

SIERRA[®]

Marine Parts Catalog 2023



**ENGINE & DRIVE PARTS
POWER SYSTEMS
INSTRUMENTATION
SWITCHES
ENGINE DIAGNOSTICS
HOSES
OILS & LUBRICANTS
TOOLS & ACCESSORIES**

SIERRA[®]

PARTS THAT KEEP YOU MOVING



AC Shore Power Products

Whether you are done boating for the day or spending the evening on the water dockside, you can depend on Sierra's AC Shore Power products to help keep your vessel's power systems in good operating order. Our products offer a simple, easy-to-install solution for providing flexible power options to keep your battery topped off and key electrical devices up and running.

Sierra AC Shore Power products supply superior performance and are perfect for use in harsh marine environments.

sierraparts.com

Part Number	Description	OE Manufacturer	OEM Part Number	Page #
AC12340	12ft Cordset, 30A	Marinco	199116	79
AC12350	25ft Cordset, 30A	Marinco	199117	79
AC12360	50ft Cordset, 30A	Marinco	199120	79
AC12370	25ft Cordset, 50A	Marinco	6152SPP-25	79
AC12380	50ft Cordset, 50A	Marinco	6152SPP	79
AC12430	Y Adapter 50A 125/250V (SS2-50P) Male To (2) 30A 125V Females (L5-30R)	Marinco	153AY	79
AC12440	Pigtail Adapter 50A 125/250V (SS2-50P) Male to 30A 125V (L5-30R) Female	Marinco	121A	80
AC12450	"50A 125/250V (SS2-50R) Female to (2) 30A 125V (L5-30P) Male Shore Power Reverse"Y" Adapter,	Marinco	RY504-2-30	79
AC12460	"Y Adapter 30A 125V(L5-30P) Male to (2) 30A 125V (L5-30R) Females"	Marinco	157AY	79
AC12470	Female Connector, 50A 125/250V SS2-50R	Marinco	6364CRN	80
AC12480	Pigtail Adapter 15A 125V (5-15P) Male Straight Blade to 30A 125V (L5-30R) Female Locking	Marinco	104SPP	80
AC12490	Female Connector, 30A 125V L5-30R	Marinco	305CRCN	80
AC12500	Pigtail Adapter 30A 125V (L5-30P) Male to 50A 125/250V (SS2-50R)Female	Marinco	117A	80
AC12510	Pigtail Adapter 30A 125V (L5-30P) Male to 15A 125V (5-15R) Female	Marinco	P30-15	80
AC12520	Inlet, 30A 125V, Square, White	Marinco	301EL-B	80
WH10620P	Plug, Trolling Motor	Marinco	12VBP	71
WH10620R	Receptacle, Trolling Motor	Marinco	12VBR	71
WH10620	Plug and Receptacle Set, Trolling Motor	Marinco	12VBR	71
18-79967	Fuel Filter Screen	Mercury	8M0090809	410
18-2468	Pin Rod Eye	Mercury	17-8M0161312	459
18-3688	Water Pump Kit	Mercury	8M0113799	419
18-3689	Water Pump Kit	Mercury	8M0113801	419
18-3690	Water Pump Kit	Mercury	812966A12	418
18-3691	Water Pump Kit	Mercury	8M0094529	418
18-79965	Inline Fuel Filter	Mercury	35-789884T	410
18-79969	Fuel Water Separating Filter	Mercury	35-8M0126144	408
18-9229	Oil Change Kit	Mercury	8M0081917	220
18-9230	Oil Change Kit	Mercury	8M0169547	220
18-9234	Oil Change Kit	Mercury	8M0182227	220
18-9235	Oil Change Kit	Mercury	8M0182228	220

Part Number	Description	OE Manufacturer	OEM Part Number	Page #
18-97350	Carburetor Repair Kit, Mercury	Mercury	1398-823707 2	399
18-97351	Carburetor Repair Kit, Mercury	Mercury	1395-9844A1	399
18-97352	Carburetor Repair Kit, Mercury	Mercury	1395-51091	399
18-97353	Carburetor Repair Kit, Mercury	Mercury	1399-51991	399
18-97354	Carburetor Repair Kit, Mercury	Mercury	1395-811287	399
18-97355	Carburetor Repair Kit, Mercury	Mercury	1399-8153	399
18-97356	Carburetor Repair Kit, Mercury	Mercury	1399-879194026	399
18-97357	Carburetor Repair Kit, Mercury	Mercury	1395-7826	399
18-97358	Carburetor Repair Kit, Mercury	Mercury	1395-9023	399
18-97359	Carburetor Repair Kit, Mercury	Mercury	1399-8154	399
AC12390	AC Inlet Port with 16" Extension Cord	Noco	GCP1	79
AC12400	AC Inlet Port with 6' Extension Cord	Noco	GCP1E	79
AC12410	AC Inlet Port with 12' Extension Cord	Noco	GCP1EX	79
AC12420	AC Inlet Port with Twin 18" Extension Cord	Noco	GCP2	79
18-1799	Sensor, Exhaust Temperature	Suzuki	34830-87J20	489
18-3687	Thermostat	Suzuki	17670-90J11	488
18-4553	Kit, Water Pump Repair	Suzuki	17400-92J00	487
18-4554	Kit, Water Pump Repair	Suzuki	17400-92J23	487
18-4556	Kit, Water Pump Repair	Suzuki	17400-94J00	487
18-4557	Kit, Water Pump Repair	Suzuki	17400-94L21	488
18-6962	Starter	Suzuki	31100-9810	482
18-79949	Fuel Filter	Suzuki	15410-88L00	484
18-0486	Oil Strainer Seal	Yamaha	67F-13415-00-00	538
18-6963	Starter	Yamaha	6EM-81800-01-00	500
18-6964	Starter	Yamaha	6BG-81800-00-00	500
18-99164	Upper Unit Casing Gasket	Yamaha	67F-45113-00-00	545

SIERRA[®]

PARTS THAT KEEP YOU MOVING



Sierra Fuel Systems

- Fuel line assemblies utilizing Silverado 4000 hose available for all OE manufacturers
- Fuel filters for the most popular engine applications
- Meets or exceeds major governing body requirements
- High flow capacity fuel water separators rated at 90 gallons per hour



All references to Original Equipment Manufacturers, their trade names, or their part numbers are for replacement part identification only. All Sierra Marine Products are designed to meet or exceed the OEM part they are intended to replace and are backed by the best warranty in the business.

TABLE OF CONTENTS

GAUGE SECTION

Ordering Information.....	2-3	Driftwood	11	Heavy Duty	18
Eyebrow Bezels.....	21	Lido Pro/Lido	9-10	Premier Stainless Multifunction	19
GPS Speedometers.....	5	Sahara.....	12	White Multifunction	19
Multi Gauges	14	Sterling	13	Deep-Vee Multifunction	20
Matrix Gauges	4	Black Sterling.....	14	Digital Gauge.....	19
Premier Pro	6	Amega.....	15	Depth Gauge	19
White Premier Pro	7	Arctic.....	16	Senders	20
Argent Pro	8	Eclipse.....	17	Sender Codes/Accessories	22-23

SIERRA SWITCH & POWER SYSTEMS (MARINE WORKS SECTION)

Audible Engine Warning System	68	Indicator Lights	52	Waterproof Terminals and	
Battery Cables.....	78	Interior RV Style Switches	44	Connectors	73
Battery Isolators.....	72	Lanyards.....	32	Shore Power.....	79-80
Battery Switches.....	72	Lever Switches	71	Solenoid Switches	78
Battery Accessories	78	NMEA Cabels	66-67	Switch/Control Panels	35
Bus Bars/Covers.....	59-62	Push Button Switches.....	50-52	Test Clips.....	74
Circuit Breakers	64-65	Push Pull Switches	49-51	Testers	75
Compartment Locks		Replacement Knobs	33	Toggle Switches.....	45-48
and Latches	75-76	Rocker Switches.....	35-43	Trailer Bearing Kits/Sets.....	72
Contura® Switches.....	34,37-41	Rotary Switches		Trailer Connectors	68-69
Cotter Pins.....	72	& Accessories	33-34	Adapters.....	69
Docking Lights	76	Solderless Terminals and		Converters and Isolators.....	69
Electrical Tools and Testers	75	Connectors.....	73-74	Universal (Splice-In Style)	
Emergency Engine		Electrical Accessories	73-74	Trailer Connectors.....	68
Cut-off Switches.....	32, 53	Quick Disconnects,		Heavy Duty Connectors.....	69
Face and Boot Nuts.....	32, 48	Butt Connectors &		Polarized Connectors.....	69
Fuse Blocks	56-58	Bullet Terminals.....	73-74	Trailer Seals	72
Fuse Holders	63-64	Ring, Spade and Hook		Trim Motors	76
Fuse Kits.....	53-54	Terminals.....	73-74	Trolling Motor Plugs.....	70
Fuses.....	53-55	Terminal and Wiring			
Ignition Switches.....	25-31	Accessory Kits.....	73-74		
Illumination Modules.....	33	Terminal Studs.....	62		

SHIELDS MARINE HOSE SECTION

Air Conditioner.....	114-115	Exhaust Hose	92-97	Oil Hose.....	102
Bilge Hose	87-90	Exhaust Protector Valves	126	Potable Hose.....	98-100
Brass Connectors.....	108	Fuel Hose	102-109	Product Application Guide	82-84
Conduit	127-128	Gasket Material	129	Sanitation Hose	110-113
Coolant/Engine		Hose Clamps.....	126	Speedometer Pitot Tubing.....	129
Intake Hose.....	114-115	Hump Couplers.....	122, 124	Ventilation Hose.....	114-115
Drain Hose.....	87-90	Livewell Hose	87-90	Wet Exhaust Hose.....	116-127

Some of the exploded views contained in this catalog are courtesy of Seloc Publishing.

GENERATOR PARTS SECTION

FUEL 130-131	Cooling (Cont.).....	OIL & LUBE 138
Air Filters 130	Thermostat Gaskets..... 135-136	Oil 139
Carb Kits 130	Thermostat Kits..... 136-137	ELECTRICAL..... 140
Fuel Filters 130-131	IGNITION..... 133-134	Alternators/Alternator Belts 140
Senders..... 131	Distributor Caps 137	Anodes..... 140
COOLING..... 132-137	Plug Wire Sets 138	Hourmeters 139
Impellers 132	Rotors 138	Solenoid 140
Impeller Kits 133	INTERNAL ENGINE.. 137-138	Starters 140
Thermostats 134	Oil Filters..... 138-139	APPLICATION GUIDE . 138-151

SIERRA MARINE SECTION

ACCESSORIES/MISCELLANEOUS 156-243

FUEL 156-182	Gas Filled Lift Supports and Accessories (Nautalift™) 226-227	Oil Drain Kits 219
Bowl Wrench..... 158		Hydro Defense Marine Grease .. 219
Carburetor to Carburetor Kit Interchange..... 179-181	IGNITION..... 183-202	TOOLS & SHOP
Carburetors 174-178	Distributors..... 183-186	SUPPLIES 222-225
Drain Bowls/O-Rings..... 158-160	Distributor Parts 186-187	Clamp Assortments..... 225
Fuel Connectors..... 167	Spark Plug Wire Sets..... 192-193	Degreasers 224
Fuel Filters 161	OIL FILTERS 203-205	Engine Flushers 225
Fuel Hose..... 176	Quick-Reference Guide . 1167-1190	Fuel Tester 221
Fuel Line Assemblies 163-166, 169-170	Alpha Cross Reference 1191-1193	Fuel Inj. Cleaners/Boosters..... 222
Fuel Pumps..... 171-172	OIL & LUBE 207-222	Fuel Injector Cleaning Kit..... 222
Fuel Water	Engine Care Products..... 208-224	Gear Lube Adapters..... 224
Separators/Brackets 157-158	Engine Oil 208-216	Grease Guns..... 224
Intake Manifolds..... 174	Fluid Dispensers 223	Loctite® Products..... 224
International Fuel Products..... 170	Fuel Injection Cleaning 222	Manuals, Seloc 236-238
Primer Bulbs 162	Gear Lube 218	Oil Extractors 223
Racor Filters 160	Gear Lube Capacity Charts 1194-1199	Oil Filter Wrenches 223
Fuel / Gas Filters	Oil Change Kits 220	Oil Pads 223
w/ Replacement Bowls 160	Oil Cross Ref. Charts 214	STATS 239-243
	Oil Display Rack..... 207	Sanitation System Cleaner 222
		Safe-Skeg 235
		Testers 233-234
		Tools..... 228-234

CHRIS-CRAFT® 580-591

COOLING..... 589-591	Fuel (Cont.)	Ignition (Cont.).....
Manifolds & Related Product 589-591	Floats 586	Distributor Caps 581
ELECTRICAL..... 585-586	Freeze Plugs..... 588	Distributors..... 583-584
Battery Cables 585	Fuel Hose..... 587	Multi Meter/DVA Tester..... 583
Solenoids 585	Fuel Pumps..... 587	Rotors 581
Starters 585-586	Fuel Water	Spark Plug Wire/Sets..... 582
Voltage Regulators..... 585-586	Separators/Brackets 588	Tune-Up Kits 580
FUEL 586-588	IGNITION..... 580-585	INTERNAL ENGINE.. 590-591
Carburetor Kits..... 586	Contact Sets 592-583	Gaskets..... 590
Exhaust Protector Valves..... 588	Coils..... 584	Head Gaskets 591
	Condensers..... 581	Oil Filters..... 591
	Conversion Kits..... 583	

CHRYSLER/FORCE® 244-261

<p>COOLING..... 252</p> <p>Impellers/Repair Kits 252-253</p> <p>Thermostats 252</p> <p>DRIVE..... 258-261</p> <p>Gear Bearings 261</p> <p>O-Rings 261</p> <p>Oil Seals 261</p> <p>Prop Nut Kits 260</p> <p>Seal Kits 258-259</p> <p>ELECTRICAL..... 247</p> <p>Starters 247</p> <p>Trim & Tilt Motors 247</p> <p>Voltage Regulators 247</p>	<p>FUEL 248-252</p> <p>Carburetor Kits and Related Products 248</p> <p>Fuel Connectors 252</p> <p>Fuel Line Assemblies 252</p> <p>Fuel Pump Kits 248</p> <p>Fuel Water Separators/Brackets 156-160, 251</p> <p>Primer Bulbs 252</p> <p>IGNITION..... 244-246</p> <p>Battery Cables 246</p> <p>Coils 244</p> <p>Condensers 244</p> <p>Ignition Wire 246</p>	<p>Ignition (Cont.)</p> <p>Solenoids 244</p> <p>Spark Plug Boots 246</p> <p>Spark Plug Wires/Sets 246</p> <p>Strators/Kits 244</p> <p>Switch Boxes 244</p> <p>INTERNAL ENGINE.. 256-261</p> <p>Bearing Carriers 258</p> <p>Gaskets/Sets 256-258</p> <p>Head Gaskets 256-257</p> <p>Pistons/Rings 256</p>
--	--	--

CHRYSLER INBOARD® 592-608

<p>COOLING..... 598-608</p> <p>Exhaust Protector Valves 599</p> <p>Exploded Views 600-604</p> <p>Impellers/Kits 600-605</p> <p>Manifolds & Related Product 600-608</p> <p>Thermostats 598</p> <p>Water Pumps 599</p> <p>ELECTRICAL..... 596-597</p> <p>Alternators 597</p> <p>Battery Cables 596</p> <p>Solenoids 596</p> <p>Starters 597</p> <p>Voltage Regulators 596-597</p>	<p>FUEL 597-598</p> <p>Carburetor Kits and Related Products 597</p> <p>Flame Arrestors 598</p> <p>Fuel Hose 598</p> <p>Fuel Pumps 598</p> <p>Fuel Water Separators/Brackets 152-160, 596</p> <p>IGNITION..... 592-596</p> <p>Coils 594</p> <p>Condensers 592</p> <p>Contact Sets 592</p> <p>Conversion Kits 594</p> <p>Distributor Caps 592</p>	<p>Ignition (Cont.)</p> <p>Distributors 593</p> <p>Rotors 592</p> <p>Spark Plug Wires/Kits 593</p> <p>Tune-Up Kits 592</p> <p>INTERNAL ENGINE..... 599</p> <p>Gaskets 599</p> <p>Oil Filters 599</p>
---	---	--

CRUSADER® 609-632

<p>COOLING..... 620-631</p> <p>Exhaust Protector Valves 621</p> <p>Exploded Views 622-626</p> <p>Impellers/Repair Kits 614-615</p> <p>Manifolds & Related Product 627-631</p> <p>Senders 621</p> <p>Thermostats/Kits 621</p> <p>Water Pumps 621</p> <p>ELECTRICAL..... 617-618</p> <p>Solenoids 617</p> <p>Starter Brush Set 617</p> <p>Starters 617</p> <p>Voltage Regulators 618</p>	<p>FUEL 618-620</p> <p>Carburetor Kits and Related Products 618</p> <p>Carburetors 618</p> <p>Flame Arrestors 619</p> <p>Fuel Hose 619</p> <p>Fuel Pumps 619-620</p> <p>Fuel Water Separators/Brackets .. 152-160, 618</p> <p>IGNITION..... 609-617</p> <p>Coils 616</p> <p>Condensers 611</p> <p>Contact Sets 611</p> <p>Conversion Kits 613</p> <p>Distributor Caps 612-613</p>	<p>Ignition (Cont.)</p> <p>Ignition Modules 616</p> <p>Distributors/Parts 612</p> <p>Rotors 612-613</p> <p>Spark Plug Wires/Kits 614</p> <p>Tune-Up Kits 609-610</p> <p>INTERNAL ENGINE..... 632</p> <p>Gasket Sets/Gaskets 632</p> <p>Head Gaskets 632</p> <p>Oil Filters 632</p> <p>MODEL IDENTIFICATION CHART 609</p>
--	---	---

DIESEL 678-689

HIGH PERFORMANCE PRODUCTS 664-677

HONDA® 262-272

COOLING..... 266-269	ELECTRICAL..... 262-263	IGNITION..... 262
Gaskets..... 266-267	Starters 263	Camshaft Sensors 265
Impellers/Repair Kits..... 266-267	Tilt/Trim Motors 263	Coils..... 262
Thermostats..... 266	Wiring Harness 263	Spark Plug Wire/Kits/Boots..... 262
DRIVE..... 271-272	FUEL 264-265	INTERNAL ENGINE.. 270-271
Anodes 272	Fuel Connectors..... 264	Bearings..... 271
Oil Seals 271-272	Fuel Filters/Kits 156-160, 264	Oil Filters..... 271
Seal Kits 272	Fuel Line Assemblies..... 264	MODEL IDENTIFICATION
Prop Nut Kits..... 272	Primer Bulbs 264	CHART 262

INBOARD ACCESSORIES 575-579

Anodes 579	Packing..... 579	Transmission Repair Kits..... 579
Flywheel Bell Housing 578	Seals & Seats..... 579	Water Pumps..... 577
Impellers/Kits..... 575-578	Transmission Oil Coolers 578	Water Pump Gaskets 577

INDMAR® 633-636

INTERNAL ENGINE COMPONENTS 668-677

JABSCO® 575-576

JOHNSON/EVINRUDE® 273-373

COOLING..... 298-313	ELECTRICAL..... 282-288	Ignition (Cont.)
Exploded Views 312	Rectifiers/Regulators..... 285	Coils..... 275
Impellers/Kits 298-301	Solenoids..... 283	Power Packs 277-278
Thermostats/Kits..... 311	Starters 286-288	Spark Plug Wires/Kits 280
Water Pump	Stators..... 282	Switches..... 281-282
Housings/Kits..... 301-307	Tilt/Trim Motors 282	Tune-Up Kits 274
DRIVE..... 327-371	FUEL 289-298	INTERNAL ENGINE.. 314-322
Anodes..... 363	Carburetor Kits and	Bearings/Kits..... 317-318
Bearings..... 351-352	Related Products 289-290	Connecting Rods 317
Drive Shafts 354	Clamp Assortment..... 298	Crankshaft Seal Kits 322
Exploded Views 338-347	Fuel Connectors..... 297	Gaskets/Sets..... 323
Gears/Sets..... 356-357	Fuel Filters 296	Head Gaskets 323-328
Lower Gearcase Assemblies ... 348	Fuel Hose..... 297	Hose..... 323
Oil Seals..... 351	Fuel Line Assemblies..... 297	Oil Filters..... 323
O-Rings..... 370	Fuel Pumps/Kits..... 292-293	Pistons/Rings..... 314-316
Prop Nuts/Kits..... 349	Fuel Water Separators/	Stainless Steel Bolts 330
Prop Shafts 355	Brackets 295	MODEL IDENTIFICATION
Seal Kits..... 363-366	Primer Bulbs 297	CHART 273-274
Shims..... 361	IGNITION..... 274-282	STARTER SYSTEM 337
Spacers/Washers..... 349	Condensers..... 274	Rewind Springs..... 337
	Contact Sets 274	Starter Pawls..... 337
		Starter Rope..... 337

JOHNSON PUMP® 576-577

MALLORY® 1006-1007

MARINE POWER® 637-638

MCCULLOCH/SCOTT-ATWATER® 374

MERCURISER® 690-872

COOLING.....749-804

- Exploded Views . 753-754, 778-789
- Impellers/Kits 749-751
- Manifolds and
 Related Products 778-790
- Molded Hose..... 767-770
- Oil/Temperature Senders..... 766
- Pulleys 749
- Serpentine Belts..... 777
- Thermostat Housings..... 756
- Thermostats/Kits 755-756
- V-Belts..... 771
- Water Pumps/Kits 751-752
- Water Circulating Pumps 749

DRIVE.....826-872

- Anodes..... 864-865
- Bearings/Kits..... 854-857
- Bellows..... 846
- Carrier Bearings..... 857
- Drive Shafts 854
- Engine Couplers 849
- Exhaust Protector Valves..... 867
- Exploded Views 830-839
- Gear Housing Assemblies.. 840-841
- Gears/Sets..... 841
- Gimbal Bearings 843
- Lower Gear Cases..... 840-841
- O-Rings..... 869
- Oil Seals..... 868
- Outdrive Gasket Sets..... 828
- Pivot Pins..... 863

Drive (Cont.).....

- Power Trim Cylinders/Kits..... 862
- Power Trim Hoses..... 859-861
- Prop Nuts/Kits 859
- Prop Shafts 853
- Seal Kits..... 865-866
- Shift Cables/Kits..... 847-848
- Shift Spool Assemblies 854
- Shims/Kits..... 840
- Transom Seal/Kits..... 845-846
- U-Joints..... 842
- Upper Gear Cases 841
- Upper Units/Kits 841-844
- Yokes/Yoke Assemblies 842

ELECTRICAL.....712-724

- Alternators..... 718-720
- Solenoids 716-717
- Starters 712-715
- Trim/Tilt Motors 717-718
- Voltage Regulators..... 720

FUEL725-748

- Carburetor Kits and
 Related Product 735-736
- Carburetors 730-731
- Electrical Fuel Pumps 740-741
- Flame Arrestors..... 740
- Fuel Filters 748
- Fuel Hose..... 735
- Fuel Water Separators/
 Brackets..... 746-748

Fuel (Cont.)

- Fuel Injection Components.. 726-727
- Mechanical Fuel Pumps.... 740-741

IGNITION.....692-712

- Coils 695-696
- Condensers..... 694
- Contact Sets 693
- Conversion Kits..... 697
- Distributor Caps 694-695
- Distributors..... 698-701
- Ignition Modules..... 696
- Rotors 694
- Spark Plug Wires/Kits 709
- Tune-Up Kits 692-693

INTERNAL ENGINE..805-827

- Bearings..... 810-815
- Crankshaft/Timing
 Cover Seals 815
- Cylinder Head Assemblies..... 805
- Gaskets/Sets..... 816-826
- Head Gaskets 821
- Hydraulic Lifters 806
- Modular Gasket Sets 671-677
- Oil Filters..... 805
- Oil Pans 805
- Pistons/Rings..... 806-810
- Valve Stem Seals..... 815

**MODEL IDENTIFICATION
CHART690-691**

MERCURY/MARINER® 375-475

COOLING..... 411-423

- Impellers/Repair Kits..... 412-414
- Thermostats/Kits 411
- Water Pump
 Housings/Kits..... 411-419

DRIVE..... 453-475

- Anodes..... 461
- Bearings/Kits..... 453-456
- Clutches 457-458
- Drive Shafts 457
- Exploded Views 447-452
- Gearcases/Housings..... 458
- Gears/Sets 454-455
- Manual Release Valve 383
- Oil Seals..... 467
- O-Rings..... 470
- Power Trim Hoses..... 460
- Prop Nuts/Kits 460
- Prop Shafts 457
- Seal Kits..... 462-465
- Spanner Nuts/Washers..... 459

ELECTRICAL..... 383-396

- Alternators..... 392
- Relays 389
- Serpentine Belts..... 392
- Solenoids 388-389
- Starters 392-394
- Stators..... 385-386
- Tilt/Trim Motors 384-385
- Trigger Assemblies..... 386
- Voltage Regulators..... 388

FUEL 397-411

- Air Filters..... 411
- Carburetor Kits and
 Related Products 397-398
- Fuel Connectors..... 403
- Fuel Filters 410-411
- Fuel Line Assemblies..... 405-406
- Fuel Pumps/Kits..... 402
- Fuel Water Separators/
 Brackets..... 408-409
- Primer Bulbs 406-407

IGNITION..... 376-383

- Condensers..... 377
- Contact Sets 376-377
- Coils 378
- Spark Plug Wires/Kits 382-383
- Switch Boxes 378-379
- Switches..... 383
- Tune-Up Kits 376

INTERNAL ENGINE.. 424-446

- Bearings..... 427
- Gasket/Sets 433-446
- Motor Mounts..... 428
- Oil Filters..... 432
- Pistons/Rings..... 424-427
- Timing Belts 432

**MODEL IDENTIFICATION
CHART 375-376**

STARTER SYSTEM 396

- Rewind Springs/Rope 396

NISSAN/TOHATSU® 476-480

OBERDORFER® 577-579

OMC STERNDRIVE/COBRA® 873-945

<p>COOLING..... 898-912</p> <ul style="list-style-type: none"> Exploded Views 905-907 Impellers/Kits 899 Manifolds and Related Products 908-910 Molded Hose..... 903 Temperature Senders 902 Thermostats/Kits 902-903 V-Belts..... 904 Water Circulating Pumps 898 Water Pump Housings/Kits 902 <p>DRIVE..... 923-945</p> <ul style="list-style-type: none"> Anodes 937-938 Bearing Housings..... 935 Bearings..... 931 Bellows /Kits..... 929 Carrier Bearings..... 931,934 Drive Shafts 932-933 Engine Couplers 930 Exploded Views 923-924 Gear Housings 925 Gears/Sets..... 933 Gimbal Bearings 925 Oil Seals..... 941 O-Rings..... 943 Prop Nuts/Kits 936 Prop Shafts 933 Seal Kits..... 937, 939-941 Shafts..... 936 	<p>Drive (Cont.)</p> <ul style="list-style-type: none"> Shims 925 Shift Rods 935 Trailer Clips 936 Transom Seals/Kits..... 930 U-Joints..... 926 Yoke Assemblies..... 926 <p>ELECTRICAL..... 884-889</p> <ul style="list-style-type: none"> Alternators/Rebuild Kits 888 Relays..... 889 Solenoids 886 Starters 884-885 Tilt/Trim Motors 889 Voltage Regulators..... 888 <p>ENGINE MANAGEMENT. 898</p> <ul style="list-style-type: none"> Oil Pressure Light Switch..... 898 <p>FUEL 889-898</p> <ul style="list-style-type: none"> Carburetor Kits and Related Products 891-892 Carburetors..... 890 Flame Arrestors..... 895 Fuel Filters 897-898 Fuel Hose..... 894 Fuel Injection Components 889 Fuel Pumps..... 894-895 Fuel Water Separators/ Brackets..... 895-897 Hose Barbs 909 	<p>IGNITION..... 873-884</p> <ul style="list-style-type: none"> Coils..... 876 Condensers..... 874 Contact Sets 874 Conversion Kits..... 877-878 Distributor Caps 875 Distributors..... 878-880 Ignition Modules..... 875 Rotors 874-875 Spark Plug Wires/Kits 883 Tune-Up Kits 873-874 <p>INTERNAL ENGINE.. 913-922</p> <ul style="list-style-type: none"> Bearings..... 915 Crankshaft/Timing Cover Seals 915 Cylinder Head Assemblies..... 913 Drain Screws..... 922 Gaskets/Sets..... 916-922 Head Gaskets 918 Hydraulic Lifters 914 Modular Gasket Sets 671-677 Oil Filters..... 913 Pistons/Rings..... 914 Valve Stem Seals..... 922
---	--	---

PERSONAL WATER CRAFT® 571-574

PLEASURECRAFT® 639-652

<p>COOLING..... 648-651</p> <ul style="list-style-type: none"> Exploded Views 649 Impellers/Kits 648 Manifolds and Related Products 649-651 Thermostats/Kits 648 Water Pumps 648 <p>DRIVE..... 652</p> <ul style="list-style-type: none"> Power Trim Hoses..... 652 Prop Nuts/Kits 652 <p>ELECTRICAL..... 645-646</p> <ul style="list-style-type: none"> Alternators..... 646 Solenoids 646 Starters 645-646 	<p>FUEL 646-648</p> <ul style="list-style-type: none"> Carburetor Kits and Related Products 647 Float..... 646 Fuel Filters 648 Fuel Pumps..... 648 Fuel Water Separators/Brackets 647 Sensors..... 647 <p>IGNITION..... 639-645</p> <ul style="list-style-type: none"> Coils..... 644-645 Condensers..... 640 Contact Sets 640 Conversion Kits..... 641-642 Distributor Caps 641 	<p>Ignition (Cont.)</p> <ul style="list-style-type: none"> Distributors..... 642-643 Rotors 640 Spark Plug Wires/Kits 643 Tune-Up Kits 639-640 <p>INTERNAL ENGINE.. 651-652</p> <ul style="list-style-type: none"> Gaskets/Sets..... 651 Head Gaskets 652 Oil Filters..... 652 Pipe Plugs..... 651 <p>MODEL IDENTIFICATION CHART 639</p>
---	--	---

Some of the exploded views contained in this catalog are courtesy of Seloc Publishing.

PRESTOLITE® 1008

SHERWOOD PUMP® 578

SUZUKI® 481-494

COOLING..... 486-489

- Impellers/Kits 486-487
- Thermostat Gaskets..... 488-489
- Water Pump Gaskets/Kits. 487-488

DRIVE..... 492-494

- Anodes..... 492
- Lower Unit Seal Kits..... 492-494
- O-Rings..... 494
- Oil Seals..... 494
- Prop Nuts/Kits..... 492

ELECTRICAL..... 482-483

- Starters 482
- Tilt/Trim Motors 483

FUEL 483-485

- Carburetor Kits..... 483
- Fuel Connectors..... 485
- Fuel Water
 - Separators/Brackets 484
- Oxygen Sensor 484
- Primer Bulbs 485

IGNITION..... 481

- Spark Plug Wires/Kits 481

INTERNAL ENGINE.. 489-492

- Bearings..... 490
- Connecting Rods/Kits 490
- Gaskets..... 490-491
- Head Gaskets 490-491
- Oil Filters..... 491
- Pistons/Rings..... 489

MODEL IDENTIFICATION CHART 481

UNIVERSAL 653-663

COOLING..... 656-663

- Exploded Views 656-661
- Manifolds and
 - Related Products 622-663

ELECTRICAL..... 654-655

- Alternators..... 654
- Solenoids 654

FUEL 655

- Carburetor Kits..... 655
- Fuel Water Separators..... 655
- Fuel Hose..... 655

IGNITION..... 653-654

- Coils/Leads 654
- Condensers..... 653

Ignition (Cont.).....

- Contact Sets 653
- Distributor Caps 653
- Rotors 653-654
- Tune-Up Kits 653

VOLVO-PENTA® 946-1003

COOLING..... 973-985

- Exploded Views 977-978
- Gaskets/Sets..... 980-982
- Hose..... 983
- Impellers/Kits 974-975
- Manifolds and
 - Related Products 977-980
- Molded Hose..... 983
- Thermostats/Kits 983-984
- V-Belts..... 976
- Water Pump Kits 973
- Water Pumps 974-975

DRIVE..... 997-1003

- Anodes..... 1001-1002
- Bellows/Kits..... 998
- Engine Couplers 997
- Exhaust Hose..... 998
- Gimbal Bearings 999
- O-Rings..... 1003
- Oil Seals..... 1003
- Power Trim Hoses..... 997
- Prop Nuts/Kits 1000
- Seal Kits..... 1002-1003
- Trailer Clips 998
- U-Joints..... 999
- Yokes 999

ELECTRICAL..... 961-966

- Alternators 962-963
- Relays..... 965
- Solenoids 964
- Starters 961-962
- Tilt/Trim Motors..... 965-966

ENGINE APPLICATION GUIDE 946-948

ENGINE MANAGEMENT. 972

- Oil Pressure Light Switch 972

FUEL 966-972

- Carburetor Kits and
 - Related Product 966-967
- Carburetors 966
- Electrical Fuel Pumps 968
- Fuel Filters 970-971
- Fuel Hose 967
- Fuel Water Separators/
 - Brackets..... 969-970
- Mechanical Fuel Pumps 968
- Sensors..... 972

IGNITION..... 949-961

- Camshaft Sensor 951

Ignition (Cont.).....

- Coils..... 951
- Condensers..... 949
- Contact Sets 949
- Conversion Kits..... 953
- Crankshaft Sensor 951
- Distributor Caps 950
- Distributors..... 952-953
- Rotors 949-950
- Spark Plug Wires/Kits 954
- Tune-Up Kits 949

INTERNAL ENGINE.. 986-997

- Air Filters..... 987
- Bearings..... 990
- Belts..... 986
- Camshafts/Kits..... 986
- Cylinder Head Assemblies 988
- Expansion Plugs 987
- Gaskets/Sets..... 991-997
- Head Gaskets 992-993
- Hydraulic Lifters 989
- Modular Gasket Sets 671-677
- Oil Filters..... 987-988
- Pistons/Rings 989
- Valves 986
- Valve Lifters 986
- Valve Stem Seals..... 990

YAMAHA® 495-570

COOLING.....517-536

- Impellers/Kits 517-518
- Thermostats/Kits 532-536
- Water Pump Housing/Kits.. 520-531

DRIVE.....553-570

- Anodes..... 554
- Carrier Bearings..... 553
- Exploded Views 556-565
- O-Rings..... 570
- Oil Seals..... 570
- Prop Nuts/Kits 554-555
- Prop Shafts 553
- Seal Kits..... 567-570

ELECTRICAL..... 499-504

- Brush Holder Assemblies..... 503
- Starters 499-500
- Tilt/Trim Motors 503-504

FUEL504-517

- Carburetor Kits and
Related Products 504-506
- Fuel Connectors..... 516-517
- Fuel Filters 513-515
- Fuel Line Assemblies..... 516
- Fuel Pump Diaphragms/Kits... 509-510
- Fuel Pumps..... 509
- Fuel Water Separators/
Brackets 511-512
- Primer Bulbs 516

IGNITION..... 495-499

- CDIs/Assemblies..... 495
- Coils 495-496
- Ignition Switches 496-497
- Spark Plug Wires/Kits 496

INTERNAL ENGINE.. 537-553

- Bearings/Kits..... 538
- Connecting Rods/Kits 538
- Gaskets/Sets..... 540-542
- Head Gaskets 542
- Oil Filters..... 538-539
- Timing Belts 540
- Pistons/Rings..... 537

**MODEL IDENTIFICATION
CHART 495**

YAMAHA STERNDRIVE® 1004-1005

INTERCHANGE SECTION

- Gear Lube Capacity Charts. 1184-1189
- Oil Filter Quick-Reference ... 1155-1183
- Carburetor to Carburetor Kit
Interchange..... 179-182
- Competitive Interchange.... 1021-1039
- Mallory Distributor Parts
Guide 1006-1007

- Original Equipment Part No.
Interchange Guide 1040-1085
- Outboard Model to Year to
Horsepower Guide..... 1009-1020
- Part Number to Page Number Guide
Electrical Products..... 1087-1090
- Gauges 1086-1087

- Part Number to Page Number Guide (Cont.)
Generator Parts 1091
- Shields 1090
- Sierra 1092-1154
- Prestolite Distributor Parts Guide.. 1008
- Sierra Oil Cross-Reference 214





	Premier Pro	White Premier Pro	Driftwood	Lido	Lido Pro	Argent Pro
Fuel Gauge	2" 62718P	2" 62551P	2" 61549P	2" 65496P	2" 59655P	2" 65524P
Hourmeter 10,000 hrs (non-illuminated)	2" 62719P	2" 62538P	2" 62952P	2" 65497P	2" 59416P	
Oil Pressure Gauge (SW) 0-80 PSI	2" 62720P	2" 62542P	2" 61550P	2" 65501P	2" 59653P	2" 65526P
Oil Pressure Gauge (SW) 0-100 PSI		2" 62543P		2" 65498P		2" 65525P
Water Pressure Kit (Outboard) 30 PSI	2" 69865P		2" 62960P	2" 65507P	2" 63523P	2" 65551P
Water Pressure Kit (Outboard) 40 PSI		2" 67657P				
GPS Speedo 35 MPH	3" 781-627-035P	3" 781-625-035P			3" 781-310-035P	
GPS Speedo 60 MPH	3" 781-627-060P	3" 781-625-060P			3" 781-310-060P	3" 781-294-060P
GPS Speedo 80 MPH	3" 781-627-080P	3" 781-625-080P				
GPS Speedo 120 MPH	3" 781-627-120P	3" 781-625-120P				
Speedo Kit 35 MPH (Pitot Type)				3" 61751P	3" 61751P	
Speedo Kit 50 MPH (Pitot Type)			3" 61547P	3" 61752P	3" 61752FP	3" 65529P, 5" 65530P
Speedo Kit 60 MPH (Pitot Type)						
Speedo Kit 65 MPH (Pitot Type)	3" 62722P	3" 62546P		3" 65510P	3" 59713P	
Speedo Kit 70 MPH (Pitot Type)						3" 65531P
Speedo Kit 80 MPH (Pitot Type)				3" 65670P		
Tachometer, 0-6000 RPM O/B & 4 Cycle Gas	3" 62724P					
Tachometer, 0-7000 RPM O/B & 4 Cycle Gas		3" 62561P	3" 61546P	3" 65693P	3" 59737P	3" 65535P, 5" 65536P
Tachometer, 0-8000 RPM O/B & 4 Cycle Gas	3" 62725P					
Tachometer 0-4000 RPM Diesel Alt		3" 62547P		3" 65671P		3" 65537P
Diesel Magnetic Pickup, 90-180 Teeth		3" 62548P		3" 65692P		
Tach/Hour 0-7000 RPM O/B & 4 Cycle Gas		3" 62565P		3" 65129P		3" 65545P
Tachometer - System check gauge				3" 64477FP		
Water Temp (SW) 120-240°F	2" 62729P	2" 62540P	2" 61552P*	2" 65509P	2" 59654P	2" 65553P
Water Temperature Kit (Outboards)	2" 62748P			2" 65508P		
Trim Gauge Evinrude/Johnson	2" 62726P	2" 62550P		2" 65502P		2" 65547P
Trim Gauge Honda			2" 62375P	2" 65503P		
Trim Gauge Mercury OB & IO, Mariner, Force,	2" 62727P	2" 62549P	2" 61551P	2" 65504P	2" 59657P	2" 65548P
Cobra, Volvo DP & SX, Yamaha 2001 & Up	2" 62726P	2" 62550P		2" 65502P		2" 65547P
Trim Gauge 2002 and newer Suzuki 4-Stroke	2" 62728P			2" 65505P		
Trim Gauge pre 2001 Yamaha outboards	2" 62730P □	2" 62555P	2" 61548P	2" 65506P	2" 59656P	2" 65550P
Voltmeter 12v						
Voltmeter 24v						
12V Battery Condition Indicator				2" 65495P		
Engine Synchronizer Gauge				2" 65206SSP		
System Check Gauge - Evinrude/Johnson						
Systems Monitor – Suzuki						
Ammeter 60-0-60						

* **Twin Engine Outboard Add On Kit** - Tachometer, Voltmeter

* **Twin Engine Inboard/Sterndrive Kit** - Tachometer, Water Temperature, Oil Pressure, Voltmeter

* **Outboard Kit** - Tachometer, Speedometer (65 MPH with pitot tube), Fuel Gauge (compatible with common marine senders), and Voltmeter. Matching Trim Gauges, Hourmeters and Water Pressure or Temperature Kits are available separately. (Not for diesels.)

* **Sterndrive Kit** - Tachometer, Speedometer (65 MPH with pitot tube), Fuel Gauge, Water Temperature Gauge, Oil Pressure Gauge (all compatible with common marine senders), and Voltmeter. Matching Trim Gauges and Hourmeters are available separately for stern drive applications. (Not for diesels.)

* (100-220°F) range.

* 0-3500 RPM.



Sahara	Sterling	Black Sterling	Omega	Arctic	Eclipse	Heavy Duty
2" 59707P	2" 63477P	2" 67021P	2" 57902P	2" 68365P	2" 68390P	2" 80150P
			2" 84760P	2" 68366P	2" 68391P	2" 82760P
2" 59705P	2" 63479P	2" 67022P	2" 57903P	2" 68367P	2" 68392P	2" 80180P
			2" 57929P		2" 68393P	2" 80181P
2" 69870P	2" 63481P		2" 61238P			
		2" 67382P	2" 68357P	2" 68369P	2" 68394P	
			3" 781-579-035P	3" 781-683-035P	3" 781-684-035P	
			3" 781-579-060P	3" 781-683-060P	3" 781-684-060P	
			3" 781-579-080P	3" 781-683-080P	3" 781-684-080P	
3" 61826P			3" 58342P	3" 68370P	3" 68395P	
3" 61163P		3" 68960P	3" 57898P			
3" 59704P	3" 63475P		3" 57900P	3" 68371P	3" 68396P	
		3" 67285P				
3" 63076P	3" 63476P		3" 57899P	3" 68372P	3" 68397P	
						3" 82288P
3" 59703P	3" 63473P	3" 67363P	3" 58255P	3" 68374P	3" 68399P	
			3" 68358P	3" 68373P	3" 68398P	3" 82302P
						3" 82303P
3" 69743P	3" 63474P	3" 67364P	3" 68443P	3" 68375P	3" 68400P	
3" 61901P			3" 58935P			
2" 59706P	2" 63480P	2" 67020P	2" 57904P	2" 68376P	2" 68401P	2" 80590P
			2" 58862P*	2" 68377P	2" 68402P	
2" 61908P	2" 63483P	2" 67365P	2" 58431P	2" 68378P	2" 68403P	
2" 62369P	2" 64475P	2" 67855P	2" 68359P	2" 68379P	2" 68404P	
2" 59709P	2" 63482P	2" 67023P	2" 57905P	2" 68380P	2" 68405P	
2" 61908P	2" 63483P	2" 67365P	2" 58431P	2" 68378P	2" 68403P	
			2" 61748P	2" 68381P	2" 68406P	
2" 59708P	2" 63478P	2" 67019P	2" 57901P	2" 68383P	2" 68408P	2" 80134P †
						2" 80131P
			2" 68361P	2" 68384P	2" 68409P	
2" 66956P	2" 63585P		2" 65205P	2" 68385P	2" 68410P	
			2" 68356P	2" 68364P	2" 68389P	2" 80710P

* **Outboard Kit w/ Tach/Hr** - Tachometer/Hourmeter, Speedometer (65 MPH w/ Pitot Tube, Fuel Gauge (compatible with common marine senders), and Voltmeter.

* **Inboard/Sterndrive Kit** - Tachometer/Hourmeter, Speedometer (65 MPH w/ Pitot Tube, fuel Gauge, Water Temperature Gauge, Oil Pressure Gauge (all compatible with common marine senders), and Voltmeter.

* Matching Trim Gauges are available separately. Not for diesels.

† 8-16 VDC



MATRIX GAUGES

The Matrix gauge set is intended to operate on Mercury SmartCraft engines (max 4 engines/2 stations) utilizing the SmartCraft® protocol. The gauges operate on 12 volt systems and support single, dual, triple or quad engine applications. In a Matrix gauge set, the 3" tachometer is the master and connects directly to the SmartCraft data bus. All other gauges are slaves and connect to the tachometer RS-485 private bus (immune to electrical noise, more robust and reliable). The tachometer reads SmartCraft engine parameters and forwards them on the private bus for the slave gauges.



FEATURES:

- Smart Tachometer CANbus driven
- All 2" gauges receive data from tachometers
- LCD on Tachometer and Speedo displays all available data and alarms
- IP67 waterproof/ submersible housings (with Connector fitted)
- Dry Nitrogen filled to minimize fogging
- LED dimmable, automotive style backlighting (red)
- CANbus connectivity

SELECTION GUIDE:

GAUGE DESCRIPTION	SIZE	PART NO.	PART NO.	DESCRIPTION
Speedometer w/ LCD US 90 MPH	3"	70002D	69995K	Harness - Tachometer to Smartcraft, 30"
Fuel Primary	2"	70003D	69996K	Harness - Tachometer to NMEA 2000, 30"
Voltmeter 10 - 16 VDC	2"	70004D	69997K	Harness - Tachometer to Speedometer, 48"
Temperature 240F	2"	70006D	69999K	Harness - Any 2" gauge to another, 8"
Water pressure 40 PSI	2"	69994D		
Oil Pressure 80 PSI	2"	70005D		
Trim	2"	69993D		
Tachometer - Smartcraft	3"	70000D		
Tachometer - NEMA 2000	3"	70001D		

PARAMETERS SUPPORTED

• Engine RPM	• Reserve Oil Level	• Throttle Position	• Tank 2
• Coolant Temperature	• Water Pressure	• Load Percent	• RPM Synch
• Engine Oil Pressure	• Coolant Pressure	• Oil Level	• Trim Synch
• Engine Hours	• Oil Temperature	• Boost Pressure	
• Fuel Low	• Fuel Pressure	• Tank 1	



GPS SPEEDOMETERS

These GPS speedometers provide accurate speed over ground readings and heading information all in one attractive package. Available in various speed ranges to meet your application, the GPS speedometer is offered in a number of popular styles to match the colors in your boat like Premier Pro, White Premier Pro, Amega, Arctic, Eclipse, Lido Pro and Argent Pro instrument lines.



781-683-035P

781-684-080P

FEATURES:

- Available in speed ranges of 35 MPH, 60 MPH, 80 MPH and 120 MPH.
- Included LCD heading display to show course over ground.
- Use our GPS antenna (sold separately) or connect to an existing NMEA 0183 GPS device – connectors included.
- Speed accuracy of +/-1 MPH (once moving).
- Heading accuracy of +/-1 degree (once moving).
- Ideal for slow speed applications like pontoon boats and for high speed performance boats where pitot tubes do not perform well.

SELECTION GUIDE:

PART NUMBER	GAUGE DESCRIPTION	SIZE	DIAL RANGE	SENDER CODE
Premier Pro:				
781-627-035P	35 MPH	3"	0-35 MPH	GPS RECEIVER
781-627-060P	60 MPH	3"	0-60 MPH	GPS RECEIVER
781-627-080P	80 MPH	3"	0-80 MPH	GPS RECEIVER
781-627-120P	120 MPH	3"	0-120 MPH	GPS RECEIVER
White Premier Pro:				
781-625-035P	35 MPH	3"	0-35 MPH	GPS RECEIVER
781-625-060P	60 MPH	3"	0-60 MPH	GPS RECEIVER
781-625-080P	80 MPH	3"	0-80 MPH	GPS RECEIVER
781-625-120P	120 MPH	3"	0-120 MPH	GPS RECEIVER
Amega:				
781-579-035P	35 MPH	3"	0-35 MPH	GPS RECEIVER
781-579-060P	60 MPH	3"	0-60 MPH	GPS RECEIVER
781-579-080P	80 MPH	3"	0-80 MPH	GPS RECEIVER
Arctic:				
781-683-035P	35 MPH	3"	0-35 MPH	GPS RECEIVER
781-683-060P	60 MPH	3"	0-60 MPH	GPS RECEIVER
781-683-080P	80 MPH	3"	0-80 MPH	GPS RECEIVER
Eclipse:				
781-684-035P	35 MPH	3"	0-35 MPH	GPS RECEIVER
781-684-060P	60 MPH	3"	0-60 MPH	GPS RECEIVER
781-684-080P	80 MPH	3"	0-80 MPH	GPS RECEIVER
Lido Pro:				
781-310-035P	35 MPH	3"	0-35 MPH	GPS RECEIVER
781-310-060P	60 MPH	3"	0-60 MPH	GPS RECEIVER
Argent Pro:				
781-294-060P	60 MPH	3"	0-35 MPH	GPS RECEIVER

- Display Packaged Item

GPS RECEIVERS

- Highly sensitive receiver
- Precise information output even when mounted under a fiberglass console or bimini top
- Durable exterior
- Updates once every second to output accurate NMEA 0183 information (*Updates 10 times per second.)



68982P
GPS RECEIVER
 4 ft. long

69053P*
GPS RECEIVER (HIGH SPEED)
 4 ft. long



68755P
GPS RECEIVER
 25 ft. long

PREMIER PRO

A very popular OEM line, Premier features black dials with modern white and blue graphics. When lighted, white dial grads become red and pointer lights white. These instruments feature automotive type light-piping and a fog-resistant design for outstanding readability.

**FEATURES:**

- Full automotive type lighting, no “halo” around dial edges. When lit, white dial grads become red, pointer lights white.
- Black dial, white graduations/numerals (metrics in blue), white pointer staff.
- Scratch resistant curved glass lenses, with black, near-flush bezels.
- U.S. and metric scales, with ISO symbols, where appropriate.
- Optional add-on eyebrow or square bezels available
- (See Gauge Accessories for details).
- Line includes standard ignition engine synchronizer kits including module.
- Fog-Resistant Design! Complies with SAE J-1810.

SELECTION GUIDE:

GAUGE DESCRIPTION	SIZE	DIAL RANGE	SENDER CODE	PART NO.
Fuel Gauge:	2"	E-1/2-F	REQUIRES "F"	62718P •
Hourmeter:	2"	10,000 Hrs.	NONE REQUIRED	62719P •
Oil Pressure Gauge (Electric):				
Oil Pressure 80 PSI	2"	0-80 PSI	REQUIRES "C"	62720P •
GPS Speedometer:				
35 MPH	3"	0-35 MPH	GPS RECEIVER	781-627-035P
60 MPH	3"	0-60 MPH	GPS RECEIVER	781-627-060P
80 MPH	3"	0-80 MPH	GPS RECEIVER	781-627-080P •
120 MPH	3"	0-120 MPH	GPS RECEIVER	781-627-120P
Speedometer Kits:				
65 MPH (Pitot type)	3"	10-65 MPH	INCLUDES "G"	62722P •
80 MPH (Pitot type) Head Only	3"	20-80 MPH		62723PH
Tachometers (Electric):				
O/B & 4-Stroke Gas Engines*	3"	0-6000 RPM	O/B ALT./COIL	62724P •
O/B & 4-Stroke Gas Engines*	3"	0-8000 RPM	O/B ALT./COIL	62725P •
Trim Gauges (Outboard, I/O):				
Johnson/Evinrude (All) & Suzuki				
4-stroke 2002 & Up	2"	UP-DOWN	BY ENG. MFR	62726P •
Mercury O/B & I/O, Mariner, Force, Cobra,				
Volvo DP & SX, Yamaha 2001 & Up	2"	UP-DOWN	BY ENG. MFR	62727P •
Yamaha Outboards pre-2001	2"	UP-DOWN	BY ENG. MFR	62728P •
Voltmeter-12 Volt:	2"	8-16 VDC	NONE REQUIRED	62730P •
Water Pressure Kit (Outboard):** (Each kit includes fittings and 20 feet of tubing)	2"	30 PSI	INCLUDES "WP"	69865P •
Water Temp. Kit (Outboard):** (For all electric-start outboards)	2"	COLD-HOT	INCLUDES "J"	62748P •
Water Temp. Gauge (I/O, I/B):	2"	120-240°F	REQUIRES "D"	62729P •
Instrument Set "INBOARD/STERNDRIVE" Contains: 62724P, 62722P, 62718P, 62730P, 62729P, 62720P				62715P •

• Display Packaged Item

* Not tested for complete aftermarket ignition systems, will work with aftermarket replacement parts.

** Adapter (P/N 61886P) is required for Yamaha.
Use 4000 RPM tachometer or lower for diesel applications.

WHITE PREMIER PRO

Ideal for inboards, including diesels, Premier White features polished stainless steel bezels and clean white dials with modern black and blue graphics. When illuminated, black dial grads become red and pointer lights red. Automotive type light-piping and fog-resistant design combine for outstanding readability.



62561P

62551P

FEATURES:

- Full automotive type lighting, no “halo” around dial edges. When illuminated, black dial grads become red, pointer lights red.
- White dial, black graduations/numerals (metrics in blue), red pointer staff.
- Scratch resistant curved glass lenses, with polished stainless steel near-flush bezels.
- U.S. and metric scales, with ISO symbols, where appropriate.
- Optional add-on eyebrow or square bezels available (See Gauge Accessories for details).
- Fog-Resistant Design! Complies with SAE J-1810.

SELECTION GUIDE:

GAUGE DESCRIPTION	SIZE	DIAL RANGE	SENDER CODE	PART NO.
Fuel Gauge:	2"	E-1/2-F	REQUIRES "F"	62551P •
Hourmeter:	2"	10,000 Hrs.	NONE REQUIRED	62538P •
Oil Pressure Gauges (Electric):				
Oil Pressure 80 PSI	2"	0-80 PSI	REQUIRES "C"	62542P •
Oil Pressure 100 PSI	2"	0-100 PSI	REQUIRES "C"	62543P •
GPS Speedometer:		0-35 MPH	GPS RECEIVER	781-627-035P
35 MPH	3"	0-35 MPH	GPS RECEIVER	781-625-035P
60 MPH	3"	0-60 MPH	GPS RECEIVER	781-625-060P
80 MPH	3"	0-80 MPH	GPS RECEIVER	781-625-080P •
120 MPH	3"	0-120 MPH	GPS RECEIVER	781-625-120P
Speedometer Kits:	3"	10-65 MPH	INCLUDES "G"	62722P •
65 MPH (Pitot type)	3"	10-65 MPH	INCLUDES "G"	62546P •
65 MPH (Pitot type) Head Only	3"	10-65 MPH		62546PH
Tachometer (Electric):	3"	0-6000 RPM	O/B ALT./COIL	62724P •
O/B & 4-Stroke Gas Engines*	3"	0-7000 RPM	O/B ALT./COIL	62561P •
Tachometer/Hourmeter (Electric):				
O/B & 4-Stroke Gas Engines*	3"	0-7000 RPM	O/B ALT./COIL	62565P •
Tachometers (Electric):	2"	UP-DOWN	BY ENG. MFR	62726P •
Diesel Alternator**	3"	0-4000 RPM	SEE "T"	62547P •
Diesel Magnetic Pickup, 90-180 Teeth	3"	0-4000 RPM	REQUIRES "B"	62548P
Trim Gauges (Outboard, I/O):	2"	UP-DOWN	BY ENG. MFR	62728P •
Johnson/Evinrude (All) & Suzuki				
4-Stroke 2002 & Up	2"	UP-DOWN	BY ENG. MFR	62550P •
Mercury O/B & I/O, Mariner, Force, Cobra,	2"	30 PSI	INCLUDES "WP"	69865P •
Volvo DP & SX, Yamaha 2001 & Up	2"	UP-DOWN	BY ENG. MFR	62549P •
Voltmeters-12 & 24 Volt:	2"	120-240°F	REQUIRES "D"	62729P •
12 Volt System	2"	8-18 VDC	NONE REQ'D	62555P •
Water Temp. Gauge (I/O, I/B):	2"	120-240°F	REQUIRES "D"	62540P •
Water Pressure Kit, O/B	2"	40 PSI	INCLUDES "WP"	67657P •
Instrument Set "INBOARD/STERNDRIVE" Contains: 62561P, 62546P, 62551P, 62555P, 62540P, 62542P				67654P •

• Display Packaged Item

* Not tested for complete aftermarket ignition systems, will work with aftermarket replacement parts.

** May require alternator tap.

Use 4000 RPM tachometer or lower for diesel applications.

ARGENT PRO

Black graphics on a silver background, pointer has black hub with fade resistant acrylic orange staff. Pointer is internally illuminated for excellent night visibility. Dial graphics light red when illuminated and scratch resistant glass lens with fog-resistant design and polished stainless steel bezel.

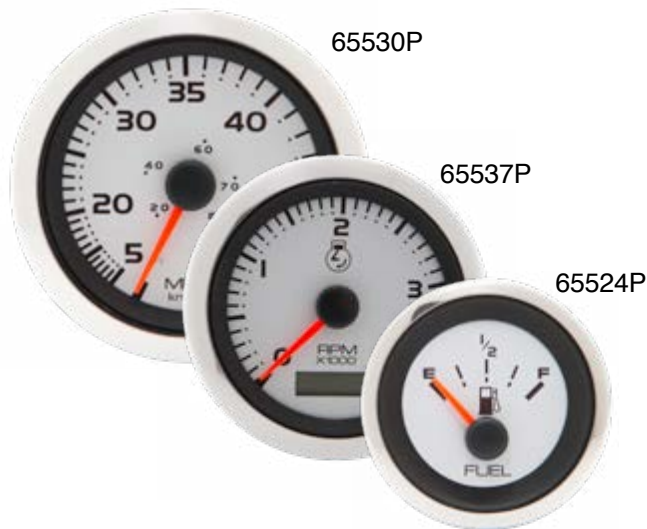
**FEATURES:**

- Translucent dial as well as internally illuminated pointer staff, provides the best in night visibility.
- Easy to read black graphics on a silver dial background. Domed glass lenses are scratch resistant.
- Low profile bezels follow the curvature of the lens, with no 'lip' to trap and hold water.
- Optional add-on eyebrow or Square bezels available (See gauge accessories for details)

FOG RESISTANT GAUGE FEATURES:

- Fog-Resistant Design! Complies with SAE J-1810.

SELECTION GUIDE:

GAUGE DESCRIPTION	SIZE	DIAL RANGE	SENDER CODE	PART NO.
Fuel Gauge:	2"	E-1/2-F	REQUIRES "F"	65524P •
Oil Pressure Gauge (Electric):				
Oil Pressure 80 PSI	2"	0-80 PSI	REQUIRES "C"	65526P •
Oil Pressure 100 PSI	2"	0-80 PSI	REQUIRES "C"	65525P •
GPS Speedometer:				
60 MPH (Head Only)	3"	0-60 MPH	GPS RECEIVER	781-294-060P
Speedometer Kits:				
50 MPH (Pitot type)	3"	5-50 MPH	INCLUDES "G"	65529P •
50 MPH (Pitot type)	5"	5-50 MPH	INCLUDES "G"	65530P
70 MPH (Pitot type)	3"	20-70 MPH	INCLUDES "G"	65531P •
Tachometers (Electric):				
O/B & 4-Stroke Gas Engines*	3"	0-7000 RPM	O/B ALT./COIL	65535P •
O/B & 4-Stroke Gas Engines*	5"	0-7000 RPM	O/B ALT./COIL	65536P
Diesel Alternator*	3"	0-4000 RPM	O/B ALT./COIL	65537P •
Tachometer/Hourmeter (Electric):				
O/B & 4-Stroke Gas Engines*	3"	0-7000 RPM	O/B ALT./COIL	65545P •
Trim Gauges (Outboard, I/O):				
Johnson/Evinrude (All) & Suzuki				
4-stroke 2002 & Up	2"	UP-DOWN	BY ENG. MFR	65547P •
Mercury O/B & I/O, Mariner, Force, Cobra,				
Volvo DP & SX, Yamaha 2001 & Up	2"	UP-DOWN	BY ENG. MFR	65548P •
Voltmeter-12 Volt:	2"	10-16 VDC	NONE REQUIRED	65550P •
Water Pressure Kit (Outboard):***				
Each kit includes fittings & 20 feet of tubing)	2"	30 PSI	INCLUDES "WP"	65551P •
Water Temp. Gauge (I/O) (Electric):	2"	120-240°F	REQUIRES "D"	65553P •

• Display Packaged Item

* Not tested for non-original-equipment (aftermarket) ignition systems.

*** Adapter (P/N 61886P) is required for Yamaha.
Use 4000 RPM tachometer or lower for diesel applications.



LIDO PRO

We have added a selection of fog resistant gauges to our hottest white dial line. Lido Pro features a crisp, white dial with a fire orange pointer tip. Red through-dial and white perimeter lighting provide great night readability. Coverage for popular OB and I/O applications - complete gauge kits available **.



FEATURES:

- White dial, black numerals, black pointer with fire-orange tip.
- Scratch resistant curved glass lenses, with polished stainless steel, near-flush bezels.
- U.S. and metric scales, with ISO symbols.
- Optional add-on eyebrow or square bezels available (See Gauge Accessories for details).
- White perimeter and red thru-dial lighting.

FOG RESISTANT GAUGE FEATURES:

- Fog-Resistant Design! Complies with SAE J-1810.

SELECTION GUIDE:

GAUGE DESCRIPTION	SIZE	DIAL RANGE	SENDER CODE	PART NO.
Fuel Gauge:	2"	E-1/2-F	REQUIRES "F"	59655P •
Hourmeter:	2"	10,000 Hrs.	NONE REQ'D	59416P •
Oil Pressure Gauges (Electric):				
Oil Pressure 80 PSI	2"	0-80 PSI	REQUIRES "C"	59653P •
GPS Speedometer:				
35 MPH	3"	0-35 MPH	GPS RECEIVER	781-310-035P
60 MPH	3"	0-60 MPH	GPS RECEIVER	781-310-060P
Speedometer Kits:				
50 MPH (Pitot type)	3"	10-50 MPH	INCLUDES "G"	61752FP •
65 MPH (Pitot type)	3"	10-65 MPH	INCLUDES "G"	59713P •
Tachometer (Electric):				
O/B & 4-Stroke Gas Engines*	3"	0-7000 RPM	O/B ALT./COIL	59737P •
Trim Gauges (Outboard, I/O): Mercury O/B & I/O, Mariner, Force, Cobra, Volvo DP & SX, Yamaha 2001 & Up	2"	UP-DOWN	BY ENG. MFR.	59657P •
Voltmeter-12 Volt:	2"	8-18 VDC	NONE REQ'D	59656P •
Water Pressure Kit (Outboard):***				
Each kit includes fittings and 20 feet of tubing)	2"	30 PSI	INCLUDES "WP"	63523P •
Water Temp. Gauge (I/O, I/B):	2"	120-240°F	REQUIRES "D"	59654P •
Instrument Set "OUTBOARD"	Contains: 59737P, 59713P, 59655P, 59656P			67669P •
Instrument Set "INBOARD/STERNDRIVE"	Contains: 59737P, 59713P, 59655P, 59656P, 59654P, 59653P			67653P

- Display Packaged Item

* Not tested for complete aftermarket ignition systems, will work with aftermarket replacement parts.

*** Adapter (P/N 61886P) is required for Yamaha. Use 4000 RPM tachometer or lower for diesel applications.



LIDO

Hottest selling white dial line! A comprehensive family of instruments for most engine types, Lido features crisp white dials and fire-orange pointer tips. Red through-dial and white perimeter lighting provide great night readability. Excellent inboard coverage with engine sync gauges* and diesel alternator and magnetic pickup tachometers**.

*Module required, not included with gauge. **Magnetic Pickup sender available separately.



FEATURES:

- White dial, black numerals, black pointer with fire-orange tip.
- Scratch resistant curved glass lenses, with polished stainless steel, near-flush bezels.
- U.S. and metric scales, with ISO symbols.
- Optional add-on eyebrow or square bezels available (See Gauge Accessories for details).
- White perimeter and red thru-dial lighting.
- Comprehensive line includes tachometers for diesel alternator and magnetic pickup PLUS synchronizer gauge (Suitable for gas or diesel engines with appropriate module. Module required, not included with gauge).

SELECTION GUIDE:

GAUGE DESCRIPTION	SIZE	DIAL RANGE	SENDER CODE	PART NO.
Engine Sync (gauge only)	2"	PORT-STBD.	REQUIRES "L"	65495P •
Fuel Gauge:	2"	E-1/2-F	REQUIRES "F"	65496P •
Hourmeter:	2"	10,000 Hrs.	NONE REQ'D	65497P •
Oil Pressure Gauges (Electric):				
Oil Pressure 80 PSI	2"	0-80 PSI	REQUIRES "C"	65501P •
Oil Pressure 100 PSI	2"	0-100 PSI	REQUIRES "C"	65498P •
Speedometer Kits:				
35 MPH (Pitot type)	3"	5-35 MPH	INCLUDES "G"	61751P
35 MPH (Pitot type) Head Only	3"	5-35 MPH		61751PH
50 MPH (Pitot type)	3"	10-50 MPH	INCLUDES "G"	61752P •
50 MPH (Pitot type) Head Only	3"	10-50 MPH		61752PH
65 MPH (Pitot type)	3"	10-65 MPH	INCLUDES "G"	65510P •
80 MPH (Pitot type)	3"	20-80 MPH	INCLUDES "G"	65670P •
80 MPH (Pitot type) Head Only	3"	20-80 MPH		65670PH
Systems Check-Evinrude/Johnson:	2"	SYSTEM DATA	BY ENG. MFR.	65206SSP
Tachometer (Electric):				
O/B & 4-Stroke Gas Engines*	3"	0-7000 RPM	O/B ALT./COIL	65693P •
Systems Check – Evinrude/Johnson	3"	0-7000 RPM	O/B ALT./COIL	64477FP •
Tachometer/Hourmeters (Electric):				
O/B & 4-Stroke Gas Engines*	3"	0-7000 RPM	O/B ALT./COIL	65129P •
Diesel Alternator**	3"	0-4000 RPM	SEE "T"	65671P •
Diesel Magnetic Pickup, 90-180 Teeth	3"	0-4000 RPM	REQUIRES "B"	65692P •
Trim Gauges (Outboard, I/O):	2"	30 PSI	INCLUDES "WP"	65551P •
Johnson/Evinrude (All) & Suzuki	2"	120-240°F	REQUIRES "D"	65553P •
4-stroke 2002 & Up	2"	UP-DOWN	BY ENG. MFR.	65502P •
Honda	2"	UP-DOWN	BY ENG. MFR.	65503P
Mercury O/B & I/O, Mariner, Force, Cobra,				
Volvo DP & SX, Yamaha 2001 & Up	2"	UP-DOWN	BY ENG. MFR.	65504P •
Yamaha Outboards pre-2001	2"	UP-DOWN	BY ENG. MFR.	65505P •
Voltmeter-12 Volt:	2"	8-18 VDC	NONE REQ'D	65506P •
Water Pressure Kit (Outboard):***				
Each kit includes fittings and 20 feet of tubing)	2"	30 PSI	INCLUDES "WP"	65507P •
Water Temp. Kit (Outboard):***				
(For all electric-start outboards)	2"	COLD-HOT	INCLUDES "J"	65508P •
Water Temp. Gauge (I/O, I/B):	2"	120-240°F	REQUIRES "D"	65509P •

• Display Packaged Item

* Not tested for complete aftermarket ignition systems, will work with aftermarket replacement parts.

** May require alternator tap. *** Adapter (P/N 61886P) is required for Yamaha.

Use 4000 RPM tachometer or lower for diesel applications.

DRIFTWOOD

Features light gray dials, clean black numerals and a black pointer hub with white staff. These instruments lend a sophisticated look to any dash. Combination blue through-dial and white perimeter lighting are included for excellent readability at night.

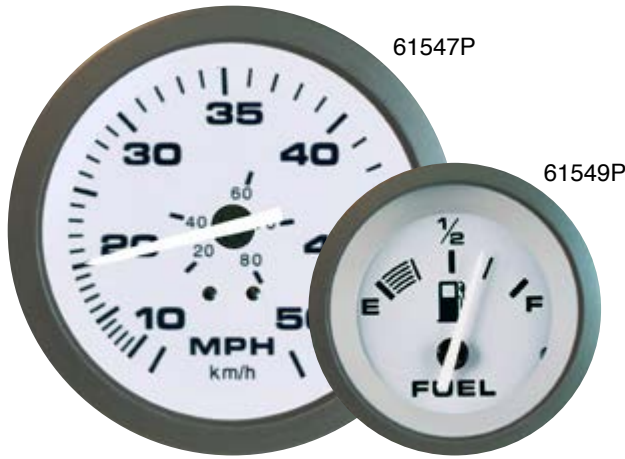

FEATURES:

- Light gray dial, black graduations/numerals, white pointer staff.
- Scratch resistant curved glass lenses, with black, near-flush bezels.
- White perimeter and blue thru-dial lighting.
- U.S. and metric scales, with ISO symbols, where appropriate.
- Optional add-on eyebrow or square bezels available (See Gauge Accessories for details).

SELECTION GUIDE:

GAUGE DESCRIPTION	SIZE	DIAL RANGE	SENDER CODE	PART NO.
Fuel Gauge:	2"	E-1/2-F	REQUIRES "F"	61549P •
Hourmeter:	2"	10,000 Hrs.	NONE REQ'D	62952P •
Oil Pressure Gauge (Electric):	2"	0-80 PSI	REQUIRES "C"	61550P •
Speedometer Kits:				
50 MPH (Pitot type)	3"	10-50 MPH	INCLUDES "G"	61547P •
Tachometer (Electric):				
O/B & 4-Stroke Gas Engines*	3"	0-7000 RPM	O/B ALT./COIL	61546P •
Trim Gauges (Outboard, I/O):				
Honda	2"	UP-DOWN	BY ENG. MFR.	62375P
Mercury O/B & I/O, Mariner, Force, Cobra,				
Volvo DP & SX, Yamaha 2001 & Up	2"	UP-DOWN	BY ENG. MFR.	61551P •
Voltmeter-12 Volt:	2"	8-18 VDC	NONE REQ'D	61548P •
Water Pressure Kit (Outboard):**				
(Kit includes fittings/20 feet of tubing)	2"	30 PSI	INCLUDES "WP"	62960P •
Water Temp. Gauge (I/O, I/B):	2"	100-220°F	REQUIRES "D"	61552P •

• Display Packaged Item

* Not tested for complete aftermarket ignition systems, will work with aftermarket replacement parts.

** Adapter (P/N 61886P) is required for Yamaha. Use 4000 RPM tachometer or lower for diesel applications.



SAHARA

With crisp tan dials and fire-orange pointer tip, Sahara gives any dash the elegant OEM look. Combined red through-dial and white perimeter lighting provide great night readability. These aren't merely "close enough" — they're the real thing!

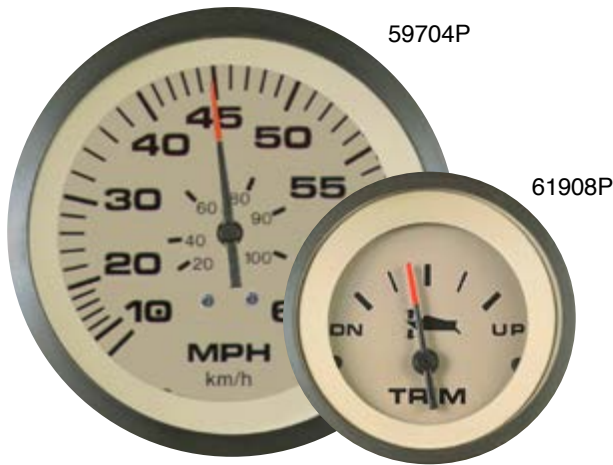

FEATURES:

- Tan dial and retainer, black graduations and numerals, black pointer with fire-orange tip.
- Scratch resistant curved glass lenses, with black matte, near-flush bezels.
- White perimeter and red thru-dial lighting.
- U.S. and metric scales, with ISO symbols, where appropriate.
- Optional add-on eyebrow or square bezels available (See Gauge Accessories for details).

SELECTION GUIDE:

GAUGE DESCRIPTION	SIZE	DIAL RANGE	SENDER CODE	PART NO.
Fuel Gauge:	2"	E-1/2-F	REQUIRES "F"	59707P •
Oil Pressure Gauge (Electric):	2"	0-80 PSI	REQUIRES "C"	59705P •
Speedometer Kits:				
35 MPH (Pitot type)	3"	5-35 MPH	INCLUDES "G"	61826P •
35 MPH (Pitot type) Head Only	3"	5-35 MPH		61826PH
50 MPH (Pitot type)	3"	10-50 MPH	INCLUDES "G"	61163P •
65 MPH (Pitot type)	3"	10-65 MPH	INCLUDES "G"	59704P •
65 MPH (Pitot type) Head Only	3"	10-65 MPH		59704PH
80 MPH (Pitot type)	3"	20-80 MPH	INCLUDES "G"	63076P •
80 MPH (Pitot type) Head Only	3"	20-80 MPH		63076PH
Systems Check – Evinrude/Johnson:	2"	SYSTEM DATA	BY ENG. MFR.	66956P
Tachometer (Electric):				
O/B & 4-Stroke Gas Engines*	3"	0-7000 RPM	O/B ALT./COIL	59703P •
Systems Check – Evinrude/Johnson	3"	0-7000 RPM	O/B ALT./COIL	61901P •
Tach/Hourmeter 0-7000 RPM	3"	0-7000 RPM	O/B ALT./Coil	69743P •
Trim Gauges (Outboard, I/O):				
Johnson/Evinrude (All) & Suzuki				
4-stroke 2002 & Up	2"	UP-DOWN	BY ENG. MFR.	61908P •
Honda	2"	UP-DOWN	BY ENG. MFR.	62369P
Mercury O/B & I/O, Mariner, Force, Cobra,				
Volvo DP & SX, Yamaha 2001 & Up	2"	UP-DOWN	BY ENG. MFR.	59709P •
Voltmeter-12 Volt:	2"	8-18 VDC	NONE REQ'D	59708P •
Water Pressure Kits (Outboard):** (Each kit includes fittings and 20 feet of tubing)	2"	40 PSI	INCLUDES "WP"	69870P •
Water Temp. Gauge (I/O, I/B):	2"	120-240°F	REQUIRES "D"	59706P •
Instrument Set "OUTBOARD"	Contains: 59703P, 59704P, 59707P, 59708P			65481P •
Instrument Set "INBOARD/STERNDRIVE"	Contains: 59703P, 59704P, 59707P, 59708P, 59706P, 59705P			65485P •
Twin Engine Add On IB/IOGauge Kit	Contains: 59703P, 59708P, 59706P, 59705P			69717P
Twin Engine Add On OBGauge Kit	Contains: 59703P, 59708P			69716P
Instrument Set OB w/Tach/Hr	Contains: 69743P, 59704P, 59707P, 59708P			69703P •
Instrument Set IB/IO w/Tach/Hr	Contains: 69743P, 59704P, 59707P, 59708P, 59706P, 59705P			69704P •

• Display Packaged Item

* Not tested for complete aftermarket ignition systems, will work with aftermarket replacement parts.

** Adapter (P/N 61886P) is required for Yamaha.

Use 4000 RPM tachometer or lower for diesel applications.

STERLING

Ideal for outboards and stern drives! With stainless steel bezels, brushed aluminum dials and black pointers, Sterling instruments give a bright, gleaming look to any dash. Perimeter lighting provided for night operation.



FEATURES:

- Brushed aluminum dial, black graduations/numerals, black pointer.
- Scratch resistant curved glass lenses, with polished stainless steel, near-flush bezels.
- Perimeter lighting.
- U.S. and metric scales, with ISO symbols, where appropriate.
- Optional add-on eyebrow or square bezels available (See Gauge Accessories for details).

SELECTION GUIDE:

GAUGE DESCRIPTION	SIZE	DIAL RANGE	SENDER CODE	PART NO.
Fuel Gauge:	2"	E-1/2-F	REQUIRES "F"	63477P •
Oil Pressure Gauge (Electric):	2"	0-80 PSI	REQUIRES "C"	63479P •
Speedometer Kits:				
65 MPH (Pitot type)	3"	10-65 MPH	INCLUDES "G"	63475P •
65 MPH (Pitot type) Head Only	3"	10-65 MPH		63475PH
80 MPH (Pitot type)	3"	20-80 MPH	INCLUDES "G"	63476P •
80 MPH (Pitot type) Head Only	3"	20-80 MPH		63476PH
Systems Check – Evinrude/Johnson:	2"	SYSTEM DATA	BY ENG. MFR.	63585P •
Tachometer (Electric):				
O/B & 4-Stroke Gas Engines*	3"	0-7000 RPM	O/B ALT./COIL	63473P •
Tachometer/Hourmeter (Electric):				
O/B & 4-Stroke Gas Engines*	3"	0-7000 RPM	O/B ALT./COIL	63474P •
Trim Gauges (Outboard, I/O):				
Honda	2"	UP-DOWN	BY ENG. MFR.	64475P
Johnson/Evinrude (All) & Suzuki				
4-stroke 2002 & Up	2"	UP-DOWN	BY ENG. MFR.	63483P •
Mercury O/B & I/O, Mariner, Force, Cobra,				
Volvo DP & SX, Yamaha 2001 & Up	2"	UP-DOWN	BY ENG. MFR.	63482P •
Voltmeter-12 Volt:	2"	8-18 VDC	NONE REQ'D	63478P •
Water Pressure Kit (Outboard):**				
(Kit includes fittings/20 feet of tubing)	2"	30 PSI	INCLUDES "WP"	63481P •
Water Temp. Gauge (I/O, I/B):	2"	120-240°F	REQUIRES "D"	63480P •

• Display Packaged Item

* Not tested for complete aftermarket ignition systems, will work with aftermarket replacement parts.

** Adapter (P/N 61886P) is required for Yamaha.
Use 4000 RPM tachometer or lower for diesel applications.

BLACK STERLING

With its rich luster and polish, Black Sterling instruments convey a look of utmost sophistication and add elegance to any dash. These instruments have fire-orange pointer tips and stainless graphics for a contemporary, ultra stylish look. Black Sterling instruments have clean, crisp black dials which highlight the stainless accents.



FEATURES:

- Scratch-resistant domed glass lens.
- Perimeter lit dial.
- Elite stainless steel bezel.
- Black pointer with fire orange tip.
- White graphics and black background on spun aluminum dial.
- Optional add-on eyebrow or square bezels available (See Gauge Accessories for details).
- Fits most stern drive and outboard applications.
- US and Metric scales where appropriate.

MULTI-GAUGE FEATURES:

- Combines 2 gauges in one.
- Saves dash space.
- Fog-Resistant Design! Complies with SAE J-1810.

SELECTION GUIDE:

GAUGE DESCRIPTION	SIZE	DIAL RANGE	SENDER CODE	PART NO.
Fuel Gauge	2"	E-1/2-F	REQUIRES "F"	67021P •
Voltmeter	2"	8-18 VDC	NONE REQ'D	67019P •
Water Temperature (Electric)	2"	100-240°F	REQUIRES "D"	67020P •
Oil Pressure (Electric)	2"	0-80 PSI	REQUIRES "C"	67022P •
50 MPH Speedometer	3"	0-50 MPH	INCLUDES "G"	68960P •
50 MPH Speedometer (Head Only)	3"	0-50 MPH		68960PH
70 MPH Speedometer Kit	3"	0-70 MPH	INCLUDES "G"	67285P •
Tachometer: O/B & 4 Cycle Gas	3"	0-7000 RPM	O/B ALT./COIL	67363P •
Tach/LCD Hr, O/B & 4 Cycle Gas	3"	0-7000 RPM	O/B ALT./COIL	67364P •
Trim: Honda	2"	UP-DOWN	BY ENG. MFR.	67855P
Trim: Mercury O/B & I/O, Mariner, Force, Cobra, Volvo DP & SX, Yamaha 2001 & Up	2"	UP-DOWN	BY ENG. MFR.	67023P •
Trim: Johnson/Evinrude (All) & Suzuki				
4-stroke 2002 & Up	2"	UP-DOWN	BY ENG. MFR.	67365P •
O/B Water Pressure Kit	2"	0-40 PSI	INCLUDES "WP"	67382P •

MULTI-GAUGE DESCRIPTION	SIZE	DIAL RANGE	SENDER CODE	PART NO.
Speedo/Fuel	3"	0-50 MPH	REQUIRES "G"	69073FP •
		E-1/2-F	REQUIRES "F"	
Tach/Volt	3"	0-7000 RMP	O/B ALT./COIL	69074FP •
		8-18 VDC	NONE REQ'D	

• Display Packaged Item

* Not tested for complete aftermarket ignition systems, will work with aftermarket replacement parts.

** Adapter (P/N 61886P) is required for Yamaha.

Use 4000 RPM tachometer or lower for diesel applications.

AMEGA

Hottest selling black dial line! Amega® Domed has clean-looking black dials with white and red graphics plus through-dial and perimeter lighting for great readability. Amega has been very popular, available in several styles since its debut in 1986.



FEATURES:

- Black dial, red graduations, white numerals, vivid white pointer staff.
- Scratch resistant curved glass lenses, with black, near-flush bezels.
- U.S. and metric scales, with ISO symbols, where appropriate.
- Perimeter and thru-dial lighting.
- A comprehensive array of outboard water pressure instrument kits.
- Optional add-on eyebrow or square bezels available (See Gauge Accessories for details).

SELECTION GUIDE:

GAUGE DESCRIPTION	SIZE	DIAL RANGE	SENDER CODE	PART NO.
Fuel Gauge:	2"	E-1/2-F	REQUIRES "F"	57902P •
Hourmeter:	2"	10,000 Hrs.	NONE REQ'D	84760P •
Oil Pressure Gauges (Electric):				
Oil Pressure 80 PSI	2"	0-80 PSI	REQUIRES "C"	57903P •
Oil Pressure 100 PSI	2"	0-100 PSI	REQUIRES "C"	57929P •
GPS Speedometer:				
35 MPH	3"	0-35 MPH	GPS RECEIVER	781-579-035P
60 MPH	3"	0-60 MPH	GPS RECEIVER	781-579-060P
80 MPH	3"	0-80 MPH	GPS RECEIVER	781-579-080P •
Speedometer Kits:				
35 MPH (Pitot type)	3"	5-35 MPH	INCLUDES "G"	58342P •
35 MPH (Pitot type) Head Only	3"	5-35 MPH		58342PH
50 MPH (Pitot type)	3"	10-50 MPH	INCLUDES "G"	57898P •
50 MPH (Pitot type) Head Only	3"	10-50 MPH		57898PH
65 MPH (Pitot type)	3"	10-65 MPH	INCLUDES "G"	57900P •
65 MPH (Pitot type) Head Only	3"	10-65 MPH		57900PH
80 MPH (Pitot type)	3"	20-80 MPH	INCLUDES "G"	57899P •
80 MPH (Pitot type) Head Only	3"	20-80 MPH		57899PH
Systems Check – Evinrude/Johnson:	2"	SYSTEM DATA	BY ENG. MFR.	65205P •
Tachometer (Electric):				
O/B & 4-Stroke Gas Engines*	3"	0-7000 RPM	O/B ALT./COIL	58255P •
Systems Check – Evinrude/Johnson	3"	0-7000 RPM	O/B ALT./COIL	58935P •
Diesel Alt	3"	0-4000 RPM	ALTERNATOR	68358P •
Force	3"	0-7000 RPM		69044P •
Tachometer/Hourmeter (Electric):				
O/B & 4-Stroke Gas Engines*	3"	0-6000 RPM	O/B ALT./COIL	57897P •
Tach/Hourmeter	3"	0-7000		68443P •
Trim Gauges (Outboard, I/O):				
Johnson/Evinrude (All) & Suzuki				
4-stroke 2002 & Up	2"	UP-DOWN	BY ENG. MFR.	58431P •
Honda	2"	UP-DOWN	BY ENG. MFR.	68359P
Mercury O/B & I/O, Mariner, Force, Cobra, Volvo DP & SX, Yamaha 2001 & Up	2"	UP-DOWN	BY ENG. MFR.	57905P •
Yamaha Outboards pre-2001	2"	UP-DOWN	BY ENG. MFR.	61748P •
Voltmeter-12 Volt:	2"	8-18 VDC	NONE REQ'D	57901P •
Water Pressure Kits (Outboard):**	2"	40 PSI	INCLUDES "WP"	68357P •
(Each kit includes fittings and 20 feet of tubing)	2"	30 PSI	INCLUDES "WP"	61238P •
Water Temp. Kit (Outboard):**				
(For all electric-start outboards)	2"	100-220°F	INCLUDES "J"	58862P •
Water Temp. Gauge (I/O, I/B):	2"	120-240°F	REQUIRES "D"	57904P •
Ammeter, Amega 60-0-60	2"	60-0-60	NONE REQ'D	68356P •
Battery Condition Indicator, 12 VDC			NONE REQ'D	68361P •
Instrument Set "OUTBOARD"	Contains:	58255P, 57900P, 57902P, 57901P		68362P •
Instrument Set "INBOARD/STERNDRIVE"	Contains:	58255P, 57900P, 57902P, 57901P, 57904P, 57903P		68363P •
Twin Engine Add On IB/O Gauge Kit	Contains:	58255P, 57901P, 57904P, 57903P		69722P •
Twin Engine Add On OB Gauge Kit	Contains:	58255P, 57901P		69721P •
Instrument Set OB w/Tach/Hr	Contains:	68443P, 57900P, 57902P, 57901P		69708P •
Instrument Set IB/O w/Tach/Hr	Contains:	68443P, 57900P, 57902P, 57901P, 57904P, 57903P		69709P •

- Display Packaged Item

* Not tested for complete aftermarket ignition systems, will work with aftermarket replacement parts.

** Adapter (P/N 61886P) is required for Yamaha.

Use 4000 RPM tachometer or lower for diesel applications.

ARCTIC

Stylish white bezel design, black on white graphics, accurate and reliable, these tough instruments look good on all types of boats. Domed glass sheds water and resists scratching.

**FEATURES:**

- Instruments available for most outboards, stern drives and gasoline-powered inboards.
- Scratch-resistant domed glass lenses.
- Enhanced illumination: through-dial and perimeter lighting for excellent readability at night.
- Low-range speedometers.
- U.S. and metric scales, with ISO symbols, where appropriate.
- Optional add-on eyebrow or square bezels available (See Gauge Accessories for details).

SELECTION GUIDE:

GAUGE DESCRIPTION	SIZE	DIAL RANGE	SENDER CODE	PART NO.
Ammeter	2"	60-0-60	NONE REQ'D	68364P •
Fuel Gauge	2"	(E-F)	REQUIRES "F"	68365P •
Hourmeter	2"	10,000 hrs		68366P •
Eng Oil Pressure gauge 0-80 PSI	2"	0-80 PSI	REQUIRES "C"	68367P •
Water Pressure Kits (Outboard): (Each kit includes fittings and 20 feet of tubing).	2"	0-40 PSI	INCLUDES "WP"	68369P •
GPS Speedometer:				
35 MPH	3"	0-35 MPH	GPS RECEIVER	781-683-035P
60 MPH	3"	0-60 MPH	GPS RECEIVER	781-683-060P
80 MPH	3"	0-80 MPH	GPS RECEIVER	781-683-080P •
Speedo Kit 0-35 mph (inc Pitot and Hose)	3"	5-35 MPH	INCLUDES "G"	68370P •
Speedo Kit 0-65 mph (inc Pitot and Hose)	3"	10-65 MPH	INCLUDES "G"	68371P •
Speedo Kit 0-80 mph (inc Pitot and Hose)	3"	20-80 MPH	INCLUDES "G"	68372P •
Tachometer 0-4000 RPM Diesel Alt	3"	0-4000 RPM	ALTERNATOR	68373P •
Tachometer 0-7000 RPM	3"	0-7000 RPM	O/B ALT./COIL	68374P •
Tach/Hourmeter 0-7000 RPM Petrol/Gas	3"	0-7000 RPM	O/B ALT./COIL	68375P •
I/O, I/B Water Temp Gauge	2"	120-240°F	REQUIRES "D"	68376P •
Outboard Water Temp Kit (Cold-Hot)	2"	100-220°F	INCLUDES "J"	68377P •
Trim, Johnson/Evinrude (All) & Suzuki				
4-stroke 2002 & Up	2"	UP-DOWN	BY ENG. MFR.	68378P •
Trim, Honda	2"	UP-DOWN	BY ENG. MFR.	68379P
Trim, Mercury O/B & I/O, Mariner, Force, Cobra, Volvo DP & SX, Yamaha 2001 & Up	2"	UP-DOWN	BY ENG. MFR.	68380P •
Trim, Yamaha Outboards pre-2001	2"	UP-DOWN	BY ENG. MFR.	68381P •
12v Voltmeter, 8-18 Volts	2"	8-18 VDC	NONE REQ'D	68383P •
12 Battery Condition Indicator	2"		NONE REQ'D	68384P •
System Check - Evinrude/Johnson	2"		BY ENG. MFR.	68385P •
Instrument Set "OUTBOARD"	Contains: 68374P, 68371P, 68365P, 68383P			68387P •
Instrument Set "INBOARD/STERNDRIVE"	Contains: 68374P, 68371P, 68365P, 68383P, 68376P, 68367P			68388P •
Instrument Set OB w/Tach/Hr	Contains: 68375P, 68371P, 68365P, 68383P			69710P •
Instrument Set IB/IO w/Tach/Hr	Contains: 68375P, 68371P, 68365P, 68383P, 68376P, 68367P			69711P •
Twin Engine Add On IB/IO Gauge Kit	Contains: 68374P, 68383P, 68376P, 68367P			69724P
Twin Engine Add On OB Gauge Kit	Contains: 68374P, 68383P			69723P

• Display Packaged Item

* Not tested for complete aftermarket ignition systems, will work with aftermarket replacement parts.

** Adapter (P/N 61886P) is required for Yamaha.

Use 4000 RPM tachometer or lower for diesel applications.

ECLIPSE

Smart white and blue graphics on a black dial background, these very low profile bezels follow the curve of the lense to eliminate water trapping. Design with domed glass sheds water and resists scratching.



FEATURES:

- Instruments available for most outboards, stern drives and gasoline-powered inboards.
- Scratch-resistant domed glass lenses.
- Perimeter lighting for excellent readability at night.
- U.S. and metric scales, with ISO symbols, where appropriate.
- Optional add-on eyebrow or square bezels available (See Gauge Accessories for details).

SELECTION GUIDE:

GAUGE DESCRIPTION	SIZE	DIAL RANGE	SENDER CODE	PART NO.
Ammeter	2"	60-0-60	NONE REQ'D	68389P •
Fuel Gauge	2"	(E-F)	REQUIRES "F"	68390P •
Hourmeter	2"	10,000 hrs		68391P •
Eng Oil Pressure gauge 0-80 PSI	2"	0-80 PSI	REQUIRES "C"	68392P •
Eng Oil Pressure gauge 0-100 PSI	2"	0-100 PSI	REQUIRES "C"	68393P •
Water Pressure Kits (Outboard): (Each kit includes fittings and 20 feet of tubing).	2"	0-40 PSI	INCLUDES "WP"	68394P •
GPS Speedometer:				
35 MPH	3"	0-35 MPH	GPS RECEIVER	781-684-035P
60 MPH	3"	0-60 MPH	GPS RECEIVER	781-684-060P
80 MPH	3"	0-80 MPH	GPS RECEIVER	781-684-080P •
Speedo Kit 0-35 mph (inc Pitot and Hose)	3"	5-35 MPH	INCLUDES "G"	68395P •
Speedo Kit 0-65 mph (inc Pitot and Hose)	3"	10-65 MPH	INCLUDES "G"	68396P •
Speedo Kit 0-80 mph (inc Pitot and Hose)	3"	20-80 MPH	INCLUDES "G"	68397P •
Tachometer 0-4000 RPM Diesel Alt	3"	0-4000 RPM	ALTERNATOR	68398P •
Tachometer 0-7000 RPM	3"	0-7000 RPM	O/B ALT./COIL	68399P •
Tach/Hourmeter 0-7000 RPM Petrol/Gas	3"	0-7000 RPM	O/B ALT./COIL	68400P •
I/O, I/B Water Temp Gauge	2"	120-240°F	REQUIRES "D"	68401P •
Outboard Water Temp Kit (Cold-Hot) -includes "J"	2"	100-220°F	INCLUDES "J"	68402P •
Trim, Johnson/Evinrude (All) & Suzuki				
4-stroke 2002 & Up	2"	UP-DOWN	BY ENG. MFR.	68403P •
Trim, Honda	2"	UP-DOWN	BY ENG. MFR.	68404P
Trim, Mercury O/B & I/O, Mariner, Force,				
Cobra, Volvo DP & SX, Yamaha 2001 & Up	2"	UP-DOWN	BY ENG. MFR.	68405P •
Trim, Yamaha Outboards pre-2001	2"	UP-DOWN	BY ENG. MFR.	68406P •
12v Voltmeter, 8-18 Volts	2"	8-18 VDC	NONE REQ'D.	68408P •
12v Battery Condition Indicator	2"		NONE REQ'D.	68409P •
System Check - Evinrude/Johnson	2"		BY ENG. MFR.	68410P •
Instrument Set "OUTBOARD"	Contains: 68399P, 68396P, 68390P, 68408P			68412P •
Instrument Set "INBOARD/STERNDRIVE"	Contains: 68399P, 68396P, 68390P, 68408P, 68401P, 68392P			68413P •
Twin Engine Add On IB/IO Gauge Kit	Contains: 68399P, 68408P, 68401P, 68392P			69726P
Twin Engine Add On OB Gauge Kit	Contains: 68399P, 68408P			69725P
Instrument Set OB w/Tach/Hr	Contains: 68400P, 68396P, 68390P, 68408P			69712P •
Instrument Set IB/IO w/Tach/Hr	Contains: 68400P, 68396P, 68390P, 68408P, 68401P, 68392P			69713P •

• Display Packaged Item

* Not tested for complete aftermarket ignition systems, will work with aftermarket replacement parts.

** Adapter (P/N 61886P) is required for Yamaha.

Use 4000 RPM tachometer or lower for diesel applications.

HEAVY DUTY

A classic line for inboards including diesels, Heavy Duty includes mechanical water temperature and oil pressure gauges, ammeters, engine sync gauges* and a range of diesel tachometers, including a programmable tach/hourmeter.

*Module required, not included with gauge.



FEATURES:

- Classic white graphics and pointer on deep black faces.
- Low-profile polished stainless steel bezels.
- Perimeter lighting and scratch resistant glass lenses.
- Tachometers for diesels available.
- Several temperature and mechanical oil pressure gauges available.
- Programmable tach/hourmeter offered.
- Ideal replacement for Stewart-Warner® “Deluxe” instruments.
- Optional add-on eyebrow or square bezels available (See Gauge Accessories for details).

SELECTION GUIDE:

GAUGE DESCRIPTION	SIZE	DIAL RANGE	SENDER CODE	PART NO.
Ammeters:				
Direct Reading 40 Amp Range	2"	40-0-40A	NONE REQ'D.	80712P
Direct Reading 60 Amp Range	2"	60-0-60A	NONE REQ'D.	80710P •
Fuel Gauge:	2"	E-1/2-F	REQUIRES "F"	80150P •
Hourmeter:	2"	10,000 Hrs.	NONE REQ'D.	82760P •
Oil Pressure Gauges (Electric):				
Oil Pressure 80 PSI	2"	0-80 PSI	REQUIRES "C"	80180P •
Oil Pressure 100 PSI	2"	0-100 PSI	REQUIRES "C"	80181P •
Oil Temperature Gauge (Electric):				
Oil Temperature 320°F	2"	140-320°F	REQUIRES "E"	80596P
Speedometer Kits:				
Tachometers (Electric):				
Diesel Alternator**	3"	0-3500 RPM	SEE "T"	82302P •
Diesel Magnetic Pickup, 90-180 Teeth	3"	0-3500 RPM	REQUIRES "B"	82303P •
Diesel Signaflex ***	3"	0-3500 RPM	SIGNAFLEX	82301P
O/B & 4-Stroke Gas Engines*	3"	0-6000 RPM	O/B ALT./COIL	82288P •
Water Temp. Gauges (Electric):				
Water Temp 240°F	2"	120-240°F	REQUIRES "D"	80590P •
Water Temp 280°F, Nylon	2"	100-280°F	REQUIRES "P"	80593P
Voltmeters - 12 & 24 Volt:				
12 Volt System	2"	10-16 VDC	NONE REQ'D.	80134P •
24 Volt System	2"	20-32 VDC	NONE REQ'D.	80131P •

• Display Packaged Item

* Not tested for complete aftermarket ignition systems, will work with aftermarket replacement parts.

** May require alternator tap.

***Singnaflex senders and drive tips are for domestic diesel engines only (not for Lehman, Renault, Volvo, Yanmar, etc.)

Use 4000 RPM tachometer or lower for diesel applications.



R3 DIGITAL GAUGE TOUCH SCREEN DISPLAY

Introducing the Sierra R3 Digital Touch Screen Display, the first aftermarket fully round, edge-to-edge LCD color display. The R3 replaces multiple analog or can bus gauges at once and fits in a standard 3 3/8" hole cutout. Customizable touch screen with seven pre-loaded digital faces that can be changed on the fly ensures everyone's style is covered with the R3.

NEW

- IP67 Protection
- 850 NIT backlit display for full sunlight readability
- 432 x 432 screen resolution
- Rugged and reliable CAN Display
- 2 x CAN Bus & 1 x RS485 connection
- 6 x Analog, 1 x Frequency Input
- 5 x Outputs
- NMEA 2000
- Flash Memory 8MB
- RAM 256KB
- EEPROM 4KB
- Display PCAP LCD 2.93" Round
- Viewing Angle 70°
- Contrast Ratio 700:1
- Power 10-32VDC
- Sounder: Internal Buzzer



72236P



SIERRA DEPTH GAUGE AND TRANSDUCER KIT

- Clamshell packaging for easy POP display
- Depth range to 600ft and on plane readings up to 60mph
- Includes two interchangeable faces (Black, White) and three bezels (Black, White, Chrome) designed to match most Sierra gauge series
- Automatic range and sensitivity adjustments for no-worry usage
- Polarized LCD display for easy viewing in any environment
- 30ft transducer cable length for small or large boat installations on package
- Installation and User Manual available on SierraMarine.com or using the QR code
- Dual-mount transducer can be transom mounted or internally glue mounted to hull
- Dual Depth alarms can be set to warn of depth changes
- 1 touch alarm muting instantly silences audible alarm
- User selected unit of measure (feet or meter)
- Keel offset designed to properly adjust depth readings
- LED backlit display for easy viewing at night
- High speed transducer resolution of 7X per second
- Covered by Sierra Limited Lifetime Warranty



26000P

Fits 2 1/8" hole

DISPLAY PACKAGE

PREMIER STAINLESS SERIES 5" MULTI FUNCTION GAUGE KIT

- Anti-fog coated lens reduces fogging
- Domed glass lens resists scratching and total lens washout in sunlight
- Stainless steel Bezel,
- Silicon dampened pointers reduces pointed bounce in rough waters,
- Reverse polarity protection
- Optional eyebrow bezels available for stylish look,
- Perimeter lit dial and pointer, incandescent bulb lighting
- Includes pitot tube and water pressure installation kit

20000P

Fits: Mercury and Yamaha Engines.
Tachometer/Trim/Water (30PSI)
Speedometer (80MPH)
Fuel, Voltmeter

20010P

Fits: Evinrude and Suzuki Engines
Tachometer/Trim/Water (30PSI)
Speedometer (80MPH)
Fuel, Voltmeter



DISPLAY PACKAGE

WHITE SERIES 5" MULTI FUNCTION GAUGE KIT

- Anti-fog coated lens reduces fogging
- Fully backlit dial with white numerals and gradients while backlit red for balanced lighting
- Fully backlit pointer, incandescent bulb lighting
- Domed glass lens resists scratching and total lens washout in sunlight
- Stainless steel Bezel
- Silicon dampened pointers reduces pointed bounce in rough waters
- Reverse polarity protection
- Optional eyebrow bezels available for stylish look
- Speedometer pitot tube and water pressure installation kit included

21000P

Fits: Mercury and Yamaha engines
Tachometer/Trim/Water (40PSI)
Speedometer (80MPH)
Fuel, Voltmeter

21010P

Fits: Evinrude and Suzuki Engines
Tachometer/Trim/Water (40PSI)
Speedometer (80MPH)
Fuel, Voltmeter



DISPLAY PACKAGE

DEEP-VEE SERIES 5" MULTI FUNCTION GAUGE KIT

- Anti-fog coated lens reduces fogging
- GPS speedometer for accurate speed readings, no clogged or damaged pitots and tubing to worry about
- Fully backlit dial with gray numerals and gradients while backlit blue for balanced lighting
- Fully backlit pointer, 3D dial design provides larger dial viewing area without increasing gauge footprint
- Domed glass lens resists scratching and total lens washout in sunlight
- Stainless steel Bezel
- Silicon dampened pointers reduces pointed bounce in rough waters
- Reverse polarity protection
- Optional eyebrow bezels available for stylish look
- LED lighting
- Hourmeter included in tachometer
- GPS receiver included, Deutsch electrical connectors included



22000P

Fits: Mercury and Yamaha engines
Tachometer/Hourmeter/Fuel/Voltmeter
GPS Speedometer/Trim



22010P

Fits: Fits: Evinrude and Suzuki Engines
Tachometer/Hourmeter/Fuel/Voltmeter
GPS Speedometer/Trim

22020P

Fits: Honda Engines
Tachometer/Hourmeter/Fuel/Voltmeter
GPS Speedometer/Trim

MARINE OIL PRESSURE AND TEMPERATURE SENDER INTERCHANGE



Illustration A
OIL PRESSURE SWITCH



Illustration B
OIL PRESSURE SENDER



Illustration C
TEMPERATURE SENDER



Illustration D
TEMPERATURE SWITCH



Illustration E
SAFETY SHUT-OFF SWITCH

PART NO.	Stewart Warner Part No.	Faria Part No.	Medallion Part No.	Datcon Part No.	VDO Part No.	Crusader Part No.	Mer cruiser Part No.	Volvo Part No.	BRP Part No.	VeeThree Part No.	Range	N.P.T. Thread Size	Terminal Type
OP22900	364L-F										6 psi Trip	1/8-27	10-32 stud
OP22891	364K-F										15 psi Trip	1/8-27	10-32 stud
18-5894								3852215	0379948		9 psi Trip	1/8-27	Spade
18-5899	279-A	90512	A-2547	02504-00	360 801	700425	815425T	3857532	982650	IA15001	80 psi	1/8-27	10-32 stud
OP24301	279B-F	90519	A-2547-1	02505-00	360 811		850362			IA15016	100 psi	1/8-27	10-32 stud
OP24891	82514	90511	A-2622	02504-01				872064		IA15003	80 psi DS	1/8-27	10-32 stud
TS25101	83304				232011017088						200 Trip	3/8-18	1/4" blade
18-5896	362CZ-D	90401	B-936							52320S010	240°	1/8-27	10-32 stud
TS26611	362AN-D	90402	B-936-1							52320S004	240°	1/4-18	10-32 stud
TS26621	362AJ-D	90403	B-936-2				97257A 1			52320S009	240°	3/8-18	10-32 stud
TS26631	362AH-D	90404	B-936-3			700427	97258A 1		171960	52320S003	240°	1/2-14	10-32 stud
TS26641		90406	B-936	02017	323094						240° DS	1/8-27	10-32 stud
TS26651	362BD-D		A-2618-2								240° DS	1/4-18	10-32 stud
18-5897	352BC-D		A-2618-3					872068		52320S018	240° DS	3/8-18	10-32 stud
18-5898	362BB-D		A-2618-4							52320S017	240° DS	1/2-14	10-32 stud
18-7513								3862500			239°	1/8-27	

*OP72533

1/4-18 1/4" spade

• Retail Packaged Item

*Note: DS specifies Dual Station sender

*3-wire hookup to starter, pump and ignition. I/O and inboard units require a method to shut off the electronic fuel pump when the engine fails or is shut down. This switch senses low oil pressure and shuts the fuel pump off.

HOURMETERS



56966P
HOURMETER, ROUND
(2")



56967P
HOURMETER, RECT.
(Hole Size: 1.5" x 1")
Outside dimensions: 2.1" x 1.2"



56968P
SMALL ENGINE
HOURMETER
(W/ 5' SENSOR WIRE)
Replaces: Yamaha
ENG-METER-2C-01
2 or 4 Stroke Gasoline
- No power or ground required



56969P
SMALL ENGINE TACH
/HOURMETER
(W/ 5' SENSOR WIRE)
Fits: 2 or 4 stroke, 2 Cylinders or Less
-No power or ground required

GAUGE ACCESSORIES

BEZELS

EYEBROW BEZELS

Our Eyebrow Bezels give any boat that sporty race boat look. Durable and corrosion proof, these chrome plated bezels attach directly to the gauge. The bezels can be rotated to any angle allowing you to customize the look of your dash.

FEATURES:

- Directly attach to the gauge
- No extra holes to drill
- Can be set at any angle
- Corrosion proof ABC/PVC construction
- Buy individually or in 4 or 6 gauge sets.



69380P
BEZEL KIT
For: 4 Gauge Kit

Contains:
69268P (x2) and 69269P (x2)



69381P
BEZEL KIT
For: 6 Gauge Kit

Contains:
69268P (x4) and 69269P (x2)



69269P
EYEBROW BEZEL (3")
3 3/8" I.D.



69270P
EYEBROW BEZEL
(5")



IA65477
ACCESSORY, AIRCRAFT BEZEL (3")
3 3/8" I.D.

FUEL SENDERS (CODE F): 240-33 OHM RANGE



56948P
FUEL SENDER KIT (W/GAUGE)
4-24" Tank



90424P
FUEL SENDER
4-24" tank depth



64082
FUEL SENDER GASKET

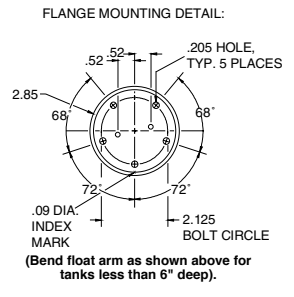
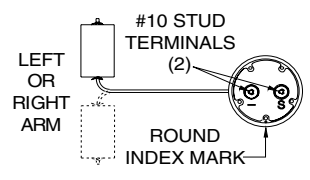
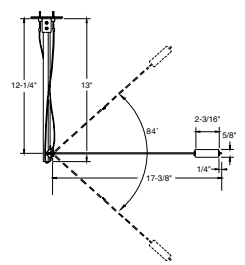

TACHOMETER ACCESSORIES (CODE B)



IH14767
TACH HARNESS
For: Evinrude/Johnson



IH15105
TACH HARNESS
For: Mariner/Merc O/B

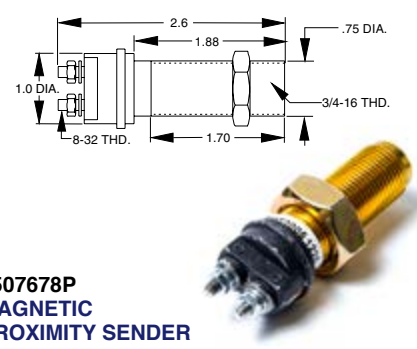

1507678P
MAGNETIC PROXIMITY SENDER

SPEEDOMETER SENDERS AND ACCESSORIES (CODE G)



56973P
PITOT
For: 30-80 mph Speedometers



59677P
PACK O'PITOTS
(Package of 12)



67437P
PITOT HOSE KIT (W/ HARDWARE)
• 25' of hose
0.150" I.D. • 0.250" O.D.



56353P
PITOT TUBING
For: 30-80 mph, 100'
0.150" I.D. • 0.250" O.D.



67457P
PITOT TUBING
25'
0.150" I.D. • 0.250" O.D.

CODE T

Diesel Alternator Tachometers..... alternator

NOTE: Alternator must have an AC tap, usually marked “AC”, “R” or “W”. If such a tap is not present, a local alternator repair shop can usually add one.

You will need to know the number of magnetic poles in your alternator.

Consult the alternator maker or local alternator repair shop if you do not know this.

Also, you will have to calculate the pulley ratio from crankshaft to alternator.

Tachometers are factory calibrated for several combinations of poles and pulley ratios, but in almost all cases you will need a Portable Master Shop Tachometer for initial calibration.

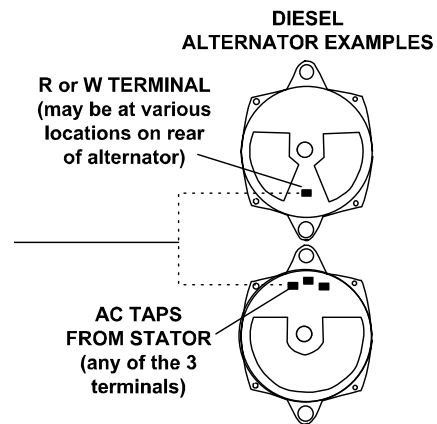

CODE WP

Water Pressure (0-15/0-30/0-40/0-60 PSI):
(Included with water pressure gauge kits, which contain the instrument, 20 feet of pitot tubing and the parts shown at right.)

NOTE: For Yamaha, also order adapter **61886P**

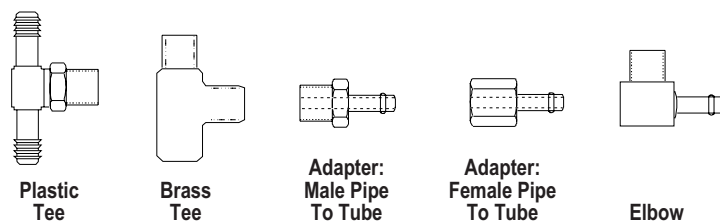

MISCELLANEOUS ACCESSORIES

 <p>61886P YAMAHA ADAPTER FOR WP KIT/TEMP SENDER I.D. 1/8" NPT</p>	 <p>1502778 RUDDER ANGLE IND. SENDER, SINGLE STATION</p>	 <p>1827871P BULB & SOCKET KIT</p>	 <p>10860 BLANK GAUGE INSERT (2")</p>
 <p>IA62995 LIGHT KIT, WEDGE BASE 12VDC</p>	 <p>FS45430 FUSE HOLDER, PANEL MOUNT</p>	 <p>IA55009 Z BRACKET O/B Temp. Sender</p>	



SIERRA[®]

PARTS THAT KEEP YOU MOVING



Power Systems

Sierra offers a range of electrical marine components such as battery accessories, tools and testers, terminals and connectors, switches, and circuit breakers.

Like all Sierra products, quality is insured by our industry leading Limited Lifetime Warranty.

IGNITION SWITCHES FOR WORLD OUTBOARD MOTORS

- Exact OEM replacement installation
- Ideal for DFI, EFI and MPI engines
- Heavy duty potted construction
- Minimal bleed per circuit
- Molded umbrella type key



MP51090**
MP51092 – BULK 100 PCS/CTN
IGNITION SWITCH
 3 Position Magneto – OFF- RUN-START
 PUSH to Choke
 Replaces: Mercury 87-17009A5



MP52000**
MP52002 – BULK 100 PCS/CTN
IGNITION SWITCH
 3 Position Magneto – OFF- RUN-START
 PUSH to Choke
 Replaces: Mercury 87-88107A5



MP51010**
MP51012 – BULK 100 PCS/CTN
IGNITION SWITCH
 Suzuki 2 & 4 stroke Outboards
 Replaces: 37110-99E00
 Colors on wires match factory color codes



MP51020**
MP51022 – BULK 100 PCS/CTN
IGNITION SWITCH
 Yamaha Control Box 2 & 4 stroke
 Replaces: 703-82510-12-00
 Colors on wires match factory color codes



MP51030**
MP51032 – BULK 100 PCS/CTN
IGNITION SWITCH
 Yamaha Dash Mount 2 & 4 stroke
 Dual Engine Application
 Replaces: 61B-82510-01-00,
 61B-82510-00-00
 Colors on wires match factory color codes



MP51040**
MP51042 – BULK 100 PCS/CTN
IGNITION SWITCH
 Yamaha Control Box 2 & 4 stroke
 Push to Choke
 Replaces: 703-82510-43-00
 Colors on wires match factory color codes

MP51050**
MP51052 – BULK 100 PCS/CTN
IGNITION SWITCH
 Yamaha Dash Mount 2 & 4 stroke
 Dual Engine Application, Push to Choke
 Replaces: 6K1-82510-06-00
 Colors on wires match factory color codes



Sierra offers the most complete selection of high quality polyester and brass ignition switches for the marine industry.

Marine grade glass-filled polyester switches

- Maximum corrosion protection – eliminates oxidation
- Inner seal between cylinder lock and contact plate
- Non-conductive housing eliminates potential shorts
- 20 Amp rating
- 2, 3 and 4 position switches
- Switches for magneto and conventional ignitions

Brass ignition switches

- Corrosion resistant construction
- Up to 15 Amp rating
- 2, 3 and 4 position switches
- Switches for magneto and conventional ignitions

** Display Packaged

4 POSITION CONVENTIONAL - ACCESSORY - OFF - RUN - START



MP39800**
MP39802 – BULK 100 PCS/CTN

DESCRIPTION	
Material	Polyester
Length	Long: 1 1/8" maximum panel thickness
Terminal Type	4 Blade
Back Up Nut	Brass
Face Nut	Hex black plastic face nut
Hole Size	7/8"
Rated;	
Ignition	15 Amp @ 12v DC
Solenoid	30 Amp @ 12v DC
Accessory	15 Amp @ 12v DC

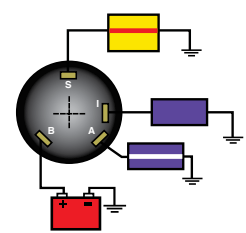

MP41040**
MP41042 – BULK 100 PCS/CTN

DESCRIPTION	
Material	Polyester
Length	Long: 1 1/8" maximum panel thickness
Terminal Type	4 Screw Tab
Back Up Nut	Brass
Face Nut	Knurled black plastic w/rubber cap
Hole Size	7/8"
Rated;	
Ignition	15 Amp @ 12v DC
Solenoid	30 Amp @ 12v DC
Accessory	15 Amp @ 12v DC

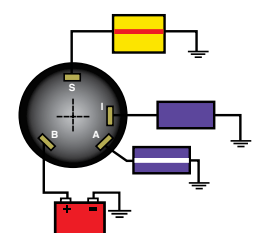

MP39070**
MP39072 – BULK 100 PCS/CTN

DESCRIPTION	
Material	Brass
Length	Long: 1" maximum panel thickness
Terminal Type	4 Screw Tab
Back Up Nut	Brass
Face Nut	Knurled black chrome w/rubber cap
Hole Size	7/8"
Rated;	
Ignition	15 Amp @ 12v DC
Solenoid	30 Amp @ 12v DC
Accessory	15 Amp @ 12 VDC

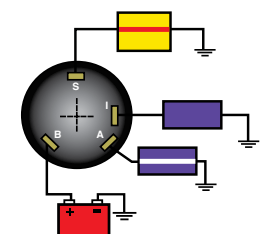

MP39700-1**
MP39702-1 – BULK 100 PCS

DESCRIPTION	
Material	Polyester
Length	Long: 1 1/8" maximum panel thickness
Terminal Type	4 Color Code Wires
Back Up Nut	Brass
Face Nut	Knurled black plastic w/rubber cap
Hole Size	7/8"
Rated;	
Ignition	15 Amp @ 12 VDV
Solenoid	30 Amp @ 12 VDC
Accessory	15 Amp @ 12 VDC

WIRE & DIAGRAM COLOR CODES

- Red - Battery
- Black - Magneto Ground
- Yellow w/ Red Stripe - Solenoid
- Black w/ Yellow Stripe - Magneto
- Purple - Ignition
- Yellow w/ Black Stripe - Choke
- Purple w/ White Stripe - Accessory

4 POSITION CONVENTIONAL - ACCESSORY - OFF - RUN - START



MP41020**
MP41022 – BULK 100 PCS/CTN

DESCRIPTION	
Material	Brass
Length	Long: 1" maximum panel thickness
Terminal Type	4 Screw Tab
Back Up Nut	Brass
Face Nut	Hex Chrome Face Nut
Hole Size	7/8"
Rated;	
Ignition	15 Amp @ 12v DC
Solenoid	30 Amp @ 12v DC
Accessory	15 Amp @ 12 VDC

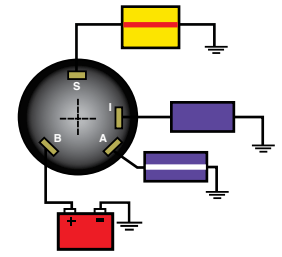

UN12140**
UN12142 – BULK 100 PCS/CTN

DESCRIPTION	
Material	Die Cast Zinc
Length	Short: 5/8" maximum panel thickness
Terminal Type	4-Threaded Stud
Back Up Nut	Die Cast Zinc
Face Nut	Knurled Chrome Face Nut
Hole Size	9/16"
Rated;	
Ignition	15 Amp @ 12v DC
Solenoid	30 Amp @ 12v DC
Accessory	15 Amp @ 12v DC

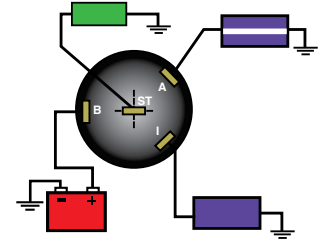

3 POSITION CONVENTIONAL - OFF - RUN - START



MP39060-1**
MP39062-1 – BULK 100 PCS/CTN

DESCRIPTION	
Material	Brass
Length	Long: 1 1/8" maximum panel thickness
Terminal Type	3 Screw Tab
Back Up Nut	Brass
Face Nut	Hex Chrome Face Nut
Hole Size	7/8"
Rated;	
Ignition	15 Amp @ 12v DC
Solenoid	30 Amp @ 12v DC

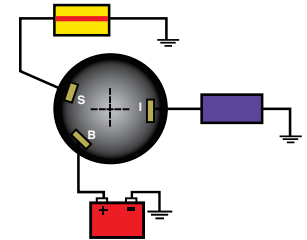

MP39080-1**
MP39082-1 – BULK 100 PCS/CTN

DESCRIPTION	
Material	Brass
Length	Long: 1 1/8" maximum panel thickness
Terminal Type	3 Screw Tab
Back Up Nut	Brass
Face Nut	Knurled black plastic w/rubber cap
Hole Size	7/8"
Rated;	
Ignition	15 Amp @ 12v DC
Solenoid	30 Amp @ 12v DC

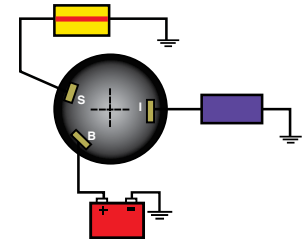

MP39120**
MP39122 – BULK 100 PCS/CTN

DESCRIPTION	
Material	Polyester
Length	Long: 1 1/8" maximum panel thickness
Terminal Type	3 Screw Tab
Back Up Nut	Brass
Face Nut	Hex black plastic face nut
Hole Size	7/8"
Rated;	
Ignition	15 Amp @ 12v DC
Solenoid	30 Amp @ 12v DC

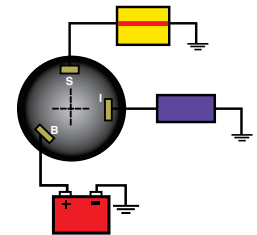

MP39780**
MP39782 – BULK 100 PCS/CTN

DESCRIPTION	
Material	Polyester
Length	Short: 5/8" maximum panel thickness
Terminal Type	3 Screw Tab
Back Up Nut	Brass
Face Nut	Hex black plastic face nut
Hole Size	7/8"
Rated;	
Ignition	15 Amp @ 12v DC
Solenoid	30 Amp @ 12v DC

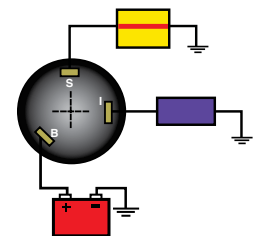

3 POSITION CONVENTIONAL - OFF - RUN - START



MP39200**
MP39202 – BULK 100 PCS/CTN

DESCRIPTION	
Material	Polyester
Length	Long: 1 1/8" maximum panel thickness
Terminal Type	3 Screw Tab
Back Up Nut	Brass
Face Nut	Knurled black plastic w/rubber cap
Hole Size	7/8"
Rated:	
Ignition	15 Amp @ 12v DC
Solenoid	30 Amp @ 12v DC

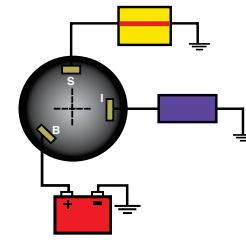

MP39770**
MP39772 – BULK 100 PCS/CTN

DESCRIPTION	
Material	Polyester
Length	Long: 1 1/8" maximum panel thickness
Terminal Type	3 Blade
Back Up Nut	Brass
Face Nut	Knurled black plastic w/rubber cap
Hole Size	7/8"
Rated:	
Ignition	15 Amp @ 12v DC
Solenoid	30 Amp @ 12v DC

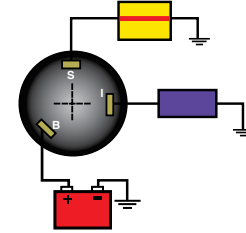

MP41030**
MP41032 – BULK 100 PCS/CTN

DESCRIPTION	
Material	Polyester
Length	Short: 5/8" maximum panel thickness
Terminal Type	3 Screw Tab
Back Up Nut	Brass
Face Nut	Knurled black plastic w/rubber cap
Hole Size	7/8"
Rated:	
Ignition	15 Amp @ 12v DC
Solenoid	30 Amp @ 12v DC

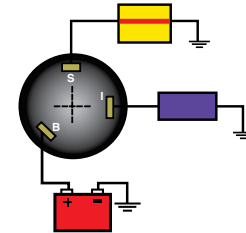

2 POSITION CONVENTIONAL - OFF - RUN USE WITH SEPARATE STARTER BUTTON



MP39010
MP39012 – BULK 100 PCS/CTN

DESCRIPTION	
Material	Brass
Length	Short: 5/8" maximum panel thickness
Terminal Type	2 Screw Tab
Back Up Nut	Brass
Face Nut	Hex Chrome Face Nut
Hole Size	3/4"
Rated:	
Ignition	5 Amp @ 12 VDV

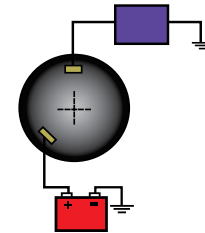

MP39020**
MP39022 – BULK 100 PCS/CTN

DESCRIPTION	
Material	Brass
Length	Long: 1 1/8" maximum panel thickness
Terminal Type	2 Screw Terminal
Back Up Nut	Brass
Face Nut	Hex Chrome Face Nut
Hole Size	7/8"
Rated:	
Ignition	15 Amp @ 12v DC

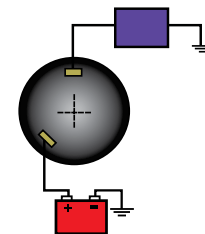

MP39820-1 – INDIVIDUAL BOX
MP39822-1 – BULK 100 PCS/CTN

DESCRIPTION	
Material	Brass
Length	Long: 1 1/8" maximum panel thickness
Terminal Type	2 Screw Terminal
Back Up Nut	Brass
Face Nut	Knurled Chrome Plated w/rubber cap
Hole Size	7/8"
Rated:	
Ignition	15 Amp @ 12v DC

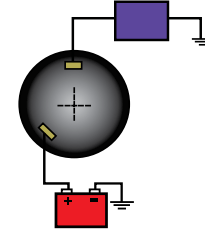

WIRE & DIAGRAM COLOR CODES

- Red - Battery
- Black - Magneto Ground
- Yellow w/ Red Stripe - Solenoid
- Black w/ Yellow Stripe - Magneto
- Purple - Ignition
- Yellow w/ Black Stripe - Choke
- Purple w/ White Stripe - Accessory

** Display Packaged



MP39710-1**
MP39712-1 - BULK 100 PCS
PUSH TO CHOKE

DESCRIPTION	
Material	Polyester
Length	Short: 5/8" maximum panel thickness
Terminal Type	7 Color Code Wires
Back Up Nut	Brass
Face Nut	Knurled black plastic w/rubber cap
Hole Size	7/8"
Rated;	
Ignition	15 Amp @ 12 VDV
Solenoid	30 Amp @ 12 VDC
Accessory	15 Amp @ 12 VDC
Choke	7 Amp @ 12 VDC



For Outboard engines without choke circuit

MP39720-1**
MP39722-1 - BULK 100 PCS

DESCRIPTION	
Material	Polyester
Length	Short: 5/8" maximum panel thickness
Terminal Type	6 Color Code Wires
Back Up Nut	Brass
Face Nut	Knurled black plastic w/rubber cap
Hole Size	7/8"
Rated;	
Ignition	15 Amp @ 12 VDV
Solenoid	30 Amp @ 12 VDC
Accessory	15 Amp @ 12 VDC



MP41010**
MP41012 - BULK 100 PCS/CTN
PUSH TO CHOKE

DESCRIPTION	
Material	Polyester
Length	Short: 5/8" maximum panel thickness
Terminal Type	7 Screw Tab
Back Up Nut	Brass
Face Nut	Hex black plastic face nut
Hole Size	7/8"
Rated;	
Ignition	15 Amp @ 12v DC
Solenoid	30 Amp @ 12v DC
Choke	7 Amp @ 12v DC
Accessory	15 Amp @ 12v DC

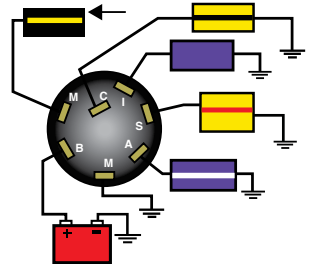

MP41080**
MP41082 - BULK 100 PCS/CTN
PUSH TO CHOKE

DESCRIPTION	
Material	Polyester
Length	Short: 5/8" maximum panel thickness
Terminal Type	6 Screw Tab, 1 Boss Screw
Back Up Nut	Plastic
Face Nut	Hex black plastic face nut
Hole Size	7/8"
Rated;	
Ignition	15 Amp @ 12v DC
Solenoid	30 Amp @ 12v DC
Choke	7 Amp @ 12v DC
Accessory	15 Amp @ 12v DC

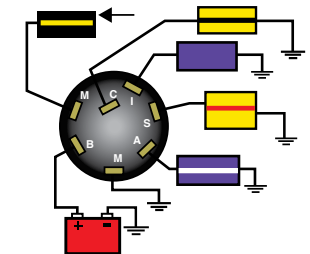

MP39730**
MP39732 - BULK 100 PCS

For Outboard engines without choke circuit

DESCRIPTION	
Material	Polyester
Length	Short: 5/8" maximum panel thickness
Terminal Type	6 Screw Tab
Back Up Nut	Brass
Face Nut	Hex black plastic face nut
Hole Size	7/8"
Rated;	
Ignition	15 Amp @ 12v DC
Solenoid	30 Amp @ 12v DC
Accessory	15 Amp @ 12v DC

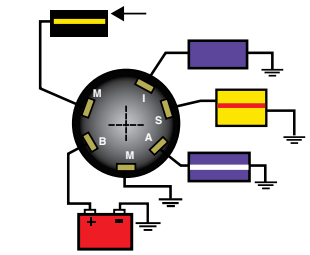

3 POSITION MAGNETO - OFF - RUN - START



MP39760**
MP39762 - BULK 100 PCS/CTN
PUSH TO CHOKE

DESCRIPTION	
Material	Polyester
Length	Short: 5/8" maximum panel thickness
Terminal Type	5 Screw Tab, 1 Boss Screw
Back Up Nut	Plastic
Face Nut	Hex black plastic face nut
Hole Size	7/8"
Rated;	
Ignition	15 Amp @ 12v DC
Solenoid	30 Amp @ 12v DC
Choke	7 Amp @ 12v DC

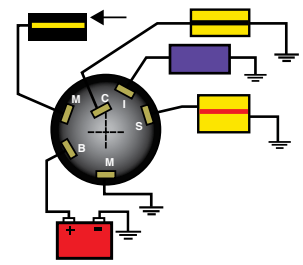

MP41000**
MP41002 - BULK 100 PCS/CTN
PUSH TO CHOKE

DESCRIPTION	
Material	Polyester
Length	Short: 5/8" maximum panel thickness
Terminal Type	6 Screw Tab
Back Up Nut	Brass
Face Nut	Hex black plastic face nut
Hole Size	7/8"
Rated;	
Ignition	15 Amp @ 12v DC
Solenoid	30 Amp @ 12v DC
Choke	7 Amp @ 12v DC

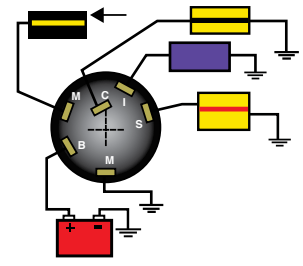

For Outboard engines without choke circuit



MP39740-1**
MP39742-1 - BULK 100 PCS

DESCRIPTION	
Material	Polyester
Length	Short: 5/8" maximum panel thickness
Terminal Type	5 Color Code Wires
Back Up Nut	Plastic
Face Nut	Knurled black plastic w/rubber cap
Hole Size	7/8"
Rated;	
Ignition	15 Amp @ 12 VDV
Solenoid	30 Amp @ 12 VDC
Accessory	15 Amp @ 12 VDC



MP41090-1**
MP41092-1 - BULK 100 PCS
PUSH TO CHOKE

(Colors on switch wires match factory color codes.)

DESCRIPTION	
Material	Polyester
Length	Short: 5/8" maximum panel thickness
Terminal Type	6 Color Coded Wires
Back Up Nut	Brass
Face Nut	Knurled black plastic w/rubber cap
Hole Size	7/8"
Rated;	
Ignition	15 Amp @ 12v DC
Solenoid	30 Amp @ 12v DC
Choke	7 Amp @ 12v DC



MP41070-2**
MP41072-2 - BULK 100 PCS/CTN
PUSH TO CHOKE / MERCURY CONTROL BOX APPLICATIONS

(Colors on switch wires match factory color codes.)

DESCRIPTION	
Material	Polyester
Length	Short: 5/8" maximum panel thickness
Terminal Type	6 Color Coded Wire Leads/Potted
Back Up Nut	Not Required
Face Nut	Hex black plastic face nut
Hole Size	7/8"
Rated;	
Ignition	15 Amp @ 12v DC
Solenoid	30 Amp @ 12v DC
Choke	7 Amp @ 12v DC

WIRE & DIAGRAM COLOR CODES

- Red - Battery
- Yellow w/ Red Stripe - Solenoid
- Purple - Ignition
- Purple w/ White Stripe - Accessory
- Black - Magneto Ground
- Black w/ Yellow Stripe - Magneto
- Yellow w/ Black Stripe - Choke

** Display Packaged

3 POSITION MAGNETO - OFF - RUN - START

MP52000**
MP52002 - BULK 100 PCS
PUSH TO CHOKE

DESCRIPTION	
Material	Polyester
Length	Short: 5/8" maximum panel thickness
Terminal Type	6 Color Coded Wire Leads/Potted
Back Up Nut	Plastic
Face Nut	Hex black plastic face nut
Hole Size	7/8"
Rated;	
Ignition	15 Amp @ 12v DC
Solenoid	30 Amp @ 12v DC
Choke	7 Amp @ 12v DC



MP51090**
MP51092 - BULK 100 PCS
PUSH TO CHOKE

DESCRIPTION	
Material	Polyester
Length	Short: 5/8" maximum panel thickness
Terminal Type	6 Color Coded Wire Leads/Potted
Back Up Nut	Not Required
Face Nut	Hex black plastic face nut
Hole Size	7/8"
Rated;	
Ignition	15 Amp @ 12v DC
Solenoid	30 Amp @ 12v DC
Choke	7 Amp @ 12v DC



MP39090**
MP39092 - BULK 100 PCS/CTN
PUSH TO CHOKE

DESCRIPTION	
Material	Polyester
Length	Long: 1 1/8" maximum panel thickness
Terminal Type	6 Screw Tab
Back Up Nut	Anodized steel
Face Nut	Hex plastic face nut w/snap on rubber cap
Hole Size	7/8"
Rated;	
Ignition	15 Amp @ 12v DC
Solenoid	30 Amp @ 12v DC
Choke	7 Amp @ 12v DC

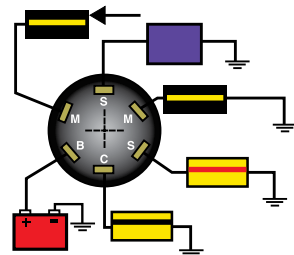

MP39040**
MP39042 - BULK 100 PCS/CTN

DESCRIPTION	
Material	Brass
Length	Long: 1 1/8" maximum panel thickness
Terminal Type	5 Screw Tab
Back Up Nut	Brass
Face Nut	Hex Chrome Face Nut
Hole Size	7/8"
Rated;	
Ignition	10 Amp @ 12v DC
Solenoid	30 Amp @ 12v DC

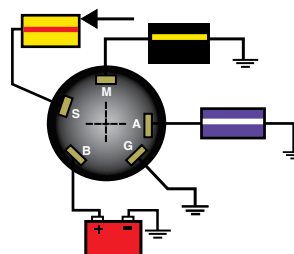

MP39100**
MP39102 - BULK 100 PCS/CTN

DESCRIPTION	
Material	Polyester
Length	Long: 1 1/8" maximum panel thickness
Terminal Type	5 Screw Tab
Back Up Nut	Brass
Face Nut	Hex black plastic face nut
Hole Size	7/8"
Rated;	
Ignition	15 Amp @ 12v DC
Solenoid	30 Amp @ 12v DC

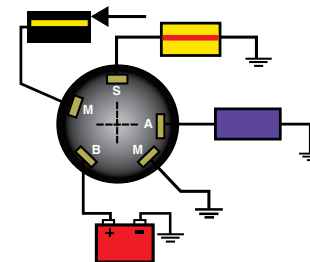

MP39830**
MP39832 - BULK 100 PCS/CTN

DESCRIPTION	
Material	Polyester
Length	Long: 1 1/8" maximum panel thickness
Terminal Type	6 Screw Tab
Back Up Nut	Brass
Face Nut	Hex black plastic face nut
Hole Size	7/8"
Rated;	
Ignition	15 Amp @ 12v DC
Solenoid	30 Amp @ 12v DC

*Terminal to power separately controlled choke circuit

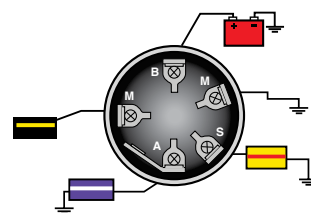

EMERGENCY ENGINE CUT-OFF SWITCHES

- Kills ignition when lanyard is pulled
- For use with conventional or magneto ignitions
- Unique design of MP40960 and MP40970 keeps plunger down when lanyard connected
- Seals out moisture
- Makes reconnection easier
- Panel thickness up to 1/4"

MP28870
EMERGENCY CUT-OFF SWITCH**

Replaces: OMC 585134
Circuit closed with lanyard off.
Use **MP28900** replacement lanyard.

MP28872-1
"Bulk" - 100 pieces per carton



MP40950
EMERGENCY CUT-OFF SWITCH**

4 terminals allow selection of normally open or normally closed circuit.
Use **MP40990** replacement lanyard.



MP40960
EMERGENCY CUT-OFF SWITCH**

4 terminals allow selection of normally open or normally closed circuit.

Use **MP40980** replacement lanyard.

MP40962
"Bulk" - 100 pieces per carton



MP40970-1
EMERGENCY CUT-OFF SWITCH**

4 terminals allow selection of normally open or normally closed circuit.

Use **MP40990** replacement lanyard.

MP40972-1
"Bulk" - 100 pieces per carton.

REPLACEMENT LANYARDS



**18-1282
LANYARD**

Replaces: OMC 398602 Tiller Steer Models - ALL



MP28850
LANYARD**

Replaces: Honda, Mercury, Mariner, BRP, Yamaha, Suzuki, OMC



MP28860
LANYARD**

Replaces: Yamaha 682-82556-00-00



MP28880
LANYARD**

Replaces: OMC 432230
1995-Older



MP28890
LANYARD**

Replaces: OMC 176288
1996 and Newer



MP28900
LANYARD**

Replaces: OMC 432230

1995-Older

MP28902-1 "Bulk" - 100 pieces per carton



MP40980
LANYARD**

MP40982
"Bulk" - 100 pieces per carton



MP40990
LANYARD**

MP40992
"Bulk" - 100 pieces per carton

FACE AND BOOT NUTS



MP39190
WEATHER PROOF BOOT NUT**

Fits: All Sierra polyester ignition switches, 1996 & later. 13/16"-16 Thread. Rotating rubber seal. Seals out moisture and dust from lock cylinder



MP39270
FACENUT**

For polyester ignition switches MP39100 thru MP39120. Nut has extra long threads for positive engagement on mounting bushing for early (Pre-1995) style with 13/16"-20 thread ONLY!

ROTSWITCH® ROTARY SWITCHES

- Unique ergonomic design, styling and performance
- 20 AMP @ 12 Volts DC
- Durable cam design for long life
- UV stabilized thermoplastic housing
- Knob acts as umbrella - Silicone lip seal mates with stalk
- Separate light modules optional
- Replaces toggle or rocker switches with minimal panel alterations
- 1/2" hole size

** Display Packaged



RotoSwitch® provides illumination with different colors providing immediate visual information of switch position.

	BULK ① NUMBER	PART NUMBER	NUMBER OF BATTERY FEEDS	CIRCUITS "ON"			
				45° COUNTER CLOCKWISE	12 O'CLOCK	45° CLOCKWISE	90° CLOCKWISE
	MP78712 *MP59012	MP78710**	1	—	OFF	#1	—
	MP78722	MP78720	1	—	OFF	#1 (M)	—
	*MP59032	MP78730**	1	#1	OFF	#2	—
	MP59042	MP78740	1	#1 (M)	OFF	#2 (M)	—
	MP78802 *MP59102	MP78800**	2	#1	OFF	#2	—
	MP78822 *MP59122	MP78820	1	#2	OFF	#1&2	—
	*MP59132	MP78830	1	—	OFF	#2	#1&2
	*MP59162	MP78860**	1	OFF	#1	#2	#1&2

① Bulk - 100 pieces per carton.

* Switch Only - No Knob

(M)=MOMENTARY

REPLACEMENT KNOBS

All include rubber umbrella seal. Original Ergotech design knob.



MP79740
MP79742 (BULK 100 PCS/CTN)
Black knob with black indicator.



MP79760**
MP79762 (BULK 100 PCS/CTN)
Black knob with light tube. Use with illumination module.



MP78372
Black knob with light tube for use with light module.

Mounting Accessories for RotoSwitch®.



MP78960
MP78962 (BULK 100 PCS/CTN)
Anti-rotation collar. Use when installing non-illuminated RotoSwitches in very thin dash panels. This adapter prevents the switch from "slipping" if excessive force is used to actuate the switch.

ILLUMINATION MODULES

Add flexibility and function to any installation of RotoSwitch® rotary switches. By using a variety of colored lenses, the status of each switch – "Off", "On-1", "On-2" – can instantly be determined.



MP78870**
MP78872 (BULK 100 PCS/CTN)



MP78910**
MP78912 (BULK 100 PCS/CTN)



MP78942 ①



MP78950
MP78952

C = Clear R = Red G = Green B = Black

** Display Packaged

CONTURA® ROTARY SWITCHES



- Fits in industry standard panel opening
- Patented mechanism that translates rotary to linear motion
- Secondary cam provides definitive detent positions
- Integrated illumination module up to 3 LED's for effortless installation
- IP67 sealing protection for above-panel components"

DIAGRAM	PART #	SWITCH FUNCTION	DIAGRAM	PART #	SWITCH FUNCTION
	RS20000 RED/GREEN	ON-ON		RS20040	ON - ON - ON / 1 - 2 - 3
	RS20010	OFF - (ON)		RS20050 STARTER	OFF - ON - (ON) / OFF - 1 - 1&2
	RS20020 RED	ON - OFF - ON		RS20060 PROGRESSIVE	OFF - ON - ON2 / OFF - 1 - 1&2
	RS20030	(ON) - OFF - (ON)			

		BULK ^① NUMBER	PART NUMBER	NUMBER OF BATTERY FEEDS	CIRCUITS "ON"		
					#1	#2	#3
	RS2004	RS20040	2	3, 6	3, 4	1, 4	
	RS2002	RS20020	2	1, 4	OFF	3, 6	
	RS2006	RS20060	2	OFF	3	3, 6	
	RS2003	RS20030	2	(1, 4)	OFF	(3, 6)	
	RS2001	RS20010	2	3, 6	-	OFF	
	RS2000	RS20000	2	3, 6	-	1, 4	
	RS2005	RS20050	2	OFF	3	(1, 3)	

①Bulk - 100 pieces per carton.

* Switch Only - No Knob

(M)=MOMENTARY

COMPACT ROCKER SWITCHES



PART NUMBER	SWITCH FUNCTION	PART NUMBER	SWITCH FUNCTION
RK40800	ON - OFF SPST	RK40840	OFF - ON SPDT
RK40810	OFF - (ON) SPST	RK40850	ON - OFF - ON SPDT
RK40820	OFF - ON SPST	RK40860	ON - OFF - (ON) SPDT
RK40830	OFF - (ON) SPDT	RK40870	(ON) - OFF - (ON) SPDT

- Ideal for applications with panel size constraints
- Fits standard rectangular cutout
- High profile rocker action provides crisp, positive-type feel
- Rated to 12A @ 125VAC/ 10A @ 250VAC

- Suitable for low voltage 12/24 VDC
- Legends printed on switch
- Visi-rocker indicated if switch is 'ON'



**SP21040
TOGGLE PANEL**

- Curved base design for modern, stylish look
 - Large, backlit labels for easy readability in darkness
 - Backlit LEDs change color when circuit is activated
 - Backlit display independent for easy dimming
 - Integrated ATO/ATC style fuse circuit protection
 - IP7 Rated for protection against water and dust intrusion
 - Watertight mounting gasket included
- Replaces: Blue Sea 4306

SWITCH PANELS

**WEATHER RESISTANT
SWITCH PANELS**

- IP66 Rated
- Push to reset circuit breakers with weather boot
- LED illuminated rocker switches with 12V/24V Rating
- Watertight mounting gasket included
- Designed for Vertical or Horizontal installation



**SP21000
SP21002 (BULK)**
4P Contura Rocker
w/ Circuit Breaker
Replaces: Blue Sea 8372



**SP21010
SP21012 (BULK)**
6P Contura Rocker
w/ Circuit Breaker
Replaces: Blue Sea 8371



**SP21020
SP21022 (BULK)**
6 Function Touch 12V/24V
Backlit Panel



**SP21030
SP21032 (BULK)**
10 Function Touch
12V/24V Backlit Panel

**MEMBRANE TOUCH
CONTROL PANELS**

- CE Certified, Panel is IP67 rated
- LED- ON indication
- 10A Self-resettable fuse for each function
- Programmable buttons
- Faceplate PET membrane touch panel
- Circuit Protection: Built-in Resettable Fuse (PPTC)
- Switch Ratings: 10A per function at 12VDC
- Panel Rating: Max Cumulative Amp: 35A
- Voltage Rating: 11-30VDC

Panel Dimensions: 91mm x 75mm
Control Box Dimensions: 136 x 90 x 32mm
Panel Cut-Out: 15mm hole



**RS20180
(PACK OF 10)**
TERMINAL, 17-20AWG WIRE
15A Current Rating Tin Crimp
Type Wire Terminal

**RS20190
(PACK OF 10)**
TERMINAL, 13.5-17AWG WIRE
15A Current Rating Tin Crimp
Type Wire Terminal



RS20200
HOUSING, TERMINAL
Direct Fit for Halo Rocker
Switches

HALO ROCKER SWITCHES



- Perimeter Illuminated for unique and stylish look Independent Illumination of rocker actuator
- IP68 sealed rocker switch
- Switch rated up to 20A at 12VDC
- Fit industry standard panel cutout
- Dedicated TE connector for use with .110 terminals



RK40660B

DIAGRAM	PART #	HALO COLOR	SWITCH FUNCTION
	RK40610B** RK40610G**	Blue Halo Green Halo	ON-OFF SPST
	RK40620B** RK40620G**	Blue Halo Green Halo	(ON-OFF) SPST
	RK40630B** RK40630G**	Blue Halo Green Halo	ON - ON SPST
	RK40640B** RK40640G**	Blue Halo Green Halo	ON - OFF - ON SPDT
	RK40650B** RK40650G**	Blue Halo Green Halo	ON - OFF DPST
	RK40660B** RK40660G**	Blue Halo Green Halo	ON - ON DPST
	RK40670B** RK40670G**	Blue Halo Green Halo	ON - OFF - ON DPDT
	RK40680B** RK40680G**	Blue Halo Green Halo	(ON) - OFF - (ON) DPDT
	RK40690B** RK40690G**	Dependent Blue Halo Dependent Green Halo	ON - OFF - ON SPDT
	RK40700B** RK40700G**	Dependent Blue Halo Dependent Green Halo	ON - OFF - ON DPDT

** Display Packaged

ILLUMINATED CONTURA® XIV ROCKER SWITCHES

- Sealed to IP66/68 for above-panel components
- Silver plated butt contact mechanism provides maximum reliability
- Greaseless construction designed for extreme temperatures
- Removable actuator for easy style change or replacement
- Panel seal prevents water ingress beneath panel to protect critical connections
- LED illuminated



RK19140
ACTUATOR
Square Lens



RK19150
ACTUATOR
Square and
Red Line Lens



RK19160
ACTUATOR
Two Square Lenses



RK19170
ACTUATOR
Two Line Lenses

Diagram	Part Number	Switch Function
	RK19000**	ON - OFF SPST
	RK19010**	(ON) - OFF SPST
	RK19020**	ON - OFF SPST
	RK19030**	ON - ON SPST
	RK19040**	ON - OFF - ON SPDT
	RK19050**	ON - OFF - ON SPDT
	RK19060**	(ON) - OFF - (ON) SPDT
	RK19070**	ON - OFF DPST
	RK19080**	(ON) - OFF DPST
	RK19090**	ON - OFF - ON DPDT
	RK19100**	ON - OFF - (ON) DPDT
	RK19110**	(ON) - OFF - (ON) DPDT
	RK19120**	OFF - ON - (ON) SPDT
	RK19130**	OFF - ON - ON SPDT

** Display Packaged

STANDARD WEATHER RESISTANT CONTURA® V ROCKER SWITCHES

- Non-corrosive plastic construction
- Protects against dust and prolonged spray to IP66 and IP68 standards
- Meets UL 1500, ISO 8846 ignition protection requirements
- Supplied with neoprene mounting gasket
- Removable actuators
- Brass blade terminals, silver contacts - Rated: 20 amps @12 VDC



RK22180
ACTUATOR
BLACK CONTURA V
(2EA)

Diagram	Part Number	Switch Function
	RK19210**	ON-OFF SPST
	RK19220**	ON-OFF-ON SPDT
	RK19230**	MOM ON-OFF SPST
	RK19240**	MOM ON-OFF-MOM ON DPDT

** Display Packaged

ILLUMINATED WEATHER RESISTANT CONTURA® V ROCKER SWITCHES

- Non-corrosive plastic construction
- Protects against dust and prolonged spray to IP66 and IP68 standards
- Meets UL 1500, ISO 8846 ignition protection requirements
- Supplied with neoprene mounting gasket
- Illuminates red in "ON" position
- Removable actuators
- Brass blade terminals, silver contacts - Rated: 20 amps @12 VDC



DIAGRAM	PART NUMBER	SWITCH FUNCTION
	RK19310**	ON-OFF SPST
	RK19320**	ON-OFF-ON SPDT



RK22190**
ACTUATOR
BLACK CONTURA V
WITH LENS (2EA)



RK22200**
ACTUATOR
BLACK CONTURA V
WITH 2 LENS (2EA)



RK22290**
ACTUATOR
REMOVAL TOOL

** Display Packaged

STANDARD WEATHER RESISTANT CONTURA® III ROCKER SWITCHES



- Non-corrosive plastic construction
- Protects against dust and prolonged spray to IP66 and IP68 standards
- Meets UL 1500, ISO 8846 ignition protection requirements
- Supplied with neoprene mounting gasket
- Removable actuators
- Brass blade terminals, silver contacts - Rated: 20 amps @12 VDC

DIAGRAM	ONE PADDLE PART #	TWO PADDLES (GREY & BLACK) PART #	SWITCH FUNCTION
	BLACK RK19680**	RK19680TP**	ON-OFF SPST
	BLACK RK19690**	RK19690TP**	ON-OFF-ON SPDT
	BLACK RK19720**	RK19710TP**	MOM ON-OFF SPST
	BLACK RK19760**	RK19750TP**	MOM ON-OFF-MOM ON SPDT
	BLACK RK19860**	RK19850TP**	MOM ON-OFF-MOM ON DPDT
	BLACK RK19880**	RK19870TP**	MOM ON-OFF DPST



****RK22100**
ACTUATOR
BLACK CONTURA III
(2EA)



****RK22110**
ACTUATOR
GRAY CONTURA III
(2EA)

** Display Packaged

ILLUMINATED WEATHER RESISTANT CONTURA® III ROCKER SWITCHES



- Non-corrosive plastic construction
- Protects against dust and prolonged spray to IP66 and IP68 standards
- Meets UL 1500, ISO 8846 ignition protection requirements
- Supplied with neoprene mounting gasket
- Illuminates red in "ON" position - 12V LED bulb
- Removable actuators
- Brass blade terminals, silver contacts - Rated: 20 amps @12 VDC

DIAGRAM	ONE PADDLE PART #	TWO PADDLES (GREY & BLACK) PART #	SWITCH FUNCTION
	BLACK RK19700**	RK19700TP**	OFF-ON SPST
	BLACK RK19780**	RK19770TP**	MOM ON-OFF-ON SPDT
	BLACK RK19820	RK19810TP**	MOM ON-OFF-ON DPDT
	BLACK RK19910**	RK19890TP**	OFF-ON DPST
	BLACK RK19740**	RK19730TP**	ON-OFF-ON SPDT
	BLACK RK19840**	RK19830TP**	ON-OFF-ON DPDT



RK22120**
ACTUATOR
BLACK CONTURA III
WITH LENS (2EA)



RK22130**
ACTUATOR
GRAY CONTURA III
WITH LENS (2EA)



RK22140**
ACTUATOR
BLACK CONTURA III
WITH 2 LENSES (2EA)



RK22150**
ACTUATOR
GRAY CONTURA III
WITH 2 LENSES (2EA)

** Display Packaged

STANDARD WEATHER RESISTANT CONTURA® II ROCKER SWITCHES



- Protects against dust and prolonged spray to IP66 and IP68 standards
- Supplied with neoprene mounting gasket
- Removable actuators
- Brass blade terminals, silver contacts - Rated: 20 amps @12 VDC

DIAGRAM	PART NUMBER	SWITCH FUNCTION	DIAGRAM	PART NUMBER	SWITCH FUNCTION
	RK19400-1**	OFF-ON SPST		RK19930-1**	MOM ON-OFF-ON DPDT
	RK19410-1**	OFF-MOM ON SPST		RK19430-1**	MOM ON-OFF-MOM ON SPST
	RK19410-RED**	OFF-MOM ON SPST Red actuator - for horn		RK19940-1**	OFF-MOM ON DPST
	RK19420-1**	ON-OFF-ON SPDT		RK19480-1**	MOM ON-OFF-MOM ON DPDT
				RK19490-1**	ON-OFF-ON DPDT



RK22160**
ACTUATOR
BLACK CONTURA II
(2EA)



RK22170**
ACTUATOR
RED CONTURA II
(2EA)

ILLUMINATED WEATHER RESISTANT CONTURA® II ROCKER SWITCHES



- Non-corrosive plastic construction
- Removable actuators
- Brass blade terminals, silver contacts
- Rated: 20 amps @12 VDC

DIAGRAM	PART NUMBER	SWITCH FUNCTION
	RK19440-1**	OFF-ON SPST
	RK19450-1**	MOM ON - OFF SPST
	RK19460-1**	ON-OFF-ON SPDT
	RK19540-1**	ON-OFF-ON DPDT
	RK19550-1**	MOM ON-OFF-MOM ON DPDT

** Display Packaged

STANDARD ROCKER SWITCHES - WITH BLACK ACTUATORS



- Non-corrosive plastic construction
- Black actuators w/ black face plate
- Silver contacts
- Brass blade terminals
- Rated: 20 amps @ 12 VDC

DIAGRAM	BULK #	PART NUMBER	SWITCH FUNCTION
	RK40142	RK40140**	ON-OFF SPST
	RK40152	RK40150**	MOM ON - OFF SPST
	RK40172	RK40170**	ON-OFF-ON SPDT
	RK40352	RK40350**	MOM ON-OFF-MOM ON SPDT
	RK40472	RK40470**	MOM ON-OFF-MOM ON DPDT
	RK40482	RK40480**	ON-OFF-ON DPDT
	RK40362	RK40360**	ON-OFF-MOM ON SPDT
	RK19572	RK19570	ON(1)-OFF-ON(1&2) DPDT



ILLUMINATED ROCKER SWITCHES

- Dependent pilot light - illuminates in "on" position
- Non-corrosive plastic construction
- Silver contacts
- Brass blade terminals
- Rated: 20 amps @ 12 VDC



DIAGRAM	BULK #	PART NUMBER	SWITCH FUNCTION
	RK40102	RK40100**	ON-OFF SPST
	RK40112	RK40110**	ON-OFF-ON SPDT
	RK40122	RK40120**	MOM ON - OFF SPST
	RK40132	RK40130**	MOM ON-OFF-MOM ON SPDT

** Display Packaged

ILLUMINATED ROCKER SWITCHES - SOFT SPOT LIGHT



- Independent pilot light - illuminates when panel lights ON
- Illuminates white when panel lights are ON, changes to red when switch is ON
- Soft spotlight helps preserve night vision • Non-corrosive plastic construction
- Silver contacts • Brass blade terminals • Rated: 20 amps @ 12 VDC

DIAGRAM	BULK #	PART NUMBER	SWITCH FUNCTION
	RK40372	RK40370**	ON-OFF SPST
	RK40382	N/A	MOM ON - OFF SPST
	RK40392	RK40390**	ON-OFF-ON SPDT
	RK40402	RK40400**	MOM ON-OFF-MOM ON SPDT



WEATHER RESISTANT ILLUMINATED ROCKER SWITCHES



- Certified to IP 66 and IP 68 - protected against dust, prolonged spray and submersion
- Supplied with neoprene mounting gasket
- Removable actuators
- Brass blade terminals, silver contacts
- Snap in lens of choice (Amber, Clear, Green, Red)
- Rated: 20 amps @12 VDC

DIAGRAM	PART NUMBER	SWITCH FUNCTION	KIT DETAILS
	RK19500K	OFF-ON SPST	Dependent pilot light - illuminates in "on" position Includes 1 lens of each color
	RK19510K	OFF-ON SPST	Independent pilot light - illuminates when panel light is turned "on" Includes 1 lens of each color
	RK19520K	ON-OFF-ON SPDT	Dependent pilot lights - each light illuminates in "on" position Includes 2 lenses of each color
	RK19530K	OFF-ON SPST	One dependent pilot light - illuminates in "on" position. One independent pilot light - illuminates when panel lights "on" Includes 2 lenses of each color

** Display Packaged

ROCKER SWITCH MOUNTING BRACKETS

FOR INSTALLING TWO OR MORE ROCKER SWITCHES

- Fits Sierra Standard and Contura® Rocker Switches
- Sections snap together without tools
- Mounting hole for 2 end unit set - 2.02" (51.31 mm) wide x 1.90" (48.26 mm) high add 1.03" (26.16 mm) for additional sections



UN19700
BLANK COVER



UN19710**
1 CENTER SECTION



UN19720
TWO END SECTIONS



UN19730**
2 CENTER SECTIONS



UN19740**
1 END SECTION



UN19750**
2 - **UN19740 END SECTIONS
1 - **UN19710 - CENTER SECTION
1 - **UN19700 - BLANK COVER

INTERIOR & RV STYLE SWITCHES

NARROW BODY ROCKER SWITCHES

ON - OFF SPST



- RK21880**** Non Illuminated
- For use in RK22070 panel
 - Fits 7/16" X 1 1/4" cut out
 - Blade Terminals
 - 20 Amp @ 12 VDC

NARROW BODY ROCKER SWITCH

ON - OFF SPST



- RK19640****
RK19642 (Bulk - 100pcs./carton)
- Fits .550" X 1.125" cut out
 - Blade Terminals
 - 10 Amp @ 12 VDC

NARROW BODY ROCKER SWITCH

ON - OFF SPST



- RK19630****
RK19632 (Bulk - 100pcs./carton)
- Fits .550" x 1.125" cut out
 - Blade Terminals
 - 10 Amp @ 12 VDC
 - Glows red in ON position

SURFACE MOUNT ILLUMINATED ROCKER SWITCHES

OFF-ON SPST



- RK21420**** Red
RK21430 Green
- Illuminates in ON position
 - Mount in 1/2" round holes
 - Brass blade terminals
 - 16 Amp @ 12 VDC

** Display Packaged

STANDARD TOGGLE SWITCHES



- Non-corrosive plastic construction
- Brass blade terminals, silver contacts
- 15/32" L x 15/32"-32 mounting stem
- Rated: 20 amps @12 VDC or 25 amp @ 12 VDC

*Rated 25 amp @ 12 VDC

DIAGRAM	BULK #	PART NUMBER	SWITCH FUNCTION
	TG4002252*	TG40020-1***	ON-OFF SPST
	TG4003252*	TG40030-1***	MOM ON-OFF SPST
	TG4004252*	TG40040-1***	ON-OFF-ON SPDT
	TG4005252*	TG40050-1***	MOM ON-OFF-MOM ON SPDT
	TG4016252*	TG40160-1***	ON-OFF-MOM ON SPDT
	TG4045252*	TG40450-1***	ON-OFF-ON DPDT
	TG4046252*	TG40460-1***	MOM ON-OFF-MOM ON DPDT
	TG40492	TG40490**	ON(1)-OFF-ON(1&2) DPDT

ILLUMINATED TOGGLE SWITCHES



- Non-corrosive plastic construction
- Illuminates white when panel lights are ON, changes to red when switch is ON
- Brass blade terminals, silver contacts
- 15/32" L x 15/32" -32 mounting stem
- Rated: 20 amps @12 VDC

DIAGRAM	BULK #	PART NUMBER	SWITCH FUNCTION
	TG40062	TG40060**	ON-OFF SPST
	TG40072	TG40070**	ON-OFF-ON SPDT
	TG40082	TG40080	MOM ON-OFF SPST
	TG40092	TG40090	MOM ON-OFF-MOM ON SPDT

TIP LIT TOGGLE SWITCHES



- Lights through tip of handle
- Non-corrosive plastic construction
- Illuminates white when panel lights are ON, changes to red when switch is ON
- Brass blade terminals, silver contacts
- 15/32" L x 15/32"-32 mounting stem
- Rated: 20 amps @12 VDC

DIAGRAM	BULK #	PART NUMBER	SWITCH FUNCTION
	TG40302	TG40300**	ON-OFF SPST
	TG40312	TG40310**	MOM ON-OFF SPST
	TG40322	TG40320**	ON-OFF-ON SPDT
	TG40332	TG40330**	MOM ON-OFF-MOM ON SPDT
	TG40342	TG40340	ON-OFF-MOM ON SPDT
	TG19522	TG19520**	ON-OFF-ON DPDT
	TG19532	TG19530**	MOM ON-OFF-MOM ON DPDT

** Display Packaged

WEATHER RESISTANT TOGGLE SWITCH

ON-OFF-ON SPDT



- Illuminates red in "on 1" position
- Illuminated white in "off" or "on 2" position
- O-ring seal in bushing seals out moisture and dirt
- Can be wired for independent or dependent illumination
- Rated: 20 amps @ 12 VDC

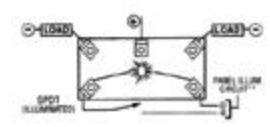

TG40010
TG40012 (Bulk - 100pcs./carton)

SATIN CHROME TIP TOGGLE SWITCHES



- Satin Chrome Handle with matching retaining ring
- Lights through tip of handle
- Non-corrosive plastic construction
- Illuminates white when panel lights are ON, changes to red when switch is ON
- Brass blade terminals, silver contacts
- 15/32" L X 13/32"-32 mounting stem
- Rated: 20 Amp @ 12 VDC

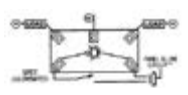

TG23010**
TG23012 (Bulk 100pcs./carton)
TOGGLE SWITCH
ON-OFF-ON SPDT

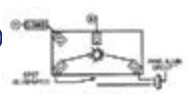

TG23030**
TG23032 (Bulk 100pcs./carton)
TOGGLE SWITCH
(ON)-OFF SPST

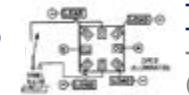

TG23050**
TG23052 (Bulk 100pcs./carton)
TOGGLE SWITCH
(ON)-OFF (ON) DPDT

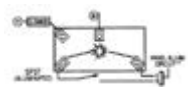

TG23000**
TG23002 (Bulk 100pcs./carton)
TOGGLE SWITCH
ON-OFF SPST

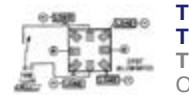

TG23020**
TG23022 (Bulk 100pcs./carton)
TOGGLE SWITCH
ON-OFF-ON DPDT

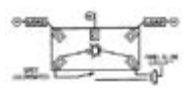

TG23040**
TG23042 (Bulk 100pcs./carton)
TOGGLE SWITCH
(ON)-OFF-(ON) SPDT

HEAVY DUTY 25 AMP TOGGLE SWITCHES



- Nickel Plated Brass Mounting Stem and Hardware
- Handle 11/16" (17.46mm) long
- Mounting Stem 15/32"-32 thread, 15/32" (11.81mm) long
- Fits panels up to 1/4" (6.35 mm) thick
- Rated : 25 Amp @ 12 VDC



TG22000**
TG22002 (Bulk 100pcs./carton)
ON-OFF SPST



TG22010**
TG22012 (Bulk 100pcs./carton)
ON-OFF-ON SPDT



TG22020**
TG22022 (Bulk 100pcs./carton)
ON-OFF-ON DPDT



TG22030**
TG22032 (Bulk 100pcs./carton)
MOM ON-OFF SPST



TG22040**
TG22042 (Bulk 100pcs./carton)
MOM ON-OFF-MOM
ON SPDT

** Display Packaged

HEAVY DUTY 50 AMP TOGGLE SWITCHES



- Super tough zinc die cast
- Heavy copper screw terminals
- Chrome plated plastic handle w/ metal core
- 15/32" L x 15/32"-32 mounting stem
- Rated: 50 Amp @ 12 VDC

TG21500**
TG21502 (Bulk - 100pcs./carton)
 ON-OFF SPST

TG21592 (Bulk - 100pcs./carton)
 ON-OFF-ON SPST

TG21600**
TG21602 (Bulk - 100pcs./carton)
 MOM ON-OFF-MOM ON SPDT

WEATHER RESISTANT TOGGLE SWITCHES



- Plasticized coating seals out moisture and dirt
- Nickel plated brass handle, mounting stem and hardware
- 10" L 16 gauge wire leads
- Handle 11/16" (17.46 mm) long
- Mounting stem 15/32"-32, 13/32" (10.31mm) long
- Fits panel up to 3/16" (4.76 mm) thick
- Includes MP39030 weather proof boot nut
- Rated: 15 amps @ 12 VDC

TG19560-1
TG19562-1 (Bulk - 100pcs./carton)
 OFF-ON SPST

TG19540-1
TG19542-1 (Bulk - 100pcs./carton)
 OFF-MOM ON SPST



TG40000**
TG40002 (Bulk - 100pcs./carton)
 ON-OFF SPST

- Heavy duty all brass construction
- Chrome plated bat handle
- 3/8" L x 7/16"-28 mounting stem
- 2 screw terminals
- Rated: 20 Amps @ 12 VDC



TG21050-1**
TG21052-1 (Bulk - 100pcs./carton)
 ON-OFF SPST

- Heavy duty toggle switch
- Chrome plated bat handle
- 15/32" L x 15/32"-32 mounting stem
- Two 6" wire leads
- Rated: 35 Amps @ 12 VDC
- Rated: 6 Amps @ 125 VAC



TG21040**
TG21042 (Bulk - 100pcs./carton)
 ON-OFF SPST

- Heavy duty toggle switch
- Chrome plated brass bat handle
- 3/8" L x 15/32"-32 mounting stem
- 2 screw terminals
- Rated: 35 Amps @ 12 VDC
- Rated: 20 Amps @ 125 VAC



****TG21020-2****
***TG21022-2 (Bulk - 100pcs./carton)**
 ON-OFF SPST

- Heavy duty die cast toggle switch
- Chrome plated brass bat handle
- 15/32" L x 15/32"-32 mounting stem
- Sealed bushing
- 2 screw terminals
- Rated: 35 Amps @ 12 VDC
- Rated: 20 Amps @ 125 VAC



TG21070**
TG21072 (Bulk - 100pcs./carton)
 ON-OFF SPST

- Heavy duty toggle switch
- Chrome plated brass bat handle
- 15/32" L x 15/32"-32 mounting stem
- 2 screw terminals
- Rated: 35 Amps @ 12 VDC
- Rated: 20 Amps @ 125 VAC



TG21080
TG21082 (Bulk - 100pcs./carton)
 ON-OFF-ON SPDT

- Heavy duty toggle switch
- Chrome plated brass bat handle
- 3/8" L x 15/32"-32 mounting stem
- 3 screw terminals
- Rated: 35 Amps @ 12 VDC
- Rated: 20 Amps @ 125 VAC

** Display Packaged

DUCKBILL TOGGLE SWITCHES



- Non-corrosive plastic construction
- Brass blade terminals
- 1/2" mounting hole
- Supplied with bezel nut and spacer ring
- Rated: 15 Amps @ 12 VDC



TG21360**
TG21362 (Bulk 100pcs/carton)
 ON-OFF SPST
 Glows Red in ON position
 1" translucent plastic handle

TG21390
TG21392 (Bulk 100pcs/carton)
 ON-OFF SPST
 Glows Green in ON position

TG21130**
TG21132 (Bulk 100pcs/carton)
 ON-OFF SPST

TG21140
TG21142 (Bulk 100pcs/carton)
 ON-OFF-ON SPDT
 1" black plastic handle



MP39220**
MP39222 (Bulk 100pcs/carton)
 WEATHER PROOF BOOT NUT
 • For illuminated toggle switches (except Duckbill)
 • 1/2" boot seals out moisture yet allows illumination to show



MP39030**
MP39032 (Bulk 100pcs/carton)
 WEATHER PROOF BOOT NUT (GRAY)
 • For standard toggles w/ 15/32" mounting stem
 • Completely covers toggle handle
 • Seals out moisture & dirt
 • Nickel plated brass nut



MP39240-1**
MP39242 (Bulk 100pcs/carton)
 WEATHER PROOF BOOT NUT (BLACK)
 • For standard toggles w/ 15/32" mounting stem
 • Completely covers toggle handle
 • Seals out moisture & dirt



MP39280**
MP39282 (Bulk 100pcs/carton)
 WEATHER PROOF BOOT NUT (BLACK)
 • For standard toggles w/ 15/32" mounting stem
 • Completely covers toggle handle
 • Seals out moisture & dirt
 • 2 piece construction chrome ring retains switch

** Display Packaged

WEATHER-RESISTANT PUSH SWITCHES



MP39380**
MP39382 (Bulk 100pcs/carton)
 OFF-ON SPST

- Solid brass construction
- Gasket sealed case
- 3/8" mounting bushing
- 2 screw terminals
- 3/4" chrome plated brass knob
- For panels up to 1" thick
- Rated: 15 amp @ 12 VDC



MP39390**
MP39392 (Bulk 100pcs/carton)
 OFF-ON SPST
 with chrome plated plastic knob

MP39390B**
MP39392B (Bulk 100pcs/carton)
 OFF-ON SPST
 with chrome plated brass knob

- Solid brass construction
- Vinyl coated body to resist AAmoisture
- Two 18 gauge x 12" wire leads
- 3/8" mounting bushing
- For panels up to 1" thick
- Rated: 15 amp @ 12 VDC

HEAVY DUTY MARINE PUSH PULL SWITCHES



MP39600
MP39602(Bulk 100pcs./carton)
 OFF-ON (1 & 2) SPST
 • Pull for ON - turns on two separate circuits
 • Solid brass construction
 • 3/8" mounting bushing
 • 3 screw terminals
 • For panels up to 1" thick
 • Chrome plated solid brass knob
 • Rated: 15 amp @ 12 VDC



MP39580**
MP39582 (Bulk 100pcs./carton)
 OFF-ON(1)-ON(1&2) SPDT
 • First pull energizes #1
 • Second pull energizes both circuits
 • Solid brass construction
 • 3/8" mounting bushing
 • 3 screw terminals
 • For panels up to 1" thick
 • Chrome plated solid brass knob
 • Rated: 15 amp @ 12 VDC



MP39590**
MP39592 (Bulk 100pcs./carton)
 OFF-ON(1)-ON(1&2) SPDT
 • First pull energizes #1
 • Second pull energizes both circuits
 • Solid brass construction
 • 3/8" mounting bushing
 • 3 blade terminals
 • For panels up to 1" thick
 • Chrome finish plastic knob
 • Rated: 15 amp @ 12 VDC



MP39622 (Bulk 100pcs./carton)
 OFF-ON(1)-ON(2&3) SPDT
 • First pull energizes #1
 • Second pull energizes two separate circuits
 • For anchor/running lights or similar function
 • Solid brass construction
 • 3/8" mounting bushing
 • 4 screw terminals
 • For panels up to 1" thick
 • Chrome plated solid brass knob
 • Rated: 15 amp @ 12 VDC



MP39640
MP39642 (Bulk 100pcs./carton)
 OFF-ON(1)-ON(2) SPDT
 • First pull energizes #1
 • Second pull energizes circuit 2
 • Solid brass construction
 • 3/8" mounting bushing
 • 3 screw terminals
 • For panels up to 1" thick
 • Chrome plated solid brass knob
 • Rated: 15 amp @ 12 VDC



HEAVY DUTY PUSH BUTTON SWITCHES

MOMENTARY ON-OFF SPST



MP39160**
MP39162 (Bulk 100pcs./carton)
 with rubber boot nut

MP39182 (Bulk 100pcs./carton)
 with std. chrome face nut

- Corrosion resistant plastic construction
- 1 7/16"L x 5/8" mounting stem
- 2 boss screw terminals
- Rated: 30 Amp @ 12 VDC



MP21460
MP21462 (Bulk 100pcs./carton)
 PUSH ON - PUSH OFF

- Two 5" wire leads for easy connection
- 3/8"L x 15/32" mounting stem
- Rated: 3 amps @125 VAC

PUSH BUTTON ANTI-VANDAL SWITCHES

- Sleek, Stainless Steel Design with Halo LED illumination
- Quick connect tab terminals for easy installation and daisy chaining
- Sealed to IP67 for above panel components
- UL1500 Ignition Protection



PART NUMBER	SWITCH FUNCTION	AMP RATING	ILLUMINATION COLOR	BLUE SEA#
AV10030	OFF-(ON)	10	None	-
AV10030B	OFF-(ON)	10	Blue	4161
AV10030G	OFF-(ON)	10	Green	-
AV10030R	OFF-(ON)	10	Red	4163
AV10030W	OFF-(ON)	10	White	-
AV10040	OFF-ON	10	None	-
AV10040B	OFF-ON	10	Blue	4160
AV10040G	OFF-ON	10	Green	-
AV10040R	OFF-ON	10	Red	4162
AV10040W	OFF-ON	10	White	-
AV10050R**	OFF-(ON)	10	Red	-
AV10060R*	OFF-ON	10	Red	-
AV10060B	OFF-ON	10	Blue	-
AV10060G	OFF-ON	10	Green	-
AV10060W	OFF-ON	10	White	-
AV10100R	OFF-ON	20	Red	4192
AV10100B	OFF-ON	20	Blue	4190
AV10120B	(ON2)-(ON1)-OFF	20	Blue/Red	-
AV10130B	OFF-ON	20	Blue	-

* Power legend on Switch
 ** Legend Horn Switch

** Display Packaged

HEAVY DUTY MARINE PUSH PULL SWITCHES



MP39510
MP39512 (Bulk 100pcs/carton)
 OFF-ON SPST
 • Pull for ON
 • Solid brass construction
 • 3/8" mounting bushing
 • 2 screw terminals
 • For panels up to 1" thick
 • Cream plastic knob
 • Rated: 15 amp @ 12 VDC



MP39520**
MP39522 (Bulk 100pcs/carton)
 OFF-ON SPST
 • Pull for ON
 • Solid brass construction
 • 3/8" mounting bushing
 • 2 screw terminals
 • For panels up to 1" thick
 • Chrome plated plastic knob
 • Rated: 15 amp @ 12 VDC



MP39530**
MP39532 (Bulk 100pcs/carton)
 OFF-ON SPST
 • Pull for ON
 • Solid brass construction
 • 3/8" mounting bushing
 • 2 screw terminals
 • For panels up to 1" thick
 • Chrome plated solid brass knob
 • Rated: 15 amp @ 12 VDC



MP39540**
MP39542 (Bulk 100pcs/carton)
 OFF-ON SPST
 • Pull for ON
 • Solid brass construction
 • 3/8" mounting bushing
 • 2 blade terminals
 • For panels up to 1" thick
 • Chrome finish plastic knob
 • Rated: 15 amp @ 12 VDC



MP39570**
MP39572 (Bulk 100pcs/carton)
 OFF-ON(1)-ON(1&2) SPDT
 • First pull energizes #1
 • Second pull energizes both circuits
 • Solid brass construction
 • 3/8" mounting bushing
 • 3 screw terminals
 • For panels up to 1" thick
 • Chrome finish plastic knob
 • Rated: 15 amp @ 12 VDC



MP39610**
MP39612 (Bulk 100pcs/carton)
 OFF-ON(1)-ON(2&3) SPDT
 • First pull energizes #1
 • Second pull energizes two separate circuits
 • For anchor/running lights or similar function
 • Solid brass construction
 • 3/8" mounting bushing
 • 4 screw terminals
 • For panels up to 1" thick
 • Chrome finish plastic knob
 • Rated: 15 amp @ 12 VDC

BRASS PUSH BUTTON SWITCHES MOMENTARY ON-OFF SPST

- Solid brass construction
- For starter, horn or other functions
- 1 1/4"L x 5/8" mounting stem
- 2 screw terminals (except MP39340)
- Rated: 20 amp @ 12 VDC



MP39310**
MP39312 (Bulk 100pcs/carton)
 with chrome plated brass
 face nut and button



MP39320**
MP39322 (Bulk 100pcs/carton)
 with rubber boot nut



MP39340**
MP39342 (Bulk 100pcs/carton)
 with rubber boot nut
 blade terminals

** Display Packaged

HEAVY DUTY BRASS PUSH BUTTON SWITCHES

MOMENTARY ON-OFF SPST

- Solid brass construction
- For starter, horn or other functions
- 1 3/8" L x 5/8"-32 mounting stem
- 2 boss screw terminals
- Rated: 35 amp @ 12 VDC



MP39360
MP39362 (Bulk 100pcs/carton)
 with recessed plunger button
 prevents accidental actuation



MP39410
MP39412 (Bulk 100pcs/carton)
 with large 15/16" anodized
 face nut and button

MP39420
MP39422 (Bulk 100pcs/carton)
 with chrome plated brass face
 nut and button

COMPACT PUSH BUTTON SWITCHES

MOMENTARY ON-OFF SPST

- Contoured plastic button
- Chrome plated brass mounting stem
- 1/2" Mounting hole
- 2 brass blade terminals
- Rated 15 amp @ 12 VDC
- MP39690 commonly used as Horn Switch



MP39680**
MP39682 (Bulk 100pcs/carton)
 Black Button

MP39690**
MP39692 (Bulk 100pcs/carton)
 Red Button

MP39670
MP39672 (Bulk 100pcs/carton)
 White Button



MP39300**
MP39302 (Bulk 100pcs/carton)
 MOM ON-OFF SPST
 • Large black plastic button
 • Chrome plated brass housing
 • For fog horns or sirens
 • Overall width 2 5/8"

INDICATOR LIGHTS

UN22100**
UN22102 (Bulk 100pcs/carton)
 RED



UN22110**
UN22112 (Bulk 100pcs/carton)
 GREEN

UN22120**
UN22122 (Bulk 100pcs/carton)
 AMBER

SMALL INDICATOR LIGHTS
 12 VDC use only
 • 5/16" mounting hole
 • 5" tinned copper wire leads



UN22150**
UN22152 (Bulk 100pcs/carton)
 RED

UN22160
UN22162 (Bulk 100pcs/carton)
 GREEN

SMALL INDICATOR LIGHTS
 125 VAC use only
 • 5/16" mounting hole
 • 5" tinned copper wire leads

LARGE INDICATOR LIGHTS
 12 VDC use only
 • 1/2" mounting hole
 • 4" tinned copper wire leads



UN21280**
UN21282 (Bulk 100pcs/carton)
 RED



UN21290**
UN21292 (Bulk 100pcs/carton)
 GREEN



UN21320
UN21322 (Bulk 100pcs/carton)
 AMBER

** Display Packaged

EMERGENCY ENGINE CUT-OFF SWITCHES

MOMENTARY ON-OFF SPST



- MP39350****
MP39352 (Bulk 100pcs/carton)
 PUSH BUTTON SWITCH
 MOM ON - OFF SPST
- Solid brass construction
 - Weather resistant plasticized coating
 - Rubber boot nut
 - Two 12" L 18 gauge wire leads
 - Mounting bushing 15/16" L X 5/8"-32
 - Rated: 10 amps @ 12 VDC



- MP39260****
MP39262 (Bulk 100pcs/carton)
 WEATHER PROOF BOOT NUT
 (BLACK)
- For push button switches
 - Chrome face nut
 - Seals out moisture & dirt
 - Tapered design



- UN42000****
UN42002 (Bulk 100pcs/carton)
 MOM ON - OFF SPST
- Extra heavy duty die cast construction
 - Silver contacts
 - 2 boss screw terminals
 - Rubber boot nut
 - Rated: 60 amp @ 12 VDC



- MP39140**
MP39142 (Bulk 100pcs/carton)
 PUSH BUTTON SWITCH
 COVER (BLACK)

FUSES



AGA GLASS TUBE FUSES
 1/4" X 5/8"

PART #	RATING	PER PACK
FS79060**	20 AMP	5
FS79070	30 AMP	5



SFE GLASS TUBE FUSES

PART #	RATING	SIZE	PER PACK
FS79270	14 AMP	1/4" X 1"	5
FS79280	20 AMP	1/4" X 1 1/4"	5



AGU GLASS TUBE FUSES
 13/32" X 1 1/2"

PART #	RATING	PER PACK
FS79820	20 AMP	2
FS79870**	50 AMP	2



AGU GLASS TUBE FUSES
 1/4" X 1 1/4"

PART #	RATING	PER PACK
FS79090	1 AMP	5
FS79100	1.5 AMP	5
FS79110**	2 AMP	5
FS79470	2.5 AMP	5
FS79120**	3 AMP	5
FS79130**	4 AMP	5
FS79140**	5 AMP	5
FS79150**	6 AMP	5
FS79160**	7.5 AMP	5
FS79170**	10 AMP	5
FS79180**	15 AMP	5
FS79190**	20 AMP	5
FS79200**	25 AMP	5
FS79210**	30 AMP	5
FS79220	35 AMP	5



FS79630**
BILGE PUMP & ACCESSORY FUSE KIT
 Contains FIVE fuses (1 each)
 AGC 5, 10, 15, 30 amp, and 1 SFE 20 amp.

*Color coded AMP ratings, plug in automotive style.

ATM & ATO STYLE FUSES



ATO® STYLE FUSES
0.207" W X 0.752" H X 0.76" L

PART #	RATING	COLOR	PER PACK
FS79480**	1 AMP	BLACK	5
FS79490**	2 AMP	GRAY	5
FS79500**	3 AMP	VIOLET	5
FS79510**	4 AMP	PINK	5
FS79520**	5 AMP	TAN	5
FS79530**	7.5 AMP	BROWN	5
FS79540**	10 AMP	RED	5
FS79550**	15 AMP	BLUE	5
FS79560**	20 AMP	YELLOW	5
FS79570**	25 AMP	CREAM	5
FS79580**	30 AMP	GREEN	5
FS79590**	40 AMP	ORANGE	5



ATM STYLE FUSES
0.15" W x 0.429" H x 0.76" L

PART #	RATING	COLOR	PER PACK
FS80000**	2 AMP	GRAY	5
FS80010**	3 AMP	VIOLET	5
FS80030**	5 AMP	TAN	5
FS80040**	7.5 AMP	BROWN	5
FS80050**	10 AMP	RED	5
FS80060**	15 AMP	BLUE	5
FS80070**	20 AMP	YELLOW	5
FS80080**	25 AMP	CLEAR	5
FS80090**	30 AMP	GREEN	5



FS79690**
ATO® FUSE KIT ASSORTMENT



FS79680**
ATM FUSE KIT ASSORTMENT

MAXI™ FUSES

- Tin plated copper blades for corrosion protection
- Visible indication of blown condition
- Maximum voltage - 32 VDC

PART #	RATING	COLOR	PER PACK
FS81010	30 AMP	GREEN	1
FS81020	40 AMP	ORANGE	1
FS81030	50 AMP	RED	1
FS81040	60 AMP	BLUE	1
FS81050	70 AMP	AMBER	1



MAXI™ FUSE BLOCK



FS81080

FS81082
(Bulk 100pcs/carton)

- Black Reinforced Polycarbonate
- For Maxi™ fuses 30-80 A
- Snap-on cover insulates conductive parts - meets ABYC & USCG requirements
- Accepts 18-4 AWG wire from sides or bottom
- Maximum voltage - 32 VDC
- Meets SAE J1171

BATTERY FUSES

Standardized color coding for easy amperage identification
 32VDC Maximum Voltage
 20A-60A Ratings
 ISO 8820-4: 2002



PART #	AMPERAGE	COLOR	REPLACES
FS84100	30A	Light Green	Blue Sea: 5175
FS84110	40A	Light Blue	Blue Sea: 5176
FS84120	50A	Red	Blue Sea: 5177
FS84130	60A	Gold	Blue Sea: 5178
FS84140	75A	Brown	Blue Sea: 5180
FS84150	80A	Lime	Blue Sea: 5181
FS84160	90A	Purple	Blue Sea: 5182
FS84170	100A	Yellow	Blue Sea: 5183
FS84180	125A	Green	Blue Sea: 5184

PART #	AMPERAGE	COLOR	REPLACES
FS84190	150A	Orange	Blue Sea: 5185
FS84200	175A	White	Blue Sea: 5186
FS84210	200A	Blue	Blue Sea: 5187
FS84220	250A	Pink	Blue Sea: 5189
FS84230	300A	Grey	Blue Sea: 5190

BATTERY FUSE MOUNTING BAR

FS84240
MARINE RATED
BATTERY FUSE
MOUNTING BAR



FS84260
MARINE RATED
DUAL BATTERY
FUSE MOUNTING BAR
 Replaces: Blue Sea 2151



FMX FUSES

Standardized color coding for easy amperage identification
 32VDC Maximum Voltage
 20A-60A Ratings
 ISO 8820-4: 2002



PART #	AMPERAGE	COLOR
FS84000	20A	Light Blue
FS84010	30A	Pink
FS84020	40A	Green
FS84030	50A	Red
FS84040	60A	Yellow



FS82000
ANL FUSE HOLDER
 Replaces: Blue Sea 5005

- Works with 35-300A ANL Fuses (Not Included)
- Compact design Width 49mm x Length 98mm x • Height 50mm (Including Cover)
- Stainless Steel Studs for superior corrosion protection
- ABYC/USCG Compliant transparent cover for clear view of fuse
- Cover features recessed area to apply labels for easy circuit identification
- Bendable/Removable side plates for flexible wiring options
- LED Blown Fuse Indicator
- Max Operating Voltage 32VDC
- Max Continuous Current 35-300A
- Terminal Stud Size 2 x M10



Available with various AMP ratings at 32VDC.
 Ceramic Body for Superior Insulation
 Brass, Gold-Plated Element for Superior Electrical Contact
 Ignition Protected (ISO8846)

PART #	AMP	BULK #	BLUE SEA#
FS82010	100	FS82012	-
FS82020	150	FS82022	5127
FS82030	200	FS82032	5129
FS82040	250	FS82042	5131
FS82050	300	FS82052	5133
FS82060	350	FS82062	5135
FS82070	400	FS82072	5136

100% rating: 4 Hours Min
 150% Rating: 60 Seconds Min
 200% Rating: 15 Secs Min

FUSE BLOCK FOR GLASS TUBE

STANDARD FUSE BLOCKS



- Use with SFE, AGC, or MDL fuses up to 20 Amp
- Heavy duty black molded base
- 8-32 terminal screws
- Tin plated brass fuse clips

PART #	# OF GANGS
FS40500-1	2
FS40502-1*	2
FS40510-1**	4
FS40512-1*	4
FS40520-1**	6
FS40522-1*	6
FS40530-1	8

* Bulk 100pcs./carton

HOT FEED FUSE BLOCKS

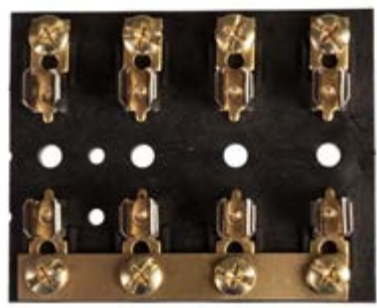

- Use with SFE, AGC, or MDL fuses up to 20 Amp
- Common bus bar connects hot side of fuses for power feed
- Heavy duty black molded base
- 8-32 terminal screws and stud terminal for power connection
- Tin plated brass fuse clips

PART #	# OF GANGS
FS40590-1**	4
FS40592-1*	4
FS40600-1	6
FS40602-1*	6
FS40610-1	8
FS40612-1*	8

* Bulk 100pcs./carton

HOT FEED/COMMON GROUND FUSE BLOCKS



- Use with SFE, AGC, or MDL fuses up to 20 Amp
- Common bus bar connects hot side of fuses for power feed
- Separate bus bar for ground or unfused common hot feed
- Heavy duty black molded base
- 8-32 stud terminals for power/ground connection
- 1/4" Q.D. terminals for circuit hookup
- Tin plated brass fuse clips

PART #	# OF GANGS
FS40630-1	4
FS40632-1*	4
FS40640-1	6
FS40642-1*	6
FS40650-1	8
FS40652-1*	8

* Bulk 100pcs./carton



- Use with SFE, AGC, or MDL fuses up to 20 Amp
- Common bus bar connects hot side of fuses for power feed
- Separate bus bar for ground or unfused common hot feed
- Heavy duty black molded base
- 8-32 terminal screws and stud terminals for power/ground connection
- Tin plated brass fuse clips

PART #	# OF GANGS
FS40540-1	2
FS40542-1*	2
FS40550-1**	4
FS40552-1*	4
FS40560-1**	6
FS40562-1*	6
FS40570-1**	8
FS40572-1*	8

* Bulk 100pcs./carton

408 SERIES FUSE BLOCKS

Accepts ATP/ATC/ATO blade type fuses up to 30A
 Transparent cover with recessed area for label decals (60pc decal set included)
 Storage for 2 spare fuses | Blown fuse LED indication for easy determination
 32VDC Max Rating | 100A Maximum Cumulative | M5 Stud Size, M4 Screw Size



FS40800**
 • 6 Gang w/ Cover
 • Replaces: Blue Sea 5028
Overall size - 3 3/8"W x 3 1/16"L x 1 5/8"H



FS40820**
 • 12 Gang w/ Cover
 • Replaces: Blue Sea 5029
Overall size - 3 3/8"W x 5 1/4"L x 1 5/8"H



FS40830**
 • 6 Gang w/ Bus Bar and Cover
 • Replaces: Blue Sea 5025
Overall size - 3 3/8"W x 3 11/16"L x 1 5/8"



FS40840**
 • 12 Gang w/ Bus Bar and Cover
 • Replaces: Blue Sea 5026
Overall size - 3 3/8"W x 5 1/4"L x 1 5/8"H



FS40810**
408 SERIES GROUND BUS BAR
 • 12 Terminal w/ Cover
 • Transparent cover with recessed area for label decals
 • M5 Stud Size, M4 Screw Size,
Overall size - 3 3/8"W x 2 1/4"L x 1 5/8"H

409 SERIES FUSE BLOCKS



FS40900**

FS40902 (Bulk)

AGC GLASS TYPE WITH BUS BAR

- Replaces: Blue Sea 5015
- Available in 4 and 6 gang options with or without bus bars
- Common source fuse block with negative busbar and cover
- Includes blown fuse indication LED's



FS40910**

FS40912 (Bulk)

AGC GLASS TYPE COMMON SOURCE

- Replaces: Blue Sea 5018
- Available in 4 and 6 gang options with or without bus bars
- Common source fuse block with negative busbar and cover
- Includes blown fuse indication LED's



FS40920**

FS40922 (Bulk)

AGC GLASS TYPE INDEPENDENT SOURCE

- Available in 4 and 6 gang options
- Compact and designed for 24-hour circuits
- Includes blown fuse indication LED's

ATO/ATC STYLE FUSE BLOCKS



WITH GROUND BUS BAR

PART #	# OF GANGS
FS40420**	6
FS40422*	6
FS40430**	4
FS40432*	4
FS40440**	14
FS40442*	14
FS40450**	8
FS40452*	8
FS40740**	10
FS40742*	10



WITHOUT GROUND BUS BAR

PART #	# OF GANGS
FS40410**	14
FS40412*	14
FS56242*	4
FS56232*	6
FS56252*	10

- For ATO/ATC fuses
- Interlocking modules snap together
- 1/4" tin plated copper tab terminals
- Flame resistant reinforced polyester base
- Rated 30 Amps per circuit, 160 Amp total for block

* Bulk 100pcs./carton

* Bulk 100pcs./carton

GROUND BUS BAR FOR ATO/ATC FUSE BLOCKS



FS40730**

FS40732 (Bulk 100pcs./carton)

- Replacement bus bar for Sierra ATO/ATC fuse blocks
- 14 - 1/4" tin plated copper tab terminals

SEALED BUS BAR AND PLUG KIT

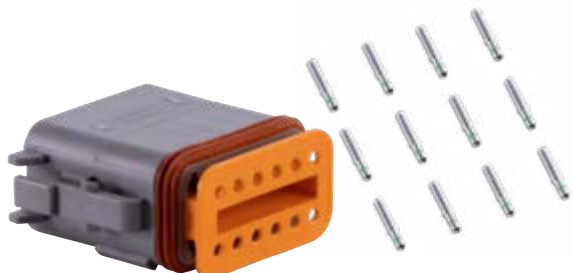

FS46820

12 PIN AMPHENOL PLUG KIT

Designed for protecting electrical connections. For use with Sealed Bus Bars. Includes: Connector, Wedge and (12) 14 AWG machined terminals. Replaces: TDT06-12S

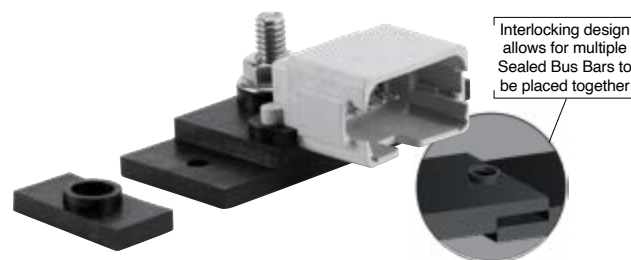

FS46800

SEALED 150A, 12 PIN BUS BAR

Sealed bus bars are a superior corrosion resistant alternative to conventional bus bars. Replaces: ESBB-12

Interlocking design allows for multiple Sealed Bus Bars to be placed together

DUAL BUS BARS

100-150 AMP HEAVY DUTY

FS46600**
FS46602 (Bulk)



- 100A, 12 Gang
- Tin-plated copper bus allowing current up to 100A

FS46610**
FS46612 (Bulk)



- 100A, 6 Gang
- Tin-plated copper bus allowing current up to 100A

FS46620**
FS46622 (Bulk)



- Replaces: Blue Sea 2722
- 100A, 6 Gang
- Tin-plated copper bus allowing current up to 150A

FS46630**
FS46632 (Bulk)



- 100A, 12 Gang
- Tin-plated copper bus allowing current up to 150A

• Combines negative and positive buses in one block • Stainless steel studs and M4 screws

150 AMP 2-STEP

FS46660**
FS46662 (Bulk)



- Replaces: Blue Sea 2701
- 6 Gang

FS46670**
FS46672 (Bulk)



- Replaces: Blue Sea 2702
- 12 Gang

• Stepped bus bars allowing more flexible wiring options • Stainless steel studs and M4 screws

DUAL BRASS BUS BARS



FS40660**
FS40662 (Bulk 100pcs./carton)

- 4 - 8-32 Screw Terminals
- Overall size - 1.5"L x 1.5"W x .44"H



- Combines negative and positive buses in one block
- Brass terminal bar
- 150 AMP

FS40680**
FS40682 (Bulk 100pcs./carton)

- 12 - 8-32 Screw Terminals
- Overall size - 4.5"L x 1.5"W x .44"H



FS40690**
FS40692 (Bulk 100pcs./carton)

- 16 - 8-32 Screw Terminals
- Overall size - 6"L x 1.5"W x .44"H



FS40670**
FS40672 (Bulk 100pcs./carton)

- 8 - 8-32 Screw Terminals
- Overall size - 3"L x 1.5"W x .44"H



FS56152 (Bulk 100pcs./carton)

- 20 - 8-32 Screw Terminals
- Overall size - 7.5"L x 1.5"W x .44"H



100 AMP



FS46680**
FS46682 (Bulk)

- Replaces: Blue Sea 2314
- 5 Gang w/ Cover
- 3/16" - 24 Stud Size
- #8 - 32 Screw Size
- Overall size - 4.2" x 0.88" x 1.37"**

FS46690**
FS46692 (Bulk)

- Replaces: Blue Sea 2315
- 4 Stud w/ Cover
- 3/16" - 24 Stud Size
- Overall size - 4.2" x 0.88" x 1.37"**

• Tin-Plated Copper Bus Bar • Flame Retardant ABS Base



FS46700**
FS46702 (Bulk)
150A COMMON BUS BAR

- Replaces: Blue Sea 2300
- 12 Gan w/ Cover
- 3/16" - 24 Stud Size
- #8 - 32 Screw Size
- 60lb-in Stud Torque
- 15lb-in Screw Torque
- Overall size - 4.2" x 0.88" x 1.37"**

FS46710**
FS46712 (Bulk)
250A MAXI POWER

- 6 Stud
- 5/16"-18 Stud Size
- 60lb-in Stud Torque
- Overall size - 7.925" x 1.5" x 1.62"**

• Tin-Plated Copper Bus Bar • Stainless Steel Screws and Studs

CORROSION RESISTANT COMMON BUS BARS



- Use as common hot feed or common ground block
- Tin plated copper bus
- Stainless steel studs & screws
- Large diameter nuts provide large electrical contact area
- Stainless steel screws with lock washers

150 AMP COMMON BUS



FS46100**
FS46102 (Bulk 100pcs./carton)

- 5 - 8-32 Screw Terminals
- 2 - 10-24 Stud Terminals
- Over all size - 4.13"L x .75"W x 1.44"H**

FS46150**
FS46152 (Bulk 100pcs./carton)

- 4 -10-24 Stud Terminals
- Over all size - 4.13"L x .75"W x 1.44"H**



FS46200**
FS46202 (Bulk 100pcs./carton)

- 10 - 8-32 Screw Terminals
- 2 - 1/4"-20 Stud Terminals
- Over all size - 6"L x 1.25"W x 1.44"H**

FS46250**
FS46252 (Bulk 100pcs./carton)

- 4 - 1/4"-20 Stud Terminals
- Over all size - 6"L x 1.25"W x 1.44"H**



FS46400
FS46402 (Bulk 100pcs./carton)

- 20 - 8-32 Screw Terminals
- 2 - 1/4"-20 Stud Terminals
- Over all size - 9 1/4"L x 1.25"W x 1.44"H**

FS46450
FS46452 (Bulk 100pcs./carton)

- 6 - 1/4"-20 Stud Terminals
- Over all size - 9 1/4"L x 1.25"W x 1.44"H**

CORROSION RESISTANT COMMON BUS BARS

250 AMP COMMON BUS



FS46300
FS46302 (Bulk 100pcs./carton)

- 12 - 8-32 Screw Terminals
 - 2 - 1/4"-20 Stud Terminals
- Over all size - 7.88"L x 1.5"W x 1.75"H



FS46350
FS46352 (Bulk 100pcs./carton)

- 4 - 1/4"-20 Stud Terminals
- Over all size - 7.88"L x 1.5"W x 1.75"H

600 AMP COMMON BUS



FS46551
FS46552 (Bulk 100pcs./carton)

- 4 x 3/8-16 Stud Terminals
- Over all size - 7.00"L x 2"W x 2"H



FS46561
FS46562 (Bulk 100pcs./carton)

- 8 x 3/8-16 Stud Terminals
- Over all size - 11.375"L x 2"W x 2"H

BARRIER TYPE JUNCTION BLOCKS



- Each screw pair is 1 isolated circuit
- Closed back insulates power from mounting circuit
- Nickel plated brass bus bar



FS45620**
FS45622 (Bulk 100pcs./carton)

- 4 Gang Block
 - 8 - 10-32 Screw Terminals
- Overall size - 3.94"L x 1.312"W x 0.812"H



FS45630
FS45632 (Bulk 100pcs./carton)

- 6 Gang Block
 - 12 - 10-32 Screw Terminals
- Overall size - 4.36"L x 1.312"W x 0.812"H



FS45640
FS45642 (Bulk 100pcs./carton)

- 8 Gang Block
 - 16 10-32 Screw Terminals
- Overall size - 5.33"L x 1.312"W x 0.812"H



FS45650
FS45652 (Bulk 100pcs./carton)

- 10 Gang Block
 - 20 10-32 Screw Terminals
- Overall size - 6.31"L x 1.312"W x 0.812"H

BUS BARS INSULATING COVERS



• ABS cover designed to prevent accidental shorting



FSC46100
Fits FS46100, FS46150



FSC46200
Fits FS46200, FS46250



FSC46300
Fits FS46300, FS46350



FSC46400
Fits FS46400, FS46450



FSC46550
Fits FS46551



FSC46560
Fits FS46561

BRASS BUS BARS

- Use as common hot feed or common ground block
- Brass terminal bar
- 150 AMP



FS40720**
FS40722 (Bulk 100pcs./carton)

- 4 - 8-32 Screw Terminals
- Overall size - 4.5"L x .5" W x 1"H**



FS40750
FS40752 (Bulk 100pcs./carton)

- 10 - 10-32 Screw Terminals
 - 2 - 1/4"-20 Stud Terminals
- Overall size - 5.75"L x 1.25 W x 1.19"H**

HEAVY DUTY TERMINAL STUDS

- 48VDC Max Operating Voltage
- Glass Fiber reinforced Nylon base ensures great mechanical strength and durability



FS46540**
FS46542 (Bulk)
TERMINAL STUD,
SINGLE M10
REPLACES: BLUE SEA 2003
• Replaces 3/8"



FS46570**
FS46572 (Bulk)
TERMINAL STUD,
SINGLE M8
REPLACES: BLUE SEA 2002
• Replaces 5/16"



FS46580**
FS46582 (Bulk)
TERMINAL STUD,
DUAL M10
REPLACES: BLUE SEA 2017
• Replaces 3/8"
• Includes isolating plate



FS46590**
FS46592 (Bulk)
TERMINAL STUD,
SINGLE M8/M10
REPLACES: BLUE SEA 2018
• Replaces 5/16"
• Includes isolating plate

ATO/ATC STYLE FUSE HOLDERS



- FS35870****
FS35872 (Bulk 100pcs./carton)
 FUSE HOLDER
- Weather proof sealed case
 - 5" - 12 gauge wire leads
 - For ATO/ATC style fuses up to 30 amps



- FS69130****
N-186913 (Bulk 100pcs./carton)
 FUSE HOLDER
- 5" - 12 gauge wire leads
 - For ATO/ATC style fuses up to 30 amps
 - Includes 30 amp fuse



- FS45410****
FS45412 (Bulk 100pcs./carton)
 FUSE HOLDER
- 8" - 14 gauge wire loop
 - For ATO/ATC style fuses up to 20 amps

WEATHER RESISTANT GLASS TUBE STYLE FUSE HOLDERS



WEATHER RESISTANT FUSE HOLDER
 WITH SPARE FUSE COMPARTMENT

PART #	DETAILS
FS69150**	10 GA 8" wire loop w/ two 30 Amp fuses
FS69160**	12 GA 8" wire loop w/ two 20 Amp fuses
FS69170**	14 GA 8" wire loop w/ two 15 Amp fuses
FS69180**	16 GA 8" wire loop w/ two 10 Amp fuses



- FS69140****
 HEAVY DUTY FUSE HOLDER
- Weather resistant
 - 5" - 8 gauge wire leads
 - For 30 to 50 Amp AGC fuses



- FS45440****
FS45442 (Bulk 100pcs./carton)
 FUSE HOLDER
- Weather proof sealed case
 - 15" - 14 gauge wire loop
 - For up to 20 amp SFE, AGC, MDL fuses



- FS45470****
FS45472 (Bulk 100pcs./carton)
 FUSE HOLDER
- Weather proof sealed case
 - 15" - 10 gauge wire loop
 - Includes 30 amp SFE fuse



- FS45460****
FS45462 (Bulk 100pcs./carton)
 FUSE HOLDER
- Weather proof sealed case
 - 15" - 14 gauge wire loop
 - Includes 20 amp SFE fuse

IN-LINE GLASS TUBE STYLE FUSE HOLDERS



- FS45350****
FS45352 (Bulk 100pcs./carton)
 FUSE HOLDER
- Black plastic twist lock case
 - 8" - 14 gauge wire loop
 - Includes 20 amp SFE fuse



- FS45400****
FS45402 (Bulk 100pcs./carton)
 FUSE HOLDER
- White plastic twist lock case
 - 7" 16 gauge wire loop
 - For glass fuses up to 10 amp



- FS45360****
FS45362 (Bulk 100pcs./carton)
 FUSE HOLDER
- Red plastic twist lock case
 - 8" - 14 gauge wire loop
 - Includes 14 amp SFE fuse



- FS69100****
 FUSE HOLDER
- Black plastic twist lock case
 - 7"- 14 gauge wire loop
 - Includes 15 amp fuse



- FS45380****
FS45382 (Bulk 100pcs./carton)
 FUSE HOLDER
- Black plastic threaded case
 - 7" - 12 gauge wire loop
 - Includes 30 amp SFE fuse



- FS69120****
 FUSE HOLDER
- Heavy Duty
 - 12 gauge tinned copperwire
 - Includes 30 amp fuse



- FS45390****
FS45392 (Bulk 100pcs./carton)
 FUSE HOLDER
- Black plastic threaded case
 - 7" - 12 gauge wire loop
 - Includes 20 amp SFE fuse

PANEL MOUNT GLASS TUBE STYLE FUSE HOLDERS

FS22082 (Bulk 100pcs./carton) FUSE HOLDER

- Panel mount with red fuse label
- For glass fuses up to 20 amp
- For panels up to 5/16" thick



FS45430** FS45432 (Bulk 100pcs./carton) FUSE HOLDER

- Panel mount
- Weather resistant gasket sealed
- For AGC, MDL fuses
- For panels up to 5/16" thick



HIGH AMPERAGE CIRCUIT BREAKERS

* Perfect for rigging trolling motors, windless, and other high amp electrical equipment

AUTO RESET

* INCLUDES STUD MOUNTING PLATE



CB42240**
40 Amp • 12V
CB42250-1**
50 Amp • 12V

MANUAL RESET

* INCLUDES STUD MOUNTING PLATE



CB43240**
40 Amp • 12V

CB43250**
50 Amp • 12V

CB45250
50 Amp • 24V

TOGGLE TYPE CIRCUIT BREAKERS

- High quality exact replacement on many top brands
- Color coded handles for quick identification of AC/DC
- White handles for DC, black handles for AC
- Clamshell packaging



PART #	AMP RATING	COLOR
CB40200	5	WHITE
CB40220	10	WHITE
CB40230	15	WHITE
CB40240	20	WHITE
CB40250	35	WHITE
CB40190	50	WHITE
CB40260	15	BLACK
CB40270	20	BLACK
CB40280	30	BLACK

PUSH BUTTON RESETTABLE CIRCUIT BREAKERS

- Ignition protected design for safe use in below deck boat applications.
- Compatible with AC and DC circuits
- Push-to-Reset Operation
- Mounts in 3/8" hole
- Uses optional MP39210 weatherproof boot to protect circuit breaker in harsh environments"

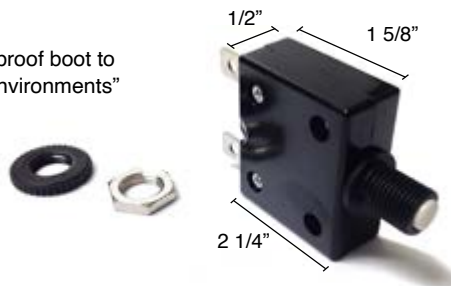

PART #	AMP RATING	COLOR
CB41100	3	WHITE
CB41200**	5	WHITE
CB41210	10	WHITE
CB41220**	15	WHITE
CB41230**	20	WHITE
CB41210B**	10	BLACK



CB41250
25A
BLUE SEA# 7058



CB41260
30A
BLUE SEA# 7059



CB41270
45A
BLUE SEA# 7061

STD TOGGLE CIRCUIT BREAKERS

- Compatible with AC and DC circuits
- Exact OEM replacement for many top brands
- Hydraulic-magnetic trip mechanism will not trip by surges caused by start-up currents.
- Standard safety 'Trip Free' feature so switch cannot be held 'ON'."



PART #	AMP RATING	COLOR	POLE	BLUE SEA#
CB50400	5	BLACK	SINGLE	7200
CB50410	10	BLACK	SINGLE	7204
CB50420	25	BLACK	SINGLE	7216
CB50430	25	WHITE	SINGLE	7218
CB50440	404	BLACK	SINGLE	7224
CB50450	50	BLACK	SINGLE	7228
CB50460	30	WHITE	DOUBLE	7238
CB50470	50	WHITE	DOUBLE	7242

FLAT ROCKER CIRCUIT BREAKERS

- Compatible with AC and DC circuits
- Exact OEM replacement for many top brands
- Hydraulic-magnetic trip mechanism will not trip by surges caused by start-up currents.
- Standard safety 'Trip Free' feature so switch cannot be held 'ON'.



PART #	AMP RATING	POLE	BLUE SEA#
CB50300	5	SINGLE	7540
CB50310	10	SINGLE	7541
CB50320	15	SINGLE	7542
CB50480	20	SINGLE	7543
CB50330	30	SINGLE	7545
CB50500	30	DOUBLE	7560
CB50340	50	SINGLE	7546
CB50490	50	DOUBLE	7561
CB50350	60	SINGLE	7547
CB50360	80	SINGLE	7548
CB50370	100	SINGLE	7549
CB50380	150	DOUBLE	7475
CB50390	200	DOUBLE	7476
CB50510	100	DOUBLE	7564

FLUSH/PANEL MOUNT CIRCUIT BREAKERS

- 1/4" Stainless Steel Studs on the face of the circuit breaker for easy installation
- Connected terminal boots
- Combined use as a switch and circuit protection
- Standard safety 'Trip Free' feature so switch cannot be held 'ON'
- Ignition protected design for safe use in below deck boat applications



PART #	AMP RATING	MOUNT	BLUE SEA#
CB50520	25	FLUSH	7180
CB50530	30	FLUSH	7181
CB50540	40	FLUSH	7182
CB50550	50	FLUSH	7183
CB50560	80	FLUSH	7186
CB50570	100	FLUSH	7187
CB50580	135	FLUSH	-
CB50590	150	FLUSH	7189
CB50600	200	FLUSH	-
CB50610	40	PANEL	7082
CB50620	50	PANEL	7083
CB50630	60	PANEL	7084
CB50640	80	PANEL	7086
CB50650	100	PANEL	7087
CB50660	150	PANEL	7089
CB50670	200	PANEL	-



- CB60000-1****
CB60002-1 (std. pk of 25)
- Ignition Protected
 - Waterproof
 - Can be used as switch and circuit breaker
 - Replaces Minnkota MKR-19
 - Rated - 60 A
 - Maximum voltage 42 VDC
 - Stainless steel hardware

Sierra's NMEA 2000 series of waterproof cables and adapters are NMEA approved and specifically designed to fit marine requirements. Our NMEA series cables follow the requirements of a serial data communication network to interconnect marine electronic equipment on vessels.

- Rated to IPX7 for reliable, water-tight connections
- Premium metal connection collars ensure connections are tight and secure
- Interchangeable with other NMEA 2000 products
- Terminals built with gold-plated copper alloy for superior conductivity



Part No.	Kit Type	Product Description	Replaces Ancor
PC51200	Kit to create a single device NMEA 2000 Network	Sierra's NMEA 2000 series of waterproof cables and adapters are NMEA approved and specifically designed to fit marine requirements. Our NMEA series follow the requirements of a serial data communication network to interconnect marine electronic equipment	270201
PC51210	Kit to create a dual device NMEA 2000 Network	Sierra's NMEA 2000 series of waterproof cables and adapters are NMEA approved and specifically designed to fit marine requirements. Our NMEA series follow the requirements of a serial data communication network to interconnect marine electronic equipment	270202
PC51230	Kit to create multiple device NMEA 2000 Network	Sierra's NMEA 2000 series of waterproof cables and adapters are NMEA approved and specifically designed to fit marine requirements. Our NMEA series follow the requirements of a serial data communication network to interconnect marine electronic equipment	-



**PC51180
NMEA 2000 HUB**

Sierra's NMEA 2000 series of waterproof cables and adapters are NMEA approved and specifically designed to fit marine requirements. Our NMEA series follow the requirements of a serial data communication network to interconnect marine electronic equipment on vessels. Equipment designed to this system will have the ability to share data, including commands and status with other compatible equipment over a single channel. From fish finders to deep sea vessels autopilot, you can always find suitable products for your devices' usage with Sierra!

**18-99606
33 CFR WATER
SENSOR PROBE**

Water accumulation in fuel is extremely hard on fuel systems which is why many boats employ a fuel water separator to ensure clean, moisture-free fuel is delivered to the engine. However, especially on metal drain bowl systems, it is impossible to know when water has built up unless a water detection sensor is installed. Sierra is now offering solutions for water in fuel detection. Use With 18-7924, 18-7988, & 18-99203 Collection Bowls

- Features 1/2"-20 UNF threads
 - Stainless Steel body for use in below deck applications
 - Includes 3-pin Deutsch adapter harness
- Replaces: Racor® RK23191-01



**18-99607
WATER-IN-FUEL
NMEA 2000 MODULE**

The WIF to N2K is a simplified, compact water-in-fuel sensor to NMEA 2000 plug in converter module. It monitors the water-in-fuel sensor on your marine diesel filters through the NMEA 2000 network and shows an alert on your multifunction display. Works on all MFD's with water-in-fuel programming installed. Compatible with R3 Digital Gauge Touch Screen Display.



**18-99608
WATER-IN-FUEL
NMEA 2000 MODULE
AND SENSOR KIT**

The WIF to N2K is a simplified, compact water-in-fuel sensor to NMEA 2000 plug in converter module. It monitors the water-in-fuel sensor on your marine diesel filters through the NMEA 2000 network and shows an alert on your multifunction display. Works on all MFD's with water-in-fuel programming installed. Includes 18-99606 Water-in-Fuel, Fire-rated Sensor that works with all 1/2"-20 UNF threads. Compatible with R3 Digital Gauge Touch Screen Display.



Sierra's NMEA 2000 series of waterproof cables and adapters are NMEA approved and specifically designed to fit marine requirements. Our NMEA series follow the requirements of a serial data communication network to interconnect marine electronic equipment on vessels. Equipment designed to this system will have the ability to share data, including commands and status with other compatible equipment over a single channel. From fish finders to deep sea vessels autopilot, you can always find suitable products for your devices' usage with Sierra!

2000 EXTENSION CABLES MICRO-C HI-POWER (METAL)

PART #	SIZE	BULK #	ANCOR#
PC51000	2'	PC51002	270001
PC51010	3'	PC51012	-
PC51020	6'	PC51022	270002
PC51030	12'	PC51032	270005
PC51040	30'	PC51042	270010

2000 DROP CABLES MICRO-C (METAL)

PART #	SIZE	BULK #	ANCOR#
PC51140	2'	PC51142	270300
PC51150	3'	PC51152	270301
PC51160	6'	PC51162	270302
PC51170	16'	PC51172	270305



PC51050
PC51052 (Bulk)
NMEA 2000 POWER T CABLE
ANCOR# 270000
• 3 ft.
• Metal



PC51060
PC51062 (Bulk)
NMEA MICRO 1 T PIECE
ANCOR# 270101
• Metal



PC51070
PC51072 (Bulk)
NMEA 2000 TERMINATION RESISTOR
ANCOR# 270105
• Female
• Metal



PC51080
PC51082 (Bulk)
NMEA 2000 TERMINATION RESISTOR
ANCOR# 270106
• Male
• Metal



PC51090
PC51092 (Bulk)
NMEA MICRO 90 ELBOW
ANCOR# 270108
• Metal



PC51100
PC51102 (Bulk)
NMEA MICRO 2 TEE PIECE
ANCOR# 270103
• Metal



PC51110
PC51112 (Bulk)
NMEA MICRO 4 T PIECE
ANCOR# 270104
• Male
• Metal



PC51120
PC51122 (Bulk)
M12 METAL CAP FOR FEMALE CONN
ANCOR# 270112
• Female



PC51130
PC51132 (Bulk)
M12 METAL CAP FOR CONN
ANCOR# 270111
• Male



MP41400**
COMPLETE AUDIBLE WARNING KIT
 Contains:
OP22900** Oil pressure switch 6 PSI (1/8" - 27) normal closed
TS25101 Temperature switch (3/8" - 18)
MC33502 Buzzer switch
OP22891 Optional oil pressure switch 15 PSI (1/8" - 27) normal closed
 Buzzer alerts operator of high engine temperatures or low engine oil pressure. Kit includes instructions, oil pressure switch (set at 6 PSI) and temperature switch (set at 200° F).



MP39210**
WEATHER PROOF BOOT NUT
 • Seals out dirt and moisture
 • For use with push button resettable circuit breakers

4 POLE FLAT CONNECTORS

Shrouded connectors provide better protection against weather dirt and moisture. Unshrouded connectors are found on most OEM trailers. The plugs are interchangeable and can connect together.

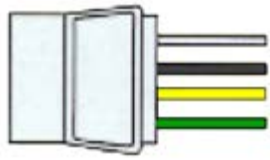

White Ground
Brown Tail, License, Marker Lamps
Yellow Left Turn Signal/Stop Lamp
Green Right Turn Signal/Stop Lamp

** Display Packaged

UNSHROUDED



SHROUDED

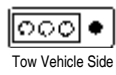

DESCRIPTION	SET OF BOTH HALVES PART #	TOW VEHICLE SIDE PART #	WIRE LENGTH	TRAILER SIDE PART NUMBER	WIRE LENGTH
4 Pole Flat - Unshrouded	TC43654**	NSS	4-12"	TC44054**	4-12"
4 Pole Flat - Unshrouded		TC44094	3-48", 1-18"	TC44054**	4-12"
4 Pole Flat - Shrouded			4-12"	TC44254	4-12"
4 Pole Flat - Shrouded		TC44224	3-48", 1-18"	TC44254	4-12"
4 Pole Flat - Shrouded rewire kit	TC43754	TC44224	3-48", 1-18"	NSS	4-20'
4 Pole Flat - Shrouded rewire kit w/ Splicers	TC43744	TC44224	3-48", 1-18"	NSS	4-20'
4 Pole Flat - Shrouded 5' Extension Harness	WH10350				
4 Pole Flat - Shrouded 25' rewire kit				WH10003	4-25'

5 POLE FLAT CONNECTORS

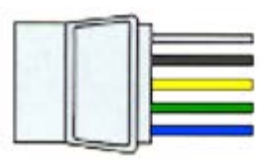

White Ground
Brown Tail, License, Marker Lamps
Yellow Left Turn Signal/Stop Lamp
Green Right Turn Signal/Stop Lamp
Blue Trailer Brake Solenoid

** Display Packaged



DESCRIPTION	SET OF BOTH HALVES PART #	TOW VEHICLE SIDE PART #	WIRE LENGTH	TRAILER SIDE PART NUMBER	WIRE LENGTH
5 Pole Flat - Unshrouded 18" Extension Harness	TC51000**				
5 Pole Flat - Unshrouded		TC51100	5-48"	N/A	5-70"

POLARIZED CONNECTORS

These polarized connector sets plug together only one way to prevent cross connections. Constructed of rugged plastic with molded-in terminals for durability. Wire connections are easy and fast with just a screwdriver. Soft, pliable rubber caps protect the rear of each connector. Dozens of uses. Sold only in mating pairs.



TC43604**
2 Pole Polarized Round

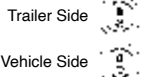

TC43624
4 Pole Polarized Round

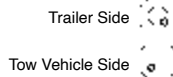

TC43634**
2 Pole Polarized - Flat with 12" wires on each half.

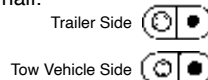

2-WIRE FLAT CONNECTOR
WH10300**
12", 16 GA, 2 Plugs
Ready Wired #E301120
WH10310
60", 16 GA, 2 Plugs
Ready-Wired #E302120

HEAVY DUTY CONNECTORS

TC44984**
7 Pole (Blade) RV Style Thermoplastic Converter Kit
This kit is used on tow vehicle to convert any Sierra standard 4 pole flat connector to a 7 pole blade connector used on RV's.



Tow Vehicle Side



ELECTRONIC TAILLIGHT CONVERTERS

These reliable electronic devices enable tow vehicles and trailers with mismatched light systems to work together.

TC43504

Amber/Red to Red Taillight Converter
Universal SPLICE-IN trailer converter for cars and trucks with separate stop and turn signals. Electronic taillight module converts tow vehicle's amber turn signal and red brake light into one combined red brake/turn signal on your trailer.



TC43944
7 Pole RV Style Connector

Trailer Side



ADAPTERS

These adapters allow a tow vehicle with a 4, 6 or 7 pole socket to tow a trailer with a different configuration plug. Quality molded plastic connector stores in glove box when not in use.



TC50000**
7 Pole RV Style Blade

to 5 pole flat - 18" extension harness



TC51300**
7 Pole RV Style Blade

to 5 pole flat



TC42834
7 POLE RV STYLE BLADE

to 6 Pole Pin



TC42894
4 POLE ROUND

to 4 Pole Flat



TC42904
6 POLE ROUND

to 4 Pole Flat

TROLLING MOTOR PLUGS



WH10600-1**
WH10602-1 (PKG OF 100)
 V-GROOVE FEMALE MOTOR
 SIDE TROLLING MOTOR
 SOCKET
 12 Volt
 6" - 8 gauge w/ butt connectors
 Use with WH10610-1



WH10610-1**
WH10612-1 (PKG OF 100)
 V-GROOVE MALE BOAT SIDE
 TROLLING MOTOR PLUG
 12 Volt
 6" - 8 gauge w/ butt connectors
 Use with WH10600-1



WH10520-1**
WH10522 (PKG OF 100)
 MALE BOAT SIDE
 TROLLING MOTOR PLUG
 12 Volt
 6" - 8 gauge w/ butt connectors
 Use with WH10530-1



WH10530-1**
WH10532 (PKG OF 100)
 FEMALE MOTOR SIDE
 TROLLING MOTOR SOCKET
 12 Volt
 6" - 8 gauge w/ butt connectors
 Use with WH10520-1



WH10540-1**
WH10542 (PKG OF 100)
 MALE BOAT SIDE
 TROLLING MOTOR PLUG
 24 Volt
 6" - 8 gauge w/ butt connectors
 Use with WH10550-1



WH10550-1**
WH10552 (PKG OF 100)
 FEMALE MOTOR SIDE
 TROLLING MOTOR SOCKET
 24 Volt
 6" - 8 gauge w/ butt connectors
 Use with WH10540-1



WH10470-1**
WH10472 (PKG OF 100)
 FEMALE BOAT SIDE
 TROLLING MOTOR SOCKET
 12 Volt
 6" - 10 gauge w/ butt connectors
 Use with WH10480-1



WH10480-1**
WH10482 (PKG OF 100)
 MALE MOTOR SIDE
 TROLLING MOTOR PLUG
 12 Volt
 6" - 10 gauge w/ butt connectors
 Use With WH10470-1



WH10490-1**
WH10492 (PKG OF 100)
 FEMALE BOAT SIDE
 TROLLING MOTOR SOCKET
 24 Volt
 6" - 10 gauge w/ butt connectors
 Use with WH10500-1



WH10500-1**
WH10502 (PKG OF 100)
 MALE MOTOR SIDE
 TROLLING MOTOR PLUG
 24 Volt
 6" - 10 gauge w/ butt connectors
 Use with WH10490-1



WH10560**
 FEMALE BOAT SIDE
 TROLLING MOTOR SOCKET
 12 Volt • 3 Slots
 10" - 10 gauge w/ butt connectors
 Use with WH10570



WH10570**
 MALE MOTOR SIDE
 TROLLING MOTOR PLUG
 12 Volt • 3 Plugs
 10" - 10 gauge w/ butt connectors
 Use with WH10560



WH10640**
 MALE BOAT SIDE
 TROLLING MOTOR PLUG
 24 Volt • 60 AMP
 Use with WH10650



WH10650**
 FEMALE MOTOR SIDE
 TROLLING MOTOR SOCKET
 24 Volt • 60 AMP
 Use with WH10640

TROLLING MOTOR PLUGS



WH10620
TROLLING MOTOR PLUG AND RECEPTACLE SET

For 2 or 3-wire configurations of: 12V, 24V, 12/24V, 24/36V, or 36V Systems;

- Water-tight sealing cap and O-ring seal;
- Corrosion resistant, plated-brass electrical components;
- Standard 1 1/8" diameter mounting hole for easy installation;
- Mounting plate and locking ring for front and rear access installation;

- Easily replaces other trolling motor receptacles;
- Can be used for many other DC applications;
- Max amp rating of 62A @ 36VDC when used with Sierra WH10620P Plug
- Accepts 16 to 6 AWG wire without the need of an expensive adapter



WH10620P
TROLLING MOTOR PLUG



WH10620R
TROLLING MOTOR RECEPTACLE

TRAILER ACCESSORIES



CARSIDE CONNECTORS

WH10040
48", 16 GA 4/Pole
Ready-Wired #B240010

WH10230**
48", 16GA 5/Pole
Ready-Wired #M242010



TRAILER SIDE CONNECTORS

WH10220
TRAILER SIDE CONNECTOR
24", 16 GA, 4/Pole
Ready-Wired #M241120



WH10240**
24", 16 GA 5/Pole
Ready-Wired #M243120
Use with WH10230

VOLTAGE SENSITIVE RELAY



BS11040**
BS11042 (BULK)
VOLTAGE SENSITIVE RELAY
REPLACES: BLUE SEA 7601

Automatically combines two batteries when charging and isolates the two batteries when not charging. Built-in LED indication when VSR is engaged. Port for remote LED indicating VSR status. CE and IP67 Certifications

- Specifications
- 12VDC Nominal Voltage
 - 13.3VDC Combine Voltage
 - 12.8VDC Open Voltage
 - 125A Continuous Current Rating
 - 140A Intermittent Current Rating
 - Power Consumption: 10mA (Standby)/330mA (Engage), 0mA (Storage Mode)



BS11050**
BS11052 (BULK)
VOLTAGE SENSITIVE RELAY AND CABLE KIT

- Includes
- 1x VSR with mounting screws
 - 1x 6 Meter red cable terminated at both ends
 - 2x Positive marine battery terminals
 - 1x Negative marine battery terminal
 - 2x Copper crimp lugs for red cable
 - 1x Copper crimp lugs for black cable
 - 2x Red heat shrink
 - 1x Insulated blue ring terminal
 - 6x 200mm cables ties
 - 1x Instruction Manual

LEVER / BATTERY SWITCHES



MP38910
LEVER OPERATED BATTERY DISCONNECT SWITCH

Rated 175 A continuous, 800 A intermittent

- 3/8" brass terminals
- Chrome Plated Brass Lever
- Includes faceplate



UN77310**
BATTERY SWITCH

Polyester housing is rust and corrosion proof. Removable plastic key for security. Two position switch "Off-On". Two 10MM X 1.5MM stud terminals. For panels up to 1.25 thick. Four mounting holes in a rectangle 1.3" and .8" on centers. 350 amp continuous rating. 500 amp intermittent rating.

LEVER / BATTERY SWITCHES (CONTINUED)



BS11000**
BS11002 (BULK)
 BATTERY SWITCH
 REPLACES: BLUE SEA 6006

M4x35 Mounting Screws (Qty: 4) Included
 Meets Ignition Protection Standard (ISO8846/ SAE J1171), IP66 Rated

- On-Off Function
- 48VDC Maximum Voltage Rating
- M10 Stud Size
- 1250A Cranking Rating (10 Seconds)
- 455A Intermittent Rating (5 Minutes)
- 275A Continuous Rating
- 1 Battery Input
- 2 Switch Positions
- Tin-plated Copper Battery Studs
- 4/0 AWG Cable Size to Meet Ratings
- Tinned Copper Studs
- 120 lb-in Stud Torque



BS11010**
BS11012 (BULK)
 BATTERY SWITCH W/ AFD



BS11020**
BS11022 (BULK)
 BATTERY SWITCH
 (1-2-BOTH-OFF)
 REPLACES: BLUE SEA 6007

M4x35 Mounting Screws (Qty: 4) Included
 Meets Ignition Protection Standard (ISO8846/ SAE J1171), IP66 Rated

- 1-2-Both-Off Function
- 48VDC Maximum Voltage Rating
- M8 Stud Size
- 1000A Cranking Rating (10 Seconds)
- 300A Intermittent Rating (5 Minutes)
- 200A Continuous Rating
- 1 Battery Input
- 4 Switch Positions
- Tin-Plated Battery Studs
- 4/0 AWG Cable Size to Meet Ratings
- Tinned Copper Studs
- 120 lb-in Stud Torque



BS11030**
BS11032 (BULK)
 BATTERY SWITCH W/ AFD
 (1-2-BOTH-OFF)

BATTERY ISOLATORS

Sierra battery isolators allow for worry free protection against discharging you start battery along with you house battery. Insures battery isolation without needing to check a switch. Allows two or three batteries to be charged at once. All are negative ground.



18-6851



18-6852



18-6855

PART NO.	DIMENSIONS	BATTERIES	ALTERNATORS	TERMINALS	MAX. OUTPUT
18-6851 ♦	6 1/2" w x 4 1/2" d x 3 1/2" h	3	1	4 - 3/8-16	120 Amp
18-6852 ♦	8" w x 4 1/2" d x 3 1/2" h	2	1	3 - 3/8-16	165 Amp
18-6854 ♦	8" w x 4 1/2" d x 3 1/2" h	3	1	4 - 3/8-16	160 Amp
18-6855 ♠	3 1/4" w x 4 1/2" d x 3 1/2" h	2	1	4-1/4"-18	75 Amp
18-6856 ♠	15" w x 4 1/2" d x 3 1/2" h	2	1	3 - 3/8-16 • 1-1/4"-28	270 Amp

♦ Will not work with Delco CS series alternators

♠ Will work with Delco CS series alternators



18-6854



18-6856

TRAILER BEARINGS

FOR STRAIGHT SPINDLES

18-1105	1" Bearing Kit (BRG #L44643-L44610)
18-1106	1 1/16" Bearing Kit (BRG #L44649-L44610)
18-1107	1 1/4" Bearing Kit (BRG # LM67048-LM67010)

FOR STEP SPINDLES

18-1109	1 1/4" & 3/4" Bearing Kit (BRG #LM67048-LM67010, LM11949-LM11910)
18-1110	1 3/8" & 11/16" Bearing Kit (BRG #L68149-L68111, L44649-L44610)

TRAILER BEARING KITS



TRAILER BEARING SEALS

PART #	DIMENSIONS		
	O.D	SHAFT SIZE	WIDTH
18-1175	1.985	1.125	.467
18-1176	1.985	1.250	.257
18-1178	2.566	1.750	.500



COTTER PINS (PKG. OF 10)

PART #	DIMENSIONS	STD. PKG.
18-1199 ①	1/8" x 2"	10
18-3748 ①	7/64" x 1 1/2"	5
18-3746 ①	1/8" x 1"	10
18-3747 ①	5/32" x 1 1/2"	10

① THIS PRODUCT IS PRICED PER PIECE. TO ORDER PRICED PER PACKAGE, PLEASE ADD A-9 TO THE PART NUMBER.

WATERPROOF TERMINALS



16-14 GAUGE RING TERMINALS

STUD SIZE	WIRE GAUGE	INSUL COLOR	PKG. OF 10
8	16-14	Blue	EC63120
10	16-14	Blue	EC63130
1/4"	16-14	Blue	EC63140
5/16"	16-14	Blue	EC63190
3/8"	16-14	Blue	EC63200

12-10 GAUGE RING TERMINALS

STUD SIZE	WIRE GAUGE	INSUL COLOR	PKG. OF 10
8	12-10	Yellow	EC63720
10	12-10	Yellow	EC63240
1/4"	12-10	Yellow	EC63250
5/16"	12-10	Yellow	EC63260
3/8"	12-10	Yellow	EC63300

WATERPROOF CONNECTORS

22-10 GAUGE BUTT CONNECTORS

WIRE GAUGE	INSUL COLOR	PKG. OF 10	100 PACK BOX
22-18	Red	EC64000	EC64000-100
16-14	Blue	EC64110	EC64110-100
12-10	Yellow	EC64230	EC64230-100



RING TERMINALS

22-18 GAUGE RING TERMINALS

STUD SIZE	WIRE GAUGE	INSUL COLOR	PKG. OF 10	100 PACK BOX PART #
6	22-18	Red	EC04010	EC04010-100
8	22-18	Red	EC04020	EC04020-100
10	22-18	Red	N/A	EC04030-100



16-14 GAUGE RING TERMINALS

STUD SIZE	WIRE GAUGE	INSUL COLOR	PKG. OF 10	100 PACK BOX PART #
8	16-14	Blue	EC04120	EC04120-100
10	16-14	Blue	EC04130	EC04130-100
1/4"	16-14	Blue	EC04140	EC04140-100
5/16"	16-14	Blue	EC04190	EC04190-100
3/8"	16-14	Blue	EC04200	EC04200-100



12-10 GAUGE RING TERMINALS

STUD SIZE	WIRE GAUGE	INSUL COLOR	PKG. OF 10	100 PACK BOX PART #
6	12-10	Yellow	N/A	EC04710-100
8	12-10	Yellow	N/A	EC04720-100
10	12-10	Yellow	EC04240	EC04240-100
1/4"	12-10	Yellow	EC04250	EC04250-100
5/16"	12-10	Yellow	EC04260	EC04260-100
3/8"	12-10	Yellow	EC04300	EC04300-100



QUICK DISCONNECTS, BULLET, BUTT & SPADE TERMINALS

.157 BULLET TERMINALS

WIRE TYPE	WIRE GAUGE	INSUL COLOR	VISUAL PART # / QTY.	PKG. OF 10	100 PACK BOX PART #
FEMALE	22-18	Red	N/A	EC04080	EC04080-100
MALE	22-18	Red	N/A	N/A	EC04070-100
FEMALE	16-14	Blue	N/A	EC04180**	EC04180-100
MALE	16-14	Blue	N/A	EC04170**	EC04170-100
SET	16-14	Blue	EC01570** / 3 SETS	N/A	N/A



SET

SPADE LUG TERMINALS

STUD SIZE	WIRE GAUGE	INSUL COLOR	PKG. OF 10	100 PACK BOX PART #
8	22-18	Red	EC04090	EC04090-100
10	22-18	Red	EC04100	EC04100-100
8	16-14	Blue	EC04210	EC04210-100
10	16-14	Blue	EC04220	EC04220-100



.250 QUICK DISCONNECTS

Wire Type	Gauge	Insul. Color	Pkg. of 10	100 Pack Box Part #
Female	22-18	Red	EC04050	EC04050-100
Female	16-14	Blue	EC04150	EC04150-100
Male	16-14	Blue	N/A	EC04160-100
Female	12-10	Yellow	ec04280	N/A
Fully Insul. Female	16-14	Blue	EC04500	EC04500-100
Fully Insul. Male	16-14	Blue	EC04490	EC04490-100



BUTT CONNECTORS

Wire Gauge	Insul. Color	Pkg. of 10	100 Pack Box Part #
22-18	Red	EC04000**	EC04000-100
16-14	Blue	EC04110**	EC04110-100
12-10	Yellow	EC04230	EC04230-100

SHRINK/PROTECTIVE FLEX TUBING

TYPE	DIA.	VISUAL PACK PART #	QTY	LENGTH
FLEX TUBING	3/8"	EC01620	1	3'
FLEX TUBING	1/2"	EC01630	1	3'
SHRINK TUBE	ASSORT.	EC01750**	7	ASSORT.



NYLON CABLE CLAMPS

DIA.	VISUAL PACK PART #	QTY
5/16"	EC01440	7
3/8"	EC01450	6
1/2"	EC01460	5



CLIPS & LEADS



EC01380



EC01370

ALLIGATOR CLIPS/TEST LEADS

TYPE/SIZE	PKG OF 2
CLIP 2" w/SCREW TERM	EC01370**
CLIP 1-1/4" INSULATED	EC01380**

EC10250**
3/4" TEST CLIPS
50 AMP
Replaces: OMC 390926
(One Pair)





EC09040
DUAL VOLTAGE CIRCUIT TESTER
 Dual bulb tester for testing both 6 and 12 volt circuits. Also can be used to check spark plug wires. This is the most commonly used tester for troubleshooting auto, truck, van and boat wiring. Supplied with ground wire and clip. Packed one per card.



EC01310
TERMINALS & CONNECTORS
 175 of the most popular terminals in a shatterproof nylon box.



EC01350
TERMINALS & CONNECTORS W/CRIMP TOOL
 30 pc. terminal assortment packed with crimp tool/wire cutter. Attractive 5 compartment clamshell fits neatly in tool box or glove compartment.

 Handy for emergencies. Perfect for the do-it-yourselfers.

LOCKS & LATCHES



MP49410-1**
MP49412 (Bulk 100pcs./carton)

- Turn to open mechanism – no finger pull
- Can be locked or left in latch only position
- Totally corrosion resistant
- Black glass reinforced polyester
- Supplied with 2 keys
- 1" hole size - 1" depth
- 3/4" panel thickness



MP49430**
MP49432 (Bulk 100pcs./carton)

- Turn to open mechanism – no finger pull
- Non-Locking version
- Totally corrosion resistant
- Black glass reinforced polyester
- 1" hole size - 1" depth
- 3/4" panel thickness



MP50562 (Bulk 100pcs./carton)

- Black sculpted knob
- Turn to open mechanism – no finger pull
- Can be locked or left in latch only position
- Totally corrosion resistant
- Black glass reinforced polyester
- Supplied with 2 keys
- 1" hole size - 1" depth
- 3/4" panel thickness

LOCKS & LATCHES

CAM LOCKS



Secure lockers, hatches, compartments and drawers. 1001 uses. 5 sizes available.

- 3/4" hole size
- +/- 1/4" offset
- 1 1/4" grip length from center of hole.

SIZE	PART #
3/8" DEPTH	CL49300**
5/8" DEPTH	CL49310 **
7/8" DEPTH	CL49320**
1-1/8" DEPTH	CL49330**
1-1/8" DEPTH	CL52422 (Bulk - 100 pcs.)
1-1/8" DEPTH	CL49330KA**
1-3/8" DEPTH	CL49332 (Bulk - 100 pcs)

LIFT LATCH

Dozens of applications: bait lockers, fish wells, equipment lockers, hatches, storage compartments. Locking and non-locking styles available. Plate/ring are stainless steel. Holes for #8 mounting screws are 1.5" (w) and 1.312" (h) on center. 3/4" hole size.



MP49500 Non-locking hatch lift only. Measures 2.16" x 1.90" x.25"(h)

HEAVY DUTY DOCKING LIGHTS



Protect your boat from damage while docking at night!

- ✗ 30,000 cp. bulb illuminates below the declline. Makes nighttime docking **SAFE & EASY!**
- ✗ Newly-designed housing is **FULLY** sealed! Water cannot enter hull through Docking Light! Old-style O-ring no longer needed to seal hull.
- ✗ **ALIGN & CHANGE** Eyeball from **EXTERIOR** of the hull. Just loosen set screw to align or change Eyeball.
- ✗ **ELIMINATES** the need for access to the rear of the installed Docking Light!
- ✗ New Eyeball **WILL** fit into "old-style" Docking Light housing!
- ✗ New-style housing will fit existing cut-out with only slight modification.
- ✗ Mil-Spec sealed **Waterproof/Dustproof** rocker switch panel included.
- ✗ US Patent #5672004
- ✗ **Intended for Docking Only, Not for Continuous Use.**

DOCKING LIGHTS			
PART #	DESCRIPTION	COLOR	WATTS
95001	12v Marine Docking Light Set - Incandescent Bulb (Set of 2)	White	100
95002	12v Marine Replacement Light for 95001 (bulb w/ eyeball)		
95013	28v Marine Docking Light Set - Incandescent Bulb (Set of 2)	White	50
95004	28v Marine Replacement Light for 95013 (bulb w/ eyeball)		
AUXILIARY LIGHTS			
95011	12v Single Light Kit - Halogen Bulb (Set of 1)	White	100
95026	12v Marine Docking Light Set - Halogen Bulb (bulb w/ eyeball)		
PARTS			
95005	Housing	White	---
95006	Hardware Kit	--	---

POWER POLE REPLACEMENT PUMPS



18-6818
TRIM MOTOR
Replaces:
Power Pole PUMP SPN-F
Fits: Power Pole Sportsman Models



18-6819
TRIM MOTOR
Replaces:
Power Pole PUMP PRO-F
Fits: Power Pole Pro Models

MARINE GRADE USB CHARGER



AP10030 AP10040 AP10050

PART NUMBER	TYPE	ILLUMINATED
AP10030	USB-A	Yes
AP10040	USB-A / USB-C	Yes
AP10050	USB-C	Yes



- EA01000****
USB CHARGER W/ VOLTMETER AND GRAPH DISPLAY
- Fits perfect with Contura rocker switch panels
 - Modern, curved panel design
 - USB Charger and Voltmeter included
 - CE Certified
 - Water-tight mounting gasket included

Dimensions: 114mm x 58mm
 Mounting Depth: 56mm
 Panel Cut-Out: 105mm x 45mm



- EA01010****
12V AUX POWER SOCKET W/ VOLTMETER AND GRAPH DISPLAY
- Socket panel
 - Contura Rocker Switch Panels.
 - Modern, curved panel design
 - IP66 Rated protects against strong water jets
 - CE Certified
 - Water-tight mounting gasket included

Dimensions: 114mm x 58mm
 Mounting Depth: 56mm
 Panel Cut-Out: 105mm x 45mm



- EA01020****
VOLTMETER PANEL, WEATHER RESISTANT
- Weather resistant volt meter panel with 3-digit LED display.
 - Modern, curved panel design
 - Digital volt meter features a 3 digit LED display
 - Backlit label allows for easy readability in darkness
 - Fits perfect with Contura rocker switch panels
 - CE Certified. IP66 Rated

Dimensions: 114 x 54 x 75mm
 Input Range: 2.5-30VDC
 Mounting Depth: 75mm
 Panel Cut-Out 105mm x 45mm



- EA01050****
12VDC AUX POWER SOCKET, ILLUMINATED
- Watertight cap
 - Twist locks system securely locks plug into socket
 - Quick Connect 1/4" Terminals
 - 9-36V 20A Rated
 - Flame retardant Nylon reinforced enclosure
 - 1 1/8" Diameter Cut-Out Dimensions



- EA01100****
12VDC AUX POWER SOCKET, ILLUMINATED, CURVE MOUNT
- Mounted vertically, horizontally, or underneath a dash.
 - Watertight cap
 - Quick Connect 1/4" Terminals
 - 9-36V 20A Rated
 - Flame retardant Nylon reinforced enclosure
 - Surface-Mount allowing easy installation on any surface (no cut-out hole required!)



- EA01040****
BUZZER, STAINLESS STEEL W/ FLASHING LED WARNING
- 80dB warning buzzer with flashing red LED halo
 - IP50 Rated
 - 12VDC Rated



- EA01070****
VOLTMETER, DIGITAL
- Fits a standard 1 1/8" Cutout
 - Compact Size
 - Digital LED 3-digit display
 - Self-powered from DC Voltage being measured
 - Floating decimal point for better resolution below 10V
 - IP67 Rated, Completely Sealed
 - Reverse polarity protection
 - 2-Wire Design



- EA0180****
VOLTMETER, DIGITAL, SWITCH MOUNT
- Fits in standard Contura switch cutout
 - Compact Size
 - Digital LED 3-digit display
 - Self-powered from DC Voltage being measured
 - Floating decimal point for better resolution below 10V
 - IP67 Rated, Completely Sealed
 - Reverse polarity protection
 - 2-Wire Design



- EA01090****
VOLTMETER, DIGITAL, GRAPH DISPLAY
- Battery Level Display around the circumference of the display
 - Fits a standard 1 1/8" Cutout

Voltage Range	Current	Sampling Rate	Resolution
2.5-3.0	< 30mA	20ms	0.01V

AP10070
MARINE GRADE 12V PLUG

- 12VDC Maximum Voltage
 - LED illuminates when power is present
 - Twist-Locking mechanism to keep the plug securely in place
 - Sealing ring designed to keep out moisture in wet environments
 - Built-in strain relief and cord seal for increased longevity
- Replaces: Blue Sea 1010



SOLENOIDS



- BA58003**
- Use as battery isolation switch
 - Steel housing copper contacts
 - 12 Volts insulated
 - Continuous rating: 80 amp @ 12 VDC
 - Intermittent rating: 750 amp make 100 amp break 10 seconds ON 30 minutes OFF



- 18-5840**
- Steel housing copper contacts
 - 12 Volts grounded
 - Continuous rating: 85 amp @ 12 VDC



- BA58020**
- Motor reversing
 - Dynamic braking when both coils are in same electrical state
 - 12/24V DC
 - Intermittent rating: 150A
 - Continuous rating: 75 amp (5 min.)



- BA58010 SOLENOID SWITCH**
- Weather resistant plastic coating
 - Composite mounting bracket
 - 12 V insulated
 - Rated 85 A continuous duty

BATTERY ACCESSORIES

FS46900 TERMINAL ORGANIZER

Battery Terminal Organizers provide an easy DC power distribution point without overloading single battery terminals while also providing versatility and corrosion resistance. Designed to fit most 12V top post batteries and adheres to ABYC 10.8.4.1 and 10.8.3 recommendations.

- 4 x 1/4"-20 Studs and 2 x 5/16"-18 Studs for different wire size connections
- Tin-Plated Copper Bus and Stainless Steel Hardware for maximum conductivity and corrosion resistance

Includes: Organizers for positive and negative terminals all-in-one convenient retail package. Fits Group 24-31 Series Batteries



BT44440 NEGATIVE BATTERY TERMINAL

BT44450 POSITIVE BATTERY TERMINAL



Plated-Lead design and plated nut provides maximum conductivity and corrosion resistance; Terminal stud bolts to battery cable lug allowing for quick, easy removal of battery; Conforms to ABYC standards for any size battery cable connection.

- Batt Stud Size:
- 5/16" Negative
 - 3/8" Positive



BT44430 LEAD UNIVERSAL BATTERY TERMINAL



BATTERY CABLES
Gauge cable with soldered lug terminals on each end to accept a 3/8" stud.

PART #	SIZE	COLOR	GAUGE	PART #	SIZE	COLOR	GAUGE
BC88523	2'	RED	4	BC88563	6'	RED	2
BC88533	2'	BLACK	4	BC88573	6'	BLACK	2
BC88543	4'	RED	2	BC88583	8'	RED	1
BC88553	4'	BLACK	2	BC88593	8'	BLACK	1

MISCELLANEOUS ACCESSORIES

- Total current of 3.15A delivers fast charging times even in extreme temperatures
- Designed to charge tablets, e-readers, mobiles, gaming devices, cameras, and many other compatible devices
- Integrated over-current and thermal overload protection to safeguard electronics
- Center Green LED indicated charging status

- Fits industry standard 1.45" x 0.83" panel cutout for effortless installation
- Curved access doors for stylish look
- Sealed up to IP65 for above-panel components
- Panel seal prevents water ingress beneath panel to protect critical connections
- Designed for 12V and 24V operation"



AP10010**
DUAL PORT USB 2.0 CHARGER CURVED DOOR



AP10020**
DUAL PORT USB 2.0 CHARGER SQUARE DOOR

SHORE POWER CORDSETS

New



- 30A, 125VAC Rated
- Watertight plug assembly for safety and overall durability
- Heavy-duty, marine-grade 10/3 STW cable
- Strand Count: 41
- Nominal Diameter: 0.669"

- PVC Cord Jacket
- Plug Body: Nylon
- Jacket Rating: STW 600V @ 60°C
- Standard threaded

Part No	Replaces	Length	Strand Count	Amps	Rated
AC12340	199116	12'	41	30	125VAC
AC12350	199117	25'	41	30	125VAC
AC12360	199120	50'	41	30	125VAC
AC12370	6152SPP-25	25'	104	50	125/250VAC
AC12380	6152SPP	50'	104	50	125/250VAC

PLUGS AND INLETS



New

- AC12390**
AC INLET WITH 16" EXTENSION CORD
- Use as a pass-thru 15A 125VAC connection
 - Press-fit, watertight rubber cap and rubber gasket protects from water intrusion
 - 16-inch extension cord provides enough length to conveniently reach component plugs
 - Heavy duty wire for superior performance
 - Simple installation requiring only a 2" hole saw and a phillips screw driver

Cable Specs:
Conductor Size: 14 AWG
Conductors: 3
Input: 5-15P
Output: 5-15R
Cord Length: 16"
Max Amperage: 15A
Max Voltage: 125VAC
ETL Listed



New

- AC12400**
AC INLET WITH 6' EXTENSION CORD
- Use as a pass-thru 15A 125VAC connection
 - Press-fit, watertight rubber cap and rubber gasket protects from water intrusion
 - 6-foot extension cord provides enough length to conveniently reach component plugs
 - Heavy duty wire for superior performance
 - Simple installation requiring only a 2" hole saw and a phillips screw driver

Cable Specs:
Conductor Size: 14 AWG
Conductors: 3
Input: 5-15P
Output: 5-15R
Cord Length: 6'
Max Amperage: 15A
Max Voltage: 125VAC
ETL Listed



New

- AC12410**
AC INLET WITH 12' EXTENSION CORD
- Use as a pass-thru 15A 125VAC connection
 - Press-fit, watertight rubber cap and rubber gasket protects from water intrusion
 - 12-foot extension cord provides enough length to conveniently reach component plugs
 - Heavy duty wire for superior performance
 - Simple installation requiring only a 2" hole saw and a phillips screw driver

Cable Specs:
Conductor Size: 14 AWG
Conductors: 3
Input: 5-15P
Output: 5-15R
Cord Length: 12'
Max Amperage: 15A
Max Voltage: 125VAC
ETL Listed



New

- AC12420**
AC INLET WITH TWIN 18" EXTENSION CORD
- Use as a pass-thru 15A 125VAC connection to twin AC out cables
 - Press-fit, watertight rubber cap and rubber gasket protects from water intrusion J47
 - (2) 18-inch extension cords provide enough length to conveniently reach component plugs
 - Heavy duty wire for superior performance
 - Simple installation requiring only a 2" hole saw and a phillips screw driver

Cable Specs:
Conductor Size: 14 AWG
Conductors: 3
Input: 5-15P
Output: 5-15R
Cord Length: 18"
Cords: 2
Max Amperage: 15A
Max Voltage: 125VAC
ETL Listed

ADAPTERS AND Y ADAPTERS



New

- AC12430**
Y ADAPTER, 50A 125/250V (SS2-50P) MALE TO (2) 30A 125V FEMALES (L5-30R)
- 50A 125/250V Male Locking to (2) 30A 125V Female Locking Adapters
- Max Amperage: 50A
 - Max Voltage: 250VAC
 - Jacket: PVC
 - Jacket Rating: STW 600VAC @ 60°C
 - Contacts: Nickel-Plated Brass
 - Molded Plugs: Nylon
 - Mechanical Spec: SS2-50P Male to (2) L5-30R Female Twist-Lock
 - ETL Listed



New

- AC12450**
50A 125/250V (SS2-50R) FEMALE TO (2) 30A 125V (L5-30P) MALE SHORE POWER REVERSE "Y" ADAPTER,
- (2) 30A 125V Male Locking to 50A 125V Female Locking Adapters
 - Max Amperage: 30A
 - Max Voltage: 250VAC
 - Jacket: PVC
 - Jacket Rating: STW 600VAC @ 60°C
 - Contacts: Nickel-Plated Brass
 - Molded Plugs: Nylon
 - Mechanical Spec: (2) L5-30P Male to L5-30R Female Twist-Lock



New

- AC12460**
Y ADAPTER, 30A 125V(L5-30P) MALE TO (2) 30A 125V (L5-30R) FEMALES
- 30A 125V Male Locking to (2) 30A 125V Female Locking Adapters
 - Max Amperage: 30A
 - Max Voltage: 125VAC
 - Jacket: PVC
 - Jacket Rating: STW 600VAC @ 60°C
 - Contacts: Nickel-Plated Brass
 - Molded Plugs: Nylon
 - Mechanical Spec: L5-30P Male to (2) L5-30R Female Twist-Lock
 - CSA Listed

ADAPTERS AND Y ADAPTERS (CONTINUED)



NEW

AC12540
15A AC INLET PORT

- 30A, 125VAC rated
- 3-Wire locking design
- Corrosion and UV resistant design
- Convenient sealing cap stays in open position without holding in place
- Rear enclosure keep electrical components covered for maximum safety
- Elegant, premium designed sealing cover
- Easy to install or retrofit older inlets
- UL Listed
- CSA Listed



NEW

AC12520
30A 125V SQUARE WHITE INLET

- 30A, 125VAC rated
- 3-Wire locking design
- Corrosion and UV resistant design
- Convenient sealing cap stays in open position without holding in place
- Rear enclosure keep electrical components covered for maximum safety
- Elegant, premium designed sealing cover
- Easy to install or retrofit older inlets
- UL Listed
- CSA Listed



NEW

AC12530
30A 125V(L5-30R) BLACK LOCKING RECEPTACLE

- 30A, 125VAC rated
- 2-Pole, 3-Wire
- NEMA configuration L5-30R
- Black, reinforced nylon
- Metal components are brass construction
- UL Listed
- CSA Certified



NEW

AC12500
PIGTAIL ADAPTER, 30A 125V (L5-30P) MALE TO 50A 125/250V (SS2-50R) FEMALE

- Use to connect a 30A 125VAC Male dock side connector to a 50A 125/250VAC Boat side Female Inlet
- Max Amperage: 30A
- Max Voltage: 125VAC
- Cable Size: 10 AWG
- Conductors: 3
- Jacket: PVC
- Jacket Rating: STW 600VAC @ 60°C
- Contacts: Nickel-Plated Brass
- Molded Plugs: Nylon
- Mechanical Spec: L5-30P Male to SS2-50R Female Twist-Lock
- CSA Listed



NEW

AC12440
PIGTAIL ADAPTER, 50A 125/250V (SS2-50P) MALE TO 30A 125V (L5-30R) FEMALE

- Use to connect a 50A 125/250VAC Male Dockside connector to a 30A 125V Female Boatside Inlet
- Max Amperage: 30A
- Max Voltage: 250VAC
- Jacket: PVC
- Jacket Rating: STW 600VAC @ 60°C
- Contacts: Nickel-Plated Brass
- Molded Plugs: Nylon
- Mechanical Spec: SS2-50P Male to L5-30R Female Twist-Lock
- CSA Listed



NEW

AC12510
PIGTAIL ADAPTER, 30A 125V (L5-30P) MALE TO 15A 125V (5-15R) FEMALE

- Use to connect a 30A 125VAC Male dock side connector to a 15A 125VAC Boatside Female Inlet
- Max Amperage: 15A
- Max Voltage: 125VAC
- Cable Size: 10 AWG
- Conductors: 3
- Jacket: PVC
- Jacket Rating: STW 600VAC @ 60°C
- Contacts: Nickel-Plated Brass
- Molded Plugs: Nylon
- Mechanical Spec: 5-15P Male to L5-30R Female Twist-Lock
- CSA Listed



NEW

AC12480
PIGTAIL ADAPTER, 15A 125V (5-15P) MALE STRAIGHT BLADE TO 30A 125V (L5-30R) FEMALE LOCKING

- Use to connect a 15A 125VAC Male Straight Blade Dockside connector to a 30A 125VAC Female Locking Boatside Inlet
- Max Amperage: 15A
- Max Voltage: 125VAC
- Cable Size: 10 AWG
- Conductors: 3
- Jacket: PVC
- Jacket Rating: STW 600VAC @ 60°C
- Contacts: Nickel-Plated Brass
- Molded Plugs: Nylon
- Mechanical Spec: 5-15P Male to L5-30R Female Twist-Lock
- CSA Listed



NEW

AC12490
FEMALE CONNECTOR, 30A 125V L5-30R

- 30A, 125VAC rated
- NEMA L5-30R Configuration
- Marine-Grade, Heavy-Duty Construction
- Ribbed outer casing for superior grip
- Water-proof seal keeps out moisture and contaminants
- Strain relief secures cord in place with stainless steel hardware
- UL Listed
- CSA Listed



NEW

AC12470
FEMALE CONNECTOR, 50A 125/250V SS2-50R

- 50A, 125VAC rated
- NEMA SS-2 Configuration
- Marine-Grade, Heavy-Duty Construction
- Ribbed outer casing for superior grip
- Water-proof seal keeps out moisture and contaminants
- Strain relief secures cord in place with stainless steel hardware
- UL Listed
- CSA Listed

SIERRA[®]

PARTS THAT KEEP YOU MOVING



Shield Hoses

Each Shields hose is designed for a specific application and meets strict standards set by the USCG, ABYC and other regulatory agencies.

Four of our marine exhaust hoses have qualified for Lloyd's Register Type Approval, meeting the highest standards of production quality..

Product Application Guide

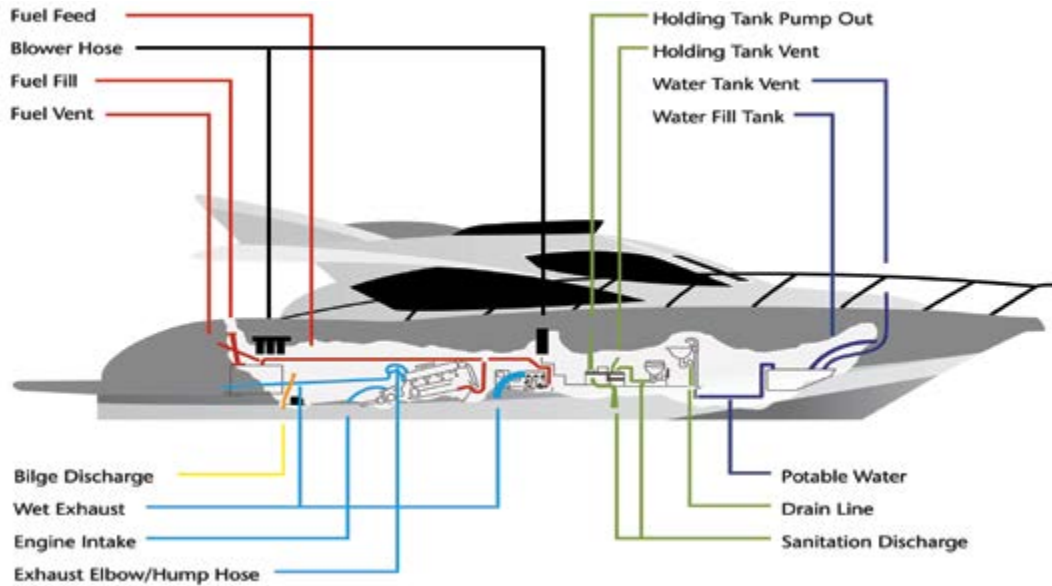

PRODUCT APPLICATION GUIDE KEY

- | | |
|--|--|
| EX — Designed to give excellent service | NA — Not available in size range |
| G — Designed to give good service in normal applications | 1 — Can easily be bent into tight radius |
| C — Product can give good service with proper installation, may not be suitable in all applications. | 2 — Can be bent into gradual radius |
| X — Not recommended | 3 — May kink in applications requiring bend radius |

SERIES NO.	NAME	PG. NO.	SIZE RANGE	APPLICATION						
				Submersible Bilge Pump	Remote Bilge Pump	Hand Bilge Pump	Livewell Inlet	Livewell Drain Above Water Line	Livewell Drain Below Water Line	Flexibility
	BILGE/LIVEWELL									
Series 120	Shields Bilgeflex	83	5/8" - 1 1/2"	G	X	C	X	X	X	1
Series 123	Shields Bilgevac	83	3/4" - 1 1/8"	EX	G	EX	X	C	X	1
Series 140	Shields Vac Std.	84	1 1/4" - 1 1/2"	EX	EX	EX	G	G	C	1
Series 141	Shields Multiflex	85	5/8" - 3"	EX	G	EX	X	G	X	1
Series 142	Shields Vac Cuffs	84	1 1/4" - 1 1/2"							
Series 146	Shields Vac Extra Heavy Duty/Commercial Grade	85	5/8" - 3"	EX	EX	EX	EX	EX	EX	2
Series 147	Shields Vac H.D. Cuffs	84	1 1/2"							
Series 148	Shields Vac Extra Heavy Duty	86	5/8" - 1 1/2"	EX	EX	EX	EX	EX	EX	2
Series 149	Shields Livewell Hose	86	5/8" - 1 1/2"	EX	EX	EX	EX	EX	EX	1

SERIES NO.	NAME	PG. NO.	SIZE RANGE	APPLICATION					
	ENGINE HOSE			Engine Intake	Generator Intake	Engine Coolant Hose Straight or Limited Bend	Engine Coolant Hose Severe Bend	Exhaust Water Injection	Flexibility
Series 130	Shields #1300 Heater Hose	87	1/2" - 3/4"	X	X	G	X	X	3
Series 135	Shields #1350 H.D. Water Hose	87	1/2" - 1"	X	C	G	X	G	3
Series 160	Shields #1600 Water Hose	87	3/8" - 1 1/4"	X	G	EX	X	G	2
Series 200	Shields Marine Exhaust	88	1/2" - 14"	X	C	EX	X	G	3
Series 202	Shields Nautiflex Silicone Exhaust Hose	89	1" - 14"	X	X	EX	X	C	3
Series 250	Shieldsflex II	90	1/2" - 8"	EX	EX	EX	EX	EX	2
Series 252	Shieldsaust - C	91	3/4" - 8"	EX	EX	EX	EX	EX	1
Series 254	Shields ExoFlex	81	3/4" - 8"	EX	EX	EX	EX	EX	1
Series 262	Shields Corrugated Nautiflex Silicone Exhaust Hose	92	3/4" - 10"	EX	EX	EX	EX	EX	1
Series 321	Shields Complex All in One Hose	93	5/8" - 2"	EX	EX	EX	EX	EX	2

Product Application Guide (Cont.)

SERIES NO.	NAME	PG. NO.	SIZE RANGE	APPLICATION							
				Non-Pressurized Supply	Pressurized Supply		Water Tank Fill	Drain Lines Below Water Line	Drain Lines To Sump or Above Water Line	Water Tank Vent	Flexibility
					Hot	Cold					
	FRESH WATER SYSTEM/POTABLE										
Series 141	Shields Multiflex	94	5/8" - 3"	C	X	X	EX	X	EX	C	1
Series 148	Shields Vac Extra Heavy Duty	94	5/8" - 1 1/2"	N/A	X	X	EX	EX	EX	EX	2
Series 149	Shields Livewell Hose	95	5/8" - 1 1/2"	X	X	X	X	EX	EX	C	2
Series 150	Shields PVC Tubing — Clear	95	3/16" - 1 1/2"	G	X	X	C	X	G	G	3
Series 162	Shields All Clear Reinforced PVC — Red Tracer	96	3/8" - 1 1/2"	EX	EX	EX	G	G	G	G	2
Series 163	Shields Braided Wash Down Hose	96	5/8"								
Series 164	Shields Clear White Reinforced PVC — Blue Tracer	97	1/2" - 3/4"	EX	G	EX	N/A	G	G	G	3
Series 168	Shields Heavy Duty Reinforced PVC Tubing	97	1/4" - 1 1/2"	EX	EX	EX	G	EX	EX	EX	2

SERIES NO.	NAME	PG. NO.	SIZE RANGE	APPLICATION						
				Oil Tank Fill	Fuel Tank Fill	Fuel Feed Inboard/Outdrive	Fuel Feed Outboard	Fuel Tank Vent Inboard	Fuel Tank Vent Outboard	Flexibility
	FUEL SYSTEM									
Series 309	Shields Oil Tank Fill Hose	98	1 1/2"	EX	X	N/A	N/A	N/A	N/A	1
Series 315	Shields 315 - Silverado 2000	98	3/8" - 5/8"	N/A	N/A	X	EX	C	EX	2
Series 337	Shields Silverado 4000	99	5/16" - 3/8"	N/A	N/A	X	EX	N/A	N/A	1
Series 350	Shields FIRE-ACOL	100	1 5/8" - 2 3/8"	EX	EX	N/A	N/A	N/A	N/A	1
Series 351	Shields FIRE-ACOL-C	100	1 1/2"	EX	EX	N/A	N/A	N/A	N/A	1
Series 355	Shields Fuel Fill	101	1 1/2" - 2"	EX	EX	N/A	N/A	N/A	N/A	1
Series 365	Shields FIRE-ACOL-15	101	3/8" - 1/2"	N/A	N/A	EX	EX	N/A	N/A	1
Series 375	Shields Fire Sleeve	82	3/8"	N/A	N/A	EX	N/A	N/A	N/A	1
Series 368	Shields Low Permeation Marine Fuel Hose	102	1/4" - 1/2"	N/A	N/A	EX	EX	N/A	N/A	1
Series 369	Shields FIRE-ACOL Fuel Vent Hose	102	5/8"	N/A	N/A	X	X	EX	EX	1
Series 321	Shields Complex All in One Hose	103	5/8" - 2"	EX	EX	C	X	EX	X	1
Fuel Accessories	Ferrule Vise / Dies	104	1/4" - 1/2"	For making fuel line assemblies without clamps						
Fuel Accessories	Shields Brackets / Filters / Fuel Line Assemblies	105	-	-	-	-	-	-	-	-

SERIES NO.	NAME	PG. NO.	SIZE RANGE	APPLICATION					
				Toilet to Holding Tank	Holding Tank Pump Out	Holding Tank to Overboard Discharge	Toilet Water Inlet	Holding Tank Vent	Flexibility
	SANITATION SYSTEM								
Series 101	Shields Sanitation Hose	106	1" & 1 1/2"	EX	EX	EX	N/A	N/A	1
Series 105	Shields Poly X Sanitation Hose	106	1" & 1 1/2"	EX	EX	EX	N/A	N/A	1
Fittings	Shields For Series: 101, 105, 144, 148	106	3/4" - 1 1/2"						
Series 144	Shields Super PVC Sanitation	107	1" & 1 1/2"	EX	EX	EX	N/A	N/A	2
Series 146	Shields Vac Extra Heavy Duty/Industrial	107	5/8" - 3"	G	EX	G	EX	EX	2
Series 148	Shields Vac Extra Heavy Duty	108	5/8" - 1 1/2"	G/EX	EX	EX	EX	EX	2
Series 250	Shieldsflex II	109	1/2" - 8"	EX	EX	EX	EX	EX	2
	Shields Sanitation System Cleaners	108	1 Gallon	Cleans contaminants that restrict system performance					

SERIES NO.	NAME	PG. NO.	SIZE RANGE	APPLICATION		
				Blower Hose	A/C Duct	Exhaust Vent Stove Head
	VENTILATION/ AC DUCT					
Series 400	Shields Vinylvent	110	3" - 4"	EX	X	X
Series 402	Shields Vinylvent	110	3" - 4"	EX	X	X
Series 420	Shields Extra Heavy Duty Vinylvent	110	3" - 4"	EX	X	G
Series 450	Shields Fibervent	111	3" - 6"	EX	G	EX
Series 460	Shields AC Ducting Hose	111	3" - 7"	EX	EX	EX

Product Application Guide (Cont.)

SERIES NO.	NAME	PG. NO.	SIZE RANGE	APPLICATION				
				Straight Pipe Connector Less than 4 x I.D. of Hose	Straight Pipe Connector More than 4 x I.D. of Hose	Require Moderate Bend	Severe Bend	Flexibility
	 WET EXHAUST SYSTEM							
Series 200	Shields Marine Exhaust	112	1/2" - 14"	EX	C	X	X	3
Series 202	Nautiflex Silicone Exhaust Hose	113	1" - 14"	EX	C	X	X	3
Series 250	Shieldsflex II	114	1/2" - 8"	EX	EX	EX	C	2
Series 252	Shieldsaust - C	115	3/4" - 8"	EX	EX	EX	EX	1
Series 254	Shields ExoFlex	81	3/4" - 8"	EX	EX	EX	EX	1
Series 262	Corrugated Nautiflex Silicone Exhaust Hose	116	3/4" - 16"	EX	EX	EX	EX	1
Series 321	Shields Complex All in One Hose	117	5/8" - 2"	EX	EX	EX	C	2
Various	Hump Hose & Elbows	118-121	2" - 10"	See our selection for straight or angled connections				

SERIES NO.	NAME	PG. NO.	SIZE RANGE	APPLICATION
	MISCELLANEOUS			
	Exhaust Protector Valves	122	4" - 6"	Prevents water from entering exhaust system
	Hose Clamps	122	5/16" - 7"	Marine grade 316 stainless steel
	Exhaust Hose Clamps - T-Bolt Band Clamps	122	1" - 14"	Designed to fit Shields Series: 200, 201, 210, 250, 252
Series 128	Flame Retardant Split Wire Conduit	123	1/4" - 2"	Provides chafing protection for wiring systems
Series 129	Expandable Braided Sleeving (Scissor Cut)	123	1/2" - 2"	Conduit designed to be cut with scissors
Series 126	Shields Sternflex	124	2"	Provides protection for outboard rigging cables & hose
	Neoprene Sheet Rubber	125	1/8" - 1/4"	Used under fuel tanks to comply with USCG requirements
Series 151	Speedometer Pitot Tubing	125	1/8" - 4mm	Connection from pitot to speedometer
Series 157	LLDPE Tubing	82		Transfer of air and liquids in industrial applications



SHIELDS CODE NUMBERS

All Shields Marine Hoses are identified by a 9 digit code number.

Example:

16-120-0580

The first two digits identify the product as a Shields hose:
16 = Shields Hose

The third three digits identify the size of the hose:
058 = 5/8"

The second three digits identify the type of hose:
120 = Bilgeflex

The last digit identifies the package quantity as follows:

1	6' or 6 1/4' Length
2	9' Length
3	10' Length
4	12 1/2' Length
5	25' Length
6	50' Length
7	100' Length
8	75' Length
0	Standard Bulk Pack
0-xx	Special Bulk Length (Example: 0-36 = 3')

SHIELDS EXOFLEX 254 SERIES MARINE WET EXHAUSE/WATER HOSE



Shields Marine ExoFlex Hose has a EPDM cover and is constructed of synthetic plies with steel wire helices. It is black corrugated material is very flexible with a 1.5" x ID" radius. ExoFlex hose is suitable for delivery of cooling water and exhaust gas. Tighter corrugations allow for optimal clamp locations. The hose is resistant to ozone and abrasions as well as heat and saltwater. This hose is Lloyds approved. The temperature ranges from -22°F – + 212°F with peaks to 239°F. The hose meets SAE J2006 Type 2 standards.

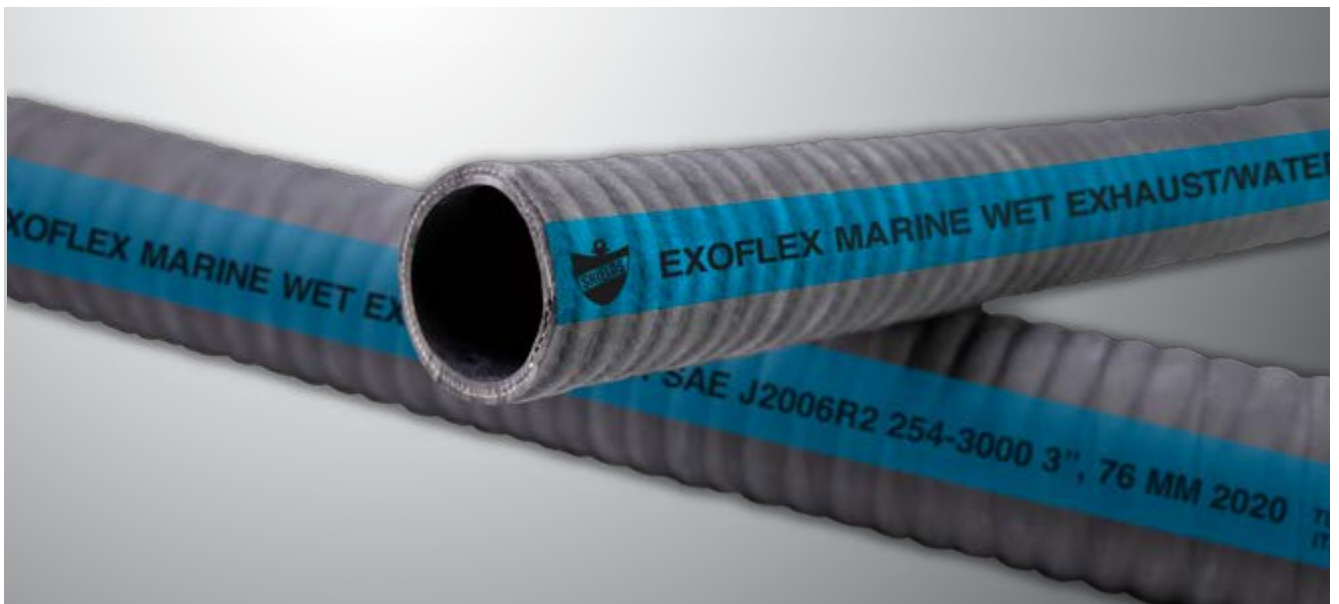

Now double the ozone resistance required by SAEJ2006

I.D.	Bend Radius	50' Coil Code #	12 1/2' Coil Code #	6 1/4' Coil Code #
3/4"	1 1/8"	16-254-0340	16-254-0344	—
1"	1 1/2"	16-254-1000	16-254-1004	16-254-1001
1 1/4"	1 7/8"	16-254-1140	16-254-1144	—
1 1/2"	2 1/4"	16-254-1120	16-254-1124	—
1 5/8"	2 7/16"	16-254-1580	16-254-1584	—
1 3/4"	2 5/8"	16-254-1340	16-254-1344	—
2"	3"	16-254-2000	16-254-2004	16-254-2001
2 1/4"	3 3/8"	16-254-2140	16-254-2144	16-254-2141
2 3/8"	3 9/16"	16-254-2380	16-254-2384	—
2 1/2"	3 3/4"	16-254-2120	16-254-2124	16-254-2121
3"	4 1/2"	16-254-3000	16-254-3004	16-254-3001
3 1/2"	5 1/4"	16-254-3120	16-254-3124	16-254-3121
4"	6"	16-254-4000	16-254-4004	16-254-4001
4 1/2"	6 3/4"	16-254-4120	16-254-4124	16-254-4121
5"	7 1/2"	—	16-254-5004	16-254-5001
6"	9"	16-254-6000	16-254-6004	—
8"	12"	—	16-254-8004	16-254-8001



This certification provides unbiased, third party confirmation worldwide that these Shields hoses meet the highest standards of production quality. Certification ensures the proper level of product safety and inspires user confidence.

SHIELDS FUEL FEED LINE WITH FIRE SLEEVE

Shields Stainless Steel Braided PTFE hose is an ideal choice for marine applications. The Fire Sleeve includes a straight quick connector and fire sleeve. This hose is designed to dissipate any potential static charges for added safety. It is compatible with a wide range of chemicals and additives, and is not affected by heat aging, ozone or UV exposure. Operating temperature ranges from -60°C to +260°C.

CFR 33 USCG Approved. Ultra low Permeation.

I.D.	Length	Code No.
3/8"	36"	16-375-0380-36
3/8"	96"	16-375-0380-96
3/8"	30"	16-375-0380-30



SHIELDS NATURAL LLDPE TUBING

Shields Natural LLDPE Tubing is useful for the transfer of air and liquids in industrial applications such as fiberglass hull production, water and water softener lines and vending equipment. This hose is flexible and lightweight and comes in a natural color. It's linear low-density polyethylene has a superior chemical and moisture resistance. Operating temperature ranges from -50°C to +125°F.

I.D.	Length	Code No.
1/2"	100'	16-157-0120
3/8"	100'	16-157-0380



SHIELDS BILGEFLEX



Shields Bilgeflex Hose is a single layer corrugated polyethylene hose. It is resistant to mild chemicals and salt water and there is a clamping cuff every foot. It is available in black or white (add B or W to suffix to specify color). This hose is primarily used for bilge pump discharge.

Do not attach to thru hull fitting below the water line.



I.D.	mm	Bend Radius	mm	Vac Rating	Wt. "C"	Code # *	Bulk Pack	m	50' (15.2m) R/O Ctn. Code #	Dist. Pkg. 9' (2.7M) Polypac Code #	6' (1.8M) Polypac Code #	25' (7.6M) R/O Ctn.
5/8"	15.9	1/2"	12.7	20	5	16-120-0580	600'	182.9	16-120-0586	16-120-0582	16-120-0581	—
3/4"	19.1	3/4"	19.1	20	6	16-120-0340	500'	152.4	16-120-0346	16-120-0342	16-120-0341	—
1 1/8"	28.6	1"	25.4	20	7	16-120-1180	300'	91.4	16-120-1186	16-120-1182	16-120-1181	—
1 1/4"	31.8	1 1/2"	38.1	20	10	16-120-1140	200'	61.0	16-120-1146	—	—	—
1 1/2"	38.1	2"	50.8	20	13	16-120-1120	150'	45.7	16-120-1126	—	—	16-120-1125

* Add B or W suffix to specify black or white

SHIELDS BILGEVAC



Shields Bilgevac Hose is a black PVC hose with a flexible vinyl helix. It is very flexible, abrasion resistant and is resistant to mild chemicals and saltwater. This hose is primarily used for bilge pump discharge and drains (sinks, shower, scupper, and livewell). Do not attach to thru hull fitting below the water line.

I.D.	mm	Bend Radius	mm	Wt. "C"	Bulk Pack 100' (30.5m) Coil Code #	Dist. Pkg. 50' (15.2m) R/O Ctn. Code #
3/4"	19.1	3/4"	50.8	8	16-123-0340	16-123-0346
1 1/8"	28.6	1"	76.2	16	16-123-1180	16-123-1186



SHIELDS VAC STANDARD

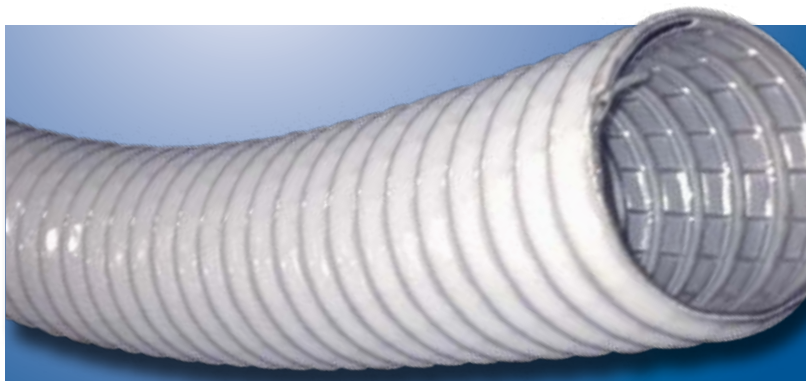

Shields Vac Standard Hose is PVC supported by vinyl covered steel wire and is very flexible. It is Nylon reinforced and is resistant to mild chemicals and saltwater. This hose is primarily used for bilge pump intake and discharge, diaphragm style hand operated bilge pump intake and discharge and drains (sinks, shower, and scupper). This hose uses 142 left hand thread cuffs. **Do not attach to thru hull fitting below the water line.**

I.D.	mm	Bend Radius	mm	Vac Rating	Wt. "C"	Bulk Pack Code #	Dist. Pkg. 50' (15.2m) R/O Ctn. Code#
1 1/4"	31.8	3/4"	19.1	28	19	16-140-1140 ①	16-140-1146
1 1/2"	38.1	3/4"	19.1	28	23	16-140-1120 ①	16-140-1126

① 2 x 50' per box



SHIELDS VAC CUFFS

Shields Vac Cuffs provide added clamping protection for Shields Vac Hose. For watertight seal apply with sealing compound. Use with Series 140 & 141. Glue using PVC cement.

Size	mm	Wt. "C"	Code No.	For:	Thread
1 1/4"	31.8	12.5	16-142-1140	Series 140	Left Hand
1 1/2"	38.1	13.0	16-142-1120	Series 140	Left Hand
1 1/2"	38.1	13.0	16-147-1120	Series 141	Right Hand

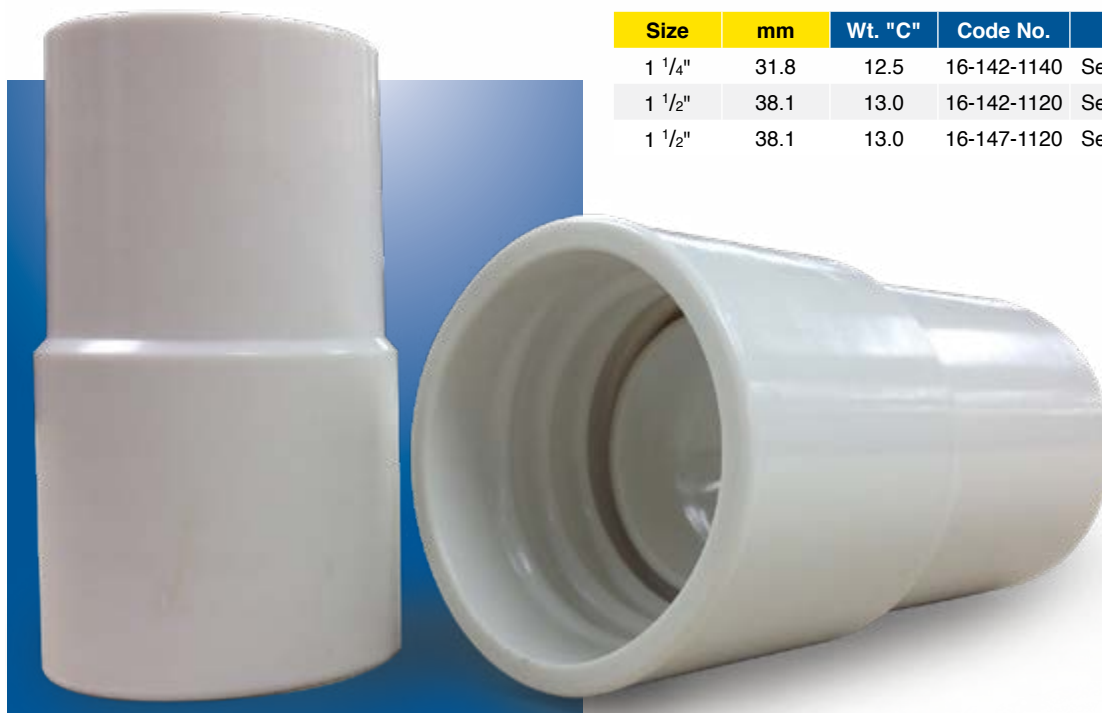

SHIELDS MULTIFLEX



Shields Multiflex Hose has a clear FDA formula PVC with black vinyl helix. It is abrasion resistant, flexible and is resistant to mild chemicals and saltwater. This hose is primarily used for bilge pump discharge, potable water tank fill and drains (sinks, shower, livewell and scupper). This hose uses 147 right hand thread cuffs. **Do not attach to thru hull fitting below the water line. Do not use ethylene glycol based antifreeze in hose.**

I.D.	mm	Bend Radius	mm	Wt. "C"	Bulk Pack 100' (30.5m) Coil Code #	Dist. Pkg. 50' (15.2m) R/O Ctn. Code #	10' (3.1m) Length Code#
5/8"	15.9	1/2"	12.7	8	16-141-0580B	16-141-0586B	—
3/4"	19.1	3/4"	19.1	10	16-141-0340B	16-141-0346B	—
1"	25.4	7/8"	22.2	13	16-141-1000B	16-141-1006B	—
1 1/8"	28.6	1"	25.4	16	16-141-1180B	16-141-1186B	—
1 1/4"	31.8	1 1/2"	38.1	19	16-141-1140B	16-141-1146B	—
1 1/2"	38.1	2"	50.8	24	16-141-1120B	16-141-1126B	—
2"	50.8	5"	127.0	34	16-141-2000B	—	16-141-2003B
1 1/2"	38.1	2"	50.8	24	16-141-1120W	—	16-141-1123W

SHIELDS VAC EXTRA HEAVY DUTY - INDUSTRIAL GRADE



Shields Vac Extra Heavy Duty/Industrial Grade Hose has a smooth cover and clear FDA formula PVC with a white vinyl helix. It is rated for full vacuum and is resistant to mild chemicals and saltwater. This hose is primarily used for bilge pump intake and discharge, potable water tank fill, drains (sinks, shower, and scupper), livewell intake and drain, and sanitation (intake, vent and pump out). This hose is utilized for below the waterline connections. **Do not use ethylene glycol based antifreeze in hose. Do not use in pressurized water systems.**

I.D.	mm	Bend Radius	mm	Vac Rating	Wt. "C"	Bulk Pack 100' (30.5m) Coil Code #	50' (15.2m) R/O Ctn. Code #	Dist. Pkg. 10' (3.1m) Length Code#
5/8"	15.9	3	76.2	28	15	16-146-0580	16-146-0586	—
3/4"	19.1	3	76.2	28	16	16-146-0340	16-146-0346	—
1"	25.4	3	76.2	28	27	16-146-1000	16-146-1006	—
1 1/8"	28.6	4	101.6	28	25	16-146-1180	16-146-1186	—
1 1/4"	31.8	3	76.2	28	30	16-146-1140	16-146-1146	—
1 1/2"	38.1	4	101.6	28	40	16-146-1120	16-146-1126	—
2"	50.8	5	127.0	28	57	16-146-2000	—	16-146-2003
2 1/2"	63.5	7	177.8	28	74	16-146-2120	—	—
3"	76.2	9	228.6	28	94	16-146-3000	—	16-146-3003

SHIELDS VAC EXTRA HEAVY DUTY/FDA

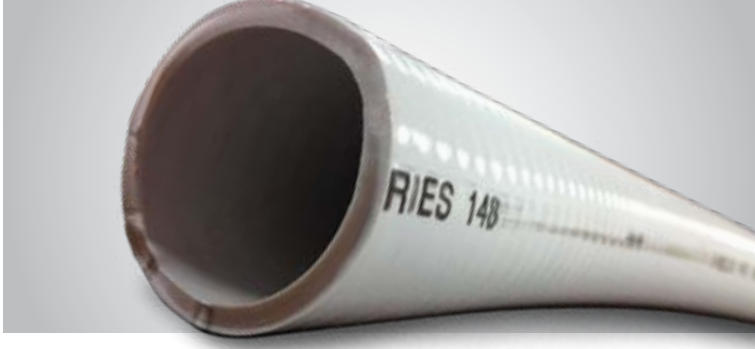

Shields Vac Extra Heavy Duty/FDA Hose has a smooth white FDA grade PVC with vinyl helix. It is rated for full vacuum and is resistant to mild chemicals, permeation, and saltwater. This hose is primarily used for bilge pump intake and discharge, drains (sinks, shower, and scupper), livewell intake and drain, potable water tank fill, and sanitation (toilet to holding tank, intake, self draining lines vent and pump out). This hose is resistant to odor permeation. Do not use ethylene glycol based antifreeze in hose. Do not use in pressurized water systems.

I.D.	mm	Bend Radius	mm	Vac Rating	Wt. "C"	Bulk Pack 100' (30.5m) Coil Code #	Dist. Pkg. 50' (15.2m) R/O Ctn. Code #	25' (7.6m) R/O Ctn. Code #
5/8"	15.9	3	76.2	28	15	16-148-0580W	16-148-0586W	—
3/4"	19.1	3	76.2	28	20	16-148-0340W	16-148-0346W	—
1"	25.4	3	76.2	28	27	16-148-1000W	16-148-1006W ①	—
1 1/8"	28.6	4	101.6	28	29	16-148-1180W	16-148-1186W	—
1 1/4"	31.8	4	101.6	28	31	16-148-1140W	16-148-1146W	—
1 1/2"	38.1	5	127.0	28	40	16-148-1120W	16-148-1126W ①	16-148-1125W

① WARNING: Lines containing raw sewage should be plumbed to be self-draining.

SHIELDS LIVEWELL HOSE



Shields Livewell Hose has a black smooth cover with vinyl helix. It is rated for full vacuum and is resistant to mild chemicals and saltwater. This hose is primarily used for bilge pump intake and discharge, drains (sinks, shower, and scupper), livewell intake and drain, and sanitation (intake and vent). This hose is utilized for below the waterline connections. Do not use ethylene glycol based antifreeze in hose.

I.D.	mm	Bend Radius	mm	Vac Rating	Wt. "C"	Bulk Pack 100' (30.5m) Coil Code #	Dist. Pkg. 50' (15.2m) R/O Ctn. Code #
5/8"	15.9	3	76.2	28	15	16-149-0580	16-149-0586
3/4"	19.1	3	76.2	28	16	16-149-0340	16-149-0346
1"	25.4	3	76.2	28	24	16-149-1000	16-149-1006
1 1/8"	28.6	4	101.6	28	25	16-149-1180	16-149-1186
1 1/4"	31.8	4	101.6	28	28	16-149-1140	16-149-1146
1 1/2"	38.1	5	127.0	28	39	16-149-1120	16-149-1126

SHIELDS 1300/1350 WATER/HEATER HOSE



Shields 1300/1350 Water/Heater Hose is fabric reinforced and has an EPDM tube and cover. This hose is primarily used for engine heater hose, heat exchanger, A/C circulation, and drain lines (sink, icebox, shower and livewell). It is resistant to mild chemicals, heat, cold, ozone and saltwater. The temperature ranges from -40°F – +212°F.

SHIELDS 1300 Water/Heater Hose

I.D.	mm	O.D.	mm	Working Pressure	Wt. "C"	Bulk Pack Code #	m	Dist. Pkg. 50' (15.2m) R/O Ctn. Code #	Dist. Pkg. 25' (7.6m) R/O Ctn. Code #
1/2"	12.7	3/4"	18.69	62 PSI	17	16-130-0120 (500' reel)	152.4	16-130-0126	—
5/8"	15.9	7/8"	22.3	62 PSI	21	16-130-0580 (500' reel)	152.4	16-130-0586	16-130-0585
3/4"	19.1	1"	25.48	50 PSI	26	16-130-0340 (500' reel)	152.4	16-130-0346	16-130-0345

SHIELDS 1350 HEAVY DUTY Water/Heater Hose

I.D.	mm	O.D.	mm	Working Pressure	Wt. "C"	Bulk Pack Code #	m	Dist. Pkg. 50' (15.2m) R/O Ctn. Code #
1/2"	12.7	13/16"	20.6	200 PSI	19	16-135-0120 (550' reel)	167.6	16-135-0126
5/8"	15.9	31/32"	24.59	200 PSI	26	16-135-0580 (450' reel)	137.2	16-135-0586
3/4"	19.1	1 1/64"	28.4	200 PSI	33	16-135-0340 (400' reel)	121.9	16-135-0346
1"	25.4	1 3/64"	36.6	150 PSI	52	16-135-1000 (300' reel)	91.4	16-135-1006

SHIELDS 1600 WATER/HEATER HOSE

Shields 1600 Water/Heater Hose has a good bend radius, is fabric reinforced, and has an EPDM tube and cover. This hose is primarily used for critical water connections, heat exchanger, toilet intake, small engine intake, bilge pump intake/discharge, and below water line drains and scuppers. It is resistant to mild chemicals, heat, cold, ozone and saltwater. The temperature ranges from -40°F – +190°F



I.D.	mm	O.D.	mm	Working Pressure	Wt. "C"	Bulk Pack Code #	m	Dist. Pkg. 50' (15.2m) R/O Ctn. Code #
3/8"	9.5	45/64"	17.8	300 PSI	17	16-160-0380B (500' reel)	152.4	16-160-0386B
1/2"	12.7	27/32"	21.3	300 PSI	22	16-160-0120B (450' reel)	137.2	16-160-0126B
5/8"	15.9	1"	25.4	300 PSI	28	16-160-0580B (400' reel)	121.9	16-160-0586B
3/4"	19.1	1 9/64"	28.8	300 PSI	34	16-160-0340B (300' reel)	91.4	16-160-0346B
1"	25.4	1 29/64"	36.8	300 PSI	52	16-160-1000B (250' reel)	76.2	16-160-1006B
1 1/4"	31.8	1 3/4"	44.5	200 PSI	62	16-160-1140B (200' reel)	61.0	16-160-1146B

SHIELDS MARINE EXHAUST/WATER HOSE (No Wire)



Shields Marine Exhaust / Water Hose is reinforced with 2 or 4 plies of synthetic cord and is made of black, heavy-walled synthetic rubber. This hose is primarily used for straight connections in wet exhaust systems and engine water circulation lines. It is resistant to engine heat, exhaust fumes, ozone, mild chemicals, antifreeze and saltwater. This hose also has double the ozone resistance required by SAEJ2006. The temperature ranges from -20°F – + 200°F continuous, +250°F intermittent. The hose meets SAE J2006 Type R1 standards.

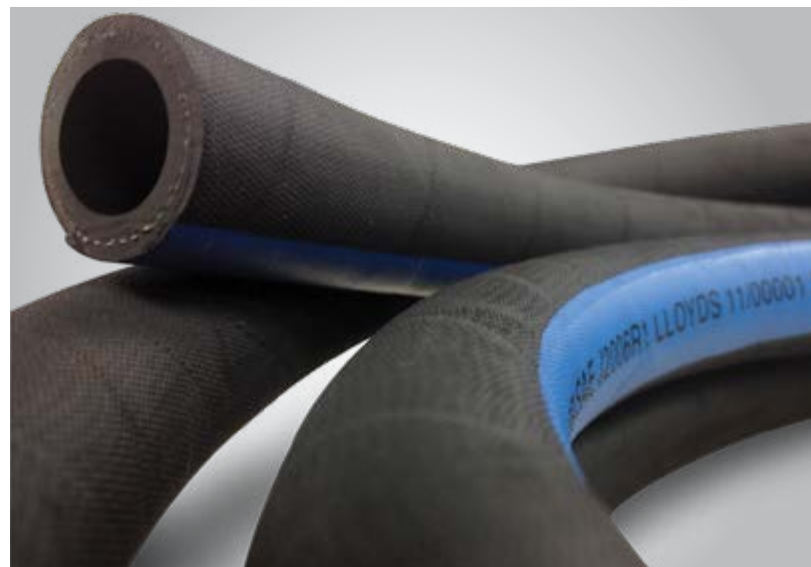

This certification provides unbiased, third party confirmation worldwide that these Shields hoses meet the highest standards of production quality. Certification ensures the proper level of product safety and inspires user confidence.

Now double the ozone resistance required by SAEJ2006

I.D.	mm	O.D.	Ply	Wt. "C"	50' Coil Code #	12 1/2' Length Code #	6 1/4' Length Code #
1/2"	13	7/8"	2	24	16-200-0120	16-200-0124	16-200-0121
5/8"	16	1 1/32"	2	33	16-200-0580	16-200-0584	16-200-0581
3/4"	19	1 9/64"	2	37	16-200-0340	16-200-0344	16-200-0341
7/8"	22	1 17/64"	2	42	16-200-0780	16-200-0784	—
1"	25	1 3/8"	2	48	16-200-1000	16-200-1004	16-200-1001
1 1/8"	28	1 1/2"	2	52	16-200-1180	16-200-1184	—
1 1/4"	32	1 45/64"	2	60	16-200-1140	16-200-1144	16-200-1141
1 5/16"	33	1 47/64"	2	62	—	—	—
1 3/8"	35	1 13/16"	2	66	—	—	—
1 1/2"	38	1 15/16"	2	70	16-200-1120	16-200-1124	16-200-1121
1 5/8"	42	2 3/32"	2	77	16-200-1580	16-200-1584	16-200-1581
1 3/4"	45	2 13/64"	2	82	16-200-1340	16-200-1344	16-200-1341
1 7/8"	48	2 23/64"	2	96	16-200-1780	16-200-1784	—
2"	51	2 31/64"	2	102	16-200-2000	16-200-2004	16-200-2001
2 1/8"	54	2 19/32"	2	107	16-200-2180	—	—
2 1/4"	58	2 3/4"	2	114	16-200-2140	16-200-2144	16-200-2141
2 3/8"	60	2 7/8"	2	132	16-200-2380	16-200-2384	—
2 1/2"	63	3"	2	136	16-200-2120	16-200-2124	16-200-2121
2 5/8"	67	3 3/32"	2	147	—	—	—
2 3/4"	70	3 17/64"	2	152	—	—	—
2 7/8"	73	3 7/16"	2	174	—	16-200-2784	16-200-2781
3"	76	3 9/16"	2	182	16-200-3000	16-200-3004	16-200-3001
3 1/8"	80	3 45/64"	2	190	—	16-200-3184	16-200-3181
3 1/2"	90	4 3/32"	2	198	—	16-200-3124	16-200-3121
3 3/4"	95	4 9/32"	2	221	—	16-200-3344	16-200-3341
4"	102	4 17/32"	4	229	—	16-200-4004	16-200-4001
4 1/2"	114	5 1/8"	2	300	—	—	16-200-4121
5"	127	5 5/8"	2	332	—	16-200-5004	—
5 1/2"	140	6 3/16"	2	396	—	—	—
6"	152	6 11/16"	2	427	—	16-200-6004	16-200-6001
8"	203	8 25/32"	4	670	—	16-200-8004	—
10"	254	10 7/8"	4	934	—	16-200-10004	—
12"	305	12 7/8"	4	1095	—	16-200-12004	—
14"	350	14 7/8"	4	1430	—	—	—

SHIELDS NAUTIFLEX SILICONE EXHAUST HOSE



Shields Nautiflex Silicone Exhaust Hose has a blue silicone cover with a smooth finish for easy clean up. This hose is flexible, easy to install and has four plies of synthetic fabric. It also remains stable at elevated temperatures. This hose is primarily used for straight connections in the wet exhaust system and engine water circulation lines. The temperature ranges from -20°F – $+350^{\circ}\text{F}$. The hose meets SAE J2006 Type R1 and ISO 13363:2004 – Type 2 – Class B standards.

I.D.	mm	O.D.	Wt. "C"	3' (.9m) Length Code #	6' (1.8m) Length Code #	12 (3.7m) Length Code #
1"	25	1 $\frac{3}{8}$ "	33.1	—	—	—
1 $\frac{1}{8}$ "	28	1 $\frac{1}{2}$ "	37.2	—	—	—
1 $\frac{1}{4}$ "	32	1 $\frac{5}{8}$ "	41.3	16-202-1140-36	—	16-202-1144
1 $\frac{3}{8}$ "	35	1 $\frac{3}{4}$ "	45.4	—	—	—
1 $\frac{1}{2}$ "	38	1 $\frac{7}{8}$ "	49.6	16-202-1120-36	—	16-202-1124
1 $\frac{3}{4}$ "	45	2 $\frac{1}{8}$ "	57.8	—	—	—
2"	51	2 $\frac{3}{8}$ "	66.1	—	16-202-2001	16-202-2004
2 $\frac{3}{8}$ "	60	2 $\frac{3}{4}$ "	78.5	16-202-2380-36	—	16-202-2384
2 $\frac{1}{2}$ "	63	2 $\frac{7}{8}$ "	82.6	16-202-2120-36	16-202-2121	16-202-2124
2 $\frac{5}{8}$ "	67	2 $\frac{63}{64}$ "	86.8	16-202-2580-36	—	16-202-2584
2 $\frac{3}{4}$ "	70	3 $\frac{1}{8}$ "	90.9	—	—	—
2 $\frac{7}{8}$ "	73	3 $\frac{1}{4}$ "	94.1	—	—	—
3"	76	3 $\frac{3}{8}$ "	99.2	16-202-3000-36	—	16-202-3004
3 $\frac{1}{4}$ "	82	3 $\frac{1}{2}$ "	103.4	16-202-3140-36	16-202-3141	16-202-3144
3 $\frac{1}{2}$ "	90	3 $\frac{7}{8}$ "	115.7	16-202-3120-36	—	16-202-3124
4"	102	4 $\frac{3}{8}$ "	132	16-202-4000-36	—	16-202-4004
5"	127	5 $\frac{3}{8}$ "	165	16-202-5000-36	16-202-5001	16-202-5004
5 $\frac{1}{2}$ "	140	5 $\frac{7}{8}$ "	181.5	—	—	—
6"	152	6 $\frac{3}{8}$ "	198	16-202-6000-36	—	16-202-6004
8"	203	8 $\frac{3}{8}$ "	264	16-202-8000-36	16-202-8001	16-202-8004
10"	254	10 $\frac{3}{8}$ "	330	16-202-1000036	—	16-202-10004
12"	305	12 $\frac{3}{8}$ "	396	16-202-1200036	—	16-202-12004
14"	350	14 $\frac{5}{8}$ "	462	16-202-1400036	—	—



SHIELDSFLEX II MARINE WATER/EXHAUST HOSE (w/ Wire)

Shieldsflex II Marine Water/Exhaust Hose has a black synthetic rubber tube and cover. It is reinforced with wire helix imbedded between plies of HD synthetic cord. It is resistant to exhaust fumes, ozone, mild chemicals, antifreeze and saltwater. This hose is abrasion and odor permeation resistant. It now has double the ozone resistance required by the SAEJ2006. Shieldsflex II is primarily used for engine intake, wet exhaust connections (use where bends or long lengths are required), bilge pump intake/discharge, scupper lines, toilet intake/discharge, and holding tank vent/pump out. The temperature ranges from -20° F – +200°F continuous, +250°F intermittent. The hose meets SAE J2006 Type R2 standards. Bend Radius = 5 x I.D.

I.D.	mm	O.D.	Ply	Wt. "C"	50' (15.2m) Coil Code#	25' (7.6m) Cartons	12 1/2' (3.8m) Length Code#	6 1/4' (1.9m) Length Code #
1/2"	13	27/32"	2	24	16-250-0120	16-250-0125	16-250-0124	—
5/8"	16	61/64"	2	28	16-250-0580	—	16-250-0584	16-250-0581
3/4"	19	1 1/16"	2	32	16-250-0340	16-250-0345	16-250-0344	16-250-0341
7/8"	22	1 3/16"	2	36	16-250-0780	—	16-250-0784	16-250-0781
1"	25	1 5/16"	2	40	16-250-1000	16-250-1005	16-250-1004	16-250-1001
1 1/8"	28	1 7/16"	2	44	16-250-1180	16-250-1185	16-250-1184	16-250-1181
1 1/4"	32	1 19/32"	2	50	16-250-1140	16-250-1145	16-250-1144	16-250-1141
1 5/16"	33	1 5/8"	2	51	16-250-1560	—	16-250-1564	16-250-1561
1 3/8"	35	1 23/32"	2	58	16-250-1380	—	16-250-1384	16-250-1381
1 1/2"	38	1 53/64"	2	62	16-250-1120	16-250-1125	16-250-1124	16-250-1121
1 5/8"	42	2"	2	80	16-250-1580	—	16-250-1584	16-250-1581
1 3/4"	45	2 1/8"	2	88	16-250-1340	—	16-250-1344	—
1 7/8"	48	2 19/64"	2	93	16-250-1780	—	16-250-1784	16-250-1781
2"	51	2 13/32"	2	99	16-250-2000	—	16-250-2004	16-250-2001
2 1/8"	54	2 17/32"	2	107	16-250-2180	—	16-250-2184	—
2 1/4"	58	2 11/16"	2	127	16-250-2140	—	16-250-2144	16-250-2141
2 3/8"	60	2 3/4"	2	132	16-250-2380	—	16-250-2384	16-250-2381
2 1/2"	63	2 7/8"	2	137	16-250-2120	—	16-250-2124	16-250-2121
2 5/8"	67	3 1/16"	2	147	—	—	16-250-2584	—
2 3/4"	70	3 3/16"	2	164	16-250-2340	—	16-250-2344	16-250-2341
2 7/8"	73	3 5/16"	2	170	16-250-2780	—	16-250-2784	16-250-2781
3"	76	3 7/16"	2	177	16-250-3000	—	16-250-3004	16-250-3001
3 1/8"	80	3 5/8"	2	200	—	—	16-250-3184	16-250-3181
3 1/2"	90	4"	2	223	16-250-3120	—	16-250-3124	16-250-3121
4"	102	4 5/8"	2	269	16-250-4000	—	16-250-4004	16-250-4001
4 1/8"	105	4 47/64"	2	276	—	—	—	—
4 1/2"	114	5 3/32"	2	319	16-250-4120	—	16-250-4124	16-250-4121
5"	127	5 5/8"	2	398	16-250-5000	—	16-250-5004	16-250-5001
5 1/8"	130	5 3/4"	2	417	—	—	—	—
5 1/2"	140	6 3/16"	2	443	—	—	—	—
6"	152	6 21/32"	2	482	—	—	16-250-6004	16-250-6001
8"	203	8 25/32"	2	780	—	—	16-250-8004	—



This certification provides unbiased, third party confirmation worldwide that these Shields hoses meet the highest standards of production quality. Certification ensures the proper level of product safety and inspires user confidence.

Now double the ozone resistance required by SAEJ2006

SHIELDSAUST-C

**Now double the ozone resistance required by SAEJ2006**

Shieldsaust – C Hose has a black synthetic rubber tube and cover. It is reinforced with double wire helix imbedded between plies of synthetic cord and is abrasion resistant. It is resistant to exhaust fumes, ozone, mild chemicals, antifreeze, and saltwater. This hose is primarily used for wet exhaust connections with significant bends, engine intake and scupper lines. The temperature ranges from -20°F to +200°F continuous, +250°F intermittent. The hose now has double the ozone resistance required by SAEJ2006. This hose meets SAE J2006 Type R2 standards. Bend Radius = 4 x I.D.

I.D.	mm	O.D.	Ply	Wt. "C"	50' (15.2m) Coil Code#	12 1/2' (3.8m) Length Code#	6 1/4' (1.9m) Length Code #
3/4"	19	1 1/8"	2	27	16-252-0340	16-252-0344	—
1"	25	1 11/32"	2	33	16-252-1000	16-252-1004	16-252-1001
1 1/4"	32	1 39/64"	2	45	16-252-1140	16-252-1144	16-252-1141
1 1/2"	38	1 15/16"	2	70	16-252-1120	16-252-1124	—
1 5/8"	42	2 3/32"	2	80	16-252-1580	16-252-1584	—
1 3/4"	45	2 7/32"	2	85	16-252-1340	16-252-1344	—
1 7/8"	48	2 21/64"	2	91	16-252-1780	16-252-1784	16-252-1781
2"	51	2 7/16"	2	95	16-252-2000	16-252-2004	16-252-2001
2 1/8"	54	2 9/16"	2	100	—	16-252-2184	16-252-2181
2 1/4"	58	2 23/32"	2	107	—	16-252-2144	—
2 3/8"	60	2 51/64"	2	110	16-252-2380	16-252-2384	16-252-2381
2 1/2"	63	2 59/64"	2	115	16-252-2120	16-252-2124	16-252-2121
2 3/4"	70	3 3/16"	2	126	—	16-252-2344	—
2 7/8"	73	3 5/16"	2	137	16-252-2780	16-252-2784	—
3"	76	3 7/16"	2	143	16-252-3000	16-252-3004	16-252-3001
3 1/8"	80	3 19/32"	2	150	—	16-252-3184	16-252-3181
3 1/2"	90	4 1/16"	2	200	16-252-3120	16-252-3124	16-252-3121
4"	102	4 9/16"	2	231	16-252-4000	16-252-4004	16-252-4001
4 1/8"	105	4 11/16"	2	238	—	—	—
4 1/2"	114	5 1/8"	2	278	—	16-252-4124	—
5"	127	5 9/16"	2	300	—	16-252-5004	16-252-5001
6"	152	6 9/16"	2	394	16-252-6000	16-252-6004	16-252-6001
8"	203	8 11/16"	2	607	—	16-252-8004	—



This certification provides unbiased, third party confirmation worldwide that these Shields hoses meet the highest standards of production quality. Certification ensures the proper level of product safety and inspires user confidence.

SHIELDS NAUTIFLEX CORRUGATED SILICONE EXHAUST HOSE



Shields Nautiflex Corrugated Silicone

Exhaust Hose has a blue silicone tube and cover with a smooth finish for easy cleaning. The hose is wire reinforced and will not collapse under suction or in a bend. The corrugated cover allows the hose to bend for easy installation. The Nautiflex, two ply construction, has wire captured between fabric plies. This hose is primarily used for main engine exhaust, generator exhaust, engine coolant circulation, engine intake and generator intake. It is resistant to exhaust fumes, ozone, mild chemicals, antifreeze and saltwater. The hose remains stable at elevated temperatures. The temperatures ranges from -20°F – +350°F. This hose meets SAEJ2006 Type R2 and ISO 13362:2004 – Type 1 – Class B standards. Bend Radius = 4 x I.D.

I.D.	mm	O.D.	Wt. "C"	10' (3.1m) Length Code #	12 1/2' (3.8m) Length Code #	50' (15.2m) Coil Code #	6 1/4' (1.9m) Length Code #
3/4"	19	1 3/8"	34	—	16-262-0344	16-262-0340	—
1"	25	1 27/64"	42	16-262-1003	16-262-1004	16-262-1000	—
1 1/8"	28	1 1/2"	46	16-262-1183	—	16-262-1180	—
1 1/4"	32	1 45/64"	52	—	16-262-1144	16-262-1140	—
1 3/8"	35	1 55/64"	60	16-262-1383	16-262-1384	16-262-1380	—
1 1/2"	38	2"	71	16-262-1123	16-262-1124	16-262-1120	—
1 5/8"	42	2 11/64"	74	—	—	—	—
1 3/4"	45	2 19/64"	78	16-262-1343	16-262-1344	—	—
1 7/8"	48	2 13/32"	82	—	16-262-1784	—	—
2"	51	2 17/32"	87	16-262-2003	16-262-2004	16-262-2000	—
2 1/8"	54	2 5/8"	94	—	—	—	—
2 3/8"	60	2 7/8"	101	16-262-2383	16-262-2384	16-262-2380	—
2 1/2"	63	3 3/64"	113	—	16-262-2124	16-262-2120	—
2 3/4"	70	3.312"	125	16-262-2343	—	16-262-2340	—
2 7/8"	73	3 7/16"	134	16-262-2783	16-262-2784	16-262-2780	—
3"	76	3 35/64"	139	16-262-3003	16-262-3004	16-262-3000	—
3 1/2"	90	4 19/64"	227	16-262-3123	16-262-3124	16-262-3120	—
4"	102	4 49/64"	255	16-262-4003	16-262-4004	16-262-4000	—
5"	127	5 3/4"	310	16-262-5003	—	16-262-5000	—
6"	152	6 15/16"	484	16-262-6003	—	—	—
8"	203	9 7/64"	768	16-262-8003	—	—	—
10"	254	11 17/64"	1136	16-262-10003	—	—	—
12"	305	13.359"	1518	16-262-12003	—	—	—
14"	350	15.281"	1812	—	—	—	—
16"	404	17.562"	2277	—	—	—	—

* Special Order



SHIELDS COMPLEX - ALL IN ONE HOSE FOR INSPECTED VESSELS

Shields Complex is a versatile wire reinforced hose specially designed for inspected vessels. Complex is rated for fuel, vital water and non-vital water systems on boats requiring SAE J1942 hoses. Applications include bilge, coolant, oil and fuel systems using gasoline, gasohol, diesel, bio-diesel, wet exhaust systems, non-potable water systems, engine intake, toilet and holding tank connections.



Tube: Black Nitrile

Reinforcement: 2 textile plies w/ dual wire helix

Cover: Black Chlorprene

Temp. Range: -20F to +212F

Specifications - SAE J1942 Code F, VW, NVW; SAE J1527 A1; SAE J2006 R2; SAE 20R2 B; SAE J20R4 B; SAE 20R5 B, SAE 30R5, ISO 7840 A1

Additional sizes available. 150' minimum order.

I.D.	mm	O.D.	Ply	Wt. "C"	Bend Radius	WP	50' Coil Code #	12 1/2' (3.8m) Length Code #	10' (3.1m) Length Code #	6 1/4' (1.9m) Length Code #
5/8"	15.9	1"	2	33	1.5	75	16-321-0580	16-321-0584	—	16-321-0581
3/4"	19.1	1.19"	2	39	1.5	75	16-321-0340	16-321-0344	16-321-0343	16-321-0341
1"	25.4	1.41"	2	53	2	75	16-321-1000	16-321-1004	16-321-1003	16-321-1001
1 1/8"	28.6	1.56"	2	62	3	75	16-321-1180	16-321-1184	—	16-321-1181
1 1/4"	31.8	1.66"	2	64	3	75	16-321-1140	16-321-1144	16-321-1143	16-321-1141
1 1/2"	38.1	1.91"	2	78	3	50	16-321-1120	16-321-1124	16-321-1123	16-321-1121
2"	50.8	2.48"	2	118	5	50	16-321-2000	16-321-2004	—	16-321-2001

SHIELDS MULTIFLEX



Shields Multiflex Hose has a clear FDA formula PVC with black vinyl helix. It is abrasion resistant, flexible and is resistant to mild chemicals and saltwater. This hose is primarily used for bilge pump discharge, potable water tank fill and drains (sinks, shower, livewell and scupper). This hose uses 147 right hand thread cuffs. **Do not attach to thru hull fitting below the water line. Do not use ethylene glycol based antifreeze in hose.**

I.D.	mm	Bend Radius	mm	Wt. "C"	Bulk Pack 100' (30.5m) Coil Code #	Dist. Pkg. 50' (15.2m) R/O Ctn. Code#	10' (3.1m) Length Code #
5/8"	15.9	1/2"	12.7	8	16-141-0580B	16-141-0586B	-
3/4"	19.1	3/4"	19.1	10	16-141-0340B	16-141-0346B	-
1"	25.4	7/8"	22.2	13	16-141-1000B	16-141-1006B	-
1 1/8"	28.6	1"	25.4	16	16-141-1180B	16-141-1186B	-
1 1/4"	31.8	1 1/2"	38.1	19	16-141-1140B	16-141-1146B	-
1 1/2"	38.1	2"	50.8	24	16-141-1120B	16-141-1126B	-
2"	50.8	5"	127.0	34	16-141-2000B	-	16-141-2003B
1 1/2"	38.1	2"	50.8	24	16-141-1120W	-	16-141-1123W

SHIELDS VAC EXTRA HEAVY DUTY/FDA

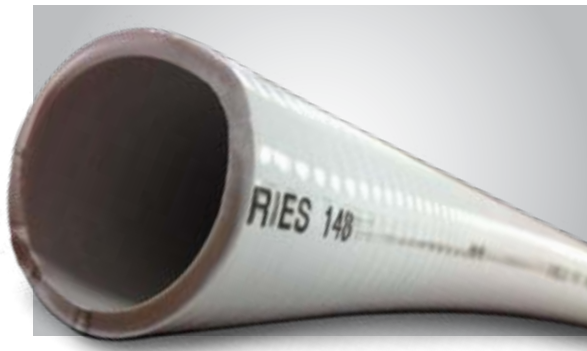

Shields Vac Extra Heavy Duty/FDA Hose has a smooth white FDA grade PVC with vinyl helix. It is rated for full vacuum and is resistant to mild chemicals, permeation, and saltwater. This hose is primarily used for bilge pump intake and discharge, drains (sinks, shower, and scupper), livewell intake and drain, potable water tank fill, and sanitation (toilet to holding tank, intake, self draining lines vent and pump out). This hose is resistant to odor permeation. **Do not use ethylene glycol based antifreeze in hose. Do not use in pressurized water systems.**



I.D.	mm	Bend Radius	mm	Vac Rating	Wt. "C"	Bulk Pack 100' (30.5m) Coil Code #	Dist. Pkg. 50' (15.2m) R/O Ctn. Code#	25' (7.6m) R/O Ctn. Code #
5/8"	15.9	3	76.2	28	15	16-148-0580W	16-148-0586W	—
3/4"	19.1	3	76.2	28	20	16-148-0340W	16-148-0346W	—
1"	25.4	3	76.2	28	27	16-148-1000W	16-148-1006W ①	—
1 1/8"	28.6	4	101.6	28	29	16-148-1180W	16-148-1186W	—
1 1/4"	31.8	4	101.6	28	31	16-148-1140W	16-148-1146W	—
1 1/2"	38.1	5	127.0	28	40	16-148-1120W	16-148-1126W ①	16-148-1125W

SHIELDS LIVEWELL HOSE



Shields Livewell Hose has a black smooth cover with vinyl helix. It is rated for full vacuum and is resistant to mild chemicals and saltwater. This hose is primarily used for bilge pump intake and discharge, drains (sinks, shower, and scupper), livewell intake and drain, and sanitation (intake and vent). This hose is utilized for below the waterline connections. **Do not use ethylene glycol based antifreeze in hose. Not for potable water.**

I.D.	mm	Bend Radius	mm	Vac Rating	Wt. "C"	Bulk Pack 100' (30.5m) Coil Code #	Dist. Pkg. 50' (15.2m) R/O Ctn. Code#
5/8"	15.9	3	76.2	28	15	16-149-0580	16-149-0586
3/4"	19.1	3	76.2	28	16	16-149-0340	16-149-0346
1"	25.4	3	76.2	28	24	16-149-1000	16-149-1006
1 1/8"	28.6	4	101.6	28	25	16-149-1180	16-149-1186
1 1/4"	31.8	4	101.6	28	28	16-149-1140	16-149-1146
1 1/2"	38.1	5	127.0	28	39	16-149-1120	16-149-1126

SHIELDS PVC TUBING - CLEAR

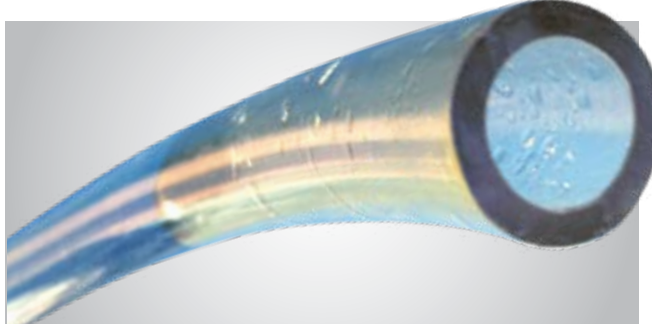

Shields Clear PVC Tubing has a single layer FDA formula vinyl. This hose is primarily used for non-pressurized potable water system supply and drain lines (sink, shower, icebox). **This hose is NOT for use in hot water or pressurized water systems.**

I.D.	mm	Wall	mm	Burst Pressure 700	Wt. "C"	Code #	Bulk Pack	mm	100' (30.5m) R/O Ctn. Code#	Dist. Pkg. 50' (15.2m) R/O Ctn. Code#	25' (7.6m) Polypac Code #
3/16"	4.8	.062	1.6	65#	3	16-150-0360	750'	228.6	16-150-0367	16-150-0366	16-150-0365
1/4"	6.4	.078	2.0	60#	4	16-150-0140	500'	152.4	16-150-0147	16-150-0146	16-150-0145
5/16"	7.9	.093	2.4	55#	5	16-150-0560	200'	61.0	16-150-0567	16-150-0566	16-150-0565
3/8"	9.5	.094	2.4	55#	6	16-150-0380	200'	61.0	—	16-150-0386	16-150-0385
1/2"	12.7	.11	2.8	45#	12	16-150-0120	200'	61.0	16-150-0127	16-150-0126	16-150-0125
5/8"	15.9	.11	2.8	40#	15	16-150-0580	200'	61.0	16-150-0587	16-150-0586	16-150-0586
3/4"	19.1	.11	2.8	35#	19	16-150-0340	200'	61.0	16-150-0347	16-150-0346	16-150-0346
1"	25.4	.125	3.2	20#	27	16-150-1000	100'	30.5	16-150-1007	16-150-1006	16-150-1006
1 1/8"	28.6	.125	3.2	20#	29	16-150-1180	100'	30.5	—	16-150-1186	16-150-1186
1 1/4"	31.8	.125	3.2	20#	31	16-150-1140	100'	30.5	—	16-150-1146	16-150-1146
1 1/2"	38.1	.125	3.2	20#	34	16-150-1120	50'	15.2	—	16-150-1126	16-150-1126

SHIELDS ALL CLEAR PVC TUBING POLYESTER REINFORCED (Red-Tracer)

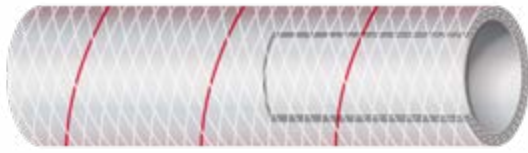

Shields Clear Polyester Reinforced Red Tracer PVC Tubing has a clear heavy wall FDA formula vinyl. It has a polyester braid reinforcement. This hose is primarily used for pressurized water system supply (hot or cold), drain lines (sink, shower, icebox), wash down pump connections and head intake.

I.D.	mm	O.D.	mm	Burst Pressure	Wt. "C"	Bulk Pack 250' (76.2m) Coil Code #	Dist. Pkg. 50' (15.2m) R/O Ctn. Code#	25' (7.6m) Polypac Code #	10' (3.1m) Polypac Code #
3/8"	9.5	9/16"	14.3	500#	7	16-162-0380	16-162-0386	16-162-0385	16-162-0383
1/2"	12.7	23/32"	18.3	500#	11	16-162-0120	16-162-0126	16-162-0125	16-162-0123
5/8"	15.9	27/32"	21.4	400#	14	16-162-0580	16-162-0586	16-162-0585	16-162-0583
3/4"	19.1	31/32"	24.6	325#	17	16-162-0340	16-162-0346	16-162-0345	16-162-0343
1"	25.4	1 5/16"	33.3	325#	24	16-162-1000	16-162-1006	16-162-1005	16-162-1003
1 1/8"	28.6	1 3/8"	34.9	375#	32	16-162-1180 ①	16-162-1186	—	—
1 1/4"	31.8	1 5/8"	41.3	325#	44	16-162-1140 ①	16-162-1146	—	—
1 1/2"	38.1	1 15/16"	49.2	300#	67	16-162-1120 ①	16-162-1126	—	—

SHIELDS BRAIDED WASH DOWN HOSE



Shields Braided Wash Down Hose has a white FDA formula vinyl tube and clear vinyl cover. It has a polyester braid reinforcement and a 250 PSI burst pressure. This hose has brass ends, is lightweight and easy to handle. This hose is primarily used for dockside wash down and is safe for potable water.

I.D.	mm	Length	mm	Bulk Pack	Wt.	Code#
5/8"	15.9	25'	7.6	5	3.25	16-163-0585
5/8"	15.9	50'	15.2	5	6.50	16-163-0586
5/8"	15.9	75'	22.9	5	9.75	16-163-0588
5/8"	15.9	100'	30.5	5	13.00	16-163-0587

SHIELDS CLEAR WHITE PVC TUBING POLYESTER REINFORCED (Blue-Tracer)

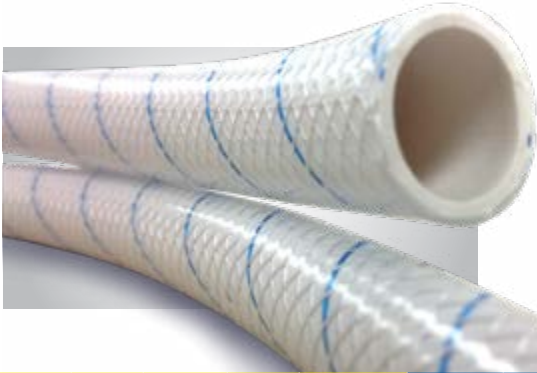

Clear White Blue Tracer PVC Tubing has a white FDA formula vinyl tube. It has a clear vinyl cover, polyester braid reinforcement. This hose is primarily used for pressurized water system supply (hot or cold), drain lines (sink, shower, icebox), wash down pump connections and head intake.

I.D.	mm	O.D.	mm	Burst Pressure	Wt. "C"	Bulk Pack 250' (76.2m) Coil Code #	Dist. Pkg. 50' (15.2m) R/O Ctn. Code#	25' (7.6m) Polypac Code #	10' (3.1m) Polypac Code #
1/2"	12.7	1 1/16"	17.5	500#	10	16-164-0120	16-164-0126	16-164-0125	16-164-0123
5/8"	15.9	1 3/16"	20.6	400#	13	16-164-0580	16-164-0586	16-164-0585	16-164-0583
3/4"	19.1	1 5/16"	23.8	325#	17	16-164-0340	16-164-0346	16-164-0345	16-164-0343

SHIELDS HEAVY DUTY POLYESTER REINFORCED PVC TUBING

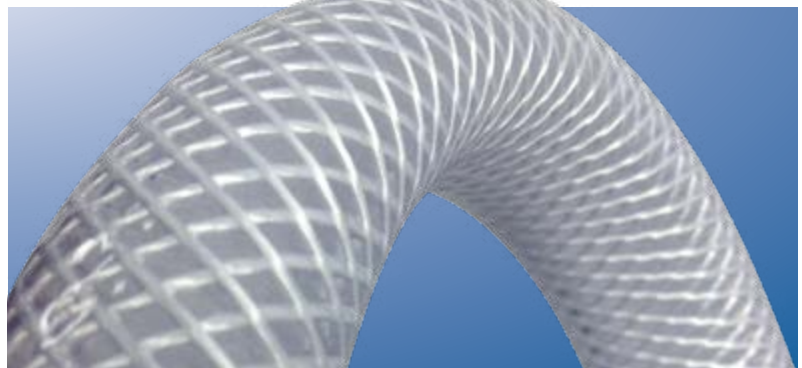
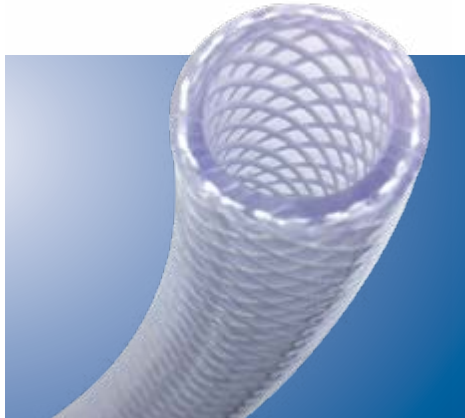

Shields Heavy-Duty Polyester Reinforced PVC Tubing has a clear extra heavy wall FDA formula vinyl. It has superior kink resistance and a polyester braid reinforcement. This hose is primarily used for pressurized water system supply (hot or cold), wash down pump connections and head intake.

I.D.	mm	O.D.	mm	Burst Pressure	Wt. "C"	Code #	Bulk Pack	Dist. Pkg. 50' (15.2m) R/O Ctn. Code#
1/4"	6.4	.438"	11.1	250#	5.6	16-168-0140	300'	16-168-0146
1/2"	12.7	.750"	19.1	200#	13.5	16-168-0120	300'	16-168-0126
5/8"	15.9	.875"	22.2	200#	16.2	16-168-0580	300'	16-168-0586
3/4"	19.1	1.025"	26.0	150#	21.1	16-168-0340	300'	16-168-0346
1"	25.4	1.312"	33.3	125#	31.2	16-168-1000	200'	16-168-1006
1 1/4"	31.8	1.656"	42.1	100#	51	16-168-1140	100'	16-168-1146
1 1/2"	38.1	1.937"	49.2	100#	65	16-168-1120	100'	16-168-1126

SHIELDS OIL TANK FILL HOSE



Shields Oil Tank Fill Hose has a nitrile/PVC blend for excellent oil resistance. It has a flexible corrugated design, smooth bore and a vinyl helix to prevent collapse. It also resists ozone and cold temperature cracking. This hose is primarily used for 2-cycle oil tank fill.

I.D.	mm	Bend Radius	mm	Wt. "C"	Bulk Pack 100' (30.5m) Coil Code #	Dist. Pkg. 50' (15.2m) R/O Ctn. Code#	10' (3.1m) Polypac Code #
1 1/2"	38.1	4"	101.6	22	16-309-1120	16-309-1126	16-309-1123

SHIELDS SILVERADO 2000 FUEL VENT LINE



Silverado 2000 Fuel Vent Line is primarily used for fuel tank vent (outside the engine compartment) and is for pleasure boats only. The Temperature range is -5°F to +180°F. It meets SAE J1527 Type B2 standards.



I.D.	mm	O.D.	mm	Ply	Burst Pressure	Wt. "C"	Bulk Pack Code #	50' (15.2m) R/O Ctn. Code#	Dist. Pkd. 25' (7.6m) R/O Ctn. Code #	10' (3.1m) Polypac Code #	Bulk Pack 100' (30.5m) Coil Code#
5/8"	15.9	29/32"	23.0	2	175#	24.0	16-315-0580 (250' reel)	16-315-0586	16-315-0585	16-315-0583	16-315-0587

SHIELDS SILVERADO 4000 OUTBOARD FUEL LINE

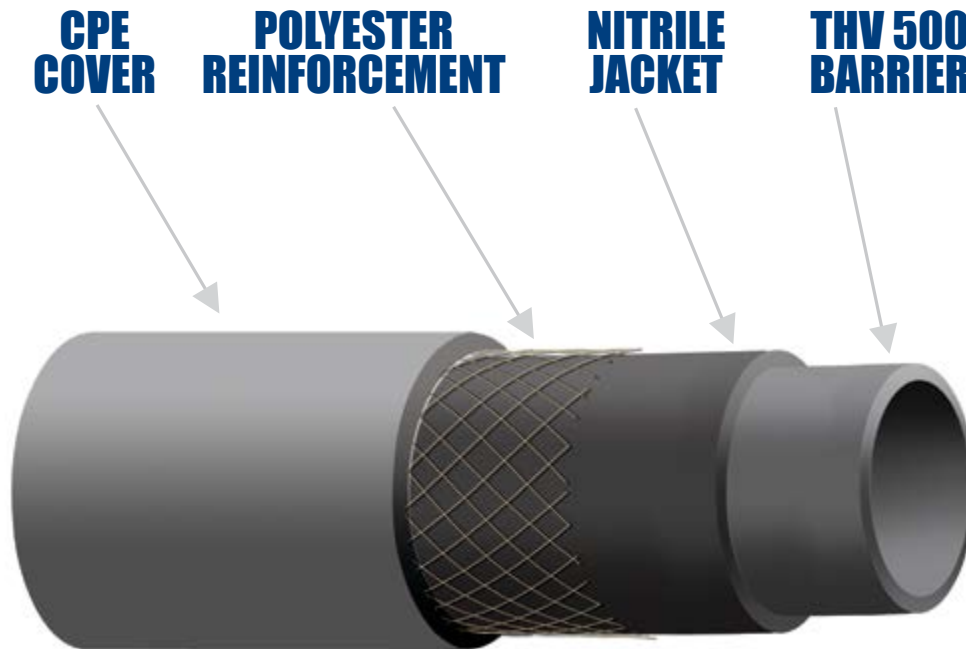

CONSTRUCTION

The series 337 fuel lines (Silverado 4000) is the best B1 fuel line in the market place. Utilizing a complex construction technique involving a THV500 barrier layer, a Nitrile jacket, Polyester reinforcement and a CPE cover; we are able to offer a hose that outperforms all competitors. The Silverado 4000 hose has a small O.D., is extremely flexible and easy to clamp. Not only does the Silverado 4000 meet all requirements it has become the only fuel line worthy to be utilized in Sierra's fuel line assemblies.



Silverado 4000 Outboard Fuel Line is resistant to ethanol blended fuels. This hose is EPA and CARB compliant. Silverado 4000 has a THV barrier layer to prevent permeation, polyester reinforcement for strength and a weather and UV resistant CPE cover. The gray color keeps hose cooler and helps prevent vapor lock. This hose is for above deck primer bulb applications, and is not fire retardant.



Meets SAE J1527 Type B1-15

I.D.	mm	O.D.	mm	Wt. "C"	Bulk Pack Code #	50' (15.2m) R/O Ctn. Code#	Dist. Pkd. 25' (7.6m) R/O Ctn. Code #	10' (3.1m) Polypac Code #
1/4"	6.4	7/16"	10.90	6	16-337-0140	16-337-0146	16-337-0145	16-337-0143
5/16"	7.9	1/2"	12.75	7	16-337-0560	16-337-0566	16-337-0565	16-337-0563
3/8"	9.5	35/64"	13.72	7.65	16-337-0380	16-337-0386	16-337-0385	16-337-0383

SHIELDS FIRE-ACOL FUEL FILL HOSE

Shields Fire – Acol – Fuel Fill Hose resists gasoline/alcohol blends and is compounded for low permeation. Special compound resists cover deterioration due to alcohol fuel resting in hose. It is abrasion resistant and it is reinforced with wire helix imbedded between plies of HD synthetic cord. This imported hose is primarily used for fuel fill (gas or diesel) and is for pleasure boats only. The temperature range is -5°F to 180°F. It meets SAE J1527 Type A2 and ISO 7840 Type A2 NMMA/CE Type Accepted standards.



I.D.	mm	O.D.	mm	Ply	Burst Pressure	Wt. "C"	50' (15.2m) Coils Code#	12 1/2' (3.8m) Length Code #	12 1/2' (3.8m) Carton Code #	10' (3.1m) Length Code #	10' (3.1m) Carton Code #
1 1/2"	38	1 57/64"	48	2	90	77	16-350-1120	16-350-1124		16-350-1123	—
1 5/8"	41.3	2 3/64"	52.0	2	90#	89	—	16-350-1584	—	16-350-1583	—
1 7/8"	47.6	2 9/32"	58.0	2	90#	114	16-350-1780	16-350-1784	—	16-350-1783	16-350-1783BX
2"	50.8	2 31/64"	63.1	2	90#	121	16-350-2000	16-350-2004	—	16-350-2003	—
2 3/8"	60.3	2 27/32"	72.2	2	90#	137	16-350-2380	16-350-2384	—	16-350-2383	—

SHIELDS FIRE-ACOL "C" FUEL FILL HOSE



Shields Fire – Acol – “C” Fuel Fill Hose resists gasoline/alcohol blends and has a corrugated cover for extra flexibility. This hose is compounded for low permeation and is reinforced with a wire helix imbedded between plies of HD synthetic cord. It is also abrasion resistant. This hose is primarily used for extra flexible fuel fill (gas or diesel) and is for pleasure boats only. The temperature range is -5°F to 180°F. It meets SAE J1527 type A2 and NMMA Type Accepted standards.



I.D.	mm	O.D.	mm	Ply	Burst Pressure	Wt. "C"	Bulk Pack 50' (15.2m) Coils	Dist. Pkg.		
								12 1/2' (3.8m) Length	10' (3.1m) Length	
1 1/2"	38.1	1 57/64"	48.0	2	90#	77	16-351-1120	16-351-1124	16-351-1123	

SHIELDS FUEL FILL HOSE



Shields Fire – Acol – Fuel Fill Hose resists gasoline/ alcohol blends and is compounded for low permeation. It is abrasion resistant and it is reinforced with wire helix imbedded between piles of HD synthetic cord. This imported hose is primarily used for fuel fill (gas or diesel) and is for pleasure boats only. It meets SAE J1527 Type A2 and ISO 7840 Type A2 NMMA/CE Type Accepted standards.



I.D.	mm	O.D.	mm	Ply	Burst Pressure	Wt. "C"	50' (15.2m) Coils Code#	12 1/2' (3.8m) Length Code #	12 1/2' (3.8m) Carton Code #	10' (3.1m) Length Code #	10' (3.1m) Carton Code #	25' (7.6m) Length Code #
1 1/2"	38.1	1 57/64"	48.0	2	90#	77	16-355-1120	16-355-1124	16-355-1124BX	16-355-1123	16-355-1123BX	16-355-1125
2"	51	2 31/64"	63.1	2	90#	111	16-355-2000	16-355-2004	—	16-355-2003	—	—

SHIELDS FIRE-ACOL 15 LOW PERMEATION FUEL HOSE



Shields Fire-Acol 15 – Low Permeation Fuel Hose has a special design NBR tube with an embedded plastic barrier layer to prevent permeation. The design of this hose provides easy coupling insertion and the NBR/PVC cover is weather and UV resistant. The hose is also polyester reinforced and fire-resistant. This hose is primarily used for fuel feed (gasoline up to 85% ethanol blended fuels/ diesel/bio-diesel all blends). The temperature range is -20°F to 212°F.

★Meets new CARB 10 g/M2/24 hrs. standard



This hose complies with EPA and CARB very low permeation requirements. It meets USCG Type A1-15 requirements for pleasure boats, SAE J1527 Type A1-15, ISO 7840 Type A1, and NMMA/CE Type accepted standards

I.D.	mm	O.D.	mm	Max WP	Wt. "C"	Bulk Pack 250' reel Code#	50' R/O Ctn. Code #	10' Polypac Code #
3/8"	9.5	49/64"	19.3	100	22	16-365-0380	16-365-0386	—
1/2"	12.7	29/32"	22.86	100	27	16-365-0120	16-365-0126	—

SHIELDS LOW PERMEATION MARINE FUEL HOSE



Shields Low Permeation Marine Fuel Hose has a plastic barrier veneer with an NBR outer layer tube to prevent permeation. This polyester reinforced hose complies with EPA and CARB very low permeation requirements and is weather/UV resistant. This hose is primarily used for fuel feed (gasoline up to 85% ethanol blended fuels/diesel/all bio-diesel blends). It meets USCG Type A1 – 15 requirements for pleasure boats and meets SAE J1527 Type A1-15, ISO 7840 Type A1, and NMMA/CE type accepted standards. The temperature ranges from -20°F to 212°F.



★Meets new CARB 10 g/M2/24 hrs. standard

I.D.	mm	O.D.	mm	Max WP	Wt. "C"	Bulk Pack 250' reel Code #	50' R/O Ctn. Code #	25' R/O Ctn Code#	10' Polypac Code#
1/4"	6.4	35/64"	13.72	100	11	16-368-0140	16-368-0146	16-368-0145	16-368-0143
5/16"	7.9	5/8"	15.49	100	13	16-368-0560	16-368-0566	16-368-0565	16-368-0563
3/8"	9.5	11/16"	17.27	100	16	16-368-0380	16-368-0386	16-368-0385	16-368-0383
1/2"	12.7	13/16"	20.83	100	20	16-368-0120	16-368-0126	16-368-0125	16-368-0123

SHIELDS FIRE-ACOL FUEL VENT



Shields Fire-Acol Fuel Vent hose resists gasoline/alcohol blended fuel and is fire resistant. It features a weather/UV resistant NBR/PVC cover. This hose is primarily used for fuel vent lines (gasoline up to 85% ethanol blended fuels/diesel fuels). It meets USCG Type A2 requirements for pleasure boats and meets SAE J1527 Type A2, ISO 7840 Type A2 and NMMA/CE Type accepted standards. The temperature ranges from -20°F to 160°F.



I.D.	mm	O.D.	mm	Max WP	Wt. "C"	Bulk Pack 250' reel Code #	50' R/O Ctn. Code #	25' R/O Ctn Code#	10' Polypac Code#
5/8"	15.9	31/32"	24.6	50	25	16-369-0580	16-369-0586	16-369-0585	16-369-0583

SHIELDS COMPLEX - ALL IN ONE HOSE FOR INSPECTED VESSELS

Shields Complex is a versatile wire reinforced hose specially designed for inspected vessels. Complex is rated for fuel, vital water and non-vital water systems on boats requiring SAE J1942 hoses. Applications include bilge, coolant, oil and fuel systems using gasoline, gasohol, diesel, bio-diesel, wet exhaust systems, non-potable water systems, engine intake, toilet and holding tank connections.



Tube: Black Nitrile

Reinforcement: 2 textile plies w/ dual wire helix

Cover: Black Chlorprene

Temp. Range: -20F to +212F

Specifications - SAE J1942 Code F, VW, NVW; SAE J1527 A1; SAE J2006 R2; SAE 20R2 B; SAE J20R4 B; SAE 20R5 B, SAE 30R5, ISO 7840 A1

Additional sizes available. 150' minimum order.

I.D.	mm	O.D.	Ply	Wt. "C"	Bend Radius	WP	50' Coil Code #	12 1/2' (3.8m) Length Code#	10' (3.1m) Length Code #	6 1/4" (3.8m) Length Code#
5/8"	15.9	1"	2	33	1.5	75	16-321-0580	16-321-0584	—	16-321-0581
3/4"	19.1	1.19"	2	39	1.5	75	16-321-0340	16-321-0344	16-321-0343	16-321-0341
1"	25.4	1.41"	2	53	2	75	16-321-1000	16-321-1004	16-321-1003	16-321-1001
1 1/8"	28.6	1.56"	2	62	3	75	16-321-1180	16-321-1184	—	16-321-1181
1 1/4"	31.8	1.66"	2	64	3	75	16-321-1140	16-321-1144	16-321-1143	16-321-1141
1 1/2"	38.1	1.91"	2	78	3	50	16-321-1120	16-321-1124	16-321-1123	16-321-1121
2"	50.8	2.48"	2	118	5	50	16-321-2000	16-321-2004	—	16-321-2001



FERRULE VISE/DIES

Hand operated vise for making fuel line assemblies without clamps. Vise uses ordinary barbed fittings with series 700 solid brass ferrules. Makes professional looking leak proof fuel lines. Furnished with removable handle. Dies must be ordered separately. When ordering dies, please consult chart under brass ferrules to determine proper size.

Part #	Description
No. 18-J662-xxx	Dies give longitudinal crimp.
No. 18-J664-xxx	Dies give circular and longitudinal crimp.

* Special Order Only

45° SAE FEMALE SWIVEL



Code No.	Hose I.D.	Tube	Thread
18-502-1476	1/4"	1/4"	7/16-20
18-502-3858	3/8"	3/8"	5/8-18
18-502-1234	1/2"	1/2"	3/4-16
18-502-1278	1/2"	5/8"	7/8-14

Standard Package: 100 pieces

ADAPTER — MALE PIPE TO SAE 45° FLARE



Code No.	Tube	Pipe
18-600-1414	1/4"	1/4"
18-600-3814	3/8"	1/4"
18-600-3838	3/8"	3/8"
18-600-1212	1/2"	1/2"
18-600-5812	5/8"	1/2"

Standard Package: 100 pieces

ADAPTER — MALE PIPE TO SAE 45° FLARE 90°



Code No.	Tube	Pipe
18-601-3814	3/8"	1/4"

MALE PIPE



Bulk Pack Code No.	Hose Barb Sierra No.	Hose I.D.	Thread
18-500-1418	18-8043	1/4"	1/8"
18-500-1414	18-8042	1/4"	1/4"
18-500-5618	18-8054	5/16"	1/8"
18-500-5614	18-8055	5/16"	1/4"
18-500-3818	18-8073	3/8"	1/8"
18-500-3814	18-8074	3/8"	1/4"
18-500-3838	18-8108	3/8"	3/8"
18-500-1238	—	1/2"	3/8"
18-500-1212	—	1/2"	1/2"
18-500-5838	18-8041	5/8"	3/8"

STD. PKG. 100 STD.CTN.12 (1 PER CARD)

SOLID BRASS FERRULES



Code No.	Hose Type	Die Set
18-700-5500	16-368-0140	18-J662-550
18-700-6250	16-368-0560	18-J662-625
18-700-6750	16-368-0140	18-J662-675
18-700-7000	16-368-0380	18-J662-700
18-700-7750	16-365-0380	18-J662-775
18-700-8250	16-368-0120	18-J662-825
18-700-8500	—	—
18-700-9000	—	—
18-700-9250	16-368-0120	18-J662-900
18-700-9500	—	—
18-700-1025	16-369-0580	18-J662-1025

FUEL WATER SEPARATORS



Compact
30 GPH for up to 115 HP motors
(Use with N-187774S head.)



Standard



Extra Capacity



AquaVue™ drain bowl style filters with see through plastic bowl or fire resistant metal bowl for below deck installation.

Part #	Description	Rating
18-7928-1	Filter w/ AquaVue™ bowl	10 Micron
18-7929	Filter w/ Metal bowl	10 Micron
18-7866	Extra Capacity - 6"	10 Micron
18-7944	Short - 3.88"	10 Micron
18-7945	Long - 4.35"	10 Micron
18-7844	Short - 3.88"	21 Micron
18-7845	Long - 4.35"	21 Micron
18-7865	Compact Filter	10 Micron

Available in standard packs of 12.

FEATURES

Ethanol blended fuel absorbs more water and loosens more particulates than regular fuels. Proper filtration is required for every horsepower engine. Sierra fuel water separators remove over 99.8% of emulsified water from your gasoline. Sierra's 10 micron filters are over 90% efficient at removing particles as small as 10 micron. All filters flow at 90 GPH to feed even the hungriest motor. Sierra 10 micron filters are recommended to prevent damage to sensitive inboard and outboard fuel injection systems.

PRIMER BULBS

Sierra is a leading supplier of primer bulbs to the marine aftermarket. Our bulbs are molded in house. We use double check valves with viton balls and stainless steel springs.



Part #	Description
18-8002EP-1	Primer bulb for 1/4" hose
18-8004EP-1	Primer bulb for 5/16" hose
18-8005EP-1	Primer bulb for 3/8" hose

CUSTOM FUEL LINE ASSEMBLIES

- Sierra can fabricate custom assemblies for OEM applications.
- Any combination of hose and fittings is possible.
- Use type A hose to the splash well and type B hose to the engine.
- Customizable length.
- Inlet can be 3/8" with 5/16" outlet.
- Numerous OEM connectors available.



BRACKETS

Sierra brackets are precision machined powder coated aluminum or marine grade stainless steel. They are available with 3/8" or 1/4" inlets.



Part # Boxed	Description	Bulk Standard Pack
18-7776	3/8" Thread Stainless Steel	14
18-7777	1/4" Thread Stainless Steel	14
18-7775	3/8" Thread Aluminum	48
18-7853-1	1/4" Thread Aluminum	48
18-7774	1/4" Thread Aluminum (Compact)	60
18-4264	3/8" Pipe Plugs	—
18-4256	1/4" Pipe Plugs	—

SHIELDS SANITATION HOSE

Shields Sanitation Hose is kink resistant and flexible. It has an EPDM tube and cover, it is wire reinforced and has two fabric plies. This sanitation hose is resistant to toilet chemicals, odor permeation, ozone, salt water and heat. This hose is primarily used for toilet to holding tank, holding tank pump out, and maximum resistance to odor permeation.

Bend Radius = 5 x I.D.



I.D.	mm	O.D.	Ply	Burst Pressure	Wt. "C"	Bulk Pack 50'(15.2m) Coil Code #	Dist. Pkg. 12 1/2' (3.8m) Length Code#	25" (7.6mm) Coil Code#	10' (3.1m) Code #
1"	25	1 5/16"	2	200#	38	16-101-1000	—	—	16-101-1003
1 1/2"	38	1 55/64"	2	150#	55	16-101-1120	16-101-1124	—	16-101-1123

SHIELDS POLY X SANITATION HOSE



Shields Poly X Sanitation Hose has a lifetime warranty against odor permeation. This ultimate sanitation hose combines the flexibility of a rubber hose with the permeation resistance of polyurethane. Poly X can easily be slipped over most fittings and the polyurethane cover is extremely abrasion resistant. This hose has a glossy cover for easy clean up. This hose is primarily used for head to holding tank and holding tank pump out.

The tube is made of smooth, white NBR and is chemical and detergent resistant. The cover is comprised of smooth polyurethane and has a glossy cover. It is heat, weather, ozone and abrasion resistant. Bend Radius = 5 x I.D.



I.D.	mm	O.D.	mm	Ply	Vac Rating	Wt. "C"	50' (15.2m) Code #	12 1/2' (3.8m) Code#	10' (3.1m) Code #
3/4"	19	1 7/16"	36.5	2	28	38	16-105-0340	16-105-0344	—
1"	25	1 21/64"	33.7	2	28	46	16-105-1000	16-105-1004	16-105-1003
1 1/2"	38	1 27/32"	46.8	2	28	66	16-105-1120	16-105-1124	16-105-1123

SHIELDS SANITATION HOSE FITTINGS

Fiberglass reinforced nylon fittings designed to fit Series 101, Series 105 and Series 144 and 148 hoses without heating or special tools. For use in sanitation systems, deck drain systems and water tank fill. Fittings are durable, chemical and fuel resistant, will not rust or cause electrolysis.

Style	Bulk Code #	Blister Pack Code #	Hose I.D.	mm	Thread
Straight Male	N800-0340	—	3/4"	19.1	3/4" MP
Straight Male	N800-1000	—	1"	25.4	1" MP
Straight Male	N800-1180	—	1 1/8"	28.6	1" MP
Straight Male	N800-1140	—	1 1/4"	31.8	1 1/4" MP
Straight Male	N800-1120B	18-800-1120	1 1/2"	38.1	1 1/2" MP
Straight Female	N801-1120	18-801-1120	1 1/2"	38.1	1 1/2" FP
90 Degree Male	N802-1120	18-802-1120	1 1/2"	38.1	1 1/2" MP
90 Degree Female	N803-1120	18-803-1120	1 1/2"	38.1	1 1/2" FP
Hose Tee	N806-1120	18-806-1120	1 1/2"	38.1	N/A



SHIELDS SUPER PVC SANITATION HOSE



Shields Super PVC Sanitation Hose is smooth off white PVC with a vinyl helix. It contains an anti-fungus /bacterial agent to inhibit odor causing growth. It is resistant to mild chemicals, saltwater, and permeation. This hose is primarily used for toilet to holding tank (self draining lines) and holding tank pump out. It has a five year limited warranty. Do not use ethylene glycol based anti-freeze in hose. CAUTION - Do not use for potable water.

I.D.	mm	Bend Radius	mm	Vac Rating	Wt. "C"	Bulk Pack 100'(30.5m) Coil Code #
1"	25.4	3	76.2	28	27	16-144-1000Ⓞ
1 1/2"	38.1	5	127.3	28	40	16-144-1120Ⓞ

Ⓞ **WARNING:** Lines containing raw sewage should be plumbed to be self-draining.

SHIELDS VAC EXTRA HEAVY DUTY - INDUSTRIAL GRADE



Shields Vac Extra Heavy Duty/Commercial Grade Hose has a smooth cover and clear FDA formula PVC with a white vinyl helix. It is rated for full vacuum and is resistant to mild chemicals and saltwater. This hose is primarily used for bilge pump intake and discharge, potable water tank fill, drains (sinks, shower, and scupper), livewell intake and drain, and sanitation (intake, vent and pump out). This hose is utilized for below the waterline connections. Do not use ethylene glycol based antifreeze in hose. Do not use in pressurized water systems.

I.D.	mm	Bend Radius	mm	Vac Rating	Wt. "C"	Bulk Pack 100' (30.5m) Coil Code #	50' (15.2m) R/O Ctn. Code #	Dist Pkg. 10' (3.1m) Length Code #
5/8"	15.9	3	76.2	28	15	—	16-146-0586	—
3/4"	19.1	3	76.2	28	16	16-146-0340	16-146-0346	—
1"	25.4	3	76.2	28	27	16-146-1000	16-146-1006	—
1 1/8"	28.6	4	101.6	28	25	16-146-1180	16-146-1186	—
1 1/4"	31.8	3	76.2	28	30	—	—	—
1 1/2"	38.1	4	101.6	28	40	16-146-1120	16-146-1126	—
2"	50.8	5	127.0	28	57	16-146-2000	—	16-146-2003
2 1/2"	63.5	7	177.8	28	74	—	—	—
3"	76.2	9	228.6	28	94	16-146-3000	—	16-146-3003

SHIELDS VAC EXTRA HEAVY DUTY/FDA

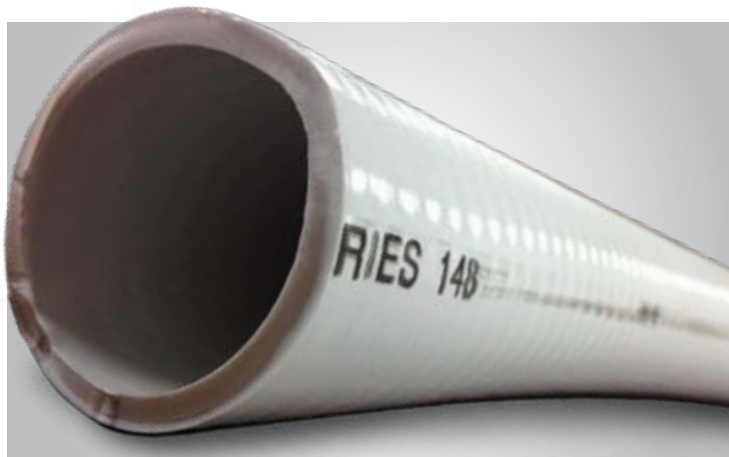

Shields Vac Extra Heavy Duty/FDA Hose has a smooth white FDA grade PVC with vinyl helix. It is rated for full vacuum and is resistant to mild chemicals, permeation, and saltwater. This hose is primarily used for bilge pump intake and discharge, drains (sinks, shower, and scupper), livewell intake and drain, potable water tank fill, and sanitation (toilet to holding tank, intake, self draining lines vent and pump out). This hose is resistant to odor permeation. Do not use ethylene glycol based antifreeze in hose. Do not use in pressurized water systems.

I.D.	mm	Bend Radius	mm	Vac Rating	Wt. "C"	Bulk Pack 100' (30.5m) Coil Code #	Dist. Pkg. 50' (15.2m) R/O Ctn. Code #	25' (7.6m) R/O Ctn. Code #
5/8"	15.9	3	76.2	28	15	16-148-0580W	16-148-0586W	—
3/4"	19.1	3	76.2	28	20	16-148-0340W	16-148-0346W	—
1"	25.4	3	76.2	28	27	16-148-1000W	16-148-1006W ①	—
1 1/8"	28.6	4	101.6	28	29	16-148-1180W	16-148-1186W	—
1 1/4"	31.8	4	101.6	28	31	16-148-1140W	16-148-1146W	—
1 1/2"	38.1	5	127.0	28	40	16-148-1120W	16-148-1126W ①	16-148-1125W

① **WARNING:** Lines containing raw sewage should be plumbed to be self-draining.

SHIELDS SANITATION SYSTEM CLEANER

Shields Sanitation Hose Cleaner is a USDA certified bio-based product safe for all sanitation system components. This powerful cleaner removes uric scale, calcium carbonate and other solids to help keep sanitation systems working at their best. Available in concentrate and ready to use.



Part No.	Size	Description
18-9093	1 Gallon	Ready to Use
18-9095	1 Gallon	Concentrate



SHIELDSFLEX II MARINE WATER/EXHAUST HOSE (w/ Wire)

Shieldsflex II Marine Water/Exhaust Hose has a black synthetic rubber tube and cover. It is reinforced with wire helix imbedded between plies of HD synthetic cord. It is resistant to exhaust fumes, ozone, mild chemicals, antifreeze and saltwater. This hose is abrasion and odor permeation resistant. It now has double the ozone resistance required by the SAEJ2006. Shieldsflex II is primarily used for engine intake, wet exhaust connections (use where bends or long lengths are required), bilge pump intake/discharge, scupper lines, toilet intake/discharge, and holding tank vent/pump out. The temperature ranges from -20° F – +200°F continuous, +250°F intermittent. The hose meets SAE J2006 Type R2 standards.



I.D.	mm	O.D.	Ply	Wt. "C"	50' (15.2m) Coil Code #	25' (7.6m) Cartons	12 1/2' (3.8m) Length Code #	6 1/4' (1.9m) Length Code	10' (3.1m) Length Code#
1/2"	13	27/32"	2	24	-0120	16-250-0125	16-250-0124	—	16-250-0123
5/8"	16	61/64"	2	28	16-250-0580	16-250-0585	16-250-0584	16-250-0581	16-250-0583
3/4"	19	1 1/16"	2	32	16-250-0340	16-250-0345	16-250-0344	16-250-0341	16-250-0343
7/8"	22	1 3/16"	2	36	16-250-0780	—	16-250-0784	16-250-0781	16-250-0783
1"	25	1 5/16"	2	40	16-250-1000	16-250-1005	16-250-1004	16-250-1001	16-250-1003
1 1/8"	28	1 7/16"	2	44	16-250-1180	16-250-1185	16-250-1184	16-250-1181	16-250-1183
1 1/4"	32	1 19/32"	2	50	16-250-1140	16-250-1145	16-250-1144	16-250-1141	16-250-1143
1 5/16"	33	1 5/8"	2	51	16-250-1560	—	16-250-1564	16-250-1561	16-250-1563
1 3/8"	35	1 23/32"	2	58	16-250-1380	—	16-250-1384	16-250-1381	16-250-1383
1 1/2"	38	1 53/64"	2	62	16-250-1120	16-250-1125	16-250-1124	16-250-1121	16-250-1123
1 5/8"	42	2"	2	80	16-250-1580	—	16-250-1584	16-250-1581	16-250-1583
1 3/4"	45	2 1/8"	2	88	16-250-1340	—	16-250-1344	—	16-250-1343
1 7/8"	48	2 19/64"	2	93	16-250-1780	—	16-250-1784	16-250-1781	16-250-1783
2"	51	2 13/32"	2	99	16-250-2000	—	16-250-2004	16-250-2001	16-250-2003
2 1/8"	54	2 17/32"	2	107	16-250-2180	—	16-250-2184	—	—
2 1/4"	58	2 11/16"	2	127	16-250-2140	—	16-250-2144	16-250-2141	16-250-2143
2 3/8"	60	2 3/4"	2	132	16-250-2380	—	16-250-2384	16-250-2381	16-250-2383
2 1/2"	63	2 7/8"	2	137	16-250-2120	—	16-250-2124	16-250-2121	16-250-2123
2 5/8"	67	3 1/16"	2	147	—	—	16-250-2584	—	—
2 3/4"	70	3 3/16"	2	164	16-250-2340	—	16-250-2344	16-250-2341	16-250-2343
2 7/8"	73	3 5/16"	2	170	16-250-2780	—	16-250-2784	16-250-2781	16-250-2783
3"	76	3 7/16"	2	177	16-250-3000	—	16-250-3004	16-250-3001	16-250-3003
3 1/8"	80	3 5/8"	2	200	—	—	16-250-3184	16-250-3181	—
3 1/2"	90	4"	2	223	16-250-3120	—	16-250-3124	16-250-3121	16-250-3123
4"	102	4 5/8"	2	269	16-250-4000	—	16-250-4004	16-250-4001	16-250-4003
4 1/8"	105	4 47/64"	2	276	—	—	—	—	—
4 1/2"	114	5 3/32"	2	319	16-250-4120	—	16-250-4124	16-250-4121	—
5"	127	5 5/8"	2	398	16-250-5000	—	16-250-5004	16-250-5001	16-250-5003
5 1/8"	130	5 3/4"	2	417	—	—	—	—	—
5 1/2"	140	6 3/16"	2	443	—	—	—	—	—
6"	152	6 21/32"	2	482	—	—	16-250-6004	16-250-6001	—
8"	203	8 25/32"	2	780	—	—	16-250-8004	—	—



This certification provides unbiased, third party confirmation worldwide that these Shields hoses meet the highest standards of production quality. Certification ensures the proper level of product safety and inspires user confidence.

Now double the ozone resistance required by SAEJ2006

SHIELDS 400/402 VINYLVENT



Shields Vinylvent Ducting Hose is PVC supported by anodized wire helix. It is resistant to UV and the ozone. This hose is primarily used for venting of bilge fumes.

I.D.	mm	O.D.	mm	Wt. "C"	Dist. Pkg. 50' (76.2m) Length Code # White	Dist Pkg. 10' (3.1m) Polypac Code # White
3"	76.2	3 1/8"	79.4	8	16-400-3000W	16-400-3003-1
4"	101.6	4 1/8"	104.8	10	16-400-4000W	16-400-4003-1
3"	76.2	3 1/8"	79.4	8	16-402-3000	16-402-3003-1
4"	101.6	4 1/8"	104.8	10	16-402-4000	16-402-4003-1

SHIELDS EXTRA HEAVY DUTY VINYLVENT



Shields Extra Heavy Duty Vinylvent has an extra heavy PVC wall. It is supported by vinyl coated helical wire and is resistant to ozone, UV, and corrosion. It is flame resistant and meets the UL 94V standard. This hose is primarily used for venting of bilge fumes.



I.D.	mm	O.D.	mm	Wt. "C"	Code No.
3"	76	3 1/8"	79.4	17	16-420-3000
4"	102	4 1/8"	104.8	25	16-420-4000

Bulk Pack: 3" 6 x 50 4" 4 x 50

SHIELDS FIBERVENT



Shields Fibervent is vinyl coated, woven fiberglass hose. It is supported by vinyl coated helical wire and is resistant to ozone, UV, and corrosion. The hose is flame resistant and meets the UL 181 Class 1 standard. This hose is primarily used for venting of bilge fumes and A/C ducting hose. The temperature ranges from -20° F to +250° F.

Bulk	m	I.D.	mm	O.D.	mm	Rating	Vac Wt. "C"	Code No.
6 x 25'	1.8x7.6	3"	76.2	3 1/4"	82.6	20	13	16-450-3000
8 x 25'	2.4x7.6	4"	101.6	4 1/4"	108	20	15	16-450-4000
8 x 25'	2.4x7.6	5"	127	5 1/4"	133.4	20	17	16-450-5000
4 x 25'	1.2x7.6	6"	152.4	6 1/4"	158.8	20	19	16-450-6000

SHIELDS AIR CONDITIONER DUCTING HOSE

Shields Air Conditioner Ducting Hose has a smooth tube for maximum airflow. This is a vinyl coated, woven fiberglass hose and is supported by vinyl coated helical wire. It is resistant to ozone, UV, and corrosion. The hose is flame resistant and meets the UL94-V-0 standard. This hose is primarily used for venting of bilge fumes and A/C ducting hose. The temperature ranges from -20° – +200°F



Bulk	m	I.D.	mm	O.D.	mm	Wt. "C"	Code No.
5 x 25'	1.5x7.6	3"	76	3 1/4"	82.5	22	—
6 x 25'	1.8x7.6	4"	102	4 1/4"	108	24	16-460-4000
5 x 25'	1.5x7.6	5"	127	5 1/4"	133.4	32	16-460-5000
4 x 25'	1.2x7.6	6"	152	6 1/4"	158.8	36	—
2 x 25'	.6x7.6	7"	178	7 1/4"	184.2	44	—

SHIELDS MARINE EXHAUST/WATER HOSE (No Wire)



Shields Marine Exhaust / Water Hose is reinforced with 2 or 4 plies of synthetic cord and is made of black, heavy-walled synthetic rubber. This hose is primarily used for straight connections in wet exhaust systems and engine water circulation lines. It is resistant to engine heat, exhaust fumes, ozone, mild chemicals, antifreeze and saltwater. This hose also has double the ozone resistance required by SAEJ2006. The temperature ranges from -20°F – +200°F continuous, +250°F intermittent. The hose meets SAE J2006 Type R1 standards.

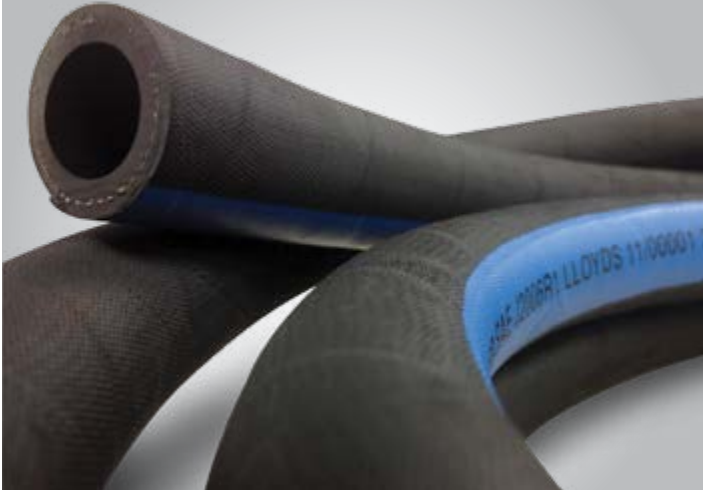

This certification provides unbiased, third party confirmation worldwide that these Shields hoses meet the highest standards of production quality. Certification ensures the proper level of product safety and inspires user confidence.

Now double the ozone resistance required by SAEJ2006

I.D.	mm	O.D.	Ply	Wt. "C"	50' (15.2m) Coil Code #	12 1/2' (3.8m) Length Code #	6 1/4' (1.9m) Length Code	10' (3.1m) Length Code#
1/2"	13	7/8"	2	24	16-200-0120	16-200-0124	16-200-0121	—
5/8"	16	1 1/32"	2	33	16-200-0580	16-200-0584	16-200-0581	—
3/4"	19	1 9/64"	2	37	16-200-0340	16-200-0344	16-200-0341	16-200-0343
7/8"	22	1 17/64"	2	42	16-200-0780	16-200-0784	—	—
1"	25	1 3/8"	2	48	16-200-1000	16-200-1004	16-200-1001	16-200-1003
1 1/8"	28	1 1/2"	2	52	16-200-1180	16-200-1184	—	—
1 1/4"	32	1 45/64"	2	60	16-200-1140	16-200-1144	16-200-1141	—
1 5/16"	33	1 47/64"	2	62	—	—	—	—
1 3/8"	35	1 13/16"	2	66	—	—	—	—
1 1/2"	38	1 15/16"	2	70	16-200-1120	16-200-1124	16-200-1121	16-200-1123
1 5/8"	42	2 3/32"	2	77	16-200-1580	16-200-1584	16-200-1581	—
1 3/4"	45	2 13/64"	2	82	16-200-1340	16-200-1344	16-200-1341	16-200-1343
1 7/8"	48	2 23/64"	2	96	16-200-1780	16-200-1784	—	—
2"	51	2 31/64"	2	102	16-200-2000	16-200-2004	16-200-2001	16-200-2003
2 1/8"	54	2 19/32"	2	107	16-200-2180	—	—	—
2 1/4"	58	2 3/4"	2	114	16-200-2140	16-200-2144	16-200-2141	—
2 3/8"	60	2 7/8"	2	132	16-200-2380	16-200-2384	—	16-200-2383
2 1/2"	63	3"	2	136	16-200-2120	16-200-2124	16-200-2121	16-200-2123
2 5/8"	67	3 3/32"	2	147	—	—	—	—
2 3/4"	70	3 17/64"	2	152	—	—	—	—
2 7/8"	73	3 7/16"	2	174	—	16-200-2784	16-200-2781	—
3"	76	3 9/16"	2	182	16-200-3000	16-200-3004	16-200-3001	16-200-3003
3 1/8"	80	3 45/64"	2	190	—	16-200-3184	16-200-3181	—
3 1/2"	90	4 3/32"	2	198	—	16-200-3124	16-200-3121	16-200-3123
3 3/4"	95	4 9/32"	2	221	—	16-200-3344	16-200-3341	—
4"	102	4 17/32"	4	229	—	16-200-4004	16-200-4001	16-200-4003
4 1/2"	114	5 1/8"	2	300	—	—	16-200-4121	—
5"	127	5 5/8"	2	332	—	16-200-5004	—	16-200-5003
5 1/2"	140	6 3/16"	2	396	—	—	—	—
6"	152	6 11/16"	2	427	—	16-200-6004	16-200-6001	16-200-6003
8"	203	8 25/32"	4	670	—	16-200-8004	—	16-200-8003
10"	254	10 7/8"	4	934	—	16-200-10004	—	—
12"	305	12 7/8"	4	1095	—	16-200-12004	—	—
14"	350	14 7/8"	4	1430	—	—	—	—

* Special Order

SHIELDS NAUTIFLEX SILICONE EXHAUST HOSE

Shields Nautiflex Silicone Exhaust Hose has a blue silicone cover with a smooth finish for easy clean up. This hose is flexible, easy to install and has four plies of synthetic fabric. It also remains stable at elevated temperatures. This hose is primarily used for straight connections in the wet exhaust system and engine water circulation lines. The temperature ranges from – 20°F – +350°F. The hose meets SAE J2006 Type R1 and ISO 13363:2004 – Type 2 – Class B standards.



Wet Exhaust Hose SAE J2006 Type R1

I.D.	mm	O.D.	Wt. "C"	3' (9.m) Length Code #	6' (1.8m) Length Code #	12' (3.7m) Length Code #
1"	25	1 ³ / ₈ "	33.1	—	—	—
1 ¹ / ₈ "	28	1 ¹ / ₂ "	37.2	—	—	—
1 ¹ / ₄ "	32	1 ⁵ / ₈ "	41.3	16-202-1140-36	—	16-202-1144
1 ³ / ₈ "	35	1 ³ / ₄ "	45.4	—	—	—
1 ¹ / ₂ "	38	1 ⁷ / ₈ "	49.6	16-202-1120-36	—	16-202-1124
1 ³ / ₄ "	45	2 ¹ / ₈ "	57.8	—	—	—
2"	51	2 ³ / ₈ "	66.1	—	16-202-2001	16-202-2004
2 ³ / ₈ "	60	2 ³ / ₄ "	78.5	16-202-2380-36	—	16-202-2384
2 ¹ / ₂ "	63	2 ⁷ / ₈ "	82.6	16-202-2120-36	16-202-2121	16-202-2124
2 ⁵ / ₈ "	67	2 ⁶³ / ₆₄ "	86.8	16-202-2580-36	—	16-202-2584
2 ³ / ₄ "	70	3 ¹ / ₈ "	90.9	—	—	—
2 ⁷ / ₈ "	73	3 ¹ / ₄ "	94.1	—	—	—
3"	76	3 ³ / ₈ "	99.2	16-202-3000-36	—	16-202-3004
3 ¹ / ₄ "	82	3 ¹ / ₂ "	103.4	16-202-3140-36	16-202-3141	16-202-3144
3 ¹ / ₂ "	90	3 ⁷ / ₈ "	115.7	16-202-3120-36	—	16-202-3124
4"	102	4 ³ / ₈ "	132	16-202-4000-36	—	16-202-4004
5"	127	5 ³ / ₈ "	165	16-202-5000-36	16-202-5001	16-202-5004
5 ¹ / ₂ "	140	5 ⁷ / ₈ "	181.5	—	—	—
6"	152	6 ³ / ₈ "	198	16-202-6000-36	—	16-202-6004
8"	203	8 ³ / ₈ "	264	16-202-8000-36	16-202-8001	16-202-8004
10"	254	10 ³ / ₈ "	330	16-202-1000036	—	16-202-10004
12"	305	12 ³ / ₈ "	396	16-202-1200036	—	16-202-12004
14"	350	14 ⁵ / ₈ "	462	16-202-1400036	—	—



SHIELDSFLEX II MARINE WATER/EXHAUST HOSE (w/ Wire)

Shieldsflex II Marine Water/Exhaust Hose has a black synthetic rubber tube and cover. It is reinforced with wire helix imbedded between plies of HD synthetic cord. It is resistant to exhaust fumes, ozone, mild chemicals, antifreeze and saltwater. This hose is abrasion and odor permeation resistant. It now has double the ozone resistance required by the SAEJ2006. Shieldsflex II is primarily used for engine intake, wet exhaust connections (use where bends or long lengths are required), bilge pump intake/discharge, scupper lines, toilet intake/discharge, and holding tank vent/pump out. The temperature ranges from -20° F – +200°F continuous, +250°F intermittent. The hose meets SAE J2006 Type R2 standards.



I.D.	mm	O.D.	Ply	Wt. "C"	50' (15.2m) Coil Code #	25' (7.6m) Cartons	12 1/2' (3.8m) Length Code#	6 1/4' (1.9m) Length Code #	10' (3.1m) Length Code #
1/2"	13	27/32"	2	24	16-250-0120	16-250-0125	16-250-0124	—	16-250-0123
5/8"	16	61/64"	2	28	16-250-0580	16-250-0585	16-250-0584	16-250-0581	16-250-0583
3/4"	19	1 1/16"	2	32	16-250-0340	16-250-0345	16-250-0344	16-250-0341	16-250-0343
7/8"	22	1 3/16"	2	36	16-250-0780	—	16-250-0784	16-250-0781	16-250-0783
1"	25	1 5/16"	2	40	16-250-1000	16-250-1005	16-250-1004	16-250-1001	16-250-1003
1 1/8"	28	1 7/16"	2	44	16-250-1180	16-250-1185	16-250-1184	16-250-1181	16-250-1183
1 1/4"	32	1 19/32"	2	50	16-250-1140	16-250-1145	16-250-1144	16-250-1141	16-250-1143
1 5/16"	33	1 5/8"	2	51	16-250-1560	—	16-250-1564	16-250-1561	16-250-1563
1 3/8"	35	1 23/32"	2	58	16-250-1380	—	16-250-1384	16-250-1381	16-250-1383
1 1/2"	38	1 53/64"	2	62	16-250-1120	16-250-1125	16-250-1124	16-250-1121	16-250-1123
1 5/8"	42	2"	2	80	16-250-1580	—	16-250-1584	16-250-1581	16-250-1583
1 3/4"	45	2 1/8"	2	88	16-250-1340	—	16-250-1344	—	16-250-1343
1 7/8"	48	2 19/64"	2	93	16-250-1780	—	16-250-1784	16-250-1781	16-250-1783
2"	51	2 13/32"	2	99	16-250-2000	—	16-250-2004	16-250-2001	16-250-2003
2 1/8"	54	2 17/32"	2	107	16-250-2180	—	16-250-2184	—	—
2 1/4"	58	2 11/16"	2	127	16-250-2140	—	16-250-2144	16-250-2141	16-250-2143
2 3/8"	60	2 3/4"	2	132	16-250-2380	—	16-250-2384	16-250-2381	16-250-2383
2 1/2"	63	2 7/8"	2	137	16-250-2120	—	16-250-2124	16-250-2121	16-250-2123
2 5/8"	67	3 1/16"	2	147	—	—	16-250-2584	—	—
2 3/4"	70	3 3/16"	2	164	16-250-2340	—	16-250-2344	16-250-2341	16-250-2343
2 7/8"	73	3 5/16"	2	170	16-250-2780	—	16-250-2784	16-250-2781	16-250-2783
3"	76	3 7/16"	2	177	16-250-3000	—	16-250-3004	16-250-3001	16-250-3003
3 1/8"	80	3 5/8"	2	200	—	—	16-250-3184	16-250-3181	—
3 1/2"	90	4"	2	223	16-250-3120	—	16-250-3124	16-250-3121	16-250-3123
4"	102	4 5/8"	2	269	16-250-4000	—	16-250-4004	16-250-4001	16-250-4003
4 1/8"	105	4 47/64"	2	276	—	—	—	—	—
4 1/2"	114	5 3/32"	2	319	16-250-4120	—	16-250-4124	16-250-4121	—
5"	127	5 5/8"	2	398	16-250-5000	—	16-250-5004	16-250-5001	16-250-5003
5 1/8"	130	5 3/4"	2	417	—	—	—	—	—
5 1/2"	140	6 3/16"	2	443	—	—	—	—	—
6"	152	6 21/32"	2	482	—	—	16-250-6004	16-250-6001	—
8"	203	8 25/32"	2	780	—	—	16-250-8004	—	—



This certification provides unbiased, third party confirmation worldwide that these Shields hoses meet the highest standards of production quality. Certification ensures the proper level of product safety and inspires user confidence.

Now double the ozone resistance required by SAEJ2006

SHIELDSAUST-C



Now double the ozone resistance required by SAEJ2006

Shieldsaust – C Hose has a black synthetic rubber tube and cover. It is reinforced with double wire helix imbedded between plies of synthetic cord and is abrasion resistant. It is resistant to exhaust fumes, ozone, mild chemicals, antifreeze, and saltwater. This hose is primarily used for wet exhaust connections with significant bends, engine intake and scupper lines. The temperature ranges from -20°F to + 200°F continuous, +250°F intermittent. The hose now has double the ozone resistance required by SAEJ2006. This hose meets SAE J2006 Type R2 standards.

I.D.	mm	O.D.	Ply	Wt. "C"	50' (15.2m) Coil Code #	12 1/2' (3.8m) Length Code#	6 1/4' (1.9m) Length Code #	10' (3.1m) Length Code #
3/4"	19	1 1/8"	2	27	16-252-0340	16-252-0344	—	16-252-0343
1"	25	1 11/32"	2	33	16-252-1000	16-252-1004	16-252-1001	16-252-1003
1 1/4"	32	1 39/64"	2	45	16-252-1140	16-252-1144	16-252-1141	16-252-1143
1 1/2"	38	1 15/16"	2	70	16-252-1120	16-252-1124	—	16-252-1123
1 5/8"	42	2 3/32"	2	80	16-252-1580	16-252-1584	—	—
1 3/4"	45	2 7/32"	2	85	16-252-1340	16-252-1344	—	16-252-1343
1 7/8"	48	2 21/64"	2	91	16-252-1780	16-252-1784	16-252-1781	16-252-1783
2"	51	2 7/16"	2	95	16-252-2000	16-252-2004	16-252-2001	16-252-2003
2 1/8"	54	2 9/16"	2	100	—	16-252-2184	—	—
2 1/4"	58	2 23/32"	2	107	—	16-252-2144	—	—
2 3/8"	60	2 51/64"	2	110	16-252-2380	16-252-2384	16-252-2381	16-252-2383
2 1/2"	63	2 59/64"	2	115	16-252-2120	16-252-2124	16-252-2121	16-252-2123
2 3/4"	70	3 3/16"	2	126	—	16-252-2344	—	—
2 7/8"	73	3 5/16"	2	137	16-252-2780	16-252-2784	—	16-252-2783
3"	76	3 7/16"	2	143	16-252-3000	16-252-3004	16-252-3001	16-252-3003
3 1/8"	80	3 19/32"	2	150	—	16-252-3184	16-252-3181	—
3 1/2"	90	4 1/16"	2	200	16-252-3120	16-252-3124	16-252-3121	16-252-3123
4"	102	4 9/16"	2	231	16-252-4000	16-252-4004	16-252-4001	16-252-4003
4 1/8"	105	4 11/16"	2	238	—	—	—	—
4 1/2"	114	5 1/8"	2	278	—	16-252-4124	—	—
5"	127	5 9/16"	2	300	—	16-252-5004	16-252-5001	—
6"	152	6 9/16"	2	394	16-252-6000	16-252-6004	16-252-6001	—
8"	203	8 11/16"	2	607	—	16-252-8004	—	—



This certification provides unbiased, third party confirmation worldwide that these Shields hoses meet the highest standards of production quality. Certification ensures the proper level of product safety and inspires user confidence.

SHIELDS NAUTIFLEX CORRUGATED SILICONE EXHAUST HOSE



Shields Nautiflex Corrugated Silicone Exhaust Hose has a blue silicone tube and cover with a smooth finish for easy cleaning. The hose is wire reinforced and will not collapse under suction or in a bend. The corrugated cover allows the hose to bend for easy installation. The Nautiflex, two ply construction, has wire captured between fabric plies. This hose is primarily used for main engine exhaust, generator exhaust, engine coolant circulation, engine intake and generator intake. It is resistant to exhaust fumes, ozone, mild chemicals, antifreeze and saltwater. The hose remains stable at elevated temperatures. The temperatures ranges from -20°F + 350°F. This hose meets SAEJ2006 Type R2 and ISO 13362:2004 – Type 1 – Class B standards.



I.D.	mm	O.D.	Wt. "C"	10' (3.1m) Length Code #	12 1/2' (3.8m) Length Code#	50' (15.2m) Coil Code #	6 1/4' (1.9m) Length Code #
3/4"	19	1 3/8"	34	—	16-262-0344	16-262-0340	—
1"	25	1 27/64"	42	16-262-1003	16-262-1004	16-262-1000	—
1 1/8"	28	1 1/2"	46	16-262-1183	—	16-262-1180	—
1 1/4"	32	1 45/64"	52	—	16-262-1144	16-262-1140	—
1 3/8"	35	1 55/64"	60	16-262-1383	16-262-1384	16-262-1380	—
1 1/2"	38	2"	71	16-262-1123	16-262-1124	16-262-1120	—
1 5/8"	42	2 11/64"	74	—	—	—	—
1 3/4"	45	2 19/64"	78	16-262-1343	16-262-1344	—	—
1 7/8"	48	2 13/32"	82	—	16-262-1784	—	—
2"	51	2 17/32"	87	16-262-2003	16-262-2004	16-262-2000	—
2 1/8"	54	2 5/8"	94	—	—	—	—
2 3/8"	60	2 7/8"	101	16-262-2383	16-262-2384	16-262-2380	—
2 1/2"	63	3 3/64"	113	—	16-262-2124	16-262-2120	—
2 3/4"	70	3.312"	125	16-262-2343	—	16-262-2340	—
2 7/8"	73	3 7/16"	134	16-262-2783	16-262-2784	16-262-2780	—
3"	76	3 35/64"	139	16-262-3003	16-262-3004	16-262-3000	—
3 1/2"	90	4 19/64"	227	16-262-3123	16-262-3124	16-262-3120	—
4"	102	4 49/64"	255	16-262-4003	16-262-4004	16-262-4000	—
5"	127	5 3/4"	310	16-262-5003	—	16-262-5000	—
6"	152	6 15/16"	484	16-262-6003	—	—	—
8"	203	9 7/64"	768	16-262-8003	—	—	—
10"	254	11 17/64"	1136	16-262-10003	—	—	—
12"	305	13.359"	1518	16-262-12003	—	—	—
14"	350	15.281"	1812	—	—	—	—
16"	404	17.562"	2277	—	—	—	—

* Special Order

SHIELDS COMPLEX - ALL IN ONE HOSE FOR INSPECTED VESSELS

Shields Complex is a versatile wire reinforced hose specially designed for inspected vessels. Complex is rated for fuel, vital water and non-vital water systems on boats requiring SAE J1942 hoses. Applications include bilge, coolant, oil and fuel systems using gasoline, gasohol, diesel, bio-diesel, wet exhaust systems, non-potable water systems, engine intake, toilet and holding tank connections.



Tube: Black Nitrile
 Reinforcement: 2 textile plies w/ dual wire helix
 Cover: Black Chlorprene
 Temp. Range: -20F to +212F

Specifications - SAE J1942 Code F, VW, NVW;
 SAE J1527 A1; SAE J2006 R2; SAE 20R2 B;
 SAE J20R4 B; SAE 20R5 B, SAE 30R5,
 ISO 7840 A1

Additional sizes available. 150' minimum order.

• Do not use in application requiring low-permeation fuel feed hose (SAE J1527 A-1-15)

I.D.	mm	O.D.	Ply	Wt. "C"	Bend Radius	WP	50' (15.2m) Coil Code #	12 1/2' (3.8m) Length Code#	10' (3.1m) Length Code #	6 1/4' (1.9m) Length Code #
5/8"	15.9	1"	2	33	1.5	75	16-321-0580	16-321-0584	—	16-321-0581
3/4"	19.1	1.19"	2	39	1.5	75	16-321-0340	16-321-0344	16-321-0343	16-321-0341
1"	25.4	1.41"	2	53	2	75	16-321-1000	16-321-1004	16-321-1003	16-321-1001
1 1/8"	28.6	1.56"	2	62	3	75	16-321-1180	16-321-1184	—	16-321-1181
1 1/4"	31.8	1.66"	2	64	3	75	16-321-1140	16-321-1144	16-321-1143	16-321-1141
1 1/2"	38.1	1.91"	2	78	3	50	16-321-1120	16-321-1124	16-321-1123	16-321-1121
2"	50.8	2.48"	2	118	5	50	16-321-2000	16-321-2004	—	16-321-2001

SHIELDS SILICONE COUPLERS - SINGLE & DOUBLE HUMP W/Reinforced Fabric



Shields Single and Double Hump Couplers have a blue silicone cover with a smooth finish for easy clean up and are fabric reinforced. The couplers remain stable at elevated temperatures and provide angular and longitudinal vibration absorption in wet exhaust systems. Shields couplers correct slight offsets in pipes. They are resistant to exhaust fumes, ozone, mild chemicals, antifreeze and saltwater. The temperature range is -20°F to +350°F. It meets SAE J2006 Type R1 standards.

SINGLE HUMP

DOUBLE HUMP

	I.D.	mm	Length	mm	Wt. Ea. (lbs)	Code No.
	4"	102	6"	152	2	16-272-4000
	5"	127	6"	152	2	16-272-5000
	6"	152	8"	203	2	16-272-6000
	8"	203	8"	203	3	16-272-8000
	10"	254	12"	305	4	16-272-10000
DOUBLE	6"	152.4	14"	356	3	16-274-6000
	8"	203.2	14"	356	3	16-274-8000
	10"	254	14"	356	4	16-274-10000

SHIELDS SILICONE COUPLERS - SINGLE HUMP

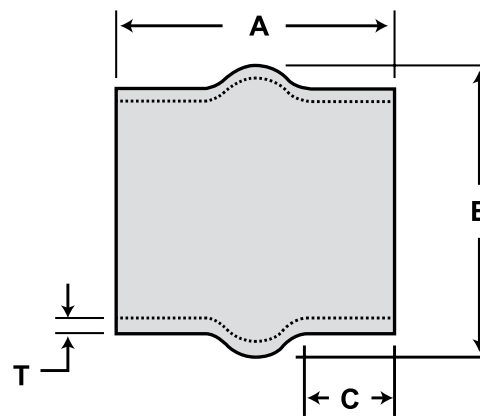

Hump Hose

Shields Silicone Single and Double Hump Couplers are very high temperature silicone exhaust connectors. The maximum operating temperature is 450°F (232°C). It meets SAE J2006 Type R1 standards.

Part Number	ID	mm	A	mm	B	mm	C	mm	T	mm
16-220S4000	4.0	101.6	5.25	133	5.50	140	2.00	51	.25	6
16-220S5000	5.0	127	6.00	152	6.50	165	2.25	57	.25	6
16-220S6000	6.0	152.4	7.00	178	7.50	190	2.75	70	.25	6

SHIELDS SILICONE ELBOWS - 45°

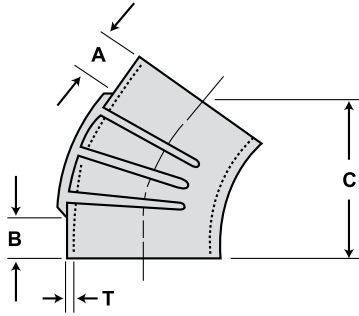

45° Elbow



Part Number	ID	mm	A	mm	B	mm	C	mm	T	mm
16-245S3000	3.0	76.2	1.50	38	1.50	38	5.50	140	.25	6
16-245S4000	4.0	101.6	1.50	38	1.50	38	5.50	140	.25	6
16-245S6000*	6.0	152.4	2.00	51	2.00	51	6.50	165	.25	6

* Asterisk indicates ribbed elbow

SHIELDS SILICONE ELBOWS - 90°

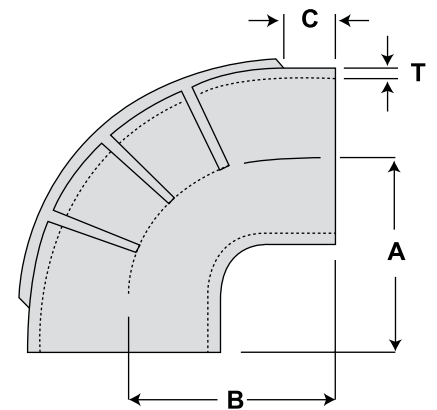

90° Elbow

Part Number	ID	mm	A	mm	B	mm	C	mm	T	mm
16-290S2000	2.0	50.8	4.25	108	5.25	133	2.75	70	.20	5
16-290S3000	3.0	76.2	5.25	133	5.25	133	1.50	38	.25	6
16-290S4000	4.0	101.6	5.75	146	5.75	146	1.50	38	.25	6
16-290S5000	5.0	127	6.00	152	6.00	152	1.62	41	.25	6
16-290S6000*	6.0	152.4	7.00	178	7.00	178	2.25	57	.25	6
16-290S8000*	8.0	203.2	8.50	216	8.50	216	2.00	51	.37	9

SHIELDS EPDM COUPLERS - SINGLE HUMP

100% High temperature EPDM rubber. Maximum operating temperature 250° F (120° C).

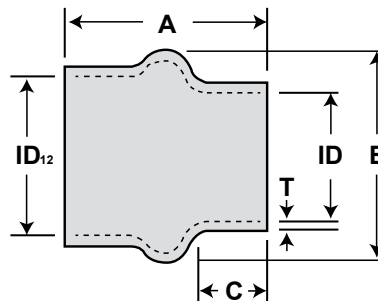

Reducing Hump Hose

Hump Hoses

Part Number	ID	mm	A	mm	B	mm	C	mm	T	mm
16-220-3000-1	3.00	76.2	5.25	133.35	4.50	114.3	2.00	50.8	0.25	6.35
16-220-3120-1	3.50	88.9	5.25	133.35	5.00	127	2.00	50.8	0.25	6.35
16-220-4000-1	4.00	101.6	5.25	133.35	5.50	139.7	2.00	50.8	0.25	6.35
16-220-5000-1	5.00	127	6.00	152.4	6.50	165.1	2.25	57.15	0.25	6.35
16-220-6000-1	6.00	152.4	7.00	177.8	7.50	190.5	2.75	69.85	0.25	6.35
16-220-8000-1	8.00	203.2	5.00	127	9.50	241.3	1.50	38.1	0.25	6.35

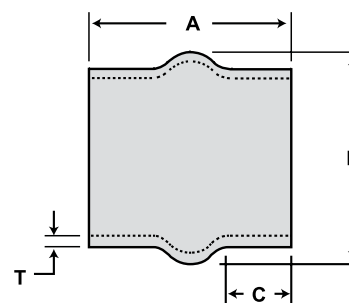

Hump Hose

Reducing Hump Hoses

Part Number	ID	mm	ID2	mm	A	mm	B	mm	C	mm	T	mm
16-221-4X3	4.00	101.6	3.00	76.2	5.25	133.6	5.50	139.7	1.50	38.1	0.25	6.35
16-221-4X3	4.00	101.6	3.00	76.2	5.25	133.6	5.50	139.7	1.50	38.1	0.25	6.35
16-221-6X5	6.00	152.4	5.00	127	6.00	152.4	7.50	190.5	2.12	53.85	0.25	6.35
16-221-8X6	8.00	203.2	6.00	152.4	6.00	152.4	9.50	241.3	1.38	35.05	0.25	6.35

SHIELDS EPDM ELBOWS - 45°

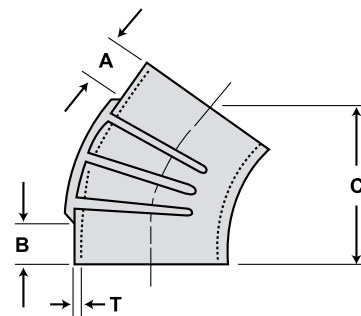

45° Elbow

*Asterisk indicates ribbed elbow

Part Number	ID	mm	A	mm	B	mm	C	mm	T	mm
16-245-3000-1	3.00	76.2	1.50	38.1	1.50	38.1	5.50	139.7	0.25	6.35
16-245-3120-1	3.50	88.9	1.50	38.1	1.50	38.1	5.50	139.7	0.25	6.35
16-245-4000-1	4.00	101.6	1.50	38.1	1.50	38.1	5.50	139.7	0.25	6.35
16-245-4120-1	4.50	144.3	1.50	38.1	1.50	38.1	5.75	146.1	0.25	6.35
16-245-5000-1	5.00	127	1.62	41.15	1.62	41.15	5.25	133.35	0.25	6.35
16-245-6000-1*	6.00	152.4	2.00	50.8	2.00	50.8	6.50	165.1	0.25	6.35
16-245-8000-1*	8.00	203.2	2.25	57.15	2.25	57.15	8.25	209.6	0.37	9.40

SHIELDS EPDM ELBOWS - 90°

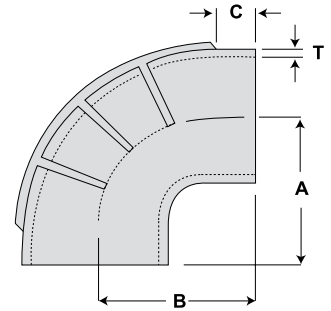

90° Elbow

*Asterisk indicates ribbed elbow

Part Number	ID	mm	A	mm	B	mm	C	mm	T	mm
16-290-2000-1	2.00	50.8	4.25	107.95	5.25	133.35	2.75	69.85	0.20	5.08
16-290-2120-1	2.50	63.5	4.25	107.95	4.25	107.95	1.50	38.1	0.20	5.08
16-290-3000-1	3.00	76.2	5.25	133.35	5.25	133.35	1.50	38.1	0.25	6.35
16-290-3120-1	3.50	88.9	5.50	139.7	5.50	139.7	1.75	44.45	0.25	6.35
16-290-4000-1	4.00	101.6	5.75	146.05	5.75	146.05	1.50	38.1	0.25	6.35
16-290-4120-1	4.50	114.3	6.00	152.4	6.00	152.4	1.50	38.1	0.25	6.35
16-290-5000-1	5.00	127	6.00	152.4	6.00	152.4	1.62	41.15	0.25	6.35
16-290-6000-1*	6.00	152.4	7.00	177.8	7.00	177.8	2.25	57.15	0.25	6.35
16-290-8000-1*	8.00	203.2	8.50	215.9	8.50	215.9	2.00	50.8	0.37	9.40

SHIELDS EPDM ELBOWS - 90° REDUCING ELBOW

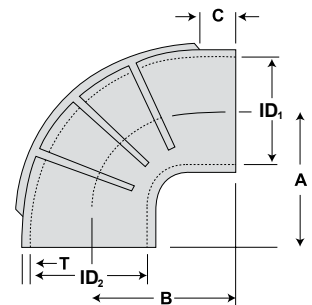

90° Reducing Elbow

Part Number	ID	mm	ID2	mm	A	mm	B	mm	C	mm	T	mm
16-291-5004001	4.00	101.6	5.00	127	5.75	146	6.00	152.4	1.75	44.45	0.25	6.35

Also available with series 720 T-bolt clamps. Order part number with "Kit" Suffix.



SHIELDS EXHAUST PROTECTOR VALVES

Specially compounded rubber flapper valves designed to prevent water from entering the exhaust system in following seas or when backing down. Made with weather resistant EPDM with U/V stabilizer.

Code #	Pipe Size	mm	O.E.M	O.E.#
18-4456*	3"	76.2	Mercury	34765A1
18-4457*	4"	101.6	Mercury	12644A1
18-4458*	5" or 6"	127 or 152.4	—	—

* Display Packaged
Must be cut to fit 5" pipe (two 45 cuts required)
18-#'s include stainless steel hose clamp.

SHIELDS CONSTANT TENSION CLAMPS

• Clamping Silicone Heater/Exhaust Hose

Dia. Range (in.)	Sierra No.	Fits Series 202 Sizes
1.75 - 2.625	18-725-2000	1 3/4", 1 7/8", 2"

SHIELDS HOSE CLAMPS

All components are manufactured from marine grade 316 stainless steel. These clamps are designed to fit many applications from 5/16" to 7" diameter hoses.



Sierra No.	Bulk No.	Diameter Size	Std. No
18-710-06-2	18-710-06	7/16" to 3/4"	006
18-710-08-2	18-710-08	1/2" to 7/8"	008
18-710-10-2	18-710-10	9/16" to 1 1/16"	010
18-710-12-2	18-710-12	11/16" to 1 1/4"	012
18-710-16-2	18-710-16	1 1/16" to 1 1/2"	016
18-710-20-2	18-710-20	1 3/16" to 1 3/4"	020
18-710-24-2	18-710-24	1 1/16" to 2"	024
18-710-28-2	18-710-28	1 5/16" to 2 1/4"	028
18-710-32-2	18-710-32	1 9/16" to 2 1/2"	032
18-710-36-2	18-710-36	1 13/16" to 2 3/4"	036
18-710-40-2	18-710-40	2 1/16" to 3"	040
18-710-44-2	18-710-44	2 5/16" to 3 1/4"	044
18-710-48-2	18-710-48	2 9/16" to 3 1/2"	048
18-710-52-2	18-710-52	2 13/16" to 3 3/4"	052
18-710-56-2	18-710-56	3 1/16" to 4"	056
18-710-60-2	18-710-60	3 5/16" to 4 1/4"	060
18-710-64-2	18-710-64	3 9/16" to 4 1/2"	064
18-710-72-2	18-710-72	4 1/16" to 5"	072
18-710-80-2	18-710-80	4 9/16" to 5 1/2"	080
18-710-88-2	18-710-88	5 1/16" to 6"	088
18-710-96-2	18-710-96	5 5/8" to 6 1/2"	096
18-710-104-2	18-710-104	5" to 7"	104

SHIELDS EXHAUST HOSE CLAMPS T-BOLT BAND CLAMPS



These exhaust hose clamps are designed to fit Shields series 200, 250, and are perfect for any application below the water line. The band is 316 stainless steel and is .025 thick by .75 wide. Other hardware includes an extra long 1/4" bolt and a nylon inset locknut. The bolt, nut and trunion are 18-8 (304) stainless steel. Maximum torque of 75 inch pounds.

Dia. Range	mm	Hose I.D.	mm	Wt. "C"	Code No.
1.18 - 1.47	30.0 - 37.3	1"	25.4	9.4	18-720-1000 ©
1.70 - 2.03	43.2 - 51.6	1 1/2"	38.1	12.5	18-720-1120 ©
1.48 - 1.62	37.59 - 41.15	1 1/4"	31.75	11	18-720-1140 ©
2.27 - 2.67	57.7 - 67.8	2"	50.8	12.8	18-720-2000
2.68 - 3.34	68.1 - 84.8	2 1/2"	63.5	15.6	18-720-2120
3.10 - 3.76	78.7 - 95.5	3"	76.2	15.8	18-720-3000
3.59 - 4.25	91.2 - 108	3 1/2"	88.9	17.2	18-720-3120
4.18 - 4.84	106.2 - 122.9	4"	101.6	18.8	18-720-4000
4.25 - 4.91	108.0 - 124.7	4 1/8"	104.8	18.9	18-720-4180
4.75 - 5.41	120.7 - 137.4	4 1/2"	114.3	20	18-720-4120
4.68 - 5.34	118.9 - 135.6	4 1/2"	114.3	20	18-720-4120S *
5.30 - 5.96	134.6 - 151.4	5"	127.0	22	18-720-5000
5.18 - 5.84	131.6 - 148.3	5"	127.0	22	18-720-5000S *
5.75 - 6.41	146.1 - 162.8	5 1/2"	139.7	25	18-720-5120
5.68 - 6.34	144.3 - 161.0	5 1/2"	139.7	25	18-720-5120S *
6.38 - 7.04	162.1 - 178.8	6"	152.4	27	18-720-6000
6.18 - 6.84	157.0 - 173.7	6"	152.4	27	18-720-6000S*
8.42 - 9.08	213.9 - 230.6	8"	203.2	29	18-720-8000
8.18 - 8.84	207.8 - 224.5	8"	203.2	29	18-720-8000S *
10.45 - 11.11	265.4 - 282.2	10"	254.0	31	18-720-10000
10.18 - 10.84	258.6 - 275.3	10"	254.0	31	18-720-10000S *
12.38 - 13.04	314.5 - 331.2	12"	304.8	33	18-720-12000
12.18 - 12.84	309.4 - 326.1	12"	304.8	33	18-720-12000S *
14.50 - 15.16	368.3 - 385.1	14"	355.6	41.1	18-720-14000
14.30 - 14.96	363.2 - 380.0	14"	355.6	41.1	18-720-14000S *

© Clamps for 1" and 1 1/2" are 5/8" wide * Designed to fit Series 202 silicone exhaust hose

SHIELDS EXPANDABLE BRAIDED SLEEVING (Scissor Cut)

Shields Expandable Conduit is designed to be cut with a scissors making it ideal for field installation where a hot knife required by other conduit is not practical. Conduit features a dense braid for excellent coverage and high abrasion resistance. Temperature range -94°F to 257°F, melt temperature 482°F. Meets RoHS, ABYC & UL 94 V2 standards.



Sierra No.	Description	Expansion Range		Shop Spool Ft.	Wt. /Spool lbs.
		Min.	Max.		
16-129-0147	1/4" Expandable Braided Sleeving	5/32"	7/16"	100	0.46
16-129-0127	1/2" Expandable Braided Sleeving	1/4"	3/4"	100	0.82
16-129-0348	3/4" Expandable Braided Sleeving	5/8"	1"	75	0.84
16-129-1006	1" Expandable Braided Sleeving	3/4"	1 3/16"	50	0.62
16-129-1126	1 1/2" Expandable Braided Sleeving	1 1/4"	2"	50	0.93
16-129-2006	2" Expandable Braided Sleeving	1 3/4"	2 1/2"	50	1.75



SHIELDS FLAME RETARDANT SPLIT WIRE CONDUIT

Flame retardant polypropylene is black with a blue stripe. It provides chafing protection for wiring systems and is split longitudinally for easy access to harness. It has a temperature range of +275°F. It meets ABYC standard 8.15.19. and UL 94 V2.



I.D.	mm	Wt. "C"	Code #	Pack	m	Dist. Pkg.		50' (15.2m) Box Code #
						100' (30.1m) R/O Ctn. Code#	50' (15.2m) R/O Ctn. Code #	
1/4"	6.4	1.26	16-128-0140B	3200'	975	16-128-0147B	16-128-0146B	16-128-0146B-1
3/8"	9.5	1.58	16-128-0380B	1800'	549	16-128-0387B	16-128-0386B	16-128-0386B-1
1/2"	12.7	2.31	16-128-0120B	1100'	335	16-128-0127B	16-128-0126B	16-128-0126B-1
5/8"	15.9	2.94	16-128-0580B	750'	229	16-128-0587B	16-128-0586B	16-128-0586B-1
3/4"	19.1	3.47	16-128-0340B	450'	137	16-128-0347B	16-128-0346B	16-128-0346B-1
1"	25.4	5.78	16-128-1000B	300'	91	16-128-1007B	16-128-1006B	16-128-1006B-1
1 1/4"	31.8	9.24	16-128-1140B	200'	61	—	16-128-1146B	—
1 1/2"	38.1	15.23	16-128-1120B	100'	31	—	16-128-1126B	—
2"	50.8	21.00	16-128-2000B	100'	31	—	—	—

SHIELDS STERNFLEX



Shields Sternflex has a polyethylene co-polymer wall with an integral polyethylene helix. It is resistant to abrasion, crushing and UV. This hose is primarily used as a cover for the harness and for the hoses on the bracket mounted on outboard engines.

I.D.	mm	Bend Radius	mm	Wt. "C"	Bulk Pack 50' (15.2m) Length Code #	Dist. Pkg. 10' (3.1m) Box Code No.
2"	50.8	3	76.2	39	16-126-2000B	16-126-2003B
2"	50.8	3	76.2	39	16-126-2000G	16-126-2003G
2"	50.8	3	76.2	39	16-126-2000W	16-126-2003W

B= Black G= Grey W= White

RIGGING FLANGE

Use with Shields 2" Sternflex P/N 16-126-2000B



- 18-9761B - Part No.**
 - U/V stabilized black plastic flange
- 18-9761G - Part No.**
 - U/V stabilized grey plastic flange
- 18-9761W - Part No.**
 - U/V stabilized white plastic flange

RIGGING HOSE KIT

Hides all engine cables and hoses. Can be added to any style outboard



- 18-9883B - Part No.**
 - Contains:
 - (1) U/V stabilized flange
 - 5' 2" Black Sternflex
- 18-9883G - Part No.**
 - Contains:
 - (1) U/V stabilized flange
 - 5' 2" Grey Sternflex
- 18-9883W - Part No.**
 - Contains:
 - (1) U/V stabilized flange
 - 5' 2" White Sternflex



18-9762
RIGGING HOSE FLANGE WITH FUEL PORT

UV Stabilized plastic flange; Hides all engine cables and fuel line while allowing easy access to the primer bulb.
Replaces: RFFHP-1-DP



18-9763
RIGGING HOSE UNION WITH FUEL PORT

UV Stabilized plastic union; Hides all engine cables and fuel line while allowing easy access to the primer bulb.
Replaces: RFHU-1-DP

18-9764

RIGGING FLANGE AND UNION KIT

Replaces: THM-RFFHP1DP

18-9773

RIGGING HOSE KIT WITH FUEL LINE PORT

UV Stabilized plastic flange; Hides all engine cables and fuel line while allowing easy access to the primer bulb. Kit includes 5' of black sternflex hose

Replaces: 990C0-20010

* Fuel line assembly not included



CABLE BOOT

Includes mounting grommet



18-4454-1
For 3" Hole

18-4455
For 4 1/2" Hole

SHIELDS NEOPRENE SHEET RUBBER

Solid Neoprene sheet rubber is designed for use under fuel tanks to comply with USCG requirements for air space. Also for gaskets, component padding and under wire straps. It can be custom cut to a variety of strips and shapes. It is offered in bulk rolls 36" wide x 10' long.



BULK SHEET

Thickness	mm	Width	mm	Length	mm	Code No.
1/8"	3.2	36"	914.4	10'	3.1	N18NEO60
3/16"	4.8	36"	914.4	10'	3.1	N316NEO60
1/4"	6.4	36"	914.4	10'	3.1	N14NEO60
3/8"	9.5	36"	914.4	10'	3.1	N38NEO60

DISTRIBUTOR BOXES

Thickness	mm	Width	mm	Length	mm	Code No.
1/8"	3.2	2"	50.8	10'	3.1	16-18X2X10
1/4"	6.4	2"	50.8	10'	3.1	16-14X2X10
3/8"	9.5	2"	50.8	10'	3.1	16-38X2X10
1/8"	3.3	1"	25.4	10'	3.1	16-18X1X10
1/4"	6.4	1"	25.4	10'	3.1	16-14X1X10
3/8"	9.7	1"	25.4	10'	3.1	16-38X1X10



SHIELDS HOSE — MISCELLANEOUS / NEOPRENE / PITOT

SHIELDS SPEEDOMETER PITOT TUBING

This black vinyl tubing is HW reinforced with a polyester braid and provides a tight connection between your speedometer pickup (Pitot) and your speedometer.

Nominal I.D.	mm	Braid	Wt. "C"	Code #	Bulk Pack	mm	Dist. Pkg. 25' (7.6m) Polypac Code#
1/8" (.125")	3.2	0	2.2	16-151-0180	1500'	457.2	16-151-0185
4 mm (.157")	4.0	1	4.3	16-151-0180H.W.	300'	91.4	16-151-0185 H.W.





23-1100
AIR FILTER
Replaces: Kohler 267709
Fits: 3.5 CFZ, 4 CZ, 5 CFZ, 6.5 CZ



23-1101
AIR FILTER
Replaces: Westerbeke 39705
Fits: 8.0 BTDA(60Hz) / 6.0 BTDA(50Hz), 10.0 BTDA(60Hz) / 7.5 BTDA(50Hz), 12.5 BTDB(60Hz) / 9.4 BTDB(50Hz), 15.0 BTDC(60Hz) / 12.0 BTDC(50Hz)



23-1104
AIR FILTER
Replaces: Fischer Panda IC78.460.000B
Fits: PMS 4200, PMS04, PMS15, PMS 16 DP, PMS 20, PMS 22



23-1105
AIR FILTER
Replaces: Fischer Panda IC78.460.000A
Fits: PMS 8 Mini, PMS 8 DP, PMS 6500, PMS 12 DP, PMS 12 Mini



23-1102
AIR FILTER ELEMENT
Replaces: Northern Lights 24-22009
Fits: M843NW3: 12/10Kw, M844W3: 16/12Kw, M844LW3: 20/16Kw



23-1103
AIR FILTER ELEMENT
Replaces: Northern Lights 24-28003
Fits: M673LD3: 5 / 4.5Kw, M673L3: 6/5Kw



23-1130
AIR FILTER
Replaces: Kohler 278857
Fits: 4 CCFZ(variation 4), 4EFOZ(variation 4), 5 CCOZ(variation 4), 5EOZ(variation 4), 6.5 EFOZ(variation 4), 8EOZ(variation 4), 8EFOZ, 9 CCOZ, 9EOZ, 9EFOZ, 10EOZ, 6.5EFOZD, 7 EFOZD, 8EOZD, 8.5 EFOZD, 9 EOZD, 9EFOZD, 10EOZD



23-7200
CARB KIT
Replaces: Westerbeke 36450
Fits: 6.5 TWG(60Hz)/4.9 TWG(50Hz), 8.0 TWG(60Hz)/6.4 TWG(50Hz), 8.5 BTG(60Hz)/6.5 BTG(50Hz), 12.5 BTG(60Hz)/10.0 BTG(50Hz), 15.0 BTG/A(60Hz)/12.0 BTG/A(50Hz), 20.0 BEG(60Hz)/16.0 BEG(50Hz), 25.0 BEG(60Hz)/20.0 BEG(50Hz)



23-7201
CARB KIT
Replaces: Westerbeke 38100
Fits: 4.0 BCG(60Hz)/3.0 BCG(50Hz), 4.5 BCG(60Hz)/3.75 BCG(50Hz), 4.5 BCGTC(60Hz)/3.75 BCGTC(50Hz), 5.0 BCG(60Hz)/4.2 BCG(50Hz), 6.5 BCG(60Hz)/4.8 BCG(50Hz), 7.0 BCG(60Hz)/5.0 BCG(50Hz), 7.0 BCGA(60Hz)/5.0 BCGA(50Hz), 7.0 BCGB(60Hz)/6.0 BCGB(50Hz), 7.2 BCGTC(60Hz)/6.0 BCGTC(50Hz), 8.0 BEG(60Hz)/6.4 BEG(50Hz), 9.6 BCGTC(60Hz)/8.0 BCGTC(50Hz), 10.0 BEG(60Hz)/8.0 BEG(50Hz), 12.5 BEG(60Hz)/10.0 BEG(50Hz), 15.0 BEG(60Hz)/12.0 BEG(50Hz)



23-7202
CARB KIT
Replaces: Kohler GM24510
Fits: 4EF, 5E, 6EF, 7.3E, 5ECD, 4EFCD, 6EFCD and 7.3 ECD



23-7740
FUEL FILTER
Replaces: Kohler 252898
Fits: 11 CCFZ (variation 2), 11.5 CCFZ (variation 2), 11EFOZ (variation 2), 11.5EFOZ (variation 2), 13EOZ (variation 2), 13EFOZ (variation 2), 13.5 CCOZ (variation 2), 14 CCOZ (variation 2), 14EOZ (variation 2), 15 CCFZ (variation 3), 15.5EOZ (variation 2), 16EFOZ (variation 3), 17.5EFOZ (variation 3), 18.5 CCOZ (variation 3), 19EFOZ (variation 3), 20 CCFZ (variation 3), 20EOZ (variation 3), 20EFOZ (variation 3), 23EOZ (variation 3), 24 CCOZ (variation 3), 24EOZ (variation 3), 17EFOZD (variation 3), 17.5EFOZD (variation 3), 19EFOZD (variation 3), 20EOZD (variation 3), 20EFOZD (variation 3), 23EOZD (variation 3), 24EOZD (variation 3)



23-7751
FUEL FILTER
Replaces: Kohler 229715
Fits: 4 CCFZ, 4EFOZ, 5 CCOZ, 5EOZ, 6.5 EFOZ, 8EOZ, 6.5EFOZD, 8EOZD



23-7760

FUEL FILTER

Replaces: Onan A026K278, 149-2106
Fits: MDKAU, MDKAV, MDKBG, MDKAW (Spacesaver), MDKAZ, MDKBD, MDKBE, MDKBF, MDKBD (w/ Isolated Ground), MDKBE (w/ Isolated Ground), MDKBF (w/ Isolated Ground), MDKAD/E/F



23-7761

FUEL FILTER

Replaces: Kohler GM32359
Fits: 7 EFOZD(variation 1), 8.5 EFOZD(variation 1), 9 EOZD(variation 1), 9EFOZD(variation 1), 10EOZD(variation 1), 11EFOZD(variation 3), 11.5EFOZD(variation 3), 13EOZD(variation 3), 13EFOZD(variation 3), 14 EOZD(variation 3), 15.5 EOZD(variation 3), 17 EFOZD(variation 1), 17.5EFOZD(variation 1), 19EFOZD(variation 1), 20EOZD(variation 1), 20EFOZD(variation 1), 23EOZD(variation 1), 24EOZD(variation 1), 23EFOZD, 27EFOZD, 28EOZD, 32EOZD



23-7762

FUEL FILTER

Replaces: Kohler 267987
Fits: MDJA (Spec A-R), MDJB (Spec A-R), MDJC (Spec A-R), MDJE (Spec A), MDJF (Spec A)



23-7764

FUEL FILTER

Replaces: Westerbeke 24363
Fits: 15.0 BTD(60Hz) / 12.0 BTD(50Hz), 15.0 BTDA(60Hz) / 12.0 BTDA(50Hz), 15.0 BTDB(60Hz) / 12.0 BTDB(50Hz), 15.0 WTA(60Hz) / 12.0 WTA(50Hz), 20.0 BED(60Hz) / 16.0 BED(50Hz), 20.0 BEDA(60Hz) / 16.0 BEDA(50Hz), 20.0 WTA(60Hz) / 16.0 WTA(50Hz), 25.0 BED(60Hz) / 20.0 BED(50Hz), 25.0 WTA(60Hz) / 20.0 WTA(50Hz), 32.0 BED(60Hz) / 25.0 BED(50Hz), 32.0 BEDB(60Hz) / 25.0 BEDB(50Hz), 32.0 WTF(60Hz) / 25.0 WTF(50Hz)



23-7780

FUEL FILTER

Replaces: Kohler GM34570
Fits: 9 EFGD, 10 EG, 10 EGD, 13 EG, 13 EGD, 13 EGZ, 15 EG, 15 EGD, 15 EGZ



23-7750

FUEL FILTER ELEMENT

Replaces: Onan 149-0428
Fits: MDJA (Spec A-R), MDJB (Spec A-R), MDJC (Spec A-R), MDJE (Spec A), MDJF (Spec A)



23-7720

FUEL FILTER KIT

Replaces: Westerbeke 35920
Onan 149-1445

Fits: Westerbeke: 4.0 BCG(60Hz)/3.0 BCG(50Hz), 6.5 BCG(60Hz)/4.8 BCG(50Hz), 6.5 TWG(60Hz)/4.9 TWG(50Hz), 8.0 TWG(60Hz)/6.4 TWG(50Hz), 9.0 BTG(60Hz)/7.0 BTG(50Hz), 11.0 TWG(60Hz)/8.5 TWG(50Hz)



23-7770

FUEL FILTER KIT

Replaces: Westerbeke 47006, 30200
Fits several models. See application chart on pages 142-155



23-7771

FUEL FILTER KIT

Replaces: Kohler 249433
Fits: 3.5 CFZ(Variation 2), 4 CZ(Variation 2), 5 CFZ(Variation 2), 6.5 CZ(Variation 2), 8E(Variation 2), 10E(Variation 2), 12.5E(Variation 2)



23-1000

GLOW PLUG (12 Volt)

Replaces: Westerbeke 24353
Fits: 4.4 BCD(60Hz), 4.4 WMD(60Hz) / 3.3 WMD(50Hz), 6.0 BCD(60Hz) / 4.5 BCD(50Hz), 7.7 WMD(60Hz) / 5.8 WMD(50Hz), 8.0 BTD(60Hz) / 6.0 BTD(50Hz), 8.0 BTDA(60Hz) / 6.0 BTDA(50Hz), 8.0 WMD(60Hz) / 6.0 WMD(50Hz), 10.0 BTD(60Hz) / 7.5 BTD(50Hz), 10.0 BTDA(60Hz) / 7.5 BTDA(50Hz), 11.0 BTD(60Hz) / 8.3 BTD(50Hz), 11.0 WMD(60Hz) / 8.3 WMD(50Hz), 12.5 BTD(60Hz) / 9.4 BTD(50Hz), 12.5 BTDA(60Hz) / 9.4 BTDA(50Hz), 12.5 BTDB(60Hz) / 9.4 BTDB(50Hz), 12.5 WMD(60Hz) / 9.4 WMD(50Hz), 15.0 BTD(60Hz) / 12.0 BTD(50Hz), 15.0 BTDA(60Hz) / 12.0 BTDA(50Hz), 15.0 BTDB(60Hz) / 12.0 BTDB(50Hz), 15.0 BTDC(60Hz) / 12.0 BTDC(50Hz), 15.0 WTA(60Hz) / 12.0 WTA(50Hz), 20.0 BED(60Hz) / 16.0 BED(50Hz), 20.0 BEDA(60Hz) / 16.0 BEDA(50Hz), 20.0 WTA(60Hz) / 16.0 WTA(50Hz), 25.0 BED(60Hz) / 20.0 BED(50Hz), 25.0 WTA(60Hz) / 20.0 WTA(50Hz), 32.0 BED(60Hz) / 25.0 BED(50Hz), 32.0 BEDB(60Hz) / 25.0 BEDB(50Hz), 32.0 WTF(60Hz) / 25.0 WTF(50Hz)



23-5840

TEMPERATURE SENDER

Replaces: Westerbeke 35109
Fits several models. See application chart on pages 142-155



23-5880

OIL PRESSURE SENDER

Replaces: Westerbeke 24132
Fits several models. See application chart on pages 142-155



**23-2000
IMPELLER**

Replaces: **Westerbeke** 33112
(Impeller Only)
Fits: 6.5 TWG(60Hz)/4.9 TWG(50Hz), 8.0 TWG(60Hz)/6.4 TWG(50Hz), 8.5 BTG(60Hz)/6.5 BTG(50Hz), 11.0 TWG(60Hz)/8.5 TWG(50Hz), 12.5 BTG(60Hz)/10.0 BTG(50Hz), 15.0 BTG(60Hz)/12.0 BTG(50Hz), 15.0 BTGA(60Hz)/12.0 BTGA(50Hz), 20.0 WTA(60Hz)/16.0 WTA(50Hz)



**23-2001
IMPELLER**

Replaces: **Westerbeke** 32620
(Impeller Only)
Fits: 4.0 BCG(60Hz)/3.0 BCG(50Hz), 4.5 BCG(60Hz)/3.75 BCG(50Hz), 4.5 BCGB(60Hz)/3.75 BCGB(50Hz), 4.5 BCGTC(60Hz)/3.75 BCGTC(50Hz), 6.5 BCG(60Hz)/4.8 BCG(50Hz), 7.0 BCG(60Hz)/5.0 BCG(50Hz), 7.0 BCGA(60Hz)/5.0 BCGA(50Hz), 7.0 BCGB(60Hz)/6.0 BCGB(50Hz), 7.2 BCGTC(60Hz)/6.0 BCGTC(50Hz), 9.0 BTG(60Hz)/ 7.0 BTG(50Hz), 9.6 BCGTC(60Hz)/8.0 BCGTC(50Hz), 3.0 WMD(60Hz)/ 2.4 WMD(50Hz), 3.8/4.2 BCDT(60Hz) / 3.5 BCDT(50Hz), 5.0 BCG(60Hz)/4.2 BCG(50Hz), 5.0 BCGA(60Hz)/5.2 BCGA(50Hz), 7.0 BCGC(60Hz)/5.9 BCGC(50Hz), 8.0 BEG(60Hz)/6.4 BEG(50Hz), 10.0 BEG(60Hz)/8.0 BEG(50Hz), 12.5 BEG(60Hz)/10.0 BEG(50Hz), 15.0 BEG(60Hz)/12.0 BEG(50Hz)



**23-2002
IMPELLER**

Replaces: **Kohler** 229826
Fits: 8E (SN 296899 and Up), 10E (SN 296899 and Up), 12.5E (SN 296899 and Up), 12.5CF (SN 296899 and Up), 15C, 16CF, 20C



**23-2003
IMPELLER**

Replaces: **Kohler** 250872, **Jabsco** 22799-0001
Fits: 8E (SN 296898 and Below), 10E (SN 296898 and Below), 12.5E (SN 296898 and Below), 12.5CF (SN 296898 and Below)



**23-2004
IMPELLER KIT**

Replaces: **Kohler** 359978
(Impeller only)
Fits: Kohler Pump GM28487; Fits Models 4EF, 5E, 6EF, 7.3E, 4 EFCD, 5 ECD, 6 EFCD, 7.3 ECD,



**23-2005
IMPELLER KIT**

Replaces: **Northern Lights** 25-12009
(Impeller only)



**23-3300
IMPELLER KIT**

Replaces: **Onan** 132-0349
Fits: MDKAV, MDKBG, MDKAW (Spacesaver), MDKAZ, MDKBD, MDKBE, MDKBF, MDKBD (w/ Isolated Ground), MDKBE (w/ Isolated Ground), MDKBF (w/ Isolated Ground)



**23-3301
IMPELLER KIT**

Replaces: **Westerbeke** 11907
Fits: 20.0 BEG(60Hz)/16.0 BEG(50Hz), 25.0 BEG(60Hz)/20.0 BEG(50Hz), 20.0 SBEG(60Hz)/16.0 SBEG(50Hz), 20.0 SBEGA(60Hz)/16.0 SBEGA(50Hz), 22.5 SBEG(60Hz)/18.7 SBEG(50Hz), 22.5 SBEGA(60Hz)/18.7 SBEGA(50Hz), 20.0 BED(60Hz)/16.0 BED(50Hz), 20.0 BEDA(60Hz)/16.0 BEDA(50Hz), 25.0 BED(60Hz)/20.0 BED(50Hz), 25.0 WTA(60Hz)/20.0 WTA(50Hz), 32.0 BED(60Hz)/25.0 BED(50Hz), 32.0 BEDA(60Hz)/25.0 BEDA(50Hz), 32.0 BEDB(60Hz)/25.0 BEDB(50Hz), 32.0 WTF(60Hz)/25.0 WTF(50Hz)



**23-3302
IMPELLER KIT**

Replaces: **Westerbeke** 33112
Fits: 6.5 TWG(60Hz)/4.9 TWG(50Hz), 8.0 TWG(60Hz)/6.4 TWG(50Hz), 8.5 BTG(60Hz)/6.5 BTG(50Hz), 11.0 TWG(60Hz)/8.5 TWG(50Hz), 12.5 BTG(60Hz)/10.0 BTG(50Hz), 15.0 BTG(60Hz)/12.0 BTG(50Hz), 15.0 BTGA(60Hz)/12.0 BTGA(50Hz), 20.0 WTA(60Hz)/16.0 WTA(50Hz)
Includes **23-2000** Impeller



**23-3303
IMPELLER KIT**

Replaces: **Kohler** 229826
Fits: Kohler Pump GM46962; Fits: Models 8E (SN 296899 and Up), 10E (SN 296899 and Up), 12.5E (SN 296899 and Up), 12.5CF (SN 296899 and Up), 15C, 16CF, 20C



**23-3304
IMPELLER KIT**

Replaces: **Kohler** 229955
Fits: 8E (SN 296898 and Below), 10E (SN 296898 and Below), 12.5E (SN 296898 and Below), 12.5CF (SN 296898 and Below)



**23-3305
IMPELLER KIT**

Replaces: **Westerbeke** 32620
Fits: 4.0 BCG(60Hz)/3.0 BCG(50Hz), 4.5CG(60Hz)/3.75 BCG(50Hz), 4.5 BCGB(60Hz)/3.75 BCGB(50Hz), 4.5 BCGTC(60Hz)/3.75 BCGTC(50Hz), 6.5 BCG(60Hz)/4.8 BCG(50Hz), 7.0 BCG(60Hz)/5.0 BCG(50Hz), 7.0 BCGA(60Hz)/5.0 BCGA(50Hz), 7.0 BCGB(60Hz)/6.0 BCGB(50Hz), 7.2 BCGTC(60Hz)/6.0 BCGTC(50Hz), 9.0 BTG(60Hz)/ 7.0 BTG(50Hz), 9.6 BCGTC(60Hz)/8.0 BCGTC(50Hz), 3.0 WMD(60Hz)/ 2.4 WMD(50Hz), 3.8/4.2 BCDT(60Hz) / 3.5 BCDT(50Hz)



**23-3306
IMPELLER KIT**
Replaces: **Westerbeke** 46622
Fits: 5.0 BCG(60Hz)/4.2 BCG(50Hz), 5.0 BCGA(60Hz)/5.2 BCGA(50Hz), 7.0 BCGC(60Hz)/5.9 BCGC(50Hz), 8.0 BEG(60Hz)/6.4 BEG(50Hz), 10.0 BEG(60Hz)/8.0 BEG(50Hz), 12.5 BEG(60Hz)/10.0 BEG(50Hz), 15.0 BEG(60Hz)/12.0 BEG(50Hz)



**23-3307
IMPELLER KIT**
Replaces: **Westerbeke** 34440
Fits: 4.0 BCD(60Hz), 4.4 BCD(60Hz), 4.4 WMD(60Hz)/3.3 WMD(50Hz), 5.0 BCD(60Hz)/4.0 BCD(50Hz), 5.0 BCDA(60Hz)/4.0 BCDA(50Hz), 5.0 BCDB(60Hz)/4.0 BCDB(50Hz), 6.0 BCD(60Hz)/4.5 BCD(50Hz), 7.6 BTD(60Hz)/5.7 BTD(50Hz), 7.7 WMD(60Hz)/5.8 WMD(50Hz), 8.0 BTD(60Hz)/6.0 BTD(50Hz), 8.0 BTDA(60Hz)/6.0 BTDA(50Hz)(Before March 2004), 8.0 WMD(60Hz)/6.0 WMD(50Hz), 10.0 BTD(60Hz)/7.5 BTD(50Hz), 10.0 BTDA(60Hz)/7.5 BTDA(50Hz), 11.0 BTD(60Hz)/8.3 BTD(50Hz), 11.0 WMD(60Hz)/8.3 WMD(50Hz), 12.5 BTD(60Hz)/9.4 BTD(50Hz), 12.5 BTDA(60Hz)/9.4 BTDA(50Hz), 12.5 BTDB(60Hz)/9.4 BTDB(50Hz), 12.5 WMD(60Hz)/9.4 WMD(50Hz), 15.0 BTDC(60Hz)/12.0 BTDC(50Hz)



**23-3308
IMPELLER KIT**
Replaces: **Kohler** 352122
Fits: 33EFOZ, 33 CFOZ, 40 CFOZ, 40EOZ, 40EFOZ, 50 COZ, 50 CFOZ, 50EOZ, 55EFOZ, 65 COZ, 65EOZ, 70EFOZ, 80EOZ, 80EFOZ, 99EOZ



**23-3309
IMPELLER KIT**
Replaces: **Onan** 132-0436
Fits: MDDCA, MDDCB, MDDCC, MDDCC, MDDCG, MDDCD, MDDCE, MDDCH, MDDCJ



**23-3310
IMPELLER KIT**
Replaces: **Onan** 541-1519
Fits: MDKKB, MDKBL, MDKBM, MDKBN, MDKAL/A/B



**23-3311
IMPELLER KIT**
Replaces: **Fischer Panda** J009-46840
Mase 80161
Fits: AGTPM 4, PMS 4, IS 2.5, IS 4.0, IS 4.7, IS 7.1



**23-3312
IMPELLER KIT**
Replaces: **Fischer Panda** J009-1027B-1
Mase 92911
Fits: IS 13.2, IS 10.2, IS 14.0, IS 19.0, IS 23.1T, PMS 15, PMS 16 DP, PMS 20, PMS 22, PMS 25, PMS 30, PMS 40, PMS 50



**23-3313
IMPELLER KIT**
Replaces: **Westerbeke** 33104
Fits: 15.0 BTD(60Hz) / 12.0 BTD(50Hz), 15.0 BTDA(60Hz) / 12.0 BTDA(50Hz), 15.0 BTDB(60Hz) / 12.0 BTDB(50Hz), 15.0 WTA(60Hz) / 12.0 WTA(50Hz)



**23-3314
IMPELLER KIT**
Replaces: **Kohler** 359978
Fits: Kohler Pump GM28487; Fits Models 4EF, 5E, 6EF, 7.3E, 4 EFCD, 5 ECD, 6 EFCD, 7.3 ECD

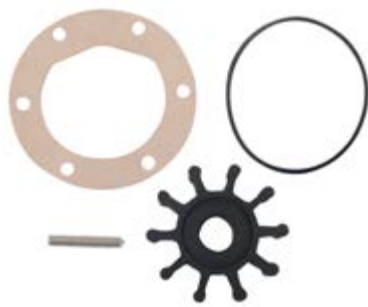

**23-3315
IMPELLER KIT**
Replaces: **Northern Lights** 25-12009
Fits: M673LD3, M673L3, M673LD2, M673L2



**23-0400
QUAD RING**
Replaces: **Northern Lights** 25-12031



**23-4005
SEA WATER PUMP BELT**
Replaces: **Westerbeke** 13810
Fits: 32.0 BED(60Hz) / 25.0 BED(50Hz), 32.0 BEDA(60Hz) / 25.0 BEDA(50Hz), 32.0 BEDB(60Hz) / 25.0 BEDB(50Hz)



**23-4006
SEA WATER PUMP BELT**

Replaces: Westerbeke 31152
Fits: 20.0 BED(60Hz) / 16.0 BED(50Hz), 20.0 BEDA(60Hz) / 16.0 BEDA(50Hz), 20.0 WTA(60Hz) / 16.0 WTA(50Hz), 25.0 BED(60Hz) / 20.0 BED(50Hz)



**23-4007
SEA WATER PUMP BELT**

Replaces: Westerbeke 30376
Fits: 4.0 BCD(60Hz), 4.4 BCD(60Hz), 4.4 WMD(60Hz) / 3.3 WMD(50Hz), 5.0 BCD/BCDA/BCDB(60Hz) / 4.0 BCD/BCDA/BCDB(50Hz)



**23-3600
THERMOSTAT**

Replaces: Westerbeke 24688
Temperature Rating: 180°
Fits: 3.0 WMD(60Hz)/2.4 WMD(50Hz), 4.4 BCD(60Hz), 4.4 WMD(60Hz) / 3.3 WMD(50Hz), 7.7 WMD(60Hz) / 5.8 WMD(50Hz), 8.0 BTD(60Hz) / 6.0 BTD(50Hz), 8.0 BTDA(60Hz) / 6.0 BTDA(50Hz), 8.0 WMD(60Hz) / 6.0 WMD(50Hz), 10.0 BTD(60Hz) / 7.5 BTD(50Hz), 10.0 BTDA(60Hz) / 7.5 BTDA(50Hz), 11.0 BTD(60Hz) / 8.3 BTD(50Hz), 11.0 WMD(60Hz) / 8.3 WMD(50Hz), 12.5 BTD(60Hz) / 9.4 BTD(50Hz), 12.5 BTDA(60Hz) / 9.4 BTDA(50Hz), 12.5 BTDB(60Hz) / 9.4 BTDB(50Hz), 12.5 WMD(60Hz) / 9.4 WMD(50Hz), 12.6 BTD(60Hz) / 10.4 BTD(50Hz), 15.0 BTD(60Hz) / 12.0 BTD(50Hz), 15.0 BTDC(60Hz) / 12.0 BTDC(50Hz), 20.0 SBEG(60Hz) / 16.0 SBEG(50Hz), 20.0 SBEGA(60Hz) / 16.0 SBEG(50Hz), 22.5 SBEG(60Hz) / 18.7 SBEG(50Hz), 22.5 SBEGA(60Hz) / 18.7 SBEGA(50Hz)



**23-3601
THERMOSTAT**

Replaces: Westerbeke 35736
Temperature Rating: 140°
Fits: 6.5 BCG(60Hz)/4.8 BCG(50Hz), 6.5 TWG(60Hz)/4.9 TWG(50Hz), 8.0 TWG(60Hz)/6.4 TWG(50Hz), 8.5 BTG(60Hz)/6.5 BTG(50Hz), 9.0 BTG(60Hz)/7.0 BTG(50Hz), 11.0 TWG(60Hz)/8.5 TWG(50Hz), 12.5 BTG(60Hz)/10.0 BTG(50Hz), 15.0 BTG/A(60Hz)/12.0 BTG/A(50Hz), 20.0 BEGA(60Hz)/16.0 BEG(50Hz), 25.0 BEG(60Hz)/20.0 BEG(50Hz)



**23-3602
THERMOSTAT**

Replaces: Westerbeke 37387
Temperature Rating: 140°
Fits: 4.5 BCG(60Hz)/3.75 BCG(50Hz), 7.0 BCG(60Hz)/5.0 BCG(50Hz), 7.0 BCGA(60Hz)/5.0 BCGA(50Hz)



**23-3603
THERMOSTAT**

Replaces: Westerbeke 39378
Temperature Rating: 160°
Fits: 4.5 BCGB(60Hz)/3.75 BCGB(50Hz), 4.5 BCGTC(60Hz)/3.75 BCGTC(50Hz), 5.0 BCG(60Hz)/4.2 BCG(50Hz), 5.0 BCGA(60Hz)/5.2 BCGA(50Hz), 7.0 BCGB(60Hz)/6.0 BCGB(50Hz), 7.0 BCGC(60Hz)/5.9 BCGC(50Hz), 7.2 BCGTC(60Hz)/6.0 BCGTC(50Hz), 5.0 SBCG(60Hz)/4.0 SBEG(50Hz), 6.5 SBCG(60Hz) / 5.4 SBCG(50Hz)



**23-3604
THERMOSTAT**

Replaces: Westerbeke 46097
Temperature Rating: 140°
Fits: 8.0 BEG(60Hz)/6.4 BEG(50Hz), 10.0 BEG(60Hz)/8.0 BEG(50Hz), 12.5 BEG(60Hz)/10.0 BEG(50Hz), 15.0 BEG(60Hz)/12.0 BEG(50Hz)



**23-3605
THERMOSTAT**

Replaces: Westerbeke 24690
Temperature Rating: 180°
Fits: 8.0 SBEG(60Hz) / 6.4 SBEG(50Hz), 10.0 SBEG(60Hz) / 8.0 SBEG(50Hz), 12.5 SBEG(60Hz) / 10.0 SBEG(50Hz), 14.0 SBEG(60Hz) / 11.6 SBEG(50Hz), 15.0 BTDA(60Hz) / 12.0 BTDA(50Hz), 15.0 BTDB(60Hz) / 12.0 BTDB(50Hz), 20.0 BED(60Hz) / 16.0 BED(50Hz), 20.0 BEDA(60Hz) / 16.0 BEDA(50Hz), 20.0 WTA(60Hz) / 16.0 WTA(50Hz), 25.0 BED(60Hz) / 20.0 BED(50Hz)



**23-3606
THERMOSTAT**

Replaces: Onan 309-0130
Temperature Rating: 143°
Fits: MDJA, MDJB, MDJC, MDJE, MDJF, MJA, MJB, MJC



**23-3607
THERMOSTAT**

Replaces: Kohler 352018
Temperature Rating: 195°
Fits: 33EFOZ(Variation 1), 33 CFOZ(Variation 1), 40 CFOZ(Variation 1), 40EOZ(Variation 1), 40EFOZ(Variation 1), 50 COZ(Variation 1), 50 CFOZ(Variation 1), 50EOZ(Variation 1), 55EFOZ(Variation 1), 65 COZ(Variation 1), 65EOZ(Variation 1), 70EFOZ(Variation 1), 80EOZ(Variation 1), 80EFOZ(Variation 1), 99EOZ(Variation 1), 100EFOZ(Variation 1), 125EOZ(Variation 1), 125EFOZ(Variation 1), 150EOZ(Variation 1)



**23-3608
THERMOSTAT**

Replaces: Kohler 249930
Temperature Rating: 190°
Fits: 4EF, 5E, 6EF, 7.3E, 8E, 10E, 12.5E, 12.5CF, 15C, 16CF, 20C



**23-3609
THERMOSTAT**

Replaces: Kohler 252896
Temperature Rating: 170°
Fits: 11 CCFZ, 11.5 CCFZ, 11EFOZ, 11.5EFOZ, 13EOZ, 13EFOZ, 13.5 CCOZ, 14 CCOZ, 14 EOZ, 15.5EOZ, 16EFOZ, 17.5EFOZ, 18.5 CCOZ, 19EFOZ, 20 CCFZ, 20EOZ, 20EFOZ, 23EOZ, 24 CCOZ, 24EOZ



23-0800
THERMOSTAT GASKET
Replaces: *Westerbeke* 42260
Fits: 4.5 BCGB(60Hz)/3.75 BCGB(50Hz), 4.5 BCGTC(60Hz)/3.75 BCGTC(50Hz), 7.0 BCGB(60Hz)/6.0 BCGB(50Hz), 7.2 BCGTC(60Hz)/ 6.0 BCGTC(50Hz), 9.6 BCGTC(60Hz)/8.0 BCGTC(50Hz)



23-0801
THERMOSTAT GASKET
Replaces: *Westerbeke* 46124
Fits: 5.0 BCG(60Hz)/4.2 BCG(50Hz), 5.0 BCGA(60Hz)/5.2 BCGA(50Hz), 7.0 BCGC(60Hz)/5.9 BCGC(50Hz), 5.0 SBCG(60Hz) / 4.2 SBEG(50Hz), 6.5 SBCG(60Hz) / 5.4 SBCG(50Hz)



23-0802
THERMOSTAT GASKET
Replaces: *Westerbeke* 34196
Fits: 4.0 BCG(60Hz)/3.0 BCG(50Hz), 6.5 BCG(60Hz)/4.8 BCG(50Hz), 8.0 TWG(60Hz)/6.4 TWG(50Hz), 9.0 BTG(60Hz)/7.0 BTG(50Hz), 11.0 TWG(60Hz)/8.5 TWG(50Hz), 6.0 BCD(60Hz) / 4.5 BCD(50Hz), 8.0 BTD(60Hz) / 6.0 BTD(50Hz), 10.0 BTD(60Hz) / 7.5 BTD(50Hz), 11.0 BTD(60Hz) / 8.3 BTD(50Hz), 12.5 BTD(60Hz) / 9.4 BTD(50Hz), 12.5 BTDA(60Hz) / 9.4 BTDA(50Hz), 12.6 BTD(60Hz) / 10.4 BTD(50Hz)



23-0803
THERMOSTAT GASKET
Replaces: *Westerbeke* 33417
Fits: 6.5 TWG(60Hz)/4.9 TWG(50Hz), 8.0 BEG(60Hz)/6.4 BEG(50Hz), 8.5 BTG(60Hz)/6.5 BTG(50Hz), 10.0 BEG(60Hz)/8.0 BEG(50Hz), 12.5 BEG(60Hz)/10.0 BEG(50Hz), 12.5 BTG(60Hz)/10.0 BTG(50Hz), 15.0 BEG(60Hz)/12.0 BEG(50Hz), 15.0 BTG/A(60Hz)/12.0 BTG/A(50Hz), 8.0 SBEG(60Hz) / 6.4 SBEG(50Hz), 10.0 SBEG(60Hz) / 8.0 SBEG(50Hz), 12.5 SBEG(60Hz) / 10.0 SBEG(50Hz), 14.0 SBEG(60Hz) / 11.6 SBEG(50Hz)



23-0804
THERMOSTAT GASKET
Replaces: *Westerbeke* 33373
Fits: 15.0 BTDA(60Hz) / 12.0 BTDA(50Hz), 15.0 BTDB(60Hz) / 12.0 BTDB(50Hz), 15.0 WTA(60Hz) / 12.0 WTA(50Hz), 20.0 BED(60Hz) / 16.0 BED(50Hz), 20.0 BEDA(60Hz) / 16.0 BEDA(50Hz), 20.0 WTA(60Hz) / 16.0 WTA(50Hz), 25.0 BED(60Hz) / 20.0 BED(50Hz), 25.0 WTA(60Hz) / 20.0 WTA(50Hz)



23-0805
THERMOSTAT GASKET
Replaces: *Westerbeke* 40434
Fits: 20.0 BEG(60Hz)/16.0 BEG(50Hz), 25.0 BEG(60Hz)/20.0 BEG(50Hz), 20.0 SBEG(60Hz) / 16.0 SBEG(50Hz), 20.0 SBEGA(60Hz) / 16.0 SBEG(50Hz), 22.5 SBEG(60Hz) / 18.7 SBEG(50Hz), 22.5 SBEGA(60Hz) / 18.7 SBEGA(50Hz)



23-0806
THERMOSTAT GASKET
Replaces: *Westerbeke* 24323
Fits: 4.4 BCD(60Hz), 4.4 WMD(60Hz) / 3.3 WMD(50Hz), 7.7 WMD(60Hz) / 5.8 WMD(50Hz), 8.0 WMD(60Hz) / 6.0 WMD(50Hz), 11.0 WMD(60Hz) / 8.3 WMD(50Hz), 12.5 WMD(60Hz) / 9.4 WMD(50Hz)



23-0807
THERMOSTAT GASKET
Replaces: *Westerbeke* 33966
Fits: 15.0 BTD(60Hz) / 12.0 BTD(50Hz)



23-0808
THERMOSTAT GASKET
Replaces: *Westerbeke* 37922
Fits: 4.5 BCG(60Hz)/3.75 BCG(50Hz), 7.0 BCG(60Hz)/5.0 BCG(50Hz), 7.0 BCGA(60Hz)/5.0 BCGA(50Hz)



23-0809
THERMOSTAT GASKET
Replaces: *Kohler* 267718
Fits: 3.5CFZ, 4CZ, 5CFZ, 6.5CZ



23-0810
THERMOSTAT GASKET
Replaces: *Kohler* 229432
Fits: 11CCFOZ(variation 1,6), 11.5CCFOZ(variation 1,6), 11EFOZ(variation 1,6), 11.5EFOZ(variation 1,6), 13EOZ(variation 1,6), 13EFOZ(variation 1,6), 13.5CCOZ(variation 1,6), 14CCOZ(variation 1,6), 14EOZ(variation 1,6), 15CCFOZ, 15.5 EOZ(variation 1,6), 16EFOZ, 17.5EFOZ, 18.5CCOZ, 19EFOZ, 20CCFOZ, 20EOZ, 20EFOZ, 23EOZ, 24CCOZ, 24EOZ



23-0811
THERMOSTAT GASKET
Replaces: *Kohler* 249865
Fits: 11CCFOZ(variation 2,3,4,5), 11.5CCFOZ(variation 2,3,4,5), 11EFOZ(variation 2,3,4,5), 11.5EFOZ(variation 2,3,4,5), 13EOZ(variation 2,3,4,5), 13EFOZ(variation 2,3,4,5), 13.5CCOZ(variation 2,3,4,5), 14CCOZ(variation 2,3,4,5), 14EOZ(variation 2,3,4,5), 15.5 EOZ(variation 2,3,4,5), 11EFOZD, 11.5EFOZD, 13EOZD, 13EFOZD, 14EOZD, 15.5EOZD, 17EFOZD, 17.5EFOZD, 19EFOZD, 20EOZD, 20EFOZD, 23EOZD, 24EOZD



23-0812
THERMOSTAT GASKET

Replaces: Kohler 229433
Fits: 11 CCFOZ, 11.5 CCFOZ, 11EFOZ, 11.5EFOZ, 13EOZ, 13EFOZ, 13.5 CCOZ, 14 CCOZ, 14 EOZ, 15 CCFOZ, 15.5EOZ, 16EFOZ, 17.5EFOZ, 18.5 CCOZ, 19EFOZ, 20 CCFOZ, 20EOZ, 20EFOZ, 23EOZ, 24 CCOZ, 24EOZ, 11EFOZD, 11.5EFOZD, 13EFOZD, 14 EOZD, 15.5 EOZD, 17 EFOZD, 17.5EFOZD, 19EFOZD, 20EOZD, 20EFOZD, 23EOZD, 24EOZD



23-0813
THERMOSTAT GASKET

Replaces: Kohler 229963
Fits: 8E, 10E, 12.5E, 12.5CF, 15C, 16CF, 20C, 10EG, 13EG, 13EGZ, 15EG, 15EGZ, 4CCFOZ, 4EFOZ, 5CCOZ, 5EOZ, 6.5EFOZ, 8CCFOZ, 8EOZ, 8EFOZ, 9CCOZ, 9EOZ, 9EFOZ, 10EOZ, 23EFOZ, 27EFOZ, 28EOZ, 32EOZ, 6.5EFOZD, 7EFOZD, 8EOZD, 8.5EFOZD, 9EOZD, 9EFOZD, 10EOZD



23-0814
THERMOSTAT GASKET

Replaces: Kohler 352031
Fits: 33EFOZ(variation 1,2,3), 33CFOZ(variation 1,2,3), 40CFOZ(variation 1,2,3), 40EOZ(variation 1,2,3), 40EFOZ(variation 1,2,3), 50COZ(variation 1,2,3), 50CFOZ(variation 1,2,3), 50EOZ(variation 1,2,3), 55EFOZ(variation 1,2,3), 65COZ(variation 1,2,3), 65EOZ(variation 1,2,3), 70EFOZ(variation 1,2,3), 80EOZ(variation 1,2,3), 80EFOZ(variation 1,2,3), 99EOZ(variation 1,2,3), 100EFOZ(variation 1,2,3), 125EOZ(variation 1,2,3), 125EFOZ(variation 1,2,3), 150EOZ(variation 1,2,3)



23-0830
THERMOSTAT GASKET

Replaces: Northern Lights 11-10015
Fits: Used with 35-12500 and 35-11000 thermostats



23-3650
THERMOSTAT KIT

Replaces: Westerbeke 24688, 24323
Temperature Rating: 180°
Fits: 4.4 BCD(60Hz), 4.4 WMD(60Hz) / 3.3 WMD(50Hz), 7.7 WMD(60Hz) / 5.8 WMD(50Hz), 8.0 WMD(60Hz) / 6.0 WMD(50Hz), 11.0 WMD(60Hz) / 8.3 WMD(50Hz), 12.5 WMD(60Hz) / 9.4 WMD(50Hz)



23-3651
THERMOSTAT KIT

Replaces: Westerbeke 35736, 34196
Temperature Rating: 140°
Fits: 4.0 BCG(60Hz)/3.0 BCG(50Hz), 6.5 BCG(60Hz)/4.8 BCG(50Hz), 8.0 TWG(60Hz)/6.4 TWG(50Hz), 9.0 BTG(60Hz)/7.0 BTG(50Hz), 11.0 TWG(60Hz)/8.5 TWG(50Hz)



23-3652
THERMOSTAT KIT

Replaces: Westerbeke 35736, 33417
Temperature Rating: 140°
Fits: 6.5 TWG(60Hz)/4.9 TWG(50Hz), 8.5 BTG(60Hz)/6.5 BTG(50Hz), 12.5 BTG(60Hz)/10.0 BTG(50Hz), 15.0 BTG/A(60Hz)/12.0 BTG/A(50Hz)



23-3653
THERMOSTAT KIT

Replaces: Westerbeke 24688, 34196
Temperature Rating: 180°
Fits: 8.0 BTD(60Hz) / 6.0 BTD(50Hz), 10.0 BTD(60Hz) / 7.5 BTD(50Hz), 11.0 BTD(60Hz) / 8.3 BTD(50Hz), 12.5 BTD(60Hz) / 9.4 BTD(50Hz), 12.5 BTDA(60Hz) / 9.4 BTDA(50Hz), 12.6 BTD(60Hz) / 10.4 BTD(50Hz)



23-3654
THERMOSTAT KIT

Replaces: Westerbeke 39378, 42260
Temperature Rating: 160°
Fits: 4.5 BCGB(60Hz)/3.75 BCGB(50Hz), 4.5 BCGTC(60Hz)/3.75 BCGTC(50Hz), 7.0 BCGB(60Hz)/6.0 BCGB(50Hz), 7.2 BCGTC(60Hz)/6.0 BCGTC(50Hz), 9.6 BCGTC(60Hz)/8.0 BCGTC(50Hz)



23-3655
THERMOSTAT KIT

Replaces: Westerbeke 39378, 46124
Temperature Rating: 160°
Fits: 5.0 BCG(60Hz)/4.2 BCG(50Hz), 5.0 BCGA(60Hz)/5.2 BCGA(50Hz), 7.0 BCGC(60Hz)/5.9 BCGC(50Hz), 5.0 SBEG(60Hz) / 4.0 SBEG(50Hz), 6.5 SBEG(60Hz) / 5.4 SBEG(50Hz)



23-3656
THERMOSTAT KIT

Replaces: Westerbeke 46097, 33417
Temperature Rating: 140°
Fits: 8.0 BEG(60Hz)/6.4 BEG(50Hz), 10.0 BEG(60Hz)/8.0 BEG(50Hz), 12.5 BEG(60Hz)/10.0 BEG(50Hz), 15.0 BEG(60Hz)/12.0 BEG(50Hz)



23-3657
THERMOSTAT KIT

Replaces: Westerbeke 24690, 33417
Temperature Rating: 180°
Fits: 8.0 SBEG(60Hz) / 6.4 SBEG(50Hz), 10.0 SBEG(60Hz) / 8.0 SBEG(50Hz), 12.5 SBEG(60Hz) / 10.0 SBEG(50Hz), 14.0 SBEG(60Hz) / 11.6 SBEG(50Hz)



23-3658
THERMOSTAT KIT
Replaces: **Westerbeke** 24688, 33966
Temperature Rating: 180°
Fits: 15.0 BTD(60Hz) / 12.0 BTD(50Hz)



23-3659
THERMOSTAT KIT
Replaces: **Westerbeke** 37387, 37922
Temperature Rating: 140°
Fits: 4.5 BCG(60Hz)/3.75 BCG(50Hz), 7.0 BCG(60Hz)/5.0 BCG(50Hz), 7.0 BCGA(60Hz)/5.0 BCGA(50Hz)



23-3660
THERMOSTAT KIT
Replaces: **Westerbeke** 24690, 33373
Temperature Rating: 180°
Fits: 15.0 BTDA(60Hz) / 12.0 BTDA(50Hz), 15.0 BTDB(60Hz) / 12.0 BTDB(50Hz), 15.0 WTA(60Hz) / 12.0 WTA(50Hz), 20.0 BED(60Hz) / 16.0 BED(50Hz), 20.0 BEDA(60Hz) / 16.0 BEDA(50Hz), 20.0 WTA(60Hz) / 16.0 WTA(50Hz), 25.0 BED(60Hz) / 20.0 BED(50Hz), 25.0 WTA(60Hz) / 20.0 WTA(50Hz)



23-3661
THERMOSTAT KIT
Replaces: **Westerbeke** 35736, 40434
Temperature Rating: 140°
Fits: 20.0 BEG(60Hz)/16.0 BEG(50Hz), 25.0 BEG(60Hz)/20.0 BEG(50Hz)



23-3662
THERMOSTAT KIT
Replaces: **Westerbeke** 24688, 40434
Temperature Rating: 180°
Fits: 20.0 SBEG(60Hz) / 16.0 SBEG(50Hz), 20.0 SBEGA(60Hz) / 16.0 SBEGA(50Hz), 22.5 SBEG(60Hz) / 18.7 SBEG(50Hz), 22.5 SBEGA(60Hz) / 18.7 SBEGA(50Hz)



23-3664
THERMOSTAT KIT
Replaces: **Kohler** 249930, 29963
Temperature Rating: 190°
Fits: 8E, 10E, 12.5E, 12.5CF, 15C, 16CF, 20C, 10 EG, 13 EG, 13 EGZ, 15 EG, 15 EGZ



23-3665
THERMOSTAT KIT
Replaces: **Kohler** 252896, 229432
Temperature Rating: 170°
Fits: 11 CCF0Z(Variation 1, 6), 11.5 CCF0Z(Variation 1, 6), 11EFOZ(Variation 1, 6), 11.5EFOZ(Variation 1, 6), 13EOZ(Variation 1, 6), 13EFOZ(Variation 1, 6), 13.5 CCOZ(Variation 1, 6), 14 CCOZ(Variation 1, 6), 14 EOZ(Variation 1, 6), 15.5EOZ(Variation 1, 6), 16EFOZ, 17.5EFOZ, 18.5 CCOZ, 19EFOZ, 20 CCF0Z, 20EOZ, 20EFOZ, 23EOZ, 24 CCOZ, 24EOZ

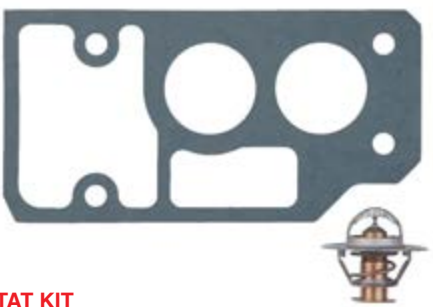

23-3666
THERMOSTAT KIT
Replaces: **Kohler** 352018, 352031
Temperature Rating: 195°
Fits: 33EFOZ(Variation 1), 33 CFOZ(Variation 1), 40 CFOZ(Variation 1), 40EOZ(Variation 1), 40EFOZ(Variation 1), 50 COZ(Variation 1), 50 CFOZ(Variation 1), 50EOZ(Variation 1), 55EFOZ(Variation 1), 65 COZ(Variation 1), 65EOZ(Variation 1), 70EFOZ(Variation 1), 80EOZ(Variation 1), 80EFOZ(Variation 1), 99EOZ(Variation 1), 100EFOZ(Variation 1), 125EOZ(Variation 1), 125EFOZ(Variation 1), 150EOZ(Variation 1)



23-2700
DISTRIBUTOR CAP
Replaces: **Westerbeke** 40859
Fits: 20.0 BEG(60Hz)/16.0 BEG(50Hz), 25.0 BEG(60Hz)/20.0 BEG(50Hz), 20.0 SBEG(60Hz) / 16.0 SBEG(50Hz), 20.0 SBEGA(60Hz) / 16.0 SBEGA(50Hz), 22.5 SBEG(60Hz) / 18.7 SBEG(50Hz), 22.5 SBEGA(60Hz) / 18.7 SBEGA(50Hz)



23-2702
DISTRIBUTOR CAP
Replaces: **Westerbeke** 35608
Fits: 6.5 BCG(60Hz)/4.8 BCG(50Hz), 9.0 BTG(60Hz)/7.0 BTG(50Hz)



23-2703
DISTRIBUTOR CAP
Replaces: **Westerbeke** 46592
Fits: 8.0 BEG(60Hz)/6.4 BEG(50Hz), 10.0 BEG(60Hz)/8.0 BEG(50Hz), 12.5 BEG(60Hz)/10.0 BEG(50Hz), 15.0 BEG(60Hz)/12.0 BEG(50Hz), 8.0 SBEG(60Hz) / 6.4 SBEG(50Hz), 10.0 SBEG(60Hz) / 8.0 SBEG(50Hz), 12.5 SBEG(60Hz) / 10.0 SBEG(50Hz), 14.0 SBEG(60Hz) / 11.6 SBEG(50Hz)



23-4501
PLUG WIRE SET
Replaces: Westerbeke 46596
Fits: 8.0 BEG(60Hz)/6.4 BEG(50Hz), 10.0 BEG(60Hz)/8.0 BEG(50Hz), 12.5 BEG(60Hz)/10.0 BEG(50Hz), 15.0 BEG(60Hz)/12.0 BEG(50Hz), 8.0 SBEG(60Hz) / 6.4 SBEG(50Hz), 10.0 SBEG(60Hz) / 8.0 SBEG(50Hz), 12.5 SBEG(60Hz) / 10.0 SBEG(50Hz), 14.0 SBEG(60Hz) / 11.6 SBEG(50Hz)



23-2800
ROTOR
Replaces: Westerbeke 34093
Fits: 6.5 TWG(60Hz)/4.9 TWG(50Hz), 8.0 TWG(60Hz)/6.4 TWG(50Hz), 8.5 BTG(60Hz)/6.5 BTG(50Hz), 11.0 TWG(60Hz)/8.5 TWG(50Hz), 12.5 BTG(60Hz)/10.0 BTG(50Hz), 15.0 BTG/A(60Hz)/12.0 BTG/A(50Hz)



23-2801
ROTOR
Replaces: Westerbeke 35610
Fits: 4.0 BCG(60Hz)/3.0 BCG(50Hz)



23-2802
ROTOR
Replaces: Westerbeke 40860
Fits: 20.0 BEG(60Hz)/16.0 BEG(50Hz), 25.0 BEG(60Hz)/20.0 BEG(50Hz), 20.0 SBEG(60Hz) / 16.0 SBEG(50Hz), 20.0 SBEGA(60Hz) / 16.0 SBEGA(50Hz), 22.5 SBEG(60Hz) / 18.7 SBEG(50Hz), 22.5 SBEGA(60Hz) / 18.7 SBEGA(50Hz)



23-2803
ROTOR
Replaces: Westerbeke 43050
Fits: 4.5 BCG(60Hz)/3.75 BCG(50Hz), 4.5 BCGTC(60Hz)/3.75 BCGTC(50Hz), 5.0 BCG(60Hz)/4.2 BCG(50Hz), 5.0 BCGA(60Hz)/5.2 BCGA(50Hz), 7.0 BCG(60Hz)/6.0 BCG(50Hz), 7.0 BCGC(60Hz)/5.9 BCGC(50Hz), 7.2 BCGTC(60Hz)/6.0 BCGTC(50Hz), 8.0 BEG(60Hz)/6.4 BEG(50Hz), 9.6 BCGTC(60Hz)/8.0 BCGTC(50Hz), 10.0 BEG(60Hz)/8.0 BEG(50Hz), 12.5 BEG(60Hz)/10.0 BEG(50Hz), 15.0 BEG(60Hz)/12.0 BEG(50Hz), 5.0 SBCG(60Hz) / 4.0 SBEG(50Hz), 6.5 SBCG(60Hz) / 5.4 SBEG(50Hz), 8.0 SBEG(60Hz) / 6.4 SBEG(50Hz), 10.0 SBEG(60Hz) / 8.0 SBEG(50Hz), 12.5 SBEG(60Hz) / 10.0 SBEG(50Hz), 14.0 SBEG(60Hz) / 11.6 SBEG(50Hz)



23-2804
ROTOR
Replaces: Westerbeke 42201
Fits: 4.5 BCG(60Hz)/3.75 BCG(50Hz), 7.0 BCG(60Hz)/5.0 BCG(50Hz), 7.0 BCGA(60Hz)/5.0 BCGA(50Hz), 9.0 BTG(60Hz)/7.0 BTG(50Hz), 6.5 BCG(60Hz)/4.8 BCG(50Hz)



23-7800
OIL FILTER
Replaces: Westerbeke 36918
Fits: several models. See application chart on page 142-155



23-7802
OIL FILTER
Replaces: Westerbeke 48078
Fits: 3.0 BPMG (60Hz)



23-7801
OIL FILTER
Replaces: Onan 185-7444
(Fits: MDKAU, MDKBH)
Fischer Panda 15853-99170
Fits: PMS 8 MINI, PMS 8 DP, PMS 4200, PMS 6500, PMS 12 DP, PMS 12 Mini



23-7820
OIL FILTER
Replaces: Kohler 279449
Fits: 12.5CF, 15C, 16CF, 20C



23-7821
OIL FILTER
Replaces: Kohler 359771
Fits: 4EF, 5E, 6EF, 7.3E



23-7822
OIL FILTER
Replaces: Kohler 229678
Fits: 4 CCFZ, 4 EFOZ, 5 CCOZ, 5 EOZ, 6.5 EFOZ, 8 EOZ



23-7823
OIL FILTER
Replaces: Kohler 267714
Fits: 3.5 CFZ, 3.5 EFZ, 4 CZ, 4 ESZ, 5 CFZ, 5 EFZ, 6.5 CZ, 6.5 ESZ



23-7824
OIL FILTER
Replaces: Kohler GM47465
Fits: 7 EFOZD(Var 1), 8.5 EFOZD(Var 1), 9 EOZD(Var 1), 9 EFOZD(Var 1), 10 EOZD(Var 1), 11 EFOZD, 11.5 EFOZD, 13 EOZD, 13 EFOZD, 14 EOZD, 15.5 EOZD, 17 EFOZD, 17.5 EFOZD, 19 EFOZD, 20 EOZD, 20 EFOZD, 23 EOZD, 24 EOZD



23-7825
OIL FILTER
Replaces: Westerbeke 35828
Fits: 11.0 BTD(60Hz) / 8.3 BTD(50Hz), 12.5 BTD(60Hz) / 9.4 BTD(50Hz), 12.5 BTDA(60Hz) / 9.4 BTDA(50Hz), 12.5 WMD(60Hz) / 9.4 WMD(50Hz), 15.0 BTD(60Hz) / 12.0 BTD(50Hz), 15.0 BTDA(60Hz) / 12.0 BTDA(50Hz), 15.0 BTDB(60Hz) / 12.0 BTDB(50Hz)



23-7826
OIL FILTER
Replaces: Westerbeke 40154
Fits: 20.0 BED(60Hz) / 16.0 BED(50Hz), 20.0 BEDA(60Hz) / 16.0 BEDA(50Hz), 25.0 BED(60Hz) / 20.0 BED(50Hz), 25.0 WTA(60Hz) / 20.0 WTA(50Hz), 32.0 BED(60Hz) / 25.0 BED(50Hz), 32.0 BEDA(60Hz) / 25.0 BEDA(50Hz)



23-7840
OIL FILTER
Replaces: Onan 122-0810
Fits: MDKBD, MDKBE, MDKBF, MDKBD (w/ Isolated Ground), MDKBE (w/ Isolated Ground), MDKBF (w/ Isolated Ground), MDKAD/E/F



23-7841
OIL FILTER
Replaces: Onan 122-0185
Fits: MDJB, MDJC, MDJE, MDJF, MJA, MJB, MJC



23-7842
OIL FILTER
Replaces: Onan 185-5835
Fits: MDKAV, MDKBG, MDKAW (Spacesaver), MDKAZ, MDKAL/A/B, MDKKB, MDKBL, MDKBM, MDKBN

As with Marine Engines, Generators require routine maintenance and changing of engine oil is critical to maintaining and extending their useful life. With the addition of many oil filters for the Marine Generator market, Sierra offers several grades of oil for the gasoline and diesel Generator applications. These oils are specifically formulated for the Marine Industry to provide excellent lubrication and corrosion protection. All of these oils are backed by Sierra's **Industry Leading Warranty**.



Part#	Description	Qty	Case Qty
18-9420-2	10W30 4-Stroke	Qt.	12
18-9400-2	25W40 4-Stroke	Qt.	12
18-9553-2	15W40 Diesel Oil	Qt.	12
18-9410-2	SAE 30 Full Syn.	Qt.	12



56966P
HOURMETER
Round



56967P
HOURMETER
Rectangular





23-6400

ANODE

Replaces:

Westerbeke 11885, Kohler 260085

Fits several models. See application chart on page 142-155



23-6401

ANODE

Replaces: Onan 130-4434

Fits: MDKAV, MDKBG, MDKAW (Spacesaver), MDKAZ, MDKBD, MDKBE, MDKBF, MDKBD (w/ Isolated Ground), MDKBE (w/ Isolated Ground), MDKBF (w/ Isolated Ground), MDKBH, MDKBK, MDKBL, MDKBM, MDKBN, MDKBP, MDKBR, MDKBS, MDKBV, MDKBT, MDKBU



23-6402

ANODE

Replaces: Onan 130-6228

Fits: MDDCA, MDDCB, MDDCC, MDDCF, MDDCG, MDDCD, MDDCE, MDDCH, MDDCJ

23-5800

SOLENOID

Replaces: Westerbeke 24639

Fits: 3.0 WMD(60Hz)/2.4 WMD(50Hz), 4.0 BCD(60Hz), 4.4 BCD(60Hz), 4.4 WMD(60Hz) / 3.3 WMD(50Hz), 5.0 BCD/BCDA/BCDB(60Hz) / 4.0 BCD/BCDA/BCDB(50Hz), 6.0 BCD(60Hz) / 4.5 BCD(50Hz), 7.6 BTD(60Hz) / 5.7 BTD(50Hz), 7.7 WMD(60Hz) / 5.8 WMD(50Hz), 8.0 BTD(60Hz) / 6.0 BTD(50Hz), 8.0 BTDA(60Hz) / 6.0 BTDA(50Hz), 8.0 WMD(60Hz) / 6.0 WMD(50Hz), 10.0 BTD(60Hz) / 7.5 BTD(50Hz), 10.0 BTDA(60Hz) / 7.5 BTDA(50Hz), 11.0 BTD(60Hz) / 8.3 BTD(50Hz), 11.0 WMD(60Hz) / 8.3 WMD(50Hz), 12.5 BTD(60Hz) / 9.4 BTD(50Hz), 12.5 BTDA(60Hz) / 9.4 BTDA(50Hz), 12.5 BTDB(60Hz) / 9.4 BTDB(50Hz), 12.5 WMD(60Hz) / 9.4 WMD(50Hz), 15.0 BTD(60Hz) / 12.0 BTD(50Hz), 15.0 BTDA(60Hz) / 12.0 BTDA(50Hz), 15.0 BTDB(60Hz) / 12.0 BTDB(50Hz), 15.0 BTDC(60Hz) / 12.0 BTDC(50Hz), 15.0 WTA(60Hz) / 12.0 WTA(50Hz), 20.0 BED(60Hz) / 16.0 BED(50Hz), 20.0 BEDA(60Hz) / 16.0 BEDA(50Hz), 20.0 WTA(60Hz) / 16.0 WTA(50Hz), 25.0 BED(60Hz) / 20.0 BED(50Hz), 25.0 WTA(60Hz) / 20.0 WTA(50Hz), 32.0 BED(60Hz) / 25.0 BED(50Hz), 32.0 BEDA(60Hz) / 25.0 BEDA(50Hz), 32.0 BEDB(60Hz) / 25.0 BEDB(50Hz), 32.0 WTF(60Hz) / 25.0 WTF(50Hz)



23-4000

ALTERNATOR BELT

Replaces: Westerbeke 39181

Fits: 20.0 BED(60Hz) / 16.0 BED(50Hz), 20.0 BEDA(60Hz) / 16.0 BEDA(50Hz), 25.0 BED(60Hz) / 20.0 BED(50Hz)



23-4001

ALTERNATOR BELT

Replaces: Westerbeke 11672

Fits: 15.0 BTDA(60Hz) / 12.0 BTDA(50Hz), 15.0 BTDB(60Hz) / 12.0 BTDB(50Hz), 20.0 WTA(60Hz) / 16.0 WTA(50Hz)



23-4003

ALTERNATOR BELT

Replaces: Westerbeke 45232

Fits: 7.6 BTD(60Hz) / 5.7 BTD(50Hz), 8.0 BTDA(60Hz) / 6.0 BTDA(50Hz), 10.0 BTDA(60Hz) / 7.5 BTDA(50Hz), 12.5 BTDB(60Hz) / 9.4 BTDB(50Hz), 15.0 BTDC(60Hz) / 12.0 BTDC(50Hz)



23-4004

ALTERNATOR BELT

Replaces: Westerbeke 30475

Fits: 12.5 BTG(60Hz)/10.0 BTG(50Hz), 15.0 BTG/A(60Hz)/12.0 BTG/A(50Hz), 8.0 BTD(60Hz) / 6.0 BTD(50Hz), 10.0 BTD(60Hz) / 7.5 BTD(50Hz), 12.5 BTD(60Hz) / 9.4 BTD(50Hz), 12.5 BTDA(60Hz) / 9.4 BTDA(50Hz), 12.5 WMD(60Hz) / 9.4 WMD(50Hz), 15.0 BTD(60Hz) / 12.0 BTD(50Hz)



23-5600

STARTER

Replaces: Westerbeke 30593

Fits: 4.4 WMD(60Hz)/3.3 WMD(50Hz), 7.7 WMD(60Hz)/5.8 WMD(50Hz), 8.0 BTDA(60Hz)/6.0 BTDA(50Hz), 8.0 WMD(60Hz)/6.0 WMD(50Hz), 10.0 BTDA(60Hz)/7.5 BTDA(50Hz), 11.0 BTD(60Hz)/8.3 BTD(50Hz), 11.0 WMD(60Hz)/8.3 WMD(50Hz), 12.5 BTD(60Hz)/9.4 BTD(50Hz), 12.5 BTDA(60Hz)/9.4 BTDA(50Hz), 12.5 BTDB(60Hz)/9.4 BTDB(50Hz), 12.5 WMD(60Hz)/9.4 WMD(50Hz), 12.6 BTD(60Hz)/10.4 BTD(50Hz), 15.0 BTD(60Hz)/12.0 BTD(50Hz), 15.0 BTDA(60Hz)/12.0 BTDA(50Hz), 15.0 BTDB(60Hz)/12.0 BTDB(50Hz), 15.0 BTDC(60Hz)/12.0 BTDC(50Hz)

SIERRA[®]

PARTS THAT KEEP YOU MOVING



Generator Parts

Sierra offers over 100 products focused entirely on servicing the generator market. Applications cover all applicable product categories with a focus on Kohler[®], Onan[®] and Westerbeke[®] Generator Sets.

Like all Sierra products, quality is insured by our industry leading Limited Lifetime Warranty.

Model	OEM	Starter	Alternator	Fuel Filter	Impeller	Impeller Kit	Thermostat
3.0 WMD(60Hz) / 2.4 WMD(50Hz)	Westerbeke	—	—	23-7770	23-2001	23-3305	23-3600
3.8/4.2 BCDT(60Hz) / 3.5 BCDT(50Hz)	Westerbeke	—	—	—	23-2001	23-3305	—
4.0 BCD(60Hz)	Westerbeke	—	—	23-7770	—	23-3307	—
4.4 BCD(60Hz)	Westerbeke	—	—	—	23-2001	23-3307	23-3600
4.4 WMD(60Hz) / 3.3 WMD(50Hz)	Westerbeke	23-5600	—	23-7770	—	23-3307	23-3600
5.0 BCD/BCDA/BCDB(60Hz) / 4.0 BCD/BCDA/BCDB(50Hz)	Westerbeke	—	—	23-7770	—	23-3307	—
5.0 BCDB(60Hz) / 4.0 BCDB(50Hz)	Westerbeke	—	—	—	—	—	—
6.0 BCD(60Hz) / 4.5 BCD(50Hz)	Westerbeke	—	—	23-7770	—	23-3307	23-3600
7.6 BTD(60Hz) / 5.7 BTD(50Hz)	Westerbeke	—	—	23-7770	—	23-3307	—
7.7 WMD(60Hz) / 5.8 WMD(50Hz)	Westerbeke	23-5600	—	23-7770	—	23-3307	23-3600
8.0 BTD(60Hz) / 6.0 BTD(50Hz)	Westerbeke	—	—	23-7770	—	23-3307	23-3600
8.0 BTDA(60Hz) / 6.0 BTDA(50Hz)	Westerbeke	23-5600	—	23-7770	23-3307 (Before March 2004)	23-3307	23-3600
8.0 BCDT(60Hz) / 7.0 BCDT(50Hz)	Westerbeke	—	—	23-7770	—	—	—
8.0 WMD(60Hz) / 6.0 WMD(50Hz)	Westerbeke	23-5600	—	23-7770	—	23-3307	23-3600
10.0 BTD(60Hz) / 7.5 BTD(50Hz)	Westerbeke	—	—	23-7770	—	23-3307	23-3600
10.0 BTDA(60Hz) / 7.5 BTDA(50Hz)	Westerbeke	23-5600	—	23-7770	—	23-3307	23-3600
11.0 BTD(60Hz) / 8.3 BTD(50Hz)	Westerbeke	23-5600	—	23-7770	—	23-3307	23-3600
11.0 WMD(60Hz) / 8.3 WMD(50Hz)	Westerbeke	23-5600	—	23-7770	—	23-3307	23-3600
12.5 BTD(60Hz) / 9.4 BTD(50Hz)	Westerbeke	23-5600	—	23-7770	—	23-3307	23-3600
12.5 BTDA(60Hz) / 9.4 BTDA(50Hz)	Westerbeke	23-5600	—	23-7770	—	23-3307	23-3600
12.5 BTDB(60Hz) / 9.4 BTDB(50Hz)	Westerbeke	23-5600	—	23-7770	—	23-3307	23-3600
12.5 WMD(60Hz) / 9.4 WMD(50Hz)	Westerbeke	23-5600	—	23-7770	—	23-3307	23-3600
12.6 BTD(60Hz) / 10.4 BTD(50Hz)	Westerbeke	23-5600	—	23-7770	—	—	23-3600
15.0 BTD(60Hz) / 12.0 BTD(50Hz)	Westerbeke	23-5600	—	23-7764	—	23-3313	23-3600
15.0 BTDA(60Hz) / 12.0 BTDA(50Hz)	Westerbeke	23-5600	—	23-7764	—	23-3313	23-3605
15.0 BTDB(60Hz) / 12.0 BTDB(50Hz)	Westerbeke	23-5600	—	23-7764	—	23-3313	23-3605
15.0 BTDC(60Hz) / 12.0 BTDC(50Hz)	Westerbeke	23-5600	—	23-7770	—	23-3307	23-3600
15.0 WTA(60Hz) / 12.0 WTA(50Hz)	Westerbeke	—	—	23-7764	—	23-3313	23-3605
20.0 BED(60Hz) / 16.0 BED(50Hz)	Westerbeke	—	—	23-7764	—	23-3301	23-3605
20.0 BEDA(60Hz) / 16.0 BEDA(50Hz)	Westerbeke	—	—	23-7764	—	23-3301	23-3605
20.0 WTA(60Hz) / 16.0 WTA(50Hz)	Westerbeke	—	—	23-7764	23-2000	23-3302	23-3605
25.0 BED(60Hz) / 20.0 BED(50Hz)	Westerbeke	—	—	23-7764	—	23-3301	23-3605
25.0 WTA(60Hz) / 20.0 WTA(50Hz)	Westerbeke	—	—	23-7764	—	23-3301	23-3605
32.0 BED(60Hz) / 25.0 BED(50Hz)	Westerbeke	—	—	23-7764	—	23-3301	—
32.0 BEDA(60Hz) / 25.0 BEDA(50Hz)	Westerbeke	—	—	23-7764	—	23-3301	23-3605
32.0 BEDB(60Hz) / 25.0 BEDB(50Hz)	Westerbeke	—	—	—	—	23-3301	—
32.0 WTF(60Hz) / 25.0 WTF(50Hz)	Westerbeke	—	—	23-7764	—	23-3301	—
3.0 BPMG (60Hz)	Westerbeke	—	—	23-7770	—	—	—
4.0 BCG(60Hz) / 3.0 BCG(50Hz)	Westerbeke	—	—	23-7720	23-2001	23-3305	23-3601
4.5 BCG(60Hz) / 3.75 BCG(50Hz)	Westerbeke	—	—	—	23-2001	23-3305	23-3602

Thermostat Kit	Oil Filter	Air Filter	Thermostat Gasket	Anode	Carb Kit	Glow Plug	Temp. Sender	Oil Pressure Sender	Solenoid
—	23-7800	—	—	23-6400	—	—	23-5840	23-5880	23-5800
—	—	—	—	—	—	—	—	—	—
—	23-7800	—	—	—	—	—	23-5840	23-5880	23-5800
23-3650	23-7800	—	23-0806	23-6400	—	23-1000	23-5840	23-5880	23-5800
23-3650	23-7800	—	23-0806	23-6400	—	23-1000	23-5840	23-5880	23-5800
—	23-7800	—	—	23-6400	—	—	23-5840	23-5880	23-5800
—	23-7800	—	—	—	—	—	—	—	—
—	23-7800	—	23-0802	23-6400	—	23-1000	23-5840	23-5880	23-5800
—	23-7800	—	—	—	—	—	—	23-5880	23-5800
23-3650	23-7800	—	23-0806	—	—	23-1000	23-5840	23-5880	23-5800
23-3653	23-7800	—	23-0802	—	—	23-1000	23-5840	23-5880	23-5800
—	23-7800	23-1101	—	—	—	23-1000	23-5840	23-5880	23-5800
—	23-7800	—	—	23-6400	—	—	—	—	—
23-3650	23-7800	—	23-0806	—	—	23-1000	23-5840	23-5880	23-5800
23-3653	23-7800	—	23-0802	23-6400	—	23-1000	23-5840	23-5880	23-5800
—	23-7800	23-1101	—	—	—	23-1000	23-5840	23-5880	23-5800
23-3653	23-7825	—	23-0802	—	—	23-1000	23-5840	23-5880	23-5800
23-3650	23-7800	—	23-0806	23-6400	—	23-1000	23-5840	23-5880	23-5800
23-3653	23-7825	—	23-0802	—	—	23-1000	23-5840	23-5880	23-5800
23-3653	23-7825	—	23-0802	—	—	23-1000	23-5840	23-5880	23-5800
—	23-7800	23-1101	—	—	—	23-1000	23-5840	23-5880	23-5800
23-3650	23-7825	—	23-0806	—	—	23-1000	23-5840	23-5880	23-5800
23-3653	23-7800	23-1101	23-0802	23-6400	—	—	—	—	—
23-3658	23-7825	—	23-0807	—	—	23-1000	23-5840	—	23-5800
23-3660	23-7825	—	23-0804	—	—	23-1000	23-5840	—	23-5800
23-3660	23-7825	—	23-0804	—	—	23-1000	23-5840	—	23-5800
—	23-7800	23-1101	—	—	—	23-1000	23-5840	—	23-5800
23-3660	—	—	23-0804	—	—	23-1000	23-5840	—	23-5800
23-3660	23-7826	—	23-0804	—	—	23-1000	23-5840	—	23-5800
23-3660	23-7826	—	23-0804	—	—	23-1000	23-5840	—	23-5800
23-3660	—	—	23-0804	—	—	23-1000	23-5840	—	23-5800
23-3660	23-7826	—	23-0804	—	—	23-1000	23-5840	—	23-5800
23-3660	23-7826	—	23-0804	—	—	23-1000	23-5840	—	23-5800
—	23-7826	—	—	—	—	23-1000	23-5840	—	23-5800
—	23-7826	—	—	—	—	—	23-5840	—	23-5800
—	23-7826	—	—	—	—	23-1000	23-5840	—	23-5800
—	23-7826	—	—	—	—	23-1000	23-5840	—	23-5800
—	23-7802	—	—	—	—	—	—	—	—
23-3651	—	—	23-0802	23-6400	23-7201	—	23-5840	—	—
23-3659	23-7800	—	23-0808	23-6400	23-7201	—	23-5840	—	—

Model	OEM	Starter	Alternator	Fuel Filter	Impeller	Impeller Kit	Thermostat
4.5 BCGB(60Hz)/ 3.75 BCGB(50Hz)	Westerbeke	—	—	—	23-2001	23-3305	23-3603
4.5 BCGTC(60Hz)/ 3.75 BCGTC(50Hz)	Westerbeke	—	—	—	23-2001	23-3305	23-3603
4.5 BCGTE(60Hz) / 3.75 BCGTE(50Hz)	Westerbeke	—	—	—	—	—	—
5.0 BCG(60Hz)/ 4.2 BCG(50Hz)	Westerbeke	—	—	23-7770	23-2001	23-3306	23-3603
5.0 BCGA(60Hz)/ 5.2 BCGA(50Hz)	Westerbeke	—	—	23-7770	23-2001	23-3306	23-3603
6.5 BCG(60Hz)/ 4.8 BCG(50Hz)	Westerbeke	—	—	23-7720	23-2001	23-3305	23-3601
6.5 TWG(60Hz)/ 4.9 TWG(50Hz)	Westerbeke	—	—	23-7720	23-2000	23-3302	23-3601
7.0 BCG(60Hz)/ 5.0 BCG(50Hz)	Westerbeke	—	—	—	23-2001	23-3305	23-3602
7.0 BCGA(60Hz)/ 5.0 BCGA(50Hz)	Westerbeke	—	—	—	23-2001	23-3305	23-3602
7.0 BCGB(60Hz)/ 6.0 BCGB(50Hz)	Westerbeke	—	—	—	23-2001	23-3305	23-3603
7.0 BCGC(60Hz)/ 5.9 BCGC(50Hz)	Westerbeke	—	—	23-7770	23-2001	23-3306	23-3603
7.0 BCGD(60Hz) / 5.8 BCGD(50Hz)	Westerbeke	—	—	23-7770	23-2001	23-3306	—
7.2 BCGTC(60Hz)/ 6.0 BCGTC(50Hz)	Westerbeke	—	—	23-7770	23-2001	23-3305	23-3603
8.0 BEG(60Hz)/ 6.4 BEG(50Hz)	Westerbeke	—	—	23-7770	23-2001	23-3306	23-3605
8.0 TWG(60Hz)/ 6.4 TWG(50Hz)	Westerbeke	—	—	23-7720	23-2000	23-3302	23-3601
8.5 BTG(60Hz)/ 6.5 BTG(50Hz)	Westerbeke	—	—	—	23-2000	23-3302	23-3601
8.5 BTGA(60Hz) / 6.8 BTGA(50Hz)	Westerbeke	—	—	—	23-2000	23-3302	23-3601
9.0 BTG(60Hz)/ 7.0 BTG(50Hz)	Westerbeke	—	—	23-7720	23-2001	23-3305	23-3601
9.6 BCGTC(60Hz)/ 8.0 BCGTC(50Hz)	Westerbeke	—	—	—	23-2001	23-3305	23-3603
10.0 BEG(60Hz)/ 8.0 BEG(50Hz)	Westerbeke	—	—	23-7770	23-2001	23-3306	23-3605
11.0 TWG(60Hz)/ 8.5 TWG(50Hz)	Westerbeke	—	—	23-7720	23-2000	23-3302	23-3601
12.5 BEG(60Hz)/ 10.0 BEG(50Hz)	Westerbeke	—	—	23-7770	23-2001	23-3306	23-3605
12.5 BTG(60Hz)/ 10.0 BTG(50Hz)	Westerbeke	—	—	—	23-2000	23-3302	23-3601
15.0 BEG(60Hz)/ 12.0 BEG(50Hz)	Westerbeke	—	—	23-7770	23-2001	23-3306	23-3605
15.0 BTG/(60Hz)/ 12.0 BTG/A(50Hz)	Westerbeke	—	—	—	23-2000	23-3302	23-3601
20.0 BEG(60Hz)/ 16.0 BEG(50Hz)	Westerbeke	—	—	—	—	23-3301	23-3601
25.0 BEG(60Hz)/ 20.0 BEG(50Hz)	Westerbeke	—	—	—	—	23-3301	23-3601
5.0 SBCG(60Hz) / 4.0 SBCG(50Hz)	Westerbeke	—	—	23-7770	23-2001	23-3306	23-3603
6.5 SBCG(60Hz) / 5.4 SBCG(50Hz)	Westerbeke	—	—	23-7770	23-2001	23-3306	23-3603
8.0 SBEG(60Hz) / 6.4 SBEG(50Hz)	Westerbeke	—	—	23-7770	23-2001	23-3306	23-3605
10.0 SBEG(60Hz) / 8.0 SBEG(50Hz)	Westerbeke	—	—	23-7770	23-2001	23-3306	23-3605
12.5 SBEG(60Hz) / 10.0 SBEG(50Hz)	Westerbeke	—	—	23-7770	23-2001	23-3306	23-3605
14.0 SBEG(60Hz) / 11.6 SBEG(50Hz)	Westerbeke	—	—	23-7770	23-2001	23-3306	23-3605
18.0 SBEG	Westerbeke	—	—	—	—	—	—
18.0 SBEGA	Westerbeke	—	—	—	—	—	—
20.0 SBEG(60Hz) / 16.0 SBEG(50Hz)	Westerbeke	—	—	23-7770	—	23-3301	23-3600
20.0 SBEGA(60Hz) / 16.0 SBEGA(50Hz)	Westerbeke	—	—	23-7770	—	23-3301	23-3600
22.5 SBEG(60Hz) / 18.7 SBEG(50Hz)	Westerbeke	—	—	23-7770	—	23-3301	23-3600
22.5 SBEGA(60Hz) / 18.7 SBEGA(50Hz)	Westerbeke	—	—	23-7770	—	23-3301	23-3600
5.5 EDC(60Hz) / 5.0 EDC(50Hz)	Westerbeke	—	—	23-7770	—	—	—
7.6 EDT(60Hz) / 5.7 EDT(50Hz)	Westerbeke	—	—	23-7770	—	—	—

Thermostat Kit	Oil Filter	Air Filter	Thermostat Gasket	Anode	Carb Kit	Glow Plug	Temp. Sender	Oil Pressure Sender	Solenoid
23-3654	23-7800	—	23-0800	23-6400	23-7201	—	—	—	—
23-3654	23-7800	—	23-0800	23-6400	23-7201	—	—	—	—
	23-7800								
23-3655	23-7800	—	23-0801	23-6400	23-7201	—	—	—	—
23-3655	23-7800	—	23-0801	23-6400	—	—	—	—	—
23-3651	—	—	23-0802	23-6400	23-7201	—	23-5840	—	—
23-3652	23-7800	—	23-0803	23-6400	23-7200	—	23-5840	—	—
23-3659	23-7800	—	23-0808	23-6400	23-7201	—	23-5840	—	—
23-3659	23-7800	—	23-0808	23-6400	23-7201	—	23-5840	—	—
23-3654	23-7800	—	23-0800	23-6400	23-7201	—	—	—	—
23-3655	23-7800	—	23-0801	23-6400	—	—	—	—	—
—	23-7800	—	—	23-6400	—	—	—	—	—
23-3654	23-7800	—	23-0800	23-6400	23-7201	—	—	—	—
23-3656	23-7800	—	23-0803	23-6400	23-7201	—	23-5840	23-5880	—
23-3651	23-7800	—	23-0802	23-6400	23-7200	—	23-5840	—	—
23-3652	23-7800	—	23-0803	23-6400	23-7200	—	23-5840	23-5880	—
—	23-7800	—	—	23-6400	23-7200	—	—	—	—
23-3651	—	—	23-0802	23-6400	—	—	23-5840	—	—
23-3654	23-7800	—	23-0800	23-6400	23-7201	—	—	—	—
23-3656	23-7800	—	23-0803	23-6400	23-7201	—	23-5840	23-5880	—
23-3651	23-7800	—	23-0802	23-6400	—	—	23-5840	—	—
23-3656	23-7800	—	23-0803	23-6400	23-7201	—	23-5840	23-5880	—
23-3652	23-7800	—	23-0803	23-6400	23-7200	—	23-5840	23-5880	—
23-3656	23-7800	—	23-0803	23-6400	23-7201	—	23-5840	23-5880	—
23-3652	23-7800	—	23-0803	23-6400	23-7200	—	23-5840	23-5880	—
23-3661	23-7800	—	23-0805	23-6400	23-7200	—	23-5840	23-5880	—
23-3661	23-7800	—	23-0805	23-6400	23-7200	—	23-5840	23-5880	—
23-3655	23-7800	—	23-0801	23-6400	—	—	—	—	—
23-3655	23-7800	—	23-0801	23-6400	—	—	—	—	—
23-3657	23-7800	—	23-0803	23-6400	—	—	—	—	—
23-3657	23-7800	—	23-0803	23-6400	—	—	—	—	—
23-3657	23-7800	—	23-0803	23-6400	—	—	—	—	—
23-3657	23-7800	—	23-0803	23-6400	—	—	—	—	—
	23-7800								
	23-7800								
23-3662	23-7800	—	23-0805	23-6400	—	—	—	—	—
23-3662	23-7800	—	23-0805	23-6400	—	—	—	—	—
23-3662	23-7800	—	23-0805	23-6400	—	—	—	—	—
23-3662	23-7800	—	23-0805	23-6400	—	—	—	—	—
—	23-7800	—	—	23-6400	—	—	—	—	—
—	23-7800	—	—	23-6400	—	—	—	—	—

Model	OEM	Starter	Alternator	Fuel Filter	Impeller	Impeller Kit	Thermostat
8.0 EDT(60Hz) / 6.0 EDT(50Hz)	Westerbeke	—	—	23-7770	—	—	—
10.0 EDT(60Hz) / 7.5 EDT(50Hz)	Westerbeke	—	—	23-7770	—	—	—
11.5 EDT(60Hz) / 9.2 EDT(50Hz)	Westerbeke	—	—	23-7770	—	—	—
12.5 EDT(60Hz) / 9.4 EDT(50Hz)	Westerbeke	—	—	23-7770	—	—	—
12.6 EDT(60Hz) / 10.4 EDT(50Hz)	Westerbeke	—	—	23-7770	—	—	—
15.0 EDT(60Hz) / 12.0 EDT(50Hz)	Westerbeke	—	—	23-7770	—	—	—
4 CCFOZ	Kohler	—	—	23-7751	23-2002(SN 296899 & Up) 23-2003(SN 296898 & below)	23-3303(SN 296899 & Up) 23-3304(SN 296898 & below)	—
4EFOZ	Kohler	—	—	23-7751	23-2002(SN 296899 & Up) 23-2003(SN 296898 & below)	23-3303(SN 296899 & Up) 23-3304(SN 296898 & below)	—
5 CCOZ	Kohler	—	—	23-7751	23-2002(SN 296899 & Up) 23-2003(SN 296898 & below)	23-3303(SN 296899 & Up) 23-3304(SN 296898 & below)	—
5EOZ	Kohler	—	—	23-7751	23-2002(SN 296899 & Up) 23-2003(SN 296898 & below)	23-3303(SN 296899 & Up) 23-3304(SN 296898 & below)	—
6.5 EFOZ	Kohler	—	—	23-7751	23-2002(SN 296899 & Up) 23-2003(SN 296898 & below)	23-3303(SN 296899 & Up) 23-3304(SN 296898 & below)	—
8EOZ	Kohler	—	—	23-7751	23-2002(SN 296899 & Up) 23-2003(SN 296898 & below)	23-3303(SN 296899 & Up) 23-3304(SN 296898 & below)	—
8EFOZ	Kohler	—	—	—	23-2002(SN 296899 & Up) 23-2003(SN 296898 & below)	23-3303(SN 296899 & Up) 23-3304(SN 296898 & below)	—
8CCFOZ	Kohler	—	—	—	23-2002(SN 296899 & Up) 23-2003(SN 296898 & below)	23-3303(SN 296899 & Up) 23-3304(SN 296898 & below)	—
9CCOZ	Kohler	—	—	—	23-2002(SN 296899 & Up) 23-2003(SN 296898 & below)	23-3303(SN 296899 & Up) 23-3304(SN 296898 & below)	—
9EOZ	Kohler	—	—	—	23-2002(SN 296899 & Up) 23-2003(SN 296898 & below)	23-3303(SN 296899 & Up) 23-3304(SN 296898 & below)	—
9EFOZ	Kohler	—	—	—	23-2002(SN 296899 & Up) 23-2003(SN 296898 & below)	23-3303(SN 296899 & Up) 23-3304(SN 296898 & below)	—
10EOZ	Kohler	—	—	—	23-2002(SN 296899 & Up) 23-2003(SN 296898 & below)	23-3303(SN 296899 & Up) 23-3304(SN 296898 & below)	—
11 CCFOZ	Kohler	—	—	23-7740(Var 2)	23-2003	23-3304	23-3609
11.5 CCFOZ	Kohler	—	—	23-7740(Var 2)	23-2003	23-3304	23-3609
11EFOZ	Kohler	—	—	23-7740(Var 2)	23-2003	23-3304	23-3609
11.5EFOZ	Kohler	—	—	23-7740(Var 2)	23-2003	23-3304	23-3609
13EOZ	Kohler	—	—	23-7740(Var 2)	23-2003	23-3304	23-3609
13EFOZ	Kohler	—	—	23-7740(Var 2)	23-2003	23-3304	23-3609
13.5 CCOZ	Kohler	—	—	23-7740(Var 2)	23-2003	23-3304	23-3609
14 CCOZ	Kohler	—	—	23-7740(Var 2)	23-2003	23-3304	23-3609
14 EOZ	Kohler	—	—	23-7740(Var 2)	23-2003	23-3304	23-3609
15 CCFOZ	Kohler	—	—	23-7740(Var 3)	23-2003	23-3304	23-3609
15.5EOZ	Kohler	—	—	23-7740(Var 2)	23-2003	23-3304	23-3609
16EFOZ	Kohler	—	—	23-7740(Var 3)	23-2003	23-3304	23-3609
17.5EFOZ	Kohler	—	—	23-7740(Var 3)	23-2003	23-3304	23-3609
18.5 CCOZ	Kohler	—	—	23-7740(Var 3)	23-2003	23-3304	23-3609
19EFOZ	Kohler	—	—	23-7740(Var 3)	23-2003	23-3304	23-3609
20 CCFOZ	Kohler	—	—	23-7740(Var 3)	23-2003	23-3304	23-3609
20EOZ	Kohler	—	—	23-7740(Var 3)	23-2003	23-3304	23-3609
20EFOZ	Kohler	—	—	23-7740(Var 3)	23-2003	23-3304	23-3609
23EOZ	Kohler	—	—	23-7740(Var 3)	23-2003	23-3304	23-3609
24 CCOZ	Kohler	—	—	23-7740(Var 3)	23-2003	23-3304	23-3609

Model	OEM	Starter	Alternator	Fuel Filter	Impeller	Impeller Kit	Thermostat
24EOZ	Kohler	—	—	23-7740(Var 3)	23-2003	23-3304	23-3609
6.5EFOZD	Kohler	—	—	23-7751	23-2002	23-3303	—
7 EFOZD	Kohler	—	—	23-7761 (Var 1)	23-2002	23-3303	—
8EOZD	Kohler	—	—	23-7751	23-2002	23-3303	—
8.5 EFOZD	Kohler	—	—	23-7761 (Var 1)	23-2002	23-3303	—
9 EOZD	Kohler	—	—	23-7761 (Var 1)	23-2002	23-3303	—
9EFOZD	Kohler	—	—	23-7761 (Var 1)	23-2002	23-3303	—
10EOZD	Kohler	—	—	23-7761 (Var 1)	23-2002	23-3303	—
11EFOZD	Kohler	—	—	23-7761 (Var 1)	23-2003	23-3304	—
11.5EFOZD	Kohler	—	—	23-7761 (Var 1)	23-2003	23-3304	—
13EOZD	Kohler	—	—	23-7761 (Var 1)	23-2003	23-3304	—
13EFOZD	Kohler	—	—	23-7761 (Var 1)	23-2003	23-3304	—
14 EOZD	Kohler	—	—	23-7761 (Var 1)	23-2003	23-3304	—
15.5 EOZD	Kohler	—	—	23-7761 (Var 1)	23-2003	23-3304	—
17 EFOZD	Kohler	—	—	23-7740(Var 3), 23-7761(Var 1)	23-2003	23-3304	—
17.5EFOZD	Kohler	—	—	23-7740(Var 3), 23-7761(Var 1)	23-2003	23-3304	—
19EFOZD	Kohler	—	—	23-7740(Var 3), 23-7761(Var 1)	23-2003	23-3304	—
20EOZD	Kohler	—	—	23-7740(Var 3), 23-7761(Var 1)	23-2003	23-3304	—
20EFOZD	Kohler	—	—	23-7740(Var 3), 23-7761(Var 1)	23-2003	23-3304	—
23EFOZ	—	—	—	—	23-2002	23-3303	—
23EOZD	Kohler	—	—	23-7740(Var 3), 23-7761(Var 1)	23-2003	23-3304	—
23EFOZD	Kohler	—	—	23-7761	23-2002	23-3303	—
24EOZD	Kohler	—	—	23-7740(Var 3), 23-7761(Var 1)	23-2003	23-3304	—
27EFOZ	—	—	—	—	23-2002	23-3303	—
27EFOZD	Kohler	—	—	23-7761	23-2002	23-3303	—
28EOZ	—	—	—	—	23-2002	23-3303	—
28EOZD	Kohler	—	—	23-7761	23-2002	23-3303	—
32EOZ	—	—	—	—	23-2002	23-3303	—
32EOZD	Kohler	—	—	23-7761	23-2002	23-3303	—
33EFOZ	Kohler	—	—	—	—	23-3308	—
33 CFOZ	Kohler	—	—	—	—	23-3308	23-3607
40 CFOZ	Kohler	—	—	—	—	23-3308	23-3607
40EOZ	Kohler	—	—	—	—	23-3308	—
40EFOZ	Kohler	—	—	—	—	23-3308	—
50 COZ	Kohler	—	—	—	—	23-3308	23-3607
50 CFOZ	Kohler	—	—	—	—	23-3308	23-3607
50EOZ	Kohler	—	—	—	—	23-3308	—
55EFOZ	Kohler	—	—	—	—	23-3308	—
65 COZ	Kohler	—	—	—	—	23-3308	23-3607
65EOZ	Kohler	—	—	—	—	23-3308	—
70EFOZ	Kohler	—	—	—	—	23-3308	—
80EOZ	Kohler	—	—	—	—	23-3308	—
80EFOZ	Kohler	—	—	—	—	23-3308	—
99EOZ	Kohler	—	—	—	—	23-3308	—
100EFOZ	Kohler	—	—	—	—	—	—
125EOZ	Kohler	—	—	—	—	—	—
125EFOZ	Kohler	—	—	—	—	—	—
150EOZ	Kohler	—	—	—	—	—	—
3.5 CFZ	Kohler	—	—	23-7771 (Var 2)	23-2003 (SN 296898 & below)	—	—
3.5 EFZ	Kohler	—	—	—	—	—	—
4 CZ	Kohler	—	—	23-7771 (Var 2)	23-2003 (SN 296898 & below)	—	—

Thermostat Kit	Oil Filter	Air Filter	Thermostat Gasket	Anode	Carb Kit	Glow Plug	Temp. Sender	Oil Pressure Sender	Solenoid
23-3665	23-7824	—	23-0810(Var 1,6), 23-0811(Var 2,3,4,5), 23-0812(All Var)	—	—	—	—	—	—
		23-1130	23-0813	—	—	—	—	—	—
—	23-7824(Var 1)	23-1130	23-0813	—	—	—	—	—	—
—		23-1130	23-0813	—	—	—	—	—	—
—	23-7824(Var 1)	23-1130	23-0813	—	—	—	—	—	—
—	23-7824(Var 1)	23-1130	23-0813	—	—	—	—	—	—
—	23-7824(Var 1)	23-1130	23-0813	—	—	—	—	—	—
—	23-7824(Var 1)	23-1130	23-0813	—	—	—	—	—	—
—	23-7824	—	23-0811, 23-0812	—	—	—	—	—	—
—	23-7824	—	23-0811, 23-0812	—	—	—	—	—	—
—	23-7824	—	23-0811, 23-0812	—	—	—	—	—	—
—	23-7824	—	23-0811, 23-0812	—	—	—	—	—	—
—	23-7824	—	23-0811, 23-0812	—	—	—	—	—	—
—	23-7824	—	23-0811, 23-0812	—	—	—	—	—	—
—	23-7824	—	23-0811, 23-0812	—	—	—	—	—	—
—	23-7824	—	23-0811, 23-0812	—	—	—	—	—	—
—	23-7824	—	23-0811, 23-0812	—	—	—	—	—	—
—	23-7824	—	23-0811, 23-0812	—	—	—	—	—	—
—	23-7824	—	23-0811, 23-0812	—	—	—	—	—	—
—	23-7824	—	23-0813	—	—	—	—	—	—
—	23-7824	—	23-0811, 23-0812	—	—	—	—	—	—
—	23-7824	—	—	—	—	—	—	—	—
—	23-7824	—	23-0811, 23-0812	—	—	—	—	—	—
—	23-7824	—	23-0813	—	—	—	—	—	—
—	23-7824	—	—	—	—	—	—	—	—
—	23-7824	—	23-0813	—	—	—	—	—	—
—	23-7824	—	—	—	—	—	—	—	—
—	23-7824	—	23-0813	—	—	—	—	—	—
—	23-7824	—	—	—	—	—	—	—	—
—	—	—	23-0814(Var 1,2,3)	—	—	—	—	—	—
23-3666	—	—	23-0814(Var 1,2,3)	—	—	—	—	—	—
23-3666	—	—	23-0814(Var 1,2,3)	—	—	—	—	—	—
—	—	—	23-0814(Var 1,2,3)	—	—	—	—	—	—
—	—	—	23-0814(Var 1,2,3)	—	—	—	—	—	—
23-3666	—	—	23-0814(Var 1,2,3)	—	—	—	—	—	—
23-3666	—	—	23-0814(Var 1,2,3)	—	—	—	—	—	—
—	—	—	23-0814(Var 1,2,3)	—	—	—	—	—	—
—	—	—	23-0814(Var 1,2,3)	—	—	—	—	—	—
23-3666	—	—	23-0814(Var 1,2,3)	—	—	—	—	—	—
—	—	—	23-0814(Var 1,2,3)	—	—	—	—	—	—
—	—	—	23-0814(Var 1,2,3)	—	—	—	—	—	—
—	—	—	23-0814(Var 1,2,3)	—	—	—	—	—	—
—	—	—	23-0814(Var 1,2,3)	—	—	—	—	—	—
—	—	—	23-0814(Var 1,2,3)	—	—	—	—	—	—
—	—	—	23-0814(Var 1,2,3)	—	—	—	—	—	—
—	—	—	23-0814(Var 1,2,3)	—	—	—	—	—	—
—	—	—	23-0814(Var 1,2,3)	—	—	—	—	—	—
—	—	—	23-0814(Var 1,2,3)	—	—	—	—	—	—
—	—	—	23-0814(Var 1,2,3)	—	—	—	—	—	—
—	—	—	23-0814(Var 1,2,3)	—	—	—	—	—	—
—	—	—	23-0814(Var 1,2,3)	—	—	—	—	—	—
—	—	—	23-0814(Var 1,2,3)	—	—	—	—	—	—
—	—	—	23-0814(Var 1,2,3)	—	—	—	—	—	—
—	—	—	23-0814(Var 1,2,3)	—	—	—	—	—	—
—	23-7823	23-1101	23-0809	—	—	—	—	—	—
—	23-7823	—	—	—	—	—	—	—	—
—	23-7823	23-1101	23-0809	—	—	—	—	—	—

Model	OEM	Starter	Alternator	Fuel Filter	Impeller	Impeller Kit	Thermostat
4EF	Kohler	—	—	23-7762	23-2004	23-3314	23-3608
4EFCD	Kohler	—	—	—	—	—	—
4EFKD	Kohler	—	—	—	—	—	—
4 ESZ	Kohler	—	—	—	—	—	—
5 CFZ	Kohler	—	—	23-7771 (Var 2)	23-2003 (SN 296898 & below)	—	—
5ECD	Kohler	—	—	—	23-2004	23-3314	—
5 EFZ	Kohler	—	—	23-7762	—	—	—
5EKD	Kohler	—	—	—	—	—	—
5E	Kohler	—	—	23-7762	23-2004	23-3314	23-3608
6EF	Kohler	—	—	23-7762	23-2004	23-3314	23-3608
6EFCD	Kohler	—	—	—	23-2004	23-3314	—
6EFKD	Kohler	—	—	—	—	—	—
6.5 CZ	Kohler	—	—	23-7771 (Var 2)	23-2003 (SN 296898 & below)	—	—
6.5 ESZ	Kohler	—	—	23-7762	—	—	—
7.3E	Kohler	—	—	23-7762	23-2004	23-3314	23-3608
7.3ECD	Kohler	—	—	—	23-2004	23-3314	—
7.3EKD	Kohler	—	—	—	—	—	—
8E	Kohler	—	—	23-7762 (GR4 Ver), 23-7771 (Var 2) Inline	23-2002 (296899 & Up), 23-2003 (296898 & below)	23-3303 (SN 296899 & Up) 23-3304 (SN 296898 & below)	23-3608
8EFKD	Kohler	—	—	—	—	—	—
9EFGD	Kohler	—	—	23-7780	—	—	—
10E	Kohler	—	—	23-7762 (GR4 Ver), 23-7771 (Var 2) Inline	23-2002 (296899 & Up), 23-2003 (296898 & below)	23-3303 (SN 296899 & Up) 23-3304 (SN 296898 & below)	23-3608
10EG	Kohler	—	—	23-7780	—	—	—
10EGD	Kohler	—	—	23-7780	—	—	—
10EKD	Kohler	—	—	—	—	—	—
11EFGD	Kohler	—	—	—	—	—	—
12.5E	Kohler	—	—	23-7762 (GR4 Ver), 23-7771 (Var 2) Inline	23-2002 (296899 & Up), 23-2003 (296898 & below)	23-3303 (SN 296899 & Up) 23-3304 (SN 296898 & below)	23-3608
12.5CF	Kohler	—	—	—	23-2002 (296899 & Up), 23-2003 (296898 & below)	23-3303 (SN 296899 & Up) 23-3304 (SN 296898 & below)	23-3608
13EG	Kohler	—	—	23-7780	—	—	—
13EGZ	Kohler	—	—	23-7780	—	—	—
13EGD	Kohler	—	—	—	—	—	—
15C	Kohler	—	—	—	23-2002	23-3303	23-3608
15EG	Kohler	—	—	23-7780	—	—	—
15EGD	Kohler	—	—	23-7780	—	—	—
15EGZ	Kohler	—	—	23-7780	—	—	—
16CF	Kohler	—	—	—	23-2002	23-3303	23-3608
17.5CF	Kohler	—	—	—	—	—	—
20C	Kohler	—	—	—	23-2002	23-3303	23-3608
MDKAU	Onan	—	—	23-7760	—	—	—
MDKAV	Onan	—	—	23-7760	—	23-3300	—
MDKBG	Onan	—	—	23-7760	—	23-3300	—
MDKAW (Spacesaver)	Onan	—	—	23-7760	—	23-3300	—
MDKAZ	Onan	—	—	23-7760	—	23-3300	—
MDKBD	Onan	—	—	23-7760	—	23-3300	—
MDKBE	Onan	—	—	23-7760	—	23-3300	—
MDKBF	Onan	—	—	23-7760	—	23-3300	—
MDKBD (w/ Isolated Ground)	Onan	—	—	23-7760	—	23-3300	—
MDKBE (w/ Isolated Ground)	Onan	—	—	23-7760	—	23-3300	—
MDKBF (w/ Isolated Ground)	Onan	—	—	23-7760	—	23-3300	—

Thermostat Kit	Oil Filter	Air Filter	Thermostat Gasket	Anode	Carb Kit	Glow Plug	Temp. Sender	Oil Pressure Sender	Solenoid
—	23-7821	—	—	23-6400	23-7202	—	—	—	—
—	—	—	—	—	—	—	—	—	—
—	—	—	—	—	—	—	—	—	—
—	23-7823	—	—	—	—	—	—	—	—
—	23-7823	23-1101	23-0809	—	—	—	—	—	—
—	—	—	—	—	—	—	—	—	—
—	23-7823	—	—	—	—	—	—	—	—
—	—	—	—	—	—	—	—	—	—
—	23-7821	—	—	23-6400	23-7202	—	—	—	—
—	23-7821	—	—	23-6400	23-7202	—	—	—	—
—	—	—	—	—	—	—	—	—	—
—	—	—	—	—	—	—	—	—	—
—	23-7823	23-1101	23-0809	—	—	—	—	—	—
—	23-7823	—	—	—	—	—	—	—	—
—	23-7821	—	—	23-6400	23-7202	—	—	—	—
—	—	—	—	—	—	—	—	—	—
—	—	—	—	—	—	—	—	—	—
23-3664	—	—	23-0813	—	—	—	—	—	—
—	—	—	—	—	—	—	—	—	—
—	—	—	—	—	—	—	—	—	—
23-3664	—	—	23-0813	—	—	—	—	—	—
23-3664	—	—	23-0813	—	—	—	—	—	—
—	—	—	—	—	—	—	—	—	—
—	—	—	—	—	—	—	—	—	—
—	—	—	—	—	—	—	—	—	—
23-3664	—	—	23-0813	—	—	—	—	—	—
23-3664	23-7820	—	23-0813	—	—	—	—	—	—
23-3664	—	—	23-0813	—	—	—	—	—	—
23-3664	—	—	23-0813	—	—	—	—	—	—
—	—	—	—	—	—	—	—	—	—
23-3664	23-7820	—	23-0813	—	—	—	—	—	—
23-3664	—	—	23-0813	—	—	—	—	—	—
—	—	—	—	—	—	—	—	—	—
23-3664	—	—	23-0813	—	—	—	—	—	—
23-3664	23-7820	—	23-0813	—	—	—	—	—	—
—	—	—	—	—	—	—	—	—	—
23-3664	23-7820	—	23-0813	—	—	—	—	—	—
—	23-7804	—	—	—	—	—	—	—	—
—	23-7842	—	—	23-6401	—	—	—	—	—
—	23-7842	—	—	23-6401	—	—	—	—	—
—	23-7842	—	—	23-6401	—	—	—	—	—
—	23-7842	—	—	23-6401	—	—	—	—	—
—	23-7840	—	—	23-6401	—	—	—	—	—
—	23-7840	—	—	23-6401	—	—	—	—	—
—	23-7840	—	—	23-6401	—	—	—	—	—
—	23-7840	—	—	23-6401	—	—	—	—	—
—	23-7840	—	—	23-6401	—	—	—	—	—
—	23-7840	—	—	23-6401	—	—	—	—	—
—	23-7840	—	—	23-6401	—	—	—	—	—
—	23-7840	—	—	23-6401	—	—	—	—	—

Model	OEM	Starter	Alternator	Fuel Filter	Impeller	Impeller Kit	Thermostat
MDKBH	Onan	—	—	—	—	—	—
MDKBK	Onan	—	—	—	23-2000	23-3310	—
MDKBL	Onan	—	—	—	23-2000	23-3310	—
MDKBM	Onan	—	—	—	23-2000	23-3310	—
MDKBN	Onan	—	—	—	23-2000	23-3310	—
MDKBP	Onan	—	—	—	—	—	—
MDKBR	Onan	—	—	—	—	—	—
MDKBS	Onan	—	—	—	—	—	—
MDKBV	Onan	—	—	—	—	—	—
MDKBT	Onan	—	—	—	—	—	—
MDKBU	Onan	—	—	—	—	—	—
MDDCA	Onan	—	—	—	—	23-3309	—
MDDCB	Onan	—	—	—	—	23-3309	—
MDDCC	Onan	—	—	—	—	23-3309	—
MDDCF	Onan	—	—	—	—	23-3309	—
MDDCG	Onan	—	—	—	—	23-3309	—
MDDCD	Onan	—	—	—	—	23-3309	—
MDDCE	Onan	—	—	—	—	23-3309	—
MDDCH	Onan	—	—	—	—	23-3309	—
MDDCJ	Onan	—	—	—	—	23-3309	—
MDJA	Onan	—	—	23-7750 (Spec A-R)	—	—	23-3606
MDJB	Onan	—	—	23-7750 (Spec A-R)	—	—	23-3606
MDJC	Onan	—	—	23-7750 (Spec A-R)	—	—	23-3606
MDJE	Onan	—	—	23-7750 (Spec A)	—	—	23-3606
MDJF	Onan	—	—	23-7750 (Spec A)	—	—	23-3606
MJA	Onan	—	—	—	—	—	23-3606
MJB	Onan	—	—	—	—	—	23-3606
MJC	Onan	—	—	—	—	—	23-3606
MDKAD/E/F	Onan	—	—	23-7760	—	—	—
MDKAL/A/B	Onan	—	—	—	23-2000	23-3310	—
AGTPM 4	Fischer Panda	—	—	—	23-2001	23-3311	—
PMS 4	Fischer Panda	—	—	—	23-2001	23-3311	—
PMS 8 Mini	Fischer Panda	—	—	—	23-2001	23-3305	—
PMS 8 DP	Fischer Panda	—	—	—	23-2001	23-3305	—
PMS 4200	Fischer Panda	—	—	—	23-2001	23-3305	—
PMS 6500	Fischer Panda	—	—	—	23-2001	23-3305	—
PMS 12 DP	Fischer Panda	—	—	—	23-2001	23-3305	—
PMS 12 Mini	Fischer Panda	—	—	—	23-2001	23-3305	—
PMS 15	Fischer Panda	—	—	—	—	23-3312	—
PMS 16 DP	Fischer Panda	—	—	—	—	23-3312	—
PMS 20	Fischer Panda	—	—	—	—	23-3312	—
PMS 22	Fischer Panda	—	—	—	—	23-3312	—
PMS 25	Fischer Panda	—	—	—	—	23-3312	—
PMS 30	Fischer Panda	—	—	—	—	23-3312	—
PMS 40	Fischer Panda	—	—	—	—	23-3312	—
PMS 50	Fischer Panda	—	—	—	—	23-3312	—
M673LD3	Northern Lights	—	—	—	23-2005	23-3315	—
M673L3	Northern Lights	—	—	—	23-2005	23-3315	—
M673LD2	Northern Lights	—	—	—	23-2005	23-3315	—
M673L2	Northern Lights	—	—	—	23-2005	23-3315	—
M753	Northern Lights	—	—	—	—	—	—
M753G	Northern Lights	—	—	—	—	—	—
M753K	Northern Lights	—	—	—	—	—	—

Thermostat Kit	Oil Filter	Air Filter	Thermostat Gasket	Anode	Carb Kit	Glow Plug	Temp. Sender	Oil Pressure Sender	Solenoid
—	23-7804	—	—	23-6401	—	—	—	—	—
—	—	—	—	23-6401	—	—	—	—	—
—	—	—	—	23-6401	—	—	—	—	—
—	—	—	—	23-6401	—	—	—	—	—
—	—	—	—	23-6401	—	—	—	—	—
—	—	—	—	23-6401	—	—	—	—	—
—	—	—	—	23-6401	—	—	—	—	—
—	—	—	—	23-6401	—	—	—	—	—
—	—	—	—	23-6401	—	—	—	—	—
—	—	—	—	23-6401	—	—	—	—	—
—	—	—	—	23-6401	—	—	—	—	—
—	—	—	—	23-6402	—	—	—	—	—
—	—	—	—	23-6402	—	—	—	—	—
—	—	—	—	23-6402	—	—	—	—	—
—	—	—	—	23-6402	—	—	—	—	—
—	—	—	—	23-6402	—	—	—	—	—
—	—	—	—	23-6402	—	—	—	—	—
—	—	—	—	23-6402	—	—	—	—	—
—	—	—	—	23-6402	—	—	—	—	—
—	—	—	—	23-6402	—	—	—	—	—
—	—	—	—	—	—	—	—	—	—
—	23-7841	—	—	—	—	—	—	—	—
—	23-7841	—	—	—	—	—	—	—	—
—	23-7841	—	—	—	—	—	—	—	—
—	23-7841	—	—	—	—	—	—	—	—
—	23-7841	—	—	—	—	—	—	—	—
—	23-7841	—	—	—	—	—	—	—	—
—	23-7841	—	—	—	—	—	—	—	—
—	23-7840	—	—	—	—	—	—	—	—
—	23-7842	—	—	—	—	—	—	—	—
—	—	—	—	—	—	—	—	—	—
—	—	23-1104	—	—	—	—	—	—	—
—	23-7804	23-1105	—	—	—	—	—	—	—
—	23-7804	23-1105	—	—	—	—	—	—	—
—	23-7804	23-1104	—	—	—	—	—	—	—
—	23-7804	23-1105	—	—	—	—	—	—	—
—	23-7804	23-1105	—	—	—	—	—	—	—
—	23-7804	23-1105	—	—	—	—	—	—	—
—	—	23-1104	—	—	—	—	—	—	—
—	23-7842	23-1104	—	—	—	—	—	—	—
—	—	23-1104	—	—	—	—	—	—	—
—	23-7842	23-1104	—	—	—	—	—	—	—
—	—	—	—	—	—	—	—	—	—
—	—	—	—	—	—	—	—	—	—
—	—	—	—	—	—	—	—	—	—
—	—	—	—	—	—	—	—	—	—
—	—	23-1103	—	—	—	—	—	—	—
—	—	23-1103	—	—	—	—	—	—	—
—	—	23-1103	—	—	—	—	—	—	—
—	—	23-1103	—	—	—	—	—	—	—
—	—	—	—	—	—	—	—	—	—
—	—	—	—	—	—	—	—	—	—
—	—	—	—	—	—	—	—	—	—

Model	OEM	Starter	Alternator	Fuel Filter	Impeller	Impeller Kit	Thermostat
M753W	Northern Lights	—	—	—	—	—	—
M753w2	Northern Lights	—	—	—	—	—	—
M773L	Northern Lights	—	—	—	—	—	—
M773LW2	Northern Lights	—	—	—	—	—	—
M773LW3: 9/7Kw	Northern Lights	—	—	—	—	—	—
M843	Northern Lights	—	—	—	—	—	—
M843N	Northern Lights	—	—	—	—	—	—
M843NK	Northern Lights	—	—	—	—	—	—
M843NK2	Northern Lights	—	—	—	—	—	—
M843NW	Northern Lights	—	—	—	—	—	—
M843NW2	Northern Lights	—	—	—	—	—	—
M843NW3	Northern Lights	—	—	—	—	—	—
M844	Northern Lights	—	—	—	—	—	—
M844K	Northern Lights	—	—	—	—	—	—
M844L	Northern Lights	—	—	—	—	—	—
M844LK	Northern Lights	—	—	—	—	—	—
M844LW	Northern Lights	—	—	—	—	—	—
M844LW2	Northern Lights	—	—	—	—	—	—
M844W	Northern Lights	—	—	—	—	—	—
M844W2	Northern Lights	—	—	—	—	—	—
M844W3: 16/12KW	Northern Lights	—	—	—	—	—	—
M844LW3: 20/16Kw	Northern Lights	—	—	—	—	—	—
M844NK2	Northern Lights	—	—	—	—	—	—
M844LK2	Northern Lights	—	—	—	—	—	—
M844NW2	Northern Lights	—	—	—	—	—	—
M844NW3	Northern Lights	—	—	—	—	—	—
ML844	Northern Lights	—	—	—	—	—	—
ML844K	Northern Lights	—	—	—	—	—	—
ML844L	Northern Lights	—	—	—	—	—	—
ML844LK	Northern Lights	—	—	—	—	—	—
M864K	Northern Lights	—	—	—	—	—	—
M864W	Northern Lights	—	—	—	—	—	—
M864W3: 25/20Kw	Northern Lights	—	—	—	—	—	—
M16C	Northern Lights	—	—	—	—	—	—
M20CL	Northern Lights	—	—	—	—	—	—
M20CR	Northern Lights	—	—	—	—	—	—
IS 2.5	Mase	—	—	—	—	23-3311	—
IS 4.0	Mase	—	—	—	—	23-3311	—
IS 4.7	Mase	—	—	—	—	23-3311	—
IS 7.1	Mase	—	—	—	—	23-3311	—
IS 13.2	Mase	—	—	—	—	—	—
IS 8.1	Mase	—	—	23-7751	—	—	—
IS 10.2	Mase	—	—	—	—	23-3312	—
IS 14.0	Mase	—	—	—	—	23-3312	—
IS 15.6T	Mase	—	—	—	—	—	—
IS 19.0	Mase	—	—	—	—	23-3312	—
IS 23.1T	Mase	—	—	—	—	23-3312	—
IS 28.0	Mase	—	—	—	—	—	—
IS 31.0	Mase	—	—	—	—	—	—
IS 42.0	Mase	—	—	—	—	—	—



FUEL WATER SEPARATOR KITS

Part No.	Description	Bracket	Filter	Micron Rating	Bowl	Application	OE Interchange
18-79912	1/4" Aluminum (Tall Filter)	18-7853-1	18-79911	10	N/A	Both Above and Below Deck	Mercury - 35-8M0082290
18-7983-1	1/4" Aluminum (Short Filter)	18-7853-1	18-7944	10	N/A	Both Above and Below Deck	Mercury - 35-802893A4, Q4, 35-60494A4, 35-807172A4, 35-60494A1, 35-57250A1, 35-55501A1, 35-52456A1
18-7982-1	1/4" Aluminum (Tall Filter)	18-7853-1	18-7945	10	N/A	Both Above and Below Deck	Honda - 06177-ZX2-000HE
18-7966-1	1/4" Aluminum (High Capacity Filter)	18-7853-1	18-7866	10	N/A	Both Above and Below Deck	Yamaha - MAR-SEPAR-AT-OR
18-7986-1	3/8" Aluminum (Tall Filter)	18-7775	18-7945	10	N/A	Both Above and Below Deck	
18-7984-1	1/4" Stainless Steel (Tall Filter)	18-7777	18-7945	10	N/A	Both Above and Below Deck	Yamaha - MAR-SPRTR-HD-SS
18-7985-1	3/8" Stainless Steel (Tall Filter)	18-7776	18-7948	10	N/A	Both Above and Below Deck	
18-7848-1	1/4" Aluminum (Short Filter)	18-7853-1	18-7844	21	N/A	Both Above and Below Deck	Mercury - 35-807172A4, Q4, 35-60494A4, 35-805369A4, 35-57250A1, 35-55501A1, 35-52456A1, 35-60494A1, 52444
18-7852-1	1/4" Aluminum (Tall Filter)	18-7853-1	18-7845	21	N/A	Both Above and Below Deck	Yamaha - MAR-SEPAR-AT-OR
18-7775-1	3/8" Aluminum (Tall Filter)	18-7775	18-7845	21	N/A	Both Above and Below Deck	
18-7777-1	1/4" Stainless Steel (Tall Filter)	18-7777	18-7845	21	N/A	Both Above and Below Deck	Yamaha - ABB-SPRTR-HD-SS
18-7776-1	3/8" Stainless Steel (Tall Filter)	18-7776	18-7845	21	N/A	Both Above and Below Deck	
18-99192	FWS Gas Kit 120R	18-79120	18-7947	10	18-7987 AquaVue™	Outboards Above Deck Only	120R-RAC-01
18-99292	FWS Gas Kit 120R	18-79120	18-7947UL	10	18-7988 Metal Bowl	Below Deck	120R-RAC-02
18-99189	FWS Gas Kit 320R	18-79320	18-7948	10	18-7922-1 AquaVue™	Outboards Above Deck Only	320R-RAC-01
18-99289	FWS Gas Kit 320R	18-79320	18-7948	10	18-7924 Metal Bowl	Below Deck	320R-RAC-02
18-99294	FWS Diesel Kit 120	18-79120	18-99194	2	18-99201 AquaVue™	Outboards Above Deck Only	120AS
18-99293	FWS Diesel Kit 120	18-79120	18-99193	10	18-99201 AquaVue™	Outboards Above Deck Only	120AT
18-99299	FWS Diesel Kit 120	18-79120	18-99199	30	18-99201 AquaVue™	Outboards Above Deck Only	120AP
18-99291	FWS Diesel Kit 120 33 CFR	18-79120	18-99194UL	2	18-7988 Metal Bowl	Below Deck	120RMAM2
18-99295	FWS Gas Kit 120 33 CFR	18-79120	18-99199UL	30	18-7988 Metal Bowl	Below Deck	120RMAM30
18-78867	Filter-Fuel Bowl Combo	N/A	18-78866	10	18-7922-1 AquaVue™	Outboards Above Deck Only	Upgrade Kit MAR-10MEL-00-00
18-79913	FWS Gas Kit 1/4" Head	18-7853-1	18-78866	10	18-7922-1 AquaVue™	Outboards Above Deck Only	Upgrade Kit MAR-10MAS-00-00
18-79914	FWS Gas Kit 3/8" Head	18-7775	18-78866	10	18-7922-1 AquaVue™	Outboards Above Deck Only	Upgrade Kit MAR-10MAS-00-00
18-79915	FWS Gas Kit 1/4" Head	18-7853-1	18-78866	10	18-7924 Metal Bowl	Below Deck	Upgrade Kit MAR-10MAS-00-00
18-79916	FWS Gas Kit 3/8" Head	18-7775	18-78866	10	18-7924 Metal Bowl	Below Deck	Upgrade Kit MAR-10MAS-00-00

Includes Bracket, Filter & 2 pipe plugs*

3/8" Pipe Plugs - 18-4264 & 1/4" Pipe Plugs - 18-4256

• Display Packaged



FUEL WATER SEPARATOR KITS - BONUS PACK CONTAINS SPARE FILTER			
Part No.	Kit Type	Micron Rating	Contents
18-7983-2 •	1/4" Aluminum	10	2 - 18-7944 & 1 - 18-7853-1
18-7982-2 •	1/4" Aluminum	10	2 - 18-7945 & 1 - 18-7853-1
18-7848-2 •	1/4" Aluminum	21	2 - 18-7844 & 1 - 18-7853-1
18-7852-2 •	1/4" Aluminum	21	2 - 18-7845 & 1 - 18-7853-1

*Each kit contains 2 brass pipe plugs

FUEL WATER SEPARATORS

Sierra fuel water separators remove over 99.8% of emulsified water from your gasoline. Sierra's 10 micron filters are over 90% efficient at removing particles as small as 10 micron. All filters flow @ 90 GPH to feed even the hungriest motor. Sierra 10 micron filters are recommended to prevent damage to sensitive inboard, sterndrive and outboard fuel injection systems.



11/16" - 16 thread size



- UNIVERSAL DESIGN -

FUEL WATER SEPARATOR BRACKETS

Part No.	Thread	Material	Replaces
18-7777	1/4"	Stainless Steel	Yamaha MAR-FLTHD-SS-12
18-7776	3/8"	Stainless Steel	
18-7853-1	1/4"	Aluminum	Mercury 89876A3, 89876, 55481 Yamaha MAR-FLTHD-AL-12
18-7775	3/8"	Aluminum	

FILTERS

Part No.	Description	Micron Rating	Replaces
18-7944	Short - 3.875"	10	Mercury - 35-807172, 35-802893Q, 35-806771, 35-8053691, 35-805369, 35-604941, 35-60494, 35-57250, 35-55501, 35-52456
18-7945	Long - 4.35"	10	Mercury - 35-802893Q, 35-806771, 35-8053691, 35-805369, 35-604941, 35-60494, 35-57250, 35-55501, 35-52456 Honda 17670-ZX2-000HE Yamaha - ABB-FUELF-IL-TR
18-7866	High Capacity - 6"	10	Yamaha - MAR-FUELF-IL-TR
18-7967	V6 EFI 1995-Earlier with sensor (black)	10	Mercury - 35-18458Q3, 35-18458A3, 35-18458A2, 35-17808A1, 35-14571A1
18-7968	V6 EFI 1996-Up with sensor (blue)	10	Mercury - 35-18458Q4, 35-184585
18-7844	Short - 3.875"	21	Mercury - 35-807172, 35-802893Q
18-7845	Long - 4.35"	21	Mercury - 35-806771, 35-8053691, 35-60494A4, 35-604941, 35-57250, 35-55501 Yamaha - ABB-FUELF-IL-TR
18-79911	Long - 8.5"	10	Mercury - 35-8M0079962

FUEL WATER SEPARATOR COVERS

Part No.	Description
18-8953	Fits: Yamaha mini-10 size filter
18-8954	Fits: Yamaha 18-7866 sized filter
18-8955	Fits: 18-7944 & 18-7945 sized filter

SIERRA AquaVue™ & METAL COLLECTION BOWL FUEL WATER SEPARATOR KITS

Sierra AquaVue™ and metal collection bowl separator filters allow water to be drained from the filter to extend service life. Use the AquaVue™ collection bowl for outboard, above deck installations. USCG regulations require the use of the flame resistant metal collection bowl below deck.



11/16" - 16 thread size

10 MICRON FILTER KITS W/COLLECTION BOWLS

Part No.	Kit Type	Contents
18-7932-1	1/4" Aluminum w/ AquaVue™ collection bowl	1 - 18-7919 & 1 - 18-7853-1, 1 - 18-7922-1
18-7951	1/4" Aluminum w/ metal collection bowl	1 - 18-7919 & 1 - 18-7853-1, 1 - 18-7924
18-7937-1	1/4" Stainless Steel w/ AquaVue™ collection bowl	1 - 18-7919 & 1 - 18-7777, 1 - 18-7922-1
18-7938	1/4" Stainless Steel w/ metal collection bowl	1 - 18-7919 & 1 - 18-7777, 1 - 18-7924

REPLACEMENT BOWLS

Part No.	Description	Replaces
18-7922-1	AquaVue™ Collection Bowl	Suzuki 99105-20004-BWL
18-7924	Metal Collection Bowl	Yamaha MAR-10171-00-10

REPLACEMENT ELEMENTS & ELEMENT BOWL ASSEMBLIES

Part No.	Description	Replaces
18-7919	Spin on replacement 10 Micron, 7 1/2" tall	Mercury 35-809097, 35-8M0103095 Yamaha MAR-24563-00-00 Racor S3213
18-7928-1	Filter & AquaVue™ Collection Bowl Mercury/Yamaha Style Contains: 18-7919 , 18-7922-1	Racor B32013
18-7929	Filter & Metal Collection Bowl Mercury/Yamaha Style Contains: 18-7919 , 18-7924	Mercury 35-809100 Racor B32020MAM
18-0179	Bowl O-Ring Standard Metal and AquaVue™ Collection Bowl	Racor RK22244
18-9884	Bowl Wrench	Racor RK22628

Includes Bracket, Filter & 2 pipe plugs* 3/8" Pipe Plugs - 18-4264 & 1/4" Pipe Plugs - 18-4256 • Display Packaged

COMPACT BRACKET & SEPARATOR KIT FOR OUTBOARDS UP TO 115HP 10 MICRON FILTRATION FOR SMALL OUTBOARD MOTORS



18-7965-1 10 MICRON COMPACT SEPARATOR KIT

Replaces: Yamaha
MAR-MINIF-LT-AS

Contains:

- 1 - 18-7774 bracket
- 1 - 18-7865 filter



18-7774 COMPACT ALUMINUM BRACKET

13/16" - 18 thread size



18-7865 REPLACEMENT FILTER

Replaces: Yamaha MAR-MINIF-IL-TR

18-79906 FUEL FILTER

For: Racor style Mini-10
Bowl-style filter

Use with drain bowls 18-7987 & 18-7988



18-7987 AquaVue™ BOWL

For: Racor style Mini-10



18-7988 COLLECTION BOWL

For: Racor style Mini-10

OMC REPLACEMENT FUEL FILTERS



18-7920 10 MICRON REPLACEMENT FILTER

Replaces: OMC 771839,
Racor S3214, Mercury 35-809099
1" - 12 thread size



18-7941-1 FILTER & AquaVue™ BOWL

OMC style
Contains: 18-7920, 18-7922-1



18-7943 FILTER & METAL BOWL

OMC style
Contains: 18-7920, 18-7924



18-7946
10 MICRON REPLACEMENT FILTER
Replaces: OMC 502905
 OMC thread



18-7846
21 MICRON REPLACEMENT FILTER
Replaces: OMC 502905
 OMC thread



18-7930
FUEL FILTER
Replaces: OMC 173326
For: 1977-83 Fuel system with add-on filter kit

VOLVO STYLE FUEL WATER SEPARATOR KITS



18-8149
HIGH CAPACITY
FUEL WATER SEPARATING FILTER
10 MICRON
Replaces: Volvo 3847644
 For use with side-by-side fuel pump applications.



18-7778
VOLVO ALUMINUM
REPLACEMENT BRACKET
Replaces: Volvo 3850861
 13/16" - 18 thread size



18-6999
UNIVERSAL FUEL WATER
SEPARATOR KIT MOUNTING
BRACKET
Fits: All 305 and 350 Mercruiser engines with Center Riser manifolds

REPLACEMENT RACOR® CARTRIDGES & SPIN-ON FILTERS

TURBINE SERIES FILTERS

PART #	DESCRIPTION	OEM PART NO.	MICRON RATING
18-99186	Fuel Cartridge - 500 Series	2010SM-OR	2
18-99182	Fuel Cartridge - 500 Series	2010TM-OR	10
18-99183	Fuel Cartridge - 500 Series	2010PM-OR	30
18-99191	Fuel Cartridge - 900 Series	2040N-02	2
18-99185	Fuel Cartridge - 900 Series	2040N-10	10
18-99184	Fuel Cartridge - 900 Series	2040N-30	30
18-99187	Fuel Cartridge - 1000 Series	2020N-02	2
18-99181	Fuel Cartridge - 1000 Series	2020N-10	10
18-99180	Fuel Cartridge - 1000 Series	2020N-30	30

- Remove 99% of particles per ISO 19438
- Media is SAE approved.
- Filters offer lift tabs on top of the caps for easy installation and removal.
- All Sierra filters are designed to meet or EXCEED your engine manufacturers' requirements.



Matches OE letter color code:
 Red = 30 microns
 Blue = 10 microns
 Brown = 2 microns

SPIN-ON FILTERS

PART #	DESCRIPTION	OEM PART NO.	MICRON RATING
18-99193	Fuel Cartridge 120	R12T	10
18-99194	Fuel Cartridge - 121	R12S	2
18-99196	Fuel Cartridge - 230	R20S	2
18-99199	Fuel Cartridge - 120	R12P	30
18-99200	Fuel Cartridge - R20P	R20P	30
18-7947UL	Fuel water Separator 33CFR	S324OUL	10
18-99179	23OR Fuel Water Separator	R20TUL	10
18-99193UL	Fuel Water Separator 33CFR	R12TUL	10
18-99194UL	Fuel Water Separator 33CFR	R12SUL	2
18-99199UL	Fuel Water Separator 33CFR	R12PUL	30

- 2, 10, 30 Micron Filter offerings
- Filters water to be drained from the bowl to extend service life of the filter
- Prevents engine damage such as fowled injectors and increases the life of downstream filters



- Remove 99% of particles per ISO 19438
- 10 Micron gas filters offer 90GPH to feed the hungriest of motors
- All filters include bowl O-rings

REPLACEMENT RACOR® BOWLS

PART #	DESCRIPTION	REPLACES	
18-99201	120 AquaView Clear Bowl- Mini 2 Port	RK10215	Use With 120 Series Filters; Replacement Bowl For R12t, R12s, R12p, 18-99193, 18-99194, 18-99199
18-99203	230 Series Metal Bowl	RK22368	Use with 230 Series Racor Style Filters; Replacement bowl for 18-99196, 18-99200.
18-99202	230 Series AquaView Clear Bowl 2 Port	RK350-02	Use with 230 Series Racor Filters; Replacement bowl for 18-99196, 18-99200.

REPLACEMENT ELEMENTS & ASSEMBLIES FOR RACOR® FILTER KITS



ELEMENT & BOWL KITS

PART #	DESCRIPTION	CONTAINS
18-7969	• Filter & Metal Bowl	18-7948, 18-7924
18-7994-1	• Filter & AquaVue™ Bowl	18-7948, 18-7922-1

REPLACEMENT ELEMENT ONLY

PART #	ELEMENT FOR RACOR	REPLACES
18-7947	120RRAC01 (Uses Mini Bowl below)	Honda 17670-ZW1-030GH Racor S3240 Suzuki 99105-20006
18-7948	320RRAC01 (1" - 14 thread size) (short filter)	Honda 17670-ZW1-801AH Mercury 35-886638 Racor S3227 Suzuki 99105-20005
18-7949	660RRAC02 (1" - 14 thread size) (tall filter)	Racor® S3232

REPLACEMENT ELEMENTS & ASSEMBLIES FOR RACOR® FILTER KITS



REPLACEMENT BOWL

PART #	DESCRIPTION	REPLACES
18-7987	AquaVue™ Mini Bowl	Racor® RK10222 Suzuki 99105-20006-BWL
18-7988	Mini Metal Bowl	-
18-99201	AquaVue™ Mini Bowl 2 ports	Racor® RK10215
18-99202	230 Series AquaVue™ Mini Bowl	Racor® RK22350-02
18-99203	230 Series Metal Bowl	Racor® RK22368

FWS ALUMINUM BRACKET

18-79320	Aluminum Bracket	Racor® 320R series bracket RK20180
18-79120	Aluminum Bracket	Racor® 120 series bracket RK10214 Gasoline/Diesel Engines

BOWL WRENCH

18-9884	Bowl Wrench	Racor® RK22628
---------	-------------	----------------



• Display Packaged

DIESEL FUEL FILTERS

20 MICRON



18-7931
Replaces:
Detroit Diesel 5574508
For: 8V-92, 8V-71

20 MICRON



18-7934
Replaces:
Cerlist Diesel 1512904
Model M

20 MICRON



18-7935
Replaces:
Fram CCS 1136
Fram FCS 1136 Filter Bracket

20 MICRON



18-7970
Replaces:
Cerlist Diesel 1512903
Model 3M

DIESEL FUEL FILTERS



18-79960
FUEL FILTER ELEMENT
Replaces: Yanmar 104500-55710
Fits: All GM Series, YM Series, HM Series, QM Series

20 MICRON



18-7858
Replaces: Volvo 858201
For: CAV Type Unit
For: AQ120B, 125A, B, 131A, 140A, 145A,B, 151, BB, 140, 145A

20 MICRON



18-7942
Replaces: Volvo 466987, 3825133
For: MD100A, TMD100A, MD100B, MD120A, TMD120A, TAMD120A, MD120B, TMD120B, TAMD120B, MD70B, TMD70B, TAMD70B, THAMD70B, AQAD70B, MD70C, TMD70C, TAMD70C, AQD70C, TAMD60A, TAMD60B, TAMD60C, D5/D7 MARINE GENSET, D5A-T, D5A-TA, D7A-T, D7A-TA, D7C-TA, D63 MARINE, D71/73 MARINE, KAD32P, TAMD42WJ, KAD43P/44P/300, KAMD43P/44P/300, TAMD103A, TAMD61A, TAMD62A, TAMD71A, TAMD72A, TAMD72P, TAMD72WJ, TAMD74, TAMD75 MARINE, TMD102A, TAMD102A, TAMD102D, TMD122A, TAMD122A, TAMD122P, TMD31L, TAMD31P/L/M/S, AD31P/L, TMD41L, TAMD41P/L/M/H



18-8124
Replaces: Volvo 829913
For: 2001, 2001B, 2002, 2002B, 2003, 2003B/T/TB, AQD2B, MD11C/D, MD17C/D, MD1B, MD2B, MD3B, MD5A/B/C, MD7/B



18-8125
Replaces: Volvo 3583443
For: D4-180i-B, D4-180i-C, D4-210A-A, D4-210A-B, D4-210i-A, D4-210i-B, D4-225A-B, D4-225A-C, D4-225i-B, D4-225i-C, D4-260A-A, D4-260A-B, D4-260A-C, D4-260D-B, D4-260D-C, D4-260i-A, D4-260i-B, D4-260i-C, D4-300A-A, D4-300A-C, D4-300D-A, D4-300D-C, D4-300i-A, D4-300i-C, D6-280A-A, D6-280A-B, D6-280i-A, D6-280i-B, D6-310A-A, D6-310A-B, D6-310D-A, D6-310D-B, D6-310i-A, D6-310i-B, D6-330A-B, D6-330A-C, D6-330D-B, D6-330D-C, D6-330i-B, D6-330i-C, D6-350A-A, D6-350A-B, D6-370A-B, D6-370A-C, D6-370D-A, D6-370D-B, D6-370D-C, D6-370i-A, D6-370i-B, D6-370i-C, D6-435D-A, D6-435D-C, D6-435i-A, D6-435i-C

FUEL FILTERS

20 MICRON



FUEL FILTER
18-7723
Fits: 1/4" and 5/16" hose
18-7724
Fits: 3/8" and 7/16" hose



18-7828-1
FUEL FILTER
 Small Capacity for 1/4" Fuel Line



18-7829
FUEL FILTER
Replaces: Mercury 35-16494, 35-816296, T, Q, 35-816296K03
 Small Capacity for 1/4" Fuel Line



18-7830
FUEL FILTER
Replaces: Mercury 35-16494, 35-816296-1, 35-816296T1, Q22, 35-8162961, 35-816396Q1, 35-816296B2, 35-816296B1, 35-134301
 Small Capacity for 1/4" Fuel Line



18-7829
FUEL FILTER
Replaces: Mercury 35-16494, 35-816296, T, Q, 35-816296K03
 Small Capacity for 1/4" Fuel Line



18-7790
FUEL FILTER KIT
Complete Kit Contains: Housing, Replaceable Element & Fittings for 1/4", 5/16", & 3/8" Fuel Lines



18-7856-1
FUEL FILTER
Replaces: A.C. Delco GF-61
For: 5/16" Fuel Line



18-7857-1
FUEL FILTER
Replaces: A.C. Delco GF-61P
For: 3/8" Fuel Line

FUEL FILTERS



**18-7791
FUEL FILTER ELEMENT**
Replacement element for
18-7790 filter kit



**18-9884
BOWL WRENCH**
Replaces: Racor RK22628
Fits: Sierra, Racor and other aftermarket filter bowls

PRIMER BULBS



- Meets current EPA regulations in effect 1/1/2011 of 15 g/m2/24 hrs.
- Both EPA/CARB certified
- Utilizes Fluoroelastomer (FKM) material for traditional look and operation.
- 7 1/2" overall length including barbs



**18-8002EP-1
PRIMER BULB ASSEMBLY**
1/4" I.D.



**18-8004EP-1
18-8004-10EP-1
PRIMER BULB ASSEMBLY**
Replaces: Mercury 89396A38, 89396Q38
Johnson/Evinrude 174511
5/16" I.D.



**18-8005EP-1
18-8005-10EP-1
PRIMER BULB ASSEMBLY**
Replaces: Mercury 13330A3, 13330Q,
Johnson/Evinrude 174512
3/8" I.D.

SILVERADO 4000 COMPLETE FUEL LINE ASSEMBLIES



- **Premium Rubber Fuel Line**
 - Polyester braid
 - Weather resistant CPE cover
 - Flexible THV barrier layer
- **Updated packaging**
- **Best hose on the market-resists kinking & easy to clamp.**



CHRYSLER / FORCE

8' LENGTH COMPLETE FUEL LINE ASSEMBLIES

^{3/8"}
FUEL LINE ASSEMBLY

18-8011EP-2 SILVERADO 4000 Premium

OE# FS409752



*



18-8071
TANK
CONNECTOR
(SOLD SEPARATELY)



18-8005EP-1
PRIMER
BULB



18-8062
FUEL
CONNECTOR



*

FUEL LINE ASSEMBLY COMPONENTS

HONDA

9' LENGTH COMPLETE FUEL LINE ASSEMBLIES

^{3/8"}
FUEL LINE ASSEMBLY

18-81042EP-2 SILVERADO 4000 Premium OE#

17700-ZW9-010
17700-ZW9-020



*



18-80401
FUEL
CONNECTOR



18-8005EP-1
PRIMER
BULB



18-80403
FUEL
CONNECTOR



*



18-80400
TANK
CONNECTOR
(SOLD SEPARATELY)

FUEL LINE ASSEMBLY COMPONENTS

Honda Fuel Application: 8, 9.9, 15, 25, 30, 40, 50, 75, 90, 115, 130 HP (2001-02)

JOHNSON / EVINRUDE

8' LENGTH COMPLETE FUEL LINE ASSEMBLIES

^{3/8" High Flow}
FUEL LINE ASSEMBLY

18-8009EP-2 SILVERADO 4000 Premium

OE# 398549



*



18-8092
FUEL
CONNECTOR



18-8005EP-1
PRIMER
BULB



18-8092
FUEL
CONNECTOR



*



18-8063
TANK
CONNECTOR
(SOLD SEPARATELY)

FUEL LINE ASSEMBLY COMPONENTS

Fits: All V8, 1984 & later V6, 1985 & later 120 HP, 140 HP outboards, 2 HP (1 cyl.) - 75 HP (3 cyl.) (1976-02)

* Tanks and Engines for picture purpose only.

JOHNSON / EVINRUDE (continued)

8' LENGTH COMPLETE FUEL LINE ASSEMBLIES

FUEL LINE ASSEMBLY ^{3/8"}

18-8014EP-2 SILVERADO 4000 Premium

OE# 174509



FUEL LINE ASSEMBLY COMPONENTS

Fits: All V6 & V8 (1976-02)

MERCURY / MARINER

8' LENGTH COMPLETE FUEL LINE ASSEMBLIES

FUEL LINE ASSEMBLY ^{3/8"}

18-8010EP-2 SILVERADO 4000 Premium



FUEL LINE ASSEMBLY COMPONENTS

FUEL LINE ASSEMBLY ^{3/8"}

18-8012EP-2 SILVERADO 4000 Premium

**OE# 32-858114Q08,
32-858114K08**



FUEL LINE ASSEMBLY COMPONENTS

Has 1/8" NPT threaded fitting on engine end and 1/4" NPT threaded fitting on the tank end. Primer bulb is included in this 8ft. (2.44 m) assembly. Fits various applications using the older style twist type disconnects at the engine end and either a bayonet or thread-in fitting on the tank end.

* Tanks and Engines for picture purpose only.

3/8" FUEL LINE ASSEMBLY

18-8024EP-2 SILVERADO 4000 Premium

OE# 32-858104Q08,
32-858104K08



*



18-8074
HOSE BARB

18-8005EP-1
PRIMER
BULB

18-8076
FUEL
CONNECTOR



*

FUEL LINE ASSEMBLY COMPONENTS

Has standard quick connect type fitting on engine end and 1/4" NPT threaded fitting on the tank end. Primer bulb is included in this 8 ft. (2.44 m) assembly. Fits Force 40 HP and larger (1993 & Newer), Force 9.9/15/25HP (1998), and all Mercury/Mariner outboards using clip on type disconnect at engine ends and a tank with threaded fuel pickup fitting.

3/8" FUEL LINE ASSEMBLY

18-8025EP-2 SILVERADO 4000 Premium

OE# 32-858105Q08,
32-858105K08



*



18-8068
18-8082
TANK
CONNECTOR
(SOLD SEPARATELY)

18-8084
FUEL
CONNECTOR

18-8005EP-1
PRIMER
BULB

18-8076
FUEL
CONNECTOR



*

FUEL LINE ASSEMBLY COMPONENTS

Has standard quick connect type fitting on engine end and bayonet style fitting on the tank end. Primer bulb is included in this 8 ft. (2.44 m) assembly. Fits Force 40 HP and larger (1993 & Newer), Force 9.9/15/25HP (1998), and all Mercury/Mariner outboards using clip-on type disconnect at the engine end and an older style tank with bayonet type connection.

3/8" FUEL LINE ASSEMBLY

18-8016EP-2 SILVERADO 4000 Premium

OE# 32-858109Q12,
32-858109K12



*



18-80402
TANK
CONNECTOR
(SOLD SEPARATELY)

18-8091
FUEL
CONNECTOR

18-8005EP-1
PRIMER
BULB

18-8076
FUEL
CONNECTOR



*

FUEL LINE ASSEMBLY COMPONENTS

Has double sealed quick connect type fitting on tank end and clip-on type quick connect on engine end. Primer bulb is included in this 8ft. (2.44m) assembly. Fits Force 40 HP and larger (1993 & Newer), Force 9.9/15/25HP (1998) and all Mercury Mariner outboards using clip-on type disconnects at both tank and engine ends



* Tanks and Engines for picture purpose only.

YAMAHA

8' LENGTH COMPLETE FUEL LINE ASSEMBLIES

3/8"
FUEL LINE ASSEMBLY

18-8017EP-2 SILVERADO 4000 Premium

OE# 6YL-24306-60-00



*



**18-8077-1
TANK
CONNECTOR**
(SOLD SEPARATELY)



**18-8076
FUEL
CONNECTOR**

**18-8005EP-1
PRIMER
BULB**

**18-8076
FUEL
CONNECTOR**



*

FUEL LINE ASSEMBLY COMPONENTS
Fits: F75-F250 and 115-300 HP

UNIVERSAL

8' LENGTH FUEL LINE ASSEMBLIES

5/16"
FUEL LINE ASSEMBLY

18-8013EP-2 SILVERADO 4000 Premium



*



**18-8004EP-1
PRIMER
BULB**



*

FUEL LINE ASSEMBLY COMPONENTS

3/8"
FUEL LINE ASSEMBLY

18-8015EP-2 SILVERADO 4000 Premium



*



**18-8005EP-1
PRIMER
BULB**



*

FUEL LINE ASSEMBLY COMPONENTS

12' LENGTH COMPLETE FUEL LINE ASSEMBLIES

5/16"
FUEL LINE ASSEMBLY

18-8032EP-2 SILVERADO 4000 Premium



*





**18-8004EP-1
PRIMER
BULB**



*

FUEL LINE ASSEMBLY COMPONENTS



* Tanks and Engines for picture purpose only.

 HOSE BARBS	HOSE BARB APPLICATION						 18-8045 REDUCING NIPPLE FITTING 1/8" x 1/4" NPT HEX	 18-4256 PIPE PLUG 1/4" Threads
	Part #	Mercury O.E. #	OMC O.E. #	Barb	NPT	Conn. Type		
	18-8041	—	—	5/8"	3/8"	Male		
	18-8042	—	—	1/4"	1/4"	Male		
	18-8043	—	—	1/4"	1/8"	Male		
	18-8054	22-63186	—	5/16"	1/8"	Male		
	18-8055	22-63187	173311	5/16"	1/4"	Male		
	18-8073	—	—	3/8"	1/8"	Male		
	18-8074	—	173312	3/8"	1/4"	Male		
	18-8093	—	—	1/4"	1/4"	Female		
	18-8094	—	—	5/16"	1/4"	Female		
	18-8095	—	—	3/8"	1/4"	Female		
	18-8108	—	—	3/8"	3/8"	Male		
	18-8109	—	—	5/16"	3/8"	Male		

 18-4264 PIPE PLUG 3/8" Threads	 18-8046 FUEL TANK ELBOW 1/8" NPT x 1/4" NPT 90°	 18-8047 FUEL TANK ELBOW 1/4" NPT Threads 90°	 18-8067 18-8110-9① Bulk Pack of 12 (18-8067) FUEL ELBOW 3/8" Barb with 1/4" NPT Thread 90°
---	---	---	--

 18-1650 SHUT OFF VALVE 3 way 1/4" FNPT Valve	 18-1651 SHUT OFF VALVE 2 way 1/4" FNPT Male/ Male Shut off Valve	 18-1652 SHUT OFF VALVE 2 way 1/4" FNPT Male/ Female Shut off Valve	 18-1653 SHUT OFF VALVE 2 way 1/4" FNPT Female/ Female Shut off Valve
---	--	---	--

 18-1654 SHUT OFF VALVE 4 way 1/4" FNPT Valve	 18-1655 SHUT OFF VALVE 3 way 1/4" FNPT Valve w/ Detent	 18-1656 SHUT OFF VALVE 3 way 3/8" FNPT Valve w/ Detent
---	--	---

PKG. OF 10 	SNAPPER CLAMPS					FUEL LINE ★ Universal ★ Vinyl ★ 35 psi working pressure *Not intended for diesel fuel 
	PART #	O.E.	O.E. #	CLAMP RANGE	CLAMP SIZE	
	18-8020 ①	Mercury J/E	54-41582-7 322652	.538 - .608	8	
	18-8021 ①	J/E	911616	.597 - .665	10	
	18-8034 ①	J/E	329654	.670 - .780	12	
	18-8200 ①	J/E	322653	.360 - .406	2	
	18-8201 ①	J/E	124249	.410 - .468	4	
	18-8202 ①	J/E	322654	.475 - .536	6	
	18-8203 ①	J/E	329653	.750 - .875	14	
	18-8204 ①	J/E	324825	.875 - .975	19	

FUEL LINE HOSE SILVERADO 4000 16-337-0566 5/16" I.D.  50' Reels ALCOHOL RESISTANT SAE J1527 Type B1-15 and ISO 8469	16-337-0386 3/8" I.D.  18-7598 PULL-START LOCK	 18-7599 FUEL LOCK Protect your outboard from theft, disconnect fuel line and simply install fuel lock. Designed to fit clip on style fuel connectors. Fits: Johnson Evinrude, Mercury/Mariner, Yamaha and Honda.
---	---	---

① Priced per Package

FUEL LINE HOSE

MADE FROM AN ALCOHOL RESISTANT COMPOUND — 50' REELS



**18-8048
BLEEDER HOSE**

.090 I.D. x .220 O.D.
Similar to Mercury
32-99130122, 32-892024122

18-8050
.0625 I.D. x .190 O.D.
Similar to Mercury 32-9938779



**18-8051
FUEL LINE HOSE
for OMC Pressurized Systems**

Replaces: J/E 322656
(Double)



**18-8052
FUEL LINE HOSE**

3/16" I.D.
Non-Pressurized Systems
Replaces: J/E 122838

REMOTE VENT KIT



**18-369-RVK15
REMOTE VENT KIT**

Water intrusion through the fuel tank is a common occurrence on boats with direct deck fills that are located near the waterline or open to splashes. The solution is a kit designed to move the direct fuel fill venting to a remote location allowing the use of a non-venting, sealed fuel cap. Protect your tank from water intrusion by relocating the direct fuel fill vent to a safer location. Designed for most boats, especially pontoons.

- Sealed Fuel Cap
- Thru Hull Stainless Steel
- Barb Tee 5/8"
- 6 Stainless Steel Hose Clamps
- Diurnal Control Valve
- 15' Shields 5/8" Type A2 Fire-Acol Fuel Vent Hose
- Step by Step Instructions/ Installation Diagram

PRIMER BULBS



- **Nitrile construction.**
- **Manufactured for countries that do not need EPA/CARB compliancy.**
- **Resistant to alcohol laden fuels.**



**18-8002S
PRIMER BULB ASSEMBLY**
1/4" I.D.



**18-8004S
18-8004-10S
PRIMER BULB ASSEMBLY**
Replaces: Mercury 89396A38, 89396Q38
Johnson/Evinrude 174511
5/16" I.D.



**18-8005S
18-8005-10S
PRIMER BULB ASSEMBLY**
Replaces: Mercury 13330A3, 13330Q,
Johnson/Evinrude 174512
3/8" I.D.

* Tanks and Engines for picture purpose only.

SILVERADO 4000 COMPLETE FUEL LINE ASSEMBLIES



- Eight of the most popular numbers, utilizing the Silverado 4000 line and the non-domestic primer bulb.
- Updated packaging.



JOHNSON / EVINRUDE

8' LENGTH COMPLETE FUEL LINE ASSEMBLIES

3/8" High Flow FUEL LINE ASSEMBLY

18-8009S-1 SILVERADO 4000 Premium

OE# 398549



**18-8063
TANK
CONNECTOR**
(SOLD SEPARATELY)



**18-8092
FUEL
CONNECTOR**



**18-8005S
PRIMER
BULB**



**18-8092
FUEL
CONNECTOR**



FUEL LINE ASSEMBLY COMPONENTS
Fits: All V8, 1984 & later V6, 1985 & later 120 HP, 140 HP outboards, 2 HP (1 cyl.) - 75 HP (3 cyl.) (1976-02)



8' LENGTH COMPLETE FUEL LINE ASSEMBLIES

3/8" FUEL LINE ASSEMBLY

18-8014S-1 SILVERADO 4000 Premium

OE# 174509



**18-8074
HOSE BARB**
(SOLD SEPARATELY)



**18-8005S
PRIMER
BULB**



**18-8092
FUEL
CONNECTOR**



FUEL LINE ASSEMBLY COMPONENTS
Fits: All V6 & V8 (1976-02)



MERCURY / MARINER

8' LENGTH COMPLETE FUEL LINE ASSEMBLIES

3/8" FUEL LINE ASSEMBLY

18-8016S-1 SILVERADO 4000 Premium

OE# 32-858109Q12,
32-858109K12



**18-80402
TANK
CONNECTOR**
(SOLD SEPARATELY)



**18-8091
FUEL
CONNECTOR**



**18-8005S
PRIMER
BULB**



**18-8076
FUEL
CONNECTOR**



FUEL LINE ASSEMBLY COMPONENTS

Has double sealed quick connect type fitting on tank end and clip-on type quick connect on engine end. Primer bulb is included in this 8ft. (2.44m) assembly.
Fits Force 40 HP and larger (1993 & Newer), Force 9.9/15/25HP (1998) and all Mercury Mariner outboards using clip-on type disconnects at both tank and engine ends



YAMAHA

8' LENGTH COMPLETE FUEL LINE ASSEMBLIES

3/8" FUEL LINE ASSEMBLY

18-8017EP-2 SILVERADO 4000 Premium

OE# 6YL-24306-60-00



**18-8077-1
TANK
CONNECTOR**
(SOLD SEPARATELY)



**18-8076
FUEL
CONNECTOR**



**18-8005EP-1
PRIMER
BULB**



**18-8076
FUEL
CONNECTOR**



FUEL LINE ASSEMBLY COMPONENTS
Fits: F75-F250 and 115-300 HP



* Tanks and Engines for picture purpose only.

YAMAHA

8' LENGTH COMPLETE FUEL LINE ASSEMBLIES

FUEL LINE ASSEMBLY ^{3/8"}

18-8017S-1 SILVERADO 4000 Premium

OE# 6YL-24306-60-00



**18-8076
FUEL
CONNECTOR**

**18-8005S
PRIMER
BULB**

**18-8076
FUEL
CONNECTOR**



*

*

FUEL LINE ASSEMBLY COMPONENTS
Fits: F75-F250 and 115-300 HP

UNIVERSAL

8' LENGTH FUEL LINE ASSEMBLIES

FUEL LINE ASSEMBLY ^{5/16"}

18-8013S-1 SILVERADO 4000 Premium



**18-8004S
PRIMER
BULB**



*

*

FUEL LINE ASSEMBLY COMPONENTS

8' LENGTH FUEL LINE ASSEMBLIES

FUEL LINE ASSEMBLY ^{3/8"}

18-8015S-1 SILVERADO 4000 Premium



**18-8005S
PRIMER
BULB**



*

*

FUEL LINE ASSEMBLY COMPONENTS

12' LENGTH COMPLETE FUEL LINE ASSEMBLIES

FUEL LINE ASSEMBLY ^{5/16"}

18-8032S-1 SILVERADO 4000 Premium



**18-8004S
PRIMER
BULB**



















*

*

FUEL LINE ASSEMBLY COMPONENTS

* Tanks and Engines for picture purpose only.

 <p>18-7254 Replaces: Chrysler 3745414 Inlet: 3/8" - 24 • Outlet: 1/2" - 20 Use replacement gasket 18-0889</p>	 <p>18-7255 Replaces: Chrysler 3745415 Inlet: 3/8" - 24 • Outlet: 1/2" - 20</p>	 <p>18-7256 Replaces: Mercruiser 32722, Crusader 32722</p>
 <p>18-7260</p>	 <p>18-7265 Replaces: Chris-Craft 16.83-08758, F18308762</p>	 <p>18-7266 Replaces: Ford DJL 9350A</p>
 <p>18-7267 Replaces: Mercruiser 62092, 62092T, 54552 OMC 982063 Gasket included</p>	 <p>18-7268 Replaces: OMC 981650 Volvo 3855276 Dual Diaphragm requires sight glass</p>	 <p>18-7270 Replaces: Crusader 21140 Gasket included</p>
 <p>18-7272 Replaces: Crusader 97039</p>	 <p>18-7274 Replaces: Mercruiser 86246, 86246A1, 78485, 71646 86246T OMC 509409</p>	 <p>18-7275 Replaces: Mercruiser 86247, 86247T, 86247A2, 78820, 63196, 46860 OMC 509410 Gasket included</p>
 <p>18-7278 Replaces: Mercruiser 86234A4, 86234A05, 86234A3, 86234, 77594, 71327, 47585 OMC 985602, 985603, 982240, 509395 Use replacement gasket 18-0889 Use replacement pump filter 18-7860</p>	 <p>18-7281 Replaces: Volvo 826493, 3855276 OMC 981650 Gasket included</p>	 <p>18-7282 Replaces: Mercruiser 42725A3, 861676T09 OMC 509407 Use replacement gasket 18-0889 Use replacement pump filter 18-7784</p>
 <p>18-7283 Replaces: Mercruiser 97401A2, 97401A8, 861678A1, 8M0058164, 97401 OMC 509404 Use replacement gasket 18-0889</p>	 <p>18-7284 Replaces: Mercruiser 41141A2, 862077A1 OMC 509408 Use replacement gasket 18-0889 Use replacement pump filter 18-7784</p>	

ALL SIERRA FUEL PUMPS INCLUDE MOUNTING GASKET



18-7286
Replaces: Volvo 841161



18-7288-1
Replaces:
MerCruiser 812454A1, 862048A1, 812454A3,
97399A2, 97399



18-7289
Replaces: OMC 982997
Gasket included



18-7258
Replaces: OMC 380986, GM 6414989



18-7326
ELECTRIC FUEL PUMP
• 8 psi, 25 gpm
Replaces: MerCruiser 805656A2, 805656A6,
805656A5, 805025A2, 861155A6, 861155A5
OMC/Volvo 3858261, 3850809, 3854620, 3857986



18-7330
ELECTRIC FUEL PUMP
• 120 psi
Replaces: OMC/Volvo 3857650,
3855958, 988037, 3854280



18-7331
ELECTRIC FUEL PUMP
• 8 psi, 45 gpm
Replaces: OMC/Volvo 3858714,
3850810, 3857985



18-7332
ELECTRIC FUEL PUMP
Includes bracket and mounting hardware
43 GPH – 7 PSI Max. – 1/4 NPSF for 3/8 hose
– operates with both gasoline and diesel fuel - 24 Volt only



18-7333
ELECTRIC FUEL PUMP
UNIVERSAL
12V, 72GPH at 5.75 PSI, 1/4" NPSF
for 3/8" hose, for use with gasoline and diesel fuel.
OP72533 pressure safety switch recommended.

Year	Engine	Application	OE #	#'s Superseded from	Part #
MERCURISER					
1996	262/4.3L	Low Pressure Supply Pump For F.I. System	805656A2		18-7326
1996	262/4.3L	Carbureted w/electric pump - Low PSI	805656A2		18-7326
1992-93	262/4.3L	Carbureted w/electric pump - Low PSI	805656A2		18-7326
OMC					
1992-94	262/4.3L	Low Pressure	3858261	385,080,938,508,103,000,000	18-7326
1997-98	350/5.7L, 454/7.4L, & 502/8.2L	Engines w/MPI - High Pressure	3857650		18-7330
1996	454/7.4L & 502/8.2L	Engines w/MPI - High Pressure	3857650		18-7330
1993-94	4.3L thru 5.8L	Low pressure electric fuel pump	3858261	3850809	18-7326
1992-1994	454/7.4L & 502/8.2L	GM Mark V Eng. - Low Pressure	3858714	3850810, 3857985	18-7331
VOLVO-PENTA					
1994-99	262/4.3L (HU-WT)	High Pressure pump	3857650		18-7330
1994-99	262/4.3L GL/GS (All)	Carbureted - Low Pressure	3858261	3850809	18-7326
1994-99	262/4.3L GI (HU-WT)	W.Elec. Pump - Low Pressure	3858261	3850809	18-7326
1994-99	454/7.4L & 502/8.2L (HU-WT)	Low pressure system	3858714	3850810, 3857985	18-7331
1993-99	350/5.7L, 454/7.4L, & 502/8.2L	Engines w/MPI - High Pressure	3857650		18-7330
1996-99	454/7.4L & 502/8.2L (HU-WT)	Engines w/MPI - High Pressure	3857650		18-7330
1994-99	5.0L thru 5.8L	Low pressure electric fuel pump	3858261	3850809	18-7326
1994-99	454/7.4L & 502/8.2L (HU-WT)	GM Mark V Eng. - Low Pressure	3858714	3850810, 3857985	18-7331
1992-93	454/7.4L	GM Mark V Eng. - Low Pressure	3858714	3850810, 3857985	18-7331

ALL SIERRA FUEL PUMPS INCLUDE MOUNTING GASKET

Many fuel pumps are often used on similar engines. In order to identify the correct fuel pump for your application, it is necessary to determine the position of the inlet, outlet and separator fitting (where applicable) in relation to the rocker arm. The angle between the rocker arm and the fuel inlet is expressed in terms of clock position. Place pump with rocker arm in the 12 o'clock position. The rocker arm must be held behind the fuel pump body. (The bottom of the fuel pump body must face you.) Observe the relationship of the fuel inlet to the rocker arm. This position is the clock position of the pump. Examples of this in the outline drawing below show that if the fuel inlet is at position "A", it is considered a 6 o'clock pump, if at position "B", a 3 o'clock pump, and at position "C" an 8 o'clock pump.

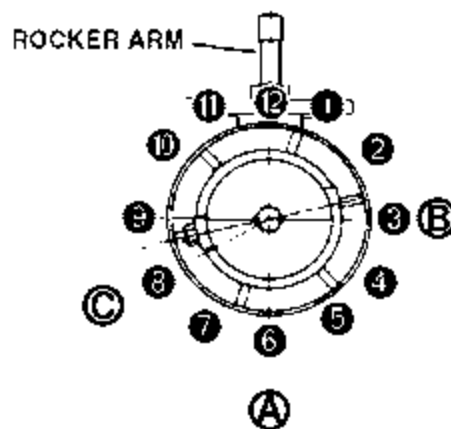

AC STYLE FUEL PUMPS

Engines Manufactured Before February 1, 1979			CLOCK POSITION			
Engine	Application	Flange I.D. #	Inlet	Outlet	Separator	Part #
GM153, 230, 250, 292, (4&6 cyl)	Crusader, Mercruiser, OMC	6790	8	4	—	18-7256
Hercules B, D, J, JXD, Series, M Series	Chris-Craft, US Marine, Owens Yacht	7241	6	9	—	—
GM225, PB-V215 (V-6)	OMC, Palmer	40001	8	4	—	—
GM-V-8, 283, 307, 327, 350, 409	Chris-Craft, Owens, Universal, Crusader	40155	9	3	10	18-7260
GM V-8 307, 350	OMC	40778	4	10	9	—
Chrysler V-8 273, 318, 340, 360	Chrysler	40781	4	8	—	—
Engines Manufactured After January 31, 1979						
Chrysler V-8 318, 360	Chrysler	6766	4	8	4	18-7254
Chrysler V-8 361, 400, 413, 440	Chrysler	6767	4	8	4	18-7255
GM V-8 305, 350, 400	Mercruiser, OMC, Chris-Craft	41412	9	3	9	18-7265
Ford V-8 302, 351w	Ford, Mercruiser, Commander	41413	5	4	4	18-7266
Ford V-8 302, 351w	OMC, Mercruiser, Pleasurecraft, Thermo-Electron	41414	7	5	4	18-7267
GM V-8 305, 307, 350, 400	Harman, OMC, Thermo-Electron (5.25-6.5 PSI)	41415	7	5	8	18-7268*
GM V-8 454	Mercruiser	41416	9	8	7	—
GM V-8 305, 350, 400	Thermo-Electron (5.75-7PSI)	41417	7	5	8	18-7270
GM V-8 454	Thermo-Electron	41418	3	9	8	18-7271
GM V-8 283, 305, 350, 400	Chris-Craft, Crusader, Hardin, Thermo-Electron (5.75-6.5 PSI)	41419	3	9	8	18-7272
GM V-8 305, 350, 400	Mercruiser	41421	10	9	7	18-7274
GM V-8 454	Hawk, Mercruiser	41422	9	3	7	18-7275

*18-7268 – Dual Diaphragm requires sight glass

CARTER STYLE FUEL PUMPS

Engine	Application	Flange I.D. #	Inlet	Outlet	Sight Tube Connection	Part #
GM (4 & 6 cyl) 153,181,250, 225	Chris-Craft, Indmar, Marine Power, Mercruiser, OMC	60032	8	4	3	18-7278
GM V-8 305, 350	Volvo Penta	61125/6973	9	11	9	18-7281
For Inline (4 cyl) 120, 140, 3.0L, 224 CID	Mercruiser	60337	2	3	8	18-7282
GM V-6 262/4.36	OMC	60201	2	4	9	18-7289
GM V-8 305, 350	Mercruiser, Panther	60600	10	9	4	18-7283
GM V-6 231, 262	Hardin, Mercruiser	60315	8	3	8	18-7284
XP Stamped Steel Pump	Volvo Penta AQ120B (spec# 867465), AQ125A/B, AQ131A/B/C/D, AQ140A (spec# 867464), BB140A, AQ145A, BB145A, AQ151A/B/C, AQ171A/C, AQ230A/B, AQ250A/B, AQ251A	60029	3	6	11	18-7286



18-7628
INTAKE MANIFOLD
 Small-block GM with vortec cylinder heads
 Brass-lined water jackets for salt water applications

ALL SIERRA CARBURETORS INCLUDE BASE GASKET

- Precision remanufactured to meet or exceed OEM specifications
- Re-calibrated and re-engineered to maximize fuel efficiency and performance
- All carburetors are flow tested throughout the entire throttle range
- Fuel mixture and idle settings are pre-set to ensure that only minor idle and choke adjustments are necessary during installation
- All bases are resurfaced and throttle shaft bushings replaced

UNIVERSAL CARBURETORS



18-7635
CARBURETOR
(REMANUFACTURED)
 300 CFM Holley 2V
 Use replacement gasket **18-0360**



18-7636
CARBURETOR
(REMANUFACTURED)
 500 CFM Holley 2V
 Use replacement gasket **18-0994**



18-7637
CARBURETOR
(REMANUFACTURED)
 600 CFM Holley 4V (Front inlet)
 Gasket included • Use replacement gasket **18-0647**



18-7638
CARBURETOR
(REMANUFACTURED)
 600 CFM Holley 4V-side inlet



18-7640
CARBURETOR
(REMANUFACTURED)
 Universal Q-jet with electric choke
 Use replacement carb kit **18-7018**
 Use replacement gasket **18-0462**

MERCURISER CARBURETORS

NEW CASTING NON-REMANUFACTURED



18-7370N
CARBURETOR
 Replaces: 3310-860070A2, 3310-806077A2, 3310-806078A2, 1389-9562A1, 1389-9350A2, 1389-8490A2, 1389-815396A2, 3310-806077A2
 For: MCM 120/2.5L & 140/3.0L
 Gasket included • Use replacement gasket **18-0994**



18-7373N
MERCARB 2V
CARBURETOR
 Replaces:
 Mercuriser 3310-864941A01
 2002-2004 4.3L engines (s/n OM615000-OW300012)
 Use Replacement Carb Kit **18-7098-1**
 Gasket included • Use replacement gasket **18-0994**



18-7375N
CARBURETOR
 Replaces: 3310-864942A01, 3310-861448A1
 For: 1998-2004 MCM 5.0L
 Gasket included • Use replacement gasket **18-0994**



18-7376N
CARBURETOR
 Replaces: 3310-864943A01, 3310-861245A1
 For: 1998 and newer 5.7L applications
 Gasket included • Use replacement gasket **18-0994**



**18-7603-1
CARBURETOR
(REMANUFACTURED)**
2 Barrel - Rochester
Replaces: **MerCruiser**
1347-818622, 1376-5659A1,
1347-818622 1,
1347-818622R02
Rochester 7044185
Use replacement carb kit **18-7075**
Use replacement gaskets **18-0994** & **18-0434**



**18-7604-1
CARBURETOR
(REMANUFACTURED)**
4 Barrel - Rochester
Replaces:
MerCruiser 3304-9354A2,
1347-804623R02
Use replacement carb kit **18-7095**
Use replacement gasket **18-2848**



**18-7605-1
CARBURETOR
(REMANUFACTURED)**
4 Barrel - Rochester
Replaces: **MerCruiser** 1347-9661A3,
1347-804623A1, 1347-804623R02
Rochester 17057283, 17057285,
17059291, 17059292, 17080564,
17080565
Use replacement carb kit **18-7095**
Use replacement gasket **18-2848**



**18-7607-1
CARBURETOR
(REMANUFACTURED)**
Replaces: **Rochester** 17082403
For: Rochester Carb: Crusader 454
Use replacement carb kit **18-7095**
Use replacement gasket **18-2848**



**18-7609-1
CARBURETOR
(REMANUFACTURED)**
2 Barrel - Rochester
Replaces: **MerCruiser** 1347-818619, 1347-818619 1,
1347-818619 1R02,
Rochester 7036543, 7040082, 7041369, 7043182,
7044182, 17059054
Use replacement carb kit **18-7070**
Use replacement gasket **18-0356**



**18-7610-1
CARBURETOR
(REMANUFACTURED)**
2 Barrel - Rochester
Replaces: **MerCruiser** 1347-818621, 1347-818621 1,
1347-818621 1R02
Rochester 17081060
Use replacement carb kit **18-7070**
Use replacement gasket **18-0356**



**18-7611-2
CARBURETOR
(REMANUFACTURED)**
2 Barrel - Rochester
Replaces: **MerCruiser** 3310-807312A1, 3310-807312R02
Use replacement carb kit **18-7098-1**
Use replacement gasket **18-0994**



**18-7615-1
CARBURETOR
(REMANUFACTURED)**
4 Barrel - Rochester
Replaces: **MerCruiser** 1347-816373A4,
1347-804624R1, 1347-804624R02
Rochester 17057298, 17059280, 17059288,
17080561, 17085013
Use replacement carb kit **18-7095**
Use replacement gasket **18-2848**



**18-7616-1
CARBURETOR
(REMANUFACTURED)**
4 Barrel - Rochester
Replaces: **MerCruiser** 1347-8288A1,
1347-804626R02 **Rochester** 1708563, 17057287,
17059287, 17059290, 17080560
Use replacement carb kit **18-7072**
Use replacement gasket **18-2848**



**18-7639
CARBURETOR
(REMANUFACTURED)**
Replaces: 3310-864943A01, 861245A1
MerCarb-5.7L 2V 1998 and newer 5.7L
(OL010337-OW300754) & 5.7L MIE
(OL002003-OW090899)
Use replacement carb kit **18-7098-1**
Use replacement gasket **18-0994**



**18-7617-1
CARBURETOR
(REMANUFACTURED)**
4 Barrel - Rochester
Replaces: **MerCruiser** 1347-9863A3,
1347-804625R1, 1347-804625R02
Rochester 17059280
Use replacement carb kit **18-7095**
Use replacement gasket **18-2848**



**18-7618-1
CARBURETOR
(REMANUFACTURED)**
4 Barrel - Rochester
Replaces: **MerCruiser** 13478289A1, 1347-804624R1,
1347-804624R02
Rochester 17059289, 7044291, 17080561, 17080562
Use replacement carb kit **18-7095**
Use replacement gasket **18-2848**



**18-7619-1
CARBURETOR
(REMANUFACTURED)**
4 Barrel - Rochester
Replaces: **MerCruiser** 1347-9142A2, 1347-8460 A3
Rochester 17081299, 17083522, 17059283,
17059298
Use replacement carb kit **18-7077**
Use replacement gasket **18-0462**

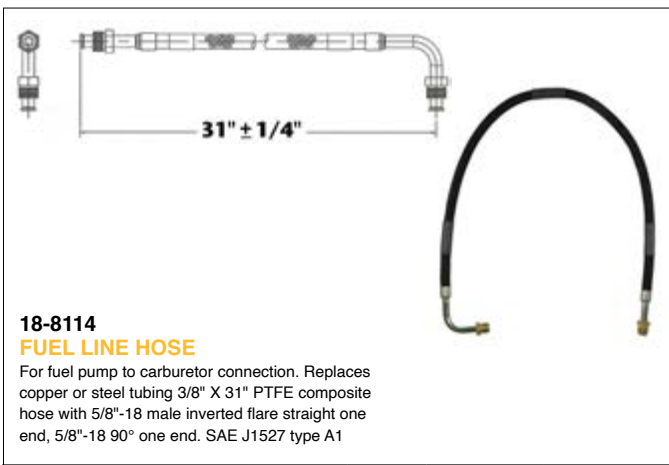

18-8114
FUEL LINE HOSE

For fuel pump to carburetor connection. Replaces copper or steel tubing 3/8" X 31" PTFE composite hose with 5/8"-18 male inverted flare straight one end, 5/8"-18 90° one end. SAE J1527 type A1

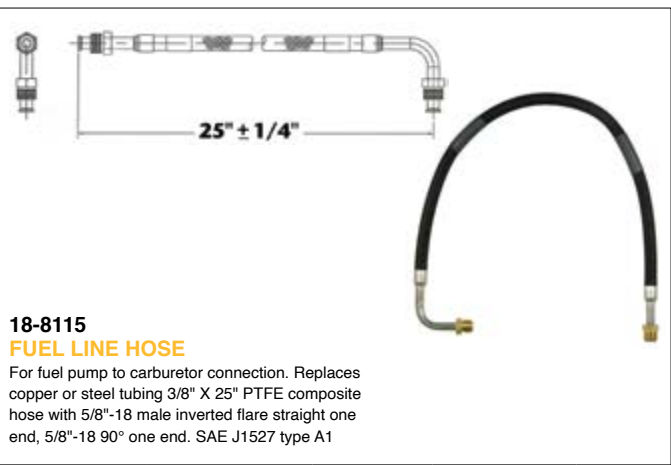

18-8115
FUEL LINE HOSE

For fuel pump to carburetor connection. Replaces copper or steel tubing 3/8" X 25" PTFE composite hose with 5/8"-18 male inverted flare straight one end, 5/8"-18 90° one end. SAE J1527 type A1

MERCURISER CARBURETORS APPLICATION

Model	Year	# of Cyl.	Beginning Serial #	Ending Serial #	Original Carb #	Replacement Carb #	Mfg. Carb.	Carb Code & Model	Carb #
90	1970-1971	L4	2851424	3225967	1351-4263A1	1347-818619 1	7040082	R2/2GC	18-7609-1
90	1972	L4	3225868	3226957	1351-4263A2	1347-818619 1	7041369	R2/2GC	18-7609-1
110	1963-1966	L4	1357370	2044033	1336-2076	—	7036543	R2/2GC	18-7609-1
120	1972-1973	L4	3377341	3770649	1351-4263A3	1347-818619 1	7041369	R2/2GC	18-7609-1
120	1974-1975	L4	3770650	4469865	1351-5202A1	1347-818619 1	7043182	R2/2GC	18-7609-1
120	1976-1978	L4	4469866	5192048	1351-6065A2	1347-818619 1	7044182	R2/2GC	18-7609-1
120	1979-1982	L4	5192049	6229717	1351-7354A1	1347-818619 1	17059054	R2/2GC	18-7609-1
120/2.5L	1983-1989	L4	6229718	OC853255	1351-8480A2	1348-818621 1	17081060	R2/2GC	18-7610-1
140	1970	L4	2816417	2911439	1351-4032A1	1347-818620 1	7040080	R2/2GC	—
140	1970-1973	L4	2911440	3771644	1351-4293A1	1347-818620 1	7040084	R2/2GC	—
140	1974-1978	L4	3771645	5157668	1351-5203A1	1347-818620 1	7043184	R2/2GC	—
140	1979-1982	L4	5157669	6229717	1351-7355A1	1347-818620 1	17059052	R2/2GC	—
140/3.0L	1983-1989	L4	6229718	OC856556	1351-8480A2	1348-818621 1	17081060	R2/2GC	18-7610-1
165 (6 Cyl)	1970-1972	L6	2770032	3354791	1351-4282A1	1347-818620 1	7040083	R2/2GC	—
165 (6 Cyl)	1972-1973	L6	3354702	3774864	1351-4871A1	1347-818620 1	7042183	R2/2GC	—
165 (6 Cyl)	1974-1978	L6	3774865	5178958	1351-5204A1	1347-818620 1	7043183	R2/2GC	—
488	—	—	6170297	1347-8460 6916778	1347-9142A2	—	17059283 17059298 17083522 17081299	R4/4ME	18-7619-1
165 (6 Cyl)	1979-1981	L6	5178959	5813433	1351-7356A1	1347-818620 1	17059050	R2/2GC	—
180/1903.7LX	—	—	6916779	Later	1347-8460 1347- 9142A2	—	17059283 17059298 17083522 17081299 17083522	R4/4ME R4/4ME	18-7619-1
205/4.3LX	1985-1991	V-6	OA331455	OD714369	3304-9354A2	3304-9354A2	N/A	R4/4MV	18-7604-1
898/200/5.0L	1987-95	V-8	OB525982	OF600999	1389-9670A2	3310-807312A1	N/A	M2/MERCARB	18-7611-2
888	1971-1977	V-8	3108723	4887829	1376-5659A1	1376-818622 1	7044185	R2/2GC	18-7603-1
228	1977-1978	V-8	4765100	5069430	1347-6427A1	1347-9661A3	17057282	R4/4MV	18-7605-1
228 TR &MIE	1977-1978	V-8	4765100	5069430	1347-6438A1	1347-9661A3	17057283	R4/4MV	18-7605-1
228	1978-1981	V-8	5069431	6021783	1347-7361A1	1347-9661A3	17059292	R4/4MV	18-7605-1
228	1982	V-8	6021784	6218461	1347-8296A4	1347-9661A3	17080565	R4/4MV	18-7605-1
223/230/5.0LX	1983-1995	V-8	6218462	OF600999	1347-9661A3	1347-9661A3	17080565	R4/4MV	18-7605-1
228 MIE	1978-1982	V-8	5069431	6040745	1347-7364A1	1347-9661A3	17059291	R4/4MV	18-7605-1
230 MIE	1982-1987	V-8	6040746	OB788151	1347-8290A1	1347-9661A3	17080564	R4/4MV	18-7605-1
255 MIE (GM)	1975-1978	V-8	4175500	4924564	1347-5732A1	1347-8289A1	7044291	R4/4MV	18-7618-1
255 MIE (GM)	1978	V-8	4924565	5195908	1347-7062A1	1347-8289A1	17059289	R4/4MV	18-7618-1
255 MIE (GM)	1979-1980	V-8	5195909	5907057	1347-7365A1	1347-8289A1	17059289	R4/4MV	18-7618-1
260 MIE	1980-1986	V-8	5907058	OB522505	1347-8289A1	1347-8289A1	17080562	R4/4MV	18-7618-1
260/5.7MIE	1987-1993	V-8	OB522506	OF024999	1347-9662A4	1347-816373A4	17080561	R4/4MV	18-7615-1
255	1975-1976	V-8	41745500	4767999	1347-5732A1	1347-8289A1	7044291	R4/4MV	18-7618-1

APPLICATION CONTINUED ON NEXT PAGE

MERCUISER CARBURETORS APPLICATION									
Model	Year	# of Cyl.	Beginning Serial #	Ending Serial #	Original Carb #	Replacement Carb #	Mfg. Carb.	Carb Code & Model	Carb #
260	1978	V-8	4908850	5060805	1347-6492A1	1347-816373A4	17057298	R4/4MV	18-7615-1
260	1978-1982	V-8	5060806	6024393	1347-7362A1	1347-816373A4	17059288	R4/4MV	18-7615-1
260	1982-1986	V-8	6024393	OB525981	1347-8292A4	1347-816373A4	17080561	R4/4MV	18-7615-1
260/5.7L ALPHA	1987-1993	V-8	OB525982	OF000454	1347-9662A4	1347-816373A4	17080561	R4/4MV	18-7615-1
5.7L(2BBL)	1996-1997	V-8	OF601000	OK999999	3310-807312A1	3310-807312A1	—	M2/MERCARB	18-7611-1
5.7L (Gen II)	1998-2004	V-8	OL010037	OW300754	3310-864943101	3310-864943101	N/A	M2/MERCARB	18-7639
5.7L BRAVO (w/o High Rise Intake)	1987-1991	V-8	OB525982	OD617327	1347-9662A4	1347-816373A4	17080561	R4/4MV	18-7615-1
5.7L BRAVO (w/ High Rise Intake)	1987-1991	V-8	OB525982	OD617327	1347-8289A1	1347-8289A1	17080562	R4/4MV	18-7618-1
350 MAGNUM ALPHA	1986-1991	V-8	OA635178	OD617327	1347-8289A1	1347-8289A1	17080562	R4/4MV	18-7618-1
5.7L SKI	1985-1993	V-8	OA338533	OF025099	1347-9415T	1347-9415T	17085013	R4/4MV	18-7615-1
5.7L SKI(2BBL)	1996-1997	V-8	OF775200	OK999999	3310-807312A1	3310-807312A1	—	M2/MERCARB	18-7611-2
300MR/TRS	1985-1986	V-8	6668677	OB430367	1347-7498A7	1347-7498A7	17059280	R4/4MV	18-7615-1
330 MCM	1977-1978	V-8	4623115	5027230	1347-6493A1	1347-8291A3	17057287	R4/4MV	18-7616-1
330 MCM	1977-1981	V-8	5027231	6083144	1347-7363A1	1347-8291A3	17059290	R4/4MV	18-7616-1
330 MCM	1982-1987	V-8	6083145	OB816540	1347-8291A3	1347-8291A3	1708563	R4/4MV	18-7616-1
330 MIE	1977-1978	V-8	4623115	5226384	1347-6493A1	1347-8288A1	17057287	R4/4MV	18-7616-1
330 MIE	1979-1980	V-8	5226385	5889913	1347-7366A1	1347-8288A1	17059287	R4/4MV	18-7616-1
340/7.4L MIE	1981-1992	V-8	5889914	OD715493	1347-8288A1	1347-8288A1	17080560	R4/4MV	18-7616-1
7.4L MIE	1995-1997	V-8	OF350000	OK999999	3310-806969A1	3310-806969A1	9780	WEBER	—
7.4L BRAVO I/II	1988-1991	V-8	OB771113	OD603117	1347-8291A3	1347-8291A3	17080563	R4/4MV	18-7616-1
7.4L BRAVO I/II	1995-1997	V-8	OF352000	OK999999	3310-806969A1	3310-806969A1	9780	WEBER	—
7.4L BRAVO III	1996-1997	V-8	OF800700	OK999999	3310-806969A1	3310-806969A1	9780	WEBER	—
370/400	1978-1987	V-8	4179554	OB714586	1347-7498A2	1347-9863A3	17059280	R4/4MV	18-7617-1
454 MAG ALPHA	1986-1988	V-8	OA631894	OB785148	1347-8291A3	1347-8291A3	17080563	R4/4MV	18-7616-1
454 MAG BRAVO	1988-1992	V-8	OB721206	OD808068	1347-7498A2	1347-9863A3	17059280	R4/4MV	18-7617-1

SIERRA[®]
PARTS THAT KEEP YOU MOVING

ALL SIERRA CARBURETORS INCLUDE BASE GASKET

- Precision remanufactured to meet or exceed OEM specifications
- Re-calibrated and re-engineered to maximize fuel efficiency and performance
- All carburetors are flow tested throughout the entire throttle range
- Fuel mixture and idle settings are pre-set to ensure that only minor idle and choke adjustments are necessary during installation
- All bases are resurfaced and throttle shaft bushings replaced

sierraparts.com



ALL SIERRA CARBURETORS INCLUDE BASE GASKET

**NEW CASTING
NON-REMANUFACTURED**

Heat riser choke



**18-7609-1
CARBURETOR
(REMANUFACTURED)**

2 Barrel Rochester
Replaces: OMC 382733, 980530,
982217, 984180, 381494, 772831
Use replacement carb kit **18-7070**
Use replacement gasket **18-0356**



**18-7615-1
CARBURETOR
(REMANUFACTURED)**

4 Barrel Rochester
Replaces: OMC 981705, 982223, 983855,
981359, 981564, 985822, 981803, 981428
Use replacement carb kit **18-7095**
Use replacement gasket **18-2848**



**18-7605-1
CARBURETOR
(REMANUFACTURED)**

4 Barrel Rochester
Replaces: OMC 382821, 383766, 384194
Use replacement carb kit **18-7095**
Use replacement gasket **18-2848**



**18-7619-1
CARBURETOR
(REMANUFACTURED)**

For: V-8, 305 & 350 CID
Models: AQ225B, C, D, E, F, 225 A,B, BB225 A, AV, B, C, 290 A, AQ260A, B, 260 A, AV, B, C,
501 A/M S4A, 570 M S4A
Use replacement carb kit **18-7095**
Use replacement gasket **18-0462**

OMC STERN DRIVE CARBURETOR APPLICATION

HP	MODEL	YEAR	OMC CARBURETOR #	MFG CARBURETOR #	CARB. CODE & MODEL	PART #
80	80	1968-1969	382733, 772831	7028085, 17059053, 17086064, 17087311	R2, 2GC	18-7609-1
90	90	1970-1971	382733, 772831	7028085, 17059053, 17086064, 17087311	R2, 2GC	18-7609-1
120	120 (400 SERIES)	1972-1986	381668, 980528, 982219	7044186, 17059056	R2, 2GC	-
140	140 (400 SERIES)	1973-1985	979821, 980530, 982217, 984180	17086107	R2, 2GC	-
155	155	1967-1972	772831	7026180	R2, 2GC	18-7609-1
165	165	1972-1976	979821, 980530	17086107	R2, 2GC	18-7609-1
185	185	1989	984180	17086064	R2, 2GC	18-7609-1
200	200	1966-1968	381494	7025187	R2, 2GC	18-7609-1
210	210	1968-1972	382821, 383866	7028282, 7028280	R4, 4MV	18-7605-1
214	215	1971-1976	382821	7028280	R4, 4MV	18-7605-1
225	225	1971-1976	382821	7028280	R4, 4MV	18-7605-1
230	230	1971-1976	382821	7028280	R4, 4MV	18-7605-1
230	230 (800 SERIES)	1979-1989	981705, 982223	17057290, 17059285, 17059286, 17086117	R4, 4MV	18-7615-1
245	245	1972-1975	384194	7040284	R4, 4MV	18-7605-1
250	250	1970-1974	384194	7040284	R4, 4MV	18-7605-1
260	260 (800 SERIES)	1975-1976	384194	7040284	R4, 4MV	18-7605-1
260	260 (800 SERIES)	1979-1989	982223	17057290, 17059285, 17059286, 17086117	R4, 4MV	18-7615-1
	2.5L	1982-1986	982219, 982217	17059056, 17059053	R2, 2GC	-
	3.0L	1982-1986	982219, 982217	17059056, 17059053	R2, 2GC	-
	3.0L	1987-1990	984180	17086064	R2, 2GC	-
	3.8L (4V)	1979-1985	983855	17082515, 17085010	R4, 4MV	18-7615-1
	4.3L (4V)	1979-1989	983855	17082515, 17085010	R4, 4MV	18-7615-1
	5.0L (GM / 4V)	1979-1989	982223	17057290, 17059285, 17059286, 17086117	R4, 4MV	18-7615-1
	5.7L (4V)	1979-1989	982223	17057290, 17059285, 17059286, 17086117	R4, 4MV	18-7615-1
	305 CID □	1977-1983	981359, 982215,	17057290, 17059285, 17059286, 17086117	R4, 4MV	18-7615-1
	350 CID □	1977-1983	981564, 982223	17057290, 17059285, 17059286, 17086117	R4, 4MV	18-7615-1
	350 (4V)	1988-1989	985822	17057290, 17059285, 17059286, 17086117	R4, 4MV	18-7615-1
	454 CID □	1977-1978	981803, 981428	17057290, 17059285, 17059286, 17086117	R4, 4MV	18-7615-1

18-7039
CARB KIT

Contains adjustable needles & seats

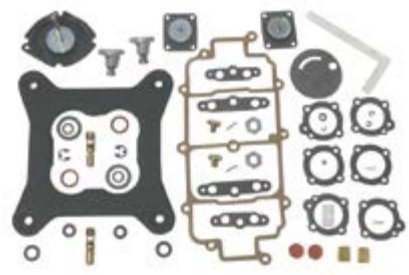

18-7095
CARB KIT

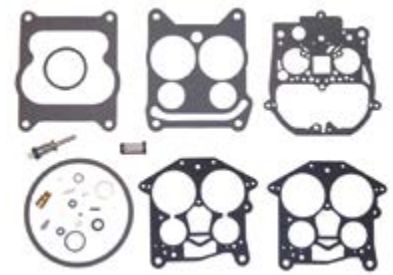

CARBURETOR TO CARBURETOR KIT INTERCHANGE

Carburetor #	Carb. Kit #	Float #	Carburetor #	Carb. Kit #	Float #	Carburetor #	Carb. Kit #	Float #
INBOARD			CARTER/WEBER (CONT.)			HOLLEY (CONT.)		
2669	18-7025	—	9782	18-7748	—	R-9394A	18-7729	—
2853	18-7022	18-7201	9665S	18-7748	—	R-50399A	18-7729	—
2955	18-7022	—	9772SA	18-7748	—	R-50399-1A	18-7729	—
3041	18-7022	18-7201	9776S	18-7748	—	R-50405A	18-7729	—
3116	18-7022	18-7201	9776SA	18-7748	—	R-50405-1A	18-7729	—
3204	18-7022	18-7201	9776SB	18-7748	—	R-50417A	18-7236	—
3212	—	—	9779S	18-7748	—	R-50417-1A	18-7236	—
3213	18-7091	—	9780S	18-7748	—	R-50418A	18-7729	—
3214	18-7091	—	FORD			R-50419A	18-7729	—
3285	18-7022	18-7201	C9FF-9510-D	18-7096	18-7206	R-50419-1A	18-7237	—
3314	18-7022	18-7201	C9FF-9510-E	18-7096	18-7206	R-50419-2A	18-7237	—
3354	18-7022	18-7201	D1FF-9510-LA	18-7081	18-7206	R-50461A	18-7236	—
3392	18-7091	—	D1FF-9510-MA	18-7096	18-7206	R-50461-1A	18-7236	—
3543	18-7091	—	D1FF-9510-NA	18-7096	18-7206	R-50462A	18-7729	—
3660	18-7022	—	D1JJ-9510-B	18-7081	18-7206	R-50462-1A	18-7729	—
3887	18-7022	18-7201	D2JL-9510-C	18-7096	18-7206	R-50463A	18-7237	—
3951	18-7080	—	D2JL-9510-E	18-7096	18-7206	R-50463-1A	18-7237	—
3971	18-7080	—	D3JL-9510-S	18-7081	18-7206	R-50464A	18-7017	—
3979	—	—	D4JL-9510-F	18-7017	—	R-50467A	18-7236	—
3980	18-7089	—	D4JL-9510-G	18-7017	—	R-50467-1A	18-7236	—
3981	—	—	D4JL-9510-J	18-7017	—	R-50468A	18-7729	—
4157	18-7022	18-7201	E0JL-9510-CA	18-7096	—	R-50468-1A	18-7729	—
4207	18-7080	—	E8JL-9510-DA	18-7017	—	R-50469A	18-7245	—
4208	18-7080	—	E9JL-DA	18-7017	—	R-50469-1A	18-7245	—
4268	—	—	F1JL-AA	18-7236	—	R-50470A	18-7017	—
4394	18-7080	—	F1JL-EA	18-7727	—	R-50483A	18-7727	—
4476	18-7091	—	F1JL-BA	18-7729	—	R-80262A	18-7729	—
4695	18-7023	—	F1JL-CA	18-7245	—	R-80263A	18-7236	—
4699	18-7089	—	F1JL-EA	18-7727	—	R-80264A	18-7729	—
6117	18-7023	—	HOLLEY			R-80265A	18-7237	—
6130	18-7089	—	R-4397A	18-7096	—	R-80311A	18-7241	—
6212	18-7089	—	R-4473A	18-7096	18-7206	R-80311-1A	18-7241	—
6310	18-7022	—	R-4473AAS	18-7096	18-7206	R-80311-2A	18-7241	—
6446	18-7092	—	R-4607A	18-7096	18-7206	R-80312A	18-7238	—
9263	18-7091	—	R-4608A	18-7096	18-7206	R-80312-1A	18-7238	—
9264	18-7091	—	R-4608AAS	18-7096	18-7206	R-80313A	18-7246	—
9661	18-7749	—	R-6150A	18-7081	18-7206	R-80313-1A	18-7246	—
9770	18-7749	—	R-6151A	18-7096	18-7206	R-80315A	18-7237	—
9781	18-7749	—	R-6151AAA	18-7096	18-7206	R-80315-1A	18-7237	—
9770SA	18-7749	—	R-6152A	18-7096	18-7206	R-80316A	18-7246	—
9781S	18-7749	—	R-6152AAA	18-7096	18-7206	R-80316-1A	18-7246	—
9600	18-7748	—	R-6317A	18-7081	18-7206	R-80318A	18-7017	—
9662	18-7748	—	R-6317-1A	18-7081	18-7206	R-80318-1A	18-7017	—
9663	18-7748	—	R-6407A	18-7096	18-7206	R-80319A	18-7245	—
9665	18-7748	—	R-6647A	18-7728	—	R-80319-1A	18-7245	—
9666	18-7748	—	R-6647AAA	18-7728	—	R-80320A	18-7236	—
9772	18-7748	—	R-6576A	18-7096	18-7206	R-80320-1A	18-7236	—
9773	18-7748	—	R-7036A	18-7081	18-7206	R-80321A	18-7246	—
9774	18-7748	—	R-7128A	18-7017	—	R-80321-1A	18-7246	—
9776	18-7748	—	R-7159A	18-7017	—	R-80328A	18-7239	—
9776	18-7748	—	R-7163A	18-7017	—	R-80328-1A	18-7239	—
9777	18-7748	—	R-9392A	18-7096	—	R-80328-2A	18-7239	—
9780	18-7748	—	R-9393A	18-7729	—	R-80330A	18-7241	—

CARBURETOR TO CARBURETOR KIT INTERCHANGE (Cont.)

Carburetor #	Carb. Kit #	Float #	Carburetor #	Carb. Kit #	Float #	Carburetor #	Carb. Kit #	Float #
HOLLEY (CONT.)			MERCURY MARINE (CONT.)			ROCHESTER (CONT.)		
R-80330-1A	18-7241	—	1347-7363A1	18-7095	18-7201	17057138	18-7086	18-7202
R-80378A	18-7242	—	1347-7364A1	18-7095	18-7201	17057139	—	18-7202
R-80378-1A	18-7242	—	1347-7365A1	18-7095	18-7201	17057282	18-7072	18-7201
R-80382A	18-7244	—	1347-7366A1	18-7095	18-7201	17057283	18-7072	18-7201
R-80382-1A	18-7244	—	1347-7498A2	18-7095	18-7201	17057287	18-7072	18-7201
R-80383A	18-7245	—	1347-7498A7	18-7095	18-7201	17057290	18-7095	18-7201
R-80383-1A	18-7245	—	1347-8288A1	18-7095	18-7201	17057292	18-7072	18-7201
R-80385A	18-7246	—	1347-8289A1	18-7095	18-7201	17057295	18-7072	18-7201
R-80386A	18-7244	—	1347-8290A1	18-7095	18-7201	17057298	18-7072	18-7201
R-80386-1A	18-7244	—	1347-8291A3	18-7095	18-7201	17057299	18-7072	18-7201
R-80390A	—	—	1347-8292A4	18-7095	18-7201	17058280	18-7072	18-7201
R-80364	18-7729	—	1347-8296A4	18-7095	18-7201	17059050	18-7070	18-7200
R-80434	—	—	1347-8460A3	18-7077	18-7201	17059051	18-7086	18-7200
R-80444A	18-7241	—	1347-9142A2	18-7095	18-7201	17059052	18-7070	18-7200
R-84018AA	18-7039	—	1347-9415T	18-7095	18-7201	17059053	18-7070	18-7200
R-84022AA	18-7040	—	1347-9661A3	18-7095	18-7201	17059054	18-7070	18-7200
R-84023AA	18-7039	—	1347-9662A4	18-7095	18-7201	17059055	—	18-7200
R-84024AA	18-7040	—	1347-9863A3	18-7095	18-7201	17059056	—	18-7200
R-84026AA	18-7040	—	1351-3635A1	18-7070	18-7200	17059057	18-7086	18-7200
R-84026-1AA	18-7040	—	1351-4032A1	18-7070	18-7200	17059058	18-7086	18-7200
R-84026-2AA	18-7040	—	1351-4263A1	18-7070	18-7200	17059059	18-7086	18-7202
R-84028AA	18-7039	—	1351-4263A2	18-7070	18-7200	17059060	18-7086	18-7200
R-84037AA	18-7040	—	1351-4263A3	18-7070	18-7200	17059280	18-7095	18-7201
R-84038AA	18-7039	—	1351-4282A1	18-7070	18-7200	17059283	18-7095	18-7201
R-84039AA	18-7039	—	1351-4293A1	18-7070	18-7200	17059285	18-7095	18-7201
R-84040AA	18-7040	—	1351-4871A1	18-7070	18-7200	17059286	18-7095	18-7201
R-84041AA	18-7070	—	1351-5202A1	18-7070	18-7200	17059287	18-7095	18-7201
R-84042AA	18-7040	—	1351-5203A1	18-7070	18-7200	17059288	18-7095	18-7201
R-84044AA	18-7039	—	1351-5204A1	18-7070	18-7200	17059289	18-7095	18-7201
R-84044-1AA	18-7039	—	1351-6065A2	18-7070	18-7200	17059290	18-7095	18-7201
R-84046A	18-7727	—	1351-7354A1	18-7070	18-7200	17059291	18-7095	18-7201
R-84046AA	18-7039	—	1351-7355A1	18-7070	18-7200	17059292	18-7095	18-7201
MERCURY MARINE			1351-7356A1	18-7070	18-7200	17059293	18-7095	18-7201
1336-2076	18-7070	18-7200	1351-8480A2	18-7070	18-7200	17059294	18-7095	18-7201
1336-3594A1	18-7070	18-7200	1356-4066	18-7096	18-7206	17059295	18-7095	18-7201
1337-2103	—	—	1356-4642	18-7081	18-7206	17059296	18-7095	18-7201
1337-2604	—	—	1356-5155	18-7096	18-7206	17059298	18-7095	18-7201
1338-2161	18-7071	—	1356-5169	18-7096	18-7206	17065977	18-7072	18-7201
1338-2166	18-7071	—	1376-5659A1	18-7075	18-7202	17080050	18-7086	18-7200
1338-2428	18-7071	—	1376-5659A2	18-7075	18-7202	17080350	—	18-7202
1338-2431	18-7071	—	1376-5744A1	18-7075	18-7202	17080560	18-7095	18-7201
1338-2608	18-7071	—	1376-5990A1	18-7076	18-7202	17080561	18-7095	18-7201
1338-2609	18-7071	—	1376-6152A1	18-7075	18-7202	17080562	18-7095	18-7201
1338-2633	18-7070	18-7200	1376-6491A1	—	18-7202	17080563	18-7095	18-7201
1338-2991	18-7070	18-7200	1376-8295A3	—	18-7202	17080564	18-7095	18-7201
1346-2770	18-7080	—	1389-815396A2	18-7098-1	18-7202	17080565	18-7095	18-7201
1347-3237A2	18-7072	18-7201	1389-815397A2	18-7098-1	18-7202	17081060	18-7070	18-7200
1347-3237A3	18-7072	18-7201	1389-8488A2	18-7097	18-7202	17081299	18-7077	18-7201
1347-3237A4	18-7072	18-7201	1389-8489A5	18-7097	18-7202	17082403	18-7095	18-7201
1347-3342	18-7072	18-7201	1389-8490A2	18-7097	18-7202	17083110	18-7086	18-7200
1347-3353	18-7072	18-7201	1389-9562A1	18-7098-1	18-7202	17083515	18-7095	18-7201
1347-3689A1	18-7072	18-7201	1389-9563A1	18-7098-1	18-7202	17083522	18-7095	18-7201
1347-4179A1	18-7072	18-7201	1389-9564A1	18-7098-1	18-7202	17084001	18-7095	18-7201
1347-4179A2	18-7072	18-7201	1389-9670A2	18-7098-1	18-7202	17084516	18-7095	18-7201
1347-4180A1	18-7072	18-7201	3300-8886A2	18-7095	18-7201	17085008	18-7086	18-7200
1347-4533A1	18-7072	18-7201	3304-9353A2	18-7097	18-7202	17085010	18-7072	18-7201
1347-5326A2	18-7072	18-7201	3304-9354A2	18-7095	18-7201	17085013	18-7095	18-7201
1347-5732A1	18-7072	18-7201	3304-9565A1	18-7098-1	18-7202	17086064	18-7070	18-7200
1347-5981A1	18-7072	18-7201	ROCHESTER			17086069	18-7095	18-7201
1347-6427A1	18-7072	18-7201	17056197	18-7075	18-7202	17086107	18-7086	18-7200
1347-6438A1	18-7072	18-7201	17056287	18-7072	18-7201	17086115	18-7095	18-7201
1347-6492A1	18-7072	18-7201	17057130	18-7086	18-7202	17086116	18-7095	18-7201
1347-6493A1	18-7072	18-7201	17057131	18-7086	18-7202	17086117	18-7095	18-7201
1347-7062A1	18-7072	18-7201	17057132	18-7076	18-7202	17087311	18-7070	18-7200
1347-7361A1	18-7095	18-7201	17057133	18-7086	18-7202	17087311	18-7095	18-7201
1347-7362A1	18-7095	18-7201	17057134	18-7086	18-7202	7013071	18-7019	—

CARBURETOR TO CARBURETOR KIT INTERCHANGE (Cont.)

Carburetor #	Carb. Kit #	Float #	Carburetor #	Carb. Kit #	Float#	Carburetor #	Carb. Kit #	Float #
ROCHESTER (CONT.)			ROCHESTER (CONT.)			ZENITH-STROMBERG (CONT.)		
7015087	—	18-7200	7040083	18-7070	18-7200	C3231R	18-7085	—
7015088	—	18-7200	7040084	18-7070	18-7200	C3232F	18-7085	—
7015089	—	18-7200	7040283	18-7072	18-7201	C3232M	18-7085	—
7015090	18-7019	—	7040284	18-7072	18-7201	C3232R	18-7085	—
7015091	18-7019	—	7041187	—	18-7200	OUTBOARD TILLOTSON		
7015097	—	18-7200	7041280	18-7072	18-7201	AJ-50A	18-7013	18-7057
7015098	—	18-7200	7041285	18-7072	18-7201	AJ-52A	18-7013	18-7057
7019082	18-7070	18-7200	7041369	18-7070	18-7200	AJ-53A	18-7013	18-7057
7019084	18-7019	—	7041831	18-7072	18-7201	AJ-53AT	18-7013	18-7057
7020082	—	18-7200	7042181	—	18-7200	AJ-54A	18-7013	18-7057
7020084	18-7019	—	7042183	18-7070	18-7200	AJ-54AT	18-7013	18-7057
7020085	18-7019	—	7043182	18-7070	18-7200	AJ-55AO	18-7013	18-7057
7020087	—	—	7043183	18-7070	18-7200	AJ-55AT	18-7013	18-7057
7020088	18-7070	18-7200	7043184	18-7070	18-7200	AJ-56A	18-7013	18-7057
7020991	—	—	7043259	—	18-7201	AJ-56AB	18-7013	18-7057
7020992	18-7070	18-7200	7043282	—	18-7201	AJ-57A	18-7013	18-7057
7020993	18-7070	18-7200	7044182	18-7070	18-7200	CO-10A	18-7037	18-7057
7020994	18-7071	—	7044185	18-7075	18-7202	CO-10B	18-7037	18-7057
7020995	—	—	7044186	—	18-7200	CO-11A	18-7037	18-7057
7020996	18-7071	—	7044187	18-7075	18-7202	CO-1A	18-7037	18-7057
7023080	—	18-7200	7044283	18-7072	18-7201	CO-2A	18-7037	18-7057
7023084	—	—	7044284	18-7072	18-7201	CO-3A	18-7037	18-7057
7023085	—	—	7044286	18-7072	18-7201	CO-4A	18-7037	18-7057
7023088	—	—	7044287	18-7072	18-7201	CO-4B	18-7037	18-7057
7023089	—	—	7044288	18-7072	18-7201	CO-4C	18-7037	18-7057
7023181	—	—	7044289	18-7072	18-7201	CO-4D	18-7037	18-7057
7023183	—	—	7044290	18-7072	18-7201	CO-5A	18-7037	18-7057
7023186	—	18-7200	7044291	18-7072	18-7201	CO-6A	18-7037	18-7057
7023188	—	18-7200	7045197	18-7076	18-7202	CO-6B	18-7037	18-7057
7024083	18-7071	—	7045282	—	18-7201	CO-6C	18-7037	18-7057
7024084	—	—	7045283	18-7072	18-7201	CO-7A	18-7037	18-7057
7024086	—	—	SOLEX			CO-7B	18-7037	18-7057
7024087	18-7071	—	44PA1	18-7000	—	CO-7C	18-7037	18-7057
7024089	18-7071	—	44PHN-3	18-7001	—	CO-7A	18-7037	18-7057
7024180	18-7071	—	VOLVO-PENTA			CO-8A	18-7037	18-7057
7024181	18-7071	—	826359-2	18-7095	18-7201	CO-9A	18-7037	18-7057
7024182	—	—	826414-5	18-7086	18-7202	KA-10A	18-7013	18-7057
7024188	—	18-7200	826415-2	18-7095	18-7201	KA-10AT	18-7013	18-7057
7025082	18-7070	18-7200	826442-6	18-7095	18-7201	KA-11A	18-7013	18-7057
7025180	—	—	835556-2	18-7095	18-7201	KA-11AT	18-7013	18-7057
7025183	18-7071	—	841667-9	18-7086	18-7202	KA-12A	18-7013	18-7057
7025184	18-7071	—	856138-3	18-7072	18-7201	KA-12AT	18-7013	18-7057
7025188	18-7070	18-7200	856236-5	18-7040	—	KA-13A	18-7013	18-7057
7025564	—	—	841047-4	18-7095	18-7201	KA-13AT	18-7013	18-7057
7025638	18-7071	—	841048-2	18-7086	18-7202	KA-14A	18-7013	18-7057
7025662	18-7071	—	841313-0	18-7095	18-7202	KA-14AT	18-7013	18-7057
7025756	—	—	M875398-0	18-7085	—	KA-15A	18-7013	18-7057
7026084	18-7070	—	ZENITH			KA-16A	18-7013	18-7057
7026088	18-7070	18-7200	34VN	—	—	KA-16AT	18-7013	18-7057
7027080	18-7072	18-7201	8963, A-J	—	—	KA-17A	18-7013	18-7057
7027081	18-7072	18-7201	8983, A-H	—	—	KA-17AT	18-7013	18-7057
7027083	18-7072	18-7201	12091, A	—	—	KA-18A	18-7013	18-7057
7027088	18-7072	18-7201	12206	—	—	KA-18AT	18-7013	18-7057
7028085	18-7070	18-7200	ZENITH-STROMBERG			KA-19A	18-7013	18-7057
7028086	18-7070	18-7200	C1865F	18-7085	—	KA-19AT	18-7013	18-7057
7028188	18-7070	18-7200	C1865R	18-7085	—	KA-20A	18-7013	18-7057
7028280	18-7072	18-7201	C3040F	18-7085	—	KA-21A	18-7013	18-7057
7028282	18-7072	18-7201	C3040R	18-7085	—	KA-21AT	18-7013	18-7057
7029280	18-7072	18-7201	C3098F	18-7085	—	KA-21B	18-7013	18-7057
7029285	18-7072	18-7201	C3098R	18-7085	—	KA-21BT	18-7013	18-7057
7036543	18-7070	18-7200	C3200F	18-7085	—	KA-21C	18-7013	18-7057
7036646	18-7070	18-7200	C3200R	18-7085	—	KA-21CT	18-7013	18-7057
7037082	18-7072	18-7201	C3201F	18-7085	—	KA-21D	18-7013	18-7057
7040080	18-7070	18-7200	C3201M	18-7085	—	KA-21DT	18-7013	18-7057
7040081	18-7070	18-7200	C3201R	18-7085	—	KA-22A	18-7013	18-7057
7040082	18-7070	18-7202	C3231F	18-7085	—	KA-22B	18-7013	18-7057

ACCESSORIES — FUEL - CARBURETOR TO CARBURETOR KIT INTERCHANGE

CARBURETOR TO CARBURETOR KIT INTERCHANGE (Cont.)

Carburetor #	Carb. Kit #	Float #	Carburetor #	Carb. Kit #	Needle & Seat #	Carburetor #	Carb. Kit #	Needle & Seat #
TILLOTSON (CONT.)			TILLOTSON (CONT.)			TILLOTSON (CONT.)		
KA-22C	18-7013	18-7057	KC-9C	18-7013	18-7057	WB-2C	18-7037	18-7057
KA-23A	18-7013	18-7057	KD-1A	18-7013	18-7057	WB-30A	18-7037	18-7057
KA-24A	18-7013	18-7057	KD-1B	18-7013	18-7057	WB-31A	18-7037	18-7057
KA-24AT	18-7013	18-7057	KD-1BR	18-7013	18-7057	WB-3A	18-7037	18-7057
KA-25A	18-7013	18-7057	KD-2A	18-7013	18-7057	WB-3B	18-7037	18-7057
KA-26A	18-7013	18-7057	KD-4A	18-7013	18-7057	WB-3C	18-7037	18-7057
KA-26B	18-7013	18-7057	KD-5A	18-7013	18-7057	WB-4A	18-7037	18-7057
KA-27A	18-7013	18-7057	KD-6A	18-7013	18-7057	WB-4B	18-7037	18-7057
KA-2A	18-7013	18-7057	KD-6AT	18-7013	18-7057	WB-4C	18-7037	18-7057
KA-2AT	18-7013	18-7057	KD-6B	18-7013	18-7057	WB-5A	18-7037	18-7057
KA-5A	18-7013	18-7057	KD-6BT	18-7013	18-7057	WB-5B	18-7037	18-7057
KA-5A	18-7013	18-7057	KD-7A	18-7013	18-7057	WB-6A	18-7037	18-7057
KA-7A	18-7013	18-7057	KD-7B	18-7013	18-7057	WB-7A	18-7037	18-7057
KA-7B	18-7013	18-7057	RD-10A	18-7037	18-7057	WB-7B	18-7037	18-7057
KA-8A	18-7013	18-7057	TC-1A	18-7037	18-7057	WB-8A	18-7037	18-7057
KA-8AT	18-7013	18-7057	TC-1B	18-7037	18-7057	WB-8B	18-7037	18-7057
KA-9A	18-7013	18-7057	WB-10A	18-7037	18-7057	WB-8C	18-7037	18-7057
KA-9AT	18-7013	18-7057	WB-10B	18-7037	18-7057	WB-8D	18-7037	18-7057
KB-10A	18-7013	18-7057	WB-10C	18-7037	18-7057	WB-9A	18-7037	18-7057
KB-11A	18-7013	18-7057	WB-10D	18-7037	18-7057	WB-9B	18-7037	18-7057
KB-12A	18-7013	18-7057	WB-10E	18-7037	18-7057	WB-9C	18-7037	18-7057
KB-14A	18-7013	18-7057	WB-11A	18-7037	18-7057	WB-9D	18-7037	18-7057
KB-3A	18-7013	18-7057	WB-11B	18-7037	18-7057	WM-16	18-7021	18-7061
KB-3AT	18-7013	18-7057	WB-12A	18-7037	18-7057	WM-17	18-7021	18-7061
KB-4A	18-7013	18-7057	WB-12B	18-7037	18-7057	WALBRO		
KB-5A	18-7013	18-7057	WB-13A	18-7037	18-7057	WMK-36	18-7021	18-7061
KB-6A	18-7013	18-7057	WB-13B	18-7037	18-7057	WMK-38	18-7021	18-7061
KB-6B	18-7013	18-7057	WB-13C	18-7037	18-7057	WMK-39	18-7021	18-7061
KB-7A	18-7013	18-7057	WB-13D	18-7037	18-7057	WMK-40	18-7021	18-7061
KB-7B	18-7013	18-7057	WB-14A	18-7037	18-7057	WMK-41	18-7021	18-7061
KB-8A	18-7013	18-7057	WB-14B	18-7037	18-7057	WMK-41-1A	18-7021	18-7061
KB-9A	18-7013	18-7057	WB-15A	18-7037	18-7057	WMK-41-1B	18-7021	18-7061
KC-10A	18-7013	18-7057	WB-15B	18-7037	18-7057	WMK-41-3A	18-7021	18-7061
KC-10AT	18-7013	18-7057	WB-15C	18-7037	18-7057	WMK-41-3B	18-7021	18-7061
KC-11A	18-7013	18-7057	WB-15D	18-7037	18-7057	WO-8A-1	—	18-7061
KC-11AT	18-7013	18-7057	WB-16A	18-7037	18-7057	WO-8A-2	—	18-7061
KC-13A	18-7013	18-7057	WB-16B	18-7037	18-7057	WO-8A-3	—	18-7061
KC-14A	18-7013	18-7057	WB-16C	18-7037	18-7057	WO-8A-4	—	18-7061
KC-14AT	18-7013	18-7057	WB-16D	18-7037	18-7057	WO-8A-5	—	18-7061
KC-15A	18-7013	18-7057	WB-17A	18-7037	18-7057	WO-8A-6	—	18-7061
KC-15AT	18-7013	18-7057	WB-17B	18-7037	18-7057	WO-9-1	—	18-7061
KC-1A	18-7013	18-7057	WB-17C	18-7037	18-7057	WO-9-2	—	18-7061
KC-1AT	18-7013	18-7057	WB-19A	18-7037	18-7057	WO-9-3	—	18-7061
KC-2A	18-7013	18-7057	WB-19B	18-7037	18-7057	WO-9-4	—	18-7061
KC-2AT	18-7013	18-7057	WB-19C	18-7037	18-7057	WO-9-5	—	18-7061
KC-3A	18-7013	18-7057	WB-19D	18-7037	18-7057	WO-9-6	—	18-7061
KC-3AT	18-7013	18-7057	WB-1A	18-7037	18-7057	WO-9A-1	—	18-7061
KC-4A	18-7013	18-7057	WB-1B	18-7037	18-7057	WO-9A-2	—	18-7061
KC-5A	18-7013	18-7057	WB-1C	18-7037	18-7057	WO-9A-3	—	18-7061
KC-5AT	18-7013	18-7057	WB-20A	18-7037	18-7057	WO-9A-4	—	18-7061
KC-5B	18-7013	18-7057	WB-20B	18-7037	18-7057	WO-9A-5	—	18-7061
KC-5BT	18-7013	18-7057	WB-21A	18-7037	18-7057	WO-9A-6	—	18-7061
KC-5BTA	18-7013	18-7057	WB-21B	18-7037	18-7057			
KC-5C	18-7013	18-7057	WB-21C	18-7037	18-7057			
KC-5CT	18-7013	18-7057	WB-22A	18-7037	18-7057			
KC-5CTA	18-7013	18-7057	WB-23A	18-7037	18-7057			
KC-6A	18-7013	18-7057	WB-24A	18-7037	18-7057			
KC-6AT	18-7013	18-7057	WB-25A	18-7037	18-7057			
KC-7A	18-7013	18-7057	WB-26A	18-7037	18-7057			
KC-7AT	18-7013	18-7057	WB-26B	18-7037	18-7057			
KC-7B	18-7013	18-7057	WB-27A	18-7037	18-7057			
KC-7BT	18-7013	18-7057	WB-27B	18-7037	18-7057			
KC-8A	18-7013	18-7057	WB-28A	18-7037	18-7057			
KC-9A	18-7013	18-7057	WB-2A	18-7037	18-7057			
KC-9B	18-7013	18-7057	WB-2B	18-7037	18-7057			



FLAMETHROWER ELECTRONIC DISTRIBUTORS

Magnetic triggered billet distributors designed to meet or exceed SAE J1171 Standards.

Performance Features:

- Cobalt magnets and Hall Effect trigger for stable timing and precise spark distribution.
- Compensates for inherent electronic delay
- Synchronized peak current and spark timing reduces heat build-up
- Compatible with most capacitive discharge ignition boxes
- Integrated patented Ignitor II technology with adaptive dwell control
- Non-vented distributor cap equipped with stainless steel fasteners
- Triple screen spark arrestor for added protection



Part No.	Description
18-5481	Ford 351W (Conventional Rotation)
18-5483	Small and BB Chevrolet (Standard Deck height) (Conventional Rotation)
18-5477	Ford 302 (Conventional Rotation)
18-5479	Small and BB Chevrolet (Standard Deck height) Reverse Rotation

THUNDERBOLT HEI DISTRIBUTORS

Designed as a direct replacement for Mercury Thunderbolt IV Ignition Distributors. Meets or Exceeds SAE J1171 Standards.

Performance Features:

- Battery Powered (HEI) High Energy Ignition.
- Uses a Hall-Effect type sensor to trigger ignition accurately even at extremely low RPM.



Part No.	Description
18-5470	GM V8
18-5471	GM V6



DELCO HVS DISTRIBUTORS

Aluminum housing construction replaces weaker Factory plastic housing. Designed as a direct replacement for late model GM HVS Distributor. Meets or Exceeds SAE J1171 Standards.

Performance Features:

- Includes steel gear, which is compatible with flat tappet or hydraulic roller cams.
- Reliable high signal strength trigger system.
- Ball bearing and bushing combination provide maximum timing stability and long life.

Part No.	Description
18-5350	GM Vortec V6
18-5351	GM Vortec V8



DELCO EST DISTRIBUTORS



Aluminum housing construction. Designed as a direct replacement for late model GM EST Distributor. Meets or Exceeds SAE J1171 Standards.

Performance Features:

- Includes steel gear, which is compatible with flat tappet or hydraulic roller cams.
- Reliable high signal strength trigger system.
- Ball bearing and bushing combination provide maximum timing stability and long life.

Part No.	Description
18-5475	GM 4 Cyl
18-5476	GM V6
18-5484-1	GM V8



CONVERSION KITS FOR DELCO EST DISTRIBUTORS



18-5512
V-4 DELCO EST CONVERSION KIT
 Description: Converts 4 Cylinder GM Engines to Electronic
 Includes: Distributor, Coil, Ignition Wires, and Harnesses



18-5513
V-6 DELCO EST CONVERSION KIT
 Description: Converts 6 Cylinder GM Engines to Electronic
 Includes: Distributor, Coil, Ignition Wires, and Harnesses



18-5514
V-8 DELCO EST CONVERSION KIT
 Description: Converts 8 Cylinder GM Engines to Electronic
 Includes: Distributor, Coil, Ignition Wires, and Harnesses

YLM STYLE MAGNETIC BREAKERLESS ELECTRONIC DISTRIBUTOR

Designed for 12 Volt Negative ground systems, the Sierra YLM Series Marine distributors replace original equipment marine distributors with modern, high performance technology. This complete, self-contained ignition system combines the triggering device and amplifier into a single unit that sits inside the distributor housing. A self-contained module/pickup assembly has no moving parts to wear out. Sierra's time tested reliability you need in extreme marine conditions. A simple wiring hook up allows this system to fit a wide variety of marine applications. This ignition system drives both original equipment and high performance coils.



Performance Features:

- Improved performance and combustion efficiency.
- Improved spark plug life.
- Accurate spark timing.
- Reduced maintenance.
- Easy installation.

Part No.	Description	Replaces
18-5496-2	Ford 351C, 460 CID (Conventional Rotation)	YLM567CV
18-5497-2	Chrysler V8 273, 318 (67 & UP) 340, 360 CID "LA" Engines (Conventional Rotation)	YLM579AV
18-26310-2	GM 4.3L/262 CID Engines (EVEN Fire) (Conventional Rotation)	YLM700AV
18-26311-2	GM 327Q, 350Q Engines (Conventional Rotation)	YLM566AV
18-5486-2	GM L4, 153 & 181 CID (Conventional Rotation)	YLM673AV
18-5489-2	Ford 351W (Conventional Rotation)	YLM554CV
18-5494-2	GM V8 482, 502, 540 CID (Except 348, 409, & Tall Deck Big Block) (Conventional Rotation)	YLM624AV
18-5495-2	Ford 302 (Conventional Rotation)	YLM512CV
18-5498-2	GM V8, 482, 502, 540 CID (Except 348, 409 & Tall Deck Big Block) (Reverse Rotation)	YLM624BV

CONVERSION KITS FOR DELCO EST DISTRIBUTORS



18-5518
I/L 4 SIERRA ELECTRONIC DISTRIBUTOR CONVERSION KIT
 Description: Converts 4 Cylinder GM Engines to Electronic
 Includes: Distributor, Coil, Ignition Wires, and Harnesses



18-5520
V-8 SIERRA ELECTRONIC DISTRIBUTOR CONVERSION KIT
 Description: Converts 8 Cylinder GM Engines to Electronic
 Includes: Distributor, Coil, Ignition Wires, and Harnesses

YL STYLE POINT-TYPE DISTRIBUTORS

Using new materials and technology, the Sierra YL Series Distributor delivers more performance and reliability for today's marine performance engines. This proven ignition system drives both original equipment and high performance coils.

Performance Features:

- Stabilized points eliminate point float and bounce.
- High dielectric condenser with brass case eliminates corrosion.
- Mylar insulation provides greater protection against current leaks and shorting.
- Super Duty cap and rotor.
- Self-Lubricating bushings.



Part No.	Description	Replaces
18-5309-1	Ford 302 (Conventional Rotation)	YL512CV
18-5312-1	Ford 351 (Conventional Rotation)	YL554CV
18-5313-1	Most GM V8 (Conventional Rotation)	YL624AV
18-5315-1	Most GM 4 Cylinder Engines (120 & 140HP) (Conventional Rotation)	YL673AV
18-5316-1	Most GM V8 (Reverse Rotation)	YL624BV
18-5339-1	GM V8 327	YL566AV
18-26104-1	Ford V8 351C (Conventional Rotation)	YL567EV
18-26107-1	4.3L/262 CID Engines (EVEN Fire) (Conventional Rotation)	YL700AV
18-26110-1	Chrysler V8, 273, 318 (1967 & Up), 340 and 360 "LA" Engines	YL579AV
18-26111-1	3.7L Mercruiser (Conventional Rotation)	YL648AV
18-26112-1	GM L6, 194, 230, 250, 292 CID (Conventional Rotation)	YLM676AV

DISTRIBUTOR PARTS



18-5515
DELCO EST DISTRIBUTOR COIL TO MODULE HARNESS
 Fits: Engines equipped with a Delco EST Distributor



18-5516
DELCO EST DISTRIBUTOR TIMING TOOL
 For: Engines equipped with Delco EST and cannot be placed in base timing mode with a diagnostic tool.



18-5517
DELCO EST SHIFT INTERRUPT HARNESS
 For: Engines equipped with a Delco EST Distributor and requires a shift interrupt lead.



18-26800
MARINE CAP CLIP KIT
 Replaces: Mallory 670
 Fits: Mallory Tall Cap



18-26810
PIGTAIL, GM HEI 4 TERMINAL
 Fits: Delco EST Distributors



18-26811
PIGTAIL, GM HEI 2 TERMINAL
 Fits: Delco EST Distributors



18-26812
CONNECTOR, HEI COIL GRAY
 Fits: Delco EST Ignition Coil



18-26813
CONNECTOR, HEI COIL BLACK
 Fits: Delco EST Ignition Coil

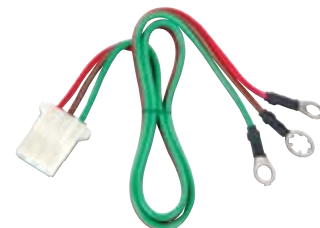

18-26815
DISTRIBUTOR HARNESS
 Replaces: Mallory 29349
 Fits: YLM & YLU Distributors

DISTRIBUTOR PARTS (cont.)



18-61051
SCREW KIT (4 PER PKG)
 Fits: Mercruiser V6 & V8 Thunderbolt Distributor Caps



18-26821
DISTRIBUTOR
CHEV REV GEAR
 Fits: Mallory Distributors in Chevrolet BB & SB reverse rotation engines



18-28150
WIRE SEPARATOR / BLUE



18-28151
WIRE SEPARATOR / BLACK



18-28175
WIRE MARKERS

ELECTRONIC CONVERSION KIT APPLICATION

CHEVROLET MARINE

Model	Cylinders	Years	Footnotes	Distributor Make	Distributor #	Ignitor Kit	Ignitor II Kit
All Models	V6	1980-1988	Ⓔ	Prestolite	IBM-7021	18-5293-1	18-5287-1
All Models	V8	1976-1988	Ⓔ, Ⓕ	Prestolite	IBM-7011	18-5298	18-5288
All Models	V8	1976-1988	Ⓔ, Ⓕ	Prestolite	IBM-7013	18-5299	18-5288-1

CHRIS-CRAFT

Model	Cylinders	Years	Footnotes	Distributor Make	Distributor #	Ignitor Kit	Ignitor II Kit
All Models	V8	1963-1971	Ⓔ, Ⓕ	Prestolite	IBM-4115	18-5298	18-5288
All Models	V8	1963-1971	Ⓔ, Ⓕ	Prestolite	IBM-4116	18-5298	18-5288
All Models	V8	1981-1985	Ⓔ, Ⓕ	Prestolite	-	18-5299	18-5288-1
FL153	I4	1975-1980	Ⓔ, Ⓕ	Delco	-	18-5297	18-5285
FL181	I4	1975-1980	Ⓔ, Ⓕ	Delco	-	18-5297	18-5285

CHRYSLER INBOARD

Model	Cylinders	Years	Footnotes	Distributor Make	Distributor #	Ignitor Kit	Ignitor II Kit
273	V8	1983-1988	Ⓔ, Ⓕ	Prestolite	IBM-7016	18-5299	18-5288-1
273	V8	1983-1988	Ⓔ, Ⓕ	Prestolite	IBM-7017	18-5299	18-5288-1
318	V8	1983-1988	Ⓔ, Ⓕ	Prestolite	IBM-7016	18-5299	18-5288-1
318	V8	1983-1988	Ⓔ, Ⓕ	Prestolite	IBM-7017	18-5299	18-5288-1
340	V8	1983-1988	Ⓔ, Ⓕ	Prestolite	IBM-7016	18-5299	18-5288-1
340	V8	1983-1988	Ⓔ, Ⓕ	Prestolite	IBM-7017	18-5299	18-5288-1
440	V8	1983-1988	Ⓔ, Ⓕ	Prestolite	IBM-7016	18-5299	18-5288-1
440	V8	1983-1988	Ⓔ, Ⓕ	Prestolite	IBM-7017	18-5299	18-5288-1
M318A	V8	1959-1972	Ⓔ, Ⓕ	Prestolite	IBM-4106	18-5298	18-5288
M318B	V8	1959-1972	Ⓔ, Ⓕ	Prestolite	IBM-4106	18-5298	18-5288
M318C	V8	1959-1972	Ⓔ, Ⓕ	Prestolite	IBM-4106	18-5298	18-5288
M318X	V8	1965-1966	Ⓔ, Ⓕ	Prestolite	IBM-4120	18-5298	18-5288
M413	V8	1959-1972	Ⓔ, Ⓕ	Prestolite	IBM-4106	18-5298	18-5288
M413D	V8	1959-1972	Ⓔ, Ⓕ	Prestolite	IBM-4106	18-5298	18-5288
M426X	V8	1959-1972	Ⓔ, Ⓕ	Prestolite	IBM-4106	18-5298	18-5288
M80	V8	1959-1972	Ⓔ, Ⓕ	Prestolite	IBM-4106	18-5298	18-5288
M81	V8	1959-1972	Ⓔ, Ⓕ	Prestolite	IBM-4106	18-5298	18-5288

Ⓔ Clockwise Rotation
 Ⓕ Factory Electronic Ignition
 Ⓖ Excluding distributor number YL670AV

Ⓔ Use with Screw Down Distributor Cap
 Ⓕ Use with Clip Down Distributor Cap
 Ⓖ Ignitor II cannot be used with solid core Ignition Wires

CRUSADER

Model	Cylinders	Years	Footnotes	Distributor Make	Distributor #	Ignitor Kit	Ignitor II Kit
185	V8	1961-1969	④, ⑥	Mallory	YL431A	18-5296-2	18-5290
185	V8	1961-1969	④, ⑥	Mallory	YD431A	18-5296-2	18-5290
220	V8	1961-1969	④, ⑥	Mallory	YL431A	18-5296-2	18-5290
220	V8	1961-1969	④, ⑥	Mallory	YD431A	18-5296-2	18-5290
230	V8	1961-1969	④, ⑥	Mallory	YL431A	18-5296-2	18-5290
230	V8	1961-1969	④, ⑥	Mallory	YD431A	18-5296-2	18-5290
283	V8	1961-1969	④, ⑥	Prestolite	IBM-4110	18-5298	18-5288
302	V8	1975-1978	④, ⑥	Prestolite	IBM-7007	18-5298	18-5288
302	V8	1975-1978	④, ⑥	Prestolite	IBM-7007A	18-5298	18-5288
305	V8	1977-1982	④, ⑥	Prestolite	IBM-7011	18-5298	18-5288
305	V8	1977-1982	④, ⑥	Prestolite	IBM-7011C	18-5298	18-5288
305	V8	1977-1982	④, ⑥	Prestolite	IBM-7011D	18-5298	18-5288
305	V8	1983-1987	④, ⑥	Mallory	-	18-5296-2	18-5290
305	V8	1987-1988	②, ⑥	Prestolite	IDU-7801	18-5239	18-5240
327	V8	1961-1969	④, ⑥	Prestolite	IBM-4110	18-5298	18-5288
350	V8	1977-1982	④, ⑥	Prestolite	IBM-7011	18-5298	18-5288
350	V8	1977-1982	④, ⑥	Prestolite	IBM-7011C	18-5298	18-5288
350	V8	1977-1982	④, ⑥	Prestolite	IBM-7011D	18-5298	18-5288
350	V8	1983-1987	④, ⑥	Mallory	-	18-5296-2	18-5290
350	V8	1987-1988	②, ⑥	Prestolite	IDU-7801	18-5239	18-5240
409	V8	1961-1969	④, ⑥	Prestolite	IBM-4110	18-5298	18-5288
454	V8	1977-1982	④, ⑥	Prestolite	IBM-7011	18-5298	18-5288
454	V8	1977-1982	④, ⑥	Prestolite	IBM-7011C	18-5298	18-5288
454	V8	1977-1982	④, ⑥	Prestolite	IBM-7011D	18-5298	18-5288
454	V8	1983-1987	④, ⑥	Mallory	-	18-5296-2	18-5290
454	V8	1987-1988	②, ⑥	Prestolite	IDU-7801	18-5239	18-5240

DEARBORN MARINE

Model	Cylinders	Years	Footnotes	Distributor Make	Distributor #	Ignitor Kit	Ignitor II Kit
221 CID	V8	1961-1969	3, 6	Mallory	YL362	18-5296-2	18-5290
221 CID	V8	1961-1969	3, 6	Mallory	YL455	18-5296-2	18-5290
221 CID	V8	1961-1969	3, 6	Mallory	YL519	18-5296-2	18-5290
260 CID	V8	1961-1969	3, 6	Mallory	YL362	18-5296-2	18-5290
260 CID	V8	1961-1969	3, 6	Mallory	YL455	18-5296-2	18-5290
260 CID	V8	1961-1969	3, 6	Mallory	YL519	18-5296-2	18-5290
262 CID	V8	1960-1969	3, 6	Mallory	YL350A	18-5296-2	18-5290
262 CID	V8	1960-1969	3, 6	Mallory	YL387A	18-5296-2	18-5290
272 CID	V8	1960-1969	3, 6	Mallory	YL350A	18-5296-2	18-5290
272 CID	V8	1960-1969	3, 6	Mallory	YL387A	18-5296-2	18-5290
289 CID	V8	1961-1969	3, 6	Mallory	YL362	18-5296-2	18-5290
289 CID	V8	1961-1969	3, 6	Mallory	YL455	18-5296-2	18-5290
289 CID	V8	1961-1969	3, 6	Mallory	YL519	18-5296-2	18-5290
292 CID	V8	1960-1969	3, 6	Mallory	YL350A	18-5296-2	18-5290
292 CID	V8	1960-1969	3, 6	Mallory	YL387A	18-5296-2	18-5290
312 CID	V8	1960-1969	3, 6	Mallory	YL350A	18-5296-2	18-5290
312 CID	V8	1960-1969	3, 6	Mallory	YL387A	18-5296-2	18-5290
352 CID	V8	1961-1969	3, 6	Mallory	YL362	18-5296-2	18-5290
352 CID	V8	1961-1969	3, 6	Mallory	YL455	18-5296-2	18-5290
352 CID	V8	1961-1969	3, 6	Mallory	YL519	18-5296-2	18-5290
390 CID	V8	1961-1969	3, 6	Mallory	YL362	18-5296-2	18-5290

APPLICATION CONTINUED ON NEXT PAGE

- ① Clockwise Rotation
- ② Factory Electronic Ignition
- ③ Excluding distributor number YL670AV

- ④ Use with Screw Down Distributor Cap
- ⑤ Use with Clip Down Distributor Cap
- ⑥ Ignitor II cannot be used with solid core Ignition Wires

DEARBORN MARINE

Model	Cylinders	Years	Footnotes	Distributor Make	Distributor #	Ignitor Kit	Ignitor II Kit
390 CID	V8	1961-1969	3, 6	Mallory	YL455	18-5296-2	18-5290
390 CID	V8	1961-1969	3, 6	Mallory	YL519	18-5296-2	18-5290
427 CID	V8	1965-1969	③, ⑥	Mallory	YL494A-2	18-5296-2	18-5290
427 CID	V8	1965-1969	③, ⑥	Mallory	YL494B-2	18-5296-2	18-5290

FORD MARINE

Model	Cylinders	Years	Footnotes	Distributor Make	Distributor #	Ignitor Kit	Ignitor II Kit
302 CID	V8	1973-1988	⑤, ⑥	Prestolite	IBM-7007	18-5298	18-5288
302 CID	V8	1973-1988	⑥, ⑥	Prestolite	IBM-7008	18-5298	18-5288
302 CID	V8	1973-1988	⑥, ⑥	Prestolite	IBM-7019	18-5299	18-5288-1
302 CID	V8	1973-1988	⑥, ⑥	Prestolite	IBM-7020	18-5299	18-5288-1
351 CID	V8	1973-1988	⑤, ⑥	Prestolite	IBM-7007	18-5298	18-5288
351 CID	V8	1973-1988	⑥, ⑥	Prestolite	IBM-7008	18-5298	18-5288
351 CID	V8	1973-1988	⑥, ⑥	Prestolite	IBM-7019	18-5299	18-5288-1
351 CID	V8	1973-1988	⑥, ⑥	Prestolite	IBM-7020	18-5299	18-5288-1
460 CID	V8	1973-1988	⑤, ⑥	Prestolite	IBM-7007	18-5298	18-5288
460 CID	V8	1973-1988	⑤, ⑥	Prestolite	IBM-7008	18-5298	18-5288
460 CID	V8	1973-1988	⑥, ⑥	Prestolite	IBM-7019	18-5299	18-5288-1
460 CID	V8	1973-1988	⑥, ⑥	Prestolite	IBM-7020	18-5299	18-5288-1

GRAY MARINE

Model	Cylinders	Years	Footnotes	Distributor Make	Distributor #	Ignitor Kit	Ignitor II Kit
138	V8	1950-1969	③, ⑥	Mallory	YL429	18-5296-2	18-5290
138	V8	1950-1969	③, ⑥	Mallory	YL429C	18-5296-2	18-5290
138	V8	1950-1969	③, ⑥	Mallory	YL429D	18-5296-2	18-5290
178	V8	1950-1969	③, ⑥	Mallory	YL429	18-5296-2	18-5290
178	V8	1950-1969	③, ⑥	Mallory	YL429C	18-5296-2	18-5290
178	V8	1950-1969	③, ⑥	Mallory	YL429D	18-5296-2	18-5290
401 CID	V8	ALL	③, ⑥	Mallory	YL455A	18-5296-2	18-5290
401 CID	V8	ALL	③, ⑥	Mallory	YL455A	18-5296-2	18-5290
CF175	V8	1965-1968	⑤, ⑥	Prestolite	IBM-4119	18-5298	18-5288
CF175	V8	1965-1968	⑤, ⑥	Prestolite	IBM-4119A	18-5298	18-5288
CF195	V8	1965-1968	⑤, ⑥	Prestolite	IBM-4119	18-5298	18-5288
CF195	V8	1965-1968	⑤, ⑥	Prestolite	IBM-4119A	18-5298	18-5288
CH175	V8	1965-1968	⑤, ⑥	Prestolite	IBM-4119	18-5298	18-5288
CH175	V8	1965-1968	⑤, ⑥	Prestolite	IBM-4119A	18-5298	18-5288
CH195	V8	1965-1968	⑤, ⑥	Prestolite	IBM-4119	18-5298	18-5288
CH195	V8	1965-1968	⑤, ⑥	Prestolite	IBM-4119A	18-5298	18-5288

INDMAR

Model	Cylinders	Years	Footnotes	Distributor Make	Distributor #	Ignitor Kit	Ignitor II Kit
All Models	V8	1979-1979	③, ⑥	Prestolite	IBM-7011	18-5298	18-5288

MARINE POWER

Model	Cylinders	Years	Footnotes	Distributor Make	Distributor #	Ignitor Kit	Ignitor II Kit
305 CID	V8	1978-1983	⑤, ⑥	Prestolite	IBM-7011	18-5298	18-5288
305 CID	V8	1978-1983	⑥, ⑥	Prestolite	IBM-7013	18-5299	18-5288-1
350 CID	V8	1978-1983	⑤, ⑥	Prestolite	IBM-7011	18-5298	18-5288
350 CID	V8	1978-1983	⑥, ⑥	Prestolite	IBM-7013	18-5299	18-5288-1
454 CID	V8	1978-1983	⑤, ⑥	Prestolite	IBM-7011	18-5298	18-5288
454 CID	V8	1978-1983	⑤, ⑥	Prestolite	IBM-7013	18-5299	18-5288-1

MERCUISER

Model	Cylinders	Years	Footnotes	Distributor Make	Distributor #	Ignitor Kit	Ignitor II Kit
110	I4	ALL	①, ⑥	Delco	-	18-5297	18-5285
120	I4	ALL	①, ⑥	Delco	-	18-5297	18-5285

APPLICATION CONTINUED ON NEXT PAGE

- ① Clockwise Rotation
- ② Factory Electronic Ignition
- ③ Excluding distributor number YL670AV
- ④ Use with Screw Down Distributor Cap
- ⑤ Use with Clip Down Distributor Cap
- ⑥ Ignitor II cannot be used with solid core Ignition Wires

MERCURISER

Model	Cylinders	Years	Footnotes	Distributor Make	Distributor #	Ignitor Kit	Ignitor II Kit
140	I4	ALL	①, ⑥	Delco	-	18-5297	18-5285
140	V6	ALL	⑥	Delco	-	18-5294	-
150	V6	ALL	⑥	Delco	-	18-5294	-
160	V6	ALL	⑥	Delco	-	18-5294	-
165	I4	ALL	①, ⑥	Delco	-	18-5297	18-5285
165	V6	ALL	⑥	Delco	-	18-5294	-
170	I4	ALL	①, ⑥	Delco	-	18-5297	18-5285
180	I4	ALL	①, ⑥	Delco	-	18-5297	18-5285
190	I4	ALL	①, ⑥	Delco	-	18-5297	18-5285
198	V8	ALL	③, ⑥	Mallory	-	18-5296-2	18-5290
200	V6	ALL	⑥	Delco	-	18-5294	-
215	V8	ALL	③, ⑥	Mallory	-	18-5296-2	18-5290
225	V8	ALL	③, ⑥	Mallory	-	18-5296-2	18-5290
228	V8	ALL	③, ⑥	Mallory	-	18-5296-2	18-5290
233	V8	ALL	⑤, ⑥	Prestolite	-	18-5298	18-5288
233	V8	ALL	④, ⑥	Prestolite	-	18-5299	18-5288-1
250	V8	ALL	③, ⑥	Mallory	-	18-5296-2	18-5290
255	V8	ALL	③, ⑥	Mallory	-	18-5296-2	18-5290
260	V8	ALL	③, ⑥	Mallory	-	18-5296-2	18-5290
280	V8	ALL	③, ⑥	Mallory	-	18-5296-2	18-5290
330	V8	ALL	③, ⑥	Mallory	-	18-5296-2	18-5290
370	V8	ALL	③, ⑥	Mallory	-	18-5296-2	18-5290
400	V8	ALL	③, ⑥	Mallory	-	18-5296-2	18-5290
440	V8	ALL	③, ⑥	Mallory	-	18-5296-2	18-5290
470	I4	ALL	①, ⑥	Delco	-	18-5297	18-5285
485	I4	ALL	①, ⑥	Delco	-	18-5297	18-5285
888	V8	ALL	⑤, ⑥	Prestolite	-	18-5298	18-5288
888	V8	ALL	③, ⑥	Mallory	-	18-5296-2	18-5290
898	V8	ALL	③, ⑥	Mallory	-	18-5296-2	18-5290
120 Alpha 1	V6	ALL	⑥	Delco	-	18-5294	-
140 Alpha 1	V6	ALL	⑥	Delco	-	18-5294	-
460 TRS	V8	ALL	③, ⑥	Mallory	-	18-5296-2	18-5290
470R	I4	ALL	①, ⑥	Delco	-	18-5297	18-5285
488R	I4	ALL	①, ⑥	Delco	-	18-5297	18-5285
5.7 Ski	V8	ALL	③, ⑥	Mallory	-	18-5296-2	18-5290

OMC

Model	Cylinders	Years	Footnotes	Distributor Make	Distributor #	Ignitor Kit	Ignitor II Kit
100HP	I4	1964-1988	①, ⑥	Delco	-	18-5297	18-5285
110HP	I4	1964-1988	①, ⑥	Delco	-	18-5297	18-5285
120HP	I4	1964-1988	①, ⑥	Delco	-	18-5297	18-5285
140HP	I4	1964-1988	①, ⑥	Delco	-	18-5297	18-5285
150HP	V6	1964-1966	⑥	Delco	1110309	18-5297	18-5285
150HP	V6	1964-1966	⑥	Delco	1110322	18-5297	18-5285
165HP	V6	1972-1976	⑥	Delco	980156	18-5297	18-5285
2.5L	I4	1982-1988	①, ⑥	Delco	982351	18-5297	18-5285
3.0L	I4	1982-1988	①, ⑥	Delco	982351	18-5297	18-5285
ALL	V8	1966-1988	③, ⑥	Mallory	-	18-5296-2	18-5290
ALL	V8	1974-1988	⑤, ⑥	Prestolite	980902	18-5298	18-5288
ALL	V8	1974-1988	⑤, ⑥	Prestolite	981080	18-5298	18-5288
ALL	V8	1974-1988	⑤, ⑥	Prestolite	982320	18-5298	18-5288
ALL	V8	1982-1988	④, ⑥	Prestolite	IBM-7013C	18-5299	18-5288-1
ALL	V8	1982-1988	④, ⑥	Prestolite	IBM-7013D	18-5299	18-5288-1

① Clockwise Rotation
 ② Factory Electronic Ignition
 ③ Excluding distributor number YL670AV

④ Use with Screw Down Distributor Cap
 ⑤ Use with Clip Down Distributor Cap
 ⑥ Ignitor II cannot be used with solid core Ignition Wires

ONAN							
Model	Cylinders	Years	Footnotes	Distributor Make	Distributor #	Ignitor Kit	Ignitor II Kit
MDJC	I4	1961-1980	ⓐ	Autolite	IGW-4409A	18-5295	-

PLEASURECRAFT MARINE							
Model	Cylinders	Years	Footnotes	Distributor Make	Distributor #	Ignitor Kit	Ignitor II Kit
302 CID	V8	1975-1978	ⓐ, ⓑ	Prestolite	IBM-7007	18-5298	18-5288
302 CID	V8	1975-1978	ⓑ, ⓐ	Prestolite	IBM-7008	18-5298	18-5288
305 CID	V8	1976-1982	ⓑ, ⓐ	Prestolite	IBM-7011	18-5298	18-5288
305 CID	V8	1983-1988	ⓑ, ⓐ	Prestolite	IBM-7013	18-5299	18-5288-1
350 CID	V8	1976-1982	ⓐ, ⓑ	Prestolite	IBM-7011	18-5298	18-5288
350 CID	V8	1983-1988	ⓐ, ⓑ	Prestolite	IBM-7013	18-5299	18-5288-1
351 CID	V8	1975-1978	ⓑ, ⓐ	Prestolite	IBM-7007	18-5298	18-5288
351 CID	V8	1975-1978	ⓑ, ⓐ	Prestolite	IBM-7008	18-5298	18-5288
454 CID	V8	1976-1982	ⓑ, ⓐ	Prestolite	IBM-7011	18-5298	18-5288
454 CID	V8	1983-1988	ⓑ, ⓐ	Prestolite	IBM-7013	18-5299	18-5288-1
460 CID	V8	1975-1978	ⓑ, ⓐ	Prestolite	IBM-7007	18-5298	18-5288
460 CID	V8	1975-1978	ⓑ, ⓐ	Prestolite	IBM-7008	18-5298	18-5288

THERMO-ELECTRON							
Model	Cylinders	Years	Footnotes	Distributor Make	Distributor #	Ignitor Kit	Ignitor II Kit
305 CID	V8	1977-1982	ⓑ, ⓐ	Prestolite	IBM-7011D	18-5298	18-5288
305 CID	V8	1981-1982	ⓑ, ⓐ	Prestolite	IBM-7013	18-5299	18-5288-1
350 CID	V8	1977-1982	ⓑ, ⓐ	Prestolite	IBM-7011D	18-5298	18-5288
350 CID	V8	1981-1982	ⓑ, ⓐ	Prestolite	IBM-7013	18-5299	18-5288-1
454 CID	V8	1977-1982	ⓑ, ⓐ	Prestolite	IBM-7011D	18-5298	18-5288
454 CID	V8	1981-1982	ⓑ, ⓐ	Prestolite	IBM-7013	18-5299	18-5288-1

UNIVERSAL							
Model	Cylinders	Years	Footnotes	Distributor Make	Distributor #	Ignitor Kit	Ignitor II Kit
Atomic 4	I4	1968-1970	ⓐ, ⓑ	Delco	1112446	18-5297	18-5285

VOLVO PENTA							
Model	Cylinders	Years	Footnotes	Distributor Make	Distributor #	Ignitor Kit	Ignitor II Kit
All Models	I4	ALL	ⓑ	Bosch	231178017	18-5292	-
All Models	V8	1977-1982	ⓑ, ⓐ	Prestolite	IBM-7011A	18-5298	18-5288
All Models	V8	1977-1982	ⓐ, ⓑ	Prestolite	IBM-7013A	18-5299	18-5288-1
All Models	V8	1986-1988	ⓐ, ⓑ	Prestolite	IDU-7801	18-5239	18-5240

WAUKESHA							
Model	Cylinders	Years	Footnotes	Distributor Make	Distributor #	Ignitor Kit	Ignitor II Kit
FC (12 Volt)	I4	1959-1973	ⓑ	Autolite	IGW-4301-3	18-5295	-
FCS (12 Volt)	I4	1959-1973	ⓑ	Autolite	IGW-4301-3	18-5295	-
FS (12 Volt)	I4	1959-1973	ⓑ	Autolite	IGW-4301-3	18-5295	-
IC (12 Volt)	I4	1959-1973	ⓐ, ⓑ	Autolite	IGW-4301-3	18-5295	-
VGR-155	I4	1975-1978	ⓐ, ⓑ	Delco	1112470	18-5297	18-5285

WISCONSIN							
Model	Cylinders	Years	Footnotes	Distributor Make	Distributor #	Ignitor Kit	Ignitor II Kit
VE4 (12 Volt)	I4	1948-1957	ⓑ	Autolite	IGW Series	18-5295	-
VF4 (12 Volt)	I4	1948-1957	ⓑ	Autolite	IGW Series	18-5295	-
VL4 (12 Volt)	I4	1948-1957	ⓑ	Autolite	IGW Series	18-5295	-
VP4 (12 Volt)	I4	1948-1957	ⓑ	Autolite	IGW Series	18-5295	-

- ⓐ Clockwise Rotation
- ⓑ Factory Electronic Ignition
- ⓒ Excluding distributor number YL670AV
- ⓓ Use with Screw Down Distributor Cap
- ⓔ Use with Clip Down Distributor Cap
- ⓕ Ignitor II cannot be used with solid core Ignition Wires

IGNITION WIRE IDENTIFICATION CHART



1



8



15



2



9



16



3



10



17



4



11



18



5



12



19



6



13



20



7



14

IGNITION WIRE LEAD TYPES

Sierra #	No. of Wires	Coil Wire	Dist. End	Spark Plug End	Coil End	Coil Dist. End	Sierra #	No. of Wires	Coil Wire	Dist. End	Spark Plug End	Coil End	Coil Dist. End
OUTBOARD IGNITION WIRES							OUTBOARD IGNITION WIRES						
18-28083	1	-	1	1	-	-	18-28084	3	-	1	1	-	-
18-8815-1	1	-	4	4	-	-	18-28082	4	-	9	1	-	-
18-8816-1	1	-	4	4	-	-	18-28085	4	-	1	1	-	-
18-8818-1	1	-	4	4	-	-	18-8839-1	4	-	4	6	-	-
18-8819-1	1	-	11	6	-	-	18-28080	6	-	9	1	-	-
18-5227-1	1	-	11	6	-	-	18-28081	6	-	11	1	-	-
18-5228-1	1	-	11	6	-	-	18-28086	6	-	1	1	-	-
18-5231-1	1	-	4	4	-	-	18-28090	6	-	4	6	-	-
18-5229-9-1	5	-	18	4	-	-	18-8840-1	6	-	4	6	-	-
18-5230-9-1	5	-	18	4	-	-	18-8846-1	4	-	19	20	-	-

IGNITION WIRE LEAD TYPES (Continued)

Sierra #	No. of Cylinders	Coil Wire	Dist. End	Spark Plug End	Coil End	Coil Dist. End
STERNDRIVE/INBOARD IGNITION WIRES						
18-28100*	1	12	-	-	1	5
18-28101*	1	12	-	-	1	4
18-28102*	1	14	-	-	9	5
18-28042	4	12	5	1	5	5
18-28050	4	12	4	2	9	9
18-8800-1	4	13	5	2	9	5
18-8807-1	4	13	5	2	9	5
18-8808-2	4	13	5	3	9	5
18-8811-1	4	12	7	3	7	7
18-8813-1	4	20	9	14	13	13
18-8814-1	4	11/11	2	2	2	4
18-8833-1	4	9	4	1	4	4
18-8841-1	4	11	15	15/16	4	15
18-8801-1	6	13	5	2	9	5
18-8809-1	6	13	5	1	9	5
18-8810-1	6	13	6	1	10	6
18-8829-1	6	21	17	1	8	8
18-8835-1	6	15.5	4	1	4	4
18-28019	8	12/15	4	1	-	-
18-28033	8	14	4	2	5	4
18-28043	8	14	9	2	9	9
18-28044	8	12	5	3	9	9
18-28046	8	12/24	9	1	9	5

Sierra #	No. of Cylinders	Coil Wire	Dist. End	Spark Plug End	Coil End	Coil Dist. End
STERNDRIVE/INBOARD IGNITION WIRES						
18-8802-1	8	13	5	1	9	5
18-8803-1	8	13	5	1	9	5
18-8804-1	8	12	6	1	10	6
18-8805-1	8	13	5	1	9	5
18-8806-1	8	13	5	1	9	5
18-8817-1	8	12	5	2	2	2
18-8820-1	8	14	4	1	6	4
18-8821-1	8	12	6	1	5	6
18-8822-1	8	15.5	4	1	4	4
18-8823-1	8	12/17	9	1	11	5
18-8824-1	8	14	4	1	6	4
18-8826-1	8	14	9	2	11	9
18-8827-1	8	9	9	1	11	9
18-8828-1	8	21	17	1	8	8
18-8830-1	8	16	4	1	10	4
18-8832-1	8	9	4	1	4	4
18-8834-1	8	12	6	1	10	6
18-8836-1	8	16	4	1	4	4
18-8837-1	8	8	1	1	10	1
18-8838-2	8	-	8	12	-	-
18-8842-1	8	9	5	3	5	5
18-8843-1	8	16	5	3	5	5
18-8844-1	8	14	4	2	6	4

Sierra #	No. of Cylinders	Coil Wire	Dist. End	Spark Plug End	Coil End	Coil Dist. End
GENERATOR IGNITION WIRES						
23-4501	4	-	5	12	-	-



PREMIUM MARINE SPARK PLUG WIRE LEADS

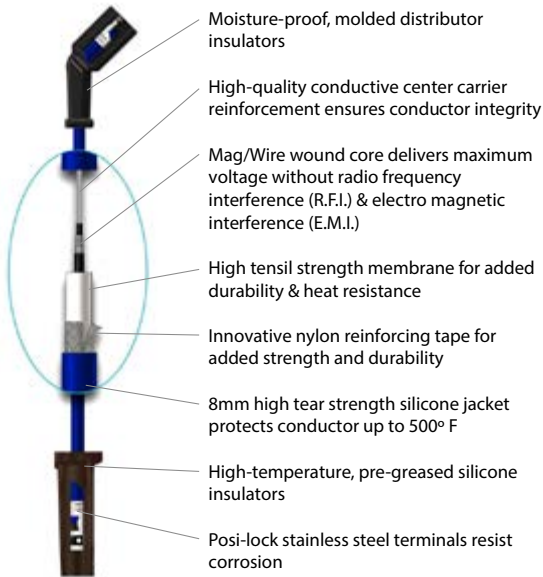

Sierra's **MAGFORCE** Ignition Wires are "Electronics Friendly" protecting all of your electronic devices and electronic engine controls from RFI and EMI while delivering the maximum amount of voltage. Exact fit design ensures easy installation and years of trouble - free service.



See application below.

PLUG WIRE SET APPLICATION CHARTS

CHRIS-CRAFT						CHRYSLER					
Engine	Cyl.	Distributor	Year Start	Year Stop	Plug Wire Set	Engine	Cyl.	Distributor	Year Start	Year Stop	Plug Wire Set
181 CID (3.0L)	4	Conventional	ALL	ALL	18-8800-1	M273	8	Conventional & Electronic	1968	1974	18-8826-1
302	8	Conventional	ALL	ALL	18-28044	LM318	8	Conventional & Electronic	1968	1985	18-8826-1
351	8	Conventional	ALL	ALL	18-28044	M328	8	Conventional & Electronic	1960	1995	18-8826-1
460	8	Conventional	ALL	ALL	18-28044	M340	8	Conventional & Electronic	1968	1985	18-8826-1
350	8	Conventional	1970	1990	18-8803-2	M360	8	Conventional & Electronic	1975	1985	18-8826-1
350	8	Conventional ❶	1970	1990	18-8823-1	361	8	Conventional & Electronic	1968	1985	18-8827-1
454	8	Conventional	ALL	ALL	18-8817-1	383	8	Conventional & Electronic	1960	1988	18-8827-1
502	8	Conventional	ALL	ALL	18-8817-1	400	8	Conventional & Electronic	1968	1985	18-8827-1
❶ Models designed with Mallory side terminals						440	8	Conventional & Electronic	1968	1985	18-8827-1

CRUSADER-PCM					
Engine	Cyl.	Distributor	Year Start	Year Stop	Plug Wire Set
262 CID 4.3L	6	Prestolite	ALL	ALL	18-8801-1
262 CID 4.3L	6	Delco EST	ALL	ALL	18-8810-1
262 CID 4.3L	6	Delco HVS	ALL	ALL	18-8828-1
220 (305 CID 5.0L)	8	Mallory/Prestolite ❶	Up to	1987	18-8803-2
220 (305 CID 5.0L)	8	Mallory/Prestolite ❷	1987	1992	18-8803-2
270 (350 CID 5.7L)	8	Mallory/Prestolite ❶	Up to	1987	18-8803-2
270 (350 CID 5.7L)	8	Mallory/Prestolite ❷	1987	1992	18-8803-2
TB350	8	Delco EST ❸	1992	& Up	18-8824-1
5.7L Classic	8	Mallory	1999	& Up	18-8803-2
5.7L MPI Classic	8	Delco HVS	2007	& Up	18-8828-1
MP5.0L Captain's Choice	8	Delco HVS	2002	2005	18-8828-1
MP5.7L Captain's Choice	8	Delco HVS	2002	2005	18-8828-1
MP6.0L	8	Distributorless	2002	& Up	18-8838-1
350 (454 CID 7.4L)	8	Mallory ❹	Up to	1991	18-8803-2
454XL (454 CID 7.4L)	8	Delco EST ❺	1991	& Up	18-8824-1
CM454HO (454 CID 7.4L)	8	Delco EST ❻	1991	& Up	18-8824-1
454XL (454 CID 7.4L)	8	Delco EST ❻	1993	& Up	18-8824-1
MP8.1L	8	Distributorless	ALL	ALL	18-8838-1
502 (502 CID 8.2L)	8	Prestolite ❽	Up to	1991	18-8803-2
502 (502 CID 8.2L)	8	Delco EST ❹	Up to	1991	18-8824-1
502XL (502 CID 8.2L)	8	Delco EST ❻	1991	& Up	18-8824-1
TB502XL (502 CID 8.2L)	8	Delco EST ❼	1994	& Up	18-8824-1

❶ Serial Number up to 68702 ❷ Serial Number 68703-90232 ❸ Serial Number 90232 & UP ❹ Serial Number up to 88710

❺ Serial Number 88710 & Up ❻ Serial Number 92882 & Up ❼ Serial Number 94268 & Up

PLUG WIRE SET APPLICATION CHARTS (Cont.)

INDMAR

Engine	Cyl.	Distributor	Year Start	Year Stop	Plug Wire Set
140	8	Prestolite	Up to	1993	18-8803-2
200	8	Prestolite	Up to	1993	18-8803-2
225	8	Prestolite	Up to	1993	18-8803-2
250	8	Prestolite	Up to	1993	18-8803-2
275	8	Prestolite/Mallory	Up to	1993	18-8803-2
300	8	Prestolite/Mallory	Up to	1993	18-8803-2
350	8	Prestolite/Mallory	Up to	1993	18-8803-2
400	8	Prestolite/Mallory	Up to	1993	18-8803-2
5.7L EFI	8	Delco EST	1994	2009	18-8836-1
5.7L EFI	8	Delco HVS	2007	& Up	18-8828-1
6.0L EFI	8	Distributorless	2003	& Up	18-8838-1
6.2L EFI	8	Distributorless	2010	& Up	18-8838-1
454 Carbureted (7.4L)	8	Delco EST	1994	2011	18-8824-1
8.1L Vortec	8	Distributorless	2003	2011	18-8838-1
502 Carbureted (8.2L)	8	Delco EST	1994	2011	18-8824-1

MARINE POWER

Engine	Cyl.	Distributor	Year Start	Year Stop	Plug Wire Set
181	4	Delco	1986	1992	18-8800-1
262	6	Prestolite Ⓢ	1986	1992	18-8801-1
350	8	Prestolite Ⓢ	1986	1992	18-8802-1
350	8	Mallory	1986	1992	18-8802-1
3.0L	4	Delco EST	1993	& Up	18-8833-1
4.3L	6	Delco EST	1993	& Up	18-8835-1
5.0L	8	Delco EST	1993	2005	18-8822-1
5.0L	8	Delco HVS	2005	& Up	18-8828-1
5.7L	8	Delco EST	1993	2005	18-8822-1
5.7L	8	Delco HVS	2005	& Up	18-8828-1
7.4L	8	Delco EST	1993	2000	18-8832-1
8.2L	8	Delco EST	1993	2000	18-8832-1

Ⓢ Screw down cap

MERCURISER

Model	Cyl.	Distributor	Year Start	Year Stop	Serial # Start	Serial # End	Plug Wire Set
110	4	Delco	1963	1966	1537370	2044033	18-8800-1
120	4	Delco	1964	1986	1666601	0B531853	18-8800-1
2.5L	4	Delco	1987	1989	0B531854	0C853255	18-8800-1
140	4	Delco	1968	1986	2508261	0B450800	18-8800-1
3.0L	4	Delco	1987	1989	0B450801	0C856558	18-8800-1
3.0L, LX	4	Prestolite	1990	1991	0C856559	0D504541	18-8800-1
3.0L, LX	4	Delco Digital	1990	1991	0C856559	0D504541	18-8811-1
3.0L	4	Delco EST	1991	& Up	0D504542	& Up	18-8833-1
3.0LX	4	Delco EST	1991	1997	0D504542	0K999999	18-8833-1
3.0L MPI	4	Delco EST	2012	& Up	1A072812	& Up	18-8833-1
165	4	Delco	1987	1987	0B434940	0B774251	18-8808-2
170	4	Delco	1985	1986	6916779	0B434940	18-8808-2
180	4	Prestolite	1987	1987	0B436391	0B775248	18-8800-1
190	4	Delco	1985	1986	6916779	0B436390	18-8808-2
3.7L	4	Delco	1988	1989	0B774252	& Up	18-8808-2
3.7LX	4	Delco	1988	1989	0B775249	& Up	18-8808-2
3.7LX	4	Prestolite	1988	1989	0B775249	& Up	18-8800-1
470	4	Delco	1976	1984	4208370	6916778	18-8808-2

MERCURISER CONTINUED ON NEXT PAGE

PLUG WIRE SET APPLICATION CHARTS (Cont.)

MERCURISER

Model	Cyl.	Distributor	Year Start	Year Stop	Serial # Start	Serial # End	Plug Wire Set
485	4	Delco	1980	1982	5685394	6218036	18-8808-2
488	4	Delco	1981	1984	6170297	6916778	18-8808-2
140	L6	Delco	1963	1963	1538930	1725960	18-8809-1
150	L6	Delco	1964	1966	1666495	2048046	18-8809-1
160	L6	Delco	1967	1969	2048022	2770031	18-8809-1
165	L6	Delco	1970	1981	2770032	5813433	18-8809-1
200	L6	Delco	1969	1969	2453769	2712072	18-8809-1
185	6	Prestolite	1983	1984	6330183	6919655	18-8801-1
175	6	Thunderbolt IV	1987	1987	0B527955	0B773242	18-8810-1
185	6	Thunderbolt IV	1985	1987	6919656	0B527954	18-8810-1
205	6	Thunderbolt IV	1985	1987	0A331445	0B775129	18-8810-1
262 Mag	6	Delco EST	1996	1997	0F803800	0K999999	18-8835-1
4.3L	6	Thunderbolt IV	1988	1996	0B773243	0F802999	18-8810-1
4.3L Alpha	6	Thunderbolt V	1998	& Up	0L010044	& Up	18-8810-1
4.3L Bravo	6	Thunderbolt V	1998	& Up	0L010044	& Up	18-8810-1
4.3L EFI	6	Delco EST	1998	1998	0L012009	0L359999	18-8835-1
4.3L EFI	6	Thunderbolt V	1999	2004	0L360000	& Up	18-8810-1
4.3L MPI	6	Delco HVS	2001	& Up	0M300000	& Up	18-8829-1
4.3LH Alpha	6	Thunderbolt V	1998	2004	0L010044	& Up	18-8810-1
4.3LH Bravo	6	Thunderbolt V	1998	2004	0L010044	& Up	18-8810-1
4.3LX, LXH	6	Thunderbolt IV	1988	1997	0B775130	0K999999	18-8810-1
215 MCM & MIE (Ford)	8	Autolite/Mallory	1970	1972	2781153	3563181	18-8803-2
225 MCM & MIE (Ford)	8	Autolite/Mallory/Mercury	1973	1974	3385721	4166999	18-8803-2
888 (Ford)	8	Autolite/Mallory	1971	1977	3108723	4887829	18-8803-2
190 (GM)	8	Delco	1963	1964	1564539	1730903	18-8803-2
198 MIE	8	Mallory	1977	1977	4776402	4931099	18-8803-2
200	8	Thunderbolt IV	1985	1987	6899058	8774444	18-8821-1
228	8	Mallory	1977	1982	4765100	6218461	18-8803-2
228	8	Thunderbolt IV	1983	1984	6218462	6899268	18-8821-1
228 MIE	8	Mallory	1977	1980	4765100	5907057	18-8803-2
230	8	Thunderbolt IV	1985	1987	6899269	0B773739	18-8821-1
230 MIE (LH)	8	Thunderbolt IV	1981	1987	5907058	0B788151	18-8821-1
230 MIE (RH)	8	Thunderbolt IV	1981	1987	5907058	0B788151	18-8821-1
5.0L	8	Thunderbolt IV	1988	1995	0B774445	0F600999	18-8821-1
5.0L Alpha	8	Thunderbolt V	1998	& Up	0L015751	& Up	18-8821-1
5.0L Bravo	8	Thunderbolt V	1998	& Up	0L015751	& Up	18-8821-1
5.0L EFI	8	Delco EST	1998	1998	0L012052	0L339999	18-8822-1
5.0L MIE (LH)	8	Thunderbolt IV	1988	1988	0B788152	0C396832	18-8821-1
5.0L MIE (RH)	8	Thunderbolt IV	1988	1988	0B788152	0C396832	18-8821-1
5.0L MPI Alpha	8	Delco HVS	2001	& Up	0M300000	& Up	18-8828-1
5.0LX	8	Thunderbolt IV	1988	1995	0B773740	0F600999	18-8821-1
898	8	Mallory	1977	1982	4762210	6218461	18-8803-2
898	8	Thunderbolt IV	1983	1984	6218462	6899057	18-8821-1
225 (GM)	8	Delco	1963	1969	1539620	2694014	18-8803-2
225 MIE (GM)	8	Thunderbolt	1968	1968	2278647	2694014	18-8803-2
250 MCM & MIE	8	Thunderbolt	1968	1969	2314301	2639854	18-8803-2
250	8	Mallory	1977	1977	4768000	4908849	18-8803-2
255 MCM & MIE	8	Mallory	1975	1976	3258728	4501254	18-8803-2
255 MCM & MIE	8	Mercury	1976	1976	4498701	4767999	18-8803-2
255 MIE	8	Mercury	1977	1980	4768000	5907057	18-8803-2
260	8	Mallory	1978	1982	4908850	6218461	18-8803-2
260	8	Thunderbolt IV	1982	1987	6218462	0B773304	18-8821-1
260 MIE (LH)	8	Thunderbolt IV	1981	1986	5907058	0B788151	18-8821-1

MERCURISER CONTINUED ON NEXT PAGE

PLUG WIRE SET APPLICATION CHARTS (Cont.)

MERCUISER							
Model	Cyl.	Distributor	Year Start	Year Stop	Serial # Start	Serial # End	Plug Wire Set
260 MIE (RH)	8	Thunderbolt IV	1981	1986	5907058	0B788151	18-8821-1
270 MCM & MIE	8	Thunderbolt	1969	1972	2851074	3385720	18-8803-2
280 TRS	8	Mercury/Mallory	1975	1975	4176250	4499390	18-8803-2
300	8	Thunderbolt IV	1985	1986	6668677	0B430367	18-8821-1
320 EFI	8	Thunderbolt IV	1987	1989	0A543604	0C622418	18-8821-1
350 Mag Alpha	8	Thunderbolt IV	1986	1994	0A635178	0F353690	18-8821-1
350 Mag Alpha	8	Thunderbolt V	1995	1997	0F353691	0K999999	18-8821-1
350 Mag Alpha EFI	8	Delco EST	1996	1997	0F800300	0K999999	18-8822-1
350 Mag Bravo MPI	8	Delco EST	1995	1996	0F415189	0K999999	18-8822-1
350 Mag EFI Ski	8	Delco EST	1994	1997	0F215561	0K999999	18-8822-1
350 Mag MPI	8	Delco EST	1998	1998	0L010019	0L325952	18-8822-1
350 Mag MPI Alpha	8	Delco HVS	2001	& Up	0M300000	& Up	18-8828-1
350 Mag MPI Bravo	8	Delco HVS	2001	& Up	0M300000	& Up	18-8828-1
350 Mag MPI Horizon	8	Delco HVS	2001	& Up	0M300000	& Up	18-8828-1
350 Mag MPI Horizon MIE	8	Delco HVS	2001	& Up	0M300000	& Up	18-8828-1
350 Mag MPI MIE	8	Delco HVS	2001	& Up	0M300000	& Up	18-8828-1
350 Mag MPI Ski	8	Thunderbolt IV	1991	1996	0D505450	0K40399	18-8821-1
350 Mag MPI Ski	8	Thunderbolt V	1991	1997	0D505450	0K999999	18-8821-1
5.7L Alpha	8	Thunderbolt IV	1988	1995	0B773305	0F600999	18-8821-1
5.7L Alpha	8	Thunderbolt V	1996	1997	0F601000	& Up	18-8821-1
5.7L Bravo	8	Thunderbolt IV	1988	1993	0B773305	0F353524	18-8821-1
5.7L Bravo	8	Thunderbolt V	1994	& Up	0F353525	& Up	18-8821-1
5.7L EFI	8	Delco EST	1995	1998	0F225560	0L339999	18-8822-1
5.7L EFI MIE	8	Delco EST	1997	1997	0K040300	0K999999	18-8822-1
5.7L MIE	8	Thunderbolt IV	1988	1995	0B788152	0F746099	18-8821-1
5.7L MIE	8	Thunderbolt V	1996	1997	0F622100	0K999999	18-8821-1
5.7L MIE	8	Thunderbolt V	1998	& Up	0L002003	& Up	18-8821-1
5.7L Ski	8	Mallory/Prestolite	1985	1995	0A338553	0F775199	18-8802-1
5.7L Ski	8	Thunderbolt IV	1987	1995	0B514627	0F775199	18-8821-1
5.7L Ski	8	Thunderbolt V	1996	1997	0F775200	0K999999	18-8821-1
5.7L Ski	8	Thunderbolt V	1998	& Up	0L002005	& Up	18-8821-1
5.7LX Alpha & Bravo	8	Thunderbolt V	1996	1997	0F601000	0K999999	18-8821-1
5.7LX Bravo & EFI	8	Delco EST	1996	1997	0F752400	0K999999	18-8822-1
233 MCM & MIE (Ford)	8	Mercury/Prestolite	1975	1977	4173000	4902304	18-8803-2
255 MCM & MIE (Ford)	8	Mercury/Mallory	1973	1980	3258728	5907057	18-8803-2
MX 6.2L MPI	8	Delco HVS	2001	& Up	0M300000	& Up	18-8828-1
MX 6.2L MPI Horizon	8	Delco HVS	2001	& Up	0M300000	& Up	18-8828-1
MX 6.2L MPI Horizon MIE	8	Delco HVS	2001	& Up	0M300000	& Up	18-8828-1
MX 6.2L MPI MIE	8	Delco HVS	2001	& Up	0M300000	& Up	18-8828-1
377 MAG MPI BRAVO	8	Delco HVS	ALL	ALL	1A300000	& Up	18-8828-1
325 MCM & MIE	8	Thunderbolt	1969	1974	2278747	& Up	18-8803-2
325 MCM & MIE	8	Mallory	1969	1972	2278747	& Up	18-8803-2
390	8	Mallory	1968	1970	ALL		18-8803-2
330	8	Mallory	1977	1981	4623115	6083144	18-8803-2
330	8	Thunderbolt	1977	1981	4623115	6083144	18-8803-2
330	8	Thunderbolt IV	1982	1987	6083145	0B816540	18-8821-1
340 MIE	8	Thunderbolt IV	1981	1987	5889914	0B788365	18-8821-1
350 MIE	8	Thunderbolt	1974	1976	3780450	4623109	18-8803-2
370 TRS	8	Mallory/Holley	1978	1985	4179554	6721527	18-8803-2
370 TRS	8	Thunderbolt IV	1985	1987	6721528	0B714586	18-8821-1
400 TRS	8	Mallory/Holley	1980	1986	5668232	0B457644	18-8803-2
440 TRS	8	Mallory/Holley	1983	1986	6181070	0B485220	18-8803-2
450	8	Thunderbolt IV	1995	1996	0F347100	0F347277	18-8821-1

MERCUISER CONTINUED ON NEXT PAGE

PLUG WIRE SET APPLICATION CHARTS (Cont.)

MERCUISER

Model	Cyl.	Distributor	Year Start	Year Stop	Serial # Start	Serial # End	Plug Wire Set
454 Mag Alpha	8	Thunderbolt IV	1986	1988	0A631894	0B785148	18-8821-1
454 Mag Bravo	8	Thunderbolt IV	1988	1997	0B721206	0K999999	18-8821-1
454 Mag EFI	8	Delco EST	1994	1996	0F115700	0F802349	18-8822-1
454 Mag MPI	8	Delco EST	1996	2001	0F802350	M024999	18-8822-1
454 Mag MPI Horizon MIE	8	Delco EST	1999	2001	0L002200	0L674000	18-8822-1
454 Mag MPI Ski	8	Delco EST	1995	1997	0F215800	0K999999	18-8822-1
7.4L Bravo I, II, III	8	Thunderbolt IV	1988	1997	0B771113	0K999999	18-8821-1
7.4L Bravo III	8	Thunderbolt V	1992	1997	603118	0K999999	18-8821-1
7.4L EFI MIE	8	Thunderbolt IV	1988	1996	0B788366	0F820141	18-8821-1
7.4L MIE	8	Thunderbolt IV	1988	1996	0B788366	0F820141	18-8821-1
7.4L MIE	8	Thunderbolt V	1992	1997	0D715494	0K999999	18-8821-1
7.4L MPI (L29)	8	Delco EST	1998	2001	0L010003	0M024330	18-8822-1
7.4L MPI MIE	8	Delco EST	1995	2001	0F563052	0M025999	18-8822-1
7.4LX Bravo EFI & MPI	8	Delco EST	1996	1997	0F602010	0K999999	18-8822-1
390	8	Thunderbolt	1969	1970	2781129	2825059	18-8803-2
460 TRS	8	Mallory/Holley	1983	1986	6180970	6181046	18-8803-2
460 Cyclone	8	ALL	1983	1985	ALL		18-8803-2
496 Mag & Mag HO	8	Delco (coil over plug)	2000	& Up	0M025000	& Up	18-8838-1
8.1 MIE & HO MIE	8	Delco (coil over plug)	2000	& Up	0M025000	& Up	18-8838-1
502 Mag Bravo	8	Thunderbolt IV	1990	1993	0G878221	0F114528	18-8821-1
502 Mag EFI	8	Delco EST	1993	1996	0B40650	0F802599	18-8822-1
502 Mag MPI	8	Delco EST	1996	2001	0F802600	0M024999	18-8822-1
525 SC	8	Thunderbolt IV	1991	1995	0D456000	0F877734	18-8821-1
8.2L MIE	8	Thunderbolt IV	1990	1996	0C878221	0F819619	18-8821-1
8.2L MPI MIE	8	Delco EST	1996	2001	0F819620	0L674200	18-8822-1

OMC

Engine	Cyl.	Distributor	Year Start	Year Stop	Plug Wire Set
2.3L	4	Mallory	1987	1990	18-8807-1
2.3L	4	Prestolite	1990	1990	18-8807-1
2.5L	4	Delco	1981	1986	18-8800-1
3.0L	4	Delco	1982	1990	18-8800-1
3.0L	4	Delco EST	1990	1998	18-8833-1
3.8L	6	Prestolite	1981	1985	18-8801-1
4.3L	6	Prestolite Ⓣ	1985	1990	18-8801-1
4.3L	6	Prestolite	1991	1993	18-8801-1
4.3L	6	Delco EST	1994	1998	18-8835-1
5.0L (GM)	8	Prestolite Ⓛ	1979	1982	18-8802-1
5.0L (GM)	8	Mallory	1981	1988	18-8802-1
5.0L (GM)	8	Prestolite Ⓣ	1983	1988	18-8802-1
5.0L (Ford)	8	Prestolite Ⓣ	1989	1990	18-8806-1
5.0L (Ford)	8	Prestolite	1991	1996	18-8806-1
5.0L (Ford)	8	Ford HEI	1993	1996	18-8820-1
5.0L (GM)	8	Prestolite	1998	1998	18-8801-1
5.0L (GM)	8	Delco EST	1998	1998	18-8822-1
5.7L	8	Mallory	1982	1990	18-8802-1
5.7L	8	Prestolite Ⓣ	1982	1990	18-8802-1
5.7L	8	Prestolite Ⓣ	1991	1998	18-8802-1
5.7L	8	Delco EST	1996	1998	18-8822-1
5.8L	8	Prestolite Ⓣ	1989	1990	18-8842-1
5.8L	8	Prestolite Ⓣ	1991	1996	18-8842-1
5.8L	8	Ford HEI	1993	1996	18-8820-1

OMC CONTINUED ON NEXT PAGE

PLUG WIRE SET APPLICATION CHARTS (Cont.)

OMC					
Engine	Cyl.	Distributor	Year Start	Year Stop	Plug Wire Set
7.4L	8	Mallory	1988	1988	18-8802-1
7.4L	8	Prestolite ②	1988	1988	18-8802-1
7.4L	8	Distributorless	1990	1991	18-8843-1
7.4L	8	Delco EST	1995	1998	18-8832-1
7.5L	8	Prestolite ②	1987	1987	18-8803-2
7.5L	8	Prestolite ②	1987	1989	18-8803-2
8.2L	8	Mallory	1984	1985	18-8802-1
8.2L	8	Prestolite ②	1984	1985	18-8802-1
8.2L	8	Delco EST	1998	1998	18-8832-1
80	4	ALL	1962	1968	18-8800-1
90	4	ALL	1962	1968	18-8800-1
100	4	Delco	1972	1973	18-8800-1
110	4	Delco	1964	1964	18-8800-1
120	4	Delco	1965	1981	18-8800-1
140	4	Delco	1973	1981	18-8800-1
170	8	Prestolite ①	1974	1974	18-8802-1
175	8	Prestolite ①	1975	1977	18-8802-1
185	8	Mallory	1967	1968	18-8802-1
185	8	Mallory	1978	1980	18-8802-1
185	8	Prestolite ①	1978	1980	18-8802-1
190	8	Prestolite ①	1974	1977	18-8802-1
200	8	Mallory	1979	1988	18-8802-1
200	8	Prestolite ①	1979	1981	18-8802-1
210	8	Mallory	1968	1970	18-8802-1
215	8	Mallory	1971	1971	18-8802-1
225	8	Mallory	1972	1976	18-8802-1
225	8	Mallory	1978	1978	18-8802-1
230	8	Mallory	1979	1981	18-8802-1
230	8	Prestolite ①	1979	1981	18-8802-1
230	8	Mallory	1975	1976	18-8802-1
235	8	Mallory	1971	1971	18-8802-1
235	8	Prestolite ①	1975	1977	18-8802-1
240	8	Prestolite ①	1978	1978	18-8802-1
245	8	Mallory	1975	1975	18-8802-1
250	8	Mallory	1970	1974	18-8802-1
250	8	Prestolite ①	1979	1979	18-8802-1
260	8	Mallory	1975	1976	18-8802-1
260	8	Mallory	1979	1981	18-8802-1
260	8	Prestolite ①	1979	1981	18-8802-1
290 JET	8	Mallory	1974	1975	18-8802-1
305	8	Mallory	1977	1979	18-8802-1
305	8	Mallory	1980	1981	18-8802-1
305	8	Prestolite ①	1981	1981	18-8802-1
350	8	Mallory	1977	1979	18-8802-1
350	8	Mallory	1980	1981	18-8802-1
350	8	Prestolite ①	1981	1981	18-8802-1
454	8	Mallory	1977	1979	18-8803-2
454	8	Mallory	1980	1981	18-8803-2
454	8	Prestolite ①	1981	1981	18-8803-2

① Clip down cap ② Snap down cap

PLUG WIRE SET APPLICATION CHARTS (Cont.)

VOLVO					
Model	Cyl.	Distributor	Year Start	Year End	Plug Wire Set
AQ115A, B	4	Volvo	1969	1975	18-28050
AQ120B	4	Volvo	1977	1980	18-8813-1
AQ125A, B	4	Volvo	1981	1985	18-8813-1
AQ130A, B, C, D	4	Volvo	1968	1977	18-28050
AQ131A, B, C, D	4	Volvo	1985	1989	18-8813-1
AQ140A	4	Volvo	1975	1979	18-8813-1
AQ145A, B	4	Volvo	1979	1985	18-8813-1
AQ151A, B, C	4	Volvo	1985	1989	18-8813-1
AQ175A	6	Volvo	1981	1985	18-8801-1
AQ190A	8	Volvo	1976	1977	18-8802-1
AQ200B	8	Mallory (Tall Cap)	1974	1976	18-8802-1
AQ200B	8	Mallory (Flat Cap)	1974	1976	18-8823-1
AQ200C	8	Mallory (Tall Cap)	1976	1977	18-8802-1
AQ200C	8	Mallory (Flat Cap)	1976	1977	18-8823-1
AQ205A	6	Volvo	1988	1989	18-8801-1
AQ211A	8	Volvo	1986	1989	18-8802-1
AQ225B	8	Mallory (Tall Cap)	1974	1976	18-8802-1
AQ225B	8	Mallory (Flat Cap)	1974	1976	18-8823-1
AQ231A, B	8	Volvo	1986	1989	18-8802-1
AQ240A	8	Volvo	1976	1977	18-8802-1
AQ255A	8	Mallory (Flat Cap)	1977	1978	18-8823-1
AQ255B	8	Mallory (Tall Cap)	1978	1978	18-8802-1
AQ255B	8	Mallory (Flat Cap)	1978	1978	18-8823-1
AQ260A	8	Mallory (Tall Cap)	1979	1985	18-8802-1
AQ260A	8	Mallory (Flat Cap)	1979	1985	18-8823-1
AQ260B	8	Mallory (Tall Cap)	1985	1986	18-8802-1
AQ271A, B, C, D	8	Volvo	1986	1989	18-8802-1
AQ280A	8	Mallory (Tall Cap)	1978	1979	18-8802-1
AQ280A	8	Mallory (Flat Cap)	1978	1979	18-8823-1
AQ290A	8	Mallory (Tall Cap)	1979	1985	18-8802-1
AQ290A	8	Mallory (Flat Cap)	1979	1985	18-8823-1
AQ311A, B	8	Volvo	1986	1989	18-8802-1
BB140A	4	Volvo	1975	1979	18-8813-1
BB145A	4	Volvo	1979	1985	18-8813-1
BB225A, AV, B, C	8	Volvo	1973	1977	18-8802-1
BB231A	8	Volvo	1987	1987	18-8802-1
BB260A, AV, B, C	8	Volvo	1978	1985	18-8802-1
BB261A	8	Volvo	1988	1989	18-8802-1
230A, B	4	Volvo	1989	1992	18-8813-1
250A, B	4	Volvo	1989	1992	18-8813-1
432A	6	Delco EST	1992	1993	18-8835-1
434A	6	Delco EST	1992	1993	18-8835-1
3.0GLM	4	Delco EST	1993	1994	18-8833-1
3.0GLM	4	Delco EST	2002	2004	18-8833-1
3.0GLP	4	Delco EST	2002	2010	18-8833-1
3.0GSM	4	Delco EST	1994	2002	18-8833-1
3.0GSP	4	Delco EST	1993	2002	18-8833-1
3.0GX1	4	Delco EST	2008	2009	18-8833-1
4.3GI	6	Delco EST	1994	2000	18-8835-1
4.3GL	6	Delco EST	1993	2010	18-8835-1
4.3GS	6	Delco EST	1993	1999	18-8835-1
4.3GX1	6	Delco HVS	2001	2015	18-8829-1
4.3GX1	6	Delco EST	2001	2002	18-8835-1

VOLVO CONTINUED ON NEXT PAGE

PLUG WIRE SET APPLICATION CHARTS (Cont.)

VOLVO					
Model	Cyl.	Distributor	Year Start	Year End	Plug Wire Set
4.3GXIE	6	Delco HVS	2009	2015	18-8829-1
4.3SI	6	Delco HVS	2001	2009	18-8829-1
4.3SI-BF	6	Delco HVS	2001	2002	18-8829-1
5.0FI	8	Ford	1994	1996	18-8820-1
5.0FL	8	Prestolite	1994	1996	18-8802-1
5.0GI	8	Delco EST	1997	2000	18-8836-1
5.0GL	8	Prestolite	1997	2001	18-8802-1
5.0GL	8	Delco EST	2001	2006	18-8836-1
5.0GXI	8	Delco HVS	2001	2015	18-8828-1
5.0GXI-A	8	Delco EST	2001	2002	18-8836-1
5.0GXIC	8	Delco HVS	2007	2009	18-8828-1
5.0GXIE	8	Delco HVS	2007	2015	18-8828-1
5.0OSI	8	Delco HVS	2001	2009	18-8828-1
5.0OSiE	8	Delco HVS	2008	2009	18-8828-1
5.7GI	8	Delco EST	1993	1997	18-8836-1
5.7Gi	8	Delco HVS	2001	2015	18-8828-1
5.7GI	8	Delco EST	2004	2005	18-8836-1
5.7GiC	8	Delco HVS	2008	2009	18-8828-1
5.7GiCE	8	Delco HVS	2008	2009	18-8828-1
5.7GiE	8	Delco HVS	2007	2015	18-8828-1
5.7GIL	8	Delco HVS	2002	2009	18-8828-1
5.7GIL-A	8	Delco EST	2001	2001	18-8836-1
5.7GL	8	Prestolite	1993	1997	18-8802-1
5.7GL	8	Delco EST	1993	1997	18-8836-1
5.7GL	8	Delco EST	2001	2004	18-8836-1
5.7GL-A	8	Mallory	2001	2001	18-8802-1
5.7GSI	8	Delco EST	1996	2001	18-8836-1
5.7GSP	8	Prestolite	1996	2000	18-8802-1
5.7GXI	8	Delco HVS	2001	2015	18-8828-1
5.7GXI-A, B	8	Delco EST	2000	2002	18-8836-1
5.7GXIC	8	Delco HVS	2007	2008	18-8828-1
5.7GXICE	8	Delco HVS	2007	2010	18-8828-1
5.7GXIE	8	Delco HVS	2007	2015	18-8828-1
5.7GXIL	8	Delco HVS	2001	2008	18-8828-1
5.7GXIL-A, B	8	Delco EST	2000	2002	18-8836-1
5.7OSi	8	Delco HVS	2001	2009	18-8828-1
5.7OSiE	8	Delco HVS	2008	2009	18-8828-1
5.7OSXI	8	Delco HVS	2001	2009	18-8828-1
5.7OSXiE	8	Delco HVS	2008	2009	18-8828-1
5.8FI	8	Ford	1994	1996	18-8820-1
5.8FL	8	Prestolite	1994	1996	18-8803-1
5.8FSI	8	Prestolite	1994	1996	18-8803-1
7.4GI	8	Delco EST	1994	2000	18-8836-1
7.4GL	8	Prestolite	1993	1997	18-8802-1
7.4GLI	8	Prestolite	1993	1996	18-8802-1
7.4GLP	8	Prestolite	1993	1997	18-8802-1
7.4GLP	8	Prestolite	1994	1997	18-28051
7.4GLP	8	Delco EST	1995	1996	18-8836-1
7.4GSI	8	Delco EST	1994	2000	18-8836-1
8.1Gi-A	8	Distributorless	1999	2015	18-8838-1
8.1GiC	8	Distributorless	2007	2015	18-8838-1

VOLVO CONTINUED ON NEXT PAGE

PLUG WIRE SET APPLICATION CHARTS (Cont.)

VOLVO

Model	Cyl.	Distributor	Year Start	Year End	Plug Wire Set
8.1GiCE	8	Distributorless	2007	2015	18-8838-1
8.1GiE	8	Distributorless	2007	2015	18-8838-1
8.1GiL	8	Distributorless	2000	2008	18-8838-1
8.1GSi	8	Distributorless	2000	2001	18-8838-1
8.1GXi	8	Distributorless	2001	2015	18-8838-1
8.1GXiE	8	Distributorless	2007	2015	18-8838-1
8.1GXil	8	Distributorless	2001	2008	18-8838-1
8.1IPSCE	8	Distributorless	2008	2015	18-8838-1
8.1OSi	8	Distributorless	2003	2009	18-8838-1
8.1OSiE	8	Distributorless	2008	2009	18-8838-1
8.2GLI	8	Prestolite	1993	1994	18-8803-1
8.2GLP	8	Prestolite	1993	1994	18-8803-1
8.2GSI	8	Delco EST	1995	2000	18-8836-1
DPX375	8	Distributorless	2000	2002	18-8838-1
DPX385	8	Delco EST	1996	2000	18-8836-1
DPX415	8	Delco EST	1996	2000	18-8836-1
DPX420	8	Distributorless	2000	2002	18-8838-1
V6-200	6	Delco HVS	2012	2015	18-8829-1
V6-225	6	Delco HVS	2012	2015	18-8829-1
V8-270	8	Delco HVS	2012	2015	18-8828-1
V8-300	8	Delco HVS	2012	2015	18-8828-1
V8-320	8	Delco HVS	2012	2015	18-8828-1

YAMAHA STERNDRIVE

Model	Cyl.	Distributor	Year Start	Year End	Plug Wire Set
3.0L	4	Delco EST	1990	1993	18-8835-1
4.3L	6	YEMS	1989	1989	18-8835-1
4.3L	6	Delco EST	1990	1990	18-8835-1
5.0L	8	YEMS	1989	1989	18-8836-1
5.7L	8	Delco EST	1989	1990	18-8836-1
7.4L	8	Delco EST	1992	1992	18-8836-1

SIERRA®













OIL FILTERS

Sierra oil filters are engineered with premium grade materials that will not only withstand but excel in the extreme environment of the Marine world. Sierra ensures the excellent performance of their filters by:

- Epoxy coating all canisters for corrosion resistance.
- Using a heavy-wall steel canister for further corrosion protection.
- Using high-efficiency filter media that meets or exceeds the OE's filtration.
- Backed by Sierra's industry leading warranty.

DIESEL OIL FILTERS

 <p>18-0033 Replaces: Volvo 21707133</p>	 <p>18-0034 Replaces: Volvo 477556</p>
 <p>18-0035 Replaces: Volvo 3582732 Full Flow</p>	 <p>18-0036 Replaces: Volvo 3582733 Bypass</p>
 <p>18-7871 Replaces: Mercruiser 35-805809</p>	 <p>18-7880 Replaces: Caterpillar 1R-0658 Volvo-Penta 466634</p>
 <p>*18-7884 Replaces: Universal 299381 Volvo-Penta 834337 Thread Spec: 3/4" x 16NPT</p>	 <p>*18-7886 Replaces: Perkins 2654403 Thread Spec: 3/4" x 16NPT</p>
 <p>*18-7910-1 Replaces: Westerbeke 30220 Yanmar 124450-35100, 119350-35151, 119350-35150 Thread Spec: 20mm x 1.5</p>	 <p>18-8780 Replaces: Indmar 872024, Indmar 6.0L & 6.2L S/N above 164786</p>

* Anti-Drain-Back Valve
Valve eliminates dry starts, prevents oil from draining back into crankcase during engine shutdown.

STERNDRIVE & INBOARD OIL FILTERS



***18-7824-2**
Short GM
Replaces:
 Chris-Craft 16.81-08746
 Crusader 201104
 Indmar 50-1001
 Mercruiser 35-802885Q, 32716, 866340Q02, Q03, 866340K01,
 Mercruiser Vazer,
 35-866340Q02, 35-866340K01,
 35-866340Q,
 52731A1, 52731, 52022, 32717,
 14957
 OMC 173232, 778864
 Pleasurecraft R077002
 Volvo-Penta 835440
 Yamaha YSC-10231-20-0C
Thread Spec: 13/16" x 16NPT



***18-7875**
Long Ford
Replaces:
 Chris-Craft 16.81-06536
 Chrysler 1851658, 56874, F724002
 Crusader 9002514
 Mercruiser 60565, 35-802886Q
 OMC 173231, 502900
 Pleasurecraft R077001
 Yamaha YSC-16231-20-0C
Thread Spec: 3/4" x 16NPT



***18-7876-1**
Long GM
Replaces:
 Mercruiser 35-866340Q03, 35-866340Q02, 52731, 52731A1, 54111,
 35-802885Q, 14957, 52022, 32717,
 32716
 OMC 173233, 502901
 Volvo 3850559
 Yamaha YSC-14231-20-0C
Thread Spec: 13/16" x 16NPT



***18-7878-1**
Short Ford
Replaces:
 Chrysler 3549957, L-19, L-1008
 Mercruiser 803470, 46692, 38463
 OMC 502904
 Volvo 430143, 1266286, 3517857
Thread Spec: 3/4" x 16NPT



***18-7879-1**
V-6 GM
Replaces:
 Chrysler L-319
 Mercruiser 35-802884Q, 41815,
 35-883702Q, K
 OMC 173834, 502903
 Volvo 841750
Thread Spec: 18mm x 1.5



18-57824
Replaces:
 Ilmor MV8V1021
Fits: Mastercraft and Ilmor V8 GM New LS
 Series SB engines (Remote Mount)



18-8779
Replaces:
 Indmar 872025
Fits: 6.2L Ford Engines 2015-2016



18-57702
CRANKCASE FILTER
Replaces: 876069
Fits: Volvo MD30A, TMD30A, TAM30A,
 MD31A, TMD31A, TAM31A, MD40A,
 TMD40A, TMD40B, TAM40A, TAM40B,
 TMD41A, TAM41A

4-CYCLE OUTBOARD OIL FILTERS



18-7758
Replaces:
 Mercury 35-877761K01, 35-877761Q01
Thread Spec: 22mm x 1.5



***18-7902**
Replaces:
 Yamaha 3FV-13440-20-00, 3FV-13440-00-00
Thread Spec: 20mm x 1.5



***18-7896**
Replaces:
 Johnson/Evinrude 778886, 5033539
 Suzuki 16510-61A20-MHL
Thread Spec: 3/4" x 16NPT



















***18-7897**
Replaces:
 Johnson/Evinrude 778887, 5033919
 Suzuki 16510-82703
Thread Spec: 3/4" x 16NPT



18-7901
Replaces:
 Mercury 825467A1, 825467T1
 Yamaha 6G8-13440-00-00

* Anti-Drain-Back Valve

Valve eliminates dry starts, prevents oil from draining back into crankcase during engine shutdown.

 <p>18-7903 Replaces: Johnson/Evinrude 5033102, 763364 Suzuki 16510-05240</p>	 <p>*18-7905-1 Superseded from 18-7895 Replaces: Suzuki 16510-96J00 Thread Spec: 20mm x 1.5</p>	 <p>*18-7906-2 Replaces: Yamaha 69J-13440-00-00, 69J-13440-01-00 Mercury 35-822626T7, 35-822626Q15, 35-8226267 Thread Spec: 3/4" x 16NPT</p>	
 <p>*18-7909 Replaces: Honda 15400-POH-305PE, 15400-POH-305, 15400-ZJI-004, 15400-PLM-A01PE Thread Spec: 20mm x 1.5</p>	 <p>*18-7911-1 Replaces: Honda 15400-PFB-007 Nissan 3R0-07615-0 Yamaha 5GH-13440-00-00 Thread Spec: 20mm x 1.5</p>	 <p>*18-7913 Replaces: Honda 15400-PFB-014 Mercury 35-822626Q1, Q03 Thread Spec: 20mm x 1.5</p>	
 <p>*18-7914 Replaces: Mercury 35-822626Q2, 35-822626Q04, 35-877768K01, 35-822626K04, 35-822626T2, 35-8M0064104, 35-8M0008397 Thread Spec: 20mm x 1.5</p>	 <p>*18-7915-1 Replaces: Johnson/Evinrude 778885, 5031411 Suzuki 16510-87J00 Thread Spec: 3/4" x 16NPT</p>	 <p>*18-7916 Replaces: Johnson/Evinrude 434839 Thread Spec: 3/4" x 16NPT</p>	
 <p>*18-7918 Replaces: Mercury 35-883701K01, 35-877769K01 Thread Spec: 24mm x 1.5</p>	 <p>*18-7921 Replaces: Mercury 35-896546T, 35-877767K01 Thread Spec: 24mm x 1.5</p>	 <p>*18-7954 Replaces: Yamaha N26-13440-02-00, N26-13440-00-00 Fits: F350 Thread Spec: 3/4" x 16NPT</p>	
 <p>18-7974 Replaces: Volvo 3827069 Thread Spec: 18mm x 1.5</p>	 <p>18-8003-1 Replaces: Volvo 8692305</p>	 <p>18-8700 OIL FILTER Replaces: 5GH-13440-50-00, 5GH-13440-20, 5JW-13400-00-00, 2MB-E3440-00-00, 1WD-E3440-00-00 Fits: F15(2006-12), F20(2006-12), F25(2009-12), F40(2008-12), F50(2005-12), F60(2005*-12), F70(2010-12), T25(2009-12), T50(2005-12), T60(2005-12)</p>	 <p>18-8870 OIL FILTER Replaces: Suzuki 16510-45H10 Fits: F9.9 Type T/TH(Sn 110001 & Newer), F15(SN 110001 & Newer)</p>

* Anti-Drain-Back Valve
Valve eliminates dry starts, prevents oil from draining back into crankcase during engine shutdown.

NOW AVAILABLE FROM SIERRA HIGH PERFORMANCE ATV/UTV OILS & LUBRICANTS



10W-40

FULL SYNTHETIC OIL

0W-40

FULL SYNTHETIC OIL

80W-90

SEMI-SYNTHETIC HYPOID OIL

2-STROKE

FULL SYNTHETIC OIL

5W-50

FULL SYNTHETIC OIL

FOAM FILTER OIL

**PRIME
LINE**

Powersports Service Parts

OIL & LUBRICANT DISPLAY RACK

Generate incremental sales by selling high-margin oil and lubricant products from Sierra. Create exciting displays and rotate products frequently, using this quality fixture that helps sell the products for you.

This gleaming, black metal display with heavy-duty casters and high impact graphics works to make a powerful impression. Comes complete with 4 high-tech metal shelves, heavy-duty casters and custom graphics.

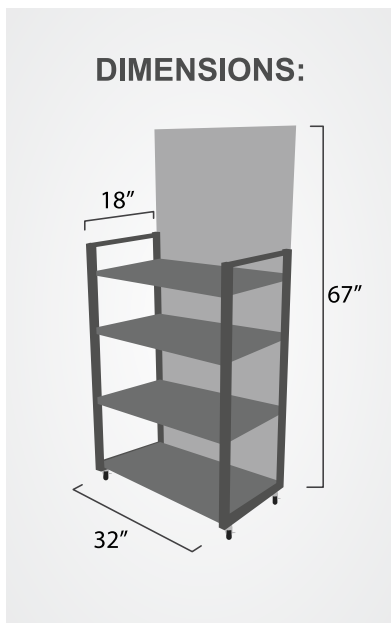

PART NO. 18-9490-1
(RACK ONLY • DOES NOT INCLUDE PRODUCT)



OIL

TC-W3



Sierra TC-W3 is a high performance lubricant that has been manufactured and designed to meet and exceed all (Domestic & Import) engine manufacturers warranties. Exceeds JASO, ISO, API and NMMA, for advanced generation 2-cycle lubricants.

- Ideal for oil injection systems or pre-mix applications.
- Significantly reduced aquatic toxicity to fish compared to other outboard oils on the market today.
- Reduces ring sticking, deposit formation and exhaust port blockage. Less friction allowing for easier starting.
- Formulated to improve performance and extend engine life by reducing wear on critical engine components.
- Ideal for today's high horsepower outboards that demand maximum performance.
- Excellent performance with lower quality fuels.
- Exceeds the industry standards established in 1997.
- Guaranteed and backed by our famous Sierra comprehensive warranty. (Will not void your engine manufacturer's warranty)

PREMIUM BLEND TC-W3	
Part No.	Description
18-9500-1	Pint (12 per case) (473ml)
18-9500-1P	84 case pallet (Pt.) 12 per case
18-9500-2	Quart (12 per case) (946ml)
18-9500-3	Gallon (6 per case) (3.78L)
18-9500-3P	36 case pallet (Ga.)
18-9500-4	2.5 Gallon (2 per case) (9.46L)
18-9500-6	16 Gallons (60.57L)
18-9500-7	55 Gallons (208L)

DIRECT INJECTION, TC-W3			
Part No.	Description	OE	OE No.
18-9530-3	Gallon (3.78L)	Mercury Optimax Yamaha HPDI BRP Ficht, DI E-TEC XD-50	92-858037K01 LUB-2STRK-M1-4 764354
18-9530-4	2.5 Gallon (2 per case) (9.46L)	Mercury Optimax Yamaha HPDI BRP Ficht, DI E-TEC XD-50	
18-9530-6	16 Gallon (61L)		
18-9530-7	55 Gallon Drum	Mercury Optimax Yamaha HPDI BRP Ficht, DI E-TEC XD-50	92-858039K01 LUB-2STRK-M1-55 777228



2-STROKE OIL MIXING BOTTLE

Re-usable bottle for precise measuring of oil to fuel ratio for your engine.

18-9798
32 FL. OZ bottle

FULL SYNTHETIC TC-W3 2-STROKE OUTBOARD			
Part No.	Description	OE	OE No.
18-9540-2	Quart (964ml)	BRP E-Tec/Universal E-TEC XD-100	—
18-9540-3	Gallon (3.78L)	BRP E-Tec/Universal E-TEC XD-100	764357
18-9540-7	55 Gal. Drum	BRP E-Tec/Universal E-TEC XD-100	777120

20W-40 FC-W 4-STROKE MINERAL OUTBOARD ENGINE OIL

20W-40 FC-W 4-STROKE MINERAL OUTBOARD OIL

- Formulated to protect your engine in the most demanding marine conditions.
- Developed to replace the 10W-30 in warmer climates.
- Meets or exceeds OE specifications for Outboard Oil.
- Advanced additive package to prevent rust and corrosion, breakdown under high RPM and maximum load conditions.



20W40 FC-W 4-STROKE MINERAL OUTBOARD ENGINE OIL			
Part No.	Yamaha No.	Description	Case Qty.
18-9450-2	LUB-20W40-FC-12	Quart (946ml)	12

See OE Cross Reference Chart on Page 214

25W-50 FC-W SEMI-SYNTHETIC MARINE ENGINE OIL

25W-50 FC-W MARINE ENGINE OIL

- For use in supercharged Mercury Verado.
- Offered in liter, 4 liter and 16 gallon containers.
- Semi-Synthetic formulation for superior protection under high loads and operating stress.
- NMMA FC-W® Certified/API-SL.



25W-50 FC-W SEMI-SYNTHETIC OIL

Part No.	Mercury No.	Description	Case Qty.
18-9552-3	92-858084K01	4 Liter (4.2224 qt.)	6
18-9552-8	—	1 Liter (1.0556 qt.)	12

10W-40 FC-W SEMI-SYNTHETIC MARINE ENGINE OIL

10W-40 FC-W SEMI-SYNTHETIC ENGINE OIL

- Direct Suzuki replacement oil.
- Semi-Synthetic formulation for superior protection under high loads and operating stress
- Offered in quart, gallon, 16 gallon and 55 gallon drums.
- NMMA FC-W® Certified/API-SL.



10W-40 FC-W SEMI-SYNTHETIC OIL

Part No.	Suzuki No.	Description	Case Qty.
18-9551-2	990C0-10W40-1QT	Quart (946ml)	12
18-9551-3	990C0-10W40-1GL	Gallon (3.785L)	6
18-9551-6	—	16 Gallon (61L)	—
18-9551-7	—	55 Gallon (208L)	—

15W-40 DIESEL ENGINE OIL

15W-40 DIESEL ENGINE OIL

- Meets the following manufactures specifications: Volvo VDS-3; Cummins CES20078, CES20077, CES20076; Detroit Diesel DDC93D214; CAT ECF-2, ECF-1; Global DHD-1.
- Increased detergency to fight soot and carbon deposits.
- Certified to API CI-4+ Rating. Meets the highest standards of diesel oil in the marine industry.



15W-40 DIESEL ENGINE OIL

Part No.	Mercury No.	Volvo No.	Description	Case Qty.
18-9553-2	—	40005011	Quart (946ml)	12
18-9553-3	—	40005012	Gallon (3.785L)	6
18-9554-5	—	40005013	5 Gallon (18.95L)	—

10W-30 FC-W 4-STROKE MARINE OUTBOARD ENGINE OIL

10W-30 4-STROKE MARINE OUTBOARD ENGINE OIL is a highly refined petroleum product formulated with premium base stock and highly refined additives. Specifically formulated to meet or exceed the tough requirements of the Marine 4-Stroke motor manufacturers, Mercury, Yamaha, Johnson-Evinrude, Suzuki and Honda.

- Excellent anti-wear characteristics
- Reduces friction
- Formulated to offer maximum corrosion protection
- Reduces sludge keeps engine cleaner for better efficiency
- Low temperature viscosity offers better cold starting
- Meets and exceeds quality performance API SJ, CF-2, CH-4, NMMA FC-W® Certified



10W30 FC-W MARINE OUTBOARD ENGINE OIL

Part No.	Mercury No.	Description	Case Qty.
18-9420-2	92-802833Q1	Quart (946ml)	12
18-9420-3	92-802835Q1	Gallon (3.785L)	6
18-9420-30	92-802835Q1	30 Gallon (113.6L)	—
18-9420-7	92-802836A1	55 Gallon (208L)	—

25W-40 FC-W 4-STROKE MARINE STERN DRIVE ENGINE OIL

25W-40 4-STROKE MARINE STERN DRIVE ENGINE OIL has been formulated to provide excellent lubrication and corrosion protection. Stern drive and inboard engines operate under high load and running stresses. This product is developed for the marine environment and will out perform standard 4-cycle automotive engine oils. Sierra's 25W-40 oil offers excellent detergency, anti-oxidants, antiwear, and corrosion protection. The benefits to your engine are reduced wear to the internal components, protection of internal parts from corrosion, cleaner pistons, and prevention of ring sticking. Excellent low temperature operating properties. Meets or exceeds quality performance API SJ, CF-4, CH-4. **Recommended for use in Mercruiser and OMC.**

- NMMA FC-W® Certified

25W40 FC-W 4-STROKE STERN DRIVE ENGINE OIL

Part No.	Mercruiser No.	Description	Case Qty.
18-9400-2	92-802837Q1	Quart (946ml)	12
18-9400-30		30 Gallon (113.6L)	
18-9400-4	92-857389A1	5 Quart (4.7 L)	4
18-9400-7	92-802841A1	55 Gallon (208L)	



10W40 FC-W SYNTHETIC BLEND ENGINE OIL

Full Synthetic Oil Approved for Year Round Use
 Developed for High Performing Engines
 Developed for excellent protection against severe wear at both high and low temperatures

FULL SYNTHETIC ENGINE OIL SAE 30

Part No.	Volvo No.	Description	Case Qty.
18-9559CAT-2	21681794	1 Quart (946ml)	12
18-9559CAT-3	21681795	5 Quarts (4.7L)	4
18-9559CAT-7	—	55 Gallon (208L)	

* Convenient 5 qt Container



25W40 FC-W SYNTHETIC BLEND ENGINE OIL

This 4-cycle oil is blended with premium grade synthetic and mineral based stock combined with superior designed additives formulated for the stress endured by sterndrive and inboard engines.

- Superior corrosion protection
- Advanced lubrication for reduction of wear to internal engine components.
- Outstanding friction reduction and wear protection.
- Removes thermal breakdown under high RPM's, extreme temperatures and loads.
- Extensively tested for outstanding performance.
- NMMA FC-W® Certified/API-SL.

25W40 FC-W SYNTHETIC BLEND MERCUISER STERNDRIVE ENGINE OIL

Part No.	Mercruiser No.	Description	Case Qty.
18-9440-2	92-883724K01	Quart (946ml)	12
18-9440-4	92-883725K01	5 Quart (4.7 L)	4
18-9440-7	92-858057K01	55 Gallon (208L)	



25W40 FC-W SYNTHETIC BLEND 4-STROKE OUTBOARD OIL

This oil is blended with premium grade synthetic and mineral based stock combined with superior designed additives formulated for the extreme rigors of the marine environment.

- Superior corrosion protection.
- Advanced lubrication for reduction of wear to internal engine components.
- Minimized piston ring deposits.
- Extensively tested for outstanding performance.
- NMMA FC-W® Certified/API-SL.

SYNTHETIC BLEND 4-STROKE OUTBOARD OIL 25W40

Part No.	Mercury No.	Description	Case Qty.
18-9440-3	92-883723K01	4 Liter (4.2224 qt.)	6
18-9440-8	92-883722K01	1 Liter (1.0556 qt.)	12



SAE 30 FULL SYNTHETIC MARINE ENGINE OIL

A special blend of synthetic base oil and a balanced additive system that exceeds the FC-W requirements for marine engine oil.

- Recommended for gasoline and diesel inboard and sterndrive engines.
- Superior engine protection during startups, operation and storage.
- Reduces friction and wear for extended engine life.
- Longer lubrication effectiveness than mineral oils.
- Reduces oil consumption and improves fuel economy.
- API-CF/SL.

FULL SYNTHETIC ENGINE OIL SAE 30

Part No.	Volvo No.	Description	Case Qty.
18-9410-2	3842343	1 Quart (946ml)	12
18-9410-4	3842344*	5 Quarts (4.7L)	4
18-9410-7	3858061	55 Gallon (208L)	

* Convenient 5 qt Container



SYNTHETIC OIL 10W30 FC-W

Formulated specifically for 4-stroke outboard and sterndrive engine technology. A special blend of synthetic base oil and a balanced additive system that exceeds the FC-W requirements for marine engine oils. Recommended for use in both outboard and sterndrive applications. Offers faster lubrication at start up in low temperatures, excellent protection at high temperatures, and greater resistance to oxidation for lower oil consumption.

- NMMA FC-W® Certified/API-SL.

10W30 SYNTHETIC MARINE ENGINE LUBRICANT

Part No.	Volvo No.	Description	Case Qty.
18-9690-2	—	1 Quart (946ml)	12
18-9690-3	—	1 Gallon	6

NMMA FC-W Certified for use in 4 stroke OB and stern drive applications



15W-40 HEAVY DUTY ENGINE OIL

This oil is specifically formulated for the heavy duty inboard marine market, including cruisers and towboats calling for a 15W-40.

- Meets API Service classification up to CK-4.
- Meets the performance specifications for API service classification SM.
- Premium base stocks and additive package ingredients places Sierra Heavy Duty at the leading edge of lubrication technology.
- Suitable for fuels on any sulfur level
- Not for use in gasoline engines equipped with catalytic converters.
- Replaces: Shell Rotella T4, Delo 400, MerCruiser, Indmar, Pleasurecraft, Crusader, Volvo Penta, MasterCraft



15W40 MULTI-VEHICLE ENGINE OIL

Part No.	Indmar No.	Description	Case Qty.
18-9553-2	872005	Quart (946ml)	12
18-9554-4	872006 (7QT)	5 Quart (4.7L)	4
18-9553-5	-	5 Gallon (18.95L)	
18-9554-7	-	55 Gallon (208L)	

5W-30 SEMI-SYNTHETIC ENGINE OIL

Our 5W-30 Semi-Synthetic is an ultra-high performance engine oil that utilizes premium base stocks and industry leading additives.

- Meets and or exceeds FC-W Catalyst and FC-W specifications
- Proprietary additive package
 - Enhanced detergent package to suspend and prevent sludge.
 - Reduces friction to maintain high performance
 - Prevents thermal and oxidation break down under extreme temperatures
 - High shear stability maintains viscosity to prevent excessive thinning in high performance applications
 - Advanced ZDDP additive technology prevents phosphorus depletion extending catalyst life while maintaining anti-wear protections.
- Meets or exceeds API SM category requirements
- Replaces: Honda, Indmar, Ilmor, PCM



5W-30 SEMI-SYNTHETIC FC-WCAT

Part No.	Indmar No.	Description	Case Qty.
18-9555-2	872003	Quart (946ml)	12
18-9555-4	872004 (7QT)	5 Quart (4.7L)	4
18-9555-7	-	55 Gallon (208L)	

5W-30 FULL SYNTHETIC ENGINE OIL

A full synthetic 5W-30 is an ultra-high engine performance oil that utilizes premium base stocks and industry leading additives.

- Meets and or exceeds FC-W Catalyst and FC-W specifications
- Proprietary additive package
 - Enhanced detergent package to suspend and prevent sludge.
 - Reduces friction to maintain high performance
 - Prevents thermal and oxidation break down under extreme temperatures
 - High shear stability maintains viscosity to prevent excessive thinning in high performance applications
 - Advanced ZDDP additive technology prevents phosphorus depletion extending catalyst life while maintaining anti-wear protections.
- Meets or exceeds API SM category requirements
- Replaces: Yamalube, MerCruiser, Indmar, Mobile 1, Ilmor, Indmar, PCM, MasterCraft



5W-30 FULL SYNTHETIC FC-WCAT

Part No.	Ilmor/MasterCraft	Description	Case Qty.
18-9558-2	550022689	Quart (946ml)	12
18-9558-4	550046126	5 Quart (4.7L)	4
18-9558-7	-	55 Gallon (208L)	

25W-40 CATALYST ENGINE OIL

These oils have been specifically designed to meet the unique requirements of modern 4-stroke recreational engines with or without emission catalyst systems.

- Approved for all 4-Stroke applications including Outboard, Sterndrive and Inboard. Exceeds all 4-Stroke requirements including FC-W and FC-W Cat Compatible.
- Formulated to offer maximum corrosion protection.
- Advanced lubrication for extended engine life and wear protection.
- Capitalizing “ZDDP” anti-wear additive technology to prevent phosphorus depletion and extend the emission catalyst life.
- NMMA FC-W® Certified.



25W40 CATALYST OIL			
Part No.	Mercury No.	Description	Case Qty.
18-9400CAT-2	92-8M0078627	1 Quart (946ml)	12
18-9400CAT-4	—	5 Quart (4.7 L)	4
18-9400CAT-7	92-8M0078621	55 Gallon (208L)	

10W-30 CATALYST ENGINE OIL

Our NMMA FC-W Catalyst Compatible Engine Oils have been specifically designed to meet the unique requirements of modern 4-stroke recreational engines with or without emission catalyst systems.

- Approved for all 4-Stroke applications including Outboard, Sterndrive and Inboard and exceeds all 4-Stroke requirements including FC-W and FC-W Cat Compatible.
- Provides superior corrosion protection under extreme conditions.
- Industry leading wear protection and deposit control.
- Capitalizing on “ZDDP” anti-wear additive technology to prevent phosphorus depletion and extend the emission catalyst life.
- NMMA FC-W® Certified



10W30 CATALYST OIL			
Part No.	Mercury No.	Description	Case Qty.
18-9420CAT-2	92-8M0078625	Quart (946ml)	12
18-9420CAT-3	92-8M0078626	Gallon	6
18-9420CAT-7	92-8M0078618	55 Gallon (208L)	

25W-40 SYNTHETIC CATALYST ENGINE OIL

A special blend specifically designed to meet the unique requirements of modern 4-stroke recreational engines with or without emission catalyst systems.

- Minimizes corrosion that is formed inside the engine.
- Displays enhanced detergent and dispersants properties to suspend and prevent engine sludge formation.
- Industry leading wear protection and deposit control.
- Prevents excessive thinning under extreme performance operations.
- Capitalizing on “ZDDP” anti-wear additive technology to prevent phosphorus depletion and extend the emission catalyst life.
- NMMA FC-W® Certified/API-SL.



25W40 SYNTHETIC CATALYST OIL			
Part No.	Mercury No.	Description	Case Qty.
18-9440CAT-2	92-8M0078629	Quart (946ml)	12
18-9440CAT-4	—	5 Quart (4.7 L)	4
18-9440CAT-7	92-8M0078624	55 Gallon (208L)	

SIERRA OIL CROSS-REFERENCE CHARTS

PREMIUM BLEND TC-W3

Part No.	Description
18-9500-1	Pint (12 per case) (473ml)
18-9500-1P	84 case pallet (Pt.) 12 per case
18-9500-2	Quart (12 per case) (946ml)
18-9500-3	Gallon (6 per case) (3.78L)
18-9500-3P	36 case pallet (Ga.)
18-9500-4	2.5 Gallon (2 per case) (9.46L)
18-9500-6	16 Gallons (60.57L)
18-9500-7	55 Gallons (208L)

DIRECT INJECTION, TC-W3

Part No.	Description	OE	OE No.
18-9530-3	Gallon (3.78L)	Mercury Optimax Yamaha HPDI BRP Ficht, DI E-TEC XD-50	92-858037K01 LUB-2STRK-M1-4 764354
18-9530-4	2.5 Gallon (2 per case) (9.46L)	Mercury Optimax Yamaha HPDI BRP Ficht, DI E-TEC XD-50	
18-9530-6	16 Gallon (61L)		
18-9530-7	55 Gallon Drum	Mercury Optimax Yamaha HPDI BRP Ficht, DI E-TEC XD-50	92-858039K01 LUB-2STRK-M1-55 777228

FULL SYNTHETIC TC-W3 2-STROKE OUTBOARD

Part No.	Description	OE	OE No.
18-9540-2	Quart (964ml)	BRP E-Tec/Universal E-TEC XD-100	—
18-9540-3	Gallon (3.78L)	BRP E-Tec/Universal E-TEC XD-100	764357
18-9540-7	55 Gal. Drum	BRP E-Tec/Universal E-TEC XD-100	777120

20W40 FC-W 4-STROKE MINERAL OUTBOARD OIL

Part No.	Yamaha No.	Description	Case Qty.
18-9450-2	LUB-20W40-FC-12	Quart (946ml)	12

25W-50 FC-W SEMI-SYNTHETIC OIL

Part No.	Mercury No.	Description	Case Qty.
18-9552-3	92-858084K01	4 Liter (4.2224 qt.)	6
18-9552-8	—	1 Liter (1.0556 qt.)	12

10W-40 FC-W SEMI-SYNTHETIC OIL

Part No.	Suzuki No.	Description	Case Qty.
18-9551-2	990C0-10W40-1QT	Quart (946ml)	12
18-9551-3	990C0-10W40-1GL	Gallon (3.785L)	6
18-9551-6		16 Gallon (61L)	
18-9551-7		55 Gallon (208L)	

15W-40 DIESEL ENGINE OIL

Part No.	Mercury No.	Volvo No.	Description	Case Qty.
18-9553-2	—	40005011	Quart (946ml)	12
18-9553-3	—	40005012	Gallon (3.785L)	6
18-9554-5	—	40005013	5 Gallon (18.95L)	

10W30 SYNTHETIC MARINE ENGINE LUBRICANT

Part No.	Volvo No.	Description	Case Qty.
18-9690-2	—	1 Quart (946ml)	12
18-9690-3	—	1 Gallon	6
NMMA FC-W Certified for use in 4 stroke OB and stern drive applications			

10W30 FC-W 4-STROKE OUTBOARD ENGINE OIL

Part No.	Mercury No.	Description	Case Qty.
18-9420-2	92-802833Q1	Quart (946ml)	12
18-9420-3	92-802835Q1	Gallon (3.785L)	6
18-9420-7	92-802836A1	55 Gallon (208L)	0

25W40 FC-W 4-STROKE STERN DRIVE ENGINE OIL

Part No.	Mercuriser No.	Description	Case Qty.
18-9400-2	92-802837Q1	Quart (946ml)	12
18-9400-30		30 Gallon (113.6L)	
18-9400-4	92-857389A1	5 Quart (4.7 L)	4
18-9400-7	92-802841A1	55 Gallon (208L)	

25W40 FC-W SYNTHETIC BLEND MERCURISER STERNDRIIVE OIL

Part No.	Mercuriser No.	Description	Case Qty.
18-9440-2	92-883724K01	Quart (946ml)	12
18-9440-4	92-883725K01	5 Quart (4.7 L)	4
18-9440-7	92-858057K01	55 Gallon (208L)	

FULL SYNTHETIC ENGINE OIL SAE 30

Part No.	Volvo No.	Description	Case Qty.
18-9410-2	3842343	1 Quart (946ml)	12
18-9410-4	3842344*	5 Quarts (4.7L)	4
18-9410-7	3858061	55 Gallon (208L)	
* Convenient 5 qt Container			

25W40 FC-W SYNTHETIC BLEND 4-STROKE OUTBOARD OIL

Part No.	Mercury No.	Description	Case Qty.
18-9440-3	92-883723K01	4 Liter (4.2224 qt.)	6
18-9440-8	92-883722K01	1 Liter (1.0556 qt.)	12

25W40 CATALYST OIL

Part No.	Mercury No.	Description	Case Qty.
18-9400CAT-2	92-8M0078627	1 Quart (946ml)	12
18-9400CAT-4	—	5 Quart (4.7 L)	4
18-9400CAT-7	92-8M0078621	55 Gallon (208L)	

10W30 CATALYST OIL

Part No.	Mercury No.	Description	Case Qty.
18-9420CAT-2	92-8M0078625	Quart (946ml)	12
18-9420CAT-3	92-8M0078626	Gallon	6
18-9420CAT-7	92-8M0078618	55 Gallon (208L)	

25W40 SYNTHETIC CATALYST OIL

Part No.	Mercury No.	Description	Case Qty.
18-9440CAT-2	92-8M0078629	Quart (946ml)	12
18-9440CAT-4	—	5 Quart (4.7 L)	4
18-9440CAT-7	92-8M0078624	55 Gallon (208L)	

SIZE	CASES PER PALLET
Quart	84
Gallon	36
5 Quart	36

10W-40 FULL SYNTHETIC ATV/UTV ENGINE OIL

- Off Road Formulation- Suitable for ATV, UTV, & Dirt Bike Applications
- Meets API SM & JASO MA Specifications
- Designed for use in wet clutch applications
- Designed for use in liquid & air cooled engines
- Formulated with premium performance additives to prevent rusting prevalent in recreation due to their seasonal use
- Provides exceptional wear protection and deposit control for engine longevity

10W40 FULL SYNTHETIC ATV/UTV ENGINE OIL

Part No.	OE CROSS	Description	Case Qty.
72-5100-2	Arctic Cat 0436-880 Honda HP4 Yamaha Yamalube Performance All Purpose 10w40	1 Quart (946ml)	12
72-5100-3	Arctic Cat 0436-879	1 Gallon (3.785L)	6
72-5100-7	—	55 Gallon drum (208L)	



0W-40 FULL SYNTHETIC ATV/UTV ENGINE OIL

- Off Road Formulation- Suitable for ATV, UTV, & Dirt Bike Applications
- To be used in extreme cold environments
- Meets API SM & JASO MA Specifications
- Designed for use in wet clutch applications
- Designed for use in liquid & air cooled engines
- Formulated with premium performance additives to prevent rusting prevalent in recreation vehicles due to their seasonal use
- Exceptional wear protection and deposit control for engine longevity

0W40 FULL SYNTHETIC ATV/UTV ENGINE OIL

Part No.	OE CROSS	Description	Case Qty.
72-5101-2	Arctic Cat 1436-434 Can-Am XPS 779139	1 Quart (946ml)	12
72-5101-3	Arctic Cat 1436-435 Can-Am #779140	1 Gallon (3.785L)	6
72-5101-7	—	55 Gallon drum (208L)	



2-STROKE FULL SYNTHETIC ENGINE OIL MULTI-PURPOSE

- 2-Stroke Full Synthetic Oil with Ester Technology
- Designed for use in direct inject & pre-mix applications
- Multi-Use for many markets: ATV, UTV, PWC, Snowmobile, & Small Engines
- Meets JASO FD, ISO-L-EGD, & API TC 2-stroke performance standards

2-STROKE FULL SYNTHETIC MULTI-PURPOSE ENGINE OIL

Part No.	OE CROSS	Description	Case Qty.
72-5103-2	Arctic Cat 4639-349 Honda HP2 Yamaha Yamalube All Performance Two Stroke Ski-Doo XPS 779126 Polaris VES Kawasaki K61021-208A	1 Quart (946ml)	12
72-5103-3	Arctic Cat 5639-469 Honda HP2 Yamaha Yamalube All Performance Two Stroke Ski-Doo 779127 Polaris VES	1 Gallon (3.785L)	6
72-5103-4	Honda HP2 Yamaha Yamalube All Performance Two Stroke Polaris VES	5 Gallon (18.95L)	
72-5103-5	Honda HP2, Polaris VES	16 Gallon (61L)	
72-5103-7	Honda HP2, Polaris VES	55 Gallon drum (208L)	



80W-90 SEMI-SYNTHETIC HYPOID GEAR OIL

- To be used in front/rear differentials
- Suitable for use in applications calling for an API GL-5 gear oil
- Formulated with premium performance additives that provide extreme pressure protection, anti-weld, anti-scuff and anti-wear properties



80W90 SEMI-SYNTHETIC HYPOID GEAR OIL

Part No.	OE CROSS	Description	Case Qty.
72-5102-2	Arctic Cat 1436-159 Honda 08208-0080 Polaris Angle Drive Fluid	1 Quart (946ml)	12
72-5102-4	Arctic Cat 0436-901 Polaris Angle Drive Fluid	5 Gallon (18.95L)	
72-5102-5	Polaris Angle Drive Fluid	16 Gallon (61L)	
72-5102-7	Polaris Angle Drive Fluid	55 Gallon drum (208L)	

5W-50 FULL SYNTHETIC ENGINE OIL

- 5W-50 Full Synthetic Engine Oil
- Off Road Formulation- Suitable for ATV, UTV, & Dirt Bike Applications
- To be used in extreme cold environments
- Meets API SM & JASO MA Specifications
- Designed for use in wet clutch applications
- Designed for use in liquid & air cooled engines
- Formulated with premium performance additives to prevent rusting prevalent in recreation vehicles due to their seasonal use
- Exceptional wear protection and deposit control for engine longevity



5W50 FULL SYNTHETIC ENGINE OIL

Part No.	OE CROSS	Description	Case Qty.
72-5104-2	Polaris PS-4	1 Quart (946ml)	12
72-5104-3	Polaris PS-4	1 Gallon (3.785L)	6

FOAM FILTER OIL

- Foam Filter Oil
- Dyed red for easy detecting during application
- Increases surface area of foam filter to trap small particles extending engine life
- Waterproof formula



FOAM FILTER OIL

Part No.	OE CROSS	Description	Case Qty.
72-5105-2	—	1 Quart (946ml)	12
72-5105-3	—	1 gallon (3.785L)	6
72-5105-7	—	55 gallon drum (208L)	

POWERSPORTS OIL FULL PRODUCT LISTING

P/N	Description	P/N	Description
72-5100-2	10W-40 Full Synthetic High Performance Engine Oil - QT	72-5103-3	2 Stroke Full Synthetic High Performance Engine Oil - GAL
72-5100-3	10W-40 Full Synthetic High Performance Engine Oil - GAL	72-5103-4	2 Stroke Full Synthetic High Performance Engine Oil - 5 GAL
72-5100-7	10W-40 Full Synthetic High Performance Engine Oil 55 - GAL	72-5103-5	2 Stroke Full Synthetic High Performance Engine Oil - 16 GAL
72-5101-2	0W-40 Full Synthetic High Performance Engine Oil - QT	72-5103-7	2 Stroke Full Synthetic High Performance Engine Oil - 55 GAL
72-5101-3	0W-40 Full Synthetic High Performance Engine Oil - GAL	72-5104-2	5W-50 Full Synthetic High Performance Engine Oil - QT
72-5101-7	0W-40 Full Synthetic High Performance Engine Oil - 55 GAL	72-5104-3	5W-50 Full Synthetic High Performance Engine Oil - GAL
72-5102-2	80W-90 Semi Synthetic High Performance Hypoid Gear Oil - QT	72-5105-2	Foam Filter Oil - QT
72-5102-4	80W-90 Semi Synthetic High Performance Hypoid Gear Oil - 5 GAL	72-5105-3	Foam Filter Oil - GAL
72-5102-5	80W-90 Semi Synthetic High Performance Hypoid Gear Oil - 16 GAL	72-5105-7	Foam Filter Oil - 55 GAL
72-5102-7	80W-90 Semi Synthetic High Performance Hypoid Gear Oil - 55 GAL		
72-5103-2	2 Stroke Full Synthetic High Performance Engine Oil - QT		

EXTENDED LIFE COOLANT / ANTIFREEZE

Our Premium Blend Extended Life formula provides year-round protection against freezing and boil-over in all water-cooled engines. Protects for 2,500 hours or 5 years. Hybrid, nitrated HOAT/NOAT formula with ethylene glycol base is compatible with all other coolants.

The 50/50 is pre-mixed with deionized water; not intended to be diluted. This formula provides excellent metal protection and cavitation protection capabilities. Product color is clear red/orange.

EXTENDED LIFE COOLANT / ANTIFREEZE

Part No.	Mercury No.	Description
18-9305	92-877770K1	55 Gallon (208L), 50/50 Pre-mixed



HEAVY DUTY EXTENDED LIFE COOLANT / ANTIFREEZE

The Heavy Duty Extended Life formula provides year-round protection against freezing and boil-over in all diesel engines. Protects for 15,000 hours or 7 years. Poly organic POAT formula with ethylene glycol base is compatible with all other coolants.

The 50/50 is pre-mixed with deionized water; not intended to be diluted. Provides excellent metal protection and cavitation protection capabilities. Product color is yellow.

HEAVY DUTY EXTENDED LIFE COOLANT / ANTIFREEZE

Part No.	Mercury No.	Description
18-9350	—	1 Gallon (3.78L), Full Strength



GEAR LUBE



SYNTHETIC GEAR LUBE

Specifically formulated to optimize gear life by reducing friction and providing superior wear protection in severe operating conditions. The unique synthetic formulation is shear stable and resists oxidation to ensure high performance over a wide range of ambient operating temperatures.

• API GL-5/MIL-L-210E • Weight: 75W-90 • Color: Gold

Part No.	Volvo No.	Description	Case Qty.
18-9680-2	1141679	1 Quart (946ml)	12
18-9680-5	1141681	5 Gallon	
18-9680-7	1141682	55 Gallon	

SIERRA HI-PERFORMANCE “SYNTHETIC BLEND” LOWER UNIT GEAR LUBE



- Synthetic blended marine formulation reduces operating friction for increased performance and protection of gears, bearings and other gear case components.
- Recommended for use in high performance and high load operating conditions in both outboard and I/O lower units.
- Sierra Hi-Performance gear lube has been designed to surpass the performance of the O.E. Hi-Performance gear lubricants . . . for the finest product available demand Sierra Hi-Performance gear lube.
- Recommended for engines 75 HP and above.
- GL-5 Rated
- Color: Blue-Green
- Weight: 80W-90

Replaces: Mercury (Quicksilver) Hi-Performance Blend
 OMC (System Matched) Ultra-HPF Blend
 Yamaha (Yamalube) LUB-GEARL-11-00

Part No.	Description
18-9650-0	10 Oz. Tube (12 per case) (283.5g)
18-9650-2	Quart (12 per case) (946ml) • Replaces: Mercury 92-858064Q01
18-9650-5	5 Gallons (18.95L) • Replaces: Mercury 92-858008Q01
18-9650-6	16 Gallon (61L) • Replaces: Mercury 92-858067Q01
18-9650-6P	9 - 16 Gallon container pallet
18-9650-7	55 Gallons (208L) • Replaces: Mercury 92-858068Q01

SIERRA TYPE “C” GEAR LUBE

- Formulated for older model outboards and I/O's equipped with electric shift.
- Reduces friction and protects gears, bearings and other gearcase components.
- Weight: 75W

Replaces: OMC (System Matched) Premium Blend

Part No.	Description
18-9620-2	Quart (12 per case) (946ml)



SIERRA PREMIUM LOWER UNIT GEAR LUBE

- Recommended for all general marine applications requiring a GL-5 class lubricant.
- Ideal for replacing all old hypoid 90 application needs.
- Formulated for use in freshwater or saltwater conditions and all standard marine applications.
- Reduces friction and protects gears, bearings and other gearcase components.
- Recommended for engines under 75 HP.
- Color: Amber • Weight: 80W-90

Replaces: Mercury (Quicksilver) Premium Blend
 OMC (System Matched) Hi-Vis Lubricant
 Yamaha (Yamalube) LUB-GEARL-11-04

Part No.	Description
18-9600-0	10 Oz. Tube (12 per case) (283.5g) • Replaces: Mercury 92-802844Q02
18-9600-9	Kit Contains: (1) 18-9786 & (2) 18-9600-0
18-9600-2	Quart (12 per case) (946ml) • Replaces: Mercury 92-858058Q01
18-9600-7	55 Gallons (208L) • Replaces: Mercury 92-858062Q01



18-9600-9 GEAR LUBE KIT

Contains:

Part No.	Description	Qty.
18-9786	Lower Unit Fill Tube	1
18-9600-0	10 oz. Tube Lower Unit Gear Lube	2

• Color: Amber • Weight: 80W-90



18-9650-2QP HIGH PERFORMANCE GEAR LUBRICANT PUMP KIT

Retail space can be tight at times. Sierra has a perfect solution when it comes to gear lubricants. Introducing our new High-Performance Gear Lube Kit. This complete retail kit includes one quart of 18-9650-2 synthetic blend gear oil, oil pump, and three attachments to fit most outboard and sterndrive applications. What's more is the pump will fit most quart bottles with a small mouth, like you would use anything but Sierra Oils and Lubricants!
 Replaces: Mercury 91-8M0101435

ENGINE CARE PRODUCTS

SIERRA PRO PERFORMANCE GREASE

- Specifically formulated for marine applications
- Premium lithium formulation for optimum corrosion protection in freshwater and saltwater applications
- Ideal for marine trailer wheel bearing, universal joints, outdrive pivot joints, gimbal bearings and shaft splines
- Operating Temp: -40°F - 350°F

Part No.	Mercury No.	Description
18-9200-0	92-8M0071838	8 Oz. Tube (226.8g) (Case of 12)
18-9200-1	92-8M0071841	15 Oz. Cartridge (425.2g) (Case of 10)
18-9200-2*	92-8M0071837	3 Oz. (85.05g) Cartridge (Pkg. of 2)
18-9200-4*	92-8M0071837	3 Oz. (85.05g) Cartridge (Pkg. of 4)

*Display Packaged



SIERRA HYDRO DEFENSE MARINE GREASE

18-9240-1
(14oz Cartridge)

Replaces:
Mercury 92-802863A1

- Prohibits rust and corrosion.
- Prevents wear against the most extreme friction in marine applications.
- Will not break down in marine conditions.
- Contains PTFE for minimum wear and added friction protection.
- For use on prop shafts, trailer bearings, throttle and shift cables and linkage, swivel pins and more!



OIL DRAIN KITS



For easy installation this kit includes:

- 42" hose with hose hanger
- Universal oil pan replacement plug
- End cap

Note: Does not fit late model oil pan utilizing metric threads M12- 1.75

- Makes changing your oil a snap and without the mess!
- Permanently mounts to bottom of oil pan to make changing oil more convenient.
- Drains 4 quarts of oil in less than 15 minutes without a pump.
- Fittings on hose machined from corrosion resistant brass.
- Assembly sized to pass through most common hull drains.

Part No.	Description	Application
18-7891	For: GM, Chrysler & Most Ford	Oil Pans 1/2" — 20 Threads



18-7894 OIL DRAIN ADAPTER

Machined from corrosion resistant brass.

For: Mercruiser 224 CID (3.7L) Engines
1/4" - 18 NPT Threads
Remove adapter from 18-7891 & replace



18-2446 FILL/DRAIN KIT – OUTBOARD

• 3/8" - 16 thread
Fits: Johnson/Evinrude & Mercury Gearcase



18-2447 FILL/DRAIN KIT – STERN DRIVE

• 3/8" - 16 thread
Fits: Stern Drive Gearcase, Mercruiser, OMC & Volvo Penta SX & DP



18-2448 LOWER UNIT FILL/DRAIN KIT

• M8 - 1.25 thread
Fits: Yamaha, Nissan/Tohatsu, & Honda Lower Units



OIL CHANGE KITS

Having all of the right parts to get a job done can be a pain. Sierra has taken the guess work out with our Oil Change Kits. Featuring our industry leading NMMA certified oils and oil filters Sierra Oil Change Kits are packed with all the necessary items to complete your engines maintenance routine. Additionally, each kit includes a disposable funnel, shop rag, drain case seal (if applicable), and a service reminder decal to place on or near the engine. Convenience and ease of use in one package. Sierra Oil Change Kits, largest selection on the market and ready for you.

Part No.	Application	Oil	Oil Qty	Oil Filter	Crankcase Gasket
18-9217	Yamaha F225 to F300 4.2L All Years	18-9420	7	18-7954	Yes
18-9221	Mercury 4-Stroke, 4-Cylinder Outboard Engines	10W-30 FC-W Catalyst	7	18-7758	Yes
18-9222	Mercury Verado® Engines	18-9400CAT	7	18-7758	Yes
18-9223	Mercury 200-400R Verado® Outboard Engines	25W-40 FC-W Syn. Blend Catalyst	8	18-7918	-
18-9224	Volvo Penta: 4.3L, 5.0L, 5.7L, and 8.1L Engines	18-9559CAT	5	18-7989	-
18-9225	Volvo Penta: 4.3L, 5.0L, 5.7L, 7.4L and 8.1L Engines	18-9559CAT	5	18-7876-1	-
18-9226	Suzuki DF150-DF350 Outboard Engines	18-9551	8	18-7905-1	-
18-9227	Suzuki DF25-60A Outboard Engines	18-9551	4	18-7915-1	-
18-9228	Mercury 25W-40 25-30 HP Oil Change Kit	25W-40 FC-W Catalyst	2	18-7913	Yes
18-9229	Mercury 25W40 1.7L 75-115HP EFI NEW	25W-40 FC-W Catalyst	5	18-7758	Yes
18-9230	Mercury 10W30 1.7L 175-225HP 3.4L V6 & 250-300HP 4.6L V8 NEW	10W-30 FC-W Catalyst	5	18-8703	Yes
18-9231	Suzuki DF70A-140A All Years/Models	10W-40 FC-W Syn Blend	6	18-7905-1	Yes
18-9232	Sterndrive Oil Change Kit - Fits Mercury/Mercruiser V6 GM Short block	25W-40 FC-W Syn. Blend Catalyst	5	118-7879-1	-
18-9233	Sterndrive Oil Change Kit - Fits Mercury, Mercruiser, Force or Mariner sterndrive applications	25W-40 FC-W Syn. Blend Catalyst	6	118-7824-2	-
18-9234	Sterndrive Oil Change Kit - Fits Mercury/Mercruiser 4.3L GM Short block w/o Remote Oil NEW	25W-40 FC-W Syn. Blend Catalyst	5	118-7879-1	-
18-9235	Sterndrive Oil Change Kit - Fits Mercury/Mercruiser Inline 4 and 6 cyl/5.0L, 6.2L V8 small block/ V6 w/Remote Oil NEW	25W-40 FC-W Syn. Blend Catalyst	6	118-7824-2	-
18-9394	Yamaha F75-F115 Engines; Warm Temp App	20W-40 FC-W	4	18-7911-1	Yes
18-9395	Yamaha F150-F200 Engines; Warm Temp App	20W-40 FC-W	5	18-7906-2	Yes
18-9396	Yamaha F200-F250 Engines; Warm Temp App	20W-40 FC-W	6	18-7911-1	Yes
18-9397	Yamaha Engines F30-F70; Warm Temp App	20W-40 FC-W	3	18-8700	-
18-9399	Yamaha VF200, VF225, VF250 All Years	5W-30 FC-W Syn. Blend	8	18-7954	Yes
18-9390	Yamaha F30, F40, F50, F60, F70, T50 and T60 All Years	10W-30 FC-W	3	18-7911-1	Yes
18-9391	Yamaha F75, F80, F90, F100 and F115 All Years	10W-30 FC-W	5	18-7906-2	Yes
18-9392	Yamaha F150 All Years	10W-30 FC-W	5	18-7906-2	Yes
18-9393	Yamaha F200, F225, and F250 3.3L All Years	10W-30 FC-W	6	18-7906-2	Yes
18-9392	Yamaha F150 (2004 & Up)	10W-30 FC-W	5	18-7906-2	Yes
18-9393	F200 (2002 & Up) F225(2002 & Up), F225 Sport (2008), F250A (2005 & Up), F250B (2005 & Up)	10W-30 FC-W	7	18-7906-2	Yes
18-9390	F30(2001-06), F40 (1999-08), F40A(2009 & Up), F50(1995 & Up) T50(1996 & Up) F60(2002 & Up), T60(2003 & Up), F70(2010 & Up)	10W-30 FC-W	3	18-7911-1	Yes
18-9391	F75(2003 & Up), F80(1999-02), F90(2003 & Up), F115(2000 & Up)	10W-30 FC-W	5	18-7911-1	Yes



18-0003
DISPOSABLE FUNNEL
 Disposable and Environmentally Friendly Oil Funnel for use in ANY/ALL marine engine applications
Replaces: ACC-FLDFU-NN-EL



18-0038
OIL DRIP TRAY
 Molded plastic oil drip tray to capture oil filter for seamless & Clean removal; Exact OE specification to meet/exceed OE quality & fitment; back by Sierra's industry leading lifetime warranty.
Replaces: 8M0052100



FUEL STABILIZER
18-9080
 Universal (1 gal. • 6 per case)
 • Promotes quick starting.
 • Keeps carburetor and fuel system clean.
 • Reduces gum and varnish build up.
 • Improves engine performance.
 • Stabilizes gasoline without ethanol up to 24 months.⓪
 • 1/4 oz. per gallon for everyday use or 1/2 oz. for storage.
Replaces: Mercury 92-817529A12, 92-78383A12
 OMC 174275, 175068, 775613
 ⓪ Stabilization for gasoline containing ethanol will vary.

FOGGING OIL

18-9550-0
 (12 OZ. / 340g)
 (12 per case)

18-9550-3
 (1 Gallon / 3.78L)
 (6 per case)

- Protects internal engine components from rust and corrosion.
- Specifically formulated for seasonal storage of outboard and sterndrive engines.
- Ideal for all 2-cycle and 4-cycle engines.
- Sierra engine storage oil provides a protective chemical film over surface without leaving a greasy residue or a smoky discharge.



EGUARD — ETHANOL TREATMENT

- Stabilizes E10 gasoline for up to 12 months.
- Prevents fuel system corrosion from water attracted by E10 fuels.
- Cleans fuel system and improves performance.
- Contains a non-alcohol water remover that helps to reduce the chance of phase separation.
- Bottled in easy to use precision measuring pkg.
- Safe for use in all gasoline powered engines including generators and outdoor power equipment.
- Safe for use in both 2-cycle and 4-cycle engines.
- Prevents gum and varnish formation for optimum performance and quick starts.
- Mix Ratio: 1oz per 10gal.

18-9775
 8 oz.

18-9776
 1 quart

18-9777
 1 gallon



18-9493
eGUARD COUNTER DISPLAY
 • Double sided header provides specific information for "In-Season" and "Off-Season" use.
 • Compact, saves counter space.
 • Holds twelve 8oz. bottles



18-79816
FUEL TESTER
Replaces: Mercury 91-879172T28
 • Tests quality of fuel by measuring alcohol content.
18-79816-24
FUEL TESTER (Display Pack of 24)



18-9751-2
POWER TRIM & STEERING FLUID
 1 QT. (946 mL)

18-9702-2
SYNTHETIC POWER STEERING FLUID
 Formulated for Mercury outboard Power Steering Systems Superior protection against rust and corrosion. Resists oxidation for longer life. Engineered superior performance at low temperatures. Fluid Formulated to readily mix with the fluid already in your tank.
Replaces: Mercury 858077K01



18-9701-2
SYNTHETIC POWER STEERING AND TRIM FLUID
 Formulated for Volvo Penta Hydraulic Steering and Power Trim Systems. Superior protection against rust and corrosion. Resists oxidation for longer life. Engineered superior performance at low temperatures
Replaces: Volvo Penta 3851039



18-9750-0
POWER TRIM & TILT FLUID
 10 Oz. (283.5g)

- Formulated for high operating pressure
- Anti-foam additives assure uniform flow with reduced air contamination in hydraulic systems
- Designed for heavy duty use at high operating pressures in applications subject to varied temperature ranges
- Provides proper lubrication and corrosion protection for internal hydraulic components



- 18-9570-0**
CARBON FREE AEROSOL
 12 oz. Aerosol (340g)
- Specially designed to improve engine performance and efficiency.
- Thoroughly removes gum, varnish and carbon deposits
 - Cleans intake ports, valves, pistons and combustion chambers
 - Frees sticky rings
 - Designed for regular maintenance of 2 and 4-cycle engines



18-9580-3
COMBUSTION CLEAN
 12 oz. (340g)

- Formulated to improve engine performance and efficiency.
- Dissolves gum and varnish from fuel system
 - Removes internal carbon deposits
 - Frees sticky rings
 - Displaces moisture
 - Stabilizes fuel during storage
 - Designed for use in 2 and 4-cycle marine engines



18-8600
E-GO! FUEL INJECTION CLEANING KIT
 For: Mercury, Honda, Yamaha

- Cleans away layers of fuel deposits when the engine is running.
- Helps maintain injector's cleanliness and performance throughout the life of your engine.
- For best results, use E-GO! Blast Fuel Injector Cleaner (18-8606).

- Contains:**
- Cleaning System Container **18-8601**
 - Hose **18-8602**
 - Small Fitting **18-8603**
 - Large Fitting **18-8604**
 - Carrying Case **18-8605**



18-8608
E-GO FLEXIBLE NOZZLE SUPPORT
 Support for Throttle Body Adaptor



18-8609
E-GO! THROTTLE BODY ADAPTER
 Fits: All engines with Throttle body fuel supply



18-8610
E-GO! ADAPTER
 Fits: All Yamaha EFI

18-8606
E-GO! BLAST FUEL INJECTOR CLEANER
 Replaces: Mercury 92-8M0062765
 For: Mercury, Yamaha, Honda

- Cleans all fuel injector types
- Prevents rough idling and stalling
- Reduces intake and port deposits
- Maximizes fuel economy

Use with 18-8600 Fuel Injector Cleaning Kit
 * Labeled for US/Canada sales ONLY



18-8607
E-GO! BOOST FUEL SYSTEM BOOSTER

- For: Mercury, Yamaha, Honda
- Cleans entire fuel system
 - Cleans all fuel injector types
 - Prevents rough idling and stalling
 - Stabilizes fuel during storage
 - Maximizes fuel economy
 - Easy! Just pour and go

* Labeled for US domestic sales ONLY



SANITATION SYSTEM CLEANER

18-9093 (1 Gal.)
(Ready-To-Use)

18-9095 (1 Gal.)
(Concentrate)

- Removes uric scale, calcium carbonate and other solids
- Safe for all sanitation system components
- USDA certified bio based product
 - Non-toxic, Biodegradable, Non-hazardous



18-9730-1
LITHIUM SPRAY GREASE (WHITE)
 12 Oz. (340g)

- Multi-purpose spray lubricant for Marine applications
- Ideal for lubricating shift components and miscellaneous applications where a light grease lubricant is required
- Water and heat resistant
- Prevents corrosion



LQ-5 FILTERED LUBRICANT

18-9182 8.5 FL. OZ
18-9183 16 FL. OZ



2-STROKE OIL MIXING BOTTLE

18-9798
 32 FL. OZ bottle
 Re-usable bottle for precise measuring of oil to fuel ratio for your engine.





18-9884
BOWL WRENCH

Replaces: Racor RK22628
Fits: Sierra, Racor and other aftermarket filter bowls



18-52207
TUBE KIT

Replacement tubes for oil extractors
18-52204 and **18-52104**.



18-9780
FLEX FILL SPOUT

Pouring device for quart bottles

18-52205
FLUID DISPENSER
For easily dispensing fluids for any application.

- Large 1.2 gallon capacity
- Sealed internal pump components
- Flow control valve equipped
- Quick connect fittings
- 20PSI Max Pressure
- Includes pressure gauge
- Integrated pressure relief valve



18-52206
FLUID DISPENSER/EXTRACTOR
For removing/dispersing fluid in difficult to reach areas.

- No-drip cap
- 7 oz. capacity
- 7 1/2" flexible tube

18-52204
OIL EXTRACTOR

For Quick, Easy & Clean Oil Changes

- Large 8.8 Liter (2.3 Gallon) capacity not only can extract fluids, but is capable of dispensing too! Simply move the bi-directional valve and this unit will create a vacuum or move the valve the other direction and it creates pressure to dispense the fluid.
- Built-in shut-off valve to prevent overfilling
- Comes complete with 5 feet of flexible hose and two rigid dipstick tubes.



18-52104
OIL EXTRACTOR

For Quick, Easy & Clean Oil Changes

- This 8.8 Liter (2.3 Gallon) capacity air operated extractor can be used to remove a wide range of fluids, such as engine oil, brake fluid, antifreeze and more
- Built-in shut-off valve to prevent overfilling
- This unit can be used away from the air source by creating a vacuum, closing off both shut-off valves, then take to where it's needed
- Comes complete with 5 feet of flexible hose, two rigid dipstick tubes, and a brake bleeding kit



OIL FILTER WRENCHES



18-9778
Size: 2-7/16" thru 3"
Fits small outboard filters

18-9789
Size: 2-9/16" thru 3-1/4"

18-9790
Size: 3-5/16" thru 3-3/4"



OIL ABSORBENT PADS
Oil Zap II Absorbent & Disposable
18-81103 (150 pad Shop Pack)



18-9779
GEAR LUBE PUMP
Universal Gear Lube Pump for use with standard or wide mouth bottles.
Includes adapters for all major outboard engine manufacturers.
Premium construction with aluminum fittings for long life.



18-9781
OIL PUMP
Replaces: Mercury 91-850730Q01, 91-8M0072133
• Ideal for "do-it-yourself" owners
• Quart size application is perfect for most marine drives
• Includes lube fitting for domestic lower units with flexible fill line



LOWER UNIT FILL TUBE
18-9786 (Standard) **18-9787** (Import)
• Flush & fill tool for small gearcases requiring the 10 ounce tube package
• Ideal for "do-it-yourself" in home maintenance
• Includes appropriate lower unit fitting for specific applications



18-9898
HOSE PINCH-OFF PLIERS
Use to pinch off rubber hoses up to 1 1/2" OD



18-9794
GEAR LUBE ADAPTER
Replaces: Mercury 91-883704Q03
For: Nissan, Yamaha, Honda, Tohatsu
For use with Sierra quart pumps or lower unit fill tubes.
Metric 8-1.25 thread



18-9795
GEAR LUBE ADAPTER
 For: Suzuki lower unit
 For use with Sierra quart pumps or lower unit fill tubes.
 Metric 10-1.25 thread



18-81006
GREASE FILLER ADAPTER
 Fits: OMC and Volvo Dual Prop



18-9788
LUBE PUMP
5 Gallon (18.95L)
 For filling lower units on outboards and stern drives.
 Tapered/unthreaded hose end.
 Designed for use with our 18-9600-5, 18-9620-5 and 18-9650-5



GREASE GUNS
18-9782-1 18-9783*
 (14 Oz.) (3 Oz.)
Replaces:
 Mercury 91-74057Q6
 Heavy duty all steel construction for dependable, long service life.
 * Display Packaged



18-9784
BARREL PUMP
 For: 16 thru 55 gallon drum



18-9804
GREASE GUN FLEX HOSE

- Designed for hand operated or pneumatic grease guns
- Ideal for hard to reach grease fittings
- 12 inch length
- Heavy duty with flex hose



18-9785
EASY LUBE
Replaces:
 Mercury 91-30500

- Ideal for quick and easy lube jobs using squeeze tubes
- Compact size, perfect for under seat and tackle box storage
- Use with all 10 oz. grease tubes

33%
 more than
OEM



18-9031-1
BELLOWS ADHESIVE
 Securely seals ALL Universal and Exhaust Bellows to provide maximum coverage across OEMs. Oil, Gasoline, Water and Grease Resistant for Premier Application and Hold
 Replaces: Mercury 92-86166Q1



18-9066
LOCTITE® THREADLOCKER
 Medium Strength
 Color: Blue Gel



37701
THREADLOCKER
 High Strength



22355
ODC FREE CLEANER
 12 oz.
Replaces: OMC 390905
 Color: Clear
APPLICATION:
 Clean parts before reassembly. Removes dirt, oil and solvent. Leaves no residue. Solvent is non-flammable and low-toxicity. Cold degreaser.



18-0116
GASKET MATERIAL
 Synthaseal non-asbestos:
 Excellent oil resistance: Designed to seal rough surfaces: Will withstand 350° F.



18-9125
OETIKER CLAMP KIT
 Replaces: Johnson Evinrude 787133, 787145

Part #	Qty.	Johnson/Evinrude #	Oetiker #	Description	
18-9141	1	787145	14100082	Oetiker Jaw Pincers	
Part #	Qty.	Johnson/Evinrude #	Oetiker #	Nominal ID	
				Inches	mm
18-9126-9	10	346930	16700004	3/8"	9.5
18-9127-9	10	348838	16700006	13/32"	10.5
18-9128-9	10	349516	16700007	7/16"	11.3
18-9129-9	10	347107	16700010	1/2"	13.3
18-9130-9	10	347108	16700011	17/32"	13.8
18-9131-9	10	346931	16700012	35/64"	14
18-9132-9	10	346785	16700013	9/16"	14.5
18-9133-9	10	346786	16700016	5/8"	15.7
18-9134-9	10	348839	16700017	11/16"	17
18-9135-9	10	346151	16700024	13/16"	21
18-9136-9	10	346152	16700031	1"	25.6
18-9137-9	10	346153	16700037	1 3/16"	30.1
18-9138-9	10	349759	16700040	1 1/4"	31.6
18-9139-9	10	349729	16700053	1 5/8"	41
18-9140-9	10	346150	16700020	23/32"	18.5

All clamps are standard package of 10. Each package of 10 is available individually.

18-9145
OETIKER CLAMP KIT
 Replaces: Yamaha YB-6AW04-A, Mercruiser 91-803146A2

Part #	Qty.	Yamaha #	Oetiker #	Description
18-9141	1	YB-6AW04-4	14100082	Oetiker Jaw Pincers

Part #	Qty.	Yamaha #	Oetiker #	Nominal ID	
				Inches	mm
18-9133-9	50	YB-6AW04-1	16700016	5/8"	15.7
18-9146-9	50	YB-6AW04-3	16702498	25/32"	19.8

All clamps are standard package of 10. Each Package of 10 is available individually.

18-2455
DRAIN PLUG GASKET ASSORTMENT
 Fits: Multiple Manufacturers & Most Drives
 Contains 50 each of 18-4698, 18-4253, 18-2945, 18-4248, 18-8331, 18-60103

18-8997
DUAL FEED FLUSH - ROUND CUPS
 Universal
 Fits most engines up to 115 H.P.

18-8998-1
ENGINE FLUSHER RECTANGULAR CUPS
 Universal
 Fits most engines 120 H.P. and UP

18-8999
DUAL FEED FLUSH - RECTANGULAR CUPS
 Universal
 Fits most engines 120 H.P. and UP

18-9009
INBOARD FLUSHER
 Universal
 Fits most inboard engines

18-9010
MOTOR FLUSHER
 (Heavy Duty)
 • High quality EPDM rubber cups
 • Corrosion resistant dicromate finish
 • Installs in seconds
 • Use with a standard garden hose
 • Hose connector complete with rubber washer
 • No tools required
 Flushes cooling system of salts and sediments and allows engine to idle for tuning and engine adjustment in your own driveway. Simply slip attachment over the engine's side water intakes. Coated spring steel arms clamp suction cup securely over the engine's side water intakes.

18-9895
DUAL WATER PICKUP SEAL
 Replaces: Mercury/Evinrude 881150K1
 Fits: Mercury and E-Tec Engine with Nose Cone Dual Water Pickup.

NAUTALIFT™ GAS LIFT SUPPORTS AND ACCESSORIES

MARINE GRADE GAS FILLED SUPPORTS



Features:

- Annealed steel rods, nitride coated for corrosion resistance
- Engineered polymer rod ends
- Composite bushings
- Internal lip seal
- Exact fit OEM replacement
- Updated Packaging

Part No.	OE No.	Extended Lgth (In.)	Compressed Lgth. (in.)	Rated (lbs.)	Part No.	OE No.	Extended Lgth (In.)	Compressed Lgth. (in.)	Rated (lbs.)
GS62600	GSNI-4900-20	7.5	5.5	20	GS62720	GSNI-5200-20	17	11	20
GS62610	GSNI-4900-40	7.5	5.5	40	GS62730	GSNI-5200-30	17	11	30
GS62620	GSNI-4900-80	7.5	5.5	80	GS62740	GSNI-5200-40	17	11	40
GS62630	GSNI-5000-20	10	7	20	GS62750	GSNI-5200-60	17	11	60
GS62640	GSNI-5000-40	10	7	40	GS62760	GSNI-5200-90	17	11	90
GS62650	GSNI-5000-60	10	7	60	GS62770	GSNI-5300-20	20	12	20
GS62660	GSNI-5100-20	12	8.5	20	GS62780	GSNI-5300-30	20	12	30
GS62670	GSNI-5100-30	12	8.5	30	GS62790	GSNI-5300-40	20	12	40
GS62680	GSNI-5150-20	15	9.5	20	GS62800	GSNI-5300-60	20	12	60
GS62690	GSNI-5150-30	15	9.5	30	GS62810	GSNI-2300-80	20	12	80
GS62700	GSNI-5150-40	15	9.5	40	GS62820	GSNI-2300-90	20	12	90
GS62710	GSNI-5150-60	15	9.5	60	GS62830	GSNI-2300-120	20	12	120



Industry standard 16mm composite end fittings — no rust, no rattles, no problems.

Composite bushing — long wearing, retains lubrication for smooth operation.

Electrostatic black paint finish on steel tube for corrosion protection and appearance.

Nitrided rod. Corrosion resistant. Micro fine finish holds oil to lubricate seals.

NAUTALIFT™ STAINLESS STEEL GAS LIFT SUPPORTS

MARINE GRADE GAS FILLED SUPPORTS



Features:

- Designed for demanding saltwater applications
- 316L Stainless Steel Rod and Cylinder
- Engineered polymer rod ends
- Composite bushings
- Internal lip seal
- Updated Packaging



Part No.	OE No.	Extended Lgth (In.)	Compressed Lgth. (in.)	Rated (lbs.)	Part No.	OE No.	Extended Lgth (In.)	Compressed Lgth. (in.)	Rated (lbs.)
GSS62600	GSSX-4900-20	7.5	5.5	20	GSS62740	GSSX-5200-40	17	11	40
GSS62610	GSSX-4900-40	7.5	5.5	40	GSS62750	GSSX-5200-50	17	11	50
GSS62630	GSSX-5000-20	10	7	20	GSS62760	GSSX-5200-90	17	11	90
GSS62640	GSSX-5000-40	10	7	40	GSS62770	GSSX-5300-20	20	12	20
GSS62670	GSSX-5100-30	12	8.5	30	GSS62780	GSSX-5300-30	20	12	30
GSS62680	GSSX-5150-20	15	9.5	20	GSS62790	GSSX-5300-40	20	12	40
GSS62700	GSSX-5150-40	15	9.5	40	GSS62800	GSSX-5300-60	20	12	60
GSS62710	GSSX-5150-60	15	9.5	60	GSS62820	GSSX-2300-90	20	12	90
GSS62720	GSSX-5200-20	17	11	20	GSS62830	GSSX-2300-120	20	12	120



GS62840
Black zinc plated steel flat bracket with 10mm ball stud. 2.25" wide



GS62850
Stainless steel flat bracket with 10mm ball stud. 2.25" wide



GS62860
Black zinc plated steel 90° angle bracket with 10mm ball stud. 2" wide • .65" base



GS62870
Stainless steel 90° angle bracket with 10mm ball stud. 2" wide • .65" base



GS62880
Black zinc plated steel 90° angle bracket with 10mm ball stud. 2" x 1.2" base



GS62900
Stainless steel 90° angle bracket with 10mm ball stud. 2" x 1.2" base



GS62910
Zinc plated steel 10mm ball stud with threaded shaft. 5/16" - 18



GS62920
Stainless steel 10mm ball stud with threaded shaft. 5/16" - 18



GS62890
Rod end with internal threads for either end of Nautalift gas filled lift supports. Unique construction makes installation easy and safe.



18-95560
ENGINE OIL PRIMER



18-79834
LIFTING EYE TOOL
For: Johnson/Evinrude V4 & V6



18-79817
UNIVERSAL ENGINE PULLER
Fits: 2 and 4 bbl manifolds



Part #	O.E.#	Description
18-9885	328360	Collar
18-9886	328361	Collar
18-9887	328363	Collar
18-9892	341440	Collar
18-9888	328364	Gauge Bar
18-9889	328365	Gauge Bar
18-9890	328366	Gauge Bar
18-9891	328367	Gauge Bar
18-9894	393279	Screw



18-79825
GIMBAL BEARING INSTALLER TOOL
For: Mercruiser, OMC and Volvo
Use with **18-4442** Alignment tool



18-79820-1
GIMBAL PULLER TOOL
For: Mercruiser, OMC and Volvo



18-79833-1
FLYWHEEL PULLER TOOL
For: Mercury



18-79823
STEPLESS CLAMP 90 DEGREE TOOL
Fits: Crimp type stepless clamps



18-9896
LIFTING EYE TOOL
Replaces: Mercury 91-904551, 91-90455T1, 91-90455T, 91-878232, 91-75132, 91-47448A1



18-9897
VERADO FLYWHEEL PULLER/LIFTING EYE
Replaces: Mercury 91-895343T02, 91-895343T01, 91-895343A02
Fits: All verado engines as a lifting eye and flywheel puller.



18-9879
INTERMEDIATE SHIFT CABLE SNAKE
Description: Use to easily remove and install intermediate shift cables in Mercury drives.



18-79815
FUEL FILTER TOOL
Replaces: Yamaha YB-ACC04
For: Yamaha F150-F350, 2.6L & 3.3LHPDI (2006 & Up)



18-79814
FUEL FILTER TOOL
Replaces: Mercury 91-896661



18-79813
BEARING CARRIER PULLER TOOL
For: Mercruiser, Mercury and Yamaha



18-9876
SHIM GAUGE BAR
Replaces: 349957
For: 40 HP, V-8 with thru hub exhaust



18-9806E
SHIFT CABLE TOOL
Replaces:
 Mercury Marine 91-12037
 Description: Installs and removes shift cables on MC-I, R-MR, Alpha One, Alpha One/Gen II drive units. Use with **18-2190** and **18-2190E** cables.



18-9807
SHIFT CABLE ADJUSTMENT TOOL
Replaces: Mercury Marine 91-12427, 91-12427T
 Description: Attaches over the shift cable, used for proper Bravo drive unit shift cable adjustment at the shift plate.



18-9874
DRIVE SHAFT PRELOAD TOOL
Replaces: Mercury Marine 91-14311A2, 91-44307A1, 91-14311A04, 91-14311A1
 Description: Preloads drive shaft bearing when checking pinion height and backlash on MC-I, R-MR, Alpha One, Alpha One/Gen II drive units and outboards.



18-9808
NEEDLE BEARING DRIVER
Replaces: Mercury Marine 91-15755T, 91-15755, 91-37263, 91-31109
 Description: Installs needle bearings in MC-I, R-MR, Alpha One, and Alpha One/Gen II bearing carriers.



18-9803
SPANNER NUT WRENCH
Replaces: Mercury Marine 91-17256
 Description: Removes and installs driveshaft bearing retainer on MC-I, R-MR, Blackhawk, all Bravo and all Alpha drive units.



18-9809
BEARING CARRIER RETAINER TOOL
Replaces: Mercury Marine 91-17257
 Description: Loosens and tightens bearing carrier retainer on Bravo Two drives.



18-9810
SHIFT CABLE ANCHOR ADJUSTMENT TOOL
Replaces:
 Mercury Marine 91-17262A1
 Description: Used to install shift cable core wire on all Bravo drive units.



18-9812
BEARING & SEAL INSTALLATION TOOL
Replaces:
 Mercury Marine 91-17275A1
 Description: Installs shifter shaft bushings on all Bravo drive units.



18-9817
SHIFT SHAFT BUSHING TOOL
Replaces: Mercury Marine 91-31107T, 91-31107, 91-24150, 91-23033T, 91-23033
 Description: Removes and installs the shift shaft bushing in the gear case of MC-I, R-MR and Alpha One drive units and outboards.



18-9823
DRIVER HEAD
Replaces: Mercury Marine 91-33489
 Description: Installs the small roller bearing in the gimbal housing of MC-I, R-MR and Alpha One drive units.



18-9824
DRIVER HEAD
Replaces: Mercury Marine 91-33491
 Description: Installs needle bearing in forward gear and removes and installs seals and bearing in gimbal housing of MC-I, R-MR and Alpha One drive units.



18-9825
DRIVER HEAD
Replaces: Mercury Marine 91-33492T, 91-33492
 Description: Removes and installs lower swivel pin needle bearing in gimbal ring on MC-I, R-MR and Alpha One drive units.



18-9826
BEARING CUP DRIVER
Replaces: Mercury Marine 91-33493, 91-33493T
 Description: Installs upper drive shaft bearing cup in drive shaft housing of MC-I, R-MR and Alpha One drive units.



18-9827
BEARING CUP DRIVER
Replaces: Mercury Marine 91-34379T
 Description: Installs drive shaft bearing cup in gear housing of MC-I, R-MR, Alpha One drive units and outboards.

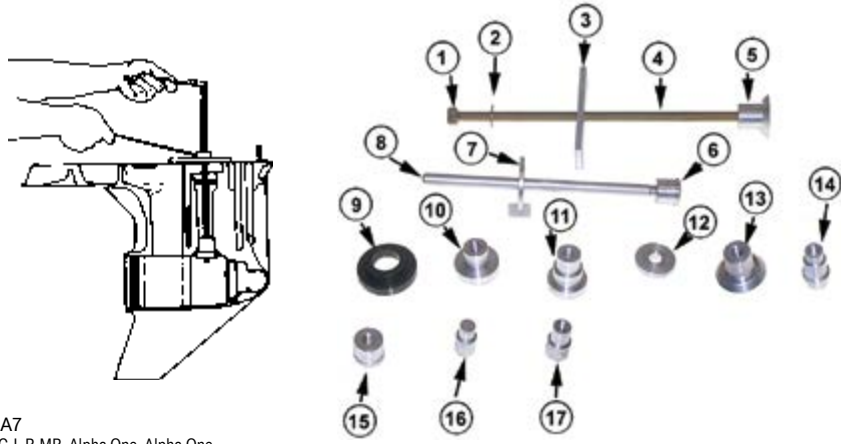

**18-9820-1
INSTALLATION TOOL KIT**

Replaces: Mercury Marine 91-31229A7
Description: removes and installs bearings in MC-I, R-MR, Alpha One, Alpha One Gen II and all Bravo gear cases.

— CONTAINS —

Part #	O.E. #	Description	Part #	O.E. #	Description	Part #	O.E. #	Description	
1	NSS	11-24156	8	18-9835	91-37323	14	18-9832	91-37292	Bearing Puller
2	NSS	12-34961	9	18-9816	91-30366T1	15	18-9822	91-32336	Driver Head
3	NSS	91-29310	10	18-9828	91-36379	16	18-9833	91-37311	Driver Head
4	18-9819	91-31229	11	NSS	91-15755T	17	18-9834	91-37312	Driver Head
5	NSS	91-32325T	12	18-9836	91-37350				
6	18-9848	91-52393	13	18-9849	91-52394				
7	18-9815	91-37324							



**18-9835
DRIVER ROD**

Replaces: Mercury Marine 91-37323
Description: Used with various drivers to install bearings on Alpha One, Gen II and Bravo One and Two gear cases.



**18-9838
U-JOINT ADAPTER**

Replaces: Mercury Marine 91-38756
Description: Supports yoke when disassembling u-joint on all drive units.

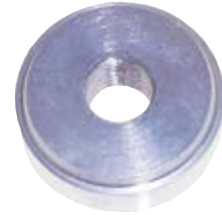

**18-9839
BEARING CUP DRIVER**

Replaces: Mercury Marine 91-38918T
Description: Installs bearing cup in top cover of drive shaft housing of MC-I, R-MR, Alpha One drive units and outboards.



**18-9842
DRIVE SHAFT
RETAINER WRENCH**

Replaces: Mercury Marine 91-43506T
Description: Removes and installs threaded bearing retainer on Alpha stern drives and outboards.

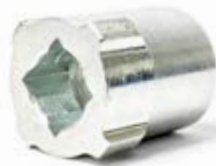

**18-9844
TAPERED INSERT TOOL**

Replaces: Mercury Marine 91-43579
Description: Installs tapered insert retainer into water inlet hose on all Bravo drive units.



**18-9845
SEAL DRIVER**

Replaces: Mercury Marine 91-43591T
Description: Installs upper drive shaft oil seal on Alpha One and Alpha One/Gen II drive units.



**18-9847
BELLOWS EXPANDER TOOL**

Replaces: Mercury Marine 91-45497A1
Description: Installs exhaust bellows on MC-I, R-MR, Alpha One, Bravo One and Two and Blackhawk drive units.



**18-9850
BACKLASH INDICATOR**

Replaces: Mercury Marine 91-53459
Description: Checks gear backlash on TR, TRS, MC-I, R-MR, Alpha One, Alpha One/Gen II and Bravo One and Two drive units.



**18-9851
OIL SEAL DRIVER**

Replaces: Mercury Marine 91-55916
Description: Installs oil seals in TR and Bravo One and Two drive unit bearing carrier.



18-9852
BEARING DRIVER

Replaces: Mercury Marine 91-55918

Description: Installs needle bearings in Bravo One and Two and TR drive unit bearing carrier.



18-9855
DRIVEN GEAR SHIMMING TOOL

Replaces: Mercury Marine 91-60523

Description: Measures upper drive gear clearance on MC-I, R-MR, Alpha One and Alpha One/Gen II drive units.



18-9856
DRIVE GEAR SHIMMING TOOL

Replaces: Mercury Marine 91-60526T

Description: Measures upper drive gear clearance on MC-I, R-MR, Alpha One, Alpha One/Gen II drive units.



18-9858
BEARING CARRIER RETAINER WRENCH

Replaces: Mercury Marine 91-61069T

Description: Removes and installs bearing carrier retainer nuts on Bravo One and Two, MC-I, R-MR, Alpha One, Alpha One/Gen II, TRS drive units and outboards.



18-9859
PULLER

Replaces: Mercury Marine 91-63616

Description: Removes upper swivel shaft on MC-I, R-MR, Alpha One, Alpha One/Gen II, Bravo One, Two and Three and Blackhawk gimbal rings.



18-9860
BEARING DRIVER

Replaces: Mercury Marine 91-63638T

Description: Removes and installs lower drive shaft pinion bearing on TR and Bravo One and Two drive units.



18-9861
HINGE PIN TOOL

Replaces: Mercury Marine 91-78310

Description: Removes and installs hinge pins from all Mercury Marine drive units.



18-9870
SLEEVE INSTALLATION TOOL

Replaces: Mercury Marine 91-818162

Description: Installs the aluminum sleeve in the u-joint bellows of all Bravo, Alpha One/Gen II, Blackhawk drive units and outboards.



18-9863
BEARING DRIVER

Replaces: Mercury Marine 91-89865
Description: Installs bearing carrier seals on Bravo One and Two drive units.



18-9865
DRIVE SHAFT BEARING TOOL

Replaces: Mercury Marine 91-90774
Description: Presses bearing cone onto Alpha One/ Gen II drive shaft housing pinion gear.



18-9866
DIAL INDICATOR HOLDING TOOL

Replaces: Mercury Marine 91-89897
Description: Secures dial indicator to gear housing when checking backlash on MC-I, R-MR, Alpha One, TR, TRS drive units and outboards.



18-8611
O2 SENSOR SOCKET

- Universal
- 7/8" (22mm) w/ 25/32" wire opening
- 3/8" Drive



18-8612
O2 SENSOR SOCKET

- Universal
- 7/8" or 22mm w/ 9/32" wire opening
- 3/8" Drive



18-8613
O2 SENSOR WRENCH

- Universal
- 7/8" or 22mm
- 3/8" drive
- 6 point



18-8614
O2 SENSOR WRENCH

- Universal
- 7/8" or 22mm
- 1/2" drive, 2" overall depth



18-8615
O2 SENSOR WRENCH

- Universal
- Includes 6 and 12 point socket
- 3/8" Drive



18-8616
O2 SENSOR WRENCH

- Universal
- Includes 6 and 12 point socket
- 3/8" Drive, 2 1/8" offset



18-8617
O2 SENSOR WRENCH

- Universal
- 6 point
- 3/8" Drive, 1.2" overall depth



18-9800
COMPRESSION TESTER

Description: Perfect for hard to reach bottom spark plug holes on older Mercury models.

18-9902
DEEP WELL COMPRESSION TEST ADAPTER

For deep well spark plug holes to perform compression testing. Works with 18-9900 compression tester.

- 14mm and 18mm threads
- Reaches 8" beyond the installation surface



18-9801
MULTI METER/DVA TESTER

Replaces: Mercury Marine 91-99750A1
Description: Tests electrical and ignition systems. Consists of a VOA meter with built-in direct voltage adapter.

18-9900
DIGITAL COMPRESSION TESTER

For Testing Compression on Gasoline powered engines.

- Stores max compression value for up to 12 cylinders
- Backlit LCD Display
- Auto Shutoff
- Sealed and Vibration protected
- Displays values in PSI, Bar, and kPa
- Fits many Outboard, Inboard, PWC, ATV, Recreational gasoline engines





18-9903
ENGINE IGNITION ANALYZER

Description: For the diagnosis and performance measurement of all types of spark ignition systems, from conventional to the newest Coil on Plug in use.

- Displays everything on a 3.5" color screen.
- Rechargeable battery provides 6+ hours of use.
- Durable design (MIL-STD-810) drop test approved.
- Comes with hard shell carrying case.
- Includes **18-9914** Plug Wire Sensor Clip and Extension Lead.



18-9914
PLUG WIRE SENSOR CLIP EXTENSION

Description: Extension Lead with Plug wire sensor clip for 18-9903.

- 2 m (78") long shielded cable with BNC connector.
- Sensor accepts wires of up to 9 mm (3/8") diameter.
- Cable can also be used with coil on plug sensor supplied with the 18-9903.



18-9904
FAULT FINDER

Description: For locating electrical short and open circuits.

- Includes 18-9906 & 18-9907.
- Operates on 6 to 42 VDC systems.
- 8 in. flexible probe reaches in congested places.
- Adjustable sensitivity.
- Transmitter and receiver LEDs signal open or short circuit conditions.
- Auto polarity transmitter that leads with 5 amp alligator clips.
- Includes hard shell carrying case.



18-9905
AC/DC LOW CURRENT CLAMP METER

Description: Designed to accurately measure current, current leaks (parasitic draws down to 1mA) and electrical loads from 1mA to 100 amp AC/DC and voltages from 0 to 600 AC/DC.

- Current measurement: 1 mA up to 100 A.
- Voltage measurement up to 600 V.
- Clamp opens up to 1/2" (12.5 mm).
- Operates with one rotary switch.
- Includes soft shell carrying case.



18-9908
AC/DC 600A CLAMP METER

Description: Allows the measurement of AC/DC currents with a resolution down to 0.1 A, and up to a maximum of 600A, making it ideal for testing all kinds of loads such as found in: electric motors, fuel pumps, charging systems, starter currents, alternators, etc.

- Current measurement: up to 600A.
- Voltage measurement: up to 600 V.
- Clamp opens up to 1" (25.4 mm).
- Operates with one rotary switch.
- Includes soft shell carrying case.



Front View

18-9906
CORDLESS CIRCUIT TESTER

Description: Specifically designed for use on autos, trucks, trailers, RV's & boats.

- No ground or clip necessary.
- Range of operation: 3 to 28 VDC.
- Powered by one AA alkaline battery.
- Wireless design eliminates tangles.



18-9907
FUSE SOCKET TEST CONNECTORS

Description: Covers the most common fuse socket adapters requirements in the automotive and vehicular electrical repair field.

- Fits all Maxi, ATO and Mini type fuses.
- Maximum conductivity and durability.
- Molded for easy insertion and removal.



18-9911
REFLECTIVE TAPE

Description: A package of specially formulated self adhesive reflective tape strips, for use as a target for optical tachometers. Its highly reflective surface is designed to scatter the light (infrared, laser or visible) emitted by the optical tachometer, improving the detection of the rotating or moving object from a wide range of angles and distances.

- 6 strips - 8" (L) x 0.2" (W) / 20 cm (L) x 0.5 cm (W)



18-9910

OXYGEN SENSOR TESTER/SIMULATOR

Description: For testing and diagnostics on any Oxygen Sensor, to quickly determine whether the sensor is defective and needs replacement.

- Signal output shown in real time on LED bar graph.
- Auto detection of common wire misconnections.
- Works with zirconium, titanium & air/fuel ratio sensors.
- Comes with hard shell carrying case.



18-9913

SMARTACH (DIESEL AND GASOLINE ENGINE TACHOMETER)

Description: A tachometer designed for use on any engine equipped with an alternator, and only requires a simple connection to the electrical system (e.g. battery, alternator, cigarette lighter connector) to measure engine RPM.

- Measures from 200 to 9,999 RPM
- 0.05% accuracy.
- Large 4½ digit LCD display.
- Comes with hard shell carrying case.



18-9915

FUEL INJECTOR ANALYZER

Checking the operation of any gasoline or diesel fuel injector. Works on Solenoid, Piezo (Direct Injectors), and Mechanical Injectors for gasoline and diesel engines. Compare readings between injectors with a "candlestick" graph that displays maximum, minimum, and average readings for each injector. This is drop impact resistant and comes with a rechargeable Li-ion battery that provides 6+ hours of working time.

- Display injector waveforms in real time
- Detect and display ECM control signals
- Monitor Pintle Valve Motion and Response
- Detect and display engine speed
- 3.5" color TFT LCD display



18-9909

PROFESSIONAL DVOM

Description: Offers full auto range features and functionality. Equipped with a 4 digit LCD display with analog bar graph it is capable of measuring AC/DC voltage up to 600 Volt and AC/DC current up to 10 A. Other functions includes tachometer for RPM measurement, dwell, temperature, resistance, frequency, fuel injection test, diode test, continuity check and overload protection.

- State of the art design and styling.
- 4 digit LCD display with analog bar graph.
- AC/DC voltage measurement: up to 600 V.
- AC/DC current measurement: up to 10 A.
- Tachometer function measures 30 to 20000 RPM
- Comes with hard shell carrying case.



EC01350

TERMINALS & CONNECTORS W/CRIMP TOOL

30 pc. terminal assortment packed with crimp tool/wire cutter. Attractive 5 compartment clamshell fits neatly in tool box or glove compartment. Handy for emergencies. Perfect for the do-it-yourselfers.



EC09040

DUAL VOLTAGE CIRCUIT TESTER

Dual bulb tester for testing both 6 and 12 volt circuits. Also can be used to check spark plug wires. This is the most commonly used tester for troubleshooting auto, truck, van and boat wiring. Supplied with ground wire and clip. Packed one per card.



18-8960

IGNITION SPARK TESTER

Description: Use to check for ignition spark in up to 4 ignition wires at a time.



18-9802

TIMING LIGHT

Replaces: Mercury Marine 91-99379

Description: Checks ignition timing. Powered by two "D" cell batteries, portable.



18-4442

ENGINE ALIGNMENT TOOL

Replaces: Mercury Marine 91-57797A3, 91-57797A2, 91-57797A1, 91-8M0067546, 91-48347, 91-37384

Description: Used to verify engine alignment on all MC-I, R-MR, Alpha One and Alpha One/Gen II.

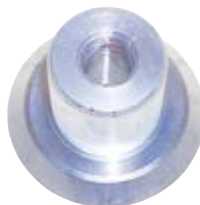

18-9849

BEARING PULLER

Replaces: Mercury Marine 91-52394

Description: Removes and installs bearings in MC-I, R-MR, Alpha One, Alpha One/Gen II, all Bravo and outboard gear cases.



18-9862

BEARING DRIVER

Replaces:

Mercury Marine 91-87119

Description: Installs driveshaft bearing onto driveshaft.



18-9873

BEARING DRIVER

Replaces:

Mercury Marine 91-813653

Description: Installs u-joint oil seal into bearing carrier, also used to pilot the puller rod for gear housing needle bearing installation on Bravo One and Two drive units.

 <p>18-9815 PILOT PLATE Replaces: Mercury Marine 91-37324 Description: Removes and installs bearings in MC-I, R-MR, Alpha One, Alpha One/Gen II, all Bravo and outboard gear cases.</p>	 <p>18-9816 MANDREL Replaces: Mercury Marine 91-30366T1 Description: Removes and installs bearings in MC-I, R-MR, Alpha One, Alpha One/Gen II, all Bravo and outboard gear cases.</p>	 <p>18-9819 PULLER SHAFT Replaces: Mercury Marine 91-31229 Description: Removes and installs bearings in MC-I, R-MR, Alpha One, Alpha One/Gen II, all Bravo and outboard gear cases.</p>	 <p>18-9822 DRIVER HEAD Replaces: Mercury Marine 91-32336 Description: Removes and installs bearings in MC-I, R-MR, Alpha One, Alpha One/Gen II, all Bravo and outboard gear cases.</p>												
 <p>18-9828 DRIVER HEAD Replaces: Mercury Marine 91-36379 Description: Removes and installs bearings in MC-I, R-MR, Alpha One, Alpha One/Gen II, all Bravo and outboard gear cases.</p>	 <p>18-9832 BEARING PULLER Replaces: Mercury Marine 91-37292 Description: Removes and installs bearings in MC-I, R-MR, Alpha One, Alpha One/Gen II, all Bravo and outboard gear cases.</p>	 <p>18-9833 DRIVER HEAD Replaces: Mercury Marine 91-37311 Description: Removes and installs bearings in MC-I, R-MR, Alpha One, Alpha One/Gen II, all Bravo and outboard gear cases.</p>	 <p>18-9834 DRIVER HEAD Replaces: Mercury Marine 91-37312 Description: Removes and installs bearings in MC-I, R-MR, Alpha One, Alpha One/Gen II, all Bravo and outboard gear cases.</p>												
 <p>18-9848 DRIVER Replaces: Mercury Marine 91-52393 Description: Removes and installs bearings in MC-I, R-MR, Alpha One, Alpha One/Gen II, all Bravo and outboard gear cases.</p>	 <p>STARTER ROPE (200' Spools)</p> <table border="1"> <thead> <tr> <th>Part #</th> <th>Description</th> <th>Replaces</th> </tr> </thead> <tbody> <tr> <td>18-4911</td> <td>5/32" x 200'</td> <td>OMC 322236</td> </tr> <tr> <td>18-4913</td> <td>3/16" x 200'</td> <td>OMC 316705</td> </tr> <tr> <td>18-4914</td> <td>1/8" x 200'</td> <td>OMC 316706</td> </tr> </tbody> </table>	Part #	Description	Replaces	18-4911	5/32" x 200'	OMC 322236	18-4913	3/16" x 200'	OMC 316705	18-4914	1/8" x 200'	OMC 316706	 <p>18-4904 STARTER HANDLE & ROPE #4.5 (9/64") Rope Handle Only: 18-4901</p>	 <p>CABLE BOOT 18-4454-1 For 3" Hole 18-4455 For 4 1/2" Hole</p>
Part #	Description	Replaces													
18-4911	5/32" x 200'	OMC 322236													
18-4913	3/16" x 200'	OMC 316705													
18-4914	1/8" x 200'	OMC 316706													

Safe-Skeg

Whether you are looking to protect your new skeg, repair your damaged one, or even just add some shine. Safe-Skeg is made of 316 Marine Grade Stainless Steel Construction and installation takes minutes.

- Material Thickness: 1.5mm, 50% thicker than the competition.
- Drain Hole to protect against corrosion and freeze-up.
- Brilliantly polished with seamless design.
- Skid Plate not necessary due to extra thickness in material.



Motor	Horsepower	Stroke	Year Range	Part No.
Evinrude/Johnson	150-175-185-200-225	2	1986-2003	35-SS630

SELOC MANUALS

OUTBOARDS

* Available on SelocOnline



18-01101*
**CHRYSLER/
 FORCE**
 ALL ENGINES
1962-1999
 3-150 HP,
 1 - 5 cyl.,
 including
 L-Drive.



18-01200*
HONDA
 ALL ENGINES
1978-2001
 2-130 HP,
 1 - 4 cyl.,
 including Jet
 Drives.



18-01202*
HONDA
2002-2014
 2-225 HP,
 1 - 4 cyl. & V6,
 including Jet
 Drives.



18-01301*
**JOHNSON/
 EVINRUDE**
1958-1972
 1.5-125 HP,
 1 - 4 cyl.



18-01302*
**JOHNSON/
 EVINRUDE**
1973-1989
 1.25-60 HP,
 1 - 2 cyl.



18-01308*
**JOHNSON/
 EVINRUDE**
1973-1991
 60-235 HP,
 3 - 6 cyl.



18-01311*
**JOHNSON/
 EVINRUDE**
1992-2001
 65-300 HP, V4, V6
 & V8, including jet
 drives.



18-01312*
**JOHNSON/
 EVINRUDE**
1990-2001
 1.25-70 HP,
 2 & 4-Stroke In
 Line engines.



18-01313*
EVINRUDE
2002-2014
 15-300 HP,
 All engines.



18-01314*
JOHNSON
2002-2007
 3.5-250 HP,
 All engines.



18-01400
MARINER
1977-1989
 2-60 HP,
 1 - 2 cyl.



18-01402
MARINER
1977-1989
 45-220 HP,
 3 - 6 cyl.



18-01404*
MERCURY
1965-1989
 2-40 HP,
 1 & 2-cyl.



18-01406*
MERCURY
1965-1989
 40-115 HP,
 3 & 4-cyl.



18-01408*
MERCURY
1965-1989
 90-300 HP,
 6 - cyl.



18-01416*
**MERCURY/
 MARINER**
1990-2000
 2.5-275 HP, All
 2-Stroke models.



18-01418*
MERCURY
2001-2014
 2.5-300 HP,
 All 2-Stroke
 Engines.



18-01422*
MERCURY
2005-2011
 2.5-300 HP,
 All 4-Stroke
 Engines.



18-01500*
**NISSAN/
 TOHATSU**
1992-2013
 2.5-140 HP,
 All Engines.



18-01600*
SUZUKI
1988-2003
 2-225 HP, All
 2-Stroke Engines.



18-01602*
SUZUKI
1996-2007
 2.5-300 hp,
 All 4-Stroke
 Engines.



18-01701*
YAMAHA
1984-1996
 2-250 HP, All
 2 & 4-Stroke
 Engines.

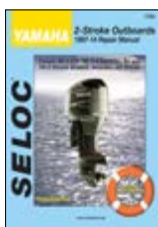

18-01703*
YAMAHA
1997-2014
 2-300 HP,
 All 2-Stroke
 Engines.



18-01705*
YAMAHA
1995-2004
 2.5-225 HP,
 All 4-Stroke
 Engines.

SELOC MANUALS

STERN DRIVES & INBOARDS

* Available on SelocOnline



18-01707*
YAMAHA
2005-2010
2.5-350 HP, All
4-Stroke Engines.

SUZUKI
1975-1998
QM, GM/HM,
JH, JH2 Diesel
Engines.
Web Only

YANMAR
2008-2014
2.5-300 hp All 4
Stroke Engines.
Web Only



18-03200*
MERCUISER
1964-1991
All gas engines and
stern drives.

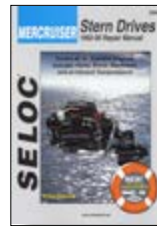

18-03206*
MERCUISER
1992-2000
Covers all engines &
drive units, including
transmissions.



18-03208*
MERCUISER
2001-2013
All gas engines & drives,
includes inboards &
transmissions.



18-03400*
OMC
1964-1986
All gas engines
and drives.



18-03404*
OMC COBRA
1986-1998
Covers all gas engines &
Cobra/King Cobra drives.



18-03600*
VOLVO/PENTA
1968-1991
Covers all gas engines
& drives.



18-03602*
VOLVO/PENTA
1992-1993
Covers all stern drive
units powered by Volvo
4-cylinder engines.



18-03606*
VOLVO/PENTA
1992-2002
Covers all gas engines
& drives.



18-03608*
VOLVO/PENTA
2003-2012
Covers all gas
engines & drives.

PERSONAL WATERCRAFT

* Available on SelocOnline



18-09000
SEA-DOO
1988-1991
All Sea-Doo &
Bombardier models.



18-09006*
SEA-DOO/
BOMBARDIER
2002-2011
All 4-Stroke Models.



18-09200
KAWASAKI
1973-1991
300-650 Series.



18-09202
KAWASAKI
1992-1997
550-1100 Series.



18-09400
POLARIS
1992-1997
650-1050 Series,
inc. Fuji-powered
models.

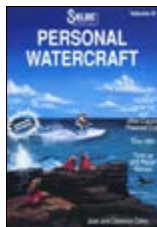

18-09600
YAMAHA
1987-1991
All Yamaha, Jet-
N-Cat & Cayuna
models.



18-09602
YAMAHA
1992-1997
650-1200 Series.



18-09606*
YAMAHA
2002-2011
All 4-Stroke Models.



18-00535
PEGBOARD DISPLAY RACK
Face-out display of 9 SKUs, 18 books. 9 pockets, 2 books deep.
Signage included.
14 x 27 x 9. Gray

SELOC MANUALS

**18-00534****REVOLVING FLOOR DISPLAY RACK**

Face-out display of 20 SKUs, 40 books. 4 sides with 5 pockets, 2 books deep. Signage included. 66" x 18" x 18". Gray

SELOC PRO

Seloc Pro is the most comprehensive database tool available to marine technicians! Unlimited access to our database of boat and mechanical repair - a completely automated repair and refinishing system with hull and mechanical labor times, service procedures, wiring diagrams, specifications and an estimating module with parts and pricing.

18-05500**SELOC PRO ONLINE (1 YEAR SUBSCRIPTION)****18-05002****SELOC ONLINE.COM CD DISPLAY**

Attractive countertop POP display holds six SelocOnline.com cd's. Must purchase 6 cd's to receive free display.

SIERRA[®]



18-ADA500 (While Supplies Last)
STATS TESTER (CONSOLE)



18-ADA501HC (While Supplies Last)
STATS ACCESSORY HARD CASE



18-ADA502 (While Supplies Last)
STATS TESTER (CONSOLE) NEOPRENE CASE



18-ADA503 (While Supplies Last)
STATS DONGLE CASE

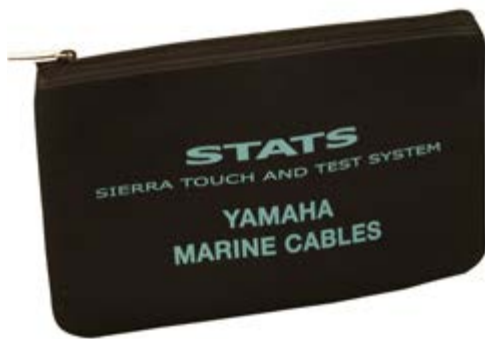

18-ADA504 (While Supplies Last)
STATS YAMAHA NEOPRENE CARRY CASE



18-ADA505 (While Supplies Last)
STATS MERCURY/MERCURISER/MEFI CARRY CASE



18-ADA506 (While Supplies Last)
STATS BRP/SEADOO NEOPRENE CARRY CASE



18-ADA507 (While Supplies Last)
STATS KAWASAKI NEOPRENE CARRY CASE



18-ADA508 (While Supplies Last)
STATS SUZUKI NEOPRENE CARRY CASE



18-ADA509 (While Supplies Last)
STATS VOLVO NEOPRENE BAG



18-ADA510 (While Supplies Last)
STATS MEFI NEOPRENE CARRY CASE



18-ADA511 (While Supplies Last)
STATS HONDA NEOPRENE BAG



18-ADA512 (While Supplies Last)
STATS GENERIC NEOPRENE BAG



18-ADC400 (While Supplies Last)
STATS DONGLE A UNIVERSAL



18-ADC401 (While Supplies Last)
STATS DONGLE B SEADOO 4 TECH ENGINES



18-ADC409 (While Supplies Last)
STATS DONGLE C SEADOO DI ENGINES



18-ADC412 (While Supplies Last)
STATS DONGLE D BRP DESS (2 STROKE)



18-ADC199 (While Supplies Last)
JACK SCREWS FOR STATS CONSOLE
 Enables the Master Cable to be secured to the 25-way connector on the STATS tester



18-ADC450 (While Supplies Last)
STATS POWER CABLE (12V)



18-ADC153 (While Supplies Last)
STATS USB CABLE



18-ADC300E (While Supplies Last)
STATS MASTER CABLE (20')



18-ADC402 (While Supplies Last)
STATS BRP SAFETY KEY PROGRAMMING CABLE



18-ADC406 (While Supplies Last)
STATS KAWASAKI T-IN POWER CABLE



18-ADC404 (While Supplies Last)
STATS BRP DIAGNOSTICS CABLE



18-ADC407 (While Supplies Last)
STATS MERCURYDIAGNOSTIC CABLE



18-ADC408 (While Supplies Last)
STATS BRP T-IN POWER CABLE



18-ADC410 (While Supplies Last)
STATS MERCURY OUTBOARD CABLE



18-ADC411 (While Supplies Last)
STATS HYDROSPACE/BENELLI/WEBER DIAGNOSTIC CABLE



18-ADC414 (While Supplies Last)
STATS KAWASAKI POWER CABLE (4-STROKE)



18-ADC415 (While Supplies Last)
STATS VOLVO DIESEL DIAGNOSTIC CABLE



18-ADC416 (While Supplies Last)
STATS KAWASAKI FITCH DI CABLE



18-ADC417 (While Supplies Last)
STATS YANMAR DIESEL DIAGNOSTIC CABLE



18-ADC419 (While Supplies Last)
STATS KAWASAKI KEY PROGRAMMING CABLE



18-ADC418 (While Supplies Last)
STATS YAMAHA REMOTE PROGRAMMING CABLE



18-ADC420 (While Supplies Last)
STATS SUZUKI 4 PIN DIAGNOSTIC CABLE



18-ADC421 (While Supplies Last)
STATS SUZUKI 8 PIN DIAGNOSTIC CABLE



18-ADC422 (While Supplies Last)
STATS BRP DESS DIAGNOSTIC CABLE



18-ADC423 (While Supplies Last)
STATS JO HNSON EVINRUDE DIAGNOSTIC CABLE



18-ADC425 (While Supplies Last)
STATS MEFI 5-6 DIAGNOSTIC CABLE



18-ADC427 (While Supplies Last)
STATS HONDA DIAGNOSTIC CABLE



18-5169
CONDENSER
Replaces: F12042-1



18-5241
CONDENSER
Replaces: F12181-1



18-5803
SOLENOID
Replaces: F177917



18-5835
SOLENOID
Replaces: 89-803822T, 89-F460917-1, F460917-1, 89-817109A3
For: Early model 35-150 HP



18-5834
SOLENOID
Replaces: 89-817109A2
For: 75 HP (3 cyl.) S/N G127500 & UP



18-5775
SWITCH BOX
Replaces: 332-7778A12



18-5881
SWITCH BOX
Replaces: 332-5772A7, 332-5772A5



18-5790
SWITCH BOX ASSEMBLY
Replaces: 18495A26



18-5870
STATOR
Replaces: 398-832075A4



18-5873
STATOR & KIT
Replaces: 398-832075A6
For: 100, 115, 125 HP



18-5186
IGNITION COIL
Replaces: 339-7370A13, 339-7370B13, 339-832757B4

COIL & STATOR APPLICATION

Year	HP	S/N	Coil	Stator	Year	HP	S/N	Coil	Stator
1992-95	40/50	E000001-E138599	18-5186	-	1990-95	120	ALL	18-5186	-
1996-99	40/50	E138600-E369299	-	18-5870	1994-95	120	E065487-E138599	18-5186	18-5873
1991-95	70	E000001-E138599	18-5186	-	1994-95	SPORT JET 120	E095088-E141088	18-5186	18-5873
1996-99	75	E138600-UP	-	18-5870	1996-99	120	E138600-UP	-	18-5870
1991-95	90	E000001-E138599	18-5186	-	1989-94	150	ALL	18-5186	-
1996-99	90	E138600-UP	-	18-5870					

CHRYSLER IGNITION

HP	Model	Contact Set	Con-denser	Tune-Up Kit	Starter Solenoid	HP	Model	Contact Set	Con-denser	Tune-Up Kit	Starter Solenoid
4.5	42HA	—	18-5241	—	N/A	9.9 [Ⓜ]	92/93H9F,98/99H9A	—	18-5241	—	N/A
4.9	44HA,44/45HB, HC, HD	—	18-5241	—	N/A	9.9	92/93HA-HE,H0G, 94H1F	—	18-5241	—	N/A
5	52/53HA	—	18-5241	—	N/A	9.9 [Ⓢ]	94/95HA	—	18-5241	—	18-5803
5	54/55HA, HB, HC, HD	—	18-5241	—	N/A	9.9 [Ⓢ]	94/95HA-HE	—	18-5241	—	N/A
6	60HA,62/63HA-HH, H9M	—	18-5241	—	N/A	10 [Ⓢ]	102/103HD,H8B, 108/109HA,H8B	—	18-5241	—	—
6	64HA-HC, H0F, H1G, H2H, H8D, H9E	—	18-5241	—	N/A	10	102/103/104/105HA, HB, HC	—	18-5241	—	N/A
7	72/73HA	—	18-5241	—	N/A	12.9 [Ⓢ]	122/123H9E, 128/129H9A	—	18-5241	—	—
8	82/83HA-HH,H9K	—	18-5241	—	N/A	12.9	122/123/124/125HA, HC, HD	—	18-5241	—	N/A
9.9	92H1H,H1J,H2J,H3K	—	18-5241	—	N/A						

Ⓜ Items ending in "D" are Display Packaged - Regular number is Non-Display

APPLICATION CONTINUED ON NEXT PAGE

CHRYSLER IGNITION (Cont.)

HP	Model	Contact Set	Con-denser	Tune-Up Kit	Starter Solenoid	HP	Model	Contact Set	Con-denser	Tune-Up Kit	Starter Solenoid
15	152H1G, H1H, H2H, H3J	—	18-5241	—	N/A	35③	356/357HA-HF	18-5162	—	—	18-5803
15	152/153HA, HB, HOF	—	18-5241	—	N/A	35	360/361HA, HB	18-5149	18-5169	—	—
15①	152/153HC, H8D, H9E	—	18-5241	—	—	45③	450 THRU 457HA, HC-HH	18-5162	—	—	18-5803
15	154/155HA, 154HB	—	18-5241	—	N/A	45②	450 THRU 457HA, HC-HH	18-5149	18-5169	—	18-5803
15	158/159HA, H8B, H9C	—	18-5241	—	—	45①	450 THRU 457HC-HH	18-5162	N/A	N/A	18-5803
20	202H2N,202/203HA-HG, H0L	—	18-5241	—	N/A	45	450/451HK, 452/453HC-HJ, H8K	18-5149	18-5169	—	—
20①	202/203H1M,H9K	—	18-5241	—	—	45	456/7H0L, HJ, H1M, H9K, 457H3P, H2N	18-5162	—	—	18-5803
20	204/205HA-HG	—	18-5241	—	N/A	45	458/459HA, HG	18-5162	N/A	N/A	18-5803
20①	206/207H9B	—	18-5241	—	—	45③	458/459HA-HF	18-5162	—	—	18-5803
25	252H1F,H2F, H3G,252/253H8C	—	18-5241	—	N/A	45①	458/459HA-HF	18-5162	N/A	N/A	18-5803
25②	252/253HB, H8D,254/255HB	—	18-5241	—	N/A	45②	458/459HA-HF	18-5149	18-5169	—	18-5803
25	252/253/254/255HA	—	18-5241	—	N/A	45	459H0J, H9H	18-5162	—	—	18-5803
25③	252/253/254/255HB, 256/257HA	18-5162	—	—	—	45	464HA	18-5149	18-5169	—	18-5803
25②	256/257HA,H8C	—	18-5241	—	N/A	50	503H3A, 507H1A, H2B, H2C, H3D, R3E	18-5162	—	—	18-5803
30②	302/303H9C,HB	—	18-5241	—	N/A	55	551HA	18-5162	—	—	18-5803
30	302/303/304/305HA	—	18-5241	—	N/A	55②	554 THRU 559HA, HC-HG	18-5149	18-5169	—	18-5803
30③	302/303/304/305HB, 306/607HA	18-5162	—	—	—	55③	554 THRU 559HA, HC-HG	18-5162	—	—	18-5803
30②	304/305HB, 306/607HA	—	18-5241	—	N/A	55①	554 THRU 559HA, HC-HG	18-5162	N/A	N/A	18-5803
35②	350/351HK,H8L, 356/357HK,H8M	—	18-5241	—	N/A	70	706/707HA, HC-HF	N/A	N/A	N/A	18-5803
35③	350/351/354/355HC-HH	18-5162	—	—	18-5803	75	756/757HA	N/A	N/A	N/A	18-5803
35②	350/351/354/355HC-HH	18-5149	18-5169	—	18-5803	85	856/857HA, HC, HD, HE	N/A	N/A	N/A	18-5803
35①	350/351/354/355HH, 356/357HF	18-5162	N/A	N/A	18-5803	90	906/907HA	N/A	N/A	N/A	18-5803
35③	350/351/356/357HK	18-5162	—	—	—	105	1056/1057HA-HF, 1058HA, HB, HC	N/A	N/A	N/A	18-5803
35	350/352/353/354/355HA, 352/353HF	18-5149	18-5169	—	18-5803	105	1058HD, 1059HD	N/A	N/A	N/A	18-5803
35	352/353HC-HE, HG-HJ, H2P, H8K, H9L	18-5149	18-5169	—	—	120	1206/1207HA-HF, 1208 HA, HB, HC	N/A	N/A	N/A	18-5803
35	353H0M, H1N	18-5149	18-5169	—	—	120	1208HD,1209HD	N/A	N/A	N/A	18-5803
35②	356/357HA-HF	18-5149	18-5169	—	18-5803	130	1306/1307HA	N/A	N/A	N/A	18-5803
						135	1356/1357HA, 1358HA, HB, HC	N/A	N/A	N/A	18-5803
						135	1358HD,1359HD	N/A	N/A	N/A	18-5803
						150	1508HA	N/A	N/A	N/A	18-5803

① Magnapower ignition (w/alternator & C-D Unit) ③ Standard ignition (w/alternator) ⑤ 95HA S/N 3300 & up, 95HA S/N 3125 & up
 ② Magneto ignition (no alternator) ④ 94 HA S/N 3299 & below, 95HA S/N 3124

FORCE IGNITION

Year	Model	Serial #	Contact Set	Condenser	Solenoid	Switch Box
1984-87	9.9/15	N/A	—	18-5241	—	—
1996-99	40/50	E138600-E369299	—	—	18-5834②	—
1984-87	50	N/A	18-5162	—	18-5803	—
1988	50	N/A	—	—	18-5803①	—
1991B, 1992C	70	E000001-E039023	18-5162	—	18-5803	18-5790
1991-95	70	E000001-E138599	—	—	—	18-5790
1996-99	75	E138600-UP	—	—	18-5834②	—
1991D-1992C	90	E000001-E039023	N/A	N/A	—	18-5775
1991	90 L-DRIVE	N/A	N/A	N/A	—	18-5775
1991-95	90	E000001-E138599	—	—	—	18-5790
1996-99	90	E138600-UP	—	—	18-5834②	—
1993-94	SPORT JET 90	E023150-E033710	N/A	N/A	—	18-5775
1991D-1992C& 1993, 1994	120	E000001-E093699	N/A	N/A	—	18-5881
1995	120	E093700-E138599	N/A	N/A	—	18-5881
1996-99	120	E138600-UP	—	—	18-5834②	18-5790
1991-92	120 L-DRIVE	N/A	N/A	N/A	—	18-5881

① Except "D" Models ② Style II

PREMIUM MARINE SPARK PLUG WIRE LEADS

Sierra's MAGFORCE Ignition Wires are "Electronics Friendly" protecting all of your electronic devices and electronic engine controls from RFI and EMI while delivering the maximum amount of voltage. Exact fit design ensures easy installation and years of trouble - free service.

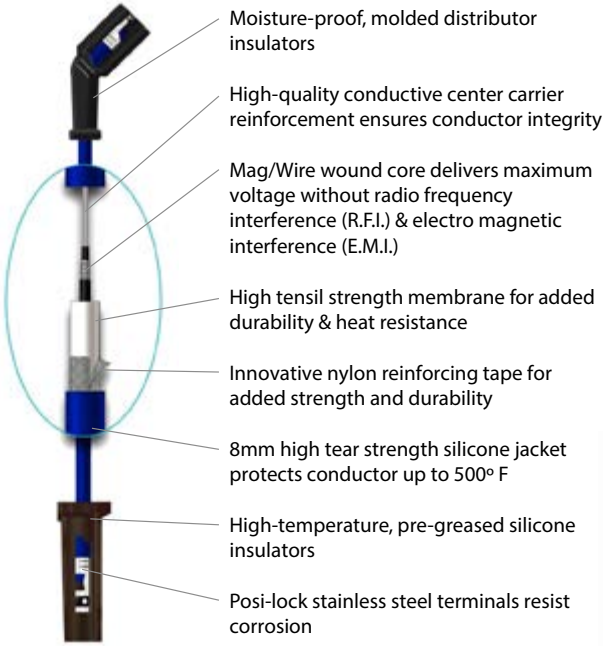

- Moisture-proof, molded distributor insulators
- High-quality conductive center carrier reinforcement ensures conductor integrity
- Mag/Wire wound core delivers maximum voltage without radio frequency interference (R.F.I.) & electro magnetic interference (E.M.I.)
- High tensil strength membrane for added durability & heat resistance
- Innovative nylon reinforcing tape for added strength and durability
- 8mm high tear strength silicone jacket protects conductor up to 500° F
- High-temperature, pre-greased silicone insulators
- Posi-lock stainless steel terminals resist corrosion



Part No.	Description
18-8819-1	7" Spark Plug Wire
18-5228-1	9" Spark Plug Wire
① 18-5228-1D	9" Spark Plug Wire
②③ 18-5229-9-1	22" Spark Plug Wire (pkg of 5)
②③ 18-5230-9-1	10" Spark Plug Wire (pkg of 5)



18-9802 TIMING LIGHT

Self-powered accurate up to 10,000 RPM's



BATTERY CABLES

Gauge cable with soldered lug terminals on each end to accept a 3/8" stud.



Part No.	Size	Color	Gauge
BC88523	2'	Red	4
BC88533	2'	Black	4
BC88543	4'	Red	2
BC88553	4'	Black	2
BC88563	6'	Red	2
BC88573	6'	Black	2
BC88583	8'	Red	1
BC88593	8'	Black	1

18-5225 SPARK PLUG WIRE KIT

Replaces: Mercury 84-99215A26, 84-813706A26
Kit includes 25 ft. roll of 7mm hypalon ignition wire with a metallic core and a large assortment of three different end fittings to fit outboard motors.



18-5222 IGNITION WIRE Silicone Core (100' Spool) 8mm



18-5226 IGNITION WIRE Metallic Core (100' Spool) 7mm Hypalon



PKG. OF 10



18-5224 18-5224-9② IGNITION WIRE TERMINAL

PKG. OF 10



18-5750 18-5750-9② UNIVERSAL SPARK PLUG BOOTS Supplied complete w/ Terminal Connector



18-5752 UNIVERSAL SPARK PLUG BOOTS (8mm)



18-5206 CONDENSER Replaces: 398-176

① Items ending in "D" are Display Packaged - Regular number is Non-Display

② Priced per Package

③ Uses 7mm wire copper core

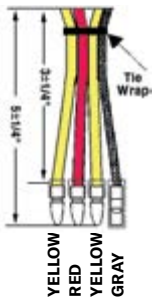

18-5744
VOLTAGE REGULATOR

Replaces: 8152794, 883071A1, 856747T1, 854514A1, 830179A1, 8174111, 815279T5, 815279T4
Force engines with 16 amp - 20 amp charging system model years 1993-present



18-6762
TILT/TRIM MOTOR

Replaces: 449541-3, 455541

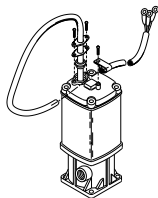

18-6775
TILT/TRIM MOTOR

Replaces: 824051, 830250A6
For: 90 HP (1995-97) and 120 HP (1995-97)
Contains: All parts necessary, a new 3-wire motor/reservoir, drive shaft coupler, oil seal, o-ring and hardware.

If you have this 3-wire single ram system, use **18-6775**



18-6286
TILT/TRIM MOTOR

Heavy Duty Late Model Mercury/Force 25-50HP Outboards w/2-wire connection and flat blade shaft. 4 bolt mount.
Replaces: 827675A1



18-6279
TILT/TRIM MOTOR

Replaces: 820545, F694541-1
Late model Force outboards w/2 wire connection

18-6777
TILT/TRIM MOTOR

Replaces: 818903A1, 819762A4-A7, 819479A1, 819480A1, 81977A8-A9, 822870A1, 830250A3-T3, 832021A1-T4-A2-T2, 855654A1-T2, 19217A1-A5
Contains: All parts necessary, a new 2-wire motor/reservoir, drive shaft coupler, oil seal, O-ring and hardware.

For:

HP	Years	HP	Years
40	1992-94	90	1991-94
50	1991-94	120	1990-94
70	1991-95	150	1989-94
75	1996-99		

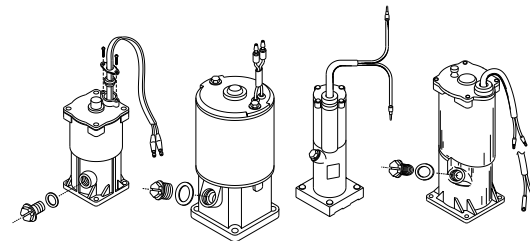

If you have any of the 2-wire single ram systems, use **18-6777**



18-6439
STARTER

Replaces: 50-803903T, 50-F575955
Fits: 50HP (1984-92)



18-6441
STARTER

Replaces: 50-803900T, 50-F514955
Fits: 25 HP (1983-84, 1989), 30 hp (1979), 35 HP (1976-78, 1986-91)



18-5613
OUTBOARD STARTER

Replaces: Mercury/Force FK616955, F616955, F490955, F480955, FS438955, F438955-1, F85955-1, FA85955, FS438955, FS480955, FS489955, FS490955



18-5618
OUTBOARD STARTER

Replaces: Mercury/Force 50-819968-2, 50-8199684, 50-8199683, 50-8199681, 50-819968, 50-898265003



18-5622
OUTBOARD STARTER

Replaces: Mercury/Force 50-820193, 50-820193T1



18-5697
DRIVE BRUSH KIT

Replaces: 75384, F15164

CHRYSLER/FORCE

Years	Starter	OEM #	Drive Assembly	O.E. #	Tooth Count	Drive Brush Kit	O.E. #
1983-84	18-6441	50-F514955/514955	18-5655	F15150	10	18-5697	F15157
1989	18-6441	50-F514955/514955	18-5655	F15150	10	18-5697	F15157
1979	18-6441	50-F514955/514955	18-5655	F15150	10	18-5697	F15157
1976-78	18-6441	50-F514955/514955	18-5655	F15150	10	18-5697	F15157
1986-91	18-6441	50-F514955/514955	18-5655	F15150	10	18-5697	F15157
1966-89	①	201955/FK575955	-	F15150	9	18-5697	F15164
1966-92	18-6439	50-F575955	18-5655	F15150	10	18-5697	F15164
1966-92	①	50-F514955/514955	-	-	10	18-5697	F15164
1992-99	18-5622	50-820193/50-820193T1	18-5677	811902	13	18-5697	F15164
1992-94	①	50-819271/50-820193A1	18-5677	811902	13	18-5697	F15164
1966-89	18-5613	50-819085/F616955-1/F616955	-	819222	9	18-5697	F15164
1966-89	18-5613*	480955/FK616955	-	F15100, F15110	9	18-5697	F15164
1991-95	18-5613	50-819085/F616955-1/F616955	-	819222	9	-	F15190
1996-98	18-5613	50-819085/F616955-1/F616955	-	819222	9	-	F15190
1989	18-5613	50-819085/F616955-1/F616955	-	819222	9	18-5697	F15164
1992-97	18-5618	50-819968-2	-	820583	9	-	F15190
1991-98	18-5613	50-819085/F616955-1/F616955	-	819222	9	-	F15190
1990-91	18-5613	50-819085/F616955-1/F616955	-	819222	9	18-5697	F15164
1990-91	18-5613	50-819085/F616955-1/F616955	-	819222	9	18-5697	F15164
1990-94	18-5613	50-819085/F616955-1/F616955	-	819222	9	18-5697	F15164
1989A-1992C	18-5613	50-819085/F616955-1/F616955	-	819222	9	-	F15190
1989-1994	18-5613	50-819085/F616955-1/F616955	-	819222	9	-	F15190

① No replacement starter available, drive parts only

* Only fits 140 HP (1983-1984)



**18-7033
CARB KIT**
Replaces: FK10003, FK10026, FK10053, FK10102-1



**18-7037
CARB KIT**
Replaces: FK10004, FK10005, FK10007, FK10008, FK10027, FK10057, FK10108, FRK739



**18-7041
NEEDLE & SEAT**
Replaces: FO16311, FO10790



**18-7057
NEEDLE & SEAT**
Replaces: FO10790
.078 Bore



**18-7805
FUEL PUMP KIT**
Replaces: F24747-1



**18-7806-1
FUEL PUMP KIT**



**18-7817
DIAPHRAGM KIT**
Replaces: 21-42990A7, A8, A9, A10, 21-857005A1

CHRYSLER

HP	Model	Carb Kit	Needle & Seat	Fuel Pump Kit
3.6	32/33HA,HB,HC	18-7037	18-7057	N/A
4.5	42HA	18-7037	18-7057	18-7805
5	52/53HA	—	—	18-7805
6	60HA	18-7037	18-7057	18-7805
6	60HOD,H8B,H9C	—	—	18-7805
6	61HOC,H8B,H9B	—	—	18-7805
6	62H8J,H9K,H9L	—	—	18-7805
6	67H9B,H9C	—	—	18-7805
6	62/63H9M	18-7037	18-7057	18-7805
6	62/63HA ①	18-7037	18-7057	18-7805

① S/N 3001 & up

APPLICATION CONTINUED ON NEXT PAGE

CHRYSLER (Cont.)				
HP	Model	Carb Kit	Needle & Seat	Fuel Pump Kit
6	62/63HA ②	—	—	18-7805
6	62/63H9M,HC,HD,HE,HF,HG,HH	18-7037	18-7057	18-7805
6	64HA,HB,HC	18-7037	18-7057	18-7805
6	64H0F,H1G,H2H,H9E,65H0A	—	—	18-7805
6	64H8D	18-7037	18-7057	18-7805
7	72/73HA	—	—	18-7805
7.5	70H9A	—	—	18-7805
7.5	71H1B,H2C,H3D,H9A	—	—	18-7805
7.5	72H1D,H2E,H3F,H0C,H9B	—	—	18-7805
7.5	75H9A,77H0B,H1C,H9B	—	—	18-7805
8	82/83HA,HC,HD,HE,HF,HG,HH,H9K	18-7037	18-7057	18-7805
8	82/87H8J	—	—	18-7805
9.9	91H0B,H9A	18-7037	18-7057	18-7805
9.9	91H3C,95H3J	—	—	18-7805
9.9	92H1H,98H1B	18-7037	18-7057	18-7805
9.9	92H1J/H2J,H3K	—	—	18-7805
9.9	92/93H0G,H9F,HD,HE	18-7037	18-7057	18-7805
9.9	92/93HA	—	—	18-7805
9.9	92/93HB ④	18-7037	18-7057	18-7805
9.9	92/93HB ⑤	—	—	18-7805
9.9	94H1F,94/95HA,95H2H	—	—	18-7805
9.9	94/95HB,HD,HE, 95H0F,H1G	18-7037	18-7057	18-7805
9.9	98H2C 98/99H9A	—	—	18-7805
10	100HA,101H8B	18-7037	18-7057	18-7805
10	102/103HA,HB,HC,HD,H8B	18-7037	18-7057	18-7805
10	104/105HA,HB,HC	18-7037	18-7057	18-7805
10	108/109HA,H8B	18-7037	18-7057	18-7805
12	121H9A,125H9E	18-7037	18-7057	18-7805
12.9	122/123HA,HC,HD,H9E	18-7037	18-7057	18-7805
12.9	124/125HA,HC,HD	18-7037	18-7057	18-7805
12.9	128/129 H9A	18-7037	18-7057	18-7805
15	152H1G	18-7037	18-7057	18-7805
15	152H1H,H2H,H3J	—	—	18-7805
15	158H3D	—	—	18-7805
15	152/153HA,HC,HB,H0F,H8D,H9E	18-7037	18-7057	18-7805
15	154HB,154/155HA	18-7037	18-7057	18-7805
15	158/159,HA,H8B,H9C	18-7037	18-7057	18-7805
20	202/203HA,HB,HD,HE,HF,HG	—	—	18-7805
20	202/3H0L,H1M,H9K,202H2N	18-7037	18-7057	—
20	204/205HA,HB,HD,HE,HF,HG	—	—	18-7805
20	206/207H9B	18-7037	18-7057	—
25	252H3G,257H3D ⑥	18-7037	18-7057	—
25	252/253HA,HB,H8C,H8D,252H1F,H2F	18-7037	18-7057	—
25	254/255HA,HB 256/257HA,HB	18-7037	18-7057	—
30	302/303HA,HB	18-7037	18-7057	—
30	302/303H9C	—	18-7057	—
30	304/305HA,HB	18-7037	18-7057	—
30	306/307H0C,H9B	—	18-7057	—
30	306/307HA,307H1D,H2E	18-7037	18-7057	—
35	350 THRU 355HA,HC,HD	18-7037	18-7057	18-7806-1
35	350/351,HE,HF,HG,HH,HK,H8L	18-7037	18-7057	—
35	352/353H8K,H9L,353H0M,H1N	18-7037	18-7057	—

① S/N 3001 & up

② S/N 3000 & under

③ 554HF S/N 11072 & up 555HF 14439 & up, 557HF 14581 & up 558HF 11108 & up, 559HF 14309 & up

④ Tillotson carb CO-3A

⑤ Tillotson carb MD-144A

⑥ Tillotson carb WB-19D

CHRYSLER (Cont.)

HP	Model	Carb Kit	Needle & Seat	Fuel Pump Kit
35	352/353HE, HF, HG, HH, HJ, H2P	18-7037	18-7057	—
35	354/355HE, HF, HG, HH	18-7037	18-7057	—
35	356/357HC, HD, HC, HE, HF, HK, H8M	18-7037	18-7057	—
35	357H3N, R3P, 360/361HA, HB	18-7037	18-7057	—
35	356/357HA, HB	18-7037	18-7057	18-7806-1
45	450/451HK	18-7037	18-7057	—
45	450 THRU 457HA, HC, HD	18-7037	18-7057	18-7806-1
45	450 THRU 457HE, HF, HG, HH	18-7037	18-7057	—
45	452/453HJ, H8K	18-7037	18-7057	—
45	456/457HOL, HJ, H1M, H9K, 457H2N	18-7037	18-7057	—
45	458/459HA, HB	18-7037	18-7057	18-7806-1
45	458/459HD, HC, HE, HF, HG	18-7037	18-7057	—
45	459H0J, H9H	18-7037	18-7057	—
45	468/469HA	18-7037	18-7057	—
50	503H3A, 507H1A, H2B, H2C, H3D, R3E	18-7037	18-7057	—
55	551HA, 554 THRU 559HA, HD, HF ③	18-7037	18-7057	18-7806-1
55	554 THRU 559HE, HG	18-7037	18-7057	—
55	558/559HH, HJ, HK, H9L	18-7033	18-7057	—
55	559HOM, HON, H1N, H2P, H3R, V3S	18-7033	18-7057	—
60	608/609HA	18-7033	18-7057	—
65	659HA, HB	—	18-7057	—
70	706/707HA, HC, HD, HE	18-7033	18-7057	18-7806-1
70	706/707HF, 709HOAN, H9A	18-7037	18-7041	—
70	T700H9A	18-7037	18-7057	—
75	754H0B, 456H0F, H2H, 757HD, H9E	18-7033	18-7057	—
75	756/757HA, HB, HC, 756H1G	18-7037	18-7041	—
75	758H0B, H1C, P/S759H9A	18-7037	18-7041	—
75	758H2D, T750H9A	18-7037	18-7057	—
85	850H0A, H1C, 851H9A, P/S855H9A	18-7033	18-7057	—
85	856H0H, H1J, H2K	18-7033	18-7057	—
85	856/7HA, HC, HD	18-7033	18-7057	18-7806-1
85	856/7HE	18-7037	18-7041	—
85	857HF, H9G	18-7033	18-7057	—
85	858H0C, H1D, H2E	18-7033	18-7057	—
85	859HA, H8A, H9B, T850H9A	18-7033	18-7057	—
90	906/907HA, HB, HC	18-7033	18-7057	—
100	T1000H9A, 1002H0AN, 1004H0B, H9A	—	18-7057	—
100	1006H0B, H1C, 1007H9A, 1008H0A, H1B	—	18-7057	—
105	1055HA	18-7037	18-7057	—
105	1055HB	—	18-7057	—
105	1056/1057HA, HB, HC, HD	18-7037	18-7057	18-7806-1
105	1056/1057HE, HF	18-7037	18-7057	—
105	1057HH, 1058H2G	—	18-7057	—
105	1058 HA, HB, HC	18-7037	18-7057	18-7806-1
105	1058/9HD, HE	18-7037	18-7057	—
105	1058/1059HF, 1059HG	—	18-7057	—
115	1159HA	—	18-7057	—
120	1206/1207HA, HB, HC, HD	18-7037	18-7057	18-7806-1
120	1206/1207HE, HF	18-7037	18-7057	—
120	1208HA, HB, HC	18-7037	18-7057	18-7806-1
120	1208/1209HD, HE	18-7037	18-7057	—
120	1208/1209HF, 1209HG	—	18-7057	—
130	1306/1307HA	18-7037	—	18-7806-1
135	1358HA, HB, HC	18-7037	18-7057	18-7806-1
150	1508HA	18-7037	—	18-7806-1

③ 554HF S/N 11072 & up 555HF 14439 & up, 557HF 14581 & up 558HF 11108 & up, 559HF 14309 & up

FORCE					
HP	MODEL	YEAR	BEGINNING SERIAL #	ENDING SERIAL #	FUEL PUMP KIT
5	5	1988-1996	N/A	N/A	18-7805
7.5	7.5	1985	N/A	N/A	18-7805
9.9 / 15	9.9 / 15	1984-1998	N/A	N/A	18-7805
25	25	1989	N/A	N/A	18-7806-1
35	35	1986-1987	N/A	N/A	18-7806-1
35A	35A	1988-1991	N/A	N/A	18-7806-1
35B	35B	1988-1991	N/A	N/A	18-7806-1
35C	35C	1989-1991	N/A	N/A	18-7806-1
40 / 50	40 / 50	1992	E000001	E065371	18-7806-1
40 / 50	40 / 50	1992-1994	E065372	E093669	18-7817
40 / 50	40 / 50	1995	E093700	E138599	18-7817
40 / 50	40 / 50	1997-1999	E138600	& UP	18-7817
50	50	1984-1992	N/A	N/A	18-7806-1
60	60	1985	N/A	N/A	18-7806-1
70	70	1991B / 1992C	E000001	E039023	18-7806-1 ①
70	70	1992-1995	E039024	E138599	18-7817 ①
75	75	1996-1999	E138600	& UP	18-7817
85	85	1983-1988 / 1989A, 1989B	N/A	N/A	18-7806-1
85	85	1989C-H / L-DRIVE	N/A	N/A	18-7806-1
90	90	1991A / 1991B / 1991C	N/A	N/A	18-7806-1
90	90	1991D-1992C	E000001	E039023	18-7806-1 ①
90	90	1992-1994	E039024	E093699	18-7817 ①
90	90	1995-1999	E093700	& UP	18-7817
90	90 L-Drive	1991	N/A	N/A	18-7806-1
90	90	1990	N/A	N/A	18-7806-1
90	90 L-DRIVE	1990	N/A	N/A	18-7806-1
90	SPORT JET 90	1993-1994	E023150	E066619	18-7806-1
90	SPORT JET 90	1995-1996	E138325	E138599	18-7806-1
90	SPORT JET 90XR	1996-1997	E141089	& UP	18-7806-1
120	120	1990A-1991C	N/A	N/A	18-7806-1
120	120	1991D-1992C	E000001	E093699	18-7817 ①
120	120	1993-1994	E000001	E093699	18-7817
120	120	1995	E093700	E138599	18-7817
120	120	1996-1999	E0138600	& UP	18-7817
120	120 L-DRIVE	1990-1992	N/A	N/A	18-7806-1
120	120 SPORT JET	1995-1997	E095088	E138599	18-7806-1
125	125	1984-1989	N/A	N/A	18-7806-1
125	125 L-DRIVE	1989	N/A	N/A	18-7806-1
150	150	1989-1992	UP TO	E065371	18-7806-1
150	150	1993-1994	E000001	E093699	18-7817

① Serial # E000001-E065371 use 18-7806-1

FUEL WATER SEPARATORS



Sierra offers a complete line of 10 and 21 micron fuel water separating filters including drainable bowl filters to protect your carbureted and fuel injected engine.

Refer to pages 156-161 for a complete listing of OEM and universal applications.

Sierra fuel water separators remove over 99.8% of emulsified water from your gasoline. Sierra's 10 micron filters are over 90% efficient at removing particles as small as 10 micron. All filters flow @ 90 GPH to feed even the hungriest motor. Sierra 10 micron filters are recommended to prevent damage to sensitive inboard and outboard fuel injection systems.

8' LENGTH COMPLETE FUEL LINE ASSEMBLIES

FUEL LINE ASSEMBLY

18-8011EP-2 SILVERADO 4000 Premium

OE# FS409752



**18-8071
TANK
CONNECTOR**
(SOLD SEPARATELY)



**18-8005EP-1
PRIMER
BULB**



**18-8062
FUEL
CONNECTOR**



FUEL LINE ASSEMBLY COMPONENTS

CHRYSLER FUEL APPLICATION

Engine	Year	Engine	Year	Engine	Year
6 HP	1976-82	35 HP	1974-89	90 HP	1975-77, 1983-84, 1991-94
7.5 HP	1979-85	40 HP	1992-94	100 HP	1979-84
8 HP	1976-79	45 HP	1974-84	105 HP	1976-78, 1982
9.9 HP	1979-95	50 HP	1981-94	115 HP	1977-84
10 HP	1976-78	55 HP	1974-83	120 HP	1976-77, 1990-94
12 HP	1979	60 HP	1984-85	125 HP	1981-88
15 HP	1976-95	65 HP	1978	135 HP	1976-77
20 HP	1978-82	70 HP	1979-80, 1991-95	140 HP	1978-84
25 HP	1975-78, 1981-84, 1989	75 HP	1975-84	150 HP	1989-94
30 HP	1979-82	85 HP	1977-88		



**18-8002EP-1
18-8002EP-1-10^①**
PRIMER BULB
1/4"



**18-8004EP-1
18-8004EP-1-10^①**
PRIMER BULB
5/16"
Large capacity bulb

**18-8005EP-1
18-8005EP-1-10^①**
PRIMER BULB
3/8"
Large capacity bulb



**18-8062
FUEL CONNECTOR**
3/8" barb
Replaces: 197787-3
Mates with **18-8071**



**18-8071
TANK CONNECTOR**
1/4" NPT .432 O.D.
Mates with **18-8062**
(Male)



^① Discount shop pack of 10 - Priced per package



**18-3556
THERMOSTAT**
Replaces: F85068-2, F84068-2, F85068-1, F85068
140°



**18-3557
THERMOSTAT**
Replaces: F97068-2
3/4" - 130°



**18-3555
THERMOSTAT**
Replaces: F335068
1" - 143°



**18-3030
IMPELLER**
Replaces: 47-803630T, F523065, F523065-1
For: Force outboard, 85 HP (1975-89, except 1989 D, F, G, H), 125 HP A,B,&C (1981-88)



**18-3017
18-3017-10^②**
IMPELLER
Replaces: 47-89984T4, 47-F694065, 47-803631T



**18-3056
18-3056-10^②**
IMPELLER
Replaces: 47-430262



**18-3057
IMPELLER**
Replaces: 47-85089-3

APPLICATION ON NEXT PAGE

^① Items ending in "D" are Display Packaged - Regular number is Non-Display
^② Discount shop pack of 10 - Priced per package



①18-3251D Display Pack of 10

18-3251 WATER PUMP KIT
For: 85HP (1989 D, F, G, H) 90HP (all except 1995-97 & Sport Jet) 120HP (all except 1995-97 & Sport Jet) 125HP (1988-89) 150HP (1989-up)

— CONTAINS —

Part #	Desc.	O.E. #	Qty.
18-0416	Gasket, Wear Plate	27-F694830	1
18-3017	Impeller	47-89984T4	1

①18-3214D Display Pack of 10

18-3214 IMPELLER REPAIR KIT
Replaces: 46-43024A7

— CONTAINS —

Part #	Desc.	O.E. #	Qty.
18-2564-1	Water Pump Base to Face Plate Gasket	27-43033-1	1
18-2565	Water Pump Base to Gear Hsg. Gasket	27-43047-1	1
18-2566	Face Plate to Water Pump Cover Gasket	27-817277	1
18-2944	Seal Ring	26-45577	1
18-3056	Impeller	47-43026-1	1
18-3122	Impeller Plate	817276	1
18-7420	O-Ring	25-21836	1

①18-3215D Display Pack of 10

18-3215 IMPELLER REPAIR KIT

— CONTAINS —

Part #	Desc.	O.E. #	Qty.
18-2560	Impeller Washer Gasket	12-86645	2
NSS	Gear Hsg. to Face Plate Gasket	27-85087	1
18-2562	Gear Hsg. to Face Plate Gasket	27-99326-1	1
18-3057	Impeller	47-85089-3	1
18-7419	O-Ring	25-69202	1

① Items ending in "D" are Display Packaged - Regular number is Non-Display
 ② Discount shop pack of 10 - Priced per package

CHRYSLER/FORCE					
HP	Year	Serial No.	Impeller	Impeller Kit	Thermostat
9.9	1979-97	ALL	18-8903	18-3240	—
9.9/15	1998	E288600-E344999 ③	18-3062	—	—
10	1974-78	ALL	18-8903	18-3240	—
12	1979	ALL	18-8903	18-3240	—
15	1974-97	ALL	18-8903	18-3240	—
20	1973-78	ALL	18-8903	18-3240	—
20	1979-82	ALL	18-8901	18-3240	—
25	1973-78	ALL	18-8903	18-3240	—
25	1996-98	E127700-E344999	18-3057	18-3215	18-3556
30	1980-82	ALL	18-8901	—	—
35	1976-78, 83-84 & 86-88	ALL	18-8901	—	18-3556
35	1979-82	ALL	18-3084	—	18-3556
40/50	1992-94	E065372-E093669	—	—	18-3556
40/50	1995-99	E093700-E369299	18-3057	—	18-3556

① Except model "C" for 1988 ② 1989 "D" & "E" models ③ Mercury Lower Unit

APPLICATION CONTINUED ON NEXT PAGE

CHRYSLER/FORCE (Cont.)

HP	Year	Serial No.	Impeller	Impeller Kit	Thermostat
50	1984-91,1992A	N/A	—	—	18-3556
70	1979-80	ALL	18-3085		—
70	1991-95	E138600-E345999	18-8900	—	—
75	1979	ALL	18-3085		—
75	1980	ALL	18-3030		—
75	1996-98	E138600-E345999	18-8900	—	—
75	1999	E345000-UP	18-3057	—	—
85	1977-88	ALL	18-3030		—
85	1989	A,B	18-3030		—
85	1989	C,E	18-3030		—
85	1989	D, F, G, H	18-3017		—
85	L-DRIVES 1989	A,B,C	18-3017	—	—
90	1991A,B,C,D-1992C	E000001-E039023	18-3017	18-3251	—
90	1992-94	E039024-E093699	18-3017	18-3251	—
90	1995-97	E093700-UP	18-3056	18-3214	—
90 L-DRIVE	1991	N/A	18-3017	18-3251	—
90 & L-DRIVE	1990	N/A	18-3017	18-3251	—
SPORT JET 90	1993-94	E023150-E066619	—	—	—
SPORT JET 90	1995-96	E138325-E138599	—	—	—
SPORT JET 95XR	1996-97	E141089-UP	—	—	—
100	1979-80	ALL	18-3030		—
105	1977-78	ALL	18-3030		—
115	1977-80	ALL	18-3030		—
120/135	1977	ALL	18-3030		—
120	1990A-91C	N/A	18-3017	18-3251	—
120	1991D-92C& 1993, 1994	E000001-E093699	18-3017	18-3251	—
120	1995-97	E093700-UP	18-3056	18-3214	—
120 L-DRIVE	1990-92	N/A	18-3017	18-3251	—
120 SPORT JET	1995-97	E095088-E138599	—	—	—
125	1981-89	ALL	18-3030	—	— ① ②
125	1988	C	18-3030	—	—
125 L-DRIVE	1989	N/A	18-3017	18-3251	—
140	1978-80	ALL	18-3030		—
150	1989-92	UP TO E065371	18-3017	18-3251	—
150	1993-UP	E000001-E093699	18-3017	18-3251	—

① Except model "C" for 1988

② 1989 "D" & "E" models

③ Mercury Lower Unit

CHRYSLER IMPELLER APPLICATION

HP	Model	Year	Serial #	Impeller	Impeller Kit	Thermostat
9.9	9.9	1979-1997	All	18-8903	18-3240	N/A
9.9 / 15	9.9 / 15	1998	E288600 - E344999 ①	18-3062	N/A	N/A
10	10	1974-1978	All	18-8903	18-3240	N/A
12	12	1979	All	18-8903	18-3240	N/A
15	15	1974-1997	All	18-8903	18-3240	N/A
20	20	1973-1978	All	18-8903	18-3240	N/A
20	20	1979-1982	All	18-8901	18-3240	N/A
25	25	1973-1978	All	18-8903	18-3240	N/A
25	25	1996-1998	E127700 - E344999	18-3057	18-3215	18-3556
30	30	1980-1982	All	18-8901	N/A	N/A
35	35	1976-1978	All	18-8901	N/A	18-3556
35	35	1983-1984	All	18-8901	N/A	18-3556
35	35	1986-1988	All	18-8901	N/A	18-3556

① Mercury lower unit

② Except model "c" for 1988

③ 1989 "D" & "E" models

APPLICATION CONTINUED ON NEXT PAGE

CHRYSLER IMPELLER APPLICATION						
HP	Model	Year	Serial #	Impeller	Impeller Kit	Thermostat
35	35	1979-1982	All	18-3084	N/A	18-3556
40 / 50	40 / 50	1992-1994	E065372 - E093669	N/A	N/A	18-3556
40 / 50	40 / 50	1995-1999	E093700 - E369299	18-3057	N/A	18-3556
50	50	1984-1991	N/A	N/A	N/A	18-3556
50	50	1992A	N/A	N/A	N/A	18-3556
70	70	1979-1980	All	18-3085	N/A	N/A
70	70	1991-1995	E138600 - E345999	18-8900	N/A	N/A
75	75	1979	All	18-3085	N/A	N/A
75	75	1980	All	18-3030	N/A	N/A
75	75	1996-1998	E138600 - E345999	18-8900	N/A	N/A
75	75	1999	E345000 & UP	18-3057	N/A	N/A
85	85	1977-1988	All	18-3030	N/A	N/A
85	85	1989	A, B	18-3030	N/A	N/A
85	85	1989	C, E	18-3030	N/A	N/A
85	85	1989	D, F, G, H	18-3017	N/A	N/A
85	L-DRIVES	1985	A, B, C	18-3017	N/A	N/A
90	A, B, C, D	1991	E000001 - E039023	18-3017	18-3251	N/A
90	C	1992	E000001 - E039023	18-3017	18-3251	N/A
90	90	1983-1984	ALL	18-3030	N/A	N/A
90	90	1992-1994	E039024 - E093699	18-3017	18-3251	N/A
90	90	1995-1997	E093700 & UP	18-3056	18-3214	N/A
90	90 L-DRIVE	1991	N/A	18-3017	18-3251	N/A
90	90 / 90 L-DRIVE	1990	N/A	18-3017	18-3251	N/A
90	SPORT JET 90	1993-1994	E023150 - E066619	N/A	N/A	N/A
90	SPORT JET 90	1995-1996	E138325 - E138599	N/A	N/A	N/A
95	SPORT JET 95XR	1996-1997	E141089 & UP	N/A	N/A	N/A
100	100	1979-1981	ALL	18-3030	N/A	N/A
100	100	1983-1984	ALL	18-3030	N/A	N/A
105	105	1977-1978	ALL	18-3030	N/A	N/A
105	105	1982	ALL	18-3030	N/A	N/A
115	115	1977-1982	ALL	18-3030	N/A	N/A
120 / 135	120 / 135	1977	ALL	18-3030	N/A	N/A
120	1990A	1990	N/A	18-3017	18-3251	N/A
120	1991C	1991	N/A	18-3017	18-3251	N/A
120	1991D	1991	E000001 - E093699	18-3017	18-3251	N/A
120	1992C	1992	E000001 - E093699	18-3017	18-3251	N/A
120	1993-1994	1993-1994	E000001 - E093699	18-3017	18-3251	N/A
120	120	1995-1997	E093700 & UP	18-3056	18-3214	N/A
120	120 L-DRIVE	1990-1992	N/A	18-3017	18-3251	N/A
120	120 SPORT JET	1995-1997	E095088 - E138599	N/A	N/A	N/A
125	125	1981-1989	ALL	18-3030	N/A	N/A ②③
125	125	1988	C	18-3030	N/A	N/A
125	125 L-DRIVE	1989	N/A	18-3017	18-3251	N/A
140	140	1978-1982	ALL	18-3030	N/A	N/A
150	150	1989-1992	UP TO E065371	18-3017	18-3251	N/A
150	150	1993 & UP	E000001 - E093699	18-3017	18-3251	N/A

① Mercury lower unit

② Except model "c" for 1988

③ 1989 "D" & "E" models



FORCE PISTON APPLICATION

HP/Model	Cyl.	Bore Size	Piston	OEM Part #	Rings	OEM Part #
40-50	2	3.312 / STD.	—	700-834794T3, FA691015, 700-F694015	18-39010 ①	39-817869A1, FA663260
40-50	2	3.322 / .010	18-4630	700-834794A4, 700-FSA694015	—	39-817869A2, FSA335260
40-50	2	3.342 / .030	18-4631	700-834794A5, 700-818134A1	—	39-817869A3, 39-818110A1
40-50	2	3.375 / STD.	18-4632	700-834800A4, 700-819005A8	18-3998 ①	39-8204757A2, FA528269, FA528260, 39-820457A1, 39-820457A2
40-50	2	3.385 / .010	18-4633	700-834800A5, 700-819005A12, 700-834800A2	18-3999	39-820641A1
40-50	2	3.405 / .030	18-4634	700-834800A6	—	39-818129A2
85-90 & L-DRIVES	3	3.312 / STD.	—	700-834794T3, FA691015	18-39010 ①	39-817869A1, FA663260
85-90 & L-DRIVES	3	3.322 / .010	18-4630	700-834794A4, 700-FSA694015	—	39-817869A2, FSA335260
85-90 & L-DRIVES	3	3.342 / .030	18-4631	700-834794A5, 700-818134A1	—	39-817869A3, 39-818110A1
90 L-DRIVE, SPORT JET	3	3.375 / STD.	18-4632	700-834800A4, 700-819005A8	18-3998 ①	39-8204757A2, FA528269, FA528260, 39-820457A1, 39-820457A2
90 L-DRIVE, SPORT JET	3	3.385 / .010	18-4633	700-834800A5, 700-819005A12, 700-834800A2	18-3999	39-820641A1
90 L-DRIVE, SPORT JET	3	3.405 / .030	18-4634	700-834800A6	—	39-818129A2
120-150	4	3.312 / STD.	—	700-834794T3, FA691015, 700-F694015	18-39010 ①	39-817869A1, FA663260
120-150	4	3.322 / .010	18-4630	700-834794A4, 700-FSA694015	—	39-817869A2, FSA335260
120-150	4	3.342 / .030	18-4631	700-834794A5, 700-818134A1	—	39-817869A3, 39-818110A1
120 L-DRIVE, SPORT JET	4	3.375 / STD.	18-4632	700-834800A4, 700-819005A8	18-3998 ①	39-8204757A2, FA528269, FA528260, 39-820457A1, 39-820457A2
120 L-DRIVE, SPORT JET	4	3.385 / .010	18-4633	700-834800A5, 700-819005A12, 700-834800A2	18-3999	39-820641A1
120 L-DRIVE, SPORT JET	4	3.405 / .030	18-4634	700-834800A6	—	39-818129A2

① Keystone Rings

CHRYSLER POWERHEAD GASKET SET APPLICATION

HP	Years	Part #	HP	Years	Part #	HP	Years	Part #
45	1972-83 ①	—	85	1970-73, 1977-88	—	120	1971-77	—
50	1981-87	—	90	1974-77	—	125	1983-88 ②	—
55	1972-76 ①	—	100	1979-81, 1983	—	130	1972	—
70	1970-73, 1979-80	—	105	1972-78, 1982	—	135	1974-77	—
75	1974-83	—	115	1977-83	—	140	1978-83	—

① Beginning mid year 1972 All BC, BE, HC & HE Models

② For 1988 A & B Models

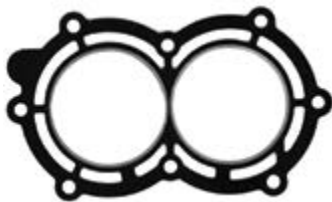

18-3851
HEAD GASKET
Replaces: 27-F286529-3
For: 9.9 and 15 HP

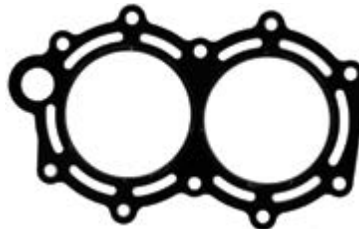

18-3852
HEAD GASKET
Replaces: 27-F513529
For: 25 and 35 HP

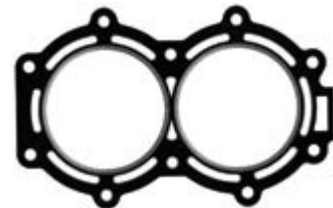

18-3853
HEAD GASKET
Replaces: 27-F691529-1
For: 45 and 50 HP

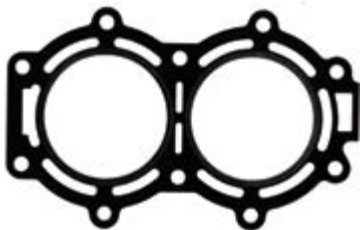

18-3854
HEAD GASKET
Replaces: 27-F658529
For: 50 HP



18-3855
HEAD GASKET
Replaces: 27-820438
For: 70, 75,85 and 90 HP

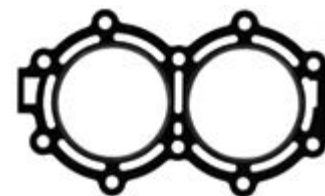

18-3856
HEAD GASKET
Replaces: 27-F201529-1
For: 1984-1987 "A" models 50 HP

18-3857

HEAD GASKET

Replaces: 27-824615/27-824615-2, F476529, F476529-1, F476529-2, 27-F476529-4
For: 100 thru 140 H.P.



18-3859

HEAD GASKET

Replaces: 27-819138-2
For: 25 HP (E127700-E344999)



HEAD GASKET APPLICATION

HP	Model/Year	Serial #	Part No.	HP	Model/Year	Serial #	Part No.
9.9/15	1984-92,A,B	N/A	18-3851	90	1990-92,C,E	N/A	18-3855
9.9/15	1992-98	E000001 & UP	18-3851	90	1991-99	E000001 & UP	18-3855
25	1989A,B	N/A	18-3852	90	1990-91 L-DRIVE,A,B,C,D	N/A	18-3855
35	1986-91,A,B,C	N/A	18-3852	90	1993-95 SPORT JET	E023150-E138599	18-3855
40	1992C & 1992-99	E000001 & UP	18-3853	95	1996-97 SPORT JET XR	E141089 & UP	18-3855
50	1990A,1989-92,B,C,D,Z	N/A	18-3853	120	1990-92,A,C	N/A	18-3857
50	1984-87,A	N/A	18-3856	120	1990-99	E000001 & UP	18-3857
50	1988-89,A /1987-88,B,C,D	N/A	18-3854	120	1990-92,A,B,C,D L-DRIVE	N/A	18-3857
70	1991-92,B,C	N/A	18-3855	120	1995-99 SPORT JET,XR,XR2	N/A	18-3857
70	1992-95	E000001 & UP	18-3855	125	1983-89, A	N/A	18-3857
75	1996-99	E138600 & UP	18-3855	125	1986-89, B	N/A	18-3857
85	1984-89,A,L /1986-89,B,C,	N/A	18-3855	125	1988-89, C	N/A	18-3857
85	1986,M,N	N/A	18-3855	125	1989, D, E	N/A	18-3857
85	1985 L-DRIVE A,B,C	N/A	18-3855	150	1989A-1992C		N/A
85	1989,D,E,F,G,H	N/A	18-3855	150	1989-1994	E000001-E093699	N/A
90	1990-91,A,B,D	N/A	18-3855				

PKG. OF 2



18-0141
18-0141-9①
BYPASS GASKET
Replaces: 27-F85762

PKG. OF 2



18-0315
18-0315-9①
CARBURETOR GASKET
Replaces: 27-F440906

PKG. OF 2



18-0960
18-0960-9①
CARBURETOR MOUNTING GASKET
Replaces: 27-F85906



18-0314
CARBURETOR ADAPTER GASKET
Replaces: 27-828316, 27-F178168, 27-F178168-1, F178168

PKG. OF 2



18-0855
18-0855-9①
CARBURETOR ADAPTER FLANGE GASKET
Replaces: 27-F85168-2

PKG. OF 2



18-0915
DEFLECTOR PLATE GASKET
Replaces: 27-F406406



18-0861
CYLINDER DRAIN REED PLATE GASKET
Replaces: 27-F85748-2

PKG. OF 2



18-0119
18-0119-9①
EXHAUST PLATE GASKET
Replaces: 27-F85154-1



18-0958
EXHAUST PLATE GASKET
Replaces: 27-F372154-1

PKG. OF 2





18-0869
18-0869-9①
PORT COVER GASKET
Replaces: 27-F40223, 27-820500A3

PKG. OF 2



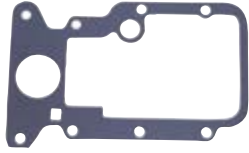

18-0115
18-0115-9①
POWERHEAD BASE GASKET
Replaces: 27-F307279-2

① Priced per Package

 <p>18-0154 LOWER EXHAUST CYLINDER GASKET Replaces: 27-F40279-1</p>	<p>PKG. OF 2</p>  <p>18-0854 18-0854-9① THERMOSTAT COVER GASKET Replaces: 27-F476067</p>	<p>PKG. OF 2</p>  <p>18-0873 18-0873-9① THERMOSTAT GASKET Replaces: 27-F97067, 27-819377</p>
--	--	---

 <p>18-0622 LOWER WEAR PLATE GASKET Replaces: 27-19701</p>	<p>PKG. OF 2</p>  <p>18-0415 18-0415-9① WATER PUMP GASKET Replaces: 27-F523031</p>	<p>PKG. OF 2</p>  <p>18-0416 WEAR PLATE GASKET Replaces: 27-F694830</p>
---	--	--

<p>PKG. OF 2</p>  <p>18-2534 SEAL (40") Replaces: F184122-1</p>	 <p>18-2370 BEARING CARRIER Replaces: 19291A3 For: Force 40/50 HP (1995-99), 70 HP (1991-95), 75 HP (1996-98), Mercury/Mariner 30/40 HP 2 cyl (9854537-OP016999), 30/40 4-stroke (OG760300-up), 40/50 HP/30Jet 3 cyl (9973100-up), 60 HP 3 cyl (OD000750-up), 60 HP 4-stroke 9973100-up)</p>	<p>①18-2375D </p> <p>18-2375 DRAIN PLUG (MAGNET) 18-23751-9① (Package of 50 without gasket)</p>
---	--	---

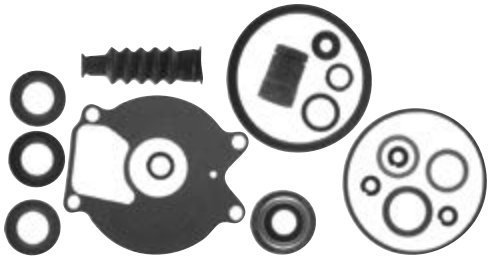
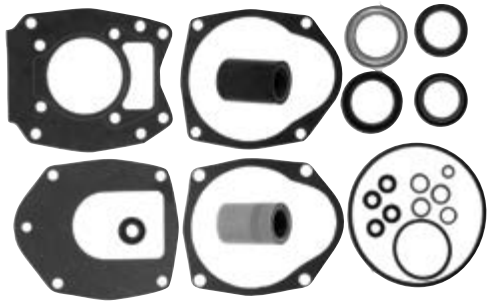
 <p>18-2624 LOWER UNIT SEAL KIT Replaces: 26-85090A2</p> <p>— CONTAINS —</p>	 <p>18-2626 LOWER UNIT SEAL KIT Replaces: 26-43035A4</p> <p>— CONTAINS —</p>
---	--

PART #	DESC.	O.E. #	QTY.	PART #	DESC.	O.E. #	QTY.
18-0579	Oil Seal	26-41131	1	18-0522	Oil Seal	26-43036	1
18-0580	Oil Seal	26-41132	1	18-0583	Oil Seal	26-43035	1
18-0586	Seal	26-99325	2	18-2002	Oil Seal	26-76868	1
18-7419	O-Ring	25-69202	1	18-2053	Oil Seal	26-70081	1
18-2562	Gear Hsg to Face Plate Gasket	27-99326-1	1	18-2054	Oil Seal	26-816464	1
18-2945	Drain Screw Gasket	12-19183	2	18-2563	Face Plate to Water Pump Cover Gasket	27-43034-1	1
18-2742	Boot	85552	1	18-2564-1	Water Pump Base to Face Plate Gasket	27-43033-1	1
18-2560	Washer	12-86645	2	18-2565	Water Pump Base to Gear Hsg Gasket	27-43047-2	1
18-7135	O-Ring	25-35276	1	18-2566	Face Plate to Water Pump Cover Gasket	27-817277	1
18-7956	O-Ring	25-85549	1	18-2945	Drain Screw Gasket	12-19183	3
18-7100	O-Ring	25-85594	1	18-4261	Washer	19643	1
18-7959	O-Ring	25-99691	1	18-7198	O-Ring	25-45710	1

① Priced per Package

APPLICATION FOR SEAL KITS ON PAGE 260



18-2629
LOWER UNIT SEAL KIT
 Replaces: 26-85090A1



18-2630
LOWER UNIT SEAL KIT
 Replaces: FK1060



18-2631
LOWER UNIT SEAL KIT
 Replaces: FK1061



18-2632
LOWER UNIT SEAL KIT
 Replaces: FK1063-2, FK1063-1
 – CONTAINS –

PART #	DESC.	O.E. #	QTY.
18-2945	Drain Screw Gasket	10-79953A2	3
18-7127	O-Ring	25-F84305	1
18-0500	Seal	26-817472	1
NSS	Seal	26-F84307-1	1
18-7169	O-Ring	25-F24278	1
18-7176	O-Ring	25-90011	1
18-7467	O-Ring	25-54030	1
18-7141	O-Ring	802047	1



18-2637-1
LOWER UNIT SEAL KIT
 Replaces: FK1064

– CONTAINS –

PART #	DESC.	O.E. #	QTY.
18-0500	Seal	26-817472	1
18-2945	Drain Screw Gasket	12-19183	2
18-7149	O-Ring	25-525555	1
18-7171	O-Ring	25-F525305	1
18-7191	O-Ring	25-F474342	1



18-2635
LOWER UNIT SEAL KIT
 Replaces: 26-814669A2, 26-814669A1, FK1234
 – CONTAINS –

PART #	DESC.	O.E. #	QTY.
18-0500	Seal	26-817472	1
18-0622	Lower Wear Plate Gasket	27-19701	1
18-2051	Seal	26-69188	1
18-2052	Seal	26-69189	1
18-2945	Drain Screw Gasket	12-19183	3
18-7168	O-Ring	25-48171	2
18-7173	O-Ring	25-30224	1
18-7950	O-Ring	25-45258	1

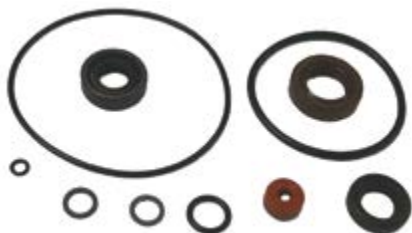

18-2639
LOWER UNIT SEAL KIT
 Replaces: FK1068
 – CONTAINS –

PART #	DESC.	O.E. #	QTY.
18-0584	Seal	26-66022	1
18-2945	Drain Screw Gasket	12-19183	2
18-7134	O-Ring	25-F498618	1
18-7141	O-Ring	25-25007	1
18-7176	O-Ring	25-90011	1

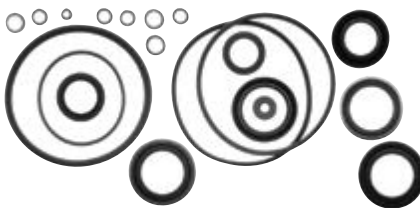

18-2640
LOWER UNIT SEAL KIT
 Replaces: FK1203-1, FK1203
 – CONTAINS –

PART #	DESC.	O.E. #	QTY.
18-0500	Seal	26-817472	1
18-2014	Seal	26-F694305	1
18-2076	Seal	26-12224	1
18-2077	Seal	26-14077	1
18-2945	Drain Screw Gasket	12-19183	3
18-7426	Grommet	25-30271	1
18-7127	O-Ring	25-F84305	1
18-7134	O-Ring	25-F498618	1
18-7169	O-Ring	25-F24278	1
18-7176	O-Ring	25-F74305	1
18-7413	O-Ring	25-62702	4



18-2697-1
LOWER UNIT SEAL KIT
 Replaces: 26-41365A3
 – CONTAINS –

PART #	DESC.	O.E.#	QTY.
18-0581	Oil Seal	26-413651	2
18-0584	Oil Seal	26-66022	1
18-0585	Oil Seal	26-821928	1
18-0586	Oil Seal	26-99325	1
18-2728	Water Tube Seal	26-42102-1	1
18-2945	Drain Screw Gasket	12-19183	2
18-3149-2	Water Pump Base	46-42040A5	1
18-4261	Washer	19643	1
18-7162	O-Ring	25-33145	1

CHRYSLER/FORCE LOWER UNIT SEAL KIT APPLICATION

Model / HP	Year	Seal Kit	Model / HP	Year	Seal Kit	Model / HP	Year	Seal Kit
6/7.5	1978-Up	18-2637	55	1972 1/2-1974	—	85 L Drive	1989	18-2640
9.9/15	1997 & prior	—	55 ②	1978-82	18-2630	90	1974-77	18-2631
9.9/15	1998	18-2697-1	55 ①	1983	—	90	1983	18-2632
20/25	1972-78	18-2639	60 ②	1984 & Prior	18-2630	90	1990-94	18-2640
25	1989	—	60 ①	1985	—	90	1995-99	18-2626
25	1996-97	18-2624	65 ①	All	—	90 L Drive	1990-91	18-2640
25	1998	18-2629	70	1970-73	18-2631	105	1970-76	18-2631
35	1970-72	18-2630	70	1979	18-2631	105	1979-83	18-2632
35	1972 1/2	—	70	1991-95	18-2635	120	1990-94	18-2640
35	1973	18-2630	75	1975-79	18-2631	120	1995-99	18-2626
35	1974-75	—	75	1980-83	18-2632	125 ③	1983-89	18-2632
35	1986-91	18-2639	75	1996-98	18-2635	125 D & E	1989	18-2640
35 B	1989-91	—	75	1999	18-2626	125 L Drive	1989	18-2640
40	1992-94	—	85	1980-89	18-2632	150	1989-94	18-2640
50	1984-94	—	① With one piece lower units		② With two piece lower units	③ 1989 A,B,C Models Only		

⑥ 18-3701D



18-3701 PROP NUT KIT

— CONTAINS —

Part #	O.E. #	Description	QTY.
18-3200	F697140	Tab Washer	2
18-3700	F7000	Prop Nut	1



18-4446 PROP WRENCH KIT (18-4444 Wrench Only)

— CONTAINS —

Part #	Desc.	QTY.
18-3200	Tab Washer	2
18-3700	Prop Nut	1
18-4444	Prop Wrench	1

PROP NUT & TAB WASHER APPLICATION

HP	Year	Model Type	Tab Washer	Prop Nut	Prop Nut Kit
90 ④	1990	A	—	18-3700	—
90	1990	B, C	18-3200	18-3700	18-3701
90	1991	ALL	18-3200	18-3700	18-3701
90 L-Drive	1990	C	18-3200	18-3700	18-3701
90 L-Drive	1991	ALL	18-3200	18-3700	18-3701
120	1990	A	—	18-3700	—
120	1990	B,C	18-3200	18-3700	18-3701
120	1991	ALL	18-3200	18-3700	18-3701
120 L-Drive	1990	ALL	18-3200	18-3700	18-3701
120 L-Drive	1991	B,D	18-3200	18-3700	18-3701
125 L-Drive	1989	ALL	—	18-3700	—
150	1989	ALL	—	18-3700	—
150	1990	A	—	18-3700	—
150	1990	B, C, D	18-3200	18-3700	18-3701
150	1991	ALL	18-3200	18-3700	18-3701

④ 903F90A, X90A, 908F90A, X90A Models only.



18-2254 PROP SHAFT Replaces: 44-850308



18-3719 PINION NUT Replaces: 11-35921, 11-47411, 11-826375, 11-F694188 5/8" - 18 thread • 1 1/16" wrench

18-1112
REVERSE GEAR
THRUST BEARING
 Replaces: 31-F523901

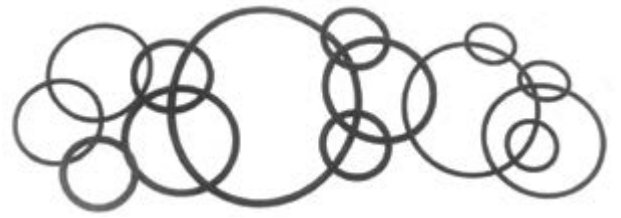

O-RINGS

Part No.	O.E. No.	Dimensions	
		I.D.	Width
18-7120	25-F498618	0.215	0.065
18-7127	25-F84305, 25-32507, F83404	3.315	0.135
18-7134 ●⑦	25-20195, 25-201951	0.5	0.1
18-7169 ●⑦	25-F24278	3.5	0.135
18-7176 ●⑦	25-F74305	2.16	0.1
18-7457	25-F455305	1.799	0.103
18-7950	25-45258	9.843	0.984
18-7952 ●⑦	25-88657	2.4803	0.1378
18-7956 ●⑦	25-85549	2.4803	0.1969
18-7100 ●⑦	25-85594	0.2362	0.1575

● PKG OF 5



18-1113
REVERSE GEAR BEARING
 Replaces: 31-F523143



OIL SEALS

Part No.	O.E. No.	Part No.	O.E. No.	Part No.	O.E. No.
18-0500	26-817472	18-0580	26-41132	18-2054	26-8164641, 26-816464, 26-76384
18-0502	26-819396	18-0583	26-43035	18-8354	26-828627
18-0503	26-F40307-2	18-0584	26-66022, 26-F346118		
18-0579	26-41131	18-0586	26-99325		

PARTS THAT KEEP YOU MOVING



SIERRA

Honda Model Number Identification

	Manufacturer	Horse-power	Model Year	Shaft Length	Steering System	Market
BF2	BF = Honda	EX: 2	DX = 1999 DY = 2000 D1 = 2001 D2 = 2002 D3 = 2003 D4 = 2004 D5 = 2005 D6 = 2006 DK0 = 2007-up	S = 15" L = 20"	H = Throttle Grip C = Centrifugal Clutch	A = American

EXAMPLE: BF2D1SCHA = Honda, 2 HP, 2001 Model, 15", Centrifugal Clutch w/Throttle Grip, American

	Manufacturer	Special Features	Horse-power	Model Year	Shaft Length	Steering System	Starter	Market
BF5- BF20	BF = Honda	P = High Thrust Propeller = Standard Propeller	EX: 5 20	D1 = 2001 D2 = 2002 D3 = 2003 D4 = 2004 D5 = 2005 D6 = 2006 DK0 = 2007-up	S = 15" L = 20" XL = 25"	H = Throttle Grip C = Centrifugal Clutch	S = Electric = Manual T = Electric w/ Power Tilt	A = American





EXAMPLE: BFP5D1LHSA = Honda, High Thrust Prop., 5 HP, 2001 Model, 20", Throttle Grip, Elec. Start, American

	Manufacturer	Horse-power	Model Year	Shaft Length	Steering System	Tilt & Trim	Market
BF25- BF225	BF = Honda	EX: 25 115 225	AX = 1999 AY = 2000 A1 = 2001 A2 = 2002 A3 = 2003 A4 = 2004 A5 = 2005 A6 = 2006 K0 = 2007-up	S = 15" L = 20" X = 25" XX = 30"	R = Remote Control H = Tiller Handle	T = Tilt & Trim = Manual Tilt J = Jet Drive	A = American

EXAMPLE: BF25A1LRTA = Honda, 25 HP, 2001 Model, 20", Remote Control, Tilt & Trim, American

NOTE: After the 2006 model year Honda Marine dropped specific year designations.

 18-7494 COIL Replaces: 30520-PNA-007 Fits: 130/ 135/ 150/ 105 jet/ & 150 HP VTEC 1998-2007	 18-23251 IGNITION COIL Replaces: 30520-PWC-003 Fits: BF75(2007 & Up), BF90(2007 & Up)	 PKG. OF 10 18-5224 18-5224-9^① SPARK PLUG WIRE TERMINAL
---	--	--

 18-5225 SPARK PLUG WIRE KIT Kit includes 25 ft. Roll of 7 MM Hypalon Ignition Wire With a Metallic Core and a Large Assortment of Three Different End Fittings to Fit Outboard Motors.	 18-5226 IGNITION WIRE Metallic Core 100' Spool 7mm Hypalon	 PKG. OF 10 18-5750 18-5750-9^① UNIVERSAL SPARK PLUG BOOTS Supplied complete with Terminal Connector	 18-5752 UNIVERSAL SPARK PLUG BOOT (8mm)
---	--	--	--

 18-6475 ALTERNATOR Replaces: 31630-ZW5-003 Fits: BF115 (1999 & Up), BF130 (1999-2004)	 18-6476 ALTERNATOR Replaces: 31630-ZY6-003 Fits: BF135 & BF150 (2004 & Up)	 18-6409 ALTERNATOR Replaces: 31630-ZY3-003 Fits: BF200 2002-14, BF225 02-14
---	--	---

① Priced per Package



18-6445
STARTER
 Replaces: Honda 31200-ZW9-802
 Fits: 8 & 9.9HP (2001 & Up)



18-6959
STARTER
 Replaces: 31200-ZY6-003, 31200-ZY9-003,
 31200-ZY9A-0031
 Fits: 75-150HP 2004-2010



18-15061
OUTBOARD STARTER
 Replaces: 31200-ZW1-004
 Fits: BF75-90(1997-06)



18-6433
OUTBOARD STARTER
 Replaces: 31200-ZV5-013
 Fits: 40 H.P. (1999-UP)



18-6258
TILT/TRIM MOTOR
 Replaces: 36120-ZV5-821
 Fits: BF35,BF40,BF45,BF50 (1992-2002)



18-6742
TRIM MOTOR
 Replaces: 36120-ZY3-023
 Fits: 200-225 HP (02-Up), 175 HP (07-Up)



18-6743
TRIM MOTOR
 Replaces: 36120-ZY9-003
 Fits: 75-90 HP (07-Up)



18-6745
TRIM MOTOR
 Replaces: 36120-ZY6-013
 Fits: 135-150 HP (04-Up), 115 HP (07-Up)



18-6793
TRIM MOTOR
 Replaces: 36120-ZV5-822
 Fits: 40,50 H.P. (2002-03)



18-6823
WIRING HARNESS
 Replaces: Universal
 Converts 3-wire Tilt and Trim motors to
 2-Wire design

FUEL WATER SEPARATORS

Sierra offers a complete line of 10 and 21 micron fuel water separating filters including drainable bowl filters to protect your carbureted and fuel injected engine.

Refer to pages 153-157 for a complete listing of OEM and universal applications.

Sierra fuel water separators remove over 99.8% of emulsified water from your gasoline. Sierra's 10 micron filters are over 90% efficient at removing particles as small as 10 micron. All filters flow @ 90 GPH to feed even the hungriest motor. Sierra 10 micron filters are recommended to prevent damage to sensitive inboard and outboard fuel injection systems.

Sierra #	Honda #	Description
18-7947	17670-ZW1-030GH	Spin on Replacement Filter
18-7948	17670-ZW1-801AH	Spin on Replacement Filter
18-7521	16910-ZVL-003	Fuel Filter
18-7720	16900-SR3-004	Fuel Filter
18-7786	16900-SA5-004	Fuel Filter Kit
18-7785	16010-ST5-993	Fuel Filter Kit

9' LENGTH COMPLETE FUEL LINE ASSEMBLIES

3/8"
FUEL LINE ASSEMBLY

18-81042EP-2 *SILVERADO 4000 Premium* OE# 17700-ZW9-010
17700-ZW9-020



*



**18-80400
TANK
CONNECTOR**
(SOLD SEPARATELY)



**18-80401
FUEL
CONNECTOR**



**18-8005EP-1
PRIMER
BULB**



**18-80403
FUEL
CONNECTOR**



*

FUEL LINE ASSEMBLY COMPONENTS

Honda Fuel Application: 8, 9.9, 15, 25, 30, 40, 50, 75, 90, 115, 130 HP (2001-02)

* Tanks and Engines for picture purpose only.

**18-8002EP-1
18-8002EP-1-10①
PRIMER BULB**
1/4"



**18-8004EP-1
18-8004EP-1-10①
PRIMER BULB**
5/16"
Large capacity bulb

**18-8005EP-1
18-8005EP-1-10①
PRIMER BULB**
3/8"
Replaces: 174512
Large capacity bulb

**18-38008
FUEL CONNECTOR**
Replaces: 17660-ZV5-902
Fits: 3/8" hose barb, Use with 18-80406



**18-80401
FUEL CONNECTOR**
Female hose connector, new style, 3/8" hose, Will not interchange with OE's 5/16" hose assemblies. Mates with **18-80400**, tank outlet



**18-80403
FUEL CONNECTOR**
Female 3/8 hose connector with rectangular locking post, Will not interchange with OE's 5/16" hose assemblies. For late model engine: For use with our 18-81042 fuel hose assembly, motor end. Mates with **18-80407**



**18-80400
TANK CONNECTOR**
Replaces: 16977-ZV5-A00
Male tank outlet, new style, 1/4"NPT, nickel plated brass. Male connector, for fuel tank. Mates with **18-80401**



**18-80406
FUEL CONNECTOR**
Replaces: 16977-ZV5-900
Male tank outlet, old style, 1/4" NPT.



**18-80407
FUEL CONNECTOR**
Replaces: 17710-ZW9-033
5/16" with interlocking post
Fits: BF8-BF130 (2003)
Mates with **18-80403**, **18-80408**



**18-80408
FUEL CONNECTOR**
Replaces: 17650-ZW9-003
Female 5/16" connector with rectangular locking post. Fits late model engine Mates with **18-80407**



**18-80420
FUEL CONNECTOR**
Replaces: 17650-921-003ZB
Fits: BF5/BF8A 2001 and earlier
Mates with 17710-881-00ZA



FUEL FILTERS



Part No.	OE No.
18-7712	16910-GB2-005
18-8226 *	16910-ZV4-015

* Retail Packaged Item



18-7521
FUEL FILTER
Replaces: Honda 16910-ZVL-003
Honda BF225d/250D (2007-Later)



18-79909
FUEL FILTER
Replaces: 16901-ZY3-003
Fits: BF115D LA, BF115D XA, BF115D XCA, BF115DK1 LA, BF115DK1 XA, BF115DK1 XCA, BF135A4 LA, BF135A4 XA, BF135A4 XCA, BF135A5 LA, BF135A5 XA, BF135A5 XCA, BF135A6 LA, BF135A6 XA, BF135A6 XCA, BF135AK0 LA, BF135AK0 XA, BF135QK0 XCA, BF135AK2 LA, BF135AK2 XA, BF135AK2 XCA, BF150A4 LA, BF150 4 XA, BF150A4 XCA, BF150A5 LA, BF150A5 XA, BF150A5 XCA, BF150A4 XCA, BF150A5 LA, BF150A5 XA, BF150A5 XCA, BF150A6 LA, BF150A6 XA, BF150A6 XCA, BF150AK0 LA, BF150AK0 XA, BF150AK0 XCA, BF175AK1 LA, BF175AK1 XA, BF175AK1 XCA, BF175AK2 LA, BF175AK2 XA, BF175AK2 XCA, BF200A2 LA, BF200A2 XA, BF200A2 XCA, BF200A2 XXA, BF200A2 XXCA, BF200A3 LA, BF200A3 XA, BF200A3 XCA, BF200A3 XXA, BF200A3 XXCA, BF200A4 LA, BF200A4 XA, BF200A4 XCA, BF200A4 XXA, BF200A4 XXCA, BF200A5 LA, BF200A5 XA, BF200A5 XCA, BF200A5 XXA, BF200A5 XXCA, BF200A6 LA, BF200A6 XA, BF200A6 XCA, BF200A6 XXA, BF200AK0 LA, BF200AK0 XA, BF200AK0 XCA, BF200AK1 LA, BF200AK1 XA, BF200AK1 XCA, BF200AK2 LA, BF200AK2 XA, BF200AK2 XCA



18-79908
FUEL FILTER
Replaces: 16911-ZY3-010
Fits: BF90(2007 & Up), BF115(1997 & Below, 2002 & Up), BF130(2002-04), BF135(2004 & Up), BF150(2004 & Up), BF175(2007 & Up), BF200(2002 & Up), BF225(2002 & Up), BF250(1997 & Below)



18-97300
FUEL FILTER
Replaces: Honda 16700-ZVL-003
Fits: BF225

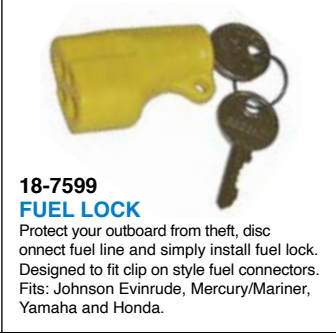

18-7599
FUEL LOCK
Protect your outboard from theft, disconnect fuel line and simply install fuel lock. Designed to fit clip on style fuel connectors. Fits: Johnson Evinrude, Mercury/Mariner, Yamaha and Honda.



18-7658
OXYGEN SENSOR
Replaces: 35655-ZY9-003



18-7659
OXYGEN SENSOR
Replaces: 35668-ZY6-003



18-32153
OXYGEN SENSOR
Replaces: 35655-ZY3-C01, 35655-ZZ5-004
Fits: BF40D, BF50D, BF250A (1997 & Prior), BF40DK2, BF50DK2, BF225AK1, BF225AK2 (2007 & Up)



18-25200
CAMSHAFT SENSOR
Replaces: 37500-PNB-003
Fits: 75 hp MFI



18-25201
CAMSHAFT SENSOR
Replaces: 37510-PNB-003
Fits: BF5 (2007 & Up), BF135 (2004 & Up), BF150 (2004 & Up)



18-7552
SENSOR, MAP
Replaces: 37830-PGK-A01
Fits: BF135A 2004-2006, BF135AK0, BF150A 2004-2006, BF150AK0, BF200A 2002-2006, BF200AK0, BF225A 2002-2006, BF225AK0



18-7558
SENSOR, KNOCK
Replaces: 30530-PPL-A01
Fits: BF135A 2004-2006, BF150 2004-2006



18-7559
SENSOR, KNOCK
Replaces: 30530-P8F-A01
Fits: BF200A 2002-2006, BF200AK0, BF225 2002-2006, BF225AK0

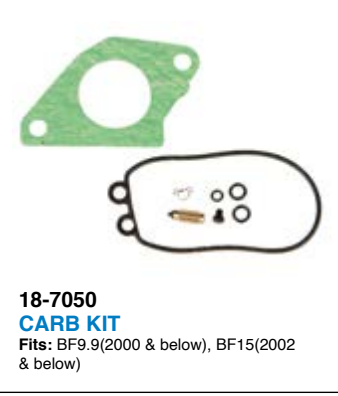

18-7050
CARB KIT
Fits: BF9.9(2000 & below), BF15(2002 & below)



18-7051
CARB KIT
Fits: BF9.9(2001 & Up), BF15(2003 & Up)



18-7052
CARB KIT
Fits: BF75(1997 & Up), BF90(1997 & Up)



18-7053
CARB KIT
Fits: BF8(1996 & below), BF75(1996 & below), BF100(1996 & below)



18-7047
NEEDLE VALVE
Replaces: 16011-ZV4-005
Fits: BF8(2001 & Up), BF9.9(All), BF15(All), BF20(2003 & Up), BF25(All), BF30(All), BF35(1997), BF40(All), BF45(1997), BF50(All), BF75(1997 & Up), BF90(1997 & Up)

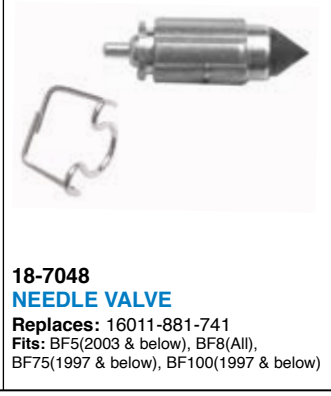

18-7048
NEEDLE VALVE
Replaces: 16011-881-741
Fits: BF5(2003 & below), BF8(All), BF75(1997 & below), BF100(1997 & below)

① Discount shop pack of 10 - Priced per package



18-3628-1
THERMOSTAT

Replaces: 19300-ZW9-003
For: BF8D1, BF8D2, BF8D3BF15D3, BF15D4, BF15D5, BF15D6, BF15DK0, BF20D3, BF20D4, BF20D5, BF20D6, BF20DK0, BF25D4, BF25D5, BF25D6, BF25DK0, BF30D4, BF30D5, BF30D6, BF30DK0, BF40A4, BF40A5, BF40A6, BF40AK0, BF40D, BF50A4, BF50A5, BF50A6, BF50AK0, BF50D, BF60A, BFP60A, BF75DK0, BF90DK0, BF200A2, BF225A2
60°C



18-3630
THERMOSTAT

Replaces: 19300-ZV5-043
For: BF25A, BF25A1, BF25A2, BF25A3, BF25AW, BF25AX, BF25AY, BF30A, BF30A1, BF30A2, BF30A3, BF30AW, BF30AX, BF30AY, BF35AM, BF40A, BF40A1, BF40A2, BF40A3, BF40AW, BF40AX, BF40AY, BF45AM, BF50A, BF50A1, BF50A2, BF50A3, BF50AW, BF50AX, BF50AY, BF75A1, BF75A2, BF75A3, BF75A4, BF75A6, BF75AT, BF75AW, BF75AX, BF75AY, BF90A1, BF115A1, BF115A2, BF115AX, BF115AY, BF130A1, BF130A2, BF130AX, BF130AY
72°C



18-3122
IMPELLER PLATE

Replaces: 19231-ZW1-003
For: 75-90 HP



18-3031
IMPELLER

Replaces: 19210-ZY3-003
Fits: BF200 & BF225 (2002 & Up)



18-3100
IMPELLER

Replaces: 19210-ZW9-013, 19210-ZW9-003
Fits: BF8D/9.9D short, long shaft



18-3056
18-3056-10②
IMPELLER

Replaces: 19210-ZW1-003
For: 75-90 HP



18-32455
IMPELLER

Replaces: 19210-ZW9-A32, 19210-ZW9-A31
For: Honda 8 & 9.9 (2001 & Up); Honda 15 & 20 (2003 & Up)



18-3246
IMPELLER

Replaces: 19210-ZV4-013, 19210-ZV4-651
For: BF9.9, BF15, AH, AK, AM, AW Series # 14ZV40M



18-3247
IMPELLER

Replaces: 19210-ZV4-651
For: 8, 9.9, 15 HP



18-3248
IMPELLER

Replaces: 19210-ZV5-003
For: 35, 40, 45, 50 HP



18-3249
IMPELLER

Replaces: 19210-ZV7-003
For: 25, 30 HP



18-3250
IMPELLER

Replaces: 19210-ZW1-B04
For: 75, 90, 115, 130 HP



18-3268
IMPELLER KEY

Replaces: 90752-ZV4-650
Fits: BF9.9A, BF15A



18-3269
IMPELLER KEY

Replaces: 90752-ZV7-000
Fits: BF25, BF30



18-3270
IMPELLER KEY

Replaces: 90752-ZV5-003
Fits: BF35, BF40, BF45, BF50



18-3271
IMPELLER KEY

Replaces: 90752-ZW1-B02
Fits: BF75-BF90 AX & Up, BF115, BF130



18-3187
IMPELLER REPAIR KIT

Replaces: 06192-ZW1-305
Fits: BF75-90, (1996-98)
Includes impeller **18-3056**

18-3214D

18-3214
WATER PUMP KIT

Replaces: 19021-ZW1-003
For: BF 70/BF 90 1996-98
Includes impeller **18-3056**



18-3279
WATER PUMP SERVICE KIT
Replaces: 06192-881-C00
Fits: BF8A (USA)
 Includes impeller **18-3245**

18-3280
WATER PUMP SERVICE KIT
Replaces: 06192-ZV4-000
Fits: BF9.9A/BF15A
 Includes impeller **18-3247**

18-3281
WATER PUMP SERVICE KIT
Replaces: 06192-ZV7-000
Fits: BF25/30
 Includes impeller **18-3249**

18-3282
WATER PUMP SERVICE KIT
Replaces: 06192-ZV5-003
Fits: BF35/45, BF40/50
 Includes impeller **18-3248**

18-3283
WATER PUMP SERVICE KIT
Replaces: 06192-ZW1-000
Fits: BF115/130, BF75/90 AX & Later
 Includes impeller **18-3250**

18-3284
WATER PUMP SERVICE KIT
Replaces: 06192-ZY6-000
Fits: BF135 / BF150
 Includes impeller **18-3250**

18-3285
WATER PUMP SERVICE KIT
Replaces: 06192-ZY3-000
Fits: BF200/225
 Includes impeller **18-3031**

18-3478
WATER PUMP REPAIR KIT
Without Housing
Replaces: 06192-ZW9-A30
Fits: BFP8D/BFP9.9D (2003-06), BF15D/BF20D (2003-06), BFP20D (2004-06), BFP8D/BFP9.9D/BF15D/BFP15D/BF20D (K0, K2, K3), BFP20D (K0)

— CONTAINS —			
Part #	Desc.	O.E.#	Qty.
18-32455	Impeller	19210-ZW9-A32	1
NSS	Gasket, Water Pump	19232-ZW9-000	1
NSS	O-Ring	91301-ZG3-000	1
18-3025	Key, Impeller	90752-ZW9-A30	1

18-3489
WATER PUMP REPAIR KIT
Without Housing
Replaces: 06192-ZX2-C00
Fits: BF250A (ALL)

— CONTAINS —			
Part #	Desc.	O.E.#	Qty.
18-3031	Impeller	19210-ZY3-003	1
18-99154	Gasket, Water Pump	19234-ZX2-C00	1
18-8299	O-Ring	91356-ZY3-003	1
NSS	Key, Impeller	90752-ZY3-003	1

18-3492
WATER PUMP REPAIR KIT
Without Housing
Replaces: 06192-ZW1-B04
Fits: BF75A/BF90A/BF115A/BF130A (1999-02)

— CONTAINS —			
Part #	Desc.	O.E.#	Qty.
18-3250	Impeller	19210-ZW1-B04	1
NSS	Gasket, Water Pump	19234-ZW1-B00	1
NSS	Gasket, Water Pump	19242-ZW1-B00	1
NSS	Seal, Water Pump	91251-ZW1-B04	2

18-3493
WATER PUMP REPAIR KIT
Without Housing
Replaces: 06192-ZW9-000
Fits: BF8D/BFP8D/BF9.9D/BFP9.9D (2002-06), BF8D, BFP8D/BF9.9D/BFP9.9D (K0, K2, K3)

— CONTAINS —			
Part #	Desc.	O.E.#	Qty.
18-3100	Impeller	19210-ZW9-013	1
NSS	Gasket, Water Pump	19232-ZW9-000	1
NSS	O-Ring	91301-ZG3-000	1
18-3022	Key, Impeller	90752-ZW9-000	1

18-4536
WATER PUMP REPAIR KIT
Without Housing
Replaces: 06192-ZV4-A00
Fits: BF9.9A/15A (1998-01)

— CONTAINS —			
Part #	Desc.	O.E.#	Qty.
18-3247	Impeller	19210-ZV4-651	1
18-2495	Gasket, Water Pump	19232-ZV4-610	2
18-8298	Seal, Water Pump	91252-935-004	1

① Items ending in "D" are Display Packaged - Regular number is Non-Display • ② Discount shop pack of 10 - Priced per package













HONDA 4-STROKE WATER PUMP REPAIR KIT APPLICATION

Model	HP	Year	Honda Code	Impeller	Gasket	Kit without Housing
BF5A	5	1998-06	6315899	—	18-2524	—
BF5A	5	K0, K2, K3	6315899	—	18-2524	—
BF8A	8	1998-00	6315386	—	18-2608 18-2609	18-3279
BF8A	8	2003-06	6315386	—	18-2608 18-2609	18-3279
BF8A	8	K0	6315386	—	18-2608 18-2609	18-3279
BF8D	8	2002-06	7452345	18-3100	—	18-3493
BF8D	8	K0, K2, K3	7452345	18-3100	—	18-3493
BFP8D	8	2002-06	7452345	18-3100	—	18-3493
BFP8D	8	2002-06	7452352	18-32455	—	18-3478
BFP8D	8	K0, K2, K3	7452345	18-3100	—	18-3493
BFP8D	8	K0, K2, K3	7452352	18-32455	—	18-3478
BF9.9A	9.9	1998-01	6310494	18-3247	18-2495	18-4536
BF9.9A	9.9	1999-02	7452360	18-3247	18-2495	18-3280
BF9.9D	9.9	2002-06	7452345	18-3100	—	18-3493
BF9.9D	9.9	K0, K2, K3	7452345	18-3100	—	18-3493
BFP9.9D	9.9	2002-06	7452345	18-3100	—	18-3493
BFP9.9D	9.9	2002-06	7452352	18-32455	—	18-3478
BFP9.9D	9.9	K0, K2, K3	7452345	18-3100	—	18-3493
BFP9.9D	9.9	K0, K2, K3	7452352	18-32455	—	18-3478
BF15A	15	1998-01	6310494	18-3247	18-2495	18-4536
BF15A	15	1999-02	7452360	18-3247	18-2495	18-3280
BF15D	15	2003-06	7452352	18-32455	—	18-3478
BF15D	15	K0, K2, K3	7452352	18-32455	—	18-3478
BFP15D	15	K0, K2, K3	7452352	18-32455	—	18-3478
BF20D	20	2003-06	7452352	18-32455	—	18-3478
BF20D	20	K0, K2, K3	7452352	18-32455	—	18-3478
BFP20D	20	2004-06	7452352	18-32455	—	18-3478
BFP20D	20	K0	7452352	18-32455	—	18-3478
BF25A	25	2001-03	7452378	18-3249	18-2496	18-3281
BF25D	25	2004-06	7452378	18-3249	18-2496	18-3281
BF25D	25	K0, K2, K3	7452378	18-3249	18-2496	18-3281
BF30A	30	2001-03	7452378	18-3249	18-2496	18-3281
BF30D	30	2004-06	7452378	18-3249	18-2496	18-3281
BF30D	30	K0, K2, K3	7452378	18-3249	18-2496	18-3281
BF40A	40	2000-06	7452386	18-3248	18-2496 18-0176	18-3282
BF40A	40	K0	7452386	18-3248	18-2496 18-0176	18-3282
BF40D	40	K2	7452386	18-3248	18-2496 18-0176	18-3282
BF40D	40	Pre-1997	7452386	18-3248	18-2496 18-0176	18-3282
BF50A	50	2000-06	7452386	18-3248	18-2496 18-0176	18-3282
BF50A	50	K0	7452386	18-3248	18-2496 18-0176	18-3282
BF50D	50	K2	7452386	18-3248	18-2496 18-0176	18-3282
BF50D	50	Pre-1997	7452386	18-3248	18-2496 18-0176	18-3282
BF75A	75	1997-98	4921441	18-3056	18-2565	18-3214
BF75A	75	1999-02	6706634	-	-	18-3492
BF75A	75	2003-06	7452394	18-3250	NSS	18-3283
BF75D	75	K0, K2	7452394	18-3250	NSS	18-3283
BF90A	90	1997-98	4921441	18-3056	18-2565	18-3214

APPLICATION CONTINUED ON NEXT PAGE

HONDA 4-STROKE WATER PUMP REPAIR KIT APPLICATION (CONT.)

Model	HP	Year	Honda Code	Impeller	Gasket	Kit without Housing
BF90A	90	1999-02	6706634	-	-	18-3492
BF90A	90	2003-06	7452394	18-3250	NSS	18-3283
BF90D	90	K0, K2	7452394	18-3250	NSS	18-3283
BF115A	115	1999-02	6706634	-	-	18-3492
BF115A	115	2003-06	7452394	18-3250	NSS	18-3283
BF115A	115	K0	7452394	18-3250	NSS	18-3283
BF115D	115	K1	7632797	18-3250	18-2497	18-3284
BF115D	115	Pre-1997	7632797	18-3250	18-2497	18-3284
BF130A	130	1999-02	6706634	-	-	18-3492
BF130A	130	2003-04	7452394	18-3250	NSS	18-3283
BF135A	135	2004-06	7632797	18-3250	18-2497	18-3284
BF135A	135	K0, K2	7632797	18-3250	18-2497	18-3284
BF150A	150	2004-06	7632797	18-3250	18-2497	18-3284
BF150A	150	K0, K2	7632797	18-3250	18-2497	18-3284
BF175A	175	K1	7452402	18-3031	18-2499 18-8299	18-3285
B175A	175	K2	7452402	18-3031	18-2499 18-8299	18-3285
BF200A	200	2002-06	7452402	18-3031	18-2499 18-8299	18-3285
BF200A	200	K0, K1, K2	7452402	18-3031	18-2499 18-8299	18-3285
BF225A	225	2002-06	7452402	18-3031	18-2499 18-8299	18-3285
BF225A	225	K0, K1, K2	7452402	18-3031	18-2499 18-8299	18-3285
BF250A	250	ALL		18-3031	18-99154	18-3489

 <p>18-2499 WATER PUMP GASKET Replaces: 19234-ZY3-000 Fits: BF200, BF225</p>	 <p>18-2524 WATER PUMP GASKET Replaces: 19232-ZV1-A10 Fits: BF5</p>	 <p>18-2608 WATER PUMP GASKET Replaces: 19232-881-850 Fits: BF8A</p>	 <p>18-2609 WATER PUMP GASKET Replaces: 19234-881-850 Fits: BF8A</p>
 <p>18-0176 WATER PUMP GASKET Replaces: 19242-ZV5-000</p>	 <p>18-2495 WATER PUMP GASKET Replaces: 19232-ZV4-610 Fits: BF9.9A, BF15A</p>	 <p>18-2496 WATER PUMP GASKET Replaces: 19233-ZV5-000 Fits: BF25, BF30</p>	<p>PKG. OF 2</p>  <p>18-2563 18-2563-9^① IMPELLER GASKET Replaces: 19232-ZW1-003</p>
<p>PKG. OF 2</p>  <p>18-2564-1 18-2564-9^① IMPELLER GASKET Replaces: 19234-ZW1-003</p>	<p>PKG. OF 2</p>  <p>18-2565 18-2565-9^① IMPELLER GASKET Replaces: 19242-ZW1-003</p>	 <p>18-2480 GASKET SET Replaces: 16010-ZV4-005 Fits: BF8(2001), BF9.9(2001 & below), BF15(2002 & below), BF25(All), BF30(All), BF35(1997), BF40(All), BF45(1997), BF50(All), BF75(1997-06), BF90(1997-06)</p>	 <p>18-2481 GASKET SET Replaces: 16010-ZW9-003 Fits: BF8(2002 & Up), BF9.9(2002 & Up), BF15(2003 & Up), BF20(2003 & Up)</p>

^① Priced Per Package



18-2482
GASKET SET
Replaces: 16010-881-003
Fits: BF5(2003 & below), BF8(2000 & below, 2003 & Up), BF50(1996 & below), BF75(1996 & below), BF100(1996 & below)



18-2470
CARB MOUNTING GASKET
Replaces: 16221-ZV4-610
Fits: BF9.9 (2000 & below), BF15 (2002 & below)



18-2471
CARB MOUNTING GASKET
Replaces: 16221-ZW9-000
Fits: BF8(2001 & Up), BF9.9(2001 & Up)



18-2472
CARB MOUNTING GASKET
Replaces: 16221-ZW1-000
Fits: BF75(1997-06), BF90(1997-06)



18-2473
CARB MOUNTING GASKET
Replaces: 16201-881-850
Fits: BF8(2000 & below, 2003 & Up), BF75(1996 & below), BF100(1996 & below)



PKG. OF 2
18-2945
18-2945-9^①
18-29451-9^①
 (PKG. OF 50)
DRAIN SCREW GASKET
 Used with **18-2244** Drain Screw



18-0300
INTAKE MANIFOLD GASKET
Replaces: 17105-ZY6-000
Fits: BF135-BF150



18-0248
INTAKE MANIFOLD GASKET
Replaces: 17151-ZW5-000



18-0382
THROTTLE BODY GASKET
Replaces: 17109-ZY6-000
Fits: BF75-BF150



18-0396
THROTTLE BODY GASKET
Replaces: 17109-ZY3-004
Fits: BF200-BF225 (2002 & UP)

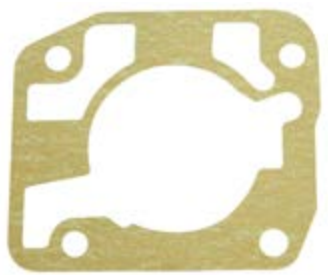

18-0737
THROTTLE BODY GASKET
Replaces: 16176-P0A-004



18-8298
SEAL
Replaces: 91252-935-004
Fits: BF8A

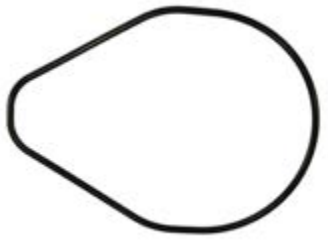

18-8299
MOLDED RUBBER SEAL (O-RING MATERIAL)
Replaces: 91356-ZY3-003
Fits: BF200, BF225

^① Priced per Package

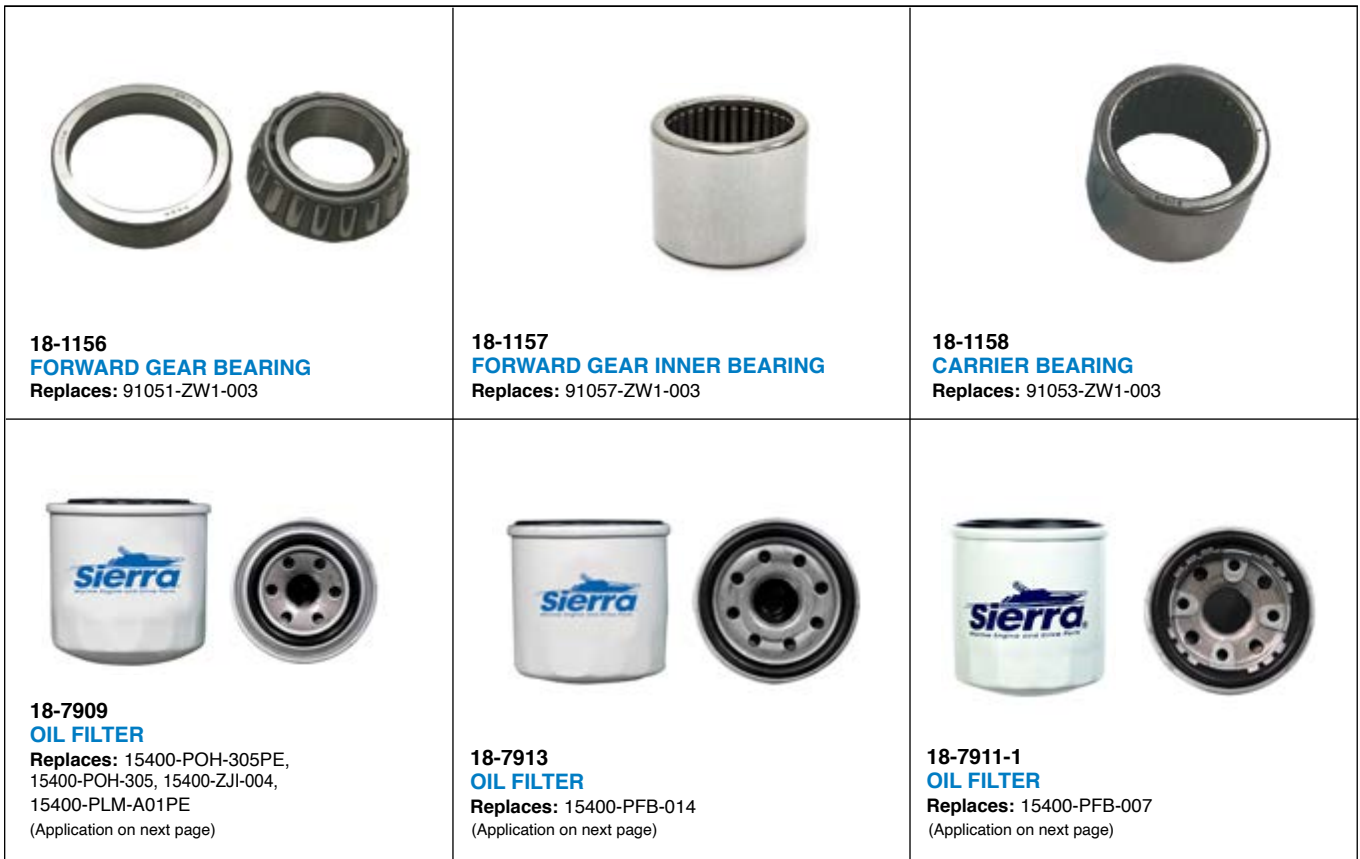

Models	Years	SS Number	Replace	Part No.	Models	Years	SS Number	Replace	Part No.
BF8D, BFP8D	2001-Current	15400-PFB-004	15400-PFB-014	18-7913	BF50A	1998-Earlier	15400-PJ7-005	15400-PFB-014	18-7913
BF9D, BFP9D	2001-Current	15400-PM3-004	15400-PFB-014	18-7913	BF25	1999-2005	15400-ZW4-003	15400-PFB-007	18-7911-1
BF15D, BFP15D	2003-Current	15400-PM3-405	15400-PFB-014	18-7913	BF30	1999-2005	15400-ZW4-003	15400-PFB-007	18-7911-1
BF20D	2003-Current	15400-PJ7-015	15400-PFB-014	18-7913	BF40	1999-2005	15400-ZW4-003	15400-PFB-007	18-7911-1
BF25A	1998-Earlier	15400-PJ7-005	15400-PFB-014	18-7913	BF50	1999-2005	15400-ZW4-003	15400-PFB-007	18-7911-1
BF30A	1998-Earlier	15400-PJ7-005	15400-PFB-014	18-7913	BF75, BF90	1997-Current	15400-P0H-305PE	15400-PLM-A01PE	18-7909
BF35AM	1998-Earlier	15400-PJ7-005	15400-PFB-014	18-7913	BF115, BF130	1999-Current	15400-P0H-305	15400-PLM-A01PE	18-7909
BF40A	1998-Earlier	15400-PJ7-005	15400-PFB-014	18-7913	BF135, BF150	2004-Current	15400-ZJI-004	15400-PLM-A01PE	18-7909
BF45AM	1998-Earlier	15400-PJ7-005	15400-PFB-014	18-7913	BF200, BF225	2002-Current	15400-ZJI-999AH	15400-PLM-A01PE	18-7909

Zinc is for saltwater only applications.
Magnesium is for fresh water only applications.
Aluminum is for brackish water, or if boat is used in both fresh and salt environments.

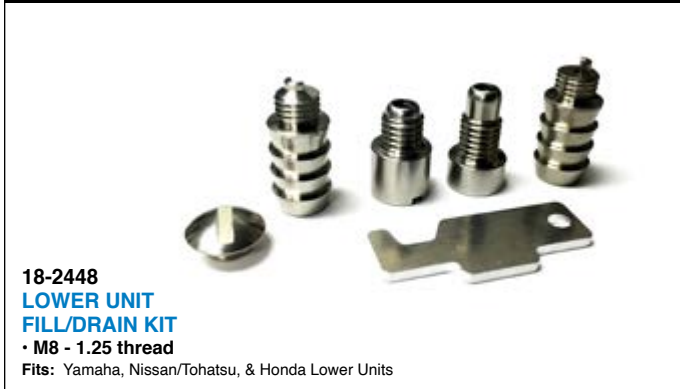

SEE PAGES 203-205 & 1155-1183 FOR ADDITIONAL OIL FILTER INFORMATION

- ① Aluminum ② Magnesium ③ Zinc ④ Priced per Package
 ⑤ Items ending in "D" are Display Packaged - Regular number is Non-Display



② 18-6241
 ③ 18-6011
 ① 18-6011A
ANODE
 Replaces: 41107-ZW1-003ZA
 BF75-BF90 (1997-98)



① 18-6165A
ANODE, TRIM TAB
 Replaces: 41107-ZV5-00-00
 Fits: BF25, BF30, BF35, BF45, BF50 (1997-Up)



① 18-6163A
 ② 18-6163M
ANODE KIT
 Fits: Honda BF90-115 Engines

PKG. OF 10



18-3200
 18-3200-9④
TAB WASHER
 Replaces: 90508-ZW1-003
 For: 75-90 HP

⑤ 18-3701D



18-3701
PROP NUT KIT
 — CONTAINS —

Part #	O.E. #	Description
18-3200	90508-ZW1-003	Tab Washer
18-3700	90301-ZW1-003	Prop Nut



18-8362-1
LOWER UNIT SEAL KIT
 For: Series 14ZV50M, BF35AM, BF45AM, BF40A, BF40AW, BF40AX, BF50A, BF50AW, BF50AX



18-8363
LOWER UNIT SEAL KIT
 For BF9.9, BF15

PKG. OF 5



18-7198
 18-7198-9④
O-RING
 Replaces: 91353-ZW1-003



OIL SEALS

Part No.	Description	O.E. No.
18-0522	Drive Shaft	91254-ZW1-003
18-0583	Drive Shaft	91251-ZW1-003
18-2002	Prop Shaft	91252-ZW1-003
18-2053	Prop Shaft	91255-ZW1-003
18-2054	Shift Shaft	91253-ZW1-003



Johnson/Evinrude Model Identification

OUTBOARDS 1980-1998









Model Variation	Style	Horse-power	Design Feature	Shaft Length	Year Built
A = Australia B = Belgium C = Canada H = Hong Kong S = South Africa T = Tracker V = Boat Builder	J = Johnson E = Evinrude C = Commercial V = Quiet Rider	Example: 20 40 200	AE = Elec. Start - Alaska AR = Rope Start - Alaska BA = AC Lighting - Rope Start BE = Belgium Derated - Elec. Start BF = Belgium Derated - Rope Start BG = Belgium Derated - Rope Start BI = Belgium Derated - Rope Start BR = Euro Rope Start C = Counter Rotation CE = Canada Derated - Elec. Start CR = Canada Derated - Rope Start D = Remote Electric DE = Derated - Elec. Start DR = Derated - Rope Start DT = Derated - Elec. Start/Trim & Tilt E = ER = Elec. Start - Sport Styling ES = Elec. Start - Special FA = 4-stroke - Rope Start FE = 4-stroke - Elec. Start/Remote FP = Commercial w/Program Tilt FR = 4-stroke - Rope Start FRE = 4-stroke - Elec. Start/Remote FS = FICHT - Trim & Tilt FT = FICHT - Trim & Tilt/Special Styling G = Special Styling H = Less Integral Tank/Hydraulic Steering I = FICHT Fuel Injection IE = Italy Elec. Start IK = Italy Elec. Start J = Jet Drive K = 3-CYL 25/35 KC = Kerosene Rope Start KG = Kerosene/Gasoline KS = Kerosene Rope Start M = Manual Tilt - Elec. Start MS = Manual Tilt - Elec. Start/Special N = Counter Rotation P = Power Steering Q = 3-CYL 25/35 Trim & Tilt R = Rope Start RA = Australia Rope Start RC = Rope Start - Commercial/CD Ignition RD = Rope Start - Deluxe RE = Remote Elec. RP = Commercial w/Program Tilt RS = Rope Start - Commercial RW = Commercial w/Program Tilt S = Sail - Special Styling SC = Special Styling/Counter Rotation SE = Elec. Start Non-Tilt Sail SI = Italy Special Derated SL = 60 Degree V - Trim & Tilt SP = Special Styling SR = Rope Start - Sail - Non-Tilt ST = Special Styling - Trim & Tilt T = Trim & Tilt - Elec. Start TE = Tiller Elec. TR = Trim & Tilt - Sport styling TT = Tiller - Trim & Tilt U = Manual Tilt V = Special Gearcase W = 110 Degree Angle Drive - Rope Start WM = Elec. Commercial - Manual Tilt WMP = Same as "WM" w/Chrome Pump WT = Elec. Commercial - Trim & Tilt WTP = Same as "WT" w/Chrome Pump	= 15" L = 20" Y = 22.5" X = 25" Z = 30" Elec. Start	I = 1 N = 2 T = 3 R = 4 O = 5 D = 6 U = 7 C = 8 E = 9 S = 0 EX: CS = 1980 ES = 1990 EU = 1997 SC = 2008

EXAMPLE: VE70TLEDA - Boat Builder Model, Evinrude, 70 HP, Trim & Tilt w/Elec. Start, 1996 Model

Johnson/Evinrude Model Identification OUTBOARDS 1999 AND NEWER

Style	Horsepower	Design Feature	Shaft Length	Year Built
J= Johnson E= Evinrude	Example: 20 40 200	3 = 3-Cyc (25 or 35 HP) 4 = Four Stoke Engine B = Blue Paint C = Counter-Rotation w/Trim & Tilt D = E-TEC E = Electric Start w/Remote Steering F = FICHT Fuel Injection G = Graphite Paint J = Jet M = Military Model P = Power Trim & Tilt R = Rope Start w/Tiler Steering S = Special Styling (White Evinrude) T = Tiller Steering TE = Tiller Electric W = Commercial Model	= 15" L = 20" Y = 22.5" X = 25" Z = 30"	I = 1 N = 2 T = 3 R = 4 O = 5 D = 6 U = 7 C = 8 E = 9 S = 0 EX: EE = 1999 SC = 2008

EXAMPLE: E70PLEEA - Evinrude Model, 70 HP, Power Trim & Tilt, 20", 1999 Model

 <p>18-5001 TUNE-UP KIT Replaces: 172525</p> <table border="1" style="width: 100%; border-collapse: collapse; font-size: small;"> <thead> <tr> <th colspan="4" style="text-align: center;">— CONTAINS —</th> </tr> <tr> <th>Part #</th> <th>Desc.</th> <th>O.E.#</th> <th>Qty.</th> </tr> </thead> <tbody> <tr> <td>18-5200</td> <td>Condenser</td> <td>580256</td> <td>1</td> </tr> <tr> <td>18-5157</td> <td>Contact set</td> <td>580290</td> <td>2</td> </tr> </tbody> </table>	— CONTAINS —				Part #	Desc.	O.E.#	Qty.	18-5200	Condenser	580256	1	18-5157	Contact set	580290	2	<p style="text-align: right;">①18-5002D Display Package</p>  <p>18-5002 TUNE-UP KIT Replaces: 172523</p> <table border="1" style="width: 100%; border-collapse: collapse; font-size: small;"> <thead> <tr> <th colspan="4" style="text-align: center;">— CONTAINS —</th> </tr> <tr> <th>Part #</th> <th>Desc.</th> <th>O.E.#</th> <th>Qty.</th> </tr> </thead> <tbody> <tr> <td>18-5205</td> <td>Condenser</td> <td>581419</td> <td>2</td> </tr> <tr> <td>18-5156</td> <td>Contact Set</td> <td>580148</td> <td>2</td> </tr> </tbody> </table>	— CONTAINS —				Part #	Desc.	O.E.#	Qty.	18-5205	Condenser	581419	2	18-5156	Contact Set	580148	2	<p style="text-align: right;">①18-5003D Display Package</p>  <p>18-5003 TUNE-UP KIT Replaces: 172806</p> <table border="1" style="width: 100%; border-collapse: collapse; font-size: small;"> <thead> <tr> <th colspan="4" style="text-align: center;">— CONTAINS —</th> </tr> <tr> <th>Part #</th> <th>Desc.</th> <th>O.E.#</th> <th>Qty.</th> </tr> </thead> <tbody> <tr> <td>18-5205</td> <td>Condenser</td> <td>581419</td> <td>2</td> </tr> <tr> <td>18-5141</td> <td>Contact Set</td> <td>581207</td> <td>2</td> </tr> </tbody> </table>	— CONTAINS —				Part #	Desc.	O.E.#	Qty.	18-5205	Condenser	581419	2	18-5141	Contact Set	581207	2
— CONTAINS —																																																		
Part #	Desc.	O.E.#	Qty.																																															
18-5200	Condenser	580256	1																																															
18-5157	Contact set	580290	2																																															
— CONTAINS —																																																		
Part #	Desc.	O.E.#	Qty.																																															
18-5205	Condenser	581419	2																																															
18-5156	Contact Set	580148	2																																															
— CONTAINS —																																																		
Part #	Desc.	O.E.#	Qty.																																															
18-5205	Condenser	581419	2																																															
18-5141	Contact Set	581207	2																																															
 <p>18-5006 TUNE-UP KIT Superseded from 18-5006D Replaces: 172522</p> <table border="1" style="width: 100%; border-collapse: collapse; font-size: small;"> <thead> <tr> <th colspan="4" style="text-align: center;">— CONTAINS —</th> </tr> <tr> <th>Part #</th> <th>Desc.</th> <th>O.E.#</th> <th>Qty.</th> </tr> </thead> <tbody> <tr> <td>18-5199</td> <td>Condenser</td> <td>580321</td> <td>2</td> </tr> <tr> <td>18-5156</td> <td>Contact Set</td> <td>580148</td> <td>2</td> </tr> </tbody> </table>	— CONTAINS —				Part #	Desc.	O.E.#	Qty.	18-5199	Condenser	580321	2	18-5156	Contact Set	580148	2	 <p>18-5011 TUNE-UP KIT Replaces: 172521</p> <table border="1" style="width: 100%; border-collapse: collapse; font-size: small;"> <thead> <tr> <th colspan="4" style="text-align: center;">— CONTAINS —</th> </tr> <tr> <th>Part #</th> <th>Desc.</th> <th>O.E.#</th> <th>Qty.</th> </tr> </thead> <tbody> <tr> <td>18-5199</td> <td>Condenser</td> <td>580321</td> <td>1</td> </tr> <tr> <td>18-5156</td> <td>Contact Set</td> <td>580148</td> <td>1</td> </tr> </tbody> </table>	— CONTAINS —				Part #	Desc.	O.E.#	Qty.	18-5199	Condenser	580321	1	18-5156	Contact Set	580148	1	 <p>18-5141 CONTACT SET Replaces: 581207</p>																
— CONTAINS —																																																		
Part #	Desc.	O.E.#	Qty.																																															
18-5199	Condenser	580321	2																																															
18-5156	Contact Set	580148	2																																															
— CONTAINS —																																																		
Part #	Desc.	O.E.#	Qty.																																															
18-5199	Condenser	580321	1																																															
18-5156	Contact Set	580148	1																																															
 <p>18-5156 CONTACT SET Replaces: 580148</p>	 <p>18-5157 CONTACT SET Replaces: 580290</p>	<p style="text-align: center;">CONDENSERS</p> <p>18-5199 Replaces: 580321</p> <p>18-5205 Replaces: 581419</p>	 <p>18-5200 CONDENSER Replaces: 580256</p>																																															

APPLICATION BEGINS ON NEXT PAGE

① Items ending in "D" are Display Packaged - Regular number is Non-Display

JOHNSON/EVINRUDE TUNE-UP KIT APPLICATION											
HP	Year Start	Year Stop	Contact Set	Condenser	Tune-Up Kit	HP	Year Start	Year Stop	Contact Set	Condenser	Tune-Up Kit
1.2	1986	1990	18-5156	18-5199	18-5011	25	1955	1955	18-5156	18-5199	18-5006
1.5	1968	1970	18-5156	18-5199	18-5011	25	1969	1976	18-5156	18-5205	18-5002
2	1971	1985	18-5156	18-5199	18-5011	28	1962	1964	18-5156	18-5205	18-5002
3	1952	1968	18-5156	18-5199	18-5006	30	1956	1956	18-5156	18-5199	18-5006
3	1989	1990	18-5156	18-5199	18-5006	33	1965	1970	18-5156	18-5205	18-5002
4	1969	1976	18-5156	18-5199	18-5006	35	1958	1959	18-5156	18-5199	18-5006
4	1981	1988	18-5156	18-5199	18-5006	35	1976	1976	18-5141	18-5205	18-5003
5	1965	1968	18-5156	18-5199	18-5006	38	1968	1968	18-5156	18-5199	18-5006
5.5	1954	1964	18-5156	18-5199	18-5006	40	1960	1961	18-5156	18-5199	18-5006
6	1965	1976	18-5156	18-5199	18-5006	40	1962	1973	18-5156	18-5205	18-5002
7.5	1956	1958	18-5156	18-5199	18-5006	40	1974	1976	18-5141	18-5205	18-5003
9.5	1964	1973	18-5156	18-5199	18-5006	40 Comm	1981	1983	18-5141	18-5205	18-5003
10	1950	1963	18-5156	18-5199	18-5006	50	1958	1959	18-5157	18-5200	18-5001
9.9	1970	1970	18-5156	18-5199	18-5006	60	1964	1967	18-5157	18-5200	18-5001
9.9	1974	1976	18-5141	18-5205	18-5003	75	1961	1967	18-5157	18-5200	18-5001
15	1956	1956	18-5156	18-5199	18-5006	80	1966	1967	18-5157	18-5200	18-5001
15	1974	1976	18-5141	18-5205	18-5003	90	1964	1965	18-5157	18-5200	18-5001
18	1956	1961	18-5156	18-5199	18-5006	90	1968	1968	18-5157	18-5200	18-5001
18	1962	1973	18-5156	18-5205	18-5002	100	1966	1966	18-5157	18-5200	18-5001
20	1968	1973	18-5156	18-5205	18-5002						

 <p>18-5163 IGNITION COIL Replaces: 581130, 763809</p>	 <p>18-5170 IGNITION COIL Replaces: 583740, 583298</p>	 <p>18-5172 IGNITION COIL Replaces: 581786, 502881</p>
<p>① 18-5176D Display Package</p>  <p>18-5176 IGNITION COIL KIT Replaces: 582106, 582330 582366, 583737, 584561</p>	<p>① 18-5179D Display Package</p>  <p>18-5179 IGNITION COIL Replaces: 582508</p>	<p>① 18-5181D Display Package</p>  <p>18-5181 IGNITION COIL Replaces: 582995, 584477</p>
 <p>18-5192 IGNITION COIL Replaces: 581610, 582091, 502888</p>	 <p>18-5194 IGNITION COIL Replaces: 582160, 584632, 502890, 581032</p>	 <p>18-5196 IGNITION COIL Replaces: 581407, 502880</p> <p style="text-align: right;">Display Package</p>

APPLICATION BEGINS ON NEXT PAGE

① Items ending in "D" are Display Packaged - Regular number is Non-Display

JOHNSON/EVINRUDE IGNITION COIL APPLICATION

HP	Year Start	Year Stop	Coil	Qty.	HP	Year Start	Year Stop	Coil	Qty.	HP	Year Start	Year Stop	Coil	Qty.
2	1971	1973	18-5181	1	20	1966	1972	18-5181	2	60	1980	1984	18-5176	2
2	1975	1985	18-5181	1	20	1973	1973	18-5163	1	60	1985	1987	18-5179	3
2	1995	2001	18-5179	1	20	1985	1987	18-5179	2	60	1988	1988	18-5176	3
2.5	1987	1988	18-5170	1	20	1988	1988	18-5176	2	60	1989	2001	18-5179	3
3	1955	1968	18-5181	2	20	1989	1998	18-5179	2	65	1972	1973	18-5194	3
3	1989	1990	18-5181	2	25	1951	1953	18-5181	2	65	1984	1984	18-5176	3
3	1991	1997	18-5170	1	25	1955	1955	18-5181	2	65	1985	1988	18-5179	3
3	1998	2001	18-5179	1	25	1969	1972	18-5181	2	65	1989	1990	18-5176	3
3	2003	2005	18-5179	1	25	1973	1976	18-5163	1	65	1991	2001	18-5179	3
3.3	1995	1997	18-5179	1	25	1973	1976	18-5172	2	70	1974	1975	18-5194	3
4	1969	1976	18-5181	2	25	1977	1984	18-5176	2	70	1979	1984	18-5176	3
4	1977	1980	18-5176	2	25	1985	1987	18-5179	2	70	1985	1987	18-5179	3
4	1981	1988	18-5181	2	25	1988	1988	18-5176	2	70	1988	1988	18-5176	3
4	1986	1987	18-5179	2	25	1989	2005	18-5179	2	70	1989	2001	18-5179	3
4	1987	2001	18-5170	1	28	1962	1964	18-5181	2	75	1975	1975	18-5194	3
4	1988	1988	18-5176	2	28	1986	1996	18-5179	2	75	1979	1984	18-5176	3
4	1989	1996	18-5179	2	28	1995	1998	18-5170	1	75	1985	1987	18-5179	3
4.5	1980	1983	18-5176	2	30	1956	1956	18-5181	2	75	1988	1988	18-5176	3
5	1965	1968	18-5181	2	30	1984	1984	18-5176	2	75	2000	2001	18-5170	2
5	1996	1998	18-5170	1	30	1985	1987	18-5179	2	85	1973	1975	18-5194	3
5	1997	2001	18-5179	2	30	1988	1988	18-5176	2	85	1976	1977	18-5192	4
5.5	1954	1964	18-5181	2	30	1989	2005	18-5179	2	85	1978	1980	18-5176	4
6	1965	1976	18-5181	2	30	1999	2001	18-5170	1	85	1991	1995	18-5179	4
6	1977	1979	18-5176	2	33	1965	1970	18-5181	2	88	1987	1987	18-5179	4
6	1984	1984	18-5176	2	35	1957	1959	18-5181	2	88	1988	1988	18-5176	4
6	1985	1990	18-5179	2	35	1976	1976	18-5172	2	88	1989	1996	18-5179	4
6	1991	2005	18-5170	1	35	1977	1984	18-5176	2	90	1981	1984	18-5176	4
6	1997	2001	18-5179	2	35	1986	1987	18-5179	2	90	1985	1987	18-5179	4
6	2003	2004	18-5179	2	35	1988	1988	18-5176	2	90	1988	1988	18-5176	4
7.5	1954	1958	18-5181	2	35	1989	1994	18-5179	2	90	1989	1998	18-5179	4
7.5	1980	1983	18-5176	2	35	1996	1996	18-5179	2	90	1995	2006	18-5170	2
8	1984	1984	18-5176	2	40	1960	1973	18-5181	2	100	1979	1980	18-5176	4
8	1985	1990	18-5179	2	40	1974	1974	18-5196	2	100	1984	1984	18-5176	4
8	1991	2005	18-5170	1	40	1975	1979	18-5172	2	100	1985	1997	18-5179	4
9.5	1964	1973	18-5181	2	40	1983	1983	18-5172	2	100	1988	1988	18-5176	4
9.9	1974	1976	18-5196	2	40	1984	1984	18-5176	2	100	1998	2001	18-5170	2
9.9	1977	1984	18-5176	2	40	1985	1987	18-5179	2	105	1997	2001	18-5170	2
9.9	1985	1992	18-5179	2	40	1988	1988	18-5176	2	105	2003	2003	18-5170	2
9.9	1993	2001	18-5170	1	40	1989	2005	18-5170	1	110	1986	1987	18-5179	4
10	1949	1952	18-5181	2	40	1999	2001	18-5179	2	110	1988	1988	18-5176	4
10	1953	1953	18-5181	2	45	1986	1992	18-5179	2	110	1989	1989	18-5179	4
10	1954	1963	18-5181	2	45	1992	1997	18-5170	1	112	1994	1996	18-5179	4
10	2003	2007	18-5170	1	48	1987	1987	18-5179	2	115	1973	1975	18-5194	4
14	1988	1988	18-5179	2	48	1988	1988	18-5176	2	115	1976	1977	18-5192	4
14	1989	1989	18-5176	2	48	1989	1996	18-5170	1	115	1978	1984	18-5176	4
15	1953	1953	18-5181	2	50	1971	1975	18-5194	2	115	1985	1985	18-5179	4
15	1955	1956	18-5181	2	50	1979	1984	18-5176	2	115	1990	1998	18-5179	4
15	1965	1968	18-5181	2	50	1985	1987	18-5179	2	115	1995	2006	18-5170	2
15	1974	1976	18-5196	2	50	1988	1988	18-5176	2	120	1985	1987	18-5179	4
15	1977	1984	18-5176	2	50	1989	2005	18-5170	1	120	1988	1988	18-5176	4
15	1985	1992	18-5179	2	50	1995	1998	18-5179	2	120	1989	1994	18-5179	4
15	1993	2007	18-5170	1	55	1978	1984	18-5176	2	125	1989	1990	18-5179	4
18	1957	1972	18-5181	2	55	1985	1992	18-5179	2	125	1992	1998	18-5179	4
18	1973	1973	18-5163	1	55	1992	2005	18-5170	1	130	1995	2001	18-5179	4

APPLICATION CONTINUED ON NEXT PAGE

JOHNSON/EVINRUDE IGNITION COIL APPLICATION (Cont.)

HP	Year Start	Year Stop	Coil	Qty.	HP	Year Start	Year Stop	Coil	Qty.	HP	Year Start	Year Stop	Coil	Qty.
135	1973	1975	18-5194	4	155	1985	1985	18-5179	6	200	1986	2001	18-5179	6
135	1976	1976	18-5192	4	155	1987	1987	18-5179	6	200	1999	1999	18-5170	3
135	2000	2001	18-5170	2	155	1988	1988	18-5176	6	225	1986	2001	18-5179	6
140	1977	1977	18-5192	4	155	1989	1992	18-5179	6	225	1999	1999	18-5170	3
140	1978	1984	18-5176	4	175	1977	1978	18-5192	6	235	1978	1978	18-5192	6
140	1985	1987	18-5179	4	175	1979	1983	18-5176	6	235	1979	1984	18-5176	6
140	1988	1988	18-5176	4	175	1985	1991	18-5179	6	235	1985	1985	18-5179	6
140	1989	1994	18-5179	4	175	1991	2006	18-5170	3	250	1991	2001	18-5179	6
150	1978	1978	18-5192	6	185	1984	1984	18-5176	6	275	1985	1988	18-5179	6
150	1979	1984	18-5176	6	185	1985	1985	18-5179	6	300	1985	1995	18-5179	6
150	1985	1991	18-5179	6	185	1989	1990	18-5179	6					
150	1988	1988	18-5176	6	185	1992	1994	18-5179	6					
150	1991	2006	18-5170	3	200	1976	1978	18-5192	6					
155	1984	1984	18-5176	6	200	1979	1983	18-5176	6					



**18-5758
POWER PACK**
Replaces: 582453, 583380, 582452



**18-5759
POWER PACK**
Replaces: 582125, 581805



**18-5760
POWER PACK**
Replaces: 582138, 582400, 582642, 582556



**18-5761
POWER PACK**
Replaces: 583114



**18-5763
POWER PACK**
Replaces: 582285, 583170



**18-5764
POWER PACK**
Replaces: 582261, 586696



**18-5766-1
POWER PACK**
Replaces: 583748



**18-5767
POWER PACK**
Replaces: 584783



**18-5768
POWER PACK**
Replaces: 584908, 5001344



**18-5770-1
POWER PACK**
Superseded from 18-5770
Replaces: 584028



**18-5771
POWER PACK**
Replaces: 584032



18-5772-1
POWER PACK
 Superseded from 18-5772
 Replaces: 584041



18-5773
POWER PACK
 Replaces: 584642, 763803



18-5774-1
POWER PACK
 Superseded from 18-5774
 Replaces: 585145, 5004532, 585189, 5004533



18-5781-1
POWER PACK
 Replaces: 586661, 584636, 586212, 585114



18-5782
POWER PACK
 Replaces: 582705, 763793



18-5784-1
 Superseded from 18-5784
POWER PACK
 Replaces: 583110, 582811, 763794



18-5785
POWER PACK
 Replaces: 585261



18-5885
POWER PACK
 Replaces: 583865
 For: V-6 5800 rpm limit



18-5886
POWER PACK & SENSOR
 Replaces: 436367, 584122
 For: V6 engines with optical sensor and BLUE sleeve on power pack. Do not use with gray sleeved stator.



18-5887
POWER PACK
 Replaces: 584985
 For: V6 engines with optical sensor and GRAY sleeve on power pack. Do not use with black sleeved stator.



18-5891
POWER PACK
 Replaces: 583605
 For: 3 & 6 cyl. 6700 rpm limit



18-5893
POWER PACK
 Replaces: 586667, 584037, 586217, 583476
 For: V-4 & V-8 6700 rpm limit



18-5884
OPTICAL SENSOR
 Replaces: 586343
 For: V-4 & V-6 engines



18-9802
TIMING LIGHT
 Self-powered accurate up to 10,000 RPM's



18-5794-1
IGNITION MODULE
 Superseded from 18-5794-1
 Replaces: 584489, 584329, 583896, 584331

Model	Years	Power Pack	Model	Years	Power Pack	Model	Years	Power Pack
4	1977-80,1984	18-5758	40	1986-88	18-5763	100	19,681,972	—
4	1993	—	40	1991-93	18-5794-1	100	1979-80	18-5759 ①
4 DLX	1986-88, 1994-99	18-5763	40 Rope Start	1993- 01	18-5768	100	1988	—
4.5	1980-84	18-5758	40 Electric Start	1993- 01	18-5785	100, 115	1989-99 Crossflow	18-5770-1
4.5	1986-87	18-5763	40 COM.	1986-88	18-5764	110 (TCLDF only)	1986	18-5783
5	1984	18-5758	45	1991-92	18-5794-1	110	1986-87	18-5784-1
5	1985	—	48	1987-88	18-5763	110	1988	—
5	1986-88, 1993-98	18-5763	48	1991-93	18-5794-1	115	1969-70	—
6	1977-79,1984	18-5758	50	1971-75	—	115	1973-77	—
6	1985	—	50	1979,1981-84	18-5758	115	1978-84	18-5759 ①
6	1986-88, 1993-01	18-5763	50	1985	—	115	1985	18-5783
6.5COM.	1992-99	18-5763	50	1986-88	18-5763	120	1986	—
7.5	1980-83	18-5758	50	1991-93	18-5794-1	120	1988-99	18-5772-1
8	1993-95	18-5763	50 Rope Start	1993- 01	18-5768	125	1971-72	—
9.9,15	1977-84	18-5758	50 Electric Start	1993- 01	18-5785	130	1988-99	18-5772-1
9.9,15	1985	—	50 (3 cyl)	1996-99	18-5774-1 ⑧	135	1973-76	—
9.9,15	1986-88	18-5763	55	1976-77	—	140	1977	—
9.9,15	1993-99	18-5767	55	1978-82	18-5758	140	1978-83	18-5759 ①
14	1987	18-5763	55	1991-92	18-5794-1	140	1986	—
10/15COM.	1992	18-5763	60	1970-71	—	140	1988-99	18-5772-1
10,15COM.	1993-99	18-5767	60	1980-84	18-5758	150	197 -78	—
20	1981-84	18-5758	60	1985	—	175	1979-83	18-5760 ①
20	1985	—	60	1986-88	—	175	1986-88	18-5761
20	1986-88	18-5763	60	1989-92	18-5766-1	175	1989-91	18-5885
20	1989-92	18-5794-1	60	1993-95	18-5774-1 ⑧	175	1991-92	18-5886 ①
20	1993-95	18-5768	60	1996-99	18-5774-1 ⑧	175	1993-03	18-5887
20	1996-01	18-5768 ⑩	65	1972-73	—	185	1984	18-5760 ①
25	1977-84	18-5758 ④	65	1989-92	18-5766-1	185	1990, 1992	18-5893
25	1985	—	65	1993-95	18-5774-1 ⑧	185	1993-99	18-5781-1
25	1986-88	18-5763	70	1974-78	—	200	1976-78	—
25	1989-92	18-5794-1	70	1979-84	18-5760	200	1979-83	18-5760 ①
25	1993-95	18-5768	70	1985	18-5782 ⑧	200	1987	18-5891
25	1996-01	18-5768 ⑩	70	1986-88	—	200, 225	1988-92	18-5893
25 COM.	1986-88	18-5764 ⑦	70	1989-92	18-5766-1	200, 225	1993-99	18-5781-1
28	1986-88	18-5763	70	1993-95	18-5774-1 ⑧	225	1987	18-5891
28	1989-92	18-5794-1	70	1996-99	18-5774-1 ⑧	235	1978	—
28	1996-01	18-5768	75	1975-78	—	235	1979-84	18-5760 ① ⑤ ⑥
30	1984	18-5758	75	1979-84	18-5760	250	1991	18-5893
30	1985	—	75	1985	18-5782 ⑧	275	1986-87	—
30	1986-88	18-5763	75	1986-88	—	300	1987	—
30	1989-92	18-5794-1	85	1969-72	—	300	1991	18-5893
30	1993-95	18-5768	85	1973-77	—	V-8	1993-99	18-5773
30	1996-01	18-5768 ⑩	85	1978-80	18-5759 ①	1.6L	1984 & prior	18-5759 ⑨
35	1977-84	18-5758	88, 90	1986-87	18-5784-1	1.6L	1985	18-5782
35	1985	—	88	1988	—	1.6L	1986-87	18-5784-1
35	1986-88	18-5763	88,90	1989-99 Crossflow	18-5770-1	2.0L	1988-99	18-5772-1
35	1989-92	18-5794-1	90	1981-83	18-5759 ①	2.5, 2.6L	1986-88	18-5761 ⑨
35	1993-95	18-5768	90	1985	18-5783			
40	1982	18-5758	90	1988	—			
40	1985	—	100	1971	—			

① 2 Power Packs required per engine
 ④ All Models except Worktwin, Workhorse and Commercial Model for 1983
 ⑤ Port side only for 1983 model STLCT
 ⑥ Port side only for 1984 models with suffix



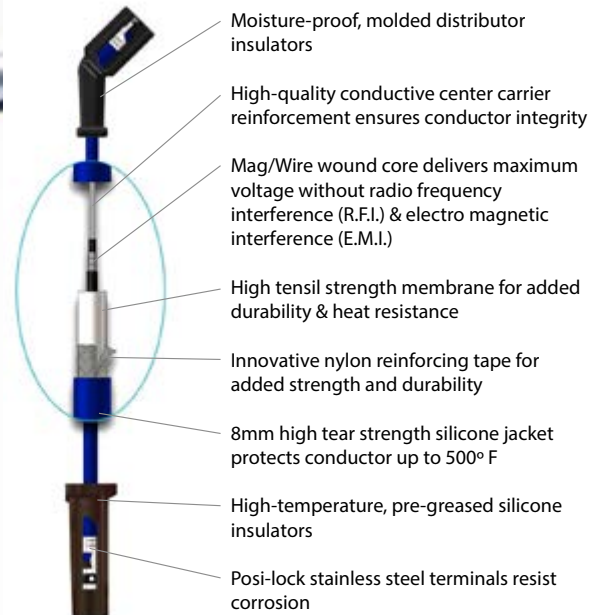

beginning with "S"
 ⑦ 2 cyl. only
 ⑧ 3 cyl. only
 ⑨ Sea Drive Series
 ⑩ Except remote models

① Refer to picture
 ② For 2 stroke models only

Sierra's MAGFORCE Ignition Wires are "Electronics Friendly" protecting all of your electronic devices and electronic engine controls from RFI and EMI while delivering the maximum amount of voltage. Exact fit design ensures easy installation and years of trouble - free service.



Part #	OEM #	Description	Part #	OEM #	Description
18-8815-1	OMC 582365	4" Spark Plug Wire	18-5230-9-1 ①③	Universal	10" Spark Plug Wire (pkg of 5)
18-8816-1	OMC 582365	6" Spark Plug Wire	v18-8839-1	—	90 & 115 hp Outboard Wire Set Two - 14" • Two - 16"
18-5231-1	OMC 582365	9" Spark Plug Wire	18-8840-1	—	150 & 175 hp Outboard Wire Set Two - 14" • Two - 16"
18-5231-1D ②	OMC 582365	9" Spark Plug Wire	18-28090	—	V6 Outboard Plug Wire Set
18-8818-1	OMC 582365	12" Spark Plug Wire	18-28092	—	V4 Outboard Plug Wire Set
18-5229-9-1 ①③	Universal	22" Spark Plug Wire (pkg of 5)			

<p>PKG. OF 10</p>  <p>18-5224 18-5224-9^① SPARK PLUG WIRE TERMINAL Replaces: 510364</p>	 <p>18-5225 SPARK PLUG WIRE KIT Includes 25 ft Roll of Hypalon Ignition Wire with a copper conductor and a large assortment of three different end fittings to fit Johnson/Evinrude motors.</p>	 <p>18-5226 IGNITION WIRE (100' Spool) Hypalon Replaces: 510883, 772584</p>
<p>PKG. OF 10</p>  <p>18-5750 18-5750-9^① UNIVERSAL SPARK PLUG BOOTS Supplied complete w/ Terminal Connector Replaces: 581027, 580339</p>	 <p>18-5752 UNIVERSAL SPARK PLUG BOOT 8mm</p>	 <p>MP39100 IGNITION SWITCH Replaces: 386545 (5 Terminals - 3 Position)</p>
 <p>MP39760 IGNITION SWITCH Replaces: 393301, 508180 (6 Terminals - Push to Choke - 3 Position)</p>	 <p>MP39830 IGNITION SWITCH Replaces: 386545 (6 Terminals - Pistol Shaped Key - 3 Position) Pollak</p>	 <p>MP28890 IGNITION LANYARD Replaces: 176288 1996-Newer</p>
 <p>18-1282 LANYARD & CLIP Replaces: 398602 Tiller Steer Models - ALL</p>	 <p>MP28870 MP28872-1 (Bulk - 100 pc/carton) SWITCH & LANYARD Replaces: 585134</p>	 <p>MP28880 LANYARD Replaces: 432230 1995-older</p>

① Priced per package

② Items ending in "D" are Display Packaged - Regular number is Non-Display

③ Uses 7mm copper core



MP28900
MP28902-1 "Bulk"- 100 pieces per carton
LANYARD
Replaces: 432230
 1995-Older



18-5877
STATOR
Replaces: 584643, 763779
For: 185-300 HP Loopers (1993-2001)



18-5878
STATOR
Replaces: 584981, 763759
For: 150-175 HP (1993-2006)
 Gray Sleeve

JOHNSON/EVINRUDE STATOR APPLICATION			
HP	Year Start	Year Stop	Stator
185	1993	1994	18-5877
200	1993	2001	18-5877
225	1993	2001	18-5877
250	1993	2001	18-5877
300	1993	1995	18-5877
150	1993	2006	18-5878
175	1993	2006	18-5878



18-6277
TILT/TRIM ASSEMBLY
Replaces: 435548
Heavy Duty, 2 Wire Connection, Flat Blade Shaft (O-ring included)
Fits: OMC V6(1993), Commercial V8 (1993-Up)



18-6823
WIRING HARNESS
Replaces: Universal
Converts 3-wire Tilt and Trim motors to 2-Wire design



18-6280
TILT/TRIM ASSEMBLY
Replaces: 437801
Heavy Duty, OMC J Suffix 40,48,50HP(1992-Up)w/ 2 Wire Connection and Hollow Hex Shaft
 (O-ring included)



18-6281
TILT/TRIM MOTOR
Replaces: 438786, 439937, 5005254
(O-ring included)
Plastic housing
Heavy Duty for OMC Outboards 75HP-250HP EFI(1998-Up)



18-6285
TILT/TRIM ASSEMBLY
Replaces: 433226
(O-ring included)
Heavy Duty OMC (1989-92) M Suffix 40,48,50HP w/ 2 Wire Connection and Hollow Hex Shaft



18-6756
TILT/TRIM MOTOR
Replaces: 172588, 173944
Fits: (1982-98) 2 cylinder 2 stroke engines that have been fitted with tilt kit 173946.



18-6759
TILT/TRIM MOTOR
Replaces: 394176, 391264, 393988, 985237
Newer 2 wire design for most 3, 4, 6 and 8 cyl. applications 1982 to present. 3 bolt.
(MOTOR ONLY)
Use 18-7510 O-ring (O-ring included)
Replaces: 321163



18-6761
TILT/TRIM MOTOR
Replaces: 387277, 582048, 582155, 584107
(O-ring included)
Older 3 wire design for most 3, 4, 6 cylinder outboards up to 1981 (Motor Only)



18-6762
TILT/TRIM MOTOR
Replaces: 172543
For most 85, 115 & 135 hp V-4 applications (Motor and Reservoir)



18-6767-1
TILT/TRIM MOTOR
Replaces: 172850, 173564, 173596
For: 1974 (115 & 135 HP)
For most 45 hp commercial models 1989-90, 2 cylinder applications (1984-88), 3 cylinder applications (1977-83) and 4 cylinder applications (1974-77) (Motor and Reservoir)
For Repair Kit use 18-6252



18-6780
TILT/TRIM MOTOR
Replaces: 438529, 438531, 434496
For: 90, 115, 200, 225 HP (1991-Up); 120, 140 HP (1991-94); 130 HP (1995-Up)



18-6815
TRIM MOTOR
Replaces: Johnson/Evinrude
Fits: 2004-09 40-50HP 2006-09 60HP, 2009 25-30HP Evinrude



18-6744
TRIM MOTOR
Replaces: 5006319
Fits: 75-90 HP (04-Up), 115 HP (07-Up), 130 HP (10-Up)



18-6816
TRIM MOTOR
Replaces: 172588, 173944
Fits: 40, 50, 70, and 75HP with short shaft



18-6252
TILT & TRIM MOTOR REPAIR KIT
For use with 18-6767-1
*** Includes Brushes**



18-5705
POWER TRIM RELAY
Replaces:
582472, 584416, 586224
5 Terminal • Single Pull
Double Throw • 12 Volt

Contact	Resistive	Conductive
Open	40 Amps	30 Amps
Closed	20 Amps	15 Amps



18-5801
SOLENOID
Replaces: 985064, 586842,
586730
Grounded Base



18-5823
SOLENOID
Replaces: 584580
Fits: 9.9 4-stroke(1995-01), 9.9 (1993 & Up),
15 4-stroke(1995-01), 15 (1993 & Up), 8 (1996-98),



18-5833
SOLENOID
Replaces: 586774
Fits: E40 (2004-07), E50 (2004-06), E60 (2006-07), E75 (2004-07), E90 (2004-07), E115 (2007), E150 (2007), E175 (2007), E200 (2005-07), E225 (2005-07), E250 (2005-07)



18-5807
SOLENOID
Replaces: 378444,
Prestolite SAW4206



18-5808
SOLENOID
Replaces: 395419, 582708



18-5813
SOLENOID
Replaces: 584128



18-5814
SOLENOID
Replaces: 581528, 172869



BATTERY CABLES

Gauge cable with soldered lug terminals on each end to accept 3/8" stud.

Part No.	Size	Color	Gauge	Part No.	Size	Color	Gauge
BC88523	2'	Red	4	BC88563	6'	Red	2
BC88533	2'	Black	4	BC88573	6'	Black	2
BC88543	4'	Red	2	BC88583	8'	Red	1
BC88553	4'	Black	2	BC88593	8'	Black	1

JOHNSON/EVINRUDE STARTER SOLENOID APPLICATION

HP	Year Start	Year Stop	Starter Solenoid
9.9	1990	1992	18-5813
15	1990	1992	18-5813
18	1957	1959	18-5807
20	1985	1998	18-5808
25	1972	2005	18-5808
25	2009	2009	18-5833
28	1986	1996	18-5808
30	1984	2005	18-5808
30	2009	2009	18-5833
33	1965	1967	18-5807

HP	Year Start	Year Stop	Starter Solenoid
33	1968	1970	18-5808
35	1957	1959	18-5807
35	1976	1988	18-5808
35	1991	2001	18-5808
40	1960	1966	18-5807
40	1967	1976	18-5808
40	1984	2005	18-5808
40	2004	2009	18-5833
45	1989	1992	18-5808
48	1987	1996	18-5808

① Without Electric Shift ② With Electric Shift
APPLICATION CONTINUED ON NEXT PAGE

JOHNSON/EVINRUDE STARTER SOLENOID APPLICATION (CONT.)

HP	Year Start	Year Stop	Starter Solenoid	HP	Year Start	Year Stop	Starter Solenoid
50	1958	1959	18-5807	100	1984	2001	18-5808
50	1971	1975	18-5808	105	1998	2003	18-5808
50	1979	2005	18-5808	110	1986	1989	18-5808
50	2004	2009	18-5833	112	1994	1996	18-5808
55	1968	1969	18-5808	115	1969	1970	18-5808
55	1976	1981	18-5808	115	1973	1985	18-5808
55	1989	1992	18-5808	115	1990	2006	18-5808
55	1996	1997	18-5808	115	2007	2009	18-5833
55	2008	2009	18-5833	120	1985	1994	18-5808
60	1964	1966	18-5807	125	1971	1972	18-5808
60	1967	1971	18-5808	125	1989	1990	18-5808
60	1980	2001	18-5808	125	1992	1998	18-5808
60	2006	2009	18-5833	130	1995	2000	18-5808
65	1968	1968	18-5808	130	2009	2009	18-5833
65	1972	1973	18-5808	135	1973	1976	18-5808
65	1984	2001	18-5808	135	2001	2001	18-5808
65	2008	2009	18-5833	140	1977	1994	18-5808
70	1970	2001	18-5808	150	1978	2006	18-5808
75	1960	1964	18-5807	150	2007	2009	18-5833
75	1965	1965	18-5807 ❶	155	1984	1992	18-5808
75	1965	1965	18-5808 ❷	175	1977	2006	18-5808
75	1975	1988	18-5808	175	2007	2009	18-5833
75	2004	2009	18-5833	185	1984	1985	18-5808
80	1966	1966	18-5807 ❶	185	1989	1994	18-5808
80	1966	1967	18-5808 ❷	200	1976	2001	18-5808
85	1968	1980	18-5808	200	2005	2009	18-5833
85	1991	1995	18-5808	225	1986	2001	18-5808
88	1987	1996	18-5808	225	2005	2009	18-5833
90	1964	1964	18-5807	235	1978	1985	18-5808
90	1965	1965	18-5808	250	1991	2001	18-5808
90	1981	2006	18-5808	250	2005	2009	18-5833
90	2004	2009	18-5833	275	1985	1988	18-5808
100	1966	1968	18-5808	300	1985	1995	18-5808
100	1971	1972	18-5808	300	2008	2009	18-5833
100	1979	1980	18-5808				

❶ Without Electric Shift ❷ With Electric Shift

JOHNSON/EVINRUDE TRIM RELAY/SOLENOID APPLICATION

HP	Year Start	Year Stop	Trim Relay / Solenoid	HP	Year Start	Year Stop	Trim Relay / Solenoid
60	1986	2001	18-5705	125	1989	1998	18-5705
65	1991	1995	18-5705	135	1976	1976	18-5814
70	1980	1981	18-5814	140	1977	1981	18-5814
70	1981	2001	18-5705	140	1981	1994	18-5705
75	1980	1981	18-5814	150	1978	1981	18-5814
75	1982	1987	18-5705	150	1981	2006	18-5705
75	2000	2003	18-5705	175	1977	1981	18-5814
85	1976	1980	18-5814	175	1981	2006	18-5705
85	1991	1995	18-5705	185	1984	1985	18-5705
88	1986	1996	18-5705	185	1990	1994	18-5705
90	1981	1981	18-5814	200	1976	1981	18-5814
90	1981	2006	18-5705	200	1981	1983	18-5705
100	1979	1980	18-5814	200	1986	2005	18-5705
100	1984	2005	18-5705	225	1986	2005	18-5705
110	1986	1989	18-5705	235	1978	1981	18-5814
115	1976	1981	18-5814	235	1981	1985	18-5705
115	1981	1985	18-5705	250	1991	2005	18-5705
115	1990	2006	18-5705	275	1985	1988	18-5705
120	1985	1994	18-5705	300	1985	1995	18-5705



18-5708
RECTIFIER
Replaces: 582399, 583408
6-10 AMP



18-5709
RECTIFIER
Replaces: 581778
4-5 AMP



18-5826
REGULATOR/RECTIFIER
Replaces: 584890

REGULATOR/RECTIFIER APPLICATION ON NEXT PAGE

PARTS THAT KEEP YOU MOVING



SIERRA[®]

Model	Year	Part #	Model	Year	Part #
9.9,15	1974-92	18-5709	90	1981-92	18-5708
20	1989-98 ④	18-5709	90-115 60 DEGREE-V4	1996-UP	—
25	1977-03 (2 CYL) ④	18-5709	100	1971,1979-80,1984-92 ③	18-5708
25/40/50TL/ J ELEC TR	1992	—	115	1973-92	18-5708
25SIK/ SIL/ SIT	1994-1995	—	120/140	1985	—
25/35 3 CYL.	1995-UP	18-5826	125	1971-72	18-5708
28	1989-96	18-5709	135	1974 ⑦	18-5708
30	1989-03 (2 CYL) ④	18-5709	135	1973,1975-76	18-5708
35	1976-93 (2 CYL) ④	18-5709	140	1977-88	18-5708
35JET/ TL/ J ELEC.	1992-1993	—	150	1979-88	18-5708
35JET/ M-TE/ TTL	1993-1995	—	150/175 60 DEGREE-V6	1991-1995	—
35JET/ EL/ TL/ TTL	1996	—	150/175 60 DEGREE-V6	1996-UP	—
35JET ELEC.	1997	—	155	1984-88	18-5708
40	1974-76,1988-92	18-5709	175	1977-83	18-5708
40/50TE/ EL/ TL/ TTL	1993-1996	—	185	1984-88	18-5708
40/ 50 ELEC. 2 CYCLE.	1993-03 (2 CYCLE.)	—	185/200/225	1993-1994	—
45	1989-92 COMM	18-5709	185/200/225/200COMM	1990-1992	—
45SS	1989-90	18-5709	200	1976-83	18-5708
48	1989-92	18-5709	200/225	1986-1989	—
50	1971-75	18-5708	200/225/200COMM	1994-1997	—
50	1979-92	18-5709	235	1978-88	18-5708
55	1976-77	18-5708	250/300	1991-1995	—
55	1978-81, 1980-92 ①	18-5709	250	1997	—
60	1970 ⑥, 1971	18-5708	275	1985-1986	—
60	1980-88	18-5709	275/300 (3.6L)	1987	—
60	1989-91 ⑥	18-5708	275/300	1988	—
SST60	1989-90	18-5708	300 (3.6L) — PORT & STBD.	1985-1986	—
60	1992-01	—	300	1989-1990	—
65	1972-73, 1988-91	18-5708	1.8/2.0L V4 "S"	1987-1990	—
65 ELEC.	1992	—	2.7L V6	1986-1987	—
70	1974-91 ②	—	3.0L V6	1988-1990	—
70	1992-01	18-5708	3.0L V6	1993-1998	—
75	1975-88	18-5708	3.6L V8	1987	—
85	1970-80	18-5708	4.0L V8	1989-1990	—
88	1989-92	18-5708	V-4 & V-6 Crossflow with 35 AMP	ALL	—

① Also Commercial Models
 ② 1991 EL & TL Models only
 ③ Except 1992 Models WTLNE & WTXENE

④ Electric Start only
 ⑤ D Models only

⑥ EL & TL Models only
 ⑦ 135443, 135483 Models only



18-6434
OUTBOARD STARTER
 Replaces: 386430, 763454
 Fits: 9.9, 15 HP (1974-92), 8 HP 4 Stroke (1996-98)



18-5640
OUTBOARD STARTER
 Replaces: 395207, 387094, 585062, 586288, 778992
 Fits: 150-235 HP, V6 models



18-5909
OUTBOARD STARTER
 Replaces: 587078, 587291
 Fits: Evinrude G2 Engines: C150 (AA-AB), C175 (AA-AB), A200 (AF-AG), C200 (AA-AB), E200 (AB-AG), H200 (AG-AH), E225 (AB-AG), H225 (AG-AH), A250 (AF-AG), E250 (AB-AG), H250 (AG-AH), A300 (AF-AG), E300 (AB-AG), H300 (AG-AH)

**ALL STARTERS ARE COUNTER CLOCKWISE ROTATION
 STARTER APPLICATION ON PAGE 288**



18-5612
OUTBOARD STARTER
 Replaces: 432925, 586287, 586286
 Fits: 175 HP models (1992)



18-5617
OUTBOARD STARTER
 Replaces: 586274, 778995
 Fits: 9.9, 15 HP models



18-5619
OUTBOARD STARTER
 Replaces: 584799, 396235, 391511, 397023,
 586731, 586890
 Fits: V6/V8 Looper models



18-5624
OUTBOARD STARTER
 Replaces: 583482, 585056, 586279
 Fits: 20-35 HP models (1989 & up)



18-5627
OUTBOARD STARTER
 Replaces: 583473, 585059, 585459, 778991
 Fits: 20-35 HP models (1987-93)



18-5628
OUTBOARD STARTER
 Replaces: 393570, 585060, 586285, 778994
 Fits: 140 HP models (1993)



18-5629
OUTBOARD STARTER
 Replaces: 392133, 585061, 386591, 586278
 Fits: 18-40 HP models



18-5630
OUTBOARD STARTER
 Replaces: 387684, 585063, 389275, 384163,
 586280, 778993
 Fits: 50-60 HP, 2 cyl. models



18-5631
OUTBOARD STARTER
 Replaces: 584818, 586277, 778996
 Fits: V-4, 60° models (1997 & up)



18-5632
OUTBOARD STARTER
 Replaces: 584980, 586284
 Fits: V-4, 60° models (1997 & up)



18-5634
OUTBOARD STARTER
 Replaces: 585057, 585051, 385529, 389954,
 586283
 Fits: 140 HP models (1977)



18-5648
OUTBOARD STARTER
 Replaces: 585058, 586281, 386657, 391735,
 585050, 384777
 Fits: 70 HP models

ALL STARTERS ARE COUNTER CLOCKWISE ROTATION
 STARTER APPLICATION ON NEXT PAGE



18-6826
STARTER

Replaces: 586768, 587045
Fits: 40-90HP E-Tec Engines



18-6863
STARTER

Replaces: 584608, 586275
Fits: Johnson/Evinrude 9.9-15HP 4-Stroke Engines



18-6945
STARTER

Replaces: 5036972
Fits: Johnson, Suzuki 25HP 2006-11



18-6251
OUTBOARD STARTER REPAIR KIT

Prestolite
4 Brush



18-5655
DRIVE ASSEMBLY

Replaces: 321648
See next page for additional application



18-5671
DRIVE ASSEMBLY

Replaces: 384781
See next page for additional application



18-5674
DRIVE ASSEMBLY

Replaces: 387683
See chart below for additional application



18-5678
DRIVE ASSEMBLY

Replaces: 585269, 586101
See chart below for additional application



18-5679
DRIVE ASSEMBLY

Replaces: 585267, 586100
See chart below for additional application



18-5697
DRIVE BRUSH KIT

Replaces: 385952
See chart below for additional application

HP	Years	Starter #	O.E. Part #	O.E. #	Drive Assembly ②	O.E. #	Tooth Count	Drive Brush Kit ②	O.E. #
9.9/ 15	1974-92	—	386430	395264	—	319977	10	NA	NA
9.9/ 15	1993 & UP	18-5617	586274	395264	—	319977	10	NA	NA
9.9/ 15	1997 & Up 4 stroke	—	584613	NSS	18-5679 ①	585267	10	18-5697	385952
20 ⑦	1985-88	18-5629	586278	393354	18-5655	321648	11	18-5697	385952
20 thru 30 ⑦	1993-98	18-5629	586278	393354	18-5655	321648	11	18-5697	385952
25 thru 35 ⑦	1977-88	18-5629	586278	NSS	18-5655	321648	11	18-5697	385952
20 thru 30 ⑥	1989-92	18-5627	585059	393354	18-5671 ①	384781	9	18-5697	385952
25 thru 35	1997-99 3 cylinders	18-5631	586277	586100	NSS ①	NSS	10	18-5697	385952
40-50	1984-88	18-5630	586280	NSS	18-5671 ①	384781	9	18-5697	385952
50	1972	18-5630	586280	NSS	18-5671 ①	585269	9	18-5697	385952
40-50 ①	1989-99	18-5624	586279	NSS	18-5678 ①	585269	9	18-5697	385952
55	1978	18-5630	586280	NSS	18-5678 ①	585269	9	18-5697	385952
60	1985 2 cylinders	18-5630	586280	NSS	18-5678 ①	585269	9	18-5697	385952
50	1985-99 3 cylinders	18-5648	586281	NSS	18-5678 ①	585269	9	18-5697	385952
55	1969	18-5648	586281	NSS	18-5678 ①	585269	9	18-5697	385952
60	1971	18-5648	586281	NSS	18-5671* ①	384781	9	18-5697	385952
60	1986-01 3 cylinders	18-5648	586281	NSS	18-5678 ①	585269	9	18-5697	385952
65	1985-01 3 cylinders	18-5648	586281	NSS	18-5678 ①	585269	9	18-5697	385952
70, 75	1980-01	18-5648	586281	NSS	18-5678 ①	585269	9	18-5697	385952
85 thru 115	1973-99 crossflows	18-5634	586283	NSS	18-5679 ①	586100	10	18-5697	385952

**ALL STARTERS ARE COUNTER CLOCKWISE ROTATION
STARTER APPLICATION CONTINUED ON NEXT PAGE**

HP	Years	Starter #	O.E. Part #	O.E. #	Drive Assembly ②	O.E. #	Tooth Count	Drive Brush Kit ②	O.E. #
90, 115	1995-99 looper	18-5632	586284	NA	NA	NA	NA	18-5697	385952
120 thru 140	1985-94	18-5628	586285	NSS	18-5679 ①	586100	10	18-5697	385952
130	1995-99	18-5628	586285	NSS	18-5679 ①	586100	10	18-5697	385952
V-6 Crossflow	1976-92	18-5640	586288	393285	18-5674	387683	8	18-5697	385952
150, 175 60°	1991-99 loopers	18-5612	586286	NA	NA	NA	NA	18-5697	385952
150 thru 175 V-6	1997-03	18-5612	586287	NSS	NSS	NA	NA	NA	433850
200 thru 300	1986-Up std. rotation	18-5619	586411	397375	NA	NA	10	18-5697	385952

Note: Some starters will replace Prestolite versions however replacement parts are for Bosch versions only.
 * Starter drive retained with nut

NSS Not sold separately
 ① Drive kit includes drive assembly with clip style retainer
 ② Drive kits, drive assemblies, and brush sets offered are for "Bosch Style" starters only.

⑤ With 9 tooth pinion
 ⑦ For Bosch models

4-STROKE FUEL SYSTEM KITS



18-7761
CARBURETOR REBUILD KIT
 Fits: Johnson/Evinrude Four-Stroke 4-6 hp. (2007)

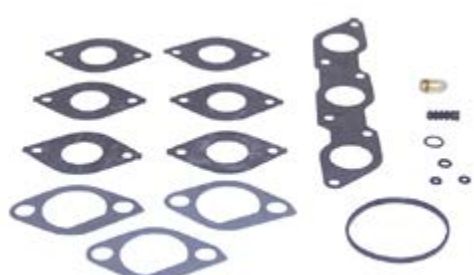

18-7773
CARBURETOR REBUILD KIT
 Replaces: 5032424
 Fits: 25, 30 HP (2000-01) (2004 & Up)

2-STROKE FUEL SYSTEM KITS



18-7010
CARB KIT
 Replaces: 382050, 382051, 382054



18-7219
CARB KIT
 Replaces: 439073, 431897



18-7221
CARB KIT
 Replaces: 435442



18-7222
CARB KIT
 (with float)
 Replaces: 392061, 398729, 396701



18-7223
CARB KIT w/ Needle & Seat
 Replaces: 398452, 391305, 398453, 439072, 391937



18-7024
CARB KIT
 Replaces: 382053, 382052, 385356, 439075



18-7042
CARB KIT
 (without float)
 Replaces: 392061, 398729, 396701



18-7043
CARB KIT
 Replaces: 382045, 382046, 382047, 382049, 383052, 383067, 398532, 439071, 398514



18-7046
CARB KIT
 Replaces: 390055, 392550, 398526, 435443, 434888, 439076, 433519
 Contains 18-7038 Needle/Seat

2-STROKE FUEL SYSTEM KITS



18-7247
CARB KIT
 Replaces:
 438996, 436852
 For: V4 & V6 (60°) 1988-2001

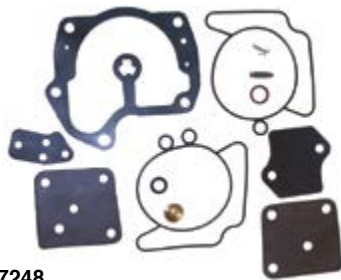

18-7248
CARB KIT
 Replaces:
 437327, 439079, 439078, 435676,
 435677, 435678, 435752



18-0871-1
SERVICE VALVE WITH O-RING
 Superseded from 18-0871
 Replaces: 175158
 Fits: All Johnson/Evinrude with primer valve (except 1993 9.9 & 15hp.)



18-7044-1
SERVICE VALVE KIT
 Replaces: 175158+437228
 Fits: All Johnson/Evinrude with primer valve (except 1993 9.9 & 15 H.P.)



18-0993
COVER & GASKET ASSEMBLY
 Replaces: 437228
 Fits: All Johnson/Evinrude with primer valve (except 1993 9.9 & 15hp.)



NEEDLE & SEAT

Part #	Replaces
18-7093	396521, 678882, 378895
18-7094	379313, 396522
18-7093	396520, 379312, 387262

PKG. OF 10



18-7106
18-7106-9^①
NEEDLE PACKING
 Replaces: 307583



18-7210
FLOAT
 Replaces: 382363

PKG. OF 5



18-7296
18-7296-9^①
ADJUSTING NEEDLE RETAINER
 Replaces: 315232

① Priced per Package

HP	YEAR	CARB. KIT W/O FLOAT	CARB. KIT W/ FLOAT	NEEDLE & SEAT	CARB. FLOAT
1.5	1970-90	18-7043	—	18-7094	—
2	1970-90	18-7043	—	18-7094	—
3	1952-67	18-7043	—	18-7038	—
3	1968	18-7043	—	18-7094	—
4	1983-89	18-7223	—	18-7094	—
4	1991-93	18-7223	—	18-7094	—
4.5	1982-84,1987	18-7223	—	18-7094	—
5	1965-67	18-7043	—	18-7094	—
5	1968	18-7024	—	18-7093	—
5	1984-85	18-7223	—	18-7094	—
5.5	1954-67	18-7043	—	18-7094	—
6	1954-79	18-7043	—	18-7094	—
6	1968	18-7024	—	18-7093	—
6	1984-85	18-7223	—	18-7094	—
6, 8	1986-96	18-7219	—	—	—
7.5	1955-58	18-7043	—	18-7094	—
7.5	1982-83	18-7223	—	18-7094	—
8	1984-85	18-7223	—	18-7094	—
9.9	1974-88	18-7223	—	18-7094	—

① Commercial ② Also Commercial ③ Early Production ④ Cross Flow ⑤ Except 1995-Up 3 Cylinder Models

HP	YEAR	CARB. KIT W/O FLOAT	CARB. KIT W/ FLOAT	NEEDLE & SEAT	CARB. FLOAT
9.9/15	1989-96	18-7219	—	—	—
10	1954-63	18-7043	—	18-7094	—
14	1968 ③	18-7223	—	18-7094	—
15	1955-56	18-7043	—	18-7094	—
15	1974-88	18-7223	—	18-7094	—
18	1957-68	18-7043	—	18-7094	—
18	1969-73	18-7042	18-7222	18-7093	18-7210
20	1957-68	18-7043	—	18-7094	—
20	1969-90	18-7042	18-7222	18-7093	18-7210
20	1991-96	18-7219	—	18-7094	—
25	1954-55	18-7024	—	18-7093	—
SAIL DR	1978-UP	18-7042	18-7222	18-7093	18-7210
25	1969-95 ⑤	18-7042	18-7222	18-7093	18-7210
28	1962-64	18-7010	—	18-7093	—
28	1976-95	18-7042	18-7222	18-7093	18-7210
30	1956	18-7024	—	18-7093	—
30	1976-UP	18-7042	18-7222	18-7093	18-7210
33	1965-70	18-7010	—	18-7093	—
35	1957-59	18-7024	—	18-7093	—
35	1959	18-7010	—	18-7093	—
35	1976-95 ⑤	18-7042	18-7222	18-7093	18-7210
40	1960-63, 1971	18-7010	—	18-7093	—
40	1965-70, 1972-78	18-7024	—	18-7093	—
40	1971-90, 1979-92 ①	18-7042	18-7222	18-7093	18-7210
45	1971-97 ②	18-7042	18-7222	18-7093	18-7210
48	1992-97	18-7042	18-7222	18-7093	18-7210
50	1958-59	—	—	18-7093	—
50	1971-97	18-7042	18-7222	18-7093	18-7210
55	1968-69, 1971-97 ②	18-7042	18-7222	18-7093	18-7210
60	1964-67	—	—	18-7093	—
60	1970-97	18-7042	18-7222	18-7093	18-7210
65	1972-97	18-7042	18-7222	18-7093	18-7210
70	1972-97 (3 CYL)	18-7042	18-7222	18-7093	18-7210
75	1960-63	—	—	18-7093	—
75	1975-88	18-7042	18-7222	18-7093	18-7210
80	1966-67	—	—	18-7093	—
85	1968	—	—	18-7093	—
85	1971-79	18-7046	—	18-7093	—
85	1969-70, 1991-93	18-7046	—	18-7038	—
V-4	1969-79	18-7046	—	18-7038	—
V-4	1983-84	18-7046	—	18-7038	—
88,90	1985-95	18-7046	—	18-7038	—
90	1981-82, 1983 ③	18-7046	—	18-7038	—
90	1995-02	18-7247	—	—	—
100	1971, 1980	18-7046	—	18-7038	—
100	1972, 1979	18-7046	—	18-7093	—
100	1998-01	18-7247	—	—	—
105	1999-01	18-7247	—	—	—
115	1969, 1980-95	18-7046	—	18-7038	—
115	1995-02	18-7046	—	18-7093	—
115	1995-02	18-7247	—	—	—
V-6	1976-90 ④	18-7046	—	18-7038	—
115	1983	18-7046	—	18-7038	—
120	1985-90	18-7248	—	18-7094	—
120	1985-90, 1993	18-7248	—	18-7094	—

① Commercial ② Also Commercial ③ Early Production ④ Cross Flow ⑤ Except 1995-Up 3 Cylinder Models

HP	YEAR	CARB. KIT W/O FLOAT	CARB. KIT W/ FLOAT	NEEDLE & SEAT	CARB. FLOAT
125	1971-72	18-7046	—	18-7093	—
125	1993	18-7248	—	18-7094	—
125C	1989-95	18-7248	—	18-7094	—
135	1973-76	18-7046	—	18-7093	—
140	1977, 1980-83	18-7046	—	18-7038	—
140	1978-79	18-7046	—	18-7093	—
140	1985-90	18-7248	—	18-7094	—
140	1993	18-7248	—	18-7094	—
150	1979-90	18-7046	—	18-7038	—
150	1992-96, 1998-02	18-7247	—	—	—
155	1984-93 ①	18-7046	—	18-7038	—
175	1977-91	18-7046	—	18-7038	—
175	1992-96, 1998-02	18-7247	—	—	—
185	1984	18-7046	—	18-7038	—
185	1989-93	18-7221	—	18-7094	—
200	1976-83	18-7046	—	18-7038	—
200	1986-90	18-7248	—	18-7094	—
200	1992-93	18-7221	—	18-7094	—
225	1986-90, 1992-93	18-7221	—	18-7094	—
235	1978-84	18-7046	—	18-7038	—
250	1991-93	18-7221	—	18-7094	—
275/3.6L	1985-88	18-7221	—	18-7094	—
300	1988, 1991-93	18-7221	—	18-7094	—

① Commercial ② Also Commercial ③ Early Production ④ Cross Flow ⑤ Except 1995-Up 3 Cylinder Models



**18-7350
FUEL PUMP**
Replaces: 397839, 391638, 395091, 397274
For: 6/8/9.9/15 HP 1981-92
Uses kit **18-7823**



**18-7351
FUEL PUMP**
Replaces: 434728, 438562
For: 9.9/15 HP 1993-2006
Uses kit **18-7800**



**18-7352
FUEL PUMP**
Replaces: 438556, 388268, 385781, 394543, 382354, 395713, 398338, 432451, 398387, 433387
For: 25-55 HP 1976-89 (non-VRO)
Uses kit **18-7821**



**18-7353
FUEL PUMP**
Replaces: 438555, 433386
For: 20-30 HP 1990-2000
Uses kit **18-7800**



**18-7800
FUEL PUMP KIT**
Replaces: 438616, 433519



**18-7801
FUEL PUMP KIT**
Replaces: 379777



**18-7820
FUEL PUMP KIT**
Replaces: 393103



**18-7821
FUEL PUMP KIT**
Replaces: 398514, 395867



**18-7822
FUEL PUMP KIT**
Replaces: 432962



18-7823
FUEL PUMP KIT
Replaces: 393088



PKG. OF 2
18-7796
CHECK VALVE
Replaces: 335334
(Enlarged to show detail)



18-3497
DIAPHRAGM KIT
Replaces: 5033372
4-5 HP (2003-06), 6 HP (2005-06)
4-Stroke



18-3498
DIAPHRAGM KIT
Replaces: 5036216, 5037584
10-15 HP (2005-07)
4-Stroke



18-3499
DIAPHRAGM KIT
Replaces: 5030699
9.9, 15 HP (2002-04), 25HP (2004-06),
30HP (2004-07), 40-70 HP (2002-06)
4-Stroke

FUEL PUMP REPAIR KIT APPLICATION

ALL KITS ARE FOR NON-VRO (VARIABLE RATIO OILING) PUMPS

HP	Year Start	Year Stop	Fuel Pump Repair Kit	HP	Year Start	Year Stop	Fuel Pump Repair Kit	HP	Year Start	Year Stop	Fuel Pump Repair Kit
2.5	1987	1988	18-7823	25	2001	2001	18-3497④	50	1990	2012	18-7800
3	1989	1997	18-7823	25	2004	2005	18-3497④	50	AA	AG	18-7800
4	1982	2001	18-7823	28	1962	1963	18-7801	50	1999	2006	18-3497④
4	2003	2007	18-3497④	28	1986	1987	18-7821	55	1983	1984	18-7820
4.5	1982	1987	18-7823	28	1988	1990	18-7822	55	1985	1990	18-7821
5	1982	1983	18-7823	28	1990	1998	18-7800	55	1991	2005	18-7800
5	1985	1993	18-7823	30	1984	1984	18-7820	55	2008	2012	18-7800
5	1996	1998	18-7823	30	1985	1987	18-7821	55	AA	AG	18-7800
5	2003	2007	18-3497④	30	1988	1990	18-7822①	60	1964	1967	18-7801
6	1984	2005	18-7823	30	1990	2005	18-7800②	60	1982	1984	18-7820
6	1987	1987	18-7821	30	2001	2001	18-3497④	60	1985	1985	18-7821
6	2003	2007	18-3497④	30	2004	2007	18-3497④	60	1988	1988	18-7821
7.5	1980	1983	18-7823	35	1958	1959	18-7801	60	2002	2006	18-3497④
8	1982	2005	18-7823	35	1976	1984	18-7820	60	2005	2012	18-7800
8	1987	1987	18-7821	35	1986	1987	18-7821	60	AA	AG	18-7800
9.9	1974	1992	18-7823	35	1988	1990	18-7822	65	1984	1984	18-7820
9.9	1987	1990	18-7821②	35	1990	2001	18-7800	65	1985	1985	18-7800④
9.9	1990	1999	18-7800	40	1960	1964	18-7801	65	1985	1986	18-7821
10	1996	2007	18-7800	40	1971	1976	18-7820	65	1989	1989	18-7821
10	2002	2004	18-3497④	40	1983	1984	18-7820	65	1991	2001	18-7800
10	2005	2007	18-3497④	40	1985	1987	18-7821	65	2008	2012	18-7800
14	1988	1989	18-7823	40	1988	1990	18-7822①	65	AA	AF	18-7800
15	1974	1998	18-7823	40	1990	2012	18-7800②	70	1982	1984	18-7820
15	1987	1990	18-7821②	40	AA	AG	18-7800	70	1998	2006	18-3497④
15	1990	2007	18-7800	40	1999	2006	18-3497④	75	1960	1965	18-7801
15	2002	2004	18-3497④	45	1958	1959	18-7801	75	1982	1984	18-7820
15	2005	2007	18-3497④	45	1986	1990	18-7821	75	2004	2012	18-7800
20	1985	1987	18-7821	45	1991	1997	18-7800	75	AA	AF	18-7800
20	1988	1990	18-7822①	48	1987	1987	18-7821	80	1966	1967	18-7801
20	1990	1998	18-7800②	48	1988	1990	18-7822①	85	1977	1983	18-7820
25	1971	1976	18-7823	48	1990	1996	18-7800②	88	1987	1990	18-7821①
25	1977	1984	18-7820	50	1958	1959	18-7801	88	1990	1996	18-7800②
25	1985	1987	18-7821	50	1982	1984	18-7820	90	1964	1965	18-7801
25	1988	1990	18-7822①	50	1985	1987	18-7821	90	1981	1983	18-7820
25	1990	2005	18-7800④	50	1988	1990	18-7822	90	1997	1998	18-7800

④ Priced per Package

APPLICATION CONTINUED ON NEXT PAGE

FUEL PUMP REPAIR KIT APPLICATION

ALL KITS ARE FOR NON-VRO (VARIABLE RATIO OILING) PUMPS

HP	Year Start	Year Stop	Fuel Pump Repair Kit	HP	Year Start	Year Stop	Fuel Pump Repair Kit	HP	Year Start	Year Stop	Fuel Pump Repair Kit
90	2004	2012	18-7800	112	1994	1996	18-7800	150	1978	1984	18-7820
90	AA	AF	18-7800	115	1982	1983	18-7820	175	1977	1983	18-7820
100	1966	1966	18-7801	115	1997	1998	18-7800	200	1977	1983	18-7820
100	1989	1990	18-7821	115	2004	2005	18-7800	235	1978	1984	18-7820
100	1996	1997	18-7800	125	1995	1998	18-7800				
105	1997	2003	18-7800	140	1977	1983	18-7820				

④ Priced per Package

APPLICATION CONTINUED ON NEXT PAGE

FUEL PUMP APPLICATION

HP	Year Start	Year Stop	Fuel Pump	HP	Year Start	Year Stop	Fuel Pump
6	1988	1991	18-7350	35	1990	1994	18-7353
8	1988	1991	18-7350	35	1996	1996	18-7353
9.9	1981	1992	18-7350	40	1968	1976	18-7352
9.9	1993	1999	18-7351	40	1983	1984	18-7352
10	1997	1998	18-7351	50	1974	1975	18-7352
10	2000	2001	18-7351	50	1979	1984	18-7352
10	2003	2007	18-7351	55	1976	1981	18-7352
15	1981	1998	18-7350	55	1983	1984	18-7352
15	1993	2007	18-7351	60	1980	1984	18-7352
20	1990	1998	18-7353	85	1977	1980	18-7352
25	1977	1984	18-7352	90	1981	1983	18-7352
25	1990	2005	18-7353	90	1997	1998	18-7352
28	1990	1996	18-7353	100	1979	1980	18-7352
30	1984	1984	18-7352	100	1997	1997	18-7352
30	1990	2005	18-7353	115	1977	1983	18-7352
33	1968	1970	18-7352	115	1997	1998	18-7352
35	1976	1984	18-7352	140	1977	1983	18-7352

FUEL WATER SEPARATOR KITS



**21 MICRON
FILTER KITS FOR
CARBURETED ENGINES**



KIT TYPE	PART #	MICRON RATING	CONTENTS
1/4" Aluminum (Short Filter)	18-7848-1 •	21	1 - 18-7844 filter & 1 18-7853-1 bracket 2 - 18-4256 1/4" PIPE PLUGS
1/4" ALUMINUM BONUS PACK CONTAINS SPARE FILTER	18-7848-2 •	21	2 - 18-7844 FILTER & 1 18-7853-1 BRACKET 2 - 18-4256 1/4" PIPE PLUGS
1/4" ALUMINUM (TALL FILTER) CONTAINS SPARE FILTER	18-7852-1 •	21	1 - 18-7845 FILTER & 1 18-7853-1 BRACKET 2 - 18-4256 1/4" PIPE PLUGS
3/8" ALUMINUM (TALL FILTER)	18-7775-1 •	21	1 - 18-7845 FILTER & 1 18-7775 BRACKET 2 - 18-4264 3/8" PIPE PLUGS
1/4" STAINLESS STEEL (TALL FILTER)	18-7777-1 •	21	1 - 18-7845 FILTER & 1 18-7777 BRACKET 2 - 18-4256 1/4" PIPE PLUGS
3/8" STAINLESS STEEL (TALL FILTER)	18-7776-1 •	21	1 - 18-7845 FILTER & 1 18-7776 BRACKET 2 - 18-4264 3/8" PIPE PLUGS

• Display Packaged

**- UNIVERSAL DESIGN -
DIRECT REPLACEMENT FOR MERCURY AND YAMAHA
FUEL WATER SEPARATOR BRACKETS**



Bracket Type	Part #
1/4" Stainless Steel	18-7777
3/8" Stainless Steel	18-7776



Bracket Type	Part #
1/4" Aluminum	18-7853-1
3/8" Aluminum	18-7775

10 MICRON FILTER KITS FOR FUEL INJECTED ENGINES

• Display Packaged

Kit Type	Part #	Micron Rating	Contents
1/4" Aluminum (Short Filter)	18-7983-1 •	10	1 - 18-7944 filter & 1 18-7853-1 bracket 2 - 18-4256 1/4" pipe plugs
1/4" Aluminum Bonus Pack Contains spare filter	18-7983-2 •	10	2 - 18-7944 filter & 1 18-7853-1 bracket 2 - 18-4256 1/4" pipe plugs
1/4" Aluminum (Tall Filter)	18-7982-1 •	10	1 - 18-7945 filter & 1 18-7853-1 bracket 2 - 18-4256 1/4" pipe plugs
1/4" Aluminum Bonus Pack Contains spare filter	18-7982-2 •	10	2 - 18-7945 filter & 1 18-7853-1 bracket 2 - 18-4256 1/4" pipe plugs
1/4" Aluminum (High Capacity Filter)	18-7966-1 •	10	1 - 18-7866 filter & 1 18-7853-1 bracket 2 - 18-4256 1/4" pipe plugs
3/8" Aluminum (Tall Filter)	18-7986-1 •	10	1 - 18-7945 filter & 1 18-7775 bracket 2 - 18-4264 3/8" pipe plugs
1/4" Stainless Steel (Tall Filter)	18-7984-1 •	10	1 - 18-7945 filter & 1 18-7777 bracket 2 - 18-4256 1/4" pipe plugs
3/8" Stainless Steel (Tall Filter)	18-7985-1 •	10	1 - 18-7945 filter & 1 18-7776 bracket 2 - 18-4264 3/8" pipe plugs



10 MICRON FILTER KITS WITH DRAIN BOWLS

Sierra AquaVue™ and metal bowl separator filters allow water to be drained from the filter to extend service life. Use the AquaVue™ bowl for outboard, above deck installations. USCG regulations require the use of the flame resistant metal bowl below deck.

Kit Type	Part #	Micron Rating	Contents
1/4" Aluminum w/ AquaVue™ bowl	18-7932-1 •	10	1 - 18-7919 filter & 1 18-7853-1 bracket 1 - 18-7922-1 AquaVue™ bowl 2 - 18-4256 1/4" pipe plugs
1/4" Aluminum w/ metal drain bowl	18-7951 •	10	1 - 18-7919 filter & 1 18-7853-1 bracket 1 - 18-7924 metal bowl 2 - 18-4256 1/4" pipe plugs
1/4" Stainless Steel w/ AquaVue™ bowl	18-7937-1 •	10	1 - 18-7919 filter & 1 18-7777 bracket 1 - 18-7922-1 AquaVue™ bowl 2 - 18-4256 1/4" pipe plugs
1/4" Stainless Steel w/ metal drain bowl	18-7938 •	10	1 - 18-7919 filter & 1 18-7777 bracket 1 - 18-7924 metal bowl 2 - 18-4256 1/4" pipe plugs

COMPACT BRACKET AND SEPARATOR KIT - FOR SMALL OUTBOARDS AND FRESH WATER APPLICATIONS

**18-7774
COMPACT ALUMINUM BRACKET**



**18-7965-1
10 MICRON COMPACT
SEPARATOR KIT**
Contents:
1 - 18-7774 bracket
1 - 18-7865 filter



• Display Packaged

REPLACEMENT FILTERS



UNIVERSAL DESIGN

10 MICRON REPLACEMENT FILTERS

Part No.	Description
18-7944	Short - 3.875"
18-7945	Long - 4.35"
18-7866	High Capacity - 6"
18-7865	Compact 10 Micron

21 MICRON REPLACEMENT FILTERS

Part No.	Description
18-7844	Short - 3.875"
18-7845	Long - 4.35"

REPLACEMENT FILTERS FOR OMC

10 MICRON REPLACEMENT FILTERS

Part No.	Description	Replaces
18-7946	OMC thread	OMC 502905
18-7989	Cobra EFI	OMC 502906

21 MICRON REPLACEMENT FILTERS

Part No.	Description	Replaces
18-7846	OMC thread	OMC 502905
18-7789	Cobra EFI	OMC 502906



• Display Packaged

10 MICRON REPLACEMENT FILTERS AND KITS WITH DRAIN BOWLS

REPLACEMENT ELEMENTS

Part No.	Description	Replaces
18-7919	Spin on replacement	Racor S3213
18-7920	Spin on replacement OMC style	OMC 502906 Racor S3214

ELEMENT & BOWL KITS

Part No.	Description
18-7928-1 •	Filter & AquaVue™ Bowl Contains: 18-7919 filter, 18-7922-1 bowl
18-7929 •	Filter & Metal Bowl Contains: 18-7919 filter, 18-7924 bowl
18-7941-1 •	Filter & AquaVue™ Bowl Contains: 18-7920 filter, 18-7922-1 bowl
18-7943 •	Filter & Metal Bowl Contains: 18-7920 filter, 18-7924 bowl

REPLACEMENT BOWLS

Part No.	Description
18-7922-1	AquaVue™ Collection Bowl
18-7924	Metal Collection Bowl

18-79781
FUEL FILTER
Replaces: 433190
60° V4 and V6



18-7953
FUEL FILTER
Replaces: 5035974
Fits: 25HP (2006-07) / 90,115,140
4 stroke (2005-06)



18-7716
FUEL FILTER
Replaces: 5032323
Fits: Johnson 25 4-Stroke (2004-05), 30
4-Stroke (2004-07), 40/60/70 4-Stroke
(2002-06), 90/115/140 4-Stroke (2003-04,
2006), Evinrude 25/30/40/50/70 4-Stroke
(2000-01)



18-7719
FUEL FILTER
Replaces: 5032238
Fits: Johnson 4/5 (2003-07), 6 4-Stroke
(2005-07), 10/15 4-Stroke (2002-07),
40/50/60/70 4-Stroke (2002-06), Evin-
rude 40/50 4-Stroke (2000-01)



18-7722
FUEL FILTER
• 3/8" barbs
Replaces: 5005266
For: E-Tec 40, 50, 60, 75, 90,115, 150, 175 & 200DPL



18-7826
FUEL FILTER
Replaces: 305185



INLINE FUEL FILTERS

Part No.	Application
18-7828-1 •	1/4" Small Capacity (For 1/4" Fuel Line)
18-7829	1/4" Large Capacity (For 1/4" Fuel Line)
18-7830	5/16" Replaces: OMC 398327
18-7831	3/8" Replaces: OMC 398319

8' LENGTH COMPLETE FUEL LINE ASSEMBLIES

3/8" FUEL LINE ASSEMBLY **18-8009EP-2 SILVERADO 4000 Premium** **OE# 398549** 



18-8063 TANK CONNECTOR
(SOLD SEPARATELY)



18-8092 FUEL CONNECTOR



18-8005EP-1 PRIMER BULB





18-8092 FUEL CONNECTOR



FUEL LINE ASSEMBLY COMPONENTS
Fits: 2 HP (1 cyl.) - 75 HP (3 cyl.) (1976-02)

8' LENGTH COMPLETE FUEL LINE ASSEMBLIES

3/8" FUEL LINE ASSEMBLY **18-8014EP-2 SILVERADO 4000 Premium** **OE# 174509** 



18-8074 HOSE BARB
(SOLD SEPARATELY)



18-8005EP-1 PRIMER BULB



18-8092 FUEL CONNECTOR



FUEL LINE ASSEMBLY COMPONENTS
Fits: All V6 & V8 (1976-02)



18-8004EP-1
18-8004-10EP-1
PRIMER BULB
5/16"
Replaces: 174511, 775638
Large capacity bulb



18-8005EP-1
18-8005-10EP-1
PRIMER BULB
3/8"
Replaces: 174512
Large capacity bulb

HOSE BARB APPLICATION

INLINE FUEL FILTERS				
Part No.	OMC No.	Barb	NPT	Conn. Type
18-8055	173311	5/16"	1/4"	Male
18-8074	173312	3/8"	1/4"	Male



18-8056
18-8056-10
FUEL CONNECTOR
5/16"
Replaces: 174508, 775640
Mates with 18-8063



18-8063 TANK CONNECTOR
Replaces: 502867, 772681, 0772681
(1/4" NPT)
Mates with 18-8056 & 18-8092



18-8072 FUEL ELBOW
3/8" Barb w/ 3/8" NPT Thread
Replaces: 174177
90°



18-8092 FUEL CONNECTOR
3/8"
Replaces: 176445, 775641
Mates with 18-8063



18-3290 INDICATOR ELBOW
Replaces: 321886
Pipe threaded to hose



BLEEDER HOSE
18-8048 **18-8050**
.090 I.D. x .220 O.D. .0625 I.D. x .190 O.D.



18-8051 FUEL LINE HOSE
1/8" I.D.
Replaces: 322656
For OMC Pressurized Systems



18-8052 FUEL LINE HOSE
3/16" I.D.
Replaces: 122838
Non-Pressurized Systems



SAE J1527 USCG Type B1-15 SILVERADO 4000
16-337-0560
5/16" I.D.
16-337-0380
3/8" I.D.
Also available in 50' reels.

* Tanks and Engines for picture purpose only.

① Discount shop pack of 10 - Priced per package



18-9125
OETIKER CLAMP KIT
Replaces: 787133, 787145

Part #	Qty	Johnson/Evinrude #	Oetiker #	Description	
18-9141	1	787145	14100082	Oetiker Jaw Pincers	
Nominal ID					
Part #	Qty	Johnson/Evinrude #	Oetiker #	Inches	mm
18-9126-9	10	346930	16700004	3/8"	9.5
18-9127-9	10	348838	16700006	13/32"	10.5
18-9128-9	10	349516	16700007	7/16"	11.3
18-9129-9	10	347107	16700010	1/2"	13.3
18-9130-9	10	347108	16700011	17/32"	13.8
18-9131-9	10	346931	16700012	35/64"	14
18-9132-9	10	346785	16700013	9/16"	14.5
18-9133-9	10	346786	16700016	5/8"	15.7
18-9134-9	10	348839	16700017	11/16"	17
18-9135-9	10	346151	16700024	13/16"	21
18-9136-9	10	346152	16700031	1"	25.6
18-9137-9	10	346153	16700037	1 3/16"	30.1
18-9138-9	10	349759	16700040	1 1/4"	31.6
18-9139-9	10	349729	16700053	1 5/8"	41
18-9140-9	10	346150	16700020	23/32"	18.5

All clamps are standard package of 10. Each package of 10 is available individually.

PKG. OF 10



SNAPPER CLAMPS

Part No.	Clamp O.E. No.	Range	Size
① 18-8020	322652	.538 - .608	8
① 18-8021	911616	.597 - .665	10
① 18-8034	329654	.670 - .780	12
① 18-8200	322653	.360 - .406	2
① 18-8201	124249	.410 - .468	4
① 18-8202	322654	.475 - .536	6
① 18-8203*	329653	.750 - .875	14
① 18-8204*	324825	.875 - .975	19



18-8905
IMPELLER REPAIR KIT
Replaces: 5008968
For: 15 (AA-AF), 25 (AA-AF), 30 (AA-AF)

— 18-8905 CONTAINS —

Part No.	Description	OE #	Qty
18-3295	Key	344470	1
18-4539	Impeller	5008967	1
NSS	Spring, Pressure Relief	355169	1
NSS	Spring, Thermostat	355209	1



18-3001
IMPELLER
Replaces: 277181, 434424



18-3002
IMPELLER
Replaces: 375638, 775518



18-3006
IMPELLER
Replaces: 378891, 775521



18-3015
IMPELLER
Replaces: 396852, 433935, 797407
With Key
For: 2.5, 3, 4 Ultra, Excel



18-3043
IMPELLER
Replaces: 389642



18-3044
IMPELLER
Replaces: 385072





18-3050
18-3050-10①
IMPELLER
Replaces: 386084



18-3051
IMPELLER
Replaces: 395289

① This product is priced per piece. To order price per package, please add -9 to the part number.

 <p>18-3096 IMPELLER Replaces: 5031417 Fits: 25-30HP (2000-01, 2004-07), 40-50HP (1999-06)</p>	 <p>18-8906 IMPELLER Replaces: 436137 Fits: 5HP (1996-98), 6-8HP (1991-2005)</p>	 <p>18-8907 IMPELLER Replaces: 5033542 Fits: 90, 115, 140 (2003-06)</p>	
 <p>18-3053-1 IMPELLER Replaces: 396725 Wedge Key</p>	 <p>18-3055 IMPELLER Replaces: 389589</p>	 <p>18-3059 IMPELLER Replaces: 381538, 389289, 394534, 395864, 397131, 435821, 435748, 439948, 5001593 Includes 18-3299 Impeller Key</p>	 <p>18-3082 IMPELLER Replaces: 382547 Slotted Key</p>
 <p>18-3083 IMPELLER Replaces: 377230, 777213</p>	 <p>18-3090 IMPELLER Replaces: 387361, 763735</p>	 <p>18-3091 IMPELLER Replaces: 389576</p>	 <p>18-3099 IMPELLER Replaces: 5033112 For: 4 Stroke 9.9 and 15 HP (2002-up)</p>
 <p>18-3104-1 IMPELLER Replaces: 432941, 437059, 765350</p>	 <p>18-3366 IMPELLER Replaces: 390286</p>	 <p>18-3368 IMPELLER Replaces: 396809</p>	 <p>18-45312 IMPELLER Replaces: 114812 Fits: J/E 2(1993-99), 3(1991-99)</p>
 <p>18-4539 IMPELLER Replaces: 5008967 Fits: 15 (AA-AF), 25 (AA-AF), 30 (AA-AF)</p>	 <p>18-45221 IMPELLER Replaces: 382221 Fits: Johnson Evinrude 1.5/2 hp (1967-84)</p>	 <p>18-3102 IMPELLER PLATE Replaces: 305303</p>	 <p>18-3103 IMPELLER PLATE Replaces: 303069</p>

APPLICATION BEGINS ON PAGE 307

① Discount shop pack of 10 - Priced per package



18-3127
IMPELLER PLATE
Replaces: 319275



18-3346
CUP & PLATE ASSEMBLY
Replaces: 435027



18-3126
WEAR PLATE
Replaces: 321940



18-3343
WEAR PLATE
Replaces: 320981



18-3178
WEAR PLATE
Replaces: 318995



18-3455
INSERT CUP
Replaces: 340619
For: 40, 50, 25 Jet, 30 Jet 1995-Up, E-Tec 40/50/60 HP All



18-3358
INSERT CUP
Replaces: 328751



18-3501
DIAPHRAGM & CUP ASSEMBLY
Replaces: 435957
For: 8 (1996-97), 10 (1996-97), 15 (1996-97), 40 (1995-97), 50 (1995-97), 55 (1995-97), 60 (1993-96), 65 (1993-96), 70 (1993-96), 120 (1993-94), 125 (1993-95), 130 (1995-96), 140 (1993-94), 250 (1994-95), 300 (1994-95)



18-3180
WATER PUMP HOUSING
Replaces: 435390

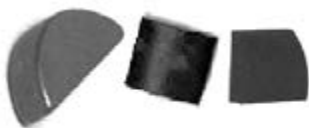

IMPELLER KEYS

Part No.	Replaces	Std. Pkg
18-3295 ③	330619, 344470	3
18-3138 ① ③	334897	2
18-3108	308928	1
18-3299 ③	331107	5
18-3326	300611	1

① Pkg of 2 ② Pkg of 3



18-3129
WATER PUMP HOUSING
Replaces: 435673, 438591, 436954, 432955



18-3336
WATER PUMP HOUSING
Replaces: 384087

APPLICATION BEGINS ON PAGE 307

③ This product is priced per piece. To order priced per package, please add -9 to the part number.



18-3363
WATER PUMP HOUSING
 Replaces: 330560



18-3367
WATER PUMP HOUSING
 Replaces: 393632



18-3405
WATER PUMP HOUSING
 Replaces: 435959



18-4569
IMPELLER HOUSING
 Replaces: 339720



18-4571
IMPELLER HOUSING
 Replaces: 360347
 Fits: 200-300HP (2009 & Up)



18-3201
IMPELLER REPAIR KIT
 Replaces: 379763

— CONTAINS —

Part #	Desc.	O.E. #	Qty.
18-3001	Impeller	277181, 434424	1
NSS	Plate	203132	1



18-3202
IMPELLER REPAIR KIT

— CONTAINS —

Part #	Desc.	O.E. #	Qty.
18-3001	Impeller	277181, 434424	1
18-3102	Impeller Plate	305303	1



18-3203
IMPELLER REPAIR KIT
 Replaces: 379766, 379766

— CONTAINS —

Part #	Desc.	O.E. #	Qty.
18-3002	Impeller	375638	1
18-3103	Impeller Plate	303069	1

APPLICATION BEGINS ON PAGE 307

© This product is priced per piece. To order priced per package, please add -9 to the part number.

①18-3211D

Display Package



**18-3211
IMPELLER REPAIR KIT**

— CONTAINS —

Part #	Desc.	O.E. #	Qty.
18-3059	Impeller	395864, 397131, 435821	1
18-2536	Rubber Seal	321120	1
18-2557	Impeller Gasket	324701, 338484	1
18-3299	Impeller Key	331107	1
18-7158	O-Ring	310967, 310585	1
18-3138	Impeller Key	334897	1



**18-3453
WATER PUMP KIT**
With Housing
Replaces: 5006511
For: E-Tec 40/50/60 HP All



**18-3454
WATER PUMP KIT**
With Housing
Replaces: 438592
For: 40, 50, 25 Jet, 30 Jet 1995-Up
Includes impeller 18-3104-1



**18-3325
WATER PUMP KIT**
Replaces: 387326

— CONTAINS —

Part #	Desc.	O.E. #	Qty.
18-7134	O-Ring	339543	1
18-3108	Flywheel Key	308928	1
18-3337	Grommet	315837	1
18-3083	Impeller	377230	1
18-3343	Impeller Plate	320981	1
18-2705-9	Grommet	315748	1



**18-3327
WATER PUMP KIT**
With Housing
Replaces: 394711, 386697, 391698, 389112, 387610

— CONTAINS —

Part #	Desc.	O.E. #	Qty.
18-3050	Impeller	386084	1
18-3180	Housing	435390	1
18-3178	Wear Plate	318995	1
NSS	Water Pump Cup	324097	1
18-3329	Grommet	302497	1
18-2392	Grommet	327035	1
18-2025	Oil Seal	318972	1
18-7116	O-Ring	303097	1
18-7139	O-Ring	319085	1
18-3326	Pin	300771	1
18-3369	Stainless Steel Bolt	319126	4



**18-3376
WATER PUMP KIT**
Without Housing
Replaces: 384956

— CONTAINS —

Part #	Desc.	O.E. #	Qty.
18-3083	Impeller	377230	1
18-3343	Impeller Plate	320981	1
18-3108	Flywheel Key	308928	1
18-3337	Grommet	315837	1
18-7134	O-Ring	339543	1
18-2705-9	Grommet	315748	1
18-3136	Screw (Long)	324430	2
18-3369	Stainless Steel Bolt	319126	2



**18-3377
WATER PUMP KIT**
Without Housing
Replaces: 382468

— CONTAINS —

Part #	Desc.	O.E. #	Qty.
18-3002	Impeller	375638	1
18-3103	Impeller Plate	303069	1
18-3329	Water Tube Grommet	302497	1
18-3326	Pin	300771	1

APPLICATION BEGINS ON PAGE 307

① Items ending in "D" are Display Packaged - Regular number is Non-Display



18-3378
WATER PUMP KIT
 With Housing
 Replaces: 391635, 439077

— CONTAINS —

Part #	Desc.	O.E. #	Qty.
18-3055	Impeller	389589	1
18-3343	Impeller Plate	320981	1
18-3336	Housing	384087	1
18-2709	Wear Plate Gasket	336530	1
18-3365	Stainless Steel Bolt	909533	2
18-3369	Stainless Steel Bolt	319126	2
18-2705-9	Seal	315748	1
18-3337	Water Tube Grommet	315837	1
18-7134	O-Ring	303059	1



18-3380
WATER PUMP KIT
 Without Housing
 Replaces: 390770

— CONTAINS —

Part #	Desc.	O.E. #	Qty.
18-3055	Impeller	389589	1
18-3343	Impeller Plate	320981	1
18-2709	Wear Plate Gasket	336530	1
18-3365	Stainless Steel Bolt	909533	2
18-3136	Stainless Steel Bolt	319126	2
18-2705-9	Seal	315748	1
18-3337	Water Tube Grommet	315837	1
18-7134	O-Ring	303059	1



18-3381
WATER PUMP KIT
 Without Housing
 Replaces: 393509

— CONTAINS —

Part #	Desc.	O.E. #	Qty.
18-3051	Impeller	395289	1
NSS	Impeller Plate	328755	1
18-0124	Impeller Plate Gasket	325537	1
18-3358	Water Pump Cup	328751	1
18-2539	Rubber Seal	328753	1
18-3329	Grommet	302497	1
18-7100	O-Ring	301877	1
18-7105	O-Ring	311338	2
18-7146	O-Ring	554545	1
NSS	Stainless Steel Bolt	331979	6



18-3382
WATER PUMP KIT
 With Housing
 Replaces: 393630

— CONTAINS —

Part #	Desc.	O.E. #	Qty.
18-3051	Impeller	395289	1
NSS	Impeller Plate	328755	1
18-3367	Housing	393632	1
18-3358	Water Pump Cup	328751	1
18-0124	Impeller Plate Gasket	325537	1
18-3329	Grommet	302497	1
18-7100	O-Ring	301877	1
18-7105	O-Ring	311338	2
18-7146	O-Ring	554545	1
NSS	Stainless Steel Bolt	331979	6



18-3383
WATER PUMP KIT
 With Housing
 Replaces: 395270

— CONTAINS —

Part #	Desc.	O.E. #	Qty.
18-3051	Impeller	395289	1
18-3363	Housing	330560	1
18-3358	Water Pump Cup	328751	1
18-3360	Impeller Housing Gasket	329390	1
18-3329	Grommet	302497	1
NSS	Stainless Steel Bolt	331979	4





18-3384
WATER PUMP KIT
Without Housing
Replaces: 386124

— CONTAINS —

Part #	Desc.	O.E. #	Qty.
18-7158	O-Ring	310585	1
18-3108	Flywheel Key	308928	1
18-3043	Impeller	389642	1
NSS	Impeller Plate	317841	1
18-2026	Oil Seal	321453	1
NSS	Screw	306643	2
18-3136	Screw	323626	4
18-2389	Grommet	314832	2



18-3385
WATER PUMP KIT
Without Housing
Replaces: 396932

— CONTAINS —

Part #	Desc.	O.E. #	Qty.
18-3368	Impeller	396809	1
18-3343	Impeller Plate	320981	1
18-2705-9	Seal	315748	1
18-7481	Rubber Seal	324981	1
18-7134	O-Ring	303059	1
18-3337	Water Tube Grommet	315837	1
18-3365	Stainless Steel Bolt	909533	2
18-3369	Stainless Steel Bolt	319126	2



18-3387
WATER PUMP KIT
Without Housing
Replaces: 432956

— CONTAINS —

Part #	Desc.	O.E. #	Qty.
18-2703	Grommet	314008	1
18-3053-1	Impeller	396725	1
18-2705-9	Seal	315748	1
NSS	SS Bolt	331979	4
18-7174	O-Ring	326649	1
18-7481	O-Ring	324981	1
18-2709	Wear Plate Gasket	336530	1
18-3126	Wear Plate	321940	1
18-3127	Impeller Plate	319275	1
18-3138	Impeller Key	334897	1
18-3299	Flywheel Key	331107	1
18-3153	Stainless Steel Bolt	908158	1



18-3388
WATER PUMP KIT
Without Housing
Replaces: 386533, 389143

— CONTAINS —

Part #	Desc.	O.E. #	Qty.
18-0969	Impeller Housing Gasket	319586	1
18-3108	Stainless Steel Key	323950	1
18-2703	Grommet	314008	1
18-3127	Impeller Plate	319275	1
18-2705-9	Seal	315748	1
18-3082	Impeller	382547	1
18-3153	Stainless Steel Bolt	334597	1
18-2709	Wear Plate Gasket	336530	1
NSS	Stainless Steel Bolt	331979	4
18-3126	Wear Plate	321940	1



18-3389
WATER PUMP KIT
With Housing
Replaces: 436957, 0438591, 0432955

— CONTAINS —

Part #	Desc.	O.E. #	Qty.
18-7481	O-Ring	324981	1
18-2703	Grommet	314008	1
18-3053-1	Impeller	396725	1
18-3127	Impeller Plate	319275	1
18-2705-9	Seal	315748	1
NSS	Stainless Steel Bolt	908158	1
18-3299	Flywheel Key	331107	1
18-7174	O-Ring	326649	1
18-2709	Wear Plate Gasket	336530	1
18-3129	Housing	435673	1
18-3138	Impeller Key	334897	1
18-3126	Wear Plate	321940	1



18-3390
WATER PUMP KIT
Without Housing
Replaces: 395060, 0435447, 0434421, 5001594

— CONTAINS —

Part #	Desc.	O.E. #	Qty.
18-3059	Impeller	397131, 435821	1
18-2557	Impeller Gasket	324701, 338484	1
18-3299	Impeller Key	331107	1
18-7158	O-Ring	310967, 310585	1
NSS	Stainless Steel Screw	306643	2
18-2703	Grommet	314008	1
18-2704	Grommet	320943	1
18-2706	Grommet	321008	1
18-3136	Stainless Steel Bolt	323626	4
18-2769	Rubber Seal	332000	1
NSS	Stainless Steel Bolt	331979	4
18-3346	Cup Plate Assy.	435027	1
18-3138	Impeller Key	334897	1



18-3391
WATER PUMP KIT
With Housing
Replaces: 395072

– CONTAINS –

Part #	Desc.	O.E. #	Qty.
18-3346	Cup & Plate Assy.	435027	1
18-2769	O-Ring	332000	1
18-2557	Impeller Plate Gasket	338484, 324701	1
18-2704	Grommet	320943	1
18-3136	Stainless Steel Bolt	323626	4
18-3299	Flywheel Key	331107	1
18-3153	Stainless Steel Bolt	908158	1



18-3392
WATER PUMP KIT
With Housing
Replaces: 434421, 5001594

– CONTAINS –

Part #	Desc.	O.E. #	Qty.
18-3059	Impeller	395864, 397131, 435821	1
18-3346	Cup & Plate Assy.	435027	1
18-3299	Impeller Key	331107	1
18-7158	O-Ring	310967, 310585	1
NSS	Stainless Steel Screw	306643	2
18-2703	Grommet	314008	1
18-2704	Grommet	320943	1
18-2706	Grommet	321008	1
18-3136	Stainless Steel Bolt	323626	4
18-2769	Rubber Seal	332000	1
18-2557	Impeller Gasket	324701, 338484	1
NSS	Stainless Steel Bolt	331979	4



18-3393
WATER PUMP KIT
With Housing
Replaces: 395073, 388644

– CONTAINS –

Part #	Desc.	O.E. #	Qty.
18-3043	Impeller	389642	1
18-2557	Impeller Gasket	324701, 338484	1
18-3346	Cup & Plate Assy.	435027	1
18-3108	Water Pump Key	323950	1
18-0110	Shift Housing Gasket	324670	1
18-7158	O-Ring	310967, 310585	1
NSS	Stainless Steel Screw	306643	2
18-2703	Grommet	314008	1
18-2704	Grommet	320943	1
18-2706	Grommet	321008	1
18-3136	Stainless Steel Bolt	323626	4
18-2769	O-Ring	332000	1
18-7143	O-Ring	322501	1
NSS	Stainless Steel Bolt	331979	4



18-3394
WATER PUMP KIT
Without Housing
Replaces: 433548, 0433549, 0438592

– CONTAINS –

Part #	Desc.	O.E. #	Qty.
18-7481	O-Ring	324981	1
18-2708	Grommet	333758	1
18-2709	Wear Plate Gasket	336530	1
18-3104-1	Impeller	432941	1
18-3138	Impeller Key	334897	1
18-2705-9	Seal	315748	1
NSS	Stainless Steel Bolt	331979	4
18-3126	Wear Plate	321940	1



18-3399
WATER PUMP KIT
With Housing
Replaces: 396933, 0439077

– CONTAINS –

Part #	Desc.	O.E. #	Qty.
18-7134	O-Ring	303059	1
18-3337	Grommet	315837	1
18-3368	Impeller	396809	1
18-2709	Wear Plate Gasket	336530	1
18-3369	Screw (Short)	319126	2
18-2705-9	Seal	315748	1
18-3336	Housing	384087	1
18-3365	Screw (Long)	909533	2
18-3343	Wear Plate	320981	1



18-3400
WATER PUMP KIT
Without Housing
Replaces: 391698, 0394711

– CONTAINS –

Part #	Desc.	O.E. #	Qty.
18-3050	Impeller	386084	1
18-3178	Impeller Plate	318995	1
NSS	Water Pump Cup	324097	1
18-3329	Grommet	302497	1
18-2392	Grommet	327035	1
18-2025	Oil Seal	318972	1
18-7116	O-Ring	303097	1
18-3369	Screw	319126	4
18-3326	Pin	300771	1
18-7139	O-Ring	319085	1



18-3401
WATER PUMP KIT

Without Housing
Replaces: 395271, 394394, 0395270

— CONTAINS —

Part #	Desc.	O.E. #	Qty.
18-3051	Impeller	395289	1
18-3360	Gasket	329398	1
18-3358	Cup	328773	1
18-7440-1	O-Ring	301967	2
18-2013	Oil Seal	321786	1
18-3329	Grommet	302497	1
18-0108	Gasket	324449	1
NSS	Stainless Steel Bolt	331979	4



18-4529
WATER PUMP KIT

Without Housing
Replaces: 396644
Fits: 4HP (1986-92), 5HP (1980-83, 1996-01), 6HP (1984-01, 2003-05), 8HP (1980-01, 2003-05)

— CONTAINS —

Part #	Desc.	O.E. #	Qty.
NSS	Drive Key	331130	1
NSS	Grommet	321129	1
18-3329	Grommet	302497	1
18-4277	Screws	324430	4
18-4578	Impeller Hsg Plate	324640	1
18-4551	Impeller Hsg Cup	324641	1
NSS	Impeller Hsg Gasket	325040	2
18-3091	Impeller Assembly	389576	1
18-7413	O-Ring	303191	1



18-3403
WATER PUMP KIT

Without Housing
Replaces: 388644

— CONTAINS —

Part #	Desc.	O.E. #	Qty.
18-7158	O-Ring	310585	1
18-3108	Key	308928	1
18-2703	Grommet	314008	1
NSS	Screw	306643	4
18-2026	Seal	321453	1
18-3136	Housing Screw	323626	1
18-3043	Impeller	389642	1
18-3346	Cup & Plate Assembly	435027	1
18-2536	Gasket	321120	1
18-2704	Grommet	320943	1



18-3315-2
WATER PUMP KIT

With Housing
Replaces: 435929, 5001595
For: 90/115SL (1995-UP), 120/125ESX (1993-94), 120/130/140/150/175/V-6/V-8(1993-UP)

— CONTAINS —

Part #	Desc.	O.E. #	Qty.
18-2557	Gasket	324701	1
18-3405	Housing, WP	435485	1



18-4537
WATER PUMP KIT

Without Housing
Replaces: 5008972
Fits: 15 (AA-AF), 25 (AA-AF), 30 (AA-AF)

— CONTAINS —

Part #	Desc.	O.E. #	Qty.
18-0124	Gasket	325537	1
NSS	Plate	328755	1
18-2539	Seal	328753	1
18-3295	Key	344470	1
18-4539	Impeller	5008967	1
NSS	Spring, Pressure Relief	355169	1
NSS	Spring, Thermostat	355209	1
18-3358	Cup	328751	1
18-7146	O-Ring	554545	1
18-1595	Screw M6X25	353590	6
18-3367	Housing, Impeller	393632	1
18-2147	Bushing	328754	1
18-3329	Grommet	302497	1
18-7100	O-Ring	301877	1
18-1823	Seal and Pin Assembly	5007770	1



18-3472
WATER PUMP KIT

Without Housing
Replaces: 5007972
Fits: 200-300HP (2009 & Up)

— CONTAINS —

Part #	Desc.	O.E. #	Qty.
18-2557	Gasket, Water Pump	338484	1
18-4579	Plate, Outer Wear	338485	1
18-7963	Seal, Impeller Plate	331353	1
18-3059	Impeller	5001593	1
18-71336	O-Ring, Impeller to Plate	302035	1
18-3299	Key, Impeller	331107	1
NSS	Cup, Insert	338486	1
18-7143	O-Ring, Cup to Housing	331188	1
18-4571	Housing, Impeller	360347	1
18-71338	O-Ring, Water Tube	346865	4
18-9084	Cover, Impeller Housing	354578	1
18-1597	Screw, Housing	302325	4
NSS	Screw, Cover to Housing	306643	2
18-2704	Grommet, Pump to Exhaust Housing	320943	1
18-1824	Grommet, Sleeve, 20" Models	349354	1
18-1826	Grommet, Sleeve, 25" and 30"	338601	1
NSS	Sleeve, Extension 25" Models	354580	1

APPLICATION BEGINS ON NEXT PAGE

Ⓢ This product is priced per piece. To order priced per package, please add -9 to the part number.

JOHNSON/EVINRUDE WATER PUMP KIT APPLICATION									
HP	Year	Impeller	Impeller Plate	Plate & Cup	Cup	Repair Kit	Pump Kit w/o Hsg.	Pump Kit w/Hsg.	Housing Kit
50	1986-88	18-3368	18-3343	—	—	—	18-3385	18-3399	18-3336
50	1989-98	18-3104-1	—	—	—	—	18-3394	—	—
55	1968-69	18-3082	—	—	—	—	—	—	—
55	1976-78	18-3083	—	—	—	—	—	—	18-3336
55	1979-85	18-3055	18-3343	—	—	—	18-3380	18-3378	18-3336
60	1964-67	—	—	—	—	—	—	—	—
60	1970-71	18-3082	—	—	—	—	—	—	—
60	1980-85	18-3055	—	—	—	—	18-3380	18-3378	18-3336
60	1986-94	18-3053-1	18-3127	—	—	—	18-3387	18-3389	—
60	1995-Up	18-3053-1	18-3127	—	—	—	18-3387	—	—
65	1968	—	—	—	—	—	—	—	—
65	1972-73	18-3082	—	—	—	—	—	—	—
65 Comm.	1984-94	18-3053-1	18-3127	—	—	—	18-3387	18-3389	—
65 Comm.	1995-Up	18-3053-1	18-3127	—	—	—	18-3387	—	—
70	1974-78	18-3082	18-3127	—	—	—	18-3388	—	—
70	1979-94	18-3053-1	18-3127	—	—	—	18-3387	18-3389	—
70	1995-Up	18-3053-1	18-3127	—	—	—	18-3387	—	—
75	1960-65	—	—	—	—	—	—	—	—
75	1974-78	18-3082	18-3127	—	—	—	18-3388	—	—
75	1979-88	18-3053-1	18-3127	—	—	—	18-3387	18-3389	18-3129
80	1966-67	—	—	—	—	—	—	—	—
85	1968	—	—	—	—	—	—	—	—
85	1969-72	18-3044	—	—	—	—	—	—	—
85	1973-77	18-3043	—	—	—	—	18-3384	—	—
85	1978	18-3043	—	18-3346	—	—	—	18-3393⑦	18-3391
85	1979-95	18-3059	—	18-3346	—	18-3211	18-3390	18-3392	18-3391
90	1964-68	—	—	—	—	—	—	—	—
90	1979-Up	18-3059	—	18-3346	—	18-3211	18-3390	18-3392②	18-3391
90	2013 & Up	18-3059	18-4579	—	—	—	18-3476	—	—
90 SL,DI	1995 & UP	18-3059	—	18-3346	—	18-3211	18-3390	18-3315-2	18-3405
100	1969-72	18-3044	—	—	—	—	—	—	—
100	1979-Up	18-3059	—	18-3346	—	18-3211	18-3390	18-3392	18-3391
100 Comm. ①	1984-Up	18-3059	—	18-3346	—	18-3211	18-3390	18-3392	18-3391
105 Comm.	1998-2001	18-3059	—	18-3346	—	18-3211	18-3390	18-3315-2	18-3405
115	1969-70	18-3044	—	—	—	—	—	—	—
115	1973-76	18-3043	—	—	—	—	18-3384	—	—
115	1977-78	18-3043	—	18-3346	—	—	—	18-3393⑦	18-3391
115	1979-Up	18-3059	—	18-3346	—	18-3211	18-3390	18-3392②	18-3391
115	2013 & Up	18-3059	18-4579	—	—	—	18-3476	—	—
115 SL,DL	1995 & UP	18-3059	—	18-3346	—	18-3211	18-3390	18-3315-2	18-3405
120 25" ④	1993-2000	18-3059	—	18-3346	—	18-3211	18-3390	18-3315-2	18-3405
125	1971-72	18-3044	—	—	—	—	—	—	—
125 ESX 25" ③	1993-94	18-3059	—	18-3346	—	18-3211	18-3390	18-3392	18-3391
125 ESX 25"	1994-95	18-3059	—	18-3346	—	18-3211	18-3390	18-3392	18-3391
125 ESX 25" ④	1993-94	18-3059	—	18-3346	—	18-3211	18-3390	—	—
130	1997 & UP	18-3059	—	18-3346	—	18-3211	18-3390	18-3315-2	18-3405
130	2013 & Up	18-3059	18-4579	—	—	—	18-3476	—	—
130 25"	1994-2000	18-3059	—	18-3346	—	18-3211	18-3390	18-3315-1	18-3405
135	1973-75	18-3043	—	—	—	—	18-3384	—	—
135	1976	18-3043	—	—	—	—	—	—	—
135 25"	2001	18-3059	—	18-3346	—	18-3211	18-3390	18-3315-2	18-3405
140	1977-78	18-3043	—	18-3346	—	—	—	18-3393⑦	18-3391

① Except chrome pumps

② Except SL models 1995 & Up/FFI models

③ "S" Suffix

④ "F" Suffix

⑤ Except 1993-94 25" & 30" V6 & V8

⑦ For water pumps using 1 water tube

⑧ 90 degree gearcase

JOHNSON/EVINRUDE WATER PUMP KIT APPLICATION (CONT.)

HP	Year	Impeller	Impeller Plate	Plate & Cup	Cup	Repair Kit	Pump Kit w/o Hsg.	Pump Kit w/Hsg.	Housing Kit
140	1979-Up	18-3059	—	18-3346	—	18-3211	18-3390	18-3392	18-3391
140 25" ④	1993	18-3059	—	18-3346	—	18-3211	18-3390	18-3315-2	18-3405
140 25"	1994-2000	18-3059	—	18-3346	—	18-3211	18-3390	18-3315-2	18-3405
150	1976-78	18-3043	—	18-3346	—	—	—	18-3393 ⑦	18-3391
150	1979-Up	18-3059	—	18-3346	—	18-3211	18-3390	18-3392	18-3391
150 20"	1993 & UP	18-3059	—	18-3346	—	18-3211	18-3390	18-3392	18-3391
150 SL 20"	1994-98	18-3059	—	18-3346	—	18-3211	18-3390	18-3315-2	18-3405
150 EL 20"	1996-98	18-3059	—	18-3346	—	18-3211	18-3390	18-3315-2	18-3405
150 25"	1993 & UP	18-3059	—	18-3346	—	18-3211	18-3390	18-3315-2	18-3405
150 DI	1997 & UP	18-3059	—	18-3346	—	18-3211	18-3390	18-3315-2	18-3405
150	2000 & UP	18-3059	—	18-3346	—	18-3211	18-3390	18-3315-2	18-3405
175	1976-78	18-3043	—	18-3346	—	—	—	18-3393 ⑦	18-3391
175 SL 20"	1994-98	18-3059	—	18-3346	—	18-3211	18-3390	18-3315-2	18-3405
175 EL 20"	1996-98	18-3059	—	18-3346	—	18-3211	18-3390	18-3315-2	18-3405
175 25"	1993 & UP	18-3059	—	18-3346	—	18-3211	18-3390	18-3315-2	18-3405
175 DI	1997 & UP	18-3059	—	18-3346	—	18-3211	18-3390	18-3315-2	18-3405
175	2000 & UP	18-3059	—	18-3346	—	18-3211	18-3390	18-3315-2	18-3405
200	1976-78	18-3043	—	18-3346	—	—	—	18-3393 ⑦	18-3391
200	2009 & Up	18-3059	18-4579	—	—	—	18-3472	—	18-4571
200 Comm.	1990	18-3059	—	18-3346	—	18-3211	18-3390	18-3392	18-3391
200 25" & 30"	1993-97	18-3059	—	18-3346	—	18-3211	18-3390	18-3315-2	18-3405
225	2009 & Up	18-3059	18-4579	—	—	—	18-3472	—	18-4571
225 20"	1993 & UP	18-3059	—	18-3346	—	18-3211	18-3390	18-3392	18-3391
225 25" & 30"	1993-97	18-3059	—	18-3346	—	18-3211	18-3390	18-3315-2	18-3405
235	1978	18-3043	—	18-3346	—	—	—	18-3393 ⑦	18-3391
235	1979-Up	18-3059	—	18-3346	—	18-3211	18-3390	18-3392	18-3391
250	2009 & Up	18-3059	18-4579	—	—	—	18-3472	—	18-4571
275	2009 & Up	18-3059	18-4579	—	—	—	18-3472	—	18-4571
300	2009 & Up	18-3059	18-4579	—	—	—	18-3472	—	18-4571
V4 Cross 20" & 25"	1993 & UP	18-3059	—	18-3346	—	18-3211	18-3390	18-3392	18-3391
V4 Loop 20"	1993 & UP	18-3059	—	18-3346	—	18-3211	18-3390	18-3392	18-3391
V4,V6,V8 ⑤	1982-94	18-3059	—	18-3346	—	18-3211	18-3390	18-3392	18-3391
V6,V8 20"	1993 & UP	18-3059	—	18-3346	—	18-3211	18-3390	18-3392	18-3391
V6 & V8 25" & 30"	1993 & UP	18-3059	—	18-3346	—	18-3211	18-3390	18-3315-2	18-3405
Sea Drives	1979-Up	18-3059	—	18-3346	—	18-3211	18-3390	18-3392 ⑥	18-3391

① Except chrome pumps

② Except SL models 1995 & Up/FFI models

③ "S" Suffix

④ "F" Suffix

⑤ Except 1993-94 25" & 30" V6 & V8

⑦ For water pumps using 1 water tube

⑥ 90 degree gearcase



18-3563
POPPET
RELIEF VALVE
V-6 Crossflow
Replaces: 321027



18-3564
POPPET
RELIEF VALVE
V-4 Crossflow
Replaces: 318395



18-1219
GROMMET
V-6 Crossflow
Replaces: 320880

PKG. OF 2



18-1221
18-1221-9 ①
RETAINER GASKET
V-4 / V-6 Loop Charge
Replaces: 330273



18-1243
VALVE SPRING
V-4 / V-6 Crossflow
Replaces: 317245

① Priced per Package

 <p>18-1222 THERMOSTAT GASKET V-4 / V-6 Loop Charge Replaces: 394408</p>	 <p>18-3567 RUBBER VALVE V-6 Crossflow Replaces: 321221</p>	 <p>18-3565 RETAINER V-6 Crossflow Replaces: 321220</p>	 <p>18-2391 GROMMET V-4 Crossflow Replaces: 321692</p>												
 <p>18-3500 THERMOSTAT Replaces: 394409, 434137 For: 3 cyl. (1992 & UP), 90° Looper (1990-1992) 140°</p>	 <p>18-3544 THERMOSTAT Replaces: 435491 Fits: E100 (2004-06), E110 (04-06), E115 (2002-06), E75 (2002-03), E90 (2002-03), E150 (1991-94), E175 (1991-94), J105 (2003), J115 (2002-06), J150 (1991-92, 1993-94, 2002-06), J175 (1991-92, 1994, 2002-06), J90 (2004-06)</p>	 <p>18-3545 THERMOSTAT 130° Replace: 437090 Fits: E115 (1997), E135, E150, E175 (2000-06)</p>	 <p>18-3546 THERMOSTAT 130° Replaces: 5001036 Fits: E200, E225, E250 (2000-05), J200, J225, J250 (2000-01)</p>												
 <p>18-3543 THERMOSTAT 143° Replaces: 393659, 434841, 378065, 508626, 5005440 Fits: 40-250hp E-tech, 6-55hp, Cross V4 & V6, 9.9 4-Stroke (1994-01), 15 4-Stroke (1994-01)</p>	 <p>18-3643 THERMOSTAT Replaces: 433379 Fits: 6-8HP (1990), 9.9/15HP (1990-92), 40/48/50HP (1990-94), 45/55 (1992-94)</p>	 <p>18-3557 THERMOSTAT 143° Replaces: 396987, 382385</p>	 <p>18-3561 THERMOSTAT Replaces: 436195 143°</p>												
 <p>18-1506 VERNATHERM 143° Replaces: 394411 For: 10/15 (1993-95), 60/125/185 (1989-90), 65 (1987-89), 70/200/225 (1986-90), 120/140/300 (1985-90), 275 (1985-88)</p>	<p>①18-3669D Display Package</p>  <p>18-3669 THERMOSTAT KIT – CONTENTS –</p> <table border="1"> <thead> <tr> <th>Part #</th> <th>Description</th> <th>O.E. #</th> </tr> </thead> <tbody> <tr> <td>18-3557</td> <td>Thermostat</td> <td>396987</td> </tr> <tr> <td>18-2548</td> <td>Thermostat Cover Gasket</td> <td>332108</td> </tr> <tr> <td>18-0929</td> <td>Thermostat Gasket</td> <td>313416</td> </tr> </tbody> </table>	Part #	Description	O.E. #	18-3557	Thermostat	396987	18-2548	Thermostat Cover Gasket	332108	18-0929	Thermostat Gasket	313416	<p>①18-3673D Display Package</p>  <p>18-3673 THERMOSTAT KIT V-4 Crossflow Uses thermostat 18-3543</p>	<p>①18-3674D Display Package</p>  <p>18-3674 THERMOSTAT KIT V-6 Crossflow Uses thermostat 18-3543</p>
Part #	Description	O.E. #													
18-3557	Thermostat	396987													
18-2548	Thermostat Cover Gasket	332108													
18-0929	Thermostat Gasket	313416													
 <p>18-3566 TELL TALE HOSE ELBOW Replaces: 331894</p>	 <p>18-1507 THERMOSTAT SEAL Replaces: 335981 For: 60° V-4 & V-6</p>	 <p>18-1734 THERMOSTAT SEAL Replaces: 334742 For: OMC thermostat application 6, 8, 10, 15, 40, 48, 50 HP (1989-94)</p>													

APPLICATION ON NEXT PAGE

① Items ending in "D" are Display Packaged - Regular number is Non-Display

Crossflow V-4 Engine

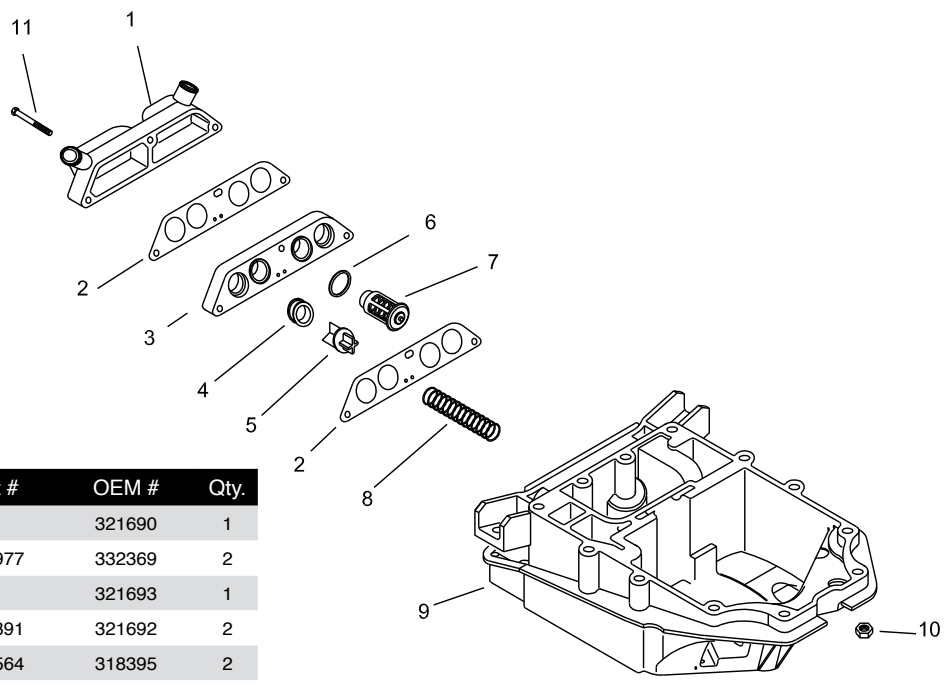

Fig. #	Description	Part #	OEM #	Qty.
1	Cover	~	321690	1
2	Gasket	18-0977	332369	2
3	Valve Body	~	321693	1
4	Grommet	18-2391	321692	2
5	Valve	18-3564	318395	2
6	Thermostat Gasket	18-0675	321932	2
7	Thermostat	18-3543	434841, 393659	2
8	Spring	18-1243	317245	2
9	Adapter	~	331039	1
10	Nut	~	306422	4
11	Screw Cover	~	305652	3

Crossflow V-6 Engine

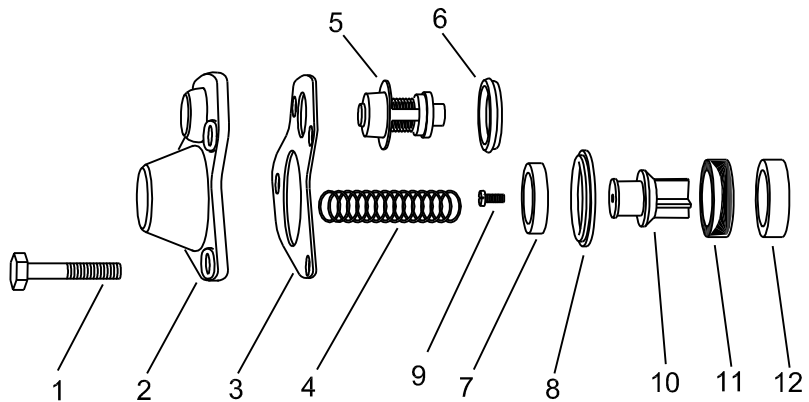

Fig. #	Description	Part #	OEM #	Qty.	Fig. #	Description	Part #	OEM #	Qty.
1	Screw	—	306778	4	7	Retainer	18-3565	321220	1
2	Cover	—	321013	1	8	Seal	18-3567	321221	1
3	Gasket	18-2546	321184	1	9	Stainless Steel Bolt	—	306643	1
4	Spring	18-1243	317245	1	10	Valve	18-3563	321027	1
5	Thermostat	18-3543	393659	1	11	Grommet	18-1219	320880	1
6	Thermostat Gasket	18-0182	310058	1	12	Valve Cap	—	321222	1

JOHNSON/EVINRUDE THERMOSTAT APPLICATION

HP	Years	Thermostat Kit	Thermostat	Valve	Valve Seat	Valve Diaphragm	Valve Retainer	Valve Cup	Valve Spring	Grommet
5	1965-68, 1986	18-3672 ⑤	18-3543	—	—	—	—	—	—	—
5.5	1959-64	18-3672 ⑤	18-3543	—	—	—	—	—	—	—
6	1965-79, 1986	18-3672 ⑤	18-3543	—	—	—	—	—	—	—
6	1990	18-3643	—	—	—	—	—	—	—	—
7.5	1980-86	18-3672 ⑤	18-3543	—	—	—	—	—	—	—
8	1986	18-3672 ⑤	18-3543	—	—	—	—	—	—	—
8	1990	18-3643	—	—	—	—	—	—	—	—
9.5	1964-73	18-3672 ⑤	18-3543	—	—	—	—	—	—	—

① All 1989-91 models except DR & DT ③ Commercial also ⑤ For complete Thermostat Kit including gaskets & spring use 18-3674
 ② Commercial ④ Except 60 degree models

APPLICATION CONTINUED ON NEXT PAGE

JOHNSON/EVINRUDE THERMOSTAT APPLICATION										
HP	Years	Thermostat Kit	Thermostat	Valve	Valve Seat	Valve Diaphragm	Valve Retainer	Valve Cup	Valve Spring	Grommet
9.9	1974-86	18-3672 ⑤	18-3543	—	—	—	—	—	—	—
9.9	1990-92	18-3643	—	—	—	—	—	—	—	—
10	1959-63	18-3672 ⑤	18-3543	—	—	—	—	—	—	—
15	1974-86	18-3672 ⑤	18-3543	—	—	—	—	—	—	—
15	1990-92	18-3643	—	—	—	—	—	—	—	—
18	1959-73	18-3672 ⑤	18-3543	—	—	—	—	—	—	—
20	1981-94	18-3672 ⑤	18-3543	—	—	—	—	—	—	—
25 ①	1969-94	18-3672 ⑤	18-3543	—	—	—	—	—	—	—
28	1989-94	18-3672 ⑤	18-3543	—	—	—	—	—	—	—
30	1986-94	18-3672 ⑤	18-3543	—	—	—	—	—	—	—
35	1959, 1976-94	18-3672 ⑤	18-3543	—	—	—	—	—	—	—
40	1960-69	18-3672 ⑤	18-3543	—	—	—	—	—	—	—
40	1990-94	18-3643	—	—	—	—	—	—	—	—
45	1989-92 ②	18-3672 ⑤	18-3543	—	—	—	—	—	—	—
45	1992-94	18-3643	—	—	—	—	—	—	—	—
48	1990-94	18-3643	—	—	—	—	—	—	—	—
50	1971-75, 1979, 1981-86	18-3672 ⑤	18-3543	—	—	—	—	—	—	—
50	1990-94	18-3643	—	—	—	—	—	—	—	—
55	1976-92 ③	18-3672 ⑤	18-3543	—	—	—	—	—	—	—
55	1992-94	18-3643	—	—	—	—	—	—	—	—
60	1969-70	18-3669 ⑤	18-3557	—	—	—	—	—	—	—
60	1980-86	18-3672 ⑤	18-3543	—	—	—	—	—	—	—
60, 60TTL	1993	—	18-3561	—	—	—	—	—	—	—
65	1971-73	18-3669	18-3557	—	—	—	—	—	—	—
65	1993	—	18-3561	—	—	—	—	—	—	—
65C	1984-86	18-3669	18-3557	—	—	—	—	—	—	—
65 Jet	1994-95	18-3673	18-3543	18-3564	—	—	—	—	18-1243	18-2391
70	1974-86	18-3669	18-3557	—	—	—	—	—	—	—
70, 70TTL	1993	—	18-3561	—	—	—	—	—	—	—
75	1978-88	18-3669	18-3557	—	—	—	—	—	—	—
80 Jet	1994-95	18-3673	18-3543	18-3564	—	—	—	—	18-1243	18-2391
85	1978-80	18-3673	18-3543	18-3564	—	—	—	—	18-1243	18-2391
85	1993-95	18-3673	18-3543	18-3564	—	—	—	—	18-1243	18-2391
88	1987-95	18-3673	18-3543	18-3564	—	—	—	—	18-1243	18-2391
90 ④	1983-95	18-3673	18-3543	18-3564	—	—	—	—	18-1243	18-2391
90 Jet	1994	18-3673	18-3543	18-3564	—	—	—	—	18-1243	18-2391
100	1979-80	18-3673	18-3543	18-3564	—	—	—	—	18-1243	18-2391
100	1990-95	18-3673	18-3543	18-3564	—	—	—	—	18-1243	18-2391
100 Comm	1984-95	18-3673	18-3543	18-3564	—	—	—	—	—	—
110	1985-89	18-3673	18-3543	18-3564	—	—	—	—	18-1243	18-2391
112	1994-95	18-3673	18-3543	18-3564	—	—	—	—	18-1243	18-2391
115 ④	1978-95	18-3673	18-3543	18-3564	—	—	—	—	18-1243	18-2391
120	1988-91	—	—	—	—	18-1222	—	18-1221	—	—
140	1978-85	18-3673	18-3543	18-3564	—	—	—	—	18-1243	18-2391
140	1988-91	—	—	—	—	18-1222	—	18-1221	—	—
150	1978-91	18-3672 ⑤	18-3543	18-3563	18-1219	18-3567	18-3565	—	18-1243	18-0182
155	1984-91	18-3672 ⑤	18-3543	18-3563	18-1219	18-3567	18-3565	—	18-1243	18-0182
175	1977-91	18-3672 ⑤	18-3543	18-3563	18-1219	18-3567	18-3565	—	18-1243	18-0182
185	1984-85	18-3672 ⑤	18-3543	18-3563	18-1219	18-3567	18-3565	—	18-1243	18-0182
200	1977-83	18-3672 ⑤	18-3543	18-3563	18-1219	18-3567	18-3565	—	18-1243	18-0182
200	1988-93	—	—	—	—	18-1222	18-3565	18-1221	—	—
225	1988-93	—	—	—	—	18-1222	18-3565	18-1221	—	—
235	1978-85	18-3672 ⑤	18-3543	18-3563	18-1219	18-3567	18-3565	—	18-1243	18-0182

① All 1989-91 models except DR & DT

② Commercial

③ Commercial also

④ Except 60 degree models

⑤ For complete Thermostat Kit including gaskets & spring use 18-3674



Piston Rings are available individually

SIERRA PISTON KIT CONTENTS
(SEE APPLICATION CHARTS FOR SPECIFIC APPLICATIONS)

HP	Cyl.	Bore Size	Piston	OEM Part No.	Piston Ring	OEM Part No.	OEM Part No.	Circlips	OEM Part No.
9.9/15	2	2.188 / std.	—	397487	—	386279	N/A	—	325262
9.9/15	2	2.218 / .030	—	396574	18-3933	386280	N/A	—	325262
9.9/15	2	2.188 / std.	—	387660	—	386279	N/A	—	325262
9.9/15	2	2.218 / .030	18-4062	387661	18-3933	386280	N/A	—	325262
25-35	2	3.000 / std.	18-4107	392621	18-3910	396377	320954	18-4290 ①	317831
25-35	2	3.020 / .020	—	N/A	18-3911	396378	320954	18-4290 ①	317831
25-35	2	3.030 / .030	—	396576	18-3912	396379	320954	18-4290 ①	317831
35-60	2 & 3	3.187 / std.	—	391798	18-3913	391170, 434107	322188	18-4290 ①	317831
35-60	2 & 3	3.207 / .020	—	N/A	18-3914	N/A	322188	18-4290 ①	317831
35-60	2 & 3	3.217 / .030	—	396581	18-3915	391416, 434109	322188	18-4290 ①	317831
60-75	3	3.000 / std.	18-4124	387284	18-3910	396377	320954	18-4290 ①	317831
60-75	3	3.020 / .020	18-4114	387285	18-3911	396378	320954	18-4290 ①	317831
60-75	3	3.030 / .030	18-4104	396583	18-3912	396379	320954	18-4290 ①	317831
50-70	3	3.187 / std.	—	394461	18-3913	391170, 434107	322188	18-4290 ①	317831
50-70	3	3.217 / .030	—	398483	18-3915	391416, 434109	322188	18-4290 ①	317831

SIERRA V-4/V-6 PISTON KIT CONTENTS
(SEE APPLICATION CHARTS FOR SPECIFIC APPLICATIONS)

Model/HP	Cyl.	Bore Size	Piston	OEM Part #	Piston Ring	OEM Part #	Wrist Pin	OEM Part #	Circlips	OEM Part #
85-300	4 & 6	3.5	—	393271, 393924	18-3904	394930	18-4280	327861	18-4290 ①	317831
85-300	4 & 6	3.52	18-4110	—	18-3906	396503, 385662	18-4280	327861	18-4290 ①	317831
85-300	4 & 6	3.53	18-4100	396585, 396588	18-3905	396504	18-4280	327861	18-4290 ①	317831
150-235	4 & 6	3.625	—	392455	—	390509	18-4280	327861	18-4290 ①	317831
150-235	4 & 6	3.645	18-4113	N/A	—	N/A	18-4280	327861	18-4290 ①	317831
150-235	4 & 6	3.655	18-4103	396587	18-3908	390510	18-4280	327861	18-4290 ①	317831
LOOPERS										
120-300	4 & 6	3.685 (port)	18-4065	432072, 432969	18-3975	431870	N.S.S.	—	—	326765
120-300	4 & 6	3.685 (starboard)	18-4066	432073, 432970	18-3975	431870	N.S.S.	—	—	326765
120-300	4 & 6	3.715 (port)	18-4067	432077, 433003	—	431844	N.S.S.	—	—	326765
120-300	4 & 6	3.715 (starboard)	—	432078, 433004	—	431844	N.S.S.	—	—	326765
120-300	4 & 6	3.500 (port)	18-4122	393566	18-3904	394930	18-4280	327861	18-4290 ①	317831
120-300	4 & 6	3.500 (starboard)	—	391481	18-3904	394930	18-4280	327861	18-4290 ①	317831
120-300	4 & 6	3.520 (port)	—	N/A	18-3906	396503, 385662	18-4280	327861	18-4290 ①	317831
120-300	4 & 6	3.520 (starboard)	18-4111	N/A	18-3906	396503, 385662	18-4280	327861	18-4290 ①	317831
120-300	4 & 6	3.530 (port)	18-4102	393612	18-3905	396504	18-4280	327861	18-4290 ①	317831
120-300	4 & 6	3.530 (starboard)	18-4101	391653	18-3905	396504	18-4280	327861	18-4290 ①	317831
185, 200-225	6	3.5995 (port)	standard 18-4190	436860	18-3901	436254	—	—	—	—
185, 200-225	6	3.5995 (starboard)	—	436859	18-3901	436254	—	—	—	—
185, 200-225	6	3.5995 (port)	0.02 18-4195	439015	18-3947	439538	—	—	—	—
185, 200-225	6	3.5995 (starboard)	0.02 18-4086	439516	18-3947	439538	—	—	—	—
185, 200-225	6	3.5995 (port)	0.03 18-4165	439515	—	439538	—	—	—	—
185, 200-225	6	3.5995 (starboard)	0.03 18-4087	439515	—	439538	—	—	—	—

① This product is priced per piece. To order priced per package, please add -9 to the part number.

INLINE PISTON & RINGS APPLICATION

HP	Year	Cyl	Std. Bore	Std. Piston	.020 OS Piston	.030 OS Piston	Std. Rings	.020 OS Rings	.030 OS Rings
5/6/8/7.5	1986-95	2	1.937	—	—	—	18-3972	—	—
9.9/15	1974-80	2	2.188	—	—	18-4062	—	—	18-3933
9.9/15	1981-93	2	2.188	—	—	—	—	—	18-3933
10	1988-90	2	2.188	—	—	—	—	—	18-3933
14	1988-90	2	2.188	—	—	—	—	—	18-3933
15 4-Stroke	1995-UP	2	2.188	—	—	—	—	—	18-3933
18 Jet	1995-98	2	3	18-4107	—	—	18-3910	18-3911	18-3912
20	1981-99	2	3	18-4107	—	—	18-3910	18-3911	18-3912
25	1977-80	2	3	—	—	—	18-3910	18-3911	18-3912
25	1981-96	2	3	18-4107	—	—	18-3910	18-3911	18-3912
25	1983-93	2	3.187	—	—	—	18-3913	18-3914	18-3915
28	1986-96	2	3	18-4107	—	—	18-3910	18-3911	18-3912
28 Jet	1995-96	2	3.187	—	—	—	18-3913	18-3914	18-3915
30	1984-98	2	3	18-4107	—	—	18-3910	18-3911	18-3912
35	1976-80	2	3	—	—	—	18-3910	18-3911	18-3912
35	1981-92	2	3	18-4107	—	—	18-3910	18-3911	18-3912
35	1986-87	2	3.187	—	—	—	18-3913	18-3914	18-3915
35 Jet	1990-98	2	3.187	—	—	—	18-3913	18-3914	18-3915
40	1975-83	2	3.187	—	—	—	18-3913	18-3914	18-3915
40	1984-98	2	3.187	—	—	—	18-3913	18-3914	18-3915
40 Comm.	1981-97	2	3.187	—	—	—	18-3913	18-3914	18-3915
45 Comm.	1985-92	2	3.187	—	—	—	18-3913	18-3914	18-3915
45SS	1987-90	2	3.187	—	—	—	18-3913	18-3914	18-3915
48	1987-97	2	3.187	—	—	—	18-3913	18-3914	18-3915
50	1981-95	2	3.187	—	—	—	18-3913	18-3914	18-3915
50	1995-98	3	3.187	—	—	—	18-3913	18-3914	18-3915
55	1976-79	2	3.187	—	—	—	18-3913	18-3914	18-3915
55 Comm.	1980-95	2	3.187	—	—	—	18-3913	18-3914	18-3915
60	1980-85	2	3.187	—	—	—	18-3913	18-3914	18-3915
60 (49 CID Model)	1986-88	3	3	18-4124	18-4114	18-4104	18-3910	18-3911	18-3912
60	1986-98	3	3.187	—	—	—	18-3913	18-3914	18-3915
65, 65 Comm.	1972-73	3	3	—	—	—	18-3910	18-3911	18-3912
49 CID Model	1984-86	3	3	18-4124	18-4114	18-4104	18-3910	18-3911	18-3912
65	1987-95	3	3.187	—	—	—	18-3913	18-3914	18-3915
65 Jet	1991-95	4	3.5	—	18-4110	18-4100	18-3904	18-3906	18-3905
70	1974-75	3	3	—	—	—	18-3910	18-3911	18-3912
70	1976-85	3	3	18-4124	18-4114	18-4104	18-3910	18-3911	18-3912
70	1986-94	3	3.187	—	—	—	18-3913	18-3914	18-3915
75	1975	3	3	—	—	—	18-3910	18-3911	18-3912
75	1976-88	3	3	18-4124	18-4114	18-4104	18-3910	18-3911	18-3912

JOHNSON/EVINRUDE PISTONS (for V-4, V-6 and V-8 Applications)

HP	Cyl	Year	Std. Bore	STANDARD		.020° OS		.030° OS		Piston Rings	.020 OS Rings	.030 OS Rings	Powerhead Bearing Set
				Port	STBD	Port	STBD	Port	STBD				
65 Jet	4	1991-95	3.5	—	—	18-4110	18-4110	18-4100	18-4100	18-3904	18-3906	18-3905	18-1386
80 Jet	4	1991-96	3.5	—	—	18-4110	18-4110	18-4100	18-4100	18-3904	18-3906	18-3905	—
85	4	1979-80, 1991-95	3.5	—	—	18-4110	18-4110	18-4100	18-4100	18-3904	18-3906	18-3905	18-1386
88	4	1987-95	3.5	—	—	18-4110	18-4110	18-4100	18-4100	18-3904	18-3906	18-3905	18-1386
90	4	1981-98	3.5	—	—	18-4110	18-4110	18-4100	18-4100	18-3904	18-3906	18-3905	18-1386
100 ①	4	1979-97	3.5	—	—	18-4110	18-4110	18-4100	18-4100	18-3904	18-3906	18-3905	18-1386
110	4	1986-90	3.5	—	—	18-4110	18-4110	18-4100	18-4100	18-3904	18-3906	18-3905	18-1386
115	4	1974-77	3.5	—	—	18-4110	18-4110	18-4100	18-4100	18-3904	18-3906	18-3905	—
115	4	1978-98	3.5	—	—	18-4110	18-4110	18-4100	18-4100	18-3904	18-3906	18-3905	18-1386

① Except 1991 60° V Models

JOHNSON/EVINRUDE PISTONS (for V-4, V-6 and V-8 Applications) (Cont.)

HP	Cyl	Year	Std. Bore	STANDARD		.020" OS		.030" OS		Piston Rings	.020 OS Rings	.030 OS Rings	Powerhead Bearing Set
				Port	STBD	Port	STBD	Port	STBD				
120	4	1985-87	3.5	—	—	—	18-4111	18-4102	18-4101	18-3904	18-3906	18-3905	—
120	4	1988-94	3.685	18-4065	18-4066	—	—	18-4067	—	18-3975	—	—	—
125 Comm.	4	1992-95	3.685	18-4065	18-4066	—	—	18-4067	—	18-3975	—	—	—
130	4	1995-98	3.685	18-4065	18-4066	—	—	18-4067	—	18-3975	—	—	—
135	4	1974-76	3.5	—	—	18-4110	18-4110	18-4100	18-4100	18-3904	18-3906	18-3905	—
140	4	1977	3.5	—	—	18-4110	18-4110	18-4100	18-4100	18-3904	18-3906	18-3905	—
140	4	1978-84	3.5	—	—	18-4110	18-4110	18-4100	18-4100	18-3904	18-3906	18-3905	18-1386
140	4	1985-87	3.5	—	—	—	18-4111	18-4102	18-4101	18-3904	18-3906	18-3905	—
140	4	1988-94	3.685	18-4065	18-4066	—	—	18-4067	—	18-3975	—	—	—
1600CC	4	1988	3.5	—	—	18-4110	18-4110	18-4100	18-4100	18-3904	18-3906	18-3905	18-1386
150	6	1973-77	3.5	—	—	18-4110	18-4110	18-4100	18-4100	18-3904	18-3906	18-3905	—
150	6	1978-91	3.5	—	—	18-4110	18-4110	18-4100	18-4100	18-3904	18-3906	18-3905	—
155 Comm.	6	1984-92	3.5	—	—	18-4110	18-4110	18-4100	18-4100	18-3904	18-3906	18-3905	—
175	6	1977-83	3.5	—	—	18-4110	18-4110	18-4100	18-4100	18-3904	18-3906	18-3905	—
175	6	1986-91	3.625	—	—	18-4113	18-4113	—	—	—	—	18-3908	—
185	6	1984-85	3.5	—	—	18-4110	18-4110	18-4100	18-4100	18-3904	18-3906	18-3905	—
185	6	1990-93	—	—	—	—	—	—	—	—	—	—	18-1389
185 Looper	6	1993-94	3.5995	18-4190	—	18-4195	18-4086	18-4165	—	—	—	—	—
200	6	1976-83	3.5	—	—	18-4110	18-4110	18-4100	18-4100	18-3904	18-3906	18-3905	18-1389
200	6	1985-87	3.5	—	—	—	18-4111	18-4102	18-4101	18-3904	18-3906	18-3905	—
200 ①	6	1988-93	3.685	18-4065	18-4066	—	—	18-4067	—	18-3975	—	—	18-1389
200-225 Looper	6	1993-01	3.5995	18-4190	—	18-4195	18-4086	18-4165	18-4087	—	—	—	—
225	6	1985-87	3.5	—	—	—	18-4111	18-4102	18-4101	18-3904	18-3906	18-3905	18-1389
225	6	1988-93	3.685	18-4065	18-4066	—	—	18-4067	—	18-3975	—	—	18-1389
235	6	1980-85	3.625	—	—	18-4113	18-4113	18-4103	18-4103	—	—	18-3908	—
250/300	6	1990-93	3.685	18-4065	18-4066	—	—	18-4067	—	18-3975	—	—	—
2500CC	6	1988	3.5	—	—	18-4110	18-4110	18-4100	18-4100	18-3904	18-3906	18-3905	—
250	6	1988-92	3.685	18-4065	18-4066	—	—	18-4067	—	18-3975	—	—	—
275	8	1988-92	3.685	18-4065	18-4066	—	—	18-4067	—	18-3975	—	—	—
275	8	1985-87	3.5	—	—	—	18-4111	18-4102	18-4101	18-3904	18-3906	18-3905	—
300	8	1988-92	3.685	18-4065	18-4066	—	—	18-4067	—	18-3975	—	—	—
300/3.6L	8	1985-87	3.5	—	—	—	18-4111	18-4102	18-4101	18-3904	18-3906	18-3905	—

60° Eagle Series

HP	Cyl.	Bore Size	Piston	OE No.	Piston Ring	OE No.
90-175	4 & 6	3.600 (port)	—	436242	18-4088	436353
90-175	4 & 6	3.600(starboard)	—	436243	18-4088	436353
90-175	4 & 6	3.620 (port)	—	N/A	N/A	N/A
90-175	4 & 6	3.620 (starboard)	—	N/A	N/A	N/A
90-175	4 & 6	3.630 (port)	—	439519	N/A	436354

OMC V-4/V-6 60° Eagle Series Pistons

H.P.	Year	CYL.	STD. Bore	Standard		.020" OS		.030" OS		Std. Rings	.030" OS Rings
				(Port)	STBD	(Port)	STBD	(Port)	STBD		
90-175	1991-2000	4 & 6	3.600	—	—	—	18-4058	—	—	18-4088	—

OMC SEA DRIVE PISTONS

H.P.	Year	CYL.	STD. BORE	STANDARD		.020" OS		.030" OS		STD. Rings	.020" OS Rings	.030 OS Rings
				(Port)	STBD	(Port)	STBD	(Port)	STBD			
1.6L	1983-89	4	3.500	18-4120	18-4120	18-4110	18-4110	18-4100	18-4100	18-3904	18-3906	18-3905
1.8L	1987	4	3.500	—	—	—	18-4111	18-4102	18-4101	18-3904	18-3906	18-3905
2.5L	1982, 1984-85	6	3.500	18-4120	18-4120	18-4110	18-4110	18-4100	18-4100	18-3904	18-3906	18-3905
2.6L	1982-86	6	3.625	18-4123	18-4123	18-4113	18-4113	—	—	18-3907	—	18-3908
2.7L	1987	6	3.500	—	—	—	18-4111	18-4102	18-4101	18-3904	18-3906	18-3905
3.6L	1987	8	3.500	—	—	—	18-4111	18-4102	18-4101	18-3904	—	18-3905

ORIGINAL EQUIPMENT MANUFACTURER RECOMMENDS THE REPLACEMENT OF ROD BOLTS WITH EVERY POWER HEAD REBUILD.



ROD BOLTS

Part #	OE#	Application
18-4075	308186	For V-4 & V-6 Crossflow engines
18-4075-9①②	308186	For V-4 & V-6 Crossflow engines
18-4076	330081	For V-4 Looper engines



**18-1752
CONNECTING ROD**

Replaces: 394462
For: 40HP (1999-01), 50HP (1995-98), 60HP (1989-01), 70HP (1986-01)



**18-4148-1
CONNECTING ROD**

Replaces: 394488, 5004705
For V-4 Looper engines and some V-6 applications



**18-1753
CONNECTING ROD**

Replaces: 395861
For: 30HP (1999-01), 40 HP (1985-02), 45HP (1986-87, 1990-97), 48HP (1987-96), 50HP (1985-02), 55HP (1985-93, 1999-01), 60 HP (1985)



**18-1352
CENTER MAIN BEARING**

Replaces: 378252



**18-1353
CENTER MAIN BEARING**

Replaces: 387041



**18-1360
ROD BEARING**

Replaces: 396041



**18-1361
ROD CRANK END BEARING**

Replaces: 387787



**18-1378
ROD BEARING**

Replaces: 388344



**18-1374
WRIST PIN BEARING**

Replaces: 395627



**18-1376
WRIST PIN BEARING**

Replaces: 434844



**18-1377
CENTER MAIN BEARING**

Replaces: 320499



**18-4712
SLEEVE**

I.D. 3.1875 • O.D. 3.453 • Wall 0.125 • Length 5.556
Replacement straight sleeve with ports cutin

APPLICATION BEGINS ON NEXT PAGE

① Priced per Package

② Package of 12



18-4040
NEEDLE BEARINGS
 (18 Needles)
 Replaces: 387142, 387139
 (Crank End)
 (Must re-use cage)



POWERHEAD BEARINGS

Part #	Replaces:	Description
18-1391	330854	Lower Crankshaft Bearing
18-1395	385503	Lower Crankshaft Bearing

POWERHEAD BEARING KITS

18-1386

Contains

Part No.	Bearing Type	OE No.	Qty.
18-1353	Ctr. Main	387041	1
18-1377	Ctr. Main	320499	1
18-1374	Wrist Pin	395627	4
18-1395	Lower Crankshaft	385503	1
18-1361	Rod Crank End	387787	4



18-1389

Contains

Part No.	Bearing Type	OE No.	Qty.
18-1353	Ctr. Main	387041	2
18-1377	Ctr. Main	320499	2
18-1376	Wrist Pin	434844	6
18-1360	Rod	396041	4



HP	Year	Sleeve	Connecting Rod	Rod Bolt	Wrist Pin Brg.	Rod Brg. Complete	Rod Brgs.	Center Main Brg.	Split Brg. (sleeve)	Upper Crank Brg.	Lower Crank Brg.	Powerhead Brg. Kit
2 CYLINDER												
9.9	1974-83	-	-	-	-	-	-	-	-	-	-	-
9.9	1974-83	-	-	-	-	-	-	-	-	-	-	-
9.9	1974-80	-	-	-	-	-	-	-	-	-	-	-
9.9	1981-83	-	-	-	-	-	-	-	-	-	-	-
9.9	1986-92	-	-	-	-	-	-	-	-	-	-	-
9.9	1984-97	-	-	-	-	-	-	-	-	-	-	-
9.9	1998	-	-	-	-	-	-	-	-	-	-	-
14 Comm	1988-89	-	-	-	-	-	-	-	-	-	-	-
15	1974-83	-	-	-	-	-	-	-	-	-	-	-
15	1984-97	-	-	-	-	-	-	-	-	-	-	-
15 Comm	1994	-	-	-	18-1296	-	-	-	-	-	-	-
18	1960-68	-	-	-	-	-	18-4040	-	-	-	-	-
18	1970-73	-	-	-	-	-	18-4040	-	-	-	-	-
18 Jet	1996-97	-	-	-	18-1374	18-1378	-	-	-	-	18-1391	-
20	1981-84	-	-	-	18-1374	18-1378	18-4040	-	-	-	18-1391	-
20	1985-97	-	-	-	18-1374	18-1378	-	-	-	-	18-1391	-
25	1970-76	-	-	-	-	-	18-4040	-	-	-	-	-
25	1977	-	-	-	-	18-1378	18-4040	-	-	-	18-1391	-
25	1978-80	-	-	18-4075	-	18-1378	18-4040	-	-	-	18-1391	-
25	1981-84	-	-	-	18-1374	18-1378	18-4040	-	-	18-1391	18-1391	-
25 ①	1985-97	-	-	-	-	-	-	-	-	-	18-1391	-
25	1985-97	-	-	18-4075	18-1374	18-1378	-	-	-	-	-	-
25 Comm	1982-84	-	-	-	18-1374	18-1378	18-4040	-	-	-	18-1391	-
25 Comm	1985-97	-	-	-	18-1374	18-1378	-	-	-	-	18-1391	-
28	1987-97	-	-	-	18-1374	18-1378	-	-	-	-	18-1391	-
30	1981-93	-	-	18-4075	18-1374	18-1378	18-4040	-	-	-	-	-
30	1984-1992	-	-	18-4075	-	18-1378	18-4040	-	-	-	-	-
30	1985-97	-	-	-	18-1374	18-1378	18-4040	-	-	-	18-1391	-
30	1984	-	-	-	-	18-1378	18-4040	-	-	-	18-1391	-
33	1965-69	-	-	-	-	18-1378	18-4040	-	-	-	-	-
33	1970	-	-	-	-	18-1378	18-4040	-	-	-	-	-

① Except "D" Models
 ② Two Cylinder Models

③ Three Cylinder Models
 ④ 90 Degree Models

⑤ 60 Degree Models
 ⑥ V-4, V-6 & V-8 Model engines do not include upper bearings in kits

APPLICATION CONTINUED ON NEXT PAGE

HP	Year	Sleeve	Connecting Rod	Rod Bolt	Wrist Pin Brg.	Rod Brg. Complete	Rod Brgs.	Center Main Brg.	Split Brg. (sleeve)	Upper Crank Brg.	Lower Crank Brg.	Powerhead Brg. Kit
35	1976-80	-	-	-	-	18-1378	18-4040	-	-	-	18-1391	-
35	1981-84	-	-	18-4075	18-1374	-	18-4040	-	-	-	18-1391	-
35	1985-97	-	-	-	18-1374	18-1378	-	-	-	-	18-1391	-
35	1976-1993	-	-	18-4075	18-1374	18-1378	-	-	-	-	-	-
35	1977	-	-	18-4075	-	-	-	-	-	-	-	-
35	1978-1980	-	-	18-4075	-	18-1378	18-4040	-	-	-	18-1391	-
35	1981-1993	-	-	18-4075	18-1374	18-1378	-	-	-	-	18-1391	-
40	1984-92	18-4712	-	18-4075	18-1374	18-1378	-	18-1352	-	-	18-1391	-
40	1961-70	-	-	-	-	-	18-4040	-	-	-	-	-
40	1971-73	-	-	-	-	18-1378	18-4040	-	-	-	-	-
40	1974-76	-	-	-	-	18-1378	18-4040	18-1352	-	-	18-1154	-
40	1984-86	-	-	-	18-1374	18-1378	-	18-1352	-	18-1372	18-1154	-
40	1987-97	-	-	-	18-1374	18-1378	-	18-1352	-	-	18-1154	18-1389
40	1983	-	-	18-4075	-	-	-	18-1352	-	-	18-1154	-
40 Comm	1982-83	-	-	-	-	18-1378	-	18-1352	-	-	-	-
40 Comm	1984-85	-	-	-	-	18-1378	-	18-1352	-	18-1372	-	-
40 Comm	1989-90	-	-	-	-	18-1378	-	18-1352	-	-	-	-
40 Comm	1994	-	-	-	18-1374	18-1378	-	18-1352	-	-	-	-
40 Comm	1995-97	-	-	-	18-1374	-	-	18-1352	-	-	-	-
45 Comm	1985-86	-	-	-	18-1374	18-1378	-	18-1352	-	18-1372	-	-
45 Comm	1987-94	-	-	-	18-1374	18-1378	-	18-1352	-	18-1372	-	-
45 Comm	1995-97	-	-	-	18-1374	-	-	18-1352	-	-	-	-
45 Comm	1987	-	-	-	18-1374	18-1378	-	18-1352	-	-	18-1154	-
45ss	1987-90	-	-	-	18-1374	18-1378	-	18-1352	-	18-1372	-	-
48	1987	18-4712	-	-	18-1374	18-1378	-	18-1352	-	18-1372	-	-
48	1987-92	18-4712	-	18-4075	18-1374	18-1378	-	18-1352	-	-	-	-
48	1988-96	-	-	-	18-1374	18-1378	-	18-1352	-	-	-	-
50	1979-83	18-4712	-	18-4075	18-1374	18-1378	18-4040	18-1352	-	18-1372	-	-
50	1979-86	-	-	-	18-1374	18-1378	-	18-1352	-	18-1372	-	-
50	1981-93	18-4712	-	18-4075	18-1374	18-1378	-	18-1352	-	-	-	-
50 ¹	1987-97	-	-	-	18-1374	18-1378	-	18-1352	-	-	-	-
50 ¹	1995-97	-	-	-	18-1374	18-1378	-	18-1352	-	-	-	-
55	1968-69	-	-	-	-	18-1378	18-4040	18-1352	-	-	-	-
55	1976-81	-	-	-	18-1374	18-1378	18-4040	18-1352	-	18-1372	-	-
55 Comm	1982	-	-	-	18-1374	18-1378	18-4040	18-1352	-	18-1372	-	-
55 Comm	1983-86	-	-	-	18-1374	18-1378	-	18-1352	-	18-1372	-	-
55 Comm	1987-94	-	-	-	18-1374	18-1378	-	18-1352	-	-	-	-
55 Comm	1995-97	-	-	-	18-1374	18-1378	-	18-1352	-	-	-	-
55	1978-93	18-4712	-	18-4075	-	-	-	-	-	-	-	-
60	1980-85	18-4712	-	18-4075	18-1374	18-1378	-	18-1352	-	18-1372	-	-
60	1964-67,70-71	-	-	-	-	18-1378	18-4040	18-1352	-	-	-	-
60	86-90	-	-	-	18-1374	18-1378	-	18-1352	-	18-1372	-	-
60	1991-93	-	-	-	18-1374	18-1378	-	18-1352	-	-	-	-
60	1994-97	-	-	-	18-1374	-	-	18-1352	-	-	-	-
SST-60	1989-90	-	-	-	18-1374	18-1378	-	18-1352	-	18-1372	-	-
3 Cylinder												
60	1985	-	-	18-4075	18-1374	18-1378	18-4040	18-1352	-	18-1372	-	-
60	1986-90	-	-	-	18-1374	18-1378	18-4040	18-1352	-	18-1372	-	-
60	1986-88	-	-	18-4075	18-1374	18-1378	18-4040	18-1352	-	18-1372	-	-
60	1989-92	-	-	18-4075	18-1374	18-1378	18-4040	18-1352	-	-	-	-
65	1968	-	-	-	-	18-1378	18-4040	18-1352	-	-	-	-
65	1972-73	-	-	-	-	18-1378	18-4040	18-1352	-	18-1372	-	-

¹ Except "D" Models
² Two Cylinder Models

³ Three Cylinder Models
⁴ 90 Degree Models

⁵ 60 Degree Models
⁶ V-4, V-6 & V-8 Model engines do not include upper bearings in kits

APPLICATION CONTINUED ON NEXT PAGE

HP	Year	Sleeve	Connecting Rod	Rod Bolt	Wrist Pin Brg.	Rod Brg. Complete	Rod Brgs.	Center Main Brg.	Split Brg. (sleeve)	Upper Crank Brg.	Lower Crank Brg.	Powerhead Brg. Kit
65 Comm	1984	-	-	-	18-1374	18-1378	18-4040	18-1352	-	18-1372	-	-
65 Comm	1985-90	-	-	-	18-1374	18-1378	18-4040	18-1352	-	18-1372	-	-
65 Comm	1991-93	-	-	-	18-1374	18-1378	18-4040	18-1352	-	-	-	-
65 Comm.	1994-97	-	-	-	18-1374	18-1378	18-4040	18-1352	-	-	-	-
65	1984-86	-	-	18-4075	18-1374	18-1378	18-4040	18-1352	-	18-1372	18-1154	-
70	1976-85	-	-	18-4075	18-1374	18-1378	18-4040	18-1352	-	18-1372	18-1154	-
70	1974-75	-	-	-	-	18-1378	18-4040	18-1352	-	18-1372	-	-
70	1976-90	-	-	-	18-1374	18-1378	18-4040	18-1352	-	18-1372	18-1154	-
70	1976-84	-	-	18-4075	18-1374	18-1378	18-4040	18-1352	-	18-1372	18-1154	-
70	1985-90	-	-	-	18-1374	18-1378	18-4040	18-1352	-	18-1372	18-1154	-
70	1991-93	-	-	-	18-1374	18-1378	18-4040	18-1352	-	-	-	-
70	1994-97	-	-	-	18-1374	-	-	18-1352	-	-	-	-
75	1960-65	-	-	-	-	18-1378	18-4040	18-1352	-	-	-	-
75	1975	-	-	-	-	18-1378	18-4040	18-1352	-	18-1372	18-1154	-
75	1976-84	-	-	18-4075	18-1374	18-1378	18-4040	18-1352	-	18-1372	18-1154	-
75	1982-88	-	-	18-4075	18-1374	18-1378	18-4040	18-1352	-	18-1372	18-1154	-
75	1985-88	-	-	-	18-1374	18-1378	18-4040	18-1352	-	18-1372	18-1154	-
75 ⑥	1976-88	-	-	18-4075	18-1374	18-1378	18-4040	18-1352	-	18-1372	18-1154	-
V-4 CROSSFLOW												
65JET	1992-95	-	-	18-4075	18-1374	18-1361	18-4040	18-1353	18-1377	-	18-1395	18-1386
80	1966-67	-	-	-	-	18-1378	18-4040	18-1352	-	-	-	-
80JET	1993-97	-	-	18-4075	18-1374	18-1361	18-4040	18-1353	18-1377	-	18-1395	18-1386
80JET	1992-97	-	-	-	18-1374	18-1361	18-4040	18-1353	18-1377	-	18-1395	18-1386
85	1968-72	-	-	-	-	18-1378	18-4040	18-1352	-	-	18-1154	-
85	1973	-	-	-	18-1374	18-1378	18-4040	18-1352	-	-	18-1395	-
85	1974-78	-	-	-	18-1374	18-1361	18-4040	18-1352	-	-	18-1395	-
85 ⑥	1979-80	-	-	18-4075	18-1374	18-1361	18-4040	18-1353	18-1377	-	18-1395	18-1386
85 ⑥	1991-95	-	-	-	18-1374	18-1361	18-4040	18-1353	18-1377	-	18-1395	18-1386
85	1979-80,92	-	-	18-4075	18-1374	18-1361	18-4040	18-1353	18-1377	-	18-1395	18-1386
85TTL	1992-95	-	-	18-4075	18-1374	18-1361	18-4040	18-1353	18-1377	-	18-1395	18-1386
88	1987-91	-	-	18-4075	18-1374	18-1361	18-4040	18-1353	18-1377	-	18-1395	18-1386
88 ⑥	1987-96	-	-	18-4075	18-1374	18-1361	18-4040	18-1353	18-1377	-	18-1395	18-1386
88	1987-92	-	-	18-4075	18-1374	18-1361	18-4040	18-1353	18-1377	-	18-1395	18-1386
88	1993	-	-	18-4075	18-1374	18-1361	18-4040	18-1353	18-1377	-	18-1395	18-1386
88	1992-96	-	-	18-4075	18-1374	18-1361	18-4040	18-1353	18-1377	-	18-1395	18-1386
90	1981-86	-	-	18-4075	18-1374	18-1361	18-4040	18-1353	18-1377	-	18-1395	18-1386
90	1986-91	-	-	18-4075	18-1374	18-1361	18-4040	18-1353	18-1377	-	18-1395	18-1386
90	1992-94	-	-	18-4075	18-1374	18-1361	18-4040	18-1353	18-1377	-	18-1395	18-1386
90 ⑥ ④	1981-97	-	-	18-4075	18-1374	18-1361	18-4040	18-1353	18-1377	-	18-1395	18-1386
90 ④	1981-97	-	-	18-4075	18-1374	18-1361	18-4040	18-1353	18-1377	-	18-1395	18-1386
90 ⑤	1995-97	-	-	18-4075	18-1374	18-1361	18-4040	18-1353	18-1377	-	18-1395	18-1386
90JET ⑥	1994-95	-	-	18-4075	18-1374	18-1361	18-4040	18-1353	18-1377	-	18-1395	18-1386
90	1981-92	-	-	18-4075	18-1374	18-1361	18-4040	18-1353	18-1377	-	18-1395	18-1386
90	1993	-	-	18-4075	18-1374	18-1361	18-4040	18-1353	18-1377	-	18-1395	18-1386
100	1966-68	-	-	-	-	18-1378	18-4040	18-1352	-	-	18-1154	-
100	1971-72	-	-	-	-	18-1378	18-4040	18-1352	-	-	18-1154	-
100 ⑥	1979-80	-	-	18-4075	18-1374	18-1361	18-4040	18-1353	18-1377	-	18-1395	18-1386
100	1984-85	-	-	18-4075	18-1374	18-1361	18-4040	18-1353	18-1377	-	18-1395	18-1386
100	1986-91	-	-	18-4075	18-1374	18-1361	18-4040	18-1353	18-1377	-	18-1395	18-1386
100 ⑥	1990-94	-	-	18-4075	18-1374	18-1361	18-4040	18-1353	18-1377	-	18-1395	18-1386
100 Comm ⑥	1984-97	-	-	18-4075	18-1374	18-1361	18-4040	18-1353	18-1377	-	18-1395	18-1386
100	1979-81,92	-	-	18-4075	18-1374	18-1361	18-4040	18-1353	18-1377	-	18-1395	18-1386

① Except "D" Models
② Two Cylinder Models

③ Three Cylinder Models
④ 90 Degree Models

⑤ 60 Degree Models
⑥ V-4, V-6 & V-8 Model engines do not include upper bearings in kits

HP	Year	Sleeve	Connecting Rod	Rod Bolt	Wrist Pin Brg.	Rod Brg. Complete	Rod Brgs.	Center Main Brg.	Split Brg. (sleeve)	Upper Crank Brg.	Lower Crank Brg.	Powerhead Brg. Kit
100	1992-97	-	-	18-4075	18-1374	18-1361	18-4040	18-1353	18-1377	-	18-1395	18-1386
100	1993	-	-	18-4075	18-1374	18-1361	18-4040	18-1353	18-1377	-	18-1395	18-1386
100 Comm	1984-87,89-92	-	-	18-4075	18-1374	18-1361	18-4040	18-1353	18-1377	-	18-1395	18-1386
100 Comm.	1993	-	-	18-4075	18-1374	18-1361	18-4040	18-1353	18-1377	-	18-1395	18-1386
110 ⑥	1986-89	-	-	18-4075	18-1374	18-1361	18-4040	18-1353	18-1377	-	18-1395	18-1386
112 ⑥	1994- 96	-	-	-	18-1374	18-1361	18-4040	18-1353	18-1377	-	18-1395	18-1386
115	1969-70	-	-	-	-	18-1378	18-4040	18-1352	-	-	18-1154	-
115	1973	-	-	18-4075	18-1374	18-1378	18-4040	18-1352	-	-	18-1395	-
115	1974-78	-	-	18-4075	18-1374	18-1361	18-4040	18-1352	-	-	18-1395	-
115 ⑥ ④	1990-97	-	-	-	18-1374	18-1361	18-4040	18-1353	18-1377	-	18-1395	18-1386
115 ⑥	1979-85	-	-	18-4075	18-1374	18-1361	18-4040	18-1353	18-1377	-	18-1395	18-1386
115	1991-92	-	-	18-4075	18-1374	18-1361	18-4040	18-1353	18-1377	-	18-1395	18-1386
115	1990-91	-	-	18-4075	18-1374	18-1361	18-4040	18-1353	18-1377	-	18-1395	18-1386
115	1993	-	-	18-4075	18-1374	18-1361	18-4040	18-1353	18-1377	-	18-1395	18-1386
115	1992-94	-	-	18-4075	18-1374	18-1361	18-4040	18-1353	18-1377	-	18-1395	18-1386
115 ④	1990-97	-	-	-	18-1374	18-1361	18-4040	18-1353	18-1377	-	-	-
115 ⑤	1995-97	-	-	-	-	18-1361	18-4040	18-1353	18-1377	-	-	-
115JET ⑥	1994-97	-	-	-	18-1374	18-1361	18-4040	18-1353	18-1377	-	18-1395	18-1386
115C	1984	-	-	18-4075	18-1374	18-1361	18-4040	18-1353	18-1377	-	18-1395	18-1386
120 ⑥	1985-94	-	-	-	18-1376	18-1360	-	18-1353	18-1377	-	-	-
125	1971-72	-	-	-	-	18-1378	18-4040	18-1352	-	-	-	-
125 Comm ⑥	1989-95	-	-	-	18-1376	18-1360	-	18-1353	18-1377	-	-	-
125Esx ⑥	1991-94	-	-	-	18-1376	18-1360	-	18-1353	18-1377	-	-	-
130 ⑥	1994-97	-	-	-	18-1376	18-1360	-	18-1353	18-1377	-	-	-
135	1973	-	-	-	18-1374	18-1378	18-4040	18-1352	-	-	18-1395	-
135	1974-76	-	-	18-4075	18-1374	18-1361	18-4040	18-1352	-	-	18-1395	-
140	1977-78	-	-	18-4075	18-1374	18-1361	18-4040	18-1352	-	-	18-1395	-
140	1979	-	-	18-4075	-	-	-	-	-	-	-	-
140 ⑥	1979-84	-	-	-	18-1374	18-1361	18-4040	18-1353	18-1377	-	18-1395	18-1386
140 ⑥	1985-94	-	-	-	18-1376	18-1360	-	18-1353	18-1377	-	-	-
140	1977-84	-	-	18-4075	18-1374	18-1361	18-4040	18-1353	18-1377	-	18-1395	18-1386
1600CC	1988	-	-	18-4075	-	-	-	-	-	-	-	-
1.6L	-	-	-	18-4075	-	-	-	-	-	-	-	-
V-6 CROSSFLOW												
150 ⑥	1978-91	-	-	-	18-1374	18-1361	18-4040	18-1353	18-1377	-	18-1395	-
150 ⑤	1991-97	-	-	-	-	18-1361	18-4040	18-1353	-	-	-	-
150 Comm ⑤	1993-95	-	-	-	-	18-1361	18-4040	18-1353	-	-	-	-
150	1978-85	-	-	18-4075	18-1374	18-1361	18-4040	18-1353	18-1377	-	18-1395	-
150	1978-88	-	-	18-4075	18-1374	18-1361	18-4040	18-1353	18-1377	-	18-1395	-
150	1986-91	-	-	18-4075	18-1374	18-1361	18-4040	18-1353	18-1377	-	-	-
150	1989-91	-	-	18-4075	18-1374	18-1361	18-4040	18-1353	18-1377	-	-	-
155 Comm	1984-85	-	-	18-4075	18-1374	18-1361	18-4040	18-1353	18-1377	-	18-1395	-
155 Comm ⑥	1984-92	-	-	-	18-1374	18-1361	18-4040	18-1353	18-1377	-	18-1395	-
155 Comm	1986-91	-	-	18-4075	-	-	-	-	-	-	-	-
175 ⑥	1977-91	-	-	-	18-1374	18-1361	18-4040	18-1353	18-1377	-	18-1395	-
175 ⑤	1991-97	-	-	-	-	18-1361	18-4040	18-1353	-	-	-	-
175	1977-83	-	-	18-4075	18-1374	18-1361	18-4040	18-1353	18-1377	-	-	-
175	1986-90	-	-	18-4075	18-1374	18-1361	18-4040	18-1353	18-1377	-	-	-
175	1977-83,85	-	-	18-4075	18-1374	18-1361	18-4040	18-1353	18-1377	-	-	-
185 ⑥	1984-85	-	-	18-4075	18-1374	18-1361	18-4040	18-1353	18-1377	-	18-1395	18-1389
185	1990	-	18-4148-1	18-4076	-	-	-	-	-	-	-	-
185 ⑥	1990-94	-	-	-	18-1376	18-1360	-	18-1353	18-1377	-	-	18-1389

① Except "D" Models
② Two Cylinder Models

③ Three Cylinder Models
④ 90 Degree Models

⑤ 60 Degree Models
⑥ V-4, V-6 & V-8 Model engines do not include upper bearings in kits

APPLICATION CONTINUED ON NEXT PAGE

HP	Year	Sleeve	Connecting Rod	Rod Bolt	Wrist Pin Brg.	Rod Brg. Complete	Rod Brgs.	Center Main Brg.	Split Brg. (sleeve)	Upper Crank Brg.	Lower Crank Brg.	Powerhead Brg. Kit
185	1990-93	-	18-4148-1	18-4076	-	-	-	-	-	-	-	-
185	1992-94	-	18-4148-1	18-4076	-	-	-	-	-	-	-	-
200 ⑥	1976-83	-	-	18-4075	18-1374	18-1361	18-4040	18-1353	18-1377	-	18-1395	18-1389
200	1986-97	-	-	-	18-1376	18-1360	-	18-1353	18-1377	-	-	-
200 Comm	1990	-	18-4148-1	18-4076	-	-	-	-	-	-	-	-
200 Comm	1990-94	-	-	-	18-1376	18-1360	-	18-1353	18-1377	-	-	-
200	1976-83	-	-	18-4075	18-1374	18-1361	18-4040	18-1353	18-1377	-	18-1395	-
200C	1990	-	-	18-4076	18-1376	18-1360	-	18-1353	18-1377	-	-	-
200	1986-91	-	-	18-4076	-	-	-	-	-	-	-	-
200	1986-93	-	-	18-4076	-	-	-	-	-	-	-	-
225 ⑥	1986-97	-	-	-	18-1376	18-1360	-	18-1353	18-1377	-	-	18-1389
235 ⑥	1978-85	-	-	18-4075	18-1374	18-1361	18-4040	18-1353	18-1377	-	18-1395	-
235	1978-79	-	-	18-4075	18-1374	18-1361	18-4040	18-1353	18-1377	-	-	-
235	1980-85	18-4718	-	18-4075	18-1374	18-1361	18-4040	18-1353	18-1377	-	-	-
250	1991-95	-	-	-	18-1376	18-1360	-	18-1353	18-1377	-	-	-
250	1997	-	-	-	18-1376	18-1360	-	18-1353	18-1377	-	-	-
275	1985-88	-	-	-	18-1376	18-1360	-	18-1353	18-1377	-	-	-
3.6L	1985-87	-	-	-	18-1376	18-1360	-	18-1353	18-1377	-	-	-
300	1988-95	-	-	-	18-1376	18-1360	-	18-1353	18-1377	-	-	-
2500CC	1988	-	-	-	-	-	-	-	-	-	-	-
2.5L	1982,84-85	-	-	-	-	-	-	-	-	-	-	-
2.6L	1982-86	18-4718	-	-	-	-	-	-	-	-	-	-
V-4 LOOPER												
120	1985	-	-	18-4076	18-1376	18-1360	-	18-1353	18-1377	-	-	-
120	1985-94	-	-	18-4076	18-1376	18-1360	-	18-1353	18-1377	-	-	-
125	1985-94	-	-	18-4076	18-1376	18-1360	-	18-1353	18-1377	-	-	-
140	1985-94	-	-	18-4076	18-1376	18-1360	-	18-1353	18-1377	-	-	-
1.8L	ALL	-	-	18-4076	-	-	-	-	-	-	-	-
V-6 LOOPER												
225	1986-91	-	-	18-4076	18-1376	18-1360	-	18-1353	18-1377	-	-	-
225	1986-93	-	-	18-4076	18-1376	18-1360	-	18-1353	18-1377	-	-	-
2.7L	1987	-	-	18-4076	-	-	-	-	-	-	-	-
275	1985-88	-	-	18-4076	18-1376	18-1360	-	18-1353	18-1377	-	-	-
300	1985-95	-	-	18-4076	18-1376	18-1360	-	18-1353	18-1377	-	-	-

① Except "D" Models
② Two Cylinder Models

③ Three Cylinder Models
④ 90 Degree Models

⑤ 60 Degree Models
⑥ V-4, V-6 & V-8 Model engines do not include upper bearings in kits



18-4329
CRANKSHAFT SEAL KIT
For: 20-35 HP

HP	Years	HP	Years
20	1981-89	30	1984-89
25	1977-89	35	1976-89
28	1986-88		



18-4330
CRANKSHAFT SEAL KIT
For: 40-75 HP



18-4331
CRANKSHAFT SEAL KIT
For: Crossflow V-4 - V-6



18-1286
UPPER CRANKSHAFT SEAL
Replaces: 336232
For: 60° & EFI 90-115HP & 150-175HP



***18-7896**
OIL FILTER
 Replaces: 778886, 5033539
 90-115 EFI (2003-05)



***18-7897**
OIL FILTER
 Replaces: 778887, 5033919
 140 EFI (2003-05)



18-7903
OIL FILTER
 Replaces: 5033102, 763364
 9.9-15HP (2002-07)



***18-7915-1**
OIL FILTER
 Replaces: 778885, 5031411
 25-70 HP (1998-2005)



***18-7916**
OIL FILTER
 Replaces: 434839
 9.9 & 15 HP models from (1995-2001)
 OMC Built



18-70936
HOSE (CYLINDER HEAD, STARBOARD)
 Replaces: 340975, 321724
 Fits: 90 (1994-95), 100 (1996-97), 115 (1994-97), E88 (1996), E90 (1996-98), E100 (1996-97), E112 (1996), E115 (1996-98), J88 (1996), J90 (1996-98), J100 (1997-98), J112 (1996), J115 (1996-98)



18-70937
HOSE (CYLINDER HEAD, PORT)
 Replaces: 340976
 Fits: 90 (1994-95), 100 (1996-97), 115 (1994-97), E88 (1996), E90 (1996-98), E100 (1996-97), E112 (1996), E115 (1996-98), J88 (1996), J90 (1996-98), J100 (1997-98), J112 (1996), J115 (1996-98)

— CONTAINS —

Part #	Desc.	O.E. #	Qty.
18-0933	Air Silencer Gasket	314115	1
18-0935	Base To Cover Gasket	314322	1
NSS	Carburetor to Manifold Gasket	317305	1
18-2543	Water Jacket Gasket	318609	1
18-0118	Carburetor Gasket	325092	3
18-2913	Exhaust Cover Gasket	318609	2
18-2938	Exhaust Cover Gasket	331917	1
18-2548	Thermostat Gasket	332108	1
18-2865	Adapter to Powerhead Gasket	313763	1
18-0929	Thermostat Gasket	313416	1

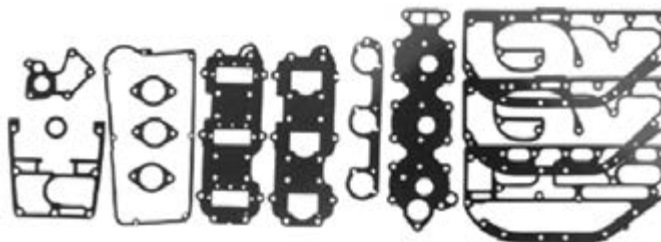

18-4300
POWERHEAD GASKET SET
 Replaces: 385416, 439084

— CONTAINS —

Part #	Desc.	O.E. #	Qty.
18-2876	By-Pass Cover Gasket	307133	4
18-2866	Exhaust Cover Gasket	317914	2
NSS	Water Pass. Gasket	317951	1
18-0117	Exhaust Plate Gasket	317995	1
18-0955	Exhaust Cover Gasket	318156	1
18-2873-9	Cyl. Cover Starboard Gasket	318335	2
18-0957	Adapter To Powerhead Gasket	318373	1
18-2867	Manifold to Crankcase Gasket	319174	1
18-2864	Adapter to Powerhead Gasket	321727	1
18-0991	Leaf Plate Gasket	321907	4
18-0134	Carburetor to Manifold Gasket	327707	2
18-2857	Air Silencer	386573,	
	To Carburetor Gasket	319771	2

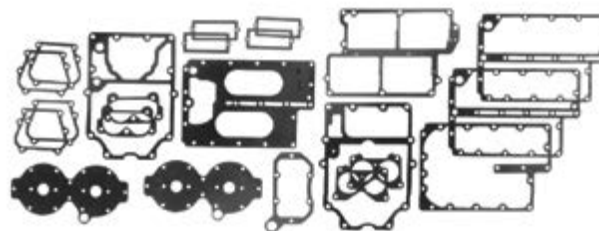

18-4301
POWERHEAD GASKET SET
 Replaces: 388602

APPLICATIONS BEGIN ON PAGE 329

* Anti-Drain-Back Valve
 Valve eliminates dry starts, prevents oil from draining back into crankcase during engine shutdown.

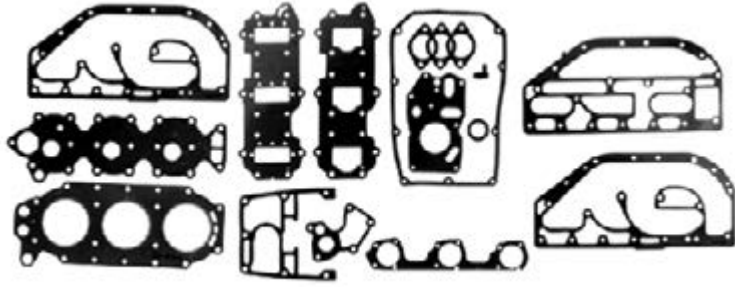

18-4302
POWERHEAD GASKET SET
 Replaces: 390078

— CONTAINS —

Part #	Desc.	O.E. #	Qty.
18-2960	Head Gasket	313413	1
18-2865	Adapter to Powerhead Gasket	313763	1
NSS	Carb to Manifold Gasket	317305	1
18-2543	Water Jacket Gasket	318609	1
18-0989	Air Silencer Gasket	321794	1
18-0118	Carburetor Gasket	325092	3
18-0102	Exhaust Manifold Gasket	323469	1
18-2913	Exhaust Cover Gasket	331916	2
18-2938	Exhaust Cover Gasket	331917	1
18-2548	Thermostat Cover Gasket	332108	1
18-0975	Carb to Silencer Gasket	333008	1

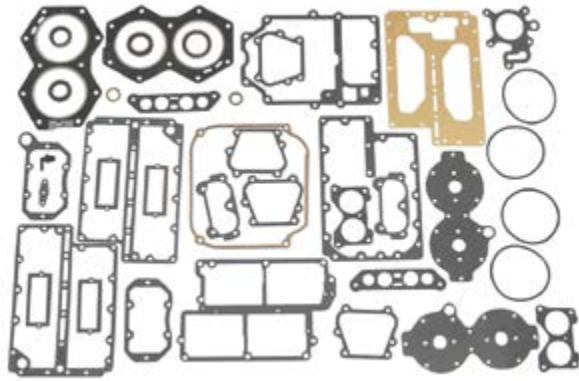

18-4303-1
POWERHEAD GASKET SET
 Replaces: 389556, 391300, 439085

— CONTAINS —

Part #	Desc.	O.E. #	Qty.
18-0850	Fuel Pump Mtg Gasket	303615	1
18-2876	By-Pass Cover Gasket	307133	4
18-2866	Exhaust Cover Gasket	317914	2
NSS	Water Passage Gasket	317951	1
18-0117	Exhaust Plate Gasket	317995	1
18-2873-9	Gasket	318335	2
18-2074	Seal	0339620	1
18-2956	Water Jacket Head Gasket	318358	2
18-2867	Manifold to Crankcase Gasket	319174	1
18-2857	Air Silencer to Carb. Gasket	386573, 319771	2
18-0985	Air Silencer Gasket	321722	1
18-2864	Adapter to Powerhead Gasket	321727	1
18-0991	Leaf Plate Gasket	321907	4
18-2547	Water Pass. Cover Gasket	322858	1
18-0102	Exhaust Manifold Gasket	323469	1
18-0134	Intake Plate Gasket	326926	1
18-0977	Thermostat Gasket	332369	2

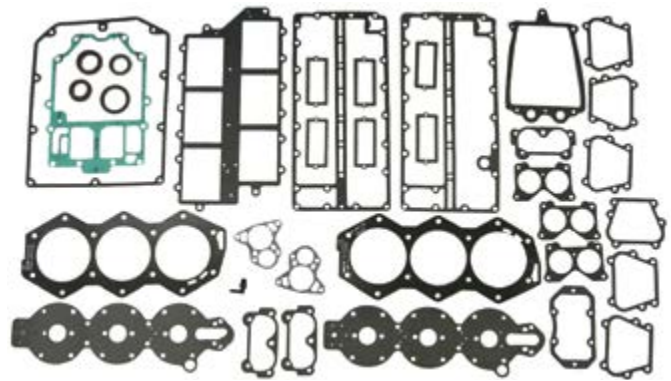

18-4304-1
POWERHEAD GASKET SET
 Replaces: 391988

— CONTAINS —

Part #	Desc.	O.E. #	Qty.
18-2549	Exhaust Plate Gasket	321543	1
18-2876	By-Pass Cover Gasket	307133	6
18-2544	Water Jacket Cover Gasket	321028	2
18-2545	Exhaust Plate Gasket	321182	1
18-0979	Air Silencer Gasket	321183	1
18-2546	Thermostat Gasket	321184	2
18-0991	Leaf Plate Gasket	321907	6
18-2547	Water Passage Cover Gasket	322858	1
18-0995	Adapter to Powerhead Gasket	323222	1
18-0134	Carburetor To Manifold Gasket	327707	3
18-0148	Intake Manifold Gasket	329718	1
18-2964	Head Gasket	320745, 335360, 766779	2
18-2550	Powerhead Gasket	323214	1
18-2857	Air Silencer To Carburetor Gasket	386573, 319771	1
18-2001	Oil Seal	330137	1
18-2074	Oil Seal	0339620	2
18-8307	Oil Seal	331103	1

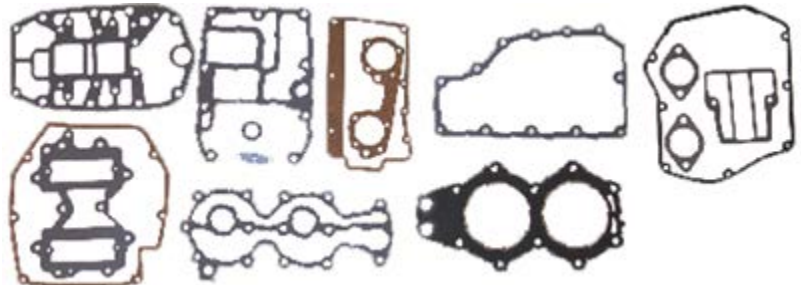

18-4305
POWERHEAD GASKET SET
 Replaces: 393433, 437806, 439083
 For: 2 cylinder models only

— CONTAINS —

Part #	Desc.	O.E. #	Qty.
18-0851	Relief Port Twin Gasket	329826	1
18-0850	Fuel Pump Mtg. Gasket	303615	1
18-0941	Water Jacket Cover Gasket	315538	1
18-0118	Carburetor Gasket	325092	2
18-0120	Exhaust Cover Gasket	325211	1
18-0128	Powerhead Mtg. Twin Gasket	326468, 351018	1
18-3802	Head Gasket	327795, 335359	1
18-0136	Powerhead Mounting Gasket	328283	1
NSS	Airbox Split Twin Gasket	330698	1
18-0154	Airbox Split Twin Gasket	—	1
18-0159	Airbox Split Twin Gasket	330909	1
18-0983	Carb. to Air Box Twin Gasket	321497	1
18-0182	Thermostat Gasket	310058	1
18-0963	Intake Manifold Twin Gasket	335633	1

— CONTAINS —

Part #	Desc.	O.E. #	Qty.
18-0850	Fuel Pump Mtg. Gasket	303615	1
18-0122	Outer Leaf Plate Gasket	325260	1
18-0961	Carburetor to Intake Manifold Gasket	318932	1
18-0967	By-Pass Cover Gasket	319332	1
18-0112	Powerhead Mtg. Gasket	324717	1
18-0959	Inner Leaf Plate Gasket	318924	1
18-2907	Adapter Housing Gasket	325721	1
18-2905	Water Cover Gasket	329920	1
18-2853	Exhaust Cover Gasket	318925	2
18-2963	Head Gasket	330818	1
18-2879	Filter Cap to Pump Gasket	331363, 338876	1

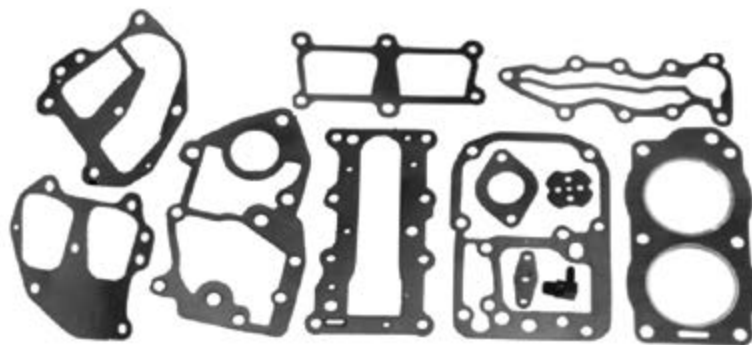

18-4306
POWERHEAD GASKET SET
Replaces: 394546

— CONTAINS —

Part #	Desc.	O.E. #	Qty.
18-0850	Fuel Pump Mounting Gasket	303615	1
18-0971	By-Pass Gasket	319661	1
18-0981	Leaf Plate Gasket	321479	1
18-0106	Exhaust Manifold Gasket	324323	2
18-0118	Carburetor Gasket	325092	1
18-2862	Manifold to Leaf Plate Gasket	321573, 326260	1
18-0126	Inner Exhaust Cover Gasket	326264	1
18-2852	Powerhead to Lower Unit Gasket	330621	1
18-3803	Head Gasket	329419, 765012	1



18-4307
POWERHEAD GASKET SET
Replaces: 433941, 392567, 392615, 389206

— CONTAINS —

Part #	Desc.	O.E. #	Qty.
18-0142	Intake Manifold Gasket	328622	1
18-0155	Rectifier Mtg. Gasket	330412	2
18-0138	Adapter to Powerhead Gasket	328590	1
18-0140	AirBox Gasket	328604	2
18-2074	Oil Seal	0339620	1
18-2075	Oil Seal	0353076	1
18-7418	O-Ring	326741	4
18-3837	Head Gasket	328623	2
18-0978	Cover to Base Gasket	331598	2

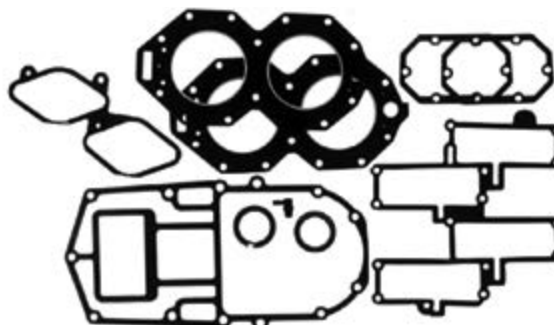

18-4310
POWERHEAD GASKET SET
Replaces: 396750

— CONTAINS —

Part #	Desc.	O.E. #	Qty.
18-0963	Intake Manifold GasketTwin	335633	1
18-0850	Fuel Pump Mtg. Gasket	303615	1
18-0118	Carburetor Gasket	325092	2
18-0983	Carburetor to Airbox	321497	1
18-3802	Head Gasket	327795, 335359	1
18-0941	Water Jacket Cover Gasket	315538	1
NSS	Air Box Split Gasket	330698	1
18-0128	Powerhead Mounting Gasket	326468, 351018	1
18-0136	Powerhead Mounting Gasket	328283	1
18-1224	Exhaust Cover Gasket	315869	1
18-1218	Exhaust Cover Gasket	315868	1
18-0182	Seal	310058	1

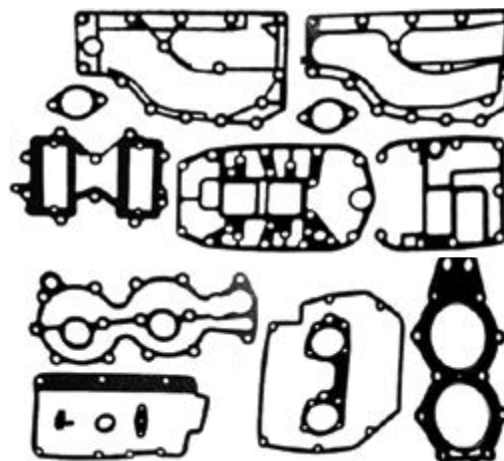

18-4318
POWERHEAD GASKET SET
Replaces: 390076

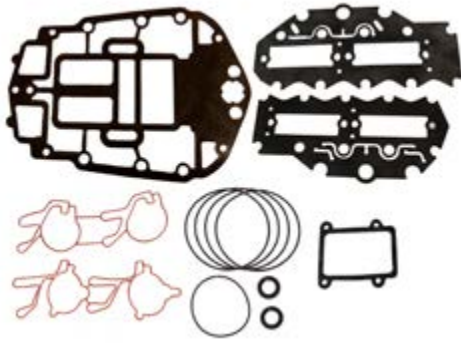

18-4402
POWERHEAD GASKET SET
 Replaces: 437779, 439559
 Fits: 90 V4 60 degree (1995-00), 115 V4 60 degree (1995-00)

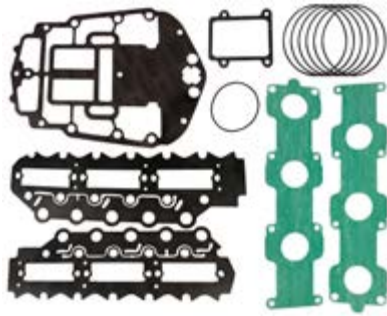

18-4420
POWERHEAD GASKET SET
 Replaces: 439202
 Fits: 150 Ficht FFI, 175 Ficht FFI

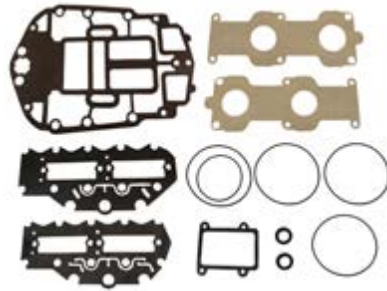



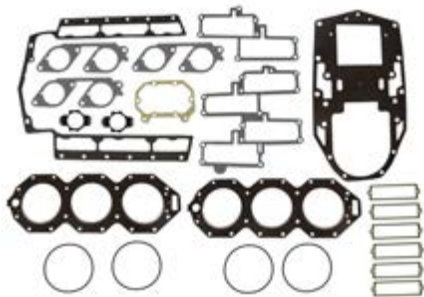



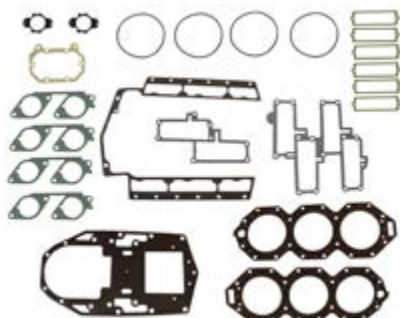





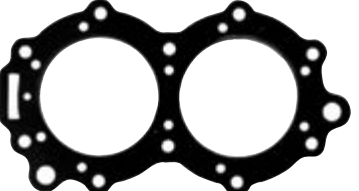

18-4421
POWERHEAD GASKET SET
 Replaces: 5000400
 Fits: 90 Ficht FFI, 115 Ficht FFI, 135 Ficht FFI

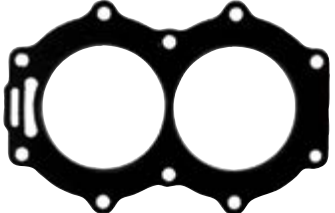

















18-4428
POWERHEAD GASKET SET
 Replaces: 437725
 Fits: 200 BB (1993 & Up), 225 BB (1993 & Up), 225 Ficht FFI (1999 & Up), 250 Carb only (2000)



18-4429
POWERHEAD GASKET SET
 Fits: 200 Ficht FFI (1999-01), 225 (2000-04), 250 (2000-04), 3.3L (2000-04)

<p>PKG. OF 2</p>  <p>18-2884 18-2884-9^① HEAD GASKET Replaces: 313782</p>	<p>PKG. OF 2</p>  <p>18-2885 18-2885-9^① HEAD GASKET Replaces: 303438</p>	<p>PKG. OF 2</p>  <p>18-2888-9^① HEAD GASKET Replaces: 332010, 326953</p>
 <p>18-2950 HEAD GASKET Replaces: 309612, 766870</p>	 <p>18-2951 HEAD GASKET Replaces: 304720</p>	 <p>18-2952 HEAD GASKET Replaces: 203034</p>
 <p>18-2954 HEAD GASKET Replaces: 319633</p>	 <p>18-2956 HEAD GASKET Replaces: 318358</p>	 <p>18-2957 HEAD GASKET Replaces: 307069</p>
 <p>18-2958 HEAD GASKET Replaces: 315539</p>	 <p>18-2959 HEAD GASKET Replaces: 306048</p>	 <p>18-2960 HEAD GASKET Replaces: 313413</p>
 <p>18-2961 HEAD GASKET Replaces: 329103</p>	 <p>18-2962 HEAD GASKET Replaces: 322332</p>	 <p>18-2963 HEAD GASKET Replaces: 330818, 320533, 318914</p>

① Priced per Package

 <p>18-2964 HEAD GASKET Replaces: 320745, 335360, 766779</p>	 <p>18-3800 HEAD GASKET Replaces: 325273</p>	 <p>18-3801 HEAD GASKET Replaces: 325647, 335361</p>
 <p>18-3802 HEAD GASKET Replaces: 320658, 327795, 335359</p>	 <p>18-3803 HEAD GASKET Replaces: 324324, 329419, 765012 For: 2 cylinder models only</p>	 <p>18-3836 HEAD GASKET Replaces: 329836</p>
 <p>18-3837 HEAD GASKET Replaces: 328623</p>	 <p>18-3838 HEAD GASKET Replaces: 331211</p>	 <p>18-3839 HEAD GASKET Replaces: 333670, 334726</p>
 <p>18-3841-2 HEAD GASKET Replaces: 203130</p>	 <p>18-3866 HEAD GASKET Replaces: 340115, 333549 For: V-4 Loop Charge</p>	 <p>18-3895 HEAD GASKET Replaces: 332816</p>
 <p>18-3896 HEAD GASKET Replaces: 332817</p>	 <p>18-0491 HEAD GASKET Replaces: 346007 Fits: 200 Ficht FFI (1999-01), 225 (2000-04), 250 (2000-04), 3.3L (2000-04)</p>	 <p>18-0492 HEAD GASKET Replaces: 340919, 345257 Fits: 200 BB (1993 & Up), 225 BB (1993 & Up), 225 Ficht FFI (1999 & Up) 250 Carb only (2000)</p>
<p>PKG. OF 12</p>  <p>18-7110 18-7110-9① CYLINDER HEAD O-RING Replaces: 335523 3.960 O.D. x 0.103 H Fits: 90/115 HP (1995-98), 100 HP (1998), 105 HP (1997-98), 150/175 HP (1991-97) 90 Ficht FFI, 115 Ficht FFI, 135 Ficht FFI, 150 Ficht FFI, 175 Ficht FFI, 90 V4 60 degree(1995-00), 115 V4 60 degree (1995-00), 150 60 degree(1991-00), 175 60 degree(1991-00)</p>		

① Priced per Package

HEAD GASKET/GASKET SET APPLICATION

HP	Year	Head Gasket	Low Comp. Head Gasket	Gasket Set	HP	Year	Head Gasket	Low Comp. Head Gasket	Gasket Set
1.5	1968-70	18-2884	—	—	65 Comm.	1987-95	18-3836	—	—
2, Colt, Jr.	1971-90	18-2884	—	—	65 Jet	1991-95	18-2956 ①	— ①	18-4303-1
2.5,3,4,4.5, Ultra, Excel 4	1981-93	18-2888-9	—	—	70	1974-76	18-2960	18-3895	18-4300 ⑨
3	1957-68	18-3841-2	—	—	70	1977-85	18-2960	18-3895	18-4302
4	1969-80	18-3841-2	—	—	70	1986-97	18-3836	—	—
4.5	1980	18-3841-2	—	—	75	1960-65	18-2959 ①	—	—
5	1965-68	18-2961	—	—	75	1975	18-2960	18-3895	18-4300 ⑨
5	1984-95	18-3800	—	—	75	1977-88	18-2960	18-3895	18-4302
5.5	1957-58	18-2885	—	—	80	1966-67	18-2959 ①	—	—
5.5	1959-64	18-2961	—	—	80 Jet	1991-96	18-2956 ①	18-2956	18-4303-1
6	1965-79	18-2961	—	—	85	1968-72	18-2959 ①	—	—
6	1984-95	18-3800	—	—	85	1979-80,91-95	18-2956 ①	— ①	18-4303-1
6.5 Comm.	1989-90	18-3800	—	—	88	1987-95	18-2956 ①	— ①	18-4303-1
7.5	1957-58	18-2952	—	—	90	1964-65	18-2959 ①	—	—
7.5	1980-93	18-3800	—	—	90	1981-95	18-2956 ①	— ①	18-4303-1
8	1984-95	18-3800	—	—	100	1966-72	18-2959 ①	—	—
9.5	1964-73	18-2950	—	—	100 ③	1979-95	18-2956 ①	— ①	18-4303-1
9.9	1974-92	18-2963	—	18-4306 ②	1600CC	1988	18-2956 ①	— ①	18-4303-1
10 Comm.	1989-90	18-2963	—	18-4306	110	1986-89	18-2956 ①	— ①	18-4303-1
14	1988-90	18-2963	—	18-4306	115	1969-70	18-2959 ①	—	—
15	1974-92	18-2963	—	18-4306 ④	115	1973-77	18-2956 ①	— ①	—
18	1959-73	18-2962	—	—	115	1978-95	18-2956 ①	— ①	18-4303-1
18 Jet	1995-98	18-3803	—	18-4307	120	1985-87	18-3837 ①	—	18-4310
20	1981-99	18-3803	—	18-4307	120	1988-94	18-3866 ①	—	—
25	1969-76	18-2962	—	—	125 Comm.	1992-95	18-3866 ①	—	—
25	1977-78	18-2954	—	—	130	1995-98	18-3866 ①	—	—
25 ⑤	1979-03	18-3803	—	18-4307	135	1973-76	18-2956 ①	— ①	18-4301
28	1986-96	18-3803	—	18-4307	140	1977	18-2956 ①	— ①	18-4301
30 ⑤	1984-03	18-3803	—	18-4307	140	1978-84	18-2956 ①	— ①	18-4303-1
33	1965-70	18-2951	—	—	140	1985-87	18-3837 ①	—	18-4310
35	1957-58	18-2951	—	—	140	1988-94	18-3866 ①	—	—
35	1976-78	18-2954	—	—	150	1973-91	18-2964 ①	18-3896 ①	18-4304-1
35	1979-88	18-3803	—	18-4307	155 Comm.	1984-92	18-2964 ①	18-3896 ①	18-4304-1
35 ⑥	1987	18-3802	—	18-4305	2500CC	1988	18-2964 ①	18-3896 ①	18-4304-1
40	1960-80	18-2957	—	—	175	1977-83	18-2964 ①	18-3896 ①	18-4304-1
40 Comm.	1981-90	18-2957	—	18-4324	175	1986-91	18-3801 ①	18-3897 ①	—
40	1984-97	18-3802	—	18-4305	185	1984-85	18-2964 ①	18-3896 ①	18-4304-1
40 Comm.	1994-97	18-3802	—	18-4305	185	1990-93	18-3839 ①	—	—
45 Comm.	1985-97	18-3802	—	18-4305	200	1976-83	18-2964	18-3896 ①	18-4304-1
45SS	1987-90	18-3802	—	—	200	1986-87	18-3838	—	—
48	1987-97	18-3802	—	18-4305	200 ③	1988-93	18-3839	—	—
50	1958-59	—	—	—	225	1986-87	18-3838	—	—
50	1971-75	18-2958	—	18-4305 ⑦	225	1988-93	18-3839	—	—
50	1979-80	18-3802	—	18-4318	235	1978-79	18-2964	18-3896 ①	—
50	1981-97	18-3802	—	18-4305	235	1980-85	18-3801	18-3897 ①	—
55	1968-69	18-2960	18-3895	—	275/3.6L	1985-87	18-3840	—	—
55	1977-79	18-3802	—	18-4318	OMC SEA DRIVE				
55	1980-97	18-3802	—	18-4305	HP	Year	Head Gasket	Low Comp. Head Gasket	Gasket Set
55	1995	18-3802	—	—	1.6L	1983-90	18-2956	-	18-4303-1
60	1970-71	18-2960	18-3895	—	1.8L	1987	18-3837	-	-
60	1980-85	18-3802	—	18-4305	2.0L	1988-90	18-3866 ①	-	18-4322
60	1986-88	18-2960	18-3895	18-4302	2.5L	1982,84-85	18-2964	18-3896 ①	18-4304-1
60	1989-97	18-3836	—	—	2.6L	1982-86	18-3801 ①	18-3897 ①	-
SST60	1989-90	18-3836	—	—	2.7L	1987	18-3838	-	-
65	1968	—	—	—	3.0L	1988-90	18-3839	-	-
65	1972-73	18-2960	18-3895	18-4300 ⑨	3.6L	1987	18-3840	-	-
65 Comm.	1984-86	18-2960	—	18-4302					

① Two head gaskets required per engine
 ② 1976 G & H Suffix models only
 ③ Commercial models also

④ 1976 A Suffix models only
 ⑤ For 2 cylinder models only
 ⑥ D Suffix models only

⑦ 18-2958 Head Gasket required to complete set
 ⑨ Head Gasket Not Available in Gasket Set

STAINLESS STEEL BOLTS



HEX WASHER



HEX

HEAD STYLES



PAN



FILLISTER

PKG. OF 5

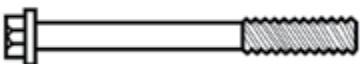

18-4277
Replaces: 324430
1/4" x 20 x 2"
HEX
For: Water pump housings, exhaust covers, intake manifolds, ignition coils and more

PKG. OF 2

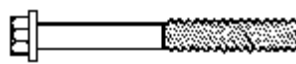

18-3136
18-3136-9①
Replaces: 323626
1/4" x 20 x 1 3/4"
HEX WASHER
For: Water pump housings, exhaust covers, intake manifolds, ignition coils and more



18-3365
Replaces: 909533
1/4" x 20 x 1"
HEX WASHER
For: Flywheel covers, intake covers and more

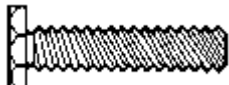

18-3369
Replaces: 302325
1/4" x 20 x 1"
HEX
For: Impeller housings, ignition coils, exhaust covers, shift covers and starter brackets

PKG. OF 5

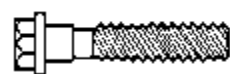

18-4276
18-4276-9①
Replaces: 324334
1/4" x 20 x 1 1/32"
HEX WASHER
For: Water pump housings, exhaust covers, intake manifolds, ignition coils and more

PKG. OF 2



18-0118
18-0118-9①
CARB GASKET
Replaces: 325092

PKG. OF 2



18-0134
18-0134-9①
V-4 & V-6
CARB TO MANIFOLD GASKET
Replaces: 327707

PKG. OF 2



18-0961
18-0961-9①
CARB MOUNTING GASKET
Replaces: 318932



18-0437
COVER GASKET
Replaces: 334353



18-0628
COVER GASKET
Replaces: 341501



18-1241
FLOAT BOWL AND NOZZLE GASKET



18-2579
FLOAT BOWL GASKET
Replaces: 338882



18-2582
CARB BOWL GASKET
Replaces: 338813



18-8352
CARBURETOR MOUNTING GASKET
Replaces: 332253

PKG. OF 2



18-2890
18-2890-9①
FLOAT BOWL GASKET
Replaces: 331203, 338886, 302994

PKG. OF 2



18-2893-9①
FLOAT BOWL GASKET
Replaces: 303750

PKG. OF 2



18-2903
18-2903-9①
FLOAT BOWL GASKET
Replaces: 332696, 338880

PKG. OF 2



18-2906
18-2906-9①
FLOAT BOWL GASKET
Replaces: 333418, 333884, 338884
V-4, V-6

PKG. OF 2























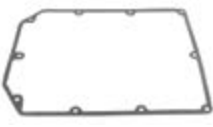

18-2908
18-2908-9①
FLOAT BOWL GASKET
Replaces: 331499, 338878

PKG. OF 2



















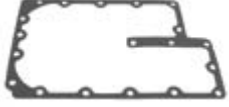



18-0850
18-0850-9①
FUEL PUMP GASKET
Replaces: 303615



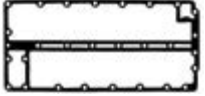
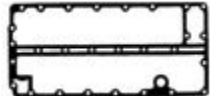

















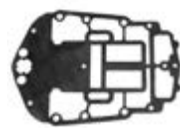



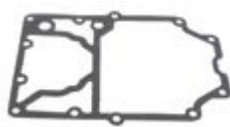

① Priced per package

<p>PKG. OF 2</p>  <p>18-2879 18-2879-9① FILTER CAP TO PUMP GASKET Replaces: 331363, 338876, 312634</p>	<p>PKG. OF 2</p>  <p>18-2900 18-2900-9① CAP TO FUEL PUMP GASKET Replaces: 332694, 338879, 312679</p>	<p>PKG. OF 2</p>  <p>18-2889 18-2889-9① FILTER BOWL GASKET Replaces: 302675</p>	<p>PKG. OF 2</p>  <p>18-2892 18-2892-9① FILTER BOWL GASKET Replaces: 303355</p>	 <p>18-0140 AIR BOX GASKET Replaces: 328604</p>
 <p>18-0159 AIR BOX GASKET Replaces: 330909</p>	 <p>18-0933 AIR SILENCER GASKET Replaces: 314115 70/75 HP</p>	 <p>18-0935 BASE TO COVER GASKET Replaces: 314322 70/75 HP</p>	<p>PKG. OF 2</p>  <p>18-0975 18-0975-9① CARB TO SILENCER GASKET Replaces: 333008 3 Cyl.</p>	 <p>18-0978 COVER TO BASE GASKET Replaces: 331598 For: 185, 200 & 225 H.P., V-6</p>
 <p>18-0979 AIR SILENCER GASKET Replaces: 321183 V-6</p>	<p>PKG. OF 2</p>  <p>18-0983 18-0983-9① CARB TO AIR BOX TWIN GASKET Replaces: 321497</p>	 <p>18-0985 AIR SILENCER GASKET Replaces: 321722 V-4</p>	 <p>18-0989 AIR SILENCER GASKET Replaces: 321794 3 Cyl.</p>	<p>PKG. OF 2</p>  <p>18-2857 18-2857-9① AIR SILENCER GASKET Replaces: 386573, 319771</p>
<p>PKG. OF 2</p>  <p>18-0122 18-0122-9① 9.9 & 15 HP OUTER LEAFPLATE GASKET Replaces: 325260</p>	<p>PKG. OF 2</p>  <p>18-0130 18-0130-9① REED BLOCK GASKET Replaces: 332266 For: V-4, V-6 & V-8</p>	 <p>18-0142 INTAKE MANIFOLD GASKET Replaces: 328622</p>	<p>PKG. OF 2</p>  <p>18-0144 18-0144-9① REED BLOCK GASKET Replaces: 328626 For: 120-140 H.P V-4</p>	
 <p>18-0148 INTAKE MANIFOLD GASKET Replaces: 329718 V-6</p>	 <p>18-0161 LOWER MANIFOLD GASKET Replaces: 331532 For: V-6</p>	<p>PKG. OF 2</p>  <p>18-0959 18-0959-9① INNER LEAF PLATE GASKET Replaces: 318924 9.9 & 15 HP</p>	<p>PKG. OF 2</p>  <p>18-0963 18-0963-9① INTAKE MANIFOLD TWIN GASKET Replaces: 335633</p>	

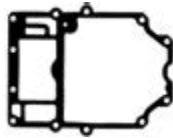

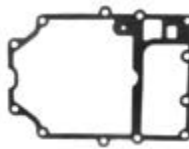



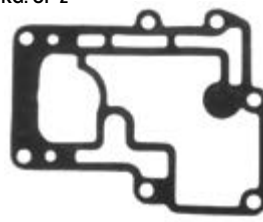
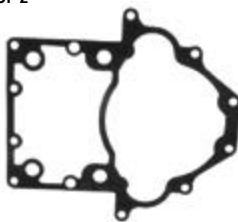

















① Priced per package

<p>PKG. OF 2</p>  <p>18-0981 18-0981-9① LEAF PLATE GASKET Replaces: 321479 25 & 35 HP</p>	<p>PKG. OF 2</p>  <p>18-0987 18-0987-9① THROTTLE BODY TO MANIFOLD GASKET Replaces: 332319</p>	<p>PKG. OF 2</p>  <p>18-0991 18-0991-9① LEAF PLATE GASKET Replaces: 321907 V-4/V-6</p>	<p>PKG. OF 2</p>  <p>18-0973 18-0973-9① CARB GASKET Replaces: 315052 V-4 Carburetor mounting includes: 100, 115, 125, 135, 140, 150, 175, 200, 235(1977-79), 85 (1969-79)</p>	 <p>18-1212 INTAKE MANIFOLD GASKET Replaces: 326926 For: 3 cyl.</p>
<p>PKG. OF 2</p>  <p>18-2862 18-2862-9① LEAF PLATE GASKET Replaces: 321573, 326260 25/35 HP</p>	<p>PKG. OF 2</p>  <p>18-2867 18-2867-9① MANIFOLD TO CRANKCASE GASKET Replaces: 319174 For: V-4</p>	<p>PKG. OF 2</p>  <p>18-0102 EXHAUST MANIFOLD GASKET Replaces: 323469 V-4</p>	<p>PKG. OF 2</p>  <p>18-0106 18-0106-9① EXHAUST MANIFOLD GASKET Replaces: 324323 25/35</p>	 <p>18-0117 EXHAUST PLATE GASKET Replaces: 317955 V-4</p>
 <p>18-0120 EXHAUST PLATE GASKET Replaces: 325211</p>	<p>PKG. OF 2</p>  <p>18-0126 18-0126-9① INNER EXHAUST COVER GASKET Replaces: 326264</p>	 <p>18-0945 OUTER EXHAUST GASKET Replaces: 336430, 323217</p>	 <p>18-0955 EXHAUST COVER GASKET Replaces: 318156 V-4</p>	 <p>18-1207 EXHAUST MANIFOLD GASKET Replaces: 329833, 343863</p>
 <p>18-1218 EXHAUST COVER GASKET Replaces: 315868</p>	 <p>18-1224 EXHAUST COVER GASKET Replaces: 315869</p>	<p>PKG. OF 2</p>  <p>18-2545 18-2545-9① EXHAUST PLATE GASKET Replaces: 321182 V-6</p>	<p>PKG. OF 2</p>  <p>18-2549 18-2549-9① EXHAUST COVER GASKET Replaces: 321435 V-6</p>	
<p>PKG. OF 2</p>  <p>18-2853 18-2853-9① EXHAUST COVER GASKET Replaces: 318925 9.9/15 HP</p>	<p>PKG. OF 2</p>  <p>18-2866 18-2866-9① EXHAUST COVER GASKET Replaces: 317914 V-4</p>	<p>PKG. OF 2</p>  <p>18-2871 18-2871-9① EXHAUST COVER GASKET Replaces: 304762</p>		











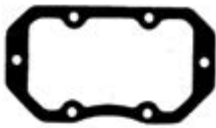







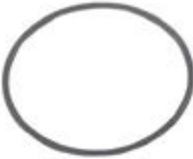

① Priced per package

<p>PKG. OF 2</p>  <p>18-2886 18-2886-9① COVER PLATE GASKET Replaces: 203171</p>	<p>PKG. OF 2</p>  <p>18-2913 18-2913-9① EXHAUST COVER GASKET Replaces: 331916, 319097 3 Cyl.</p>	<p>PKG. OF 2</p>  <p>18-2938 18-2938-9① EXHAUST COVER GASKET Replaces: 331917 3 Cyl.</p>	 <p>18-1283 MOLDED INTAKE PORT GASKET Replaces: 335818 For: V6 60° Eagle series 90-115HP (1995-00)</p>	 <p>18-1284 MOLDED INTAKE PORT GASKET Replaces: 335819 For: V6 60° Eagle series 90-115HP (1995-00)</p>
 <p>18-1285 MOLDED INTAKE PORT GASKET Replaces: 335403 For: V6 60° Eagle series 150-175HP (1991-00)</p>	 <p>18-0112 POWERHEAD BASE GASKET Replaces: 324717 9.9 & 15 HP</p>	 <p>18-0128 POWERHEAD BASE GASKET Replaces: 326468, 351018</p>	 <p>18-0136 POWERHEAD BASE GASKET Replaces: 328283</p>	 <p>18-0138 POWERHEAD BASE GASKET Replaces: 328590</p>
 <p>18-0690 BASE GASKET Replaces: 347205 Fits: 200 BB (1993 & Up), 200 Ficht FFI (1999-01), 225 BB (1993 & Up), 225 Ficht FFI (1999 & Up), 225 (2000-04), 250 Carb only (2000), 250 (2000-04), 3.3L (2000-04)</p>	 <p>18-0691 BASE GASKET Fits: 150 Ficht FFI, 175 Ficht FFI</p>	 <p>18-0692 BASE GASKET Replaces: 339601 Fits: 90 V4 60 degree (1995-00), 90 Ficht FFI, 1150V4 60 degree (1995-00), 115 Ficht FFI, 135 Ficht FFI, 150 60 degree (1991-00), 175 60 degree (1991-00)</p>	 <p>18-0693 INTAKE GASKET Replaces: 336226 Fits: 135(2005-06), 150(1991-98), 150(1991-06), 175(1991-06)</p>	 <p>18-0694 INTAKE GASKET Replaces: 336227 Fits: 135(2005-06), 150(1991-05), 175(1991-05)</p>
 <p>18-0695 INTAKE GASKET Replaces: 336389 Fits: 90(1995-06), 115(1995-06), 100(1998-01, 2005)</p>	 <p>18-0696 INTAKE GASKET Replaces: 336388 Fits: 90(1995-06), 100(1998-01, 2005), 115(1995-06)</p>	 <p>18-0957 POWERHEAD BASE GASKET Replaces: 318373</p>	 <p>18-0965 ADAPTER OUTER POWERHEAD GASKET Replaces: 333879</p>	 <p>18-0995 POWERHEAD BASE GASKET Replaces: 323222 V-6</p>
<p>PKG. OF 2</p>  <p>18-1205 18-1205-9① ADAPTER COVER GASKET Replaces: 329828</p>	<p>PKG. OF 2</p>  <p>18-2550 18-2550-9① POWERHEAD BASE GASKET Replaces: 323214 V-6</p>	<p>PKG. OF 2</p>  <p>18-2852 18-2852-9① POWERHEAD BASE GASKET Replaces: 330621 25/35 HP</p>	<p>PKG. OF 2</p>  <p>18-2864 18-2864-9① POWERHEAD BASE GASKET Replaces: 321727 V-4</p>	<p>PKG. OF 2</p>  <p>18-2865 18-2865-9① POWERHEAD BASE GASKET Replaces: 313763 3 Cyl.</p>
<p>PKG. OF 2</p>  <p>18-2877 18-2877-9① BAFFLE GASKET Replaces: 314421 18/25 HP</p>	<p>PKG. OF 2</p>  <p>18-2878 18-2878-9① BAFFLE GASKET Replaces: 319710 25/35</p>	<p>PKG. OF 2</p>  <p>18-2894 18-2894-9① EXHAUST HOUSING GASKET Replaces: 304314</p>	<p>PKG. OF 2</p>  <p>18-2898 POWERHEAD BASE GASKET Replaces: 309956 V-4</p>	













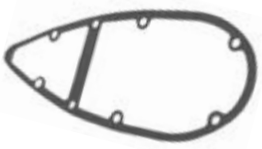











① Priced per package

<p>PKG. OF 2</p>  <p>18-2901 18-2901-9① EXHAUST HOUSING GASKET Replaces: 313065, 306205 5, 5.5, 6 HP</p>	<p>PKG. OF 2</p>  <p>18-2904 18-2904-9① EXHAUST PLATE GASKET Replaces: 319348 28, 33, 40 HP</p>	<p>PKG. OF 2</p>  <p>18-2907 18-2907-9① EXHAUST HOUSING GASKET Replaces: 325721</p>	<p>PKG. OF 2</p>  <p>18-0967 18-0967-9① BYPASS COVER GASKET Replaces: 319332 9.9 & 15 HP</p>	<p>PKG. OF 2</p>  <p>18-0971 BYPASS GASKET Replaces: 319661 25 & 35 HP</p>
<p>PKG. OF 2</p>  <p>18-2876 18-2876-9① BYPASS COVER GASKET Replaces: 307133</p>	<p>PKG. OF 2</p>  <p>18-0941 WATER JACKET GASKET Replaces: 315538 50/55 HP</p>	<p>PKG. OF 2</p>  <p>18-2543 18-2543-9① WATER JACKET GASKET Replaces: 318609 3 Cyl.</p>	<p>PKG. OF 2</p>  <p>18-0892 DEFLECTOR HOSE Replaces: 322411</p>	<p>PKG. OF 2</p>  <p>18-2544 18-2544-9① WATER JACKET GASKET Replaces: 321028 V-6</p>
<p>PKG. OF 2</p>  <p>18-2856 18-2856-9① WATER JACKET GASKET Replaces: 319665 25/35 HP</p>	<p>PKG. OF 2</p>  <p>18-3899 WATER COVER GASKET Replaces: 327674 For: 20, 25, 25C, 30, 35</p>	<p>PKG. OF 2</p>  <p>18-2872-9① WATER JACKET GASKET Replaces: 307257, 318334 V-4</p>	<p>PKG. OF 2</p>  <p>18-2873-9① WATER JACKET GASKET Replaces: 318335 V-4</p>	<p>PKG. OF 2</p>  <p>18-2905 18-2905-9① WATER COVER GASKET Replaces: 329920 9.9, 15 HP</p>
<p>PKG. OF 2</p>  <p>18-3360 IMPELLER HOUSING GASKET Replaces: 329390 20-25 HP</p>	<p>PKG. OF 2</p>  <p>18-0182 18-0182-9① THERMOSTAT GASKET Replaces: 310058</p>	<p>PKG. OF 2</p>  <p>18-0397 THERMOSTAT GASKET Replaces: 318917</p>	<p>PKG. OF 2</p>  <p>18-0412 18-0412-9① THERMOSTAT GASKET Replaces: 337068</p>	<p>PKG. OF 2</p>  <p>18-0441 18-0441-9① THERMOSTAT GASKET Replaces: 329076</p>
<p>PKG. OF 2</p>  <p>18-0929 18-0929-9① THERMOSTAT GASKET Replaces: 313416 3 Cyl.</p>	<p>PKG. OF 2</p>  <p>18-0675 THERMOSTAT GASKET Replaces: 321932 V-4</p>	<p>PKG. OF 2</p>  <p>18-0977 18-0977-9① THERMOSTAT GASKET Replaces: 332369 V-4</p>	<p>PKG. OF 2</p>  <p>18-1202 18-1202-9① THERMOSTAT GASKET Replaces: 329830</p>	<p>PKG. OF 2</p>  <p>18-1222 THERMOSTAT GASKET Replaces: 394408</p>

① Priced per package

<p>PKG. OF 2</p>  <p>18-2547 18-2547-9① WATER PASSAGE GASKET Replaces: 322858 V-4/V-6</p>	<p>PKG. OF 2</p>  <p>18-2548 18-2548-9① THERMOSTAT GASKET Replaces: 332108 3 Cyl.</p>	<p>PKG. OF 2</p>  <p>18-2546 18-2546-9① THERMOSTAT GASKET Replaces: 321184 V-6</p>	<p>PKG. OF 2</p>  <p>18-0124 18-0124-9① IMPELLER PLATE GASKET Replaces: 325537</p>	
<p>PKG. OF 2</p>  <p>18-0445 18-0445-9① WATER PUMP GASKET Replaces: 323312 35HP</p>	<p>PKG. OF 2</p>  <p>18-0969 18-0969-9① IMPELLER HOUSING GASKET Replaces: 319586</p>	<p>PKG. OF 5</p>  <p>18-2536 IMPELLER HOUSING SEAL Replaces: 321120 V-4, V-6</p>	<p>PKG. OF 5</p>  <p>18-2539 18-2539-9① RUBBER SEAL Replaces: 328753</p>	<p>PKG. OF 2</p>  <p>18-2557 18-2557-9① IMPELLER GASKET Replaces: 324701, 338484 V-4, V-6, V-8</p>
<p>PKG. OF 2</p>  <p>18-2709 18-2709-9① WEAR PLATE GASKET Replaces: 336530</p>	<p>PKG. OF 2</p>  <p>18-0679 THERMOSTAT GASKET Replaces: 311145</p>	<p>PKG. OF 2</p>  <p>18-7428 18-7428-9① O-RING Replaces: 307103</p>	<p>PKG. OF 2</p>  <p>18-7481 18-7481-9① O-RING Replaces: 324981</p>	<p>PKG. OF 2</p>  <p>18-0155 18-0155-9① RECTIFIER MOUNTING GASKET Replaces: 330412</p>
<p>PKG. OF 2</p>  <p>18-0851 18-0851-9① RELIEF GASKET Replaces: 329826</p>	<p>PKG. OF 2</p>  <p>18-0110 18-0110-9① SHIFT HOUSING GASKET Replaces: 324670</p>	<p>PKG. OF 2</p>  <p>18-0313 SHIFT ROD GASKET Replaces: 352165 For: E-Tec 75/90/115/150/ 175/200/225/250 HP</p>	<p>PKG. OF 2</p>  <p>18-0882 18-0882-9① SHIFT ROD GASKET Replaces: 304764</p>	
<p>PKG. OF 2</p>  <p>18-2855 18-2855-9① SHIFT HOUSING GASKET Replaces: 314082</p>	<p>PKG. OF 2</p>  <p>18-2874 18-2874-9① SOLENOID COVER GASKET Replaces: 314876 V-4</p>	<p>PKG. OF 2</p>  <p>18-2880 18-2880-9① COVER PLATE GASKET Replaces: 304023</p>		

① Priced per package

 <p>18-0540 EXHAUST LEG RUBBER SEAL Replaces: 320936</p>	 <p>18-2537 EXHAUST SEAL LEG Replaces: 324937</p>	<p>PKG. OF 2</p>  <p>18-2869 18-2869-9① EXHAUST HOUSING GASKET Replaces: 305312</p>	<p>PKG. OF 2</p>  <p>18-2891 18-2891-9① BEARING HOUSING GASKET Replaces: 303339 6HP</p>	
 <p>18-8353 OIL SEAL Replaces: 320961</p>	 <p>18-1219 GROMMET Replaces: 320880</p>	 <p>18-2389 GROMMET Replaces: 314832</p>	 <p>18-2391 GROMMET Replaces: 321692</p>	 <p>18-2392 GROMMET Replaces: 327035</p>
<p>PKG. OF 2</p>  <p>18-2703 18-2703-9① GROMMET Replaces: 314008</p>	 <p>18-2704 GROMMET Replaces: 320943</p>	<p>PKG. OF 2</p>  <p>18-2706 18-2706-9① GROMMET Replaces: 321008</p>	<p>PKG. OF 2</p>  <p>18-2708 GROMMET Replaces: 333758</p>	 <p>18-3329 GROMMET Replaces: 302497 9.9-35 HP</p>
 <p>18-3332 GROMMET Replaces: 304026</p>	 <p>18-3337 GROMMET Replaces: 315837 40-50 HP</p>	<p>PKG. OF 2</p>  <p>18-1221 18-1221-9① RETAINER GASKET Replaces: 330273</p>	 <p>18-2532 GEARCASE COVER SEAL Replaces: 305762 2 Cyl.</p>	 <p>18-2534 SEAL 40" Replaces: 309044 Material equivalent to that of O.E. spool # 309044 0.1005 O.D.</p>
 <p>18-7963 O-RING Replaces: 331353</p>	<p>PKG. OF 2</p>  <p>18-2705-9① OIL SEAL Replaces: 315748</p>	<p>PKG. OF 2</p>  <p>18-2769 18-2769-9① RUBBER SEAL Replaces: 332000</p>	<p>PKG. OF 2</p>  <p>18-0917 TILT MOTOR GASKET Replaces: 311508</p>	 <p>18-8372 MOLDED SEAL Replaces: 323582 For: 5 & 7.5 HP (1978-83) Outboards</p>

① Priced per package

PKG. OF 2



18-2881
18-2881-9^④
HOUSING TO TANK GASKET
 Replaces: 332403, 125530
 For: 6 Gallon Fuel Tank

PKG. OF 2



18-2887
18-2887-9^④
FUEL TANK GASKET
 Replaces: 302557



18-4904
STARTER HANDLE & ROPE
 (Uses 9/64" Rope)
 Handle Only: 18-4901

STARTER ROPE

18-4911
 5/32" x 200'
 Replaces: 322236, 772577

18-4913
 3/16" x 200'
 Replaces: 316705, 772578

18-4914
 1/8" x 200'
 Replaces: 316706, 772579



18-1505
STARTER GEAR
 Replaces: 318940
 For: 9.9 - 15HP
 (1974-1992)



18-6501
REWIND SPRING
 Replaces: 395460, 307573



18-6503
REWIND SPRING
 Replaces: 318944



18-6509
REWIND SPRING
 Replaces: 326877



18-6511
REWIND SPRING
 Replaces: 312932



18-6522
REWIND SPRING
 Replaces: 323653, 338534

H.P.	YEARS	REWIND SPRING	H.P.	YEARS	REWIND SPRING	H.P.	YEARS	REWIND SPRING	H.P.	YEARS	REWIND SPRING
2	1969-80	18-6511	4.5	1980-90	18-6511	10	1950-63	18-6501	18	1968-73	18-6501
3	1954-68	18-6501	5.5	1954-68	18-6501	12	1980-92	18-6522	20	1956-73,	18-6501
4 ^①	1969-92	18-6511	7.5	1954-68	18-6501	12	1956-68	18-6501		85-97	
4 ^②	1969-80	18-6511	9.9	1980-92	18-6522	15	1979-92	18-6522	28	1969-92	18-6501
4 ^③	1981-92	18-6509	9.9	1974-78	18-6503	15	1956-68	18-6501	25	1969-05	18-6501
			10	1980-92	18-6522	15	1974-78	18-6503	30	1984-05	18-6501
									35	1976-94	18-6501

① 1992 4D Models only
 ② Except 4D
 ③ All 4D

PKG. OF 3



18-6513
18-6513-9^④
STARTER PAWL
 Replaces: 203698

PKG. OF 2



18-6512-9^④
STARTER PAWL
 Replaces: 330525

HP	Years	Pawl	HP	Years	Pawl	HP	Years	Pawl
2	1971-88	18-6513	18	1957-73	18-6513	30	1984-90	18-6512-9
Jr/Colt	1990	18-6513	20	1981-90	18-6512-9	35	1976-77	18-6513
3	1957-67	18-6513	25	1969-76	18-6513	35	1978-90	18-6512-9
4	1978-90	18-6513	25	1977	18-6513	45	1958-59	18-6513
5.5	1957-64	18-6513	25	1978-90	18-6512-9	50	1958-89	18-6513
7.5	1957-76	18-6513	25C	1982-90	18-6512-9	60	1964-66	18-6513
10	1957-62	18-6513	30	1957-61	18-6512-9	75	1960-65	18-6513
						80	1966	18-6513

④ Priced per package

- 78 — Gear Housing Seal Kit 18-2658
- 77 — Water Pump Repair Kit W/ HOUSING 18-3382

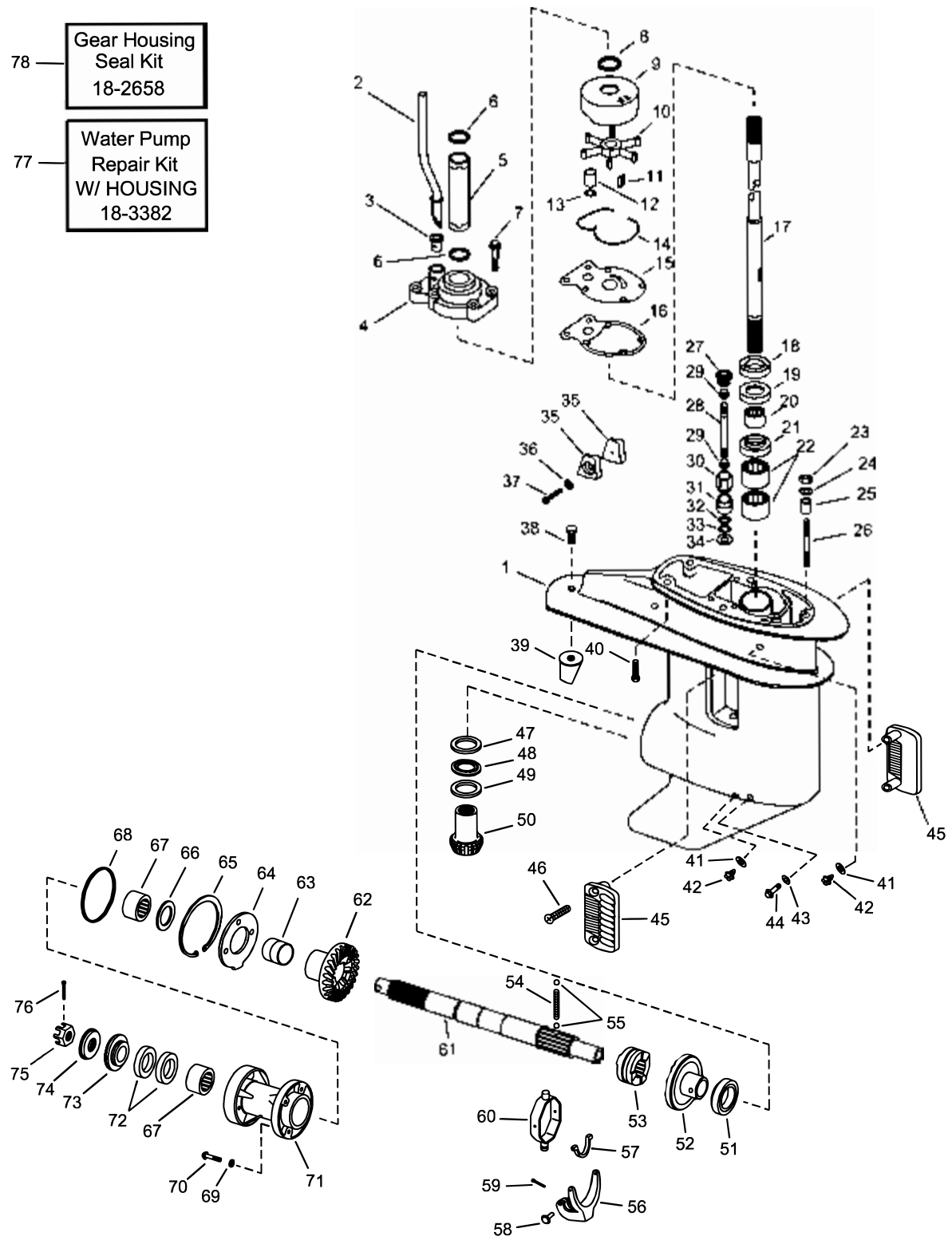

Complete Gear Housings Listed on Page 366

Figure #	Description	Part #	O.E.M. #	Qty.	Figure #	Description	Part #	O.E.M. #	Qty.
1	Gear Housing	—	434030	1	46	Screw, Screen Retaining	—	325539	2
2	Tube Water	—	395339	1	47	Washer, Thrust	—	327716	1
3	Grommet	18-3329	302497	1	48	Bearing, Thrust	—	388027	1
4	Housing, Water Pump	18-3367	393632	1	49	Washer, Thrust	—	330441	1
5	Tube, Extension	—	326692	1	50	Gear, Pinion	18-1288	328313	1
6	O-Ring	18-7105	311338	2	51	Bearing, Forward Gear	—	386186	1
7	Bolt, Water Pump Housing	—	328725	6	52	Gear, Forward	18-1287	392475	1
8	O-Ring	18-7146	554545	1	53	Clutch Sliding	18-1290	337020	1
9	Insert, Water Pump Housing	18-3358	328751	1	54	Spring, Detent	—	327070	1
10	Impeller	18-3051	395289	1	55	Ball, Detent	18-2243-9	316506	2
11	Key, Water Pump	18-3295	344470	1	56	Lever Shifter	—	337019	1
12	Bushing	—	328754	1	57	Cradle, Sliding Clutch	—	438311	1
13	O-Ring	18-7100	301877	1	58	Pin, Shift	—	302504	1
14	Seal, Rubber	18-2539	328753	1	59	Cotterpin, Shift Lever	—	303049	1
15	Plate, Wear	—	328753	1	60	Yoke & Connector Assy.	—	390023	1
16	Gasket, Water Pump	18-0124	325537	1	61	Shaft, Propeller	—	439143	1
17	Drive Shaft (15")	—	341635	1	62	Gear, Reverse	18-1289	327655	1
	Drive Shaft (20")	—	341636	1	63	Bushing, Reverse Gear	—	319635	1
18	Seal Drive Shaft (upper)	18-2065	332261	1	64	Plate, Retainer	—	319746	1
19	Seal Drive Shaft (lower)	18-2033	321938	1	65	Ring, Retaining	—	319747	1
20	Bearing, Driveshaft	—	386473	1	66	Washer, Forward Gear Thrust	—	319684	1
21	Collar, Housing	—	322018	1	67	Bearing, Propshaft	—	437288	2
22	Bearing, Pinion	—	437288	2	68	O-Ring	18-7108	338518	1
23	Nut, Housing	—	306422	1	69	Seal	18-7475	332584	2
24	Washer, Locking	—	301250	1	70	Bolt, Carrier Retaining	—	319743	2
25	Bushing, Housing Alignment	—	319785	1	71	Carrier, Bearing	—	433428	1
26	Stud	—	320173	1	72	Seal, Propshaft	18-2026	321453	2
27	Connector, Shift	—	325624	1	73	Spacer, Prop	18-4229	319890	1
28	Shift Rod	—	331479	1	74	Spacer, Prop	18-4232	323943	1
29	Keeper, Nylon Shift	—	325625	2	75	Prop Nut	18-3707	319891	1
30	Nut, Shiftshaft Retaining	—	331465	1	76	Cotter Pin, Prop Nut	18-3743	320785	1
31	Bushing	—	326361	1	77	Water Pump Kit	18-3382	393639	1
32	O-Ring	18-7180	303347	1	78	Gear Housing Seal Kit	18-2658	396351	1
33	O-Ring	18-7100	301877	1					
34	Washer, Expanding	18-0189	321738	1					
35	Anode Kit	—	434029	1					
36	Lockwasher	—	304454	1					
37	Bolt, Anode Retaining	—	333677	1					
38	Bolt, Trim Tab Retaining	—	329217	1					
39	Trim Tab	—	336203	1					
40	Bolt, Housing Retaining	—	328333	4					
41	Gasket, Drain Plug	18-4248	311598	2					
42	Plug, Drain	18-2387	307551	2					
43	Seal	18-7475	332584	1					
44	Pin, Shift Lever Pivot	—	308376	1					
45	Screen, Water Inlet	—	336202, 336206	2					

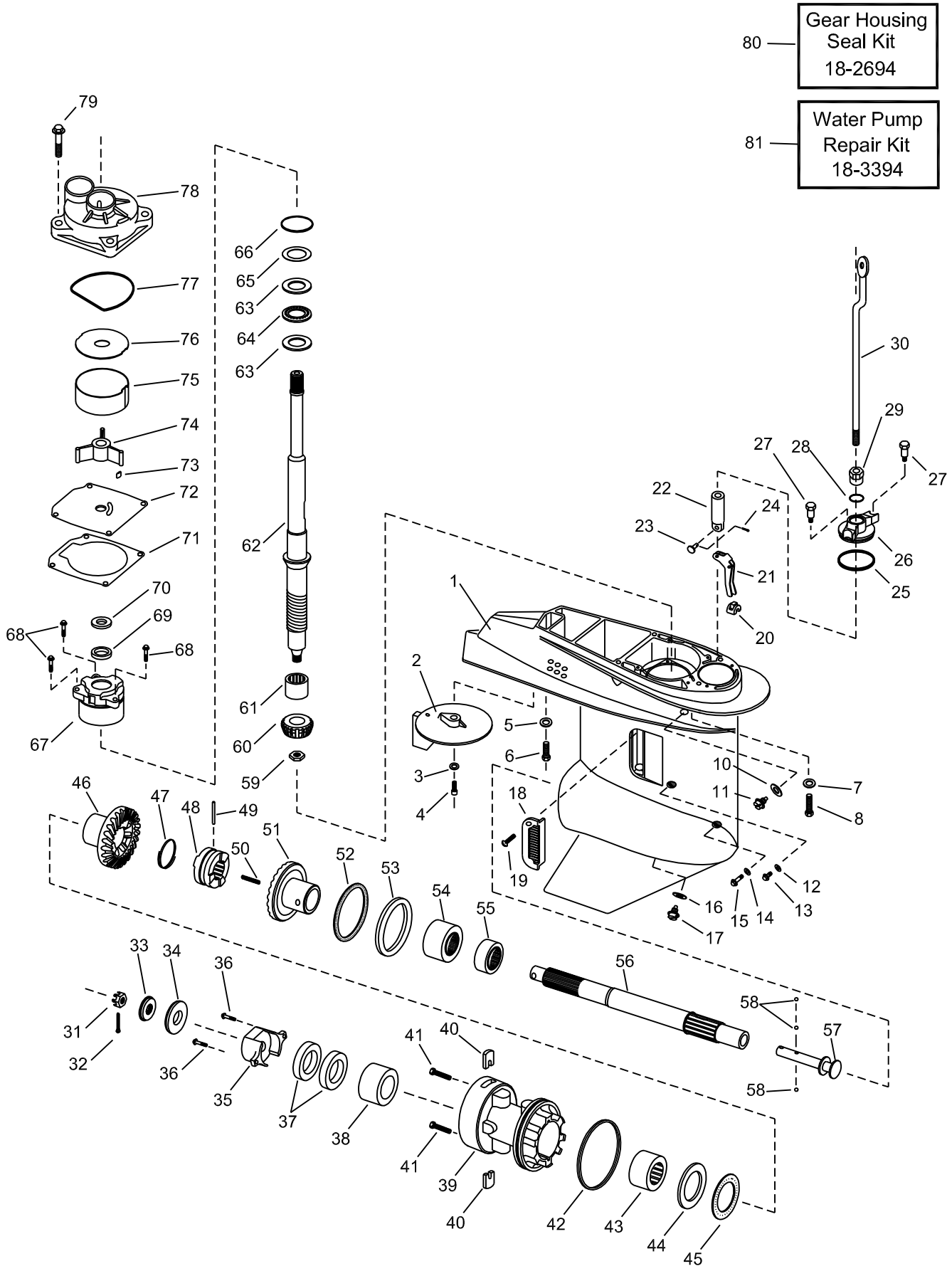

Complete Gear Housings Listed on Page 366

Figure #	Description	Part #	O.E.M. #	Qty.	Figure #	Description	Part #	O.E.M. #	Qty.
1	Housing, Gearcase	—	435275	1	47	Spring Clutch	18-2398	320311	1
2	Trim Tab	—	340539	1	48	Clutch Sliding	18-2308	332491	1
3	Washer, Anode	—	330266	1	49	Pin, Clutch Cross	—	320310	1
4	Bolt, Anode Retaining	—	330930	1	50	Spring Shifter	—	332484	1
5	Washer	—	330265	1	51	Gear Set, Forward & Pinion	NSS	397627	1
6	Bolt	—	313697	1	52	Thrust Bearing, Forward Gear	18-1364	397538	1
7	Washer	—	330266	4	53	Thrust Washer, Forward Gear	18-0197	333725	1
8	Bolt	—	305282	4	54	Bearing Forward, Outer	18-1351	382407	1
10	O-Ring	18-4253-9	336982	1	55	Thrust Bearing, Forward Gear	18-1369	432264	1
11	Drain Plug, Upper	18-1236	309243	1	56	Propeller Shaft	18-2288	439138	1
12	Seal	18-7475	332584	1	57	Shaft, Shift Dog	—	332503	1
13	Retaining Screw	—	324852	1	58	Ball, Detent	18-2243-9	316506	3
14	O-Ring Screw	18-7109	317178	1	59	Nut, Pinion	—	313339	1
15	Screw, Shift Lever	—	333770	1	60	Gear Set, Forward & Pinion	NSS	397627	1
16	Gasket, Drain Plug	18-4248	311598	1	61	Bearing Pinion	18-1356	382343	1
17	Drain Fill Plug, Lower	18-2378	318544	1	62	Driveshaft (std)	—	433066	1
18	Screen, Water Intake	—	332494	2		Driveshaft (long)	18-1721	433067	1
19	Bolt, Inlet Screen Retainer	—	325539	2	63	Washer, Thrust	18-0201	333771	2
20	Cradle, Shifter	—	332507	1	64	Thrust Bearing, Driveshaft	18-1368	398901	1
21	Lever, Shift	—	332492	1	65	Shim (.003)	—	313273	AR
22	Connector, Shift Rod	—	332508	1		Shim (.004)	—	313274	AR
23	Pin, Connector	—	302504	1		Shim (.005)	—	313275	AR
24	Cotter Pin	—	306376	1		Shim (.006)	—	313276	AR
25	O-Ring, Shift Rod Cover	—	338522	1		Shim (.007)	—	313277	AR
26	Cover, Shift Rod	—	434588	1	66	O-Ring, Gear Housing	18-7173	310327	1
27	Bolt, Shift Rod Cover	—	316037	2	67	Cap, Upper Driveshaft,			
28	O-Ring, Shift Rod	18-7137	318372	1		Retaining	—	435274	1
29	Bushing, Shift Rod	—	333780	1	68	Bolt, Driveshaft Retaining	—	317624	3
30	Shift Rod (std.)	—	332509	1	69	Seal Lower	18-2059	321466	1
	Shift Rod (long)	—	332510	1	70	Seal Upper	18-2064	332205	1
31	Nut, Prop	18-3705	314503	1	71	Gasket, Impeller	18-2709	336530	1
32	Pin, Cotter	18-3742	314502	1	72	Plate, Impeller	NSS	341038	1
33	Spacer, Prop	18-4228	315810	1	73	Key, Impeller	18-3138	334897	1
34	Washer, Prop Thrust	18-4230	320305	1	74	Impeller	18-3104-1	432941	1
35	Anode, Bearing Housing	—	398873	1	75	Skirting, Insert	NSS	324980	1
36	Bolt, Anode Retaining	—	328694	2	76	Plate, Insert Top	18-3126	321940	1
37	Oil Seals, Prop Shaft	18-2060	321467	2	77	Seal, Rubber	18-7481	324981	1
38	Bearing, Needle	18-1355	386765	1	78	Housing, W/P	18-3129	438544	1
39	Bearing Carrier Assembly	18-1708	432276	1	79	Bolt, Water Pump Housing	18-3369	302325	4
40	Tabs, Retaining	—	332495	2	80	Gear Housing Seal Kit	18-2694	433550	1
41	Bolt, Carrier Retaining	—	328744	2	81	Water Pump Repair Kit	18-3394	433548	1
42	O-Ring, Bearing Housing	18-7172	553126	1					
43	Bearing, Needle	18-1354	386764	1					
44	Thrust Washer, Reverse Gear	18-0196	332514	1					
45	Thrust Bearing, Reverse Gear	18-1363	397537	1					
46	Gear, Reverse	18-2309	332489	1					

AR As required

NSS Not Sold Separate

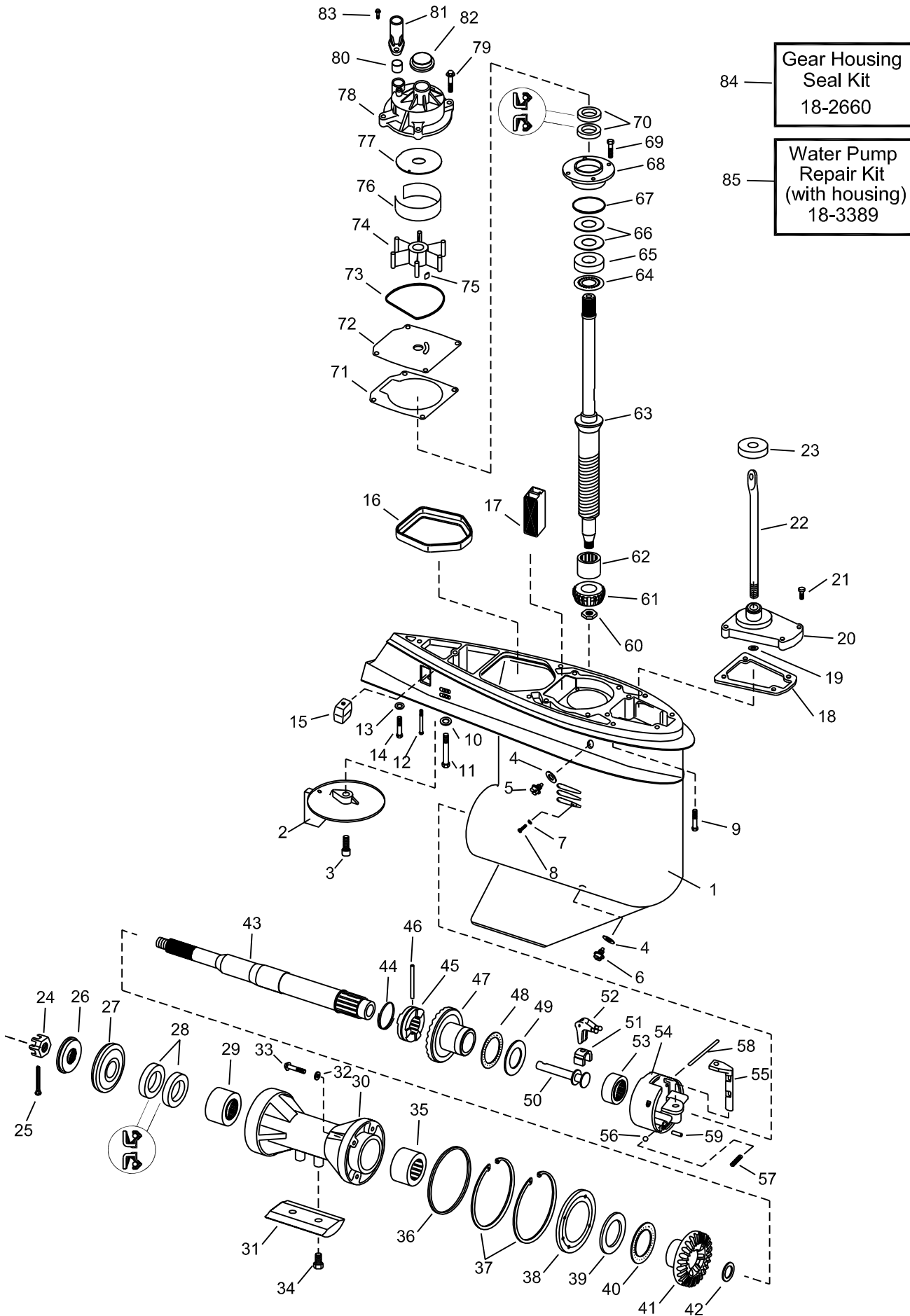

Complete Gear Housings Listed on Page 366

Figure #	Description	Part #	O.E.M. #	Qty.	Figure #	Description	Part #	O.E.M. #	Qty.
1	Housing Gearcase	—	392478	1	43	Propshaft	18-2250	439185,	1
2	Trim Tab	—	318544	1				439131	
3	Bolt, Trim Tab	—	313715	1	44	Retaining Spring	18-2399	324369	1
4	O-Rings, Drain Plugs	18-7145	333572	2	45	Clutch Sliding	—	318303	1
5	Drain Fill Plug, Upper	18-2387	307551	1	46	Pin, Clutch Dog	18-1714	313448	1
6	Magnetic Drain Screw	18-2378	318544	1	47	Gear Set, Forward & Pinion	—	397338	1
7	Seal	18-7475	332584	1	48	Thrust Bearing, Forward Gear	18-1371	385043	1
8	Bolt, Pinion Retaining	—	324852	1	49	Thrust Washer, Forward Gear	18-0198	324766	1
9	Bolt, Housing	—	308843	4	50	Shaft, Shifter	—	326668	1
10	Lockwasher	—	306314	1	51	Cradle, Shifter	18-3766	334163	1
11	Bolt, Long Gearcase	—	313697	1	52	Lever, Shift	—	324037	1
12	Bolt, Anode	—	328096	1	53	Bearing, Housing	NSS	NSS	
13	Lockwasher	—	306470	1	54	Bearing Housing Assy.	—	391365	1
14	Bolt, Short Gearcase	—	306503	1	55	Detent Shift	—	326670	1
15	Anode, Cavitation	18-6024	436745	1	56	Detent Ball	—	327345	1
16	Seal, Exhaust	18-2537	324937	1	57	Detent Spring	—	911961	1
17	Screen, Water Inlet	—	314175	1	58	Pin, Shifter Housing	—	320145	1
18	Gasket, Shiftshaft Housing	18-2855	314082	1	59	Pin, Housing	18-3765	331880	1
19	O-Rings, Shiftshaft	18-7137	318372	1	60	Nut, Pinion	—	313339	1
20	Shiftshaft Housing	—	388651	1	61	Gear, Pinion	NSS	NSS	
21	Bolt, Shiftshaft Housing	—	302325	4	62	Bearing, Pinion	18-1356	382343	1
22	Shiftshaft	—	327337	1	63	Driveshaft(std)	—	437376	1
23	Slinger, Shift Arm	18-2706	321008	1	64	Bearing, Thrust	—	317230	1
24	Nut, Propeller	18-3705	314503	1	65	Washer, Thrust	18-1367	385068	1
25	Cotter Pin, Prop Nut	18-3742	314502	1	66	Shim (.003)	18-2232	323889	AR
26	Spacer, Prop Nut	18-4228	315810	1	66	Shim (.004)	18-2233	323890	AR
27	Thrust Washer	18-4222	127084, 318841	1	66	Shim (.005)	18-2234	317232	AR
					67	O-Ring Bearing Housing	18-7128	313754	1
28	Outer Seal, Carrier	18-8326	330137	1	68	Driveshaft Retaining Housing	—	385087	1
					69	Bolt, Driveshaft Retaining	—	909386	4
28	Inner Seal, Carrier	18-2001	342787	1	70	Seal	18-8325	342786	1
29	Carrier Bearing (Aft)	18-1350	379504	1	71	Gasket, Water Pump	18-2709	336530	1
30	Carrier Assembly	—	434391	1	72	Plate, Impeller	18-3127	341038	1
31	Anode, Carrier	—	306470	1	73	Seal, Water Pump Housing	18-7481	324981	1
32	Seal	18-7475	332584	4	74	Impeller	18-3053-1	396725	1
33	Bolt, Carrier to Retainer	18-2379	320041	4	75	Key, Impeller	18-3138	334897	1
34	Bolt, Carrier Anode	—	127466	2	76	Liner, Water Pump Housing	—	321940	1
35	Carrier Bearing (Fore)	18-1351	382407	1	77	Liner, Top Plate	18-3126	324980	1
36	O-Ring , Bearing Housing	18-7127	313446	1	78	Housing, Water Pump	18-3129	435673	1
37	Retaining Rings	—	313445	2	79	Bolt, Water Pump Housing	—	302325	1
38	Retaining Plate, Carrier	—	313453	1	80	Seal, Guide tube	18-2703	314008	1
39	Large Thrust Washer, Reverse Gear	18-0193	313447	1	81	Guide, Water Tube	—	319276	1
					82	Grommet	18-2705-9	342786	1
40	Thrust Bearing, Reverse Gear	18-1366	382408	1	83	Screw, Guide Tube	—	908158	1
41	Gear, Reverse	18-2208	318304	1	84	Gear Housing Seal Kit	18-2660	396349	1
42	Small Thrust Washer, Reverse Gear	—	316484	1	85	Water Pump Repair Kit, Complete	18-3389	432955	1

AR As required

NSS Not Sold Separate

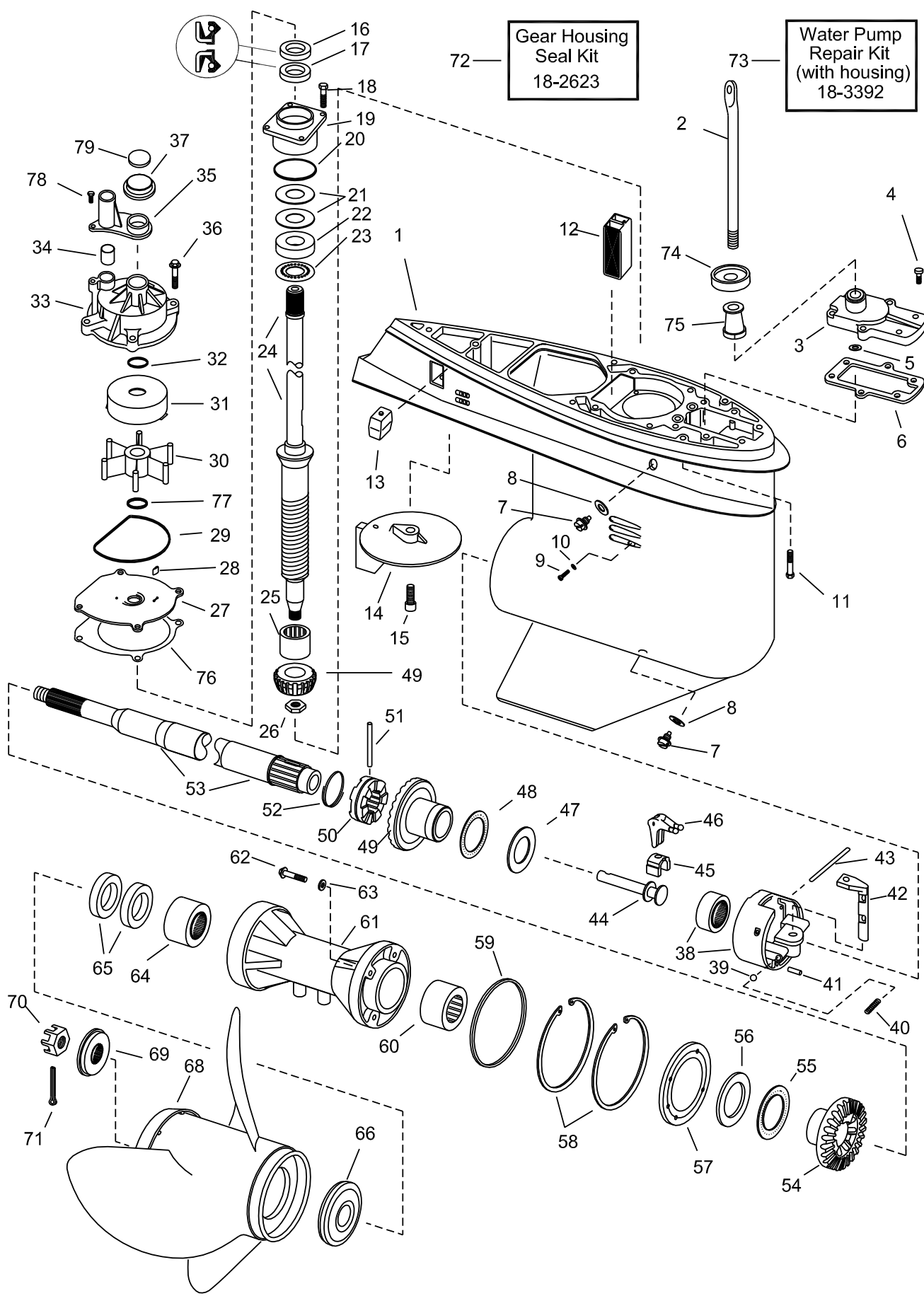

Complete Gear Housings Listed on Page 366

Figure #	Description	Part #	O.E.M. #	Qty.	Figure #	Description	Part #	O.E.M. #	Qty.
1	Housing Gearcase	—	431642	1	43	Pin, Shift Lever	—	320145	1
2	Shift Rod (long)	—	332120	1	44	Shift Shaft	18-3763	322941	1
	Shift Rod (x-long)	—	332121	1	45	Cradler, Shifter	18-3766	334163	1
3	Cover, Shift Rod	—	388618	1	46	Shift Lever	—	324037	1
4	Screw, Cover	18-3369	302325	6	47	Thrust Washer, Forward Gear	18-0198	324766	1
5	O-Ring, Shift Rod	18-7137	318372	1	48	Thrust Bearing, Forward Gear	18-1371	385043	1
6	Gasket, Shift Housing	18-0110	324670	1	49	Gear Set, Forward & Pinion	18-2218	398035	1
7	Magnetic Drain Screw	18-2378	318544	1	50	Sliding Clutch	18-2220	323664	1
8	O-Rings, Plugs	18-7145	333572	1	51	Pin, Clutch Dog	18-1714	313448	1
9	Screw	—	324852	1	52	Retaining Spring	18-2399	324369	1
10	O-Ring	18-7475	332584	1	53	Propeller Shaft	18-2252	387818	1
11	Screw, Gearcase to housing	—	331999	5	54	Gear, Reverse	18-2219	333077	1
12	Screen, Water intake	—	323466	1	55	Thrust Bearing, Reverse Gear	18-1366	382408	1
13	Anode	18-6024	393023	1	56	Thrust Washer, Reverse Gear	18-0195	314731	1
14	Trim Tab	—	327640	1	57	Retainer Plate/Bearing Housing	—	314732	1
15	Screw, Trim tab	—	313715	1	58	Retaining Rings	—	313445	2
16	Oil Seal, Upper	18-2061	329922	1	59	O-Ring, Bearing Housing	18-7127	313446	1
17	Oil Seal, Lower	18-2062	329923	1	60	Carrier Bearing (Fore)	18-1351	382407	1
18	Screw, Housing to gearcase	—	317624	4	61	Bearing Housing	—	397087	1
19	Bearing Housing	—	397493	1	62	Screw, Retainer	18-2377	316563	4
20	O-Ring Bearing Housing	18-7130	314728	1	63	O-Ring	18-7475	332583	1
21	Shim .003	18-2229	323362	AR	64	Roller Bearing (Aft)	18-1350	379504	1
	Shim .004	18-2230	323361	AR	65	Oil Seals, Prop Shaft	18-2001	330137	2
	Shim .005	18-2231	314745	AR	66	Thrust Washer	18-4222	318841	1
22	Thrust Washer, Pinion	18-0200	327656	1	68	Propeller	—	Various	1
23	Thrust Bearing, Pinion	18-1365	387656	1	69	Spacer, Prop Nut	18-4228	315810	1
24	Drive Shaft (long)	—	394613	1	70	Nut, Propeller	18-3705	314503	1
	Drive Shaft (x-long)	—	394614	1	71	Cotter Pin, Prop Nut	18-3742	314502	1
25	Bearing, Pinion	18-1357	384195	1	72	Gear Housing Seal Kit	18-2623	396354	1
26	Nut, Pinion	18-3719	314730	1	73	Water Pump Repair Kit (w/housing)	18-3392	395062	1
27	Wear Plate	18-3346	330380	1					
28	Key, Impeller	18-3299	331107	1	74	Grommet	18-2706	321008	1
29	Seal, Impeller Housing	18-7963	331353	1	75	Spacer, Shift rod	—	321122	1
30	Impeller	18-3059	395864	1	76	Gasket, Impeller housing plate	18-2557	324701	1
31	Cup, Impeller	18-3346	330379	1	77	O-Ring, Drive Shaft	—	302035	1
32	O-Ring, Drive Shaft	18-2769	332000	1	78	Screw, Cover to impeller	—	306643	2
33	Housing, Water Pump	18-3130	395040	1	79	O-Ring, Driveshaft to crankcase	18-7158	310585	1
34	Grommet, Water Tube	18-2703	314008	1					
35	Pump cover	—	321159	1					
36	Screw, Impeller housing	—	328715	4					
37	Grommet	18-2704	320943	1					
38	Bearing Housing Assembly	—	391365	1					
39	Ball, Detent	—	327345	1					
40	Spring, Detent	—	326666	1					
41	Pin, Housing	18-3765	331880	1					
42	Detent, Shifter	—	323946	1					

AR As required

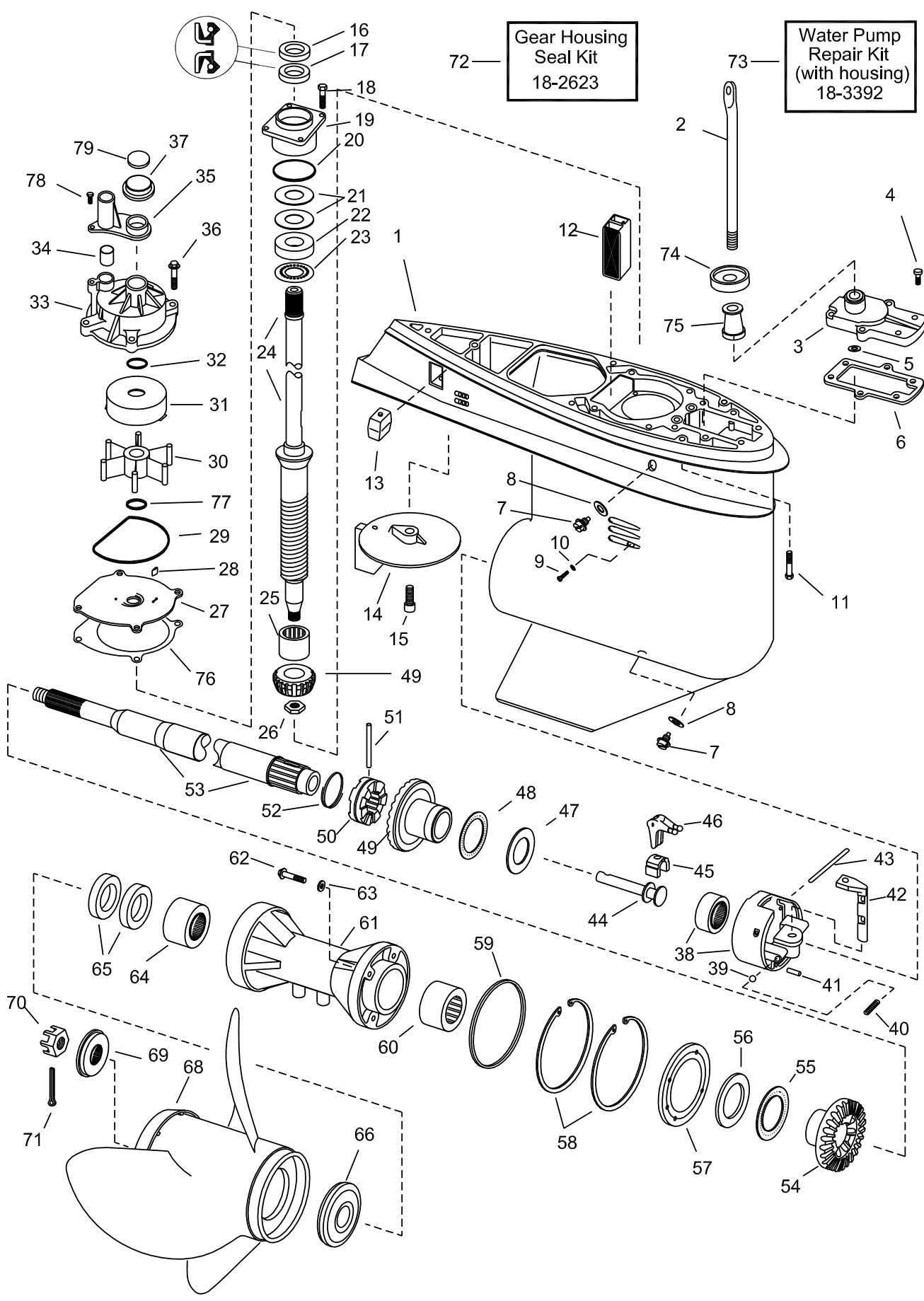

Complete Gear Housings Listed on Page 366

Figure #	Description	Part #	O.E.M. #	Qty.	Figure #	Description	Part #	O.E.M. #	Qty.
1	Housing Gearcase	—	438050	1	43	Pin, Shift Lever	—	328825	1
2	Shift Rod (long)	—	324407	1	44	Shift Shaft	18-3763	322941	1
2	Shift Rod (x-long)	—	324408	1	45	Cradler, Shifter	18-3766	334163	1
3	Cover & Shift Rod	—	435482	1	46	Shift Lever	18-3762	322938	1
4	Screw, Cover	18-3369	302325	6	47	Thrust Washer, Forward Gear	18-0199	327669	1
5	O-Ring, Shift Rod	18-7137	318372	1	48	Thrust Bearing, Forward Gear	18-1370	389042	1
6	Gasket, Shift Housing	18-0110	324670	1	49	Gear Set, Forward & Pinion	NSS	435020	1
7	Magnetic Drain Screw	18-2378	318544	2	50	Sliding Clutch	18-2216	337774	1
8	O-Rings, Plugs	18-7145	333572	2	51	Pin, Clutch Dog	18-1714	313448	1
9	Screw	—	324852	1	52	Retaining Spring	18-2399	324369	1
10	O-Ring	18-7120	307853	1	53	Propeller Shaft	18-2187	395209	1
11	Screw, Gearcase to housing	—	320741	5	54	Gear, Reverse	NSS	910994	1
12	Screen, Water intake	—	321123	1	55	Thrust Bearing, Reverse Gear	18-1366	382408	1
13	Anode	18-6024	393023	1	56	Thrust Washer, Reverse Gear	18-0195	314731	1
14	Trim Tab	—	327640	1	57	Retainer Plate/Bearing Housing	—	321174	1
15	Screw, Trim tab	—	313715	1	58	Retaining Rings	—	321171	2
16	Oil Seal, Upper	18-2061	329922	1	59	O-Ring, Bearing Housing	18-7133	305123	1
17	Oil Seal, Lower	18-2062	329923	1	60	Carrier Bearing (Fore)	18-1351	382407	1
18	Screw, Housing to gearcase	—	316534	4	61	Bearing Housing	—	397094	1
19	Bearing Housing	—	438963	1	62	Screw, Retainer	18-2377	316563	4
20	O-Ring Bearing Housing	18-7130	314728	1	63	O-Ring	18-7109	317178	1
21	Shim .003	18-2229	323362	AR	64	Roller Bearing (Aft)	18-1158	387247	1
21	Shim .004	18-2230	323361	AR	65	Oil Seals, Prop Shaft	18-2002	320862	2
21	Shim .005	18-2231	314745	AR	66	Thrust Washer	18-4223	333592	1
22	Thrust Washer, Pinion	18-0200	327656	1	68	Propeller	—	various	1
23	Thrust Bearing, Pinion	18-1365	387665	1	69	Spacer, Prop Nut	18-4231	320570	1
24	Drive Shaft (long)	see app chart	435755	1	70	Nut, Propeller	18-3708-1	398042	1
24	Drive Shaft (x-long)	see app chart	435756	1	71	Cotter Pin, Prop Nut	18-3741	306394	1
25	Bearing, Pinion	18-1117	387817	1	72	Gear Housing Seal Kit	18-2623	396353	1
26	Nut, Pinion	18-3719	314730	1	73	Water Pump Repair Kit (w/housing)	18-3392	434421	1
27	Cup & Plate Assembly	18-3346	330380	1					
28	Key, Impeller	18-3299	331107	1	74	Grommet	18-2706	321008	1
29	Seal, Impeller Housing	18-7963	331353	1	75	Spacer, Shift rod	—	321122	1
30	Impeller	18-3059	397131	1	76	Gasket, Impeller housing plate	18-2557	324701	1
31	Cup & Plate Assembly	18-3346	330379	1	77	O-Ring, Drive Shaft	18-7158	310585	1
32	O-Ring, Drive Shaft	18-7158	310585	1	78	Screw, Cover to impeller	—	306643	2
33	Housing, Water Pump	18-3130	395040	1	79	O-Ring, Driveshaft to crankcase	18-7158	310585	1
34	Grommet, Water Tube	18-2703	314008	1					
35	Pump cover	—	321159	1					
36	Screw, Impeller housing	18-3136	323626	4					
37	Grommet	18-2704	320943	1					
38	Bearing Housing Assembly	—	389455	1					
39	Ball, Detent	18-1501	160084	1					
40	Spring, Detent	18-1502	911962	1					
41	Pin, Housing	18-3765	331880	1					
42	Detent, Shifter	—	323946	1					

AR As required



18-4840^②
COMPLETE LOWER GEARCASE ASSEMBLIES
 Replaces: 435277
 Fits: 40/48/50hp w/20" Shaft (1989-92)



18-4841^②
COMPLETE LOWER GEARCASE ASSEMBLIES
 Replaces: 435276
 Fits: 40/48/50hp w/15" Shaft (1989-92)



18-4843^②
COMPLETE LOWER GEARCASE ASSEMBLIES
 Replaces: 435279
 Fits: 40/48/50hp w/15" Shaft (1993 and Up)

PKG. OF 5



18-2377
18-2377-9^①
RETAINER SCREW
 Replaces: 316563

PKG. OF 4



18-2379
18-2379-9^①
LOWER UNIT CARRIER SCREW
 Replaces: 320041

PKG. OF 5



18-4253-9^①
18-42531-9^①
 (PKG. OF 50)
DRAIN SCREW O-RING
 Replaces: 336982
 Used w/ 18-1236 Drain Screw

PKG. OF 5



18-4248
18-4248-9^①
18-42481-9^①
 (PKG. OF 50)
DRAIN/FILL PLUG WASHER
 (Plastic)
 Replaces: 311598
 Used with 18-2387 Drain Screw

PKG. OF 2



18-2945
18-2945-9^①
18-29451-9^①
 (PKG. OF 50)
DRAIN SCREW GASKET
 Replaces: 307552



18-1236
DRAIN SCREW
 Replaces: 309243
 For: 40-50 HP (1989-97)
 Cobra Drives



18-2387
18-23871-9^①
 (PKG. OF 50)
LOWER UNIT DRAIN/FILL SCREW
 Slot Head



18-4255
E-TEC DRAIN SCREW
 Replaces: 307551
 Allan Head

Just the Package

^① Priced per package

^② All gearcase assemblies pictured above are primed only. Be prepared to paint the gearcase to match your customer's engine.



18-4249
E-TEC DRAIN SCREW WITH MAGNET
 Replaces: 318544
 Allan Head



18-3708-1
PROP NUT & KEEPER
 Replaces: 398042

PKG. OF 5



PROP NUTS

PART #	O.E. #
18-3705 ②	314503
18-3706 ②	318971
18-3707 ②	319891

PKG. OF 10



COTTER PINS

PART #	O.E. #	DIMEN.
18-3735 ②	5030087	5/32" X 1 3/8"
18-3740 ②	302804	3/32" X 1"
18-3741 ②	309955	1/8" X 1 3/4"
18-3742 ②	314502	1/8" X 1 1/4"
18-3743 ②	320785	1/8" X 3/4"
18-3744 ②	552906	3/32" X 3/4"

③ **18-3715D** Display Package



18-3715
PROP NUT KIT
 Replaces: 175266
 — CONTAINS —

Part #	O.E. #	Description
18-3708-1	398042	Prop Nut/Keeper
18-3741	309955	Cotter Pin
18-4231	320570	Prop Spacer

③ **18-3716D** Display Package



18-3716
PROP NUT KIT
 Replaces: 175267
 — CONTAINS —

Part #	O.E.#	Description
18-3705	314503	Prop Nut
18-3742	314502	Cotter Pin
18-4228	315810	Prop Spacer

③ **18-3717D** Display Package



18-3717
PROP NUT KIT
 Replaces: 175268
 — CONTAINS —

Part #	O.E. #	Description
18-3707	319891	Prop Nut
18-3743	320785	Cotter Pin
18-4232	323943	Prop Spacer



18-3753
PROP NUT KIT
 Replaces: 5005034
 Fits: 40-130 (2001 & Up)



18-3768
COVER NUT
 Replaces: 911751
 For: Cobra drives: 115 (1994-97), 232 (1987-90), 252 (1986), 262 (1989), 302 (1987)



18-4222
THRUST WASHER
 Replaces: 318841, 127084



18-4223
THRUST WASHER
 Replaces: 333592



18-4228
PROP SPACER
 Replaces: 315810



18-4229
THRUST WASHER
 Replaces: 319890



18-4230
THRUST WASHER
 Replaces: 320305



18-4231
PROP SPACER
 Replaces: 320570



18-4232
PROP SPACER
 Replaces: 323943

APPLICATION ON NEXT PAGE

① Priced per package ② This product is priced per piece. To order priced per package, please add -9 to the part number.
 ③ Items ending in "D" are Display Packaged - Regular number is Non-Display

JOHNSON/EVINRUDE

HP	Year	Spacer Before Prop	Washer After Prop	Prop Nut	Cotter Pin	Prop Nut Kit
9.9/15	1974-75	—	—	18-3706	18-3740	—
9.9/15	1976-99	—	—	18-3706	18-3744	—
20	1984-90	18-4229	18-4232	18-3707	18-3743	18-3717
20/30/35	1991-99	—	18-4232	18-3707	18-3743	18-3717
25 ⑥	1991	—	18-4232	18-3707	18-3743	18-3717
25 ⑦	1991	18-4232	18-4228	18-3705	18-3742	18-3716
25 ⑧	1992	—	18-4232	18-3707	18-3743	18-3717
25/30	1984-90	18-4229	18-4232	18-3707	18-3743	18-3717
35	1976-90	18-4229	18-4232	18-3707	18-3743	18-3717
40 ① ④	1984-99	18-4230	18-4228	18-3705	18-3742	18-3716
40 Comm	1996-97	18-4222	18-4228	18-3705	18-3742	18-3716
40 Comm	1998-99	—	18-4228	18-3705	18-3742	18-3716
45 Comm ②	1986-97	—	18-4228	18-3705	18-3742	18-3716
48 ①	1987-96	18-4230	18-4228	18-3705	18-3742	18-3716
50/60 TTL	1996-98	18-4222	18-4228	18-3705	18-3742	18-3716
50 ②	1971-74	18-4222	18-4228	18-3705	18-3742	18-3716
50 ① ④	1975-99	18-4230	18-4228	18-3705	18-3742	18-3716
50 EL&DT	1996-98	—	18-4228	18-3705	18-3742	18-3716
50 Comm ②	1977-79	18-4222	18-4228	18-3705	18-3742	18-3716
55	1968-69	18-4222	18-4228	18-3705	18-3742	18-3716
55 ①	1976-79	18-4230	18-4228	18-3705	18-3742	18-3716
55 Comm ②	1980-97	18-4222	18-4228	18-3705	18-3742	18-3716
55 Comm	1998-99	—	18-4228	18-3705	18-3742	18-3716
60/70 ④	1996-99	—	18-4228	18-3705	18-3742	18-3716
60	1970-71, 1986-95	18-4222	18-4228	18-3705	18-3742	18-3716
60 ①	1980-85	18-4230	18-4228	18-3705	18-3742	18-3716
65	1972-73	18-4222	18-4228	18-3705	18-3742	18-3716
65 Comm	1984-95	18-4222	18-4228	18-3705	18-3742	18-3716
65 Comm	1996-99	—	18-4228	18-3705	18-3742	18-3716
70	1974-95	18-4222	18-4228	18-3705	18-3742	18-3716
75 ②	1975-84	18-4222	18-4228	18-3705	18-3742	18-3716
75 ①	1975-85	18-4230	18-4228	18-3705	18-3742	18-3716
Formula E	1986-90	18-4230	18-4228	18-3705	18-3742	18-3716
Sprint	1986-90	18-4230	18-4228	18-3705	18-3742	18-3716
85	1969-80, 1995	18-4222	18-4228	18-3705	18-3742	18-3716
88/90	1981-95	18-4222	18-4228	18-3705	18-3742	18-3716
88	1996	—	18-4228	18-3705	18-3742	18-3716
90 ① ④	1996-99	—	18-4228	18-3705	18-3742	18-3716
90 ②	1996	—	18-4231	18-3708-1	—	—
90 V-4 ④	1997-99	—	18-4228	18-3705	18-3742	18-3716
90 V-4 ② ④	1997	18-4223	18-4231	18-3708-1	—	—
90 FSX/ FPX ④	1998-99	18-4223	18-4231	18-3708-1	—	—
100	1979-80	18-4222	18-4228	18-3705	18-3742	18-3716
100 ⑨	1988-94	18-4222	18-4228	18-3705	18-3742	18-3716
100 ⑩	1992	—	18-4231	18-3708-1	—	—
100 Comm ④	1996, 1998	—	18-4228	18-3705	18-3742	18-3716
100 Comm	1995-97, 1999	18-4223	18-4231	18-3708-1	—	—
100 Comm ③	1984-90	18-4223	18-4231	18-3708-1	18-3741	18-3715
110	1986-89	18-4222	18-4228	18-3705	18-3742	18-3716
112	1996	—	18-4228	18-3705	18-3742	18-3716
115	1973-94	18-4222	18-4228	18-3705	18-3742	18-3716
115 ① ④	1996-99	—	18-4228	18-3705	18-3742	18-3716
115 ②	1996	—	18-4231	18-3708-1	—	—
115 V-4 ④	1997-99	—	18-4228	18-3705	18-3742	18-3716
115 V-4 ② ④	1997	18-4223	18-4231	18-3708-1	—	—
115 FSX/ FPX ④	1998-99	18-4223	18-4231	18-3708-1	—	—
120 ③	1985	18-4223	18-4231	18-3708-1	18-3741	18-3715

APPLICATION CONTINUED ON NEXT PAGE

- ① Models equipped with small gearcase
- ② Models equipped with large gearcase
- ③ Models equipped with V-6 gearcase
- ④ For 3-Blade propeller only
- ⑤ Use 18-4222 for 4-Blade propeller









- ⑥ All models except DR, DE & DT
- ⑦ Models DR, DE & DT only
- ⑧ Except models RSU, RSLU, RWENB, RWLENB
- ⑨ Except 1992 models WTLNE, WTXNENE
- ⑩ Models WTLNE, WTXNENE

- ① 1992 ES models only
- ② Except 1992 ESX models
- ③ 1992 TL models only
- ④ 1992 CX, TX models only

JOHNSON/EVINRUDE						
HP	Year	Spacer Before Prop	Washer After Prop	Prop Nut	Cotter Pin	Prop Nut Kit
120	1986-94	18-4222	18-4228	18-3705	18-3742	18-3716
125 ①	1971-94	18-4222	18-4228	18-3705	18-3742	18-3716
125 ②	1992	—	18-4231	18-3708-1	—	—
125 Comm	1991	—	18-4231	18-3708-1	18-3741	18-3715
125 Comm	1992-96	18-4223	18-4231	18-3708-1	—	—
130	1995-99	18-4223	18-4231	18-3708-1	—	—
135	1973-76	18-4222	18-4228	18-3705	18-3742	18-3716
140	1977-84	18-4222	18-4228	18-3705	18-3742	18-3716
140 ③	1985	18-4223	18-4231	18-3708-1	18-3741	18-3715
140 ④	1986-94	18-4222	18-4228	18-3705	18-3742	18-3716
140 ③	1990	18-4223	18-4231	18-3708-1	18-3741	18-3715
140 ④	1992	—	18-4231	18-3708-1	—	—
150	1978-90	18-4223	18-4231	18-3708-1	18-3741	18-3715
150	1991-95	—	18-4231	18-3708-1	18-3741	18-3715
150 ④	1996-99	18-4223	18-4231	18-3708-1	—	—
155 Comm	1984-90	18-4223	18-4231	18-3708-1	18-3741	18-3715
155 Comm	1991-95	—	18-4231	18-3708-1	18-3741	18-3715
175	1977-90	18-4223	18-4231	18-3708-1	18-3741	18-3715
175	1992	—	18-4231	18-3708-1	—	—
175 ④	1993-99	18-4223	18-4231	18-3708-1	—	—
185	1984-85	18-4223	18-4231	18-3708-1	18-3741	18-3715
185 Comm ④	1991-95	—	18-4231	18-3708-1	18-3741	18-3715
200	1976-90	18-4223	18-4231	18-3708-1	18-3741	18-3715
200/225 ④	1991-95	—	18-4231	18-3708-1	18-3741	18-3715
200/225 ④	1996-99	18-4223	18-4231	18-3708-1	—	—
225	1986-90	18-4223	18-4231	18-3708-1	18-3741	18-3715
235	1978-85	18-4223	18-4231	18-3708-1	18-3741	18-3715
250/300	1991	18-4223 ⑤	18-4231	18-3708-1	18-3741	18-3715
250/300	1992	—	18-4231	18-3708-1	—	—
250/300 ④	1993-95	18-4223	18-4231	18-3708-1	—	—
250	1996-99	18-4223	18-4231	18-3708-1	—	—
2.6L	1984-85	18-4223	18-4231	18-3708-1	18-3741	18-3715
275	1986	18-4223	18-4231	18-3708-1	18-3741	18-3715
3.6L	1986-90	18-4223	18-4231	18-3708-1	18-3741	18-3715

OMC SEA DRIVE						
V4	1982-90	18-4222	18-4228	18-3708-1	18-3742	18-3715
V6	1982-90	18-4223	18-4231	18-3708-1	18-3741	18-3715
V8	1987, 1989-90	18-4223	18-4231	—	—	—

- | | | |
|---------------------------------------|--|---------------------------|
| ① Models equipped with small gearcase | ⑥ All models except DR, DE & DT | ① 1992 ES models only |
| ② Models equipped with large gearcase | ⑦ Models DR, DE & DT only | ② Except 1992 ESX models |
| ③ Models equipped with V-6 gearcase | ⑧ Except models RSU, RSLU, RWENB, RWLENB | ③ 1992 TL models only |
| ④ For 3-Blade propeller only | ⑨ Except 1992 models WTLNE, WTXNENE | ④ 1992 CX, TX models only |
| ⑤ Use 18-4222 for 4-Blade propeller | ⑩ Models WTLNE, WTXNENE | |

 <p>18-8304 OIL SEAL Replaces: 321830</p>	 <p>18-0195 THRUST WASHER Reverse & Forward Gear Replaces: 314731 For: 45-60 HP - 2 Cyl, 3 Cyl, V-4 & V-6</p>	 <p>18-0197 THRUST WASHER Forward Gear Replaces: 333725 For: 40-55 HP - 1989-1995</p>	 <p>18-0198 THRUST WASHER Forward Gear Replaces: 324766 For: 3 Cyl, V-4 & V-6</p>
 <p>18-0200 THRUST WASHER Drive Shaft Replaces: 327656 For: V-4 & V-6</p>	 <p>18-0201 THRUST WASHER Drive Shaft Replaces: 333771 For: 40-60 HP - 1990-1995</p>	 <p>18-1117 PINION BEARING Replaces: 387817</p>	 <p>18-1154 BALL BEARING Replaces: 377139</p>



18-1158
CARRIER BEARING
 Replaces: 387247



18-1161
TAPERED ROLLER BEARING
 Replaces: 983891



18-1299
LOWER MAIN BEARING
 Replaces: 433503
 For: V4 & V6 60° engines



18-1344
NEEDLE BEARING
 Ref. # J-1812
 Fits: Driveshaft bearing cup 18-4807
 (OE# 439476)



18-1350
NEEDLE BEARING
 (CARRIER)
 Replaces: 379504



18-1351
NEEDLE BEARING
 (CARRIER)
 Replaces: 382407



18-1354
NEEDLE BEARING
 Replaces: 386764



18-1355
NEEDLE BEARING
 Replaces: 386765



18-1356
NEEDLE BEARING
 (PINION)
 Replaces: 382343



18-1357
NEEDLE BEARING
 (PINION)
 Replaces: 384195



18-1363
THRUST BEARING
 Replaces: 397537



18-1364
THRUST BEARING
 Replaces: 397538



18-1365
THRUST BEARING
 Replaces: 387656



18-1366
THRUST BEARING
 Replaces: 382408



18-1367
THRUST BEARING
 Replaces: 385068



18-1368
THRUST BEARING
 Replaces: 398901



18-1369
THRUST BEARING
 Replaces: 432264



18-1370
THRUST FORWARD
BEARING
 Replaces: 389042



18-1371
THRUST FORWARD
BEARING
 Replaces: 385043

HP	Year	Drive Shaft Bearing	Pinion Gear Bearing	Fore Carrier Bearing	Aft Carrier Bearing	Fwd. Gear Thrust Bearing	Rev Gear Thrust Bearing	Fore Propshaft Bearing	Aft. Propshaft Bearing
25D	1989-95	18-1368	18-1356	18-1354	18-1355	18-1364	18-1363	18-1369	18-1351
35	1987	—	—	18-1354	18-1355	—	—	—	—
40	1984-88	—	—	18-1354	18-1355	—	—	—	—
40	1989-Up	18-1368	18-1356	18-1354	18-1355	18-1364	18-1363	18-1369	18-1351
45 Comm	1985-Up	—	18-1367	18-1356	18-1351	18-1350	18-1371	18-1366	—
48	1987-88	—	—	18-1354	18-1355	—	—	—	—
48	1989-96	18-1368	18-1356	18-1354	18-1355	18-1364	18-1363	18-1369	18-1351
50	1973-74	18-1367	18-1356	18-1351	18-1350	18-1366	18-1366	—	—
50	1975	—	—	18-1354	18-1355	—	—	—	—
50	1979-88	—	—	18-1354	18-1355	—	—	—	—
50	1989-Up	18-1368	18-1356	18-1354	18-1355	18-1364	18-1363	18-1369	18-1351
50 ①	1995-Up	18-1367	18-1356	18-1351	18-1350	18-1371	18-1366	—	—
55	1976-81	—	—	18-1354	18-1355	—	—	—	—
55 ②	1980-82	18-1367	18-1356	18-1351	18-1350	18-1366	18-1366	—	—
55 Comm	1983-Up	—	18-1367	18-1356	18-1351	18-1350	18-1371	18-1366	—
60 ②	1980-81	18-1367	18-1356	18-1351	18-1350	18-1366	18-1366	—	—
60	1980-85	—	—	18-1354	18-1355	—	—	—	—
60 ③	1986-87	—	—	18-1354	18-1355	—	—	—	—
60 ④	1986-97	18-1367	18-1356	18-1351	18-1350	18-1371	18-1366	—	—
65	1973	18-1367	18-1356	18-1351	18-1350	18-1371	18-1366	—	—
65 Comm	1984-97	—	18-1367	18-1356	18-1351	18-1350	18-1371	18-1366	—
70 ④	1974-97	18-1367	18-1356	18-1351	18-1350	18-1371	18-1366	—	—
70 ③	1979-85	—	—	18-1354	18-1355	—	—	—	—
75 ④	1975-88	18-1367	18-1356	18-1351	18-1350	18-1371	18-1366	—	—
75 ③	1979-87	—	—	18-1354	18-1355	—	—	—	—
85	1973-80	18-1365	18-1357	18-1351	18-1350	18-1371	18-1366	—	—
85	1991-95	18-1365	18-1357	18-1351	18-1350	18-1371	18-1366	—	—
88	1987-96	18-1365	18-1357	18-1351	18-1350	18-1371	18-1366	—	—
90	1981-97	18-1365	18-1357	18-1351	18-1350	18-1371	18-1366	—	—
100	1979-80	18-1365	18-1357	18-1351	18-1350	18-1371	18-1366	—	—
100	1990-94	18-1365	18-1357	18-1351	18-1350	18-1371	18-1366	—	—
100 Comm	1984-90	—	18-1365	18-1117	18-1351	18-1158	18-1370	18-1366	—
100 Comm ⑧	1989-90	—	18-1365	18-1357	18-1351	18-1350	18-1371	18-1366	—
100 Comm	1991-93	—	18-1365	18-1117	18-1351	—	18-1370	18-1366	—
110	1986-89	18-1365	18-1357	18-1351	18-1350	18-1371	18-1366	—	—
112	1994-95	18-1365	18-1357	18-1351	18-1350	18-1371	18-1366	—	—
115	1973-85	18-1365	18-1357	18-1351	18-1350	18-1371	18-1366	—	—
115	1990-95	18-1365	18-1357	18-1351	18-1350	18-1371	18-1366	—	—
120	1985	18-1365	18-1117	18-1351	18-1158	18-1370	18-1366	—	—
120	1986-92	18-1365	18-1357	18-1351	18-1350	18-1371	18-1366	—	—
125 Comm ⑤	1989-90	—	18-1365	18-1117	18-1351	18-1158	18-1370	18-1366	—
125 Comm ⑥	1989-90	—	18-1365	18-1357	18-1351	18-1350	18-1371	18-1366	—
125 Comm	1991-94	—	18-1365	18-1117	18-1351	—	18-1370	18-1366	—
125	1992	18-1365	18-1357	18-1351	18-1350	18-1371	18-1366	—	—
135	1973-76	18-1365	18-1357	18-1351	18-1350	18-1371	18-1366	—	—
140	1977-84	18-1365	18-1357	18-1351	18-1350	18-1371	18-1366	—	—
140	1985	18-1365	18-1117	18-1351	18-1158	18-1370	18-1366	—	—
140	1986-92	18-1365	18-1357	18-1351	18-1350	18-1371	18-1366	—	—
140 TX	1988-90	18-1365	18-1117	18-1351	18-1158	18-1370	18-1366	—	—
140 TX	1991-92	18-1365	18-1117	18-1351	—	18-1370	18-1366	—	—
150	1978-90	18-1365	18-1117	18-1351	18-1158	18-1370	18-1366	—	—
150	1991-95	18-1365	18-1117	18-1351	—	18-1370	18-1366	—	—
150 Comm	1993-95	—	18-1365	18-1117	18-1351	—	18-1370	18-1366	—
155 Comm	1984-90	—	18-1365	—	18-1351	18-1158	—	18-1366	—
155 Comm ⑤	1989-90	18-1365	18-1117	18-1351	18-1158	18-1370	18-1366	—	—
155 Comm ⑦	1989-90	18-1365	18-1117	18-1351	18-1158	18-1370	18-1366	—	—
175	1977	18-1365	18-1117	18-1351	18-1158	—	18-1366	—	—
175	1978-90	18-1365	18-1117	18-1351	18-1158	18-1370	18-1366	—	—
175	1991-97	18-1365	18-1117	18-1351	—	18-1370	18-1366	—	—
185	1984-85	18-1365	18-1117	18-1351	18-1158	18-1370	18-1366	—	—
185	1990	18-1365	18-1117	18-1351	18-1158	18-1370	18-1366	—	—
185	1992-94	18-1365	18-1117	18-1351	—	18-1370	18-1366	—	—
200	1976-77	18-1365	18-1117	18-1351	18-1158	—	18-1366	—	—
200	1978-90	18-1365	18-1117	18-1351	18-1158	18-1370	18-1366	—	—
200	1991-97	18-1365	18-1117	18-1351	—	18-1370	18-1366	—	—
200 Comm	1990-91	—	18-1365	18-1117	18-1351	18-1158	18-1370	18-1366	—
225	1986-90	18-1365	18-1117	18-1351	18-1158	18-1370	18-1366	—	—
225	1991-97	18-1365	18-1117	18-1351	—	18-1370	18-1366	—	—
235	1978-85	18-1365	18-1117	18-1351	18-1158	18-1370	18-1366	—	—

① 3 Cyl. Models

② Rope Start Models

③ 15" Transom Models

④ 20" Transom Models

⑤ WTP Models

⑥ ESX Models

⑦ WTA Models Only

⑧ Models with "S" Prefix Only

OUTBOARD SHAFTS



18-1723
LOWER DRIVE SHAFT
 Replaces: 346004
 For: V4 60° includes: E100, E115, E75, E 90, J115 & J90



18-2277
LOWER DRIVE SHAFT
 Replaces: 335722



18-2279
LOWER DRIVE SHAFT
 Replaces: 335679



18-1722
DRIVE SHAFT
 Replaces: 438399
 For: 20" Models, 40-50HP (1997-99)



18-1721
DRIVE SHAFT
 Replaces: 433067
 For: 20" Models, 40-50(1989-92)

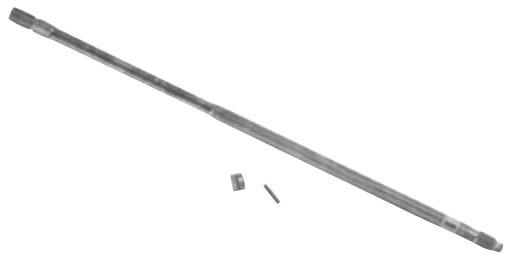

18-2325
UPPER DRIVE SHAFT ASSEMBLY
 Replaces: 435760



18-2326
UPPER DRIVE SHAFT ASSEMBLY
 Replaces: 436232



18-2327
UPPER DRIVE SHAFT ASSEMBLY
 Replaces: 436234



18-2328
UPPER DRIVE SHAFT ASSEMBLY
 Replaces: 435761



18-2330
UPPER DRIVE SHAFT ASSEMBLY
(Extra Long)
 Replaces: 436235



18-2093
SEAL
 Replaces: 319664, 333096, 398051
 For: 20 - 35 HP(1977-95) seal for prop-shaft 18-2026, driveshaft 18-2033, upper crankcase 18-8351

HP	Year	Lower Drive Shaft	Upper Drive Shaft	Upper Drive Shaft (Extra Long)	HP	Year	Lower Drive Shaft	Upper Drive Shaft	Upper Drive Shaft (Extra Long)
85 TTL	1991	18-2277	—	—	140 TX	1990-91	—	—	—
85 TTL	1992-95	18-2277	18-2326	—	140 TL	1991-94	18-2277	18-2326	—
88	1991	18-2277	—	—	140 TX	1992-94	—	—	—
88	1992-96	18-2277	18-2326	—	150	1990	—	—	—
90	1991	18-2277	—	—	150	1991	—	—	—
90	1992-97	18-2277	18-2326	—	150	1992-97	—	18-2327	18-2330
90 ① ②	1995-96	—	18-2327	—	150 Comm	1993-95	—	18-2327	18-2330
90 ② ③	1995-96	—	—	18-2330	155 Comm	1990	18-2279③	—	—
90 ②	1997	18-2277	18-2326	—	155 Comm ⑤	1990	—	—	—
100	1991	18-2277	—	—	155 Comm	1991	—	—	—
100	1992-94	18-2277	18-2326	—	155 Comm	1992	—	18-2326	—
100 Comm	1991	—	—	—	175	1990	—	—	—
100 Comm	1992-97	—	18-2326	—	175	1991	—	—	—
112	1994-96	18-2277	18-2326	—	175	1992-97	—	18-2327	18-2330
115	1991	18-2277	—	—	185	1990	—	—	—
115	1992-97	18-2277	18-2326	—	185	1991	—	—	—
115 ① ②	1995-96	—	18-2327	—	185	1992-94	—	18-2326	—
115 ② ③	1995-96	—	—	18-2330	200	1990	—	—	—
115 ②	1997	18-2277	18-2326	—	200	1991	—	—	—
120	1991-93	18-2277	—	—	200	1992-97	—	18-2326	—
120 ④	1993	—	—	—	200 Comm	1990	—	—	—
120 TL	1994	18-2277	18-2326	—	225	1990	—	—	—
120 TX	1994	—	—	—	225	1991	—	—	—
125 Comm	1991-95	—	18-2326	—	225	1992-97	—	18-2326	—
125	1992-93	18-2277	—	—	250	1991-95	18-2279	—	—
125 ④	1993	—	—	—	250	1997	18-2279	—	—
125	1994	18-2277	18-2326	—	300	1990	18-2279	—	—
130	1995-97	—	18-2326	—	300	1991-95	18-2279	—	—

① 20" Models ② 60 Degree V Models ③ 25" Models ④ F Suffix Only ⑤ WTP Models Only

18-1725
PROP SHAFT
Replaces: 436834
For: V4 60HP



18-2187
PROP SHAFT
Replaces: 395209, 391472



18-2250
PROP SHAFT
Replaces: 387879



18-2251
PROP SHAFT
Replaces: 435022, 433017, 436740



18-2252
PROP SHAFT
Replaces: 387818, 436888



18-2355
PROP SHAFT
Replaces: 386659
For: 35, 40, 48, 50, 55, 60, 70, 75 HP 2 & 3 cyl. outboards (1975-1987)



18-2288
PROP SHAFT
Replaces: 397541, 439138





18-1287
FORWARD GEAR & BUSHING

Replaces: 392475
For: 25-35HP (1975-88)



18-1291
GEAR SET

For: Commercial V4 gearcases
— CONTAINS —

Part #	Desc.	O.E.#
NSS	Forward Gear	435123
NSS	Reverse Gear	336574
18-2216	Clutch	337774



18-1292
GEAR SET

For: Late model V-6 150-225 H.P. with large reverse gear
— CONTAINS —

Part #	Desc.	O.E.#
NSS	Forward Gear	5004216
NSS	Reverse Gear	336561



18-1293
GEAR SET

For: 20HP (1984-98), 25HP(1985-02), 30HP (1984-02) 35HP (1984-01)
— CONTAINS —

Part #	Desc.	O.E.#
18-1287	Forward Gear	392475
18-1289	Reverse Gear	327655
18-1288	Pinion	328313
18-1290	Clutch	337020



18-1288
PINION GEAR

Replaces: 328313
For: 25-35HP (1984-96)



18-2208
REVERSE GEAR

Replaces: 318304



18-2216
SLIDING CLUTCH

Replaces: 337772, 337774, 334516, 336562, 910995



18-2217
GEAR SET

— CONTAINS —

Part #	Desc.	O.E.#
NSS	Forward Gear	435020
NSS	Reverse Gear	910994
18-2216	Sliding Clutch	337772



18-2218
FORWARD GEAR SET

Replaces: 434063, 989966, 985050, 436746
Includes: Forward & Pinion Gears



18-2219
REVERSE GEAR

Replaces: 333077, 317838, 340490



18-2220
SLIDING CLUTCH

Replaces: 323664, 320630



18-2221
GEAR SET

— CONTAINS —

Part #	Desc.	O.E.#
18-2218	Forward Gear	434063
18-2219	Reverse Gear	333077
18-2220	Sliding Clutch	323664



18-2287
CLUTCH DOG

Replaces: 319895



18-2308
SLIDING CLUTCH

Replaces: 332491



18-1289
REVERSE GEAR

Replaces: 327655
For: 25-35HP (1984-96)



18-2309
REVERSE GEAR
Replaces: 332489



18-1290
CLUTCH DOG
Replaces: 337020
For: 25-35HP (1992-98)



18-1500
INTAKE WATER SCREEN
Replaces: 337778
For: 100, 120, 125, 140, 150, 175, 200, 225 (1993)
(OMC Cobra & V-6)



18-1712
BEARING RETAINER
Replaces: 980014
For: 100, 120, 140, 165, 175, 190, 225, 235 (1968-77)



18-4807
DRIVESHAFT BEARING RETAINER CAP
Replaces: 439476
To replace bearing use **18-1344**



18-3766
SHIFT CRADLE
Replaces: 334163
For: V-4/V-6, Cobra, Stringer



18-71102
CONTROL BOX REPAIR KIT
For: OMC 397272 + 390610

PKG. OF 2



18-2243-9^①
DETENT BALL
Replaces: 316506
9.9 - 35 HP



18-3765
HOUSING PIN
Replaces: 331880
For: 18-3767 bearing housing



18-2398
RETAINING SPRING
Replaces: 320311
For: 2 & 3 CYL.



18-2399
RETAINING SPRING
Replaces: 324369
For: V-4 & V-6

ALL FORWARD GEARS INCLUDE PINION GEARS

HP	Year	Model	Prop Shaft	Gear Set	Fwd. Gear	Rev. Gear	Clutch
20	1985-95	ALL		18-1293	18-1287 ⑩	18-1289	18-1290
25	1985-95	ALL		18-1293	18-1287 ⑩	18-1289	18-1290
25D	1989-95	ALL	18-2288	N/A	N/A	18-2309	18-2308
30	1984-96	ALL		18-1293	18-1287 ⑩	18-1289	18-1290
35	1984-94	ALL ①		18-1293	18-1287 ⑩	18-1289	18-1290
35	1987	AE, AR, AT	—	—	—	—	18-2287
40	1984-88	ALL	—	—	—	—	18-2287
40	1989-97	ALL	18-2288	N/A	N/A	18-2309	18-2308
48	1987-88	ALL	—	—	—	—	18-2287
48	1989-96	ALL	18-2288	N/A	N/A	18-2309	18-2308
50	1975	ALL	—	—	—	—	18-2287
50	1979-88	ALL	—	—	—	—	18-2287
50	1989-97	2 Cyl.	18-2288	N/A	N/A	18-2309	18-2308
50	1997	3 Cyl.	18-2250	—	—	18-2208	—
55	1976-78	ALL	—	—	—	—	18-2287
60	1980-85	Electric Start	—	—	—	—	18-2287
60	1986-87	⑥	18-2250	—	—	18-2208	—
60 ⑧	1986-87	3 Cyl.	—	—	—	—	18-2287
60	1988-97	ALL	18-2250	—	—	18-2208	—
65	1984	ALL	18-2250	—	—	18-2208	—
65	1987	ALL	18-2250	—	—	18-2208	—
65	1990-91	ALL	18-2250	—	—	18-2208	—
65 COMM	1985-97	ALL	18-2250	—	—	18-2208	—
65 COMM Remote	1992-95	ALL	18-2250	—	—	18-2208	—
65 COMM Rope	1992-95	ALL	18-2250	—	—	18-2208	—
70	1975	①	N/A	—	—	18-2208	—
70	1976	ALL	N/A	—	—	18-2208	—
70	1977-85	⑥	18-2250	—	—	18-2208	—
70 ⑧	1979-85	ALL	—	—	—	—	18-2287
70	1986-97	ALL	18-2250	—	—	18-2208	—
70TTL	1992-95	ALL	18-2250	—	—	18-2208	—
75 ⑧	1975-87	ALL	—	—	—	—	18-2287
75	1976	⑥	N/A	—	—	18-2208	—
75	1977	⑥	18-2250	—	—	18-2208	—
75	1978-80	□	18-2250	—	—	18-2208	—
75	1982-87	⑥	18-2250	—	—	18-2208	—
75	2000-01	FPX & FX	18-2251	18-1291	—	—	18-2216
85	1973-77	ALL	—	—	—	18-2219	—
85	1978-80	ALL	18-2252	18-2221	18-2218	18-2219	18-2220
85	1991-95	ALL	18-2252	18-2221	18-2218	18-2219	18-2220
88	1987-96	ALL	18-2252	18-2221	18-2218	18-2219	18-2220
90	1981-98 ②	ALL	18-2252	18-2221	18-2218	18-2219	18-2220
90	1995-01	25" Transoms	18-2251	18-1291	—	—	18-2216
90	1999	ALL	18-1725	18-2221	18-2218	18-2219	18-2220
100	1979-80,90-95	ALL	18-2252	18-2221	18-2218	18-2219	18-2220
100 COMM	1984-90	ALL	18-2187	—	—	—	18-2216
100 COMM	1989-90,1998	③	18-2252	18-2221	18-2218	18-2219	18-2220
100 COMM	1993-01	ALL	18-2251	18-1291	—	—	18-2216
105 JET	1992	ALL	18-2251	18-2217	—	—	18-2216
105	1997-99	ALL	18-2251	18-1291	—	—	18-2216
105 COMM	2000-01	ALL	18-2251	18-1291	—	—	18-2216
110	1986-89	ALL	18-2252	18-2221	18-2218	18-2219	18-2220

① Models with "E" suffix only
 ② Models with " WTP" only
 ③ Models with "S" prefix only
 ④ Models "ESX" only
 ⑤ All models except "ESX"
 ⑥ 20" Transom only
 ⑦ All models except 140TX
 ⑧ 15" Models
 ⑨ 1993 Models "ESX" "F" suffix only
 ⑩ Except 1999 "FCX" Models
 ⑪ Except 1998 "FSX" Models
 ⑫ Models with "F" suffix only
 ⑬ Models with "S" suffix only
 ⑭ Fits new style reverse gear with 6 clutch ears only
 ⑮ Except AE, AR & AT models
 ⑯ Pinion 18-1288 sold separately

ALL FORWARD GEARS INCLUDE PINION GEARS

HP	Year	Model	Prop Shaft	Gear Set	Fwd. Gear	Rev. Gear	Clutch
112	1994-96	ALL	18-2252	18-2221	18-2218	18-2219	18-2220
115	1973-76	ALL	—	—	—	18-2219	—
115	1977	ALL	18-2252	—	—	18-2219	18-2220
115	1978-85, 1990-98	ALL	18-2252	18-2221	18-2218	18-2219	18-2220
115	1995-01	25" Transoms	18-2251	18-1291	—	—	18-2216
115	1999	20" 60 degree V4	18-2252	18-2221	18-2218	18-2219	18-2216
115	1999	25" 60 degree V4	18-2251	—	—	—	18-2216
120	1985	ALL	—	—	—	—	18-2216
120	1986-92	ALL	18-2252	18-2221	18-2218	18-2219	18-2220
120	1993-94	TL & TX ⑦	18-2252	18-2221	18-2218	18-2219	18-2220
120	1993-94	TX ⑥	18-2251	18-1291	—	—	18-2216
125 COMM	1989-90	④	18-2252	18-2221	18-2218	18-2219	18-2200
125 COMM	1989-90	⑤	18-2187	—	—	—	18-2216
125 COMM	1992-94, 1996	⑤	18-2251	—	—	—	18-2216
125	1991	②	18-2251	—	—	—	18-2216
125	1991-95	④ ⑨	18-2252	18-2221	18-2218	18-2219	18-2220
125	1993-95	⑥	18-2251	18-1291	—	—	18-2216
125	1996-98	ALL	18-2251	18-1291	—	—	18-2216
130	1995-01	TL & TX & 25"	18-2251	18-1291	—	—	18-2216
135	2001	ALL	18-2251	18-1291	—	—	18-2216
140	1977	ALL	18-2252	—	—	—	18-2220
140	1978-84, 1986-87	ALL	18-2252	18-2221	18-2218	18-2219	18-2220
140	1985	ALL	18-2187	—	—	—	18-2216
140	1988-94	⑦	18-2252	18-2221	18-2218	18-2219	18-2220
140	1988-90	TX	18-2187	—	—	—	18-2216
140	1993-94	TX ⑥	18-2251	18-1291	N/A	N/A	18-2216
150	1978-79	ALL	—	—	—	—	18-2216 □
150	1980-87	CHECK O.E.	18-2187	18-2217	—	—	18-2216
150	1988-89,90	ALL	18-2187	18-2217	—	—	18-2216
150	1991-99 ①	ALL	18-2251	N/A	—	—	18-2216
150	2004	ALL	18-2251	18-1292	N/A	N/A	18-2216
150 COMM	1993-96	ALL	18-2251	N/A	—	—	18-2216
155 COMM	1984-88	ALL	18-2187	—	—	—	18-2216
155 COMM WTP	1986-88	ALL	18-2187	—	—	—	18-2216
155 COMM							
WTL & WTX	1989-90	ALL	18-2187	—	—	—	18-2216
155 COMM	1989-90	②	18-2187	18-2217	—	—	18-2216
155 COMM	1991-92	ALL	18-2251	N/A	—	—	18-2216
175	1977	ALL	—	N/A	N/A	N/A	18-2220
175	1978-83	ALL	—	—	—	—	18-2216 □
175	1985-90	ALL	18-2187	18-2217	—	—	18-2216
175/185	1991-99 ①	ALL	18-2251	N/A	—	—	18-2216
185	1984-85	ALL	18-2187	18-2217	—	—	18-2216
200	1979-86	ALL	—	18-2217	—	—	18-2216
200	1988-90	ALL	18-2187	18-2217	—	—	18-2216
200	1991-99	ALL	18-2251	N/A	—	—	18-2216
200	2002-03	ALL	18-2251	18-1292	N/A	N/A	18-2216
220	1987	ALL	18-2187	18-2217	—	—	18-2216
225	1986-87	ALL	—	18-2217	—	—	18-2216
225	1988-89	ALL	18-2187	18-2217	—	—	18-2216
225	1991-99	ALL	18-2251	N/A	—	—	18-2216
225	2002-04	ALL	18-2251	18-1292	N/A	N/A	18-2216

② Models with "WTP" only
 ③ Models with "S" prefix only
 ④ Models "ESX" only
 ⑤ All models except "ESX"

⑥ 20" Transom only
 ⑦ All models except 140TX
 ⑧ 15" Models
 ⑨ 1993 Models "ESX" "F" suffix only

① Except 1999 "FCX" Models
 ② Except 1998 "FSX" Models
 ③ Models with "F" suffix only
 ④ Models with "S" suffix only

⑤ Fits new style reverse gear with 6 clutch ears only
 ⑥ Except AE, AR & AT models
 ⑦ Pinion 18-1288 sold separately

ALL FORWARD GEARS INCLUDE PINION GEARS

HP	Year	Model	Prop Shaft	Gear Set	Fwd. Gear	Rev. Gear	Clutch
235	1979-85	ALL	—	18-2217	—	—	18-2216
250	1991-99	ALL	18-2251	—	—	—	18-2216
250	2002-03	ALL	18-2251	18-1292	N/A	N/A	18-2216
275	1985-88	ALL	18-2251	—	—	—	18-2216
3.6L	1985-87	ALL	18-2251	—	—	—	18-2216
300	1988-95	ALL	18-2251	—	—	—	18-2216

- ① Models with "E" suffix only
- ② Models with "WTP" only
- ③ Models with "S" prefix only
- ④ Models "ESX" only
- ⑤ All models except "ESX"
- ⑥ 20" Transom only
- ⑦ All models except 140TX
- ⑧ 15" Models
- ⑨ 1993 Models "ESX" "F" suffix only
- ⑩ Except 1999 "FCX" Models
- ⑪ Except 1998 "FSX" Models
- ⑫ Models with "F" suffix only
- ⑬ Models with "S" suffix only
- ⑭ Fits new style reverse gear with 6 clutch ears only
- ⑮ Except AE, AR & AT models
- ⑯ Pinion 18-1288 sold separately

SEA DRIVE SHAFTS AND GEARS

HP	Year	Model	Prop Shaft	Gear Set	Fwd. Gear	Rev. Gear	Clutch
1.6	1990 ①	ALL	18-2252	18-2221	18-2218	18-2219	18-2220
2	1990 ②	ALL	18-2187	—	—	—	18-2216
2	1990 ①	ALL	18-2187	—	—	—	18-2216
3	1990 ①	ALL	18-2187	18-2217	—	—	18-2216
3	1990	ALL	18-2187	18-2217	—	—	18-2216
4	1990	ALL	18-2187	—	—	—	18-2216
1.6	1989	ALL	18-2252	18-2221	18-2218	18-2219	18-2220
2	1989	ALL	18-2187	—	—	—	18-2216
3	1989	ALL	18-2187	18-2217	—	—	18-2216
4	1989	ALL	18-2187	—	—	—	18-2216
1.6	1988	ALL	18-2252	18-2221	18-2218	18-2219	18-2220
2	1988	ALL	18-2187	—	—	—	18-2216
3	1988	ALL	18-2187	18-2217	—	—	18-2216
1.6	1987	ALL	18-2252	18-2221	18-2218	18-2219	18-2220
1.8	1987	ALL	18-2252	18-2221	18-2218	18-2219	18-2220
2.7	1987	ALL	18-2187	18-2217	—	—	18-2216
3.6	1987	ALL	18-2187	—	—	—	18-2216
1.6	1986	ALL	18-2252	18-2221	18-2218	18-2219	18-2220
2.6	1986	ALL	18-2187	18-2217	—	—	18-2216
1.6 V-4	1985 ③	ALL	18-2252	18-2221	18-2218	18-2219	18-2220
2.6 V-6	1985 ④	ALL	18-2187	—	—	—	18-2216
2.5/2.6	1985 ③	ALL	18-2187	—	—	—	18-2216
1.6 V-4	1984 ③	ALL	18-2252	18-2221	18-2218	18-2219	18-2220
2.6 V-6	1984 ④	ALL	18-2187	—	—	—	18-2216
2.5/2.6	1984 ③	ALL	18-2187	—	—	—	18-2216
1.6	1983	ALL	18-2252	18-2221	18-2218	18-2219	18-2220
2.6	1983	ALL	N/A	—	—	—	18-2216
2.5/2.6	1982	ALL	—	—	—	—	18-2216

- ① Models with "E" suffix only
- ② Models with "WTP" only
- ③ Models with "S" prefix only
- ④ Models "ESX" only



SHIMS

	Part #	Desc.	O.E. #	I.D.	Part #	Desc.	O.E. #	I.D.
	18-2224 ^③	.003 Shim	320166	1.58	18-2229 ^{① ③}	.003 Shim	323362	1.24
	18-2225 ^③	.004 Shim	320167	1.56	18-2230	.004 Shim	323361	1.24
	18-2226 ^③	.005 Shim	320168	1.53	18-2231	.005 Shim	314745	1.24
	18-2227 ^③	.006 Shim	320169	1.53	18-2232	.003 Shim	323889	1.22
	18-2228	.007 Shim	320170	1.53	18-2233	.004 Shim	323890	1.22
					18-2234 ^{① ③}	.005 Shim	317232	.22

HP	Year	0.003 Shim	0.004 Shim	0.005 Shim	0.006 Shim	0.007 Shim
60	1980-1987	18-2224	18-2225	18-2226	18-2227	18-2228
60	1988-95	18-2232	18-2233	18-2234	—	—
60SST	1989-1990	18-2224	18-2225	18-2226	18-2227	18-2228
60TTL	1992	18-2232	18-2233	18-2234	—	—
65C	1984-91,93-95	18-2232	18-2233	18-2234	—	—
65C	1992	18-2232	18-2233	18-2234	—	—
70	1975-76	18-2232	18-2233	18-2234	—	—
70	1977-85	18-2224	18-2225	18-2226	18-2227	18-2228
70	1986-95	18-2232	18-2233	18-2234	—	—
70TTL	1992	18-2232	18-2233	18-2234	—	—
75	1975-1988	18-2224	18-2225	18-2226	18-2227	18-2228
85	1975-79	18-2229	18-2230	18-2231	—	—
85	1980,91	18-2229	18-2230	18-2231	—	—
85TTL	1992-95	18-2229	18-2230	18-2231	—	—
88	1987-95	18-2229	18-2230	18-2231	—	—
90	1981-95	18-2229	18-2230	18-2231	—	—

① STD PKG OF 2 ② Includes 1 each of 18-2229, 18-2230 & 18-2231
 ③ This product is priced per piece. To order priced per package, please add -9 to the part number
APPLICATION CONTINUED ON NEXT PAGE

HP	Year	0.003 Shim	0.004 Shim	0.005 Shim	0.006 Shim	0.007 Shim
100	1979	18-2229	18-2230	18-2231	—	—
100	1980,90-95	18-2229	18-2230	18-2231	—	—
100C	1984-87,89-95	18-2229	18-2230	18-2231	—	—
100PLY	1989	18-2229	18-2230	18-2231	—	—
105JET	1992-93	18-2229	18-2230	18-2231	—	—
110	1986-89	18-2229	18-2230	18-2231	—	—
115	1980-85,90-95	18-2229	18-2230	18-2231	—	—
115	1975-79	18-2229	18-2230	18-2231	—	—
120	1985-95	18-2229	18-2230	18-2231	—	—
125, 125C	1989-95	18-2229	18-2230	18-2231	—	—
125ESX	1989-90	18-2229	18-2230	18-2231	—	—
125WTPL	1990	18-2229	18-2230	18-2231	—	—
135	1975-76	18-2229	18-2230	18-2231	—	—
140	1977-79	18-2229	18-2230	18-2231	—	—
140	1980-95	18-2229	18-2230	18-2231	—	—
150	1979-95	18-2229	18-2230	18-2231	—	—
150C	1986-91,95	18-2229	18-2230	18-2231	—	—
155C	1984-87,89-95	18-2229	18-2230	18-2231	—	—
175	1977	18-2229	18-2230	18-2231	—	—
175	1978-88,90-95	18-2229	18-2230	18-2231	—	—
185	1984-85,90-95	18-2229	18-2230	18-2231	—	—
200	1976-77	18-2229	18-2230	18-2231	—	—
200	1978-83,86-95	18-2229	18-2230	18-2231	—	—
200C	1990	18-2229	18-2230	18-2231	—	—
225	1986-93	18-2229	18-2230	18-2231	—	—
235	1978-85	18-2229	18-2230	18-2231	—	—
1600cc	1988	18-2229	18-2230	18-2231	—	—
2500cc	1988	18-2229	18-2230	18-2231	—	—

① STD PKG OF 2 ② Includes 1 each of 18-2229, 18-2230 & 18-2231
 ③ This product is priced per piece. To order priced per package, please add -9 to the part number

Zinc is for saltwater only applications.
Magnesium is for fresh water only applications.
Aluminum is for brackish water, or if boat is used in both fresh and salt environments.

 <p>③ 18-6115 ANODE TRANSOM BRACKET Replaces: 433580 For: 60-225 (1991-93) For use on Stern Bracket</p>	 <p>③ 18-6017 ① 18-6017A ② 18-6100 ANODE Replaces: 173029, 123009 (1981-91) 9.9-115 HP For use on gearcase and transom bracket assembly</p>	 <p>18-6018 ANODE Replaces: 327606 1983-89 2HP, For Motor Leg</p>
 <p>③ 18-6024 ① 18-6024A ANODE Replaces: 393023, 436745 (1982-87) 60-300 HP For use on gearcases</p>	 <p>③ 18-6025 ANODE Replaces: 433458, 398331 (1987-92) 60-300HP For use on Stern Bracket</p>	 <p>② 18-6026 ANODE Replaces: 392462 For exhaust housing, 2 & 3 Cyl. (1984-99)</p>
 <p>③ 18-6095 ① 18-6095A ANODE Replaces: 431708 (1988-90) 45-300 HP For use on Prop Shaft Bearing Carrier</p>	 <p>③ 18-6020 ANODE Replaces: 976669 (1969-89) Kit for V4 & V6</p>	 <p>③ 18-6027 ANODE Replaces: 392123 (1982-98) 40-300 HP Front Lower Leg Extension</p>

① Aluminum ② Magnesium ③ Zinc

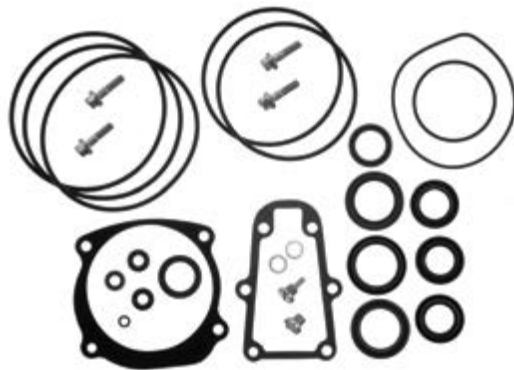

18-2623
LOWER UNIT SEAL KIT
Replaces: 439141

-- CONTAINS --

Part #	Desc.	O.E. #	Qty.
18-0110	Shift Housing Gasket	314082	1
18-2001	Seal	330137	2
18-2002	Seal	320862	2
18-2026	Seal	321453	2
18-2061	Seal	329922	1
18-2062	Seal	329923	1
18-2377	Screw	316563	4
18-2378	Magnetic Drain Screw	318544	1
18-2536	O-Ring	315788	1
18-2557	Impeller Gasket	338484	1
18-4248	Washer	311598	2
18-7109	O-Ring	317178	1
18-7120	O-Ring	307853	1
18-7127	O-Ring	313446	1
18-7130	O-Ring	314728	1
18-7133	O-Ring	305123	2
18-7137	O-Ring	318372	2
18-7142	O-Ring	322119	1
18-7144	O-Ring	333572	3
18-7145	O-Ring	332584	1
18-7475	Washer	328743	4
18-8300	Seal	341280	1
18-8301	Seal	341281	1



18-2656
LOWER UNIT SEAL KIT
Replaces: 396350

-- CONTAINS --

Part #	Desc.	O.E. #	Qty.
18-2025	Oil Seal	318971	1
18-2028	Oil Seal	321480	2
18-2029	Oil Seal	321481	2
18-4248	Washer	311598	2
18-7100	O-Ring	301877	1
18-7104	O-Ring	308627	1
18-7120	O-Ring	307853, 322598	1
18-7139	O-Ring	319085	1
18-7145	O-Ring	333572	2

18-2658
LOWER UNIT SEAL KIT
 Replaces: 396351



— CONTAINS —

Part #	Desc.	O.E. #	Qty.
18-0124	Impeller Plate Gasket	325537	1
18-2026	Oil Seal	321453	2
18-2033	Oil Seal	321928	1
18-2065	Oil Seal	332261	1
18-2539	Rubber Seal	328753	1
18-4248	Washer	311598	2
18-7100	O-Ring	301877	1
18-7105	O-Ring	311338	2
18-7108	O-Ring	313893	1
18-7109	O-Ring	317178	3
18-7145	O-Ring	333572	2
18-7146	O-Ring	554545	1
18-7180	O-Ring	303347	1
18-2030	Oil Seal	321786	1
NSS	Oil Seal	321459	1

18-2659
LOWER UNIT SEAL KIT
 Replaces: 396355



— CONTAINS —

Part #	Desc.	O.E. #	Qty.
18-0969	Impeller Housing Gasket	319586	1
18-2059	Oil Seal	321466	1
18-2060	Oil Seal	321467	2
18-2064	Oil Seal	332205	1
18-2532	Foam Seal	305762	1
18-2537	Rubber Seal	324937	1
18-2855	Shift Housing Cover to Gear Case Gasket	314082	1
18-4248	Washer	311598	2
18-7115	O-Ring	302588	1
18-7120	O-Ring	307853	1
18-7137	O-Ring	318372	1
18-7140	O-Ring	320303	1
18-7145	O-Ring	333572	2
18-7475	Quad Ring	332584	3

18-2660
LOWER UNIT SEAL KIT
 Replaces: 396349

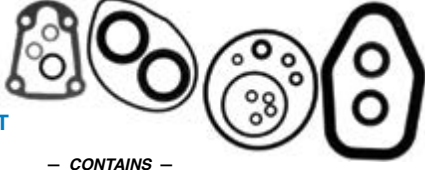

— CONTAINS —

Part #	Desc.	O.E. #	Qty.
18-2059	Oil Seal	321466	1
18-2064	Oil Seal	332205	1
18-2537	Rubber Seal	324937	1
18-2855	Shift Housing Cover to Gearcase Gasket	314082	1
18-4248	Washer	311598	2
18-7120	O-Ring	307853	1
18-7127	O-Ring	313446	1
18-7128	O-Ring	313754	1
18-7137	O-Ring	318372	1
18-7145	O-Ring	333572	2
18-7475	Quad Ring	332584	4
18-7174	O-Ring	910582, 326649	1
18-2001	Oil Seal	330137	2

18-2679
LOWER UNIT SEAL KIT



— CONTAINS —

Part #	Desc.	O.E. #	Qty.
18-2022	Oil Seal	303345	1
18-2035	Oil Seal	327031	1
18-2891	Bearing Housing Gasket	303339	1
18-4248	Washer	311598	2
18-7100	O-Ring	301877	1
18-7117	O-Ring	303360	1
18-7120	O-Ring	307853	1
18-2534	Spaghetti Seal	309044	1

18-2680
LOWER UNIT SEAL KIT



— CONTAINS —

Part #	Desc.	O.E. #	Qty.
18-2023	Oil Seal	313282	1
18-2035	Oil Seal	327031	1
18-2891	Bearing Housing Gasket	303339	1
18-4248	Washer	311598	2
18-7100	O-Ring	301877	1
18-7117	O-Ring	303360	1
18-7120	O-Ring	307853	1
18-2534	Spaghetti Seal	309044	1

18-2681
LOWER UNIT SEAL KIT



— CONTAINS —

Part #	Desc.	O.E. #	Qty.
18-2023	Oil Seal	313282	1
18-2024	Oil Seal	314167	1
18-2891	Bearing Housing Gasket	303339	1
18-4248	Washer	311598	2
18-7100	O-Ring	301877	1
18-7117	O-Ring	303360	1
18-7120	O-Ring	307853	1
18-2534	Spaghetti Seal	309044	1

18-2682
LOWER UNIT SEAL KIT

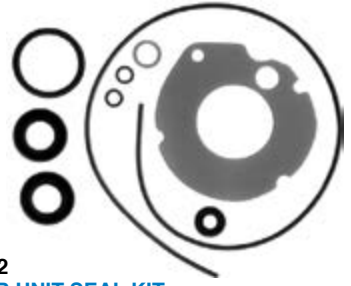

— CONTAINS —

Part #	Desc.	O.E. #	Qty.
18-2022	Oil Seal	303345	2
18-2891	Bearing Housing Gasket	303339	1
18-4248	Washer	311598	2
18-7100	O-Ring	301877	1
18-7117	O-Ring	303360	1
18-7120	O-Ring	307853	1
18-2534	Spaghetti Seal	309044	1

18-2683
LOWER UNIT SEAL KIT



— CONTAINS —

Part #	Desc.	O.E. #	Qty.
18-2023	Oil Seal	313282	2
18-2891	Bearing Housing Gasket	303339	1
18-4248	Washer	311598	2
18-7100	O-Ring	301877	1
18-7117	O-Ring	303360	1
18-7120	O-Ring	307853	1
18-2534	Spaghetti Seal	309044	1

18-2684
LOWER UNIT SEAL KIT



— CONTAINS —

Part #	Desc.	O.E. #	Qty.
18-0882	Shift Rod Gasket	304764	1
18-2032	Oil Seal	321788	1
18-4248	Washer	311598	2
18-7100	O-Ring	301877	1
18-7120	O-Ring	307853	1
18-2031	Oil Seal	321787	1
18-2534	Spaghetti Seal	309044	1

18-2685
LOWER UNIT SEAL KIT



— CONTAINS —

Part #	Desc.	O.E. #	Qty.
18-2030	Oil Seal	321786	3
18-2031	Oil Seal	321787	1
18-4248	Washer	311598	2
18-7100	O-Ring	301877	1
18-7112	O-Ring	302493	1
18-7120	O-Ring	307853	1
18-2534	Spaghetti Seal	309044	1
18-0882	Shift Rod Gasket	304764	1



18-2686
LOWER UNIT SEAL KIT

— CONTAINS —

Part #	Desc.	O.E. #	Qty.
18-0882	Shift Rod Gasket	304764	1
18-2005	Oil Seal	313284	1
18-2021	Oil Seal	302564	1
18-4248	Washer	311598	2
18-7100	O-Ring	301877	1
18-7115	O-Ring	302588	1
18-7120	O-Ring	307853, 322598	1

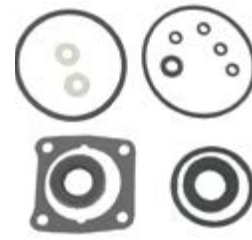

18-2689
LOWER UNIT SEAL KIT

— CONTAINS —

Part #	Desc.	O.E. #	Qty.
18-0173	Oil Seal	313283	1
18-0174	Oil Seal	326716	1
18-0886	Lower Gearcase Gasket	307099	1
18-4248	Washer	311598	2
18-7115	O-Ring	302588	1
18-7118	O-Ring	305242	1
18-7120	O-Ring	307853, 322598	4
18-7152	O-Ring	307082	1
18-7428	O-Ring	307103	1

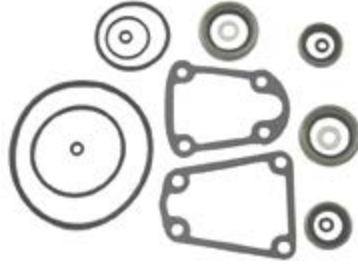

18-2690
LOWER UNIT SEAL KIT

— CONTAINS —

Part #	Desc.	O.E. #	Qty.
18-2855	Shift Housing Cover to Gearcase Gasket	314082	1
18-2874	Solenoid Cover Gasket	314876	1
18-4248	Washer	311598	2
18-7120	O-Ring	307853, 322598	4
18-7127	O-Ring	313446	1
18-7129	O-Ring	314491	1
18-7130	O-Ring	314728	1
18-7126	O-Ring	313340	1



18-2691
LOWER UNIT SEAL KIT

— CONTAINS —

Part #	Desc.	O.E. #	Qty.
18-2874	Solenoid Cover Gasket	314876	1
18-4248	Washer	311598	2
18-7109	O-Ring	317178	4
18-7127	O-Ring	313446	1
18-2001	Oil Seal	330137	2
18-7130	O-Ring	314728	1
18-2059	Oil Seal	321466	2



18-2692
LOWER UNIT SEAL KIT

— CONTAINS —

Part #	Desc.	O.E. #	Qty.
18-0110	Shift Housing Gasket	324670	1
18-2026	Oil Seal	321453	2
18-2874	Solenoid Cover Gasket	314876	1
18-4248	Washer	311598	2
18-7109	O-Ring	317178	4
18-7120	O-Ring	322598	1
18-7127	O-Ring	313446	1
18-7130	O-Ring	314728	1
18-7137	O-Ring	318372	1
18-2001	Oil Seal	330137	2



18-2694
LOWER UNIT SEAL KIT
Replaces: 433550

— CONTAINS —

Part #	Desc.	O.E. #	Qty.	Part #	Desc.	O.E. #	Qty.
18-2709	Wear Plate Gasket	336530	1	18-7481	Seal	315788	1
18-7115	O-Ring	302588	1	18-2708	Seal	333758	1
18-7127	O-Ring	313446	1	18-2059	Oil Seal	321466	2
18-7120	O-Ring	307853, 322598	1	18-2018	Oil Seal	0767970	2
18-7172	O-Ring	553126	1	18-2064	Oil Seal	332205	1
18-7137	O-Ring	318372	1	18-2705-9	Seal	315748	1
18-7475	O-Ring	332584	1	18-4248	Washer	311598	1
				18-7173	O-Ring	310327, 910582	1



18-8337
LOWER UNIT SEAL KIT

Replaces: 5031456

For: 40/50 HP 4 stroke (1999-2003)

— CONTAINS —

Part #	Desc.	O.E. #	Qty.
18-0461	Water Pump Gasket	—	1
18-7151	O-Ring	—	1
18-7413	O-Ring	303191	2
18-8331	Drain Plug Gasket	—	3
18-8334	Shift Shaft Seal	—	1
18-8345	Seal	—	2



18-8387
LOWER UNIT SEAL KIT

Replaces: 5007987

For: E-Tec 15, 25, 30 (2010 & Up)



18-8383

SEAL KIT

Replaces: 5000309

For: E-Tec 40, 50, 60 HP

18-8384

SEAL KIT

Replaces: E-Tec 5006373

For: E-Tec 75/90/115/150/175/200/225/250 HP

GEAR HOUSING SEAL KITS APPLICATION

Model	Year	Seal Kit	Model	Year	Seal Kit		
5.5	⑧	1955-67	18-2679	85	1991-95	18-2623	
6	⑧	1955-67	18-2679	88	1985-Up	18-2623	
6	⑨	1967-68	18-2680	90 (Elect.)	1964-65	18-2689	
6	⑩	1968-79	18-2681	90 (V-4)	1973-83	18-2692	
7.5	⑧	1955-67	18-2679	90	1985-Up	18-2623	
9.5 (M Suffix)		1964-67	18-2682	100 (Large Prop Shaft)	1971-72	18-2691	
9.5 (B Suffix)		1967-73	18-2683	100 (V-4)	1973-83	18-2692	
9.9/15		1974-Up	18-2656	100 (Comm)	1984-90	18-2623	
9.9/15 (4 Stroke)		1974-Up	18-2656	100 (Comm)	1991-95	18-2623	
10		1958-67	18-2682	100	③	1991-92	18-2623
18		1958-73	18-2684	110 (V-4)	1973-83	18-2692	
20		1966-73	18-2684	110	1985-89	18-2623	
20		1979-82	18-2684	115 (Small Prop Shaft)	1969-71	18-2690	
20		1985-Up	18-2658	115 (V-4)	1973-83	18-2692	
25		1955-59	18-2686	115	1985-Up	18-2623	
25		1968-78	18-2684	120	1985	18-2623	
25		1979-82	18-2685	120	1986-92	18-2623	
25		1984	-	120	1993	18-2623	
25		1985-Up	18-2658	125 (Large Prop Shaft)	1971-72	18-2691	
25	①	1990-95	18-2694	125	④	1991-92	18-2623
25 (Comm)		1985-Up	-	125		1993	18-2623
28		1962-70	18-2686	125 (Comm)	1991-93	18-2623	
28		1985-98	-	135 (V-4)	1973-83	18-2692	
30		1955-59	18-2686	140 (V-4)	1973-83	18-2692	
30		1976-95	18-2658	140	1985	18-2623	
33		1962-70	18-2686	140	⑤	1986-92	18-2623
35		1955-59	18-2686	140	⑥	1992-93	18-2623
35		1977-92	18-2658	140	①	1992-95	18-2623
40 (Manual Shift)		1960-73	18-2686	150 (V-6)		1978-86	18-2623
40 (Elect. Shift)		1962-70	-	150	⑦	1991	18-2623
40		1976-88	18-2659	150		1991-95	18-2623
40		1989-Up	18-2694	155 (Comm)		1984-90	18-2623
48		1976-88	18-2659	155 (Comm)		1991-93	18-2623
48		1989-96	18-2694	175 (V-6)		1977-86	18-2623
50		1971-74	-	175	②	1991	18-2623
50		1976-88	18-2659	175	⑦	1992	18-2623
50		1989-Up	18-2694	175		1991-95	18-2623
50 (3 cyl.)		1995-Up	18-2660	185		1991-93	18-2623
55		1968-69	18-2690	200 (V-6)		1976-86	18-2623
55		1976-88	18-2659	200		1991-95	18-2623
60 (Manual/Elect.)		1960-68	18-2689	225		1991-95	18-2623
60		1970-71	18-2690	235 (V-6)		1977-86	18-2623
60 (2 cyl.)		1976-88	18-2659	V-8	⑦	1985-91	18-2623
60 (3 cyl.)		1978-Up	18-2660	250 (V-8)		1991-95	18-2623
65 (Manual/Elect.)		1960-68	18-2689	300 (V-8)		1991-95	18-2623
65		1978-Up	18-2660				
70		1978-Up	18-2660				
75 (Manual/Elect.)		1960-68	18-2689	OMC SEA DRIVE			
75		1978-91	18-2660	1.6L		1985-90	18-2623
75 (Small Gearcase)		1976-88	18-2659	1.8L		1987	18-2623
V-4		1978-84	18-2623	2.0L		1988-90	18-2623
85 (Manual/Elect.)		1968	18-2689	2.5L		1984-85	18-2623
85 (Small Prop Shaft)		1969-71	18-2690	2.6L		1984-86	18-2623
85 (Large Prop Shaft)		1971-72	18-2691	2.7L		1987	18-2623
85 (V-4)		1973-83	18-2692	3.0L		1988-90	18-2623
				3.6L		1987	18-2623
				4.0L		1989-90	18-2623

- ① "D" Suffix Only
- ② Models "GL" & "EX" only
- ③ 1992 Models except WTLNE, WTXENE
- ④ 1992 ESX Models only

- ⑤ 1992 TL Models only
- ⑥ CX Models only
- ⑦ 1992 Counter Rotation
- ⑧ 1967 "D" Suffix Only

- ⑨ 1967 "S" Suffix Only
1968 "C" Suffix Only
- ⑩ 1968 "A" & "R" Suffixes Only
- TX & Counter Rotation Models



18-2595
SHIFT ROD & WEAR PLATE GASKET SET
 Replaces: 982132

18-2595 SHIFT ROD & WEAR PLATE GASKET SET APPLICATION					
HP	YEARS	HP	YEARS	HP	YEARS
85	1978-80	125	1989-90	235	1978-85
88	1987-90	140	1977-90	275	1985-90
90	1981-90	150	1978-90	3.6L	1985-90
100	1979-90	155C	1984-90	300	1985-90
100C	1984-89	175	1977-90		
110	1986-89	185	1984-90		
115	1978-90	200	1976-90		
120	1985-90	225	1986-90		

OIL SEALS



Part #	O.E. #	Shaft Size	Dimensions (in)		Part #	O.E. #	Shaft Size	Dimensions (in)	
			O.D.	Width				O.D.	Width
18-0173	313283	0.795	1.320	0.307	18-2062	329923	0.875	1.375	0.207
18-0174	326716	0.750	1.382	0.242	18-2063	330327	0.625	1.124	0.188
18-0543	321895,	1.540	1.926	0.243	18-2064	332205	0.730	1.130	0.194
	313507				18-2065	332261	0.625	1.375	0.195
18-0559	332585	0.285	0.357	0.940	18-2066	911019	1.000	1.375	0.435
18-2000	309989	1.375	2.000	0.313	18-2067	911685	2.000	2.509	0.315
18-2001	330137	1.125	1.624	0.250	18-2068	911701	0.500	0.905	0.250
18-2002	320862	1.188	1.692	0.250	18-2068	915702	0.500	0.905	0.250
18-2005	313284	0.625	1.128	0.250	18-2068	916058	0.500	0.905	0.250
18-2012	310599	1.000	1.499	0.250	18-2068	3853655	.500	.905	.250
18-2016	313992	1.187	1.875	0.250	18-2071	981195	1.500	2.125	0.250
18-2018	305987	1.000	1.375	0.250	18-2072	981196	1.750	2.502	0.250
18-2020	310649	2.500	3.000	0.250	18-2073	981268	1.625	2.502	0.250
18-2021	313258	0.750	1.375	0.250	18-2074	318451, 339620	1.625	2.125	0.250
18-2022	303345	0.554	1.000	0.375	18-2075	353076, 326751	1.562	2.062	0.300
18-2023	313282	0.554	1.062	0.312	18-8300	341280	0.866	1.378	0.280
18-2024	314167	0.425	0.937	0.312	18-8301	341281	1.220	1.693	0.280
18-2025	318972	0.500	0.875	0.250	18-8304	321830	20.37mm	31.8mm	6.35mm
18-2026	317843, 321453	0.875	1.250	0.188	18-8307	331103	1.100	1.628	0.448
18-2028	318973	0.500	1.250	0.188	18-8325	342786	28mm	41.5mm	7/11
18-2029	319256, 321481	0.687	1.250	0.250	18-8326	342787	18mm	29mm	8/12
18-2030	321786	0.625	1.125	0.188		911795			
18-2031	321787	0.625	1.125	0.312	18-8349	3852548	1.375	2.186	0.500
18-2032	321788	0.500	1.000	0.188	18-8351	321504, 308500	1.110	1.570	0.320
18-2033	321928	0.625	1.375	0.250	18-8367	334950	1.250	1.687	0.250
18-2034	324639	0.437	0.937	0.188					
18-2035	300599, 327031	0.425	0.875	0.313					
18-2058	313353	1.938	2.438	0.250					
18-2059	318223, 321466	0.750	1.126	0.200					
18-2060	303804, 321467	1.000	1.375	0.250					
18-2061	329922	0.822	1.375	0.195					

OIL SEAL APPLICATION

HP	YEARS	PROPSHAFT	QTY.	DRIVESHAFT	QTY.	UPPER CRANKCASE	QTY.	LOWER CRANKCASE	QTY.
1.5,2,2.5,3	1958-68	-	1	18-2035	1	-	-	-	-
1.5,2	1968-90	18-2035	1	18-2035	1	-	-	-	-
2.5,4	② 1973-80	18-2035	1	18-2035	2	-	-	-	-
2.5	1987	18-2034	2	18-2035	2	-	-	-	-
2.5,4	② 1981-95	-	1	18-2035	2	-	-	-	-
3 Weedless	1958-68	18-2035	1	-	-	-	-	-	-
3,4,6 Weedless	1968-82	18-2024	1	18-2024	1	-	-	-	-
4	1981-90	18-2034	2	-	-	-	-	-	-
4	1984, 1986-95	-	-	18-2034	2	-	-	-	-
4.5,7.5	1980-87	-	1	18-2034	2	-	-	-	-
5,5.5,6,7.5	① 1957-64	18-2022	1	18-2035	1	-	-	-	-
5,6,8	1980-87	-	-	18-2034	2	-	-	-	-
6	1965-67	-	1	18-2023	1	-	-	-	-
6	1968-79	18-2023	1	18-2024	1	-	-	-	-
9.5	1964-73	18-2022	1	18-2022	1	-	-	-	-
9.9	1974-83	18-2029	1	18-2028	1	18-8304	-	-	1
9.9	1984-95	18-2029	1	18-2028	1	18-8304	-	18-2032	1
10	1957-58	18-2005	1	18-2032	1	-	-	-	-
10	1959-63	18-2022	1	18-2022	1	-	-	-	-

① 1968 Models 5802M,3M,6802C,3C

② Standard Gearcase

OIL SEAL APPLICATION (Cont.)

HP	YEARS	PROPSHAFT	QTY.	DRIVESHAFT	QTY.	UPPER CRANKCASE	QTY.	LOWER CRANKCASE	QTY.
10	1981	18-2023 (inner)	1	-	-	18-8304	-	-	1
10	1989	18-2031+18-2027	1	18-2063+18-2027	1	18-8304	-	18-2032	1
14	1988-90	18-2031+18-2027	1	18-2063+18-2027	1	18-8304	-	18-2032	1
15	1974-83	18-2029	2	18-2028	1	18-8304	-	-	1
15	1984-95	18-2029	2	18-2028	1	18-8304	-	18-2032	1
18	1957	18-2005	1	18-2032	1	18-2060	1	-	-
18	1958-73	18-2005	1	18-2032	1	18-2018	1	-	-
20	1981-82	18-2031+18-2030	1	18-2030	1	18-8351	-	-	-
20	1983	18-2031+18-2030	1	18-2027+18-2030	1	18-8351	-	-	-
20	1984	18-2025+18-2027	1	18-2063+18-2030	1	18-8351	-	-	-
20	1985-86	18-2026	1	18-2033	1	-	-	-	-
20	1987-95	18-2026	1	18-2033+18-2065	1	-	-	-	-
25	1969-76	18-2005	1	18-2032	1	18-2018	1	-	-
25	1977-78	18-2005	1	18-2032	1	18-8351	-	-	-
25	1979-82	18-2031+18-2030	1	18-2030	1	18-8351	-	-	-
25	1983	18-2031+18-2030	1	18-2027+18-2030	1	18-8351	-	-	-
25	1984	18-2031+18-2027	1	18-2063+18-2030	1	18-8351	-	-	-
25	1985-86	18-2026	1	18-2033	2	18-8351	-	-	-
25	1987-95	18-2026	1	18-2033+18-2065	1	18-8351	-	-	-
25C	1982	18-2030	1	18-2030	1	18-8351	-	-	-
25C	1983	18-2031+18-2027	1	18-2027+18-2030	1	-	-	-	-
25C	1984-90	18-2031+18-2027	1	18-2063+18-2027	1	-	-	-	-
28	1962-64	18-2021	1	18-2005	1	18-8351	-	-	-
28	1987-90	18-2031+18-2027	1	18-2063+18-2027	1	-	-	-	-
30	1984-86	18-2026	1	18-2033	1	-	-	-	-
30	1987-95	18-2026	1	18-2033 (Inner)	1	-	-	-	-
33	1965-76	18-2021	1	18-2005	1	18-8351	-	-	-
35	1957-59	18-2021	1	18-2005	1	18-2018	1	-	-
35	1976	18-2026	1	18-2027	2	18-8351	-	-	-
35	1977-86	18-2026	2	18-2033	2	18-8351	-	18-2093	-
35	1987-90	18-2026	2	18-2033 (Inner)	1	-	-	18-2093	-
40	1960-61	18-2021	1	18-2005	1	18-2018	1	-	-
40	1962-73	18-2021	1	18-2005	1	18-8351	-	-	-
40	1974-76	18-2021	1	18-2029	1	18-0543	1	18-2001	1
40C	1981-86	18-2021	1	18-2029	2	18-0543	1	18-2001	2
40	1984-85	18-2060	2	18-2059	2	18-0543	1	18-2001	1
40 (AR,AE,AT)	1988	18-2001	1	18-2063+18-2027	1	18-0543	1	18-8307	-
40	1986-89	18-2060	2	18-2064+18-2059	1	18-0543	1	18-8307	-
45C	1985	18-2001	2	18-2063+18-2027	1	18-0543	1	18-8307	-
45C	1986	18-2001	2	18-2064+18-2059	1	18-0543	1	18-8307	-
45C	1987	18-2001	2	18-2063+18-2027	1	18-0543	1	18-8307	-
45C	1988-94	18-2001	2	18-2063+18-2027	1	18-0543	1	18-2001	-
45C	1995	18-2001	2	18-2064+18-2059	1	18-0543	1	-	-
48	1988-95	18-2060	2	18-2064+18-2059	1	18-0543	1	18-2063 (Inner)	1
50	1971-74	18-2001 (Manual)	2	18-2027	2	18-0543	1	18-2001	1
50	1975	18-2060	2	18-2059	1	18-0543	1	18-2001	1
50	1979	18-2001	2	18-2027	2	18-0543	1	18-2001	1
50	1980	18-2060	2	18-2059	1	18-0543	1	18-2001	1
50/60 (rope start)	1981-83	18-2001	2	18-2027	1	18-0543	1	18-2001	1
50/60 (Electric)	1981-83	18-2060	2	18-2059	1	18-0543	1	18-2001	1
50/60	1984-85	18-2060	2	18-2059	1	18-0543	1	18-2001	1
50/60 Small Gearcase	1986-87	18-2060	2	18-2064+18-2059	1	18-0543	1	18-2001	1
50/60 Large Gearcase	1986-87	18-2001	2	18-2064+18-2059	1	18-0543	1	18-2001	1
50/60	1988-89	18-2001	2	18-2064+18-2059	1	18-0543	1	18-2001	1
50	1990-95	18-2060	2	18-2064+18-2059	1	18-0543	1	18-2063 (Inner)	1
55	1968-69	18-2012	2	18-2059	2	18-0543	1	18-2001	1
55	1976-77	18-2060	2	18-2059	2	18-0543	1	18-2001	1
55	1978	18-2059	1	18-2059	2	18-0543	1	18-2001	1
55	1979-83	18-2001	2	18-2027	1	18-0543	1	18-2001	1
55 (Electric)	1980-83	18-2012	2	18-2059	2	18-0543	1	18-2001	1
55C	1984	18-2001	2	18-2063+18-2027	1	18-0543	1	18-2001	1
55C	1985	18-2001	2	18-2063	1	18-0543	1	18-2001	1
55C	1986	18-2001	2	18-2064+18-2059	1	18-0543	1	18-8307	-
55C	1987-94	18-2001	2	18-2063+18-2027	1	18-0543	1	18-8307	-
55C	1995	18-2001	2	18-2064+18-2059	1	18-0543	1	-	-
60 (Manual Shift)	1964-68	18-0173	1	18-0174	1	-	-	-	-
60	1970	18-2012	1	18-2059	2	18-0543	1	18-2001	1
60 (3 Cylinder)	1971	18-2001	2	18-2059	2	18-0543	1	18-2001	1
60 (Rope)	1980-83	18-2001	2	18-2027	2	18-0543	1	18-2001	1
60 (Electric)	1980-83	18-2001	2	18-2059	2	18-0543	1	18-2001	1

OIL SEAL APPLICATION (Cont.)

HP	YEARS	PROPSHAFT	QTY.	DRIVESHAFT	QTY.	UPPER CRANKCASE	QTY.	LOWER CRANKCASE	QTY.
60	1984-85	18-2060	2	18-2059	2	18-0543	1	18-2001	1
60SST	1989	18-2060	2	18-2064+18-2059	1	18-0543	1	18-2001	1
60SST	1990	18-2060	2	18-2064+18-2059	1	18-0543	1	18-8307	-
60 (3 Cylinder)	1987-95	18-2001	2	18-2064+18-2059	1	18-0543	1	18-8307	-
65 (Manual Shift)	1968	18-0173	1	18-0174	1	18-0543	1	-	-
65 (3 Cylinder)	1972-73	18-2001	2	18-2059	2	18-0543	1	18-2001	1
65C	1984-85	18-2001	2	18-2059	2	18-0543	1	18-2001	1
65C	1986-89	18-2001	2	18-2064+18-2059	1	18-0543	1	18-2001	1
70 (Large Gearcase)	1974-85	18-2001	2	18-2059	2	18-0543	1	18-2001	1
70 (Large Gearcase)	1986-95	18-2001	2	18-2064+18-2059	1	18-0543	1	18-8307	-
70 (Small Gearcase)	1977-85	18-2060	2	18-2059	2	18-0543	1	18-8307	-
75 (Manual Shift)	1960-62	18-0173	1	18-0174	1	-	-	-	-
75 (Large Gearcase)	1975-84	18-2001	2	18-2059	2	18-0543	1	18-2001	1
75 (Large Gearcase)	1986-87	18-2001	2	18-2064+18-2059	1	18-0543	1	18-8307	-
75 (Small Gearcase)	1975-84	18-2060	2	18-2059	2	18-0543	1	18-2001	1
80	1966-68	18-0173	1	18-0174	1	-	-	-	-
85	1969-70	18-2012	2	18-2059	2	18-2074	1	18-2001	1
85	1971-72	18-2001	2	18-2059	2	18-2074	1	18-2001	1
85	1973-80	18-2001	2	18-2026	2	18-2074	2	18-2001	1
88	1987-94	18-2001	2	18-2061+18-2062	1	18-2074	2	18-8307	-
90	1981-83	18-2001	2	18-2026	2	18-2074	2	18-2001	1
90	1984-94	18-2001	2	18-2061+18-2062	1	18-2062	1	18-8307	-
90 Seadrive	1985-90	18-2001	2	18-2061+18-2062	1	18-2074	2	18-2001	1
100	1971-72	18-2001	2	18-2059	2	18-2074	1	18-2001	1
100	1979-80	18-2001	2	18-2026	2	18-2074	2	18-2001	1
100C	1984-90	18-2002	2	18-2061+18-2062	1	18-2074	2	18-8307	-
110	1986-88	18-2001	2	18-2061+18-2062	1	18-2074	2	18-2001	1
115	1969-70	18-2012	2	18-2059	2	18-2074	1	18-2001	1
115	1973-83	18-2001	2	18-2026	2	18-2074	1	18-2001	1
115	1984-85	18-2001	2	18-2061+18-2062	1	18-2074	2	18-2001	1
115	1990-94	18-2001	2	18-2061+18-2062	1	18-2074	2	18-8307	-
120	1985	18-2002	2	18-2061+18-2062	1	18-2074	2	18-2075	2
120	1986-88	18-2001	2	18-2061+18-2062	1	18-2074	2	18-2075	2
120	1989	18-2002	2	18-2061+18-2062	1	18-2074	2	18-2075	2
120	1990-94	18-2001	2	18-2061+18-2062	1	18-2074	2	18-2075	2
125	1971-72	18-2001	2	18-2059	2	18-2074	1	18-2001	1
125C	1989	18-2002	2	18-2061+18-2062	1	18-2074	2	18-2075	1
125C (ESX models)	1989	18-2001	2	18-2061	1	18-2062	1	18-2075	1
135	1973-76	18-2001	2	18-2026	2	18-2074	2	18-2001	1
140	1977-83	18-2001	2	18-2026	2	18-2074	2	18-2001	1
140	1984	18-2001	2	18-2026	2	18-2074	2	18-2001	1
140	1985	18-2002	2	18-2061+18-2062	1	18-2074	2	18-2075	2
140	1986-94	18-2001	2	18-2061+18-2062	1	18-2074	2	18-2075	2
140TX	1989	18-2002	1	18-2061+18-2061	1	18-2074	2	18-2075	2
150	1978-83	18-2002	2	18-2026	2	18-2074	2	18-2075	2
150	1984	18-2002	2	18-2061+18-2062	1	18-2074	2	18-2075	2
150	1985-90	18-2002	2	18-2061+18-2062	1	18-2074	2	18-8307	-
155C	1984-85	18-2002	2	18-2061+18-2062	1	18-2074	2	18-2001	1
155C	1986-90	18-2002	2	18-2061+18-2062	1	18-2074	2	18-8307	-
175	1977-85	18-2002	2	18-2026	2	18-2074	2	18-2001	1
175	1986-90	18-2002	2	18-2061+18-2062	1	18-2074	2	18-8307	-
185	1984-85	18-2002	2	18-2061+18-2062	1	18-2074	2	18-2001	1
185	1990	18-2002	2	18-2061+18-2062	1	18-2074	2	18-2075	1
200	1976-83	18-2002	2	18-2026	2	18-2074	2	18-2001	1
200	1984-85	18-2002	2	18-2061+18-2062	1	18-2074	2	18-8307	-
200,225	1986-90	18-2002	2	18-2061+18-2062	1	18-2074	2	18-2075	2
235	1978-83	18-2002	2	18-2026	2	18-2074	2	18-2001	1
235	1984-85	18-2002	2	18-2061+18-2062	1	18-2074	2	18-2001	1
275	1985-88	18-2002	2	18-2061+18-2062	1	18-2074	2	18-2075	2

OIL SEAL APPLICATION - DRIVESHAFT HOUSING

HP	Years	Sierra Oil Seal	Qty.	Desc.	HP	Years	Sierra Oil Seal	Qty.	Desc.
5/6/6.5/8 ①	1987-90	18-2034	1	EH,L	75/80/85	1961-68	18-2060	1	PS
45/55 ①	1990	18-2063	1	EH A	90/100	1964-68	18-2060	1	PS
50/60/65	1958-68	18-2060	1	PS					

① Commercial models also
PS Pivot shaft

EH A Exhaust housing to adapter
EH,L Driveshaft to exhaust housing

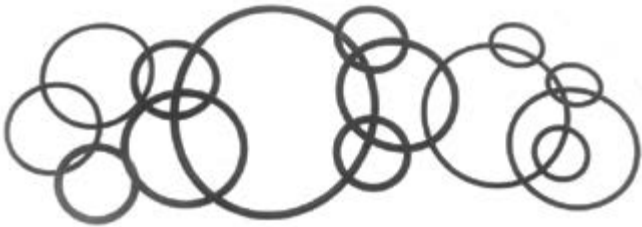

O-RINGS

Part #	O.E. #	Dimensions (in)	
		I.D.	Width
18-7100	25	301877	.245 .155
18-7101	25	305739	.250 .065
18-7102	25	307450	.430 .065
18-7103	25	308624	.924 .103
18-7104	25	308627	2.210 .135
18-7105	25	311338	.750 .065
18-7107	25	313175	4.750 .135
18-7108	25	313893	2.550 .100
18-7108	25	338518	2.550 .100
18-7109	25	317178	.214 .048
18-7111	1	301824	.197 .113
18-7112	1	302493	1.170 .135
18-7114	2	302540	1.000 .135
18-7115	1	302588	1.735 .135
18-7116	1	303067	.360 .100
18-7117	1	303360	1.060 .135
18-7118	25	305242	.300 .135
18-7120	1	307853	.215 .065
18-7121	1	308621	3.100 .135
18-7123	1	308876	2.235 .100
18-7126	1	313340	1.690 .100
18-7127	1	313446	3.315 .135
18-7128	1	313754	1.835 .100
18-7129	25	314491	.970 .065
18-7130	1	314728	2.125 .100
18-7133	25	305123	3.780 .135
18-7133	25	322119	3.780 .135
18-7134	25	303059	.500 .100
18-7135	1	310584	.750 .135
18-7137	25	318372	0.320 .155
18-7138	25	318717	1.500 .210
18-7139	25	319085	1.080 .210
18-7140	25	320303	2.750 .135
18-7141	25	321117	.180 .065
18-7142	2	322119,	3.940 .135
18-7143	25	322501,	
		331188	1.310 .100
18-7144	25	326849	4.250 .135

Part #	O.E. #	Dimensions (in)	
		I.D.	Width
18-7145	25	333572	.250 .100
18-7146	25	554545	1.120 .100
18-7150	35	303598	.225 .115
18-7150	35	331380	.225 .115
18-7150	35	334913	.225 .115
18-7152	25	307082	2.625 .135
18-7153	25	911851	.862 .103
18-7153	25	3852565	.862 .103
18-7155	25	305270	1.620 .135
18-7156	25	309731	1.185 .100
18-7158	25	310967	.740 .100
18-7158	25	310585	.740 .100
18-7162	25	302337	2.025 .135
18-7164	25	302537	1.375 .100
18-7165-9	25	304174	.500 .065
18-7167	25	310414	3.625 .135
18-7168	25	202893	.370 .065
18-7169	25	911686	3.500 .135
18-7170	25	307239	1.359 .139
18-7172	25	553126	3.250 .135
18-7173-9	25	310327	1.875 .135
18-7174	25	910582	.620 .100
18-7174	25	326649	.620 .100
18-7178	25	320140	.920 .135
18-7180	25	303347	.445 .090
18-7198	25	308626	1.430 .100
18-7400	25	908194	4.000 .100
18-7401	25	908383	2.485 .100
18-7403	25	909316	1.500 .100
18-7404	25	909747	.300 .100
18-7406	25	911311	0.250 .065
18-7407	25	911700	4.125 .135
18-7407	5	3852531	4.125 .135
18-7408	25	911718	1.060 .100
18-7409	25	911871	1.175 .100
18-7411	25	321921	1.237 .103
18-7413	25	303191	.301 .070
18-7416	25	329380	.612 .103
18-7417	25	329381	.362 .103
18-7440-1	4	301967	.799 .103
18-7457	1	319662	1.799 .103
18-7461	1	308458	1.612 .103
18-7475	15	332584	.250 .065
■18-7477	25	909048	.480 .100
18-7510	5	321163	2.750 .070

① PKG. OF 1 ② PKG. OF 5 ③ PKG. OF 10 ④ PKG. OF 2 ■ Indicates quad rings rather than O-Rings
 ⑤ This product is priced per piece. To order priced per package, please add -9 to the part number.

POWERHEAD				
HP	YEAR	O RING	QTY	DESC
5.5	1959	18-7180	1	L C
9.5	1964-73	18-7156	1	U C
18	1957-72	18-7114	1	CCH
18/25	1957-76	18-7164	1	LL C
20/25 ①	1977,79-90	18-7174	1	L C
20/25	1990-95	18-7146	1	CCH O
25/35	1957,69-76	18-7114	1	CCH
25/18	1971-76	18-7164	1	U C
25 ⑥	1989-90	18-7123	1	CCH
25 ⑥	1989-90	18-7457	1	U C
25/35	1978	18-7134	1	L C
28	1962-64	18-7164	1	LL C
28/30/35	1976-77,79-90	18-7174	1	L C
28/30/35	1990-95	18-7146	1	CCH O
33/35/40	1957-75	18-7164	1	LL C
35	1987	18-7128	1	U C
35	1987	18-7123	1	CCH
40/45 ①	1976,81-95	18-7123	1	CCH
40) ①	1976,81-95	18-7128	1	U C
45/45SS ①	1985-95	18-7128	1	U C
45SS/48	1987-95	18-7123	1	CCH
48/50/55 ①	1971-95	18-7128	1	U C
50	1958-59	18-7133	1	CCH
50/55 ①	1968-90	18-7123	1	CCH
55/60	1968-71	18-7117	1	CCH O
60/65/75/80	1960-68	18-7133	2	CCH
60/SST60	1970-71,81-95	18-7128	1	U C
60/SST60	1970-95	18-7123	1	CCH
60/SST60	1989-90	18-7158	1	L C
65 ①	1972-73,85-95	18-7123	1	CCH
65 ①	1972-73,85-95	18-7128	1	U C
65/70 ①	1989-90	18-7158	1	L C
70	1974-90	18-7123	1	CCH
70	1974-90	18-7128	1	U C
75	1975-88	18-7128	1	U C
75	1975-88	18-7123	1	CCH
V-4	1969-71	18-7117	1	CCH O
85)	1968-80	18-7133	4	CCH
88/90/100 ①	1964,81-95	18-7133	4	CCH
100	1966	18-7120	4	CCHS
110/115	1969-95	18-7133	4	CCH
125/135/140	1971-84	18-7133	4	CCH
150/155/175 ①	1977-90	18-7133	4	CCH
200/235/185	1976-85	18-7133	4	CCH
CCH S	Crankcase Head Screw	CCH O	Crankcase Head Outer	
L C	Lower Crankshaft	U C	Upper Crankshaft	
LL C	Large Lower Crankshaft	CCH	Crankcase Head	
①	Commercial Models Only	⑥	89 Models DR, DE, DT	

POWERHEAD				
HP	YEAR	O RING	QTY	DESC
4	1969-90	18-7111	1	FC
5 THRU 300 ①	1957-90	18-7111	2	FC
20/25/30	1984-86	18-7101	1	EPMV
35/40	1984-86	18-7101	1	EPMV
45 ①	1986-87	18-7101	1	EPMV
50	1985-86	18-7101	1	EPMV
55 ①	1986-88	18-7101	1	EPMV
60/65/70 ①	1985-86	18-7101	1	EPMV
75	1983-86	18-7101	1	EPMV
V-4/6 ①	1980-86	18-7101	1	EPMV
200/225	1986-88	18-7115	1	EPP
V-8	1985-86	18-7115	1	EPP
①	Commercial Models Also	FC	Fuel Connector	
EPMV	Electric Fuel Primer Manual Valve	EPP	Electric Primer Pump	

POWER TILT AND TRIM				
HP	YEAR	O RING	QTY	DESC
35/40/45 ①	1986-89	18-7168	1	LA
45SS	1988-90	18-7134	1	TEC
45SS	1988	18-7141	4	OL
50/55/60 ①	1981-89	18-7168	1	LA
60/70/75	1981-90	18-7174	2	MVS,L
60/70/75	1981-90	18-7141	4	OL
60/70/75	1981-90	18-7165-9	2	MVS,S
60/70/75	1981-90	18-7102	1	FP
70/75	1981	18-7174	1	TR
V-4/6 ①	1977-79	18-7168	3	RV
V-4/6 ①	1977-90	18-7174	1	TR
V-4/6/8	1977-90	18-7174	2	MVS,L
V-4/6/8 ①	1977-90	18-7102	1	FP
V-4/6/8 ①	1977-90	18-7165-9	2	MVS,S
V-4/6/8 ①	1977-90	18-7141	4	OL
85	1976-79	18-7168	1	LA
115/135	1974-77	18-7168	1	LA
200	1976	18-7168	3	RV
200/300	1990	18-7168	3	RV

① Commercial Models Also
 TEC Trim End Cap to Rod
 LA Line Assembly
 RV Relief Valve
 MVS,L Manifold Valve Seat, Large
 MVS,S Manifold Valve Seat, Small
 TR Trim rod
 OL Oil Line
 FP Fill Plug

POWER STEERING				
HP	YEAR	O RING	QTY	DESC
60/70/75	1981-90	18-7168	4	CP
V-4/6/8	1980-90	18-7168	4	CP
V-6/8	1986-90	18-7129	2	SC
V-6/8	1986	18-7135	3	PVHT
CP	Pump Control Piston	SC	Steering Cylinder	
RV	Pump Hsg. Relief Valve	PVHT	Piston to Valve Hsg. Tube Seal	
SV	Spoon Valve			

DRIVESHAFT HOUSING				
HP	YEAR	O RING	QTY	DESC
2.5	1987-88	18-7101	1	SS
4 ③	1981-90	18-7101	1	SS
4 ②	1984,86-90	18-7168	1	K&S
4 ④	1984,86-90	18-7146	2	SB
4.5	1980-84,86-87	18-7168	1	K&S
4.5	1980-87	18-7146	2	SB
4.5	1980	18-7146	1	EHC
5	1984-90	18-7168	1	K&S
5	1984-90	18-7146	2	SB
6	1984-90	18-7168	1	K&S
6	1984-90	18-7146	2	SB
6.5 ①	1989-90	18-7168	1	K&S
6.5 ①	1989-90	18-7146	2	SB
7.5	1980-83	18-7146	2	SB
7.5	1980-83	18-7168	1	K&S
7.5	1980	18-7146	1	EHC
8	1984-90	18-7146	2	SB
8	1984-90	18-7168	1	K&S
28	1962-64	18-7115	1	SB
33	1965-70	18-7115	1	SB
35	1959	18-7114	1	PS
40	1960-70	18-7102	1	SS
40	1961-70	18-7114	1	PS
40 ⑤	1971-76,81-90	18-7115	1	SB
45SS	1987,88	18-7115	1	SB
60	1964-67	18-7180	4	SA
65	1968	18-7180	4	SA
75	1960-61,64-65	18-7180	4	SA
80	1966-67	18-7180	4	SA

DRIVESHAFT HOUSING (Cont.)					GEARCASE (Cont.)				
HP	YEAR	O RING	QTY	DESC	HP	YEAR	O RING	QTY	DESC
85	1968	18-7180	4	SA	25	ⓐ 1989-90	18-7137	1	SR
90	1964-65	18-7180	4	SA	28/33	1962-63,65-67	18-7165-9	1	WT E
100	1966-68	18-7180	4	SA	28/33	1962-70	18-7134	1	DS CC
① Commercial ② "RD" Models Only ③ "BR" "RL" "RC" "RE" Models Only ④ "R" "RD" Models Only ⑤ '82-'90 Commercial EHC Exhaust Housing Cover					K&S Knob & Shaft to Swivel Bracket PS Pivot Shaft SS Shift Shaft SA Shock Absorber SB Swivel Bracket				
GEARCASE					28/33/35	1962-70	18-7115	1	PBH
1.5/2	1968-90	18-7173-9	1	PBH	28	1963-64	18-7100	1	SR
2/2.5/4	1988-90	18-7145	1	D&F S	28	1987-95	18-7475	1	SR PP
3/4	1957-79	18-7168	1	DS CC	30/35/33	1965-70,84-85	18-7120	1	SR PP
3/4 Std. Gearcase	1964-80	18-7173-9	1	PBH	30/33	1965-95	18-7100	1	SR
4	☆ 1981-95	18-7162	1	PBH	30/35	1976-86	18-7109	2	PBH S
4 RD Models	1984,86-95	18-7118	1	SR	30/35	ⓐ 1976-95	18-7108	1	PBH
4.5	1980-87	18-7118	1	SR	30/35	1976-95	18-7105	2	IH S
5/5.5	1957-68	18-7180	1	DS BH	30/35	ⓐ 1983-95	18-7180	1	SR S
5	1965-68	18-7173-9	1	PBH	30	1984-90	18-7146	1	IH
5/6/108	1984-95	18-7118	1	SR	30/35	1986-95	18-7475	1	SR PP
5/6/6.5/8 6.5 HP Comm	1988-95	18-7145	2	D&F S	30/35	ⓐ 1986-95	18-7100	1	IH
5/6/108	1989-95	18-7168	1	WT E	30/35	ⓐ 1987-95	18-7145	2	D&F S
5.5/6	1957-79	18-7100	1	SR	35	1957-58	18-7165-9	1	WT E
5.5/6/7.5	1957-79	18-7117	1	PBH	35	ⓐ 1957-59,87	18-7134	1	DS CC
5.5	1964	18-7120	1	SR PP	35/40	ⓐ 1957-90	18-7100	1	SR
6/7.5	1957-79	18-7180	1	DS BH	35	1976-77	18-7174	1	DS CC
6	1965-79	18-7120	1	SR PP	35	ⓐ 1983-84,86-90	18-7146	1	IH
6.5/7.5 7.5 HP Comm	1980-90	18-7118	1	SR	35	ⓐ 1987	18-7140	1	PBH
6.5 Comm	1989-90	18-7168	1	WT E	35	ⓐ 1987	18-7137	1	SR
7.5/9.5	1957-73	18-7100	1	SR	35	ⓐ 1987	18-7115	1	DS BH
9.5/10	1958-73	18-7117	1	PBH	35	ⓐ 1987,90	18-7475	1	BS
9.5	1964-73	18-7120	1	SR PP	35	ⓐ 1987-90	18-7475	2	PBH S
9.5	1965-66,68,70-73	18-7168	1	WT E	40	ⓐ 1960-85,89-90	18-7115	1	PBH
9.5/9.9/15	1974-84	18-7116	1	DS CC	40/48	ⓐ 1960-88	18-7134	1	DS CC
9.9/15	1974-95	18-7100	1	SR	40	* 1962-70	18-7152	1	PBH
9.9/15	1974-95	18-7168	1	WT E	40	ⓐ 1965-66,71,73-85	18-7120	1	SR PP
9.9/15	1974-90	18-7104	1	PBH	40	☆ 1966,70	18-7120	4	PBH S
9.9/15	1974-90	18-7139	1	IH	40	1971,73-76,81-85	18-7165-9	1	WT E
9.9/15	1984-85	18-7120	1	SR PP	40	1984	18-7109	4	PBH S
9.9/15	1986-95	18-7475	1	SR PP	40/45	ⓐ 1984-86	18-7120	1	BS
9.9/15	1988-92	18-7145	2	D&F S	40/48	1984-88	18-7140	1	PBH
9.9/15	1993-96	18-4248	2	D&F S	40/48	1984-88	18-7115	1	DS BH
10	1957	18-7112	1	PBH	40/45 45 HP Comm	1984-95	18-7137	1	SR
10/14	ⓐ 1957-63,88-90	18-7100	1	SR	40/45 45 HP Comm	1987-95	18-7475	1	BSS
10/18/25	1957-77	18-7116	1	DS CC	40/50	ⓐ 1988-95	18-7145	2	D&F S
10/14 Comm	1988-90	18-7145	2	D&F S	40/48/50	1989-90	18-7109	1	SR PP
14 Comm	1988-89	18-7475	1	SR PP	40 Comm	1989-90	18-7165-9	1	WT E
15A	1987-90	18-7174	1	WT	40 Comm	1989-90	18-7475	1	SR PP
18/25	1957-76	18-7112	1	PBH	40/48/50	1989-95	18-7172	1	PBH
18/20/25	ⓐ 1957-95	18-7100	1	SR	40/48/50	1989-95	18-7173-9	1	DS BH
18/20/28	1964-85	18-7120	1	SR PP	45 Comm	1985-88	18-7134	1	IH
20/25	1977,85-95	18-7105	2	IH S	45 Comm	1985-95	18-7128	1	DS BH
20/25	1985-90	18-7146	1	IH	45 Comm	1985-95	18-7127	1	PBH
20/25	1985-95	18-7180	1	SR S	45/48 45 HP Comm	1987-95	18-7145	2	D&F S
20/25	1985-95	18-7108	1	PBH	45SS	1987-90	18-7134	2	DS CC
20/25	ⓐ 1986-95	18-7475	1	SR PP	45 Comm	1995	18-7475	4	PBH S
20/25/30	1987-95	18-7475	2	PBH S	48	1987-88	18-7475	3	PBH S
20/25/28	ⓐ 1988-95	18-7145	2	D&F S	48/50	1987-95	18-7475	1	BS
20/25	1988-95	18-7100	1	IH	48	1987-95	18-7137	1	SR
20/30	1990	18-7475	1	BS	50/60	1958-67	18-7118	1	SR
25	ⓐ 1969-86	18-7120	1	SR PP	50/60/65	1958-68	18-7174	1	WT E
25	1977	18-7109	2	PBH S	50/55	1958-69	18-7174	1	DS CC
25	1978	18-7134	1	DS CC	50/55/60	1968-71	18-7126	1	DS BH
25	1989-95	18-7475	1	BS	50/55	1968-72	18-7129	1	PS OP
25	ⓐ 1989-90	18-7172	1	PBH	50	1971	18-7100	1	SR
25	ⓐ 1989-90	18-7109	1	SR PP	50	ⓐ 1971-74,79,81	18-7127	1	PBH
25	ⓐ 1989-90	18-7173-9	1	DS BH	50	ⓐ 1971-81	18-7128	1	DS BH
					50/55/60	1971-84	18-7109	4	PBH S
					50/55	ⓐ 1971-88	18-7134	1	DS CC
					50	☆ 1973-74	18-7156	2	SA,L
					50/55	ⓐ 1973-74	18-7146	1	SA,S
					50	ⓐ 1973-95	18-7137	1	SR
					50	ⓐ 1975,79,81,			

GEARCASE (Cont.)					GEARCASE (Cont.)				
HP	YEAR	O RING	QTY	DESC	HP	YEAR	O RING	QTY	DESC
	82-88	18-7115	1	DS BH	V-4	1966-68	18-7118	1	SR
50	⑧ 1975,79,81-88	18-7140	1	PBH	V-4	1966-68	18-7120	1	SR PP
50/60	1981-86	18-7120	1	BSS	80	1967	18-7120	4	PBH S
55	① 1968-69,79-81, 83-95	18-7127	1	PBH	V-4	1968-95	18-7127	1	PBH
55	⑩ 1976-82	18-7140	1	PBH	V-4/6/8	1969-72	18-7129	1	PS OP
55	⑩ 1976-82	18-7115	1	DS BH	V-4/6/8	1969-95	18-7130	1	DS BH
55	⑨ 1979-81,83-95	18-7128	1	DS BH	V-4	1971-86	18-7109	4	PBH S
55	⊕ 1981-88	18-7120	1	BS	V-4	1973-74	18-7146	1	SA,S
55 Comm	1988,90-95	18-7475	4	PBH S	V-4	1973-77	18-7156	2	SA,L
55 Comm	1989-95	18-7475	1	BS	V-4/6/8	1973-95	18-7137	1	SR
55 Comm	1989-95	18-7145	2	D&F S	V-4,6,8	1973-90	18-7158	1	DS CC
60 71 "E" Models	1964,66-67, 70-71	18-7120	4	PBH S	V-4	1975-77	18-7178	1	SA,S
60	⑦ 1964-67,80-87	18-7115	1	DS BH	V-4	1981-86	18-7120	1	BS
60/65/75 Std. Gearcase	1964-68	18-7152	1	PBH	V-4/6	1987-95	18-7475	4	PBH S
60	1964-71,86-88	18-7174	1	DS CC	V-4/6/8	1987-95	18-7475	1	BS
60 67 Std. Gearcase	1966-67	18-7120	1	SR PP	V-4/6/8	1987-95	18-7145	2	D&F S
60/65	1968-71	18-7129	1	PS OP	85/90	1964-68	18-7152	1	PBH
60	③ 1970-81,86-95	18-7127	1	PBH	100	1966-68	18-7167	1	PBH
60	③ 1980-81,86-95	18-7128	1	DS BH	100	1984-90	18-7142	1	PBH
60	1980-85	18-7134	1	DS CC	100 Comm	1986-90	18-7475	1	BS
60	② 1980-87	18-7140	1	PBH	100 Comm	1987	18-7109	4	PBH S
60/SST60	1980-95	18-7137	1	SR	120	1985	18-7142	1	PBH
60/SST60/					125	1971	18-7173-9	1	PBH
65 65 HP Comm	1987-95	18-7475	1	BS	125 Comm	1989-90	18-7142	1	PBH
60/SST60/					125 Comm	1990	18-7174	1	WT
65 65 HP Comm	1987-95	18-7145	2	D&F S	140	1985,88-90	18-7142	1	PBH
SST60	1989-90	18-7140	1	PBH	V-6	1976-78	18-7178	1	SA,S
SST60	1989-90	18-7174	1	DS CC	V-6	1976-78	18-7156	2	SA,L
60/65/70 65 HP Comm	1989-90	18-7158	1	DS CC	V-6	1976-85	18-7109	4	PBH S
SST60	1989-90	18-7115	1	DS BH	V-6	1976-90	18-7142	1	PBH
65/75	1960-68	18-7118	1	SR	V-6	1986	18-7120	1	BS
65 Std. Gearcase	1968	18-7120	1	SR PP	155	⑨ 1984,89-90	18-7142	1	PBH
65 Std. Gearcase	1968	18-7115	1	DS BH	155	③ 1984-90	18-7144	3	PBH
65	⊕ 1968-73, 85-88,90	18-7174	1	DS CC	200/225	1987	18-7120	1	BS
65	⊕ 1971,73,85-86	18-7109	4	PBH S	V-8	1985-86	18-7120	1	BS
65	⊕ 1972-73,85-95	18-7127	1	PBH	V-8	1985-90	18-7144	3	PBH
65	⊕ 1973,85-95	18-7137	1	SR	V-8	1985-90	18-7174	1	WT
65	⊕ 1973,85-95	18-7128	1	DS BH					
65/70 75 "B" Models	1973-75	18-7156	2	SA,L					
65/70 75 "B" Models	1973-75	18-7146	1	SA,S					
65 Comm	1985-86	18-7120	1	BS					
65/70 65 HP Comm	1988-95	18-7475	4	PBH S					
70/75	1960-65,74-88	18-7174	1	DS CC					
70/75	1974-85	18-7109	4	PBH S					
70/75	1974-95	18-7137	1	SR					
70	⑦ 1974-95	18-7128	1	DS BH					
70	⑦ 1974-95	18-7127	1	PBH					
70 15" Transom	1977-85	18-7115	1	DS BH					
70 15" Transom	1977-85	18-7140	1	PBH					
70	1981-87	18-7120	1	BS					
70	1988-95	18-7475	1	BS					
70	1988-95	18-7145	2	D&F S					
75	1960,63-65	18-7120	4	PBH S					
75	1961-65	18-7174	1	WT E					
75	⑤ 1964-65,75-88	18-7115	1	DS BH					
75	1965	18-7120	1	SR PP					
75	⑥ 1975-87	18-7127	1	PBH					
75 20" Transom	1975-87	18-7128	1	DS BH					
75 15" Transom	1975-88	18-7140	1	PBH					
75	1981-86	18-7120	1	BS					
75	1987-88	18-7475	1	BS					
75	1987-88	18-7145	2	D&F S					
V-4	1964-66,68-70	18-7120	4	PBH S					
V-4	1964-67	18-7174	1	WT E					
V-4	1964-68	18-7115	1	DS BH					
V-4	1964-72	18-7174	1	DS CC					

- ① 35 hp '87 Models RC, RL
- ② '62-'70 w/o Selectric Shift/'89-'90 Comm.
- ③ '65 Std Gearcase/'75-'87 15" Transom
- ④ '76-'87 20" Transom
- ⑤ '77-'85 20" Transom
- ⑥ '79-'81 Electric Start
- ⑦ '79-'81 Rope Start
- ⑧ '79-'81 Rope Start/'82 Comm.
- ⑨ '79-'81 Rope Start/'83-'90 Comm.
- ⑩ '80-'81 Electric Start/'86-'87 — 15" Transom
- ⑪ '80-'81 Rope Start/'86,'87 — 20" Transom
- ⑫ '87 Models AR, AE
- ⑬ '87 Models RC, RL
- ⑭ '89 Models DR, DE, DT
- ⑮ '89 WTLZ, WTXZ Models '90 WTESM, WTXESM Comm.
- ⑯ '89 WTLZ, WTXZ / '90 WTLES, WTESM Comm.
- ⑰ '89 WTPLY, WTALY, WTPXY, WTAXY, '90 WTPLA, WTALA, WTPXA/Comm.
- ⑱ AR, AE Models
- ⊕ B, BR Models
- ⊕ Comm. Models Also
- ★ Electric Start
- * Selectric Shift

- BS Bearing Setscrew
- DS BH Driveshaft Bearing Hsg.
- DS CC Driveshaft to Crankcase
- D & F S Drain & Fill Screw
- WT E 5" Gearcase Extension, Water Tube
- GC 1 Gearcase (11 7/16")
- GC 2 Gearcase (12 7/8")
- GC3 Gearcase (19 1/2")
- IH Impeller Hsg.
- IHS Impeller Hsg. Spacer
- PBH Prop Bearing Hsg.
- PBH S Prop Bearing Hsg. Screw
- PS OP Prop Shaft Oil Pump
- SA,L Shift Assembly, Large
- SA,S Shift Assembly, Small
- SR Shift Rod
- SR PP Shift Rod Pivot Pin
- SR S Shift Rod Scraper
- WT Water Tube



18-5225
SPARK PLUG WIRE KIT
 Kit includes 25 ft Roll of Hypalon Ignition Wire With a Copper Conductor and a Large Assortment of Three Different End Fittings to Fit McCulloch Motors
 Wire available in 100' Spool 18-5226



18-5226
IGNITION WIRE
 Metallic Core
 100' Spool
 7mm Hypalon



18-5153
CONTACT SET
 Replaces: 75101A, 1340135, 36550135



18-5241
CONDENSER
 Replaces: 38850115

HP	Years	Contact Set	Condenser	HP	Years	Contact Set	Condenser
3.6	1953-57	18-5153	—	7.5	1961-68	18-5153 ②	—
6	1960-62	18-5153 ②	—	10	1958	—	18-5241 ②
7.5	1952-87	18-5153 ②	—	25	1959	18-5153 ② ③	—
7.5	1958	18-5153 ② ③	—	30 - 33	1955-56	18-5153 ②	—
7.5	1960	18-5153 ②	—	40	1957-59	18-5153 ② ③	—

② Two Required ③ REPCO Magneto Only

8' LENGTH COMPLETE FUEL LINE ASSEMBLIES

5/16"
FUEL LINE ASSEMBLY

18-8013EP-2 SILVERADO 4000 Premium



18-8004EP-1
PRIMER BULB



FUEL LINE ASSEMBLY COMPONENTS

8' LENGTH COMPLETE FUEL LINE ASSEMBLIES

3/8"
FUEL LINE ASSEMBLY

18-8015EP-2 SILVERADO 4000 Premium



18-8005EP-1
PRIMER BULB



FUEL LINE ASSEMBLY COMPONENTS

12' LENGTH COMPLETE FUEL LINE ASSEMBLIES

5/16"
FUEL LINE ASSEMBLY

18-8032EP-2 SILVERADO 4000 Premium



18-8004EP-1
PRIMER BULB



FUEL LINE ASSEMBLY COMPONENTS



PRIMER BULB ASSEMBLY
 Comes complete with two Hose Clamps



18-7852-1
FUEL WATER SEPARATOR KIT
 Includes:
 18-7845 Filter - 18-7853-1 Bracket
 18-4256 1/4" (2) Brass Plugs
 18-9004 Pipe Sealant with Teflon® is recommended for use on filter bracket fitting threads



FUEL FILTERS
18-7828-1 **18-7830**
 (1/4" Small) (5/16")
18-7829 **18-7831**
 (1/4" Large) (3/8")



Part #	Description
18-8002EP-1	For 3/4" I.D. Hose
18-8004PE-1	For 5/16" I.D. (large capacity bulb)
18-8005EP-1	For 3/8" I.D. (large capacity bulb)

* Tanks and Engines for picture purpose only.

MERCURY OUTBOARD

HP	CYL	BEG. S/N	YEAR	HP	CYL	BEG. S/N	YEAR	HP	CYL	BEG. S/N	YEAR
2.2	1	8075603	1984	8	2	C221500	1990	35	2	1755799	1965
2.2	1	8087123	1985	9.8	2	5206550	1979	35	2	1960827	1966
2.2	1	A800761	1986	9.8	2	5541280	1980-81	35	2	2097800	1967
2.2	1	A805221	1987	9.8	2	5965263	1982	35	2	2300972	1968
2.2	1	A817421	1988	9.8	2	6263906	1983	35	2	2487558	1969
2.2	1	A837101	1989	9.8	2	6438338	1984	35	2	6445653	1984
3	1	A855097	1990	9.8	2	6620196	1985	35	2	6626696	1985
3.4 L	6	6436883	1984	9.8 (100)	2	1397581	1961	35	2	A922171	1986
3.4 L	6	A129445	1985	9.8 (110)	2	1455240	1962	35	2	B110789	1987
3.4 L	6	A912426	1986	9.8 (110)	2	1474328	1963	35	2	B238644	1988
3.5	1	6202173	1983	9.8 (110)	2	1607083	1964	35	2	B393190	1989
3.5	1	6434771	1984	9.8 (110)	2	1742746	1965	35 (300)	4	1271885	1960
3.5	1	6594744	1985	9.8 (110)	2	1865779	1966	40	2	2874704	1970
3.6	1	5404657	1980-81	9.8 (110)	2	2098352	1967	40	2	3043031	1971
3.6	1	5910968	1982	9.8 (110)	2	2290663	1968	40	2	3219678	1972
3.9	1	1655013	1964	9.8 (110)	2	2508759	1969	40	2	3474578	1973
3.9	1	1738941	1965	9.8 (110)	2	2798057	1970	40	2	3859435	1974
3.9	1	1865633	1966	9.8 (110)	2	3002814	1971	40	2	4118385	1975
3.9	1	2098037	1967	9.8 (110)	2	3263263	1972	40	2	4362215	1976
3.9	1	2278851	1968	9.8 (110)	2	3482753	1973	40	2	4564002	1977
4	1	2498136	1969	9.8 (110)	2	3795658	1974	40	2	4860103	1978
4	1	2771662	1970	9.8 (110)	2	4079675	1975	40	2	5174089	1979
4	1	3028361	1971	9.8 (110)	2	4304785	1976	40	2	5556230	1980-81
4	1	3296137	1972	9.8 (110)	2	4605112	1977	40	2	5991215	1982
4	1	3529446	1973	9.8 (110)	2	4839254	1978	40	2	6228285	1983
4	1	3764825	1974	9.9	2	A918999	1986	40	4	C159200	1989
4	2	5589202	1980-81	9.9	2	B114231	1987	40	4	C221500	1990
4	2	9075839	1976	9.9	2	B233200	1988	40 350	2	1356948	1961
4	2	9172806	1978	9.9	2	B385500	1989	45	4	1476510	1962
4	1	A818721	1988	9.9	2	C221500	1990	45	4	A914859	1986
4	1	A837101	1989	10	2	1290910	1960	45	4	B110789	1987
4	1	A855097	1990	15	2	1288910	1960	45	4	B238644	1988
4	1	A906702	1986	15	2	1346448	1961	45	4	B393190	1989
4	1	B114109	1987	15	2	B293117	1988	45 (400)	4	1279685	1960
4.5	1	4108120	1975	15	2	B385500	1989	45 (400)	4	1384806	1961
4.5	1	4377557	1976	15	2	C221500	1990	50	4	1421113	1961
4.5	1	4597262	1977	18	2	5860332	1980-81	50	4	1477910	1962
4.5	1	4869518	1978	18	2	5954911	1982	50	4	1552535	1963
4.5	1	5270784	1979	18	2	6171607	1983	50	4	1605952	1964
4.5	1	5595532	1980-81	18	2	6443973	1984	50	4	1755549	1965
4.5	1	6025119	1982	18	2	6617631	1985	50	4	1870389	1966
4.5	1	6232381	1983	20	2	1558310	1963	50	4	2097445	1967
4.5	1	6428076	1984	20	2	1606903	1964	50	4	2305101	1968
4.5	1	6608536	1985	20	2	1755849	1965	50	4	2514919	1969
5	1	A819951	1988	20	2	1866496	1966	50	4	2736807	1970
5	1	A837101	1989	20	2	1997990	1967	50	4	3009934	1971
5	1	A855097	1990	20	2	2296267	1968	50	4	3235063	1972
6	2	1408611	1961	20	2	2550065	1969	50	4	3478003	1973
6	2	1485612	1962	20	2	2827677	1970	50	4	3816308	1974
6	2	1551443	1963	20	2	2991679	1971	50	4	4141450	1975
6	2	1607513	1964	20	2	3226958	1972	50	4	4357650	1976
6	2	1745521	1965	20	2	3537531	1973	50	4	4576237	1977
6	2	1958278	1966	20	2	3755885	1974	50	4	4962056	1978
6	2	2096171	1967	20	2	4103290	1975	50	4	5193259	1979
6	2	2284857	1968	20	2	4293920	1976	50	4	5531630	1980-81
6	2	A910596	1986	20	2	4580036	1977	50	4	5949386	1982
6	2	B114231	1987	20	2	4819249	1978	50	4	6275323	1983
6	2	B233200	1988	20	2	5183393	1979	50	4	6448808	1984
6	2	B385500	1989	20	2	5606492	1980-81	50	4	6586624	1985
7.5	2	2529895	1969	20	2	A910971	1986	50	3	A912478	1986
7.5	2	2810637	1970	20	2	B114231	1987	50	3	B110789	1987
7.5	2	3016581	1971	20	2	B238464	1988	50	3	B239242	1988
7.5	2	3274633	1972	20	2	B385500	1989	50	3	B396036	1989
7.5	2	3488153	1973	20	2	C221500	1990	50	3	C221500	1990
7.5	2	3801458	1974	22 (200)	2	1292910	1960	60	3	1303411	1960
7.5	2	4087015	1975	22 (200)	2	1339948	1961	60	3	6428681	1984
7.5	2	4314385	1976	25	2	1467499	1962	60	3	6609651	1985
7.5	2	4691222	1977	25	2	5705532	1980-81	60	3	A197392	1986
7.5	2	4851693	1978	25	2	5942041	1982	60	3	B110789	1987
7.5	2	5226935	1979	25	2	6185159	1983	60	3	B239242	1988
7.5	2	5524660	1980-81	25	2	6453343	1984	60	3	B396036	1989
7.5	2	5936301	1982	25	2	6593849	1985	60	3	C221500	1990
7.5	2	6239857	1983	25	2	A911346	1986	65	4	1542745	1963
7.5	2	6430041	1984	25	2	B114231	1987	65	4	1606282	1964
7.5	2	6611886	1985	25	2	B238464	1988	65	4	1765044	1965
8	2	A197112	1986	25	2	B385500	1989	65	4	1869564	1966
8	2	B114231	1987	25	2	C221500	1990	65	4	2119749	1967
8	2	B233200	1988	35	4	1570507	1963	65	4	2309311	1968
8	2	B385500	1989	35	2	1628795	1964	65	4	2503991	1969

OUTBOARD - MERCURY/MARINER - MODEL IDENTIFICATION

MERCURY OUTBOARD

HP	CYL	BEG. S/N	YEAR	HP	CYL	BEG. S/N	YEAR	HP	CYL	BEG. S/N	YEAR
65	4	2803562	1970	90	3	B110054	1987	150	6	3752620	1974
65	4	2997339	1971	90	3	B240451	1988	150	6	4125985	1975
65	3	3293184	1972	90	3	C100000	1989	150XS	6	4319880	1976
65	3	3547987	1973	90	3	C221500	1990	150XS	6	4602012	1977
65	3	3807833	1974	90cc	2	A907702	1986	150XS	6	4868648	1978
65	3	4136685	1975	90cc	2	B114221	1987	V-150	6	4868998	1978
65	3	4382057	1976	95	6	1869776	1966	V-150	6	5129480	1979
70	3	1296411	1960	95	6	2097280	1967	V-150	6	5503247	1980-81
70	3	1413611	1961	100	6	1503332	1962	V-150	6	5944791	1982
70	3	1503459	1962	100	6	1518384	1963	V-150	6	6220254	1983
70	3	4382057	1976	100	6	1665002	1964	V-150	6	6443213	1984
70	3	4571652	1977	100	6	1755459	1965	V-150	6	6616991	1985
70	3	4825249	1978	100	6	2318586	1968	V-150	6	A904646	1986
70	3	5128280	1979	100	6	2484633	1969	V-150	6	B116662	1987
70	3	5579017	1980-81	100	4	B209468	1988	V-150	6	B242881	1988
70	3	5974683	1982	100	4	C100000	1989	V-150	6	C100861	1989
70	3	6279960	1983	100	4	C221500	1990	V-150	6	C221500	1990
70	3	B110054	1987	102cc	2	A819211	1988	V-150XR2	6	A905191	1986
70	3	B240451	1988	102cc	2	A837101	1989	V-150XR2	6	B289430	1988
70	3	C100000	1989	110	6	1870204	1966	V-150XR4	6	B242885	1988
75	4	6432901	1984	110	6	2097385	1967	V-175	6	4301235	1976
75	4	6613221	1985	115	6	2836019	1970	V-175	6	4563802	1977
75	4	A197882	1986	115	6	3023086	1971	V-175	6	4838074	1978
75	3	C100000	1989	115	6	3270480	1972	V-175	6	5180109	1979
75	3	C221500	1990	115	6	3525441	1973	V-175	6	5488752	1980-81
80	4	1335465	1960	115	6	3761035	1974	V-175	6	6618751	1985
80	4	1398630	1961	115	6	4112635	1975	V-175	6	A918329	1986
80	4	2559001	1969	115	6	4310785	1976	V-175	6	B116662	1987
80	4	2783253	1970	115	6	4567952	1977	V-175	6	B241881	1988
80	4	2986444	1971	115	6	4855153	1978	V-175	6	C100861	1989
80	4	3186263	1972	115	6	5168574	1979	V-175	6	C221500	1990
80	4	4831999	1978	115	6	5600967	1980-81	V-200	6	4839034	1978
80	4	5141097	1979	115	6	6006834	1982	V-200	6	5158929	1979
80	4	5582562	1980-81	115	6	6262961	1983	V-200	6	5464486	1980-81
80	4	5987161	1982	115	6	6440183	1984	V-200	6	6073192	1982
80	4	6232941	1983	115	6	6630171	1985	V-200	6	6203991	1983
80	3	A966142	1987	115	6	A907777	1986	V-200	6	6435503	1984
80	3	B240451	1988	115	6	B117567	1987	V-200	6	6625221	1985
80	3	C100000	1989	115	6	B239242	1988	V-200	6	A913228	1986
85	6	1460999	1963	115	4	C100000	1989	V-200	6	B116662	1987
85	6	1648888	1964	115	4	C221500	1990	V-200	6	B241881	1988
85	4	3493913	1973	125	6	2314956	1968	V-200	6	C100861	1989
85	4	3865695	1974	125	6	2536210	1969	V-200	6	C221500	1990
85	4	4092965	1975	135	6	2839369	1970	210cc	2	A918999	1986
85	4	4590512	1977	135	6	3036066	1971	210cc	2	B114231	1987
85XS	4	4366802	1976	V-135	6	A909997	1986	210cc	2	B233405	1988
90	6	1755444	1965	V-135	6	B116662	1987	210cc	2	B385500	1989
90	6	4854301	1978	V-135	6	B241881	1988	V-220	6	B241881	1988
90	6	5160324	1979	V-135	6	C100861	1989	V-225	6	5615282	1980-81
90	6	5594657	1980-81	V-135	6	C221500	1990	V-250	6	C139860	1989
90	6	5996390	1982	140	6	3293234	1972	V-250	6	C221500	1990
90	6	6246856	1983	140	6	4865678	1978	V-275	6	C139860	1989
90	6	6436123	1984	140	6	5189788	1979	V-275	6	C221500	1990
90	6	6623151	1985	140	6	5625108	1980-81	V-300	6	5611648	1980-81
90	6	A902436	1986	150	6	3502806	1973	V-300	6	6239853	1983



18-5007
TUNE-UP KIT

—CONTENTS—

Part #	O.E. #	Description
18-5153	398-174	Contact Set
18-5206	398-693	Condenser



18-5139
CONTACT SET

Replaces: 336-4318A2, 336-4318A4, 336-4318A3, 336-3948A3, 336-3948A2
(2) 18-5139 = (1) 336-4318A2



18-5140
CONTACT SET
Replaces: 398-2202

18-5148
CONTACT SET
Replaces: 394-1100A3, 394-1100A2, 394-352A1

18-5153
CONTACT SET
Replaces: 398-174



18-5169
CONDENSER
Replaces: 394-1130A1, 394-1130, 397-741, 397-359

18-5206
CONDENSER
Replaces: 398-693

18-5207
CONDENSER
Replaces: 398-713

HP	Model	Beginning Serial No	Ending Serial No	Contact Set	Condenser	Tune-Up Kit
3.9		1655013	2498155	18-5140	18-5212	18-5008
4		2498136	2693114	18-5140	18-5212	18-5008
4	⑧	2771622	A809600	18-5139	—	—
4.5		4107220	& UP	18-5139	—	—
6		1610265	2529894	18-5140	18-5212	18-5008
7.5	⑤	214324	& UP	18-5153	18-5207	—
7.5		2529895	2721150	18-5140	18-5212	18-5008
7.5		3274633	3801457	18-5139	—	—
9.8		1470349	1865778	18-5153	18-5206	18-5007
9.8		1865776	2708898	18-5140	18-5212	18-5008
9.8		2798057	3263262	18-5139	—	—
9.8		3263263	3795657	18-5139	—	—
10		1120828	112327	18-5153	18-5206	18-5007
10		595628	112327	18-5153	18-5206	18-5007
10		595628	& UP	18-5153	18-5206	18-5007
15		1200114	1499331	18-5153	18-5206	18-5007
20		860979	& UP	18-5153	18-5206	18-5007
20		2827677	3226957	18-5139	—	—
20		3226958	3537530	18-5139	—	—
22		1158546	1499331	18-5153	18-5206	18-5007
25 KF9		377150	379008	18-5148	18-5169	—
25 KG9		377150	379008	18-5148	18-5169	—
25 MARK40		377150	379008	18-5148	18-5169	—
35	350	1271884	1448139	18-5148	18-5169	—
35		1571114	2874703	18-5140	18-5212	18-5008
40		831021	1279684	18-5148	18-5169	—
45		1139538	& UP	18-5148	18-5169	—
30	MK 30 55			—	18-5169	—
30		1271884	1448139	—	18-5169	—
35	35A	1271884	1448139	—	18-5169	—
40		1279685	1476509	—	18-5169	—
45		1476510	1531958	—	18-5169	—
50		1421113	2305100	—	18-5169	—
50		1770179	2116317	—	18-5169	—
50	⑥	2116318	2305100	—	18-5169	—
65 (4CYL)		1542745	2309310	—	18-5169	—

⑤ Phelon Magneto only ⑥ Manual start only ⑧ Except "Gnat"



18-5187

IGNITION COIL

Replaces: 339-856991A1, 339-850227
For: Mariner 200DFI, 225DFI, V135DFI (2.5L), V150DFI (2.5L) and Mercury 3.0DFI

①18-5181D

Display Package



18-5181

IGNITION COIL

Replaces: 802371A1

①18-5186D

Display Package



18-5186

IGNITION COIL

Replaces: 339-7370A13, 339-832757A4

18-5158

IGNITION COIL

Replaces: 8M0077471, 879984T01, 879984A1, 879984T00

For: 40-60 EFI 4 Cylinder (OT409000-1C453839) USA (OP153500-1C453839) Belgium, 30-40 EFI 3 Cylinder (OT409000-1B226999) USA (OP153500-0P400999) Belgium, 30-40 EFI 3 Cylinder (1C000001-Up), 75-115 DFI 3 Cylinder (OT980000-Up), 80 JET 3 Cylinder (1B586067-Up), 200-225 DFI 3.0L (1B504989-1B912785), 200 Pro XS DFI 3.0L (1B504989-1B912785), 250 DFI 3.0L (1B528615-Up), 115 Pro XS 3 Cylinder (1B751825-Up), 125 DFI 3 Cylinder (1B736885-Up), 240 EFI SportJet (0E406400-Up), 600 SCi (0M952908-0M962885), 662 SCi (0M956580-Up), 700 SCi (0M962886-Up), 850 SCi (0M952900-Up), 1025 SCi (0M962886-Up), 1075 SCi (0M957032-Up), 1200 SCi (0M956534-Up)



18-5159

IGNITION COIL

Replaces: 339-8M0077473, 339-883778A02, 339-883778A01

For: 1650 (0M965309-Up), 1550 (0M973231-Up), 1100 (0M965965-Up), 1350 (0M965309-Up), 110 Jet (2.5L) (1B690542-Up), 150 Pro XS (2.5L) (1B690542-Up), 200 (DFI) 3.0L (1B504989-Up), 200 (3.0L-DFI)(DTS) (1B504989-Up), 200 Pro XS (DFI) 3.0L (1B504989-Up), 225 (DFI) 3.0L (1B504989-Up), 225 (3.0L-DFI)(DTS) (1B504989-Up), 250 (DFI) 3.0L (1B528615-Up), V-135 (DFI) 2.5L (1B417702-Up), V-150 (DFI) 2.5L (1B417702-Up), V-175 (DFI) 2.5L (1B417702-Up), 2.5XS (2.5L DFI) (OT997974-1E000796)



18-5433

IGNITION COIL

Replaces: 32193A2, 38547, 392-806529A1, 898253T24
(Uses External Resistor)



18-5154

PENCIL COIL

Replaces: 339-880615T01

Fits: 350SCi Verado (1B716557-2B143542), 200-275 Verado (6 Cyl) (OT980000-2B578935), 300 Verado (0P520553-2B578935), 200 Pro Verado (6 Cyl) (2B034840-2B577715), 250-300 Pro Verado (1B830170-2B577715), 75-115 EFI (1B366823-2B094995), 135-175 Verado (1B227000-2B576734), 200 Verado (4 Cyl) (1B517159-2B578935), 350 Verado (2B141617 & Up), 350 Pro Verado (2B141124 & Up), 400 Verado (2B141124 & Up)



18-5775

SWITCH BOX

Replaces: 332-7778A6, 332-7778A9, 332-7778A12, 332-7778A7, 332-7778A3, 332-7778A1, 332-5524A1, F7778A9, F749301



18-5776

SWITCH BOX

Replaces: 339-7452A3, 339-7452A2, 339-7452A1



18-5777

SWITCH BOX

Replaces: 339-7452A15, 339-7452A19, 339-7452A9, 339-7452A7



18-5778

SWITCH BOX

Replaces: 339-7452A14, 339-7452A21, 339-7452A11, 339-7452A8
S/S to 18-5777



18-5787

SWITCH BOX ASSEMBLY

Replaces: 332-4911A8
For: 40 HP



① Items ending in "D" are Display Packaged - Regular number is Non-Display



18-5790
SWITCH BOX ASSEMBLY
 Replaces: 18495A26, 18495A19
 18495A12
 For: 75-90 HP



18-5791
SWITCH BOX ASSEMBLY
 Replaces: 19052A8, 19052A5,
 19052A3
 For: 50-60 HP



18-5792
SWITCH BOX ASSEMBLY
 Replaces: 16061T
 For: 4/5 HP



18-5793
SWITCH BOX ASSEMBLY
 Replaces: 823034, 823034T
 For: 2.5/3.3 HP



18-5881
SWITCH BOX
 Replaces: 332-5772A7, 332-5772A5, 332-5772A3,
 332-5772A2, 332-5772A1, F720301



18-1152
DISTRIBUTOR ROTOR SHAFT BEARING
 Replaces: 30-26379
 SKF France 6002-2 RSI/HT

4-STROKE ENGINES

HP	Model	Beginning Serial No	Ending Serial No	Coil	Switch Box
30EFI (3 Cyl.)	USA	0T409000	1B226999	18-5158	N/A
30EFI (3 Cyl.)	Belgium	0P153500	0P400999	18-5158	N/A
30EFI (3 Cyl.)	Belgium	1C000001	& Up	18-5158	N/A
40EFI (3 Cyl.)	USA	0T409000	1B226999	18-5158	N/A
40EFI (3 Cyl.)	Belgium	0P153500	0P400999	18-5158	N/A
40EFI (3 Cyl.)	Belgium	1C000001	& Up	18-5158	N/A
40EFI (4 Cyl.)	USA	0T409000	1C453839	18-5158	N/A
40EFI (4 Cyl.)	Belgium	0P153500	1C453839	18-5158	N/A
50EFI (4 Cyl.)	USA	0T409000	1C453839	18-5158	N/A
50EFI (4 Cyl.)	Belgium	0P153500	1C453839	18-5158	N/A
60EFI (4 Cyl.)	USA	0T409000	1C453839	18-5158	N/A
60EFI (4 Cyl.)	Belgium	0P153500	1C453839	18-5158	N/A
75EFI (4 Cyl.)	USA	1B366823	2B094995	18-5154	N/A
90EFI (4 Cyl.)	USA	1B366823	2B094995	18-5154	N/A
115EFI (4 Cyl.)	USA	1B366823	2B094995	18-5154	N/A
135 Verado (4 Cyl.)	USA	1B227000	2B576734	18-5154	N/A
150 Verado (4 Cyl.)	USA	1B227000	2B576734	18-5154	N/A
175 Verado (4 Cyl.)	USA	1B227000	2B576734	18-5154	N/A
200 Verado (4 Cyl.)	USA	1B517159	2B578935	18-5154	N/A
200 Verado (6 Cyl.)	USA	0T980000	2B578935	18-5154	N/A
200 Pro Verado (6 Cyl.)	USA	2B034840	2B577715	18-5154	N/A
225 Verado (6 Cyl.)	USA	0T980000	2B578935	18-5154	N/A
250 Verado (6 Cyl.)	USA	0T980000	2B578935	18-5154	N/A
250 Pro Verado	USA	1B830170	2B577715	18-5154	N/A
275 Verado (6 Cyl.)	USA	0T980000	2B578935	18-5154	N/A
275 Pro Verado	USA	1B830170	2B577715	18-5154	N/A
300 Verado	USA	0P520553	2B578935	18-5154	N/A
300 Pro Verado	USA	1B830170	2B577715	18-5154	N/A
350 Verado	USA	2B141617	& Up	18-5154	N/A
350SCi Verado	USA	1B716557	2B143542	18-5154	N/A
350 Pro Verado	USA	2B141124	& Up	18-5154	N/A
400 Verado	USA	2B141124	& Up	18-5154	N/A

① Two Required ② Three Required ③ Four Required ④ Six Required

2-STROKE ENGINES					
HP	Model	Beginning Serial No	Ending Serial No	Coil	Switch Box
4		G710613	& UP	—	18-5792
6		A197112	G760299	18-5186 ①	18-5777
6		G760300	T800749	18-5186	—
8		A197112	G760299	18-5186 ①	18-5777
8		A760300	& UP	18-5186	18-5777
210CC	Sail Power	A918999	& UP	18-5186 ①	18-5777
9.9		A197112	G760299	18-5186 ①	18-5777
9.9		G760300	& UP	18-5186	18-5777
10		D038000	G760299	—	18-5777
15		B292414	G760299	18-5186 ①	18-5777
15		G760300	& UP	18-5186	18-5777
15	Sea-Pro	G044027	G437999	18-5186	—
15		G438000	G760299	18-5186	18-5777
15		G760300	& UP	18-5186	—
15	Comm.	G760300	& UP	18-5186	—
15	Non-Comm.	G760300	& UP	18-5186	—
15XD	Comm	G760300	& UP	18-5186	—
15XD	Non-Comm.	760300	& UP	18-5186	—
18		5837437	6443972	18-5186 ①	18-5776
18		6443973	& UP	18-5186 ①	—
18 BULLET	Comm.	6443973	&UP	18-5186	—
20		3537531	3755884	18-5186	—
20		6443973	G044026	18-5186 ①	18-5777
20		G044027	G437999	18-5186	—
20		G438000	G760299	18-5186 ①	18-5777
20	Comm.	G760300	T800999	18-5186	—
20 NON	Comm.	G760300	T800999	18-5186	—
20 JET		G044027	G760299	18-5186	—
20 JET		G760300	& UP	18-5186	—
25		5705532	6443972	18-5186 ①	18-5776
25	Uses Nut Connection	6443973	& UP	18-5186 ①	18-5776
25	Uses Bullet Connection	6443973	& UP	18-5186	18-5777
25		B238464	G044026	18-5186 ①	18-5777
25		G04027	G437999	18-5186	—
25		G438000	G760299	18-5186	—
25	Comm	G760300	& UP	18-5186	—
25	Non-Comm.	G760300	& UP	18-5186	—
30	Jet	C159200	G589999	18-5186 ①	18-5881
35	Uses Nut Connection	6445653	B110788	18-5186 ①	18-5776
35	Uses Bullet Connection	6445653	B110788	18-5186 ①	18-5778
35		B110789	& UP	18-5186	18-5778
40		3336258	3859434	18-5186	—
40 (2 cyl.)		3859435	5823917	18-5186	—
40 (2 cyl.)		5823918	6443973	18-5186 ①	18-5776
40 (4 Cyl.)		C159200	& UP	18-5186 ③	18-5881
45/50 (4 Cyl.)		5531630	& UP	18-5186 ③	18-5881
45 (3 Cyl.)	Jet	G290584	G589999	18-5186	—
50 (4 Cyl.)		5193259	5531629	18-5186	18-5881
50 (4 Cyl.)		5531630	& UP	18-5186	18-5881
50/60 (3 Cyl.)		6428681	D000749	18-5186 ②	18-5775
50/55/60 (3 Cyl.)		D000750	G589999	18-5186 ②	18-5791
55 (3 Cyl.)		D000750	G589999	18-5186	—
60 (3 Cyl.)		6428681	D000749	18-5186	18-5775
60 (3 Cyl.)		D000750	G589999	18-5186	—
65 (3 Cyl.)		4382057	4571651	—	18-5775
65 jet		D283222	G437999	18-5186	—

① Two Required ② Three Required ③ Four Required ④ Six Required

2-STROKE ENGINES (CONT.)					
HP	Model	Beginning Serial No	Ending Serial No	Coil	Switch Box
70	MK75,78	1110600	& UP	18-5433	N/A
70 (6 Cyl.)		1296411	1566239	18-5433	N/A
Mercury 70		4571652	5128279	—	18-5775
Mariner70		5128280	& UP	18-5186 ②	18-5775
70		1296411	1566239	18-5433 ①	N/A
70		5579016	6428680	18-5186 ②	18-5775
70/75 (3 Cyl.)		C272000	D283221	18-5186 ②	18-5775
75 (3 cyl)		D283222	G437999	18-5186 ③	18-5790
75 (4 Cyl.)		6432901	& UP	18-5186 ③	18-5881
75 (3 Cyl.)		C222000	D283221	18-5186 ②	18-5775
75 (3 Cyl.)		D283222	G437999	18-5186 ②	18-5790
75DFI (3 Cyl.)		0T980000	& Up	18-5158	N/A
800 (6 Cyl.)		1335465	1566239	18-5433 ①	N/A
Mariner 80 (4 Cyl.)		5144547	& UP	18-5186 ③	—
Merc 80 (4 Cyl.)		5582562	6432900	18-5186 ③	—
80 (4 Cyl.)		4831999	5141096	—	18-5881
80 (4 Cyl.)		5141097	6432900	18-5186	18-5881
80 (3 Cyl.)		A996142	& UP	18-5186 ②	18-5775
80 Jet		D283222	G437999	—	18-5881
80 Jet (3 Cyl.)		1B586067	& Up	18-5158	N/A
85 (6 Cyl.)		1460999	1766823	18-5433 ①	N/A
85 (4 Cyl.)		4366802	4831998	—	18-5881
90		1766824	1869775	18-5433 ①	N/A
90 (6 cyl.)		5299506	& UP	18-5186 ④	18-5775 ①
90 (3 Cyl.)		A996142	D283221	18-5186 ②	18-5775
90 (3 Cyl.)		D283222	G437999	18-5186	18-5790
90 (Powerhead)	Sport Jet	E023150	E095087	—	18-5775
90DFI (3 Cyl.)		0T980000	& Up	18-5158	N/A
95		1869776	1935100	18-5433 ①	N/A
100 (6 cyl.)		1464949	2318585	18-5433 ①	N/A
100 (4 Cyl.)		B209468	G437999	18-5186 ③	18-5881
105 Jet		D082000	G303045	18-5186 ④	18-5775 ①
110		1870204	2314955	18-5433 ①	N/A
110 Jet	2.5L		1B490865	18-5187	N/A
110 Jet	2.5L	1B690542	& Up	18-5158	N/A
115 (6 Cyl.)		5314656	& Up	18-5186 ④	18-5775 ①
115 (6 Cyl.)		5314656	& Up	18-5186	—
115 (4 Cyl.)		B209468	6437999	18-5186 ③	—
115 (3 Cyl.)		C100000	G437999	—	18-5881 ①
115 DFI (3 Cyl.)		0T980000	& Up	18-5158	N/A
115 Pro XS (3 Cyl.)		1B751825	& Up	18-5158	N/A
125 (4 Cyl.)		D283222	G437999	18-5186	18-5881 ①
125 DFI (3 Cyl.)		1B736885	& Up	18-5158	N/A
V-135		A904646	G960499	18-5186 ④	18-5775 ①
V-135 DFI	2.5L	G590000	1B417701	18-5187	N/A
V-135 DFI	2.5L	1B417702	& Up	18-5158	N/A
140		5327663	& Up	18-5186 ④	18-5775 ①
140 Jet		D082000	G960499	18-5186 ④	18-5775 ①
150		A904646	G960499	18-5186	18-5775
V-150	Orange Coil	4868998	A904645	—	18-5775 ①
V-150	Blue Coil	4868998	A904645	18-5186	18-5775 ①
V-150		5129480	G960499	18-5186 ④	18-5775 ①
V-150 XR2		6616991	A904645	18-5186 ④	18-5775 ①
V-150 XR4		B242885	D819999	18-5186 ④	18-5775 ①
V-150 DFI	2.5L	G590000	1B417701	18-5187	N/A
V-150 DFI	2.5L	1B417702	& Up	18-5158	N/A

① Two Required ② Three Required ③ Four Required ④ Six Required

2-STROKE ENGINES (CONT.)

HP	Model	Beginning Serial No	Ending Serial No	Coil	Switch Box
150 Pro XS	2.5L	1B690542	& Up	18-5158	N/A
V-175		4301235	5180108	—	18-5775 ①
V-175,EFI, XR1		5180109	G960499	18-5186 ④	18-5775 ①
V-175 EFI		D000750	G960499	18-5186	—
V-175 DFI	2.5L	T178500	1B417701	18-5187	N/A
V-175 DFI	2.5L	1B417702	& Up	18-5158	N/A
V-200, XR1		5363918	G960499	18-5186 ④	18-5775 ①
V-200 EFI		C100861	G960499	18-5186	—
V-200 DFI		G590000	1B504988	18-5187	—
200 DFI		G960500	T800999	18-5187	N/A
200 DFI	3.0L	T801000	1B504988	18-5187	N/A
200 DFI	3.0L	1B504989	1B912785	18-5158	N/A
200 DFI (DTS)	3.0L	T980000	1B504988	18-5187	N/A
200 DFI (DTS)	3.0L	1B504989	& Up	18-5158	N/A
200XS DFI	2.5L	T235000	1E002110	18-5187	N/A
200 Pro XS	3.0L	1B504989	& Up	18-5158	N/A
200 Sport XS	3.0L	1E000797	1E002583	18-5187	N/A
V-220		B117316	& Up	18-5186 ④	18-5775 ①
V-225	2.4L	5628028	& Up	18-5186 ④	18-5775 ①
V-225 DFI		G590000	B504988	18-5187	—
V-225 PRO XS		B104549	B426650	18-5187	—
225 DFI	3.0L	G590000	1B504988	18-5187	N/A
225 DFI	3.0L	1B504989	1B912785	18-5158	N/A
225 DFI (DTS)	3.0L	T980000	1B504988	18-5187	N/A
225 DFI (DTS)	3.0L	1B504989	& Up	18-5158	N/A
240 EFI SportJet		E406400	& Up	18-5158	N/A
V-250	3.4L	C101891	& Up	18-5186	—
250XS	3.0L	T651945	1E002341	18-5187	N/A
250 DFI	3.0L	1B528615	& Up	18-5158	N/A
V-275	3.4L	C101891	& Up	18-5186	—
V-300	3.4L	5611648	& Up	18-5186	—

① Two Required ② Three Required ③ Four Required ④ Six Required

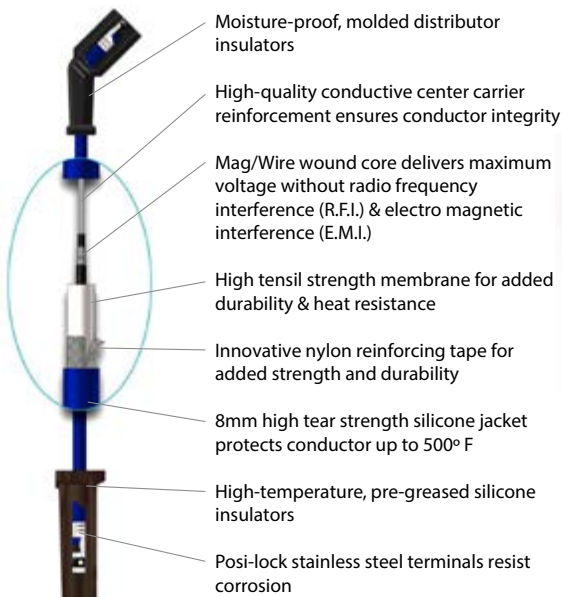

Sierra's MAGFORCE Ignition Wires are "Electronics Friendly" protecting all of your electronic devices and electronic engine controls from RFI and EMI while delivering the maximum amount of voltage. Exact fit design ensures easy installation and years of trouble - free service.



Part #	OEM #	Description
18-8819-1	—	7" Spark Plug Wire (8mm)
18-5228-1		
18-5228-1D ③	84-813715A1	9" Spark Plug Wire (8mm)
★ 18-5227-1		
18-5227-1D ②③	84-813715A1	9" Spark Plug Wire (7mm)
18-5229-9-1 ①②	—	22" Spark Plug Wire (7mm)
18-5230-9-1 ①②	—	10" Spark Plug Wire (7mm)

★ Metallic core wire ① PKG. OF 5 ② 7mm copper core wire
 ③ Items ending in "D" are Display Packaged - Regular number is Non-Display



18-5225
SPARK PLUG WIRE KIT
Replaces: 84-99215A26, 84-813706A26, 84-93475A26, 84-93212A1, 84-90816A26
Kit includes 25 ft. Roll of 7 MM Hypalon Ignition Wire With a Metallic Core and a Large Assortment of Three Different End Fittings to Fit Outboard Motors.



18-5226
IGNITION WIRE
Metallic Core
100' Spool
7mm Hypalon



PKG. OF 10
18-5224
18-5224-9¹
SPARK PLUG WIRE TERMINAL
Replaces: 20121, 8M0084600



PKG. OF 10
18-5750
18-5750-9¹
UNIVERSAL SPARK PLUG BOOTS
Supplied complete w/Terminal Connector



18-5752
UNIVERSAL SPARK PLUG BOOT
8mm



18-28080
WIRE SET
Replaces: 84-821945A56
Fits: 225(3.0L Carb) and 225/250(3.0L EFI) (G303045 & Below)



18-28081
WIRE SET
Replaces: 84-813706A56
Fits: 225(3.0L Carb) and 225/250(3.0L EFI) w/CDM Modules (G303045 & Up)



18-28082
WIRE SET
Replaces: 84-813715A8
Fits: 100, 115, 125 & 80 Jet(4 cyl) (0G301750 & Below)



18-28083
PLUG WIRE
Replaces: 84-881908T
(1 WIRE)
Fits: Mercury V6 EFI/DFI/DTS



18-28084
PLUG WIRE SET
Replaces: 84-881908T
(3 WIRES)
Fits: Mercury 30-40 EFI 4-stroke(3 cyl)



18-28085
PLUG WIRE SET
Replaces: 84-881908T
(4 WIRES)
Fits: Mercury 40-6- EFI 4-stroke (4cyl)



18-28086
PLUG WIRE SET
Replaces: 84-881908T
(6 WIRES)
Fits: Mercury V6 EFI/DFI/DTS



MP41000
IGNITION SWITCH
Push to Choke – 3 Position – 6 Terminal
Replaces: 87-88107, 87-88107A5
See ELECTRICAL PRODUCTS - Ignition Switches section for wiring diagram.



MP41070-2
IGNITION SWITCH
Push to Choke – 3 Position – 6 Wire Sealed Polyester
Replaces: 87-17009A2



MP51090 (Display Pkg.)
MP51092
IGNITION SWITCH
3 Position Magneto – OFF- RUN- START PUSH to Choke
Replaces: 87-17009A5



MP52000 (Display Pkg.)
MP52002
IGNITION SWITCH
3 Position Magneto – OFF- RUN- START PUSH to Choke – 8 Wire
Replaces: 87-88107A5



18-6751
MANUAL RELEASE VALVE
Replaces: 893929A01, 813442A2, 813442A1, 811618A1, 811618, 812843A1, 99660A1
Fits: Most 2 & 4 Stroke Outboards with Integral tilt and trim



18-6771
TILT/TRIM RESERVOIR
Replaces: 18525A1



18-6778
TILT/TRIM RESERVOIR
Replaces: 883166A1, 883166A2
For: Motors with 4 screw attachments

(2 Wire w/ Relays)



18-6273-1
TILT/TRIM MOTOR
High Performance Cartridge Pump
w/Replaceable Motor

Replaces: 99186, 99186-1, 99186-T
Fits: 35-220 HP (1985-93) Mercury/Mariner Outboards
w/ Design I, 3 Ram, 3 Wire Tilt/Trim Units w/ Side Fill Reservoir. Integral Trim/Tilt System
Uses relay **18-5737**



18-6757
TILT/TRIM MOTOR

Fits: Mercury 35-220 HP (1985-92) w/ Design I, 3-Ram
Side Fill Integral Trim/Tilt System w/ Square Style Eaton
Motor and **18-6273-1** Tilt/Trim Motor Pump Assy
Uses wire harness **18-6823**



18-6763
TILT/TRIM MOTOR

Replaces: 92975A28, A32
To 1984 for Most Mercury Outboards
(Motor and Reservoir Only)



18-6765
TILT/TRIM ASSEMBLY

Replaces: 823653A5, 92459A4, 823653A9
Fits: 250,275 HP & V-3.4L,
Serial No.5611648-UP
(Motor Only)
Replaces: 17649A02



18-6773
TRIM MOTOR

Replaces: 828708, 878265A4
For most late model Mercury/Mariner 1996 & UP (135,150,
XR6 Mag III, 175, 200, 225, 250 HP — 105 - 140 HP Jet)



18-6774
TRIM MOTOR

Replaces: 811628, 828708A1, 878265A6
High-performance cartridge, replaceable motor. Design II, Ram 3, 2 wire, tilt/trim units.
Squared style Eaton
Uses wire harness **18-6823**

18-6775
TILT/TRIM MOTOR

Reference OE reservoir 811673 1
Contains: All parts necessary, a new 3-wire
motor/reservoir, drive shaft coupler, oil seal,
O-ring and hardware.
Yellow fill plug.

For:

Models	Models
65 Jet	100 4-Cyl.
75 3-Cyl.	115 4-Cyl.
80 Jet	125 4-Cyl.
90 3-Cyl.	

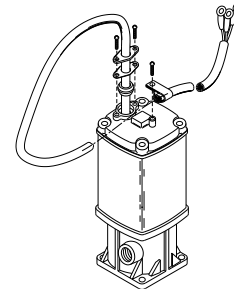

If you have this 3-wire single ram
system, use **18-6775**

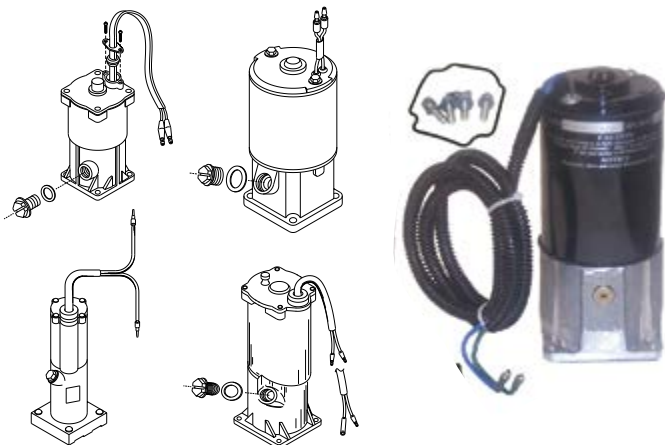

18-6777
TILT/TRIM MOTOR

Replaces: 818903A1, 819762A4-A7, 819479A1, 819480A1, 81977A8-A9,
822870A1, 830250A3-T3, 832021A1-T4-A2-T2, 855654A1-T2, 19217A1-
A5, 854472A2, A3, A4, 2B094995 and below
Now considered Mercury Design 1.
Contains: All parts necessary, a new 2-wire motor/reservoir, drive shaft coupler, oil
seal, O-ring and hardware. Yellow fill plug. Square base O-ring.

For:

Models	Models
30 Jet	60 3-Cyl., Bigfoot
30 4-Stroke	65 Jet
35	75 3-Cyl.
40 2, 3, 4-Cyl.	75 4-Stroke
40 4-Stroke, Bigfoot	80 Jet
45 4-Stroke, Bigfoot, Bodensee	90 3-Cyl.
50 3-Cyl.	90 4-Stroke
50 4-Stroke, Bigfoot	100 4-Cyl.
55 3-Cyl.	115 4-Cyl.
	125 4-Cyl.

If you have any of the 2-wire single systems, use **18-6777**



18-6448
ELECTRIC START CONVERSION KIT
Fits: Mercury 30 HP



18-6274
TILT/TRIM MOTOR
Replaces: 14336A20, 865380A13
Low pressure / high flow



BATTERY CABLES
Gauge Cable with soldered lug terminals on each end to accept a 3/8" stud.

Part No.	Size	Color	Gauge	Part No.	Size	Color	Gauge
BC88523	2'	red	4	BC88563	6'	red	2
BC88533	2'	black	4	BC88573	6'	black	2
BC88543	4'	red	2	BC88583	8'	red	1
BC88553	4'	black	2	BC88593	8'	black	1



18-9801
MULTI METER/DVA TESTER
Replaces: 91-99750A1
A must for testing Mercury ignition systems.



18-9800
COMPRESSION TESTER
Perfect for hard to reach bottom spark plug holes on older Mercury models.



18-9802
TIMING LIGHT
Replaces: 91-99379
Self-powered accurate up to 10,000 RPM's.



18-5864
STATOR
Replaces: 86617A20
For: 6-25 HP



18-5865
STATOR
Replaces: 398-5704A7
For: 50-70 HP



18-5870
STATOR
Replaces: 398-832075A4-A21
For: 30-125 HP
Replacement for the 18-5873 & 18-5874 kits



18-5871
STATOR
Replaces: 398-5454A32
For: 135-300 V6



18-5873
STATOR KIT
Replaces: 398-832075A6
For: 100, 115, 125 HP
Includes 18-5870 stator



18-5874
STATOR KIT
Replaces: 398-832075A14, 398-832075A20, 398-818535A15, 398-5919A8, 398-5919A6, 398-5919A2, 398-5454A63, 398-5454A25, 398-5454A21
For: 30-50 HP
Includes 18-5870 stator



18-5876
STATOR
Replaces: 398-9610A19
For: 135-200 HP



18-5854
STATOR
 Replaces: 398-5454A17
 *Note: Extra black lead goes to engine ground.



18-5855
STATOR
 Replaces: 336-3996A7



18-5856
STATOR
 Replaces: 398-5255



18-5857
STATOR
 Replaces: 398-5454A7



18-5859
STATOR
 Replaces: 398-5454A26, 398-5454A22, 398-5919A7, 398-5919A3



18-5860
STATOR
 Replaces: 398-5454A35



18-5797
TRIGGER ASSEMBLY
 Replaces: 96455A8, 96455A1, 68162A6, 68162A3
 For: 3 cyl.



18-5798
TRIGGER ASSEMBLY
 Replaces: 96455A9, 96455A6, 68162A8, 68162A5, 68162A1
 For: 6 cyl.

STATOR & TRIGGER APPLICATIONS

HP	Beg. S/N	End S/N	Trigger	Stator	HP	Beg. S/N	End S/N	Trigger	Stator
6	A197112	G760299	—	18-5864	18XD	6443973	B238463	—	18-5864
7.5	2810637	3274632	—	18-5855	20	2827677	3226957	—	18-5855
8	A197112	G760299	—	18-5864	20	6443973	G044026	—	18-5864
9.8	2798057	3263262	—	18-5855	20, 20 JET	G044027	G437999	—	18-5863
9.9	A197112	G760299	—	18-5864	20, 20 JET	G438000	G760299	—	18-5864
XR10,10 MAG & SEA PRO	D038000	G760299	—	18-5864	20XD	6443973	B238463	—	18-5864
15	A197112	G760299	—	18-5864	25	5705532	6443972	—	18-5864
15 SEA PRO, SUPER 15	G044365	G437999	—	18-5863	25, 25 SEA PRO & MARATHON	B238464	G044026	—	18-5864
15 SEA PRO, SUPER 15	G438000	G760299	—	18-5864	25, 25 SEA PRO & MARATHON	G044027	G437999	—	18-5863
18	5837437	6443972	—	18-5864	25, 25 SEA PRO & MARATHON	G438000	G760299	—	18-5864

APPLICATION CONTINUED ON NEXT PAGE

STATOR & TRIGGER APPLICATIONS

HP	Beg. S/N	End S/N	Trigger	Stator	HP	Beg. S/N	End S/N	Trigger	Stator
25XD	5705532	G044026	—	18-5864	V150	A904646	C100860	18-5798	18-5860 ②
30 2 cyl electric models	G055314	& UP	—	18-5870 **	V150	A904646	C100860	18-5798	18-5871
30 JET 3 cyl electric models	G590000	T408999	—	18-5870 **	V150	C100861	C239552	18-5798	—
30 Jet 4 cyl electric models	C159200	D055047	—	18-5874 **	V150	C239553	D081999	18-5798	18-5860 ③
35 2 cyl	6445653	B110788	—	18-5864	V150	C239553	D081999	18-5798	— †
40 2 cyl	3859435	5823917	—	18-5856 ①	V150	C239553	D081999	18-5798	—
40 2 cyl electric start	G055314	& UP	—	18-5870 **	V150	D082000	G960499	18-5798	18-5876
40 3 cyl electric start	G531301	& UP	—	18-5870 **	V150 EFI	D082000	G960499	18-5798	18-5876
40 3 cyl electric start (Belgium)	9973100	& UP	—	18-5874 **	V150 XRI EFI	D082000	G303045	18-5798	18-5876
40 4 cyl electric start	C159200	D055047	—	18-5874	150 XR-4	B242885	C100860	18-5798	18-5860
40 JET electric start	T178500	& UP	—	18-5874 **	150 XR-4	C100861	C239552	18-5798	—
45 4 cyl manual start only	5531630	B110788	—	—	150 XR-4	C239553	D081999	18-5798	18-5860 ③
45 4 cyl electric models	5531630	& UP	—	18-5870	150 XR-4	C239553	D081999	18-5798	— †
45 JET electric models	G590000	T129554	—	18-5874 **	150 XR-4	C239553	D081999	18-5798	—
50 4 cyl manual start only	4357640	& UP	—	—	150 XR-4, MAG II	C239553	D081999	18-5798	—
50 4 cyl electric models	4357640	& UP	—	18-5870	150 XR-4, MAG II	C239553	D081999	18-5798	—
50 3 cyl	6428681	D000749	18-5797	18-5865	150 XR-6, MAG III	D082000	G960499	18-5798	18-5876
50, 55 3 cyl electric start	G590000	& UP	—	18-5870	V175	4301235	6618750	18-5798	18-5857
50 3 cyl electric models (Belgium)	9973100	& UP	—	18-5870	V175	6618751	C100860	18-5798	18-5871 ④
55 3 cyl electric models	D000750	G589999	—	18-5870	V175	6618751	C100860	18-5798	18-5857 ④
55 3 cyl electric models (Belgium)	9741042	9973088	—	18-5870	V175	6618751	C100860	18-5798	18-5860 ⑤
60 3 cyl	6428681	D000749	18-5797	18-5865	V175	C100861	C239552	18-5798	—
60 3 cyl electric models	G590000	& UP	—	18-5870 **	V175	C239553	D081999	18-5798	18-5860 ③
60 3 cyl electric models (Belgium)	9973100	& UP	—	18-5870 **	V175	C239553	D081999	18-5798	—
60 3 cyl Bigfoot	G590000	G760299	—	18-5874 **	V175	C239553	D081999	18-5798	— †
65 (650) 3 cyl	4382057	4571651	—	18-5865	V175	D082000	G960499	18-5798	18-5876
70 3 cyl	4571652	A996141	18-5797	18-5865	V175 MAG, EFI	D000750	D081999	18-5798	—
75 4 cyl	6432901	& UP	—	18-5859	V175 EFI	D303046	G960499	18-5798	18-5876
75 3 cyl electric models	G438000	& UP	—	18-5870	V175 XRI EFI	D000750	D081999	18-5798	—
80 (80, 800) 4 cyl	4831999	6432900	—	18-5859	V175 XRI EFI	D082000	G303045	18-5798	18-5876
80 JET	G438000	& UP	—	18-5870 **	V200	4839034	6625220	18-5798	18-5857 ④
85 (850) 4 cyl	4366802	4831998	—	18-5859	V200	6618751	C100860	18-5798	18-5860
90 6 cyl	5299506	& UP	18-5798	18-5854	V200	C100861	D081999	18-5798	18-5860 ③
90 3 cyl electric models	G438000	& UP	—	18-5870	V200	C100861	C291519	18-5798	— †
90 3 cyl (Belgium) electric models	9927000	& UP	—	18-5870	V200	C100861	C291519	18-5798	—
100 4 cyl	G438000	& UP	—	18-5870 **	V200	D082000	G960499	18-5798	18-5876
100 4 cyl	9927000	& UP	—	18-5870 **	V200 EFI	C100861	OD081999	18-5798	—
100 4 cyl with voltage reg.	B209468	G437999	—	18-5873 **	V200 EFI	G303046	G960499	18-5798	18-5876
100 4 cyl with voltage reg. (Belgium)	9523024	9926999	—	18-5873 **	V200 XRI EFI	C291520	D081999	18-5798	— †
105 JET	D082000	G960499	18-5798	18-5876	V200 XRI EFI	D082000	G960499	18-5798	18-5876
115 6 cyl	5314656	& UP	18-5798	18-5854	V220	B117316	& UP	—	18-5860
115 4 cyl electric models	G438000	& UP	—	18-5870 **	V225	5628028	& UP	18-5798	18-5857
115 4 cyl electric models (Belgium)	9927000	& UP	—	18-5870 **	SPORTJET MODELS				
115 4 cyl with voltage reg.	C10000	G437999	—	18-5873 **	90	ALL W/RED STATOR		—	18-5870
115 4 cyl with voltage reg. (Belgium)	9559771	9926999	—	18-5873 **	95XR	ALL W/RED STATOR		—	18-5870
125 4 cyl	G438000	& UP	—	18-5870 **	120XR	ALL W/RED STATOR		—	18-5870
125 4 cyl (Belgium)	9927000	& UP	—	18-5870 **	175XR2	ALL		—	—
125 4 cyl with voltage reg.	D283222	G437999	—	18-5873 **					
125 4 cyl with voltage reg. (Belgium)	9793577	9926999	—	18-5873 **					
V135	A904646	C100860	18-5798	18-5860 ②					
V135	A904646	C100860	18-5798	18-5871					
V135	C100861	C239552	18-5798	—					
V135	C239553	D081999	18-5798	18-5860 ③					
V135	C239553	D081999	18-5798	—					
V135	C239553	D081999	18-5798	—					
V135	D082000	G960499	18-5798	18-5876					
140	5327663	& UP	18-5798	18-5854					
140 JET	UP TO	G760299	18-5798	18-5876					
V150	4868998	A904645	18-5798	18-5857					

① Electric start models only
 ② Stators with 5/8" laminations only
 ③ Applications with 16 amp Stator and non-louvered flywheel cover
 ④ Applications not using a voltage regulator
 ⑤ Stators with 5/8" laminations and used with 15 amp voltage regulator
 ⑥ Flywheel without screws
 ** May require the purchase of voltage regulator if not currently equipped
 † Applications with clear 40 amp stator with louvered flywheel cover

All Voltage Regulators have built-in capacitors that provide high voltage spike protection.

18-5741
VOLTAGE REGULATOR

Replaces: 815279A2, 815279-1
For: Mercury engines with 16 amp or 40 amp charging system model/years 1989-91

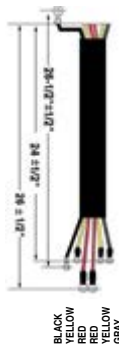

18-5743
VOLTAGE REGULATOR

Replaces: 815279-3, 815279-5, 883072T
For: Mercury engines with 16 amp or 40 amp charging system model/years 1992 to present
*Note: Black wire (not pictured) goes to engine ground.

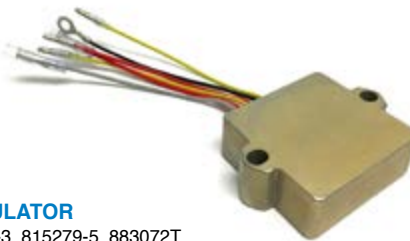

18-5732
VOLTAGE REGULATOR

Replaces: 893640T01
Fits: 30/40/50/60 EFI 4 Stroke



18-5707
RECTIFIER

Replaces: 62351A1, 62351A2, 816770, 816770T
All applications with square, 3 post rectifier



18-5802
SOLENOID

Replaces: 65057A1, 65057T1, 65057, 54981



18-5808
SOLENOID

Replaces: 47886, 47886T

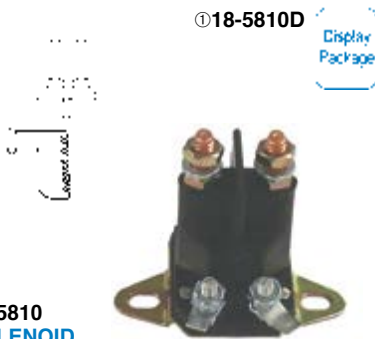

18-5810
SOLENOID

Horizontal Post



18-5811-1
STARTER SOLENOID

Replaces: 809463A1, 8094631, 809463, 8094621, 809462
For: PG260 Series Starters, (Verado 200-275 HP), (75/95 1.5L DFI), (115/135/150/175/200 2.5L DFI), (225 3.0L DFI)

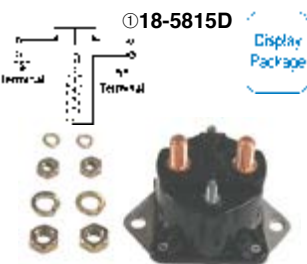

18-5815
SOLENOID

Replaces: 89-68258A4, 89-853654A1, 89-76545, 89-76545T, 89-65258, 89-61053, 89-15857

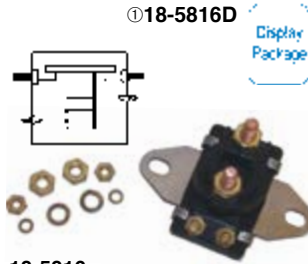

18-5816
SOLENOID

Replaces: 89-96054, 89-96054T, 89-91975
Flat Bracket

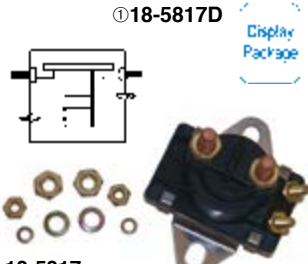

18-5817
SOLENOID

Replaces: 89-96158, 89-96158T, 94318, 846070
Vertical Post, Angled Bracket

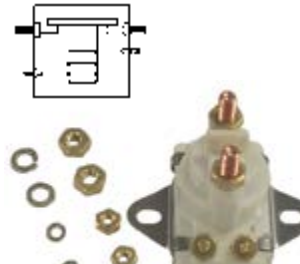

18-5818
SOLENOID

Replaces: 89-818864, 89-818864T

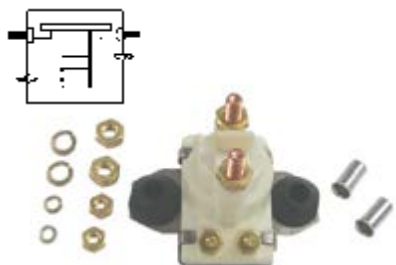

18-5819
SOLENOID

Replaces: 89-818997A1, 89-818997T1, 89-818997A2

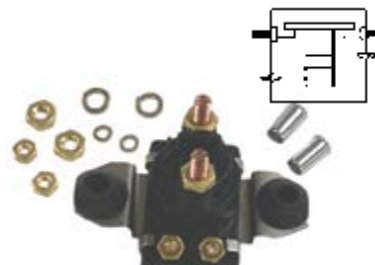

18-5820
SOLENOID

Replaces: 89-818999A2, v89-825842A1, 89-850188T1



18-5821
STARTER SOLENOID

Replaces: 89-825096T, 825096T01
Fits: 9.9 4-Stroke(1999 & Up), 15 4-stroke (1999 & Up), 30 4-stroke(2002 & Up), 40/50/60 4-stroke(2001 & Up), 75/90 4-stroke(2000 & Up)

APPLICATION ON NEXT PAGE

① Items ending in "D" are Display Packaged - Regular number is Non-Display

 <p>18-5834 SOLENOID Replaces: 89-817109A2 For: 75 HP (3 cyl.) S/N G127500 & UP</p>	 <p style="text-align: center;">①18-5836D Display Package</p> <p>18-5836 SOLENOID Replaces: 25661, 256611, 25661T1</p>	 <p>18-5729 POWER TRIM RELAY Replaces: 87-18211 For: 35 (2 cyl.) (with Ram Trim) OC159200 & UP 60 (3 cyl.) (with Ram Trim) OB122920 - OD000749</p>	 <p>18-5737 POWER TRIM RELAY Replaces: 87-19761 For: 40 (4 cyl.) (with Relays) OC159200 & UP</p>
 <p>18-5849 RELAY, SHROUDED, TRIM Replaces: 882751A1, 828151A1, 828151, 882751A2 Fits: Power Trim Relay used on most 2-stroke and 4-stroke (non-Verado®) engines.</p>	 <p>18-5850 RELAY, SHROUDED Replaces: 882751A04 Fits: 135hp. - 350hp Verado (2005 - Current); 496Mag & 496HO (2004 - Current); 8.1HO (2004 - Current)</p>	 <p>18-5851 RELAY, SHROUDED Replaces: 865202T, 807057T, 807057</p>	 <p>18-5852 RELAY, SHROUDED Replaces: 821509T01, 821509, 853292 Fits: Four-Stroke: 45hp (OG231123-OG472132); 50hp. (OG231123-OT178499)</p>

① Items ending in "D" are Display Packaged - Regular number is Non-Display

SOLENOID APPLICATION

HP	Beg. S/N	End. S/N	Starter Solenoid/Relay	Power Trim Relay	
4-Stroke					
9.9 (4-Stroke)(323cc)	0G760300	0T979999	18-5821	—	
15 (4-Stroke)(323cc)	0G760300	1B727495	18-5821	—	
30 (4-Stroke) Carb	0G760300	& Up	—	18-5849	
30 (4-Stroke) EFI	0T409000	1B226999	18-5821	18-5849	
40 (4-Stroke)(3 cyl) Carb	0G760300	& Up	—	18-5849	
40 (4-Stroke)(3 cyl) EFI	0T409000	& Up	18-5821	18-5849	
40 (4-Stroke)(4 cyl) Carb	0T228405	0T598999	18-5821	18-5849	
40 (4-Stroke)(4 cyl) EFI	0T409000	& Up	18-5821	18-5849	
45 (4-Stroke) Bodensee	0G231123	0G472132	18-5821	18-5852	
45 (4-Stroke) Bodensee	0G472133	0T178499	18-5821	18-5849	
50 (4-Stroke)	0G231123	0T178499	18-5821	18-5852	
50 (4-Stroke)(4 cyl) Carb 996cc	0T178500	0T598999	18-5821	18-5849	
50 (4-Stroke)(4 cyl) EFI 996cc	0T409000	& Up	18-5821	18-5849	
60 (4-Stroke)(4 cyl) Carb 996cc	0T178500	0T598999	18-5821	18-5849	
60 (4-Stroke)(4 cyl) EFI 996cc	0T409000	& Up	18-5821	18-5849	
75 (4-Stroke) Carb 1596cc	0G960500	1B226999	18-5821	—	
75 (4-Stroke) EFI 1596cc	1B366823	& Up	18-5834	—	
90 (4-Stroke) Carb 1596cc	0G960500	1B226999	18-5821	—	
90 (4-Stroke) EFI 1731cc	1B366823	& Up	18-5821	—	
115 (4-Stroke) EFI w/ 2 relay trim	0T178500	0T800999	—	18-5849	
115 (4-Stroke) EFI 1731cc	0T809000	1B366822	—	18-5849	
115 (4-Stroke) EFI 1731cc	1B366823	& Up	18-5821	—	
135 (4-Stroke) Verado	1B227000	& Up	18-5850	18-5850	
150 (4-Stroke) Verado	1B227000	& Up	18-5850	18-5850	
175 (4-Stroke) Verado	1B227000	& Up	18-5850	18-5850	
200 (4-Stroke)(4 cyl) Verado	1B517159	& Up	18-5850	18-5850	
200 (4-Stroke)(6 cyl) Verado	0T980000	& Up	18-5850	18-5850	
225 (4-Stroke)(6 cyl) Verado	0T980000	& Up	18-5850	18-5850	
250 (4-Stroke)(6 cyl) Verado	0T980000	& Up	18-5850	18-5850	
275 (4-Stroke)(6 cyl) Verado	0T980000	& Up	18-5850	18-5850	
300 (4-Stroke)(6 cyl) Verado	1B517434	& Up	18-5850	18-5850	
350 (4-Stroke)(6 cyl) Verado	1B716557	& Up	18-5850	18-5850	
2-Stroke					
HP	Beg. S/N	End. S/N	Starter Solenoid	Power Trim Solenoid	Power Trim Relay
6/8/9.9	A197112	OD280999	18-5816	—	—
15	A197112	OD280999	18-5816	—	—
18	5837437	& UP	18-5816	—	—
20	4709593	6443972	18-5815	—	—
20	6443973	0G044026	18-5816	—	—
25	5705532	G044026	18-5816	—	—
30 (2 cyl) 644cc	G053314	& UP	—	—	18-5849
30 JET non-handle	C159200	G589999	18-5816	—	—
35 2 cyl (w/ 3 Ram Trim)	6445653	C159199	18-5817	18-5817	—

① Use 18-5817 for applications with circuit breaker and fuse. ③ For units with 10-32, 5/16-18 terminals. ⑤ For design II applications use 18-5820.
 ② For units with 8-32, 1/4-20 terminals. ④ Use 18-5818 if off white solenoid is needed. ⑥ w/rubber bushing solenoid

SOLENOID APPLICATION

HP	Beg. S/N	End. S/N	Starter Solenoid	Power Trim Solenoid	Power Trim Relay
35 2 cyl (w/ 1 Ram Trim)	C159200	& UP	18-5817	—	18-5729
40 2 cyl	2874704	5556229	18-5836	—	—
40 2 cyl	5556230	5823917	18-5815	—	—
40 2 cyl	5823918	G053313	18-5817	—	—
40	G053314	& UP	18-5816 ⑤	—	—
40 4 Cyl.(w/solenoids)	C159200	& UP	18-5816	18-5820	—
40 4 Cyl.(w/relays)	C159200	& UP	18-5816	—	18-5737
45 4 Cyl.(w/o circuit breaker)	5531630	6146848	18-5815	18-5815	—
45 4 Cyl.(w/circuit breaker)	5531630	6146848	18-5815	18-5817	—
45 4 Cyl.(w/o circuit breaker)	6146849	B110788	18-5817	18-5815 ①	—
45 4 Cyl.(w/circuit breaker)	6146849	B110788	18-5817	18-5817	—
45 4 Cyl.	B110789	& UP	18-5817	18-5817	—
45 JET (w/flush mount solenoid)	D000750	G290584	18-5816	—	—
45 JET	G290585	G589999	18-5820	—	—
50	3008819	4140999	18-5836	—	—
50	4141000	5531629	18-5815	—	—
50 4 Cyl.(w/circuit breaker)	5531630	6146848	18-5815	18-5815 ①	—
50 4 Cyl.(w/circuit breaker)	5531630	6146848	18-5815	18-5817	—
50 4 Cyl.(w/o circuit breaker)	6146849	& UP	18-5817	18-5815 ①	—
50 4 Cyl.(w/circuit breaker)	6146849	& UP	18-5817	18-5817	—
50 3 Cyl.	6428681	B122929	18-5816	18-5817	—
50 3 Cyl. (w/ 3 Ram Trim)	B122930	C160935	18-5817	18-5817	—
50 3 Cyl. (w/ 1 Ram Trim)	B122930	D000749	18-5817	—	18-5729
50 3 Cyl.	D000750	G290584	18-5816	—	18-5849
50 3 cyl	G290585	G589999	18-5820	—	18-5849
50 3 cyl	G590000	& UP	—	—	18-5849
55 3 Cyl.	D000750	G290584	18-5816 ⑤	—	18-5849
55 3 Cyl.	G290585	G589999	18-5820	—	18-5849
60 3 Cyl.	6428681	B122929	18-5816	18-5817	—
60 3 Cyl. (w/solenoids)	B122930	D000749	18-5817	18-5817	—
60 3 Cyl. (w/relays)	B122930	D000749	18-5817	—	18-5729
60 3 Cyl.	D000750	G290584	18-5816 ⑤	—	18-5849
60 3 Cyl.	G290585	G589999	18-5820	—	18-5849
65 4 Cyl.	2446775	3293183	18-5836	—	—
65 3 Cyl.	3547987	4571651	18-5815	—	—
65 JET	G127500	& UP	18-5834	—	—
70 3 Cyl.	4571652	5579016	18-5815	—	—
70 3 Cyl.	5579017	6104369	18-5815	18-5815 ①	—
70 3 Cyl.	6104370	6428680	18-5816	18-5815 ①	—
70 3 Cyl.	A996147	& UP	18-5817	18-5817	—
75 4 Cyl.	6432901	& UP	18-5816	18-5817	—
75 3 cyl w/ 1 Ram Trim	C222000	D252460	—	—	18-5849
75 3 Cyl.	D252461	G127499	18-5817	18-5819	—
75 3 Cyl.	G127500	G360002	18-5834	18-5819	—
75 3 Cyl.	G360003	& UP	18-5834	—	18-5849
75 Optimax 3 cyl (1.5L)	T801000	& UP	18-5834	—	18-5849
80	2559001	3493912	18-5836	—	—
80 4 Cyl.	4831999	5582561	18-5815	—	—
80 4 Cyl.	5582562	6030903	18-5815	18-5815 ①	—
80 4 Cyl.	6030904	6432900	18-5816	18-5815 ①	—
80 3 Cyl.	A996142	& UP	18-5817	18-5817	—
80 JET 4 cyl	D283222	& UP	18-5834	—	—
80 JET 3 cyl	B586067	& UP	18-5834	—	18-5849
85 4 Cyl.	3493913	3865694	18-5836	—	—
85 4 Cyl.	3865695	4831998	18-5815	—	—
90	4845301	5299505	18-5815	18-5815	—
90	5299506	6026608	18-5815	18-5815 ①	—
90	6026609	6436122	18-5816	18-5815 ①	—
90	6436123	& UP	18-5816	18-5817	—
90 3 Cyl.	A996142	C221999	18-5817	18-5817	—
90 3 Cyl. w/ 1 Ram Trim	C222000	D252460	—	—	18-5849
90 3 Cyl.	D252461	G127499	—	18-5819	—
90 3 Cyl.	G127500	G360002	18-5834	18-5819	—
90 3 Cyl.	G360003	& UP	18-5834	—	18-5849
90 Optimax 3 cyl (1.5L)	T801000	& UP	18-5834	—	18-5849
100 6 Cyl.	2318586	3253111	18-5836	—	—
100 4 Cyl. w/ 1 Ram Trim & 5/16-18 starter terminal	B209468	D252460	18-5834	—	18-5849
100 4 Cyl. w/ 3 Ram Trim & 5/16-18 starter terminal	B209468	D252460	18-5834	—	—
100 4 Cyl.	D252461	G359967	18-5834	18-5819	—
100 4 Cyl.	G359968	& UP	18-5834	—	18-5849
105 JET w/ flush mounted starter solenoid	D082000	G303045	18-5815	—	—
105 JET w/ rubber mounted starter solenoid	D082000	G303045	18-5834	—	—
105 JET	G303046	& UP	18-5834	—	—
110 6Cyl.	1870204	2314955	18-5836	—	—
115	2836019	4112634	18-5836	18-5836	—
115	4112635	5600966	18-5815	18-5815	—
115	5600967	6051525	18-5815	18-5815 ①	—
115	6051526	6436122	18-5816	18-5817 ①	—
115	6436123	& UP	18-5816	18-5817	—
115 4 Cyl. w/ 3 Ram Trim & 5/16-18 starter terminal	C100000	D252460	18-5834	—	—
115 4 Cyl. w/ 1 Ram Trim & 5/16-18 starter terminal	C100000	D252460	18-5834	—	18-5849
115 4 Cyl.	D252461	G359967	18-5834	18-5819	—
115 4 Cyl.	G359968	& UP	18-5834	—	18-5849
115 Optimax 3 cyl (1.5L)	T801000	& UP	18-5834	—	18-5849

① Use 18-5817 for applications with circuit breaker and fuse.

③ For units with 10-32, 5/16-18 terminals.

⑤ For design II applications use 18-5820.

② For units with 8-32, 1/4-20 terminals.

④ Use 18-5818 if off white solenoid is needed.

⑥ w/rubber bushing solenoid

SOLENOID APPLICATION					
HP	Beg. S/N	End. S/N	Starter Solenoid	Power Trim Solenoid	Power Trim Relay
115 Pro XS	B751825	& UP	18-5834	—	18-5849
125	2314956	3253111	18-5836	—	—
125 4 Cyl.	D283222	G359967	18-5834	18-5819	—
125 4 Cyl.	G359968	& UP	18-5834	—	18-5849
125 Optimax 3 cyl (1.5L)	B736885	& UP	18-5834	—	18-5849
135	2839369	3293233	18-5836	—	—
V135	A904646	C100860	18-5815 ③	18-5817	—
V135	A904646	C100860	18-5816 ②	18-5817	—
V135	C100861	C239552	18-5815	18-5817	—
V135	C239553	D081999	18-5815 ④	18-5817	—
V135 (w/flush mounted solenoid)	D082000	G201874	18-5815	18-5819	—
V135 (w/rubber bushing solenoid)	D082000	G201874	18-5834	18-5819	—
V135 (w/flush mounted solenoid)	G201875	G303045	18-5815	—	18-5849
V135 (w/rubber bushing solenoid)	G201875	G303045	18-5834	—	18-5849
V135	G303046	& UP	18-5834	—	18-5849
V135 DFI	G590000	& UP	18-5834	—	18-5849
140	3293234	3502805	18-5836	18-5836	—
140	4865678	& UP	18-5815	18-5815	—
140 JET	G303046	T178499	18-5834	—	18-5849
150	3502806	4121434	18-5836	18-5836	—
150	4121435	4865677	18-5815	18-5836	—
150 XS	4868648	5327662	18-5815	18-5815	—
V150	4868998	6042945	18-5815	18-5817	—
V150	6042946	A904645	18-5816	18-5817	—
V150	A904646	C100860	18-5815 ③	18-5817	—
V150	A904646	C100860	18-5817 ②	18-5817	—
V150	C100861	C239552	18-5815	18-5817	—
V150	C239553	D081999	18-5815 ④	18-5817	—
V150, 150 EFI w/flush mounted solenoid	D082000	G201874	18-5815	18-5819	—
V150, 150EF w/rubber mount solenoid	D082000	G201874	18-5834	18-5819	—
V150, 150 EFI w/flush mounted solenoid	G201875	G303045	18-5815	—	18-5849
V150, 150EF w/rubber mount solenoid	G201875	G303045	18-5834	—	18-5849
V150, 150 EFI	G303046	& UP	18-5834	—	18-5849
V150 DFI	G590000	& UP	18-5834	—	18-5849
150 XR-4/Magnum II	B242885	C239552	18-5815	18-5817	—
150 XR-4/Magnum II w/standard color solenoid	C239553	D081999	18-5815	18-5817	—
150 XR-4/Magnum II w/off white color solenoid	C239553	D081999	18-5815	18-5818 ⑥	—
150 XR-6/Magnum III w/flush mounted solenoid	D082000	G201874	18-5815	18-5819	—
150 XR-6/Magnum III w/rubber mounted solenoid	D082000	G201874	18-5834	18-5819	—
150 XR-6/Magnum III	G201875	G303045	18-5815	—	—
150 XR-6/Magnum III w/flush mounted solenoid	G201875	G303045	18-5815	—	18-5849
150 XR-6/Magnum III w/rubber mounted solenoid	G201875	G303045	18-5834	—	18-5849
150 XR-6/Magnum III	G303046	& UP	18-5834	—	18-5849
V175	4301235	6618750	18-5815	18-5815	—
V175	6618751	C239552	18-5816 ②	18-5817	—
V175	6618751	C239552	18-5815 ③	18-5817	—
V175	C100861	C239552	18-5815	18-5817	—
V175	C239553	D081999	18-5815 ④	18-5817	—
V175, 175 EFI w/ flush mounted solenoid	D082000	G201874	18-5815	18-5819	—
V175, 175 EFI w/ rubber mounted solenoid	D082000	G201874	18-5834	18-5819	—
V175, 175 EFI w/ flush mounted solenoid	G201875	G303045	18-5815	—	18-5849
V175, 175 EFI w/ rubber mounted solenoid	G201875	G303045	18-5834	—	18-5849
V175, 175 EFI	G303046	& UP	18-5834	—	18-5849
V175 DFI	G590000	& UP	18-5834	—	18-5849
V175 Pro XS	B516339	& UP	18-5834	—	18-5849
V200	4839034	6073191	18-5815	18-5815	—
V200	6073192	6225220	18-5816	18-5817	—
V200	6625221	C100860	18-5816 ②	18-5817	—
V200	6625221	C100860	18-5815 ③	18-5817	—
V200	C100861	C291519	18-5815	18-5817	—
V200 (2.5L)	C291520	D081999	18-5815 ④	18-5817	—
V200 w/ flush mounted solenoid	D082000	G201874	18-5815	18-5819	—
V200 w/ rubber mounted solenoid	D082000	G201874	18-5834	18-5819	—
V200, 200 EFI (w/flush mounted solenoid)	D082000	G201874	18-5815	18-5819	—
V200, 200 EFI (w/rubber bushing solenoid)	D082000	G201874	18-5834	18-5819	—
V200, 200 EFI (w/flush mounted solenoid)	G201875	G303045	18-5815	—	18-5849
V200, 200 EFI (w/rubber bushing solenoid)	G201875	G303045	18-5834	—	18-5849
V200, 200 EFI	G303046	& UP	18-5834	—	18-5849
V200 DFI	G386496	& UP	18-5834	—	18-5849
V220 (Laser)	B117316	& UP	18-5815	18-5817	—
V225 2.4L	5628028	& UP	18-5815	18-5815	—
V225 3.0L	D280813	G129221	18-5834	18-5819	—
V225 3.0L	G129222	G303045	18-5834	18-5819	—
V225 3.0L	G129222	G303045	18-5834	—	18-5849
V225 3.0L	G303046	& UP	18-5834	—	18-5849
V225 DFI	G590000	& UP	18-5834	—	18-5849
V225 Sea Pro / Marathon	G245605	& UP	18-5834	—	18-5849
V225 Pro XS	B104549	& UP	18-5834	—	18-5849
V225/250 EFI	G129222	& UP	18-5834	—	18-5849
V250XB	G980600	& UP	18-5834	—	18-5849
V250 Pro XS	B426561	& UP	18-5834	—	18-5849
V250/275 (3.4L)	C101891	& UP	18-5815	18-5817	—
300 (3.4L)	5611648	& UP	18-5815	18-5817	—

① Use 18-5817 for applications with circuit breaker and fuse.

③ For units with 10-32, 5/16-18 terminals.

⑤ For design II applications use 18-5820.

② For units with 8-32, 1/4-20 terminals.

④ Use 18-5818 if off white solenoid is needed.

⑥ w/rubber bushing solenoid



18-5929
ALTERNATOR
Replaces: 892940T
All Verado's



18-6454
ALTERNATOR
Replaces: 875285T1, 8M0064021, 889955A03, 834832, 881248T, 857006T
5S/ 50 amp Spool mount
Fits: 2.5L



18-6408
ALTERNATOR
Replaces: 863077T
For: Mercruiser 377 Scorpion 97-Up



18-6455
ALTERNATOR
Replaces: 875286T, 875286A1, 881247A1
5S/ 50 amp
Fits: 1.5L and 3.0L
For: 200 DFI, 200 DFI/DTS, 225 EFI, 225 EFI, Sea Pro, 225 DFI/DTS, 250 EFI



18-6840
ALTERNATOR
Replaces: 50-897755T, 897755T
Fits: 75-115HP EFI (4-Stroke)



18-18000
SERPENTINE BELTS
Replaces: 57-892318
For: 75 DFI (2005-06), 90 DFI (2005-06), 15 DFI (2004-06)



18-15128
SERPENTINE BELTS
Replaces: 57-880566014
Fits: All Verados-135-275HP

18-18100
SERPENTINE BELTS
Replaces: 57-828507Q4
For: 135 DFI (1998-Up), 150 DFI (1998-Up), 175 DFI (2001-Up)

18-15129
SERPENTINE BELTS
Replaces: 57-828507 1
Fits: 200 DFI (1997 & Up), 225 DFI (1998 & Up)



18-6500
SERVICE END ALTERNATOR HARNESS
Replaces: 84-881262A2
Fits: Optimax (1998-01) For: Delco Alternators

ALL STARTERS ARE COUNTER CLOCKWISE ROTATION



18-6435
STARTER
Replaces: 50-888161T, 50-884044T, 50-859377T, 50-893888T
Fits: 40,50,60 HP 4 Stroke 4 Cyl, 0P094500 & UP: 50,60 HP EFI 4 Stroke 4 Cyl, 0P153500-UP



18-6436
STARTER
Replaces: 50-859171T, 50-834749, 50-898265001
Fits: 40HP Italy 4 Stroke 0G760300-UP: 45HP Bodensee 0G760300-UP: 50HP 4 Stroke 0G760300-UP: 50HP Bigfoot 4 Stroke 0G760300-UP



18-6437
STARTER
Replaces: 50-888151T, 50-830308T, 50-859169T, 50-893886T
Fits: 25HP 4 Stroke 0G760300 & UP



18-6438
STARTER
Replaces: 50-888160T, 50-884045T, 50-859170T, 50-854636T, 50-893887T
Fits: 30,40HP 3 Cyl 4 Stroke 0G760300 & UP



18-6425
STARTER
Replaces: 50-804312T1
For: 4 Stroke 75 HP, and 90HP except Verado



18-6440
STARTER
Replaces: 50-892339T, 50-853329T
Fits: 90, V135, V150, V175, V200, 2.5L DFI, 0T178500 & UP; 200, 250HP, 3.0L, 0T467442 & UP, and Inline 4 and 6 cyl. Verados. Models with solenoid operated bendix.



18-5601
STARTER
Replaces: 50-55601, 50-55601A2, 50-38890A1
Fits: 35-50 HP models



18-5602
STARTER
Replaces: 50-67341, 50-58788A3, 50-893891T, 50-44369A1
Fits: 35-40 HP, 2 cyl. & 50 HP, 4 cyl. models



18-5642
STARTER
Replaces: 50-66015, 50-66015T, 50-893891T, 50-44369A1
Fits: 50-90 HP models (1976-99), 10 Tooth Drive Gear



18-6282
STARTER
Replaces: 50-8329972, 50-832997003
Fits: Mercury V6 Jet (1996 and up), 8 Tooth Drive Gear



18-6283
STARTER
Replaces: 50-8331535, 50-898265008
For: Mercury 2.5 DFI(1999 and up), 200HP V6 DFI(1996-99), 225HP V6 DFI(1998 and up), 3.0L V6(1999 and up) 9 Tooth Drive Gear
Uses Drive Kit 18-5658



18-5605
STARTER
Replaces: 50-73521, 50-73521T, 50-898265005
Fits: 40-50 HP models



18-5608
STARTER
Replaces: 50-44415, 50-77141, 50-79472, 50-44414, 50-79472 1, 50-893893
Fits: 2.5L, 3.4L & 135 Jet models



18-5610
STARTER
Replaces: 50-66015T, 50-660151, 50-660153, 50-893892T, 50-893892T
(8 Tooth)
Fits: 1.7L, 1.9L & 1.4L (1988-2008)



18-5611
STARTER
Replaces: 50-90983A-1, 50-90983T1, 50-8M0033984
For: 6-15 HP (1986-96), 18-25 HP (1980-87), 10 tooth drive gear



18-5620
STARTER
Replaces: 50-818445-3, 50-818445-2, 50-818445 5, 50-898265009
Fits: 2.5L, 3.0L & 225-250 HP models (1993-2000)

ALL STARTERS ARE COUNTER CLOCKWISE ROTATION



18-5621
STARTER
Replaces: 50-822462, 50-822462T1, 50-893890T
Fits: 30-60 HP models



18-5636
STARTER
Replaces: 50-57465A1, 50-57867, 50-64975, 50-72467, 50-58788A3
Length: 11 1/2"
Fits: 65-175 HP models (1973-88)



18-6824
OUTBOARD STARTER
Replaces: 50-60594A, A1, T01
Fits: 2.0, 2.4, and 2.5L Racing Engines



18-6825
STARTER
Replaces: 50-86976
(9 Tooth)
Fits: 200-225HP V6 engines



18-6828
STARTER
Replaces: 50-41583
Fits: 35, 35 (2 CYL.), 402, 40 (2 CYL.)



18-6829
STARTER
Replaces: 50-852570, T, 50-857065, 50-859168, T, 859168, T
Fits: Mercury, Mariner 9.9-15HP 4-Stroke Engines



18-6864
STARTER
Replaces: 50-819271, 50-820193A1
Fits: Mercury 40-50HP Engines



18-6940
STARTER
Replaces: 50-825991A2
Fits: 9.9HP 4- Stroke Engines



18-6943
STARTER
Replaces: 50-893894
Fits: 9.9-15HP Engines



18-55505
OUTBOARD STARTER
Replaces: 8M0142679
Fits: 175-300 HP; 250-300 VERADO; 250 4.6L V8 Verado (4-stroke) - 2B529482 AND UP, 300 4.6L V8 Verado (4-stroke) - 2B529482 AND UP, 300 4.6L V8 Verado (4-stroke) SEAPRO - 2B529482 AND UP, 225 4.6L V8 (4-STROKE) SEAPRO - 2B529482 AND UP, 250 4.6L V8 (4-STROKE) SEAPRO - 2B529482 AND UP, 250 4.6L V8 (4-STROKE) RACING - 1E080500 AND UP, 300 4.6L V8 (4-STROKE) RACING - 1E080500 AND UP, 200 4.6L V8 PRO XS (4-STROKE) 2B529482 AND UP, 225 4.6L V8 PRO XS (4-STROKE) 2B529482 AND UP, 250 4.6L V8 PRO XS (4-STROKE) 2B529482 AND UP, 300 4.6L V8 PRO XS (4-STROKE) 2B529482 AND UP, 175 3.4L V6 (4-STROKE) 2B529482 AND UP, 200 3.4L V6 (4-STROKE) 2B529482 AND UP, 225 3.4L V6 (4-STROKE) 2B529482 AND UP, 200 3.4L V6 (4-STROKE) SEAPRO 2B529482 AND UP, 175 3.4L V6 PRO XS (4-STROKE) 2B529482 AND UP



18-55506
OUTBOARD STARTER
Replaces: 8M0137769
Fits: 75 EFI (4-STROKE) - 2B095049 AND UP, 75 EFI (4-STROKE) SEAPRO 2B095049 AND UP, 80 EFI (4-STROKE) 2B095049 AND UP, 90 EFI (4-STROKE) 2B095049 AND UP, 90 EFI (4-STROKE) SEAPRO 2B095049 AND UP, 100 EFI (4-STROKE) 2B095049 AND UP, 115 EFI (4-STROKE) 2B095049 AND UP, 115 EFI (4-STROKE) SEAPRO 2B095049 AND UP, 65 JET (4-STROKE) 2B095049 AND UP, 80 JET (4-STROKE) 2B095049 AND UP, 115 PRO XS (4-STROKE) 2B225488 AND UP

APPLICATION ON NEXT PAGE

ALL STARTERS ARE COUNTER CLOCKWISE ROTATION



18-6251
STARTER REPAIR KIT
Prestolite
4 Brush

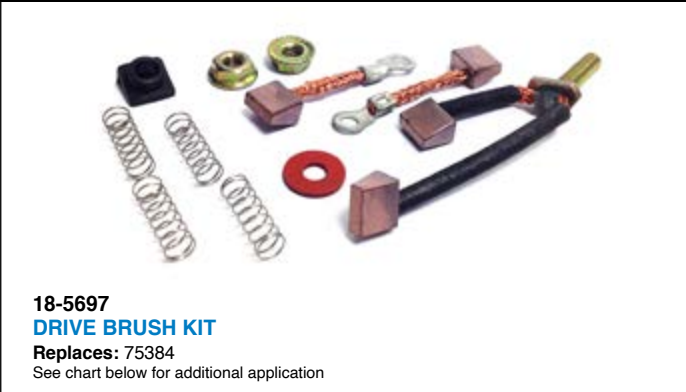

18-5697
DRIVE BRUSH KIT
Replaces: 75384
See chart below for additional application



18-5650
DRIVE ASSEMBLY
Replaces: 57380
See chart below for additional application



18-5656
DRIVE ASSEMBLY
Replaces: 68575
(10 Tooth)
See chart below for additional application

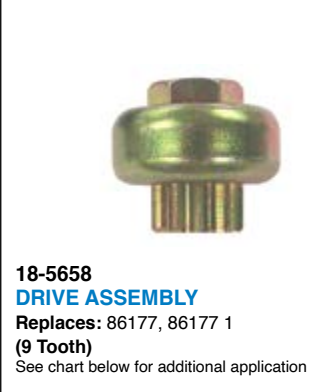

18-5658
DRIVE ASSEMBLY
Replaces: 86177, 86177 1
(9 Tooth)
See chart below for additional application



18-5674
DRIVE ASSEMBLY
Replaces: 75661, 13310T1
(8 Tooth)
See chart below for additional application

MERCURY

H.P.	Beg. Serial #	Ending Serial #	O.E.M #	Starter #	O.E. #	Drive Assembly	O.E. #	Drive Tooth Count	Brush Kit	O.E. #
6	A197112	& Up	50-8M0033984/50-90983A1	18-5611	96562		—	10	—	—
7.5	3801458	4851692	50-73531	⑥	96562		96562/75427	10	18-5697	75384
7.5	4851693	& Up	50-78011	⑥	96562		96562/75427	10	18-5697	75384
8/9.9/15	A197112	& Up	50-8M0033984/50-90983A1	18-5611	96562		—	10	—	—
18	5837437	& Up	50-8M0033984/50-90983A1	18-5611	96562		—	—	—	—
20	4709593	6443973	50-76275	⑥	96562		96562/75427	10	—	—
20	6443973	& Up	50-8M0033984/50-90983A1	18-5611	96562		—	10	—	—
25	5705532	& Up	50-8M0033984/50-90983A1	18-5611	96562		—	10	—	—
30 2 cyl.	G053314	& Up	50-893890T/50-822462	18-5621	N.L.A.	18-5656	68575	10	18-5697	75384
30 JET	G159200	G589999	50-898265005/50-73521	18-5605	68575 3	18-5656	68575	10	18-5697	75384
30 JET 3 cyl.	G590000	T408999	50-893890T/50-822462	18-5621	90643	18-5656	68575	10	18-5697	75384
35 2 cyl.	6445653	& Up	50-41583T/50-41583	⑥	N.L.A.		43076/ 43076T	10	18-5697	75384
35/40 2 cyl.	6445652	& DOWN	50-55601A2/50-55601	18-5601	N.L.A.	18-5650	57380	9	18-5697	75384
40 2 cyl.	G053314	& Up	50-893890T/50-822462	18-5621	68575 3	18-5656	68575	10	18-5697	75384
40H.P. 3 cy.	G590000	G760299	50-893890T/50-822462	18-5621	68575 3	18-5656	68575	10	18-5697	75384
40 3 cyl.	G760300	& Up	50-893890T/50-822462	18-5621	68575 3	18-5656	68575	10	18-5697	75384
40 4 cyl.	C159200	& Up	50-898265005/50-73521	18-5605	68575 3	18-5656	68575	10	18-5697	75384
40 JET	T178500	& Up	50-893890T/50-822462	18-5621	68575 3	18-5656	68575	10	18-5697	75384
45 4 cyl.	5531630	& Up	50-898265005/50-73521	18-5605	68575 3	18-5656	68575	10	18-5697	75384
45 JET	D000750	G589999	50-44369A1/50-65436/50-60315	18-5605 ⑧	68575 3	18-5656	—	—	—	—
45 JET	G590000	T129554	50-893890T/50-822462	18-5621	68575 3	18-5656	68575	10	18-5697	75384
50 4 cyl.	4357639	& Below	50-55601A2/50-38890A1	18-5601	N.L.A.	18-5650	57380	9	18-5697	75384
50 4 cyl.	4357640	& Up	50-898265005/50-73521	18-5605	68575 3	18-5656	68575	10	18-5697	75384
50 3 cyl.	B122930	G589999	50-44369A1	18-5605 ⑧	68575 3	18-5656	—	—	—	—
50 3 cyl.	G590000	& Up	50-893890T/50-822462	18-5621	68575 3	18-5656	68575	10	18-5697	75384
55 3 cyl.	D000750	G589999	50-44369A1	18-5605 ⑧	68575 3	18-5656	—	—	—	—
55 3 cyl.	G590000	& Up	50-893890T/50-822462	18-5621	68575 3	18-5656	68575	10	18-5697	75384
60 3 cyl.	6428681	G589999	50-44369A1/50-65436/50-60315	18-5605 ⑧	68575 3	18-5656	—	—	—	—
60 3 cyl.	G590000	& Up	50-893890T/50-822462	18-5621	68575 3	18-5656	68575	10	18-5697	75384
60 3 cyl. Bigfoot	G590000	G760299	50-893890T/50-822462 1	18-5621	68575 3	18-5656	68575	10	18-5697	75384
65 4 cyl.	2803822	3293183	50-57867A1/50-58788	18-5636	68575 3	18-5656	68575	10	18-5697	75384
65 3 cyl.	3293184	4571651	50-44369A1/50-65436/50-60315	18-5605	68575 3	18-5656	—	—	—	—
65 Jet	D283222	& Up	50-893891T/50-66015	18-5642	68575 3	18-5656	68575	10	18-5697	75384
70 3 cyl.	457165	A996142	50-44369A1/50-65436/50-60315	18-5605	68575	18-5656	—	—	—	—
80 4 cyl.	2783253	3493912	50-57867A1/50-58788	18-5636	N.L.A.		68575	10	18-5697	75384
80 4 cyl.	4831999	& Up	50-893891T/50-66015	18-5642 ⑦	68575 3	18-5656	68575	10	18-5697	75384
85 4 cyl.	3865694	& Below	50-5788A3/50-58788	18-5636	N.L.A.	18-5656	68575	10	18-5697	75384
85 4 cyl.	3865695	4366801	50-67341	18-5602	68575 3	18-5656	68575	10	18-5697	75384
80 Jet	D283222	& Up	50-893892T/50-66015-1	18-5610	68575 3	18-5656	75660/13310T1	8	18-5697	75384
90	4845301 ②	& Up	50-72467/50-64975/50-57465A1	18-5636	68575 3	18-5656	68575	10	18-5697	75384
90 3 cyl.	A996142	& Up	50-893891T/50-66015	18-5642	68575 3	18-5656	68575	10	18-5697	75384
100 4 cyl.	B209468	G965520	50-893892T/50-66015-1	18-5610	68575-3	18-5674	75660/13310T1	8	18-5697	75384
105 JET	G760299	& Below	50-893893/50-44414/50-44415/50-79472/50-77141	18-5608	13310T 1	18-5674	75660/13310T1	8	18-5697	75384
115 6 cyl. ②	4855153	& Up	50-72467/50-64975/50-57465A1	18-5636	68575 3	18-5656	68575	10	18-5697	75384
115 4 cyl.	C100000	& Up	50-893892T/50-66015-1	18-5610	68575 3	18-5674	75660/13310T1	8	18-5697	75384
125 4 cyl.	D283222	& Up	50-893892T/50-66015-1	18-5610	68575 3	18-5674	75660/13310T1	8	18-5697	75384
135 V-6	A904646	G960499	50-893893/50-79472/50-77141/50-44414/50-44415	18-5608	13310T 1	18-5674	75660/13310T1	8	18-5697	75384

Note: Some starters will replace Prestolite versions however replacement parts are for Bosch versions only.
 ② Inline 6 cylinder
 ④ With 8 tooth pinion
 ⑤ With 9 tooth pinion
 ⑥ No replacement starter available, drive parts only
 ⑦ Bosch models only
 ⑧ Some applications require Mercury adapter #44368 (prior to S/N 0D000750)

MERCURY

H.P.	Beg. Serial #	Ending Serial #	O.E.M #	Starter #	O.E. #	Drive Assembly	O.E. #	Drive Tooth Count	Brush Kit	O.E. #
140 6 cyl. Inline ②	4865678	& UP	50-72467/50-64975/50-57465A1	18-5636	68575 3	18-5656	68575	10	18-5697	75384
140 JET	G960499	& Below	50-893893/50-44414/50-44415/50-79472/50-77141	18-5608	1310T 1	18-5674	75660/13310T1	8	18-5697	75384
150 ②	4121435	& Up	50-72467/50-64975/50-57465A1	18-5636	68575 3	18-5656	68575	10	18-5697	75384
V150	4868998	G960499	50-793793/50-79472/50-77141	18-5608	13310T 1	18-5674	75660/13310T1	8	18-5697	75384
150 XR2	4868998	A904645	50-44414,50-44415	18-5608	N.L.A.	18-5674	75660/13310T1	8	18-5697	75384
150 XR4	B242885	D819999	50-893893/50-79472/50-77141/50-44414/50-44415	18-5608	13310T 1	18-5674	75660/13310T1	8	18-5697	75384
150 XR6	D082000	G960499	50-893893/50-79472/50-77141/50-44414/50-44415	18-5608	13310T 1	18-5674	75660/13310T1	8	18-5697	75384
150 EFI	G303046	T408999	50-893893/50-79472/50-77141/50-44414/50-44415	18-5608	13310T 1	18-5674	75660/13310T1	8	18-5697	75384
V175	4301235	G960499	50-893893/50-79472/50-77141	18-5608	13310T 1	18-5674	75660/13310T1	8	18-5697	75384
175 EFI, XRI, MAG	D000750	G960499	50-893893/50-44414/50-44415	18-5608	N.L.A.	18-5674	75660/13310T1	8	18-5697	75384
200	4839034	G960499	50-893893/50-79472/50-77141	18-5608	13310T 1	18-5674	75660/13310T1	8	18-5697	75384
200 EFI, XRI	C100861	G960499	50-893893/50-44414/50-44415	18-5608	N.L.A.	18-5674	75660/13310T1	8	18-5697	75384
2.4EFI/2.5EFI/	ALL	—	50-893893/50-79472/50-77141/50-44414/50-44415	18-5608	13310T 1	18-5674	75660/13310T1	8	18-5697	75384
2.5 Carb/	ALL	—	50-893893/50-79472/50-77141/50-44414/50-44415	18-5608	13310T 1	18-5674	75660/13310T1	8	18-5697	75384
3.4L/MOD VP ④	ALL	—	50-893893/50-79472/50-77141/50-44414/50-44415	18-5608	13310T 1	18-5674	75660/13310T1	8	18-5697	75384
V200 ⑤	5363918	6435503	50-86976	18-6825	8677 1	18-5658	86177/86177 1	9	18-5697	75384
V225	5628028	D280812	50-86976	18-6825	8677 1	18-5658	86177/86177 1	9	18-5697	75384
225 3.0L Carb	D280813	T408999	50-898265009/50-818445-3/50-818445-2	18-5620	13310T 1	18-5674	75661/13310T1	8	18-5697	75384
225/250 EFI 3.0L	G129222	& Up	50-898265009/50-818445-3/50-818445-2	18-5620	13310T 1	18-5674	75661/13310T1	8	18-5697	75384
250XB	G980600	& Up	50-898265009/50-818445-3/50-818445-2	18-5620	13310T 1	18-5674	75661/13310T1	8	18-5697	75384

Note: Some starters will replace Prestolite versions however replacement parts are for Bosch versions only. ② Inline 6 cylinder ③ With 8 tooth pinion ④ With 9 tooth pinion ⑤ Bosch models only Some applications require Mercury adapter #44368 (prior to S/N 0D000750)

18-4915

STARTER ROPE

Replaces: 50-12066A9, 50-12066Q9, 50-45093, 50-28985A2, 50-22791A1, 50-12066A1



18-6506

REWIND SPRING

Replaces: 24-29340A1, T1



REWIND SPRING APPLICATION

Model/HP	Beg. S/N	End S/N	Rewind Spring	Model/HP	Beg. S/N	End S/N	Rewind Spring
Merc 4	2498136	4107219	18-6506	Merc 35	1217222	1271884	18-6506
Merc 4.5	4107220	& UP	18-6506	Merc 35	1356948	1448139	18-6506
Merc 6	1408611	2387383	18-6506	Merc 35	1571114	1960826	18-6506
Merc 7.5	2529895	& UP	18-6506	Merc 35	1960827	2097279	—
Mar 8	M-677-000101	& UP	—	Merc 35	2097832	2258863	—
Merc 9.8		ALL	18-6506	Merc 35	2300962	2453068	—
Mar 9.9	M-682-000551	M-682-032885	—	Merc 35	2487558	2874703	—
Mark (10) 10		ALL	18-6506	Merc 35	6445653	& UP	—
Merc 10	1290910	1455239	18-6506	Mark (55) 40	831021	& UP	18-6506
Mark (15) 15		ALL	18-6506	Merc 40	1279685	1476509	18-6506
Merc 15	1288910	1349697	18-6506	Mar 40		ALL	—
Mar 15	M-684-000101	& UP	—	Merc 40	2874704	3336257	—
Merc 20	3537531	6443972	18-6506	Merc 40	3326258	& UP	—
Merc 20	1292910	3537530	18-6506	Merc 40	C159200	& UP	—
Mar 20	M-653-07615	& BELOW	—	Mark (58) 45	1139538	& UP	18-6506
Mar 20	M-653-07616	& UP	—	Merc 45	1476510	1531568	18-6506
Mar 20	M-6A9-000101	& UP	—	Merc 50	1421113	2116317	18-6506
Mark (28) 22		ALL	18-6506	Merc 50	5531630	& UP	— ②
Merc 25	1467499	1499331	18-6506	Merc 50	1770179	& UP	—
Mar 25	M-648-19025	& BELOW	& BELOW	Mark (75) 60		ALL	18-6506
Mar 25	M-695-000101	& UP	& UP	Merc 60		ALL	18-6506
Mar 28		ALL	—	Merc 65	1542745	1765043	18-6506
Merc 30	1271885	1356947	18-6506	Mark (78) 70		ALL	18-6506
Mar 30		ALL	18-6521	Merc 70		ALL	18-6506

① Above Prop Exhaust ② 4 cyl. only

 <p>18-7354 CARB KIT Replaces: 1395-8506 V-175 outboards Serial Number 4301235 thru OC100860</p>	 <p>18-7355 CARB KIT Replaces: 1395-811691 2</p>	 <p>18-7356 CARB KIT Replaces: 1395-811691 3</p>	 <p>18-7004 CARB KIT Replaces: 1395-6200</p>
 <p>18-7005 CARB KIT Replaces: 1395-6452</p>	 <p>18-7006-1 CARB KIT Replaces: 1399-1717, 1399-2015, 1399-3523, 1395-4808, 1395-8791994024, 879194024</p>	 <p>18-7007 CARB KIT Replaces: 1399-5135, 1399-5198</p>	 <p>18-7013 CARB KIT For: AJ, KA, KB, KC, KD Carburetor</p>
 <p>18-7021 CARB KIT For: WM, WMK</p>	 <p>18-7211-1 CARB KIT Replaces: 1395-8112231</p>	 <p>18-7212 CARB KIT Replaces: 1395-97611, 1395-9761, 1395-9803, 1395-9725, 1395-9645, 1395-9377, 1395-9179, 1395-811357</p>	 <p>18-7213 CARB KIT Replaces: 8107492</p>
 <p>18-7214 CARB KIT Replaces: 8107493</p>	 <p>18-7215 CARB KIT Replaces: 1395-9024</p>	 <p>18-7226 CARB KIT Replaces: 1395-9650 Fits: 30 JET, 40/45 4 CYL 4 Stroke, Carb models WMA-7B,9,10,13</p>	 <p>18-7290 CARB KIT Replaces: 84419M</p>
 <p>18-7291 CARB KIT Replaces: 84475M</p>	 <p>18-7293 CARB KIT Replaces: 92520M</p>	 <p>18-7738 CARB KIT Replaces: 802706A1 For: 9.9 4 Stroke (323cc) (1999 & up) and 15 4 Stroke (1998 & up)</p>	 <p>18-7743 CARB KIT Replaces: 804346T1 For: 75 4 Stroke (2000 & up), 90 4 Stroke (2000 & up)</p>

SIERRA OFFERS MORE!



ALL SIERRA MANIFOLDS:

Sierra offers an extensive selection of over 400 Rotating Electrical products, all backed by an industry leading warranty. Protect your customer and your reputation. Use only a certified marine product from Sierra.

- Alternators
- Starters
- Trim Motors
- Solenoids
- Rectifiers
- Accessories

 <p>18-7750-1 CARB KIT Replaces: 1395-8236354, 1395-8236353, 1395-8236352, 1395-8236351, 1395-823635, 1395-811222, 1395-9599</p>	 <p>18-7815 CARB KIT Replaces: 1399-5137</p>	 <p>18-7765 CARB KIT Replaces: 11502M</p>	 <p>18-7769 CARB KIT Replaces: 814481M</p>	 <p>18-97351 CARB KIT Replaces: 1395-9844A1</p>
 <p>18-7770 CARB KIT Replaces: 84456M</p>	 <p>18-97358 CARB KIT Replaces: 1395-9023 Fits: 45-50HP Mercury 1980-1986</p>	 <p>18-97359 CARB KIT Replaces: 1399-8154 Fits: 18-25 HP 2 CYL</p>	 <p>18-97350 CARB KIT Replaces: 1398-823707 2 Fits: Mercury 9.9-25 HP</p>	 <p>18-97352 CARB KIT Replaces: 1395-51091</p>
 <p>18-97353 CARB KIT Replaces: 1399-51991</p>	 <p>18-97354 CARB KIT Replaces: 1395-811287</p>	 <p>18-97355 CARB KIT Replaces: 1399-8153</p>	 <p>18-97356 CARB KIT Replaces: 1395-811287</p>	 <p>18-97357 CARB KIT Replaces: 1395-7826</p>
 <p>18-7062 INLET VALVE Replaces: 1395-95951 Fits: WME-1,1A,1B,4,5,6,6A,7, 7B,8,9,10,10A,11,14,15,15A,17, 18,20,20A,21,21A,22,22B,23, 24,26,27,28,32,32A,33,34,35, 36,36A,37,37A,38,39A,40,40A, 42,42A,43,44,45,50,52,53,57, 58,63,64,65,66,67,68,69,79,81</p>	 <p>18-7057 NEEDLE & SEAT Replaces: 1399-1473, 1395-9258, 1399-1138, 1399-9258 1 .078 Bore</p>	 <p>18-0715 FLOAT CHAMBER GASKET Replaces: 809086, 25-809086</p>	 <p>18-7061 NEEDLE & SEAT Replaces: 1395-8318, 1395-83181 .065 Bore</p>	 <p>18-7295 NEEDLE VALVE Replaces: 1395-9022</p>
 <p>18-7233 NEEDLE & SEAT Replaces: 1395-7824</p>	 <p>18-36850 NEEDLE & SEAT Replaces: 1395-8116901 Fits: Mercruiser 2.5 & 3.0L Carbs</p>	 <p>18-7380 FLOAT Replaces: 809569 15 (4-Stroke) All, 50 (4-Stroke)</p>	 <p>18-7381 FLOAT Replaces: 16253 4 (SN A855097 & Up), 5 (SN A855097 & Up)</p>	 <p>18-7382 FLOAT Replaces: 804184 75 (4-Stroke) All, 90 (4-Stroke) All</p>
 <p>18-7208 FLOAT Replaces: 1395-8983, 1395-8673</p>	 <p>18-72000 FLOAT Replaces: 1395-9594 Fits: WME1,1A,1B,4,5,6,6A,7,7B,8,9, 10,10A,11,14,15,15A,17,18,20,20A, 21,21A,22,22B,23,24,26,27,28,32, 32A,33,34,35,36,36A,37,37A,38, 39A,40,40A,42,42A,43,44,45,50, 52,53,57,58,63,64,65,66,67, 68,69,79,81</p>	 <p>18-7249 FLOAT KIT Replaces: 19273 Fits: WM-3,5,6,8,9,10,11,12,13, 13A,14,15,15A,16,16A,17,18</p>	 <p>18-7209 FLOAT Replaces: 1395-9293</p>	 <p>18-36956 FLOAT Replaces: 1395-9267 Fits: Mercury V6 w/ Dual Float Carbs</p>

MARINER CARBURETOR KIT APPLICATION

HP	Year/Serial No.	Carb Kit	HP	Year/Serial No.	Carb Kit	HP	Year/Serial No.	Carb Kit
6 C-D	Ser.No.Code 6H8 & 6H6	18-7765	25A	M-648-24991 & Up ML-648-64046 & Up E-648-27056 & Up EL-648-56526- & Up	18-7770	30A	M-689-230100 & Up ML-689-530100 & Up E-689-250100 & Up EL-689-550100 & Up	18-7770
8C	Ser.No.Code 6G1	18-7765						
9.9C	M-682-070796 & Up ML-682-368040 & Up E-682-251511 & Up EL-682-55146 & Up	18-7769	25C	Ser.No.Code 695	18-7770	48	M-670-02641 & Up ML-670-34581 & Up	18-7290
			15C	M-684-052848 & Up ML-684-332302 & Up E-684-252381 & Up EL-684-553251 & Up	18-7769	28	M-664-05306 & Up ML-664-41686 & Up E-664-26236 & Up EL-664-57421 & Up	18-7770
55	Ser.No.Code 663	18-7290						
W55	Ser.No.Code 663	18-7290						
						60	Ser.No.Code 675	18-7290

MERCURY CARBURETOR KIT APPLICATION

HP	Year -S/N	Carburetor Model	Carburetor Kit	Gasket Kit	Needle & Seat	
3.9	1964-68	KB-7A,KB-7B	18-7013	18-7006-1	18-7057	18-7208
	80-81,86-87	KB-10A	18-7013	18-7006-1	18-7057	18-7208
4 (1 cyl.)		WMD-1	—	18-7006-1	18-7061	18-7208
4.5	1980-85	KD-10A	18-7013	18-7006-1	18-7057	18-7208
4.5	1980-85	WMD-1	18-7021	18-7006-1	18-7061	18-7208
6	1961-68	KB-6A,6B,7B,AJ57A	18-7013	18-7006-1	18-7057	18-7208
		39,41,47,49	—	18-7212	—	—
7.5	1969-73	KB-9A,KB-12A	18-7013	18-7006-1	18-7057	18-7208
		BB-7C	—	18-7007	18-7295	18-7209
7.5		WMB-2, 4	—	—	18-7295	18-7209
		39,41,47,49,57	18-7212	—	—	—
9.8	1962-73	KB-5A,8A,11A	18-7013	18-7006-1	18-7057	18-7208
		BB-6A,BB-6C	—	18-7007	18-7295	18-7209
9.8		WMB-1, 3	—	—	18-7295	18-7209
9.9 (2 stroke)	S/N A197112-Up	WMC-5,5A,5B,7,7A,17, 17B, 17C, 18, 18A, 18B, 19, 19A, 20, 20A, 20B	—	18-7212	—	—
9.9 (2 stroke)		WMC-23, 28, 34, 39, 41, 41A, 47, 47A, 49, 49A, 57	—	18-7212	—	—
(323cc)		—	18-7738	—	—	—
10	1957-61	AJ-52A	18-7013	18-7006-1	18-7057	18-7208
10		AJ-56AB	—	18-7006-1	18-7057	18-7208
10		KB-1A, 4A	—	18-7006-1	18-7057	18-7208
Marathon		50,50A,55,55A	—	18-7212	—	—
XR-10	All	WMC-23,48, 48A, 49, 49A	—	18-7212	—	—
MAG 10	All	WMC-23,48, 48A, 49, 49A	—	18-7212	—	—
15	1959-61	AJ-52A,AJ-56A	18-7013	18-7006-1	18-7057	18-7208
15(150)		KB-1A, 4A	—	18-7006-1	18-7057	18-7208
15	S/N A197112-Up	WMC-5,5A,5B,7,7A,17, 17B, 17C, 18, 18A, 18B, 19, 19A, 20, 20A, 20B	—	18-7212	—	—
15		WMC-23, 28, 34, 39, 41, 41A, 47, 47A, 49, 49A, 57	—	18-7212	—	—
15	S/N OG590000-Up	—	18-7738	—	—	—
Marathon		50,50A,55,55A	—	18-7212	—	—
		46A,50,53,54,56	—	18-7212	—	—
		50,53,54,56	—	18-7212	—	—
15 (4-Stroke)	S/N OG590000-Up	—	18-7738	—	—	—
		11,12	—	18-7212	—	—
18		WMC-13, 13A, 14, 14A, 15A, 16A, 24, 25, 26, 27, 29, 30, 31, 31A	—	18-7212	—	—
		11,12	—	18-7212	—	—
20		WMC-13, 13A, 14, 14A, 15A, 16A, 24, 25, 26, 27, 29, 30, 31, 31A	—	18-7212	—	—
20 (200)	1963-72	KA-20A,22A,22B,22C, 23A,25A	18-7013	18-7006-1	18-7057	18-7208
		BA-2D,BA-2E	—	18-7007	—	18-7209
		46A,50,53,54,56	—	18-7212	—	—
22	1958-59	KA-KC	18-7013	18-7006-1	18-7057	18-7208
		11,12	—	18-7212	—	—
25 (2 cyl)		WMC-13, 13A, 14, 14A, 15A, 16A, 24, 25, 26, 27, 29, 30, 31, 31A, 32, 32A, 35, 35A, 35B, 36, 37, 44, 45, 46, 46A, 50, 53, 54, 56	—	18-7212	—	—
		63,64,65,66,67	18-7750-1	18-7211-1	—	18-72000
30 (300) 4-cyl		AJ-54A	—	—	18-7057	18-7208
30 (300) 4-cyl		KB-2A	—	17-7006-1	18-7057	18-7208
30 JET (3 cyl)		WME-53, 68, 69	18-7750-1	18-7211-1	—	18-72000
30 JET (4 cyl)		WMA-10, 13	18-7226	—	—	—
		9C,13A	18-7013	18-7006-1	18-7061	18-7208
35	1963-69	KB-2A	18-7013	18-7006-1	18-7057	18-7208
		WMK-38	18-7021	18-7006-1	18-7061	18-7208
35	1984-89	AJ-54A	—	—	18-7057	18-7208
		KA-2A,KA-9A	18-7013	18-7006-1	18-7057	18-7208
40	1954-59	AJ	18-7013	18-7006-1	18-7057	18-7208
40	1970-74	WMK-1,WMK-8	18-7021	18-7006-1	18-7061	18-7208
		WMK-31	18-7021	18-7006-1	18-7061	18-7208
		64,65,66,67	18-7750-1	18-7211-1	—	18-72000
40 (3 cyl)		WME-53, 68, 69	18-7750-1	18-7211-1	—	18-72000
40 (4 cyl.)		WMA-4	—	18-7215	18-7295	18-7209
40 (4 cyl.)		WMA-7B	18-7226	—	—	18-7209
40 (4 cyl.)		WMA-9, 10, 13	18-7226	—	—	—
45	1958-62	KA-2A	18-7013	18-7006-1	18-7057	18-7208
45	1958-62	AJ-54A	18-7013	18-7006-1	18-7057	18-7208
45 (4 cyl.)	1986	Tillotson/Walbro	—	18-7007	—	18-7209
45 (4 cyl.)	1987-Up	WMA-4	—	18-7215	18-7295	18-7209
45 (4 cyl.)		KA-17A	18-7013	—	18-7057	18-7208
45 (4 cyl.)		WMA-7B	18-7226	—	—	18-7208
45 (4 cyl.)		WMA-9, 10, 13	18-7226	—	—	—

APPLICATION CONTINUED ON NEXT PAGE

MERCURY CARBURETOR KIT APPLICATION (Cont.)

HP	Year -S/N	Carburetor Model	Carburetor Kit	Gasket Kit	Needle & Seat	
45 JET (3 cyl)		WME-57, 58	18-7750-1	18-7211-1	—	18-72000
		24A,26A,26B,27A	18-7013	18-7006-1	18-7057	18-7208
50	1976-85	BA-3B,BA-3C,BA-3D	—	18-7007	—	18-7209
50 (3 cyl.)	1986-90	WM-13, 13A, 15, 15A, 16, 16A, 18	—	18-7004	—	18-7249
50 (3 cyl.)		WME-22,22B,23,24,26, 27, 28, 35, 43, 44, 45, 53, 68, 69	18-7750-1	18-7211-1	—	18-72000
50 (4cyl)	1986-Up	WMA-1,3	—	18-7215	18-7295	18-7209
50 (4cyl)		BA-3A, 3B, 3C, 3D, 4A	—	18-7007	18-7295	18-7209
50 (4cyl)		WMK-8	18-7021	18-7006-1	18-7061	18-7208
55 (3 cyl.)		WM-13, 13A, 15, 15A, 16, 16A, 18	18-7249	18-7004	—	—
55		WME-22, 22B, 23, 24, 26, 27,28, 35, 43, 44, 45, 57, 58	18-7750-1	18-7211-1	—	18-72000
60 (3 cyl.)	S/N D000750-Up	WME-22,22B,23,24,26, 27, 28,35, 43, 44, 45, 57, 58	18-7750-1	18-7211-1	—	18-72000
60 (3 cyl.)	1984-90	WM-13,13A, 15, 15A, 16, 16A, 18	—	18-7004	—	18-7249
60	1957-60	AJ-53A,AJ-55A,KB	18-7013	18-7006-1	18-7057	18-7208
60 600 (6 cyl)		KB-3A	—	18-7006-1	18-7057	18-7208
65 650 (4 cyl)	1963-71	KC-2A,5A,5B,5C, 11A,15A	18-7013	18-7006-1	18-7057	18-7208
65 650 (3 cyl)	1972-75	WMK-5,WMK-12, WMK-13,WMK-20	18-7021	18-7006-1	18-7061	18-7208
65	1976	WM-2,WM-4	—	18-7004	18-7061	18-7208
Jet 65 (3 cyl)	S/N A996142-Up	WME-1,1A,1B,4,5,6,6A, 7, 7B, 8, 9, 10, 10A, 15, 15A, 17, 18, 19, 25, 29, 30, 31, 41, 46, 47, 48, 49, 59, 60, 61, 62, 75, 76, 77	18-7750-1	18-7211-1	—	18-72000
70	1958-62	KC,KA-2A	18-7013	18-7006-1	18-7057	18-7208
70 700 (6 cyl)		KA-8A, 12A	18-7013	18-7006-1	18-7057	18-7208
70	1977-83	WM-6,8, 9, 11 60,61,62	18-7750-1	18-7211-1	—	18-72000
75 (4 cyl.)	1984-86	WM-14, 17 60,61,62	18-7750-1	18-7211-1	—	18-72000
75 (4 Stroke)	S/N OG960500-Up	— 60,61,62	18-7743 18-7750-1	— 18-7211-1	— —	— 18-72000
80 (4 cyl.)	1960-61	KD-4A	18-7013	18-7006-1	18-7061	18-7208
80 (4 cyl.)	1969-72	WMK-2	18-7021	18-7006-1	18-7061	18-7208
80 (4 cyl.)	1978-83	WM-5,10,12, 14, 17	—	18-7004	18-7061	18-7249
80 800 (6 cyl)		KA-10A, 11A, 14A, 16A, KC-3A 34,40,40A,50,51,52,79	18-7750-1	18-7211-1	—	18-72000
85	1973-75	WMK-4,WMK-16, WMK-17	18-7021	18-7006-1	18-7061	18-7208
85 850 (6 cyl)	1963-65	KA,KC	18-7013	18-7006-1	18-7057	18-7208
85	1976-77	WM-3,WM-5 48,49,59,60,61,62	18-7750-1	18-7211-1	—	18-72000
90 (4 Stroke)	S/N OG960500-Up	—	18-7743	—	—	—
90 (6 cyl.)	1965	KC-6A WMK-39	18-7013 18-7021	18-7006-1 18-7006-1	18-7057 18-7061	18-7208 18-7208
95	1966-67	KC-6A 40,40A,50,51,52,79	18-7013 18-7750-1	18-7006-1 18-7211-1	18-7057 —	18-7208 18-72000
100 (6 cyl.)	1962-69	KC-1A,7A,10A,14A	18-7013	18-7006-1	18-7057	18-7208
100 (6 cyl.)		KD-1A, 1B, 2A, 3A	18-7013	18-7006-1	18-7061	18-7208
V-105 Jet	1994-95 S/N OD082000-OG303045	WMH-13, 13B, 23, 31	18-7355	18-7213	—	—
V-105 Jet	1996 & Up S/N OG303046 & Up	WMV-2, 2A	18-7356	18-7214	—	—
110		KC-1A, 7A, 7B, 10A, 14A 40,40A,50,51,52	18-7013 18-7750-1	18-7006-1 18-7211-1	18-7057 —	18-7208 18-72000
115 (6 cyl.)	1970-77	KD-6A,KD-6B	18-7013	18-7006-1	18-7061	18-7208
115 (6 cyl.)	1970-88	WMK-3,10,15, 18, 26, 28, 32, 36, 40, 41, 41-1A, 41-1B, 41-3A, 41-3B	18-7021	18-7006-1	18-7061	18-7208
125	1968-69	KD-1A,1B,2A, 3A 34,40,40A,50,51,52, 81	18-7013 18-7750-1	18-7006-1 18-7211-1	18-7057 —	18-7208 18-72000
135	1970-71	KD-7A,KD-7B	18-7013	18-7006-1	18-7057	18-7208
135	1970-71	WMK-4	18-7021	18-7006-1	18-7061	18-7208
V-135	1986-88 S/N OA904646-OC100860	WH-33, 40	18-7354	18-7005	18-7233	—
V-135	1986-88 S/N OA904646-OC100860	WH-32, 35, 38	18-7354	18-7005	—	—
V-135	1989-90 S/N OC100861-OC239552	WH-35, 38	—	18-7005	18-7233	—
V-135	1989-90 S/N OC100861-OC239552	WH-40, 48	18-7354	18-7005	18-7233	—
V-135	1991 S/N OC239553-OD081999	WMH-8, 8A	18-7355	18-7213	—	—
V-135	1992-95 S/N OD082000-OG303045	WMH-12A, 12B, 28, 30	18-7355	18-7213	—	—
V-135	1996-98 S/N OG303046-OG760299	WMV-1, 1A	18-7356	18-7214	—	—
V-135	1999 & Up S/N OG760300 & Up	WMV-1A, 15, 15A	18-7356	18-7214	—	—
140	1972	WMK-7,WMK-9	18-7021	18-7006-1	18-7061	18-7208
140	1978-80	WMK-25,WMK-29	18-7021	18-7006-1	18-7061	18-7208
V-140 Jet	1994-95 S/N OG082000-OG303045	WMH-16, 21, 34, 39	18-7355	18-7213	—	—
V-140 Jet	1996-98 S/N OG303046-OG760299	WMV-5, 5A	18-7356	18-7214	—	—
V-140 Jet	1999 & Up S/N OG760300 & Up	WMV-5A	18-7356	18-7214	—	—
150	1973-77	WMK-11	18-7021	18-7006-1	18-7061	18-7208
150	1973-78	WMK-14,WMK-19, WMK-22	— 18-7021	— 18-7006-1	— 18-7061	— 18-7208
3.4L	1984-86	WO-3 29,35,38,40,48	— —	— 18-7005	18-7233 18-7233	— —
V-150	1979-85 S/N OA904645 & Below	WH-9	—	18-7005	—	—
V-150	1979-85 S/N OA904645 & Below	WH-12	—	18-7005	18-7233	—
V-150	1979-85 S/N OA904645 & Below	WH-29	18-7354	18-7005	18-7233	—
V-150	1986-90 S/N OA904646-OC239552	WH-35, 38	—	18-7005	18-7233	—
V-150	1986-90 S/N OA904646-OC239552	WH-40, 48	18-7354	18-7005	18-7233	—
V-150	1990-91 S/N OC239553-OD081999	WMH-1, 7	18-7355	18-7213	—	—
V-150	1992-95 S/N OD082000-OG303045	WMH-13, 13B, 23, 31	18-7355	18-7213	—	—
V-150	1996-98 S/N OG303046-OG760299	WMV-2, 2A	18-7356	18-7214	—	—
V-150	1999 & Up S/N OG760300 & Up	WMV-3A, 16, 16A	18-7356	18-7214	—	—
V-150 (XR4, MAGII)	1988 S/N OB242885-OC100860	WH-41A	18-7354	18-7005	18-7233	—
V-150 (XR4, MAGII)	1989 S/N OC100861-OC239552	WH-41	18-7354	18-7005	18-7233	—
V-150 (XR4, MAGII)	1989 S/N OC100861-OC239552	WH-41A	18-7354	18-7005	18-7233	—























APPLICATION CONTINUED ON NEXT PAGE

MERCURY CARBURETOR KIT APPLICATION (Cont.)

HP	Year -S/N	Carburetor Model	Carburetor Kit	Gasket Kit	Needle & Seat
V-150 (XR4, MAGII)	1990-91 S/N OC239553-OD081999	WMH-6	18-7355	18-7213	— —
V-150 (XR6, MAGIII)	1996-98 S/N OG303046-OG760299	WMV-3, 3A	18-7356	18-7214	— —
V-150 (XR6, MAGIII)	1999 & Up S/N OG760300 & Up	WMV-3A, 16, 16A	18-7356	18-7214	— —
V-150 (XR6, MAGIII)	1992-95 S/N OD082000-OG303045	WMH-14A, 25, 32A	18-7355	18-7213	— —
V-175	1976-88 S/N 4301235-OC100860	WH-1, 4, 7, 7A, 13, 17, 28, 39, 46	—	18-7005	18-7233 —
V-175	1976-88 S/N 4301235-OC100860	WH-17R, 30, 34	18-7354	18-7005	18-7233 —
V-175	1990 S/N OC100861-OC239552	WH-34	18-7354	18-7005	18-7233 —
V-175	1991 S/N OC239553-OD081999	WMH-2, 11	18-7355	18-7213	— —
V-175	1992-95 S/N OD082000-OG303045	WMH-15, 22, 33	18-7355	18-7213	— —
V-175	1996-98 S/N OG303046-OG760299	WMV-4, 4A	18-7356	18-7214	— —
V-175	1999 & Up S/N OG760300 & Up	WMV-4A	18-7356	18-7214	— —
		22,26,28,31,39,46	—	18-7005	18-7233 —
V-200	1991 S/N OC291520-OD081999	WMH-3	18-7355	18-7213	— —
V-200	1992-95 S/N OD082000-OG303045	WMH-16, 21, 34, 39	18-7355	18-7213	— —
V-200	1996-98 S/N OG303046-OG760299	WMV-5, 5A	18-7356	18-7214	— —
V-200	1999 & Up S/N OG760300 & Up	WMV-5A	18-7356	18-7214	— —
V200	1980-82 S/N 4839034-OC100860	WH-3A,11	—	18-7005	— —
V-225 (2.4L)	1981 & Up 5628028 & Up	WH-5, 20	—	18-7005	18-7233 —
	thru G303045	WMH-19,45,46,47	18-7355	18-7213	— —
V225	1980-81	WH-15	—	18-7005	18-7233 —
V-225 (3.0L)	S/N OD280813-OG303045	WMH-19, 46, 47	18-7355	18-7213	— —
V-225 (3.0L)	S/N OG303046-OG760299	WMV-7, 13	18-7356	18-7214	— —
V-225 (3.0L)	S/N OG303046 & Up	WMV-13, 13A	18-7356	18-7214	— —
V-225 (3.0L) Seapro/Marathon	S/N OG245605-OG303045	WMH-45	18-7355	18-7213	— —
V-225 (3.0L) Seapro/Marathon	S/N OG303046-OG760299	WMH-6, 11A	18-7356	18-7214	— —
V-225 (3.0L) Seapro/Marathon	S/N ALL & Up	WMV-11, 11A, 13, 13A, 19	18-7356	18-7214	— —
V250	1989-90	WD-8A-1,2,3,4,5,6	—	—	18-7061 —
V275	1989-91	WD-9/9A-1,2,3,4,5,6	—	—	18-7061 —
V300	1980 & Up S/N 5611648 & Up	WD-3, 5	—	—	18-7061 —
		28,30,31,32,33,34	18-7213	—	— —
XR4	1988-90	WH-41,WH-41A	—	18-7005	— —
		28,30,31,32,33,34	18-7213	—	— —

① Except EFI, XRI

 <p>18-7336 FUEL PUMP Replaces: 75-250 DFI</p>	 <p>18-7338 FUEL PUMP Replaces: 75-150 EFI, 150-300 Verado®</p>	 <p>18-7346 FUEL PUMP Replaces: 75-150 EFI, 150-300 Verado®</p>
 <p>18-7347 FUEL PUMP Replaces: 75EFI, 80EFI, 90EFI, 100EFI (4-Stroke)1B172291-1B366822 115EFI (4-Stroke) 0T178500-1B366822"</p>	 <p>18-97301 FUEL PUMP Replaces: 6.2 MPI Stern drive, 75-115 HP outboard</p>	 <p>18-97302 FUEL PUMP Replaces: Mercury 8M0062771, 6.2 MPI Stern drive,75- 115HP outboard</p>
 <p>18-97303 FUEL PUMP Replaces: 150HP PRO XS/Verado®-400R Verado® racing</p>		 <p>18-97304 FUEL PUMP Replaces: 150HP PRO XS/Verado®-400R Verado® racing</p>

 <p>18-8957 CHECK VALVE Replaces: 22-8189941, 22-818994</p>	<p>PKG. OF 2</p>  <p>18-8956 COUPLER Couples 3/8" to 5/16" Hose Replaces: 22-8M0001721</p>	 <p>18-8958 FITTING Replaces: 22-424254</p>	 <p>18-8866 FUEL PUMP Replaces: 899106T01, 892874T01 Fits: Mercury 4 stroke outboard</p>
 <p>18-7804 FUEL PUMP KIT Replaces: 23014A1</p>	 <p>18-7806-1 FUEL PUMP KIT</p>	 <p>18-7807 FUEL PUMP KIT Replaces: 55278A1</p>	 <p>18-7808 FUEL PUMP KIT Replaces: 55278A5</p>
 <p>18-7809 FUEL PUMP KIT Replaces: 55278A4, 55278A3</p>	 <p>18-7810 FUEL PUMP KIT Replaces: 90363A1</p>	 <p>18-7811 FUEL PUMP KIT Replaces: 89031A1, 66599A1</p>	 <p>18-7812 FUEL PUMP KIT Replaces: 89031A2, 66599A2</p>
 <p>18-7813 FUEL PUMP KIT Replaces: 89031A3, 66599A3</p>	 <p>18-7814 FUEL PUMP KIT Replaces: 89031A4</p>	 <p>18-7817 FUEL PUMP KIT Replaces: 21-42990A7, A8, A9, A10, 21-857005A1</p>	 <p>18-7818-1 FUEL PUMP KIT Replaces: 42909A1, 42909A2, 42909A3, 42909A4</p>
 <p>18-7833 FUEL PUMP DIAPHRAGM Replaces: 11497M</p>	 <p>18-7834 FUEL PUMP DIAPHRAGM Replaces: 91748M</p>	 <p>18-7837 FUEL PUMP DIAPHRAGM Replaces: 84262M</p>	 <p>18-7838 FUEL PUMP DIAPHRAGM Replaces: 84265M</p>
 <p>18-7839 FUEL PUMP DIAPHRAGM Replaces: 80606M</p>	 <p>18-7840 FUEL PUMP DIAPHRAGM Replaces: 84141M</p>	 <p>18-7847 FUEL PUMP DIAPHRAGM</p>	

DIAPHRAGM APPLICATION ON NEXT PAGE

MERCURY FUEL PUMP KITS

HP	Beginning	Ending	Fuel Pump Kit	HP	Beginning	Ending	Fuel Pump Kit
7.5	3488153	& UP	18-7815 ②	115 (4 CYL)	D283222	& UP	18-7817
8	A197112	& UP	18-7212	115 (6 CYL) DFI	G960500	T178999	18-7817
9.8	3482753	& UP	18-7815 ②	115 (3 CYL) DFI	T801000	& UP	18-7817
9.9	A197112	& UP	18-7212	115 PRO XS	B751825	& UP	18-7817
10	1057994	1455239	18-7804	120	ALL		18-7806-1
15	1200114	1349667	18-7804	120XR	ALL		18-7806-1
15	B292414	& UP	18-7212	125 (1250) 6 CYL	2314956	2839386	18-7804
20	1866496	2296266	18-7804	125 (4 Cyl.)	D283222	& UP	18-7817
20	3537531	A910970	18-7815 ②	125 (1250BP) 6 CYL	2400058	2641954	18-7817
20	6443973	T800749	18-7212	125 (3 CYL) DFI	B736885	& UP	18-7817
20 JET	G044027	& UP	18-7212	135	2839369	3293233	18-7807
22	1158546	1499331	18-7804	V-135	C100860	& Below	18-7812 ①
25	1467499	1499331	18-7804	V-135	A904646	& UP	18-7817 ⑤
25	6443973	& UP	18-7212	V-135 TRIANGULAR F/P	A904646	C100860	18-7813
30	950250	1448139	18-7804	V-135 SQUARE F/P	A904646	D081999	18-7817
30 JET	C159200	T408999	18-7817	V-135	D082000	T178499	18-7817
35	6445652	& BELOW	18-7804	V-135 DFI (DESIGN II)	G590000	G760299	18-7817
35	6445653	B110788	18-7809	V135 DFI	G760300	& UP	18-7817
35	B110789	& UP	18-7817	140	3293234	3502805	18-7807
40 (2 cyl.)	831021	1476509	18-7804	140	4865678	5327662	18-7811
40 (2 CYL)	2874704	5556229	18-7807	140 JET	ALL		18-7817
40 (2 CYL)	C159200	& UP	18-7817	150	3502806	4865677	18-7807
40 (2 CYL)	G053314	& UP	18-7817	150 EFI	G303046	& UP	18-7817
40 (3 CYL)	G590000	T999999	18-7817	V-150	C100860	& Below	18-7812 ①
40 FOUR STROKE JET 2 CYCLE	G760300	& UP	18-7817	V-150	A904646	C100860	18-7817 ⑤
45	1139538	1531958	18-7804	V-150 XR2	ALL		18-7812
45 (4 cyl.)	B110789	& UP	18-7817	V-150 (150HP)	4868998	A904645	18-7812
45/50 (4 cyl.)	3478003	B110788	18-7815 ②	V-150 SQUARE F/P	A904646	C100860	18-7817
45 JET	6428681	& UP	18-7817	V-150	C100861	D081999	18-7817
45 JET	D000750	T129554	18-7817	V-150 CARB & EFI	D082000	B226999	18-7817
50 (4 cyl.)	2116318	4357639	18-7804	V-150 DFI (DESIGN I)	G590000	G760299	18-7817
50 (3 cyl.)	6428681	B122929	18-7809	V-150 DFI (DESIGN II)	G590000	G760299	18-7817
50 (3 cyl.)	B122930	T999999	18-7817	V-150 DFI	G760300	& UP	18-7817
50/55 (3 cyl.)	D000750	& UP	18-7817	V-175	C100860	& Below	18-7812 ①
60	1072997	1542744	18-7804	175 EFI	G303046	G589999	18-7817
60	6428681	B122929	18-7809	V-175	6618751	& UP	18-7817 ⑤
60 (3 cyl.)	B122930	& UP	18-7817	V-175 TRIANGULAR F/P	4301235	C100860	18-7812
60 (3 cyl.)	D000750	& UP	18-7817	V-175 SQUARE F/P	4301235	& UP	18-7817
65	1542745	2803561	18-7804	V-175	C100861	D303045	18-7817
65	ALL 3 CYL		18-7807	V-175	D303046	G960499	18-7817
65 JET	D283222	& UP	18-7817	V-175 EFI	D000750	D081999	18-7817
65 (650) 4 CYL	2119749	2803561	18-7804	V-175 EFI	D082000	T408999	18-7817
70	1143038	1566239	18-7804	V-175 EFI	T409000	T800999	18-7817
70 (3 cyl.)	4571652	6428680	18-7809	V-175 DFI	T178500	& UP	18-7817
70 (3 cyl.)	A996142	C221999	18-7818-1	V-175 PRO XS	B516339	& UP	18-7817
75 (4 CYL) SQUARE F/P	6432901	& UP	18-7817	200 EFI	G303046	G589999	18-7817
75 (3 CYL) 90 DEGREE OIL CHECK VALVE	C222000	D283221	18-7818-1	V-200	6073192	6357229	18-7810
75 (3 CYL) INLINE OIL CHECK VALVE	C222000	D283221	18-7817	V-200	6357230	6625220	18-7814 ①
75 (3 CYL)	D283222	& UP	18-7817	V-200	4839034	6073191	18-7812
75 (3 CYL) DFI	T980000	& UP	18-7817	V-200	6625221	& UP	18-7817 ⑤
75 (4 cyl.)	6432901	& UP	18-7808 ①	V-200	6625221	C291519	18-7817
75 (4 cyl.)	6432901	& UP	18-7817 ⑤	V-200	C291520	B226999	18-7817
75 (3 cyl.)	A996142	D283221	18-7818-1	V-200 EFI	C100861	D081999	18-7817
80	1335465	2670574	18-7804 ③	V-200	D082000	T408999	18-7817
80	2783253	2856331	18-7807 ③	V-200 (2.5L) EFI	T409000	& UP	18-7817
80	2559001	2670574	18-7808 ④	V-200 (3.0L) EFI	T750164	& UP	18-7817
80	4831999	6432900	18-7808	V-200 DFI	G590000	T598999	18-7817
80 (3 CYL)	A966142	C221999	18-7818-1	V-200 DFI	T599000	T5800999	18-7817
80 JET (3 CYL)	0D283222	& UP	18-7817	V-200 DFI	T801000	& UP	18-7817
80 JET (4 CYL)	B586067	& UP	18-7817	V-200 PRO XS	B504989	& UP	18-7817
85	1460999	1766823	18-7804	V-220 LASER	B117316	& UP	18-7817
85	3493913	4831998	18-7808	V-225	5628028	& UP	18-7810
90 (6 cyl.)	1766824	4845300	18-7804	V-225 SEA PRO/MARATHON (3.0L)	D208813	& UP	18-7817
90 (6 CYL)	5299506	6436122	18-7811 ①	V-225 (3.0L) EFI	G129222	& UP	18-7817
90 (6 CYL)	6436123	& UP	18-7817 ⑤	V-225 (3.0L) DFI	G590000	T598999	18-7817
90 (3 CYL)	A996142	D283221	18-7818-1	V-225 DFI	T599000	T800999	18-7817
90 (3 CYL) INLINE OIL CHECK VALVE	C222000	D283221	18-7817	V-225 DFI	T801000	& UP	18-7817
90 (3 CYL) 90 DEGREE OIL CHECK VALVE	C222000	D283221	18-7818-1	V-225 DTS	T599000	B417701	18-7817
90 (3 CYL)	D283222	& UP	18-7817	V-225 DTS	B417702	& UP	18-7817
90 (3 CYL) DFI	T801000	& UP	18-7817	V-225 PRO XS	B104549	& UP	18-7817
95 (950) 6 CYL	1869776	2318585	18-7804	V-250 (3.4L)	C101891	& UP	18-7817
95XR	ALL		18-7806-1	V-250 (3.0L) EFI	G129222	& UP	18-7817
100	2318586	3253111	18-7804	V-250XB	G980600	T800999	18-7817
100 (4 CYL) 90 DEGREE OIL CHECK VALVE	B209468	D283221	18-7818-1 ⑥	V-250 DFI	B528615	& UP	18-7817
100 (4 CYL) INLINE OIL CHECK VALVE	B209468	D283221	18-7817 ⑦	V-250 PRO XS	B426561	& UP	18-7817
100 (4 CYL)	D283222	G965520	18-7817	V-275 (3.4L)	C101891	& UP	18-7817
105 JET	ALL		18-7817	V-300 (3.4L)	5611648	& UP	18-7812
110	1870204	2314955	18-7804	XR4/XR6	C100860	& Below	18-7817
115	3761034	& BELOW	18-7807	Magnum II	ALL		18-7817
115 (115, 1150) SQUARE F/P	6436123	& UP	18-7817				

① Except models with square fuel pump
 ② Models equipped with Tillotson BA, BB, BD carburetors
 ③ Dual fuel pump applications
 ④ Single fuel pump applications
 ⑤ Models with square fuel pumps
 ⑥ Use with white fuel pump body
 ⑦ Use with black fuel pump body

MARINER DIAPHRAGMS (Japanese Models)

Model	S/N Code	S/N	Diaphragms	Model	S/N Code	S/N	Diaphragms
5C	6E3	ALL	18-7834	28	644	M-664-151346 & UP	②
6C	6H8	ALL	18-7833	30	689	ALL	②
6D	6H6	ALL	18-7833	40 TC	6E9	ALL	②
8B	677	ML-677-316416 & UP	18-7837	40A APE	676	M-676-A00346 — 001990	18-7839
8B	677	M-677-012921 & UP	18-7837	40A APE	676	M-676-A001991 & UP	②
8C	6G1	ALL	18-7833	40A APE	676	ML-676-A41356 — 302250	18-7839
9.9C	682	ALL	①	40A APE	676	ML-676-A302251 & UP	②
15A	651	ALL	18-7839	40A APE	676	E-676-A10121 — 100355	18-7839
15C	684	ALL	①	40A APE	676	E-676-A100356 & UP	②
20A APE	653	ALL	18-7839	40A APE	676	EL-676-A50631 — 400940	18-7839
20C TPE	6A9	ALL	②	40A APE	676	EL-676-A400941 & UP	②
25A	648	EL-648-550230 & BELOW	18-7839	40B TPE	676	ALL	②
25A	648	EL-648-550231 & UP	②	40C TC	6E9	ALL	②
25A	648	E-648-26825 & BELOW	18-7839	48	670	ML-670-302510 & BELOW	18-7839
25A	648	E-648-26826 & UP	②	48	670	ML-670-302511 — 311995	②
25A	648	ML-648-304174 & BELOW	18-7839	48	670	M-670-02640 & BELOW	18-7839
25A	648	ML-648-304174 & UP	②	48	670	M-670-02641 — 002160	②
25A	648	M-648-19025 & BELOW	18-7839	W48	670	ML-670-311996 & UP	18-7839
25A	648	M-648-19026 & UP	②	W48	670	M-670-002161 & UP	18-7839
25C TPE	695	EL-695-550101 — 555959	②	55	663	EL-663-315379 — 317710	18-7839
25C TPE	695	EL-695-555960 & UP	18-7839	55	663	EL-663-317711 & UP	②
25C TPE	695	E-695-250101 — 253861	②	55	663	E-663-004041 — 004317	18-7839
25C TPE	695	E-695-253862 & UP	18-7839	55	663	E-663-004318 & UP	②
25C TPE	695	ML-695-300101 — 318173	②	55	663	ML-663-36475 & BELOW	18-7839
25C TPE	695	ML-695-318174 & UP	18-7839	55	663	M-663-02730 & BELOW	18-7839
25C TPE	695	M-695-000101 — 023895	②	W55	663	ML-663-578278 — 583880	18-7839
25C TPE	695	M-695-023896 & UP	18-7839	W55	663	ML-663-583881 & UP	②
28	644	EL-664-570795 & BELOW	18-7839	60 2 CYL	6F0	ALL	18-7839
28	644	EL-664-570796 & UP	②	60 2 CYL	675	EL-675-30101 — 300280	18-7839
28	644	E-664-270310 & BELOW	18-7839	60 2 CYL	675	EL-675-300281 — 304180	②
28	644	E-664-270311 & UP	②	60 2 CYL	675	EL-675-304180 & UP	18-7839
28	644	ML-664-451125 & BELOW	18-7839	60 2 CYL	675	E-675-00101 — 000190	18-7839
28	644	ML-664-451126 & UP	②	60 2 CYL	675	E-675-00181 — 001170	②
28	644	M-664-151345 & BELOW	18-7839	60 2 CYL	675	E-675-001171 & UP	18-7839

① Requires the use of both 18-7837 and 18-7838

② Requires the use of both 18-7839 and 18-7840

8' LENGTH COMPLETE FUEL LINE ASSEMBLIES
18-8010EP-2 SILVERADO 4000 Premium

3/8" FUEL LINE ASSEMBLY

FUEL LINE ASSEMBLY COMPONENTS

8' LENGTH COMPLETE FUEL LINE ASSEMBLIES
18-8012EP-2 SILVERADO 4000 Premium OE# 32-858114Q08, 32-858114K08

3/8" FUEL LINE ASSEMBLY

FUEL LINE ASSEMBLY COMPONENTS

Has 1/4" NPT threaded fitting on engine end and 1/4" NPT threaded fitting on the tank end. Primer bulb is included in this 8ft. (2.44 m) assembly. Fits various applications using the older style twist type disconnects at the engine end and either a bayonet or thread-in fitting on the tank end.

8' LENGTH COMPLETE FUEL LINE ASSEMBLIES
18-8024EP-2 SILVERADO 4000 Premium OE# 32-858104Q08, 32-858104K08

3/8" FUEL LINE ASSEMBLY

FUEL LINE ASSEMBLY COMPONENTS

Has standard quick connect type fitting on engine end and 1/4" NPT threaded fitting on the tank end. Primer bulb is included in this 8 ft. (2.44 m) assembly. Fits Force 40 HP and larger (1993 & Newer), Force 9.9/15/25HP (1998), and all Mercury/Mariner outboards using clip on type disconnect at engine ends and a tank with threaded fuel pickup fitting.

* Tanks and Engines for picture purpose only.

8' LENGTH COMPLETE FUEL LINE ASSEMBLIES



3/8"
FUEL LINE ASSEMBLY

18-8025EP-2 *SILVERADO 4000 Premium*

OE# 32-858105Q08,
32-858105K08



*

*

FUEL LINE ASSEMBLY COMPONENTS

Has standard quick connect type fitting on engine end and bayonet style fitting on the tank end. Primer bulb is included in this 8 ft. (2.44 m) assembly.
Fits Force 40 HP and larger (1993 & Newer), Force 9.9/15/25HP (1998) , and all Mercury/Mariner outboards using clip-on type disconnect at the engine end and an older style tank with bayonet type connection.

8' LENGTH COMPLETE FUEL LINE ASSEMBLIES

3/8"
FUEL LINE ASSEMBLY

18-8016EP-2 *SILVERADO 4000 Premium*

OE# 32-858109Q12,
32-858109K12



*

*

FUEL LINE ASSEMBLY COMPONENTS

Has double sealed quick connect type fitting on tank end and clip-on type quick connect on engine end. Primer bulb is included in this 8ft. (2.44m) assembly.
Fits Force 40 HP and larger (1993 & Newer), Force 9.9/15/25HP (1998) and all Mercury Mariner outboards using clip-on type disconnects at both tank and engine ends

* Tanks and Engines for picture purpose only.

PRIMER BULBS



18-8002EP-1
18-8002EP-1-10^①
PRIMER BULB
1/4"

18-8005EP-1
18-8005EP-1-10^①
PRIMER BULB
3/8"

18-8004EP-1
18-8004EP-1-10^①
PRIMER BULB
5/16"

Replaces: 13330A3,
13330Q, 13330Q5
Large capacity bulb

Replaces: 89396A38,
89396Q38
Large capacity bulb



HOSE BARB APPLICATION



PART #	MERCURY OE #	BARB	NPT	CONN. TYPE
18-8054	22-63186	5/16"	1/8"	Male
18-8055	22-63187	5/16"	1/4"	Male
18-8073	-	3/8"	1/8"	Male
18-8074	-	3/8"	1/4"	Male

18-7599 FUEL LOCK

Protect your outboard from theft, disconnect fuel line and simply install fuel lock. Designed to fit clip on style fuel connectors. Fits: Johnson Evinrude, Mercury/Mariner, Yamaha and Honda.

① Discount shop pack of 10 - Priced per package



18-7083
PRIMER BULB
Replaces: 858763, 8168773, 8168772, 8168771, 816877, 684311
Fits: 30 2cyl(All), 30 JET 3cyl(All), 40 2cyl(All), 40 3cyl(All), 40 JET(All), 50 3cyl(G590000 & Up), 55 3cyl(G590000 & Up), 60 3cyl(G590000 & Up), 60 3cyl Bigfoot(All), 65 JET (All), 75 3cyl(D283222 & Up), 90 3cyl(D283222 & Up)



18-80410-1
FUEL CONNECTOR
 Superseded from 18-8076
Replaces: 22-13563T3
Female Hose connector 3/8"
Fits: 4/5 2-Stroke (1999 & Up)
 Mates with **18-80412**



18-80412
FUEL CONNECTOR
Replaces: 22-816856T2
Male Hose connector 5/16"
Fits: 100 4-cyl. (1988-99), 115 4-cyl. (1989 & up), 125 4-cyl. (1994 & up), 65 Jet (1994 & up), 75 3-cyl. (1987 & up), 80 Jet (1994 & up), 90 3-cyl. (1987 & up)
 Mates with **18-80410-1**



18-8068
TANK CONNECTOR
(1/4" NPT)
(Female)



18-8069
FUEL CONNECTOR
 5/16"
Replaces: 22831Q3, 22831A3, 22831A4, 22831B3, 22831A1
(Female)



18-8070
FUEL CONNECTOR
 5/16"
Replaces: 30185A3, 30185Q3, 30185B3, 30185A1, 29196, 16610M
(Male)



18-8075
FUEL CONNECTOR
(1/4")
Replaces: 22-14213M, 2214213Q, 22-81042M
 Mates with **18-8077-1**



18-8076
FUEL CONNECTOR
(3/8")
Replaces: 22-13563A3, 22-13563Q3
 Mates with **18-8077-1**



18-8077-1
TANK CONNECTOR
(1/4" NPT)
 Mates with **18-8075, 18-8076, 18-8085**



18-8082
TANK CONNECTOR
Mercury Straight Fitting
(1/4" NPT)
(Female)



18-8083
FUEL CONNECTOR
 3/8"
(Female)



18-8084
FUEL CONNECTOR
 3/8"
Replaces: 30185A3, 30185Q3, 30185B3, 30185A1, 29196, 22-16610M
(Male)



18-8085
18-8085-10
FUEL CONNECTOR
(5/16")
 Mates with **18-8077-1**



18-8091
FUEL CONNECTOR
(3/8")
Replaces: 22-13563Q7, 22-13563T7, 22-13563A7
 22-13563A6
 Mates with **18-80402**



18-80402
FUEL CONNECTOR
(1/4" NPT)
 Mates with **18-8091**

① Discount shop pack of 10 - Priced per package



18-7519
WATER SEPARATING
FUEL FILTERS
Replaces: Mercury
 8M0106635, 175-300HP
 V6 and V8 Four Stroke
 Outboards



18-79969
WATER SEPARATING
FUEL FILTERS
Replaces:
 Mercury 35-8M0126144



- UNIVERSAL DESIGN -
DIRECT REPLACEMENT FOR MERCURY AND YAMAHA
FUEL WATER SEPARATOR BRACKETS

Bracket Type	Part No.	Replaces
1/4" Aluminum	18-7853-1	Mercury 89876A3, 89876, 55481
3/8" Aluminum	18-7775	
1/4" Stainless Steel	18-7777	
3/8" Stainless Steel	18-7776	

FUEL WATER SEPARATOR KITS



21 MICRON FILTER KITS FOR CARBURETED ENGINES

Kit Type	Part No.	Micron Rating	Contents	Replaces
1/4" Aluminum (Short Filter)	18-7848-1 •	21	1 18-7844 filter 1 18-7853 bracket 2 18-4256 1/4" pipe plugs	25-807172A4, Q4, 25-60494A4, 35-805369A4, 35-57250A1, 35-52456A1, 35-60494A1, 52444
1/4" Aluminum Bonus Pack Contains Spare Filter	18-7848-2	21	2-18-7844 filter 1 18-7853-1 bracket	
1/4" Aluminum (Tall Filter)	18-7852-1	21	1 18-7845 filter 1 18-7853-1 bracket 2 18-4256 1/4" pipe plugs	
1/4" Aluminum Bonus Pack Contains Spare Filter	18-7852-2 •	21	2 18-7845 filter 1 18-7853 bracket 2 18-4256 1/4" pipe plugs	
3/8" Aluminum (Tall Filter)	18-7775-1	21	1 18-7845 filter 1 18-7775 bracket 2 18-4264 3/8" pipe plugs	
1/4" Stainless Steel (Tall Filter)	18-7777-1 •	21	1 18-7845 filter 1 18-7777 bracket 2 18-4256 1/4" pipe plugs	
3/8" Stainless Steel (Tall Filter)	18-7776-1	21	1 18-7845 filter 1 18-8888 bracket 2 18-4264 3/8" pipe plugs	

• Display Packaged

10 MICRON FILTER KITS FOR FUEL INJECTED ENGINES

• Display Packaged



Kit Type	Part #	Micron Rating	Contents
1/4" Aluminum (Short Filter)	18-7983-1 •	10	1 - 18-7944 filter & 1 18-7853-1 bracket • 2 - 18-4256 1/4" pipe plugs
1/4" Aluminum Bonus Pack (Contains spare filter)	18-7983-2 •	10	2 - 18-7944 filter & 1 18-7853-1 bracket • 2 - 18-4256 1/4" pipe plugs
1/4" Aluminum (Tall Filter)	18-7982-1 •	10	1 - 18-7945 filter & 1 18-7853-1 bracket • 2 - 18-4256 1/4" pipe plugs
1/4" Aluminum Bonus Pack (Contains spare filter)	18-7982-2 •	10	2 - 18-7945 filter & 1 18-7853-1 bracket • 2 - 18-4256 1/4" pipe plugs
1/4" Aluminum (High Capacity Filter)	18-7966-1 •	10	1 - 18-7866 filter & 1 18-7853-1 bracket • 2 - 18-4256 1/4" pipe plugs
3/8" Aluminum (Tall Filter)	18-7986-1	10	1 - 18-7945 filter & 1 18-7775 bracket • 2 - 18-4264 3/8" pipe plugs
1/4" Stainless Steel (Tall Filter)	18-7984-1 •	10	1 - 18-7945 filter & 1 18-7777 bracket
3/8" Stainless Steel (Tall Filter)	18-7985-1 •	10	1 - 18-7945 filter & 1 18-7776 bracket • 2 - 18-4264 3/8" pipe plugs
1/4" Aluminum (Tall Filter)	18-79912	10	1 - 18-79911 & 1 - 18-7853-1



10 MICRON FILTER KITS WITH DRAIN BOWLS

Sierra AquaVue™ and metal bowl separator filters allow water to be drained from the filter to extend service life. Use the AquaVue™ bowl for outboard, above deck installations. USCG regulations require the use of the flame resistant metal bowl below deck.

Kit Type	Part #	Micron Rating	Contents
1/4" Aluminum w/ AquaVue™ bowl	18-7932-1 •	10	1 - 18-7919 filter & 1 18-7853-1 bracket 1 - 18-7922-1 AquaVue™ bowl 2 - 18-4256 1/4" pipe plugs
1/4" Aluminum w/ metal drain bowl	18-7951 •	10	1 - 18-7919 filter & 1 18-7853-1 bracket 1 - 18-7924 metal bowl 2 - 18-4256 1/4" pipe plugs
1/4" Stainless Steel w/ AquaVue™ bowl	18-7937-1 •	10	1 - 18-7919 filter & 1 18-7777 bracket 1 - 18-7922-1 AquaVue™ bowl 2 - 18-4256 1/4" pipe plugs
1/4" Stainless Steel w/ metal drain bowl	18-7938 •	10	1 - 18-7919 filter & 1 18-7777 bracket 1 - 18-7924 metal bowl 2 - 18-4256 1/4" pipe plugs

• Display Packaged

COMPACT BRACKET AND SEPARATOR KIT FOR SMALL OUTBOARDS AND FRESH WATER APPLICATIONS

18-7774
COMPACT ALUMINUM BRACKET



18-7965-1
10 MICRON COMPACT SEPARATOR KIT
Contains:
1 - 18-7774 bracket
1 - 18-7865 filter



REPLACEMENT FILTERS



UNIVERSAL DESIGN - DIRECT REPLACEMENT FOR MERCURY AND YAMAHA

10 MICRON REPLACEMENT FILTERS		
Part No.	Description	Replaces
18-7944	Short - 3.875"	35-807172, 35-802893Q, 35-806771, 35-8053691, 35-805369, 35-604941, 35-60494, 35-57250, 35-55501, 35-52456
18-7945	Long 4.35"	35-802893Q, 35-806771, 35-8053691, 35-805369, 35-604941, 35-60494, 35-57250, 35-55501, 35-52456
18-7866	High Capacity - 6"	
18-7865	Compact 10 Micron	
18-7967	Early Model with sensor	35-18458Q3, 35-18458A3, 35-18458A2, 35-17808A1, 35-14571A1
18-7968	Late model with sensor	35-18458Q4, 35-184585

10 MICRON REPLACEMENT FILTERS		
Part No.	Description	Replaces
18-79911	Long 8.5"	35-8M0079962
18-7596	Long 4.35"	35-866594K01

21 MICRON REPLACEMENT FILTERS		
Part No.	Description	Replaces
18-7844	Short - 3.875	35-807172, 35-807172, 35-806771
18-7845	Long - 4.35"	35-8053691, 35-60494A4, 35-604941, 35-57250, 35-55501



10 MICRON REPLACEMENT FILTERS AND KITS WITH DRAIN BOWLS

(SEE CHART BELOW)

- Display Packaged

REPLACEMENT FILTERS

Part No.	Description	Replaces
18-7919	Spin on replacement	35-809097, 35-8M0103095, Racor S3213
18-7920	Spin on replacement	35-809099, Racor S3214
18-7948	Spin on replacement	35-886638, Racor S3227

REPLACEMENT BOWLS

Part No.	Description
18-7922-1	AquaVue™ Collection Bowl
18-7924	Metal Collection Bowl

FILTER & BOWL KITS

Part No.	Description
18-7928-1	Filter & AquaVue™ Bowl Mercury Style • Contains: 18-7919 Filter, 18-7922-1 Bowl
18-7929	Filter & Metal Bowl Mercury Style • Contains: 18-7919 Filter, 18-7924
18-7969	Filter & Metal Bowl • Contains: 18-7948 Filter, 18-7924 Bowl
18-7994-1	Filter & AquaVue™ Bowl • Contains 18-7948 Filter, 18-7922-1 Bowl

18-8955
FUEL WATER SEPARATOR COVER
 Fits: 18-7944 & 18-7945 sized filter



18-8222
FUEL FILTER
 Replaces: Mercury 35-8M0157133, 2/5 2 Cyl (1999 & Up), 4/5/6 4 Stroke (1999 & Up), 8/9.9 4-stroke (2005 & Up)

18-7936
FUEL FILTER ELEMENT
 Replaces: 35-888289T2
 Fits: 225 EFI (2003-06) (SN OT653945 & Up)



18-7712
FUEL FILTER (INLINE)
 Superseded from 18-8225
 Replaces: 35-16248
 Fits: 4/5 2 cyl (1999 & Up), 4/5/6 4 stroke (1999 & Up), 8/9.9 4-stroke (2005 & Up)



18-7713
FUEL FILTER (INLINE)
 Replace: 35-80365M
 Fits: Mercury/Mariner 9.9 4-Stroke(1995-98), 15 4-Stroke (1998 & Up), Yamaha 6(1989, 1992-99), 8 (1989-99, 2001-02), F4(1999-02), F9.9(1989-95, 1997-99, 2001-02), FT 9.9 (1988-90)



18-7718
FUEL FILTER (INLINE)
 5/16"
 Replaces: 35-879885T
 For: 135/150/175 4-Stroke Verado (S/N 1B227000 & Up), 200/225 4-Stroke Verado (S/N OT980000 & Up), 250/275 4-Stroke Verado (S/N OT801000 & Up)



18-7714
FUEL FILTER (INLINE)
 Replaces: 35-877565T1
 Fits: 25 4-Stroke (1998 & Up), 30 4-Stroke (1999-01), 30 3 cyl 4-Stroke (1999-01), 40 4-Stroke (1998-01), 40 4-Stroke 4 cyl (2001-02), 40 Carb 3-cyl 4-Stroke (2002 & Up), 50 4-Stroke 4 cyl (2001-02), 60 4-Stroke 4 cyl (2001-02), 75 4-Stroke (2000 & Up), 90 4-Stroke (2000 & Up)



18-79965
FUEL FILTER (INLINE)
 Replaces: 35-789884T
 For: 75/90/115 Optimax (1.5L) 1B227000 & Above



18-79967
FUEL FILTER SCREEN
 Replaces: 8M0090809
 For: "75/90/115 Pro XS HP 2B094996 & Above 150 EFI 4 Stroke 1B905505 & Above 200/300 6 Cylinder Verado 2B144123 & Above (Gen V) 350-400 6 Cylinder Verado"



18-7802
FUEL FILTER
 Replaces: 35-87946A3, 35-87946-Q3, Q4
 For: 6 HP thru 25 HP



18-7832
FUEL FILTER
 Replaces: 1399-3938, 1399-1754, 1399-1136
 For: AJ, KA, KB, KC, KD, WM, WMC Carb.



18-7979
FUEL FILTER
 Replace: 881540
 Fits: 115 EFI (4 Stroke), 75HP (4 Stroke), 75HP (4 Stroke) (Bodensee), 90HP (4 Stroke)



18-7981
FUEL FILTER
 Replaces: 35-884380T, 35-8M0020349
 Fits: All Verados, 90HP (DFI) (3 cyl), 115 DFI (3 cyl) / 200HP (DFI) / 225HP (DFI) (including 3.0L DFI)



FUEL FILTERS



Part #	Application
18-7828-1	1/4" small capacity (For 1/4" fuel line)
18-7829	1/4" large capacity (For 1/4" fuel line) Replaces: 35-16494, 35-816296, 35-816296T, 35-816296K03
18-7830	5/16" Replaces: 35-164941, 35-816296-1, 35-816296T1, 35-8162961, 35-816396Q1 35-816296B2, 35-816296B1, 35-134301
18-7831	3/8" Replaces: 802128A1



18-7997
AIR FILTER
Replaces: 35-853333T, 35-853333
Fits: V115 DFI (2.5L) (2000), V-135 DFI (2.5L) (1998 & Up), V-150 DFI (2.5L) (1998 & Up), V-175 DFI (2.5L) (2001 & Up), 200 DFI (1998-02), 225 DFI (1998-02)



18-7999
AIR FILTER
Replaces: 35-896247
For: 135/150/175 4-Stroke Verado (S/N 1B227000 & Up)



18-7523
AIR FILTER
Replaces: Mercury 35-880084T01, 200-250HP 3.0L V6 Optimax Engines



18-7113-9Ⓜ
O-RING
Replaces: 25-897536, 25-98277
Fits: 18-7802 Filter Element (35-87946Q3)

PKG. OF 10



18-3605
THERMOSTAT KIT
Fits: V-135 DFI (2.5L)(1998 & Up), V-150 DFI (2.5L)(1998 & Up), V-175 DFI (2.5L)(2000 & Up)



①**18-3606D**
18-3606
THERMOSTAT KIT 130°
Fits: 200 3.0L DFI DTS (ALL), 200 3.0L EFI (2003 & Up) (OT750164 & Up), 200 DFI (1997 & Up)(OG386496 & Up), 225 3.0L EFI (1999 & Up)(OG760300 & Up), 225 3.0L EFI SeaPro (2004 & Up)(OT801000 & Up), 225 3.0L DFI DTS (2003 & Up)(OT599000 & Up), 225 DFI (1998 & Up) (OG590000 & Up), 250 3.0L EFI (1999 & Up) (OG760300 & Up), 250 Long 3.0L EFI (OT861319 & Up)



18-43175
THERMOSTAT KIT 130°
Replaces: 855676002
Fits: Mercury 15 Carb(2cyl) 4-Stroke(R235949& Up), 15 SeaPro 4-Stroke(R051685 & Up), 20 Carb(2cyl) 4-Stroke(R235168 & Up), 25 EFI(3cyl)4-Stroke(R106999 & Up), 25 Jet EFI(3cyl)4-Stroke(R165086 & Up), 25 SeaPro 4-Stroke(R051710 & Up), 30 EFI(3cyl)4-Stroke(T409000-1B226999), 8 4-Stroke(209cc)(R042475 & Up), 9.9 4-Stroke(209cc)(R042475 & Up)



18-3672
THERMOSTAT KIT
- CONTAINS -

Part #	Desc.	O.E. #
18-3553	Thermostat, Brass	75692
18-0182	Thermostat Gasket	27-62386

HP	Beg. S/N	End S/N	HP	Beg. S/N	End S/N
V135	A904646	& UP	V150 MAGII	C239553	4571651
V150	A904646	& UP	V150 MAGIII	D082000	4825248
V150 XR4	C239553	C159199	V175	C100861	& UP
V150 XR6	D082000	& UP	V200	6435503	& UP



18-3569
THERMOSTAT KIT
Replaces: 803061T1
Includes 18-3549 thermostat

HP	Beg. S/N	End S/N	HP	Beg. S/N	End S/N
70 3 cyl.	A996142	& UP	100 4 cyl.	B209468	& UP
75 3 cyl.	C222000	& UP	115 4 cyl.	C100000	& UP
80 3 cyl.	A996142	& UP	125 4 cyl.	D283222	& UP
90 3 cyl.	A996142	& UP			



18-43052
THERMOSTAT KIT
Replaces: 14586A3, 75962A9, 75962A10, 75962A11
Fits: Mercury 6-25 hp 2-Stroke



18-3535
THERMOSTAT 130°
Replaces: 885599004
Fits: 200 3.0L DFI DTS (ALL), 200 3.0L EFI (2003 & Up) (OT750164 & Up), 200 DFI (1997 & Up)(OG386496 & Up), 225 3.0L EFI (1999 & Up)(OG760300 & Up), 225 3.0L EFI SeaPro (2004 & Up)(OT801000 & Up), 225 3.0L DFI DTS (2003 & Up)(OT599000 & Up), 225 DFI (1998 & Up)(OG590000 & Up), 250 3.0L EFI (1999 & Up) (OG760300 & Up), 250 Long 3.0L EFI (OT861319 & Up)



18-3536
THERMOSTAT 143°
Replaces: 833072003
Fits: V135 DFI 2.5L (1998 & Up)(OG590000 & Up), V150 DFI 2.5L (1998 & Up)(OG590000 & Up), V175 DFI 2.5L (2001 & Up)(OT178500 & Up)



18-3537
THERMOSTAT 143°
Replaces: 833072002, 833072004
Fits: 75 3 cyl DFI 1.5L (2006 & Up)(OT980000 & Up), 90 3 cyl DFI 1.5L (2004 & Up)(OT801000 & Up), 115 3 cyl DFI 1.5L (2004 & Up)(OT801000 & Up)

① Items ending in "D" are Display Packaged - Regular number is Non-Display

② Priced per package



18-3631
THERMOSTAT W/ HOUSING
Replaces: 892864T04
Fits: 135-300 Verado



18-3633
THERMOSTAT
Replaces: 8M0090819
Fits: 75-115HP, 115 Pro XS (2B094996 & Up)



18-3635
THERMOSTAT
Replaces: 892864T06
Fits: 75-115HP (1B366823-2B094995), 150 EFI (1B905505 & Up)



18-3638
THERMOSTAT
Replaces: 804540
Fits: 2.5-3.5HP (OR131842 & Up), 4-6HP (OR411838 & Up)



18-3640
THERMOSTAT
Replaces: 8M0117413
Fits: 40-60HP (1C050252 & Up)



18-3642
THERMOSTAT
Replaces: 855676A1
Fits: 40HP (3Cyl) (1C049739 & Up)



18-3553
THERMOSTAT
Replaces: 62981, 66850, 75692
143°

18-3553 THERMOSTAT APPLICATION

HP	Beg. S/N	End. S/N	HP	Beg. S/N	End. S/N
7.5	5226935	& UP	V150	A904646	& UP
9.8	5206550	& UP	V175	C100861	& UP
40	3336258	C159199	V200	6435503	& UP
50/60	D000750	& UP	V220	B117316	& UP
65	3547987	4571651	V225	5628028	& UP
70	4571652	4825248	V300/3.4L	5611648	& UP
70/75/80/90	A996142	& UP	XR4	C239553	D081999
100/115	B209468	& UP	Magnum II	C239553	D081999
V135	A904646	& UP			



18-3549
THERMOSTAT
Replaces: 14586
For: 6, 7, 8, 9.9 & 15 HP
Mercury/Mariner A197112 & Later
120°

18-3549 THERMOSTAT APPLICATION

MARINER		
HP	Serial #	
6,8,9,9 (2 cyl.)	A197112	Later
Sea Pro 10	D038000	Later
15 (2 cyl.)	B292414	Later
18XD, 20XD, 25XD	B114231	Later
25 (2 cyl.) 25 Sea Pro	B238464	Later
30 (2 cyl.)	G055314	Later
45 Jet, 50, 55, 60 (3 cyl.)	G290585	Later
MERCURY		
Sea Pro 10	D038000	Later
15 (2 cyl.)	B292414	Later
18XD, 20XD, 25XD	B114231	Later
25 (2 cyl.) 25 Sea Pro	B238464	Later
30 (2 cyl.)	G055314	Later
45 Jet, 50, 55, 60 (3 cyl.)	G290585	Later



18-3556
THERMOSTAT
Replaces: 895338
3/4" – 130°



















18-43051
THERMOSTAT COVER KIT
Fits: Mercury V6



18-5896
SENDER
Replaces: 12415
1/8" - 27NPT Threads



18-3007
IMPELLER
Replaces: 47-89983,
47-89983T

 <p>18-3008 IMPELLER Replaces: 47-20813, 47-25287</p>	 <p>18-3012 IMPELLER Replaces: 47-22748</p>	 <p>18-3017 18-3017-10^① IMPELLER Replaces: 47-89984, 47-899842, 47-89984T3, 47-89984T4, 47-899844, 47-30221, 47-65960, 47-85460</p>	
 <p>18-3039 IMPELLER Replaces: 47-65957, 47-89981, 47-39074 • .456" ID</p>	 <p>18-3052 IMPELLER Replaces: 47-56780, 47-65958, 47-89982</p>	 <p>18-3054 IMPELLER Replaces: 47-68988, 47-89980 • .438" ID</p>	
 <p>18-3056 18-3056-10^① IMPELLER Replaces: 47-430261, 47-430262, 47-43026T2, 47-430264</p>	 <p>18-3057 IMPELLER Replaces: 47-85089-3</p>	 <p>18-3062 IMPELLER Replaces: 47-420381, 47-420382, 47-42038Q02</p>	
 <p>18-3063 IMPELLER Replaces: 47-95611M, 47-81242M</p>	 <p>18-3066 IMPELLER Replaces: 47-11590M</p>	 <p>18-3067 IMPELLER Replaces: 47-84797M, 47-81604M</p>	 <p>18-3069 IMPELLER Replaces: 47-81423M, 47-97108M, 47-82824M</p>
 <p>18-3072 IMPELLER Replaces: 47-80395M</p>	 <p>18-3073 IMPELLER Replaces: 47-96305M</p>	 <p>18-3074 IMPELLER Replaces: 47-84027M, 47-84027T, 47-96619M</p>	 <p>18-3098 IMPELLER Replaces: 47-161543, 47-16154</p>

APPLICATION BEGINS ON PAGE 420

① Discount shop pack of 10 - Priced per package

 <p>18-45312 IMPELLER Replaces: 47-95289, 47-952892 Fits: Mercury 2(T884302 & Up), 2.5(A855097 & Up), 3.3(G710613 & Up)</p>	 <p>18-8900 IMPELLER Replaces: 47-19453</p>	 <p>18-3293 IMPELLER KEY Replaces: 28-43037 Also large O/B's</p>		
 <p>18-3300 IMPELLER KEY Replaces: 28-83444M For models: 40A, 40B, 40C</p>	 <p>18-3305 IMPELLER KEY Replaces: 28-81912M, 28-83701M For models: 6C-D, 8C, 9.9C, 15C</p>	 <p>18-3109 WATER TUBE GUIDE Replaces: 23-29804, 23-29804T, 23-52928 (Use with 18-3116 Housing)</p>		
 <p>18-3013 UPPER WATER PUMP SEAL Replaces: 26-821309 For: 4-Stroke O/B's, 25/30/40/45/50 HP s/n OG760300 & UP</p>	 <p>18-3110 WATER PUMP HOUSING WITH BUSHING Replaces: 26-38970, 26-36557A1, 26-29677 (Part of 18-3116 Housing)</p>	 <p>18-3014 LOWER WATER PUMP SEAL Replaces: 26-821310 For: 4-Stroke O/B's, 25/30/40/45/50 HP s/n OG760300 & UP</p>	 <p>18-3151 WATER COUPLING ASSEMBLY Replaces: 816597</p>	
 <p>18-3154 WATER COUPLING ASSEMBLY Replaces: 826763A</p>	 <p>18-1730 COUPLING Replaces: 43585 For: 200, 225, 250 & 275 Verado's</p>	 <p>18-3113 INSERT CUP Replaces: 70977</p>	 <p>18-3114 INSERT CUP Replaces: 48752, 48752T</p>	
 <p>18-3115 INSERT CUP Replaces: 48753</p>	 <p>18-3435 INSERT CUP</p>	 <p>18-3107 IMPELLER PLATE Replaces: 54705, 32768</p>	 <p>18-3117 IMPELLER PLATE Replaces: 32435, 324351, 30605</p>	
 <p>18-3122 IMPELLER PLATE Replaces: 817276, 8172761, 8172763</p>	 <p>18-3139 IMPELLER PLATE Replaces: 46895</p>	 <p>18-3436 IMPELLER PLATE</p>	 <p>18-3116 WATER PUMP HOUSING Replaces: 46-96148, 46-96148A1, 46-96148T1, 46-64141A1, 46-48743A1</p>	 <p>18-3118 WATER PUMP HOUSING Replaces: 46-48746A1, 46-77822A1, 46-48746A3</p>



18-3414
WATER PUMP BASE
Replaces: 46-96146A5, 46-73804A1



18-3416
WATER PUMP BASE
Replaces: 46-96146A6, 46-96146A2, 46-78400A1, 46-73802A2



18-3419
WATER PUMP BASE
Replaces: 46-42579A3



18-3422
WATER PUMP BASE
Replaces: 46-77516A1, 46-73842A2, 46-68390A1, 46-65498A1, 46-48745A1



18-3423
WATER PUMP BASE
Replaces: 46-73640A1



18-3424
WATER PUMP BASE
Replaces: 46-77177A1



18-3445
WATER PUMP BASE
Replaces: 46-812966A7, 46-812996A3, 46-812996A9
For: 40-60 HP



18-43212
WATER PUMP HOUSING
Replaces: 46-803750A02, 46-8037502
Fits: Mercury 8/9.9 4-Stroke(209cc)



18-3207D
IMPELLER REPAIR KIT
Replaces: 47-89983T2, 47-89983Q1
— CONTAINS —



18-3214D
IMPELLER REPAIR KIT
Replaces: 47-43026T6, 47-43026T8, 47-43026T11
— CONTAINS —

Part #	Desc.	O.E. #	Qty.
18-3007	Impeller	47-89983	1
18-2945	Drain Screw Gasket	12-20260,12-19183	2
18-2823	Low. Water Pump Base to Face Plate Gasket	27-32769, 27-19553	1
18-2824	Upper Face Plate to Pump Body Gasket	27-32770	1
18-2825	Water Pump Base Gasket	27-32771, 27-19551	1
18-2841	Water Pump Base Gasket	27-77417, 27-19552	1
18-2948	Rubber Washer	12-49221-1	1
18-3107	Plate	54705	1
18-7155	O-Ring	25-26855	1
18-7174	O-Ring	25-45711	1
18-7115	O-Ring	25-26722	1

Part #	Desc.	O.E. #	Qty.
NSS	Water Pump Base to Face Plate Gasket	27-43033-1	1
18-2565	Water Pump Base to Gear Housing Gasket	27-43047-1	1
18-2566	Face Plate to Water Pump Cover Gasket	27-817277	1
18-2944	Seal Ring	26-45577	1
18-3056	Impeller	47-43026-1	1
18-3122	Impeller Plate	817276	1
18-7420	O-Ring	25-21836	2



18-3215D
IMPELLER REPAIR KIT
Replaces: 47-85089T7
— CONTAINS —



18-3149-2
WATER PUMP KIT
Replaces: 46-42040A1, 46-42040A3, 46-42040A5, 46-42040T5
For: 10 Magnum, Marathon, Sea Pro, Viking
15 Marathon, Sea Pro 6, 8, 9.9HP, XR10

Part #	Desc.	O.E. #	Qty.
18-2560	Impeller Washer Gasket	12-86645	2
NSS	Gear Housing to Face Plate Gasket	27-85087	1
18-2562	Gear Housing to Face Plate Gasket	27-99326-1	1
18-3057	Impeller	47-85089-3	1
18-7419	O-Ring	25-69202	1

18-3149-2
WATER PUMP KIT
Replaces: 46-42040A1, 46-42040A3, 46-42040A5, 46-42040T5
For: 10 Magnum, Marathon, Sea Pro, Viking
15 Marathon, Sea Pro 6, 8, 9.9HP, XR10

APPLICATION BEGINS ON PAGE 420

① Items ending in "D" are Display Packaged - Regular number is Non-Display



18-3265
IMPELLER REPAIR KIT

Replaces: 47-43026Q06, 47-43026T11, 47-8M0100526
For: 135/150/175 4-Stroke Verado (S/N 1B227000 & Up), 200/225 4-Stroke Verado (S/N OT980000 & Up), 250/275 4-Stroke Verado (S/N OT801000 & Up)



18-3217
IMPELLER KIT
Similar to: 46-96148A5 without base or housing

— CONTAINS —

Part #	Desc.	O.E. #	Qty.
18-3109	Water Tube	23-29804	1
18-3017	Impeller	47-89984	1
18-2919	Water Pump Gasket	27-42631-1	1
18-3110	Grommet	26-38970	1
18-2945	Drain Screw Gasket	12-20260,12-19183	2
18-2826	Water Pump Base to Gear Housing Gasket	27-85610	1
18-2914	Water Pump Gasket	27-85608-1	1
18-2915	Water Pump Gasket	27-85609-1	1
18-2944	Seal Ring	26-45577	1
18-3117	Plate	32435	1
18-7158	O-Ring	25-30613	1
18-7162	O-Ring	25-33145	1
18-7173-9	O-Ring	25-30224	1
18-7176	O-Ring	25-90011	1
NSS	Water Pump Gasket	27-32438	1
18-7426	O-Ring	35-30271	1

18-3239D



18-3239
IMPELLER REPAIR KIT

— CONTAINS —

Part #	Desc.	O.E. #	Qty.
18-3039	Impeller	47-89981	1
18-3139	Impeller Plate	46895	1
18-7409	O-Ring	—	1



18-3406
UPPER WATER PUMP REPAIR KIT

Replaces: 817275A08
For: 135/150/175 4-Stroke Verado (S/N 1B227000 & Up), 200/225 4-Stroke Verado (S/N OT980000 & Up), 250/275 4-Stroke Verado (S/N OT801000 & Up)



18-3407
UPPER WATER PUMP REPAIR KIT

Replaces: 817275A09
For: 135/150/175 4-Stroke Verado (S/N 1B227000 & Up), 200/225 4-Stroke Verado (S/N OT980000 & Up), 250/275 4-Stroke Verado (S/N OT801000 & Up)

APPLICATION BEGINS ON PAGE 420

① Items ending in "D" are Display Packaged - Regular number is Non-Display

18-3314
WATER PUMP KIT



— CONTAINS —

Part #	Desc.	O.E. #	Qty.
18-3109	Water Tube Guide	23-29804	1
18-3017	Impeller	47-89984	1
18-3116	Housing	46-96148A1	1
18-3414	Base	46-96146A5	1
18-2919	Water Pump Gasket	27-42631-1	1
18-3110	Grommet	26-38970	1
18-2945	Drain Screw Gasket	12-20260, 12-19183	2
18-2826	Water Pump Base to Gear Housing Gasket	27-85610-1	1
18-2914	Water Pump Gasket	27-85608-1	1
18-2915	Water Pump Gasket	27-85609-1	1
18-2944	Seal Ring	26-45577	1
18-3117	Plate	32435	1
18-7158	O-Ring	25-30613	1
18-7162	O-Ring	25-33145	1
18-7173-9	O-Ring	25-30224	1
18-7176	O-Ring	25-90011	1
NSS	Gasket	27-32438	1
18-7426	O-Ring	35-30271	1

18-3316
WATER PUMP KIT
Replaces: 46-78400A2, 46-96148A8, 46-32437A3



— CONTAINS —

Part #	Desc.	O.E. #	Qty.
18-3109	Water Tube Guide	23-29804	1
18-3017	Impeller	47-89984	1
18-3116	Housing	46-96148A1	1
18-3416	Base	46-96146A6	1
18-2919	Water Pump Gasket	27-42631-1	1
18-3110	Grommet	26-38970	1
18-2945	Drain Screw Gasket	26-20260, 12-19183	2
18-2826	Water Pump Base to Gear Housing Gasket	27-85610-1	1
18-2914	Water Pump Gasket	27-85608-1	1
18-2915	Water Pump Gasket	27-85609-1	1
18-2944	Seal Ring	26-45577	1
18-3117	Plate	32435	1
18-7158	O-Ring	25-30613	1
18-7162	O-Ring	25-33145	1
18-7173-9	O-Ring	25-30224	1
18-7176	O-Ring	25-90011	1
NSS	Gasket	27-32438	1
18-7196	O-Ring	25-38099	1
18-7426	O-Ring	35-30271	1

18-3319
WATER PUMP KIT
Replaces: 46-42579A4



— CONTAINS —

Part #	Desc.	O.E. #	Qty.
18-3109	Water Tube Guide	23-29804	1
18-3017	Impeller	47-89984	1
18-3116	Housing	46-96148A1	1
18-3419	Base	46-42579A3	1
18-2919	Water Pump Gasket	27-42631-1	1
18-3110	Grommet	26-38970	1
18-2945	Drain Screw Gasket	26-20260, 12-19183	2
18-2826	Water Pump Base to Gear Housing Gasket	27-85610-1	1
18-2914	Water Pump Gasket	27-85608-1	1
18-2915	Water Pump Gasket	27-85609-1	1
18-2944	Seal Ring	26-45577	1
18-3117	Plate	32435	1
18-7158	O-Ring	25-30613	1
18-7162	O-Ring	25-33145	1
18-7173-9	O-Ring	25-30224	1
18-7176	O-Ring	25-90011	1
NSS	Gasket	27-32438	1
18-7426	O-Ring	35-30271	1

18-3507
WATER PUMP KIT
(Without Base)
Replaces: 46-60366A1



— CONTAINS —

Part #	Desc.	O.E. #	Qty.
18-3007	Impeller	47-89983	1
18-3118	Upper Pump Housing	46-77822A1	1
18-2945	Drain Screw Gasket	12-20260, 12-19183	2
18-2823	Lower Water Pump Base to Face Plate Gasket	27-32769, 27-19553	1
18-2824	Upper Face Plate To Body Gasket	27-32770, 27-19551	1
18-2825	Water Pump Base Gasket	27-32771	1
18-2841	Water Pump Base Gasket	27-77417, 27-19552	1
18-2948	Drain Plug	12-49221-1	1
18-3107	Plate	54705	1
18-7155	O-Ring	25-26855	1
18-7174	O-Ring	25-45711	1
18-7115	O-Ring	25-26722	1

18-3517
WATER PUMP KIT
(Without Base)

Replaces: 46-96148A5, 46-96148A8, 46-78400A2, 46-73804A3, 46-73802A3, 46-69222A3, 46-64141A11, 46-60367A4, 46-58618A4, 46-57234A3, 46-48747A3, 46-42579A4, 46-44292A4, 46-32437A1



— CONTAINS —

Part #	Desc.	O.E. #	Qty.
18-3109	Water Tube	23-29804	1
18-3017	Impeller	47-89984	1
18-3116	Housing	46-96148A1	1
18-2919	Water Pump Gasket	27-42631-1	1
18-3110	Grommet	26-38970	1
18-2945	Drain Screw Gasket	26-20260, 12-19183	2
18-2826	Water Pump Base to Gear Housing Gasket	27-85610-1	1
18-2914	Water Pump Gasket	27-85608-1	1
18-2915	Water Pump Gasket	27-85609-1	1
18-2944	Seal Ring	26-45577	1
18-3117	Plate	32435	1
18-7158	O-Ring	25-30613	1
18-7162	O-Ring	25-33145	1
18-7173-9	O-Ring	25-30224	1
18-7176	O-Ring	25-90011	1
NSS	Water Pump Gasket	27-32438	1
18-7426	O-Ring	35-30271	1

18-3322
WATER PUMP KIT
Replaces: 46-77516A3



— CONTAINS —

Part #	Desc.	O.E. #	Qty.
18-3007	Impeller	47-89983	1
18-3118	Upper Pump Housing	46-77822A1	1
18-3422	Water Pump Base	46-77516A1	1
18-2945	Drain Screw Gasket	12-20260, 12-19183	2
18-2823	Lower Water Pump Base to Face Plate Gasket	27-32769, 27-19553	1
18-2824	Upper Face Plate To Body Gasket	27-32770, 27-19551	1
18-2825	Water Pump Base Gasket	27-32771	1
18-2841	Water Pump Base Gasket	27-77417, 27-19552	1
18-2948	Drain Plug	12-49221-1	1
18-3107	Plate	54705	1
18-7155	O-Ring	25-26855	1
18-7174	O-Ring	25-45711	1
18-7115	O-Ring	25-26722	1

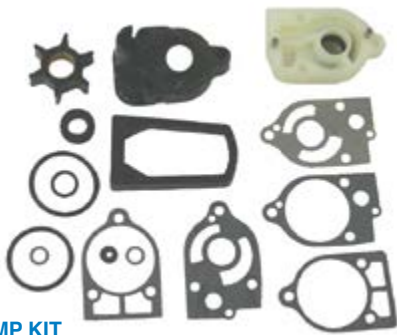

18-3323
WATER PUMP KIT
 Replaces: 46-73640A2

— CONTAINS —

Part #	Desc.	O.E. #	Qty.
18-3007	Impeller	47-89983	1
18-3118	Upper Pump Housing	46-77822A1	1
18-3423	Water Pump Base	46-73640A1	1
18-2945	Drain Screw Gasket	12-20260, 12-19183	2
18-2823	Lower Water Pump Base to Face Plate Gasket	27-32769, 27-19553	1
18-2824	Upper Face Plate To Body Gasket	27-32770, 27-19551	1
18-2825	Water Pump Base Gasket	27-32771	1
18-2841	Water Pump Base Gasket	27-77417, 27-19552	1
18-2948	Drain Plug	12-49221-1	1
18-3107	Plate	54705	1
18-7155	O-Ring	25-26855	1
18-7174	O-Ring	25-45711	1
18-7115	O-Ring	25-26722	1



18-3324
WATER PUMP KIT
 Replaces: 46-77177A3

— CONTAINS —

Part #	Desc.	O.E. #	Qty.
18-3007	Impeller	47-89983	1
18-3118	Upper Pump Housing	46-77822A1	1
18-3424	Water Pump Base	46-77177A1	1
18-2945	Drain Screw Gasket	12-20260, 12-19183	2
18-2823	Lower Water Pump Base to Face Plate Gasket	27-32769, 27-19553	1
18-2824	Upper Face Plate To Body Gasket	27-32770, 27-19551	1
18-2825	Water Pump Base Gasket	27-32771	1
18-2841	Water Pump Base Gasket	27-77417, 27-19552	1
18-2948	Drain Plug	12-49221-1	1
18-3107	Plate	54705	1
18-7155	O-Ring	25-26855	1
18-7174	O-Ring	25-45711	1
18-7115	O-Ring	25-26722	1

NEW



18-3690
WATER PUMP KIT
 Replaces: 812966A12
 30-60HP Various Serial Ranges

NEW



18-3691
WATER PUMP KIT
 Replaces: 8M0094529
 65-115HP 2B095049 115HP 2B225488 and up



18-3571
WATER PUMP HOUSING KIT
 Replaces: 817275A1
 V-6 outboard



18-3572
WATER PUMP HOUSING KIT
 Replaces: 46-43024A3, 817275A2



18-3148
WATER PUMP REPAIR KIT
 Without Housing
 Replaces: 46-84277M, 46-84277T

— CONTAINS —

Part #	Desc.	O.E. #	Qty.
18-0768	Wear Plate Gasket	—	1
18-3074	Impeller	47-84027M	1
18-3305	Woodruff Key	28-8192M	1



18-3446
WATER PUMP KIT
 Replaces: 46-70941A3
 For: 4/4.5 HP

— CONTAINS —

Part #	Desc.	O.E. #	Qty.
18-3039	Impeller	47-89981	1
18-3139	Impeller Plate	46895	1



18-3448
WATER PUMP KIT
 Replaces: 46-48744A3
 For: 20 HP 1967-80

— CONTAINS —

Part #	Desc.	O.E. #	Qty.
18-3052	Impeller	47-89982	1
18-2827	Upper Face Plate Gasket	27-39623	1
18-2828	Lower Face Plate Gasket	27-39625	1
18-2829	Water Pump Base Gasket	27-39626	1



18-4531
WATER PUMP REPAIR KIT
 Without Housing

Replaces: 821354A2
 Fits: 25 (4-Stroke), 30 (2 Cyl.), 30 (4-Stroke), 40 (2 Cyl.), 40 (3 Cyl.), 40 (4-Stroke), 50 (3 Cyl.), 50 (4-Stroke), 50 Big Foot (4-Stroke)

— CONTAINS —

Part #	Desc.	O.E.#	Qty.
NSS	Seal, Short 1 3/4"	43023	1
NSS	Seal, Long 2 1/4"	8235471	1
18-2560	Washer	12-866451	2
18-0345	Gasket, Upper Water Pump	27-822189	1
NSS	Gasket, Lower Water Pump	27-822217	1
NSS	Plate, Wear	8213542	1
18-3057	Impeller	47-850893	1



18-3570
WATER PUMP KIT

— CONTAINS —

Part #	Desc.	O.E. #	Qty.
NSS	Water Pump Housing	—	1
18-3056	Impeller	47-430262	1
18-2599	Face Seal & Tool	26-816575A2	1
18-3122	Impeller Plate	817276	1



18-3425
WATER PUMP KIT
 Without Housing

Replaces: 84188M, 84188T

— CONTAINS —

Part #	Desc.	O.E.#	Qty.
18-0292	Wear Plate to Pump Housing Gasket	27-81417M	1
18-3435	Insert Cup	—	1
18-0294	Wear Plate to Pump Base Gasket	—	1
18-3069	Impeller	47-81423M, 47-97108M	1
18-0256	Bolt	—	2
18-3436	Impeller Plate	—	1
18-3297	Impeller Key	—	1

HP	Beg. S/N	End. S/N	HP	Beg. S/N	End. S/N
817275A2 APPLICATION					
40 (4 stroke)			817275A2 APPLICATION (Cont.)		
(4 cyl.) Big Foot	OT228405	& UP	80 Jet	OD283222	& UP
935cc Big Foot	OG231123OT178499		90 (3 cyl.)	OA996142	& UP
50 (4 stroke)			90 (4 stroke)	OG960500	& UP
996cc Big Foot	OT178500	& UP	100 (4 cyl.)	OB209468	& UP
60 (3 cyl.)			115 (4 cyl.)	OC100000	& UP
Big Foot	OD000750	& UP	125 (4 cyl.)	OD283222	& UP
60 (4 stroke)			817275A1 APPLICATION		
Big Foot	OT178500	& UP	45 (4 stroke)		
65 Jet	OC283222	& UP	Big Foot Bodensee	OG231123	& UP
70 (3 cyl.)	OA996142	& UP	V-200 DFI (3.0L)	OG386496	OG589999
75 (3 cyl.)	OC222000	& UP	V-200 DFI (3.0L)	OG590000	& UP
75 (4 stroke)	OG960500	& UP	V-225 (3.0L)		
80 (3 cyl.)	OA996142	& UP	Carb & EFI	OD280813	& UP
			V-225 DFI	OG590000	& UP
			V-250 (3.0L) EFI	OG129222	& UP

new



18-3688
WATER PUMP KIT
 Replaces: 8M0113799
 Fits: 80 & 100 OP459572-2B094995 Belgium
 75-115 1B366823-2B094995

new



18-3689
WATER PUMP KIT
 Replaces: 8M0113801
 Fits: 35-60HP 1C453840 & UP



18-48317
COMPLETE WATER PUMP KIT
 Replaces: 46-803750A03
 Fits: Mercury 8-9.9 4-Stroke(209cc)(R042475 & Up)

MARINER COOLING SYSTEM APPLICATION

Mariner Models	S/N Code	S/N	Impeller	Plate	Impeller Cup	Impeller Repair Kit	Complete Kit
2A	646	All	18-3072	—	—	—	—
2B	6A1	All	18-3072	—	—	—	—
4A	6E0	All	18-3073	—	—	—	—
5C	6E3	All	18-3073	—	—	—	—
6C	6H8	All	18-3066	—	—	—	—
6D	6H6	All	18-3066	—	—	—	—
8A(M)	655	000000-000300	18-3063	—	—	—	—
8A(ML)	655	000000-300101	18-3063	—	—	—	—
8B(M)	677	000101 & Up	18-3063	—	—	—	—
8B(ML)	677	300101 & Up	18-3063	—	—	—	—
8C	6G1	All	18-3066	—	—	—	—
9.9C	682	All	18-3074	—	—	18-3148	—
15A(M)	651	000285 & Below	18-3063	—	—	—	—
15A(ML)	651	3000100 & Below	18-3063	—	—	—	—
15C	684	All	18-3074	—	—	18-3148	—
20C(M)	6A9	000101-005810	18-3067	18-3436	—	—	—
20C(ML)	6A9	300101-306542	18-3067	18-3436	—	—	—
20C(E)	6A9	250101-250819	18-3067	18-3436	—	—	—
20C(EL)	6A9	550101-550693	18-3067	18-3436	—	—	—
20C(M)	6A9	010112 & Up	18-3067	—	—	—	—
20C(ML)	6A9	306543 & Up	18-3067	—	—	—	—
20C(E)	6A9	250820 & Up	18-3067	—	—	—	—
20C(EL)	6A9	550694 & Up	18-3067	—	—	—	—
25C(M)	695	000101-014870	18-3067	18-3436	—	—	—
25C(ML)	695	000000-312185	18-3067	18-3436	—	—	—
25C(E)	695	000000-252290	18-3067	18-3436	—	—	—
25C(EL)	695	000000-553575	18-3067	18-3436	—	—	—
25C(M)	695	014871 & Up	18-3067	—	—	—	—
25C(ML)	695	312186 & Up	18-3067	—	—	—	—
25C(E)	695	252291 & Up	18-3067	—	—	—	—
25C(EL)	695	553576 & Up	18-3067	—	—	—	—
28	664	All	18-3067	—	—	—	—
30	689	All	18-3067	—	—	—	—
30A(M)	689	000366-014805	18-3067	18-3436	—	—	—
30A(ML)	689	301911-315315	18-3067	18-3436	—	—	—
30A(E)	689	100251-103275	18-3067	18-3436	—	—	—
30A(EL)	689	401216-407815	18-3067	18-3436	—	—	—
30A(M)	689	022059 & Up	18-3067	—	—	—	—
30A(ML)	689	321377 & Up	18-3067	—	—	—	—
30A(E)	689	105325 & Up	18-3067	—	—	—	—
30A(EL)	689	411947 & Up	18-3067	—	—	—	—
48/48W	670	All	18-3069	18-3436	18-3435	18-3425	—
55/W55	663	All	18-3069	18-3436	18-3435	18-3425	—
60	675,6F0	All	18-3069	18-3436	18-3435	18-3425	—

MERCURY COOLING SYSTEM APPLICATION

Horsepower	Beginning Serial#	Ending Serial #	Impeller	Impeller Plate	Insert Cup	Upper Housing	Base	Impeller Repair Kit	Thermo-stat	Upper Kit	Complete Kit
3.3 (with shift)	D901217	& UP	18-3098	—	—	—	—	—	—	—	—
3.5	358136	6202172	18-3012	—	—	—	—	—	—	—	—
3.5	6202173	& UP	18-3054	—	—	—	—	—	—	—	—
3.6	5404657	& UP	18-3054	—	—	—	—	—	—	—	—
3.9	1655013	2498135	18-3012	18-3139	—	—	—	—	—	—	—
4 (1 cyl.)	2498136	4107219	18-3039	18-3139	—	—	—	18-3239	—	—	—
4 (2 cyl.)	5589202	& UP	18-3054	—	—	—	—	—	—	—	—
4 (made in USA)	5595532	A809600	18-3054	18-3139	—	—	—	—	—	—	—
4 (made in USA)	5595532	& UP	18-3039	18-3139	—	18-3446	—	18-3239	—	—	18-3446
4 (1 cyl.)	A809601	& UP	18-3098	—	—	—	—	—	—	—	—
4.5	4107220	5595531	18-3039	18-3139	—	—	—	18-3239	—	—	18-3446
4.5	5595532	& UP	18-3054	18-3139	—	—	—	—	—	—	—
4.5	5595532	& UP	18-3039	18-3139	—	—	—	18-3239	—	—	18-3446
5	574128	786612	18-3012	—	—	—	—	—	—	—	—
5 (1 cyl.)	A809601	& UP	18-3098	—	—	—	—	—	—	—	—
5 4-STROKE	R000001	& UP	18-3098	—	—	—	—	—	—	—	—
6	888005	1916138	18-3012	—	—	—	—	—	—	—	—
6	1916139	2193817	18-3039	18-3139	—	—	—	18-3239	—	—	—
6	A197112	OT800749	18-3062	—	—	—	—	—	—	—	—
6	1582403	1916138	18-3039	—	—	—	—	—	—	—	—
6	1916139	2193817	18-3039	—	—	—	—	—	—	—	—
6	2193818	2529894	18-3039	—	—	—	—	—	—	—	—
6	2385673	2387383	18-3039	—	—	—	—	—	—	—	—
7.5	2529895	4131609	18-3039	18-3139	—	—	—	—	—	—	—
7.5	4131610	5226934	18-3039	18-3139	—	—	—	18-3239	—	—	18-3446
7.5	5206550	& UP	18-3054	—	—	—	—	—	—	—	—
7.5	5206550	& UP	18-3039	18-3139	—	—	—	18-3239	—	—	—

- 1 Models with aluminum upper pump housings
- 2 Models with aluminum water pumps
- 3 Models with plastic upper pump housings
- 4 Models with plastic water pumps
- 5 Pump screws without insulators
- 6 Pump screws with insulators
- 7 Models with driveshaft retaining nut
- 8 Models without driveshaft retaining nut
- 9 Models with flush hole
- 10 Models without flush hole
- 11 Models having plastic upper housing use #48752 inset cup
- 12 Units already having a complete pump replacement using 46-46893A 6 should use the 2193818-2529894 serial group for components
- 13 Units already having a complete pump replacement using 46-46893A 6 should use USA 3795658-4126549 serial group for components
- 14 Units which have already had a complete pump replacement with the 46-46893A 6 pump should use the "Early Mariner Impellers" chart for components

MERCURY COOLING SYSTEM APPLICATION											
Horsepower	Beginning Serial#	Ending Serial #	Impeller	Impeller Plate	Insert Cup	Upper Housing	Base	Impellar Repair Kit	Thermo-stat	Upper Kit	Complete Kit
8	A197112	& UP	18-3062	—	—	—	—	—	—	—	—
8 (4-stroke Bodensee)	G760300	& UP	18-3062	—	—	—	—	—	—	—	—
110 (9.8)	1865779	2196388	18-3039	—	—	—	—	—	—	—	—
110 (9.8)	2196389	3795657	18-3039	—	—	—	—	—	—	—	—
110 (9.8)	3795658	4126459	18-3039	—	—	—	—	—	—	—	—
110 (9.8)	4126460	5206549	18-3039	18-3139	—	—	—	18-3239	—	—	—
110	5206550	& UP	18-3054	—	—	—	—	—	—	—	—
9.8	5206550	& UP	18-3039	18-3139	—	—	—	18-3239	18-3553	—	18-3446
9.9	A197112	& UP	18-3062	—	—	—	—	—	—	—	—
9.9 (4 Stroke) Standard Case	G760300	T979999	18-3062	—	—	—	—	—	—	—	—
XR10 SeaPro	D038000	& UP	18-3062	—	—	—	—	—	18-3549	—	—
10	500022	1057993	18-3008	—	—	—	—	—	—	—	—
15	B292414	& UP	18-3062	—	—	—	—	—	18-3549	—	—
15 SeaPro	G044365	& UP	18-3062	—	—	—	—	—	—	—	—
16	700000	& UP	18-3008	—	—	—	—	—	—	—	—
18	5837437	& UP	18-3057	—	—	—	—	—	—	—	—
20	860970	1292909	18-3008	—	—	—	—	—	—	—	—
20	2827677	6443972	18-3052	—	—	—	—	18-3252	—	—	18-3448
20	6443973	T800749	18-3057	—	—	—	—	18-3215	—	—	—
22	1158546	1238089	18-3008	—	—	—	—	—	—	—	—
25,25XD,25 Sea Pro	5705532	& UP	18-3057	—	—	—	—	18-3215	—	—	—
25 (3 cyl.)	E268781	& UP	18-3057	—	—	—	—	18-3215	—	—	—
30	950250	1260724	18-3008	—	—	—	—	—	—	—	—
30	1271884	1448139	18-3007	18-3107	—	—	—	18-3207	—	18-3507	—
30 Jet	C159200	G589999	18-3007	18-3107	18-3115	18-3118	18-3424	18-3207	—	18-3507	18-3324
30 Jet	G590000	& UP	18-3057	—	—	—	—	—	—	—	—
30 (2 cyl)	G053314	T598999	18-3057	—	—	—	—	—	—	—	—
35	1217222	1448139	18-3007	—	—	—	—	—	—	—	—
35	1571114	1960826	18-3007	18-3107	—	—	—	18-3207	—	18-3507	—
35	1960827	2453068	18-3007	18-3107	—	—	—	18-3207	—	18-3507	—
35	6445653	& UP	18-3007	18-3107	18-3115	18-3118	18-3424	18-3207	—	18-3507	18-3324
40	941751	1224480	18-3008	—	—	—	—	—	—	—	—
40	1224481	1476509	18-3007	—	—	—	—	—	—	—	—
40	2874704	4362214	18-3007	18-3107	18-3115	18-3118	18-3422	18-3207	—	18-3507	18-3322
40 (2 cyl) thru 1983	4860103	& UP	18-3057	18-3107	18-3115	18-3118	18-3424	18-3207	—	18-3507	18-3324
40 (3 cyl)	G531301	& UP	18-3057	—	—	—	—	—	—	18-3507	—
40 (4 cyl)	C159200	& UP	18-3007	18-3107	18-3115	18-3118	18-3424	18-3207	—	—	—
40 (4-stroke) 2:1 ratio	G760300	T408999	18-3057	—	—	—	—	—	—	—	—
40 (EFI 4-stroke) 1.83:1 ratio	& UP	18-8900	—	—	—	18-3445	—	—	—	—	—
40 (EFI 4-stroke) 2.31:1 ratio	B344398	18-3056	—	—	—	—	18-3214	—	—	—	—
40 (4-stroke, 4 cyl.) 2.31:1 ratio	T598999	18-3056	—	—	—	—	18-3214	—	—	—	—
40 (4-stroke,Std)	G231123	T178499	18-3057	—	—	—	—	—	—	—	—
40 4-stroke Carb Big Foot	& UP	18-3056	—	—	—	—	—	—	—	—	—
40	1279685	1476509	18-3007	—	—	—	—	—	—	18-3507	—
45	5531630	& UP	18-3007	18-3107	18-3115	18-3118	18-3424	18-3207	—	—	—
45 Jet (3 cyl)	D000750	& UP	18-8900	—	—	—	—	—	—	—	—
45 (4-stroke,std) Bodensee	G231123	& UP	18-3057	—	—	—	—	—	—	—	—
45 (4-stroke,Big Foot) Bodensee	& UP	18-3056	—	—	—	—	18-3214	—	—	—	—
50	1421113	1460498	18-3007	—	—	—	—	—	—	18-3507	—
50	1477910	1521913	18-3007	—	—	—	—	—	—	—	—
50	1521914	2305100	18-3007	18-3107	—	—	—	18-3207	—	18-3507	—
50 aluminum w/p	2305101	2478119	18-3007	—	—	—	—	—	—	—	—
50 plastic w/p	2305101	2478119	18-3007	—	—	—	—	—	—	—	—
500	2514919	4357639	18-3007	18-3107	18-3115	18-3118	18-3422	18-3207	—	18-3507	—
50 (4cyl)	4357640	5531629	18-3007	18-3107	18-3115	18-3118	18-3423	18-3207	—	18-3507	—
50 (4cyl)	5531630	& UP	18-3007	—	—	18-3118	—	—	—	—	—
50 (4 cyl)	4962056	& UP	18-3007	18-3107	18-3115	18-3118	18-3424	18-3207	—	18-3507	—
50 (3 cyl)	6428681	D000749	18-3007	18-3107	18-3115	18-3118	18-3424	18-3207	—	—	—
50 (3 cyl)	D000750	G589999	18-8900	—	—	—	18-3445	—	18-3553	—	—
50 (3 cyl)	G590000	& UP	18-3057	—	—	—	—	—	—	—	—
50 (4-stroke,Std)	G231123	T178499	18-3057	—	—	—	—	—	—	—	—
50 (4-stroke, 4 cyl.) Standard	T598999	18-8900	—	—	—	18-3445	—	—	—	—	—
50 (4-stroke, 4 cyl.) Big Foot	& UP	18-3056	—	—	18-3572	—	18-3214	—	—	—	—
50 (EFI 4-stroke) Standard	B344398	18-8900	—	—	—	18-3445	—	—	—	—	—
50 (EFI 4-stroke) Big Foot	B344398	18-3056	—	—	—	—	18-3214	—	—	—	—
55 (3 cyl)	D000750	& UP	18-8900	—	—	—	18-3445	—	—	—	—
60	6428681	D000749	18-3007	18-3107	18-3115	18-3118	18-3424	18-3207	—	—	18-3324
60 (3cyl) Standard	D000750	& UP	18-3056	18-3122	—	—	—	18-3214	18-3553	—	—
60 Marathon	D000750	& UP	18-3056	18-3122	—	—	—	18-3214	—	—	—
60 Big Foot	D000750	& UP	18-3056	18-3122	—	—	—	18-3214	18-3553	—	—
60 (3 cyl)	D000750	& UP	18-8900	—	—	—	—	—	18-3553	—	—
60 4-Stroke Standard	T598999	18-8900	—	—	—	18-3445	18-3214	—	—	—	—
60 4-Stroke, Big Foot	OT178500	T598999	18-3056	—	—	—	—	18-3214	—	—	—
60 4-Stroke EFI Big Foot	B344398	18-3056	—	—	—	—	—	—	—	—	—

1 Models with aluminum upper pump housings	8 Models without driveshaft retaining nut
2 Models with aluminum water pumps	9 Models with flush hole
3 Models with plastic upper pump housings	10 Models without flush hole
4 Models with plastic water pumps	11 Models having plastic upper housing use #48752 inset cup
5 Pump screws without insulators	12 Units already having a complete pump replacement using 46-46893A 6 should use the 2193818-2529894 serial group for components
6 Pump screws with insulators	13 Units already having a complete pump replacement using 46-46893A 6 should use USA 3795658-4126549 serial group for components
7 Models with driveshaft retaining nut	14 Units which have already had a complete pump replacement with the 46-46893A 6 pump should use the "Early Mariner Impellers" chart for components

MERCURY COOLING SYSTEM APPLICATION

Horsepower	Beginning Serial#	Ending Serial #	Impeller	Impeller Plate	Insert Cup	Upper Housing	Base	Impeller Repair Kit	Thermo-stat	Upper Kit	Complete Kit
65(4 cyl) aluminum w/p	1542745	280351	18-3017	18-3117	18-3114	—	—	18-3217	—	18-3507	—
65 (4cyl) plastic w/p	1542745	280351	18-3017	—	—	18-3116	—	—	—	—	—
65 (4cyl)	2803562	2874263	18-3017	—	—	18-3116	—	—	—	—	—
65 (4cyl)	2997439	3293183	18-3017	—	—	18-3116	—	—	—	—	—
65(3 cyl)	3293184	4382056	18-3007	18-3107	18-3115	18-3118	18-3422	18-3207	—	18-3507	—
65(3 cyl)	4382057	4571651	18-3007	18-3107	18-3115	18-3118	18-3424	18-3207	—	—	—
65 Jet	0D283222	& UP	18-3056	18-3122	—	—	—	18-3214	—	—	—
70	1413611	1436114	18-3017	18-3117	—	—	—	18-3217	—	18-3507	—
70 (6cyl)	1482212	1503458	18-3017	—	—	—	—	—	—	—	—
700 E-2 (6cyl)	1503459	1503958	18-3017	—	—	—	—	—	—	—	—
700 EL-2 (6cyl)	1503459	1566239	18-3017	—	—	—	—	—	—	—	—
700 E-2 (6cyl)	1503959	1566239	18-3017	—	—	18-3116	—	—	—	—	—
700 EL-2 (6cyl)	1505111	1566239	18-3017	—	—	18-3116	—	—	—	—	—
70 (3 cyl)	4571652	4977156	18-3007	18-3107	18-3115	18-3118	18-3423	18-3207	18-3553	18-3507	—
70	4977157	6428680	18-3007	18-3107	18-3115	18-3118	18-3424	18-3207	—	—	—
70	B110054	& UP	18-3056	—	—	—	—	18-3214	—	—	18-3517
70 (3cyl)	A996142	C221999	18-3056	—	—	18-3572	—	—	18-3553	—	—
70 (3cyl)	A996142	C221999	18-3056	—	—	18-3572	—	—	18-3553	—	—
75 (4 cyl)	6432901	& UP	18-3017	18-3117	18-3114	18-3116	18-3414	18-3217	—	—	—
75 (3 cyl)	A996142	C221999	18-3056	—	—	—	—	18-3214	18-3553	—	—
75 (3 cyl)	C222000	& UP	18-3056	—	—	—	—	18-3214	18-3569	—	—
75 (3 cyl)	C222000	& UP	18-3056	18-3122	—	—	—	18-3214	18-3569	—	—
75 (3cyl) Optimax	T980000	& UP	18-3056	—	—	18-3572	—	—	—	—	—
75 4-STROKE	G960500	B366822	18-3056	—	—	—	—	18-3214	—	—	—
75 4-STROKE	B366823	& UP	18-3056	—	—	18-3572	—	—	—	—	—
80	1355468	3493912	18-3017	18-3117	—	—	—	18-3217	—	—	18-3517
80 (6cyl)	1335465	1398629	18-3017	—	—	—	—	—	—	—	—
80 (4 cyl)	4831999	6432900	18-3017	18-3117	18-3114	18-3116	18-3414	18-3217	—	—	—
80 (3 cyl)	A996142	C221999	18-3056	—	—	—	—	18-3214	18-3553	—	—
80 (3 cyl)	A996142	C221999	18-3056	—	—	18-3572	—	—	18-3553	—	—
80 Jet	D283222	& UP	18-3056	18-3122	—	—	—	18-3214	—	—	—
850 E & EL (6cyl)	1460999	1567039	18-3017	18-3117	—	—	—	18-3217	—	—	18-3517
850 E-1, EL-1 (6cyl)	1566240	1766823	18-3017	—	—	—	—	—	—	—	—
85 (4 cyl)	4590512	& UP	18-3017	18-3117	18-3114	18-3116	18-3414	18-3217	—	—	—
85 XS (4cyl)	3493913	4831998	18-3017	—	—	18-3116	—	—	—	—	—
850 XS (4cyl)	3493913	4831998	18-3017	—	—	18-3116	—	—	—	—	—
850, 850 XS (4cyl)	3493913	4590511	18-3017	—	—	18-3116	—	—	—	—	—
900 (90hp) (6 cyl)	1766824	1869775	18-3017	18-3117	—	—	—	18-3217	—	—	18-3517
90 (6 cyl)	4845301	& UP	18-3017	18-3117	18-3114	18-3116	18-3414	18-3217	—	—	—
90 (3 cyl)	B110054	C221999	18-3056	—	—	—	—	18-3214	—	—	—
90 (3 cyl)	A996142	& UP	18-3056	—	—	—	—	18-3214	18-3553	—	—
90 (3 cyl)	A996142	& UP	18-3056	18-3122	—	—	—	18-3214	18-3553	—	—
90 4-STROKE	G960500	B366822	18-3056	—	—	18-3572	—	18-3214	—	—	—
90 4-STROKE	B366823	& UP	18-3056	—	—	18-3572	—	18-3214	—	—	—
95	1869776	2318585	18-3017	18-3117	—	—	—	18-3217	—	—	—
115 (3CYL) Optimax	T801000	& UP	18-3056	—	—	18-3572	—	—	—	—	—
950 (95hp) (6 cyl)	1869776	2318585	18-3017	—	—	—	—	—	—	—	—
1000(6 cyl)	1464949	1503331	18-3017	18-3117	—	—	—	18-3217	—	—	—
1000 (6cyl)	1503332	2318585	18-3017	—	—	18-3116	—	—	—	—	—
100 (4 cyl)	B209468	& UP	18-3056	—	—	—	—	18-3214	18-3553	—	—
100 (4 cyl)	B209468	& UP	18-3056	18-3122	—	—	—	18-3214	18-3553	—	18-3517
1000 SS (6cyl)	2318586	2413843	18-3017	—	—	18-3116	—	—	—	—	—
1000 SS (6cyl)	2318586	2413843	18-3017	—	—	18-3116	—	—	—	—	—
1000 SS E-1	2484633	2836018	18-3017	—	—	18-3116	—	—	—	—	—
1000 SS E-1	2484633	2836018	18-3017	—	—	18-3116	—	—	—	—	—
1000 BP (6cyl)	2399698	3253111	18-3017	—	—	N.L.A.	—	—	—	—	—
105 Jet	0D182000	& UP	18-3017	18-3117	18-3114	18-3116	18-3419	18-3217	—	—	—
110	1870204	2314955	18-3017	18-3117	—	—	—	18-3217	—	—	—
110	1870204	2314955	18-3017	—	—	18-3317	—	—	—	—	—
115 (6cyl)	2836019	4112634	18-3017	18-3117	—	—	—	18-3217	—	—	18-3517
115 (6cyl)	4112635	4394236	18-3017	—	—	—	—	—	—	—	—
115 (6 cyl)	4394237	& UP	18-3017	18-3117	18-3114	18-3116	18-3414	18-3217	—	—	—
115 (4 cyl)	C100000	& UP	18-3056	—	—	—	—	18-3214	18-3569	—	—
115 (4cyl)	C100000	& UP	18-3056	—	—	18-3572	—	—	18-3569	—	—
115 (4 cyl)	B209468	& UP	18-3056	18-3122	—	—	—	18-3214	—	—	—
115 4-STROKE	T178500	B366822	18-3056	—	—	—	—	18-3214	—	—	—
115 4-STROKE	B366823	& UP	18-3056	—	—	18-3572	—	—	—	—	—
115 (3cyl) Optimax	T801000	& UP	18-3056	—	—	18-3572	—	—	—	—	—
115 Pro XS	B751825	& UP	18-3056	—	—	18-3572	—	—	—	—	—
125 (6cyl)	2314956	2839368	18-3017	18-3117	—	—	—	18-3217	—	—	—
125 (6cyl)	2314956	2839368	18-3017	—	—	—	—	—	—	—	—
125 (4 cyl)	D283222	& UP	18-3056	—	—	—	—	—	18-3569	—	—
125 (4cyl)	D283222	& UP	18-3056	—	—	18-3572	—	—	—	—	—
125 (3cyl) Optimax	B736885	& UP	18-3056	—	—	18-3572	—	—	—	—	—

- 1 Models with aluminum upper pump housings
- 2 Models with aluminum water pumps
- 3 Models with plastic upper pump housings
- 4 Models with plastic water pumps
- 5 Pump screws without insulators
- 6 Pump screws with insulators
- 7 Models with driveshaft retaining nut

- 8 Models without driveshaft retaining nut
- 9 Models with flush hole
- 10 Models without flush hole
- 11 Models having plastic upper housing use #48752 inset cup
- 12 Units already having a complete pump replacement using 46-46893A 6 should use the 2193818-2529894 serial group for components
- 13 Units already having a complete pump replacement using 46-46893A 6 should use USA 3795658-4126549 serial group for components
- 14 Units which have already had a complete pump replacement with the 46-46893A 6 pump should use the "Early Mariner Impellers" chart for components

MERCURY COOLING SYSTEM APPLICATION

Horsepower	Beginning Serial#	Ending Serial #	Impeller	Impeller Plate	Insert Cup	Upper Housing	Base	Impellar Repair Kit	Thermo-stat	Upper Kit	Complete Kit
135	2839369	3293233	18-3017	18-3117	—	—	—	18-3217	—	—	18-3517
V 135	904646	& UP	18-3017	18-3117	18-3114	18-3116	18-3419	18-3217	—	—	—
135 4-STROKE VERADO	B227000	& UP	18-3056	—	—	18-3572	—	—	—	—	18-3407
140	3293234	3502805	18-3017	18-3117	—	—	—	18-3217	—	—	18-3517
140	4865678	& UP	18-3017	18-3117	18-3114	18-3116	18-3414	18-3217	—	—	18-3517
140 Jet	D082000	& UP	18-3017	18-3117	18-3114	18-3116	18-3419	18-3217	—	—	—
150	3502806	4121434	18-3017	18-3117	—	—	—	18-3217	—	—	18-3517
150 (6cyl)	4121435	4865677	18-3017	18-3117	18-3114	18-3116	18-3414	18-3217	—	—	18-3517
150 (6cyl)	4121435	4865677	18-3017	—	—	—	18-3414	—	—	—	—
1500 XS (6cyl)	4868648	5327662	18-3017	—	—	—	—	—	—	—	—
V 150	A904646	& UP	18-3017	18-3117	18-3114	18-3116	18-3419	18-3217	—	—	18-3517
V 150	A904645	& BELOW	18-3017	18-3117	18-3114	18-3116	18-3416	18-3217	—	—	18-3517
V-135 DFI	G590000	& UP	18-3017	—	—	—	—	—	—	—	—
V-150 Carb	4868998	A904645	18-3017	—	—	—	—	—	—	—	—
V-150 Carb	4868998	A904645	18-3017	—	—	—	—	—	—	—	—
V-150 Carb, EFI, DFI	A904646	& UP	18-3017	—	—	—	—	—	—	—	—
V-150XR2,4,6 -	4868998	& UP	18-3017	—	—	—	—	—	—	—	MAGNUM II, III
V150XR2,4,6 -	4868998	& UP	18-3017	—	—	—	—	—	—	—	MAGNUM II, III
150 4-STROKE VERADO (4cyl)	& UP	18-3056	—	—	18-3572	—	—	—	18-3406	18-3407	—
V 175	6618751	& UP	18-3017	18-3117	18-3114	18-3116	18-3419	18-3217	—	—	18-3517
V 175	4301235	6618750	18-3017	18-3117	18-3114	18-3116	18-3416	18-3217	—	—	18-3517
V-175 Carb, EFI, DFI	6618751	& UP	18-3017	—	—	—	—	—	—	—	—
175 4-STROKE VERADO (4cyl)	& UP	18-3056	—	—	18-3572	—	—	—	18-3406	18-3407	—
V 200	6625221	& UP	18-3017	18-3117	18-3114	18-3116	18-3419	18-3217	—	—	18-3517
V-200	4839034	6625220	18-3017	18-3117	18-3114	18-3116	18-3416	18-3217	—	—	—
V-200	4839034	6625220	18-3017	—	—	—	—	—	—	—	—
V-200 DFI (3.0L)	G386496	G589999	18-3056	—	—	—	—	18-3214	—	—	18-3517
V-200 EFI (3.0L)	T750164	B504988	18-3056	—	—	—	—	—	—	—	—
V-200 Carb, & EFI (2.5L)	6625221	& UP	18-3017	—	—	—	—	—	—	—	—
V-200 DFI (3.0L)	G590000	T598999	18-3056	—	—	18-3572	—	—	—	—	—
V-200 DFI (3.0L)	T590000	B504988	18-3056	—	—	18-3572	—	—	—	—	—
V-200 DFI (3.0L)	B504989	& UP	18-3056	—	—	18-3572	—	—	—	—	18-3407
200 4-STROKE VERADO (4cyl)	& UP	18-3056	—	—	18-3572	—	—	—	18-3406	18-3407	—
200 4-STROKE 4.8 INCH	T980000	& UP	18-3056	—	—	18-3572	—	—	—	18-3406	18-3407 TORPEDO
V 220 LASER	B117316	& UP	18-3017	18-3117	18-3114	18-3116	18-3419	18-3217	—	—	18-3517
V-225 (2.4L)	5628028	& UP	18-3017	—	—	—	—	—	—	—	—
V-225 (2.4L)	5628028	& UP	18-3017	—	—	—	—	—	—	—	—
V-225 (3.0L) CARB & EFI	D280813	G760299	18-3056	—	—	—	—	—	—	—	—
V-225 (3.0L) CARB & EFI	G760300	T408999	18-3056	—	—	18-3571	—	—	—	—	—
V-225 (3.0L) EFI	T409000	B504988	18-3056	—	—	18-3571	—	—	—	—	—
V-225 DFI	G590000	T598999	18-3056	—	—	18-3571	—	—	—	—	—
V-225 DFI	T599000	B504988	18-3056	—	—	18-3571	—	—	—	—	—
V-225 DFI	B504989	& UP	18-3056	—	—	18-3571	—	—	—	—	18-3407
V-225 Pro XS	B104549	B752546	18-3056	—	—	18-3571	—	—	—	—	—
V-225 Pro XS	B752547	& UP	18-3056	—	—	18-3571	—	—	—	—	18-3407
225 4-STROKE VERADO	T980000	& UP	18-3056	—	—	18-3572	—	—	—	—	18-3407 4.8 INCH TORPEDO
V-250 (3.0L) EFI	G129222	T408999	18-3056	—	—	18-3571	—	—	—	—	—
V-250 (3.0L) EFI	T409000	B504988	18-3056	—	—	18-3572	—	—	—	—	—
V-250 DFI	B528615	& UP	18-3056	—	—	18-3572	—	—	—	—	18-3407
V-250 Pro XS	B426561	B752546	18-3056	—	—	18-3571	—	—	—	—	—
V-250 Pro XS	B752547	& UP	18-3056	—	—	18-3572	—	—	—	—	18-3407
250 4-STROKE VERADO	T980000	& UP	18-3056	—	—	18-3572	—	—	—	—	18-3407 4.8 INCH TORPEDO
275 4-STROKE VERADO	T980000	& UP	18-3056	—	—	18-3572	—	—	—	—	18-3407 4.8 INCH TORPEDO
300 4-STROKE VERADO	B517434	& UP	18-3056	—	—	18-3572	—	—	—	—	18-3407 4.8 INCH TORPEDO
MARK 5	574128	786612	18-3012	—	—	—	—	—	—	—	—
MARK 6, 6A	888005	& UP	18-3012	—	—	—	—	—	—	—	—
MARK 50	ALL	& UP	18-3007	—	—	—	—	—	—	—	—
MARK 55	831021	& UP	18-3007	—	—	—	—	—	—	—	—
MARK 55A	1227131	& UP	18-3007	—	—	—	—	—	—	—	—
MARK 58 E, MARK 58A (M&E)	& UP	18-3007	—	—	—	—	—	—	—	—	—
9	OG129222	& UP	18-3056	18-3117	18-3114	18-3116	18-3419	18-3214	—	—	18-3517
XR4/Magnum II	ALL		18-3017	—	—	—	—	18-3217	—	—	—

- 1 Models with aluminum upper pump housings
- 2 Models with aluminum water pumps
- 3 Models with plastic upper pump housings
- 4 Models with plastic water pumps
- 5 Pump screws without insulators
- 6 Pump screws with insulators
- 7 Models with driveshaft retaining nut

- 8 Models without driveshaft retaining nut
- 9 Models with flush hole
- 10 Models without flush hole
- 11 Models having plastic upper housing use #48752 inset cup
- 12 Units already having a complete pump replacement using 46-46893A 6 should use the 2193818-2529894 serial group for components
- 13 Units already having a complete pump replacement using 46-46893A 6 should use USA 3795658-4126549 serial group for components
- 14 Units which have already had a complete pump replacement with the 46-46893A 6 pump should use the "Early Mariner Impellers" chart for components

ARE SUPPLIED COMPLETE WITH PISTON RINGS, WRIST PIN AND CIRCLIPS.

MARINER (JAPANESE MODELS)
Sierra Piston Kit Contents (See Application Charts for Specific Applications)

Model / HP	Cyl.	Bore Size	Piston	OEM Part #	Piston Ring	OEM Part #
9.9 / 15	2	std	18-4135	761-7982M, 761-7982T, 761-7134M, 761-7133M, 761-7131M	—	39-15320M, 39-15320T
48	2	std	18-4138	761-8484M, 761-7198M, 761-7197M, 761-7196M	—	—

MARINER PISTON RINGS - JAPANESE MODELS

.25mm O.S.	O.E. #	.25mm O.S.	O.E. #	.25mm O.S.	O.E. #	.50mm O.S.	O.E. #
18-3977	39-18939M, 39-18939T	18-3986	39-81096M	18-3992	39-83196M	18-3978	39-15322M

MARINER PISTON AND RINGS APPLICATION - JAPANESE MODELS

Model	Ser# Code	Ser #	Standard Piston	.25mm Piston	.50mm Piston	Standard Rings	.25mm Rings	.50mm Rings	Qty. Req'd
9.9	682	ALL	18-4135	—	—	—	18-3977	18-3978	2
15C	684	ALL	18-4135	—	—	—	18-3977	18-3978	2
30A	689	ALL	18-4138	—	—	—	—	—	2
20C, 25A	6A9	ALL	—	—	—	—	18-3986	—	2
25C	695	ALL	—	—	—	—	18-3986	—	2
28	664	ALL	—	—	—	—	18-3986	—	2
48	670	S-02441 & Up / L33132 & UP	—	—	—	—	18-3992	—	2
W48	670	M 002731 & Up / ML 314101 & Up	—	—	—	—	18-3992	—	2
60	675	E 00101-001170 / EL 30101-304180	—	—	—	—	18-3992	—	2

MERCURY / MARINER
Sierra Piston Kit Contents (See Application Charts for Specific Applications)

Model / HP	Cyl.	Bore Size	Piston	OEM Part #	Piston Ring	OEM Part #	Circlips	OEM Part #
2 RING PISTONS - HIGH DOME								
35-140	2-6	2.875 / Std.	—	774-9137A12	18-3918	39-817096A6	—	40-52035
35-140	2-6	2.890 / .015	—	774-9137A13	18-3919	39-817096A16	—	40-52035
35-140	2-6	2.905 / .030	—	774-9137A14	—	39-817096A26	—	40-52035
2 RING PISTONS - LOW DOME								
35-140	2-6	2.875 / Std.	—	774-9137A9	18-3918	39-817096A6	—	40-52035
35-140	2-6	2.890 / .015	18-4515	774-9137A10	18-3919	39-817096A16	—	40-52035
35-140	2-6	2.905 / .030	—	774-9137A11	—	39-817096A26	—	40-52035
3 RING PISTONS - HIGH DOME								
35-140	2-6	2.875 / Std.	—	776-8896A3	① 18-3902	39-78816A12, 39-45155A12	—	40-52035
35-140	2-6	2.890 / .015	—	776-8897A2	18-3916	39-78811A12, 39-45204A12	—	40-52035
35-140	2-6	2.905 / .030	—	776-8898A2	① 18-3917	39-88392A12, 39-88392	—	40-52035
3 RING PISTONS - LOW DOME								
35-140	2-6	2.875 / Std.	—	776-8600A9	② 18-3902	39-78816A12	—	40-52035
35-140	2-6	2.890 / .015	—	776-9095A1	② 18-3916	39-78811A12, 39-45204A12	—	40-52035
35-140	2-6	2.905 / .030	18-4156	776-9096A1	18-3917	39-88392A12, 39-88392	—	40-52035
2 RING PISTONS - CROSSFLOW								
40-50	4	2.565 / Std.	—	780-9229A7, 743-5172A6, 743-3193A4, 743-3193A2	18-3966	39-18653A12	—	40-52035
40-50	4	2.580 / .015	18-4621	780-9229A10, 743-3366A2, 743-3366A1	—	39-18653A1	—	40-52035
40-50	4	2.595 / .030	18-4622	780-9229A11, 743-7716A2	—	39-18653A2	—	40-52035
50-60	3	2.875 / Std.	—	783-9613A1	18-4019	39-19721A6	—	40-52035
50-60	3	2.890 / .015	18-4017	783-9613A2, 783-9613T2	18-4020	39-19721A1	—	40-52035
50-60	3	2.905 / .030	18-4018	783-9613A3, 783-9613T3	—	39-19721A2	—	40-52035
70-115	3-4	3.375 / Std.	—	777-815965T4, 777-815965A4	18-3979	39-96170A12	—	40-52035
70-115	3-4	3.390 / .015	—	777-815965A5	—	39-96170A3	—	40-52035
70-115	3-4	3.405 / .030	—	777-815965A6	18-3981	39-96170A4	—	40-52035
75-125	3-4	3.500 / Std.	18-4626	2704-826191T4, 2704-826191A4, 2704-826191A6, 2704-821896A6, 2704-812896A2	18-3982	39-822321A12, 39-824905A12	—	40-52035
75-125	3-4	3.515 / .015	18-4627	2704-821896A3	—	39-822321A1	—	40-52035
75-125	3-4	3.530 / .030	18-4628	2704-821896A4	18-3984	39-822321A2	—	40-52035

3 RING PISTON AND RINGS APPLICATION (REFERENCE ONLY ③)

HP	Cyl.	Beginning Serial No.	Ending Serial No.	Std. Cyl. Dia. (Bore)	Std. Piston	.015 O.S. Piston	.030 O.S. Piston	Std. Rings	.015 O.S. Rings	.030 O.S. Rings
3.5	1	6202173	& UP	2	—	—	—	—	—	—

APPLICATION CONTINUED ON NEXT PAGE

① 3 ring high dome NLA, 2 ring piston are now substituted ② 3 ring low dome NLA, 2 ring piston are now substituted
 ③ Chart is for referencing only, pistons received will be 2 ring version
 ④ This product is priced per piece. To order priced per package, please add -9 to the part number.

3 RING PISTON AND RINGS APPLICATION (REFERENCE ONLY ③)										
HP	Cyl.	Beginning Serial No.	Ending Serial No.	Std. Cyl. Dia. (Bore)	Std. Piston	.015 O.S. Piston	.030 O.S. Piston	Std. Rings	.015 O.S. Rings	.030 O.S. Rings
3.6	1	5404657	& UP	2	—	—	—	—	—	—
3.9	1	1655013	2498135	2	—	—	—	—	—	—
4 (1CYL)	1	2498136	A809600	2	—	—	—	—	—	—
4.5	1	4107220	& UP	2	—	—	—	—	—	—
7.5	2	2529895	& UP	2	—	—	—	—	—	—
9.8	2	1470349	& UP	2	—	—	—	—	—	—
20	2	1922910	5942040	2.562	—	—	—	—	—	—
25	2	1467499	149931	2.562	—	—	—	—	—	—
30 Jet (40 HP)	4	0C159200	& UP	2.562	—	18-4621	18-4622	18-3966	—	—
30 Jet (40 HP)		0C159200	& UP	2.562	—	18-4621	18-4622	18-3966	—	—
35	2	6445653	& UP	2.875	—	—	—	18-3918	18-3916	—
40 (4 cyl)	4	1279085	1476509	2.562	—	—	—	—	—	—
40	2	2045260	C159199	2.875	—	—	—	18-3918	18-3916	—
40, 402	2	3336258	6445652	2.875	—	—	—	18-3918	18-3916	—
40	4	0C159200	& UP	2.562	—	18-4621	18-4622	18-3966	—	—
45	4	1476510	& UP	2.562	—	18-4621	18-4622	18-3966	—	—
45	4	5531630	0B110788	2.562	—	18-4621	18-4622	18-3966	—	—
45	4	0B110789	& UP	2.562	—	18-4621	18-4622	18-3966	—	—
45 JET	3	D000750	G589999	2.955	—	18-4017	18-4018	18-4019	18-4020	—
50,500	4	2116318	6428680	2.562	—	18-4621	18-4622	18-3966	—	—
50	3	6428681	B122929	2.875	18-4500	18-4515	—	18-3918	18-3916	—
50	3	B122930	D000749	2.875	18-4500	—	—	18-3918	18-3916	—
50	3	D000750	G589999	2.955	—	18-4017	18-4018	18-4019	18-4020	—
55	3	6428681	B122929	2.875	18-4500	18-4515	—	18-3918	18-3916	—
55	3	B122930	D000749	2.875	18-4500	18-4515	—	18-3918	18-3916	—
55	3	D000750	G589999	2.955	—	18-4017	18-4018	18-4019	—	—
60	6	1303411	1542744	2.562	—	—	—	—	18-4020	—
60	3	6428681	B122929	2.875	—	—	—	18-3918	18-3916	—
60	3	B122930	D000749	2.875	—	—	—	18-3918	18-3916	—
60	3	D000750	G589999	2.955	—	18-4017	18-4018	18-4019	18-4020	—
65,650	3	3293184	4382056	2.875	—	—	—	18-3918	18-3916	—
65,650	3	4382057	4571651	2.875	—	—	—	18-3918	18-3916	—
70	3	4571652	A996141	2.875	—	—	—	18-3918	18-3916	—
70 (3 cyl.) w/Rod #646-818846	3	A996142	& UP	3.375	—	—	—	18-3979	—	—
75	4	6432901	& UP	2.875	—	—	—	18-3918	18-3916	—
75 (3 cyl.) w/Rod #646-818846	3	C222000	D283221	3.375	—	—	—	18-3979	—	18-3981
75 (3 cyl.)	3	D283222	& UP	3.5	18-4626	18-4627	18-4628	18-3982	—	—
80,800	4	2559001	3493912	2.875	—	—	—	18-3918	18-3916	—
80,800	4	4831999	6432900	2.875	—	—	—	18-3918	18-3916	—
80 Jet	3	D283222	& UP	3.5	18-4626	18-4627	18-4628	18-3982	—	—
85,850	4	3493913	4831998	2.875	—	—	—	18-3918	18-3916	—
85,850	4	4366802	4831998	2.875	—	—	—	18-3918	18-3916	—
85 Mar.	4	4731898	4842728	2.875	—	—	—	18-3918	18-3916	—
90,900	6	4845301	& UP	2.875	—	—	—	18-3918	18-3916	—
90 (3 cyl.) w/Rod #646-818846	3	A996142	D283221	3.375	—	—	—	18-3979	—	18-3981
90 (3 cyl.)	3	D283222	& UP	3.5	18-4626	18-4627	18-4628	18-3982	—	—
95	6	1869776	2318585	2.875	—	—	—	18-3918	18-3916	—
100 SS	6	2318586	2836018	2.875	—	—	—	18-3918	18-3916	—
100 BP	6	2399698	3253111	2.875	—	—	—	18-3918	18-3916	—
100 (4 cyl.) w/Rod #646-818846	4	B209468	D283221	3.375	—	—	—	18-3979	—	18-3981
100 (4cyl)	4	D283222	& UP	3.5	18-4626	18-4627	18-4628	18-3982	—	—
115 1150	6	2836019	5829643	2.875	—	—	—	18-3918	18-3916	—
115 Merc.	6	5829644	B209467	2.875	18-4500	18-4515	—	18-3918	18-3916	—
115 Mar.	6	5738891	5861526	2.875	—	—	—	18-3918	18-3916	—
115 Mar.	6	5861527	C100000	2.875	18-4500	18-4515	—	18-3918	18-3916	—

APPLICATION CONTINUED ON NEXT PAGE

3 RING PISTON AND RINGS APPLICATION (REFERENCE ONLY ③)

HP	Cyl.	Beginning Serial No.	Ending Serial No.	Std. Cyl. Dia. (Bore)	Std. Piston	.015 O.S. Piston	.030 O.S. Piston	Std. Rings	.015 O.S. Rings	.030 O.S. Rings
115 (4 cyl) w/Rod #646-818846	4	C100000	D283221	3.375	—	—	—	18-3979	—	18-3981
115 (4cyl)	4	D283222	& UP	3.5	18-4626	18-4627	18-4628	18-3982	—	—
125 BP	6	2641855	3253111	2.875	—	—	—	18-3918	18-3916	—
135	6	2839369	3293233	2.875	—	—	—	18-3918	18-3916	—
140 1400	6	3293234	3502805	2.875	—	—	—	18-3918	18-3916	—
140 1400	6	4865678	& UP	2.875	18-4500	18-4515	—	18-3918	18-3916	—
150 1500	6	3502806	5327622	2.875	18-4500	18-4515	—	18-3918	18-3916	—

③ Chart is for referencing only, pistons received will be 2 ring version

2 RING INLINE PISTON & RINGS APPLICATION

HP	Cyl.	Beginning Serial No.	Ending Serial No.	Dia. (Bore)	Pistons		Port		Port		Piston Rings			
					Std. (Port)	Stbd.	.015" O.S.	Stbd.	.030 O.S.	Stbd.	Std.	.015" O.S.	.030 O.S.	
105 JET	V-6	D082000	& UP	3.125	—	—	—	18-4013	—	—	18-3921	18-3922	18-3923	
V-135	V-6	A904646	C239552	3.125	—	—	—	18-4560	—	—	18-4575	18-3921	18-3922	18-3923
V-135 (w/ rod 644-8141)	V-6	C239553	G960499	3.125	—	—	—	18-4013	—	—	18-3921	18-3922	18-3923	
V-135 (2.5L) (w/o rod 636-8141)	V-6	C239553	G960499	3.125	—	—	—	18-4560	—	—	18-4575	18-3921	18-3922	18-3923
V-140 JET	V-6	D082000	G960499	3.5	—	18-4636	—	18-4638	NA	NA	18-3982	—	18-3984	
V-140 JET	V-6	G960500	UP	3.5	—	18-4636	—	18-4638	NA	NA	18-3982	—	18-3984	
V-150 MAR	V-6	5600162	6038680	3.125	—	—	—	18-4560	—	—	18-4575	18-3921	18-3922	18-3923
V-150 MAR	V-6	6038681	C239552	3.125	—	—	—	18-4560	—	—	18-4575	18-3921	18-3922	18-3923
V-150, 150, 1500	V-6	4868998	6042945	3.125	—	—	—	18-4560	—	—	18-4575	18-3921	18-3922	18-3923
V-150	V-6	6042946	C239552	3.125	—	—	—	18-4560	—	—	18-4575	18-3921	18-3922	18-3923
V-150 (w/ rod 644-8141)	V-6	C239553	G960499	3.125	—	—	—	18-4013	—	—	18-3921	18-3922	18-3923	
V-150 (2.5L) (w/o rod 636-8141)	V-6	C239553	G960499	3.125	—	—	—	18-4560	—	—	18-4575	18-3921	18-3922	18-3923
V-150 EFI XR6 MAGIII	V-6	D082000	G960499	3.5	—	18-4636	—	18-4638	NA	NA	18-3982	—	—	
V-150 XR4 MAGIII	V-6	B242885	C239552	3.375	—	—	—	18-4565	18-4570	—	—	18-3924	18-3925	—
V-150 XR4 MAGIII	V-6	C239553	D081999	3.375	—	—	—	18-4565	—	—	—	18-3924	18-3925	—
V-175, 175, 1750	V-6	4301235	6618750	3.125	—	—	—	18-4560	—	—	18-4575	18-3921	18-3922	18-3923
V-175	V-6	6618751	C239552	3.375	—	—	—	—	—	—	—	18-3927 ④	—	—
V-175	V-6	C239553	D081999	3.375	—	—	—	18-4565	—	—	—	18-3924	18-3925	—
V-175	V-6	D082000	G960499	3.5	—	18-4636	—	18-4638	NA	NA	18-3982	—	18-3984	
V-175	V-6	G960500	& UP	3.5	—	18-4636	—	18-4638	NA	NA	18-3982	—	18-3984	
V-175 I XRI EF	V-6	D000750	D081999	3.5	—	18-4636	—	18-4638	NA	NA	18-3982	—	18-3984	
V-175	V-6	D000750	D081999	3.5	—	18-4636	—	18-4638	NA	NA	18-3982	—	18-3984	
V-175 XRI EFI	V-6	D082000	G303045	3.5	—	18-4636	—	18-4638	NA	NA	18-3982	—	18-3984	
V-175 XRI EFI	V-6	G303046	& UP	3.5	—	18-4636	—	18-4638	NA	NA	18-3982	—	18-3984	
V-200, 2,002,000	V-6	4839034	6203990	3.375	—	—	—	—	—	—	—	18-3927 ④	—	—
V-200 (2.4L)	V-6	6203991	C291519	3.375	—	—	—	—	—	—	—	18-3927 ④	—	—
V-200 (2.5L) (w/ rod #644-818141)	V-6	C291520	D081999	3.5	—	18-4636	—	18-4638	NA	NA	18-3982	—	18-3984	
V-200 (2.5L)	V-6	D082000	& UP	3.5	—	18-4636	—	18-4638	NA	NA	18-3982	—	18-3984	
V-200 XRI EFI	V-6	C100861	C291519	3.375	—	—	—	—	—	—	—	18-3927 ④	—	—
V-200 XRI EFI	V-6	C291520	G960499	3.5	—	18-4636	—	18-4638	NA	NA	18-3982	—	18-3984	
V-220	V-6	B117316	UP	3.375	—	—	—	—	—	—	—	18-3927 ④	—	—
V-225	V-6	5628028	D280812	3.375	—	—	—	—	—	—	—	18-3927 ④	—	—
V-225 (3.0L)	V-6	D280813	UP	3.625	18-4639	18-4640	18-4641	18-4642	—	—	18-4644	18-4050	—	—

SIERRA V-6 PISTON KIT CONTENTS (SEE APPLICATION CHARTS FOR SPECIFIC APPLICATIONS)

Model / HP	Cyl.	Bore Size	Piston	OEM Part #	Piston Ring	OEM Part #	Wrist Pin	Circlips
135, 150 2 Liter	V-6	3.125 / Std. (port)	—	765-7442T32	18-3921	39-93481A12	NA	N.S.S.
135, 150 2 Liter	V-6	3.125 / Std. (stbd)	—	765-7441T32	18-3921	39-93481A12	NA	N.S.S.
135, 150 2 Liter	V-6	3.140 / .015 (port)	—	765-7444A11	18-3922	39-78918A4	NA	N.S.S.
135, 150 2 Liter	V-6	3.140 / .015 (stbd)	18-4013	765-7443A11	18-3922	39-78918A4	NA	N.S.S.
135, 150 2 Liter	V-6	3.155 / .030 (port)	—	765-7446A11	18-3923	39-85636A4	NA	N.S.S.

- | | | | |
|---------------------------------|----------------------------------|---------------------------------|----------------------------------|
| 4 of — = 1 of 39-21665A12 | 3 of 18-3919 = 1 of 39-817096A16 | 6 of 18-3924 = 1 of 39-18487A12 | 3 of 18-4019 = 1 of 39-19721A6 |
| 4 of 18-3902 = 1 of 39-78816A12 | 3 of 18-3920 = 1 of 39-817096A26 | 2 of 18-3925 = 1 of 39-815267A4 | 6 of 18-3982 = 1 of 39-822321A12 |
| 4 of 18-3916 = 1 of 39-78811A12 | 6 of 18-3921 = 1 of 39-93481A12 | 6 of 18-3966 = 1 of 39-18653A12 | 6 of 18-4050 = 1 of 39-827179A12 |
| 4 of 18-3917 = 1 of 39-88392A12 | 2 of 18-3922 = 1 of 39-78918A4 | 6 of 18-3968 = 1 of 39-18653A2 | 6 of 18-3927 = 1 of 39-813011A12 |
| 3 of 18-3918 = 1 of 39-817096A6 | 2 of 18-3923 = 1 of 39-85636A4 | 6 of 18-3967 = 1 of 39-18653A1 | |

APPLICATION CONTINUED ON NEXT PAGE

SIERRA V-6 PISTON KIT CONTENTS (SEE APPLICATION CHARTS FOR SPECIFIC APPLICATIONS)									
Model / HP	Cyl.	Bore Size	Piston	OEM Part #	Piston Ring	OEM Part #	Wrist Pin	Circlips	
135, 150 2 Liter	V-6	3.155 / .030 (stbd)	—	765-7445T11	18-3923	39-85636A4	NA	N.S.S.	
135-175	V-6	3.125 / Std. (port)	—	765-7442A3, A36	18-3921	39-93481A12	NA	N.S.S.	
135-175	V-6	3.125 / Std. (stbd)	18-4545	765-7441A3, A36	18-3921	39-93481A12	NA	N.S.S.	
135-175	V-6	3.140 / .015 (port)	—	765-7442A2, A12	18-3922	39-78918A4	NA	N.S.S.	
135-175	V-6	3.140 / .015 (stbd)	18-4560	765-7443A2, A12	18-3922	39-78918A4	NA	N.S.S.	
135-175	V-6	3.155 / .030 (port)	—	N/A	18-3923 ④	39-85636A4	NA	N.S.S.	
135-175	V-6	3.155 / .030 (stbd)	18-4575	N/A	18-3923 ④	39-85636A4	NA	N.S.S.	
175-225	V-6	3.375 / Std. (port)	—	766-8667A41/ T41	18-3927 ④	39-813011A12	NA	N.S.S.	
175-225	V-6	3.375 / Std. (stbd)	—	766-8666A41/ T41	18-3927 ④	39-813011A12	NA	N.S.S.	
175-225	V-6	3.390 / .015 (port)	—	766-8667A36/ A43	18-3925	39-815267A4	NA	N.S.S.	
175-225	V-6	3.390 / .015 (stbd)	—	766-8666A36/ A43	18-3925	39-815267A4	NA	N.S.S.	
175-225	V-6	3.405 / .030 (port)	—	NLA	—	NLA	NA	N.S.S.	
150 XR4/MAG II	V-6	3.375 / Std. (port)	—	766-8667A42/ T42	18-3924	39-18487A12	NA	N.S.S.	
150 XR4/MAG II	V-6	3.375 / Std. (stbd)	—	766-8666A42/ T42	18-3924	39-18487A12	NA	N.S.S.	
150 XR4/MAG II	V-6	3.390 / .015 (port)	18-4565	766-8667A36/ A43	18-3925	39-815267A4	NA	N.S.S.	
150 XR4/MAG II	V-6	3.390 / .015 (stbd)	—	766-8666A36/ A43	18-3925	39-815267A4	NA	N.S.S.	
150 XR4/MAG II	V-6	3.405 / .030 (port)	—	NLA	—	NLA	NA	N.S.S.	
140-200, XR6/MAG III	V-6	3.500 / Std. (port)	—	785-9737T9	18-3982	39-822321A12	NA	N.S.S.	
140-200, XR6/MAG III	V-6	3.500 / Std. (stbd)	18-4636	785-9738T9	18-3982	39-822321A12	NA	N.S.S.	
140-200, XR6/MAG III	V-6	3.515 / .015 (port)	—	785-9737A10	—	39-822321A1	NA	N.S.S.	
140-200, XR6/MAG III	V-6	3.515 / .015 (stbd)	18-4638	785-9738T10	—	39-822321A1	NA	N.S.S.	
225 (3.0L)	V-6	3.6265 / Std. (port)	18-4639	700-858294T1	18-4050	39-827179A12	NA	N.S.S.	
225 (3.0L)	V-6	3.6265 / Std. (stbd)	18-4640	700-858295T1	18-4050	39-827179A12	NA	N.S.S.	
225 (3.0L)	V-6	3.6415 / .015 (port)	18-4641	700-878571A2	—	39-826293A12	NA	N.S.S.	
225 (3.0L)	V-6	3.6415 / .015 (stbd)	18-4642	700-878572A2	—	39-826293A12	NA	N.S.S.	
225 (3.0L)	V-6	3.6565 / .030 (port)	18-4643	700-878573A2	—	39-826297A12	NA	N.S.S.	
225 (3.0L)	V-6	3.6565 / .030 (stbd)	18-4644	700-878574A2	—	39-826297A12	NA	N.S.S.	

- | | | | |
|---------------------------------|----------------------------------|---------------------------------|----------------------------------|
| 4 of — = 1 of 39-21665A12 | 3 of 18-3919 = 1 of 39-817096A16 | 6 of 18-3924 = 1 of 39-18487A12 | 3 of 18-4019 = 1 of 39-19721A6 |
| 4 of 18-3902 = 1 of 39-78816A12 | 3 of 18-3920 = 1 of 39-817096A26 | 2 of 18-3925 = 1 of 39-815267A4 | 6 of 18-3982 = 1 of 39-822321A12 |
| 4 of 18-3916 = 1 of 39-78811A12 | 6 of 18-3921 = 1 of 39-93481A12 | 6 of 18-3966 = 1 of 39-18653A12 | 6 of 18-4050 = 1 of 39-827179A12 |
| 4 of 18-3917 = 1 of 39-88392A12 | 2 of 18-3922 = 1 of 39-78918A4 | 6 of 18-3968 = 1 of 39-18653A2 | 6 of 18-3927 = 1 of 39-813011A12 |
| 3 of 18-3918 = 1 of 39-817096A6 | 2 of 18-3923 = 1 of 39-85636A4 | 6 of 18-3967 = 1 of 39-18653A1 | |
- ④ For chrome bore blocks

PKG. OF 200



NEEDLE BEARINGS

Part #	Replaces:	Description
18-4036 ①	29-47270	Piston End
18-4037 ①	29-71422	Main Bearing

NEEDLE BEARINGS



Part #	Replaces	Description
18-4038	31-62596A1, 31-63075A1, 31-61424A2, 31-58859A1, 31-55332A1, 31-47245A1	Crank End - w/o Cage

16 Needles - Must re-use cage



**18-1194
ROD BEARING**
Replaces: 31-17514A1, 8M004528, 31-17514A2, 31-8M0045428, 31-17514, 31-67526A1, 31-67526A2, 31-67526, 31-821146A1, 31-814337A1, 879366
For: 30-60HP 2&3 Cyl., Mag II, V-135-200 & XR4



**18-1153
BALL BEARING**
Replaces: 30-63326, 30-63326T, 30-49313, 30-54215, 30-20464



**18-1154
BALL BEARING**
Replaces: 30-63742



**18-1196
UPPER MAIN BEARING**
Replaces: 31-74248T, 31-74248
For: V135, 150, 175, 200 (carb)



**18-1345
BALL BEARING**
Replaces: 30-67923T, 30-67923, 30-41421
For: 135-225 HP V-6



**18-1398
BALL BEARING**
Replaces: 30-72961, 30-20861
For: 3.5-9.8 HP & Mercruiser belt driven water pump

① This product is priced per piece. To order priced per package, please add -9 to the part number.

**18-1404
BEARING REPAIR KIT**

Replaces: Mercury 31-802096T1
Fits all Alph 1/Gen II Gear cases 1998 and newer



**18-2144
MOTOR MOUNT**

Replaces: 67209, 77326, 78687, 78687T
**Small Diameter
Upper Motor Mount**

Includes: (1) Upper Motor Mount and (1) 1 1/4" O.D. x 1/2" I.D. Stainless Steel Washer



HP	Cyl.	Beg. S/N	End S/N	Center Main Bearing	Con. Rod Crank End	Main Valve Block	Con. Rod Piston End	Lower Main Bearing	Lower O-ring	Lower Oil Seal	Lower Oil Seal 2	Upper O-ring	Upper Main Bearing	Upper Oil Seal	Upper Roller Bearing
3.5		6202173	& UP	—	—	—	—	—	—	—	—	18-7152	18-1398	—	—
3.6		5404657	& UP	—	—	—	—	18-1398	—	—	—	18-7152	18-1398	—	—
3.9	1	1655013	2498135	—	—	—	—	18-1398	—	—	—	18-7152	18-1398	—	—
4 (40)	1	2498136	4107219	—	—	—	—	18-1398	—	—	—	18-7152	18-1398	—	—
4	1	5595532	& UP	—	—	—	—	18-1398	—	—	—	18-7152	18-1398	—	—
4 (40)	2	5589202	& UP	—	—	—	—	18-1398	18-7102	—	—	—	—	18-0515	—
4.5 (4.5, 45)	1	4107220	& UP	—	—	—	—	18-1398	—	—	—	18-7152	18-1398	—	—
4.5	1	5595532	& UP	—	—	—	—	18-1398	—	—	—	18-7152	18-1398	—	—
6 (60)		1916139	2529894	—	—	—	—	18-1398	—	—	—	18-7459	18-1398	—	—
6		A197112	T800749	—	—	—	—	—	—	—	—	—	—	—	—
7.5 (75)		2529895	5226934	—	—	—	—	18-1398	—	—	—	18-7152	18-1398	—	—
10 (100)		1290910	& UP	—	—	—	—	—	—	—	—	—	—	—	—
10 (MARATHON, XR10, SEAPRO)		D038000	& UP	—	—	—	—	—	—	—	—	—	—	—	—
15 (150)		1290910	1499331	—	—	—	—	—	—	18-2026	18-2026	—	18-1153	—	—
15		B292414	& UP	—	—	—	—	—	—	—	—	—	—	—	—
15 (EXPORT SEAPRO)		G044365	G202749	—	—	—	—	—	—	18-0537	—	—	—	—	—
15 (SEAPRO)		G438000	& UP	—	—	—	—	—	—	—	—	—	—	—	—
15 (SUPER)		B238464	G202749	—	—	—	—	—	—	18-0537	—	—	—	—	—
18		5837437	6239752	—	—	—	—	—	—	18-0537	—	—	—	—	—
20		1558310	2296266	—	—	—	—	—	—	18-2026	18-2026	—	18-1153	—	—
20 (200, 20)		2296267	& UP	—	—	—	—	—	—	—	—	—	—	—	—
25 (KF 9)	4	377150	495761	—	—	—	—	—	—	—	—	—	—	—	—
10 (MK10)	2	1057994	1122327	—	—	—	—	—	—	—	—	—	—	—	—
15 (MK15)	2	1200114	1287384	—	—	—	—	—	—	—	—	—	—	—	—
16 (MK20)	2		ALL	—	—	—	—	—	—	—	—	—	—	—	—
20 (MK25)	2	860979	& UP	—	—	—	—	—	—	—	—	—	—	—	—
22 (MK28)	2	1158546	1238089	—	—	—	—	—	—	—	—	—	—	—	—
30 (MK30)	4		ALL	—	—	—	—	—	—	—	—	—	—	—	—
35 (MK35)	4	1217222	1271884	—	—	—	—	—	—	—	—	—	—	—	—
25 (MK40)	4	711400	& UP	—	—	—	—	—	—	—	—	—	—	—	—
40 (MK50)	4		ALL	—	—	—	—	—	—	—	—	—	—	—	—
40(MK55)	4	831021	& UP	—	—	—	—	—	—	—	—	—	—	—	—
45 (MK58)	4	1139538	& UP	—	—	—	—	—	—	—	—	—	—	—	—
60 (MK75)	6		ALL	18-4037	—	—	—	—	—	—	—	—	—	—	—
70 (MK78)	6	1143038	& UP	18-4037	—	—	—	—	—	—	—	—	—	—	—
3.5 / 3.6 / 3.9	1		ALL	—	—	—	—	18-1398	—	—	—	—	18-1398	—	—
9.8	2	1865779	& UP	—	—	—	—	18-1398	—	—	—	—	18-1398	—	—
20	2	1292910	6443972	—	—	—	—	18-1153	—	—	—	—	18-1153	—	—
20 (20 XD)	2	6443973	B114230	—	—	—	—	—	—	18-0537	—	—	—	—	—
25	2	1467499	1499331	—	—	—	—	—	—	—	—	—	—	—	—
25	2	5705532	6241936	—	—	—	—	—	—	18-0537	—	—	—	—	—
25 (250)		1290910	1499331	—	—	—	—	—	—	—	—	—	—	—	—
30 (300)	4	1271885	1448139	—	—	—	—	18-1154	18-7151	—	18-2016	18-7151	18-1154	—	—
30 (644cc)	2	G053314	D589999	—	—	—	18-4036	18-1154	18-7176	18-2016	—	—	—	—	—
30 (644cc)	2	G590000	T598999	—	18-1194	—	18-4036	—	—	—	—	—	—	—	—
30 JET	4	C159200	& UP	18-4037	—	—	—	18-1154	—	—	—	—	18-1154	—	—

APPLICATION CONTINUED ON NEXT PAGE

HP	Cyl.	Beg. S/N	End S/N	Center Main Bearing	Con. Rod Crank End	Main Valve Block	Con. Rod Piston End	Lower Main Bearing	Lower O-ring	Lower Oil Seal	Lower Oil Seal 2	Upper O-ring	Upper Main Bearing	Upper Oil Seal	Upper Roller Bearing
30 JET	3	G590000	& UP	—	—	—	18-4036	18-1154	—	—	—	—	—	—	—
35 (350, 35A)	4	121722	1448139	—	—	—	—	18-1154	—	—	—	—	18-1154	—	—
35 (350)	2	1571114	1898815	—	—	—	—	18-1154	18-7151	—	—	—	18-1154	—	—
35	2	6445653	B110788	—	—	—	18-4038	18-4036	18-1154	—	—	—	—	—	—
40 (400E, 400M)	4	1279685	1367697	—	—	—	—	18-1154	—	—	—	—	18-1154	—	—
40 (400E, 400M)	4	1384806	1476509	—	—	—	—	—	—	—	—	—	—	—	—
40 (400)	2	2874704	3045259	—	—	—	18-4038	18-4036	18-1154	18-2016	18-2016	—	18-2016	—	—
40 (400)	2	3045260	3336257	—	—	—	18-4038	18-4036	—	—	—	—	—	—	—
40 (402)		3336258	4117709	—	—	—	18-4038	18-4036	—	—	—	—	—	—	—
40 (402, 40)		4117710	5556229	—	—	—	18-4038	18-4036	—	18-2016	18-2016	—	18-2016	—	—
40	2	5556230	6443972	—	—	—	18-4038	18-4036	—	—	—	—	—	—	—
40	2	G053314	& UP	—	—	—	18-1194	18-4036	18-1154	18-2016	—	—	—	—	—
40	3	G531301	& UP	—	—	—	18-1194	18-4036	18-1154	18-2016	—	—	—	—	—
40	4	C159200	& UP	18-4037	—	—	—	18-1154	18-7161	18-2016	—	—	18-7151	18-1154	—
45 (450)	4	1476510	1531568	—	—	—	—	18-1154	—	18-2016	18-7151	18-1154	18-1154	—	—
45	4	5531630	& UP	18-4037	—	—	—	18-1154	18-7151	18-2016	18-7151	18-1154	18-1154	—	—
45 JET		D000750	D589999	—	—	—	—	18-4036	18-1154	18-7176	18-2016	—	—	—	18-2016
45 JET (59 CID)	3	G590000	& UP	—	—	—	18-1194	18-4036	18-1154	18-7176	18-2016	—	—	—	—
50 (500)	4	1421113	1755548	—	—	—	—	18-1154	18-7151	—	18-2016	18-7151	18-1154	18-2016	—
50 (500)		1770179	2305100	—	—	—	—	—	—	—	—	—	—	—	—
50 (500, 50)		2305151	5193253	—	—	—	—	—	—	—	—	—	—	—	—
50	4	5193259	5531629	18-4037	—	—	—	18-1154	—	—	—	—	18-1154	—	—
50	4	5531630	& UP	18-4037	—	—	—	—	—	—	—	—	—	—	—
50	3	6428681	D000749	18-4037	18-4038	—	18-4036	—	18-7161	18-2016	18-2016	—	—	—	18-2016
50	3	D000750	G589999	—	—	—	—	18-4036	18-1154	18-7176	18-2016	—	—	—	18-2016
50	3	G590000	& UP	—	—	—	18-1194	18-4036	18-1154	18-7176	18-2016	—	—	—	—
55	3	D000750	G589999	—	—	—	—	18-4036	18-1154	18-7176	18-2016	—	—	—	18-2016
55	3	G590000	& UP	—	—	—	18-1194	18-4036	18-1154	18-7176	18-2016	—	—	—	—
60 (600)	4	1303411	1542744	18-4037	—	—	—	18-1154	18-7151	—	18-2016	18-7151	18-1154	18-2016	—
60	3	6428681	D000749	18-4037	18-4038	—	18-4036	—	18-7161	18-2016	18-2016	—	—	—	18-2016
60	3	D000750	G589999	—	—	—	18-4038	18-4036	18-1154	18-7176	18-2016	—	—	—	18-2016
60 (59 CID)	3	G590000	& UP	—	—	—	18-1194	18-4036	18-1154	—	—	—	—	—	—
65 (650)	4	1545745	1765043	18-4037	—	—	—	18-1154	18-7151	—	18-2016	—	—	—	18-2016
65 (650)	4	1765044	2119748	18-4037	—	—	—	—	—	—	—	—	—	—	—
65 (650)	4	2119749	2309310	18-4034	—	—	—	—	—	—	—	—	—	—	—
65 (650)	4	2309311	3293183	18-4037	—	—	—	—	—	—	—	—	—	—	—
65 (650)	3	3293184	4571651	18-4037	18-4038	—	18-4036	—	18-7161	18-2016	18-2016	18-7961	—	—	18-2016
65 (650)	3	8006640	8042349	18-4037	18-4038	—	18-4036	—	—	—	—	—	—	—	—
65 (650)	3	9020074	9135824	18-4037	18-4038	—	18-4036	—	—	—	—	—	—	—	—
65 (650)	3	7013633	7087822	18-4037	18-4038	—	18-4036	—	—	—	—	—	—	—	—
65 JET		D283222	& UP	—	—	—	—	—	—	18-2016	—	—	—	—	18-0523
70 (700)	6	1296411	1566239	18-4037	—	—	—	18-1154	18-7151	—	18-2016	18-7151	18-1154	18-2016	—
70	3	4571652	5579016	18-4037	18-4038	—	18-4036	—	18-7161	18-2016	18-2016	—	—	—	18-2016
70	3	5579017	6428680	18-4037	18-4038	—	18-4036	—	—	—	—	—	—	—	—
70 CONNECTING ROD #638-8532-1	3	A996142	C221999	—	—	—	—	—	—	18-2016	—	—	—	—	18-0523
75	4	6432901	& UP	18-4037	18-4038	—	18-4036	18-1154	18-7161	18-2016	18-2016	18-7961	—	—	18-2016
75 CONNECTING ROD #638-8532-1	3	C222000	& UP	—	—	—	—	—	—	18-2016	—	—	—	—	18-0523
75 DFI (1.5L)		T980000	B189548	—	—	—	—	—	—	18-2016	—	—	—	—	—
80 (800)	6	1335465	1566239	18-4037	—	—	—	18-1154	18-7151	—	18-2016	18-7151	18-1154	18-2016	—
80 (800)	4	2559001	2670574	18-4037	18-4038	—	18-4036	18-1154	18-2016	18-2016	18-2016	18-7961	—	—	18-2016
80 (800)	4	2783253	3493912	18-4037	18-4038	—	18-4036	—	—	—	—	—	—	—	—
80 (800, 80)	4	4831999	5582561	18-4037	18-4038	—	18-4036	18-1154	18-7161	18-2016	18-2016	18-7961	—	—	18-2016

APPLICATION CONTINUED ON NEXT PAGE

HP	Cyl.	Eng. S/N	End S/N	Center Main Bearing	Con. Rod Crank End	Main Valve Block	Con. Rod Piston End	Lower Main Bearing	Lower O-ring	Lower Oil Seal	Lower Oil Seal 2	Upper O-ring	Upper Main Bearing	Upper Oil Seal	Upper Roller Bearing
80 (80)	4	5582562	6422900	18-4037	18-4038	—	18-4036	—	—	—	—	—	—	—	—
80 CONNECTING ROD #638-8532-1	3	A996142	C221999	—	—	—	—	—	—	18-2016	—	—	—	18-0523	—
80 JET		D283222	& UP	—	—	—	—	—	—	18-2016	—	—	—	18-0523	—
85 (850, 76 CID)	6	1460999	1464848	18-4037	—	—	—	18-1154	18-7151	—	18-2016	18-2016	—	18-2016	—
85 (850, 90 CID)	6	1566240	1766823	18-4037	—	—	—	18-1345	18-2016	—	18-2016	—	—	18-2016	—
85 (850)	4	3493913	3865694	18-4037	18-4038	—	18-4036	18-1154	18-7161	18-2016	18-2016	18-7961	—	18-2016	—
85 (850)	4	3865695	4831998	18-4037	18-4038	—	18-4036	—	—	—	—	—	—	—	—
90 (900)	6	1766824	1850448	18-4037	—	—	—	18-1154	18-2016	—	18-2016	—	—	18-2016	—
90 (900)	6	1850449	1869775	18-4037	—	—	—	—	—	—	—	—	—	—	—
90 (900, 90)	6	4845301	5594656	18-4037	18-4038	—	18-4036	18-1154	18-7161	18-2016	18-2016	—	—	18-2016	—
90 (90)	6	5594657	& UP	18-4037	18-4038	—	18-4036	—	—	—	—	—	—	—	—
90 (90) CONNECTING ROD #638-8532-1	3	A996142	D283221	—	—	—	—	—	—	18-2016	—	—	—	18-0523	—
95 (950E)	6	1869776	2318585	18-4037	—	—	—	18-1154	18-7151	—	18-2016	—	—	18-2016	—
95 (950E-SS)		1869776	2318585	18-4037	—	—	—	18-1154	18-2016	—	18-2016	—	—	18-2016	—
95 (950E-SS-1)		1869776	2318585	18-4037	—	—	—	—	—	—	—	—	—	—	—
100 (1000)	6	1464949	2318585	18-4037	—	—	—	18-1154	18-7151	—	18-2016	—	—	18-2016	—
100 (1000SS)		2318586	2836018	18-4037	—	—	—	18-1154	18-7151	—	18-2016	—	—	18-2016	—
100 (1000BP)		2399698	2641854	18-4037	—	—	—	—	—	—	—	—	—	—	—
100 (1000BP)		2641855	3253111	18-4037	18-4038	—	18-4036	18-1154	18-7151	18-2016	18-2016	18-7961	—	18-2016	—
100	4	B209468	& UP	—	—	—	—	—	—	—	—	—	—	—	—
105 JET		D820000	& UP	—	18-1194	—	—	18-1345	—	—	—	—	—	—	—
110 (1100E)		1870204	2314955	18-4037	—	—	—	18-1154	18-7151	—	18-2016	—	—	18-2016	—
110 (1100-SS)	6	1870204	2314955	18-4037	—	—	—	18-1154	18-2016	—	18-2016	—	—	18-2016	—
110 (1100E-SS-1)	6	1870204	2314955	18-4037	—	—	—	—	—	—	—	—	—	—	—
115 (1150)	6	2836019	3525440	18-4037	18-4038	—	18-4036	18-1154	18-7151	18-2016	18-2016	18-7961	—	18-2016	—
115 (1150, 115)		3525441	5600966	18-4037	18-4038	—	18-4036	—	—	—	—	—	—	—	—
115	6	5600967	6262960	18-4037	18-4038	—	18-4036	—	—	—	—	—	—	—	—
115	6	6262961	C099999	18-4037	18-4038	—	18-4036	—	—	—	—	—	—	—	—
115 CONNECTING ROD #638-8532-1	4	C100000	D283221	—	—	—	—	—	—	18-2016	—	—	—	18-0523	—
115 OPTIMAX	6	G960500	T178499	—	18-1194	—	—	—	—	—	—	—	—	—	—
125 (1250, 1250BP)	6	2314956	2641954	18-4037	18-4038	—	18-4036	18-1154	18-2016	—	—	18-7961	—	18-2016	—
125 (1250BP)		2641955	3253111	18-4037	18-4038	—	—	—	—	—	—	—	—	—	—
125	4	D283222	& UP	—	—	—	—	—	—	18-2016	—	—	—	18-0523	—
135 (1350)		2839369	3293233	18-4037	18-4038	—	18-4036	18-1154	18-7151	18-2016	18-2016	18-7961	—	18-2016	—
1400		3293234	3502805	18-4037	18-4038	—	18-4036	18-1154	—	—	—	—	—	—	—
1400-140		4865678	& UP	18-4037	18-4038	—	18-4036	—	—	—	—	—	—	—	—
140 JET	V-6	D082000	& UP	—	—	—	—	18-1345	18-0860	18-2016	18-2016	18-0858	—	18-2016	—
V-135 W/ METAL CAGED MAIN BRG	V-6	A904646	C239552	—	18-1194	—	—	—	—	—	—	—	—	—	—
V-135 W/ PLASTIC CAGED MAIN BRG	V-6	A904646	C239552	—	18-1194	—	—	—	—	—	—	—	—	—	—
V-135 CONNECTING ROD #636-8118	V-6	C239553	D082000	—	18-1194	—	—	—	—	—	—	—	—	—	—
V-135	V-6	D082000	& UP	—	18-1194	—	—	—	—	—	—	—	—	—	—
V-135 DFI	V-6	D082000	G760299	—	—	—	—	18-1345	—	—	—	—	—	—	—
V-135 DFI	V-6	G760300	& UP	—	18-1194	—	—	—	—	—	—	—	—	—	—

APPLICATION CONTINUED ON NEXT PAGE

HP	Cyl.	Beg. S/N	End S/N	Center Main Bearing	Con. Rod Crank End	Main Valve Block	Con. Rod Piston End	Lower Main Bearing	Lower O-ring	Lower Oil Seal	Lower Oil Seal 2	Upper O-ring	Upper Main Bearing	Upper Oil Seal	Upper Roller Bearing
1500-1500XS	V-6	3502806	5327662	18-4037	18-4038	—	18-4036	18-1154	18-7161	18-2016	18-2016	18-7961	—	18-2016	—
1500-1500XS	V-6	8005615	8052649	18-4037	18-4038	—	18-4036	—	—	—	—	—	—	—	—
1500-1500XS	V-6	7010533	7112772	18-4037	18-4038	—	18-4036	—	—	—	—	—	—	—	—
V-150 (V-1500)	V-6	4868998	C100860	—	—	—	—	18-1345	—	18-2016	18-2016	—	—	18-2016	18-1196
V-150	V-6	C100861	C239552	—	18-1194	—	—	18-1345	18-0860	18-2016	18-2016	18-0858	—	18-2016	—
V-150 CONNECTING ROD #636-8118	V-6	C239553	D081999	—	18-1194	—	—	18-1345	18-0860	18-2016	18-2016	18-0858	—	18-2016	—
V-150 CONNECTING ROD #644-818141	V-6	C239553	D081999	—	18-1194	—	—	—	—	—	—	—	—	—	—
V-150 DFI	V-6	D082000	& UP	—	18-1194	—	—	18-1345	18-0860	18-2016	18-2016	18-0858	—	18-2016	—
V-150 EFI	V-6	D082000	& UP	—	—	—	—	18-1345	—	—	—	—	—	—	—
150	V-6	4868998	D081999	—	18-1194	—	—	—	—	—	—	—	—	—	—
XR-4	V-6	G760300	& UP	—	18-1194	—	—	—	—	—	—	—	—	—	—
XR-4	V-6	B242885	C239552	—	18-1194	—	—	—	—	—	—	—	—	—	—
XR-4	V-6	C239553	D081999	—	18-1194	—	—	—	—	—	—	—	—	—	—
XR-6	V-6	D082000	& UP	—	—	—	—	18-1345	—	—	—	—	—	—	—
V-175 (1750)	V-6	4301235	6618750	—	—	—	—	18-1345	—	18-2016	18-2016	—	—	18-2016	18-1196
V-175	V-6	6618751	C239552	—	18-1194	—	—	18-1345	18-0860	18-2016	18-2016	18-0858	—	18-2016	—
V-175	V-6	C239553	D081999	—	18-1194	—	—	18-1345	18-0860	18-2016	18-2016	18-0858	—	18-2016	—
V-175	V-6	D082000	& UP	—	18-1194	—	—	—	—	—	—	—	—	—	—
V-175 XRI	V-6	D000750	D081999	—	18-1194	—	—	18-1345	18-0860	18-2016	18-2016	18-0858	—	18-2016	—
V-175 EFI	V-6	D082000	& UP	—	—	—	—	18-1345	—	—	—	—	—	—	—
V-175	V-6	T178500	& UP	—	18-1194	—	—	18-1345	18-0860	18-2016	18-2016	18-0858	—	18-2016	—
DFI & PRO XS															
175 (1750)	V-6	8058870	& UP	—	18-1194	—	—	—	—	—	—	—	—	—	—
V-200 (V2000)	V-6	4839034	5363917	—	18-1194	—	—	18-1345	—	—	—	—	—	—	—
V-200 (V2000)	V-6	5363918	6073191	—	18-1194	—	—	18-1345	—	18-2016	18-2016	—	—	18-2016	18-1196
V-200 (2.4L)	V-6	6073192	C291519	—	18-1194	—	—	18-1345	18-0860	18-2016	18-2016	18-0858	—	18-2016	—
V-200 (2.5L) CONNECTING ROD #636-8118	V-6	C291520	D081999	—	18-1194	—	—	—	—	—	—	—	—	—	—
V-200 (2.5L) CONNECTING ROD #644-818141	V-6	C291520	D081999	—	18-1194	—	—	—	—	—	—	—	—	—	—
V-200	V-6	D082000	& UP	—	—	—	—	18-1345	—	—	—	—	—	—	—
V-200 EFI	V-6	C100861	C291519	—	18-1194	—	—	18-1345	18-0860	18-2016	18-2016	18-0858	—	18-2016	—
V-200 EFI CONNECTING ROD #644-818141	V-6	C291520	D081999	—	18-1194	—	—	—	—	—	—	—	—	—	—
V-200 EFI CONNECTING ROD #636-8118	V-6	C291520	D081999	—	18-1194	—	—	—	—	—	—	—	—	—	—
V-200 EFI (2.5L)	V-6	D082000	B226999	—	—	—	—	18-1345	—	—	—	—	—	—	—
V-220	V-6	B117316	& UP	—	18-1194	—	—	—	—	—	—	—	—	—	—
V-225	V-6	5628028	D280812	—	18-1194	—	—	18-1345	18-0860	18-2016	18-2016	—	—	18-2016	—
V-225 (225, SEAPRO)	V-6	D280813	& UP	—	—	—	—	18-1345	—	—	—	—	—	—	—
V-225 DFI	V-6	G590000	T325116	—	—	—	—	18-1345	18-0860	—	—	—	—	—	—
V-225	V-6	G129222	& UP	—	—	—	—	18-1345	18-0860	—	—	—	—	—	—
V-250 EFI	V-6	G129222	T325116	—	—	—	—	18-1345	18-0860	—	—	—	—	—	—
V-250	V-6	C101891	& UP	—	—	—	—	18-1345	—	—	—	—	—	18-2016	—
V-250 DFI & PRO XS	V-6	B528615	& UP	—	—	—	—	18-1345	18-0860	—	—	—	—	—	—
V-275	V-6	C101891	& UP	—	—	—	—	—	—	—	—	—	—	—	—
V-3.4L	V-6	5611648	& UP	—	—	—	—	18-1345	—	—	—	—	—	—	—



18-7901
OIL FILTER

Replaces: 825467A1, T1
For: 9.9HP S/N OH000058-OH017099 (1995-98)

18-7758
OIL FILTER

Replaces Mercury:
8M0123025, 175 3.4L Pro XS (2B529482 & Up), 200 3.4L V6 (2B529482 & Up), 200 4.6L V8 Pro XS (2B529482 & Up), 225 3.4L V6 (2B529482 & Up), 225 4.6L V8 Pro XS (2B529482 & Up), 250 4.6L V8 (1E080500 & Up), 250 4.6L V8 (2B529482 & Up), 250 4.6L V8 Verado® (2B529482 & Up)



18-7758
OIL FILTER

Replaces: 35-877761K01, 35-877761Q01
For: 75/90/115 hp. (S/N 1B366823 (2006) & Up)



18-7918
OIL FILTER

Replaces: 35-883701K01, 35-877769K01
For: Verado 200-300 HP, Inline 6 cylinder



18-7921
OIL FILTER

Replaces: 35-896546T, 35-877767K01
For: Verado 135-200 HP, Inline 4 cylinder



18-7906-2
OIL FILTER

Superseded from 18-7906-1
Replaces: 35-822626T7, 35-822626Q15, 35-8226267
Fits: 225 HP (Non-Verado)



18-7913
OIL FILTER

Replaces: 35-822626Q1
For: 8 HP (323cc) 2001-2004 / 9.9 HP (323cc) 1999-2004 / 15 HP. (323cc) 1998 and NEWER / 20 HP. 2008 and NEWER / 30 HP (492cc) 2006 and NEWER



18-7914
OIL FILTER

Replaces: 35-822626Q2, 35-822626Q04, 35-877768K01, 35-822626K04, 35-822626T2, 35-8M0064104, 35-8M0008397
For: 25 HP. (498cc) 1998-2005 / 30 HP. (747cc) 1999-2005 / 40, 50, 60 HP. 1995 and NEWER / 75, 90 Carbureted 2000-2005 / 115 EFI (S/N 1B366822 and BELOW)



18-79966
OIL FILTER

Replaces: Mercury 875284T01, 75/90/115 Opti-max (1.5L) 1B227000 & Above



18-1800
OIL RESERVIOR FLOAT SWITCH
Replaces: 12886A6

TIMING BELTS

Sierra Timing Belts provide extended durability and smoother performance characteristics required by today's marine engines.

FEATURES:

- Neoprene or Nitrile construction for maximum durability based on application
- Positive Slip Proof engagement
- Fiberglass tension member for excellent flex and elongation behavior
- Chemical and Contaminant Resistance for Long Life
- Meets or Exceeds OEM belt specifications
- Modified Curvilinear or Trapezoidal tooth profile for direct OE fitment/replacement
- Recommended periodic maintenance interval of 5 years or 1000 hours of use
(Note: Timing belt should be inspected every 100 hours and replaced as necessary.)
- Inexpensive insurance to prevent catastrophic engine failure



Part No.	Replaces	Fits
18-15146	8M0072670	25 HP EFI (3 CYL) Fourstroke 0R106999 and Above; 25 HP JET EFI (3 CYL) 0R165086 and Above; 30 HP EFI (3 CYL) Fourstroke 0R106999 and Above
18-15147	835392Q	9.9 HP Fourstroke 0G760300-1B226999; 15 HP Fourstroke 1B227000-1B727495; 15 HP Fourstroke 0G760300-1B226999
18-15148	8M0065179	40 HP (3 CYL) Fourstroke 1C049739 and Above; 40-50-60 HP Fourstroke 1C050252 and Above
18-15149	57-895120	8 HP Fourstroke 0R042475 and Above; 9.9 HP Fourstroke 0R042475 and Above
18-15150	57-895120002	10 HP Carb (2 CYL) Fourstroke 0R575531-0R833819; 15 HP Carb (2 CYL) Fourstroke 0R235949-0R833819; 15 HP Carb Fourstroke JCI 0R558208-0R833819; 15 HP SEAPRO Fourstroke 0R051685-0R123564; 15 HP SEAPRO Fourstroke 0R123565 and Above; 20 HP Carb (2 CYL) Fourstroke 0R235168-0R833819

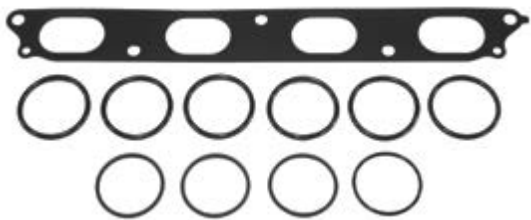

18-0663
PLENUM GASKET KIT

Fits: Mercury 75 4-Stroke (2000-03),
90 4-Stroke (2000 & Up),

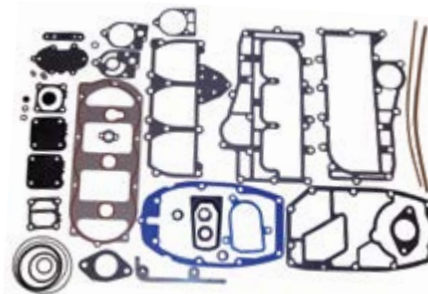

18-4326
POWERHEAD GASKET SET

Replaces: 27-43779A87
For: 50,55,60 HP, 3 cyl.

— CONTAINS —

Part #	Desc.	O.E.#	Qty.
18-4261	Fiber Washer	19643	1
18-0320	Gasket	27-13937-6	6
18-0324	Gasket	27-15172-3	3
18-0670	Gasket	27-43007 5	1
18-2565	Gasket	27-43047-1	1
18-2945	Drain Screw Gasket	12-20260	3
18-7164	O-Ring	25-33466	1
18-7198	O-Ring	25-45710	1
18-7167	O-Ring	25-45254	1
18-0182	Gasket	27-62386	1
18-2740	Cylinder Block Gasket	27-43005 7	1
18-2741	Gasket	27-43004 7	2
18-0339	Thermostat Gasket	27-43006-2	1
18-0341	Exhaust Gasket	27-43008, 27-430082, 27-430083, 27-430085	1
18-2563	Gasket	27-43034-1	1
NSS	Gasket	22-43033-1	1
18-2566	Impeller Gasket	27-817277	1
18-7105	O-Ring	25-62705	2
NSS	O-Ring	25-64067	1
18-0858	O-Ring	25-54029	1
18-7803	Diaphragm Kit	21-857005A1	1

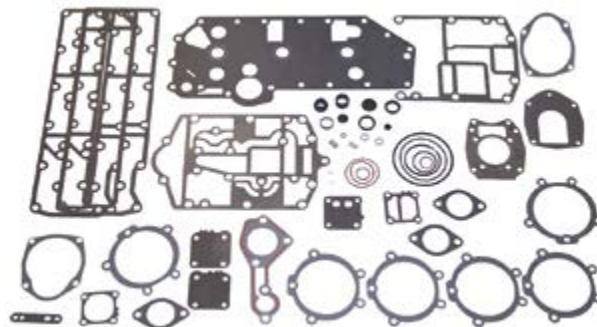

18-4336
POWERHEAD GASKET SET

Replaces: 27-43004A99, 27-43004A90, 27-43004A86
For: 70, 80, 90HP 3 cyl outboards

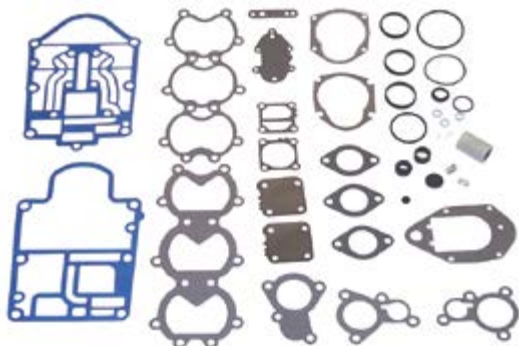

18-4337
POWERHEAD GASKET SET

Replaces: 27-812867A97, 27-812867A96, 27-812867A91
For: 45 Jet, 50HP, 55HP, 60HP, 3 cyl outboards

CONTAINS —

Part #	Desc.	O.E.#	Qty.
18-7152	O-Ring	25-20863	1
18-2945	Drain Screw Gasket	12-19183	3
18-7173-9	O-Ring	25-30224	1
18-0182	Thermostat Gasket	27-62386	1
18-2719	Induction Manifold Gasket	27-812869	1
18-2721	Adapter Plate Gasket	27-827284	1
18-2729	Thermostat Cover Gasket	27-812867 2	1
18-2749	Thermostat Gasket	27-812867 1	1
NSS	Exhaust Gasket	27-812866	1
18-0319	Exhaust Cover Gasket	27-828533	1
18-0622	Lower Wear Plate Gasket	27-19701	1
18-0345	Water Pump Gasket	27-722189	1
18-2593	Water Pump Gasket	N/A	1
18-2566	Impeller Gasket	27-817277	1
18-7176	O-Ring	25-90011	1
18-7950	O-Ring	25-45258	1
18-7817	Diaphragm Kit	21-857005A1	1

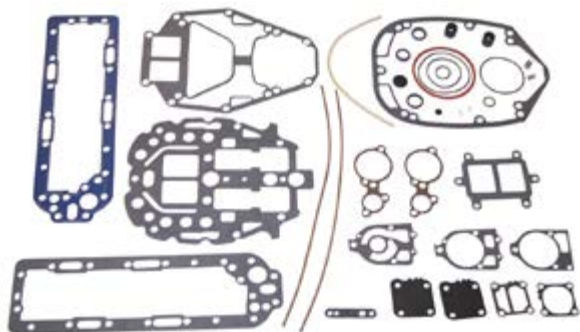

18-4338
POWERHEAD GASKET SET

Replaces: 27-814754A00
For: V-135, V-150 DFI outboards

CONTAINS —

Part #	Desc.	O.E.#	Qty.
18-2506-1	Exhaust Plate Gasket	27-99176-3	1
18-0860	O-Ring	25-62700	1
18-0858	O-Ring	25-54029	1
18-0182	Thermostat Gasket	27-62386	2
18-0642	Divider Plate Gasket	27-19050-3	1
18-2735	Divider Plate Gasket	27-190506	1
18-0936	Gasket	27-78690	2
18-2511	Gasket	27-99173-2	1
18-0643	Powerhead Base Gasket	27-183071	1
18-2919	Gasket	27-42631-1	1
18-7176	O-Ring	25-90011	1
18-2914	Water Pump Gasket	27-85608-1	1
18-2915	Water Pump Gasket	27-85609-1	1
18-7159	O-Ring	25-31534	1
18-7153	O-Ring	25-25439	1
18-7174	O-Ring	25-45711	2
18-0970	Fuel Pump Gasket	27-98769-1	1
18-0135	Adapter Cover Gasket	27-78246	1
18-2514	Crankcase Gasket	27-53650	2

GASKET SET APPLICATION BEGINS ON PAGE 439 • POWERHEAD GASKET SETS DO NOT INCLUDE HEAD GASKETS

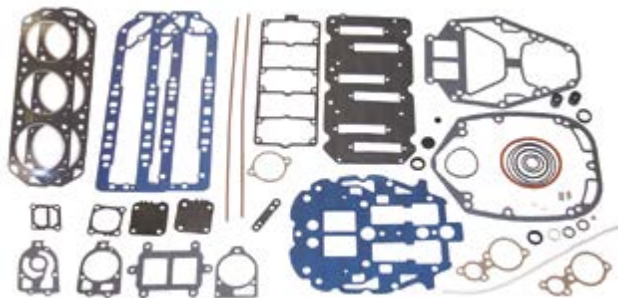

18-4339
POWERHEAD GASKET SET

Replaces: 27-14697A87
For: V200EFI and V220 outboards

CONTAINS --			
Part #	Desc.	O.E.#	Qty.
18-3862	Head Gasket	27-41246-1	2
18-7153	O-Ring	25-21836	1
18-7164	O-Ring	25-33466	1
18-7159	O-Ring	25-31534	1
18-0135	Gasket	27-78246	1
18-7426	Slinger	25-30271	1
18-0182	Gasket	27-62386	2
18-0860	O-Ring	25-62700	1
18-0936	Gasket	27-78690	2
18-2919	Gasket	27-42631-1	1
18-2915	Gasket	27-85609-1	1
18-2506-1	Exhaust Plate Gasket	27-99176-3	1
18-2503	Drive Shft Gasket	27-99177-1	1
18-2513	Cork	27-11338	2
18-0644	Reed Plate Gasket	27-14697-2	1
18-0645	Gasket	27-16737-1	1
18-2502	Gasket	27-90484-1	2
18-2511	Gasket	27-99173-2	1
18-2914	Gasket	27-85608-1	1
18-3110	Grommet	26-38970	2
18-7174	O-Ring	25-45711	2
18-7176	O-Ring	25-90011	1
18-8305	Divider Plate Seal	26-814754	1
18-0858	O-Ring	25-54029	1
18-0952	Gasket	27-88907	1
18-7421	O-Ring	25-20415	1
18-0970	Fuel Pump Gasket	27-98769-1	1
18-7817	Diaphragm Kit	21-857005A1	1

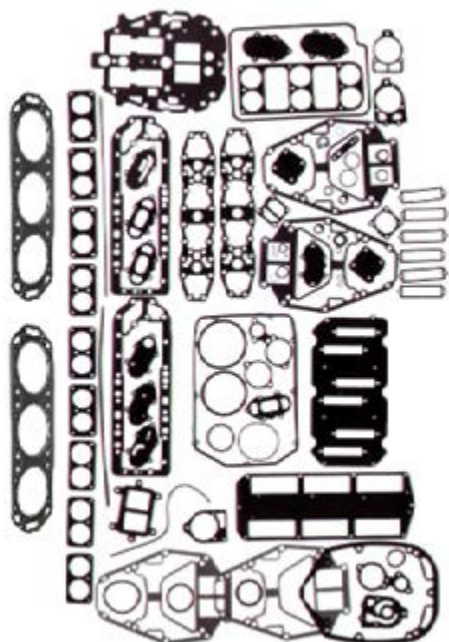

18-4317
POWERHEAD GASKET SET

Replaces: 27-90484A88, 27-90484A86, 27-90484A32

-- CONTAINS --			
Part #	Desc.	O.E.#	Qty.
18-0182	Thermostat Gasket	27-62386	2
18-0858	O-Ring	25-4029	1
18-0860	O-Ring	25-62700	1
18-0129	Reed Block Gasket	27-65744-3	6
18-0135	Adapter Cover Gasket	27-78246	1
18-0936	Relief Valve Plate Gasket	27-78690	2
18-0952	Relief Valve Plate Gasket	27-88907	2
18-7421	O-Ring	25-20415	2
18-7411	O-Ring	25-35480	1
18-2501	Reed Block Housing Gasket	27-93536-1	1
18-2502	Divider Plate Gasket	27-90484-1	2
18-2503	Drive Shaft Hsg. to Exhaust Plate Gasket	27-99177-1	1
18-2506	Exhaust Plate Gasket	27-99176-3	1
18-2508	Exhaust Plate Gasket	27-99776-1	2
18-2509	Carb. Mtg. Gasket	27-67751	3
18-2510	Reed Block Housing Gasket	27-96761-1	1
18-2511	Drive Shaft Housing to Plate Gasket	27-99173-2	1
18-2513	Cyl Block Sealing Gasket	27-11338	2
18-2803	Carb. Mounting Gasket	27-90430	3
18-2808	Cyl. Cover	27-96278	2
18-2826	Water Pump Base to Gear Housing Gasket	27-85610-1	1
18-2914	Water Pump Gasket	27-85608-1	1
18-2915	Water Pump Gasket	27-85609-1	1
18-3110	Bushing	26-38970	2
18-7153	O-Ring	25-25439	1
18-7157	O-Ring	25-29976	1
18-7159	O-Ring	25-31534	1
18-7162	O-Ring	25-33145	1
18-7164	O-Ring	25-33466	1
18-7168	O-Ring	25-48171	4
18-7174	O-Ring	25-45711	2
18-7176	O-Ring	25-90011	1
18-7812	Fuel Pump Kit	89031A2	1
18-3863	Head Gasket	27-96542-1	2
18-0359	Induction Silencer Cover Gasket	27-67275-1	1
18-0384	Carburetor Gasket	27-89221-1	3
18-2919	Water Pump Gasket	27-42631-1	1
18-7406	O-Ring	--	1

-- CONTAINS --			
Part #	Desc.	O.E.#	Qty.
18-0912	Drive Shaft Hsg. Plate Gasket	27-66102-1	1
18-0133	Water Jacket Cover Gasket	27-73665	1
18-0944	Water Jacket Cover Gasket	27-85496-1	1
18-0107	Exhaust Cover Gasket	27-85498-1	1
18-7421	O-Ring	25-20415	1
18-3110	Grommet	26-38970	2
18-7411	O-Ring	25-35480	1
18-2500	VC Gasket	27-85493	1
18-2514	Crankcase to Cyl Block Gasket	27-53650	2
18-2802	Carb. Flange Gasket	27-48164-1	2
18-2826	Water Pump Base to Gear Housing Gasket	27-85610	1
18-2835	Powerhead Gasket	27-69238	1
18-2914	Water Pump Gasket	27-85608	1
18-2915	Water Pump Gasket	27-85609-1	1
18-7153	O-Ring	25-25439	1
18-7157	O-Ring	25-29976	1
18-7161	O-Ring	25-32546	1
18-7162	O-Ring	25-33145	1
18-7167	O-Ring	25-47254	2
18-7807	Fuel Pump Kit	55278A1	1
18-0351	Distributor Cap Gasket	27-55896	1
18-7426	O-Ring	25-30271	1
18-4261	Washer	19643	1

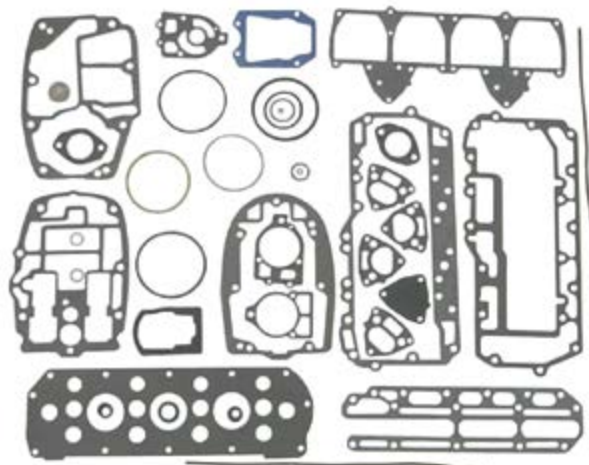

***18-4351**
POWERHEAD GASKET SET
Replaces: 27-64203A75, 27-64203A74, 27-64203A73

GASKET SET APPLICATION BEGINS ON PAGE 439
*POWERHEAD GASKET SETS DO NOT INCLUDE HEAD GASKETS

-- CONTAINS --

Part #	Desc.	O.E.#	Qty.
18-0182	Thermostat Gasket	27-62386	2
18-0858	O-Ring	254029	1
18-0860	O-Ring	25-62700	1
18-0129	Reed Block Gasket	27-65744-3	6
18-0135	Adapter Cover Gasket	27-78246	1
18-0936	Relief Valve Plate Gasket	27-78690	2
18-0952	Relief Valve Plate Gasket	27-88907	2
18-7421	O-Ring	25-20415	2
18-7411	O-Ring	25-35480	1
18-2501	Reed Block Hsg. Gasket	27-93536-1	1
18-2502	Divider Plate Gasket	27-90484-1	2
18-2503	Drive Shaft Hsg. to Exhaust Plate Gasket	27-99177-1	1
18-2506	Exhaust Plate Gasket	27-99176-3	1
18-2508	Exhaust Plate Gasket	27-99776-1	2
18-2509	Carb. Mtg. Gasket	27-67751	3
18-2510	Reed Block Hsg. Gasket	27-96761-1	1
18-2511	Drive Shaft Hsg. to Plate Gasket	27-99173-2	1
18-2513	Cyl Block Sealing Gasket	27-11338	2
18-2803	Carb. Mtg. Gasket	27-90430	3
18-2808	Cyl. Cover	27-96278	2
18-2826	Water Pump Base to Gear Housing Gasket	27-85610-1	1
18-2914	Water Pump Gasket	27-85608-1	1
18-2915	Water Pump Gasket	27-85609-1	1
18-3110	Bushing	26-38970	2
18-7153	O-Ring	25-25439	1
18-7157	O-Ring	25-29976	1
18-7159	O-Ring	25-31534	1
18-7162	O-Ring	25-33145	1
18-7164	O-Ring	25-33466	1
18-7168	O-Ring	25-48171	4
18-7174	O-Ring	25-45711	2
18-7176	O-Ring	25-90011	1
18-7812	Fuel Pump Kit	89031A2	1
18-3862	Head Gasket	27-41246-1	2
18-0359	Induction Silencer Cover Gasket	27-67275-1	1
18-0384	Carburetor Gasket	27-89221-1	3
18-2919	Water Pump Gasket	27-42631-1	1
18-7406	O-Ring	—	1
18-7176	O-Ring	25-90011	1

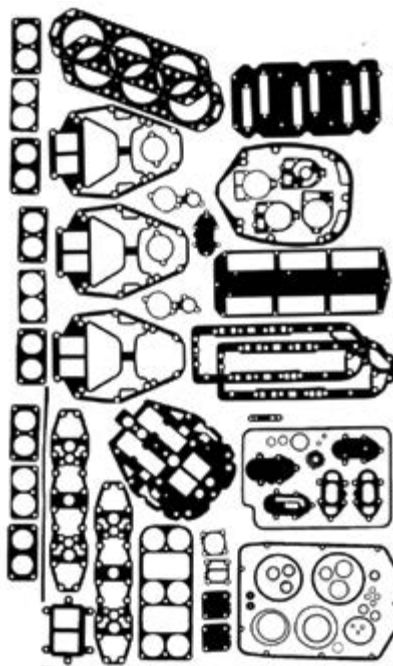

**18-4319
POWERHEAD GASKET SET**

Replaces: 27-11338A88, 27-89221A88, 27-89221A85, 27-89221A84, 27-89221A32, 27-11338A85



***18-4325
POWERHEAD GASKET SET**
Replaces: 27-85491A90, 25-85491A87

-- CONTAINS --

Part #	Desc.	O.E.#	Qty.
18-0940	Baffle Plate to Exhaust Gasket	27-85488-2	1
18-0879	Adapter Plate Gasket	27-38501-1	1
18-2810	Block Cover Gasket	27-43777-2	1
18-0103	Powerhead to Ext. Plate Gasket	27-79650-1	2
18-0137	Baffle Plate Gasket	27-85492-2	1
18-2800	Carb. Flange Gasket	27-75791-1	2
18-0870	Transfer Port Cover Gasket	27-27936-1	2
18-0539	Rubber Seal Gasket	37721	1
18-7161	O-Ring	25-32546	1
18-2844	Thermostat Gasket	27-48818-1	1
18-2823	Lower Water Pump Base to Face Plate Gasket	27-19553	1
18-0938	Water Inlet Tube Gasket	27-79797-1	1
18-2825	Water Pump Base Gasket	27-32771	1
18-7153	O-Ring	25-25439	1
18-7151	O-Ring	25-20081	1

-- CONTAINS --

Part #	Desc.	O.E.#	Qty.
18-0870	Transfer Port Cover Gasket	27-27936-1	2
18-0879	Adapter Plate Gasket	27-30501-1	1
18-0103	Powerhead to Ext. Plate Gasket	27-79650-1	2
18-0938	Water Inlet Tube Gasket	27-79797-1	1
18-0942	Baffle Plate Gasket	27-85491-2	1
18-0137	Baffle Plate Gasket	27-85492-2	1
18-7421	O-Ring	25-20415	1
18-2507	Cyl Block Cover Gasket	27-85487	1
18-2800	Carb. Flange Gasket	27-75791-1	2
18-2810	Block Cover Gasket	27-43777-2	1
18-2823	Lower Water Pump Base to Face Plate Gasket	27-32769, 27-19553	1
18-2824	Upper Face Plate to Pump Body Gasket	27-32770, 27-19551	1
18-2825	Water Pump Base Gasket	27-32771	1
18-2841	Water Pump Base Gasket	27-77417, 27-19552	1
18-7151	O-Ring	25-20081	2
18-7153	O-Ring	25-25439	1
18-7115	O-Ring	25-26722	1
18-7155	O-Ring	25-26855	1
18-7160	O-Ring	25-31986	1
NSS	O-Ring	25-29619	1
18-7413	O-Ring	25-62702	2
18-7804	Fuel Pump Kit	23014A1	1
18-2571-9	Carb Flange Gasket	27-31402	2



***18-4353
POWERHEAD GASKET SET**
Replaces: 27-72486A32, 27-72486A79, 27-72486A78, 27-72486A76, 27-46110A72, 27-46110A2, 27-46110A1

-- CONTAINS --

Part #	Desc.	O.E.#	Qty.
18-0182	Thermostat Gasket	27-62386	1
18-0879	Adapter Plate Gasket	27-38501-1	1
18-0988	Powerhead to Plate Gasket	27-62860-1	1
18-0938	Water Inlet Tube Gasket	27-79797-1	1
18-0940	Baffle Plate to Exhaust Gasket	27-85488-2	1
NSS	Baffle Plate to Block Gasket	27-85489-2	1
18-7421	O-Ring	25-20415	1
18-7411	O-Ring	25-35480	1
18-2802	Carb Flange Gasket	27-48164-1	1
18-2805	Block Cover Gasket	27-85490-2	1
18-2823	Lower Water Pump Base to Face Plate Gasket	27-19553	1
18-2824	Upper Face Plate to Pump Body Gasket	27-19551	1
18-2825	Water Pump Base Gasket	27-32771	1
18-2838	Transfer Port Cover Gasket	27-55279-1	1
18-2841	Water Pump Base Gasket	27-19552	1
18-7115	O-Ring	25-26722	1
18-7143	O-Ring	25-65936	2
18-7145	O-Ring	25-64068	3
18-7153	O-Ring	25-25439	1
18-7155	O-Ring	25-26855	1
18-7160	O-Ring	25-31986	1
18-7167	O-Ring	25-47254	1
18-7413	O-Ring	25-62702	3
NSS	O-Ring	25-64067	1
18-7807	Fuel Pump Kit	55278A1	1
18-4261	Washer	19643	1



***18-4355**
POWERHEAD GASKET SET
 Replaces: 27-78028A78, 27-55306A75, 27-55306A74, 27-55306A73, 27-55306A72

-- CONTAINS --

Part #	Desc.	O.E.#	Qty.
18-7153	O-Ring	25-25439	1
18-7120	O-Ring	25-38933	1
18-3110	Bushing	26-38970	2
18-7164	O-Ring	25-33466	1
18-7167	O-Ring	25-47254	1
18-2802	Carb. Flange Gasket	27-48164-1	3
18-7413	O-Ring	25-62702	2
18-7161	O-Ring	25-32546	2
18-7173-9	O-Ring	25-30224	1
18-3110	Grommet	26-38970	1
18-7421	O-Ring	25-20415	1
18-7162	O-Ring	25-33145	1
18-7157	O-Ring	25-29976	1
18-2914	Water Pump Gasket	27-85608-1	1
18-2915	Water Pump Gasket	27-85609-1	1
NSS	Water Pump Gasket	27-32438	1
18-2826	Water Pump Base to Gear Housing Gasket	27-85610-1	1
18-0912	Drive Shaft Hsg. Gasket	27-66102-1	1
18-2573	Water Jacket Cover Gasket	27-72142-1	1
18-2574	Exhaust Cover Gasket	27-85495-2	1
NSS	Transfer Port Gasket	27-85653-1	1
18-2513	Crankcase to Cyl. Block Gasket	27-53862	2
18-2807	Block Cover Gasket	27-98185	1
18-2835	Powerhead Gasket	27-69238-1	1
18-2839	Exhaust Cover	27-85497-2	1
18-7807	Fuel Pump Kit	55278A1	2
18-7813	Fuel Pump Kit	89031A3	1
18-7426	O-Ring	25-30271	1

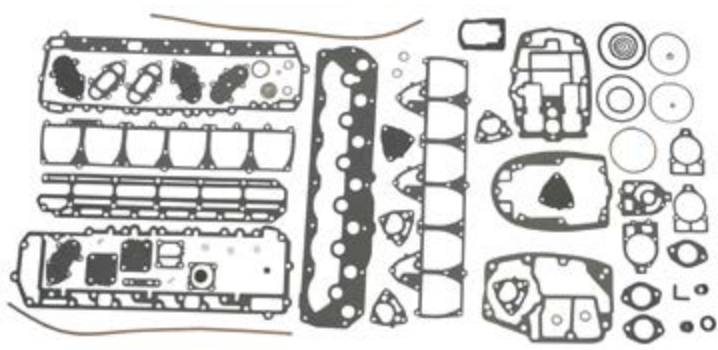

***18-4356**
POWERHEAD GASKET SET
 Replaces: 27-85653A87, 27-85653A79, 27-85653A32, 27-60476A75, 27-60476A74, 27-60476A73, 27-60476A72

GASKET SET APPLICATION BEGINS ON PAGE 439
***POWERHEAD GASKET SETS DO NOT INCLUDE HEAD GASKETS**



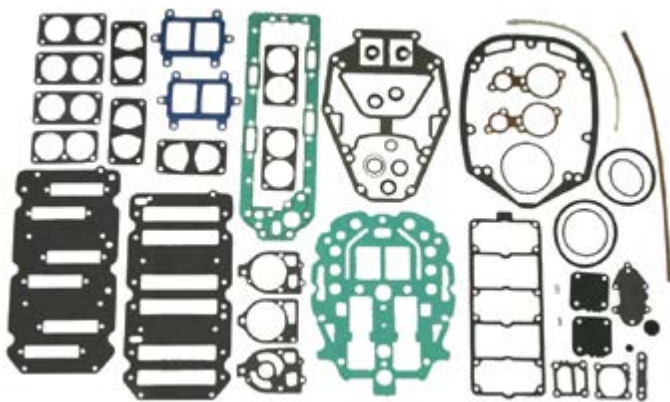

***18-4359**
POWERHEAD GASKET SET
 Replaces: 27-815791A92, 27-815792A90, 27-815810A90, 27-815809A90

— CONTAINS —			
Part #	Desc.	O.E.#	Qty.
18-0135	Gasket, Adapter	27-78246	1
18-0182	Gasket, Thermostat	27-62386	2
18-0384	Gasket, Carburetor	27-89221-1	3
18-0641	Gasket, Carb Mounting	27-828292	3
18-0642	Gasket, Divider Plate	27-19050-3	1
18-0643	Gasket, Exh. Plate	27-18307-1	1
18-0644	Gasket, Reed Plate	27-14697-2	1
18-0645	Gasket, Adapter Plate	27-16737-1	1
NSS	Gasket, Reed Plate	27-813859	1
18-0838	O-Ring	—	1
18-0858	O-Ring	25-54029	1
18-0860	O-Ring	25-62700	1
18-0936	Gasket, Relief Valve	27-78690	2
18-2506	Gasket, Pwr Head	27-99176-3	1
18-2509	Gasket, Carb Mounting	27-67751	3
18-2511	Gasket, Drive Shaft To Hsg Plate	27-99173-2	1
18-2513	Gasket, Crankcase Cvr.	27-11338	2
18-2914	Gasket, Water Pump	27-85608-1	1
18-2915	Gasket, Water Pump	27-85609-1	1
18-2919	Gasket, Water Pump	27-42631-1	1
18-3110	Seal	26-38970	2
18-7153	O-Ring	25-25439	1
18-7157	O-Ring	25-29976	1
18-7159	O-Ring	25-31534	1
18-7174	O-Ring	25-45711	1
18-7176	O-Ring	25-90011	1
18-8305	Seal, Divider Plate	26-814754	1



18-64217
POWERHEAD GASKET SET
 Replaces: 27-815791A00
 Fits: Mercury 150/175 EFI(G960500-T408999)



18-3845
HEAD GASKET
 Replaces: 27-825032
 For: 4-Stroke O/B's, 40/45/50 HP S/N OG760300 & Up

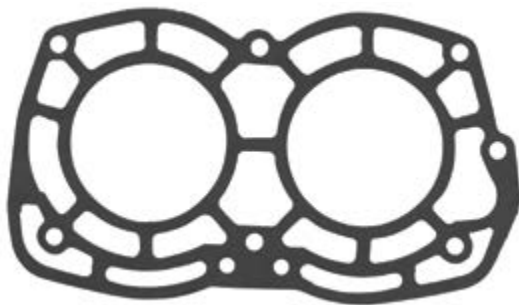

18-2736
HEAD GASKET
 Replaces: 27-863895, 27-863891, 27-863893
 For: 15-25HP 2 cyl



18-3804
HEAD GASKET
 Replaces: 27-19138M, 19138, 27-84733M
 For: Model 30A; S/N Code 689



18-3828
HEAD GASKET
 Replaces: 27-18937M, 27-18937, 27-98990M, 27-83899M
 For: Model 9.9C; S/N Code 682 & Model 15C, S/N Code 684



18-3861
HEAD GASKET
 Replaces: 27-187851, 27-187853, 27-18785T
 For: Model 135, 150 and XR4

GASKET SET APPLICATION BEGINS ON PAGE 439
 *POWERHEAD GASKET SETS DO NOT INCLUDE HEAD GASKETS



18-3862
HEAD GASKET
 Replaces: 27-41246-1
 For: Model 175, 200, XR4



18-3844
HEAD GASKET
 Replaces: 27-803508
 For: 4-Stroke O/B's, 4/5/6 HP S/N OR000001 & Up



18-3871
HEAD GASKET
 Replaces: 27-18786-1
 For: Model 175, XR4, Mag II

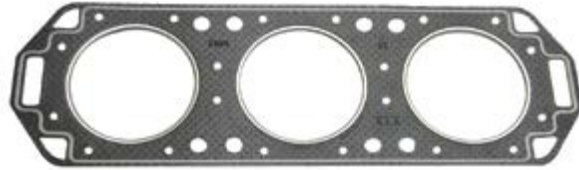

18-3863
HEAD GASKET
 Replaces: 27-96542-1
 For: Model 150



18-3864
HEAD GASKET
 Replaces: 27-822844-1
 For: Model 175, 200 and XR6



18-3872
HEAD GASKET
 Replaces: 27-41245-1
 For: 200 and 225 HP



18-3827
HEAD GASKET
 Replaces: 27-8254821, 27-825482
 For: 8, 9.9 HP 4-Stroke

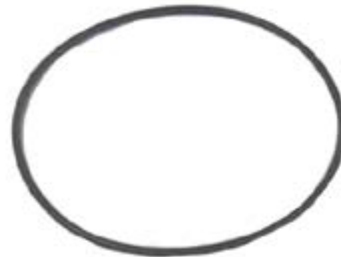

PKG. OF 5
18-7400
18-7400-9^①
O-RING HEAD GASKET
 Replaces: 25-818573
 1 per cylinder, 3 per cylinder head

① Priced per Package

GASKET SET APPLICATION ON NEXT PAGE
***POWERHEAD GASKET SETS DO NOT INCLUDE HEAD GASKETS**



HEAD GASKET/GASKET SET APPLICATION













Model	Cyl.	Beg. S/N	End S/N	Gasket Set	Head O-Rings	Head Gasket	Head Seals
4/5/6 (4 stroke)	1 CYL	R000001	& UP	—	—	18-3844	—
8 FOUR STROKE (232cc)		H000058	H017349	—	—	18-3827	—
8 FOUR STROKE (232cc)		G760300	T178499	—	—	18-3827	—
9.9 FOUR STROKE (232cc)		H000058	H017349	—	—	18-3827	—
18 (18XD)	2	6416713	6443972	—	—	—	—
20 (20,20XD, 200)	2	6443973	OT800999	—	—	—	—
20 JET	2	G044027	& UP	—	—	—	—
30 JET (40 HP)	4 CYL	C159200	& UP	18-4325	—	—	—
35	2 CYL	6445653	B110788	18-4355	—	—	—
40,402	2 CYL	3336258	G053313	18-4355	—	—	—
40	4 CYL	C159200	& UP	18-4325	—	—	—
40 FOUR STROKE (232cc)	3 CYL	G231123	T178499	—	—	18-3845	—
45	4 CYL	5531630	OB110788	18-4353	—	—	—
45	4 CYL	B110789	& UP	18-4325	—	—	—
45 Jet	3 CYL	D000750	& UP	18-4337	—	—	—
45 FOUR STROKE (BODENSEE)		G231123	T178499	—	—	18-3845	—
50,500	4 CYL	2116318	& UP	18-4353	—	—	—
50, 60	4 CYL	6428681	B122929	—	—	—	—
50	3 CYL	D000750	OG589999	18-4337	—	—	—
50	3 CYL	B122930	D000749	18-4326	—	—	—
50 FOUR STROKE		G231123	T178499	—	—	18-3845	—
55	3 CYL	6428681	B122929	—	—	—	—
55	3 CYL	D000750	& UP	18-4337	—	—	—
65 (650)	3 CYL	3293184	4382056	—	—	—	—
65 (650)	3 CYL	4382057	4571651	—	—	—	—
70	3 CYL	4571652	A996141	—	—	—	—
70	3 CYL	A996142	& UP	18-4336	—	—	—
75	4 CYL	6432901	& UP	—	—	—	—
80	3 CYL	A996142	& UP	18-4336	—	—	—
80 Jet	4 CYL	D283222	& UP	—	—	—	—
80,800	4 CYL	2559001	3493912	18-4350	—	—	—
80,800	4 CYL	4831999	6432900	—	—	—	—
85,850	4 CYL	3493913	4366801	18-4351	—	—	—
85,850	4 CYL	4366802	4831998	—	—	—	—
90,900	6 CYL	4845301	& UP	18-4356	—	—	—
90	3 CYL	A996142	& UP	18-4336	—	—	—
100	4 CYL	B209468	& UP	—	—	—	—
105 JET	6 CYL	D082000	& UP	18-4359	—	18-3864	— 1
115	4 CYL	C100000	& UP	—	—	—	—
125	4 CYL	D283222	& UP	—	—	—	—
140 (140, 1400)	6 CYL	3293234	3502805	18-4356	—	—	—
140 (140, 1450)	6 CYL	4865678	& UP	18-4356	—	—	—
140 (140, 1400)	6 CYL	4865678	& UP	18-4356	—	—	—
150 (1500)	6 CYL	3502806	5327622	18-4356	—	—	—
V-135	V-6	A904646	C239552	18-4317	—	18-3863	—
V-135	V-6	C239553	G960499	18-4359	—	18-3861	— 1
V-135 DFI	V-6	G590000	G960499	18-4338	—	—	— 1
140 JET	V-6	D082000	G960499	18-4359	—	18-3864	— 1
V-150 (150, 1500)	V-6	4868998	6042945	18-4315	—	—	—
V-150	V-6	6042946	C239552	18-4317	—	18-3863	—
V-150	V-6	C239553	G960499	18-4359	—	18-3861	— 1
V-150	V-6	G960500	& UP	18-4338	—	—	— 6
V-150 (XR/MAGNUM II)	V-6	B242885	C239552	18-4319	—	—	—
V-150 XR4	V-6	C239553	D081999	18-4359	—	18-3871	— 1
V-150 (XR6/MAGNUM III)	V-6	D082000	G960499	18-4359	—	18-3864	— 1
V-150 (EFI)		D082000	G960499	18-4359	N/A	—	— 1

























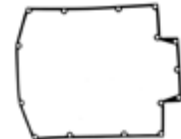



① Gasket set includes head gasket ④ Used on a 2.5L with a 3.5" bore 2 Cyl head o-rings & seal not included in gskt kit
 ② 2 head gaskets required ⑤ Requires 3 per cylinder head 3 Cyl head o-rings not included in gskt kit 6 Cyl head gaskets & seal not included in gskt set
 ③ Used on a 2.4L with a 3.38" bore 1 head gaskets not included in gskt set

HEAD GASKET/GASKET SET APPLICATION

Model	Cyl.	Beg. S/N	End S/N	Gasket Set	Head O-Rings	Head Gasket	Head Seals
150 MAR	V-6	5600162	6038680	18-4315	—	—	—
150 MAR	V-6	6038681	C239553	18-4317 □	—	18-3863□	—
150 MAR	V-6	C239554	& UP	18-4359	—	18-3861□	—
V-175 (175, 1750)	V-6	4301235	6618750	18-4315	—	—	—
V-175	V-6	6618751	C239552	18-4319 □	—	18-3862	—
V-175	V-6	C239553	D081999	18-4359	—	18-3871□	— 1
V-175	V-6	D082000	G960499	18-4359	—	18-3864□	—
V-175 (EFI)	V-6	D000750	D081999	18-4359	—	18-3871□	— 1
V-175 XRI EFI	V-6	D000750	D081999	18-4359	—	18-3864□	—
V-175 (EFI)	V-6	D082000	G303045	18-4359	—	18-3864□	— 1
V-200 (200,2000)	V-6	4839034	6073191	—	—	18-3872□	—
V-200	V-6	6073192	6203990	—	—	18-3872□	—
V-200	V-6	6203991	C291519	18-4319 □	—	18-3862□	—
V-200	V-6	C291520	D081999	18-4359	—	18-3864□	— 1
V-200	V-6	D082000	G960499	18-4359	—	—	— 1
V-200 (EFI)	V-6	C100861	OC291519	18-4339	—	18-3862	—
V-200 (EFI)	V-6	C291520	G960499	18-4359	—	18-3864	— 1
V-200 (DFI) 3.0L	V-6	G386496	G589999	—	18-7400	—	—
V-200 (DFI) 3.0L	V-6	G590000	G960499	18-4335	18-7400	—	— 2
V-200 (DFI) 3.0L	V-6	G960500	T178499	—	18-7400	—	— 3
V-200 XRI EFI	V-6	C100861	C291519	—	—	18-3862□	—
V-200 XRI EFI	V-6	C291520	& UP	18-4359	—	18-3864□	—
V-220	V-6	B117316	& UP	18-4339	—	18-3862□	—
V-225 SEA PRO	V-6	G245605	OT408999	—	18-7400 □	—	—
V-225 (EFI) 3.0L	V-6	G129222	T408999	—	18-7400 □	—	—
V-225 DFI (3.0L)	V-6	G590000	OG960499	18-4335	18-7400 □	—	— 3
V-225 DFI (3.0L)	V-6	G960500	T178499	—	18-7400 □	—	— 3
V-250 (EFI) 3.0L	V-6	G129222	T408999	—	18-7400 □	—	—





















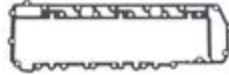





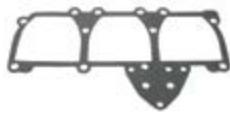

- ① Gasket set includes head gasket
- ② 2 head gaskets required
- ③ Used on a 2.4L with a 3.38" bore
- ④ Used on a 2.5L with a 3.5" bore
- ⑤ Requires 3 per cylinder head
- ⑥ Used on a 2.4L with a 3.38" bore
- ⑦ 1 head gaskets not included in gskt set
- ⑧ Cyl head o-rings & seal not included in gskt kit
- ⑨ Cyl head o-rings not included in gskt kit
- ⑩ Cyl head gaskets & seal not included in gskt set

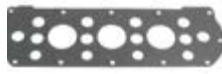
 <p>18-0324 CARB TO MANIFOLD GASKET Replaces: 27-15172 3, 27-151724, 27-15172, 27-93214</p>	 <p>18-0384 CARB GASKET Replaces: 27-892211, 27-817533, 27-89221, 27-8M0027781 200/225 HP</p>	 <p>18-0633 CARB MOUNTING GASKET Replaces: 27-192061, 27-42178, 27-19206, 27-414491, 27-41449</p>	 <p>18-0641 CARB MOUNTING GASKET Replaces: 27-828292</p>
<p>PKG. OF 3</p>  <p>18-2509 CARB MOUNTING GASKET Replaces: 27-67751 V-6</p>	<p>PKG. OF 2</p>  <p>18-2571-9Ⓞ CARB FLANGE GASKET Replaces: 27-31402</p>	<p>PKG. OF 2</p>  <p>18-2572 18-2572-9Ⓞ CARB FLANGE GASKET Replaces: 27-63309, 27-22023</p>	<p>PKG. OF 2</p>  <p>18-2800 18-2800-9Ⓞ CARB MOUNTING GASKET Replaces: 27-757911, 27-75791, 27-69659, 27-26891 20-45-50 HP</p>
<p>PKG. OF 2</p>  <p>18-2802 18-2802-9Ⓞ CARB FLANGE GASKET Replaces: 27-48164, 27-481641</p>	<p>PKG. OF 3</p>  <p>18-2803 18-2803-9Ⓞ CARB MOUNTING GASKET Replaces: 27-90430, 27-904301 V-6</p>	<p>PKG. OF 4</p>  <p>18-2804 18-2804-9Ⓞ CARB MOUNTING GASKET Replaces: 27-733771, 27-73377 3-4 Cyl.</p>	<p>PKG. OF 2</p>  <p>18-2568 18-2568-9Ⓞ STRAINER COVER SCREW GASKET Replaces: 27-25848</p>



























<p>PKG. OF 2</p>  <p>18-2569 18-2569-9^① FILTER COVER GASKET Replaces: 27-25849</p>	<p>PKG. OF 2</p>  <p>18-2570 18-2570-9^① STRAINER COVER GASKET Replaces: 27-25851, 27-34614</p>	<p>PKG. OF 2</p>  <p>18-2575 18-2575-9^① CARB BOWL GASKET Replaces: 1399-99</p>	<p>PKG. OF 2</p>  <p>18-0970 18-0970-9^① FUEL PUMP GASKET Replaces: 27-987691, 27-98769</p>	 <p>18-0740-1 THROTTLE BODY GASKET Replaces: 27-805396</p>												
 <p>18-0359 INDUCTION SILENCER COVER GASKET Replaces: 27-672751, 27-67275</p>	 <p>18-2737 REED BLOCK GASKET Replaces: 27-850283 For: 200 DFI, 225 DFI</p>	 <p>18-0129 REED BLOCK GASKET Replaces: 27-657443, 27-657442, 27-657441, 27-65744 V-6</p>	 <p>18-0320 REED BLOCK GASKET Replaces: 27-13937-6</p>	 <p>18-0644 REED PLATE GASKET Replaces: 27-146972</p>												
<p>PKG. OF 2</p>  <p>18-2501 18-2501-9^① REED BLOCK HOUSING GASKET Replaces: 27-935361, 27-93536, 27-67738 V-6</p>	<p>PKG. OF 2</p>  <p>18-2510 18-2510-9^① REED BLOCK HOUSING GASKET Replaces: 27-967611, 27-96761 V-200</p>	<p>PKG. OF 5</p>  <p style="text-align: center;">CRANKCASE GASKETS</p> <table border="1" style="width: 100%; border-collapse: collapse;"> <thead> <tr> <th style="text-align: left;">Part #</th> <th style="text-align: left;">Replaces:</th> <th style="text-align: left;">Description</th> </tr> </thead> <tbody> <tr> <td>NSS ②</td> <td>27-60286</td> <td>Crankcase to Cyl. Block 3 Cyl.</td> </tr> <tr> <td>18-2513 ②</td> <td>27-11338, 27-67208</td> <td>Cyl. Block Sealing V-6</td> </tr> <tr> <td>18-2514 ②</td> <td>27-53650</td> <td>Crankcase to Cyl. Block 4 Cyl.</td> </tr> </tbody> </table>			Part #	Replaces:	Description	NSS ②	27-60286	Crankcase to Cyl. Block 3 Cyl.	18-2513 ②	27-11338, 27-67208	Cyl. Block Sealing V-6	18-2514 ②	27-53650	Crankcase to Cyl. Block 4 Cyl.
Part #	Replaces:	Description														
NSS ②	27-60286	Crankcase to Cyl. Block 3 Cyl.														
18-2513 ②	27-11338, 27-67208	Cyl. Block Sealing V-6														
18-2514 ②	27-53650	Crankcase to Cyl. Block 4 Cyl.														
 <p>18-0645 ADAPTER PLATE GASKET Replaces: 27-167371</p>	 <p>18-0624 ATTENUATOR GASKET Replaces: 27-188891</p>	 <p>18-0107 EXHAUST COVER GASKET Replaces: 27-85498-1, 27-85498, 27-64203, 27-72510 4 Cyl.</p>	 <p>18-0131 BAFFLE GASKET Replaces: 27-695252, 27-695251, 27-69525, 27-64857 3 Cyl.</p>	 <p>18-0133 WATER JACKET GASKET Replaces: 27-73665, 27-52892 4 Cyl.</p>												
 <p>18-0137 BAFFLE GASKET Replaces: 27-85492-2 50 HP</p>	 <p>18-0371 BAFFLE GASKET Replaces: 27-78409, 27-39316, 27-72915 20 HP</p>	 <p>18-0373 BAFFLE GASKET Replaces: 27-78411, 27-45088, 27-72917 20 HP</p>	 <p>18-0918 PLATE TO EXHAUST MANIFOLD GASKET Replaces: 27-695242, 27-695241, 27-69524 3 Cyl.</p>	 <p>18-2712 ADAPTER PLATE GASKET Replaces: 27-414181, 27-41418, 27-85979 For: 15-25 2 cyl</p>												
 <p>18-2621 BAFFLE GASKET Replaces: 27-139581 For: 100HP 4 cyl, 115HP 4 cyl</p>	 <p>18-2710 REED BLOCK GASKET Replaces: 27-414172, 27-414171, 27-41417, 27-85978 For: 15-25HP 2 cyl</p>	 <p>18-0380 THERMOSTAT GASKET Replaces: 27-83940M</p>	 <p>18-2721 THERMOSTAT GASKET Replaces: 27-827284 For: 30-60HP 3 cyl outboards</p>	 <p>18-2729 THERMOSTAT GASKET Replaces: 27-8128672 For: 30-40HP 2 cyl, 45 Jet, 50-60 3 cyl</p>												

① Priced per Package



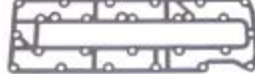

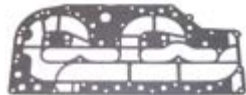





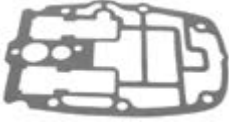



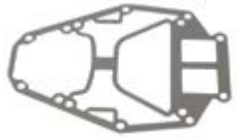

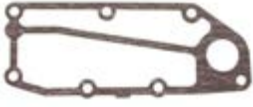

② This product is priced per piece. To order priced per package, please add -9 to the part number

 <p>18-2749 THERMOSTAT GASKET Replaces: 27-8128671, 27-812867 For: 45 Jet, 50-60 HP 3 cyl</p>	 <p>18-3675 THERMOSTAT GASKET Replaces: 27-850318, 27-8503181 For: 200-250HP 3.0L, (DFI and EFI)</p>	<p>PKG. OF 2</p>  <p>18-0922 18-0922-9① BAFFLE GASKET Replaces: 27-703351, 27-70335 3 Cyl.</p>	 <p>18-0940 BAFFLE GASKET Replaces: 27-854882, 27-854881, 27-85488, 27-78027, 27-55308</p>	 <p>18-0942 BAFFLE GASKET Replaces: 27-85491-2, 27-854913, 27-854911, 27-85491, 27-72486, 27-46110 45/50 HP</p>
 <p>18-0944 BAFFLE GASKET Replaces: 27-854961, 27-85496, 27-64204, 27-72508</p>	 <p>18-0232 COVER GASKET Replaces: 27-81031M</p>	<p>PKG. OF 2</p>  <p>18-2573 WATER JACKET GASKET Replaces: 27-721421, 27-72142, 27-60475 6 Cyl.</p>	<p>PKG. OF 2</p>  <p>18-2574 18-2574-9① EXHAUST COVER GASKET Replaces: 27-854952, 27-854951, 27-85495, 27-72507, 27-60476 6 Cyl.</p>	<p>PKG. OF 2</p>  <p>18-2836 BAFFLE GASKET Replaces: 27-78035, 27-72919, 27-46233, 27-31439 7.5-10 HP</p>
<p>PKG. OF 2</p>  <p>18-2839 18-2839-9① EXHAUST COVER GASKET Replaces: 27-854972, 27-854971, 27-85497, 27-72509, 27-60477</p>	 <p>18-0151 DIVIDER PLATE GASKET Replaces: 27-76636, 27-75952 V-6</p>	 <p>18-0642 DIVIDER PLATE GASKET Replaces: 27-190503, 27-19050, 27-190502, 27-190505</p>	<p>PKG. OF 2</p>  <p>18-2502 18-2502-9① DIVIDER PLATE GASKET Replaces: 27-904841, 27-90484, 27-87396 V-6</p>	 <p>18-0870 TRANSFER PORT COVER GASKET Replaces: 27-279361, 27-27936</p>
 <p>18-0926 TRANSFER PORT COVER GASKET Replaces: 27-73645</p>	 <p>18-0932 TRANSFER PASSAGE COVER GASKET Replaces: 27-768621, 27-76862 3 Cyl.</p>	<p>PKG. OF 3</p>  <p>18-2838 18-2838-9① TRANSFER PORT COVER GASKET Replaces: 27-552791, 27-55279</p>	 <p>18-0372 CYLINDER BLOCK GASKET Replaces: 27-78410, 27-52579, 27-72916 20 HP</p>	 <p>18-2740 CYLINDER BLOCK GASKET Replaces: 27-430057, 27-430056, 27-430055, 27-430053, 27-430052, 27-430051 For: 65 Jet, 75HP 3 cyl, 90HP 3 cyl</p>
 <p>18-2943 CYLINDER BLOCK GASKET Replaces: 27-443281, 27-443282, 27-443283, 27-443284 For: 80 Jet, 100HP, 115HP, and 125HP 4 cyl outboards</p>	<p>PKG. OF 2</p>  <p>18-2500 18-2500-9① EXHAUST COVER GASKET Replaces: 27-85493, 27-72505, 27-52893 80 HP</p>	<p>PKG. OF 2</p>  <p>18-2505 18-2505-9① CYLINDER BLOCK GASKET Replaces: 27-961711, 27-96171 75-80 HP</p>	<p>PKG. OF 2</p>  <p>18-2507 18-2507-9① CYLINDER BLOCK GASKET Replaces: 27-85487, 27-78026, 27-72487, 27-37816 40-50 HP</p>	<p>PKG. OF 2</p>  <p>18-2805 18-2805-9① BLOCK COVER GASKET Replaces: 27-85490-2 35-40 HP</p>
<p>PKG. OF 2</p>  <p>18-2504 18-2504-9① BLOCK COVER GASKET Replaces: 27-88449, 27-76401, 27-74511, 27-60310 3 Cyl.</p>	<p>PKG. OF 2</p>  <p>18-2806 18-2806-9① CYLINDER COVER GASKET Replaces: 27-65788 V-6</p>	<p>PKG. OF 2</p>  <p>18-2807 18-2807-9① BLOCK COVER GASKET Replaces: 27-981853, 27-9818512, 27-981851, 27-98185, 27-85494, 27-72506, 27-64940, 27-53863 90-115 HP</p>	<p>PKG. OF 2</p>  <p>18-2808 18-2808-9① CYLINDER COVER GASKET Replaces: 27-96278 V-6</p>	











① Priced per Package





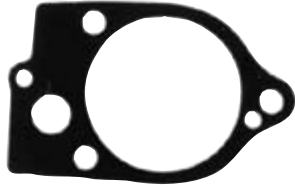













 <p>18-60917 CYLINDER COVER GASKET Replaces: 27-803508017 Fits: Mercury 8/9.9 (R042475 & Up)</p>	<p>PKG. OF 2</p>  <p>18-2810 18-2810-9① BLOCK COVER GASKET Replaces: 27-437772, 27-437771, 27-43777, 27-96483 45-50 HP</p>	<p>PKG. OF 2</p>  <p>18-2837 18-2837-9① BLOCK COVER GASKET Replaces: 27-41382, 27-78087, 27-72918, 27-66358, 27-31436</p>	 <p>18-0333 POWERHEAD BASE GASKET Replaces: 27-39401</p>	 <p>18-0334 MOUNTING PLATE TO DRIVESHAFT HOUSING GASKET Replaces: 27-39402</p>
 <p>18-0336 ADAPTER PLATE GASKET Replaces: 27-41670-3, 27-41670-5 18 HP</p>	 <p>18-0649 SHIFT ROD HOUSING GASKET Replaces: 27-858935 For: 200 HP T801000 & UP, 200 HP OPTIMAX DFI G438000 & UP, 225 HP EFI G438000 & UP, 225 HP OPTIMAX DFI G590000-G960499, 250 HP EFI G438000 & UP, (MODELS WITH "C-3 CASTING": 200 HP OPTIMAX DFI G386496-G437999, 225 HP D280813-G437999, 225 HP EFI G129222-G437999, 250 HP EFI G129222-G437999)</p>	 <p>18-0341 EXHAUST PLATE GASKET Replaces: 27-430086, 27-43008, 27-430082, 27-430083, 27-430085 For: 70-90, 100, 115 & 125 HP</p>	 <p>18-0791 SHIFT SHAFT COVER GASKET Replaces: 27-880729 For: All Verado's 135/150/175/200 225/250/275</p>	
 <p>18-0369 POWERHEAD BASE GASKET Replaces: 27-75909 V-6</p>	 <p>18-0378 POWERHEAD BASE GASKET Replaces: 27-823142, 27-823142 2</p>	 <p>18-0670 POWERHEAD BASE GASKET Replaces: 27-430075, 27-430073, 27-43007</p>	 <p>18-0385 POWERHEAD BASE GASKET Replaces: 27-89937, 27-31557, 27-30803, 27-45748 4.5-9.8 HP</p>	 <p>18-0643 POWERHEAD BASE GASKET Replaces: 27-18307-1, 27-183076</p>
 <p>18-0879 ADAPTER PLATE GASKET Replaces: 27-385011, 27-38501, 27-37724</p>	 <p>18-0135 ADAPTER COVER GASKET Replaces: 27-78246, 27-78246 1</p>	 <p>18-0103 POWERHEAD BASE GASKET Replaces: 27-796501, 27-79650, 27-37725, 27-72496</p>	 <p>18-0139 POWERHEAD BASE GASKET Replaces: 27-884511, 27-88451, 27-78623, 27-76589</p>	 <p>18-2735 DIVIDER PLATE GASKET Replaces: 27-190506 For: 140 Jet, 115-200HP (2.5L), XR-6</p>
 <p>18-2713 DRIVESHAFT HOUSING GASKET Replaces: 27-433374, 27-43337, 27-43337A1, 27-433371, 27-433372, 27-433373, 27-96286 For: 15-25 2 cyl</p>	 <p>18-2714 EXHAUST COVER GASKET Replaces: 27-414995, 27-414994, 27-414993, 27-414992, 27-892157 For: 15-25 HP, 2 Cyl.</p>	 <p>18-2716 EXHAUST COVER GASKET Replaces: 27-414991, 27-41499, 27-92332 For: 18XD, 20XD (2 cyl), 25XD</p>	 <p>18-2741 EXHAUST COVER PLATE GASKET Replaces: 27-430047, 27-430045, 27-430043, 27-430042, 27-430041, 27-43004009 For: 65 Jet, 75HP 3 cyl, 90HP 3 cyl</p>	
 <p>18-2717 EXHAUST MANIFOLD GASKET Replaces: 27-414758, 27-414757, 27-414756, 27-414755, 27-414754, 27-414753, 27-414752, 27-414751, 27-41475, 27-92331, 27-892158 For: 15-25HP 2 cyl</p>	 <p>18-0319 POWERHEAD BASE GASKET Replaces: 27-828553 For: 30-60HP 2 cyl and 3 cyl</p>	 <p>18-2610 OUTER EXHAUST PLATE GASKET Replaces: 27-8127754, 27-812755 For: 80 Jet, 100HP, 115HP, and 125HP 4 cyl outboards</p>	 <p>18-2739 EXHAUST PLATE GASKET Replaces: 27-8329335, 27-8329334, 27-8329333, 27-8329332, 27-8329331, 27-832933006 For: 250XS (3.0L) DFI</p>	 <p>18-2611 INNER EXHAUST PLATE GASKET Replaces: 27-8127551, 27-8127755, 27-812755A01 For: 80 Jet, 100HP, 115HP, and 125HP 4 cyl outboards</p>

① Priced per Package

 <p>18-0912 DRIVE SHAFT HOUSING PLATE GASKET Replaces: 27-661021, 27-66102, 27-60945</p>	 <p>18-0934-1 POWERHEAD BASE GASKET Replaces: 27-78069</p>	 <p>18-0988 POWERHEAD BASE GASKET Replaces: 27-628601, 27-62860, 27-37976</p>	 <p>PKG. OF 2 18-2503 18-2503-9① DRIVE SHAFT HOUSING TO EXHAUST PLATE GASKET Replaces: 27-991771, 27-991772, 27-99177, 27-78068 V-6</p>	 <p>PKG. OF 2 18-2506-1 18-2506-1-9① EXHAUST PLATE GASKET Replaces: 27-991763, 27-991764, 27-991762, 27-99176 V-175/V-200</p>
 <p>PKG. OF 2 18-2508-1 18-2508-1-9① EXHAUST PLATE GASKET Replaces: 27-997761, 27-99776, 27-96440 V-135/V-150</p>	 <p>PKG. OF 2 18-2809 18-2809-9① BLOCK COVER GASKET Replaces: 27-437792, 27-437791, 27-43779, 27-96485 50-60-HP</p>	 <p>PKG. OF 2 18-2511 18-2511-9① DRIVE SHAFT HOUSING TO EXHAUST PLATE GASKET Replaces: 27-99173-2 V-6</p>	 <p>PKG. OF 2 18-60919 EXHAUST COVER GASKET Replaces: 27-834952001 Fits: Mercury 8/9.9 (R042475 & Up)</p>	 <p>PKG. OF 2 18-2835 18-2835-9① POWERHEAD BASE GASKET Replaces: 27-692381, 27-69238, 27-66101, 27-64173, 27-60479 75-90-115-140 Hp</p>
 <p>18-0982-1 POWERHEAD GASKET Replaces: 27-56304, 27-48713</p>	 <p>18-60918 ENGINE BASE GASKET Replaces: 27-835427003 Fits: Mercury 8/9.9 (R042475 & Up)</p>	 <p>PKG. OF 2 18-0182 18-0182-9① THERMOSTAT GASKET Replaces: 27-62386</p>	 <p>18-0323 THERMOSTAT GASKET Replaces: 27-14318-2, 27-14318 3</p>	 <p>18-0339 THERMOSTAT GASKET Replaces: 27-43006-2, 27-430066 70-90 HP</p>
 <p>18-0835 THERMOSTAT GASKET Replaces: 27-824853, 27-8248531 Fits: Mercury 9.9-60 H.P., 4-Stroke</p>	 <p>18-0292 WEAR PLATE TO PUMP HOUSING GASKET Replaces: 27-81417M</p>	 <p>18-60920 THERMOSTAT GASKET Replaces: 27-853702005 Fits: Mercury 8/9.9 (R042475 & Up)</p>	 <p>PKG. OF 2 18-0936 18-0936-9① RELIEF VALVE PLATE GASKET Replaces: 27-78690 V-6</p>	 <p>PKG. OF 2 18-0952 18-0952-9① RELIEF VALVE PLATE GASKET Replaces: 27-88907 V-6</p>
 <p>PKG. OF 2 18-2558 18-2558-9① IMPELLER GASKET Replaces: 27-19204-2 6/8/9/15</p>	 <p>PKG. OF 2 18-0294 18-0294-9① WEAR PLATE TO PUMP BASE GASKET Replaces: 27-81421M</p>	 <p>PKG. OF 2 18-2559 18-2559-9① IMPELLER GASKET Replaces: 27-42206, 27-19202 6/8/9/15</p>	 <p>PKG. OF 2 18-2561-9① IMPELLER GASKET Replaces: 27-85087 18/25 S/N 6443972 & Below</p>	

① Priced per Package

<p>PKG. OF 2</p>  <p>18-2564-1 IMPELLER GASKET 70/75/80/90/100/115 Replaces: 27-430331, 27-43033</p>	<p>PKG. OF 2</p>  <p>18-2565 18-2565-9① IMPELLER GASKET 70/75/80/90/100/115 Replaces: 27-430472, 27-430471, 27-43047</p>	<p>PKG. OF 2</p>  <p>18-2566 18-2566-9① IMPELLER GASKET 75/90/100/115 Replaces: 27-817277, 27-8172771</p>	<p>PKG. OF 2</p>  <p>18-2562 18-2562-9① IMPELLER GASKET 18/20/25 S/N 6443973 & Above Replaces: 27-993261, 27-99326</p>
<p>PKG. OF 2</p>  <p>18-2563 18-2563-9① IMPELLER GASKET 70/75/80/90/100/115 Replaces: 27-430341, 27-43034</p>	<p>PKG. OF 2</p>  <p>18-2801-9① WATER PUMP GASKET Replaces: 27-32438 4-6 Cyl.</p>	<p>PKG. OF 2</p>  <p>18-2823 18-2823-9① LOWER, WATER PUMP GASKET Replaces: 27-32769, 27-19553 40-50-70 HP</p>	<p>PKG. OF 2</p>  <p>18-2824 18-2824-9① UPPER, WATER PUMP GASKET Replaces: 27-32770, 27-19551</p>
<p>PKG. OF 2</p>  <p>18-2825 18-2825-9① WATER PUMP BASE GASKET Replaces: 27-32771 40-50-70</p>	<p>PKG. OF 2</p>  <p>18-2826 18-2826-9① WATER PUMP BASE GASKET Replaces: 27-85610 1, 27-85670 4</p>	<p>PKG. OF 2</p>  <p>18-2827 18-2827-9① UPPER FACE PLATE GASKET Replaces: 27-39623 20 HP</p>	<p>PKG. OF 2</p>  <p>18-2828 18-2828-9① LOWER WATER PUMP GASKET Replaces: 27-39625 20 HP</p>
<p>18-0622 LOWER WEAR PLATE GASKET Replaces: 27-19701</p> 	<p>18-2593 WATER PUMP GASKET Replaces: 27-194541 For: 45 Jet, 50HP, 55HP, 60HP 3 cyl outboards</p> 	<p>18-0345 WATER PUMP GASKET Replaces: 27-822189 For: 25-60HP outboards, 2, 3 cyl. & 4 stroke models</p> 	<p>PKG. OF 2</p> <p>18-2841 18-2841-9① WATER PUMP BASE GASKET Replaces: 27-77417, 27-19552</p> 

<p>PKG. OF 2</p>  <p>18-2914 18-2914-9① WATER PUMP GASKET Replaces: 27-856081, 27-85608, 27-32433, 27-30603, 27-8M0090319</p>	<p>PKG. OF 2</p>  <p>18-2915 18-2915-9① WATER PUMP GASKET Replaces: 27-856091, 27-858524, 27-85609, 27-32434, 27-30604</p>	<p>PKG. OF 2</p>  <p>18-2919 18-2919-9① WATER PUMP GASKET Replaces: 27-426311, 27-42631</p>
 <p>18-0521 WATER TUBE RUBBER SEAL Replaces: 26-36557</p>	 <p>18-0563 WATER TUBE RUBBER SEAL Replaces: 26-36556</p>	 <p>18-0539 EXHAUST LEG RUBBER SEAL Replaces: 37721</p>
 <p>18-2728 WATER TUBE SEAL Replaces: 26-42102, 26-421021</p>	<p>PKG. OF 2</p>  <p>18-2560 18-2560-9① IMPELLER GASKET Replaces: 12-86645, 12-866451, 8M0027721 18/20/25</p>	<p>PKG. OF 5</p>  <p>18-2430 18-2430-9① 18-24301-9① (PKG. OF 50) DRAIN SCREW GASKET Replaces: 26-830749 For: All Verado</p>
<p>PKG. OF 2</p>  <p>18-2945 18-2945-9① DRAIN SCREW GASKET Replaces: 12-20260, 12-19183, 12-191832, 191833, F50556, F8077, F8186 Used in most lower units and sea water pumps</p>	<p>PKG. OF 2</p>  <p>18-2948 18-2948-9① RUBBER WASHER Replaces: 12-492211, 12-49221, 12-23245 For plastic flush screw and fuel tank vent</p>	 <p>18-4261 WASHER Replaces: 19643</p>
 <p>18-8305 DIVIDER PLATE SEAL Replaces: 26-814754, 428381, 42838, 69668, 88726</p>	 <p>18-4698 18-46981-9① (PKG. OF 50) DRAIN FILL WASHER Replaces: 27-81987, 27-81987M</p>	 <p>18-4275 WASHER Replaces: 12-29245, 12-824793, 12-38753, 12-32733, 12-25945, 12-22388</p>
<p>PKG. OF 2</p>  <p>18-4858-9① WASHER Replaces: 12-45176 Fits: Mercury Outboard 25 H.P. and Up, Mercruiser #1, R, MR, Alpha I Gen II and Bravo Drive Units</p>	 <p>18-8309 WATER COOLED REGULATOR SEAL Replaces: 18717</p>	 <p>18-2731 GROMMET Replaces: 26-81607M For: 28 HP</p>

① Priced per Package

35 & 40 2 Cylinder

Serial # 2736807-G053313

50, 60, 65 3 Cylinder

Serial # 3293184-D000749

70 3 Cylinder

Serial # 4571652-6428680

40, 45, 50 4 Cylinder

Serial # 4357640 & later

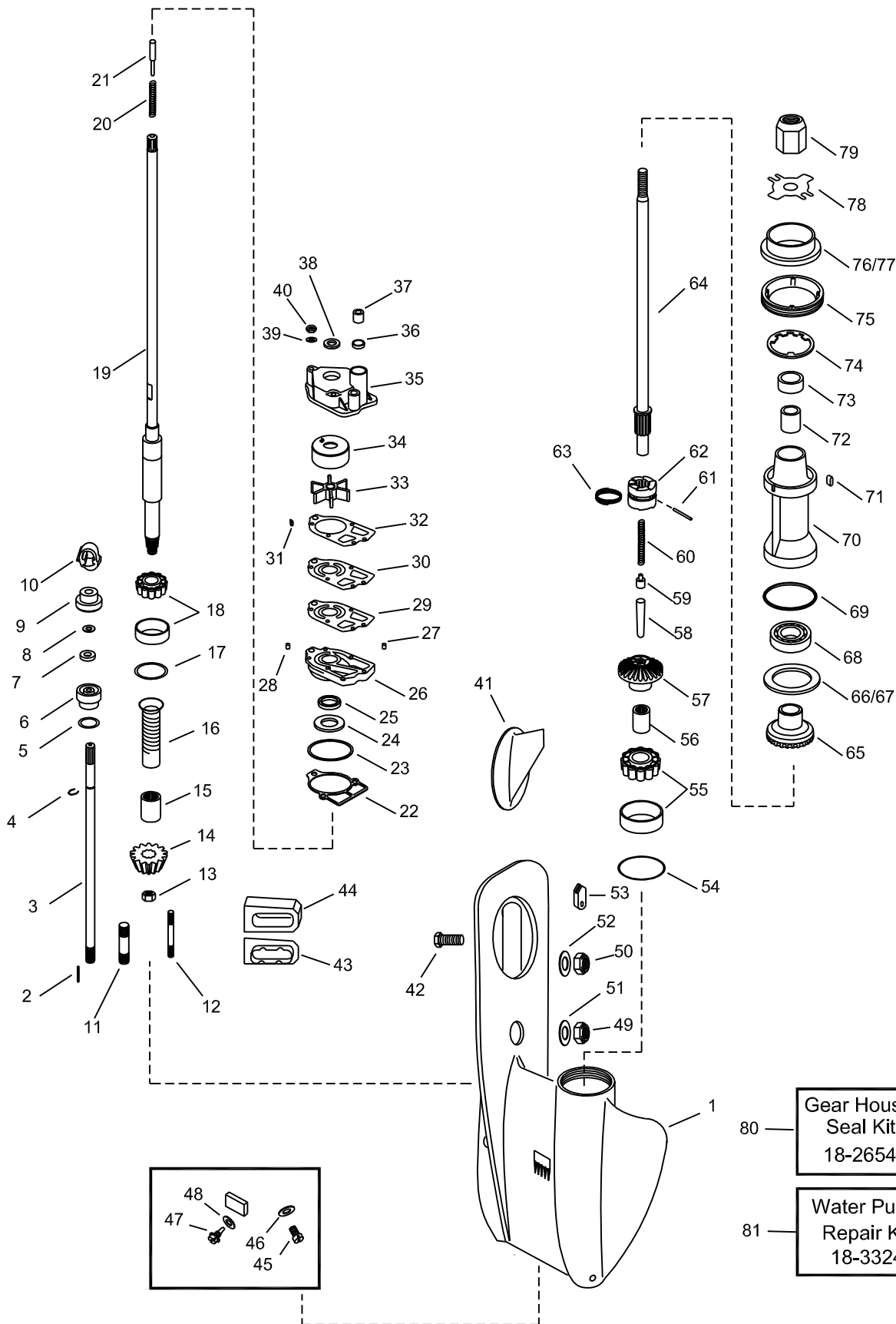

Figure #	Description	Part #	O.E.M. #	Qty.	Figure #	Description	Part #	O.E.M. #	Qty.
1	Gear Housing	—	1643-9539A1	1	48	Flush Plug Washer	18-2948	12-492211	1
2	Dowel Pin	—	17-85500	2	49	Nut	—	11-34933	1
3	Shift Shaft	—	76163A1	1	50	Nut	—	1134863	1
4	E-Clip	18-4295	53-29641	1	51	Washer	—	12-65791	1
5	O-Ring	18-7153	25-25439	1	52	Washer	—	12-45175	1
6	Shift Shaft Bushing	18-2155	23-77631A2	1	53	Shift Cam	—	76039	1
7	Seal	18-2054	26-816461	1	54	Shim Set	—	15-38374A1	AR
8	Washer	18-2316	12-77674	1	55	Tapered Roller Bearing	18-1162	31-38356A1	1
9	Reverse Lock Base	—	78036	1	56	Roller Bearing	18-1096	31-21739	1
10	Reverse Lock Cam	—	433081	1	57	Forward Gear	—	43-55608A4	1
11	Stud	—	16-33778	3	58	Cam Follower	—	38441	1
12	Stud	—	16-57933	2	59	Slide	—	20843	1
13	Pinion Nut	—	11-55910	1	60	Spring	—	24-38114	1
14	Pinion Gear	—	43-98097	1	61	Cross Pin	—	17-38113	1
15	Roller Bearing	—	31-62091	1	62	Clutch	—	52-92911	1
16	Sleeve	—	88181	1	63	Spring	—	24-39845	1
17	Shim Set	—	15-92881A1	AR	64	Prop Shaft	—	44-75365	1
18	Tapered Bearing	—	31-77420A1	1	65	Reverse Gear	—	43-79158	1
19	Drive Shaft	—	45-981801	1	66	Thrust Washer	—	12-32004	1
20	Spring	—	24-20254	1	67	Shim Set	—	15-20927A1	AR
21	Pin	—	17-30545	1	68	Ball Bearing	18-1190	30-20839T	1
22	Gasket	18-2841	27-19552	1	69	O-Ring	18-7160	2531986	1
23	O-Ring	18-7115	25-26722	1	70	Bearing Carrier	—	69386A1	1
24	Seal	18-2055	26-79831	1	71	Key	—	28-30281	1
25	Seal	18-2011	26-90562	1	72	Roller Bearing	—	3121700	1
26	Water Pump Base	18-3424	46-77177A1	1	73	Seal	18-2051,	26-69188,	1
27 & 28	Pin, Dowel	—	17-35973	1			18-2052	26-619189	
29	Gasket	18-2823	27-19553	1	74	Tab Washer	—	14-53012	1
30	Face Plate	18-3107	54705	1	75	Cover Nut	—	11-87763	1
31	Key	—	28-56662	1	76	Thrust Hub	18-4233	73345A1	1
32	Gasket	18-2824	27-19551	1	77	Thrust Hub	18-3204	14-76281	1
33	Impeller	18-3007	47-89983	1	78	Tab Washer	18-3204	14-76281	1
34	Insert	18-3115	48753	1	79	Nut	18-3702	11-69578A	1
35	Water Pump body	18-3118	46-77822A1	1	80	Gear Housing Seal Kit	18-2654	26-79831A1	1
36	Nylon Washer	—	12-38453	1	81	Water Pump Repair Kit	18-3324	46-77177A3	1
37	Seal	—	26-38452	1					
38	Slinger	—	25-20273	1					
39	Washer	18-4275	12-29245	3					
40	Nut	—	11-13438	3					
41	Trim Tab	18-6011	31640A1	1					
42	Screw	—	10-66024	1					
43	Support Plate	—	92815	1					
44	Exhaust Tube Seal	18-0539	37721	1					
45	Drain Screw	18-2244	10-79953	2					
46	Drain Screw Gasket	18-2945	12-19183	2					
47	Flush Plug	—	19-48750	1					

AR As required

70, 75, 80, 90

Serial # A996142 & later

100, 115, 125 4 Cylinder

Serial # B209468 & later

68 — Gear Housing Seal Kit
18-2626

69 — Water Pump Repair Kit
18-3214

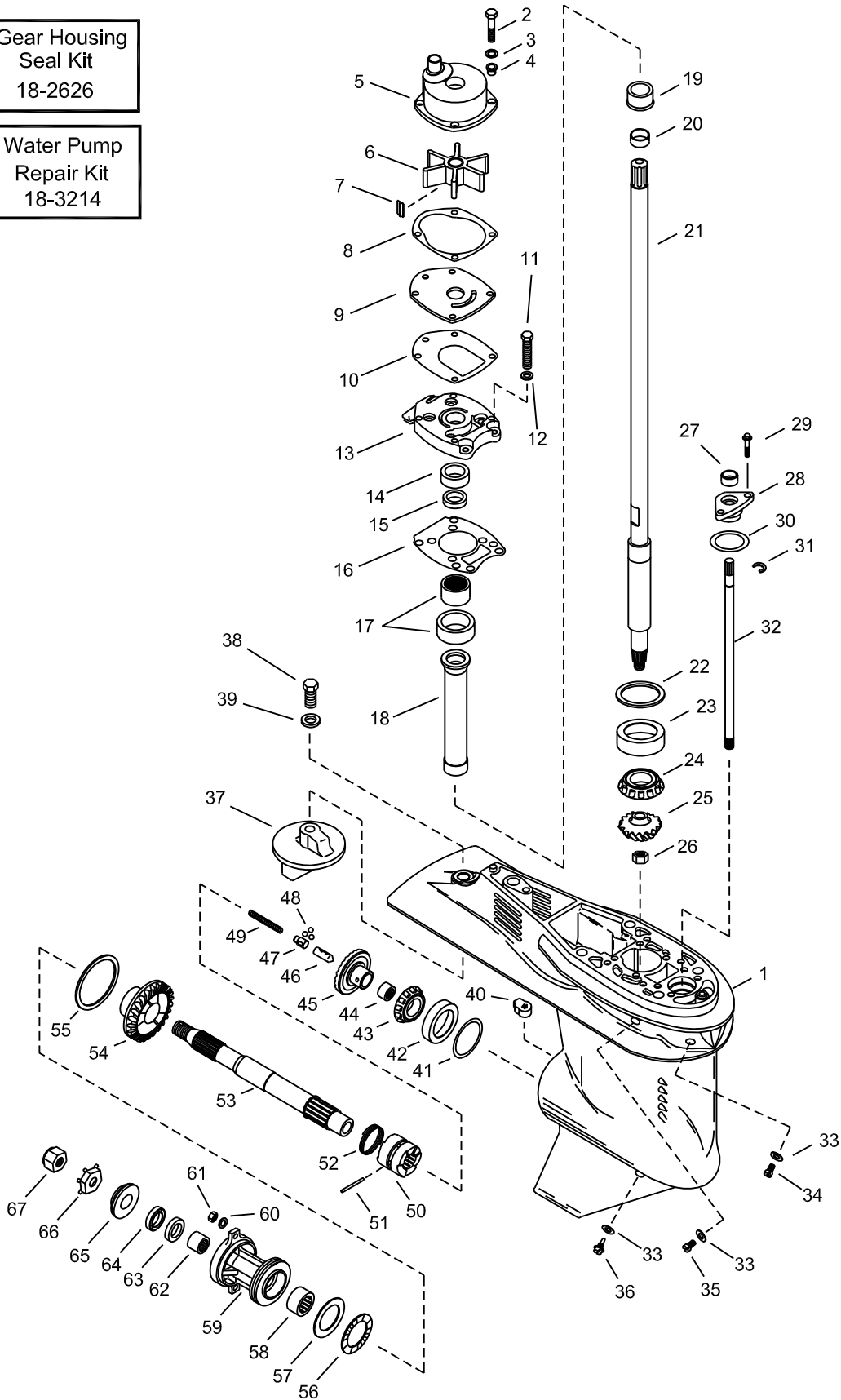

OUTBOARD - MERCURY/MARINER - GEARCASE ASSEMBLY

Figure #	Description	Part #	O.E.M. #	Qty.	Figure #	Description	Part #	O.E.M. #	Qty.
1	Gear Housing	—	1667-9011A73	1	49	Spring	—	24-30622	1
2	Screw	—	10-8248327	4	50	Clutch	18-2236	52-822539	1
3	Washer	18-4275	12-29245	4	51	Cross Pin	18-2357	17-30632	1
4	Insulator	18-0568	23-43045	4	52	Spring	18-2348	24-30893	1
5	Water Pump Housing	18-3572	817275A2	1	53	Prop Shaft	—	44-12238T	1
6	Impeller	18-3056	47-430262	1	54	Reverse Gear	—	43-12635	1
7	Impeller Key	18-3293	28-43037	1	55	O-Ring	18-7961	25-97386	1
8	Gasket	18-2566	27-817277	1	56	Thrust Bearing	18-1112	31-12576	1
9	Face Plate	18-3122	817276	1	57	Thrust Washer	—	12-12577	1
10	Gasket	18-2564-1	27-430331	1	58	Roller Bearing	18-1113	31-12578	1
11	Screw	—	10-824832-6	6	59	Bearing Carrier	—	12596A2	1
12	Washer	18-4275	12-29245	6	60	Washer	—	12-70132	2
13	Pump Base	—	43055A4	1	61	Nut	—	11-401198	2
14	Seal	18-0583	26-43035	1	62	Roller Bearing	18-1158	31-30956	1
15	Seal	18-0522	26-43036	1	63	Seal	18-2002	26-76868	1
16	Gasket	18-2565	27-430472	1	64	Seal	18-2053	26-70081	1
17	Carrier w/Bearing	—	43040A1	1	65	Thrust Washer	18-4221	13191A1	1
18	Tube, Oiler	—	43046	1	66	Tab Washer	18-3200	14-31210	1
19	Sleeve	—	42461A1	1	67	Prop Nut	18-3700	11-52707	1
20	Ring	—	42461A1	1					
21	Drive Shaft	—	45-43031A1	1					
22	Shim Assembly	—	15-44492A1	AR					
23	Race (sold with #24)	18-1118	31-42677A1	1					
24	Bearing (sold with #23)	18-1118	31-42677A1	1					
25	Pinion Gear	—	43-44484	1					
26	Pinion Nut	18-3719	11-35921	1					
27	Seal	18-2054	26-8164641	1					
28	Bushing Assembly	—	23-43052A4	1					
29	Screw	—	10-824832-6	2					
30	O-Ring	18-7198	25-45710	1					
31	E-Ring	18-4295	53-29641	1					
32	Shift Shaft	—	43048A1	1					
33	Drain Screw Gasket	18-2945	12-19183	3					
34	Plug	—	10-28653	1					
35	Drain Screw	18-2244	10-79953	1					
36	Plug	18-2375	22-67892A1	1					
37	Trim Tab	18-6011	31640A1	1					
38	Bolt, Anode Mounting	18-6245	10-15942	1					
39	Washer, Anode Mounting	18-4858-9	12-45176	1					
40	Shim Cam	—	76039	1					
41	Shim Assembly	—	15-44491A1	AR					
42 & 43	Bearing & Race	18-1156	13-30894A1	1					
44	Roller Bearing	18-1157	31-30895	1					
45	Forward Gear	—	43-12634A2	1					
46 & 47	Cam Follower Assembly	—	12239A1	1					
48	Ball Bearing	—	30-44530	3					

AR As required

V-150

Serial # A904645 & earlier

V-175

Serial # 6648750 & earlier

V-200

Serial # 6625220 & earlier

86 — Gear Housing Seal Kit
18-2653

87 — Water Pump Repair Kit
(with housing)
18-3217

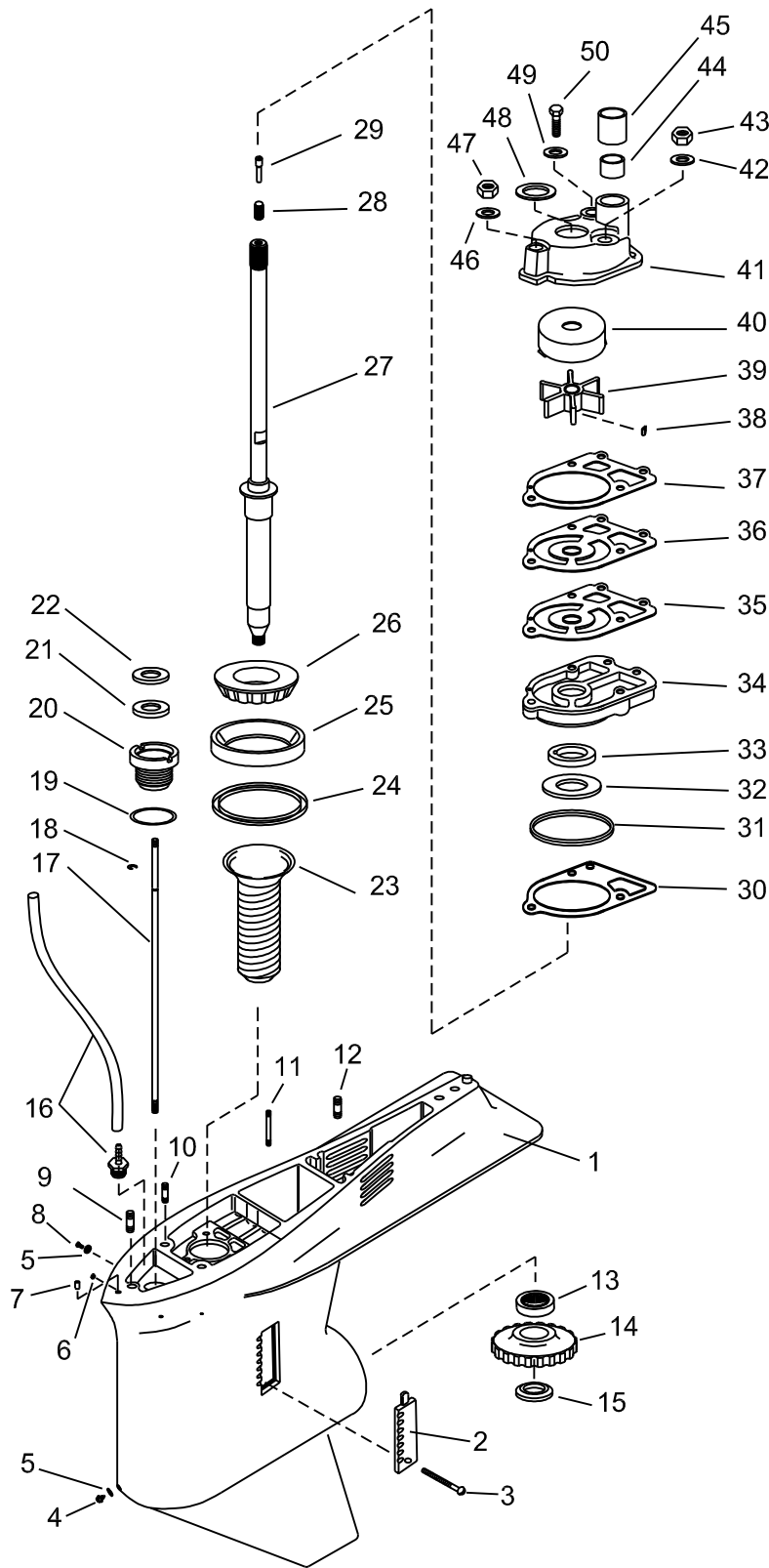

Complete Gear Housings Listed on Page 458

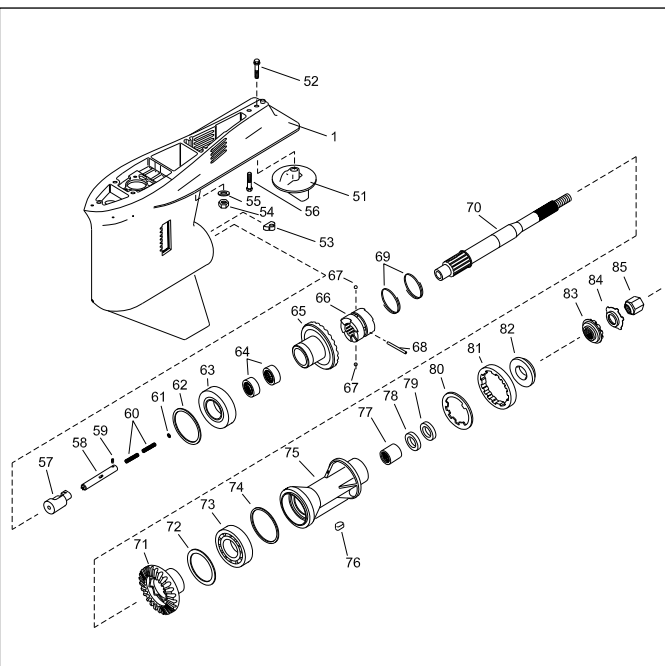



















Figure #	Description	Part #	O.E.M. #	Qty.
34	Water Pump Base	18-3416	46-96146A6	1
35	Gasket	18-2914	27-856081	1
36	Face Plate	18-3117	32435	1
37	Gasket	18-2915	27-856091	1
38	Key	~	28-56654	1
39	Impeller	18-3017	47-899842	1
40	Insert	18-3114	48752	1
41	Water Pump Body	18-3116	43-96148A1	1
42	Washer	18-4275	12-29245	3
43	Nut	18-3722	11-20361	2
44	Seal	18-3110	26-38970	1
45	Guide Sleeve	18-3109	23-29804	1
46	Washer	~	12-36001	1
47	Nut	18-3722	11-45592	1
48	Slinger	18-7426	25-30271	1
49	Washer	18-4275	12-29245	3
50	Screw	~	10-96411	1
51	Trim Tab	18-6011	3164A1	1
52	Screw	~	10-66024	1
53	Shift Cam	~	78956	1
54	Nut	18-3721	11-34933	1
55	Washer	~	12-45176	2
56	Screw	~	10-65210	1
57	Cam Follower	~	89594A1	1
58	Actuator Rod	~	79911 1	1
59	Locating Pin	~	17-78906	1
60	Spring	~	24-749910	2
61	Washer	~	12-78910	1
62	Shim Assembly	18-2285	15-47397A1	AR
63	Bearing	18-1166	31-78172A1	1
64	Forward Gear	~	43-78082A3	1
65	Roller Bearing	~	31-73363	2
66	Clutch	~	52-823174	1
67	Detent Pin	~	17-78909	2
68	Cross Pin	~	17-78905	1
69	Retaining Spring	~	24-78962	2
70	Prop Shaft	18-2239	44-94148	1
71	Reverse Gear	~	43-85462	1
72	Thrust Ring	~	68100 1	1
73	Ball Bearing	18-1155	30-88957	1
74	O-Ring	18-7159	25-31534	1
75	Key	~	28-30281	1
76	Roller Bearing	18-1158	31-30956	1
77	Seal (Inner)	18-2002	26-76868	1
78	Seal (Outer)	18-2053	26-70081	1
79	Tab Washer	18-2299	14-79447	1
80	Cover Nut	18-3751	79448	1
81	Thrust Hub	18-4220	13171	1
82	Spline Washer	18-3714	12-31211A2	1
83	Tab Washer	18-3200	14-31210	1
84	Prop Nut	18-3700	11-52707	1
85	Prop Nut	18-3700	11-52707	1

Figure #	Description	Part #	O.E.M. #	Qty.
1	Gear Housing	~	1647-9148A65	1
2	Water Insert (Starboard)	~	66885	1
	Water Insert (Port)	~	66884	1
3	Screw	18-3197	10-76156	1
4	Drain Screw	18-2375	22-67892A1	1
5	Drain Screw Gasket	18-2945	12-19183	2
6	Nut	18-2344	11-45812	1
7	Dowel Pin	~	17-43044	2
8	Drain Screw	18-2244	10-79953	1
9	Stud	~	16-78638	1
10	Stud	~	16-56297	1
11	Stud	~	16-30667	2
12	Stud	~	16-579201	2
13	Roller Bearing	~	31-35934A1	1
14	Pinion Gear	~	43-780811	1
15	Pinion Nut	18-3719	11-35921	1
16	Speedometer Tube	~	22-85822A10	1
17	Shift Shaft	~	78902 2	1
18	E-Clip	18-4295	53-29641	1
19	O-Ring	18-7153	25-25439	1
20	Shift Shaft Bushing	18-2155	23-77631A2	1
21	Seal	18-2054	26-816461	1
22	Rubber Washer	18-2316	12-77674	1
23	Sleeve	~	23-98621	1
24	Shim Assembly	18-2295	15-57007A1	AR
25	Roller Bearing	~	31-53079A1	1
26	Roller Bearing	~	31-53079A1	1
27	Drive Shaft Assembly	~	45-98682A1	1
28	Spring	~	24-34576	1
29	Pin	~	17-30545	1
30	Gasket	18-2826	27-856101	1
31	O-Ring	18-7162	25-33145	1
32	Seal	18-2014	26-89238	1
33	Seal	18-2013	26-16977	1

AR As required

 <p>18-1190 BALL BEARING Replaces: 30-20839T, 30-20839, 30-62699, FI000034 Reverse gear for Force, Mercury, Mariner from 25-60HP (2, 3 cylinders, & 4-stroke) including 30Jet - 45Jet</p>	 <p>18-1111 REVERSE GEAR BEARING Replaces: 31-62799A1</p>	 <p>18-1112 REVERSE GEAR THRUST BEARING Replaces: 31-12576</p>	 <p>18-1113 REVERSE GEAR BEARING Replaces: 31-12578, 31-12578T</p>
 <p>18-1115 PINION BEARING Replaces: 31-32898, 31-32898T, 31-29982</p>	 <p>18-1117 PINION BEARING Replaces: 31-42647A1, 31-42647, 31-F694057</p>	 <p>18-1118 DRIVE SHAFT BEARING Replaces: 31-42677A1</p>	 <p>18-1143 TAPERED ROLLER BEARING Replaces: 31-36387A1</p>
 <p>18-1126 TAPERED ROLLER BEARING Replaces: 31-54036A1</p>	 <p>18-1153 BALL BEARING Replaces: 30-63326, 30-63326T, 30-49313, 30-54215, 30-20464</p>	 <p>18-1154 BALL BEARING Replaces: 30-63742, 30-63742T</p>	
 <p>18-1155 BALL BEARING Replaces: 30-88957A1, 30-88957T, 30-35914, 30-17927, 30-88957</p>	 <p>18-1156 FORWARD GEAR BEARING Replaces: 31-30894A1</p>	 <p>18-1197 TAPERED FORWARD GEAR BEARING Replaces: 31-828439A2 For: Alpha One Gen II (1996-97) (s/n 0F680000-0K999999)</p>	
 <p>18-1157 FORWARD GEAR INNER BEARING Replaces: 31-30895, 31-30895T</p>	 <p>18-1158 CARRIER BEARING Replaces: 31-30956, 31-30956T, 31-F523058</p>	 <p>18-1159 TAPERED ROLLER BEARING Replaces: 31-35928A1, 31-35928T1</p>	

APPLICATION BEGINS ON NEXT PAGE



18-1163
TAPERED ROLLER BEARING
Replaces: 31-48941A1



18-1162
TAPERED ROLLER BEARING
Replaces: 31-38356A1, 31-F84901, FA84901, F84903



18-1166
TAPERED ROLLER BEARING
Replaces: 31-78172A1



18-1170
LOWER PINION BEARING
Replaces: 31-812767A1



18-0557
SEAL CARRIER
Replaces: 888909A1
For: All Verado's
135/150/175/200/225/250/275



18-2370
CARRIER BEARING
Replaces: 19291A3
(Force 40/50 HP 1995-99, 70 HP 1991-95, 75 HP 1996-98)
(Mercury/Mariner 30/40 HP 2 cyl 9854537-P016999, 30/40 4-stroke G760300-up, 40/50 HP/30Jet 3 cyl 9973100-up, 60 HP 3 cyl D000750-up, 60 HP 4-stroke 9973100-up)

Model	Serial Number	Bearing (Drive Shaft)	Bearing Pinion	Inside Bearing Forward Gear	Outside Bearing Forward Gear	Bearing Reverse Gear	Thrust Bearing Reverse Gear	Bearing Model Carrier
30 (4-stroke, Bigfoot)	G760300 & Up	18-1118	—	18-1157	18-1156	18-1113	18-1112	18-1158
30 (4-stroke, non-Bigfoot)	G760300 & Up	—	—	—	18-1107	—	—	—
30 EFI (4-stroke, Bigfoot)	T409000 & Up	18-1118	—	18-1157	18-1156	18-1113	18-1112	18-1158
30 EFI (4-stroke, non-Bigfoot)	T409000 & Up	—	—	—	18-1107	—	—	—
35 (2 cyl.)	6445653 & Up	—	—	—	18-1162	—	N/A	—
350	1960827 - 2874703	—	—	18-1162	—	N/A	—	—
400 (2 cyl.)	2874704 - 3336257	—	—	—	18-1162	—	N/A	—
402	3336258 - 4117709	—	—	—	18-1162	—	N/A	—
402	4117710 - 4860102	—	—	—	18-1162	—	N/A	—
402/40 (2 cyl.)	4860103 - 5556229	—	—	—	18-1162	—	N/A	—
40 (2 cyl.)	5556230 - G053313	—	—	—	18-1162	—	N/A	—
40 (4 cyl.)	C159200 & Up	—	—	—	18-1162	—	N/A	—
40 (4-stroke, Bigfoot)	G231123 & Up	18-1118	—	18-1157	18-1156	18-1113	18-1112	18-1158
40 (4-stroke, non-Bigfoot)	G231123 & Up	—	—	—	18-1107	—	—	—
40 (4-stroke, 4 cyl. Bigfoot)	T228405 & Up	18-1118	—	18-1157	18-1156	18-1113	18-1112	18-1158
40 (4-stroke, 4 cyl. non-Bigfoot)	T228405 & Up	—	—	—	18-1170	—	—	—
40 EFI (4-stroke, 3 cyl. non-Bigfoot)	T409000 & Up	—	—	—	18-1103	18-1190	—	—
40 EFI (4-stroke, 3 cyl. Bigfoot)	T409000 & Up	18-1118	—	18-1157	18-1156	18-1113	18-1112	18-1158
40 EFI (4-stroke, 4 cyl. non-Bigfoot)	T409000 & Up	—	—	—	18-1170	—	—	—
45 (4 cyl.)	5531630 & Up	—	—	—	18-1162	—	N/A	—
45 (Bodensee 4-stroke, Bigfoot)	G231123 - T178499	18-1118	—	18-1157	18-1156	18-1113	18-1112	18-1158
45 (Bodensee 4-stroke, non-Bigfoot)	G231123 - T178499	—	—	—	18-1103	—	—	—
500	2305101 - 2858813	—	—	—	18-1162	—	N/A	—
500	2858814 - 4140999	—	—	—	18-1162	—	N/A	—
500	4141000 - 4357639	—	—	—	18-1162	—	N/A	—
500 / 50	4357640 - 4962055	—	—	—	18-1162	—	N/A	—
500 / 50	4962056 - 5531629	—	—	—	18-1162	—	N/A	—
50 (4 cyl.)	5531630 & Up	—	—	—	18-1162	—	N/A	—
50 (3 cyl.)	6428681 - D000749	—	—	—	18-1162	—	N/A	—
50 (3 cyl.)	D000750 - G589999	—	—	—	18-1170	—	N/A	—
50 (4-stroke, Bigfoot)	G231123 & Up	18-1118	—	18-1157	18-1156	18-1113	18-1112	18-1158
50 (4-stroke, non-Bigfoot)	G231123 & Up	—	—	—	18-1107	—	—	—

① Standard Rotation Only.
 ② For Units With A Casting Number Of 1655-9572C Only.
 ③ For Units With A Casting Number Of 1674-814247C Only.
 ④ Two Bearings Required.
 ⑤ For 5/8 Dual Bearing Application.
 ⑥ Use 18-1155 For Counter Rotation Applications.

Model	Serial Number	Bearing (Drive Shaft)	Bearing Pinion	Inside Bearing Forward Gear	Outside Bearing Forward Gear	Bearing Reverse Gear	Thrust Bearing Reverse Gear	Bearing Model Carrier
30 (4-stroke, Bigfoot)	G760300 & Up	18-1118	—	18-1157	18-1156	18-1113	18-1112	18-1158
30 (4-stroke, non-Bigfoot)	G760300 & Up	—	—	—	18-1107	—	—	—
30 EFI (4-stroke, Bigfoot)	T409000 & Up	18-1118	—	18-1157	18-1156	18-1113	18-1112	18-1158
30 EFI (4-stroke, non-Bigfoot)	T409000 & Up	—	—	—	18-1107	—	—	—
35 (2 cyl.)	6445653 & Up	—	—	—	18-1162	—	N/A	—
350	1960827 - 2874703	—	—	18-1162	—	N/A	—	—
400 (2 cyl.)	2874704 - 3336257	—	—	—	18-1162	—	N/A	—
402	3336258 - 4117709	—	—	—	18-1162	—	N/A	—
402	4117710 - 4860102	—	—	—	18-1162	—	N/A	—
402/40 (2 cyl.)	4860103 - 5556229	—	—	—	18-1162	—	N/A	—
40 (2 cyl.)	5556230 - G053313	—	—	—	18-1162	—	N/A	—
40 (4 cyl.)	C159200 & Up	—	—	—	18-1162	—	N/A	—
40 (4-stroke, Bigfoot)	G231123 & Up	18-1118	—	18-1157	18-1156	18-1113	18-1112	18-1158
40 (4-stroke, non-Bigfoot)	G231123 & Up	—	—	—	18-1107	—	—	—
40 (4-stroke, 4 cyl. Bigfoot)	T228405 & Up	18-1118	—	18-1157	18-1156	18-1113	18-1112	18-1158
40 (4-stroke, 4 cyl. non-Bigfoot)	T228405 & Up	—	—	—	18-1170	—	—	—
40 EFI (4-stroke, 3 cyl. non-Bigfoot)	T409000 & Up	—	—	—	18-1103	18-1190	—	—
40 EFI (4-stroke, 3 cyl. Bigfoot)	T409000 & Up	18-1118	—	18-1157	18-1156	18-1113	18-1112	18-1158
40 EFI (4-stroke, 4 cyl. non-Bigfoot)	T409000 & Up	—	—	—	18-1170	—	—	—
45 (4 cyl.)	5531630 & Up	—	—	—	18-1162	—	N/A	—
45 (Bodensee 4-stroke, Bigfoot)	G231123 - T178499	18-1118	—	18-1157	18-1156	18-1113	18-1112	18-1158
45 (Bodensee 4-stroke, non-Bigfoot)	G231123 - T178499	—	—	—	18-1103	—	—	—
500	2305101 - 2858813	—	—	—	18-1162	—	N/A	—
500	2858814 - 4140999	—	—	—	18-1162	—	N/A	—
500	4141000 - 4357639	—	—	—	18-1162	—	N/A	—
500 / 50	4357640 - 4962055	—	—	—	18-1162	—	N/A	—
500 / 50	4962056 - 5531629	—	—	—	18-1162	—	N/A	—
50 (4 cyl.)	5531630 & Up	—	—	—	18-1162	—	N/A	—
50 (3 cyl.)	6428681 - D000749	—	—	—	18-1162	—	N/A	—
50 (3 cyl.)	D000750 - G589999	—	—	—	18-1170	—	N/A	—
50 (4-stroke, Bigfoot)	G231123 & Up	18-1118	—	18-1157	18-1156	18-1113	18-1112	18-1158
50 (4-stroke, non-Bigfoot)	G231123 & Up	—	—	—	18-1107	—	—	—
50 EFI (4-stroke, non-Bigfoot)	T409000 & Up	—	—	—	18-1107	—	—	—
50 EFI (4-stroke, Bigfoot)	T409000 & Up	18-1118	—	18-1157	18-1156	18-1113	18-1112	18-1158
55 (3 cyl.)	D000750 - G589999	—	—	—	18-1170	—	N/A	—
55 Seapro, Marathon, Pontoon	D000750 & Up	18-1118	—	18-1157	18-1156	18-1113	18-1112	18-1158
60 (3 cyl.)	6428681 - D000749	—	—	—	18-1162	—	N/A	—
60 (3 cyl.)	D000750 - G589999	—	—	—	18-1170	—	N/A	—
60 EFI (4-stroke, non-Bigfoot)	T409000 & Up	—	—	—	18-1103	—	—	—
60 EFI (4-stroke, Bigfoot)	T409000 & Up	18-1118	—	18-1157	18-1156	18-1113	18-1112	18-1158
650 (4 cyl.)	1542745 - 1765403	18-1153	—	18-1157	18-1156	—	N/A	18-1158
650 (4 cyl.)	2119749 - 2309310	18-1153	—	18-1157	18-1156	—	N/A	18-1158
650 (4 cyl.)	2309311 - 2452709	18-1153	—	18-1157	18-1156	—	N/A	18-1158
650 (4 cyl.)	2503991 - 2803561	18-1153	—	18-1157	18-1156	—	N/A	18-1158
650 (4 cyl.)	2803562 - 2874263	—	—	18-1157	18-1156	—	N/A	18-1158
650 (4 cyl.)	2997339 & Up	—	—	18-1157	18-1156	—	N/A	18-1158
650 (3 cyl.)	3293184 - 3525440	—	—	—	18-1162	—	N/A	—
650 (3 cyl.)	3547987 - 4571651	—	—	—	18-1162	—	N/A	—
70 (3 cyl.)	4571652 - 4977156	—	—	—	18-1162	—	N/A	—
70 (3 cyl.)	4977157 - 5579016	—	—	—	18-1162	—	N/A	—
70 (3 cyl.)	5579017 - 6428680	—	—	—	18-1162	—	N/A	—
70 (3 cyl.)	A996142 - & Up	18-1118	N/A	18-1157	18-1156	18-1113	18-1112	18-1158
75 (4 cyl.)	6432901 & Up	—	—	18-1157	18-1156	N/A	N/A	18-1158
75 (3 cyl.)	A996142 - & Up	18-1118	N/A	18-1157	18-1156	18-1113	18-1112	18-1158
800 (4 cyl.)	2559001 - 3144218	18-1153	—	18-1157	18-1156	—	N/A	18-1158
800 (4 cyl.)	3144219 - 3493912	—	—	18-1157	18-1156	—	N/A	18-1158
80 (4 cyl.)	4831999 - 6432900	—	—	18-1157	18-1156	N/A	N/A	18-1158
80 (3 cyl.)	A996142 & Up	18-1118	N/A	18-1157	18-1156	18-1113	18-1112	18-1158
850 (4 cyl.)	3493913 - 4831998	—	—	18-1157	18-1156	—	N/A	18-1158
900 (6 cyl.)	1766824 - 1869775	18-1153	—	18-1157	18-1156	—	N/A	18-1158
900/90 (6 cyl.)	4845301 - & Up	—	—	18-1157	18-1156	N/A	N/A	18-1158
90 (3 cyl.)	A996142 & Up	18-1118	N/A	18-1157	18-1156	18-1113	18-1112	18-1158
100 (4 cyl.)	B209468 - & Up	18-1118	N/A	18-1157	18-1156	18-1113	18-1112	18-1158
1150	2836019 - 2933900	18-1153	—	18-1157	18-1156	—	N/A	18-1158
1150	2933901 - 3525440	18-1153	—	18-1157	18-1156	—	N/A	18-1158
1150	3525441 - 4112634	18-1153	—	18-1157	18-1156	—	N/A	18-1158
1150	4112635 - 4855152	—	—	18-1157	18-1156	—	N/A	18-1158
1150 / 115	4855153 - 5314655	—	—	18-1157	18-1156	N/A	N/A	18-1158
115 (6 cyl.)	5314656 - 5600966	—	—	18-1157	18-1156	N/A	N/A	18-1158
115 (6 cyl.)	5600967 - 6436122	—	—	18-1157	18-1156	N/A	N/A	18-1158
115 (6 cyl.)	6436123 & Up	—	—	18-1157	18-1156	N/A	N/A	18-1158
115 (4 cyl.)	C100000 & Up	18-1118	N/A	18-1157	18-1156	18-1113	18-1112	18-1158

① Standard Rotation Only.
 ③ For Units With A Casting Number Of 1655-9572C Only.
 ④ For Units With A Casting Number Of 1674-814247C Only.
 ⑤ Two Bearings Required.
 ⑥ For 5/8 Dual Bearing Application.
 ⑦ Use 18-1155 For Counter Rotation Applications.
 ⑧ Using pinion stamped 43-19672.

Model	Serial Number	Bearing (Drive Shaft)	Bearing Pinion	Inside Bearing Forward Gear	Outside Bearing Forward Gear	Bearing Reverse Gear	Thrust Bearing Reverse Gear	Bearing Model Carrier
125 (4 cyl.)	0T627234 & Below ⑥	18-1118	N/A	18-1157	18-1156	18-1113	18-1112	18-1158
1250	2314956 - 2839368	18-1153	—	18-1157	18-1156	—	N/A	18-1158
1350	2839369 - 2940020	18-1153	—	18-1157	18-1156	—	N/A	18-1158
1350	2940021 - 3293233	18-1153	—	18-1157	18-1156	—	N/A	18-1158
1400	3293234 - 3502805	18-1153	—	18-1157	18-1156	—	N/A	18-1158
140	4865687 & Up	—	—	18-1157	18-1156	N/A	N/A	18-1158
1500	3502806 - 4121434	18-1153	—	18-1157	18-1156	—	N/A	18-1158
1500	4121435 - 4865677	—	—	18-1157	18-1156	—	N/A	18-1158
V-135	A904646 & Up	18-1143	18-1117	—	18-1166	18-1155	N/A	18-1158
V-135	C100861 & Up	18-1143	18-1117	—	18-1166 ① ⑦	18-1155 ①	N/A	18-1158
V-135	C239553 & Up	18-1143	18-1117	—	18-1166 ① ⑦	18-1155 ①	N/A	18-1158
V-135	D082000 & Up	18-1143	18-1117	18-1115 ①	18-1166 ① ⑦	18-1155 ①	N/A	18-1158
V-150	4868998 - 5432021	—	—	—	18-1166	18-1155	N/A	18-1158
V-150	5432022 - 6042945	—	—	—	18-1166	18-1155	N/A	18-1158
V-150	6042946 - 6443212	—	—	—	18-1166	18-1155	N/A	18-1158
V-150	6443213 - 6616990	—	—	—	18-1166	18-1155	N/A	18-1158
V-150	6616991 - A904645	—	—	—	18-1166	18-1155	N/A	18-1158
V-150	A904646 & Up	18-1143	18-1117	—	18-1166	18-1155	N/A	18-1158
V-150	C100861 & Up	18-1143	18-1117	—	18-1166①	18-1155	N/A	18-1158
V-150	C239553 & Up	18-1143	18-1117	—	18-1166 ① ⑦	18-1155 ①	N/A	18-1158
V-150	D082000 & Up	18-1143	18-1117	18-1115 ①	18-1166 ① ⑦	18-1155 ①	N/A	18-1158
V-150XRI (EFI)	D082000 & Up	18-1143	—	18-1157	18-1156 ①	N/A	N/A	18-1158
V-150XRI (EFI)	D082000 & Up	18-1143	18-1117	18-1115 ⑥ ①	18-1166 ① ⑦	18-1155 ①	N/A	18-1158
V-150XRI (EFI)	D082000 & Up	18-1143	18-1117	18-1115 ⑥ ①	18-1166 ① ⑦	18-1155 ①	N/A	18-1158
V-175	4301235 - 5393736	—	—	—	18-1166	18-1155	N/A	18-1158
V-175	5393737 - 6618750	—	—	—	18-1166	18-1155	N/A	18-1158
V-175	6618751 & Up	18-1143	18-1117	—	18-1166	18-1155	N/A	18-1158
V-175	C100861 & Up	18-1143	18-1117	—	18-1166 ① ⑦	18-1155 ①	N/A	18-1158
V-175	C239553 & Up	18-1143	18-1117	—	18-1166 ① ⑦	18-1155 ①	N/A	18-1158
V-175	D082000 & Up	18-1143	18-1117	18-1115 ①	18-1166 ① ⑦	18-1155 ①	N/A	18-1158
V-175XRI (EFI)	D000750 & Up	18-1143	18-1117	—	18-1166	18-1155	N/A	18-1158
V-175XRI (EFI)	D000750 & Up	18-1143	18-1117	—	18-1166	18-1155	N/A	18-1158
V-175XRI (EFI)	D082000 & Up	18-1143	—	18-1157	18-1156 ①	N/A	N/A	18-1158
V-175XRI (EFI)	D082000 & Up	18-1143	18-1117	18-1115 ⑥ ①	18-1166 ① ⑦	18-1155 ①	N/A	18-1158
V-175XRI (EFI)	D082000 & Up	18-1143	18-1117	18-1115 ⑥ ①	18-1166 ① ⑦	18-1155 ①	N/A	18-1158
V-200	4839034 - 5363917	—	—	—	18-1166	18-1155	N/A	18-1158
V-200	5363918 - 6073191	—	—	—	18-1166	18-1155	N/A	18-1158
V-200	6073192 - 6203990	—	—	—	18-1166	18-1155	N/A	18-1158
V-200	6203991 - 6435502	—	—	—	18-1166	18-1155	N/A	18-1158
V-200	6435503 - 6625220	—	—	—	18-1166	18-1155	N/A	18-1158
V-200	6625221 - C100860	18-1143	18-1117	—	18-1166	18-1155	N/A	18-1158
V-200/	C100861 - C291519	18-1143	18-1117	—	18-1166	18-1155	N/A	18-1158
V-200 (EFI)	C291520 - D081999	18-1143	18-1117	—	18-1166 ① ⑦	18-1155 ①	N/A	18-1158
V-200 (2.5L)	C291520 - D081999	18-1143	18-1117	—	18-1166 ① ⑦	18-1155 ①	N/A	18-1158
V-200	D082000 & Up	18-1143	18-1117	18-1115 ①	18-1166 ① ⑦	18-1155 ①	N/A	18-1158
V-200XRI (EFI)	C291520 & Up	18-1143	18-1117	—	18-1166	18-1155	N/A	18-1158
V-200XRI (EFI)	D082000 & Up	18-1143	—	18-1157	18-1156 ①	N/A	N/A	18-1158
V-200XRI (EFI)	D082000 & Up	18-1143	18-1117	18-1115 ⑥ ①	18-1166 ① ⑦	18-1155 ①	N/A	18-1158
V-200XRI (EFI)	D082000 & Up	18-1143	18-1117	18-1115 ⑥ ①	18-1166 ① ⑦	18-1155 ①	N/A	18-1158
V-220	B117316 & Up	18-1143	18-1117	—	18-1166	18-1155	N/A	18-1158
V-225	5628028 & Up	—	—	—	18-1166	18-1155	N/A	18-1158
225	D280813 & Up	18-1143	18-1117	18-1157 ①	18-1159 ①	18-1155 ①	N/A	18-1158
XR-4 ③	B242885 & Up	18-1143	—	18-1157	18-1156	N/A	N/A	18-1158
XR-4	B242885 & Up	18-1143	—	18-1157	18-1156	N/A	N/A	18-1158
XR-4 ③	C100861 & Up	18-1143	—	18-1157	18-1156	N/A	N/A	18-1158
XR-4 ④	C100861 & Up	18-1143	—	18-1157	18-1156	N/A	N/A	18-1158
XR-4	C239553 & Up	18-1143	—	18-1157	18-1156	N/A	N/A	18-1158
XR-6	D082000 & Up	18-1143	—	18-1157	18-1156	N/A	N/A	18-1158

① Standard Rotation Only.

③ For Units With A Casting Number Of 1655-9572C Only.

④ For Units With A Casting Number Of 1674-814247C Only.

⑤ Two Bearings Required.

⑥ For 5/8 Dual Bearing Application.

⑦ Use 18-1155 For Counter Rotation Applications.

⑧ Using pinion stamped 43-19672.



18-2244
18-22441-9①
 (PKG. OF 50 WITHOUT GASKET)
DRAIN PLUG
 • 3/8" -16 thread
Replaces: 10-20259, 10-28634, 10-28634A1, 10-79953A2, 10-79953Q2, 10-79953, 10-79953Q04, 816610A1, 816610A2, F40109, 10-F50109
 Includes gasket **18-2945**

② **18-2375D**



18-2375
18-23751-9①
 (PKG. OF 50 WITHOUT GASKET)
DRAIN PLUG
 • 3/8" -16 thread
Replaces: 10-14834, 10-14834A1, 22-67892, 22-67892A1, 22-67892A05, 22-67892A06, 28-8M0058389
 Includes gasket **18-2945**



18-2155
SHIFT SHAFT HOUSING BUSHING
Replaces: 23-37428A1, 23-55419A1, 23-77631A2
 35-200 HP

① Priced per Package

② Items ending in "D" are Display Packaged - Regular number is Non-Display



18-3719
PINION NUT
Replaces: 11-35921, 11-47411, 11-826375, 11-F694188
5/8" - 18 thread • 1 1/16" wrench



18-2359
DRIVE SHAFT NUT SET
— INCLUDES —

Sierra #	Description	Replaces:
18-3719	Pinion Nut	11-35921
18-2343-9 ²	Pinion Nut Washer	12-92721

² Priced per Package



18-1736
DRIVESHAFT ASSEMBLY
Replaces: 45-43031A1
Fits: 100 4 cyl (1988 & Up), 115 4 cyl (1989 & Up), 125 4 cyl (1994 & Up)



18-1737
DRIVESHAFT (32 1/4" long)
Replaces: 45-440001
Fits: V-115 DFI 2.5L (2000), V-135 (1986 & Up), V-135 DFI 2.5L (1998 & Up), V-150 (1978 & Up), V-150 EFI (1996-01), V-150 Mag/EFI (1993-95), V-150 DFI 2.5L (1998 & Up), V-150 Mag (1980-85), V-175 (1976-99), V-175 EFI (1996 & Up), V-175 Mag/EFI (1991-95), V-175 DFI 2.5L (2001 & Up), V-175 XRI EFI (1991-95), V-200 (1978 & Up), V-200 EFI (1989-01), V-200 Mag/EFI (1992-95), V-200 EFI 2.5L (2002 & Up), V-200 XRI/EFI (1991-95), XR-4 (1988-91), XR-6 (1992 & Up)



18-2239
PROP SHAFT
Replaces: 44-94148



18-2254
PROP SHAFT
Replaces: 44-850308



18-2260
PROP SHAFT
Replaces: 44-17915



18-2236
SLIDING CLUTCH
Replaces: 52-12777, 52-34239, 52-814756, 52-822539, 52-822539T



18-1550
COMPLETE GEAR SET
Replaces: 43-850036T, 43-881260A3, 52-850048T
Forward, Pinion, Reverse and Clutch for 4 cyl.: Fits: 100 4 cyl with 6 JAW reverse clutch(1988-98), 115 4 cyl with 6 JAW reverse clutch(1989-98), 125 4 cyl with 6 JAW reverse clutch(1994-98) (2.07:1 Ratio)



18-1551
COMPLETE GEAR SET
Replaces: 43-803615T2, 52-859340T, 43-828175A1
Forward, Pinion, Reverse and Clutch for V-6:
Fits: V-150 (XR6, Mag III)(1997 & Up), V-150 EFI (1997 & Up), V150 DFI (1998 & Up), V-175 (1997 & Up), V-175 EFI (1997 & Up), V-175 DFI (2001 & Up), V-200 (1997 & Up), V-200EFI 2.5L (1997 & Up) (1.87:1 Ratio)



18-1560
REVERSE GEAR
Replaces: 43-850036T, 43-850036
Fits: 75 4-Stroke (2000-02), 90 4-Stroke (2000-02), 100 4 cyl with 6 JAW Rev Clutch (1988 & Up), 115 4 cyl with 6 JAW Rev Clutch (1989 & Up), 115 4-Stroke EFI (2001 & Up), 125 4 cyl with 6 JAW Rev Clutch (1994 & Up) (2.07:1 Ratio)



18-1564
GEAR SET
Replaces: 43-803615T2, 43-803615T1
Fits: V-150 (1978 & Up), V-150 EFI (1996-01), V-150 DFI 2.5L (1998 & Up), V-150 EFI 2.5L (2002 & Up), V-175 EFI (1996-01), V-175 DFI 2.5L (2001 & Up), V-175 EFI 2.5L (2002-03), V-200 (1978 & Up), V-200 EFI (1989-01), V-200 EFI 2.5L (2002 & Up) (1.87:1 Ratio)

SHAFT APPLICATION BEGINS ON NEXT PAGE



18-1565

CLUTCH

Replaces: 52-859340T

Fits: V-115 DFI 2.5L (2000), V-135 (1986 & Up), V-135 DFI 2.5L (1998 & Up), V-150 (1978 & Up), V-150 EFI (1996-01), V-150 Mag/EFI (1993-95), V-150 DFI 2.5L (1998 & Up), V-150 Mag (1980-85), V-175 (1976-99), V-175 EFI (1996 & Up), V-175 Mag/EFI (1991-95), V-175



18-4830

GEAR HOUSING ASSEMBLY

Replaces: 1667-9011G59

Fits: 100 4cyl (1988-99), 115 4cyl (1989 & Up), 115 3cyl DFI (2004 & Up), 115 EFI 4-Stroke(2001 & Up), 125 4cyl (1994 & Up), 30 4-Stroke (1999-01), 30 Carb 3cyl 4-Stroke (2002 & Up), 40 4-Stroke (1998-01), 40 4-Stroke 4cyl (2001-02), 40 Carb 3cyl 4-Stroke (2002 & Up), 40 EFI 4cyl 4-Stroke (2002 & Up), 40 Jet (2001 & Up), 45 Jet (1994-98), 50 4-Stroke (1995-00), 50 4cyl 4-Stroke (2001-02), 50 Bigfoot 4-Stroke(1995-00), 50 EFI 4cyl 4-Stroke (2002 & Up), 55 3cyl (1996 & Up), 60 3cyl (1984 & Up), 60 3cyl Bigfoot (1998), 60 4cyl 4-Stroke (2001-02), 60 EFI 4cyl 4-Stroke (2002 & Up), 65 Jet (1994 & Up), 75 3cyl (1987 & Up), 75 4-Stroke (2000 & Up), 75 3cyl 1.5L DFI (1995 & Up), 80 Jet (1994 & Up), 90 3cyl (1987 & Up), 90 4-Stroke (2000 & Up), 90 3cyl 1.5L DFI (2004 & Up) with 6 Jaw Clutch (Design II)



18-4832

GEAR HOUSING ASSEMBLY

Replaces:1647-9148T93

Fits: 140 Jet (All), Magnum III (1992-99), V-115 DFI 2.5L (2000), V-135 (1986 & Up), V-135 DFI 2.5L (1998 & Up), V-150 (1978 & Up), V-150 EFI (1996-01), V-150 DFI 2.5L (1998 & Up), V-175 (1976-99), V-175 EFI (1996-01), V-175 DFI 2.5L (2001 & Up), V-200 (1978 & Up), V-200 EFI (1989-01), V-200 EFI 2.5L (2002 & Up), XR6 (1992 & Up)

MERCURY OUTBOARD LOWER UNIT APPLICATIONS

Model	Serial Number	Drive Shaft	Pinion Nut	Propeller Shaft	Clutch
40 Four Stroke - BigFoot	0T178500 - 1B226999		18-3719	18-2254	—
50 Four Stroke - BigFoot	0G231123 - 1B226999		18-3719	18-2254	—
60 Sea Pro/Marathon/BigFoot	0G590000 & UP		18-3719	18-2254	— ②
60 Four Stroke - BigFoot	0T178500 - 1B226999		18-3719	18-2254	—
650 (4 cyl.)	1542745 - 1765403	N.L.A.	—	—	18-2236
650 (4 cyl.)	2119749 - 2309310	—	—	—	18-2236
650 (4 cyl.)	2309311 - 2452709	—	18-3719	—	18-2236
650 (4 cyl.)	2503991 - 2803561	—	18-3719	—	18-2236
650 (4 cyl.)	2803562 - 2874263	—	18-3719	—	18-2236
650 (4 cyl.)	2997339 & Up	—	18-3719	—	18-2236
70 (3 cyl.)	A996142 - & Up	—	18-3719	—	18-2236 ③
70 (3 cyl.)	A996142 - & Up	—	18-3719	18-2254	—
75 (4 cyl.)	6432901 & Up	—	18-3719	—	18-2236
75 (3 cyl.)	A996142 - & Up	—	18-3719	—	18-2236 ③
75 (3 cyl.)	A996142 - 0G760299	—	18-3719	18-2254	—
75 (3 cyl.)	0G760300 & Up	—	18-3719	18-2254	—
75 DFI	0T980000 & Up	—	18-3719	18-2254	—
75 Four Stroke	0G960500 - 0T800999	—	18-3719	18-2254	—
800 (4 cyl.)	2559001 - 3144218	—	18-3719	—	18-2236
800 (4 cyl.)	3144219 - 3493912	—	18-3719	—	18-2236
80 (4 cyl.)	4831999 - 6432900	—	18-3719	—	18-2236
80 (3 cyl.)	A996142 & Up	—	18-3719	—	18-2236
80 (3 cyl.)	A996142 & Up	—	18-3719	18-2254	— ②
850 (4 cyl.)	3493913 - 4831998	—	18-3719	—	18-2236
900 (6 cyl.)	1766824 - 1869775	N.L.A.	—	—	18-2236
900/90 (6 cyl.)	4845301 - & Up	—	18-3719	—	18-2236
90 (3 cyl.)	A996142 - 0G760299	—	18-3719	—	18-2236 ③
90 (3 cyl.)	A996142 - 0G760299	—	18-3719	18-2254	— ②
90 (3 cyl.)	0G760300 & Up	—	18-3719	18-2254	—
90 DFI	0T801000 & Up	—	18-3719	18-2254	—
90 Four Stroke	0G960500 - 0T800999	—	18-3719	18-2254	—

① Long shaft only

③ Offshore only

⑤ 3 Jaw reverse clutch

nut

② Standard rotation only

④ 6 Jaw reverse clutch

⑥ Pre-load pin, w/o driveshaft

N.L.A. No longer available

APPLICATION CONTINUED ON NEXT PAGE

MERCURY OUTBOARD LOWER UNIT APPLICATIONS

Model	Serial Number	Drive Shaft	Pinion Nut	Propeller Shaft	Clutch
100 (4 cyl.)	B209468 - 0G760299	—	18-3719	—	18-2236
100 (4 cyl.)	B209468 - 0G760299	—	18-3719	18-2254	— ④
100 (4 cyl.)	0G760300 & Up	—	18-3719	18-2254	—
1150	2836019 - 2933900	—	18-3719	—	18-2236
1150	2933901 - 3525440	—	18-3719	—	18-2236
1150	3525441 - 4112634	—	18-3719	—	18-2236
1150	4112635 - 4855152	—	18-3719	—	18-2236
1150 / 115	4855153 - 5314655	—	18-3719	—	18-2236
115 (6 cyl.)	5314656 - 5600966	—	18-3719	—	18-2236
115 (6 cyl.)	5600967 - 6436122	—	18-3719	—	18-2236
115 (6 cyl.)	6436123 & Up	—	18-3719	—	18-2236
115 (4 cyl.)	C100000 - 0G760299	—	18-3719	—	18-2236
115 (4 cyl.)	C100000 - 0G760299	—	18-3719	18-2254	—④
115 (4 cyl.)	0G760300 & Up	—	18-3719	18-2254	—
115 DFI	0T801000 & Up	—	18-3719	18-2254	—
115 Four Stroke	0T178500 - 0T800999	—	18-3719	18-2254	—
1250	2314956 - 2839368	—	18-3719	—	18-2236
125 (4 cyl.)	0D283222 - 0G760299	—	18-3719	—	18-2236
125 (4 cyl.)	0D283222 - 0G760299	—	18-3719	18-2254	—④
125 (4 cyl.)	0G760300 & Up	—	18-3719	18-2254	—
1350	2839369 - 2940020	—	18-3719	—	18-2236
1350	2940021 - 3293233	—	18-3719	—	18-2236
1400	3293234 - 3502805	—	18-3719	—	18-2236
140	4865687 & Up	—	18-3719	—	18-2236
1500	3502806 - 4121434	—	18-3719	—	18-2236
1500	4121435 - 4865677	—	18-3719	—	18-2236
V-135	0A904646 - 0G437999	18-1737	18-3719	18-2239	—
V-135	0G438000 - 0T178499	18-1737	18-3719	18-2239②	—
V135 DFI	G590000 - 1B417701	18-1737	18-3719	18-2239	18-1565
V140	T178500 & Up	—	18-3719	18-2239	—
V-150 (Casting # 1647-6670C)	4868998 - 0A904645	—	18-3719	—	—
V-150 (Casting #1647-8675C)	4868998 - 0A904645	—	18-3719	18-2239	—
V-150	4868998 - 0A904645	18-1737	18-3719	18-2239	—
V-150	0A904646 - 0G437999	18-1737	18-3719	18-2239	—
V-150	0G438000 & Up	18-1737	18-3719	18-2239	18-1565
V-150 XR-4 (Casting #1655-9572C)	B242885 - 0D081999	—	18-3719	—	18-2236
V-150 XR-4 (Casting #1674-814247C)	B242885 - 0D081999	—	18-3719	—	18-2236
V-150 XR-6	D082000 - 0G303045	18-1737	18-3719	18-2239	18-2236
V-150 XR-6	0G438000 & Up	18-1737	18-3719	18-2239	18-1565
V-150XR1 (EFI)	D082000-0G437999	18-1737	18-3719	—②	18-2236②
V-150XR1 (EFI)	0G438000 & Up	18-1737	18-3719	18-2239②	18-1565
V150 DFI	G590000 & Up	18-1737	18-3719	18-2239	—
V-175	4301235 - 5393736	—⑥	18-3719	—	—
V-175	5393737 - 6618750	—⑥	18-3719	18-2239	—
V-175	6618751 - 0G437999	18-1737	18-3719	18-2239	—
V-175	0G438000 & Up	18-1737	18-3719	18-2239	18-1565
V-175XR1 (EFI)	D000750 - 0G437999	18-1737	18-3719	18-2239	—
V-175XR1 (EFI)	0G438000 & Up	18-1737	18-3719	18-2239	18-1565
V-200	4839034 - 6625220	—⑥	18-3719	18-2239	—
V-200	6625221 - 0G437999	18-1737	18-3719	18-2239	—
V-200	0G438000 & Up	18-1737	18-3719	18-2239	18-1565
V-200 (EFI)	C100861 - 0G437999	18-1737	18-3719	18-2239	—
V-200 (EFI)	0G438000 & Up	18-1737	18-3719	18-2239	18-1565
V-200 (2.5L)	C291520 - D081999	—	18-3719	18-2239②	—
V-200 DFI	0G438000 & Up	—	18-3719	18-3719	—
V-220	B117316 & Up	—	18-3719	18-3719	18-2239
V-225	5628028 & Up	—①	18-3719	18-3719	18-2239
225	D280813 & Up	—	18-3719	18-3719	—
HIGH PERFORMANCE MODELS					
2.4 EFI	B290010 & Up	—	18-3719	18-3719	18-2260 ②③
XR-2	B290314 - C276429	—	18-3719	18-3719	18-2260②
MOD-VP	B290066 - C276379	—	18-3719	18-3719	18-2260

- ① Long shaft only ③ Offshore only ⑤ 3 Jaw reverse clutch nut
 ② Standard rotation only ④ 6 Jaw reverse clutch ⑥ Pre-load pin, w/o driveshaft N.L.A. No longer available



**18-3751
SPANNER NUT**
Replaces: 79448
For: V-6



**18-2298
TAB WASHER**
Replaces: 14-18323, 14-17460



**18-2299
TAB WASHER**
Replaces: 14-79447, 14-52833



Part #	O.E. #	Thread Size	Std. Pkg.
*18-3720 ⑦	11-34932	3/8" - 24	1
*18-3721 ⑦	11-34933, 11-95702, 11-82671015, 11-46355, 11-33962, 11-29241, 11-24648, 11-22178, 11-21298	7/16" - 20	6
*18-3722 ⑦	11-35888, 11-20361, 11-8267089	1/4" - 28	5
*18-3723 ⑦	11-45592	5/16" - 24	1

*To order locknuts in packages of 5, add -9 to end of part number



**18-2468
PIN ROD EYE**
Replaces: 17-8M0161312

⑦ Priced per package

POWER TRIM HOSE
For all power trim equipped, inline engines except models with power trim pump mounted between the engine clamp brackets.

Part #	Replaces:	Description
18-2110	32-45327, 32-88005, 32-97153A1	Small Diameter 2 required per engine
18-2111	32-88006, 32-45959, 32-97154A1	Large Diameter 2 required per engine

18-3701 PROP NUT KIT
Replaces: 11-52707A1, 11-52707A2, 11-52707Q1
— CONTAINS —

Part #	O.E. #	Description
18-3200 (2)	14-31210, 14-816629	Tab Washer
18-3700	11-52707	Prop Nut

PKG. OF 10

18-3200-9 TAB WASHER
Replaces: 14-31210, 14-816629, 14-816629Q, 14-F697140

18-3702 PROP NUT KIT
Replaces: 11-69578A1, T1, Q1
— CONTAINS —

Part #	O.E. #	Description
18-3204 (2)	14-76281	Tab Washer
18-3704	11-69578	Prop Nut

PKG. OF 10

18-3204-9 TAB WASHER
Superseded from 18-3204
Replaces: 14-76281

18-3700 PROP NUT
Replaces: 11-52707, 11-52707A1, 11-52707Q1, 11-52707A2, 11-827614 F7040

18-3704 PROP NUT
Replaces: 11-69578

18-3703 PROP NUT
Replaces: 11-88228
For: 9.9-25 HP 1986-UP

18-3714 BRASS CASTLE WASHER
Replaces: 12-31211A2, 12-31211, 12-31211A3, 12-31211Q03
For: 135-275 HP (V6 2 cycle)

TAB WASHER/PROP NUT/PROP NUT KIT APPLICATION

HP	Beg. S/N	End. S/N	Tab Washer	Prop Nut	Prop Nut Kit	HP	Beg. S/N	End. S/N	Tab Washer	Prop Nut	Prop Nut Kit
9.9	G760300	& UP	—	18-3703	—	80	2559001	& UP	18-3200	18-3700	18-3701
15	G590000	& UP	—	18-3703	—	85	1460999	3493912	18-3200	—	—
18	5837437	& UP	—	18-3703	—	85	3493913	4831998	18-3200	18-3700	18-3701
20	6443973	& UP	—	18-3703	—	90	1766824	4845300	18-3200	—	—
25	6416713	& UP	—	18-3703	—	90	4845301	& UP	18-3200	18-3700	18-3701
35	—	—	18-3204-9	18-3704	18-3702	95	1869776	2318585	18-3200	—	—
40	—	—	18-3204-9	18-3704	18-3702	100	1464949	2484632	18-3200	—	—
50	—	—	18-3204-9	18-3704	18-3702	100	2484633	2836018	18-3200	18-3700	18-3701
60	—	—	18-3204-9	18-3704	18-3702	100	B209468	& UP	18-3200	18-3700	18-3701
65	1542745	2503990	18-3200	—	—	110	1870204	2314955	18-3200	—	—
65	2503991	3293183	18-3200	18-3700	18-3701	115	2836019	& UP	18-3200	18-3700	18-3701
70	1482212	1566239	18-3200	—	—	125	2314956	2536209	18-3200	—	—
70	—	A996141	18-3204-9	18-3704	18-3702	125	2536210	2839368	18-3200	18-3700	18-3701
70	A996142	& UP	18-3200	18-3700	18-3701	135	2839369	3293233	18-3200	18-3700	18-3701
75	6432901	& UP	18-3200	18-3700	18-3701	140	3293234	& UP	18-3200	18-3700	18-3701
80	1405637	1566239	18-3200	—	—	150(Inline)	3502806	& UP	18-3200	18-3700	18-3701
③ Fits most applications ④ 4-Stroke Bigfoot						V-6	All	—	18-3200	18-3700	18-3701

18-4444 PROP WRENCH
Replaces: 91-95830A1, 91-95830, 91-38277A1

18-4446 PROP WRENCH KIT
— CONTAINS —

Part #	Desc.	O.E. #	Qty.
18-3200	Tab Washer	14-31210, 14-816629	2
18-3700	Prop Nut	11-52707	1
18-4444	Prop Wrench	91-95830A1	1

18-4459 PROP WRENCH
Replaces: 91-821887A1, 91-859046Q4, 91-859046T4

① Items ending in "D" are Display Packaged - Regular number is Non-Display
② Priced per Package



**18-9075
SPACER**
Replaces: 23-888690
For: 2-Stroke: 115hp. - 300hp. (1993-Current)
4-Stroke: 115hp. - 225hp. (2002-Current)



**18-9076
COLLAR**
Replaces: 23-888690-1
For: 2-Stroke: 115hp. - 300hp. (1993-Current)
4-Stroke: 115hp. - 225hp. (2002-Current)



**18-9077
WAVE WASHER**
Replaces: 13-888363-2
For: 2-Stroke: 115hp. - 300hp. (1993-Current) 4-Stroke: 115hp. - 225hp. (2002-Current)



**18-9079
WAVE WASHER KIT**
Replaces:
Fits: Yamaha 2-stroke 115-300hp (1993 & Up); Yamaha 4-stroke 115-225hp (2002 & Up); Mercury 4-stroke 225 EFI S/N OT653945 & Up



**18-9078
STAINLESS STEEL WASHER**
Replaces: 12-855682-2
For: 2-Stroke: 115hp. - 300hp. (1993-Current)
4-Stroke: 115hp. - 225hp. (2002-Current)



THRUST WASHER

Part #	Replaces
18-4220	12-13171, 12-77987, 12-8354671, 12-77987A1, 12-835467, 12-835467Q01 V-6 Outboards & Mercruiser Sterndrives
18-4221	13191A1, 75282A1 4 & 6 Inline - 75-150 HP



**18-4233
THRUST WASHER**
Replaces: 73345, 73345A1, 12-92647M 35-70 HP



**18-9010
MOTOR FLUSHER
Heavy Duty**



**18-3607
RETAINER BRACKET**
Replaces: 893409
For: 200/225 4-Stroke Verado (S/N OT980000 & Up), 250/275 4-Stroke Verado (S/N OT801000 & Up)

Zinc is for saltwater only applications.
Magnesium is for fresh water only applications.
Aluminum is for brackish water or salt water environments.



**18-6156A
18-6156M
ANODE KIT**
Verado 4 cyl. All Models



**18-6157A
18-6157M
ANODE KIT**
Replaces: 8M0058677
Verado 6 cyl. All Models



② **18-6241**
③ **18-6011**
① **18-6011A
ANODE**
Replaces:
31640, 31640A1, 97-31640Q4, 97-31640B4, 31640A4, 31640A2, 316404, 316403, 72436A1
Use on inline 3, 4 & 6 Cyl, V6



③ **18-6014**
① **18-6014A
ANODE**
Replaces:
46399A1, 822777A1, 822777Q1, 822777A4, 822777A3, 8227772, 822777, 463999A2
For use with 225 (3.0L Carb.) models



③ **18-6016**
④④ **18-60161**
③⑤ **18-60161-9**
① **18-6016A**
② **18-6244
ANODE**
Replaces:
76214, 97-76214Q5, 97-762145, 76214A5, 786214A2, 762142, 762142A1
200, 225, 250HP, V-155-V-200, & All Bravos



③ **18-6068
ANODE**
Replaces: 826134, 826134A1, 97-826134Q

④ Aluminum ② Magnesium ③ Zinc
④ Standard package of 10 priced per piece ⑤ Standard package of 10 priced per package



③ 18-6249
① 18-6249A
ANODE
Replaces: 43396A2, 818298A1, Q1
For use on transom mount bracket:
175HP/150EFI/200EFI
(S/N OG303046 & Up)



① 18-6245D
18-6245 ANODE MOUNTING BOLT
Replaces: 10-32470
For use with: 18-6011, 18-6014, 18-6016
7/16" X 1 3/4" Allen Head Cap Screw



18-2599 FACE SEAL AND TOOL
Replaces: 26-816575A2



18-2742 SHIFT SHAFT BOOT
Replaces: 85552

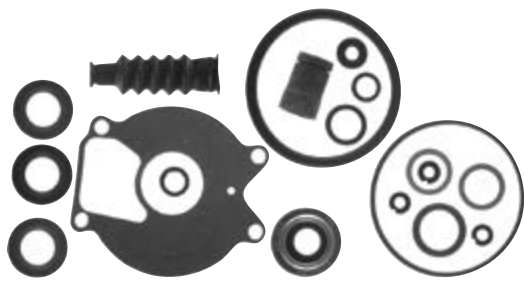

18-2624 LOWER UNIT SEAL KIT
Replaces: 26-85090A2

— CONTAINS —

Part #	Desc.	O.E.#	Qty.
18-0579	Oil Seal	26-41131	1
18-0580	Oil Seal	26-41132	1
18-0586	Seal	26-99325	2
18-7419	O-Ring	25-69202	1
18-2562	Gear Hsg to Face Plate Gasket	27-99326-1	1
18-2945	Drain Screw Gasket	12-20260	2
18-2742	Boot	85552	1
18-2560	Washer	12-86645	2
18-7135	O-Ring	25-35276	1
18-7188	O-Ring	25-805726	2
18-7956	O-Ring	25-85549	1
18-7100	O-Ring	25-85594	1

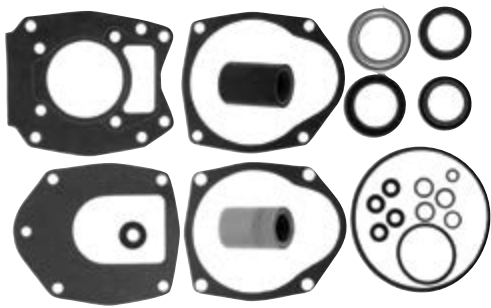

18-2626 LOWER UNIT SEAL KIT
Replaces: 26-43035A4, 26-43034A1, 26-43034A2, 26-43034A3

— CONTAINS —

Part #	Desc.	O.E.#	Qty.
18-0522	Oil Seal	26-43036	1
18-0583	Oil Seal	26-43035	1
18-2002	Oil Seal	26-30550, 26-76868	1
18-2053	Oil Seal	26-70081	1
18-2054	Oil Seal	26-8164641	1
18-2563	Face Plate to Water Pump Cover Gasket	27-43034-1	1
18-2564-1	Water Pump Base to Face Plate Gasket	27-43033-1	1
18-2565	Water Pump Base to Gear Housing Gasket	27-43047-2	1
18-2566	Face Plate to Water Pump Cover Gasket	27-817277	1
18-2945	Drain Screw Gasket	12-19183	3
18-4261	Washer	19643	1
18-7188	O-Ring	25-805726	1
18-7198	O-Ring	25-45710	1

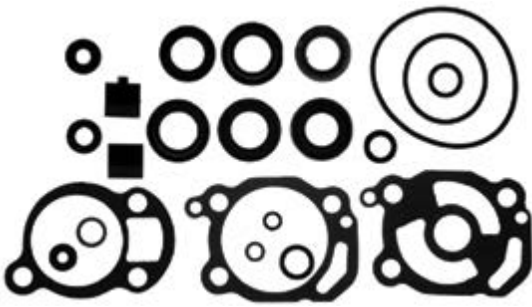

18-2627 LOWER UNIT SEAL KIT
Replaces: 26-66303A1

— CONTAINS —

Part #	Desc.	O.E.#	Qty.
18-0595	Seal	26-66303	2
18-2004	Seal, Water Pump Base	26-20070	2
18-2006	Seal, Water Pump Base	26-897154	1
18-2019	Seal	26-26805	1
18-2827	Upper Face Plate to Water Pump Gasket	27-39623	1
18-2828	Lower Water Pump Base to Face Gasket	27-39625	1
18-2945	Drain Screw Gasket	12-20260	1
18-4261	Washer	12-20262	1
18-7120	O-Ring	25-38933	1
18-7163	O-Ring	25-33465	1
18-7164	O-Ring	25-33466	1
18-7180	O-Ring	25-26802	2

① Aluminum ③ Zinc

– CONTAINS –

Part #	Desc.	O.E.#	Qty.
18-2006	Seal	26-897154	2
18-2560	Washer	12-86645	2
18-2562	Gear Housing to Face Plate Gasket	27-99326-1	1
18-2742	Boot	85552	1
18-2945	Drain Screw Gasket	12-20260	2
18-7135	O-Ring	25-35276	1
18-7419	O-Ring	25-69202	1
18-7956	O-Ring	25-85549	1
18-7100	O-Ring	25-85594	1
18-8348	Slinger	25-86203	1



18-2629
LOWER UNIT SEAL KIT
Replaces: 26-85090A1

– CONTAINS –

Part #	Desc.	O.E.#	Qty.
18-0500	Seal	26-817472	1
18-0622	Gasket, Lower Wear Plate	27-19701	1
18-2051	Seal	26-69188	1
18-2052	Seal	26-69189	1
18-2945	Drain Screw Gasket	12-19183	3
18-7168	O-Ring	25-48171	2
18-7173-9	O-Ring	25-30224	1
18-7950	O-Ring	25-45258	1



18-2635
LOWER UNIT SEAL KIT
Replaces: 26-814669A2

– CONTAINS –

Part #	Desc.	O.E.#	Qty.
18-2563	Face Plate to Water Pump Gasket	27-43034-1	1
18-2564-1	Water Pump Base to Face Plate Gasket	22-43033-1	1
18-2945	Drain Screw Gasket	12-19183,12-20260	2
18-2599	Face Seal & Tool	26-816575A2	1
18-2014	Oil Seal	26-89238	1
18-2013	Oil Seal	26-16977	1
18-2054	Oil Seal	26-8164641	1
18-7159	O-Ring	25-31534	1
18-7176	O-Ring	25-90011	1
18-7420	O-Ring	25-21836	2
18-7440-1	O-Ring	25-36318	2

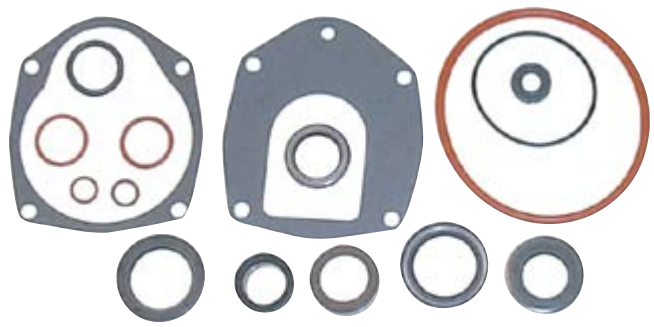

18-2642
LOWER UNIT SEAL KIT
Replaces: 26-816575A5

– CONTAINS –

Part #	Desc.	O.E.#	Qty.
18-2599	Face Seal and Tool	26-818575A2	1
18-2564-1	Water Pump Base To Face Plate Gasket	27-43033-1	1
18-2566	Face Plate to Water Pump Cover Gasket	27-817277	1
18-2945	Drain Screw Gasket	12-19183	1
18-2944	Seal	26-45577	1
18-2002	Oil Seal	26-30550, 26-76868	1
18-2009	Oil Seal	26-892361	1
18-2013	Oil Seal	26-16977	1
18-2014	Oil Seal	26-89238	1
18-2056	Oil Seal	26-965031	2
18-2076	Oil Seal	26-12224	1
18-2077	Oil Seal	26-14077	1
18-7159	O-Ring	25-31534	1
18-7168	O-Ring	25-48171	2
18-7176	O-Ring	25-90011	1
18-7420	O-Ring	25-21836	2
18-7440-1	O-Ring	25-36318	2
18-2056	Oil Seal	26-66302	2
18-7413	O-Ring	25-62702	2
18-2009	Oil Seal	26-892361	1
18-2430	Drain Screw Gasket	26-830749	1



18-2646-1
LOWER UNIT SEAL KIT
Replaces: 26-816575A3, 26-816575A1



18-2653
LOWER UNIT SEAL KIT
 Replaces: 26-55682A1

-- CONTAINS --			
Part #	Desc.	O.E.#	Qty.
18-3110	Grommet	26-38970	1
18-2002	Oil Seal	26-30550, 26-76868	2
18-2007	Oil Seal	26-94038	1
18-2009	Oil Seal	26-892361	1
18-2013	Oil Seal	26-16977	1
18-2014	Oil Seal	26-89238	1
18-2048	Oil Seal	26-24590	1
18-2050	Oil Seal	26-55682	1
18-2053	Oil Seal	26-70081	1
18-2826	Water Pump Base to Gear Housing Gasket	27-85610-1	1
18-2914	Water Pump Gasket	27-85608-1	1
18-2915	Water Pump Gasket	27-85609-1	1
18-2948	Rubber Washer	12-49221-1	1
18-7153	O-Ring	25-25439	1
18-7157	O-Ring	25-29976	1
18-7158	O-Ring	25-30613	1
18-7159	O-Ring	25-31534	1
18-7161	O-Ring	25-32546	1
18-7162	O-Ring	25-33145	1
18-7173-9	O-Ring	25-30224	1
NSS	Water Pump Gasket	27-32438	1
18-7426	O-Ring	25-30271	1
18-2945	Drain Screw Gasket	12-20260, 12-19183	2

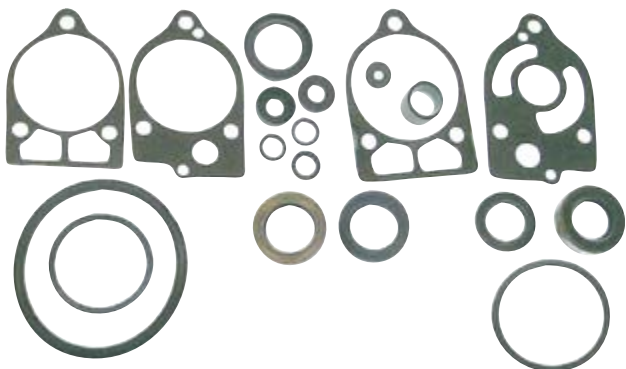

18-2654
LOWER UNIT SEAL KIT
 Replaces: 26-79831A1

-- CONTAINS --			
Part #	Desc.	O.E.#	Qty.
18-2008	Oil Seal	26-56788	1
18-2011	Oil Seal	26-90562	1
18-2048	Oil Seal	26-24590	1
18-2051	Oil Seal	26-69188	1
18-2052	Oil Seal	26-69189	1
18-2054	Oil Seal	26-816464	1
18-2055	Oil Seal	26-79831	1
18-2823	Lower Water Pump Base to Face Plate Gasket	27-32769	1
18-2824	Upper Face Plate to Pump Body Gasket	27-19551	1
18-2825	Water Pump Base Gasket	27-32770	1
18-2841	Water Pump Base Gasket	27-19552, 27-77417	1
18-2948	Rubber Washer	12-49221-1	1
18-7153	O-Ring	25-25439	1
18-7155	O-Ring	25-26855	1
18-7160	O-Ring	25-31986	1
18-7115	O-Ring	25-26722	1
18-2945	Drain Screw Gasket	12-20260, 12-19183	2

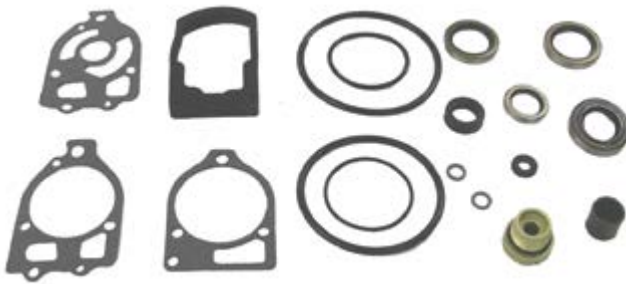

18-2655
LOWER UNIT SEAL KIT
 Replaces: 26-89238A2

-- CONTAINS --			
Part #	Desc.	O.E.#	Qty.
18-2155	Bushing Gasket	23-77631A2	1
18-2919	Gasket	27-42631-1	1
18-2002	Oil Seal	26-30550, 26-76868	2
18-2013	Oil Seal	26-16977	1
18-2014	Oil Seal	26-89238	1
18-2914	Water Pump Gasket	27-85608-1	1
18-2915	Water Pump Gasket	27-85609-1	1
18-3110	Bushing	26-38970	1
18-7159	O-Ring	25-31534	1
18-7176	O-Ring	25-90011	1
18-7157	O-Ring	25-29976	1
18-7153	O-Ring	25-25439	1
18-2009	Oil Seal	26-89236	1
18-7426	O-Ring	25-30271	1
18-2945	Drain Screw Gasket	12-20260, 12-19183	2



18-2697-1
LOWER UNIT SEAL KIT
 Replaces: 26-41365A3

-- CONTAINS --			
Part #	Desc.	O.E.#	Qty.
18-0581	Oil Seal	26-413651	2
18-0584	Oil Seal	26-66022	1
18-0585	Oil Seal	26-821928	1
18-0586	Oil Seal	26-99325	1
18-2728	Water Tube Seal	26-42102-1	1
18-2945	Drain Screw Gasket	12-19183	2
18-3149-2	Water Pump Base	46-42040A5	1
18-4261	Washer	19643	1
18-7162	O-Ring	25-33145	1

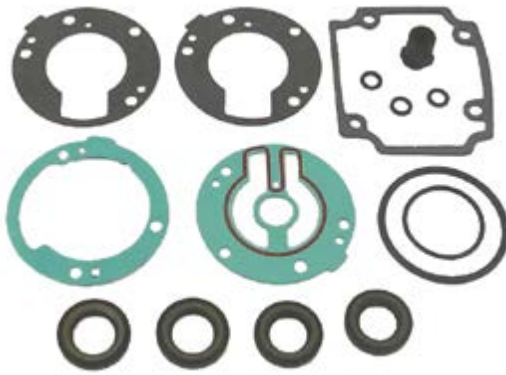

18-2785
LOWER UNIT SEAL KIT
 Replaces: 27-41899M

-- CONTAINS --

Part #	Desc.	O.E.#	Qty.
18-4698	Drain or Fill Washer Gasket	27-81987M	3
18-0554	Oil Seal	26-84813M	1
18-0296	Oil Seal	26-854017M	2



18-2645-1
LOWER UNIT SEAL KIT
 Replaces: Mercury 26-76868A04
 Fits: All Mercury Bravo I, II, III, X and XR Drive Engines



18-74501
GEAR HOUSING SEAL KIT
 Replaces: 27-99049M
 Fits: Mariner 9.9C & 15C models



18-2725
LOWER UNIT SEAL KIT
 Replaces: 26-830749A01
 For: 135/150/175 4-Stroke Verado (S/N 1B227000 & Up), 200/225 4-Stroke Verado (S/N OT980000 & Up), 250/275 4-Stroke Verado (S/N OT801000 & Up)



18-8382
LOWER UNIT SEAL KIT
 Replaces: 26-816575A4
 For: 200 HP (T801000 & UP), 200 HP OPTIMAX DFI (G438000 & UP), 225 HP EFI (G438000 & UP), 225 HP OPTIMAX DFI (G590000-G960499), 250 HP EFI (G438000 & UP), MODELS WITH "C-3 CASTING": 200 HP OPTIMAX DFI (G386496-G437999), 225 HP (D280813-G437999), 225 HP EFI (G129222-G437999), 250 HP EFI (G129222-G437999)



GEAR HOUSING SEAL KIT APPLICATION

HP	Beg. Serial #	End. Serial #	Part #	HP	Beg. Serial #	End. Serial #	Part #
4 (1cyl)	5595532	A809600	-	60 (3 cyl)	6428681	D000749	18-2654
4.5 (1 cyl)	4107220	& UP	-	60 (3 cyl)			
6	A197112	& UP	18-2697-1	non-Bigfoot	D000750	& UP	18-2635
7.5	4851693	& UP	-	60 (3 cyl)			
8	A197112	& UP	18-2697-1	Bigfoot	D000750	& UP	18-2626
8 Bodensee (4-stroke)	G760300	T178499	18-2697-1	60 (4-stroke) Bigfoot	T178500	& UP	18-2626
9.8	4839254	& UP	-	60 (4-stroke)			
9.9	A197112	& UP	18-2697-1	non-Bigfoot	T178500	& UP	18-2635
9.9 (4-stroke) non-Bigfoot	G760300	& UP	18-2697-1	60 Seapro/ Marathon/ Big Foot (3 cyl)	D000750	& UP	18-2626
9.9 (4-stroke) Bigfoot	G760300	& UP	18-2624	70	4571652	A996141	18-2654
Seapro/XR10	D038000	& UP	18-2697-1	70	A996142	& UP	18-2626
15	A197112	& UP	18-2697-1	75 (4 cyl)	6432901	& UP	18-2653
15 (4-stroke) non-Bigfoot	G760300	& UP	18-2697-1	75 (3 cyl)	A996142	& UP	18-2626
15 (4-stroke) Bigfoot	G760300	& UP	18-2624	75 (4-stroke)	G960500	& UP	18-2626
Magnum/ Marathon 15XD/ Super 15	ALL		18-2624	80 (4 cyl)	4831999	6432900	18-2653
18	5837437	6443972	18-2629	80 (3 cyl)	A966142	& UP	18-2626
18	6443973	& UP	18-2624	90 (6 cyl)	4845301	& UP	18-2653
20	4709593	6443972	18-2627	90 (3 cyl)	A996142	& UP	18-2626
20	6443973	& UP	18-2624	90 (4-stroke)	G960500	& UP	18-2626
25	5705532	6443972	18-2629	100 (4 cyl)	B209468	& UP	18-2626
25	6443973	& UP	18-2624	115 (6 cyl)	4855153	B209467	18-2653
25 Lightning (3 cyl)	E268781	& UP	18-2624	115 (4 cyl)	C100000	& UP	18-2626
30 (4-stroke) (3 cyl) Bigfoot	G760300	& UP	18-2626	115EFI (4-stroke)	T178500	& UP	18-2626
35	6445653	& UP	18-2654	125 (4 cyl)	D283222	& UP	18-2626
40 (2 cyl)	4860103	G053313	18-2654	V-135	A904646	& UP	18-2655
40 (4 cyl)	C159200	& UP	18-2654	V-135 DFI	G590000	& UP	18-2655
40 (4-stroke) (3 cyl) Bigfoot	G760300	& UP	18-2626	140 (6 cyl)	4865678	& UP	18-2653
45	5531630	& UP	18-2654	V-150	4868648	A904645	18-2653
50 (4 cyl)	4357640	& UP	18-2654	V-150 (carb)	A904646	& UP	18-2655
50 (3 cyl)	6428681	D000749	18-2654	V-150 XR4, XR6, MAGII, III	B242885	& UP	18-2655
50 (3 cyl)	D000750	G589999	18-2635	V-150 EFI	D820000	& UP	18-2655
50 (4-stroke) (4 cyl) Bigfoot	G760300	& UP	18-2626	V-150 DFI	G590000	& UP	18-2655
50 (4-stroke) Bigfoot	G231123	& UP	18-2626	V-175	4301235	6618750	18-2653
50 (4-stroke) non-Bigfoot	T178500	& UP	18-2635	V-175 (carb)	6618751	& UP	18-2655
55 (3 cyl)	D000750	& UP	18-2635	V-175 XRI(EFI)	D000750	& UP	18-2655
				V-200	4839034	6625220	18-2653
				V-200 (carb)	6625221	& UP	18-2655
				V-200 XRI(EFI)	C100861	& UP	18-2655
				V-200 DFI (3.0L)	G386496	G960499	18-2642
				V-220	B117316	& UP	18-2655
				V-225	5628028	& UP	18-2653
				V-225	D280813	& UP	18-2646-1
				V-225/225 DFI	G386496	& UP	18-2642
				V-250	G386496	& UP	18-2642

MARINER LOWER UNIT SEAL KITS (Japanese Models)

Model	Serial #	O.E. Kit #	Part #
20C	(6A9-) ALL	27-41899M/27-95660M	18-2785
25C	(695-) ALL	27-41899M/27-95660M	18-2785
30A	(689-) ALL	27-41899M/27-95660M	18-2785
W48	(670-) ALL	27-92648M	—
55/W55	(663-) ALL	27-92648M	—
60	(675-) ALL (6F0-) ALL	27-92648M	—

OIL SEALS



Part #	O.E. #	Shaft Size (in.)	Dimensions (in.)	
			O.D.	Width
18-0531	26-72785	0.790	1.880	0.248
18-0537	26-85107	1.020	1.507	0.251
18-0554	26-84813M	0.787	1.339	0.260
18-0560 ③	26-888483	1.250	1.690	0.256
18-0564 ④	26-888483	1.250	1.690	0.256
18-0579	26-41131	1.141	1.313	0.344
18-0580	26-41132	0.750	1.250	0.312
18-0581	26-413651	0.500	0.984	0.200
18-0583	26-43035	1.063	1.496	0.197
18-0584	26-66022	0.056	1.000	0.312
18-0585	26-821928	0.687	1.125	0.312
18-0586	26-99325	0.675	1.125	0.250
18-0595	26-66303	0.688	1.125	0.250
18-2002	26-76868, 26-30550	1.188	1.692	0.250
18-2004	26-20070	0.625	1.000	0.250
18-2006	26-897154	0.625	1.125	0.312
18-2008	26-56788	0.875	1.250	0.375
18-2010	26-897153	0.437	0.875	0.250
18-2053	26-70081	1.185	1.754	0.360
18-2052	26-43036	1.045	1.474	0.187
18-2053	26-43036	1.045	1.474	0.187
18-0523	26-43993	1.640	2.132	0.282
18-0525	26-45587	0.390	0.628	0.124
18-0526	26-48443	0.750	1.379	0.256
18-0527	26-56397	0.750	1.127	0.343
18-0529	26-62818	1.640	2.256	0.319

① Line Cutter Seal ② Pkg. of 4 ③ Metal ④ Rubber

POWERHEAD SEALS APPLICATION

HP	Cyl.	Beginning Serial No.	Ending Serial No.	Upper Crankshaft	Qty.	Lower Crankshaft	Qty.
3.5	1	6202173	UP	—	—	18-0527	1
3.6	1	5404657	UP	—	—	18-0527	1
4	1	2771622	4107219	—	—	18-0527	1
4	1	5589202	UP	18-0515	1	—	—
4.5	1	4107220	UP	—	—	18-0527	1
7.5/9.8/110	2	2810637	3274633	—	—	18-0527	1
10/15/20/25	2	1290910	1499331	—	—	18-2013	1
20	2	1558310	2031773	—	—	18-2013	2
20	2	2031774	2827677	—	—	18-2013	2
18,20,25XD	2	6443973	UP	—	1	18-0537	1
20 JET	2	G053314	UP	—	1	18-0537	1
30	2	1271885	1356947	18-2016	1	18-2016	1
30JET	2	C159200	UP	18-2016	1	18-2016 ①	2
MK 35 A	2	1217222	1271884	18-2016	1	18-2016	1
35	2	1356948	1571113	18-2016	1	18-2016	1
35	2	1571114	2874703	—	—	18-2016 (lower)	1
35	2	6445653	UP	18-2016	1	18-2016	2
40	4	1279685	2874703	18-2016	1	18-2016	1
40	2	2874704	3336257	18-2016	1	18-2016	2
40	2	3336258	4117709	18-2016	1	18-2016	1
40	2	4117710	5556229	18-2016	1	18-2016	1
40	2	5556230	6445653	18-2016	1	18-2016	2
40	4	C159200	UP	18-2016	1	18-2016 ①	2
45	4	1476510	1531568	18-2016	1	18-2016	1
45	4	5531630	UP	18-2016	1	18-2016	2
45 JET	3	ALL	—	—	—	18-2016 (inner)	1
50	4	1421113	2858813	18-2016	1	18-2016 (inner)	1
50	4	2855514	UP	18-2016	1	18-2016	2
50/60	3	6428681	D000750	18-2016	1	18-2016	2
50/55/60	3	D000750	UP	—	—	18-2016 (inner)	1
60	6	1303411	1542744	18-2016	1	18-2016	1
65	4	1542745	2803561	18-2016	1	18-2016 (inner)	1
65	4	2803562	3293183	18-2016	1	18-2016	2
65	3	3293184	3547986	18-2016	1	18-2016	2
65	3	3547987	4571651	18-2016	1	18-2016	2
65 JET	3	D283222	UP	18-0523	1	18-2016	1

① Fits most models

POWERHEAD SEALS APPLICATION

HP	Cyl.	Beginning Serial No.	Ending Serial No.	Upper Crankshaft	Qty.	Lower Crankshaft	Qty.
70	6	1296411	1566239	18-2016	1	18-2016 (inner)	1
70	3	4571652	6428680	18-2016	1	18-2016	2
70	3	A996142	UP	18-0523	1	18-2016	1
75	4	6432901	A996141	18-2016	1	18-2016	2
75	3	A996142	D283221	18-0523	1	18-2016	1
75	3	D283222	UP	18-0523	1	18-2016	1
80	6	1335465	1566239	18-2016	1	18-2016	1
80	4	2559001	4831998	18-2016	1	18-2016	2
80	4	4831999	UP	18-2016	1	18-2016	2
80	3	A996142	UP	18-0523	1	18-2016	1
80 JET	4	D283222	UP	18-0523	1	18-2016	1
85	6	1460999	1766823	18-2016	1	18-2016	1
85	4	3493913	4831998	18-2016	1	18-2016	2
90	6	1766824	1869775	18-2016	1	18-2016 (outer)	1
90	6	4845301	A996141	18-2016	1	18-2016	2
90	3	A996142	D283221	18-0523	1	18-2016	1
90	3	D283221	UP	18-0523	1	18-2016	1
95	6	1869776	2318585	18-2016	1	18-2016 (inner)	1
100	6	1464949	2836018	18-2016	1	18-2016	1
100BP	6	2641855	3253111	18-2016	1	18-2016	2
100	4	B209468	D283221	18-0523	1	18-2016	1
100	4	D283222	UP	18-0523	1	18-2016	1
105JET	V-6	D082000	UP	18-2016	1	18-2016	2
110	6	1870204	2314955	18-2016	1	18-2016	1
115	6	2836019	3525440	18-2016	1	18-2016	2
115	6	3525441	C100000	18-2016	1	18-2016	2
125	6	2314956	3253111	18-2016	1	18-2016 (inner)	1
135	6	2839369	3293233	18-2016	1	18-2016	2
135	V-6	A904646	UP	18-2016	1	18-2016	2
140	6	3293234	UP	18-2016	1	18-2016	2
140JET	V-6	D082000	UP	18-2016	1	18-2016	2
150	6	3502806	5327662	18-2016	1	18-2016	2
150	V-6	4868998	6042945	18-2016	1	18-2016	2
150	V-6	6042946	UP	18-2016	1	18-2016	2
175	V-6	4301235	5875203	18-2016	1	18-2016	2
175	V-6	5875204	6618751	18-2016	1	18-2016	2
175	V-6	6618751	UP	18-2016	1	18-2016	2
200	V-6	4839034	5875303	18-2016	1	18-2016	2
200	V-6	5875303	6073191	18-2016	1	18-2016	2
200	V-6	6073192	UP	18-2016	1	18-2016	2
220	V-6	B117316	UP	18-2016	1	18-2016	2
225	V-6	5628028	UP	18-2016	1	18-2016	2

① Fits most models

LOWER UNIT SEALS APPLICATION

HP	Beginning Serial No.	Ending Serial No.	Prop Shaft Inner/Outer	Water Pump Base Upper/Lower	Water Pump Housing	Shift Shaft
3.5/3.6	5404657	UP	-	18-2010	-	-
3.9	1655013	2498135	18-0515	-	-	-
4	2498136	5589201	18-0515	-	-	-
4	5589202	5595531	-	18-2010	-	-
4/4.5	5589203	A809601	-	18-2010	②	-
6	1408611	2529894	18-0515	-	-	-
7.5	2529895	3801457	18-0515	-	-	-
7.5	3801458	5206549	-	-	-	-
7.5	5206550	UP	-	18-2010	②	-
9.8	1470349	3795657	18-0515	-	-	-
9.8	3795658	5206549	-	-	-	-
9.8	5206550	UP	-	18-2010	②	-
18	5837437	6443972	-	18-2006/18-2006	-	-
20	1558310	1866494	18-2019/18-2019	18-2006	18-2004	-
20	1866495	6443972	18-2019/18-2019	18-2004/18-2006	18-2004	-
25	5705532	6443972	-	18-2006/18-2006	-	-
30	1271885	1356947	18-2011	18-2011	18-2015	18-2009
30	G055314	UP	18-2051/18-2052	-	-	-
MK 35A	1217222	1271884	18-2011	18-2011	18-2015	18-2009
35	1356948	1448139	18-2011	18-2011	18-2015	18-2009
35	1571114	1960826	18-2011	18-2011	18-2017	18-2009
35	1960827	2874703	18-2011/18-2015	18-2011/18-2055	18-2017	18-2009
35	6445653	UP	18-2051/18-2052	18-2011/18-2055	-	18-2054
40	1279685	2874703	18-2011	18-2011	18-2015	18-2009
40	2874704	3336257	18-2008	18-2011/18-2055	18-2017	18-2009
40	3336258	4117709	18-2008	18-2011/18-2055	18-2017	18-2048
40	4117710	4860102	18-2051/18-2052	18-2011/18-2055	-	18-2009/18-2048

② .438 ID ONLY

LOWER UNIT SEALS APPLICATION (Cont.)

HP	Beginning Serial No.	Ending Serial No.	Prop Shaft Inner/Outer	Water Pump Base Upper/Lower	Water Pump Housing	Shift Shaft
40	4860103	6445652	18-2051/18-2052	18-2011/18-2055	-	18-2054
40 4cyl	C159200	G053313	18-2051/18-2052	18-2011/18-2055	-	18-2054
40 2cyl	G055314	UP	18-2051/18-2052	-	-	-
45	1476510	1531568	18-2011	18-2011	18-2017	18-2009
45 4cyl	5531630	UP	18-2051/18-2052	18-2011/18-2055	-	18-2054
50	1421113	1639472	18-2011	18-2011	18-2017	18-2009
50	1639473	1770178	18-2011	18-2011	18-2017	18-2009
50	1770179	2305100	18-2011/18-2015	18-2011/18-2055	18-2017	18-2009
50	2305101	2858813	18-2011/18-2015	18-2011/18-2055	18-2017	18-2048
50	2858814	4140999	18-2008	18-2011/18-2055	18-2017	18-2009/18-2048
50	4141000	4962055	18-2051/18-2052	18-2011/18-2055	-	18-2009/18-2048
50	4962056	5531630	18-2051/18-2052	18-2011/18-2055	-	18-2054
50 3cyl	6428681	D000750	18-2051/18-2052	18-2011/18-2055	-	18-2054
50/55/60 3 cyl	D000751	UP	18-2051/18-2052	-	-	18-2054
60	1303411	1542744	-	18-2011	18-2015	-
60	6428681	D000750	18-2051/18-2052	18-2011/18-2055	-	18-2054
65	1542745	2874263	18-2002/18-2002	18-2007	18-2013	18-2009
65	2874263	3293183	18-2002/18-2002	18-2007/18-2050	18-2013	18-2009/18-2048
65 3cyl	3293184	4136684	18-2008	18-2011/18-2055	18-2017	18-2009/18-2048
65 3cyl	4136685	4571651	18-2051/18-2052	18-2011/18-2055	18-2017	18-2009/18-2048
70	1296411	1413610	18-2011	-	18-2015	-
70	1413611	1566239	18-2002/18-2002	18-2007	18-2013	18-2009
70 3cyl	4571652	4977156	18-2051/18-2052	18-2011/18-2055	-	18-2009/18-2048
70 3cyl	4977157	5579016	18-2051/18-2052	18-2011/18-2055	-	18-2054
70 3cyl	5579017	A996142	18-2051/18-2052	18-2011/18-2055	-	18-2009
70/75 3cyl	A996142	UP	18-2002/18-2053	18-0522 (lower)	-	-
75 4cyl	6432901	A996142	18-2002/18-2053	18-2013/18-2007	-	18-2054
80	1335465	1398629	18-2002/18-2002	18-2007	18-2013	18-2009
80	1398630	1566239	18-2002/18-2002	18-2007	18-2013	18-2009
80 4cyl	2559001	3144218	18-2002/18-2002	18-2013/18-2007	18-2013	18-2009/18-2048
80 4cyl	3144219	4831998	18-2002/18-2002	18-2050/18-2007	18-2013	18-2009/18-2048
80 4cyl	4831999	5582561	18-2002/18-2002	18-2013/18-2007	-	18-2054
80 4cyl	5582562	A996142	18-2002/18-2053	18-2013/18-2007	-	18-2054
80 3cyl	A996142	UP	18-2002/18-2053	18-0522 (lower)	-	-
85	1460999	1766823	18-2002/18-2002	18-2007	18-2013	18-2009
85 4cyl	3493913	4590511	18-2002/18-2002	18-2050/18-2007	-	18-2009/18-2048
85 4cyl	4590512	4831998	18-2002/18-2002	18-2013/18-2007	-	18-2009/18-2048
90	1766824	1869775	18-2002/18-2002	18-2013/18-2007	18-2013	18-2009
90	4845301	5594656	18-2002/18-2002	18-2013/18-2007	-	18-2054
90	5594657	A996142	18-2002/18-2053	18-2013/18-2007	-	18-2054
90 3cyl	A996142	UP	18-2002/18-2053	18-0522 (lower)	-	-
95	1869776	2318585	18-2002/18-2002	18-2013/18-2007	18-2013	18-2009/18-2048
100,100SS	1464949	2836018	18-2002/18-2002	18-2013/18-2007	18-2013	18-2009
100BP	2399698	2641854	18-2002/18-2002	18-2013/18-2007	18-2013	18-2009/18-2048
100 4cyl	B209468	UP	18-2002/18-2053	18-0522 (lower)	-	-
110	1870204	2314955	18-2002/18-2002	18-2013/18-2007	18-2013	18-2009/18-2048
115	2836019	3525440	18-2002/18-2002	18-2013/18-2007	18-2013	18-2009/18-2048
115	3525440	4112634	18-2002/18-2002	18-2013/18-2007	-	18-2009/18-2048
115	4112635	4855152	18-2002/18-2002	18-2013/18-2007	-	18-2009/18-2048
115	4855153	5600966	18-2002/18-2002	18-2013/18-2007	-	18-2054
115	5600967	C100000	18-2002/18-2053	18-2013/18-2007	-	18-2054
115 4cyl	C100000	UP	18-2002/18-2053	18-0522 (lower)	-	-
125	2314956	2839368	18-2002/18-2002	18-2013/18-2007	18-2013	18-2009
135	2839369	3293233	18-2002/18-2002	18-2013/18-2007	18-2013	18-2009
140	3293234	3502805	18-2002/18-2002	18-2013/18-2007	18-2013	18-2009/18-2048
140	4865678	UP	18-2002/18-2002	18-2013/18-2007	-	18-2054
150	3502806	4121434	18-2002/18-2002	18-2013/18-2007	-	18-2009/18-2048
150	4121434	5327662	18-2002/18-2002	18-2013/18-2007	-	18-2009/18-2048

V-6'S

150/150XR2	4868998	5432021	18-2002/18-2002	18-2013/18-2014	-	18-2054
150/150XRS	5432021	A904646	18-2002/18-2002	18-2013/18-2014	-	18-2054
135/150/XR2	A904646	UP	18-2002/18-2002	18-2013/18-2014	-	18-2054
175	4301235	6618750	18-2002/18-2002	18-2013/18-2014	-	18-2054
175	6618751	UP	18-2002/18-2002	18-2013/18-2014	-	18-2054
200	4839034	6073191	18-2002/18-2002	18-2013/18-2014	-	18-2054
200	6073192	UP	18-2002/18-2002	18-2013/18-2014	-	18-2054
220	B117316	UP	18-2002/18-2002	18-2013/18-2014	-	18-2054
225	5628028	D280813	18-2002/18-2002	18-2013/18-2014	-	18-2054
250/275	C101891	UP	18-2002/18-2002	-	-	18-2054
3.4	5611648	UP	18-2002/18-2002	-	-	18-2054

POWER TRIM OIL SEAL

H.P.	Beginning S/N	Ending S/N	Oil Seals	Qty.	Desc.
115	2836019	3525440	18-2048	1	Starboard Mounting Bracket
140	3293234	UP	18-2048	1	Starboard Mounting Bracket
150	3502806	4865677	18-2048	1	Starboard Mounting Bracket
150 XS	4868648	5327662	18-2048	1	Starboard Mounting Bracket

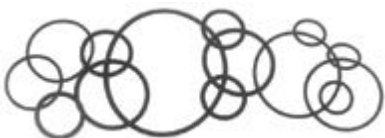

O-RINGS

Part #	O.E. #	DIMENSIONS (in.)		Part #	O.E. #	DIMENSIONS (in.)	
		O.D.	Width			O.D.	Width
18-0858 ③④	25-54029	2.800	0.103	18-7166 ②④	25-45254	0.615	0.065
18-0860 ③④	25-62700	3.237	0.103	18-7167 ②④	25-861844	3.609	0.139
18-7102 ②④	25-62706	0.426	0.07	18-7168 ②④	25-20587, 25-21720, 25-26834, 25-48171, 25-801334436	0.37	0.065
18-7103 ②④	25-29845	0.924	0.103	18-7169 ②④	25-35984, 25-70937	3.5	0.135
18-7105 ②④	25-62705, 25-F7848342	0.75	0.065	18-7170 ②④	25-33504	1.365	0.135
18-7107 ②④	25-67202	4.75	0.135	18-7171 ②④	25-30529	1.92	0.1
18-7114 ②④	25-23145, 25-843315, 25-F702736	1	0.135	18-7172 ②④	25-31305	3.25	0.135
18-7115 ①	25-26722	1.735	0.135	18-7173-9 ②④	25-27018, 25-30224Q	1.875	0.135
18-7116 ①	25-20633, 25-22174, 25-62704, 25-85148, 25-F24342, 802206	0.36	0.1	18-7174 ②④	25-45711	0.62	0.1
18-7117 ①	25-35027	1.046	0.139	18-7175 ②④	25-62817	3.75	0.27
18-7120 ①	25-38933	0.215	0.065	18-7176 ②④	25-896523, 25-F74305, F74305-1, F74305, F694555	2.16	0.1
18-7121 ①	25-35029, 25-882613, 802231	3.1	0.135	18-7177 ②④	25-53421, 25-59712	2.625	0.065
18-7124		2.5	0.103	18-7180 ②④	12-31060, 25-26802, 25-8M2000926	0.445	0.09
18-7125		2.3	0.103	18-7188 ②	25-805726	0.361	0.0635
18-7135 ①	25-20365, 25-35276	0.75	0.135	18-7198 ②④	25-45710	1.43	0.1
18-7143 ②④	27-58025, 25-65936, 391-5081	1.31	0.1	18-7411 ②④	25-35480, 25-47386, 25-8M2000816	1.25	0.1
18-7145 ②④	25-64068	0.25	0.1	18-7413 ②④	22-22175, 25-62702, 25-F50342-1, F50342, F17510	0.301	0.07
18-7146 ②④	25-47632	1.12	0.1	18-7419 ②④	25-69202	2.675	0.103
18-7151 ②④	25-20081, 25-39572	3	0.135	18-7420 ②④	25-21836	0.796	0.139
18-7152 ②④	25-20863	2.625	0.135	18-7421 ②④	25-16524	0.15	0.065
18-7153 ②④	25-25439, 25-20679, 25-F53795-1, F53795	0.862	0.103	18-7426 ③④	25-30271	0.74	0.31
18-7155 ②④	25-26855	1.62	0.135	18-7440-1 ③	25-36318	0.799	0.103
18-7156 ②④	25-29439	1.185	0.1	18-7449 ①	25-97387	4.487	0.103
18-7157 ②④	25-29976	3.5	0.21	18-7459 ①	20311, 25-20826	2.234	0.139
18-7158 ②④	25-30613, 25-846357	0.74	0.1	18-7464 ①	25-39695, 25-846361	4.234	0.139
18-7159 ②④	25-31534, 25-48451	3.855	0.21	18-7467 ②④	25-54030, 25-F523555, F532555	2.987	0.103
18-7160 ②④	25-31986	2.635	0.21	18-7474 ①	25-94288	1.239	0.07
18-7161 ②④	25-32546	3.25	0.07	18-7956 ③④	25-85549	2.48	0.1969
18-7162 ②④	25-32424, 25-33145	2.025	0.135	18-7100 ②④	25-85594	0.2362	0.1575
18-7163 ②④	25-33465, 25-853220, 25-807149	2.415	0.1	18-7961	25-47254	3.65	0.135
18-7164 ②④	25-33466, 25-67675, 25-846356, 27-898101789	1.375	0.1	18-76695	25-803513007	1.220	.095
18-7165-9 ②④	25-45253, 25-806609, 25-F461342	0.5	0.065				
18-7165-9 ②④	25-32509	0.5	0.065				

① Pkg. of 1 ② Pkg. of 5 ③ Pkg. of 2

MARINER O-RINGS (Japanese Models)

Part No.	O.E. No.	Dimensions		Part No.	O.E. No.	Dimensions	
		I. D.	Width (mm)			I. D.	Width (mm)
18-0298	25-82275M	41.50	3.0				

POWERHEAD SEALS & O-RING APPLICATION

Model	Beginning Serial #	Ending Serial #	Lower O-Ring	Lower Oil Seal	Upper O-Ring	Upper Oil Seal
3.5 (1cyl)	6202173	& UP	N/A	N.L.A	18-7152	N/A
3.9 (39) (1cyl)	1655013	2498135	N/A	N.L.A	18-7152	N.L.A
4 (1cyl)	1655013	2498135	N/A	N/A	18-7152	N/A
4 (40) (1cyl)	2498136	2693114	N/A	N.L.A	18-7152	N.L.A
4 (1cyl)	2771622	4107219	N.L.A.	N/A	18-7152	N.L.A
4 (40) (2cyl)	5589202	& UP	18-7102	N/A	N/A	18-0515
4.5 (4.5, 45) (1cyl)	4107220	4597261	N/A	N/A	18-7152	N.L.A
4.5 (4.5, 45) (1cyl)	4597262	5595531	N/A	N.L.A	18-7152	N/A
4.5 (4.5, 45) (1cyl)	5595532	& UP	N/A	N.L.A	18-7152	N/A
6 (60)	1916139	2529894	N/A	N.L.A	18-7459	N.L.A
6 (2cyl)	1408611	2529894	N/A	N/A	18-7152	N/A
7.5 (75)	2529895	2721150	N/A	N.L.A	18-7152	N.L.A

④ This product is priced per piece. To order priced per package, please add -9 to the part number.

POWERHEAD SEALS & O-RING APPLICATION						
Model	Beginning Serial #	Ending Serial #	Lower O-Ring	Lower Oil Seal	Upper O-Ring	Upper Oil Seal
7.5 (2cyl)	2810637	3801457	N/A	N.L.A	18-7152	N/A
7.5 (75) (2cyl)	3274633	& UP	N/A	N/A	18-7152	N/A
7.5 (7.5, 75)	3801458	& UP	N/A	N/A	18-7152	N/A
9.8 (110)	1865779	2798056	N/A	N.L.A	18-7152	N.L.A
9.8 (110)	2798057	3795657	N/A	N.L.A	18-7152	N/A
9.8 (2cyl)	2810637	3274633	N/A	N/A	18-7152	N/A
9.8 (9.8, 110)	3795658	& UP	N/A	N/A	18-7152	N/A
9.8 (2cyl)	3274633	& UP	N/A	N/A	18-7152	N/A
10 (100)	1290910	1499331	N/A	18-2026	N.L.A.	N.L.A
110 (2cyl)	2810637	3274633	N/A	N/A	18-7152	N/A
110 (2cyl)	3274633	& UP	N/A	N/A	18-7152	N/A
15 (150)	1290910	1499331	N/A	18-2026	N.L.A.	N.L.A
15 (SEA PRO)	G044365	G437999	N/A	18-0537	N/A	N/A
15 (SEA PRO)	G438000	& UP	N/A	26-12566 1	N/A	N/A
15 (SUPER)	B238464	& UP	N/A	18-0537	N/A	N/A
15 (18, 18XD)	5837437	& UP	N/A	18-0537	N/A	N/A
20 (200)	1290910	1499331	N/A	18-2026	N.L.A.	N.L.A
20 (200)	1558310	2031773	N/A	18-2026	N.L.A.	N/A
20 (2cyl)	2031774	2827677	N/A	N/A	18-7151	N/A
20 (20, 200)	2827677	6443972	N/A	18-2056	18-7151	N/A
20 (20, 20XD)	6443973	T800749	N/A	18-0537	N/A	N/A
20 JET	G044027	& UP	N/A	18-0537	N/A	N/A
25 (250)	1290910	1499331	N/A	18-2026	N.L.A.	N.L.A
25 (25, 25XD) (2cyl)	5705532	& UP	N/A	18-0537	N/A	N/A
30 (2cyl)	1271885	1448139	18-7151	N.L.A	18-7151	18-2016
30 (2cyl) 644cc	G053314	& UP	18-7176	18-2016	N/A	N/A
30 (2cyl) 430cc	G575500	& UP	N/A	18-2016	N/A	N/A
30 JET (4cyl)	C159200	D279349	18-7161	18-2016	18-7151	18-2016
30 JET (4cyl)	D279350	& UP	18-7161	18-2016	18-7151	18-2016
30 JET (3cyl)	G531301	& UP	18-7176	18-2016	N/A	N/A
MK 35A (2cyl)	1217222	1271884	18-7151	N/A	18-7151	N/A
35 (350)	1271884	1448139	18-7151	N.L.A	18-7151	18-2016
35 (2cyl)	1356948	1571113	18-7151	N/A	18-7151	N/A
35 (2cyl)	1571114	2874703	18-7151	N/A	18-7172	N.L.A
35 (2cyl)	6445653	& UP	N/A	18-2016	18-7167	18-2016
40 (402) (2cyl)	1279685	1476509	18-7151	N/A	18-7151	18-2016
40 (4cyl)	1279685	2874703	18-7151	N/A	18-7151	N/A
40 (2cyl)	2874704	3336257	N/A	18-2016	18-7167	18-2016
40 (2cyl)	3336258	3346479	N/A	18-2016	18-7961	18-2016
40 (2cyl)	3336258	4117709	N/A	N/A	18-7167	N/A
40 (2cyl)	4117710	& UP	N/A	18-2016	18-7167	18-2016
40 (2cyl)	5556230	6445653	N/A	N/A	18-7167	N/A
40 (4cyl)	C159200	D279349	18-7161	18-2016	18-7151	18-2016
40 (402) (2cyl)	3477010	4117709	N/A	18-2016	N/A	18-2016
40 (2cyl) 644cc	G053314	& UP	18-7176	18-2016	N/A	N/A
40 (4cyl)	D279350	& UP	18-7161	18-2016	18-7151	18-2016
40 (3cyl)	G531301	& UP	18-7176	18-2016	N/A	N/A
45 (450) (4cyl)	1476510	1531568	18-7151	N.L.A	18-7151	18-2016
45 (4cyl)	5531630	& UP	18-7151	18-7151	18-7151	18-2016
45 JET	D000750	G589999	18-7176	18-2016	18-7176	N/A
45 JET	G590000	& UP	18-7176	18-2016	N/A	N/A
50 (500) (4cyl)	1421113	1639472	18-7151	18-7151	18-7151	18-2016
50 (500) (4cyl)	1639473	2858813	18-7151	N/A	18-7151	18-2016
50 (50, 500) (4cyl)	2855514	& UP	18-7151	18-2016	18-7151	18-2016
50 (3cyl)	D000750	G589999	18-7176	18-2016	N/A	N/A
50 (3cyl)	6428681	D000750	18-7161	18-2016	N/A	18-2016
50 (3cyl)	D000750	& UP	18-7176	N/A	N/A	N/A
50 (3cyl)	G590000	& UP	18-7176	18-2016	N/A	N/A
55 (3cyl)	D000750	G589999	18-7176	18-2016	N/A	N/A
55 (3cyl)	G590000	& UP	18-7176	18-2016	N/A	N/A
60 (3cyl)	6428681	D000749	18-7161	18-2016	N/A	18-2016
60 (3cyl)	D000750	& UP	18-7176	N/A	N/A	N/A
60 (600) (4cyl)	1303411	1542744	18-7151	N/A	18-7151	18-2016
60 (3cyl)	D000750	G589999	18-7176	18-2016	N/A	N/A
65 (650) (4cyl)	1542745	2803561	18-7151	N/A	18-7172	18-2016
65 (650) (4cyl)	2803562	3203183	18-7151	18-2016	18-7172	18-2016
65 (650) (3cyl)	3293184	4571651	18-7161	18-2016	18-7167	18-2016
65 (3cyl)	3547987	4571651	18-7161	N/A	N/A	N/A
65 JET	D283222	& UP	N/A	18-2016	N/A	18-0523
70 (700) (6cyl)	1296411	1566239	18-7151	N/A	18-7151	18-2016
70 (3cyl)	4571652	6428680	18-7161	18-2016	N/A	18-2016
70 (3cyl)	A996142	B240450	N/A	18-2016	N/A	18-0523

APPLICATION CHART CONTINUES ON NEXT PAGE

POWERHEAD SEALS & O-RING APPLICATION (Cont.)

Model	Beginning Serial #	Ending Serial #	Lower O-Ring	Lower Oil Seal	Upper O-Ring	Upper Oil Seal
70 (3cyl)	B240451	& UP	18-0858	18-2016	N/A	18-0523
75 (4cyl)	6432901	& UP	18-7161	18-2016	18-7961	18-2016
75 (3cyl)	C222000	& UP	N/A	18-2016	N/A	18-0523
80 (800) (6cyl)	1335465	1566239	18-7151	N/A	18-7151	18-2016
80 (800) (4cyl)	2559001	3493912	18-7151	18-2016	18-7961	18-2016
80 (80, 800) (4cyl)	4831999	6432900	18-7161	18-2016	18-7961	18-2016
80 (3cyl)	A996142	B240450	N/A	18-2016	N/A	18-0523
80 (3cyl)	B240451	& UP	18-0858	18-2016	N/A	18-0523
80 JET	D283222	G760299	N/A	18-2016	N/A	18-0523
80 JET w/ROUND UPPER O-RING	G760300	& UP	N/A	18-2016	N/A	18-0523
80 JET w/SQUARE UPPER O-RING	G760300	& UP	N/A	18-2016	N/A	18-0523
85 (850) (6cyl)	1460999	1464848	18-7151	N/A	18-7151	18-2016
85 (850) (6cyl)	1566240	1766823	18-7151	N/A	N.L.A.	18-2016
85 (850) (4cyl)	3493913	4831998	18-7161	18-2016	18-7961	18-2016
90 (900) (6cyl)	1766824	1869775	18-7151	N/A	N.L.A.	18-2016
90 (90, 900) (6cyl)	4845301	& UP	18-7161	18-2016	18-7961	18-2016
90 (3cyl)	A996142	B240450	N/A	18-2016	N/A	18-0523
90 (3cyl)	B240451	C221999	18-0858	18-2016	N/A	18-0523
90 (3cyl)	C222000	& UP	N/A	18-2016	N/A	18-0523
95 (950) (6cyl)	1869776	2318585	18-7151	N/A	N.L.A.	18-2016
100 (1000) (6cyl)	1464949	2318585	18-7151	N/A	N.L.A.	18-2016
100 (1000SS) (6cyl)	2318586	2413847	18-7151	N/A	N.L.A.	18-2016
100 (1000SS) (6cyl)	2484633	2836018	18-7151	18-2016	N.L.A.	18-2016
100 (1000BP) (6cyl)	2399698	2641854	18-7151	18-2016	N.L.A.	18-2016
100 (1000BP) (6cyl)	2641855	3253111	18-7151	18-2016	18-7961	18-2016
100 (4cyl)	B209468	G760299	N/A	18-2016	N/A	18-0523
100 w/ROUND UPPER O-RING (4cyl)	G760300	& UP	N/A	18-2016	N/A	18-0523
100 w/SQUARE UPPER O-RING (4cyl)	G760300	& UP	N/A	18-2016	25-858225	18-0523
110 (1100)	1870201	2314955	18-7151	N/A	N.L.A.	18-2016
115 (1150) (6cyl)	2836019	3525440	18-7151	18-2016	18-7961	18-2016
115 (115, 1150) (6cyl)	3525441	& UP	18-7161	18-2016	18-7961	18-2016
115 (4cyl)	C100000	G760299	N/A	18-2016	N/A	18-0523
115 w/ROUND UPPER O-RING (4cyl)	G760300	& UP	N/A	18-2016	N/A	18-0523
115 w/SQUARE UPPER O-RING (4cyl)	G760300	& UP	N/A	18-2016	N/A	18-0523
115 DFI (1.5L)	T801000	& UP	N/A	18-2016	N/A	N/A
115 PRO XS	B751825	& UP	N/A	18-2016	N/A	N/A
125 (1250) (6cyl)	2314956	2839368	18-7151	N/A	18-7961	18-2016
125 (4cyl)	D283222	G760299	N/A	18-2016	N/A	18-0523
125 w/ROUND UPPER O-RING (4cyl)	G760300	& UP	N/A	18-2016	N/A	18-0523
125 w/SQUARE UPPER O-RING (4cyl)	G760300	& UP	N/A	18-2016	N/A	18-0523
135 (1350) (6cyl)	2839369	3293233	18-7151	18-2016	18-7961	18-2016
140 (140, 1400) (6cyl)	3293234	& UP	18-7161	18-2016	18-7961	18-2016
150 (1500) (6cyl)	3502806	4865677	18-7161	18-2016	18-7961	18-2016
150 (1500XS) (6cyl)	4868648	5327662	18-7161	18-2016	18-7961	18-2016
V-105 JET	D082000	& UP	18-0860	18-2016	18-0858	18-2016
V-135 CARB w1.50 ID UPPER BRG	A904646	C100860	18-0860	18-2016	18-0858	18-2016
V-135 CARB w1.37 ID UPPER BRG	A904646	C100860	18-0860	18-2016	18-0858	18-2016
V-135 CARB	C100861	& UP	18-0860	18-2016	18-0858	18-2016
V-135 CARB	C239553	& UP	18-0860	18-2016	18-0858	18-2016
V-135 DFI	G590000	& UP	18-0860	18-2016	18-0858	18-2016
V-140 JET	D082000	& UP	18-0860	18-2016	18-0858	18-2016
V-150 (V-1500) CARB	4868998	A904645	N/A	18-2016	N/A	18-2016
V-150 w1.50 ID UPPER BRG	A904646	C100860	18-0860	18-2016	18-0858	18-2016
V-150 w1.37 ID UPPER BRG	A904646	C100860	18-0860	18-2016	18-0858	18-2016
V-150 CARB	C100861	C239552	18-0860	18-2016	18-0858	18-2016
V-150 XR4 / MAGNUM II	B242885	C239552	18-0860	18-2016	18-0858	18-2016
V-150 CARB	C239553	& UP	18-0860	18-2016	18-0858	18-2016
V-150 XR4 / 6 MAG II, III	C239553	& UP	18-0860	18-2016	18-0858	18-2016
V-150 EFI	D082000	& UP	18-0860	18-2016	18-0858	18-2016
V-150 DFI	G590000	& UP	18-0860	18-2016	18-0858	18-2016
V-175 (V-175, 1750) CARB	4301235	5393736	N/A	18-2016	N/A	18-2016
V-175 CARB	5393737	6618750	N/A	18-2016	N/A	18-2016
V-175 CARB	6618751	C239552	18-0860	18-2016	18-0858	18-2016
V-175 CARB	C239553	& UP	18-0860	18-2016	18-0858	18-2016
V-175 EFI	D000750	& UP	18-0860	18-2016	18-0858	18-2016
V-175 DFI	T178500	& UP	18-0860	18-2016	18-0858	18-2016
V-175 PRO XS	B516339	& UP	18-0860	18-2016	18-0858	18-2016
V-200 (V-200, 2000) CARB	4839034	5363917	25-67207	18-2016	N/A	18-2016
V-200 CARB	5363918	6073191	N/A	18-2016	N/A	18-2016
V-200 CARB	6073192	C291519	18-0860	18-2016	18-0858	18-2016
V-200 CARB	C291520	& UP	18-0860	18-2016	18-0858	18-2016
V-200 EFI	C100861	C291519	18-0860	18-2016	18-0858	18-2016

APPLICATION CHART CONTINUES ON NEXT PAGE

POWERHEAD SEALS & O-RING APPLICATION

Model	Beginning Serial #	Ending Serial #	Lower O-Ring	Lower Oil Seal	Upper O-Ring	Upper Oil Seal
V-200 EFI (2.5L)	C291520	& UP	18-0860	18-2016	18-0858	18-2016
V-200 DFI	G386496	& UP	18-0860	N/A	N/A	N/A
V-200 PRO XS	B504989	& UP	18-0860	N/A	N/A	N/A
V-200 LASER	B117316	& UP	18-0860	18-2016	18-0858	18-2016
V-225 (2.4L)	5628028	& UP	18-0860	18-2016	N/A	18-2016
V-225 (3.0L) SEA PRO / MARATHON CARB	G245605	G303045	18-0860	N/A	N/A	N/A
V-225 (3.0L) SEA PRO / MARATHON CARB	G303046	& UP	18-0860	N/A	N/A	N/A
V-225 DFI	G590000	& UP	18-0860	N/A	N/A	N/A
V-225 PRO XS	B104549	& UP	18-0860	N/A	N/A	N/A
V-225 EFI	G129222	G303045	18-0860	N/A	N/A	N/A
V-225 EFI	G303046	& UP	18-0860	N/A	N/A	N/A
V-250 w/o UPPER BEARING FITTING	C101891	& UP	N/A	N.L.A	N/A	18-2016
V-250 w/UPPER BEARING FITTING	C101891	& UP	N/A	N.L.A	N/A	18-2016
V-250 EFI	G129222	G303045	18-0860	N/A	N/A	N/A
V-250 EFI	G303046	& UP	18-0860	N/A	N/A	N/A
V-250 DFI	B528615	& UP	18-0860	N/A	N/A	N/A
V-250 PRO XS	B426561	& UP	18-0860	N/A	N/A	N/A
V-275 CARB w/o UPPER BEARING FITTING	C101891	& UP	N/A	N.L.A	N/A	N/A
V-275 CARB w/UPPER BEARING FITTING	C101891	& UP	N/A	N.L.A	N/A	N/A
V-300 (3.4L)	5611648	& UP	N/A	N.L.A	N/A	N/A

① Requires 2 ② Shift Shaft Retainer ④ Fits most applications

LOWER UNIT O-RING APPLICATION

HP	Beg. S/N	End S/N	Bearing Carrier	Water Pump Base	Shift Shaft	Drive Shaft
3.9	1655013	2498135	18-7121	18-7156	18-7180	18-7168
4	2498136	5589201	18-7121	18-7156	18-7180	18-7168
4/4.5	5589203	A809601	18-7171	18-7156	18-7180	-
6	1408611	2529894	18-7171	18-7156	18-7180	18-7168
6	A197112	UP	18-7162	-	-	-
7.5	2529895	3801457	18-7171	18-7156	18-7180	18-7168
7.5	3801458	5206549	18-7171	18-7156	18-7180	-
7.5	5206550	UP	18-7171	18-7156	18-7180	18-7116
8	A197112	UP	18-7162	-	-	-
9.8	1470349	3795657	18-7171	18-7156	18-7180	18-7168
9.8	3795658	5206549	18-7171	18-7156	18-7180	-
9.8	5206550	UP	18-7171	18-7156	18-7180	18-7116
9.9/15	A197112	UP	18-7162	-	-	-
18	5837437	6443972	-	18-7419	-	-
20	1558310	1866494	18-7163	18-7164	18-7180	18-7180
20	1866495	6443972	18-7163	18-7164	18-7180	18-7180
25	5705532	6443972	-	18-7419	-	-
18/20/25XD	6443973	UP	-	18-7419	18-7135 ②	-
30	1271885	1356947	18-7152	18-7115	18-7153	-
30	G055314	UP	-	-	18-7155 ②	-
MK 35A	1217222	1271884	18-7152	18-7115	18-7153	-
35	1356948	1448139	18-7152	18-7115	18-7153	-
35	1571114	1960826	18-7160	18-7155	18-7153	-
35	1960827	2874703	18-7160	18-7155	18-7153	-
35	6445653	UP	18-7160	18-7115	18-7153	-
40	1279685	2874703	18-7152	18-7115	18-7153	-
40	2874704	3336257	18-7160	18-7155	18-7153	-
40	3336258	4117709	18-7160	18-7155	18-7153	-
40	4117710	4860102	18-7160	18-7155	18-7153	-
40	4860103	6445652	18-7160	18-7115	18-7153	-
40 4cyl	C159200	G053313	18-7160	18-7115	18-7153	-
40 2cyl	G055314	UP	-	-	18-7155 ②	-
45	1476510	1531568	18-7160	18-7155	18-7153	-
45 4cyl	5531630	UP	18-7160	18-7115	18-7153	-
50	1421113	1639472	18-7152	18-7155	18-7153	-
50	1639473	1770178	18-7160	18-7155	18-7153	-

① Requires 2 ② Shift Shaft Retainer ④ Fits most applications

LOWER UNIT O-RING APPLICATION

HP	Beg. S/N	End S/N	Bearing Carrier	Water Pump Base	Shift Shaft	Drive Shaft
50	1770179	2305100	18-7160	18-7155	18-7153	-
50	2305101	2858813	18-7160	18-7155	18-7153	-
50	2858814	4140999	18-7160	18-7155	18-7153	-
50	4141000	4962055	18-7160	18-7155	18-7153	-
50	4962056	5531630	18-7160	18-7155	18-7153	-
50 3cyl	6428681	D000750	18-7160	18-7155	18-7153	-
50/55/60 3 cyl	D000751	UP	-	18-7173-9	-	-
60	1303411	1542744	-	18-7115	-	-
60	6428681	D000750	18-7160	18-7155	18-7153	-
65	1542745	2874263	18-7157	18-7173-9	18-7153	18-7158
65	2874263	3293183	18-7157	18-7162	18-7153	18-7158
65 3cyl	3293184	4136684	18-7160	18-7155	18-7153	-
65 3cyl	4136685	4571651	18-7160	18-7155	18-7153	-
70	1296411	1413610	18-7114	18-7155 ①	-	-
70	1413611	1566239	18-7157	18-7173-9	18-7153	18-7158
70 3cyl	4571652	4977156	18-7160	18-7155	18-7153	-
70 3cyl	4977157	5579016	18-7160	18-7115	18-7153	-
70 3cyl	5579017	A996142	18-7160	18-7115	18-7153	-
70/75 3cyl	A996142	UP	-	-	18-7198	-
75 4cyl	6432901	A996142	18-7157	18-7162	18-7153	-
80	1335465	1398629	18-7157	18-7155	18-7153	18-7158
80	1398630	1566239	18-7157	18-7173-9	18-7153	18-7158
80 4cyl	2559001	3144218	18-7157	18-7173-9	18-7153	18-7158
80 4cyl	3144219	4831998	18-7157	18-7162	18-7153	-
80 4cyl	4831999	5582561	18-7157	18-7162	18-7153	-
80 4cyl	5582562	A996142	18-7157	18-7162	18-7153	-
80 3cyl	A996142	UP	-	-	18-7198	-
85	1460999	1766823	18-7157	18-7173-9	18-7153	18-7158
85 4cyl	3493913	4590511	18-7157	18-7162	18-7153	-
85 4cyl	4590512	4831998	18-7157	18-7162	18-7153	-
90	1766824	1869775	18-7157	18-7162	18-7153	18-7158
90	4845301	5594656	18-7157	18-7162	18-7153	-
90	5594657	A996142	18-7157	18-7162	18-7153	-
90 3cyl	A996142	UP	-	-	18-7198	-
95	1869776	2318585	18-7157	18-7173-9	18-7153	18-7158
100,100SS	1464949	2836018	18-7157	18-7173-9	18-7153	18-7158
100BP	2399698	2641854	18-7157	18-7173-9	18-7153	18-7158
100 4cyl	B209468		-	-	18-7198	-
110	1870204	2314955	18-7157	18-7173-9	18-7153	18-7158
115	2836019	3525440	18-7157	18-7173-9	18-7153	18-7158
115	3525440	41122634	18-7157	18-7173-9	18-7153	-
115	41122635	4855152	18-7157	18-7162	18-7153	-
115	4855153	5600966	18-7157	18-7162	18-7153	-
115	5600967	C100000	18-7157	18-7162	18-7153	-
115 4cyl	C100000	UP	-	-	18-7198	-
125	2314956	2839368	18-7157	18-7173-9	18-7153	18-7158
135	2839369	3293233	18-7157	18-7173-9	18-7153	18-7158
140	3293234	3502805	18-7157	18-7173-9	18-7153	-
140	4865678	UP	18-7157	18-7162	18-7153	-
150	3502806	4121434	18-7157	18-7173-9	18-7153	-
150	4121434	5327662	18-7157 ④	18-7162	18-7153	-

HP	Beg. S/N	End S/N	Bearing Carrier	Water Pump	Shift Shaft	Drive Shaft
150/150XR2	4868998	5432021	18-7159	18-7162	18-7153	-
150/150XRS	5432021	A904646	18-7159	18-7176	18-7153	-

① Requires 2 ② Shift Shaft Retainer ④ Fits most applications

HP	Beg. S/N	End S/N	Bearing Carrier	Water Pump	Shift Shaft	Drive Shaft
135/150/XR2	A904646	UP	18-7159	18-7176	18-7153	-
175	4301235	6618750	18-7159	18-7162	18-7153	-
175	6618751	UP	18-7159	18-7176	18-7153	-
200	4839034	6073191	18-7159	18-7162	18-7153	-
200	6073192	UP	18-7159	18-7176	18-7153	-
220	B117316	UP	18-7159	18-7176	18-7153	-
225	5628028	D280813	18-7159	18-7162	18-7153	-
250/275	C101891	UP	18-7159	-	18-7153	-
3.4	5611648	UP	18-7159	-	18-7153	-

SWIVEL BRACKET ASSEMBLY O-RING APPLICATION

HP	Beg. S/N	End S/N	O-Ring	Qty	Desc	HP	Beg. S/N	End S/N	O-Ring	Qty	Desc
3.9	1655013	2498135	18-7153	2	SB	V 135	A904646	UP	18-7174	1	TT
4	2498136	3529445	18-7153	1	SB	V 150	4868998	UP	18-7164	1	SB
6	1436115	2529894	18-7153	2	SB	V 150	5432022	6606990	18-7168	2	TLL
7.5	2529895	3488152	18-7153	2	SB	V 150	6443213	UP	18-7174	1	TT
9.9	1470349	3482752	18-7153	2	SB	V 175	4301235	UP	18-7164	1	SB
35 ①	B110789	C159199	18-7164	1	SB,U	V 175	5488752	6618750	18-7168	2	TLL
35 ①	B110789	C159199	18-7174	1	TT	V 175	6618751	UP	18-7174	1	TT
45 4 Cyl ①	B110789	UP	18-7174	1	TT	V 200	4839034	UP	18-7164	1	SB
45 4 Cyl ①	B110789	UP	18-7164	1	SB,U	V 200	5464486	6625220	18-7168	2	TLL
50 3 Cyl ①	B122930	C160935	18-7164	1	SB,U	V 200	6625221	UP	18-7174	1	TT
50 3 Cyl ①	B122930	C160935	18-7174	1	TT	V 200 EFI	C100861	UP	18-7174	1	TT
60 3 Cyl ①	B122930	C160935	18-7174	1	TT	V 200 EFI	C100861	UP	18-7164	1	SB
60 3 Cyl ①	B122930	C160935	18-7164	1	SB,U	V 220	B117316	UP	18-7174	1	TT
70	A996142	UP	18-7174	2	TT	V 220	B117316	UP	18-7164	1	SB
70	A996142	UP	18-7164	1	SB	V 225	5628028	UP	18-7164	1	SB
75	6432901	UP	18-7174	2	TT	V 225	5628028	UP	18-7168	2	TLL
75	6432901	UP	18-7164	1	SB	V 250	C101891	UP	18-7168	2	TLL
80	A996142	UP	18-7164	1	SB	V 250	C101891	UP	18-7174	1	TT
80	A996142	UP	18-7174	2	TT	V 275	C101891	UP	18-7174	1	TT
90	6436123	UP	18-7164	1	SB	V 275	C101891	UP	18-7168	2	TLL
90	6436123	UP	18-7174	2	TT	3.4 LT	5611648	UP	18-7168	2	TLL
100	B209468	UP	18-7164	1	SB	3.4 LT	5611648	UP	18-7174	1	TT
100	B209468	UP	18-7174	1	TT	3.4 LT	5611648	UP	18-7164	1	SB
115	6436123	UP	18-7164	1	SB	XR-4/Magnum II	B242885	UP	18-7174	1	TT
115	6436123	UP	18-7174	2	TT	XR-4/Magnum II	B242885	UP	18-7164	1	SB
V 135	A904646	UP	18-7164	1	SB						

① Models with power trim only TLL Tilt Lock Lever
 SB,U Swivel Bracket, Upper TT Tilt Tube
 SB Swivel Bracket





18-5225
SPARK PLUG WIRE KIT
 Kit includes 25 ft. Roll of 7 MM Hypalon Ignition Wire With a MetAllic Core and a Large Assortment of Three Different End Fittings to Fit Outboard Motors.



18-5226
IGNITION WIRE
 MetAllic Core
 100' Spool
 7mm Hypalon

PKG. OF 10



18-5224
18-5224-9①
SPARK PLUG WIRE TERMINAL

PKG. OF 10



18-5750
18-5750-9①
UNIVERSAL SPARK PLUG BOOTS
 Supplied complete w/Terminal Connector



18-5752
UNIVERSAL SPARK PLUG BOOT
 8mm



18-5133
IGNITION COIL
 Replaces: 3A0060401M, 3A0060481M
 Fits: 2002 and Prior M and NS Model 25C2, C3, 30A3, A4; 2003 25C3, A4; 2005 25C3



18-5134
CDI
 Replaces: 3G2060602M
 Fits: 2002 and Prior M and NS Model 15D2, 18E, E2, 9.9D, D2; 2003 15D2, 18E2, 9.9D2



18-5143
EXCITER COIL
 Replaces: Tohatsu 369060210M
 Fits: 4C, 5B, 5BS (2003)



18-5165
EXCITER COIL
 Replaces: Nissan 3G3060211M
 Fits: 9.9D(2002 and below)9.9D2(2003 and below), 15D(2002 and below), 15D2(2003 and below), 18E(2002 and below), 18E2(2003 and below)



18-5166
IGNITION COIL
 Replaces: Nissan/Tohatsu 3M3060482M, 3G2-06040-2
 Fits: 9.9D(2002 and below)9.9D2(2003 and below), 15D(2002 and below), 15D2(2003 and below), 18E(2002 and below), 18E2(2003 and below)

① Priced per Package

NISSAN/TOHATSU IGNITION APPLICATION

Model	Year Start	Year Stop	Ignition Coil	CDI	Exciter Coil
FS8	2003	2014	-	-	-
M15	1997	2002	-	18-5134	18-5165
M15	2003	2003	18-5166	18-5134	18-5165
M18	1997	2003	18-5166	18-5134	18-5165
M2.5	1997	2005	-	-	-
M25	1997	2005	18-5133	-	-
M3.5	1997	2005	-	-	-
M30	1997	2003	18-5133	-	-
M4	2003	2003	-	-	18-5143

APPLICATION CONTINUES ON NEXT PAGE

NISSAN/TOHATSU IGNITION APPLICATION

Model	Year Start	Year Stop	Ignition Coil	CDI	Exciter Coil
M5	2003	2003	-	-	18-5143
M9.9	1997	2003	18-5166	18-5134	18-5165
MFS8	2006	2014	-	-	-
MFS8	2003	2004	-	-	-
MFS9.8	2003	2014	-	-	-
NS2.5	1997	2005	-	-	-
NS3.5	1997	2005	-	-	-
NS15	1997	2002	-	18-5134	-
NS18	1997	2002	-	18-5134	-
NS9.9	1997	2002	-	18-5134	-
NSF8	2004	2004	-	-	-
NSF8	2010	2014	-	-	-
NSF9.8	2005	2005	-	-	-
NSF9.8	2010	2014	-	-	-



18-6418
OUTBOARD STARTER

Replaces: Tohatsu 353760104M
Fits: M45A2, M50C, M60A, M70A2, M90A, M140A, NS45A2, NS50C, NS60A, NS70A2, NS90A, NSD90A, NS120A, NS140A
(9 Tooth)



18-6432
OUTBOARD STARTER

Replaces: Tohatsu 3C8760101M
Fits: M50D, M60B, M60C, MD40D, MD50A MFS25A, MFS30A, NS40D, NS50D, NS60C, NS70B, NS70C, NSD25A, NSD30A, NSD50A



18-6448
ELECTRIC START CONVERSION KIT

Fits: Tohatsu 25 & 30 HP



18-6823
WIRING HARNESS

Replaces: Universal
Converts 3-wire Tilt and Trim motors to 2-Wire design



18-7712

FUEL FILTER (INLINE)

Superseded from 18-8225

Replaces: 369022300M

Fits: 2 stroke, 5 HP thru 9.8 HP/4 stroke, 4 HP thru 30 HP



18-7828-1
(1/4" Small) Small Capacity
(For 1/4" Fuel Line)

18-7830 (5/16")

18-7831 (3/8")

18-7829
(1/4" Large) Large Capacity
(For 1/4" Fuel Line)

FUEL FILTERS



FUEL WATER SEPARATORS



Sierra offers a complete line of 10 and 21 micron fuel water separating filters including drainable bowl filters to protect your carbureted and fuel injected engine.

Refer to pages 156-160 for a complete listing of OEM and universal applications.

Sierra fuel water separators remove over 99.8% of emulsified water from your gasoline. Sierra's 10 micron filters are over 90% efficient at removing particles as small as 10 micron. All filters flow @ 90 GPH to feed even the hungriest motor. Sierra 10 micron filters are recommended to prevent damage to sensitive inboard and outboard fuel injection systems.



18-8002EP-1
18-8002EP-1-10②
PRIMER BULB
1/4"

18-8004EP-1
18-8004EP-1-10②
PRIMER BULB
5/16"
Large capacity bulb

18-8005EP-1
18-8005EP-1-10②
PRIMER BULB
3/8"
Large capacity bulb



18-8078
TANK CONNECTOR
1/4" N.P.T .508 O.D.
Nissan Tank Large Inlet
Fits: All models
Mates with 18-8079
(Male)



18-80410-1
FUEL CONNECTOR
Superseded from 18-8076
Replaces: 394-70250-0
Female Hose connector
3/8"
Fits: 4HP-30HP 4-stroke



18-8079
FUEL CONNECTOR
(Tank End, Quick Connect)
Replaces: 3B2702810M,
65750-95500
Fits: All models
Mates with 18-8078
Female to 3/8" hose barb



18-8088
FUEL CONNECTOR
(Engine End)
Replaces: 3B2702501M
3/16" Hose
Fits: 5-90HP 2-stroke and TLDI models
Mates with 18-8089



18-8089
FUEL CONNECTOR
(Engine End)
Replaces: 3B2-70260-O
(Metric Threads)
3/16" Hose
Fits: 5-90HP 2-stroke and TLDI models
Mates with 18-8088

PKG. OF 10



SNAPPER CLAMPS
18-8020 18-8021
18-8020-9① 18-8021-9①
#8 For 5/16" Hose #10 For 3/8" Hose



18-7290
CARB KIT
Replaces: 345871224M
Kit contains enough components
to rebuild 2 carburetors
For: All 35/40C HP (1 per engine)



18-7291
CARB KIT
Replaces: 346871220M
For: All 25/30 HP (1 per engine);
All 45A2, 50C, 60C, 70A2 (2 per engine)



18-7765
CARB KIT
Replaces: 369871221M
For: All 4/5 HP (1 per engine)

 <p>18-8920 IMPELLER Replaces: 3B2650211M Fits: 8 (8B models), 9.8 (9.8B model), 8 4-Stroke (All), 9.8 4-Stroke (All)</p>	 <p>18-8921 IMPELLER Replaces: 334650210M Fits: 9.9 (All), 15 (All), 18 (All), 9.9 4-Stroke (All B Models), 15 4-Stroke (All B Models), 18 4-Stroke(All)</p>	 <p>18-8922 IMPELLER Replaces: 3C8650212M Fits: 40 3-cyl (D models), 40 TLDI 2-Stroke(All) 50 3-cyl (D models), 50 TLDI 2-Stroke (All), 70 TLDI 2-Stroke (All), 90 TLDI 2-Stroke</p>	 <p>18-8923 IMPELLER Replaces: 345650210M Fits: 25 (25C model), 25 4-Stroke (All A Models, B Models with white bushing), 30 (30A model), 30 4-Stroke (All A Models, B models with white bushing), 40 2-cyl (40C model)</p>
 <p>18-8924 IMPELLER Replaces: 3C7650211M, 3B7650212M Fits: 60 3-cyl (B & C models), 70 3-cyl (B & C models), MD 70, MD 90(TLDI), 115, 140, 90 2-Stroke</p>	 <p>18-45404 IMPELLER Replaces: 353650210M Fits: Nissan/Tohatsu NS50C, NS60A, NS70A2(2002 & Up)</p>	 <p>18-43175 THERMOSTAT KIT Replaces: 3R3010300M Fits: Nissan/Tohatsu 9.9-30 HP 4-Stroke</p>	 <p>18-43212 WATER PUMP HOUSING Replaces: 3B2650160M Fits: 8/9.9 4-Stroke(209cc)</p>
 <p>18-48317 COMPLETE WATER PUMP KIT Replaces: 3B2873222M Fits: F8/9.8</p>	 <p>18-4434 POWERHEAD GASKET SET Replaces: 3C8-87121-4 Fits: All 40-50 HP</p>	 <p>18-7911-1 OIL FILTER Replaces: 3R0-07615-0 Fits: 9.9-30HP</p>	 <p>18-74611 LOWER UNIT SEAL KIT Replaces: 346873217M Fits: 25 (1997-05); 30 (1997-03)</p>
 <p>18-4435 POWERHEAD GASKET SET Replaces: 3F3871210M Fits: All 60-70 HP</p>	 <p>18-4436 POWERHEAD GASKET SET Replaces: 3B7871218M Fits: All 90 HP</p>	 <p>18-74610 LOWER UNIT SEAL KIT Replaces: 398873213M Fits: 18 & 15 (1997-08); 9.9 (1997-04)</p>	 <p>18-74611 LOWER UNIT SEAL KIT Replaces: 346873217M Fits: 25 (1997-05); 30 (1997-03)</p>

① Priced per Package

② Discount shop pack of 10 - Priced per package



18-3850
HEAD GASKET
Replaces: 3C8010055M
Fits: All 40-50 HP



18-3886
HEAD GASKET
Replaces: 3T9010050M
Fits: All 90 HP



18-4299
HEAD GASKET
Replaces: 3F3010051M
Fits: All 60-70 HP



18-51000
RECOIL STARTER SPRING
Replaces: 3AA050040M
Fits: Tohatsu 8 4-Stroke(2004-12), 9.8 4-Stroke(2004-12)



18-60103
DRAIN PLUG GASKET
Replaces: 332600060M
Fits: All Nissan/Tohatsu models



18-60103-50
DRAIN PLUG GASKET
Fits: All Nissan/Tohatsu models



18-60917
CYLINDER COVER GASKET
Replaces: 3V1010240M
Fits: F8/9.8



18-60918
ENGINE BASE GASKET
Replaces: 3V1013030M
Fits: F8/9.8



18-60919
EXHAUST COVER GASKET
Replaces: 3V1023050M
Fits: F8/9.8



18-60920
THERMOSTAT GASKET
Replaces: 346-01032-0
Fits: F8/9.8



18-2448
LOWER UNIT FILL/DRAIN KIT
M8 - 1.25 thread
Fits: Yamaha, Nissan/Tohatsu, & Honda Lower Units



18-72656
DRAIN PLUG & GASKET
Replaces: Nissan-Tohatsu 332600052M, 332600060M
M8 - 1.25 thread
Fits: Nissan/Tohatsu - All Models



18-73964
PROP NUT KIT
Fits: Nissan/Tohatsu F8/9.8



18-76695
O-RING
Replaces: Nissan-Tohatsu 3R0074220M
Fits: 8/9.9 s/n Or042475 and Up

Suzuki Model Identification

Model Description	Horsepower	Model Variation Length	Shaft Year	Model
DT = 2-cycle	Examples:	E - Elec. Start w/Tiller Handle	S = 15"	D = 1983 T = 1996
DF = 4 cycle	9.9	R - Start w/Remote Control	L = 20"	E = 1984 V = 1997
PU = Jet Drive	40	C - Oil Injection	X = 25"	F = 1985 W = 1998
	115	G - Counter Rotation		G = 1986 X = 1999
	250	N - High Thrust Propeller		H = 1987 Y = 2000
		T - Power Tilt & Trim w/Elec. Start w/Remote Control		J = 1988 K1 = 2001
	H - Power Tilt & Trim w/Elec. Start w/Tiller Handle	K = 1989 K2 = 2002		
	SF - Super Four	L = 1990 K3 = 2003		
	SS - Super Six	M = 1991 K4 = 2004		
	M - Manual Start w/Tiller Handle	N = 1992 K5 = 2005		
V - Comlink Voice Caution System	P = 1993 K6 = 2006			
	R = 1994 K7 = 2007			
	S = 1995 K8 = 2008			
	T = 1996			

EXAMPLE: DT40CRSN - 2-cycle, 40 HP, Oil Injection, Elec. Start w/remote control, 15", 1992 Model Year

<p>PKG. OF 10</p>  <p>18-5224 18-5224-9① SPARK PLUG WIRE TERMINAL</p>	 <p>18-5225 SPARK PLUG WIRE KIT Kit includes 25 ft. Roll of 7 MM Hypalon Ignition Wire With a Metallic Core and a Large Assortment of Three Different End Fittings to Fit Outboard Motors.</p>	 <p>18-5226 IGNITION WIRE Metallic Core 100' Spool 7mm Hypalon</p>
<p>PKG. OF 10</p>  <p>18-5750 18-5750-9① UNIVERSAL SPARK PLUG BOOTS Supplied complete w/Terminal Connector</p>	 <p>18-5752 UNIVERSAL SPARK PLUG BOOTS 8mm</p>	 <p>18-5151 IGNITION COIL Replaces: 33410-94400, 33410-92L10 Fits: DT40C(1986-98)</p>
 <p>18-5152 IGNITION COIL Replaces: 32140-93900 Fits: DT 9.9(1983-87), DT15 (1983-88)</p>	 <p>18-5144 CDI Replaces: 32900-93911 Fits: DT15</p>	 <p>MP51010 (CLAMSHELL) MP51012 (BULK 100 PCS/CTN) IGNITION SWITCH Replaces: 37110-99E00 Colors on wires match factory color codes Suzuki 2 & 4 Stroke Outboards</p>

① Priced per Package



18-6414
OUTBOARD STARTER
 Replaces: 31100-95600
 Fits: 75 HP



18-6416
OUTBOARD STARTER
 Replaces: 31100-94610
 Fits: 115, 140 H.P. (9 Tooth) (1984-UP)



18-6417
OUTBOARD STARTER
 Replaces: 31100-92E00
 Fits: 150, 200, 225 H.P. (1985-UP)



18-6419
OUTBOARD STARTER
 Replaces: 31100-89J00
 Fits: 4 Stroke DF40 (1999-01) (9 tooth)



18-6827
STARTER
 Replaces: 31100-94600, 31100-94601, 31100-94610
 Fits: 115, 140HP engines



18-6429
OUTBOARD STARTER
 Replaces: 31100-94702
 Fits: DT 55/65 (1985-88)



18-6831
STARTER
 Replaces: Suzuki 31100-90J00
 Hitachi S114-837, A
 Fits: Suzuki 90-115HP 2001-08



18-6941
STARTER
 Replaces: 31100-93J00, 96J00, 96J01
 Fits: 70-300HP 2004-up



18-6945
STARTER
 Replaces: 31100-95J00, 95J01
 Fits: Johnson, Suzuki 25HP 2006-11

NEW



18-6962
STARTER
 Replaces: Suzuki 31100-98110



18-56009
BRUSH HOLDER ASSEMBLY
 Replaces: 31173-99E00
 Fits: 115-140 HP 2 Stroke VV
 Use with **18-6416** Starter



18-9802
TIMING LIGHT
 Self-powered accurate up to 10,000 RPM's



18-80014
TRIM CYLINDER O-RINGS
Replaces: Suzuki 48627-95E00
For: DF60, DF140, DF150, DF175, DF200



18-6786-1
TILT/TRIM MOTOR
Replaces:
38100-87D10-0ED, 38100-87D10-35J,
38100-87D10-0IT, 38100-92E00-0ED
For: V4 & V6 (1990-up), DT90 (1991-97),
DT100 & DT200 (1991-2000), DT150 &
DT225 (1991-2003), DT175 (1991-92)
3 Bolt flange 2 wire connection

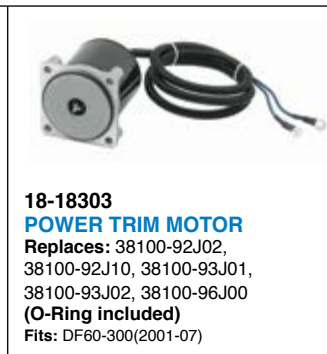

18-18303
POWER TRIM MOTOR
Replaces: 38100-92J02,
38100-92J10, 38100-93J01,
38100-93J02, 38100-96J00
(O-Ring included)
Fits: DF60-300(2001-07)

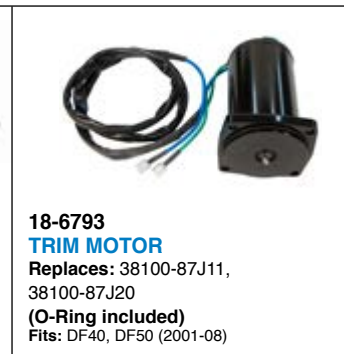

18-6793
TRIM MOTOR
Replaces: 38100-87J11,
38100-87J20
(O-Ring included)
Fits: DF40, DF50 (2001-08)

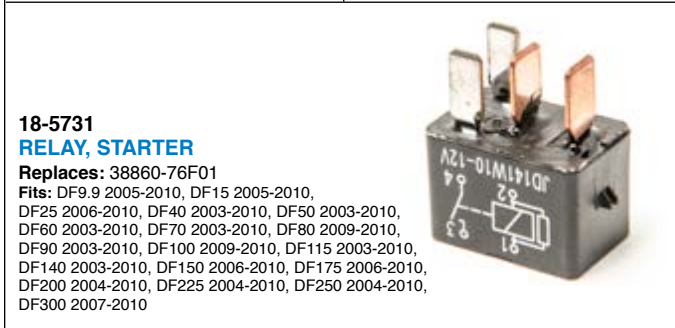

18-5731
RELAY, STARTER
Replaces: 38860-76F01
Fits: DF9.9 2005-2010, DF15 2005-2010,
DF25 2006-2010, DF40 2003-2010, DF50 2003-2010,
DF60 2003-2010, DF70 2003-2010, DF80 2009-2010,
DF90 2003-2010, DF100 2009-2010, DF115 2003-2010,
DF140 2003-2010, DF150 2006-2010, DF175 2006-2010,
DF200 2004-2010, DF225 2004-2010, DF250 2004-2010,
DF300 2007-2010



18-1527
RELAY ASSEMBLY
Replaces: Suzuki 38410-93J12
Fits: DF100, DF115, DF150, DF175,
DF200, DF225, DF250, DF300



18-6823
WIRING HARNESS
Replaces: Universal
Converts 3-wire Tilt and Trim motors
to 2-Wire design

4-STROKE FUEL SYSTEM KITS



18-7761
CARBURETOR REBUILD KIT
Fits: Suzuki DF4-DF6 (2005 & Up)

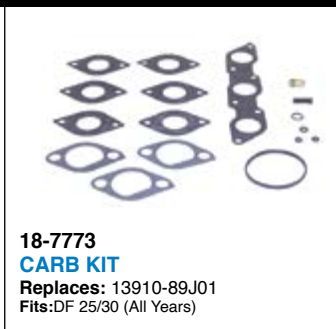

18-7773
CARB KIT
Replaces: 13910-89J01
Fits: DF 25/30 (All Years)



18-3495
DIAPHRAGM KIT
Replaces: 15170-93911
Fits: DT8(All 1988-97), DT9.9(All 1988-97),
DT15(All 1988-97)

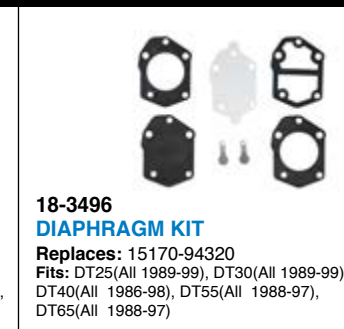

18-3496
DIAPHRAGM KIT
Replaces: 15170-94320
Fits: DT25(All 1989-99), DT30(All 1989-99),
DT40(All 1986-98), DT55(All 1988-97),
DT65(All 1988-97)



18-3497
DIAPHRAGM KIT
Replaces: 15170-91J00
DF4-DF6 (2003 & UP)



18-3498
DIAPHRAGM KIT
Replaces: 15170-94J00, 15170-94J0V
DF9.9-DF15 HP(2005 & UP)



18-3499
DIAPHRAGM KIT
Replaces: 15170-99E00
DF9.9,DF15 (1997-2004), DF25 (2000-2006)
(Non-V twin), DF40,DF50 (1999-2006),
DF60,DF70 (1998-2007),

2-STROKE FUEL SYSTEM KITS

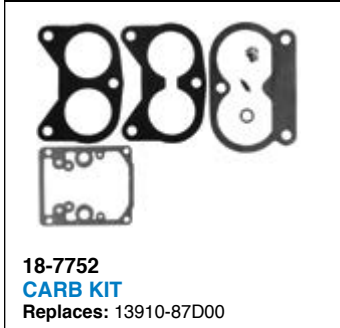

18-7752
CARB KIT
Replaces: 13910-87D00



18-7753
CARB KIT
Replaces: 13910-94400



18-7754
CARB KIT
Replaces: 13910-94701



18-7755
CARB KIT
Replaces: 13910-95D00

CARBURETOR KIT APPLICATION

HP/Model	Year	Part No.	HP/Model	Year	Part No.	HP/Model	Year	Part No.
DT25C	1989-98	18-7755	DT65	1985-97	18-7753	DT100	1989-98	18-7752
DT30C	1988-97	18-7755	DT75	1985-97	18-7754	DT115	1986-98	18-7754
DT40C	1984-98	18-7753	DT85	1985-98	18-7753	DT140	1986-98	18-7753
DT55	1985-97	18-7754	DT90	1989-97	18-7752	V-6	ALL	18-7752



NEW

**18-79949
FUEL FILTER**

Replaces: 15410-88L00, Suzuki DF40-60HP, DF 40A 04003F-410001, DF 50A 05003F-710001, DF 60A 06003F-810001



**18-8622
FUEL FILTER**

Replaces: Suzuki 15410-87J00, DF40 (1999-2009), DF50 (1999-2010)



**18-79999
FUEL FILTER**

Replaces: Suzuki 15440-99E0, DF60 (1998-09), DF70 (1998-08)



**18-79991
FUEL FILTER**

Replaces: Suzuki 15440-90J00 DF90 (2001-08), DF100 (2009-11), DF115 (2001-12), DF140 (2002-12)



**18-79992
FUEL FILTER**

Replaces: Suzuki 15440-96J01, DF150T (2006-18), DF150T S/N110122 & NEWER, DF150Z S/N 110010 & NEWER, DF150A (2019-20), DF150AP (2017-20), DF175 (2006-18), DF175T S/N 110093 & NEWER, DF175Z S/N 110012 & NEWER, DF175A (2019-20), DF175AP (2017-20), DF200A (2015-20), DF200AP (2015-20)



**18-80010
FUEL FILTER**

Replaces: Suzuki 15642-90J00 DF70A (2009-13) DF80 (2009-11), DF90 (2001-08), DF90A (2009-12), DF100 (2009-11), DF115 (2001-12), DF140 (2002-12), DF150 (2006-18), DF150A (2019-20), DF150AP (2017-20), DF150AS (2020), DF175 (2006-18), DF175A (2019-20), DF175AP (2017-20) DF200 (2004-14)



**18-32154
OXYGEN SENSOR**

Replaces: 18213-98J00
Fits: DF100A, DF115A, DF140A, DF250A, (2011-Up), DF300 (2007-Up)

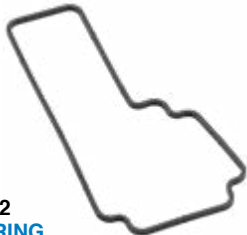

**18-80012
VST O-RING**

Replaces: Suzuki 15626-99E00, DF40 (1999-10), DF50 (1999-10), DF60 (1998-09), DF70 (1998-08)



**18-99160
FUEL INJECTOR INSULATOR**

Replaces: Suzuki 15751-94900, DF40 (1998-10), DF50 (1999-10), DT115 (1996-01), DT140 (1997-01), DT150 (1998-03), DT200 (1998-00)



**18-80017
FUEL PUMP VST BUSHING**

Replaces: Suzuki 15647-93J00, DF70A (2009-13), DF80 (2009-11), DF90 (2001-08), DF90A (2009-13), DF100 (2009-11), DF115 (2001-12), DF140 (2002-12), DF150 (2006-18), DF150A (2019-20), DF150AP (2017-20), DF150AS (2020), DF175 (2006-18), DF175A (2019-20), DF175AP (2017-20), DF200 (2004-14)



FUEL PUMPS

Engineered for maximum durability and long-life, Sierra's electric fuel pumps keep marine engines on the water, where they belong. Our electric fuel pumps feature a positive displacement gerotor pump and carbon commutator providing reduced amperage draw and superior RFI suppression.

Part No.	OEM Number	Replaces
18-1760	Suzuki 15100-90J11	DF40 (2015-2018), DF50 (2014-2019), DF60 (2015-2019), DF70 (2012-2019), DF80 (2013-2018), DF90 (2012-2019), DF100 (2013-2019), DF115 (2015-2019), DF140 (2013-2019)
18-80011	Suzuki 15100-72812	DT85 (1986-00), DT115 (1986-01), DT140 (1986-01), DT150 (1986-03), DT200 (2000), DT225 (1990-03)
18-97305	Suzuki 15100-988J00	DF225-DF350



FUEL WATER SEPARATORS

Sierra offers a complete line of 10 and 21 micron fuel water separating filters including drainable bowl filters to protect your carbureted and fuel injected engine.

Refer to pages 156-160 for a complete listing of OEM and universal applications.

Sierra fuel water separators remove over 99.8% of emulsified water from your gasoline. Sierra's 10 micron filters are over 90% efficient at removing particles as small as 10 micron. All filters flow @ 90 GPH to feed even the hungriest motor. Sierra 10 micron filters are recommended to prevent damage to sensitive inboard and outboard fuel injection systems.

Sierra #	Suzuki #	Description
18-7953	15410-87J30	Fuel Filter Fits: DF25, DF70, DF90, DF115, DF140 (Incl.140T & 140Z) (2006 & Newer)
18-7936	15412-93J00	Fuel Filter Element
18-7947	99105-20006	Spin on Replacement Filter
18-7987	99105-20006-BWL	AquaVue™ Mini Collection Bowl
18-7948	99105-20005	Spin on Replacement Filter
18-7922-1	99105-20004BWL	AquaVue™ Collection Bowl
18-7735	15410-94400	Fuel Filter Kit
18-7711	15410-96J00	Fuel Filter (Inline)
18-7716	15410-87J10	Fuel Filter
18-7719	15410-98500	Fuel Filter

• Retail Packaged Item



SUZUKI® PREMIUM FUEL LINE ASSEMBLY

- 4-stroke DF models designed with 13mm quick-disconnect tank connector and a prong engine connector to replace most 15 to 140 HP assemblies.
- 2-stroke DT models complete with 13mm tank adapter to replace small (11mm) and large (13mm) bore fuel lines assemblies in one convenient kit.
- 8'-3/8" Premium B1-15 Braided Fuel line
- EPA/CARB or International Primer Bulbs
- Hi visibility packaging

Part No.	Switch Function	Adapter Size	Replaces	Region
18-81043EP-2	2-Stroke DT Fuel Line Assembly - EPA	3/8"	65700-87D83 + 65740-95500	US
18-81043S-1	2-Stroke DT Fuel Line Assembly - Non EPA	3/8"	-	Can/Intl
18-81044EP-2	4-Stroke DF Fuel Line Assembly - EPA	3/8"	65700-91J28	US
18-81044S-1	4-Stroke DF Fuel Line Assembly - Non EPA	3/8"	-	Can/Intl

PRIMER BULBS



18-8002EP-1
18-8002EP-1-10①
PRIMER BULB
 1/4"

18-8004EP-1
18-8004-10EP-1①
PRIMER BULB
 5/16"
 Large capacity bulb

18-8005EP-1
18-8005-10PE-1①
PRIMER BULB
 3/8"
 Large capacity bulb



18-80409
FUEL CONNECTOR
 • 1/4" barb
Motor Side
Replaces: 65720-94401
Fits: DT4-DT65
Mates with 18-80418

18-80418
FUEL CONNECTOR
 • 1/4" barb
Replaces: 65750-94404
Fits: DT4-DT140
Mates with 18-80409 & 18-809

18-80419
FUEL CONNECTOR
Replaces: 65750-87J10, 65750-87J11
Fits: DF25-DF140 (5/16" version of 18-80404)
Mates with 18-80425

18-80425
FUEL CONNECTOR
Replaces: 65720-986B0
Fits: DF25-DF140
Mates with 18-80404 & 18-80419

18-8062
FUEL CONNECTOR
 • 3/8" barb
Replaces: 65750-98505
Mates with 18-8071

18-8071
TANK CONNECTOR
 1/4" NPT .432 O.D.
Replaces: 99105-00192
Mates with 18-8062 (Male)

18-8078
TANK CONNECTOR
 1/4" N.P.T .508 O.D.
Replaces: 65740-95500, 99105-00193
Fits: All models
Mates with 18-8079 (Male)

18-8079
FUEL CONNECTOR
Tank End, Quick Connect
Replaces: 65750-95510, 65750-95500
Fits: All models
Mates with 18-8078
Female to 3/8" hose barb

18-8087
FUEL CONNECTOR
 • 5/16" barb
Motor Side
Replaces: 65720-94411
Fits: DT75-DT140

18-80404
FUEL CONNECTOR
 3/8"
Fits: DF25-DF140 HP
Mates with 18-80425

18-80405
FUEL CONNECTOR
Female to 3/8" hose barb
Mates with 18-8078

18-8090
FUEL CONNECTOR
(1/4" NPT)
Mates with 18-80418

18-1424
IDLE AIR CONTROL MOTOR
Replaces: Suzuki 18137-77E00
Fits: DF90T (2001-08), DF100T (2009-10), DF100A (2016-19), DF115T (2001-10), DF115A (2015-19), DF140T (2002-10), DF140A (2015-19)

* Tanks and Engines for picture purpose only.

① Discount shop pack of 10 - Priced per package



18-3023
IMPELLER

Replaces: 17461-90J00, 17461-90J01, 17461-94500, 17461-94501, 17461-94502, 17461-94503, 17461-94504, 17461-94505, 17461-94506, 17461-94510, 17461-94511, 17461-94520
Fits: 2 Stroke DF90, DF115, DF140 (2000-05), DT115 (1981-01), DT140 (1981-01), DT150 (1986-01), DT200 (1986-00)



18-3035
IMPELLER

Replaces: 17461-93J00
For: DF200, DF225, DF250 (2004-05)



18-3049
IMPELLER

Replaces: 17461-87E11, 17461-87E12
Fits: DF 60/70 (1998-01), DF 90-100 (1989-01)



18-3000
IMPELLER

Replaces: 17461-92D02
Fits: DT 8C/9.9C (1989-97)



18-3092
IMPELLER

Replaces: 17461-93001, 17461-93003, 17461-93004



18-3094
IMPELLER

Replaces: 17461-94700, 17461-94701



18-3095
IMPELLER

Replaces: 17461-95300, 17461-95301, 17461-95302



18-3096
IMPELLER

Replaces: 17461-96301, 17461-96311, 17461-96312



18-3097
IMPELLER

Replaces: 17461-98501, 17461-98502, 17461-98503, 17461-985M0



18-3099
IMPELLER

Replaces: 17461-93902, 17461-93901, 17461-93903
For: DT 9.9, 15 (1983-97), DF 9.9, 15 (1997-05)



18-3292
IMPELLER KEY

Replaces: 17462-93990, 09420-03005
Fits: DT 8C/9.9C (1989-97), DF 9.9/15 (1997-04), DT 9.9 (1985-87), DT 15 (1983-88), DT 15C (1989-97)



18-3296
IMPELLER KEY

Replaces: 09420-05005
Fits: DT 115/140 (1983-01)



18-3188
IMPELLER PLATE

Replaces: 17471-98503
Fits: DT 6 (1984-02), DT 8 (1986-97)



18-3189
IMPELLER PLATE

Replaces: 17471-87D01
Fits: V-6 2-Stroke (1986-03)



18-3190
IMPELLER PLATE

Replaces: 17471-93902
Fits: DF 9.9/15 (1997-04), DT 9.9 (1985-87), DT 15 (1983-88), DT 15C (1989-97)



18-3191
IMPELLER PLATE

Replaces: 17471-94501
Fits: DT 115/140 (1983-01)



18-3193
IMPELLER PLATE

Replaces: 17471-92D10
Fits: DT 8C/9.9C (1989-97)



18-3242
IMPELLER REPAIR KIT

Replaces: 17400-96350, 17400-96351, 17400-96353

MODEL	YEAR	MODEL	YEAR
DT20	1986-88	DT35	1987-89
DT25	1984-88	DT40C	1984-98
DT30	1984-87		



18-3243
IMPELLER REPAIR KIT

Replaces: 17400-94700, 17400-94701

— CONTAINS —

MODEL	YEAR	MODEL	YEAR
DT55	1985-95	DT65	1985-95



18-3244
IMPELLER REPAIR KIT
Replaces: 17400-95550, 17400-95350, 17400-95351
Fits: DT75, DT85 (1985-95)
 – CONTAINS –

Part #	Description	O.E. #
18-3095	Impeller	17461-95300
18-0459	Gasket	17472-95200



18-3253
WATER PUMP KIT
Replaces: 17400-87D11
Fits: V6 2-Stroke (1986-03)



18-3254
WATER PUMP KIT
Replaces: 17400-87E03, 17400-87E04
Fits: DF 60/70 (1998-06), DT 90-100 (1989-01)



18-3255
WATER PUMP KIT
Replaces: 17400-92D01
Fits: DT 8C/9.9C (1989-97)



18-3256
WATER PUMP KIT
Replaces: 17400-93951
Fits: DF 9.9/15 (1997-06), DT 9.9 (1985-87), DT 15 (1983-88), DT 15C (1989-97)



18-3257
WATER PUMP KIT
Replaces: 17400-94611
Fits: DT 115/140 (1983-01)



18-3258
WATER PUMP KIT
Replaces: 17400-90J11, 17400-90J20
Fits: DF 90/115/140 (2001-05)



18-3259
WATER PUMP KIT
Replaces: 17400-98551
Fits: DT 6 (1984-02), DT8 (1986-97)



18-3260
WATER PUMP KIT
Replaces: 17400-98652
Fits: DT 4 (1984-98), DT 5 (1999-02)



18-3264
WATER PUMP REPAIR KIT
Replaces: 17400-93J00, 17400-93J02
For: DF200, DF225, DF250 (2004-09)



18-3267
WATER PUMP KIT
Replaces: 17400-98J00, 17400-98J01
Fits: DF300 (2007-Current)



18-3266
WATER PUMP REPAIR KIT
Replaces: 17400-98661
For: DF4, DF6 (2003-07)



18-3264-1
WATER PUMP KIT
Replaces: Suzuki 17400-93J04
Fits: DF200 (2004-14) DF225(All) DF250 (All)



18-4544
WATER PUMP KIT
Replaces: Suzuki 17400-87L04
Fits: DF40A-DF60A (2010 -18)



18-4552
WATER PUMP KIT
Replaces: Suzuki 17400-88L00
Fits: DF40A-DF60A (2010 - 18)



18-4558
WATER PUMP KIT
Replaces: Suzuki 17400-96J03
Fits: DF150, DF150AP, DF150G, DF175, DF175AP, DF175, DF200A, DF200AP(2006-18)

NEW



18-4553
WATER PUMP KIT
Replaces: Suzuki 17400-92J00
Fits: DF90, DF115, DF140 (2006-08)

NEW



18-4554
WATER PUMP KIT
Replaces: Suzuki 17400-92J23
Fits: DF100A, DF115, DF115A, DF140A, DF150AP, DF175AP (2019-18)

NEW



18-4556
WATER PUMP KIT
Replaces: Suzuki 17400-94J00
Fits: DF9.9, DF15 (2007-18)

NEW



18-4557
WATER PUMP KIT
 Replaces: Suzuki 17400-94L21
 Fits: DF25A, DF30A (2014-18)



18-3480
WATER PUMP HOUSING
 Replaces: 17411-93901
 Fits: DT9.9(1983-87, 2004-10), DT15(1983-97, 2004-10)



18-3481
WATER PUMP HOUSING
 Replaces: 17411-94421
 Fits: DF25(All models 2000-05), DF25(models DF25Q, DF25Q(QR)), DF25T 2006-07, DF30(All 2000-07), DT40C(1986-98), DF40(All 2000-07), DF50(All 1999-10)



18-0761
PUMP CASE GASKET
 Replaces: 17472-91J00
 For: DF4 (2003-05), DF6 (2003-05)



18-0778
PUMP CASE GASKET
 Replaces: 17472-93J00
 For: DF150(2006-10), DF175(2006-10), DF200(2004-10), DF225(2004-10), DF250(2004-10)



18-0459
WATER PUMP GASKET
 Replaces: 17472-95200



18-0460
WATER PUMP GASKET
 Replaces: 17472-95310



18-0461
WATER PUMP GASKET
 Replaces: 17472-96301



18-0477-9①
WATER PUMP GASKET
 Replaces: 17472-98503
 Fits: DT 6 (1984-02), DT8 (1986-97)

PKG. OF 5



18-0478
WATER PUMP GASKET
 Replaces: 17472-93911
 Fits: DF 9.9/15 (1997-04), DT 9.9 (1985-87), DT 15 (1983-88), DT 15C (1989-97)

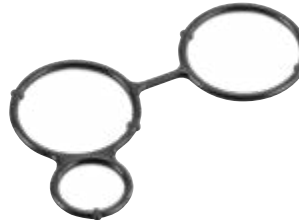

18-80015
WATER RETURN SEAL
 Replaces: 51116-93J00
 Fits: DF150 (2006-18), DF150A (2019-20), DF150AP (2017-20), DF150AS (2020), DF175 (2006-18), DF175A (2019-20), DF175AP (2017-20), DF200A (2015-20), DF200AP (2015-20), DF200AS (2020), DF225 (2004-20), DF250 (2004-20), DF250AP (2013-20), DF300 (2007-11), DF350



18-3685
THERMOSTAT
 Replaces: 17660-90J00
 Fits: DF90, DF100, DF115, DF140, DF150, DF175, DF200



18-3686
THERMOSTAT
 Replaces: 17660-99E00
 Fits: DF25, DF30, DF40, DF50, DF60, DF70, DF80, DF90, DF200, DF225, DF250, DF300

NEW



18-3687
THERMOSTAT
 Replaces: 17660-99E00
 Fits: DF25, DF30, DF40, DF50, DF60, DF70, DF80, DF90, DF200, DF225, DF250, DF300



18-3684
THERMOSTAT
 Replaces: 17670-90J11
 Fits: DF70, DF80, DF90, DF100, DF115, DF140, DF150, DF175, DF200, DF225, DF250, DF300,



18-0792
THERMOSTAT GASKET
 Replaces: 13119-91J00



18-0793
THERMOSTAT GASKET
 Replaces: 17582-93J00



18-0794
THERMOSTAT GASKET
 Replaces: 17685-97J00



18-0795
THERMOSTAT GASKET
Replaces: 17685-89J00



18-0796
THERMOSTAT GASKET
Replaces: 17685-99E00



18-0797
THERMOSTAT GASKET
Replaces: 17685-87D10



NEW

18-1799
EXHAUST
TEMPERATURE SENSOR
Replaces: 34830-87J20
Fits: DF40, DF50, DF60, DF70, DF80, DF90, DF100, DF140, DF150, DF175, DF200, DF225, DF250, DF300, DF350

HP/Model	Year	Impeller	Gasket	Water Pump Kit	HP/Model	Year	Impeller	Gasket	Water Pump Kit
DT2/2.2	1983-97	18-3097	—	—	DT50M	1980-84	18-3094	18-0460	18-3243
DT3.5	1983-84	18-3097	—	—	DF50	1999-09	18-3096	18-0461	18-3242
DT4	1984-98	18-3097	—	18-3260	DF50	2010	18-3096	18-0461	—
DF4	2003-10	18-3097	18-0761	18-3266	DT55	1985-97	18-3094	18-0460	18-3243
DT5	1977-83, 1999-02	18-3097	—	18-3260	PU55 (jet)	1989-94	18-3094	18-0460	—
DT6	1984-02	18-3097	18-0477-9	18-3259	DT60	1983	18-3094	18-0460	18-3243
DF6	2003-10	18-3097	18-0761	18-3266	DT60	1984	18-3095	18-0460	—
DT8	1980-87	18-3097	18-0477-9	18-3259	DF60	1998-09	18-3049	—	—
DT8	1988-97	18-3000	—	18-3255	DF60	2010	18-3096	18-0461	—
DF8	2010	18-3099	—	—	DT65	1982-prior	18-3094	18-0459	—
DT9.9	1977-82	18-3092	—	—	DT65	1985-97	18-3094	18-0460	18-3243
DT9.9	1983-87	18-3099	18-0478	18-3256	DF70	1998-09	18-3049	—	—
DT9.9	1988-97	18-3000	—	18-3255	DF70	2010	18-3096	18-0461	—
DF9.9	1997-10	18-3099	18-0478	18-3256	DT75	1983-97	18-3095	18-0459	18-3244
DT14	1977-80	18-3092	—	—	DF80	2009-10	18-3049	—	—
DT15	1983-97	18-3099	18-0478	18-3256	DT85	1983-00	18-3095	18-0459	18-3244
DT15C	1989-97	18-3099	18-0478	—	PU85 (jet)	1989-97	18-3095	18-0459	—
DF15	1997-10	18-3099	18-0478	18-3256	DT90	1989-97	18-3049	—	18-3254
DT16	1977-82	18-3092	—	—	DF90	2001-08	18-3023	—	—
DT20	1986-88	18-3096	18-0461	18-3242	DF90	2009-10	18-3049	—	—
DT25	1980-82	18-3092	—	—	DT100	1987-01	18-3049	—	18-3254
DT25	1983-88	18-3096	18-0461	18-3242	DF100	2009-10	18-3023	—	—
DF25	2000-06	18-3096	18-0461	18-3242	DT115	1986-01	18-3023	—	18-3257**
DF25 V-Twin	2006-10	18-3096	18-0461	—	DF115	2001-10	18-3023	—	18-3258*
DT30	1983-87	18-3096	18-0461	18-3242	DT140	1986-01	18-3023	—	18-3257
DT30	1988-97	—	18-0461	—	DF140	2002-10	18-3023	—	—
DF30	2000-07	18-3096	18-0461	18-3242	DT150	1986-03	18-3023	—	18-3253
DT35	1980-82	18-3094	18-0459	—	DF150	2006-10	18-3023	18-0778	—
DT35	1987-89	18-3096	18-0461	18-3242	DT175	1987-92	18-3023	—	18-3253
DT40	1980-82	18-3094	18-0459	—	DF175	2006-10	18-3023	18-0778	—
DT40	1983	18-3094	18-0460	—	DT200	1986-00	18-3023	—	18-3253
DT40/DT40C	1984-98	18-3096	18-0461	18-3242	DF200	2004-10	18-3035	18-0778	18-3264
DF40	1999-09	18-3096	18-0461	18-3242	DT225	1990-03	18-3023	—	18-3253
DF40	2010	18-3096	18-0461	—	DF225	2004-10	18-3035	18-0778	18-3264
PU40 (jet)	1989-94	18-3096	18-0461	—	DF250	2004-10	18-3035	18-0778	18-3264
DT50	1982-prior	18-3094	18-0459	—	DF300	2007-10	18-3035	18-0651	18-3267
DT50	1983-84	18-3094	18-0460	18-3243	—	—	—	—	—

① Priced per Package

* SN 681517 & earlier

** SN 812175 & Later



O.E. INTERCHANGE

Part #	Description	O.E. #
NSS	Piston Rings	12140-93121
NSS	Piston Rings	12140-96351-050
18-39540	Piston Rings	12140-94400
18-40110	Piston Kit	12110-94400
18-40140	Piston Kit	12110-93120
NSS	Piston Pin	12151-94400
NSS	Wrist Pin	12151-93100
NSS	Wrist Pin	12151-92502
NSS ① ②	Circlips	09381-14001
18-42950-9 ① ②	Circlips	09381-18002
NSS	Circlips	09381-20003

HP/Model	Years	PISTON		RINGS		WRIST PIN		CIRCLIP	
		Std.	.50mm	Std.	.50mm	Std.	.50mm	Std.	.50mm
DT9.9	1983-87	18-40140	—	—	—	—	—	—	—
DT15	1983-88	18-40140	—	—	—	—	—	—	—
DT25	1983-88	—	—	—	—	—	—	—	18-42950-9
DT30	1983-87	—	—	—	—	—	—	—	18-42950-9
DT40	1984-98	18-40110	—	18-39540	—	—	—	—	—



18-1757K
CONNECTING ROD KIT
 Replaces: 12161-93902
 Fits: DT9.9 (1983-87), DT15 (1983-97)



18-1759K
CONNECTING ROD KIT
 Replaces: 12161-94400
 Fits: DT40 (1986-98)



18-1414
ROD BEARING
 Replaces: 09263-14022
 Fits: DT9.9 (1983-87), DT15 (1983-97),
 DT14/16 (1980-82)



18-1417
WRIST PIN BEARING
 Replaces: 09263-20072
 Fits: 40 (1984-98)



18-3806
HEAD GASKET
 Replaces: 11141-98401,
 11141-98411



18-3807
HEAD GASKET
 Replaces: 11141-98101, 11141-98130



18-3808
HEAD GASKET
 Replaces: 11141-93901, 11141-93960



18-3809
HEAD GASKET
 Replaces: 11141-96303,
 11141-96344



18-3810
HEAD GASKET
 Replaces: 11141-94401,
 11141-94450



18-3814
HEAD GASKET
 Replaces: 11141-95505,
 11141-95512



18-3816
HEAD GASKET
 Replaces: 11141-98504,
 11141-98510, 11141-98522

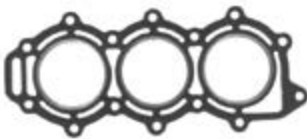

18-3819
HEAD GASKET
 Replaces: 11141-95D90,
 11141-95D10



18-3820
HEAD GASKET
 Replaces: 11141-94701,
 11141-94702, 11141-94720



18-3822
HEAD GASKET
 Replaces: 11141-87E90,
 11141-87E10



18-3823
HEAD GASKET
 Replaces: 11141-94506,
 11141-94620



18-3824
HEAD GASKET

Replaces: 11141-94600, 11141-94620



18-3825
HEAD GASKET

Replaces: 11141-87D90, 11141-87D60

Model	Year	Cyl	Head Gasket	Model	Year	Cyl	Head Gasket	Model	Year	Cyl	Head Gasket
2	1983-89	1	18-3806	25	1989	3	18-3819	85	1983-87	3	18-3814
5	1983	2	18-3816	30	1983-87	2	18-3809	90	1989	V-4	18-3822
6	1984-89	2	18-3807	30	1988-89	3	18-3819	100	1989	V-4	18-3822
8	1983-87	2	18-3807	35	1987-89	2	18-3810	115	1983-85	4	18-3823
8	1988-89	2	-	40	1984-89	2	18-3810	115	1986-89	4	18-3824
9.9	1983-87	2	18-3808	50	1984	2	-	140	1983-85	4	18-3823
9.9	1988-89	2	-	55	1985-89	3	18-3820	140	1986-89	4	18-3824
15	1983-89	2	18-3808	65	1985-89	3	18-3820	150	1986	V-6	18-3825
25	1983-88	2	18-3809	75	1983-87	3	18-3814	200	1986	V-6	18-3825



18-7896
OIL FILTER

Replaces: 16510-61A20-MHL
Fits: DF70A, DF80A, DF90A, DF90-DF115



18-7897
OIL FILTER

Replaces: 16510-82703
Fits: DF140



18-7903
OIL FILTER

Replaces: 16510-05240
For: DF9.9, DF15 (1996-06)



18-7905-1
OIL FILTER

Superseded from 1807895
Replaces: 16510-96J00
Fits: DF150-DF300



18-7915-1
OIL FILTER

Replaces: 16510-87J00
Fits: DF25-DF70



18-8870
OIL FILTER

Replaces: 16510-45H10
Fits: F9.9 Type T/TH(Sn 110001 & Newer), F15(SN 110001 & Newer)



18-4703
DRAIN SCREW MAGNETIC

Replaces: Suzuki 55128-93L00
Fits: DF150, DF175, DF200, DF225, DF250, DF300



18-4704
DRAIN SCREW

Replaces: Suzuki 55128-93J10
Fits: DF150, DF175, DF200, DF225, DF250, DF300

PKG. OF 5



18-8331-9
DRAIN PLUG GASKET

Replaces: 09168-10022



18-8334
SHIFT SHAFT SEAL

Replaces: 25223-94400



18-0651
PUMP CASE PANEL GASKET

Replaces: 17472-98J00
Fits: F300 (2007)



18-0650
OIL SEAL HOUSING GASKET

Replaces: 56132-95J00
Fits: F 25 V-Twin (2006-07)

PKG. OF 10



COTTER PINS

Part No.	Replaces
18-3737 ②	09204-02004
For: DT9.9 & 15C, DF9.9 & 15, 8 & 9.9C	
Oil Injected	09204-03003
18-3735 ②	09204-03004
For: DT20, 25C, 30C	



**18-3726
PROP NUT**
Replaces: 09141-18005



**18-3757
PROP NUT**
Replaces: Suzuki 57633-90J02
Fits: 4 Stroke Outboards
DF70/80/90/110/115/140A All Years



**18-3699
PROP NUT KIT**
Replaces Suzuki 57630-90J00
Fits: 4 Stroke Outboards DF70/80/90/110/115/140A All Years



**18-3775
PROP NUT KIT**
Replaces: 57630-92E00
For: V-6

— CONTAINS —

Part No.	O.E. #	Description
18-3726	09141-18005	Prop Nut
18-3735	09204-03003, 09204-03004	Cotter Pin
—	09160-18019	Washer
18-3795	57633-87D30	Spacer



**18-3777
PROP NUT KIT**
Replaces: 57630-94300
For: DT40/55/65

— CONTAINS —

Part No.	O.E. #	Description
18-3726	09141-18005	Prop Nut
18-3735	09204-03003, 09204-03004	Cotter Pin
—	09160-18019	Washer



**18-3778
PROP NUT KIT**
Replaces: 57630-96300
For: DT20/25C/30C

— CONTAINS —

Part No.	O.E. #	Description
NSS	09141-14008	Prop Nut
18-3735	09204-03003, 09204-03004	Cotter Pin
—	09160-14028	Washer
—	57633-96300	Spacer



**18-3774
PROP NUT KIT**
Replaces: 57630-94500
For: DT75/85/90/100/115,
140 with V-Style,
DF60/70 with V Style

— CONTAINS —

Part No.	O.E. #	Description
18-3726	09141-18005	Prop Nut
18-3735	09204-03003, 09204-03004	Cotter Pin
—	09160-18028	Washer
—	57633-94500	Spacer



③ **18-6032
ANODE**
Replaces: 55320-95310
55-140 HP



③ **18-6033
ANODE**
Replaces: 55125-87D00
150-200 HP



③ **18-6098
ANODE**
Replaces: 55125-96310
DF25, DF30, DT20, DT25, DT25C,
DT30, DT30C, DT35



⑤ **18-6161A**
④ **18-6161M**
ANODE KIT
Fits: Suzuki 90-140HP Engines



**18-8380
LOWER UNIT SEAL KIT**
Replaces: 25700-93J00
For: All DF150/DF175/DF200/
DF225/DF250



**18-8381
LOWER UNIT SEAL KIT**
Replaces: 25700-99E00
For: DF 60(2001 & Up), DF70(2001 & Up)

① Priced per Package ② This product is priced per piece. To order priced per package, please add -9 to the part number
⑤ Aluminum ④ Magnesium ③ Zinc

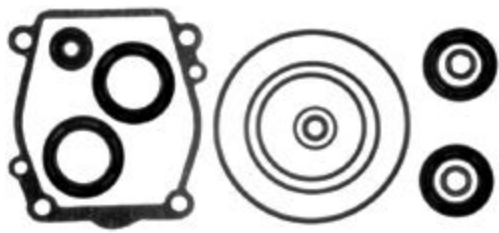

18-8335
LOWER UNIT SEAL KIT
 Replaces: 25700-87D00

– CONTAINS –

Part #	Description	O.E. #	Qty.
18-7118	O-Ring	09280-08008	1
18-7183	O-Ring	09280-69001	1
NSS	Drain Plug Gasket	09168-10022	2
18-7440-1	O-Ring	—	1
18-0544	Oil Seal	09282-24004	2



18-8337
LOWER UNIT SEAL KIT
 Replaces: 25700-94400

– CONTAINS –

Part #	Description	O.E. #	Qty.
18-0461	Water Pump Gasket	17472-96301	1
18-7151	O-Ring	09280-75001	1
18-7413	O-Ring	09280-08005	2
NSS	Drain Plug Gasket	09168-10022	3
18-8334	Shift Shaft Seal	25223-94400	1
18-8345	Seal	09289-22007	2
18-7180	O-Ring	—	1

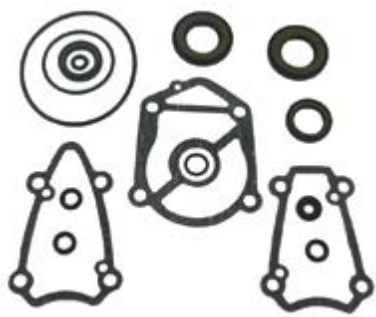

18-8338
LOWER UNIT SEAL KIT
 Replaces: 25700-94500

– CONTAINS –

Part #	Description	O.E. #	Qty.
18-7118	O-Ring	09280-08008	1
NSS	Drain Plug Gasket	09168-10022	3
18-7182	Oil Seal	—	1
18-7133	O-Ring	—	1



18-8339
LOWER UNIT SEAL KIT
 Replaces: 25700-94700

– CONTAINS –

Part #	Description	O.E. #	Qty.
18-0460	Water Pump Gasket	17472-95310	1
18-7151	O-Ring	09280-76006	1
18-7180	O-Ring	—	1
18-7413	O-Ring	09280-08005	1
18-8329	Seal	09289-17005	1
NSS	Drain Plug Gasket	09168-10022	3
18-8334	Shift Shaft Seal	25223-94400	1
18-8345	Seal	09289-22007	2



18-8340
LOWER UNIT SEAL KIT
 Replaces: 25700-95500

– CONTAINS –

Part #	Description	O.E. #	Qty.
18-0459	Water Pump Gasket	17472-95200	1
NSS	Drain Plug Gasket	09168-10022	3
18-8334	Shift Shaft Seal	25223-94400	1
18-7180	O-Ring	—	1
18-7413	O-Ring	09280-08005	1
18-7127	O-Ring	—	1

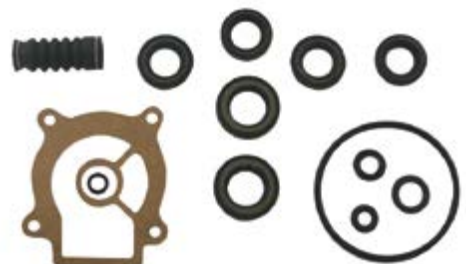

18-8341
LOWER UNIT SEAL KIT
 Replaces: 25700-95D00

– CONTAINS –

Part #	Description	O.E. #	Qty.
18-0461	Water Pump Gasket	17472-96301	1
18-7118	O-Ring	09280-50005	1
18-7413	O-Ring	09280-08005	1
18-7140	O-Ring	09282-17006	1
NSS	Drain Plug Gasket	09168-10022	3



18-8373
LOWER UNIT SEAL KIT
 Replaces: 25700-90J01
 Fits: DF 90/115 (All Years)



18-8374
LOWER UNIT SEAL KIT
 Replaces: 25700-92J00
 Fits: DF140 (All Years)



18-8385
SEAL KIT
 Replaces: 25700-95J00
 Fits: DF25 V-Twin (2006-07)

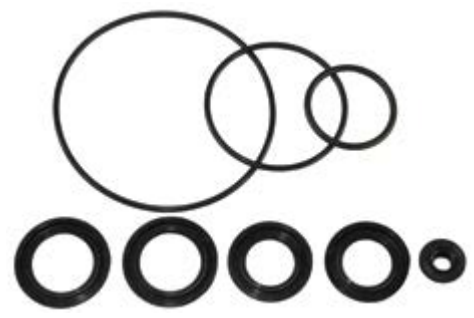

18-8386
SEAL KIT
 Replaces: 25700-98J00
 Fits: DF300 (2007)

SEAL KIT APPLICATION

HP/MODEL	YEAR	PART #	HP/MODEL	YEAR	PART #
DT25C	All	18-8341	DT115	All	18-8338
DF25	All	18-8341	DF115	All	18-8373
DF25 V-Twin	2006-07	18-8385	DT140	All	18-8338
DT30C	All	18-8341	DF140	All	18-8374
DF30	All	18-8341	DT150	All	18-8335
DT40C	All	18-8337	DF150	All	18-8380
DF40	All	18-8337	DT175	All	18-8335
DF50	All	18-8337	DF175	All	18-8380
DT55	All	18-8339	DT200	All	18-8335
DF60	2001-07	18-8381	DF200	All	18-8380
DT65	All	18-8339	DT225	All	18-8335
DF70	2001-07	18-8381	DF225	All	18-8380
DT75	All	18-8340	DF250	All	18-8380
DT85	All	18-8340	DF300	All	18-8386
DF90	All	18-8373			

PKG. OF 2



OIL SEALS

Part #	O.E. #	I.D.	Dimensions O.D. (mm)	Width
18-0544	09282-24004	23.2	40.3	7
18-8345	09289-22007	22.2	35	5
18-8375		29	45	6

PKG. OF 5

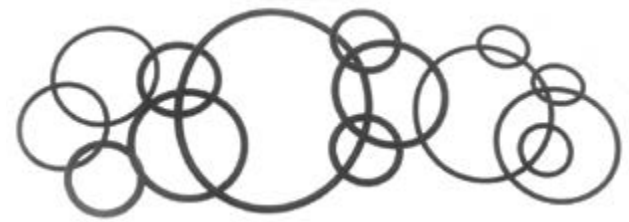

O-RINGS

Part No.	O.E. No.	I. D.	Dimensions Width (mm)
18-7118 ①	09280-08008	69.40	3.10
18-7140 ①	09280-75002	69.00	3.50

① This product is priced per piece. To order priced per package, please add -9 to the part number

Model Description	Horsepower	Trim & Tilt/Starting Method	Shaft Length	Control Method	Model Year	Special Model Variation Code (Used on 25HP engines)
B = Inshore series C = C series model CV = C series D = Twin rotating propellers DX = Twin rotating propellers OX66 EFI E = Enduro series model F = Four stroke engine model LF = Left hand four stroke L = Left hand engine model LX = Left hand OX66 EFI LZ = Left hand HPDI P = Pro series model PX = Pro series OX66 EFI S = Saltwater series model SX = Saltwater series OX66 EFI T = Four stroke engine with high thrust V = V max series model VX = V max OX66 EFI VZ = V max HPDI Z = HPDI series	Example: 6 9.9 200 250	T = Power tilt or trim/tilt (1984-1990) P = Power tilt with electric start E = Electric start (1984-1990) M = Manual tilt with manual start	S = 15" L = 20" X = 25" U = 30"	R = Remote control H = Tiller handle J = Jet drive unit	N = 1984 K = 1985 J = 1986 H = 1987 G = 1988 F = 1989 D = 1990 P = 1991 Q = 1992 R = 1993 S = 1994 T = 1995 U = 1996 V = 1997 W = 1998 X = 1999 Y = 2000 Z = 2001 A = 2002 B = 2003 C = 2004 D = 2005	2 = 3 Cyl. 1997 3 = 3 Cyl.

Starting in April 2005 (2006 Model Year and newer) Yamaha no longer designated model years at the end of the model number identification. Beginning at this time any subsequent "new model" will have a letter designation between the Horsepower and the Control / Tilt Method.

Example:





VZ300TLRD = 2005





VZ300TLR = New model after April 2005.

VZ300BTLR = Newest Model and direct replacement for previous models.

EXAMPLE: SX150TLRY - Saltwater EFI, 150 HP, Trim & Tilt w/electric start, 20", Remote control, 2000 model

 <p>18-5130 CDI Replaces: 688-85540-16-00 Fits: 90(1988-91), C75(1994-96), C85(1991-96), CV85(1989-90), E75(1995-96)</p>	 <p>18-5131 CDI Replaces: 695-85540-11, 695-85540-12-00 Fits: 9.9(1984-95), 15(1984-95), C25(1992-97), CV25(1990)</p>	 <p>18-5132 CDI Replaces: 63V-85540-00-00, 63V-85540-01-00, 63V-85540-02-00 Fits: 9.9(1999-09), 15(1999-09)</p>
---	--	---

 <p>18-5110 IGNITION COIL Replaces: 6E5-85570-11-00 For: 115 (4 cyl.) 1985-91</p>	 <p>18-5111 IGNITION COIL Replaces: 697-85570-11-00 For: 55 (2 cyl.) 1989-94 and 90 1984-88</p>	 <p>18-5112 IGNITION OIL Replaces: 6E7-85570-19-00, 680-85570-09-00, 6E7-85570-10-00, 695-85570-10-00 For: 9.9/15 (1988-93)</p>	 <p>18-5128 IGNITION COIL Replaces: 6R3-85570-01-00 For: 115/130/150HP (1994-04) 175HP (1994-95, 1997-98, 2000) 200HP (1994-98) 225HP (1997) B115HP 1998-99) C115HP (1997-98) for late model V4 & V6</p>
--	--	---	---

 <p>18-5183 COIL, CHARGE Replaces: 63V-85520-00, 63V-85520-01 Fits: 9.9(1996-09), 15(1996-09)</p>	 <p>18-5195 COIL, IGNITION Replaces: 689-81311-40-00 Fits: 25(1984-87), 30(1984-86), C30(1991-92), C40(1994-97), CV30(1989-90), CV40(1990)</p>	 <p>18-5138 COIL, IGNITION Replaces: 680-85570-00-00; 680-85570-02-00 Fits: T6 (02-05); F6, F8 (01-05); C25 (96-97)</p>	 <p>18-5113 COIL, IGNITION Replaces: 61N-85570-00-00, 61N-85570-10-00 Fits: 25(1994-95, 2001-09)</p>
--	---	---	---



18-25652
COIL, PULSER
 Replaces: 63V-85580-01-00
 Fits: 9.9(2003-09), 15(2003-09)



18-25604
LIGHTING COIL
 Replaces: 63V-85533-00-00
 Fits: 9.9(1996-09), 15(1996-09)



18-5135
CDI
 Replaces: 6E5-85540-10-00, 6E5-85540-11-00, 6E5-85540-12-00
 Fits: 115 ET 1984-1989; 130 ET 1988-1989; C115TLR 1991-1996; C115TXR 1992-1996; L130ETX 1989; 1989 2-225HP



18-5136
CDI
 Replaces: 6F5-85540-21-00, 6F5-85540-22-00
 Fits: 40HP 2 Cylinder (Int'l)

Sierra's MAGFORCE Ignition Wires are "Electronics Friendly" protecting all of your electronic devices and electronic engine controls from RFI and EMI while delivering the maximum amount of voltage. Exact fit design ensures easy installation and years of trouble - free service.

Part #	OEM #	Application
18-5217-1	67F-82341-00-00	F75 (2003-2017), F80 (1999-2003), F90 (2003-2017), F100 (1999-2003)
18-5218-1	67F-82342-00-00	F75 (2003-2017), F80 (1999-2003), F90 (2003-2017), F100 (1999-2003)
18-5219-1	67F-82343-00-00	F75 (2003-2017), F80 (1999-2003), F90 (2003-2017), F100 (1999-2003)
18-5220-1	67F-82344-00-00	F75 (2003-2017), F80 (1999-2003), F90 (2003-2017), F100 (1999-2003)
18-8847-1 (Set)	67F-82341-00-00 + 67F-82342-00-00 + 67F-82343-00-00 + 67F-82344-00-00	F75 (2003-2017), F80 (1999-2003), F90 (2003-2017), F100 (1999-2003)

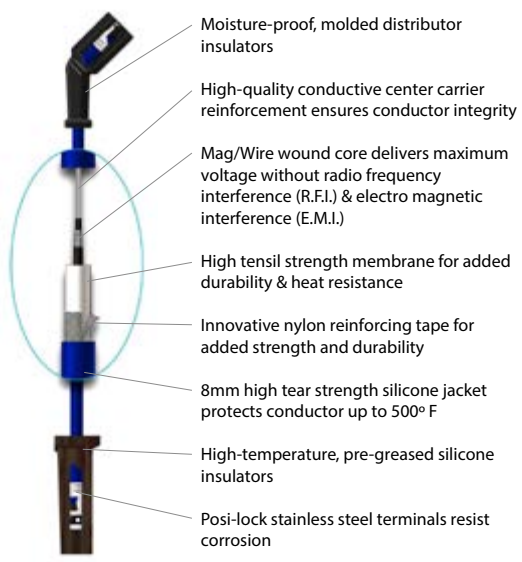

MP39160
MOMENTARY PUSH SWITCH
 For outboard installations.



MP51020 (CLAMSHELL)
MP51022 (BULK 100 PCS/CTN)
IGNITION SWITCH
 Replaces: 703-82510-12-00
Yamaha Control Box 2 & 4 stroke
 Colors on wires match factory color codes



MP51030 (CLAMSHELL)
MP51032 (BULK 100 PCS/CTN)
IGNITION SWITCH
 Replaces: 61B-82510-01-00, 61B-82510-00-00
Yamaha Dash Mount 2 Stroke
 Dual Engine Application Colors on wires match factory color codes



MP51040 (CLAMSHELL)
MP51042 (BULK 100 PCS/CTN)
IGNITION SWITCH
 Replaces: 703-82510-43-00
 Yamaha Control Box 2 & 4 stroke
 Push to Choke
 Colors on wires match factory color codes



MP51050 (CLAMSHELL)
MP51052 (BULK 100 PCS/CTN)
IGNITION SWITCH
 Replaces: 6K1-82510-06-00
 Yamaha Dash Mount 2 & 4 Stroke
 Dual Engine Application, Push to Choke
 Colors on wires match factory color codes



MP28860
IGNITION LANAYARD
 Replaces: 682-82556-00-00



18-5225
SPARK PLUG WIRE KIT
 Kit includes 25 ft. Roll of 7 MM Hypalon Ignition Wire With a Metallic Core and a Large Assortment of Three Different End Fittings to Fit Outboard Motors.



18-5226
IGNITION WIRE
 Metallic Core
 100' Spool
 7mm Hypalon



PKG. OF 10
18-5224
18-5224-9①
SPARK PLUG WIRE TERMINAL
 Replaces: Mercury 20121
 OMC 510364



18-5752
UNIVERSAL SPARK PLUG BOOTS
 8mm



PKG. OF 10
18-5750
18-5750-9①
UNIVERSAL SPARK PLUG BOOTS
 Replaces: OMC 581027, 580339
 Supplied complete w/Terminal Connector

① Priced per Package

YAMAHA OUTBOARD IGNITION CHART APPLICATION

HP	Year Start	Year Stop	CDI	Ignition Coil	Charge Coil (Stator)	Pulser Coil	Lighting Coil
9.9	1984	1995	18-5131	18-5111	-	-	-
9.9	1996	1998	-	-	18-5183	18-25652	18-25604
9.9	1999	2009	18-5132	-	18-5183	18-25652	18-25604
15	1984	1995	18-5131	18-5112	-	-	-
15	1996	1998	-	-	18-5183	18-25652	18-25604
15	1999	2009	18-5132	-	18-5183	18-25652	18-25604
20	1996	1997	-	18-5113	-	-	-
25	1984	1987	-	-	18-5195	-	-
25	1994	2009	-	18-5113	-	-	-
30	1984	1986	-	-	18-5195	-	-
90	1984	1988	-	18-5111	-	-	-
90	1988	1991	18-5130	-	-	-	-
115	1984	1989	18-5135	18-5110	-	-	-
115	1994	2009	-	18-5128	-	-	-
130	1988	1989	18-5135	18-5110	-	-	-
130	1994	2004	-	18-5112	-	-	-
150	1984	1989	-	18-5110	-	-	-
150	1994	2009	-	18-5112	-	-	-
175	1984	1989	-	18-5110	-	-	-

APPLICATION CONTINUED ON NEXT PAGE

YAMAHA OUTBOARD IGNITION CHART APPLICATION (Cont.)

HP	Year Start	Year Stop	CDI	Ignition Coil	Charge Coil (Stator)	Pulser Coil	Lighting Coil
175	1994	1995	-	18-5112	-	-	-
175	2000	2000	-	18-5112	-	-	-
200	1984	1989	-	18-5110	-	-	-
200	1994	1998	-	18-5112	-	-	-
225	1994	1997	-	18-5112	-	-	-
B115	1998	1999	-	18-5112	-	-	-
C25	1992	1995	18-5131	18-5112	-	-	-
C25	1996	1997	18-5131	18-5138	-	-	-
C30	1991	1992	-	-	18-5195	-	-
C30	1993	1997	-	18-5113	-	-	-
C40	1991	1997	-	-	18-5195	-	-
C55	1991	1994	-	18-5111	-	-	-
C75	1994	1996	18-5130	-	-	-	-
C85	1991	1996	18-5130	-	-	-	-
C115	1991	1996	18-5135	18-5110	-	-	-
C115	1997	2000	-	18-5112	-	-	-
C150	1996	1999	-	18-5112	-	-	-
CV25	1990	1990	18-5131	18-5112	-	-	-
CV30	1989	1990	-	-	18-5195	-	-
CV40	1990	1990	-	-	18-5195	-	-
CV55	1989	1990	-	18-5111	-	-	-
CV85	1989	1990	18-5130	-	-	-	-
D150	1997	1999	-	18-5112	-	-	-
E48	1995	1996	-	18-5112	-	-	-
E75	1995	1996	18-5130	-	-	-	-
F6	2001	2008	-	18-5138	-	-	-
F8	2001	2015	-	18-5138	-	-	-
F9.9	2005	2006	-	-	-	-	-
F9.9	2007	2014	-	18-5138	-	-	-
F15	1998	1999	-	-	-	-	-
F15	2000	2005	-	-	-	-	-
F25	1998	2004	-	-	-	-	-
F25	2005	2005	-	-	-	-	-
F30	2001	2005	-	-	-	-	-
F40	2000	2008	-	-	-	-	-
L130	1989	1989	18-5135	18-5110	-	-	-
L130	1994	2001	-	18-5112	-	-	-
L150	1986	1989	-	18-5110	-	-	-
L150	1994	1999	-	18-5112	-	-	-
L200	1986	1989	-	18-5110	-	-	-
L200	1994	1999	-	18-5112	-	-	-
P115	1994	1996	-	18-5112	-	-	-
P150	1994	1999	-	18-5112	-	-	-
P175	1994	1999	-	18-5112	-	-	-
P200	1994	1999	-	18-5112	-	-	-
PROV150	1986	1989	-	18-5110	-	-	-
S115	1996	1999	-	18-5112	-	-	-
S130	1996	1999	-	18-5112	-	-	-
S150	1996	1999	-	18-5112	-	-	-
S175	1996	1999	-	18-5112	-	-	-
S200	1996	1999	-	18-5112	-	-	-
T8	2001	2010	-	18-5138	-	-	-
T9.9	2005	2006	-	-	-	-	-
T9.9	2007	2014	-	18-5138	-	-	-
T25	2001	2004	-	-	-	-	-

APPLICATION CONTINUED ON NEXT PAGE

YAMAHA OUTBOARD IGNITION CHART APPLICATION (Cont.)

HP	Year Start	Year Stop	CDI	Ignition Coil	Charge Coil (Stator)	Pulser Coil	Lighting Coil
T25	2005	2005	-	-	-	-	-
T25	2006	2006	-	-	-	-	-
V150	2000	2008	-	18-5112	-	-	-
V175	2000	2000	-	18-5112	-	-	-
V6EXCEL	1987	1989	-	18-5110	-	-	-
V6SPECIAL	1984	1986	-	18-5110	-	-	-



18-5819
SOLENOID

Replaces: 65W-81941-00-00
Fits: F25 (1998-04), F30 (2001-04), F40 (2000-04)



18-5853
SOLENOID

Replaces: 61A-81941-00-00, 6E5-81941-11-00, 6E5-81941-10-00, 6E5-81941-00-00
For: 2-Stroke: 115hp - 150hp. (1994-Current); 175hp (1994-2000); 200hp (1994-2005); 225hp. (1995-2004); 250hp (1990-2004)



18-5821
STARTER SOLENOID

Replaces: 6G1-81941-10-00
Fits: 9.9/15(1988-97), 20(1996-97), 25(1985, 1988-99), 30(1985-87, 1989-93, 1996-99, 2001), 40(1989-90, 1992-01), 50(1989-97, 1999-02), 1990(1992-02), F15(1998-03), F40(1999), F50(1996-02), F60(2002-03), F75(2003-04), F80(1999-03), F90(2003-04), F100(1999-02)



18-5879
SOLENOID

Replaces: 688-81950-10-00, 688-81941-00-00
For: 2-Stroke: 40hp (1984-88); 50hp (1984-88); 60hp. (2001-06); 70hp. (1991-Current); 90hp. (1984-91)



18-5746
STATOR ASSEMBLY

Replaces: 6H3-85510-A0, 6H3-85510-A1
Fits: E60(1995-99), P60(1991), 70(1984-91)



18-6410
OUTBOARD STARTER

Replaces: Yamaha 689-81800-13-00, 689-81800-11, 689-81800-12
Fits: 25-40HP (11 tooth)



18-6963
STARTER

Replaces: Yamaha 6EM-81800-01-00



18-6964
STARTER

Replaces: Yamaha 6BG-81800-00-00



18-6411
OUTBOARD STARTER

Replaces: 6H3-81800-11-00, 6H3-81800-10
Fits: 60HP



18-6412
OUTBOARD STARTER

Replaces: 697-81800-12, 99999-03249-00
Fits: 55-60HP 2 cylinder (9 tooth)

 <p>18-6413 OUTBOARD STARTER Replaces: 6E5-81800-11-00, 6E5-81800-12-00 Fits: 55-60HP 2 cylinder (9 tooth)</p>	 <p>18-6415 OUTBOARD STARTER Superseded from 18-6861 Replaces: 6N7-81800-10-00 Fits: 115-250HP (9 tooth)</p>	 <p>18-6961 STARTER Replaces: 6CB-81800-00-00 Fits: 200, 225, 250 4 Cycle (2006 & Up)</p>	 <p>18-6420 OUTBOARD STARTER Replaces: 6L2-81800-20-00 Fits: 20HP MLHU & MSHU (1996), 20HP MLHV & MSHV 1997 25 (1988-98)</p>
 <p>18-6421 OUTBOARD STARTER Replaces: 6F5-81800-11, 6J4-81800-01-00 Fits: 25HP (1999&2001), 30HP (1996-99 & 2001), 40HP (1992-03) C40 1997-02, P40 (1998) 50 (1992-97 & 2000 & 2002-03) C50 (1998-01), P50 (1993-96)</p>	 <p>18-6422 OUTBOARD STARTER Replaces: 6H4-81800-12-00 Fits: 40HP (1984-86), 50HP (1986-88), Pro 50 (1987-88)</p>	 <p>18-6423 OUTBOARD STARTER Replaces: 688-81800-12-00 Fits: C75 (1994-96), (1998-99), P75 (1996-99), C80 TLRV (1997), C85 (1991- 96) CV85 (1990), 90 (1984-03), B90 (1998-99) C90 (1997-01)</p>	 <p>18-6425 OUTBOARD STARTER Replaces: 67F-81800-02-00 Fits: F75 (2003), F80 (2001-02), F90 (2003), F100 (2001-02)</p>
 <p>18-6426 OUTBOARD STARTER Replaces: 68F-81800-01-00 Fits: LZ150(00-05), LZ200(00-11), VZ150(00-11), VZ175(01-11), VZ200(01- 04), Z150(00-05), Z175(01-05), Z200(00-11)</p>	 <p>18-6427 OUTBOARD STARTER Replaces: 68V-81800-01-00 Fits: F115 2001-03</p>	 <p>18-6832 STARTER Replaces: 60V-81800-00-00, 60X-81800-00-00 Fits: 250HP engines 2003-04</p>	 <p>18-6833 STARTER Replaces: 69J-81800-00-00 Fits: 2002-2004 200-225HP</p>
 <p>18-6942 STARTER Replaces: 69W-81800-00-00 Hitachi S114-682 Fits: 2002-04 60HP, 2003-04 50HP</p>	 <p>18-6943 STARTER Replaces: 66M-81800-01-00, 02-00 Fits: 9.9-15HP Engines</p>	 <p>18-6963 STARTER Replaces: 6EM-81800-01-00 Fits: F115/LF115 14-18 VF115 15-18</p>	 <p>18-6964 STARTER Replaces: 6BG-81800-00-00 Fits: F25-F40</p>

SIERRA®

HP	Stroke	Model	Year	Starter	HP	Stroke	Model	Year	Starter
9.9		9.9	1984-1997	18-6420	40		C40	1991-1997	18-6410
9.9	4	F9.9ELR2	2006 & UP	18-6943	40		C40ELRP	1991	18-6410
9.9		F9.9ELR2D	2005	18-6943	40		C40ELRQ - C40TLRZ	1992-2001	18-6410
9.9	4	F9.9MLH2	2006 & UP	18-6943	40		CV40ELD	1990	18-6410
9.9		F9.9MLH2D	2005	18-6943	40		F40TLRX	1999	18-6413
9.9	4	F9.9MSH2D	2006 & UP	18-6943	40		P40	1998	18-6421
9.9		F9.9MSH2D	2005	18-6943	40		P40TLHW - P40TLRW	1998	18-6421
9.9	4	T9.9ELH2	2006 & UP	18-6943	50		50	1984-1988	18-6422
9.9		T9.9ELH2D	2005	18-6943	50		50	1989-2009	18-6421
9.9	4	T9.9ELR2 - T9.9EXH2	2006 & UP	18-6943	50		50EJRQ - 50TLHV	1992-2001	18-6421
9.9		T9.9EXH2D	2005	18-6943	50	2	50TLR	2006 & UP	18-6421
15		15	1984-1997	18-6420	50		50TLRA - 50TLRZ	1996-2005	18-6421
15	4	F15ELH	2006 & UP	18-6943	50		C50	1998-2001	18-6421
15		F15ELHA - F15ELHD	2002-2005	18-6943	50		C50TLRW - C50TLRZ	1998-2001	18-6421
15	4	F15ELHK	2006 & UP	18-6943	50		F50	1995-2002	18-6413
15		F15ELHY - F15ELHZ	2000-2001	18-6943	50		F50TJRA - F50TLRZ	1995-2002	18-6413
15	4	F15ESH	2006 & UP	18-6943	50		P50	1991-1996	18-6421
15		F15ESHA - F15ESHD	2002-2005	18-6943	50		P50TLRR - P50TLRU	1993-1996	18-6413
15	4	F15ESHK	2006 & UP	18-6943	50		T50	1996-2002	18-6413
15		F15ESHY - F15ESHZ	2000-2001	18-6943	50		T50TLRA - T50TLRY	1996-2002	18-6413
15	4	F15MLH	2006 & UP	18-6943	55		C55	1991-1995	18-6412
15		F15MLHA - F15MLHD	2002-2005	18-6943	55		CV55	1989-1990	18-6412
15	4	F15MLHK	2006 & UP	18-6943	60		60	2001-2005	18-6411
15		F15MLHY - F15MLHZ	2000-2001	18-6943	60	2	60TLR	2006 & UP	18-6411
15	4	F15MSH	2006 & UP	18-6943	60		60TLRA - 60TLRZ	2001-2005	18-6411
15		F15MSHA - F15MSHD	2002-2005	18-6943	60		C60	1996-2001	18-6411
15	4	F15MSHK	2006 & UP	18-6943	60		C60ELRU - C60TLRZ	1996-2001	18-6411
15		F15MSHY - F15MSHZ	2000-2001	18-6943	60		P60	1991-1999	18-6411
15	4	F15PLH	2006 & UP	18-6943	60		P60TLHP - P60TLHX	1991-1999	18-6411
15		F15PLHA - F15PLHD	2002-2005	18-6943	70		70	1984-2009	18-6411
15	4	F15PLHK	2006 & UP	18-6943	70		70ETLD - 70ETLN	1984-1990	18-6411
15		F15PLHZ	2001	18-6943	70	2	70TLR	2006 & UP	18-6411
15	4	F15PLR	2006 & UP	18-6943	70		70ETLN - 70TRP	1984-2005	18-6411
15		F15PLRA - F15PLRD	2002-2005	18-6943	70		C70	2000-2001	18-6411
15	4	F15PLRK	2006 & UP	18-6943	70		C70TLRY - C70TLRZ	2000-2001	18-6411
15		F15PLRZ	2001	18-6943	75		C75	1994-1999	18-6423
25		25 (2 CYL)	1984-1987	18-6410	75		C75TLRS - C75TLRX	1994-1999	18-6423
25		25 (2 CYL)	1988-2009	18-6420	75		F75	2003-2004	18-6425
25		C25	1991-1997	18-6410	75		F75	2005-2011	18-6427
25		CV25	1990	18-6410	75		F75TLRB - F75TLRD	2003-2005	18-6425
25	2	25ELH	2006 & UP	18-6420	75		F75TLRD	2005	18-6427
25		25ELH - 25ELN	1984-1987	18-6410	75		P75	1996-1999	18-6423
25	2	25ELR	2006 & UP	18-6420	75		P75TLHU - P75TLHX	1996-1999	18-6423
25	2	25ESH	2006 & UP	18-6420	80		C80	1997	18-6423
25		25ESH - 25ESN	1984-1987	18-6410	80		C80TLRV	1997	18-6423
25	2	25ESR	2006 & UP	18-6420	80		F80	1999-2003	18-6425
25		25LH - 25LN	1984-1987	18-6410	80		F80TJRA - F80TLRZ	2001-2003	18-6425
25	2	25MLH	2006 & UP	18-6420	85		C85	1991-1996	18-6423
25		25MLHX3	1999	18-6421	85		C85ELD - C85TLRU	1990-1996	18-6410
25	2	25MSH	2006 & UP	18-6420	85		CV85	1989-1990	18-6423
25		25MSHX3 - 25MSHZ3	1999-2001	18-6421	85		CV85ELF	1989	18-6410
25		25SH - 25SN	1984-1987	18-6410	90		90	1984-2009	18-6423
25		C25ELD - C25HSHV	1990-1997	18-6410	90		90ETLD - 90TJRZ	1984-2001	18-6410
30		30	1984-1986	18-6410	90	2	90TLR	2006 & UP	18-6410
30		30	1987-2001	18-6421	90		90TLRA - 90TLRZ	1991-2005	18-6410
30		30ELHT - 30ELHY	1995-2001	18-6421	90		B90	1997-1999	18-6423
30		30ELJ - 30ELN	1984-1986	18-6410	90		B90TLRV - B90TLRX	1997-1999	18-6410
30		30ELRT - 30ELRZ	1995-2001	18-6421	90		C90	1997-2001	18-6423
30		30ESJ - 30ESN	1984-1986	18-6410	90		C90TLRV - C90TLRZ	1997-2001	18-6410
30		30ESRT - 30MSHZ	1995-2001	18-6421	90		F90	2003-2004	18-6425
30		C30	1991-1997	18-6410	90		F90	2006-2011	18-6427
30		C30ELD - C30MLHS	1990-1997	18-6410	90	4	F90TJR	2006 & UP	18-6427
30		CV30	1989-1990	18-6410	90		F90TJRB - F90TJRC	2003-2004	18-6425
30		CV30ELF	1989	18-6410	90	4	F90TLR	2006 & UP	18-6427
40		40	1984-1988	18-6422	90		F90TLRB - F90TLRC	2003-2004	18-6425
40		40	1989-2005	18-6421	90	4	F90TXR	2006 & UP	18-6427
40		40EJRQ	1992	18-6421	100		F100	1999-2003	18-6425
40		40EJRR - 40TLHV	1993-2001	18-6421	100		F100TLRA - F100TXRZ	2001-2003	18-6425
40	2	40TLR	2006 & UP	18-6421	115		115	1984-1996	18-6413
40		40TLRA - 40TLRZ	1994-2005	18-6421	115		115	2000-2009	18-6415

APPLICATION CONTINUED ON NEXT PAGE

HP	Stroke	Model	Year	Starter	HP	Stroke	Model	Year	Starter
115		115ETLD	1990	18-6413	175		Z175TXRA - Z175TXRZ	2001-2005	18-6426
115		115ETLD-JD	1990	18-6413	200		200	1984-1996	18-6413
115		115ETLF	1989	18-6413	200		200ETLD - 200TXRT	1984-1996	18-6413
115		115ETLF-JD	1989	18-6413	200	4	F200TXR	2006 & UP	18-6833
115		115ETLG	1988	18-6413	200		F200TXRA - F200TXRD	2002-2005	18-6833
115		115ETLG-JD	1988	18-6413	200	4	F200XTR	2006 & UP	18-6833
115		115ETLH	1987	18-6413	200		L200	1986-1996	18-6413
115		115ETLH-JD	1987	18-6413	200		L200ETF - L200TXRU	1986-1996	18-6413
115		115ETLJ - 115TXRT	1984-1996	18-6413	200	4	LF200TXR	2006 & UP	18-6833
115		C115	1991-1996	18-6413	200		LF200TXRA - LF200TXRD	2002-2005	18-6833
115		C115	2000	18-6415	200		LX200	1999-2001	18-6415
115		C115LXRQ - C115TXRU	1991-1996	18-6413	200		LZ200	2002-2011	18-6426
115		F115	2000-2011	18-6427	200	2	LZ200TXR	2006 & UP	18-6426
115	4	F115TJR	2006 & UP	18-6427	200		LZ200TXRA - LZ200TXRZ	2000-2005	18-6426
115		F115TJRA - F115TJRD	2002-2005	18-6427	200		P200TLRS - P200TLRU	1994-1996	18-6413
115	4	F115TLR	2006 & UP	18-6427	200		S200	1996	18-6413
115		F115TLRA - F115TLRZ	2001-2005	18-6427	200		S200TXRU	1996	18-6413
115	4	F115TXR	2006 & UP	18-6427	200		SX200	1999-2005	18-6415
115		F115TXRA - F115TXRZ	2001-2005	18-6427	200		V-200	1998-1999	18-6424
115		LF115	2000-2011	18-6427	200		V200TLRW - V200TLRX	1998-1999	18-6415
115	4	LF115TXR	2006 & UP	18-6427	200		VX200	2000-2003	18-6424
115		LF115TXRA - LF115TXRD	2002-2005	18-6427	200		VX200TLRA - VX200TLRZ	2001-2003	18-6415
115		P115	1993-1996	18-6413	200		VZ200	2001-2004	18-6426
115		P115TLRR - S115TLRU	1993-1996	18-6413	200		VZ200TLRA - VZ200TLRZ	2001-2004	18-6426
130		130	1988-1996	18-6413	200		Z200	2000-2011	18-6426
130		130	2000-2004	18-6415	200	2	Z200TLR	2006 & UP	18-6426
130		130ETLD - 130TXRT	1988-1995	18-6413	200		Z200TLRD	2005	18-6426
130		L130	1989-1996	18-6413	200		Z200TLRY - Z200TLRZ	2000-2001	18-6426
130		L130	2000-2001	18-6415	200	2	Z200TXR	2006 & UP	18-6426
130		L130ETXD - S130TXRU	1990-1996	18-6413	200		Z200TXRA - Z200TXRZ	2000-2005	18-6426
150		150	1984-1996	18-6413	225		225TUR	1995	18-6415
150		150	2000-2009	18-6415	225		225TXRS	1994	18-6415
150		150ETLD - 150TXRT	1990-1997	18-6413	225		225TXRT	1995	18-6415
150		C150	1996	18-6413	225	4	F225TUR	2006 & UP	18-6833
150		C150TLRU	1996	18-6413	225		F225TURA - F225TURD	2002-2005	18-6833
150		C150TXRU	1996	18-6413	225	4	F225TXR	2006 & UP	18-6833
150		DX150	1999-2005	18-6415	225		F225TXRA - F225TXRD	2002-2005	18-6833
150		L150	1986-1996	18-6413	225		L225	1994-1999	18-6424
150		L150ETXD - L150TXRU	1986-1996	18-6413	225		L225TUR - L225TXRX	1994-1999	18-6415
150	4	LF150TXR	2006 & UP	18-6413	225	4	LF225TUR	2006 & UP	18-6833
150		LX150	1999-2001	18-6415	225		LF225TURA - LF225TURD	2002-2005	18-6833
150		LZ150	2000-2005	18-6426	225	4	LF225TXR	2006 & UP	18-6833
150	2	LZ150TXR	2006 & UP	18-6426	225		LF225TXRA - LF225TXRD	2002-2005	18-6833
150		LZ150TXRA - LZ150TXRZ	2000-2005	18-6426	225		LX225	2000-2003	18-6424
150		Z150	2000-2005	18-6415	225		LX225TXRA - LX225TXRZ	2000-2003	18-6415
150		P150	1991-1996	18-6413	225		S225	1996-1999	18-6424
150		P150TLRQ - P150TLRU	1986-1996	18-6413	225		S225TURU - S225TXRX	1996-1999	18-6415
150		PRO V-150	1986-1990	18-6413	225		SX225	2000-2003	18-6424
150		S150	1996	18-6413	225		SX225TURA - SX225TXRZ	2000-2003	18-6415
150		S150TLRU / S150TXRU	1996	18-6413	225		V225	1998-1999	18-6424
150		SX150	2000-2001	18-6415	225		V225TLRW - V225TLRX	1998-1999	18-6415
150		V-150	2000-2008	18-6415	225		VX225	2000-2003	18-6424
150		VX150	2000-2004	18-6415	225		VX225TLRA - VX225TLRZ	2000-2003	18-6415
150		VZ150	2000-2011	18-6426	250		250	1990-1995	18-6424
150	2	VZ150TLR	2006 & UP	18-6426	250		250ETXD - 250TXRT	1990-1995	18-6415
150		VZ150TLRA - Z150TLRZ	2000-2004	18-6426	250		L250	1990-1999	18-6424
150	2	Z150TXR	2006 & UP	18-6426	250		L250ETXD - L250TXRX	1990-1999	18-6415
150		Z150TXRA - Z150TXRZ	2000-2004	18-6426	250		LX250	2000-2003	18-6424
175		175	1984-1995	18-6413	250		LX250TURA - LX250TXRZ	2000-2003	18-6415
175		175	2000	18-6415	250		S250	1996-1999	18-6424
175		175ETLD - 175TXRT	1984-1995	18-6413	250		S250TURU - S250TXRX	1996-1999	18-6415
175		P175	1994-1996	18-6413	250		SX250	2000-2003	18-6424
175		P175TLRS - P175TLRU	1994-1996	18-6413	250		SX250TURA - SX250TXRZ	2000-2003	18-6415
175		S175 / S175TXRU	1996	18-6413			V-6 SPECIAL	1984-1986	18-6413
175		V-175	2000	18-6415			V-6 SPECIAL L	1984	18-6413
175		VZ175	2001-2011	18-6426			V-6SPECIAL X	1984	18-6413
175	2	VZ175TLR	2006 & UP	18-6426					
175		VZ175TLRA - VZ175TLRZ	2001-2005	18-6426					
175		Z175	2001-2005	18-6426					
175	2	Z175TXR	2006 & UP	18-6426					



18-50000
STARTER HANDLE
Replaces: 689-15755-01-00 + 6G1-15779-00-00
Fits: Yamaha 15 hp & Up (1988 & Up)



18-50001
STARTER HANDLE
Replaces: 6G1-15755-00-00, 6G1-15779-00-00
Fits: 2.5-9.9 hp(1988 & Up)



18-56005
BRUSH HOLDER ASSEMBLY
Replaces: 6E5-81840-10-00
Fits starters: 689-81800-13-00(18-6410), 6H3-81800-11-00 (18-6410), 6F5-81800-11-00, 6J481800-01-00(18-6421), 6H4-81800-12-00 (18-6422), 6E5-81800-11-00, 6E5-81800-12-00 (18-6413)



18-6789-1
TRIM MOTOR
Replaces: Yamaha 62X-43880-09-00
Fits: 40 (1995-00), C40 (1997-01), P40 (1998), 50 (1995-00), C50 (1998-01), T50 (1996-00), P50 (1995-96)



18-6783-1
TRIM MOTOR
Replaces: Yamaha 6E4-43880-04-00
Fits: 115-225HP Engines



18-6798
TRIM MOTOR
Replaces: 69J-43880-00-00, 60V-43880-00-00
(O-Ring included)
Fits: F200, F225 (2004-06), F250 (2005-06), LF200, LF225, LF250, LZ200, LZ225, LZ250 (2004-06)



18-6748
TRIM MOTOR
Replaces: 67C-43880-00-00, 67C-43880-01-00
Fits: F30, F40 (2001 & Up)



18-6259
TILT/TRIM MOTOR
Replaces: 6H1-43880-00-00
(O-Ring Included)
Fits: 70/90HP (1987-91), C85/P60HP (1991)



18-6787
TILT/TRIM MOTOR
Replaces: 67F-43880-00-00
(O-Ring Included)
Fits: Yamaha 4-Stroke F75 (2003-04), F80 (1999-03), F90 (2003-04), F100 (1999-02)



18-6789
TILT/TRIM MOTOR
 Superseded from 18-6812
Replaces: 62X-43880-09-00
(O-Ring Included)
Fits: Yamaha 40-100hp (1995-03)



18-6760
TRIM MOTOR
Replaces: 6G5-43880-02-00
(O-Ring Included)
For: 115-200HP (1987-96)



18-6781
TILT/TRIM MOTOR
Replaces: 6H1-43880-02-00
2-wire connection, 3 bolt mount
For: 40HP (1994) 50HP (1992-95) 60HP (1997-up) 70HP (1996-up) 90HP (1992-up)



18-6782
TILT/TRIM MOTOR
Replaces: 61A-43880-01-00, 61A-43880-02-00
3-bolt mount, 4 wire connection (O-Ring Included)
For: 225-250HP



18-6811
POWER TRIM MOTOR
Replaces: 62Y-43880-11-00, 62Y-43880-00-00, 69W-43880-00-00
(O-Ring included)
Fits: 40(2003 & Up), 50(2003 & Up), C40(2003), F50(2003-04), T50(2003-04), 2002-04 60hp 4-stroke



18-6821
TRIM MOTOR
 Replaces: 688-43880-11-00,
 6E5-43880-01-00, -02-00
 Fits: Yamaha 50-200HP 1985-86



18-6836
TRIM MOTOR
 Replaces: 6C5-43880-00-00,
 6C5-43880-01-00
 Fits: 2005-06 F50 and F60



18-1522
RELAY, TRIM ASSEMBLY
 Replaces: 63P-81950-00
 Fits: 25-150, 200-225 HP (06-Up), 50-90, 250 HP (05-Up),
 150 HP (04-Up)



18-1523
RELAY, TRIM ASSEMBLY
 Replaces: 61A-81950-01
 Fits: F25 HP (98-Up), T25 HP (01-Up), 60 HP (93-Up), 70
 HP (93-Up), 75 HP (94-99), 80 HP (97), 85 HP (93-96), 90
 HP (93-09), 150 HP (99-05), 200 HP (98-05), 225 HP
 (90-04), 250 HP (90-04)



18-1524
RELAY ASSEMBLY
 Replaces: 6H1-81950-01-00
 Fits: 40 (1994-05), 50 (1994-05), C40 (1997-01), C50
 (1998-01), F30 (2000-08), F40 (2000-08), F50 (1995-04),
 F60 (2002-04), P40 (1998), P50 (1992-96), T50 (1996-04),
 T60 (2003-04)



18-1525
RELAY ASSEMBLY
 Replaces: 60E-81950-00-00
 Fits: F30LA (2013-19), F30LEHA (2013-19), F40JEA (2008-19), F40JEHA (2008-19), F40LA (2008-19), F40LEHA (2008-
 19), F40SA (2018-19), F50SA (2018-19), F50LA (2012), F50LB (2013-19), F50TLR (2005-11), T50LA (2012), T50LB
 (2013-19), T50TLR (2005-11), F60JA (2012), F60JB (2013-19), F60LA (2012), F60LB (2013-19), F60TJR (2005-10),
 F60TLR (2005-11), T60LA (2012), T60LB (2013-19), T60TLR (2005-11), F70LA (2010-19), F75LA (2012-17), F75TLR
 2005-11), F90JA (2012-17), F90LA (2012-17), F90TJR (2005-11), F90TLR (2005-11), F90TXR (2005-11), F90XA (2012-
 17), LF115XA (2011-18), LF115XB (2014-18), F115JA (2011-14), F115JB (2014-18), F115LA (2011-14), F115LB (2014-
 18), F115XA (2011-14), F115XB (2014-18)



18-6823
WIRING HARNESS
 Converts 3-wire Tilt and Trim motors to
 2-Wire design

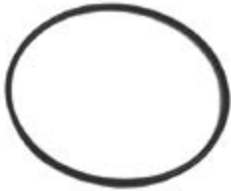

18-7484
BACK-UP RING
 Replaces: 65W-43871-00-00
 For: F25-F40 1999-2008 w/Power Trim



18-2083
FUEL INJECTOR SEAL
 Replaces: 68V-13766-00-00



18-2081
 Replaces: 64E-43822-00-00
18-2082
 Replaces: 64E-4384J-00-00



18-9802
TIMING LIGHT
 Self-powered accurate up to 10,000 RPM's



18-7058
CARBURETOR KIT
 Replaces: 63V-W0093-00-00
 Fits: 9.9(1996-09), 15(1996-09)



18-7059
CARBURETOR KIT
 Replaces: 677-W0093-00-00,
 677-W0093-04-00
 Fits: 9.9(1984-85), 15(1984-85)

 <p>18-7002 CARBURETOR KIT Replaces: 6E5-W0093-06-00 Fits: 115 (1986-88, 1992-93, 1995), 130 (1988, 1992-93, 1995), 150, 175 (1986-87, 1992-95), 200 (1986-87, 1992-95), 225 (1992-93)</p>	 <p>18-7290* CARB KIT Replaces: 696-W0093-02-00 *Kit contains enough components to rebuild 2 carburetors</p>	 <p>18-7291 CARB KIT Replaces: 6H1-W0093-01-00 (3) of 18-7291 = (1) of 6H1-W0093-01-00</p>	
 <p>18-7293 CARB KIT Replaces: 6A1-W0093-01-00</p>	 <p>18-7736 CARB KIT Replaces: 67D-W0093-00-00 For: (1999-02) F4</p>	 <p>18-7737 CARB KIT Replaces: 61N-W0093-00-00 For: (1993-97) C30</p>	
 <p>18-7738 CARB KIT Replaces: 66M-W0093-01-00, 66M-W0093-00-00 For: (1998-02) F15</p>	 <p>18-7739 CARB KIT Replaces: 6L2-W0093-00-00 For: (1996-97) 20 (1988-02) 25 3 cyl</p>	 <p>18-7740 CARB KIT Replaces: 6E9-W0093-02-00 For: (1990-94) C40 2 cyl</p>	
 <p>18-7741 CARB KIT Replaces: 6E9-W0093-03-00 For: (1995-98) C40 2 cyl</p>	 <p>18-7742 CARB KIT Replaces: 6H0-W0093-00-00 For: (1997) C80</p>	 <p>18-7743 CARB KIT Replaces: 67F-W0093-00-00 For: (1999-02) F80/F100</p>	 <p>18-7744 CARB KIT Replaces: 6N6-W0093-02-00 For: (1990-91) 115, 130, L130</p>
 <p>18-7747 CARB KIT Replaces: 6G5-W0093-08-00 For: (1985-86) 150/175/200, V6 Special</p>	 <p>18-7756 CARB KIT Replaces: 64D-W0093-00-00 For: (1996-01) 150/150L/175 (1996-99) 200/L200 (2000-01) 150/175 (1997-98) D150</p>	 <p>18-7759 CARB KIT Replaces: 6K7-W0093-09-00 For: (1990-91) 150/175/200 (1991-92) P200</p>	 <p>18-7765 CARB KIT Replaces: 6G1-W0093-00-00</p>



18-7766
CARB KIT
Replaces: 6H3-W0093-02-00
 (3) of 18-7766 = (1) of 6H3-W0093-02-00



18-7767
CARB KIT
Replaces: 6H4-W0093-01-00
 (3) of 18-7767 = (1) of 6H4-W0093-01-00



18-7768
CARB KIT
Replaces: 6H4-W0093-03-00
 (3) 18-7768 = (1) 6H4-W0093-03-00



18-7769
CARB KIT
Replaces: 6E7-W0093-04-00



18-7770
CARB KIT
Replaces: 689-W0093-02-00



18-7772
CARB KIT
Replaces: 61A-W0093-01-00, 61A-W0093-00-00
For: (1991-96) 225/250 3.1 liter, L225, L250



18-34601
CARBURETOR
Replaces: 67D-14301-13-00
Fits: F4(2005 & Up)



18-7049
NEEDLE VALVE
Replaces: 62Y-14392-00-00, 61N-14392-00-00, 6L2-14392-00-00
Fits: C30(1993-97)



18-7054
NEEDLE VALVE
Replaces: 6G1-14546-00-00, 6G1-14546-01-00
Fits: 3(1988-02), 6(1986-00), 8(1984-03), 9.9(1996-03), 15(1996-03), F25(1998-03), F30(2000-02), F40(2000-02), T25(2001-03)



18-7054
NEEDLE VALVE
Replaces: 6G1-14546-00-00, 6G1-14546-01-00
Fits: 3(1988-02), 6(1986-00), 8(1984-03), 9.9(1996-03), 15(1996-03), F25(1998-03), F30(2000-02), F40(2000-02), T25(2001-03)



18-7055
NEEDLE VALVE
Replaces: 6E5-14546-00-00, 6J8-14546-00-00
Fits: 25 MLHV3(1997), 25MLHW3(1998), 25 MSHV3(1997), 25 MSHW3(1998), 30(1987-98), 115(1986-09), 130(1988-04), 150(1986-09), 175(1986-95, 2000), 200(1986-98), 225(1990-97), B115(1998-99), 250(1991-95), C115(1991-00), C150(1996-99), D150(1997-99), L130(1989-01), L150(1986-99), L200(1986-99), L225(1994-96), L250(1990-96), P115(1993-96), P150(1991-99), P175(1994-99), P200(1991-99), S115(1996-99), S130(1996-99), S150(1996-99), S175(1996-99), S200(1996-99), S225(1996), S250(1996), V150(2000-08), V175(2000)



18-7056
NEEDLE VALVE
Replaces: 6H3-14590-00-00, 6H3-14590-01-00, 67F1439A-00-00, 6H2-14591-00-00
Fits: 40(1984-92), 50(1984-92), 70(1984-01), C40(1991-94), C60(1996-01), C70(2000-01), CV40(1990), E60(1995-00), F80(2000-02), F100(2000-02), P50(1991-92), P60(1991-99)



18-7060
NEEDLE VALVE
Replaces: 692-14590-00-00, 692-14590-01-00
Fits: 90(1984-02), B90(1997-99), C75(1994-99), C80(1997), C85(1991-96), C90(1997-01), CV85(1989-90), E75(1995-00), P75(1996-99)

















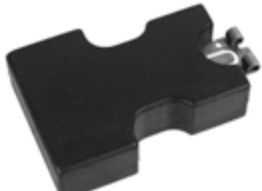



18-7073
NEEDLE VALVE
Replaces: 6E8-14380-12-00, 6E7-14390-12-00
Fits: 9.9(1986-95), 15(1986-95)



18-7079
NEEDLE VALVE
Replaces: 626-14390-90
Fits: 9.9(1984-85), 15(1984-85)



18-7063
FLOAT
Replaces: 6L2-14385-00-00
Fits: 20(1996-97), 25(1988-09), C30(1993-97), F15(1989-06), F40(1999), F50(1995-03), F60(2002-04), F9.9(2005-06), T50(1996-04), T60(2003-04), T9.9(2005-06)

 <p>18-7064 FLOAT Replaces: 63V-14985-00 Fits: 9.9(1996-09), 15(1996-09), F25(1998-13), F30(2001-05), F40(2000-08), T25(2001-13)</p>	 <p>18-7065 FLOAT Replaces: 647-14385-00-00 Fits: 4(1984-85), 5(1984-85), 9.9(1984-85), 15(1984-85)</p>	 <p>18-7066 FLOAT Replaces: 648-14385-00-00 Fits: 25(1984-87), 30(1984-86), C25(1991-97), C30(1991-92), Cv25(1990), CV30(1989-90)</p>	 <p>18-7067 FLOAT Replaces: 6G1-14985-00-00 Fits: 3(1988-02), 6(1986-00), 8(1984-00), 40(1984-88), 50(1984-88), 70(1984-91), C60(1996-01), E60(1995-00), PRO 50(1987-88), P60(1991)</p>
 <p>18-7068 FLOAT Replaces: 6E5-14385-01-00, 6E5-14385-00-00 Fits: 115(1984), 150(1984), 175(1984), 200(1984)</p>	 <p>18-7069 FLOAT Replaces: 6E5-14385-02-00 Fits: 115(1986-09), 130(1988-04), 150(1986-09), 175(1986-00), 200(1986-98), 200(1990-97), B115(1998-99), C115(1991-00), C150(1996-99), D150(1997-99), L130(1989-01), L150(1986-99), L200(1986-99), P115(1993-96), P150(1991-99), P175(1994-99), P200(1991-99), PRO150(1986-90), S115(1996-99), S130(1996-99), S150(1996-99), S175(1996-99), S200(1996-99), V150(2000-08), V6 Excel(1987-89), V6 Special(1986)</p>	 <p>18-7392 FLOAT Replaces: 676-14985-01-00 Fits: 90(1984-90), C40(1991-97), C75(1994-99), C80(1997), C85(1991-96), CV40(1990), CV85(1989-90), E75(1995-00)</p>	 <p>18-7393 FLOAT Replaces: 6E7-14385-00-00 Fits: 4(1986-94), 5(1994), 9.9(1986-95), 15(1986-95)</p>
 <p>18-0707 SEAL, VITON Replaces: 6CB-13016-00 Fits: F115(2011-14), F175(2014), F200(2011-14), F225(2010-14), F250(2010-14), F300(2010-14), F350(2012-14), FL250(2010), FL300(2010), LF115(2011-14), LF200(2011-14), LF225(2010-14), LF250(2010-14), LF300(2010-14), LF350(2012-14), VF150(2013-14), VF200(2010-14), VF225(2009-14), VF250(2009-14)</p>	 <p>18-0710 FLOAT CHAMBER GASKET Replaces: 68V-14984-00 Fits: F115 (2000-10), LF115 (2000-10), F200 (2002-10), LF200 (2002-10), F225(2002-05), LF225(2002-05), F225TXR models(2007-10), LF225TXR models(2007-10)</p>	 <p>18-0711 FLOAT CHAMBER GASKET Replaces: 66K-14984-00 Fits: DX 150(1999-05), LX 150(1999-01), LZ 150(2000-05), PX 150(1999), VX 150(2000-04), VZ 150(2000-10), Z 150(2000-05), VZ 175(2001-10), Z175(2001-05), LX200(1999-01), LZ200(2000-10), SX200(1999-05), V200(1999), VX200(2000-05), VZ200(2001-09), Z200 (2000-10), L225(1999), LX225(2000-03), S225(1999), SX225(2000-03), V225(1999), VX225(2000-04), VZ225(2003-09), L250(1999), LX250(2000-03), LZ250(2003-05), S250(1999), SX250(2000-03), VX250(2002-04), VZ250(2003-09), Z250(2003-05), LZ300(2004-06), VZ300(2004-09), Z300(2004-06)</p>	
 <p>18-0712 FLOAT CHAMBER GASKET Replaces: 63P-14984-00 Fits: F150 TLR (2004-10), F150 TXR (2004-10), LF150 TXR (2004-10)</p>	 <p>18-0713 FLOAT CHAMBER GASKET Replaces: 6P2-14984-00 Fits: F225TLR(2007-09), F250(2005-10), LF250(2005-10)</p>	 <p>18-0714 FLOAT CHAMBER GASKET Replaces: 6AW-14984-00 Fits: F300(2007-09), LF300(2007-09), F350(2007-10), LF350(2007-10)</p>	
 <p>18-0715 FLOAT CHAMBER GASKET Replaces: 65L-14984-00 Fits: V200(1998), L225(1997-98), S225(1997-98), V225(1998), L250(1997-98), S250(1997-98)</p>	 <p>18-0716 FLOAT CHAMBER GASKET, VITON Replaces: 6CB-14984-00 Fits: F115(2001-14), F200(2011-14), F225(2010-14), F250(2010-14), F300(2010-14), F350(2011-14), FL250(2010), FL300(2010), LF115(2011-14), LF200(2011-14), LF225(2010-14), LF250(2010-14), LF300(2010-14), LF350(2011-14), VF150(2013-14), VF200(2010-14), VF225(2010-14), VF250(2009-14)</p>	 <p>18-0717 FLOAT CHAMBER GASKET, VITON Replaces: 6C5-14984-00 Fits: F50(2005-14), F60(2005-14), F70(2010-14), F75(2005-14), F90(2005-14), T50(2005-14), T60(2005-14)</p>	 <p>18-99146 FLOAT CHAMBER GASKET Replaces: 677-14384-01 Fits: 9.9(1984-95), 15(1984-95)</p>

H.P.	Year	Carb Kit	Per Engine	Needle Valve Assy	Per Engine	H.P.	Year	Carb Kit	Per Engine	Needle Valve Assy	Per Engine
2	1984-88	18-7293	1			C90	1997-01			18-7060	3
3	1988-02	18-7765	1	18-7054	1	F100	1999-02	18-7743	3	18-7056	3
F4	1999-02	18-7736	1			115	1986-88, 1992-95	18-7002	2	18-7055	4
6	1986-96	18-7765	1	18-7054	1	115	1990-91	18-7744	2	18-7055	4
6	1997-00		1	18-7054	1	115	1992-09		2	18-7055	4
8	1984-96	18-7765	1	18-7054	1	B115	1998-99			18-7055	4
8	1997-00		1	18-7054	1	C115	1991			18-7055	4
9.9	1984-85	18-7059	1	18-7079	1	C115	1992-95	18-7002	2	18-7055	4
9.9	1986-95	18-7769	1	18-7073	1	C115	1996-00			18-7055	4
9.9	1996-03	18-7058	1	18-7054	1	P115	1993-96	18-7002	2	18-7055	4
9.9	2004-09	18-7058	1			S115	1996-99			18-7055	4
F9.9	2006	18-7738	1			130	1988, 1992-95	18-7002	2	18-7055	4
T9.9	2005-06	18-7738	1			130	1990-91	18-7744	1	18-7055	4
15	1984-85	18-7059	1	18-7079	1	130	1992-04			18-7055	4
15	1986-92	18-7769	1	18-7073	1	L130	1989			18-7055	4
15	1993-95			18-7073	1	L130	1990-91	18-7744	1	18-7055	4
15	1996-03	18-7058	1	18-7054	1	L130	1992-95	18-7002	2	18-7055	4
15	2004-09	18-7058	1			L130	1996-01			18-7055	4
F15	1998-05	18-7738	1			S130	1996-99			18-7055	4
20	1996-97	18-7739	1			150	1985-86	18-7747	1	18-7055	6
25 (2 cyl)	1984-87	18-7770	1			150	1987, 1992-95	18-7002	3	18-7055	6
25 (2 cyl)	1988-09	18-7739	1			150	1990-91	18-7759	1	18-7055	6
F25	1998-03		1	18-7054	1	150	1996-01	18-7756	3	18-7055	6
C25	1991-1997	18-7770	1			150	2002-09			18-7055	6
CV25	1990	18-7770	1			C150	1996-99	18-7756	3	18-7055	6
T25	2001-03		1	18-7054	1	D150	1997-99	18-7756	3	18-7055	6
30	1984-86	18-7770	1			L150	1988, 1992-95	18-7002	3	18-7055	6
30	1987-98		1	18-7055	1	L150	1990-91	18-7759	1	18-7055	6
F30	2000-02		1	18-7054	1	L150	1996-99	18-7756	3	18-7055	6
C30	1991-92	18-7770	1			Z150					
C30	1993-97	18-7737	1	18-7049	1	P150	1991	18-7759	1	18-7055	6
CV30	1989-90	18-7770	1			P150	1992-95	18-7002	3	18-7055	6
40	1984-88	18-7767	3	18-7056	3	P150	1996-99	18-7756	3	18-7055	6
40	1989-92	18-7768	3	18-7056	3	PRO V150	1987	18-7002	3		
40	1993-05	18-7768	3			PRO V150	1990	18-7759	1		
F40	2000-02			18-7054	3	S150	1996-99	18-7756	3	18-7055	6
C40	1991-93	18-7740	1	18-7056	2	V150	2000-01	18-7756	3		
C40	1994-97	18-7741	1			V150	2002-08			18-7055	6
C40	2002-03	18-7768	3			175	1985-86	18-7747	2		
P40	1998	18-7768	1			175	1987, 1992-95	18-7002	3	18-7055	6
E48	1995-00	18-7290	2		*	175	1990-91	18-7759	1	18-7055	6
50	1984-88	18-7767	3	18-7056	3	175	1992-95			18-7055	6
50	1989-92	18-7768	3	18-7056	3	175	2000	18-7756	3	18-7055	6
50	1993 & Up	18-7768	3			P175	1994-95	18-7002	3	18-7055	6
C50	1998-01	18-7768	3			P175	1996-99	18-7756	3	18-7055	6
PRO 50	1987-88	18-7767	3			S175	1996-99	18-7756	3	18-7055	6
PRO 50	1989-90	18-7768	3			V175	2000	18-7756	3		
P50	1991-92	18-7768	3	18-7056	3	200	1985	18-7747	2		
P50	1993-96	18-7768	3			200	1986-87, 1992-95	18-7002	3	18-7055	6
C55	1991-95	18-7290	2		*	200	1990-91	18-7759	1	18-7055	6
CV55	1989-90	18-7290	2		*	200	1996-98	18-7756	3	18-7055	6
60	2001-02			18-7056	3	L200	1988, 1992-95	18-7002	3	18-7055	6
C60	1996-01	18-7766	3	18-7056	3	L200	1990-91	18-7759	1	18-7055	6
E60	1995-00	18-7766	3	18-7056	3	L200	1996-99	18-7756	3	18-7055	6
P60	1991	18-7766	3	18-7056	3	P200	1991	18-7759	1	18-7055	6
P60	1992-99			18-7056	3	P200	1993-95	18-7002	3	18-7055	6
70	1984-91	18-7766	3	18-7056	3	P200	1996-99	18-7756	3	18-7055	6
70	1992-01			18-7056	3	S200	1996-99	18-7756	3	18-7055	6
C70	2000-01			18-7056	3	V6 Special	1984-86	18-7747	2		
C75	1994-97	18-7291	3	18-7060	3	V6 Excel	1987-89	18-7759	1		
C75	1998-99	18-7742	3	18-7060	3	225	1990-91	18-7759	1	18-7055	6
E75	1995-00	18-7291	3	18-7060	3	225	1992-95	18-7002	3	18-7055	6
P75	1996-99			18-7060	3	225	1996-97	18-7756	3	18-7055	6
C80	1997	18-7742	3	18-7060	3	L225	1994-96	18-7772	6	18-7055	6
F80	1999-02	18-7743	3	18-7056	3	S225	1996	18-7772	6	18-7055	6
C85	1991-96	18-7291	3	18-7060	3	250	1990-95	18-7772	6	18-7055	6
CV85	1989-90	18-7291	3	18-7060	3	L250	1991-96	18-7772	6	18-7055	6
90	1984-91	18-7291	3	18-7060	3	S250	1996	18-7772	6	18-7055	6
90	1992-02			18-7060	3						
B90	1997-99			18-7060	3						

① Kit contains enough components to rebuild 2 carburetors



18-7339
FUEL PUMP
Replaces: F150 (2011-19)



18-7345
FUEL PUMP
Replaces: F200 (2006-10), F225 (2006-10)



18-97306
FUEL PUMP
Replaces: F/LF200-350



18-97309
FUEL PUMP
Replaces: 425HP



18-7339
FUEL PUMP
Replaces: F150 (2011-19)



18-35302
FUEL PUMP ASSEMBLY
Replaces: 66M-24410-10-00
Fits: F9.9(2005-06), T9.9(2005-06), F15(1998-06)



18-7334
FUEL PUMP
Replaces:
692-24410-00-00, 663-24410-00-00,
6A0-24410-00-00, 6A0-24410-05-00,
6A0-24410-04-00, 6A0-24410-03-00,
6A0-24410-02-00, 6A0-24410-01-00
For: 2-Stroke 40 HP - 90 HP (1984-2009)
Uses Kit **18-7797**



18-7340
FUEL PUMP
Replaces: 68V-13907-03-00,
68V-13907-02-00, 68V-13907-01-00,
68V-13907-00-00
Fits: F115(2000-04, 2006-11), LF115(2000-11)



18-7341
FUEL PUMP
Replaces: 66K-13907-00-00
Fits: DX150(1999-01),
LX150(1999-01), LX200(1999-01),
LX225(2000-01), LX250(2000-01),
PX150(1999), SX150(1999-01),
SX200(1999-01), SX225(2000-01),
SX250(2000-01), V200(1999),
V225(1999), VX150(2000-01),
VX200(2000-01), VX225(2000-01)



18-7342
FUEL PUMP
Replaces: 68F-13907-00,
68F-13907-01-00, 68F-13907-
00-00
Fits: LZ150(2000-05), LZ200(2000-12),
VZ150(2000-12), VZ175(2001-12),
VZ200(2001-04), Z150(2000-05),
Z175(2001-05), Z200(2000-12)



18-7343
FUEL PUMP
Replaces: 60V-13907-00-00
Fits: LZ250(2003-05), LZ300(2004-06),
VZ200(2005-09), VZ225(2003-09),
VZ250(2003-09), VZ300(2004-09),
Z250(2003-05), Z300(2004-06)



18-7349
FUEL PUMP
Replaces:
6E5-24410-03-00, 6E5-24410-10-00,
6E5-24410-04-00, 6E5-24410-02-00,
6E5-24410-01-00, 6E5-24410-00-00
For: 2-Stroke 115 HP - 300 HP
(1984-2004)
Uses Kit **18-7788**



18-7388
DIAPHRAGM
Replaces: 6G1-24411-00-00
Fits: 3(1988-02), 6(1986-00),
8(1984-09), 9.9(1996-09), 15(1996-09)



18-7390
DIAPHRAGM
Replaces: 63V-24411-00-00
Fits: 9.9(1996-09), 15(1996-09)



18-7391
DIAPHRAGM
Replaces: 692-24411-00-00
Fits: 40(1995-05), 50(1995-09), 60(2001-05),
70(1995-09), 90(1995-09), B90(1997-99),
C25(1996-97), C30(1996-97), C40(1995-03),
C50(1998-01), C55(1995), C60(1996-01),
C70(2000-01), C75(1995-99), C80(1997),
C85(1995-96), C90(1997-01), E48(1995-00),
E60(1995-00), E75(1995-00), P40(1998),
P50(1995-96), P60(1995-99), P75(1996-99)



18-7787
FUEL PUMP KIT
For: 40-90 HP

-- CONTAINS --		
Part #	Description	O.E. #
18-7840	Diaphragm (Front)	663-24411-00-00
18-7839	Diaphragm	648-24411-00-00



18-7788
FUEL PUMP KIT
Replaces: 6E5-24411-00-00
(V-4, V-6)

-- CONTAINS --		
Part #	Description	O.E. #
18-7843	Gasket (Rear)	6E5-24411-00-00
18-7842	Diaphragm (Top)	6E5-24471-00-00



18-7367
FUEL PUMP KIT
Contains: 18-7833 & 18-7388



18-7368
FUEL PUMP KIT
Contains: 18-7834 & 18-7389



18-7369
FUEL PUMP KIT
Contains: 18-7388 & 18-7390

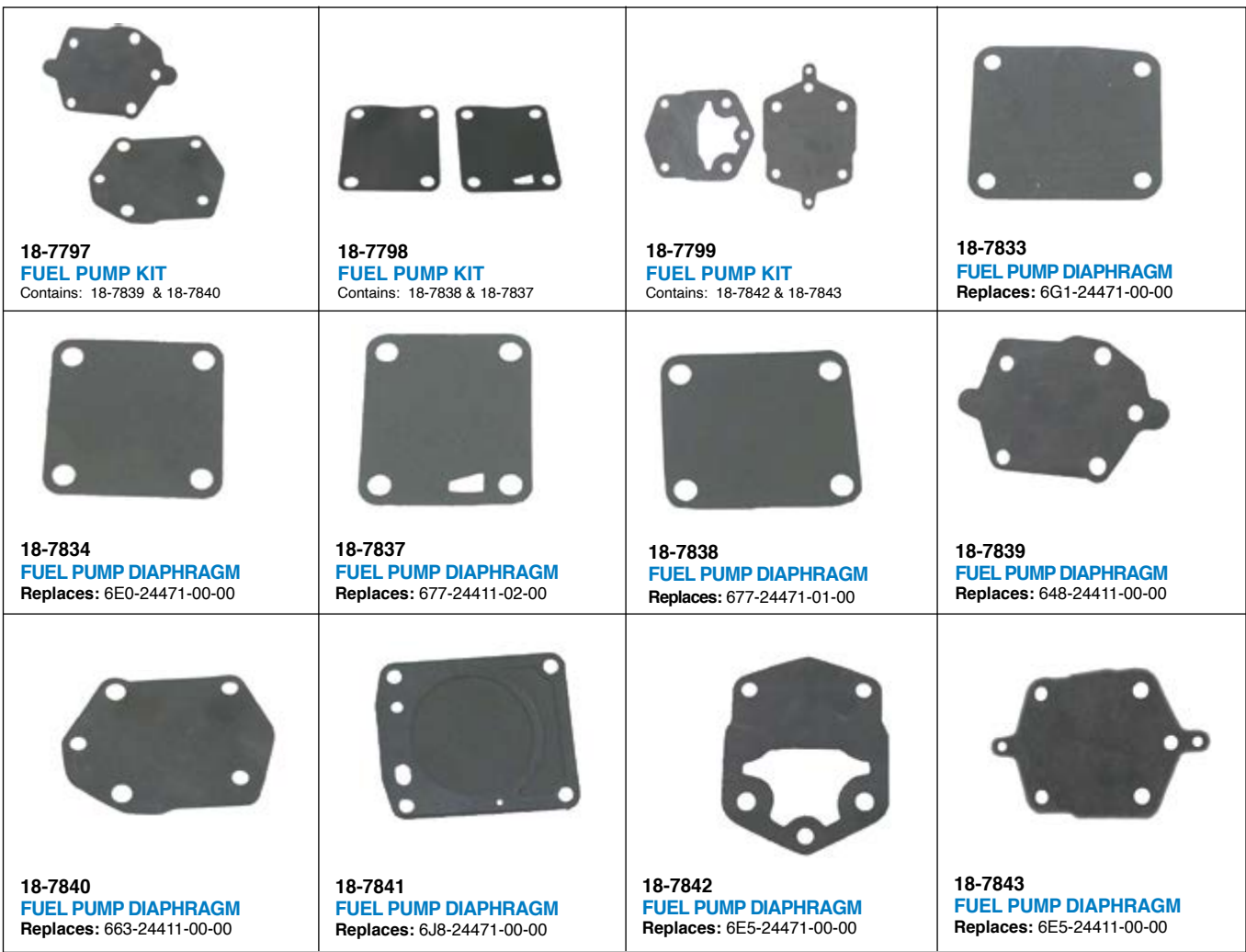

18-7797
FUEL PUMP KIT
Contains: 18-7839 & 18-7840

18-7798
FUEL PUMP KIT
Contains: 18-7838 & 18-7837

18-7799
FUEL PUMP KIT
Contains: 18-7842 & 18-7843

18-7833
FUEL PUMP DIAPHRAGM
Replaces: 6G1-24471-00-00

18-7834
FUEL PUMP DIAPHRAGM
Replaces: 6E0-24471-00-00

18-7837
FUEL PUMP DIAPHRAGM
Replaces: 677-24411-02-00

18-7838
FUEL PUMP DIAPHRAGM
Replaces: 677-24471-01-00

18-7839
FUEL PUMP DIAPHRAGM
Replaces: 648-24411-00-00

18-7840
FUEL PUMP DIAPHRAGM
Replaces: 663-24411-00-00

18-7841
FUEL PUMP DIAPHRAGM
Replaces: 6J8-24471-00-00

18-7842
FUEL PUMP DIAPHRAGM
Replaces: 6E5-24471-00-00

18-7843
FUEL PUMP DIAPHRAGM
Replaces: 6E5-24411-00-00

MODEL	YEAR	DIAPHRAGM	KITS	MODEL	YEAR	DIAPHRAGM	KITS	MODEL	YEAR	DIAPHRAGM	KITS
3	1988-02	18-7833 / 18-7388	18-7367	E75	1995-00	18-7840		Z175	2001-01	18-7842	
4	1984-99	18-7834	18-7368	P75	1996-99	18-7840		Z175	2002-04	18-7842 / 18-7843	18-7799
5	1984-85	18-7834	18-7368	C80	1997	18-7840		200	1984-98	18-7842 / 18-7843	18-7799
5	1986-91	18-7834		85	1990	18-7798		L200	1986-99	18-7842 / 18-7843	18-7799
5	1994-02	18-7834	18-7368	C85	1991-94	18-7839 / 18-7840	18-7797	LX200	1999-01	18-7842	
6	1986-00	18-7833 / 18-7388	18-7367	C85	1995-96	18-7840		LZ200	2000-01	18-7842	
8	1984-09	18-7833 / 18-7388	18-7367	CV85	1989-90	18-7839 / 18-7840	18-7797	LZ200	2002-04	18-7842 / 18-7843	18-7799
9.9	1984-95	18-7837 / 18-7838	18-7798	90	1984-94	18-7839 / 18-7840	18-7797	P200	1991-99	18-7842 / 18-7843	18-7799
9.9	1996-09	18-7388 / 18-7390	18-7369	90	1995-09	18-7840		S200	1996-99	18-7842 / 18-7843	18-7799
15	1984-95	18-7837 / 18-7838	18-7798	B90	1997-99	18-7840		SX200	1999-01	18-7842	
15	1996-09	18-7388 / 18-7390	18-7369	C90	1997-01	18-7840		SX200	2002-04	18-7842 / 18-7843	18-7799
20	1996-97	18-7837		115	1984-04	18-7842 / 18-7843	18-7799	V200	1999	18-7842	
25	1984-87	18-7840		B115	1998-99	18-7842 / 18-7843	18-7799	V200	1998	18-7842 / 18-7843	18-7799
25	1984-87			C115	1991-00	18-7842 / 18-7843	18-7799	VX200	2000-01	18-7842	
25	1988-09	18-7837		P115	1993-96	18-7842 / 18-7843	18-7799	VX200	2002-04	18-7842 / 18-7843	18-7799
C25	1991-95	18-7840	18-7797	S115	1996-99	18-7842 / 18-7843	18-7799	VZ200	2001	18-7842	
C25	1996-97	18-7840		130	1988-04	18-7842 / 18-7843	18-7799	VZ200	2002-04	18-7842 / 18-7843	18-7799
CV25	1990	18-7839 / 18-7840	18-7797	C150	1996-99	18-7842 / 18-7843	18-7799	Z200	2000-01	18-7842	
25	1990	18-7837		L130	1989-99	18-7842 / 18-7843	18-7799	Z200	2002-04	18-7842 / 18-7843	18-7799
30	1984-86	18-7839 / 18-7840	18-7797	L130	2000-01	18-7842		225	1990-97	18-7842 / 18-7843	18-7799
30	1987-90	18-7841		S130	1996-99	18-7842 / 18-7843	18-7799	L225	1994-99	18-7842 / 18-7843	18-7799
30	1991-02	18-7841		150	1984-04	18-7842 / 18-7843	18-7799	LX225	2000-01	18-7842	
C30	1991-95	18-7839 / 18-7840	18-7797	D150	1997-99	18-7842 / 18-7843	18-7799	LX225	2002-03	18-7842 / 18-7843	18-7799
C30	1996-97	18-7840		L150	1986-99	18-7842 / 18-7843	18-7799	S225	1996-99	18-7842 / 18-7843	18-7799
CV30	1989-90	18-7839 / 18-7840	18-7797	LX150	1999-01	18-7842		SX225	2000-01	18-7842	
40	1984-94	18-7839 / 18-7840	18-7797	LZ150	2000-01	18-7842		SX225	2002-03	18-7842 / 18-7843	18-7799
40	1995-01	18-7840		LZ150	2002-04	18-7842 / 18-7843	18-7799	V225	1999	18-7842	
C40	1991-94	18-7839 / 18-7840	18-7797	DX150	1999-01	18-7842		V225	1998	18-7842 / 18-7843	18-7799
C40	1995-02	18-7840		DX150	2002-04	18-7842 / 18-7843	18-7799	VX225	2000-01	18-7842	
CV40	1990	18-7839 / 18-7840	18-7797	P150	1991-99	18-7842 / 18-7843	18-7799	VX225	2002-04	18-7842 / 18-7843	18-7799
P40	1998	18-7840		S150	1996-99	18-7842 / 18-7843	18-7799	VZ225	2003-04	18-7842 / 18-7843	18-7799
E48	1995-00	18-7840		SX150	1999-01	18-7842		250	1990-95	18-7842 / 18-7843	18-7799
50	1986-94	18-7839 / 18-7840	18-7797	SX150	2002-04	18-7842 / 18-7843	18-7799	L250	1990-99	18-7843	
50	1995-09	18-7840		V150	2000-01	18-7842		LX250	2000-01	18-7842	
C50	1998-01	18-7840		V150	2002-04	18-7842 / 18-7843	18-7799	LX250	2002-03	18-7842 / 18-7843	18-7799
P50	1991-94	18-7839 / 18-7840	18-7797	VX150	2000-01	18-7842		LZ250	2003-04	18-7842 / 18-7843	18-7799
P50	18-1995-96	18-7840		VX150	2002-01	18-7842 / 18-7843	18-7799	S250	1996-99	18-7842 / 18-7843	18-7799
55	1990	18-7798		VZ150	2000-04	18-7842		SX250	2000-01	18-7842	
C55	1991-94	18-7839 / 18-7840	18-7797	VZ150	2002-04	18-7842 / 18-7843	18-7799	SX250	2002-03	18-7842 / 18-7843	18-7799
CV55	1989-90	18-7839 / 18-7840	18-7797	Z150	2000-01	18-7842		VX250	2002-04	18-7842 / 18-7843	18-7799
60	2001-05	18-7840		Z150	2002-04	18-7842 / 18-7843	18-7799	VZ250	2003-04	18-7842 / 18-7843	18-7799
C60	1996-01	18-7840		PRO 150H	1987	18-7798		Z250	2003-04	18-7842 / 18-7843	18-7799
E60	1995-00	18-7840		175	1984-95	18-7842 / 18-7843	18-7799	LZ300	2004	18-7842 / 18-7843	18-7799
P60	1991-94	18-7839		175	1996-00	18-7842		VZ300	2004	18-7842 / 18-7843	18-7799
70	1984-94	18-7839 / 18-7840	18-7797	P175	1994-99	18-7842 / 18-7843	18-7799	Z300	2004	18-7842 / 18-7843	18-7799
70	1995-09	18-7840		S175	1996-99	18-7842 / 18-7843	18-7799	V6			
C70	2000-01	18-7840		V175	2000	18-7842		Special	1984-86	18-7842 / 18-7843	18-7799
C75	1994	18-7839 / 18-7840	18-7797	VZ175	2001	18-7842		V6 Excel	1987-89	18-7842 / 18-7843	18-7799
C75	1995-99	18-7840		VZ175	2002-04	18-7842 / 18-7843	18-7799				

**- UNIVERSAL DESIGN -
FUEL WATER SEPARATOR BRACKETS**



Bracket Type	Part #	Replaces	Bracket Type	Part #	Replaces
1/4" Stainless Steel	18-7777	MAR-FLTHD-SS-12	1/4" Aluminum	18-7853-1	MAR-FLTHD-AL-12
3/8" Stainless Steel	18-7776		3/8" Aluminum	18-7775	

FUEL WATER SEPARATOR KITS



**21 MICRON FILTER KITS
FOR CARBURETED ENGINES**

Kit Type	Part #	Micron Rating	Contents	Replaces
1/4" Aluminum (Short Filter)	18-7848-1 •	21	1 - 18-7844 filter & 1 18-7853-1 bracket 2 - 18-4256 1/4" pipe plugs	
1/4" Aluminum Bonus Pack Contains spare filter	18-7848-2	21	2 - 18-7844 filter & 1 18-7853-1 bracket 2 - 18-4256 1/4" pipe plugs	
1/4" Aluminum (Tall Filter)	18-7852-1	21	1 - 18-7845 filter & 1 18-7853-1 bracket 2 - 18-4256 1/4" pipe plugs	MAR-SEPAR-AT-OR
1/4" Aluminum Bonus Pack Contains spare filter	18-7852-2 •	21	2 - 18-7845 filter & 1 18-7853-1 bracket 2 - 18-4256 1/4" pipe plugs	
3/8" Aluminum (Tall Filter)	18-7775-1	21	1 - 18-7845 filter & 1 18-7775 bracket 2 - 18-4264 3/8" pipe plugs	
1/4" Stainless Steel (Tall Filter)	18-7777-1	21	1 - 18-7845 filter & 1 18-7777 bracket 2 - 18-4256 1/4" pipe plugs	ABB-SPRTR-HD-SS
3/8" Stainless Steel (Tall Filter)	18-7776-1	21	1 - 18-7845 filter & 1 18-7776 bracket 2 - 18-4264 3/8" pipe plugs	



**10 MICRON FILTER KITS
FOR FUEL INJECTED ENGINES**

Kit Type	Part #	Micron Rating	Contents	Replaces
1/4" Aluminum (Short Filter)	18-7983-1 •	10	1 - 18-7944 filter & 1 18-7853-1 bracket 2 - 18-4256 1/4" pipe plugs	
1/4" Aluminum Bonus Pack Contains spare filter	18-7983-2 •	10	2 - 18-7944 filter & 1 18-7853-1 bracket 2 - 18-4256 1/4" pipe plugs	
1/4" Aluminum (Tall Filter)	18-7982-1 •	10	1 - 18-7945 filter & 1 18-7853-1 bracket 2 - 18-4256 1/4" pipe plugs	
1/4" Aluminum Bonus Pack Contains spare filter	18-7982-2 •	10	2 - 18-7945 filter & 1 18-7853-1 bracket 2 - 18-4256 1/4" pipe plugs	
1/4" Aluminum (High Capacity Filter)	18-7966-1 •	10	1 - 18-7866 filter & 1 18-7853-1 bracket 2 - 18-4256 1/4" pipe plugs	MAR-SEPAR-AT-OR
3/8" Aluminum (Tall Filter)	18-7986-1	10	1 - 18-7945 filter & 1 18-7775 bracket 2 - 18-4264 3/8" pipe plugs	
1/4" Stainless Steel (Tall Filter)	18-7984-1 •	10	1 - 18-7945 filter & 1 18-7777 bracket 2 - 18-4256 1/4" pipe plugs	MAR-SPRTR-HD-SS
3/8" Stainless Steel (Tall Filter)	18-7985-1 •	10	1 - 18-7945 filter & 1 18-7776 bracket 2 - 18-4264 3/8" pipe plugs	

• Display Packaged



10 MICRON FILTER KITS WITH DRAIN BOWLS

Sierra AquaVue™ and metal bowl separator filters allow water to be drained from the filter to extend service life. Use the AquaVue™ bowl for outboard, above deck installations. USCG regulations require the use of the flame resistant metal bowl below deck.

• Display Packaged

Kit Type	Part #	Micron Rating	Contents
1/4" Aluminum w/ AquaVue™ bowl	18-7932-1 •	10	1 - 18-7919 filter & 1 18-7853-1 bracket 1 - 18-7922-1 AquaVue™ bowl 2 - 18-4256 1/4" pipe plugs
1/4" Aluminum w/ metal drain bowl	18-7951 •	10	1 - 18-7919 filter & 1 18-7853-1 bracket 1 - 18-7924 metal bowl 2 - 18-4256 1/4" pipe plugs
1/4" Stainless Steel w/ AquaVue™ bowl	18-7937-1 •	10	1 - 18-7919 filter & 1 18-7777 bracket 1 - 18-7922-1 AquaVue™ bowl 2 - 18-4256 1/4" pipe plugs
1/4" Stainless Steel w/ metal drain bowl	18-7938 •	10	1 - 18-7919 filter & 1 18-7777 bracket 1 - 18-7924 metal bowl 2 - 18-4256 1/4" pipe plugs

COMPACT BRACKET AND SEPARATOR KIT - FOR SMALL OUTBOARDS AND FRESH WATER APPLICATIONS



18-7774
COMPACT ALUMINUM BRACKET



18-7965-1
10 MICRON
COMPACT SEPARATOR KIT
Replaces: MAR-MINIF-LT-AS
Contains:
1 - 18-7774 bracket
1 - 18-7865 filter



18-78866
HIGH PERFORMANCE
FUEL/WATER
SEPARATING FILTER
Replaces: Replaces:
Yamaha MAR-10MEL-00-00,
MAR-FUELF-IL-TR



REPLACEMENT FILTERS



UNIVERSAL DESIGN - DIRECT REPLACEMENT
FOR MERCURY AND YAMAHA

10 MICRON REPLACEMENT FILTERS

Part #	Description	Replaces
18-7944	Short - 3.875"	
18-7945	Long - 4.35"	ABB-FUELF-IL-TR
18-7866	High Capacity - 6"	MAR-FUELF-IL-TR
18-7865	Compact 10 Micron	MAR-MINIF-IL-TR

21 MICRON REPLACEMENT FILTERS

Part #	Description	Replaces
18-7844	Short - 3.875"	
18-7845	Long - 4.35"	ABB-FUELF-IL-TR



18-8953
FUEL WATER
SEPARATOR COVER
Fits: Yamaha mini-10 size filter



18-8954
FUEL WATER
SEPARATOR COVER
Fits: Yamaha 18-7866 sized filter



10 MICRON REPLACEMENT FILTERS AND KITS WITH DRAIN BOWLS

• Display Packaged

Part #	Description	Replaces
18-7919	Spin on replacement	MAR-24563-00-00 Racor S3213
18-7920	Spin on replacement	Racor S3214
18-7947	Spin on replacement • Fits - 120RRAC01	Racor S3240
18-7948	Spin on replacement • Fits - 320RRAC01	Racor S3227
18-7949	Spin on replacement • Fits - 660RRAC02	Racor S3232

Part #	Description	Replaces
18-7922-1	AquaVue™ Collection Bowl	
18-7924	Metal Collection Bowl	MAR-10171-00-10

Part #	Description
18-7928-1 •	Filter & AquaVue™ Bowl • Mercury/Yamaha Style Contains: 18-7919 filter, 18-7922-1 bowl
18-7929 •	Filter & Metal Bowl • Mercury/Yamaha Style Contains: 18-7919 filter, 18-7924 bowl



18-7486
O-RING,
FUEL FILTER BOWL
Replaces:
61A-24564-00-00
Fits: V6



18-7488
GASKET,
FUEL FILTER BOWL
Replaces:
6P3-24564-00-00
Fits: F/LF 150 - F300 (2006 - Current),
VZ150 - VZ300 (2006 - Current), Z200 -
Z300 (2006 - Current)



18-7710-1
FUEL FILTER
Replaces:
68T-24251-00-00
Fits: F6, F8 (2001 & Up)



18-7713
FUEL FILTER (INLINE)
Replaces: 646-24251-02-00
Fits: 6 (1989, 1992-99), 8 (1989-99,
2001-02), F4 (1999-02), F9.9 (1989-95,
1997-99, 2001-02), FT 9.9 (1988-90)



18-7780
FUEL FILTER
Replaces: 6F5-24563-00-00
For: 9.9 - 225NR



18-7781
FUEL FILTER
Replaces: 61N-24563-00-00
For: 9.9/90° SX



18-7782
FUEL FILTER
Replaces: 61A-24563-00-00
For: V6, 3.1L, D-T



18-7516
FUEL FILTER
Replaces: 67F-24251-02-00
For: F100 (1999-01)



18-7517
FUEL FILTER
Replaces: 65L-24563-00-00
For: 150-250 (1997-05)



18-7518
FUEL FILTER
Replaces: 65L-24563-00-00
For: 150-250 (1997-05)



18-7955
10 MICRON FUEL FILTER
ELEMENT
Replaces: 68F-24563-10-00
Fits: 150hp -300hp. (2004-2006)
Models Z, VZ, LZ



18-7979
FUEL FILTER
Replaces: 68V-24563-00-00



18-79799
FUEL FILTER
Replaces: 6D8-WS24A-00-00
F50-F115 after April 2006
For filter housing marked "6D8" ONLY!



18-79809
FUEL FILTER
Replaces: 6P3-24563-01-00,
6P3-WS24A-00-00,
6P3-WS24A-01-00
F150, F200, F225, F250,
Z-VZ 150 to 300 hp. after April 2006
For filter housing marked "6P3" ONLY!



FUEL FILTERS

Part No.	Application
18-7828-1	1/4" Small Capacity (For 1/4" Fuel Line)
18-7829	1/4" Large Capacity (For 1/4" Fuel Line)
18-7830	5/16" Replaces: 65W-24251-10-00
18-7831	3/8"



18-79905
10 MICRON FUEL FILTER
Replaces: 69J-24501-10-00
Fits: F150 - F225 (2006 - Current), F250
- (2005 - Current)



18-79970
FUEL FILTER
Replaces: 6BG-13915-00
Fits: F30(2013), F40(2008-13),
F50(2005-13), F60(2005-13),
F70(2010-13), F75(2005-13),
F90(2005-13), T50(2005-13),
T60(2005-13)



18-79972
ELEMENT, FILTER
(CARB INLET)
Replaces: 67F-14371-01
Fits: F75(2003-04), F80(2002-03),
F90(2003-04), F100(2002-03)



18-79973
FUEL FILTER
Replaces: 6C5-13915-00
Fits: F50(2005-13), F60(2005-13),
F70(2010-13), F75(2005-13), F90(2005-
13), T50(2005-13), T60(2005-13)



18-79977
FUEL FILTER

Replaces: 6L5-24251-00
Fits: 3(1992-02), F2.5(2003-12), F4(1999-08)



18-79979
FUEL FILTER

Replaces: 6CB-24501-00
Fits: F225 4.2L (2010), F250 4.2L (2010), F300 4.2L (2010), LF225 4.2L (2010), LF250 4.2L (2010), LF300 4.2L (2010), VF200 4.2L (2009-10), VF225 4.2L (2009-10), VF250 4.2L (2009-10)



18-79980
FUEL FILTER

REPLACES: 68F-24563-00
Fits: LZ150(2000-04), LZ200(2000-04), LZ250(2003-04), VZ150(2000-04), VZ175(2001-04), VZ200(2001-04), VZ225(2003-04), VZ250(2003-04), Z150(2000-04), Z175(2001-04), Z200(2000-04), Z250(2003-04)

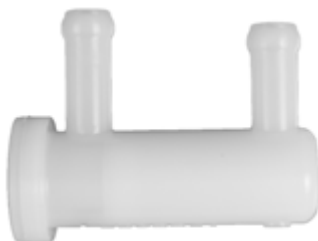

18-79981
FUEL FILTER

Replaces: 69J-24501-00
Fits: F150(2004-05), F200(2002-05), F225(2002-05), LF150(2004-05), LF200(2002-05), F225(2002-05)



18-79982
FUEL FILTER

Replaces: 69J-24502-00
Fits: F150(2005-14), F200(2005-10), F225(2005-10), F75(2005-14), F90(2005-14), FL150(2010), LF150(2005-14), LF200(2005-10), LF225(2005-10)



18-79983
FUEL FILTER

Replaces: 6C5-24251-00
Fits: F115(2014-15), F30(2013-15), F40(2008-15), F50(2005-15), F60(2005-15), F70(2010-15), F75(2005-15), F90(2005-15), LF115(2014-15), T50(2005-15), T60(2005-11), VF115(2015)



18-79984
FUEL FILTER

Replaces: 6AW-24502-10, 6AW-24502-00-00
Fits: 2007-09, F350(2007-11), FL350(2010), LF300(2007-09), LF350(2007-11)



18-79985
FUEL FILTER

Replaces: 68V-24502-30, 68V-24502-20-00
Fits: F115(2010-11), LF115(2010-11)



18-79986
FUEL FILTER

Replaces: 68V-24502-02, 68V-24502-01-00, 68V-24502-00-00
Fits: F115(2005-09), LF115(2005-09)



18-79907
VST FILTER

Replaces: 60V-24251-01-00
Fits: LZ150(2005), VZ150(2005-10), Z150(2005), VZ175(2005-10), Z175(2005), LZ200(2005-10), VZ200(2005-09), Z200(2005-10), VZ225(2005-09), LZ250(2005), VZ250(2005-09), Z250(2005), LZ300(2005-06), VZ300(2005-09), Z300(2005-06)



18-79900
VST FILTER (TAN)

Replaces: 66K-13915-00-00
Fits: DX150 (1999-05), LX150 1999-01, PX150 (1999), SX150 (1999-04), VX150 (2000-04), LX200 (1999-01), SX200 (1999-05), V200 (1999), VX200 (2000-05), L225 (1999), LX225 (2000-03), S225 (1999), SX225 (2000-03), V225 (1999), VX225 (2000-04), L250 (1999), LX250 (2000-03), SX250 (2000-03), VX250 (2002-04)



18-79901
VST FILTER (BLUE)

Replaces: 65L-13915-00-00
Fits: L225 (1997-98), S225 (1997-98), L250 (1997 - 98), V200 (1998), V225 (1998)



18-79902
VST FILTER
Replaces:
63P-13915-00-00
Fits: F150 TXR(2004-09), F150 TLR(2004-09), F150 TJR(2009), LF150 TXR(2004-09), F250 TXR(2005-09), F250 TUR(2005-09), F300 TXR(2007-09), F300 TUR(2007-09), F350 TXR(2007-09), F350 TUR(2007-09), F225TLR (2007-09)



18-79903
VST FILTER
Replaces:
68V-13915-00-00
Fits: F115 (2000-09), F200 TXR(2002-09), LF200 TXR(2002-09), F225 TXR(2002-09), F225 TUR(2002-09)



18-79904
VST FILTER (YELLOW)
Replaces:
68F-13915-00-00
Fits: HPDI 150(2000-05), V-Max HPDI 150(2000-09), V-Max HPDI 175(2001-09), HPDI 200(2000-09), HPDI 225(2003-09), HPDI 250 (2003-09), HPDI 300(2004-09)



18-79978
VST FILTER
Replaces: 6CB-13915-00
Fits: F225 4.2L (2010), F250 4.2L (2010), F300 4.2L (2010), LF225 4.2L (2010), LF250 4.2L (2010), LF300 4.2L (2010), VF200 4.2L (2009-10), VF225 4.2L (2009-10), VF250 4.2L (2009-10)



18-79910
FUEL FILTER ASSEMBLY
Replaces: 61N-24560-00, 61N-24560-10
Fits: 15(1994-09), 20(1996-97), 25(1994-09), 30(1995-01), 40(1994-05), 50(1994-09), 60(2001-05), 70(1994-09), 9.9(1994-09), 90(1994-09), B90(1997-99), C25(1994-97), C30(1994-97), C40(1994-03), C50(1998-01), C55(1994-95), C60(1996-01), C75(1994-99), C80(1997), C85(1994-96), C90(1997-01), E48(1995-00), E60(1995-00), E75(1995-00), F15(2005-10), F20(2006-10), F25(2005, 2009-10), F40(1999), F50(1995-04), F9.9(2005-06)



18-79950
VST KITS
Replaces: Kit 1
Fits: F150(04-12), LF150(04-12)

— CONTAINS —

Part #	Description	O.E. #
18-79902	VST Filter	63P-13915-00-00
18-79905	Fuel Filter, 10 Micron	69J-24501-10-00
18-0712	Float Chamber Gasket	63P-14984-00-00



18-79951
VST KITS
Replaces: Kit 2
Fits: F115(00-11), F200(02-10), F225(02-06), F225TXR(07-10), LF115(00-11), LF200(02-10), LF225(02-06), LF225 TXR(07-10)

— CONTAINS —

Part #	Description	O.E. #
18-79903	VST Filter	68V-13915-00-00
18-0710	Float Chamber Gasket	68V-14984-00-00



18-79952
VST KITS
Replaces: Kit 3
Fits: DX150(99-05), L225(99), L250(99), LX150(99-01), LX200(99-01), LX225(00-03), LX250(00-03), PX150(99), S225(99), S250(99), SX150(99-04), SX200(00-05), SX225(00-03), SX250(00-03), V200(99), V225(99), VX150(00-04), VX200(00-05), VX225(00-04), VX250(02-04)

— CONTAINS —

Part #	Description	O.E. #
18-79900	VST Filter	66K-13915-00-00
18-0711	Float Chamber Gasket	66K-14984-00-00



18-79953
VST KITS
Replaces: Kit 4
LZ150(00-05), LZ200(00-11), LZ250(03-05), LZ300(04-06), VZ150(00-11), VZ175(01-11), VZ200(01-09), VZ225(03-09), VZ250(03-09), VZ300(04-09), Z150(00-05), Z175(01-05), Z200(00-11), Z250(03-05), Z300(04-06)

— CONTAINS —

Part #	Description	O.E. #
18-79904	VST Filter	68F-13915-00-00
18-0711	Float Chamber Gasket	66K-14984-00-00



18-79954
VST FILTER & GASKET KIT
Fits: F225TLR (2007-2009), F250 (2005-2010), LF250 (2005-2010)

— CONTAINS —

Part #	Description	O.E. #
18-79902	VST Filter	63P-13915-00-00
18-0713	Float Chamber Gasket	6P2-14984-00-00



18-79955
VST FILTER & GASKET KIT
Fits: F300 (2007-2009), LF300 (2007-2009), F350 (2007-2010), LF350 (2007-2010)

— CONTAINS —

Part #	Description	O.E. #
18-79902	VST Filter	63P-13915-00-00
18-0714	Float Chamber Gasket	6AW-14984-00-00



18-79956
VST FILTER & GASKET KIT
Fits: F115 (2001-2014), F200 (2011-2014), F250 (2010-2014), F300 (2010-2014), F350 (2011-2014), FL250 (2010), FL300 (2010), LF115 (2011-2014), LF200 (2011-2014), LF225 (2010-2014), LF250 (2010-2014), LF300 (2010-2014), LF350 (2011-2014), VF150 (2013-2014), VF200 (2010-2014), VF225 (2010-2014), VF250 (2009-2014)

— CONTAINS —

Part #	Description	O.E. #
18-79902	VST Filter	63P-13915-00-00
18-0716	Float Chamber Gasket, Viton	6CB-14984-00-00



18-79957
VST FILTER & GASKET KIT
Fits: F50 (2005-2014), F60 (2005-2014), F70 (2010-2014), F75 (2005-2014), F90 (2005-2014), T50 (2005-2014), T60 (2005-2014)

— CONTAINS —

Part #	Description	O.E. #
18-79973	Fuel Filter	6C5-13915-00-00
18-0717	Float Chamber Gasket, Viton	6C5-14984-00-00



18-2083
FUEL INJECTOR SEAL
Replaces:
68V-13766-00-00



18-7655
OXYGEN SENSOR

Replaces: 67H-8592A-01-00, 67H-8592A-00-00
Fits: PX150 (1999), DX150 (99-05), LX150, LX200 (99-01), VX150 (00-04)



18-7606
WATER SENSOR PROBE

Replaces: MAR-10171-30-00

8' LENGTH COMPLETE FUEL LINE ASSEMBLIES

3/8"
FUEL LINE ASSEMBLY

18-8017EP-2 SILVERADO 4000 Premium

OE# 6YL-24306-60-00



18-8077-1
TANK CONNECTOR
(SOLD SEPARATELY)



18-8076
FUEL CONNECTOR

18-8005EP-1
PRIMER BULB

18-8076
FUEL CONNECTOR



*

*

FUEL LINE ASSEMBLY COMPONENTS

Fits: F75-F250 and 115-300 HP



3/8"
FUEL LINE ASSEMBLY

18-8017S-1 SILVERADO 4000 Premium

OE# 6YL-24306-60-00



18-8077-1
TANK CONNECTOR
(SOLD SEPARATELY)



18-8076
FUEL CONNECTOR

18-8005S
PRIMER BULB

18-8076
FUEL CONNECTOR



*

*

FUEL LINE ASSEMBLY COMPONENTS

Fits: F75-F250 and 115-300 HP



PRIMER BULBS



18-8002EP-1
18-8002EP-1-10①
PRIMER BULB
1/4"

18-8005EP-1
18-8005EP-1-10①
PRIMER BULB
3/8"

Replaces: 174512
Large capacity bulb

18-8004EP-1
18-8004EP-1-10①
PRIMER BULB
5/16"

Large capacity bulb



18-8040
FUEL TANK ELBOW

Universal Fitting with
1/4" NPT Threads
Replaces: ABA-FBARB-90-DG
(Brass)



18-8055
HOSE BARB

1/4" NPT threads for connection of 5/16" I.D.
hose
Replaces: ABA-FLINE-BA-RB
(Brass)



18-8077-1
TANK CONNECTOR
(1/4" NPT)

Fits: F75-F250 and 115-300HP
Mates with 18-80413, 18-80414, 18-80415







18-80413
FUEL CONNECTOR
1/4"
Replaces: 6Y1-24305-06-00, 6Y1-24305-04
Mates with 18-8077-1

18-80414
FUEL CONNECTOR
Replaces: 6G1-24305-05-00, 6G1-24305-04
Fits: 6(1989, 1992-93), 8(1984-85, 1989-93, 2001-02), 9.9(1984-93, 2000-03), 15(1984-93, 2000-03), 25(1984-85, 1988-93, 2000-03), 30(1984-87, 1989-93, 1999, 2001-02), 40(1984-86, 1988-90, 1992-93, 2000-03), 50(1986-93, 2000-03), 60(2001-03), 70(1984-93, 2000-03), 90(1984-93, 2000-03), C25(1991, 1993), C30(1991-93), C40(1991-93, 2000-02), C50(2000-01), C55(1991-93), C60(2000-01), C70(2000-01), C85(1991-93), C90(2000-01), E48(2000), F6(2001-03), F8(2001-03), F9.9(1985-93, 2001-03), F15(1998-99, 2000-01), F25(1998-99, 2000-03), F30(2001-03), F40(1999, 2000-03), F50(1999, 2000-03), F60(2002-03), T8(2001-03), T9.9(1991-93, 1999, 2001-03), T25(2001-03), T50(1999, 2000-03), T60(2003)

Use with Yamaha 6mm fuel line
Mates with 18-8077-1



18-80415
FUEL CONNECTOR
1/4"
Replaces: 6Y1-24305-06-00, 6Y1-24305-04
Mates with 18-8077-1



18-80415
FUEL CONNECTOR
Replaces: 6E5-24305-05, 6Y2-24305-05
Use with Yamaha 8mm fuel line
Mates with 18-8077-1

18-9145
OETIKER CLAMP KIT
Replaces: YB-6AW04-A



Part #	Qty.	Yamaha #	Oetiker #	Description	
18-9141	1	YB-6AW04-4	14100082	Oetiker Jaw Pincers	
Part #	Qty.	Yamaha #	Oetiker #	Nominal ID	
				Inches	mm
18-9133-9	50	YB-6AW04-1	16700016	5/8"	15.7
18-9146-9	50	YB-6AW04-3	16702498	25/32"	19.8

All clamps are standard package of 10. Each Package of 10 is available individually.

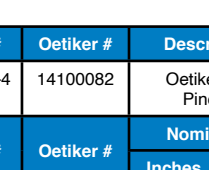











18-80415
FUEL CONNECTOR
Replaces: 6E5-24305-05, 6Y2-24305-05
Use with Yamaha 8mm fuel line
Mates with 18-8077-1

* Tanks and Engines for picture purpose only.

① Discount shop pack of 10 - Priced per package

 <p>18-3040 IMPELLER Replaces: 63V-44352-01-00</p>	 <p>18-3042 IMPELLER Replaces: 67F-44352-00-00</p>	 <p>18-3063 IMPELLER Replaces: 662-44352-01-00</p>	 <p>18-3065 IMPELLER Replaces: 6L2-44352-00-00</p>
--	--	---	--

 <p>18-3066 IMPELLER Replaces: 6G1-44352-00-00</p>	 <p>18-3067 IMPELLER Replaces: 689-44352-02-00</p>	 <p>18-3068 IMPELLER Replaces: 6H4-44352-02-00</p>	 <p>18-3069 IMPELLER Replaces: 6H3-44352-00-00</p>	 <p>18-3070 IMPELLER Replaces: 688-44352-03-00</p>
---	---	---	---	---

 <p>18-3071 IMPELLER Replaces: 6E5-44352-01-00</p>	 <p>18-3072 IMPELLER Replaces: 646-44352-01-00</p>	 <p>18-3073 IMPELLER Replaces: 6E0-44352-00-00</p>	 <p>18-3074 IMPELLER Replaces: 682-44352-01-00</p>	 <p>18-3088 IMPELLER Replaces: 6F5-44352-00-00</p>
---	---	---	---	---



18-45617-1
IMPELLER
 Replaces: 6CE-44352-00-00
 Fits: F225-F350, FL250-FL350 & VF250 Engines



18-8910
IMPELLER
 Replaces: 68T-44352-00-00



18-8911
IMPELLER
 Replaces: 6L5-44352-00-00



18-8925
IMPELLER
 Replaces: 6AW-44352-00-00



18-3185
WATER PUMP HOUSING
 Replaces: 61N-44311-01-00,
 61N-44311-00-00



18-43263
WATER PUMP HOUSING
 Replaces: 68D-G4311-01-00



18-3170
WATER PUMP HOUSING
 Replaces: 6E5-44311-00-00



18-3173-1
WATER PUMP HOUSING
 Replaces: 61A-44311-00-00,
 61A-44311-01-00



18-3171
WATER PUMP HOUSING
 Replaces: 688-44311-01-00



18-3356
WATER PUMP HOUSING
 Includes Impeller Cup
 Replaces: 63V-44301-00-00
 Fits: Two-Stroke: 9.9hp-15hp (1996-Current), Four-Stroke:
 6hp-8hp (2001-Current); 9.9hp. (2006-Current); 15hp
 (1998-Current)



18-3482
WATER PUMP HOUSING
 Replaces: 6CE-44311-01-00



18-3486
WATER PUMP HOUSING
 Replaces: 6L2-44311-01-00
 Fits: F25C (2016-17)



18-3483
WATER PUMP HOUSING
 Replaces: 6AW-44311-01-00
 Fits: F300, LF300 (2007-09), F350A, LF350A (2010-11),
 F350B, LF350B (2012-15), F350C, LF350C (2016-18), FL350
 (2010)



18-3484
WATER PUMP HOUSING
 Replaces: 6AW-44311-01-00
 Fits: F15C, F20 (2006-17)



18-3485
WATER PUMP HOUSING
 Replaces: 6CJ-44311-00-00
 Fits: F70A (2010-17)



18-4567
WATER PUMP HOUSING
 Replaces: 6AH-44311-00
 Fits: F4 (2009-17), F6 (2009-17)



18-9081
WATER PUMP HOUSING COVER
 Replaces: 6E5-44312-00-00
 Fits: 75 (2017), 90 (2016-2017), 115 (1984-2017), 130 (1988-2004), 150-250 (1984-2017), 250 (1990-2017), 300 (2004-2009)



18-9082
WATER PUMP HOUSING COVER
 Replaces: 6AW-44312-00-00
 Fits: F225 (2010-15), F250 (2010), F250 (2010-15), F300 (2007-15), F350 (2007-15), FL250 (2010), FL300 (2010), FL350 (2010), LF225 (2010-15), LF250 (2010-15), LF300 (2007-15), LF350 (2007-15), VF250 (2015)

PKG. OF 2



18-43716
IMPELLER PIN
 Replaces: 93604-18080-00
 Fits: 3(1988-02), 4(1984-99), 5(1984-01), F2.5(2003-14), F4(1999-14), F6(2009-14)



IMPELLER KEYS

Part No.	OE No.
18-3297	90280-03M03-00
18-3305	90280-03024-00, 90280-03003-00
18-3300	90280-04M00-00
18-3301	90280-04M04-00
18-3302	90280-04M05-00



BOLTS

Part No.	OE No.	Application
18-0256	97095-08045-00 97080-08045-00	8-1.25 x 45mm F6 (2001-05), F8 (2001-05) M8-1.25x45mm 18-8S/S



18-9079
WAVE WASHER KIT
 Replaces: 61A-45538-00-00 + 61A-45527-00-00 + 90206-22M19 + 90201-22M01
 Fits: Yamaha 2-stroke 115-300hp (1993 & Up); Yamaha 4-stroke 115-225hp (2002 & Up); Mercury 4-stroke 225 EFI S/N 0T653945 & Up

— CONTAINS —

Part #	Desc.	O.E.#	Qty.
18-9075	Spacer	61A-45538-00-00	1
18-9076	Collar	61A-45527-00-00	1
18-9077	Wave Washer	90206-22M19-00	1
18-9078	Stainless Steel Washer	90201-22M01-00	2



18-1829
WATER SEAL DAMPER
 Replaces: 6AW-44365-00-00
 Fits: F225 (2010-15), F250 (2010), F250 (2010-15), F300 (2007-15), F350 (2007-15), FL250 (2010), FL300 (2010), FL350 (2010), LF225 (2010-15), LF250 (2010-15), LF300 (2007-15), LF350 (2007-15), VF250 (2015)



18-1837
WATER DAMPER SEAL
 Replaces: 6L2-44367-10
 Fits: F25C (2016-17)



18-1840
WATER DAMPER SEAL
 Replaces: 6EE-G4366-00
 Fits: F2.5 (2015-17)



18-1830
 Superseded from 18-1828
WATER DAMPER SEAL
 Replaces: 663-44366-00
 Fits: F30 (2013-17), F40A (2008-17)



18-1836
WATER DAMPER SEAL
 Replaces: 6L2-44367-00
 Fits: F15C, F20 (2006-17)

**18-1830
WATER SEAL DAMPER**

Replaces: 663-44366-00
Fits: 25 ML, MS(1997-02), 30(1987-01), 40(1984-05), 50(1986-09), 60(2001-05), 70(1984-09), 90(1984-09), B90(1997-99), C30(1995), C40(1991-01), C50(1998-01), C55(1991-95), C60(1996-01), C70(2000-01), C75(1994-99), C80(1997), C85(1991-96), C90(1997-01), E48(1995-00), E60(1995-00), E75(1995-00), F30(2001-05, 2013), F40(1999-13), F50(1995-13), F60(2002-13), F70(2010-13), F75(2003-11), F80(1999-03), F90(2003-13), F100(1999-03), F200(2002-12), F225(2002-12), F250(2005-12), L225(1994-99), L250(1990-99), LF200(2002-12), LF225(2002-10), LF250(2005-12), LX225(2000-03), LX250(2000-03), LZ250(2003-05), LZ300(2004-06), P40(1998), P50(1991-96), P60(1991-99), P75(1996-99), S225(1996-99), S250(1996-99), SX225(2000-03), SX250(2000-03), T25(2001-13), T50(1996-13), T60(2003-13), V200(1998-99), V225(1998-99), VX200(2000-05), VX225(2000-04), VX250(2002-04), VZ200(2005-09), VZ225(2005-09), VZ250(2003-09), VZ300(2004-09), Z250(2003-05), Z300(2004-06)



**18-1831
WATER SEAL DAMPER**
Replaces: 682-44366-00
Fits: 9.9(1984-95), 15(1984-95)



**18-1832
WATER SEAL DAMPER**
Replaces: 682-44367-00
Fits: 9.9(1984-95), 15(1984-95)



**18-1833
WATER SEAL DAMPER**
Replaces: 647-44366-00
Fits: 6(1986-00), 8(1984-00), 9.9(1996-09), 15(1996-09), F9.9(2005-06), F15(1998-06), T9.9(2005-06)



**18-1834
WATER SEAL DAMPER**
Replaces: 682-44365-00
Fits: 6(1986-00), 8(1984-00), 9.9(1996-09), 15(1996-09), F9.9(2005-06), F15(1998-06), T9.9(2005-06)



**18-1835
WATER SEAL DAMPER**
Replaces: 6E5-44365-00-00
Fits: 75 (2017), 90 (2016-2017), 115 (1984-2017), 130 (1988-2004), 150-250 (1984-2017), 250 (1990-2017), 300 (2004-2009)

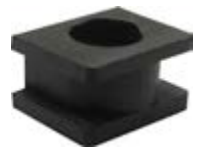

**18-3505
WATER SEAL DAMPER**
Replaces: 63V-44365-10-00
Fits: 2-Stroke: 9.9hp & 15hp 1997-Current
 4-Stroke: F6 & F/T8 2001-Current; F/T 9.9 2005-Current; F15 1998-Current



**18-3166
WATER SEAL DAMPER**
Replaces: 6E0-44366-00-00
For: 2 (1984-85, 88-99, 2002), 3 (1988-99, 02), 4 (1984-85, 88-99), 5 (1984-85, 95-02), F2.5 (2003-05)



**18-3176
WATER SEAL DAMPER**
Replaces: 68T-44366-00-00
For: F6, F8 (2001-05), C30 (1993-97)



**18-3148
WATER PUMP KIT
Without Housing**
Replaces: 682-W0078-A1-00

— CONTAINS —

Part #	Desc.	O.E.#	Qty.
18-0768	Gasket, Water Pump	682-44315-A0-00	2
NSS	Bolt	97095-06045-00	4
18-3074	Impeller	682-44352-01-00	1
18-3297	Key, Impeller	90280-03024-00	1
NSS	Grommet	682-44365-00-00	1
NSS	Cup, Insert	682-44322-00-00	1
NSS	Plate, Wear	682-44323-00-00	1



**18-3411
WATER PUMP KIT W/HOUSING**
Replaces: 682-W0078-A1, 682-44300-01
For: 9.9(1984-95), 15(1984-95), F9.9(1985-96), FT9.9(1985-90), T9.9(1991-96)

— CONTAINS —

Part #	Desc.	O.E.#	Qty.
18-0768	Gasket, Water Pump	682-44315-A0-00	2
NSS	Bolt	97095-06040-00	4
18-3074	Impeller	682-44352-01-00	1
18-3297	Key, Impeller	90280-03M03-00	1
NSS	Seal, Water	682-44365-00-00	1
NSS	Cup, Insert	682-44322-00-00	1
NSS	Plate, Wear	682-44323-00-00	1
NSS	Housing, Water Pump	682-44300-01-00	1



**18-3310
WATER PUMP KIT
Without Housing**
Replaces: 6G5-W0078-01-00

— CONTAINS —

Part #	Description	O.E.#	Qty.
18-0244	Gasket, Water Pump	6E5-44315-00-00	1
18-0256	Bolt	97395-08045-00-00	4
18-3071	Impeller	6E5-44352-00-00	1
18-3302	Key, Impeller	90280-04M05-00	1
18-3345	Plate, Wear	6G5-44323-00-00	1
18-7483	O-Ring, Water Pump	93210-37M67-00	1
18-7485	O-Ring, Water Pump	93210-86M38-00	1
NSS	Cup, Insert	6E5-44322-00-00	1
NSS	Washers, Bolt	90209-08M02-00	4



**18-3311
WATER PUMP KIT
With Housing**
Replaces: 6G5-W0078-A1-00

— CONTAINS —

Part #	Description	O.E.#	Qty.
18-0244	Gasket, Water Pump	6E5-44315-A0-00	1
18-0256	Bolt	97095-08045-00	4
18-3071	Impeller	6E5-44352-01-00	1
18-3170	Housing, Water Pump	6E5-44311-00-00	1
18-3302	Key, Impeller	90280-04M05-00	1
18-3333	Cup, Insert	61A-44322-00-00	1
18-3345	Plate, Wear	6G5-44323-01-00	1
18-7483	O-Ring (6G8)	93210-37M67-00	1
18-7485	O-Ring	93210-86M38-00	1
NSS	Pin, Dowel	93606-12019-00	2
NSS	Washer, Bolt	90209-08M02-00	4

18-3312
WATER PUMP KIT
 Without Housing
 Replaces: 6N6-W0078-00-00



— CONTAINS —

Part #	Description	O.E. #	Qty.
18-0244	Gasket, Water Pump	6E5-44315-A0-00	1
18-0256	Bolt	97095-08045-00	4
18-3071	Impeller	6E5-44352-01-00	1
18-3302	Key, Impeller	90280-04M05-00	1
18-3333	Cup, Insert	61A-44322-00-00	1
18-3344	Plate, Wear	6E5-44323-00-00	1
18-7483	O-Ring (6G8)	93210-37M67-00	1
18-7485	O-Ring	93210-86M38-00	1
NSS	Pin, Dowel	93606-12019-00	2
NSS	Washer, Bolt	90209-08M02-00	4

18-3313-1
WATER PUMP KIT
 (with Housing)
 Replaces: 6N6-W0078-01-00



— CONTAINS —

Part #	Description	O.E. #	Qty.
18-0244	Gasket, Water Pump	6E5-44315-A0-00	1
18-0256	Bolt	97095-08045-00	4
18-3071	Impeller	6E5-44352-01-00	1
18-3173-1	Housing, Water Pump	6E5-44311-00-00	1
18-3302	Key, Impeller	90280-04M05-00	1
18-3333	Cup, Insert	61A-44322-00-00	1
18-3344	Plate, Wear	6E5-44323-00-00	1
18-7483	O-Ring (6G8)	93210-37M67-00	1
18-7485	O-Ring	93210-86M38-00	1
NSS	Pin, Dowel	93606-12019-00	2
NSS	Washer, Bolt	90209-08M02-00	4

18-3370
WATER PUMP KIT
 Without Housing
 Replaces: 692-W0078-00-00,
 692-W0078-01-00, 692-W0078-A0-00



— CONTAINS —

Part #	Description	O.E. #	Qty.
18-0239	Gasket, Water Pump	688-44315-A0-00	1
18-0240	Gasket, Water Pump	688-44316-A0-00	1
18-3070	Impeller	688-44352-03-00	1
18-3301	Key, Impeller	90280-04M04-00	1
18-7436	O-Ring	93210-46044-00	1
NSS	Bolt	97395-08050-00	4
NSS	Cup, Insert	688-44322-00-00	1
NSS	Plate, Wear	688-44323-00-00	1
NSS	Gasket, Water Pump	688-44324-A0-00	1

18-3371
WATER PUMP KIT (with Housing)
 Replaces: 692-W0078-A0-00



— CONTAINS —

Part #	Description	O.E. #	Qty.
18-3070	Impeller	688-44352-03-00	1
18-3171	Housing, Water Pump	688-44311-01-00	1
18-3301	Key, Impeller	90280-04M04-00	1
18-7436	O-Ring	93210-46044-00	1
NSS	Bolt	97395-08070-00	2
NSS	Bolt	97395-08050-00	2
NSS	Cup, Insert	688-44322-00-00	1
NSS	Plate, Wear	688-44323-00-00	1
NSS	Gasket, Water Pump	688-44315-A0-00	1
NSS	Gasket, Water Pump	688-44324-A0-00	1
NSS	Gasket, Water Pump	688-44316-A0-00	1

18-3372
WATER PUMP KIT
 Without Housing
 Replaces: 6E5-W0078-01-00



— CONTAINS —

Part #	Description	O.E. #	Qty.
18-0244	Gasket, Water Pump	6E5-44315-A0-00	1
18-0256	Bolt	97095-08045-00	4
18-3071	Impeller	6E5-44352-01-00	1
18-3302	Key, Impeller	90280-04M05-00	1
18-3344	Plate, Wear	6E5-44323-00-00	1
18-7483	O-Ring	93210-37M67-00	1
18-7485	O-Ring	93210-86M38-00	1
NSS	Pin, Dowel	93606-12019-00	2
NSS	Washer, Bolt	90209-08M02-00	4
NSS	Cup, Insert	6E5-44322-00-00	1

18-3373
WATER PUMP KIT
 (with Housing)
 Replaces: 6E5-W0078-A1-00



— CONTAINS —

Part #	Description	O.E. #	Qty.
18-0244	Gasket, Water Pump	6E5-44315-A0-00	1
18-0256	Bolt	97095-08045-00	4
18-3071	Impeller	6E5-44352-01-00	1
18-3170	Housing, Water Pump	6E5-44311-00-00	1
18-3302	Key, Impeller	90280-04M05-00	1
18-3344	Plate, Wear	6E5-44323-00-00	1
18-7483	O-Ring (6G8)	93210-37M67-00	1
18-7485	O-Ring	93210-86M38-00	1
NSS	Pin, Dowel	93606-12019-00	2
NSS	Washer, Bolt	90209-08M02-00	4
NSS	Cup, Insert	6E5-44322-00-00	1

18-3395
WATER PUMP KIT
 Without Housing
 Replaces: 61A-W0078-01-00



— CONTAINS —

Part #	Description	O.E. #	Qty.
18-0244	Gasket, Water Pump	6E5-44315-A0-00	1
18-0256	Bolt	97095-08045-00	4
18-3071	Impeller	6E5-44352-01-00	1
18-3302	Key, Impeller	90280-04M05-00	1
18-3333	Cup, Insert	61A-44322-00-00	1
18-3345	Plate, Wear	6G5-44323-01-00	1
18-7483	O-Ring (6G8)	93210-37M67-00	1
18-7485	O-Ring	93210-86M38-00	1
NSS	Pin, Dowel	93606-12019-00	2
NSS	Washer, Bolt	90209-08M02-00	4

18-3396-1
WATER PUMP KIT
 (with Housing)
 Replaces: 61A-W0078-A2-00, 61A-W0078-A3-00



— CONTAINS —

Part #	Description	O.E. #	Qty.
18-0244	Gasket, Water Pump	6E5-44315-A0-00	1
18-0256	Bolt	97095-08045-00	4
18-3071	Impeller	6E5-44352-01-00	1
18-3173-1	Housing, Water Pump	6E5-44311-00-00	1
18-3302	Key, Impeller	90280-04M05-00	1
18-3333	Cup, Insert	61A-44322-00-00	1
18-3345	Plate, Wear	6G5-44323-01-00	1
18-7483	O-Ring (6G8)	93210-37M67-00	1
18-7485	O-Ring	93210-86M38-00	1
NSS	Pin, Dowel	93606-12019-00	2
NSS	Washer, Bolt	90209-08M02-00	4

18-3397
WATER PUMP KIT

Without Housing
Replaces: 679-W0078-00-00, 679-W0078-A0-00
— CONTAINS —



Part #	Description	O.E. #	Qty.
18-3088	Impeller	6F5-44352-00-00	1
18-0256	Bolt	97095-08045-00	2
18-3300	Key, Impeller	90280-04M00-00	1
18-3334	Cup, Insert	676-44322-00-00	1
NSS	Gasket, Water Pump	676-44315-A0-00	1
NSS	Gasket, Water Pump	676-44324-A0-00	1
NSS	Gasket, Water Pump	679-44316-A0-00	1
NSS	Plate, Wear	676-44323-00-00	1
NSS	Bolt	97095-08055-00	2
NSS	Seal, Water	663-44366-00-00	1
NSS	Washer, Bolt	92990-08600-00	4

18-3398
WATER PUMP KIT
(with Housing)

Replaces: 6F5-W0078-A0-00, 6F5-W0078-00-00
— CONTAINS —



Part #	Description	O.E. #	Qty.
18-3088	Impeller	6F5-44352-00-00	1
18-0237	Gasket, Water Pump Outer	676-44315-A0-00	1
18-0256	Bolt	97095-08045-00	2
18-3300	Key, Impeller	90280-04M00-00	1
18-3334	Cup, Insert	676-44322-00-00	1
NSS	Gasket, Water Pump	676-44324-A0-00	1
NSS	Gasket, Water Pump	679-44316-A0-00	1
NSS	Plate, Wear	676-44323-00-00	1
NSS	Housing, Water Pump	676-44311-00-00	1
NSS	Bolt	97095-08055-00	2
NSS	Seal, Water	663-44366-00-00	1
NSS	Washer, Bolt	92990-08600-00	4

18-3428-1
WATER PUMP KIT

Without Housing
Replaces: 6H3-W0078-00-00, 6H3-W0078-A0-00
— CONTAINS —



Part #	Description	O.E. #	Qty.
18-0240	Gasket, Water Pump	688-44316-A0-00	1
18-0256	Bolt	97095-08045-00	2
18-0756-1	Gasket, Water Pump	6H3-44315-A0-00	1
18-0757	Gasket, Outer Plate	6H3-44324-A0-00	1
18-3069	Impeller	697-44352-00-00	1
18-3297	Key, Impeller	90280-03M03-00	1
18-3435	Cup, Impeller	663-44322-00-00	1
18-7436	O-Ring	93210-46044-00	1
NSS	Bolt	97095-08055-00	2
NSS	Plate, Wear	63D-44323-00-00	1

18-3461
WATER PUMP KIT
(with Housing)

Replaces: 6H3-W0078-00-00, A0-00, 6H3-44311-00-00
For: 70(1984-91), P60(1991), T50(1996)
— CONTAINS —



Part #	Description	O.E. #	Qty.
NSS	Housing, Water Pump	6H3-44311-00-00	1
18-0240	Gasket, Water Pump	688-44316-A0-00	1
18-0256	Bolt	97095-08045-00	2
18-0756-1	Gasket, Water Pump	6H3-44315-A0-00	1
18-0757	Gasket, Outer Plate	6H3-44324-A0-00	1
18-3069	Impeller	697-44352-00-00	1
18-3297	Key, Impeller	90280-03M03-00	1
18-3435	Cup, Impeller	663-44322-00-00	1
18-7436	O-Ring	93210-46044-00	1
NSS	Bolt	97395-08055-00	2
NSS	Plate, Wear	6H3-44323-00-00	1

18-3429
WATER PUMP KIT

Without Housing
Replaces: 6H4-W0078-00-00, 6H4-W0078-A0-00
— CONTAINS —



Part #	Description	O.E. #	Qty.
18-0256	Bolt	97095-08045-00	2
18-0258	Bolt	97095-08055-00	2
18-0292	Gasket, Wear Plate to Housing	663-44315-A0-00	1
18-0294	Gasket, Wear Plate to Base	663-44324-A0-00	1
18-3068	Impeller	6H4-44352-00-00	1
18-3297	Key, Impeller	90280-03M03-00	1
18-3435	Cup, Insert	663-44322-00-00	1
18-3436	Plate, Wear	663-44323-00-00	1
NSS	Gasket, Water Pump	663-44316-A0-00	1
NSS	Seal	93101-23070-00	1

18-3408
WATER PUMP KIT With Housing

Replaces: 6H4-W0078-00, A0, 663-44311-02
For: 40(1984-87), 50(1984-87), Pro50(1987)
— CONTAINS —



Part #	Description	O.E. #	Qty.
NSS	Housing, Water Pump	6J8-44311-00-00	1
18-0256	Bolt	97095-08045-00	2
18-0258	Bolt	97395-08055-00	2
18-0292	Gasket, Wear Plate to Housing	663-44315-A0-00	1
18-0294	Gasket, Wear Plate to Base	663-44324-A0-00	1
18-3068	Impeller	6H4-44352-00-00	1
18-3297	Key, Impeller	90280-03M03-00	1
18-3435	Cup, Insert	663-44322-00-00	1
18-3436	Plate, Wear	663-44323-00-00	1
NSS	Gasket, Water Pump	663-44316-00-00	1
NSS	Seal	93101-23070-00	1

18-3433
WATER PUMP KIT

Without Housing
Replaces: 63V-W0078-01-00
Fits: 9.9/15(1996-04), F15 (1998-04)
— CONTAINS —



Part #	Description	O.E. #	Qty.
18-0256	Bolt	97095-08045-00	4
18-3040	Impeller	63V-44352-01-00	1
18-3195	Plate, Wear	63V-44323-00-00	1
NSS	Key, Impeller	63V-44338-00-00	1
18-3444	Cup, Insert	63V-44322-00-00	1
NSS	Seal, Water	647-44366-00-00	1

18-3412
WATER PUMP KIT
(with Housing)

Replaces: 63V-W0078-01, 63V-44301-00
For: 9.9(1996-09), 15(1996-09), F9.9(2005-06), F15(1998-05), T9.9(2005-06)
— CONTAINS —



Part #	Description	O.E. #	Qty.
18-0256	Bolt	97095-08045-00	4
18-3040	Impeller	63V-44352-01-00	1
18-3195	Plate, Wear	63V-44323-00-00	1
NSS	Key, Impeller	63V-44338-00-00	1
18-3356	Housing, Water Pump	63V-44301-00-00	1
18-3444	Cup, Insert	63V-44322-00-00	1
NSS	Seal, Water	647-44366-00-00	1

18-3434
WATER PUMP KIT

Without Housing

Replaces: 63D-W0078-01-00, 63D-44311-00-00

Fits: 40/50(1995-03), P40(1998), C40 3 cyl(1997-02), C50(1999-01), F40 2.6L(1999), F50(1995-03), P50 (1995-96), F60(2002-03)

For kit with housing, order **18-3415**

— CONTAINS —

Part #	Desc.	O.E.#	Qty.
18-0483	Gasket, Pump Case	63D-44316-00-00	1
18-3069	Impeller	697-44352-00-00	1
18-3186	Plate, Wear	63D-44323-00-00	1
18-3297	Key, Impeller	90280-03M03-00	1
18-3449	Cup, Insert	63D-44322-00-00	1
NSS	Bolt (Set of 4)	90119-08M15-00	1
NSS	Cover, Pump Housing	63D-44312-00-00	1
NSS	Washer, Bolt	90209-08M02-00	4
NSS	O-Ring	93210-59MG7-00	1
NSS	Seal, Water	663-44366-00-00	1



18-3415
WATER PUMP KIT
(with Housing)

Replaces: 63D-W0078-01-00, 63D-44311-00-00

Fits: 40/50(1995-03), P40(1998), C40 3 cyl(1997-02), C50(1999-01), F40 2.6L(1999), F50(1995-03), P50 (1995-96), F60(2002-03)

For kit w/o housing, order **18-3434**



Part #	Desc.	O.E.#	Qty.
18-0483	Gasket, Water Pump Case	63D-44316-00-00	1
18-3069	Impeller	697-44352-00-00	1
18-3186	Plate, Wear	63D-44323-00-00	1
18-3297	Key, Impeller	90280-03M03-00	1
18-3449	Cup, Insert	63D-44322-00-00	1
NSS	Bolt (Set of 4)	90119-08M15-00	1
NSS	Cover, Water Pump Housing	63D-44312-00-00	1
NSS	Washer, Bolt	90209-08M02-00	4
NSS	O-Ring	93210-59MG7-00	1
NSS	Seal, Water	663-44366-00-00	1
NSS	Housing, Water Pump	63D-44311-00-00	1

18-3440
WATER PUMP KIT

Without Housing

Replaces: 66T-W0078-00-00

Fits: T25 (2001-04), F30 (2001-04), F40 (2000-04)

— CONTAINS —

Part #	Desc.	O.E.#	Qty.
18-0483	Gasket, Pump Case	63D-44316-00-00	1
18-3068	Impeller	6H4-44352-00-00	1
18-3196	Plate, Impeller	66T-44323-00-00	1
18-3297	Key, Impeller	90280-03M03-00	1
18-3449	Cup, Insert	63D-44322-00-00	1
NSS	Bolt (Set of 4)	90119-08M15-00	1
NSS	Cover, Pump Housing	63D-44312-00-00	1
NSS	O-Ring	93210-59MG7-00	1
NSS	Seal, Water	663-44366-00-00	1
NSS	Washer	90209-08M02-00	4



18-3413
WATER PUMP KIT
(with Housing)

Replaces: 66T-W0078-00, 66T-44311-00

For: F30(2001-05), F40(2000-08), T25 (2001-06)

For kit w/o housing, order **18-3440**



Part #	Desc.	O.E.#	Qty.
18-0483	Gasket, Water Pump Case	63D-44316-00-00	1
18-3068	Impeller	6H4-44352-00-00	1
18-3196	Plate, Wear	66T-44323-00-00	1
18-3297	Key, Impeller	90280-03M03-00	1
18-3449	Cup, Insert	63D-44322-00-00	1
NSS	Bolt (Set of 4)	90119-08M15-00	1
NSS	Cover, Water Pump Housing	63D-44312-00-00	1
NSS	O-Ring	93210-59MG7-00	1
NSS	Seal, Water	663-44366-00-00	1
NSS	Washer, Bolt	90209-08M02-00	4
NSS	Housing, Water Pump	66T-44311-00-00	1

18-3442
WATER PUMP REPAIR KIT

Without Housing

Replaces: 68V-W0078-00-00

For: F115 2002-2010 / LF115 2002-2010

— CONTAINS —

Part #	Desc.	O.E.#	Qty.
18-0244	Gasket, Water Pump	6E5-44315-A0-00	2
18-0256	Bolt	97095-08045-00	4
18-3071	Impeller	6E5-44352-01-00	1
18-3302	Key, Impeller	90280-04M05-00	1
18-3519	Cup, Insert	61A-44322-02-00	1
18-3521	Plate, Wear	68V-44323-00-00	1
18-7483	O-Ring (6G8)	93210-37M67-00	1
18-7485	O-Ring	93210-86M38-00	1
NSS	Pin, Dowel	93606-12019-00	2
NSS	Washer	90209-08M02-00	4

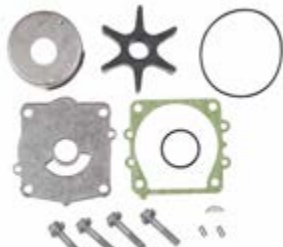

18-3523-1
WATER PUMP KIT
(with Housing)

Replaces: 68V-W0078-00, 61A-44311-01

Fits: F115 & LF115 (2002 & Up)



Part #	Desc.	O.E.#	Qty.
18-0244	Gasket, Water Pump	6E5-44315-A0-00	2
18-0256	Bolt	97095-08045-00	4
18-3071	Impeller	6E5-44352-01-00	1
18-3173-1	Housing, Water Pump	61A-44311-01-00	1
18-3302	Key, Impeller	90280-04M05-00	1
18-3519	Cup, Insert	61A-44322-02-00	1
18-3521	Plate, Wear	68V-44323-00-00	1
18-7483	O-Ring (6G8)	93210-37M67-00	1
18-7485	O-Ring	93210-86M38-00	1
NSS	Pin, Dowel	93606-12019-00	2
NSS	Washer, Bolt	90209-08M02-00	4

18-3450
WATER PUMP KIT

Without Housing

Replaces: 68T-W0078-00-00

For: F6, F8 (2001-05)

— CONTAINS —

Part #	Desc.	O.E.#	Qty.
18-0256	Bolt	97095-08045-00	4
18-3142	Plate, Wear	68T-44323-00-00	1
18-3176	Seal, Water Damper	68T-44366-00-00	1
NSS	Key, Impeller	63V-44338-00-00	1
18-3444	Cup, Insert	63V-44322-00-00	1
18-8910	Impeller	68T-44352-00-00	1
NSS	O-Ring	93210-44398-00	1



18-3410
WATER PUMP KIT (with Housing)

Replaces: 68T-W0078-00, 63V-44301-00

For: F6(01-08), F8(01-09), F9.9(07-09)



Part #	Desc.	O.E.#	Qty.
18-0256	Bolt	97095-08045-00	4
18-3142	Plate, Wear	68T-44323-00-00	1
18-3176	Seal, Water Damper	68T-44366-00-00	1
NSS	Key, Impeller	63V-44338-00-00	1
18-3356	Housing, Water Pump	63V-44301-00-00	1
18-3444	Cup, Insert	63V-44322-00-00	1
18-8910	Impeller	68T-44352-00-00	1
NSS	O-Ring	93210-44398-00	1

**18-3451
WATER PUMP KIT**

Replaces: 67F-W0078-00-00
Fits: F75 (2003-06), F80(1999-03), F90(2003-04), F100(1999-02)



— CONTAINS —

Part #	Desc.	O.E.#	Qty.
NSS	Bolt	90119-08M87-00	2
NSS	Bolt	90119-08M13-00	2
18-3042	Impeller	67F-44352-00-00	1
18-3143	Plate, Wear	67F-44323-00-00	1
NSS	Cup, Insert	67F-44322-00-00	1
18-3301	Key, Impeller	90280-04M04-00	1
18-7436	O-Ring	93210-46044-00	1
NSS	Gasket, Water Pump	688-44315-A0-00	1
NSS	Gasket, Water Pump	688-44324-A0-00	1
NSS	Gasket, Water Pump	688-44316-A0-00	1
NSS	Washer, Bolt	90209-08M02-00	4

**18-3409
WATER PUMP KIT (with Housing)**

Replaces: 67F-W0078-00, 67F-44311-01
For: F75(2006-10),F80(1999-03), F90(2006-10), F100(1999-03)



— CONTAINS —

Part #	Desc.	O.E.#	Qty.
NSS	Bolt	90119-08M87-00	2
NSS	Bolt	90119-08M13-00	2
18-3042	Impeller	67F-44352-00-00	1
18-3143	Plate, Wear	67F-44323-00-00	1
NSS	Cup, Insert	67F-44322-00-00	1
18-3301	Key, Impeller	90280-04M04-00	1
18-7436	O-Ring	93210-46044-00	1
NSS	Gasket, Water Pump	688-44315-A0-00	1
NSS	Gasket, Water Pump	688-44324-A0-00	1
NSS	Gasket, Water Pump	688-44316-A0-00	1
NSS	Housing, Water Pump	67F-44311-01-00	1
NSS	Washer, Bolt	90209-08M02-00	4

**18-3465
WATER PUMP KIT**

Without Housing
Replaces: 6H3-W0078-02-00
Fits: T50(1997-05), 60(2001-03), C60(1997-01), C70(2000-01), P60(1997-99), T60(2003-05), 70(1997-03)



— CONTAINS —

Part #	Desc.	O.E.#	Qty.
18-3069	Impeller	697-44352-00-00	1
18-0256	Bolt	97095-08045-00	2
18-0757	Gasket, Water Pump	6H3-44324-A0-00	1
18-3297	Key, Impeller	90280-03M03-00	1
18-3435	Cup, Insert	663-44322-00-00	1
18-7436	O-Ring	93210-46044-00	1
NSS	Plate, Wear	6H3-44323-00-00	1
NSS	Gasket, Water Pump	6H3-44315-A0-00	1
NSS	Gasket, Water Pump	6H3-44324-A0-00	1
NSS	Bolt	97095-08055-00	2
NSS	Washer, Bolt	90209-08M02-00	4

**18-3466
WATER PUMP KIT (with Housing)**

Replaces: 6H3-W0078-01, 6H3-44311-00
For: 70(1992-03), C60(1996-01), E60(1995-96), P60(1992-99), C70(2000-01), T50(1997-10), T60(2003-10)



— CONTAINS —

Part #	Desc.	O.E.#	Qty.
NSS	Housing, Water Pump	6H3-44311-00-00	1
18-0256	Bolt	97095-08045-00	2
18-0757	Gasket, Water Pump	6H3-44324-A0-00	1
18-3069	Impeller	697-44352-00-00	1
18-3297	Key, Impeller	90280-03M03-00	1
18-3435	Cup, Insert	663-44322-00-00	1
18-7436	O-Ring	93210-46044-00	1
NSS	Plate, Wear	6H3-44323-00-00	1
NSS	Gasket, Water Pump	6H3-44315-A0-00	1
NSS	Gasket, Water Pump	688-44316-A0-00	1
NSS	Bolt	97095-08055-00	2
NSS	Washer, Bolt	90209-08M02-00	4

**18-3470
WATER PUMP REPAIR KIT**

Without Housing
Replaces: 6CE-W0078-01
Fits: F225 (2010-15), F250 (2010), F250 (2010-15), F300 (2007-15), F350 (2007-15), FL250 (2010), FL300 (2010), FL350 (2010), LF225 (2010-15), LF250 (2010-15), LF300 (2007-15), LF350 (2007-15), VF250 (2015)



— CONTAINS —

Part #	Desc.	O.E.#	Qty.
NSS	O-Ring, Outer	93210-94003-00	1
18-0256	Bolt	97095-08045-00	4
18-2091	Seal, Oil	93104-22M07-00	2
18-3302	Key, Impeller	90280-04M05-00	1
NSS	Cup, Insert	6AW-44322-00-00	1
NSS	Gasket, Water Pump	6CE-44315-00-00	1
NSS	Plate, Wear	6CE-44323-01-00	1
18-45617-1	Impeller	6CE-44352-00-00	1
18-7483	O-Ring (6G8)	93210-37M67-00	1
NSS	Washer, Bolt	90209-08M02-00	4
NSS	Pin, Dowell	93606-12019-00	2

**18-3471
WATER PUMP REPAIR KIT (with Housing)**

Replaces: 6CE-W0078-01 + 6CE-44311-01
Fits: F225 (2010-15), F250 (2010), F250 (2010-15), F300 (2007-15), F350 (2007-15), FL250 (2010), FL300 (2010), FL350 (2010), LF225 (2010-15), LF250 (2010-15), LF300 (2007-15), LF350 (2007-15), VF250 (2015)



— CONTAINS —

Part #	Desc.	O.E.#	Qty.
NSS	O-Ring, Outer	93210-94003-00	1
18-0256	Bolt	97095-08045-00	4
18-2091	Seal, Oil	93104-22M07-00	2
18-3302	Key, Impeller	90280-04M05-00	1
NSS	Cup, Insert	6AW-44322-00-00	1
NSS	Gasket, Water Pump	6CE-44315-00-00	1
NSS	Plate, Wear	6CE-44323-01-00	1
18-3482	Housing, Water Pump	6CE-44311-01-00	1
18-45617-1	Impeller	6CE-44352-00-00	1
18-7483	O-Ring (6G8)	93210-37M67-00	1
NSS	Washer, Bolt	90209-08M02-00	4
NSS	Pin, Dowel	93606-12019-00	2

**18-3516
WATER PUMP REPAIR KIT**

Without Housing
Replaces: 60X-W0078-00-00
For: VZ200 (3.3L) 2005-2010, VZ225 (3.3L) 2003-2010, VZ250 (3.3L) 2003-2010, VZ300 (3.3L) 2005-2010

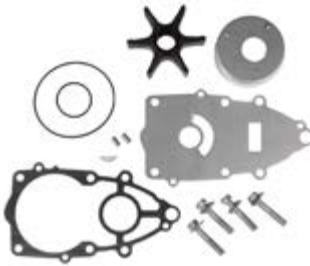

— CONTAINS —

Part #	Desc.	O.E.#	Qty.
18-0256	Bolt	97095-08045-00	4
18-3071	Impeller	6E5-44352-01-00	1
18-3302	Key, Impeller	90280-04M05-00	1
18-3519	Cup, Insert	61A-44322-02-00	1
NSS	Plate, Wear	60X-44323-00-00	1
18-7483	O-Ring (6G8)	93210-37M67-00	1
18-7485	O-Ring	93210-86M38-00	1
18-0406	Gasket, Water Pump	60X-44315-A0-00	1
NSS	Pin, Dowel	93606-12019-00	2
NSS	Washer, Bolt	90209-08M02-00	4

**18-3522-1
WATER PUMP KIT (with Housing)**

Replaces: 60X-W0078-00, 61A-44311-01
For: VZ200(2005-09), VZ225(2003-09), VZ250(2003-09), VZ300(2004-09)



— CONTAINS —

Part #	Desc.	O.E.#	Qty.
18-0256	Bolt	97095-08045-00	4
18-3071	Impeller	6E5-44352-01-00	1
18-3173-1	Housing, Water Pump	6E5-44311-00-00	1
18-3302	Key, Impeller	90280-04M05-00	1
18-3519	Cup, Insert	61A-44322-02-00	1
NSS	Plate, Wear	60X-44323-00-00	1
18-7483	O-Ring (6G8)	93210-37M67-00	1
18-7485	O-Ring, Outer	93210-86M38-00	1
NSS	Gasket, Water Pump	60X-44315-A0-00	1
NSS	Pin, Dowel	93606-12019-00	2
NSS	Washer, Bolt	90209-08M02-00	4

**18-3425
WATER PUMP KIT**

Without Housing
Replaces: 663-W0078-00-00, 663-W0078-A0-00
— CONTAINS —



Part #	Description	O.E. #	Qty.
18-0256	Bolt	97095-08045-00	2
18-0292	Gasket, Water Pump	663-44315-00-00	1
18-0294	Gasket, Water Pump	663-44324-A0-00	1
18-3069	Impeller	697-44352-00-00	1
18-3297	Key, Impeller	90280-03M03-00	1
18-3435	Cup, Insert	663-44322-00-00	1
18-3436	Plate, Wear	663-44323-00-00	1
NSS	Bolt	97095-08055-00	2
NSS	Seal, Water	663-44366-00-00	1

**18-3430
WATER PUMP REPAIR KIT**

Without Housing
Replaces: 6J8-W0078-A1-00
— CONTAINS —



Part #	Description	O.E. #	Qty.
18-0294	Gasket, Water Pump	663-44324-A0-00	1
18-3068	Impeller	6H4-44352-00-00	1
18-3435	Cup, Insert	663-44322-00-00	1
18-3436	Plate, Wear	663-44323-00-00	1
NSS	Gasket, Water Pump	663-44315-A0-00	1
NSS	Gasket, Water Pump	663-44324-A0-00	1
NSS	Bolt	97395-08050-00	2
NSS	Bolt	97395-08040-00	2
NSS	Washer, Bolt	90209-08M02-00	4

**18-3431
WATER PUMP KIT**

Without Housing
Replaces: 6L2-W0078-00-00
— CONTAINS —



Part #	Description	O.E. #	Qty.
NSS	Cup, Insert	6L2-44322-00-00	1
NSS	Bolt	97095-06040-00	4
18-3065	Impeller	6L2-44352-00-00	1
18-7483	O-Ring (6G8)	93210-37M67-00	1
NSS	Plate, Wear	6L2-44323-00-00	1

**18-3460
WATER PUMP KIT**

Replaces: 6N0-W0078-A0-00, 6G1-W0078-A1-00, 6G1-W0078-01-00
Fits: 6(1986-00), 8(1984-05)
— CONTAINS —



Part #	Desc.	O.E.#	Qty.
18-0753	Gasket, Water Pump	6G1-44315-A0-00	1
18-3066	Impeller	6G1-44352-00-00	1
NSS	Cup, Insert	6G1-44322-00-00	1
NSS	Plate, Wear	6G1-44323-00-00	1
NSS	Plate, Bolt	6G1-44328-00-00	2
NSS	Bolt	97095-06045-00	4
NSS	Seal, Water	647-44366-00-00	1

**18-3462
WATER PUMP KIT**

Replaces: 6A1-W0078-02-00
Fits: 2(1988-02)
— CONTAINS —



Part #	Desc.	O.E.#	Qty.
NSS	Protector, Oil Seal	6A1-44325-00-00	1
18-3072	Impeller	646-44352-01-00	1
NSS	Cup, Insert	646-44322-00-00	1
18-3357	Plate, Wear	646-44323-00-00	1
18-7463	O-Ring	93210-19123-00	1
NSS	Seal, Water	646-44366-01-00	1
NSS	Seal, Oil	93101-11M44-00	2
NSS	Pin, Dowel	93604-09068-00	2
NSS	Bolt	97095-05016-00	2

**18-3463
WATER PUMP KIT**

Replaces: 6A1-W0078-01-00
Fits: 2(1984-87)
— CONTAINS —



Part #	Desc.	O.E.#	Qty.
NSS	Protector, Oil Seal	6A1-44325-00-00	1
NSS	Impeller	646-44322-00-00	1
NSS	Cup, Insert	646-44322-00-00	1
18-3357	Plate, Wear	646-44323-00-00	1
18-7463	O-Ring	93210-19123-00	1
NSS	Seal, Water	646-44366-01-00	1
NSS	Seal, Oil	93103-11051-00	1
NSS	Pin, Dowel	93604-09068-00	2
NSS	Bolt	97095-05016-00	2

**18-3515
WATER PUMP REPAIR KIT**

Replaces: 6P2-W0078-00-00
For: F225 Produced after 04/2007 / F250 Produced after 4/2006
— CONTAINS —

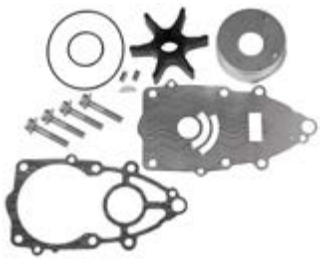

Part #	Desc.	O.E.#	Qty.
18-0256	Bolt	97095-08045-00	4
18-0406	Gasket, Water Pump	60X-44315-A0-00	1
18-3071	Impeller	6E5-44352-01-00	1
18-3302	Key, Impeller	90280-04M05-00	1
18-3518	Plate, Wear	6P2-44323-00-00	1
18-3519	Cup, Insert	61A-44322-02-00	1
18-7483	O-Ring (6G8)	93210-37M67-00	1
18-7485	O-Ring	93210-86M38-00	1
NSS	Pin, Dowel	93606-12019-00	2
NSS	Washer, Bolt	90209-08M02-00	4

**18-3432
WATER PUMP KIT**

Replaces: 61N-W0078-11-00
Fits: F25(1998-05)
— CONTAINS —



Part #	Desc.	O.E.#	Qty.
18-0191	Plate, Washer	92990-06600-00	4
NSS	Bolt	97095-06040-00	4
18-3068	Impeller	6H4-44352-00-00	1
18-3185	Housing, Water Pump	61N-44311-01-00	1
NSS	Plate, Wear	61N-44323-00-00	1
18-3297	Key, Impeller	90280-03M03-00	1
18-3443	Cup, Insert	61N-44322-01-00	1
18-7115	O-Ring	93210-45161-00	1
NSS	Seal, Water	6L2-44367-00-00	1

18-48619
COMPLETE
WATER PUMP KIT
 Replaces: 68D-WG078-00-00
 Fits: Yamaha F4(2002-08)



— CONTAINS —

Part #	Desc.	O.E.#	Qty.
18-43263	Housing, Water Pump	68D-G4311-01-00	1
18-3073	Impeller	6E0-44352-00-00	1
18-43531	Cup, Insert	6E0-44322-02-00	1
18-43716	Pin, Impeller	93604-18080-00	1
18-43818	Bolt	97095-06045-00	4
18-60541	Gasket, Water Pump	6BX-G4315-01-00	1
NSS	Plate, Wear	6E0-44323-00-00	1
NSS	Tube, Rubber	67D-44366-00-00	1
NSS	Washer, Bolt	N/A	4
NSS	Plate, Bolt	68D-G4328-00-00	2

18-3473
WATER PUMP KIT
With Housing
 Replaces: 6EE-W0078-00-00
 Fits: F4 (2009-17), F6 (2009-17)



— CONTAINS —

Part #	Description	O.E.#	Qty.
18-3073	Impeller	6E0-44352-00	1
18-4567	Housing, Water Pump	6EE-G4311-00	1
18-60541	Gasket, Water Pump	6EE-G4315-00	1
18-4546	Cup, Insert	6EE-G4322-00	1
18-4573	Plate, Wear	6EE-G4323-00	1
18-1840	Damper, Water Seal 2	6EE-G4366-00	1
18-43716	Pin, Dowel (647)	93604-18080	2
18-0261	Bolt	97080-06045	4

18-3474
WATER PUMP KIT
Without Housing
 Replaces: 6CB-W0078-00-00
 Fits: VF225, VF250 (2009-18)



— CONTAINS —

Part #	Description	O.E.#	Qty.
18-3519	Cup, Insert	61A-44322-02	1
18-0451	Gasket, Water Pump	6CB-44315-00-00	1
18-4572	Plate, Wear	6CB-44323-00-00	1
18-3071	Impeller	6E5-44352-01	1
NSS	Bolt, With Washer	90119-08M14	4
18-3302	Key, Woodruff	90280-04002	1
18-7483	O-Ring (6G8)	93210-37M67	1
18-7485	O-Ring (6E5)	93210-86M38	1
NSS	Pin, Dowel (614)	93606-12019	2

18-3475
WATER PUMP KIT
Without Housing
 Replaces: 69G-W0078-00
 Fits: T9.9 (2007-17)



— CONTAINS —

Part #	Description	O.E.#	Qty.
18-3444	Cup, Insert	63V-44322-00	1
18-3040	Impeller	63V-44352-01	1
NSS	Key, Woodruff	664-44338-00	1
18-3142	Plate, Wear	68T-44323-00	1
18-3176	Damper, Water Seal 2	68T-44366-00	1
NSS	O-Ring (55X)	93210-44704	1
18-0256	Bolt	97095-08045	4

18-3477
WATER PUMP KIT
Without Housing
 Replaces: 6AW-W0078-00-00
 Fits: F300, LF300 (2007-09)



— CONTAINS —

Part #	Description	O.E.#	Qty.
18-0452	Gasket, Water Pump	6AW-44315-00	1
NSS	Cup, Insert	6AW-44322-00	1
18-0421	Plate, Wear	6AW-44323-00	1
18-3028	Key, Impeller	6AW-44336-00	1
18-8925	Impeller	6AW-44352-00	1
NSS	Bolt, With Washer	90119-08M14	4
18-7483	O-Ring (6G8)	93210-37M67	1
NSS	O-Ring (6G8)	93210-94003	1
NSS	Pin, Dowel (614)	93606-12019	2

18-3479
WATER PUMP KIT
With Housing
 Replaces: 6AH-W0078-00
 Fits: F15C, F20 (2006-17)



— CONTAINS —

Part #	Description	O.E.#	Qty.
18-3444	Cup, Insert	63V-44322-00	1
18-9090	Plate	63V-44328-01	2
18-3040	Impeller	63V-44352-01	1
NSS	Key, Woodruff	664-44338-00	1
18-3142	Plate, Wear	68T-44323-00	1
NSS	Housing, Water Pump	6AH-44311-00	1
18-1836	Damper, Water Seal	6L2-44367-00	1
18-71333	O-Ring (620)	93210-49046	1
NSS	Pin, Dowel (688)	93604-10M03	2
18-0256	Bolt, Hexagon	97095-08045	4

18-3490
WATER PUMP KIT
Without Housing
 Replaces: 6BG-W0078-00-00
 Fits: F30 (2013-17), F40A (2008-17)



— CONTAINS —

Part #	Description	O.E.#	Qty.
18-9083	Cover, Water Pump Housing	63D-44312-00	1
18-0483	Gasket, Water Pump	63D-44316-00	1
18-3449	Cup, Insert	63D-44322-00	1
18-3186	Plate, Wear	63D-44323-00	1
18-1830	Seal, Water Damper 2	663-44366-00	1
18-3068	Impeller	6H4-44352-02	1
NSS	Bolt, With Washer	90119-08M15	4
18-3297	Key, Woodruff	90280-03M03	1
18-71334	O-Ring	93210-59MG7	1

18-3494
WATER PUMP KIT
Without Housing
 Replaces: 6CJ-W0078-00-00
 Fits: F70A (2010-17)



— CONTAINS —

Part #	Description	O.E.#	Qty.
18-9083	Cover, Water pump Housing	63D-44312-00	1
18-3449	Cup, Insert	63D-44322-00	1
18-1830	Seal, Water Damper 2	663-44366-00	1
NSS	Gasket, Water Pump	6CJ-44315-00	1
18-0449	Gasket, Water Pump	6CJ-44316-00	1
18-3186	Plate, Wear	6CJ-44323-00	1
18-0450	Gasket, Water Pump	6CJ-44324-00	1
18-3069	Impeller	6H3-44352-00	1
NSS	Bolt, With Washer	90119-08M14	2
18-0260	Bolt, With Washer	90119-08M33	2
18-3297	Key, Woodruff (697)	90280-03M03	1
18-0297	Oil Seal (663)	93101-23070	2
18-7436	O-Ring	93210-46044	1
NSS	Pin, Dowel (688)	93604-10M03	2



18-4527
WATER PUMP KIT
With Housing
Replaces: 6FM-W0078-00-00
Fits: F25C (2016-17)

— CONTAINS —

Part #	Description	O.E. #	Qty.
18-4576	Plate, Wear	6FM-44323-01	1
18-3486	Housing, Water Pump	6L2-44311-01	1
NSS	Cup, Insert	6L2-44322-00	1
18-9092	Plate	6L2-44328-00	2
18-3065	Impeller	6L2-44352-00	1
18-1837	Seal, Water Damper 3	6L2-44367-10	1
18-3305	Key, Woodruff (662)	90280-03024	1
NSS	O-Ring	93210-45161	1
NSS	Pin, Dowel (688)	93604-10M03	2
18-8407	Bolt, With Washer	97595-06540	4



18-4532
WATER PUMP KIT
Without Housing
Replaces: 6EG-W0078-00-00
Fits: F2.5 (2015-17)

— CONTAINS —

Part #	Description	O.E. #	Qty.
18-1840	Seal, Water Damper 2	6EE-G4366-00	1
18-99157	Gasket, Water Pump	6EG-G4315-00	1
18-4547	Cup, Insert	6EG-G4322-00	1
18-4574	Plate, Wear	6EG-G4323-00	1
18-9089	Plate	6EG-G4328-00	2
18-8911	Impeller	6L5-44352-00	1
NSS	Pin, Dowel (688)	93604-10M03	2
18-8406	Bolt W/ Washer	97595-06535	4



18-4533
WATER PUMP KIT
Without Housing
Replaces: 65N-W0078-A0-00
Fits: B115 (1998-99), D150 (1997-98), DX150 (1999-05)

— CONTAINS —

Part #	Description	O.E. #	Qty.
18-3519	Cup, Insert	61A-44322-02	1
18-0453	Gasket, Water Pump	65N-44315-A0	1
18-0408	Plate, Wear	65N-44323-00	1
18-3071	Impeller	6E5-44352-01	1
NSS	Bolt, With Washer	90119-08M14	4
18-3302	Key, Woodruff (6E5)	90280-04M05	1
18-7483	O-Ring (6G8)	93210-37M67	1
18-7485	O-Ring (6E5)	93210-86M38	1
NSS	Pin, Dowel (614)	93606-12019	2



18-4534
WATER PUMP KIT
Without Housing
Replaces: 69M-WG078-00-00
Fits: F2.5 (2003-15)

— CONTAINS —

Part #	Description	O.E. #	Qty.
18-3166	Seal, Water Damper 2	6E0-44366-00	1
18-7119	O-Ring	93210-33M85	1
18-3164	Cup, Insert	6L5-44322-00	1
18-8911	Impeller	6L5-44352-00	1
18-0409	Plate, Wear	69M-G4323-00	1
18-43716	Pin, Dowel	93604-18080	2
18-71330	O-Ring	93210-05001	1
NSS	Bolt	97095-06040	4
18-9091	Plate	69M-G4328-00	1

YAMAHA 4-STROKE WATER PUMP APPLICATION CHART

HP Model	Year	Impeller	Cup	Plate	Housing	Damper Seal	Water Pump Cover	Kit without Housing	Kit with Housing
F2.5	2003-15	18-8911	-	18-0409	-	18-3166	-	18-4534	-
F2.5	2016-18	18-8911	18-4547	18-4574	-	18-1840	-	18-4532	-
4	1984-99	18-3073	-	-	-	-	-	-	-
F4	1999-13	18-3073	-	-	-	-	-	-	-
F4	2014-18	18-3073	18-4546	18-4573	18-4567	18-1840	-	18-3473	-
F6	2001-08	18-8910	18-3444	18-3142	18-3356	18-3176	-	18-3450	18-3410
F6	2009-17	18-3073	18-4546	18-4573	18-4567	-	-	18-3473	-
F8	2001-17	18-8910	18-3444	18-3142	18-3356	18-3176	-	18-3450	18-3410
T8	2001-10	18-3040	18-3444	18-3142	18-3356	18-3176	-	18-3450	18-3410
F9.9	1985-05	18-3074	-	-	-	18-1834	-	18-3148	18-3411
F9.9	2005-06	18-3040	18-3444	18-3195	18-3356	18-1833	-	18-3433	18-3412
F9.9	2007-17	18-8910	18-3444	18-3142	18-3356	18-3176	-	18-3450	18-3410
FT9.9	1985-90	18-3074	-	-	-	18-1834	-	18-3148	18-3411
T9.9	1985-05	18-3074	-	-	-	18-1834	-	18-3148	18-3411
T9.9	2005-06	18-3040	18-3444	18-3195	18-3356	18-1833	-	18-3433	18-3412
T9.9	2007-17	18-3040	18-3444	18-3142	18-3356	18-3176	-	18-3475	-
F15	1998-06	18-3040	18-3444	18-3195	18-3356	18-1833	-	18-3433	18-3412
F15C	2006-18	18-3040	18-3444	18-3142	18-3484	18-1836	-	18-3479	-
F20	2006-18	18-3040	18-3444	18-3142	18-3484	18-1836	-	18-3479	-
F25	1998-05	18-3068	18-3443	-	18-3185	-	-	-	18-3432
F25A	2009-17	18-3068	18-3443	-	18-3185	-	-	-	18-3432
F25B	2012-17	18-3068	18-3443	-	18-3185	-	-	-	18-3432
F25C	2016-17	18-3065	-	18-4576	18-3486	18-1837	-	18-4527	-
T25	2001-06, 2009-17	18-3068	18-3449	18-3196	-	-	-	18-3440	18-3413
F30	2001-05	18-3068	18-3449	18-3196	-	-	-	18-3440	18-3413
F30	2013-17	18-3068	18-3449	18-3186	-	18-1830	18-9083	18-3490	18-3413

APPLICATION CONTINUES ON NEXT PAGE

YAMAHA 4-STROKE WATER PUMP APPLICATION CHART

HP Model	Year	Impeller	Cup	Plate	Housing	Damper Seal	Water Pump Cover	Kit without Housing	Kit with Housing
F40	1999	18-3069	18-3449	18-3186	-	-	-	18-3434	18-3415
F40	2000-06	18-3068	18-3449	18-3196	-	-	-	18-3440	18-3413
F40A	2008-17	18-3068	18-3449	18-3186	-	18-1830	18-9083	18-3490	18-3413
F40B	2007-08	18-3068	18-3449	18-3196	-	-	-	18-3440	18-3413
F50	1995-17	18-3069	18-3449	18-3186	-	-	-	18-3434	18-3415
F50	1996	18-3069	18-3435	-	-	-	-	18-3428-1	18-3461
F50	1997	18-3069	18-3435	-	-	-	-	18-3465	18-3466
T50	1996	18-3069	18-3435	-	-	-	-	18-3428-1	18-3461
T50	1997-17	18-3069	18-3435	-	-	-	-	18-3465	18-3466
F60	2002-17	18-3069	18-3449	18-3186	-	-	-	18-3434	18-3415
T60	2003-17	18-3069	18-3435	-	-	-	-	18-3465	18-3466
F70A	2010-17	18-3069	18-3449	-	18-3485	-	-	18-3494	-
F75A	2003-17	18-3042	-	18-3143	-	18-1830	-	18-3451	18-3409
F75B	2017	18-3071	18-3519	18-3521	18-3173-1	18-1835	18-9081	18-3442	18-3523-1
F80	1999-03	18-3042	-	18-3143	-	18-1830	-	18-3451	18-3409
F90	2003-11	18-3042	-	18-3143	-	18-1830	-	18-3451	18-3409
F90A	2012-17	18-3042	-	18-3143	-	18-1830	-	18-3451	18-3409
F90B	2016-17	18-3071	18-3519	18-3521	18-3173-1	18-1835	18-9081	18-3442	18-3523-1
VF90A	2018	18-3071	18-3519	18-3521	18-3173-1	18-1835	18-9081	18-3442	18-3523-1
F100	1999-03	18-3042	-	18-3143	-	18-1830	-	18-3451	18-3409
F115/LF115	2000-01	18-3071	18-3333	18-3344	18-3173-1	18-1835	18-9081	-	18-3313-1
F115/LF115	2002-17	18-3071	18-3519	18-3521	18-3173-1	18-1835	18-9081	18-3442	18-3523-1
VF115	2015-17	18-3071	18-3519	18-3521	18-3173-1	18-1835	18-9081	18-3442	18-3523-1
F150 / LF150	2004-11	18-3071	18-3519	18-3345	18-3173-1	18-1835	18-9081	18-3395	18-3396-1
F150A / LF150A	2012-14	18-3071	18-3519	18-3345	18-3173-1	18-1835	18-9081	18-3395	18-3396-1
F150B / LF150B	2015-18	18-3071	18-3519	18-3345	18-3173-1	18-1835	18-9081	18-3395	18-3396-1
F150C / LF150C	2017	18-3071	18-3519	18-3345	18-3173-1	18-1835	18-9081	18-3395	18-3396-1
VF150	2013-17	18-3071	18-3519	18-3345	18-3173-1	18-1835	18-9081	18-3395	18-3396-1
VF150A	2018	18-3071	18-3519	18-3345	18-3173-1	18-1835	18-9081	18-3395	18-3396-1
F175A	2014-18	18-3071	18-3519	18-3345	18-3173-1	18-1835	18-9081	18-3395	18-3396-1
F175 / LF175C	2017	18-3071	18-3519	18-3345	18-3173-1	18-1835	18-9081	18-3395	18-3396-1
VF175	2015-18	18-3071	18-3519	18-3345	18-3173-1	18-1835	18-9081	18-3395	18-3396-1
F200/LF200	2002-10	18-3071	18-3519	18-3345	18-3173-1	18-1835	18-9081	18-3395	18-3396-1
F200A/LF200A	2010-17	18-3071	18-3519	18-3345	18-3173-1	18-1835	18-9081	18-3395	18-3396-1
F200B/LF200B	2012-18	18-3071	18-3519	18-3345	18-3173-1	18-1835	18-9081	18-3395	18-3396-1
F200C/LF200C	2013-18	18-3071	18-3519	18-3345	18-3173-1	18-1835	18-9081	18-3395	18-3396-1
VF200	2009-18	18-3071	18-3519	-	18-3173-1	18-1835	18-9081	-	-
F225 / LF225	2002-10	18-3071	18-3519	18-3345	18-3173-1	18-1835	18-9081	18-3395	18-3396-1
F225 / LF225	2007-09	18-3071	18-3519	18-3518	18-3173-1	18-1835	18-9081	18-3515	-
F225A/LF225A (3.3L)	2011-17	18-3071	18-3519	18-3345	18-3173-1	18-1835	18-9081	18-3395	18-3396-1
F225A/LF225A (4.2L)	2010-17	18-45617-1	-	-	18-3482	18-1829	18-9082	18-3470	18-3471
F225B/LF225B (4.2L)	2016-17	18-45617-1	-	-	18-3482	18-1829	18-9082	18-3470	18-3471
F225B/LF225B (3.3L)	2016-17	18-3071	18-3519	18-3345	18-3173-1	18-1835	18-9081	18-3395	18-3396-1
VF225 (4.2L)	2009-18	18-3071	18-3519	-	18-3173-1	18-1835	18-9081	18-3474	-
F250 / LF250 (3.3L)	2005	18-3071	18-3519	18-3345	18-3173-1	18-1835	18-9081	18-3395	18-3396-1
F250 / LF250 (3.3L)	2006-11	18-3071	18-3519	18-3518	18-3173-1	18-1835	18-9081	18-3515	-
F250A / LF250A (3.3L)	2010-17	18-3071	18-3519	18-3518	18-3173-1	18-1835	18-9081	18-3515	-
F250A / LF250A (4.2L)	2014-17	18-45617-1	-	-	18-3482	18-1829	18-9082	18-3470	18-3471
F250B / LF250B (3.3L)	2008-09	18-3071	18-3519	18-3518	18-3173-1	18-1835	18-9081	18-3515	-
F250B / LF250B (4.2L)	2016-17	18-45617-1	-	-	18-3482	18-1829	18-9082	18-3470	18-3471
FL250	2010	18-45617-1	-	-	18-3482	18-1829	18-9082	18-3470	18-3471
VF250	2009-18	18-3071	18-3519	-	18-3173-1	18-1835	18-9081	18-3474	-
VF250 (XA Models)	2015-18	18-45617-1	-	-	18-3482	18-1829	18-9082	18-3470	18-3471
F300 / LF300 (5.3L)	2007-09	18-8925	-	18-0421	18-3483	18-1835	18-9081	18-3477	-
F300 / LF300 (4.2L)	2010-18	18-45617-1	-	-	18-3482	18-1829	18-9082	18-3470	18-3471
FL300	2010, 2016	18-45617-1	-	-	18-3482	18-1829	18-9082	18-3470	18-3471
F350 / LF350 (5.3L)	2007-09	18-8925	-	18-0421	18-3483	18-1835	18-9081	18-3477	-

CHART CONTINUED ON NEXT PAGE

YAMAHA 4-STROKE WATER PUMP APPLICATION CHART

HP Model	Year	Impeller	Cup	Plate	Housing	Damper Seal	Water Pump Cover	Kit without Housing	Kit with Housing
F350A / LF350A (5.3L)	2010-11	18-8925	-	18-0421	18-3483	18-1835	18-9081	18-3477	-
F350B / LF350B (5.3L)	2012-15	18-8925	-	18-0421	18-3483	18-1835	18-9081	18-3477	-
F350C / LF350C (5.3L)	2016-18	18-8925	-	18-0421	18-3483	18-1835	18-9081	18-3477	-
FL350 (5.3L)	2010	18-8925	-	18-0421	18-3483	18-1835	18-9081	18-3477	-

YAMAHA 2-STROKE WATER PUMP APPLICATION CHART

HP Model	Year	Impeller	Cup	Plate	Housing	Damper Seal	Water Pump Cover	Kit without Housing	Kit with Housing
2	1984-87	18-3072	-	18-3357	-	18-3166	-	18-3463	-
2	1988-02	18-3072	-	18-3357	-	18-3166	-	18-3462	-
3	1988-02	18-8911	18-3164	18-3163	-	18-3166	-	-	-
4	1984-99	18-3073	-	-	-	18-3166	-	-	-
5	1984-02	18-3073	-	-	-	18-3166	-	-	-
6	1986-00	18-3066	-	-	-	18-1833	-	18-3460	-
8	1984-09	18-3066	-	-	-	18-1833	-	18-3460	-
9.9	1984-95	18-3074	-	-	-	18-1834	-	18-3148	18-3411
9.9	1996-09	18-3040	18-3444	18-3195	-	18-1833	-	18-3433	18-3412
15	1984-95	18-3074	-	-	-	18-1834	-	18-3148	18-3411
15	1996-09	18-3040	18-3444	18-3195	-	18-1833	-	18-3433	18-3412
20	1996-97	18-3065	-	-	-	-	-	18-3431	-
25	1984-85	18-3067	-	-	-	-	-	-	-
25	1986-87	18-3067	-	-	-	-	-	-	-
25 (2 cyl)	1988-09	18-3065	-	-	-	-	-	18-3431	-
25 (3 cyl)	1997-02	18-3068	-	-	-	-	-	-	-
C25	1991-97	18-3067	-	-	-	-	-	-	-
CV25	1990	18-3067	-	-	-	-	-	-	-
30	1984-85	18-3067	-	-	-	-	-	-	-
30	1986	18-3067	-	-	-	-	-	-	-
30	1987-02	18-3068	18-3435	18-3436	-	-	-	18-3430	-
C30	1991-92	18-3067	-	-	-	-	-	-	-
C30	1993-97	18-3068	18-3443	-	18-3185	6L2-44367-00-00	-	-	18-3432
CV30	1989-90	18-3067	-	-	-	-	-	-	-
40	1984-87	18-3068	18-3435	18-3436	-	-	-	18-3429	18-3408
40	1988-94	18-3068	18-3435	18-3436	-	-	-	18-3429	-
40	1995-05	18-3069	18-3449	18-3186	-	-	-	18-3434	18-3415
C40	1990-91	18-3088	-	-	-	-	-	18-3397	-
C40	1992-97	18-3088	-	-	-	-	-	18-3397	18-3398
C40	1997-03	18-3069	18-3449	18-3186	-	-	-	18-3434	18-3415
P40	1998	18-3069	18-3449	18-3186	-	-	-	18-3434	18-3415
E48	1995-2000	18-3069	-	-	-	-	-	-	-
50	1984-87	18-3068	18-3435	18-3436	-	-	-	18-3429	18-3408
50	1988-94	18-3068	18-3435	18-3436	-	-	-	18-3429	-
50	1995-09	18-3069	18-3449	18-3186	-	-	-	18-3434	18-3415
C50	1998-01	18-3069	18-3449	18-3186	-	-	-	18-3434	18-3415
PRO 50	1987	18-3068	18-3435	18-3436	-	-	-	18-3429	18-3408
PRO 50	1988-90	18-3068	18-3435	18-3436	-	-	-	18-3429	-
P50	1991-94	18-3068	18-3435	18-3436	-	-	-	18-3429	-
P50	1995-96	18-3069	18-3449	18-3186	-	-	-	18-3434	-
50 Jet	1986-95	18-3068	-	-	-	-	-	-	-
C55	1991-95	18-3069	18-3435	18-3436	-	-	-	18-3425	-
CV55	1989-90	18-3069	18-3435	18-3436	-	-	-	18-3425	-
60	2001-03	18-3069	18-3435	-	-	-	-	18-3465	-
60	2004-05	18-3070	-	-	18-3171	18-1830	-	18-3370	18-3371
C60	1996-01	18-3069	18-3435	-	-	-	-	18-3465	18-3466
E60	1995-96	18-3069	18-3435	-	-	-	-	18-3465	18-3466
E60	1997-00	18-3069	-	-	-	-	-	-	-
P60	1991	18-3069	18-3435	-	-	-	-	18-3428-1	18-3461

CHART CONTINUED ON NEXT PAGE

YAMAHA 2-STROKE WATER PUMP APPLICATION CHART

HP Model	Year	Impeller	Cup	Plate	Housing	Damper Seal	Water Pump Cover	Kit without Housing	Kit with Housing
P60	1992-99	18-3069	18-3435	-	-	-	-	18-3465	18-3466
70	1984-91	18-3069	18-3435	-	-	-	-	18-3428-1	18-3461
70	1992-03	18-3069	18-3435	-	-	-	-	18-3465	18-3466
70	2004-09	18-3070	-	-	18-3171	18-1830	-	18-3370	18-3371
C70	2000-01	18-3069	18-3435	-	-	-	-	18-3465	18-3466
C75	1994-99	18-3070	-	-	18-3171	18-1830	-	18-3370	18-3371
E75	1995-00	18-3070	-	-	-	-	-	-	-
P75	1996-99	18-3070	-	-	-	-	-	-	-
C80	1997	18-3070	-	-	-	-	-	-	-
C85	1991-96	18-3070	-	-	18-3171	18-1830	-	18-3370	18-3371
CV85	1989-90	18-3070	-	-	18-3171	18-1830	-	18-3370	18-3371
90	1984-09	18-3070	-	-	18-3171	18-1830	-	18-3370	18-3371
90 Jet	1986-89	18-3070	-	-	-	-	-	-	-
90 Jet	1992-94	18-3071	-	-	-	-	-	-	-
B90	1997-99	18-3070	-	-	-	18-1830	-	-	-
C90	1997-01	18-3070	-	-	18-3171	18-1830	-	18-3370	18-3371
115	2002-09	18-3071	18-3333	18-3344	18-3173-1	18-1835	18-9081	18-3312	18-3313-1
115	1995-01	18-3071	18-3333	18-3344	18-3173-1	18-1835	18-9081	18-3312	18-3313-1
115 (6N6), (6E5)	1984-94	18-3071	-	18-3344	18-3170	18-1835	-	18-3372	18-3373
115 (6N6)	1994	18-3071	18-3333	18-3344	18-3173-1	18-1835	18-9081	18-3312	18-3313-1
B115	1998-99	18-3071	18-3519	18-0408	18-3173-1	18-1835	18-9081	18-4533	-
C115	1991-92	18-3071	-	18-3344	18-3170	18-1835	-	18-3372	18-3373
C115	1993-00	18-3071	18-3333	18-3344	18-3173-1	18-1835	18-9081	18-3312	18-3313-1
P115 (62A)	1993-96	18-3071	18-3333	18-3344	18-3173-1	18-1835	18-9081	18-3312	18-3313-1
S115	1996-99	18-3071	18-3519	18-3344	18-3173-1	18-1835	18-9081	18-3312	18-3313-1
130 (6L1), (6N7)	1988-92	18-3071	-	18-3344	18-3170	18-1835	-	18-3372	18-3373
130 (6N7)	1993-96	18-3071	18-3333	18-3344	18-3173-1	18-1835	18-9081	18-3312	18-3313-1
130	1997-04	18-3071	18-3519	18-3344	18-3173-1	18-1835	18-9081	18-3312	18-3313-1
L130 (6L6), (6N4)	1989-92	18-3071	-	18-3344	18-3170	18-1835	-	18-3372	18-3373
L130 (6N4)	1993-96	18-3071	18-3333	18-3344	18-3173-1	18-1835	18-9081	18-3312	18-3313-1
L130	1997-01	18-3071	18-3519	18-3344	18-3173-1	18-1835	18-9081	18-3312	18-3313-1
S130	1996-99	18-3071	18-3519	18-3344	18-3173-1	18-1835	18-9081	18-3312	18-3313-1
150 (6R2), (6G4)	1984-91	18-3071	-	18-3344	18-3170	18-1835	-	18-3310	18-3311
150 (6R2)	1992-09	18-3071	18-3333	18-3345	18-3173-1	18-1835	18-9081	18-3395	18-3396-1
C150 (6E5)	1996-99	18-3071	18-3333	18-3345	18-3173-1	18-1835	18-9081	18-3395	18-3396-1
D150	1997-98	18-3071	18-3519	18-0408	18-3173-1	18-1835	18-9081	18-4533	-
DX150	1999-05	18-3071	18-3519	18-0408	18-3173-1	18-1835	18-9081	18-4533	-
L150 (6R0), (6K0)	1986-91	18-3071	-	18-3344	18-3170	18-1835	-	18-3310	18-3311
L150 (6R0)	1992-99	18-3071	18-3333	18-3345	18-3173-1	18-1835	18-9081	18-3395	18-3396-1
LX150	1999-01	18-3071	18-3333	18-3345	18-3173-1	18-1835	18-9081	18-3395	18-3396-1
P150	1986-91	18-3071	-	18-3344	18-3170	18-1835	-	18-3310	18-3311
P150	1992-99	18-3071	18-3333	18-3345	18-3173-1	18-1835	18-9081	18-3395	18-3396-1
PRO V150 (6J9)	1986-89	18-3071	-	18-3344	18-3170	18-1835	-	18-3310	18-3311
PRO V150D (6N9)	1990	18-3071	-	18-3344	18-3170	18-1835	-	18-3310	18-3311
PX150	1999	18-3071	18-3333	18-3345	18-3173-1	18-1835	18-9081	18-3395	18-3396-1
S150	1996-99	18-3071	18-3333	18-3345	18-3173-1	18-1835	18-9081	18-3395	18-3396-1
SX150	1999-04	18-3071	18-3333	18-3345	18-3173-1	18-1835	18-9081	18-3395	18-3396-1
V150	2000-08	18-3071	18-3333	18-3345	18-3173-1	18-1835	18-9081	18-3395	18-3396-1
VX150	2000-04	18-3071	18-3333	18-3345	18-3173-1	18-1835	18-9081	18-3395	18-3396-1
VZ150	2000-14	18-3071	18-3333	18-3345	18-3173-1	18-1835	18-9081	18-3395	18-3396-1
Z150/LZ150	2000-05	18-3071	18-3333	18-3345	18-3173-1	18-1835	18-9081	18-3395	18-3396-1
175 (6G5)	1984-91	18-3071	-	18-3344	18-3170	18-1835	-	18-3310	18-3311
175 (6R3)	1992-00	18-3071	18-3333	18-3345	18-3173-1	18-1835	18-9081	18-3395	18-3396-1
P175 (62H)	1994-99	18-3071	18-3333	18-3345	18-3173-1	18-1835	18-9081	18-3395	18-3396-1
S175	1996-99	18-3071	18-3333	18-3345	18-3173-1	18-1835	18-9081	18-3395	18-3396-1
V175	2000	18-3071	18-3333	18-3345	18-3173-1	18-1835	18-9081	18-3395	18-3396-1

CHART CONTINUED ON NEXT PAGE

YAMAHA 2-STROKE WATER PUMP APPLICATION CHART

HP Model	Year	Impeller	Cup	Plate	Housing	Damper Seal	Water Pump Cover	Kit without Housing	Kit with Housing
VZ175	2001-12	18-3071	18-3333	18-3345	18-3173-1	18-1835	18-9081	18-3395	18-3396-1
Z175	2001-05	18-3071	18-3333	18-3345	18-3173-1	18-1835	18-9081	18-3395	18-3396-1
200 (6G6), (6R4)	1984-91	18-3071	-	18-3344	18-3170	18-1835	-	18-3310	18-3311
200 (6R4)	1992-99	18-3071	18-3333	18-3345	18-3173-1	18-1835	18-9081	18-3395	18-3396-1
L200 (6K1), (6R1)	1986-91	18-3071	-	18-3344	18-3170	18-1835	-	18-3310	18-3311
L200	1992-99	18-3071	18-3333	18-3345	18-3173-1	18-1835	18-9081	18-3395	18-3396-1
LX200	1999-01	18-3071	18-3333	18-3345	18-3173-1	18-1835	18-9081	18-3395	18-3396-1
LZ200	2000-12	18-3071	18-3333	18-3345	18-3173-1	18-1835	18-9081	18-3395	18-3396-1
P200	1991-99	18-3071	18-3333	18-3345	18-3173-1	18-1835	18-9081	18-3395	18-3396-1
S200	1996-99	18-3071	18-3333	18-3345	18-3173-1	18-1835	18-9081	18-3395	18-3396-1
SX200	1999-05	18-3071	18-3333	18-3345	18-3173-1	18-1835	18-9081	18-3395	18-3396-1
V200	1998-99	18-3071	18-3333	18-3345	18-3173-1	18-1835	18-9081	18-3395	18-3396-1
VX200	2000-05	18-3071	18-3333	18-3345	18-3173-1	18-1835	18-9081	18-3395	18-3396-1
VZ200	2001-04	18-3071	18-3333	18-3345	18-3173-1	18-1835	18-9081	18-3395	18-3396-1
VZ200	2005-09	18-3071	18-3519	-	18-3173-1	18-1835	18-9081	18-3516	-
Z200	2000-12	18-3071	18-3333	18-3345	18-3173-1	18-1835	18-9081	18-3395	18-3396-1
V6 Special (6G7)	1984-86	18-3071	-	18-3344	18-3170	18-1835	-	18-3310	18-3311
V6 Excel (6K7)	1987-89	18-3071	-	18-3344	18-3170	18-1835	-	18-3310	18-3311
225 (6R5)	1990-91	18-3071	-	18-3344	18-3170	18-1835	-	18-3310	18-3311
225	1992-97	18-3071	18-3333	18-3345	18-3173-1	18-1835	18-9081	18-3395	18-3396-1
L225	1994-99	18-3071	18-3333	18-3345	18-3173-1	18-1835	18-9081	18-3395	18-3396-1
LX225	2000-03	18-3071	18-3333	18-3345	18-3173-1	18-1835	18-9081	18-3395	18-3396-1
S225	1996-99	18-3071	18-3333	18-3345	18-3173-1	18-1835	18-9081	18-3395	18-3396-1
SX225	2000-03	18-3071	18-3333	18-3345	18-3173-1	18-1835	18-9081	18-3395	18-3396-1
V225	1998-99	18-3071	18-3333	18-3345	18-3173-1	18-1835	18-9081	18-3395	18-3396-1
VX225	2000-04	18-3071	18-3333	18-3345	18-3173-1	18-1835	18-9081	18-3395	18-3396-1
VZ225	2003-09	18-3071	18-3519	-	18-3173-1	18-1835	18-9081	18-3516	-
250	1990-95	18-3071	18-3333	18-3345	18-3173-1	18-1835	18-9081	18-3395	18-3396-1
L250	1990-99	18-3071	18-3333	18-3345	18-3173-1	18-1835	18-9081	18-3395	18-3396-1
LX250	2000-03	18-3071	18-3333	18-3345	18-3173-1	18-1835	18-9081	18-3395	18-3396-1
LZ250	2003-05	18-3071	18-3333	18-3345	18-3173-1	18-1835	18-9081	18-3395	18-3396-1
S250	1996-99	18-3071	18-3333	18-3345	18-3173-1	18-1835	18-9081	18-3395	18-3396-1
SX250	2000-03	18-3071	18-3333	18-3345	18-3173-1	18-1835	18-9081	18-3395	18-3396-1
VX250	2002-04	18-3071	18-3333	18-3345	18-3173-1	18-1835	18-9081	18-3395	18-3396-1
VZ250	2003-09	18-3071	18-3519	-	18-3173-1	18-1835	18-9081	18-3516	-
LZ300	2004-06	18-3071	18-3519	-	18-3173-1	18-1835	18-9081	18-3515	-
VZ300	2004-09	18-3071	18-3519	-	18-3173-1	18-1835	18-9081	18-3516	-
Z250	2003-05	18-3071	18-3333	18-3345	18-3173-1	18-1835	18-9081	18-3395	18-3396-1
Z300	2004-06	18-3071	18-3519	-	18-3173-1	18-1835	18-9081	18-3515	-



 <p>18-3524 THERMOSTAT Replaces: 6CE-12411-00-00 Fits: F225/LF225 (2010-2016), F250/LF250 (2010-2016), VF250 (2015), F300/LF300 (2010-2016), FL250/FL300 (2010)</p>	<p>50°C</p>  <p>18-3525 THERMOSTAT Replaces: 60V-12411-00 Fits: F115(2005-14), LF115(2005-14), LZ250(2003-05), LZ300(2004-06), VZ200(2005-09), VZ225(2005-09), VZ250(2005-09), VZ300(2005-09), Z250(2003-05), Z300(2004-06)</p>	<p>60°C</p>  <p>18-3625 THERMOSTAT (Seal Included) Replaces: 6F5-12411-03-00 9.9EL, 9.9ES, 15EL, 15ES (1986-1995), 9.9L, 9.9S, 15L, 15S (1986-1990), 9.9M, 15ML, 15MS, C55EL (1991-1995), C25EL, C40EL (1991-1997), C25ML (1993-1997), C25MS, C40MS, C40PL (1992-1997), C30EL (1991-1992), CV30EL (1989-1990), C40ML (1994-1995), C55TL (1993-1995), CV25EL, CV25EM, CV40EL (1990), CV55EL (1989)</p>
<p>50°C</p>  <p>18-3623 THERMOSTAT (Seal Included) Replaces: 6E5-12411-02-00 8MSH-0405, 8MSH-0406, 8MSH-0407, 8MSH-0608, 8MSHD-2005</p>	<p>60°C</p>  <p>18-3632 THERMOSTAT Replaces: 67F-12411-01-00 Fits: F75-F250 (2005 & Up)</p>	 <p>18-3634 THERMOSTAT Replaces: 6AW-12411-00-00 Fits: F300/LF300 (2007-09), F350/LF350 (2007-09), F350A/LF350A (2010-11), F350B/LF350B (2012-15), F350C/LF350C (2016-18)</p>
 <p>18-3636 THERMOSTAT Replaces: 6DA-12411-01-00 Fits: F150C/LF150C (2017), VF150 (2013-17), VF150A (2018), F175A (2014-18), F175C/LF175C (2017), VF175 (2015-18), F200B/LF200B (2012-18), F200C/LF200C (2013-18)</p>	 <p>18-3637 THERMOSTAT Replaces: 6CB-12411-10-00 Fits: VF200LA/VF225LA/VF250LA (2011-18)</p>	 <p>18-3639 THERMOSTAT Replaces: 6EK-12411-00-00 Fits: F115/LF115/VF115 (2014-18)</p>
 <p>18-3641 THERMOSTAT Replaces: 6FP-12411-00-00 Fits: F75B (2017-18), F90B (2016-18), VF90A (2018)</p>	<p>50°C</p>  <p>18-3540 THERMOSTAT Replaces: 6E5-12411-30-00 Fits: 9.9-15 (1996-06), 20 (1996-97), 25 (1988-95), 30 3-cyl (1987-91), 40 (1986-05), C40 3-cyl (1998-02), 50 (1986-05), C50 (1998-01), P50 (1987-96), 115 (1984-05), B115 (1998-99), C115 (1991-00), P115 (1993-96), S115/S130 (1996-98), 130L130 (1988-05), 150/175/200 (1986-05), C150 (1996-99), D150/DX150 (1997-05), L150/L200 (1986-99), LX150/LX200 (1999-01), P150 (1986-99), PX150 (1999), SX150/SX200 (1999-04), V150 (2000-05), VX150 (2000-05), VZ150/VZ175/VZ200 (2001-05), Z150/Z175/Z200 (2000-05), P200 (1991-93), V200/V225 (1998-99), VX200/VX225 (2000-05), V6 Special (1984-86), V6 Excel (1987-89), 225 2.6L (1990-97), 250/L250 2.6L (1990-95) Note: Will not fit 3.1 L</p>	
<p>60°C</p>  <p>18-3541 THERMOSTAT Replaces: 66M-12411-01-00 Fits: F6 (2001-05), F8 (2001-05), T8 (2001-05), F9.9 (1985-05), T9.9 (1985-05), T9.9 (1991-05), F15 (1998-05), F25 (1998-05), T25 (2001-05), F30 (2001-05), F40 (1999), F40 3cyl (2000-05), F50 (1995-05), T50 (1996-05), F60 (2002-05), T60 (2003-05), F80 (1999-00), F100 (1999-00)</p>	<p>50°C</p>  <p>18-3622 THERMOSTAT KIT Superseded from 18-3627 Replaces: 6H3-12411-11-00 60TLR-0405, 70TLR-0405, 70TLR-0406, 70TLR-0407, 70TLR-0408</p>	<p>50°C</p>  <p>18-3624 THERMOSTAT KIT Replaces: 69M-12411-01-00 F2.5MSH-0405, F2.5MSH-0406, F2.5MSH-0407, F2.5MSH0608, F2.5MSHD-2005</p>

APPLICATION STARTS ON NEXT PAGE

①18-3608D Display Package

18-3608
THERMOSTAT KIT
Fits: 115 (1991-02), C115 (1991-99), P115 (1993-96), S115 (1996-99), 130 (1991-02), L130 (1991-00), S130 (1996-99), 150 (1991-02), C150 (1996-99), L150 (1991-99), P150 (1991-99), S150 (1996-99), V150 (2000-02), Z150 (2001-02), 175 (1991-95, 97), P175 (1994-99), V175 (2000), Z175 (2001-02), 200 (1991-98), L200 (1991-99), P200 (1991-99), S200 (1996-99), V200 (1998-99), Z200 (2001-02), 225 (1991-97), V225 (1998-99)

— CONTAINS —

Part #	Desc.	O.E. #	Qty.
18-3540	Thermostat	6E5-12411-30-00	1
18-0844	Gasket	688-12414-A1-00	1

①18-3609D Display Package

18-3609
THERMOSTAT KIT
Fits: 25 (1996-98, 2001-02), 40 (1991-99, 01), C40 (1997-02), P40 (1998), 50 (1991-97, 1999-02), C50 (1998-01), P50 (1991-96), L225 (1994-99), S225 (1996-99), 250 (1991-95), L250 (1991-99), S250 (1996-99)

— CONTAINS —

Part #	Desc.	O.E. #	Qty.
18-3540	Thermostat	6E5-12411-30-00	1
18-0829	Gasket	61A-12414-A0-00, 6J8-12414-A0-00	1

60°C

18-3611
THERMOSTAT KIT
Fits: 15 (2006), F15 (1998-06), F25 (1999-06), F30 (2001-06), F40 (1999-06), F50 (1996-06), F60 (2002-06), F9.9 (2005-06), T25 (2001-06), T50 (1996-06), T60 (2003-06), T9.9 (2005-06)

— CONTAINS —

Part #	Desc.	O.E. #	Qty.
18-3541	Thermostat	66M-12411-01-00	1
18-0835	Gasket	62Y-12414-00-00	1

YAMAHA 2-STROKE THERMOSTAT APPLICATION

HP/Model	Year	Thermostat	Gasket	Thermostat Kit	Qty. Per Engine
4	1986-88	18-3540	—	—	1
4	1989-99	18-3623	—	—	1
5	1995-02	18-3623	—	—	1
6	1986-88	18-3540	—	—	1
6	1989-00	18-3623	—	—	1
8	1986-88	18-3540	—	—	1
8	1989-09	18-3623	—	—	1
9.9	1986-95	18-3625	18-0836	—	1
9.9	1996-09	18-3540	18-0836	—	1
15	1984-85	—	18-0836	—	1
15	1986-95	18-3625	18-0836	—	1
15	1996-09	18-3540	18-0836	—	1
20	1996-97	18-3540	18-0829	18-3609	1
25 (2 cyl)	1984-87	—	18-0232	—	1
25 (2 cyl)	1988-09	18-3540	18-0829	18-3609	1
C25	1991-97	18-3625	18-0232	—	1
CV25	1990	18-3625	18-0232	—	1
30	1984-85	—	18-0232	—	1
30	1986	18-3625	18-0835	—	1
30	1987-88	18-3540	18-0829	18-3609	1
30	1989-91	18-3623	18-0829	—	1
30	1992-02	—	18-0829	—	1
C30	1991-92	18-3625	18-0232	—	1
C30	1993-94, 1996-97	18-3623	18-0232	—	1
40	1984-85	—	18-0829	—	1
40	1986-05	18-3540	18-0829	18-3609	1
C40	1991-97	18-3625	—	—	1
C40	1998-03	18-3540	18-0829	18-3609	1
P40	1998	18-3540	18-0829	18-3609	1
50	1984-85	—	18-0829	—	1
50	1986-09	18-3540	18-0829	18-3609	1
C50	1998-01	18-3540	18-0829	18-3609	1
PRO 50	1987-90	18-3540	18-0829	18-3609	1
P50	1991-96	18-3540	18-0829	18-3609	1
50 Jet	1986-00	18-3540	18-0829	18-3609	1
C55	1991-95	18-3625	—	—	1
CV55	1989-90	18-3625	—	—	1
60	2001-05	Kit Only	18-0835	18-3622	1
C60	1996-01	Kit Only	18-0835	18-3622	1
E60	1995-00	Kit Only	18-0835	18-3622	1
P60	1991-99	Kit Only	18-0835	18-3622	1
70	1984-09	Kit Only	18-0835	18-3622	1

APPLICATION CONTINUED ON NEXT PAGE

YAMAHA 2-STROKE THERMOSTAT APPLICATION

HP/Model	Year	Thermostat	Gasket	Thermostat Kit	Qty. Per Engine
C70	2000-01	Kit Only	18-0835	18-3622	1
C75	1994-99	—	18-0844	—	1
E75	1995-00	—	18-0844	—	1
P75	1996-99	—	18-0844	—	1
C80	1997	—	18-0844	—	1
90	1984-09	—	18-0844	—	1
90 Jet	1986-00	—	18-0844	—	1
B90	1997-99	—	18-0844	—	1
C90	1997-01	—	18-0844	—	1
115	1984-09	18-3540	18-0844	18-3608	2
B115	1998-99	18-3540	18-0844	18-3608	2
C115	1991-00	18-3540	18-0844	18-3608	2
P115	1993-96	18-3540	18-0844	18-3608	2
S115	1996-99	18-3540	18-0844	18-3608	2
130	1988-04	18-3540	18-0844	18-3608	2
L130	1989-01	18-3540	18-0844	18-3608	2
S130	1996-99	18-3540	18-0844	18-3608	2
C150	1996-99	18-3540	18-0844	18-3608	2
150	1984	—	18-0844	—	2
150	1985	18-3623	18-0844	—	2
150	1986-09	18-3540	18-0844	18-3608	2
D150	1997-99	18-3540	18-0844	18-3608	2
DX150	1999-05	18-3540	18-0844	18-3608	2
L150	1986-99	18-3540	18-0844	18-3608	2
LX150	1999-01	18-3540	18-0844	18-3608	2
LZ150	2000-05	18-3540	18-0844	18-3608	2
Z150	2000-05	18-3540	18-0844	18-3608	2
P150	1991-99	18-3540	18-0844	18-3608	2
PX150	1999	18-3540	18-0844	18-3608	2
PRO V150	1986-90	18-3540	18-0844	18-3608	2
S150	1996-99	18-3540	18-0844	18-3608	2
SX150	1999-04	18-3540	18-0844	18-3608	2
V150	2000-08	18-3540	18-0844	18-3608	2
VX150	2000-04	18-3540	18-0844	18-3608	2
VZ150	2000-11	18-3540	18-0844	18-3608	2
175	1984	—	18-0844	—	2
175	1985	18-3623	18-0844	—	2
175	1986-00	18-3540	18-0844	18-3608	2
P175	1994-99	18-3540	18-0844	18-3608	2
S175	1996-99	18-3540	18-0844	18-3608	2
V175	2000	18-3540	18-0844	18-3608	2
VZ175	2001-10	18-3540	18-0844	18-3608	2
Z175	2001-05	18-3540	18-0844	18-3608	2
200	1984	—	18-0844	—	2
200	1985	18-3623	18-0844	—	2
200	1986-98	18-3540	18-0844	18-3608	2
L200	1986-99	18-3540	18-0844	18-3608	2
LX200	1999-01	18-3540	18-0844	18-3608	2
LZ200	2000-11	18-3540	18-0844	18-3608	2
P200	1991-99	18-3540	18-0844	18-3608	2
SX200	1999-05	18-3540	18-0844	18-3608	2
V200	1998-99	18-3540	18-0829	18-3609	2
VX200	2000-05	18-3540	18-0829	18-3609	2
VZ200	2001-04	18-3540	18-0844	18-3608	2
VZ200	2005-09	18-3525	-	-	2
Z200	2000-11	18-3540	18-0844	18-3608	2

APPLICATION CONTINUED ON NEXT PAGE

YAMAHA 2-STROKE THERMOSTAT APPLICATION

HP/Model	Year	Thermostat	Gasket	Thermostat Kit	Qty. Per Engine
V6 Special	1985-86	18-3540	18-0844	18-3608	2
V6 Excel	1987-89	18-3540	18-0844	18-3608	2
225	1990-97	18-3540	18-0844	18-3608	2
L225	1994-99	18-3540	18-0829	18-3609	2
S225	1996-99	18-3540	18-0829	18-3609	2
LX225	2000-03	18-3540	18-0829	18-3609	2
SX225	2000-03	18-3540	18-0829	18-3609	2
V225	1998-99	18-3540	18-0829	18-3609	2
V225	2003-09	18-3525	-	-	2
VX225	2000-04	18-3540	18-0829	18-3609	2
VZ250	2003-09	18-3525	-	-	2
250	1990-95	18-3540	18-0829	18-3609	2
L250	1990-99	18-3540	18-0829	18-3609	2
LX250	2000-03	18-3540	18-0829	18-3609	2
S250	1996-99	18-3540	18-0829	18-3609	2
SX250	2000-03	18-3540	18-0829	18-3609	2
VX250	2002-04	18-3540	18-0829	18-3609	2
Z250 / LZ250	2003-05	18-3525	-	-	2
VZ300	2004-09	18-3525	-	-	2
Z300 / LZ300	2004-06	18-3525	-	-	2

YAMAHA 4-STROKE THERMOSTAT APPLICATION

HP/Model	Year	Thermostat	Gasket	Thermostat Kit	Qty. Per Engine
F2.5	2003-17	Kit Only	18-0754	18-3624	1
F4	1999-17	18-3541	18-0754	—	1
F6	2001-08	18-3541	18-99120	—	1
F6	2009-17	18-3541	18-0754	—	1
F8	2001-10	18-3541	18-99120	—	1
F8A	2011-14	18-3541	18-99120	—	1
F8B	2015-18	18-3541	18-99120	—	1
T8	2001-10	18-3541	18-99120	—	1
F9.9	1985-05	18-3541	18-99120	—	1
F9.9 (66N)	2005-06	18-3541	18-0835	18-3611	1
F9.9A	2011-12	18-3541	18-99120	—	1
F9.9B	2013-18	18-3541	18-99120	—	1
F9.9F	2007-10	18-3541	18-99120	—	1
FT9.9	1985-90	18-3541	18-99120	—	1
T9.9	1991-05	18-3541	18-99120	—	1
T9.9 (66R)	2005-06	18-3541	18-0835	18-3611	1
T9.9A	2011-12	18-3541	18-99120	—	1
T9.9B	2013-18	18-3541	18-99120	—	1
T9.9G	2007-10	18-3541	18-99120	—	1
F15	1998-06	18-3541	18-0835	18-3611	1
F25	1998-05	18-3541	18-0835	18-3611	1
F25A	2009-18	18-3541	18-0835	18-3611	1
F25B	2012-18	18-3541	18-0835	18-3611	1
F25	1998-08	18-3541	18-0835	18-3611	1
T25	2001-04	18-3541	18-0835	18-3611	1
T25	2001-08	18-3541	18-0835	18-3611	1
T25	2009-18	18-3541	18-0835	18-3611	1
F30	2001-05	18-3541	18-0835	18-3611	1
F30	2013-18	18-3541	18-0835	18-3611	1
F40	1999-06	18-3541	18-0835	18-3611	1

APPLICATION CONTINUED ON NEXT PAGE

YAMAHA 4-STROKE THERMOSTAT APPLICATION

HP/Model	Year	Thermostat	Gasket	Thermostat Kit	Qty. Per Engine
F40A	2008-18	18-3541	18-0835	18-3611	1
F40B	2007-08	18-3541	18-0835	18-3611	1
F50	1995-18	18-3541	18-0835	18-3611	1
T50	1996-18	18-3541	18-0835	18-3611	1
F60	2002-18	18-3541	18-0835	18-3611	1
T60	2003-18	18-3541	18-0835	18-3611	1
F70A	2010-18	18-3541	18-0835	18-3611	1
F75A	2003-17	18-3632	—	—	1
F75B	2017-18	18-3641	—	—	1
F80	1999-00	18-3541	—	—	1
F80	2001-03	18-3632	—	—	1
F90	2003-11	18-3632	—	—	1
F90A	2012-17	18-3632	—	—	1
F90B	2016-18	18-3641	—	—	1
VF90A	2018	18-3641	—	—	1
F100	1999-00	18-3541	—	—	1
F100	2001-03	18-3632	—	—	1
F115 / LF115	2000-14	18-3525	—	—	1
F115 / LF115	2014-18	18-3639	—	—	1
VF115	2015-18	18-3639	—	—	1
F150 / LF150	2004-11	18-3632	18-99127	—	1
F150A / LF150A	2012-14	18-3632	18-99127	—	1
F150B / LF150B	2015-18	18-3632	18-99127	—	1
F150C / LF150C	2017	18-3636	—	—	1
VF150	2013-17	18-3636	—	—	1
VF150A	2018	18-3636	—	—	1
F175A	2014-18	18-3636	—	—	1
F175C / LF175C	2017	18-3636	—	—	1
VF175	2015-18	18-3636	—	—	1
F200 / LF200	2005-10	18-3632	—	—	2
F200A / LF200A	2011-17	18-3632	—	—	2
F200B / LF200B	2012-18	18-3636	—	—	1
F200C / LF200C	2013-18	18-3636	—	—	1
VF200	2009-10	18-3632	—	—	2
VF200LA	2011-18	18-3637	—	—	2
F225 / LF225	2005-10	18-3632	—	—	2
F225A / LF225A	2011-17	18-3632	—	—	2
F225A / LF225A	2010-17	18-3524	—	—	2
F225B / LF225B	2016-17	18-3524	—	—	2
F225B / LF225B	2008-09	18-3632	—	—	2
VF225	2009-10	18-3632	—	—	2
VF225LA	2011-18	18-3637	—	—	2
F250 / LF250	2005-11	18-3632	—	—	2
F250A / LF250A	2010-17	18-3524	—	—	2
F250B / LF250B	2016-17	18-3524	—	—	2
VF250	2010	18-3632	—	—	2
VF250LA	2011-18	18-3637	—	—	2
VF250XA	2015-17	18-3524	—	—	2
F300 / LF300	2007-09	18-3634	—	—	2
F300A / LF300A	2010-18	18-3524	—	—	2
F350 / LF350	2007-09	18-3634	—	—	2
F350A / LF350A	2010-11	18-3634	—	—	2
F350B / LF350B	2012-15	18-3634	—	—	2
F350C / LF350C	2016-18	18-3634	—	—	2

**ALL PISTONS
ARE SUPPLIED WITH PISTON RINGS, WRIST PIN AND CIRCLIPS**



Piston Rings are available individually.

V-4 & V-6 Pistons and Rings

STANDARD

18-4129 (Stbd.)

Replaces: 6G5-11631-00-93

— CONTAINS —

Part #	Rings	O.E. #
18-3934	Standard	6E5-11610-03-00

V-6 Loop Charged Engines (1992-2001)

18-4080 (Port)

Replaces: 6R5-11642-11-93

— CONTAINS —

Part #	Rings	O.E. #
18-39320	Standard	6R5-11603-00

18-4082 (Port)

Replaces: 6R5-11645-11-00

18-4083 (Stbd.)

Replaces: 6R5-11635-11-00

18-4084 (Port)

Replaces: 6R5-11646-11-00

18-4085 (Stbd.)

Replaces: 6R5-11636-11-00

STANDARD

18-4135 Replaces: 6E7-11631-00-97

— CONTAINS —

Part #	Rings	O.E. #
NSS	Standard	682-11610-01-00

18-4138 Replaces: 689-11631-00-95

— CONTAINS —

Part #	Rings	O.E. #
18-3954	Standard	689-11610-01-00

18-4141 Replaces: 6H4-11631-00-96

— CONTAINS —

Part #	Rings	O.E. #
18-3960	Standard	6H4-11610-00-00

18-4097 Replaces: 6H1-11631-03-95

— CONTAINS —

Part #	Rings	O.E. #
18-3969	Standard	688-11603-A0-00

★ ★ ★ Inline Pistons and Rings ★ ★ ★

.25mm O.S.

Part #	Rings	O.E. #
18-3977	25mm O.S.	682-11610-11-00

18-4145 Replaces: 61N-11635-00-00

— CONTAINS —

Part #	Rings	O.E. #
NSS	25mm O.S.	61N-11604-00-00

.50mm O.S.

18-4146	Replaces: 61N-11636-00-00
----------------	---------------------------



PISTON APPLICATION

HP/Model	Years	PISTON			RINGS		
		Std.	.25mm	.50mm	Std.	.25mm	.50mm
9.9/15	1984-96	18-4135	—	—	—	18-3977	—
9.9/15	1997-2009	18-4135	—	—	—	18-3977	—
25	1985	18-4138	—	—	—	—	—
30	1984-86	18-4138	—	—	—	—	—
C30	1991-92	18-4138	—	—	—	—	—
C30	1993-97	—	18-4145	18-4146	18-3957	—	—
40	1984-88	18-4141	—	—	18-3960	—	18-3962
C40	1997-99,2001-02	—	—	—	18-3960	—	18-3962
P40	1998	—	—	—	18-3960	—	18-3962
E48	1997	—	—	—	18-3969	—	—
50	1984-88	18-4141	—	—	18-3960	—	18-3962
50	1996-97, 1999, 2000,2002-03	18-4141	—	—	18-3960	—	18-3962
C50	1998-99, 2001	—	—	—	18-3960	—	18-3962
P50	1996	—	—	—	18-3960	—	18-3962
Pro50	1987-88	18-4141	—	—	18-3960	—	—
60	2001-05	—	—	—	—	—	—
C60	1996-01	—	—	—	—	—	—
E60 MLH,T,U,V	1995-00	—	—	—	—	—	—
P60	1991-99	—	—	—	—	—	—
70	1984-09	—	—	—	—	—	—
C70	2000-01	—	—	—	—	—	—
75	1994-98	—	—	—	18-3969	—	—
C75	1996	—	—	—	18-3969	—	—

APPLICATION CONTINUED ON NEXT PAGE

PISTON APPLICATION (Cont.)

HP/Model	Years	Std.	PISTON		Std.	RINGS	
			.25mm	.50mm		.25mm	.50mm
C75	1998-99	—	—	—	18-3969	—	—
E75	1996-97	—	—	—	18-3969	—	—
P75	1996-99	—	—	—	18-3969	—	—
C80	1997	—	—	—	18-3969	—	—
C85	1996	—	—	—	18-3969	—	—
90	1994-09	—	—	—	18-3969	—	—
C90	1997-01	—	—	—	18-3969	—	—

V4 & V-6 Engines	Years	PISTON						RINGS		
		Port Std.	Stbd. Std.	Port .25mm	Stbd. .25mm	Port .50mm	Stbd. .50mm	Std.	Std.	
115 w/22mm wrist pin	V-4	1984-86	—	18-4129	—	—	—	—	18-3934	18-3936
115 w/22mm wrist pin	V-4	1987-92	—	18-4129	—	—	—	—	18-3934	18-3936
115 w/23mm wrist pin	V-4	1993-03	18-4080	—	18-4082	18-4083	18-4084	18-4085	18-39320	18-3936
130 w/22mm wrist pin	V-4	1984-92	—	18-4129	—	—	—	—	18-3934	18-3936
130 w/23mm wrist pin	V-4	1993-03	18-4080	—	18-4082	18-4083	18-4084	18-4085	18-39320	18-3936
150, 175 w/22mm wrist pin	V-6	1984-92	—	18-4129	—	—	—	—	18-3934	18-3936
150, 175 w/23mm wrist pin	V-6	1993-99	18-4080	—	18-4082	18-4083	18-4084	18-4085	18-39320	18-3936
200, 225 w/22mm wrist pin	V-6	1984-92	—	18-4129	—	—	—	—	18-3934	18-3936
200, 225 w/22mm wrist pin	V-6	1993-99	18-4080	—	18-4082	18-4083	18-4084	18-4085	18-39320	18-3936
SPECIAL J,K,LN,XN (6G7)	V-6	1984-86	—	18-4129	—	—	—	—	18-3934	18-3936



18-1756
CONNECTING ROD
Replaces: 688-11650-03-00
Fits: 55 (1991-95), 75 (1994-99), 80 (1997), 85 (1991-96), 90 (1997, 2000-01)



18-4157
CONNECTING ROD
Replaces: 6R5-11650-10-00
For: V6 150/175/200 (1992-03)



18-1410
ROD BEARING
Replaces: 93310-32337-00
Fits: 115 (1993-03), 130 (1993-00, 2002-03), 150 (1992-00, 2002-03), 175 (1992-98, 2000), 200 (1992-98), 225 (1992-93, 1997)



18-1411
ROD BEARING
Replaces: 93310-620V5-00
Fits: 9.9 (1996-97), 15 (1996-97)



18-4077
ROD BEARING
Replaces: 93310-730V8-00
For: 45, 55, 90 HP -3 Cyl.



18-0191
Replaces: 92990-06600-00

18-0192
Replaces: 92990-10600-00, 929-90106-00-00, 92900-10600-00, 92901-10600-00, 92902-10600-00, 92903-10600-00, 92995-10600-00

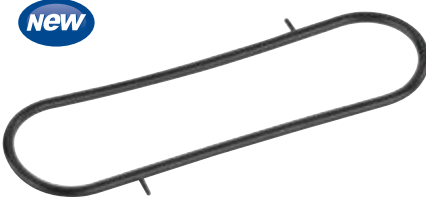

18-0486
OIL STRAINER SEAL
Replaces: 67F-13415-00-00
75-115HP Outboards, All Models, All Years



18-79974
OIL STRAINER
Replaces: 6J8-13411-00
Fits: 20(1996-97), 25(1988-01), 30(1987-02), 40(1989-05), 50(1989-09), 60(2001-05), 70(1989-09), C30(1995), P40(1998), P50(1991-96), P60(1991-99), PRO50(1989-90)



18-79975
OIL STRAINER
Replaces: 6E5-13411-00
Fits: 115(1988-09), 130(1988-05), 150(1989-09), 175(1989-00), 200(1989-98), 225(1990-97), B115(1998-99), D150(1997-99), DX150(1999-05), L130(1989-01), L150(1988-99), L200(1988-99), LX150(1999-01), LX200(1999-01), LZ150(2000-05), LZ200(1999-12), P115(1993-96), P150(1991-99), P175(1994-99), P200(1991-99), PRO V150(1988-90), PX150(1999), S115-(1996-99), S130(1996-99), S150(1996-99), S200(1996-99)SX150(1999-04), SX200(1999-05), V150(2000-08), V175(2000), V6 Excel(1988-89), VX150(2000-04), VZ150(2000-12), VZ175(2001-12), VZ200(2001-04), Z150(2000-05), Z175(2001-05), Z200(2000-12)



18-79976
OIL STRAINER
Replaces: 61A-13411-00
Fits: 225(1994-95), 250(1990-95), L225(1994-99), L250(1990-99), LX225(2000-03), LX250(2000-03), LZ250(2003-05), LZ300(2004-06), S225(1996-99), S250(1996-99), SX225(2000-03), SX250(2000-03), V200(1998-99), V225(1998-99), VX200(2000-05), VX225(2000-04), VX250(2002-04), VZ200(2005-09), VZ225(2003-09), VZ250(2003-09), VZ300(2004-09), Z250(2003-05), Z300(2004-06)



18-79971
OIL STRAINER, ELECTRIC
Replaces: 68F-13440-00
Fits: LZ150(2000-05), LZ200(2000-12), LZ250(2003-05), LZ300(2004-06), VZ150(2000-12), VZ175(2001-12), VZ175(2001-12), VZ200(2001-09), VZ225(2003-09), VZ250(2003-09), VZ300(2004-09), Z150(2000-05), Z175(2001-05), Z200(2000-12), Z250(2003-05), Z300(2004-06)



18-79961
OIL STRAINER
Replaces: 6H1-13411-00
Fits: 90(1990-01), B90(1997-99), C90(2000-01), P75(1996-99)



18-7911-1
OIL FILTER
Replaces: 5GH-13440-00, 5GH-13440-10, 5GH-13440-30



18-7954
OIL FILTER
Replaces: N26-13440-02-00, N26-13440-00-00
Fits: F350



18-2456
CRANKCASE OIL DRAIN PLUG
 Replaces: 90340-14M06-00
 Fits: 15-350HP 1995-2018
 M14x1.25

4-CYCLE OUTBOARD OIL FILTERS



18-8700
OIL FILTER
 Replaces: 5GH-13440-50-00, 5GH-13440-20, 5JW-13400-00-00, 2MB-E3440-00-00, 1WD-E3440-00-00
 Fits: F15(2006-12), F20(2006-12), F25(2009-12), F40(2008-12), F50(2005-12), F60(2005*-12), F70(2010-12), T25(2009-12), T50(2005-12), T60(2005-12)

Make-Model	Years	Replaces	Part No.
F/T9.9	1990-03	6G8-13440-00-00	18-7901
F/T50	1995-99	3FV-13440-20-00, 3FV-13440-00-00	18-7902
F15,F25	1998-99	3FV-13440-20-00, 3FV-13440-00-00	18-7902
F80/F100	1999	3FV-13440-20-00, 3FV-13440-00-00	18-7902
F40	1999-00	3FV-13440-20-00, 3FV-13440-00-00	18-7902
F200/F225	2002-06	69J-13440-00-00, -01-00, -03-00	18-7906-2
F150	2004-06	69J-13440-00-00, -01-00, -03-00	18-7906-2
F250	2005-06	69J-13440-00-00, -01-00, -03-00	18-7906-2
F350	2008-up	N26-13440-02-00, N26-13440-00-00	18-7954



18-9390
OIL CHANGE KIT
 Replaces: LUB-MRNSM-KT-10
 Fits: F30(2001-06), F40(1999-08), F40A(2009 & Up), F50(1995 & Up), T50(1996 & Up), F60(2002 & Up), T60(2003 & Up), F70(2010 & Up)



18-9391
OIL CHANGE KIT
 Replaces: LUB-MRNMD-KT-10
 Fits: F75(2003 & Up), F80(1999-02), F90(2003 & Up), F100(1999-02), F115(2000 & Up)



18-9392
OIL CHANGE KIT
 Replaces: LUB-MRNMD-KT-10
 Fits: F150(2004 & Up)



18-9393
OIL CHANGE KIT
 Replaces: LUB-MRNLG-KT-10
 Fits: F200 3.3L(2002 & Up), F225 3.3L(2002 & Up), F225 Sport(2008), F250A 3.3L(2005 & Up), F250B 3.3L(2005 & Up)

FEATURES:

- Neoprene or Nitrile construction for maximum durability based on application
- Positive Slip Proof engagement
- Fiberglass tension member for excellent flex and elongation behavior
- Chemical and Contaminant Resistance for Long Life
- Meets or Exceeds OEM belt specifications
- Modified Curvilinear or Trapezoidal tooth profile for direct OE fitment/replacement
- Recommended periodic maintenance interval of 5 years or 1000 hours of use (Note: Timing belt should be inspected every 100 hours and replaced as necessary.)
- Inexpensive insurance to prevent catastrophic engine failure

TIMING BELTS



Sierra Timing Belts provide extended durability and smoother performance characteristics required by today's marine engines.

Part No.	Replaces	Fits
18-15130	6C5-46241-00-00	Fits: F25 (2009-2017), T25 2009-2017), F30 (2013-2017), F40 (2008-2017), F50 (2005-2017), T50 (2005-2010), F60 (2005-2017), T60 (2005-2017), F70 (2010-2017)
18-15131	67F-46241-00-00	Fits: F75 (2003-2011), F80 (1999-2003), F90 (2005-2015), F100 (1999-2003), F115 (2000-2014), LF115 (2000-2014)
18-15132	6P2-46241-02-00	Fits: F200 (2011-2017), LF200 (2011-2017), F225 (2007-2017), F250 (2005-2017), LF250 (2005-2017)
18-15133	6G8-46241-00-00	Fits: F9.9 (1985-2005), FT9.9 (1985-1990), T9.9 (1991-2005)
18-15134	6CB-W4624-00-00	Fits: F225 (2010-2017), LF225 (2010-2017), F250 (2010-2017), FL250 (2010), LF250 (2010-2017), F300 (2010-2017), FL300 (2010), LF300 (2010-2017), VF200 (2009-2017), VF225 (2009-2017), VF250 (2009-2017)
18-15135	65W-46241-00-00	Fits: F25 (1998-2005), T25 (2001-2005), F30 (2001-2005), F40 (2000-2008)
18-15136	6AH-46241-00-00	Fits: F15 (2006-2017), F20 (2006-2017)
18-15137	66M-46241-00-00	Fits: F9.9 (2005-2006), F15 (1998-2005)
18-15138	68T-46241-00-00	Fits: F6 (2001-2008), T8 (2001-2010), F8 (2001-2017), F9.9 (2007-2017), T9.9 (2007-2017)
18-15139	6AW-W4624-00-00	F300/LF300 (5.3L) (2007-09), F350/LF350 (5.3L) (2007-09), F350A/LF350A (5.3L) (2010-11), F350/LF350 (5.3L) (2012-15), F350C/LF350C (2016-18)
18-15140	63P-46241-00-00	F150/LF150 (2004-11), F150/LF150 (2012-14), F150B/LF150B (2015-18)
18-15141	69J-46241-00-00	F200/LF200 (2002-10), F225/LF225 (2002-10)
18-15142	6DA-W4624-00-00	F150C/LF150C (2017-18), VF150 (2013-17), VF150A (2018)
18-15143	60V-46241-00-00	VZ200 (2005-09), VZ225 (2005-09), VZ250 (2005-09), Z250/LZ250 (2003-05), VZ300 (2005-09), Z300/LZ300 (2004-06)
18-15144	62Y-46241-00-00	F40 (1999), F50 (1995-03), T50 (1996-04), F60 (2002-04), T60 (2003-04)
18-15145	68F-46241-10-00	VZ150 (2004-14), Z150/LZ150 (2004-05)

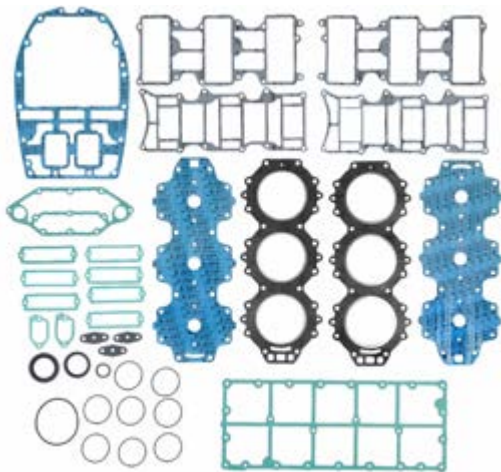

**18-4400
POWERHEAD GASKET SET**

Replaces: 61A-W0001-01-00, 61A-W0001-A1-00
— CONTAINS —

Part #	Desc.	O.E. #	Qty.
18-3891	Head Gasket	61A-11181-00-A0	2
18-0829	O-Ring	61A-12414-A0-00, 6J8-12414-A0-00	2
18-0808	Pressure Control Valve Gasket	6G5-11382-A1-00	1

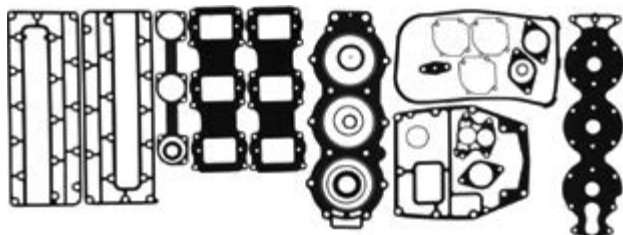

**18-4415
POWERHEAD GASKET SET**

Replaces: 688-W0001-00-00, 688-W0001-A0-00
— CONTAINS —

Part #	Desc.	O.E. #	Qty.
18-0840	Fuel Bowl Seal	676-14984-00-00	3
18-3805	Head Gasket	688-11181-02-00	1
18-0844	Thermostat Cover Gasket	688-12414-A1-00	1
18-0846	Carburetor Mounting Gasket	688-14198-A1-00	3
18-0847	Exhaust Cover Gasket	688-41112-A0-00	2
18-0826	Drain Screw Gasket	90430-14115-00-00	1
18-0767	Water Jacket Cover Gasket	688-11193-01-00	1
18-0845	Intake Manifold Reed Plate Gasket	688-13621-A1-00	2
18-7441	O-Ring	93210-62269-00	1

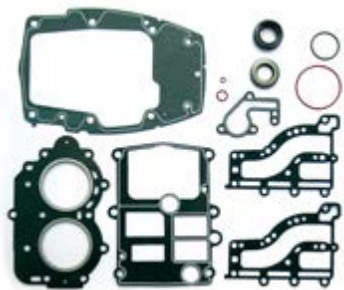

18-99097
GASKET SET
 Replaces: 682-W0001-06
 Fits: 9.9(1994-95), 15(1994-95)



18-99103
GASKET SET
 Replaces: 68F-W0001-01
 Fits: LZ150(2004-05), LZ200(2004-10), VZ150(2004-10), VZ175(2004-10), VZ200(2004), Z150(2004-05), Z175(2004-05), Z200(2004-10)



18-99104
GASKET SET
 Replaces: 6A0-W0001-21
 Fits: C40(1992-94)



18-99117
GASKET SET
 Replaces: 6G1-W0001-A2
 Fits: 6(1996), 8(1996)

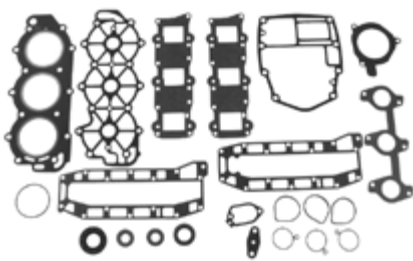

18-99061
GASKET SET
 Replaces: 63D-W0001-00
 Fits: 40(1995-05), 50(1995-069), C40(1997-02), C50(1998-01), P40(1998), P50(1995-96)



18-99073
GASKET SET
 Replaces: 65W-W0001-20
 Fits: F25(1998-00)

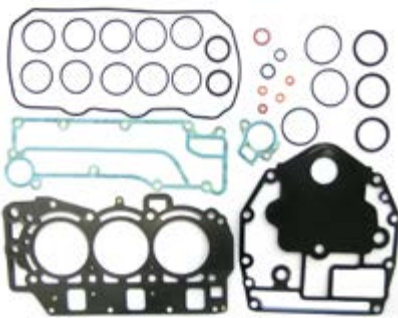

18-99092
GASKET SET
 Replaces: 67C-W0001-00
 Fits: F30(2001), F40(2000-01)



18-99093
GASKET SET
 Replaces: 67C-W0001-20
 Fits: F30(2001), F40(2000-01), T25(2001)



18-99175
POWERHEAD GASKET SET
 Replaces: 63V-W0001-00, 63V-W0001-01
 Fits: 9.9(1996-00), 15(1996-00)

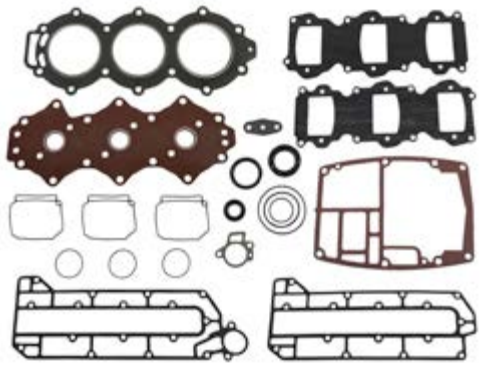

18-99176
POWERHEAD GASKET SET
 Replaces: 6H3-W0001-02
 Fits: 60(2001-05), 70(1994-09), C70(2000-01), P60(1994-99)

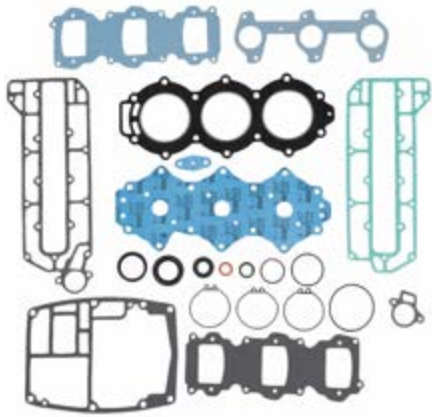

18-4427
POWERHEAD GASKET SET
 Replaces: 6H3-W0001-A0-00

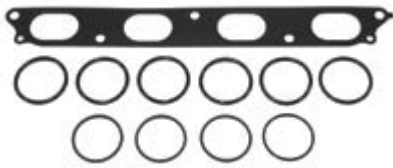

18-0663
PLENUM GASKET KIT
 Fits: Yamaha F75 (2003-04), F80 (1999-03), F90 (2003-04), F100 (1999-02)

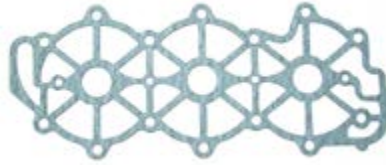

18-99059
HEAD GASKET
 Replaces: 63D-11193-A0
 Fits: 40(1995-05), 50(1995-09), C40(1997-03), C50(1998-01), P40(1998), P50(1995-96)



18-99060
HEAD GASKET
 Replaces: 63D-11181-A1
 Fits: 40(1997-05), 50(1997-08), C40(1997-03), C50(1998-01), P40(1998)



18-99062
HEAD GASKET
 Replaces: 68F-11181-00
 Fits: LZ150(2000-05), LZ200(2000-10), VZ150(2000-10), VZ175(2001-10), VZ200(2001-04), Z150(2000-05), Z175(2001-05), Z200(2000-10)

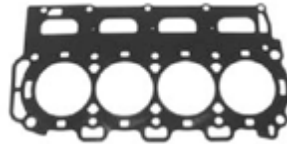

18-99094
HEAD GASKET
 Replaces: 67F-11181-02
 Fits: F75(2004-05), F90(2004-05), F115(2004-05), LF115(2004-05)



18-3804
HEAD GASKET
 Replaces: 689-11181-02-00, 689-W0001-A1-00



18-3805
HEAD GASKET
 Replaces: 688-11181-02-00, 688-11181-A1-00



18-3827
HEAD GASKET
 Replaces: 6G8-11181-00-00, 6G8-11181-A1-00



18-3828
HEAD GASKET
 Replaces: 6E7-11181-00-00, 6E7-11181-A1-00



18-3829
HEAD GASKET
 Replaces: 6J8-11181-00-00, 6J8-11181-A1-001



18-3830
HEAD GASKET
 Replaces: 6H4-11181-00-00, 6H4-11181-A1-00



18-3831
HEAD GASKET
 Replaces: 6H3-11181-01-00, 6H3-11181-A1-00



18-3832
HEAD GASKET
 Replaces: 6E5-11181-02-00, 6E5-11181-A1-00



18-3847
HEAD GASKET
 Replaces: 6L2-11181-A1-00, 6L2-11181-A2-00



18-3848
HEAD GASKET
 Replaces: 697-11181-A0-00, 697-11181-A1-00



18-3849
HEAD GASKET
 Replaces: 695-11181-A0-00, 695-11181-A1-00



18-3891
HEAD GASKET
 Replaces: 61A-11181-A0-00, 61A-11181-A1-00



18-3892
HEAD GASKET
 Replaces: 676-11181-A0-00, 676-11181-A1-00



18-3894
HEAD GASKET
 Replaces: 6G5-11181-00-00, 6G5-11181-A0-00

POWERHEAD GASKET SETS / HEAD GASKETS APPLICATION

HP	Year	Powerhead Gasket Set	Head Gasket	HP	Year	Powerhead Gasket Set	Head Gasket
6	1988-96	18-99117		F80	1999-01		18-99094
8	1984-96	18-99117		F80	2002-03		18-99094
9.9	1984-87		18-3828	C85	1991	18-4415	18-3805
9.9	1988-91		18-3828	C85	1992-93		18-3805
9.9	1992-93		18-3828	C85	1994-96		18-3805
9.9	1994-95		18-3828	CV85	1989-90	18-4415	18-3805
9.9	1996	18-99175		90	1984-93		18-3805
9.9	1997-00	18-99175	18-99140	90	1994-09		18-3805
9.9	2001-08		18-99140	B90	1997-99		18-3805
F9.9	1986-89		18-3827	C90	1997-01		18-3805
F9.9	1990-05		18-3827	F90	2003-04		18-99094
FT9.9	1985-87		18-3827	F90	2005-11		18-99094
FT9.9	1988-89		18-3827	F100	1999-01		18-99094
FT9.9	1990		18-3827	F100	2002-03		18-99094
T9.9	1991-05		18-3827	115	1984		18-3832
15	1984-87		18-3828	115	1985		18-3832
15	1988-91		18-3828	115	1986 ¹		18-3832
15	1992-93		18-3828	115	1986-89 ²		18-3832
15	1994-95	18-99097		115	1990-99		18-3832
15	1996	18-99175		115	2000-01		18-3832
15	1997-00	18-99175	18-99140	115	2002-09		18-3832
15	2001-08		18-99140	B115	1998-99		18-3832
20	1996-97		18-3847	C115	1991-95		18-3832
25 (2 cyl)	1984-87		18-3804	C115	1996-99		18-3832
25 (2 cyl)	1988-93		18-3847	C115	2000		18-3832
25 (2 cyl)	1994-09		18-3847	F115	2000-01		18-99094
25 (3 cyl)	1997-02		18-3829	F115	2002-05		18-99094
C25	1991-93	18-4417	18-3849	F115	2006-11		18-99094
C25	1994-97		18-3849	LF115	2000-01		18-99094
CV25	1990	18-4417	18-3849	LF115	2002-05		18-99094
F25	1998-01	18-99073		LF115	2006-11		18-99094
30	1984-86		18-3804	P115	1993-96		18-3832
30	1987-94		18-3829	S115	1996-99		18-3832
30	1993-02		18-3829	130	1988-99		18-3832
C30	1991-92		18-3804	130	2000-01		18-3832
C30	1995-97		18-3829	130	2002-04		18-3832
CV30	1989-90		18-3804	L130	1989		18-3832
F30	2000	18-99093		L130	1990-99		18-3832
F30	2001-05	18-99092		L130	2000-01		18-3832
40	1984-88		18-3830	S130	1996-99		18-3832
40	1989-91	18-4419	18-3830	150	1984-89		18-3894
40	1992-94		18-3830	150	1990-95		18-3894
40	1995-05	18-99061	18-99060	150	1996-03		18-3894
C40 2 Cyl	1991		18-3892	150	2004-09		18-3894
C40 2 Cyl	1992-93		18-3892	C150	1996-99		18-3894
C40 2 Cyl	1994-97	18-4414	18-3892	D150	1997-99		18-3894
C40 3 Cyl	1998-03	18-99061	18-99060	DX150	1999-03		18-3894
CV40	1990		18-3892	DX150	2004-05		18-3894
F40	2000-08	18-99092		L150	1986-89		18-3894
P40	1998	18-99061	18-99060	L150	1990-95		18-3894
50	1984-88		18-3830	L150	1996-99		18-3894
50	1989-91	18-4419	18-3830	LX150	1999-01		18-3894
50	1992-94	18-4419	18-3830	LZ150	2000-03		18-99062
50	1995-09	18-99061	18-99060	LZ150	2004-05	18-99103	18-99062
C50	1998-01	18-99061	18-99060	Z150	2000-03		18-99062
PRO 50	1987-88		18-3830	Z150	2004-05	18-99103	18-99062
PRO 50	1989-90	18-4419	18-3830	P150	1991-93		18-3894
P50	1991	18-4419	18-3830	P150	1994-95		18-3894
P50	1992-94		18-3830	P150	1996-99		18-3894
P50	1995-96	18-99061	18-99060	PX150	1999		18-3894
C55	1991		18-3848	PRO V150	1987-89		18-3894
C55	1992-93		18-3848	PRO V150	1990		18-3894
C55	1994-95		18-3848	S150	1996-99		18-3894
CV55	1989-90		18-3848	SX150	1999-03		18-3894
60	2001-05	18-99176	18-3831	SX150	2004		18-3894
C60	1996-01		18-3831	V150	2000-03		18-3894
E60	1995-00		18-3831	V150	2004-08		18-3894
P60	1991	18-4427	18-3831	VX150	2000-03		18-3894
P60	1992-93		18-3831	VX150	2004		18-3894
P60	1994-99	18-99176	18-3831	VZ150	2000-03		18-99062
70	1984-91	18-4427	18-3831	VZ150	2004-11	18-99103	18-99062
70	1992-93		18-3831	175	1984-89		18-3894
70	1994-09	18-99176	18-3831	175	1990-95		18-3894
C70	2000-01	18-99176	18-3831	175	2000		18-3894
C75	1994-96		18-3805	P175	1996-99		18-3894
C75	1998-99		18-3805	S175	1996-99		18-3894
E75	1995-00		18-3805	V175	2000		18-3894
F75	2003-04		18-99094	VZ175	2001-02		18-99062
F75	2005, 2007-11		18-99094	VZ175	2003-11	18-99103	18-99062
F75	2006		18-99094	Z175	2001-03		18-99062
P75	1996-99		18-3805	Z175	2004-05	18-99103	18-99062
C80	1997		18-3805	200	1984-89		18-3894







① LJ:-357803/XJ:-700843
 ② LJ: 357804/XJ: 700844

③ 2.6 litre engine
 ④ 3.1 litre engine

HP	Year	Powerhead Gasket Set	Head Gasket	HP	Year	Powerhead Gasket Set	Head Gasket
200	1990-95		18-3894	L225 ④	1994-96	18-4400	18-3891
200	1996-98		18-3894	L225	1997-99		18-3891
L200	1986-89		18-3894	S225	1996	18-4400	18-3891
L200	1990-95		18-3894	S225	1997-99		18-3891
L200	1996-99		18-3894	LX225	2000-03		18-3891
LX200	1999-01		18-3894	SX225	2000-03		18-3891
LZ200	2000-03		18-99062	V225	1998-99		18-3891
LZ200	2004-11	18-99103	18-99062	VX225	2000-04		18-3891
P200	1991-95		18-3894	VZ225	2003-04		
P200	1996-99		18-3894	VZ225	2005-09		
S200	1996-99		18-3894	250	1990-95	18-4400	18-3891
SX200	1999-03		18-3894	L250	1990-96	18-4400	18-3891
SX200	2004-05		18-3894	L250	1997-99		18-3891
V200	1998-99		18-3891	LX250	2000-03		18-3891
VX200	2000-05		18-3891	LZ250	2003-04		
VZ200	2000-03		18-99062	LZ250	2005		
VZ200	2004-09	18-99103	18-99062	S250	1996	18-4400	18-3891
Z200	2000-03		18-99062	S250	1997-99		18-3891
Z200	2004-11	18-99103	18-99062	SX250	2000-03		18-3891
V6 Special	1984-86		18-3894	VZ250	2003-04		
V6 Excel	1987-89		18-3894	VZ250	2005-09		
225 ③	1990-95		18-3894	Z250	2003-04		
225	1996-97		18-3894	Z250	2005		
225 ④	1994-95	18-4400	18-3891				

- ① LJ:-357803/XJ:-700843
- ② LJ: 357804/XJ: 700844

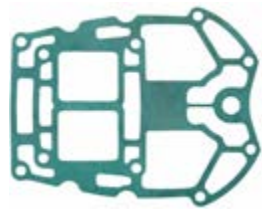
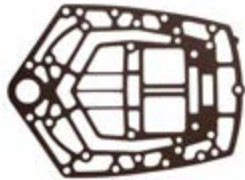
- ③ 2.6 litre engine
- ④ 3.1 litre engine

 <p>18-0406 WATER PUMP GASKET Replaces: 60X-43315-A0-00 Fits: VZ200 (3.3L) 2005-10, VZ225 (3.3L) 2003-10, VZ250 (3.3L) 2003-10, VZ300 (3.3L) 2005-10</p>	 <p>18-0605 EXHAUST MANIFOLD SEAL Replaces: 67F-41138-00-00 Fits: F75 2003-Current: F80 1999-2003; F90 2003-Current: F100 1999-2003; F115 2000-Current.</p>	 <p>18-0617 EXHAUST SEAL Replaces: 67F-45127-00-00 Fits: F75 2003-Current: F80 1999-2003; F90 2003-Current: F100 1999-2003; F115 2000-Current.</p>	 <p>18-0618 EXHAUST MANIFOLD GASKET Replaces: 68V-45123-00-00</p>
 <p>18-0656 EXHAUST TUBE SEAL Replaces: 69J-45123-00-00</p>	 <p>18-0755 CRANKCASE DRAIN GASKET Replaces: 90430-14M09-00, 904-30142-28-00, 90430-14228-00 Fits: Four-Stroke 9.9hp.- 300hp. / 1999 - Current</p>	 <p>18-0849 FUEL PUMP MOUNTING GASKET Replaces: 650-24431-A0-00</p>	 <p>18-0856-1 GASKET Replaces: 64D-14384-01-00</p>
 <p>18-99000 EXHAUST MANIFOLD GASKET Replaces: 61A-41134-A0 Fits: 225(1994-95), 250(1992-95), L225 (1994-99), L250(1992-99), LX225(2000-03), LX250(2000-03), LZ250(2003-05), LZ300 (2004-05), S225(1996-99), S250(1996-99), SX225(2000-03), SX250(2000-03), V200(1998-99), V225(1998-99), VX200(2000-05), VX250 (2000-04), VZ200(2005), VZ225(2003-05), VZ250(2003-05), VZ300(2004-05), Z250(2003-05), Z300(2004-05)</p>		 <p>18-99001 UPPER CASING GASKET Replaces: 61A-45114-A0 Fits: 225(1994-95), 250(1992-95), L225 (1994-99), L250(1992-99), LX225(2000-03), LX250(2000-03), S225(1996-99), S250 (1996-99), SX225(2000-03), SX250 (2000-03), V200(1998-99), V225(1998-99), VX200(2000-05), VX225(2000-04), VX250(2002-04)</p>	
 <p>18-99002 EXHAUST MANIFOLD GASKET Replaces: 62Y-41133-00 Fits: F25(1998-00), F40(1999), F50(1995-00), T50(1996-00)</p>	 <p>18-99004 UPPER CASING GASKET Replaces: 63D-45114-A0 Fits: 40(1995-05), 50(1995-09), C40(1997-03), C50(1998-01), P40(1998), P50(1995-96)</p>	 <p>18-99005 MUFFLER GASKET Replaces: 63D-45123-00 Fits: 40(1995-05), 50(1995-09), C40(1997-03), C50(1998-01), P40(1998), P50(1995-96)</p>	 <p>18-99006 EXHAUST MANIFOLD GASKET Replaces: 63V-41133-A1 Fits: 9.9(1997-09), 15(1997-09)</p>



18-99013
UPPER CASING GASKET
Replaces: 66M-45113-00
Fits: F9.9 (2005-06), F15(1998-05), T9.9(2005-06)

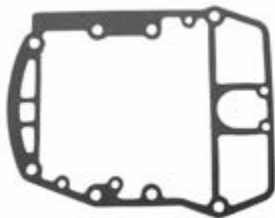

18-99015
UPPER CASING GASKET
Replaces: 676-45114-A0
Fits: C40(1991-97), CV40(1990)

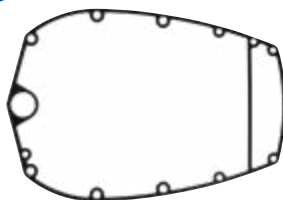

NEW
18-99164
UPPER UNIT CASING GASKET
Replaces: Yamaha 67F-45113-00-00, 75-115HP Outboards, All Models



18-99008
EXHAUST MANIFOLD GASKET
Replaces: 64J-41133-10
Fits: F40(2008-10), F60(2002-04), T25(2009-10), T60(2003-04)



18-99014
EXHAUST MANIFOLD GASKET
Replaces: 676-41133-A0
Fits: C40(1992-97)

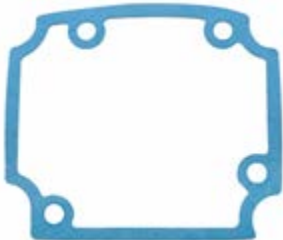

18-99010
EXHAUST MANIFOLD GASKET
Replaces: 664-41134-A0
Fits: C25(1992-97), C30(1992-97)



18-99016
EXHAUST MANIFOLD GASKET
Replaces: 67C-41133-00
Fits: F25(2001-05, 2009-10), F30(2001-05), F40(2000-08), F50(2001-04), T25(2005-06)



18-99018
EXHAUST MANIFOLD GASKET
Replaces: 67F-41133-A1
Fits: F75(2003-10), F90(2004-10), F115(2004-10), LF115(2004-10)



18-99019
EXHAUST MANIFOLD GASKET
Replaces: 67F-41134-A0
Fits: F75(2003-10), F80(1999-03), F90(2003-10), F100(1999-03), F115(2000-10), LF115(2000-10)



18-99020
MUFFLER GASKET
Replaces: 67F-45123-00
Fits: F75(2003-10), F80(1999-03), F90(2003-10), F100(1999-03)



18-99021
EXHAUST MANIFOLD GASKET
Replaces: 682-41133-A0
Fits: 9.9(1992-95), 15(1992-95)



18-99022
UPPER CASING GASKET
Replaces: 682-45113-A1
Fits: 9.9(1984-95), 15(1984-95)



18-99023
EXHAUST MANIFOLD GASKET
Replaces: 688-41133-00
Fits: 90(1984-09), B90(1997-99), C75(1994-96, 98-99), C80(1997), C85(1991-96), C90(1997-01), CV85(1989-90), E75(1995-00), P75(1996-99)

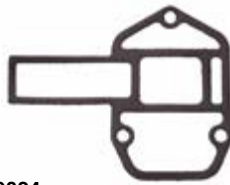

18-99024
EXHAUST MANIFOLD GASKET
Replaces: 688-41134-A0
Fits: 90(1984-09), B90(1997-99), C75(1994-99), C80(1997), C85(1991-96), C90(1997-01), CV85(1989-90), E75(1995-00), P75(1996-99)

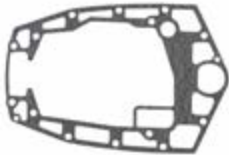

18-99025
UPPER CASING GASKET
Replaces: 688-45114-A1
Fits: 90(1984-09), B90(1997-99), C75(1994-99), C80(1997), C85(1991-96), C90(1997-01), CV85(1989-90), E75(1995-00), P75(1996-99)



18-99026
MUFFLER GASKET
Replaces: 688-45123-00
Fits: 90(1984-09), B90(1997-99), C75(1994-99), C80(1997), C85(1991-96), C90(1997-01), CV85(1989-90), E75(1995-00), P75(1996-99)

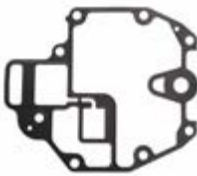

18-99027
OIL PAN GASKET
Replaces: 68T-13475-00
Fits: F6(2001-08), F8(2001-10), F9.9(2007, 2010), T8(2001-10), T9.9(2007-10)

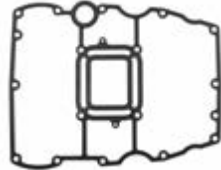

18-99028
OIL PAN GASKET
Replaces: 68V-15312-00
Fits: F75(2003-10), F90(2004-10), F115(2004-10), LF115(2004-10)



18-99030
UPPER CASING GASKET
Replaces: 697-45114-A0
Fits: E48(1995-00), C55(1992-95)



18-99032
EXHAUST MANIFOLD GASKET
Replaces: 69J-41134-A0
Fits: F200(2002-05), F225(2002-05), LF200(2002-05), LF225(2002-05)

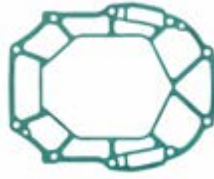

18-99033
EXHAUST MANIFOLD GASKET
Replaces: 69J-41135-A0
Fits: F200(2002-10), F225(2002-10), F250(2005-10), LF200(2002-10), LF225(2002-10), LF250(2005-10)



18-99034
EXHAUST MANIFOLD GASKET
Replaces: 69J-41136-A0
Fits: F200(2002-05), F225(2002-05), F250(2005), LF200(2002-05), LF225(2002-05), LF250(2005)



18-99037
EXHAUST MANIFOLD GASKET
Replaces: 6E5-41134-A0
Fits: 115(1992-09), 130(1992-04), B115(1998-99), C115(1992-00), L130(1994-01), P115(1993-96), S115(1996-99), S130(1996-99)



18-99038
EXHAUST MANIFOLD GASKET
Replaces: 6E5-41135-A0
Fits: 115(1992-09), 130(1992-04), 150(1992-09), 175(1992-95), 200(1992-98), 225(1992-97), B115(1998-99), C115(1992-00), C150(1996-99), D150(1997-99), DX150(1999-05), L150(1992-01), L200(1992-99), LX150(1999-01), LX200(1999-01), LZ150(2000-05), LZ200(2000-10), P115(1993-96), P150(1992-99), P175(1994-99), P200(1992-99), PX150(1999), S115(1996-99), S130(1996-99), S150(1996-99), S175(1996-99), S200(1996-99), SX150(1999-04), SX200(1999-05), V150(2000-08), V175(2000), VX150(2000-04), VZ150(2000-10), VZ175(2001-10), VZ200(2001-04), Z150(2000-05), Z175(2001-05), Z200(2000-10)



18-99039
EXHAUST MANIFOLD GASKET
Replaces: 6G5-41134-A1
Fits: 115(2003-04), 130(2003-04), 150(2003-09), DX150(2003-05), LZ150(2003-05), LZ200(2003-10), SX150(2003-04), SX200(2003-05), V150(2003-08), VX150(2003-04), VZ150(2003-10), VZ175(2003-10), VZ200(2003-04), Z150(2003-05), Z175(2003-05), Z200(2003-10)



18-99040
UPPER CASING GASKET
Replaces: 6G5-45114-A1
Fits: 115(2003-09), 130(2003-04), 150(2003-09), DX150(2003-05), LZ150(2003-05), LZ200(2003-10), SX150(2003-04), SX200(2003-05), V150(2003-08), VX150(2003-04), VZ150(2003-10), VZ175(2003-10), VZ200(2003-04), Z150(2003-05), Z175(2003-05), Z200(2003-10)



18-99045
UPPER CASING GASKET
Replaces: 6G8-45113-A1
Fits: F9.9(1997-05), T9.9(1995-05)



18-99046
UPPER CASING GASKET
Replaces: 6H3-45114-A1
Fits: 60(2002-05), 70(1984-069), C60(1996-01), C70(2001-02), E60(1995-00), P60(1991-99)



18-99047
MUFFLER GASKET
Replaces: 6H3-45123-00
Fits: 60(2001-05), 70(1984-09), C60(1996-01), C70(2000-01), E60(1995-00), P60(1991-99)



18-99049
REED GASKET
Replaces: 60V-13621-A0
Fits: LZ250(2003-05), LZ300(2004-06), VZ200(2005-09), VZ225(2003-09), VZ250(2003-09), VZ300(2004-09), Z250(2003-05), Z300(2004-06)



18-99050
INTAKE GASKET
Replaces: 60V-13645-00
Fits: LZ250(2003-05), LZ300(2004-06), VZ200(2005-09), VZ225(2003-09), VZ300(2004-09), Z250(2003-05), Z300(2004-06)



18-99051
VALVE COVER GASKET
Replaces: 61A-11193-A1
Fits: L225(1996-99), L250(1996-99), LX225(2000-03), LX250(2000-03), S225(1996-99), S250(1996-99), SX225(2000-03), SX250(2000-03), V200(1998-99), V225(1998-99), VX200(2000-05), VX225(2000-04)



18-99053
INTAKE GASKET
Replaces: 61A-13621-A0
Fits: 225(1994-95), 250(1992-95), DX150(1999-05), L225(1994-99), L250(1992-99), LX150(1999-01), LX200(1999-01), LX225(2000-03), LX250(2000-03), LZ150(2000-05), LZ200(2000-10), PX150(1999), S225(1996-99), S250(1996-99), SX150(1999-04), SX200(1999-05), SX225(2000-03), SX250(2000-03), V200(1998-99), V225(1998-99), VX150(2000-04), VX200(2000-05), VX225(2000-04), VX250(2002-04), VZ150(2000-10), VZ175(2001-10), VZ200(2001-04), Z150(2000-05), Z175(2001-05), Z200(2000-10)



18-99054
INTAKE GASKET
Replaces: 61A-13645-00
Fits: 225(1994-95), 250(1990-95), L225(1994-96), L250(1990-96), S225(1996), S250(1996)

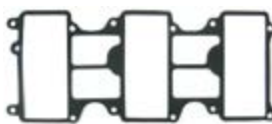



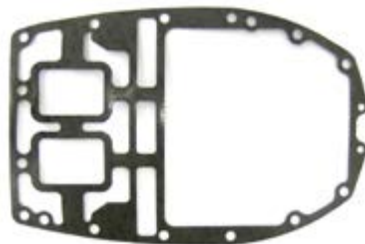









18-99055
MANIFOLD GASKET
Replaces: 61A-13646-00
Fits: 225(1994-95), 250(1990-95), L225(1994-96), L250(1990-96), S225(1996), S250(1996)



















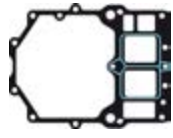





















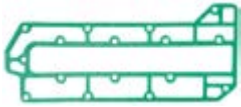









18-99056
BASE GASKET
Replaces: 61A-45113-A0
Fits: 225(1994-95), 250(1990-95), L225(1994-99), L250(1990-99), LX225(2000-03), LX250(2000-03), S225(1996-99), S250(1996-99), SX225(2000-03), SX250(2000-03), V200(1998-99), V225(1998-99), VX200(2000-05), VX225(2000-04), VX250(2002-04)



18-99057
VALVE COVER GASKET
Replaces: 61T-11193-A1
Fits: C30(1993-97)

 <p>18-99064 INTAKE GASKET Replaces: 64E-13645-A0 Fits: 150(1996-99), 200(1996-98), 225(1996-97), D150(1997-99), L150(1996-99), L200(1996-99), P150(1996-99), P175(1996-99), P200(1996-99), S150(1996-99), S175(1996-99), V150(2000-08), V175(2000)</p>	 <p>18-99066 INTAKE GASKET Replaces: 65L-13645-00 Fits: DX150(1999-05), L225(1997-99), L250(1997-99), LX150(1999-01), LX200(1999-01), LX225(2000-03), LX250(2000-03), LZ150(2000-05), LZ200(2000-10), PX150(1999), S225(1997-99), S250(1997-99), SX150(1999-04), SX200(1999-05), SX200(2000-03), SX225(2000-03), SX250(2000-03), V200(1998-99), V225(1998-99), VX150(2000-04), VX200(2000-05), VX225(2000-04), VX250(2002-04), VZ150(2000-10), VZ175(2001-10), VZ200(2001-04), Z150(2000-05), Z175(2001-05), Z200(2000-10)</p>		 <p>18-99067 INTAKE GASKET Replaces: 65L-13646-00 Fits: DX150(1999-05), L225(1997-99), L250(1997-99), LX150(1999-01), LX200(1999-01), LX225(2000-03), LX250(2000-03), LZ150(2000-05), LZ200(2000-10), PX150(1999), S225(1997-99), S250(1997-99), SX150(1999-04), SX200(1999-05), SX200(2000-03), SX225(2000-03), SX250(2000-03), V200(1998-99), V225(1998-99), VX150(2000-04), VX200(2000-05), VX225(2000-04), VX250(2002-04), VZ150(2000-10), VZ175(2001-10), VZ200(2001-04), Z150(2000-05), Z175(2001-05), Z200(2000-10)</p>	
 <p>18-99063 LOWER CASING GASKET Replaces: 63V-45315-A0 Fits: 9.9(1996-09), 15(1996-09), F9.9(2005-06), F15(1998-05), T9.9(2005-06)</p>	 <p>18-99068 BREATHER COVER GASKET Replaces: 65W-11169-00 Fits: F25(1998-01), T25(2001)</p>	 <p>18-99069 BASE GASKET Replaces: 65W-11351-00 Fits: F25(1998-02), T25(2001-02)</p>	 <p>18-99070 CRANKCASE GASKET Replaces: 65W-11356-00 Fits: F25(1998-05), T25(2001-06)</p>	 <p>18-99071 GASKET Replaces: 65W-14457-10 Fits: F25(1999-05), T25(2001-06)</p>
 <p>18-99072 EXHAUST GASKET Replaces: 65W-41114-00 Fits: F25(1998-05), T25(2001-06)</p>	 <p>18-99074 BASE GASKET Replaces: 66M-11351-10 Fits: F9.9(2005-06), F15(2005), T9.9(2005-06)</p>	 <p>18-99075 CYLINDER COVER GASKET Replaces: 66M-11356-00 Fits: F9.9(2005-06), F15(1998-05), T9.9(2005-06)</p>	 <p>18-99076 WATER PUMP GASKET Replaces: 66M-13329-10 Fits: F9.9(2005-06), F15(2001-05), T9.9(2005-06)</p>	 <p>18-99078 GASKET Replaces: 66M-41138-00 Fits: F15(1998-04)</p>
 <p>18-99079 UPPER CASING GASKET Replaces: 66M-45115-00 Fits: F9.9(2005-06), F15(1998-05), T9.9(2005-06)</p>	 <p>18-99080 INTAKE GASKET Replaces: 676-13646-A0 Fits: C40(1991-97), CV40(1990)</p>	 <p>18-99082 WATER PUMP GASKET Replaces: 676-44315-A1 Fits: C40(1991-97), CV40(1990)</p>	 <p>18-99083 WATER PUMP GASKET Replaces: 676-44324-A0 Fits: C40(1991-97), CV40(1990)</p>	 <p>18-99084 EXHAUST GASKET Replaces: 676-45127-00 Fits: C40(1991-97), CV40(1990)</p>
 <p>18-99085 EXHAUST GASKET Replaces: 676-45128-00 Fits: C40(1991-97), CV40(1990)</p>	 <p>18-99086 WATER PUMP GASKET Replaces: 679-44316-A0 Fits: C40(1991-97), CV40(1990)</p>	 <p>18-99087 LOWER CASING GASKET Replaces: 679-45315-A0 Fits: C40(1991-94), CV40(1990)</p>	 <p>18-99088 CYLINDER COVER GASKET Replaces: 67C-11356-00 Fits: F30(2001-05), F40(2000-08)</p>	

 <p>18-99089 EXHAUST GASKET Replaces: 67C-41114-00 Fits: F30(2001), F40(2000-01)</p>	 <p>18-99091 GASKET Replaces: 67C-45113-00 Fits: F25(2001), F30(2001), F40(2000-01), t25(2001)</p>	 <p>18-99095 BASE GASKET Replaces: 682-11351-A0 Fits: 9.9(1984-95), 15(1984-95)</p>	 <p>18-99096 GASKET Replaces: 682-41112-A1 Fits: 9.9(1984-95), 15(1984-95)</p>	 <p>18-60508 THERMOSTAT GASKET Replaces: 60V-12414-A0-00 Fits: Yamaha LZ250(2003-05), LZ300(2004-06), VZ200(2005-09), VZ225(2003-09), VZ250(2003-09), VZ300(2004-09), Z250(2003-05), Z300(2004-06)</p>
 <p>18-99098 INTAKE GASKET Replaces: 688-13621-A1 Fits: 90(1992-09), B90(1997-99), C75(1994-99), C80(1997), C85(1992-96), C90(1997-01), E75(1995-00), P75(1996-99)</p>	 <p>18-99099 VALVE COVER GASKET Replaces: 68F-11193-01 Fits: LZ150(2000-05), LZ200(2000-08), VZ150(2000-08), VZ175(2001-08), VZ200(2001-04), Z150(2000-05), Z175(2001-05), Z200(2000-08)</p>	 <p>18-99100 GASKET Replaces: 68F-11381-00 Fits: LZ150(2000-05), LZ200(2000-10), VZ150(2000-10), VZ175(2001-10), VZ200(2001-04), Z150(2000-05), Z175(2001-05), Z200(2000-10)</p>	 <p>18-99101 EXHAUST GASKET Replaces: 68F-41114-00 Fits: LZ150(2000-05), LZ200(2000-10), VZ150(2000-10), VZ175(2001-10), VZ200(2001-04), Z150(2000-05), Z175(2001-05), Z200(2000-10)</p>	 <p>18-99102 BASE GASKET Replaces: 68F-45113-00 Fits: 150(2004-08), DX150(2004-05), LZ150(2000-05), LZ200(2000-08), SX150(2004), SX200(2004-05), V150(2004-08), VX150(2004), VZ150(2000-08), VZ175(2001-08), VZ200(2001-04), Z150(2000-05), Z175(2001-05), Z200(2000-08)</p>
 <p>18-99105 INTAKE GASKET Replaces: 6E5-13621-A1 Fits: 115(1992-09), 130(1992-04), 150(1992-09), 175(1992-95, 2000), 200(1992-98), B115(1998-969), C115(1992-00), C150(1996-99), L130(1992-01), L150(1992-99), L200(1992-98), P115(1993-96), P150(1993), S115(1996-99), S130(1996-99), S150(1996-99), S175(1996-99), S200(1996-99)</p>	 <p>18-99106 VALVE COVER GASKET Replaces: 6E9-11193-A0 Fits: C40(1991-97), CV40(1990)</p>	 <p>18-99107 EXHAUST GASKET Replaces: 6E9-41114-A0 Fits: C40(1992-97)</p>	 <p>18-99108 VALVE COVER GASKET Replaces: 6G1-11193-A1 Fits: 6(1986-00), 8(1984-09)</p>	 <p>18-99109 REED GASKET Replaces: 6G1-13621-A1 Fits: 6(1991-00), 8(1991-09)</p>
 <p>18-99110 INTAKE GASKET Replaces: 6G1-13645-A1 Fits: 6(1991-00), 8(1991-09)</p>	 <p>18-99111 INTAKE GASKET Replaces: 6G1-14198-A1 Fits: 6(1986-00), 8(1984-09)</p>	 <p>18-99112 EXHAUST GASKET Replaces: 6G1-41112-A1 Fits: 6(1986-00), 8(1984-09)</p>	 <p>18-99113 EXHAUST GASKET Replaces: 6G1-41114-A0 Fits: 6(1991-00), 8(1991-09)</p>	 <p>18-99114 EXHAUST GASKET Replaces: 6G1-41133-A0 Fits: 6(1992-00), 8(1992-09)</p>
 <p>18-99115 BASE GASKET Replaces: 6G1-45113-A1 Fits: 6(1986-00), 8(1984-09)</p>	 <p>18-99116 WATER PUMP GASKET Replaces: 6G1-45315-A0 Fits: 6(1986-00), 8(1984-09)</p>	 <p>18-99118 CARBURETOR GASKET Replaces: 6G5-14483-A1 Fits: C150(1996-99)</p>	 <p>18-99119 BASE GASKET Replaces: 6G8-11351-A0 Fits: F9.9(1985-05), FT9.9(1985-90), T9.9(1991-05)</p>	 <p>18-99120 THERMOSTAT GASKET Replaces: 6G8-12414-A0 Fits: F6(2001-04), F8(2001-04), F9.9(1985-05, 2007, 2010), FT9.9(1985-90), T8(2001-04), T9.9(1991-05, 2007-10)</p>

 <p>18-99121 INTAKE GASKET Replaces: 6G8-13646-A0 Fits: F9.9(1985-05), FT9.9(1985-90), T9.9(1991-05)</p>	 <p>18-99122 INTAKE GASKET Replaces: 6G8-14198-A0 Fits: F9.9(1992-05), T9.9(1992-05)</p>	 <p>18-99124 THERMOSTAT GASKET Replaces: 6H3-12414-A1 Fits: 60(2001-05), 70(1984-09), C60(1996-01), C70(2000-01), E60(1995-00), P60(1991-99)</p>	 <p>18-99125 INTAKE GASKET Replaces: 6H3-13622-00 Fits: 70(1985-91), P60(1991)</p>	 <p>18-99126 INTAKE GASKET Replaces: 6H3-14198-01 Fits: 70(1984-91), P60(1991)</p>
 <p>18-99128 EXHAUST GASKET Replaces: 6H3-41114-A0 Fits: 60(2001-05), 70(1992-09), C60(1996-01), C70(2000-01), E60(1995-00), P60(1992-99)</p>	 <p>18-99129 EXHAUST GASKET Replaces: 6H3-41112-A0 Fits: 60(2001-05), 70(1986-09), C60(1996-01), C70(2000-01), E60(1995-00), P60(1991-99)</p>	 <p>18-99130 EXHAUST GASKET Replaces: 6H3-45113-A0 Fits: 60(2001-025), 70(1984-09), C60(1996-01), C70(2000-01), E60(1995-00), P60(1991-99)</p>	 <p>18-99132 REED GASKET Replaces: 6H4-13621-A1 Fits: 40(1984-05), 50(1984-09), C40(1997-03), C50(1998-01), P40(1998), P50(1991-96), PR50(1989), Pro 50(1987-90)</p>	 <p>18-99133 GASKET Replaces: 6H4-14198-01 Fits: 40(1989-05), 50(1989-09), C40(1997-03), C50(1998-01), P40(1998), P50(1991-96), PR50(1989), Pro 50(1989-90)</p>
 <p>18-99134 END CAP GASKET Replaces: 6H4-15369-A1 Fits: 40(1984-01), 50(1984-09), C40(1997-03), C50(1998-01), P40(1998), P50(1991-96), PR50(1989), Pro 50(1987-90)</p>	 <p>18-99135 EXHAUST GASKET Replaces: 6H4-41112-A0 Fits: 40(1992-05), 50(1992-09), C40(1997-03), C50(1998-01), P40(1998), P50(1992-96)</p>	 <p>18-99136 INTAKE GASKET Replaces: 6K7-13646-A1 Fits: 225(1990-95), P150(1994-95), P175(1994-95), P200(1992-95), V6 Excel(1987-89)</p>	 <p>18-99137 EXHAUST GASKET Replaces: 6L2-41133-A2 Fits: 25(2004-08)</p>	 <p>18-99138 WATER PUMP GASKET Replaces: 6L2-45315-A0 Fits: 20(1996-97), 25(1992-09)</p>
 <p>18-99139 INTAKE GASKET Replaces: 6OV-13646-00 Fits: LZ250(2003-05), LZ300(2004-06), VZ200(2005-09), VZ225(2003-09), VZ250(2003-09), VZ300(2004-09), Z250(2003-05), Z300(2004-06)</p>	 <p>18-99140 HEAD GASKET Replaces: 63V-11181-A1, 63V-11181-A2 Fits: 9.9(1997-08), 15(1997-08)</p>	 <p>18-99141 COVER GASKET Replaces: 6H3-11193-A1 Fits: 60(2001-05), 70(1984-09), C60(1996-01), C70(2000-01), E60(1995-00), P60(1991-99)</p>	 <p>18-99142 THERMOSTAT GASKET Replaces: 6E9-12414-A0, 6E9-12414-A1 Fits: C40(1992-97)</p>	 <p>18-99143 VALVE SEAL GASKET Replaces: 6H3-13621-A1 Fits: 60(2001-05), 70(1992-09), C60(1996-01), C70(2000-01), E60(1995-00), P60(1992-99)</p>
 <p>18-99144 MIXING COVER GASKET Replaces: 6E7-14227-00 Fits: 9.9(1984-95), 15(1984-95)</p>	 <p>18-99145 CARBURATOR GASKET Replaces: 677-14198-00, 677-14198-A1 Fits: 9.9(1984-91), 15(1984-91)</p>	 <p>18-99147 FUEL PUMP GASKET Replaces: 6G1-24431-01 Fits: 3(1990-02), 6(1990-00), 8(1990-09), 9.9(1996-09), 15(1996-09)</p>	 <p>18-99148 OUTER EXHAUST COVER GASKET Replaces: 688-41114-A0 Fits: 90(1992-09), B90(1998-99), C75(1994-99), C80(1997), C85(1992-96), C90(1997-01), E75(1995-00), P75(1996-99)</p>	 <p>18-99149 WATER PUMP GASKET Replaces: 663-44316-A0 Fits: 25(1997-02), 30(1992-01), 40(1992-94), 50(1992-94), C30(1995), C55(1992-95), E48(1995-00), P50(1992-94)</p>

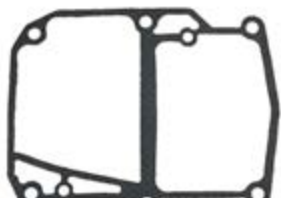

18-99150
UPPER CASING GASKET
 Replaces: 63V-45113-A1
 Fits: 9.9(1997-09), 15(1997-09)

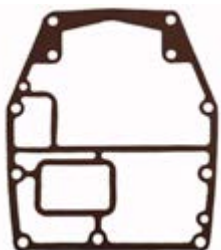

18-99151
UPPER CASING GASKET
 Replaces: 688-45113-A0
 Fits: 90(1984-09), B90(1997-99),
 C75(1994-99), C80(1997), C85(1991-96),
 C90(1997-01), C85(1989-90), E75(1995-
 00), P75(1996-99)



18-99152
LOWER CASING GASKET
 Replaces: 683-45315-A0
 Fits: 9.9(1984-95), 15(1984-95),
 F9.9(1986-05)



18-0765
FLOAT CHAMBER GASKET
 Replaces: 6L2-14384-00-00

PKG. OF 2



18-0775
18-0775-9①
CARB
MOUNTING GASKET
 Replaces: 648-14198-A0-00



18-0785
CARB MOUNTING GASKET
 Replaces: 6E5-14198-A1-00



18-0786
FLOAT CHAMBER GASKET
 Replaces: 6E5-14384-02-00



18-2592
FLOAT BOWL GASKET
 Replaces: 6E5-14384-03-00
 For: V-4 Outboards: 115, 130, 150, 175,
 200, 225 (1986-96) V-6 Special & Excel
 (1986-89)



18-0840-1
FLOAT CHAMBER
GASKET
 Replaces: 676-14984-00-00



18-0807-1
REED PLATE
GASKET
 Replaces: 6K7-13645-A1-00





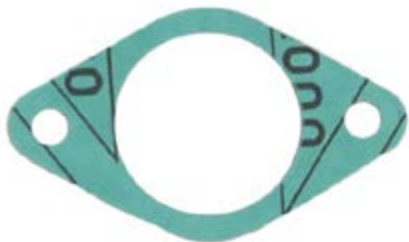







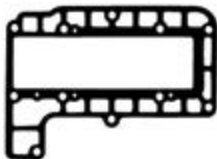

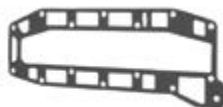



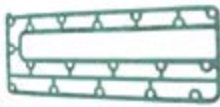







18-0809
REED BLOCK
GASKET
 Replaces: 6G5-13645-A1-00



18-0808
PRESSURE CONTROL
VALVE GASKET
 Replaces: 6G5-11382-A1-00



18-64415
O₂ SENSOR KIT
 Replaces: 68F-W1135-00-00
 Fits: Yamaha DX150(2001-05), LX150(2001), LX200(2001), LX225(2001-02),
 LX250(2001-02), LZ150(2000-05), LZ200(2000-12), SX150(2001-04),
 SX200(2001-05), SX225(2001-02), SX250(2001-02), VX150(2001-04),
 VX200(2001-02), VX225(2001-02), VZ150(2000-14), VZ175(2001-12),
 VZ200(2001-04), Z150(2000-05), Z175(2001-05), Z200(2000-12)

 <p>18-0250 EXHAUST COVER GASKET Replaces: 664-41114-A0-00</p>	 <p>18-0744 OUTER EXHAUST COVER GASKET Replaces: 6L2-41114-A1-00</p>	 <p>18-0798 EXHAUST COVER GASKET Replaces: 6H4-41114-A0-00</p>	 <p>18-0799 EXHAUST COVER GASKET Replaces: 6E5-41112-A1-00</p>	 <p>18-0812 EXHAUST COVER GASKET Replaces: 6G5-41112-A1-00</p>
 <p>18-0823 EXHAUST MANIFOLD GASKET Replaces: 6E5-13645-A1-00</p>	 <p>18-0847 EXHAUST COVER GASKET Replaces: 688-41112-A0-00 Fits: 90 HP</p>	 <p>18-0739 UPPER CASING GASKET Replaces: 689-45113-A1-00</p>	 <p>18-0813 POWERHEAD BASE GASKET Replaces: 6G5-45113-A0-00</p>	 <p>18-0232 COVER GASKET Replaces: 655-12414-A1-00</p>
 <p>18-0782 COVER GASKET Replaces: 6E5-11381-A1-00</p>	 <p>18-0829 COVER GASKET Replaces: 61A-12414-A0-00 6J8-12414-A0-00</p>	 <p>18-99127 THERMOSTAT GASKET Replaces: 63P-12414-00-00 Fits: F150/LF150 (2004-11), F150A/LF150A (2012-14), F150B/LF150B (2015-18)</p>	 <p>18-0754 THERMOSTAT GASKET Replaces: 68D-E2414-A0-00 Fits: F2.5MSH-0405, F2.5MSH-0406, F2.5MSH-0407, F2.5MSH0608, F2.5MSHD-2007</p>	 <p>18-0836 THERMOSTAT GASKET Replaces: 682-12414-A1-00 Fits: 9.9, 15 (1984-06)</p>
 <p>18-0835 THERMOSTAT GASKET Replaces: 62Y-12414-00-00 Fits: F 9.9, T9.9 (2005-06), 15 (2006), F15, F25 (1998-06), T25, F30 (2001-06), F40 4cyl (1999), F40 3cyl (2000-06), F50 (1996-06), T50 (1996-06), F60 (2002-06), T60 (2003-06)</p>	 <p>18-0844 THERMOSTAT GASKET Replaces: 688-12414-A1-00 Fits: 90 HP V-4, V-6</p>	 <p>18-0767 WATER JACKET GASKET Replaces: 688-11193-01-00 Fits: 90 HP</p>	 <p>18-0779 WATER JACKET GASKET Replaces: 6G5-11193-A0-00</p>	
 <p>18-0781 WATER JACKET GASKET Replaces: 6E5-11193-A0-00</p>	 <p>18-0815 WATER JACKET GASKET Replaces: 6H4-11193-A1-00</p>	 <p>18-0483 PUMP CASE GASKET Replaces: 63D-44316-00-00 Fits: 40 (1995-04), 50 (1995-97, 1999-04)</p>	 <p>18-0753 WATER PUMP GASKET Replaces: 6G1-44315-A0-00 Fits: 6 (1986-00), 8 (1984-05)</p>	 <p>18-0239 WATER PUMP GASKET Replaces: 688-44315-A0-00</p>



18-60521
CYLINDER COVER GASKET
 Replaces: 69M-11196-A0-00
 Fits: Yamaha F2.5(2003-14), F4(1999-14), F6(2009-14)



18-60529
EXHAUST MANIFOLD GASKET
 Replaces: 66T-41133-A0-00
 Fits: Yamaha T40/T30 Enduro Series



18-60522
CYLINDER COVER GASKET
 Replaces: 66T-11181-A0-00
 Fits: Yamaha F2.5(2003-14), F4(1999-14), F6(2009-14)



18-60530
EXHAUST OUTER COVER GASKET
 Replaces: 66M-41114-01-00
 Fits: Yamaha F9.9(2005-06), F15(2005-06), T9.9(2005-06)



18-60527
ENGINE GASKET
 Replaces: 67D-45113-A0-00
 Fits: Yamaha F4(1999-08)

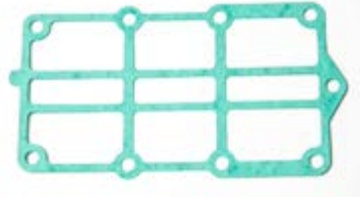

18-60532
EXHAUST OUTER COVER GASKET
 Replaces: 66T-41114-A0-00
 Fits: Yamaha T40/T30 Enduro Series



18-60520
CYLINDER COVER GASKET
 Replaces: 66T-11193-A0-00
 Fits: Yamaha T40/T30 Enduro Series



18-60534
MANIFOLD GASKET
 Replaces: 66M-13645-00-00
 Fits: Yamaha F9.9(2005-06), F15(1998-06), T9.9(2005-06)



18-60535
MANIFOLD GASKET
 Replaces: 65W-13645-00-00
 Fits: F25(1998-05), T25(2001-06)



18-60541
WATER PUMP COVER GASKET
 Replaces: 6BX-G4315-01-00
 Fits: F4(2009-14), F6(2009-14)



18-0240
WATER PUMP GASKET
 Replaces: 688-44316-A0-00

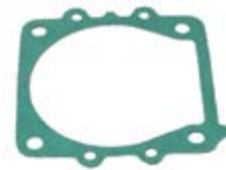

18-0244
WATER PUMP GASKET
 Replaces: 6E5-44315-A0-00





18-0292
WEAR PLATE TO PUMP HOUSING GASKET
 Replaces: 663-44315-A0-00





18-0294
18-0294-9①
WEAR PLATE TO PUMP BASE GASKET
 Replaces: 663-44324-A0-00



PKG. OF 2
18-0756-1
WATER PUMP GASKET
 Replaces: 6H3-44315-A0-00

<p>PKG. OF 2</p>  <p>18-0757 OUTER PLATE GASKET Replaces: 6H3-44324-A0-00</p>	 <p>18-0768 18-0768-9^① WEAR PLATE GASKET Replaces: 682-44315-A0-00</p>	 <p>18-0826 DRAIN SCREW GASKET Replaces: 90430-14115-00 Fits: 40-90 HP</p>
---	---	---

 <p>18-4274 PROP SPACER Replaces: 688-45997-01-00</p>	 <p>18-2448 LOWER UNIT FILL/DRAIN KIT M8 - 1.25 thread Fits: Yamaha, Nissan/Tohatsu, & Honda Lower Units</p>	 <p>18-4698 18-46981-9^① (PKG. OF 50) DRAIN FILL WASHER Replaces: 90430-08020-00</p>	 <p>18-2371 18-23711-9^① (PKG. OF 50) DRAIN SCREW M8 - 1.25 thread Replaces: 90340-08002-00, 90340-08M04-00 Uses Gasket 18-4698</p>	 <p>18-2374 MAGNETIC DRAIN SCREW M8 - 1.25 thread Replaces: 688-45341-00-00, 688-45341-10-00 Uses Gasket 18-4698</p>
--	---	---	---	--

 <p>18-2388 PROP SHAFT Replaces: 688-45611-00-00 For: F40 (1999) F50(1999-00) C60/C70/C90 (2000-01) C75 (1994) C85 (1991-94)</p>	<p>RECOIL STARTER SPRINGS</p>  <p>18-51001 Replaces: 63V-15713-00-00 Fits: 9.9(1996-09), 15(1996-09), F6(2001-08), F8(2001-14), F9.9(2005-14), F15(1998-14), F20(2006-14), T8(2002-10), T9.9(2007-14)</p> <p>18-51002 Replaces: 67D-15713-00-00 Fits: F2.5(2003-14), F4(1999-14), F6(2009-14)</p> <p>18-51003 Replaces: 66T-15713-00-00 Fits: F25(2009-14), F30(2001-05), F40(2001-08)</p>
--	--

Model	Year	Part #	Model	Year	Part #
40EJRP - 50TLHS	1984-1997	N/A	F115TLR	2006 & UP	N/A
50ETSN - 50TLHS	1984-1994	N/A	F115TLRA - F115TLRZ	2001-2005	N/A
T50TLRY - C90TLRZ	1989-2001	18-2388	F115TXR	2006 & UP	N/A
50ETSK	1984-2001	N/A	F115TXRA -200ETXN	1984-2004	N/A
115TLR	2006 & UP	N/A	V-6 SPECIAL	1985-1986	N/A
115TLRA - 115TRR	1991-2005	N/A	V-6 SPECIAL L	1984-1986	N/A
115TXR	2006 & UP	N/A	V-6 SPECIAL LK	1985	N/A
115TXRA - 115TXRA	1991-2005	N/A	V-6 SPECIAL X	1984-1986	N/A
F115TJR	2006 & UP	N/A	V-6 SPECIAL XK	1985	N/A
F115TJRA - F115TJRD	2002-2005	N/A			

 <p>18-2773 CARRIER BEARING Replaces: 663-45331-00-94 For: E48 (1995, 1997-00) / C55 (1991-95)</p>	 <p>18-2782 CARRIER BEARING Replaces: 688-45331-00-94 For: F40 (1999) F50/T50 (1996-00) 60 (2002-03) C60 (1996-01) E60 (1995-99) P60 (1991-99) 70 (1984-03) C70 (2000-01) C75 (1994-96 / 1998-99) E75 (1995-00) P75 (1996-99) C80 (1997) C85 (1991-96)</p>
---	---

^① Priced per Package

Zinc is for saltwater only applications.
 Magnesium is for fresh water only applications.
 Aluminum is for brackish water, or if boat is used in both fresh and salt environments.

 <p>18-6118A^① CYLINDER BLOCK ANODE Replaces: 68V-11325-01-00 Fits: F75-F250 / 2004 through April 2006 Production</p>	 <p>18-6119A^① 18-6119Z^③ TRIM TAB ANODE Replaces: 61A-45371-00-00</p>	 <p>18-6120A^① 18-6120Z^③ GEARCASE ANODE Replaces: 61N-45251-01-00</p>	 <p>18-6121A^① 18-6121Z^③ TRIM TAB ANODE Replaces: 6K1-45371-02-00 Fits: FL150 (2004-2005); L150 - L200 (1987-2002)</p>	 <p>18-6122A^① 18-6122Z^③ TRIM TAB ANODE Replaces: 69L-45371-00-00 Fits: VZ200 - VZ300 / 3.3L (2005-Current), VX225 - VX250 / 2.6L (2002-2005), Z250 - Z300 / 3.3L (2004-Current)</p>												
 <p>18-6246 TRIM TAB BOLT Replaces: 90105-10M00-00 M10 - 1.25 x 45mm thread</p>	 <p>18-6034 ANODE Replaces: 6K1-45371-00-00 For use on lower drive 150,200 HP (1986)</p>	 <p>18-6112 18-6035 ANODE Replaces: 6J9-45371-01-00 For: 150-200 HP</p>	 <p>18-6111 18-6070 ANODE Replaces: 688-45371-02-00 For use on lower casing drive For: 60, 70, 90HP (1984-04) C60, C75, C85, C90 (1994-01), E60, E75 (1995-00), F50 (1996-00), P60, P75 (1991-99), T50 (1996-00)</p>	 <p>18-6090 ANODE Replaces: 6G5-45251-01-00 For use on transom bracket For: 115-225HP (1988-02)</p>												
 <p>18-6091 ANODE Replaces: 6H1-45251-02-00 For: 40-90 HP</p>	 <p>18-6096 ANODE Replaces: 664-45371-01-00 For: 20-50 HP</p>	 <p>18-6097 ANODE Replaces: 6E5-45371-01-00 For use on lower casing drive For: 115, 130 HP(1984-04), V6 Special (1985-86)</p>	 <p>18-6132A 18-6132M ANODE For: Yamaha 200-250 Outboards</p>	 <p>18-6133A 18-6133M ANODE Fits: Yamaha 150-200 Outboards</p>												
 <p>18-6162A^① 18-6162M^② ANODE KIT Fits: Yamaha 60-90HP Engines</p>		 <p>18-73891 PROP SPACER Replaces: 68D-G5987-00-00 Fits: Yamaha F2.5(2001 & Up), F4(2001 & Up), F6(2006 & Up)</p>	 <p>18-73914 PROP SPACER Replaces: 670-45997-02-00 Fits: Yamaha 40-50(1984-05)</p>													
 <p>18-73918 PROP THRUST WASHER Replaces: 63P-45987-00-00, 6E5-45987-01-00 Fits: Yamaha F115-F200(2004-14)</p>	 <p>18-73990 PROP NUT KIT Fits: Yamaha 40(1984-01), 50(1984-95), C55, F40-F50(1995-00)</p>	<p>COTTER PINS</p> <table border="1"> <thead> <tr> <th>Part #</th> <th>O.E. #</th> <th>Pkg of</th> </tr> </thead> <tbody> <tr> <td>18-2380</td> <td>91490-30030-00, 91401-30030-00, 91401-30028-00, 91402-30028-09, 91402-30028-00, 91402-30022-00</td> <td>10</td> </tr> <tr> <td>18-3735</td> <td>91490-40030-00</td> <td>10</td> </tr> <tr> <td>18-3748</td> <td>91490-30045-00</td> <td>5</td> </tr> </tbody> </table>			Part #	O.E. #	Pkg of	18-2380	91490-30030-00, 91401-30030-00, 91401-30028-00, 91402-30028-09, 91402-30028-00, 91402-30022-00	10	18-3735	91490-40030-00	10	18-3748	91490-30045-00	5
Part #	O.E. #	Pkg of														
18-2380	91490-30030-00, 91401-30030-00, 91401-30028-00, 91402-30028-09, 91402-30028-00, 91402-30022-00	10														
18-3735	91490-40030-00	10														
18-3748	91490-30045-00	5														

① Aluminum ② Magnesium ③ Zinc



**18-73995
PROP NUT KIT**
Replaces: 66T-W4599-00-00
Fits: *F30 (2001-05, 2013-19), F40 (2000-19), F50 (2001-19), F60 (2002-19)
Replacing propeller nuts and tab washers is always good practice when replacing a propeller.
Keep a kit with your spare prop in the event of an unexpected propeller change.
Propeller nut features a nylon insert securing the propeller under extreme conditions.*



**18-73996
PROP NUT KIT**
Replaces: 67F-W4599-00-00
Fits: *T50 (2001-18), T60 (2003-18), 60 (2004-05), 70 (2004-09), 90 (2004-09), F70 (2010-18), F75 (2003-17), F80 (1999-03), F90 (2003-17), F100 (1999-03), T50 (2001-18), T60 (2003-18)
Replacing propeller nuts and tab washers is always good practice when replacing a propeller.
Keep a kit with your spare prop in the event of an unexpected propeller change.
Propeller nut features a nylon insert securing the propeller under extreme conditions.*



**18-73907
PROP NUT**
Replaces: 90171-14056-00
Fits: Yamaha 20-30 HP (1980 & up)



**18-3781
PROP NUT KIT**
Replaces: 6H1-W4599-00-00
For: T50, C60, E60, P60, 70, C75, C80, C85, 90
— CONTAINS —

Part #	O.E. #	Desc.
18-3732	90171-16011-00	Prop Nut
18-4274	688-45997-01	Spacer
18-2380	91490-30030	Cotter Pin



**18-3782
PROP NUT KIT**
Replaces: 6G5-W4599-00-00
— CONTAINS —

Part #	O.E. #	Desc.
18-3726	90171-18M04	Prop Nut
18-4274	688-45997-01	Spacer
18-3735	91490-40030	Cotter Pin

ALL V-4 & V-6 (Except D150)



**18-3771
PROP NUT KIT**
Replaces: 689-W4599-00
— CONTAINS —

Part #	O.E. #	Desc.
18-3732	689-45997-00	Spacer
18-3792	90171-14013-00	Prop Nut
18-2380	91490-30030-00	Cotter Pin



**18-3709
PROP NUT**
Replaces: 647-45616-02
Fits: 4(1984-91), 5(1984-85)



**18-3726
PROP NUT**
Replaces: 90171-18M04
For: All V-4 & V-6 (Except D150)



**18-3732
PROP NUT**
Replaces: 90171-16011-00
95307-16900-00
Fits: Yamaha 20-30 hp(1980 & Up)



**18-3773
PROP NUT**
Replaces: 90171-10M01
Fits: 6(1986-00), 8(1986-09), 9,9(1984-09), 15(1984-09), F6(2001-08), F8(2001-12), F9,9(1985-12), F15(1998-13), F20(2006-13)



**18-3792
PROP NUT**
Replaces: 90171-14013-00, 90171-14056-00

HP/Model	Years	Nut #	Spacer #	Cotter Pin #	Kit #
2(6A1)	1984-95	—	—	18-3748	—
4(6E0)	1984-90	—	—	18-3748	—
4(6E0)	1991	—	—	18-2380	—
5	1984-85	—	—	18-3748	—
9,9(6GB)	1984-85	—	—	18-3748	—
20	1996-97	18-3792	—	18-2380	18-3771
25(6H7)(6L2)	1984-09	18-3792	—	18-2380	18-3771
C25(695)	1991-97	18-3792	—	18-2380	18-3771
CV25	1990	18-3792	—	18-2380	18-3771
F25	1998-05, 2009-10	18-3792	—	18-2380	18-3771
30(689)(6J8)	1984-02	18-3792	—	18-2380	18-3771
C30(689)(61T)	1991-97	18-3792	—	18-2380	18-3771
CV30	1990	18-3792	—	18-2380	18-3771
40(6H4)(63B,C,D)	1984-05	18-3732	—	18-2380	—
C40(6R6)	1990-03	18-3732	—	18-2380/18-3748	—
50(6H5)(62X)	1984-09	18-3732	—	18-2380/18-3748	—
PRO50(6H5)(62X)	1987-90	18-3732	—	18-2380	—
T50	2001-10	18-3732	18-3789	18-3735	18-3772
C55(697)	1991-95	18-3732	—	18-3735	—
60	2004-05	18-3732	18-3789	18-3735	18-3772
P60(6H2)	1991-99	18-3732	18-4274	18-3735	18-3781
T60	2003-10	18-3732	18-3789	18-3735	18-3772
70(6H3)	1984-03	18-3732	18-4274	18-3735	18-3781
70	2004-09	18-3732	18-3789	18-3735	18-3772
F70	2010	18-3732	18-3789	18-3735	18-3772
C75(692)	1994-99	18-3732	18-4274	18-3735	18-3781
F75	2003-10	18-3732	18-3789	18-3735	18-3772
F80	1999-03	18-3732	18-3789	18-3735	18-3772
C85(688)	1991-96	18-3732	18-4274	18-3735	18-3781
90(6H1)	1984-03	18-3732	18-4274	18-3735	18-3781
90	2004-09	18-3732	18-3789	18-3735	18-3772
F90	2003-10	18-3732	18-3789	18-3735	18-3772
F100	1999-03	18-3732	18-3789	18-3735	18-3772
115(6E5)(6N6)	1984-09	18-3726	18-4274	18-3735	18-3782
C115(6E5)	1991-00	18-3726	18-4274	18-3735	18-3782
P115(62A)	1993-96	18-3726	18-4274	18-3735	18-3782
130(6L1)(6N7)	1988-04	18-3726	18-4274	18-3735	18-3782
L130(6L6)(6N4)	1989-01	18-3726	18-4274	18-3735	18-3782
150(6G4)(6R2)	1984-09	18-3726	18-4274	18-3735	18-3782
PRO V 150, (6J9)(6N9)	1986-90	18-3726	18-4274	18-3735	18-3782
P150(6N9)	1991-99	18-3726	18-4274	18-3735	18-3782
L150(6RO)	1986-99	18-3726	18-4274	18-3735	18-3782
175(6G5)(6R3)	1984-00	18-3726	18-4274	18-3735	18-3782
P175(62H)	1994-99	18-3726	18-4274	18-3735	18-3782
200(6G6)(6R4)	1984-95	18-3726	18-4274	18-3735	18-3782
L200(6K1)(6R1)	1987-99	18-3726	18-4274	18-3735	18-3782
P200(61H)	1991-99	18-3726	18-4274	18-3735	18-3782
225(6R5)(62J)	1990-97	18-3726	18-4274	18-3735	18-3782
L225(62K)	1994-99	18-3726	18-4274	18-3735	18-3782
250(61A)	1990-95	18-3726	18-4274	18-3735	18-3782
L250(61B)	1990-99	18-3726	18-4274	18-3735	18-3782
V6 SPECIAL(6G7)	1984-86	18-3726	18-4274	18-3735	18-3782
V6 EXCEL(6K7)	1987-89	18-3726	18-4274	18-3735	18-3782

① Items ending in "D" are Display Packaged - Regular number is Non-Display
 ② This product is priced per piece. To order price per package, please add -9 to the part number.

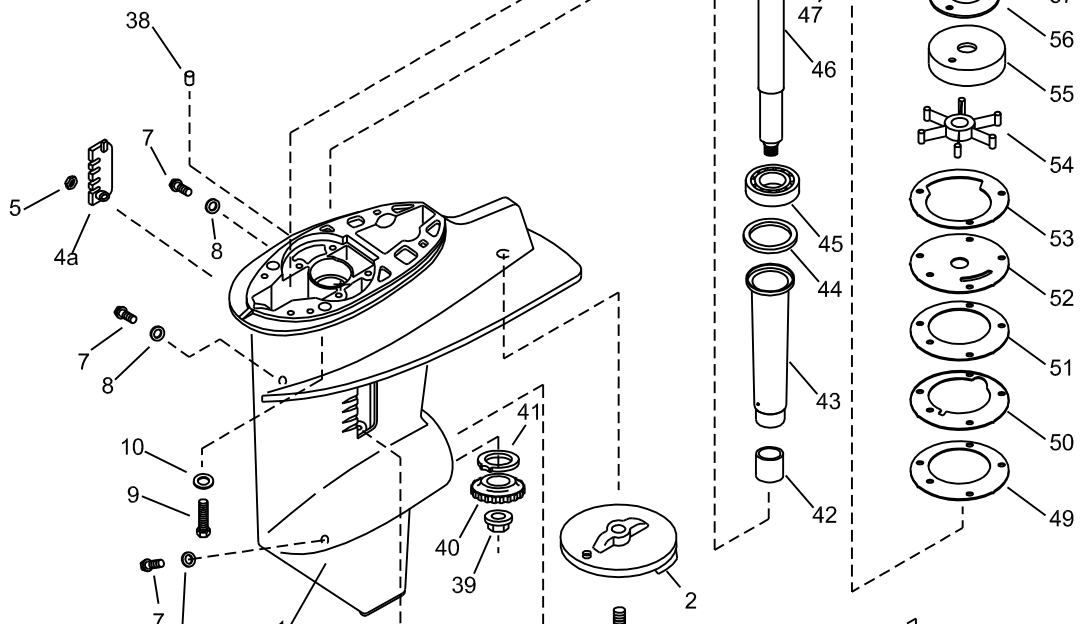
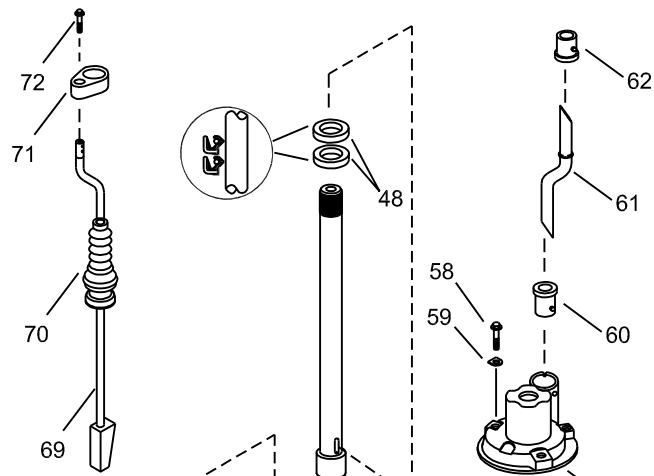
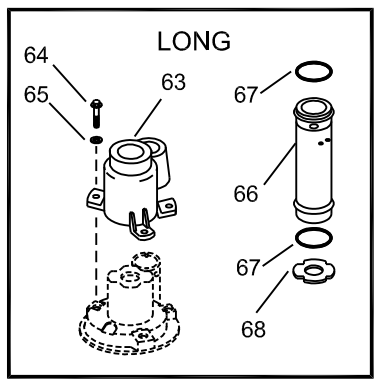

73 — Gear Housing Seal Kit 18-2785

74 — Water Pump Repair Kit 18-3427

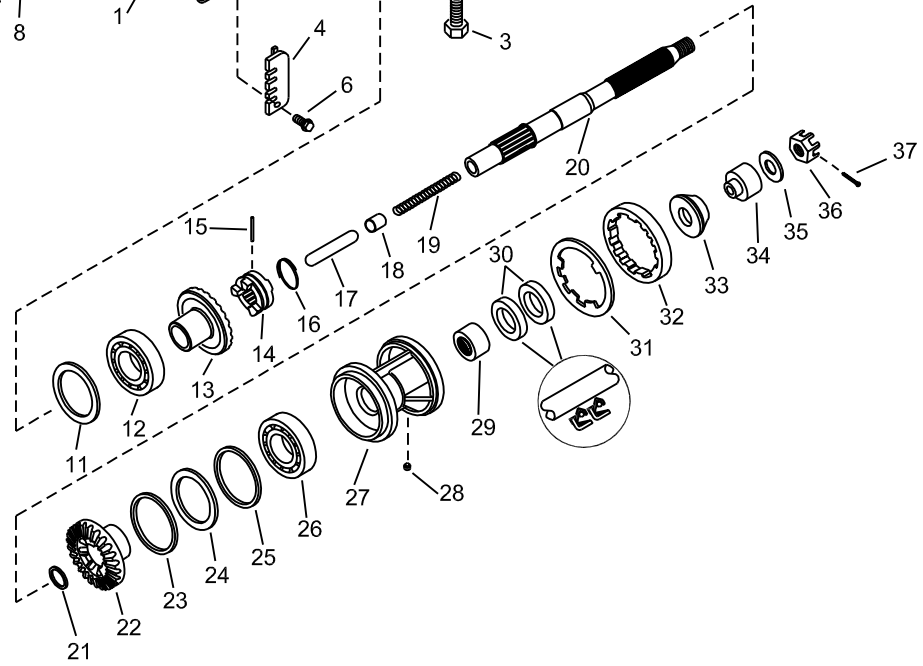
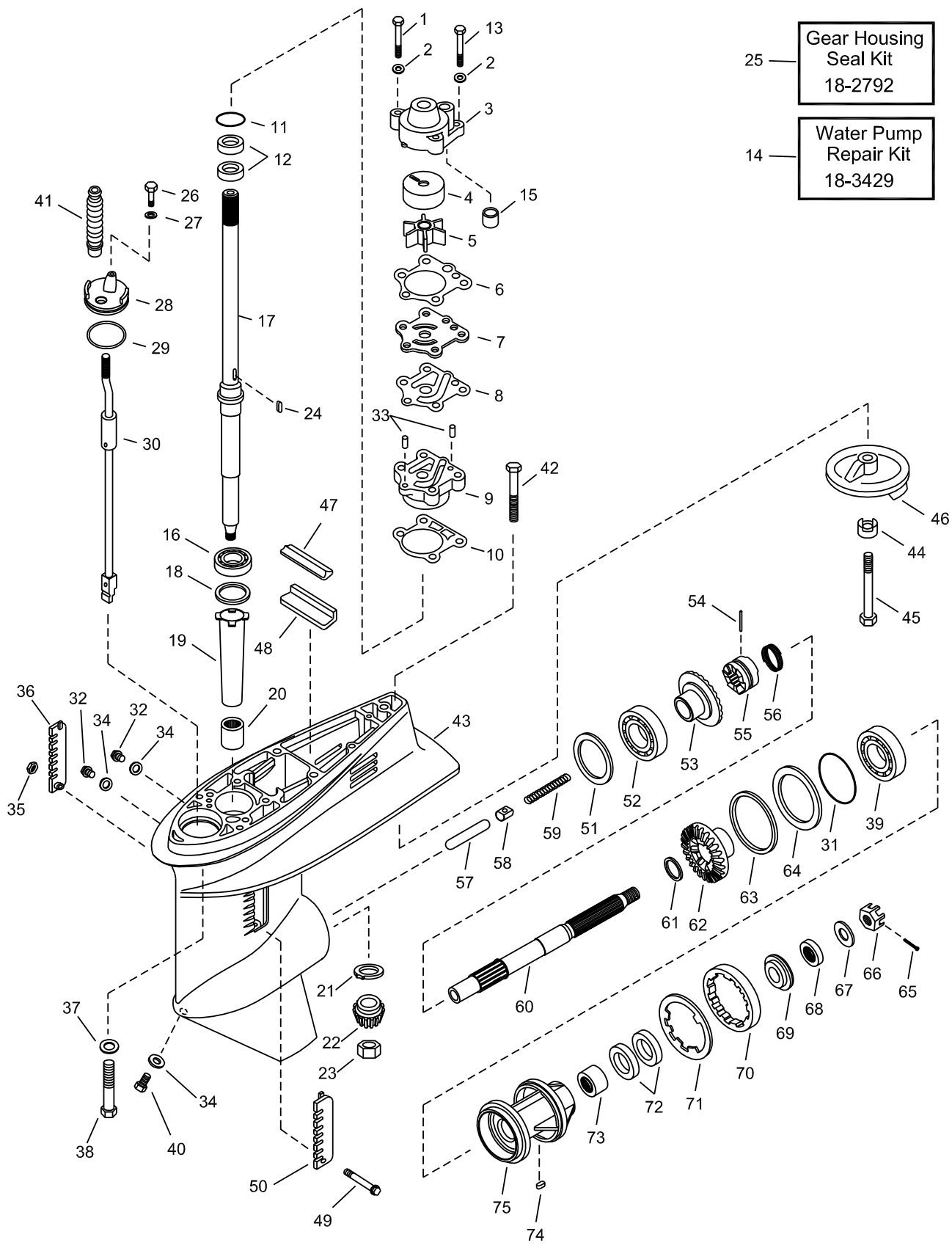

Figure #	Description	Part #	O.E.M. #	Qty.	Figure #	Description	Part #	O.E.M. #	Qty.
1	Housing, Gearcase	—	689-45311-04-EK3	1	37	Cotter Pin	18-2380	91490-30030-00	
2	Trim Tab	18-6096A, 18-6113	664-45371-01-00	1	38	Pin, Dowel	—	93606-12019-00	2
					39	Nut, Pinion	—	90179-09M02-00	2
3	Bolt, Trim Tab	—	90105-08M02-00	1	40	Gear, Pinion	—	689-45551-00-00	1
4	Cover, Water Inlet (port)	—	689-45214-01-01	1	41	Bearing, Thrust	—	664-45552-09-00	1
4a	Cover, Water Inlet (stbd)	—	689-45215-01-00	1	42	Bearing, Pinion	—	93315-017U4-00	1
5	Nut, Nylock	—	90185-05904-00	1	43	Sleeve, Drive Shaft	—	689-45536-00-00	1
6	Bolt, Water Inlet	—	98680-05525-00	1	44	Shim Pinion Gear (0.5mm)	—	664-45587-00-05	AR
7	Plug, Drain & Vent	—	90340-08M04-00	3		Shim Pinion Gear (0.8mm)	—	664-45587-00-08	AR
8	Gasket, Plug	—	90430-08020-00	3		Shim Pinion Gear (0.12mm)	—	664-45587-01-12	AR
9	Bolt, Gearcase Mounting	—	90105-10059-00	2		Shim Pinion Gear (0.30mm)	—	664-45587-01-30	AR
10	Washer, Gearcase Mounting	—	92990-10600-00	4		Shim Pinion Gear (0.50mm)	—	664-45587-01-50	AR
11	Shim Forward Gear (0.5mm)	—	664-45567-00-05	AR	45	Bearing, Drive Shaft	—	93332-000U4-00	1
	Shim Forward Gear (0.8mm)	—	664-45567-00-08	AR	46	Drive Shaft (long)	—	689-45501-10-00	1
	Shim Forward Gear (0.12mm)	—	664-45567-01-12	AR	47	Key, Impeller	—	664-44338-00-00	1
	Shim Forward Gear (0.30mm)	—	664-45567-01-30	AR	48	Oil Seal, Pump Base	18-0296	93101-22067-00	2
	Shim Forward Gear (0.50mm)	—	664-45567-01-50	AR	49	Gasket, Base	18-0773	689-44316-A0-00	1
12	Bearing, Forward Gear	—	93332-00005-00	1	50	Base, Water Pump	—	689-44325-02-5B	1
13	Gear, Forward	—	689-45560-00-00	1	51	Gasket, Base	18-0773	689-44316-A0-00	1
14	Clutch, Dog	—	664-45631-01-00	1	52	Impeller Plate	—	689-44323-03-00	1
15	Pin, Clutch Dog	—	90250-05010-00	1	53	Gasket, Impeller Plate	—	689-44324-A0-00	1
16	Ring, Cross Pin	—	648-45633-00-00	1	54	Impeller	18-3067	689-44352-02-00	1
17	Plunger, Shift	—	648-45635-00-00	1	55	Insert Cup	18-3439	689-W4432-02-00	1
18	Slide, Shift	—	648-45634-00-00	1	56	Damper, Water Seal	—	689-44367-01-00	1
19	Spring, Compression	—	90501-10065-00	1	57	Housing, Water Pump	—	689-44311-03-00	1
20	Shaft, Propeller	—	689-45611-00-00	1	58	Bolt, Pump Housing	—	90101-06M56-00	3
21	Thrust, Washer, Prop Shaft	—	90201-20417-00	1	59	Washer, Housing (short shaft)	—	90209-06M04-00	3
22	Gear, Reverse	—	689-45571-00-00	1	60	Seal, Lower Water Tube	—	626-44365-01-00	1
23	Shim Reverse Gear (0.5mm)	—	664-45577-00-05	AR	61	Water Tube (long shaft)	—	689-44361-10-00	1
	Shim Reverse Gear (0.8mm)	—	664-45577-00-08	AR	62	Seal, Upper Water Tube	18-0552	689-44366-00-00	1
	Shim Reverse Gear (0.12mm)	—	664-45577-01-12	AR	63	Extension, Housing (long shaft)	—	689-44312-00-5B	1
	Shim Reverse Gear (0.30mm)	—	664-45577-01-30	AR	64	Bolt, Extension (long shaft)	—	97080-06035-00	3
	Shim Reverse Gear (0.50mm)	—	664-45577-01-50	AR	65	Washer, Bolt (long shaft)	—	92990-06600-00	3
24	Washer Thrust	—	664-45576-00-00	1	66	Extension Tube (long shaft)	—	689-44362-00-94	1
25	O-Ring, Bearing Carrier	—	93210-30MA3-00	1	67	O-Ring, Extension Tube	—	93210-26240-00	2
26	Bearing, Reverse Gear	—	93306-00612-00	1	68	Plate (long shaft)	—	689-44328-03-00	1
27	Bearing, Carrier	—	689-45331-01-94	1	69	Shift Cam Assembly (short shaft)	—	664-44150-01-00	1
28	Key, Bearing Carrier	—	90282-04010-00	1	69	Shift Cam Assembly (long shaft)	—	664-44150-11-00	1
29	Bearing, Prop Shaft	—	93315-22004-00	1	70	Boot, Shift Rod	—	664-44147-00-00	1
30	Seal, Prop Shaft	18-0554	93101-20M07-00	2	71	Bracket, Shift Shaft	—	689-44176-01-00	1
31	Tab Washer	—	90214-45M02-00	1	72	Screw, Bracket	—	97780-50610-00	1
32	Nut, Cover	—	664-45384-00-00	1	73	Gear Housing Seal Kit	18-2785	689-W0001-22-00	1
33	Prop Spacer (fore)	—	664-45987-01-00	1	74	Water Pump Repair Kit	—	689-W0078-A6-00	1
34	Prop Spacer (aft)	—	689-45997-00-00	1					
35	Washer, Prop Mounting	—	92990-14200-00	1					
36	Nut, Propeller	—	90171-14013-00	1					

AR As required



25 — Gear Housing Seal Kit 18-2792

14 — Water Pump Repair Kit 18-3429

Figure #	Description	Part #	O.E.M. #	Qty.	Figure #	Description	Part #	O.E.M. #	Qty.
1	Bolt, Water Pump Housing	—	97395-08055-00	2	39	Bearing, Ball	—	93306-00702-00	1
2	Washer, Water Pump Housing	—	92990-08600-00	4	40	Plug, Drain	18-2374	688-45341-00-00	1
3	Housing, Water Pump	—	663-44311-02-00	1	41	Propeller	—	various	1
4	Insert, Water Pump	18-3435	663-44322-00-00	1	42	Bolt, Trim Tab	—	97575-08675-00	1
5	Impeller	18-3068	6H4-44352-02-00	1	43	Casing, Lower	—	6H4-45301-01-EK	1
6	Gasket, Wear Plate to Water Pump	18-0292	663-44315-A0-00	1	44	Washer, Locking	—	92990-08100-00	1
					45	Bolt, Lower Casing	—	97095-08085-00	1
7	Wear Plate, Water Pump	18-3436	663-44323-00-00	1	46	Tab, Trim	18-6096A	664-45371-01-00	1
8	Gasket, Wear Plate to Water Pump	18-0294	663-44324-A0-00	1	47	Seal Rubber	—	688-45375-00-00	1
					48	Guide, Seal Rubber	—	663-45376-00-94	1
9	Base, Water Pump	—	663-44341-00-94	1	49	Screw Ovalhead	—	98780-05535-00	1
10	Gasket, Pump Base	—	663-44316-A0-00	1	50	Cover, Water Inlet (port)	—	668-45214,02-00	1
11	O-Ring, Pump Base	18-0298	93210-41042-00	1	51	Shim Forward Gear (0.5mm)	—	6H4-45567-00-05	1
12	Oil Seal, Pump Base	18-0297	93101-23070-00	2		Shim Forward Gear (0.8mm)	—	6H4-45567-00-08	AR
13	Bolt, Water Pump Housing	18-0256	97095-08045-00	2		Shim Forward Gear (0.12mm)	—	6H4-45567-01-12	AR
14	Water Pump Repair Kit	18-3429	6H4-W0078-00-00	1		Shim Forward Gear (0.30mm)	—	6H4-45567-01-30	AR
15	Water Seal	—	663-44366-00-00	1		Shim Forward Gear (0.50mm)	—	6H4-45567-01-50	AR
16	Bearing, Tapered Roller	—	93332-00079-00	1	52	Bearing, Tapered Roller	—	93332-000V4-00	1
17	Drive Shaft (Short)	—	6H4-45501-00-00	1	53	Gear, Forward	—	6H4-45560-00-00	1
17	Drive Shaft (Long)	—	6H4-45501-10-01	1	54	Pin, Cross (clutch dog)	—	90250-06023-00	1
18	Shim (0.5mm)	—	663-45587-00-05	AR	55	Clutch, Sliding	—	663-45631-01-00	1
	Shim (0.8mm)	—	663-45587-00-08	AR	56	Retainer Ring, Cross Pin	—	663-45633-00-00	1
	Shim (0.12mm)	—	663-45587-01-12	AR	57	Plunger, Shift	—	676-45635-00-00	1
	Shim (0.30mm)	—	663-45587-01-30	AR	58	Slide, Shift	—	663-45634-00-00	1
	Shim (0.50mm)	—	663-45587-01-50	AR	59	Spring, Compression	—	60501-16M01-00	1
19	Sleeve, Drive Shaft	—	6H4-45536-00-0	1	60	Shaft, Propeller	—	679-45611-01-00	1
20	Bearing, Needle	—	93315-32224-00	1	61	Washer, Plate	—	90201-22429-00	1
21	Bearing (not used 1988 & later)	—	663-45552-00-00	1	62	Gear, Reverse	—	6H4-45571-00-00	1
22	Gear, Pinion	—	6H4-45551-00-00	1	63	Shim Reverse Gear (0.5mm)	—	663-45577-00-05	AR
23	Nut, Pinion Gear	—	90170-12138-00	1		Shim Reverse Gear (0.8mm)	—	663-45577-00-08	AR
24	Key, Woodruff	18-3305	90280-03024-00	1		Shim Reverse Gear (0.12mm)	—	663-45577-01-12	AR
25	Gearcase Seal Kit	—	6H4-W0001-20-00	1		Shim Reverse Gear (0.30mm)	—	663-45577-01-30	AR
26	Bolt, Plate	—	97095-06016-00	1		Shim Reverse Gear (0.50mm)	—	663-45577-01-50	AR
27	Washer, Plate	—	92990-06600-00	1	64	Washer, Thrust	—	663-45576-00-00	1
28	Plate	—	6H4-45321-01-00	1	65	Pin, Cotter	18-2380	91490-30030-00	1
29	O-Ring, Plate	—	93210-49046-00	1	66	Nut, Castle	18-3732	90171-16011-11	1
30	Shift Cam Assembly (short shaft)	—	6H4-44150-01-00	1	67	Washer	—	92990-16200-00	1
	Shift Cam Assembly (long shaft)	—	6H4-44150-12-01	1	68	Spacer, Prop Mounting (aft)	—	670-45997-02-00	1
31	O-Ring, Bearing Housing	—	93210-66M98-00	1	69	Spacer, Prop Mounting (fore)	—	663-45987-02-00	1
32	Plug, Vent	—	90340-08M04-00	2	70	Nut, Cover	—	697-45385-00-00	1
33	Pin, Dowel	—	93604-08062-00	2	71	Washer, Tab	—	90214-48M03-00	1
34	Gasket, Drain Plug	—	90430-08020-00	3	72	Oil Seal, Bearing Housing	18-0296	93101-22067-00	2
35	Nut, Nylock	—	90185-05904-00	1	73	Bearing, Needle	—	93317-22204-00	1
36	Cover, Water Inlet (stbd)	—	688-45215-02-00	1	74	Key, Bearing Housing	—	90282-04010-00	1
37	Washer, Locking	—	92990-10100-00	4	75	Housing, Bearing	—	679-45331-00-94	1
38	Bolt	—	97078-10040-00	4					

AR As required

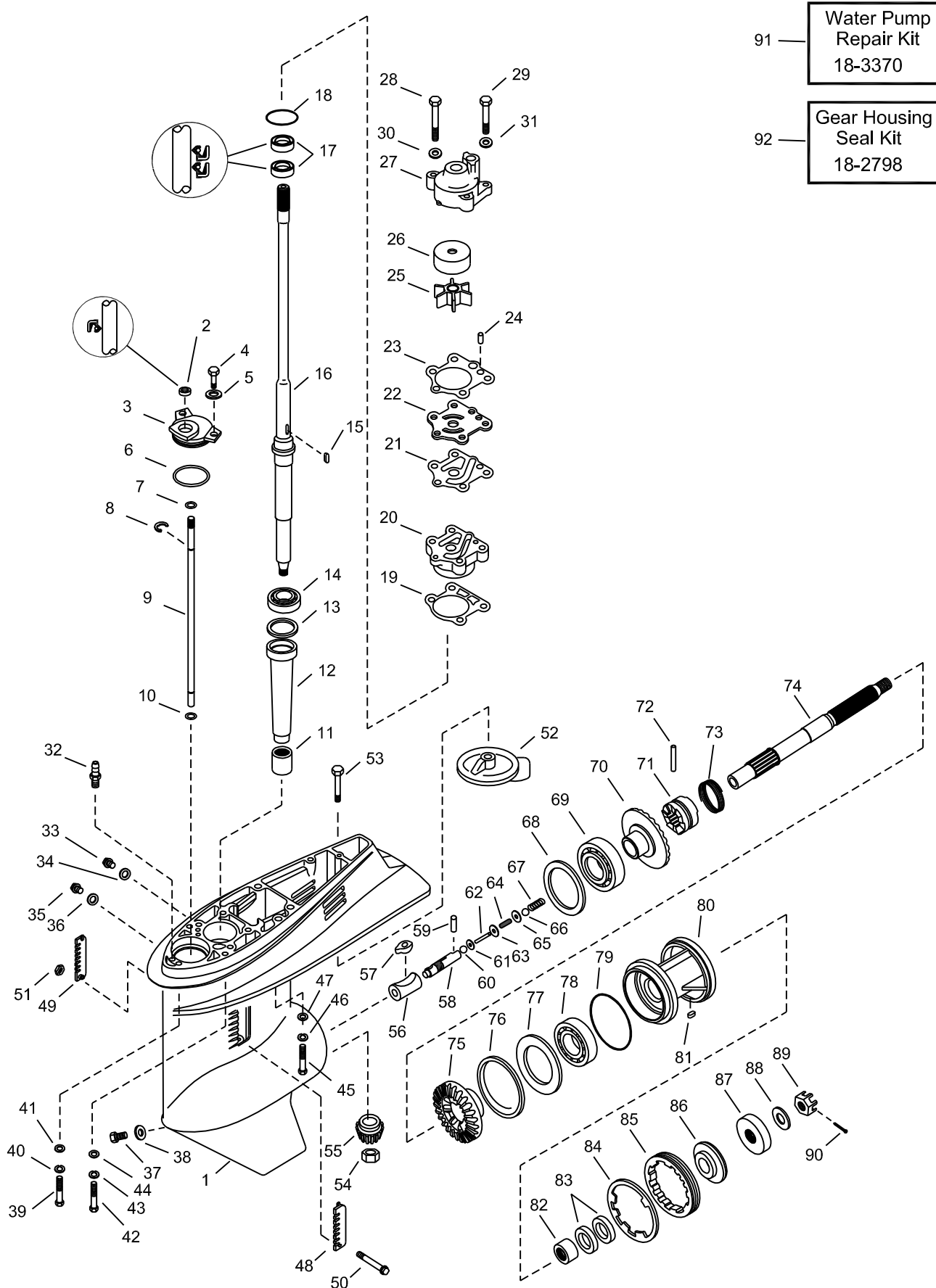

91 — Water Pump Repair Kit 18-3370

92 — Gear Housing Seal Kit 18-2798

Figure #	Description	Part #	O.E.M. #	Qty.	Figure #	Description	Part #	O.E.M. #	Qty.
1	Gearcase	—	6H1-45301-04-EK	1	50	Screw, Water Inlet	—	98680-05545-00	1
2	Oil Seal, Shift Shaft	18-0267	93106-09014-00	1	51	Nut, Water Inlet	—	90185-05002-00	1
3	Plate, Shift Rod	—	688-45321-00-00	1	52	Trim Tab	18-6070	988-45371-02-00	1
4	Bolt, Shift Rod Retainer	—	97395-06016-00	2	53	Bolt, Anode Mounting	—	90105-10M00-00	1
5	Washer	—	92990-06600-00	2	54	Nut, Pinion	—	90170-16M01-00	1
6	O-Ring	—	93210-49046-00	1	55	Gear, Pinion	—	688-45551-01-00	1
7	O-Ring	—	93210-07540-01	1	56	Shifter	—	6H1-45641-01-00	1
8	Circlip	—	99001-08600-00	1	57	Shift Cam	—	6H1-44151-00-00	1
9	Rod, Shift	—	6H1-44144-00-00	1	58	Shift Slide	—	6H1-45634-02-00	1
10	Circlip	—	93450-07M00-00	1	59	Pin	—	93603-12M11-00	1
11	Bearing, Pinion	—	93315-325V1-00	1	60	Nut, Spring	—	90183-02M03-00	1
12	Sleeve, Drive shaft	—	688-45536-01-00	1	61	Shift Plunger	—	6H1-45635-00-00	1
13	Shim Drive Shaft (0.10mm)	—	688-45587-01-10	AR	62	Shaft	—	6H1-45668-00-00	1
	Shim Drive Shaft (0.12mm)	—	688-45587-01-12	AR	63	Shift Plunger	—	6H1-45635-00-00	1
	Shim Drive Shaft (0.15mm)	—	688-45587-01-15	AR	64	Spring, Compression	—	90501-12M48-00	1
	Shim Drive Shaft (0.18mm)	—	688-45587-01-30	AR	65	Washer, Plate	—	90201-03313-00	1
	Shim Drive Shaft (0.30mm)	—	688-45587-01-40	AR	66	Nut, Spring	—	90183-02M03-00	1
	Shim Drive Shaft (0.40mm)	—	688-45587-01-50	AR	67	Spring, Compression	—	90501-16M65-00	1
	Shim Drive Shaft (0.50mm)	—	688-45587-01-16	AR	68	Shim Forward Gear (0.10mm)	—	688-45567-01-10	AR
14	Bearing, Upper Drive Shaft	—	93332-000U3-00	1		Shim Forward Gear (0.12mm)	—	688-45567-01-12	AR
15	Key, Impeller	18-3301	90280-04M04-00	1		Shim Forward Gear (0.15mm)	—	688-45567-01-15	AR
16	Drive Shaft	—	6H1-45501-11-00	1		Shim Forward Gear (0.18mm)	—	688-45567-01-18	AR
17	Oil Seal, Pump Base	18-0587	93101-25M03-00	2		Shim Forward Gear (0.30mm)	—	688-45567-01-30	AR
18	O-Ring, Base	18-7436	9321-46044-00	1		Shim Forward Gear (0.40mm)	—	688-45567-01-40	AR
19	Gasket, Base	18-0240	688-44316-A0-00	1		Shim Forward Gear (0.50mm)	—	688-45567-01-50	AR
20	Base, Water Pump	—	688-44341-01-94	1	69	Bearing, Forward Gear	—	93332-000W7-00	1
21	Gasket, Wear Plate to Base	—	688-44324-A0-00	1	70	Gear, Forward	—	688-45560-00-00	1
22	Wear Plate	18-3341	688-44323-00-00	1	71	Clutch, Dog	—	6H1-45631-01-00	1
23	Gasket, Wear Plate to Housing	18-0239	688-44315-A0-00	1	72	Pin, Cross	—	90250-07M02-00	1
24	Pin	—	93604-10M03-00	1	73	Spring, Cross Pin	—	688-45633-00-00	1
25	Impeller	18-3070	688-44352-03-00	1	74	Shaft, Propeller	—	6H1-45611-01-00	1
26	Insert, Water Pump	—	688-44322-00-00	1	75	Gear, Reverse	—	6H1-45571-00-00	1
27	Housing, Water Pump	18-3171	688-44311-01-00	1	76	Shim Reverse Gear (0.10mm)	—	688-45577-01-10	AR
28	Bolt, Water Pump	—	97395-08070-00	2		Shim Reverse Gear (0.12mm)	—	688-45577-01-12	AR
29	Bolt, Water Pump	—	97395-08050-00	2		Shim Reverse Gear (0.15mm)	—	688-45577-01-15	AR
30 &						Shim Reverse Gear (0.18mm)	—	688-45577-01-18	AR
31	Washer, Water Pump	—	90209-08M02-00	4		Shim Reverse Gear (0.30mm)	—	688-45577-01-30	AR
32	Nipple, Hose	—	6E5-45378-00-00	1		Shim Reverse Gear (0.40mm)	—	688-45577-01-40	AR
33	Plug, Drain	18-2371	90340-08M04-00	1		Shim Reverse Gear (0.50mm)	—	688-45577-01-50	AR
34	Gasket, Vent & Drain Plugs	18-46981-9	90430-08020-00	1	77	Washer, Thrust	—	688-45576-00-00	1
35	Plug, Drain	18-2371	90340-08M04-00	1	78	Bearing, Reverse Gear	—	93306-207U0-00	1
36	Gasket, Vent & Drain Plugs	18-46981-9	90430-08020-00	1	79	O-Ring, Bearing Housing	—	93210-85M97-00	1
37	Plug, Drain	18-2374	688-45341-00-00	1	80	Housing, Bearing	18-2782	688-45331-00-94	1
38	Gasket, Vent & Drain Plugs	18-46981-9	90430-08020-00	1	81	Key	—	90282-04010-00	1
39	Bolt	—	97395-10040-00	2	82	Bearing, Needle	—	93317-325U0-00	1
40	Washer, Lock	—	92990-10100-00	2	83	Oil Seal	18-0587	93101-25M03-00	2
41	Washer, Flat	—	92990-10600-00	2	84	Washer, Tab	—	688-45383-02-00	1
42	Bolt	—	97395-10040-00	2	85	Nut, Cover	—	688-45384-00-00	1
43	Washer, Lock	—	92990-10100-00	2	86	Spacer, Forward	—	688-45987-01-00	1
44	Washer, Flat	—	92990-10600-00	2	87	Spacer	18-4274	688-45997-01-00	1
45	Bolt	—	97395-08060-00	1	88	Washer, Propeller	—	90201-17M00-00	1
46	Washer, Lock	—	92990-08100-00	1	89	Nut, Castle	18-3732	90171-16011-00	1
47	Washer, Lock	—	92990-08100-00	1	90	Pin, Cotter	18-3735	91490-40030-00	1
48	Cover, Water Inlet (Port)	—	688-45214-02-00		91	Water Pump Repair Kit	18-3370	692-W0078-00-00	1
49	Cover, Water Inlet (Stbd)	—	688-45215-02-00	1	92	Gear Housing Seal Kit	—	688-W0001-20-00	1

AR As required

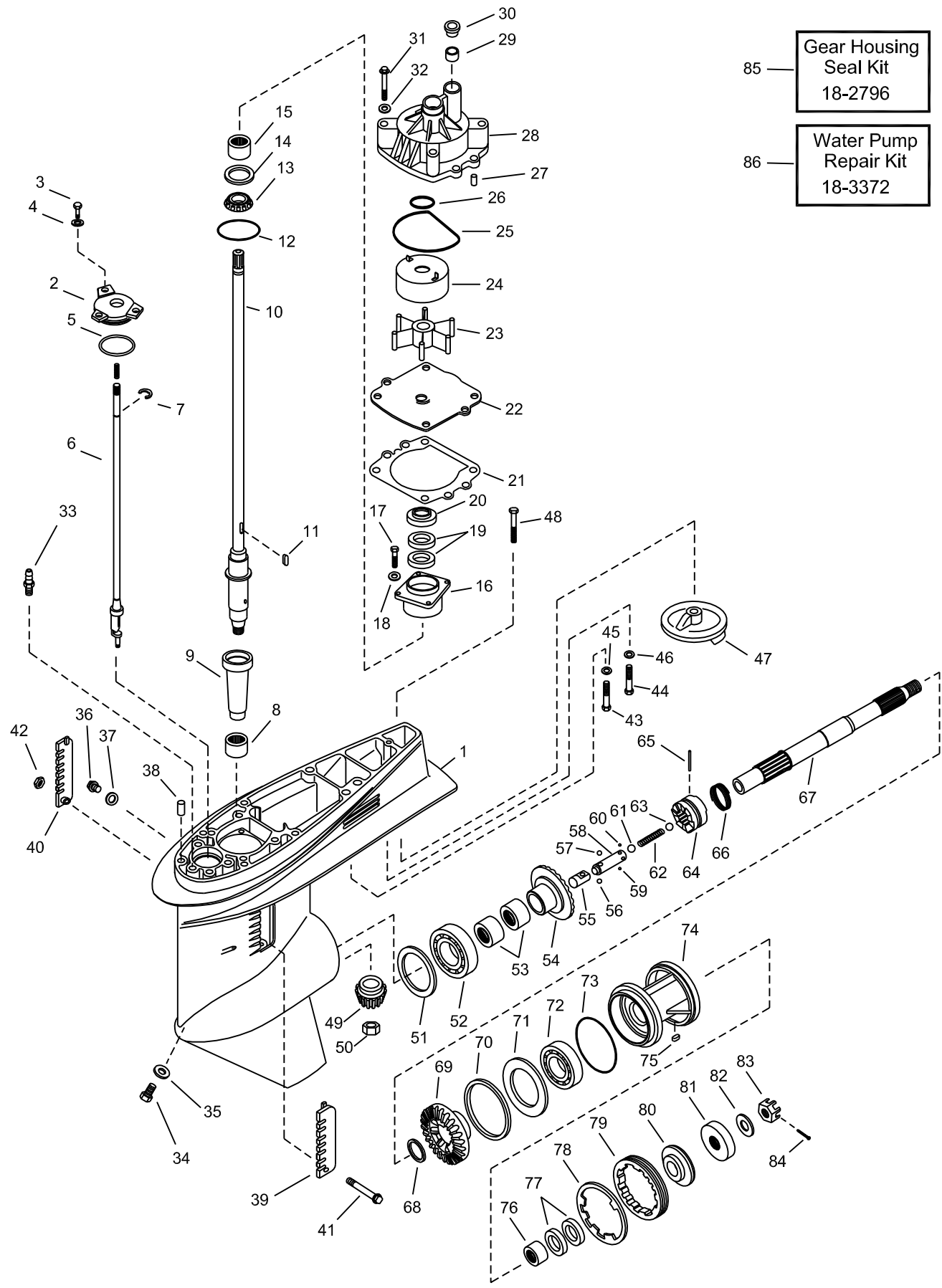

Gear Housing Seal Kit
18-2796

Water Pump Repair Kit
18-3372

Figure #	Description	Part #	O.E.M. #	Qty.	Figure #	Description	Part #	O.E.M. #	Qty.
1	Housing, Gearcase	—	6E5-45301-03Ek	1	47	Trim Tab	18-6097A	6E5-45371-01-00	1
2	Plate, Shift Rod Cover	—	6E5-45321-00-00	1	48	Bolt, Trim Tab	—	90105-10M00-00	1
3	Bolt, Shift Rod Cover	—	97395-06020-00	3	49	Gear Pinion	—	6E5-45551-02-00	1
4	Washer	—	90209-06M04-00	3	50	Nut, Pinion	—	90170-16M01-00	1
5	O-Ring, Plate	—	93210-5867-00	1	51	Shim (0.10mm)	—	6E5-45567-01-10	AR
6	Shift Rod Assembly	—	6E5-44150-01-00	1		Shim (0.12mm)	—	6E5-45567-01-12	AR
7	Circlip	—	99001-08600-00	1		Shim (0.15mm)	—	6E5-45567-01-15	AR
8	Bearing, Needle	—	93315-628U9-00	1		Shim (0.18mm)	—	6E5-45567-01-18	AR
9	Sleeve, Drive Shaft	—	6E5-45536-00-00	1		Shim (0.30mm)	—	6E5-45567-01-30	AR
10	Drive Shaft (long)	—	6E5-45501-01-00	1		Shim (0.40mm)	—	6E5-45567-01-40	AR
	Drive Shaft (x-long)	—	6E5-45501-21-00	1		Shim (0.50mm)	—	6E5-45567-01-50	AR
11	Key, Impeller	—	90280-04M05-00	1	52	Bearing, Forward Gear	—	93332-000U7-00	1
12	O-Ring, Housing	—	93210-54534-00	1	53	Bearing, Needle	—	93315-425U7-00	2
13	Bearing, Tapered	—	93341-930U0-00	1	54	Gear, Forward	—	6E5-45560-01-00	1
14	Shim (0.10mm)	—	6E5-45587-01-10	AR	55	Shifter	—	6E5-45641-01-00	1
	Shim (0.12mm)	—	6E5-45587-01-12	AR	56	Ball, Detent	—	93507-32031-00	1
	Shim (0.15mm)	—	6E5-45587-01-15	AR	57	Ball, Detent	—	93507-32031-00	1
	Shim (0.18mm)	—	6E5-45587-01-18	AR	58	Slide, Shift	—	6E5-45634-01-00	1
	Shim (0.30mm)	—	6E5-45587-01-30	AR	59	Ball, Detent	—	93503-16010-00	1
	Shim (0.40mm)	—	6E5-45587-01-40	AR	60	Ball, Detent	—	93503-16010-00	1
	Shim (0.50mm)	—	6E5-45587-01-50	AR	61	Ball, Detent	—	93511-32027-00	1
15	Bearing, Needle	—	93315-430V5-00	1	62	Spring, Compression	—	90501-16M37-00	1
16	Housing, Bearing	—	6E5-45331-0094	1	63	Ball, Detent	—	93511-32027-00	1
17	Bolt, Bearing Housing	—	97395-08025-00	4	64	Clutch, Dog	—	6R5-45631-01-00	1
18	Washer	—	92990-08600-00	4	65	Cross Pin, Clutch	—	90250-08M07-00	1
19	Seal, Drive Shaft	18-0265	93101-28M16-00	2	66	Retainer, Cross Pin	—	6E5-45631-01-00	1
20	Cover, Oil Seal	—	6E5-45344-00-00	1	67	Shaft, Propeller	—	6E5-45611-01-00	1
21	Gasket, Wear Plate	18-0244	6E5-44315-A0-00	1	68	Washer, Thrust	—	90201-30M92-00	1
22	Wear Plate	18-3344	6G5-44323-00-00	1	69	Gear, Reverse	—	6E5-45571-04-00	1
23	Impeller	18-3071	6E5-44352-00-00	1	70	Shim (0.10mm)	—	6L6-45577-00-10	AR
24	Insert, Water Pump	—	6E5-44322-00-00	1		Shim (0.12mm)	—	6L6-45577-00-12	AR
25	O-Ring, Water Pump	18-7485	93210-86M38-00	1		Shim (0.15mm)	—	6L6-45577-00-15	AR
26	O-Ring, Water Pump	18-7483	93210-37M67-00	1		Shim (0.18mm)	—	6L6-45577-00-18	AR
27	Pin, Water Pump Housing	—	93606-12019-00	2		Shim (0.30mm)	—	6L6-45577-00-30	AR
28	Housing, Water Pump	18-3170	6E5-44311-00-00	1		Shim (0.40mm)	—	6L6-45577-00-40	AR
29	Damper, Water Seal	—	6E5-44365-00-00	1		Shim (0.50mm)	—	6L6-45577-00-50	AR
30	Cover, Pump Housing	—	6E5-44312-00-0	1	71	Washer, Thrust	—	6E5-45576-00-00	1
31	Bolt, Water Pump	—	97080-08045-00	4	72	Bearing, Reverse Gear	—	93306-208U0-00	1
32	Washer	—	90209-08M02-00	4	73	O-Ring, Bearing Housing	—	93210-86M39-00	1
33	Nipple, Hose	—	6E5-45378-00-00	1	74	Housing, Bearing	—	6E5-45332-00-94	1
34	Drain, Plug Lower	18-2374	688-45341-00-00	1	75	Key, Bearing Housing	—	90282-04010-00	1
35	Gasket, Drain Plug	18-4698	90430-08020-00	1	76	Bearing, Needle	—	93315-430U8-00	1
36	Drain Plug Upper	—	90340-08M04-00	1	77	Seal, Prop Shaft	18-0266	93101-30M17-00	2
37	Gasket, Drain Plug	18-4698	90430-08020-00	1	78	Washer, Tab	—	688-45383-02-00	1
38	Pin, Locating	—	93608-12M05-00	2	79	Nut, Cover	—	688-45384-00-00	1
39	Cover, Water Inlet (Port)	—	688-45214-02-00	1	80	Washer, Thrust	—	6E5-45987-01-00	1
40	Cover, Water Inlet (Stbd)	—	688-45215-02-00	1	81	Spacer, Prop	18-4274	688-45997-01-00	1
41	Screw, Water Inlet	—	90142-05M03-00	1	82	Washer, Prop	—	92990-18200-00	1
42	Nut, Water Inlet	—	90185-05002-00	1	83	Nut, Prop	18-3726	90171-18M04-00	1
43	Bolt	—	97395-10070-00	1	84	Pin, Cotter	18-3735	91490-40030-00	1
44	Bolt	—	97395-10070-00	1	85	Gear Housing Seal Kit	18-2796	6E5-W0001-51-00	1
45	Washer	—	92990-10100-00	1	86	Water Pump Repair Kit	18-3372	6E5-W0078-00-00	1
46	Washer	—	92990-10100-00	1					

AR As required

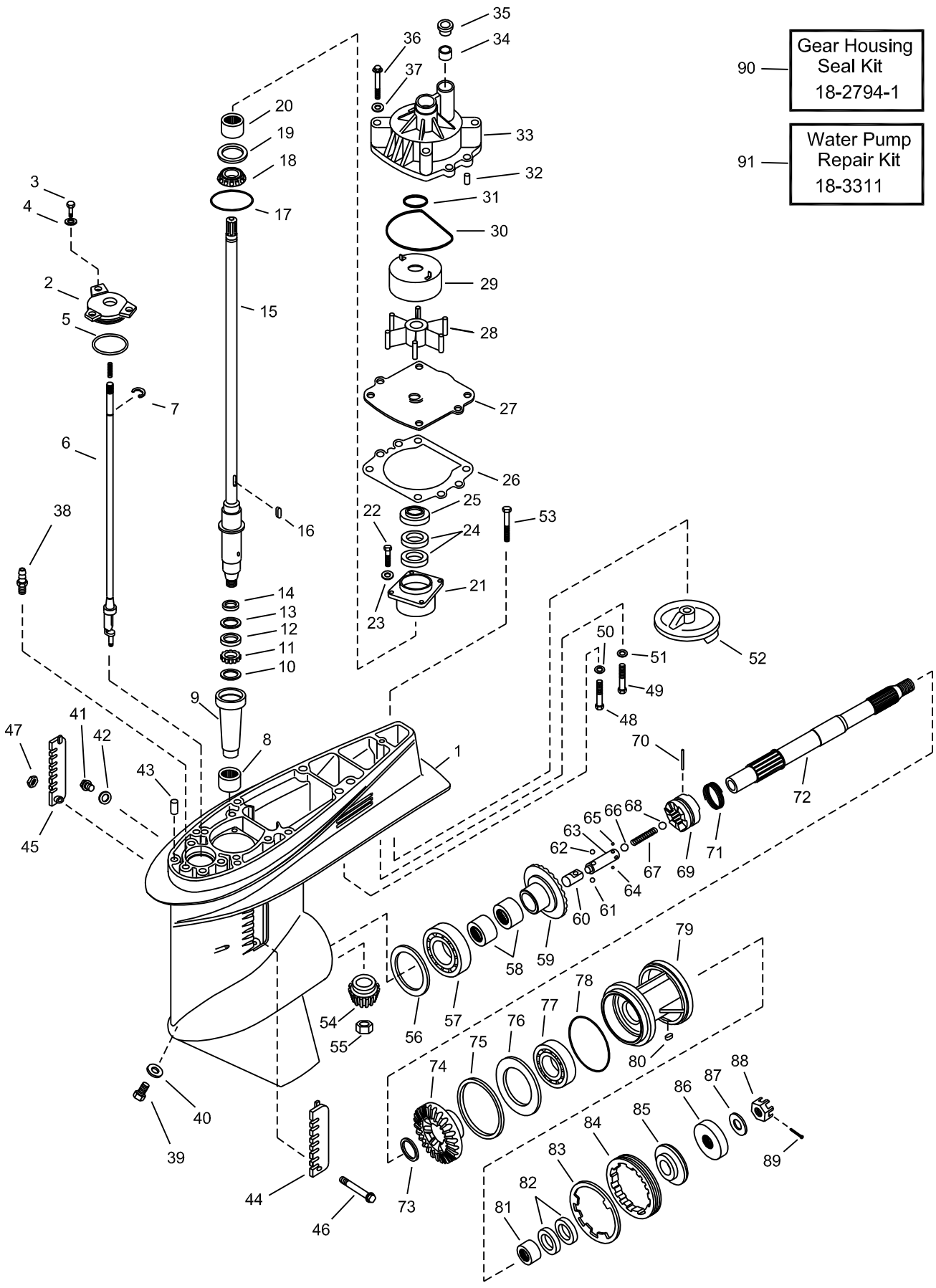

Gear Housing
Seal Kit
18-2794-1

Water Pump
Repair Kit
18-3311

Figure #	Description	Part #	O.E.M. #	Qty.	Figure #	Description	Part #	O.E.M. #	Qty.
1	Housing, Gearcase	—	6J9-45301-02-Ek	1	49	Bolt	—	97395-10070-00	1
2	Plate, Shift Rod Cover	—	6E5-45321-00-00	1	50	Washer	—	92990-10100-00	1
3	Bolt, Shift Rod Cover	—	97395-06020-00	3	51	Washer	—	92990-10100-00	1
4	Washer	—	90209-06M04-00	3	52	Trim Tab	18-6035	6J9-45371-01-00	1
5	O-Ring, Plate	—	93210-58677-00	1	53	Bolt, Trim Tab	—	90105-10M00-00	1
6	Shift Rod Assembly	—	6G5-44150-01-00	1	54	Gear Pinion	—	6G5-45551-01-00	1
7	Circlip	—	99001-08600-00	1	55	Nut, Pinion	—	90170-16M01-00	1
8	Bearing, Needle	—	90250-08M07-00	1	56	Shim (0.10mm)	—	6G5-45567-01-10	AR
9	Sleeve, Drive Shaft	—	6G5-45536-01-00	1		Shim (0.12mm)	—	6G5-45567-01-12	AR
10	Washer	—	90209-33M13-00	1		Shim (0.15mm)	—	6G5-45567-01-15	AR
11	Spring, Compression	—	90501-05M64-00	AR		Shim (0.18mm)	—	6G5-45567-01-30	AR
12	Collar	—	90387-33M00-00	1		Shim (0.30mm)	—	6G5-45567-01-40	AR
13	Washer	—	90209-33M13-00	1		Shim (0.40mm)	—	6G5-45567-01-50	AR
14	Washer	—	90209-33M12-00	1		Shim (0.50mm)	—	6G5-45567-01-10	AR
15	Drive Shaft (long)	—	6G5-45501-01-00	1	57	Bearing, Forward Gear	—	93332-00V3-00	1
	Drive Shaft (x-long)	—	6G5-45501-21-00	1	58	Bearing, Needle	—	93315-425V3-00	2
16	Key, Impeller	—	90280-04M05-00	1	59	Gear, Forward	—	6G5-45631-00-00	1
17	O-Ring, Housing	—	93210-54534-00	1	60	Shifter	—	6E5-45641-01-00	1
18	Bearing, Tapered	—	93341-930U0-00	1	61	Ball, Detent	—	93507-32031-00	1
19	Shim (0.10mm)	—	6E5-45587-01-10	AR	62	Ball, Detent	—	93507-32031-00	1
	Shim (0.12mm)	—	6E5-45587-01-12	AR	63	Slide, Shift	—	6E5-45634-01-00	1
	Shim (0.15mm)	—	6E5-45587-01-15	AR	64	Ball, Detent	—	93503-16010-00	1
	Shim (0.18mm)	—	6E5-45587- 01-18	AR	65	Ball, Detent	—	93503-16010-00	1
	Shim (0.30mm)	—	6E5-45587-01-30	AR	66	Ball, Detent	—	93511-32027-00	1
	Shim (0.40mm)	—	6E5-45587-01-40	AR	67	Spring, Compression	—	90501-16M37-00	1
	Shim (0.50mm)	—	6E5-45587-01-50	AR	68	Ball, Detent	—	93511-32027-00	1
20	Bearing, Needle	—	93315-430V5-00	1	69	Clutch, Dog	—	6E5-45633-01-00	1
21	Housing, Bearing	—	6E5-45331-00-94	1	70	Cross Pin, Clutch	—	90250-08M07-00	1
22	Bolt, Bearing Housing	—	97395-08025-00	4	71	Retainer, Cross Pin	—	6E5-45633-01-00	1
23	Washer	—	92990-08600-00	4	72	Shaft, Propeller	—	6J9-45611-01-00	1
24	Seal, Drive Shaft	18-0265	93101-28M16-00	2	73	Washer, Thrust	—	90201-30M92-00	1
25	Cover, Oil Seal	—	6E5-45344-00-00	1	74	Gear, Reverse	—	6G5-45571-02-00	1
26	Gasket, Wear Plate	18-0244	6E5-44315-A0-00	1	75	Shim (0.10mm)	—	6G5-45577-02-10	AR
27	Wear Plate	18-3345	6G5-44323-00-00	1		Shim (0.12mm)	—	6G5-45577-02-12	AR
28	Impeller	18-3071	6E5-44352-00-00	1		Shim (0.15mm)	—	6G5-45577-02-15	AR
29	Insert, Water Pump	—	6E5-44322-00-00	1		Shim (0.18mm)	—	6G5-45577-02-18	AR
30	O-Ring, Water Pump	18-7485	93210-86M38-00	1		Shim (0.30mm)	—	6G5-45577-02-30	AR
31	O-Ring, Water Pump	18-7483	93210-37M67-00	1		Shim (0.40mm)	—	6G5-45577-02-40	AR
32	Pin, Water Pump Housing	—	93606-12019-00	2		Shim (0.50mm)	—	6G5-45577-02-50	AR
33	Housing, Water Pump	18-3170	6E5-44311-00-00	1	76	Washer, Thrust	—	6G5-45576-00-00	1
34	Damper, Water Seal	—	6E5-44365-00-00	1	77	Bearing, Reverse Gear	—	93306-209U0-00	1
35	Cover, Pump Housing	—	6E5-44312-00-00	1	78	O-Ring, Bearing Housing	18-0275	93210-97M55-00	1
36	Bolt, Water Pump	—	97080-08045-00	4	79	Bearing Housing Assembly	—	6J9-45332-00-94	1
37	Washer	—	90209-08M02-00	4	80	Key, Bearing Housing	—	90282-04010-00	1
38	Nipple, Hose	—	6E5-45378-00-00	1	81	Bearing, Needle	—	93315-430U8-00	1
39	Drain, Plug Lower	18-2374	688-45341-00-00	1	82	Seal, Prop Shaft	18-0266	93101-30M17-00	2
40	Gasket, Drain Plugs	—	90430-08020-00	2	83	Washer, Tab	—	9G5-45383-01-00	1
41	Drain Plug Upper	—	90340-08M04-00	1	84	Nut, Cover	—	6G5-45384-00-00	1
42	Gasket, Drain Plugs	—	90430-08020-00	2	85	Washer, Thrust	—	6E5-45987-00-00	1
43	Pin, Locating	—	93608-12M05-00	2	86	Spacer, Prop	18-4274	688-45997-01-00	1
44	Cover, Water Inlet (Port)	—	6J9-45214-00-00	1	87	Washer, Prop	—	92990-18200-00	1
45	Cover, Water Inlet (Stbd)	—	6J9-45215-00-00	1	88	Nut, Prop	18-3726	90171-18M04-00	1
46	Screw, Water Inlet	—	90142-05M04-00	1	89	Pin, Cotter	18-3735	91490-40030-00	1
47	Nut, Water Inlet	—	90185-05002-00	1	90	Gear Housing Seal Kit	18-2794-1	6G5-W0001-21-00	1
48	Bolt	—	97395-10070-00	1	91	Water Pump Repair Kit	18-3311	6G5-W0078-00-00	1

AR As required

**FINDING THE
RIGHT
SIERRA PARTS
HAS NEVER
BEEN EASIER**

- **Up-To-Date
Product Info**
- **Search by Sierra or
OEM part number or
Engine Model No.**
- **Includes Images
& Exploded Views**

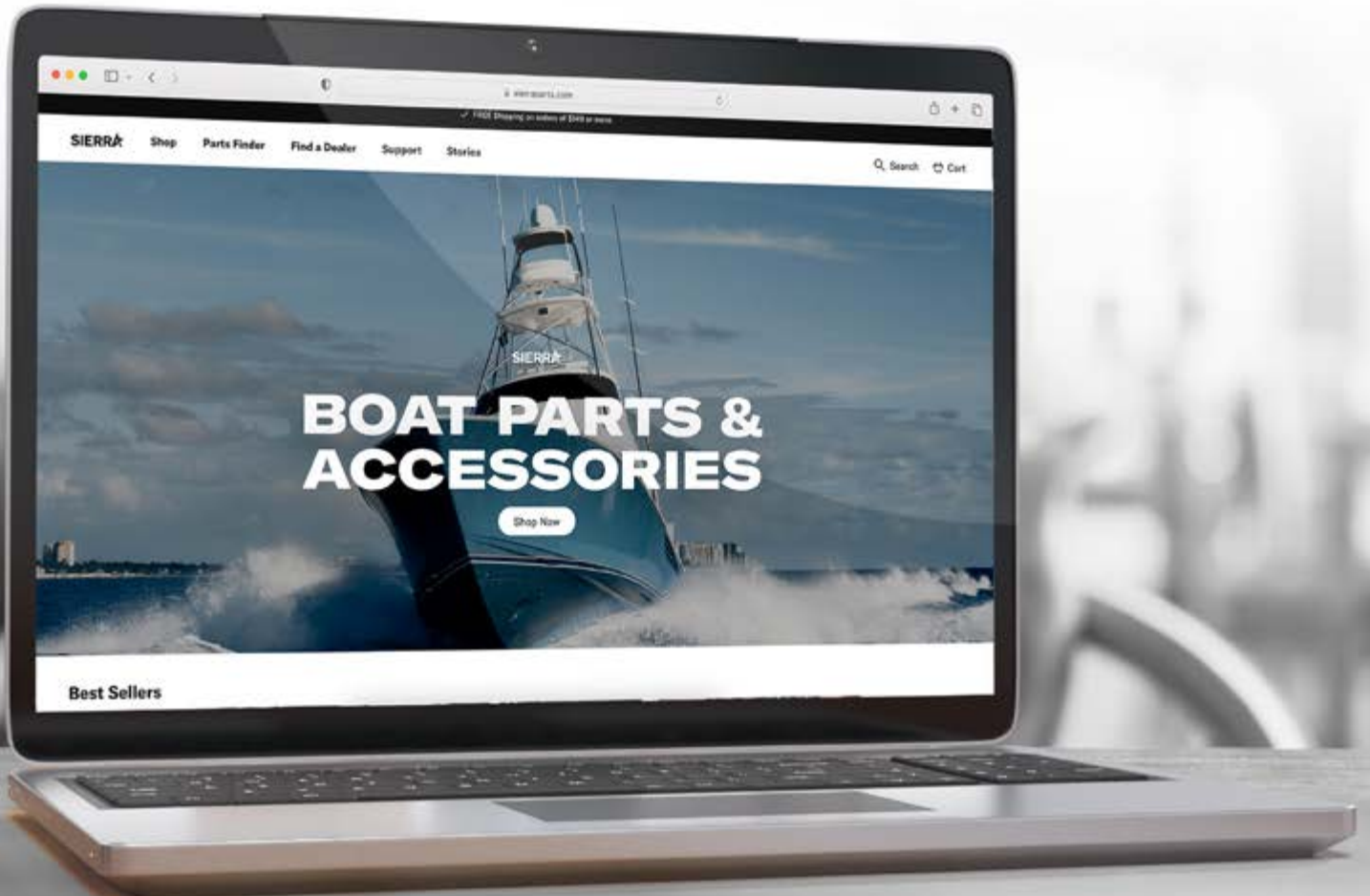

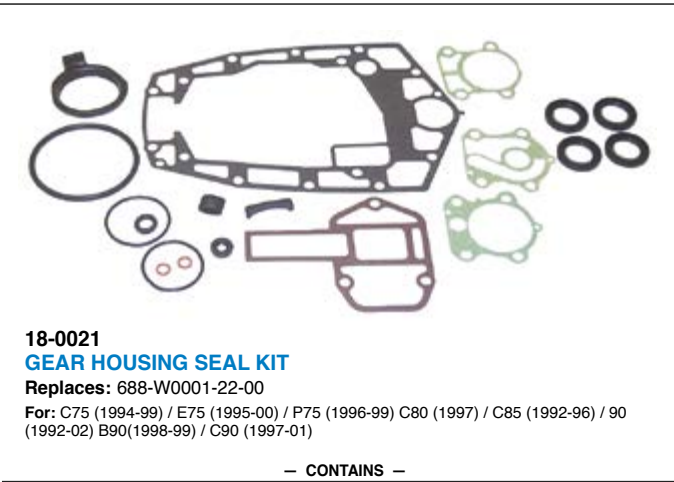

18-0021
GEAR HOUSING SEAL KIT
 Replaces: 688-W0001-22-00
 For: C75 (1994-99) / E75 (1995-00) / P75 (1996-99) C80 (1997) / C85 (1992-96) / 90 (1992-02) B90(1998-99) / C90 (1997-01)

— CONTAINS —

Part #	Desc.	O.E.#	Qty.
18-0239	Gasket	688-44315-A0	1
18-0240	Gasket	688-44316-A0	1
18-7436	O-Ring	93210-46044-00-00	2
18-0267	Oil Seal	93106-09014	1
18-0587	Oil Seal	93101-25M03	4
18-4698	Plug, Drain	90430-08020	2



18-0027
GEAR HOUSING SEAL KIT
 Replaces: 6A1-W0001-23-00
 For: 2HP (1989-02)

— CONTAINS —

Part #	Desc.	O.E.#	Qty.
18-4698	Plug, Drain	90430-08020	2



18-0022
GEAR HOUSING SEAL KIT
 Replaces: 689-W0001-23-00
 For: C25 (1992-97) / C30 (1992)

— CONTAINS —

Part #	Desc.	O.E.#	Qty.
18-99010	Exhaust Manifold Gasket	664-41134-A0-00	1
18-0296	Seal, Propshaft	93101-22067	2
18-0554	Seal	93101-20M07	2
18-0773	Gasket	689-44316-A0	1
18-4698	Plug, Drain	90430-08020	3



18-0023
GEAR HOUSING SEAL KIT
 Replaces: 689-W0001-C2-00
 For: C25 (1986-87) C25 (1990-91) 30 (1986) C30 (1990-91)

— CONTAINS —

Part #	Desc.	O.E.#	Qty.
18-99010	Exhaust Manifold Gasket	664-41134-A0-00	1
18-0554	Seal	93101-20M07	2
18-4698	Plug, Drain	90430-08020	3

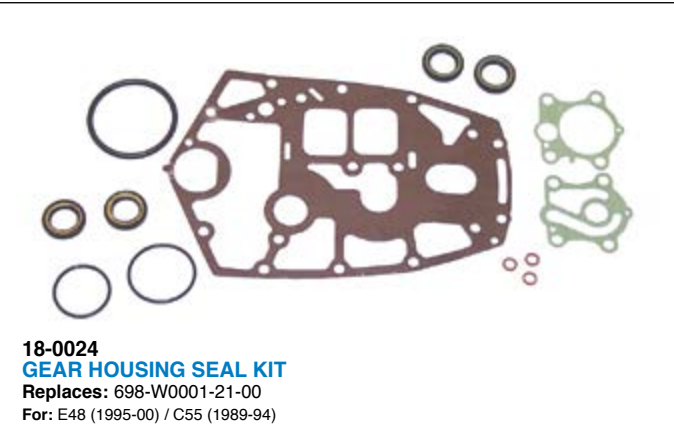

18-0024
GEAR HOUSING SEAL KIT
 Replaces: 698-W0001-21-00
 For: E48 (1995-00) / C55 (1989-94)

— CONTAINS —

Part #	Desc.	O.E.#	Qty.
18-0292	Gasket	663-44315-A0	1
18-0294	Gasket	663-44324-A0	1
18-0297	Seal, Drive Shaft	93101-23070	2
18-0296	Seal, Propshaft	93101-22067	2
18-0298	O-Ring	93210-41042	1
18-7160	O-Ring	93210-66M98	1
18-4698	Plug, Drain	90430-08020	3



18-2785
GEAR HOUSING SEAL KIT
 Replaces: 689-W0001-21-00, 689-W0001-C1-00

— CONTAINS —

Part #	Desc.	O.E.#	Qty.
18-0776	Grommet	682-44365-00-00	1
18-0552	Grommet	689-44366-00-00	1
18-4698	Drain or Fill Washer Gasket	YSG-14090-90-8G	3
18-0554	Oil Seal	93101-20M07-00	1
18-0296	Oil Seal	93101-22067-00	2
18-7405	O-Ring	93210-40M10-00	1
18-0766	Exhaust Tube Gasket	664-41134-A0-00	1
18-0773	Wear Plate Gasket	689-44316-A0-00	1



18-0028
GEAR HOUSING SEAL KIT
 Replaces: 6E0-W0001-C1-00
 For: 4HP (1984-99) / F4 (1999-02) / 5HP (1984-02)

— CONTAINS —



18-0029
GEAR HOUSING SEAL KIT
 Replaces: 6G1-W0001-C1-00
 For: 6HP (1986-96) 8HP (1984-96)

— CONTAINS —

Part #	Desc.	O.E.#	Qty.
18-4698	Plug, Drain	90430-08020	3

Part #	Desc.	O.E.#	Qty.
18-4698	Plug, Drain	90430-08020	3



18-0030
GEAR HOUSING SEAL KIT
 Replaces: 6L2-W0001-C3-00
 For: 20HP (1996-97) 25HP (1988-02) 2 cyl model

— CONTAINS —



18-0031
GEAR HOUSING SEAL KIT
 Replaces: 6N0-W0001-C0-00
 For: 6HP (1997-00), 8HP (1997-04)

— CONTAINS —

Part #	Desc.	O.E.#	Qty.
18-0554	Seal	93101-20M07	2
18-4698	Plug, Drain	90430-08020	2

Part #	Desc.	O.E.#	Qty.
18-4698	Plug, Drain	90430-08020	3

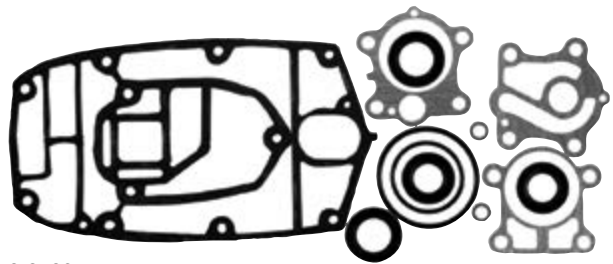

18-2789
LOWER UNIT SEAL KIT
 Replaces: 6J8-W0001-21-00, 6J8-W0001-C2-00

— CONTAINS —

Part #	Desc.	O.E.#	Qty.
18-0292	Wear Plate to Pump Housing Gasket	663-44315-A0-00	1
18-0294	Wear Plate to Pump Base Gasket	663-44324-A0-00	1
18-4698	Drain or Fill Washer	YSG-14090-90-8G	2
18-0554	Oil Seal	93101-20M07-00	2
18-0297	Oil Seal	93101-23070-00	2
18-0298	O-Ring	93210-41042-00	1

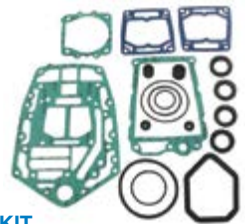

18-2794-1
LOWER UNIT SEAL KIT
 Replaces: 6F3-W0001-21-00, 6F3-W0001-C1-00, 6E5-W0001-51-00, 6E5-W0001-F1-00, 6G5-W0001-21-00, 6G5-W0001-C1-00

— CONTAINS —

Part #	Desc.	O.E.#	Qty.
18-0244	Water Pump Gasket	6E5-44315-A0-00	1
18-4698	Drain or Fill Washer Gasket	YSG-14090-90-8G	2
18-0265	Oil Seal	93101-28M16-00	2
18-0266	Oil Seal	93101-30M17-00	2
18-0267	Oil Seal	93106-09014-00	1
18-7483	O-Ring	93210-37M67-00	1
18-7485	O-Ring	93210-86M38-00	1
18-0275	O-Ring	93210-97M55-00	1



18-2799
LOWER UNIT SEAL KIT
 Replaces: 61A-W0001-21-00, 61A-W0001-C1-00

— CONTAINS —

Part #	Desc.	O.E.#	Qty.
18-0244	Water Pump Gasket	6E5-44315-A0-00	1
18-4698	Drain or Fill Washer Gasket	YSG-14040-90-8G	2
18-0265	Oil Seal	93101-28M16-00	2
18-0266	Oil Seal	93101-30M17-00	1
18-0267	Oil Seal	93106-09014-00	1
18-7483	O-Ring	93210-37M67-00	1
18-7485	O-Ring	93210-86M38-00	1
18-7444	O-Ring	93210-04384-00	1



18-1700
LOWER UNIT SEAL KIT
 Replaces: Yamaha 6H2-W0001-20-00
 Fits: 60TLR/70TLR (2004-Up)



18-74501
GEAR HOUSING SEAL KIT
Replaces: 683-W0001-C1-00
Fits: Yamaha 9.9/15(1984-91)



18-74504
GEAR HOUSING SEAL KIT
Replaces: 6H3-W0001-22-00
Fits: Yamaha 60(2002), C60(1996-01), E60(1995-00), P60(1992-99), 70(1992-02)



18-74507
GEAR HOUSING SEAL KIT
Replaces: 63V-W0001-21-00
Fits: Yamaha 9.9(1997-00), 15(1997-00)



18-74510
GEAR HOUSING SEAL KIT
Replaces: 65L-W0001-C0-00
Fits: Yamaha 225/L225(1997-99), 3.1L, 250/L250(1997-99), SX225/SX250(2000-02), LX225/LX250(2000-02)



18-74512
GEAR HOUSING SEAL KIT
Replaces: 66K-W0001-20-00
Fits: Yamaha V200/V225(1998-99), VX200/VX225(2000-02), VX250(2002)



18-74515
GEAR HOUSING SEAL KIT
Replaces: 68V-W0001-20-00
Fits: Yamaha F115/LF115(2000-05)



18-74527
GEAR HOUSING SEAL KIT
Replaces: 6G9-W0001-C6-00
Fits: Yamaha F9.9(1997-05)



18-74535
GEAR HOUSING SEAL KIT
Replaces: 67F-W0001-20-00
Fits: Yamaha F75/F90(2003-05), F80/F100(1999-02)



18-74540
SEAL KIT
Replaces: 62Y-W0001-20-00
Fits: Yamaha F40 4cyl(1999), F50(1995-00)



18-74546
GEAR HOUSING SEAL KIT
Fits: Yamaha T40/T30 Enduro International Series

GEAR HOUSING SEAL KIT APPLICATION

Model #	Year	Lower Unit Gasket Kit	Model #	Year	Lower Unit Gasket Kit	Model #	Year	Lower Unit Gasket Kit
2	1986-88	—	70	1984-85, 1988-91	—	VZ150	2000-11	18-2794-1
2	1989-02	18-0027	C75	1994-99	18-0021	175	1984-00	18-2794-1
4	1984-99	18-0028	E75	1995-00	18-0021	P175	1994-99	18-2794-1
F4	1999-08	18-0028	P75	1996-99	18-0021	S175	1996-99	18-2794-1
5	1984-02	18-0028	C80	1997	18-0021	V175	2000	18-2794-1
6	1988-96	18-0029	C85	1991	—	VZ175	2001-11	18-2794-1
6	1997-00	18-0031	C85	1992-96	18-0021	Z175	2001-05	18-2794-1
8	1984-96	18-0029	CV85	1989-90	—	200	1984-98	18-2794-1
8	1997-09	18-0031	90	1984-91	—	L200	1986-99	18-2794-1
T8	2001-10	—	90	1992-09	18-0021	LX200	1999-01	18-2794-1
20	1996-97	18-0030	B90	1997-99	18-0021	LZ200	2000-11	18-2794-1
25 ①	1984-85	18-2785	C90	1997-	18-0021	P200	1991-99	18-2794-1
25 ①	1986-87	18-0023	115	1986-09	18-2794-1	S200	1996-99	18-2794-1
25 ①	1988-09	18-0030	C115	1992-00	18-2794-1	SX200	1999-05	18-2794-1
25 ②	1997-02	18-2789	P115	1993-96	18-2794-1	VZ200	2001-04	18-2794-1
C25	1991	18-0023	S115	1996-99	18-2794-1	Z200	2000-11	18-2794-1
C25 ①	1992-97	18-0022	130	1988-04	18-2794-1	V6 Special	1984-86	18-2794-1
CV25	1990	18-0023	L130	1989-01	18-2794-1	V6 Excel	1987-89	18-2794-1
30	1984-85	18-2785	S130	1996-99	18-2794-1	225 ③	1990-97	18-2794-1
30	1986	18-0023	150	1984-09	18-2794-1	225 ④	1994-96	18-2799
30	1987-02	18-2789	C150	1996-99	18-2794-1	L225 ④	1994-96	18-2799
C30	1991	18-0023	L150	1986-99	18-2794-1	S225	1996	18-2799
C30	1992	18-0022	LX150	1999-01	18-2794-1	250	1990-95	18-2799
40	1984-94	—	LZ150	2000-05	18-2794-1	L250	1990-96	18-2799
C40	1992-94	18-99104	Z150	2000-05	18-2794-1	S250	1996	18-2799
50	1986-94	—	P150	1991-99	18-2794-1			
PRO 50	1987-90	—	PX150	1999	18-2794-1			
P50	1992-94	—	PRO V150	1987-90	18-2794-1			
C55	1991	—	S150	1996-99	18-2794-1			
C55	1992-95	18-0024	SX150	1999-04	18-2794-1			
CV55	1989-90	—	V150	2000-08	18-2794-1			
P60	1991	—	VX150	2000-04	18-2794-1			

- ① 2 cylinder model ② 3 cylinder model ④ 3.1 liter engine
 ③ 2.6 liter engine

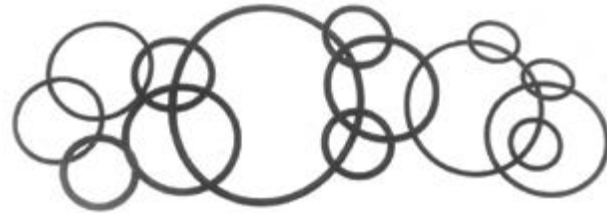

OIL SEALS

Part #	OE#	Dimensions		
		I.D.	O.D.	Width
18-0265	93101-28M16-00	27	43.25	7
18-0266	93101-30M17-00	28.5	45.25	7
18-0267	93106-09014-00	8.75	19.2	5.25
18-0296	93101-22067-00	23	36.25	6
18-0297	93101-23070-00	22.75	37.25	6
18-0554	93101-20M07-00	21.5	34	6.25
18-0570	93102-23096-00	22.75	38.25	7
18-0587	93101-25M03-00	24	40.25	6
18-0588	93102-25M28-00	24.5	48.4	8
18-2079	93101-22M15-00	21.75	35.2	6
18-2085	93102-35M13-00	34	52.25	8
18-2091	93104-22M07-00	22	29.25	5

O-RINGS

Part #	Std. Pkg.	O.E.#	Part #	Std. Pkg.	O.E.#
18-0275	1	93210-97M55-00	18-7485	1	93210-86M38-00
18-0298	1	93210-41042-00	18-7511-9	5	93210-16716-00
18-7119	1	93210-33M85-00	18-76689	1	65W-14198-00-00
18-7432 ⑤	2	93210-32738-00	18-76690	1	93210-46M16-00
18-7436	1	93210-46044-00	18-76691	1	93210-27ME3-00
18-7442	1	93210-74M35-00	18-76693	1	93210-31MJ5-00
18-7444	1	93211-04384-00	18-76694	1	93210-24M79
18-7463	1	93210-19123-00			
18-7468	1	6G5-43864-00-00			
18-7469	1	64E-43869-00-00			
18-7470	1	65W-43865-00-00			
18-7483	1	93210-37M67-00			

⑤ This product is priced per piece. To order priced per package, please add -9 to the part number.



18-6859
SOLENOID
Replaces: Sea-Doo 278-001-376, 278-001-802
 Sea-Doo PWC



18-6860
SOLENOID PLUG
Replaces: Sea-Doo
 Used on Sea-Doo 1995 and UP



18-6862
STARTER
Replaces: Yamaha 6M6-81800-10-00, 64X-81800-00-00



18-6866
STARTER
Replaces: Sea-Doo 278-000-576, 278-000-577, 278-001-038, 278-001-301



18-6867
STARTER
Replaces: Sea-Doo 278-000-484, 278-000-485, 278-001-300, 278-001-935
 Denso 228000-4550



18-6868
STARTER
Replaces: Sea-Doo 278-000-186, 311, 316
 Denso 995435, 128000-4860, 61, 62, 63, 64



18-6869
STARTER
Replaces: Sea-Doo 278-001-497, 278-001-936



18-6873
STARTER
Replaces: Kawasaki 21163-3715, 21163-3719 Denso 428000-0081
 99-2005 JH1200 Ultra 150 w/1176cc, 2002-05 JT1200 STX-R w/1176cc



18-6877
STARTER
Replaces: Honda PWC 31200-HW1-671



18-6904
STARTER
Replaces: Kawasaki 21163-3720, 21163-3721



18-6905
STARTER
Replaces: Sea-Doo 290-888-993, 999, 420-888-9933, -994, -996



18-6906
STARTER
Replaces: Yamaha PWC 64X-81800-00-00



18-6907
STARTER
Replaces: Yamaha PWC 6D3-81800-00-00
 2005-08 VX1100 Wave Runner w/1100cc



18-6908
STARTER
 Replaces: Yamaha PWC 63M-81800-00-00



18-6909
STARTER
 Replaces: Yamaha PWC 6S5-81800-00-00



18-6919
STARTER
 Replaces: Arctic Cat PWC 3008-093, 3008-327, 3008-462, 3008-536



18-6921
STARTER
 Replaces: Yamaha PWC 60E-81800-00-00



18-6875
TRIM MOTOR
 Replaces: Kawasaki PWC 21174-3703
 Super Sport 750,900,110 ZXI, STX, XI



18-6650
VOLTAGE REGULATOR
 Replaces: 6M6-81960-A0-00
 Fits: Most models 1990-2014



18-6651
VOLTAGE REGULATOR
 Replaces: 66V-81960-00-00
 Fits: GP1200 (2000-02); XL, XLT1200 (1999-05)



18-6652
VOLTAGE REGULATOR
 Replaces: 6K8-81960-A0-00
 Fits: Waverunner 500 (1987-93)



18-6857
VOLTAGE REGULATOR
 Replaces: Yamaha PWC 63M-81960-00-00
 800 1998-05; 1100 WR 1995-96; 1100 WV 1997



18-6876
VOLTAGE REGULATOR
 Replaces: Sea-Doo 278-001-554



18-6878
VOLTAGE REGULATOR
 Replaces: Sea-Doo 278-000-123



18-6879
VOLTAGE REGULATOR
 Replaces: Sea-Doo 278-001-239



18-5129
COIL, IGNITION
 Replaces: 62L-85570-00-00
 Fits: 1994-1995 FX-1 FX700S, T



18-5147
CHARGE COIL
 Replaces: Yamaha 62T-85520-00-00; 62T-85520-01-00
 Fits: Wave Raider RA700 (94-97); Wave Raider Deluxe (1995); Wave Venture WVT700 (95-98); Wave Runner III WRA650 (1996); Wave Runner III WRA700 (1997); Super Jet SJ700 (96-06); Wave Runner XL700 (99-04)



18-5146
COIL, LIGHTING
 Replaces: 62T-85533-00-00
 Fits: Wave Venture WVT700 (95-98); Wave Raider RA700 (94-97); Wave Raider Deluxe RA700 (1995); Wave Blaster WB700, WB760 (96-97); Wave Runner III WRA650 (1996); Wave Runner III WRA700 (1997); Waverunner GP760 97-00; Wave Runner XP760 (98-99); Wave Runner XL700 (99-04); Super Jet SJ700 (96-11)



18-15080
IDLER GEAR ASSEMBLY
 Replaces: Polaris 3240120
 Yamaha 6M6-8183E00-00
 Use with 18-6908, 18-6862 Yamaha Starters, fits some Kawasaki, Polaris, Sea-Doo and Tiger Shark PWC's.



18-8880
OIL FILTER
 Replaces: BRP 420956741
 For: SeaDoo & 4 Stroke

Model	Year	Starter	Trim Motor	Voltage Regulator	Model	Year	Starter	Trim Motor	Voltage Regulator
YAMAHA					SEA-DOO (CONT.)				
EXS1200 Exciter	98-99	18-6908			GTI w/ 718cc	1996-97	18-6867		18-6878
EXT1100 Exciter	96-98	18-6908			GTI w/ 718cc	98-04	18-6867		18-6879
EXT1200 Exciter	98-99	18-6908			GTI w/ 718cc	2005	18-6867		
FX700 FX1 w/ 701cc	94-95	18-6862			GTI LE w/ 718cc	2002	18-6867		18-6879
FX1000 Wave Runner w/ 998cc	2002-05	18-6921			GTI LE w/ 718cc	2003	18-6867		
FX1100 Wave Runner w/ 1100cc	2004-05	18-6921			GTI LE w/ 718cc	2004	18-6867		
FX1800 FX Waverunner w/ 1812cc	2008	18-6909			GTI LE w/ 782cc	2005	18-6869		
GP760 Wave Runner w/ 760cc	97-00	18-6906			GTI LE RFI	2004			18-6876
GP800 Wave Runner w/ 784cc	98-05	18-6908		18-6857	GTI w/ 1494cc	2006-08	18-6905		
GP1200 Wave Runner w/ 1176cc	97-99	18-6908			GTI RFI	2004			18-6876
GP1200 Wave Runner w/ 1176cc	2000-02	18-6908			GTI SE w/ 1494cc	2006-07	18-6905		
GP1300 Wave Runner w/ 1300cc	2003-08	18-6908			GTS w/ 581cc	92-94	18-6868		
LST1200	99-05	18-6908			GTS w/ 718cc	97-00	18-6867		18-6878
RA700 Wave Raider w/701cc	94-97	18-6862			GTS w/ 718cc	2001	18-6867		18-6879
RA760 Wave Raider w/ 760cc	1996	18-6906			GTS - 2 passenger w/ 581cc	1995	18-6867		
RA1100 Wave Raider w/ 1100cc	95-96	18-6908			GTS - 3 passenger w/ 581cc	95-96	18-6867		
SJ650 Super Jet w/ 650cc	90-93	18-6862			GTX w/ 581cc	1992	18-6868		
SJ700 Super Jet w/ 701cc	94-11	18-6862			GTX w/ 650cc	93-94	18-6868		
SRT1000	2003-05	18-6921			GTX - 2 passenger w/ 650cc	1995	18-6867		
SRT1100	2005	18-6921			GTX - 3 passenger w/ 650cc	1995	18-6867		
SUV 1200 w/1176cc	99-04	18-6908			GTX w/ 782cc	96-97	18-6866		
Wave Runner 1100cc	1995-96			18-6857	GTX DI	2000-03			18-6876
WB700 Wave Blaster w/ 701cc	93-96	18-6862			GTX RFI w/ 782cc	1998	18-6866		
WR650 Wave Runner LX w/ 650cc	90-94	18-6862			GTX RFI	2000-02			18-6876
WB760 Wave Blaster w/ 760cc	96-97	18-6906			GTX 155 w/ 1494cc	2008	18-6905		
WRA650 Wave Runner III w/650cc	90-96	18-6862			GTX 215 w/ 1494cc	2008	18-6905		
WRA700 Wave Runner III w/ 701cc	94-97	18-6862			GTX 4-Tec w/ 1494cc	2002	18-6905		
WRB650 Wave Runner w/ 650cc	91-95	18-6862			GTX 4-Tec w/ 1494cc	2003-04	18-6905		
WRB700 Wave Runner w/ 700cc	93-94	18-6862			GTX 4-Tec w/ 1494cc	2005-08	18-6905		
WVT700 Wave Vent w/ 701cc	95-98	18-6862			GTX Wake w/ 1494cc	2005-07	18-6905		
WVT760 Wave Venture w/ 760cc	1997	18-6906			GTX Wake 155 w/ 1494cc	2005-08	18-6905		
WVT1100 Wave Vent w/ 1100cc	1996	18-6908			GTX Wake 215 w/ 1494cc	2008	18-6905		
WVT1100 Wave Vent w/ 1100cc	1997	18-6908		18-6857	HX w/ 718cc	1995	18-6867		
VX1100 Wave Runner w/ 1100cc	2005-08	18-6907			HX w/ 718cc	96-97	18-6867		18-6878
XL700 Wave Runner w/ 701cc	99-04	18-6862			LRV DI	2002			18-6876
XL760 Wave Runner w/ 760cc	1997	18-6906			RX	2001-02			
XL800 Wave Runner w/ 784cc	00-01	18-6908			RX DI	00-03			18-6876
XL1200 Wave Runner w/ 1176cc	98-00	18-6908			RX limited	2000			
XLT800 Wave Runner w/ 784cc	2002-04	18-6908			RXP w/ 1494cc	2004-05	18-6905		
XLT1200 Wave Runner w/ 1176cc	2001-05	18-6908			RXP w/ 1494cc	2006-07	18-6905		
XRT1200	00-01	18-6908			RXP 155 w/ 1494cc	2008	18-6905		
SEA-DOO					RXP 215 w/ 1494cc	2008	18-6905		
3D DI w/ 782cc	2004-05	18-6869			RXP X 255 w/ 1494cc	2008	18-6905		
3D DI w/ 1494cc	2007	18-6905			RXT w/ 1494cc	2005-07	18-6905		
Explorer	93-94	18-6868			RXT 215 w/ 1494cc	2008	18-6905		
Explorer	95-97	18-6867			RXT 255 w/ 1494cc	2008	18-6905		
GS w/ 718cc	97-01	18-6867		18-6879	SP w/ 581cc	92-94	18-6868		
GSI w/ 718cc	1997	18-6867		18-6879	SP w/ 581cc	1995	18-6867		
GSX RFI w/ 782cc	1999	18-6869			SP w/ 581cc	1996	18-6867		18-6878
GSX RFI w/ 782cc	2000	18-6869		18-6876	SP w/ 718cc	1997	18-6867		
GSX RFI w/ 782cc	2001	18-6869			SPI w/ 581cc	93-94	18-6868		
GSX w/ 782cc	1996	18-6866			SPI w/ 581cc	1995	18-6867		
GSX w/ 782cc	1997	18-6866		18-6879	SPI w/ 581cc	1996	18-6867		18-6878
GSX limited	1998				SPX w/ 581cc	1993	18-6868		

APPLICATION CONTINUED ON NEXT PAGE

Model	Year	Starter	Trim Motor	Voltage Regulator	Model	Year	Starter	Trim Motor	Voltage Regulator
SEA-DOO (CONT.)					ARCTIC CAT (Cont.)				
SPX w/ 650cc	1994	18-6868			Monte Carlo 640 w/ 639cc	94-97	18-6919		
SPX w/ 650cc	1995	18-6867			Monte Carlo 770 w/ 768cc	96-97	18-6919		
SPX w/ 718cc	1996	18-6867		18-6878	Monte Carlo 900 w/ 900cc	1996	18-6919		
SPX w/ 782cc	1997	18-6867			Monte Carlo 1000 w/ 999cc	1997	18-6919		
SPX w/ 782cc	98-99	18-6866			Montego 640 w/ 639cc	94-97	18-6919		
XP w/ 581cc	1992	18-6868			Montego Dlx 640 w/639cc	94-97	18-6919		
XP w/ 650cc	93-94	18-6868			Tigershark 640 w/639cc	1993	18-6919		
XP w/ 718cc	1995	18-6867			Tigershark 900 w/900cc	1995	18-6919		
XP w/ 782cc	96-97	18-6866			TS640 w/639cc	1993	18-6919		
XP	2002				TS770, 770L, 770R w/ 768cc	98-99	18-6919		
XP800	ALL but '95			18-6878	TS900L w/ 900cc	1999	18-6919		
XP800	1995				TS1000L, R w/ 999cc	1998	18-6919		
XP DI	2003-04			18-6876	TS1100Li, R w/ 1100cc	1999	18-6919		
XP Limited VTS motor	98-05				KAWASAKI				
Challenger	1998	18-6867			JH1200 Ultra 150 w/ 1176cc	99-05	18-6873		
Challenger	96-99	18-6866			JT1200 STX-R w/ 1176cc	2002-05	18-6873		
Challenger	2004-07	18-6905			JT1200 STX-12F w/1199cc	2003-07		18-6904	
Challenger 180, 230	2008	18-6905			JT1500 STX-15F w/1498cc	2004-09		18-6904	
Islandia	2004-08	18-6905			JT1500 Ultra 250X w/ 1498cc	2007-09		18-6904	
Speedster	98-99	18-6866			JT1500 Ultra LX w/ 1498cc	2007-09		18-6904	
Speedster	95-99	18-6867			Super Sport 750	ALL		18-6875	
Speedster	2004-07	18-6905			Super Sport 900	ALL		18-6875	
Speedster 150, 200	2008	18-6905			Super Sport 110	ALL		18-6875	
Speedster Wake	2008	18-6905			Super Sport ZXI	ALL		18-6875	
Sportster	95-99	18-6867			Super Sport STX	ALL		18-6875	
Sportster	2003-06	18-6905			Super Sport XI	ALL		18-6875	
Utopia	2004-08	18-6905			HONDA				
ARCTIC CAT					Aquatrax F-12 w/ 1235cc	2002-07	18-6877		
Barracuda 639cc	94-95	18-6919			Aquatrax F-12X w/ 1235cc	2002-07	18-6877		
Daytona w/ 639cc	93-95	18-6919			Aquatrax F-12X GPSC w/ 1235cc	2005-07	18-6877		
Daytona 770 w/ 768cc	96-97	18-6919			Aquatrax R-12 w/ 1235cc	2004-06	18-6877		
Daytona 1000 w/ 999cc	1997	18-6919			Aquatrax R-12X w/ 1235cc	2003-07	18-6877		















**PARTS
THAT
KEEP
YOU
MOVING**







sierraparts.com



IMPELLERS/IMPELLER KITS FOR JABSCO

 <p>18-3275 IMPELLER KIT Replaces: Jabsco 17935-0001 For: TAMD74A, A-A, A-B (2000-05); TAMD74C-A, C-B (2000-05); TAMD74L-A, B (1999-2005); TAM-D74P-A, P-B (1998-2005); TAMD75P-A (1998-2005); TAMD71B (1989-2000); TAMD73P-A (1997-98); TAMD73WJ-A (1997-99)</p>	 <p>18-3076 IMPELLER KIT Includes: Impeller & Gaskets Replaces: Jabsco 22405-0001</p>	 <p>18-3306 IMPELLER KIT Replaces: Jabsco 13554-0001 Yanmar 119773-42600-00 DIA 2 1/4" SIDE WIDTH 1 15/16" (Neoprene)</p>
 <p>18-3036 IMPELLER KIT Replaces: Jabsco 673-0003 (Nitrile)</p>	 <p>18-3038 IMPELLER KIT Replaces: Jabsco 920-0003, 17937-0003 (Nitrile)</p>	 <p>18-3077 IMPELLER KIT Replaces: Jabsco 920-0001 12 SPLINES 8 FINS (Neoprene)</p>
 <p>①18-3046D Display Package IMPELLER KIT Replaces: Jabsco 18838-0001</p>	 <p>18-3047 IMPELLER KIT Replaces: Jabsco 18948-0001</p>	 <p>①18-3081D Display Package IMPELLER KIT Replaces: Jabsco 1210-0001 12 SPLINES 12 FINS</p>
 <p>18-3080 IMPELLER KIT Replaces: Jabsco 673-0001 Diameter 2" • Side Width 7/8" (Neoprene)</p>	 <p>18-3078 IMPELLER KIT Replaces: Jabsco 836-0001 Cummins 160596, 166758, 556540, 556850, 21601R Diameter 3 3/4" • Side Width 2 1/2" (Neoprene)</p>	 <p>18-3079 IMPELLER KIT Replaces: Jabsco 4528-0001 Diameter 1 9/16" • Side Width 3/4" (Neoprene)</p>
 <p>①18-3075D Display Package IMPELLER KIT Replaces: Jabsco 4568-0001, 2877-0001, 14510-46090, 124310-46090 Diameter 2 1/4" • Side Width 1 1/4" (Neoprene)</p>	 <p>18-3037 IMPELLER KIT Replaces: Jabsco 836-0003 Diameter 3 3/4" • Side Width 2 1/2" (Nitrile)</p>	 <p>18-45713 IMPELLER KIT Replaces: Jabsco 18653-0001 Fits: F4B Pump</p>

① Items ending in "D" are Display Packaged - Regular number is Non-Display

 <p>18-3020 IMPELLER Replaces: Jabsco 1210-0003 (Nitrile)</p>	 <p>18-3021 IMPELLER Replaces: Jabsco 4598-0001 Diameter 2 9/16" • Side Width 2" (Neoprene)</p>	 <p>18-45712 IMPELLER Replaces: Jabsco 17636-0001, 21676-0001 Fits: F9B-9 Pump</p>	<p>PKG. OF 2</p>  <p>18-3125 18-3125-9① WATER PUMP GASKET Replaces: Jabsco 3101-0000</p>	 <p>18-2005 SEAL Replaces: Jabsco 92700-0060</p>
--	--	---	---	---

JABSCO COMPONENT APPLICATIONS

Pump Model	Impeller Kit	Oil Seal	Pump Model	Impeller Kit	Oil Seal	Pump Model	Impeller Kit	Oil Seal
777-0001	18-3077	18-2005	1673-9051	18-3081	—	3890-9011	18-3077	—
777-0003	18-3077	—	2300-9001	18-3077	—	5330-9001	18-3077	—
777-9003	18-3077	—	2300-9003	18-3077	—	5330-9101	18-3077	—
777-9004	18-3077	—	2300-9004	18-3077	—	5560-0001	18-3077	18-2005
777-9005	18-3077	—	2300-9005	18-3077	—	5660-0001	18-3077	18-2005
777-9051	18-3077	—	3270-0001	18-3081	18-2005	5850-0001	18-3081	18-2005
1673-0001	18-3081	18-2005	3270-0003	18-3081	18-2005	7120-9001	18-3077	—
1673-0003	18-3081	18-2005	3290-9001	18-3081	—	7320-9001	18-3077	—
1673-1001	18-3081	18-2005	3380-0001	18-3081	18-2005	8170-9001	18-3077	—
1637-1003	18-3081	18-2005	3480-9002	18-3081	—	17120-0001	18-3079	18-2005
1673-9001	18-3081	—	3480-9011	18-3081	—	22740-0301	—	18-2005
1673-9003	18-3081	—	3590-9001	18-3079	—	22740-0351	—	18-2005

IMPELLERS/IMPELLER KITS FOR JOHNSON PUMP

 <p>18-3275 IMPELLER KIT Replaces: Johnson Pump 09-819B For: TAMD74A, A-A, A-B (2000-05); TAMD74C-A, C-B (2000-05); TAMD74L-A, B (1999-2005); TAM-D74P-A, P-B (1998-2005); TAMD75P-A (1998-2005); TAMD71B (1989-2000); TAMD73P-A (1997-98); TAMD73WJ-A (1997-99)</p>	 <p>18-3080 IMPELLER KIT Replaces: Johnson Pump 09-1026B Diameter 2" • Side Width 7/8" (Neoprene)</p>	 <p>18-3077 IMPELLER KIT Replaces: Johnson Pump 09-1028B Yanmar 127610-42200 Cummins 650607 12 SPLINES 8 FINS</p>
<p>②18-3081D Display Package</p>  <p>18-3081 IMPELLER KIT Replaces: Johnson Pump 09-1027B 12 SPLINES 12 FINS</p>	<p>②18-3075D Display Package</p>  <p>18-3075 IMPELLER KIT Replaces: Johnson Pump 09-801B Diameter 2 1/4" • Side Width 1 1/4" For: Johnson Pump # F4B-8007 (Neoprene)</p>	 <p>18-3079 IMPELLER KIT Replaces: Johnson Pump 09-806B, Yanmar 104211-42070 Diameter 1 9/16" • Side Width 3/4" (Neoprene)</p>
 <p>18-3037 IMPELLER KIT Replaces: Johnson Pump 09-1029B-9 (Nitrile)</p> <p>18-3078 IMPELLER KIT Replaces: Johnson Pump 09-1029B Diameter 3 3/4" • Side Width 2 1/2" For: Johnson Pump #'s F8B-3000, F8B500, F8B-8007, F8B-50017 (Neoprene)</p>	 <p>18-3306 IMPELLER KIT Replaces: Johnson Pump 09-812B</p>	 <p>18-3036 IMPELLER KIT Replaces: Johnson Pump 09-1026B-9 (Nitrile)</p>

① Priced per Package

② Items ending in "D" are Display Packaged - Regular number is Non-Display

 <p>18-3038 IMPELLER KIT Replaces: Johnson Pump 09-1028B-9 (Nitrile)</p>	 <p>18-3076 IMPELLER KIT Includes: Impeller & Gaskets Replaces: Johnson Pump 09-808B, 09-45589</p>	 <p>18-3089 WATER PUMP KIT Includes: Impeller, Seal, Gasket, End & Cover Screws Replaces: Johnson Pump 09-45825 Use with 18-3587-1 Pump</p>	 <p>18-3020 IMPELLER Replaces: Johnson Pump 09-1027B-9 (Nitrile)</p>
 <p>18-45712 IMPELLER Replaces: Johnson Pump 09814B Fits: F9B-9 Pump</p>	 <p>18-45713 IMPELLER Replaces: Johnson Pump 09-810B Fits: F4B Pump</p>	 <p>18-45714 IMPELLER Replaces: Johnson Pump 09-821B Fits: F75B Pump</p>	<p>PKG. OF 2</p>  <p>18-3125 18-3125-9^① WATER PUMP GASKET Replaces: 3298-0000</p>
 <p>18-3586-1 WATER PUMP Replaces: Johnson Pump 10-24228-1 For Impeller Repair Kit use 18-3081 Use replacement Impeller 18-3020</p>	 <p>18-3587-1 WATER PUMP Replaces: Johnson Pump 10-24232-1 For Impeller Repair Kit use 18-3089</p>		

IMPELLERS FOR OBERDORFER PUMPS

 <p>18-3061 IMPELLER Replaces: Oberdorfer 8922 Sherwood 10615 12 FINS For: GM engines with V-Belt</p>	<p>②18-3075D Display Package</p>  <p>18-3075 IMPELLER KIT Replaces: Oberdorfer B6620 12 FINS</p>	 <p>18-3077 IMPELLER KIT Replaces: Oberdorfer C7441 Sherwood 18200 12 SPLINES 8 FINS</p>
 <p>18-3078 IMPELLER KIT Replaces: Oberdorfer 7054 12 SPLINES 9 FINS</p>	<p>①18-3046D Display Package</p>  <p>18-3046 IMPELLER KIT Replaces: Sherwood 9959K with 18-3060 Impeller Replaces: Sherwood 9959</p>	 <p>18-3047 IMPELLER KIT Replaces: Sherwood 10615K with 18-3061 Impeller Replaces: Sherwood 10615</p>

① Priced per Package
② Items ending in "D" are Display Packaged - Regular number is Non-Display



**18-3060
IMPELLER**
Replaces: Sherwood 9959
Onan 132-0317
12 FINS



**18-3021
IMPELLER**
Replaces:
Oberdorfer 6603
Diameter 2 9/16" • Side width 2"
(Neoprene)

PKG. OF 2



**18-3140
18-3140-9^①
WATER PUMP GASKET**
Replaces: Sherwood 10931

SHERWOOD COMPONENT APPLICATIONS

Pump #	Impeller Kit	Impeller	Seal & Seat Assembly	Pump #	Impeller Kit	Impeller	Seal & Seat Assembly	Pump #	Impeller Kit	Impeller	Seal & Seat Assembly
A-03	—	18-3060	—	G-50	18-3047	18-3061	—	N-10410G	18-3046	18-3060	—
B-04	18-3047	18-3061	—	G-55-2	—	18-3061	—	N-10460	—	18-3060	—
C-03	18-3047	18-3061	—	G-56	—	18-3061	—	N-10470	—	18-3060	—
D-05	—	18-3061	—	G-85	18-3047	18-3061	—	N-10510G	18-3046	18-3060	—
D-55	18-3046/18-3047	18-3060/18-3061	—	G-1004	—	18-3061	—	P-101	—	18-3061	—
D-60	18-3046	18-3060	—	G-1005	—	18-3061	—	P-102	—	18-3061	—
D-65	18-3046	18-3060	—	G-1006	—	18-3061	—	P-105	18-3047	18-3061	—
D-75	18-3046	18-3060	—	G-85106	—	18-3061	—	P-10550G	18-3046/18-3047	18-3060/18-3061	—
E-35	—	18-3061	—	H-85	—	18-3061	—	P-10560G	18-3046	18-3060	—
F-10	18-3047	18-3061	—	J-70	—	18-3060	—	P-10610G	18-3046	18-3060	—
F-75	18-3047	18-3061	—	K-90	—	18-3061	—	P-10650G	18-3046	18-3060	—
F-95	—	18-3061	—	L-10	—	18-3061	18-3069	P-10710G	18-3046	18-3060	—
G-3	—	18-3061	—	L-10B	—	18-3061	—	Q-10770G	18-3046	18-3060	—
G-4	—	18-3061	—	L-80	—	18-3061	—	Q-10755G	—	18-3060	—
G-5	18-3047	18-3061	—	L-90	—	18-3061	—	Q-10855G	18-3046	18-3060	—
G-5-1	—	18-3061	—	L-9930G	18-3046	18-3060	—	R-40G	18-3046	18-3060	—
G-7	—	18-3061	—	M-70	—	18-3061	—	R-101	—	18-3061	—
G-8	—	18-3061	—	M-71	—	18-3061	—	R-102	—	18-3060	—
G-7B	—	18-3061	—	M-10065G	—	18-3060	—	R-10870G	18-3046	18-3060	—
G-15	—	18-3060	—	M-10180G	18-3046	18-3060	—	R-10920G	18-3046	18-3060	—
G-26	—	18-3061	—	M-10210G	18-3046	18-3060	—	R-10930G	18-3046	18-3060	—
G-30-2	—	18-3060	—	M-10263G	18-3046	18-3060	—	R-10935G	18-3046	18-3060	—
G-30-2B	—	18-3060	—	M-10264G	18-3046	18-3060	—	R-10970G	18-3046	18-3060	—
G-45-1	—	18-3061	—	M-10270G	18-3046	18-3060	—	RP-B-C	—	18-3061	—
G-45-2	—	18-3061	—	M-10280G	18-3046	18-3060	—	S-11040G	18-3046	18-3061	—
G-46	—	18-3061	—	N-10390G	18-3046	18-3060	—	S-11095G	—	18-3061	—



**18-2434
FLYWHEEL BELL HOUSING**
Replaces:
Crusader 96938
Marine Power 0100-000
Mercruiser 814309A1
Pleasurecraft R142006
Volvo Penta 3857846-4
GM V-8's Big & Small Block Inboard/Ski models.



**18-2589
TRANSMISSION OIL COOLER**
• 1" Water Hose Connection
• 9" Tube Bundle Overall Length
• Approximately 12"
• Oil-6 GPM MAX Water 25 GPM MAX
• Shipped bare metal, ready for primer and factory paint finish.



**18-2587
TRANSMISSION OIL COOLER**
Replaces: Mercruiser 99356A2
• Replacement Power Steering Cooler for Mercruiser
• Power Steering Fluid-4 GPM MAX Water 25 GPM MAX
• 6" tube bundle, overall length 8", 1 1/4" water inlet and outlet
• Shipped bare metal, ready for primer and factory paint finish.



**18-2588
TRANSMISSION OIL COOLER**
• 1 1/4" Water Hose Connection
• 9" x 2" and 3/8" NPT Inlet/Outlet Oil Fitting
• Oil-6 GPM MAX Water 25 GPM MAX
• 10" tube bundle, overall length 12", 1 1/4" water inlet and outlet
• Shipped bare metal, ready for primer and factory paint finish.

TRANSMISSION REPAIR KITS

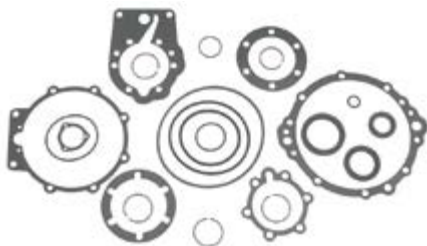

18-2590 SEAL KIT

Replaces: Borg Warner A4876HA
• Service kit for Borg-Warner Velvet Drive 71 and 72 series transmission



18-2591 OVERHAUL KIT

Includes: Gaskets, Seals, Sealing Rings, Bronze and Steel Plates
• Service kit for Borg-Warner Velvet Drive 71 and 72 series transmission

ANODES

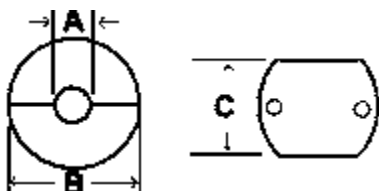

SHAFT ANODES

ZINC ANODES			NOMINAL DIMENSIONS		
Part #	Nom. Weight LBS. (KG)	A-Diameter IN. (MM)	Dimension B IN. (MM)	Dimension C IN. (MM)	
18-6040	.90 (.40)	1 1/8 (29)	2 1/8 (54)	2 1/8 (54)	



RUDDER ANODES

ZINC ANODES			NOMINAL DIMENSIONS		
Part #	Nom. Weight LBS. (KG)	A-Diameter IN. (MM)	Dimension B IN. (MM)		
18-6045	.20 (.09)	1 7/8 (47)	1/4 (6)		
18-6046	.90 (.40)	2 13/16 (71)	1/2 (13)		
18-6047	1.40 (.64)	3 3/4 (95)	1/2 (13)		
18-6107	-	5 (127)	5/8 (16)		
18-6108	4.63 (2.10)	5 1/8 (130)	7/8 (22)		
18-6109	9.32 (4.22)	6 1/2 (165)	7/8 (22)		

COMPLETE ENGINE ANODES (with Brass Plug)

ZINC ANODES			NOMINAL DIMENSIONS			Replacement Anode Only
Part #	Nom. Weight LBS. (KG)	A-Length IN. (MM)	B-Diameter IN. (MM)	Plugs (pis) IN. (MM)		
18-6134	.12 (.05)	2-0 (50)	1/4 (6)	1/8 (3)	-	
18-6059	.10 (.05)	1 3/4 (44)	3/8 (10)	1/4 (6)	-	
18-6060	.20 (.09)	2-0 (50)	1/2 (13)	3/8 (10)	-	
18-6136	.20 (.09)	2-0 (50)	3/8 (10)	3/8 (10)	18-6053	
18-6062	.30 (.14)	2-0 (50)	5/8 (16)	1/2 (13)	18-6137	
18-6063	.45 (.20)	2-0 (50)	3/4 (19)	3/4 (19)	-	

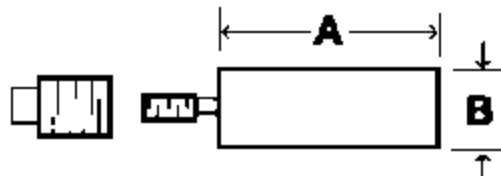

PACKING (* All 3 foot packing comes in display packaging)

PREMIUM SQUARE MARINE TEFLON PACKAGING					PREMIUM SQUARE MARINE LUBRICATED FLAX PACKAGING				
AP#	Diameter	Length*	Wt. (lbs.)	Pkg.	AP#	Diameter	Length*	Wt. (lbs.)	Pkg.
4720	1/8"	3 ft.	—	1	4701	3/16"	3 ft.	—	1
4721	3/16"	3 ft.	—	1	4711	3/16"	—	1	1
4731	3/16"	—	1	1	4712	1/4"	—	1	1
4722	1/4"	3 ft.	—	1	4713	5/16"	—	1	1
4732	1/4"	—	1	1					
4734	3/8"	—	1	1					
4735	1/2"	—	1	1					



18-6140 ZINC ANODE

Replaces: 301068
For: 5424, M-30, M-35, M3-20, M3-20A, M4-30, M4-30A, M-35A



18-6141 ZINC ANODE

Replaces: 301069
For: 5416, M-12, M-18, M-20, M-25, M-25XP, M-25XPA, M-30, M2-12



SHAFT KEY

Part #	Shaft Dimensions
18-2334	2 1/8" x 1/4"

<p style="text-align: center;">①18-5250D Display Package</p>  <p>18-5250 TUNE-UP KIT</p> <p>—CONTAINS—</p> <table border="0" style="width: 100%; font-size: x-small;"> <tr> <th>Part #</th> <th>O.E. #</th> <th>Description</th> </tr> <tr> <td>18-5311</td> <td>16.69-00049</td> <td>Contact Set</td> </tr> <tr> <td>18-5345</td> <td>16.69-00050</td> <td>Condenser</td> </tr> <tr> <td>18-5418</td> <td>16.69-00051</td> <td>Rotor</td> </tr> </table> <p>Delco 4 & 6 cyl.</p>	Part #	O.E. #	Description	18-5311	16.69-00049	Contact Set	18-5345	16.69-00050	Condenser	18-5418	16.69-00051	Rotor	<p style="text-align: center;">①18-5251D Display Package</p>  <p>18-5251 TUNE-UP KIT</p> <p>—CONTAINS—</p> <table border="0" style="width: 100%; font-size: x-small;"> <tr> <th>Part #</th> <th>O.E. #</th> <th>Description</th> </tr> <tr> <td>18-5314</td> <td>16.69-00039</td> <td>Contact Set</td> </tr> <tr> <td>18-5338</td> <td>16.69-00040</td> <td>Condenser</td> </tr> <tr> <td>18-5404-1</td> <td>16.69-00149</td> <td>Rotor</td> </tr> </table> <p>Mallory 8 cyl. Tall Cap</p>	Part #	O.E. #	Description	18-5314	16.69-00039	Contact Set	18-5338	16.69-00040	Condenser	18-5404-1	16.69-00149	Rotor	 <p>18-5252 TUNE-UP KIT</p> <p>—CONTAINS—</p> <table border="0" style="width: 100%; font-size: x-small;"> <tr> <th>Part #</th> <th>Description</th> </tr> <tr> <td>18-5310</td> <td>Contact Set</td> </tr> <tr> <td>18-5344</td> <td>Condenser</td> </tr> <tr> <td>-</td> <td>Rotor</td> </tr> </table> <p>Delco 8 cyl.</p>	Part #	Description	18-5310	Contact Set	18-5344	Condenser	-	Rotor	 <p>18-5255 TUNE-UP KIT</p> <p>—CONTAINS—</p> <table border="0" style="width: 100%; font-size: x-small;"> <tr> <th>Part #</th> <th>Description</th> </tr> <tr> <td>18-5303</td> <td>Contact Set</td> </tr> <tr> <td>18-5345</td> <td>Condenser</td> </tr> <tr> <td>18-5407</td> <td>Rotor</td> </tr> </table> <p>Prestolite 8 cyl.</p>	Part #	Description	18-5303	Contact Set	18-5345	Condenser	18-5407	Rotor
Part #	O.E. #	Description																																									
18-5311	16.69-00049	Contact Set																																									
18-5345	16.69-00050	Condenser																																									
18-5418	16.69-00051	Rotor																																									
Part #	O.E. #	Description																																									
18-5314	16.69-00039	Contact Set																																									
18-5338	16.69-00040	Condenser																																									
18-5404-1	16.69-00149	Rotor																																									
Part #	Description																																										
18-5310	Contact Set																																										
18-5344	Condenser																																										
-	Rotor																																										
Part #	Description																																										
18-5303	Contact Set																																										
18-5345	Condenser																																										
18-5407	Rotor																																										

 <p>18-5256 TUNE-UP KIT</p> <p>—CONTAINS—</p> <table border="0" style="width: 100%; font-size: x-small;"> <tr> <th>Part #</th> <th>O.E. #</th> <th>Description</th> </tr> <tr> <td>18-5314</td> <td>16.69-00039</td> <td>Contact Set</td> </tr> <tr> <td>18-5338</td> <td>16.69-00040</td> <td>Condenser</td> </tr> <tr> <td>18-5411</td> <td>16.69-00042</td> <td>Rotor</td> </tr> </table> <p>Mallory 8 cyl. Flat Cap</p>	Part #	O.E. #	Description	18-5314	16.69-00039	Contact Set	18-5338	16.69-00040	Condenser	18-5411	16.69-00042	Rotor	 <p>18-5258 TUNE-UP KIT</p> <p>—CONTAINS—</p> <table border="0" style="width: 100%; font-size: x-small;"> <tr> <th>Part #</th> <th>Description</th> </tr> <tr> <td>18-5303</td> <td>Contact Set</td> </tr> <tr> <td>18-5347</td> <td>Condenser</td> </tr> <tr> <td>18-5407</td> <td>Rotor</td> </tr> </table> <p>Prestolite 8 cyl.</p>	Part #	Description	18-5303	Contact Set	18-5347	Condenser	18-5407	Rotor	 <p>18-5259 TUNE-UP KIT</p> <p>—CONTAINS—</p> <table border="0" style="width: 100%; font-size: x-small;"> <tr> <th>Part #</th> <th>Description</th> </tr> <tr> <td>18-5303</td> <td>Contact Set</td> </tr> <tr> <td>18-5347</td> <td>Condenser</td> </tr> <tr> <td>18-5429</td> <td>Rotor</td> </tr> </table> <p>Prestolite 6 & 8 cyl.</p>	Part #	Description	18-5303	Contact Set	18-5347	Condenser	18-5429	Rotor
Part #	O.E. #	Description																												
18-5314	16.69-00039	Contact Set																												
18-5338	16.69-00040	Condenser																												
18-5411	16.69-00042	Rotor																												
Part #	Description																													
18-5303	Contact Set																													
18-5347	Condenser																													
18-5407	Rotor																													
Part #	Description																													
18-5303	Contact Set																													
18-5347	Condenser																													
18-5429	Rotor																													

<p style="text-align: center;">①18-5260D Display Package</p>  <p>18-5260 TUNE-UP KIT</p> <p>—CONTAINS—</p> <table border="0" style="width: 100%; font-size: x-small;"> <tr> <th>Part #</th> <th>Description</th> </tr> <tr> <td>18-5303</td> <td>Contact Set</td> </tr> <tr> <td>18-5345</td> <td>Condenser</td> </tr> <tr> <td>18-5403</td> <td>Rotor</td> </tr> </table>	Part #	Description	18-5303	Contact Set	18-5345	Condenser	18-5403	Rotor	 <p>18-5266 TUNE-UP KIT</p> <p>Fits: Flame Thrower Distributors 18-5481, 18-5482, 18-5483, 18-5477, 18-5478 and 18-5479</p>	 <p>18-5268 TUNE-UP KIT</p> <p>—CONTAINS—</p> <table border="0" style="width: 100%; font-size: x-small;"> <tr> <th>Part #</th> <th>O.E. #</th> <th>Description</th> </tr> <tr> <td>18-5311</td> <td>16.69-00049</td> <td>Contact Set</td> </tr> <tr> <td>18-5345</td> <td>16.69-00050</td> <td>Condenser</td> </tr> <tr> <td>18-5418</td> <td>16.69-00051</td> <td>Rotor</td> </tr> <tr> <td>18-5385</td> <td>16.69-00052</td> <td>Distributor Cap</td> </tr> </table> <p>GM 4 Cyl. • Single Point</p>	Part #	O.E. #	Description	18-5311	16.69-00049	Contact Set	18-5345	16.69-00050	Condenser	18-5418	16.69-00051	Rotor	18-5385	16.69-00052	Distributor Cap
Part #	Description																								
18-5303	Contact Set																								
18-5345	Condenser																								
18-5403	Rotor																								
Part #	O.E. #	Description																							
18-5311	16.69-00049	Contact Set																							
18-5345	16.69-00050	Condenser																							
18-5418	16.69-00051	Rotor																							
18-5385	16.69-00052	Distributor Cap																							

 <p>18-5269 TUNE-UP KIT</p> <p>—CONTAINS—</p> <table border="0" style="width: 100%; font-size: x-small;"> <tr> <th>Part #</th> <th>O.E. #</th> <th>Description</th> </tr> <tr> <td>18-5311</td> <td>16.69-00049</td> <td>Contact Set</td> </tr> <tr> <td>18-5345</td> <td>16.69-00050</td> <td>Condenser</td> </tr> <tr> <td>18-5418</td> <td>16.69-00051</td> <td>Rotor</td> </tr> <tr> <td>18-5386</td> <td>-</td> <td>Distributor Cap</td> </tr> </table> <p>GM V-6 • Single Point</p>	Part #	O.E. #	Description	18-5311	16.69-00049	Contact Set	18-5345	16.69-00050	Condenser	18-5418	16.69-00051	Rotor	18-5386	-	Distributor Cap	 <p>18-5271 TUNE-UP KIT</p> <p>—CONTAINS—</p> <table border="0" style="width: 100%; font-size: x-small;"> <tr> <th>Part #</th> <th>O.E. #</th> <th>Description</th> </tr> <tr> <td>18-5314</td> <td>16.69-00039</td> <td>Contact Set</td> </tr> <tr> <td>18-5338</td> <td>16.69-00040</td> <td>Condenser</td> </tr> <tr> <td>18-5376</td> <td>16.69-00148</td> <td>Distributor Cap</td> </tr> <tr> <td>18-5404-1</td> <td>16.69-00149</td> <td>Rotor</td> </tr> </table> <p>Mallory Tall • V-8 • Single Point</p>	Part #	O.E. #	Description	18-5314	16.69-00039	Contact Set	18-5338	16.69-00040	Condenser	18-5376	16.69-00148	Distributor Cap	18-5404-1	16.69-00149	Rotor	 <p>18-5272 TUNE-UP KIT</p> <p>—CONTAINS—</p> <table border="0" style="width: 100%; font-size: x-small;"> <tr> <th>Part #</th> <th>O.E. #</th> <th>Description</th> </tr> <tr> <td>18-5314</td> <td>16.69-00039</td> <td>Contact Set</td> </tr> <tr> <td>18-5338</td> <td>16.69-00040</td> <td>Condenser</td> </tr> <tr> <td>18-5375</td> <td>16.69-00100, F6900165</td> <td>Distributor Cap</td> </tr> <tr> <td>18-5411</td> <td>16.69-00042</td> <td>Rotor</td> </tr> </table> <p>Mallory Flat • V-8 • Single Point</p>	Part #	O.E. #	Description	18-5314	16.69-00039	Contact Set	18-5338	16.69-00040	Condenser	18-5375	16.69-00100, F6900165	Distributor Cap	18-5411	16.69-00042	Rotor
Part #	O.E. #	Description																																													
18-5311	16.69-00049	Contact Set																																													
18-5345	16.69-00050	Condenser																																													
18-5418	16.69-00051	Rotor																																													
18-5386	-	Distributor Cap																																													
Part #	O.E. #	Description																																													
18-5314	16.69-00039	Contact Set																																													
18-5338	16.69-00040	Condenser																																													
18-5376	16.69-00148	Distributor Cap																																													
18-5404-1	16.69-00149	Rotor																																													
Part #	O.E. #	Description																																													
18-5314	16.69-00039	Contact Set																																													
18-5338	16.69-00040	Condenser																																													
18-5375	16.69-00100, F6900165	Distributor Cap																																													
18-5411	16.69-00042	Rotor																																													

 <p>18-5275 TUNE-UP KIT</p> <p>—CONTAINS—</p> <table border="0" style="width: 100%; font-size: x-small;"> <tr> <th>Part #</th> <th>Description</th> </tr> <tr> <td>18-5303</td> <td>Contact Set</td> </tr> <tr> <td>18-5347</td> <td>Condenser</td> </tr> <tr> <td>18-5352</td> <td>Distributor Cap</td> </tr> <tr> <td>18-5403</td> <td>Rotor</td> </tr> </table> <p>Single Point • Screw Cap • V-8</p>	Part #	Description	18-5303	Contact Set	18-5347	Condenser	18-5352	Distributor Cap	18-5403	Rotor	 <p>18-5277 TUNE-UP KIT</p> <p>—CONTAINS—</p> <table border="0" style="width: 100%; font-size: x-small;"> <tr> <th>Part #</th> <th>Description</th> </tr> <tr> <td>18-5303</td> <td>Contact Set</td> </tr> <tr> <td>18-5347</td> <td>Condenser</td> </tr> <tr> <td>18-5369</td> <td>Distributor Cap</td> </tr> <tr> <td>18-5407</td> <td>Rotor</td> </tr> </table> <p>Single Point • Clip Cap • V-8</p>	Part #	Description	18-5303	Contact Set	18-5347	Condenser	18-5369	Distributor Cap	18-5407	Rotor	 <p>18-5303 CONTACT SET</p>	 <p>18-5307 CONTACT SET</p>
Part #	Description																						
18-5303	Contact Set																						
18-5347	Condenser																						
18-5352	Distributor Cap																						
18-5403	Rotor																						
Part #	Description																						
18-5303	Contact Set																						
18-5347	Condenser																						
18-5369	Distributor Cap																						
18-5407	Rotor																						

APPLICATION BEGINS ON PAGE 585

① Items ending in "D" are Display Packaged - Regular number is Non-Display

 <p>18-5310 CONTACT SET</p>	 <p>18-5311 CONTACT SET Replaces: 16.69-00049</p>	 <p>18-5314 CONTACT SET Replaces: 16.69-00039</p>	 <p>18-5338 CONDENSER Replaces: 16.69-00040</p>	 <p>18-5344 CONDENSER</p>
 <p>18-5345 CONDENSER Replaces: 16.69-00050</p>	 <p>18-5346 CONDENSER Replaces: 1869704</p>	 <p>18-5347 CONDENSER</p>	 <p>18-5300 ROTOR Fits: Flamethrower Distributors</p>	
 <p>18-5403 ROTOR</p>	 <p>18-5404-1 ROTOR Replaces: 16.69-00149</p>	 <p>18-5407 ROTOR</p>	 <p>18-5411 ROTOR Replaces: 16.69-00042</p>	
 <p>18-5418 ROTOR Replaces: 16.69-00051</p>	 <p>18-5419 ROTOR</p>	 <p>18-5427 ROTOR Replaces: 16.69-0022</p>	 <p>18-5429 ROTOR</p>	
 <p>18-5352 DISTRIBUTOR CAP Prestolite</p>	 <p>18-5359 DISTRIBUTOR CAP</p>	 <p>18-5369 DISTRIBUTOR CAP Prestolite W/Gasket 18-5399</p>	 <p>18-5375 DISTRIBUTOR CAP Replaces: 16.69-00100, FI 6900165 Mallory</p>	
 <p>18-5376 DISTRIBUTOR CAP Replaces: 16.69-00148 Mallory</p>	 <p>18-5385 DISTRIBUTOR CAP Replaces: 16.69-00052 Delco</p>	 <p>18-5386 DISTRIBUTOR CAP Delco</p>		

**18-5226
IGNITION WIRE**

Metallic Core
100' Spool • 7mm Hypalon



PKG. OF 10

**18-5224
18-5224-9①
SPARK PLUG WIRE TERMINAL**

Replaces: Mercury 20121
OMC 510364



**18-5225
SPARK PLUG WIRE KIT**

Replaces: Mercury 84-99215A26,
84-813706A26
Kit includes 25 ft. Roll of 7 MM Hypalon Ignition Wire With
a Metallic Core and a Large Assortment of Three Different
End Fittings.



PKG. OF 10

**18-5750
18-5750-9①
UNIVERSAL SPARK PLUG BOOTS**

Supplied complete w/Terminal Connector
Replaces: OMC 581027, 580339



**18-5752
UNIVERSAL
SPARK PLUG BOOTS**

8mm



Sierra's MAGFORCE Ignition Wires are "Electronics Friendly" protecting all of your electronic devices and electronic engine controls from RFI and EMI while delivering the maximum amount of voltage. Exact fit design ensures easy installation and years of trouble-free service.

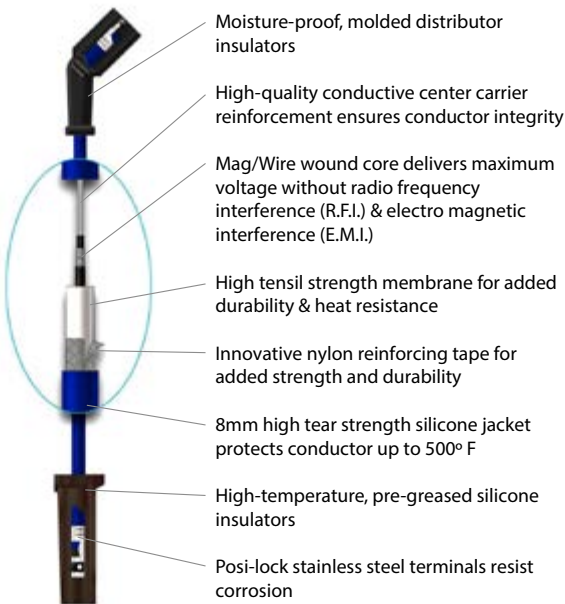

CHRIS-CRAFT

Engine	Cyl.	Distributor	Year Start	Year Stop	Plug Wire Set
181 CID (3.0L)	4	Conventional	ALL	ALL	18-8800-1
302	8	Conventional	ALL	ALL	18-28044
351	8	Conventional	ALL	ALL	18-28044
460	8	Conventional	ALL	ALL	18-28044
350	8	Conventional	1970	1990	18-8803-2
350	8	Conventional ①	1970	1990	18-8823-1
454	8	Conventional	ALL	ALL	18-8817-1
502	8	Conventional	ALL	ALL	18-8817-1

① Models designed with Mallory side terminals



FEATURES

- Senses current levels in the coil and adjusts the dwell to maintain peak energy throughout the entire RPM range.
- Develops, on average, 4 times more available energy between 3000 and 5000 RPM's and twice as much plug voltage as point-type systems.
- Ignition energy is sustained and coil life is increased when peak current level is reached just prior to spark.
- More stable timing.
- Use with 18-5472 "Flame Thrower II" Coil for optimum performance



18-5288
HI-PERFORMANCE ELECTRONIC CONVERSION KIT
 Fits: Most Prestolite V-8 with snap down cap



18-5288-1
 Superseded from 18-5289
HI-PERFORMANCE ELECTRONIC CONVERSION KIT
 Fits: Most Prestolite V-8 Distributors with screw down cap



18-5290
HI-PERFORMANCE ELECTRONIC CONVERSION KIT
 Fits: Most Mallory YL or YD 8 cylinder Distributors with clockwise and counter clockwise rotation

FEATURES

- Replaces points & condensers for true solid state ignition.
- Uses standard coil, cap and rotor.
- Easy to install, one-piece, 2-wire hook-up.
- Accurate to within 1/4° timing accuracy 0 to 6000 RPM range.
- Can be used with Flame Thrower coils 18-5466 & 18-5469.

Conventional wiring system

Ignitor wiring system

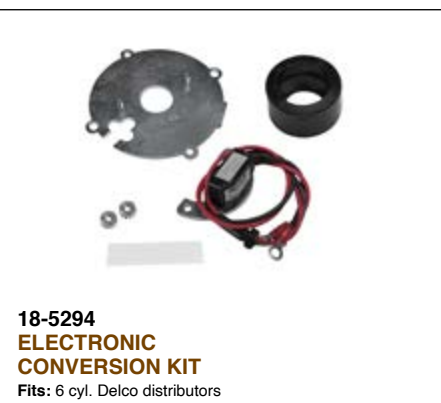

18-5294
ELECTRONIC CONVERSION KIT
 Fits: 6 cyl. Delco distributors



18-5295
ELECTRONIC CONVERSION KIT
 Fits most 4 cyl. Prestolite distributors. (Except IBM 7026)
 For: Onan, Universal, Waukesha, Wisconsin



18-5296-2D Display Package
ELECTRONIC CONVERSION KIT
 Fits: Most Mallory V-8 YL & YD 8 cyl. Distributors with clockwise or counter-clockwise rotation



18-5299
ELECTRONIC CONVERSION KIT
 (with screw down cap)
 For: Most Prestolite V-8 Distributors
 Use with 18-5403 style rotor



18-9801
MULTI METER/DVA TESTER
 Tests electrical and ignition systems. Consists of a VOA meter with built-in direct voltage adapter.



18-9802
TIMING LIGHT
 Self-powered accurate up to 10,000 RPM's

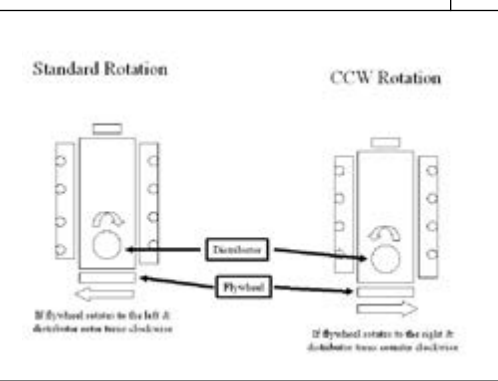

18-5483
HI-PERFORMANCE ELECTRONIC DISTRIBUTOR

Fits: Chevrolet Marine Small and Big Block engines (Standard Deck Height)

- Distributors feature the Ignitor II ignition module with adaptive dwell control adjusts the spark timing over the entire RPM range to maximize performance
- Upper roller bearing and oil impregnated bronze sintered bottom bushing are installed and aligned bored for accuracy for maximum durability
- Machined heat treated gear with tight tolerances insures durability and consistent timing to maximize and performance. Complete with high dielectric strength cap and rotor for years of performance
- Replacement cap/rotor kit: 18-5266

18-5313-1

DISTRIBUTOR

Replaces: Mallory YL624MW
 For most GM V-8 Engs.(small & large blocks)
 Uses: 18-5251 TUNE-UP KIT

— CONTAINS —

Part #	Desc.
18-5314	Contact Set
18-5338	Condenser
18-5404-1	Rotor
And 18-5376 CAP	



18-5494-2

ELECTRONIC DISTRIBUTOR

U.L. Approved Conventional Rotation
 For: Chevrolet All V8 (exc. 348, 409 & Tall Deck Big Block) includes 482, 502, 540 CID

USES:

Part #	Description
18-5376	Distributor Cap
18-5404-1	Rotor
18-5488	Module



18-5480

COMPLETE IGNITION CONVERSION KIT

Fits: GM SB & BB with Standard Deck Height

—CONTAINS—

Part #	Description
18-5472	Coil
18-8803-2	Wire Set
18-5483	Distributor



18-5433

IGNITION COIL

(Uses External Resistor)



18-5435

IGNITION COIL

(Has Internal Resistor)



FEATURES

- Oil filled for better cooling and long life
- Low resistance and improved turn ratios produces the higher voltage needed to run larger spark plug gaps for added power and better fuel economy
- More windings maximize energy and reliability over the full RPM range
- Fits existing brackets for easy installation

18-5466

HI-PERFORMANCE IGNITION COIL

1.5 ohm (oil filled), black - 8 cylinder: Flame-Thrower 40,000 volt coil.

- Designed for use with the original Ignitor Electronic Conversion Kits
- Can be used with other inductive ignition systems



18-5469

HI-PERFORMANCE IGNITION COIL

3.0 ohm (oil filled), black - 4 & 6 cylinder: Flame-Thrower 40,000 volt coil.

- Designed for use with the original Ignitor Electronic Conversion Kits
- Can be used with other inductive ignition systems



18-5472

HI-PERFORMANCE IGNITION COIL

0.6 ohm (oil filled), black - 4, 6, & 8 cylinder: Flame-Thrower 45,000 volt coil.

- Super low 0.6 ohm resistance coil designed for use with the Ignitor II Hi Performance Electronic Conversion Kits
- Compatible with capacitive discharge systems



Part No.	Description	Recommended Coil	Resistance Ohms	Part No.	Description	Recommended Coil	Resistance Ohms
18-5294	Electronic Conversion Kit	18-5469	3	18-5288	Hi Performance Electronic Conversion Kit	18-5472	0.6
18-5295	Electronic Conversion Kit	18-5469	3	18-5288-1	Hi Performance Electronic Conversion Kit	18-5472	0.6
18-5296-2	Electronic Conversion Kit	18-5466	1.5	18-5290	Hi Performance Electronic Conversion Kit	18-5472	0.6
18-5298	Electronic Conversion Kit	18-5466	1.5	18-5483	Flame-Thrower Distributor	18-5472	0.6
18-5299	Electronic Conversion Kit	18-5466	1.5				

18-5450
COIL RESISTOR
 1.5 OHM



IGNITION/ELECTRICAL SYSTEMS APPLICATION

Year	Cyl.	Model	Distributor No.	Contact Set	Condenser	Rotor	Dist. Cap	Tune-Up Kit	Distributor	Elect. Conv. Kit
1946-62	4	B,BR,BR3	IGW-4152, C	—	—	—	18-5359	—	—	—
1946-68	4	A,B,BR,BR3	IAY-4010	18-5307	18-5345 ①	18-5427	—	—	—	—
1975-80	4	FL153,181	—	18-5311	18-5338	18-5418	18-5385	—	—	—
1947-60	6	M,ML,MLO,MO, K,KL,KLO,KO	IAY-4009	18-5307	—	18-5427	—	—	—	—
1947-63	6	KS,KSO,KR, W,WO	IAY-4009	18-5307	—	18-5427	—	—	—	—
1947-63	6	W,WO	IGC-4279B	—	18-5345 ①	—	—	—	—	—
1967-71	6	225B, BVC	1110342	18-5310	18-5346	18-5419	—	—	—	—
1958-67	8	283, 283-0 Corvette Eng.	IBB-4109A	18-5303	18-5345 ①	18-5404-1	—	—	18-5313-1 ③ 18-5494-2 ④	18-5296-1
1963-71	8	283F, 327F Corvette Eng.	IBM-4115, 4116	18-5303	18-5345 ①	18-5429	—	18-5259	18-5494-2 ④	—
1958-67	8	Dual Contact	IBB-4201A, B	18-5303 ②	18-5345 ①	18-5404-1	—	—	—	18-5296-1
1958-68	8	Dual Contact	IBB-4301A, B	18-5303 ②	18-5345 ①	18-5407	18-5369	18-5255 ⑤	—	18-5298
1958-67	8	Dual Contact	1110630	—	18-5346	—	—	—	—	—
1979-80	8	ALL	IBM-7011	18-5303	18-5345 ①	18-5407	18-5369	18-5255 ⑤	—	18-5298
1981-85	8	ALL	IBM-7013	18-5303	18-5345 ①	18-5403	18-5352	18-5260 ⑥	—	18-5299

- ① For Strap Type Condenser, Use 18-5347
- ② Two Required

- ③ Contact Controlled Distributor
- ④ Electronic Ignition Distributor



- ⑤ 18-5277 Kit with distributor cap
- ⑥ 18-5275 Kit with distributor cap



**18-6835
STARTER**
Replaces: GM Engines Universal
Used on all GM Engines with either 14 1/4" or 12 3/4" flywheels.

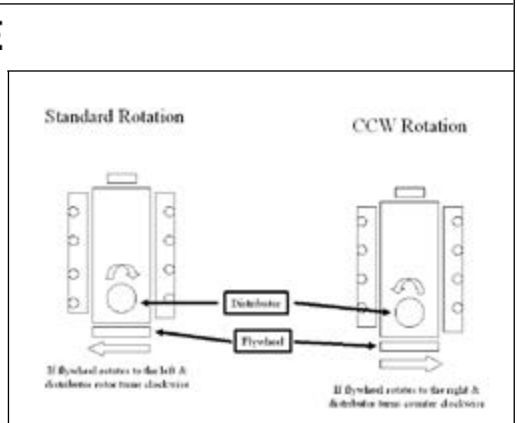

**18-5911
STARTER**
Replacement Solenoid: 18-5837
(Heavy-Duty) (No Core)
For: GM Engines, Bottom Mount Straight Across Bolt Pattern, Standard Rotation, Clockwise
Replaces: 16.61-00042
SAEJ1171

BATTERY CABLES
Gauge cable with soldered lug terminals on each end to accept a 3/8" stud.

Part #	Size	Color	Gauge	Part #	Size	Color	Gauge
BC88523	2'	red	4	BC88563	6'	red	2
BC88533	2'	black	4	BC88573	6'	black	2
BC88543	4'	red	2	BC88583	8'	red	1
BC88553	4'	black	2	BC88593	8'	black	1



**18-5838
SOLENOID**
Delco



**18-5717
STARTER BRUSH SET**
Delco



**18-5840
SOLENOID**
Prestolite 15-79, SAW4201, SAW4207, SAW4210



**18-5710
VOLTAGE REGULATOR**
Prestolite VSH-6201JY

APPLICATION ON NEXT PAGE

VOLTAGE REGULATOR, BRUSH SET, STARTER SWITCH APPLICATION

Year	Model	Volt	Original Alt. or Gen.	Volt Reg.	Original Starter No.	Brush Set	Starter Switch
1979-85	ALL	12	—	—	—	—	18-5840
1967-78	283,F,305,307,327,F,350,454	12	ALE,6207AY,Y,YS & ALE-6221AY,Y	—	MHA,MDY,MDU 1108366,417	— 18-5717	18-5840 18-5838
1961-78	283,O,F,307,327,F,Q,427,F 430,H,430-0,430-HO	12 12 12	ALD-5006 ALE-5202,B,Y ALE-5203	— — —	MDY-6007,8 MDU-7032,3,4,5 MHA-7005,6,9 10,12,13	— — — —	18-5840 18-5840 — 18-5840
1947-66	K,KR,KRO,KS,KSO,KO,M,ML MLO,MO,W,WO Series	12 12 12 12	— GFW — —	— — — —	MAS-4011, 2 MAU MBG MDL	— — — —	18-5840 18-5840 18-5840 —
1961-65	430H,430,HO	12	GHW-4807, 8	—	MDL-6007	—	18-5840



18-7019
CARB KIT

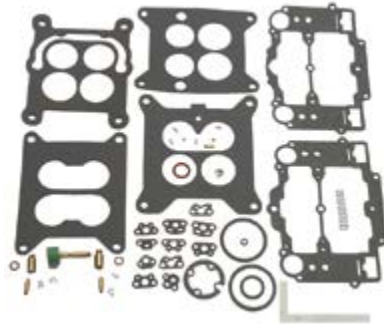

18-7022
CARB KIT



18-7023
CARB KIT



18-7025
CARB KIT



18-7070
CARB KIT



18-7072
CARB KIT

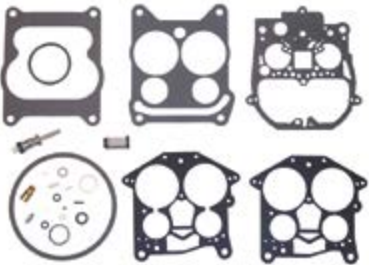

18-7095
CARB KIT



18-7200
FLOAT
(ALCOHOL RESISTANT)
Plastic



18-7201
FLOAT
(ALCOHOL RESISTANT)
Brass

APPLICATION ON NEXT PAGE

CARBURETOR KIT/FLOAT APPLICATION

Cyl.	Eng./Model	Mfg. Code	Carb. Model	Carburetor	Float Number	Car Kit. ①
4	A & B (1942-55)	Z-1	63M2E10	8963, A-J	—	—
4	K (1939-55)	Z-1	63M2AWE11	8983, A-H	—	—
4	B (1947-Up)	Z-1	63M2E10	12206	—	—
4	K (1956-62)	Z-1	63M2E11	12091, A	—	—
4	153" (2.5L), 181" (3.0L)	R-2	2GC	7041187, 7042181, 17059055	18-7200	18-7070
6	225" (3.7L)	R-2	2GC	7025181, 189	—	18-7070
8	283" (4.6L)	R-2	2GC	7019082	18-7200	18-7070
8	283" (4.6L)	R-4	4GC	7013071, 7015090	—	18-7019
8	283" (4.6L)	C-4	WCFB	2669, 3205	—	18-7025
8	283" (4.6L), 307"(5.0L), 327" (5.3L)	C-4	AFB	3660, 6310	—	18-7022
8	305"(5.0L), 350" (5.7L)	R-4	4MC	17056287, 17058280	18-7201	18-7072
8	305" (5.0L), 350" (5.7L), 454" (7.4L)	R-4	4MV	17059294, 17059295, 17059296	18-7201	18-7095
8	307" (5.0L), 327" (5.3L), 350" (5.7L)	C-4	AVS	4695, 6117	—	18-7023
8	307" (5.0L), 454" (7.4L)	R-4	4MV	7044283, 7044288, 7044289	18-7201	18-7072

① Does not include metering rods

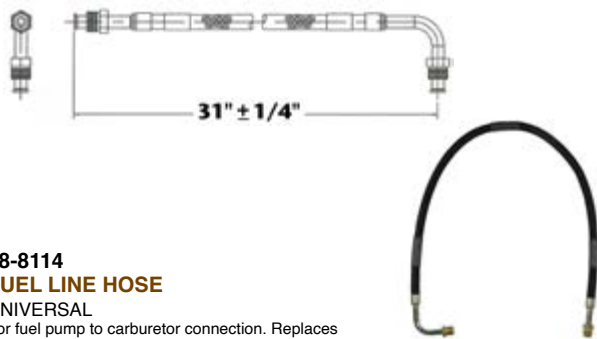

18-8114
FUEL LINE HOSE
UNIVERSAL

For fuel pump to carburetor connection. Replaces copper or steel tubing 3/8" X 31" PTFE composite hose with 5/8"-18 male inverted flare straight one end, 5/8"-18 90° one end. SAE J1527 type A1



18-8115
FUEL LINE HOSE
UNIVERSAL

For fuel pump to carburetor connection. Replaces copper or steel tubing 3/8" X 25" PTFE composite hose with 5/8"-18 male inverted flare straight one end, 5/8"-18 90° one end. SAE J1527 type A1



18-7260
FUEL PUMP

(Flange I.D. #40155, M3120)
For: GM (V-8) 283, 307, 327, 350, 400



18-7265
FUEL PUMP

Replaces: 16.83-08758, F18308762
(Flange I.D. #41412)
For: GM (V-8) 305, 350, 400



18-7272
FUEL PUMP

(Flange I.D. #41419, M73020)
For: GM (V-8) 283, 305, 350, 400



18-7278
FUEL PUMP

(Flange I.D. #60032)
For: GM (4 & 6 Cyl.) 153, 181, 250, 224, 225
Uses replacement filter 18-7860 & 18-0889 gasket

ALL SIERRA FUEL PUMPS INCLUDE MOUNTING GASKET

FUEL WATER SEPARATORS







Sierra offers a complete line of 10 and 21 micron fuel water separating filters including drainable bowl filters to protect your carbureted and fuel injected engine.

Refer to pages 156-161 for a complete listing of OEM and universal applications.

Sierra fuel water separators remove over 99.8% of emulsified water from your gasoline. Sierra's 10 micron filters are over 90% efficient at removing particles as small as 10 micron. All filters flow @ 90 GPH to feed even the hungriest motor. Sierra 10 micron filters are recommended to prevent damage to sensitive inboard and outboard fuel injection systems.

• Display Packaged

Sierra #	Chris-Craft #	Description
18-7860 •	16.83-90006	Fuel Filter
18-7964-1	—	Transmission Filter
②18-4456D Display Package  18-4456 EXHAUST PROTECTOR VALVE Includes Stainless Steel Clamp 3"	②18-4457D Display Package  18-4457 EXHAUST PROTECTOR VALVE Includes Stainless Steel Clamp 4"	②18-4458D Display Package  18-4458 EXHAUST PROTECTOR VALVE Includes Stainless Steel Clamp 5" & 6" (5" requires two 45° cuts)
PKG. OF 8  FREEZE PLUGS 18-5961 18-5962 18-5961-9 ① 18-5962-9 ① 1 5/8" 1 3/4"		

① Priced per Package

② Items ending in "D" are Display Packaged - Regular number is Non-Display



SIERRA MANIFOLDS

18-1997-1

MANIFOLD

Port & Starboard

Replaces: Barr CHV-1-83

Universal Center Riser Manifold

FITS:

Chriscraft 283, 302, 307 and 350 CID engines

Crusader 283 and 327 CID engines thru 1964; 305, 307 and 350 CID engines 1965 and later

Daytona 200-283 and 300-327

Flagship 283, 327 and 350 CID engines

Pacer 305, 307 and 350 CID engines 1965 and later

Mercury 190, 198, 225, 250, 270, 228, 898, 260, 255 and 280 models

OMC 283, 305, 307 and 350 CID engines 1968-1980

Volvo 307 and 350 CID engines

Use 18-0604 Exhaust Manifold Gasket Set

*For Exploded View - See Pages 658-659



18-1998-1

MANIFOLD

Port & Starboard

Replaces: Barr FM-1-83

Universal Center Riser Manifold

FITS:

Crusader 302 and 351 CID engines

Interceptor 221, 260 and 289 CID engines

Commander, Mercury, OMC, Palmer, Pleasurecraft & Waukesha

Comes with 18-4363 Mounting Package

Use 18-0603 Exhaust Manifold Gasket Set

*For Exploded View - See Page 660-661

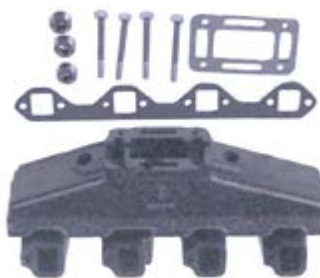

18-1898

MANIFOLD

Port & Starboard

Replaces: Barr CHVA-1-84

Marine Power 0991-110

Fits: 454 cu.in. GM big block V8 engines

Use with:

Exhaust Gasket: 18-0418

Riser Gasket: 18-2854-1 open or 18-0476-1 blocked

*For Exploded View - See Pages 656



18-1999

ELBOW

(3" exhaust)

Replaces: Barr 20-0082

Comes with 18-4364 open Mounting Package

If blocked mounting kit is required use 18-8535

Use with:

Manifold: 18-1997-1 or 18-1998-1

Riser Gasket 18-2854-1 open or

18-0476-1 blocked



18-1907

RISER

Replaces: Barr 20-0102

Indmar 53-2009, 53-2018

Barr and Indmar Ford Small Block V8 302-351cu.in.

Use with:

Manifolds: 18-1997-1 or 18-1998-1

Riser Gasket: 18-2854-1 open or

18-0476-1 blocked

Mounting Kit: 18-4364 open or

18-8535 blocked



18-1939

RISER

(4" exhaust)

Replaces: Barr 20-0100,

Marine Power 0992-593

Barr, Indmar and Marine Power Ford

Small Block V8 302-351cu.in., GM Small Block V8 305-

350cu.in., GM Big Block

V8 454cu.in.

Used with:

Manifolds: 18-1898 or 18-1997-1

or 18-1998-1

Riser Gasket: 18-2854-1 open or

18-0476-1 blocked

Mounting Kit: 18-4364 open or

18-8535 blocked



18-1991

ELBOW ADAPTER

Barr 200089P

For: 3" I.D. Exhaust Hose

Use with:

Manifold Riser: 18-1999

30°



18-1992-1

EXHAUST ELBOW

Barr 200087P

For: 3" I.D. Exhaust Hose

(As used in 18-1987 Exhaust Manifold Conversion Kit)

80°



18-1949

MANIFOLD SPACER (3")

Barr CM 20-0097

Barr, Indmar and Marine Power Ford Small Block V8

302-351cu.in., GM Small Block V8 305-350cu.in.,

GM Big Block V8 454cu.in.

Used with:

Manifolds: 18-1998-1,

18-1997-1 and 18-1898



PIPE PLUGS

PART NO.	Thread Size	PART NO.	Thread Size
18-4256	1/4"	18-4263	1/8" - 27 NPT
18-4257	1/4"	18-4264	3/8" - 18 NPT
18-4258	3/4"		

Display Package



18-4461
HOSE BARB
 3/4" - 14 NPT x 1" Hose
 Corrosion Resistant Brass Fitting



①**18-4218D** Display Package

18-4218
DRAIN TAP
 Used with:
 Most O.E.M. Manifolds
18-3223-9 Bulk Pack of 12
 1/4"



18-4364 (Open)
EXHAUST ELBOW KIT
 Replaces: Barr 20-0082-P
 Use with:
 Riser: 18-1999, 18-1907, 18-1939



18-8535
EXHAUST MANIFOLD MOUNTING KIT
 Barr, Indmar and Marine Power Ford Small Block V8 302-351 cu.in., GM Small Block V8 305-350 cu.in., GM Big Block V8 454cu.in.
 Used with:
 Risers: 18-1939, 18-1999, and 18-1907
 (Blocked)



18-8536
EXHAUST ELBOW MOUNTING KIT
 Barr, Indmar and Marine Power
 GM Small Block V8 305-350cu.in.
 Used with:
 Manifold: 18-1997-1



18-8538
EXHAUST MOUNTING KIT
 Barr and Indmar Ford Small Block V8
 302-351cu.in.
 Used with:
 Manifold: 18-1998-1



18-0603
EXHAUST MANIFOLD GASKET SET
 Use with:
 Manifold: 18-1998-1
 For: FORD 302/351 CID Engines

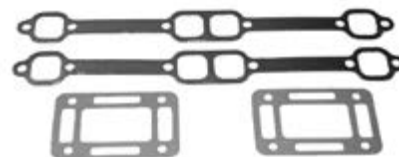

18-0604
EXHAUST MANIFOLD GASKET SET
 Use with:
 Manifold: 18-1997-1
 For: GM 305/350 CID Engines

① Items ending in "D" are Display Packaged - Regular number is Non-Display



18-0868
INTAKE MANIFOLD
GASKET SET
 Replaces: 16.50-00232



18-0476-1
RISER BLOCKOFF GASKET
 Barr, Indmar & Marine Power
 Ford Small Block V8
 302-351cu.in.
 Used with:
 Risers: 18-1939, 18-1999
 and 18-1907
 Blocked

PKG. OF 2



18-2854-1 (Open)
18-2854-9^①
EXHAUST ELBOW GASKET
 Replaces: Barr 01-0107
 Use with:
 Riser: 18-1999, 18-1939, 18-1907

PKG. OF 2



18-2949
18-2949-9^①
EXHAUST MANIFOLD
GASKET
 Replaces:
 Barr CHV-47-000
 Use with:
 Manifold: 18-1997-1

MARINE OIL FILTERS

—
 Pkg. of
 Package
 —



18-7824-2
 (Short)
 GM 153, 181, 250
Replaces: 16.81-08746
 For models 307G, 305K, 307K

18-7875
 FORD 302, 351
 (Long)
Replaces:
 16.81-06536

18-7876-1
 (Long)
 GM 283, 305, 307,
 350, 454

SEE PAGES 203-205 & 1155-1183 FOR ADDITIONAL INFORMATION



18-2946
HEAD GASKET
 Superseded from 18-3880
Replaces: 16.50-00204
 For: GM 181 CID Eng. (3.0L)



18-3876
HEAD GASKET
Replaces: 16.50-00250
 For: GM 305/350 CID Eng.
 (5.0L and 5.7L)



18-3877
HEAD GASKET
Replaces: 16.50-00259
 For: GM 454 CID Eng. (7.4L)

PKG. OF 2



18-0874
18-0874-9^①
DISTRIBUTOR
GASKET
Replaces: 16.50-00162
 GM V-6 7 V-8

PKG. OF 2



18-0876
18-0876-9^①
FUEL PUMP
GASKET
Replaces: 16.50-05756

PKG. OF 2



18-0889
18-0889-9^①
FUEL PUMP GASKET
Replaces: 16.50-00074

PKG. OF 2























18-0891
18-0891-9^①
WATER PUMP GASKET
Replaces: 16.50-00078



18-2845
VALVE COVER GASKET
Replaces: 16.11-01236
 V-8

^① Priced per Package

 <p>①18-5251D Display Package</p> <p>18-5251 TUNE-UP KIT —CONTAINS—</p> <table border="0"> <tr> <th>Part #</th> <th>Description</th> </tr> <tr> <td>18-5314</td> <td>Contact Set</td> </tr> <tr> <td>18-5338</td> <td>Condenser</td> </tr> <tr> <td>18-5404</td> <td>Rotor</td> </tr> <tr> <td>Mallory 8 cyl. Tall Cap</td> <td></td> </tr> </table>	Part #	Description	18-5314	Contact Set	18-5338	Condenser	18-5404	Rotor	Mallory 8 cyl. Tall Cap		 <p>18-5255 Display Package</p> <p>18-5255 TUNE-UP KIT —CONTAINS—</p> <table border="0"> <tr> <th>Part #</th> <th>Description</th> </tr> <tr> <td>18-5303</td> <td>Contact Set</td> </tr> <tr> <td>18-5345</td> <td>Condenser</td> </tr> <tr> <td>18-5407</td> <td>Rotor</td> </tr> <tr> <td>Prestolite 8 cyl.</td> <td></td> </tr> </table>	Part #	Description	18-5303	Contact Set	18-5345	Condenser	18-5407	Rotor	Prestolite 8 cyl.		 <p>18-5258 TUNE-UP KIT —CONTAINS—</p> <table border="0"> <tr> <th>Part #</th> <th>Description</th> </tr> <tr> <td>18-5303</td> <td>Contact Set</td> </tr> <tr> <td>18-5347</td> <td>Condenser</td> </tr> <tr> <td>18-5407</td> <td>Rotor</td> </tr> <tr> <td>Prestolite 8 cyl.</td> <td></td> </tr> </table>	Part #	Description	18-5303	Contact Set	18-5347	Condenser	18-5407	Rotor	Prestolite 8 cyl.		 <p>18-5259 TUNE-UP KIT —CONTAINS—</p> <table border="0"> <tr> <th>Part #</th> <th>Description</th> </tr> <tr> <td>18-5303</td> <td>Contact Set</td> </tr> <tr> <td>18-5347</td> <td>Condenser</td> </tr> <tr> <td>18-5429</td> <td>Rotor</td> </tr> <tr> <td>Prestolite 6 & 8 cyl.</td> <td></td> </tr> </table>	Part #	Description	18-5303	Contact Set	18-5347	Condenser	18-5429	Rotor	Prestolite 6 & 8 cyl.	
Part #	Description																																										
18-5314	Contact Set																																										
18-5338	Condenser																																										
18-5404	Rotor																																										
Mallory 8 cyl. Tall Cap																																											
Part #	Description																																										
18-5303	Contact Set																																										
18-5345	Condenser																																										
18-5407	Rotor																																										
Prestolite 8 cyl.																																											
Part #	Description																																										
18-5303	Contact Set																																										
18-5347	Condenser																																										
18-5407	Rotor																																										
Prestolite 8 cyl.																																											
Part #	Description																																										
18-5303	Contact Set																																										
18-5347	Condenser																																										
18-5429	Rotor																																										
Prestolite 6 & 8 cyl.																																											
 <p>①18-5260D Display Package</p> <p>18-5260 TUNE-UP KIT —CONTAINS—</p> <table border="0"> <tr> <th>Part #</th> <th>Description</th> </tr> <tr> <td>18-5303</td> <td>Contact Set</td> </tr> <tr> <td>18-5345</td> <td>Condenser</td> </tr> <tr> <td>18-5403</td> <td>Rotor</td> </tr> <tr> <td>Prestolite 8 cyl.</td> <td></td> </tr> </table>	Part #	Description	18-5303	Contact Set	18-5345	Condenser	18-5403	Rotor	Prestolite 8 cyl.		 <p>18-5303 CONTACT SET Replaces: 2421173, 2808870</p>	 <p>18-5307 CONTACT SET Replaces: 2084074, 1274092, 2421178</p>	 <p>18-5314 CONTACT SET Replaces: 2421820</p>																														
Part #	Description																																										
18-5303	Contact Set																																										
18-5345	Condenser																																										
18-5403	Rotor																																										
Prestolite 8 cyl.																																											
 <p>18-5338 CONDENSER</p>	 <p>18-5345 CONDENSER Replaces: 2098058, 2279949</p>	 <p>18-5347 CONDENSER Replaces: 1818757, 3420600</p>	 <p>18-5403 ROTOR</p>																																								
 <p>18-5404-1 ROTOR Replaces: 868096</p>	 <p>18-5407 ROTOR Replaces: 1658535</p>	 <p>18-5429 ROTOR Replaces: 2098611</p>	 <p>18-5430 ROTOR Replaces: 868095</p>	 <p>18-5300 ROTOR Fits: Flamethrower Distributors</p>																																							
 <p>18-5352 DISTRIBUTOR CAP Replaces: 4142817 Prestolite</p>	 <p>18-5369 DISTRIBUTOR CAP (With Gasket 18-5399) Replaces: 4142408 Prestolite</p>	 <p>18-5376 DISTRIBUTOR CAP Mallory</p>	 <p>18-5302 TUNE-UP KIT Replaces: Fits: male cap v-8 flamethrower distributors</p>																																								

① Items ending in "D" are Display Packaged - Regular number is Non-Display



18-5497-2
ELECTRONIC DISTRIBUTOR
 U.L. Approved • Conventional Rotation
 For: Chrysler V-8 273, 318 (1967-Up), 340, 360 CID
 "LA" Engines

USES:

Part #	Description
18-5376	Distributor Cap
18-5404-1	Rotor
18-5491	Reluctor
18-5488	Module

Standard Rotation

CCW Rotation

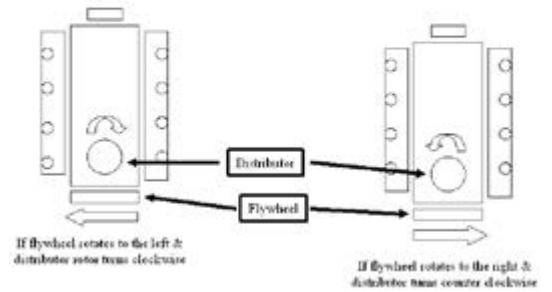

PREMIUM MARINE SPARK PLUG WIRE LEADS

Sierra's **MAGFORCE** Ignition Wires are "Electronics Friendly" protecting all of your electronic devices and electronic engine controls from RFI and EMI while delivering the maximum amount of voltage. Exact fit design ensures easy installation and years of trouble - free service.

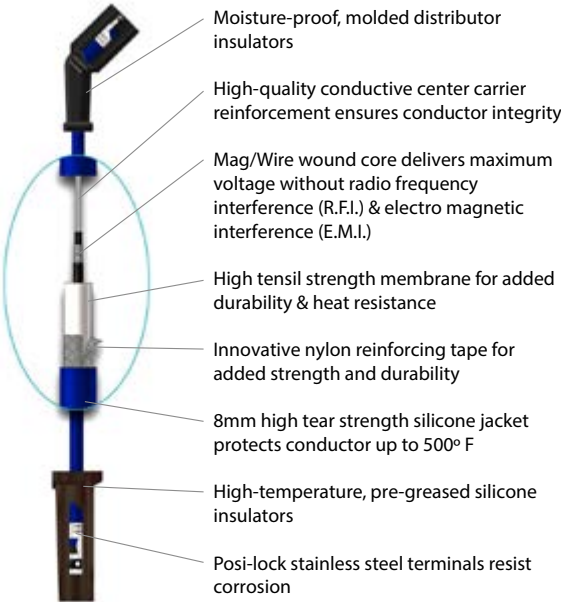

CHRYSLER MARINE IGNITION WIRES APPLICATION

Engine	Cyl.	Distributor	Years	Year Stop	Plug Wire Set
M273	8	Conventional & Electronic	1968-1974	1974	18-8826-1
LM318	8	Conventional & Electronic	1968-1985	1985	18-8826-1
M340	8	Conventional & Electronic	1968-1985	1985	18-8826-1
M360	8	Conventional & Electronic	1975-1985	1985	18-8826-1
361	8	Conventional & Electronic	1968-1985	1985	18-8827-1
383	8	Conventional & Electronic	1960-1988	1988	18-8827-1
400	8	Conventional & Electronic	1968-1985	1985	18-8827-1
440	8	Conventional & Electronic	1968-1985	1985	18-8827-1

FEATURES



- Senses current levels in the coil and adjusts the dwell to maintain peak energy throughout the entire RPM range.
- Develops, on average, 4 times more available energy between 3000 and 5000 RPM's and twice as much plug voltage as point-type systems.
- Ignition energy is sustained and coil life is increased when peak current level is reached just prior to spark.
- More stable timing.
- Use with 18-5472 "Flame Thrower II" Coil for optimum performance

IGNITOR[®] FEATURES

- ★ Replaces points & condensers for true solid state ignition.
- ★ Uses standard coil, cap and rotor.
- ★ Easy to install, one-piece, 2-wire hook-up.
- ★ Accurate to within 1/4° timing accuracy 0 to 6000 RPM range.
- ★ Can be used with Flame Thrower Coil 18-5469

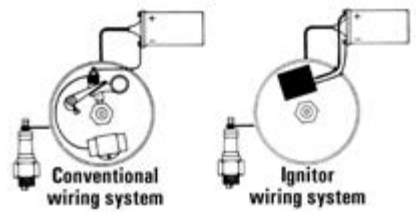

18-5294
ELECTRONIC CONVERSION KIT
 Fits: 6 cyl. Delco distributors

18-5295
ELECTRONIC CONVERSION KIT
 Fits: most 4 cyl. Prestolite distributors. (Except IBM 7026)
 For: Onan, Universal, Waukesha, Wisconsin

18-5433
IGNITION COIL
 Replaces: 201522, 2495531
 Uses External Resistor

18-5435
IGNITION COIL
 4.0 OHM
 Replaces: 200691
 Has Internal Resistor

FEATURES

- Oil filled for better cooling and long life
- Low resistance and improved turn ratios produces the higher voltage needed to run larger spark plug gaps for added power and better fuel economy
- More windings maximize energy and reliability over the full RPM range
- Fits existing brackets for easy installation

18-5469
HI-PERFORMANCE IGNITION COIL
 3.0 ohm (oil filled), black - 4 & 6 cylinder:
 Flame-Thrower 40,000 volt coil.
 • Designed for use with the original Ignitor Electronic Conversion Kits
 • Can be used with other inductive ignition systems

18-5472
HI-PERFORMANCE IGNITION COIL
 0.6 ohm (oil filled), black - 4, 6, & 8 cylinder:
 Flame-Thrower 45,000 volt coil.
 • Super low 0.6 ohm resistance coil designed for use with the Ignitor II Hi Performance Electronic Conversion Kits
 • Compatible with capacitive discharge systems

Sierra Part #	Description	Recommended Coil	Resistance Ohms
18-5294	Electronic Conversion Kit	18-5469	3.0
18-5295	Electronic Conversion Kit	18-5469	3.0

18-5450
COIL RESISTOR
 15. OHM
 Replaces: 4106140

18-5451
COIL RESISTOR
 1.5 OHM & 3.0 OHM
 Replaces: 3874767

18-5102
RELUCTOR
 Replaces: 3656017



18-5103
IGNITION PICKUP
Replaces: 3780600



18-5105
IGNITION MODULE
Replaces: 3874020

STANDARD IGNITION

Year	Cyl.	Model	Distributor No.	Contact Set	Condenser	Rotor	Dist. Cap	Tune-Up Kit	Electronic Dist.
1949-60	6	M37, M47 (CROWN), M36	IAL-4004-1M, IGC-4510-1M	18-5307	18-5345 ③	18-5430	—	—	—
1955-60	8	M44 (IMPERIAL), M45 (ROYAL)	IBB-4102A	18-5303 ①	18-5347 ②	18-5404-1	—	—	—
1955-61	6	M49	IAO	18-5307	—	18-5430	—	—	—
1959-62	8	M80,81,M273X,M318,A,B,M413	IBM	18-5303	18-5347 ②	18-5407	18-5369	18-5258	18-5497-2 ④
1955-62	6	M36, M46, (ACE), M47 (CROWN), M46-3, 4, M49,TACK DRIVE	IAO-4109-1M, IAO-4113-1M	18-5307	18-5345 ③	18-5430	—	—	—
1961-65	6	M170,,225,MH225	2098748, 2444430	—	18-5347 ②	18-5430	—	—	—
1960-72	8	M80, 81, M273, A, B, X, M318A, B, C, X, M383, B, X, M413, B, D, E, M426, B, D, X, M426 HEMI	IBM-4106,08, A,B,C,09,A	18-5303	18-5347 ②	18-5407	18-5369	18-5258	—
1965-66	8	M318X	IBM-4120,5	18-5303	18-5347 ②	18-5429	—	18-5259	18-5497-2
1969-72	6	M225X	IBR-4205,A,AS	—	18-5347 ②	—	—	—	—
1970	8	M440X	IBB-4205	18-5303 ①	18-5347 ②	18-5407	18-5369	18-5258	—
1970	6	M265X	IAO-4114-1M	18-5307	18-5347 ②	18-5430	—	—	—
1960-72	8	M80, 80A, 81, 273X, 318A, B, C, X, M383, B, X, M413, B, D, E, M426B, D, X, M200, 225, 250, 260,300,335,440X	IBM-4108B, C,9A	18-5303	18-5347 ②	18-5407	18-5369	18-5258	18-5497-2 ④
1972-77	6	M225X	IBR-7002,A,AS,S	18-5307	18-5345 ③	18-5430	—	—	—
1973	8	ALL	IBB-7003,S	18-5303 ①	18-5345 ③	18-5407	18-5369	—	18-5497-2 ④
1976	8	M318	3675979	18-5303	18-5347 ②	18-5407	—	18-5258	18-5497-2
1971-82	8	M273, ML318, ML340, ML440	IBM-7001,2, 3,IBM-7003B,BS, 7004A,B,AS, BS	18-5303	18-5345 ③	18-5407	18-5369	—	18-5497-2 ④
1983-88	8	273, 318, 340, 440	IBM-7016,7017	18-5303	18-5347 ②	18-5403	18-5352	18-5260	18-5497-2 ④
1971	8	M273, M318	IBM-4122	18-5303	18-5347 ②	18-5407	18-5369	18-5258	18-5497-2

- ① Two (2) used
- ② For lead wire type use 18-5345
- ③ For strap type use 18-5347
- ④ Does not include Models 413, 426, 440 CID

B.I.D. ELECTRONIC IGNITION

Year	Model/Engine	Distributor	Reluctor	Pickup	Elect. Control Unit	Rotor	Distributor Cap
1972-82	M318,M340, 360, 440	IDH-7001, 2S	18-5102	18-5103	18-5105	18-5407	18-5369
1979-82	318,340, 360, 440	IDH-7002,S, 3,3A,3AS,3S	18-5102	18-5103	18-5105	18-5407	18-5369
1983-88	318,340, 360, 440	IDH-7004, 7005	18-5102	18-5103	18-5105	18-5403	18-5352
1983-88	318,340, 360, 440	IDH-7006,A	18-5102	18-5103	18-5105	18-5403	18-5352



18-5225
SPARK PLUG WIRE KIT
Replaces:
Mercury 84-99215A26,
84-813706A26
Kit includes 25 ft. Roll of 7 MM Hypalon Ignition Wire With a Metallic Core and a Large Assortment of Three Different End Fittings to Fit Outboard Motors.



18-5226
IGNITION WIRE
Metallic Core
100' Spool • 7mm Hypalon

PKG. OF 10



18-5224
18-5224-9^①
SPARK PLUG WIRE TERMINAL
 Replaces: Mercury 20121
 OMC 510364

PKG. OF 10



18-5750
18-5750-9^①
UNIVERSAL SPARK PLUG BOOTS
 Supplied complete w/Terminal Connector
 Replaces: OMC 581027, 580339



18-5752
UNIVERSAL SPARK PLUG BOOT
 8mm



18-5840
SOLENOID
 Replaces: Prestolite 15-79,
 SAW4201, SAW4207, SAW4210



BATTERY CABLES
 Gauge cable with soldered lug terminals on each end to accept a 3/8" stud.

Part #	Size	Color	Gauge	Part #	Size	Color	Gauge
BC88523	2'	red	4	BC88563	6'	red	2
BC88533	2'	black	4	BC88573	6'	black	2
BC88543	4'	red	2	BC88583	8'	red	1
BC88553	4'	black	2	BC88593	8'	black	1

① Priced per Package

BRUSH SET/STARTER SWITCH APPLICATION

Year/Model	Volt	Original Starter No.	Starter Switch
1960-88 LM318X,340X,M80A, 81,170A,M225A, X,M251X, 265X,273X,M318,A,B,C, X,M383BX,M413,B,D,E, X,M426B,D,E,X,M440, X,M155,200,225,250,260,300,335,375	12 12 12 12 12 12 12	MCL-6115 MDT-6010,11 MDT-7001,10 MDT-7002,14 MDT-7021,22 MDU-6003,10 MDU-7001	— 18-5840 — 18-5840 — — —
1961-69 M225,MH225,M273,A,B, LM318,B,M318A,B,C, M383,B,X,M413,E,M426 B,D,X,M426 Hemi	12 12 12 12 12 12 12 12 12 6 & 12	MDT-6010,11 MDT-7002,14 2095150 1779955 2,095,393,509 2095509 MDT-7002,14 MDT-7001,10 MDT-7001,10	— — — — — — — — — —
1959-69	12 12 12	MDU-6003,10 MDT-7001,10 MDT-7002	— — —
1961-68	12	MDT-6010,11	18-5840
1961-65	12	MDU-7001	—
1955-71 M26,46,46-4 (Ace),M27, 47,47-4, (Crown),M28, 36,37,38,44,44-3,48 (Royal)M45(Imperial), M45-3,46-3,47-3,M49	6 6 12 12 12 12	MCL-6102,M,07 MCL-6127,28,M MCL-6020M MCL-6115 MDT-6010,11M MDU-7013	— — — — 18-5840 —



18-9802
TIMING LIGHT
 Self-powered accurate up to 10,000 RPM's



18-5710
VOLTAGE REGULATOR
 Replaces: 2847527, 2098300 Prestolite
 VSH-6201JY

Year/Model	Volt	Original Alt/Gen. No.
1970-88 M273X,LM318X	12	ANE-5201S,2S,2YS
1972-77 225,318X,340,X,400,440	12	3527502



18-5723
VOLTAGE
REGULATOR
 (Field Relay)
 Replaces: 2095946
 (Use with 18-5710)

Year/Model	Volt	Original Alt/Gen. No.
1961-70		
B,D,X, M426 Hemi	12	2095860

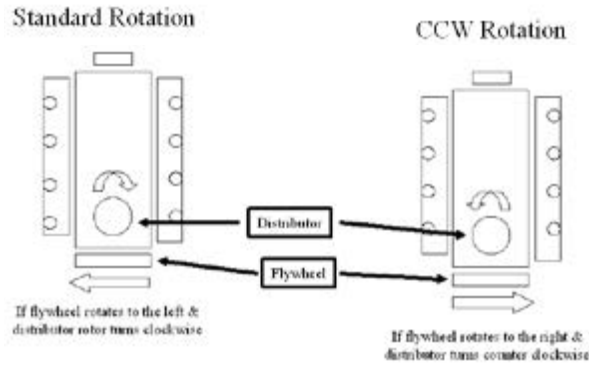

18-6270
PERMANENT MAGNET
I/O STARTER
 Heavy Duty - 12 Volt
 2 Bolt Mount - 1 Threaded Hole - CW Rotation
 Fits: Ford 460
 Permanent Magnet I/O



18-6835
STARTER
 Replaces: GM Engines Universal
 Used on all GM Engines with either 14 1/4" or 12 3/4" flywheels



18-5954
ALTERNATOR
 Replaces: 3527501, 3527502, 3744870
 61 Amps

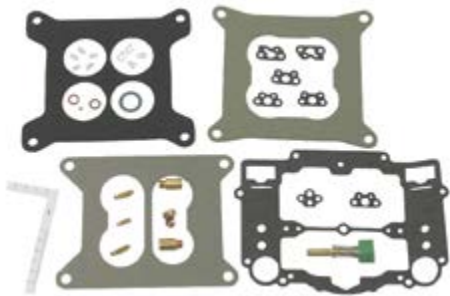

18-7089
CARB KIT

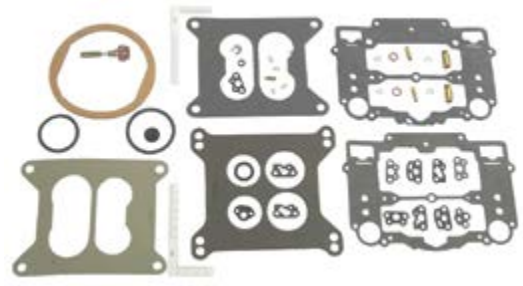

18-7091
CARB KIT

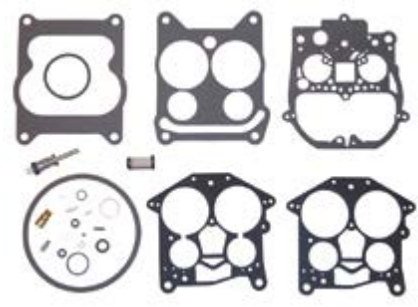

18-7095
CARB KIT



18-7201
FLOAT
 (Alcohol Resistant)
 Brass

CARBURETOR KIT / FLOAT APPLICATION

Years	Cyl.	Model or Engine Displacement	Mfg. Code	Carb. Model	Carburetor Number	Float	Carb. Kit ①
1965 -Up	8	M-273-B,LM-318-B, M-340-B, M-360-B,M383-B,M-440-B	C-4	AFB	3980, 6130, 6212	—	18-7089
1965-69	8	M-318-B,M-383, M-413,M-426, M-440	C-4	AFB	3213, 3214, 3392, 3543, 4476, 4699, 9263, 9264	—	18-7091
—	8	318" (5.2L), 360" (5.9L)	R-4	4MV	17084001, 17086115, 17086116	18-7201	18-7095
—	6	M-225, M-225D, MH-225	C-2	BBD	3389, 3390, 4268	—	—
—	8	M273A, M318A, M318G	C-2	BBD	3212, 3979, 3981	—	—

① Does not include Metering Rods.

ALL SIERRA FUEL PUMPS INCLUDE MOUNTING GASKET



18-8114
FUEL LINE HOSE
 UNIVERSAL
 For fuel pump to carburetor connection. Replaces copper or steel tubing 3/8" X 31" PTFE composite hose with 5/8"-18 male inverted flare straight one end, 5/8"-18 90° one end. SAE J1527 type A1

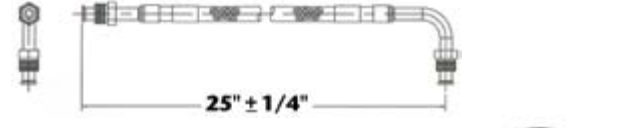

18-8115
FUEL LINE HOSE
 UNIVERSAL
 For fuel pump to carburetor connection. Replaces copper or steel tubing 3/8" X 25" PTFE composite hose with 5/8"-18 male inverted flare straight one end, 5/8"-18 90° one end. SAE J1527 type A1



FUEL WATER SEPARATORS



Sierra offers a complete line of 10 and 21 micron fuel water separating filters including drainable bowl filters to protect your carbureted and fuel injected engine.

Refer to pages 156-161 for a complete listing of OEM and universal applications.

Sierra fuel water separators remove over 99.8% of emulsified water from your gasoline. Sierra's 10 micron filters are over 90% efficient at removing particles as small as 10 micron. All filters flow @ 90 GPH to feed even the hungriest motor. Sierra 10 micron filters are recommended to prevent damage to sensitive inboard and outboard fuel injection systems.

Sierra #	Chrysler #	Description
18-7964-1	—	Transmission Filter

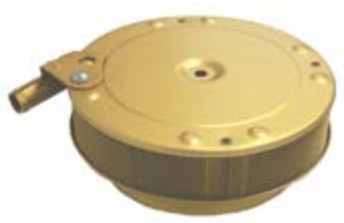

18-7230
FLAME ARRESTOR
 Replaces: 4142886
 Ht. 2.250 Element 1.470
 Throat 5.050 1 Vent Tube



18-7254
FUEL PUMP
 Replaces: 3745414
 (Flange I.D. #6766, M6766)
 For: (V-8) 318,360



18-7255
FUEL PUMP
 Replaces: 3745415
 (Flange I.D. #6767, M6767)
 For: (V-8) 361, 400, 413, 440



18-3551
THERMOSTAT
 Replaces: 4142885
 142°
 2.125 O.D. x 1.500 H



18-3645
THERMOSTAT
 Replaces: 2463441
 For: 318 & 360 CID Engines
 160°



18-3047
IMPELLER KIT
Contains: 18-3061 Impeller



18-3060
IMPELLER
Replaces: Sherwood 9959



18-3046D Display Package
18-3046
IMPELLER KIT
Replaces: Sherwood 9959K
Contains: 18-3060 Impeller



18-3061
IMPELLER
Replaces: Sherwood 10615
For: GM engines with V-Belt



18-3581
CIRCULATING WATER PUMP
(Bi-Directional)
Replaces: 3004886, 3745985, 3619542, 4417905
For: Engine Models 318, 340 & 360



18-4456D Display Package
18-4456
EXHAUST PROTECTOR VALVE
Includes Stainless Steel Clamp
3"



18-4457D Display Package
18-4457
EXHAUST PROTECTOR VALVE
Includes Stainless Steel Clamp
4"



18-4458D Display Package
18-4458
EXHAUST PROTECTOR VALVE
Includes Stainless Steel Clamp
5" & 6" (5" requires two 45° cuts)

OIL FILTERS

Part #	Replaces:
18-7875	1851658, 56874, F724002 (Long)
18-7878-1	L-19, L-1008, 3549957 (Short)
18-7879-1	L-319

SEE PAGES 203-205 & 1155-1183 FOR ADDITIONAL INFORMATION



Display Package



18-3878
HEAD GASKET
Replaces: 4417375



18-3860
HEAD GASKET
Replaces: 4142880
For: 318 CID Engines



18-0609
VALVE COVER GASKET
Replaces: 4273129
For: 318/340/360 CID

Fits Chrysler Small Block V8 318-360 cu. in. All Models 1966 & up with Fixed Exhaust

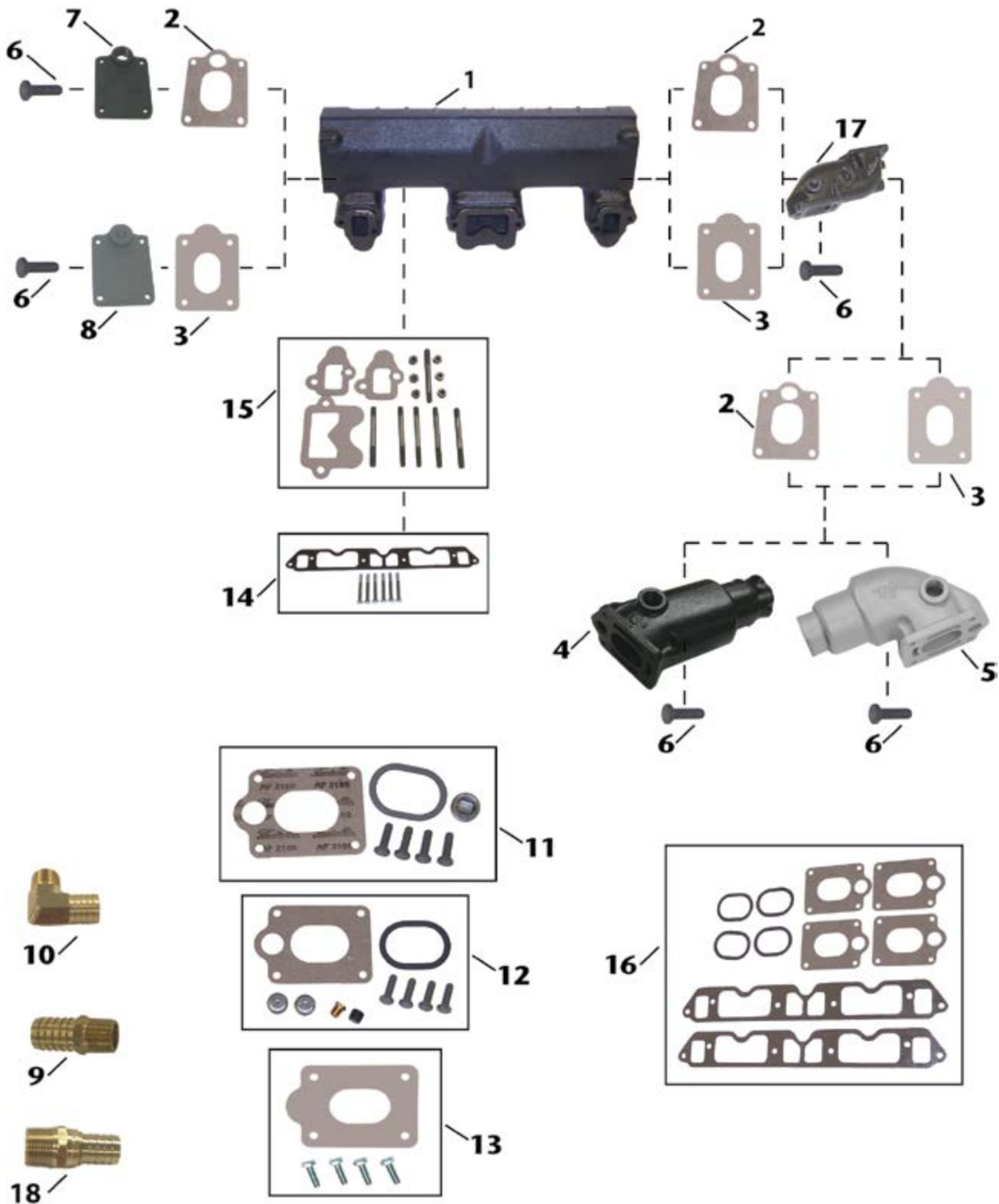

Item No.	Description	OE No.	Application
1	18-1940 MANIFOLD	4142322, 3675826	Chrysler Models 318-360CID Engines (1966 & Up); Use manifold mounting kit 18-8526 or 18-8527 (stainless).
2	18-2941 END CAP GASKET (OPEN)	2847480, 2469559	Fits: End Caps of Manifold (Starboard & Port) 18-1940; Risers: 18-1945; Elbows: 18-1946 & 18-1913
3	18-0472-1 END CAP GASKET (BLOCKED)	N/A	Fits: End Caps of Manifold (Starboard & Port) 18-1940; Risers: 18-1945; Elbows: 18-1946 & 18-1913
4	18-1946 MANIFOLD ELBOW	3527794	Use in conjunction with 18-1945. 3" exhaust outlet & a 20° down angle.
5	18-1913 MANIFOLD ELBOW	2469639, 2847405	Use in conjunction with 18-1945. 3" exhaust outlet & a 90° down angle.
6	NSS MOUNTING BOLT	N/A	Included in 18-4360, 18-4361, & 18-8506 mounting kits.
7	18-1942 MANIFOLD END PLATE (OPEN)	2846106	Use with End Plate Gasket: 18-2941 (Open); Mounting Kit: 18-4360 (Open) or 18-4361 (Open); (Port & Starboard) Manifold: 18-1940
8	NSS MANIFOLD END PLATE (BLOCKED)	2469556, 3675826	Use with End Plate Gasket: 18-2941; Mounting Kit: 18-4360 or 18-4361; (Port & Starboard) Manifold: 18-1940
9	18-4461 HOSE FITTING	N/A	3/4" - 14NPT X 1" Hose (Corrosion Resistant Brass Fitting)
10	18-8216 HOSE FITTING	N/A	3/4" - 14 NPT x 1" Hose (Corrosion Resistant Brass Fitting)
11	18-4360 MOUNTING PACKAGE (OPEN GASKET)	N/A	Use with End Plates: 18-1942 (open) or 18-1941 (Blocked); Riser/Elbow: 18-1945, 18-1946, 18-1913
12	18-4361 MOUNTING PACKAGE (OPEN GASKET)	N/A	Use with End Plates: 18-1942 (open) or 18-1941 (Blocked); Riser/Elbow: 18-1945, 18-1946, 18-1913
13	18-8506 MOUNTING KIT (BLOCKED GASKET)	N/A	Use with Riser/Elbow: 18-1945, 18-1946, 18-1913; End Plate: 18-1941 (Blocked)
14	18-8526 MOUNTING KIT	N/A	Use with Manifold: 18-1940
15	18-8527 MOUNTING KIT (STAINLESS STEEL)	N/A	Use with Manifold: 18-1940 (Kit has stainless steel studs and nuts)
16	18-4346 EXHAUST MANIFOLD GASKET SET	3745220	318 CID Engines (1969-85)
17	18-1945 MANIFOLD RISER	2846689	Use with Manifold: 18-1940; Riser Gasket: 18-2941 (Open) or 18-0472-1 (Closed); Mounting Kit: 18-4361 (Open) or 18-4360 (Open) or 18-8506 (Blocked)
18	18-8215 HOSE FITTING	N/A	3/4" - 14NPT X 3/4" Hose (Corrosion Resistant Brass Fitting)



Fits Chrysler Big Block V8 383-440 cu. in. All Models Except 413 "E" with Staggered Bolt Pattern

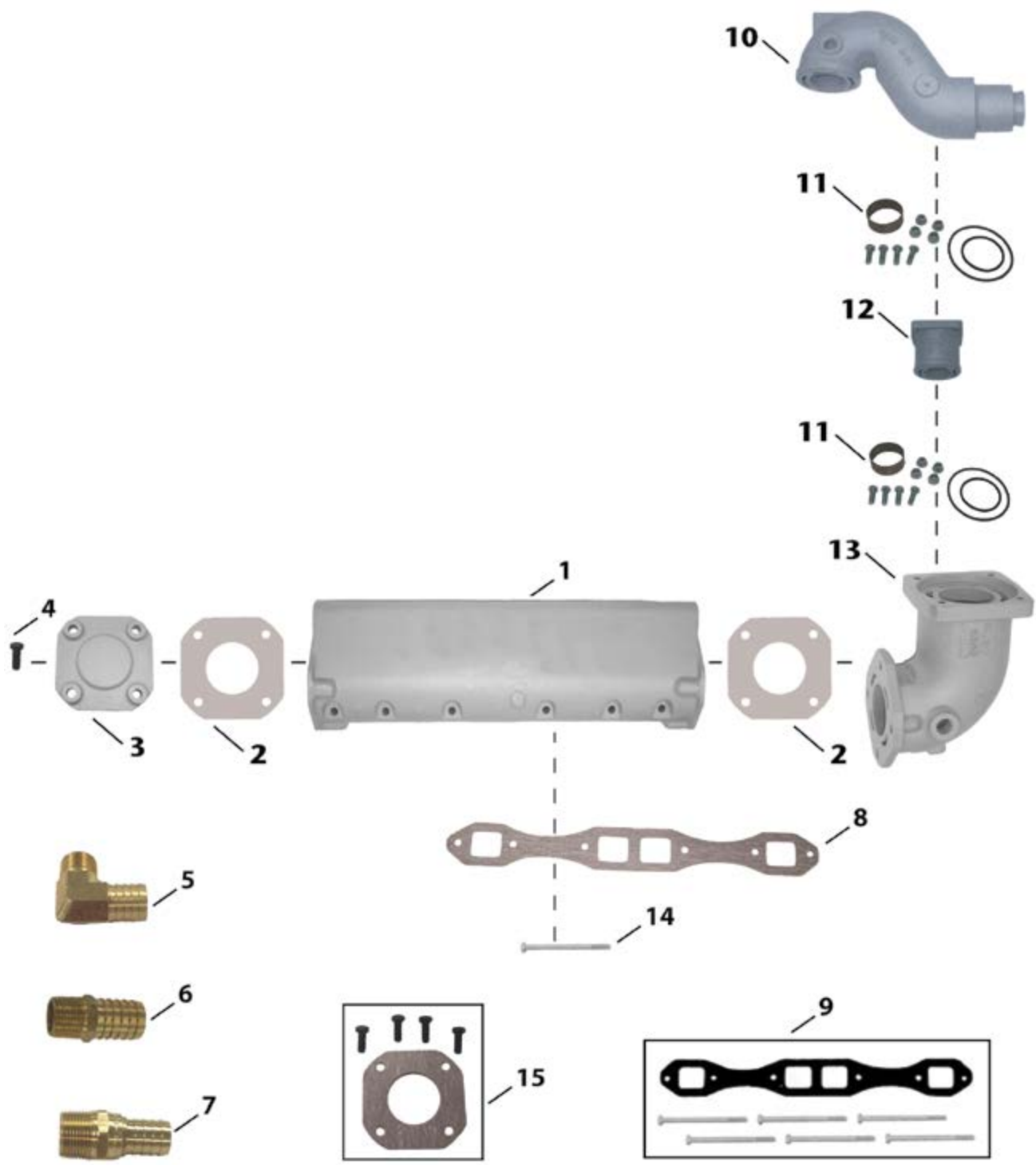

Item No.	Description	OE No.	Application
1	NSS MANIFOLD	E7081M, 3619659	Chrysler Models 383-440 cu.in. (V8 Big Block). Use with Front Plate: 18-1911
2	18-0471 ELBOW GASKET	N/A	Gasket for Elbow:18-1948 ; End Plate: 18-1911
3	18-1911 END/FRONT PLATE	N/A	Use with Elbow Gasket: 18-0471
4	NSS MOUNTING BOLT	N/A	
5	18-8216 HOSE FITTING	N/A	3/4" - 14 NPT x 1" Hose (Corrosion Resistant Brass Fitting)
6	18-4461 HOSE FITTING	N/A	3/4" - 14NPT X 1" Hose (Corrosion Resistant Brass Fitting)
7	18-8215 HOSE FITTING	N/A	3/4" - 14NPT X 3/4" Hose (Corrosion Resistant Brass Fitting)
8	NSS MANIFOLD GASKET	N/A	
9	NSS MOUNTING KIT	N/A	Big Block (V8) 383-440 cu.in. (All models except 413"E" with offset bolt pattern) Includes Manifold Gasket.
10	18-1944 RISER	2847404, 2847623, 3745639, E9923M	Use with Manifold: 18-1940; Mounting Kit: 18-8518
11	NSS MOUNTING KIT	N/A	Use with Riser: 18-1944.
12	N/A EXTENSION	N/A	Use in conjunction with 18-1948. Use mounting kit: 18-8518.
13	18-1948 RISER	E9234M	
14	NSS MOUNTING BOLT	N/A	



Fits Chrysler Small Block V8 318-360 cu. in. All Models 1966 & up with Swivel Exhaust

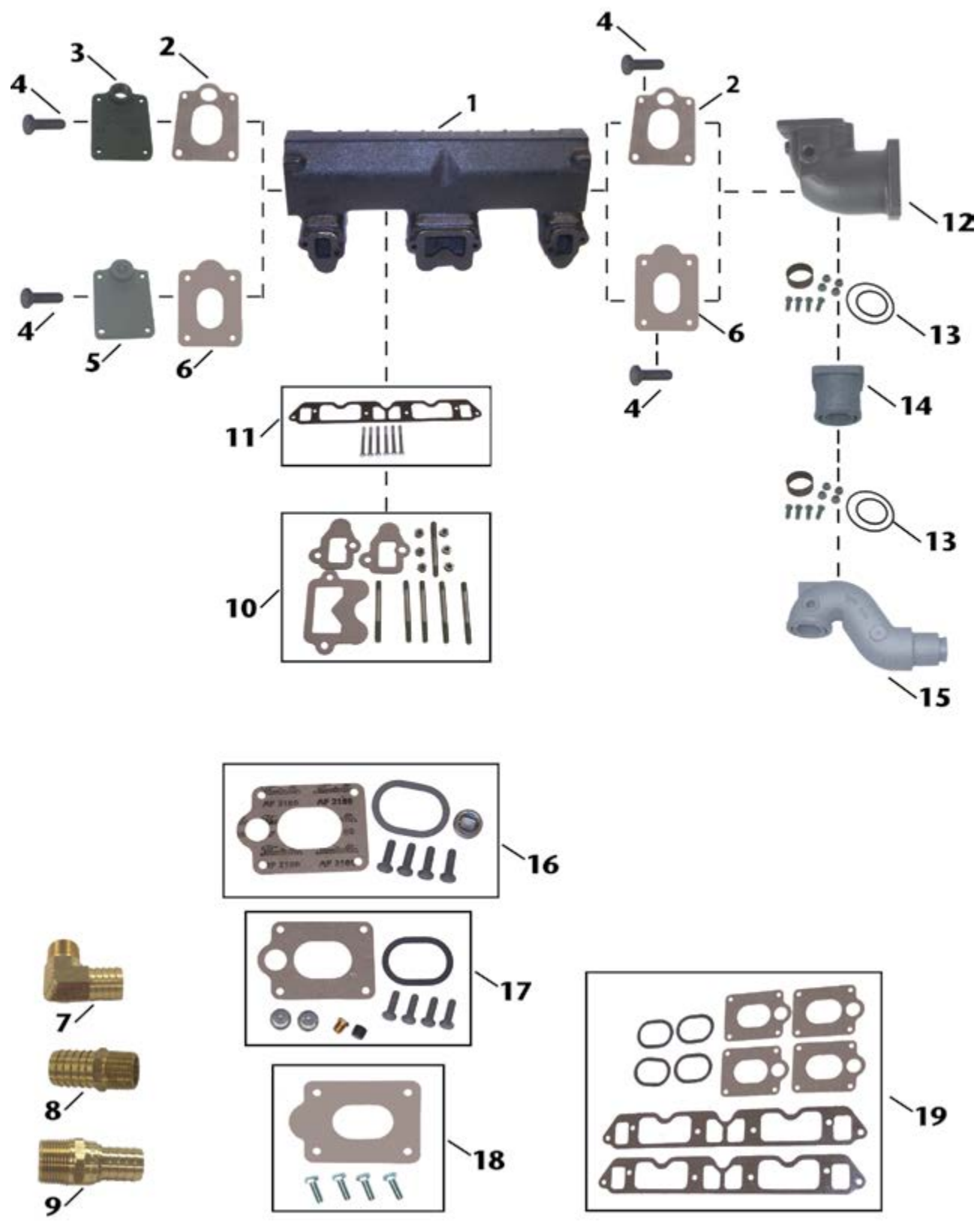

Item No.	Description	OE No.	Application
1	18-1940 MANIFOLD	4142322, 3675826	Chrysler Models 318-360CID Engines (1966 & Up); Use manifold mounting kit 18-8526 or 18-8527
2	18-2941 END CAP GASKET (OPEN)	2847480, 2469559	Fits: End Caps of Manifold (Starboard & Port) 18-1940. Included in 18-4360, & 18-4361 mounting kits.
3	18-1942 MANIFOLD END PLATE	2469556, 3675826	Use with End Plate Gasket: 18-2941; Mounting Kit: 18-4360 or 18-4361
4	NSS MOUNTING BOLT	N/A	Included in 18-4360, 18-4361, & 18-8506 mounting kits.
5	NSS MANIFOLD END PLATE	2846106	Use with End Plate Gasket: 18-0472-1 ; Mounting Kit: 18-8506
6	18-0472-1 END CAP GASKET (BLOCKED)	N/A	Fits: End Caps of Manifold (Starboard & Port) 18-1940. Included in 18-8506 mounting kit.
7	18-8216 HOSE FITTING	N/A	3/4" - 14 NPT x 1" Hose (Corrosion Resistant Brass Fitting)
8	18-4461 HOSE FITTING	N/A	3/4" - 14NPT X 1" Hose (Corrosion Resistant Brass Fitting)
9	18-8215 HOSE FITTING	N/A	3/4" - 14NPT X 3/4" Hose (Corrosion Resistant Brass Fitting)
10	18-8527 MOUNTING KIT (STAINLESS STEEL)	N/A	Use with Manifold: 18-1940 (Kit has stainless steel studs and nuts)
11	18-8526 MOUNTING KIT	N/A	Use with Manifold: 18-1940
12	N/A ELBOW	2600402	Use with Manifold: 18-1940. Use mounting kit 18-4360, 18-4361, or 18-8506.
13	N/A MOUNTING KIT	N/A	Use with Riser: 18-1944
14	N/A EXTENSION	N/A	Use mounting kit: 18-8518.
15	18-1944 RISER	N/A	Use with Manifold: 18-1940. Use with mounting kit: 18-8518
16	18-4360 MOUNTING PACKAGE (OPEN GASKET)	N/A	Use with End Plates: 18-1942 (open) or 18-1941 (Blocked).
17	18-4361 MOUNTING PACKAGE (OPEN GASKET)	N/A	Use with End Plates: 18-1942 (open) or 18-1941 (Blocked).
18	18-8506 MOUNTING KIT (BLOCKED GASKET)	N/A	Use with End Plate: 18-1941 (Blocked).
19	18-4346 EXHAUST MANIFOLD GASKET SET	3745220	318 CID Engines (1969-85)



ALL SIERRA MANIFOLDS ARE PAINTED, PACKAGED AND LEAK TESTED

18-1940

MANIFOLD

Port & Starboard

Replaces: 4142322, 3675826

Barr CM-1-6677A

Fits: Chrysler Model 273, 318, 340 & 360

CID engines (1973-1986)

Use with:

End Cap Gasket: 18-2941 Open or 18-0472-1 Blocked

Mounting Kit: 18-4360 Open or 18-4361 Open or 18-8506 Blocked

End Plate: 18-1941 Blocked or 18-1942 Open

Note: If using a blocked end plate either gasket will work. If using an open end plate use only an open gasket.



18-1997-1

MANIFOLD

Port & Starboard

Replaces: Barr CHV-1-83

Universal Center Riser Manifold

FITS:

Chrysler 283, 302, 307 and 350 CID engines

Crusader 283 and 327 CID engines thru 1964; 305, 307 and 350 CID engines 1965 and later

Daytona 200-283 and 300-327

Flagship 283, 327 and 350 CID engines

Pacer 305, 307 and 350 CID engines 1965 and later

Mercury 190, 198, 225, 250, 270, 228, 898, 260, 255 and 280 models

OMC 283, 305, 307 and 350 CID engines 1968-1980

Volvo 307 and 350 CID engines

Use 18-0604 Exhaust Manifold Gasket Set

***For Exploded View - See Pages 658-659**



18-1898

MANIFOLD

Port & Starboard

Replaces: Barr CHVA-1-84, Marine Power 0991-110

Fits: 454 cu.in. GM big block V8 engines

Use with:

Exhaust Manifold Gasket: 18-0418

***For Exploded View - See Pages 656-657**



18-1945

RISER

Replaces: 2846689, Barr CM-20-6674

Fits: Chrysler Model 273, 318, 340 & 360 CID engines (1966-1986)

Use with:

Manifold: 18-1940

Riser Gasket: 18-2941 open or 18-0472-1 blocked

Mounting Kit: 18-4361 open or 18-4360 open or 18-8506 blocked



18-1939

RISER

Replaces: Barr 20-0100, Marine Power 0992-593

Barr, Indmar and Marine Power Ford Small Block V8 302-351 cu.in., GM Small Block V8 305-350cu.in., GM Big Block V8 454cu.in.

Use with:

Manifold: 18-1997-1 or 18-1998-1 or 18-1898

Riser Gasket: 18-2854-1 open or 18-0476-1 blocked

Mounting Kit: 18-4364 open or 18-8535 blocked



18-1944

RISER

Replaces: 2847404, 2847623, 3745639, E9923M

Barr CM-20-414211

Chrysler Small Block V8 318-360cu.in.

(All models 1966 and up with swivel exhaust),

Big Block V8 383-440cu.in. (All models except

413"E" with offset bolt pattern)

Use with:

Manifold: 18-1940

Mounting Kit: 18-8518



18-1907

RISER

Replaces: Barr 20-0102, Indmar 53-2009, 53-2018

Barr and Indmar Ford Small Block V8 302-351cu.in.

Use with:

Manifold: 18-1997-1 or 18-1998-1

Riser Gasket: 18-2854-1 open or 18-0476-1 blocked

Mounting Kit: 18-4364 open or 18-8535 blocked



18-1946

ELBOW

Replaces: 3527794

Barr CM-20-6672

Fits Chrysler Model 273, 318,

340 & 360 CID engines (1966-1986)

will work in conjunction with 18-1945

Use with:

Manifold: 18-1940

Elbow Gasket: 18-2941 open or 18-0472-1 blocked

Mounting Kit: 18-4360 open or 18-4361 open or 18-8506 blocked

20°



**18-1913
ELBOW**
Replaces: Chrysler 2469556, 2469639, 2847405
 Chrysler Small Block V8 318-360 cu.in.
 (All Models 1966 and up with fixed exhaust)
 For: 18-1940 Manifold will work in conjunction with 18-1945
Use with:
 Elbow Gasket: 18-2941 open or 18-0472-1 blocked
 Mounting Kit: 18-4360 open or 18-4361 open or 18-8506 blocked



**18-1948
ELBOW**
Replaces: Chrysler E9234M
 Barr CM-20-9234
 Chrysler Big Block V8 383-440cu.in.
 (All Models except 413"E" with offset bolt pattern)
Use with:
 Elbow Gasket: 18-0471
 Mounting Kit: 18-8501



**18-1911
MANIFOLD END PLATE**
 Chrysler Big Block V8 383-440cu.in.
 (All Models except 413"E" w/offset bolt pattern)
Used with:
 Front/End Plate Gasket: 18-0471
 Mounting Kit: 18-8501



**18-1942
MANIFOLD END PLATE**
 with hole
Replaces: 24695566, 3675826
 Barr CM-1-6672-H
Use with:
 End Plate Gasket: 18-2941
 Mounting Kit: 18-4360 or 18-4361
 Fits: 18-1940 Manifold



**18-0607
INTAKE MANIFOLD GASKET SET**
Replaces: 3745217
 For: 318 CID Engines (1969-82)

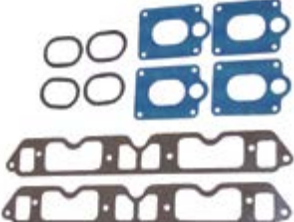

**18-4346
EXHAUST MANIFOLD GASKET SET**
Replaces: 3745220
 For: 318 CID Engines (1969-85)



**18-0956-1
EXHAUST MANIFOLD GASKET**
Replaces: 118-614
 For: 460 CID



**18-0471
ELBOW GASKET**
Used with:
 Elbow: 18-1948
 End Plate: 18-1911

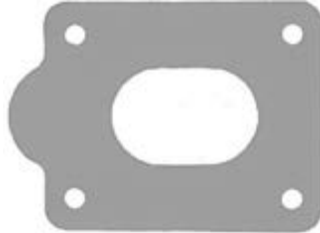

**18-0472-1 (Blocked)
ELBOW GASKET**
Used with:
 Riser/Elbow: 18-1945, 18-1946, 18-1913
 End Plate: 18-1941



**18-4360 (Open)
EXHAUST ELBOW MOUNTING KIT**
 Barr CM206672JP
Use with:
 Exhaust Elbow: 18-1946, 18-1913, 18-1945
 End Plate: 18-1942 open or 18-1941 blocked



**18-4361 (Open)
EXHAUST ELBOW MOUNTING KIT**
 Barr CM-20-6674P
Use with:
 End Plate: 18-1942 open or 18-1941 blocked
 Riser: 18-1945
 Elbow: 18-1946, 18-1913



**18-4361 (Open)
EXHAUST ELBOW MOUNTING KIT**
 Barr CM-20-6674P
Use with:
 End Plate: 18-1942 open or 18-1941 blocked
 Riser: 18-1945
 Elbow: 18-1946, 18-1913



**18-4364 (Open)
EXHAUST ELBOW KIT**
Replaces: Barr 20-0082-P
Use with:
Riser: 18-1999, 18-1907, 18-1939

PKG. OF 2



**18-2941 (Open)
18-2941-9^①
END CAP GASKET**
Replaces:
2847480, 2469559
Use with:
End Plate: 18-1941, 18-1942
Riser/Elbow: 18-1945, 18-1946, 18-1913
For: 318CID Engines

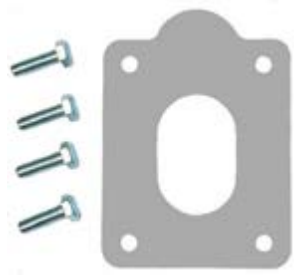

**18-8506
EXHAUST ELBOW
MOUNTING KIT**
Replaces: Barr CM-20-6674JP
Chrysler Small Block V8 318-360 cu.in. (All models 1966 and up with swivel and fixed exhaust)
Used with:
Riser: 18-1945
Elbow: 18-1946, 18-1913
End Plate: 18-1941 blocked



**18-8526
EXHAUST MANIFOLD MOUNTING KIT**
Chrysler Small Block V8 318-360cu.in.
(All models 1966 and up with swivel and fixed exhaust)
Used with:
Manifold: 18-1940



**18-8527
EXHAUST MANIFOLD MOUNTING KIT**
Replaces: Barr CM-1-6677SS P
Chrysler Small Block V8 318-360cu.in.
(All models 1966 and up with swivel and fixed exhaust)
Used with:
Manifold: 18-1940
(Kit has stainless steel studs and nuts)



**18-8535
EXHAUST ELBOW MOUNTING KIT**
Barr, Indmar and Marine Power
Ford Small Block V8 302-351cu.in.,
GM Small Block V8 305-350cu.in.,
GM Big Block V8 454cu.in.
Used with:
Risers: 18-1939, 18-1999, and 18-1907



**18-8536
EXHAUST ELBOW
MOUNTING KIT**
Barr, Indmar and Marine Power GM Small Block V8 305-350cu.in.
Used with:
Manifold: 18-1997-1



PIPE PLUGS

Part #	Thread Size	Part #	Thread Size
18-4256	1/4"	18-4263	1/8" - 27 NPT
18-4257	1/4"	18-4264	3/8" - 18 NPT
18-4258	3/4"		



**18-4218
BRASS DRAIN COCK (1/4")**
Used with:
Most O.E.M. Manifolds
18-3223-9 (Bulk Pack of 12)



**18-8538
EXHAUST MANIFOLD
MOUNTING KIT**
Barr and Indmar Ford Small Block V8 302-351cu.in.
Used with:
Manifold: 18-1998-1

PKG. OF 8



FREEZE PLUGS
18-5961 18-5962
18-5961-9 18-5962-9
1 5/8" 1 3/4"
BRONZE



**18-4461
HOSE BARB**
3/4" - 14 NPT x 1" Hose
Corrosion Resistant Brass Fitting



**18-8215
HOSE BARB**
Fits: Chrysler V8



**18-8216
HOSE BARB**
Fits: Chrysler-Small Block V8 (318-360ci), Big Block V8(383-440)

CRUSADER MODEL IDENTIFICATION

MODEL C X L X H F L 245 M SERIAL 631254

1st Space: **MANUFACTURER**
C - Crusader

2nd Space: **FACTORY FRESHWATER / CLOSED COOLING**
X-Freshwater Cooled
(Space Omitted If Raw Water Cooled)

3rd Space: **ENGINE ROTATION**
L - Rotation, Left-Hand from Rear
R - Rotation, Right-Hand from Rear

4th Space: **ENGINE TYPE**
A = 5.7L (350 CID HO) (GM)
G = 5.0L (305 CID) (GM)
Q = 6.0L (364 CID) (GM)
X = 8.1L (496 CID STD) (GM)
Z = 8.1L (496 CID HO) (GM)

5th Space: **DRIVE MANUFACTURER**
W - Borg-Warner
H - Hurth
T - Walters
V - Velvet Drive (cast iron units specify 71c or 72c)

6th Space: **DRIVE FUNCTION / APPLICATION**
R - Reverse / Reduction
V - Vee Drive / Reversed Risers
F - Full Reversing

7th Space: **PROPELLER SHAFT ROTATION**
L - Left-Hand Rotation
R - Right-Hand Rotation

8th 9th 10th Spaces: **DRIVE GEAR RATIO OR REDUCTION**
The drive gear ratio will appear in these spaces which identifies the production gear specs. The example gear number shown is a (2.45:1). If the gear being identified does not have 3 digits, a "0" will appear in 10th space.
Example: (2.0:1) will appear as 200
(1.5:1) will appear as 150

***MODELS ENDING WITH "000000" IN PLACE OF DRIVE I.D. ARE BOBTAIL ENGINES.**

11th Space: **IGNITION / FUEL TYPE USED**
D - DISTRIBUTOR (Carb)
E - THROTTLE BODY INJECTION
M - MULTI-PORT FUEL INJECTION

SERIAL NUMBER I.D.
1st DIGIT INDICATES DECADE ENGINE WAS MANUFACTURED (5 = 1990, 6 = 2000, 7 = 2010)
2nd DIGIT INDICATES YEAR ENGINE WAS MANUFACTURED.

①18-5250 Display Package



18-5250 TUNE-UP KIT

<p>Part # 18-5311 18-5345 18-5418</p>	—CONTAINS—	<p>Description Contact Set Condenser Rotor</p>
Delco 4 & 6 cyl.		

Display Package



18-5251 TUNE-UP KIT

<p>Part # 18-5314 18-5338 18-5404-1</p>	—CONTAINS—	<p>O.E. # 20117 12530 20223</p>	<p>Description Contact Set Condenser Rotor</p>
Mallory 8 cyl. Tall Cap			



18-5252 TUNE-UP KIT

<p>Part # 18-5310 18-5344 -</p>	—CONTAINS—	<p>Description Contact Set Condenser Rotor</p>
Delco 8 cyl.		

Display Package



18-5255 TUNE-UP KIT

<p>Part # 18-5303 18-5345 18-5407</p>	—CONTAINS—	<p>O.E. # 41058 41057, 705787 41059</p>	<p>Description Contact Set Condenser Rotor</p>
Prestolite 8 cyl.			



18-5256 TUNE-UP KIT

<p>Part # 18-5314 18-5338 18-5411</p>	—CONTAINS—	<p>O.E. # 20117 12530 12531</p>	<p>Description Contact Set Condenser Rotor</p>
Mallory 8 cyl. Flat Cap			

① Items ending in "D" are Display Packaged - Regular number is Non-Display



**18-5258
TUNE-UP KIT**

Part #	O.E. #	Description
18-5303	41058	Contact Set
18-5347	—	Condenser
18-5407	41059	Rotor



**18-5259
TUNE-UP KIT**

Part #	O.E. #	Description
18-5303	41058	Contact Set
18-5347	—	Condenser
18-5429	—	Rotor

①18-5260D Display Package



**18-5260
TUNE-UP KIT**

Part #	O.E. #	Description
18-5303	41058	Contact Set
18-5345	41057, 705787	Condenser
18-5403	—	Rotor



**18-5266
TUNE-UP KIT**

Fits: Flame Thrower Distributors 18-5481, 18-5482, 18-5483, 18-5477, 18-5478, 18-5479



**18-5269
TUNE-UP KIT**

Part #	O.E. #	Description
18-5311	20117	Contact Set
18-5345	12530	Condenser
18-5418	12531	Rotor
18-5386	1003317, 12532	Distributor Cap

GM V-6 — Single Point



**18-5271
TUNE-UP KIT**

Part #	O.E. #	Description
18-5314	20117	Contact Set
18-5338	12530	Condenser
18-5404-1	20223	Rotor
18-5376	20222	Distributor Cap

Mallory V-8 Tall Cap — Single Point



**18-5272
TUNE-UP KIT**

Part #	O.E. #	Description
18-5314	20117	Contact Set
18-5338	12530	Condenser
18-5411	12531	Rotor
18-5375	1003317, 12532	Distributor Cap

Mallory V-8 Flat Cap — Single Point - Side



**18-5275
TUNE-UP KIT**

Part #	O.E. #	Description
18-5303	41058	Contact Set
18-5347	—	Condenser
18-5403	41089, 41074	Rotor
18-5352	41076	Distributor Cap

Prestolite V-8 - Single Point - Screw Down Cap



**18-5276
TUNE-UP KIT**

Part #	O.E. #	Description
18-5303	41058	Contact Set
18-5347	—	Condenser
18-5403	41089, 41074	Rotor
18-5353	41069	Distributor Cap

Prestolite V-6 - Single Point - Screw Down Cap



**18-5277
TUNE-UP KIT**

Part #	O.E. #	Description
18-5303	41058	Contact Set
18-5347	—	Condenser
18-5407	41059	Rotor
18-5369	41052	Distributor Cap

Prestolite V-8 - Single Point - Clip Down Cap

APPLICATION BEGINS ON PAGE 617

Items ending in "D" are Display Packaged - Regular number is Non-Display



18-5278
TUNE-UP KIT
Delco EST - V-6



18-5279
TUNE-UP KIT
Prestolite Electronic - V-8

—CONTAINS—

Part #	Description	O.E. #	Qty.
18-5352	Distributor Cap	392-9766	1
18-5403	Rotor	392-9089	1



18-5280
TUNE-UP KIT
Delco EST - In-Line 4

—CONTAINS—

Part #	Description	O.E. #	Qty.
18-5361	Distributor Cap	986643	1
18-5406	Rotor, Delco	986651	1



18-5281
TUNE-UP KIT
Delco EST - V-8

—CONTAINS—

Part #	Description	O.E. #	Qty.
18-5354	Distributor Cap	808483	1



18-5302
TUNE-UP KIT

Replaces:
Fits: male cap v-8 flamethrower distributors



18-5303
CONTACT SET
Replaces: 41058



18-5307
CONTACT SET
Replaces: 705788



18-5310
CONTACT SET
Replaces: 12525



18-5311
CONTACT SET



18-5314
CONTACT SET
Replaces: 20117



18-5318
CONTACT SET
Replaces: 3000124



18-5338
CONDENSER
Replaces: 12530



18-5344
CONDENSER
Replaces: 12526



18-5345
CONDENSER
Replaces: 41057, 705787



18-5347
CONDENSER



18-5403
ROTOR
Replaces: 41089, 41074

 <p>18-5404-1 ROTOR Replaces: 20223</p>	 <p>18-5405 ROTOR Replaces: 38071 Use with 18-5354 Distributor Cap Fits: New GM style "Module in Cap" distributors - V-8 application</p>	 <p>18-5406 ROTOR Use with 18-5361 Distributor Cap</p>	 <p>18-5407 ROTOR Replaces: 41059</p>
 <p>18-5408 ROTOR Use with 18-5362 Distributor Cap Fits: New GM Style "Module in Cap" Distributors V6 Applications</p>	 <p>18-5411 ROTOR Replaces: 12531,1003318</p>	 <p>18-5418 ROTOR</p>	 <p>18-5300 ROTOR Fits: Flamethrower Distributors</p>
 <p>18-5420 ROTOR Replaces: 3000122</p>	 <p>18-5427 ROTOR Replaces: 705786</p>	 <p>18-5429 ROTOR</p>	 <p>18-5302 TUNE-UP KIT Replaces: Fits: Male cap v-8 flamethrower distributors</p>
 <p>18-5352 DISTRIBUTOR CAP Replaces: 41076 Prestolite</p>	 <p>18-5353 DISTRIBUTOR CAP Replaces: 41069 Prestolite</p>	 <p>18-5354 DISTRIBUTOR CAP Replaces: 38070 Fits: New GM style "Module in Cap" Distributors-V-8 applications Use 18-5405 Rotor</p>	
 <p>18-5361 DISTRIBUTOR CAP Fits: New GM style "Module in Cap" Distributors – 4 cyl. applications Use 18-5406 Rotor</p>	 <p>18-5362 DISTRIBUTOR CAP Fits: New GM Style "Module in Cap" Distributors – V6 Applications Use 18-5408 Rotor</p>	 <p>18-5369 DISTRIBUTOR CAP Includes Gasket: 18-5399 Replaces: 41052 Prestolite</p>	

 <p>18-5375 DISTRIBUTOR CAP Replaces: 12532, 1003317</p>	 <p>18-5376 DISTRIBUTOR CAP Replaces: 20222</p>	 <p>18-5384 DISTRIBUTOR CAP Replaces: 12528</p>
 <p>18-5386 DISTRIBUTOR CAP</p>	 <p>18-5389 DISTRIBUTOR CAP Replaces: 3000121</p>	<p>PKG. OF 2</p>  <p>18-5399 DISTRIBUTOR CAP GASKET Replaces: 41061</p>



FEATURES

- Senses current levels in the coil and adjusts the dwell to maintain peak energy throughout the entire RPM range.
- Develops, on average, 4 times more available energy between 3000 and 5000 RPM's and twice as much plug voltage as point-type systems.
- Ignition energy is sustained and coil life is increased when peak current level is reached just prior to spark.
- More stable timing.
- Use with 18-5472 "Flame Thrower II" Coil for optimum performance

18-5288
HI-PERFORMANCE
ELECTRONIC CONVERSION KIT
Fits: Most Prestolite V-8
Distributors with snap down cap



18-5288-1
Superseded from 18-5289
HI-PERFORMANCE
ELECTRONIC CONVERSION KIT
Fits: Most Prestolite V-8
Distributors with screw down cap



18-5290
HI-PERFORMANCE
ELECTRONIC CONVERSION KIT
Fits: Most Mallory YL or YD 8 cylinder
Distributors with clockwise and counter clockwise rotation



IGNITOR[®] FEATURES

ELECTRONIC IGNITION

- Replaces points & condensers for true solid state ignition.
- Uses standard coil, cap and rotor.
- Easy to install, one-piece, 2-wire hook-up.
- Accurate to within 1/4° timing accuracy 0 to 6000 RPM range.
- Can be used with Flame Thrower Coils 18-5466 & 18-5469.

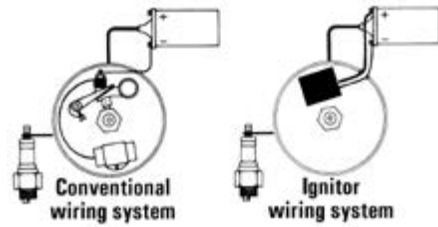

18-5294
ELECTRONIC CONVERSION KIT
Fits: 6 Cyl. Delco distributors



18-5295
ELECTRONIC CONVERSION KIT
Fits: Most 4 Cyl. Prestolite distributors (except IBM 7026)
For: Onan, Universal, Waukesha, Wisconsin



18-5296-2D Display Package

18-5296-2
ELECTRONIC CONVERSION KIT
Fits: Most Mallory YL & YD 8 cyl. Distributors with clockwise and counter clockwise rotation

18-5298-1
ELECTRONIC CONVERSION KIT
With snap down cap
For: Most Prestolite V-8 Distributors

18-5299 Display Package
ELECTRONIC CONVERSION KIT
With screw down cap
For: Most Prestolite V-8 Distributors
Use with 18-5403 style rotor

PREMIUM MARINE SPARK PLUG WIRE LEADS

Sierra's MAGFORCE Ignition Wires are "Electronics Friendly" protecting all of your electronic devices and electronic engine controls from RFI and EMI while delivering the maximum amount of voltage. Exact fit design ensures easy installation and years of trouble-free service.

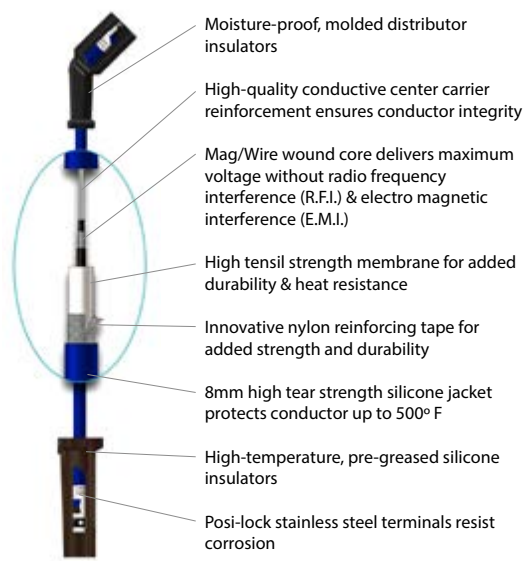

CRUSADER MARINE IGNITION WIRES APPLICATION				
Engine	Cyl.	Distributor	Years	Plug Wire Set
220 (305 CID 5.0L)	8	Mallory/Prestolite ②	1987-1992	18-8803-2
270 (350 CID 5.7L)	8	Mallory/Prestolite ①	Up to 1987	18-8803-2
270 (350 CID 5.7L)	8	Mallory/Prestolite ②	1987-1992	18-8803-2
TB350	8	Delco EST ③	1992 & Up	18-8824-1
5.7L Classic	8	Mallory	1999 & Up	18-8803-2
5.7L MPI Classic	8	Delco HVS	2007 & Up	18-8828-1
MP5.0L Captain's Choice	8	Delco HVS	2002-2005	18-8828-1
MP5.7L Captain's Choice	8	Delco HVS	2002-2005	18-8828-1
MP6.0L	8	Distributorless	2002 & Up	18-8838-1
350 (454 CID 7.4L)	8	Mallory ④	Up to 1991	18-8803-2
454XL (454 CID 7.4L)	8	Delco EST ⑤	1991 & Up	18-8824-1
CM454HO (454 CID 7.4L)	8	Delco EST ⑥	1991 & Up	18-8824-1
454XL (454 CID 7.4L)	8	Delco EST ⑥	1993 & Up	18-8824-1
MP8.1L	8	Distributorless	ALL	18-8838-1
502 (502 CID 8.2L)	8	Prestolite ①	Up to 1991	18-8803-2
502 (502 CID 8.2L)	8	Delco EST ④	Up to 1991	18-8824-1
502XL (502 CID 8.2L)	8	Delco EST ⑤	1991 & Up	18-8824-1
TB502XL (502 CID 8.2L)	8	Delco EST ⑦	1994 & Up	18-8824-1

CRUSADER MARINE IGNITION WIRES APPLICATION				
Engine	Cyl.	Distributor	Years	Plug Wire Set
262 CID 4.3L	6	Prestolite	ALL	18-8801-1
262 CID 4.3L	6	Delco EST	ALL	18-8810-1
262 CID 4.3L	6	Delco HVS	ALL	18-8829-1
220 (305 CID 5.0L)	8	Mallory/Prestolite ①	Up to 1987	18-8803-2

① Serial Number up to 68702 ② Serial Number 68703-90232 ③ Serial Number 90232 & UP
④ Serial Number up to 88710 ⑤ Serial Number 88710 & Up ⑥ Serial Number 92882 & Up
⑦ Serial Number 94268 & Up

APPLICATION BEGINS ON PAGE 617

Items ending in "D" are Display Packaged - Regular number is Non-Display



BATTERY CABLES

Gauge cable with soldered lug terminals on each end to accept 3/8" stud.

PART NO.	SIZE	COLOR	GAUGE	PART NO.	SIZE	COLOR	GAUGE
BC88523	2'	red	4	BC88563	6'	red	2
BC88533	2'	black	4	BC88573	6'	black	2
BC88543	4'	red	2	BC88583	8'	red	1
BC88553	4'	black	2	BC88593	8'	black	1



18-5225 SPARK PLUG WIRE KIT

Replaces: Mercury 84-99215A26, 84-813706A26
Kit includes 25 ft. Roll of 7 MM Hypalon Ignition Wire With a Metallic Core and a Large Assortment of Three Different End Fittings.



18-5226 IGNITION WIRE
Metallic Core
100' Spool • 7mm Hypalon

PKG. OF 10



18-5224 SPARK PLUG WIRE TERMINAL
Replaces: Mercury 20121
OMC 510364

PKG. OF 10



18-5750 UNIVERSAL SPARK PLUG BOOTS
Supplied complete w/Terminal Connector
Replaces: OMC 581027, 580339



18-5752 UNIVERSAL SPARK PLUG BOOTS
8mm

FEATURES

- Distributors feature the Ignitor II ignition module with adaptive dwell control adjusts the spark timing over the entire RPM range to maximize performance
- Upper roller bearing and oil impregnated bronze sintered bottom bushing are installed and aligned bored for accuracy for maximum durability
- Machined heat treated gear with tight tolerances insures durability and consistent timing to maximize horsepower and performance. Complete with high dielectric strength cap and rotor for years of performance

Standard Rotation

CCW Rotation

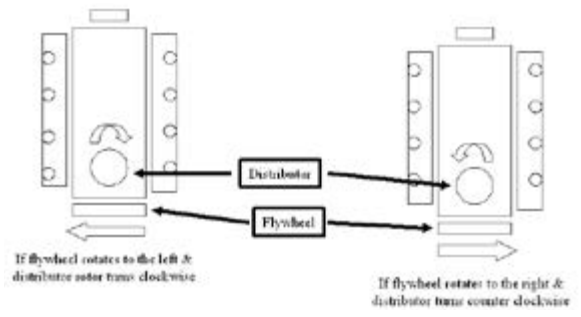

18-5483 HI-PERFORMANCE ELECTRONIC DISTRIBUTOR
Fits: Chevrolet Marine Small and Big Block engines (Standard Deck Height)
Replacement cap/rotor kit **18-5266**

18-5309-1 DISTRIBUTOR
Replaces: Mallory YL512CV
For most Ford 302 CID V-8 Eng.
Tune-Up Kit **18-5251**



— CONTAINS —

Part #	Desc.
18-5314	Contact Set
18-5338	Condenser
18-5404-1	Rotor

18-5313-1 DISTRIBUTOR

Replaces: Crusader 37061
Mallory YL624MW
For most GM V-8 Eng. small & large block Mallory Tall Cap
Tune-Up Kit **18-5251**



— CONTAINS —

Part #	Desc.
18-5314	Contact Set
18-5338	Condenser
18-5404-1	Rotor

ELECTRONIC DISTRIBUTORS
U.L. Approved

Part No.	Rotation	Application
18-5494-2	Conventional	Chevrolet All V8 (exc. 348,409 & Tall Deck Big Block)
18-5495-2	Conventional	Includes 482, 502, 540 CID Ford V-8, 302 CID

*Older reverse rotation engines with reverse cut camshaft gear

USES:			
Part #	Description	Part #	Description
18-5376	Distributor Cap	18-5488	Module
18-5404-1	Rotor		

① Priced per Package

**18-5484-1
ELECTRONIC
DISTRIBUTOR**

Conventional Rotation

Replaces: RA107039E

Late Model HEI

For V8 — 262-454 & 502 except 384/409 and tall block engines

• Designed as a plug-in replacement for GM-style fuel injection system distributors



—CONTAINS—

Description	Part #
Distributor Cap	18-5354
Rotor	18-5405

**18-5480
COMPLETE IGNITION
CONVERSION KIT**

Fits: GM SB & BB with Standard Deck Height

—CONTAINS—	
Part #	Description
18-5472	Coil
18-8803-2	Wire Set
18-5483	Distributor



**18-26812
HEI COIL GRAY CONNECTOR**



**18-26813
HEI COIL BLACK CONNECTOR**



**18-5108
PICKUP COIL
SENSOR**

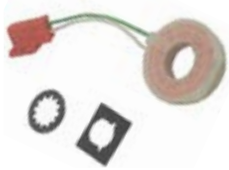

**18-5107-1
IGNITION MODULE**

4/6/8 cyl.
Replaces: 7243110



**18-26810
GM HEI 4 TERMINAL
PIGTAIL**

Fits: GM HEI Distributors w/4 terminals



**18-26811
GM HEI 2 TERMINAL
PIGTAIL**

Fits: GM HEI Distributors w/2 terminals



FEATURES

- Oil filled for better cooling and long life
- Low resistance and improved turn ratios produces the higher voltage needed to run larger spark plug gaps for added power and better fuel economy
- More windings maximize energy and reliability over the full RPM range
- Fits existing brackets for easy installation

**18-5466
HI-PERFORMANCE
IGNITION COIL**

1.5 ohm (oil filled), black - 8 cylinder: Flame-Thrower 40,000 volt coil.

- ★ Designed for use with the original Ignitor Electronic Conversion Kits
- ★ Can be used with other inductive ignition systems



**18-5469
HI-PERFORMANCE
IGNITION COIL**

3.0 ohm (oil filled), black - 4 & 6 cylinder: Flame-Thrower 40,000 volt coil.

- ★ Designed for use with the original Ignitor Electronic Conversion Kits
- ★ Can be used with other inductive ignition systems



**18-5472
HI-PERFORMANCE
IGNITION COIL**

0.6 ohm (oil filled), black - 4, 6, & 8 cylinder: Flame-Thrower 45,000 volt coil.

- ★ Super low 0.6 ohm resistance coil designed for use with the Ignitor II Hi Performance Electronic Conversion Kits
- ★ Compatible with capacitive discharge systems



Part #	Description	Recommended Coil	Resistance Ohms	Part #	Description	Recommended Coil	Resistance Ohms
18-5294	Electronic Conversion Kit	18-5469	3.0	18-5288	Hi Performance Electronic Conversion Kit	18-5472	0.6
18-5295	Electronic Conversion Kit	18-5469	3.0	18-5288-1	Hi Performance Electronic Conversion Kit	18-5472	0.6
18-5296-2	Electronic Conversion Kit	18-5466	1.5	18-5290	Hi Performance Electronic Conversion Kit	18-5472	0.6
18-5298-1	Electronic Conversion Kit	18-5466	1.5	18-5483	Flame-Thrower Distributor	18-5472	0.6
18-5299	Electronic Conversion Kit	18-5466	1.5				

**18-5433
IGNITION COIL**

Replaces: 37068, 51080
Uses External Resistor



**18-5435
IGNITION COIL
4.0 OHM**

Replaces: 41080
Has Internal Resistor



**18-5436
IGNITION COIL
3.0 OHM**

**Has Internal Resistor
(For Mallory Applications)**



**18-5438
IGNITION COIL**

Replaces: 37068
HEI



**18-5443
IGNITION COIL**

Replaces: 7243200
4cyl./V-8
For: 3.0L (1991 & up) 5.7 & 7.4 EFI (1995 & up)



**18-5450
COIL RESISTOR
1.5 OHM**



IGNITION / ELECTRICAL SYSTEMS APPLICATION										
Cyl.	Model Engine	Year	Distributor No.	Contact Set	Con-denser	Rotor	Dist. Cap	Tune-Up Kit	Distributor	Elect. Con. Kit
4	153	1961-69	YL486C,D ④	18-5314	18-5338	18-5427	—	—	—	—
4	IH60,M60, PH45,134	1971-75	IAY4010A	18-5307	18-5345 ⑥	18-5427	—	—	—	—
6	230,292 Chevy	1961-69	YL486A,B ④	18-5314	18-5338	18-5427	—	—	—	—
6	229,3.8L	1980-82	IBM7014,A	18-5303	18-5345 ⑥	18-5403	18-5353	18-5260, 18-5276 ⑥	—	—
6	229,262	1983-88	IBM7018	18-5303	18-5345 ⑥	18-5403	18-5353	18-5260	—	—
6	229,262	1983-88	IBM7021	18-5303	18-5345 ⑥	18-5403	18-5353	18-5260, 18-5276 ⑥	—	—
8	185,230, 250, 280	1962	IBM4110	18-5303	18-5345 ⑥	18-5429	—	18-5259	—	—
8	283,327,348	1961-69	YL487A	18-5314	18-5338	18-5404-1	18-5376	18-5251, 18-5271 ⑥	18-5494-2 ① 18-5498-1 ② 18-5313-1 ③	18-5296
8	185,220,230	1961-69	ZD431A, YL431A ④	18-5314	18-5338	18-5411	18-5375	18-5256	—	—
8	170,220,225HP, 275CAD	1961-69	ZD345A,B, ZD345A,B	18-5314	18-5338	18-5404-1	18-5376	18-5251, 18-5271 ⑥	18-5494-2 ① 18-5498-1 ② 18-5313-1 ③	18-5296
8	283,327,409,427	1965-71	1111161	18-5310	18-5344	—	18-5384	18-5252	18-5494-2 ① 18-5498-1 ② 18-5313-1 ③	18-5296
8	302,351	1971-75	—	18-5318	—	18-5420	18-5389	—	18-5495-2 ① 18-5309-1 ③	—
8	302	1975-78	IBM7007,A	18-5303	18-5345 ⑥	18-5407	18-5369	18-5258, 18-5277 ⑥	18-5495-2 ① 18-5309-1 ③	18-5298-1
8	305,350,454	1977-82	IBM7011,D	18-5303	18-5345 ⑥	18-5407	18-5369	18-5258, 18-5277 ⑥	18-5495-2 ① 18-5309-1 ③	18-5298-1
8	305,350,454	1977-82	IBM7013	18-5303	18-5345 ⑥	18-5403	18-5352	18-5260, 18-5275 ⑥	18-5494-2 ① 18-5498-1 ② 18-5313-1 ③	18-5299
8	305,350,454	1983-87	Mallory	18-5314	18-5338	18-5404-1	18-5376	18-5251, 18-5271 ⑥	18-5494-2 ① 18-5498-1 ② 18-5313-1 ③	18-5296
8	ALL	1987-88	IDU7801B,C B.I.D.Elec. Ign.	N/A	N/A	18-5403	18-5352	N/A	—	—

② Electronic Distributor (Counter Rotation)

④ Mallory Ignition Only

⑥ Tune-Up Kit with Distributor Cap



18-5907 STARTER
(Heavy Duty) (No Core) Clockwise Top Mount Rear Entry Starter
Will not replace non-starter mounted solenoids.
For: Opposite Rotation GM & Ford Engines.
Replaces: 42090
Replacement Solenoid: **18-5837 SAEJ1171**

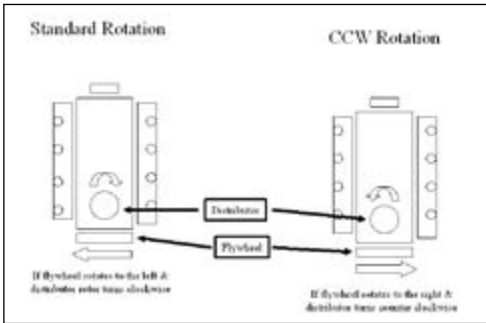

Standard Rotation CCW Rotation

If flywheel rotates to the left it distributes in the clockwise direction.

If flywheel rotates to the right it distributes in the counter clockwise direction.



18-5908 STARTER
(Heavy Duty) (No Core) Counter-Clockwise Top Mount Rear Entry Starter
For: Standard Rotation GM & Ford Engines.
Replaces: 42091
Replacement Solenoid: **18-5837 SAEJ1171**



18-6835 STARTER
Replaces: GM Engines Universal
Used on all GM Engines with either 14 1/4" or 12 3/4" flywheels



18-6834 STARTER
Replaces: GM Engines Universal
Used on all GM Engines with either 14 1/4" or 12 3/4" flywheels



18-9802 TIMING LIGHT
Self-powered accurate up to 10,000 RPM's



18-15214 RELAY, SHROUDED
Replaces: R130012
For: Fuel Pump on Crusader MEFI systems



18-5717 STARTER BRUSH SET
Replaces: 42001, 707125
Delco



18-5838 SOLENOID
Delco







18-5840 SOLENOID
Prestolite 15-79, SAW4201, SAW4207, SAW4210



18-2434 FLYWHEEL BELL HOUSING
Replaces: 96938



BRUSH SET / STARTER SWITCH APPLICATION



Year	Voltage	Original Starter No.	Brush Set	Starter Switch
1960-75	12	MDU-7015, 16	—	18-5840
1975-81	12	MEO-7044, 05	—	18-5840
1972-UP	12	96077, 96078 42031, 420036 1107710, 54, 63, 889	18-5717	18-5838

 18-5710 VOLTAGE REGULATOR Prestolite VSH-6201JY	PKG. OF 8  FREEZE PLUGS 18-5961 18-5961-9 ① 18-5962-9 ① 1 5/8" 1 3/4"	 18-7600 TEMPERATURE SENSOR Replaces: 47002	 18-7630 THROTTLE POSITION SENSOR Replaces: 47032	 18-7632-1 IDLE AIR CONTROL MOTOR Replaces: 47033
---	--	---	--	---

VOLTAGE REGULATOR APPLICATION

Year	Model	Voltage	Original Alt./Gen. No.	Voltage Regulator
1966-75	Conqueror 190, 220, 250, 320	12	ALE-5204,S	18-5710
1966-75	150, 165, 185, 190, 230, 250, 280, 320	12	ALF-5201-1, A-1,S	—
		12	ALE-5202,S	—
		12	ALK-6204A	—
		12	ALE-5204,S	18-5710

 18-7607-1 CARBURETOR (REMANUFACTURED) Replaces: Rochester 17082403 For: Rochester Carb: Crusader 454	 18-7019 CARB KIT	 18-7022 CARB KIT
---	---	---

 18-7070 CARB KIT	 18-7072 CARB KIT
--	---

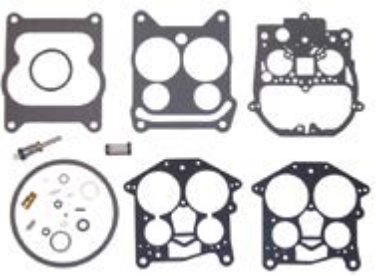
 18-7086 CARB KIT	 18-7095 CARB KIT Replaces: 45334
--	--

① Priced per Package

CARBURETOR KIT APPLICATION ON NEXT PAGE



18-7200
FLOAT
Replaces: 45303
(Alcohol Resistant)
Plastic



18-7201
FLOAT
(Alcohol Resistant)
Brass



18-7202
FLOAT
(Alcohol Resistant)
Brass

CARBURETOR KIT AND FLOAT APPLICATION

Cyl.	Model or Eng. Displacement	Mfg. Code	Carb. Model	Carburetor Number	Carb. Kit ①	Float
4	153" (2.5L)	R-2	2GC	7025082, 7028086	18-7070	18-7200
6	225" (3.7L)	R-2	2GC	7025181	18-7070	—
8	283" (4.6L), 327 (5.3L)	R-2	2GC	7024185	18-7070	—
8	305" (5.0L)	R-2	2GV	17057134	18-7086	18-7202
8	327" (5.3L), 409 (6.6L)	R-4	4GC	7020084, 085	18-7019	—
8	327" (5.3L), 409 (6.6L)	R-4	4GC	7023084, 085, 089	—	—
8	348" (5.7L)	C-4	AFB	2955	18-7022	—
8	350" (5.7L), 454 (7.4L)	R-4	4MV	17059293, 17082403	18-7095	18-7201
8	427" (7.0L)	R-4	4MV	7027081, 7028282	18-7072	18-7201

① Does Not Include Metering Rods



18-8114
FUEL LINE HOSE
UNIVERSAL
For fuel pump to carburetor connection. Replaces copper or steel tubing 3/8" X 31" PTFE composite hose with 5/8"-18 male inverted flare straight one end, 5/8"-18 90° one end. SAE J1527 type A1



18-8115
FUEL LINE HOSE
UNIVERSAL
For fuel pump to carburetor connection. Replaces copper or steel tubing 3/8" X 25" PTFE composite hose with 5/8"-18 male inverted flare straight one end, 5/8"-18 90° one end. SAE J1527 type A1



18-7231
FLAME ARRESTOR
Replaces: 97595, 97214
V-8



18-7232
FLAME ARRESTOR
Replaces: 33628
Hi-Performance



18-7256
FUEL PUMP
Replaces: 32722
(Flange I.D. #6790, M3530)
For: GM (4 & 6 Cyl.) 153, 230, 250, 292



18-7260
FUEL PUMP
(Flange I.D. #40155)
For: GM (V-8) 283, 307, 327, 350, 409



18-7267
FUEL PUMP
(Flange I.D. #41414)
For: Ford (V-8) 302



18-7268
FUEL PUMP
(Flange I.D. #41415, M6948)
For: GM (V-8) 305, 307, 350, 400
(5.25 - 6.5 PSI)
Dual Diaphragm - Requires Sight Glass

18-7270

FUEL PUMP

(Flange I.D. #41417, M73019)

For: GM (V-8) 305, 350, 400

(5.75 - 7 PSI)

Replaces: 21140

(Gasket included)



18-7272

FUEL PUMP

(Flange I.D. #41419, M73020)

For: GM (V-8) 283, 305, 350, 400

(5.75 - 6.5 PSI)

Replaces: 97039



FUEL WATER SEPARATORS



Sierra offers a complete line of 10 and 21 micron fuel water separating filters including drainable bowl filters to protect your carbureted and fuel injected engine.

Refer to pages 156-161 for a complete listing of OEM and universal applications.

Sierra fuel water separators remove over 99.8% of emulsified water from your gasoline. Sierra's 10 micron filters are over 90% efficient at removing particles as small as 10 micron. All filters flow @ 90 GPH to feed even the hungriest motor. Sierra 10 micron filters are recommended to prevent damage to sensitive inboard and outboard fuel injection systems.

Sierra #	Crusader #	Description
18-7852-1	22687	Fuel Water Separator Kit
18-7846	98041	Fuel Filter
18-7862	91606	Fuel Filter
18-7964-1		Fuel Filter
18-7717		Fuel Element (For: Rochester 2bbl & 4bbl Carburetors)



**18-3060
IMPELLER**

Replaces: 1003026, 22212

For: Ford



**18-3061
IMPELLER**

Replaces: 20300

For: GM engines with V-Belt



**18-8926
IMPELLER**

Replaces: RP061022

Fits: Crusader 5.7 & 6.0L w/ Serpentine Belt

PKG. OF 2



**18-3140
18-3140-9
WATER PUMP GASKET**

Replaces: 20502

For: Early 262, 305, 350 (ID) 454, 502



**18-3046
IMPELLER KIT**

Replaces: 1003062

Contains: 18-3060 Impeller
Diameter 2 7/16" • Side Width 1 1/4"
Use with Sherwood Pumps



**18-3047
IMPELLER KIT**

Includes 18-3061 impeller

① Priced per Package



18-3577-2
CIRCULATING WATER PUMP
 (Bi-Directional)
Replaces: 67859, 17670, 811573, 30103
For: Big block GM engines with stamped steel timing covers



18-3599-2
CIRCULATING WATER PUMP
Replaces: 20318, 7142520
For: GM V-6 & small block V-8 engines
 Uses gasket **18-0981** (included)



18-3551
THERMOSTAT
Replaces: 96319
 142°
For:

Model No.	Cubic Inch
CH190	305
CH220	305
CH270	350
CH350	454



18-3552
THERMOSTAT
Replaces: 96358
 Fresh Water Cooling Only
 160°
For:

Model No.	Cubic Inch
165	229
CH190/CH220	305
CH270	350
CH350	454

① 18-3671D

Display Package



18-3671
THERMOSTAT KIT
Replaces: 97361
 Includes Thermostat 18-3551 and 18-0875 Gasket
 142°
FOR:

Model No.	Cubic Inch
CH190	305
CH220	305
CH270	350
CH350	454



18-3649
THERMOSTAT
Replaces: 97895
 16°
 Fresh Water Cooling
 Use with 18-2917 Gasket



18-5898
SENDER
Replaces: 700427
 1/2" — 14 NPT



18-5899
OIL PRESSURE SENDER
Replaces: 700425

① 18-4456D

Display Package



18-4456
EXHAUST PROTECTOR VALVE
 Includes Stainless Steel Clamp
 3"

① 18-4457D

Display Package



18-4457
EXHAUST PROTECTOR VALVE
 Includes Stainless Steel Clamp
 4"

① 18-4458D

Display Package



18-4458
EXHAUST PROTECTOR VALVE
 Includes Stainless Steel Clamp
 5" & 6" (5" requires two 45° cuts)

① Items ending in "D" are Display Packaged - Regular number is Non-Display

Fits GM Big Block V8 454 cu. in. Models CH350 & 454XL

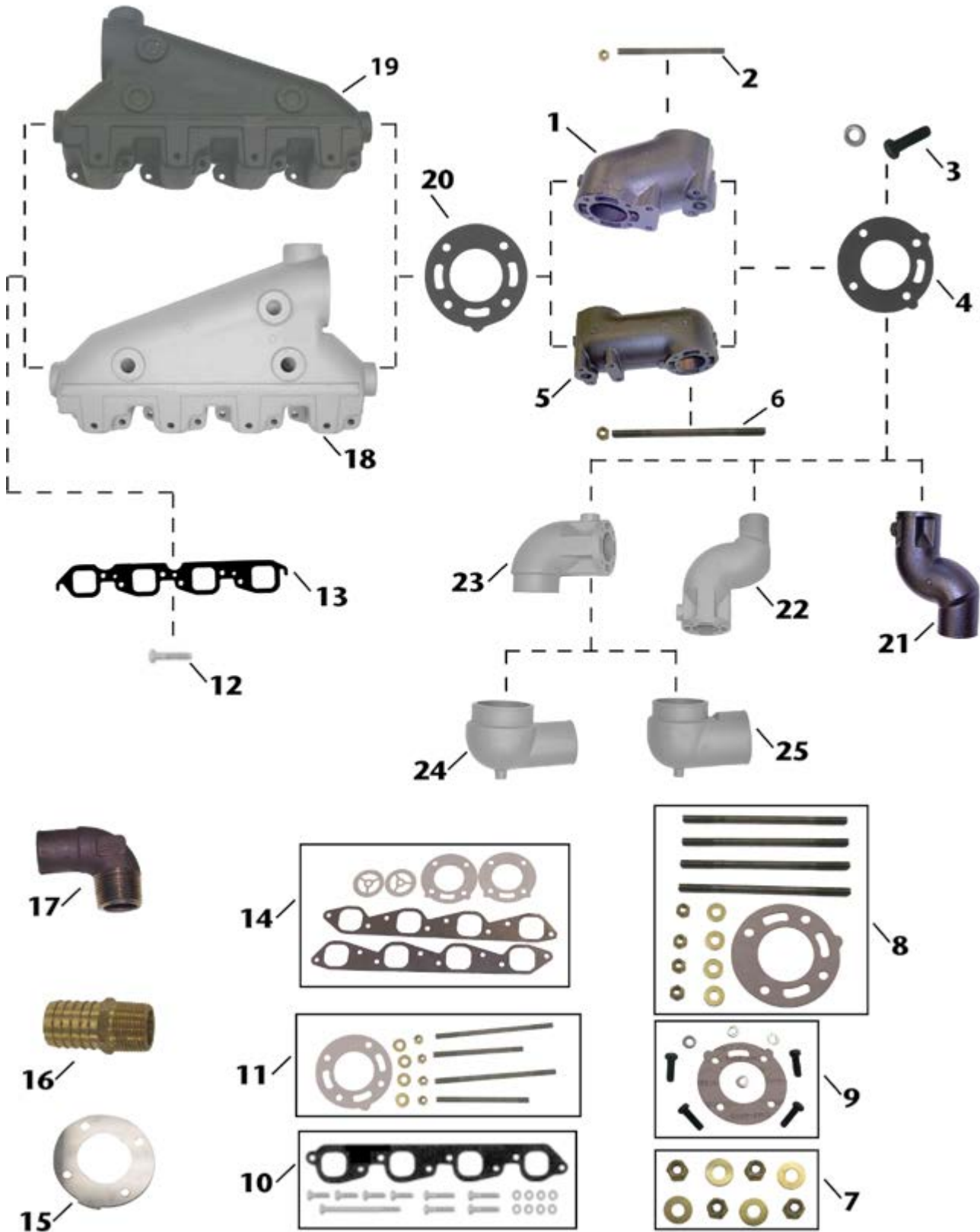

Item No.	Description	OE No.	Application
1	18-1927 4" RISER	97772	Use with Manifolds: 18-1933, & 18-1929; Elbow Gasket: 18-0309-1; Mounting Kit: 18-8523
2	NSS MOUNTING HARDWARE	N/A	Included in 18-8523 mounting kit.
3	NSS MOUNTING HARDWARE	N/A	Included in 18-8515 mounting kit.
4	18-0309-1 ELBOW GASKET	96562	Use with Exhaust Elbow: 18-1928, 18-1934, & 18-1918
5	18-1916 8" RISER	97169	Use with Manifolds: 18-1933, & 18-1929; Elbow Gasket: 18-0309-1; Mounting Kit: 18-8519
6	NSS MOUNTING HARDWARE	N/A	Included in 18-8519 mounting kit.
7	NSS WASHER & NUT KIT	N/A	Used in mounting kits: 18-8515, 18-8523, & 18-8519
8	18-8519 MOUNTING KIT	N/A	Use with Riser: 18-1916
9	18-8515 MOUNTING KIT	N/A	Use with Elbows: 18-1934, 18-1928, 18-1918
10	18-8524 MOUNTING KIT	N/A	Use with Manifolds: 18-1929 & 18-1933
11	18-8523 MOUNTING KIT	N/A	Use with Riser: 18-1927
12	NSS MOUNTING BOLT	N/A	Included in 18-8524 mounting kit.
13	18-0418 MANIFOLD GASKET	96653	Use with Manifold: 18-1929, 18-1933
14	18-0601 EXHAUST MANIFOLD GASKET SET	N/A	For: "CH" Model Big Block (V8) Chevy 454 CID (7.4L); Use with Manifolds: 18-1929, & 18-1933
15	18-1917 BLOCK OFF PLATE (STAINLESS)	97296	Use with Elbow/Riser Gasket: 18-0309-1, 18-0305-1
16	18-4461 HOSE FITTING	N/A	3/4" - 14NPT X 1" Hose (Corrosion Resistant Brass Fitting)
17	18-8112 HOSE FITTING	97296; 97854	90 degree fitting. Thread Size: 1" NPT X 1 1/4" Hose Barb
18	18-1929 MANIFOLD (STARBOARD)	97992, 97114	GM Big Block (V8) 454 cu.in. (Models CH350 & 454XL)(Starboard); Use with Manifold Gasket: 18-0418; Mounting Kit: 18-8524
19	NSS MANIFOLD (PORT)	97993, 97115	GM Big Block (V8) 454 cu.in. (Models CH350 & 454XL)(Port); Use with Manifold Gasket: 18-0418; Mounting Kit: 18-8524
20	18-0305-1 ELBOW GASKET	96108	Use with Exhaust Manifold: 18-1929, & 18-1933. Included in 18-8515 mounting kit.
21	18-1928 ELBOW W/ 4" OUTLET	97924	Use with Riser: 18-1927 or 18-1916; Elbow Gasket: 18-0309-1; Mounting Kit: 18-8515
22	18-1934 ELBOW W/ 3" OUTLET	98068	Use with Riser: 18-1927 or 18-1916; Elbow Gasket: 18-0309-1; Mounting Kit: 18-8515
23	18-1918 ELBOW W/ 2 1/2" INLET	97386	Use with Riser: 18-1927 or 18-1916; Elbow Gasket: 18-0309-1; Mounting Kit: 18-8515
24	18-1919 RE-DIRECTION ELBOW W/ 3" OUTLET	97387	Use with Elbow: 18-1918
25	18-1924 RE-DIRECTION ELBOW W/ 4" OUTLET	97624	Use with Elbow: 18-1918



**Fits GM Big Block V8 454 cu. in.
Models 454XL & 502XL**

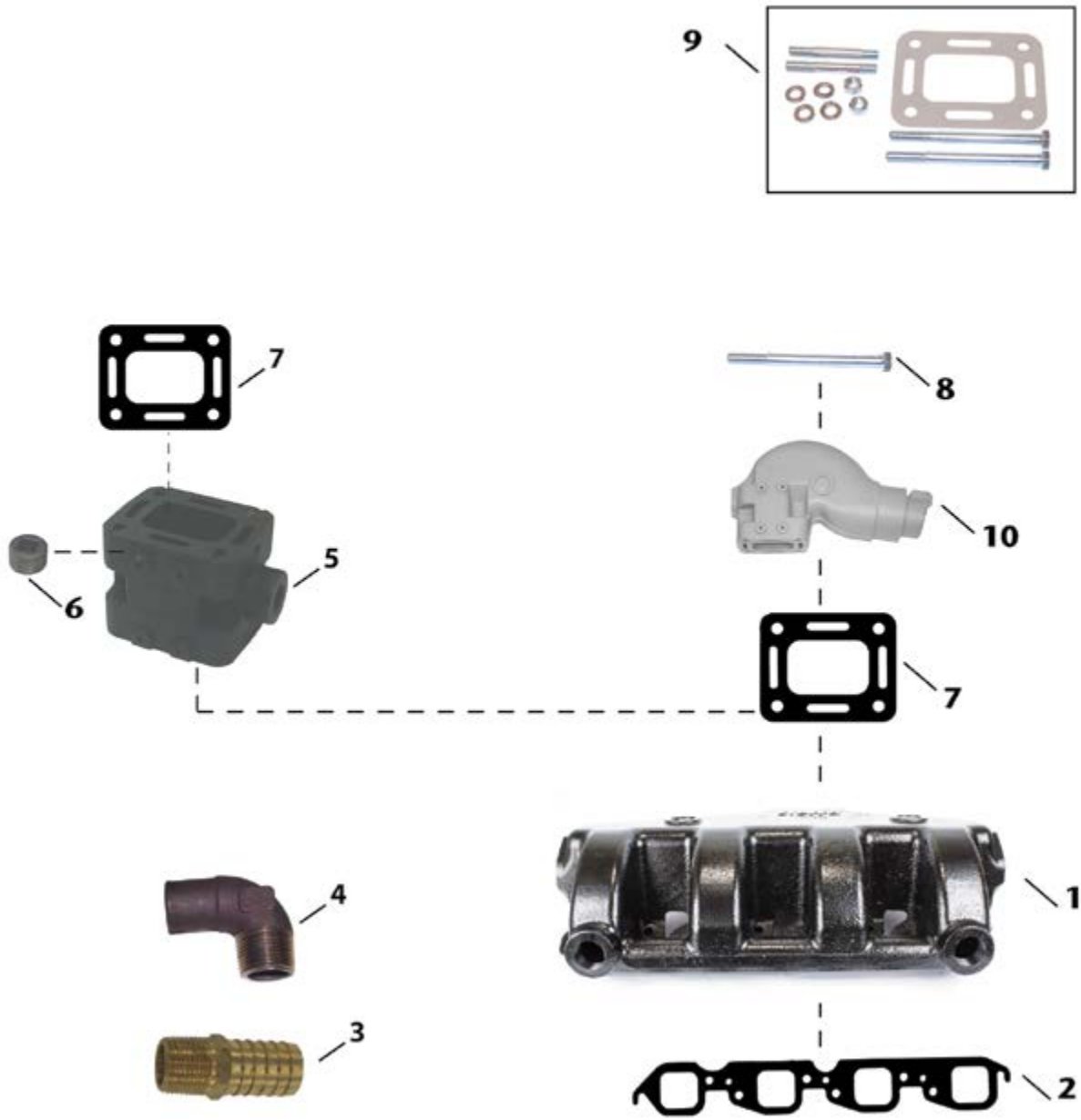

Item No.	Description	OE No.	Application	
1	18-1982	MANIFOLD	98125	GM Big Block (V8) 454-502 cu.in. (Port & Starboard); Use with Manifold Gasket: 18-0418
2	18-0418	MANIFOLD GASKET	96653	Use with Manifold: 18-1982.
3	18-4461	HOSE FITTING	N/A	3/4" - 14NPT X 1" Hose (Corrosion Resistant Brass Fitting)
4	18-8112	HOSE FITTING	97296; 97854	90 degree fitting. Thread Size: 1" NPT X 1 1/4"
5	18-1984	MANIFOLD SPACER	98128	Use with Elbow Gasket: 18-0475-1
6	18-4258	BLACKSTEEL PLUG	113186	Thread Size: 3/4" NPT X 1". Use with Spacer: 18-1984
7	18-0475-1	ELBOW GASKET (OPEN)	98127	Open gasket for universal elbow; Use with Riser: 18-1938
8	NSS	MOUNTING BOLT	N/A	Included in 18-8547 mounting kit.
9	18-8547	MOUNTING KIT	N/A	Use with Riser: 18-1938. Includes 18-0475-1 gasket.
10	18-1938	RISER	98126	Use with Manifold: 18-1982; Riser Gasket: 18-0475-1; Mounting Kit 18-8547

Fits GM Small Block V8 305-350 cu. in. Models 220 & 270

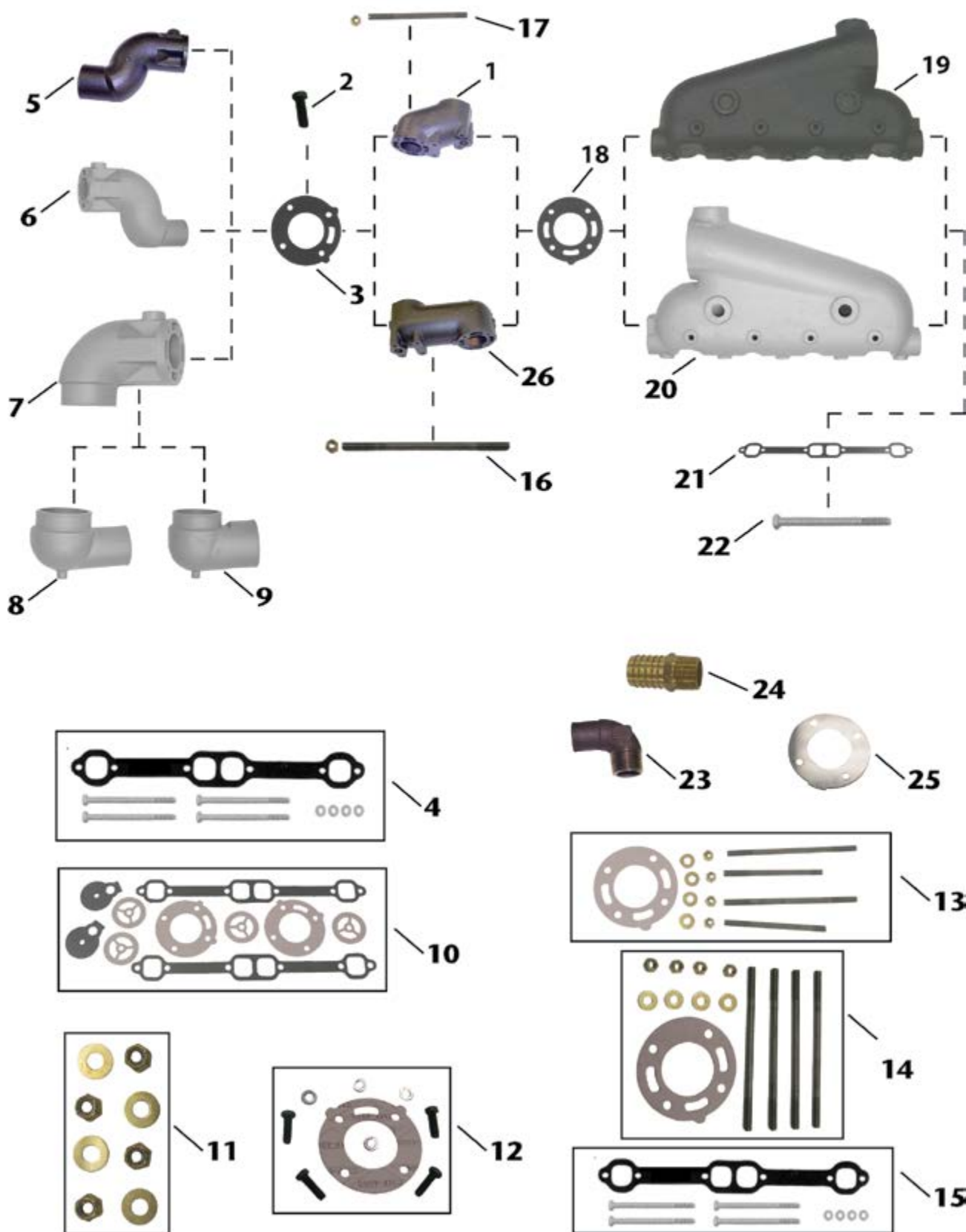

SEE NEXT PAGE FOR APPLICATION CHART

Item No.	Description	OE No.	Application	
1	18-1927	4" RISER	97772	Use with Manifold: 18-1925, 18-1926, 18-1933, & 18-1929; Elbow Gasket: 18-0309-1; Mounting Kit: 18-8523
2	NSS	MOUNTING BOLT	N/A	Included in 18-8515 mounting kit.
3	18-0309-1	ELBOW GASKET	96562	Use with Exhaust Elbow: 18-1927, or 18-1916. Included in 18-8515 mounting kit.
4	—	MOUNTING KIT	N/A	Use with Manifold: 18-1926 w/ alternator bracket
5	18-1928	ELBOW W/ 4" OUTLET	97924	Use with Manifold: 18-1925, 18-1926; Elbow Gasket: 18-0309-1; Mounting Kit: 18-8515
6	18-1934	ELBOW W/ 3" OUTLET	98068	Use with Manifold: 18-1925, 18-1926; Elbow Gasket: 18-0309-1; Mounting Kit: 18-8515
7	18-1918	ELBOW W/ 2 1/2" INLET	97386	Use with Manifold: 18-1925, 18-1926; Elbow Gasket: 18-0309-1; Mounting Kit: 18-8515
8	18-1919	RE-DIRECTION ELBOW W/ 3" OUTLET	97387	Use with Elbow: 18-1918
9	18-1924	RE-DIRECTION ELBOW W/ 4" OUTLET	97624	Use with Elbow: 18-1918
10	18-0602-1	EXHAUST MANIFOLD GASKET SET	N/A	For: "CH" Model Small Block (V8) Chevy 305 CID (5.0L) & 350 CID (5.7L)
11	NSS	WASHER & NUT KIT	N/A	Used in mounting kits: 18-8515, 18-8523, & 18-8519
12	18-8515	MOUNTING KIT	N/A	Use with Elbows: 18-1934, 18-1928, 18-1918
13	18-8523	MOUNTING KIT	N/A	Use with Riser: 18-1927
14	18-8519	MOUNTING KIT	N/A	Use with Riser: 18-1916
15	18-8521	MOUNTING KIT	N/A	Use with Manifold: 18-1925 & 18-1926
16	NSS	MOUNTING STUD	N/A	Included in 18-8519 mounting kit
17	NSS	MOUNTING STUD	N/A	Included in 18-8523 mounting kit
18	18-0305-1	ELBOW GASKET	96108	Use with Exhaust Manifolds: 18-1925 & 18-1926
19	18-1926	MANIFOLD (PORT)	97753, 96121	GM Small Block (V8) 305-351 cu.in. (Models: 220 & 270) (Port); Use with Manifold Gasket: 18-2949; Mounting Kit: 18-8521 (if manifold has alternator bracket)
20	NSS	MANIFOLD (STARBOARD)	97752, 96120	GM Small Block (V8) 305-351 cu.in. (Models: 220 & 270) (Starboard); Use with Manifold Gasket: 18-2949; Mounting Kit: 18-8521
21	18-2949	MANIFOLD GASKET	96306	Use with Manifolds: 18-1925 & 18-1926
22	NSS	MOUNTING BOLT	N/A	Included in 18-8521 mounting kits
23	18-8112	HOSE FITTING	97296; 97854	90 degree fitting. Thread Size: 1" NPT X 1 1/4"
24	18-4461	HOSE FITTING	N/A	3/4" - 14NPT X 1" Hose (Corrosion Resistant Brass Fitting)
25	18-1917	BLOCK OFF PLATE (STAIN-LESS)	97296	Use with Elbow/Riser Gaskets: 18-0309-1, 18-0305-1
26	18-1916	8" RISER	97169	Use with Manifolds: 18-1925, 18-1926; Elbow Gasket: 18-0309-1;



SIERRA MANIFOLDS ARE PAINTED, PACKAGED & LEAK TESTED



**18-1997-1
MANIFOLD**
Port & Starboard
Replaces: Barr CHV-1-83
Universal Center Riser Manifold
FITS:
283 and 327 CID engines thru 1964; 305, 307
and 350 CID engines 1965 and later
Use with:
Exhaust Manifold Gasket Set: 18-0604
***For Exploded View - See Pages 658-659**



**18-1998-1
MANIFOLD**
Port & Starboard
Replaces: Barr FM-1-83
Universal Center Riser Manifold
FITS:
302 and 351 CID engines
Comes with 18-4363 Mounting Package
Use with:
Exhaust Manifold Gasket Set: 18-0603
***For Exploded View - See Pages 660-661**



**18-1999
ELBOW**
Replaces: Barr 20-0082
Comes with 18-4364 open
If blocked mounting kit is required use 18-8535
Use with:
Manifold: 18-1997-1 or 18-1998-1 or 18-1898
Riser Gasket: 18-2854-1 open



**18-1982
MANIFOLD**
Port & Starboard
Replaces: Crusader 98125
Use:
Exhaust Manifold Gasket: 18-0418
For: GM Big Block V-8 454-502 ci



**18-1929
MANIFOLD**
Starboard
Replaces: Crusader 97992, 97114
Crusader GM Big Block V8 454cu.in.
(Models: CH350 and 454XL)
Use with:
Exhaust Manifold Gasket: 18-0418
Mounting Kit: 18-8524



**18-1933
MANIFOLD**
Port
Replaces: Crusader 97993, 97115
Crusader GM Big Block V8 454cu.in.
(Models: CH350 and 454XL)
Use with:
Exhaust Manifold Gasket: 18-0418
Mounting Kit: 18-8524



**18-1926
MANIFOLD**
Port
Replaces: Crusader 97753, 96121
Crusader GM Small Block V8 305-350-cu.in.
(Models: 220 and 270)
Use with:
Exhaust Manifold Gasket: 18-2949
Mounting Kit: 18-8521 (if manifold has alternator bracket)



**18-1898
MANIFOLD**
Port & Starboard
Replaces: Barr CHVA-1-84
Marine Power 0991-110
Fits: 454 cu.in. GM big block V8 engines
Use with:
Exhaust Manifold Gasket: 18-0418
Riser Gasket: 18-2854-1 open or 18-0476-1 blocked

***For Exploded View
See Pages 656**



18-1991
ELBOW ADAPTER
Replaces: Barr 200089P
For: 3" I.D. Exhaust Hose
Use with:
Manifold Riser: 18-1999
30°



18-1992-1
ELBOW ADAPTER
Replaces: Barr 200087P
For: 3" I.D. Exhaust Hose
 (As used in 18-1987 Exhaust Manifold Conversion Kit)
80°



18-1919
RE-DIRECTION ELBOW W/ 3" OUTLET
Replaces: Crusader 97387
 Crusader GM Small Block V8 305-350-cu.in.
 (Models: 220 and 270), GM Big Block V8 454cu.in.
 (Models: CH350 and 454XL)
Use with:
Elbow: 18-1918



18-1924
RE-DIRECTION ELBOW W/ 4" OUTLET
Replaces: Crusader 97624
 Crusader GM Small Block V8 305-350-cu.in.
 (Models: 220 and 270), GM Big Block V8 454cu.in.
 (Models: CH350 and 454XL)
Use with:
Elbow: 18-1918



18-1928
ELBOW W/ 4" OUTLET
Replaces: Crusader 97924
 Crusader GM Small Block V8 305-350cu.in. (Models: 220 and 270), GM Big Block V8 454cu.in.(Models: CH350 and 454XL)
4" Hose
Use with:
Manifold: 18-1925, 18-1926, 18-1933, 18-1929
Elbow Gasket: 18-0309-1
Mounting Kit: 18-8515



18-1934
ELBOW W/ 3" OUTLET
Replaces: Crusader 98068
 Crusader GM Small Block V8 305-350cu.in.(Models 220 and 270), GM Big Block V8 454cu.in.(Models: CH350 and 454XL)
3" Hose
Use with:
Manifold: 18-1925, 18-1926, 18-1933, 18-1929
Elbow Gasket: 18-0309-1
Mounting Kit: 18-8515



18-1918
ELBOW
Replaces: Crusader 97386
 Crusader GM Small Block V8 305-350-cu.in.
 (Models: 220 and 270), GM Big Block V8 454cu.in.
 (Models: CH350 and 454XL)
2 1/2" Inlet
Use with:
Manifold: 18-1925, 18-1926, 18-1933, 18-1929
Elbow Gasket: 18-0309-1
Mounting Kit: 18-8515
Re-direction Elbow: 18-1919, 18-1924



18-1916
8" RISER
Replaces: Crusader 97169
 Crusader Small Block V8 305-350-cu.in.
 (Models: 220 and 270), GM Big Block V8 454cu.in.
 (Models: CH350 and 454XL).
Use with:
Manifold: 18-1925, 18-1926, 18-1933, 18-1929
Riser Gasket: 18-0305-1
Mounting Kit: 18-8519



18-1927
4" RISER
Replaces: Crusader 97772
 Crusader Small Block V8 305-350-cu.in.
 (Models: 220 and 270), GM Big Block V8 454cu.in.
 (Models: CH350 and 454XL).
Use with:
Manifold: 18-1925, 18-1926, 18-1933, 18-1929
Riser Gasket: 18-0305-1
Mounting Kit: 18-8523



18-1938
RISER
Replaces: Crusader 98126, RO29015
 Crusader GM Small Block V8 305-350cu.in.(Models: CM305, CM350XL and CM350HT), GM Big Block V8 454cu.in.(Models: 454XL and 502XL)
Use with:
Manifold: 18-1982, Crusader 98243
Riser Gasket: 18-0475-1
Mounting Kit: 18-8547



**18-1907
RISER (3")**

Replaces: Barr 20-0102
Barr and Indmar Ford Small Block V8 302-351cu.in.
Indmar 53-2009 and 53-2018

Use with:
Manifold: 18-1997-1, 18-1998-1
Riser Gasket: 18-2854-1 open or 18-0476-1 blocked
Mounting Kit: 18-4364 open or 18-8535 blocked



**18-1939
RISER (4")**

Replaces: Barr 20-0100, Marine Power 0992-593
Barr, Indmar and Marine Power Ford Small Block
V8 302-351cu.in., GM Small Block V8 305-350cu.in.,
GM Big Block V8 454cu.in.

Use with:
Manifold: 18-1997-1, 18-1998-1, 18-1898
Riser Gasket: 18-2854-1 open or 18-0476-1 blocked
Mounting Kit: 18-4364 open or 18-8535 blocked



**18-8112
HOSE FITTING (90°)**

Replaces: Crusader 97854
GM Small Block V8 305-350cu.in. (Models: 220,
270, CM305, CM350XL, CM350HT), GM Big Block
V8 454 cu.in. (Models: 454XL, 502XL, CH350, 454XL)
Thread size: 1" NPT x 1 1/4" hose barb

Use with:
Manifold: 18-1997-1, 18-1998-1, 18-1982, Crusader 98243,
18-1929, 18-1933, 18-1925, 18-1926, 18-1898

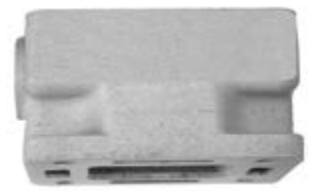

**18-1949
MANIFOLD SPACER (3")**

Replaces: Barr CM 20-0097
Barr, Indmar and Marine Power Ford Small Block
V8 302-351cu.in., GM Small Block V8 305-350cu.in.,
GM Big Block V8 454cu.in.

Use with:
Manifolds: 18-1998-1, 18-1997-1 and 18-1898



**18-1984
MANIFOLD SPACER**

Replaces: 98128
For: GM Small Block V8 305-350 cu.in., GM Big Block V8



**18-4364 (Open)
EXHAUST ELBOW MOUNTING KIT**

Replaces: Barr 20-0082-P
Use with:
Risers: 18-1999, 18-1907, 18-1939



**18-8515
EXHAUST MANIFOLD MOUNTING KIT**

Crusader GM Small Block V8 305-350cu.in.(Models: 220, 270), GM Big Block
V8 454cu.in. (Models: CH350, 454XL)
Used with:
Elbows: 18-1934, 18-1928, 18-1918



**18-8519
EXHAUST MOUNTING KIT**

Crusader GM Small Block V8 305-350cu.in.(Models: 220,
270), GM Big Block V8 454cu.in.
(Models: CH350, 454XL)
Used with:
Riser: 18-1916



**18-8521
EXHAUST MANIFOLD MOUNTING KIT**

Crusader GM Small Block V8 305-350cu.in. (Models: 220, 270)
Used with:
Manifold: 18-1925 & 18-1926

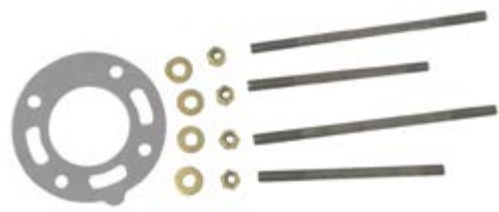

**18-8523
EXHAUST ELBOW MOUNTING KIT**

Crusader GM Small Block V8 305-350cu.in. (Models: 220, 270), GM Big Block V8
454cu.in.(Models: CH350, 454XL)
Used with:
Riser: 18-1927



18-8524
EXHAUST MANIFOLD MOUNTING KIT

Crusader GM Big Block V8 454cu.in.
(Models: CH350 and 454XL)
Used with:
Manifolds: 18-1929 and 18-1933



18-8535
(CLOSED)
EXHAUST ELBOW MOUNTING KIT

Barr, Indmar and Marine Power Ford Small Block V8 302-351cu.in., GM Small Block V8 305-350cu.in., GM Big Block V8 454cu.in.
Used with:
Risers: 18-1939, 18-1999, and 18-1907 Blocked



18-8536
EXHAUST ELBOW MOUNTING KIT

Barr, Indmar and Marine Power GM Small Block V8 305-350cu.in.
Used with:
Manifold: 18-1997-1



18-8538
EXHAUST MANIFOLD MOUNTING KIT

Barr and Indmar Ford Small Block V8 302-351cu.in.
Used with:
Manifold: 18-1998-1

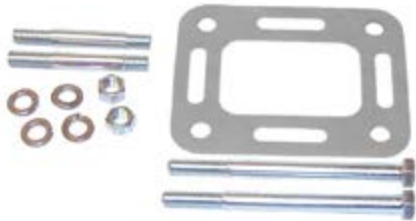

18-8547
EXHAUST ELBOW MOUNTING KIT

For: GM SB V8 305-350cu.in.
GM BB V8 454 cu. in.
Used with:
Riser: 18-1938



Display Package

18-4461
HOSE BARB
3/4" - 14 NPT x 1" Hose
Corrosion Resistant Brass Fitting



PIPE PLUGS

Part #	Thread Size	Part #	Thread Size
18-4256	1/4"	18-4263	1/8" - 27 NPT
18-4257	1/4"	18-4264	3/8" - 18 NPT
18-4258	3/4"		



①18-4218D

Display Package

18-4218
DRAIN TAP
Used with:
Most O.E.M. Manifolds
18-3223-9 Bulk Pack of 12
1/4" Brass

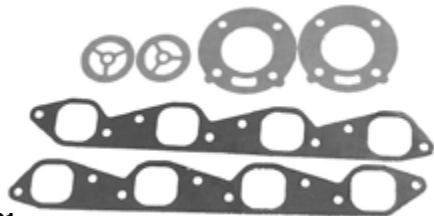

18-0601
EXHAUST MANIFOLD GASKET SET

For: "CH" Model Big Block V-8 Chevy 454 CID (7.4L)
Use with:
Manifolds: 18-1929, 18-1933

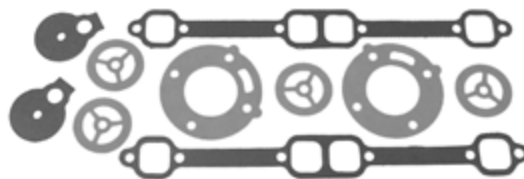

18-0602-1
EXHAUST MANIFOLD GASKET SET

For: "CH" Model Small Block V-8 Chevy 305 CID (5.0L) & 350 CID (5.7L)
Superseded from 18-0602

① Items ending in "D" are Display Packaged - Regular number is Non-Display



18-0603
EXHAUST MANIFOLD GASKET SET

For: Ford 302/351 CID Engines
Use with:
Manifold: 18-1998-1

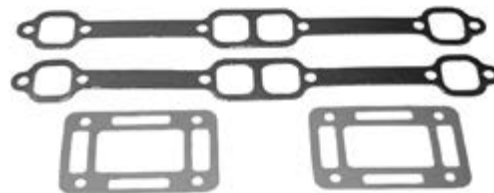

18-0604
EXHAUST MANIFOLD GASKET SET

For: GM 305/350 CID Engines
Use with:
Manifold: 18-1997-1



18-0183-1
EXHAUST MANIFOLD GASKET

Used with:
Manifold: 18-1998-1



18-0305-1
EXHAUST ELBOW GASKET

Replaces: 96108
Use with:
Exhaust Manifold: 18-1929



18-0309-1
EXHAUST ELBOW GASKET

Replaces: 96562
Use with:
Exhaust Elbow: 18-1928
V-6/V-8

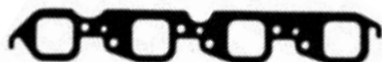

18-0418
EXHAUST MANIFOLD GASKET

Replaces: 96653
Use with:
Manifold: 18-1957-2, 18-1982,
18-1929, 18-1933, 18-1898



18-0475-1
EXHAUST ELBOW GASKET

Used with:
Riser: 18-1938
Manifold: Crusader 98243



18-0476-1
BLOCK OFF GASKET

Barr, Indmar & MarinePower
Ford Small Block V8 302-351cu.in.
Used with:
Risers: 18-1939, 18-1999 and 18-1907
Blocked



18-1917
MANIFOLD BLOCK OFF PLATE (STAINLESS)

Replaces: 97296
Crusader Small Block V8 305-350 cu.in. (Models: 220 and 270), GM Big Block V8 454cu.in. (Models: CH350 and 454XL)
Use with:
Elbow/Riser Gasket: 18-0309-1, 18-0305-1

PKG. OF 2



18-2854-1 (Open)
18-2854-9^①
EXHAUST RISER GASKET

Replaces: Barr 01-0107
Use with:
Riser: 18-1999, 18-1907, 18-1939

PKG. OF 2



18-2909
18-2909-9^①
EXHAUST MANIFOLD GASKET

Replaces: 97498
For: GM V-6
Use with:
Manifold: 18-1952-1, 18-1932

PKG. OF 2



18-2949
18-2949-9^①
EXHAUST MANIFOLD GASKET

Replaces: 96306
Barr CHV-47-000
Use with:
18-1997-1



18-0306-1
ELBOW AND CUP GASKET

Replaces: 96216
V-6/V-8

① Priced per Package



OIL FILTERS

Part #	Replaces:	
18-7824-2 (Short)	201104	GM Engines + SS330 Remote Mount
18-7875 (Long)	9002514	Ford Engines
18-7876-1 (Long)	201104	GM Engines + SS330 Remote Mount
18-7878-1 (Short)	—	220, 300, 320, 325 Remote Mount

SEE PAGES 203-205 & 1155-1183 FOR ADDITIONAL INFORMATION

18-0311
262 CID
VALVE COVER GASKET
 Replaces: 97686

PKG. OF 2

18-0875
18-0875-9^①
THERMOSTAT GASKET

PKG. OF 2

18-0976
18-0976-9^①
TIMING CHAIN COVER GASKET
 Replaces: 20129

18-2845
VALVE COVER GASKET
 Replaces: 91351
 V-8

18-3874
HEAD GASKET
 Replaces: 31137
 For: (8.2L) 502 CID/7.4L

18-3876
HEAD GASKET
 Replaces: 7057500
 For: GM 305 (5.0L)/350 (5.7L) CID Eng.

18-3877
HEAD GASKET
 Replaces: 30266
 For: GM 454 (7.4L) CID Eng.

18-3879
HEAD GASKET
 Replaces: 33408

18-3887
HEAD GASKET
 Replaces: 31136
 For: (7.4L) 454 CID GEN V

^① Priced per Package



18-5303
CONTACT SET
Replaces: 751007



18-5345
CONDENSER
Replaces: 755017



18-5407
ROTOR

PARTS FOR CONTACT CONTROLLED DISTRIBUTORS

Year	Cyl.	Model / Engine	Distributor	Contact Set	Condenser	Rotor
1979	8	All	IBM-7010	—	18-5345	18-5407
			IBM-7011	18-5303	18-5345	18-5407



18-5268
TUNE-UP KIT



18-5271
TUNE-UP KIT



18-5275
TUNE-UP KIT



18-5276
TUNE-UP KIT



18-5277
TUNE-UP KIT
Replaces: 755021



18-5278
TUNE-UP KIT



18-5279
TUNE-UP KIT



18-5280
TUNE-UP KIT



18-5281
TUNE-UP KIT



18-5283
TUNE-UP KIT

PARTS FOR IGNITION - TUNE-UP KITS

Cyl.	Ignition System	Tune-Up Kit	Cyl.	Ignition System	Tune-Up Kit
In-Line 4	Delco Single Point	18-5268	In-Line 4	Delco EST	18-5280
V-8	Mallory Single Point	18-5271	V-6	Delco EST	18-5278
V-8	Prestolite Single Point - Screw Down Cap	18-5275	V-8	Delco EST	18-5281
V-6	Prestolite Single Point - Screw Down Cap	18-5276	In-Line 4	Mallory Single Point	18-5283
V-8	Prestolite Single Point - Clip Down Cap	18-5277	V-8	Prestolite Electronic	18-5279

PREMIUM MARINE IGNITION WIRES

Sierra's **MAGFORCE** Ignition Wires are "Electronics Friendly" protecting all of your electronic devices and electronic engine controls from RFI and EMI while delivering the maximum amount of voltage. Exact fit design ensures easy installation and years of trouble - free service.

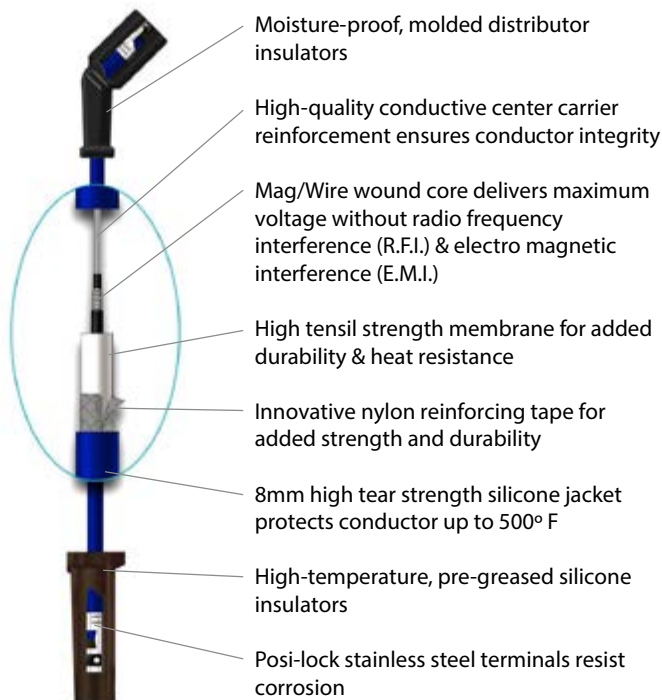

INDMAR MARINE IGNITION WIRES APPLICATION

Engine	Cyl.	Distributor	Year Start	Year Stop	Plug Wire Set
140	8	Prestolite	Up to	1993	18-8803-2
200	8	Prestolite	Up to	1993	18-8803-2
225	8	Prestolite	Up to	1993	18-8803-2
250	8	Prestolite	Up to	1993	18-8803-2
275	8	Prestolite/Mallory	Up to	1993	18-8803-2
300	8	Prestolite/Mallory	Up to	1993	18-8803-2
350	8	Prestolite/Mallory	Up to	1993	18-8803-2
400	8	Prestolite/Mallory	Up to	1993	18-8803-2
5.7L EFI	8	Delco EST	1994	2009	18-8836-1
5.7L EFI	8	Delco HVS	2007	& Up	18-8828-1
6.0L EFI	8	Distributorless	2003	& Up	18-8838-1
6.2L EFI	8	Distributorless	2010	& Up	18-8838-1
454 Carbureted (7.4L)	8	Delco EST	1994	2011	18-8824-1
8.1L Vortec	8	Distributorless	2003	2011	18-8838-1
502 Carbureted (8.2L)	8	Delco EST	1994	2011	18-8824-1



18-5480
COMPLETE IGNITION CONVERSION KIT
 Fits: GM SB & BB with Standard Deck Height



18-5433
IGNITION COIL
Has external resistor



18-5450
COIL RESISTOR
1.5 OHM

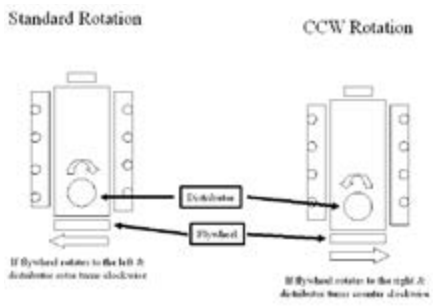

COIL AND RESISTOR

Year	Model or Engine	Service Coil	Resistor
1979	12 Volt w/ 2-Prong Resistor	18-5433	18-5450



18-5603
STARTER
Replaces: 573001
Noseless: CCW Top mount rear entry starter for standard rotation GM & Ford engines. Can be used in place of 18-5908



18-6835
STARTER
Replaces: GM Engines Universal
Used on all GM Engines with either 14 1/4" or 12 3/4" flywheels



18-5984
ALTERNATOR
Replaces: 575011
75I/70 amp, Spool Mount, Serpentine Pulley



18-6288
ALTERNATOR
Replaces: 575010
75I/70 amp, Spool Mount, Single Groove V-Belt Pulley



18-6451
ALTERNATOR
Replaces: 575014
11SI/95 amp Spool Mount, serpentine pulley
Fits: GM LS Engines



18-32150
OXYGEN SENSOR
Replaces: Indmar / Pleaurecraft / Mastercraft
Fits: GM New Generation Ls Series Small Block



18-32151
OXYGEN SENSOR
Replaces: Indmar / Malibu / Ilmor
Fits: GM New Generation Ls Series Small Block



18-32152
OXYGEN SENSOR
Replaces: Indmar / Malibu / Ilmor S556162
4-Wire; Used on ETXCAT Exhaust Manifolds for both pre and post catalyst locations (Except Ford 6.2L engines, sensor is used post catalyst only)

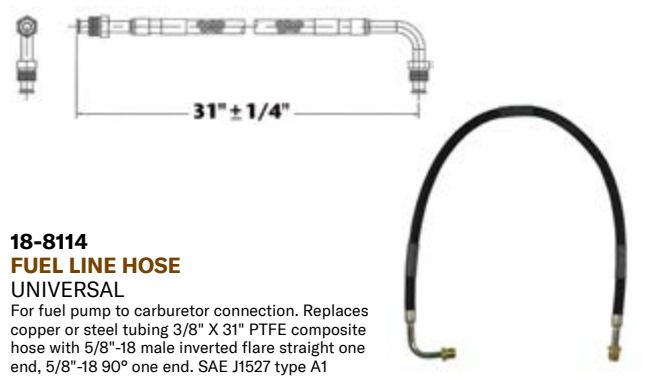

18-8114
FUEL LINE HOSE
UNIVERSAL
For fuel pump to carburetor connection. Replaces copper or steel tubing 3/8" X 31" PTFE composite hose with 5/8"-18 male inverted flare straight one end, 5/8"-18 90° one end. SAE J1527 type A1

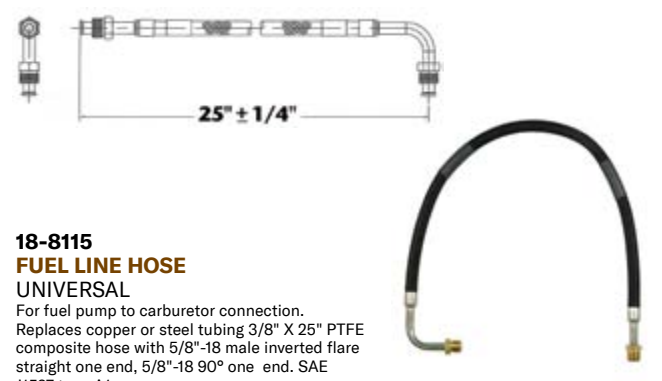

18-8115
FUEL LINE HOSE
UNIVERSAL
For fuel pump to carburetor connection. Replaces copper or steel tubing 3/8" X 25" PTFE composite hose with 5/8"-18 male inverted flare straight one end, 5/8"-18 90° one end. SAE J1527 type A1

FUEL WATER SEPARATORS



Sierra offers a complete line of 10 and 21 micron fuel water separating filters including drainable bowl filters to protect your carbureted and fuel injected engine.

Refer to pages 156-161 for a complete listing of OEM and universal applications.

Sierra fuel water separators remove over 99.8% of emulsified water from your gasoline. Sierra's 10 micron filters are over 90% efficient at removing particles as small as 10 micron. All filters flow @ 90 GPH to feed even the hungriest motor. Sierra 10 micron filters are recommended to prevent damage to sensitive inboard and outboard fuel injection systems.



18-8215
HOSE BARB
Fits: Chrysler V8



18-3586-1
WATER PUMP
Replaces: Indmar 685011
Use Impeller Repair Kit: **18-3081**



18-3587-1
WATER PUMP
Replaces: Indmar 685001
Use Impeller Repair Kit: **18-3089**



18-42608
WATER CIRCULATING PUMP
Replaces: Indmar S556050
Fits: Indmar/PCM 6.0L



18-43017
THERMOSTAT
Replaces: Indmar S985009
Fits: Mercruiser 496 Mag & HO, 8.1L MIE & HO



18-0603
EXHAUST MANIFOLD GASKET SET

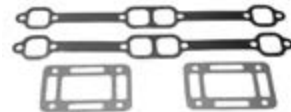

18-0604
EXHAUST MANIFOLD GASKET SET

PKG. OF 2



18-0665
18-0665-9
THERMOSTAT GASKET
Replaces: 98-5006



18-0476-1
RISER BLOCKOFF GASKET
Replaces: Barr 1-0105



18-8779
OIL FILTER
Replaces: Indmar 872025
Fits: 6.2L Ford Engines 2015-2016

MISCELLANEOUS GASKETS

Model or Engine	Gasket Set	Type	O.E. #	Gasket
Ford 302/350 CID Engines	18-0603	Thermostat	98-5006	18-0665
GM 305/350 CID Engines	18-0604	Block Off (For: Small block GM & Ford V-8 (Use with 18-1999 Manifold)	Barr 1-0105	18-0476-1

① Priced per Package

PREMIUM MARINE IGNITION WIRES

Sierra's MAGFORCE Ignition Wires are "Electronics Friendly" protecting all of your electronic devices and electronic engine controls from RFI and EMI while delivering the maximum amount of voltage. Exact fit design ensures easy installation and years of trouble - free service.

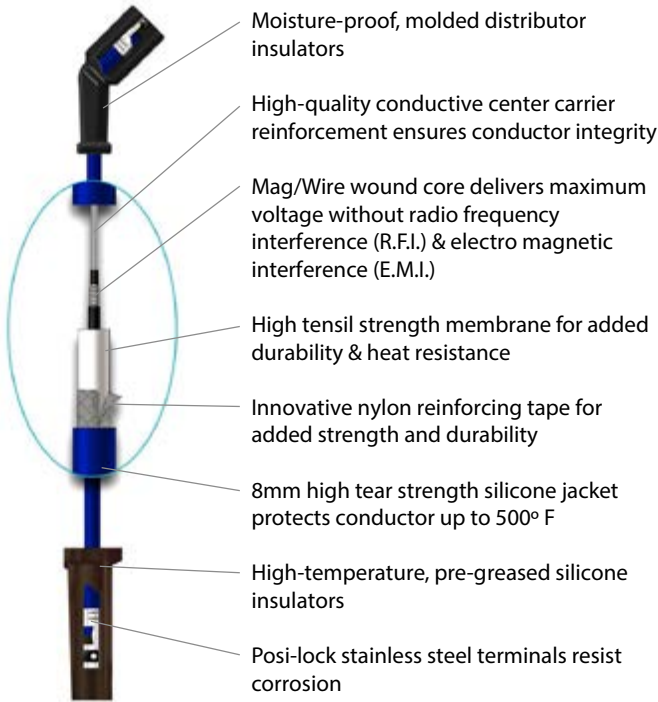

MARINE POWER IGNITION WIRES APPLICATION

Engine	Cyl.	Distributor	Year Start	Year Stop	Plug Wire Set
181	4	Delco	1986	1992	18-8800-1
262	6	Prestolite ②	1986	1992	18-8801-1
350	8	Prestolite ②	1986	1992	18-8802-1
350	8	Mallory	1986	1992	18-8802-1
3.0L	4	Delco EST	1993	& Up	18-8833-1
4.3L	6	Delco EST	1993	& Up	18-8835-1
4.3L	6	Delco HVS	2005	& Up	18-8829-1
5.0L	8	Delco EST	1993	2005	18-8822-1
5.0L	8	Delco HVS	2005	& Up	18-8828-1
5.7L	8	Delco EST	1993	2005	18-8822-1
5.7L	8	Delco HVS	2005	& Up	18-8828-1
7.4L	8	Delco EST	1993	2000	18-8832-1
8.2L	8	Delco EST	1993	2000	18-8832-1

② Screw down cap



Standard Rotation

CCW Rotation

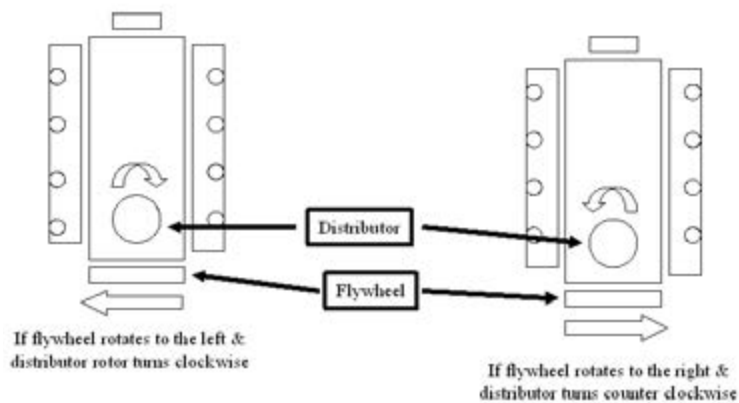

If flywheel rotates to the left & distributor rotor turns clockwise

If flywheel rotates to the right & distributor turns counter clockwise



18-6299
ALTERNATOR

Replaces: 402001
7SI/70 amp, Spool Mount, Larger 2 Groove Pulley



18-5603-1
STARTER

Replaces: 0170-000
Noseless:CCW Top mount rear entry starter for standard rotation
GM & Ford engines. Can be used in place of 18-5908



18-0476-1
RISER BLOCK-OFF
GASKET

Replaces: Barr 1-0105

PKG. OF 2



18-2909
18-2909-9^①
EXHAUST MANIFOLD
GASKET

For: GM V-6



18-8535
EXHAUST ELBOW MOUNTING KIT



18-8536
EXHAUST ELBOW MOUNTING KIT



18-4364 (Open)
EXHAUST ELBOW MOUNTING KIT

Replaces: Barr 20-0082-P
Use with:
Risers: 18-1999, 18-1907, 18-1939

EXHAUST MANIFOLD HARDWARE
MOUNTING KITS

EXHAUST ELBOW HARDWARE
MOUNTING KITS

Exhaust Manifold	Elbow O.E. No.	Gasket Set	Exhaust Elbow	Elbow O.E. No.	Closed Cooling Kit	Raw Water Cooling Kit
18-1997-1	Barr CHV-1-83 Indmar 53-1027 Marine Power 0994-000	18-8536	18-1999	Barr 20-0082	18-8535	18-4364
			18-1939	Barr 20-0100	18-8535	18-4364

① Priced per Package

PLEASURECRAFT MODEL IDENTIFICATION

MODEL 0 2 - 6 0 0 V - 0 1 SERIAL 460000

1st - 2nd Space: **MANUFACTURING CODE**

3rd - 5th Space: **ENGINE CODE**

810	= 8.1L (496 CID MPI)	(GM)
811	= 8.1L (496 CID H.O. MPI)	(GM)
600	= 6.0L (364 CID MPI)	(GM)
570	= 5.7L (350 CID LH MPI)	(GM)
571	= 5.7L (350 CID RH MPI)	(GM)
572	= 5.7L (350 CID LH Carburetor)	(GM)
573	= 5.7L (350 CID RH Carburetor)	(GM)
500	= 5.0L (305 CID LH MPI)	(GM)
501	= 5.0L (305 CID RH MPI)	(GM)
502	= 5.0L (305 CID LH Carburetor)	(GM)
503	= 5.0L (305 CID RH Carburetor)	(GM)

SERIAL NUMBER I.D.

1st DIGIT INDICATES DECADE ENGINE WAS MANUFACTURED (3 = 1990, 4 = 2000, 5 = 2010)
2nd DIGIT INDICATES YEAR ENGINE WAS MANUFACTURED.

6th Space: **DRIVE CONFIGURATION**

blank - Direct Drive
V - V-Drive

7th - 8th Space: **SPECIFICATION CODE**



①18-5251D Display Package

18-5251 TUNE-UP KIT

Part #	-CONTAINS- O.E. #	Description
18-5314	R114001, R114004	Contact Set
18-5338	R115001	Condenser
18-5404	R103001	Rotor
	Mallory 8 cyl. Tall Cap	



Display Package

18-5255 TUNE-UP KIT

Part #	-CONTAINS- O.E. #	Description
18-5303	R114002	Contact Set
18-5345	R115002	Condenser
18-5407	R103003	Rotor



①18-5260D Display Package

18-5260 TUNE-UP KIT

Part #	-CONTAINS- O.E. #	Description
18-5303	R114002	Contact Set
18-5345	R115002	Condenser
18-5403	R103004	Rotor



Display Package 

18-5266 TUNE-UP KIT

Fits: Flame Thrower Distributors 18-5481, 18-5482, 18-5483, 18-5477, 18-5478, 18-5479



Display Package

18-5271 TUNE-UP KIT

Part #	-CONTAINS- O.E. #	Description
18-5314	R114001, R114004	Contact Set
18-5338	R115001	Condenser
18-5404-1	R103001	Rotor
18-5376	R108001	Distributor Cap
	Mallory V-8 Tall Cap	



Display Package

18-5275 TUNE-UP KIT

Part #	-CONTAINS- O.E. #	Description
18-5303	R114002	Contact Set
18-5347	—	Condenser
18-5403	R103004	Rotor
18-5352	RA108003	Distributor Cap
	Prestolite V-8 Screw Down Cap	

APPLICATION ON PAGE 644

① Items ending in "D" are Display Packaged - Regular number is Non-Display



Original Package

18-5276
TUNE-UP KIT
-CONTAINS-
Part # O.E. # Description
18-5303 R114002 Contact Set
18-5347 — Condenser
18-5403 R103004 Rotor
18-5353 — Distributor Cap
Prestolite V-6 Screw Down Cap



Original Package

18-5277
TUNE-UP KIT
-CONTAINS-
Part # O.E. # Description
18-5303 R114002 Contact Set
18-5347 — Condenser
18-5407 R103003 Rotor
18-5369 RA108002 Distributor Cap
Prestolite V-8 Clip Down Cap



18-5302
TUNE-UP KIT
Fits: Male cap v-8 flamethrower distributors



18-5278
TUNE-UP KIT
Delco EST · V-6



18-5281
TUNE-UP KIT
Delco EST · V-8



18-5303
CONTACT SET
Replaces: R114002



18-5314
CONTACT SET
Replaces: R114001,
R114004



18-5338
CONDENSER
Replaces: R115001



18-5345
CONDENSER
Replaces: R115002



18-5346
CONDENSER



18-5347
CONDENSER



18-29322
CAP & ROTOR KIT
Fits: Ford HEI Distributors



18-5245
ROTOR
Replaces: R103011
For: Models MP 5.0L and 5.7L
(2002-05)



18-5403
ROTOR
Replaces: R103004



18-5404-1
ROTOR
Replaces: R103001



18-5407
ROTOR
Replaces: R103003



18-5300
ROTOR
Fits: Flamethrower Distributors

 <p>18-5244 DISTRIBUTOR CAP Replaces: RA108009 For: Models MP 5.0L and 5.7L (2002-05)</p>	 <p>18-5352 DISTRIBUTOR CAP Replaces: RA108003</p>	 <p>18-5353 DISTRIBUTOR CAP</p>
---	---	---

 <p>18-5359 DISTRIBUTOR CAP</p>	 <p>18-5369 DISTRIBUTOR CAP Replaces: RA108002 Includes: 18-5399 Gasket</p>	 <p>18-5376 DISTRIBUTOR CAP Replaces: R108001</p>	 <p>18-5389 DISTRIBUTOR CAP</p>
--	--	---	--



FEATURES

- Senses current levels in the coil and adjusts the dwell to maintain peak energy throughout the entire RPM range.
- Develops, on average, 4 times more available energy between 3000 and 5000 RPM's and twice as much plug voltage as point-type systems.
- Ignition energy is sustained and coil life is increased when peak current level is reached just prior to spark.
- More stable timing.
- Use with 18-5472 "Flame Thrower II" Coil for optimum performance

 <p>18-5288-1 Superseded from 18-5289 HI-PERFORMANCE ELECTRONIC CONVERSION KIT Fits: Most Prestolite V-8 Distributors with screw down cap</p>	 <p>18-5290 HI-PERFORMANCE ELECTRONIC CONVERSION KIT Fits: Most Mallory YL or YD 8 cylinder Distributors with clockwise and counter clockwise rotation</p>
---	--



FEATURES

- Replaces points & condensers for true solid state ignition.
- Uses standard coil, cap and rotor.
- Easy to install, one-piece, 2-wire hook-up.
- Accurate to within 1/4° timing accuracy 0 to 6000 RPM range.
- Can be used with Flame Thrower Coils 18-5466 & 18-5469.

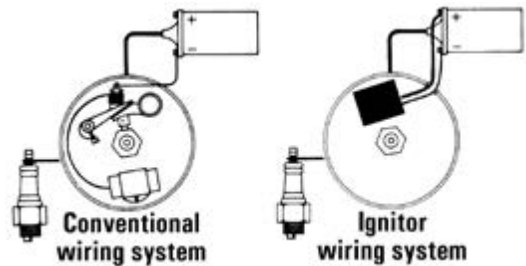

 <p>18-5294 ELECTRONIC CONVERSION KIT Fits: 6 Cyl. Delco distributors</p>	 <p>18-5295 ELECTRONIC CONVERSION KIT Fits: Most 4 Cyl. Prestolite distributors (Except IBM 7026) For: Onan, Universal, Waukesha, Wisconsin</p>	 <p>18-5296-2D ELECTRONIC CONVERSION KIT Fits: Most Mallory V-8 YL & YD 8 cyl. Distributors with clockwise and counter clockwise rotation</p>
--	---	--

APPLICATION ON PAGE 644

① Items ending in "D" are Display Packaged - Regular number is Non-Display



18-5298-1
ELECTRONIC CONVERSION KIT
 (with snap down cap)
 For: Most Prestolite V-8 Distributors



①**18-5299D** Display Package
18-5299
ELECTRONIC CONVERSION KIT
 (with screw down cap)
 For: Most Prestolite V-8 Distributors
 Use with 18-5403 Style Rotor

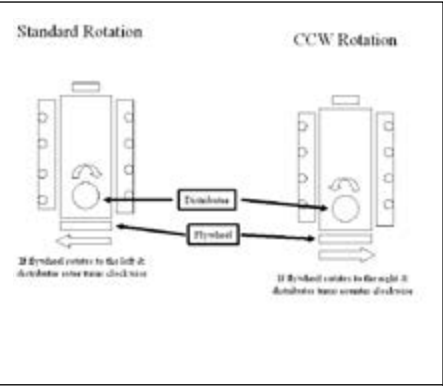

18-5309-1
DISTRIBUTOR
 Replaces: RA107001
 Mallory YL512CV
 For most Ford 302 CID V-8 Eng.
 Uses: 18-5251 TUNE-UP KIT
 — CONTAINS —

Part #	Desc.
18-5314	Contact Set
18-5338	Condenser
18-5404-1	Rotor
18-5376	Cap



18-5312-1
DISTRIBUTOR
 Replaces: Mallory YL554CV
 For most Ford 351 CID V-8 Eng.
 Uses: 18-5251 TUNE-UP KIT
 — CONTAINS —

Part #	Desc.
18-5314	Contact Set
18-5338	Condenser
18-5404-1	Rotor
18-5376	Cap



18-5313-1
DISTRIBUTOR
 Replaces: Mallory YL624MW
 For most GM V-8 Eng.
 (small & large blocks)
 Uses: 18-5251 TUNE-UP KIT
 — CONTAINS —

Part #	Desc.
18-5314	Contact Set
18-5338	Condenser
18-5404-1	Rotor
18-5376	Cap



FEATURES

- Distributors feature the Ignitor II ignition module with adaptive dwell control adjusts the spark timing over the entire RPM range to maximize performance
- Upper roller bearing and oil impregnated bronze sintered bottom bushing are installed and aligned bored for accuracy for maximum durability
- Machined heat treated gear with tight tolerances insures durability and consistent timing to maximize horsepower and performance. Complete with high dielectric strength cap and rotor for years of performance

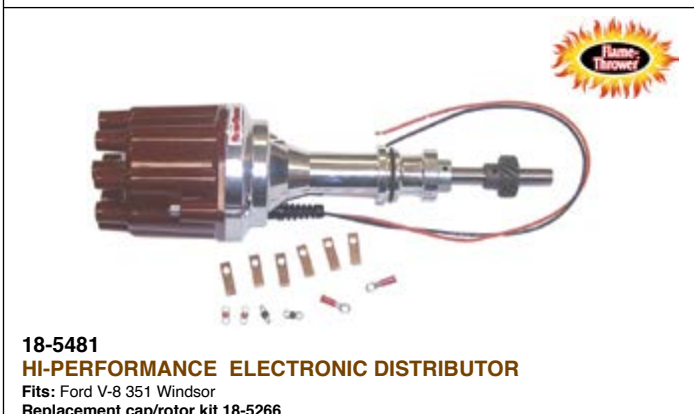

18-5481
HI-PERFORMANCE ELECTRONIC DISTRIBUTOR
 Fits: Ford V-8 351 Windsor
 Replacement cap/rotor kit 18-5266



18-5483
HI-PERFORMANCE ELECTRONIC DISTRIBUTOR
 Fits: Chevrolet Marine Small and Big Block engines
 (Standard Deck Height)
 Replacement cap/rotor kit 18-5266



18-5477
ELECTRONIC DISTRIBUTOR
 Ford 302 V-8 engines
 Replacement Cap/Rotor Kit 18-5266



18-5479
ELECTRONIC DISTRIBUTOR
 GM V-8 engines-reverse rotation
 Replacement Cap/Rotor Kit 18-5266

APPLICATION ON PAGE 644

① Items ending in "D" are Display Packaged - Regular number is Non-Display



18-5480
COMPLETE IGNITION CONVERSION KIT
Fits: GM SB & BB with Standard Deck Height

—CONTAINS—

Part #	Description
18-5472	Coil
18-8803-2	Wire Set
18-5483	Distributor

18-5484-1
ELECTRONIC DISTRIBUTOR
Conventional Rotation
Replaces: RA107039E
Late Model HEI
For V8 — 262-454 & 502 except 384/409 and tall block engines
* Designed as a plug-in replacement for GM-style fuel injection system distributors



—CONTAINS—

Description	Part #
Distributor Cap	18-5354
Rotor	18-5405
Tune-Up Kit	18-5281

18-5489-2
ELECTRONIC DISTRIBUTOR
Conventional Rotation
For Ford V-8 351W CID



—CONTAINS—

Part #	Description	Part #	Description
18-5376	Distributor Cap	18-5404-1	Rotor
18-5488	Module		

18-5494-2
ELECTRONIC DISTRIBUTOR
Conventional Rotation
For Chevrolet all V8 includes 482, 502, 540 CID (Except 348,409 & Tall Deck Big Block)



—CONTAINS—

Part #	Description	Part #	Description
18-5376	Distributor Cap	18-5404-1	Rotor
18-5488	Module		

18-5495-2
ELECTRONIC DISTRIBUTOR
Replaces: Mallory YLM512CV
Conventional Rotation
For Ford V8 302 CID



—CONTAINS—

Part #	Description	Part #	Description
18-5376	Distributor Cap	18-5404-1	Rotor
18-5488	Module		

18-5496-2
ELECTRONIC DISTRIBUTOR
Conventional Rotation
For Ford V-8 351C — 460 CID



—CONTAINS—

Part #	Description	Part #	Description
18-5376	Distributor Cap	18-5404-1	Rotor
18-5488	Module		

Sierra's MAGFORCE Ignition Wires are "Electronics Friendly" protecting all of your electronic devices and electronic engine controls from RFI and EMI while delivering the maximum amount of voltage. Exact fit design ensures easy installation and years of trouble - free service.

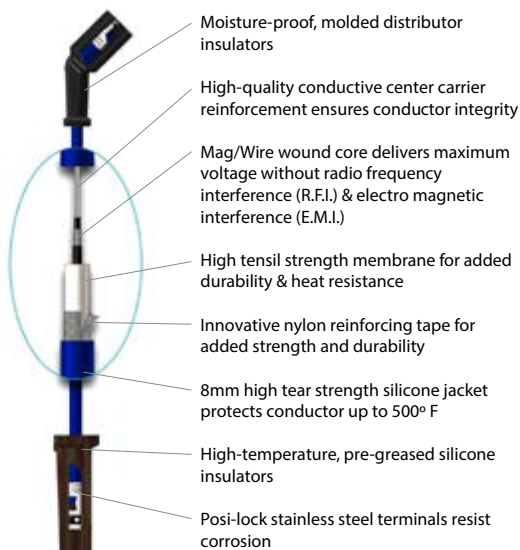

PLEASURECRAFT MARINE IGNITION WIRES APPLICATION

Engine	Cyl.	Distributor	Years	Plug Wire Set
262 CID 4.3L	6	Prestolite	ALL	18-8801-1
262 CID 4.3L	6	Delco EST	ALL	18-8810-1
262 CID 4.3L	6	Delco HVS	ALL	18-8829-1
220 (305 CID 5.0L)	8	Mallory/Prestolite ①	Up to 1987	18-8803-2

PLEASURECRAFT MARINE IGNITION WIRES APPLICATION

Engine	Cyl.	Distributor	Years	Plug Wire Set
220 (305 CID 5.0L)	8	Mallory/Prestolite ②	1987-1992	18-8803-2
270 (350 CID 5.7L)	8	Mallory/Prestolite ①	Up to 1987	18-8803-2
270 (350 CID 5.7L)	8	Mallory/Prestolite ②	1987-1992	18-8803-2
TB350	8	Delco EST ③	1992 & Up	18-8824-1
5.7L Classic	8	Mallory	1999 & Up	18-8803-2
5.7L MPI Classic	8	Delco HVS	2007 & Up	18-8828-1
MP5.0L Captain's Choice	8	Delco HVS	2002-2005	18-8828-1
MP5.7L Captain's Choice	8	Delco HVS	2002-2005	18-8828-1
MP6.0L	8	Distributorless	2002 & Up	18-8838-1
350 (454 CID 7.4L)	8	Mallory ④	Up to 1991	18-8803-2
454XL (454 CID 7.4L)	8	Delco EST ⑤	1991 & Up	18-8824-1
CM454HO (454 CID 7.4L)	8	Delco EST ⑤	1991 & Up	18-8824-1
454XL (454 CID 7.4L)	8	Delco EST ⑥	1993 & Up	18-8824-1
MP8.1L	8	Distributorless	ALL	18-8838-1
502 (502 CID 8.2L)	8	Prestolite ④	Up to 1991	18-8803-2
502 (502 CID 8.2L)	8	Delco EST ④	Up to 1991	18-8824-1
502XL (502 CID 8.2L)	8	Delco EST ⑤	1991 & Up	18-8824-1
TB502XL (502 CID 8.2L)	8	Delco EST ⑦	1994 & Up	18-8824-1

① Serial Number up to 68702 ② Serial Number 68703-90232 ③ Serial Number 90232 & UP
 ④ Serial Number up to 88710 ⑤ Serial Number 88710 & Up ⑥ Serial Number 92882 & Up
 ⑦ Serial Number 94268 & Up

18-5225

SPARK PLUG WIRE KIT

Replaces: Mercury 84-99215A26, 84-813706A26
Kit includes 25 ft. Roll of 7 MM Hypalon Ignition Wire With a Metallic Core and a Large Assortment of Three Different End Fittings.



BATTERY CABLES

Gauge cable with soldered lug terminals on each end to accept 3/8" stud.



PART NO.	SIZE	COLOR	GAUGE	PART NO.	SIZE	COLOR	GAUGE
BC88523	2'	red	4	BC88563	6'	red	2
BC88533	2'	black	4	BC88573	6'	black	2
BC88543	4'	red	2	BC88583	8'	red	1
BC88553	4'	black	2	BC88593	8'	black	1

18-5226

IGNITION WIRE
Metallic Core

100' Spool • 7mm Hypalon



PKG. OF 10

18-5224

18-5224-9[®]
SPARK PLUG WIRE
TERMINAL

Replaces: Mercury 20121
OMC 510364



PKG. OF 10

18-5750

18-5750-9[®]
UNIVERSAL SPARK
PLUG BOOTS

Supplied complete w/Terminal Connector
Replaces: OMC 581027, 580339



18-5752

UNIVERSAL
SPARK PLUG BOOT
8mm



IGNITION / ELECTRICAL SYSTEMS APPLICATION

Years	Cyl.	Model/Engine	Distributor No.	Contact Set	Condenser	Dist. Cap	Rotor	Tune-Up Kit	Coil	Distributor	Elect. Conv. Kit
1959-72	4	1C	IGW-4118A	—	18-5345	18-5359	—	—	18-5435	—	—
1959-73	4	1C	IGW-4301	—	18-5345	—	—	—	18-5435	—	—
1984-88	6	3.8L Eng.	IBM-7014A	18-5303	18-5345 ④	18-5353	18-5403	18-5260, 18-5276 ⑥	18-5433 ⑥ ⑦	—	—
1973-74	8	Mercury Dist.	B64025A2	—	18-5346 ④	18-5389	—	—	18-5433 ⑤	—	—
1976-82	8	305,350, 454 Eng.	IBM-7011	18-5303	18-5345 ④	18-5352	18-5403	18-5260, 18-5275 ⑥	18-5433 ③ ④	18-5494-2 ① 18-5498-1 ② 18-5313-1 ③	18-5299
1983-88	8	305, 350, 454 Eng.	IBM-7013	18-5303	18-5345 ④	18-5352	18-5403	18-5260, 18-5275 ⑥	18-5433 ⑥ ⑦	18-5494-2 ① 18-5498-1 ② 18-5313-1 ③	18-5299
1975-86	8	Ford 302 Eng.	IBM-7007, A	18-5303	18-5345 ④	18-5369	18-5407	18-5255, 18-5277 ⑥	18-5433 ⑥ ⑦	18-5495-2 ① 18-5309-1 ③	18-5298-1
1975-86	8	Ford 351, 460 Eng.	IBM-7008, A, B, C	18-5303	18-5345 ④	18-5369	18-5407	18-5255, 18-5277 ⑥	18-5433 ⑥ ⑦	18-5496-2 ① 18-5312-1 ③	18-5298-1
1986-UP	8	Ford 302 Eng.	Prestolite	N/A	N/A	18-5352	18-5403	N/A	18-5433 ⑥ ⑦	18-5495-2 ① 18-5309-1 ③	18-5299
1987	8	—	Prestolite	18-5303	18-5345 ④	18-5352	18-5403	18-5260, 18-5275 ⑥	18-5433 ⑥ ⑦	—	—
ALL	8	—	Mallory	18-5314	18-5338	18-5376	18-5404-1	18-5251, 18-5271 ⑥	18-5433 ⑥ ⑦	—	18-5296-2

- ① Electronic Distributor (Standard Rotation)
- ② Electronic Distributor (Counter Rotation)
- ③ Contact Controlled Distributor (Standard Rotation)

- ④ For strap type, use 18-5347
- ⑤ For applications requiring internal resistor use 18-5436
- ⑥ For applications requiring internal resistor use 18-5435

- ⑦ Use 18-5450 coil resistor
- ⑧ With distributor cap

FEATURES

- Oil filled for better cooling and long life
- Low resistance and improved turn ratios produces the higher voltage needed to run larger spark plug gaps for added power and better fuel economy
- More windings maximize energy and reliability over the full RPM range
- Fits existing brackets for easy installation

18-5466

HI-PERFORMANCE
IGNITION COIL

1.5 ohm (oil filled), black - 8 cylinder.
Flame-Thrower 40,000 volt coil.

- Designed for use with the original Ignitor Electronic Conversion Kits
- Can be used with other inductive ignition systems



18-5469

HI-PERFORMANCE
IGNITION COIL

3.0 ohm (oil filled), black - 4 & 6 cylinder.
Flame-Thrower 40,000 volt coil.

- Designed for use with the original Ignitor Electronic Conversion Kits
- Can be used with other inductive ignition systems



18-5472

HI-PERFORMANCE
IGNITION COIL

0.6 ohm (oil filled), black - 4, 6, & 8 cylinder.
Flame-Thrower 45,000 volt coil.

- Super low 0.6 ohm resistance coil designed for use with the Ignitor II Hi Performance Electronic Conversion Kits
- Compatible with capacitive discharge systems



Part #	Description	Recommended Coil	Resistance Ohms	Part #	Description	Recommended Coil	Resistance Ohms
18-5294	Electronic Conversion Kit	18-5469	3.0	18-5288-1	Hi Performance Electronic Conversion Kit	18-5472	0.6
18-5295	Electronic Conversion Kit	18-5469	3.0	18-5288-1	Hi Performance Electronic Conversion Kit	18-5472	0.6
18-5296-2	Electronic Conversion Kit	18-5466	1.5	18-5290	Hi Performance Electronic Conversion Kit	18-5472	0.6
18-5298-1	Electronic Conversion Kit	18-5466	1.5	18-5483	Flame-Thrower Distributor	18-5472	0.6
18-5299	Electronic Conversion Kit	18-5466	1.5	18-5483	Flame-Thrower Distributor	18-5472	0.6
				18-5483	Flame-Thrower Distributor	18-5472	0.6

⑨ Priced per Package

 <p>18-7648 IGNITION COIL Replaces: R117012</p>	 <p>18-5433 IGNITION COIL Replaces: R117001 Uses External Resistor</p>	 <p>18-5435 IGNITION COIL 4.0 OHM Has Internal Resistor</p>	 <p>18-5436 IGNITION COIL 3.0 OHM Has Internal Resistor</p>	 <p>18-5450 COIL RESISTOR 1.5 OHM Replaces: R119001</p>
--	---	--	--	--

 <p>18-9802 TIMING LIGHT Self-powered accurate up to 10,000 RPM's</p>	 <p>18-26810 GM HEI 4 TERMINAL PIGTAIL Fits: GM HEI Distributors w/4 terminals</p>	 <p>18-26811 GM HEI 2 TERMINAL PIGTAIL Fits: GM HEI Distributors w/2 terminals</p>	 <p>18-26812 HEI COIL GRAY CONNECTOR</p>	 <p>18-26813 HEI COIL BLACK CONNECTOR</p>
--	---	---	---	--



18-5603
STARTER
Replaces: RA122009
Noseless:CCW Top mount rear entry starter for standard rotation GM & Ford engines. Can be used in place of 18-5908



18-6443
STARTER
Replaces: RA122019
PG260, CW that fits GM 6.0L

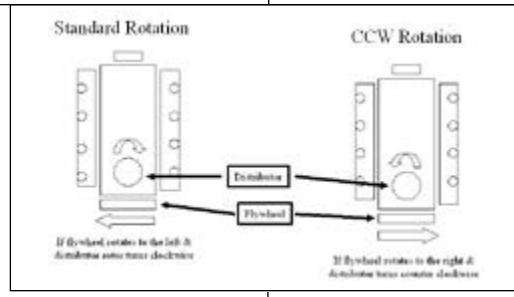

18-5907
STARTER
(Heavy-Duty) (No Core) Clockwise
Replaces: RA122008
Replacement Solenoid: 18-5837
Will not replace non-starter mounted solenoids.
Top mount rear entry started for opposite rotation GM & FORD engines.
SAEJ1171

18-5908
STARTER
(Heavy-Duty) (No Core) Counter-Clockwise
Replaces: RA122009
Replacement Solenoid: 18-5837
Top mount rear entry started for standard rotation GM & FORD engines.
SAEJ1171



18-5903
STARTER
 (No Core) Clockwise
 Replaces: RA122001
 Replacement Solenoid: 18-5801
 Bottom mount, two bolt pattern for standard rotation FORD engines.



18-5920
STARTER
 Replaces: 987811, RK122014, RA122001
 For: 5.0 & 5.8 litre Ford engines.

①18-5801D



18-5801
SOLENOID
 Replaces: R130001
 For all engines with flat solenoid bracket



18-5957
ALTERNATOR
 (3-Wire) (68 amp)
 Replaces: RA097002, RA097003, RA097006
 Replaces Mando, Motorola and original equipment Delco. Uses same electrical connections and mounting method. Equipped with fan and drive pulley. SAEJ1171



18-5984
ALTERNATOR
 Replaces: RA097007B
 7SI/70 amp, spool mount, 2 5/8" OD, 6 groove serpentine pulley Clockwise position, 65mm



18-6451
ALTERNATOR
 Fits: Gm LS Series



18-6288
ALTERNATOR
 Replaces: RA097007B
 7SI/70 amp, spool mount, single groove V-belt pulley



18-6452
ALTERNATOR
 Replaces: RA097009
 11SI/95 amp spool mount, serpentine pulley



18-6453
ALTERNATOR
 Replaces: RA097007C
 7SI/70 amp spool mount, serpentine pulley



18-15214
RELAY, SHROUDED
 Replaces: R130012
 For: Fuel Pump on Crusader MEFI systems



18-7206
FLOAT
 Nitrophenyl

① Items ending in "D" are Display Packaged - Regular number is Non-Display



18-7017
CARB KIT
 (Contains non-adjustable needles & seats)
 Replaces: RN0118-1, RN0120-1



18-7081
CARB KIT
 Replaces: RN0116, RN0116-2



18-7096
CARB KIT
 Replaces: RN0118, RN0120

CARBURETOR KIT AND FLOAT APPLICATION

Engine/Model	Cyl.	Mfg. Code	Carb. Model	Carburetor No.	Float	Carb Kit ①
155, 165, 175, 185 w/302" (5.0L)	8	H-2	2300	R-6150A,R-6317A, R-6317-1A, R-7036A (D1JJ-9510-B, D3JL-9510-S)	18-7206	18-7081
215, 255, 215 w/302" (5.0L) 351" (5.8L)	8	H-4	4160	R-4473A,R-4473AAS, R-4608A, R-4608AAS, R-6151A,R6151AAA, R-6152A,R-6152AAA, R-6407A, R-6576A (C9FF-9510-E,D2JL-9510E)	18-7206	18-7096
215, 255 w/302" (5.0L) 351" (5.8L)	8	H-4	4160	R-7159A,R-7163A, D4JL-9510-F, D4JL-9510-G	—	18-7017

① Does not include metering rods.



18-7677
KNOCK SENSOR
 Replaces: R020027



18-7697
IAC MOTOR
 Replaces: R084003



18-32150
O2 SENSOR
 Replaces: Idmar, Pleasurecraft, Mastercraft
 Fits: GM New Generation Ls Series Small Block



18-32151
O2 SENSOR
 Replaces: Idmar, Pleasurecraft, Mastercraft
 Fits: GM New Generation Ls Series Small Block

FUEL WATER SEPARATORS



Sierra offers a complete line of 10 and 21 micron fuel water separating filters including drainable bowl filters to protect your carbureted and fuel injected engine.

Refer to pages 156-161 for a complete listing of OEM and universal applications.

Sierra fuel water separators remove over 99.8% of emulsified water from your gasoline. Sierra's 10 micron filters are over 90% efficient at removing particles as small as 10 micron. All filters flow @ 90 GPH to feed even the hungriest motor. Sierra 10 micron filters are recommended to prevent damage to sensitive inboard and outboard fuel injection systems.

Sierra #	Pleasurecraft #	Description
18-7964-1		Fuel Filter



18-8127-1
FUEL FILTER
 Replaces: RP080026
 For: 1996 & Up EFI Engines



18-7267
FUEL PUMP
 Flange I.D. #41414
 For: Ford (V-8) 302



18-3577-2
CIRCULATING WATER PUMP
 (Bi-Directional)
 Replaces: RA057019
 Fits: GM Big Block



18-3584-1
CIRCULATING WATER PUMP
 (Bi-Directional)
 Replaces: RA057004
 Superseded from 18-3584
 Includes 18-0147 gasket
 Fits: Ford 302 & 351w



18-42608
CIRCULATING WATER PUMP
 Replaces: RA057036
 Fits: Indmar/PCM 6.0L



18-3599-2
CIRCULATING WATER PUMP
 Replaces: RA057018
 For: GM V-6 & small block V-8 engines
 Uses gasket 18-0981 (included)



18-3586-1
WATER PUMP
 Replaces: RA057023
 Use Impeller Repair Kit: 18-3081



18-3587-1
WATER PUMP
 Replaces: RA057024



18-5899
OIL PRESSURE SENDER
 Replaces: RO20001



18-3551
THERMOSTAT
 Replaces: R026002E
 142°
 For: FORD 302/351 CID Engines
 Raw Water Cooled



② 18-3671D
THERMOSTAT KIT
 Replaces: RP026002E
 For: Ford 302/351 CID Engines
 Includes:
 18-3551 Thermostat and
 18-0875 Gasket
 Raw Water Cooled



PKG. OF 8
FREEZE PLUGS
18-5961
18-5961-9① **18-5962-9①**
 1 5/8" 1 3/4"



18-3060
IMPELLER
 Replaces: RP061015
 Sherwood 9959
 For: Ford Engines



18-3061
IMPELLER
 Replaces: RP061017
 Sherwood 10615
 For: GM Engines
 With V-Belt



② 18-3081D
IMPELLER REPAIR KIT

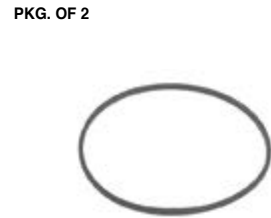

PKG. OF 2
18-7480
O-RING
 Replaces: R047111
 For use with 18-3060 & 18-3061 Impeller

① Priced per Package

② Items ending in "D" are Display Packaged - Regular number is Non-Display

Fits Ford Small Block V8 302 & 351 cu. in.

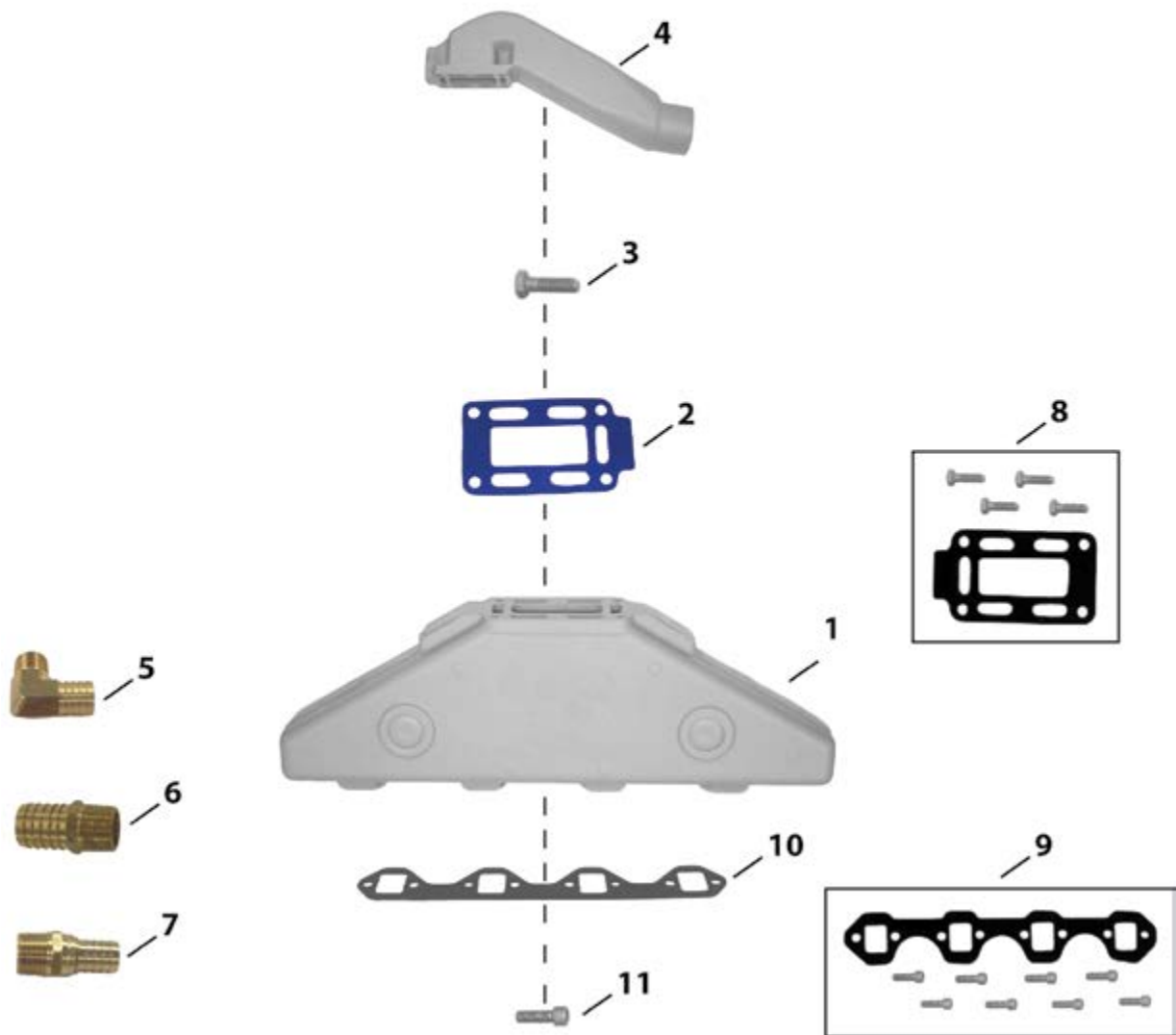

Item No.	Description	OE No.	Application
1	18-1996 MANIFOLD	RO28001	Ford Small Block (V8) 302-351 cu.in.; Use with Manifold Gasket: 18-0183-1; Mounting Kit: 18-8503
2	18-0677-1 GASKET	RM0002	Use with Riser: 18-1899; Included in 18-8504 mounting kit.
3	NSS MOUNTING BOLT	N/A	Included in 18-8504 mounting kit.
4	18-1899 RISER W/ 3" OUTLET	RO29001	Use with Manifold: 18-1996; Riser Gasket: 18-0677-1; Mounting Kit: 18-8504
5	18-8216 HOSE FITTING	N/A	3/4" - 14NPT X 1" Hose (Corrosion Resistant Brass Fitting)
6	18-4461 HOSE FITTING	N/A	3/4" - 14NPT X 1" Hose (Corrosion Resistant Brass Fitting)
7	18-8215 HOSE FITTING	N/A	3/4" - 14NPT X 3/4" Hose (Corrosion Resistant Brass Fitting)
8	18-8504 MOUNTING KIT	N/A	Use with Manifold: 18-1899. Includes 18-0677-1 gasket.
9	18-8503 MOUNTING KIT	N/A	Use with Manifold: 18-1996. Includes 18-0183-1 gasket.
10	18-0183-1 MANIFOLD GASKET	RM0007	Use with Manifold: 18-1996; Included in 18-8503 mounting kit.
11	NSS MOUNTING BOLT	N/A	Included in 18-8503 mounting kit.

SIERRA MANIFOLDS

**18-1997-1
MANIFOLD**

Port & Starboard

Replaces: Barr CHV-1-83

Universal Center Riser Manifold

FITS: GM 283, 305, 307 and 350 CID engines

Use 18-0604 Exhaust Manifold Gasket Set

*For Exploded View - See Pages 658-659



**18-1996
MANIFOLD**

Port & Starboard

Replaces: Pleasurecraft RO28001, Barr FM-1-83

Pleasurecraft Ford Small Block V8 302 and 351 cu. in.

Used with:

Exhaust Manifold Gasket: 18-0183-1 (included)

Mounting Kit: 18-8503



**18-1998-1
MANIFOLD**

Port & Starboard

Replaces: Barr FM-1-83

Universal Center Riser Manifold

FITS: Ford 302 and 351 CID engines

Use 18-0603 Exhaust Manifold Gasket Set

*For Exploded View - See Pages 660-661

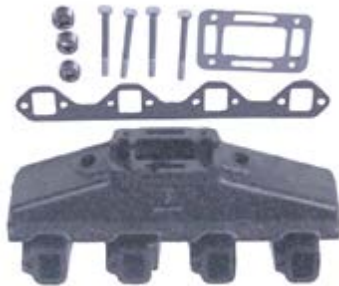

**18-1991
ELBOW ADAPTER**

Replaces: Barr 200089P

For: 3" I.D. Exhaust Hose

Use 18-1999 Manifold Riser

30°



**18-1992-1
ELBOW ADAPTER**

Replaces: Barr 200087P

For: 3" I.D. Exhaust Hose

(As used in 18-1987 Exhaust Manifold Conversion Kit)

80°



**18-1899
RISER**

Replaces: Pleasurecraft RO29001

Fits: Small block 302/351cu.in. Ford with 3" outlet.

Fits: 18-1996 Manifold

Used with:

Manifold: 18-1996

Riser Gasket: 18-0677-1

Mounting Kit: 18-8504



**18-1999
ELBOW**

Replaces: Barr 20-0082

Comes with 18-4364 open Mounting Package

If blocked mounting kit is required use 18-8535

Use 18-2854-1 open, 18-0476-1 blocked Riser Gasket

Use with;

Manifold: 18-1997 or 18-1998-1



**18-4364
EXHAUST ELBOW MOUNTING KIT**

Replaces: Barr 20-0082-P

Use with:

Riser: 18-1999, 18-1907, 18-1939



**18-8503
EXHAUST MANIFOLD MOUNTING KIT**

Pleasurecraft Ford Small Block

V8 302 and 351cu.in.

Used with:

Manifold: 18-1996



**18-8504
EXHAUST ELBOW MOUNTING KIT**

Pleasurecraft Ford Small Block

V8 302 and 351cu.in.

Used with:

Riser: 18-1899



**18-8535
EXHAUST ELBOW MOUNTING KIT**

Barr, Indmar and Marine Power Ford Small Block V8

302-351cu.in., GM Small Block V8 305-350cu.in., GM Big

Block V8 454cu.in.

Used with:

Risers: 18-1939, 18-1999, and 18-1907





18-8536
EXHAUST ELBOW MOUNTING KIT
 Barr, Indmar and Marine Power GM Small Block V8 305-350cu.in.
 Used with:
 Manifold: 18-1997-1



18-8538
EXHAUST MANIFOLD MOUNTING KIT
 Barr and Indmar Ford Small Block V8 302-351cu.in.
 Used with:
 Manifold: 18-1998-1



18-0603
EXHAUST MANIFOLD GASKET SET
 For: Ford 302/351 CID Engines
 Use with:
 Manifold: 18-1998-1

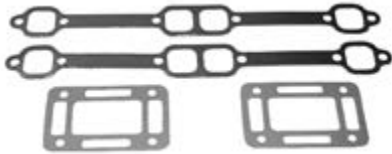

18-0604
EXHAUST MANIFOLD GASKET SET
 For: GM 305/350 CID Engines
 Use with:
 Manifold: 18-1997-1



18-0183-1
EXHAUST MANIFOLD GASKET
 Replaces: RM0007
 Use with:
 Manifold: 18-1998-1



PIPE PLUGS

Part #	Thread Size	Part #	Thread Size
18-4256	1/4"	18-4263	1/8" - 27 NPT
18-4257	1/4"	18-4264	3/8" - 18 NPT
18-4258	3/4"		



18-0676-1
EXHAUST ELBOW GASKET
 Replaces: RM0099

PKG. OF 2



18-0677-1
18-0677-9^①
 Superseded from 18-0677-1-9
EXHAUST ELBOW GASKET
 Replaces: RM0002
 Use with:
 Mounting Kit: 18-8504
 Riser: 18-1899

PKG. OF 2



18-2854-1
18-2854-9^①
EXHAUST ELBOW GASKET
 Use with:
 Riser: 18-1999, 18-1907, 18-1939

PKG. OF 2



18-2949
18-2949-9^①
EXHAUST MANIFOLD GASKET
 Replaces: Barr CHV-47-000
 Use with:
 Manifold: 18-1997-1



18-0898
OIL PUMP MOUNTING GASKET
 Replaces: 27-56859
 For: Ford Engines

②**18-4218D** Display Package



18-4218
DRAIN TAP
 Used with most O.E.M. Manifolds
18-3223-9 Bulk Pack of 12
 1/4" Brass

PKG. OF 2



18-0875
18-0875-9^①
THERMOSTAT GASKET

PKG. OF 2



18-0878
18-0878-9^①
THERMOSTAT GASKET
 Replaces: RM0003

PKG. OF 2



18-0889
18-0889-9^①
FUEL PUMP GASKET
 Replaces: 3705042

① Priced per Package
 ② Items ending in "D" are Display Packaged - Regular number is Non-Display

OIL FILTERS



Display Package

Part #	Replaces:	Application
18-7824-2	R077002	GM Engines (Short)
18-7875	R077001	Ford Engines (Long)
18-7876-1	—	GM Engines (Long)
18-7878-1	—	Ford Engines (Short)

SEE PAGES 203-205 & 1155-1183 FOR ADDITIONAL INFORMATION



18-3876 HEAD GASKET
 Replaces: GM 6269577
 For: GM 305/350 CID Engines



18-3883 HEAD GASKET
 Replaces: RM0032
 For Ford 302 and 351 CID Engines



18-4461 HOSE BARB
 3/4" - 14 NPT x 1" Hose
 Corrosion Resistant Brass Fitting



18-8215 HOSE BARB



18-2434 FLYWHEEL BELL HOUSING
 Replaces: R142006
 For: GM Blocks



18-2103 POWER TRIM HOSE
 Replaces: RO85035



18-2702-1 POWER TRIM BUSHING
 Replaces: R094020A



18-4220 THRUST WASHER
 Replaces: R096116



18-4214 LOCKING WASHER
 Replaces: RO96081



18-3701 PROP NUT KIT
 -CONTAINS-

Part #	O.E. #	Desc.
18-3200	R096117	Tab Washer
18-3700	R017066	Prop Nut



18-3700 PROP NUT
 Replaces: R017066



18-3200-9 TAB WASHER
 Replaces: R096117



18-4446 PROP WRENCH KIT
 - CONTAINS -

Part #	Desc.	O.E.#	Qty.
18-3200	Tab Washer	R096117	2
18-3700	Prop Nut	R017066	1
18-4444	Prop Wrench	—	1



18-4444 PROP WRENCH



18-4456 EXHAUST PROTECTOR VALVE
 Includes Stainless Steel Clamp
 3"



18-4457 EXHAUST PROTECTOR VALVE
 Includes Stainless Steel Clamp
 4"



18-4458 EXHAUST PROTECTOR VALVE
 Includes Stainless Steel Clamp
 5" & 6" (5" requires two 45° cuts)

① Priced per Package

② Items ending in "D" are Display Packaged - Regular number is Non-Display

UNIVERSAL



18-5307
CONTACT SET



18-5310
CONTACT SET



18-5311
CONTACT SET



18-5345
CONDENSER



18-5347
CONDENSER



18-5268
TUNE-UP KIT



18-5354
DISTRIBUTOR CAP



18-5359
DISTRIBUTOR CAP



18-5385
DISTRIBUTOR CAP



18-5418
ROTOR



18-5427
ROTOR



18-5419
ROTOR



18-5430
ROTOR



18-5433
IGNITION COIL
Requires external resistor
For: Atomic Four w/resistor (1969-70),
Super Sabre (1948-70)



18-28100
COIL LEAD
12" long w/90 degree male Dist end
and 90 degree female coil end



18-28101
COIL LEAD
12" long w/90 degree female Dist end
and 90 degree female coil end



18-28102
COIL LEAD
12" long w/90 degree male Dist end
and 180 degree male coil end

PARTS FOR CONTACT CONTROLLED DISTRIBUTORS

Year	Cyl.	Model / Engine	Distributor	Contact Set	Condenser	Cap	Tune-Up Kit	Rotor
1969-70	4	Atomic Four	DELCO	18-5311	18-5345	18-5385	18-5268	18-5418
1961-70	4	Unimite Four, HF (Herc. IXB), LSG Super Four, BFA, BN Utility Four, BR, FA, UJ Atomic Four, UJ64	IGW	—	—	18-5354	—	—
	6	Arrow, Bluefin, Economy, Bullet, Knight, Marlin, Tarpon	IGC-5501A	18-5307	18-5347①	—	—	18-5430
1954-68	6	Explorer Master, OK, OL, Z, Super Six	IAY-4009-1, IA	18-5307	—	—	—	18-5427
1963-65	6	Super Sabre	1110322	18-5310	—	—	—	18-5419
1945-60	4	HF, UJ, Atomic Four, BFA, BFS, BN, BR, EA, LSG, Racing 4, Super 4	IGW	—	—	18-5359	—	—
1955-57	6	HCS, LHS	IGW-6002B	18-5307	—	—	—	18-5430

① For lead type, use 18-5345

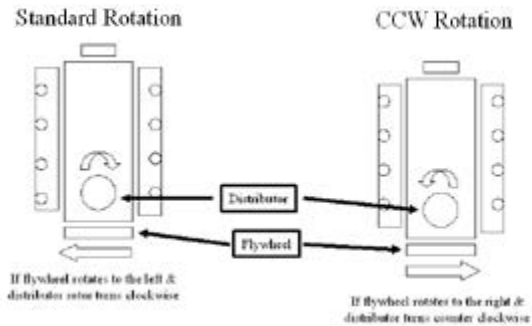

18-6264
RELAY
Arco R036
32-36 Volt, 85 Amp
Used with many winch motors



18-6263
ALTERNATOR
Replaces: 288182, 288759
12 Volt, 51 Amp, Integral Regulator,
Negative Ground, Single Groove Pulley
For: Universal and others
(I/O)



18-6284
ALTERNATOR
Hitachi Marine, Arco 84135
12 Volt, 35 Amp, Integral Regulator,
Single Groove Pulley
Fits: Yanmar Diesel
(Inboard)



18-5804
SOLENOID



18-5840
SOLENOID

PARTS FOR CHARGING SYSTEMS

PARTS FOR STARTING SYSTEMS

Year	Model	Volt	Alt. or Gen. No	Voltage Regulator	Volt	Starter No.	Starter Switch Kit
1961-68	Explorer, Master, Super Six	—	—	—	12	MAU-4046	18-5840
	Unimite Four, Atomic Four, Utility	12	ALE-5202	—	—	—	—
	Four, Blue Jacket Twin	12	ALE-5204S	18-5710	12	MAU-4006, 47	18-5840
		12	ALK-6204	—	12	MBG-4129, 31	18-5840
1955-68	Knight, Tarpon, Marlin, Bullet, Arrow, Bluefin	—	—	—	6	MAU-4046, 47	18-5840
1954-68	OK, OL, Z Superb, Z Series	—	—	—	6	MAU-4046, 47	18-5840
1961-64	11694 Super Sabre V-6	12	1100619, 54	—	12	1107260	18-5804
1955-57	AMS, HCS, LHS	—	—	—	12	MAB-4116	18-5840

**18-7070
CARB KIT**

For: 198(3.3L), 225(3.7L) E, 6Cyl.
Carb Type and Model: R-2, 2GC
Carb No:7023081,7025181



**18-7071
CARB KIT**

For: 225(3.7L) Eng., 6Cyl.
Carb Type and Model: R-1, BC
Carb No:7024083



FUEL WATER SEPARATORS



Sierra offers a complete line of 10 and 21 micron fuel water separating filters including drainable bowl filters to protect your carbureted and fuel injected engine.

Refer to pages 156-161 for a complete listing of OEM and universal applications.

Sierra fuel water separators remove over 99.8% of emulsified water from your gasoline. Sierra's 10 micron filters are over 90% efficient at removing particles as small as 10 micron. All filters flow @ 90 GPH to feed even the hungriest motor. Sierra 10 micron filters are recommended to prevent damage to sensitive inboard and outboard fuel injection systems.



**18-8114
FUEL LINE HOSE**

For fuel pump to carburetor connection. Replaces copper or steel tubing 3/8" X 31" PTFE composite hose with 5/8"-18 male inverted flare straight one end, 5/8"-18 90° one end. SAE J1527 type A1

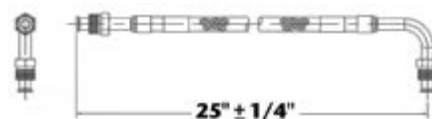

**18-8115
FUEL LINE HOSE**

For fuel pump to carburetor connection. Replaces copper or steel tubing 3/8" X 25" PTFE composite hose with 5/8"-18 male inverted flare straight one end, 5/8"-18 90° one end. SAE J1527 type A1



Fits GM 454/502 CID V8 Big Block

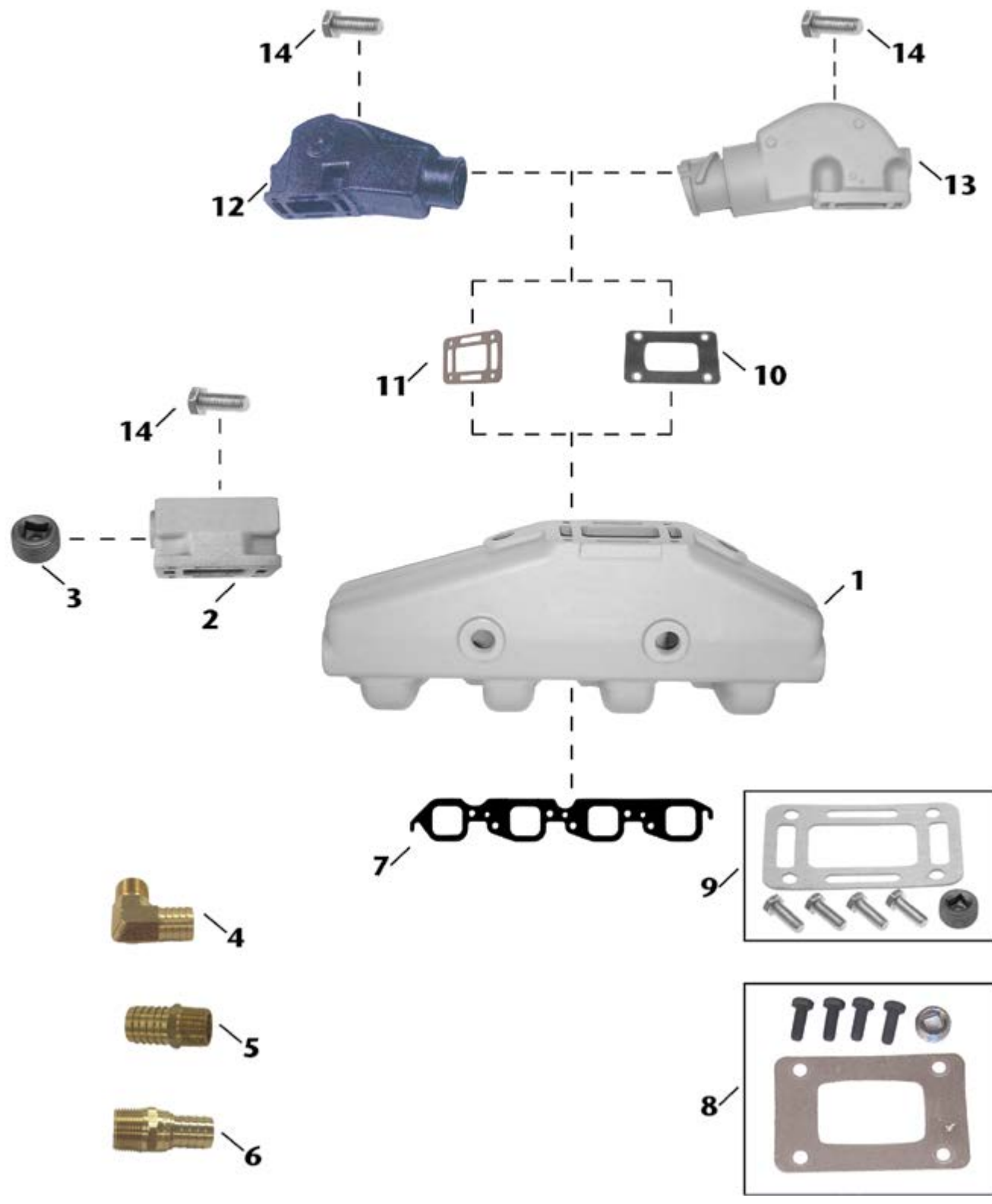

Item No.	Description	OE No.	Application
1	18-1898 MANIFOLD	BARR CHVA-1-84, MARINE POWER 0991-110	Fits 454/502 cu. in. GM Big Block V8 engines. Used with Manifold Gasket: 18-0418.
2	18-1949 MANIFOLD SPACER	N/A	Use with Manifold: 18-1898.
3	18-4258 BLACKSTEEL PLUG	N/A	Thread Size: 3/4". Use with Manifold Spacer: 18-1949.
4	18-8216 HOSE FITTING	N/A	3/4" - 14NPT X 1" Hose (Corrosion Resistant Brass Fitting)
5	18-4461 HOSE FITTING	N/A	3/4" - 14NPT X 1" Hose (Corrosion Resistant Brass Fitting)
6	18-8215 HOSE FITTING	N/A	3/4" - 14NPT X 3/4" Hose (Corrosion Resistant Brass Fitting)
7	18-0418 MANIFOLD GASKET	CRUSADER 96653	Use with Manifold: 18-1898
8	18-8535 MOUNTING KIT (BLOCKED GASKET)	N/A	Use with Risers: 18-1939, 18-1999, 18-1907. Includes 18-0476-1 elbow gasket. (Use with a closed cooling system)
9	18-4364 MOUNTING KIT (OPEN GASKET)	BARR 20-0082-P	Use with Risers: 18-1999, 18-1907, & 18-1939. Includes 18-2854-1 elbow gasket.
10	18-0476-1 ELBOW GASKET (BLOCKED)	BARR 01-0105	Used with Risers: 18-1939, 18-1999. Included in 18-8535 mounting kit.
11	18-2854-1 3" ELBOW GASKET (OPEN)	BARR 01-0107	Used with Risers: 18-1939, 18-1999. Included in 18-4364 mounting kit.
12	18-1999 3 1/2" MANIFOLD ELBOW	BARR 20-0082	Comes with 18-4364 (open) mounting package. If blocked mounting kit is required use 18-8535 mounting kit. Use with Manifold: 18-1898; Riser Gasket: 18-2854-1 (open) or 18-0476-1 (blocked)
13	18-1939 4" MANIFOLD ELBOW	BARR 20-0100, MARINE POWER 0992-593	Use with Manifold: 18-1898; Riser Gasket: 18-2854-1 (open) or 18-0476-1 (blocked); Mount- ing Kit: 18-4364 (open) or 18-8535 (blocked)
14	NSS MOUNTING BOLT	N/A	Included in 18-4364 & 18-8535 mounting kits.

SIERRA®

Fits GM 305/350 CID V8 Small Block

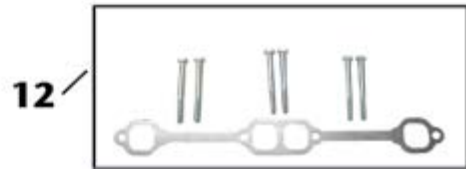
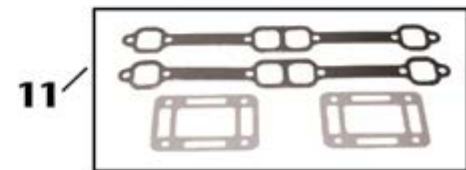
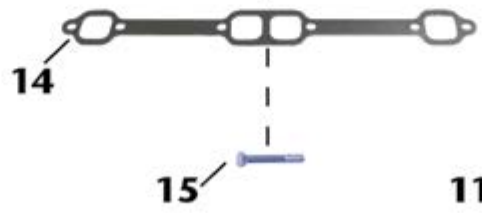
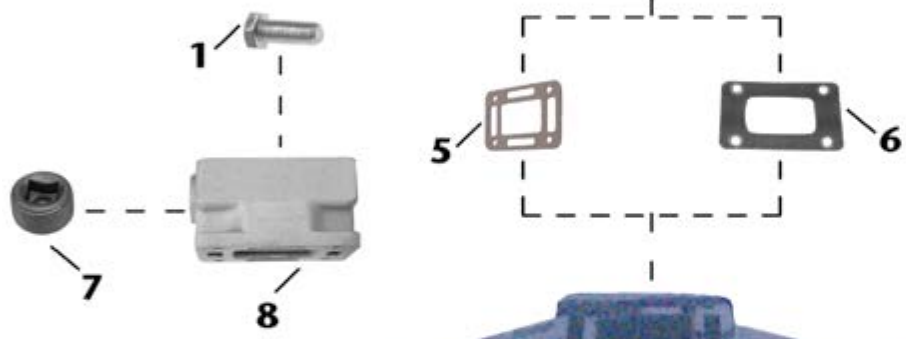
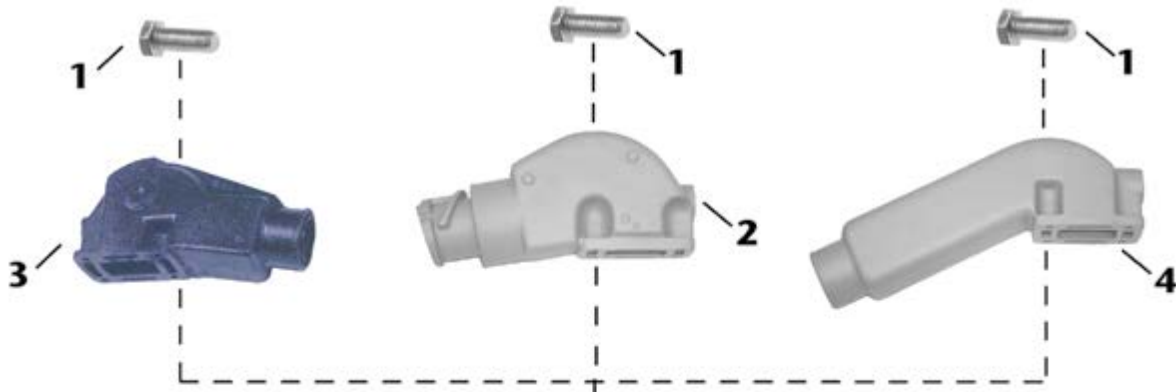

Item No.	Description	OE No.	Application	
1	NSS	MOUNTING BOLT	N/A	Included in 18-4364 & 18-8535 mounting kits.
2	18-1939	MANIFOLD ELBOW (4" hose, 7° down angle)	BARR 20-0100, MARINE POWER 0992-593	Use with Manifold: 18-1997-1; Riser Gasket: 18-2854-1 (open) or 18-0476-1 (blocked); Mounting Kit: 18-4364 (open) or 18-8535 (blocked)
3	18-1999	MANIFOLD ELBOW (3" hose, 15° down angle)	BARR 20-0082	Comes with 18-4364 (open) mounting package. If blocked mounting kit is required use 18-8535 mounting kit. Use with Manifolds: 18-1997-1; Riser Gasket: 18-2854-1 (open) or 18-0476-1 (blocked)
4	18-1907	MANIFOLD ELBOW (3" hose)	BARR 20-0100, INDMAR 53-2009, 53-2018	Use with Manifold: 18-1997-1; Riser Gasket: 18-2854-1 (open) or 18-0476-1 (blocked); Mounting Kit: 18-4364 (open) or 18-8535 (blocked)
5	18-2854-1	ELBOW GASKET (OPEN)	BARR 01-0107	Used with Risers: 18-1939, 18-1999, 18-1907. Included in 18-4364 mounting kit.
6	18-0476-1	ELBOW GASKET (BLOCKED)	BARR 01-0105	Used with Risers: 18-1939, 18-1999, 18-1907. Included in 18-8535 mounting kit.
7	18-4258	BLACKSTEEL PLUG	N/A	Thread Size: 3/4". Use with Manifold Spacer: 18-1949.
8	18-1949	MANIFOLD SPACER	N/A	Use with Manifold: 18-1997-1.
9	18-4364	MOUNTING KIT (OPEN GASKET)	BARR 20-0082-P	Use with Risers: 18-1999, 18-1907, & 18-1939. Includes 18-2854-1 elbow gasket.
10	18-8535	MOUNTING KIT (BLOCKED GASKET)	N/A	Use with Risers: 18-1939, 18-1999, 18-1907. Includes 18-0476-1 elbow gasket. (Use with a closed cooling system)
11	18-0604	EXHAUST MANIFOLD GASKET SET	N/A	GM 305-350 CID Engines; Use with Manifold: 18-1997-1
12	18-8536	MOUNTING KIT	N/A	Use with Manifold: 18-1997-1. Includes 18-2949 mounting kit.
13	18-1997-1 or 18-1964	MANIFOLD	BARR CHV-1-83	GM Small Block (V8) 305-350 cu.in. Use with Manifold Gasket 18-2949. Mounting Kit: 18-8536.
14	18-2949	MANIFOLD GASKET	BARR CHV-47-000	Use with Manifold: 18-1997-1. Included in 18-8536 mounting kit.
15	NSS	MOUNTING BOLT	N/A	Included in 18-8536 mounting kit.
16	18-8215	HOSE FITTING	N/A	3/4" - 14NPT X 3/4" Hose (Corrosion Resistant Brass Fitting)
17	18-4461	HOSE FITTING	N/A	3/4" - 14NPT X 1" Hose (Corrosion Resistant Brass Fitting)
18	18-8216	HOSE FITTING	N/A	3/4" - 14NPT X 1" Hose (Corrosion Resistant Brass Fitting)



Fits Ford 5.0L/5.8L 302/351 CID V8

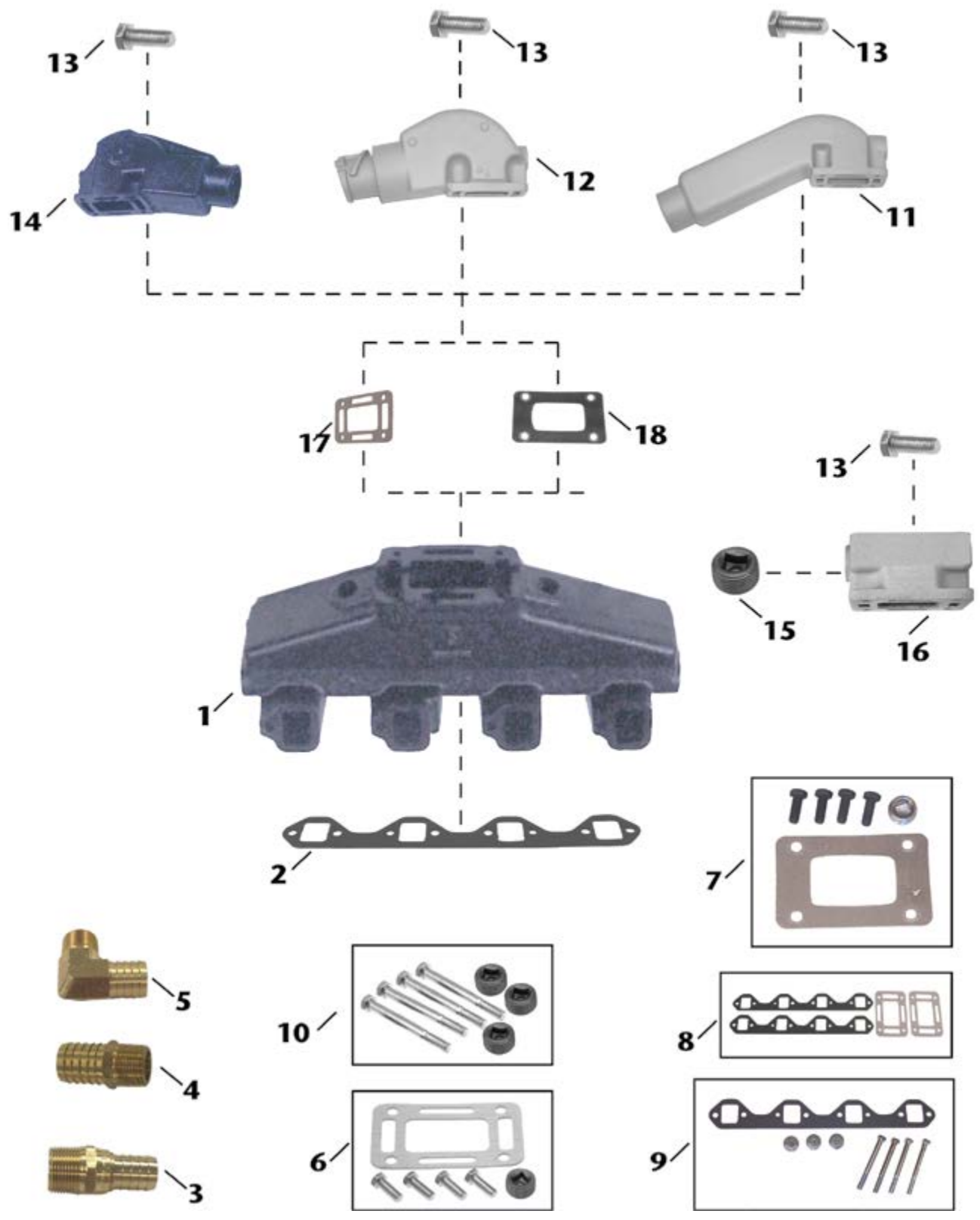

Item No.	Description	OE No.	Application
1	18-1998-1 MANIFOLD	BARR FM-1-83	Ford 302-351 (V8) CID Engines. Use with Manifold Gasket: 18-0183-1; Mounting Kit: 18-8538
2	18-0183-1 MANIFOLD GASKET	PLEASURECRAFT RM0007	Use with Manifold: 18-1998-1. Included in 18-8538 mounting kit.
3	18-8216 HOSE FITTING	N/A	3/4" - 14NPT X 1" Hose (Corrosion Resistant Brass Fitting)
4	18-4461 HOSE FITTING	N/A	3/4" - 14NPT X 1" Hose (Corrosion Resistant Brass Fitting)
5	18-8215 HOSE FITTING	N/A	3/4" - 14NPT X 3/4" Hose (Corrosion Resistant Brass Fitting)
6	18-4364 MOUNTING KIT (OPEN GASKET)	BARR 20-0082-P	Use with Risers: 18-1999, 18-1907, & 18-1939. Includes 18-2854-1 elbow gasket.
7	18-8535 MOUNTING KIT (BLOCKED GASKET)	N/A	Use with Risers: 18-1939, 18-1999, 18-1907. Includes 18-0476-1 elbow gasket. (Use with a closed cooling system)
8	18-0603 EXHAUST MANIFOLD GASKET SET	N/A	Ford 302-351 CID Engines; Use with Manifold: 18-1998-1.
9	18-8538 MOUNTING KIT	N/A	Use with Manifold: 18-1998-1. Includes 18-0183-1 manifold gasket.
10	NSS HARDWARE KIT	BARR FM-1-83-P	Hardware Only for Manifold: 18-1998-1
11	18-1907 ELBOW (3" hose)	BARR 20-0100, INDMAR 53-2009, 53-2018	Use with Manifold: 18-1998-1; Riser Gasket: 18-2854-1 (open) or 18-0476-1 (blocked); Mounting Kit: 18-4364 (open) or 18-8535 (blocked)
12	18-1939 ELBOW (7° down angle, 4" hose)	BARR 20-0100, MARINE POWER 0992-593	Use with Manifold: 18-1998-1; Riser Gasket: 18-2854-1 (open) or 18-0476-1 (blocked); Mounting Kit: 18-4364 (open) or 18-8535 (blocked)
13	NSS MOUNTING BOLT	N/A	Included in 18-4364 & 18-8535 mounting kits.
14	18-1999 MANIFOLD ELBOW (15° down angle, 3" hose)	BARR 20-0082	Comes with 18-4364 (open) mounting package. If blocked mounting kit is required use 18-8535 mounting kit. Use with Manifold: 18-1998-1; Riser Gasket: 18-2854-1 (open) or 18-0476-1 (blocked)
15	18-4258 BLACKSTEEL PLUG	N/A	Thread Size: 3/4". Use with Manifold Spacer: 18-1949
16	18-1949 MANIFOLD SPACER	N/A	Use with Manifold: 18-1998-1
17	18-2854-1 ELBOW GASKET (OPEN)	BARR 01-0107	Used with Risers: 18-1939, 18-1999, 18-1907. Included in 18-4364 mounting kit.
18	18-0476-1 ELBOW GASKET (BLOCKED)	BARR	Used with Risers: 18-1939, 18-1999, 18-1907. Included in 18-8535 mounting kit.



**MOST MANIFOLDS
ARE PAINTED, PACKAGED & LEAK TESTED**

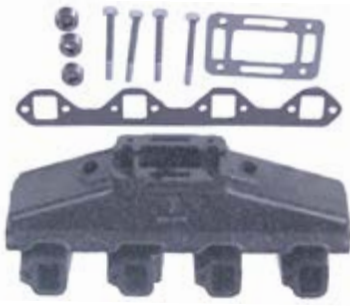

**18-1998-1
MANIFOLD**

Port & Starboard

Replaces: Barr FM-1-83

Universal Center Riser Manifold

FITS: Ford 302 and 351 CID engines

Comes with **18-4363 Mounting Package** - **Replaces:** Barr FM 1-83-P

Use with:

Exhaust Manifold Gasket Set: 18-0603



**18-1997-1
MANIFOLD**

Port & Starboard

Replaces: Barr CHV-1-83

Universal Center Riser Manifold

FITS: GM 283, 305, 307 and 350 CID engines

Use with:

Exhaust Manifold Gasket Set: 18-0604



18-1999

ELBOW (3" HOSE)

Replaces: Barr 20-0082

Comes with **18-4364 open Mounting Package**

Use with:

Manifold: 18-1997-1 or 18-1998-1 or 18-1898

Riser Gasket: 18-2854-1 open or 18-0476-1 blocked

Mounting Kit: 18-4364 open or 18-8535 blocked



18-1898

MANIFOLD

Port & Starboard

Replaces: Barr CHVA-1-84, Marine Power 0991-110

Fits: 454 cu.in. GM big block V8 engines

Use with:

Exhaust Gasket: 18-0418

Riser Gasket: 18-2854-1 open or 18-0476-1 blocked



18-1907

RISER (3" HOSE)

Replaces: Barr 20-0100, Indmar 53-2009, 53-2018

Barr and Indmar Ford Small Block V8 302-351cu.in.

Use with:

Manifolds: 18-1997-1 or 18-1998-1

Riser Gasket: 18-2854-1 open or 18-0476-1 blocked

Mounting Kit: 18-4364 open or 18-8535 blocked



18-1939

RISER (4" HOSE)

Replaces: Barr 20-0100, Marine Power 0992-593

Barr, Indmar and Marine Power Ford Small Block V8 302-351cu. in. GM

Small Block V8 305-350cu. in., GM Big Block V8 454cu. in.

Use with:

Manifold: 18-1997-1, 18-1998-1

Riser Gasket: 18-2854-1 open or 18-0476-1 blocked

Mounting Kit: 18-4364 open or 18-8535 blocked

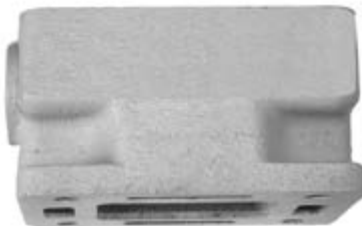

18-1949

MANIFOLD SPACER (3")

Barr CM 20-0097

Barr, Indmar and Marine Power Ford Small Block V8 302-351cu.in., GM Small Block V8 305-350cu.in.,

GM Big Block V8 454cu.in.

Used with:

Manifolds: 18-1998-1, 18-1997-1 and

18-1898



18-4364 (Open)











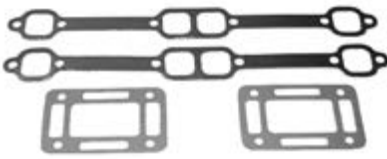

EXHAUST ELBOW KIT

Replaces:

Barr 20-0082-P

Use with:

Riser: 18-1999, 18-1907, 18-1939

 <p>18-8535 (Blocked) EXHAUST MANIFOLD MOUNTING KIT Barr, Indmar and Marine Power Ford Small Block V8 302-351cu.in., GM Small Block V8 305-350cu.in., GM Big Block V8 454cu.in. Used with: Risers: 18-1939, 18-1999, and 18-1907</p>	 <p>18-8536 EXHAUST ELBOW MOUNTING KIT Barr, Indmar and Marine Power GM Small Block V8 305-350cu.in. Used with: Manifold: 18-1997-1</p>	 <p>18-8538 EXHAUST MANIFOLD MOUNTING KIT Barr and Indmar Ford Small Block V8 302-351cu.in. Used with: Manifold: 18-1998-1</p>
 <p>18-0603 EXHAUST MANIFOLD GASKET SET For: Ford 302/351 CID Engines For use with 18-1998-1</p>	 <p>18-0604 EXHAUST MANIFOLD GASKET SET For: GM 305/350 CID Engines For use with 18-1997-1</p>	 <p>18-0183-1 EXHAUST MANIFOLD GASKET Replaces: Mercruiser 27-73866, 27-54566 Volvo 3853742, 3852455 OMC 908717 Used with: Manifold: 18-1962-1, 18-1938, 18-1998-1, 18-1996, 18-1979</p>
 <p>18-0418 EXHAUST MANIFOLD GASKET Replaces: Mercruiser 27-46820 Use with: Manifolds: 18-1957-2, 18-1982, 18-1929, 18-1933, 18-1898</p>	 <p>18-0476-1 RISER BLOCKOFF GASKET Replaces: Barr 01-0105 Indmar & Marine Power Ford Small Block V8 302-351cu.in. Used with: Risers: 18-1939, 18-1999, 18-1907</p>	<p>PKG. OF 2</p>  <p>18-2854-1 (Open) 18-2854-9^① EXHAUST ELBOW GASKET Replaces: Barr 01-0107 Use with: Riser: 18-1999, 18-1939, 18-1907</p>
<p>PKG. OF 2</p>  <p>18-2949 18-2949-9^① EXHAUST MANIFOLD GASKET Replaces: Barr CHV-47-000 Use with: Manifold: 18-1997-1</p>	 <p>18-4461 HOSE BARB Replaces: Mercruiser 22-807155 3/4" - 14 NPT x 1" Hose Corrosion Resistant Brass Fitting</p>	 <p>18-4258 PIPE PLUG Replaces: Mercruiser 22-33198, 22-33198A1, 22-41622, 22-46754 3/4" Thread size Blacksteel</p>

① Priced per Package



18-5466
HI-PERFORMANCE IGNITION COIL
 1.5 ohm (oil filled), black - 8 cylinder: Flame-Thrower 40,000 volt coil.
 • Designed for use with the original Ignitor Electronic Conversion Kits
 • Can be used with other inductive ignition systems



18-5469
HI-PERFORMANCE IGNITION COIL
 3.0 ohm (oil filled), black - 4 & 6 cylinder: Flame-Thrower 40,000 volt coil.
 • Designed for use with the original Ignitor Electronic Conversion Kits
 • Can be used with other inductive ignition systems



18-5472
HI-PERFORMANCE IGNITION COIL
 0.6 ohm (oil filled), black - 4, 6, & 8 cylinder: Flame-Thrower 45,000 volt coil.
 • Super low 0.6 ohm resistance coil designed for use with the Ignitor II Hi Performance Electronic Conversion Kits
 • Compatible with capacitive discharge systems



18-8898
COIL
 High performance coil HV for Ignitor or points



18-8899
COIL
 High performance coil HV for Ignitor II or Flamethrower



18-29716
CHROME HIGH OUTPUT COIL
Replaces: Mallory 29716
Fits: Mallory 8 cylinder



18-28150
WIRE SEPARATOR / BLUE



18-28151
WIRE SEPARATOR / BLACK



18-29720
Replaces: Mallory 29440M
 For use with Mallory UNILITE Ignition, Magnetic Breakerless Ignition and /or Electronic Advance Computer. Effective to 8000 RPM's. (External Resistor required)



18-29723
 For use with Mallory UNILITE Ignition, Magnetic Breakerless Ignition and /or Electronic Advance Computer. Effective to 8000 RPM's. (Internally Resisted)

Our PROMASTER® Coil delivers higher performance through faster rise time and longer spark duration. A rugged, glass-filled polyester case and oil-filled construction ensure long life with no energy loss from arcing. All PROMASTER® Coils include threaded brass contact terminals and spark plug type secondary post for better coil wire retention. For use with Mallory UNILITE® Ignition, Magnetic Breakerless Ignition, and/or Electronic Advance Computer. Effective to 8000 RPM.



18-28175
WIRE MARKERS



18-5285
HI-PERFORMANCE
ELECTRONIC CONVERSION KIT
Fits: 4 Cylinder Delco Distributors



18-5288-1
Superseded from 18-5289
HI-PERFORMANCE
ELECTRONIC CONVERSION KIT
Fits: Most Prestolite Distributors with screw down cap



18-5290
HI-PERFORMANCE
ELECTRONIC CONVERSION KIT
Fits: Most Mallory YL or YD 8 cylinder Distributors with clockwise and counter clockwise rotation



18-5477
ELECTRONIC DISTRIBUTOR
Fits: Ford 302 V-8 engines
Replacement Cap/Rotor Kit **18-5266**



18-5479
ELECTRONIC DISTRIBUTOR
Fits: GM V-8 engines-reverse rotation



18-5480
COMPLETE IGNITION
CONVERSION KIT
Fits: GM SB & BB with Standard Deck Height



18-5481
HI-PERFORMANCE
ELECTRONIC DISTRIBUTOR
Fits: Ford V-8 351 Windsor
Replacement cap/rotor kit: **18-5266**



18-5483
HI-PERFORMANCE ELECTRONIC DISTRIBUTOR

Fits: Chevrolet marine small and big block engines (standard deck height). Replacement cap/rotor kit: **18-5266**



18-5473
DISTRIBUTOR CAP

Black Distributor Cap with Male Terminals for Flamethrower Distributors



18-6842
ALTERNATOR

Replaces: 983424, 836, 247
For: 37-63A Marine Applications



18-6975
ALTERNATOR (Universal)

Fits: High amp 160A alternator, universal mounting pattern based on Delco CS1300 design, v-belt and 6 groove serpentine pulley included



18-6834
STARTER

Replaces: GM Engines Universal
Used on all GM Engines with either 14 1/4" or 12 3/4" flywheels



18-6835
STARTER

Replaces: GM Engines Universal
3 terminal
Used on all GM Engines with either 14 1/4" or 12 3/4" flywheels

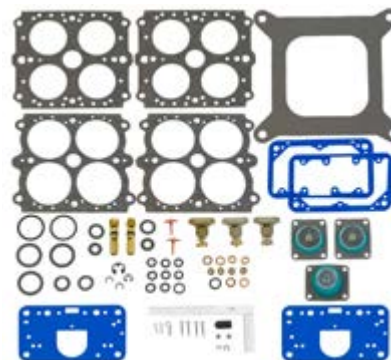

18-7751
CARB KIT

Replaces: **Mercuriser** 13220
Fits: GM 420 V8 454 (1987-89), GM 425 V8 454 (1990-93), GM 425 (Gen V) V8 454 (1992-93), 440 TRS GM 454 (1983-86), GM 450 V8 454(1995-96), 460 TRS V8 482 (1983-86), GM 465 V8 502 (1990-92), GM 465 (Gen V) V8 502 (1992-94), 500 (Gen+) GM 502 V8 (1999), 500 (Gen V) 502 V8 (1994-98), 500 Bulldog 540 V8 (1990-01)



18-7637
CARBURETOR (REMANUFACTURED)

(Gasket included)
600 CFM Holley 4V



18-7638
CARBURETOR (REMANUFACTURED)

600 CFM Holley 4V-side inlet



18-7775
FILTER BRACKET

3/8" Aluminum



18-7776
FILTER BRACKET

3/8" Stainless Steel



18-7232
FLAME ARRESTOR

Replaces: **Crusader** 33628
Mercuriser 57882, 57882T



18-7790
FUEL FILTER KIT
 Complete Kit Contains: Housing, Replaceable Element & Fittings for 1/4", 5/16", & 3/8" Fuel Lines
 Uses Filter 18-7791



18-7945C
FUEL WATER SEPARATER FILTER (Chrome)
 Replaces: Mercury 35-802893Q
 Yamaha ABB-FUELF-IL-TR



18-7824C-2
OIL FILTER (Chrome)
 Short GM
 Replaces:
 Chris-Craft 16.81-08746
 Crusader 201104, Indmar: 50-1001
 Mercruiser 35-802885Q, 32716, 866340Q02, Q03, 866340K01
 Mercruiser Vazer, OMC 173232, 502902
 Pleasurecraft R077002
 Volvo-Penta 835440
 Yamaha YSC-10231-20-0C
 Thread Spec: 13/16" x 16NPT



18-7866
FUEL FILTER
 Replaces: Yamaha MAR-FUELF-IL-TR
 High Capacity - 6" 10 Micron

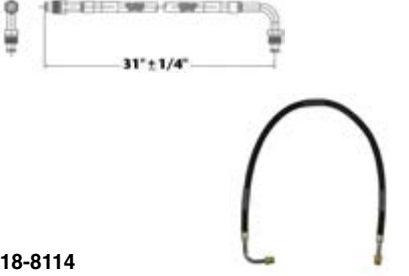

18-8114
FUEL LINE HOSE
 For fuel pump to carburetor connection. Replaces copper or steel tubing 3/8" X 31" PTFE composite hose with 5/8"-18 male inverted flare straight one end, 5/8"-18 90° one end. SAE J1527 type A1



18-8115
FUEL LINE HOSE
 For fuel pump to carburetor connection. Replaces copper or steel tubing 3/8" X 25" PTFE composite hose with 5/8"-18 male inverted flare straight one end, 5/8"-18 90° one end. SAE J1527 type A1



18-34120
ELECTRIC FUEL PUMP
 Replaces: Mallory 5110MFI
 INJ 110GPH



18-34140
ELECTRIC FUEL PUMP
 Replaces: Mallory 4140M
 140GPH MARINE



18-35102
FUEL PUMP BLOCK-OFF PLATE BB CHEV
 Replaces: Mallory 5422
 For: Chevrolet 396-502 & Ford 289-351W



18-7332
ELECTRIC FUEL PUMP
 Includes bracket and mounting hardware
 43 GPH - 7 PSI Max. - 1/4 NPSF for 3/8 hose - operates with both gasoline and diesel fuel - 24 Volt only



18-35435
ELECTRIC FUEL PUMP
 Universal - 12V 2.5-4.5 psi @ 16.8 gph 1/8" Female Pipe Thread



18-35436
ELECTRIC FUEL PUMP
 Universal - 12V 5-9 psi @ 16.8 gph 1/8" Female Pipe Thread



18-7628
INTAKE MANIFOLD
 Small-block GM with vortec cylinder heads
 Brass lined water jackets for salt water applications



18-1989
THERMOSTAT HOUSING
 Replaces: Mercruiser 8M0061381, 861006A1
 Stainless Steel
 Use 18-1989K Thermostat Service Kit for replacement parts



18-1989K
THERMOSTAT SERVICE KIT
 Service Kit for 18-1989 Thermostat Housing



18-4507
ROCKER ARM KIT (4 VALVES)
 Big-Block GM



18-4506
GUIDE PLATES
 Big-Block GM with 5/16" pushrods

CYLINDER HEAD ASSEMBLIES

All cylinder heads are new castings and complete assemblies with new stainless steel valves, hardened steel exhaust seats, valve springs, valve locks and retainers.

All GM cylinder heads utilize high performance screw-in rocker arm studs in place of factory press in rocker arm studs.



18-4485HP

CYLINDER HEAD ASSEMBLY

Fits: Mid GM small block 5.7L high performance.

Completely assembled with revised runner and combustion chambers. Add 30hp to stock motor with no additional modifications.



18-4486HP

CYLINDER HEAD ASSEMBLY

Fits: Vortec GM small block 5.7L high performance

Completely assembled with revised runner and combustion chambers. Add 30hp to stock motor with no additional modifications.



18-4484HP

CYLINDER HEAD ASSEMBLY

Fits: Early GM small block 5.7L high-performance

Completely assembled with revised runner and combustion chambers. Add 30hp to stock motor with no additional modifications.



18-4493HP

CYLINDER HEAD

Fits: Big-block GM cast iron performance



18-4503
CYLINDER HEAD (HIGH PERFORMANCE)

- Up to 60 HP increase over OE cylinder heads
- 5 angle valve seat cut
- Double drilled intake mounting
- For either standard 12 bolt GM intake or late-model 8 bolt Vortec intake
- Accepts both perimeter or center bolt valve covers
- Fits 5.7 & 6.2L small block GM V-8 applications
- OE look
- Corrosion resistance heavy-duty cast iron castings suitable for saltwater usage
- Intake Runner: 185cc
- Exhaust Runner: 62cc
- Combustion Chambers: 72cc
- Intake Stainless Steel Valves: 2.02
- Exhaust Stainless Steel Valves: 1.60
- Cast Iron Cylinder Heads: Sold in pairs only

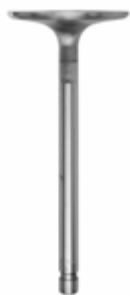

18-4735
INTAKE VALVE (2.02")
Fits: GM V-6 & V-8 engines



18-4516
RING GEAR-FLYWHEEL
14" GM flywheel w/ 168 teeth



18-4519
FLYWHEEL
14" 5.0/5.7L, 1 piece main 1987 and UP.
Bottom mount starter (Block mounted) applications.



18-4522
FLYWHEEL
14" 454, Gen IV w/ 2 piece rear main.
Bottom mount starter (Block mounted) applications.



18-4737
ROCKER ARM STUD
Fits: GM V-6 & V-8 engines



BRASS FREEZE PLUG KITS
Eliminate any chance of rusted out freeze plugs with our Brass Freeze Plug Kits. Designed for marine applications. Kit includes all plugs needed for a complete engine.

Part No.	
18-56481	Chevrolet 265-400



EDELBROCK® CARBURETORS

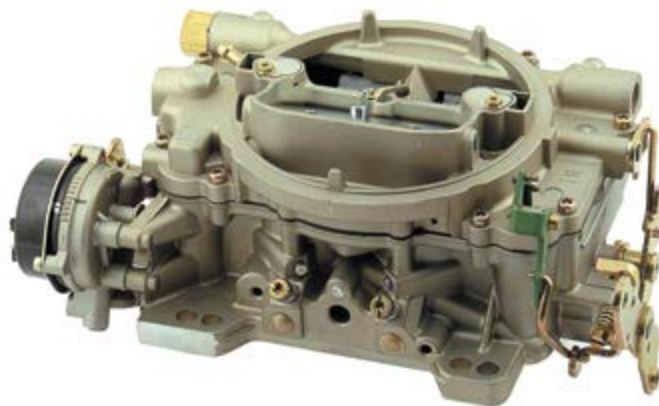

18-34080
600 CFM CARBURETOR
Fits: V-6 and small V-8 engines



18-34081
750 CFM CARBURETOR
Fits: Small and big-block GM engines



EDELBROCK® INTAKE MANIFOLDS



18-34083
BRASS WATER INTAKE
MANIFOLD
Fits: Small block GM, 1987-1995



18-34084
BRASS WATER INTAKE
MANIFOLD
Fits: Big-block GM with oval port cylinder
heads



EASY TO USE MODULAR GASKET KITS FOR FORD & CHEVROLET MARINE ENGINES

- For most popular marine versions of: Chevrolet In-line 4 & 6 cylinder V6 & V8 Engines and Ford 5.0 L & 5.8L V8 Engines
- Minimizes inventory investment to cover most major engine applications
- Maximizes inventory utilizations via mix and match system
- Utilizes generic type gasket kits common among all engine brands., (i.e. a 350CID (5.7L) Crusader & Mercruiser would use the same short block & valve grind gasket sets, but would use different exhaust manifold gasket kits)

CHEVY 4 CYL. 153/2.5L 1965-88 ③
CHEVY 4 CYL. 181/3.0L 1973-84 ③
CHEVY 4 CYL. 181/3.0L 1985-89 (4 CYL. 181/3.0L HO 1990-98 ③)



18-1271 ① ③
SHORT BLOCK GASKET SET
 — CONTAINS —

Description	Part #
Oil Pan Gasket	18-0466
Forward Crankshaft Seals	18-1213
Rear Crankshaft Seals	18-1211
Push Rod Cover	18-2815
Water Pump Gasket	18-0327
Fuel Pump Mounting Gasket	18-0889
Fuel Pump Mounting Gasket	NSS
Cam Gear Cover Gasket	18-0887
Distributor Mounting Gasket	18-0948
Distributor Mounting Gasket	18-0874



18-1274
HEAD GASKET SET
 — CONTAINS —

Description	Part #
Head Gasket	18-2946
Mercarb Mounting Gasket	18-0994
Carb. Mounting Gasket	18-0356
Thermostat Housing Gasket	18-0164
Valve Cover Gasket	18-0347
Valve Stem Seals (8)	18-0518

GM 4 CYL. 3.0L

18-1206
SHORT BLOCK GASKET SET
 — CONTAINS —

Description	Part #
Front Crankshaft Seal	18-1213
Rear Crankshaft Seal	18-0519
Fuel Pump Mounting Gasket	18-0889
Fuel Pump Mounting Gasket	NSS
Push Rod Cover Gasket	18-2815
Distributor Mounting Gasket	18-0874
Distributor Mounting Gasket	18-0948
Timing Cover Gasket	18-0887
Water Pump Gasket	18-0327



4 CYL. 3.7L MERCURISER 470



18-1276
SHORT BLOCK GASKET SET
 — CONTAINS —

Description	Part #
Oil Seal	18-2014
Mounting Gasket	NSS
Distributor Mounting Gasket	18-0874
Fuel Pump Mounting Gasket	18-0889
O-Ring	NSS
Water Pump Seal	18-0172
O-Ring	18-7145
Oil Pan Gasket	18-4366
Water Pump Timer Cover Gasket	NSS
Timing Chain Gasket Set	18-4380



18-1277
HEAD GASKET SET
 — CONTAINS —

Description	Part #
Intake Gasket	18-0158
Quadrajets Gasket	18-2848
Valve Grind Cover Gasket	18-0685
Head Gasket	18-3878
Exhaust Manifold Mounting Gasket	18-0956-1
Valve Seal	18-4023

① Except models with cast push rod cover

② Does not include intake and/or exhaust manifold gaskets

③ For models with 1 piece rear main seal use 18-1206

NSS Not Sold Separately

CHEVY 6 Cyl. 250/4.1L

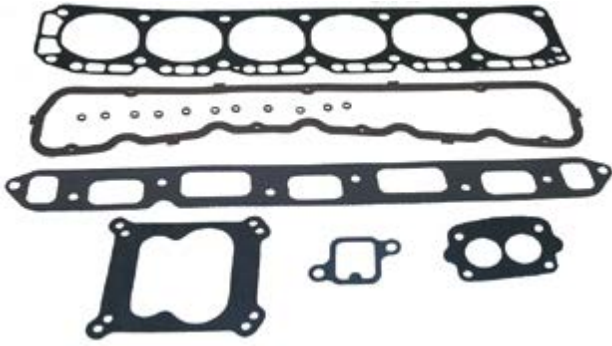

18-1264

HEAD GASKET SET

— CONTAINS —

Description	Part #
Head Gasket	18-3881
4BBL Carb Mounting Gasket	18-0463
2BBL Carb Mounting Gasket	18-0356
Exhaust Manifold Gasket	18-2830-1
T-Stat Hsg. Mounting Gasket	18-0164
Valve Cover Gasket	18-0346
Valve Stem Seals (8)	18-0518

**CHEVY V-6 262/4.3L - 1 Piece Rear Seal
CHEVY V-6 262/4.3L GEN II - 1 Piece Rear Seal
1986-1995**



18-1278

HEAD GASKET SET

— CONTAINS —

Description	Part #
Head Gasket	18-3879
2BBL Carb Mounting Gasket	18-0994
4BBL Carb Mounting Gasket	18-0463
Valve Stem Seals (6)	18-4024
Valve Stem Seals (12)	18-0518
Distributor Mounting Gasket	18-0874
Intake Gasket Set	18-1238
Valve Cover Gasket (2)	18-0311

**CHEVY V-8 305/5.0L
2 Piece Rear Seal
thru 1985**

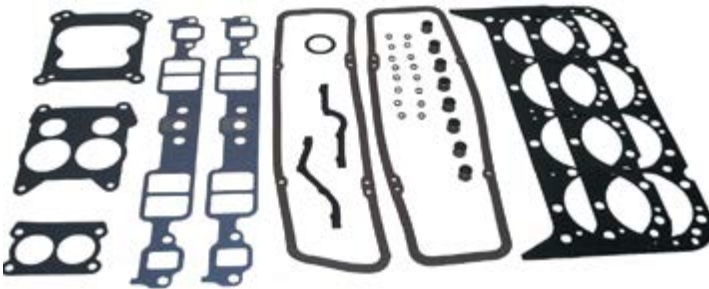

18-1266 ②

HEAD GASKET SET

— CONTAINS —

Description	Part #
Head Gasket	18-3876
2BBL Carb Mounting Gasket	18-0994
4BBL Carb Mounting Gasket	18-0463
4BBL Carb Mounting Gasket	18-0462
Intake Manifold Gasket	18-0868
Valve Cover Gasket (2)	18-2845
Valve Stem Seals (8)	18-4024
Valve Stem Seals (16)	18-0518
Distributor Mounting Gasket	18-0874

**CHEVY V-8 305/5.0L (Right Hand Rotation)
2 Piece Rear Seal
thru 1985**

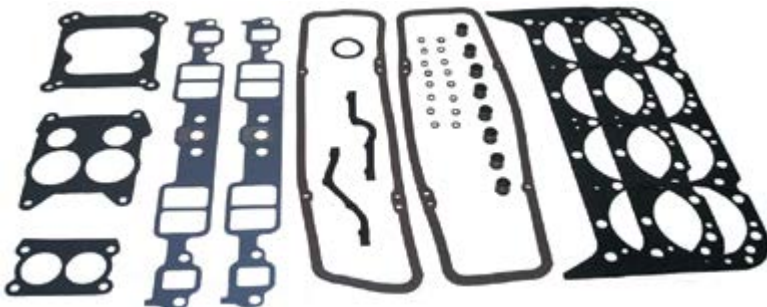

18-1266 ②

HEAD GASKET SET

— CONTAINS —

Description	Part #
Head Gasket	18-3876
2BBL Carb Mounting Gasket	18-0994
4BBL Carb Mounting Gasket	18-0463
4BBL Carb Mounting Gasket	18-0462
Intake Manifold Gasket	18-0868
Valve Cover Gasket (2)	18-2845
Valve Stem Seals (8)	18-4024
Valve Stem Seals (16)	18-0518

① Does not include oil pan gasket

② Does not include intake and/or exhaust manifold gaskets

NSS Not Sold Separately

CHEVY V-8 305/5.0L GEN II
1 Piece Rear Seal
1986-1995

18-1267 ②

HEAD GASKET SET

— CONTAINS —

Description	Part #
Head Gasket	18-3876
2BBL Carb Mounting Gasket	18-0994
4BBL Carb Mounting Gasket	18-0463
4BBL Carb Mounting Gasket	18-0462
Intake Manifold Gasket Set	18-0868
Valve Cover Gasket (2)	18-0664
Valve Stem Seals (8)	18-4024
Valve Stem Seals (16)	18-0518



CHEVY V-8 305/5.0L GEN II (Right Hand Rotation)
1 Piece Rear Seal
1986-1995

18-1263 ①

SHORT BLOCK GASKET SET

— CONTAINS —

Description	Part #
Oil Drain Screw Gasket	18-0905
Oil Filter Gasket	18-0185
Forward Crankshaft Seal	18-1213
Rear Main Bearing Gasket	18-0322
Water Pump Mounting Gasket	18-0891
Water Pump Backing Plate Gasket	18-0893
Water Pump Plate Gasket	NSS
Fuel Pump Plate Gasket	18-0876
Fuel Pump Mounting Gasket	18-0889
Timing Chain Cover Gasket	18-0976



18-1267 ②

HEAD GASKET SET

— CONTAINS —

Description	Part #
Head Gasket	18-3876
2BBL Carb Mounting Gasket	18-0994
4BBL Carb Mounting Gasket	18-0463
4BBL Carb Mounting Gasket	18-0462
Intake Manifold Gasket Set	18-0868
Valve Cover Gasket (2)	18-0664
Valve Stem Seals (8)	18-4024
Valve Stem Seals (16)	18-0518



CHEVY V-8 350/5.7L
2 Piece Rear Seal
thru 1985

18-1266 ②

HEAD GASKET SET

— CONTAINS —

Description	Part #
Head Gasket	18-3876
2BBL Carb Mounting Gasket	18-0994
4BBL Carb Mounting Gasket	18-0463
4BBL Carb Mounting Gasket	18-0462
Intake Manifold Gasket	18-0868
Valve Cover Gasket (2)	18-2845
Valve Stem Seals (8)	18-4024
Valve Stem Seals (16)	18-0518
Distributor Mounting Gasket	18-0874

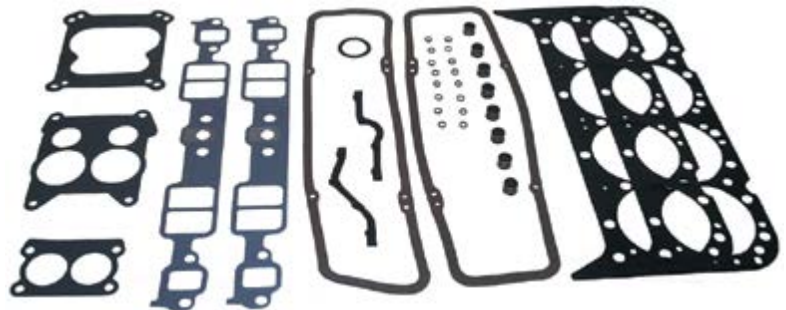

① Does not include oil pan gasket

② Does not include intake and/or exhaust manifold gaskets

NSS Not Sold Separately

**CHEVY V-8 350/5.7L (Right Hand Rotation)
2 Piece Rear Seal
thru 1985**

18-1266 ②
HEAD GASKET SET
— CONTAINS —

Description	Part #
Head Gasket	18-3876
2BBL Carb Mounting Gasket	18-0994
4BBL Carb Mounting Gasket	18-0463
4BBL Carb Mounting Gasket	18-0462
Intake Manifold Gasket	18-0868
Valve Cover Gasket (2)	18-2845
Valve Stem Seals (8)	18-4024
Valve Stem Seals (16)	18-0518



**CHEVY V-8 350/5.7L GEN II
1 Piece Rear Seal
1986-1995**

18-1267 ②
HEAD GASKET SET
— CONTAINS —

Description	Part #
Head Gasket	18-3876
2BBL Carb Mounting Gasket	18-0994
4BBL Carb Mounting Gasket	18-0463
4BBL Carb Mounting Gasket	18-0462
Intake Manifold Gasket Set	18-0868
Valve Cover Gasket (2)	18-0664
Valve Stem Seals (8)	18-4024
Valve Stem Seals (16)	18-0518
Distributor Mounting Gasket	18-0874



**CHEVY V-8 350/5.7L GEN II (Right Hand Rotation)
1 Piece Rear Seal
1986-1995**

18-1263 ①
SHORT BLOCK GASKET SET
— CONTAINS —

Description	Part #
Oil Drain Screw Gasket	18-0905
Oil Filter Gasket	18-0185
Forward Crankshaft Seal	18-1213
Rear Main Bearing Gasket	18-0322
Water Pump Mounting Gasket	18-0891
Water Pump Plate Gasket	NSS
Fuel Pump Plate Gasket	18-0876
Fuel Pump Mounting Gasket	18-0889
Timing Chain Cover Gasket	18-0468



18-1267 ②
HEAD GASKET SET
— CONTAINS —

Description	Part #
Head Gasket	18-3876
2BBL Carb Mounting Gasket	18-0994
4BBL Carb Mounting Gasket	18-0463
4BBL Carb Mounting Gasket	18-0462
Intake Manifold Gasket Set	18-0868
Valve Cover Gasket (2)	18-0664
Valve Stem Seals (8)	18-4024
Valve Stem Seals (16)	18-0518
Distributor Mounting Gasket	18-0874



① Does not include oil pan gasket ② Does not include intake and/or exhaust manifold gaskets NSS Not Sold Separately



18-1257 ②

VALUE GRIND GASKET SET

— CONTAINS —

Description	Part #
Head Gasket	18-3877
Carb Mounting Gasket	18-0462
Carb Mounting Gasket	18-0463
Carb Mounting Gasket	18-0467
Intake Manifold Gasket Set	18-0465
Valve Cover Gasket (2)	18-0464
Valve Stem Seals (16)	18-0422
Distributor Mounting Gasket	18-0874

CHEVY V-8 454/7.4L w/Square Ports



18-1259 ②

HEAD GASKET SET

— CONTAINS —

Description	Part #
Head Gasket	18-3877
Carb Mounting Gasket	18-0467
Carb Mounting Gasket	18-0463
Carb Mounting Gasket	18-0462
Intake Manifold Gasket Set	18-1231
Valve Cover Gasket (2)	18-0464
Valve Stem Seals (16)	18-4024
Distributor Mounting Gasket	18-0874

**CHEVY V-8 454/7.4L GEN V
CHEVY V-8 454/7.4L GEN V (w/square ports)
CHEVY V-8 502/8.2L GEN V**

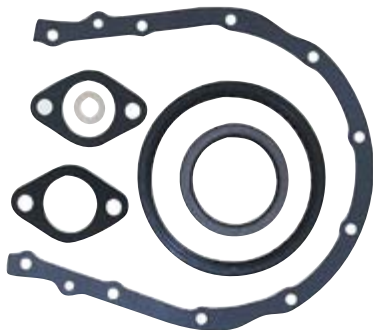

18-1261 ①

TIMING CHAIN GASKET SET

— CONTAINS —

Description	Part #
Oil Drain Screw Gasket	18-0905
Forward Crankshaft Seals	18-1233
Rear Crankshaft Seals	18-1234
Water Pump Mounting Gasket	18-0903
Timing Cover Gasket	18-0468



18-1258 ②

VALVE GRIND GASKET SET

— CONTAINS —

Description	Part #
Head Gasket	18-3874
Carb Mounting Gasket	18-0467
Carb Mounting Gasket	18-0463
Carb Mounting Gasket	18-0462
Intake Manifold Gasket Set	NSS
Valve Stem Seals (16)	NSS
Distributor Mounting Gasket	18-0874

① Does not include oil pan gasket

② Does not include intake and/or exhaust manifold gaskets

NSS Not Sold Separately

MODULAR GASKET APPLICATION

Engine/Model	Years	Serial No.	Short Block	Valve Grind Kit
Chevy 153-2.5L	1965-85	3377341-6229717 ⑤ ②	18-1271	18-1274
Chevy 153/2.5L	1986-88	6229718 & Up ⑤ ②	18-1271	18-1274
Chevy 181/3.0L	1973-84	3332137-6229717 ⑤ ② ⑤	18-1271	18-1274
Chevy 181/3.0L	1985-96	6229718 & Later ⑤ ② ⑤	N/A	18-1274
Chevy 181/3.0LX	1990-97	C856559 & Later ① ⑤ ②	N/A	18-1274
Mercury 165/3.7L (4 Cyl.)	1987-89	6916779 & Later ⑦ ③	18-1276	18-1277
Mercury 170 (4 Cyl.)	1985-86	6916779 & Later ③	18-1276	18-1277
Mercury 180/3.7L-LX (4 Cyl.)	1987-89	6916779 & Later ③	18-1276	18-1277
Mercury 190 (4 Cyl.)	1985-86	6916779 & Later ③	18-1276	18-1277
Mercury 470	1976-82	4208730-6218036 ③	18-1276	18-1277
Mercury 470	1983-84	6218037-6916778 ③	18-1276	18-1277
Mercury 485	1980-82	5685394-6218036 ③	18-1276	18-1277
Mercury 488	1983-84	6170297-6916778 ③	18-1276	18-1277
Chevy 229/3.8L	1983-84	6330183-6919655 ② ⑤	N/A	N/A
Chevy L6 250/4.1L	1970-81	2770032-5813433 ⑤	N/A	18-1264
Chevy 262/4.3L (2Pc. Rm Seal)	1985	6919656-B455459 ⑤	N/A	N/A
Chevy 262/4.3L (2Pc. Rm Seal)	1986-92	A483581 ① ⑤	N/A	N/A
Chevy 262/4.3L Gen II	1992	D714370-F802999 ① ⑤	N/A	18-1278
Chevy 262/4.3L Gen II	1993-96	D714370-F802999 ① ⑤	N/A	18-1278
Chevy 305/5.0L	1977-85	4762210-B525981 ③ ⑤	—	18-1266
Chevy 305/5.0L (Rev. Rota.)	1977-85	4762210-B525981 ③ ⑤	—	18-1266
Chevy 305/5.0L (1 Pc. Rm Seal)	1986	A482027-B525981 ① ⑤	18-1258	18-1266
Chevy 305/5.0L (Rev. Rota.) (1 Pc. Rm Seal)	1986	A482027-B525981 ① ⑤	18-1263	18-1266
Chevy 305/5.0L	1987-95	B525982 & Later ① ⑤ ⑧	—	18-1267
Chevy 305/5.0L Inboard	1987-95	B522506 & Later ① ⑤ ⑧	—	18-1267
Chevy 305/5.0L (Rev.Rota) Inboard	1987-95	B522506 & Later ① ⑤	18-1263	18-1267
Chevy 350/5.7L	1975-86	4175500-B525982 ③ ⑤ ④	—	18-1266
Chevy 350/5.7 Inboard	1975-86	4498701-B522506 ③ ⑤	—	18-1266
Chevy 350/5.7 (Rev.Rota) Inboard	1975-86	4498701-B522506 ③ ⑤	—	18-1266
Chevy 350/5.7L (1Pc. Rm Seal)	1986	6218462-B522506 ① ⑤	—	18-1266
Chevy 350/5.7L (1Pc. Rm Seal) Inboard	1986	A492879-B522506 ① ⑤	—	18-1266
Chevy 350/5.7L (Rev.Rota)(1 Pc. Rm Seal)	1986	A492879-B522506 ① ⑤	18-1263	18-1266
Chevy 350/5.7L	1987-95	B525982 & Later ① ⑤ ⑧	—	18-1267
Chevy 350/5.7L	1996-97	B525982 & Later ① ⑤ ⑧	—	18-1267
Chevy 350/5.7L Inboard	1987-95	B522506 & Later ① ⑤	18-1263	18-1267
Chevy 350/5.7L Inboard	1996-97	B522506 & Later ① ⑤	18-1263	18-1267
Chevy 350/5.7L (Rev.Rota.) Inboard	1987-95	B522506 & Later ① ⑤	18-1263	18-1267
Chevy 350/5.7L (Rev. Rota.) Inboard	1996-97	B522506 & Later ① ⑤	18-1263	18-1267
Chevy 454/7.4L	1977-92	4623115-D937001 ⑤	—	18-1257
Chevy 454/7.4L Inboard	1977-92	4623110 & Later ⑤	—	18-1257
Chevy 454/7.4L (Rev.Rota.) Inboard	1977-92	4623110 & Later ⑤ ⑧	—	18-1257
Chevy 454/7.4L (Sq. Ports)	1988-91	B721206-D805068 ⑤	—	18-1259
Chevy 454/7.4L Gen V	1992-94	D603118 & Later ⑤	18-1261	18-1258

MODULAR GASKET APPLICATION

Engine/Model	Years	Serial No.	Short Block	Valve Grind Kit
Chevy 454/7.4L Gen V	1995-97	D603118 & Later ⑤	18-1261	18-1258
Chevy 454/7.4L Gen V Inboard	1992-94	D715494 & Later ⑤	18-1261	18-1258
Chevy 454/7.4L Gen V Inboard	1995-97	D715494 & Later ⑤	18-1261	18-1258
Chevy 454/7.4L Gen V (Sq. Ports)	1992-94	D805069 & Later ⑤	18-1261	—
Chevy 454/7.4L Gen V (Sq. Ports)	1995-97	D805069 & Later ⑤	18-1261	—
Chevy 502/8.2L	1990-92	C84992-F213244 ⑤	—	18-1259
Chevy 502/8.2L Inboard	1990-92	C878221-D857199 ⑤	—	18-1259
Chevy 502/8.2L Gen V	1993-97	D824589 & Later ⑤	18-1261	—
Chevy 502/8.2L Gen V Inboard	1993-97	D857200 & Later ⑤	18-1261	—
Ford 302/5.0L	1971-77	3108723-4887829 ④ ⑤	—	18-1273
Ford 351/5.8L	1975-77	4173000-4902304 ④ ⑤	—	18-1273
Ford 351/5.8L (Rev. Rota.)	1975-77	4173000-4902304 ④ ⑤ ①	—	18-1273

- ① Full circle rear crankshaft seal, one piece oil pan gasket
- ② 3.8L models require 18-1211 rear crank seal and 18-0362 oil pan gasket
- ③ Starboard dip stick models require 18-0411 oil pan gasket set
- ④ Four piece oil pan set
- ⑤ Head & valve cover gaskets included in valve grind kit

- ⑦ Intake/exhaust manifold gasket included in kit
- ⑧ Rear main crankshaft seal also required
- ① Crankshaft seals also required
- ② Models with cast push rod cover require 18-0328
- ③ Crankshaft seals not included in short block kit
- ④ Use 18-4349 for serial no.6218462-B525981
- ⑤ For models with one piece rear main seal use 18-1206 kit

PARTS THAT KEEP YOU MOVING



SIERRA®



18-5982
ALTERNATOR
 Replaces: Cummins 216040, 3604234RX
 Fits: Cummins Diesel Marine



18-6846
ALTERNATOR
 Replaces: Volvo Penta 1502272, 3803270-2, 5001677, 845940, 72021, 872022, 872757, 873635, 873757, 873757-9, 873771



18-6849
ALTERNATOR
 Replaces: Yanmar 119773-77200
 Denso 101211-9940
 Fits: Yanmar Engines



18-6925
ALTERNATOR
 Replaces: Yanmar 128270-77200
 Hitachi LR135-105
 Fits: Yanmar Marine 3GM Engines



18-6926
ALTERNATOR
 Replaces: Yanmar 119836-77200, -2, -3, 129612-77230
 Fits: 3TNE84 3cyl diesel, 3TNE88 3cyl diesel, 4TNE84 4cyl, 1.995L, 4TNE88 4cyl, 2.190L



18-6927
ALTERNATOR
 Replaces: Yanmar 128171-77200
 Fits: Yanmar GM Engines



18-6928
ALTERNATOR
 Replaces: Yanmar 128170-77200, 77201, 77202
 Hitachi LR135-74, 74B
 Fits: 3HM, 3HMF models



18-6929
ALTERNATOR
 Replaces: Yanmar 119573-77200, 77201, 129470-77200
 Hitachi LR180-03A, B, C
 Fits: Yanmar LH Engines



18-6952
ALTERNATOR
 Replaces: Cummins 214169, 3603853RX, 3920618, 10459244
 Delco 1100077, 93, 1100211, 74, 1105474, 75, 76



18-6953
ALTERNATOR
 Replaces: Volvo 3803645, 8602629, 8602710, 14 8676496, 98, 8676499
 Fits: Diesel D3 Models



18-6955
ALTERNATOR
 Replaces: Caterpillar 3001117, 10-258
 Prestolite 110-258, 110-258A
 Volvo 849748-9
 Fits: Volvo Diesel 6 cylinder models



18-6971
ALTERNATOR
 High Amp version of V (120A)



18-6948
ALTERNATOR
 Replaces: Mercury 882571
 Fits: CMD 1.7 MI 120 I/L4, CMD 1.7 MS 120 I/L4, D1.7L DTI



18-5975
ALTERNATOR
 Replaces: Perkins 2871A651
 Valeo 2939590, Motorola 9AR3959G, 3855G, 6000G, 510-845, -860, -864
28 Volt. 45 AMP
 For: Perkins Marine Engine: 6-354-4, SAEJ1171



**18-6880
STARTER**
3 Bolt Flange
Replaces: Yanmar 123500-77010,
124610-77010, -77019 424610-77010
Hitachi S114-257, 257G, 483, 483A



**18-6930
STARTER**
Replaces: Yanmar 104211-77010, 77011



**18-6931
STARTER**
Replaces: Yanmar 119209-77010, 121120-77010,
77011, 77012, 124520-77010, 77011
Fits: 3 TNV-84-T engines



**18-6932
STARTER**
Replaces: Yanmar 121370-77010,
129242-77010, 129698-77010
Fits: 2QM, 3JH3, 3JH3E, 3JH3E-YEU, 3QM, 3QM30,
3QM30F, 3QM30H, 4JH3E



**18-6934
STARTER**
2 Bolt Flange
Replaces: Yanmar 129573-77010, 171008-77010
Hitachi S13-68, 68A, 68C, 86
Fits: Engine Model 2TR16, 2TR19



**18-6935
STARTER**
Replaces: Yanmar 119225-77010, 77011,
119226-77010
Fits: 3TN63, 3TN66, 3TN68



**18-6936
STARTER**
Replaces: Yanmar 114361-77011,
114362-77010, 77011, 114399-77010
Fits: L40S, L60S



**18-6937
STARTER**
2 Bolt Flange
Replaces: Yanmar 128170-77010,
77010D **Hitachi** S114-303, 303A
Fits: GM, GM2, GM3, GM10, GM20/2-
20F, GM30, GMF, 1GM, 2GM, 3GM



**18-6938
STARTER**
Replaces: Yanmar 119773-77010
Fits: 6LP-DTE, 6LP-STE Diesel models



**18-6872
STARTER**
12 Volt
Replaces: Volvo 233991, 240501,
837924, 842775, 843511, 847306-8,
881681
Fits: TAMD, MD, AQD Models



**18-6939
STARTER**
Replaces:
Yanmar 121254-77010, 77011,
77012, 77019, 129429-77010, 77011



**18-6944
STARTER**
Replaces:
Bosch 0-001-109-035
Caterpillar 163-3361
Perkins 185086600
Volvo 21323043, 3583555
Fits: 2001-07 D2-55A, B, C, 2003-07 D2-
75A, 4 cyl 134.2cu in. 2.2L



**18-6947
STARTER**
Replaces:
Mercuriser 50-805991
Fits: 7.3L (BRAVO & MIE) DIESEL NAV
444 V-8 1994-1996



**18-6870
STARTER**
Replaces: Mercury 50-805833, T
Fits: D7.3L D-tronic 260 LD, 300 1999 year



**18-6949
STARTER**
Replaces:
Mercuriser 50-831001562,
50-831001961
Fits: WO4CTA (150 HP) HINO 234 I/L4,
WO4CTI (210 HP) HINO 234 I/L4



**18-6954
STARTER**
Replaces:
Mercury 50-831001671, 672,
50-831002050, 051, 052
Fits: EH700 (175/220HP) HINO 393 I/L6,
HINO Diesel (See Mercuriser)



**18-6957
STARTER**
Replaces:
Mercuriser 50-801333980,
50-854178, 50-855507



**18-6958
STARTER**
24 Volt
Replaces:
Volvo 847308-4, 870998,
881682
Fits: MD, TMD, TAMD Models

CATERPILLAR ALTERNATOR/STARTER APPLICATION

Model	Year	Starter	Alternator	Amps
D2-55 A, B, C	2001-2007	18-6944	—	—
D2-75 A	2003-2007	18-6944	—	—

CUMMINS ALTERNATOR/STARTER APPLICATION

Model	Year	Starter	Alternator	Amps
6BT 5.9L	1985-UP	18-6947	—	—
6C	ALL	—	18-6952	65
6L8.9	ALL	—	18-6952	65
C8.3	ALL	—	18-6952	65
C8.3G	ALL	—	18-6952	65
CM556	ALL	—	18-6952	65
G8.3	ALL	—	18-6952	65
GTA8.3 CM558	ALL	—	18-6952	65
ISC CM2150	ALL	—	18-6952	65
ISC CM554	ALL	—	18-6952	65
ISC CM850	ALL	—	18-6952	65
ISC8.3 CM2250	ALL	—	18-6952	65
ISL CM2150 SN	ALL	—	18-6952	65
ISL CM554	ALL	—	18-6952	65
ISL CM850	ALL	—	18-6952	65
ISL G CM2250	ALL	—	18-6952	65
ISL9 CM2250	ALL	—	18-6952	65
QSC8.3 CM2250	ALL	—	18-6952	65
QSC8.3 CM554	ALL	—	18-6952	65
QSC8.3 CM850	ALL	—	18-6952	65
QSL9 CM2250	ALL	—	18-6952	65
QSL9 CM554	ALL	—	18-6952	65
QSL9 CM850	ALL	—	18-6952	65
QSL9 G CM558	ALL	—	18-6952	65

MERCURISER ALTERNATOR/STARTER APPLICATION

Model	Year	Starter	Alternator	Amps
530D-TA (Bravo & MIE)	1989-1993	18-6957	—	—
636D-TA (Bravo & MIE)	1989-1993	18-6957	—	—
6BTA5.9-M	1989-UP	18-6947	—	—
7.3L (Bravo & MIE)	1994-1998	18-6947	—	—
D183 Turbo AC (Bravo & MIE)	1990-1993	18-6957	—	—
D2.8L D-Tronic (Bravo & MIE)	1997-1999	18-6957	—	—
D219 Turbo AC (Bravo & MIE)	1990-1993	18-6957	—	—
D254 Turbo AC (Bravo & MIE)	1990-1993	18-6957	—	—
D3.0L Bravo	1994-1997	18-6957	—	—
D3.0L MIE	1994-1995	18-6957	—	—
D3.6L (Bravo & MIE)	1994-1996	18-6957	—	—
D3.6L W Bravo (Export)	1996-UP	18-6957	—	—
D4.2L (Bravo & MIE)	1994-1995	18-6957	—	—
D4.2L/ 250 D-Tronic	1997-1999	18-6957	—	—
EI 165	2004-2005	18-6957	—	—
EI 200	2004-2005	18-6957	—	—
EI 250	2004-2005	18-6957	—	—
EI 300	2004-2005	18-6957	—	—
ES 165	2004-2005	18-6957	—	—
ES 250	2004-2005	18-6957	—	—
ES300	2004-2005	18-6957	—	—
MI 200	2004-2005	18-6957	—	—
MS 200	2004-2005	18-6957	—	—
WO4CTA HINO 234 (150HP)	1990-1997	18-6949	—	—
WO4CTI HINO 234 (210HP)	1990-1997	18-6949	—	—
WO6DTA HINO 351 (310HP)	1990-1997	18-6949	—	—
WO6DTI HINO 351 (250HP)	1990-1997	18-6949	—	—

APPLICATION CONTINUED ON NEXT PAGE

VOLVO ALTERNATOR/STARTER APPLICATION					
Model	Year	Starter	Alternator	Amps	Valeo Part No.
2001	1983-1993	—	18-5959	50	—
2002, T	1983-1993	18-6839	18-5959	50	—
2003, T	1983-1993	18-6839	18-5959	50	—
AD290	ALL	—	18-5959	50	—
AD31 A, B, D, L, P, X	1986-2004	—	18-6846	60	—
AD31 A, B, D, L, P, X	1986-2004	—	18-5959	50	—
AD41D	ALL	—	18-5959	50	—
AQAD30A	1983-1986	—	18-5959	50	A13N259
AQAD30A	1983-1986	—	18-59700	50	A13N234
AQAD31A	1986-1989	—	18-5959	50	A13N259
AQAD31A	1986-1989	—	18-59700	50	A13N234
AQAD40A, B	1980-1986	—	18-5959	50	A13N259 OR A13N1M
AQAD40A, B	1980-1986	—	18-59700	50	—
AQAD41	ALL	—	18-5959	50	A13N259
AQAD41	ALL	—	18-59700	50	A13N234
AQAD41A, B, C	1986-1994	—	18-5959	50	A13N259 OR A13N1M
AQAD41A, B, C	1986-1994	—	18-59700	50	A13N234
AQD32A	1969-1977	—	18-5959	50	A13N1M
AQD32A	1969-1977	—	18-59700	50	A13N234
AQD40A, B	1977-1986	—	18-5959	50	A13N259
AQD40A, B	1977-1986	—	18-59700	50	A13N234
AQD41	ALL	—	18-5959	50	A13N259
AQD41	ALL	—	18-59700	50	A13N234
AQD41A	1986-1989	—	18-5959	50	A13N259
AQD41A	1986-1989	—	18-59700	50	A13N234
AQD70B, BL, C, CL, D	1971-1982	18-6872	18-6846	55	—
B21	ALL	—	18-5959	50	A13N2M
B21	ALL	—	18-59700	50	—
B23	ALL	—	18-5959	50	A13N2M
B23	ALL	—	18-59700	50	—
D12-650	2006-2007	—	18-6846	60	—
D12-715	2002-2004	—	18-6846	60	—
D12C	1999-2004	—	18-6846	60	—
D12-MH	2005-2007	—	18-6846	60	—
D2-55A	ALL	—	18-5939	50	—
D25A	ALL	—	18-5959	50	—
D30A	ALL	—	18-5959	50	—
D3-110	2003-2007	—	18-6953	140	—
D3-130	2003-2007	—	18-6953	140	—
D3-160	2003-2007	—	18-6953	140	—
D3-190	2003-2007	—	18-6953	140	—
D41D	ALL	—	18-5959	50	—
D49A	ALL	—	18-5959	50	—
D63	ALL	—	18-5939	50	—
D71, D	ALL	—	18-5939	50	—
D73	ALL	—	18-5939	50	—
KAD32P	1996-2005	—	18-6846	60	—
KAD42A, B, P	1991-2001	—	18-5959	50	A13N259
KAD42A, B, P	1991-2001	—	18-59700	50	A13N234
KAMD42A B, P	1991-1997	—	18-5959	50	A13N259
KAMD42A B, P	1991-1997	—	18-59700	50	A13N234
MD100	ALL	—	18-6846	55	—
MD100A, B	1965-1984	—	18-6846	60	—
MD11	ALL	—	18-59700	50	A13N234

APPLICATION CONTINUED ON NEXT PAGE

VOLVO ALTERNATOR/STARTER APPLICATION

Model	Year	Starter	Alternator	Amps	Valeo Part No.
MD11C	1975-1981	—	18-5959	50	A13N57M OR A13N1M
MD11C	1975-1981	—	18-59700	50	—
MD120	ALL	—	18-6846	55	—
MD120A	1970-1980	—	18-6846	60	—
MD17	1975-1981	—	18-5959	50	A13N2M
MD17	1975-1981	—	18-59700	50	A13N234
MD17C	1975-1984	—	18-5959	50	A13N2M
MD17C	1975-1984	—	18-59700	50	A13N234
MD17D	1975-1984	—	18-5959	50	A13N147M OR A13N1M
MD17D	1975-1984	—	18-59700	50	A13N234
MD18	ALL	—	18-5959	50	A13N147M
MD18	ALL	—	18-59700	50	—
MD21	1968-1979	—	18-5959	50	A13N147M OR A13N1M
MD21	1968-1979	—	18-59700	50	—
MD21A	1968-1979	—	18-5959	50	A13N1M
MD21A	1968-1979	—	18-59700	50	—
MD2B	1964-1975	—	18-5959	50	A13N1M
MD2B	1964-1975	—	18-59700	50	A13N234
MD2BHY	1964-1975	—	18-5959	50	A13N1M
MD2BHY	1964-1975	—	18-59700	50	—
MD30	1983-1986	—	18-5959	50	A13N147M OR A13N1M
MD30	1983-1986	—	18-59700	50	A13N234
MD30A	1983-1986	—	18-5959	50	A13N259
MD30A	1983-1986	—	18-59700	50	A13N234
MD31A	1986-1994	—	18-5959	50	A13N259
MD31A	1986-1994	—	18-59700	50	—
MD32A	1969-1977	—	18-5943	50	A13N1M
MD32A	1969-1977	—	18-59700	50	A13N234
MD3B	1971-1975	—	18-5959	50	A13N1M
MD3B	1971-1975	—	18-59700	50	A13N234
MD40A	1976-1985	—	18-5959	50	A13N259
MD40A	1976-1985	—	18-59700	50	A13N234
MD42A	1970-1979	18-6872	—	—	—
MD5	ALL	—	18-5959	50	A13N2M OR A13N147M
MD5	ALL	—	18-59700	50	—
MD5A, B, C	1975-1982	—	18-5959	50	A13N1M
MD5A, B, C	1975-1982	—	18-59700	50	—
MD6A	1971-1976	—	18-5959	35	A13N57M
MD6A	1971-1976	—	18-59700	35	A13N234
MD7	ALL	—	18-5959	50	A13N147M OR A13N2M
MD7	ALL	—	18-59700	50	A13N234
MD70B, C	1970-1985	18-6872	—	—	—
MD70B, C	1965-1985	18-6958	18-6846	60	—
MD7A, B	1976-1983	—	18-5959	50	A13N1M OR A13N259
MD7A, B	1976-1983	—	18-59700	50	A13N234
MD11	ALL	—	18-5959	50	A13N2M
TAMD 120	ALL	—	18-6955	120	—
TAMD 120 A, B	1973-1982	—	18-6955	175	—
TAMD 162 A, B, C	1988-2001	—	18-6955	175	—
TAMD102 A, D	1991-2000	—	18-6846	60	—
TAMD103A	2000-2004	—	18-6846	60	—
TAMD120	ALL	—	18-6846	55	—
TAMD120A, B	1972-1983	18-6958	18-6846	60	—
TAMD121 C, D	1983-1988	18-6958	18-6846	60	—

APPLICATION CONTINUED ON NEXT PAGE

VOLVO ALTERNATOR/STARTER APPLICATION					
Model	Year	Starter	Alternator	Amps	Valeo Part No.
TAMD121 C, D	1983-1988	18-6958	18-6846	55	—
TAMD122 A, C, D, P	1988-2002	18-6958	18-6846	60	—
TAMD162 A, B, C	1988-2001	—	18-6846	60	—
TAMD163 A, P	1994-2001	—	18-6846	60	—
TAMD163 A, P	1994-2001	—	18-6846	55	—
TAMD165A, C, P	2002-2005	—	18-6846	60	—
TAMD30, A, B, C	1983-1986	—	18-5959	50	A13N1M
TAMD30, A, B, C	1983-1986	—	18-59700	50	A13N234
TAMD31A, B, D, L, M, P, S, X	1985-2004	—	18-5959	50	A13N259
TAMD31A, B, D, L, M, P, S, X	1985-2004	—	18-59700	50	A13N234
TAMD31A, B, D, L, M, P, S, X	1985-2004	—	18-6846	60	—
TAMD40A, B, C	1979-1986	—	18-5959	50	A13N259
TAMD40A, B, C	1979-1986	—	18-59700	50	A13C234
TAMD41A	1986-1989	—	18-5959	50	A13N259 OR A13N1M
TAMD41A	1986-1989	—	18-59700	50	A13N234
TAMD60 A, B, C	1976-1987	18-6872	18-6846	60	—
TAMD61A	1986-1995	18-6872	18-6846	60	—
TAMD62A	1992-1994	18-6872	18-6846	60	—
TAMD63L, P	1994-2005	18-6872	—	—	—
TAMD70	ALL	—	18-5959	50	A13N259
TAMD70	ALL	—	18-59700	50	—
TAMD70	ALL	—	18-6846	55	—
TAMD70B, C, D	1970-1987	18-6872	18-6846	60	—
TAMD70E	1983-1987	—	18-5959	50	A13N1M
TAMD70E	1983-1987	18-6872	18-59700	50	—
TAMD70E	1983-1987	18-6872	18-6846	60	—
TAMD71A, B	1986-2000	18-6872	18-6846	60	—
TAMD72A, P, W, J	1991-1997	18-6872	18-6846	60	—
TAMD73P, W, J	1997-1999	18-6872	18-6846	60	—
TAMD74A, C, L, P	1998-2005	18-6872	18-6846	60	—
TAMD75P	1998-2005	18-6872	18-6846	60	—
THAMD70B, C	1972-1979	18-6872	18-6846	60	—
TMD 100	ALL	—	18-6955	120	—
TMD 100 B, C	1965-1988	—	18-6955	175	—
TMD100A	ALL	—	18-6846	55	—
TMD100B, C	1965-1988	—	18-6846	60	—
TMD102A	1988-2000	—	18-6846	60	—
TMD120	ALL	—	18-6955	120	—
TMD120 A,B	1970-1984	18-6958	18-6955	175	—
TMD120A, B	1970-1984	18-6958	18-6846	60	—
TMD121C	1983-1988	18-6958	18-6846	60	—
TMD122A	1988-2000	18-6958	18-6846	60	—
TMD122A	1988-2000	18-6958	18-6846	55	—
TMD30A, B	1983-1986	—	18-5959	50	A13N147M
TMD30A, B	1983-1986	—	18-59700	50	A13N234
TMD31A, B, D, L	1986-1997	—	18-5959	50	A13N259
TMD31A, B, D, L	1986-1997	—	18-59700	50	A13N234
TMD40	ALL	—	18-5959	50	A13N147M
TMD40	ALL	—	18-59700	50	A13N1M
TMD40A, B, C	1976-1986	—	18-5959	50	A13N259
TMD40A, B, C	1976-1986	—	18-59700	50	A13N234
TMD41A, B, D, L	1986-1997	—	18-5959	50	A13N259
TMD41A, B, D, L	1986-1997	—	18-59700	50	A13N234
TMD70B, C	1972-1985	18-6872	18-6846	60	—

APPLICATION CONTINUED ON NEXT PAGE

YANMAR ALTERNATOR/STARTER APPLICATION

Model	Year	Starter	Alternator	Amps
1GM	1980-1984	18-6937	18-6925 ⑥	35
1GM	1980-1984	18-6937	18-6928 ③ ⑦ ⑧	35
1GM10	1980-1981	18-6937	18-6928	35
1GM10	1982-UP	18-6937	18-6925 ④	35
1GM10	1982-UP	18-6937	18-6927 ⑤	35
1GM10C	1982-1984	18-6937	18-6925	35
1GM10L	1982-UP	—	18-6927 ⑤	35
1GM10L	1982-UP	—	18-6925 ④	35
1GM10VE	1985-UP	—	18-6927	35
1GML	1982-UP	—	18-6927	35
1GML	1982-UP	—	18-6925	35
1GMY	1982-UP	—	18-6925 ④	35
1GMY	1982-UP	—	18-6927 ⑤	35
2GM	1980-1984	18-6937	18-6925 ⑥	35
2GM	1980-1984	18-6937	18-6928 ③ ⑦ ⑧	35
2GM20	1982-UP	18-6937	18-6925	35
2GMF	1980-1984	18-6937	18-6925 ⑥	35
2GMF	1980-1984	—	18-6928 ③ ⑦ ⑧	35
2GMFL	ALL	—	18-6925	35
2GMFY(E)-E	ALL	—	18-6925	35
2GML	ALL	—	18-6925	35
2GMYE-EC	ALL	—	18-6925	35
2GMZ	ALL	—	18-6925	35
2QM15	1977-1980	—	18-6925 ⑥	35
2QM15	1977-1980	—	18-6928 ③ ⑦ ⑧	35
2QM20	1975-1980	—	18-6928	35
2TD	1982-UP	—	18-6925	35
2TM	1982-UP	—	18-6925	35
3GM	1980-1984	18-6937	18-6925	35
3GM	1980-1984	18-6937	18-6928 ③ ⑦ ⑧	35
3GMD	1982-UP	18-6937	18-6925 ⑥	35
3GMD	1982-UP	18-6937	18-6928 ③ ⑦ ⑧	35
3GMF	1982-UP	18-6937	18-6925 ⑥	35
3GMF	1982-UP	18-6937	18-6928 ③ ⑦ ⑧	35
3GMFY-E	1982-UP	—	18-6925	35
3GMLE	1982-UP	—	18-6927	35
3HM	1980-1984	—	18-6925 ⑥	35
3HM	1980-1984	—	18-6928 ③ ⑦ ⑧	35
3HMF	1980-1984	—	18-6925 ⑥	35
3HMF	1980-1984	—	18-6925 ③ ⑦ ⑧	35
3JH2	1991-1999	18-6880	18-6925	35
3JH2	1991-1999	18-6880	18-6929	80
3JH2BE	1991-1999	18-6880	18-6929	80
3JH2E	1991-1999	18-6880	18-6929	80
3JH3	1999-2003	—	18-6925	35
3JH3	1999-2003	—	18-6929	80
3JH3E	ALL	—	18-6929	80
3JH3E-YEU	ALL	18-6880	—	—
3JH3Z	ALL	—	18-6925	35
3JH4E	2003-UP	—	18-6929	80
3TM20	2004-UP	—	18-6929	80
3YM30	2004-UP	—	18-6929	80

① Hitachi S114-303 ② Hitachi S114-483A ③ Hitachi LR135-105 ④ Hitachi LR135-126 ⑤ Hitachi LR135-74B ⑥ S/N 3690-Below
 ⑦ S/N 3691-Up ⑧ W/ 2 Pin Regulator Hookup ⑨ W/O 2 Pin Regulator Hookup ⑩ W/O Plastic Cover

APPLICATION CONTINUED ON NEXT PAGE

YANMAR ALTERNATOR/STARTER APPLICATION				
Model	Year	Starter	Alternator	Amps
3TN63	1990-UP	18-6935	—	—
3TN66	1985-UP	18-6935	—	—
3TN68	1995-UP	18-6935	—	—
3TNE84	1982-UP	18-6880	18-6926	40
3TNE88	1982-UP	18-6880	18-6926	40
3TNV-84-T	ALL	18-6931	—	—
4GM	1985-UP	—	18-6925	35
4JH	1982-UP	18-6880	18-6925	35
4JH2-CE	1988-UP	18-6880	18-6929	80
4JH2-DTE	1988-UP	18-6880	18-6929	80
4JH2-E	1988-UP	18-6880	18-6929	80
4JH2-HTE	1988-UP	18-6880	18-6929	80
4JH2L-HTNE	1988-UP	18-6880	18-6925	35
4JH2L-TNE	1988-UP	18-6880	18-6925	35
4JH2-TE	1988-UP	18-6880	18-6929	80
4JH2-UTE	1988-UP	18-6880	18-6925	35
4JH3-CE	1994-2003	18-6880	18-6929	80
4JH3-DTE	1994-2003	18-6880	18-6929	80
4JH3E	1994-2003	18-6880	18-6929	80
4JH3-HTE	1994-2003	18-6880	18-6929	80
4JH3-TCE	1994-2003	18-6880	18-6929	80
4JH3-TE	1994-2003	18-6880	18-6929	80
4JH3-TE-YEU	1994-2003	18-6880	—	—
4JH3ZA	1994-2003	18-6880	18-6925	35
4JHE	ALL	—	18-6929	80
4JH-HT	1982-UP	—	18-6925	35
4JH-HT-Z	1982-UP	18-6880	18-6925	35
4JH-T	1982-UP	18-6880	18-6925	35
4JH-TE	1982-UP	—	18-6929	80
4JH-TZ	1982-UP	18-6880	18-6925	35
4JHZ	ALL	18-6880	18-6925	35
4LHA-DTE	ALL	18-6939	18-6929	80
4LHA-DTZ	ALL	18-6939	18-6929	80
4LHA-HTE	ALL	18-6939	18-6929	80
4LHA-HTZE	ALL	18-6939	18-6929	80
4LHA-STE	ALL	18-6939	18-6929	80
4LHA-STZE	ALL	18-6939	18-6929	80
4LH-DTE	1987-UP	18-6939	18-6929	80
4LH-HTE	1987-UP	18-6939	18-6929	80
4LH-STE	1987-UP	18-6939	18-6929	80
4LH-TE	ALL	18-6939	18-6929	80
4TD	1982-UP	—	18-6925	35
4TM	1982-UP	—	18-6925	35
4TNE84	1989-UP	18-6880	18-6926	40
4TNE88	1989-UP	18-6880	18-6926	40
6LP-DT	1997-UP	—	18-6849	80
6LP-DTE	1997-UP	18-6938	18-6849	80
6LP-DTZE	1997-UP	—	18-6849	80
6LP-DTZE1	1997-UP	—	18-6849	80
6LP-DTZY	1997-UP	—	18-6849	80
6LP-ST	1997-UP	—	18-6849	80

① Hitachi S114-303 ② Hitachi S114-483A ③ Hitachi LR135-105 ④ Hitachi LR135-126 ⑤ Hitachi LR135-74B ⑥ S/N 3690-Below
 ⑦ S/N 3691-Up ⑧ W/ 2 Pin Regulator Hookup ⑨ W/O 2 Pin Regulator Hookup ⑩ W/O Plastic Cover

APPLICATION CONTINUED ON NEXT PAGE

YANMAR ALTERNATOR/STARTER APPLICATION

Model	Year	Starter	Alternator	Amps
6LP-STE	1997-UP	18-6938	18-6849	80
6LP-STZE	1997-UP	—	18-6849	80
6LY2-STE	1992-UP	18-6934	18-6929	80
6LYA-STE	1992-UP	18-6934	18-6929	80
6LYA-UTE	1992-UP	18-6934	18-6929	80
6LYM-STE	1992-UP	18-6934	18-6929	80
6LYM-UTE	1992-UP	18-6934	18-6929	80
6LY-ST	1992-UP	18-6934	18-6929	80
6LY-STE	1992-UP	18-6934	18-6929	80
6LY-STM	1992-UP	18-6934	18-6929	80
6LY-STZY	1992-UP	18-6934	18-6929	80
6LY-UT	1992-UP	18-6934	18-6929	80
6LY-UTE	1992-UP	18-6934	18-6929	80
6LY-UTM	1992-UP	18-6934	18-6929	80
6LY-UTZY	1992-UP	18-6934	18-6929	80
KBW-20	ALL	—	18-6929	80
KBW-21	ALL	—	18-6929	80
6PH	1982-UP	18-6934	—	—
6PH-HTZY	1982-UP	18-6934	—	—
6PH-M-HTE	1982-UP	18-6934	—	—
6PHM-HTZ	1982-UP	18-6934	—	—
6PHM-TZ	1982-UP	18-6934	—	—
6PHS-HTPS	1982-UP	18-6934	—	—
6PHS-TPS	1982-UP	18-6934	—	—
KM2A	ALL	18-6937	18-6925 ①	35
KM2A	ALL	18-6937	18-6927 ②	35
KM2C	ALL	18-6937	—	—
KM2P	ALL	18-6937	18-6925 ①	35
KM2P	ALL	18-6937	18-6927 ②	35
KM3A	ALL	18-6937 ①	18-6929	80
KM3A	ALL	18-6880 ②	18-6929	80
KM3P	ALL	18-6937	—	—
KM3V	ALL	18-6937	18-6925 ①	35
KM3V	ALL	18-6937	18-6927 ②	35
KM5A	ALL	18-6939	18-6929	80
L40S	1984-1999	18-6936	—	—
L60S	1984-1999	18-6936	—	—
SB12	1976-1980	18-6930	—	—
SB8	1976-1980	18-6930	—	—
SVE12	1974-1976	18-6930	—	—
SVE8	1974-1976	18-6930	—	—
UJH2E	ALL	18-6880	18-6929	80
Y-5M	ALL	—	18-6925 ①	35
Y-5M	ALL	—	18-6927 ②	35
YC	1971-UP	18-6930	—	—
YSB12	1976-1977	18-6930	—	—
YSB8	1976-1977	18-6930	—	—
YSE12	1974-1976	18-6930	—	—
YSE8	1974-1976	18-6930	—	—
YSM12	1977-1980	18-6930	—	—
YSM8	1977-1980	18-6930	—	—

① Hitachi S114-303 ② Hitachi S114-483A ③ Hitachi LR135-105 ④ Hitachi LR135-126 ⑤ Hitachi LR135-74B ⑥ S/N 3690-Below
 ⑦ S/N 3691-Up ⑧ W/ 2 Pin Regulator Hookup ⑨ W/O 2 Pin Regulator Hookup ⑩ W/O Plastic Cover

DIESEL FUEL FILTERS

20 MICRON



18-7935

Replaces:

Fram CCS 1136
Fram FCS 1136 Filter Bracket

20 MICRON

18-7942

Replaces:

Volvo 466987, 3825133
For: MD100A, TMD100A, MD100B, MD120A, TMD120A, TAMMD120A, MD120B, TMD120B, TAMMD120B, MD70B, TMD70B, THAMD70B, AQAD70B, MD70C, TMD70C, TAMMD70C, AQD70C, TAMMD60A, TAMMD60B, TAMMD60C, D5/D7 MARINE GENSET, D5A-T, D5A-TA, D7A-T, D7A-TA, D7C-TA, D63 MARINE, D71/73 MARINE, KAD32P, TAMMD42WJ, KAD43P/44P/300, KAMD43P/44P/300, TAMMD103A, TAMMD61A, TAMMD62A, TAMMD71A, TAMMD72A, TAMMD72P, TAMMD72WJ, TAMMD74, TAMMD75 MARINE, TMD102A, TAMMD102A, TAMMD102D, TMD122A, TAMMD122A, TAMMD122P, TMD31L, TAMMD31P/L/M/S, AD31P/L, TMD41L, TAMMD41P/L/M/H



18-79960

FUEL FILTER ELEMENT

Replaces: Yanmar 104500-55710

Fits: All GM Series, YM Series, HM Series, QM Series

20 MICRON



18-7858

Replaces: Volvo 858201

For: CAV Type Unit

For: AQ120B, 125A, B, 131A, 140A, 145A, B, 151, BB, 140, 145A



18-8124

Replaces: Volvo 829913

For: 2001, 2001B, 2002, 2002B, 2003, 2003B/T/TB, AQD2B, MD11C/D, MD17C/D, MD1B, MD2B, MD3B, MD5A/B/C, MD7/B

20 MICRON



18-7931

Replaces: Detroit Diesel 5574508

FOR: 8V-92, 8V-71



18-8125

Replaces: Volvo 3583443

For: D4-180i-B, D4-180i-C, D4-210A-A, D4-210A-B, D4-210i-A, D4-210i-B, D4-225A-B, D4-225A-C, D4-225i-B, D4-225i-C, D4-260A-A, D4-260A-B, D4-260A-C, D4-260D-B, D4-260D-C, D4-260i-A, D4-260i-B, D4-260i-C, D4-300A-A, D4-300A-C, D4-300D-A, D4-300D-C, D4-300i-A, D4-300i-C, D6-280A-A, D6-280A-B, D6-280i-A, D6-280i-B, D6-310A-A, D6-310A-B, D6-310D-A, D6-310D-B, D6-310i-A, D6-310i-B, D6-330A-B, D6-330A-C, D6-330D-B, D6-330D-C, D6-330i-B, D6-330i-C, D6-350A-A, D6-350A-B, D6-370A-B, D6-370A-C, D6-370D-A, D6-370D-B, D6-370D-C, D6-370i-A, D6-370i-B, D6-370i-C, D6-435D-A, D6-435D-C, D6-435i-A, D6-435i-C



18-35443

FUEL PUMP

Replaces: Volvo 3582310

Fits: Volvo D30, D40, D31, D41, D42 Diesel Engines



18-57703

AIR FILTER

Replaces:

Yanmar 128270-12540

Fits: Yanmar 2GM & 3GM30



18-57704

AIR FILTER

Replaces:

Yanmar 128171-12540

Fits: Yanmar 1GM10



18-31605

SEA WATER PUMP

Replaces:

Yanmar 128397-42500

For: GMF, 2YM3GMF, 3HM, 3HMF, 3YM



18-8950

IMPELLER

Replaces:

Yanmar 124223-42092

For: 2GM20F, 2GMF, 2QM, 2QM20, 3GM30F, 3GMF, 3HM, 3HM35, 3HM35F, 3HMF, 3QM30, 3QM30F



18-8951

IMPELLER

Replaces:

Yanmar 128176-42071

For: 1GM, 1GM10



18-8952
IMPELLER
 Replaces:
 Yanmar 104211-42071
 For: 2GM, 2QM, 3GM, 3QM, YSB8, YSB12, YSM12, SB12 engines



18-45714
F75B IMPELLER
 Replaces:
 Yanmar 119574-42550, 119574-42552
 Fits: F75B Pump and 6LY Engines



18-55500
POWER HEAD GASKET
 Replaces:
 Yanmar 728170-92600
 For: 1GM (7hp)

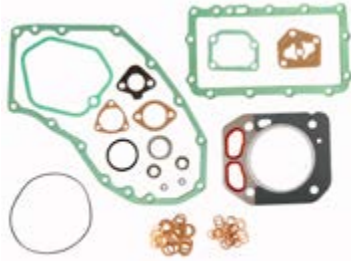

18-55501
POWER HEAD GASKET
 Replaces: Yanmar 728171-92601
 For: 1GM10 (9hp)



18-55502
POWER HEAD GASKET
 Replaces:
 Yanmar 728271-92605
 For: 2GM20 (18hp), 2GM20B, 2GM20C, 2GM20F (18hp)



18-55503
POWER HEAD GASKET
 Replaces:
 Yanmar 728374-92605
 For: 3GM30 (27hp), 3GM30 EU (27hp), 3GM30F (27hp), 3GM30F EU (27hp)



18-56000
BONNET COVER GASKET
 Replaces:
 Yanmar 128170-11310
 For: 1GM, 1GM10



18-56601
THERMOSTAT GASKET
 Replaces:
 Yanmar 104211-49160
 For: 1GM, 1GM10



18-56602
WATER PUMP GASKET
 Replaces:
 Yanmar 128170-42090
 For: 1GM, 1GM10



18-55600
HEAD GASKET
 Replaces:
 Yanmar 128170-01331
 For: 1GM (7hp)



18-55601
HEAD GASKET
 Replaces:
 Yanmar 128171-01911
 For: 1GM10 (9hp)



18-55602
HEAD GASKET
 Replaces:
 Yanmar 128271-01911
 For: 2GM20 (18hp), 2GM20B, 2GM20C, 2GM20F (18hp)



18-55603
HEAD GASKET
 Replaces:
 Yanmar 128374-01911
 For: 3GM30 (27hp), 3GM30 EU (27hp), 3GM30F (27hp), 3GM30F EU (27hp)



18-6200
ANODE
 Replaces:
 Yanmar 27210-200200
 Fits: 1GM, 1GM10, 6LY3



18-6201
ANODE
 Replaces:
 Yanmar 27210-200300
 Fits: 2GM, 3GM, 2GMF, 3GMF, 2GM20, 3GM30, 3HM, 3HM35, 2QM15, 2QM, 3QM, 2QM20, 3QM30, YSB8, YSB12, YSM8, YSM12

OIL FILTERS

Sierra oil filters are engineered with premium grade materials that will not only withstand but excel in the extreme environment of the Marine world. Sierra ensures the excellent performance of their filters by:

- Epoxy coating all canisters for corrosion resistance.
- Using a heavy-wall steel canister for further corrosion protection.
- Using high-efficiency filter media that meets or exceeds the OE's filtration.
- Backed by Sierra's industry leading warranty.

DIESEL OIL FILTERS

 <p>18-0033 Replaces: Volvo 21707133</p>	 <p>18-0034 Replaces: Volvo 477556</p>	 <p>18-0035 Replaces: Volvo 3582732 Full Flow</p>
 <p>18-0036 Replaces: Volvo 3582733 Bypass</p>	 <p>18-7871 Replaces: Mercuriser 35-805809</p>	 <p>18-7880 Replaces: Caterpillar 1R-0658 Volvo-Penta 466634</p>
 <p>*18-7884 Replaces: Universal 299381 Volvo-Penta 834337 Thread Spec: 3/4" x 16NPT</p>	 <p>*18-7886 Replaces: Perkins 2654403 Thread Spec: 3/4" x 16NPT</p>	 <p>*18-7910-1 Replaces: Westerbeke 30220 Yanmar 124450-35100, 119350-35150, 119350-35151 Thread Spec: 20mm x 1.5</p>



SEA RAY			FORD V8 (STERN DRIVE) Cont.		
MODEL NO.	S/N	YEAR	MODEL	S/N	YEAR
3.0L	B787205-B917529	1988	225-S (4bbl.)	3385721-4166999	1973-74
4.3L	B785483-B921276	1988	233	4173000-4902304	1975-77
4.3LX	B785981-B922330	1988	255	3258728-4175499	1971-74
5.7L	B784799-B917017	1988	GM V8 283, 327, 305 & 350 CID		
SRX5.7L, 350 Mag	B785241-B919012	1988	MODEL	S/N	YEAR
SRX7.4L, 454 Mag Alpha	B785149-B924857	1988	190	1564539-1730903	1963-64
SRX7.4L-H, 454 Mag Bravo	B721206-B919343	1988	898 (2bbl.)	4762210-6218461	1977-82
STERN DRIVES			898 (2bbl.)	6218462-B525981	1983-84
MODEL NO.	S/N	YEAR	200/5.0L (2bbl.)	6218462-F600999	1985-95
SRX7.4L, Alpha	B803866-C348032	1988	5.0L (2bbl.)	L015751-UP	1998-UP
SRX7.4L-H, Bravo	B803872-B999972	1988	5.0L EFI	L012052-L340000	1998-99
INBOARD ENGINES			228 (4bbl.)	4765100-5170008	1977-78
MODEL NO.	S/N	YEAR	228 (4bbl.)	5170009-6218461	1979-82
5.7L	B788204-B919356	1988	228 (4bbl.)	6218462-B525981	1982-84
7.4L	B788179-B913769	1988	230 (4bbl.)	6218462-B525981	1985-86
RENAULT 4 CYLINDER (STERN DRIVE)			230/5.0LX (4bbl.)	B525982-F600999	1987-95
MODEL	S/N	YEAR	225	1539620-2694014	1963-69
60	1887079-2049044	1965-68	250	2314301-2639854	1968-69
80	2049045-2851423	1966-69	255	4175500-4767999	1975-76
90	2851424-3226957	1970-72	250	4768000-4908849	1977
GM 4 CYLINDER (STERN DRIVE)			260/5.7L	4908850-6218461	1978-82
MODEL	S/N	YEAR	260/5.7L	621462-B525981	1982-86
110	1537370-2044033	1963-66	260/5.7L	B525982-F600999	1987-95
120	1666601-3377340	1964-72	5.7L (2bbl.)	F601000-UP	1996-98
120	3377341-3770649	1972-73	5.7L EFI	F225560-UP	1995-UP
120	3770650-4952700	1974-77	5.7LX (4bbl.)	F601000-K999999	1996-97
120	4952701-5192048	1978	5.7LX EFI	F752400-K999999	1996-97
120	5192049-6229717	1979-82	5.7LX Bravo EFI	F800300-K999999	1996-97
120	6229718-6853913	1983-84	350 Mag. Alpha	A635178-B525981	1986-87
120	6853914-B531853	1985-86	350 Mag. Alpha	B525982-F600999	1987-95
120/2.5L	B531854-C853255	1987-89	350 Mag. Alpha	F601000-K001526	1996
140	2508261-6229717	1968-82	350 Mag. Alpha	K001527-K999999	1997
140/3.0L	6229718-C856558	1982-89	350 Mag. Alpha EFI	F800300-K999999	1996-97
3.0L/LX	C856559-UP	1990-UP	350 Mag. Bravo MPI	F415189-K999999	1995-97
MERCURY MARINE 4 CYLINDER (STERN DRIVE)			350 Mag. Bravo MPI	(GEN +)	F602000-K999999
MODEL	S/N	YEAR	350 Mag. MPI (GEN+)	L010019-UP	1998-UP
470 (2bbl.)	4208730-5520114	1976-79	270	2851074-3385720	1969-72
470 (2bbl.)	5520115-6218036	1980-82	280TRS	4176250-4770199	1975-76
470 (2bbl.)	6218037-6916778	1983-84	300 Tempest	6668677-B430367	1985-86
170 (2bbl.)	6916779-UP	1985-86	320 (EFI)	A543604-C622418	1987-89
165/3.7L (2bbl.)	6916779-UP	1987-89	GM V8 427, 454, 502, 540 & 572 (STERN DRIVE)		
485 (2bbl.)	5685394-6218036	1980-82	MODEL	S/N	YEAR
488 (4bbl.)	6170297-6916778	1983-84	325	2278747-3780449	1969-72
190 (4bbl.)	6916779-UP	1985-86	330	4623115-6083144	1977-81
180/3.7LX (4bbl.)	6916779-UP	1987-89	330	6083145-B816450	1982-87
GM INLINE 6 CYLINDER (STERN DRIVE)			7.4L Bravo	B771113-D603117	1988-91
MODEL	S/N	YEAR	7.4L Bravo (Gen.V)	D603118-F800699	1992-96
140	1538930-1725960	1963	7.4L Bravo (Gen.VI)	F800700-K999999	1996-97
150	1666495-2048046	1964-66	7.4LX Bravo (MPI)(Gen.V)	F602010-F801999	1996
160	2048022-2770031	1967-69	7.4LX Bravo (MPI)(Gen.VI)	F802000-K999999	1996-97
165	2770032-5178958	1970-78	7.4L MPI (Gen.VI)	L010003-UP	1998
165	5178959-5813433	1979-81	7.4LX Bravo (TBI)(Gen.VI)	F820000-K999999	1996-97
200	2453769-2712072	1969	454 Mag. Alpha	A631894-UP	1986-88
GM V6 (STERN DRIVE)			454 Mag. Bravo (Gen.V)	D805069-F304999	1992-94
MODEL	S/N	YEAR	454 Mag. Bravo (Gen.V)	F305000-F801699	1995-96
185 (4bbl.)	6330183-6919655	1983-84	454 Mag. Bravo (Gen.VI)	F801700-K999999	1996-97
185 (2bbl.)	A331455-B527954	1985-87	454 EFI (Gen.V)	F115700-F802349	1994-96
175/4.3L (2bbl.)	B527955-D714106	1987-92	454 Mag. MPI (Gen.VI)	F802350-K999999	1996-97
4.3L (GEN II)(2bbl.)	D714107-F000877	1992-93	454 Mag. MPI (Gen.VI)	L010029-L085399	1998
4.3L (GEN II)(2bbl.)	F000878-F601126	1993-95	454 Mag. MPI (Gen.VI)	L085400-UP	1999-UP
4.3L (GEN II)(2bbl.)	F601127-F000878	1996	370 TRS	4179554-6721527	1978-85
4.3LX (GEN+)(2bbl.)	F803000-K999999	1996-97	370 TRS	6721528-B714586	1985-87
4.3L (GEN+)(2bbl.)	L010044-UP	1998-UP	400 TRS	4179554-B457644	1980-86
4.3L EFI (GEN+)(TBI)	L012009-UP	1998-UP	420	A398941-D937011	1987-89
205 (4bbl.)	A331455-B527954	1985-87	425	A398941-D937011	1990-93
205/4.3LX (4bbl.)	B527955-D714369	1987-91	440 TRS	4179554-B485220	1983-86
4.3LX (GEN II)(4bbl.)	D714370-F001219	1992-93	450 (Gen.V)	F347100-F347277	1995-96
4.3LX (GEN II)(4bbl.)	F001220-F601126	1993-95	525 SC	D456000-F348963	1991-92
4.3LX (GEN II)(4bbl.)	F601127-F802999	1996	525 SC (Gen.V)	D456000-F348963	1992-95
4.3LXH (GEN+)(4bbl.)	F803114-UP	1996-97	525 SC (Gen.V)	F615814-F745215	1996
4.3LH(GEN+)(4bbl.)	L010044-UP	1998	525 SC (Gen.VI)	F745260-UP	1996-97
262 Mag. (TBI)(GEN+)	F803800-K999999	1996-97	390	2781129-3042731	1969-70
FORD V8 (STERN DRIVE)			460 TRS	4719554-6181046	1983-86
MODEL	S/N	YEAR	465	C849992-F213244	1990-92
888 (2bbl.)	3108723-4887829	1971-77	465 (Gen.V)	C849992-F213244	1992-94
215 (4bbl.)	2781153-3385720	1970-72	500 (Gen.V)	F213293-F745159	1994-96
225 (4bbl.)	3385721-4166999	1973-74			

GM V8 427, 454, 502, 540 & 572 (STERN DRIVE) Cont.			GM MIE V8 427, 454, 482 & 502 CID (INBOARD)		
MODEL	S/N	YEAR	MODEL	S/N	YEAR
500 (Gen.VI)	F745195-L001772	1997-98	8.2L MPI (LH) Gen VI	L002450-L0086012	1998
502 Mag. Bravo	C878221-D824588	1990-92	8.2L MPI (LH) Gen VI	L0086013-UP	1999
502 Mag. Bravo (Gen.V)	D824589-F114528	1992-93	MIE 5, 6 & V8 CYLINDER DIESEL INBOARD ENGINES		
502 EFI (Gen.V)	D840650-F802599	1993-96	MODEL	HP	S/N
502 Mag.MPI (Gen.VI)	F802600-K999999	1996-97	530 D-TA	150	B993002-C539258
500 EFI	L001477-UP	1999-UP	636 D-TA	180	B993750-C696011
502 Mag.MPI (Gen.VI)	L085433-UP	1998	D183	150	C539259-D725149
600 SC	D456489-F877642	1991-92	D219	180	C696012-D850124
600 SC (Gen.V)	D456489-F877642	1992-96	D254	210	C849461-D554729
600 SC (Gen.VI)	K000227-UP	1997	D3.0L	150	D725150-UP
500 Bulldog	C577254-F745405	1990-96	D3.6L	180	D850125-UP
500 Bulldog	K000248-UP	1997	D4.2L	210	D554730-UP
575	A677429-D763716	1986-92	D7.3L	262	F060000-UP
800 SC (Gen.V)	D763836-UP	1993-96	MC 60, 80 & 90 STERN DRIVES & TRANSOM PLATES		
MCM 4,5,6 & V8 CYLINDER DIESEL STERN DRIVE ENGINE			MODEL	S/N	YEAR
MODEL	HP	S/N	YEAR		
Rover	60	31400000F-UP	1965-67	60 (O)	1830753-2063740
530 D-TA	150	B993000-B993492	1989	80	2063741-2898029
636 D-TA	180	B993500-C696047	1989	90	2898020-3225967
D183	140	B993493-D725149	1990-93	MC I, II & III	
D219	170	C696048-D850124	1990-93	MODEL	S/N
D254	200	C849484-D554729	1990-93	I	1534570-1684187
D3.0L	140	D725150-UP	1994-UP	II (1.33:1)	1474909-2278488
D3.6L	170	D850125-UP	1994-UP	MC I, II & III Cont.	
D4.2L	200	D554730-UP	1994-UP	MODEL	S/N
D7.3L	238	F060000-UP	1994-UP	II (1.78:1)	2398798-2671321
MERCURY MARINE MIE 4 CYLINDER (INBOARD)			MODEL	S/N	YEAR
MODEL	S/N	YEAR	1A, 1B & 1C	1684188-1777798	1964
470	5520115-6218036	1980-81	1A, 1B & 1C (E-Z Shift)	1776349-2065189	1965-66
FORD MIE V8 (INBOARD)			MC 120, 140, 160 & 165		
MODEL	S/N	YEAR	MODEL	S/N	YEAR
215	2781153-3563181	1970-72	120/140	2062141-378049	1967-73
225	3385721-4176999	1970-72	120/140	3780850-4893634	1974-77
233	4173000-4775784	1975-76	120/140	4893635-6225576	1978-82
255	3258728-4178299	1973-74	160	2065190-2763441	1967-69
GM MIE V8 305,327,350 CID (INBOARD)			165	2763442-3780849	1970-73
MODEL	S/N	YEAR	165	3780849-4890459	1974-77
198	4762210-6218461	1977	165	4890460-6268064	1978-82
228	4765100-5170008	1977-78	MC470 & 485		
228	5170009-5907057	1979-80	MODEL	S/N	YEAR
230/5.0L (4bbl.)	5907058-B788151	1981-87	470	4208730-4893834	1976-77
225	2278647-2694014	1968	470	4893835-6225576	1978-82
250	2314301-2639854	1968-69	485	5487437-6225576	1980-82
255	4175500-5907057	1975-80	MC 888, 225S & 233		
260/5.7L	5907058-F024999	1981-93	MODEL	S/N	YEAR
270	2851074-3077735	1969-72	888	3106717-3784374	1971-73
5.7L	F025000-K999999	1994-97	888	3784375-4782329	1974-77
5.7L (Gen+)	L002003-UP	1998	225S	3856268-4200499	1974
5.7L MPI	K040300-K999999	1997	233	4200500-4782329	1975-77
350 Mag. MPI (Gen+)	L002008-L304499	1998	MC 898, 228, 250 & 260		
350 Mag. MPI (Gen+)	L304500-UP	1999	MODEL	S/N	YEAR
350 Horizon	L304700-UP	1999-UP	898/228	4782330-4898729	1977
5.7L Ski	A338533-B514626	1985-87	898/228	4898730-6229157	1978-82
5.7L Competition Ski	B514627-F775199	1987-95	250	4791300-4898729	1977
5.7L Competition Ski	F775200-K040003	1996	260	4898730-6229157	1978-82
5.7L Competition Ski	K040004-K999999	1997	MC R, MR, ALPHA ONE, ALPHA ONE SS & ALPHA ONE GEN II		
5.7L Competition Ski	L002005-UP	1998-UP	MODEL	S/N	YEAR
(Gen+)			R	6152230-6847029	1983-84
350 Mag. Ski	D505450-K999999	1991-97	MR	6810538-A479506	1985
350 Mag. EFI Ski	F215561-K999999	1994-97	Alpha One	A470165-UP	1986-90
350 Mag. MPI Ski	F350583-F799999	1995-98	Alpha One SS	A545004-UP	1986-89
Black Scorpion Ski	F800000-UP	1996-98	Alpha One Gen II	D469859-UP	1991-UP
GM MIE V8 427, 454, 482 & 502 CID (INBOARD)			MC BRAVO & BLACKHAWK		
MODEL	S/N	YEAR	MODEL	S/N	YEAR
325	2278747-3780449	1968-74	Bravo One	B664190-UP	1988-UP
330	4623115-5889913	1977-80	Bravo Two	C564952-UP	1989-UP
340/7.4L w/B/W MK4	5889914-UP	1981-92	Bravo Three	D763691-UP	1993-UP
7.4L w/Hurth (LH) MK4	C391564-D715493	1989-92	Blackhawk	F186717-UP	1994-UP
7.4L (LH)	D715494-K999999	1992-97	MC 215E & 215H		
7.4L MPI (LH)	F563052-K999999	1995-97	MODEL	S/N	YEAR
7.4L MPI (L29) Gen VI	L002006-UP	1998	215H	2782203-2909034	1970
7.4L TBI (LH) Gen VI	F874815-K999999	1996-97	215E	2782203-2909034	1970-72
454 Mag. MPI Horizon	L002200-L086049	1998-99	MC TR & TRS		
454 EFI (SKI) (Gen.V)	F215800-F820099	1995-96	MODEL	S/N	YEAR
454 Mag. MPI (SKI)(Gen.VI)	F820100-K999999	1996-97	TR	3377316-3787239	1973
350	9780450-4623109	1974-76	TR	3787240-4794899	1974-76
390	2781129-2825059	1969-70	TR	4794900-5009866	1977
8.2L w/ Hurth	C878221-D857199	1990-92	TR	5009867-UP	1978-UP
8.2L (Gen.V)	D857200-F819619	1993-96	TRS	3787240-4203749	1974-75
8.2L MPI (LH) Gen VI	F819620-K999999	1996-97	TRS	4203750-4795399	1976
			TRS	4795400-UP	1977-UP



**18-5291
TUNE-UP KIT**

Replaces: 808483K2
GM V-8 engines w/Delco HEI-1998 and newer
(except MPI engines with 555 ECM)
Includes **18-5354** cap & **18-5402** rotor



**18-5246
TUNE-UP KIT**

Replaces: 898253T28
For: Late model V-6, 4.3L (Alpha/Bravo)



**18-5247
TUNE-UP KIT**

Replaces: 898253T29, 8M0061335, 8M0060495
For: Late model V-8 (Alpha/Bravo 350
Mag, 5.0L, & MX 6.2L)

①18-5250D



**18-5250
TUNE-UP KIT**

Replaces: 34235T1, 34235Q1

—CONTAINS—		
Part #	O.E. #	Description
18-5311	34235	Contact Set
18-5345	33662	Condenser
18-5418	58217	Rotor

Delco 4 & 6 cyl.

①18-5251D



**18-5251
TUNE-UP KIT**

—CONTAINS—

Part #	O.E. #	Description
18-5314	391-5090	Contact Set
18-5338	391-5092	Condenser
18-5404-1	391-7057	Rotor

Mallory 8 cyl. Tall Cap



**18-5252
TUNE-UP KIT**

—CONTAINS—

Part #	Description
18-5310	Contact Set
18-5344	Condenser
-	Rotor

Delco 8 cyl.



**18-5253
TUNE-UP KIT**

—CONTAINS—

Part #	O.E. #	Description
18-5318	58033	Contact Set
18-5346	58034, 81-64851	Condenser
18-5420	65864	Rotor

Autolite 8 cyl.

①18-5254D



TUNE-UP KIT

—CONTAINS—

Part #	O.E. #	Description
NSS	64850, 87-71831	Contact Set
18-5346	58034, 81-64851	Condenser
18-5420	65864, 78016	Rotor

Mercury 8 cyl.



**18-5258
TUNE-UP KIT**

—CONTAINS—

Part #	O.E. #	Description
18-5303	392-6325	Contact Set
18-5347	392-6324	Condenser
18-5407	392-6326	Rotor

Prestolite 8 cyl.



**18-5260
TUNE-UP KIT**

—CONTAINS—

Part #	O.E. #	Description
18-5303	392-6325	Contact Set
18-5345	392-6324	Condenser
18-5403	392-9767	Rotor

Prestolite 8 cyl.



**18-5266
TUNE-UP KIT**

Fits: Flame Thrower Distributors 18-5481, 18-5482, 18-5483, 18-5477, 18-5478 and 18-5479
Includes **18-5300** rotor



**18-5268
TUNE-UP KIT**

—CONTAINS—

Part #	O.E. #	Description
18-5311	34235	Contact Set
18-5345	33662	Condenser
18-5418	58217	Rotor
18-5385	393-9459	Distributor Cap

Delco In-Line 4 - Single Point



**18-5269
TUNE-UP KIT**

—CONTAINS—

Part #	O.E. #	Description
18-5311	34235	Contact Set
18-5345	33662	Condenser
18-5418	58217	Rotor
18-5386	33765	Distributor Cap

Delco In-Line 6 - Single Point

① Items ending in "D" are Display Packaged - Regular number is Non-Display



**18-5271
TUNE-UP KIT**

—CONTAINS—

Part #	O.E. #	Description
18-5314	391-5090	Contact Set
18-5338	391-5092	Condenser
18-5404-1	391-7057, 391-5088	Rotor
18-5376	391-5075	Distributor Cap

Mallory V-8 - Single Point - Top Terminal



**18-5273
TUNE-UP KIT**

—CONTAINS—

Replaces: 805759T3 / 805759Q3

Part #	O.E. #	Description
18-5431	13524A5	Rotor
18-5395	16457A4	Distributor Cap

Mercury Thunderbolt HEI - V-8



**18-5274
TUNE-UP KIT**

—CONTAINS—

Part #	O.E. #	Description
18-5432	13524A6	Rotor
18-5396	13753A2, 815407A2	Distributor Cap

Mercury Thunderbolt HEI - V-6



**18-5275
TUNE-UP KIT**

—CONTAINS—

Part #	O.E. #	Description
18-5303	392-6325	Contact Set
18-5347	392-6324	Condenser
18-5403	392-9089	Rotor
18-5352	392-9766	Distributor Cap

Prestolite V-8 - Single Point - Screw Cap



**18-5276
TUNE-UP KIT**

—CONTAINS—

Part #	O.E. #	Description
18-5303	392-6325	Contact Set
18-5347	392-6324	Condenser
18-5403	392-9089	Rotor
18-5353	392-9086	Distributor Cap

Prestolite V-6 - Single Point - Screw Cap



**18-5277
TUNE-UP KIT**

—CONTAINS—

Part #	O.E. #	Description
18-5303	392-6325	Contact Set
18-5347	392-6324	Condenser
18-5407	392-6326	Rotor
18-5369	392-6318	Distributor Cap

Prestolite V-8 - Single Point - Clip Cap



**18-5278
TUNE-UP KIT**

Replaces: 850484T3
Delco EST - V-6

—CONTAINS—

Part #	Description	O.E. #
18-5362	Distributor Cap	850484
18-5408	Rotor	850485



**18-5280
TUNE-UP KIT**

Replaces: 811635Q2
Delco EST - In-Line 4

—CONTAINS—

Part #	Description	O.E. #	Qty.
18-5361	Distributor Cap	811635, T3	1
18-5406	Rotor	811636, 1	1



**18-5281
TUNE-UP KIT**

Replaces: 808483Q2
Delco EST - V-8

—CONTAINS—

Part #	Description	O.E. #	Qty.
18-5354	Distributor Cap	808483	1
18-5405	Rotor	808484, 1, 898253010	1



**18-5283
TUNE-UP KIT**

For: Mallory Single Point In-Line 4

—CONTAINS—

Part #	Description	O.E. #
18-5397	Distributor Cap	-
18-5404-1	Rotor	391-7057
18-5314	Contact Set	391-5090
18-5338	Condenser	391-5092



**18-5302
TUNE-UP KIT**

Fits: Male cap v-8 flamethrower distributors



**18-5303
CONTACT SET**

Replaces: 392-898253005, 392-6325, 8M6001219, F16900031



**18-5310
CONTACT SET**

Replaces: 33700



**18-5311
CONTACT SET**

Replaces: 34235, 34235T



**18-5314
CONTACT SET**

Replaces: 391-5090, 391-898253004, 8M6001250



**18-5318
CONTACT SET**

Replaces: 58033, 898253007

 <p>18-5338 CONDENSER Replaces: 391-5092, 391-898253001, 391-5093, 391-5092, 8M6001217, FI6900040</p>	 <p>18-5344 CONDENSER Replaces: 33706</p>	 <p>18-5345 CONDENSER Replaces: 33662, 898253003, 898253005, 33662Q, 6325, 8M6001218, FI6900031</p>	 <p>18-5346 CONDENSER Replaces: 58034, 81-64851</p>	 <p>18-5347 CONDENSER Replaces: 392-6324, 392-898253002, 8M6001249, FI6900023, FI6900032, FI6900083, FI6900189</p>
 <p>18-5402 ROTOR Replaces: 898253009 GM V-8 engines w/Delco HEI- 1998 and newer (except MPI engines with 555 ECM)</p>	 <p>18-5245 ROTOR Replaces: 884790, 898253013 For: Late model V-6, V-8 (Alpha/ Bravo 350 Mag, 5.0L, & MX 6.2L)</p>	 <p>18-5403 ROTOR Replaces: 392-9089, 392-9089T, 392-9767, 392- 9089Q, FI6900186 FI6900190</p>	 <p>18-5404-1 ROTOR Replaces: 391-7057, 391-5088, 391-7057T, 391- 898253029, 8M6001224, FI6901224</p>	 <p>18-5405 ROTOR Replaces: 808484, 808484 1, 898253010 Use with 18-5354 Distributor Cap Fits new GM style "Module in Cap" distributors - V-8 application</p>
 <p>18-5406 ROTOR Replaces: 811636, 811636 1, 898253011 Use with 18-5361 Distributor Cap 3.0L LX</p>	 <p>18-5407 ROTOR Replaces: 392-6326, 392-6326T, FI6900044</p>	 <p>18-5300 ROTOR Replaces: 33707 Fits: Flamethrower Distributors</p>	 <p>18-5408 ROTOR Replaces: 850485, 8504851, 898253012, 8M0062084, 804424 Use with 18-5362 Distributor Cap Fits new GM Style "Module in Cap" Distributors V6 Applications</p>	 <p>18-5418 ROTOR Replaces: 58217, 898253008, 58217Q</p>
 <p>18-5420 ROTOR Replaces: 65864, 78016</p>	 <p>① 18-5431D Display Package 18-5431 ROTOR ASSEMBLY Replaces: 13524A5, T1 V-8</p>	 <p>18-5432 ROTOR ASSEMBLY Replaces: 13524A6, 13524Q06, 13524A4, 19405A4, 90576A4 V-6</p>	 <p>18-5243 DISTRIBUTOR CAP Replaces: 888731, 898253T23 For: Late model V-6 (4.3L Alpha/ Bravo)</p>	 <p>18-5244 DISTRIBUTOR CAP Replaces: 884792, 898253T22 For: Late model V-8 (Alpha/Bravo 350 Mag, 5.0L, & MX 6.2L)</p>
 <p>18-5352 DISTRIBUTOR CAP Replaces: 392-9766, 392-9766Q1, 392-9766T, FI6900185 Prestolite</p>	 <p>18-5353 DISTRIBUTOR CAP Replaces: 392-9086, 392-9086T</p>	 <p>18-5354 DISTRIBUTOR CAP Replaces: 808483, 808483T3, 804483T 804418 Fits new GM style "Module in Cap" Distributors—V-8 applications. Use 18-5405 Rotor</p>	 <p>18-5361 DISTRIBUTOR CAP Replaces: 811635, 811635T3 Use 18-5406 Rotor 3.0L LX</p>	 <p>18-5362 DISTRIBUTOR CAP Replaces: 850484, 850484T, 850484T2 Fits new GM Style "Module in Cap" Distributors — V6 Applications Use 18-5408 Rotor</p>

 <p>18-5369 DISTRIBUTOR CAP Replaces: 392-6318, 392-6318T, F16900184 Prestolite with gasket 18-5399</p>	 <p>18-5376 DISTRIBUTOR CAP Replaces: 391-5075, 391-5075Q1, F16900148 Mallory</p>	 <p>18-5384 DISTRIBUTOR CAP Replaces: 33708</p>	 <p>18-5385 DISTRIBUTOR CAP Replaces: 393-9459, 393-9459Q1, 393-9459T, 33667, F16900052</p>
 <p>18-5386 DISTRIBUTOR CAP Replaces: 33765, 33765T</p>	 <p>18-5389 DISTRIBUTOR CAP Replaces: 393-4988T, 393-4988T2, 393-4988, 393-3230</p>	 <p>18-5395 DISTRIBUTOR CAP Replaces: 16457A4, 805759T2, 805759T1, 805759A5, 805759A2, 805759A1, 90746A1, 43557A1, 43557 V-8</p>	 <p>18-5396 DISTRIBUTOR CAP Replaces: 13753A2, 815407A2 V-6</p>
 <p>18-5397 DISTRIBUTOR CAP Replaces: Mallory 9-29418 Fits: Ford 2.3L w/Mallory Distributor (87-90)</p>	 <p>18-5473 DISTRIBUTOR CAP Black Distributor Cap with Male Terminals for Flamethrower Distributors</p>	<p>PKG OF 2</p>  <p>18-5399 DISTRIBUTOR CAP GASKET Replaces: 392-6329</p>	

FEATURES

- Oil filled for better cooling and long life
- Low resistance and improved turn ratios produces the higher voltage needed to run larger spark plug gaps for added power and better fuel economy
- More windings maximize energy and reliability over the full RPM range
- Fits existing brackets for easy installation

 <p>18-5466 HI-PERFORMANCE IGNITION COIL 1.5 ohm (oil filled), black - 8 cylinder: Flame-Thrower 40,000 volt coil.</p> <ul style="list-style-type: none"> • Designed for use with the original Ignitor Electronic Conversion Kits • Can be used with other inductive ignition systems 	 <p>18-5469 HI-PERFORMANCE IGNITION COIL 3.0 ohm (oil filled), black - 4 & 6 cylinder: Flame-Thrower 40,000 volt coil.</p> <ul style="list-style-type: none"> • Designed for use with the original Ignitor Electronic Conversion Kits • Can be used with other inductive ignition systems 	 <p>18-5472 HI-PERFORMANCE IGNITION COIL 0.6 ohm (oil filled), black - 4, 6, & 8 cylinder:Flame-Thrower 45,000 volt coil.</p> <ul style="list-style-type: none"> • Super low 0.6 ohm resistance coil designed for use with the Ignitor II Hi Performance Electronic Conversion Kits • Compatible with capacitive discharge systems
---	--	--

Part No.	Description	Recommended Coil	Resistance Ohms	Part No.	Description	Recommended Coil	Resistance Ohms
18-5294	Electronic Conversion Kit	18-5469	3	18-5288-1	Hi Performance Electronic Conversion Kit	18-5472	0.6
18-5295	Electronic Conversion Kit	18-5469	3	18-5289	Hi Performance Electronic Conversion Kit	18-5472	0.6
18-5296-2	Electronic Conversion Kit	18-5466	1.5	18-5290	Hi Performance Electronic Conversion Kit	18-5472	0.6
18-5297	Electronic Conversion Kit	18-5469	3	18-5481	Flame-Thrower Distributor	18-5472	0.6
18-5298-1	Electronic Conversion Kit	18-5466	1.5	18-5483	Flame-Thrower Distributor	18-5472	0.6
18-5299	Electronic Conversion Kit	18-5466	1.5				
18-5285	Hi Performance Electronic Conversion Kit	18-5472	0.6				

① Priced per Package

CAP APPLICATION BEGINS ON PAGE 702

 <p>18-5433 IGNITION COIL Replaces: 38547, 32193A2, 392-806529A1, 898253T24 DELCO 1115202 (Uses External Resistor)</p>	 <p>18-5438 IGNITION COIL Replaces: 392-7803A4, 392-805570A2 HEI Thunderbolt Ignition</p>	 <p>18-5465 IGNITION COIL Replaces: 392-863704T, 8M0054588 2001 and newer 4.3L, 5.0L, 5.7L & 6.2L with 555 ECM (OM300000 and up)</p>	 <p>18-7493 COIL Replaces: 392889925 For: 8.1L & 496 Mag OM315053 & UP</p>	 <p>18-7648 IGNITION COIL Replaces: 392-881732</p>
 <p>18-5442 IGNITION COIL Replaces: 806673T, T1</p>	 <p>18-5443 IGNITION COIL Replaces: 817378T, 817378, 898253T27</p>	 <p>18-5117 IGNITION MODULE Replaces: GM 10482803 Fits: MCM MIE 4.3L MPI, 5.0L MPI, 350 Mag MPI and MX 6.2L MPI engines with ECM555 (2001 & Up) S/N OM300000 & Up</p>	 <p>18-5107-1 IGNITION MODULE 4/6/8 cyl. Replaces: 811637001, 811637002, 811637T, 811637, 850487, 804412, 802464 Delco EST</p>	 <p>18-5488 IGNITION MODULE Replacement module for Mallory electronic distributors</p>
 <p>18-5108 PICK-UP COIL SENSOR Replaces: 811639, T V4/V6/V8 Delco EST</p>	 <p>18-5116-1 IGNITION SENSOR KIT Replaces: 87-861780A2, Q4, 87-892150A02 For: V-6 & V-8 with Thunderbolt ignition (1981-1997) nut connectors</p>	 <p>18-7556 CRANKSHAFT SENSOR Replaces: 864297001 Fits: Mercury 5.0L, 6.2L 1998-2010</p>	 <p>18-7642 PICK-UP ASSEMBLY Replaces: 898141 Fits: Engines equipped w/ Delco HVS distributor</p>	 <p>18-26810 GM HEI 4 TERMINAL PIGTAIL Fits: GM HEI Distributors w/4 terminals</p>
 <p>18-26811 GM HEI 2 TERMINAL PIGTAIL Fits: GM HEI Distributors w/2 terminals</p>	 <p>18-26812 HEI COIL GRAY CONNECTOR</p>	 <p>18-26813 HEI COIL BLACK CONNECTOR</p>	 <p>18-61051 SCREW KIT (4 PER PKG) Fits: Mercruiser V6 & V8 Thunderbolt Distributor Caps</p>	



FEATURES

- Senses current levels in the coil & adjusts the dwell to maintain peak energy throughout entire RPM range.
- Develops, on average, 4 times more available energy between 3000 and 5000 RPM's and twice as much plug voltage as point-type systems.
- Ignition energy is sustained and coil life is increased when peak current level is reached just prior to spark.
- More stable timing.
- Use with 18-5472 "Flame Thrower II" Coil for optimum performance

APPLICATION BEGINS ON PAGE 702



18-5285
HI-PERFORMANCE
ELECTRONIC CONVERSION KIT
 Fits: 4 Cylinder Delco Distributors



18-5288-1
 Superseded from 18-5289
HI-PERFORMANCE
ELECTRONIC CONVERSION KIT
 Fits: Most Prestolite Distributors with screw down cap



18-5290
HI-PERFORMANCE
ELECTRONIC CONVERSION KIT
 Fits: Most Mallory YL or YD 8 cylinder Distributors with clockwise and counter clockwise rotation

IGNITOR
 ELECTRONIC IGNITION

FEATURES

- Replaces point & condensers for true solid state ignition.
- Uses standard coil, cap and rotor.
- Easy to install, one-piece, 2-wire hook-up.
- Accurate to within 1/4° timing accuracy 0 to 6000 RPM range.
- Can be used with Flame Thrower 18-5466 & 18-5469.

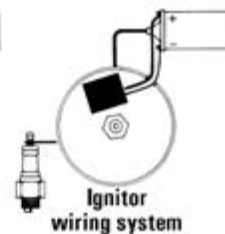
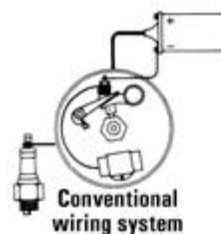

18-5294
ELECTRONIC CONVERSION KIT
 Fits: 6 Cyl. Delco Distributors



18-5295
ELECTRONIC CONVERSION KIT
 Fits: Most 4 Cyl. Prestolite Distributors (Except IBM7026)
 For: Onan, Universal, Waukesha, Wisconsin



18-5296-2
ELECTRONIC CONVERSION KIT
 Fits: Most Mallory YL or YD 8 cyl. Distributors with clockwise or counter clockwise rotation

① 18-5296-2D Display Package



① 18-5297D Display Package

18-5297
ELECTRONIC CONVERSION KIT
 For: 4 Cyl. GM



18-5298-1
ELECTRONIC CONVERSION KIT
 (with snap down cap)
 For: Most Prestolite V-8 Distributors



① 18-5299D Display Package

18-5299
ELECTRONIC CONVERSION KIT
 (with screw down cap)
 For: Most Prestolite V-8 Distributors
 Use with 18-5403 Style Rotor

APPLICATION BEGINS ON PAGE 702

① Items ending in "D" are Display Packaged - Regular number is Non-Display



FEATURES

- Distributors feature the Ignitor II ignition module with adaptive dwell control adjusts the spark timing over the entire RPM range to maximize performance
- Upper roller bearing and oil impregnated bronze sintered bottom bushing are installed and aligned bored for accuracy for maximum durability
- Machined heat treated gear with tight tolerances insures durability and consistent timing to maximize horsepower and performance. Complete with high dielectric strength cap and rotor for years of performance

Standard Rotation

CCW Rotation

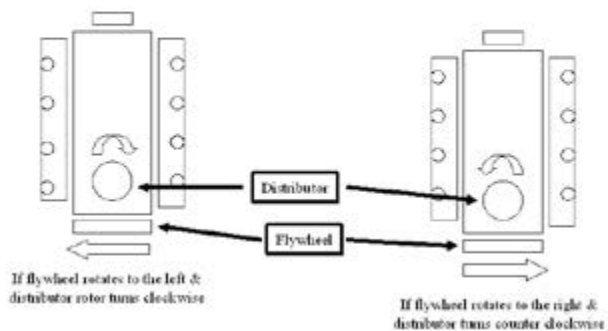

18-5481
HI-PERFORMANCE
ELECTRONIC DISTRIBUTOR
 Fits: Ford V-8 351 Windsor
 Replacement cap/rotor kit: 18-5266



18-5477
ELECTRONIC DISTRIBUTOR
 Fits: Ford 302 V-8 engines
 Replacement Cap/Rotor Kit 18-5266



18-5483
HI-PERFORMANCE
ELECTRONIC DISTRIBUTOR
 Fits: Chevrolet marine small and big block engines (standard deck height)
 Replacement cap/rotor kit: 18-5266



18-5479
ELECTRONIC DISTRIBUTOR
 Fits: GM V-8 engines-reverse rotation
 Replacement Cap/Rotor Kit 18-5266



18-5480
COMPLETE IGNITION
CONVERSION KIT
 Fits: GM SB & BB with Standard Deck Height
 —CONTAINS—

Part #	Description
18-5472	Coil
18-8803-2	Wire Set
18-5483	Distributor

18-26002-1
IGNITION SYSTEM KIT
 Fits: GM 4.3L/262 CID Even Fire Engines



18-5470
THUNDERBOLT IV V-8 DISTRIBUTOR
 Replaces: 805185A36
 Fits: GM V-8 engines
 Tune-Up Kit **18-5273**



18-5471
THUNDERBOLT IV V-6 DISTRIBUTOR
 Replaces: 805185A37
 GM V-6 engines
 Tune-Up Kit **18-5274**



18-5350
DISTRIBUTOR
 Replaces: 888751A03, 888751A02, 888751A1
 Fits: Vortec V-6 4.3L MPI (2002-UP) (S/N OM300000 and UP)



18-5351
DISTRIBUTOR
 Replaces: 884794A02, 884794A1
 Fits: Vortec V-8 2001 and up 5.0L/ 5.7L/ 6.2L MPI engines (S/N OM300000 and up)



18-5475
DISTRIBUTOR
 Replaces: 817377, 817377T
 Fits: 4 Cyl. GM w/ Delco EST Ignition
 Tune-Up Kit **18-5280**



18-5476
DISTRIBUTOR
 Replaces: 807964A1, 907964A1
 Fits: GM V-6 engines with Delco EST ignition HEI
 Tune-Up Kit **18-5278**



18-5484-1
ELECTRONIC DISTRIBUTOR
 Conventional Rotation
 Replaces: 805222A1
 Late Model HEI
 For: V8 — 262-454 & 502 except 384/ 409 and tall block engines
 • Designed as a plug-in replacement for GM-style fuel injection system distributors

—CONTAINS—	
Description	Part #
Distributor Cap	18-5354
Rotor	18-5405

Tune-Up Kit **18-5281**



18-26111-1
DISTRIBUTOR
 Replaces: Mallory YL648AV
 Fits: Mercruiser 3.7L L4/LH



18-5486-2
ELECTRONIC DISTRIBUTOR
 Superseded from 18-5486
 Conventional Rotation
 For: Chevrolet L4, 153 & 181 CID

—CONTAINS—	
Part #	Description
18-5397	Distributor Cap
18-5488	Module
18-5404-1	Rotor



**18-5489-2
ELECTRONIC
DISTRIBUTOR**
Conventional Rotation
For: Ford V8 351W CID



—CONTAINS—

Part #	Description
18-5376	Distributor Cap
18-5488	Module
18-5404-1	Rotor

**18-5494-2
ELECTRONIC
DISTRIBUTOR**
Conventional Rotation
For: Chevrolet all V8 includes 482, 502, 540 CID (Except 348,409 & Tall Deck Big Block)



—CONTAINS—

Part #	Description
18-5376	Distributor Cap
18-5488	Module
18-5404-1	Rotor

**18-5495-2
ELECTRONIC
DISTRIBUTOR**
Conventional Rotation
For: Ford V8 302 CID



—CONTAINS—

Part #	Description
18-5376	Distributor Cap
18-5488	Module
18-5404-1	Rotor

**18-5496-2
ELECTRONIC
DISTRIBUTOR**
Replaces: YLM567CV
Conventional Rotation
For: Ford V8 351C — 460 CID



—CONTAINS—

Part #	Description
18-5376	Distributor Cap
18-5488	Module
18-5404-1	Rotor

**18-5497-2
ELECTRONIC
DISTRIBUTOR**
Replaces: YLM579AV
Conventional Rotation
For: Chrysler V8 273,318 (67 & UP) 340, 360 CID "LA" engines



—CONTAINS—

Part #	Description
18-5376	Distributor Cap
18-5488	Module
18-5404-1	Rotor

**18-5309-1
DISTRIBUTOR**
Contact Controlled (Standard Rotation)
Replaces: Mallory YL512CV
For: Most Ford 302 CID V-8 Eng.
Tune-Up Kit 18-5251



—CONTAINS—

Part #	Description
18-5314	Contact Set
18-5338	Condenser
18-5404-1	Rotor

**18-5312-1
DISTRIBUTOR (Contact Controlled)**
Replaces: Mallory YL554CV
For: Most Ford 351 CID V-8 Eng.
Tune-Up Kit 18-5251



—CONTAINS—

Part #	Description
18-5314	Contact Set
18-5338	Condenser
18-5404-1	Rotor

**18-5313-1
DISTRIBUTOR**
Contact Controlled (Standard Rotation)
Replaces: 17177A1, 91823A3, 816148A1, 74905A3, 68521A4, 68521A3, 13447A1
Mallory YL624AV
For: Most GM V-8 Engs. (small & large blocks) Mallory
Tall Cap
Tune-Up Kit 18-5251



**18-5315-1
DISTRIBUTOR**
Contact Controlled (Standard Rotation)
Replaces: 87581, 87581T, 62424, 58231, 52352, 33266, 195141
Mallory YL673AV
For: Most GM 4 Cyl. Engs. (120 & 140 HP)
Tune-Up Kit 18-5251



—CONTAINS—

Part #	Description
18-5314	Contact Set
18-5338	Condenser
18-5404-1	Rotor

**18-5498-2
ELECTRONIC DISTRIBUTOR**
Replaces: 9-26307; Mallory YLM624BV
For: GM V8, 482, 502, 540 CID (Except 348, 409 & Tall Deck Big Block) (Reverse Rotation)





**18-5316-1
DISTRIBUTOR**
Replaces: Mallory YL624BV
Fits: Most GM V8 (Reverse Rotation)



**18-5339-1
DISTRIBUTOR**
Replaces: 9-26103; Mallory YL566AV
For: GM V8 327



**18-26110-1
DISTRIBUTOR**
Replaces: 9-26110; Mallory YL579AV
For: Chrysler V8, 273, 318 (1967 & Up), 340 and 360 "LA" Engines



**18-26104-1
DISTRIBUTOR**
Replaces: 9-26104; Mallory YL567EV
For: Ford V8 351C



**18-26112-1
DISTRIBUTOR**
Replaces: 9-26112; Mallory YL676AV
Fits: GM L6, 194, 230, 250, 292 CID (Conventional Rotation)



**18-5512
I/L 4 DELCO EST CONVERSION KIT**
Description: Converts 4 Cylinder GM Engines to Electronic
Includes: Distributor, Coil, Ignition Wires, and Harnesses



**18-5513
V-6 DELCO EST
CONVERSION KIT**
Description: Converts 6 Cylinder GM Engines to Electronic
Includes: Distributor, Coil, Ignition Wires, and Harnesses



**18-5514
V-8 DELCO EST
CONVERSION KIT**
Description: Converts 8 Cylinder GM Engines to Electronic
Includes: Distributor, Coil, Ignition Wires, and Harnesses



**18-5518
I/L 4 SIERRA ELECTRONIC
DISTRIBUTOR CONVERSION KIT**
Description: Converts 4 Cylinder GM Engines to Electronic
Includes: Distributor, Coil, Ignition Wires, and Harnesses



**18-5520
V-8 SIERRA ELECTRONIC
DISTRIBUTOR CONVERSION KIT**
Description: Converts 8 Cylinder GM Engines to Electronic
Includes: Distributor, Coil, Ignition Wires, and Harnesses

MODEL	Cyl.	Ignition Type	Year	Serial #	Tune-Up Kit	Contact Set	Rotor	Dist. Cap	Coil	Distributor	Spark Plug Wires
110	153/4	⊙	1963-1966	1537370-2044033	18-5250 ★	18-5311	18-5418	18-5385	18-5433	18-5315-1	18-8800-1
					18-5268 ☐						
120	153/L4	⊙	1964-1986	1666601 - B531853	18-5250 ★	18-5311	18-5418	18-5385	18-5433	18-5315-1	18-8800-1
					18-5268 ☐						
2.5L	153/L4	⊙	1987-1989	B531854 - C853255	18-5250	18-5311			18-5433		
PRESTOLITE REPLC IGN	4 CYL	⊙	1963-1989	1537370 - C853255		18-5303	18-5403				
140	181/L4	⊙	1968-1986	2508261 - B450800	18-5250 ★	18-5311	18-5418	18-5385	18-5433	18-5315-1	18-8800-1
					18-5268 ☐						
3.0L	181/L4	⊙	1987-1989	B450801 - C856558	18-5250	18-5311			18-5433		
3.0L	181/L4	⊙	1990-1991	C856559 - D504541		18-5303	18-5403		18-5433		
3.0L	181/L4	⊕	1990-1991	C856559 - D504541							18-8811-1
3.0L	181/L4	⊙	1991-1994	D504542 - F603999				18-5361	18-5443		18-8833-1
3.0L	181/L4	⊙	1998-2010	L010042 - & UP				18-5361	18-5443		18-8833-1
3.0L MPI	181/L4	⊙	2008-2010	A072812 - & UP				18-5361	18-5443		18-8833-1
3.0LX	181/L4	⊕	1990-1991	C856559 - D504541							18-8811-1
3.0LX	181/L4	⊙	1991-1997	D504542 - K999999				18-5361	18-5443		18-8833-1
3.0L/ LX	L4		1990-1995	C856559 - F603999	18-5262	18-5303	18-5403		18-5433	18-5315-1	18-8800-1
3.0L/ LX	L4		1990-1995	C856559 - F603999							18-8811-1
3.0L/LX	L4		1996 & UP	F604000 & Up	18-5280		18-5406	18-5361	18-5443		18-8833-1
PRESTOLITE REPLC IGN	4 CYL	⊙	1968-1991	2508261 - D504541		18-5303	18-5403				
165	224/L4	⊙	1987	B434941 - B774251	18-5250	18-5311			18-5433		
170	224/L4	⊙	1985-1986	6916779 - B434940	18-5250	18-5311			18-5433		
180	224/L4	⊙	1987	B436391 - B775248	18-5250	18-5311			18-5433		
180	224/L4	⊙	1987-1989	B436391 - B775248		18-5303	18-5403		18-5433		
190	224/L4	⊙	1985-1986	6916779 - B436390	18-5250	18-5311			18-5433		
3.7L	224/L4	⊙	1988-1989	B774252 - & UP	18-5250	18-5311			18-5433		
3.7LX	224/L4	⊙	1988-1989	B775249 - & UP	18-5250	18-5311			18-5433		
3.7LX	224/L4	⊙	1988-1989	B775249 - & UP		18-5303	18-5403		18-5433		
470	224/L4	⊙	1976-1984	4208730 - 6916778	18-5250 ★	18-5311	18-5418	18-5385	18-5433		18-8808-2
165, 170, 190	L4		1985-1989	6916779 & UP	18-5250 ★	18-5311	18-5418	18-5385	18-5433		18-8808-2
(224CID)					18-5268 ☐						
180LX	L4		1987-1989	B436391 & UP	18-5250 ★	18-5311	18-5418	18-5385	18-5433		18-8808-2
					18-5268 ☐						
180LX	L4		1987-1989	B436391 & UP	18-5262	18-5303	18-5403		18-5433		18-8808-2
160, 165(250cid)	L6		1967-1981	2048022-5813433	18-5250 ★	18-5311	18-5418	18-5386	18-5433		18-8809-1
					18-5269 ☐						
485	224/L4	⊙	1980-1982	5685394 - 6218036	18-5250	18-5311			18-5433		
488	224/L4	⊙	1983-1984	6170297 - 6916778	18-5250	18-5311			18-5433		
PRESTOLITE REPLC IGN	4 CYL	⊙	2010			18-5303	18-5403				
140	194/L6	⊙	1963	1538930 - 1725960	18-5250 ★	18-5311	18-5418	18-5386		18-5312-1	18-8809-1
					18-5269 ☐						
150	230/L6	⊙	1964-1966	1666495 - 2048046	18-5250 ★	18-5311	18-5418	18-5386			18-8809-1
					18-5269 ☐						
160	250/L6	⊙	1967-1970	2048022 - 2771483	18-5250	18-5311		18-5386	18-5433		
165	250/L6	⊙	1971-1981	2771484 - 5813433	18-5250	18-5311		18-5386	18-5433		
200	292/L6	⊙	1969	2453769 - 2712072	18-5250 ★	18-5311	18-5418	18-5386	18-5433		18-8809-1
					18-5269 ☐						
PRESTOLITE REPLC IGN	6 CYL	⊙	2010			18-5303	18-5403	18-5353	18-5433		
185 (4 bb)	229/V-6	⊙	1983-1984	6330183 - 6919655	18-5262 ★	18-5303	18-5403	18-5353	18-5433		18-8801-1
					18-5276 ☐						
175	262/V-6	⊙	1987	B527955 - B773242			18-5432	18-5396	18-5438		
175, 185, 4.3	262/V-6		1985-1993	6919656 - F000877	18-5274		18-5432	18-5396	18-5438		18-8810-1
185 (2bb)	262/V-6	⊙	1985-1987	6919656 - B527954			18-5432	18-5396	18-5438		
205	262/V-6	⊙	1985-1987	A331455 - B775129			18-5432	18-5396	18-5438		

- ⊙ Mallory Ignition
- ⊙ Prestolite
- ⊙ Autolite
- ⊙ Mercury Ignition
- ⊙ Holley
- ⊙ Thunderbolt IV
- ⊙ With screw down cap
- ⊙ Delco
- ⊙ Electronic dist. (std rotation) excluding Thunderbolt ignition
- ⊙ Delco EST
- ⊕ Delco digital system
- ★ With out dist cap
- ☐ With dist cap
- ☐ Mercury HEI
- ☐ Delco HEI
- ▲ Thunderbolt V
- ▼ Prestolite with clip down dist cap
- ⊕ Contact controlled dist. (Std. Rotation) excl. Thunderbolt ign.

MODEL	Cyl.	Ignition Type	Year	Serial #	Tune-Up Kit	Contact Set	Rotor	Dist. Cap	Coil	Distributor	Spark Plug Wires
205, 4.3LX 4bbl	262/V-6		1985-19996	A331455 - F802999	18-5274		18-5432	18-5396	18-5438		18-8810-1
262 TBI (GEN +)	262/V-6	☞	1996-1997	F803800 - K999999					18-5443		18-8835-1
4.3L (2bbl)	262/V-6	☞	1988-1996	B773243 - F802999			18-5432	18-5396	18-5438		
4.3L (2bbl) (GEN +)	262/V-6	☞	1998-2010	L010044 & UP			18-5432	18-5396			
4.3L EFI (GEN +) (TBI)	262/V-6	☞	1998	L012009 - L359999					18-5438		18-8835-1
4.3L EFI (GEN +) (TBI)	262/V-6	☞	1999-2001	L360000 - M299999			18-5432	18-5396	18-5438		
4.3L MPI	262/V-6	☞	2002-2010	M300000 & UP	18-5246		18-5245	18-5243	18-5465	18-5350	18-8829-1
4.3LH (GEN +) (4bbl)	262/V-6	☞	1998-2002	L010044 - M614999			18-5432	18-5396	18-5438		
4.3LX (4bbl)	262/V-6	☞	1988-1996	B775130 - F802999			18-5432	18-5396	18-5438		
4.3LX (GEN +) (2bbl)	262/V-6	☞	1996-1997	F803000 - K999999			18-5432	18-5396	18-5438		
4.3L/LH/LX/LXH	V6		1996-2001	F803000 & UP	18-5274		18-5432	18-5396	18-5438		18-8810-1
Alpha(Gen+)											
4.3L/LH/LX/LXH	V6		1996-2001	F803000 & UP	18-5274		18-5432	18-5396	18-5438		18-8810-1
Bravo(Gen+)											
4.3L EFI,262	V6		1996-1998	F803000- L359999	18-5278		18-5408	18-5362	18-5443		18-8810-1
Mag(TBI)(Gen+)											
4.3L EFI(TBI)	V6		1996 & up	L012009 - L359999	18-5278		18-5408	18-5362	18-5443	18-5476	18-8835-1
(Gen+)				L360000 & UP	18-5274		18-5432	18-5396	18-5438		18-8835-1
4.3L EFI(TBI)	V6		1999-2001	L360000 & UP	18-5274		18-5432	18-5396	18-5438		18-8810-1
215 MCM & MIE (FORD)	302/V-8	☞	1970-1972	2781153 - 3563181	18-5253 ★	18-5318	18-5402	18-5389	18-5433	18-5495-2 ☞	18-8803-2
										18-5309-1 ☞	
215 MCM & MIE (FORD)	302/V-8	☞	1970-1972	2781153 - 3563181	18-5251 ★	18-5314	18-5404-1	18-5376	18-5433	18-5495-2 ☞	18-8803-2
					18-5271 ☞					18-5309-1 ☞	
225 MCM & MIE (FORD)	302/V-8	☞	1973-1974	3385721 - 4166999	18-5253 ★	18-5318	18-5420	18-5389	18-5433	18-5495-2 ☞	18-8803-2
Ford(302cid)										18-5309-1 ☞	
225 MCM & MIE (FORD)	302/V-8	☞	1973-1974	3385721 - 4166999	18-5251 ★	18-5314	18-5404-1	18-5376	18-5433	18-5495-2 ☞	18-8803-2
					18-5271 ☞					18-5309-1 ☞	
225 MCM & MIE (FORD)	302/V-8	☞	1973-1974	3385721 - 4166999	18-5254 ★		18-5420	18-5389	18-5433	18-5495-2 ☞	18-8803-2
										18-5309-1 ☞	
888 (FORD)	302/V-8	☞	1971-1977	3108723 - 4887829	18-5254		18-5420	18-5389	18-5433	18-5495-2 ☞	18-8803-2
										18-5309-1 ☞	
888 (FORD)	302/V-8	☞	1971-1977	3108723 - 4887829	18-5253	18-5318	18-5420	18-5389	18-5433	18-5495-2 ☞	18-8803-2
888 (FORD)	302/V-8	☞	1971-1977	3108723 - 4887829	18-5258 ★	18-5303	18-5407	18-5369	18-5433	18-5495-2 ☞	
					18-5277 ☞					18-5309-1 ☞	18-8803-2
888 (FORD)	302/V-8	☞	1971-1977	3108723 - 4887829	18-5251 ★	18-5314	18-5404-1	18-5376	18-5433	18-5495-2 ☞	
					18-5271 ☞					18-5309-1 ☞	18-8803-2
190 (GM 283)	283/V-8	☞	1963-1964	1564539 - 1730903	18-5252	18-5310	18-5417	18-5384	18-5438	18-5498-1 ☞	
										18-5494-2 ☞	
										18-5313-1 ☞	
198 MIE	305/V-8	☞	1977	4776402 - 4931099		18-5314	18-5404-1		18-5433		
200 (5.0L)	305/V-8	☞	1985-1995	6899058 - F600999			18-5431	18-5395	18-5438		
228	305/V-8	☞	1977-1982	4765100 - 6218461		18-5314	18-5401-1		18-5433		
228	305/V-8	☞	1982-1984	6218462 - 6899268			18-5431	18-5395	18-5438		
228 MIE	305/V-8	☞	1977-1980	4765100 - 5907057		18-5314	18-5401-1		18-5433		
228 MCM & MIE	305/V-8		1977-1984	4765100 - 6218461	18-5251 ★	18-5314	18-5404-1	18-5376	18-5433		18-8803-2
					18-5271 ☞					18-5498-1 ☞	
228	305/V-8		1985-1986	6218462 - 6899268	18-5273		18-5431	18-5395	18-5438	18-5494-2 ☞	18-8804-1
										18-5498-1 ☞	
230, 5.0L/X MIE	305/V-8		1981-1995	5907058 - F600999	18-5273		18-5431	18-5395	18-5438	18-5494-2 ☞	18-8804-1
										18-5498-1 ☞	
198, 898 MCM &	305/V-8		1977-1982	4776402 - 6218461	18-5251 ★	18-5314	18-5404-1	18-5376	18-5433	18-5494-2 ☞	18-8803-2
					18-5271 ☞					18-5498-1 ☞	
230	305/V-8	☞	1985-1987	6899269 - MB773739			18-5431	18-5395	18-5438		
230 MIE	305/V-8	☞	1981-1987	5907058 - B788151			18-5431	18-5395	18-5438		

- ☞ Mallory Ignition
- ☞ Prestolite
- ☞ Autolite
- ☞ Mercury Ignition
- ☞ Holley
- ☞ Thunderbolt IV
- ☞ With screw down cap
- ☞ Delco
- ☞ Electronic dist. (std rotation) excluding Thunderbolt ignition
- ☞ Delco EST
- ☞ Delco digital system
- ★ With out dist cap
- ☞ With dist cap
- ☞ Mercury HEI
- ☞ Delco HEI
- ☞ Thunderbolt V
- ☞ Prestolite with clip down dist cap
- ☞ Contact controlled dist. (Std. Rotation) excl. Thunderbolt ign.

MODEL	Cyl.	Ignition Type	Year	Serial #	Tune-Up Kit	Contact Set	Rotor	Dist. Cap	Coil	Distributor	Spark Plug Wires
5.0L (GEN +)	305/V-8	♣	1998-2010	L015751 & UP			18-5431	18-5395	18-5438		
5.0L EFI (Gen+)	305/V-8	⊕	1998	L012052 - L331630	18-5281		18-5405	18-5354	18-5442	18-5494-2⊕	18-8836-1
										18-5498-1⊕	
5.0L EFI (GEN +)	305/V-8	⊕	1998	L331651 - L339999					18-5442		
5.0L EFI (GEN +)	305/V-8	⊕	1999	L331631 - L331650			18-5431		18-5438		
5.0L MPI	305/V-8	⊕	2002-2010	M300000 & UP							18-8828-1
5.0L MIE	305/V-8	⊕	1988	B788152 - C396832			18-5431	18-5395	18-5438		
5.0LX	305/V-8	⊕	1988-1995	B773740 - F600999			18-5431	18-5395			
898	305/V-8	⊕	1977-1982	4762210 - 621461		18-5314	18-5404-1		18-5433		
898	305/V-8	⊕	1983-1984	6218462 - 6899057			18-5431	18-5395	18-5438		
350MAG MPI	V8		1998-2001	L302200 & UP	18-5273		18-5431	18-5395	18-5438	18-5494-2	
(Gen+) & MIE(Gen+)										18-5498-1	
350 MAG MPI	V8		2001-2004	M300000 & UP	18-5247		18-5245	18-5244	18-5465	18-5351	
350 MAG MPI					18-5247		18-5245	18-5244			
HORIZON											
350 MAG	V8		1999-2001	L304700 & UP	18-5273		18-5431	18-5395	18-5438	18-5494-2	
HORIZON MIE										18-5498-1	
350 MAG HORIZON	V8		2001-2004	M300000 & Up	18-5247		18-5245	18-5244	18-5465	18-5351	
MIE											
350MAG MPI	V8		1999-2001	L304600 & up	18-5273		18-5431	18-5395	18-5438	18-5494-2	
SKI(Gen+)										18-5498-1	
350MAG SKI	V8		1991-1996	D505450 - K040399	18-5273		18-5431	18-5395	18-5438	18-5494-2	
										18-5498-1	
350MAG SKI	V8		1991-1996	D505450 - K040399	18-5273		18-5431	18-5395	18-5438	18-5494-2	
										18-5498-1	
350MAG SKI	V8		1991-1997	D505450 - K999999	18-5273		18-5431	18-5395	18-5438	18-5494-2	
										18-5498-1	
225 (GM)	327/V-8	⊕	1963-1969	1539620 - 2694014	18-5252 ★	18-5310	18-5417	18-5384	18-5433	18-5494-2⊕	18-8803-2
										18-5498-1⊕	
										18-5313-1⊕	
225 MIE (GM)	327/V-8	♣	1968	2278647 - 2694014			18-5420	18-5389		18-5494-2⊕	18-8803-2
										18-5498-1⊕	
250 MCM & MIE	327/V-8	♣	1968-1969	2314301 - 2639854			18-5420	18-5389		18-5494-2⊕	18-8803-2
										18-5498-1⊕	
250	350/V-8	⊕	1977	4768000 - 4908849	18-5251 ★	18-5314	18-5404-1	18-5376	18-5433	18-5494-2⊕	18-8803-2
					18-5271					18-5498-1⊕	
250 MCM & MIE (GM)	350/V-8	⊕	1975-1976	3258728 - 4521254			18-5420	18-5389	18-5433		
255 MCM (GM)	350/V-8	⊕	1976	4498701 - 4767999		18-5314	18-5404-1		18-5433		
255 MIE	350/V-8	⊕	1976-1980	4498701 - 5907057		18-5314	18-5404-1				
260	350/V-8	⊕	1978-1982	4908850 - 6218461		18-5314	18-5404-1		18-5433		
270 MCM & MIE	350/V-8	♣	1969-1972	2851074 - 3385720			18-5420	18-5389	332- 4895A 8	18-5494-2⊕	18-8803-2
										18-5498-1⊕	
280 TRS	350/V-8	⊕	1975	4176250 - 4499390			18-5420	18-5389	18-5433		
280 TRS	350/V-8	⊕	1976	4499391 - 4770199	18-5251 ★	18-5314	18-5404-1	18-5376	18-5433	18-5494-2⊕	18-8803-2
					18-5271 ⚡					18-5498-1⊕	
										18-5313-1⊕	
300	350/V-8	⊕	1985-1986	6668677 - B430367			18-5431	18-5395	18-5438		
320 EFI	350/V-8	⊕	1987-1989	A543604 - C622418			18-5431	18-5395	18-5438		
350 MAG ALPHA	350/V-8	⊕, ♣	1986-1997	A635178 - K999999			18-5431	18-5395	18-5438		
350 MAG ALPHA EFI(GEN+)	350/V-8	⊕	1996-1997	F800300 - K999999	18-5281		18-5405	18-5354	18-5442	18-5494-2⊕	18-8836-1
350 MAG BRAVO MPI	350/V-8	⊕	1995-1997	F415189 - K999999				18-5354	18-5443	18-5498-1⊕	18-8836-1
350 MAG EFI SKI	350/V-8	⊕	1994-1997	F215561 - K999999				18-5354	18-5443		18-8832-1
350 MAG MPI (GEN +)	350/V-8	⊕	1998	L010019 - L325962	18-5281		18-5405	18-5354	18-5442	18-5494-2⊕	18-8832-1
										18-5498-1⊕	

- ⊕ Mallory Ignition
- ⊕ Prestolite
- ⊕ Autolite
- ⊕ Mercury Ignition
- ⊕ Holley
- ⊕ Thunderbolt IV
- ⊕ With screw down cap
- ⊕ Delco
- ⊕ Electronic dist. (std rotation) excluding Thunderbolt ignition
- ⊕ Delco EST
- ⊕ Delco digital system
- ★ With out dist cap
- ⚡ With dist cap
- ♣ Mercury HEI
- ⊕ Delco HEI
- ♣ Thunderbolt V
- ♥ Prestolite with clip down dist cap
- ⚡ Contact controlled dist. (Std. Rotation) excl. Thunderbolt ign.

MODEL	Cyl.	Ignition Type	Year	Serial #	Tune-Up Kit	Contact Set	Rotor	Dist. Cap	Coil	Distributor	Spark Plug Wires
350 MAG MPI (GEN +)	350/V-8	☛	1999-2001	L325953 - M999999			18-5431	18-5395	18-5438		
350 MAG MPI	350/V-8	☛	2002-2010	M300000 & UP				18-5244			
350 MAG MPI HORIZON	350/V-8	☛	2002-2007	M300000 - A299999				18-5244			
350 MAG MPI HORIZON MIE	350/V-8	☛	1999-2001	L304700 - M299999			18-5431	18-5395	18-5438		
350 MAG MPI HORIZON MIE	350/V-8	☛	2002-2007	M300000 - A089999				18-5244			
350 MAG MPI MIE (GEN +)	350/V-8	☛	1998	L002008 - L302199	18-5281		18-5405	18-5354	18-5443	18-5494-2☉	18-8832-1
										18-5498-1☉	
350 MAG MPI MIE (GEN +)	350/V-8	☛	1998-2001	L302200 - M299999	18-5273		18-5431	18-5395	18-5438		18-8834-1
350 MAG MPI MIE	350/V-8	☛	2002-2007	M300000 - A089999				18-5244			
350 MAG MPI SKI	350/V-8	☛	1995-1998	F350583 - L304599	18-5281		18-5405	18-5354	18-5443	18-5494-2☉	18-8836-1
										18-5498-1☉	
350 MAG MPI SKI (GEN +)	350/V-8	☛	1999-2001	L304600 - M299999			18-5431	18-5395	18-5438		
350 MAG MPI SKI	350/V-8	☛	2002-2007	M300000 - A089999				18-5244			
350 MAG SKI	350/V-8	☉, ☛	1991-1997	D505450 - K999999			18-5431	18-5395	392-805570A 2		
350MAG BRAVO	V8		1995-1998	F415189 - L325952	18-5281		18-5405	18-5354	18-5443	18-5494-2☉	18-8836-1
MPI &(Gen+)										18-5498-1☉	
350MAG EFI SKI	V8		1996-1997	F820707 - K999999	18-5281		18-5405	18-5354	18-5443	18-5494-2☉	18-8832-1
&(Gen+)										18-5498-1☉	
5.0L Alpha &	V8		1998-2001	L015751 & up	18-5273		18-5431	18-5395	18-5438	18-5494-2☉	18-8821-1
Bravo(Gen+)										18-5498-1☉	
5.0L EFI (Gen +)	V8		1999-2001	L331631 & up	18-5273		18-5431	18-5395	18-5438	18-5494-2☉	18-8834-1
										18-5498-1☉	
5.0L MCM/MIE MPI,	V8		2001 & up	M300000 & UP	18-5247		18-5245	18-5244	18-5465	18-5351	
198, 898, 5.0L GM	V8		1983-1984	6218462 - 6899057	18-5273		18-5431	18-5395	18-5438	18-5494-2	18-8804-1
(305cid)										18-5498-1	
200, 5.0L GM	V8		1985-1995	6218462 - F600999	18-5273		18-5431	18-5395	18-5438	18-5494-2	18-8804-1
(305cid)										18-5498-1	18-8834-1
200, 5.0L GM	V8		1987-1995	B525982 - F600999	18-5273		18-5431	18-5395	18-5438	18-5494-2	
(305cid)										18-5498-1	
5.7L	350/V-8	☉, ☛	1988-2010	6218462 & UP			18-5431	18-5395			18-8828-1
5.7L EFI	350/V-8	☛	1995-1997	F225560 - K999999				18-5354			18-8828-1
5.7L EFI (GEN +)	350/V-8	☛	1998	L010035 - L325976				18-5354	18-5442		
5.7L EFI (GEN +)	350/V-8	☛	1998	L326000 - L331598				18-5354	18-5442		
5.7L EFI (GEN +)	350/V-8	☛	1998	L336000 - L339999				18-5354	18-5442		
5.7L EFI (GEN +)	350/V-8	☛	1999	L325977 - L325999			18-5431	18-5395	18-5438		
5.7L EFI (GEN +)	350/V-8	☛	1999	L331599 - L331991			18-5431	18-5395	18-5438		
5.7L EFI (GEN +)	350/V-8	☛	1999	L335716 - L335999			18-5431	18-5395	18-5438		
5.7L EFI (GEN +)	350/V-8	☛	1999-2001	L340000 - M299999			18-5431	18-5395	18-5438		
5.7L EFI MIE (GEN +)	350/V-8	☛	1997	K040300 - K999999					18-5442		
5.7L MIE	350/V-8	☉, ☛	1988-2010	B788152 & UP			18-5431	18-5395			
5.7L MPI HORIZON MIE	350/V-8	☛	2008-2010	A090000 & UP				18-5244			
5.7L MPI MIE	350/V-8	☛	2008-2010	A090000 & UP				18-5244			
5.7L MPI SKI	350/V-8	☛	2008-2010	A090000 & UP				18-5244	18-5433		
5.7L SKI	350/V-8	☉	1985-1995	A338553 - F775199	18-5251 ★	18-5314	18-5404-1	18-5376	18-5433	18-5494-2☉	18-8802-1
					18-5271 ☞					18-5498-1☉	
5.7L SKI	350/V-8	☉	1985-1996	A338553 - F775199	18-5262 ★	18-5303	18-5403	18-5352	18-5433	18-5494-2☉	18-8802-1
					18-5275 ☞					18-5498-1☉	
5.7L SKI	350/V-8	☉, ☛	1987-2010	B514627 & UP			18-5431	18-5395			
5.7LX	350/V-8	☛	1995-1997	F601000 - K999999			18-5431	18-5395	18-5438		
5.7LX BRAVO EFI (GEN +)	350/V-8	☛	1996-1997	F800300 - K999999				18-5354			
5.7LX EFI	350/V-8	☛	1996-1997	F752400 - K999999	18-5281		18-5405	18-5354	18-5442	18-5494-2☉	18-8836-1
										18-5498-1☉	
5.7L MIE & SKI	V8		1998 & up	L002003 & up	18-5273 ★		18-5431	18-5395	18-5438		18-8830-1
5.7L EFI & (Gen+)	V8		1995-1998	F225560-L339999	18-5281 ☞		18-5405	18-5354	18-5442	18-5494-2☉	18-8836-1

- ☉ Mallory Ignition
- ☊ Prestolite
- ☋ Autolite
- ☌ Mercury Ignition
- ☍ Holley
- ☎ Thunderbolt IV
- ☏ With screw down cap
- ☐ Delco
- ☑ Electronic dist. (std rotation) excluding Thunderbolt ignition
- ☒ Delco EST
- ☓ Delco digital system
- ★ With out dist cap
- ☞ With dist cap
- ☛ Mercury HEI
- ☜ Delco HEI
- ☝ Thunderbolt V
- ☞ Prestolite with clip down dist cap
- ☟ Contact controlled dist. (Std. Rotation) excl. Thunderbolt ign.

MODEL	Cyl.	Ignition Type	Year	Serial #	Tune-Up Kit	Contact Set	Rotor	Dist. Cap	Coil	Distributor	Spark Plug Wires
										18-5498-1 ⚫	
5.7L EFI & (Gen+)	V8		1999-2001	L325977 & UP	18-5273		18-5431	18-5395	18-5438	18-5494-2 ⚫	18-8834-1
										18-5498-1 ⚫	
5.7L SKI	V8		1987-1997	B514627 - K999999	18-5273		18-5431	18-5395	18-5438	18-5494-2 ⚫	18-8821-1
										18-5498-1 ⚫	
5.7L SKI	V8		1987-1995	B514627 - F775199	18-5273		18-5431	18-5395	18-5433	18-5494-2 ⚫	18-8821-1
										18-5498-1 ⚫	
5.7L SKI	V8		1998-2001	L002005 & up	18-5273		18-5431	18-5395	18-5438	18-5494-2 ⚫	18-8821-1
										18-5498-1 ⚫	
260, 350MAG	V8		1987-1995	B525982 - F600999	18-5273		18-5431	18-5395	18-5438	18-5494-2	18-8804-1
5.7L SKI/ ALPHA/										18-5498-1	
BRAVO(350cid)											
260, 350MAG,	V8		1987-1995	B525982 - F600999	18-5273		18-5431	18-5395	18-5438	18-5494-2	18-8821-1
5.7L ALPHA/										18-5498-1	
BRAVO(350cid)											
350MAG, 5.7L/	V8		1994-2001	F353525 & UP	18-5273		18-5431	18-5395	18-5438	18-5494-2	18-8821-1
LX ALPHA &										18-5498-1	
BLACK SCORPION SKI (GEN+)	350/V-8	⚫	1996-2003	F800000 - M391599				18-5354	18-5443		18-8832-1
BLACK SCORPION SKI (GEN+)	350/V-8	⚫	2003-2007	M391600 - W698432				18-5395			
SCORPION 350	350/V-8	⚫	2008-2010	W698433 & UP				18-5395			
BLACK SCORPION	V8		1996	F800000 - K040000	18-5281		18-5405	18-5354	18-5443	18-5494-2	18-8832-1
SKI(Gen+) (350cid)										18-5498-1	
BLACK SCORPION	V8		1997-1998	K040001 - L005600	18-5281		18-5405	18-5354	18-5443	18-5494-2	18-8824-1
SKI(Gen+) (350cid)										18-5498-1	
BLACK SCORPION	V8		1998-2002	L005601 - M391599	18-5281		18-5405	18-5354	18-5443	18-5494-2	18-8822-1
SKI(Gen+) (350cid)										18-5498-1	
233 MCM & MIE (FORD)	351/V-8	⚫	1975-1977	4173000 - 4902304	18-5260 ★	18-5303	18-5409	18-5352	18-5433	18-5489-2 ⚫	18-8803-2
					18-5275 ⚫					18-5312-1 ⚫	
233 MCM & MIE (FORD)	351/V-8	⚫	1975-1977	4173000 - 4902304	18-5258 ★	18-5303	18-5407	18-5369	18-5433	18-5489-2 ⚫	18-8803-2
					18-5277 ⚫					18-5312-1 ⚫	
233 MCM & MIE (FORD)	351/V-8	⚫	1975-1977	4173000 - 4902304	18-5254		18-5420	18-5389	18-5433	18-5489-2 ⚫	18-8803-2
										18-5312-1 ⚫	
255 MCM & MIE	351/V-8		1973-1974	3385721 - 4166999	18-5254		18-5420	18-5389	18-5433	18-5489-2	18-8803-2
										18-5312-1	
255 MCM & MIE	351/V-8		1973-1974	3385721 - 4166999	18-5251	18-5314	18-5404-1	18-5376	18-5433	18-5489-2	18-8803-2
					18-5271					18-5312-1	
255 MIE & MCM (FORD)	351/V-8	⚫	1973-1980	3258728 - 5907057		18-5314	18-5404-1		18-5433		
255 MIE & MCM (FORD)	351/V-8	⚫	1973-1980	3258728 - 5907057			18-5420	18-5389	18-5433		
255, 260MCM &	V8		1975-1982	3258728 - 6218461	18-5251	18-5314	18-5404-1	18-5376	18-5433	18-5494-2 ⚫	18-8803-2
MIE(350cid)					18-5271					18-5498-1 ⚫	
										18-5313-1 ⚫	
255MCM & MIE	V8		1975-1980	4498701 - 5907057	18-5254		18-5420	18-5389	18-5433	18-5494-2 ⚫	18-8803-2
(350cid)										18-5498-1 ⚫	
										18-5313-1 ⚫	
260,350MAG,	V8		1982-1994	6218462 - F600999	18-5273		18-5431	18-5395	18-5438	18-5494-2 ⚫	18-8804-1
										18-5498-1 ⚫	
										18-5313-1 ⚫	
300, 320EFI	350/V-8		1985-1989	A543604 - C622418	18-5273		18-5431	18-5395	18-5438	18-5494-2 ⚫	18-8804-1
										18-5498-1 ⚫	
377 MAG	377/V-8	⚫	2008-2010	A300000 & UP				18-5244			
377 SCORPION MCM	377/V-8	⚫	1999-2005	L416146 - M907201	18-5281		18-5405	18-5354	18-5443	18-5494-2 ⚫	
										18-5498-1 ⚫	
377 SCORPION SKI	377/V-8		1997-1998	K000656 - L00314	18-5281		18-5405	18-5354	18-5443	18-5494-2 ⚫	
										18-5498-1 ⚫	
MX 6.2L MPI	377/V-8	⚫	2000-2001	L680003 - M299999	18-5273		18-5431	18-5395	18-5438	18-5494-2 ⚫	18-8834-1

- ⚫ Mallory Ignition
- ⚫ Prestolite
- ⚫ Autolite
- ⚫ Mercury Ignition
- ⚫ Holley
- ⚫ Thunderbolt IV
- ⚫ With screw down cap
- ⚫ Delco
- ⚫ Electronic dist. (std rotation) excluding Thunderbolt ignition
- ⚫ Delco EST
- ⚫ Delco digital system
- ★ With out dist cap
- ⚫ With dist cap
- ⚫ Mercury HEI
- ⚫ Delco HEI
- ⚫ Thunderbolt V
- ⚫ Prestolite with clip down dist cap
- ⚫ Contact controlled dist. (Std. Rotation) excl. Thunderbolt ign.

MODEL	Cyl.	Ignition Type	Year	Serial #	Tune-Up Kit	Contact Set	Rotor	Dist. Cap	Coil	Distributor	Spark Plug Wires
										18-5498-1 ①	
MX 6.2L MPI (377CID)	377/V-8	ESP	2002-2007	M300000 - A299999	18-5247		18-5245	18-5244			
MX 6.2L MPI	377/V-8		2001-2004	M300000 & UP	18-5247		18-5245	18-5244	18-5465	18-5351	
MX 6.2L MPI HORIZON	377/V-8	ESP	2002-2007	M300000 - A299999	18-5247		18-5245	18-5244	18-5465	18-5351	
MX 6.2L MPI HORIZON MIE	377/V-8	ESP	2002-2010	M300000 & UP	18-5247		18-5245	18-5244	18-5465	18-5351	
MX 6.2L MPI MIE	377/V-8	☛	2000-2001	L670000 - M299999			18-5431	18-5395	18-5438		
MX 6.2L MPI MIE	377/V-8	ESP	2002-2010	M300000 - & UP				18-5244			
MX 6.2L MPI SKI	377/V-8	ESP	2002-2007	M317000 - A089999	18-5247		18-5245	18-5244			
MX 6.2L BLACK SCORPION SKI	377/V-8	ESP	2001-2003	F800000 - M391599				18-5354			N/A
MX 6.2L BLACK SCORPION SKI	377/V-8	☛	2003-2007	M391600 - W698432				18-5395			
SCORPION 377	377/V-8	☛	2008-2010	W698433 & UP				18-5395			
325 MCM & MIE	427/V-8	♣	1969-1974	2278747 & UP			18-5420	18-5389		18-5494-2 ②	18-8803-2
										18-5498-1 ①	
330 MCM & MIE	454/V-8	②	1977-1981	4623115-6083144	18-5251 ★	18-5314	18-5404-1	18-5376	18-5433	18-5494-2 ②	18-8803-2
					18-5271 ☞					18-5498-1 ①	
										18-5313-1 ③	
330 MCM & MIE	454/V-8	♣	1977-1981	4623115-6083144			18-5420	18-5389		18-5494-2 ②	18-8803-2
										18-5498-1 ①	
										18-5313-1 ③	
330	454/V-8	②	1982-1987	6083145 - B816540			18-5431	18-5395	18-5438		
330, 340, 7.4L	454/V-8		1981-1992	5889914 - D715493	18-5273		18-5431	18-5395	18-5438	18-5494-2 ②	18-8804-1
MCM & MIE(454cid)										18-5498-1 ①	
340 MIE	454/V-8	②	1981-1987	5889914 - B788365			18-5431	18-5395	18-5438		
350 MIE	454/V-8	♣	1974-1976	3780450 - 4623109			18-5420	18-5389		18-5494-2 ②	18-8803-2
										18-5498-1 ①	
370 TRS	454/V-8	②	1978-1985	4179554 - 6721527	18-5251 ★	18-5314	18-5404-1	18-5376	18-5433	18-5494-2 ②	18-8803-2
					18-5271 ☞					18-5498-1 ①	
										18-5313-1 ③	
370 TRS	454/V-8	②	1978-1985	4883520 - 6721527	18-5254		18-5420	18-5389	18-5433	18-5494-2 ②	18-8803-2
										18-5498-1 ①	
										18-5313-1 ③	
370 TRS	454/V-8	②	1985-1987	6721528 - B714586	18-5273		18-5431	18-5395	18-5433	18-5494-2 ②	18-8804-1
										18-5498-1 ①	
400 TRS	454/V-8	②	1980-1986	5668232 - B457644		18-5314	18-5404-1		18-5433		
400 TRS	454/V-8	②	1980-1986	5668232 - B457644				18-5389	18-5433		
420	454/V-8	②	1987-1989	A398941 - B622418	18-5273		18-5431	18-5395	18-5438	18-5494-2 ②	18-8837-1
										18-5498-1 ①	
425	454/V-8	②	1990-1993	B622419 - D937011			18-5431	18-5395	18-5438		18-1837-1
440 TRS	454/V-8	②	1983-1986	6181070 - B485220		18-5314	18-5404-1		18-5433		
450	454/V-8	②	1995-1996	F347100 - F347277	18-5273		18-5431	18-5395	18-5438	18-5494-2 ②	
										18-5498-1 ①	
454 MAG ALPHA	454/V-8	②	1986-1997	A631894 - B785148	18-5273		18-5431	18-5395	18-5438	18-5494-2 ②	18-8804-1
										18-5498-1 ①	
454 MAG BRAVO	454/V-8	②, ♣	1988-1997	B721206 - K999999			18-5431	18-5395	18-5438		
454 MAG EFI	454/V-8	ESP	1994-1996	F115700 - F802349				18-5354	18-5443		18-8832-1
454 MAG MPI	454/V-8	ESP	1996-1998	F802350 - L085009				18-5354	18-5443		18-8832-1
454 MAG MPI	454/V-8	ESP	1998-2001	L085010 - M024999				18-5354	18-5443		18-8832-1
454 MAG MPI HORIZON MIE	454/V-8	ESP	1998-2001	L002200 - L674000	18-5281		18-5405	18-5354	18-5443	18-5494-2 ②	
										18-5498-1 ①	
454-EFI,MAG MPI	454/V-8		1994-2001	F115700 & UP	18-5281		18-5405	18-5354	18-5443	18-5494-2 ②	18-8832-1
HORIZON MIE										18-5498-1 ①	
454 MAG MPI	454/V-8		1999-2001	L086001 - L674000	18-5281		18-5405	18-5354	18-5443	18-5494-2 ②	18-8832-1
HORIZON MIE										18-5498-1 ①	
454 MAG MPI SKI	454/V-8	ESP	1995-1997	F215800 - K999999				18-5354	18-5443		18-8832-1
525 SC	454/V-8	②, ♣	1991-1999	D456000 - L415623			18-5431	18-5395			

① Mallory Ignition
 ② Prestolite
 ③ Autolite
 ④ Mercury Ignition
 ⑤ Holley
 ⑥ Thunderbolt IV
 ☛ With screw down cap
 Ⓢ Delco
 Ⓣ Electronic dist. (std rotation) excluding Thunderbolt ignition
 Ⓤ Delco EST
 Ⓥ Delco digital system
 ★ With out dist cap
 ☞ With dist cap
 ☛ Mercury HEI
 ESP Delco HEI
 ♣ Thunderbolt V
 ♥ Prestolite with clip down dist cap
 Ⓢ Contact controlled dist. (Std. Rotation) excl. Thunderbolt ign.

MODEL	Cyl.	Ignition Type	Year	Serial #	Tune-Up Kit	Contact Set	Rotor	Dist. Cap	Coil	Distributor	Spark Plug Wires
7.4L BRAVO	454/V-8	⊖, ⬆	1988-1997	B771113 - K999999			18-5431	18-5395			
7.4L MIE	454/V-8	⊖, ⬆	1988-1997	B788366 - K999999			18-5431	18-5395			
7.4L MPI (L29)	454/V-8	⊖	1998-2001	L010003 - M024330				18-5354	18-5443		18-8832-1
7.4L MPI MIE	454/V-8	⊖	1995-1997	F563052 - K999999				18-5354	18-5443		18-8832-1
7.4L MPI MIE (L29)	454/V-8	⊖	1998-2001	L002006 - L674613				18-5354	18-5443		18-8832-1
7.4L TBI MIE	454/V-8	⊖	1996-1997	F874815 - K999999				18-5354			N/A
7.4LX BRAVO EFI	454/V-8	⊖	1996-1997	F820000 - K999999				18-5354	18-5443		18-8832-1
7.4LX BRAVO MPI	454/V-8	⊖	1996-1997	F602010 - K999999				18-5354	18-5443		18-8832-1
390	482/V-8	⬆	1969-197070	2781129 - 2825059			18-5420	18-5389			18-8803-2
460 TRS	482/V-8	⊖	1983-198686	6180970 - 6181046	18-5251	18-5314	18-5404-1	18-5376	18-5433	18-5494-2⊖	18-8803-2
										18-5498-1⊖	
										18-5313-1⊖	
460 TRS	482/V-8	⊖	1983-1986	6180970 - 6181046	18-5254		18-5420	18-5389	18-5433	18-5494-2⊖	18-8803-2
										18-5498-1⊖	
										18-5313-1⊖	
465	V8		1992-1994	D763732 - F213244	18-5273		18-5431	18-5395	18-5438		18-8837-1
496 / 8.1L	V8		2000 & Up	M025000 & UP			N/A				18-8838-1
500	502/V-8	⊖, ⬆	1994-1999	F213293 - L601036	18-5273		18-5431	18-5395	18-5438		18-8837-1
500 EFI	502/V-8	⊖	1998-2005	L001477 - M907127				18-5354	18-5443		
502 MAG	502/V-8	⊖	1990-1993	C878221 - F114528	18-5273		18-5431	18-5395	18-5438		18-8804-1
502 MAG EFI	502/V-8	⊖	1993-1996	D840650 - F802599				18-5354	18-5443		18-8832-1
502 MAG MPI	502/V-8	⊖	1996-1998	F802600 - L085000				18-5354	18-5443		18-8832-1
500(Gen+)	502/V-8		1999	L414639 - L601036	18-5273		18-5431	18-5395	18-5438		18-8837-1
500GM EFI	502/V-8		1998-2000	OL001477 & up	18-5281		18-5405	18-5354	18-5443		
502 MAG MPI	502/V-8		1993-1998	D840650 - L085000	18-5281		18-5405	18-5354	18-5443		18-8832-1
502GM MAG	502/V-8		1998-2001	L085001 & up	18-5281		18-5405	18-5354	18-5443		18-8832-1
8.2L GM MPI MIE	502/V-8		1996-2001	F819620 & up	18-5281		18-5405	18-5354	18-5443		18-8832-1
8.2L GM MPI MIE	502/V-8		1990-1996	C878221 - F819619	18-5273		18-5431	18-5395	18-5438		18-8804-1
525 SC	502/V-8		1991-1995	OD456000-OF877734	18-5273		18-5431	18-5395	18-5438		18-8804-1
525 SC	502/V-8		1996-1999	OK000012 & up	18-5273		18-5431	18-5395	18-5438		18-8837-1
575 SCi	502/V-8	⊖	2000-2005	L306696 - M950526				18-5354	18-5443		
575 SCi	502/V-8		2000-2005	L306696 & UP	18-5281		18-5405	18-5354	18-5443		
600 SC	502/V-8	⊖, ⬆	1991-2000	D456489 - L301186			18-5431	18-5395	18-5438		
600 SC	502/V-8		1991-1993	D456489 - D763875	18-5273		18-5431	18-5395	18-5438		18-8837-1
600 SC	502/V-8		1993-2001	D763876 & UP	18-5273		18-5431	18-5395	18-5438		18-8837-1
8.2L MIE	502/V-8	⊖, ⬆	1990-1996	C878221 - F819619			13524T 1	18-5395	18-5438		
8.2L MPI MIE	502/V-8	⊖	1996-1998	F819620 - L086012				18-5354	18-5443		
8.2L MPI MIE	502/V-8	⊖	1998-2001	L086013 - L674200				18-5354	18-5443		
500 BULLDOG	540/V-8	⊖, ⬆	1990-2001	C577003 - M050281	18-5273		18-5431	18-5395	18-5438		18-8837-1
575	540/V-8	⊖	1986-1992	A677429 - D763716			18-5431	18-5395	18-5438		
800 SC	572/V-8	⊖, ⬆	1993-1998	D763836 & UP	18-5273		18-5431	18-5395	18-5438		18-8837-1

- ⊖ Mallory Ignition
- ⊖ Prestolite
- ⊖ Autolite
- ⊖ Mercury Ignition
- ⊖ Holley
- ⊖ Thunderbolt IV
- ⊖ With screw down cap
- ⊖ Delco
- ⊖ Electronic dist. (std rotation) excluding Thunderbolt ignition
- ⊖ Delco EST
- ⊖ Delco digital system
- ★ With out dist cap
- ⊖ With dist cap
- ⊖ Mercury HEI
- ⊖ Delco HEI
- ⬆ Thunderbolt V
- ♥ Prestolite with clip down dist cap
- ⊖ Contact controlled dist. (Std. Rotation) excl. Thunderbolt ign.

PREMIUM MARINE IGNITION WIRES

Sierra's MAGFORCE Ignition Wires are "Electronics Friendly" protecting all of your electronic devices and electronic engine controls from RFI and EMI while delivering the maximum amount of voltage. Exact fit design ensures easy installation and years of trouble - free service.

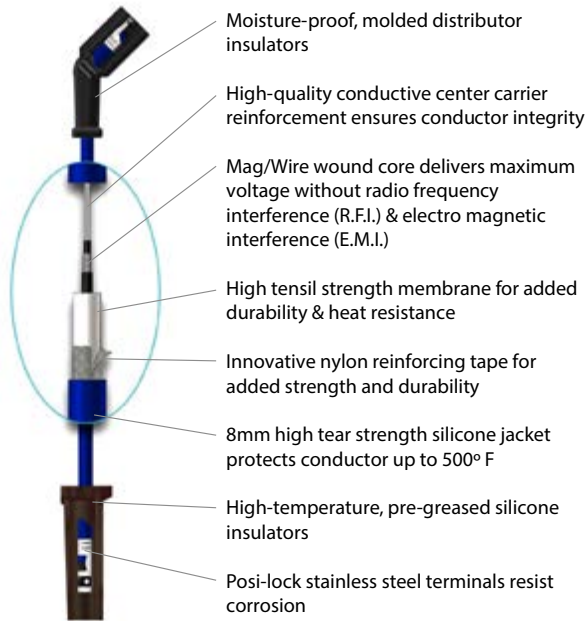

MERCURUISER MARINE IGNITION WIRES APPLICATION

Model	Cyl.	Distributor	Year Start	Year Stop	Serial # Start	Serial # End	Plug Wire Set
110	4	Delco	1963	1966	1537370	2044033	18-8800-1
120	4	Delco	1964	1986	1666601	0B531853	18-8800-1
2.5L	4	Delco	1987	1989	0B531854	0C853255	18-8800-1
140	4	Delco	1968	1986	2508261	0B450800	18-8800-1
3.0L	4	Delco	1987	1989	0B450801	0C856558	18-8800-1
3.0L, LX	4	Prestolite	1990	1991	0C856559	0D504541	18-8800-1
3.0L, LX	4	Delco Digital	1990	1991	0C856559	0D504541	18-8811-1
3.0L	4	Delco EST	1991	& Up	0D504542	& Up	18-8833-1
3.0LX	4	Delco EST	1991	1997	0D504542	0K999999	18-8833-1
3.0L MPI	4	Delco EST	2012	& Up	1A072812	& Up	18-8833-1
165	4	Delco	1987	1987	0B434940	0B774251	18-8808-2
170	4	Delco	1985	1986	6916779	0B434940	18-8808-2
180	4	Prestolite	1987	1987	0B436391	0B775248	18-8800-1
190	4	Delco	1985	1986	6916779	0B436390	18-8808-2
3.7L	4	Delco	1988	1989	0B774252	& Up	18-8808-2
3.7LX	4	Delco	1988	1989	0B775249	& Up	18-8808-2
3.7LX	4	Prestolite	1988	1989	0B775249	& Up	18-8800-1
470	4	Delco	1976	1984	4208370	6916778	18-8808-2
485	4	Delco	1980	1982	5685394	6218036	18-8808-2
488	4	Delco	1981	1984	6170297	6916778	18-8808-2
140	L6	Delco	1963	1963	1538930	1725960	18-8809-1
150	L6	Delco	1964	1966	1666495	2048046	18-8809-1
160	L6	Delco	1967	1969	2048022	2770031	18-8809-1
165	L6	Delco	1970	1981	2770032	5813433	18-8809-1
200	L6	Delco	1969	1969	2453769	2712072	18-8809-1
185	6	Prestolite	1983	1984	6330183	6919655	18-8801-1
175	6	Thunderbolt IV	1987	1987	0B527955	0B773242	18-8810-1

APPLICATION CONTINUED ON NEXT PAGE

MERCURUISER MARINE IGNITION WIRES APPLICATION

Model	Cyl.	Distributor	Year Start	Year Stop	Serial # Start	Serial # End	Plug Wire Set
185	6	Thunderbolt IV	1985	1987	6919656	0B527954	18-8810-1
205	6	Thunderbolt IV	1985	1987	0A331445	0B775129	18-8810-1
262 Mag	6	Delco EST	1996	1997	0F803800	0K999999	18-8835-1
4.3L	6	Thunderbolt IV	1988	1996	0B773243	0F802999	18-8810-1
4.3L Alpha	6	Thunderbolt V	1998	& Up	0L010044	& Up	18-8810-1
4.3L Bravo	6	Thunderbolt V	1998	& Up	0L010044	& Up	18-8810-1
4.3L EFI	6	Delco EST	1998	1998	0L012009	0L359999	18-8835-1
4.3L EFI	6	Thunderbolt V	1999	2004	0L360000	&Up	18-8810-1
4.3L MPI	6	Delco HVS	2001	& Up	0M300000	& Up	18-8829-1
4.3LH Alpha	6	Thunderbolt V	1998	2004	0L010044	& Up	18-8810-1
4.3LH Bravo	6	Thunderbolt V	1998	2004	0L010044	& Up	18-8810-1
4.3LX, LXH	6	Thunderbolt IV	1988	1997	0B775130	0K999999	18-8810-1
215 MCM & MIE (Ford)	8	Autolite/Mallory	1970	1972	2781153	3563181	18-8803-2
225 MCM & MIE (Ford)	8	Autolite/Mallory/Mercury	1973	1974	3385721	4166999	18-8803-2
888 (Ford)	8	Autolite/Mallory	1971	1977	3108723	4887829	18-8803-2
190 (GM)	8	Delco	1963	1964	1564539	1730903	18-8803-2
198 MIE	8	Mallory	1977	1977	4776402	4931099	18-8803-2
200	8	Thunderbolt IV	1985	1987	6899058	8774444	18-8821-1
228	8	Mallory	1977	1982	4765100	6218461	18-8803-2
228	8	Thunderbolt IV	1983	1984	6218462	6899268	18-8821-1
228 MIE	8	Mallory	1977	1980	4765100	5907057	18-8803-2
230	8	Thunderbolt IV	1985	1987	6899269	0B773739	18-8821-1
230 MIE (LH)	8	Thunderbolt IV	1981	1987	5907058	0B788151	18-8821-1
230 MIE (RH)	8	Thunderbolt IV	1981	1987	5907058	0B788151	18-8821-1
5.0L	8	Thunderbolt IV	1988	1995	0B774445	0F600999	18-8821-1
5.0L Alpha	8	Thunderbolt V	1998	& Up	0L015751	& Up	18-8821-1
5.0L Bravo	8	Thunderbolt V	1998	& Up	0L015751	& Up	18-8821-1
5.0L EFI	8	Delco EST	1998	1998	0L012052	0L339999	18-8822-1
5.0L MIE (LH)	8	Thunderbolt IV	1988	1988	0B788152	0C396832	18-8821-1
5.0L MIE (RH)	8	Thunderbolt IV	1988	1988	0B788152	0C396832	18-8821-1
5.0L MPI Alpha	8	Delco HVS	2001	& Up	0M300000	& Up	18-8828-1
5.0LX	8	Thunderbolt IV	1988	1995	0B773740	0F600999	18-8821-1
898	8	Mallory	1977	1982	4762210	6218461	18-8803-2
898	8	Thunderbolt IV	1983	1984	6218462	6899057	18-8821-1
225 (GM)	8	Delco	1963	1969	1539620	2694014	18-8803-2
225 MIE (GM)	8	Thunderbolt	1968	1968	2278647	2694014	18-8803-2
250 MCM & MIE	8	Thunderbolt	1968	1969	2314301	2639854	18-8803-2
250	8	Mallory	1977	1977	4768000	4908849	18-8803-2
255 MCM & MIE	8	Mallory	1975	1976	3258728	4501254	18-8803-2
255 MCM & MIE	8	Mercury	1976	1976	4498701	4767999	18-8803-2
255 MIE	8	Mercury	1977	1980	4768000	5907057	18-8803-2
260	8	Mallory	1978	1982	4908850	6218461	18-8803-2
260	8	Thunderbolt IV	1982	1987	6218462	0B773304	18-8821-1
260 MIE (LH)	8	Thunderbolt IV	1981	1986	5907058	0B788151	18-8821-1
260 MIE (RH)	8	Thunderbolt IV	1981	1986	5907058	0B788151	18-8821-1
270 MCM & MIE	8	Thunderbolt	1969	1972	2851074	3385720	18-8803-2
280 TRS	8	Mercury/Mallory	1975	1975	4176250	4499390	18-8803-2
300	8	Thunderbolt IV	1985	1986	6668677	0B430367	18-8821-1
320 EFI	8	Thunderbolt IV	1987	1989	0A543604	0C622418	18-8821-1
350 Mag Alpha	8	Thunderbolt IV	1986	1994	0A635178	0F353690	18-8821-1
350 Mag Alpha	8	Thunderbolt V	1995	1997	0F353691	0K999999	18-8821-1
350 Mag Alpha EFI	8	Delco EST	1996	1997	0F800300	0K999999	18-8822-1

APPLICATION CONTINUED ON NEXT PAGE

MERCURUISER MARINE IGNITION WIRES APPLICATION							
Model	Cyl.	Distributor	Year Start	Year Stop	Serial # Start	Serial # End	Plug Wire Set
350 Mag Bravo MPI	8	Delco EST	1995	1996	0F415189	0K999999	18-8822-1
350 Mag EFI Ski	8	Delco EST	1994	1997	0F215561	0K999999	18-8822-1
350 Mag MPI	8	Delco EST	1998	1998	0L010019	0L325952	18-8822-1
350 Mag MPI Alpha	8	Delco HVS	2001	& Up	0M300000	& Up	18-8828-1
350 Mag MPI Bravo	8	Delco HVS	2001	& Up	0M300000	& Up	18-8828-1
350 Mag MPI Horizon	8	Delco HVS	2001	& Up	0M300000	& Up	18-8828-1
350 Mag MPI Horizon MIE	8	Delco HVS	2001	& Up	0M300000	& Up	18-8828-1
350 Mag MPI MIE	8	Delco HVS	2001	& Up	0M300000	& Up	18-8828-1
350 Mag MPI Ski	8	Thunderbolt IV	1991	1996	0D505450	0K40399	18-8821-1
350 Mag MPI Ski	8	Thunderbolt V	1991	1997	0D505450	0K999999	18-8821-1
5.7L Alpha	8	Thunderbolt IV	1988	1995	0B773305	0F600999	18-8821-1
5.7L Alpha	8	Thunderbolt V	1996	1997	0F601000	& Up	18-8821-1
5.7L Bravo	8	Thunderbolt IV	1988	1993	0B773305	0F353524	18-8821-1
5.7L Bravo	8	Thunderbolt V	1994	& Up	0F353525	& Up	18-8821-1
5.7L EFI	8	Delco EST	1995	1998	0F225560	0L339999	18-8822-1
5.7L EFI MIE	8	Delco EST	1997	1997	0K040300	0K999999	18-8822-1
5.7L MIE	8	Thunderbolt IV	1988	1995	0B788152	0F746099	18-8821-1
5.7L MIE	8	Thunderbolt V	1996	1997	0F622100	0K999999	18-8821-1
5.7L MIE	8	Thunderbolt V	1998	& Up	0L002003	& Up	18-8821-1
5.7L Ski	8	Mallory/Prestolite	1985	1995	0A338553	0F775199	18-8802-1
5.7L Ski	8	Thunderbolt IV	1987	1995	0B514627	0F775199	18-8821-1
5.7L Ski	8	Thunderbolt V	1996	1997	0F775200	0K999999	18-8821-1
5.7L Ski	8	Thunderbolt V	1998	& Up	0L002005	& Up	18-8821-1
5.7LX Alpha & Bravo	8	Thunderbolt V	1996	1997	0F601000	0K999999	18-8821-1
5.7LX Bravo & EFI	8	Delco EST	1996	1997	0F752400	0K999999	18-8822-1
233 MCM & MIE (Ford)	8	Mercury/Prestolite	1975	1977	4173000	4902304	18-8803-2
255 MCM & MIE (Ford)	8	Mercury/Mallory	1973	1980	3258728	5907057	18-8803-2
MX 6.2L MPI	8	Delco HVS	2001	& Up	0M300000	& Up	18-8828-1
MX 6.2L MPI Horizon	8	Delco HVS	2001	& Up	0M300000	& Up	18-8828-1
MX 6.2L MPI Horizon MIE	8	Delco HVS	2001	& Up	0M300000	& Up	18-8828-1
MX 6.2L MPI MIE	8	Delco HVS	2001	& Up	0M300000	& Up	18-8828-1
377 MAG MPI BRAVO	8	Delco HVS	ALL	ALL	1A300000	& Up	18-8828-1
325 MCM & MIE	8	Thunderbolt	1969	1974	2278747	& Up	18-8803-2
325 MCM & MIE	8	Mallory	1969	1972	2278747	& Up	18-8803-2
390	8	Mallory	1968	1970	ALL		18-8803-2
330	8	Mallory	1977	1981	4623115	6083144	18-8803-2
330	8	Thunderbolt	1977	1981	4623115	6083144	18-8803-2
330	8	Thunderbolt IV	1982	1987	6083145	0B816540	18-8821-1
340 MIE	8	Thunderbolt IV	1981	1987	5889914	0B788365	18-8821-1
350 MIE	8	Thunderbolt	1974	1976	3780450	4623109	18-8803-2
370 TRS	8	Mallory/Holley	1978	1985	4179554	6721527	18-8803-2
370 TRS	8	Thunderbolt IV	1985	1987	6721528	0B714586	18-8821-1
400 TRS	8	Mallory/Holley	1980	1986	5668232	0B457644	18-8803-2
440 TRS	8	Mallory/Holley	1983	1986	6181070	0B485220	18-8803-2
450	8	Thunderbolt IV	1995	1996	0F347100	0F347277	18-8821-1
454 Mag Alpha	8	Thunderbolt IV	1986	1988	0A631894	0B785148	18-8821-1
454 Mag Bravo	8	Thunderbolt IV	1988	1997	0B721206	0K999999	18-8821-1
454 Mag EFI	8	Delco EST	1994	1996	0F115700	0F802349	18-8822-1
454 Mag MPI	8	Delco EST	1996	2001	0F802350	M024999	18-8822-1
454 Mag MPI Horizon MIE	8	Delco EST	1999	2001	0L002200	0L674000	18-8822-1

APPLICATION CONTINUED ON NEXT PAGE

MERCURUISER MARINE IGNITION WIRES APPLICATION

Model	Cyl.	Distributor	Year Start	Year Stop	Serial # Start	Serial # End	Plug Wire Set
454 Mag MPI Ski	8	Delco EST	1995	1997	0F215800	0K999999	18-8822-1
7.4L Bravo I, II, III	8	Thunderbolt IV	1988	1997	0B771113	0K999999	18-8821-1
7.4L Bravo III	8	Thunderbolt V	1992	1997	603118	0K999999	18-8821-1
7.4L EFI MIE	8	Thunderbolt IV	1988	1996	0B788366	0F820141	18-8821-1
7.4L MIE	8	Thunderbolt IV	1988	1996	0B788366	0F820141	18-8821-1
7.4L MIE	8	Thunderbolt V	1992	1997	0D715494	0K999999	18-8821-1
7.4L MPI (L29)	8	Delco EST	1998	2001	0L010003	0M024330	18-8822-1
7.4L MPI MIE	8	Delco EST	1995	2001	0F563052	0M025999	18-8822-1
7.4LX Bravo EFI & MPI	8	Delco EST	1996	1997	0F602010	0K999999	18-8822-1
390	8	Thunderbolt	1969	1970	2781129	2825059	18-8803-2
460 TRS	8	Mallory/Holley	1983	1986	6180970	6181046	18-8803-2
460 Cyclone	8	ALL	1983	1985	ALL		18-8803-2
496 Mag & Mag HO	8	Delco (coil over plug)	2000	& Up	0M025000	& Up	18-8838-1
8.1 MIE & HO MIE	8	Delco (coil over plug)	2000	& Up	0M025000	& Up	18-8838-1
502 Mag Bravo	8	Thunderbolt IV	1990	1993	0G878221	0F114528	18-8821-1
502 Mag EFI	8	Delco EST	1993	1996	0B40650	0F802599	18-8822-1
502 Mag MPI	8	Delco EST	1996	2001	0F802600	0M024999	18-8822-1
525 SC	8	Thunderbolt IV	1991	1995	0D456000	0F877734	18-8821-1
8.2L MIE	8	Thunderbolt IV	1990	1996	0C878221	0F819619	18-8821-1
8.2L MPI MIE	8	Delco EST	1996	2001	0F819620	0L674200	18-8822-1



**18-5225
SPARK PLUG WIRE KIT**
Replaces: Mercury 84-99215A26, 84-813706A26, 84-93475A26, 84-93212A1, 84-90816A26
Kit includes 25 ft. roll of 7 MM hypalon ignition wire with a metallic core and a large assortment of three different end fittings.



**18-5226
IGNITION WIRE**
Metallic Core
100' Spool
7mm Hypalon



BATTERY CABLES

Part No.	Size	Color	Gauge	Part No.	Size	Color	Gauge
BC88523	2'	red	4	BC88563	6'	red	2
BC88533	2'	black	4	BC88573	6'	black	2
BC88543	4'	red	2	BC88583	8'	red	1
BC88553	4'	black	2	BC88593	8'	black	1

Gauge cable with soldered lug terminals on each end to accept a 3/8" stud

PKG. OF 10



**18-5224
18-5224-9①
SPARK PLUG WIRE
TERMINAL**
Replaces: 20121, 8M0084600

PKG. OF 10



**18-5750
18-5750-9①
UNIVERSAL SPARK
PLUG BOOTS**
Supplied complete w/Terminal Connector



**18-5752
UNIVERSAL
SPARK PLUG BOOT**
8mm

Standard Rotation

CCW Rotation

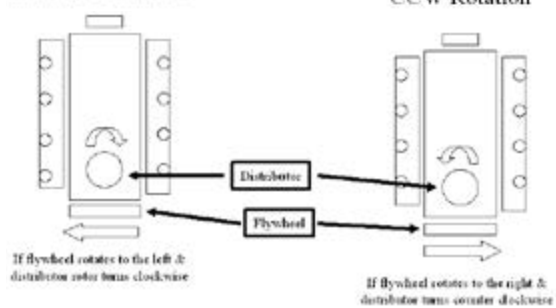

**18-5603-1
STARTER**
Replaces: 50-808011A4
Noseless:CCW Top mount rear entry starter for standard rotation GM & Ford engines. Can be used in place of 18-5908.



18-55510
INBOARD STARTER
 Replaces: 8M0095471
 Fits: 4.5L and 6.2L Non-GM Engines

18-6275-1
STARTER

Replaces:
 50-807904A1, 50-863007A1, 50-864340A2, 50-806964A4,
 50-806964A3, 50-806964A2, 50-812604A2, 50-812428A3,
 50-812428A3, 50-12177A2, 50-12121A2, 50-822330A2, 814472,
 50-99418A2, 50-77328A3, 50-77328A1
 • Permanent Magnet Gear Reduction Starter
 • Inboard
 • 2 Long Bolt Offset Pattern
 • CW Rotation • SAE J1171
 • Use w/ Late Model 3.0L Engines with 14" Flywheel
Fits: Volvo Penta, Mercruiser, Marine Power
 Uses Solenoid **18-5811-1**



18-5920
STARTER
 Superseded from 18-5923
 PMGR Replacement for 18-5903;
 302CID, 351CID Ford Engines



18-5911
STARTER
 (Heavy-Duty) (No Core) (Clockwise) (9 tooth) For GM
 engines, bottom mount straight across bolt pattern.
 Standard rotation.
 Replaces: 50-76965A4, 50-99417A2, 50-99419A3, 50-17251A3
 Replacement Solenoid: 18-5837
 SAEJ1171



18-5907
STARTER
 (Heavy-Duty) (No Core) (Clockwise) (9 tooth) Top mount rear entry starter for opposite rotation GM & Ford engines.
 Will also replace bottom mount standard rotation. Will not replace non-starter mounted solenoids.
Mercuriser built 4 cyl. 165/170/180/190/470/485/488
Replaces: 50-72550A2, 50-79604A3, 50-97499A2, 50-97499R4, 50-72550R2, 50-97499R3
 Replacement Solenoid: **18-5837**
 SAEJ1171



STARTER SOLENOIDS

Starter solenoids take extreme abuse during their life which is a main reason why they so commonly require replacement. Sierra's replacement starter solenoids are built to EXCEED OEM specifications and feature many extras not available on many competitors' products today.

- Anti-corrosion coating for maximum corrosion resistance.
- Additional sealing to prevent ingress of water around mating surfaces.
- Upgraded design and materials for increased reliability.
- Longer battery stud for easier installation of multiple connections.

PART NO.	REPLACES
18-6447	Solenoid for Sierra Starter 18-55510
18-6458	Solenoid for Sierra Starters 18-55505 and 18-55506
18-6459	Solenoid for Sierra Starter 18-6447; Delco PG260



**18-5913-1
STARTER
(Clockwise)**

**Delco permanent magnet gear reduction 2 bolt starter
12V - 11 Tooth - Offset Bolt Pattern
For: Late model GM - 14" Flywheel
Replaces: 50-812428A3, 50-812604A2,
50-822330A2, 50-864340A2
Includes 18-8402-1 (2) bolts
SAEJ1171
For: 4.3L (1996 & UP); 5.0 & 5.7L (1998 & UP)**



**18-5919-1
STARTER**

Superseded from 18-5919
**Permanent magnet I/O starter, 11 Tooth
Replaces: 50-806963A4, 50-806965A2, 50-806965A4
Includes one 18-8402-1 bolt and one 18-8404 bolt
Fits: Chevy Engines with 12 3/4" flywheels
Straight across bolt pattern
SN-OF803000AN/OF803114AN 4.3LX/LXH Alpha/Bravo 262 CID
SN-355305AN/22560AN 5.7L Alpha (EFI)/5.7L Bravo (EFI)
SAEJ1171**



**18-5910
STARTER**

**(Heavy-Duty) (No Core) (Clockwise) (9 tooth) Small block V-6 & V-8
GM engine with 14 1/4" flywheel and
bottom mount, offset bolt pattern. For standard rotation engines.
Replaces: 50-12177A2, 50-99418A2**



**18-5908
STARTER**

**(Heavy-Duty) (No Core) (Counter-Clockwise) (9 tooth)
Top mount rear entry starter for standard rotation GM & Ford engines. Front mount reverse rotation.
Replaces: 50-76965A3, 50-808011A1, 50-808011A05, 50-808011A4, 50-808011A3, 50-99419A3, 50-76967A4, 50-76967A1
50-65784A1, 50-47455, 50-17251A3, 50-17251A2
Replacement Solenoid: 18-5837
SEAJ1171**



**18-5903
STARTER**
(No Core) (Clockwise) Bottom mount, two bolt pattern for standard rotation Ford engines.
Replaces: 50-69865A1, 50-12872, 50-56886
Replacement Solenoid: 18-5801
*For PMGR style order 18-5920



**18-6870
STARTER**
Replaces: Mercury 50-805833, T
Fits: D7.3L D-tronic 260 LD, 300 1999 year



**18-6946
STARTER**
Replaces: 50-8m8021116
Fits: High Performance 11 Tooth Starter for 6.2L & 8.9L Scorpion HO applications



**18-6947
STARTER**
Replaces: Mercruiser 50-805991
Fits: 7.3L (BRAVO & MIE) DIESEL NAV 444 V-8 1994-1996



**18-6949
STARTER**
Replaces: Mercruiser 50-831001562, 50-831001961
Fits: WO4CTA (150 HP) HINO 234 I/L4, WO4CTI (210 HP) HINO 234 I/L4



**18-6957
STARTER**
Replaces: Mercruiser 50-801333980, 50-854178, 50-855507



**18-8412
STARTER STUD EXTENDER**
Extends the solenoid stud on PMGR starters for applications that require more accessory wire connections.
Threads: Female M8x1.25, Male 3/8" x 16 UNC



**18-2434
FLYWHEEL BELL HOUSING**
Replaces: 814309A1
For: GM V-8's Big & Small Blocks Inboard/Ski Models

STARTER BOLTS



Description	Mercruiser #	Part #
Starter Bolt 3/8 - 16 - 4 3/8 Long	10-8053432	18-8402-1
Starter Bolt 3/8 - 16 - 1 11/16 Long	10-8083434	18-8404-1



**18-5717
STARTER
BRUSH SET**
Replaces: 33270

**18-5804
SOLENOID**
Replaces: 13037
Delco



**18-5837
SOLENOID**
Replaces: 89-18080
Delco



**18-5838
SOLENOID**
Replaces: 33261, 33316,
60687, 89902, 89-99253
Delco



**18-5840
SOLENOID**
Prestolite 15-79,
SAW 4201, SAW4207, SAW4210



BRUSH SET/STARTER SWITCH APPLICATION

Years	Volt.	Starter No.	Brush Set	Starter Switch	Years	Volt.	Starter No.	Brush Set	Starter Switch
1977-82	12	1108755	18-5717	18-5838	1971-78	12	ALL	18-5717	18-5838
1977-82	12	1108756	18-5717	—	1969-78	12	MEO-7003	—	18-5840
1977-82	12	1109484,5,6	18-5717	18-5838					

① **18-5801D** Display Package

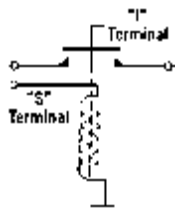

**18-5801
SOLENOID**
Replaces: 89-76416A1

① **18-5802D** Display Package

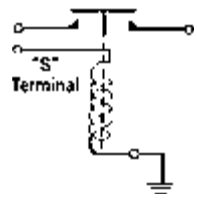

**18-5802
SOLENOID**
Grounded base
Replaces: 65057A1, 65057T1, 65057, 54981

① Items ending in "D" are Display Packaged - Regular number is Non-Display

① 18-5810D Display Package



18-5810 SOLENOID



18-5811-1 STARTER SOLENOID
Replaces: 809463A1, 8094631, 809463, 8094621, 809462
For: PG 260 Series Starters, GM V6 & V8 (1983-Up)

① 18-5815D Display Package



18-5815 SOLENOID
Replaces: 89-68258A4, 89-853654A1, 89-76545, 89-76545T, 89-65258, 89-61053, 89-15857

① 18-5816D Display Package



18-5816 SOLENOID
Replaces: 89-96054, T, 89-91975
 (Flat Bracket)

① 18-5817D Display Package



18-5817 SOLENOID
Replaces: 89-96158, 89-96158T, 94318, 846070
 (Curved Bracket)



18-5820 SOLENOID
Replaces: 89-818999A2, 89-825842A1, 89-850188T1

① 18-5836D Display Package



18-5836 SOLENOID
Replaces: 25661, 256611, 25661T1



18-9802 TIMING LIGHT
 Self-powered accurate up to 10,000 RPM's



18-6749 TRIM BRACKET
Metal Bracket
Replaces: 862548A1, 42419A1, 88893A4, 88553A1, 862548A1, 58397A3, 58397A2, 42419A1
For: MerCruiser Floor Mount Bracket



18-6750 TRIM BRACKET
Stainless Steel
Replaces: 862548A1, 42419A1
For: MerCruiser Floor Mount Bracket



18-6747 TILT/ TRIM ASSEMBLY
Replaces: 865380A25, 865380A15, 865380A05, 865380A02, 14336A28, 14336A22, 14336A17, 14336A15, 14336A9, 14336A6, 88183A12, 88183A3
 For late model sterndrive applications



18-6752 HYDRAULIC TRIM PUMP ASSEMBLY
 Low Pressure - High Flow
Metal Bracket
Replaces: 14336A9, 88183A12, 96477A3, 88183A11, 88183A6, 14336A28, 14336A22, 14336A17, 14336A15, 14336A6
Fits: 1983 and Later without "quick connect"
 Replacement Motor: 18-6772
 20 amp fuse



18-6753 HYDRAULIC TRIM PUMP ASSEMBLY
 Low Pressure - High Flow
Stainless Steel Bracket
Replaces: 14336A9, 88183A12
Fits: 1983 and Later without "quick connect"
 Replacement Motor: 18-6772
 20 amp fuse

① Items ending in "D" are Display Packaged - Regular number is Non-Display

**18-6768
COMPLETE POWER
PUMP ASSEMBLY**

Steel Bracket
Replaces: 93247A7, 93247A4, 392-8261A1, 392-8263, 88475A4, 79271A4, 74436A9
 Replacement pump for Prestolite high pressure/low flow system. Primarily used 1982 and earlier. 20 amp fuse.



**18-6799
COMPLETE POWER
TRIM PUMP ASSEMBLY**

Stainless Steel Bracket
Replaces: 93247A7, 93247A4, 392-8261A1, 392-8263, 88475A4, 79271A4, 74436A9
 Replacement pump for Prestolite high pressure/low flow system. Salt water series. Stainless steel bracket. Primarily used 1982 and earlier. 20 amp fuse.



**18-6763
TILT/TRIM MOTOR**

Replaces: 92975A6, 79271A4, 67914A2, 92975A32, 93247A7
 To 1984. Fits most Mercruiser Sterndrives (Motor and Reservoir Only)
 For Repair Kit use: **18-6253**

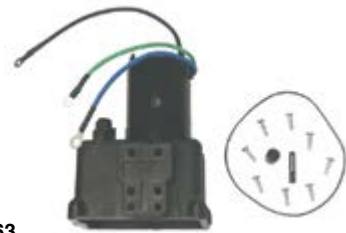

**18-6769-1
TILT/TRIM PUMP**

Low Pressure - High Flow
Replaces: 14336A8, 88183A5 From 1984
Fits: Most Mercruiser Sterndrives



**18-6772
TILT PUMP MOTOR**

Replaces: 17649, 17649T, 891736T
 For late style Alpha I, Generation II, and Bravo drives; early style square motors.
 Mercruiser Sterndrive replacement for Oildyne units



**18-6813
TRIM MOTOR**

Low pressure/high flow
Replaces: 14336A6, A8, A9, A15, A20, 88183A5, A8, A12, 865380A13
 Same as 18-6769-1, plus wiring
 Replacement Solenoid: **18-5817**



**18-6746
TILT/TRIM ASSEMBLY**

Replaces: 14336A20, 14336A25, 14336A31, 14336A8 865380A03, 865380A13, 88183A5



**18-6771
TILT/TRIM RESERVOIR**

Replaces: 18525, 18525A1, 17646



**18-6778
TILT/TRIM RESERVOIR**

Replaces: 883166A1, 883166A2
For: Tilt Motors with 4 Screw Attachments



**18-6823
WIRING HARNESS**

Replaces: Universal
 Converts 3-wire Tilt and Trim motors to 2-Wire design



**18-6253
COMMUTATOR
END PLATE**

For: Use with 18-6763

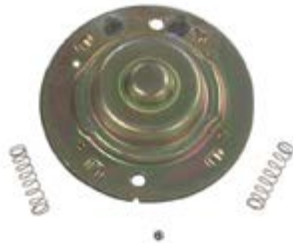

**18-15501
CIRCUIT BREAKER**

Replaces: 88-93582
60 AMP



**18-5945
ALTERNATOR**

(3-Wire) (No Core) (68 AMP) • SAE J1171
 Replaces Mando, Motorola and original equipment Delco. Uses same electrical connections and mounting method. Equipped with fan and serpentine drive pulley.



**18-5946
ALTERNATOR**

(1-Wire) (No Core) (68 AMP)
 Single wire connection fits Mercruiser and many other applications. Equipped with fan and serpentine drive pulley. SAE J1171





18-5956
ALTERNATOR
(1-Wire) (No Core) (68 AMP)
Single wire connection fits Mercruiser and many other applications. Equipped with fan and drive pulley.
Replaces: 69729, 90794, 78403A2, 78403A1, 78477, 59755, 56045
SAE J1171



18-5957
ALTERNATOR
(3-Wire) (68 AMP)
Replaces Mando, Motorola and original equipment Delco. Uses same electrical connections and mounting method. Equipped with fan and drive pulley.
Replaces: 78477, 78403A2, 92497A3, 78403A1, 90794, 69729, 59755, 56045, 817119A4, 817119A1, 98555A1, 92497, 12449A1, 12449
SAE J1171



18-5960
ALTERNATOR
Serpentine Pulley • 65 Amp
Replaces: 807653T • SAE J1171



18-5965
ALTERNATOR
65 Amp
Replaces: 817119A1, 817119A4, 805884T, 98555A1, 92497A3, 92497, 12449A1, 12449
SAE J1171



18-5967
ALTERNATOR
Serpentine Pulley • 55 Amp
Replaces: 807652T
SAE J1171



18-5966
ALTERNATOR
Single Groove Pulley • 55 Amp
Replaces: 817119A4, 12449A1, 98555A1, 92497, 817119A1, 12449A1, 12449
SAE J1171



18-5983
ALTERNATOR
Replaces: 862030T • SAE J1171
75I/70 amp, Hinge Mount, Single Groove Pulley



18-6293
ALTERNATOR
Replaces: 862031T, 862031T1 • SAE J1171
75I/70 amp, Hinge Mount, Serpentine Pulley 2.44" Diameter



18-6298
ALTERNATOR
Replaces: 863077T • SAE J1171
75I/70 amp, Hinge Mount, Serpentine Pulley 1.97" Diameter



18-6841
ALTERNATOR
Replaces: 56045, 59755, 69729, 78403A2, 78403A1, 78477, 90794
For: 37-63A Marine Applications



18-6842
ALTERNATOR
Replaces: 56045, 59755, 69729, 78403A2, 78403A1, 78477, 90794
For: 37-63A Marine Applications



18-6844
ALTERNATOR
Replaces: Mercruiser 834832, T2, 857006A3, Denso 101211-3460



18-6948
ALTERNATOR
Replaces: 882571, 8M0084523
Fits: CMD 1.7 MI 120 I/L4, CMD 1.7 MS 120 I/L4, D1.7L DTI



18-6960
ALTERNATOR
Replaces: Mercruiser 821663, 8216631, 821663A1
Denso 101211-3020, 3021



18-6975
ALTERNATOR (Universal)
Fits: High amp 160A alternator, universal mounting pattern based on Delco CS1300 design, v-belt and 6 groove serpentine pulley included

APPLICATION BEGINS ON NEXT PAGE



**18-5953-1
ALTERNATOR CONVERSION KIT**

Includes new 18-5956 68 AMP alternator, mounting brackets 18-5968, pulley (8.0" O.D. x 2.75" H), wiring, hardware and instructions. Converts model 470 aluminum block Mercruiser engines serial number 4625580 & up with stator charging system and water cooled voltage regulator to alternator system. **NOTE: Fuse kit 18-8220 (sold separately) is required on engines with a Delco starter (round solenoid mounted to starter); Prestolite starters with remote solenoid DO NOT require fuse kit. Visually inspect starter prior to ordering conversion kit.**
For: Mercruiser 224 / 3.7L



**18-5968
ALTERNATOR BRACKET**
Replacement bracket for alternator conversion kit used on 470 Series Mercruiser included in 18-5953-1 kit.



**18-5724
VOLTAGE REGULATOR**
Replaces: 78385



**18-5740
VOLTAGE REGULATOR**
Replaces: 42785



**18-8220
FUSE KIT**
Replaces: 88-79023A91
For use with 18-5953-1 alternator conversion kits installed on Mercruiser (Model 470) 3.7 liter aluminum block engines serial number 6902288 & Up. 90 AMP

Model	Cyl.	Years	Beg Serial #	End Serial #	Slave Solenoid	Reman Starter	New Starter	Reman Alternator	New Alternator
110	GM 4	1963-1966	1538370	2044033	18-5836	18-5911	18-5911	—	—
120	GM 4	1964-1975	1666601	4469865	18-5836	18-5911	18-5911	18-5957	18-5957
120	GM 4	1976-1982	4469866	6229717	18-5815	18-5911	18-5911	18-5957	18-5957
120 / 2.5L	GM 4	1983-1989	6229718	C853255	18-5817	18-5911	18-5911	—	18-5966 ④
140	GM 4	1968-1975	2508261	4460664	18-5836	18-5911	18-5911	18-5957	18-5957
140	GM 4	1976-1981	4460665	6229717	18-5815	18-5911	18-5911	18-5957	18-5957
140/3.0L	GM 4	1982-1989	6229718	C856558	18-5817	18-5911	18-5911	18-5957	18-5957
140/3.0L	GM 4	1999-2001	OL382122	OM326292	18-5817	—	18-6275-1	—	18-5983 **
140/3.0L/3.0LX	GM 4	1990-92	C856559	D831100	18-5817	18-5911	18-5911	18-5957	18-5957
140/3.0LX	GM 4	1992-97	D831101	OK999999	18-5817	N/A	18-6275-1	—	18-5966 ④
165/3.7L	Merc 4	1987-1989	B434941	C762299	18-5802	18-5907	18-5907	N/A	N/A
170	Merc 4	1985-1986	6916779	B434940	18-5802	18-5907	18-5907	N/A	N/A
180/3.7LX	Merc 4	1987-1989	B436391	C762299	18-5802	18-5907	18-5907	N/A	N/A
190	Merc 4	1985-1986	6916779	B436390	18-5802	18-5907	18-5907	N/A	N/A
470	Merc 4	1976-1984	4208730	6916778	18-5802	18-5907	18-5907	N/A	N/A
470MIE	Merc 4	1980-1981	5520115	6218036	18-5802	18-5907	18-5907	N/A	N/A
485	Merc 4	1980-1984	5685394	6916778	18-5802	18-5907	18-5907	N/A	N/A
140	GM 6	1963	1538930	1725960	18-5836	18-5911	18-5911	—	—
150	GM 6	1964-66	1666495	2048046	18-5836	18-5911	18-5911	—	—
160	GM 6	1967-69	2048022	2768031	18-5836	18-5911	18-5911	—	—
160	GM 6	1969	2768032	2770031	18-5836	18-5911	18-5911	18-5957	18-5957
165	GM 6	1970-1975	2770032	4471565	18-5836	18-5911	18-5911	18-5957	18-5957
165	GM 6	1976-1981	4471566	5813433	18-5815	18-5911	18-5911	18-5957	18-5957
200	GM 6	1969	2453769	2712072	18-5836	18-5911	18-5911	—	—
175/4.3L	GM V-6	1987-1992	B527955	D714106	18-5816	—	18-5913-1	—	18-5966 ④
185	GM V-6	1983-1984	6330183	6919655	18-5816	18-5911	18-5911	—	18-5966 ④

① For 12 3/4" Dia. Flywheel
 ② For 14" Dia. Flywheel
 ③ For permanent magnet models use 18-5919-1
 ④ 55 AMP up grade to 65 AMP use 18-5965
 ⑤ Black
 ⑥ For permanent magnet models use 18-5913-1
 ⑦ Bravo drive

⑧ Firepower ignition
 ⑨ Ignition module mounted on distributor
 ⑩ Ignition module mounted on elbow
 ⑪ LH rotation
 ⑫ NLA for models prior to S/N 4167000
 ⑬ PG 260 (9-1/4" long)
 ⑭ PG260F1 (8-1/2" long)

⑮ RH Rotation
 ⑯ Standard ignition
 ⑰ Thunderbolt ignition
 ⑱ Thunderbolt IV
 ⑲ Thunderbolt V
 ⑳ Transmission models
 ** Delco Style

Model	Cyl.	Years	Beg Serial #	End Serial #	Slave Solenoid	Reman Starter	New Starter	Reman Alternator	New Alternator
185	GM V-6	1985-1987	A331455	B527954	18-5816	N/A	18-5913-1	—	18-5966 ④
205	GM V-6	1985-1991	A331455	D714369	18-5816	N/A	18-5913-1	—	18-5966 ④
262 Mag. EFI	GM V-6	1996-1997	F803800	K999999	18-5817	N/A	18-5913-1	—	18-5960
262 Mag. EFI	GM V-6	1996-1997	F803800	K999999	18-5817	N/A	18-5913-1	—	18-5960
4.3L/LX/LXH	GM V-6	1992-1997	D714107	K999999	18-5817	—	18-5913-1	—	18-5967
4.3L/LX/LXH	GM V-6	1996-1997	F803000	K999999	18-5817	—	18-5913-1	—	18-5967
4.3L/LH	GM V-6	1998-99	L010044	OL618999	18-5817	—	18-5913-1	—	18-5967
4.3L/LH(Gen +)	GM V-6	2000-02	OL619000	OM320024	18-5817	—	18-5913-1	—	18-6293 **
4.3EFI	GM V-6	1998-99	L012009	OL618999	18-5817	—	18-5913-1	—	18-5960
4.3L EFI	GM V-6	2000-01	OL619000	OM299999	18-5817	—	18-5913-1	—	18-6293 **
4.3L MPI	GM V-6	2002	OM300000	OM320024	18-5817	—	18-5913-1	—	18-6293 **
190	GM V-8	1963-1964	1564539	1730903	18-5836	18-5911	18-5911	—	—
200	GM V-8	1985-1986	6218462	B525981	18-5816	18-5911	18-5911 ① ③	—	18-5966 ④
200	GM V-8	1985-1986	6218462	B525981	18-5816	18-5910	18-5910 ② ⑥	—	18-5966 ④
200/5.0L	GM V-8	1987-1995	B525982	F600999	18-5816	18-5910	18-5910	—	18-5966 ④
200/5.0L	GM V-8	1987-1995	B525982	F600999	18-5817	18-5910	18-5910	—	18-5966 ④
215 MCM & MIE	Ford V-8	1970-1972	2781153	3563181	18-5836	18-5908	18-5908 ①	18-5957	18-5957
215 MCM & MIE	Ford V-8	1970-1972	2781153	3563181	18-5836	18-5907	18-5907 ②	18-5957	18-5957
225	Ford V-8	1973-1974	3385721	4166999	18-5802	18-5903	—	18-5957	18-5957
225 MIE	Ford V-8	1973-1974	3385721	4176999	18-5836	18-5908	18-5908 ①	18-5957	18-5957
225 MIE	Ford V-8	1973-1974	3385721	4176999	18-5836	18-5907	18-5907 ②	18-5957	18-5957
888	Ford V-8	1971-1977	3108723	4612109	18-5802	18-5903	— ②	18-5957	18-5957
888	Ford V-8	1971-1977	4612110	& Up	18-5801	18-5903	—	18-5957	18-5957
225	GM V-8	1963-1966	1539620	2278646	18-5836	18-5911	18-5911	—	—
225 MIE	GM V-8	1968	2278647	2694014	18-5836	18-5908	18-5908 ①	—	—
225 MIE	GM V-8	1968	2278647	2694014	18-5836	18-5907	18-5907 ②	—	—
225	GM V-8	1967-1969	2278647	2694014	18-5836	—	—	—	—
228/230	GM V-8	1977-1986	4765100	B525981	18-5816	18-5911	18-5911 ① ③	—	18-5966 ④
228/230	GM V-8	1977-1986	4765100	B525981	18-5816	18-5910	18-5910 ② ⑥	—	18-5966 ④
228 MIE	GM V-8	1977-1980	4765100	5907057	18-5815	18-5908	18-5908 ①	18-5957	18-5957
228 MIE	GM V-8	1977-1980	4765100	5907057	18-5815	18-5907	18-5907 ②	18-5957	18-5957
230/5.0LX	GM V-8	1987-1995	B525982	F600999	18-5816 ⑩	18-5910	18-5910 ③	—	18-5966 ④
230/5.0LX	GM V-8	1987-1995	B525982	F600999	18-5817 ⑩	18-5910	18-5910 ③	—	18-5966 ④
230/5.0L MIE	GM V-8	1987-1988	5907058	B788151	18-5816	18-5908	18-5908 ①	—	18-5966 ④
230/5.0L MIE	GM V-8	1987-1988	5907058	B788151	18-5816	18-5907	18-5907 ②	—	18-5966 ④
5.0L(Gen +)	GM V-8	1998-99	L015751	L618999	18-5817	—	18-5913-1	—	18-5967
5.0L(Gen +)	GM V-8	2000-2002	L619000	M320024	18-5817	—	18-5913-1	—	18-6293 **
5.0L EFI	GM V-8	1998-99	L012052	L618999	18-5817	—	18-5913-1	—	18-5960
5.0L EFI	GM V-8	2000-01	L619000	M299999	18-5817	—	18-5913-1	—	18-6293 **
5.0L MPI	GM V-8	2002	M300000	M320024	18-5817	—	18-5913-1	—	18-6293 **
198 MIE	GM V-8	1977	4762210	6218461	18-5815	18-5908	18-5908 ①	18-5957	18-5957
198 MIE	GM V-8	1977	4762210	6218461	18-5815	18-5907	18-5907 ②	18-5957	18-5957
898	GM V-8	1977-1982	4762210	6218461	18-5801	18-5911	18-5911	18-5957	18-5957

① For 12 3/4" Dia. Flywheel
 ② For 14" Dia. Flywheel
 ③ For permanent magnet models use 18-5919-1
 ④ 55 AMP up grade to 65 AMP use 18-5965
 ⑤ Black
 ⑥ For permanent magnet models use 18-5913-1
 ⑦ Bravo drive

⑧ Firepower ignition
 ⑨ Ignition module mounted on distributor
 ⑩ Ignition module mounted on elbow
 ⑪ LH rotation
 ⑫ NLA for models prior to S/N 4167000
 ⑬ PG 260 (9-1/4" long)
 ⑭ PG260F1 (8-1/2" long)

⑮ RH Rotation
 ⑯ Standard ignition
 ⑰ Thunderbolt ignition
 ⑱ Thunderbolt IV
 ⑲ Thunderbolt V
 ⑳ Transmission models
 ** Delco Style

Model	Cyl.	Years	Beg Serial #	End Serial #	Slave Solenoid	Reman Starter	New Starter	Reman Alternator	New Alternator
898	GM V-8	1983-1984	621462	B525981	18-5816	18-5911	18-5911 ① ③	—	18-5966 ④
898	GM V-8	1983-1984	621462	B525981	18-5816	18-5910	18-5910 ② ⑥	—	18-5966 ④
233	Ford V-8	1975-1977	4173000	4902304	18-5801	18-5903	—	18-5957	18-5957
233 MIE	Ford V-8	1975-1976	4173000	4775784	18-5836	18-5908	18-5908 ①	18-5957	18-5957
233 MIE	Ford V-8	1975-1976	4173000	4775784	18-5836	18-5907	18-5907 ⑤	18-5957	18-5957
250 MCM & MIE	GM V-8	1968-1969	2314301	2639854	18-5836	18-5908	18-5908 ①	—	—
250 MCM & MIE	GM V-8	1968-1969	2314301	2639854	18-5836	18-5907	18-5907 ⑤	—	—
250	GM V-8	1977	4768000	4908849	18-5801	18-5911	18-5911	18-5957	18-5957
255	Ford V-8	1973-1974	3258728	4175499	18-5802	18-5903	—	18-5957	18-5957
255 MIE	Ford V-8	1973-1974	3258728	4178299	18-5836	18-5908	18-5908 ①	18-5957	18-5957
255 MIE	Ford V-8	1973-1974	3258728	4178299	18-5836	18-5907	18-5907 ⑤	18-5957	18-5957
255	GM V-8	1975-1976	4175500	4767999	18-5815	18-5911	18-5911	18-5957	18-5957
255 MIE	GM V-8	1975-1980	4175500	5907057	18-5815	18-5908	18-5908 ①	18-5957	18-5957
255 MIE	GM V-8	1975-1980	4175500	5907057	18-5815	18-5907	18-5907 ⑤	18-5957	18-5957
260	GM V-8	1978-1982	4908850	6218461	18-5801	18-5911	18-5911	18-5957	18-5957
260	GM V-8	1982-1986	6218462	B525981	18-5816	18-5911	18-5911 ① ③	—	18-5966 ④
260	GM V-8	1982-1986	6218462	B525981	18-5816	18-5910	18-5910 ② ⑥	—	18-5966 ④
260/5.7L	GM V-8	1987-1995	B525982	F600999	18-5816 ⑩	18-5910	18-5910 ⑥	—	18-5966 ④
260/5.7L	GM V-8	1987-1995	B525982	F600999	18-5817 ⑩	18-5910	18-5910 ⑥	—	18-5966 ④
260/5.7L MIE	GM V-8	1987-1995	5907058	F746099	18-5816	18-5908	18-5908 ①	—	18-5966 ④
260/5.7L MIE	GM V-8	1987-1995	5907058	F746099	18-5816	18-5907	18-5907 ⑤	—	18-5966 ④
5.7L/LX	GM V-8	1996	F601000	K001526	18-5817	—	18-5913-1	—	18-5966 ④
5.7L/LX	GM V-8	1997 & Up	K001527	& Up	18-5817	—	18-5913-1	—	18-5967
5.7L	GM V-8	2000-02	L619000	M320024	18-5817	—	18-5913-1	—	18-6293 **
5.7L/LX EFI	GM V-8	1995-1996	F225560	K001505	18-5816	—	18-5913-1	—	18-5965
5.7L/LX EFI	GM V-8	1997	K001506	K999999	18-5816	—	18-5913-1	—	18-5960
5.7L EFI	GM V-8	1998 & Up	L010035	& Up	18-5816	—	18-5913-1	—	18-5960
5.7L EFI	GM V-8	2000-01	L619000	M299999	18-5816	—	18-5913-1	—	18-6293 **
5.7L MIE	GM V-8	1994-1996	F622151	K040306	18-5816	18-5908	18-5908 ①	—	18-5966 ④
5.7L MIE	GM V-8	1994-1996	F622151	K040306	18-5816	18-5907	18-5907 ⑤	—	18-5966 ④
5.7L MIE	GM V-8	1997 & Up	K040307	& Up	18-5817	18-5908	18-5908	—	18-5967
5.7L MIE	GM V-8	1998-01	L002003	L677226	18-5817	18-5908	18-5908	—	18-6293 **
5.7L EFI MIE	GM V-8	1997	K040300	K999999	18-5816	18-5908	18-5908	—	18-5960
5.7L Ski	GM V-8	1985-1995	A338533	F775199	18-5816	—	18-5913-1 ⑤	—	18-5966 ④
5.7L Ski	GM V-8	1985-1995	A338533	F775199	18-5816	18-5907	18-5907 ①	—	18-5966 ④
5.7L Ski	GM V-8	1996	F775200	K040003	18-5817	—	18-5913-1	—	18-5966 ④
5.7L Ski	GM V-8	1997	K040004	K999999	18-5817	—	18-5913-1	—	18-5967
5.7L Ski	GM V-8	1998 & Up	L002005	& Up	18-5817	—	18-5913-1	—	18-5967
5.7L Ski	GM V-8	2000-01	L619000	L678784	18-5817	—	18-5913-1	—	18-6293 **
350 Mag. Alpha	GM V-8	1986-1995	A635178	F600999	18-5816 ⑩	18-5910	18-5910 ⑥	—	18-5966 ④
350 Mag. Alpha	GM V-8	1987-1996	B525982	K001526	18-5817 ⑩	18-5910	18-5910 ⑥	—	18-5966 ④
350 Mag. Alpha	GM V-8	1997	K001527	K999999	18-5817	—	18-5913-1	—	18-5967
350 Mag. EFI & MPI	GM V-8	1995-1996	F415189	K001500	18-5816	—	18-5913-1	—	18-5965
350 Mag. EFI & MPI	GM V-8	1997 & Up	K001501	& Up	18-5816	—	18-5913-1	—	18-5960
350 Mag MPI	GM V-8	2000-01	L619000	M299999	18-5816	—	18-5913-1	—	18-6293 **

① For 12 3/4" Dia. Flywheel
 ② For 14" Dia. Flywheel
 ③ For permanent magnet models use 18-5919-1
 ④ 55 AMP up grade to 65 AMP use 18-5965
 ⑤ Black
 ⑥ For permanent magnet models use 18-5913-1
 ⑦ Bravo drive

⑧ Firepower ignition
 ⑨ Ignition module mounted on distributor
 ⑩ Ignition module mounted on elbow
 ⑪ LH rotation
 ⑫ NLA for models prior to S/N 4167000
 ⑬ PG 260 (9-1/4" long)
 ⑭ PG260F1 (8-1/2" long)

⑮ RH Rotation
 ⑯ Standard ignition
 ⑰ Thunderbolt ignition
 ⑱ Thunderbolt IV
 ⑲ Thunderbolt V
 ⑳ Transmission models
 ** Delco Style

Model	Cyl.	Years	Beg Serial #	End Serial #	Slave Solenoid	Reman Starter	New Starter	Reman Alternator	New Alternator
350 Mag MPI / Horizon	GM V-8	2002	M300000	M320024	18-5817		18-5913-1		18-6293 **
350 Mag.MPI MIE	GM V-8	1998 & Up	L002008	& Up	18-5816	18-5908	18-5908	—	18-5960
350 Mag MPI MIE / Horizon	GM V-8	1999-01	L304700	L678398	18-5816	18-5908	18-5908		18-6293 **
350 Mag Ski	GM V-8	1991-1996	D505450	K040399	18-5816 ①	—	18-5913-1	—	18-5966 ④
350 Mag Ski	GM V-8	1991-1996	D505450	K040399	18-5817 ②	—	18-5913-1	—	18-5966 ④
350 Mag Ski	GM V-8	1997	K040400	K999999	18-5817	—	18-5913-1	—	18-5967
350 Mag EFI Ski	GM V-8	1994-1997	F215561	K999999	18-5816	—	18-5913-1	—	18-5965
350 Mag MPI Ski	GM V-8	1995-1996	F350583	F799999	18-5816	—	18-5913-1	—	18-5965
350 Mag MPI Ski	GM V-8	1998 & Up	L002600	& Up	18-5817	—	18-5913-1	—	18-5960
350 Mag MPI Ski	GM V-8	1998-02	L002600	M310021	18-5817	—	18-5913-1	—	18-6293 **
Black Scorpion	GM V-8	1996	F800000	K040000	18-5816	—	18-5913-1	—	18-5965
Black Scorpion	GM V-8	1997 & Up	K040001	& Up	18-5816	—	18-5913-1 ③	—	18-5960
Black Scorpion	GM V-8	1997 & Up	K040001	& Up	18-5816	—	18-5913-1 ④	—	18-5960
Black Scorpion	GM V-8	1997-01	K040001	L678036	18-5816	—	18-5913-1	—	18-6293 **
270 MCM & MIE	GM V-8	1969-1972	2851074	3385720	18-5836	18-5908	18-5908 ①	18-5957	18-5957
270 MCM & MIE	GM V-8	1969-1972	2851074	3385720	18-5836	18-5907	18-5907 ②	18-5957	18-5957
280 TRS	GM V-8	1975-1976	4176250	4770199	18-5815	18-5911	18-5911	18-5957	18-5957
300 TR TEMPEST	GM V-8	1985-1986	6668677	B430367	18-5816	18-5908	18-5908	—	18-5966 ④
300 MR TEMPEST	GM V-8	1985-1986	6668677	B430367	18-5816	—	18-5919-1 ①	—	18-5966 ④
300 MR TEMPEST	GM V-8	1985-1986	6668677	B430367	18-5816	—	18-5913-1 ②	—	18-5966 ④
320 EFI	GM V-8	1987-1989	A543604	C622418	18-5816	—	18-5913-1	—	18-5966 ④
MX 6.2L MPI	GM V-8	2000-2002	L680003	M320024	18-5817	—	18-5913-1	—	18-6293
MX 6.2L MPI Horizon	GM V-8	2002	M300000	M320024	18-5817	—	18-5913-1	—	18-6293
MX 6.2L MPI Horizon MIE	GM V-8	2002	M300000	M310099	18-5817	—	18-5603	—	18-6293
MX 6.2L MPI MIE	GM V-8	2002	M300000	M310099	18-5817	—	18-5603	—	18-6293
MX 6.2L Black Scorpion Ski	GM V-8	2001	L670015	L678036	18-5816	—	18-5913-1	—	18-6293
325 MCM & MIE	GM V-8	1968-1970	2278747	2761141	18-5836	18-5908	18-5908 ①	—	—
325 MCM & MIE	GM V-8	1968-1970	2278747	2761141	18-5836	18-5907	18-5907 ②	—	—
325 MCM & MIE	GM V-8	1970-1974	2761142	3780449	18-5836	18-5908	18-5908 ①	18-5957	18-5957
325 MCM & MIE	GM V-8	1970-1974	2761142	3780449	18-5836	18-5907	18-5907 ②	18-5957	18-5957
330	GM V-8	1977-1981	4623115	6083144	18-5836 ③	—	18-5913-1	18-5957	18-5957
330	GM V-8	1977-1981	4623115	6083144	18-5815 ④	—	18-5913-1	18-5957	18-5957
330	GM V-8	1982-1987	6083145	B816540	18-5816	18-5908	18-5908	—	18-5966 ④
330 MIE	GM V-8	1977-1980	4623115	5889913	18-5836 ⑤	18-5908	18-5908 ①	18-5957	18-5957
330 MIE	GM V-8	1977-1980	4623115	5889913	18-5815 ⑥	18-5907	18-5907 ②	18-5957	18-5957
340/7.4L MIE w/BW	GM V-8	1981-1992	5889914	D715493	18-5816	18-5908	18-5908 ①	—	18-5966 ④
340/7.4L MIE w/BW	GM V-8	1981-1992	5889914	D715493	18-5816	18-5907	18-5907 ②	—	18-5966 ④
7.4L	GM V-8	1988-1991	B771113	D603117	18-5816	18-5910	18-5910 ③	—	18-5966 ④
7.4L	GM V-8	1988-1996	B771113	F800699	18-5816 ④	18-5910	18-5910 ⑤	—	18-5966 ④
7.4L	GM V-8	1992-1997	D603118	K999999	18-5817 ⑤	—	18-5913-1	—	18-5966 ④
7.4LX EFI & MPI	GM V-8	1996-1997	F602010	K999999	18-5816	—	18-5913-1	—	18-5965
7.4L MPI	GM V-8	1998 & Up	L010003	& Up	18-5817	—	18-5913-1	—	18-6293
7.4L MIE	GM V-8	1989-1996	C391564	F820141	18-5816 ⑥	18-5908	18-5908	—	18-5966 ④
7.4L MIE	GM V-8	1992-1997	D715494	K999999	18-5817 ⑦	18-5908	18-5908	—	18-5966 ④
7.4L EFI & MPI MIE	GM V-8	1995-1997	F563052	K999999	18-5816	18-5908	18-5908	—	18-5965
7.4L MPI MIE	GM V-8	1998 & Up	L002006	& Up	18-5817	18-5908	18-5908	—	18-6293
350 MIE	GM V-8	1974-1976	3780450	4623109	18-5836	18-5908	18-5908 ①	18-5957	18-5957
350 MIE	GM V-8	1974-1976	3780450	4623109	18-5836	18-5907	18-5907 ②	18-5957	18-5957
370 TRS	GM V-8	1978-1985	4179554	6721527	18-5815	18-5908	18-5908	18-5957	18-5957

① For 12 3/4" Dia. Flywheel
 ② For 14" Dia. Flywheel
 ③ For permanent magnet models use 18-5919-1
 ④ 55 AMP up grade to 65 AMP use 18-5965
 ⑤ Black
 ⑥ For permanent magnet models use 18-5913-1
 ⑦ Bravo drive

⑧ Firepower ignition
 ⑨ Ignition module mounted on distributor
 ⑩ Ignition module mounted on elbow
 ⑪ LH rotation
 ⑫ NLA for models prior to S/N 4167000
 ⑬ PG 260 (9-1/4" long)
 ⑭ PG260F1 (8-1/2" long)

⑮ RH Rotation
 ⑯ Standard ignition
 ⑰ Thunderbolt ignition
 ⑱ Thunderbolt IV
 ⑲ Thunderbolt V
 ⑳ Transmission models
 ** Delco Style

Model	Cyl.	Years	Beg Serial #	End Serial #	Slave Solenoid	Reman Starter	New Starter	Reman Alternator	New Alternator
370 TRS	GM V-8	1978-1985	4179554	6721527	18-5815	18-5908	18-5908	—	18-5966 ④
370 TRS	GM V-8	1985-1987	6721528	B714586	18-5816	18-5908	18-5908	—	18-5966 ④
390 MCM & MIE	GM V-8	1969-1970	2781129	3042731	18-5836	18-5908	18-5908 ①	18-5957	18-5957
390 MCM & MIE	GM V-8	1969-1970	2781129	3042731	18-5836	18-5907	18-5907 ②	18-5957	18-5957
400 TRS	GM V-8	1980-1986	4179554	B457644	18-5815	18-5908	18-5908	18-5957	18-5957
400 TRS	GM V-8	1980-1986	4179554	B457644	18-5815	18-5908	18-5908	—	18-5966 ④
420	GM V-8	1987-1989	A398941	B622418	18-5816	18-5908	18-5908	—	18-5966 ④
425	GM V-8	1990-1992	A398941	D937011	18-5816	18-5908	18-5908	—	18-5966 ④
440 TRS	GM V-8	1983-1986	4179554	B485220	18-5815	18-5908	18-5908	18-5957	18-5957
440 TRS	GM V-8	1983-1986	4179554	B485220	18-5815	18-5908	18-5908	—	18-5966 ④
450	GM V-8	1995-1996	F347100	F347277	18-5820	—	18-5913-1	—	—
454 Mag.	GM V-8	1986-1994	A631894	F304999	18-5816	—	18-5913-1	—	18-5966 ④
454 Mag.	GM V-8	1995-1997	F305000	K999999	18-5817	—	18-5913-1	—	18-5966 ④
454 Mag. MPI	GM V-8	1994-1997	F115700	K999999	18-5816	—	18-5913-1	—	18-5965
454 Mag. MPI	GM V-8	1998 & Up	L010029	& Up	18-5816	—	18-5913-1	—	18-6293
454 Mag. MPI MIE	GM V-8	1996-1997	F820100	K999999	18-5816	—	18-5913-1	—	18-5965
454 Mag. MPI MIE	GM V-8	1998 & Up	L002200	& Up	18-5816	18-5908	18-5908	—	18-6293
454 EFI Ski	GM V-8	1995-1996	F215800	F820099	18-5816	—	18-5913-1	—	18-5965
460 TRS	GM V-8	1983-1986	4179554	6181046	18-5815	18-5908	18-5908	18-5957	18-5957
460 TRS	GM V-8	1983-1986	4179554	6181046	18-5815	18-5908	18-5908	—	18-5966 ④
465	GM V-8	1990-1994	C849992	F213244	18-5816 ③	—	18-5913-1 ⑦	—	18-5966 ④ ⑤
465	GM V-8	1990-1994	C849992	F213244	—	18-5908	18-5908 ⑩	—	—
500	GM V-8	1994-1997	F213293	& Up	18-5820	—	18-5913-1 ⑦	—	—
500	GM V-8	1994-1995	F213293	& Up	18-5820	18-5908	18-5908 ⑩	—	—
500 Bulldog	GM V-8	1990-1996	C577254	& Up	18-5820 ③	—	18-5913-1 ⑦	—	—
500 Bulldog	GM V-8	1990-1996	C577254	& Up	18-5816 ⑧	18-5908	18-5908 ⑩	—	18-5966 ④ ⑤
502 Mag. Bravo	GM V-8	1990-1993	C878221	F114528	18-5816	—	18-5913-1	—	18-5966 ④
502 Mag. MPI	GM V-8	1993-1997	D840650	K999999	18-5816	—	18-5913-1	—	18-5965
502 Mag. MPI	GM V-8	1998 & Up	L017000	& Up	18-5816	—	18-5913-1	—	18-6293
525 SC	GM V-8	1991-1993	D456000	D763831	18-5816	—	18-5913-1 ⑦	—	18-5966 ④ ⑤
525 SC	GM V-8	1991-1993	D456000	D763831	18-5816	18-5908	18-5908 ⑩	—	—
525 SC	GM V-8	1993-1997	D763871	& Up	18-5820	—	18-5913-1 ⑦	—	18-5966 ④ ⑤
525 SC	GM V-8	1993-1997	D763871	& Up	18-5820	18-5908	18-5908 ⑩	—	—
525 EFI	GM V-8	2003-2010	M900146	& Up	—	—	—	—	18-6298
575	GM V-8	1986-1992	A677429	D763716	18-5816	18-5908	18-5908	—	18-5966 ④
600 SC	GM V-8	1991-1996	D456489	F877642	18-5816 ⑧	18-5908	18-5908	—	18-5966 ④ ⑤
600 SC	GM V-8	1991-1996	D456489	F877642	18-5820 ③	18-5908	18-5908	—	—
600 SC	GM V-8	1997	K000227	& Up	18-5820	—	18-5913-1 ⑩	—	—
600 Sci	GM V-8	2005-2010	M952908	& Up	—	—	—	—	18-6298
800 SC	GM V-8	1993-1996	D763836	& Up	18-5820	18-5908	18-5908 ⑩	—	—
8.2L MIE	GM V-8	1990-1996	C878221	F819619	18-5816 ③	18-5908	18-5908	—	18-5966 ④
8.2L MIE	GM V-8	1993-1996	D857200	F819619	18-5817	18-5908	18-5908	—	18-5966 ④
8.2L MPI MIE	GM V-8	1996-1997	F819620	K999999	18-5816	18-5908	18-5908	—	18-5965
8.2L MPI MIE	GM V-8	1998 & Up	L002450	& Up	18-5816	18-5908	18-5908	—	18-6293

① For 12 3/4" Dia. Flywheel
 ② For 14" Dia. Flywheel
 ③ For permanent magnet models use 18-5919-1
 ④ 55 AMP up grade to 65 AMP use 18-5965
 ⑤ Black
 ⑥ For permanent magnet models use 18-5913-1
 ⑦ Bravo drive

⑧ Firepower ignition
 ⑨ Ignition module mounted on distributor
 ⑩ Ignition module mounted on elbow
 ⑪ LH rotation
 ⑫ NLA for models prior to S/N 4167000
 ⑬ PG 260 (9-1/4" long)
 ⑭ PG260F1 (8-1/2" long)

⑮ RH Rotation
 ⑯ Standard ignition
 ⑰ Thunderbolt ignition
 ⑱ Thunderbolt IV
 ⑲ Thunderbolt V
 ⑳ Transmission models
 ** Delco Style



18-33207
FUEL PRESSURE REGULATOR
 Replaces: 860349A1
 Fits: MCM/MIE 7.4L/LX MPI, 4545 Mag MPI, 502 Mag MPI, MIE 8.2L MPI. Mounts on Fuel Cooler.



18-33211
FUEL PRESSURE REGULATOR
 Replaces: 892681
 Fits: Mercruiser 8.1L, 496 Mag HO, 502 Mag MPI 375-400 HP.



18-7600
TEMPERATURE SENSOR
 Replaces: 805218T



18-7700
THROTTLE POSITION SENSOR
 Replaces: 853678T
 Fits: MCM/MIE 4.3L MPI, 5.0L MPI, MX6.2L MPI w/ ECM 555 and 350 Mag MPI, Black Scorpion Tow Sports, 377 Scorpion Tow Sports, 7.4L MPI(L29) & MCM 496 Mag & HO and MIE 8.1S & HO



18-7630
THROTTLE POSITION SENSOR
 Replaces: 805226A1



18-7701
IDLE SPEED CONTROL MOTOR
 Replaces: 862998
 Fits: MCM 3.0L MPI, V6 & V8(305, 350 & 496 cid)MPI engines w/ECM555 (Includes gasket)



18-7632-1
IDLE AIR CONTROL MOTOR
 Replaces: 805224A1



18-7697
IAC MOTOR
 Replaces: 803149
 Fits: MCM/MIE 350 Mag MPI, Black Scorpion Tow Sports, 377 Scorpion MCM & Tow Sports, MX6.2L MPI, 7.4L MPI(L29) & 575 Sci



18-7682
MAP SENSOR
 Replaces: 849934, 879150150
 Fits: MCM 575 Sci



18-7684
MAP SENSOR
 Replaces: 864856A1, 805217A1
 Fits: MCM/MIE GM V6 & V8 (350, 377, 454 & 502cid)EFI Engines



18-7660
MAP SENSOR
 Replaces: 881731, 8M0054726
 V-6 & V-8 MPI engines with 555 ECM



18-7550
MAP SENSOR
 Replaces: 861249, 861249A1
 Fits: Mercury 5.7L, 7.4L 1998-2001



18-7551
MAP SENSOR
 Replaces: 861425
 Fits: Mercury Scorpion,
 Black Scorpion 1998-2010



18-7668
MAP SENSOR
 Replaces: 854445
 525 EFI



18-7553
KNOCK SENSOR
 Replaces: 808015T
 Fits: Mercury 5.7L MAG 1998-2010



18-7554
KNOCK SENSOR
 Replaces: 878187
 Fits: Mercury 5.7L MAG 1994-2010



18-7677
KNOCK SENSOR
 Replaces: 806612T
 Fits: GM V8(305, 350 & 377 cid) engines



18-7703
KNOCK SENSOR
 Replaces: 805544T



18-7685
TBI INJECTOR
 Replaces: 852956A1
 Fits: MCM GM V6 & V8 (305 & 350 cid) TBI engines



18-7757
THROTTLE POSITION SENSOR
 Replaces: 803148
 For: 350 Mag OL005900 & Up



18-33104
FUEL INJECTOR
 Replaces: 802632T, 802632
 Fits: MCM/MIE 7.4L MPI L29



18-7688
FUEL INJECTOR
 Replaces: 885176
 Fits: MCM 4.3L MPI engines (s/n OM300000-1A063239)
 & 5.0L, 5.7L & 6.2L MPI engines w/ ECM 555
 (s/n OM300000-1A064824)

**18-7690
INJECTOR SEAL KIT**

Replaces: 27-852957
Use with Mercury Injector # 852956A1, 853998A1, 853998T, 853998
Fits: 262 Mag EFI (1996-97), 4.3L EFI (1998-01), 5.0L EFI (1998-01), 350 Mag Alpha EFI (Gen+) (1996-97), 350 Mag EFI SKI (1994-97), 5.7L EFI (1995-01), 5.7L EFI MIE (Gen+) (1997), 5.7L LX Bravo EFI (Gen+) (1996-97), 5.7 LX EFI (1995-97), 7.4L LX TBI (1996-97), 575 Sci (2000-05)

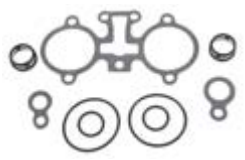

**18-7692
INJECTOR SEAL KIT**

Use with Mercury Injector # 861260T, 861260
Fits: 350 Mag MPI(98-01), 350 Mag MPI Horizon MIE(99-01), 350 Mag MPI MIE(98-01), 350 Mag MPI SKI(98-01), MX 6.2L MPI(00-01), 454 Mag MPI(99-01), 454 Mag MPI Horizon MIE(99-01), 502 Mag MPI(99-01), 8.2L MPI(99-01)



**18-7693
INJECTOR SEAL KIT**

Use with Mercury Injector # 802632T, 849896
Fits: 7.4L MPI(L29)(98-01), 7.4L MPI MIE(L29)(98-01), 500 EFI(99-05)



**18-7696
INJECTOR SEAL KIT**

Use with Mercury Injector # 805225A1
Fits: 320 EFI(87-89), 350 Mag Bravo MPI(Gen+)(97), Black Scorpion Ski(97-08), 377 Scorpion MCM(99-05), 377 Scorpion Ski(97-98), MX6.2L Black Scorpion Ski (01-07), 454 Mag EFI SKI(94-97), 454 Mag MPI(96-98), 454 Mag MPI Horizon MIE(98), 7.4L MPI MIE (95-97), 7.4LX MPI(96-97), 502 Mag MPI(93-98), 525 EFI(03-08), 8.2L MPI MIE(96-98)



**18-7695
INJECTOR SEAL KIT**

Use with Mercury Injector # 885176
Fits: 4.3L MPI(02-08), 5.0L MPI(02-08), 5.0L MPI DTS(05-08), 350 Mag MPI(02-08), 350 Mag MPI DTS(05-08), 350 Mag MPI Horizon(02-07), 350 Mag MPI Horizon DTS(05-07), 350 Mag MPI MIE(02-07), 350 Mag MPI MIE DTS(05-07), 350 Mag MPI SKI(02-07), 5.7L Horizon MIE(08), 5.7L MIE(08), 5.7L DTS MIE(08), 5.7L MPI SKI(08), MX6.2L MPI(02-07), MX6.2L MPI DTS(05-07), MX6.2L MPI Horizon(04-07), MX6.2L MPI Horizon DTS(05-07), MX6.2L MPI Horizon MIE(02-08), MX6.2L MPI Horizon MIE DTS(05-08), MX 6.2L MPI MIE(02-07), MX6.2L MPI MIE DTS(05-07), MX6.2L MPI SKI(02-07)



FUEL INJECTION SYSTEM APPLICATION

Model	Liter	CID	# CYL	Year Range	Serial # Range	Injector	IAC Valve	TPS	F/P Regulator Rail-Mounted	F/P Regulator Cooler Mounted	MAP Sensor
3.0L MPI	3.0L	181	L4	2008-2010	A072812 & UP	N/A	18-7701	N/A	N/A	N/A	N/A
262 MAG EFI	4.3L	262	V-6	1996-1997	F803800 - K999999	18-7685	18-7632-1	18-7630	N/A	N/A	18-7684
4.3L EFI	4.3L	262	V-6	1998-2001	L012009 - M299999	18-7685	18-7632-1	18-7630	N/A	N/A	N/A
4.3L MPI	4.3L	262	V-6	2002-2007	M300000 - A063239	18-7688	18-7701	18-7700	N/A	N/A	N/A ⊗
4.3L MPI	4.3L	262	V-6	2007-2010	A063240 & UP	N/A	18-7701	18-7700	N/A	N/A	N/A ⊗
5.0L EFI	5.0L	305	V-8	1998-2001	L012052 - M299999	18-7685	18-7632-1	18-7630	N/A	N/A	N/A
5.0L MPI	5.0L	305	V-6	2002-2007	M300000 - A064824	18-7688	18-7701	18-7700	N/A	N/A ⊕	N/A ⊗
5.0L MPI	5.0L	305	V-6	2007-2010	A064825 & UP	N/A	18-7701	18-7700	N/A	N/A ⊕	N/A ⊗
5.0L MPI DTS	5.0L	305	V-8	2005-2007	W310000 - A064824	18-7685	N/A	N/A	N/A	N/A	N/A
5.0L MPI DTS	5.0L	305	V-8	2010	A064825 & UP	N/A	N/A	N/A	N/A	N/A	N/A
350 MAG ALPHA EFI (GEN +)	5.7L	350	V-8	1996-1997	F800300 - K999999	18-7685	18-7632-1	18-7630	N/A	N/A	18-7684
350 MAG BRAVO MPI	5.7L	350	V-8	1995-1996	F415189 - K001500	N/A	18-7632-1	18-7630	N.L.A.	N/A	18-7684 ⊗
350 MAG BRAVO MPI (GEN +)	5.7L	350	V-8	1997	K001501 - K999999	N/A	18-7632-1	18-7630	N/A	N/A	18-7684 ⊗
350 MAG EFI SKI	5.7L	350	V-8	1994-1996	F215561 - F820706	18-7685	18-7632-1	18-7630	N/A	N/A	18-7684
350 MAG EFI SKI	5.7L	350	V-8	1996	F820707 - K040005	18-7685	18-7632-1	18-7630	N/A	N/A	18-7684
350 MAG MPI	5.7L	350	V-8	1998	L010019 - L331598	N/A	18-7697	18-7700	N/A	N/A	N/A
350 MAG MPI	5.7L	350	V-8	1998	L336000 - L346999	N/A	18-7697	18-7700	N/A	N/A	N/A
350 MAG MPI	5.7L	350	V-8	1999	L331599 - L335999	N/A	18-7697	18-7757	N/A	N/A	N/A
350 MAG MPI	5.7L	350	V-8	1999-2001	L340000 - M299999	N/A	18-7697	18-7757	N/A	N/A	N/A
350 MAG MPI	5.7L	350	V-8	2002-2007	M300000 - A064824	18-7688	18-7701	18-7700	N/A	N/A ⊕	N/A ⊗
350 MAG MPI DTS	5.7L	350	V-8	2005-2007	W310000 - A064824	18-7688	N/A	N/A	N/A	N/A	N/A ⊗
350 MAG MPI DTS	5.7L	350	V-8	2007-2010	A064825 & UP	N/A	N/A	N/A	N/A	N/A	N/A ⊗
350 MAG MPI HORIZON	5.7L	350	V-8	2002-2007	M300000 - A064824	18-7688	18-7701	18-7700	N/A	N/A ⊕	N/A ⊗
350 MAG MPI HORIZON	5.7L	350	V-8	2007	A064825 - A299999	N/A	18-7701	18-7700	N/A	N/A ⊕	N/A ⊗
350 MAG MPI HORIZON DTS	5.7L	350	V-8	2005-2007	W310000 - A064824	18-7688	N/A	N/A	N/A	N/A	N/A ⊗
350 MAG MPI HORIZON DTS	5.7L	350	V-8	2007	A064825 - A299999	N/A	N/A	N/A	N/A	N/A	N/A ⊗
350 MAG MPI HORIZON MIE	5.7L	350	V-8	1999-2001	L304700 - M299999	N/A	18-7697	18-7757	N/A	N/A	N/A
350 MAG MPI HORIZON MIE	5.7L	350	V-8	2002-2004	M300000 - M398371	18-7688	18-7701	18-7700	N/A	N/A	N/A ⊗

⊕ BRAVO APPS W/SN W060000, ORDER REGULATOR # 892681 ⊗ MAP SENSOR (TEMP & PRESSURE)

FUEL INJECTION SYSTEM APPLICATION (CONT.)

Model	Liter	CID	# CYL	Year Range	Serial # Range	Injector	IAC Valve	TPS	F/P Regulator Rail-Mounted	F/P Regular Cooler Mounted	MAP Sensor
350 MAG MPI HORIZON MIE	5.7L	350	V-8	2004-2007	M398372 - A064824	18-7688	18-7701	18-7700	N/A	N/A	N/A Ⓞ
350 MAG MPI HORIZON MIE	5.7L	350	V-8	2007	A064825 - A089999	N/A	18-7701	18-7700	N/A	N/A	N/A Ⓞ
350 MAG MPI HORIZON MIE DTS	5.7L	350	V-8	2005-2007	W390000 - A064824	18-7688	N/A	N/A	N/A	N/A	N/A Ⓞ
350 MAG MPI HORIZON MIE DTS	5.7L	350	V-8	2007	A064825 - A089999	N/A	N/A	N/A	N/A	N/A	N/A Ⓞ
350 MAG MPI MIE	5.7L	350	V-8	1998	L002008 - L302199	N/A	18-7697	18-7700	N/A	N/A	N/A
350 MAG MPI MIE	5.7L	350	V-8	1999-2001	L302200 - M299999	N/A	18-7697	18-7757	N/A	N/A	N/A
350 MAG MPI MIE	5.7L	350	V-8	2002-2004	M300000 - M398371	18-7688	18-7701	18-7700	N/A	N/A	N/A Ⓞ
350 MAG MPI MIE	5.7L	350	V-8	2004-2007	M398372 - A064824	18-7688	18-7701	18-7700	N/A	N/A	N/A Ⓞ
350 MAG MPI MIE	5.7L	350	V-8	2007	A064825 - A089999	N/A	18-7701	18-7700	N/A	N/A	N/A Ⓞ
350 MAG MPI MIE DTS	5.7L	350	V-8	2005-2007	W390000 - A064824	18-7688	N/A	N/A	N/A	N/A	N/A Ⓞ
350 MAG MPI MIE DTS	5.7L	350	V-8	2007	A064825 - A089999	N/A	N/A	N/A	N/A	N/A	N/A Ⓞ
350 MAG EFI SKI	5.7L	350	V-8	1994-1996	F215561 - F820706	18-7685	18-7632-1	18-7630	N/A	N/A	18-7684
350 MAG MPI SKI	5.7L	350	V-8	1998	L002600 - L304599	N/A	18-7697	18-7700	N/A	N/A	N/A
350 MAG MPI SKI	5.7L	350	V-8	1999-2001	L304600 - M299999	N/A	18-7697	18-7757	N/A	N/A	N/A
350 MAG MPI SKI	5.7L	350	V-8	2002-2007	M300000 - A064824	N/A	18-7701	18-7700	N/A	N/A	N/A Ⓞ
350 MAG MPI SKI	5.7L	350	V-8	2007	A064825 - A089999	N/A	18-7701	18-7700	N/A	N/A	N/A ♦
5.7L EFI	5.7L	350	V-8	1995-1997	F225560 - K999999	18-7685	18-7632-1	18-7630	N/A	N/A	18-7684
5.7L EFI (GEN +)	5.7L	350	V-8	1998-2001	L010035 - M299999	18-7685	18-7632-1	18-7630	N/A	N/A	N/A
5.7L EFI MIE (GEN +)	5.7L	350	V-8	1997	K040300 - K999999	18-7685	18-7632-1	18-7630	N/A	N/A	18-7684
5.7L MPI HORIZON MIE	5.7L	350	V-8	2008-2010	A090000 - & UP	N/A	18-7701	18-7700	N/A	N/A	N/A ♦
5.7L MPI HORIZON DTS MIE	5.7L	350	V-8	2008-2010	A090000 - & UP	N/A	N/A	N/A	N/A	N/A	N/A ♦
5.7L MPI MIE	5.7L	350	V-8	2008-2010	A090000 - & UP	N/A	18-7701	18-7700	N/A	N/A	N/A ♦
5.7L MPI DTS MIE	5.7L	350	V-8	2008-2010	A090000 - & UP	N/A	N/A	N/A	N/A	N/A	N/A ♦
5.7L MPI SKI	5.7L	350	V-8	2008-2010	A090000 - & UP	N/A	N/A	18-7700	N/A	N/A	N/A ♦
5.7LX BRAVO EFI (GEN +)	5.7L	350	V-8	1996-1997	F800300 - K999999	18-7685	18-7632-1	18-7630	N/A	N/A	18-7684
5.7LX EFI	5.7L	350	V-8	1995-1997	F225560 - K999999	18-7685	18-7632-1	18-7630	N/A	N/A	18-7684
BLACK SCORPION SKI		350	V-8	1996	F350583 - K040000	N/A	18-7697	18-7700	N.L.A.	N.L.A.	18-7684
BLACK SCORPION SKI		350	V-8	1997	K040001 - L002699	N/A	18-7697	18-7700	N/A	N/A	18-7684
BLACK SCORPION SKI		350	V-8	1998	L002700 - L005600	N/A	18-7697	18-7700	N/A	N/A	N/A
BLACK SCORPION SKI		350	V-8	1998-2002	L005601 - M391599	N/A	18-7697	18-7757	N/A	N/A	N/A
BLACK SCORPION SKI		350	V-8	2003-2010	M391600 - W698432	N/A	18-7701	18-7757	N/A	N/A	N/A
SCORPION 350	5.0L	350	V-8	2008-2010	W698433 & UP	N/A	18-7701	18-7757	N/A	N/A	N/A
377 MAG		377	V-8	2008-2010	A300000 & UP	N/A	18-7701	18-7700	N/A	N/A	N/A ♦
377 MAG DTS		377	V-8	2008-2010	A300000 & UP	N/A	N/A	N/A	N/A	N/A	N/A ♦
377 SCORPION MCM		377	V-8	1999-2005	L416146 - M907201	N/A	18-7697	18-7757	N/A	N/A	18-7684
377 SCORPION SKI		377	V-8	1997-1998	K000656 - L600314	N/A	18-7697	18-7700	N/A	N/A	18-7684
MX 6.2L MPI	6.2L	377	V-8	2000-2001	L680003 - M299999	N/A	18-7697	18-7757	N/A	N/A	N/A
MX 6.2L MPI	6.2L	377	V-8	2002-2004	M300000 - W059999	18-7688	18-7701	18-7700	N/A	N/A	N/A ♦
MX 6.2L MPI	6.2L	377	V-8	2004-2007	W060000 - A064824	18-7688	18-7701	18-7700	N/A	N/A	N/A ♦
MX 6.2L MPI	6.2L	377	V-8	2007	A064825 - A299999	N/A	18-7701	18-7700	N/A	N/A	N/A ♦
MX 6.2L MPI DTS	6.2L	377	V-8	2005-2007	W310000 - A064824	18-7688	N/A	N/A	N/A	N/A	N/A ♦
MX 6.2L MPI DTS	6.2L	377	V-8	2007	A064825 - A299999	N/A	N/A	N/A	N/A	N/A	N/A ♦
MX 6.2L MPI HORIZON	6.2L	377	V-8	2002-2004	M300000 - W059999	18-7688	18-7701	18-7700	N/A	N/A	N/A ♦
MX 6.2L MPI HORIZON	6.2L	377	V-8	2004-2007	W060000 - A064824	18-7688	18-7701	18-7700	N/A	N/A	N/A ♦
MX 6.2L MPI HORIZON	6.2L	377	V-8	2007	A064825 - A299999	N/A	18-7701	18-7700	N/A	N/A	N/A ♦
MX 6.2L MPI HORIZON DTS	6.2L	377	V-8	2005-2007	W310000 - A064824	18-7688	N/A	N/A	N/A	N/A	N/A ♦
MX 6.2L MPI HORIZON DTS	6.2L	377	V-8	2007	A064825 - A299999	N/A	N/A	N/A	N/A	N/A	N/A ♦
MX 6.2L MPI HORIZON MIE	6.2L	377	V-8	2002-2004	M300000 - M398394	18-7688	18-7701	18-7700	N/A	N/A	N/A ♦
MX 6.2L MPI HORIZON MIE	6.2L	377	V-8	2004-2007	M398395 - A064825	18-7688	18-7701	18-7700	N/A	N/A	N/A ♦
MX 6.2L MPI HORIZON MIE	6.2L	377	V-8	2007-2010	A064825 & UP	N/A	18-7701	18-7700	N/A	N/A	N/A ♦
MX 6.2L MPI HORIZON MIE DTS	6.2L	377	V-8	2005-2007	W390000 - A064824	18-7688	N/A	N/A	N/A	N/A	N/A ♦
MX 6.2L MPI HORIZON MIE DTS	6.2L	377	V-8	2007-2010	A064825 & UP	N/A	N/A	N/A	N/A	N/A	N/A ♦
MX 6.2L MPI MIE	6.2L	377	V-8	2002-2004	M300000 - M398394	18-7688	18-7701	18-7700	N/A	N/A	N/A ♦
MX 6.2L MPI MIE	6.2L	377	V-8	2004-2007	M398395 - A064825	18-7688	18-7701	18-7700	N/A	N/A	N/A ♦
MX 6.2L MPI MIE	6.2L	377	V-8	2007-2010	A064825 & UP	N/A	18-7701	18-7700	N/A	N/A	N/A ♦
MX 6.2L MPI MIE DTS	6.2L	377	V-8	2005-2007	W390000 - A064824	18-7688	N/A	N/A	N/A	N/A	N/A ♦
MX 6.2L MPI MIE DTS	6.2L	377	V-8	2007-2010	A064825 & UP	N/A	N/A	N/A	N/A	N/A	N/A ♦

Ⓞ BRAVO APPS W/SN W060000, ORDER REGULATOR # 892681

♦ MAPT SENSOR (TEMP & PRESSURE)

FUEL INJECTION SYSTEM APPLICATION (CONT.)

Model	Liter	CID	# CYL	Year Range	Serial # Range	Injector	IAC Valve	TPS	F/P Regulator Rail-Mounted	F/P Regular Cooler Mounted	MAP Sensor
MX 6.2L MPI SKI	6.2L	377	V-8	2002-2007	M317000 - W689999	18-7688	18-7701	18-7700	N/A	N/A	N/A ♦
MX 6.2L BLACK SCORPION SKI	6.2L	377	V-8	2001-2003	L005601 - M391599	N/A	18-7697	18-7757	N/A	N/A	N/A
MX 6.2L BLACK SCORPION SKI	6.2L	377	V-8	2003-2007	M391750 - W698432	N/A	18-7701	18-7757	N/A	N/A	N/A
454 MAG EFI	7.4L	454	V-8	1994-1996	F115700 - F802349	N/A	18-7632-1	18-7630	N/A	N/A	18-7684
454 MAG EFI SKI	7.4L	454	V-8	1995-1996	F215800 - F820099	N/A	18-7632-1	18-7630	N/A	N/A	18-7684
454 MAG EFI SKI	7.4L	454	V-8	1996-1997	F820099 - K999999	N/A	18-7632-1	18-7630	N/A	N/A	18-7684
454 MAG MPI	7.4L	454	V-8	1996-1997	F802350 - K147349	N/A	18-7632-1	18-7630	N/A	N/A	18-7684
454 MAG MPI	7.4L	454	V-8	1997-1998	K147350 - L085399	N/A	18-7632-1	18-7630	N/A	N/A	18-7684
454 MAG MPI	7.4L	454	V-8	1999-2001	L085400 - M024999	N/A	18-7632-1	18-7630	N/A	N/A	18-7684
454 MAG MPI HORIZON MIE	7.4L	454	V-8	1998	L002200 - L086049	N/A	18-7632-1	18-7630	N/A	N/A	18-7684
454 MAG MPI HORIZON MIE	7.4L	454	V-8	1999-2001	L086050 - L674000	N/A	18-7632-1	18-7630	N/A	N/A	18-7684
7.4L MPI (L29)	7.4L	454	V-8	1998-2001	L010003 - M024330	N/A	18-7697	18-7700	N/A	N/A	N/A
7.4L MPI MIE	7.4L	454	V-8	1995-1996	F563052 - K147349	N/A	18-7632-1	18-7630	N/A	N/A	18-7684
7.4L MPI MIE	7.4L	454	V-8	1997	K147350 - K999999	N/A	N/A	18-7630	N/A	N/A	18-7684
7.4L MPI MIE (L29)	7.4L	454	V-8	1998-2001	L010003 - L674613	N/A	N/A	18-7700	N/A	N/A	N/A
7.4LX TBI	7.4L	454	V-8	1996-1997	F820000 - K999999	N.L.A.	18-7632-1	18-7630	N/A	N/A	18-7684
7.4LX MPI	7.4L	454	V-8	1996	F602010 - K147349	N/A	18-7632-1	18-7630	N/A	N/A	18-7684
7.4LX MPI	7.4L	454	V-8	1997	K147350 - K999999	N/A	18-7632-1	18-7630	N/A	N/A	18-7684
496 MAG		496	V-8	2001-2004	M025000 - W059999	N/A	N/A	18-7700	N/A	N/A	N/A
496 MAG		496	V-8	2004	W060000 - W060573	N/A	N/A	18-7700	N/A	N/A	N/A
496 MAG		496	V-8	2004-2010	W060574 - & UP	N/A	N/A	18-7700	N/A	N/A	N/A
496 MAG DTS		496	V-8	2001-2004	M025000 - W059999	N/A	N/A	N/A	N/A	N/A	N/A
496 MAG DTS		496	V-8	2004	W060000 - W060573	N/A	N/A	N/A	N/A	N/A	N/A
496 MAG HO		496	V-8	2001-2004	M025000 - W059999	N/A	N/A	18-7700	N/A	N/A	N/A
496 MAG HO		496	V-8	2004	W060000 - W060461	N/A	N/A	18-7700	N/A	N/A	N/A
496 MAG HO		496	V-8	2004-2010	W060462 - & UP	N/A	N/A	18-7700	N/A	N/A	N/A
496 MAG HO DTS		496	V-8	2001-2004	M025000 - W059999	N/A	N/A	N/A	N/A	N/A	N/A
496 MAG HO DTS		496	V-8	2004	W060000 - W060461	N/A	N/A	N/A	N/A	N/A	N/A
496 MAG HO DTS		496	V-8	2004-2010	W060462 - & UP	N/A	N/A	N/A	N/A	N/A	N/A
496 MAG & HO EC		496	V-8	2007-2010	A066166 & UP	N/A	N/A	18-7700	N/A	N/A	N/A
496 MAG & HO DTS EC		496	V-8	2010		N/A	N/A	N/A	N/A	N/A	N/A
8.1L & HO MIE		496	V-8	2001-2004	M026000 - W089999	N/A	N/A	18-7700	N/A	N/A	N/A
8.1L & HO MIE		496	V-8	2004	W090000 - W389999	N/A	N/A	18-7700	N/A	N/A	N/A
8.1L & HO MIE		496	V-8	2004-2010	W390000 - & UP	N/A	N/A	18-7700	N/A	N/A	N/A
8.1L & HO MIE DTS		496	V-8	2001-2004	M026000 - W089999	N/A	N/A	N/A	N/A	N/A	N/A
8.1L & HO MIE DTS		496	V-8	2004	W090000 - W389999	N/A	N/A	N/A	N/A	N/A	N/A
8.1L & HO MIE EC		496	V-8	2007-2010	W697154 - & UP	N/A	N/A	18-7700	N/A	N/A	N/A
500 EFI	8.2L	502	V-8	1999-2005	L001477 - M907127	N/A	18-7632-1	N/A	N/A	N/A	18-7684
502 MAG MPI	8.2L	502	V-8	1993-1996	D840650 - K147349	N/A	18-7632-1	18-7630	N/A	N/A	18-7684
502 MAG MPI	8.2L	502	V-8	1997-1998	K147350 - L085432	N/A	18-7632-1	18-7630	N/A	N/A	18-7684
502 MAG MPI	8.2L	502	V-8	1999-2001	L085432 - M024999	N/A	18-7632-1	18-7630	N/A	N/A	18-7684
575 Sci	8.2L	502	V-8	2000-2005	L306696 - M950526	N.L.A.	18-7632-1	18-7630	N/A	N/A	N/A
575 Sci	8.2L	502	V-8	2000-2005	L306696 - M950526	N.L.A.	18-7632-1	18-7630	N/A	N/A	N/A
8.2L MAG	8.2L	502	V-8	2010	A350340 & UP	N/A	N/A	18-7700	N/A	N/A	N/A
8.2L MIE	8.2L	502	V-8	2010	A350340 & UP	N/A	N/A	18-7700	N/A	N/A	N/A
8.2L MPI MIE	8.2L	502	V-8	1996	F819620 - K147349	N/A	18-7632-1	18-7630	N/A	N/A	18-7684
8.2L MPI MIE	8.2L	502	V-8	1997-1998	K127350 - L086012	N/A	18-7632-1	18-7630	N/A	N/A	18-7684
8.2L MPI MIE	8.2L	502	V-8	1999-2001	L086013 - L674200	N/A	18-7632-1	18-7630	N/A	N/A	18-7684

① BRAVO APPS W/SN W060000, ORDER REGULATOR # 892681 ♦ MAPT SENSOR (TEMP & PRESSURE)



ALL SIERRA CARBURETORS INCLUDE BASE GASKET

- Precision remanufactured to meet or exceed OEM specifications
- Re-calibrated and re-engineered to maximize fuel efficiency and performance
- All carburetors are flow tested throughout the entire throttle range
- Fuel mixture and idle settings are pre-set to ensure that only minor idle and choke adjustments are necessary during installation
- All bases are resurfaced and throttle shaft bushings replaced



**18-7370N
CARBURETOR**

Replaces: 3310-860070A2, 3310-806077A2, 3310-806078A2, 1389-9562A1, 1389-9350A2, 1389-8490A2, 1389-815396A2
For: MCM 120/2.5L & 140/3.0L



**18-7373N
MERCARB 2V CARBURETOR**

Replaces: 3310-864941A01
2002-2004 4.3L engines
(s/n OM615000-OW300012
Uses Carb Kit **18-7098-1**



**18-7375N
CARBURETOR**

Replaces: 3310-864942A01, 3310-861448A1
For: 1998-2004 MCM 5.0L



**18-7376N
CARBURETOR**

Replaces: 3310-864943A01, 3310-861245A1
For: 1998 and newer 5.7L applications



**18-7639
CARBURETOR**

Replaces: 3310-864943A01, 861245A1
Mercarb-5.7L 2V 1998 and newer 5.7L (OL010337-OW300754) & 5.7L MIE (OL002003-OW090899)
(Remanufactured)
Uses Carb Kit **18-7098-1** & Gasket **18-0994**



**18-7640
CARBURETOR**

Universal Q-jet with electric choke
(Remanufactured)
Uses Carb Kit **18-7095** & Gasket **18-0994**



**18-7603-1
CARBURETOR**

2 Barrel - Rochester
Replaces: 1347-818622, 1376-5659A1, 1347-818622 1, 1347-818622R02
(Remanufactured)
Uses Carb Kit **18-7075** & Gaskets **18-0994** (left) & **18-0434** (right)



**18-7604-1
CARBURETOR**

4 Barrel - Rochester
Replaces: 3304-9354A2, 1347-804623R02, 1347-804623R1
(Remanufactured)
Uses Carb Kit **18-7095** & Gasket **18-2648**



**18-7605-1
CARBURETOR**

4 Barrel - Rochester
Replaces: 1347-9661A3, 1347-804623A1, 1347-804623R02
(Remanufactured)
Uses Carb Kit **18-7095** & Gasket **18-2648**



**18-7609-1
CARBURETOR**

2 Barrel - Rochester
Replaces: 1347-818619, 1347-818619 1, 1347-818619 1R
(Remanufactured)
Uses Carb Kit **18-7070** & Gasket **18-0356**



**18-7610-1
CARBURETOR**

2 Barrel - Rochester
Replaces: 1347-818621, 1347-818621 1, 1347-818621 1R02
(Remanufactured)
Uses Carb Kit **18-7070** & Gasket **18-0396**



**18-7611-2
CARBURETOR**

2 Barrel - Rochester
Replaces: 3310-807312A1, 3310-807312R02
(Remanufactured)
Uses Carb Kit **18-7097** & Gasket **18-0994**



**18-7615-1
CARBURETOR**

4 Barrel - Rochester
Replaces: 1347-816373A4, 1347-804624R1, 1347-804624R02
(Remanufactured)
Uses Carb Kit **18-7095** & Gasket **18-2548**

ALL SIERRA CARBURETORS INCLUDE BASE GASKET



**18-7616-1
CARBURETOR**
4 Barrel - Rochester
Replaces: 1347-8288A1,
1347-804626R02
(Remanufactured)
Uses Carb Kit **18-7072** & Gasket **18-2848**



**18-7617-1
CARBURETOR**
4 Barrel - Rochester
Replaces: 1347-9863A3,
1347-804624R1, 1347-804625R02
(Remanufactured)
Uses Carb Kit **18-7095** & Gasket **18-2848**



**18-7618-1
CARBURETOR**
4 Barrel - Rochester
Replaces: 1347-8289A1,
1347-804624R1, 1347-804624R02
(Remanufactured)
Uses Carb Kit **18-7095** & Gasket **18-2848**



**18-7619-1
CARBURETOR**
4 Barrel - Rochester
Replaces: 1347-9142A2, 1347-8460A3
(Remanufactured)
Uses Carb Kit **18-7095** & Gasket **18-0462**



**18-79994N
CARBURETOR**
Replaces: 3310-866142A04,
3310-866142A03
Fits: TKS-5.0L

CARBURETOR APPLICATION

Model	CID/Cyl	Year Range	Beginning Serial #	Ending Serial #	Original Carb Part Number	Carb Code/Model	Carb Repair Kit	Replacement O.E. Carb No.	Float	Sierra Carb #
90	96/L4	1970-1971	2851424	3225967	1351-4263A 1	7040082 R2/2GC	18-7746	1347-818619R02	18-7200	18-7609-1
90	96/L4	1972	3225868	3226957	1351-4263A 1	7036543 R2/2GC	18-7746	1347-818619R02	18-7200	18-7609-1
110	153/L4	1963-1966	1357370	2044033	1336-2076	R2/2GC	—	—	—	18-7609-1
120	153/L4	1972-1973	3377341	3770649	1351-4263A3	7043182 R2/2GC	18-7746	1347-818619R02	18-7200	18-7609-1
120	153/L4	1974-1975	3770650	4469865	1351-5202A1	7044182 R2/2GC	18-7746	1347-818619R02	18-7200	18-7609-1
120	153/L4	1976-1978	4469866	5192048	1351-6065A2	7044182 R2/2GC	18-7746	1347-818619R02	18-7200	18-7609-1
120	153/L4	1979-1982	5192049	6229717	1351-7354A1	17059054 R2/2GC	18-7746	1347-818619R02	18-7200	18-7609-1
120	153/L4	1983	6229718	6663797	1351-8480A 2	17081060 R2/2GC	18-7746	1347-818621R02	18-7200	18-7610-1
120	153/L4	1984	6663798	6853913	1389-8490A 2	M2/MERCARB	18-7097	3310-860070A 2	18-7202	—
120	153/L4	1985	6853914	A492055	1389-9350A 2	M2/MERCARB	18-7097	3310-860070A 2	18-7202	—
120	153/L4	1986	A492056	B531853	1389-9562A 1	M2/MERCARB	18-7098-1	3310-860070A 2	18-7202	—
2.5L	153/L4	1983-1989	B531854	C853255	3310-806077A 2	M2/MERCARB	18-7098-1	3310-860070A 2	18-7202	—
140	181/L4	1968-1969	2508261	2816416	1351-3635A 1	7036646 R/2GC	18-7746	—	18-7200	—
140	181/L4	1970	2816417	2911439	1351-4032A 1	7040080 R/2GC	18-7746	1347-818620R02	18-7200	—
140	181/L4	1970-1973	2911440	3771644	1351-4293A1	7040084 R/2GC	18-7746	1347-818620R02	18-7200	—
140	181/L4	1974-1978	3771645	5157868	1351-5203A1	7043184 R/2GC	18-7746	1347-818620R02	18-7200	—
140	181/L4	1979-1982	5157669	6229717	1351-7355A1	17059052 R/2GC	18-7746	1347-818620R02	18-7200	—
140	181/L4	1983	6229718	6671328	1351-8480A 2	17081060 R/2GC	18-7746	1347-818521R02	18-7200	—
140	181/L4	1984	6671329	6852269	1389-8490A 2	M2/MERCARB	18-7097	3310-860070A 2	18-7202	—
140	181/L4	1985	6852270	A484072	1389-9350A 2	M2/MERCARB	18-7097	3310-860070A 2	18-7202	—
140	181/L4	1986	A484073	B450800	1389-9562A 1	M2/MERCARB	18-7098-1	3310-860070A 2	18-7202	—
140/3.0L	181/L4	1983-1989	6229718	C856556	1351-8480A2	R2/2GC	—	1348-818621 1	—	18-7610-1
3.0L	181/L4	1987-1989	B450801	C856556	3310-806077A 2	M2/MERCARB	18-7098-1	3310-860070A 2	18-7202	—
3.0L	181/L4	1990	C856559	D447414	1389-815396A 2	M2/MERCARB	18-7098-1	3310-860070A 2	18-7202	—
3.0L	181/L4	1991-1993	D447415	D836075	1389-806077A 2	M2/MERCARB	18-7098-1	3310-860070A 2	18-7202	—
3.0L	181/L4	1993-1994	D836076	F603999	1389-806078A 1	M2/MERCARB	18-7098-1	3310-860070A 2	18-7202	—
3.0L	181/L4	1998-2002	L010042	M385672	3310-807504A 1	M2/MERCARB	18-7098-1	3310-8M0045397	18-7202	—
3.0L	181/L4	2003-2004	M385673	W301999	3310-864940A01	M2/MERCARB	18-7098-1	3310-8M0045397	18-7202	—
3.0L	181/L4	1999-2004	L382122	W301999	3310-864940A01	M2/MERCARB	18-7098-1	865959A01	18-7202 □	—

- ① Automatic Choke
- ② Black
- ③ Blue
- ④ Electric Choke
- ⑤ Front (Blue)

- ⑥ On-Line
- ⑦ Rear (Blue)
- ⑧ Spacer Mounted
- ⑨ Use if original carb is MERCARB
- ⑩ Use if original carb is Rochester

- ① Use with in-line transmission
- ② Use with V-drive transmission
- ③ V-drive
- ④ Wedge mounted
- ⑤ TKS Retrofit Kit

CARBURETOR APPLICATION

Model	CID/Cyl	Year Range	Beginning Serial #	Ending Serial #	Original Carb Part Number	Carb Code/Model	Carb Repair Kit	Replacement O.E. Carb No.	Float	Sierra Carb #
3.0L	181/L4	2004-2010	W302000	& UP	3310-866140A02	M2/MERCarb	18-7098-1	3310-866140A02	18-7202	—
3.0LX	181/L4	1990-1997	C856559	K999999	1389-815397A 2	M2/MERCarb	18-7098-1	3310-8M0045397	18-7202	—
3.0LX	181/L4	1990-1997	C856559	K999999	3310-805924A 2	M2/MERCarb	18-7098-1	3310-8M0045397	18-7202	—
165 (4 CYL)	224/L4	1987	B434941	B774251	1389- 9564A 1	M2/MERCarb	18-7098-1	3310-860071A 2	18-7202	—
170	224/L4	1985-1989	6916779	B434940	1389- 9564A 1	M2/MERCarb	18-7098-1	3310-860071A 2	18-7202	—
180	224/L4	1987	B436391	B775248	1347- 9142A 2	17083522 R4/4ME	18-7077	—	18-7201	—
190 (4 CYL)	224/L4	1985-1986	6916779	B436390	1347- 9142A 2	17083522 R4/4ME	18-7077	—	18-7201	—
3.7L	224/L4	1988-1989	B774252	& UP	1389- 9564A 1	M2/MERCarb	18-7098-1	3310-860071A 2	18-7202	—
3.7LX	224/L4	1988-1989	B775249	& UP	1347- 9142A 2	17083522 R4/4ME	18-7077	—	18-7201	—
470	224/L4	1976-1984	4208730	6916778	1376- 5990A 1	17057132 R2/2GC	18-7076	3310-860071A 4	18-7202 ⑩	—
470	224/L4	1983-1984	6218037	6916778	1389- 8489A 5	M2/MERCarb	18-7097	3310-860071A 2	18-7202 ⑨	—
485	224/L4	1980-1982	5685394	6218036	1376- 5990A 1	17057132 R2/2GC	18-7076	3310-860071A 4	18-7202	—
488	224/L4	1983-1984	6170297	6916778	1347- 8460A 3	17081299 R4/4ME	18-7077	—	18-7201	18-7619-1
150	230/L6	1964-1966	1830152	2048046	1338- 2633	8025188 R2/2GC	18-7746	—	18-7200	—
160	250/L6	1967-1968	2048022	2492038	1338- 2991	7026088 R2/2GC	18-7746	—	18-7200	—
160	250/L6	1969	2492036	277031	1351- 3635A 1	7036646 R/2GC	18-7746	—	18-7200	—
165 (6 CYL)	250/L6	1970-1972	3774865	3354791	1351-4282A1	7043183 R2/2GC	18-7746	1347-818620R02	18-7200	—
165 (6 Cyl)	250/L6	1979-1981	5178959	5813433	1351-7356A1	17059050 R2/2GC	18-7746	1347-818620R02	18-7200	—
165 (6 Cyl)	L6	1972-1973	3354702	3774864	1351-4871A1	R2/2GC	—	1347-818620 1	—	—
180/190 3.7L,					—	R4/4ME	—	1347-8460	—	18-7619-1
L4 Engine	—	1985-1989	6916779	Later	1347-9142A2	R4/4ME	—	—	—	18-7619-1
200 (6 CYL)	292/L6	1969	2453769	2494935	1347- 3237A 4	7037082 R4/4MV	18-7077	—	18-7201	—
185 (4bbl)	229/V-6	1993-1994	6330183	6919655	3300- 8886A 2	17083515 R4/4ME	18-7077	—	18-7201	—
175	262/V-6	1987	B527955	B773242	3304- 9565A 1	M2/MERCarb	18-7098-1	3310-807764A 1	18-7202	—
185	262/V-6	1985-1986	A331455	B527954	3304- 9353A 2	M2/MERCarb	18-7097	3310-807764A 1	18-7202	—
205	262/V-6	1985-1987	A331455	B775129	3304-9354A2	17084516 R4/4MV	18-7077	—	18-7201	18-7605-1
4.3L	262/V-6	1988-1992	B773243	D714106	3304- 9565A 1	M2/MERCarb	18-7098-1	3310-807764A 1	18-7202	—
4.3L	262/V-6	1992-1993	D714107	F000877	3304- 9565A 1	M2/MERCarb	18-7098-1	3310-807764A 1	18-7202	—
4.3L	262/V-6	1993-1995	F000878	F601126	3310-806972A 1	M2/MERCarb	18-7098-1	3310-807764A 1	18-7202	—
4.3L	262/V-6	1996-2002	F601127	M614999	3310-807764A 1	M2/MERCarb	18-7098-1	3310-807764A 1	18-7202	—
4.3L	262/V-6	2002-2004	M615000	W300012	3310-864941A01	M2/MERCarb	18-7098-1	3310-864941A01	18-7202	—
4.3L	262/V-6	2000-2004	L619000	W300012	3310-864941A01	M2/MERCarb	18-7098-1	865960A02	18-7202 ⑤	—
4.3L	262/V-6	2004- 2010	W300013	& UP	3310-866141A02	M2/MERCarb	18-7098-1	3310-866141A02	18-7202	—
4.3LH	262/V-6	1998-2002	L010044	M614999	3310-807826A 1	9666 WEBER	18-7749	—	—	—
4.3LX	262/V-6	1988-1991	B775130	D714369	3304- 9354A 2	17084516 R4/4MV	18-7077	1347-804623R02	18-7201	18-7605-1
4.3LX	262/V-6	1992-1996	D714370	F802999	3310-818660A 1	9600 WEBER	18-7749	—	—	—
4.3XH	262/V-6	1996-1997	F803114	K999999	3310-807826A 1	9666 WEBER	18-7749	—	—	—
215 MCM/MIE (FORD)	302/V-8	1970-1972	2781153	3385720	1356- 4066	C9FF9510E H4/4160	18-7096	1356-804628R02	18-7206	—
225 MCM/MIE (FORD)	302/V-8	1973-1974	3385721	4166999	1356- 5155	D2JL9510C H4/4160	18-7096	1356-804628R02	18-7206	—
888	302/V-8	1971-1977	3108723	4887829	1376-5659A1	7044185 R2/2GC	18-7075	1376-818622R02	18-7202 ⑩	18-7603-1
888	302/V-8	1971-1977	3108723	4887829	1356- 4642	D1JJ95108 H2/2300	18-7081	—	—	—
198 MIE	305/V-8	1977	4776402	4931099	1376- 6491A 1	17057139 R2/2GC	18-7075	3310-861080A 1	18-7202	—
200	305/V-8	1985-1986	6899058	A482026	1389- 8488A 2	M2/MERCarb	18-7097	3310-861080A 1	18-7202	—
200	305/V-8	1985-1987	A482027	B525981	1389- 9563A 1	M2/MERCarb	18-7098-1	3310-861080A 1	18-7202	—
200	305/V-8	1987	B525982	B774444	1389- 9670A 2	M2/MERCarb	18-7098-1	3310-807312A1	18-7202	—
228	305/V-8	1977-1978	4765100	5069430	1347-6427A1	17057282 R4/4MV	18-7077	9661A 3	18-7201	18-7605-1
228	305/V-8	1978-1981	5069431	6021783	1347-7361A1	17059292 R4/4MV	18-7077	9661A 3	18-7201	18-7605-1
228	305/V-8	1982	6021784	6218461	1347-8296A4	17080565 R4/4MV	18-7077	9661A 3	18-7201	18-7605-1
228	305/V-8	1982-1984	6218462	6899268	1347- 9661A 3	17080565 R4/4MV	18-7077	9661A 3	18-7201	18-7605-1
228 MIE	305/V-8	1977-1978	4765100	5069430	1347-6438A1	17057283 R4/4MV	18-7077	9661A 3	18-7201	18-7605-1
228 MIE	305/V-8	1978-1982	5069431	6040745	1347-7364A1	17059291 R4/4MV	18-7077	9661A 3	18-7201	18-7605-1
228 TR	305/V-8	1977-1978	4765100	5069430	1347- 6438A 1	17057283 R4/4MV	18-7077	9661A 3	18-7201	18-7605-1

- ① Automatic Choke
- ② Black
- ③ Blue
- ④ Electric Choke
- ⑤ Front (Blue)

- ⑥ On-Line
- ⑦ Rear (Blue)
- ⑧ Spacer Mounted
- ⑨ Use if original carb is MERCarb
- ⑩ Use if original carb is Rochester

- ⑪ Use with in-line transmission
- ⑫ Use with V-drive transmission
- ⑬ V-drive
- ⑭ Wedge mounted
- ⑮ TKS Retrofit Kit

CARBURETOR APPLICATION

Model	CID/Cyl	Year Range	Beginning Serial #	Ending Serial #	Original Carb Part Number	Carb Code/Model	Carb Repair Kit	Replacement O.E. Carb No.	Float	Sierra Carb #
230	305/V-8	1985-1987	6899269	B773739	1347-9661A 3	17080565 R4/4MV	18-7077	9661A 3	18-7201	18-7605-1
230 MIE	305/V-8	1982-1987	6040746	B788151	1347-8290A1	17080564 R4/4MV	18-7077	9661A 3	18-7201	18-7605-1
223/230/5.0LX	V-8	1983-1995	6218462	F600999	1347-9661A3	R4/4MV	—	1347-9661A3	—	18-7605-1
5.0L	305/V-8	1988-1995	B774445	F600999	1389-9670A 2	M2/MERCARB	18-7098-1	3310-807312A1	18-7202	—
5.0L (GEN +)	305/V-8	1998-2002	L015751	M599999	3310-861448A 1	M2/MERCARB	18-7098-1	3310-864942A01	18-7202	—
5.0L (GEN +)	305/V-8	2002-2004	M600000	W300009	3310-864942A01	M2/MERCARB	18-7098-1	3310-864942A01	18-7202	—
5.0L (GEN +)	305/V-8	2000-2004	L619000	W300009	3310-864942A01	M2/MERCARB	18-7098-1	865961A02	18-7202 ⑤	—
5.0L (GEN +)	305/V-8	2004-2010	W300010	& UP	3310-866142A03	M2/MERCARB	18-7098-1	3310-866142A04	18-7202	—
5.0LX	305/V-8	1988-1995	B773740	F600999	1347-9661A 3	17080565 R4/4MV	18-7077	9661A 3	18-7201	18-7605-1
898/200/5.0L	V-8	1987-95	B525982	F600999	1389-9670A2	M2/MERCARB	—	3310-807312A1	—	18-7611-1
898	305/V-8	1977	4762210	6021383	1376-6491A 1	17057139 R2/2GC	18-7075	3310-861080A 1	18-7202	—
898	305/V-8	1982	6021384	6218461	1376-8295A 3	17080350 R2/2GC	18-7075	3310-861080A 1	18-7202	—
898	305/V-8	1983-1984	6218462	6899057	1389-8488A 2	M2/MERCARB	18-7097	3310-861080A 1	18-7202	—
225 MCM/MIE (GM)	327/V-8	1963-1969	1539620	2694014	1347-3237A 3 ①	7037082 R4/4MV	—	1347-804624R02	—	—
250	350/V-8	1977	4768000	4908849	1347-3353 ①	7037082 R4/4MV	—	1347-804624R02	—	—
250	350/V-8	1977	4768000	4908849	1347-3237A 3 ①	7037082 R4/4MV	—	1347-804624R02	—	—
255	350/V-8	1975-1976	4175550	4767999	1347-5732A 1	7044291 R4/4MV	18-7077	1347-804624R02	18-7201	—
255 MIE (GM)	350/V-8	1975-1978	4175550	4924564	1347-5732A 1	7044291 R4/4MV	18-7077	1347-804624R02	18-7201	—
255 MIE (GM)	350/V-8	1978	4924565	5195908	1347-7062A1	17057292 R4/4MV	18-7077	1347-804624R02	18-7201	—
255 MIE (GM)	350/V-8	1979-1980	5195909	5907057	1347-7365A1	17059289 R4/4MV	18-7077	1347-804624R02	18-7201	—
260 MIE	V-8	1980-1986	5907058	B522505	1347-8289A1	R4/4MV	—	1347-8289A1	—	18-7618-1
260	350/V-8	1978	4908850	5060805	1347-6492A 1	17057298 R4/4MV	18-7077	1347-804624R02	18-7201	—
260	350/V-8	1976-1982	5060806	6024393	1347-7362A 1	17059288 R4/4MV	18-7077	1347-804624R02	18-7201	—
260	350/V-8	1982-1987	6024393	B525981	1347-8292A 4	17080561 R4/4MV	18-7077	1347-804624R02	18-7201	—
260	350/V-8	1987	B525982	B773304	1347-9662A 1	17080561 R4/4MV	18-7077	1347-804624R02	18-7201	—
260 MIE	350/V-8	1981-1987	5907058	B522505	1347-8289A 1	17080562 R4/4MV	18-7077	1347-804624R02	18-7201	—
260 MIE	350/V-8	1987	B522506	B788151	1347-9662A 1	17080561 R4/4MV	18-7077	1347-804624R02	18-7201	—
260/5.7MIE	V-8	1987-1993	B522506	F024999	1347-966A4	R4/4MV	—	1347-816373A4	—	—
260/5.7L ALPHA	V-8	1987-1993	B525982	F000454	1347-9662A4	R4/4MV	—	1347-816373A4	—	—
270 MCM/MIE	350/V-8	1969-1972	2851074	3385720	1347-4180A 1	7029285 R4/4MV	18-7077	—	18-7201	—
280 TRS	350/V-8	1975	4176250	4176468	1347-4179A 2	7040283 R4/4MV	18-7077	—	18-7201	—
280 TRS	350/V-8	1975-1976	4176469	4770199	1347-5981A 1	7044290 R4/4MV	18-7077	—	18-7201	—
300 MR/TRS	350/V-8	1985-1986	6668677	B430367	1347-7498A 7	17059280 R4/4MV	18-7077	—	18-7201	—
350 MAG ALPHA	350/V-8	1986-1991	A635178	D617327	1347-8289A 1	17080562 R4/4MV	18-7077	1347-804624R02	18-7201	—
350 MAG ALPHA	350/V-8	1992-1995	D617328	F600999	3310-806970A 1	9770SA WEBER	18-7749	3310-807262A 1	—	—
350 MAG ALPHA	350/V-8	1996-1997	F601000	K999999	3310-807262A 2	9781 WEBER	18-7748	—	—	—
350 MAG SKI	350/V-8	1991-1996	D505450	K040399	3310-806970A 1	9770SA WEBER	18-7749	—	— ①	—
350 MAG SKI	350/V-8	1991-1997	D505450	K999999	3310-807262A 2	9781 WEBER	18-7748	—	— ①	—
350 MAG SKI	350/V-8	1997	K040400	K999999	3310-860371A 1	9781SB WEBER	18-7748	—	— ②	—
5.7L (2BBL)	350/V-8	1996-1997	F601000	K999999	3310-807312A1	M2/MERCARB	18-7098-1	3310-807312A1	18-7202	18-7611-2
5.7L (GEN +) (2bbl)	350/V-8	1998-2002	L010037	M599999	3310-861245A 1	M2/MERCARB	18-7098-1	3310-864943A01	18-7202	18-7639
5.7L (GEN +) (2bbl)	350/V-8	2002-2004	M600000	W300754	3310-864943A01	M2/MERCARB	18-7098-1	3310-864943A01	18-7202	18-7639
5.7L (GEN +) (2bbl)	350/V-8	2000-2004	L015751	W300754	3310-864943A01	M2/MERCARB	18-7098-1	865962A02	18-7202 ⑤	—
5.7L (Gen II)	V-8	1998-2004	L010037	W300754	3310-864943101	M2/MERCARB	—	3310-864943101	—	18-7639
5.7L (GEN +) (2bbl)	350/V-8	2004-2010	W300755	& UP	3310-866143A03	M2/MERCARB	18-7098-1	3310-866143A03	18-7202	—
5.7L ALPHA	350/V-8	1988-1993	B773305	F000454	1347-9662A 4	17080561 R4/4MV	18-7077	1347-804624R02	18-7201	—
5.7L ALPHA	350/V-8	1993-1994	F000455	F273497	3310-805484A 1	9661 WEBER	18-7749	—	—	—
5.7L ALPHA	350/V-8	1993-1994	F000455	F273497	3310-806761A 1	9665S WEBER	18-7748	—	—	—
5.7L ALPHA	350/V-8	1994-1995	F273498	F600999	3310-806761A 3	9665S WEBER	18-7748	3310-806761A 3	—	—
5.7L BRAVO	350/V-8	1988-1991	B773305	D617327	1347-9662A 4	17080561 R4/4MV	18-7077	1347-804624R02	18-7201	—
(W/O HIGH RISE INTAKE)										
5.7L BRAVO	350/V-8	1988-1991	B773305	D617327	1347-8289A 1	17080562 R4/4MV	18-7077	1347-804624R02	18-7201	—
(W/HIGH RISE INTAKE)										

- ① Automatic Choke
- ② Black
- ③ Blue
- ④ Electric Choke
- ⑤ Front (Blue)

- ⑥ On-Line
- ⑦ Rear (Blue)
- ⑧ Spacer Mounted
- ⑨ Use if original carb is MERCARB
- ⑩ Use if original carb is Rochester

- ① Use with in-line transmission
- ② Use with V-drive transmission
- ③ V-drive
- ④ Wedge mounted
- ⑤ TKS Retrofit Kit

CARBURETOR APPLICATION

Model	CID/Cyl	Year Range	Beginning Serial #	Ending Serial #	Original Carb Part Number	Carb Code/Model	Carb Repair Kit	Replacement O.E. Carb No.	Float	Sierra Carb #
5.7L BRAVO	V-8	1987-1991	OB525982	OD617327	1347-9662A4	R4/4MV	—	1347-816373A4	—	—
W/O HIGH RISE INTAKE										
5.7L BRAVO	V-8	1987-1991	OB525982	OD617327	1347-8289A1	R4/4MV	—	1347-8289A1	—	18-7618-1
W/HIGH RISE INTAKE										
5.7L BRAVO	350/V-8	1992-1995	D617328	F600999	3310-806970A 1	9770SA WEBER	18-7749	3310-807262A 1	—	—
5.7L MIE	350/V-8	1988-1992	B768152	D715493	1347- 9662A 4	17080561 R4/4MV	18-7077	1347-804624R02	18-7201	—
5.7L MIE	350/V-8	1992-1994	D715494	F349999	3310-806761A 2 □	9665S WEBER	18-7748	3310-806761A 2	—	—
5.7L MIE	350/V-8	1995	F349300	F622099	3310-806761A 3	9665S WEBER	18-7748	3310-806761A 3	—	—
5.7L MIE (2bb)	350/V-8	1998-2002	L002003	M316999	3310-861245A 1	M2/MERCARB	18-7098-1	3310-864943A01	18-7202	18-7639
5.7L MIE (2bb)	350/V-8	2002-2004	M317000	W090899	3310-864943A01	M2/MERCARB	18-7098-1	3310-864943A01	18-7202	18-7639
5.7L MIE (2bb)	350/V-8	2000-2004	L390600	W090899	3310-864943A01	M2/MERCARB	18-7098-1	865962A02	18-7202	⑤
5.7L MIE (2bb)	350/V-8	2004-2010	W090900	& UP	3310-866143A03	M2/MERCARB	18-7098-1	3310-866143A03	18-7202	—
5.7L SKI	350/V-8	1985-1987	A338553	B514626	1347- 9415T	17085013 R4/4MV	18-7077	9415T	18-7201	—
5.7L SKI	V-8	1985-1993	A338533	F025099	1347-9415T	R4/4MV	—	1347-9415T	—	—
5.7L SKI	350/V-8	1987-1995	F450000	F775199	3310-805484A 1	9661 WEBER	18-7749	3310-806761A 3	—	—
5.7L SKI (2bb)	350/V-8	1996-1997	F775200	K999999	3310-807312A1	M2/MERCARB	18-7098-1	3310-807312A1	18-7202	18-7611-2
5.7L SKI (GEN +) (2bb)	350/V-8	1998-2002	L002005	M316999	3310-861245A 1	M2/MERCARB	18-7098-1	3310-864943A01	—	18-7639
5.7L SKI (GEN +) (2bb)	350/V-8	2002-2004	M317000	W090899	3310-864943A01	M2/MERCARB	18-7098-1	3310-864943A01	—	18-7639
5.7L SKI (GEN +) (2bb)	350/V-8	2000-2004	L390600	W090899	3310-864943A01	M2/MERCARB	18-7098-1	865962A02	18-7202	⑤
5.7L SKI (GEN +) (2bb)	350/V-8	2004-2010	W090900	& UP	3310-866143A03	M2/MERCARB	18-7098-1	3310-866143A03	18-7202	—
5.7LX (4bb)	350/V-8	1996-1997	F601000	K999999	3310-807262A 2	9761 WEBER	18-7748	—	—	—
233 MCM & MCI (FORD)	351/V-8	1975-1977	4173000	4465029	1376- 5744 1	7044187 R2/2GC	18-7075	1347-818622R02	—	18-7603-1
233 MCM & MCI (FORD)	351/V-8	1975-1977	4465030	4902304	1376- 6152A 1	17056197 R2/2GC	18-7075	1347-818622R02	—	18-7603-1
325 MCM/MIE	427/V-8	1969-1970	2278747	3042730	1347- 3342 □	7027080 R4/4MV	18-7077	—	18-7201	—
325 MCM/MIE	427/V-8	1971-1972	3042731	3780449	1347- 4533A 1 □	7041831 R4/4MV	18-7077	—	18-7201	—
325 MCM/MIE	427/V-8	1969-1972	2278747	3780449	1347- 3689A 1 □	7029280 R4/4MV	18-7077	—	18-7201	—
330 MCM	427/V-8	1977-1978	4623115	5027230	1347-6493A1	17057287 R4/4MV	18-7077	1347-804626R02	18-7201	18-7616-1
330 MCM	427/V-8	1977-1981	5027231	6083144	1347-7363A1	17059290 R4/4MV	18-7077	1347-804626R02	18-7201	18-7616-1
330 MCM	427/V-8	1982-1987	6083145	B816540	1347-8291A3	17080563 R4/4MV	18-7077	1347-804626R02	18-7201	18-7616-1
330 MIE	427/V-8	1977-1978	4623115	5226384	1347-6493A1	17057287 R4/4MV	18-7077	1347-804626R02	18-7201	18-7616-1
330 MIE	427/V-8	1979-1980	5226385	5889913	1347-7366A1	17059287 R4/4MV	18-7077	1347-804626R02	18-7201	18-7616-1
340 MIE	454/V-8	1981-1987	5889914	D788365	1347-8288A1	17080560 R4/4MV	18-7077	1347-804626R02	18-7201	18-7616-1
370	454/V-8	1978-1987	4179554	B714586	1347- 7498A 2	17059280 R4/4MV	18-7077	1347-804625R02	18-7201	—
400	454/V-8	1980-1986	4179554	B457644	1347- 7498A 2	17059280 R4/4MV	18-7077	1347-804625R02	18-7201	—
420	454/V-8	1987-1989	A398941	B622418	13549A 4	H4	18-7751	—	—	—
425	454/V-8	1990-1993	B622419	D937011	13549A 4	H4	18-7751	—	—	—
440	454/V-8	1983-1986	4179554	B485220	1393- 8862A 1	H4	18-7751	—	—	—
450	454/V-8	1995-1996	F347100	F347277	13549A14	H4	18-7751	—	—	—
454 MAG ALPHA	454/V-8	1986-1988	A631894	B785148	1347-8291A3	17080563 R4/4MV	18-7077	1347-804626R02	18-7201	18-7616-1
454 MAG BRAVO	454/V-8	1988-1992	B721206	D808068	1347-7498A2	17059280 R4/4MV	18-7077	1347-804625R02	18-7201	18-7617-1
454 MAG BRAVO	454/V-8	1992-1994	D805069	F304999	3310-806755A 1	9779 WEBER	18-7748	—	—	—
454 MAG BRAVO	454/V-8	1995-1997	F305000	K999999	3310-806755A 2	9779 WEBER	18-7748	—	—	—
7.4L BRAVO I/II	454/V-8	1988-1991	B771113	D603117	1347-8291A3	17080563 R4/4MV	18-7077	1347-804626R02	18-7201	18-7616-1
7.4L BRAVO I/II	454/V-8	1992-1994	D603118	F351999	3310-806969A 2	9780 WEBER	18-7748	—	—	—
7.4L BRAVO I/II	454/V-8	1995-1997	F352000	K999999	3310-806969A1	9780 WEBER	18-7748	3310-806969A 1	—	—
7.4L BRAVO III	454/V-8	1993-1996	D838819	F800699	3310-806755A 2	9779 WEBER	18-7748	—	—	—
7.4L BRAVO III	454/V-8	1996-1997	F800700	K999999	3310-806969A1	9780 WEBER	18-7748	3310-806969A 1	—	—
7.4L MIE	454/V-8	1988-1992	5889914	D715493	1347- 8268A 1	17080560 R4/4MV	18-7077	1347-804626R02	18-7201	18-7616-1
460	482/V-8	1983-1986	4179554	B485220	1393- 8862A 1	H4	18-7751	—	—	—
465	502/V-8	1990-1992	C849992	F213244	—	H4	18-7751	—	—	②
465	502/V-8	1990-1992	C849992	F213244	—	H4	18-7751	—	—	③
500	502/V-8	1994-1995	F213293	F615766	13549A12	H4	18-7751	—	—	④

- ① Automatic Choke
- ② Black
- ③ Blue
- ④ Electric Choke
- ⑤ Front (Blue)

- ⑥ On-Line
- ⑦ Rear (Blue)
- ⑧ Spacer Mounted
- ⑨ Use if original carb is MERCARB
- ⑩ Use if original carb is Rochester

- ① Use with in-line transmission
- ② Use with V-drive transmission
- ③ V-drive
- ④ Wedge mounted
- ⑤ TKS Retrofit Kit

CARBURETOR APPLICATION

Model	CID/Cyl	Year Range	Beginning Serial #	Ending Serial #	Original Carb Part Number	Carb Code/Model	Carb Repair Kit	Replacement O.E. Carb No.	Float	Sierra Carb #
500	502/V-8	1996-1998	F615767	L001772	13549A 15	H4	18-7751	—	— [ⓐ]	—
500 (GEN +)	502/V-8	1999	L414639	L601036	13549T21	H4	18-7751	—	— [ⓐ]	—
502 MAG	502/V-8	1990-1992	C878221	D824588	1347-814623A 2	17089112 R4/4MV	18-7077	—	18-7201	—
502 MAG	502/V-8	1992-1993	D824589	F114528	3310-806971A 1	9782 WEBER	18-7748	—	—	—
8.2L MIE	502/V-8	1990-1992	C878221	D857199	1347-814623A 2	17089113 R4/4MV	18-7077	—	—	—
8.2L MIE	502/V-8	1990-1992	C878221	D857199	3310-817693A 1	9774 WEBER	18-7748	—	—	—
8.2L MIE	502/V-8	1993-1996	D857200	F819619	3310-806971A 1	9782 WEBER	18-7748	—	—	—
500 BULLDOG	540/V-8	1990-1995	C577254	F348987	13549A10	H4	18-7751	—	— [ⓐ]	—
500 BULLDOG	540/V-8	1995-2001	F615762	M050281	13549A23	H4	18-7751	—	— [ⓐ]	—

- ⓐ Automatic Choke
- ⓑ Black
- ⓒ Blue
- ⓓ Electric Choke
- ⓔ Front (Blue)

- ⓕ On-Line
- ⓖ Rear (Blue)
- ⓗ Spacer Mounted
- ⓓ Use if original carb is MERCarb
- ⓔ Use if original carb is Rochester

- ① Use with in-line transmission
- ② Use with V-drive transmission
- ③ V-drive
- ④ Wedge mounted
- ⑤ TKS Retrofit Kit



**18-8114
FUEL LINE HOSE**

For fuel pump to carburetor connection. Replaces copper or steel tubing 3/8" X 31" PTFE composite hose with 5/8"-18 male inverted flare straight one end, 5/8"-18 90° one end. SAE J1527 type A1



**18-8115
FUEL LINE HOSE**

For fuel pump to carburetor connection. Replaces copper or steel tubing 3/8" X 25" PTFE composite hose with 5/8"-18 male inverted flare straight one end, 5/8"-18 90° one end. SAE J1527 type A1

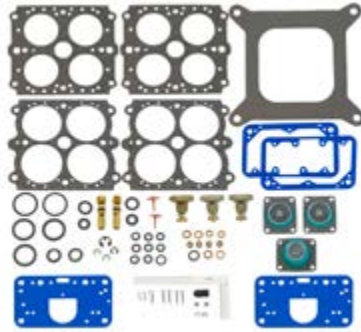

**18-7751
CARB KIT**

Replaces: 13220
Fits: GM 420 V8 454 (1987-89), GM 425 V8 454 (1990-93), GM 425 (Gen V) V8 454 (1992-93), 440 TRS GM 454 (1983-86), GM 450 V8 454 (1995-96), 460 TRS V8 482 (1983-86), GM 465 V8 502 (1990-92), GM 465 (Gen V) V8 502 (1992-94), 500 (Gen+) GM 502 V8 (1999), 500 (Gen V) 502 V8 (1994-98), 500 Bulldog 540 V8 (1990-01)



**18-7071
CARB KIT**

Replaces: 1397-3458



**18-7075
CARB KIT**

Replaces: 1397-5830, 1397-7099, 1397-8760, 1397-5831



**18-7070
CARB KIT**

Replaces: 1397-2072, 1397-7542, 1397-2637, 1397-7543, 1397-8872, 1397-3464



18-7072
CARB KIT
Replaces: 1397-3306, 1397-4329,
1397-5635, 1397-6638, 823426A1



18-7076
CARB KIT
Replaces: 1397-6367, A1



18-7077
CARB KIT
Replaces: 1397-8952, 823426A1



18-7748
CARB KIT
Replaces: 809064



18-7080
CARB KIT
Replaces: 1398-3089
Fits: 1346-2770



18-7081
CARB KIT
Replaces: 1396-4656
Contains adjustable needles and seats



18-7095
CARB KIT
Replaces: 1397-7539, 1397-7540, 1397-7544,
1397-8535, 1397-9723



18-7096
CARB KIT
Replaces: 1396-5238, 1396-5222, 1356-4092
Fits: 1356-5169, 1356-5155, 1356-4066
Contains adjustable needles and seats



18-7097
CARB KIT
Replaces: 3302-9437, 3302-804845
MerCarb 2 bbl. bottom fill accelerator pump 1983-1986
MCM 120, 140, 470, 185, 200, 898



18-7098-1
CARB KIT
Replaces: 3302-804844002,
3302-804844001, 3302-804844
MerCarb 2 bbl. side fill accelerator pump
1986 and UP MCM 4-cyl., V6 & V8





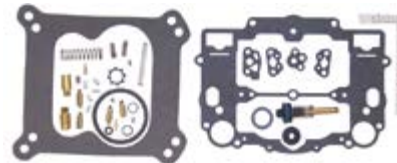

18-7728
CARB KIT





18-7749
CARB KIT
Replaces: 809065, 835076, 823728

18-7746
CARB KIT
Replaces: 823427A1, 1397-8873, 1397-8872, 1397-7547, 1397-7543, 1397-7542,
1397-3464, 1397-3459, 1397-2637, 1397-2634, 1397-2631, 1397-2067
Repair Kit for 2 BBL Rochester



 <p>18-7200 FLOAT Replaces: 1397-2060 (Alcohol Resistant) Plastic</p>	 <p>18-7201 FLOAT Replaces: 1397-3327, 1397-8546, 1397-8959 (Alcohol Resistant) Brass</p>	 <p>18-7202 FLOAT Replaces: 1397-5837, 3302-9031 (Alcohol Resistant) Brass</p>
 <p>18-36906 CARB FLOAT Replaces: 811536, 811536T Fits: Mercruiser w/ 4 bbl Weber Carb</p>	 <p>18-7666 CHOKE PULL-OFF Replaces: 1397-8582 Rochester 4V carburetors</p>	 <p>18-7664 CHOKE THERMOSTAT Replaces: 809066 Weber 4V Carburetors with electric choke</p>

 <p>18-7665 CHOKE THERMOSTAT Replaces: 70125A1, 70125A02, 70125 Rochester & Mercarb 2V with electric choke</p>	 <p>18-7667 CHOKE THERMOSTAT Replaces: 71464A01, 71464, 72625 Rochester Carburetors with divorced choke</p>
--	---

CARBURETOR KIT/FLOAT APPLICATION

Model & Serial #	Mercruiser Carb #	Mfg. Carb #	Carb. Code & Model	Carb Kit ①	Float
MCM 80 ALL	1346-2770	RBS-4394S	C1/RBS	18-7080	—
MCM 90					
3225967 & BELOW	1351-4263A1	7040082	R2/2GC	18-7746	18-7200
3225968 & ABOVE	1351-4263A2	7041369	R2/2GC	18-7746	18-7200
MCM110 ALL	1336-2076	7036543	R2/2GC	18-7070	18-7200
MCM 120/2.5L					
2520424 & BELOW	1336-2076	7036543	R2/2GC	18-7746	18-7200
2520425-3377340	1336-3594A1	7036543	R2/2GC	18-7746	18-7200
3377341-3770649	1351-4263A3	7041369	R2/2GC	18-7746	18-7200
3770650-4469865	1351-5202A1	7043182	R2/2GC	18-7746	18-7200
4469866-5192047	1351-6065A2	7044182	R2/2GC	18-7746	18-7200
5192048-6229717	1351-7354A1	17059054	R2/2GC	18-7746	18-7200
6229718 & ABOVE	1351-8480A2	17081060	R2/2GC	18-7746	18-7200
6229718 & ABOVE	1389-8490A2	N/A	M2/Mercarb	18-7097	18-7202
6229718 & ABOVE	1389-9350A2	N/A	M2/Mercarb	18-7097	18-7202
6229718 & ABOVE	1389-9562A1	N/A	M2/Mercarb	18-7098-1	18-7202
MCM 140 /3.0L/3.0LX(4 cyl.)					
2816416 & BELOW	1351-3635A1	7036646	R2/2GC	18-7746	18-7200
2816417-3332137	1351-4032A1	7040080	R2/2GC	18-7746	18-7200
3332138-3771644	1351-4293A1	7040084	R2/2GC	18-7746	18-7200
3771645-5157668	1351-5203A1	7043184	R2/2GC	18-7746	18-7200
5157669-6229717	1351-7355A1	17059052	R2/2GC	18-7746	18-7200
6229718-C856558	1351-8480A2	17081060	R2/2GC	18-7746	18-7200
6229718-C856558	1389-8490A2	N/A	M2/Mercarb	18-7097	18-7202
6229718-C856558	1389-9350A2	N/A	M2/Mercarb	18-7097	18-7202
6229718-C856558	1389-9562A1	N/A	M2/Mercarb	18-7098-1	18-7202
C856559 & ABOVE	1389-815396A2	N/A	M2/Mercarb	18-7098-1	18-7202
C856559 & ABOVE	1389-815397A2	N/A	M2/Mercarb	18-7098-1	18-7202
MCM 140 (6 cyl)					
ALL (BC)	1338-2161	7025638	R1/BC	18-7071	—

① Does not include metering rods

CARBURETOR KIT/FLOAT APPLICATION (Cont.)

Model & Serial #	Mercruiser Carb #	Mfg. Carb #	Carb. Code & Model	Carb Kit ①	Float
ALL (B)	1338-2166	7025662	R1/B	18-7071	—
MCM 150					
1823489 & BELOW	1338-2428	7024180	R1/BC	18-7071	—
1823489 & BELOW	1338-2431	7024181	R1/B	18-7071	—
1823490-1830151	1338-2608	7025183	R1/BC	18-7071	—
1823490-1830151	1338-2609	7025184	R1/B	18-7071	—
1830152 & ABOVE	1338-2633	7025188	R2/2GC	18-7070	18-7200
MCM 160					
2492035 & BELOW	1338-2991	7026088	R2/2GC	18-7746	18-7200
2492036 & ABOVE	1351-3635A1	7036646	R2/2GC	18-7746	18-7200
MCM 165 (6 cyl)					
3354701 & BELOW	1351-4282A1	7040083	R2/2GC	18-7746	18-7200
3354702-3774864	1351-4871A1	7042183	R2/2GC	18-7746	18-7200
3774865-5178958	1351-5204A1	7043183	R2/2GC	18-7746	18-7200
5178959 & ABOVE	1351-7356A1	17059050	R2/2GC	18-7746	18-7200
MCM 165/170/3.7L (4 cyl)					
6218037-6916778	1389-8489A5	N/A	M2/Mercarb	18-7097	18-7202
6916779 & ABOVE	1389-9564A1	N/A	M2/Mercarb	18-7098-1	18-7202
MCM 175/4.3L/185 (V-6)	3304-9565A1	N/A	M2/Mercarb	18-7098-1	18-7202
(229 CID) ALL					
A221455-D714106	3300-8886A2	17083515	R4/4MV	18-7095	18-7201
185 (262 CID)					
A221455-B527954	3304-9353A2	N/A	M2/Mercarb	18-7097	18-7202
MCM 205 (262 CID)	3304-9354A2	—	R4/4MV	18-7095	18-7201
A331455-D714369	3304-9565A1	N/A	M2/Mercarb	18-7098-1	18-7202
MCM/MIE 470 ALL	1376-5990A1	17057132	R2/2GC	18-7076	18-7202
MCM 485 ALL	1376-5990A1	17057132	R2/2GC	18-7076	18-7202
MCM 488 ALL	1347-8460A3	17081299	R4/4ME	18-7077	18-7201
MCM 888					
ALL HOLLEY	1356-4642	D1JJ-9510-8	H2/2300	18-7081	18-7206
ALL ROCHESTER	1376-5659A1	7044185	R2/2GC	18-7075	18-7202
MCM 180/190/3.7LX					
(4 cyl)	1347-9142A2	17083522	R4/4MV	18-7095	18-7201
MIE 198/200/5.0L					
6021383 & BELOW	1376-6491A1	17057139	R2/2GV	18-7075	18-7202
6021384 & ABOVE	1376-8295A3	17080350	R2/2GV	18-7075	18-7202
MCM 200 (6 cyl)					
2494935 & BELOW	1347-3237A2	7037082	R4/4MV	18-7072	18-7201
2494936 & ABOVE	1347-3237A4	7037082	R4/4MV	18-7072	18-7201
MCM 898/200/5.0L					
6218462 & ABOVE	1389-8488A2	N/A	M2/Mercarb	18-7097	18-7202
6218462 & ABOVE	1389-9563A1	N/A	M2/Mercarb	18-7098-1	18-7202
6218462 & ABOVE	1389-9670A2	N/A	M2/Mercarb	18-7098-1	18-7202
MCM 205/4.3LX (V-6 262 CID)					
A331455-D714369	3304-9354A2	17084516	R4/4MV	18-7095	18-7201
MCM/MIE 215 ALL	1356-4066	C9FF-9510-E	H4/4160	18-7096	18-7206
MCM/MIE 225 (FORD)					
ALL	1356-5155	D2JL-9510-C	H4/4160	18-7096	18-7206
MCM/MIE 225 (GM)	1337-2103	7025564	R4/4GC	—	—
1536920-2694014	1337-2604	7025756	R4/4GC	—	—
	1347-3353	7037082	R4/4MV	18-7072	18-7201
	1347-3237A3	7037082	R4/4MV	18-7072	18-7201
MCM 228					
5069430 & BELOW	1347-6427A1	17057282	R4/4MV	18-7072	18-7201
MCM 228TR/ MIE 228					
5069430 & BELOW	1347-6438A1	17057283	R4/4MV	18-7072	18-7201
MCM 228/230/5.0L					
5069431-6021783	1347-7361A1	17059292	R4/4MV	18-7095	

① Does not include metering rods

CARBURETOR KIT/FLOAT APPLICATION (Cont.)

Model & Serial #	Mercuriser Carb #	Mfg. Carb #	Carb. Code & Model	Carb Kit ①	Float
6021784-6218461	1347-8296A4	17080565	R4/4MV	18-7095	18-7201
6218462 & ABOVE	1347-9661A3	—	R4/4MV	18-7095	18-7201
MIE 228					
5067431-6040745	1347-7364A1	17059291	R4/4MV	18-7095	18-7201
6040746 & ABOVE	1347-8290A1	17080564	R4/4MV	18-7095	18-7201
MIE 230/5.0L ALL	1347-8290A1	17080564	R4/4MV	18-7095	18-7201
230/5.0LX	1347-9661A3	—	R4/4MV	18-7095	18-7201
MCM/MIE 233					
4465029 & BELOW	1376-5744A1	7044187	R2/2GC	18-7075	18-7202
4465030 & ABOVE	1376-6152A1	17056197	R2/2GC	18-7075	18-7202
MCM/MIE 250 AUTO. CHOKE					
4767999 & BELOW	1347-3353	7037082	R4/4MV	18-7072	18-7201
MCM/MIE 250 (EL. CHOKE)					
4767999 & BELOW	1347-3237A3	7037082	R4/4MV	18-7072	18-7201
MCM 250					
4768000 & ABOVE	1347-6492A1	17057298	R4/4MV	18-7072	18-7201
MCM/MIE 255 (GM)					
4924564 & BELOW	1347-5732A1	7044291	R4/4MV	18-7072	18-7201
4924565-5195908	1347-7062A1	17057295	R4/4MV	18-7072	18-7201
5195909-5907067	1347-7365A1	17059289	R4/4MV	18-7095	18-7201
5907068 & ABOVE	1347-8289A1	17080562	R4/4MV	18-7095	18-7201
MCM/MIE 255 (FORD)					
ALL	1356-5169	D2JL-9510E	H4/4160	18-7096	18-7206
MCM 260/5.7L BRAVO					
5060805 & BELOW	1347-6492A1	17057298	R4/4MV	18-7072	18-7201
5060806-6024393	1347-7362A1	17059288	R4/4MV	18-7095	18-7201
6024394-B525981	1347-8292A4	17080561	R4/4MV	18-7095	18-7201
B525982 & ABOVE	1347-9662A4	—	R4/4MV	18-7095	18-7201
MIE 260/5.7L 350 MAG					
A635178-D617327	1347-8289A1	17080562	R4/4MV	18-7095	18-7201
MIE 5.7 SKI					
A339533-F205099	1347-9415T	17085013	R4/4MV	18-7095	18-7201
MCM/MIE 270 ALL	1347-4180A1	7029285	R4/4MV	18-7072	18-7201
MCM 280					
4176468 & BELOW	1347-4179A2	7040283	R4/4MV	18-7072	18-7201
4176469 & ABOVE	1347-5981A1	7044290	R4/4MV	18-7072	18-7201
MCM 300 MR/TRS (GM)					
6668677 & ABOVE	1347-7498A7	—	R4/4MV	18-7095	18-7201
MCM/MIE 325 AUTO. CHOKE					
3042730 & BELOW	1347-3342	7027080	R4/4MV	18-7072	18-7201
3042731 & ABOVE	1347-4533A1	7041831	R4/4MV	18-7072	18-7201
MCM/MIE 325 EL. CHOKE					
2278747-378099	1347-3689A1	7029280	R4/4MV	18-7072	18-7201
MCM 330/454 MAGNUM (ALPHA ONE)					
5027230 & BELOW	1347-6493A1	17057287	R4/4MV	18-7072	18-7201
5027231-6083144	1347-7363A1	17059290	R4/4MV	18-7095	18-7201
6083145 & ABOVE	1347-8291A3	17080563	R4/4MV	18-7095	18-7201
MIE 330					
5226384 & BELOW	1347-6493A1	17057287	R4/4MV	18-7072	18-7201
5226385 & ABOVE	1347-7366A1	17059287	R4/4MV	18-7095	18-7201
MIE 340/7.4L					
ALL	1347-8288A1	17080560	R4/4MV	18-7095	18-7201
MCM 350 MAGNUM/5.7L BRAVO					
B525992-317327	1347-8289A1	—	R4/4MV	18-7095	18-7201
MIE 350 ALL	1347-5326A2	17065977	R4/4MV	18-7072	18-7201
MCM 370/400 ALL	1347-7498A2	17059280	R4/4MV	18-7095	18-7201
MCM 7.4L (BRAVO ONE)	1347-8291A3	17080563	R4/4MV	18-7095	18-7201
MCM 454 7.4L					

① Does not include metering rods

CARBURETOR KIT/FLOAT APPLICATION (Cont.)

Model & Serial #	Mercuriser Carb #	Mfg. Carb #	Carb. Code & Model	Carb Kit ①	Float
6083145-B816540	—	—	H4/4150, R6647A	18-7728	—
MCM 454 MAGNUM					
(BRAVO ONE)	1347-7498A2	17059280	R4/4MV	18-7095	18-7201
ALL	1347-9863A3	—	R4/4MV	18-7095	18-7201
MCM 502 MAGNUM (BRAVO ONE)					
C878221-D857199	1347-814623A2	—	R4/4MV	18-7095	18-7201
MCM 8.2L	1347-814623A2	—	R4/4MV	18-7095	18-7201

① Does not include metering rods



**18-7228
FLAME ARRESTOR**
Replaces: 85784A1



**18-7229
FLAME ARRESTOR**
Replaces: 85785T, 85785-2

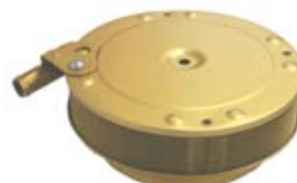

**18-7230
FLAME ARRESTOR**
Replaces: 41639A1, 41639



**18-7231
FLAME ARRESTOR**
Replaces: 85785A2



**18-7232
FLAME ARRESTOR**
Replaces: 57882, 57882T



**18-7234
FLAME ARRESTOR**
Replaces: 805016A1

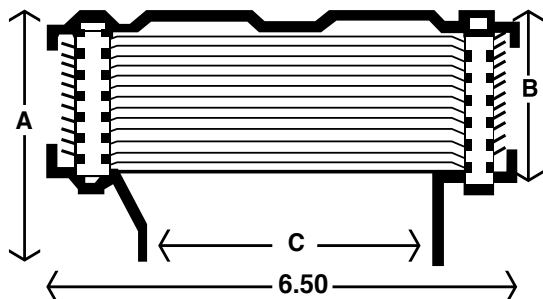

Engine	Part No.	Height A	Element B	Throat C	Vent Tubes*
4 & 6 cyl.	18-7228	2.156	1.088	3.12	1
4 & 6 cyl. ①	18-7234	2.28	1.55	3.1	0
V-8	18-7229	2.25	1.47	5.05	0
V-8	18-7230	2.25	1.47	5.05	1
V-8	18-7231	2.25	1.47	5.05	2
Hi-Performance	18-7232	2.969	2.19	5.05	2

① 7" Outside diameter * Vent tubes accept 3/8 inch ID hose

**ANODIZED ALUMINUM
FLAME ARRESTOR SPECIFICATIONS**



**18-8864
FUEL PUMP W/ REGULATOR**
Replaces: 866169T01, 866169A01
For: Gm V-8 with Gen III Cool Fuel Module-high pressure



**18-8865
FUEL PUMP**
Replaces: 866170A01
For: Gm V-8 with Gen III Cool Fuel Module-low pressure



18-7326
ELECTRIC FUEL PUMP
Replaces: 805656A2, 805656A6, 805656A5, 805025A2, 861155A6, 861155A5
For: 1992-93, 1996 F.I. & Carbureted 4.3L with inline electric pump



18-7266
FUEL PUMP
 Flange I.D. # 41413, M6696
For: Ford (V-8) 302, 351



18-7267
FUEL PUMP
 Flange I.D. # 41414
Replaces: 62092T, 62092, 54552
For: Ford (V-8) 302
 (Includes gasket)



18-7274
FUEL PUMP
 Flange I.D. # 41421, M73021
Replaces: 86246, 86246A1, 78485, 71646
For: GM (V-8) 305, 350, 400, 228 / 250 / 255 / 260 / 280



18-7275
FUEL PUMP
 Flange I.D. # 41422
Replaces: 86247, 86247T, 86247A2, 78820, 63196, 46860
For: GM (V-8) 454, 330 / 325 / 350 / 390
 (Includes gasket)



18-7278
FUEL PUMP
 Flange I.D. # M60032
Replaces: 86234A4, 86234A05, 86234A3, 86234, 77594, 71327, 47585
For: GM (4 & 6 Cyl.) 153, 181, 225, 250, 120 / 140 / 160 / 165 / 470 / 485 / 488
 Uses filter **18-7860** & gasket **18-0889**



18-7282
FUEL PUMP
 Flange I.D. # M60337
Replaces: 8M0073435, 861676T09
For: GM 4 cyl. (2.5/3.0L) & Mercruiser 3.7L
 Uses filter **18-7784** & gasket **18-0889**



18-7283
FUEL PUMP
 Flange I.D. # M60600
Replaces: 97401A2, 97401A8, 861678A1, 8M0058164, 97401
For: GM (V-8) 305, 350, 228 / 230 / 260 / 898
 Uses gasket **18-0889**



18-7284
FUEL PUMP
 Flange I.D. # M60315
Replaces: 41141A2, 862077A1
For: GM (V-6) 231, 262, 229
 Uses filter **18-7784** & gasket **18-0889**



18-7288-1
FUEL PUMP
 Flange I.D. #60601
Replaces: 812454A1, 862048A1, 812454A3, 97399A2, 97399
For: Inline (4 cyl) 120, 140, 3.0L and 224 CID
 7.4L / 454 / 420 / 330



18-35437
FUEL PUMP
Replaces: 42725A3, 861676A1, 861676T09, 8M0073435
Fits: Mercruiser 3.0L (SN L097000 & Up)
 (Includes gasket)



18-8860
FUEL PUMP
Replaces: 861677T
For: GM V-8 (454 & 502) applications
 (Includes gasket)



18-7256
FUEL PUMP
 Flange I.D. # 6790, M3530
Replaces: 32722
For: GM (4 & 6 Cyl.) 153, 230, 250, 292

APPLICATION ON NEXT PAGE

FUEL PUMP APPLICATION

Model	CID/#CYL	Year Range	Beginning Serial #	Ending Serial #	Fuel Pump #1	Fuel Pump #2	Pump Filter
120	153/L4	1964-1972	1666601	3377340	18-7278 ①	—	18-7860
120	153/L4	1964-1972	1666601	3377340	18-7256 ②	—	—
120	153/L4	1972-1982	3377341	6229717	18-7278	—	18-7860
120	153/L4	1983-1986	6229718	B531853	18-7278 ③	—	18-7860
120			4469866	& Below	18-7278	—	—
120			4469866	4952700	18-7278	—	—
120			4952701	& Up	18-7278	—	—
120			5192049	6229717	18-7278	—	—
120/2.5L			6229718	& Up	18-7278	—	—
120/2.5L			6229718	& Up	18-7282	—	—
2.5L	153/L4	1987-1989	B531854	BC853255	18-7278 ④	—	18-7860
140 (4 CYL)	181/L4	1968-1982	2508261	6229717	18-7278	—	18-7860
140 (4 CYL)	181/L4	1983-1986	6229718	B450800	18-7278 ⑤	—	18-7860
3.0L	181/L4	1987-1989	B450801	C856558	18-7278 ⑥	—	18-7860
140			4460664 & Below	& Below	18-7278	—	—
140			4460665	4918569	18-7278	—	—
140			4918570	& Up	18-7278	—	—
140 (4 Cyl.)			5157669	6229717	18-7278	—	—
140/3.0L			6229717 & Below	& Below	18-7278	—	—
140/3.0L			6229718 & Up	& Up	18-7282	—	—
3.0L/3.0LX			C856559 & Up	& Up	18-7282	—	—
140 (6 Cyl.)			1538930	1725960	18-7256	—	—
150			1666495	2048046	18-7256	—	—
160			2048022	2770031	18-7278	—	—
165			4471566	4884834	18-7278	—	—
165			5178959 & Up	& Up	18-7278	—	—
165/3.7L (4 Cyl.)			6916779 & Up	& Up	18-7282	—	—
180/3.7-LX (4 Cyl.)			6916779 & Up	& Up	18-7282	—	—
175/4.3L (262 CID)			B527955 & Up	& Up	18-7284	—	—
185 (229 CID)			6330183 & Up	& Up	18-7284	—	—
185 (262 CID)			A331455 & Up	& Up	18-7284	—	—
470	224/L4	1976-1984	4208730	6916778	18-7278	—	18-7860
485	224/L4	1980-1982	5685394	6218036	18-7278	—	18-7860
488	224/L4	1983-1984	6170297	6916778	18-7278 ⑦	—	18-7860
140 (6 CYL)	194/L6	1963	1538930	1725960	18-7256	—	—
150	230/L6	1964-1966	1666495	2048046	18-7256	—	—
160	250/L6	1967-1969	2048022	2770031	18-7278 ⑧	—	18-7860
160	250/L6	1967-1969	2048022	2770031	18-7256 ⑨	—	—
165 (6 CYL)	250/L6	1979-1981	2770032	5813433	18-7278	—	18-7860
200 (6 CYL)	250/L6	1969	2453769	2712072	18-7278	—	18-7860
200 GM			6218462	& Up	18-7283	—	—
200/5.0L GM			B525982	& Up	18-7283	—	—
185 (4bbl)	229/V-6	1983-1984	6330183	6919655	18-7284	—	—
175	262/V-6	1987	B527955	B773242	18-7284	—	—
185 (2bbl)	262/V-6	1985-1986	A331455	B527954	18-7284	—	—
205	262/V-6	1985-1987	A331455	B775129	18-7284	—	—
205/4.3L-LX (262 CID)			B527955	& Up	18-7284	—	—
4.3L	262/V-6	1988-1992	B773243	D714106	18-7284	—	—
4.3LX	262/V-6	1988-1992	B775130	D714369	18-7284	—	—
215 (FORD)	302/V-8	1970-1972	2781153	3563181	18-7267	—	—
215 Ford			3085036	& Below	18-7267	—	—

- ① low pressure lift pump
- ② high pressure fuel cool pump
- ③ fuel pump mounted with filter bowl facing up
- ④ fuel pump mounted with filter bowl facing down
- ⑤ AC fuel pump

- ⑥ Carter fuel pump
- ⑦ mechanical fuel pump
- ⑧ use if fuel pump has sight glass
- ⑨ use if fuel pump has sight tube
- ⑩ fuel pump/cooler kit

FUEL PUMP APPLICATION

Model	CID/#CYL	Year Range	Beginning Serial #	Ending Serial #	Fuel Pump #1	Fuel Pump #2	Pump Filter
215 Ford			3258182	& Up	18-7267	—	—
225 Ford	302/V-8	1973-1974	3385721	4166999	18-7267	—	—
228 MCM & MIE	305/V-8	1977-1978	4765100	5170008	18-7274	—	—
228 MCM & MIE	305/V-8	1979-1982	5170009	6218461	18-7274	—	—
228 MCM & MIE	305/V-8	1979-1982	5170009	6218461	18-7283 ①	—	—
888 (FORD)	302/V-8	1971-1977	3108723	4887829	18-7267	—	—
228	305/V-8	1982-1984	6218462	6899268	18-7283	—	—
230 MIE	305/V-8	1981-1987	5907058	B788151	18-7283	—	—
230/5.0L-GM (IB)			B522506	& Up	18-7283	—	—
230 GM			6218462	& Up	18-7283	—	—
230/5.0L-LX GM			B525982	& Up	18-7283	—	—
230	305/V-8	1985-1987	6899269	B773739	18-7283	—	—
5.0L	305/V-8	1988-1995	B774445	F600999	18-7283	—	—
5.0L MIE	305/V-8	1988	B788152	C396832	18-7283	—	—
5.0L MPI BRAVO	305/V-8	2004-2010	W060000	& Up	18-8864 ②	18-8865 ①	—
5.0LX	305/V-8	1988-1995	B773740	F600999	18-7283	—	—
898	305/V-8	1977-1982	4762210	6218461	18-7274 ①	—	—
898	305/V-8	1977-1982	4762210	6218461	18-7283 ①	—	—
898	305/V-8	1983-1984	6218462	6899057	18-7283	—	—
233 FORD			4500860	& Up	18-7267	—	—
250	350/V-8	1977	4768000	4908849	18-7274	—	—
255	350/V-8	1975-1976	4175500	4767999	18-7274	—	—
255 MIE (GM)	350/V-8	1975-1980	4175500	5907057	18-7274	—	—
255 FORD			3258728	& Up	18-7267	—	—
255 GM			5195909	& Up	18-7274	—	—
260	350/V-8	1978-1982	4908850	6218461	18-7274 ①	—	—
260	350/V-8	1978-1982	4908850	6218461	18-7283 ①	—	—
260	350/V-8	1983-1987	6218461	& Up	18-7283	—	—
260 MIE	350/V-8	1981-1987	5907058	B788151	18-7283	—	—
260/5.7 GM			B525982	& Up	18-7283	—	—
260 GM Inboard			5907058	& Up	18-7283	—	—
260/5.7L GM (IB)			5907058	& Up	18-7283	—	—
5.7L-GM			F025000	& Up	18-7283	—	—
280	350/V-8	1975-1976	4176250	4770199	18-7274	—	—
300MR/TRS GM	350/V-8	1985-1986	6668677	B430367	18-7283	—	—
320 EFI	350/V-8	1987-1989	A543604	C622418	N.L.A	—	—
325-GM			2278747	3640670	18-7275	—	—
330 GM			4623115	& Up	18-7275	—	—
330 GM/W.B.W.			6083145	& Up	18-7288-1	—	—
340/7.4L-GM (IB)			5889914	& Up	18-7288-1	—	—
350 MAG ALPHA	350/V-8	1986-1997	A635178	K999999	18-7823	—	—
350 MAG ALPHA EFI (GEN +)	350/V-8	1996	F800300	K001508	18-7283	—	—
350 MAG ALPHA EFI (GEN +)	350/V-8	1997	K001509	K999999	—	—	—
350 MAG BRAVO MPI	350/V-8	1995-1996	F415189	K001500	18-7283	—	—
350 MAG BRAVO MPI	350/V-8	1997	K001501	K999999	—	—	—
350 MAG EFI SKI	350/V-8	1994-1997	F215561	K999999	—	—	—
350 MAG MPI BRAVO	350/V-8	2004-2010	W060000	& Up	18-8864 ②	18-8865 ①	—
350 MAG MPI HORIZON	350/V-8	2004-2007	W060000	A299999	18-8864 ②	18-8865 ①	—
350 MAG MPI HORIZON MIE	350/V-8	2004-2007	M398372	A089999	18-8864 ②	18-8865 ①	—
350 MAG MPI MIE	350/V-8	2004-2007	M398372	A089999	18-8864 ②	18-8865 ①	—
350 MAG MPI MIE	350/V-8	2004-2007	M398372	A089999	18-8864 ②	18-8865 ①	—
350 MAG MPI SKI	350/V-8	1995-1996	F350583	F799999	18-7283	—	—
350 MAG SKI	350/V-8	1991-1997	D505450	K999999	18-7283	—	—

- ① low pressure lift pump
 ② high pressure fuel cool pump
 ③ fuel pump mounted with filter bowl facing up
 ④ fuel pump mounted with filter bowl facing down
 ⑤ AC fuel pump

- ⑥ Carter fuel pump
 ⑦ mechanical fuel pump
 ⑧ use if fuel pump has sight glass
 ⑨ use if fuel pump has sight tube
 ⑩ fuel pump/cooler kit

FUEL PUMP APPLICATION

Model	CID/#CYL	Year Range	Beginning Serial #	Ending Serial #	Fuel Pump #1	Fuel Pump #2	Pump Filter
350 GM			3780450	& Up	18-7275	—	—
(MAG-TOURNEY SKI)			D505450	& Up	18-7283	—	—
370 TRS-GM			6721528	& Up	18-7288-1	—	—
390-GM			2781129 - 2825059	2825059	18-7275	—	—
5.7L	350/V-8	1988-1997	B773305	K999999	18-7283	—	—
5.7L EFI	350/V-8	1995-1996	F225560	K001505	18-7283	—	—
5.7L MIE	350/V-8	1988-1997	B788152	K999999	18-7283	—	—
5.7L MPI HORIZON MIE	350/V-8	2008-2010	A090000	& Up	18-8864 ②	18-8865 ①	—
5.7L MPI MIE	350/V-8	2008-2010	A090000	& Up	18-8864 ②	18-8865 ①	—
5.7L SKI	350/V-8	1985-1997	A338553	K999999	18-7283	—	—
5.7LX	350/V-8	1996-1997	F601000	K999999	18-7283	—	—
5.7LX BRAVO EFI (GEN +)	350/V-8	1996	F800300	K001508	18-7283	—	—
5.7LX BRAVO EFI (GEN +)	350/V-8	1997	K001509	K999999	—	—	—
5.7LX EFI	350/V-8	1996	F752400	K001505	18-7283	—	—
5.7LX EFI	350/V-8	1997	K001506	K999999	—	—	—
5.7 GM (SKI)			B514627	& Up	18-7283	—	—
5.7L BRAVO (GM)350			B525982	& Up	18-7283	—	—
BLACK SCORPION SKI	350/V-8	1997	K040001	K999999	—	—	—
SCORPION 350 EC	350/V-8	2009-2010	W698433	& Up	18-8864 ②	18-8864 ①	—
233 (FORD)	351/V-8	1975-1977	4173000	4902304	18-7267	—	—
255 (FORD)	351/V-8	1973-1974	3258728	4175499	18-7267	—	—
377 MAG	377/V-8	2008-2010	A300000	& Up	18-8864 ②	18-8865 ①	—
MX 6.2L MPI	377/V-8	2004-2007	W060000	A299999	18-8864 ②	18-8865 ①	—
MX 6.2L MPI HORIZON	377/V-8	2004-2007	W060000	A299999	18-8864 ②	18-8865 ①	—
MX 6.2L MPI HORIZON MIE	377/V-8	2004-2010	M398395	& Up	18-8864 ②	18-8865 ①	—
MX 6.2L MPI MIE	377/V-8	2004-2010	M398395	& Up	18-8864 ②	18-8865 ①	—
SCORPION 377 HO EC	377/V-8	2009-2010	A091488	A092170	18-8864 ②	18-8865 ①	—
325	427/V-8	1969-1972	2278747	3780449	18-7275	—	—
330	454/V-8	1977-1981	4623115	6083144	18-7275	—	—
330 WITH B/W	454/V-8	1982-1987	6083145	B816540	18-7288-1	—	—
340 MIE	454/V-8	1981-1987	5889914	B788365	18-7288-1	—	—
350 MIE	454/V-8	1974-1976	3780450	4623109	18-7275	—	—
370 TRS	454/V-8	1978-1987	4179554	B714586	18-7288-1	—	—
400 TRS	454/V-8	1980-1986	4179554	B457644	18-7288-1	—	—
420	454/V-8	1987-1989	A398941	B622418	18-7288-1	—	—
425-GM			A398941	& Up	18-7288-1	—	—
425	454/V-8	1990-1992	B622419	D725499	18-7288-1	—	—
425 (GEN V)	454/V-8	1992-1993	D763855	D937011	18-8860	—	—
440 TRS	454/V-8	1983-1986	4179554	B485220	18-7288-1	—	—
450	454/V-8	1995-1996	F347100	F347277	18-8860	—	—
454 MAG ALPHA	454/V-8	1986-1988	A631894	B785148	18-7288-1	—	—
454 MAG BRAVO GM			B840126	& Up	18-7288-1	—	—
454 MAG BRAVO	454/V-8	1988-1992	A631894	B785148	18-7288-1	—	—
454 MAG BRAVO	454/V-8	1992-1997	D805069	K999999	18-8860	—	—
454 MAG EFI	454/V-8	1994-1996	F115700	F802349	18-8860	—	—
454 MAG EFI SKI	454/V-8	1995-1996	F215800	F820099	18-8860	—	—
454 MAG MPI	454/V-8	1996	F802350	K147349	18-8860	—	—
454 MAG MPI	454/V-8	1997	K147350	K999999	—	—	—
454 MAG MPI	454/V-8	1998-2001	L010029	M024999	—	—	—
454 MAG MPI HORIZON MIE	454/V-8	1998-2001	L002200	L674000	—	—	—
454 MAG MPI SKI	454/V-8	1996-1997	F820100	K999999	18-8860	—	—
470			5097479	& Below	18-7278	—	—

- ① low pressure lift pump
- ② high pressure fuel cool pump
- ③ fuel pump mounted with filter bowl facing up
- ④ fuel pump mounted with filter bowl facing down
- ⑤ AC fuel pump

- ⑥ Carter fuel pump
- ⑦ mechanical fuel pump
- ⑧ use if fuel pump has sight glass
- ⑨ use if fuel pump has sight tube
- ⑩ fuel pump/cooler kit

FUEL PUMP APPLICATION

Model	CID/#CYL	Year Range	Beginning Serial #	Ending Serial #	Fuel Pump #1	Fuel Pump #2	Pump Filter
470			5097480	& Up	18-7278	—	—
470			5520115	6218036	18-7278	—	—
470			6218037	& Up	18-7278	—	—
485			5685394	& Up	18-7278	—	—
488			6170297	& Up	18-7278	—	—
525SC	454/V-8	1992-1999	D725809	L415623	18-8860	—	—
7.4L BRAVO	454/V-8	1988-1991	B771113	D603117	18-7288-1	—	—
7.4L BRAVO	454/V-8	1992-1997	D603118	K999999	18-8860	—	—
7.4L EFI MIE	454/V-8	1996-1997	F874815	K999999	—	—	—
7.4L MIE	454/V-8	1988-1992	B788366	D715493	18-7288-1	—	—
7.4L MIE	454/V-8	1992-1997	D715494	K999999	18-8860	—	—
7.4L MPI	454/V-8	1998-2001	L010003	M024330	—	—	—
7.4L MPI MIE	454/V-8	1995-1997	F563052	K147349	18-8860	—	—
7.4L MPI MIE	454/V-8	1997	K147350	K999999	—	—	—
7.4L MPI MIE	454/V-8	1997-2001	L002006	L674613	—	—	—
7.4LX BRAVO EFI	454/V-8	1996-1997	F820000	K999999	—	—	—
7.4LX BRAVO MPI	454/V-8	1996-1997	F602010	K999999	18-8860	—	—
7.4L W/HURTH (IB)			C391564	& Up	18-7288-1	—	—
390	482/V-8	1969-1970	2781129	2825059	18-7275	—	—
496 MAG & HO	496/V-8	2004-2010	W060000	& Up	18-8864 ②	18-8865 ①	—
8.1S MPI MIE & HO	496/V-8	2004-2010	W090000	& Up	18-8864 ②	18-8865 ①	—
465	502/V-8	1992-1994	D456155	F213244	18-7275	—	—
500	502/V-8	1994-1998	F213293	L001772	18-7275	—	—
502 MAG BRAVO	502/V-8	1992-1993	D824589	F114528	18-8860	—	—
502 MAG EFI	502/V-8	1993-1995	D840650	F802599	18-8860	—	—
502 MAG MPI	502/V-8	1996	F802600	K147349	18-8860	—	—
502 MAG MPI	502/V-8	1997	K147350	K999999	—	—	—
502 MAG MPI	502/V-8	1998-2001	L017000	M024999	—	—	—
600SC	502/V-8	1992-2000	D725676	L601186	18-8860	—	—
8.2L MAG & HO	502/V-8	2010	A340340	& Up	18-8864 ②	18-8865 ①	—
8.2L MAG & HO MIE	502/V-8	2010	A350802	& Up	18-8864 ②	18-8865 ①	—
8.2L MIE	502/V-8	1993-1996	D857200	F819619	18-8860	—	—
8.2L MPI MIE	502/V-8	1996-1997	F819620	K147349	18-8860	—	—
8.2L MPI MIE	502/V-8	1997	K147350	K999999	—	—	—
8.2L MPI MIE	502/V-8	1998-2001	L002450	L674200	—	—	—

- ① low pressure lift pump
- ② high pressure fuel cool pump
- ③ fuel pump mounted with filter bowl facing up
- ④ fuel pump mounted with filter bowl facing down
- ⑤ AC fuel pump

- ⑥ Carter fuel pump
- ⑦ mechanical fuel pump
- ⑧ use if fuel pump has sight glass
- ⑨ use if fuel pump has sight tube
- ⑩ fuel pump/cooler kit

SIERRA[®]

FUEL WATER SEPARATORS

Sierra fuel water separators remove over 99.8% of emulsified water from your gasoline. Sierra's 10 micron filters are over 90% efficient at removing particles as small as 10 micron. All filters flow @ 90 GPH to feed even the hungriest motor. Sierra 10 micron filters are recommended to prevent damage to sensitive inboard and outboard fuel injection systems.

- UNIVERSAL DESIGN - DIRECT REPLACEMENT FOR MERCURY AND YAMAHA FUEL WATER SEPARATOR BRACKETS



Bracket Type	Part No.	Replaces
1/4" Stainless Steel	18-8777	—
3/8" Stainless Steel	18-7776	—
1/4" Aluminum	18-7853-1	Mercury 89876A3, 55481, 89876
3/8" Aluminum	18-7775	—

FUEL WATER SEPARATOR KITS



21 MICRON FILTER KITS FOR CARBURETED ENGINES

Kit Type	Part No.	Micron Rating	Contents
1/4" Aluminum (Short Filter)	18-7848-1 •	21	1 - 18-7844 filter • 1 - 18-7853-1 bracket • 2 - 18-4256 1/4" pipe plugs
1/4" Aluminum Bonus Pack (Contains spare filter)	18-7848-2 •	21	2 - 18-7844 filter • 1 - 18-7853-1 bracket • 2 - 18-4256 1/4" pipe plugs
1/4" Aluminum (Tall Filter)	18-7852-1	21	1 - 18-7845 filter • 1 - 18-7853-1 bracket • 2 - 18-4256 1/4" pipe plugs
1/4" Aluminum Bonus Pack (Contains spare filter)	18-7852-2	21	2 - 18-7845 filter • 1 - 18-7853-1 bracket • 2 - 18-4256 1/4" pipe plugs
3/8" Aluminum (Tall Filter)	18-7775-1 •	21	1 - 18-7845 filter • 1 - 18-7775 bracket • 2 - 18-4264 3/8" pipe plugs
1/4" Stainless Steel (Tall Filter)	18-7777-1 •	21	1 - 18-7845 filter • 1 - 18-7777 bracket • 2 - 18-4256 1/4" pipe plugs
3/8" Stainless Steel (Tall Filter)	18-7776-1 •	21	1 - 18-7845 filter • 1 - 18-7776 bracket • 2 - 18-4264 3/8" pipe plugs

10 MICRON FILTER KITS FOR CARBURETED ENGINES

1/4" Aluminum (Short Filter)	18-7983-1 •	10	1 - 18-7944 filter • 1 - 18-7853-1 bracket • 2 - 18-4256 1/4" pipe plugs
1/4" Aluminum Bonus Pack (Contains spare filter)	18-7983-2 •	10	2 - 18-7944 filter • 1 - 18-7853-1 bracket • 2 - 18-4256 1/4" pipe plugs
1/4" Aluminum (Tall Filter)	18-7982-1	10	1 - 18-7945 filter • 1 - 18-7853-1 bracket • 2 - 18-4256 1/4" pipe plugs
1/4" Aluminum Bonus Pack (Contains spare filter)	18-7982-2	10	2 - 18-7945 filter • 1 - 18-7853-1 bracket • 2 - 18-4256 1/4" pipe plugs
1/4" Aluminum (High Capacity Filter)	18-7966-1	10	1 - 18-7866 filter • 1 - 18-7853-1 bracket • 2 - 18-4256 1/4" pipe plugs
3/8" Aluminum (Tall Filter)	18-7986-1 •	10	1 - 18-7945 filter • 1 - 18-7775 bracket • 2 - 18-4264 3/8" pipe plugs
1/4" Stainless Steel (Tall Filter)	18-7984-1 •	10	1 - 18-7945 filter & • 1 - 18-7777 bracket
3/8" Stainless Steel (Tall Filter)	18-7985-1 •	10	1 - 18-7945 filter • 1 - 18-7776 bracket • 2 - 18-4264 3/8" pipe plugs
1/4" Aluminum (Tall Filter)	18-79912	10	1 - 18-79911 • 1 - 18-7853-1

• Display Packaged

10 MICRON FILTER KITS WITH DRAIN BOWLS

Sierra AquaVue™ and metal bowl separator filters allow water to be drained from the filter to extend service life. Use the AquaVue™ bowl for outboard, above deck installations. USCG regulations require the use of the flame resistant metal bowl below deck.

- Display Packaged



Kit Type	Part #	Micron Rating	Contents
1/4" Aluminum w/ metal drain bowl	18-7951 •	10	1 - 18-7919 filter & 1 18-7853-1 bracket 1 - 18-7924 metal bowl 2 - 18-4256 1/4" pipe plugs
1/4" Stainless Steel w/ metal drain bowl	18-7938 •	10	1 - 18-7919 filter & 1 18-7777 bracket 1 - 18-7924 metal bowl 2 - 18-4256 1/4" pipe plugs

COMPACT BRACKET AND SEPARATOR KIT - FOR SMALL OUTBOARDS AND FRESH WATER APPLICATIONS

 <p>18-7774 COMPACT ALUMINUM BRACKET</p>	 <p>18-6999 UNIVERSAL FUEL WATER SEPARATOR KIT MOUNTING BRACKET Fits: All 305 and 350 Mercuriser engines with Center Riser manifolds</p>	 <p>18-7965-1 10 MICRON COMPACT SEPARATOR KIT Contains: 1 - 18-7774 bracket 1 - 18-7865 filter</p>
--	---	--

REPLACEMENT FILTERS

	<p>UNIVERSAL DESIGN - DIRECT REPLACEMENT FOR MERCURY</p>
--	---

10 MICRON REPLACEMENT FILTERS			10 MICRON REPLACEMENT FILTERS		
Part No.	Description	Replaces	Part No.	Description	Replaces
18-7944	Short - 3.875"	35-807172, 35-802893Q, 35-806771, 35-8053691, 35-805369, 35-604941, 35-60494, 35-57250, 35-55501, 35-52456	18-7865	Compact 10 Micron	—
18-7945	Long - 8.5"	35-802893Q, 35-806771, 35-8053691, 35-805369, 35-604941, 35-60494, 35-57250, 35-55501, 35-52456	18-79911	Long - 8.5"	35-8M0079962
18-7866	High Capacity - 6"	—	21 MICRON REPLACEMENT FILTERS		
			18-7844	Short - 3.875"	35-807172, 35-802893Q
			18-7845	Long - 4.35"	35-807172, 35-806771, 35-8053691, 35-60494A4, 35-604941, 35-57250, 35-55501

10 MICRON REPLACEMENT FILTERS AND KITS WITH DRAIN BOWLS



REPLACEMENT FILTERS			REPLACEMENT BOWLS	
Part No.	Description	Replaces	Part No.	Description
18-7919	Spin-on replacement	35-809097, 35-8M0103095 Racor S3213	18-7924	Metal Collection Bowl
18-7920	Spin-on replacement	Mercury 35-809099 Racor S3214	FILTER & BOWL KITS	
18-7947	Spin-on replacement	Racor S3240	Part No.	Description
18-7948	Spin-on replacement Fits: 320RRAC01	35-886638 Racor S3227	18-7929 •	Filter & Metal Bowl, Mercury Style Contains: 18-7919 filter & 18-7924 bowl
18-7949	Spin-on replacement Fits: 660RRAC02	Racor S3232	18-7943 •	Filter & Metal Bowl, Contains: 18-7920 filter & 18-7924 bowl
			18-7969 •	Filter & Metal Bowl, Contains: 18-7948 filter & 18-7924 bowl

- Display Packaged



18-7919
FUEL/WATER
SEPARATING FILTER
Replaces: Mercruiser 35-809097,
 35-8M0103095 and Racor™ S3213
 For styles with spin on drain bowls



18-8955
FUEL WATER
SEPARATOR COVER
Fits: 18-7944 & 18-7945 sized filter



18-7784
FUEL FILTER
Replaces: Mercruiser 35-11004A1, 35-803897Q1
For: 2.5L/3.0L (6229718 & later), All MC224 CID
 (6218037 & later), All GM 262 CID (A331455 & later)
 with Carter Fuel Pumps



18-7977
"GEN III COOL FUEL
SYSTEM" FUEL FILTER
Replaces: 35-866171A01
For: 350 Mag MPI Alpha/Bravo, 350 Mag MPI Horizon Alpha/
 Bravo, 350 Mag MPI Horizon MIE, 350 Mag MPI MIE, 496 MAG,
 496 MAG H.O., 5.0 MPI Alpha/Bravo, 8.1L Inboard, 8.1L Inboard
 H.O., MX 6.2L MPI Alpha/Bravo, MX 6.2L MPI Horizon Alpha/
 Bravo, MX 6.2L MPI Horizon MIE, MX 6.2L MPI MIE



18-7964-1
TRANSMISSION FILTER KIT
Replaces: 35-815419, 8791014241, 879194241,
 35-813405A1, 35-813405, F19608751, FFF001138
For: Mercruiser V-8 Inboard with Hurth Transmission



18-7855
FUEL FILTER
Replaces: 1397-2150
 Rochester Carb inlet



18-7717
FILTER ELEMENT
Replaces: 35-93568
For: Rochester 2 bbl & 4 bbl Carburetors



18-7859
FUEL FILTER
Replaces: 35-53336, 3302-9033, 35-53336Q
For: Most GM Inline 4 & 6 cycle, Ford & Gm V-8's up to
 400 HP and all Mercruiser 224 CID



18-7721
FUEL FILTER
Replaces: 35-864572
For: All MPI & EFI engines with boost pump, 8.1L & 496cid,
 for 3/8" ID fuel lines



18-7860
FUEL FILTER
Replaces: 35-49088A2,
 35-49088Q2, 35-49088, F18390006
 (Used in 18-7278 Fuel Pump)
For: Inline 4 & 6 cycle engines



18-7869
FUEL FILTER ASSEMBLY
 Uses filter 18-7859
Replaces: 1397-8767, 1397-8545
For:

Model/HP	Serial #
GM 2.5L/3.0L	6229718 & later
GM 5.0L/5.7L	6218462 & later
All 205	A331455 & later
228 HP	6021784 & later
330 HP	6083145 & later
GM 255	590768 & later
5.7L SKI 340,230 & 260 Inboards	ALL



18-7715
FUEL FILTER
Replaces: 35-892665
Fits: Mercruiser V-8 using Gen III Cool Fuel Systems



18-79901
VST FILTER
Replaces: 65L-13915-00-00
Fits: 454 EFI (Gen V) GM 1994-96, 454 EFI (SKI) (Gen V) GM 1995, 454 Mag Bravo
 MPI (Gen VI) GM 1996-97, 454 Mag MPI (SKI) (Gen VI) GM 1996-97, 502 EFI (Gen V)
 GM 1993-95, 502 Mag MPI (Gen VI) GM 1996, 7.4L MIE MPI (LH) Gen V GM 1995-96,
 7.4L MIE MPI (LH) Gen VI GM 1996-97, 7.4LX Bravo MPI (Gen V) GM 1996, 7.4LX
 Bravo MPI (Gen VI) GM 1996-97, 8.2L MIE MPI (LH) Gen VI GM 1996-97



18-6457
COMPOSITE PULLEY
 Replaces: 807757T
 3" OD Serpentine for 13/16" width belt
 For: Late model GM V6 & V8 engines



18-3506-1
CIRCULATING PUMP
 Superseded from 18-3506
Replaces: 46-879194401
 For: V6 MCM SN: 1A063240 (2007), Newer 4.3L w/o water bypass hole
 - CURRENT



18-3577-2
CIRCULATING WATER PUMP (Bi-Directional)
Replaces: 67859, 17670, 811573, 850454, 8504541, 878342, 850454002, 59972, 54534, 49139, F6269358, F11100997, F11101053
 For: Big block GM engines



18-3573
CIRCULATING WATER PUMP
 All 8.1L big-block GM engines
Replaces: 883514, 883925
 For: Engines with composite timing cover



18-3593
WATER PUMP
Replaces: 33957, 37369, 52353, 65142, 65142A1, 814755, 880817, 884727, F2774666, F11100785, F11101079
 Late Model 4 cyl GM engines requiring hose fitting, GM Inline (4 & 6 Cyl.)



18-3599-2
CIRCULATING WATER PUMP
Replaces: 60658, 811841, 850399, 8503991, 17437, 878341, 850399002, 54793, 52226, 37951, 35341, F11101292, F11101208, F11100742
 For: GM V-6 & small block V-8 engines



18-3007
IMPELLER
Replaces: 47-89983, 4789983T
 For 60 HP



18-3016-1
IMPELLER KIT
 with gasket
Replaces: 47-862232A2, 8M0104229
 For: Late-model Bravo & High Performance. Includes 350 Mag., 4.3L., 496 Mag., 5.0L., 8.1S and MX 6.2L



18-3017
18-3017-10^①
IMPELLER
Replaces: 47-89984, 47-899842, 47-89984T3, 47-89984T4, 47-899844, 47-30221, 47-65960, 47-85460
 For all #1, R, MR, Alpha Units thru S/N D494568.
 Also for raw water pump on: 190 IB S/N 1564539-1720903 225 IB S/N 1539620-2278646



18-3056
18-3056-10^①
IMPELLER
Replaces: 47-43026-2
 For: Alpha I-Generation 2
 S/N D494569 & Above
 MerCruiser Vazer



18-3087
IMPELLER
Replaces: 47-59362, 47-59362T



18-3109
WATER TUBE GUIDE
Replaces: 23-29804, 23-29804T, 23-52928
 (used with 18-3116 Housing)



18-3110
WATER PUMP HOUSING BUSHING
Replaces: 26-38970, 26-36557A1, 26-29677
 (Part of 18-3116 Housing)



18-3114
INSERT CUP
Replaces: 48752, 48752T
 (Part of 18-3116 Housing)

^① Discount shop pack of 10 - Priced per package



18-3117
IMPELLER PLATE
Replaces: 32435, 324351, 30605
For: #1 Units thru S/N D494568



18-3122
IMPELLER PLATE
Replaces: 817276, 8172761, 8172763
For: Alpha I - Generation 2
S/N D494569 & Above



18-3293
IMPELLER KEY
Replaces: 28-43037



18-3151
COUPLING
Replaces: 816597



18-3417
WATER PUMP BASE
Replaces: 46-57234A1



18-3420
WATER PUMP BASE
Replaces: 46-44292A3, 46-44292Q03,
46-44292T1



18-3421
WATER PUMP BASE
Replaces: 46-48748A1



18-3116
WATER PUMP HOUSING
Replaces: 46-96148, 46-96148A1,
46-96148T1, 46-64141A1, 46-48743A1

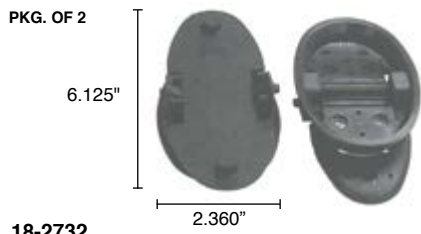

PKG. OF 2
18-2732
18-2732-9①
WATER SHUTTER
Replaces: 807166A3

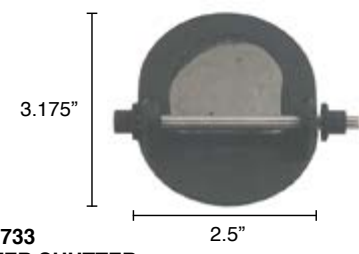

18-2733
WATER SHUTTER
Replaces: 92802, 99370A2

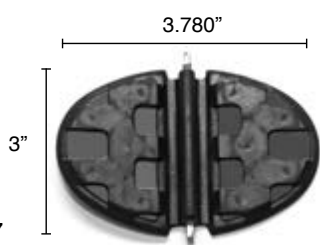

18-2727
EXHAUST
WATER SHUTTER
Replaces: 60930



18-3220
WATER TUBE
Replaces: 32-54236
For: #1 -R/MR/Alpha



18-3221
WATER TUBE
Replaces: 32-814384, 32-860220
For: Gen II



18-3222
WATER TUBE GUIDE
Replaces: 23-816583
For: Gen II



18-3197
SCREW
Replaces: 10-76156,
10-67373

① Priced per Package



**18-3160-1
SEA WATER PUMP, BRASS**
Replaces: 46-862914A13
Uses impeller **18-3016-1**



**18-3600
SEA WATER PUMP**
Replaces: 46-72774A32, 46-72774A11, 46-73823A7, 46-63450A2, 46-59112A2
Fits: V8 Engines w/ith V-Belt and 2 piece pump. Use repair kit **18-3155**



**18-36001
SEA WATER PUMP**
Replaces: 46-807151A12
Fits: V6 & V8 engines with v-belt and 1 piece pump. Use repair kit **18-3237**



**18-3155
WATER PUMP REPAIR KIT**
Replaces: 47-72774A89
Fits: Bravo Seawater Pump with 2 piece housing



**18-3160
WATER PUMP REPAIR KIT**
Replaces: 350 MAG MPI, 377 MAG MPI, 4.3L MPI, 496 MAG, 5.0L MPI, 5.7L MPI, 6.2L MPI, 8.1L MAG using brass seawater pump 46-862914A13 (18-3160)
Includes: Impeller, O-ring, Base Gasket, and Stainless Steel Wear Plate



**18-3216
IMPELLER KIT**
Replaces: 47-59362A4
Fits: 1996-97 7.4L MIE MPI(LH) Gen VI GM 454 V8, 1996-97, 7.4L TBI MIE(LH) Gen VI GM 454 V8, 1996-97 8.2L MIE MPI(LH) Gen VI GM 502 V8



**18-3318
WATER PUMP KIT**
Replaces: 47-59362Q08
Fits: Plastic 1 and 2 piece sea water pump body



**18-3237
IMPELLER REPAIR KIT**
For: Bravo I, II, III (1988 & up) B664190 & up
Fits Bravo drives with 1 piece housing

—CONTAINS —

Part #	Desc.	O.E. #	Qty.
18-3087	Impeller	47-59362	1
NSS	Wear Plate	94576	1
18-7163	O-Ring	25-33465	1



**18-3214
IMPELLER REPAIR KIT**
Replaces: 47-43026T6, T8, T11
For: Alpha I - Generation II S/N D494569 & Above
Mercuriser Vazer
For same kit with upper housing, order **18-3147**

①18-3214D *Display Package*

—CONTAINS —

Part #	Desc.	O.E. #	Qty.
18-2564-1	Impeller Gasket	22-43033-1, 27-43033-1	1
18-2565	Impeller Gasket	27-43047-1	1
18-2566	Impeller Gasket	27-817277	1
18-2944	Seal Ring	26-45577, 26-45577-1, 26-45577B, 26-45577B1	1
18-3056	Impeller	47-43026-1, 47-43026-2	1
18-3122	Impeller Plate	817276	1
18-7420	O-Ring	25-21836	2



**18-3217
IMPELLER KIT**
For: #1 Units thru S/N D494568
(Similar to #46-96148A5 without base or housing)

①18-3217D *Display Package*

—CONTAINS —

Part #	Desc.	O.E. #	Qty.
18-3109	Water Tube	23-29804	1
18-3017	Impeller	47-89984	1
18-2919	Water Pump Base to Gear Housing Gasket	27-42631-1	1
18-3110	Grommet	26-38970	1
18-2945	Drain Screw Gasket	12-19183	2
18-2826	Water Pump Base to Gear Housing Gasket	27-85610-1	1
18-2914	Lower Water Pump to Wear Plate Gasket	27-85608-1	1
18-2915	Upper Water Pump to Wear Plate Gasket	27-85609-1	1
18-2944	Seal Ring	26-45577	1
18-3117	Plate	32435	1
18-7158	O-Ring	25-30613	1
18-7162	O-Ring	25-33145	1
18-7173-9	O-Ring	30224	25-
30224			1
18-7176	O-Ring	25-90011	1
NSS	Water Pump Gasket	27-32438	1
18-7196	O-Ring	25-38099	1
18-7426	O-Ring	35-30271	1



**18-3150
WATER PUMP KIT**
Replaces: 46-807151A14, 46-807151A7
For: Bravo

①18-3309D *Display Package*

**18-3309
WATER PUMP KIT**
For: Bravo

—CONTAINS —

Part #	Desc.	O.E. #	Qty.
NSS	Wear Plate	94576	1
NSS	Wear Plate	94916	1
18-3087	Impeller	47-59362	1
18-0386	Body Gasket	27-94914	2
18-0916	Water Pump Gasket	27-805215-1	1



**18-3147
WATER PUMP KIT**
Replaces: 817275T4, 817275K05
For: Gen II-Lower s/n D469859 and Up
For same kit without upper housing, order **18-3214**

① Items ending in "D" are Display Packaged - Regular number is Non-Display

— CONTAINS —

Part #	Desc.	O.E. #	Qty.
18-3109	Water Tube	23-29804	1
18-3017	Impeller	47-89984	1
18-3116	Housing	46-96148A1	1
18-2919	Water Pump Base to Gear Housing Gasket	27-42631-1	1
18-3110	Grommet	26-38970	1
18-2945	Drain Screw Gasket	26-20260, 12-19183	2
18-2826	Water Pump Base to Gear Housing Gasket	27-85610-1	1
18-2914	Lower Water Pump to Wear Plate Gasket	27-85608-1	1
18-2915	Upper Water Pump to Wear Plate Gasket	27-85609-1	1
18-2944	Seal Ring	26-45577	1
18-3117	Plate	32435	1
18-7158	O-Ring	25-30613	1
18-7162	O-Ring	25-33145	1
18-7173-9	O-Ring	25-30224	1
18-7176	O-Ring	25-90011	1
NSS	Water Pump Gasket	27-32438	1
18-7196	O-Ring	25-38099	1
18-7426	O-Ring	35-30271	1



18-3517
WATER PUMP KIT
 Without Base
 Replaces: 46-96148A5,46-60367A1, 46-96148A8

— CONTAINS —

Part #	Desc.	O.E. #	Qty.
18-3109	Water Tube	23-29804	1
18-3017	Impeller	47-89984	1
18-3116	Housing	46-96148A1	1
18-3420	Water Pump Base	46-44292A3	1
18-2919	Water Pump Base to Gear Housing Gasket	27-42631-1	1
18-3110	Grommet	26-38970	1
18-2945	Drain Screw Gasket	12-19183	2
18-2826	Water Pump Base to Gear Housing Gasket	27-85610-1	1
18-2914	Lower Water Pump to Wear Plate Gasket	27-85608-1	1
18-2915	Upper Water Pump to Wear Plate Gasket	27-85609-1	1
18-2944	Seal Ring	26-45577	1
18-3117	Plate	32435	1
18-7158	O-Ring	25-30613	1
18-7162	O-Ring	25-33145	1
18-7173-9	O-Ring	25-30224	1
18-7176	O-Ring	25-90011	1
NSS	Water Pump Gasket	27-32438	1
18-7196	O-Ring	25-38099	1
18-7426	O-Ring	35-30271	1



18-3320
WATER PUMP KIT
 For: MR/Alpha I Units
 S/N 6854393-OD469858

— CONTAINS —

Part #	Desc.	O.E. #	Qty.
18-3109	Water Tube	23-29804	1
18-3017	Impeller	47-89984	1
18-3116	Housing	46-96148A1	1
18-3421	Water Pump Base	46-48748A1	1
18-2919	Water Pump Base to Gear Housing Gasket	27-42631-1	1
18-3110	Grommet	26-38970	1
18-2945	Drain Screw Gasket	12-19183	2
18-2826	Water Pump Base to Gear Housing Gasket	27-85610-1	1
18-2914	Lower Water Pump to Wear Plate Gasket	27-85608-1	1
18-2915	Upper Water Pump to Wear Plate Gasket	27-85609-1	1
18-2944	Seal Ring	26-45577	1
18-3117	Plate	32435	1
18-7158	O-Ring	25-30613	1
18-7162	O-Ring	25-33145	1
18-7173-9	O-Ring	25-30224	1
18-7176	O-Ring	25-90011	1
NSS	Water Pump Gasket	27-32438	1
18-7196	O-Ring	25-38099	1
18-7426	O-Ring	35-30271	1

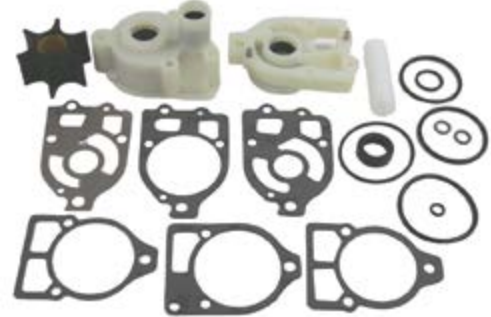

18-3321
WATER PUMP KIT
 For: #1 Units with flush
 S/N 2495186-2763441

— CONTAINS —

Part #	Desc.	O.E. #	Qty.
18-3109	Water Tube	23-29804	1
18-3017	Impeller	47-89984	1
18-3116	Housing	46-96148A1	1
18-2919	Water Pump Base to Gear Housing Gasket	27-42631-1	1
18-3417	Water Pump Base	46-57234A1	1
18-3110	Grommet	26-38970	1
18-2945	Drain Screw Gasket	12-19183	2
18-2826	Water Pump Base to Gear Housing Gasket	27-85610-1	1
18-2914	Lower Water Pump to Wear Plate Gasket	27-85608-1	1
18-2915	Upper Water Pump to Wear Plate Gasket	27-85609-1	1
18-2944	Seal Ring	26-45577	1
18-3117	Plate	32435	1
18-7158	O-Ring	25-30613	1
18-7162	O-Ring	25-33145	1
18-7173-9	O-Ring	25-30224	1
18-7176	O-Ring	25-90011	1
NSS	Water Pump Gasket	27-32438	1
18-7196	O-Ring	25-38099	1
18-7426	O-Ring	35-30271	1
18-2919	Water Pump Gasket	27-46231-1	1



18-3317
WATER PUMP KIT
 For: #1/R Units without flush
 S/N 2763442-6854392

COMPLETE WATER PUMP KIT, IMPELLER REPAIR KIT, IMPELLER APPLICATION

Model	Serial No.	Complete Water Pump Kit	Upper Pump Housing	Upper Pump Kit	Water Pump Base	Impeller Repair Kit (no housing)	Impeller
#1 Units with plastic flush screw in gear housing	2495186 - 2763441	18-3321	18-3116	18-3517	18-3421	18-3217	18-3017
1 Units w/o flush screw in gear housing	2763442 - 6854392	18-3317 ①	18-3116	18-3517	18-3417 ①	18-3217	18-3017
MR/ALPHA I	6854393 - OD594568	18-3320	18-3116	18-3517	18-3420	18-3217	18-3017
ALPHA I - Generation II & Vazer	OD494569 & ABOVE	18-3147	—	18-3570	—	18-3214	18-3056
BRAVO/Inboards w/ Plastic pump body	3040411 & ABOVE	—	—	18-3150	—	18-3318	18-3087
BRAVO/Inboards w/ Brass pump body	OM100001 & ABOVE	—	—	18-3160-1	—	18-3016-1	—

① Models which have been retro-fitted with an Alpha style lower unit (no pre-load pin in top of driveshaft) must use Alpha style parts (18-3320 and 18-3420)

GENERATION II WATER PUMP ASSEMBLY

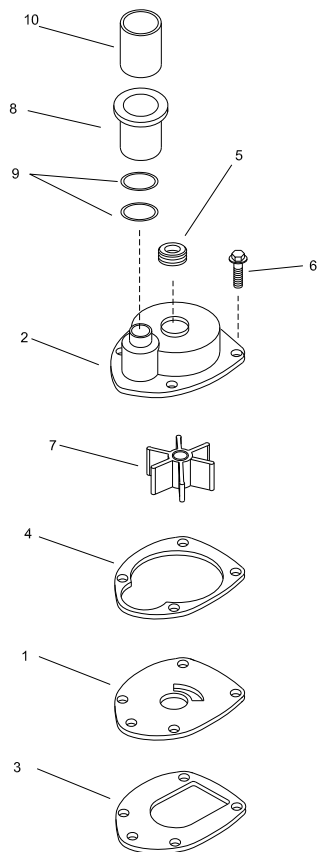

Sequence	Description	Part No.	O.E. #	Qty.
1	Face Plate	18-3122	817276	1
2	Housing Assembly	N.S.S.	817275A1	1
3	Gasket, Base	18-2564-1	27-43033-1	1
4	Gasket, Housing	18-2566	27-817277	1
5	Seal, Face	18-2599	26-816575A2	1
6	Screw, Housing	N/A	10-816928	4
7	Impeller	18-3056	47-43026-2	1
8	Coupling As- sembly	18-3151	47-43026T11	1
9	O-Ring	18-7420	25-21836	2
10	Sleeve	18-3222	23-816583	1

MR ALPHA WATER PUMP ASSEMBLY

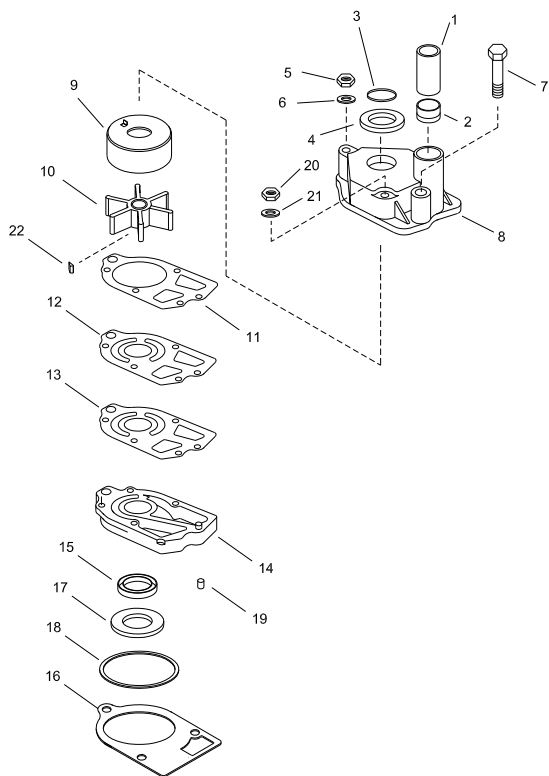

Sequence	Description	Part No.	O.E. #	Qty.
1	Guide Sleeve	18-3109	23-29804	1
2	Seal, Sleeve Guide	18-3110	26-38970	1
3	Ring, Upper	18-7158	25-30613	1
4	Ring, Dust	18-7426	25-30271	1
5	Nut, Housing	N/A	11-13436	1
6	Washer, Housing	N/A	12-36001	3
7	Screw, Housing	N/A	10-96411	1
8	Housing, Water Pump	18-3116	46-96148A1	1
9	Cup, Impeller	18-3114	48752T	1
10	Impeller	18-3017	48752	1
11	Gasket, Impeller	18-2915	47-89984	1
12	Plate, Impeller	18-3117	27-85609-1	1
13	Gasket, Stainless Steel Plate	18-2914	27-85608-1	1
14	Water Pump Base Assembly	18-3420	46-44292A3	1
15	Oil Seal, Water Pump Base	18-2013	26-16977	1
16	Gasket, Water Pump Base	18-2919	27-42631-1	1
17	Oil Seal, Water Pump Base	18-2014	26-89238	1
18	O-Ring, Water Pump Base	18-7176	25-90011	1
19	Pin, Alignment	N/A	17-42836	1
20	Nut, Housing	N/A	11-13438	1
21	Washer, Housing	18-4275	12-29245	2
22	Key, Impeller	N/A	28-56654	1

R WATER PUMP ASSEMBLY

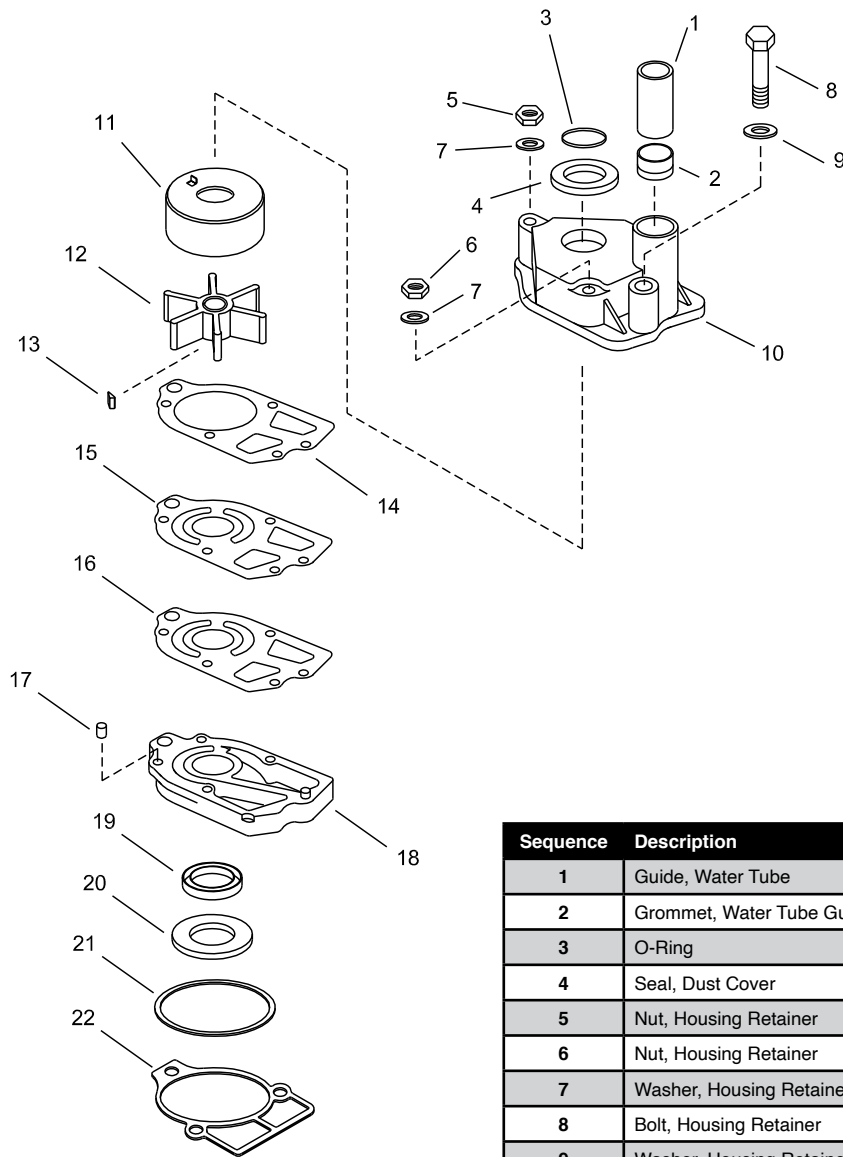

Sequence	Description	Part No.	O.E. #	Qty.
1	Guide, Water Tube	18-3109	23-29804	1
2	Grommet, Water Tube Guide	18-3110	26-38970	1
3	O-Ring	18-7158	25-30613	1
4	Seal, Dust Cover	18-7426	25-30271	1
5	Nut, Housing Retainer	18-3723	11-45592	1
6	Nut, Housing Retainer	18-3722	11-20361, 11-35888	2
7	Washer, Housing Retainer	18-4275	12-29245	3
8	Bolt, Housing Retainer	N/A	10-30720	1
9	Washer, Housing Retainer	N/A	12-36001	1
10	Housing, Impeller	18-3116	46-96148A1	1
11	Cup, Impeller	18-3114	48752	1
12	Impeller	18-3017	47-89984	1
13	Key, Impeller	N/A	28-56654	1
14	Gasket, Impeller	18-2915	27-85609-1	1
15	Wear Plate, Impeller	18-3117	32435	1
16	Gasket Wear Plate	18-2914	27-85608-1	1
17	Pin, Alignment	N/A	17-35973	1
18	Base Assembly	18-3417	46-57234A1	1
19	Oil Seal, Base Assembly	18-2013	26-16977	1
20	Oil Seal, Base Assembly	18-2014	26-89238	1
21	O-Ring, Base Assembly	18-7162	25-33145	1
22	Gasket, Base Assembly	18-2826	27-85610-1	1

 <p>18-3549 THERMOSTAT Replaces: 14586 120°</p>	 <p>18-3550 THERMOSTAT Replaces: 59078, 59078A1 140°</p>	 <p>18-3551 THERMOSTAT Replaces: 32728, 35884, 59137, 59137A1, 8072521, 8072531, 807252T1, 8M0089715 142°</p>	 <p>18-3552 THERMOSTAT Replaces: 76270, 76270T 160°</p>
--	---	---	--

 <p>18-3555 THERMOSTAT Replaces: 99155A1, 99155T2 160°</p>	 <p>18-3557 THERMOSTAT Replaces: 47594 143°</p>	 <p>18-3649 THERMOSTAT Replaces: 8072522, 807252T2, 8052732, 8M0091470 160°</p>	 <p>18-43015 THERMOSTAT Replaces: Mercury 864493 Fits: Mercruiser MCM 4.3L MPI, 5.0L MPI and MX6.2L w/dry joint exhaust and closed cooling</p>
--	---	--	--

 <p>18-43017 THERMOSTAT Replaces: Mercury 863358T, 8M0074922, 8M0076464 Fits: Mercruiser 496 Mag & HO, 8.1L MIE & HO</p>	 <p>18-3568 THERMOSTAT KIT Replaces: 99155T1</p> <table border="1"> <thead> <tr> <th>Model</th> <th>Year</th> <th>Serial #</th> </tr> </thead> <tbody> <tr> <td>5.7MIE</td> <td>1998-2001</td> <td>OL002003 & Up</td> </tr> <tr> <td>MX6.2LMPI</td> <td>2000-2001</td> <td>OL680003 & Up</td> </tr> <tr> <td>454 Horizon MIE</td> <td>1998-2001</td> <td>OL002200 & Up</td> </tr> <tr> <td>502 Mag. MPI</td> <td>1998-2001</td> <td>OL017000 & Up</td> </tr> </tbody> </table>	Model	Year	Serial #	5.7MIE	1998-2001	OL002003 & Up	MX6.2LMPI	2000-2001	OL680003 & Up	454 Horizon MIE	1998-2001	OL002200 & Up	502 Mag. MPI	1998-2001	OL017000 & Up	 <p>18-3644 THERMOSTAT KIT —CONTAINS—</p> <table border="1"> <thead> <tr> <th>Part #</th> <th>Description</th> <th>O.E.#</th> </tr> </thead> <tbody> <tr> <td>18-3649</td> <td>Thermostat 160°</td> <td>807252T2</td> </tr> <tr> <td>18-2553</td> <td>Thermostat Cover Gasket</td> <td>27-47510</td> </tr> <tr> <td>18-2917</td> <td>Thermostat Cover Gasket</td> <td>27-53045-1</td> </tr> </tbody> </table>	Part #	Description	O.E.#	18-3649	Thermostat 160°	807252T2	18-2553	Thermostat Cover Gasket	27-47510	18-2917	Thermostat Cover Gasket	27-53045-1
Model	Year	Serial #																											
5.7MIE	1998-2001	OL002003 & Up																											
MX6.2LMPI	2000-2001	OL680003 & Up																											
454 Horizon MIE	1998-2001	OL002200 & Up																											
502 Mag. MPI	1998-2001	OL017000 & Up																											
Part #	Description	O.E.#																											
18-3649	Thermostat 160°	807252T2																											
18-2553	Thermostat Cover Gasket	27-47510																											
18-2917	Thermostat Cover Gasket	27-53045-1																											

①18-3646D Display Package



**18-3646
THERMOSTAT KIT**
Replaces: 807252Q3, 807252T6
—CONTAINS—

Part #	Description	O.E.#
18-3551	Thermostat	59137
18-2917	Thermostat Housing Gasket	27-53045-1, 27-33918
18-2844	Thermostat Cover Gasket	27-48818-1
18-2553	Thermostat Cover Gasket	27-47510
18-2834	Thermostat Cover Gasket	27-60208

①18-3647D Display Package



**18-3647
THERMOSTAT KIT**
Replaces: 807252Q5, 807252T8
—CONTAINS—

Part #	Description	O.E.#
18-3649	Thermostat	807252-2
18-2844	Thermostat Cover Gasket	27-48818-1
18-2552	Thermostat Cover Gasket	27-47510
18-2553	Thermostat Cover Gasket	27-47510
18-7173-9	O-Ring	25-30224
18-2917	Thermostat Housing Gasket	27-53045-1, 27-33918

①18-3648D Display Package



**18-3648
THERMOSTAT KIT**
160°

①18-3650D Display Package



**18-3650
THERMOSTAT KIT**
Replaces: 59078T3
—CONTAINS—

Part #	Description	O.E.#
18-2831	Thermostat Gasket	27-47590-1
18-3550	Thermostat	59078

①18-3651D Display Package



**18-3651
THERMOSTAT KIT**
—CONTAINS—

Part #	Description	O.E.#
18-2554	Thermostat Cover Gasket	27-90556
18-2553	Thermostat Cover Gasket	27-47510
18-2834	Thermostat Cover Gasket	27-60208
18-2844	Thermostat Cover Gasket	27-48818-1
18-3551	Thermostat	59137

**18-3652
THERMOSTAT KIT**
—CONTAINS—

Part #	Description	O.E.#
18-2555	Thermostat Cover Gasket	27-89656-1
18-2843	Thermostat Cover Gasket	27-74830
18-3552	Thermostat	76270

THERMOSTAT APPLICATION BEGINS ON NEXT PAGE

① Items ending in "D" are Display Packaged - Regular number is Non-Display



**18-3667
THERMOSTAT KIT**
—CONTAINS—

Part #	Description	O.E.#
18-2555	Thermostat Cover Gasket	27-89656-1
18-3555	Thermostat	99155A1



① **18-3668**
THERMOSTAT KIT
Replaces: 807252T4, 807252Q4
—CONTAINS—

Part #	Description	O.E.#
18-2552	Thermostat Cover Gasket	27-33179-2
18-2553	Thermostat Cover Gasket	27-47510
18-2554	Thermostat Cover Gasket	27-41812
18-3551	Thermostat	59137
18-7173-9	O-Ring	25-30224
18-2917	Thermostat Housing Gasket	27-53045-1, 27-33918



**18-1977-1
THERMOSTAT HOUSING**
Replaces: 47441, 47441A1
Fits: 225, GM 260, 228, 898/198, 185R, 898R, 228R, 2GR



**18-1989
THERMOSTAT HOUSING**
Replaces: 8M0061381, 861006A1
Stainless Steel
Use **18-1989K** Thermostat Service Kit for replacement parts



**18-3531
THERMOSTAT HOUSING**
Replaces: 807074A1, 808064A1, 861188A1
Fits: MCM/MIE GM V-6 & V-8 (305, 350, 454 & 502 cid) engines w/closed cooling systems



**18-1989K
THERMOSTAT SERVICE KIT**
Service Kit for **18-1989** Thermostat Housing



**18-1508
THERMOSTAT SEAL**
Replaces: 25-8071341
Fits: Vazer (2007 & UP), GM V6 & V8 with closed cooling systems (1996 & UP)

THERMOSTAT APPLICATION

Engine/Model	CID#CYL	Year Range	Beginning Serial #	Ending Serial #	Housing	Thermostat Cover	Thermostat & Gasket Kit	Thermostat	Gaskets Req.	Gaskets Req. - Design II	Gaskets Req. - Design III
ROVER			3140000	UP				18-3551			
60	68/L4	1965-1968	1887079	2049044				18-3551			
80	80/L4	1966-1969	2049045	2851423				18-3551			
90	96/L4	1970-1972	2851424	3226957				18-3557	18-2831		
100 VASER	98/L4	2007-2010	w995000	& UP					18-1508		
110	153/L4	1963-1966	1537370	2044033	①			18-3551			
110	153/L4	1963-1966	1821720	2044033	⑤			18-3551			
120	153/L4	1964-1972	1666601	3377340	④			18-3551			
120	153/L4	1964-1966	1725593	2046624	⑤			18-3551			
120	153/L4	1967	2046625	2324346	⑥			18-3551			
120	153/L4	1968-1972	2324347	3377340	18-3650 ⑥, ③		18-3650	18-3550	18-2831		
120	153/L4	1972-1986	3377341	B531853	18-3650 ③		18-3650	18-3550	18-2831		
2.5L	153/L4	1987-1989	B531854	C853255	18-3650 ③		18-3650	18-3550	18-2831		
140	181/L4	1968-1986	2508261	B450800	18-3650 ③		18-3650	18-3550	18-2831		
140 (6 CYL)			1538930	1725960	—			18-3551	—		

- ① Design I
- ② Design II
- ③ Design III
- ④ Aluminum Exhaust Manifold
- ⑤ Cast Iron Exhaust Manifold
- ⑥ Closed Cooling
- ⑦ Standard Cooling
- ⑧ With check ball
- ⑨ Without check ball
- ⑩ SN 4167000 & Up
- ⑪ Original thermostat housing listed as NLA. Order update kit 87290A23
- ⑫ Original thermostat housing listed as NLA. Order update kit 90736A24
- ⑬ Complete thermostat housing kit kit
- ⑭ Single and 3-point drain system
- ⑮ 7-point drain system
- ⑯ Mechanical Throttle Body
- ⑰ Digital Throttle Body
- ⑱ Emission Control Engine
- ⑲ Manual drain system
- ⑳ Air Actuated drain system
- ㉑ Old Design
- ㉒ New Design
- ㉓ 160 degree
- ㉔ For Stainless Steel version use 18-1989

THERMOSTAT APPLICATION (Cont.)

Engine/Model	CID#CYL	Year Range	Beginning Serial #	Ending Serial #	Housing	Thermostat Cover	Thermostat & Gasket Kit	Thermostat	Gaskets Req.	Gaskets Req. - Design II	Gaskets Req. - Design III
3.0L	181/L4	1987-1989	B450801	C856558	18-3650 ③		18-3650	18-3550	18-2831		
3.0L, FWC	181/L4	1990-2010	C856559	UP	⑥		18-3647	18-3649			
3.0L	181/L4	1990-1994	C856559	F603999	18-3650 ⑦, ③		18-3650	18-3550	18-2831		
3.0L	181/L4	2000-2010	L341000	& UP	⑦		18-3647	18-3649	18-2552		
3.0L	181/L4	1998-2000	L010042	L340999	18-3650 ⑦, ③		18-3650	18-3550	18-2831		
3.0L MPI	181/L4	2008-2010	A072812	& UP			18-3647	18-3649	18-2552		
3.0L MPI FWC	181/L4	2008-2010	A072812	& UP	⑥		18-3647	18-3649			
3.0LX, FWC	181/L4	1990-1997	C856559	K999999	⑥		18-3647	18-3649			
3.0LX	181/L4	1990-1997	C856559	K999999	18-1910 ⑦, ③		18-3650	18-3550	18-2831		
150			1666495	2048046	—			18-3551	—		
160	①		2048022	2770031	—			18-3551	—		
160	②		2048022	2233574	—			18-3557	—		
160	②		2326069	2770031	—			18-3557	18-2831		
165			2770032	5813433	—		18-3650	18-3550	18-2831		
165	224/L4	1987	B434941	B774251			18-3667	18-3555	18-2555		
165			6916779	UP	—		18-3667	18-3555	18-2555		
170	224/L4	1985-1986	6916779	B434940	18-3667		18-3667	18-3555	18-2555		
175/4.3L, 4.3LX (262 CID)	③		B527955	UP	—		18-3668	18-3551	18-2553	18-2554	
175/4.3L, 4.3 LX (262 CID)	④		B527955	UP	—		18-3668	18-3551	18-2552	18-7173-9	
175/4.3L, 4.3 LX (262 CID)	④		F001220	UP	—		18-3648	18-3649 □	18-2552	18-7173-9	
180/3.7L-LX (4 CYL)			6916779	UP	—		18-3667	18-3555	18-2555		
180	224/L4	1987	B436391	B775248			18-3667	18-3555	18-2555		
185 (229 CID)			6330183	6919655	—		18-3668	18-3551	18-2553	18-2554	
185 (262 CID)			A331455	B527954	—		18-3668	18-3551	18-2553	18-2554	
190			1564539	1730903	—			18-3551	—	—	
190	224/L4	1985-1986	6916779	B436390			18-3667	18-3555	18-2555		
3.7L	224/L4	1988-1989	B774552	& UP			18-3667	18-3555	18-2555		
3.7LX	224/L4	1988-1989	B775249	& UP			18-3667	18-3555	18-2555		
470 MCMME	224/L4	1976-1982	4208730	6218036				18-3552	18-2843		
470	224/L4	1983-1984	6218037	6916778			18-3667	18-3555	18-2555		
485	224/L4	1980-1982	5685394	6218036				18-3552	18-2555		
488	224/L4	1983-1984	6170297	6916778			18-3667	18-3555	18-2555		
140 (6 CYL)	194/L6	1963	1538930	1725960				18-3551			
150	230/L6	1964-1966	1666495	2048046	①			18-3551			
150	230/L6	1964-1966	1727985	2048046	⑥			18-3551			
160	250/L6	1967-1969	2048022	2770031	①			18-3551			
160	250/L6	1967	2048022	2233574	⑥			18-3551			
160	250/L6	1968-1969	2326096	2770031	—⑥, ③			18-3557	18-2831		
165 (6 CYL)	250/L6	1970-1981	2770032	5813433	—③		18-3650	18-3550	18-2831		
200 (6 CYL)	292/L6	1969	2453769	2712072	—③			18-3557	18-2831		
185 (4bbl)	229-V-6	1983-1984	6330183	6919655	18-3678		18-3668	18-3551	18-2554	18-2553	18-2917
175	262/V-6	1987	B527955	B773242	—	18-1977-1	18-3668	18-3551	18-2554	18-2553	18-2917
175	262/V-6	1987	B527955	B773242	②, ⑤		18-3668	18-3551	18-7173-9		18-2917
185 (2bbl)	262/V-6	1985-1986	A331455	B527954	—	18-1977-1	18-3668	18-3551	18-2554	18-2553	18-2917
205	262/V-6	1985-1986	A331455	B527954	18-3668	18-1977-1	18-3668	18-3551	18-2554	18-2553	18-2917
205	262/V-6	1987	B527955	B775129	18-3668 ①	18-1977-1	18-3668	18-3551	18-2554		18-2917
205	262/V-6	1967	B527955	B775129	②, ⑤		18-3668	18-3551	18-7173-9	18-2552	18-2917
205/4.3L, 4.3 LX (262 CID)	④		B527955	D714369	—⑦		18-3668	18-3551	18-2552	18-7173-9	
205/4.3L, 4.3 LX (262 CID)	④		F001220	UP	—		18-3648	18-3649 □	18-2552	18-7173-9	

- ① Design I
- ② Design II
- ③ Design III
- ④ Aluminum Exhaust Manifold
- ⑤ Cast Iron Exhaust Manifold
- ⑥ Closed Cooling
- ⑦ Standard Cooling
- ⑧ With check ball

- ⑨ Without check ball
- ⑩ SN 4167000 & Up
- ⑪ Original thermostat housing listed as NLA. Order update kit 87290A23
- ⑫ Original thermostat housing listed as NLA. Order update kit 90736A24
- ⑬ Complete thermostat housing kit kit
- ⑭ Single and 3-point drain system

- ⑮ 7-point drain system
- ⑯ Mechanical Throttle Body
- ⑰ Digital Throttle Body
- ⑱ Emission Control Engine
- ⑲ Manual drain system
- ⑳ Air Actuated drain system
- ㉑ Old Design
- ㉒ New Design

- ♣ 160 degree
- ♠ For Stainless Steel version use 18-1989

THERMOSTAT APPLICATION (Cont.)

Engine/Model	CID#CYL	Year Range	Beginning Serial #	Ending Serial #	Housing	Thermostat Cover	Thermostat & Gasket Kit	Thermostat	Gaskets Req.	Gaskets Req. - Design II	Gaskets Req. - Design III
215 FORD			2781153	3040410	—			18-3551	—	—	
215 FORD			3040411	UP	—		18-3651	18-3551	18-2834	—	
215 FORD MCMME			3040411	3385720	—		18-3646	18-3649	18-2834	—	
225 FORD MCMME			3385721	4176999	—		18-3646	18-3649	18-2834	—	
262 MAG EFI ALPHA	262/V-6	1996-1997	0F803800	0K999999	18-3647		18-3647	18-3649	18-2917		
262 MAG EFI BRAVO	262/V-6	1996-1997	0F803800	0K999999	18-3647		18-3647	18-3649	18-2917		
4.3L	262/V-6	1988-1993	B773243	F000877	—	18-1977-1	18-3668	18-3551	18-2554	18-2553	18-2917
4.3L	262/V-6	1987-1993	B773243	F000877	②, ③		18-3668	18-3551	18-7173-9	18-2552	18-2917
4.3L	262/V-6	1993-1995	F000878	F601126	18-3647 ②, ③		18-3668	18-3649	18-2917	18-2552	18-2917
4.3L	262/V-6	1993-1995	F000878	F601126	③		18-3668	18-3551	18-0398		
4.3L FWC	262/V-6	1993-2002	F000878	M614999	18-3531 ③		18-3568	18-3555	18-0398		
4.3L ALPHA	262/V-6	1996-2002	0F601127	M614999	18-3647 ②		18-3647	18-3649	18-2917		
4.3L BRAVO	262/V-6	2996-2002	0F601127	M614999	18-3647 ②		18-3647	18-3649	18-2917		
4.3L FWC	262/V-6	2002-2010	M615000	& UP	③				18-0398		
4.3L	262/V-6	2002-2010	M615000	& UP	⑦		18-3647	18-3649	18-0398		
4.3L EFI FWC	262/V-6	1998-2001	L012009	M299999	18-3531 ③		18-3568	18-3555	18-0398		
4.3L EFI ALPHA	262/V-6	1998-2001	L012009	M299999	⑦		18-3647	18-3649	18-0398		
4.3L EFI BRAVO	262/V-6	1998-2001	L012009	M299999	⑦		18-3647	18-3649	18-0398		
4.3L MPI	262/V-6	2002-2010	M300000	& UP	⑦, ④		18-3647	18-3649	18-0398		
4.3L MPI	262/V-6	2002-2010	M300000	& UP	⑦, ⑤		18-3647	18-3649	18-0398		
4.3L MPI EC	262/V-6	2010-2011	A637496	& UP	⑦, ⑥		18-3647	18-3649	18-0398		
4.3L MPI FWC	262/V-6	2002	M300000	M614999	③		18-3568	18-3555	18-0398		
4.3L MPI FWC	262/V-6	2002-2010	M615000	& UP	③				18-0398		
4.3LH FWC	262/V-6	1998-2002	L010044	M614999	18-3531 ③		18-3568	18-3555	18-0398		
4.3LH ALPHA	262/V-6	1998-2002	L010044	M614999	⑦		18-3647	18-3649	18-0398		
4.3LH BRAVO	262/V-6	1998-2002	L010044	M614999	⑦		18-3647	18-3649	18-0398		
4.3LX	262/V-6	1988-1993	B775130	F001219	—	18-1977-1	18-3668	18-3551	18-2554	18-2553	18-2917
4.3LX	262/V-6	1988-1993	B775130	F001219	②, ③		18-3668	18-3551	18-7173-9	18-2552	18-2917
4.3LX	262/V-6	1993-1995	F001220	F601126	②, ③		18-3668	18-3551	18-7173-9	18-2552	18-2917
4.3LX	262/V-6	1993-1995	F001220	F601126	③		18-3668	18-3551	18-0398		
4.3LX FWC	262/V-6	1993-1997	F001220	K999999	③		18-3567	18-3555	18-0398		
4.3LX ALPHA	262/V-6	1996-1997	F601127	K999999	⑦		18-3647	18-3649	18-0398		
4.3LX BRAVO	262/V-6	1996-1997	F601127	K999999	⑦		18-3647	18-3649	18-0398		
4.3LXH FWC	262/V-6	1996-1997	F803114	K999999	18-3531 ③		18-3568	18-3555	18-0398		
4.3LXH ALPHA	262/V-6	1996-1997	F803114	K999999	⑦		18-3647	18-3649	18-0398		
4.3LXH BRAVO	262/V-6	1996-1997	F803114	K999999	⑦		18-3647	18-3649	18-0398		
215 MCMME (FORD)	302/V-8	1970	2781153	3040410				18-3649			
215 MCMME (FORD)	302/V-8	1971-1972	3040411	3385720			18-3646	18-3551	18-2834		
225 MCMME (FORD)	302/V-8	1973-1974	3385721	4176999			18-3646	18-3551	18-2834		
888 (FORD)	302/V-8	1971-1977	3108723	4887829	⑩		18-3646	18-3551	18-2834		
190	283/V-8	1963-1964	1564539	1730903				18-3551			
198 MIE	305/V-8	1977	4762210	6218461							
198 MIE	305/V-8	1977	4776402	4931099		18-1977-1	18-3646	18-3551	18-2844	18-0398	
200	305/V-8	1985-1987	6899058	B774444	—	18-1977-1	18-3668	18-3551	18-2554	18-2553	18-2917
200 GM			6218462	B525981	—		18-3668	18-3551	18-2553	18-2554	
2005.0L			0B525982	0F600999			18-3647	18-3649	18-2917	—	
2005.0L GM	③		B525982	UP	—		18-3668	18-3551	18-2553	18-2554	
2005.0L GM	④		B525982	UP	—		18-3648	18-3649	18-2552	18-7173-9	
228	305/V-8	1977-1982	4765100	6218461		18-1977-1	18-3646	18-3551	18-2844	18-0398	

① Design I	④ Without check ball	⑤ 7-point drain system	♣ 160 degree
② Design II	① SN 4167000 & Up	⑥ Mechanical Throttle Body	♥ For Stainless Steel version use 18-1989
③ Design III	② Original thermostat housing listed as NLA. Order update kit 87290A23	⑦ Digital Throttle Body	
④ Aluminum Exhaust Manifold	③ Complete thermostat housing kit kit	⑧ Emission Control Engine	
⑤ Cast Iron Exhaust Manifold	④ Single and 3-point drain system	⑨ Manual drain system	
⑥ Closed Cooling		⑩ Air Actuated drain system	
⑦ Standard Cooling		♣ Old Design	
⑧ With check ball		♣ New Design	

THERMOSTAT APPLICATION (Cont.)

Engine/Model	CID#CYL	Year Range	Beginning Serial #	Ending Serial #	Housing	Thermostat Cover	Thermostat & Gasket Kit	Thermostat	Gaskets Req.	Gaskets Req. - Design II	Gaskets Req. - Design III
228	305/V-8	1982-1984	6218462	6899268	—	18-1977-1	18-3668	18-3551	18-2554	18-2553	18-2917
228 MIE	305/V-8	1977-1980	4765100	5907057	18-3651	18-1977-1	18-3646	18-3551	18-2844		
230	305/V-8	1985-1987	6899269	B773739	—	18-1977-1	18-3668	18-3551	18-2554	18-2553	18-2917
230 MIE	305/V-8	1981-1987	5907058	B788151	—	18-1977-1	18-3668	18-3551	18-2554	18-2553	18-2917
230 MIE FWC	305/V-8	1981-1987	5907058	B788151	ⓐ	18-1977-1	18-3646	18-3551	18-2553	18-2844	18-2917
230 GM			6218462	B525981	—		18-3668	18-3551	18-2553	18-2554	
230 MIE			5907058	0B5225505			18-3646	18-3649 ②	18-2553	18-2844	18-2917
230 GM IB	⑤		5907058	B522505	ⓑ		18-3668	18-3551	18-2553	18-2554	
230 GM IB	⑥		5907058	B522505	ⓑ		18-3651	18-3551	18-2553	18-2844	
2305.0L GM IB	③ ⑤		B522506	B525981	ⓑ, ⓐ		18-3668	18-3551	18-2553	18-2554	18-2917
2305.0L GM IB	④ ⑤		B522506	B525981	ⓐ, ⓑ		18-3648	18-3649 ②	18-2552	18-7173-9	18-2917
2305.0L GM IB	⑥		B522506	B525981			18-3651	18-3551	18-2553	18-2844	18-2917
2305.0L-LX GM	③		B525982	F600999	—		18-3668	18-3551	18-2553	18-2554	
2305.0L-LX GM	④		B525982	UP			18-3668	18-3551	18-2552	18-7173-9	
2305.0L GM IB	④		B522506	B525981			18-3648	18-3649 ②	18-2552	18-7173-9	
2305.0L-LX GM			B525982	F600999	—		18-3648	18-3649 ②	18-2552	18-7173-9	
2305.0L MIE			0B522506	0B788151			18-3646	18-3649 ②	18-2553	18-2844	18-2917
2305.0LX GM			0B525982	0F600999			18-3647	18-3649 ②	18-2917	—	
5.0L	305/V-8	1988-1995	B774445	F600999	—	18-1977-1	18-3668	18-3551	18-2554	18-2553	
5.0L	305/V-8	1988-1995	B774445	F600999	ⓐ, ⓑ		18-3668	18-3551	18-7173-9	18-2552	
5.0L	305/V-8	1988-1995	B774445	F600999	ⓐ, ⓑ		18-3668	18-3551	18-7173-9	18-2552	
5.0L	305/V-8	1988-1995	B774445	F600999	ⓐ		18-3647	18-3649	18-0398		18-2917
5.0L (GEN+) FWC	305/V-8	1998-2002	L015751	M599999	18-3531 ⓐ		18-3668	18-3555	18-1508		18-2917
5.0L (GEN+) FWC	305/V-8	2002-2010	M600000	& UP	ⓑ				18-0398		18-2917
5.0L (GEN+) ALPHA	305/V-8	1998-2002	L015751	M599999	ⓑ		18-3647	18-3649	18-0398		
5.0L (GEN+) BRAVO	305/V-8	1998-2002	L015751	M599999	ⓑ		18-3647	18-3649	18-0398		
5.0L (GEN+)	305/V-8	2002-2010	M600000	& UP	ⓑ		18-3647	18-3649	18-0398		
5.0L EFI FWC	305/V-8	1998-2001	L012052	M299999	18-3531 ⓐ		18-3668	18-3555	18-1508		
5.0L EFI ALPHA	305/V-8	1998-2001	L012052	M299999	ⓑ		18-3647	18-3649	18-0398		
5.0L EFI BRAVO	305/V-8	1998-2001	L012052	M299999	ⓑ		18-3647	18-3649	18-0398		
5.0L MIE FWC	305/V-8	1988	B788152	C396832	ⓑ	18-1977-1	18-3646	18-3551	18-2553	18-2844	
5.0L MIE	305/V-8	1988	B788152	C396832	ⓐ, ⓑ, ①		18-3668	18-3551	18-7173-9		
5.0L MIE	305/V-8	1988	B788152	C396832	— ⓐ, ⓑ	18-1977-1	18-3668	18-3551	18-2554	18-2553	
5.0L MPI FWC	305/V-8	2002	M300000	M599999	ⓑ		18-3668	18-3555	18-0398		
5.0L MPI FWC	305/V-8	2002-2010	M600000	& UP	ⓑ				18-0398		18-2917
5.0L MPI FWC DTS	305/V-8	2005-2010	W310000	& UP	ⓑ, ⑦				18-0398		18-2917
5.0L MPI FWC EC	305/V-8	2008-2010	A300000	& UP	ⓐ, ⓑ, ⑧				18-0398		
5.0L MPI FWC EC DTS	305/V-8	2008-2010	A300000	& UP	ⓐ, ⑦, ⑧				18-0398		
5.0L MPI	305/V-8	2002-2010	M300000	& UP	ⓑ, ④		18-3647	18-3649	18-0398		18-2917
5.0L MPI ALPHA	305/V-8	2002	M300000	M599999	ⓑ, ⑤		18-3647	18-3649	18-0398		
5.0L MPI BRAVO	305/V-8	2002	M300000	M599999	ⓑ, ⑤		18-3647	18-3649	18-0398		
5.0L MPI	305/V-8	2002-2010	M600000	& UP	ⓑ, ⑤		18-3647	18-3649	18-0398		
5.0L MPI EC	305/V-8	2008-2010	A300000	& UP	ⓑ, ⑧		18-3647	18-3649	18-0398		
5.0L LX	305/V-8	1988-1995	B773740	F600999	— ⓐ	18-1977-1	18-3668	18-3551	18-2554	18-2553	18-2917
5.0LX	305/V-8	1988-1995	B773740	F600999	ⓐ, ⓑ		18-3668	18-3551	18-7173-9	18-2552	
5.0LX	305/V-8	1988-1995	B773740	F600999	ⓐ		18-3647	18-3649	18-0398		
898	305/V-8	1977-1982	4762210	6218461		18-1977-1	18-3646	18-3551	18-2844	18-0398	
898	305/V-8	1983-1984	6218462	6899057	—	18-1977-1	18-3668	18-3551	18-2554	18-2553	
225 (GM)	327/V-8	1967-1969	2399198	2694014		18-1977-1	18-3651	18-3551	18-2553	18-2844	

- ① Design I
- ② Design II
- ③ Design III
- ④ Aluminum Exhaust Manifold
- ⑤ Cast Iron Exhaust Manifold
- ⑥ Closed Cooling
- ⑦ Standard Cooling
- ⑧ With check ball
- ⑨ Without check ball
- ⓐ SN 4167000 & Up
- ① Original thermostat housing listed as NLA. Order update kit 87290A23
- ② Original thermostat housing listed as NLA. Order update kit 90736A24
- ③ Complete thermostat housing kit kit
- ④ Single and 3-point drain system
- ⑤ 7-point drain system
- ⑥ Mechanical Throttle Body
- ⑦ Digital Throttle Body
- ⑧ Emission Control Engine
- ⑨ Manual drain system
- ⑩ Air Actuated drain system
- ⓑ Old Design
- ⓐ New Design
- ♣ 160 degree
- ♥ For Stainless Steel version use 18-1989

THERMOSTAT APPLICATION (Cont.)

Engine/Model	CID#CYL	Year Range	Beginning Serial #	Ending Serial #	Housing	Thermostat Cover	Thermostat & Gasket Kit	Thermostat	Gaskets Req.	Gaskets Req. - Design II	Gaskets Req. - Design III
225 (GM)	327/V-8	1963-1967	1539620	2399197	N.L.A.			18-3551			
225 (GM)			2278647	2399197			18-3668	18-3551	18-2552	18-7173-9	
225/225S FORD			3385721	UP			18-3651	18-3551	18-2834		
250 MCM/MIE	327/V-8	1968-1969	2314301	2639854		18-1977-1	18-3651	18-3551	18-2553	18-2844	
250	350/V-8	1977	4768000	4908849		18-1977-1	18-3651	18-3551	18-2844		
250 (GM)			4768000	4908849			18-3646	18-3551	18-2844		
250 (GM)			4175500	5907057			18-3651	18-3649	18-2844	18-2917	
255 (GM)	350/V-8	1975-1976	4175500	4767999		18-1977-1	18-3646	18-3551	18-2844	18-0398	
255 (GM) MIE	350/V-8	1975-1980	4175500	5907057		18-1977-1	18-3646	18-3551	18-2844	18-0398	
255 (GM) MIE	350/V-8	1979-1980	5195909	5907057							
255 FORD			3258728	UP			18-3651	18-3551	18-2834	—	
255 FORD MCM/MIE			3258728	4178299			18-3646	18-3649	18-2834	—	
260	350/V-8	1978-1982	4908850	6218461		18-1977-1	18-3651	18-3551	18-2844	18-0398	
260	350/V-8	1982-1987	6218462	B773304	—	18-1977-1	18-3668	18-3551	18-2554	18-2553	18-2917
260 MIE FWC	350/V-8	1981-1987	5907058	B788151	Ⓢ	18-1977-1	18-3646	18-3551	18-2553	18-2844	18-2917
260 MIE	350/V-8	1981-1987	5907058	B788151	— Ⓢ	18-1977-1	18-3668	18-3551	18-2554	18-2553	18-2917
260 GM			6218462	B525981	— ▼		18-3668	18-3551	18-2553	18-2554	
260 GM			4908850	6218461			18-3646	18-3649	18-2844	18-2917	
260 GM IB	⑤		5907058	B522505	Ⓢ		18-3668	18-3551	18-2553	18-2554	
260 GM IB	⑥		5907058	B522505	Ⓢ		18-3651	18-3551	18-2553	18-2844	
260 MIE			5907058	0B522505			18-3646	18-3649	18-2553	18-2844	18-2917
260 5.7L GM IB	③ ⑤		B522506	B525981	Ⓢ Ⓢ		18-3668	18-3551	18-2553	18-2554	
260 5.7L GM IB	④ ⑤		B522506	B525981	▲ Ⓢ		18-3668	18-3551	18-2552	18-7173-9	
260 5.7L GM IB	④ ⑤		B522506	B525981	▲ Ⓢ		18-3648	18-3649 □	18-2552	18-7173-9	
260 5.7L GM IB	⑥		B522506	B525981	Ⓢ		18-3651	18-3551	18-2553	18-2844	
260 5.7L GM	③		B525982	F600999	— ▼		18-3668	18-3551 □	18-2553	18-2554	
260 5.7L GM	④		B525982	F600999			18-3668	18-3551 □	18-2552	18-7173-9	
260 5.7L GM	④		B525982	F600999			18-3648	18-3649 □	18-2552	18-7173-9	
260 5.7L GM			0B525982	0F600999			18-3647	18-3649	18-2917	—	
260 5.7L MIE			0B522506	0F024999			18-3646	18-3649	18-2553	18-2844	18-2917
270 MCM/MIE	350/V-8	1969-1972	2851074	3385720		18-1977-1	18-3646	18-3551	18-2553	18-2844	18-2917
270 GM			2851074	3077735			18-3651	18-3551	18-2553	18-2844	
280 GM	350/V-8	1975-1976	4176250	4770199		18-1977-1	18-3646	18-3649	18-2844	18-0398	
280 GM TRS			4176250	4770199			18-3651	18-3551	18-2844		
300	350/V-8	1985-1986	6668677	B430367		18-1977-1	18-3668	18-3551	18-2554	18-2553	18-2917
320 EFI	350/V-8	1987-1989	A543604	C622418		18-1977-1	18-3646	18-3551	18-2553	18-2844	18-2917
325 GM MCM/MIE			2278747	3780449			18-3646	18-3649	18-2553	18-2844	18-2917
325 GM			2278747	2313964			18-3668	18-3551	18-2553	—	
325 GM			2313965	3042730			18-3651	18-3551	18-2553	18-2844	
325 GM			3042731	UP			18-3651	18-3551	18-2844	—	
330 GM			4623115	UP			18-3651	18-3551	18-2844	—	
330 GM MCM/MIE			4623115	0B816540			18-3646	18-3649	18-2553	18-2844	18-2917
330 GM WBW	⑤		6083145	UP	Ⓢ		18-3668	18-3551	18-2553	18-2554	
330 GM WBW	⑥		6083145	UP	Ⓢ		18-3651	18-3551	18-2553	18-2844	
350 MAG ALPHA	350/V-8	1987-1995	B525982	F600999	Ⓢ, Ⓢ		18-3668	18-3551	18-7173-9		18-2917
350 MAG ALPHA	350/V-8	1986-1995	A635178	B525981	Ⓢ	18-1977-1	18-3668	18-3551	18-2554	18-2553	18-2917
350 MAG ALPHA	350/V-8	1987-1995	B525982	F600999	Ⓢ, Ⓢ		18-3668	18-3551	18-7173-9	18-2552	18-2917
350 MAG ALPHA	350/V-8	1987-1997	B525982	K999999	Ⓢ		18-3647	18-3649	18-0398		
350 MAG ALPHA EFI (GEN +)	350/V-8	1996-1997	F800300	K999999			18-3647	18-3649	18-0398		

<ul style="list-style-type: none"> ① Design I ② Design II ③ Design III ④ Aluminum Exhaust Manifold ⑤ Cast Iron Exhaust Manifold ⑥ Closed Cooling ⑦ Standard Cooling ⑧ With check ball 	<ul style="list-style-type: none"> ⑨ Without check ball ⑩ SN 4167000 & Up ⑪ Original thermostat housing listed as NLA. Order update kit 87290A23 ⑫ Original thermostat housing listed as NLA. Order update kit 90736A24 ⑬ Complete thermostat housing kit kit ⑭ Single and 3-point drain system 	<ul style="list-style-type: none"> ⑮ 7-point drain system ⑯ Mechanical Throttle Body ⑰ Digital Throttle Body ⑱ Emission Control Engine ⑲ Manual drain system ⑳ Air Actuated drain system ㉑ Old Design ㉒ New Design 	<ul style="list-style-type: none"> ㉓ 160 degree ㉔ For Stainless Steel version use 18-1989
---	---	--	---

THERMOSTAT APPLICATION (Cont.)

Engine/Model	CID/#CYL	Year Range	Beginning Serial #	Ending Serial #	Housing	Thermostat Cover	Thermostat & Gasket Kit	Thermostat	Gaskets Req.	Gaskets Req. - Design II	Gaskets Req. - Design III
350 MAG BRAVO MPI	350/V-8	1995-1997	F415189	K999999			18-3647	18-3649	18-0398		
350 MAG EFI SKI	350/V-8	1994-1997	F215561	K999999			18-3647	18-3649	18-0398		
350 MAG MPI FWC	350/V-8	1998-2001	L010019	M299999	18-3531 ①		18-3568	18-3555	18-1508		
350 MAG MPI	350/V-8	1998-2001	L010019	M299999	⑦		18-3647	18-3649	18-0398		
350 MAG MPI FWC	350/V-8	2002	M300000	M599999	⑧		18-3568	18-3555	18-0398		
350 MAG MPI FWC	350/V-8	2002-2010	M600000	& UP	⑤				18-0398		
350 MAG MPI FWC DTS	350/V-8	2005-2010	W310000	& UP	⑥, ⑦				18-0398		
350 MAG MPI FWC EC	350/V-8	2008-2010	A300000	& UP	⑨, ⑩, ⑪				18-0398		
350 MAG MPI FWC EC DTS	350/V-8	2008-2010	A300000	& UP	⑨, ⑦, ⑩		N/A		18-0398		
350 MAG MPI	350/V-8	2002	M300000	M599999	⑦, ④		18-3647	18-3649	18-0398		
350 MAG MPI ALPHA	350/V-8	2002	M300000	M599999	⑦, ⑤		18-3647	18-3649	18-0398		
350 MAG MPI BRAVO	350/V-8	2002	M300000	M599999	⑦, ⑤		18-3647	18-3649	18-0398		
350 MAG MPI	350/V-8	2002-2010	M600000	& UP	⑦, ⑤		18-3647	18-3649	18-0398		
350 MAG MPI	350/V-8	2002-2010	M600000	& UP	⑦, ④		18-3647	18-3649	18-0398		
350 MAG MPI EC	350/V-8	2008-2010	A300000	& UP	⑦, ⑩		18-3647	18-3649	18-0398		
350 MAG MPI HORIZON	350/V-8	2002	M300000	M599999	⑧		18-3568	18-3555	18-0398		
350 MAG MPI HORIZON	350/V-8	2002-2007	M600000	A299999	⑧				18-0398		
350 MAG MPI HORIZON MIE	350/V-8	1999-2001	L304700	M299999	18-3531 ①		18-3568	18-3555	18-1508		
350 MAG MPI HORIZON MIE	350/V-8	2002	M300000	M316999	⑧		18-3568	18-3555	18-1508		
350 MAG MPI HORIZON MIE	350/V-8	2002-2007	M317000	A089999	⑧				18-0398		
350 MAG MPI MIE FWC	350/V-8	1998-2001	L002008	M299999	18-3531 ①		18-3568	18-3555	18-1508		
350 MPI MIE	350/V-8	1998-2001	L002008	M299999	⑦		18-3647	18-3649	18-0398		
350 MAG MPI MIE FWC	350/V-8	2002	M300000	M316999	⑧		18-3568	18-3555	18-1508		
350 MAG MPI MIE FWC	350/V-8	2002-2007	M317000	A089999	⑧				18-0398		
350 MAG MPI MIE	350/V-8	2002-2007	M300000	A089999	⑦		18-3647	18-3649	18-0398		
350 MAG MPI SKI	350/V-8	1995-2001	F350583	M299999			18-3647	18-3649	18-0398		
350 MAG MPI SKI	350/V-8	2002-2007	M300000	A089999			18-3647	18-3649	18-0398		
350 MAG SKI	350/V-8	1991-1996	D505450	K040399	②, ③		18-3668	18-3551	18-1713-9	18-2552	18-2917
350 MAG SKI	350/V-8	1991-1997	D505450	K999999	③		18-3647	18-3649	18-0398		
5.7L	350/V-8	1988-1995	B773305	F600999	— ①	18-1977-1	18-3668	18-3551	18-2554	18-2553	18-2917
5.7L	350/V-8	1988-1995	B773305	F600999	②, ③		18-3668	18-3551	18-1713-9	18-2552	18-2917
5.7L	350/V-8	1988-1995	B773305	F600999	②, ④		18-3668	18-3551	18-1713-9	18-2552	18-2917
5.7L	350/V-8	1988-1996	B773305	K001526	③		18-3647	18-3649	18-2844	18-0398	
5.7L FWC	350/V-8	1997	K001527	K999999	18-3531 ①		18-3568	18-3555	18-1508		
5.7L ALPHA	350/V-8	1988-1997	B773305	F600999	⑦		18-3647	18-3649	18-0398		
5.7L BRAVO	350/V-8	1995-1997	F601000	K999999	⑦		18-3647	18-3649	18-0398		
5.7L (GEN+) FWC	350/V-8	1998-2002	L010037	M599999	18-3531 ①		18-3568	18-3555	18-1508		
5.7L (GEN+) ALPHA	350/V-8	1998-2002	L010037	M599999	⑦		18-3647	18-3649	18-0398		
5.7L (GEN+) BRAVO	350/V-8	1998-2002	L010037	M599999	⑦		18-3647	18-3649	18-0398		
5.7L (GEN+) FWC	350/V-8	2002-2010	M600000	& UP	⑧				18-0398		
5.7L (GEN+)	350/V-8	2002-2010	M600000	& UP	⑦		18-3647	18-3649	18-0398		
5.7L EFI FWC	350/V-8	1995-1996	F225560	K001505	⑧		18-3647	18-3649	18-2844	18-0398	
5.7L EFI FWC	350/V-8	1997-2001	K001506	M299999	18-3531 ①		18-3568	18-3555	18-1508		
5.7L EFI ALPHA	350/V-8	1995-2001	F355305	M299999	⑦		18-3647	18-3649	18-0398		
5.7L EFI BRAVO	350/V-8	1995-2001	F225560	M299999	⑦		18-3647	18-3649	18-0398		
5.7L EFI MIE (GEN+) FWC	350/V-8	1997	K040300	K999999	18-3531 ①		18-3568	18-3555	18-1508		
5.7L EFI MIE (GEN+)	350/V-8	1997	K040300	K999999	⑦		18-3647	18-3649	18-0398		
5.7L MIE	350/V-8	1988-1995	B788152	F600999	— ①	18-1977-1	18-3668	18-3551	18-2554	18-2553	18-2917
5.7L MIE	350/V-8	1988-1995	B788152	F622099	⑦, ⑧		18-3668	18-3551	18-1713-9		18-2917

- ① Design I
- ② Design II
- ③ Design III
- ④ Aluminum Exhaust Manifold
- ⑤ Cast Iron Exhaust Manifold
- ⑥ Closed Cooling
- ⑦ Standard Cooling
- ⑧ With check ball
- ⑨ Without check ball
- ⑩ SN 4167000 & Up
- ⑪ Original thermostat housing listed as NLA. Order update kit 87290A23
- ⑫ Original thermostat housing listed as NLA. Order update kit 90736A24
- ⑬ Complete thermostat housing kit
- ⑭ Single and 3-point drain system
- ⑮ 7-point drain system
- ⑯ Mechanical Throttle Body
- ⑰ Digital Throttle Body
- ⑱ Emission Control Engine
- ⑲ Manual drain system
- ⑳ Air Actuated drain system
- ㉑ Old Design
- ㉒ New Design
- ♣ 160 degree
- ♠ For Stainless Steel version use 18-1989

Thermostat Application (Cont.)

Engine/Model	CID#CYL	Year Range	Beginning Serial #	Ending Serial #	Housing	Thermostat Cover	Thermostat & Gasket Kit	Thermostat	Gaskets Req.	Gaskets Req. - Design II	Gaskets Req. - Design III
5.7L MIE	350V-8	1988-1995	B788152	F622099	⑦, ⑧		18-3668	18-3555	18-1713-9		18-2917
5.7L MIE FWC	350V-8	1988-1996	B788152	K04306	⑥		18-3647	18-3649	18-2844		
5.7L MIE FWC	350V-8	1997-2002	K040307	M316999	18-3531 ⑥		18-3568	18-3555	18-1508		
5.7L MIE	350V-8	1996-2002	F622100	M316999	⑦		18-3647	18-3649	18-0398		
5.7L MIE FWC	350V-8	2002-2010	M317000	& UP	⑥				18-0398		
5.7L MIE	350V-8	2002-2010	M317000	& UP	⑦		18-3647	18-3649	18-0398		
5.7L MPI HORIZON MIE	350V-8	2008-2010	A0900000	& UP	⑥				18-0398		
5.7L MPI MIE FWC	350V-8	2008-2010	A0900000	& UP	⑥				18-0398		
5.7L MPI MIE FWC DTS	350V-8	2008-2010	A0900000	& UP	⑥, ⑦				18-0398		
5.7L MPI MIE FWC EC	350V-8	2008-2010	A0900000	& UP	⑥, ⑥, ⑥				18-0398		
5.7L MPI MIE FWC EC DTS	350V-8	2008-2010	A0900000	& UP	⑦, ⑦, ⑥				18-0398		
5.7L MPI MIE	350V-8	2008-2010	A0900000	& UP	⑦		18-3647	18-3649	18-0398		
5.7L MPI MIE EC	350V-8	2008-2010	A0900000	& UP	⑦, ⑥		18-3647	18-3649	18-0398		
5.7L MPI SKI	350V-8	2008-2010	A0900000	& UP			18-3647	18-3649	18-0398		
5.7L MPI SKI EC	350V-8	2008-2010	A0900000	& UP	⑥		18-3647	18-3649	18-0398		
5.7L SKI	350V-8	1985-1995	A338553	F775199	— ①	18-1977-1	18-3668	18-3551	18-2554	18-2553	18-0398
5.7L SKI	350V-8	1987-1995	B514627	F775199	②, ⑥		18-3668	18-3551	18-1713-9		18-0398
5.7L SKI	350V-8	1987-1995	B514627	F775199	②, ⑥		18-3668	18-3551	18-1713-9		18-0398
5.7L SKI	350V-8	1996-2002	F775200	M316999	③		18-3647	18-3649	18-0398		
5.7L SKI	350V-8	2002-2010	M317000	& UP	⑦		18-3647	18-3649	18-0398		
5.7LX ALPHA	350V-8	1995-1997	F601000	K999999	⑦		18-3647	18-3649	18-0398		
5.7LX BRAVO	350V-8	1995-1997	F601000	K999999	⑦		18-3647	18-3649	18-0398		
5.7LX RWC	350V-8	1996	F601000	K001526	⑥		18-3647	18-3649	18-2844	18-0398	
5.7LX RWC	350V-8	1997	K001527	K999999	18-3531 ⑥		18-3568	18-3555	18-1508		
5.7LX BRAVO EFI (GEN+) FWC	350V-8	1996	F800300	K001508	⑥		18-3647	18-3649	18-2844	18-0398	
5.7LX BRAVO EFI (GEN+) FWC	350V-8	1997	K001509	K999999	⑥		18-3568	18-3555	18-0398		
5.7LX BRAVO EFI (GEN+)	350V-8	1996-1997	F800300	K999999	⑦		18-3647	18-3649	18-0398		
5.7LX EFI FWC	350V-8	1996	F752400	K001505	⑥		18-3647	18-3649	18-2844	18-0398	
5.7LX EFI FWC	350V-8	1997	K001506	K999999	18-3531 ⑥		18-3568	18-3555	13-0398		
5.7LX EFI ALPHA	350V-8	1996-1997	F752400	K999999	⑦		18-3647	18-3649	18-0398		
5.7LX EFI BRAVO	350V-8	1996-1997	F752400	K999999	⑦		18-3647	18-3649	18-0398		
5.7 GM ALPHA			F225560	0K999999			18-3647	18-3649	18-2917	—	
5.7 GM BRAVO			F225560	0K999999			18-3647	18-3649	18-2917	—	
5.7L/EFI GM ALPHA			L010037	UP			18-3647	18-3649	18-2917	—	
5.7L/EFI GM BRAVO			L010037	UP			18-3647	18-3649	18-2917	—	
5.7L MIE			F025000	0F622099			18-3647	18-3649	18-2844	—	
5.7L MIE			F622100	0K999999			18-3647	18-3649	18-2917	—	
5.7L MIE			F622100	0K999999			18-3647	18-3649	18-2844	—	
5.7L MIE			L002003	UP			18-3647	18-3649	18-2917	—	
BLACK SCORPION SKI	350V-8	1996-2001	0F800000	M391599			18-3647	18-3649	18-0398		
BLACK SCORPION SKI	350V-8	2003-2006	M391600	W690192	⑨		18-3647	18-3649	18-0398		
BLACK SCORPION SKI	350V-8	2006-2007	W690193	W698432	⑨		18-3647	18-3649	18-0398		
BLACK SCORPION SKI	350V-8	2003-2007	M391600	W698433	⑩		18-3647	18-3649	18-0398		
SCORPION 350	350V-8	2008-2010	W698433	& UP	⑨		18-3647	18-3649	18-0398		
SCORPION 350	350V-8	2008-2010	W698433	& UP	⑩		18-3647	18-3649	18-0398		
SCORPION 350 EC	350V-8	2008-2010	W698433	& UP	⑥		18-3647	18-3649	18-0398		
233 MCM (FORD)	351V-8	1975-1977	4173000	4902304			18-3646	18-3551	18-2834		
233 MIE (FORD)	351V-8	1975-1977	4173000	4902304			18-3646	18-3551	18-2834		
255 MCMME (FORD)	351V-8	1973-1974	3258728	4178299			18-3646	18-3551	18-2834		

- ① Design I
- ② Design II
- ③ Design III
- ④ Aluminum Exhaust Manifold
- ⑤ Cast Iron Exhaust Manifold
- ⑥ Closed Cooling
- ⑦ Standard Cooling
- ⑧ With check ball
- ⑨ Without check ball
- ⑩ SN 4167000 & Up
- ⑪ Original thermostat housing listed as NLA. Order update kit 87290A23
- ⑫ Original thermostat housing listed as NLA. Order update kit 90736A24
- ⑬ Complete thermostat housing kit kit
- ⑭ Single and 3-point drain system
- ⑮ 7-point drain system
- ⑯ Mechanical Throttle Body
- ⑰ Digital Throttle Body
- ⑱ Emission Control Engine
- ⑲ Manual drain system
- ⑳ Air Actuated drain system
- ㉑ Old Design
- ㉒ New Design
- ㉓ 160 degree
- ㉔ For Stainless Steel version use 18-1989

THERMOSTAT APPLICATION (Cont.)

Engine/Model	CID#CYL	Year Range	Beginning Serial #	Ending Serial #	Housing	Thermostat Cover	Thermostat & Gasket Kit	Thermostat	Gaskets Req.	Gaskets Req. - Design II	Gaskets Req. - Design III
377 MAG FWC	377V-8	2008-2010	A300000	& UP	Ⓐ, Ⓔ				18-0398		
377 MAG FWC DTS	377V-8	2008-2010	A300000	& UP	Ⓐ, Ⓣ				18-0398		
377 MAG FWC EC	377V-8	2008-2010	A300000	& UP	Ⓐ, Ⓢ				18-0398		
377 MAG FWC EC DTS	377V-8	2008-2010	A300000	& UP	Ⓐ, Ⓣ, Ⓢ				18-0398		
377 MAG	377V-8	2008-2010	A300000	& UP	Ⓣ, Ⓓ		18-3647	18-3649	18-0398		
377 MAG	377V-8	2008-2010	A300000	& UP	Ⓣ, Ⓟ		18-3647	18-3649	18-0398		
377 MAG EC	377V-8	2008-2010	A300000	& UP	Ⓣ, Ⓢ		18-3647	18-3649	18-0398		
377 SCORPION MCM	377V-8	1999-2005	L416146	M907201		18-1977-1		18-3551	18-0398		18-2553
377 SCORPION SKI	377V-8	1997-1998	K000656	L600314			18-3647	18-3649	18-0398		
MX 6.2L MPI FWC	377V-8	2000-2001	L680003	M299999	18-3531 Ⓐ		18-3568	18-3555	18-0398		
MX 6.2L MPI	377V-8	2000-2001	L680003	M299999	Ⓣ		18-3647	18-3649	18-0398		
MX 6.2L MPI FWC	377V-8	2002	M300000	M599999	Ⓐ		18-3568	18-3555	18-0398		
MX 6.2L MPI FWC	377V-8	2002-2007	M600000	A299999	Ⓐ				18-0398		
MX 6.2L MPI	377V-8	2002-2007	M300000	A299999	Ⓣ, Ⓓ		18-3647	18-3649	18-0398		
MX 6.2L MPI	377V-8	2002-2007	M300000	A299999	Ⓣ, Ⓟ		18-3647	18-3649	18-0398		
MX 6.2L MPI HORIZON	377V-8	2002	M300000	M599999	Ⓐ		18-3568	18-3555	18-0398		
MX 6.2L MPI HORIZON	377V-8	2002-2007	M600000	A299999	Ⓐ				18-0398		
MX 6.2L MPI HORIZON MIE	377V-8	2002	M300000	M316999	Ⓐ		18-3568	18-3555	18-0398		
MX 6.2L MPI HORIZON MIE	377V-8	2002-2010	M317000	& UP	Ⓐ				18-0398		
MX 6.2L MPI MIE FWC	377V-8	1999-2002	L670000	M316999	Ⓐ		18-3568	18-3555	18-0398		
MX 6.2L MPI MIE FWC	377V-8	2002-2010	M317000	& UP	Ⓐ, Ⓔ				18-0398		
MX 6.2L MPI MIE FWC DTS	377V-8	2008-2010	A0900000	& UP	Ⓐ, Ⓣ				18-0398		
MX 6.2L MPI MIE FWC EC	377V-8	2008-2010	A0900000	& UP	Ⓐ, Ⓢ, Ⓢ				18-0398		
MX 6.2L MPI MIE FWC EC DTS	377V-8	2008-2010	A0900000	& UP	Ⓐ, Ⓣ, Ⓢ				18-0398		
MX 6.2L MPI MIE	377V-8	2002-2010	M300000	& UP	Ⓣ		18-3647	18-3649	18-0398		
MX 6.2L MPI MIE	377V-8	2008-2010	A0900000	& UP	Ⓣ		18-3647	18-3649	18-0398		
MX 6.2L BLACK SCORPION	377V-8	2001-2002	L005601	M391599			18-3647	18-3649	18-0398		
MX 6.2L BLACK SCORPION	377V-8	2003-2006	M391600	W690192	Ⓢ		18-3647	18-3649	18-0398		
MX 6.2L BLACK SCORPION	377V-8	2006-2007	W690192	W698432	Ⓢ		18-3647	18-3649	18-0398		
SCORPION 377	377V-8	2008-2010	W698433	& UP	Ⓢ		18-3647	18-3649	18-0398		
SCORPION 377	377V-8	2008-2010	W698433	& UP	Ⓢ		18-3647	18-3649	18-0398		
SCORPION 377 HO EC	377V-8	2008-2010	A091488	A092170	Ⓢ		18-3647	18-3649	18-0398		
325 MCMME	427V-8	1969-1972	2278747	3780449			18-3646	18-3551	18-2553		18-0398
330 (WITH MERC TRANS)	454V-8	1977-1981	4623115	6083144			18-3646	18-3551	18-2844	18-0398	
330 (WITH BW) FWC	454V-8	1982-1987	6083145	B816540	Ⓐ		18-3646	18-3551	18-2553		18-0398
330 (WITH BW)	454V-8	1982-1987	6083145	B816540	18-3678 Ⓐ		18-3668	18-3551	18-2554	18-2553	18-0398
330 MIE (WITH MERC TRANS)	454V-8	1977-1980	4623115	5889913			18-3646	18-3551	18-2844	18-0398	
340 MIE FWC	454V-8	1981-1987	5889914	B788365	Ⓐ		18-3646	18-3551	18-2553	18-2844	18-0398
340 MIE	454V-8	1981-1987	5889914	B788365	18-3678 Ⓐ		18-3668	18-3551	18-2554	18-2844	18-0398
340 MIE	454V-8	1981-1987	5889914	B788365	Ⓣ, Ⓢ		18-3668	18-3551	18-2554	18-2553	18-0398
3407.4L MIE			5889914	OD715493			18-3646	18-3649	18-2553	18-2844	18-2917
350 MIE	454V-8	1974-1976	3780450	4623109			18-3646	18-3551	18-2844	18-0398	
350 GM (MAGNUM)			A635178	B525981			18-3668	18-3551	18-2553	18-2554	
350 GM (MAGNUM)	□		B525982	UP	Ⓐ		18-3668	18-3551	18-2553	18-2554	
350 GM (MAGNUM)	□		B525982	UP	Ⓢ		18-3668	18-3551	18-2552	18-7173-9	
350 GM (MAGNUM)	□		B525982	UP	18-3648 Ⓢ		18-3648	18-3649 □	18-2552	18-7173-9	
370	454V-8	1978-1985	4179554	6721527		18-1977-1	18-3646	18-3551	18-2553	18-2844	18-0398
370	454V-8	1985-1987	6721528	B714586			18-3668	18-3551	18-2554	18-2553	18-0398
370 TRS GM			4179554	6721527			18-3651	18-3551	18-2553	18-2844	

- Ⓐ Design I
- Ⓑ Design II
- Ⓒ Design III
- Ⓓ Aluminum Exhaust Manifold
- Ⓔ Cast Iron Exhaust Manifold
- Ⓢ Closed Cooling
- Ⓣ Standard Cooling
- Ⓤ With check ball
- Ⓥ Without check ball
- Ⓦ SN 4167000 & Up
- Ⓧ Original thermostat housing listed as NLA. Order update kit 87290A23
- Ⓨ Original thermostat housing listed as NLA. Order update kit 90736A24
- Ⓩ Complete thermostat housing kit kit
- ⓐ Single and 3-point drain system
- ⓑ 7-point drain system
- ⓓ Mechanical Throttle Body
- ⓔ Digital Throttle Body
- ⓕ Emission Control Engine
- ⓖ Manual drain system
- ⓗ Air Actuated drain system
- Ⓢ Old Design
- Ⓣ New Design
- Ⓤ 160 degree
- Ⓥ For Stainless Steel version use 18-1989

THERMOSTAT APPLICATION (Cont.)

Engine/Model	CID#CYL	Year Range	Beginning Serial #	Ending Serial #	Housing	Thermostat Cover	Thermostat & Gasket Kit	Thermostat	Gaskets Req.	Gaskets Req. - Design II	Gaskets Req. - Design III
370 TRS GM			6721528	UP			18-3668	18-3551	18-2553	18-2554	
390 GM			2781129	2825059			18-3651	18-3551	18-2553	18-2844	
390 GM MCMME			2781129	3042731			18-3646	18-3649	18-2553	18-2844	18-2917
400	454/V-8	1980-1986	4179554	0B457644			18-3646	18-3551	18-2553	18-2554	18-0398
400 TRS GM			4179554	UP			18-3651	18-3551	18-2553	18-2844	
420 GM			A398941	UP	18-3651		18-3651	18-3551	18-2553	18-2844	
420	454/V-8	1987-1989	A398941	B622418	—	18-1977-1	18-3646	18-3551	18-2553	18-2844	18-0398
425	454/V-8	1990-1993	A398941	D937011	18-3678 ①			18-3551		18-2553	18-0398
440	454/V-8	1983-1986	4179554	B485220			18-3646	18-3551	18-2553	18-2844	18-0398
450	454/V-8	1995-1996	F347100	F347277	—	18-1977-1		18-3551		18-2553	18-0398
525 SC	454/V-8	1991-1999	D456000	L415623		18-1977-1		18-3551		18-2553	18-0398
454 MAG ALPHA	454/V-8	1986-1988	A631894	B785148	18-3678 ①		18-3668	18-3551	18-2554	18-2553	18-0398
454 MAG ALPHA	454/V-8	1986-1988	A631894	B785148	②, ③		18-3668	18-3551	18-7173-9	18-2552	18-0398
454 MAG BRAVO	454/V-8	1988-1992	B721206	D805068	18-3678 ①		18-3668	18-3551	18-2554	18-2553	18-0398
454 MAG BRAVO	454/V-8	1995-1997	F305000	K999999	②, ③		18-3647	18-3649	18-0398		
454 MAG BRAVO	454/V-8	1988-1992	B721206	D805068	②, ③		18-3668	18-3551	18-7173-9		18-0398
454 MAG BRAVO	454/V-8	1992-1994	D805069	F304999	②, ③		18-3668	18-3551	18-7173-9		18-0398
454 MAG EFI	454/V-8	1995-1997	F115700	F802349	⑦		18-3647	18-3649	18-0398		
454 MAG EFI SKI	454/V-8	1995-1997	F215800	K999999	⑦		18-3647	18-3649	18-0398		
454 MAG MPI	454/V-8	1996-2001	F802350	M024999	⑦		18-3647	18-3649	18-0398		
454 MAG MPI FWC	454/V-8	1998-2001	L010029	M024999	18-3531 ⑧		18-3568	18-3555	18-0398		
454 MAG MPI HORIZON MIE	454/V-8	1998-2001	L002200	L674000	18-3531 ⑧		18-3568	18-3555	18-0398		
454 MAG MPI SKI	454/V-8	1996-1997	F820100	K999999	⑦		18-3647	18-3649	18-0398		
525 SC	454/V-8	1991-1999	D456000	L415623		18-1977-1		18-3551		18-2553	18-0398
7.4L BRAVO	454/V-8	1995-1997	0F352000	0K999999	⑦		18-3647	18-3649	18-0398		
7.4L BRAVO	454/V-8	1988-1991	B771113	D603117	18-3678 ①		18-3668	18-3551	18-2554	18-2553	18-0398
7.4L BRAVO	454/V-8	1988-1991	B771113	D603117	②, ③		18-3668	18-3551	18-7173-9	18-2552	18-0398
7.4L BRAVO	454/V-8	1992-1994	D603118	F351999	②, ③		18-3668	18-3551	18-7173-9	18-2552	18-0398
7.4L EFI MIE	454/V-8	1996-1997	F874815	K999999	⑦		18-3647	18-3649	18-0398		
7.4L EFI MIE FWC	454/V-8	1996-1997	F874815	K999999	18-3531 ⑧		18-3568	18-3555	18-0398		
7.4L MIE FWC	454/V-8	1988-1992	B788366	D715493	⑧		18-3646	18-3551	18-2553	18-2844	18-0398
7.4L MIE	454/V-8	1988-1992	B788366	D715493	⑦, ⑧		18-3668	18-3551	18-2554	18-2553	18-0398
7.4L MIE	454/V-8	1989-1994	C391564	D715493	⑦		18-3668	18-3551	18-7173-9	18-2552	18-0398
7.4L MIE FWC	454/V-8	1989-1994	C391564	D715493	⑧		18-3646	18-3551	18-2553	18-2844	18-0398
7.4L MIE	454/V-8	1989-1994	D715494	F349999	⑦		18-3668	18-3551	18-7173-9	18-2552	18-0398
7.4L MIE FWC	454/V-8	1989-1994	D715494	F820141	⑧		18-3646	18-3649	18-2553	18-2844	18-0398
7.4L MIE	454/V-8	1995-1996	F350000	F820141	⑦		18-3647	18-3649	18-0398		
7.4L MIE	454/V-8	1996-1997	F820142	K999999	⑦		18-3647	18-3649	18-0398		
7.4L MIE	454/V-8	1996-1997	F820142	K999999	⑧		18-3647	18-3649	18-2844	18-0398	
7.4L MPI	454/V-8	1998-2001	L010003	M024330	⑦		18-3647	18-3649	18-0398		
7.4L MPI MIE	454/V-8	1995-2001	F563052	M025999	⑦		18-3647	18-3649	18-0398		
7.4L MPI MIE FWC	454/V-8	1995-2001	F563052	M025999	⑧		18-3568	18-3555	18-0398		
7.4LX BRAVO EFI	454/V-8	1996-1997	F820000	K999999	⑦		18-3647	18-3649	18-0398		
7.4L BRAVO MPI	454/V-8	1996-1997	F602010	K999999	⑦		18-3647	18-3649	18-0398		
7.4L MIE			0C391564	0D715493			18-3646	18-3649	18-2553	18-2844	18-2917
7.4L MIE			0C391564	0F349999			18-3646	18-3649	18-2553	18-2844	18-2917
390 MCMME	482/V-8	1969-1970	2781129	3042731			18-3646	18-3551	18-2553	18-2844	18-0398
460	482/V-8	1983-1986	4179554	6181046			18-3668	18-3551	18-2554	18-2553	18-0398
465	502/V-8	1990-1994	C849992	F213244	18-3678			18-3551		18-2553	18-0398

- ① Design I
- ② Design II
- ③ Design III
- ④ Aluminum Exhaust Manifold
- ⑤ Cast Iron Exhaust Manifold
- ⑥ Closed Cooling
- ⑦ Standard Cooling
- ⑧ With check ball
- ⑨ Without check ball
- ⑩ SN 4167000 & Up
- ⑪ Original thermostat housing listed as NLA. Order update kit 87290A23
- ⑫ Original thermostat housing listed as NLA. Order update kit 90736A24
- ⑬ Complete thermostat housing kit kit
- ⑭ Single and 3-point drain system
- ⑮ 7-point drain system
- ⑯ Mechanical Throttle Body
- ⑰ Digital Throttle Body
- ⑱ Emission Control Engine
- ⑲ Manual drain system
- ⑳ Air Actuated drain system
- ㉑ Old Design
- ㉒ New Design
- ♣ 160 degree
- ♥ For Stainless Steel version use 18-1989

THERMOSTAT APPLICATION (Cont.)

Engine/Model	CID/#CYL	Year Range	Beginning Serial #	Ending Serial #	Housing	Thermostat Cover	Thermostat & Gasket Kit	Thermostat	Gaskets Req.	Gaskets Req. - Design II	Gaskets Req. - Design III
470			4208730	6218036			18-3652	18-3552	18-2843		
470			6218037	UP			18-3667	18-3555	18-2555	—	
485			5685394	UP			18-3652	18-3552	18-2555	—	
488			6170297	UP			18-3667	18-3555	18-2555	—	
500	502/V-8	1994-1998	F213293	L001772		18-1977-1		18-3551		18-2553	18-0398
500 (GEN+)	502/V-8	1999	L414639	L601036		18-1977-1		18-3551		18-2553	18-0398
500 EFI	502/V-8	1999-2005	L001477	M907127		18-1977-1		18-3551		18-2553	18-0398
502 MAG	502/V-8	1990-1993	C878221	F114528	⑤		18-3668	18-3551	18-7173-9	18-2552	18-0398
502 MAG EFI	502/V-8	1993-1995	D840650	F802599	⑦		18-3647	18-3649	18-0398		
502 MAG MPI	502/V-8	1996-1997	F802600	K999999	⑦		18-3647	18-3649	18-0398		
502 MAG MPI FWC	502/V-8	1998-2001	L017000	M024999	18-3531 ⑥		18-3568	18-3555	18-0398		
525 EFI	502/V-8	2003-2010	M900146	& UP			N/A		18-1508		
575 GM			0A677429	0D763716			18-3646	18-3649	18-2553	18-2844	18-2914
575			A677429	UP			18-3651	18-3551	18-2553	18-2844	
8.2L MAG	502/V-8	2010	A350340	& UP					18-1508		
8.2L MIE EC	502/V-8	2010	A350802	& UP					18-1508		
8.2L MIE	502/V-8	1990-1992	C878221	D857199	⑦		18-3668	18-3551	18-7173-9	18-2552	18-0398
8.2L MIE FWC	502/V-8	1990-1992	C878221	D857199	⑧		18-3668	18-3551	18-2553	18-2844	18-0398
8.2L MIE	502/V-8	1993-1996	D857200	F350274	⑦		18-3647	18-3649	18-0398		
8.2L MIE	502/V-8	1996	F350275	F819619	⑦		18-3647	18-3649	18-0398		
8.2L MIE FWC	502/V-8	1993-1996	D857200	F819619	⑧		18-3647	18-3649	18-2844	18-0398	
8.2L MPI MIE	502/V-8	1996-2001	F819620	L674200	⑦		18-3647	18-3649	18-0398		
8.2L MPI MIE FWC	502/V-8	1996-2001	F819620	L674200	18-3531 ⑥		18-3568	18-3555	18-1508		
500 BULLDOG	540/V-8	1990-2001	C577254	M050281		18-1977-1		18-3551		18-2553	18-0398
888 FORD			3108723	UP			18-3651	18-3551	18-2834		
888 FORD MCM			3108723	4887829			18-3646	18-3649	18-2834		
898/198 GM			4762210	6218461			18-3651	18-3551	18-2844		
898/198 GM MCMME			4762210	6218461			18-3646	18-3649	18-2844	18-2917	
898 GM		1977-1982	4762210	6218461							
898 GM			6218462	UP			18-3668	18-3551	18-2553	18-2554	

- ① Design I
- ② Design II
- ③ Design III
- ④ Aluminum Exhaust Manifold
- ⑤ Cast Iron Exhaust Manifold
- ⑥ Closed Cooling
- ⑦ Standard Cooling
- ⑧ With check ball
- ⑨ Without check ball

- ⑩ SN 4167000 & Up
- ⑪ Original thermostat housing listed as NLA. Order update kit 87290A23
- ⑫ Original thermostat housing listed as NLA. Order update kit 90736A24
- ⑬ Complete thermostat housing kit
- ⑭ Single and 3-point drain system
- ⑮ 7-point drain system
- ⑯ Mechanical Throttle Body

- ⑰ Digital Throttle Body
- ⑱ Emission Control Engine
- ⑲ Manual drain system
- ⑳ Air Actuated drain system
- ㉑ Old Design
- ㉒ New Design
- ㉓ 160 degree
- ㉔ For Stainless Steel version use 18-1989



18-7702
AIR CHARGE
TEMPERATURE SENDER
Replaces: 805223T
Fits: Mercruiser V6 & V8(350, 454, 496 & 502 cid)MPI engines



18-5897
SENDER
Replaces: 97257A1, 806490T, 97257, 806490, 811091, 36525
For Water Temperature
3/8" - 18 NPT



18-5898
SENDER
Replaces: 97258A1, 97258, 34625, F16900198, F16900152
For Water Temperature
1/2" -14 NPT



18-5899
OIL PRESSURE SENDER
Replaces: 90806, 815425T, 90806A1, 815425, 34623, 8M0068784
For Oil Pressure

TEMPERATURE SENDER/OIL SENDER APPLICATION

Model	Serial No.	Oil Pressure	Water Temperature	Model	Serial No.	Oil Pressure	Water Temperature
ROVER	3140000F & UP	—	18-5897	270	2851074-3077735	18-5899	18-5897
110	1565944-1566081	18-5899	18-5898	280	4176250 & UP	18-5899	18-5898
110	1602980 & UP	18-5899	18-5898	300 MR/TRS	6668677 & UP	18-5899 ②	18-5897 ②
120	2324346 & BELOW	18-5899	18-5898	320	A543604 & UP	18-5899 ②	18-5897 ②
120	2324347 & UP	18-5899 ① ②	18-5897 ②	325	2278747 & UP	18-5899	18-5897 ⑧ ⑨
140 (4 cyl/3.0)	2508061 - 3462607	18-5899 ②	18-5897 ②	330	4623115 & UP	18-5899	18-5898
140 (4cyl/3.0)	4512156 & UP	18-5899 ②	18-5897 ②	330/W.B.W.	6083145 & UP	18-5899 ②	18-5897 ②
3.0L/3.0LX	C856559 & UP	18-5899 ②	18-5897 ②	340/7.4L	5889914 & UP	18-5899 ②	18-5897 ②
140 (6 cyl)	1566119-1725960	18-5899	18-5898	350	3780450 & UP	18-5899	18-5898
150	1666495-2048046	18-5899	18-5898	350 (Magnum)	A635178- B525981	18-5899 ②	18-5897 ②
160	2048022-2770031	18-5899	18-5897 ④ ⑤	350 (Magnum)	B525982-0505449	—	18-5897 ② ⑥ ⑦
165	2770032 & UP	18-5899	18-5897	350 (Magnum)	D505450 & UP	18-5899 ②	18-5897 ②
165/3.7L/170/180	6916779 & UP	18-5899	—	370 (TRS)	4179554 & UP	18-5899 ②	18-5897 ②
175 (262 CID)	B527955 & UP	18-5899 ②	18-5897 ② ⑥ ⑦	390	2781129-2825059	18-5899	18-5897
4.3L (Generation II)	D714107 & UP	18-5899 ②	18-5897 ②	400	4179554 & UP	18-5899	18-5897
185 (229 CID)	6330183 & UP	18-5899 ②	18-5897 ②	420/425	A398941 & UP	18-5899 ②	18-5897 ②
185 (262 CID)	A331455 & UP	18-5899 ②	18-5897 ②	440	4179554 & UP	18-5899	18-5897
190	1504311-1730903	18-5899	18-5898	454 (Magnum)	A631894 & UP	18-5899 ②	18-5897 ②
190 (4 cyl)	6916779 & UP	18-5899	—	454 (Bravo)	B721206-D805068	18-5899 ②	18-5897 ② ⑥ ⑦
200	2453769-271202	18-5899	18-5897	460	4179554	18-5899	18-5897
200	6218462 & UP	18-5899 ②	18-5897 ②	465	C849992 & UP	18-5899 ②	18-5897 ②
200/5.0	B525982 & UP	—	18-5897 ② ⑥ ⑦	500	C577254 & UP	18-5899 ②	18-5897 ②
205 (262 CID)	A331455 & UP	18-5899 ②	18-5897 ②	502 (Bravo)	C878221 & UP	18-5899 ②	18-5897 ②
205 (4.3L)	B527955 & UP	18-5899 ②	18-5897 ② ⑥ ⑦	502 (Bravo Gen V)	D824589 & UP	—	18-5897
4.3LX (Generation II)	D714370 & UP	18-5899 ②	18-5897 ②	525	D456000 & UP	18-5899 ②	18-5897 ②
215	2781153 & UP	18-5899	18-5897	575	A677429 & UP	18-5899 ②	18-5899 ②
225 (Ford)	3385721 & UP	18-5899	18-5897	888	3108723 & UP	18-5899	18-5897
225 (GM)	1632308-2694014	18-5899	18-5897 ③ ⑨	898	4762210-6218461	18-5899	18-5898
228	4765100-6218461	18-5899	18-5898	898	6218462 & UP	18-5899 ②	18-5897 ②
228 & 230	6218462 & UP	18-5899 ②	18-5897 ②	5.7	A338553-B514626	18-5899 ②	18-5897 ②
230 (I.B.)	5907058 & UP	18-5899 ②	18-5897 ②	5.7	B514627-B525981	18-5899 ②	18-5897 ② ⑥ ⑦
230 (5.0)	B522506 & UP	18-5899 ⑩	18-5897 ⑥ ⑦	5.7 (Bravo)	B525982 & UP	—	18-5897 ⑥ ⑦
233 Ford	4173000 & UP	18-5899	18-5898	7.4 (Bravo)	B771113-D803117	18-5899 ②	18-5897 ② ⑥ ⑦
250	9314301-4908849	18-5899	18-5897 ③ ⑨	7.4 (Bravo Gen V)	D803118 & UP	—	18-5897 ②
255	3258728 & UP	18-5899	18-5898	7.4L (Hurth)	ALL	18-5899 ②	18-5897 ②
260	4908850-6218461	18-5899	18-5898	454	D805069 & UP	—	18-5897 ②
260	6218462 & UP	18-5899 ②	18-5897 ②	8.2	C878221-D857199	18-5899 ②	18-5897 ②
260/5.7	B522506 & UP	18-5899 ⑩	18-5897 ⑥ ⑦	8.2	D857200 & UP	—	18-5897 ②
260	5907058 & UP	18-5899 ②	18-5897 ②				

① S/N - 3377341-3461707 & 5192049 & UP
② Does not include Dual application
④ 2326096 & UP

⑤ 2233574 & Below use 18-5898
⑥ (3/8 - 18)
⑦ (1/2 -14) Use 18-5898

⑧ Electric Choke
⑨ Auto Choke
⑩ Thru S/N B525981 only



18-70948
MOLDED HOSE
Replaces: 32-808033
Fits: 262 Mag EFI Bravo w/Fuel Cool System (1996-97), 4.3L EFI (TBI) (1998-01), 5.0L (Gen+) Bravo (1998-07), 5.0L EFI (Gen+) (1998-01), 350 Mag Alpha (Gen+) (1997), 350 Mag Alpha EFI (Gen+) (1997), 350 Mag Bravo MPI (Gen+) (1997), 350 Mag MPI (Gen+) (1998-01), 5.7L (1997), 5.7L (Gen+) (1998-07), 5.7L EFI (1997), 5.7L EFI (Gen+) 1998-2001, 5.7LX (1997), 5.7LX Bravo EFI (Gen+) (1997), 5.7LX EFI (1997)
For: Cooler to thermostat housing



18-70949
MOLDED HOSE
Replaces: 32-807407
Fits: 454 Mag MPI (Gen VI) (1996-01), 7.4LX MPI Bravo (Gen VI) (1996-97), 502 Mag MPI (Gen VI) (1996-01) **For:** Cooler to thermostat housing



18-70954
MOLDED HOSE
Replaces: 32-8600891, 32-860089
Fits: 5.0L (Gen+) Bravo (1998-07), 5.0L EFI (Gen+) Alpha & Bravo (1998-01), 350 Mag Alpha (1997), 350 Mag EFI (Gen+) Alpha (1997), 350 Mag EFI (Gen+) Alpha (1997), 350 Mag MPI (Gen+) Bravo (1997-01), 350 Mag MPI (Gen+) Alpha (1998-01), 5.7L Alpha & Bravo (1997), 5.7L (Gen+) Alpha & Bravo (1998-07), 5.7L EFI Bravo (1997-01), 5.7LX Alpha & Bravo (1997), 5.7LX EFI (Gen+) Alpha & Bravo (1997), 6.2L MPI (2000-01) **For:** oil cooler to oil cooler



18-70956
MOLDED HOSE
Replaces: 32-16012
Fits: MC175/205 (1987), 4.3L (1988-92), 4.3L (Gen II) (1992-95), 4.3LX (Gen II) (1992-95) **For:** Oil cooler to thermostat housing with all four hose connectors cast into the thermostat housing (No "T" connector) Two hoses to manifold and two hoses to elbow



18-70955
MOLDED HOSE
Replaces: 32-16011
Fits: MC200/230 (1987), 5.0L Alpha (1988-95), 5.0LX Alpha (1988-95), MC260 (1987), 350 Mag Alpha (1987-95), 5.7L Alpha & Bravo (1988-95), 454 Mag Bravo (1988-92), 7.4L (GenV) Bravo (1992-96)
For: Oil cooler to thermostat housing with all four hose connectors cast into the thermostat housing (No "T" connector) Two hoses to manifold and two hoses to elbow



18-70952
MOLDED HOSE
Replaces: 32-887952
Fits: 5.0 L Bravo (1988-95), 5.0LX Bravo (1988-95), 350 Mag MPI Bravo (1995), 350 Mag MPI (Gen+) Bravo (1996), 5.7L Bravo (1988-96), 5.7L EFI 1995, 5.7L EFI Bravo (1996), 5.7LX EFI (Gen+) Bravo (1996) **For:** Seawater pump to oil cooler



18-70953
MOLDED HOSE
Replaces: 32-8080441
Fits: 5.0L EFI (Gen+) Bravo (1998-01), 350 Mag MPI (Gen+) (1998-01), 5.7L Bravo (1997), 5.7L (Gen+) Bravo (1998-07), 5.7L EFI Bravo 1997, 5.7L EFI (Gen+) Bravo (1998-01), 5.7LX Bravo (1997), 5.7LX EFI (Gen+) Bravo (1997), 6.2L MPI (2000-01)
For: Seawater pump to oil cooler



18-70951
MOLDED HOSE
Replaces: 32-860205, 32-8078962, 32-8078961
Fits: 262 Mag. EFI Bravo (1996-97), 4.3L (Gen+) Bravo (1998-07), 4.3L TBI (Gen+) Bravo (1998-01), 4.3LH (Gen+) Bravo (1998-02), 4.3LX(H) (Gen+) Bravo (1996-97)
For: Seawater pump to oil cooler



18-70945
MOLDED HOSE
Replaces: 32-862139
Fits: 4.3L (Gen+) (1998-07), 4.3L EFI (Gen+) (1998-01), 4.3LH (Gen+) (1998-02)
For: Thermostat housing to port manifold with 2 piece exhaust manifold



18-70947
MOLDED HOSE
Replaces: 32-862124
Fits: 4.3L (Gen+) (1998-07) (S/N 0L619000 & UP), 4.3L EFI (Gen+) (2000-01), 4.3LH (Gen+) (2000-02)
For: Thermostat housing to starboard manifold with 2 piece exhaust manifold



**18-70940
MOLDED HOSE**

Replaces: 32-860144
Fits: 262 Mag with Fuel Cool, 4.3L-LX (1996 & Up) with 1 pc. manifold, 5.0L-EFI (1998 & Up), 350 Mag-MPI 97-01, 5.7L-EFI (1996-97), 6.2L MPI(20 01 & Up).
For: Thermostat housing to port exhaust manifold



**18-70946
MOLDED HOSE**

Replaces: 32-8066362
Fits: 262 Mag EFI (Gen+) (1996-97), 4.3L (Gen+) (1998-07) (S/N 0L01004-0L618999), 4.3L EFI (Gen+) (1998-00), 4.3LH (Gen+) 1998-00, 4.3LX (Gen+) (1996-97), 4.3LXH (Gen+) (1996-97)
For: Thermostat housing to starboard manifold with 2 piece exhaust manifold



**18-44092
MOLDED HOSE
TRANSOM TO T-STAT HSG**

Replaces: 32-861635
For: Mercruiser 3.0L



**18-70958
MOLDED HOSE**

Replaces: 32-96246A4, 32-96246A1, 32-96246
Fits: MC898 (1983-84), MC200 (1985-87), MC228 (1982-84), MC230 (1985-87), 5.0L & 5.0LX Alpha (1988-95), MC260 (1983-87), 300 Tempest MR (1985-86), MC320 EFI (1987-89), 350 MAG Alpha (1986-96), 5.7L Alpha (1988-96), 5.7LX & 5.7LX EFI Alpha (1996), 454 MAG Alpha (1986-88)
For: Transom to oil cooler



**18-70934
MOLDED HOSE**

Replaces: 32-897181
Fits: 330 (1977-87), 330 MIE (1977-80), 340 MIE W/ BW (1981-87), 370 TRS (1978-87), 400 TRS (1980-86), 420 (1987-89), 425 (1990-92), 425 (Gen V) (1992-93), 440 TRS (1983-86), 450 (Gen V) (1995-96), 454 EFI (Gen V) (1994-96), 454 Mag Alpha (1986-88), 454 Mag Bravo (1988-92), 454 Mag Bravo(Gen V) (1992-97), 454 Mag MPI Bravo(Gen V) (1996-98), 454 Mag MPI SKI (Gen V)(1996-97), 460 TRS (1983-86), 465 (1990-92), 465 (Gen V) (1992-94), 500 Gen + (1999), 500 (Gen V) (1994-96), 500 (Gen VI)(1997-98), 502 EFI (Gen V)(1993-95), 502 Mag Bravo (1990-92), 502 Mag MPI Bravo (Gen VI), 502 Mag Bravo(Gen V)(1992-93), 502 Mag MPI(Gen VI)(1996), 7.4L MIE W/BW (1988-92), 7.4L Bravo (1988-91), 7.4L Bravo(Gen V)(1992-96), 7.4L Bravo (Gen VI)(1996-97), 7.4L MIE (LH)(Gen V)(1992-96), 7.4L MIE (LH)(Gen VI)(1996-97), 7.4L MIE W/Hurth (1989-92), 7.4L MIE MPI (LH)(Gen VI)(1996-97), 7.4L TBI MIE (LH)(Gen VI)(1996-97), 7.4LX Bravo MPI(Gen V)(1996-97), 7.4LX Bravo TBI(Gen VI)(1996-97), 8.2L MIE (Gen V)(1993-96), 8.2L MIE MPI (Gen VI), 8.2



**18-70935
MOLDED HOSE**

Replaces: 32-806856
Fits: 200 2bbl (1987), 230 4bbl (1987), 260 (1987), 350 Mag SKI (1991-96), 350 Mag Alpha (1987-95), 350 Mag Alpha 4bbl (1996), 350 Mag Alpha EFI (Gen+)(1996), 350 Mag Bravo MPI (1995), 350 Mag Bravo MPI (Gen+)(1996), 350 Mag EFI SKI TBI (1994-96), 350 Mag MPI SKI (1995-96), 4.3L (Gen II)(2bbl)(1993-96), 4.3LX (Gen II)(4bbl)(1993-96), 5.0L 2bbl (1988-95), 5.0LX 4bbl (1988-95), 5.7L (1988-95), 5.7L 2bbl (1996), 5.7L Alpha EFI TBI (1995), 5.7L Bravo EFI TBI(1995), 5.7L Competition SKI (1996), 5.7L EFI (2bbl TBI)(1996), 5.7L MIE (1996), 5.7LX 4bbl (1996), 5.7LX Bravo EFI (Gen+)(1996), 5.7LX EFI 4bbl TBI (1996), Black Scorpion(Gen+)(1996)
For: Oil cooler to thermostat housing.



**18-70938
MOLDED HOSE**

Replaces: 32-8066351
Fits: 262 Mag with VST (1996-97), 4.3L-LX (1993-96) Design III, 5.0L-LX (1988-95) Design III, 350Mag-EFI-MPI (1987-96), 5.7L-LX 88-96 Design III
For: Thermostat housing to port exhaust manifold



**18-70939
MOLDED HOSE**

Replaces: 32-8066361
Fits: 4.3L-LX (1993-96) Standard Cooling Design III, 5.0L-LX/5.7L-LX (1988-95) Standard Cooling Design III, 350 Mag (1987-95) Standard Cooling Design III
For: Thermostat housing to starboard exhaust manifold



**18-70943
MOLDED HOSE**

Replaces: 32-897491
Fits: 7.4L, 454 Mag, 502 Mag. For Thermostat housing to port exhaust manifold



**18-3601
GIMBAL HOUSING WATER FEED HOSE**

Replaces: 32-32461, 32-32461A1
Dia. 5/8"
Length 13 7/8"



18-3602
WATER INTAKE HOSE
 Replaces: 32-4172533, 32-8M0062309
 13 7/8" Length - 3/4" I.D.
 For: MR, Alpha I, Gen II



18-3603
WATER INTAKE HOSE
 Replaces: 32-43437, 32-8M0090859



18-70932
MOLDED HOSE
 Replaces: 32-871171, 32-87117
 For: 4.3L, 5.0L, & 5.7L Starboard
 For: Thermostat Cover to Starboard Manifold



18-70927
MOLDED HOSE
 Replaces: 32-73795
 For: 5.0L & 5.7L Port
 For: Thermostat Housing to Port Manifold



18-70931
MOLDED HOSE
 Replaces: 32-96879, 32-47640, 32-8M0071007
 For: 2.5L & 3.0L
 For: Distribution Block to Water Pump



18-70930
MOLDED HOSE
 Replaces: 32-52481
 For: GM Inline 4 & 6 cyl.
 For: Water Distribution Block to End Cap



18-70925
MOLDED HOSE
 Replaces: 32-160211, 32-871116, 32-16021
 For: 4.3L, 5.0L, & 5.7L
 For: Thermostat Cover to Port Manifold

SINGLE DIAMETER HOSE



5"

18-70704
MOLDED HOSE
 Replaces: 32-89653
 1 1/4" ID
 For: 3.7L



5"

18-70924
MOLDED HOSE
 1 3/4" ID



12 1/2"

18-71218
MOLDED HOSE
 Replaces: 32-48131, 32-48132
 1" ID
 For: 230 & 260 MIE



12 3/4"

18-71337
MOLDED HOSE
 Replaces: 32-861590A05, 32-861590A2, 32-806825
 1 3/4" ID
 For: 4.3L, 5.0L, 5.7L
 Circulating Pump Hose

STRAIGHT HOSE



18-75100
MOLDED HOSE
 Replaces: 32-8M0062614
 Straight 48"
 1" ID



18-75125
MOLDED HOSE
 Replaces: 32-8M0062665, 32-865672070, 32-5346170
 Straight 48"
 1 1/4" ID

HOSE INTERCHANGE

Part No.	Mercruiser Part No.	Part No.	Mercruiser Part No.	Part No.	Mercruiser Part No.
18-70925	32-16021 1	18-70928	32-71613	18-71337	32-87108
18-3601	32-32461	18-70927	32-73795	18-70932	32-87117 1
18-71337	32-33189	—	32-73796	18-70704	32-89653
18-3602	32-41725-33	18-70938	32-806635 1	18-70934	32-89718 1
18-3603	32-43437	18-70939	32-806636 1	18-70943	32-89749 1
18-71218	32-48132	18-70935	32-806856	18-70931	32-96879
18-70930	32-52481	18-70940	32-860144		

V-BELTS



- 1** High strength synthetic cords resist shockload failure. Their low stretch properties assure uniform performance over the life of the belt.
- 2** The compression section is a special rubber compound that assures smooth and even transfer of load forces to the cords.
- 3** Cogs are molded to precise engineering tolerances to improve flexibility and maintain cord support. Cog geometry provides a large area for air circulation to keep the belt cool and prevent damaging heat build up in the cushion section.
- 4** Rubber edges maintain positive, no-slip contact with pulley grooves for reliable energy transfer.

BELT SIZE LISTING BY NUMBER

Part No.	OE #	Effective Length (in.)	Top Width (in.)	Part No.	OE #	Effective Length (in.)	Top Width (in.)
18-15290	57-13457, 57-13457T, 57-13457Q, 57-53215, 57-53215T	29	29/64	18-15435	57-64416, 57-49211	43 1/2	29/64
18-15300	57-49756	30	29/64	18-15440	57-49213A1, 57-45856	44	29/64
18-15325	57-77274A1, 57-77274	32 1/2	29/64	18-15450	-	45	29/64
18-15345	57-74271T, 57-74271, 57-74271Q	34 1/2	29/64	18-15455	-	45 1/2	29/64
18-15370	57-65607T, 57-65607, 57-65607Q	37	29/64	18-15460	57-48120A1, 57-48120, 57-48120Q1	46	29/64
18-15380	-	38	29/64	18-15470	57-78200A1, 57-78200, 57-78200Q1	47	29/64
18-15390	57-52692	39	29/64	18-15480	57-48122, 57-48122Q	48	29/64
18-15400	57-32850, 57-69143T, 57-69143Q	40	29/64	18-15490	57-816295T, 57-816295Q	52 1/2	29/64
18-15405	57-76269, 57-76269Q	40 1/2	29/64	18-15495	57-91035A1, 57-91035Q1, 57-91035	49 1/2	29/64
18-15410	57-49043A1, 57-64032A1, 57-32860, 57-49043, 57-64032, 57-64032Q1, 57-816544	41	29/64	18-15500	57-96834T, 57-96834Q, 57-96834, 57-13458, 57-13458Q	50	29/64
18-15415	57-36356	41 1/2	29/64	18-15520	57-33170, 57-33170Q, 57-37619T	52	29/64
18-15430	57-49211, 57-64416	43	29/64	18-15550	57-13458T	55	29/64

V-BELT APPLICATION

HP	Liter	Model	Years	CID	# Cyl	Stroke	Serial #	Belt Type	Alternator/ Water Pump	Power Steering	Sea Water Pump
110		110	1963-1966	153	4	4	1537370 - 2044033	V-BELT	18-15410	—	—
120		120	1964-1973	153	4	4	1666601 - 3770649	V-BELT	18-15410	—	—
120		120	1974-1982	153	4	4	3770650 - 6229717	V-BELT	18-15410	18-15400 (40" BELT)	—
120		120	1974-1982	153	4	4	3770650 - 6229717	V-BELT	18-15410	18-15400 (40" BELT)	—
120		120	1982-1986	153	4	4	6229718 - b531853	V-BELT	18-15410 (19)	—	—
120		120	1982-1986	153	4	4	6229718 - b531853	V-BELT	18-15400 (18)	—	—
120	2.5L	120	1982-89	153	4	4	6229718 - C853255	V-BELT	18-15410	—	—
120	2.5L	120 (18)	1982-89	153	4	4	6229718 - C853255	V-BELT	18-15400	18-15370	—
140		140	1968-73	181	4	4	2508261-3770649	V-BELT	18-15410	—	—

<ul style="list-style-type: none"> (1) 1/2" wide (13mm) belt (2) 3/8" wide (10mm) belt (3) 28" wide (711mm) belt (4) 30" wide (762mm) belt (5) 37" wide (940mm) belt (6) 40" wide (1016mm) belt (7) 50" wide (1270mm) belt (8) 55" wide (1397mm) belt 	<ul style="list-style-type: none"> (9) Use with 5 1/2" (140mm) dia water pump pulley (10) Use with 5 7/8" (149mm) dia water pump pulley (11) Use with 7" (178mm) dia water pump pulley (12) Use with stamped steel sea water pump pulley (13) Use with cast aluminum sea water pump pulley (14) Use with plastic 4 3/4" (121mm) dia p/s pump pulley (15) Use with metal 5 3/4" (146mm) dia p/s pump pulley (16) For engine with high mounted p/s pump 	<ul style="list-style-type: none"> (17) For engines with low mounted p/s pump (18) For engine with power steering (19) For engines w/o power steering (20) For engines with closed cooling (21) For engines with standard cooling (22) Replacement kit includes 5 3/4" (146mm) pulley and longer serpentine belt (23) For engines with high mounted alternator
---	---	---

V-BELT APPLICATION

HP	Liter	Model	Years	CID	# Cyl	Stroke	Serial #	Belt Type	Alternator/ Water Pump	Power Steering	Sea Water Pump
140		140	1974-82	181	4	4	3770650-6229717	V-BELT	18-15410	18-15370 (37" BELT)	—
140		140	1974-82	181	4	4	3770650-6229717	V-BELT	18-15410	18-15400 (40" BELT)	—
140	3.0L	140 / 3.0L / 3.0LX	1982-1986	181	4	4	6229718 - B450800	V-BELT	18-15410 (19)	—	—
140	3.0L	140 / 3.0L / 3.0LX	1982-1999	181	4	4	6229718 - B450800	V-BELT	18-15400 (18)	18-15370	—
140	3.0L	3.0L	1987-1994	181	4	4	6229718 - F603999	V-BELT	18-15400 (18)	18-15370	—
140	3.0L	3.0L	1987-1994	181	4	4	6229718 - F603999	V-BELT	18-15400 (18)	18-15370	—
	3.0L	3.0L	1998-1999	181	4	4	L010042 - L382121	V-BELT	18-15400	18-15370	—
	3.0L	3.0L	1999-2010	181	4	4	L382122 & UP	V-BELT	—	18-15370	—
	3.0L	3.0LX	1990-1995	181	4	4	C856559 - F603999	V-BELT	18-15410 (19)	—	—
	3.0L	3.0LX	1990-1995	181	4	4	C856559 - F603999	V-BELT	18-15400 (18)	18-15370	—
	3.0L	3.0LX	1986-1997	181	4	4	F604000 - K999999	V-BELT	18-15400	18-15370	—
	3.0L	3.0L MPI	2008-2010	181	4	4	A072812 & UP	V-BELT	—	18-15370	—
150		150	1964-66		4	4	1666495-2048646	V-BELT	18-15410	—	—
160		160	1967-69		4	4	2048022-2770031	V-BELT	18-15410	—	—
165		165	1987	224	4	4	B434941 - B774251	V-BELT	—	18-15410	—
165		165	1970-73		4	4	2770032 - 3774864	V-BELT	18-15410	—	—
165		165	1974-81		4	4	3774865 - 5813433	V-BELT	18-15410	18-15370 (37" BELT)	—
165		165	1974-81		4	4	3774865 - 5813433	V-BELT	18-15410	18-15400 (40" BELT)	—
170	3.7L	165 / 170 / 180 / 190 / 3.7L	1985-89		4	4	6916779 - C762299	V-BELT	—	18-15410	—
170		170	1985-1986	224	4	4	6916779 - B434940	V-BELT	—	18-15410	—
170		470	1976-82		4	4	4208730 - 6218036	V-BELT	—	18-15405	—
170		470	1983-84		4	4	6218037 - 6916778	V-BELT	—	18-15410	—
		488	1983-84		4	4	6170297 - 6916778	V-BELT	—	18-15410	—
175		175	1987		4	4	OB527955-OB773242	V-BELT	—	18-15490	—
180		180	1987	224	4	4	B436391 - B775248	V-BELT	—	18-15410	—
190		190	1985-1986	224	4	4	691779 - B436390	V-BELT	—	18-15410	—
	3.7L	3.7L	1988-1989	224	4	4	B774252 - C762299	V-BELT	—	18-15410	—
	3.7L	3.7LX	1988-1989	224	4	4	B775249 - C762299	V-BELT	—	18-15410	—
		470	1983-1984	224	4	4	6218037 - 6916778	V-BELT	—	18-15410	—
		470 MIE	1980-1981	224	4	4	5520115 - 6218036	V-BELT	—	—	18-15345
		485	1980-1982	224	4	4	5685394 - 6218036	V-BELT	—	18-15410	—
		488	1983-1984	224	4	4	6170297 - 6916778	V-BELT	—	18-15410	—
		140	1963	194	6	4	1538930 - 1725960	V-BELT	18-15410	—	—
		150	1964-1966	230	6	4	1666495 - 2048046	V-BELT	18-15410	—	—
		160	1967-1969	250	6	4	2048022 - 2770031	V-BELT	18-15410	—	—
		165	1970-1973	250	6	4	2770032 - 3774864	V-BELT	18-15410	—	—
140		165	1974-1981	250	6	4	3774865 - 5813433	V-BELT	18-15410	18-15370 (37" BELT)	—
150		165	1974-1981	250	6	4	3774865 - 5813433	V-BELT	18-15410	18-15400 (40" BELT)	—
		200	1969	292	6	4	2453769 - 2712072	V-BELT	18-15410	—	—
		185 (4bb)	1983-1984	229	6	4	6330183 - M6919655	V-BELT	—	18-15520	18-15345
		175	1987	262	6	4	B527955 - B773242	V-BELT	—	18-15520	18-15345
		185 (2bb)	1985-1986	262	6	4	A331455 - B527954	V-BELT	—	18-15520	18-15345
		205	1985-1987	262	6	4	A331455 - B775129	V-BELT	—	18-15520	18-15345
		205	1985-1991		4		A331455 - D714369	V-BELT	18-15440	18-15520	18-15345
		205	1987		4		B527955 - OB775129	V-BELT	—	18-15490	—
		4.3L (2bb)	1988-92	262	6	4	OB773243-OD714106	V-BELT	—	18-15490	—
		4.3L	1992-96	262	6	4	D714107 - F802999	V-BELT	18-15460	—	18-15290
		4.3L ALPHA RWC	1996-1999	262	6	4	F803000 - L618999	SERPENTINE	18-15116 (14, 21, 22)	—	—
		4.3L ALPHA FWC	1996-1999	262	6	4	F803000 - L618999	SERPENTINE	—	—	—
	4.3L	4.3L ALPHA RWC	1996-1999	262	6	4	F803000 - L618999	SERPENTINE	18-15116 (15, 21)	—	—
	4.3L	4.3L ALPHA FWC	1996-1999	262	6	4	F803000 - L618999	SERPENTINE	—	—	—
	4.3L	4.3L ALPHA RWC (19)	1996-1999	262	6	4	F803000 - L618999	SERPENTINE	—	—	—
	4.3L	175 / 185 / 4.3L	1985-92	262	6	4	A331455 - D714106	V-BELT	18-15440	18-15520	18-15345
	4.3L	4.3L Gen II (2bb)	1992-96	262	6	4	OD714107-OF802999	V-BELT	—	18-15490	—
	4.3L	4.3LX (4bb)	1988-92	262	6	4	OB775130-OD714369	V-BELT	—	18-15490	—

- (1) 1/2" wide (13mm) belt
- (2) 3/8" wide (10mm) belt
- (3) 28" wide (711mm) belt
- (4) 30" wide (762mm) belt
- (5) 37" wide (940mm) belt
- (6) 40" wide (1016mm) belt
- (7) 50" wide (1270mm) belt
- (8) 55" wide (1397mm) belt

- (9) Use with 5 1/2" (140mm) dia water pump pulley
- (10) Use with 5 7/8" (149mm) dia water pump pulley
- (11) Use with 7" (178mm) dia water pump pulley
- (12) Use with stamped steel sea water pump pulley
- (13) Use with cast aluminum sea water pump pulley
- (14) Use with plastic 4 3/4" (121mm) dia p/s pump pulley
- (15) Use with metal 5 3/4" (146mm) dia p/s pump pulley
- (16) For engine with high mounted p/s pump

- (17) For engines with low mounted p/s pump
- (18) For engine with power steering
- (19) For engines w/o power steering
- (20) For engines with closed cooling
- (21) For engines with standard cooling
- (22) Replacement kit includes 5 3/4" (146mm) pulley and longer serpentine belt
- (23) For engines with high mounted alternator

V-BELT APPLICATION

HP	Liter	Model	Years	CID	# Cyl	Stroke	Serial #	Belt Type	Alternator/ Water Pump	Power Steering	Sea Water Pump
4.3L	4.3LX Gen II (4bbl)	1992-96	262	6	4	OD714370-OF802999	V-BELT	—	18-15490	—	—
4.3L	4.3L BRAVO RWC	1996-1999	262	6	4	F803000 - L618999	SERPENTINE	18-15115 (14, 21, 22)	—	—	—
4.3L	4.3L BRAVO FWC	1996-1999	262	6	4	F803000 - L618999	SERPENTINE	18-15114 (14, 20, 22)	—	—	—
4.3L	4.3L BRAVO RWC	1996-1999	262	6	4	F803000 - L618999	SERPENTINE	18-15115 (15, 21)	—	—	—
4.3L	4.3L BRAVO FWC	1996-1999	262	6	4	F803000 - L618999	SERPENTINE	18-15114 (15, 20)	—	—	—
4.3L	4.3L BRAVO RWC (19)	1996-1999	262	6	4	F803000 - L618999	SERPENTINE	—	—	—	—
5.0L	215	1970-1972	302	8	4	2781153 - 3563181	V-BELT	18-15440	—	—	—
5.0L	215 MIE	1970-1972	302	8	4	2781153 - 3563181	V-BELT	18-15440	—	—	—
5.0L	225 (FORD)	1973-74	302	8	4	3385721 - 4166999	V-BELT	18-15440	18-15520	18-15345	—
5.0L	225 MIE (FORD)	1973-74	302	8	4	3385721 - 4166999	V-BELT	18-15440	—	—	—
5.0L	888 (FORD)	1971-1977	302	8	4	3108723 - 4887829	V-BELT	18-15440 (28" BELT)	— (28" BELT)	—	—
5.0L	888 (FORD)	1971-1977	302	8	4	3108723 - 4887829	V-BELT	18-15440 (30" BELT)	18-15290 (30" BELT)	18-15440	—
5.0L	198 MIE	1977	305	8	4	4762210 - 6218461	V-BELT	18-15460	—	—	18-15345
5.0L	200	1985-1987	305	8	4	6899058 - B774444	V-BELT	—	18-15520 (9)	18-15345	—
5.0L	200	1985-1987	305	8	4	6899058 - B774444	V-BELT	18-15460 (11)	18-15490 (11)	18-15345	—
5.0L	200	1987	305	8	4	2453769 - 2712072	V-BELT	18-15410	—	—	—
5.0L	200	1987	305	8	4	B525982-B774444	V-BELT	—	18-15490	—	—
5.0L	225 MCM / 225 MIE	1967-69	305	8	4	2278647 - 2694014	V-BELT	18-15460	—	—	—
5.0L	228	1977-1982	305	8	4	4765100-6218461	V-BELT	18-15460 (17)	18-15325	18-15345	—
5.0L	228	1977-1982	305	8	4	4765100-6218461	V-BELT	18-15440 (16)	18-15495	18-15345	—
5.0L	228	1983-1984	305	8	4	6218462 - 6899268	V-BELT	— (9)	18-15520 (9)	18-15345	—
5.0L	228	1983-1984	305	8	4	6218462 - 6899268	V-BELT	18-15460 (11)	18-15490 (11)	18-15345	—
5.0L	228 MIE	1977	305	8	4	4765100 - 4929029	V-BELT	18-15460	—	—	18-15345
5.0L	228 MIE	1978-1980	305	8	4	4929030 - 5907057	V-BELT	— (9)	—	—	18-15345 (12)
5.0L	228 MIE	1978-1980	305	8	4	4929030 - 5907057	V-BELT	18-15460 (11)	—	—	18-15290 (13)
5.0L	228 MIE	1977	305	8	4	4765100 - 4929030	V-BELT	18-15460	—	—	18-15325
5.0L	228 / 230 / 5.0L	1983-95	305	8	4	6218462 - F600999	V-BELT	18-15440	18-15495	18-15345 (20)	—
5.0L	228 / 230 / 5.0L	1983-95	305	8	4	6218462 - F600999	V-BELT	18-15460	18-15520	18-15290 (21)	—
5.0L	228 / 230 / 5.0L MIE	1978-87	305	8	4	4929030 - B788151	V-BELT	18-15440	18-15495	18-15345 (12)	—
5.0L	228 / 230 / 5.0L MIE	1978-87	305	8	4	4929030 - B788151	V-BELT	18-15460	18-15520	18-15290 (13)	—
5.0L	230	1985-1987	305	8	4	6899269 - B773739	V-BELT	18-15520 (9)	18-15520 (9)	18-15345	—
5.0L	230	1983-1984	305	8	4	6899269 - B773739	V-BELT	18-15460 (11)	18-15490 (11)	18-15345	—
5.0L	230 MIE	1981-1987	305	8	4	5907058 - B788151	V-BELT	— (9)	—	—	18-15345 (12)
5.0L	230 MIE	1981-1987	305	8	4	5907058 - B788151	V-BELT	18-15460 (11)	—	—	18-15290 (13)
5.0L	230	1987	305	8	4	B525982-B773739	V-BELT	—	18-15490	—	—
5.0L	233	1975-77	305	8	4	4173000 - 4902304	V-BELT	18-15440	—	—	—
5.0L	233	1975-77	305	8	4	4173000 - 4902304	V-BELT	18-15440	18-15290	18-15345 (12)	—
5.0L	233 MIE	1975-76	305	8	4	4173000 - 4775784	V-BELT	18-15440	—	—	—
5.0L	5.0L	1988-1995	305	8	4	B774445 - F600999	V-BELT	— (9)	18-15520 (9)	18-15345 (12)	—
5.0L	5.0L	1988-1995	305	8	4	B774445 - F600999	V-BELT	18-15460 (11)	18-15490 (11)	18-15290 (13)	—
5.0L	5.0L ALPHA RWC	1998-1999	305	8	4	L012052 - L618999	SERPENTINE	18-15116 (1, 14, 21, 22)	—	—	—
5.0L	5.0L ALPHA FWC	1998-1999	305	8	4	L012052 - L618999	SERPENTINE	18-15114 (14, 20, 22)	—	—	—
5.0L	5.0L ALPHA RWC	1998-1999	305	8	4	L012052 - L618999	SERPENTINE	18-15116 (15, 21)	—	—	—
5.0L	5.0L ALPHA FWC	1998-1999	305	8	4	L012052 - L618999	SERPENTINE	18-15114 (15, 20)	—	—	—
5.0L	5.0L BRAVO RWC	1998-1999	305	8	4	L012052 - L618999	SERPENTINE	18-15115 (1, 14, 20, 22)	—	—	—
5.0L	5.0L BRAVO FWC	1998-1999	305	8	4	L012052 - L618999	SERPENTINE	18-15114 (1, 14, 21, 22)	—	—	—
5.0L	5.0L BRAVO RWC	1998-1999	305	8	4	L012052 - L618999	SERPENTINE	18-15115 (15, 21)	—	—	—
5.0L	5.0L BRAVO FWC	1998-1999	305	8	4	L012052 - L618999	SERPENTINE	18-15114 (15, 20)	—	—	—
5.0L	5.0L MIE	1988	305	8	4	B788152 - C396832	V-BELT	18-15460 (11)	—	—	57-13457Q (13)
5.0L	5.0LX	1988	305	8	4	6218462 - F600999	V-BELT	— (9)	18-15520 (9)	57-74271Q (12)	—
5.0L	5.0LX	1983-1995	305	8	4	6218462 - F600999	V-BELT	18-15460 (11)	18-15490 (11)	57-13457Q (13)	—
5.0L	5.0L (2bbl)	1988-95	305	8	4	B774445-F600999	V-BELT	—	18-15490	—	—
5.0L	5.0LX (4bbl)	1988-95	305	8	4	B773740-F600999	V-BELT	—	18-15490	—	—
5.0L	898	1977-1984	305	8	4	4762210 - 6218461	V-BELT	18-15460 (17)	18-15325 (17)	18-15345	—
5.0L	898	1977-1984	305	8	4	4762210 - 6218461	V-BELT	18-15440 (16)	18-15495	18-15345	—

- (1) 1/2" wide (13mm) belt
- (2) 3/8" wide (10mm) belt
- (3) 28" wide (711mm) belt
- (4) 30" wide (762mm) belt
- (5) 37" wide (940mm) belt
- (6) 40" wide (1016mm) belt
- (7) 50" wide (1270mm) belt
- (8) 55" wide (1397mm) belt

- (9) Use with 5 1/2" (140mm) dia water pump pulley
- (10) Use with 5 7/8" (149mm) dia water pump pulley
- (11) Use with 7" (178mm) dia water pump pulley
- (12) Use with stamped steel sea water pump pulley
- (13) Use with cast aluminum sea water pump pulley
- (14) Use with plastic 4 3/4" (121mm) dia p/s pump pulley
- (15) Use with metal 5 3/4" (146mm) dia p/s pump pulley
- (16) For engine with high mounted p/s pump

- (17) For engines with low mounted p/s pump
- (18) For engine with power steering
- (19) For engines w/o power steering
- (20) For engines with closed cooling
- (21) For engines with standard cooling
- (22) Replacement kit includes 5 3/4" (146mm) pulley and longer serpentine belt
- (23) For engines with high mounted alternator

V-BELT APPLICATION

HP	Liter	Model	Years	CID	# Cyl	Stroke	Serial #	Belt Type	Alternator/ Water Pump	Power Steering	Sea Water Pump
5.0L		898	1983-1984	305	8	4	6218462 - 6899057	V-BELT	— (9)	18-15520 (9)	18-15345 (9)
5.0L		898	1983-1984	305	8	4	6218462 - 6899057	V-BELT	18-15460 (11)	18-15490 (11)	18-15345
5.0L		898 / 200 / 5.0L	1985-1995	305	8	4	6218462 - F600999	V-BELT	18-15440 (20)	18-15495	18-15345
5.0L		898 / 200 / 5.0L	1985-1995	305	8	4	6218462 - F600999	V-BELT	18-15460 (21)	18-15520	18-15290
5.7L		250 MCM / 250 MIE	1968-69	350	8	4	2314301 - 2639854	V-BELT	18-15460	—	—
5.7L		250	1977	350	8	4	4768000 - 4908849	V-BELT	18-15440	18-15345	18-15345
5.7L		255 MCM / 255MIE	1973-74	350	8	4	3258728 - 4175499	V-BELT	18-15440	—	—
5.7L		255 (GM)	1975-76	350	8	4	4175500 - 4498700	V-BELT	18-15460	18-15300	18-15345
5.7L		255 (GM)	1976	350	8	4	4498701-4499060	V-BELT	18-15460	—	18-15345
5.7L		255 (GM)	1976	350	8	4	4499061-4767999	V-BELT	18-15460	—	18-15345
5.7L		255 MIE (GM)	1975-77	350	8	4	4175500 - 4498700	V-BELT	18-15460	—	18-15345
5.7L		255 MIE (GM)	1977-78	350	8	4	4498701 - 4924564	V-BELT	18-15460	—	18-15345
5.7L		255 MIE (GM)	1978-1980	350	8	4	4924565 - 5907057	V-BELT	—	—	18-15345
5.7L		260 MIE	1978-86	350	8	4	4924565 - B522505	V-BELT	18-15440	—	18-15345
5.7L		260 / 5.7L MIE / 5.7L Ski	1987-93	350	8	4	B522506 - F024999	V-BELT	18-15440	—	18-15345 (12)
5.7L		260 / 5.7L MIE / 5.7L Ski	1987-93	350	8	4	B522506 - F024999	V-BELT	18-15460	—	18-15290 (13)
5.7L		260	1978-1982	350	8	4	4908850 - 6218461	V-BELT	18-15440 (16)	18-15495 (17)	18-15345
5.7L		260	1978-1982	350	8	4	4908850 - 6218461	V-BELT	18-15460 (17)	—	18-15345
5.7L		260	1987	350	8	4	B525982-B773304	V-BELT	—	18-15490	—
5.7L		260	1983-1987	350	8	4	6218462 - B7733304	V-BELT	18-15460 (11)	18-15490 (11)	18-15290 (13)
5.7L		260 MIE	1987	350	8	4	B522506 - B788151	V-BELT	18-15460 (11)	—	18-15290 (13)
5.7L		260 / 5.7L	1983-1995	350	8	4	6218462 - F600999	V-BELT	18-15440	18-15495	18-15345 (20)
5.7L		260 / 5.7L	1983-1995	350	8	4	6218462 - F600999	V-BELT	18-15460	18-15520	18-15290 (21)
5.7L		270 MCM / 270 MIE	1969-1972	350	8	4	2851074 - 3385720	V-BELT	18-15460	—	—
5.7L		280 TRS	1975	350	8	4	4176250 - 4176468	V-BELT	18-15460	—	—
5.7L		280 TRS	1975	350	8	4	4176250 - 4176468	V-BELT	18-15460	18-15300	—
5.7L		280 TRS	1975-76	350	8	4	4176469 - 4499390	V-BELT	18-15460	18-15300	—
5.7L		280 TRS	1976	350	8	4	4499391 - 4499780	V-BELT	18-15460	—	—
5.7L		280 TRS	1976	350	8	4	4499781 - 4770199	V-BELT	18-15460	18-15325	—
		320 EFI	1987-89		8	4	A543604 - C622418	V-BELT	18-15440	18-15520	—
		330	1977-81		8	4	4623115-6083144		18-15470	—	18-15345
		330	1982-87		8	4	6083144 - B816540		18-15470	18-15500	18-15345 (12)
		330	1982-87		8	4	6083144 - B816540		18-15470	18-15550	18-15290 (13)
5.7L		350 MAG ALPHA	1986-1995	350	8	4	A635178 - F600999	V-BELT	18-15440 (9)	18-15520 (9)	18-15345 (20)
5.7L		350 MAG ALPHA	1986-1995	350	8	4	A635178 - F600999	V-BELT	18-15460 (11)	18-15490 (11)	18-15290 (21)
5.7L		350 MAG ALPHA	1996	350	8	4	F601000 - K001500	V-BELT	18-15460	18-15490	18-15290
5.7L		350 Mag Alpha	1987-1995	350	8	4	B525982 - F600999	V-BELT	—	18-15490	—
5.7L		350 Mag Alpha (4bb)	1996	350	8	4	F601000 - K001526	V-BELT	—	18-15490	—
5.7L		350 Mag Alpha EFI /									
		350 Mag ALPHA Gen+	1996	350	8	4	F800300 - K001508	V-BELT	—	18-15490	—
5.7L		350 Mag Bravo MPI	1995	350	8	4	F415189 - F601999	V-BELT	—	18-15490	—
5.7L		350 Mag Bravo MPI /									
		350 Mag Bravo MPI Gen+	1996	350	8	4	F602000 - K001500	V-BELT	—	18-15490	—
5.7L		350 MAG Ski	1991-96	350	8	4	D505450 - K040005	V-BELT	18-15460	—	18-15290
5.7L		350 MAG ALPHA RWC	1997-1999	350	8	4	K001501 - L618999	SERPENTINE	18-15116 (14, 21, 22)	—	—
5.7L		350 MAG ALPHA FWC	1997-1999	350	8	4	K001501 - L618999	SERPENTINE	18-15114 (14, 20, 22)	—	—
5.7L		350 MAG ALPHA RWC	1997-1999	350	8	4	K001501 - L618999	SERPENTINE	18-15116 (15, 20)	—	—
5.7L		350 MAG ALPHA FWC	1997-1999	350	8	4	K001501 - L618999	SERPENTINE	18-15114 (15, 21)	—	—
5.7L		350 MAG BRAVO RWC	1997-1999	350	8	4	K001501 - L618999	SERPENTINE	18-15115 (14, 21, 22)	—	—
5.7L		350 MAG BRAVO FWC	1997-1999	350	8	4	K001501 - L618999	SERPENTINE	18-15114 (14, 20, 22)	—	—
5.7L		350 MAG BRAVO RWC	1997-1999	350	8	4	K001501 - L618999	SERPENTINE	18-15115 (15, 21)	—	—
5.7L		350 MAG BRAVO FWC	1997-1999	350	8	4	K001501 - L618999	SERPENTINE	18-15114 (15, 20)	—	—
5.7L		350 MIE	1974-75	350	8	4	3780450-4501640		18-15480	—	—
5.7L		350 MIE	1976	350	8	4	4501641 - 4623109		18-15480	—	18-15345
5.7L		350 MAG MPI / 350 MAG SKI	1995-1996	350	8	4	F350583 - F799999	V-BELT	18-15460	—	18-15290

- (1) 1/2" wide (13mm) belt
- (2) 3/8" wide (10mm) belt
- (3) 28" wide (711mm) belt
- (4) 30" wide (762mm) belt
- (5) 37" wide (940mm) belt
- (6) 40" wide (1016mm) belt
- (7) 50" wide (1270mm) belt
- (8) 55" wide (1397mm) belt

- (9) Use with 5 1/2" (140mm) dia water pump pulley
- (10) Use with 5 7/8" (149mm) dia water pump pulley
- (11) Use with 7" (178mm) dia water pump pulley
- (12) Use with stamped steel sea water pump pulley
- (13) Use with cast aluminum sea water pump pulley
- (14) Use with plastic 4 3/4" (121mm) dia p/s pump pulley
- (15) Use with metal 5 3/4" (146mm) dia p/s pump pulley
- (16) For engine with high mounted p/s pump

- (17) For engines with low mounted p/s pump
- (18) For engine with power steering
- (19) For engines w/o power steering
- (20) For engines with closed cooling
- (21) For engines with standard cooling
- (22) Replacement kit includes 5 3/4" (146mm) pulley and longer serpentine belt
- (23) For engines with high mounted alternator

V-BELT APPLICATION

HP	Liter	Model	Years	CID	# Cyl	Stroke	Serial #	Belt Type	Alternator/ Water Pump	Power Steering	Sea Water Pump
5.7L		350 MAG SKI	1991-1996	350	8	4	D505450 - K040005	V-BELT	18-15460	—	18-15290 (12)
5.7L	5.7L		1988-1995	350	8	4	B773305 - F600999	V-BELT	— (9)	18-15520 (9)	18-15345
5.7L	5.7L		1988-1995	350	8	4	B773305 - F600999	V-BELT	18-15460 (11)	18-15490 (11)	18-15290
5.7L	5.7L		1996	350	8	4	F601000 - K001505	V-BELT	18-15460	18-15490	18-15290
5.7L	5.7L ALPHA RWC		1997-1999	350	8	4	K001506 - L618999	SERPENTINE	18-15116 (14, 21, 22)	—	—
5.7L	5.7L ALPHA FWC		1997-1999	350	8	4	K001506 - L618999	SERPENTINE	18-15114 (14, 20, 22)	—	—
5.7L	5.7L ALPHA RWC		1997-1999	350	8	4	K001506 - L618999	SERPENTINE	18-15116 (15, 21)	—	—
5.7L	5.7L ALPHA FWC		1997-1999	350	8	4	K001506 - L618999	SERPENTINE	18-15114 (15, 20)	—	—
5.7L	5.7L BRAVO FWC		1997-1999	350	8	4	K001506 - L618999	SERPENTINE	18-15114 (14, 20, 22)	—	—
5.7L	5.7L BRAVO RWC		1997-1999	350	8	4	K001506 - L618999	SERPENTINE	18-15115 (15, 21)	—	—
5.7L	5.7L BRAVO FWC		1997-1999	350	8	4	K001506 - L618999	SERPENTINE	18-15114 (15, 20)	—	—
5.7L	5.7L MIE		1988-1993	350	8	4	B522506 - F024999	V-BELT	—	—	18-15345
5.7L	5.7L MIE		1988-1993	350	8	4	B522506 - F024999	V-BELT	—	—	18-15290
5.7L	5.7L MIE		1994-1996	350	8	4	F025000 - K040306	V-BELT	18-15460	—	18-15290
5.7L	5.7L SKI		1985-1987	350	8	4	A338553 - B514626	V-BELT	—	—	18-15290 (13)
5.7L	5.7L SKI		1987-1995	350	8	4	B514627 - F775199	V-BELT	—	—	18-15345
5.7L	5.7L SKI		1987-1995	350	8	4	B514627 - F775199	V-BELT	—	—	18-15290
5.7L	5.7L SKI		1996	350	8	4	F775200 - K040003	V-BELT	18-15460	—	18-15290
5.7L	5.7LX		1996	350	8	4	F601000 - K001505	V-BELT	18-15460	18-15490	18-15290
5.7L	5.7L BRAVO EFI		1996	350	8	4	F800300 - K001505	V-BELT	18-15460	18-15490	18-15290
5.7L	5.7LX BRAVO		1996	350	8	4	F601000 - K001505	V-BELT	18-15460	18-15490	18-15290
5.7L	BLACK SCORPION SKI		1996	350	8	4	F800000 - K040000	V-BELT	18-15460	—	18-15290
5.7L	5.7L MIE / 5.7L Ski		1994-96	350	8	4	F025000 - K040306		18-15460	—	—
5.7L	5.7L		1988-96	350	8	4	B525982 - F600999		—	18-15490	—
5.7L	5.7L (2bb)		1996	350	8	4	F601000 - K001526		—	18-15490	—
5.7L	5.7L EFI (2bb)		1996	350	8	4	F752400 - K001505		—	18-15490	—
5.7L	5.7L Alpha EFI / 5.7L ALPHA TBI		1995	350	8	4	F355305 - F752389		—	18-15490	—
5.7L	5.7L Alpha EFI / 5.7L ALPHA TBI		1995	350	8	4	F225560 - F752399		—	18-15490	— (13)
5.7L	5.7LX EFI / 5.7LX TBI (4bb)		1996	350	8	4	F752400 - K001505		—	18-15490	— (12)
5.7L	233		1975-1977	351	8	4	4173000 - 4902304	V-BELT	—	18-15290 (30° BELT)	18-15345
6.2L	377 SCORPION MCM		1999-2005	377	8	4	L416146 - M907201	SERPENTINE	18-15115	—	—
7.4L	325 MCM / 325 MIE		1968-1974	427	8	4	2278747 - 3780449	V-BELT	18-15480	—	—
7.4L	330		1977-1981	454	8	4	4623115 - 6083144	V-BELT	18-15470	—	18-15345
7.4L	330		1982-1987	454	8	4	6083145 - B816540	V-BELT	18-15470	18-15500 (50° BELT)	18-15345 (12)
7.4L	330		1982-1987	454	8	4	6083145 - B816540	V-BELT	18-15470	18-15550 (55° BELT)	18-15290 (13)
7.4L	330 MIE		1977-1980	454	8	4	4623115 - 5889913	V-BELT	18-15470	—	18-15345
7.4L	340 MIE		1981-1987	454	8	4	5889914 - B788365	V-BELT	18-15470	—	18-15345 (12)
7.4L	340 MIE		1981-1987	454	8	4	5889914 - B788365	V-BELT	18-15470	—	18-15290 (13)
7.4L	340		1981-92	454	8	4	5889914 - D715493	V-BELT	18-15470	—	18-15345 (12)
7.4L	340		1981-92	454	8	4	5889914 - D715493	V-BELT	18-15470	—	18-15290 (13)
7.4L	350 MIE		1974-1975	454	8	4	3780450 - 4501640	V-BELT	18-15480	—	—
7.4L	350 MIE		1976	454	8	4	4501641 - 4623109	V-BELT	18-15480	—	18-15345
7.4L	370 TRS		1978-1985	454	8	4	4179554 - 6721527	V-BELT	18-15480	—	—
7.4L	370 TRS		1985-1987	454	8	4	6721528 - B714586	V-BELT	18-15480	18-15500	18-15345
7.4L	400 TRS		1980-1986	454	8	4	4179554 - B457644	V-BELT	18-15480	—	—
7.4L	420		1987-1989	454	8	4	A398941 - B622418	V-BELT	—	18-15500	18-15345
7.4L	425		1990-1992	454	8	4	B622419 - D725499	V-BELT	—	18-15500	18-15345
7.4L	425		1992	454	8	4	D725500 - D937011	V-BELT	—	—	18-15400
7.4L	440 TRS		1983-1986	454	8	4	4179554 - B485220	V-BELT	18-15480	—	—
7.4L	450		1995-1996	454	8	4	F347100 - F347277	V-BELT	—	—	18-15400
7.4L	454 MAG ALPHA		1986-1988	454	8	4	A631894 - B785148	V-BELT	18-15470	18-15500 (50° BELT)	—
7.4L	454 MAG ALPHA		1986-1988	454	8	4	A631894 - B785148	V-BELT	18-15470	18-15550 (55° BELT)	—
7.4L	454 MAG		1988-92	454	8	4	B721206 - D805088		18-15470	18-15550	18-15290
7.4L	454 MAG		1988-92	454	8	4	B721206 - D805088		18-15480	—	18-15290
7.4L	454 MAG		1992-97	454	8	4	D805069 - K999999		18-15480	—	18-15400

- (1) 1/2" wide (13mm) belt
- (2) 3/8" wide (10mm) belt
- (3) 28" wide (711mm) belt
- (4) 30" wide (762mm) belt
- (5) 37" wide (940mm) belt
- (6) 40" wide (1016mm) belt
- (7) 50" wide (1270mm) belt
- (8) 55" wide (1397mm) belt

- (9) Use with 5 1/2" (140mm) dia water pump pulley
- (10) Use with 5 7/8" (149mm) dia water pump pulley
- (11) Use with 7" (178mm) dia water pump pulley
- (12) Use with stamped steel sea water pump pulley
- (13) Use with cast aluminum sea water pump pulley
- (14) Use with plastic 4 3/4" (121mm) dia p/s pump pulley
- (15) Use with metal 5 3/4" (146mm) dia p/s pump pulley
- (16) For engine with high mounted p/s pump

- (17) For engines with low mounted p/s pump
- (18) For engine with power steering
- (19) For engines w/o power steering
- (20) For engines with closed cooling
- (21) For engines with standard cooling
- (22) Replacement kit includes 5 3/4" (146mm) pulley and longer serpentine belt
- (23) For engines with high mounted alternator

V-BELT APPLICATION

HP	Liter	Model	Years	CID	# Cyl	Stroke	Serial #	Belt Type	Alternator/ Water Pump	Power Steering	Sea Water Pump
7.4L	454	MAG MPI	1994-97	454	8	4	F115700 - K147349		18-15480	—	18-15400
7.4L	454	MAG MPI	1997	454	8	4	K147350 - K999999		18-15480	—	18-15290
7.4L	454	MAG Ski	1995-97	454	8	4	F215800 - K999999		18-15480	—	18-15400
7.4L	454	MAG BRAVO	1988-1992	454	8	4	B721206 - D805068	V-BELT	18-15470 (9)	18-15550 (9)	18-15290
7.4L	454	MAG BRAVO	1988-1992	454	8	4	B721206 - D805068	V-BELT	18-15480 (11)	— (11)	18-15290
7.4L	454	MAG BRAVO	1992-1997	454	8	4	D805069 - K999999	V-BELT	18-15480	—	18-15400
7.4L	454	MAG EFI	1994-1996	464	8	4	F115700 - F802349	V-BELT	18-15480	—	18-15400
7.4L	454	MAG EFI SKI	1995-1996	454	8	4	F215800 - F820099	V-BELT	18-15480	—	18-15400
7.4L	454	MAG MPI	1996-1997	454	8	4	F115700 - F147349	V-BELT	18-15480	—	18-15400
7.4L	454	MAG MPI	1997	454	8	4	K147350 - K999999	V-BELT	18-15480	—	18-15290
7.4L	525	SC	1991-1999	454	8	4	D456000 - L415623	V-BELT	—	18-15500	18-15400
7.4L	7.4L	BRAVO	1988-1991	454	8	4	B771113 - D603117	V-BELT	18-15470	18-15550 (9)	18-15290
7.4L	7.4L	BRAVO	1988-1991	454	8	4	B771113 - D603117	V-BELT	18-15480	— (11)	18-15290
7.4L	7.4L	BRAVO	1992-1997	454	8	4	D603118 - K999999	V-BELT	18-15480	—	18-15400
7.4L	7.4L	MIE (WITH B/W)	1988-1992	454	8	4	B788366 - D715493	V-BELT	18-15470	—	18-15290
7.4L	7.4L	MIE (WITH B/W)	1988-1992	454	8	4	B788366 - D715493	V-BELT	18-15470	—	18-15400
7.4L	7.4L	MIE (WITH HURTH)	1989-1992	454	8	4	C391564 - D715493	V-BELT	18-15470 (10)	—	18-15290 (12)
7.4L	7.4L	MIE (WITH HURTH)	1989-1992	454	8	4	C391564 - D715493	V-BELT	18-15480 (11)	—	18-15290 (13)
7.4L	7.4L	MIE	1992-1997	454	8	4	D715494 - K999999	V-BELT	18-15480	—	18-15400
7.4L	7.4L	MPI	1998-2001	454	8	4	L010003 - M024330	SERPENTINE	18-15114 (14, 22)	—	—
7.4L	7.4L	MPI	1998-2001	454	8	4	L010003 - M024330	SERPENTINE	18-15114 (14)	—	—
7.4L	7.4L	MPI / 7.4L MIE	1995-1996	454	8	4	F563052 - F820131	V-BELT	18-15480	—	18-15400
7.4L	7.4L	MPI / 7.4L MIE	1996-1997	454	8	4	F820132 - K999999	V-BELT	18-15480	—	18-15290
7.4L	7.4L	X BRAVO EFI	1996-1997	454	8	4	F820000 - K999999	V-BELT	18-15480	—	18-15290
7.4L	7.4L	X BRAVO MPI	1996-1997	454	8	4	F602010 - K147349	V-BELT	18-15480	—	18-15400
7.4L	7.4L	X BRAVO MPI	1997	454	8	4	K147350 - K999999	V-BELT	18-15480	—	18-15290
7.4L	7.4L	X Bravo MPI	1996-97	454	8	4	F602010 - K147349		18-15480	—	18-15400
7.4L	7.4L	MIE	1992-97	454	8	4	C391564 - K999999		18-15480	—	18-15400
7.4L	370	TRS	1978-85		8	4	4179554 - 6721527		18-15480	—	—
7.4L	370	TRS	1985-87		8	4	6721528 - B714586		18-15480	18-15500	—
	390	MCM / 390 MIE	1969-1970	482	8	4	2781129 - 3042731	V-BELT	18-15480	—	—
	400	TRS	1983-1986	482	8	4	4179554 - 6181046	V-BELT	18-15480	—	—
	420/425		1987-1992		8	4	A398941 - D725499		18-15480	18-15500	—
	420 / 425		1992		8	4	D725500 - D937011		18-15480	—	18-15400
	440	TRS	1983-1986		8	4	4179554 - B485220		18-15480	—	—
	450		1995-1996		8	4	F347100 - F347227		18-15480	—	18-15400
	460	TRS	1983-1986		8	4	4179554 - 6181046		18-15480	—	—
	465		1990-1992	502	8	4	C849992 - D725646	V-BELT	—	—	18-15290
8.2L	465		1992-1994	502	8	4	D725647 - F213244	V-BELT	—	—	18-15400
8.2L	500		1994-1998	502	8	4	F213293 - L001772	V-BELT	—	—	18-15400
8.2L	500	GEN +	1999	502	8	4	L414639 - L601036	V-BELT	—	—	18-15400
8.2L	502	MAG BRAVO	1990-1997	502	8	4	C878221 - D824588	V-BELT	18-15480	—	18-15290
8.2L	502	MAG BRAVO	1990-1997	502	8	4	C824589 - K999999	V-BELT	18-15480	—	18-15400
8.2L	502	MAG EFI	1994-1995	502	8	4	D840650 - F802599	V-BELT	18-15480	—	18-15400
8.2L	502	MAG MPI	1996-1997	502	8	4	F802600 - K147349	V-BELT	18-15480	—	18-15400
8.2L	502	MAG MPI	1997	502	8	4	K147350 - K999999	V-BELT	18-15480	—	18-15290
8.2L	502	MAG MPI	1998-2001	502	8	4	L017000 - M024999	SERPENTINE	18-15114 (14, 22)	—	—
8.2L	502	MAG MPI	1998-2001	502	8	4	L017000 - M024999	SERPENTINE	18-15114 (14)	—	—
8.2L	600	SC	1991-1992	502	8	4	D456489 - D456768	V-BELT	—	18-15500	18-15345
8.2L	600	SC	1992-2000	502	8	4	D725676 - L601186	V-BELT	—	18-15500	18-15400
8.2L	8.2L	MIE	1990-1993	502	8	4	C878221 - D857199	V-BELT	18-15480	—	18-15290
8.2L	8.2L	MIE	1993-1997	502	8	4	D857200 - K999999	V-BELT	18-15480	—	18-15400
8.2L	8.2L	MPI MIE	1996-1997	502	8	4	F819620 - K147349	V-BELT	18-15480	—	18-15400
8.2L	8.2L	MPI MIE	1997	502	8	4	K147350 - K999999	V-BELT	18-15480	—	18-15290
8.2L	500	BULLDOG	1990-2001	540	8	4	C577254 - M050281	V-BELT	— (3/8" BELT WIDTH)	—	18-15345
8.2L	500	BULLDOG	1990-2001	540	8	4	C577254 - M050281	V-BELT	— (1/2" BELT WIDTH)	—	18-15345

- (1) 1/2" wide (13mm) belt
- (2) 3/8" wide (10mm) belt
- (3) 28" wide (711mm) belt
- (4) 30" wide (762mm) belt
- (5) 37" wide (940mm) belt
- (6) 40" wide (1016mm) belt

- (7) 50" wide (1270mm) belt
- (8) 55" wide (1397mm) belt
- (9) Use with 5 1/2" (140mm) dia water pump pulley
- (10) Use with 5 7/8" (149mm) dia water pump pulley
- (11) Use with 7" (178mm) dia water pump pulley
- (12) Use with stamped steel sea water pump pulley

- (13) Use with cast aluminum sea water pump pulley
- (14) Use with plastic 3 3/4" (121mm) dia p/s pump pulley
- (15) Use with metal 5 3/4" (146mm) dia p/s pump pulley
- (16) For engine with high mounted p/s pump
- (17) For engines with low mounted p/s pump
- (18) For engine with power steering

- (19) For engines w/o power steering
- (20) For engines with closed cooling
- (21) For engines with standard cooling
- (22) Replacement kit includes 5 3/4" (146mm) pulley and longer serpentine belt
- (23) For engines with high mounted alternator

SERPENTINE BELTS



BELT INTERCHANGE

Part No.	OE #	Width	Length (in.)	Part No.	OE #	Width	Length (in.)
18-15100	57-8638763, 57-862807, 57-862087A1, 57-865615003, 57-865615Q03	13/16	106.25	18-15119	57-8638761, 57-8623523, 57-865615001, 57-865615Q01	13/16	111.25
18-15101	57-8638764, 57-862086, 57-8620861, 57-862086A1, 57-865615004, 57-865615Q04	13/16	76.5	18-15121	57-865615005, 57-865615Q05, 57-8638765, 57-865423005	13/16	87.5
18-15102	57-8638766, 57-8610491, 57-865615006, 57-865615Q06	13/16	105				
18-15103	57-8638767, 57-865615007, 57-861050, 57-865615Q07	13/16	96.75				
18-15104	57-8638768, 57-862089, 57-862089A1, 57-865615008, 57-865615Q08	13/16	99.5				
18-15112	57-8077554, 57-807755Q04	13/16	88				
18-15115	57-861757, 57-861757Q	13/16	97.5				
18-15116	57-861758, 57-861758Q	13/16	86.75				

BELT APPLICATION

Engine	Years	Serial #	Part #	Mercuriser #	Foothole	Engine	Years	Serial #	Part #	Mercuriser #	Foothole
4.3L Alpha	1996-99	OF803000-OL618999	18-15116	57-861758	2, 6	5.7L Bravo	1997-99	OK001506-OL618999	18-15115	57-861757	2, 6
4.3L Alpha	2000-04	OL619000 & up	18-15101	57-863876 4	3, 6, 7	5.7L Bravo	2002-04	OM600000 & up	18-15102	57-863876 6	3, 5, 7
4.3L Alpha	2000-04	OL619000 & up	18-15104	57-863876 8	4, 5, 7	5.7L Bravo	2000-04	OL619000 & up	18-15104	57-863876 8	4, 7
4.3L Bravo	1996-99	OF803000-OL618999	18-15114	57-861049	2, 5	5.7L Ski	1997-02	OK040004-OM316999	18-15112	57-8077554	
4.3L Bravo	1996-99	OF803000-OL618999	18-15115	57-861757	2, 6	5.7L Ski	2002-05	OM317000 & up	18-15121	57-865615005	
4.3L Bravo	2000-04	OL619000 & up	18-15104	57-863876 8	4, 7	5.7L MIE	2001-05	OL677227 & up	18-15121	57-865615005	
5.0L Bravo	2002-04	OM600000 & up	18-15102	57-863876 6	3, 5, 7	377 Scorpion MCM	1999-04	OL416146 & up	18-15115	57-861757	
5.0L Alpha	1998-99	OL012052-OL618999	18-15114	57-861049	5	377 Scorpion Ski	1997-98	OK000656 & up	18-15112	57-8077554	
5.0L Alpha	1998-99	OL012052-OL618999	18-15116	57-861758	2, 6	454 Mag MPI	1998-01	OL010029-OM024999	18-15114	57-861049	1
5.0L Alpha	2000-04	OL619000 & up	18-15101	57-863876 4	3, 6, 7	454 Mag MPI	1998-01	OL010029-OM024999	18-15102	57-863876 6	2
5.0L Alpha	2002-04	OM600000 & up	18-15102	57-863876 6	3, 5, 7	454 Mag MPI	1998-01	OL010029-OM024999	18-15103	57-865615007	4
5.0L Alpha	2001-04	OL619000 & up	18-15104	57-863876 8	4, 5, 7	454 Mag MPI Horizon MIE	1998-01	OL002200-OL674000	18-15103	57-865615007	
5.0L Bravo	1998-99	OL012052-OL618999	18-15114	57-861049	2, 5	496 Mag & HO	2000-04	OM025000 & up	18-15119	57-863876 1	
5.0L Bravo	1998-99	OL012052-OL618999	18-15115	57-861757	2, 6	500 EFI	1999-04	OL001477 & up	18-15112	57-8077554	
5.0L Bravo	2000-04	OL619000 & up	18-15104	57-863876 8	4, 7	502 Mag MPI	1998-01	OL017000-OM024999	18-15114	57-861049	1
350 Mag, Alpha	1997-04	OK001501-OL618999	18-15114	57-861049	2, 5	502 Mag MPI	1998-01	OL017000-OM024999	18-15103	57-865615007	4
350 Mag, Alpha	1997-04	OK001501-OL618999	18-15116	57-861758	2, 6	502 Mag, MPI	1998-01	OL017000-OM024999	18-15102	57-863876 6	2
350 Mag, Alpha	2000-04	OL619000 & up	18-15103	57-865615007	3, 6, 7	575 Sci	2000-05	OL306696 & up	18-15112	57-8077554	9
350 Mag, Alpha	2002-04	OM600000 & up	18-15102	57-863876 6	3, 5, 7	7.4L MPI	1998-01	OL010003-OM024330	18-15114	57-861049	1
350 Mag, Alpha	2000-04	OL619000 & up	18-15104	57-863876 8	4, 5, 7	7.4L MPI	1998-01	OL010003-OM024330	18-15102	57-863876 6	2
350 Mag, Bravo	1997-04	OK001501-OL618999	18-15114	57-861049	2, 5	7.4L MPI	1998-01	OL010003-OM024330	18-15103	57-865615007	4
350 Mag, Bravo	1997-04	OK001501-OL618999	18-15115	57-861757	2, 6	7.4L MPI MIE	1998-01	OL002006-OM025999	18-15103	57-865615007	
350 Mag, Bravo	2002-04	OM600000 & up	18-15102	57-863876 6	3, 5, 7	Black Scorpion Ski	1997-01	OK040001-OM391599	18-15112	57-8077554	
350 Mag, Bravo	2000-04	OL619000 & up	18-15104	57-863876 8	4, 7	Black Scorpion Ski	2003-05	OM391600 & up	18-15121	57-865615005	
350 Mag MPI MIE	2001-05	OL678399-up	18-15121	57-865615005	6	MX 6.2L Blk Scorpion Ski	2001	OL670015-OM391599	18-15112	57-8077554	
350 Mag MPI Ski	2001-05	OM300000 & up	18-15121	57-865615005		MX 6.2L MPI	2002-04	OM600000 & up	18-15102	57-863876 6	3, 5
350 Mag MPI Horizon MIE	2001-02	OL678399-OM316999	18-15121	57-865615005		MX 6.2L MPI	2000-04	OL680003 & up	18-15104	57-863876 8	4, 7
5.7L Alpha	1997-99	OK001501-OL618999	18-15114	57-861049	2, 5	MX 6.2L MPI Horizon	2002-04	OM600000 & up	18-15102	57-863876 6	3
5.7L Alpha	1997-99	OK001506-OL618999	18-15116	57-861758	2, 6	MX 6.2L MPI Horizon	2001-04	OM300000 & up	18-15104	57-863876 8	4
5.7L Alpha	2000-04	OL619000 & up	18-15101	57-863876 4	3, 6, 7	MX 6.2L MPI Horizon MIE	2001	OM300000-OM310099	18-15112	57-8077554	
5.7L Alpha	2002-04	OM600000 & up	18-15102	57-863876 6	3, 5, 7	MX 6.2L MPI Horizon MIE	2001-05	OM310100 & up	18-15121	57-865615005	6
5.7L Alpha	2000-04	OL619000 & up	18-15104	57-863876 8	4, 5, 7	MX 6.2L MPI MIE	1999-01	OL670000-OM310099	18-15112	57-8077554	
5.7L Bravo	1997-99	OK001506-OL618999	18-15114	57-861049	2, 5	MX 6.2L MPI MIE	2001-05	OM310100 & up	18-15121	57-865615005	6

Footnotes

- 1: Use with plastic 4-3/4" dia. p/s pump pulley
- 2: Use with metal 5-3/4" dia. p/s pump pulley
- 3: For engines with power steering

- 4: For engines without power steering
- 5: For engines with closed cooling
- 6: For engines with standard cooling

- 7: Engines with high mounted alternators
- 8: Blower
- 9: Alternator

BELT APPLICATION

Engine	Years	Serial #	Part #	Mercruiser #	Foothole
MX 6.2L MPI Ski	2002-05	OM317000 & up	18-15121	57-865615005	
8.2L MPI IE	1998-01	OL002450-OL674200	18-15103	57-865615007	

Footnotes

- 1: Use with plastic 4-3/4" dia. p/s pump pulley
- 2: Use with metal 5-3/4" dia. p/s pump pulley
- 3: For engines with power steering
- 4: For engines without power steering

- 5: For engines with closed cooling
- 6: For engines with standard cooling
- 7: Engines with high mounted alternators
- 8: Blower
- 9: Alternator

Fits GM Big Block V8 454 cu. in. Models 330, 340 & 7.4L

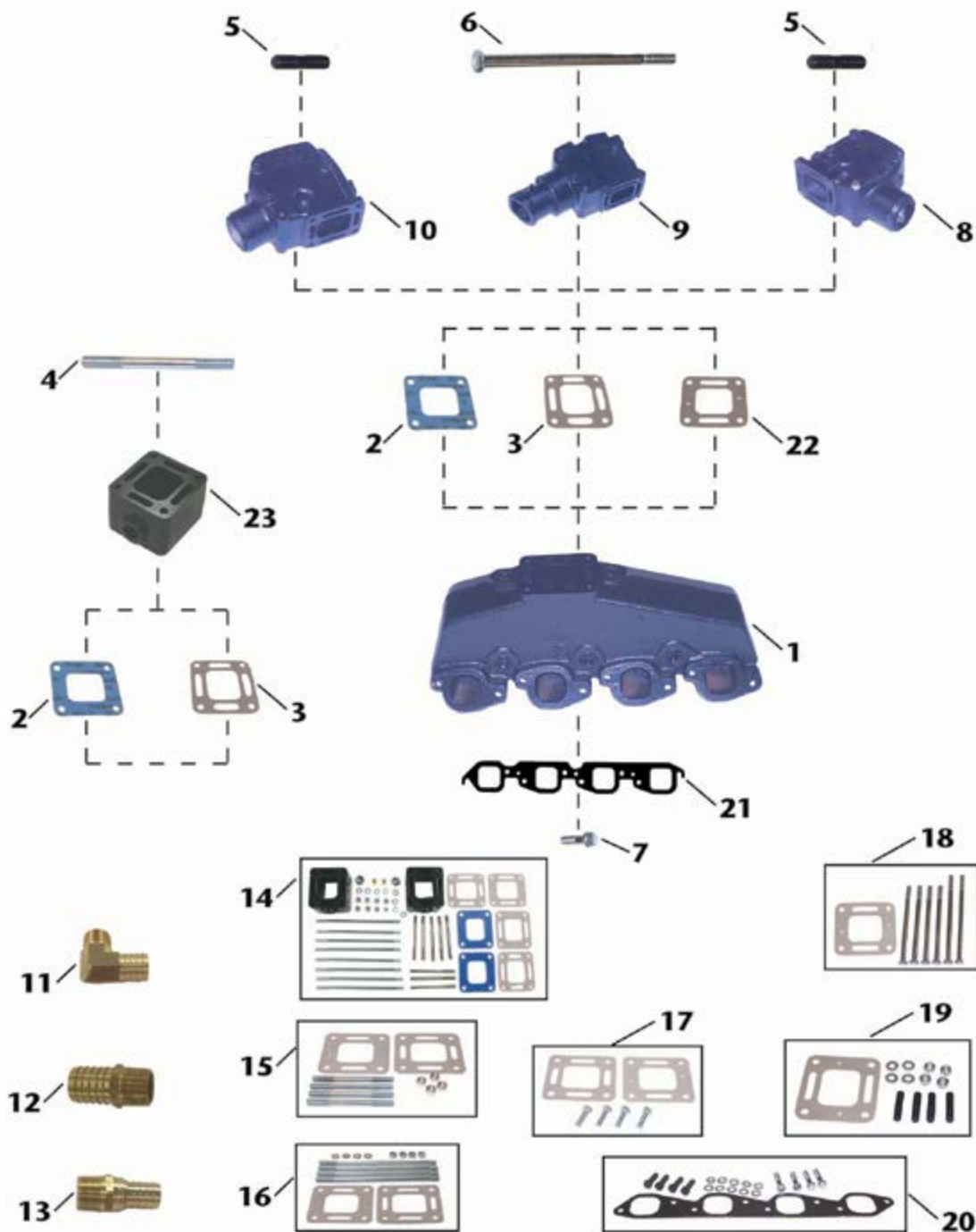

SEE NEXT PAGE FOR CHART

Item No.	Description	OE No.	Application
1	18-1957-2 MANIFOLD	807078T08, 807078Q07	GM Big Block (V8) 454 cu.in. Models 330, 340 & 7.4L. Use with 18-0418 manifold gasket; Mounting Kit: 18-8532
2	18-0672 (blocked) ELBOW GASKET (Blocked)	27-860231	Fits Manifold: 18-1957-2; Elbows: 18-1970-2, & 18-1976-2, 18-1974; Spacer 18-1908
3	18-2849-1 ELBOW GASKET (Open)	27-818832	Fits Manifold: 18-1957-2; Elbows: 18-1970-2, & 18-1976-2, 18-1974; Spacer 18-1908
4	NSS MOUNTING STUD	N/A	Included in 18-8554 mounting kit
5	NSS MOUNTING STUD	N/A	Included in 18-8529 mounting kit
6	NSS MOUNTING BOLT	N/A	Included in 18-8505 mounting kit
7	NSS MOUNTING BOLT	N/A	Included in 18-8532 mounting kit
8	18-1974-1 MANIFOLD ELBOW (3" hose • 15° down angle)	98502A2	Fits Manifold: 18-1957-2. Use Elbow gaskets: 18-2849-1, 18-0897, or 18-0672; Use mounting kit: 18-8529 (Do not use with spacer)
9	18-1976-2 MANIFOLD ELBOW (4" hose • 7° down angle)	44354A3	Fits Manifold: 18-1957-2. Use Elbow gaskets: 18-2849-1, 18-0897, or 18-0672; Use mounting kit: 18-8505, or if spacer is included use 18-8555
10	18-1970-2 MANIFOLD ELBOW (3" hose)	98504A3	Fits Manifold: 18-1957-2. Use Elbow gaskets: 18-2849-1, 18-0897, or 18-0672; Use mounting kit: 18-8529, or if spacer is included use 18-8554
11	18-8216 HOSE FITTING	N/A	3/4" - 14NPT X 1" Hose (Corrosion Resistant Brass Fitting)
12	18-4461 HOSE FITTING	N/A	3/4" - 14NPT X 1" Hose (Corrosion Resistant Brass Fitting)
13	18-8215 HOSE FITTING	N/A	3/4" - 14NPT X 3/4" Hose (Corrosion Resistant Brass Fitting)
14	18-1908K MANIFOLD SPACER KIT	807476A6, 93320A5	3" Riser Kit for Manifold: 18-1957-2. Includes (2) spacers, restrictor, open, & blocked gasket. All necessary mounting hardware is also included
15	18-8554 MOUNTING KIT	N/A	Use 18-8554 Mounting Kit when 18-1908 Spacer, 18-1970-2 Elbow and 18-1974 Elbow are used together. Included in 18-1908K. Includes (1) 18-2849-1 & 18-0897 elbow gaskets
16	18-8555 MOUNTING KIT	N/A	Use with Manifold Spacer: 18-1908 with Riser 18-1976-2. Included in 18-1908K. Includes (1) 18-2849-1 & 18-0897 elbow gaskets.
17	18-8556 MOUNTING KIT	N/A	Use with Manifold Spacer: 18-1985. Includes (1) 18-2849-1 & 18-0897 elbow gaskets
18	18-8505 MOUNTING KIT	N/A	Use with Riser: 18-1976-2. Includes 18-0897 elbow gasket
19	18-8529 MOUNTING KIT	N/A	Use with Risers: 18-1970-2 & 18-1974-1. Includes 18-0897 elbow gasket
20	18-8532 MOUNTING KIT	N/A	Use with Manifold: 18-1957-2. Includes 18-0418 manifold gasket
21	18-0418 MANIFOLD GASKET	96653 / 27-41813	Use with Manifold: 18-1957-2. Included in 18-8532 mounting kit.
22	18-0897 ELBOW GASKET (Restrictor)	27-41813	Fits Manifold: 18-1957-2; Manifold Spacers: 18-1985, & 18-1908; Elbows: 18-1970-2, & 18-1976-2, 18-1974
23	18-1908 MANIFOLD SPACER	93322A12	3" Spacer for Manifold: 18-1952-1. Use with mounting kit 18-8556 (Note: To mount elbows to spacer a separate mounting kit is needed)



**Fits GM In-Line 6 Cylinder 250 & 292 cu. in.
Models 165 & 200**

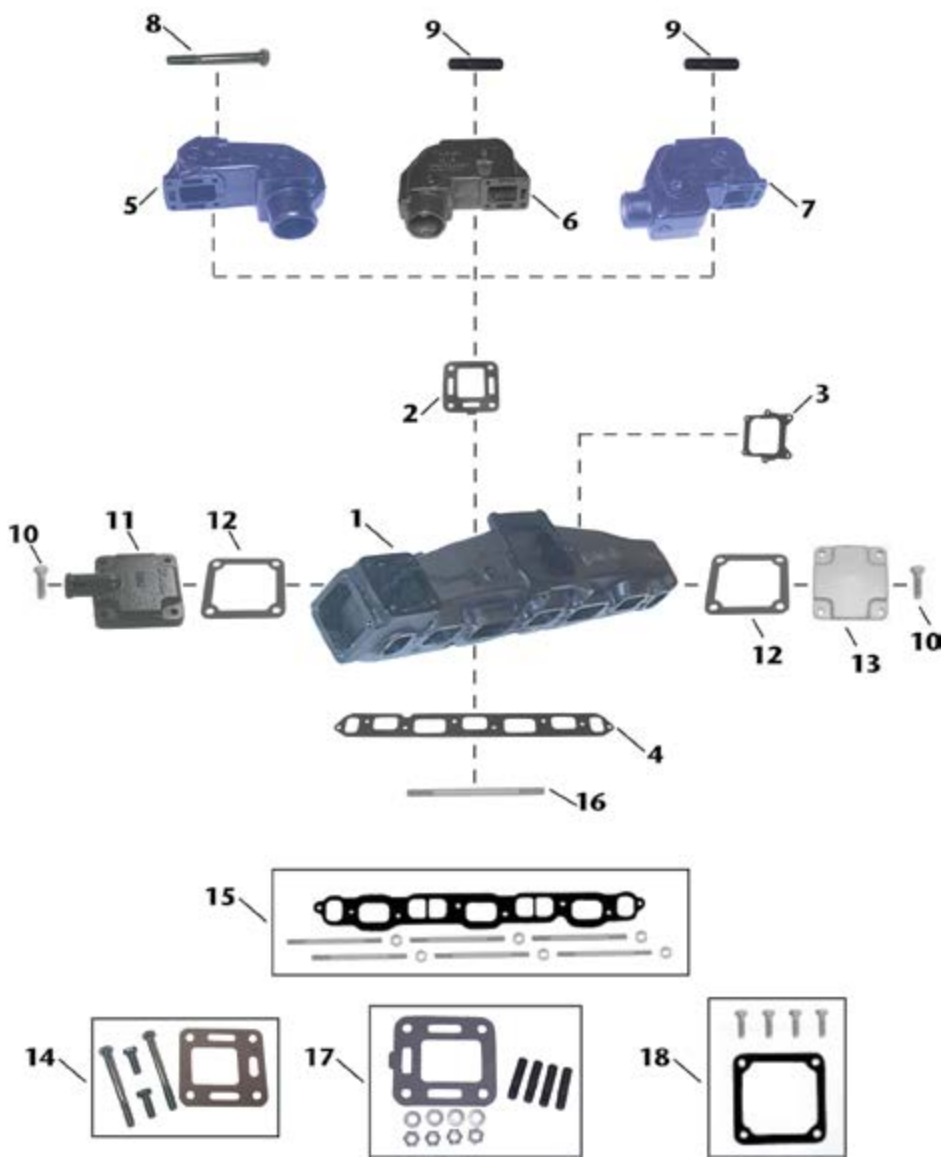

Item No.	Description	OE No.	Application
1	18-1960-1 MANIFOLD	58759A10	GM In-Line Six Cylinder 250 & 292 cu.in. Models 165 & 200. Use with 18-2830-1 manifold gasket; 18-8531 Mounting Kit
2	18-2833 ELBOW GASKET	27-99777-2	Use with Elbows: 18-1971, 18-1978 & 18-1972. Included in 18-4362 mounting kit
3	18-0353 CARBURETOR GASKET	27-58764	Fits Manifold: 18-1960-1
4	18-2830-1 MANIFOLD GASKET	27-46401	Fits Manifold: 18-1960-1. Included in 18-8531 mounting kit.
5	18-1972 MANIFOLD ELBOW	76325A2	Use with Manifold: 18-1960-1; Elbow Gasket 18-2833
6	18-1971 MANIFOLD ELBOW	76351A2	Use with Manifold: 18-1960-1; Elbow Gasket 18-2833; Mounting Kit 18-4362
7	18-1978 MANIFOLD ELBOW	76771A3	Use with Manifold: 18-1960-1; Elbow Gasket 18-2833; Mounting Kit 18-4362
8	NSS MOUNTING BOLT	N/A	Included in 18-8552 mounting hardware
9	18-3233 MOUNTING STUD	16-49545	3/8-24, 3/8-16 X 1 3/4. Included in 18-4362 mounting kit.
10	NSS MOUNTING BOLT	N/A	Included in 18-8512 mounting kit.
11	18-4009 FRONT PLATE	60252A2	Fits Manifold: 18-1960-1
12	18-2832-1 FRONT/END PLATE GASKET	27-48043-1	Fits Port & Starboard Caps of Manifold: 18-1960-1. Included in 18-8512 mounting kit
13	NSS END PLATE	N/A	Fits Manifold: 18-1960-1
14	18-8552 HARDWARE KIT	N/A	Includes only hardware for 18-1972 elbow.
15	18-8531 MOUNTING KIT	N/A	Use with Manifold: 18-1960-1. Includes 18-2830-1 manifold gasket.
16	NSS MOUNTING STUD	N/A	Included in 18-8531 mounting kit
17	18-4362 MOUNTING KIT	N/A	Use with Elbows: 18-1971 & 18-1978. Includes 18-2833 elbow gasket
18	18-8512 MOUNTING KIT	N/A	Use with Front Plate: 18-4009. Includes 18-2832-1 gasket

Fits GM V6 229 & 262 cu. in. Models 185 & 205

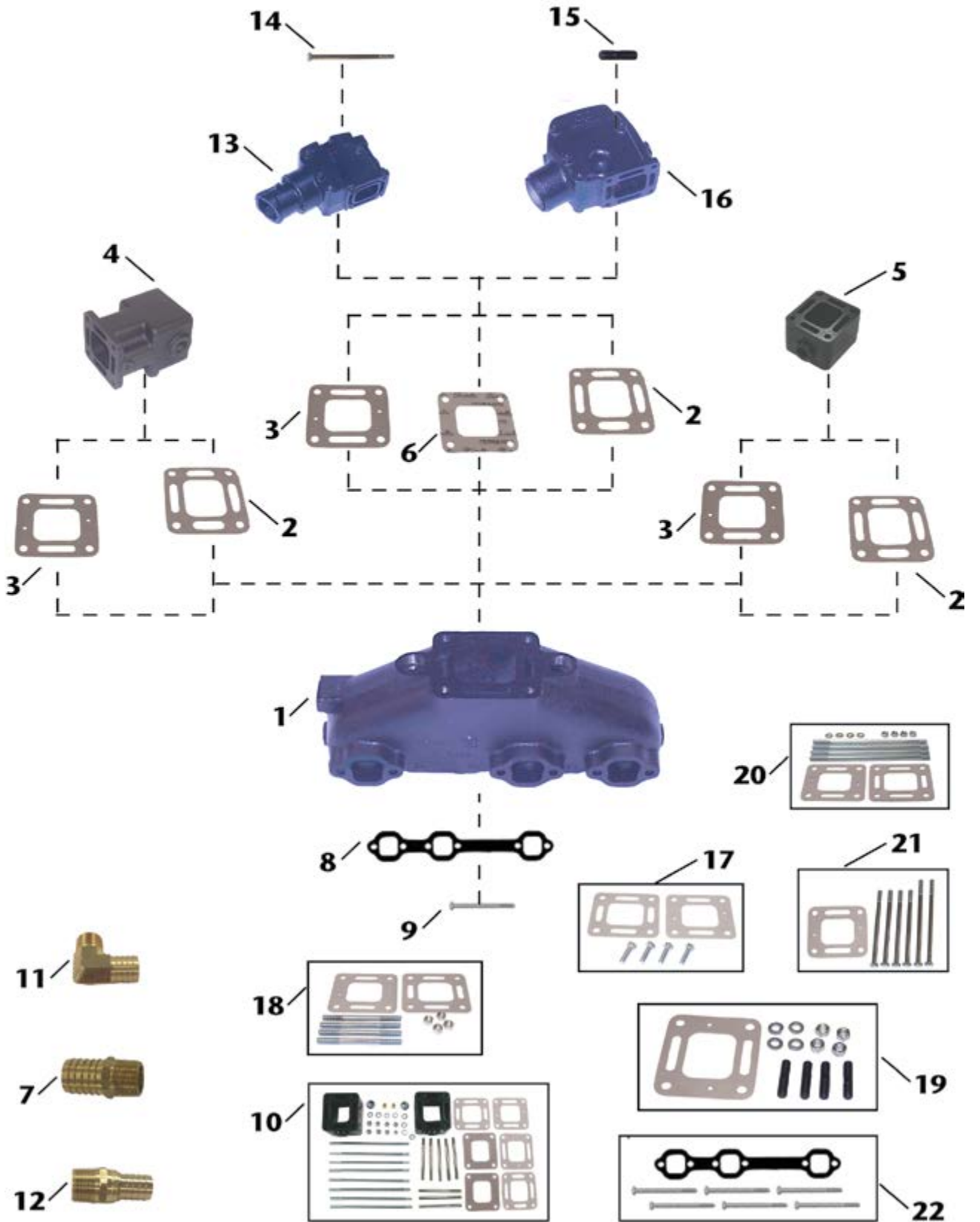

Item No.	Description	OE No.	Application
1	18-1952-1 MANIFOLD	99746A8	GM (V6) 229 & 262 cu.in. Models 185 & 205 (Port & Starboard). Use with Manifold Gasket: 18-2909; Mounting Kit: 18-8533.
2	18-2849-1 ELBOW GASKET (OPEN)	27-818832	Fits Manifold: 18-1952-1; Manifold Spacers: 18-1985, & 18-1908; Elbows: 18-1970-2, & 18-1976-2
3	18-0897 ELBOW GASKET (RESTRICTOR)	27-41813	Fits Manifold: 18-1952-1; Manifold Spacers: 18-1985, & 18-1908; Elbows: 18-1970-2, & 18-1976-2
4	18-1985 MANIFOLD SPACER	93322A12	6" Spacer for Manifold: 18-1952-1. Use with mounting kit 18-8556. (Note: To mount elbows to spacer a separate mounting kit is required)
5	18-1908 MANIFOLD SPACER	933220	3" Spacer for Manifold: 18-1952-1. Use with mounting kit 18-8555 with 18-1976-2, or mounting kit 18-8554 with 18-1970-2.
6	18-0672 ELBOW GASKET (BLOCKED)	27-860231	Fits Manifold: 18-1952-1; Elbows: 18-1970-2, & 18-1976-2
7	18-4461 HOSE FITTING	N/A	3/4" - 14NPT X 1" Hose (Corrosion Resistant Brass Fitting)
8	18-2909 MANIFOLD GASKET	N/A	Gasket for Manifold: 18-1952-1. Included in 18-8533 mounting kit.
9	NSS MOUNTING BOLT	N/A	Included in 18-8533 mounting kit.
10	18-1908K MANIFOLD SPACER KIT	807476A6, 93320A5	3" Riser Kit for Manifold: 18-1952-1. Includes (2) spacers, restrictor, open, & blocked gasket. All necessary mounting hardware is also included.
11	18-8216 HOSE FITTING	N/A	3/4" - 14NPT X 1" Hose (Corrosion Resistant Brass Fitting)
12	18-8215 HOSE FITTING	N/A	3/4" - 14NPT X 3/4" Hose (Corrosion Resistant Brass Fitting)
13	18-1976-2 MANIFOLD ELBOW (4" hose • 7° down angle)	44354A3, 807914A1	Fits Manifold: 18-1952-1. Use Elbow gaskets: 18-2849-1, 18-0897, or 18-0672; Use mounting kit: 18-8554
14	NSS MOUNTING BOLT	N/A	Included in 18-8505 mounting kit.
15	NSS MOUNTING STUD	N/A	Included in 18-8529 mounting kit.
16	18-1970-2 MANIFOLD ELBOW (3" hose • 0° down angle)	98504A3	Fits Manifold: 18-1952-1. Use Elbow gaskets: 18-2849-1, 18-0897, or 18-0672; Use mounting kit: 18-8529, or if spacer is included use 18-8555
17	18-8556 MOUNTING KIT	N/A	Use with Manifold Spacer: 18-1985. Includes (1) 18-2849-1 & 18-0897
18	18-8554 MOUNTING KIT	N/A	Use with Manifold Spacer: 18-1908 with Riser 18-1970-2. Included in 18-1908K. Includes (1) 18-2849-1 & 18-0897 elbow gaskets.
19	18-8529 MOUNTING KIT	N/A	Use with Riser: 18-1970-2. Includes 18-0897 elbow gaskets
20	18-8555 MOUNTING KIT	N/A	Use with Manifold Spacer: 18-1908 with Riser 18-1976-2. Included in 18-1908K. Includes (1) 18-2849-1 & 18-0897 elbow gasket.
21	18-8505 MOUNTING KIT	N/A	Use with Riser: 18-1976-2. Includes 18-0897 elbow gasket.
22	18-8533 MOUNTING KIT	N/A	Use with Manifold: 18-1952-1. Includes 18-2909 manifold gasket.

SIERRA®

Fits GM Small Block V8 305-350 cu. in. Models 198, 228 & 898

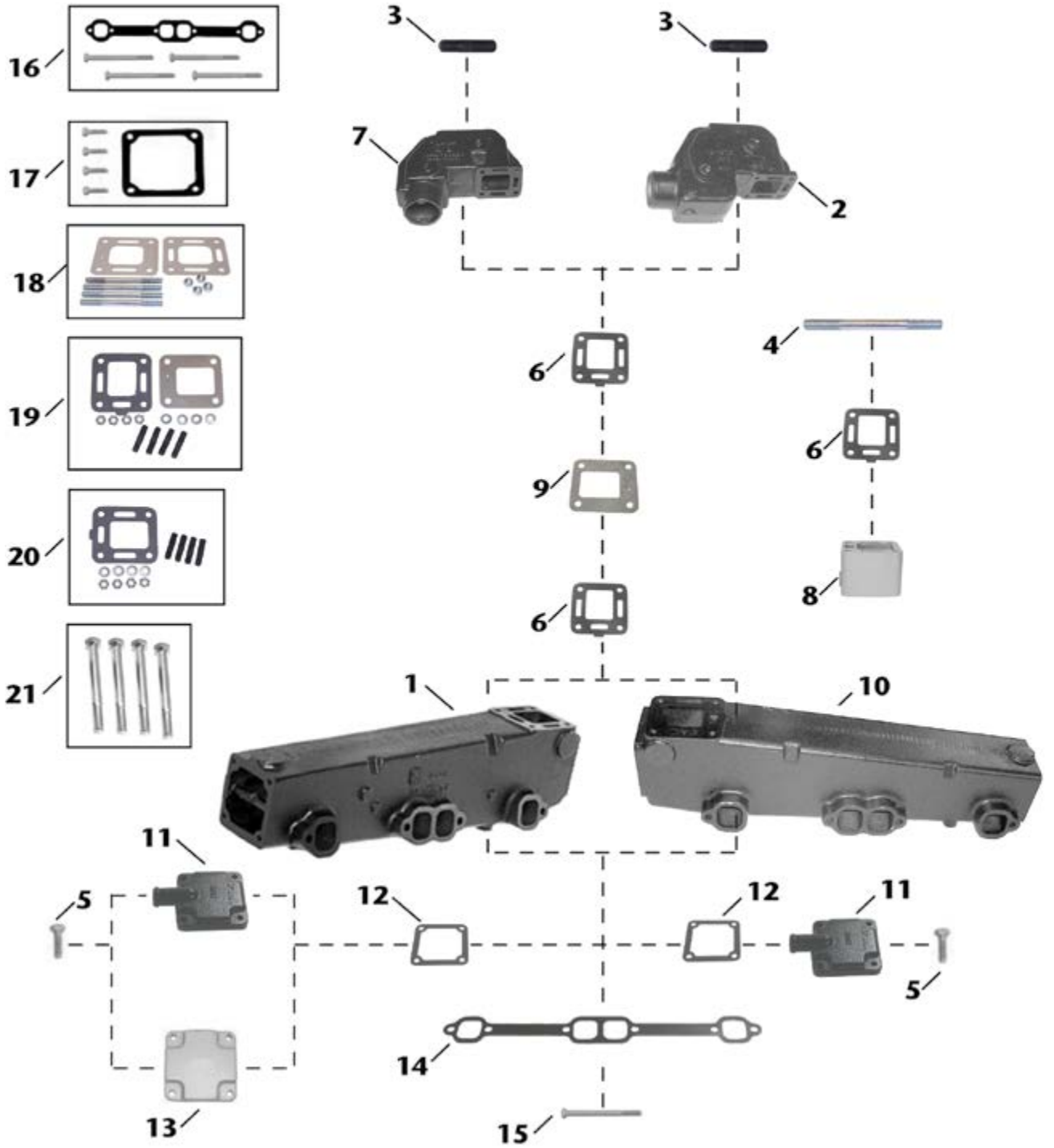

Item No.	Description	OE No.	Application	
1	18-1951-1	MANIFOLD (STARBOARD)	774235A2	GM Small Block (V8) 305-350 cu.in. Models 198, 228, & 898. (Starboard)
2	18-1978	MANIFOLD ELBOW	76771A3	Use with Manifolds: 18-1950-1, 18-1951-1; Elbow Gasket 18-2833; Mounting Kit 18-4362.
3	18-3233	MOUNTING STUD	16-49545	3/8-24, 3/8-16 X 1 3/4. Included in 18-4362 mounting kit.
4	NSS	MOUNTING STUD	N/A	Included in 18-8554 mounting kit.
5	NSS	MOUNTING BOLT	N/A	Included in 18-8512 mounting kit.
6	18-2833	ELBOW GASKET	27-99777-2	Use with Elbows: 18-1971 & 18-1978. Included in 18-4362 mounting kit.
7	18-1971	MANIFOLD ELBOW	76351A2	Use with Manifolds: 18-1950-1, 18-1951-1; Elbow Gasket 18-2833; Mounting Kit 18-4362.
8	18-1906	MANIFOLD SPACER	61851	3" Spacer for Manifold: 18-1950-1, 18-1951-1. Use with mounting kit 18-8554 with 18-1971 or 18-1978 Elbows.
9	18-4008	BLOCK OFF PLATE	60207	Use with Manifolds 18-1950-1, 18-1951-1. Requires (2) 18-2833 elbow gaskets.
10	18-1950-1	MANIFOLD (PORT)	77234A2	GM Small Block (V8) 305-350 cu.in. Models 198, 228, & 898. (Port)
11	18-4009	END PLATE	60252A2	Use with (Port & Starboard) Manifolds: 18-1950-1 & 18-1951-1; Mounting Kit: 18-8512
12	18-2832-1	FRONT/END PLATE GASKET	27-48043-1	Fits Port & Starboard Caps of Manifolds: 18-1950-1, 18-1951-1. Use with Front Plate: 18-4009. Included in 18-8512 mounting kit.
13	NSS	END PLATE	54870	Fits Manifold: 18-1950-1, 18-1951-1; Mounting Kit: 18-8512.
14	18-2949	MANIFOLD GASKET	96306	Use with Manifold: 18-1951-1
15	NSS	MOUNTING BOLT	N/A	Included in 18-8520 mounting kit.
16	18-8520	MOUNTING KIT	N/A	Use with Manifolds: 18-1950-1, 18-1951-1. Includes 18-2949 manifold gasket.
17	18-8512	MOUNTING KIT	N/A	Use with Front/End Plates: 18-4009. Includes 18-2832-1 front end plate gasket.
18	18-8554	MOUNTING KIT	N/A	Use with Manifold Spacer: 18-1908 with Riser 18-1971 or 18-1978 Elbows. Included in 18-1908K. Includes (1) 18-2849-1 & 18-0897 elbow gaskets.
19	18-8514	MOUNTING KIT	N/A	Use with Elbows: 18-1971 & 18-1978. Includes 18-2833 gasket & 18-4008 block off plate.
20	18-4362	MOUNTING KIT	N/A	Use with Elbows: 18-1971 & 18-1978. Includes 18-2833 elbow gasket.
21	NSS	HARDWARE KIT	N/A	Includes only hardware for 18-1950-1 & 18-1951-1 manifolds. Included in 18-8520 mounting kit.

SIERRA®

Fits Ford Small Block V8 302-351 cu. in. Models 215, 225, 233, 255 & 888

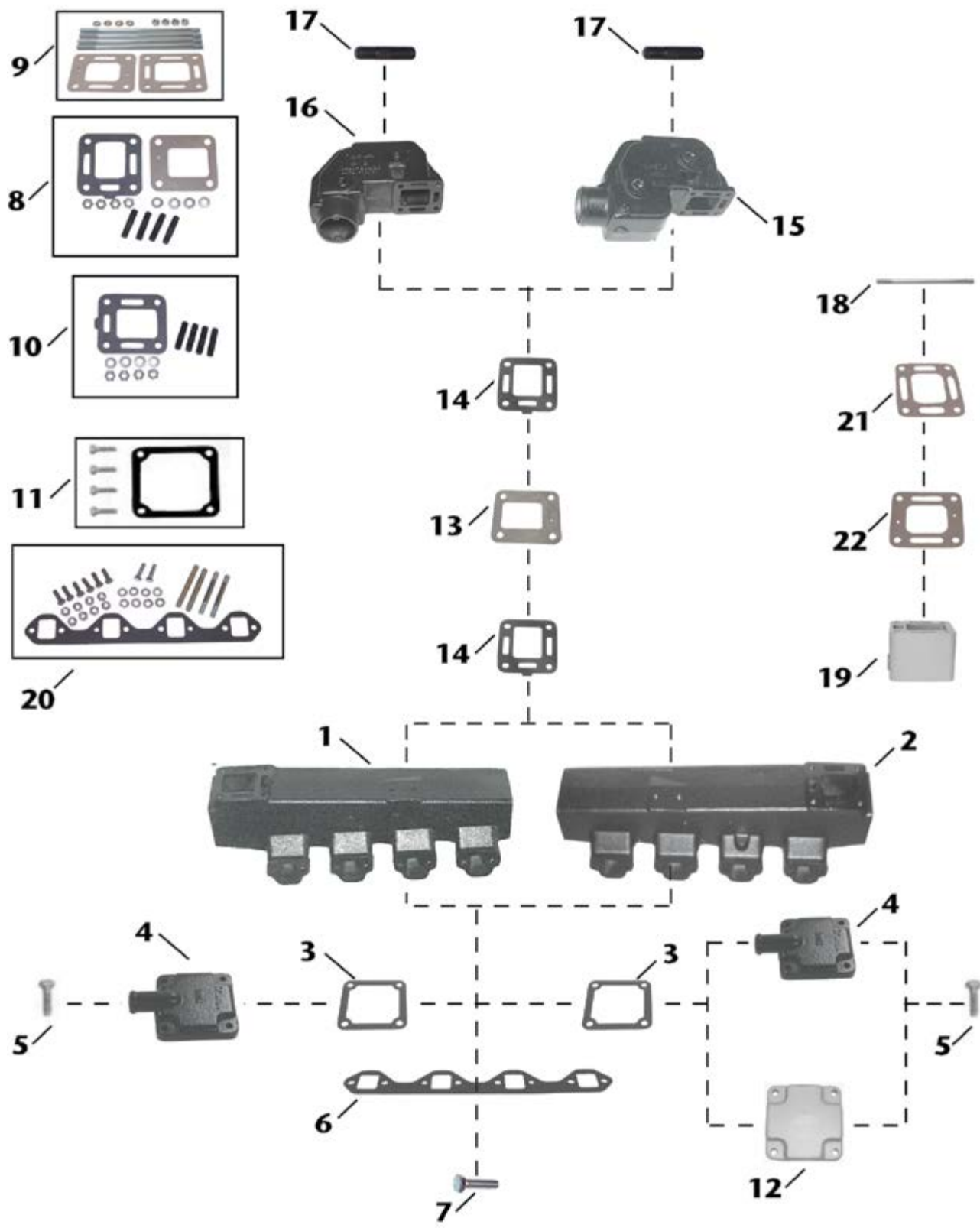

Item No.	Description	OE No.	Application
1 18-1958-1	MANIFOLD (PORT)	65604A4	Ford Small Block (V8) 302-351 cu.in. Models 215, 225, 233, 255, & 888 (Port). Use with Manifold Gasket: 18-0183-1; Mounting Kit: 18-8509
2 18-1962-1	MANIFOLD (STARBOARD)	65603A4	Ford Small Block (V8) 302-351 cu.in. Models 215, 225, 233, 255, & 888 (Port). & 888 (Starboard). Use with Manifold Gasket: 18-0183-1; Mounting Kit: 18-8509.
3 18-2832-1	FRONT/END PLATE GASKET	27-48043-1	Fits Port & Starboard Caps of Manifolds: 18-1958-1, 18-1962-1. Use with Front Plate: 18-4009. Included in 18-8512 mounting kit.
4 18-4009	FRONT PLATE	60252A2	Use with (Port & Starboard) Manifolds: 18-1958-1, 18-1962-1; Mounting Kit: 18-8512
5 NSS	MOUNTING BOLT	N/A	Included in 18-8512 mounting kit.
6 18-0183-1	MANIFOLD GASKET	27-73866	Use with Manifold: 18-1958-1, 18-1962-1. Included in 18-8509 mounting kit.
7 NSS	MOUNTING BOLT	N/A	Included in 18-8509 mounting kit.
8 18-8514	MOUNTING KIT	N/A	Use with Elbows: 18-1971 & 18-1978. Includes 18-2833 gasket & 18-4008 block off plate.
9 18-8554	MOUNTING KIT	N/A	Use with Manifold Spacer: 18-1906 with Riser 18-1971 or 18-1978. Includes (1) 18-2849-1 & 18-0897 elbow gaskets.
10 18-4362	MOUNTING KIT	N/A	Use with Elbows: 18-1971 & 18-1978. Includes 18-2833 elbow gasket.
11 18-8512	MOUNTING KIT	N/A	Use with Front/End Plates: 18-4009. Includes 18-2832-1 gasket.
12 NSS	END PLATE	54870	Fits Manifolds: 18-1958-1, 18-1962-1; Mounting Kit: 18-8512.
13 18-4008	BLOCK OFF PLATE	60207	Use with Manifolds 18-1958-1, 18-1962-1. Requires (2) 18-2833 elbow gaskets.
14 18-2833	ELBOW GASKET	27-99777-2	Use with Elbows: 18-1971 & 18-1978. Included in 18-4362 mounting kit.
15 18-1978	MANIFOLD ELBOW	76771A3	Use with Manifolds: 18-1958-1, 18-1962-1; Elbow Gasket 18-2833; Mounting Kit 18-4362.
16 18-1971	MANIFOLD ELBOW	76351A2	Use with Manifolds: 18-1958-1, 18-1962-1; Elbow Gasket 18-2833; Mounting Kit 18-4362.
17 18-3233	MOUNTING STUD	16-49545	3/8-24, 3/8-16 X 1 3/4. Included in 18-4362 mounting kit.
18 NSS	MOUNTING STUD	N/A	Included in 18-8554 mounting kit.
19 18-1906	MANIFOLD SPACER	61851	3" Spacer for Manifolds: 18-1950-1, 18-1951-1. Use with mounting kit 18-8554 with 18-1971 or 18-1978 Elbows.
20 18-8509	MOUNTING KIT	N/A	Use with Manifolds: 18-1958-1, 18-1962-1. Includes 18-0183-1 manifold gasket.
21 18-2849-1	ELBOW GASKET (OPEN)	27-818832	Fits Manifolds: 18-1958-1, 18-1962-1; Manifold Spacers: 18-1985. Included in 18-8554 mounting kit.
22 18-0897	ELBOW GASKET (RESTRICTOR)	27-41813	Fits Manifolds: 18-1958-1, 18-1962-1; Manifold Spacers: 18-1985. Included in 18-8554 mounting kit.

SIERRA®

Fits GM 4 Cylinder 181 cu. in. Models 120, 140, 2.5L & 3.0L

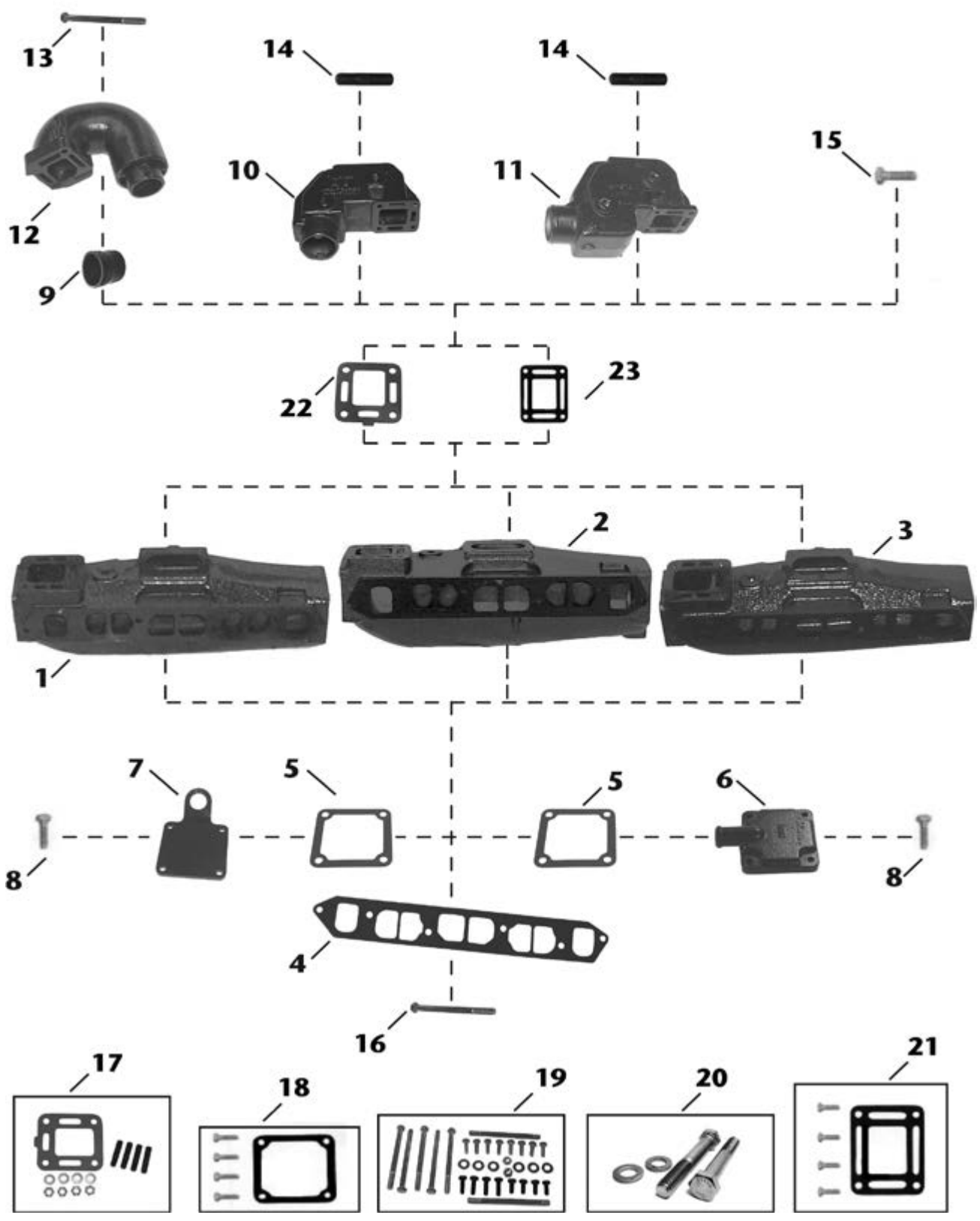

Item No.	Description	OE No.	Application
1	NSS MANIFOLD	9582A5	Fits 2.5 & 3.0L 181 CID, Model 140 with Rochester carburetor w/ electrical choke (1983-89). Use with Manifold Gasket: 18-1204-1.
2	18-1955-1 MANIFOLD	96705A1	Fits 3.0L 181 CID, Model 140 with Rochester carburetor w/ mechanical choke (1968-82). Use with Manifold Gasket: 18-1204-1. Mounting Hardware: 18-8549.
3	18-1956-3 MANIFOLD	99798A18	Fits 3.0L 181 CID, Model 140 & 3.0 with Mercarb carburetor w/ electrical choke (1983-95). Use with Manifold Gasket: 18-1204-1.
4	18-1204-1 MANIFOLD GASKET	27-96429	Fits Manifolds: 18-1954-1, 18-1955-1, 18-1956-3
5	18-2832-1 FRONT/ END CAP GASKET	27-48043-1	Fits Port & Starboard Caps of Manifolds: 18-1954-1, 18-1955-1, 18-1956-3.
6	18-4009 FRONT PLATE	60252A2	Fits Manifolds: 18-1954-1, 18-1955-1, 18-1956-3
7	NSS END PLATE	805629	Fits Manifolds: 18-1954-1, 18-1955-1, 18-1956-3
8	NSS MOUNTING BOLT	N/A	Included in 18-8512 mounting kit.
9	18-2748 EXHAUST BOOT	32-44348T	4" Inside Diameter. Use with 18-1975-1 elbow.
10	18-1971 MANIFOLD ELBOW	76351A2	Use with Manifolds: 18-1954-1, 18-1955-1, 18-1956-3; Elbow Gasket 18-2833; Mounting Kit 18-4362
11	18-1978 MANIFOLD ELBOW	76771A3	Use with Manifolds: 18-1954-1, 18-1955-1, 18-1956-3; Elbow Gasket 18-2833; Mounting Kit 18-4362
12	18-1975-1 MANIFOLD RISER	12076A2	Use with Manifolds: 18-1954-1, 18-1955-1, 18-1956-3; Elbow Gasket 18-2819-1; Mounting Hardware 18-8551; Exhaust Boot 18-2748.
13	NSS MOUNTING BOLT	N/A	Included in 18-8551 mounting hardware.
14	18-3233 MOUNTING STUD	N/A	3/8-24, 3/8-16 X 1 3/4. Included in 18-4362 mounting kit.
15	NSS MOUNTING BOLT	N/A	Included in 18-8549 mounting kit.
16	18-4362 MOUNTING KIT	N/A	Use with Elbows: 18-1971 & 18-1978. Includes 18-2833 elbow gasket
17	18-8512 MOUNTING KIT	N/A	Use with Front Plate: 18-4009 & End Plate (NSS). Includes 18-2832-1 front/end cap gasket.
18	18-8549 HARDWARE KIT	N/A	Includes only hardware for 18-1955-1 manifold.
19	18-8551 HARDWARE KIT	N/A	Includes only hardware for 18-1975-1 elbow.
20	18-2833 ELBOW GASKET	27-99777-2	Use with Elbows: 18-1971 & 18-1978. Included in 18-4362 mounting kit
21	18-2819-1 ELBOW GASKET	27-39915	Use with Elbow: 18-1973.

SIERRA®

Fits GM Small Block V8 305 & 350 cu. in. Models 200, 228, 230, 260 & 898

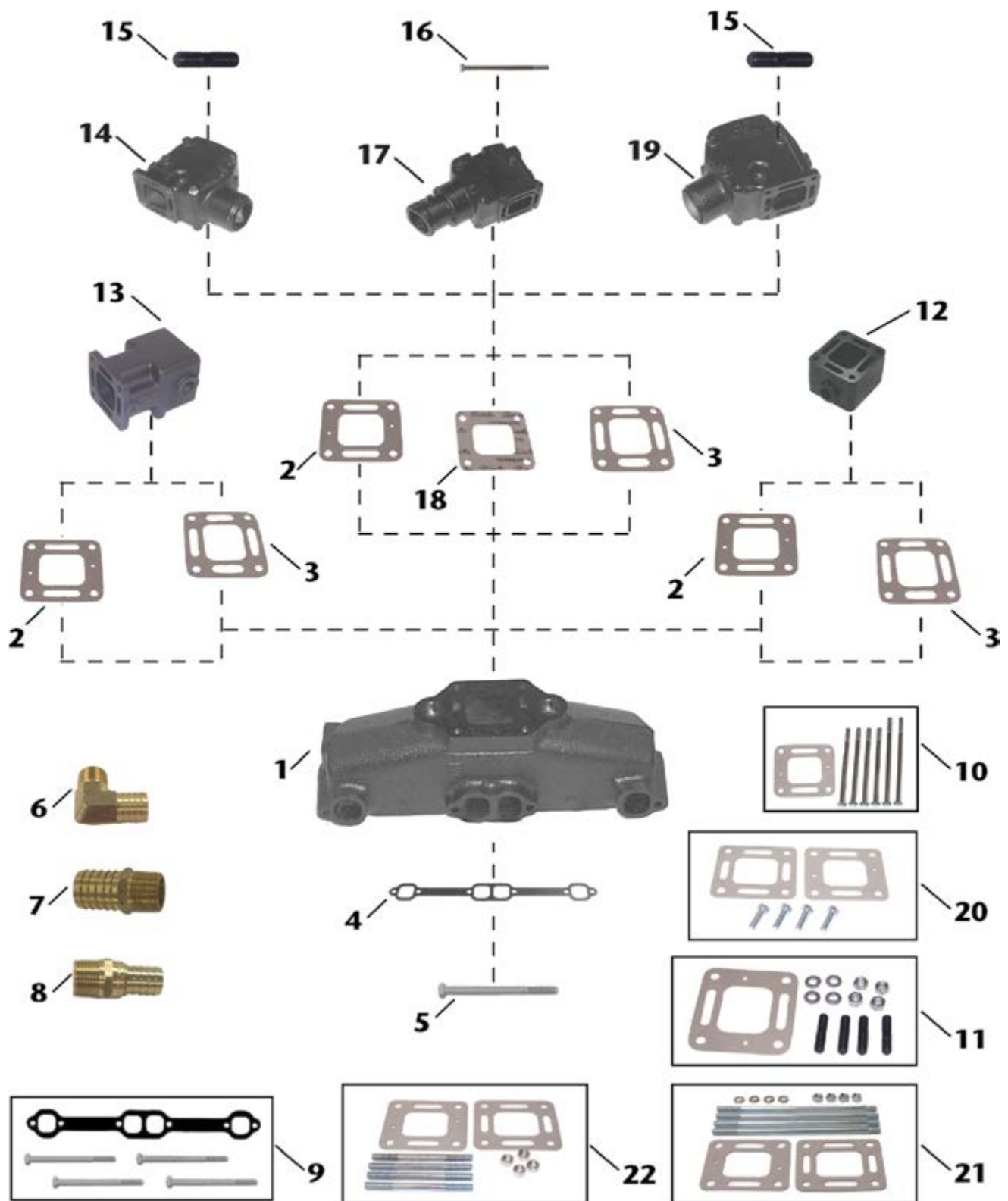

Item No.	Description	OE No.	Application	
1	18-1953-2	MANIFOLD	87114A19	GM Small Block (V8) 305-350 cu.in. Models 200, 228, 230, 260, & 898
2	18-0897	ELBOW GASKET (RESTRICTOR)	27-41813	Fits Manifold: 18-1953-2; Manifold Spacers: 18-1985, & 18-1908; Elbows: 18-1970-2, 18-1976-2, 18-1974-1
3	18-2849-1	ELBOW GASKET (OPEN)	27-818832	Fits Manifold: 18-1953-2; Manifold Spacers: 18-1985, & 18-1908; Elbows: 18-1970-2, 18-1976-2, 18-1974-1
4	18-2949	MANIFOLD GASKET	96306	Use with Manifold: 18-1953-2. Included in 18-8520 mounting kit.
5	NSS	MOUNTING BOLT	N/A	Included in 18-8520 mounting kit
6	18-8216	HOSE FITTING	22-36305	3/4" - 14NPT X 1" Hose (Corrosion Resistant Brass Fitting)
7	18-4461	HOSE FITTING	N/A	3/4" - 14NPT X 1" Hose (Corrosion Resistant Brass Fitting)
8	18-8215	HOSE FITTING	N/A	3/4" - 14NPT X 3/4" Hose (Corrosion Resistant Brass Fitting)
9	18-8520	MOUNTING KIT	N/A	Use with Manifold: 18-1953-2. Includes 18-2949 manifold gasket.
10	18-8505	MOUNTING KIT	N/A	Use with Riser: 18-1976-2. Includes 18-0897 elbow gasket.
11	18-8529	MOUNTING KIT	N/A	Use with Risers: 18-1970-2, 18-1974-1. Includes 18-0897 elbow gaskets
12	18-1908	MANIFOLD SPACER	933220A12	3" Spacer for Manifold: 18-1953-2. Use with mounting kit 18-8554 with 18-1970-2, or mounting kit 18-8555 with 18-1976-2.
13	18-1985	MANIFOLD SPACER	93322	6" Spacer for Manifold: 18-1953-2. Use with mounting kit 18-8556. (Note to mount elbows to spacer a separate mounting kit is required)
14	18-1974-1	MANIFOLD ELBOW (3" hose • 0° down angle)	98502A2	Fits Manifold: 18-1953-2. Use Elbow gasket: 18-2849-1, 18-0897, or 18-0672; Use mounting kit: 18-8529. (Do not use with spacer)
15	NSS	MOUNTING STUD	N/A	Included in 18-8529 mounting kit.
16	NSS	MOUNTING BOLT	N/A	Included in 18-8505 mounting kit.
17	18-1976-2	MANIFOLD ELBOW (4" hose • 7° down angle)	44354A3, 807914A1	Fits Manifold: 18-1953-2. Use Elbow gasket: 18-2849-1, 18-0897, or 18-0672; Use mounting kit: 18-8505, or if spacer is included use 18-8555.
18	18-0672	ELBOW GASKET (CLOSED)	27-860231	Fits Manifold: 18-1953-2; Manifold Spacers: 18-1985, & 18-1908; Elbows: 18-1970-2, 18-1976-2, 18-1974-1
19	18-1970-2	MANIFOLD ELBOW (3" hose • 15° down angle)	98504A3	Fits Manifold: 18-1953-2. Use Elbow gasket: 18-2849-1, 18-0897, or 18-0672; Use mounting kit: 18-8529, or if spacer is included use 18-8554.
20	18-8556	MOUNTING KIT	N/A	Use with Manifold Spacer: 18-1985. Includes 18-0897 & 18-2849-1. (Note: To mount elbows to spacer a separate mounting kit is required)
21	18-8555	MOUNTING KIT	N/A	Use with Riser Kit 18-1908K: Spacer 18-1908: Riser 18-1976-2: Manifold: 18-1953-1
22	18-8554	MOUNTING KIT	N/A	Use with Riser Kit 18-1908K: Spacer 18-1908: Riser 18-1970-2: Manifold: 18-1952-1

SIERRA®

SIERRA MANIFOLDS ARE PAINTED, PACKAGED & LEAK TESTED

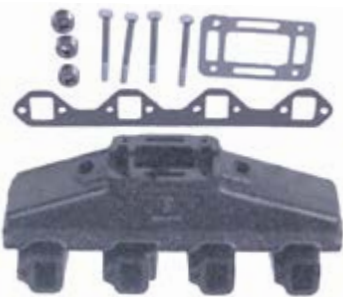

**18-1998-1
MANIFOLD**
Port & Starboard
Replaces: Barr FM-1-83
Universal Center Riser Manifold
Fits: Ford 302 and 351 CID engines
Comes with 18-4363 Mounting Package
Use with: Exhaust Manifold Gasket Set: 18-0603
***For Exploded View - See Page 660-661**



**18-1997-1
MANIFOLD**
Port & Starboard
Replaces: Barr CHV-1-83 Universal Center Riser Manifold
Fits: GM 283, 305, 307 and 350 CID engines
Use with: Exhaust Manifold Gasket Set: 18-0604



**18-1898
MANIFOLD**
Port & Starboard
Replaces: Barr CHVA-1-84, Marine Power 0991-110
Fits: 454 cu. in. GM big block V8 engines
Use with:
Exhaust Manifold Gasket: 18-0418
Riser: 18-1939, 18-1999
***For Exploded View - See Pages 656-657**



**18-1951-1*
MANIFOLD**
Supplied with Mounting Package
Replaces: 77235A2, 77235A8
Barr MC-1-77235
STARBOARD SIDE
Fits: Most Mercuriser (GM) small blocks with end riser
Use with:
Exhaust Manifold Gasket: 18-2949
Mounting Kit: 18-8548



**18-1950-1*
MANIFOLD**
Supplied with Mounting Package
Replaces: 77234A2, 77234A7
Barr MC-1-77234
PORT SIDE
Fits: Most Mercuriser (GM) small blocks with end riser
Use with:
Exhaust Manifold Gasket: 18-2949
Mounting Kit: 18-8548



**18-1952-1*
MANIFOLD**
Port & Starboard
Replaces: Mercuriser 99746A8, A17
Marine Power 611447, Barr MC-1-99746
Fits: Most 4.3L (262 CID) V-6 application
Supplied with Mounting Package
Use with:
Mounting Kit: 18-8533



**18-1953-2
MANIFOLD**
Port & Starboard
Supplied with Mounting Package
Replaces: Mercuriser 860246Q11
Will fit either side - Fits most Mercuriser(GM) small blocks with center riser.
Supplied with gaskets
Use with: Mounting Kit: 18-8520



**18-1958-1*
MANIFOLD**
Replaces: 65604A4, A12, 54100A1, 54100A5
Barr MC-1-65604 **PORT SIDE ONLY**
Fits: Most Mercuriser (Ford) V-8 small blocks
Supplied with Mounting Package
Use with: Mounting Kit: 18-8509

* SEE APPLICATION CHART ON PAGES 798-804 FOR SPECIFIC MODELS



**18-1955-1*
MANIFOLD**

New Style

Supplied with Mounting Package

Replaces: 96705A1, 52390A1

Barr MC 1 96705

Fits: Most early Model 3.0L 181 CID with Rochester Carb. 5 bolt pattern and 2.5L, 153CID (1968-82)

Use with:

Exhaust Manifold Gasket: 18-1203

End Plate: 18-4009



**18-1956-3
MANIFOLD**

Supplied with Mounting Package

Replaces: Mercruiser 860235A04, 99798A3, 99798A9, 99798A16, 99798A18, 806867A8

Marine Power 600333

Barr MC 1 99798

Fits: 2.5 & 3.0L (1983-89)



**18-1957-2*
MANIFOLD**

Port & Starboard

Replaces: Mercruiser 807078T08,

807078Q07

WILL FIT EITHER SIDE

Fits: Most Mercruiser (GM) V-8 big blocks with center riser

Use with:

Exhaust Manifold Gasket: 18-0418

Mounting Kit: 18-8532



**18-1960-1*
MANIFOLD**

Replaces: 58759A10, A14, 58759A13, 58759A1, 52969A1, 52073A1
Barr MC 1 58759

Fits: Most Mercruiser (GM) Inline 6 Cyl. Engines

Supplied with Mounting Package

Use with:

Mounting Kit: 18-8531



**18-1962-1*
MANIFOLD**

Starboard

Replaces: 65603A4, 65603A12, 54099A5, 54099A1

Barr MC-1-65603

Fits: Most Mercruiser Engines (Ford) V-8 Small blocks

Supplied with Mounting Package

Use with:

Mounting Kit: 18-8509



18-1843

EXHAUST MANIFOLD (DRY JOINT)

Replaces: 865735A02, 865049T01, 864308T01

Fits: 305, 350, 377, 5.0L, 5.7L, 6.2L(2002 and Newer)

Use with:

Manifold Gasket: 18-2949

Elbow Gaskets: 18-0720, 18-0721 or 18-0722

Elbow: 18-1845



**18-1966-1
MANIFOLD**

Replaces: 806867A2, 806867A3, 806867A8, 806867A9, 806867A12, 816329A3,

860235A03, 99798A18

Fits: 3.0L/LX (1990 & Newer); Marine Power Engine Model E181S



18-1842

V6 DRY JOINT EXHAUST MANIFOLD

Replaces: 864612T01

Fits: 4.3L Alpha/Bravo (2002 and Newer without Engine Catalyst)

Use with:

Dry Joint Elbow Gaskets: 18-0720, 18-0721

or 18-0722



DRY JOINT SPACER KIT

Part No.	Replaces
18-1844K	Mercury 864929A2 Fits: 2004-2016 sterndrive V-6 & V-8 (305, 350 & 377 cid) non-EC engines (s/n 0W310000 and up); also fits 2002-2016 inboard V-8 (350 & 377 cid) non-EC engines (s/n 0M390000 and up) Includes restricted cooling riser gaskets.
18-1847K	Mercury 864929A3 Fits: 2004-2016 sterndrive V-6 & V-8 (305, 350 & 377 cid) non-EC engines (s/n 0W310000 and up); also fits 2002-2016 inboard V-8 (350 & 377 cid) non-EC engines (s/n 0M390000 and up) Includes standard cooling riser gaskets.



**18-1999
ELBOW**

Replaces: Barr 20-0082
Fits: 3" I.D. exhaust hose.
Comes with 18-4364 open Mounting Package
Use with:
 Manifold: 18-1997-1 or 18-1998-1 or 18-1898
 Riser Gasket: 18-2854-1 open or 18-0476-1 blocked
 Mounting Kit: 18-4364 open or 18-8535 blocked



**18-1970-2*
ELBOW**

Replaces: Mercruiser 98504A3, 98503A2, 95755A2
 Marine Power 0992-115, Barr MC-20-98504
Fits: V-6 & V-8 applications, 15° (3" O.D. Riser) Comes with 18-0897 & brass plugs
Use with:
 Manifold: 18-1952-1, 18-1953-2, 18-1957-2
 Elbow Gasket: 18-0897 restrictor, 18-2849-1 open, 18-0672 blocked
 Mounting Kit: 18-8529



**18-1971*
ELBOW**

Replaces: Mercruiser 76351A2, 76351A1, 76351A04, 60426A1, 49964A1, 49964A2
 Marine Power 0993-001
Fits: Most early model Mercruiser 140 HP (4 cyl) applications
Replaces: Barr MC20-60426P
Use with:
 Manifold: 18-1960-1, 18-1958-1, 18-1950-1
 Elbow Gasket: 18-2833
 Mounting Kit: 18-4362



**18-1992-1
EXHAUST ADAPTER**

Replaces: Barr 200087P
For: 3" I.D. Exhaust Hose
 (As used in 18-1987 Exhaust Manifold Conversion Kit)
80°



**18-1972*
ELBOW**

Replaces: 76325A2, 12076A2
 Barr MC-20-76325
Fits: Most late Model 120, 140 HP Mercruiser applications
Use with:
 Manifold: 18-1955-1, 18-1954-1, 18-1956-3, 18-1901
 Elbow Gasket: 18-2833
 Mounting Kit: 18-8552



**18-1973*
ELBOW**

Replaces: 39920, 39920A1, 55538A2
 Barr MC-20-55538
Fits: Most early Model 120 HP Mercruiser applications



**18-1991
ELBOW ADAPTER**

Replaces: Barr 200089P
For: Use with 3" I.D. Exhaust Hose
Use with:
 Manifold Riser: 18-1999
30°



**18-1978
ELBOW**

Replaces: 76771A3, A2, 60427A2, 53779A2, 53779A1
 Barr MC-20-76771
 V-8 Inboard Applications Only
Use with:
 Manifold: 18-1950-1, 18-1951-1, 18-1958-1, 18-1962-1
 Elbow Gasket: 18-2833
 Mounting Kit: 18-4362

* SEE APPLICATION CHART ON PAGES 798-804 FOR SPECIFIC MODELS



**18-1905
ELBOW**

Replaces: 90880
 Mercuriser 4 Cylinder 224cu. in. 3.7L
 (Models: 165, 170, 180, 190).
Use with:
 Manifold: Mercuriser 99908
 Exhaust Elbow Mounting Gasket: 18-0113-1
 Mounting Kit: 18-8500



**18-1937
ELBOW**

Replaces: 98562A6
 Mercuriser 4 Cylinder 224cu. in. 3.7L (Models: 165, 170, 180, 190).
Use with:
 Exhaust Elbow Mounting Gasket: 18-0881-1
 Mounting Kit: 18-8530



**18-1974-1*
ELBOW**

Replaces: 98502A2, Barr MC-20-98502
Fits: V-6 & V-8 applications 0° (3" O.D. Riser)
 Comes with 18-0897 gasket & brass plugs



**18-1976-2*
ELBOW**

Replaces: Mercuriser 44354A3, 44354A9, 44354A10, 44354A13, 807914A1, 807988A2, 807988A03
 Marine Power 0992-400, Barr MC-20-44354
Fits: Most Mercuriser V-6 & V-8 applications 7° (4" O.D. Riser) Comes with 18-0897, 18-4263 & 18-4258
Use with:
 Manifold: 18-1952-1, 18-1953-2, 18-1957-2
 Riser Gasket: 18-0897 restrictor, 18-2849-1 open, 18-0672 blocked
 Mounting Kit: 18-8505



**18-1845
EXHAUST ELBOW
(DRY JOINT)**

Replaces: 864591T02
Fits: 2004 & Up V6 & V8(305, 350, 377) SN 0W310000 & Up, 2002 & Up V8(350 & 377) SN 0M317000 & Up
Use with:
 Manifolds: 18-1843, 18-1842
 Dry Joint Elbow Gaskets: 18-0720, 18-0721 or 18-0722



**18-1907
RISER**

Replaces: Barr 20-0102, Indmar 53-2009 and 53-2018
 Barr, Indmar Ford Small Block V8 302-351cu. in. • Use with 3" hose.
Use with:
 Manifold: 18-1997-1, 18-1998-1
 Riser Gasket: 18-2854-1 open or 18-0476-1 blocked
 Mounting Kit: 18-4364 open or 18-8535 blocked



**18-1939
RISER**

Replaces: Barr 20-0100, Marine Power 0992-593
 Barr, Indmar and Marine Power Ford Small Block V8 302-351cu. in. GM Small Block V8 305-350cu. in., GM Big Block V8 454cu. in. • Use with 4" hose.
Use with:
 Manifold: 18-1997-1, 18-1998-1, 18-1898
 Riser Gasket: 18-2854-1 open or 18-0476-1 blocked
 Mounting Kit: 18-4364 open or 18-8535 blocked



**18-1975-1*
RISER**

Replaces: Mercuriser 12076A1, 12076A2, 95864A2
 Marine Power 6000-33A
Fits: late Model Mercuriser 4 cyl. Engines
Use with:
 Manifold: 18-1955-1, 18-1954-1, 18-1956-3, 18-1901
 Riser Gasket: 18-2833
 Mounting Kit: 18-8551
 Bellow: 18-2748



**18-1908K
MANIFOLD RISER SPACER KIT**

Replaces: 807476A6, 93320A2, 93320A3, 93320A5, 93320A6, 93320A13
 Alpha/Bravo/Gen+/GenIV GM Small Block V-8 305, 350, 4.3L, 454, 5.0, 5.7L, 502, 7.4L, 8.2L, (3" Riser Kit)
 Complete with Mounting Hardware. Center Rise 3" PACKAGED AS SET
Use with:
 Manifold: 18-1952-1, 18-1953-2, 18-1957-2
 3"



**18-1906
MANIFOLD SPACER**

Replaces: 61851A1
 3" Spacer for 18-1950, 18-1951, 18-1958-1 & 18-1962-1 manifolds



**18-1908
MANIFOLD RISER SPACER - 3"**

Replaces: 93320
 Mercuriser GM V6 229 and 262cu.in. (Models: 185 and 205), GM Small Block V8 305-350cu.in. (Models: 200, 228, 230, 260 and 898), GM Big Block V8 454cu.in. (Models: 330, 340 and 7.4L)
Used with:
 Manifolds: 18-1952-1, 18-1953-2, 18-1957-2



**18-1985
MANIFOLD SPACER - 6"**

Replaces: Mercuriser 93322
 Marine Power 612011
 Barr MC-20-93322A3
For: 229 and 262 V6, 305-350 Small Block V8, 454 Big Block V8
Used with:
 Manifold: 18-1952-1, 18-1957-2, 18-1953-2

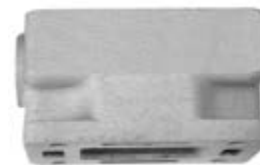

**18-1949
MANIFOLD SPACER**

Barr CM 20-0097
 3" Spacer for Barr, Indmar and Marine Power Ford Small Block V8 302-351cu.in., GM Small Block V8 305-350cu.in., GM Big Block V8 454cu.in.
Used with:
 Manifold: 18-1998-1, 18-1997-1 and 18-1898



**18-1990
MANIFOLD BLOCK OFF PLATE**
Replaces: 48045, 54870, 73813, 73813A1, 73813F1
Barr 1-73813



**18-4008
BLOCK-OFF PLATE**
Replaces: 60207
Barr MC-20-60207
Use with:
Riser: 18-1971, 18-1978



**18-1995
MANIFOLD END PLATE**
Replaces: 47638, 47638A1
GM 4 cyl. 153 cu. in.
For: Model 110/120 where carb. linkage mounts to the rear of the engine



PIPE PLUGS



**18-4009
MANIFOLD END PLATE**
Replaces: 52999, 60252, 60252A2
Barr 160252
Use with:
Manifold: 18-1960-1, 18-1958-1, 18-1950-1, 18-1951-1
End Plate Gasket: 18-2832-1
Mounting Kit: 18-8512



RISER BOLTS

Part #	Replaces	Thread Size	Description
18-4257	—	1/4"	Blacksteel Plug
18-4263	22-32802, 22-328022, 22-328021, 22-841908, 22-30139, F700633, FI5810151,	1/8" - 27 NPT	Pipe Plug
18-4264	22-32803, 22-87543, FI5880010	3/8" - 18 NPT	Pipe Plug
18-4265	22-428611, 22-42861, 22-861187	3/4" - 14 NPT	Pipe Plug (Brass hexdrive)
18-8111 ①	22-36392	1/4" - 18 NPT	Pipe Plug
18-4258	22-33198A1, 22-41622	3/4" - 14 NPT	Pipe Plug (Stainless steel w/ square drive)

Part #	Replaces	Thread Size	Description
18-8410	10-43749	3/8"-16 x 5 3/4"	Use w/o remote oil filter
18-8411	10-44387	1/8" - 16 x 6 3/4"	Use with remote oil filter



**18-8505
EXHAUST ELBOW MOUNTING KIT**
Mercury GM V6 229 and 262cu.in. (Models 185 and 205), GM Small Block V8 305-350cu.in. (Models: 200, 228, 230, 260, 898), GM Big Block V8 454cu.in. (Models: 330, 340 and 7.4L)
Used with: Riser: 18-1976-2



**18-3219
WATER TUBE & COVER ASSEMBLY**
Replaces: 32489, 32489A2, 42724A3
For: Merc I and Alpha I drives
Models: I, 1A, 1B, 1C, 1CEZ, 120, 140, 160, 165, 888, 898, 228, 225-S, 233, 250, 260, 470, 485, R, MR, Alpha
18-3229 Bolt Replaces: 10-28668



**18-4362
EXHAUST ELBOW MOUNTING KIT**
Replaces: Barr MC20-60426P
Use with: Elbow: 18-1971

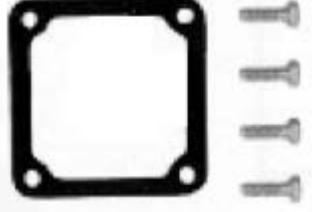

**18-8512
EXHAUST ELBOW MOUNTING KIT**
Mercury GM 4 Cylinder 181cu.in. (Models: 120, 140, 2.5L, 3.0L), GM Inline 6 Cylinder 250-292cu.in. (Models: 165 and 200), Ford Small Block V8 302-351cu.in. (Models: 215, 225, 233, 255, 888), GM Small Block V8 305, 350cu.in. (Models: 198, 228, 898)
Used with: Front Plate: 18-4009



**18-8514
EXHAUST ELBOW MOUNTING KIT**
Mercury Ford Small Block V8 302-351cu.in. (Models: 215, 225, 233, 255, 888), GM Small Block V8 305-351cu.in. (Models: 198, 228, 898)
Used with: Riser: 18-1971 & 18-1978
(Not for Fresh Water/Closed Cooling Systems)



**18-8520
EXHAUST MANIFOLD MOUNTING KIT**
Mercury GM Small Block V8 305-350cu.in. (Models: 198, 200, 228, 230, 260, 898)
Used with: Manifold: 18-1950-1, 18-1951-1, 18-1953-2

① This product is priced per piece. To order priced per package, please add -9 to the part number



18-4364 (Open)
EXHAUST ELBOW MOUNTING KIT
 Replaces: Barr 20-0082-P
 Use with:
 Riser: 18-1999, 18-1907, 18-1939



18-8529
EXHAUST ELBOW MOUNTING KIT
 Mercruiser GM V6 229 and 262cu.in. (Models 185 and 205), GM Small Block V8 305-350cu.in. (Models: 200, 228, 230, 260, 898), GM Big Block V8 454cu.in. (Models: 330, 340 and 7.4L)
 Used with:
 Riser: 18-1970-2



18-8530
EXHAUST ELBOW MOUNTING KIT
 Mercruiser 4 Cylinder 224cu.in. 3.7L (Models: 165, 170, 180, 190)
 Used with:
 Elbow/Reservoir: 18-1937



18-8531
EXHAUST MANIFOLD MOUNTING KIT
 Mercruiser GM Inline 6 Cylinder 250cu.in. (Models: 165 and 200)
 Used with:
 Manifold: 18-1960-1



18-8532
EXHAUST MANIFOLD MOUNTING KIT
 Mercruiser GM Big Block V8 454cu.in. (Models: 330, 340 and 7.4L)
 Used with:
 Manifold: 18-1957-2



18-8533
EXHAUST MANIFOLD MOUNTING KIT
 Mercruiser GM V6 229 and 262cu.in. (Models 185 and 205)
 Used with:
 Manifold: 18-1952-1



18-8535 (Blocked)
EXHAUST ELBOW MOUNTING KIT
 Barr, Indmar and Marine Power Ford Small Block V8 302-351cu.in., GM Small Block V8 305-350cu.in., GM Big Block V8 454cu.in.
 Used with:
 Risers: 18-1939, 18-1999, and 18-1907



18-8536
EXHAUST ELBOW MOUNTING KIT
 Barr, Indmar and Marine Power GM Small Block V8 305-350cu.in.
 Used with:
 Manifold: 18-1997-1



18-8538
EXHAUST MANIFOLD MOUNTING KIT
 Barr and Indmar Ford Small Block V8 302-351cu.in.
 Used with:
 Manifold: 18-1998-1



18-8554
EXHAUST ELBOW MOUNTING KIT
 For: 229 and 262 ci V6, 305 and 350 SB V8, 454 Big Block V8.
 Used with:
 Riser Kit: 18-1908K and 18-1908 Spacer
 Riser: 18-1970-2
 Manifolds: 18-1952-1, 18-1953-2 & 18-1957-2



18-8555
EXHAUST ELBOW MOUNTING KIT
 For: 229 and 262 ci V6, 305 and 350 SB V8, 454 Big Block V8.
 Used with:
 Riser Kit: 18-1908K and 18-1908 Spacer
 Riser: 18-1976-2
 Manifolds: 18-1952-1, 18-1953-2 & 18-1957-2



18-8556
EXHAUST ELBOW MOUNTING KIT
 For: 229 and 262 ci V6, 305 and 350 SB V8, 454 Big Block V8. Used to mount Spacer 18-1985 to 18-1953-2, 18-1957-2 and 18-1952-1 Manifolds



HARDWARE KITS

Part No.	Fits
18-8549	18-1950-1 Manifold
18-8551	18-1975-1 Exhaust Elbow









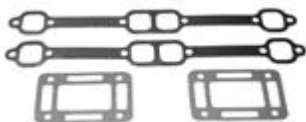

18-0183-1
EXHAUST MANIFOLD GASKET
 Replaces: Mercruiser 27-73866, 27-54566 Volvo 3853742, 3852455, OMC 908717
 Used with:
 Manifold: 18-1962-1, 18-1938, 18-1998-1, 18-1996, 18-1979



18-0353
CARB MOUNTING GASKET
 Replaces: 27-58764
 Used with:
 Manifold: 18-1960-1

 <p>18-0418 EXHAUST MANIFOLD GASKET Replaces: 27-46820 Use with : Manifolds: 18-1957-2, 18-1982, 18-1929, 18-1933, 18-1898</p>	 <p>18-0476-1 RISER BLOCK OFF GASKET Barr, Indmar & Marine Power Ford Small Block V8 302-351cu.in. Used with: Risers: 18-1939, 18-1999, 18-1907</p>	<p>PKG. OF 2</p>  <p>18-0672 18-0672-9① EXHAUST ELBOW GASKET Replaces: 27-860231,8637251, 27-41811, 27-863725 Used with: Riser: 18-1970-2, 18-1976-2</p>	 <p>18-0881-1 EXHAUST ELBOW GASKET Replaces: 27-18272, 27-97863 Included in 18-8530 mounting kit Used with: Elbow: 18-1937</p>
 <p>18-0885-1 18-0885-9① EXHAUST ELBOW GASKET Replaces: 27-48042</p>	 <p>18-0897 (Restrictor) EXHAUST ELBOW GASKET Replaces: 27-41813, 27-860233, 27-863724 Used with: Riser: 18-1976-2, 18-1970-2</p>	 <p>18-1204-1 18-1204-1-9① EXHAUST MANIFOLD GASKET Replaces: 27-96429</p>	<p>PKG. OF 2</p>  <p>18-2819-1 18-2819-9① EXHAUST ELBOW GASKET Replaces: 27-39915</p>
 <p>18-2830-1 EXHAUST MANIFOLD GASKET 6 cyl. Replaces: 27-46401</p>	<p>PKG. OF 2</p>  <p>18-1210-1 18-1210-1-9① END CAP GASKET Replaces: 27-39923</p>	<p>PKG. OF 2</p>  <p>18-2832-1 18-2832-1-9① MANIFOLD END CAP GASKET Replaces: 27-480431 Use with: Manifolds: 18-1951-1, 18-1950-1, 18-1954-1, 18-1958-1, 18-1955-1, 18-1956-3, 18-1960-1, 18-1962-1 End Plate: 18-4009</p>	 <p>18-2833 18-2833-9① EXHAUST ELBOW GASKET Replaces: 27-99772</p>
<p>PKG. OF 2</p>  <p>18-2849-1 (Open) 18-2849-9-1① EXHAUST ELBOW GASKET Replaces: 27-87105-1, 27-818832, 27-863726 Use with: Elbow: 18-1976-2, 18-1970-2</p>	 <p>18-2854-1 (Open) 18-2854-9① EXHAUST ELBOW GASKET Replaces: Barr 01-0107 Use with : Riser: 18-1999, 18-1939, 18- 1907</p>	 <p>18-2896-1 EXHAUST MANIFOLD GASKET Replaces: 27-52546, 27-32816 GM 4 cyl. 153 cu. in. For model 110/120 where carb. linkage mounts to the rear of the engine</p>	 <p>18-2909 18-2909-9① EXHAUST MANIFOLD GASKET For: GM V-6 Used with: Manifold: 18-1952-1</p>
 <p>18-2912-1 EXHAUST MANIFOLD GASKET Replaces: 27-53354</p>	 <p>18-2949 18-2949-9② EXHAUST MANIFOLD GASKET Replaces: Mercruiser 27-33395 Barr CHV-47-000 GM 5.0L & 5.7L Use with: Manifold: 18-1997-1, 18-1950-1, 18-1951-1</p>	 <p>18-0603 EXHAUST MANIFOLD GASKET SET For: Ford 302/351 CID Engines For use with 18-1998-1</p>	 <p>18-0604 EXHAUST MANIFOLD GASKET SET For: GM 305/350 CID Engines For use with 18-1997-1</p>

① Priced per Package

 18-0720 DRY JOINT GASKET (CLOSED) Replaces: 27-864549A02, 27-864549A1 Fits: 4.3L, 5.0L, 5.7L, 6.2L utilizing the Dry Joint Manifold and Riser Used with: 18-1843, 18-1842 Manifolds & 18-1845 Riser	 18-0721 DRY JOINT GASKET (OPEN) Replaces: 27-864547A02, 27-864547A1 Fits: 4.3L, 5.0L, 5.7L, 6.2L utilizing the Dry Joint Manifold and Riser Used with: 18-1843, 18-1842 Manifolds & 18-1845 Riser	 18-0722 DRY JOINT GASKET (RESTRICTED) Replaces: 27-864850A02, 27-864547A1 Fits: 4.3L, 5.0L, 5.7L, 6.2L utilizing the Dry Joint Manifold and Riser Used with: 18-1843, 18-1842 Manifolds & 18-1845 Riser
 18-4218 DRAIN TAP Replaces: 22-87238, 22-16951A1, 22-64426, 22-16951Q1 1/4" NPT 18-3223-9 Ⓜ Bulk pack of 12	 18-4224 DRAIN ELBOW ASSEMBLY Replaces: 22-806926A1, 22-862210A01 3/4" NPT	 18-4226 DRAIN PLUG Replaces: 22-806608A1, 22-806608A02
 18-4227 DRAIN ELBOW Replaces: 22-806926, 22-862210	 18-4461 HOSE BARB Replaces: 22-807155 3/4" - 14 NPT x 1" Hose Corrosion-Resistant Brass Fitting	 18-8216 HOSE BARB Replaces: 22-36305, 22-36305T 3/4" - 14 NPT x 1" hose barb Fits: Mercruiser- V6 (229 and 262ci), Small Block V8 (305-350ci), Big Block V8 (454ci)

Ⓜ Items ending in "D" are Display Packaged - Regular number is Non-Display
 Ⓜ Priced per Package

MANIFOLD/MANIFOLD GASKET APPLICATION

Liter	Model	Note	CID	# Cyl.	Stroke	Year Range	Serial # Range	Exh. Manifold Port	Exh. Manifold Starboard	Exh. Elbow	End Cap Front	End Cap Rear	Manifold Gasket	Exh. Elbow Gasket
2.5L	120		153	4	4	1966-1982	2046625 - 6229717						27-52546	18-2819-1
2.5L	120		153	4	4		2324347 - 3377340					18-1995	18-2896-1	18-2819-1
2.5L	120		153	4	4		3377341 - 5192408					18-1995	18-2896-1	18-2819-1
2.5L	120		153	4	4		5192049 - 6229717					18-1995	18-2896-1	18-2819-1
2.5	120		153	4	4	1983-1986	6229718 - B5311853				18-4009		18-1204-1	18-2833
2.5L	2.5L		153	4	4	1987-1989	B531854 - C853255	18-1956-3			18-4009	18-4009	18-1204-1	18-2833
3.0L	140		181	4	4	1968-1982	2508261 - 6229717	18-1955-1		18-1971	18-4009	18-1990	18-2912-1	18-2833
3.0L	140		181	4	4		3332138 - 5157668	18-1955-1				18-4009	18-1203	18-2833
3.0L	140		181	4	4		5157669 - 6229717	18-1955-1				18-4009	18-1203	18-2833
3.0L	140		181	4	4	1983-1986	6229718 - B450800			18-1975-1	18-4009		18-1204-1	18-2833
3.0L	3.0L		181	4	4	1990-1994	C856559 & UP	18-1956-3		18-1975-1	18-4009		18-1204-1	18-2833
3.0L	3.0L		181	4	4	1987-1989	B450801 - C856558			18-1975-1	18-4009		18-1204-1	18-2833
3.0L	3.0L		181	4	4	1998-2003	L010042 - M679999	18-1956-3		18-1975-1	18-1990		18-1204-1	18-2833
3.0L	3.0L		181	4	4	2003-2010	M680000 & UP	18-1956-3		18-1975-1			18-0680	18-2833
3.0L	3.0LX		181	4	4	1990-1997	C856559 - K999999	18-1956-3		18-1975-1	18-1990		18-0680	18-2833
3.0L	3.0L MPI / 3.0L EC		181	4	4	2008-2010	A072812 & UP						18-0680	
	150			4	4		1666495 - 2048046						18-2830-1	
	160			4	4		2048022 - 2770031						18-2830-1	
3.7L	165		224	4	4	1987	B434941 - B774251	Ⓜ		18-1937			18-0956-1	18-0881-1
3.7L	165		224	4	4	1987	B434941 - B774251	Ⓜ					18-0956-1	
3.7L	165		224	4	4		2770032 & up	18-1960-1				18-4009	18-2830-1	18-2833
3.7L	170		224	4	4	1985-1986	6916779 - B434940	Ⓜ		18-1937			18-0956-1	18-0881-1
3.7L	170		224	4	4	1985-1986	6916779 - B434940	Ⓜ					18-0956-1	18-0113-1
3.7L	180		224	4	4	1987	B436391 - B775248	Ⓜ		18-1937			18-0956-1	18-0881-1

Ⓜ For engines with aluminum exhaust manifolds Ⓜ For engines with cast iron exhaust manifolds Ⓜ 3" (76mm) O.D. & 0 degree down angle Ⓜ 3" (76mm) O.D. & 15 degree down angle Ⓜ 4" (102mm) O.D. Ⓜ 2 piece exhaust manifold Ⓜ 1 piece exhaust manifold Ⓜ Has a rectangular elbow mounting bolt pattern Ⓜ Has a square elbow mounting bolt pattern	Ⓜ In-line applications Ⓜ V-drive applications Ⓜ Standard rise Ⓜ 2" (51mm) rise Ⓜ 3" (76mm) rise Ⓜ 6" (152mm) rise Ⓜ Port Ⓜ Starboard Ⓜ Engines with risers or closed cooling may require a different gasket than listed	Ⓜ Exhaust manifold with external water rail Ⓜ Exhaust manifold w/o external water rail Ⓜ 1 piece exhaust manifold is n/a. Engine must be converted to the 2 piece exhaust system Ⓜ Engines with easy drain system Ⓜ Engines with multi-point drain system Ⓜ Intermediate collector housing
--	---	---

MANIFOLD/MANIFOLD GASKET APPLICATION (Cont.)

Liter	Model	Note	CID	# Cyl.	Stroke	Year Range	Serial # Range	Exh. Manifold Port	Exh. Manifold Starboard	Exh. Elbow	End Cap Front	End Cap Rear	Manifold Gasket	Exh. Elbow Gasket
3.7L	180		224	4	4	1987	B436391 - B775248	Ⓔ					18-0956-1	18-0113-1
3.7L	190		224	4	4	1985-1986	6916779 - B436390	Ⓐ		18-1937			18-0956-1	18-0881-1
3.7L	190		224	4	4	1985-1986	6916779 - B436390	Ⓔ					18-0956-1	18-0113-1
3.7L	3.7L		224	4	4	1988-1989	B774252 & UP	Ⓐ		18-1937			18-0956-1	18-0881-1
3.7L	3.7L		224	4	4	1988-1989	B774252 & UP	Ⓔ					18-0956-1	
3.7L	3.7LX		224	4	4	1988-1989	B775249 & UP	Ⓐ		18-1937			18-0956-1	18-0881-1
3.7L	3.7LX		224	4	4	1988-1989	B775249 & UP	Ⓔ					18-0956-1	18-0113-1
	470		224	4	4	1976-1977	4208730 - 4625579						18-0956-1	18-2833
	470 MCM / 470 MIE		224	4	4	1977-1982	4625580 - 6218036						18-0956-1	18-2833
	470		224	4	4	1983-1984	6218037 - 6916778						18-0956-1	18-0113-1
	485		224	4	4	1980-1982	5685394 - 6218036						18-0956-1	
	488		224	4	4	1983-1984	6170297 - 6916778						18-0956-1	18-0113-1
	140		194	6	4	1963	1538930 - 1725960						18-2830-1	
	150		230	6	4	1964-1966	1666495 - 2048046						18-2830-1	
	160		250	6	4	1967-1969	2048022 - 2770031						18-2830-1	
	165		250	6	4	1970-1981	2770032 - 5813433	18-1960-1		18-1971	18-4009	18-1990	18-2830-1	18-2833
	200		292	6	4	1969	2453769 - 2712072	18-1960-1		18-1971		18-1990	18-2830-1	18-2833
	185	4bbl	229	6	4	1983-1984	6330183 - 6919655	18-1952-1	18-1952-1	18-1970-2			18-2909	18-0897
	175		262	6	4	1987	B527955 - B773242	18-1952-1	18-1952-1	18-1976-2			18-2909	18-0897
	185	2bbl	262	6	4	1985-1986	A331455 - B527954	18-1952-1	18-1952-1	18-1970-2 Ⓐ			18-2909	18-0897
	185	2bbl	262	6	4	1985-1986	A331455 - B527954	18-1952-1	18-1952-1	18-1976-2 Ⓔ			18-2909	18-0897
	205		262	6	4	1985-1986	A331455 - B527954	18-1952-1	18-1952-1	18-1970-2 Ⓐ			18-2909	18-0897
	205		262	6	4	1985-1986	A331455 - B527954	18-1952-1	18-1952-1	18-1976-2 Ⓔ			18-2909	18-0897
	205		262	6	4	1987	B527955 - B775129	18-1952-1	18-1952-1	18-1976-2			18-2909	18-0897
4.3L	262 MAG EFI GEN +		262	6	4	1996-1997	F803800 - K999999	18-1952-1 Ⓐ	18-1952-1 Ⓐ	18-1976-2 Ⓐ			18-2909	18-0897
4.3L	262 MAG EFI GEN +		262	6	4	1996-1997	F803800 - K999999	Ⓔ	Ⓔ	Ⓔ			18-2909	
4.3L	4.3L		262	6	4	1988-1996	B773243 - F802999	18-1952-1	18-1952-1	18-1976-2			18-2909	18-0897
4.3L	4.3L GEN +		262	6	4	1998-2002	L010044 - M614999	18-1952-1 Ⓐ	18-1952-1 Ⓐ	18-1976-2 Ⓐ			18-2909	18-2849-1
4.3L	4.3L GEN +		262	6	4	1998-2002	L010044 - M614999	Ⓔ	Ⓔ	Ⓔ			18-2909	
4.3L	4.3L GEN +		262	6	4	2002-2004	M615000 - W309999						18-2909	
4.3L	4.3L GEN +		262	6	4	2004-2010	W310000 & UP						18-2909	
4.3L	4.3L EFI GEN +		262	6	4	1998-2002	L012009 - M322780	18-1952-1 Ⓐ	18-1952-1 Ⓐ	18-1976-2 Ⓐ			18-2909	18-2849-1
4.3L	4.3L EFI GEN +		262	6	4	1998-2002	L01009 - M322780	Ⓔ	Ⓔ	Ⓔ			18-2909	
4.3L	4.3L MPI		262	6	4	2002	M300000 - M614999	18-1952-1	18-1952-1	18-1976-2			18-2909	18-0897 ♣
4.3L	4.3L MPI		262	6	4	2002	M300000 - M614999	18-1952-1	18-1952-1	18-1976-2			18-2909	18-2849-1 ♣
4.3L	4.3L MPI		262	6	4	2002-2004	M615000 - W309999						18-2909	
4.3L	4.3L MPI		262	6	4	2004-2010	W310000 & UP						18-2909	
4.3L	4.3L MPI / 4.3L EC		262	6	4	2010-2011	A637496 & UP			Ⓔ			18-2909	
4.3L	4.3L MPI / 4.3L EC		262	6	4	2010-2011	A637496 & UP			Ⓔ			18-2909	
4.3L	4.3LH GEN +		262	6	4	1998-2002	L010044 - M614999	18-1952-1 Ⓐ	18-1952-1 Ⓐ	18-1976-2 Ⓐ			18-2909	18-2849-1
4.3L	4.3LH GEN +		262	6	4	1998-2002	L010044 - M614999	Ⓔ	Ⓔ	Ⓔ			18-2909	
4.3L	4.3LH	4 bbl	262	6	4	1988-1996	B775130 - F802999	18-1952-1	18-1952-1	18-1976-2			18-2909	18-0897
4.3L	4.3LX GEN +	2bbl	262	6	4	1996-1997	F803800 - K999999	18-1952-1 Ⓐ	18-1952-1 Ⓐ	18-1976-2 Ⓐ			18-2909	18-0897
4.3L	4.3LX GEN +	2bbl	262	6	4	1996-1997	F803800 - K999999	Ⓔ	Ⓔ	Ⓔ			18-2909	
4.3L	4.3LXH GEN +		262	6	4	1996-1997	F803814 - K999999	18-1952-1 Ⓐ	18-1952-1 Ⓐ	18-1976-2 Ⓐ			18-2909	18-0897
4.3L	4.3LXH GEN +		262	6	4	1996-1997	F803814 - K999999	Ⓔ	Ⓔ	Ⓔ			18-2909	
5.0L	215		302	8	4	1970	2781153 - 3040410	18-1958-1	18-1962-1	18-1971	18-4009	18-1990	18-0183-1	18-2833
5.0L	215		302	8	4	1971-1972	3040411 - 3385720	18-1958-1	18-1962-1	18-1971	18-4009	18-4009	18-0183-1	18-2833
5.0L	215 MIE		302	8	4	1970	2781153 - 3040410	18-1958-1	18-1962-1		18-4009	18-1990	18-0183-1	18-2833
5.0L	215 MIE		302	8	4	1971-1972	3040411 - 3563181	18-1958-1	18-1962-1		18-4009	18-4009	18-0183-1	18-2833
5.0L	225	FORD	302	8	4	1973-1974	3385721 - 4166999	18-1958-1	18-1962-1	18-1971	18-4009	18-4009	18-0183-1	18-2833
5.0L	225 MIE	FORD	302	8	4	1973-1974	3385721 - 4176999	18-1958-1	18-1962-1		18-4009	18-4009	18-0183-1	18-2833
5.0L	888		302	8	4	1971-1977	3108723 - 4867829	18-1958-1	18-1962-1	18-1971	18-4009	18-4009	18-0183-1	18-2833

- Ⓐ For engines with aluminum exhaust manifolds
- Ⓑ For engines with cast iron exhaust manifolds
- Ⓒ 3" (76mm) O.D. & 0 degree down angle
- Ⓓ 3" (76mm) O.D. & 15 degree down angle
- Ⓔ 4" (102mm) O.D.
- Ⓕ 2 piece exhaust manifold
- Ⓖ 1 piece exhaust manifold
- Ⓗ Has a rectangular elbow mounting bolt pattern
- Ⓘ Has a square elbow mounting bolt pattern

- Ⓙ In-line applications
- Ⓚ V-drive applications
- Ⓛ Standard rise
- Ⓜ 2" (51mm) rise
- Ⓨ 3" (76mm) rise
- Ⓩ 5" (127mm) rise
- ⓐ Port
- ⓑ Starboard
- ⓓ Engines with risers or closed cooling may require a different gasket than listed

- ⓔ Exhaust manifold with external water rail
- ⓕ Exhaust manifold w/o external water rail
- ⓖ 1 piece exhaust manifold is n/a. Engine must be converted to the 2 piece exhaust system
- ⓗ Engines with easy drain system
- ⓓ Engines with multi-point drain system
- ⓓ Intermediate collector housing

MANIFOLD/MANIFOLD GASKET APPLICATION (Cont.)

Liter	Model	Note	CID	# Cyl.	Stroke	Year Range	Serial # Range	Exh. Manifold Port	Exh. Manifold Starboard	Exh. Elbow	End Cap Front	End Cap Rear	Manifold Gasket	Exh. Elbow Gasket
	190		283	8	4	1963-1964	1564539 - 1730903						18-2949	
5.0L	198 MIE		305	8	4	1977	4776402 - 4931099	Ⓢ	Ⓢ	Ⓢ	18-4009	18-4009	18-2949	18-0885-1
5.0L	198 MIE		305	8	4	1977	4776402 - 4931009	18-1950-1 ④	18-1951-1 ④	④	18-4009	18-4009	18-2949	18-2833
5.0L	200		305	8	4	1985-1987	6899058 - B525981	18-1953-2	18-1953-2	18-1970-2 ①			18-2949	18-0897
5.0L	200		305	8	4	1985-1987	6899058 - B525981	18-1953-2	18-1953-2	18-1976-2 ⑤			18-2949	18-0897
5.0L	200		305	8	4	1987	B525982 - B774444	18-1953-2	18-1953-2	18-1976-2			18-2949	18-0897
5.0L	228		305	8	4	1977	4765100 - 4888929				18-4009	18-4009	18-2949	18-0885-1
5.0L	228		305	8	4	1977-1982	4888930 - 6218461	18-1950-1	18-1951-1	18-1971	18-4009	18-4009	18-2949	18-2833
5.0L	228		305	8	4	1983-1984	6218462 - 6899268	18-1953-2	18-1953-2	18-1970-2 ①			18-2949	18-0897
5.0L	228		305	8	4	1983-1984	6218462 - 6899268	18-1953-2	18-1953-2	18-1976-2 ⑤			18-2949	18-0897
5.0L	228 TR		305	8	4	1977-1978	4888930 - 5170008	18-1950-1	18-1951-1	18-1971	18-4009	18-4009	18-2949	18-2833
5.0L	228 TR		305	8	4	1977-1978	4888930 - 5170008	18-1950-1	18-1951-1	18-1971	18-4009	18-4009	18-2949	18-2833
5.0L	228 MIE		305	8	4	1977	4765100 - 4888929				18-4009	18-4009	18-2949	18-0885-1
5.0L	228 MIE		305	8	4	1977-1980	4888930 - 5907057	18-1950-1	18-1951-1		18-4009	18-4009	18-2949	18-2833
5.0L	230		305	8	4	1985-1987	6899269 - B525981	18-1953-2	18-1953-2	18-1970-2 ①			18-2949	18-0897
5.0L	230		305	8	4	1985-1987	6899269 - B525981	18-1953-2	18-1953-2	18-1976-2 ⑤			18-2949	18-0897
5.0L	230		305	8	4	1987	B525982 - B773739	18-1953-2	18-1953-2	18-1976-2			18-2949	18-0897
5.0L	230 MIE		305	8	4	1981-1987	5907058 - B788151	18-1953-2	18-1953-2	18-1974-1 ⑥			18-2949	18-0897
5.0L	230 MIE		305	8	4	1981-1987	5907058 - B788151	18-1953-2	18-1953-2	18-1970-2 ①			18-2949	18-0897
5.0L	230 MIE		305	8	4	1981-1987	5907058 - B788151	18-1953-2	18-1953-2	18-1976-2 ⑤			18-2949	18-0897
5.0L	5.0L		305	8	4	1988-1995	B774445 - F600999	18-1953-2	18-1953-2	18-1976-2			18-2949	18-0897
5.0L	5.0L GEN +		305	8	4	1988-2002	L015751 - M599999	18-1953-2	18-1953-2	18-1976-2			18-2949	
5.0L	5.0L GEN +		305	8	4	1988-2002	M600000 - W309999						18-2949	
5.0L	5.0L GEN +		305	8	4	2004-2010	W310000 & UP						18-2949	
5.0L	5.0L EFI GEN +		305	8	4	1998-2001	L012052 - M299999	18-1953-2	18-1953-2	18-1976-2			18-2949	18-2849-1
5.0L	5.0L MIE		305	8	4	1988	B788152 - C396832	18-1953-2	18-1953-2	18-1976-2			18-2949	18-0897
5.0L	5.0L MPI		305	8	4	2002	M300000 - M599999	18-1953-2	18-1953-2	18-1976-2			18-2949	18-0897
5.0L	5.0L MPI		305	8	4	2002-2004	M600000 - W309999						18-2949	
5.0L	5.0L MPI		305	8	4	2004-2010	W310000 & UP						18-2949	
5.0L	5.0LX		305	8	4	1988-1995	B773740 - F600900	18-1953-2	18-1953-2	18-1976-2			18-2949	18-0897
5.0L	898		305	8	4	1977-1982	4762210 - 6218461	Ⓢ	Ⓢ	Ⓢ	18-4009	18-4009	18-2949	18-0885-1
5.0L	898		305	8	4	1977-1982	4762210 - 6218461	18-1950-1 ④	18-1951-1 ④	④	18-4009	18-4009	18-2949	18-2833
5.0L	898		305	8	4	1983-1984	6218462 - 6899057	18-1953-2	18-1953-2	18-1970-2			18-2949	18-0897
5.0L	898		305	8	4	1983-1984	6218462 - 6899057	18-1953-2	18-1953-2	18-1976-2 ⑤			18-2949	18-0897
	225	GM	327	8	4	1963-1968	1539620 - 2399397						18-2949	
	225	GM	327	8	4	1968-1969	2399398 - 2694014				18-4009	18-1990	18-2949	18-0885-1
	225 MIE	GM	327	8	4	1968	2278647 - 2399307						18-2949	
	225 MIE	GM	327	8	4	1968-1969	2399398 - 2694014				18-4009	18-1990	18-2949	18-0885-1
	250		327	8	4	1968-1969	2314301 - 2639854				18-4009	18-1990	18-2949	18-0885-1
	250 MIE		327	8	4	1968-1969	2314301 - 2639854				18-4009	18-1990	18-2949	18-0885-1
5.7L	250		350	8	4	1977	4768000 - 4908849	Ⓢ	Ⓢ	Ⓢ	18-4009	18-4009	18-2949	18-0885-1
5.7L	250		350	8	4	1977	4768000 - 4908849	18-1950-1 ④	18-1951-1 ④	18-1971 ④	18-4009	18-4009	18-2949	18-2833
5.7L	255	GM	350	8	4	1975-1976	4175500 - 4499060				18-4009	18-1990	18-2949	18-0885-1
5.7L	255	GM	350	8	4	1976	4499061 - 4767999	18-1950-1	18-1951-1	18-1971	18-4009	18-4009	18-2949	18-2833
5.7L	255 MIE	GM	350	8	4	1975-1976	4175500 - 4499060				18-4009	18-1990	18-2949	18-0885-1
5.7L	255 MIE	GM	350	8	4	1976-1980	4499061 - 5907057	18-1950-1	18-1951-1		18-4009	18-4009	18-2949	18-2833
5.7L	260		350	8	4	1978-1982	4908850 - 6218461	18-1950-1	18-1951-1	18-1971	18-4009	18-4009	18-2949	18-2833
5.7L	260		350	8	4	1983-1987	6218462 - B773304	18-1953-2	18-1953-2	18-1970-2 ①			18-2949	18-0897
5.7L	260		350	8	4	1983-1987	6218462 - B773304	18-1953-2	18-1953-2	18-1976-2 ⑤			18-2949	18-0897
5.7L	260 MIE		350	8	4	1981-1987	5907058 - B788151	18-1953-2	18-1953-2	18-1974-1 ⑥			18-2949	18-0897
5.7L	260 MIE		350	8	4	1981-1987	5907058 - B788151	18-1953-2	18-1953-2	18-1970-2 ②			18-2949	18-0897
5.7L	260 MIE		350	8	4	1981-1987	5907058 - B788151	18-1953-2	18-1953-2	18-1976-2 ⑤			18-2949	18-0897

<ul style="list-style-type: none"> Ⓢ For engines with aluminum exhaust manifolds Ⓢ For engines with cast iron exhaust manifolds ③ 3" (76mm) O.D. & 0 degree down angle ④ 3" (76mm) O.D. & 15 degree down angle ④ 4" (102mm) O.D. ② 2 piece exhaust manifold ① 1 piece exhaust manifold Ⓢ Has a rectangular elbow mounting bolt pattern Ⓢ Has a square elbow mounting bolt pattern 	<ul style="list-style-type: none"> Ⓢ In-line applications ① V-drive applications ② Standard rise ③ 2" (51mm) rise ④ 3" (76mm) rise ⑤ 6" (152mm) rise ⑥ Port ⑦ Starboard ⑧ Engines with risers or closed cooling may require a different gasket than listed 	<ul style="list-style-type: none"> Ⓢ Exhaust manifold with external water rail Ⓢ Exhaust manifold w/o external water rail ➤ 1 piece exhaust manifold is n/a. Engine must be converted to the 2 piece exhaust system Ⓢ Engines with easy drain system Ⓢ Engines with multi-point drain system ▼ Intermediate collector housing
--	---	---

MANIFOLD/MANIFOLD GASKET APPLICATION (Cont.)

Liter	Model	Note	CID	#Cyl.	Stroke	Year Range	Serial # Range	Exh. Manifold Port	Exh. Manifold Starboard	Exh. Elbow	End Cap Front	End Cap Rear	Manifold Gasket	Exh. Elbow Gasket
5.7L	270		350	8	4	1969-1972	2851074 - 3385720				18-4009	18-1990	18-2949	18-0885-1
5.7L	270 MIE		350	8	4	1969-1972	2851074 - 3077735				18-4009	18-1990	18-2949	18-0885-1
5.7L	280 TRS		350	8	4	1975-1976	4176250 - 4770199	Ⓢ	Ⓢ	Ⓢ	18-4009	18-1990	18-2949	18-0885-1
5.7L	280 TRS		350	8	4	1975-1976	4176250 - 4770199	18-1950-1 Ⓢ	18-1951-1 Ⓢ	Ⓢ	18-4009	18-4009	18-2949	18-2833
5.7L	300		350	8	4	1985-1986	6668677 - B4300367	18-1953-2	18-1953-2				18-2949	18-2849-1
5.7L	320 EFI		350	8	4	1987-1989	A543604 - C622418	18-1953-2	18-1953-2	18-1976-2			18-2949	18-0897
5.7L	350 MAG ALPHA		350	8	4	1986-1997	A635178 - K999999	18-1953-2	18-1953-2	18-1976-2			18-2949	18-0897
5.7L	350 MAG ALPHA / 350 MAG EFI		350	8	4	1996-1997	F800300 - K999999	18-1953-2	18-1953-2	18-1976-2			18-2949	18-0897
5.7L	350 MAG BRAVO / 350 MAG MPI		350	8	4	1995	F415189 - F601999	18-1953-2	18-1953-2	18-1976-2			18-2949	18-0897
5.7L	350 MAG BRAVO GEN + / 350 MAG MPI GEN +		350	8	4	1996-1997	F602000 - K999999	18-1953-2	18-1953-2	18-1976-2			18-2949	18-0897
5.7L	350 MAG EFI / 350 MAG SKI		350	8	4	1994-1996	F215561 - F820706	18-1953-2	18-1953-2	18-1976-2			18-2949	18-0897
5.7L	350 MAG EFI GEN + / 350 MAG SKI GEN +		350	8	4	1996-1997	F820707 - K999999	18-1953-2	18-1953-2	18-1976-2			18-2949	18-0897
5.7L	350 MAG MPI		350	8	4	1998-2001	L010019 - M299999	18-1953-2	18-1953-2	18-1976-2			18-2949	18-2849-1
5.7L	350 MAG MPI		350	8	4	2002	M300000 - M599999	18-1953-2	18-1953-2	18-1976-2			18-2949	18-0897
5.7L	350 MAG MPI		350	8	4	2002-2004	M600000 - W309999						18-2949	
5.7L	350 MAG MPI		350	8	4	2004-2010	W310000 & UP						18-2949	
5.7L	350 MAG MPI / 350 MAG HORIZON		350	8	4	2002	M300000 - M599999	18-1953-2	18-1953-2	18-1976-2			18-2949	18-2849-1
5.7L	350 MAG MPI / 350 MAG HORIZON		350	8	4	2002-2004	M600000 - W309999						18-2949	
5.7L	350 MAG MPI / 350 MAG HORIZON		350	8	4	2004-2007	W310000 - A299999						18-2949	
5.7L	350 MAG MPI / 350 MAG HORIZON / 350 MAG MIE		350	8	4	1999-2001	L304700 - M299999	18-1953-2	18-1953-2	18-1976-2			18-2949	18-2849-1
5.7L	350 MAG MPI / 350 MAG HORIZON / 350 MAG MIE		350	8	4	2002	M300000 - M316999	18-1953-2	18-1953-2	18-1976-2			18-2949	18-2849-1
5.7L	350 MAG MPI / 350 MAG HORIZON / 350 MAG MIE		350	8	4	2002-2007	M317000 - A089999						18-2949	
5.7L	350 MAG MPI / 350 MAG MIE		350	8	4	1998-2001	L002008 - M299999	18-1953-2	18-1953-2	18-1976-2			18-2949	18-2849-1
5.7L	350 MAG MPI / 350 MAG MIE		350	8	4	2002	M300000 - M316999	18-1953-2	18-1953-2	18-1976-2			18-2949	18-0897
5.7L	350 MAG MPI / 350 MAG MIE		350	8	4	2002-2007	M317000 - A089999						18-2949	
5.7L	350 MAG MPI / 350 MAG SKI		350	8	4	1995-1996	F350583 - F799999	18-1953-2	18-1953-2	18-1976-2			18-2949	
5.7L	350 MAG MPI GEN + / 350 MAG SKI GEN +		350	8	4	1998-2001	L002600 - M299999	18-1953-2	18-1953-2	18-1976-2			18-2949	18-2849-1
5.7L	350 MAG MPI GEN + / 350 MAG SKI GEN +		350	8	4	2002	M300000 - M316999	18-1953-2	18-1953-2	18-1976-2			18-2949	18-0897
5.7L	350 MAG MPI GEN + / 350 MAG SKI GEN +		350	8	4	2002-2007	M317000 - A089999			Ⓢ			18-2949	18-0897
5.7L	350 MAG MPI GEN + / 350 MAG SKI GEN +		350	8	4	2002-2007	M317000 - A089999			Ⓢ			18-2949	
5.7L	350 MAG SKI		350	8	4	1991-1997	D505450 - K999999	18-1953-2	18-1953-2	18-1976-2			18-2949	18-0897
5.7L	5.7L		350	8	4	1988-1997	B773305 - K999999	18-1953-2	18-1953-2	18-1976-2			18-2949	18-0897

- Ⓢ For engines with aluminum exhaust manifolds
- Ⓢ For engines with cast iron exhaust manifolds
- Ⓢ 3" (76mm) O.D. & 0 degree down angle
- Ⓢ 3" (76mm) O.D. & 15 degree down angle
- Ⓢ 4" (102mm) O.D.
- Ⓢ 2 piece exhaust manifold
- Ⓢ 1 piece exhaust manifold
- Ⓢ Has a rectangular elbow mounting bolt pattern
- Ⓢ Has a square elbow mounting bolt pattern

- Ⓢ In-line applications
- Ⓢ V-drive applications
- Ⓢ Standard rise
- Ⓢ 2" (51mm) rise
- Ⓢ 3" (76mm) rise
- Ⓢ 6" (152mm) rise
- Ⓢ Port
- Ⓢ Starboard
- Ⓢ Engines with risers or closed cooling may require a different gasket than listed

- Ⓢ Exhaust manifold with external water rail
- Ⓢ Exhaust manifold w/o external water rail
- Ⓢ 1 piece exhaust manifold is n/a. Engine must be converted to the 2 piece exhaust system
- Ⓢ Engines with easy drain system
- Ⓢ Engines with multi-point drain system
- Ⓢ Intermediate collector housing

MANIFOLD/MANIFOLD GASKET APPLICATION (Cont.)

Liter	Model	Note	CID	# Cyl.	Stroke	Year Range	Serial # Range	Exh. Manifold Port	Exh. Manifold Starboard	Exh. Elbow	End Cap Front	End Cap Rear	Manifold Gasket	Exh. Elbow Gasket
5.7L	5.7L GEN +		350	8	4	1998-2002	L010037 - M599999	18-1953-2	18-1953-2	18-1976-2			18-2949	18-2849-1
5.7L	5.7L GEN +		350	8	4	2002-2004	M600000 - W309999						18-2949	
5.7L	5.7L GEN +		350	8	4	2004-2010	W310000 & UP						18-2949	
5.7L	5.7L EFI		350	8	4	1995-1997	F225560 - K999999	18-1953-2	18-1953-2	18-1976-2			18-2949	18-0897
5.7L	5.7L EFI GEN +		350	8	4	1998-2001	L010035 - M299999	18-1953-2	18-1953-2	18-1976-2			18-2949	18-2849-1
5.7L	5.7L EFI / 5.7L MIE		350	8	4	1997	K040300 - K999999	18-1953-2	18-1953-2	18-1976-2			18-2949	18-0897
5.7L	5.7L MIE		350	8	4	1988-1997	B788152 - K999999	18-1953-2	18-1953-2	18-1976-2			18-2949	18-0897
5.7L	5.7L MIE GEN +		350	8	4	1998-2002	L002003 - M316999	18-1953-2	18-1953-2	18-1976-2			18-2949	18-2849-1
5.7L	5.7L MIE GEN +		350	8	4	2002-2010	M317000 & UP						18-2949	
5.7L	5.7L MPI / 5.7L MIE		350	8	4	2008-2010	A090000 & UP						18-2949	
5.7L	5.7L MPI / 5.7L SKI		350	8	4	2008-2010	A090000 & UP			Ⓜ			18-2949	
5.7L	5.7L MPI / 5.7L SKI		350	8	4	2008-2010	A090000 & UP			①			18-2949	
5.7L	5.7L SKI		350	8	4	1985-1995	A338553 - F775199	18-1953-2	18-1953-2	18-1970-2 Ⓜ			18-2949	18-0897
5.7L	5.7L SKI		350	8	4	1985-1995	A338553 - F775199	18-1953-2	18-1953-2	18-1976-2 Ⓜ			18-2949	18-0897
5.7L	5.7L SKI		350	8	4	1996-1997	F775200 - K999999	18-1953-2	18-1953-2	18-1976-2			18-2949	18-0897
5.7L	5.7L SKI		350	8	4	1998-2002	L002005 - M316999	18-1953-2	18-1953-2	18-1976-2			18-2949	18-2849-1
5.7L	5.7L SKI		350	8	4	2002-2010	M317000 & UP						18-2949	
5.7L	5.7LX		350	8	4	1996-1997	F601000 - K999999	18-1953-2	18-1953-2	18-1976-2			18-2949	18-0897
5.7L	5.7LX BRAVO EFI		350	8	4	1996-1997	F800300 - K999999	18-1953-2	18-1953-2	18-1976-2			18-2949	18-0897
5.7L	5.7LX EFI		350	8	4	1996-1997	F752400 - K999999	18-1953-2	18-1953-2	18-1976-2			18-2949	18-0897
5.7L	BLACK SCORPION SKI		350	8	4	1996-1997	F800000 - K999999	18-1953-2	18-1953-2	18-1976-2			18-2949	18-0897
5.7L	BLACK SCORPION SKI		350	8	4	2003-2007	M391600 - W698432			Ⓜ			18-2949	
5.7L	BLACK SCORPION SKI		350	8	4	2003-2007	M391600 - W698432			①			18-2949	
5.7L	SCORPION 350		350	8	4	2008-2010	W698433 & UP			Ⓜ			18-2949	
5.7L	SCORPION 350		350	8	4	2008-2010	W698433 & UP			①			18-2949	
6.2L	233		351	8	4	1975-1977	4173000 - 4902304	18-1958-1	18-1962-1	18-1971	18-4009	18-4009	18-0183-1	18-2833
6.2L	233 MIE		351	8	4	1975-1977	4173000 - 4902304	18-1958-1	18-1962-1	N.L.A.	18-4009	18-4009	18-0183-1	18-2833
6.2L	233 MIE		351	8	4	1975-1977	4173000 - 4902304	18-1958-1	18-1962-1	N.L.A.	18-1990 □	18-4009	18-0183-1	18-2833
6.2L	255	FORD	351	8	4	1973-1974	3258728 - 4175499	18-1958-1	18-1962-1	18-1971	18-4009	18-4009	18-0183-1	18-2833
6.2L	255 MIE	FORD	351	8	4	1973-1974	3258728 - 4175499	18-1958-1	18-1962-1		18-4009	18-4009	18-0183-1	18-2833
6.2L	225 MIE	FORD	351	8	4	1973-1974	3258728 - 4175499	18-1958-1	18-1962-1		18-1990 □	18-4009	18-0183-1	18-2833
6.2L	377 MAG		377	8	4	2008-2010	A300000 & UP						18-2949	
6.2L	377 SCORPION MCM		377	8	4	1999-2005	L416146 - M907201	18-1953-2	18-1953-2	18-1976-2			18-2949	18-2849-1
6.2L	377 SCORPION SKI		377	8	4	1997-1998	K000656 - L600314	18-1953-2	18-1953-2	18-1976-2			18-2949	18-0897
6.2L	MX 6.2L MPI		377	8	4	2000-2001	L680003 - M299999	18-1953-2	18-1953-2	18-1976-2			18-2949	18-2849-1
6.2L	MX 6.2L MPI		377	8	4	2002	M300000 - M599999	18-1953-2	18-1953-2	18-1976-2			18-2949	18-0897
6.2L	MX 6.2L MPI		377	8	4	2002-2004	M600000 - W309999						18-2949	
6.2L	MX 6.2L MPI		377	8	4	2004-2007	W310000 - A299999						18-2949	
6.2L	MX 6.2L MPI / MX 6.2L HORIZON		377	8	4	2002	M300000 - M599999	18-1953-2	18-1953-2	18-1976-2			18-2949	18-2849-1
6.2L	MX 6.2L MPI / MX 6.2L HORIZON		377	8	4	2002-2004	M600000 - W309999						18-2949	
6.2L	MX 6.2L MPI / MX 6.2L HORIZON		377	8	4	2004-2007	W310000 - A299999						18-2949	
6.2L	MX 6.2L MPI / MX 6.2L HORIZON / MX 6.2L MIE		377	8	4	2002	M300000 - M316999	18-1953-2	18-1953-2	18-1976-2			18-2949	18-2849-1
6.2L	MX 6.2L MPI / MX 6.2L HORIZON / MX 6.2L MIE		377	8	4	2002-2007	M317000 - A089999						18-2949	
6.2L	MX 6.2L MPI / MX 6.2L MIE		377	8	4	1999-2001	L670000 - M299999	18-1953-2	18-1953-2	18-1976-2			18-2949	18-2849-1
6.2L	MX 6.2L MPI / MX 6.2L MIE		377	8	4	2002	M300000 - M316999	18-1953-2	18-1953-2	18-1976-2			18-2949	18-0897
6.2L	MX 6.2L MPI / MX 6.2L MIE		377	8	4	2002-2010	M317000 & UP						18-2949	
6.2L	MX 6.2L MPI / MX 6.2L SKI		377	8	4	2002-2007	M317000 - A089999						18-2949	
6.2L	MX 6.2L MPI / MX 6.2L SKI		377	8	4	2002-2007	M317000 - A089999						18-2949	
6.2L	MX 6.2L BLACK SCORPION SKI		377	8	4	2001-2003	L670015 - M391599	18-1953-2	18-1953-2	18-1976-2			18-2949	18-2849-1

- Ⓜ For engines with aluminum exhaust manifolds
- Ⓜ For engines with cast iron exhaust manifolds
- Ⓜ 3" (76mm) O.D. & 0 degree down angle
- Ⓜ 3" (76mm) O.D. & 15 degree down angle
- Ⓜ 4" (102mm) O.D.
- Ⓜ 2 piece exhaust manifold
- Ⓜ 1 piece exhaust manifold
- Ⓜ Has a rectangular elbow mounting bolt pattern
- Ⓜ Has a square elbow mounting bolt pattern

- Ⓜ In-line applications
- Ⓜ V-drive applications
- Ⓜ Standard rise
- Ⓜ 2" (51mm) rise
- Ⓜ 3" (76mm) rise
- Ⓜ 4" (102mm) rise
- Ⓜ 6" (152mm) rise
- Ⓜ Port
- Ⓜ Starboard
- Ⓜ Engines with risers or closed cooling may require a different gasket than listed

- Ⓜ Exhaust manifold with external water rail
- Ⓜ Exhaust manifold w/o external water rail
- Ⓜ 1 piece exhaust manifold is n/a. Engine must be converted to the 2 piece exhaust system
- Ⓜ Engines with easy drain system
- Ⓜ Engines with multi-point drain system
- Ⓜ Intermediate collector housing

MANIFOLD/MANIFOLD GASKET APPLICATION (Cont.)

Liter	Model	Note	CID	#Cyl.	Stroke	Year Range	Serial # Range	Exh. Manifold Port	Exh. Manifold Starboard	Exh. Elbow	End Cap Front	End Cap Rear	Manifold Gasket	Exh. Elbow Gasket
6.2L	MX 6.2L BLACK SCORPION SKI		377	8	4	2003-2007	M391600 - W698432						18-2949	
6.2L	MX 6.2L BLACK SCORPION SKI		377	8	4	2003-2007	M391600 - W698432						18-2949	
6.2L	SCORPION 377		377	8	4	2008-2010	W698433 & UP						18-2949	
6.2L	SCORPION 377		377	8	4	2008-2010	W698433 & UP						18-2949	
7.4L	325		427	8	4	1968	2278747 - 2313964						18-0418	
7.4L	325		427	8	4	1968-1974	2313965 - 3780449				18-4009	18-1990	18-0418	18-0885-1
7.4L	325 MIE		427	8	4	1968	2278747 - 2313964						18-0418	
7.4L	325 MIE		427	8	4	1968-1974	2313965 - 3780449				18-4009	18-1990	18-0418	18-0885-1
7.4L	330		454	8	4	1977-1981	4623115 - 6083144				18-4009	18-4009	18-0418	18-0885-1
7.4L	330		454	8	4	1982-1987	6083145 - B816540	18-1957-2	18-1957-2	18-1970-2 ①			18-0418	18-0897
7.4L	330		454	8	4	1982-1987	6083145 - B816540	18-1957-2	18-1957-2	18-1976-2 ②			18-0418	18-0897
7.4L	330 MIE		454	8	4	1977-1981	4623115 - 6083144				18-4009	18-4009	18-0418	18-0885-1
7.4L	340 MIE W/BW		454	8	4	1981-1987	5889914 - B788365	18-1957-2	18-1957-2	18-1974-1 ③			18-0418	18-0897
7.4L	340 MIE W/BW		454	8	4	1981-1987	5889914 - B788365	18-1957-2	18-1957-2	18-1970-2 ④			18-0418	18-0897
7.4L	340 MIE W/BW		454	8	4	1981-1987	5889914 - B788365	18-1957-2	18-1957-2	18-1976-2 ⑤			18-0418	18-0897
7.4L	350 MIE		454	8	4	1974-1975	3780450 - 4501640				18-4009	18-1990	18-0418	18-0885-1
7.4L	350 MIE		454	8	4	1976	4501641 - 4623109				18-4009	18-4009	18-0418	18-0885-1
7.4L	370 TRS		454	8	4	1978-1985	4179554 - 6721527				18-4009	18-1990	18-0418	18-0885-1
7.4L	370 TRS		454	8	4	1985-1987	6721528 - B714586	18-1957-2	18-1957-2	18-1976-2			18-0418	18-2849-1
7.4L	400 TRS		454	8	4	1980-1986	4179554 - B457644				18-4009	18-1990	18-0418	18-0885-1
7.4L	420		454	8	4	1987-1989	A398941 - B622418						18-0418	
7.4L	425		454	8	4	1990-1992	G398941 - D937011						18-0418	
7.4L	440 TRS		454	8	4	1983-1986	4179554 - B485220						18-0418	
7.4L	450		454	8	4	1995-1996	F347100 - F347277			②			18-0418	
7.4L	450		454	8	4	1995-1996	F347100 - F347277			④			18-0418	
7.4L	450		454	8	4	1995-1996	F347100 - F347277			⑤			18-0418	
7.4L	454 MAG ALPHA		454	8	4	1986-1988	A631894 - B785148	18-1957-2	18-1957-2	18-1976-2			18-0418	18-0897
7.4L	454 MAG BRAVO		454	8	4	1988-1997	B721206 - K999999	18-1957-2	18-1957-2	18-1976-2			18-0418	18-0897
7.4L	454 MAG EFI		454	8	4	1994-1996	F115700 - F802349	18-1957-2	18-1957-2	18-1976-2			18-0418	18-0897
7.4L	454 MAG EFI / 454 MAG SKI		454	8	4	1995-1996	F215800 - F820099	18-1957-2	18-1957-2	18-1976-2			18-0418	18-0897
7.4L	454 MAG MPI		454	8	4	1996-1997	F802350 - K999999	18-1957-2	18-1957-2	18-1976-2			18-0418	18-0897
7.4L	454 MAG MPI		454	8	4	1998-2001	L010029 - M0224999	18-1957-2	18-1957-2	18-1976-2			18-0418	18-2849-1
7.4L	454 MAG MPI / 454 MAG HORIZON / 454 MAG MIE		454	8	4	1999-2001	L086050 - L674000	18-1957-2	18-1957-2	18-1976-2			18-0418	18-2849-1
7.4L	454 MAG MPI / 454 MAG SKI		454	8	4	1996-1997	F820100 - K999999	18-1957-2	18-1957-2	18-1976-2			18-0418	18-0897
7.4L	525 SC W/BRAVO		454	8	4	1991-1996	D456000 - F877734			②			18-0418	
7.4L	525 SC W/BRAVO		454	8	4	1991-1996	D456000 - F877734			④			18-0418	
7.4L	525 SC W/BRAVO		454	8	4	1991-1996	D456000 - F877734			⑤			18-0418	
7.4L	525 SC W/SSM		454	8	4	1991-1996	D456000 - F877734			②			18-0418	
7.4L	525 SC W/SSM		454	8	4	1991-1996	D456000 - F877734			④			18-0418	
7.4L	525 SC W/SSM		454	8	4	1991-1996	D456000 - F877734			⑤			18-0418	
7.4L	7.4L BRAVO		454	8	4	1988-1997	B771113 - K999999	18-1957-2	18-1957-2	18-1976-2			18-0418	18-0897
7.4L	7.4L EFI / 7.4L MIE		454	8	4	1996-1997	F874815 - K999999	18-1957-2	18-1957-2	18-1976-2			18-0418	18-0897
7.4L	7.4L MIE W/BW		454	8	4	1988-1992	B788366 - D715493	18-1957-2	18-1957-2	18-1974-1 ③			18-0418	18-0897
7.4L	7.4L MIE W/BW		454	8	4	1988-1992	B788366 - D715493	18-1957-2	18-1957-2	18-1970-2 ④			18-0418	18-0897
7.4L	7.4L MIE W/BW		454	8	4	1988-1992	B788366 - D715493	18-1957-2	18-1957-2	18-1976-2 ⑤			18-0418	18-0897
7.4L	7.4L MIE W/HURTH		454	8	4	1989-1992	C391564 - D715493	18-1957-2	18-1957-2	18-1976-2			18-0418	18-0897
7.4L	7.4L MIE		454	8	4	1992-1997	D715494 - K999999	18-1957-2	18-1957-2	18-1976-2			18-0418	18-0897
7.4L	7.4L MPI		454	8	4	1998-2001	L010003 - M024330	18-1957-2	18-1957-2	18-1976-2			18-0418	18-2849-1
7.4L	7.4L MPI / 7.4L MIE		454	8	4	1995-1997	F563052 - K999999	18-1957-2	18-1957-2	18-1976-2			18-0418	18-0897
7.4L	7.4L MPI / 7.4L MIE		454	8	4	1998-2001	L002006 - L674613	18-1957-2	18-1957-2	18-1976-2			18-0418	18-2849-1

- ① For engines with aluminum exhaust manifolds
- ② For engines with cast iron exhaust manifolds
- ③ 3" (76mm) O.D. & 0 degree down angle
- ④ 3" (76mm) O.D. & 15 degree down angle
- ⑤ 4" (102mm) O.D.
- ⑥ 2 piece exhaust manifold
- ⑦ 1 piece exhaust manifold
- ⑧ Has a rectangular elbow mounting bolt pattern
- ⑨ Has a square elbow mounting bolt pattern

- ⑩ In-line applications
- ⑪ V-drive applications
- ⑫ Standard rise
- ⑬ 2" (51mm) rise
- ⑭ 3" (76mm) rise
- ⑮ 6" (152mm) rise
- ⑯ Port
- ⑰ Starboard
- ⑱ Engines with risers or closed cooling may require a different gasket than listed

- ⑲ Exhaust manifold with external water rail
- ⑳ Exhaust manifold w/o external water rail
- ㉑ 1 piece exhaust manifold is n/a. Engine must be converted to the 2 piece exhaust system
- ㉒ Engines with easy drain system
- ㉓ Engines with multi-point drain system
- ㉔ Intermediate collector housing

MANIFOLD/MANIFOLD GASKET APPLICATION (Cont.)

Liter	Model	Note	CID	# Cyl.	Stroke	Year Range	Serial # Range	Exh. Manifold Port	Exh. Manifold Starboard	Exh. Elbow	End Cap Front	End Cap Rear	Manifold Gasket	Exh. Elbow Gasket
7.4L	7.4LX BRAVO EFI		454	8	4	1996-1997	F820000 - K999999	18-1957-2	18-1957-2	18-1976-2			18-0418	18-0897
7.4L	7.4LX BRAVO MPI		454	8	4	1996-1997	F602010 - K999999	18-1957-2	18-1957-2	18-1976-2			18-0418	18-0897
	390 MCM / 390 MIE		482	8	4	1969-1970	2781129 - 3042731				18-1990	18-1990	18-0418	18-0885-1
	496 MAG / 496 HO		496	8	4	2001-2003	M025000 - M687143		⑨	②			18-0418	
	496 MAG / 496 HO		496	8	4	2001-2010	M0225000 & UP		⑩	②			18-0418	
	8.1S / 8.1 HO / 8.1 MIE		496	8	4	2001-2003	M026000 - M319190		⑨	②			18-0418	
	8.1S / 8.1 HO / 8.1 MIE		496	8	4	2001-2010	M026000 & UP		⑩	②			18-0418	
8.2L	465		502	8	4	1990-1994	C849992 - F213244			②			18-0418	
8.2L	465		502	8	4	1990-1994	C849992 - F213244			④			18-0418	
8.2L	465		502	8	4	1990-1994	C849992 - F213244			⑤			18-0418	
8.2L	500 BRAVO		502	8	4	1994-1998	F213293 - L001772			②			18-0418	
8.2L	500 BRAVO		502	8	4	1994-1998	F213293 - L001772			④			18-0418	
8.2L	500 BRAVO		502	8	4	1994-1998	F213293 - L001772			⑤			18-0418	
8.2L	500 GEN +		502	8	4	1999	L414639 - L601036			②			18-0418	
8.2L	500 GEN +		502	8	4	1999	L414639 - L601036			④			18-0418	
8.2L	500 GEN +		502	8	4	1999	L414639 - L601036			⑤			18-0418	
8.2L	502 MAG BRAVO		502	8	4	1990-1993	C878221 - F114528	18-1957-2	18-1957-2	18-1976-2			18-0418	18-0897
8.2L	502 MAG EFI		502	8	4	1993-1995	D840650 - F802599	18-1957-2	18-1957-2	18-1976-2			18-0418	18-0897
8.2L	502 MAG MPI		502	8	4	1996-1997	F802600 - K999999	18-1957-2	18-1957-2	18-1976-2			18-0418	18-0897
8.2L	502 MAG MPI		502	8	4	1998-2001	L017000 - M024999	18-1957-2	18-1957-2	18-1976-2			18-0418	18-2849-1
8.2L	600 SC		502	8	4	1991-1996	D456489 - F877642						18-0418	
8.2L	600 SC		502	8	4	1991-1996	D456489 - F877642						18-0418	
8.2L	8.2L MIE		502	8	4	1990-1996	C878221 - F819619	18-1957-2	18-1957-2	18-1976-2			18-0418	18-0897
8.2L	8.2L MIE / 8.2L MPI		502	8	4	1996-1997	F819620 - K999999	18-1957-2	18-1957-2	18-1976-2			18-0418	18-0897
8.2L	8.2L MIE / 8.2L MPI		502	8	4	1998-2001	L002450 - L674200	18-1957-2	18-1957-2	18-1976-2			18-0418	18-2849-1
	500 BULLDOG W/BRAVO		540	8	4	1990-1998	C577254 - L001607			②			18-0418	
	500 BULLDOG W/BRAVO		540	8	4	1990-1998	C577254 - L001607			④			18-0418	
	500 BULLDOG W/BRAVO		540	8	4	1990-1998	C577254 - L001607			⑤			18-0418	
	500 BULLDOG W/BRAVO		540	8	4	1999-2001	L414620 - M050281			②			18-0418	
	500 BULLDOG W/BRAVO		540	8	4	1999-2001	L414620 - M050281			④			18-0418	
	500 BULLDOG W/BRAVO		540	8	4	1999-2001	L414620 - M050281			⑤			18-0418	
	500 BULLDOG W/SSM		540	8	4	1990-2001	C577254 - M050261			②			18-0418	
	500 BULLDOG W/SSM		540	8	4	1990-2001	C577254 - M050261			④			18-0418	
	500 BULLDOG W/SSM		540	8	4	1990-2001	C577254 - M050261			⑤			18-0418	

- ① For engines with aluminum exhaust manifolds
- ② For engines with cast iron exhaust manifolds
- ③ 3" (76mm) O.D. & 0 degree down angle
- ④ 3" (76mm) O.D. & 15 degree down angle
- ⑤ 4" (102mm) O.D.
- ⑥ 2 piece exhaust manifold
- ⑦ 1 piece exhaust manifold
- ⑧ Has a rectangular elbow mounting bolt pattern
- ⑨ Has a square elbow mounting bolt pattern

- ⑩ In-line applications
- ⑪ V-drive applications
- ⑫ Standard rise
- ⑬ 2" (51mm) rise
- ⑭ 3" (76mm) rise
- ⑮ 6" (152mm) rise
- ⑯ Port
- ⑰ Starboard
- ⑱ Engines with risers or closed cooling may require a different gasket than listed

- ⑲ Exhaust manifold with external water rail
- ⑳ Exhaust manifold w/o external water rail
- ㉑ 1 piece exhaust manifold is n/a. Engine must be converted to the 2 piece exhaust system
- ㉒ Engines with easy drain system
- ㉓ Engines with multi-point drain system
- ㉔ Intermediate collector housing



Features...

- Manufactured to meet or exceed OEM specifications.
- High Efficiency Filter
- Field-tested and approved.
- Anti-drainback valves where required.

Part #	O.E. #	Application
18-7824-2*	54111, 14957, 32716, 35-802885Q, 35-866340K01, 35-866340Q03, 35-866340Q02, 35-866340K01, 35-866340Q, 52731A1, 52731, 52022, 32717, 14957	GM Engines ① (Short Filter)
18-7875*	60565, 35-802886Q	Ford Engines (Long Filter)
18-7876-1*	52731, 35-16595T, 35-866340Q03, 35-866340Q02, 32-802885Q, 14957, 54111, 52731A1, 52022, 32717, 32716	GM Engines (Long Filter)
18-7878-1*	803470, 803470Q, 46692, 38463	60 & 80 HP Engines (Renault) (Short Filter)
18-7879-1*	41815, 35-802884Q, 35-883702Q, K	GM V-6 Engines



OIL FILTERS

- ① Do not use on V-6 engines equipped with remote oil filter kit
- * Display Packaged

SEE PAGES 203-205 & 1155-1183 FOR ADDITIONAL INFORMATION

OIL PANS AND GASKET



Part No.	OE	OE No.	Application
18-0612	Mercury	809910, 14259	1 piece rear main seal; GM Small Block V8 (Right Handed Dipstick)
18-0613	Mercury	93476	2 piece rear main seal; GM Small Block V8 (Right Handed Dipstick)
18-0614	Mercury	845668T, 850458, 811549	1 piece rear main seal; GM Big Block V8 (Right Handed Dipstick)
18-0615	Mercury	93477T, 93477, 14760, 75639	2 piece rear main seal; GM Big Block V8 (Right Handed Dipstick)
18-0616	Mercury	14244T, 14244	1 piece rear main seal; GM V6 (Right Handed Dipstick)

Drain Plug: M12 - 1.75

CYLINDER HEAD ASSEMBLIES

All cylinder heads are new castings and complete assemblies with new- stainless steel valves, hardened steel exhaust seats, valve springs, valve locks, and retainers.
 All GM cylinder heads utilize high performance screw-in rocker arm studs in place of factory press in rocker arm studs.



18-4486HP CYLINDER HEAD ASSEMBLY

Superseded from 18-4486
Fits: Vortec GM small block 5.7L high performance
 Completely assembled with revised runner and combustion chambers.
 Add 30hp to stock motor with no additional modifications.



18-4501HP CYLINDER HEAD

Fits: Vortec GM small block 5.0L
 Completely assembled with revised runner and combustion chambers. Add 30hp to stock motor with no additional modifications.



18-7508
POWER STEERING PUMP
 Replaces: 16792A39, 16792A33



18-8297
POWER STEERING PUMP PULLEY
 Replaces: 861578
 For: Sterndrives with serpentine belt



18-1400
HYDRAULIC LIFTER
 Replaces: 17340, 17340T
 GM 4.3L/V-6 Late/5.0L/5.7L



18-1401
HYDRAULIC LIFTER
 Replaces: 56153, F724102
 Ford 302/351
 Ford 5.0L & 5.8L



18-1402
HYDRAULIC LIFTER
 Replaces: 72638, 34282, 35583, 46472, 46744, 49117, F2769931, F5232670, FI1100349, FI1100399, FI1100862, FI1100954, FI1101222
 GM 2.5L/120
 For: Mercruiser 140 (S/N 2508261-6229717), 140/3.0L (S/N 6229718-up), 3.0L/3.0LX (S/N C856559-up)

PISTONS



All pistons are supplied complete with piston rings and wrist pin.

RINGS	
STD	REPLACES
18-3928	39-74381A1, 39-75422
18-3937	39-17464, 39-65153, 39-67123, 39-34988, F328506, F3892364, FI1100386, FI1100692, FI1101321
18-3942	39-67132, 39-67119, 39-58096, 39-34479
18-3944	39-75609, FI1101057
.020	
18-3939	39-66217, 39-97125, 39-48344, FI1100387, FI1100783, FI1101134

PISTONS	
STD	REPLACES
18-4173	735-6370, 735-9686, 735-808674, 735-850097, 735-808674A1, 735-808661, 735-9703, 735-6370, FI1101184, FI1101318, FI1101334, 833232E
.020	
18-4189	737-6523, 737-6523, 737-879194035, FI1101101
.030	
18-4164	735-6371, 735-9687, 735-850098, 735-9431, 735-9704, FI1101185, FI1101320, FI1101336
18-4178	735-9715, 735-97151, 735-9715T1, FI1101317
18-4191	733-3819, 733-38191, 733-803850T, 733-4028, FI1100779, FI1100780

PISTON/RING APPLICATION

Liter	Model	Note	CID	# Cyl	Stroke	Year	Serial #	Pistons Std.	0.02	0.03	Rings Std.	0.02	0.03	Qty. Eng.
1.6L	100 VASER		98	4	4	2007-2010	W995000 & UP	-	-	-	-	-	-	
2.5L	120		153	4	4	1964-1986	1666601 - B531853	-	-	-	-	-	-	
2.5L	2.5L		153	4	4	1987-1989	B531854 - C853255	-	-	-	-	-	-	
3.0L	140		181	4	4	1968-1986	2508261 - B450800	-	-	18-4191	18-3937	18-3939	-	4
3.0L	140				4		3332138 - 5157668	-	-	18-4191	18-3937	18-3939	-	4
3.0L	140				4		5157669 - 6229717	-	-	18-4191	18-3937	18-3939	-	4
3.0L	140 / 3.0L				4		6229718 - C856558	-	-	18-4191	18-3937	18-3939	-	4
3.0L	3.0L		181	4	4	1987-1989	B450801 - C856558	-	-	-	-	-	-	
3.0L	3.0L		181	4	4	1990-1994	C856559 - F603999	-	-	-	18-3937	18-3939	-	6
3.0L	3.0L		181	4	4	1998-2010	L010042 & UP	-	-	-	-	-	-	
3.0L	3.0L MPI		181	4	4	2008-2010	A072812 & UP	-	-	-	-	-	-	
3.0L	3.0LX		181	4	4	1990-1997	C856559 - K999999	-	-	-	-	-	-	
3.7L	165 / 3.7L		224	4	4	1987-1989	B434941 - C762299	-	-(11)	-	-	-	-	
3.7L	170		224	4	4	1985-1986	6916779 - B434940	-	-	-	18-3928	18-3929	-	4
3.7L	180 / 3.7LX		224	4	4	1987-1989	B436391 - C762299	-	-(11)	-	-	-	-	
3.7L	190 / 3.7L		224	4	4	1985-1986	6916779 - B436390	-	-(11)	-	-	-	-	
3.7L	470		224	4	4	1976-1984	4208730 - 6916779	-	-	-	18-3928	18-3929	-	4
3.7L	485		224	4	4	1980-1982	5685394 - 6218036	-	-(11)	-	-	-	-	
3.7L	488		224	4	4	1983-1984	6170297 - 6916778	-	-(11)	-	-	-	-	
	150				4		1666495 - 2048046	-	-	-	18-3942	-	-	6
4.1L	160		250	6	4	1987-1989	2048022 - 2770031	-	-	-	18-3942	-	-	
4.1L	165		250	6	4	1970-1981	2770032 - 5813433	-	-	-	18-3942	-	-	
4.3L	175 / 4.3L				4		B527955 - & Up	18-4173	18-4188	18-4164	18-3937	18-3939	-	6
3.8L	185	2bb1			4	1983-1984	6330183 - 6919655	-	-	-	18-3944	-	-	
4.3L	175 / 4.3L		262	6	4	1987-1992	B527955 - D714106	-	-	-	-	-	-	
4.3L	185	2bb1	262	6	4	1985-1986	A331455 - B527954	-	-	18-4164	18-3937	18-3939	-	
4.3L	205 / 4.3LX		262	6	4	1985-1986	A331455 - B527954	-	-	18-4164	18-3937	18-3939	-	
4.3L	262 MAG EFI GEN +		262	6	4	1987-1991	B527955 - D714369	18-4173	-	-	-	-	-	
4.3L	262 MAG EFI GEN +		262	6	4	1996-1997	F803800 - K999999	-	-	-	-	-	-	
4.3L	4.3L GEN II		262	6	4	1992-1996	D714107 - F802999	18-4173	18-4188	-	-	-	-	6
4.3L	4.3L GEN +		262	6	4	1998-2010	L010044 & UP	-	-	-	-	-	-	
4.3L	4.3L EFI GEN +		262	6	4	1998-2001	L012009 - M299999	-	-	-	-	-	-	
4.3L	4.3L MPI		262	6	4	2002-2010	M322761 & UP	-	-	-	-	-	-	
4.3L	4.3LH GEN +		262	6	4	1998-2002	L010044 - M614999	-	-	-	-	-	-	
4.3L	4.3LX GEN II		262	6	4	1992-1996	D7141370 - F802999	-	-	18-4164	18-3937	18-3939	-	6
4.3L	4.3LX GEN +		262	6	4	1996-1997	F803000 - K999999	-	-	-	-	-	-	
4.3L	4.3LXH GEN +		262	6	4	1996-1997	F803114 - K999999	-	-	-	-	-	-	
4.9L	215	FORD	302	8	4	1970-1972	2781153 - 3395720	-	-	-	18-3937	18-3939	-	8
4.9L	215	FORD			4	1973-1974	3385721 - 4166999	-	-	-	18-3937	18-3939	-	8
	225	GM			4		1536920 - & Up	-	-	-	18-3937	18-3939	-	8
4.6L	190	GM	283	8	4	1963-1964	1564539 - 1730903	-	-	-	18-3942	-	-	6
5.0L	198 MIE		305	8	4	1977	4776402 - 4931099	-	-	-	-	-	-	
5.0L	200		305	8	4	1985-1987	6899058 - B525981	-	-	-	-	-	-	
5.0L	200 / 5.0L	GM	305	8	4	1987	B525982 - B774444	-	-	18-4178	18-3944	-	-	8
	200	GM			4		6218462 - & Up	-	-	-	18-3944	-	-	8
5.0L	228	GM	305	8	4	1977-1984	4765100 - 6899268	-	-	-	18-3944	-	-	8
5.0L	228 MIE		305	8	4	1977-1980	5170009 - 5907057	-	-	-	-	-	-	
5.0L	230		305	8	4	1985-1987	6899269 - B525981	-	-	-	-	-	-	
5.0L	230		305	8	4	1987-1995	B525982 - B773739	-	-	18-4178	18-3944	-	-	8
5.0L	230 MIE	GM	305	8	4	1981-1987	5907058 - B522505	-	-	-	18-3944	-	-	8
5.0L	230 MIE		305	8	4	1987	B522506 - B788151	-	-	18-4178	18-3944	-	-	8
5.0L	230 GM			8	4		6218462 - & Up	-	-	-	18-3944	-	-	8
5.0L	5.0L		305	8	4	1988-1995	B774445 - F600999	-	-	-	-	-	-	
5.0L	5.0L GEN +		305	8	4	1998-2010	L015751 & UP	-	-	-	-	-	-	
5.0L	5.0L EFI GEN +		305	8	4	1998-2001	L012052 - M299999	-	-	-	-	-	-	

- | | | |
|---|---|---|
| (1) Cast Aluminum (Use with GM Engine Code 1XW) | (5) Cast Aluminum (Use with GM Engine Code 2XY) | (9) Starboard |
| (2) Cast aluminum (Use with GM Engine Code 4XW) | (6) Cast Aluminum (Use with GM Engine Code 4XY) | (10) Port |
| (3) Forged Aluminum (Use with GM Engine Code 3UB) | (7) Flat Head | (11) .010 (25mm) Oversize |
| (4) Cast Aluminum (Use with GM Engine Code 4XX) | (8) Forged Aluminum, Recessed Head | N.L.A. No longer available from O.E. source |

I/O — MERCURUISER - INTERNAL ENGINE SYSTEM

PISTON/RING APPLICATION

Liter	Model	Note	CID	# Cyl	Stroke	Year	Serial #	Pistons Std.	0.02	0.03	Rings Std.	0.02	0.03	Qty. Eng.
5.0L	5.0L MIE		305	8	4	1988	B788152 - C398832	-	-	-	-	-	-	
5.0L	5.0L MPI		305	8	4	2002-2010	M300000 & UP	-	-	-	-	-	-	
5.0L	5.0LX		305	8	4	1988-1995	B773740 - F600999	-	-	-	-	-	-	
5.0L	898 / 198	GM	305	8	4	1977-1984	4762210 - 6899057	-	-	-	18-3944	-	-	8
5.4L	225 MCM / 225 MIE	GM	327	8	4	1963-1969	1539620 - 2694014	-	-	-	-	-	-	
5.4L	250 MCM - 250 MIE	GM	327	8	4	1968-1969	2314301 - 2639854	-	-	-	18-3937	18-3939	-	8
5.7L	250	GM	350	8	4	1977	4768000 - 4908849	18-4173	18-4188	18-4164	18-3937	18-3939	-	8
5.7L	255	GM	350	8	4	1975-1976	4175500 - 4767999	18-4173	18-4188	18-4164	18-3937	18-3939	-	8
5.7L	255 MIE	GM	350	8	4	1975-1980	4175500 - 5907057	18-4173	-	-	-	-	-	8
5.7L	260	GM	350	8	4	1978-1987	4908850 - B773304	18-4173	18-4188	18-4164	18-3937	18-3939	-	8
5.7L	260 MIE	GM	350	8	4	1981-1987	5907058 - B788151	18-4173	18-4188	18-4164	18-3937	18-3939	-	8
5.7L	260 / 5.7L	GM	350	8	4		B525982 - & Up	18-4173	18-4188	18-4164	18-3937	18-3939	-	8
5.7L	270 MCM / 270 MIE		350	8	4	1969-1972	2851074 - 3077735	-	-	-	18-3937	18-3939	-	8
5.7L	280		350	8	4	1975-1976	4176250 - 4770199	-	-	-	-	-	-	8
5.7L	300		350	8	4	1985-1988	6668677 - B430367	-	-	-	18-3937	18-3939	-	8
5.7L	320 EFI		350	8	4	1987-1989	A543604 - C622418	-	-	-	18-3937	18-3939	-	8
5.7L	320 GM EFI BRAVO			8	4		B157603 - & Up	-	-	-	18-3937	18-3939	-	8
	325	GM			4		2278747 - & Up	-	-	-	-	-	-	8
	330	GM			4		4623115 - & Up	-	18-4189	-	-	-	-	8
	330 W/B.W.	GM			4		6083145 - & Up	-	18-4189	-	-	-	-	8
5.7L	350 MAG ALPHA		350	8	4	1986-1997	A635178 - K999999	18-4173	18-4188	18-4164	18-3937	18-3939	-	8
5.7L	350 MAG ALPHA EFI GEN +		350	8	4	1996-1997	F800300 - K999999	-	-	-	-	-	-	8
5.7L	350 MAG BRAVO MPI		350	8	4	1995	F415189 - F601999	18-4173	-	18-4164	-	-	-	8
5.7L	350 MAG BRAVO MPI GEN +		350	8	4	1996-1997	F602000 - K999999	-	-	-	-	-	-	8
5.7L	350 MAG SKI		350	8	4	1994-1996	F215561 - F820706	18-4173	-	18-4164	-	-	-	8
5.7L	350 MAG EFI SKI GEN +		350	8	4	1996-1997	F820707 - K999999	-	-	-	-	-	-	8
5.7L	350 MAG MPI GEN +		350	8	4	1998-2010	L010019 & UP	-	-	-	-	-	-	8
5.7L	350 MAG MPI / 350 MAG HORIZON		350	8	4	2002-2007	M300000 - A299999	-	-	-	-	-	-	8
5.7L	350 MAG MPI / 350 MAG HORIZON / 350 MAG MIE		350	8	4	1998-2007	L304700 - A899999	-	-	-	-	-	-	8
5.7L	350 MAG / 350 MAG MIE / 350 MAG MPI GEN +		350	8	4	1998-2007	L002008 - A089999	-	-	-	-	-	-	8
5.7L	350 MAG MPI SKI		350	8	4	1995-1996	F350583 - F799999	18-4173	-	18-4164	-	-	-	8
5.7L	350 MAG MPI SKI GEN +		350	8	4	1998-2007	L002600 - A089999	-	-	-	-	-	-	8
5.7L	350 MAG SKI		350	8	4	1991-1997	D505450 - K999999	18-4173	18-4188	18-4164	18-3937	18-3939	-	8
5.7L	350	GM	350	8	4		3780450 - & Up	-	-	-	-	-	-	8
5.7L	350 MAG	GM	350	8	4		B525982 - & Up	18-4173	18-4188	18-4164	18-3937	18-3939	-	8
5.7L	5.7L		350	8	4	1988-1995	B773305 - F600999	18-4173	-	18-4164	-	-	-	8
5.7L	5.7L	2bbl	350	8	4	1996-1997	F601000 - K999999	18-4173	-	18-4164	-	-	-	8
5.7L	5.7L GEN +		350	8	4	1998-2010	L010037 & UP	-	-	-	-	-	-	8
5.7L	5.7L EFI		350	8	4	1995-1997	F225560 - K999999	18-4173	-	18-4164	-	-	-	8
5.7L	5.7L EFI GEN +		350	8	4	1998-2001	L010035 - M299999	-	-	-	-	-	-	8
5.7L	5.7L EFI MIE GEN +		350	8	4	1997	K040300 - K999999	-	-	-	-	-	-	8
5.7L	5.7L MIE		350	8	4	1988-1997	B788152 - K999999	18-4173	-	18-4164	-	-	-	8
5.7L	5.7L MIE GEN +		350	8	4	1998-2010	L002003 & UP	-	-	-	-	-	-	8
5.7L	5.7L MPI / 5.7L HORIZON / 5.7L MIE		350	8	4	2008-2010	A090000 & UP	-	-	-	-	-	-	8
5.7L	5.7L MPI / 5.7L MIE		350	8	4	2008-2010	A090000 & UP	-	-	-	-	-	-	8
5.7L	5.7L MPI / 5.7L SKI		350	8	4	2008-2010	A090000 & UP	-	-	-	-	-	-	8
5.7L	5.7L SKI		350	8	4	1985-1997	A338553 - K999999	18-4173	-	18-4164	-	-	-	8
5.7L	5.7L SKI GEN +		350	8	4	1998-2010	L002005 & UP	-	-	-	-	-	-	8
5.7L	5.7LX		350	8	4	1996-1997	F601000 - K999999	18-4173	-	18-4164	-	-	-	8
5.7L	5.7LX BRAVO EFI GEN +		350	8	4	1996-1997	F800300 - K999999	-	-	-	-	-	-	8
5.7L	5.7LX EFI		350	8	4	1996-1997	F752400 - K999999	18-4173	-	18-4164	-	-	-	8
5.7L	BLACK SCORPION SKI GEN +		350	8	4	1998-2007	F800000 - W6988432	-	-	-	-	-	-	8
5.7L	SCORPION 350		350	8	4	2008-2010	W698432 & UP	-	-	-	-	-	-	8
5.8L	233	FORD	351	8	4	1975-1977	4173000 - 4902304	-	-	-	-	-	-	8

- (1) Cast Aluminum (Use with GM Engine Code 1XW)
- (2) Cast aluminum (Use with GM Engine Code 4XW)
- (3) Forged Aluminum (Use with GM Engine Code 3UB)
- (4) Cast Aluminum (Use with GM Engine Code 4XX)

- (5) Cast Aluminum (Use with GM Engine Code 2XY)
- (6) Cast Aluminum (Use with GM Engine Code 4XY)
- (7) Flat Head
- (8) Forged Aluminum, Recessed Head

- (9) Starboard
- (10) Port
- (11) .010 (25mm) Oversize
- N.L.A. No longer available from O.E. source

PISTON/RING APPLICATION

Liter	Model	Note	CID	# Cyl	Stroke	Year	Serial #	Pistons Std.	0.02	0.03	Rings Std.	0.02	0.03	Qty. Eng.
5.8L	255	FORD	351	8	4	1973-1974	3258728 - 4175499	-	-	-	-	-	-	8
6.2L	377 MAG		377	8	4	2008-2009	A000000 - A345479	-	-	-	-	-	-	8
6.2L	377 MAG		377	8	4	2009	A345480 - A345492	-	-	-	-	-	-	8
6.2L	377 MAG		377	8	4	2009	A345493 - A345765	-	-	-	-	-	-	8
6.2L	377 MAG		377	8	4	2009	A345766 - A345767	-	-	-	-	-	-	8
6.2L	377 MAG		377	8	4	2009	A345768 - A346789	-	-	-	-	-	-	8
6.2L	377 MAG		377	8	4	2009-2010	A346790 & UP	-	-	-	-	-	-	8
6.2L	377 SCORPION STERNDRIVE		377	8	4	2000-2010	L416146 & UP	-	-	-	-	-	-	8
6.2L	377 SCORPION SKI		377	8	4	1997-1998	K000656 - L600314	-	-	-	-	-	-	8
6.2L	MX 6.2L MPI		377	8	4	2000-2007	L680003 - A299999	-	-	-	-	-	-	8
6.2L	MX 6.2L MPI / MX 6.2L MIE		377	8	4	2002-2009	M300000 - A091825	-	-	-	-	-	-	8
6.2L	MX 6.2L MPI / MX 6.2L MIE		377	8	4	2009-2010	A091826 & UP	-	-	-	-	-	-	8
6.2L	MX 6.2L MPI / MX 6.2L SKI		377	8	4	2002-2007	M317000 - W689999	-	-	-	-	-	-	8
6.2L	MX 6.2L BLACK SCORPION SKI		377	8	4	2001-2007	L670015 - W698432	-	-	-	-	-	-	8
6.2L	SCORPION 377		377	8	4	2008-2009	W698826 & UP	-	-	-	-	-	-	8
6.2L	SCORPION 377 HO / SCORPION 377 EC		377	8	4	2009-2010	A091488 - A092170	-	-	-	-	-	-	8
7.4L	325 MCM / 325 MIE		454	8	4	1969-1972	2278747 - 3780449	-	-	-	-	-	-	8
7.4L	330		454	8	4	1977-1987	4623115 - B816540	-	-	-	-	-	-	8
7.4L	330 MIE		454	8	4	1977-1980	4623115 - 5779913	-	-	-	-	-	-	8
7.4L	340 MIE		454	8	4	1981-1987	5889914 - B788365	-	18-4189	-	-	-	-	8
7.4L	350 MIE		454	8	4	1974-1976	3780450 - 4623109	-	-	-	-	-	-	8
7.4L	370 TRS		454	8	4	1978-1987	4179554 - B714586	-	-	-	-	-	-	8
	390	GM	454	8	4		2781129 - 2825059	-	-	-	-	-	-	8
7.4L	400 TRS		454	8	4	1980-1986	4179554 - B457644	-	-	-	-	-	-	8
7.4L	420		454	8	4	1987-1989	A398941 - B6222418	-	-	-	-	-	-	8
7.4L	425		454	8	4	1990-1992	B622419 - D725499	-	-	-	-	-	-	8
7.4L	425 GEN V		454	8	4	1992-1993	D725500 - D937011	-	-	-	-	-	-	8
7.4L	440 TRS		454	8	4	1983-1986	4179554 - B485220	-	-	-	-	-	-	8
7.4L	450 GEN V		454	8	4	1995-1996	F347100 - F347277	-	-	-	-	-	-	8
7.4L	454 MAG ALPHA		454	8	4	1986-1988	A631894 - B785148	-	18-4189	-	-	-	-	8
7.4L	454 MAG BRAVO		454	8	4	1988-1992	D721206 - D805068	-	-	-	-	-	-	8
7.4L	454 MAG BRAVO GEN V		454	8	4	1992-1996	D805069 - F801699	-	-	-	-	-	-	8
7.4L	454 MAG BRAVO GEN VI		454	8	4	1996-1997	F801700 - K999999	-	-	-	-	-	-	8
7.4L	454 MAG EFI GEN V		454	8	4	1994-1996	F115700 - F802349	-	-	-	-	-	-	8
7.4L	454 MAG EFI SKI GEN V		454	8	4	1995-1996	F215800 - F820099	-	-	-	-	-	-	8
7.4L	454 MAG MPI GEN VI		454	8	4	1996-2001	F802350 - M0224999	-	-	-	-	-	-	8
7.4L	454 MAG MPI / 454 MAG HORIZON / 454 MAG MIE		454	8	4	1998-2001	L002200 - L674000	-	-	-	-	-	-	8
7.4L	454 MAG MPI SKI GEN VI		454	8	4	1996-1997	F820100 - K999999	-	-	-	-	-	-	8
7.4L	454 MAG BRAVO		454	8	4		B840126 - & Up	-	-	-	-	-	-	8
	470		454	8	4		4208730 - & Up	-	-	-	18-3928	18-3929	-	4
	485		454	8	4		5685394 - & Up	-	-	-	18-3928	18-3929	-	4
	488		454	8	4		6170297 - & Up	-	-	-	18-3928	18-3929	-	4
	525 SC		454	8	4	1991-1992	D456000 - D725808	-	-	-	-	-	-	8
7.4L	525 SC GEN V		454	8	4	1992-1996	D763746 - F348963	-	-	-	-	-	-	8
7.4L	525 SC GEN V		454	8	4	1996-1999	F615814 - L415623	-	-	-	-	-	-	8
7.4L	7.4L BRAVO		454	8	4	1988-1991	B771113 - D603117	-	-	-	-	-	-	8
7.4L	7.4L BRAVO I GEN V / 7.4L BRAVO II GEN V		454	8	4	1992-1995	D603118 - F800699	- (1)	-	-	-	-	-	8
7.4L	7.4L BRAVO I GEN V / 7.4L BRAVO II GEN V		454	8	4	1992-1996	D603118 - F800699	- (2)	-	-	-	-	-	8
7.4L	7.4L BRAVO III GEN V		454	8	4	1992-1995	D603118 - F800699	- (3)	-	-	-	-	-	8
7.4L	7.4L BRAVO III GEN V		454	8	4	1992-1996	D603118 - F800699	- (4)	-	-	-	-	-	8
7.4L	7.4L BRAVO GEN VI		454	8	4	1996-1997	F800700 - K999999	-	-	-	-	-	-	8
7.4L	7.4L EFI GEN VI / 7.4L MIE GEN VI / 7.4L GEN VI MIE		454	8	4	1996-1997	F874815 - K999999	-	-	-	-	-	-	8
7.4L	7.4L MIE W/HURTH		454	8	4	1988-1992	B788366 - D715493	-	-	-	-	-	-	8
7.4L	7.4L W/HURTH		454	8	4		C391564 - & Up	-	18-4189	-	-	-	-	8

- | | | |
|---|---|---|
| (1) Cast Aluminum (Use with GM Engine Code 1XW) | (5) Cast Aluminum (Use with GM Engine Code 2XY) | (9) Starboard |
| (2) Cast aluminum (Use with GM Engine Code 4XW) | (6) Cast Aluminum (Use with GM Engine Code 4XY) | (10) Port |
| (3) Forged Aluminum (Use with GM Engine Code 3UB) | (7) Flat Head | (11) .010 (25mm)Oversize |
| (4) Cast Aluminum (Use with GM Engine Code 4XX) | (8) Forged Aluminum, Recessed Head | N.L.A. No longer available from O.E. source |

PISTON/RING APPLICATION

Liter	Model	Note	CID	# Cyl	Stroke	Year	Serial #	Pistons Std.	0.02	0.03	Rings Std.	0.02	0.03	Qty. Eng.
7.4L	7.4L MIE GEN V		454	8	4	1992-1995	D715494 - F820141	-(5)	-	-	-	-	-	8
7.4L	7.4L MIE GEN V		454	8	4	1992-1996	D715494 - F820141	-(5)	-	-	-	-	-	8
7.4L	7.4L MIE GEN VI		454	8	4	1996-1997	F820142 - K999999	-	-	-	-	-	-	8
7.4L	7.4L MPI GEN VI		454	8	4	1998-2001	L010003 - M024330	-	-	-	-	-	-	8
7.4L	7.4L MPI GEN V / 7.4L MIE GEN V		454	8	4	1995-1996	F563052 - F820103	-	-	-	-	-	-	8
7.4L	7.4L MPI GEN VI / 7.4L MIE GEN VI / 7.4LH GEN VI		454	8	4	1996-1997	F820104 - K999999	-	-	-	-	-	-	8
7.4L	7.4L MPI L-29 GEN VI / 7.4L MIE L-29 GEN VI		454	8	4	1998-2001	L002006 - M025999	-	-	-	-	-	-	8
7.4L	7.4LX BRAVO GEN VI / 7.4L BRAVO EFI		454	8	4	1996-1997	F802000 - K999999	-	-	-	-	-	-	8
7.4L	7.4LX BRAVO GEN V / 7.4L MPI GEN V		454	8	4	1996	F602010 - F801999	-	-	-	-	-	-	8
7.4L	7.4LX BRAVO GEN VI / 7.4L MPI GEN VI		454	8	4	1996-1997	F802000 - K999999	-	-	-	-	-	-	8
7.9L	390		482	8	4	1969-1970	2781129 - 2825059	-	-	-	-	-	-	8
7.9L	460 TRS		482	8	4	1983-1986	4179554 - 6181046	-	-	-	-	-	-	8
8.1L	496		482	8	4	2001-2010	M025000 & UP	-(9)	-	-	-	-	-	8
8.1L	496		496	8	4	2001-2010	M025000 & UP	-(10)	-	-	-	-	-	8
8.2L	465		502	8	4	1990-1992	C849992 - D725646	-	-	-	-	-	-	8
8.2L	465 GEN V		502	8	4	1992-1994	D725647 - F213244	-	-	-	-	-	-	8
8.2L	500 GEN V		502	8	4	1994-1996	F213293 - F745159	-	-	-	-	-	-	8
8.2L	500 GEN VI		502	8	4	1997-1999	K745195 - L601036	-	-	-	-	-	-	8
8.2L	500 EFI		502	8	4	1999-2005	L001477 - M907127	-	-	-	-	-	-	8
8.2L	502 MAG BRAVO		502	8	4	1990-1992	C878221 - D824588	-	-	-	-	-	-	8
8.2L	502 MAG BRAVO GEN V		502	8	4	1992-1993	D824589 - F114528	-	-	-	-	-	-	8
8.2L	502 MAG EFI		502	8	4	1993-1996	D640650 - F802599	-	-	-	-	-	-	8
8.2L	502 MAG MPI GEN VI		502	8	4	1996-2001	F802600 - M024999	-	-	-	-	-	-	8
8.2L	525 EFI		502	8	4	2003-2010	M900146 & UP	-	-	-	-	-	-	8
8.2L	575 Sci		502	8	4	2001-2005	L306696 - M950526	-	-	-	-	-	-	8
8.2L	600 SC		502	8	4	1991-1992	D456489 - D456768	-	-	-	-	-	-	8
8.2L	600 SC GEN V		502	8	4	1992-1996	D725676 - F877642	-	-	-	-	-	-	8
8.2L	600 SC GEN VI		502	8	4	1997-2000	K000227 - L601186	-	-	-	-	-	-	8
8.2L	8.2L MAG EC		502	8	4	2010	A350340 & UP	-	-	-	-	-	-	8
8.2L	8.2L MIE / 8.2L EC		502	8	4	2010	A350802 & UP	-	-	-	-	-	-	8
8.2L	8.2L MIE W/HURTH		502	8	4	1990-1992	C878221 - D857199	-	-	-	-	-	-	8
8.2L	8.2L MIE GEN V		502	8	4	1993-1995	D857200 - F819619	-	-	-	-	-	-	8
8.2L	8.2L MPI GEN VI / 8.2L MIE GEN VI / 8.2LH GEN VI		502	8	4	1996-2001	F819620 - L674200	-	-	-	-	-	-	8
8.9L	500 BULLDOG		540	8	4	1990-2001	C577254 - M050281	-	-	-	-	-	-	8
8.9L	575		540	8	4	1986-1992	A677429 - D763716	-(7)	-	-	18-3937	18-3939	-	8

- (1) Cast Aluminum (Use with GM Engine Code 1XW)
- (2) Cast aluminum (Use with GM Engine Code 4XW)
- (3) Forged Aluminum (Use with GM Engine Code 3UB)
- (4) Cast Aluminum (Use with GM Engine Code 4XX)
- (5) Cast Aluminum (Use with GM Engine Code 2XY)
- (6) Cast Aluminum (Use with GM Engine Code 4XY)
- (7) Flat Head
- (8) Forged Aluminum, Recessed Head
- (9) Starboard
- (10) Port
- (11) .010 (25mm) Oversize
- N.L.A. No longer available from O.E. source

MAIN BEARINGS

Part No.	Per Eng.	Size	Replaces:
18-1131	4	0.010	74313A4
18-1137 ①	1	0.020	15103-A3
18-1317	①	Std.	23-818469, 23-818469001, 23-34464, 23-85669, 23-85715, 23-52261,
18-1320	①	0.010	23-801803



ROD BEARINGS

(Sold individually, 1 per rod)

Part No.	Size	Replaces :
18-1308	Std.	23-85701, 23-15961, 23-52221, 23-52270, F3910555, F3916351, F1100305, F1100570
18-1309	0.01	23-85704, 23-52224, 23-52273, 23-1596110, F1100381, F1100573
18-1327	Std.	23-11992, 23-11992001
18-1333	0.01	23-85691, 23-69887, 23-49171
18-1334	Std.	23-85726, 23-85726001, 23-49168, 23-69884, F1100980
18-1337	0.01	23-811858, 23-811858001

CAM BEARINGS

Part No.	Per Eng.	Replaces:
18-1305	1 ①	23-85684
18-1340	5 ①	23-67484



① Complete engine set

② Priced per piece. Add -9 to order priced per package.

BEARING APPLICATION

HP	Liter	Model	Note	CID	# Cyl	Stroke	Year	Serial #	Rod Bearing			Main Bearing			Cam Bearing
									Std.	0.01	0.02	Std.	0.01	0.02	
100		100 VASER		98	4	4	2007-2010	W995000 & UP	-	-	-	-	-	-	-
120		120		153	4	4	1964-1986	1666601 - B531853	-	-	-	-	-	-	-
120	2.5L	120/2.5L		153	4	4	1987-1989	B531854 - C853255	-	18-1330	-	18-1317	-	-	-
140		140		181	4	4	1968-1986	2508261 - B450800	18-1308	18-1309	-	18-1317	-	-	18-1331
140		140		181	4	4		3462608 - 5157668	18-1308	18-1309	-	18-1317	-	-	-
140		140		181	4	4		5157669 - 6229717	18-1308	18-1309	-	18-1317	-	-	-
140	3.0L	140 / 3.0L		181	4	4		6229718 & Up	18-1308	18-1309	-	18-1317	-	-	-
	3.0L	3.0L		181	4	4	1987-1989	B450801 - C856558	18-1308	-	-	-	-	-	-
	3.0L	3.0L		181	4	4	1990-1994	C856559 - F603999	18-1308	18-1309	-	18-1317	-	-	-
	3.0L	3.0L		181	4	4	1998-1999	L010042 - L605541	18-1308	-	-	-	-	-	-
	3.0L	3.0L		181	4	4	2000-2010	L605542 & UP	-	-	-	-	-	-	-
	3.0L	3.0L MPI		181	4	4	2008-2010	A07282 & UP	-	-	-	-	-	-	-
	3.0L	3.0LX		181	4	4	1990-1997	C856559 - K999999	18-1308	-	-	-	-	-	-
		165		224	4	4	1987	B434941 - B774251	-	-	-	-	-	-	-
		170		224	4	4	1985-1986	6916779 - B434940	-	-	-	-	-	-	-
		180		224	4	4	1987	B436391 - B775248	-	-	-	-	-	-	-
		190		224	4	4	1985-1986	6916779 - B436390	-	-	-	-	-	-	-
	3.7L	3.7L		224	4	4	1988-1989	B774252 - C762299	-	-	-	-	-	-	-
	3.7L	3.7LX		224	4	4	1988-1989	B775249 - C762299	-	-	-	-	-	-	-
		470		224	4	4	1976-1984	4208730 - 6916778	-	-	-	-	-	-	-
		485		224	4	4	1980-1982	5685394 - 6218036	-	-	-	-	-	-	-
		488		224	4	4	1983-1984	6170297 - 6916778	-	-	-	-	-	-	-
		140			6	4		1538930 - 1725960	-	18-1330	-	-	-	-	-
		150				4		1666495 - 2048046	-	18-1330	-	-	-	-	-
		160		250	6	4	1967-1969	2048022 - 2770031	-	18-1330	-	-	18-1320	-	-
		165		250	6	4	1970-1981	2770032 - 5813433	-	18-1330	-	-	18-1320	-	-
4.3L	175 / 4.3L			262	6	4		B527955 & Up	18-1327	18-1337	18-1338	-	-	-	-
	185	4bbl		229	6	4	1983-1984	6330183 - 6919655	-	-	-	-	-	-	-
	175			262	6	4	1987	B527955 - B773242	-	-	-	-	-	-	-
	185	2bbl		262	6	4	1985-1986	A331455 - B527954	-	-	-	-	-	-	-
	205			262	6	4	1985-1986	A331455 - B527954	-	-	-	-	-	-	-
4.3L	262 MAG / 262 EFI / 262 GEN +			262	6	4	1996-1997	F803800 - K999999	-	-	-	-	-	-	-
4.3L	4.3L GEN II			262	6	4	1992-1996	D714107 - F802999	18-1327	18-1337	18-1338	-	-	-	-
4.3L	4.3L GEN +			262	6	4	1998-2010	L010044 & UP	-	-	-	-	-	-	-
4.3L	4.3L EFI / 4.3L GEN +			262	6	4	1998-2001	L012009 - M299999	-	-	-	-	-	-	-
4.3L	4.3L MPI			262	6	4	2002-2010	M3000000 & UP	-	-	-	-	-	-	-
4.3L	4.3LH GEN +			262	6	4	1998-2002	L010044 - M614999	-	-	-	-	-	-	-
4.3L	4.3LX			262	6	4	1988-1991	B775130 - D714369	-	-	-	-	-	-	-
4.3L	4.3LX GEN II			262	6	4	1992-1996	D714370 - F802999	-	-	-	-	-	-	-
4.3L	4.3LX GEN +			262	6	4	1996-1997	F803000 - K999999	-	-	-	-	-	-	-
4.3L	4.3LXH GEN +			262	6	4	1996-1997	F803114 - K999999	-	-	-	-	-	-	-
	185			262	6	4		A331455 & Up	18-1327	18-1337	18-1338	-	-	-	-
	205			262	6	4		A331455 & Up	18-1327	18-1337	18-1338	-	-	-	-
4.3L	205 / 4.3L / 4.3LX LX			262	6	4		B527955 & Up	18-1327	18-1337	18-1338	-	-	-	-
	4.3LX GEN II			262	6	4		D714370 & Up	18-1327	18-1337	18-1338	-	-	-	-
	190	GM		283	8	4	1963-1964	1564539 - 1730903	-	18-1330	-	-	-	-	-
	200							2453769 - 2712072	18-1308	18-1309	-	18-1317	-	-	-
	200	GM				4		6218462 & Up	18-1308	18-1309	-	-	-	-	-
5.0L	500				8	4		B525982 & Up	18-1308	18-1309	-	-	-	-	-
5.0L	215	FORD		302	8	4		2781153 - 3395720	18-1336	-	-	-	-	-	-
5.0L	225	FORD		302	8	4	1973-1974	3385721 - 4166999	-	18-1330	-	-	-	-	-
5.0L	225 S	FORD		302	8	4	1973-1974	3385721 - 4166999	-	-	-	-	-	-	-
5.0L	225	GM			8	4		1536920 - 2278646	-	18-1330	-	-	-	-	-
5.0L	225	GM			8	4		2278647 - 2399397	-	18-1330	-	18-1317	-	-	-
5.0L	225	GM			8	4		2399398 & Up	18-1308	18-1309	-	-	-	-	-
5.0L	225	GM			8	4		4765100 & Up	18-1308	18-1309	-	-	-	-	-
5.0L	888			302	8	4	1971-1977	3108723 - 4887829	-	-	-	-	-	-	-

CHART CONTINUED ON NEXT PAGE

BEARING APPLICATION

HP	Liter	Model	Note	CID	# Cyl	Stroke	Year	Serial #	Rod Bearing			Main Bearing			Cam Bearing
									Std.	0.01	0.02	Std.	0.01	0.02	
		190		283	8	4	1963-1964	1564539 - 1730903	-	-	-	-	-	-	-
5.0L		198 MIE		305	8	4	1977	4776402 - 4931099	18-1308	-	-	-	-	-	-
5.0L		200		305	8	4	1985-1987	6899058 - B774444	18-1308	-	-	-	-	-	-
5.0L		228		305	8	4	1977-1984	4765100 - 6899268	18-1308	-	-	-	-	-	-
5.0L		228 MIE		305	8	4	1977-1980	4765100 - 5907057	18-1308	-	-	-	-	-	-
5.0L		230		305	8	4	1985-1987	6899269 - B773739	18-1308	-	-	-	-	-	-
5.0L		230	GM	305	8	4	1981-1987	5907058 - B788151	18-1308	18-1309	-	-	-	-	-
5.0L		5.0L		305	8	4	1988-1995	B774445 - F600999	18-1308	-	-	-	-	-	-
5.0L		5.0L GEN +		305	8	4	1998-2010	L015751 & UP	18-1308	-	-	-	-	-	-
5.0L		5.0L EFI GEN +		305	8	4	1998-2001	L012052 - M299999	18-1308	-	-	-	-	-	-
5.0L		5.0L MIE		305	8	4	1988	B788152 - C396832	18-1308	-	-	-	-	-	-
5.0L		5.0L MPI		305	8	4	2002-2010	M3000000 & UP	18-1308	-	-	-	-	-	-
5.0L		5.0LX		305	8	4	1988-1995	B773740 - F600999	18-1308	-	-	-	-	-	-
5.0L		230 / 5.0L	GM	305	8	4		B522506 & Up	18-1308	18-1309	-	-	-	-	-
		230	GM		8	4		6218462 & Up	18-1308	18-1309	-	-	-	-	-
5.0L		230 / 5.0L / 5.0LX	GM	305	8	4		B525982 & Up	18-1308	18-1309	-	-	-	-	-
5.0L		898		305	8	4	1977-1984	4762210 - 6899057	18-1308	-	-	-	-	-	-
		225	GM	327	8	4	1963-1967	1539620 - 2399397	-	-	-	-	-	-	-
		225	GM	327	8	4	1968-1969	2399398 - 2694014	18-1308	-	-	-	-	-	-
		250		327	8	4	1968-1969	2314301 - 2639854	18-1308	18-1309	-	-	-	-	-
5.7L		250		350	8	4	1977	4768000 - 4908849	18-1308	18-1309	-	-	-	-	-
5.7L		255	GM	350	8	4	1975-1976	4175500 - 4767999	18-1308	18-1309	-	-	-	-	-
5.7L		255 MIE		350	8	4	1975-1980	4175500 - 5907057	18-1308	-	-	-	-	-	-
5.7L		260	GM	350	8	4	1978-1987	4908850 - B773304	18-1308	18-1309	-	-	-	-	-
5.7L		260 MIE		350	8	4	1981-1987	5907058 - B788151	18-1308	18-1309	-	-	-	-	-
5.7L		260 / 5.7L	GM	350	8	4		B525982 & Up	18-1308	18-1309	-	-	-	-	-
5.7L		260 / 5.7L	GM	350	8	4		B522506 & Up	18-1308	18-1309	-	-	-	-	-
5.7L		270	GM	350	8	4	1969-1972	2851074 - 3077735	18-1308	18-1309	-	-	-	-	-
5.7L		280	GM	350	8	4	1975-1976	4176250 - 4770199	18-1308	18-1309	-	-	-	-	-
5.7L		300	GM	350	8	4	1985-1986	6668677 - B430367	18-1308	18-1309	-	-	-	-	-
5.7L		320 EFI	GM	350	8	4	1987-1989	A543604 - C622418	18-1308	18-1309	-	-	-	-	-
5.7L		320 EFI BRAVO	GM	350	8	4		B157603 & Up	18-1308	18-1309	-	-	-	-	-
		325 GM			8	4		2278747 & Up	18-1334	18-1333	18-1332	-	-	-	-
		330 GM			8	4		4623115 & Up	18-1334	18-1333	18-1332	-	-	-	-
		330 W.B.W.	GM		8	4		6083045 & Up	18-1334	18-1333	18-1332	-	-	-	-
7.4L		340 / 7.4L	GM		8	4		5889914 & Up	18-1334	18-1333	18-1332	-	-	-	-
5.7L		350 MAG ALPHA		350	8	4	1986-1997	A635178 - K999999	18-1308	18-1309	-	-	-	-	-
5.7L		350	GM	350	8	4		3780450 & Up	18-1334	18-1333	18-1332	-	-	-	-
5.7L		350 MAG / 350 ALPHA / 350 EFI / 350 GEN +		350	8	4	1996-1997	F800300 - K999999	18-1308	-	-	-	-	-	-
5.7L		350 MAG / 350 BRAVO / 350 MPI		350	8	4	1995	F415189 - F601999	18-1308	-	-	-	-	-	-
5.7L		350 MAG / 350 BRAVO / 350MPI / 350 GEN +		350	8	4	1996-1997	F602000 - K999999	18-1308	-	-	-	-	-	-
5.7L		350 MAG SKI		350	8	4	1994-1996	F215561 - F820706	18-1308	-	-	-	-	-	-
5.7L		350 MAG EFI SKI GEN +		350	8	4	1996-1997	F820707 - K999999	18-1308	-	-	-	-	-	-
5.7L		350 MAG MPI GEN +		350	8	4	1988-2010	L010019 & UP	18-1308	-	-	-	-	-	-
5.7L		350 MAG MPI / 350 MAG MIE GEN +		350	8	4	1998-2007	L002008 - A089999	18-1308	-	-	-	-	-	-
5.7L		350MG / 350 MPI / 350 SKI		350	8	4	1995-1996	F350583 - F799999	18-1308	-	-	-	-	-	-
5.7L		350 MAG / 350 MPI / 350 SKI / 350 GEN +		350	8	4	1998-2007	L002600 - A089999	18-1308	-	-	-	-	-	-
5.7L		350 MAG SKI		350	8	4	1991-1997	D505450 - K999999	18-1308	-	-	-	-	-	-
5.7L		5.7L		350	8	4	1988-1997	4908850 - F600999	18-1308	-	-	-	-	-	-
5.7L		5.7L GEN +		350	8	4	1998-2010	L010037 & UP	18-1308	-	-	-	-	-	-
5.7L		5.7L EFI		350	8	4	1995-1997	F225560 - K999999	18-1308	-	-	-	-	-	-
5.7L		5.7L EFI GEN +		350	8	4	1998-2001	L010035 - M2999999	18-1308	-	-	-	-	-	-
5.7L		5.7L EFI MIE GEN +		350	8	8	1997	K040300 - K999999	18-1308	-	-	-	-	-	-
5.7L		5.7L MIE		350	8	4	1988-1997	B788152 - K999999	18-1308	-	-	-	-	-	-

CHART CONTINUED ON NEXT PAGE

BEARING APPLICATION

I/O — MERCRUISER - INTERNAL ENGINE SYSTEM

HP	Liter	Model	Note	CID	# Cyl	Stroke	Year	Serial #	Rod Bearing			Main Bearing			Cam Bearing
									Std.	0.01	0.02	Std.	0.01	0.02	
5.7L		5.7L MIE GEN +		350	8	4	1998-2010	L002003 & UP	18-1308	-	-	-	-	-	-
5.7L		5.7L MPI / 5.7L MIE		350	8	4	2008-2010	A090000 & UP	18-1308	-	-	-	-	-	-
5.7L		5.7L MPI SKI		350	8	4	2008-2010	A090000 & UP	18-1308	-	-	-	-	-	-
5.7L		5.7L SKI		350	8	4	1985-1987	A338553 - K999999	18-1308	-	-	-	-	-	-
5.7L		5.7L SKI GEN +		350	8	4	1998-2010	L002005 & UP	18-1308	-	-	-	-	-	-
5.7L		5.7LX		350	8	4	1996-1997	F601000 - F600999	18-1308	-	-	-	-	-	-
5.7L		5.7LX / 5.7LX BRAVO / 5.7LX EFI / 5.7LX GEN +		350	8	4	1996-1997	F800300 - K999999	18-1308	-	-	-	-	-	-
5.7L		5.7L EFI		350	8	4	1996-1997	F752400 - K999999	18-1308	-	-	-	-	-	-
5.7L		BLACK SCORPION SKI GEN +		350	8	4	1996-2006	F800000- W689999	18-1308	-	-	-	-	-	-
5.7L		BLACK SCORPION SKI GEN +		350	8	4	2003-2007	W690000 - W698432	18-1308	●	●	-	-	-	-
5.7L		SCORPION 350		350	8	4	2008-2010	W698433 & UP	18-1308	●	●	-	-	-	-
		233		351	8	4	1975-1977	4173000 - 4902304	-	-	-	-	-	-	-
		255	FORD	351	8	4	1973-1974	3258728 - 4175499	-	-	-	-	-	-	-
		TOURNEY SKI			8	4		D505450 & Up	18-1308	18-1309	-	-	-	-	-
		370 TRS	GM		8	4		6721528 & Up	18-1334	18-1333	18-1332	-	-	-	-
		377 MAG		377	8	4	2008-2010	A3000000 & UP	18-1334	●	●	-	-	-	-
		377 SCORPION MCM		377	8	4	1999-2005	L416145 - M907201	18-1334	●	●	-	-	-	-
		377 SCORPION SKI GEN +		377	8	4	1997-1998	K000656 - L600314	18-1334	●	●	-	-	-	-
6.2L		MX 6.2L MPI		377	8	4	2000-2007	L680003 - A299999	18-1334	●	●	-	-	-	-
6.2L		MX 6.2L MPI / MX 6.2L HORIZON		377	8	4	2002-2007	M3000000 - A299999	18-1334	●	●	-	-	-	-
6.2L		MX 6.2L MPI / MX 6.2L HORIZON / MX 6.2L MIE		377	8	4	2002-2010	M3000000 & UP	18-1334	●	●	-	-	-	-
6.2L		MX 6.2L MPI / MX 6.2L MIE		377	8	4	2002-2010	M3000000 & UP	18-1334	●	●	-	-	-	-
6.2L		MX 6.2L BLACK SCORPION SKI		377	8	4	2002-2007	M300000 - W698432	18-1334	●	●	-	-	-	-
6.2L		SCORPION 377		377	8	4	2008-2010	W698433 & UP	18-1334	●	●	-	-	-	-
7.4L		325		454	8	4	1969-1972	2278747 - 3780449	-	-	-	-	-	-	-
7.4L		330		454	8	4	1977-1987	4623115 - B816540	-	-	-	-	-	-	-
7.4L		330 MIE		454	8	4	1977-1980	4623115 - 5889913	-	-	-	-	-	-	-
7.4L		340 MIE W/B-W		454	8	4	1981-1987	5889914 - B788365	-	-	-	-	-	-	-
7.4L		350 MIE		454	8	4	1974-1976	3780450 - 4623109	-	-	-	-	-	-	-
7.4L		370 TRS		454	8	4	1978-1987	4179554 - B714586	-	-	-	-	-	-	-
		390	GM		8	4		2781129 - 2825059	18-1334	18-1333	18-1332	-	-	-	-
7.4L		400 TRS		454	8	4	1980-1986	4179554 - B457644	-	-	-	-	-	-	-
7.4L		420	GM	454	8	4	1987-1989	A398941 - B622418	18-1334	18-1333	18-1332	-	-	-	-
7.4L		425	GM	454	8	4	1990-1992	B622419 - D725499	-	-	-	-	-	-	-
7.4L		425 GEN V		454	8	4	1992-1993	D725500 - D937011	-	-	-	-	-	-	-
7.4L		440 TRS		454	8	4	1983-1986	4179554 - B485220	-	-	-	-	-	-	-
7.4L		450 GEN V		454	8	4	1995-1996	F347100 - F347277	-	-	-	-	-	-	-
7.4L		454 MAG ALPHA	GM	454	8	4	1986-1988	A631894 - B785148	18-1334	18-1333	18-1332	-	-	-	-
7.4L		454 MAG BRAVO		454	8	4	1988-1992	B721206 - D805068	-	-	-	-	-	-	-
7.4L		454 MAG BRAVO	GM	454	8	4		B840126 & UP	18-1334	18-1333	18-1332	-	-	-	-
7.4L		454 MAG BRAVO GEN V		454	8	4	1992-1996	D805069 - M801699	18-1334	18-1333	18-1332	-	-	-	-
7.4L		454 MAG BRAVO GEN VI		454	8	4	1996-1997	F801700 - K999999	-	-	-	-	-	-	-
7.4L		454 MAG EFI GEN V		454	8	4	1994-1996	F115700 - F802349	-	-	-	-	-	-	-
7.4L		454 MAG EFI SKI GEN V		454	8	4	1995-1996	F215800 - F820099	-	-	-	-	-	-	-
7.4L		454 MAG MPI GEN VI		454	8	4	1996-2001	F802350 - M024999	-	-	-	-	-	-	-
7.4L		454 MAG MPI / 454 MAG HORIZON / 454 MAG MIE		454	8	4	1998-2001	L002200 - L674000	-	-	-	-	-	-	-
7.4L		454 MAG MPI / 454 MAG SKI GEN VI		454	8	4	1996-1997	F820100 - K999999	-	-	-	-	-	-	-
7.4L		454 EFI		454	8	4		F115700 & UP	18-1334	18-1333	18-1332	-	-	-	-
		502 MAG	GM		8	4		C878221 & Up	18-1334	18-1333	18-1332	-	-	-	-
		502 MAG BRAVO GEN V			8	4		D824589 & Up	18-1334	18-1333	18-1332	-	-	-	-
		502 MAG BRAVO GEN V			8	4		D840650 & Up	18-1334	18-1333	18-1332	-	-	-	-
		502 EFI			8	4		3108723 & Up	18-1336	-	-	-	-	-	-
		525 SC		454	8	4	1991-1992	D456000 - D725808	-	-	-	-	-	-	-
		525 SC GEN V		454	8	4	1992-1996	D763746 - F745215	-	-	-	-	-	-	-
		525 SC GEN V		454	8	4	1996-1999	F745260 - L415623	-	-	-	-	-	-	-

● 8 Pair Bearing Set

CHART CONTINUED ON NEXT PAGE







BEARING APPLICATION

HP	Liter	Model	Note	CID	# Cyl	Stroke	Year	Serial #	Rod Bearing			Main Bearing			Cam Bearing
									Std.	0.01	0.02	Std.	0.01	0.02	
7.4L	7.4L	BRAVO		454	8	4	1988-1991	B771113 - D603117	-	-	-	-	-	-	-
7.4L	7.4L	BRAVO GEN V		454	8	4	1992-1996	D603118 - F800699	-	-	-	-	-	-	-
7.4L	7.4L	BRAVO GEN VI		454	8	4	1996-1997	F800700 - K299999	-	-	-	-	-	-	-
7.4L	7.4L	EFI / 7.4L MIE GEN VI		454	8	4	1996-1997	F874815 - K999999	-	-	-	-	-	-	-
7.4L	7.4L	MIE		454	8	4	1988-1992	B788366 - D715493	-	-	-	-	-	-	-
7.4L	7.4L	MIE GEN V		454	8	4	1992-1996	D715494 - F820141	-	-	-	-	-	-	-
7.4L	7.4L	LH / 7.4L MIE GEN VI		454	8	4	1996-1997	F820142 - K999999	-	-	-	-	-	-	-
7.4L	7.4L	MPI GEN V		454	8	4	1998-2001	L010003 - M024330	-	-	-	-	-	-	-
7.4L	7.4L	MPI GEN V / 7.4L MIE GEN V		454	8	4	1995-1996	F563052 - F820103	-	-	-	-	-	-	-
7.4L	7.4L	MPI GEN VI / 7.4L MIE GEN VI		454	8	4	1996-1997	F820104 - K999999	-	-	-	-	-	-	-
7.4L	7.4L	MPI GEN VI L29 / 7.4L MIE GEN VI L29		454	8	4	1998-2001	L002006 - M025999	-	-	-	-	-	-	-
7.4L	7.4L	7.4LX BRAVO TBI GEN VI		454	8	4	1988-2001	F802000 - K999999	-	-	-	-	-	-	-
7.4L	7.4L	7.4LX BRAVO MPI GEN V		454	8	4	1996	F602010 - F801999	-	-	-	-	-	-	-
7.4L	7.4L	7.4LX BRAVO MPI GEN VI		454	8	4	1996-1997	F802000 - K999999	-	-	-	-	-	-	-
7.4L	7.4L	BRAVO	GM					D603118 & Up	18-1334	18-1333	18-1332	-	-	-	-
7.4L	7.4L	BRAVO GEN V						C391564 & Up	18-1334	18-1333	18-1332	-	-	-	-
7.4L	7.4L	W/HURTH						D715494 & Up	18-1334	18-1333	18-1332	-	-	-	-
7.4L	7.4L	HR GEN V						C878221 & Up	18-1334	18-1333	18-1332	-	-	-	-
		390		482	8	4	1969-1970	2781129 - 2825059	-	-	-	-	-	-	-
		460 TRS		482	8	4	1983-1986	4179554 - 6181046	●	●	-	-	-	-	-
		496 MAG / 496 HO		496	8	4	2001-2010	M025000 & UP	-	-	-	-	-	-	-
		8.1S MPI / 8.1S MIE / 8.1S HO		496	8	4	2001-2010	M025000 & UP	-	-	-	-	-	-	-
8.2L	8.2L	465		502	8	4	1990-1992	C849992 - D725646	-	-	-	-	-	-	-
8.2L	8.2L	465 GEN V		502	8	4	1992-1994	D725647 - F213244	-	-	-	-	-	-	-
8.2L	8.2L	500 GEN V		502	8	4	1994-1996	F213293 - F745159	-	-	-	-	-	-	-
8.2L	8.2L	500 GEN VI		502	8	4	1997-1999	K745195 - L601036	-	-	-	-	-	-	-
8.2L	8.2L	500 EFI		502	8	4	1999-2000	L001477 - L306499	-	-	-	-	-	-	-
8.2L	8.2L	500 EFI		502	8	4	2000-2005	L306500 - M907127	-	-	-	-	-	-	-
8.2L	8.2L	502 MAG BRAVO		502	8	4	1990-1992	C876221 - D824588	-	-	-	-	-	-	-
8.2L	8.2L	502 MAG BRAVO GEN V		502	8	4	1992-1993	D824589 - F114528	-	-	-	-	-	-	-
8.2L	8.2L	502 MAG EFI		502	8	4	1993-1996	D840650 - F802599	-	-	-	-	-	-	-
8.2L	8.2L	502 MAG MPI GEN VI		502	8	4	1996-2001	F802600 - M024999	-	-	-	-	-	-	-
8.2L	8.2L	525 EFI		502	8	4	2003-2007	M900146 - M958499	-	-	-	-	-	-	-
8.2L	8.2L	525 EFI		502	8	4	2007-2010	M958500 & UP	-	-	-	-	-	-	-
8.2L	8.2L	575SCi		502	8	4	2000-2005	L306696 - M950526	-	-	-	-	-	-	-
8.2L	8.2L	600 SC		502	8	4	1991-1992	D456489 - D456768	-	-	-	-	-	-	-
8.2L	8.2L	600SC GEN V		502	8	4	1992-1996	D725676 - F877642	-	-	-	-	-	-	-
8.2L	8.2L	600 SC GEN VI		502	8	4	1997-2000	K000227 - L601186	-	-	-	-	-	-	-
8.2L	8.2L	MAG		502	8	4	2010	A350340 & UP	-	-	-	-	-	-	-
8.2L	8.2L	MIE		502	8	4	2010	A350802 & UP	-	-	-	-	-	-	-
8.2L	8.2L	MIE W/HURTH		502	8	4	1990-1992	C878221 - D857199	-	-	-	-	-	-	-
8.2L	8.2L	W/HURTH (IB)		502	8	4		D857200 & Up	18-1334	18-1333	18-1332	-	-	-	-
8.2L	8.2L	MIE GEN V		502	8	4		D857200 - F819619	-	-	-	-	-	-	-
8.2L	8.2L	MPI GEN VI / 8.2L MIE GEN VI / 8.2LH GEN VI		502	8	4	1996-2001	F819620 - L674200	-	-	-	-	-	-	-
		500 BULLDOG		540	8	4	1990-1996	C577254 - F745405	●	●	-	-	-	-	-
		500 BULLDOG		540	8	4	1997-2001	K000248 - M050281	●	●	-	-	-	-	-
		575		540	8	4	1986-1992	A677429 - D763716	●	●	-	-	-	-	-
		800 SC GEN V		540	8	4	1993-1998	D763836 & UP	●	-	-	-	-	-	-
		888	FORD		8	4		4762210 & Up	18-1308	18-1309	-	-	-	-	-
		898 / 198	GM					A338553 & Up	18-1308	18-1309	-	-	-	-	-

● 8 Pair Bearing Set

MERCUISER 3.7L BEARING APPLICATION

Model	Serial #	Rod Bearings			Main Bearings			Main (Thrust Bearings)		
		Std.	.010	.020	Std.	.010	.020	Std.	.010	.020
165/3.7 (4cyl)	6916779 & Up	-	-	-	-	-	-	18-1149	-	-
170 (4cyl)	6916779 & Up	-	-	-	-	-	-	18-1149	-	-
180/3.7L (4cyl)	6916779 & Up	-	-	-	-	-	-	18-1149	-	-
190 (4cyl)	6916779 & Up	-	-	-	-	-	-	18-1149	-	-
470	4208730 & Up	-	-	-	-	-	-	18-1149	-	-
485	5685394 & Up	-	-	-	-	-	-	18-1149	-	-
488	6170297 & Up	-	-	-	-	-	-	18-1149	-	-

 <p>18-0518 VALVE STEM SEAL Replaces: 26-34217, 26-72564, 26-58094, 26-75413, 26-75624</p>	 <p>18-4023 VALVE STEM SEAL Replaces: 26-75413, 26-75624, 26-72564, 26-58094 For: 165, 170, 180, 190 4 cyl. (224 CID) SN 6916779 & later</p>	 <p>18-4022 VALVE STEM SEAL Replaces: 26-75988, 26-75982, 26-67863, 26-49131, F3866612, F11100968, F11101117 For: 330 (SN 4623115 & later), 340 (IB) (SN 5889914 & later), 454 Mag (SN A631894 & later)</p>	 <p>PKG. OF 8</p> <p>18-4024 18-4024-9^② VALVE STEM SEAL Replaces: 26-97664, 26-976641 26-8M0050563, F11101200</p>
 <p>ONE PIECE REAR MAIN SEALS</p> <p>18-1234 Replaces: 24-811554, 24-17057A1, 24-801879, 24-801879T For: 7.4L, GL, GI, GSI: 8.2L, GL</p> <p>18-0519 Replaces: 26-14240, F11101300 4.3L/3.0L/5.0L 5.7L</p> <p>18-0864 Replaces: 26-90925, 27-67389</p>	 <p>TWO PIECE REAR MAIN SEALS</p> <p>18-0528 Replaces: 26-56868</p> <p>18-1211 Replaces: 26-58203, 26-49947, 26-814622, F1110026, F1110027, F1110041</p>	 <p>TIMING COVER SEALS</p> <p>18-1213 Replaces: 26-97335, 26-11973, 26-42750, 26-54799</p> <p>18-1230 Replaces: 26-56866</p> <p>18-1233 Replaces: 26-8219471, 26-821947, 26-49154, F11100986</p> <p>18-0578 Replaces: 26-67388</p>	

MERCUISER SEAL APPLICATION

Model	Serial No.	Rear Main Crankshaft Seal	Timing Cover Seal
120/2.5L	1666601 & UP	—	18-1213
120/2.5L	2786857 & UP	18-1211	18-1213
140/3.0L & LX	2508261 & UP	—	18-1213
140/3.0L & LX	6229718 & UP	18-1211	18-1213
150/160/165/200 (I/L-6)	1666495 & UP	—	18-1213
150/160/165/200 (I/L-6)	2770032 & UP	18-1211	18-1213
175/185/205/262/4.3L (V-6)	6330183 & UP	18-1211	18-1213
200/228/225/230/250/255/260/270/280/300/320/5.0L/5.7L/898 (V-8)	2453769 & UP	18-1211 ^①	18-1213
215	2781153 & UP	18-0528	—
224/L4	ALL	18-0864	18-0578
225 FORD	3885721 & UP	18-0528	—
5.0L/5.7L, 4.3L, 3.0L Std. Rotation	"All" one piece seal	18-0519	18-1213
340 (7.4L)	4623115 & UP	—	18-1233
370 TRS	5889914 & UP	—	18-1233
400 TRS	4179554 & UP	—	18-1233
420	A398941 & UP	—	18-1233
440 TRS	4179554 & UP	—	18-1233
454 MAGNUM	A631894 & UP	—	18-1233
460 TRS	4179554 & UP	—	18-1233
7.4L/8.2L/454/502 Std. Rotation	"All" one piece seal	18-1234	18-1233
7.4 BRAVO	B771113 & UP	—	18-1233
888 (188)	3108723 & UP	18-0528	—

① Lrg. Journal Crankshaft GM Engines ② Priced per Package

MANIFOLD & EXHAUST MANIFOLD GASKET SETS



18-0403

INTAKE GASKET KIT

Replaces: 27-805722A1, 27-812712, 27-61782, 27-52571
For: MCM 370, 400, 325, 454, 502 Mag, 7.4L Bravo II & MIE 8.2L1978-1997



18-0404

INTAKE GASKET KIT

Replaces: 27-805403A1
For: MCM/MIE 454 Mag MPI, 7.4L/LX MPI & 8.2L MPI 1993-UP



18-0603

EXHAUST MANIFOLD GASKET SET

For: Ford 302/351 CID Engines
For use with 18-1998-1

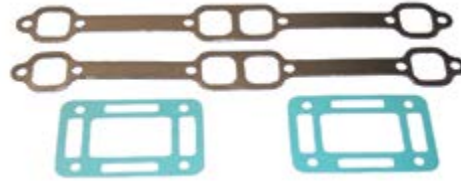

18-0604

EXHAUST MANIFOLD GASKET SET

For: GM 305/350 CID Engines
For use with 18-1997-1



18-4347-1

EXHAUST MANIFOLD GASKET SET

For: GM 175, 185, 205 (229 & 262 CID)

— CONTAINS —



18-4348

EXHAUST MANIFOLD GASKET SET

For: GM 454, 525 (7.4L & 8.2L)

— CONTAINS —

Part #	Description	O.E. #	Qty.
18-0897	Exhaust Elbow Mounting Gasket	27-41813-1	2
18-2909	Exhaust Manifold to Cyl. Head Gasket	27-99757	2

Part #	Description	O.E. #	Qty.
18-0418	Manifold to Cylinder Head Gasket	27-46820	2
18-0897	Exhaust Elbow Mounting Gasket	27-41813-1	2

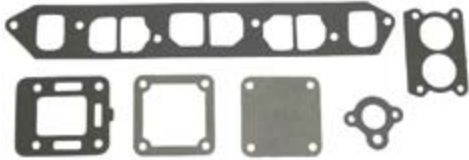

18-4367

EXHAUST MANIFOLD GASKET SET

Replaces: 27-99777A1
For: GM 153 & 181 (2.5 & 3.0L) CID Eng; 120 & 140 HP S/N 6229718 & UP
 (With Siamese Port Cylinder Heads)

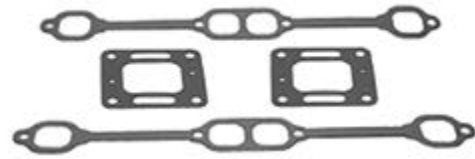

18-4349

EXHAUST MANIFOLD GASKET SET

For: GM 200, 228, 230, 260, 898 (5.0 & 5.7L)

— CONTAINS —

Part #	Description	O.E. #	Qty.
18-2949	Exhaust Manifold Gasket	27-33395	2
18-0897	Exhaust Elbow Mounting Gasket	27-41813-1	2

Part #	Description	O.E. #	Qty.
18-2949	Exhaust Manifold Gasket	27-33395	2
18-0897	Exhaust Elbow Mounting Gasket	27-41813-1	2

18-4394

EXHAUST MANIFOLD GASKET SET

Replaces: 27-33395A2, 27-33395A1
For: GM 350 (5.7L) CID Eng; 250 HP S/N 4768000-4908849 255 HP S/N 5195909 & UP

— CONTAINS —

Part #	Description	O.E. #	Qty.
18-2832-1	Manifold End Cap Gasket	27-48043	4
18-2833	Exhaust Elbow Gasket	27-99777-2	4
18-2949	Exhaust Manifold Gasket	27-33395	2
18-0885-1	Exhaust Elbow Gasket	27-48042	4

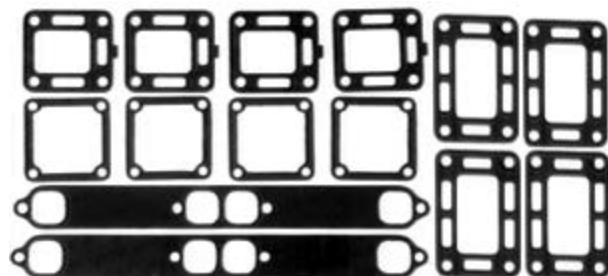

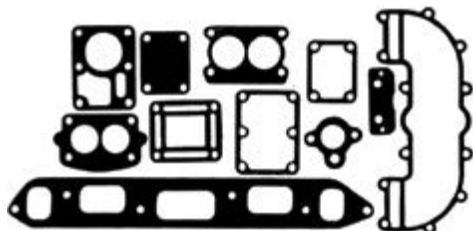

18-4395
EXHAUST MANIFOLD GASKET SET
 Replaces: 27-35898A4, 27-35898A3, 27-35898A2
 For: GM 153 (2.5L) CID Eng;
 120 HP S/N 2046625-6229717

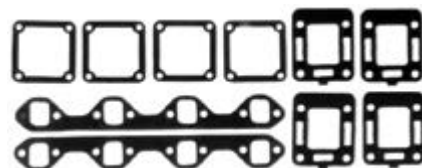

18-4399
EXHAUST MANIFOLD GASKET SET
 Replaces: 27-54566A1
 For: Ford 302/351 (5.0L & 5.8L) CID Eng; All 888 (188 HP)
 & 233 HP, 255 HP • S/N 3258728-4175498

— CONTAINS —

Part #	Description	O.E. #	Qty.
18-0183-1	Exhaust Mounting Gasket	27-46820	2
18-2832-1	Manifold End Cap Gasket	27-48043-1	4
18-2833	Exhaust Elbow to Gasket	27-99777-2	4

18-4396
EXHAUST MANIFOLD GASKET SET

Replaces: 27-46401A1
 For: 250 (4.1L) CID Eng; 165 HP S/N 2770032 & UP

— CONTAINS —

Part #	Description	O.E. #	Qty.
18-2830-1	Intake Exhaust Gasket	27-46401	1
18-2831	Thermostat Gasket	27-47590-1	1
18-2832-1	Manifold End Cap Gasket	27-48083-1	2
18-2833	Exhaust Elbow Gasket	27-99777-2	1
18-0353	Carb. Mounting Gasket	27-58764	1
18-0356	Carb. Mounting Gasket	27-64692	1
18-0928-1	Exhaust End Cap Gasket	27-73814	1

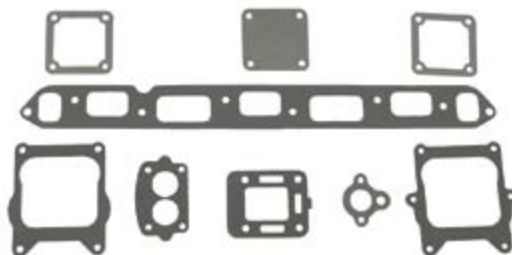

18-4398
EXHAUST MANIFOLD GASKET SET

Replaces: 27-53354A1
 For: GM 181 (3.0L) CID Eng; 140 HP S/N 3332137-6229717
 (Without Siamese Port Cylinder)

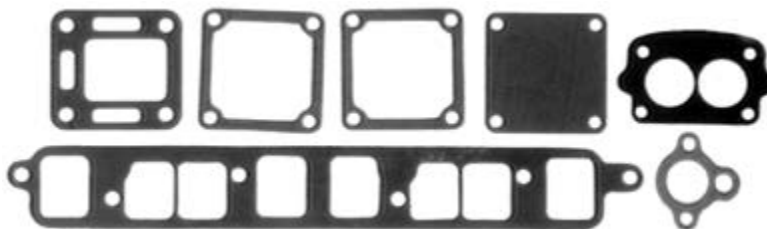

CYLINDER HEAD AND INTAKE MANIFOLD GASKET SETS

18-4383
 For: GM 153 (2.5L) CID Eng;
 S/N 2324347 & UP Includes 18-3880 Head Gasket



18-4384
 For: GM 181 (3.0L) CID Eng;
 S/N 2508261-6229717 (Except 3.0LX)



18-4386
 For: GM 305 & 350 (5.0L & 5.7L) CID Eng; With Heads (1987 & Earlier)

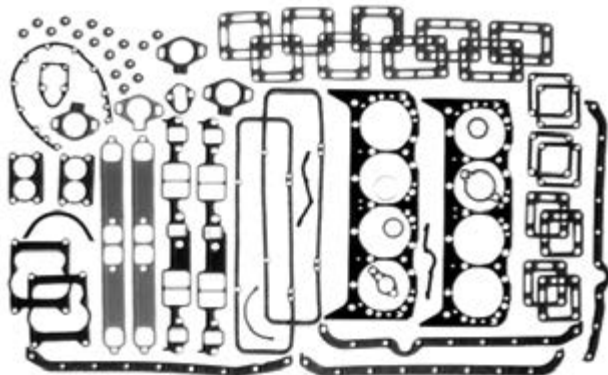

— CONTAINS —

Part #	Description	O.E. #	Qty.
18-0976	Timing Chain Cover Gasket	27-14250	1
18-0868	Intake Manifold Gasket	27-17145	1
18-2949	Exhaust Manifold Gasket	27-33395	2
18-0897	Exhaust Elbow Mounting Gasket	27-41813	2
18-0885-1	Exhaust Elbow Mounting Gasket	27-48042	4
18-2917	Lower Thermostat Housing Gasket	27-53045-1	1
18-0153	Port Dip Gasket	27-85817A1	1
18-2848	Quadrajel Base Gasket	27-58457-2	2
18-2849-1	Exhaust Elbow To Manifold Gasket	27-87105-1, 27-818832	4
18-3876	Head Gasket	27-75611	2
18-2554	Thermostat Gasket	27-41812	1
18-2832-1	Manifold End Cap Gasket	27-48043-1	4
18-2553	Thermostat Gasket	27-47510	1
18-2833	Exhaust Elbow To Manifold Gasket	27-99777-2	4
18-2844	Thermostat Cover Gasket	27-48818-1	1
18-0889	Fuel Pump Housing Gasket	27-34213	1
18-0891	Water Pump Mounting Gasket	27-34897	1
18-0905	Oil Pan Drain Plug Gasket	27-49955	1
18-0876	Water Pump Mounting Gasket	27-34898	1
18-0994	Carb. Mounting Gasket	27-70143-1	2
18-0518	Seal	26-34217	16
18-2845	Valve Cover Gasket	121-122	2

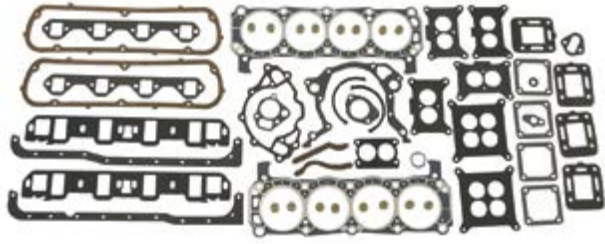

18-4385
For: Ford 302 (5.0L) CID Eng; 215, 225 & 888 (188 HP)
Includes 18-3883 Head Gasket

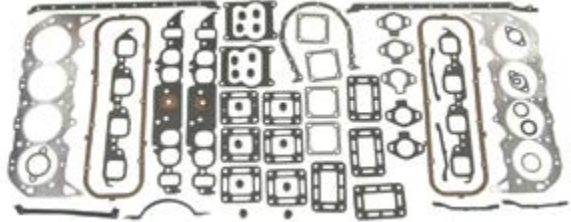

18-4387
Replaces: 27-801853
For: GM 454 (7.4L) CID Eng; Production Models
 Oval Port
Includes 18-3877 Head Gasket



18-0465
INTAKE MANIFOLD GASKET SET
Replaces: 27-65184, 27-8M0050224
For: GM 454 CID Engines, 325, 330, 340, 350 HP
 and 454 Magnums, 7.4L

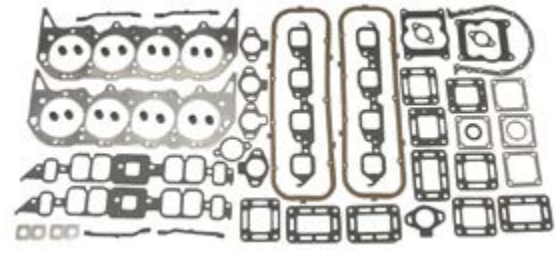

18-4365
INTAKE MANIFOLD GASKET SET
Replaces: 27-801855
For: GM 454 (7.4L) CID Eng; Production Models
 Rectangular Port
Includes 18-3877 Head Gasket



18-4388
INTAKE MANIFOLD GASKET SET
Replaces: 27-11977A88, A92
For: GM 262 CID Eng; 175, 185 & 205 HP, 4.3L
Includes 18-3879 Head Gasket

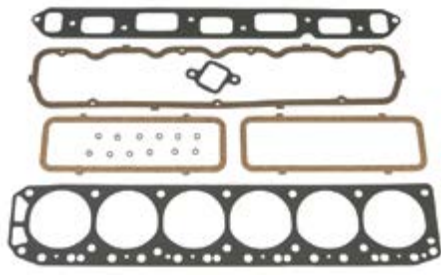

18-4389
INTAKE MANIFOLD GASKET SET
Replaces: 27-47453A1
For: All GM 165 HP (S/N 270032 & UP) & Inline 6 cyl.
 250 CID

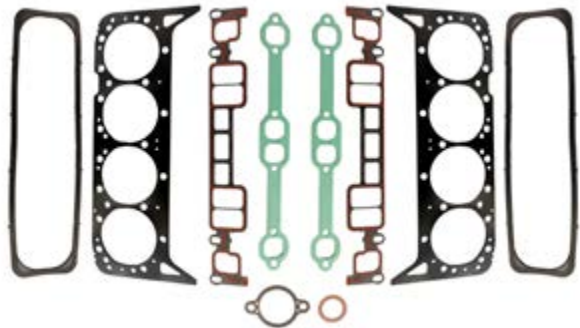

18-1254
VORTEC
HEAD GASKET SET
Replaces: 27-75611A03
For: Small Block GM V8 engines with Vortech heads

18-4392
INTAKE MANIFOLD GASKET SET
Replaces: 27-75611A2, 27-75611A1
For: GM 305 & 350 CID Eng. 898 (198 HP) 200, 228,
 230/260 (Inboard) 230, 250, 255, 260, 280 & 5.7L Ski

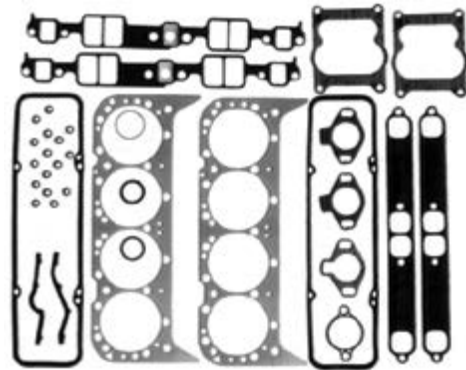

— CONTAINS —

Part #	Description	O.E. #	Qty.
18-0868	Intake Manifold Gasket	27-17145	1
18-2949	Exhaust Manifold Gasket	27-33395	2
18-2848	Quadrajel Base Gasket	27-52457-2	2
18-3876	Head Gasket	27-75611	2
18-2553	Thermostat Gasket	27-47510	1
18-2844	Thermostat Cover Gasket	27-48818-1	1
18-2554	Thermostat Gasket	27-41812	2
18-2917	Lower Thermostat Housing Gasket	27-53045-1	1
18-2845	Valve Cover Gasket	27-11999	2
18-0518	Seal	26-34217	16

OVERHAUL GASKET SETS

(Sets do not include Front and Rear Crankshaft Seals)

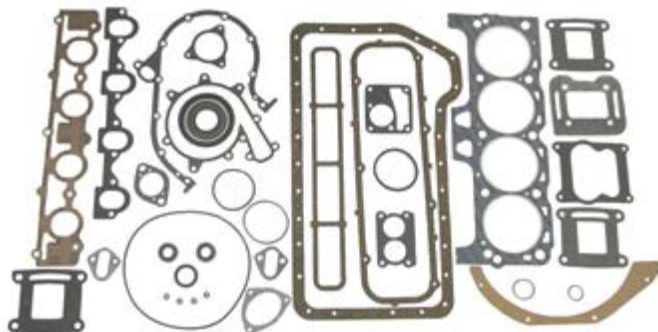

18-4381

Replaces: 27-43186A1, 27-89656A1, 27-41636A1
For: 224 (3.7L) CID Eng; 165, 170, 180, 190 HP
 S/N 6916779 & UP

-- CONTAINS --			
Part #	Description	O.E. #	Qty.
NSS	O-Ring	25-26543	4
18-0860	O-Ring	25-62700	1
18-0864	Seal	26-90925	1
18-0881-1	Exhaust Elbow Mounting Gasket	27-18272	1
18-0992	Exhaust Manifold Mounting Gasket	27-68715	1
18-0994	Carburetor Mounting Gasket	27-70143-1	1
18-0158	Intake Manifold Gasket	27-70905	1
18-0111	Exhaust Elbow Mounting Gasket	27-89657	2
18-0160	Lower Exhaust to Intake Manifold Gasket	27-94136	1
18-0113-1	Exhaust Elbow Mounting Gasket	27-97542	1
18-2843	Thermostat Cover Gasket	27-74830	1
18-2848	QuadraJet Base Gasket	27-52457-2	1
18-3878	Head Gasket	27-13709T	1
18-7121	O-Ring	25-35027	1
18-0874	Distributor Gasket	27-34486	1
18-0185	Seal	27-91892	1
18-2555	Thermostat Gasket	27-89656-1	1
18-0889	Fuel Pump Mounting Gasket	27-34213	1
18-4366	Oil Pan Gasket Set	27-72479A5	1
18-0387	Flywheel Cover Gasket	27-94976	1
18-0172	Oil Seal	26-97530	2

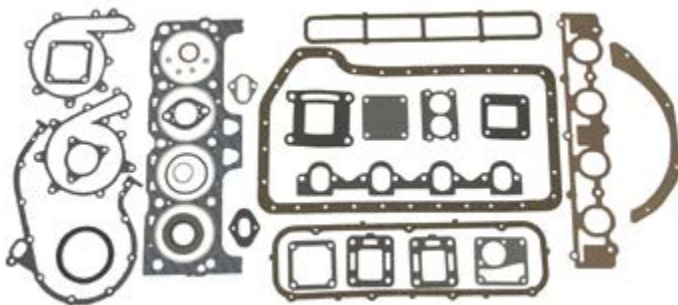

18-4382

Replaces: 27-74830A3, 27-74830A1, 27-74264A1
For: 224 (3.7L) CID Eng; 470 S/N 4208730 & UP

-- CONTAINS --			
Part #	Description	O.E. #	Qty.
18-0864	Seal	26-90925	1
18-0956-1	Exhaust Manifold Mounting Gasket	27-68715	1
18-0158	Intake Manifold Gasket	27-70905	1
18-0950	Impeller Cover Gasket	27-88046	1
18-0954	Exhaust Mounting Gasket	27-92720	1
18-0113-1	Exhaust Elbow Mounting Gasket	27-97542	1
18-2832-1	Manifold End Cap Gasket	27-48043-1	2
18-2833	Exhaust Elbow To Manifold Gasket	27-99777-2	2
18-2843	Thermostat Cover Gasket	27-74830	1
18-3878	Head Gasket	27-13709T	1
NSS	O-Ring	25-26543	4
18-0889	Fuel Pump Mounting Gasket	27-34213	1
18-7121	O-Ring	25-35029	1
18-0874	Distributor Gasket	27-34486-3	1
18-0928-1	Manifold End Cap Gasket	27-73814	1
18-0994	Carb. Mounting Gasket	27-70143-1	1
18-2555	Thermostat Cover Gasket	27-89656-1	1
18-4366	Oil Pan Gasket Set	27-72479A5	1
18-0387	Flywheel Cover Gasket	27-94976	1

MISCELLANEOUS GASKET SETS



18-0153 OIL PAN GASKET SET

Replaces: 27-85817A1, FI5110037, FI5110032, 27-72627
For: Mercruiser GM 350 CID (5.7L)



18-1239 OIL PAN GASKET

Replaces: 27-810846T, 27-810846
For: Mercruiser 3.0L GM 181



18-0348 OIL PAN GASKET SET

Replaces: 27-52550, 27-49107, FI1100229, FI5000229, FI5000245
For: Mercruiser GM 454/502 CID Eng; (7.4L and 8.2L)



18-1237 OIL PAN GASKET

Replaces: 27-138651, 27-13865, FI1101281
For: Mercruiser GM 5.7L



18-0466 OIL PAN GASKET SET

Replaces: 27-14901A1, 27-14901, 27-52144
For: Mercruiser GM 153/181 (2.5L & 3.0L)



18-1232 OIL PAN GASKET

Replaces: 27-811566, 27-845628
For: GM Big Block



18-1231 INTAKE GASKET

Replaces: 27-8181881, 27-818188
For: Rectangular port high performance big block Chevy



18-0405 OIL PAN GASKET

Replaces: 27-883964, 27-14247, 27-883964T
For: Mercruiser GM 262 CID Eng. (4.3L)



18-1238 INTAKE GASKET SET

Replaces: 27-824326
For: Mercruiser 4.3L/LX models, pre SN F802999



18-0411
OIL PAN GASKET SET
 Replaces: 27-90458A1,
 27-90458, FI5000178, FI5000183
 For: Mercruiser GM 350 CID (5.7L)
 Starboard Dipstick



18-0410
INTAKE MANIFOLD GASKET SET
 Replaces: 27-75648
 For: Ford 5.0L/302, 5.8L/351 CID Engine; (233HP) S/N 3108723 & UP



18-0868
INTAKE MANIFOLD GASKET SET
 Replaces: 27-17145, 27-72637, FI5000263, FI5000232, FI1101296
 For: Mercruiser 305, 350

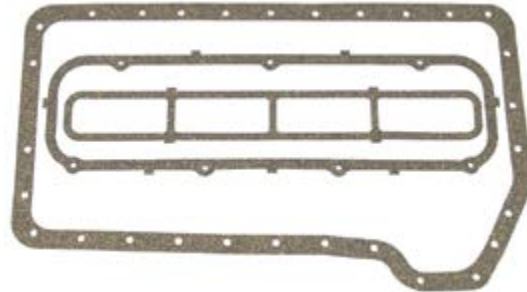

18-4366
OIL PAN GASKET SET
 Replaces: 27-72479A5, 27-72479T, 27-72479
 For: Mercruiser 224 CID (3.7L)



18-4375
TIMING CHAIN GASKET SET
 Replaces: 27-34213A2, 27-34213A1
 For: Mercruiser GM 153 & 181 CID Eng's; 110, 120, 130, 140, 150, 160 & 165 HP; 2.5L & 3.0L



18-4380
TIMING CHAIN GASKET SET
 Replaces: 27-68714A6, 27-68714A7, 27-68714, 27-72098
 For: Mercruiser 224 CID Eng.
 165, 170, 180, 190, 470, 485 & 488 HP

— CONTAINS —



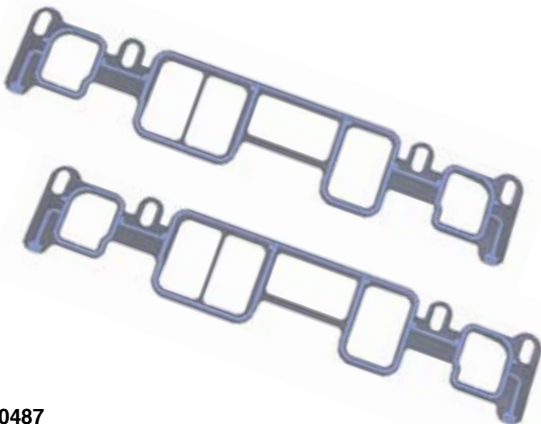







Part #	Description	O.E. #	Qty.
18-0889	Fuel Pump Mounting Gasket	27-34213	1
18-0887	Timing Cover Gasket	27-49953	1
18-0948	Distributor Gasket	27-87707	1
18-0327	Water Pump Gasket	27-33956	1



18-0487
INTAKE GASKET SET
 Replaces: 27-8243261, 27-824326002
 Fits: MCM 262 Mag & 4.3L/LX/LH/LXH Gen II (1996-up)



18-0488
INTAKE GASKET SET
 Replaces: 27-807473A1
 Fits: MCM 350 Mag, 5.0L & 5.7L/LX Gen II (1996-up)















 <p>18-2946 HEAD GASKET Superseded from 18-3880 Replaces: 27-52364, 27-81084, F15000204 For: GM 181 (3.0L) CID Eng.</p>	 <p>18-3874 HEAD GASKET Replaces: 27-811546, 27-879150139 For: (8.2L) 502 CID</p>	 <p>18-3876 HEAD GASKET Replaces: 27-75611, 27-75611001, 27-48330, 27-34278 For: GM 305 (5.0L)/350 (5.7L) CID Eng.</p>	
 <p>18-3877 HEAD GASKET Replaces: 27-13218, 27-13687, 27-19315, 27-49104, 27-61224, 27-97529, 27-8M0049045 For: GM 454 (7.4L) CID Eng., Mark IV (pre-1992)</p>	 <p>18-3878 HEAD GASKET Replaces: 27-13709, 27-13709T, 27-74264, 27-79986, 27-92166, 27-921661 For: Mercruiser 224 (3.7L) CID Eng. Model 470</p>	 <p>18-3879 HEAD GASKET Replaces: 27-11986, 27-816460, 27-879150140, 27-42744 For: GM 262 (4.3L) CID Eng.</p>	
 <p>18-3887 HEAD GASKET Replaces: 27-850470, 27-879150141, 27-811547 For: (7.4L) 454 CID GEN V and VI (1992-up)</p>	 <p>18-3881 HEAD GASKET Replaces: 27-47453, 27-72622, 27-39164, 27-34274 For: GM 250 (4.1L) CID (6 cyl) Eng.</p>	 <p>18-3883 HEAD GASKET Replaces: 27-75647, 27-75646, 27-64763, 27-56110 For: Ford 302 (5.0L) 351 (5.8L) CID Eng.</p>	
 <p>18-0353 CARB MOUNTING GASKET Replaces: 27-58764</p>	 <p>18-0354 CARB MOUNTING GASKET Replaces: 27-60715</p>	 <p>18-0685 VALVE COVER GASKET Replaces: 27-73666 224 CID (3.7L)</p>	
 <p>18-0356 CARB MOUNTING GASKET (For Rochester) Replaces: 27-64692, 27-32910</p>	 <p>18-0357 CARB MOUNTING GASKET Replaces: 27-65577, 27-56884</p>	<p>PKG. OF 2</p>  <p>18-0876 18-0876-9① FUEL PUMP GASKET For: GM 4.3L, 5.0L & 5.7L Replaces: 27-34898, F15005756</p>	<p>PKG. OF 2</p>  <p>18-0889 18-0889-9① FUEL PUMP GASKET For: GM 4.3L, 5.0L & 5.7L Replaces: 27-34213, 27-56883, F15000074</p>
<p>① Priced per Package</p>			

 <p>18-0360 CARB MOUNTING GASKET Replaces: 27-70142</p>	 <p>18-0462 CARB MOUNTING GASKET Replaces: 27-48399</p> <table border="1"> <thead> <tr> <th>Model</th> <th>Year</th> <th>S/N</th> </tr> </thead> <tbody> <tr> <td>250</td> <td>1968-69</td> <td>2314301-2639854</td> </tr> <tr> <td>270</td> <td>1969-72</td> <td>2851074-3385720</td> </tr> <tr> <td>325</td> <td>1969-70</td> <td>2278747-3042730</td> </tr> <tr> <td>390</td> <td>1969-70</td> <td>2781129-3042731</td> </tr> </tbody> </table>	Model	Year	S/N	250	1968-69	2314301-2639854	270	1969-72	2851074-3385720	325	1969-70	2278747-3042730	390	1969-70	2781129-3042731	 <p>18-0463 CARB MOUNTING GASKET (For Weber) Replaces: 27-814210</p>	 <p>18-0467 CARB MOUNTING GASKET (For Weber) Replaces: 27-41610, 27-49814</p>
Model	Year	S/N																
250	1968-69	2314301-2639854																
270	1969-72	2851074-3385720																
325	1969-70	2278747-3042730																
390	1969-70	2781129-3042731																
<p>PKG. OF 2</p>  <p>18-0994 18-0994-9① CARB MOUNTING GASKET Replaces: 27-701431, 27-8079821, 27-807982, 27-70143, 27-807982B, 27-70143B1</p>	<p>PKG. OF 2</p>  <p>18-2848 18-2848-9① CARB BASE GASKET Replaces: 27-524572, 18-52457, 18-524571</p>	<p>PKG. OF 2</p>  <p>18-0874 18-0874-9① DISTRIBUTOR GASKET For GM V6 & V8 Replaces: 27-344863, 27-344861, 27-34486, 27-52184, 27-34891, FI5000162, F3932344 For: 2.6L (1989), 3.5L (1989), 4.3L (1987-93), 5.0L (1987-88), 5.7L (1987-92), 7.4L (1988-93), 8.2L (1992-93)</p>	<p>PKG. OF 2</p>  <p>18-0948 18-0948-9① DISTRIBUTOR GASKET Replaces: 27-87707 4 Cyl.</p>															
 <p>18-0422 DISTRIBUTOR CAP GASKET Replaces: 391-5076 V8</p>	 <p>18-0740-1 THROTTLE BODY GASKET Replaces: 27-805396</p>	<p>PKG. OF 2</p>  <p>18-2552 18-2552-9① THERMOSTAT GASKET Replaces: 27-331792, 27-331791</p>	<p>PKG. OF 2</p>  <p>18-0667 18-0667-9① CONNECTOR COVER GASKET Replaces: 27-995061, 27-99506</p>															
<p>PKG. OF 2</p>  <p>18-2553 18-2553-9① THERMOSTAT GASKET Replaces: 27-47510, 27-47510Q GM V-6, V-8</p>	<p>PKG. OF 2</p>  <p>18-2554 18-2554-9① THERMOSTAT GASKET Replaces: 27-41812, 27-90556, 27-41812Q V-6 & V-8</p>	<p>PKG. OF 2</p>  <p>18-2555 18-2555-9① THERMOSTAT GASKET Replaces: 27-896561, 27-89656 4 Cyl.</p>	<p>PKG. OF 2</p>  <p>18-2831 18-2831-9① THERMOSTAT GASKET Replaces: 27-475901, 27-47590 4 & 6 Cyl.</p>															
<p>PKG. OF 2</p>  <p>18-2834 18-2834-9① THERMOSTAT GASKET Replaces: 27-60208 Ford V-8</p>	<p>PKG. OF 2</p>  <p>18-2843 18-2843-9① THERMOSTAT GASKET Replaces: 27-74830 470</p>	<p>PKG. OF 2</p>  <p>18-2844 18-2844-9① THERMOSTAT GASKET Replaces: 27-48818, 27-488181, 27-48818Q1 V-8</p>	<p>PKG. OF 2</p>  <p>18-2917 18-2917-9① THERMOSTAT GASKET Replaces: 27-53045, 27-530451, 27-33179, F10077105, FI1101276, FI1101291, FI5000096</p>															

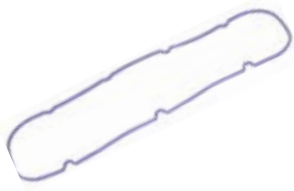



















① Priced per Package

<p>PKG. OF 2</p>  <p>18-0398 18-0398-9① THERMOSTAT GASKET Replaces: 27-8M2021920, 27-33918</p>	 <p>18-0113-1 EXHAUST ELBOW GASKET Replaces: 27-97542, 27-856705</p>	<p>PKG. OF 2</p>  <p>18-0672 18-0672-9① EXHAUST ELBOW GASKET Replaces: 27-860231, 27-8637251</p>	
 <p>18-0365 HEAT EXCHANGER END GASKET 2 3/4" dia. Replaces: 27-75450 224 CID</p>	 <p>18-0389 HEAT EXCHANGER END GASKET 3 15/16" dia. Replaces: 27-99960</p>	 <p>18-0881-1 EXHAUST ELBOW GASKET Replaces: 27-18272</p>	<p>PKG. OF 2</p>  <p>18-0885-1 18-0885-9① EXHAUST ELBOW GASKET Replaces: 27-48042</p>
 <p>18-0897 EXHAUST ELBOW GASKET Replaces: 27-41813</p>	<p>PKG.. OF 2</p>  <p>18-0928-1 18-0928-9① MANIFOLD END CAP GASKET Replaces: 27-73814, 27-738141, 27-807218</p>	 <p>18-0954 EXHAUST ELBOW GASKET Replaces: 27-92720</p>	<p>PKG. OF 2</p>  <p>18-2819-1 18-2819-9① EXHAUST ELBOW GASKET Replaces: 27-39915</p>
<p>PKG. OF 2</p>  <p>18-2832-1 18-2832-1-9① MANIFOLD END CAP GASKET Replaces: 27-480431, 27-48043</p>	<p>PKG. OF 2</p>  <p>18-2833 18-2833-9① EXHAUST ELBOW GASKET Replaces: 27-997772, 27-997771, 27-99777, 27-52076</p>	<p>PKG. OF 2</p>  <p>18-2849-1 18-2849-9-1① EXHAUST ELBOW GASKET Replaces: 27-87105, 27-871051, 27-860232, 27-818832, 27-863726</p>	<p>PKG. OF 2</p>  <p>18-1210-1 18-1210-1① END CAP GASKET Replaces: 27-39923</p>
 <p>18-0158 INTAKE MANIFOLD GASKET Replaces: 27-70905 For: 3.7L</p>	 <p>18-0183-1 EXHAUST MANIFOLD GASKET Replaces: 27-73866, 27-54566</p>	 <p>18-0418 EXHAUST MANIFOLD GASKET Replaces: 27-46820</p>	 <p>18-2830-1 EXHAUST MANIFOLD GASKET Inline 6 cyl. Replaces: 879036, 27-46401, 27-52584, 27-33121</p>

① Priced per Package

 <p>18-0680 EXHAUST MANIFOLD GASKET Replaces: 27-815528</p>	 <p>18-2896-1 EXHAUST MANIFOLD GASKET Replaces: 27-52546, 27-32816</p>	<p>PKG. OF 2</p>  <p>18-2909 18-2909-9① EXHAUST MANIFOLD GASKET Replaces: 27-99757</p>	 <p>18-2949 EXHAUST MANIFOLD GASKET Replaces: 27-33395 GM 5.0L & 5.7L</p>	 <p>18-2912-1 EXHAUST MANIFOLD GASKET Replaces: 27-53354</p>																									
 <p>18-0956-1 EXHAUST MANIFOLD GASKET Replaces: 27-68715</p>	<p>PKG. OF 2</p>  <p>18-1204-1 18-1204-1-9① EXHAUST MANIFOLD GASKET Replaces: 27-96429</p>	 <p>18-0664 VALVE COVER GASKET Replaces: 27-17467, FI1101287 For: GM 305/350, 5.0 & 5.7L</p>	 <p>18-2845 VALVE COVER GASKET Replaces: 27-11999, 27-34043, 27-52202, FI1101236, FI5000161 V-8 GM 305/350 CID, 5.0 & 5.7L</p>																										
 <p>18-25001 VALVE COVER GASKET Replaces: 27-14765, F3860315, FI1110294, FI1110958 Fits: GM 454, 7.4L</p>	 <p>18-25002 VALVE COVER GASKET Replaces: 27-811588 Fits: GM 454, 502, (1992-UP) Recessed Grooved Valve Cover</p>	 <p>18-0311 VALVE COVER GASKET Replaces: 27-11988 For: 4.3 Litre 262 CID</p>	 <p>18-0346 VALVE COVER GASKET Replaces: 27-49936, 27-34042 For: GM 250 CID (4.1L), 160/165/200 (6 cyl.)</p>																										
 <p>18-0347 VALVE COVER GASKET Replaces: 27-52145, 27-806452, 27-34041 For: GM 153 & 181 CID (2.5L & 3.0L)</p>	<p>PKG.. OF 2</p>  <p>18-0464-9① VALVE COVER GASKET Replaces: 27-49121, 27-91831 For: GM 454/502 CID (7.4L & 8.2L)</p> <table border="1"> <thead> <tr> <th>Model</th> <th>Year</th> <th>S/N</th> </tr> </thead> <tbody> <tr> <td>330</td> <td>1977-81</td> <td>4623115-6083144</td> </tr> <tr> <td>7.4 Bravo</td> <td>1988-91</td> <td>B771113-D603117</td> </tr> <tr> <td>454 Mag</td> <td>1986-92</td> <td>A631894-D805068</td> </tr> <tr> <td>370 TRS</td> <td>1978-87</td> <td>4179554-B714586</td> </tr> <tr> <td>400 TRS</td> <td>1980-86</td> <td>4179554-B457644</td> </tr> <tr> <td>400 TRS</td> <td>1983-86</td> <td>4179554-B485220</td> </tr> <tr> <td>460 TRS</td> <td>1983-86</td> <td>4179554-6181046</td> </tr> <tr> <td>502 Mag Bravo</td> <td>1990-92</td> <td>C878221-D824588</td> </tr> </tbody> </table>	Model	Year	S/N	330	1977-81	4623115-6083144	7.4 Bravo	1988-91	B771113-D603117	454 Mag	1986-92	A631894-D805068	370 TRS	1978-87	4179554-B714586	400 TRS	1980-86	4179554-B457644	400 TRS	1983-86	4179554-B485220	460 TRS	1983-86	4179554-6181046	502 Mag Bravo	1990-92	C878221-D824588	 <p>18-0352 VALVE COVER GASKET Replaces: 27-56173 For: Ford 302/351 CID (5.0L & 5.8L)</p>
Model	Year	S/N																											
330	1977-81	4623115-6083144																											
7.4 Bravo	1988-91	B771113-D603117																											
454 Mag	1986-92	A631894-D805068																											
370 TRS	1978-87	4179554-B714586																											
400 TRS	1980-86	4179554-B457644																											
400 TRS	1983-86	4179554-B485220																											
460 TRS	1983-86	4179554-6181046																											
502 Mag Bravo	1990-92	C878221-D824588																											
 <p>18-0468 TIMING COVER GASKET Replaces: 27-811572 GM 4.3L, 5.0L & 5.7L</p>	<p>PKG.. OF 2</p>  <p>18-0887 18-0887-9① TIMING COVER GASKET Replaces: 27-49953, 27-34216, FI5000201 4 & 6 Cyl.</p>	<p>PKG.. OF 2</p>  <p>18-0976 18-0976-9① TIMING CHAIN COVER GASKET Replaces: 27-14250, 27-34895, FI1101297</p>	 <p>18-0980 TIMING COVER GASKET Replaces: 27-54529, 27-49109, 110990, 1100990 GM 7.4L</p>																										

① Priced per Package

<p>PKG.. OF 2</p>  <p>18-0328 18-0328-9① PUSH ROD/LIFTER COVER GASKET Replaces: 27-34208 153 & 181 CID, 120/140 (4 Cyl.)</p>	 <p>18-0329 PUSH ROD/LIFTER COVER GASKET Replaces: 27-34209 For: 140/150/160/165 (6 cyl.)</p>	 <p>18-2815 PUSH ROD COVER GASKET Replaces: 27-814703, FI5000119, FI5000199 For: 3.0L</p>	<p>PKG. OF 2</p>  <p>18-0185 18-0185-9① REMOTE OIL SEAL Replaces: 27-91892</p>
 <p>18-1240 OUTDRIVE SEAL For Bravo Replaces: 12708</p>	<p>PKG. OF 5</p>  <p>18-2516 18-2516-9① BRAVO OUTDRIVE SEAL Replaces: 16755, 16755A1, 16755Q1</p>	<p>PKG. OF 2</p>  <p>18-2556 18-2556-9① DRIVE SHAFT HOUSING TO BELL HOUSING GASKET Replaces: 27-35996, A1</p>	 <p>18-2743 OUTDRIVE HOUSING GASKET Replaces: 27-94996, 27-949962, 27-94996A1, 27-94996A2, 27-94996Q2, 27-94996A3, 27-94996A20, 27-64818A2</p>
<p>PKG. OF 5</p>  <p>18-2820 18-2820-9① OUTDRIVE GASKET Replaces: 27-64818, Q4, 27-64818A20, 27-64818A4, 27-64818A1, 27-45821</p>	<p>PKG. OF 5</p>  <p>18-2840 18-2840-9① BELL HOUSING GASKET Replaces: 27-35982</p>	<p>PKG. OF 2</p>  <p>18-2847 18-2847-9① OUTDRIVE GASKET Replaces: 27-54014, 27-54014A1, 27-54014Q1, 27-54014T1 For: E, H, TR, TRS</p>	 <p>18-0386 WATER PUMP BODY GASKET Replaces: 27-94914, 27-72780</p>
<p>PKG. OF 2</p>  <p>18-0894 18-0894-9① WATER POCKET COVER GASKET Replaces: 27-55810, 27-55810 -1</p>	 <p>18-0916 WATER PUMP GASKET Replaces: 27-8052151, 27-805215, 27-94915, 27-72779</p>	<p>PKG. OF 2</p>  <p>18-0903 18-0903-9① WATER PUMP GASKET Replaces: 27-49110, FI1101000 454 CID</p>	 <p>18-0147 WATER PUMP GASKET For Ford V-8 Replaces: 27-56880</p>
 <p>18-0327 WATER PUMP GASKET Replaces: 27-33956, FI5000200, FI5000219 4 & 6 Cyl.</p>	<p>PKG. OF 2</p>  <p>18-0891 18-0891-9① WATER PUMP MOUNTING GASKET Replaces: 27-34897, 27-34896, FI5000077, FI5000078 For: GM 4.3L, 5.0L & 5.8L</p>	<p>PKG. OF 2</p>  <p>18-0893 18-0893-9① WATER PUMP BACK-IN PLATE GASKET Replaces: 27-35380 GM 4.3L, 5.0L & 5.7L</p>	<p>PKG. OF 2</p>  <p>18-2564-1 IMPELLER GASKET Alpha I - Generation 2 Replaces: 27-430331</p>

① Priced per Package

 <p>18-0950 IMPELLER HOUSING GASKET Replaces: 27-88046 224 CID</p>	<p>PKG. OF 2</p>  <p>18-2565 18-2565-9① IMPELLER GASKET Alpha I - Generation 2 Replaces: 27-430472</p>	<p>PKG. OF 2</p>  <p>18-2566 18-2566-9① IMPELLER GASKET Alpha I - Generation 2 Replaces: 27-817277</p>	<p>PKG. OF 2</p>  <p>18-2823 18-2823-9① LOWER WATER PUMP GASKET Replaces: 27-32769, 27-19553</p>
<p>PKG. OF 2</p>  <p>18-2824 18-2824-9① UPPER WATER PUMP GASKET Replaces: 27-32770, 27-19551</p>	<p>PKG. OF 2</p>  <p>18-2825 18-2825-9① WATER PUMP BASE GASKET Replaces: 27-32771</p>	<p>PKG. OF 2</p>  <p>18-2826 18-2826-9① WATER PUMP BASE GASKET Replaces: 27-856101, 27-856704, 27-85610</p>	<p>PKG. OF 2</p>  <p>18-2914 18-2914-9① WATER PUMP GASKET Replaces: 27-856081, 27-85608, 27-32433, 27-30603, 27-8M0090319</p>
<p>PKG. OF 2</p>  <p>18-2915 18-2915-9① WATER PUMP GASKET Replaces: 27-856091, 27-858524, 27-85609, 27-32434, 27-30604</p>	<p>PKG. OF 2</p>  <p>18-2919 18-2919-9① WATER PUMP GASKET Replaces: 27-426311, 27-42631</p>	<p>PKG. OF 2</p>  <p>18-0342 POWER TRIM HOSE CONNECTOR PLATE GASKET Replaces: 27-476441, 27-47644</p>	<p>PKG. OF 2</p>  <p>18-0388 POWER TRIM HOSE CONNECTOR GASKET Replaces: 27-988231, 27-98823</p>
<p>PKG. OF 2</p>  <p>18-0322 18-0322-9① REAR SEAL GASKET Replaces: 27-14241, 27-881715, F11101656 GM 5.0L & 5.7L</p>	<p>PKG. OF 2</p>  <p>18-0898 OIL PUMP MOUNTING GASKET Replaces: 27-56859 For: Ford Engines</p>	<p>PKG. OF 2</p>  <p>18-3289 DOUBLE LIP SEAL Replaces: 26-864319 For: Gen II Upper Housing</p>	<p>PKG. OF 2</p>  <p>18-2094 OIL SEAL Replaces: 26-36143, 26-88416 Fits: 120/140(1978-82), 165 (1978-81), 260 (1978-82), 470 (1978-82), 485 (1980-82), 898/228 (1978-82), Alpha I/Gen II (1991 & Up), Blackhawk (1994-95), Bravo III/III (1988-98), R/MR/Alpha One Sterndrive and Transom (1983-90)</p>
<p>PKG. OF 2</p>  <p>18-2944 18-2944-9① SEAL RING GASKET (Quad Ring) Replaces: 26-45577, 26-455771</p>	<p>PKG. OF 2</p>  <p>18-2945 18-2945-9① 18-29451-9① (PKG. OF 50) DRAIN SCREW GASKET Replaces: 12-20260, 12-19183, 12-191832, 12-191833, F50556, F8077, F8186 Used in most lower units and sea water pumps</p>	<p>PKG. OF 5</p>  <p>18-2948 18-2948-9① RUBBER WASHER Replaces: 12-492211, 12-49221, 12-23245</p>	<p>PKG. OF 5</p>  <p>18-2349 SHIFT SHAFT SLEEVE Replaces: 23-67370 For: Ratios 1.47, 1.62, 1.81 & 1.94. For: Gen II (1998 & up), (0L100040 & up) 1/4" Thick</p>

① Priced per Package

<p>PKG. OF 2</p>  <p>18-0905 18-0905-9^① OIL PAN DRAIN PLUG GASKET Replaces: 27-49955, 27-34502, 27-60721, 27-8M0077608</p>	<p>PKG. OF 2</p>  <p>18-4267 18-4267-9^① SHIFT SHAFT WASHER Replaces: 12-29395, 12-8M0042641</p>	<p>PKG. OF 3</p>  <p>18-0681 18-0681-9^① WASHER Replaces: 12-32834, 12-8M2001219, 12-93416, 12-934161</p>	<p>PKG. OF 5</p>  <p>18-0203 18-0203-9^① BELL HOUSING WASHER Replaces: 12-35935 All Mercuriser Stern drives 1963-1998</p>									
<p>PKG. OF 5</p>  <p>18-2316 18-2316-9^① SHIFT SHAFT WASHER Replaces: 12-77674, 12-25410 Used over 18-2349 sleeve For: Ratios 1.47, 1.62, 1.81 & 1.94 For: Gen II (1998 & up), (OL100040 & up) 1/8" Thick</p>	 <p>18-0318 WASHER Replaces: 12-815472</p>	<p>PKG. OF 5</p>  <p>18-2340 18-2340-9^① SHIFT SHAFT WASHER Replaces: 12-31266 For: #1R/MR (1/16" Thick)</p>	<p>PKG. OF 2</p>  <p>18-2343-9^① PINION NUT WASHER Replaces: 12-92721 For: MR/Alpha/Gen II</p>									
<div style="display: flex; align-items: center;">  <div style="text-align: center;"> <p>SCREWS</p> <table border="1"> <thead> <tr> <th>Part No.</th> <th>Description</th> <th>O.E. #</th> </tr> </thead> <tbody> <tr> <td>18-2361-9^①</td> <td>(PKG. OF 2) Lower Unit Mounting Screw</td> <td>10-805763, 10-853163 10-30206</td> </tr> <tr> <td>18-3197</td> <td>Water Pick-Up Insert Screw</td> <td>10-76156, 10-67373</td> </tr> </tbody> </table> </div> </div>			Part No.	Description	O.E. #	18-2361-9 ^①	(PKG. OF 2) Lower Unit Mounting Screw	10-805763, 10-853163 10-30206	18-3197	Water Pick-Up Insert Screw	10-76156, 10-67373	<p>PKG. OF 5</p>  <p>18-3721 18-3721-9^① NUT Replaces: 11-13439-1, 11-859116 For: MR/Alpha</p>
Part No.	Description	O.E. #										
18-2361-9 ^①	(PKG. OF 2) Lower Unit Mounting Screw	10-805763, 10-853163 10-30206										
18-3197	Water Pick-Up Insert Screw	10-76156, 10-67373										
 <p>18-3236 HOUSING ALIGNMENT BUSHING Replaces: 23-32632 For: #1R/MR/Alpha</p>	 <p>18-4272 WELCH PLUG O.D. 0.870" Replaces: 19-32652</p>	 <p>18-4273 WELCH PLUG O.D. 1.250" Replaces: 19-42682</p>	 <p>18-2140 ENGINE MOUNT BOLT KIT For: Mercuriser I</p>									
 <p>18-2141 ENGINE MOUNT BOLT KIT Replaces: 10-97934A1 For: R/MR/Alpha I/ Gen II/Bravo</p>	 <p>18-3728 LOCK NUT Replaces: 11-99298, 11-863332</p>	 <p>18-3729 MOTOR MOUNT BOLT 1/2" - 20 x 5 3/8" Replaces: 10-97934, 10-36289</p>	 <p>18-2193 REAR ENGINE MOUNT Replaces: 33149, 99297A1, 99297A2 For: 120/140 HP S/N 6229717 & UP; All 224 CID Blocks; All 898, 200, 228, 230, 260, 300 & 320 HP; All 350-454 Magnums</p>									

① Priced per Package

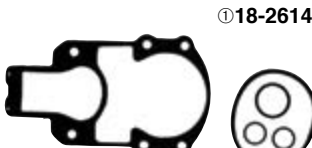

①18-2614D Display Package

**18-2614
OUTDRIVE GASKET SET**
1967-1982
Replaces: 27-64818A1, 27-64818T4, 27-64818Q4, 27-64818A20, 27-64818A4, 27-64818, 27-45821

—CONTAINS—

Part #	Description	O.E. #	Qty.
18-2820	Drive Shaft Housing to Bell Housing Gasket	27-64818	1
18-2840	Bell Housing Gasket	27-35982	1
18-7153	O-Ring	25-25439	2
18-7170	O-Ring	25-33504	1



**18-2615
OUTDRIVE GASKET SET**
(Bravo Unit)
Replaces: 16755, 16755A1, 16755Q1, 16755T1
For: All Bravo

—CONTAINS—

Part #	Description	O.E. #	Qty.
18-2516	Seal	16755	1
18-7198	O-Ring	25-45710	1
18-7153	O-Ring	25-25439	2
18-7168	O-Ring	25-48171	2
18-7105	O-Ring	25-62705	1
18-7117	O-Ring	25-35027	1

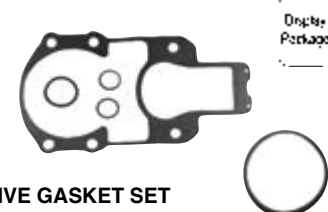

**18-2617
OUTDRIVE GASKET SET**
Old Style
Replaces: 27-35996, 27-35996A1
For: IA/IB/IC and EZ Shift (1964-1966)

—CONTAINS—

Part #	Description	O.E. #
18-2556	Drive Shaft Housing to Bell Housing Gasket	27-35996
18-2840	Bell Housing Gasket	27-35982
18-7153	O-Ring	25-25439
18-7170	O-Ring	25-33504



①18-2619-1D Display Package

**18-2619-1
OUTDRIVE GASKET SET**
Replaces: 27-64818A3, 27-94996Q2, 27-94996T2, 27-94996, 27-94996A1, 27-94996A2, 27-94996A20, 27-64818A2, 27-64818A3
For: R, MR, Alpha I, Alpha Gen II (1983-Newer)

—CONTAINS—

Part #	Description	O.E. #
18-2743	Drive Shaft Housing to Bell Housing Gasket	27-94996-2
18-2840	Bell Housing Gasket	27-35982
18-7153	O-Ring	25-25439
18-7170	O-Ring	25-33504
18-7117	O-Ring	25-35027



**18-2620
OUTDRIVE GASKET SET**
Replaces: 27-54014A1, 27-54014Q1, 27-54014T1, 27-54014
For: E, H, TR, TRS

—CONTAINS—

Part #	Description	O.E. No.
18-7175	O-Ring	25-62817
18-2847	Drive Shaft Housing to Bell Housing Gasket	27-54014

① Items ending in "D" are Display Packaged - Regular number is Non-Display

Stern Drive Model	Beginning Serial #	Ending Serial #	Bell Housing Gasket	Bell Housing O-Ring	Bell Housing RubberGasket	U-Joint O-Ring (2 Required)	Gasket Set
I	1534570	1684187	—	18-7170	—	18-7153	—
IA	1684188	2062140	18-2556	18-7170	18-2840	18-7153	18-2617
IB	1684633	2062140	18-2556	18-7170	18-2840	18-7153	18-2617
IC	1685240	2065189	18-2556	18-7170	18-2840	18-7153	18-2617
II TR	3377316	4794899	18-2847	18-7175	—	—	18-2620
120	2062141	6225576	18-2820	18-7170	18-2840	18-7153	18-2614
120	6225577	UP	18-2743	18-7170	18-2840	18-7153	18-2619-1
120	6225577	UP	18-2743 ③	18-7170	18-2840	18-7153	18-2619-1
140	2062141	6225576	18-2820	18-7170	18-2840	18-7153	18-2614
140	6225577	UP	18-2743	18-7170	18-2840	18-7153	18-2619-1
140	6225577	UP	18-2743 ③	18-7170	18-2840	18-7153	18-2619-1
160	2065190	2763441	18-2820	18-7170	18-2840	18-7153	18-2614
165	2763442	UP	18-2820	18-7170	18-2840	18-7153	18-2614
170	6225577	UP	18-2743	18-7170	18-2840	18-7153	18-2619-1
170	6225577	UP	18-2743 ③	18-7170	18-2840	18-7153	18-2619-1
185	6225577	UP	18-2743	18-7170	18-2840	18-7153	18-2619-1
185	6225577	UP	18-2743 ③	18-7170	18-2840	18-7153	18-2619-1
190	6225577	UP	18-2743	18-7170	18-2840	18-7153	18-2619-1
190	6225577	UP	18-2743 ③	18-7170	18-2840	18-7153	18-2619-1
200	6225577	UP	18-2743	18-7170	18-2840	18-7153	18-2619-1
200	6225577	UP	18-2743 ③	18-7170	18-2840	18-7153	18-2619-1
215 E/H	2782203	2915034	18-2847	18-7175	—	18-7153 □	18-2620
225	3856268	4200499	18-2820	18-7170	18-2840	18-7153	18-2614
228	4782330	6225576	18-2820	18-7170	18-2840	18-7153	18-2614
228	6225577	UP	18-2743	18-7170	18-2840	18-7153	18-2619-1
228	6225577	UP	18-2743 ③	18-7170	18-2840	18-7153	18-2619-1
230	6225577	UP	18-2743	18-7170	18-2840	18-7153	18-2619-1
230	6225577	UP	18-2743 ③	18-7170	18-2840	18-7153	18-2619-1
233	4200500	UP	18-2820	18-7170	18-2840	18-7153	18-2614

CHART CONTINUED ON NEXT PAGE

① Hydraulic Shift Only ② Borg Warner Transmission Only ③ For housing with oil reservoir check valve

Stern Drive Model	Beginning Serial #	Ending Serial #	Bell Housing Gasket	Bell Housing O-Ring	Bell Housing RubberGasket	U-Joint O-Ring (2 Required)	Gasket Set
250	4791300	4898729	18-2820	18-7170	18-2840	18-7153	18-2614
255 TRS	3377316	4203749	18-2847	18-7175	—	—	18-2620
260	4898730	6225576	18-2820	18-7170	18-2840	18-7153	18-2614
260	6225577	UP	18-2743	18-7170	18-2840	18-7153	18-2619-1
260	6225577	UP	18-2743 ③	18-7170	18-2840	18-7153	18-2619-1
280 TRS	4203750	4895399	18-2847	18-7175	—	—	18-2620
470	4208730	6225576	18-2820	18-7170	18-2840	18-7153	18-2614
470	6225577	UP	18-2743	18-7170	18-2840	18-7153	18-2619-1
470	6225577	UP	18-2743 ③	18-7170	18-2840	18-7153	18-2619-1
485	4893835	UP	18-2820	18-7170	18-2840	18-7153	18-2614
488	6225577	UP	18-2743	18-7170	18-2840	18-7153	18-2619-1
488	6225577	UP	18-2743 ③	18-7170	18-2840	18-7153	18-2619-1
888	3106717	UP	18-2820	18-7170	18-2840	18-7153	18-2614
898	4782330	6225576	18-2820	18-7170	18-2840	18-7153	18-2614
898	6225577	UP	18-2743	18-7170	18-2840	18-7153	18-2619-1
898	6225577	UP	18-2743 ③	18-7170	18-2840	18-7153	18-2619-1
R/MR/Alpha One	6225577	UP	18-2743	18-7170	18-2840	18-7153	18-2619-1
R/MR/Alpha One	6225577	up	18-2743 ③	18-7170	18-2840	18-7153	18-2619-1
Bravo (I/II)	B664190	UP	18-2516	—	—	18-7153	18-2615
TR-TRS	4794900	UP	18-2847	18-7175	18-2847	18-7153 □	18-2620

① Hydraulic Shift Only ② Borg Warner Transmission Only ③ For housing with oil reservoir check valve

**SIERRA PRODUCTS
ARE BACKED BY
AN INDUSTRY LEADING
LIMITED LIFETIME
WARRANTY.**



SIERRA 

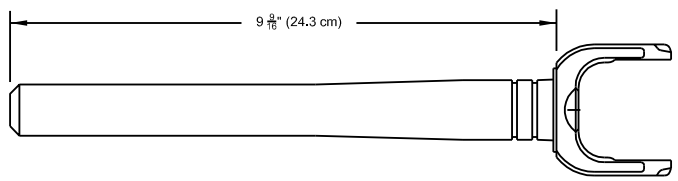
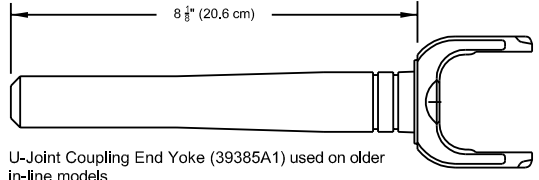
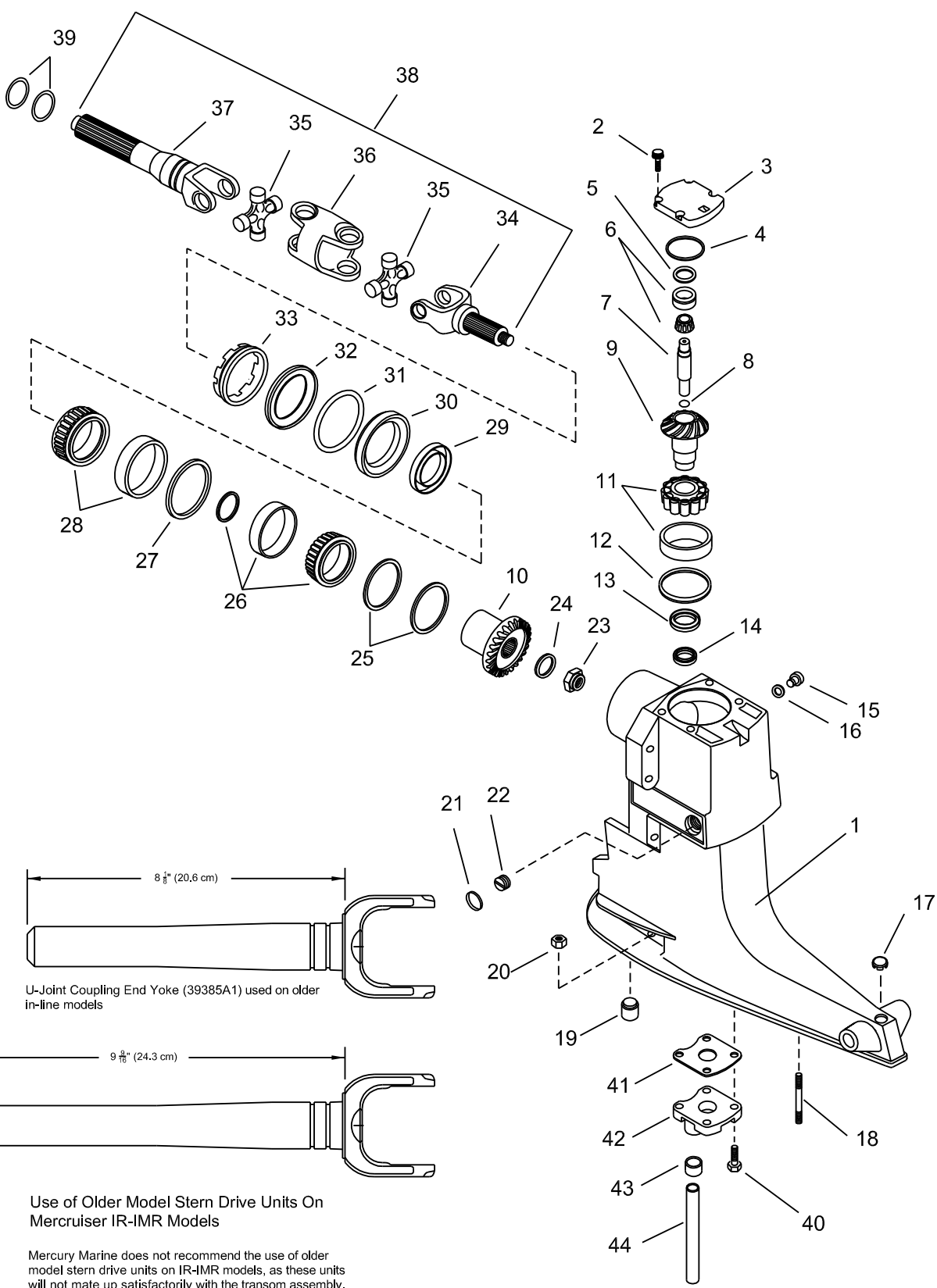

Use of Older Model Stern Drive Units On Mercruiser IR-IMR Models

Mercury Marine does not recommend the use of older model stern drive units on IR-IMR models, as these units will not mate up satisfactorily with the transom assembly. In addition, the older model in-line stern drive units are equipped with U-Joint coupling end yoke (39385A1). This yoke is shorter than yoke (59830A1) used on the IR-IMR stern drive units, and therefore, will not fully engage the engine coupler splines. **Use of an older In-Line model stern drive unit on a IR-IMR model will result in a spline failure to coupling and/or yoke.**

SEE PAGES 840-841 FOR COMPLETE REPLACEMENT HOUSINGS

Figure #	Description	Part #	OEM #	Qty.
1	Upper Gear Housing	N/A	1547-9412A18	1
2	Screw, Top Cover	N/A	10-98794	4
3	Top Cover	18-2381	94998A2	1
4	O-Ring, Top Cover	18-7161	25-32546	1
5	Shim, Bearing Cup to Top Cover	18-2283	15-45691A1	1
6	Tapered Roller Bearing	18-1165	31-61100A1	1
7	Upper Drive Shaft	N/A		1
8	O-Ring, Upper Drive Shaft	N/A	25-55801	1
9./10.	Upper Unit Gear Set	N/A		
	1.5:1	18-2201	43-18410A2, 46-18411A2	1
	Rebuild Kit	N/A	43-803116T1	1
	1.65:1	18-2203	43-45814A5	1
	Rebuild Kit	18-2257	43-803112T1	1
	1.84:1	18-2204	43-75325A3	1
	Rebuild Kit	N/A	43-803114T1	1
	1.98:1	18-2205	43-55778A3	1
	Rebuild Kit	N/A	43-803101T1	1
11	Tapered Roller Bearing	18-1161	31-35990A1	1
12	Shim Kit, Bearing Cup to Drive Shaft Housing	N/A	15-36178A1	1
13	Oil Seal, Upper Drive Shaft Housing	18-2049	26-32511	1
14	Oil Seal, Lower Drive Shaft Housing	18-2056	26-96503	1
15	Drain Screw	18-2244	10-79953A2	1
16	Drain Screw Gasket	18-2945	12-19183, 12-20260	1
17	Plug, Trim Tab Hole	18-3232	19-47579	1
18	Stud, Drive Shaft Housing	N/A	16-56295	2
19	Bushing, Drive Shaft Housing	18-3236	23-32632	1
20	Nut, Gear Housing Stud	18-2362	11-13439-1	3
21	Welch Plug, Drive Shaft Housing	N/A		
	(7/8" OD)	18-4272	19-32652	1
	(1 1/4" OD)	18-4273	19-42682	1
22	Pipe Plug, Water Pocket	18-4265	22-428611	1
23	Nut, Drive Gear to U-Joint	18-3713	11-22339	1
24	Washer, Drive Gear to U-Joint Nut	18-3712	12-45810	1
25	Shim Kit Drive Gear	18-2292	15-35980A1	1
26	Bearing Kit	N/A		
27	Spacer (comes with kit)	N/A		
28	Roller Bearing (comes with kit)	N/A		
29	Oil Seal	18-2003	26-64893	1
30	Carrier Assembly Oil Seal	18-0577	66081A2	1
31	O-Ring	18-7169	25-70937	1
32	Ring, Roller Bearing Retainer	18-4296	35983	1
33	Retaining Nut Drive Shaft Housing	18-3752	816811-1	1
34	Yoke Assembly	18-2125	46020T	1
35	Heavy Duty U-Joint	18-2104	75832A2	1
36	Center Socket	18-2128	39383T	1
37	U-Joint Shaft Coupler	18-2146	59830A1	1
38	Drive Shaft	18-9218	59830A5	1
39	O-Ring	18-7153	25-25439	2
40	Screw, Water Pocket Cover to Drive Shaft Housing	N/A	10-28668	4
41	Gasket, Water Pocket Cover	18-0894	27-55810	1
42	Water Pocket Cover (Sold as Assembly includes 40-44)	18-3219	42724A3	1
43	Bushing, Water Pump Housing	18-3110	26-38970	1
44	Water Tube	N/A	32-54236	1

AR As required

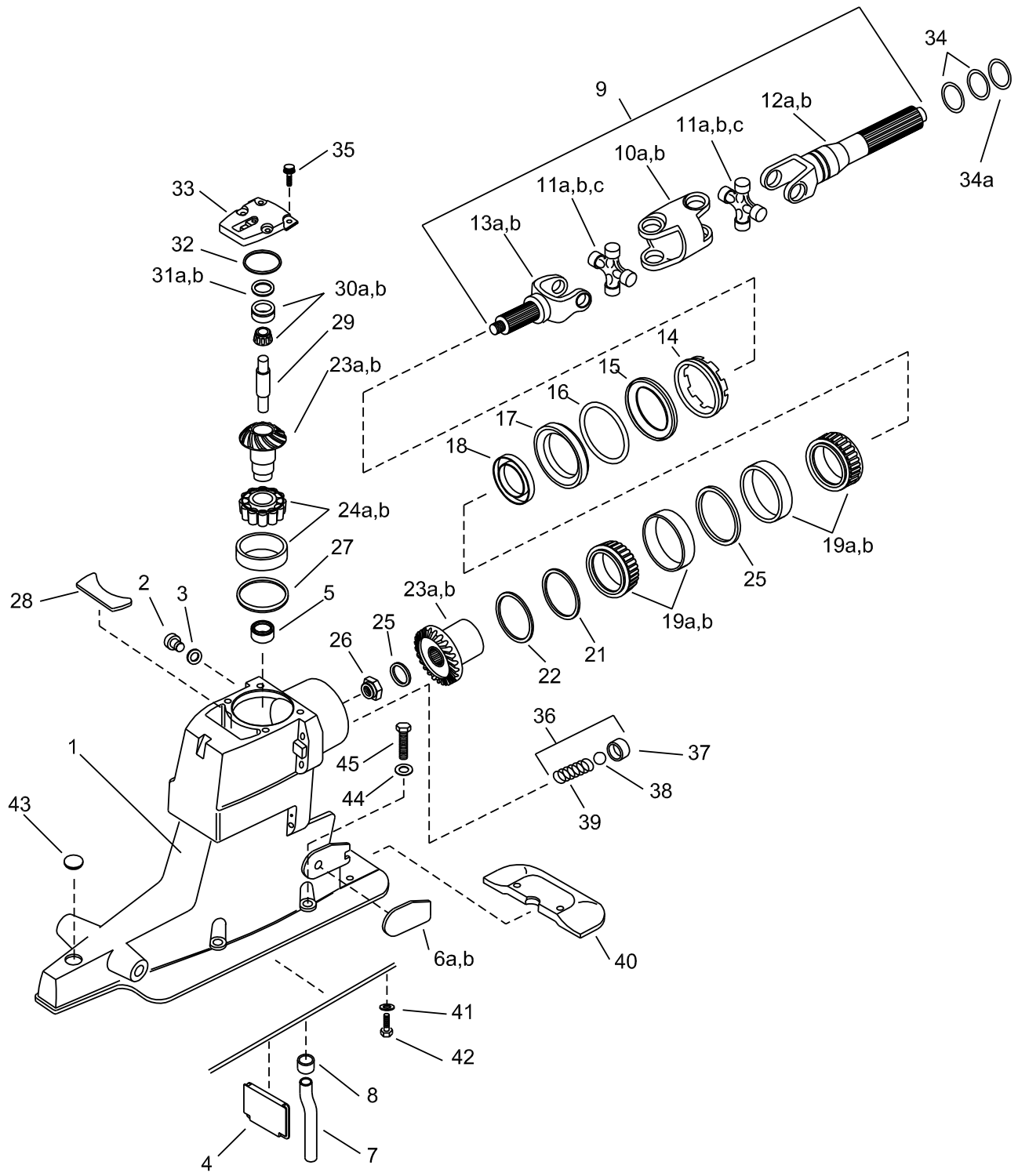

SEE PAGES 840-841 FOR COMPLETE REPLACEMENT HOUSINGS

Figure #	Description	Part #	OEM #	Qty.	Figure #	Description	Part #	OEM #	Qty.
1	Drive Shaft Housing (OL100009 & UP)	18-2411	1547-861063A 4	1		Complete Service Kit	NSS	43-803119T 1	1
2	Drain Screw	18-2244	10-79953A2	1		1.84:1/ 1.81:1 Gear Set (tooth count... 17/19)	18-2204	43-75325A3	1
3	Drain Screw Gasket	18-2945	12-19183, 12-20260	1		Std. Rebuild Kit	NSS	43-803114T 1	1
4	Filler Wall	N/A	815932	1		Complete Service Kit	NSS	43-803120 T 1	1
5	Oil Seal	18-2056	26-66302	AR		1.98:1/ 1.94:1 Gear Set (tooth count... 20/24)	18-2205	43-55778A3	1
6a	Wear Pad (Port)	NSS	814386	1		Std. Rebuild Kit	NSS	43-803101T 1	1
6b	Wear Pad (Stbd)	NSS	814387	1		Complete Service Kit	NSS	43-803118T 1	1
7	Water Tube	18-3221	32-860220	1	23a	Upper Unit Gear Set (OL100009 & UP)			
8	Seal	NSS	26-88397	1		1.47:1 Gear Set (tooth count... 20/22)	NSS	43-853641A2	1
9	Yoke Assembly (OK999999 & Below)	18-9218	814819A2	1		Complete Service Kit	NSS	43-803103T 1	1
	Yoke Assembly (OL100009 & UP)	NSS	864281A2	1		1.81:1 Gear Set (tooth count... 17/19)	18-6353	43-853643A2	1
10a	Socket, Center (old design)	18-2128	343831, 39383T	1		Complete Service Kit	NSS	43-803105T 1	1
10b	Socket, Center GKN Series	NSS	865503T	1		1.94 & 2.4:1 Gear Set (tooth count... 20/24)	18-6352	43-853642A2	1
11	Cross and Bearing					Complete Service Kit	NSS	43-803106T 1	1
11a	D469859 - F679999 (old design)	18-2174	75832A2	2	24	Roller Bearing (All but 1.47:1 ratio)	18-1161	43-803106T 1	1
11b	F680000 - OK999999 (old design- permalube)	18-2097	8055361, 805536A1, 805536A2	2	24a	Roller Bearing (1.47:1 Ratio only)	18-1142	31-32573A 1	1
11c	OL100009 & UP (GKN Series)	18-6406	865493A01	2	25	Washer	18-3712	12-45810	1
12a	Yoke, Coupling End (OK999999 & Below)	18-2146	59830A1	1	26	Nut	18-3713	11-22339	1
12b	Yoke, Coupling End (OL100009 & UP)	NSS	865491A01	1	27	Shim Kit	NSS	15-36178A1	1
13a	Yoke, Gear End (OK999999 & Below)	18-2125	46020T	1	28	Plug	NSS	861738	1
13b	Yoke, Gear End (OL100009 & UP)	NSS	865492T	1	29	Drive Shaft, Upper (F680000 & Up)	NSS	45-55796-1	1
14	Retaining Nut	18-3752	816811-1	1	30	Bearing Assembly			
15	Ring	18-4296	35983	1	30a	F680000 & UP (small bearing)	18-1179	31-32575A1	1
16	O-Ring	18-7169	25-70937	1	30b	D494569 - F679999 (large bearing)	18-1165	31-61100A1	1
17	Carrier Assembly (Set)	18-0577	66081A2	1	31	Shim Kit			
18	Oil Seal	18-2003	26-68493	1	31a	D494569 -F679999	18-2283	15-45691A1	1
19	Roller Bearing Kit (D469859 - K999999)	NSS	31-35988A2, A12	1	31b	F680000 & UP	18-2282	15-32563A1	1
19a	Roller Bearing Kit (OL100009 & UP)	18-1182	31-30894A 15	1	32	O-Ring	18-7161	25-32546	1
20	Cup Spacer (Included with 18-1160)	NSS	31-35988A2, A12	AR	33	Cover Assembly, Top (F680000 & Up)	18-2382	828692A1	1
20a	Cup Spacer (Included with 18-1182)	NSS	23-853649A 1	AR	34	O-Ring	18-7153	25-25439	2
21	Shim Kit	18-2292	15-35980A1	1	34a	O-Ring	18-7117	25-35027	1
22	Shim Spacer	18-2296	15-71013	1	35	Screw	NSS	10-98794	4
23	Upper Unit Gear Set (OD469859-OK999999)				36	Check Valve Kit, Oil Passage	18-2715 KIT	24-17997A1	1
	1.5:1/ 1.47:1 Gear Set (tooth count... 20/22)	18-2201	43-18410A2, 43-18411A2	1	37	Oil Seal (Included in Kit)	NSS	—	1
	Std.Rebuild Kit	NSS	43-803116T 1	1	38	Ball (Included in Kit)	NSS	—	1
	Complete Service Kit	NSS	43-803102T 1	1	39	Spring	NSS	—	1
	1.65:1/ 1.62:1 Gear Set (tooth count... 24/24)	18-2203	43-45814A5	1	40	Anode Plate	18-6080	821629A1	1
	Std. Rebuild Kit	18-2257	43-803112T 1	1	41	Lockwasher	N/A	13-78968	2
					42	Screw	NSS	10-28668	2
					43	Plug	N/A	19-824928	1
					44	Washer	18-4858-9	12-45176	4
					45	Bolt	NSS	10-816601	4
	AR As Required		NSS Not Sold Separate			N/A Not Available			

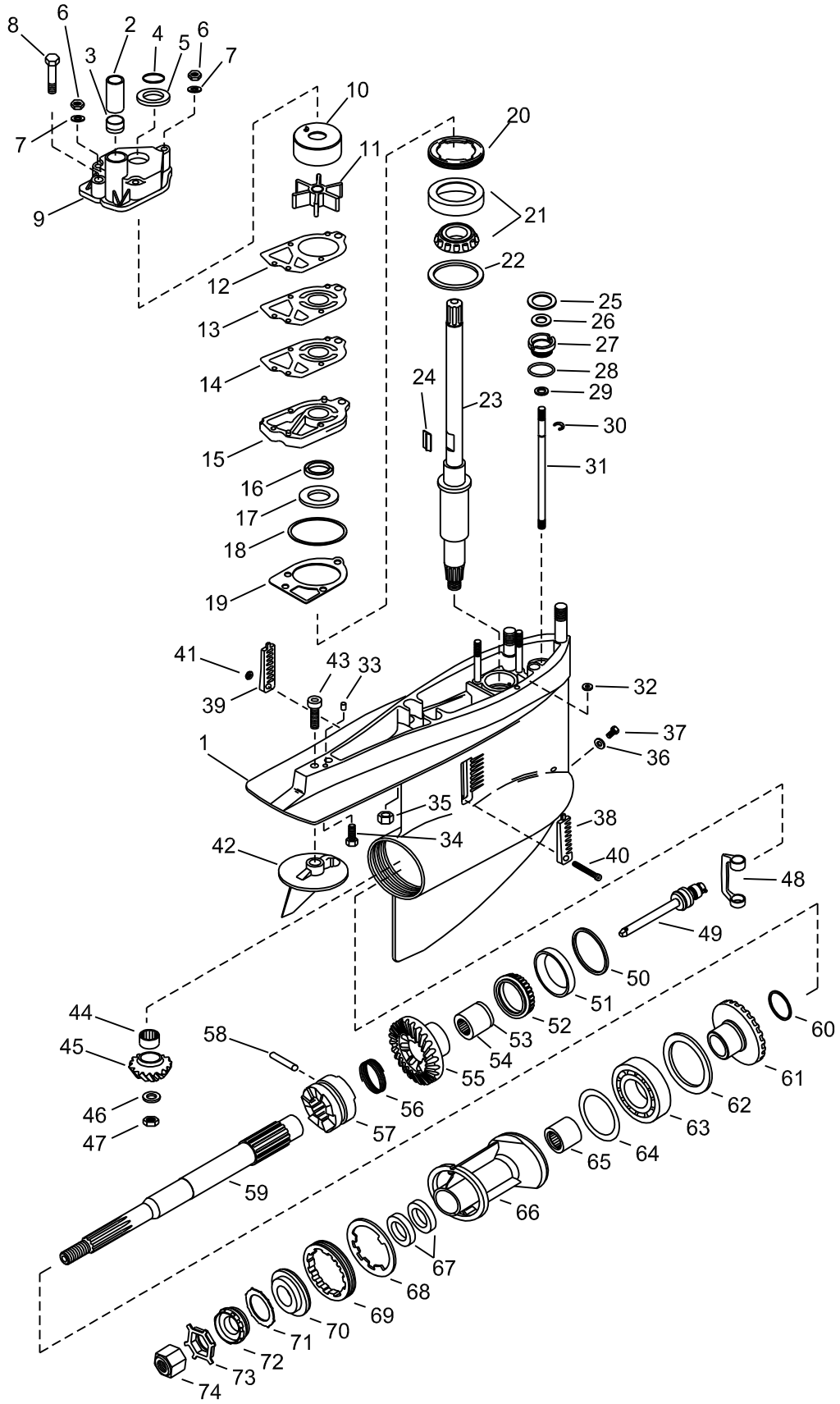

SEE PAGES 840-841 FOR COMPLETE REPLACEMENT HOUSINGS

Figure #	Description	Part #	OEM #	Qty.	Figure #	Description	Part #	OEM #	Qty.
1	Gear Housing	18-2401	1623-8951A37	1	39	Insert, Water Pick (Port)	118-3198	93424-1	1
2	Water Tube Guide	18-3109	23-29804	1	40	Screw, Insert to Gear Housing	18-3197	10-76156	1
3	Bushing/Water Pump Housing	18-3110	26-38970	1	41	Nut, Insert Screw	18-2344	11-45812	1
4	O-Ring, Upper Drive Shaft	18-7158	25-30613	1	42	Trim Tab	18-6011	31640A1	1
5	Slinger	18-7426	25-30271	1	43	Screw, Trim Tab Gear Housing	18-6245	10-32470	1
6	Stainless Steel Locknuts (5/16-24)	N/A	11-13436	1	44	Pinion Bearing	18-1117	31-42647A1	1
	Stainless Steel Locknuts (1/4-28)	N/A	11-13438	2	45	Lower Alpha Gear Set (pinion gear)	18-2206	43-17064A2, 43-17064A3, 43-42934	1
7	Washer	N/A	12-36001	3	46	Anti-Galling Washer Pinion Gear	18-2343-9	22-92721	1
8	Screw, Water Pump Body to Water Pump Base	N/A	10-96411	1	47	Pinion Nut	18-3719	11-35921	1
9	Upper Pump Housing	18-3116	46-96148A1	1	48	Shift Crank	18-2130	76865	1
10	Insert Cup	18-3114	48752	1	49	Shift Spool Assembly	18-2286	818349A1	1
11	Impeller	18-3017	47-89984	1	50	Shim Kit, Forward Gear	18-2285	15-47397A1	1
12	Gasket, Upper Water Pump to Wear Plate	18-2915	27-85609-1	1	51	Tapered Roller Bearing Set	18-1159	31-35928A1	1
13	Impeller Plate	18-3117	32435	1	52	Inner Bearing, Forward Gear	18-1157	31-30895	1
14	Gasket, Wear Plate to Water Pump Base	18-2914	27-85608-1	1	53	Retaining Clip, Inner Bearing	N/A	—	1
15	Water Pump Base	18-3420	46-44292A3	1	54		18-1157	31-30895	1
16	Oil Seal (upper)	18-2013	26-16977	1	55	Lower Alpha Gear Set (Forward Gear/Pinion)	18-2206	43-17064A2, 43-17064A3, 43-42934	1
17	Oil Seal (lower)	18-2014	26-89238	1	56	Spring, Retainer - Cross Pin	18-2348	24-30893	1
18	O-Ring, Water Pump	18-7176	25-90011	1	57	Sliding Clutch	18-2202	52-66063	1
19	Gasket, Water Pump Base to Gear Housing	18-2919	27-42631-1	1	58	Cross Pin, Clutch to Actuating Shaft	18-2357	24-30893	1
20	Retainer, Drive Shaft Bearing	18-2346	824519	1	59	Propeller Shaft	18-2166	44-66060, 44-6606-3	1
21	Tapered Roller Bearing Drive Shaft	18-1143	31-36387A1	1	60	Spacer, Reverse Gear	N/A	23-824108	1
22	Shim Kit, Lower Drive Shaft Bearing	18-2294	15-42637A1	1	61	Lower Alpha Gear Set (Reverse Gea-NSS)	18-2206	43-17064A2, 43-17064A3, 43-42934	1
23	Drive Shaft	18-2180	45-42634	1	62	Thrust Ring, Bearing Carrier	18-2342	68100-1	1
24	Drive Key Water Pump Impeller	N/A	28-56654	1	63	Ball Bearing	18-1155	30-88957A1	1
25	Shift Shaft Washer	18-4267	12-29395	1	64	O-Ring, Bearing Carrier	18-7159	25-31534	1
26	Washer Rubber Shift Shaft Bushing	18-2340	12-31266	1	65	Needle Roller Bearing	18-1158	31-30956	1
27	Shift Bushing	18-2154	23-30617A2	1	66	Bearing Carrier	18-2191	73020A-14	1
28	O-Ring, Shift Shaft Bushing	18-7153	25-25439	1	67	Oil Seals, Bearing Carrier	18-2002	26-76868	2
29	Washer, Lower Shift Shaft	NSS	12-27880	1	68	Tab Washer	18-2298	14-18323	1
30	Retaining Clip, Shift Shaft	NSS	53-29641	1	69	Spanner Nut	18-3751	79448	1
31	Stainless Steel Shift Shaft	18-2150	77481-1	1	70	Thrust Washer	18-4220	13171, 77987	1
32	Oil Passage Seal	18-2944	26-45577	1	71	Continuity Washer	N/A	13-423511	1
33	Dowel Pin, Gear Housing to Drive Shaft Housing	NSS	10-30720	2	72	Brass Castle Washer	18-3714	12-31211A2	1
34	Screw, Gear Housing to Drive Shaft Housing	NSS	10-30206	1	73	Tab Washer	18-3200	14-31210, 14-816629	1
35	Nut, Gear Housing to Drive Shaft Housing	18-2362	11-13439-1	2	74	Prop Nut	18-3700	11-52707	1
36	Drain Screw Gasket	18-2945	12-19183, 12-20260	1					
37	Drain Screw	18-2244	10-79953A2	1					
38	Insert, Water Pick (Stbd)	18-3199	93423-1	1					
		N/A	Not Available			NSS	Not Sold Separate		

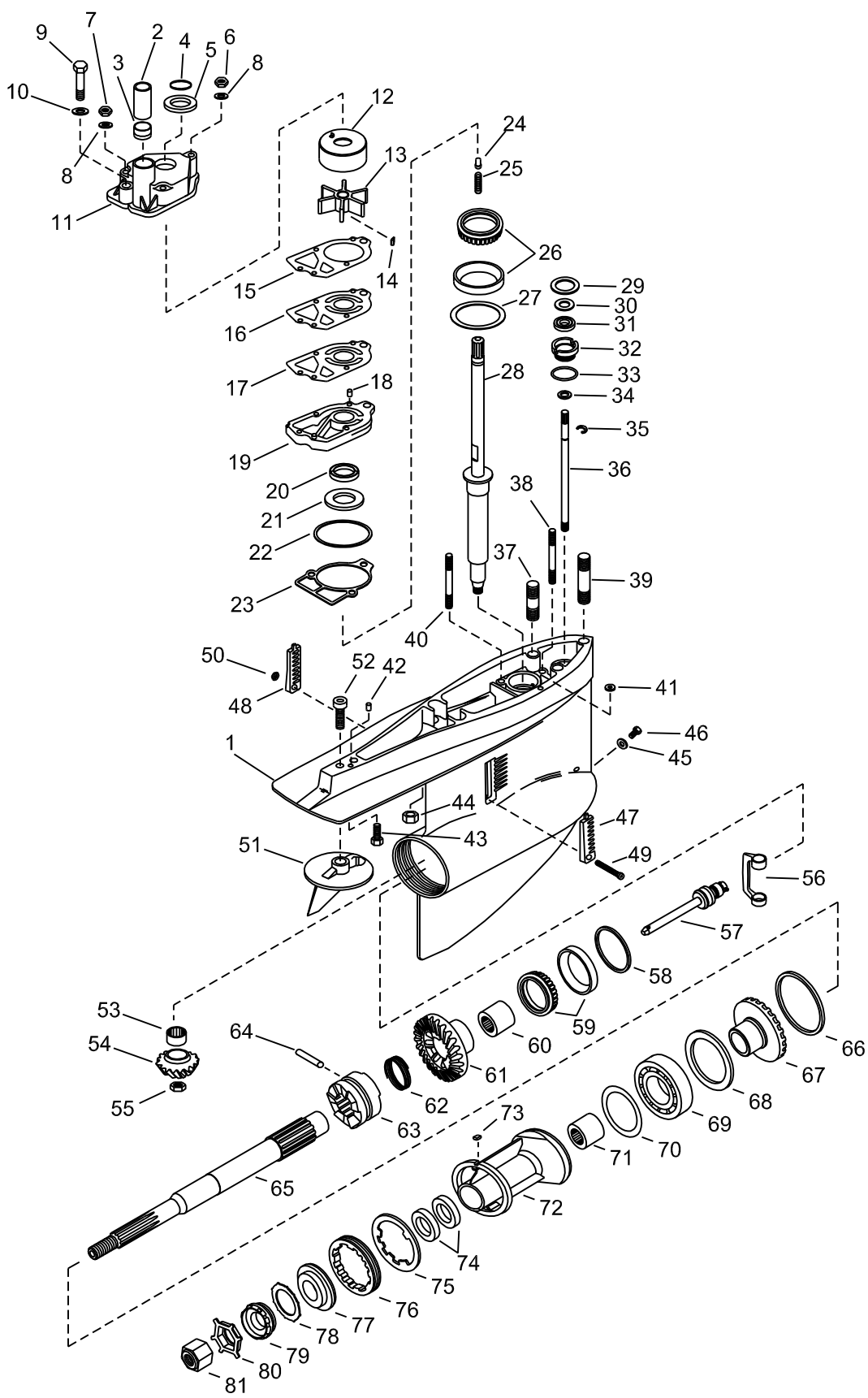

SEE PAGES 840-841 FOR COMPLETE REPLACEMENT HOUSINGS

Figure #	Description	Part #	OEM #	Qty.	Figure #	Description	Part #	OEM #	Qty.
1	Lower Gear Housing	N/A	1623-5356A4	1	42	Dowel Pin, Gear Housing to Drive Shaft Housing	N/A	17-35973	2
2	Water Tube Guide	18-3109	23-29804	1	43	Screw, Gear Housing to Drive Shaft Housing	N/A	10-30206	1
3	Bush Water Pump Housing	18-3110	26-38970	1	44	Nut Gear Housing to Drive Shaft Housing	N/A	11-82671015	2
4	O-Ring, Upper - Drive Shaft	18-7158	25-30613	1	45	Drain Screw Gasket	18-2945	12-19183, 12-20260	1
5	Slinger	18-7426	25-30271	1	46	Drain Screw	18-2244	10-79953A2	1
6	Stainless Steel Locknuts (5/16-24)	18-3723	11-45592	1	47	Insert, Water Pick (Stbd)	N/A	66885	1
7	Stainless Steel Locknuts (1/4-28)	18-3722	11-20361, 11-35888	2	48	Insert, Water Pick (Port)	N/A	66884	1
8	Washer	18-4275	12-29245	3	49	Screw Insert to Gear Housing	18-3197	10-76156	1
9	Screw	N/A	10-30720	1	50	Nut, Insert Screw	18-2344	11-45812	1
10	Washer, Water Pump Body	N/A	12-36001	1	51	Trim Tab	18-6011	31640A1	1
11	Upper Pump Housing	18-3116	46-96148A1	1	52	Screw, Trim Tab to Gear Housing	18-6245	10-32470	1
12	Insert Cup	18-3114	48752	1	53	Needle Roller Bearing	N/A	31-92366A1	1
13	Impeller	18-3017	47-89984	1	54	Lower Unit Gear Set (pinion gear)	18-2200	23-96084A4	1
14	Drive Key	N/A	28-56654	1	55	Pinion Nut	18-3719	11-35921	1
15	Gasket, Upper Water Pump to Wear Plate (upper)	18-2915	27-85609-1	1	56	Shift Crank	18-2130	76865	1
16	Impeller Plate	18-3117	32435	1	57	Shift Spool Assembly	19755A2	18-2286	1
17	Gasket, Upper Water Pump to Wear Plate (lower)	18-2914	27-85608-1	1	58	Shim Kit, Forward Gear Bearing	18-2285	15-47397A1	1
18	Dowel Pin	N/A	17-35973	2	59	Tapered Roller Bearing	18-1159	31-35928A1	1
19	Water Pump Base	18-3417	46-57234A1	1	60	Needle Roller Bearing	18-1157	31-30895	1
20	Oil Seal (upper)	18-2026	26-16977	1	61	Lower Unit Gear Set (Forward)	18-2200	23-96084A4	1
21	Oil Seal (lower)	18-2014	26-89238	1	62	Spring, Retainer, Cross Pin	18-2348	24-30893	1
22	O-Ring (2.175 ID) & (2.1091 ID)	18-7176, 18-7196	25-90011	1	63	Sliding Clutch	18-2202	52-66063	1
23	Gasket, Water Pump Base to Gear Housing	18-2826	27-85610-1	1	64	Cross Pin, Clutch to Clutch Actuating Shaft	18-2348	17-30632	1
24	Pin, Driveshaft	N/A	17-30545	1	65	Propeller Shaft	18-2166	44-66060, 44-66060-3	1
25	Spring	N/A	24-34576	1	66	Lower Unit Gear Set (reverse)	18-2200	43-96084A4	1
26	Tapered Roller Bearing	N/A	31-53079A1	1	67	Thrust Ring, Bearing Carrier	18-3759	35915	1
27	Shim Kit, Drive Shaft Bearing	18-2295	15-57007A	1	68	Ball Bearing	18-1155	30-88957A1	1
28	Drive Shaft	N/A	45-41939A1	1	69	O-Ring	18-7159	25-31534	1
29	Shift Shaft Washer	18-4267	12-29395	1	70	Needle Roller Bearing	18-1158	31-30956	1
30	Washer, Rubber Shift Shaft Bushing	18-2340	12-31266	1	71	Bearing Carrier Assembly	18-2191	73020A14	1
31	Oil Seal	26-89236	18-2009	1	72	Key, Locating - Bearing Carrier	N/A	28-30281	1
32	Shift Bushing	18-2154	23-30617A2	1	73	Oil Seals	18-2002	26-76868	2
33	O-Ring	18-7153	25-25439	1	74	Tab Washer	18-2299	14-79447	1
34	Washer, Lower Shift Shaft Bushing	N/A	12-27880	1	75	Spanner Nut	18-3751	79448	1
35	Retaining Clip, Shift Shaft	18-4295	53-29641	1	76	Thrust Washer	18-4220	13171, 77987	1
36	Stainless Steel Shift Shaft	18-2150	77481-1	1	77	Continuity Washer	NSS	13-423511	1
37	Stud, Gear Housing to Drive Shaft Housing (1-31/32")	N/A	16-56298	2	78	Brass Castle Washer	18-3714	12-31211A2	1
38	Stud, Water Pump to Gear Housing (3 - 3/8")	N/A	16-562972	1	79	Tab Washer	18-3200	14-31210, 14-816629	1
39	Stud, Gear Housing to Drive Shaft Housing (3 - 3/16")	N/A	16-46911	1	80	Prop Nut	18-3700	11-52707	1
40	Stud, Water Pump to Gear Housing (3 - 1/4")	N/A	16-69501	2					
41	Oil Passage Seal	18-2944	26-45577	1					

AR As required NSS Not Sold Seperate

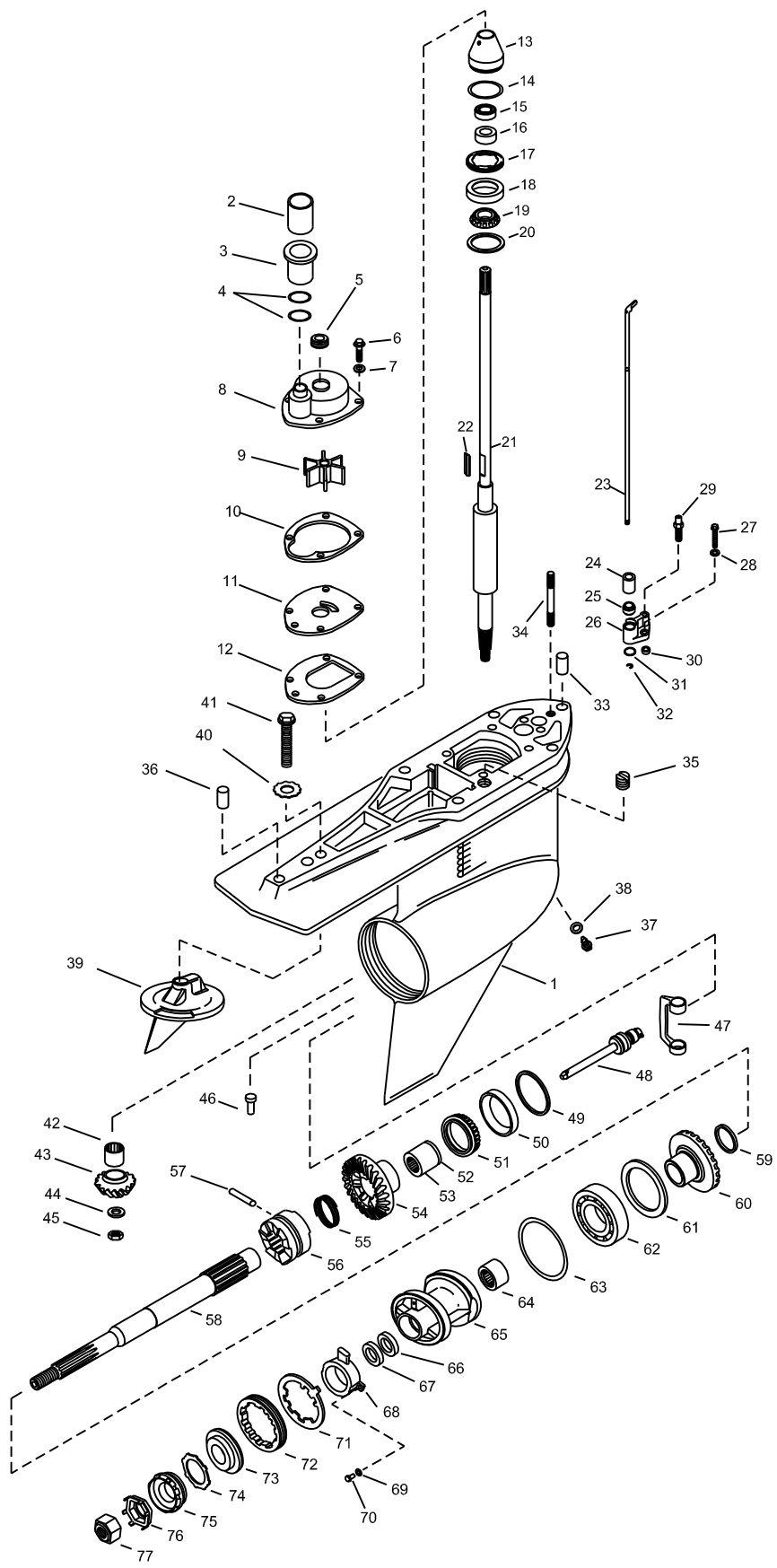

SEE PAGES 840-841 FOR COMPLETE REPLACEMENT HOUSINGS

Figure #	Description	Part #	OEM #	Qty.	Figure #	Description	Part #	OEM #	Qty.
1	Gear Housing	18-2415	1623-815822A36	1	44	Washer	18-2343-9	12-92721	1
2	Sleeve	—	23-816573	1	45	Nut	18-3719	11-35921	1
3	Coupling	18-3151	816597A1	1	46	Pin	—	17-37972-1	1
4	O-Rings	18-7420	25-21836	2	47	Shift Crank	18-2130	76865	1
5	Face Seal	18-2599	26-816575A2	1	48	Shift Spool Assembly	18-2286	818349A1	1
6	Screw, 10-32 X 5/8	NSS	10-816928	4	49	Shim Kit	18-2285	15-47397A1	1
7	Star Washer	NSS	13-69432	4	50 & 51	Forward Gear, Outer Bearing	18-1159	31-35928A1	1
8	Water Pump Body	18-3147	817275A1	1	52	Retaining Clip, Inner Bearing	NSS	—	1
9	Impeller	18-3056	47-43026-2	1	53	Forward Gear, Inner Bearing	18-1157	31-30895	1
10	Gasket	18-2563	27-817277	1	54	Forward Gear	18-2206	43-828072A2	1
11	Face Plate	18-3122	817276	1	55	Cross Pin Spring	18-2348	24-30893	1
12	Gasket	18-2564-1	27-43033-1	1	56	Sliding Clutch	18-2202	52-824112	1
13	Seal Carrier	18-2354	821759A2	1	57	Cross Pin	18-2357	17-30632	1
14	O-Ring	18-7176	25-90011	1	58	Propeller Shaft	18-2166	44-824110	1
15	Seal	18-2013	26-16977	1	59	Spacer	—	23-824108	1
16	Seal	18-2014	26-89238	1	60	Reverse Gear	18-2206	43-828072A2	1
17	Cover Nut	18-2346	824519	1	61	Thrust Ring	18-2342	681001	1
18 & 19	Bearing, Upper Driveshaft (1.50-1.65 Ratio)	18-1143	31-36387A1	1	62	Ball Bearing	18-1155	30-88957A1	1
20	Shim Kit	18-2294	15-42637A1	1	63	O-Ring	18-7159	25-31534	1
21	Drive Shaft (1:47 & 1:62)	NSS	45-853648	1	64	Roller Bearing	18-1158	31-30956	1
	Drive Shaft (1:50 & 1:65)	18-2261	45-816919	1	65	Bearing Carrier	18-2376	818763A10	1
	Drive Shaft (1:84 & 1:98) (Early Style use with 18-1143)	—	45-816472	1	66	Seal	18-2002	26-14077	1
22	Impeller Drive Key	18-3293	28-43037	1	67	Seal	18-2076	26-12224	1
23	Shift Shaft	18-2320	815919A1	1	68	Carrier Anode	18-6093	806105A1	1
24	Sleeve	18-2349	23-67370	1	69	Lockwasher, Anode Mounting	—	13-69432	2
25	Seal	18-2009	26-89236	1	70	Bolt, Anode Mounting	—	10-806290	2
26	Shift Rod Bushing Assembly	18-2353	23-815921A21	1	71	Tab Washer	18-2298	14-18323	1
27	Screw, 10-32 X 5/8	NSS	10-806290	2	72	Cover Nut	18-3751	79448	1
28	Star Washer	NSS	13-69432	2	73	Thrust Hub	18-4220	13171	1
29	Speedometer Pickup Fitting	—	NSS	1	74	Continuity Washer	NSS	13-42351-1	1
30	O-Ring	18-7440-1	25-36318	1	75	Splined Washer	18-3714	12-31211A2	1
31	O-Ring	18-7440-1	25-36318	1	76	Tab Washer	18-3200	14-31210	1
32	Retaining Ring	18-4295	53-29641	1	77	Propeller Nut	18-3700	11-52707	1
33	Dowel Pin	—	17-43044	1		Seal Kit (Not Pictured)	18-2646-1	26-816575A3	1
34	Stud, Mounting	—	16-57984	1					
35	Seal	18-2944	26-45577	1					
36	Dowel Pin	—	17-43044	1					
37	Plug	18-2375	22-67892A1	1					
38	Drain Screw Gasket	18-2945	12-19183	1					
39	Trim Tab	18-6016	76214A5	1					
40	Washer, Anode Mounting	—	13-806210	1					
41	Bolt, Anode Mounting	—	10-806327	1					
42	Pinion Bearing	18-1117	31-42647A1	1					
43	Pinion Gear	18-2206	43-828072A2	1					

NSS Not Sold Separate



18-2292
SHIM KIT
 Drive Gear
 Replaces: 15-35980A1
 Contains (1) each
 .002, .003, .005, .006, .010, .025
 For: Mercruiser Vazer



18-2294
SHIM KIT
 Lower Drive Shaft Bearing
 Replaces: 15-8M0063267, 15-42637A1
 Contains (1) each
 .002, .003, .005, .010, .020
 For: Mercruiser Vazer

SHIMS



18-2295
SHIM KIT
 Lower Drive Shaft Bearing
 Replaces: 15-57007A1, 15-33143A1
 Contains (1) each
 .002, .003, .005, .010, .020
 For: Mercruiser Vazer

Part No.	Size	O.E. #
18-0210	.210	23-1761516 ⑥
18-0214	.214	23-1761518 ⑥
18-0222	.222	23-1761522 ⑥
*18-2282	Kit	15-32563A1 • For: Mercruiser Vazer
*18-2283	Kit	15-45691A1
*18-2285	Kit	15-35931A1, 15-47397A1
*18-2296	.055	15-71013, 15-45811



- * 18-2282 (1) each .002, .003, .005, .010, .025
- * 18-2283 (1) each .002, .003, .005, .010
- * 18-2285 (1) each .002, .003, .005, .010, .020

SHIM KIT APPLICATION

HP	Serial No.	Bearing to Top Cover Kit	Bearing Cup to Drive Shaft Housing	Drive Gear	Drive Gear Spacer	Drive Shaft Bearing to Gear Housing	Reverse Gear	Forward Gear Kit
120/140	2062141 thru 2791956	18-2282 ②	N/A	18-2292	18-2296	18-2295	—	18-2285
120/140	2791957 thru 4893634	18-2283 ④	N/A	18-2292	18-2296	18-2295	—	18-2285
120/140	4893635 thru 6225576	18-2283	N/A	18-2292	18-2296	18-2295	—	18-2285
160	2065190 thru 2763441	18-2282 ②	N/A	18-2292	18-2296	18-2295	—	18-2285
165	2763442 thru 4890459	18-2283 ④	N/A	18-2292	18-2296	18-2295	—	18-2285
165	4890460 & UP	18-2283	N/A	18-2292	18-2296	18-2295	—	18-2285
888	3106717 & UP	18-2283 ③	N/A	18-2292	18-2296	18-2295	—	18-2285
898/228	4782330 thru 4898729	18-2283	N/A	18-2292	18-2296	18-2295	—	18-2285
898/228	4898730 thru 6225576	18-2283	N/A	18-2292	18-2296	18-2295	—	18-2285
225-S	3856268 thru 4200499	18-2283	N/A	18-2292	18-2296	18-2295	—	18-2285
233	4200500 & UP	18-2283	N/A	18-2292	18-2296	18-2295	—	18-2285
250	4791300 thru 4898729	18-2283	N/A	18-2292	18-2296	18-2295	—	18-2285
260	4898730 thru 6225576	18-2283	N/A	18-2292	18-2296	18-2295	—	18-2285
470	4208730 thru 4893934	18-2283	N/A	18-2292	18-2296	18-2295	—	18-2285
470	4893835 thru 6225576	18-2283	N/A	18-2292	18-2296	18-2295	—	18-2285
485	4893835 & UP	18-2283	N/A	18-2292	18-2296	18-2295	—	18-2285
R/MR/Alpha One	6225577 & UP (R)	18-2283	N/A	18-2292	18-2296	18-2295	—	18-2285
R/MR/Alpha One	6225577 & UP (MR)	18-2283	N/A	18-2292	18-2296	18-2294	—	18-2285
Alpha Gen II	D494569 thru F679999	18-2283	N/A	18-2292	18-2296	18-2294	—	18-2285
Alpha Gen II	F680000 & UP	18-2282	N/A	N/A	18-2292	18-2296	18-2294 ⑥	—

② S/N #2187468 & Below use 18-2293 ③ S/N #4433200 & UP Only ④ S/N #4530702 & UP Only ⑤ Kit ⑥ For Counter Rotation Only



18-2411
DRIVE SHAFT HOUSING ASSEMBLY
 Replaces: 1547-861063A4
 For: Gen II Upper (1998-up), 0L100040-up, 1.47:1 Ratio/Gen II Upper (1998-up) 0L100040-up, 1.62/2.00:1 Ratio's/Gen II Upper (1998-up), 0L100040-up, 1.81:1 Ratio/Gen II Upper (1998-up), 0L100040-up, 1.94/2.40:1 Ratios
 Used with: 18-2416, 18-2419 Complete Upper Gear Cases



18-2415
GEAR HOUSING ASSEMBLY
 Replaces: 1623-815822A36
 For: Ratios 1.47, 1.62 Gen II (1998 & up), (0L100040 & up)
 Used with: 18-2400 Complete Lower Gear Case



**18-2401
LOWER GEAR HOUSING**

Replaces: 1623-8951A27, 1623-8951A37, 1623-8951A5, 1623-8951A15
For: MR/ALPHA Style
 Bore size 3.2635-3.2650. Includes tapered roller bearing for non-tractor 14/28 or 17/28 gears. When installing new gears use 18-2206-1 gear kit which includes tapered roller bearing 18-1156 for tractor 13/21 gears.

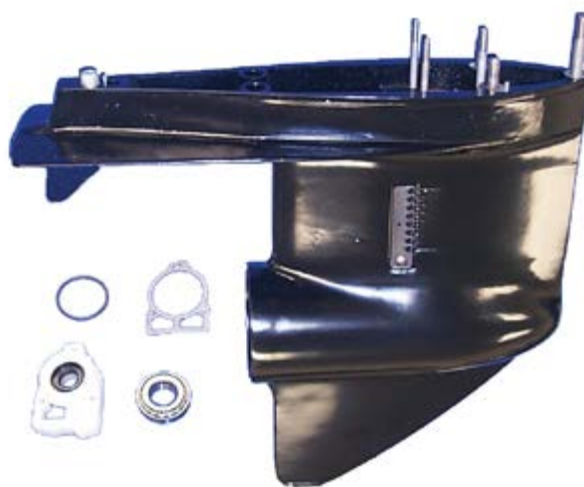

**18-2402
LOWER GEAR HOUSING**

Replaces: 1623-5356A4
For: R Style



**18-2364
UPPER UNIT
GEAR REPAIR KIT**

Replaces: 43-803119T1
For: 24-24 Teeth: 1.65:1 (1.62:1)
 Gen II applications serial number range up to OK999999 only



**18-2205
UPPER UNIT GEAR SET**

Replaces: 43-55778A3, 43-55766A2, 43-55766A3
(1.98:1 Ratio)
(Drive Gear = 20 teeth Driven Gear = 24 teeth)
For: 120/140 (S/N 2791957 & UP) and Gen II (S/N K999999 & BELOW)

**18-2201
UPPER UNIT GEAR SET**

Replaces: 43-18410A2, 43-18411A2, 43-59832A2, A4
Includes: (1) 18-1142
 Mercuriser #31-32573A1
(1.5:1 Ratio)
 (Drive Gear = 22 teeth Driven Gear = 20 teeth)
For: most V-8 Drives and Gen II (S/N K999999 & BELOW)

Stern Drive Model	Beg. S/N	End. S/N
225	3856268	4200499
260	4898730	6225576
898/228	4782330	6225576
Stern Drive Model	Beg. S/N	End. S/N
888	3106717	& UP
V8R/MR/AlphaOne	6225577	& UP



**18-2203
UPPER UNIT GEAR SET**

Replaces: 43-45814A5, 43-55765A2, 43-55765A3
**(1.65:1 Ratio) (Drive Gear = 24 teeth
 Driven Gear = 24 teeth)**
For: 6 Cyl. Inline S/N K999999 & BELOW



**18-2204
UPPER UNIT GEAR SET**

Replaces: 43-75325A3, 43-75325A2
(1.84:1 Ratio)
(Drive Gear = 17 teeth Driven Gear = 19 teeth)
For: V-6 and 470/485 (4 Cyl. etc.) and Gen II (S/N K999999 & BELOW)



**18-6352
UPPER UNIT GEAR SET**

Replaces: 43-85364A2
For: Alpha I (Gen II) (1998-up), 0L100040-up,
 1.94:1, 2.40:1 Ratios (20-24 Teeth)
For: Mercuriser Vazer
Used with: 18-2411 Drive Shaft Housing Assembly,
 18-2419 Complete Upper Gear Case



**18-6353
UPPER GEAR KIT**

Replaces: 43-85364A2
1.81 Ratio Upper Gear Set, 17-19 Teeth
For: Alpha I Gen II 1998-up/0L100040-up
For: Mercuriser Vazer



FIG. #1

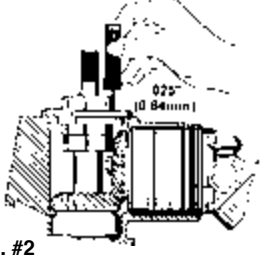

FIG. #2

FIGURES #1 - #2
Provides two separate views of the upper gear housing driven gear being properly shimmed using the Sierra installation tools.

FIGURES #3 - #4
Provides the same views of the drive gear being shimmed in the same application.

NOTE:
This installation **cannot** be performed correctly without the Sierra 18-9856 shim tool. Improper installation **will** result in gear failure. The .025 referenced in **FIG #2** & **FIG #4** is achieved when .026 will not fit the clearance but .025 will.

A service manual should always be consulted for step-by-step instructions.



FIG. #3

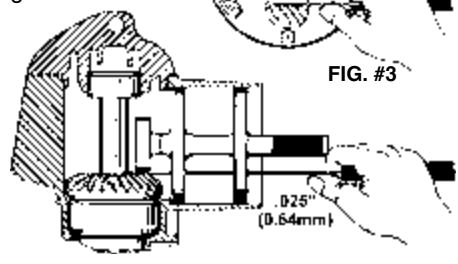

FIG. #4

**18-2257
UPPER GEAR KIT**

Replaces: 43-803112T1
6 Cyl. Inline (1.65:1 Ratio)

— CONTAINS —

Part #	Description	O.E. #	Qty.
18-2203	Gear Set	43-45814A5	1
18-2648	Seal Kit	26-32511A2	1
18-2619-1	Outdrive Gasket Set	27-94996A1	1
18-2820	Drive Shaft Housing to Bell Housing Gasket	27-64818	1
NSS	Bearing	31-35988A2	1
18-1161	Bearing	31-35990A1	1
18-1165	Bearing	31-61100A1	1
18-2743	Drive Shaft Housing to Bell Housing Gasket	27-94996-2	1



**18-2125
YOKE**
Replaces: 39384, 46020, 460201, 46020T, 4602002, 46020002
Fits all #1/ALPHA Units (S/N 1684188 - OK999999)



**18-2146
YOKE**
Replaces: 20175, 59830A1, 59830A7
Fits all #1, R, MR, Alpha I, Alpha I Gen II, Bravo & Blackhawk



**18-6400
YOKE**
Replaces: 12784, 12784T
For: Bravo (OM111207 & below) and Blackhawk



**18-6401
YOKE ASSEMBLY**
Replaces: 12784A10, 12784A4
For: Bravo I, II, III (OB664190 - up) (1998-05)



**18-9218
YOKE ASSEMBLY**
Replaces: 814819A2, 59830A5, 59829A1
For: all #1, R/MR/ALPHA Gen II OK999999 & Below (1971-97)



**18-2128
CENTER SOCKET**
Replaces: 39383, 39383T, 393831 (Rockwell)
Fits IA/IB/IC & EZ, MC-I, R, MR, Alpha One, Gen II (OL949778 & below), Bravo (OM111207 & below), MC II & TS



**18-1711
U-JOINT**
Replaces: 862132, 862132T
For: Bravo One, Two, & Three (All Ratios), Bravo One X/Two X, Three X (All Ratios), Bravo One XR/XZ(All Ratios), Bravo One XR Sportmaster (All Ratios) & Integrated Transom



**18-2097
U-JOINT**
Permalube
Replaces: 8055361, 805536A1, 805536A2
For: Generation II F680000 & UP



**18-2104
U-JOINT**
Heavy Duty
Replaces: 75832, 75832A2, 75832T, 758321, 75832A1, 75832A3, 58749, 41431, 36312
Includes both straight and 90° grease fitting.
Fits all #1 and ALPHA I Units S/N 1684188-B418818. Also TR/TRS and II SSM.



**18-2174
U-JOINT**
Heavy Duty
Replaces: 36312, 41431, 58749, 75832, 75832T, 75832A1, 75832A2, 75832A3, 758321, 75832T1
Includes both straight and 90° grease fitting.
Fits ALPHA I Units S/N B418819 & above. Also fits ALPHA I SS & BRAVO



**18-6406
U-JOINT ASSEMBLY**
Replaces: 865496A01, 865493A01, 865510T, 865496A01, 865511T
GKN new style with external clips.
Fits: Alpha I Gen II 0L949779 & UP, Bravo 0M111208 & UP
For: Mercruiser Vazer



**18-8311
GIMBAL HOUSING REBUILD KIT**
Fits: Alpha One



**18-8312
GIMBAL HOUSING REBUILD KIT**
Fits: Gen II



**18-8313
GIMBAL HOUSING REBUILD KIT**
Fits: Bravo



**18-21001
GIMBAL BEARING**
Replaces: 30-60794A2, 30-60794A4, 30-879194A02
Non Greasable
Fits: MC-1, R, MR and Alpha(1974-97), Gen II(1991-97), Bravo I/II/III (1988-95)



**18-21006
GIMBAL BEARING**
Non Greasable
Replaces: 30-862540T1, 30-862540A3, 30-862540A04, 30-879194A01
Fits: Gen II (1998-10), Bravo I/II/III & X/XR/ XZ (1996-10)



**18-21005
GIMBAL BEARING**
Replaces: 30-862540A3, 30-862540T1, 30-862540A04, 30-879194A01
Greasable
Fits: All Bravos, Alpha One Gen II (1998-up)



**18-21005K
SEAL & GIMBAL BEARING KIT**
Replaces: 30-862540A3, 30-862540T1, 30-862540A04, 30-879194A01
Greasable
Contains (1) each of 18-2094 & 18-21005
Fits: Gen II (1998-Up) and all Bravo



**18-2101
GIMBAL BEARING**
Replaces: 30-36418, 30-36056, 36147
Greasable
(Link-Belt)



**18-2100
HEAVY DUTY GIMBAL BEARING**
Replaces: 30-60794A4, 30-60794A2, 30-879194A02
Greasable
(Link Belt)
Fits: Mercruiser- 120HP / 140HP (2791957-6225576) (With Gimbal Trim Sender), 165HP (2763442 & Up), 225S (3856268-4200499), 228HP (4782330 & Up), 233HP (4200500 & Up), 250HP (4791300 & Up)



**18-2100K
SEAL & GIMBAL BEARING KIT**
Replaces: 30-60794A2, 30-60794A4, 30-879194A02
Greasable
Contains (1) each of 18-2094 & 18-2100
Fits: 1, R, MR and Alpha (1974-97)



**18-7313
SWIVEL GIMBAL RING SHAFT**
Replaces: 98230A1
Fits: Mercruiser Alpha/Gen II/Bravo I/II/III & Vazer



**18-1705
HINGE PIN**
Replaces: 77123, 77123A1, 65547
(with grease port)For gimbal housing
Fits: Alpha, Alpha Gen II S/N 0M815638 & Lower



**18-1706
HINGE PIN**
Replaces: 10-86801
For gimbal housing
Fits: Alpha Gen II S/N 0M85639 & UP
Bravo All Models with trim sender

GIMBAL BEARING APPLICATION

Model	Year Range	Serial No. Range	Gimbal Bearing	Model	Year Range	Serial No. Range	Gimbal Bearing
I	1963	1534570-1684187	30-32537T	250 / 260	1977-1982	1791300-6225576	18-21001
IA	1964	1684186-1777798	18-2101	R / MR / ALPHA I	1983-1990	6225577 & UP	18-21001
IB	1964	1684188-1777798	18-2101	ALPHA I SS	1986-1989	A545004 & UP	18-21001
IC	1964	1684188-1777798	18-2101	ALPHA I GEN II	1991-1997	D469859-K999999	18-21001
EZ-SHIFT	1964	1684188-1777798	18-2101	ALPHA I GEN II	1998-2010	L100040 & UP	18-21001
120 / 140	1967-1973	2062141-3780849	18-2101	BRAVO I	1988-1995	B664190-F729999	18-21001
120 / 140	1974-1982	3780850-6225576	18-21001	BRAVO II	1988-1995	B664190-F729999	18-21001
470 / 485	1976-1982	4208730-6225575	18-21001	BRAVO III	1988-1995	B664190-F729999	18-21001
160 / 165	1967-1973	2065190-3780849	18-2101	BRAVO I	1996-2010	F730000 & UP	18-21006
165	1974-1981	3780850 & UP	18-21001	BRAVO II	1996-2010	F730000 & UP	18-21006
888	1971-1973	3106717-3784374	18-2101	BRAVO III	1996-2010	F730000 & UP	18-21006
888	1974-1977	3784375 & UP	18-21001	X / XR / XZ	1996-2010	F730000 & UP	18-21006
225 / 233	1974	3856268 & UP	18-21001	BLACKHAWK	1994-1995	F186717 & UP	18-21001
898 / 228	1977-1982	4782330-6225576	18-21001	II	1964-1969	1602186-2671321	18-2101

 <p>18-2381 UPPER DRIVE UNIT CAP Replaces: 94998A1, 94998A2, 94998A3, 94998A4 S/N 6225577 & Later Alpha I, except Gen II</p>	 <p>18-2382 UPPER DRIVE UNIT CAP Replaces: 828692A1, 18312A3 For: Gen II S/N F680000 & UP</p>	 <p>18-3752 RETAINING NUT Replaces: 8168111, 8168112, 66071, 35992</p>	 <p>18-4296 SPACER RING Replaces: 35983 (Upper Housing)</p>
 <p>18-0577 CARRIER OIL SEAL ASSEMBLY Replaces: 66081A2, 35993A1, 66081A1, 66081A4</p>		 <p>18-2322 SHIFT SHAFT Replaces: 62104, 621041 For: I and Alpha I</p>	
 <p>18-2169 SHIFT ARM Replaces: 45589A1, 45589A3</p>	 <p>18-2599 FACE SEAL & TOOL Replaces: 26-816575A2 For: ALPHA I GENERATION II</p>	 <p>18-2622 BELL HOUSING BUSHING KIT Replaces: 23-79373A1, 23-805041A2, 27-45588, 27-79373</p>	
 <p>18-3760 BELL HOUSING BUSHING KIT Replaces: 23-806036A1 For: GEN II Serial # F680000 & UP</p>	 <p>18-3713 LOCK NUT Replaces: 11-22339, 11-97522, 11-36084, F1348, F1881 5/8" - 18</p>	 <p>18-3712 CARRIER NUT WASHER Replaces: 12-45810</p>	
 <p>18-2161 SHIFT ARM Replaces: 45518A1, 45518A2, 45518A3</p>	 <p>18-2170 SHIFT ARM SCREW Replaces: 10-45590, 10-8M0084649</p>	 <p>18-2162 SHIFT CABLE SLIDE & SCREW Replaces: 33981, 33981T, 33981T1, 8507521, 8507522</p>	

PKG. OF 5



18-2163
18-2163-9①
SHIFT SLIDE SCREW
 Replaces: Mercuriser 10-31700
 GLM: 21090
 Mallory: 9-72152

PKG. OF 5



18-2163E-9①
SHIFT SLIDE SCREW
 For: Extreme Cables Only



18-2715
CHECK VALVE KIT
 Replaces: 24-17997A1
 For: Alpha I Generation II and
 Bravo I, II, and III Drives



18-2724
TRANSOM SEAL
 Replaces: 3713
 For: Alpha Gen II, All Bravo

— CONTAINS —

Part #	Description	O.E. #	Qty.
18-2619-1	Outdrive Gasket Set	27-64818A3 27-94996A1,Q2	1
18-2100	Gimbal Bearing	30-60794A2, 30-60794A4	1
18-2161	Shift Arm	45518A2	1
18-2751	U-Joint Bellows	60932A4	1
18-2750	Exhaust Bellows	32734A3, 18654A1	1
18-2753-1	Shift Cable Bellows	74639	1
18-3601	Water Intake Hose	32-32461	1
18-3602	Water Intake Hose	32-41725-33	1
18-710-16-2	Hose Clamp	—	2
18-7314	Stainless Steel Hose Clamp	—	1
18-710-64-2	Stainless Steel Hose Clamp	—	1



18-2601-1
TRANSOM SEAL KIT
 Replaces: 30-803097T1
 R, MR, ALPHA 1 (1983-90) S/N 6225577 & UP
 ALPHA 1 SS (1986-89) S/N OA 545004 & UP
 *Greasable Gimbal Bearing

— CONTAINS —

Part #	Description	O.E. #	Qty.
18-2100	Gimbal Bearing	30-60794A4, 30-60794A2	1
18-2751	U-Joint Bellows	60932A4	1
18-2760	Exhaust Tube	78458A1	1
18-3601	Water Intake Hose	32-32461	1
18-3602	Water Intake Hose	32-41725-33	1
18-2743	Drive Shaft Housing to Bell Housing Gasket	27-94996-2	1
18-2840	Bell Housing Gasket	27-35982	1
18-7153	O-Ring	25-25439	1
18-7117	O-Ring	25-35027	1
18-710-16-2	Hose Clamp	—	2
18-7170	O-Ring	25-33504	1
18-710-24-2	Hose Clamp	—	1
18-2753-1	Shift Cable Bellows	74639	1
18-7321	Bellows Clamp	54-38863	1



18-8205
TRANSOM SEAL KIT
 Replaces: 30-803098T1
 For: 1, R, MR, Alpha 1 with exhaust tube
 *Greasable Gimbal Bearing

— CONTAINS —

Part #	Description	O.E. #	Qty.
18-3602	Water Intake Hose	32-41725-33	1
18-710-16-2	Hose Clamp	—	2
18-710-24-2	Hose Clamp	—	1
18-2753-1	Shift Cable Bellows	74639	1
18-7321	Bellows Clamp	54-38863	1
18-2100	Gimbal Bearing	30-60794A4, 30-60794A2	1
18-2743	Drive Shaft Housing to Bell Housing Gasket	27-94996-2	1
18-2840	Bell Housing Gasket	27-35982	1
18-7153	O-Ring	25-25439	1
18-7170	O-Ring	25-33504	1
18-7117	O-Ring	25-35027	1
18-2750	Exhaust Bellows	18654A1, 32734A3	1
18-2747	Drive Bellows	816431A1	1



18-8206-1
TRANSOM SEAL KIT
 Replaces: 30-803099T1
 For: Alpha 1 Gen II
 *Greasable Gimbal Bearing













— CONTAINS —

Part #	Description	O.E. #	Qty.
18-2753-1	Shift Cable Bellow	74639	1
18-2100	Gimbal Bearing	30-862540A3	1
18-2756	U-Joint Bellows	86840A3	1
18-2750	Exhaust Bellows	32734A3	1
18-2760	Exhaust Tube	78458A1	1
18-3603	Water Hose	32-43437	1
18-2615	Outdrive Mounting Kit	16755A1	1



18-8212-1
TRANSOM SEAL KIT
 Replaces: 30-803100T1, 8M0095485
 For: All Bravos 1982 & up
 *Greasable Gimbal Bearing

① Priced per Package

 <p>18-8213 TRANSOM SEAL KIT Replaces: 30-803097T1 For: R, MR, Alpha 1 (1983-90) S/N 6225577-0D469858; Alpha 1 SS (1986-89) S/N 0A545004 & Up *Sealed Gimbal Bearing 18-21001</p>	 <p>18-8217 TRANSOM SEAL KIT Replaces: 30-803098T1 For: R, MR, Alpha 1 (1983-90) w/exhaust tube S/N 6225577-0D469858; Alpha 1 SS (1986-89) w/exhaust tube S/N 0A545004 & Up *Sealed Gimbal Bearing 18-21001</p>	 <p>18-8218 TRANSOM SEAL KIT Replaces: 30-803099T1 For: Alpha 1 Gen II (1991 & Up) S/N 0D469859 & Up *Sealed Gimbal Bearing 18-21006</p>	 <p>18-8219 TRANSOM SEAL KIT Replaces: 30-803100T1 For: Bravo I/II/III (1988 & Up) S/N 0B664190 & Up; Blackhawk (1994-95) S/N 0F186717 & Up *Sealed Gimbal Bearing 18-21006</p>
 <p>18-2747 U-JOINT BELLOWS Alpha 1, Gen II Replaces: 816431A1</p>	 <p>18-2750 EXHAUST BELLOWS All #1 Units, Gen II, TRS, & Bravo I, II, III Replaces: 32734, 32734A3, 18654A1 (Includes 18-710-48-2 Clamp)</p>	 <p>18-2751 U-JOINT BELLOWS All #1 units with ridge (S/N 3469428 & UP) Replaces: 60932A1, 60932A4 (Includes 18-710-72-2 Clamp)</p>	 <p>18-2752 U-JOINT BELLOWS All #1 units without ridge (S/N 3443920 & BELOW) Replaces: 36223, 36223A1, 36223A2 (Includes 18-710-72-2 Clamp)</p>
 <p>18-2753-2 SHIFT CABLE BELLOWS All #1, #2 units, Alpha, Bravo I, II, III Replaces: 31659, 74639, 74639A2 (Includes 18-7321 Clamp)</p>	 <p>18-2756 U-JOINT BELLOWS Replaces: 86840A3, 86840A05, 8M0062406 Fits: All Bravo and Blackhawk models</p>	 <p>18-1710 BELLOW FLANGE RING Replaces: 862209, 86814 Fits: All Bravo</p>	 <p>18-1728 BELLOW FLANGE RING Replaces: 816607 Fits: Alpha One (GenII) (1991 and Up)</p>
 <p>18-2746 EXHAUST BOOT Replaces: 32-14358, 32-14358T, 31-14358001 (4" Lower Tube)</p>	 <p>18-2748 EXHAUST BOOT Replaces: 32-44348, 32-44348T, 31-44348001 (4" Upper Tube)</p>	 <p>18-2759 EXHAUST TUBE Replaces: 53114, 53114A1</p>	 <p>18-2760 EXHAUST TUBE Replaces: 78458, 78458A1 (Includes 18-7314 Clamp) For: #1, Bravo I, II, III</p>
 <p>18-2761 EXHAUST TUBE 3" I.D. Replaces: 32-90949, 32-90949T</p>	 <p>18-2762 EXHAUST TUBE Replaces: 70981, 70981A3</p>	 <p>18-2770 EXHAUST TUBE Replaces: 32-807458T</p>	

① Items ending in "D" are Display Packaged - Regular number is Non-Display

BELLOWS APPLICATION

Model	Years	Serial #	Exhaust Bellows	Shift Cable Bellows	U-Joint
I/1A/1B/1C & EZ	1963-1966	1534570-2065186	18-2750	18-2753-2	18-2752
120/140/160/165	1967-1972	2062141-3443920	18-2750	18-2753-2	18-2752
120/140/160/165	1972-1982	3469428-6225576	18-2750	18-2753-2	18-2751
888	1971-1972	3106717-3472477	18-2750	18-2753-2	18-2752
888	1973-1977	3472478 & Up	18-2750	18-2753-2	18-2751
225/233	1974-1977	3856268 & Up	18-2750	18-2753-2	18-2751
898/228/250/260	1977-1982	4782330-6225576	18-2750	18-2753-2	18-2751
R/MR/Alpha One	1983-1990	6225577 & Up	18-2750	18-2753-2	18-2751
R/MR/Alpha One	1983-1990	6225577 & Up	18-2760 ②	18-2753-2	18-2751
Alpha One Gen II	1991 & Newer	0D469859 & Up	18-2750	18-2753-2	18-2747
Bravo I/II/III	1988 & Newer	0B664190 & Up	18-2750	18-2753-2	18-2756
Bravo I/II/III	1988 & Newer	0B664190 & Up	18-2760 ②	18-2753-2	18-2756
Blackhawk	1994-1995	0F18677 & Up	18-2750	18-2753-2	18-2756
Blackhawk	1994-1995	0F18677 & Up	18-2760 ②	18-2753-2	18-2756
II	1962-1969	1474909-2671321	—	18-2753-2	—
215H	1970	2782203-2909034	—	—	18-2752
215E	1970-1972	2909035-2915034	—	18-2753-2	18-2752
TR/TRS	1973-1993	3377316 & Up	—	—	18-2751

② Tube

PKG. OF 5



18-7321
18-7321-9②
BELLOWS CLAMP
Replaces: 54-38863, 54-866507, 54-8M0090424

18-2159 INNER SHIFT CABLE

Replaces: 19543A2, 19543A4, 19543A8, 19543A10, 41951A1, 66065A1, 66069A2, 73679A2, 865436A02
Use in 18-2157, 18-2158 and their Mercruiser equivalent as replacement wire and tube
Stranded Core 73"



18-2189
Replaces: 32992A1, 34086A1, 37611A1, 38399A2
Use with 18-2248
Inner Core Wire 59"

18-2160
SHIFT CABLE
SUPPORT TUBE

Replaces: 32-38377
Replaces tube on 18-2157, 18-2158 & 18-2159



18-2248
SHIFT CABLE
ASSEMBLY

Replaces: 73723A1, 73723A01, 49518A1, 35187A1, 35187A2, 35187A4
Mercruiser #1 Drives S/N 1562900-6225576 for forward installation into bell housing.
Has new style armored strand construction. (No support tube) 54" conduit with hardware package.



18-2157

Replaces: 19543A2, 41951A1, 19543A8, 19543A10, 19543A4, 66065A1, 66069A2, 73679A2, 865436A02
Mercruiser 1 drives S/N 6225577 & UP For AFT installation into bell housing. Has old style stranded core wire with soldered tip (Uses Support Tube).



18-2158
Mercruiser #1 Drives S/N 1562900-6225576 for forward installation into bell housing. Has old style stranded core wire with soldered tip. (Uses support tube **18-2160**) 63" conduit

SHIFT CABLE ASSEMBLY

18-2190
SHIFT CABLE

Replaces: 19543A2, 19543A4, 19543A8, 19543A10, 41951A1, 66065A1, 66069A2, 73679A2, 865436A02
Mercruiser 1 drives S/N 6225577 & UP
For AFT installation into bell housing. For use in applications using core wire with armored strand construction (No Support Tube). 63" Conduit with hardware package.



18-2190E
SHIFT CABLE

Replaces: 19543A4, 19543A10, 19543A8, 19543A2, 41951A1, 66065A1, 66069A2, 73679A2, 865436A02
S/N 6225577 & UP. For AFT installation into bell housing. For use in applications using core wire with armored strand construction (No Support Tube). 63" Conduit with hardware package. Lower Shift Cable- Alpha One (Gen II) (1991-97)
Requires **18-9806E** (Xtreme Shift Cable Tool) to complete installation



18-2145
SHIFT CABLE

Replaces: 815471A3, 815471A6, 85147A5, 865437A02, 43432A2, 19297A3

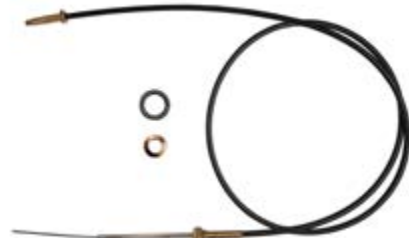



**18-2145E
SHIFT CABLE**

Replaces: 815471, A3, A6
Bravo One, Two, & Three (All Ratios), Bravo One X/Two X, Three X (All Ratios), Bravo One XR/XZ (All Ratios), Bravo One XR Sportmaster (All Ratios) & Integrated Transom



**18-9806E
SHIFT CABLE TOOL**

Installs and removes shift cables on MC-I, R-MR, Alpha I, Alpha I Gen II drive units. Use with 18-2190 and 18-2190E cables.



**18-2149
SHIFT CABLE GUIDE**

Replaces: 22879, 29880, 43433
For: Alpha & Bravo cables

PKG OF 25



**18-2303
18-2303-9①
ANCHOR SCREW SET**

Replaces: 10-20518
For: #1R, MR, Alpha, Alpha I, Gen II & Bravo



**18-3754
CABLE ANCHOR**

Replaces: 43436
For: #1R, MR, Alpha, Alpha I, Gen II & Bravo

**18-2600
LOWER SHIFT CABLE KIT**

— CONTAINS —

Part #	Description	O.E. #	Qty.
18-2753-2	Shift Cable Bellows	74639	1
18-2248	Shift Cable Assembly	73723A1	1
18-2162	Shift Slide & Screw	33981T	1
18-2149	Shift Cable End Kit	43433	1
18-2163	Shift Slide Screw	10-31700	1
18-2743	Drive Shaft Housing to Bell Housing Gasket	27-94996-2	1
18-2820	Drive Shaft Housing to Bell Housing Gasket	27-64818	1
18-2840	Bell Housing Gasket	27-35982	1
18-7117	O-Ring	25-35027	1
18-7153	O-Ring	25-25439	2
18-7170	O-Ring	25-33504	1



**18-2603
LOWER SHIFT
CABLE KIT**

Replaces: 19543T1, 19543T2, 865436A03
ALPHA I GENERATION II

— CONTAINS —

Part #	Description	O.E. #	Qty.
18-2619-1	Outdrive Gasket Set	27-94996A1	1
18-2753-2	Shift Cable Bellows	74639	1
18-2190	Shift Cable Assembly	19543A4	1
18-2743	Drive Shaft Housing to Bell Housing Gasket	27-94996-2	1



**18-2603E
LOWER SHIFT CABLE KIT**

Replaces: 19543T1, 19543T2, 865436A03
For: Alpha I Gen II
Uses 18-2190E shift cable.
Requires 18-9806E (Xtreme Shift Cable Tool) to complete installation



**18-2604
LOWER SHIFT CABLE KIT**

Replaces: 815471T1
BRAVO

— CONTAINS —

Part #	Description	O.E. #	Qty.
18-2145	Bravo Shift Cable	815471A3	1
18-2149	Shift Cable End Kit	43433	1
18-2753-1	Shift Cable Bellows	74639	1
18-2615	Outdrive Gasket Set	—	1



**18-2604E
LOWER SHIFT CABLE KIT**

Replaces: 815471T1
Uses 18-2145E shift cable.
For: Bravo



**GRADE 316
STAINLESS STEEL WORM GEAR
HOSE CLAMPS**



All components are manufactured from Marine Grade 316 stainless steel. These clamps are designed to fit many applications from 3/16" to 7" diameter hoses.

STAINLESS STEEL CLAMPS

Part #	O.E. #	Diameter Size	Std. #	Part #	O.E. #	Diameter Size	Std. #
18-710-06-2	-	7/16" to 3/4"	006	18-710-32-2	-	1 9/16" to 2 1/2"	032
18-710-10-2	-	9/16" to 1 1/16"	010	18-710-48-2 ①②	54-815504348	2 9/16" to 3 1/2"	048
18-710-12-2	-	9/16" to 1 1/4"	012	18-710-64-2 ①	-	2 1/2" to 4 1/2"	064
18-710-16-2	-	1 1/16" to 1 1/2"	016	18-710-72-2 ①③	-	3" to 5"	072
18-710-20-2	-	3/4" to 1 3/4"	020	18-710-104-2	-	5" to 7"	104
18-710-24-2	-	1 1/16" to 2"	024				

① For use with 3" Bellows ② O.E. #54-32533 ③ O.E. #'s 54-31765, 54-815504372

**18-2175
ENGINE
COUPLER**

Replaces: 12632A4

Uses 18-2146 Yoke Shaft
Flex plate style for late model, small crankshaft bolt pattern, style engines



**18-2195
ENGINE COUPLER**

Replaces: 12632A3, 12632A7

Uses 18-2146 Yoke Shaft
Flex plate style for GM 4 Cyl engines with late style, small crankshaft bolt pattern



**18-2323
ENGINE COUPLER**

Replaces: 18643A5
(Same as 18-2175 without yoke)



**18-2321
ENGINE COUPLER**

Replaces: 12632A6
(Same as 18-2195 without yoke)
For: Late model GM 4 cylinder



**18-2412-1
ENGINE
COUPLER**

Replaces: 18309A2, 18311A2, 18311A17,
812964A2, 861523A9, 8M0098795
For: Bravo



**18-2413
ENGINE
COUPLER**

Replaces: 69354A1, 69354A2
For: 470, 485 (224 cu. in.)
S/N 4208730-6218036 (1976-1982)



**18-2414
ENGINE
COUPLER**

Replaces: 97432A2
For: 165, 170, 470, 3.7L S/N 6170297 & UP (1983-1989)
180, 190, 488, 3.7LX S/N 6170297 & UP (1983-1989)



**18-2171
ENGINE
COUPLER**

Replaces: 32492A2, 32492A3, 32492A5,
38965A1, 38965A2, 76850A2
For: All GM engines except MR/ALPHA/BRAVO
with "Triangular", 3-Bolt coupler



**18-2172
ENGINE COUPLER**

Replaces: 14505A2
Used when replacing V6 or V8 2 piece rear main seal
with 3-1/2" crankshaft bolt pattern to a newer 1 piece
rear main seal engine with 3" bolt pattern



**18-2173
ENGINE
COUPLER**

Replaces: 59826A1, 59826A3
For: Ford engines



① Priced per Package

ENGINE COUPLER APPLICATION

HP	Liter	Model	CID	# Cyl	Stroke	Years	Serial #	Part #
110		110	153	4		1963-1966	1537370 - 2044033	18-2171
120		120	153	4		1964-1982	1537370 - 6229717	18-2171
120		120	153	4	4	1964-1982	1666601 - 6229717	18-2171
120		120	153	4	4	1983-1986	6229718 - B531853	18-2171 ①
120		120	153	4	4	1983-1986	6229718 - B531853	18-2195 ②
	2.5L	2.5L	153	4	4	1987-1989	B531854 - C853255	18-2171 ③
	2.5L	2.5L	153	4	4	1987-1989	B531854 - C853256	18-2195 ④
140		140	181	4	4	1968-1982	2508261 - 6229717	18-2171
140		140	181	4	4	1983-1986	6229718 - B450800	18-2171 ①
140		140	181	4	4	1983-1986	6229718 - B450800	18-2195 ②
140		140 INLINE 6		6	4	1963	1538930 - 1725960	18-2171
	3.0L	3.0L	181	4	4	1987-1989	B450801 - C856558	18-2171 ③
	3.0L	3.0L	181	4	4	1987-1989	B450801 - C856558	18-2195 ④
	3.0L	3.0L	181	4	4	1990-1994	C856559 - F603999	18-2195
	3.0L	3.0L	181	4	4	1998-2010	L097000 & UP	18-2323
	3.0L	3.0L MPI	181	4	4	2008-2010	A072812 & UP	18-2323
	3.0L	3.0LX	181	4	4	1990-1993	C856559 - F000000	18-2195
	3.0L	3.0LX	181	4	4	1994-1998	F000001 - L096999	18-2321
150		150			4	1964-1966	1666495 - 2048046	18-2171
160		160			4	1967-1969	2048022 - 2770031	18-2171
165		165	224	4	4	1987	B434941 - B774251	18-2414
165		165 INLINE 6		6	4	1970-1981	2770032 - 5813433	18-2171
170		170	224	4	4	1985-1986	6916779 - B434940	18-2414
180		180	224	4	4	1987	B436391 - B775248	18-2414
190		190	224	4	4	1985-1987	6916779 - B775248	18-2414
	3.7L	3.7L	224	4	4	1988-1989	B774252 & UP	18-2414
	3.7L	3.7LX	224	4	4	1983-1989	B775249 & UP	18-2414
		470	224	4	4	1976-1982	4208730 - 6218036	18-2413
		470	224	4	4	1983-1984	6218037 - 6916779	18-2414
		485	224	4	4	1980-1982	5685394 - 6218036	18-2413
		488	224	4	4	1983-1984	6170297 - 6916779	18-2414
		140	194	6	4	1963	1538930 - 1664117	18-2171
		150	230	6	4	1964-1966	1664118 - 2048046	18-2171
		160	250	6	4	1967-1969	2048022 - 2770031	18-2171
		165	250	6	4	1970-1981	2770032 - 5813433	18-2171
175		175			4	1987	B527955 - B773242	18-2175
185		185 (4bbl)	229	6	4	1983-1984	6330183 - 6919655	18-2171
175		175	262	V-6	4	1987	B527955 - B773242	18-2175
185		185 (2bbl)	262	6	4	1985-1986	A331455 - B527954	18-2171 ①
185		185 (2bbl)	262	6	4	1985-1986	A331455 - B527954	18-2175 ②
205		205	262	6	4	1985-1986	A331455 - B527954	21-2171 ③
205		205	262	6	4	1985-1986	A331455 - B527954	18-2175 ④
205		205	262	6	4	1987	B527995 - B775129	18-2175
		262 MAG EFI GEN+	262	V-6	4	1996-1997	F803800 - K999999	18-2323
	4.3L	4.3L	262	V-6	4	1988-1993	B527955 - F000877	18-2175
	4.3L	4.3L	262	V-6	4	1993-2010	F000878 & UP	18-2323
	4.3L	4.3L EFI GEN +	262	V-6	4	1998-2001	L012009 - M299999	18-2323
	4.3L	4.3L MPI	262	V-6	4	2002-2010	M300000 & UP	18-2323
	4.3L	4.3LH GEN +	262	V-6	4	1998-2002	L010044 - M614999	18-2323
	4.3L	4.3LX	262	V-6	4	1988-1993	B775130 - F001219	18-2175
	4.3L	4.3LX (4bbl)	262	V-6	4	1993-1995	F001220 - F802999	18-2323
	4.3L	4.3LX GEN + (2bbl)	262	V-6	4	1996-1997	F803000 - K999999	18-2323
	4.3L	4.3LXH GEN +	262	V-6	4	1996-1997	F803000 - K999999	18-2323
	5.0L	225 (FORD)	302	V-8	4	1973-1974	3385721 - 4166999	18-2173 ⑤
	5.0L	888	302	V-8	4	1971-1977	3108723 - 4887829	18-2173

- ① Use with Borg Warner transmission
- ② Low speed / work application
- ③ Coupler mounts to flywheel
- ④ Use with Hurth transmission

- ⑤ Hydraulic shift only
- ⑥ I drive only
- ⑦ Round shape coupler
- ⑧ Standard Bravo applications

- ⑨ Coupler mounts to crankshaft
- ⑩ Triangular shape coupler
- ⑪ Use with Borg Warner 71/72 series in-line transmission
- ⑫ Use with Borg Warner 5000 or Hurth 630 transmission

ENGINE COUPLER APPLICATION

HP	Liter	Model	CID	# Cyl	Stroke	Years	Serial #	Part #
		190	283	V-8	4	1963-1964	1564539 - 1730903	18-2171
5.0L		200	305	V-8	4	1985-1986	6899058 - B525981	18-2171 ①
5.0L		200	305	V-8	4	1985-1986	6899058 - B525981	18-2175 ②
5.0L		200	305	V-8	4	1985-1987	6899058 - B774444	18-2175
5.0L		228	305	V-8	4	1977-1982	4765100 - 6218461	18-2171
5.0L		228	305	V-8	4	1977-1984	6218462 - 6899268	18-2171
5.0L		230	305	V-8	4	1985-1987	6899269 - B773739	18-2171 ③
5.0L		230	305	V-8	4	1985-1987	6899269 - B773739	18-2175 ④
5.0L		5.0L ALPHA	305	V-8	4	1988-1993	B774445 - F000000	18-2175
5.0L		5.0L ALPHA	305	V-8	4	1994-1995	F000001 - F600999	18-2323
5.0L		5.0L GEN+ ALPHA	305	V-8	4	1998-2010	L015751 & UP	18-2323
5.0L		5.0L GEN + BRAVO	305	V-8	4	1998-2010	L015751 & UP	18-2412-1 ⑤
5.0L		5.0L EFI ALPHA	305	V-8	4	1998-2001	L012052 - M299999	18-2323
5.0L		5.0L EFI BRAVO	305	V-8	4	1998-2001	L015751 - M299999	18-2412-1 ⑥
5.0L		5.0LX ALPHA	305	V-8	4	1988-1993	B773740-F000000	18-2175
5.0L		5.0LX ALPHA	305	V-8	4	1994-2007	F000001 & UP	18-2323
5.0L		5.0L MPI BRAVO	305	V-8	4	1998-2007	L015751 & UP	18-2412-1
5.0L		5.0L MPI ALPHA	305	V-8	4	2002-2010	M300000 & UP	18-2323
5.0L		5.0L MPI BRAVO	305	V-8	4	2002-2010	M300000 & UP	18-2412-1 ⑦
5.0L		5.0LX ALPHA	305	V-8	4	1988-1993	B773740 - F000000	18-2175
5.0L		5.0LX ALPHA	305	V-8	4	1994-1995	F000001 - F600999	18-2323
5.0L		898	305	V-8	4	1977-1985	4762210 - 6899057	18-2171
		225 (GM)	327	V-8	4	1963-1969	1539620 - 2694014	18-2171
		250	327	V-8	4	1977	4768000 - 4908849	18-2171
5.7L		260	350	V-8	4	1978-1982	4908850 - 6218461	18-2171
5.7L		260	350	V-8	4	1982-1986	6218462 - B525981	18-2171 ⑧
5.7L		260	350	V-8	4	1982-1987	6218462 - B773304	18-2175 ⑨
5.7L		260	350	V-8	4	1987	B525982 - B773304	18-2175
5.7L		300 TEMPEST ALPHA	350	V-8	4	1985-1986	6668677 - B430367	18-2171 ⑩
5.7L		300 TEMPEST ALPHA	350	V-8	4	1986	A434310 - B430367	18-2175 ⑪
5.7L		320 EFI	350	V-8	4	1987-1989	A543604 - C622418	18-2175
5.7L		350 MAG ALPHA	350	V-8	4	1986-1993	A635178 - F000000	18-2175
5.7L		350 MAG ALPHA	350	V-8	4	1993-1997	F000001 - K999999	18-2323
5.7L		350 MAG ALPHA EFI GEN +	350	V-8	4	1996-1997	F800300 - K999999	18-2323
5.7L		350 Mag MPI ALPHA	350	V-8	4	1998-2010	L010019 & UP	18-2323
5.7L		350 MAG MPI BRAVO	350	V-8	4	1998-2010	L010019 & UP	18-2412-1 ⑫
5.7L		350 MAG MPI HORIZON ALPHA	350	V-8	4	2002-2007	M300000 - A299999	18-2323
5.7L		350 MAG MPI HORIZON BRAVO	350	V-8	4	2002-2007	M300000 - A299999	18-2412-1 ⑬
5.7L		350 MAG MPI HORIZON ALPHA	350	V-8	4	1993-2007	F000001 & UP	18-2323
5.7L		HORIZON BRAVO	350	V-8	4	1999-2007	M300000 & UP	18-2412-1
5.7L		5.7L ALPHA	350	V-8	4	1988-1993	B773305-F000000	18-2175
5.7L		5.7L ALPHA	350	V-8	4	1993-2010	F000001 & UP	18-2323
5.7L		5.7L BRAVO	350	V-8	4	1988-2010	B773305 & UP	18-2412-1 ⑭
5.7L		5.7L EFI ALPHA	350	V-8	4	1995-2001	F225560 - M299999	18-2323
5.7L		5.7L EFI BRAVO	350	V-8	4	1998-2001	L010035 - M299999	18-2412-1 ⑮
5.7L		5.7LX EFI ALPHA	350	V-8	4	1996-1997	F752400 - K999999	18-2323
5.7L		5.7LX EFI ALPHA	350	V-8	4	1993-2007	F000001 & UP	18-2323
5.7L		5.7L EFI BRAVO	350	V-8	4	1998-2007	L010035 & UP	18-2412-1 ⑯
5.7L		233	351	V-8	4	1975-1977	4173000 - 4902304	18-2173
6.2L		377 MAG	377	V-8	4	2008-2010	A300000 & UP	18-2412-1 ⑰
6.2L		MX 6.2L MPI	377	V-8	4	2000-2007	L680003 - A299999	18-2412-1 ⑱
6.2L		MX 6.2L MPI	377	V-8	4	2000-2007	L680003 - A299999	N/A ⑲
6.2L		MX 6.2L MPI HORIZON	377	V-8	4	2002-2007	M300000 - A299999	18-2412-1 ⑳
7.4L		454 MAG ALPHA	454	V-8	4	1986-1988	A631894 - B785148	18-2175 ㉑

- ① Use with Borg Warner transmission
- ② Low speed / work application
- ③ Coupler mounts to flywheel
- ④ Use with Hurth transmission

- ⑤ Hydraulic shift only
- ⑥ I drive only
- ⑦ Round shape coupler
- ⑧ Standard Bravo applications

- ⑨ Coupler mounts to crankshaft
- ⑩ Triangular shape coupler
- ⑪ Use with Borg Warner 71/72 series in-line transmission
- ⑫ Use with Borg Warner 5000 or Hurth 630 transmission



18-4442
ENGINE ALIGNMENT TOOL
Replaces: 91-57797A3, 91-57797A2, 91-57797A1, 91-8M0067546, 91-48347, 91-37384
For use with all #1 units, MR, all Alpha & Bravo units



18-9803
SPANNER NUT WRENCH
Replaces: 91-36235, 91-17256

SIERRA HYDRO DEFENSE MARINE GREASE



18-9240-1
 (14oz Cartridge)
Replaces:
 Mercury 92-802863A1

- Prohibits rust and corrosion.
- Prevents wear against the most extreme friction in marine applications.
- Will not break down in marine conditions.
- Contains PTFE for minimum wear and added friction protection.
- For use on prop shafts, trailer bearings, throttle and shift cables and linkage, swivel pins and more!



18-2200
LOWER UNIT GEAR SET
Replaces: 43-61027, 43-96084A4
 888 S/N 3106717 & UP #1 Units S/N 3469428 & UP Except, MR/AL-PHA Units (which have no pre-load pin in the top of the drive shaft).



18-2410
FORWARD GEAR SET
Replaces: 43-96084A7, 43-96084A5
For: "R" drive



18-2360
PINION & FORWARD GEAR SET
Replaces: 43-828072A3, 43-878087A2
 13-21 Teeth



18-2408
REVERSE GEAR
Replaces: 43-828073A1
For: Alpha I/Gen II lower S/N D469859 & UP



18-2409
REVERSE GEAR
Replaces: 43-92320, 43-92320T
For: "R" drive (28 teeth)



18-2206-1
LOWER UNIT GEAR SET
Replaces: 43-878087A2 + 43-828073A1, 43-828072A2
For: Alpha 1 Gen II (serial 0F680000 & Up)

18-2404
GEAR REPAIR KIT
 Replaces: 43-803079T1
 For: "R" drive



— CONTAINS —

Part #	Description	O.E. #	Qty.
18-2200	Lower Unit Gear Set	43-96084A4	1
18-2202	Sliding Clutch	52-66063	1
18-1157	Needle Roller Bearing	31-30895	1
18-1155	Ball Bearing	30-88957A1	1
18-1159	Tapered Roller Bearing	31-35928A1	1
18-2285	Shim	15-47397A1	1
18-3719	Pinion Nut	11-35921	1
18-2299	Tab Washer	14-79447	1

18-2405
GEAR REPAIR KIT
 Replaces: 43-803091T1
 For: MR/Alpha I



— CONTAINS —

Part #	Description	O.E. #	Qty.
18-2652	Lower Gear Housing Seal Kit	26-33144A2	1
18-3719	Pinion Nut	11-35921	1
18-2343-9	Washer	12-982721	1
18-2298	Tab Washer	14-18323	1
18-2299	Tab Washer	14-79447	1
18-2206-1	Gear Set	43-42934	1
18-2285	Shim	15-47397A1	1
18-1155	Ball Bearing	30-88957A1	1
18-1158	Needle Roller Bearing	31-30956	1
18-1117	Pinion Bearing	31-42647A1	1
18-1143	Alpha Bearing	31-36387A1	1
18-2294	Shim Kit	15-42637A-1	1
18-2202	Sliding Clutch	52-66063	1

18-2407
GEAR SET
 Replaces:

43-878087A4, 43-823072A2, 43-42933A3,
 43-42933A2, 43-17064A3
 For: MR/Alpha/Gen II
 lower gear housings



— CONTAINS —

Part #	Description	O.E. #	Qty.
18-2206-1	Gear Set	43-42934	1
18-1155	Ball Bearing	30-88957A1	1
18-1117	Pinion Bearing	31-42647A1	1
18-1158	Needle Roller Bearing	31-30956	1
18-1143	Alpha Bearing	31-36387A1	1
18-2294	Shim Kit	15-42637A-1	1
18-2285	Shim	15-47397	1
18-3719	Pinion Nut	11-35921	1
18-2343-9	Washer	12-982721	1



18-2202
SLIDING CLUTCH
 Replaces: 52-66063, 52-853594T, 52-853594, 52-824112
 888 S/N 3784375 & UP
 #1 Units S/N 3469428 & UP



18-2357
CROSS PIN
 Replaces:
 17-30632, 17-8M0020941, 17-8M0100263, 17-8M0084681



18-2166
PROP SHAFT
 Replaces: 44-66060, 44-660603, 44-824110, 44-660602, 44-55857
 For: All #1 & MR/ALPHA Units S/N 2791957 & above.
 Also for 165 (6 cyl.) S/N 2763442 & above.

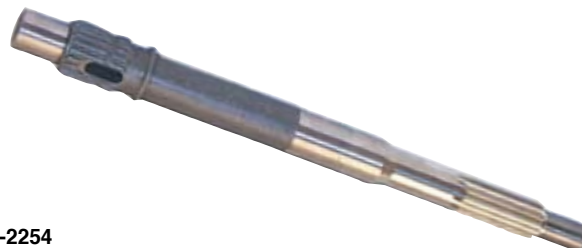

18-2254
PROP SHAFT
 Replaces: 44-850308
 For: Alpha One Gen II S/N 0L100040 & up/Vazer



18-2180
DRIVE SHAFT
 Replaces: 45-42634
 For all MR/ALPHA Units & older units which have been retro-fitted with MR/ALPHA lower units.



18-2261
DRIVE SHAFT
 Replaces: 45-816919
 All Alpha I Generation II Drives (with new style 18-3056 Impeller) Serial #D494569 & above.



18-2346
RETAINER NUT
 Replaces: 824519, 8245191, 11-42633, F694961, F694961-1
 For: MR Alpha & Gen II



18-3719
PINION NUT
 Replaces: 11-35921, 11-47411, 11-826375, 11-F694188
 5/8" - 18 thread • 1 1/16" wrench



18-2359
DRIVE SHAFT NUT SET

— INCLUDES —

Sierra #	Description	Replaces:
18-3719	Pinion Nut	11-35921
18-2343-9	Pinion Nut Washer	12-92721



18-2286
 Replaces: 66067, 66067T, 19755A2, 818349A1, 818349T1

18-2196
 Replaces: 37967, 61073, 19755A4, 19755A08

SHIFT SPOOL ASSEMBLIES

SHIFT SPOOL ASSEMBLY APPLICATION

Model	Serial #	Part #
1A (EZ-Shift)	1776349 & UP	18-2196
1B (EZ-Shift)	1775193 & UP	18-2196
1C (EZ-Shift)	1777799 & UP	18-2196
120/140	2062141-3780849	18-2196
120/140	3780850 & UP	18-2286
160	2065190-2763441	18-2196
165	2763442-3780849	18-2196
165	3780850 & UP	18-2286
888	3106717-3784374	18-2196
888	3784375 & UP	18-2286
898/228	4782330 & UP	18-2286
225-S	3856268-4200499	18-2286
233	4200500 & UP	18-2286
470/485	4208730 & UP	18-2286
R/MR/Alpha One	6225377 & UP	18-2286
Alpha One (Gen II)	D494569 & UP	18-2286



18-3759
THRUST BEARING RING
 Replaces: 35915

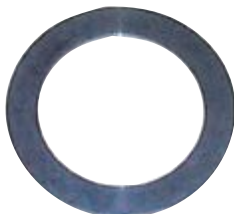

18-2342
THRUST RING
 Replaces: 68100, 681001
 For: MR/ALPHA



18-2191
CARRIER BEARING
 Replaces: 56211A1, 73020A1, 73020A14
 For: #1R/MR/Alpha I
 For: Housings with casting #73020C



18-2376
CARRIER BEARING
Replaces: 73020A20, 818763A4, 818763A10
For: Alpha Gen II & MR Units
For: Housings with casting #73020C1, Mercruiser Vazer



18-2150
SHIFT SHAFT
Replaces: 37973, 65028, 66066, 77481, 774811
Stainless Steel



18-2353
SHIFT ROD BUSHING ASSEMBLY
Replaces: 23-815921A21, 23-815921A17, 23-815921A10, 23-815921A8, 23-815921A6, 815921A2



18-2154
SHIFT SHAFT HOUSING BUSHING
Replaces: 23-30617A1, 23-30617A2
For: Mercruiser & Alpha 1 (S/N 1684188 & UP)



18-3198
WATER PICK-UP
(Port)
Replaces: 93424, 934241, 934243
For: MR Alpha



18-3199
WATER PICK-UP
(Starboard)
Replaces: 93423, 934231, 934233
For: MR Alpha



18-2320
SHIFT SHAFT
Replaces: 815919A1
For: Gen II



18-2130
SHIFT CRANK
Replaces: 66062, 76865, 8M2009865
For: All #1 Units R/MR/Alpha, Mercruiser Vazer

PKG. OF 2



18-4295
18-4295-9^①
E-CLIP
Replaces: 53-29641
For: Gen II



18-2299
TAB WASHER
Replaces: 14-79447, 14-52833



18-2298
TAB WASHER
Replaces: 14-18323, 14-17460



18-3751
SPANNER NUT
Replaces: 79448
For: Mercruiser Vazer



18-2354
CARRIER SEAL
Replaces: 821759A4, 821759A3, 821759A2, 821759A1, 815922A5, 815922A1, 807929A2, 807929A1



18-1117
PINION BEARING
Replaces: 31-42647A1



18-1120
PINION BEARING
Replaces: 31-35246
For: Lower drive shaft III, TR & Bravo I, II, III (1986-95)



18-1356
PINION BEARING
Replaces: 31-54928

Model	Year	Model	Year
215 E/H	1970-72	II, TR	1973-76
225TRS, 280 TRS	1973-76	TR, TRS	1977-93



18-1142
UPPER PINION BEARING
Replaces: 31-32573A1

^① Priced per Package



**18-1193
TAPERED
ROLLER BEARING**
Replaces: 31-33138A1
Fits: Gen II (1998-Up), Mercruiser Vazer



**18-1143
TAPERED
ROLLER BEARING**
Replaces: 31-36387A1



**18-1156
FORWARD
GEAR BEARING**
Replaces: 31-30894A1
For: Mercruiser Vazer



**18-1161
TAPERED
ROLLER BEARING**
Replaces: 31-35990A1
For: Mercruiser Vazer



**18-1162
TAPERED
ROLLER BEARING**
Replaces: 31-38356A1, 31-F84901, FA84901, F84903



**18-1165
TAPERED
ROLLER BEARING**
Replaces: 31-61100A1



**18-1173
TAPERED
ROLLER BEARING**
Replaces: 31-828437A2



**18-1179
TAPERED
ROLLER BEARING**
Replaces: 31-32575A1, T1
For: Gen II F680000 & UP, Mercruiser Vazer



**18-1126
TAPERED ROLLER
BEARING**
Replaces: 31-8M0103474



**18-1163
TAPERED ROLLER
BEARING**
Replaces: 31-48941A1



**18-1197
TAPERED FORWARD GEAR
BEARING**
Replaces: 31-828439A2
For: Alpha One Gen II (1996-97)
(s/n 0F680000-0K999999)



**18-1182
ROLLER BEARING KIT**
Replaces: 31-30894A5
For: Alpha I (Gen II) (1998 & up)
(OL100040 & up), Mercruiser Vazer



**18-1129
UPPER DRIVE
SHAFT BEARING**
Replaces: 31-86748A1,
31-8M0103473, 31-F506818,
F508814
For: Bravo I, II, III - Lower
(S/N B664190 & UP)



**18-1157
FORWARD GEAR
INNER BEARING**
Replaces: 31-30895, 31-30895T
For: Mercuriser Vazer



**18-1158
CARRIER BEARING**
Replaces: 31-30956, 31-30956T,
31-F523058
For: Mercuriser Vazer



**18-1153
BALL BEARING**
Replaces: 30-63326, 30-63326T,
30-49313, 30-54215, 30-20464



**18-1155
BALL BEARING**
Replaces: 30-88957A1, 30-88957T,
30-35914, 30-17927, 30-88957

MERCURUISER STERNDRIVE UPPER GEAR HOUSING BEARINGS

Sterndrive Model	Drive Ratio	Years	Serial #	Drive Gear (Yoke)	Driven Gear	Upper Cap
IA,IB,IC & EZ Shift	All	1964-66	1684188 - 2065186	18-1160	18-1161	18-1179
120/140	1.98	1967	2062141 - 2187468	18-1160	18-1161	18-1161
120/140	1.98	1967-71	2187469 - 3134193	18-1160	18-1161	18-1179
120/140	1.98	1971-82	3134194 - 6225576	18-1160	18-1161	18-1165
470/485	1.84	1976-82	4208730 - 6225576	18-1160	18-1161	18-1165
160	1.68	1967	2065190 - 2182197	18-1160	18-1161	18-1161
160	1.68	1967-71	2182198 - 3134193	18-1160	18-1161	18-1179
165	1.65	1971-81	3213658 - UP	18-1160	18-1161	18-1165
888	1.5	1971-73	3106717 - 3134193	18-1160	18-1161	—
888	1.5	1973-77	3134194 - UP	18-1160	18-1161	18-1165
225-S	1.5	1974	3856268 - 4200499	18-1160	18-1161	18-1165
898/228	1.65	1977-82	4782330 - 6225576	18-1160	18-1161	18-1165
233	1.32	1975-77	4200500 - UP	—	—	18-1165
250	1.32	1977	4791300 - 4898729	—	—	18-1165
255-TRS	All	1973-74	3377316 - 4203749	18-1162 ③	18-1162	—
260	1.5	1978-82	4898730 - 6225576	18-1160	18-1161	18-1165
280-TRS	All	1975-76	4203750 - 4895399	18-1162 ③	18-1162	—
R/MR/Alpha One	1.98/1.84/1.65/1.50	1984-90	6225577 - UP	18-1160	18-1161 ① ④	18-1165
R/MR/Alpha One	1.5	1984-90	6225577 - UP	18-1160	18-1142	18-1165
R/MR/Alpha One	1.32	1984-90	6225577 - UP	—	—	18-1165
R/MR/Alpha One	1.5 Heavy Duty	1984-90	6225577 - UP	—	18-1142	18-1165
Alpha One SS	1.32	1986-89	A545004 - UP	—	—	18-1165
Alpha One SS	1.5	1986-89	A545004 - UP	—	18-1142	18-1165
Alpha One Gen II	2.40/1.98/1.84/1.65	1991-95	D469859 - F679999	18-1160	18-1161 ④	18-1165
Alpha One Gen II	1.5	1991-95	D469859 - F679999	18-1160	18-1142	18-1165
Alpha One Gen II	2.40/1.94/1.81/1.62	1996-97	F680000 - K999999	18-1160	18-1161 ④	18-1179
Alpha One Gen II	1.47	1996-97	F680000 - K999999	18-1160	18-1142	18-1179
Alpha One Gen II	2.40/2.00/1.94/1.81/1.62	1998 & Up	L100040 - UP	—	18-1161	18-1179
Alpha One Gen II	1.47	1998 & Up	L100040 - UP	—	18-1142	18-1179
II-TR	—	1973-76	3377316 - 4794899	18-1162 ②	18-1162	—
SSM II	—	1982-97	ALL	18-1162 ③	18-1162	—
TR/TRS	—	1977-93	4794900 - UP	18-1162 ③	18-1162	—
Bravo I, II, III	All	—	B664190 & UP	—	—	18-1129

① Timken Cone # 89449 / Cup 89410
② Straight Shoulder Gear Only

③ Bearing for U-Joint Yoke
④ Use 18-1142 for 1.5:1 Upper Gear Ratio

MERCURUISER STERNDRIVE LOWER GEAR HOUSING BEARINGS

Sterndrive Model	Years	Beg. Serial # - End Serial #	Prop Bearing Carrier	Lower Drive Shaft (Pinion)	Upper Drive Shaft	Inside Forward Gear (Needle)	Outside Forward Gear	Reverse Gear
60	1965-66	1830753 - 2063740	—	—	—	—	18-1162	—
80/90	1966-72	2063741 - 3225967	18-1158	—	—	18-1157	18-1156	—
I	1963	1534570 - 1536617	18-1158	—	18-1153	18-1157	18-1156	—

① 18-1161 Top Bearing / 18-1163 Bottom Bearing

② Torrington#B1616
③ Prop Shaft Drive Gear

④ #15520 Stamped on Cup
⑤ Use 18-1173 for 2.40:1 ratio only (new style lower gears) our 18-2206-1

MERCUISER STERNDRIVE LOWER GEAR HOUSING BEARINGS (Cont.)

Sterndrive Model	Years	Beg. Serial # - End Serial #	Prop Bearing Carrier	Lower Drive Shaft (Pinion)	Upper Drive Shaft	Inside Forward Gear (Needle)	Outside Forward Gear	Reverse Gear
I	1963	1536618 - 1684187	18-1158	—	—	18-1157	18-1156	—
IA,IB,IC & EZ Shift	1964-66	1684188 - 2065189	18-1158	—	—	18-1157	18-1159	18-1155
120/140	1967-69	2062141 - 2791956	18-1158	—	—	18-1157	18-1159	18-1155
120/140	1970-77	2791957 - 4893634	18-1158	—	—	18-1157	18-1159	18-1155
120/140	1978-82	4893635 - 6225576	18-1158	—	—	18-1157	18-1159	18-1155
470	1976-77	4208730 - 4893934	18-1158	—	—	18-1157	18-1159	18-1155
470/485	1978-82	4893835 - 6225576	18-1158	—	—	18-1157	18-1159	18-1155
160	1967-69	2065190 - 2763441	18-1158	—	—	18-1157	18-1159	18-1155
165	1970-77	2763442 - 4890459	18-1158	—	—	18-1157	18-1159	18-1155
165	1978-81	4890460 - UP	18-1158	—	—	18-1157	18-1159	18-1155
888	1971-77	3106717 - UP	18-1158	—	—	18-1157	18-1159	18-1155
225/233	1974-77	3856268 - UP	18-1158	—	—	18-1157	18-1159	18-1155
898/228	1977	4782330 - 4898729	18-1158	—	—	18-1157	18-1159	18-1155
898/228	1978-82	4898730 - 6225576	18-1158	—	—	18-1157	18-1159	18-1155
250	1977	4791300 - 4898729	18-1158	—	—	18-1157	18-1159	18-1155
255-TRS	1973-74	3377316 - 4203749	18-1158	—	—	—	18-1159	N/A
260	1978-82	4898730 - 6225576	18-1158	—	—	18-1157	18-1159	18-1155
280-TRS	1975-76	4203750 - 4895399	18-1158	—	—	—	18-1159	N/A
R	1983	6225577 - UP	18-1158	—	—	18-1157	18-1159	18-1155
MR / Alpha One	1984-90	6225577 - UP	18-1158	18-1117	18-1143	—	18-1159 ⑤	18-1155
MR / Alpha One	1984-90	6225577 - UP	18-1158	18-1117	18-1143	18-1157 ②	18-1159 ⑤	18-1155
MR / Alpha One (CR)	1984-90	6225577 - UP	18-1158	18-1117	18-1143	—	—	—
Alpha One SS	1986-89	A545004 - UP	18-1158	18-1117	18-1143	18-1157	18-1159	18-1155
Alpha One Gen II	1991-95	D469859 - F679999	18-1158	18-1117	18-1143	18-1157	18-1159 ⑤	18-1155
Alpha One Gen II (CR)	1991-95	D469859 - F679999	18-1158	18-1117	18-1143	—	—	—
Alpha One Gen II	1996-97	F680000 - K999999	18-1158	18-1117	18-1143	18-1157	18-1156	18-1155
Alpha One Gen II (CR)	1996-97	F680000 - K999999	18-1158	18-1117	18-1143	—	—	—
Alpha One Gen II	1998-newer	L100040 - UP	18-1158	18-1117	18-1143	18-1157	18-1156 ③	18-1155
Alpha One Gen II (CR)	1998-newer	L100040 - UP	18-1158	18-1117	18-1143	—	—	—
II	1962-67	1474909 - 2275488	—	—	—	N/A	18-1156 ③	N/A
II	1968-69	2398798 - 2671321	—	—	—	—	18-1162	18-1156 ③
II-TR	1973-76	3377316 - 4794899	—	—	18-1161 ①	—	—	N/A
TR	1973-93	4794900 - UP	—	—	18-1161 ①	—	—	N/A
TRS	1973-93	4794900 - UP	18-1158	—	—	—	18-1159	N/A

① 18-1161 Top Bearing / 18-1163 Bottom Bearing

② Torrington#B1616
③ Prop Shaft Drive Gear

④ #15520 Stamped on Cup
⑤ Use 18-1173 for 2.40:1 ratio only (new style lower gears) our 18-2206-1



18-2349
SHIFT SHAFT SLEEVE
Replaces: 23-67370



18-2244
18-22441-9①
(PKG. OF 50 WITHOUT GASKET)
DRAIN PLUG
Replaces: 10-79953A2, 10-79953, 10-79953Q04, 10-28634, 10-28634A1, 10-20259, 816610A1, 816610A2, F40109, 10-F50109
For: #1/R/MR/Alpha/Alpha I Gen II Both Upper And Lower Units



②18-2375D
18-2375
18-23751-9①
(PKG. OF 50 WITHOUT GASKET)
DRAIN PLUG MAGNET
Replaces: 10-14834, 10-14834A1, 22-67892, 22-67892A1, 22-67892A05, 22-67892A06, 22-8M0058389 (Magnet)
For: Alpha MR/Gen II lower units Not to be used on #1/R lower units



18-2460
PLUG KIT
Replaces: 22-88847A1, 11-88462
Fits: Mercruiser Stern Drives



18-72005
NUT AND WASHER KIT
Fits: Mercruiser R/MR/Alpha/Gen II Drives



18-4220
THRUST WASHER
Replaces: 13171, 77987
V-6, Outboards & Mercruiser Sterndrives



18-3784
THRUST WASHER
Replaces: 805100
Fits: Bravo III (Front)



18-3701
PROP NUT KIT
Replaces: 11-52707A1, 11-52707A2, 11-52707Q1

②18-3701D Display Package

CONTAINS

Part #	O.E. #	Description	Qty
18-3200	14-31210, 14-816629, 14-816629Q, 14-F697140	Tab Washer	2
18-3700	11-52707	Prop Nut	1



18-3755
PROP NUT KIT
Fits: Bravo III (Front)



18-3756
PROP NUT KIT
Fits: Bravo III (Rear)

PKG. OF 10



18-3200
18-3200-9①
TAB WASHER
Replaces: 14-31210, 14-816629, 14-816629Q, 14-F697140



18-3787
TAB WASHER
Replaces: 805101T
Fits: Bravo III (Rear)

PKG. OF 10



18-3788-9①
TAB WASHER
Replaces: 14-34817
Fits: Bravo II



18-72510
STUD KIT
Fits: Mercruiser Coupler to Flywheel



18-3783
PROP NUT
Replaces: 11-859131, 11-805092, 11-805092T
Fits: Bravo III (Front)



18-3785
PROP NUT
Replaces: 11-82671127, 11-54034, 11-39907, 11-39823
Fits: Bravo II



18-3786
PROP NUT
Replaces: 11-862907, 11-805093
Fits: Bravo III (Rear)



18-3700
PROP NUT
Replaces: 11-52707, 11-827614, F7040
3/4" - 20 thread • 1 1/16" wrench



18-3714
BRASS CASTLE WASHER
Replaces: 12-31211A2, 12-31211, 12-31211A3, 12-31211Q03
Fits: Alpha/Bravo I (without Flo-Torq II Hub)
NOTE: Fits above product with rubber hub propellers (non-Flo-Torq II)



18-4444
PROP WRENCH
Replaces: 91-95830A1, 91-95830, 91-38277A1



18-4446
PROP WRENCH KIT
—CONTAINS—

Part #	O.E. #	Description
18-3200	14-31210, 14-816629	Tab Washer
18-3700	11-52707	Prop Nut
18-4444	91-95830A1	Prop Wrench



18-4459
PROP WRENCH
Replaces: 91-821887A1, 91-859046Q4, 91-859046T4



18-2103
POWER TRIM HOSE
Replaces: 32-47373, 32-66073, 32-68676, 32-73004, 32-79431, 32-86036, 32-86036A1, 32-86036Q

1/8" 14" 1/8"

Display Package

① Priced per Package
② Items ending in "D" are Display Packaged - Regular number is Non-Display



21"
1/8" 1/8"

18-2107
POWER TRIM HOSE
Replaces: 32-55816



11 3/4"
1/8" 1/8"

18-2106
POWER TRIM HOSE
Replaces: 32-45974



46"
1/8" 1/8"

18-2108
POWER TRIM HOSE
Replaces: 32-59841, 32-59841A1, 32-73123

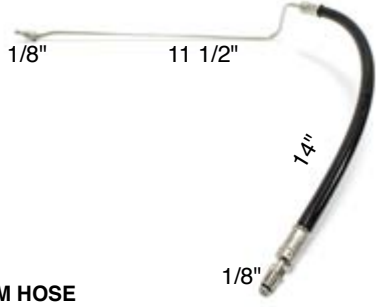

11 1/2"
1/8" 1/8" 14"

POWER TRIM HOSE
Starboard
Connector to bottom of trim cylinder MCM 120-260 & BRAVO

Part #	O.E. #	Description
18-2114	32-99902-1, 32-864960	Trim Cyl. Casting #14034-1
18-2136*	32-99902, 32-864589	Trim Cyl. Casting #98704, 98704-1

* Approximately 11 1/4" long



32"
1/8" 1/8"

18-2109
POWER TRIM HOSE
Replaces: 32-59842, 32-73005



11 1/2"
14" 1/8" 1/8"

18-2112
POWER TRIM HOSE
Replaces: 32-87234



11 1/2"
14" 1/8" 1/8"

POWER TRIM HOSE
Port • Connector to bottom of trim cylinder MCM 120-260 & BRAVO

Part #	O.E. #	Description
18-2115	32-99903-1, 32-864959	Trim Cyl. Casting #14035-1
18-2137*	32-99903, 32-864588	Trim Cyl. Casting #98703, 98703-1

* Approximately 11 1/4" long



46"

18-2435
POWER TRIM HOSE
Replaces: 32-861127, 32-95858
Fits: R/MR/Alpha/Alpha Gen II/Bravo I, II, III/Bravo X, XR, XZ
Serial number 0W099999 and below without quick connect fittings.
OEM hose color is black.



18-9099
TRAILERING CLIPS
 Replaces: 817019A1, 817019Q2, 817019A2, 879078, 86459A2, 86459A1, 86459, 41155A2, 41155A1, 32657A4, 32657A3
 I.D. 3/4" x 11 1/8" length
 For all ALPHA I, ALPHA Generation II, Bravo I, II, III, and Blackhawk



18-2372
TRIM CYLINDER END CAP
 Replaces: 88035
 1.850 Cap Diameter
 For: R/MR/Alpha

PKG. OF 2



18-2465-9④
PIVOT PIN END CAP
 Replaces: 19-14842, 19-148421
 For: R/MR/Alpha One (1983-90) Serial No. 6225577 and up
 I/II/III (1988-02) Serial No. 6225577

PKG. OF 2



18-2466-9④
PIVOT PIN END CAP
 Replaces: 19-815951
 For: Alpha One Gen II (1991-02) Serial No. OD469859 and up



18-2461
TRIM CYLINDER ANCHOR PIN KIT
 Replaces: 17-44166T1
 For: Bravo I/II/III (1988-02) Serial No. 6225577 and up



18-2462
TRIM CYLINDER ANCHOR PIN KIT
 Replaces: 17-14873A1, 17-85056
 For: R/MR/Alpha One (1983-90) Serial No. 6225577 and up (Front)



18-2463
TRIM CYLINDER ANCHOR PIN KIT
 Replaces: 17-14872A1, 17-99207
 For: R/MR/Alpha One (1983-90) Serial No. 6225577 and up (Rear)



18-2464
FRONT AND REAR ANCHOR PIN KIT
 Replaces: 17-815953T1, 56-864641A24, 56-18541A75
 For: All Alpha One Gen II



18-7633
TRIM SENDER/LIMIT KIT
 Replaces: 805320A03, 805320A1, 96863A15, 88678A5, 88678A4, 63115A12, 17693A2
 Fits: MC-I, R, MR, Alpha, Alpha Gen II, Bravo drives



18-2424
POWER TRIM CYLINDER
 Replaces: 98703A11, 98703A12, 98703A17, 98703A26
 For: BRAVO (Port)



18-2425
POWER TRIM CYLINDER
 Replaces: 98704A11, 98704A12, 98704A17, 98704A26, 8M0708280
 For: BRAVO (Starboard)



18-2426
POWER TRIM CYLINDER
 Replaces: 98703A3
 For: R/MR/ALPHA (Port)



18-2427
POWER TRIM CYLINDER
 Replaces: 98704A3
 For: R/MR/ALPHA (Starboard)



18-2649
POWER TRIM SEAL KIT
 Replaces: 25-87400A2

③ This product is priced per piece. To order priced per package, please add -9 to the part number.

④ Priced per package

POWER TRIM CYLINDER APPLICATION

I/O — MERCURUISER - DRIVE SYSTEM

Model	Year	Serial No.	Trim Cylinder Port	Trim Cylinder Starboard	Housing Port	Housing Starboard	Trim Cylinder Seal Kit
120 / 140 4 cyl	1967-1969	2062141-2791956	N/A	N/A	N/A	N/A	N/A
120 / 140	1970-1977	2791957-4893634	N/A	N/A	N/A	N/A	N/A
120 / 140	1978-1982	4893635-6225576	N/A ③	N/A ③	N/A	N/A	N/A
120 / 140	1978-1982	4893635-6225576	N/A ④	N/A ④	N.L.A	N.L.A	N/A
160 6 cyl	1967-1969	2062141-2791956	N/A	N/A	N/A	N/A	N/A
160	1967-1969	2065190-2763441	N/A	N/A	N/A	N/A	N/A
165	1970-1977	2763442-4890459	N/A	N/A	N/A	N/A	N/A
165	1978-1981	4890460-4890459	N/A ⑤	N/A ⑤	N/A	N/A	N/A
225 / 233	1974-1977	3856268 & UP	N/A	N/A	N/A	N/A	N/A
250	1977	4791300-4898729	N/A	N/A	N/A	N/A	N/A
260	1978-1982	4898730-6225576	N/A ⑥	N/A ⑥	N/A	N/A	N/A
470 / 485	1976-1977	4208730-4893934	N/A	N/A	N/A	N/A	N/A
470 / 485	1978-1982	4893835-6225575	N/A ⑦	N/A ⑦	N/A	N/A	N/A
898 / 228	1977	4782330-4898729	N/A	N/A	N/A	N/A	N/A
898 / 228	1978-1982	4898730-6225576	N/A ⑧	N/A ⑧	N/A	N/A	N/A
ALL # 1 DRIVES ⑨	1970-1982	2791957-6225576	N/A	N/A	N/A	N/A	N/A
R / MR / ALPHA I	1983-1990	6225577-D469858	18-2426 ①	18-2427 ①	N/A ⑤	N/A ⑦	18-2649
R / MR / ALPHA I	1983-1990	6225577-D469858	18-2426 ①	18-2427 ①	N/A ⑥	N/A ⑧	18-2649
R	1983-1990	6225577 & UP	18-2426 ①	18-2427 ①	N/A	N/A	18-2649
MR	1983-1990	6225577 & UP	18-2426 ①	18-2427 ①	N/A	N/A	18-2649
ALPHA I	1983-1990	6225577 & UP	18-2426 ①	18-2427 ①	N/A	N/A	18-2649
ALPHA I SS	1986-1989	A545004 & UP	18-2426 ①	18-2427 ①	N/A ⑤	N/A ⑦	18-2649
ALPHA I SS	1986-1989	A545004 & UP	N/A ②	N/A ②	N/A	N/A	18-2649
ALPHA I SS	1986-1989	A545004 & UP	N/A	N/A	N/A	N/A	18-2649
R	1983-1990	6225577 & UP	N/A ②	N/A ②	N/A	N/A	18-2649
MR	1983-1990	6225577 & UP	N/A ②	N/A ②	N/A	N/A	18-2649
ALPHA I	1983-1990	6225577 & UP	N/A ②	N/A ②	N/A	N/A	18-2649
ALPHA I GEN II	1991-2001	D469859 & UP	N/A	18-2433	N/A	N/A	18-2649
BRAVO I	1988-2010	B664190 & UP	18-2424	18-2425	N/A	N/A	18-2649
BRAVO II	1988 & UP	B664190 & UP	18-2424	18-2425	N/A	N/A	18-2649
BRAVO III	1988 & UP	B664190 & UP	18-2424	18-2425	N/A	N/A	18-2649
BRAVO SEACORE	2007-2010	W900000 & UP	N/A	N/A	N/A	N/A	18-2649
BLACKHAWK	1994-1995	F186717 & UP	18-2424	18-2425	N/A	N/A	18-2649

- ① 11 3/8" LONG TUBES - INTERNAL CYLINDER LINES
- ② 13 3/4" LONG TUBES - INTERNAL CYLINDER LINES
- ③ CASTING #14034 1
- ④ CASTING 14035 1
- ⑤ CASTING #98703
- ⑥ CASTING #98703 1
- ⑦ CASTING #98704
- ⑧ CASTING #98704 1
- ⑨ INTERNAL TRIM LINES
- ⑩ USE WITH 15 9/16" LONG TRIM CYLINDER TUBE
- ⑪ EXTERNAL TRIM LINES
- ⑫ TRIM CYLINDER WITH INTERNAL TRIM LINES
- ⑬ USE WITH 16 3/16" LONG TRIM CYLINDER TUBE
- ⑭ EXCLUDES TR, TRS, 215E, H, & EARLY II & III DRIVES

<p>PKG. OF 5</p>  <p>18-4252 CONTINUITY SPRING Replaces: 24-46312 Grounds the trim cylinder to the pivot pin shaft.</p>	 <p>18-2151 7 1/2" (Front) Replaces: 17-45738</p> <p>18-2152 10 1/2" (Rear) Replaces: 17-45735</p> <p>PIVOT PINS Used on 120, 120-260, 140, 165, 225S, 233, 250, 470, 888, 898/228 Use 18-2701 Bushing</p>	 <p>18-2393 TRIM CYLINDER PIVOT PIN Replaces: 17-14872 For: Trim cylinder rear R/MR/Alpha Use: 18-2702-1 Bushing</p>	 <p>18-2394 TRIM CYLINDER PIVOT PIN Replaces: 17-14873 3/8" - 24 thread For: Trim cylinder front R/MR/Alpha Use: 18-2702-1 Bushing</p>
 <p>18-2395 TRIM CYLINDER PIVOT PIN Replaces: 17-815953, 17-815953A1 For: Trim cylinder front & rear Gen II</p>	 <p>18-2396 TRIM CYLINDER PIVOT PIN 9 1/4" overall length • 7 1/2" shaft length Replaces: 17-44166 For: Rear Bravo</p>	 <p>18-2397 TRIM CYLINDER PIVOT PIN Replaces: 17-44167A1, 17-44167 For: Front Bravo</p>	

④ Standard package of 8 priced per piece
⑤ Standard package of 8 priced per package ⑥ Priced per Package of 4
⑦ Priced per Package

<p>PKG. OF 8</p>  <p>POWER TRIM BUSHING 18-2701 18-2701-04⑥ 18-2701-9④ Replaces: 23-89574, 23-61290, 23-45736 Fits: 120/260 Drive Units (S/N 6225276 & Down)</p>	<p>PKG. OF 8</p>  <p>POWER TRIM BUSHING 18-2702-1⑤ 18-2702-04⑥ 18-2702-1-9④ Replaces: 23-99291, 23-99291T Fits: 120/260 Drive Units (S/N 6225277 & UP)</p>	<p>PKG. OF 8</p>  <p>18-4288 18-4288-9⑦ POWER TRIM BUSHING Replaces: 23-807073, 23-44165 For: Bravo</p>	 <p>18-2345 18-2345-9⑦ TRIM CYLINDER ANCHOR PIN E-RING Replaces: 53-815949 For: Gen II</p>
<p>PKG. OF 2</p>  <p>18-4289 18-4289-9⑦ RETAINING RING Replaces: 53-805272 For: Bravo</p>	<p>PKG. OF 4</p>  <p>18-2336 18-2336-9⑦ TRIM BUSHING Replaces: 23-47392, 23-61291, 23-90203 For: TR & TRS(1977-93), Alpha One SS (1986-1989) , SSM(1982-1995)</p>	<p>PKG. OF 8</p>  <p>18-2341-1 18-2341-1-9⑦ POWER TRIM BUSHING Replaces: 23-815950, 23-8159501, 23-815950Q01 For: Gen II</p>	<p>PKG. OF 5</p>  <p>18-3232 18-3232-9⑦ PLUG Replaces: 19-47579, 19-475791 For: MR Alpha</p>

Zinc is for saltwater only applications.
 Magnesium is for fresh water only applications.
 Aluminum is for brackish water or salt water environments.

 <p>18-6154A 18-6154M 18-6154Z ANODE KIT Bravo III (2004 and Newer)</p>	 <p>18-6158M 18-6158Z 18-6158A ANODE KIT Replaces: 888755Q01 (18-6158M), 888756Q01 (18-6158A), 97-888756Q03 (18-6158A, M), 888756A1 (18-6158A, M) Mercuriser Alpha I Gen II (1991 & UP)</p>	 <p>18-6159A 18-6159M 18-6159Z ANODE KIT Replaces: 888758Q01 (18-6159A), 888757Q01 (18-6159M), 97-888758Q03 (18-6160A), 888758A1 (18-6160A), 97-888759Q03 (18-6160M), 888759A1 (18-6160AM) Mercuriser Bravo I - All Years</p>	 <p>18-6160A 18-6160M 18-6160Z ANODE KIT Replaces: 888761Q01 (18-6160A), 97-888761Q03 (18-6160A), 888761A1 (18-6160A), 888760Q01 (18-6160M), 97-888760Q03 (18-6160M), 888760A1 (18-6160M) Bravo II (1989 & Up), Bravo III (1989-03)</p>
 <p>① 18-6117A ③ 18-6117Z ANODE Replaces: 97-806188A1, 97-806188Q01 For: Bravo One bearing carrier</p>	 <p>② 18-6241 ③ 18-6011 ① 18-6011A ANODE Replaces: 31640, 31640A1, 97-31640Q4, 31640T6, 97-31640B4, 31640A4, 31640A2, 316404, 316403, 72436A1 For use on: R/MR/Alpha One, Sterndrive & Transom Assembly (1983-90) & prior drives, Alpha One, Gen II (1991 & up)</p>	 <p>③ 18-6012 ANODE Replaces: 34127A1, 34127T2, 34127A2, 34127T1, 34127 For use on: R/MR/Alpha One (Sterndrive & Transom Assembly 1983-90) & prior drives</p>	 <p>③ 18-6013 ANODE Replaces: 34762A1, 97-34672C, 32170, 32170A1 For use on: Alpha One SS (Sterndrive & Transom Assembly 1983-89) & prior drives</p>
 <p>③ 18-6014 ① 18-6014A ANODE Replaces: 46399A1, 822777A1, 822777Q1, 822777A4, 822777A3, 8227772, 822777, 46399A2 For use on: Alpha One SS (1982-89)</p>	<p>PKG. OF 2</p>  <p>⑥③ 18-6015-9 ③⑤ 18-60151-9 ⑥② 18-6242-9 ANODE Replaces: 55989A3, 55989Q9, 55989T9, 55989A9, 55989A4, 55989 Bravo I, II, III (1988-95)</p>	 <p>③ 18-6016 ③④ 18-60161 ① 18-6016A ② 18-6244 ANODE Replaces: 76214, 762142, 762142A1, 76214A5, 97-76214Q5, 786214A2, 97-762145 200, 225, 250HP, V-155-V-200, & All Bravos, Alpha One, Gen II (1991 & up) (Threaded through)</p>	 <p>③ 18-6066 ① 18-6066A ② 18-6243 ANODE Replaces: 43994A2, 821631Q1, 821631C, 821631B1, 821631A1 For use on: R/MR/Alpha One (Sterndrive & Transom Assembly 1983-90)</p>

① Aluminum ② Magnesium ③ Zinc
 ④ Standard package of 10 priced per piece ⑤ Standard package of 10 priced per package
 ⑥ Standard package of 2 priced per package

Zinc is for saltwater only applications.
Magnesium is for fresh water only applications.
Aluminum is for brackish water or salt water environments.



② 18-6114
③ 18-6067
① 18-6067A
ANODE
Replaces: 97-806189, 806189A1, 97-806189Q1
For: Alpha One, Gen II (1991 & up)



③ 18-6068
ANODE
Replaces: 826134, 826134A1, 97-826134Q
Alpha One (Gen II)



② 18-6099
③ 18-6080
① 18-6080A
ANODE
Replaces: 815933A1, 821629A1, 97-821629Q1
For: Alpha One (Gen II) (1991 & UP)



② 18-6089
③ 18-6092
① 18-6092A
ANODE
Replaces: 97-806190, 806190A1, 97-806190Q1, 806190T1, 97-806190B4
All Bravos



② 18-6079
③ 18-6093
① 18-6093A
ANODE
Replaces: 806105, 806105A1, 806105Q1, 806105T1
For: Alpha One (Gen II) (1991 & UP)



① 18-6150A
② 18-6150M
③ 18-6150Z
ANODE KIT
Replaces: 888756Q02, 888756Q4, 888756A2
For: MR & Alpha One Drives



② 18-6240
③ 18-6094
① 18-6094A
ANODE
Replaces: 821630C2, 821630A1, 97-821630Q1, 817373A1
All Bravos

- CONTAINS -

Part #	Desc.	O.E.#	Qty.
18-2599	Face Seal and Tool	26-818575A2	1
18-2564 -1	Water Pump Base To Face Plate Gasket	27-43033-1	1
18-2566	Face Plate to Water Pump Cover Gasket	27-817277	1
18-2945	Drain Screw Gasket	12-19183	1
18-2944	Seal	26-45577	1
18-2002	Oil Seal	26-30550, 26-76868	1
18-2009	Oil Seal	26-892361	1
18-2013	Oil Seal	26-16977	1
18-2014	Oil Seal	26-89238	1
18-2054	Oil Seal	26-81646-1	1
18-2056	Oil Seal	26-965031	2
18-2076	Oil Seal	26-12224	1
18-2077	Oil Seal	26-14077	1
18-7159	O-Ring	25-31534	1
18-7168	O-Ring	25-48171	2
18-7176	O-Ring	25-90011	1
18-7420	O-Ring	25-21836	2
18-7440-1	O-Ring	25-36318	2
18-2056	Oil Seal	26-66302	2
18-7413	O-Ring	25-62702	1



**18-2646-1
LOWER UNIT SEAL KIT**
Replaces: 26-816575A3, 26-816575A1
For: Alpha Gen II

- CONTAINS -

Part #	Description	O.E. #	Qty.
18-2516	Bravo Outdrive Seal	16755	1
18-1240	Outdrive Seal	12708	1
18-2945	Drain Screw Gasket	12-19183	1
18-7198	O-Ring	25-45710	1
18-7102	O-Ring	25-62706	1
18-7105	O-Ring	25-62705	1
18-7449	O-Ring	25-97387	1
18-7153	O-Ring	25-25439	2
18-7167	O-Ring	25-97386	1
18-2010	NSS	26-12709	1
18-2715	Spring Kit	24-17997A1	1
18-7117	O-Ring	25-35027	1
18-7169	O-Ring	25-70937	1



**18-2643
UPPER UNIT SEAL KIT**
Replaces: 26-16709A2, 26-16709A1
BRAVO - BLACKHAWK

- CONTAINS -

Part #	Description	O.E. #	Qty.
18-2944	Seal Gasket	26-45577	1
18-2945	Drain Screw Gasket	12-19183	3
18-7188	Drain Screw O-Ring	26-805726	1
18-7169	O-Ring	25-70937	1
18-7161	O-Ring	25-32546	1
18-7420	O-Ring	25-25439	2
18-7103	O-Ring	25-29845	2
18-7117	O-Ring	25-35027	1
18-2056	Oil Seal	26-965031	2
18-2003	Oil Seal	26-68493, 26-32080, 26-36054, 26-823894	1
NSS	Water Tube Seal	26-88397	1
18-3289	Double Lip Seal	26-864319	1
18-2715	Spring Kit	24-17997A1	1



**18-2644
UPPER UNIT SEAL KIT**
Replaces: 26-88397A1
ALPHA I GENERATION II

SEAL KIT APPLICATION BEGINS ON PAGE 867

① Aluminum ② Magnesium ③ Zinc ④ Standard package of 10 priced per piece

— CONTAINS —

Part #	Description	O.E. #	Qty.
18-2944	Seal Gasket	26-45577	1
18-2945	Drain Screw Gasket	12-19183	1
18-7163	O-Ring	25-33465	1
18-7159	O-Ring	25-31534	1
18-2002	Oil Seal	26-70019, 26-73838	2
18-0563	Seal	26-36556	1

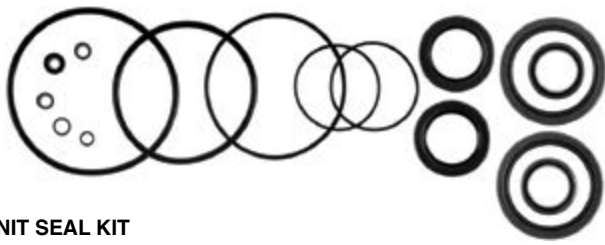

**18-2645-1
LOWER UNIT SEAL KIT**
Replaces: 26-76868A1, 26-76868A2, 26-76868A04
Bravo I, II & III MODELS

— CONTAINS —

Part #	Description	O.E. #	Qty.
18-2945	Drain Screw Gasket	12-19183	2
18-0894	Water Pocket Cover Gasket	27-55810	1
18-2003	Oil Seal	26-823894	1
18-2049	Oil Seal	26-32511	1
18-2056	Oil Seal	26-965031	1
18-2944	Seal Ring Gasket	26-45577	1
18-3110	Bushing	26-38970	1
18-7153	O-Ring	25-25439	2
18-7161	O-Ring	25-32546	1
18-7169	O-Ring	25-70937	1
NSS	O-Ring	25-55801	1



**18-2648
UPPER UNIT SEAL KIT**
Replaces: 26-32511A1
S/N 1684188 & UP
For: #1 Units (Including ALPHA) (Also fits 888 Stern drive)
S/N 3106717 & UP

— CONTAINS —

Part #	Description	O.E. #	Qty.
18-2919	Water Pump to Gear Hsg. Gasket	27-42631-1	1
18-3110	Grommet	26-38970	1
18-2002	Oil Seal	26-70019, 26-73838	1
18-2013	Oil Seal	26-16977	2
18-2014	Oil Seal	26-89238	1
18-2826	Water Pump Base to Gear Hsg. Gasket	27-85610-1	1
18-2914	Lower Water Pump to Wear Plate Gasket	27-85608-1	1
18-2915	Upper Water Pump to Wear Plate Gasket	27-85609-1	1
18-2944	Seal Ring Gasket	26-45577	1
18-2948	Gear Housing Plastic Flush Screw Gasket	12-49221-1	1
18-7158	O-Ring	25-30613	1
18-7159	O-Ring	25-31534	1
18-7162	O-Ring	25-33145	1
18-7176	O-Ring	25-90011	1
—	O-Ring	25-38099	1
18-2154	Bushing, Shift Shaft	23-30617A2	1
18-2076	Line Cutter Oil Seal	26-12224	1
18-7426	O-Ring	25-30271	1
18-2945	Drain Screw Gasket	12-20260, 12-19183	2

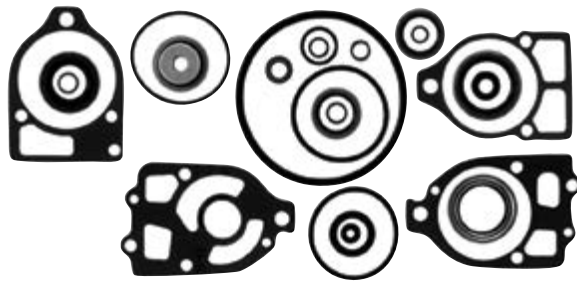

**18-2652
LOWER UNIT SEAL KIT**
Replaces: 26-33144A2, 26-33144A1, 26-89238A1
S/N 1684188 & UP
For: #1 Units (Including ALPHA)

— CONTAINS —

Part #	Description	O.E. #	Qty.
18-2652	Lower Gear Housing Seal Kit	26-33144A2	1
18-1155	Ball Bearing	30-88957A1	1
18-1117	Pinion Bearing	31-42647A1	1
18-1143	Tapered Roller Bearing	31-36387A1	1
18-3719	Pinion Nut	11-35921	1
18-2299	Tab Washer	14-79447	1
18-2298	Tab Washer	14-18323	1
18-1158	Needle Roller Bearing	31-30956	1
18-1159	Tapered Roller Bearing	31-35928A1	1
18-2285	Shim Kit	15-47397A1	1
18-1157	Needle Roller Bearing	31-30895	1
18-2343-9	Washer	12-982721	1
18-2294	Shim Kit	2470	1



**18-8208
SEAL & BEARING KIT**
Replaces: 31-803090T1
For: MR/Alpha Drive

— CONTAINS —

Part #	Description	O.E. #	Qty.
18-2340	Shift Shft Rubber Washer	12-31266	1
18-2076	Oil Seal	26-12224	1
18-7159	O-Ring	25-31534	1
18-2002	Oil Seal	26-76868	1
18-3109	Water Tube	23-29804	1
18-2154	Shift Bushing	23-30617A2	1
18-3116	Housing	46-96148A1	1
18-3017	Impeller	47-89984	1
18-2914	Water Pump Gasket	27-85608-1	1
18-7158	O-Ring	25-30613	1
18-7176	O-Ring	25-90011	1
18-2944	Seal Ring Gasket	26-45577	1
18-7173	O-Ring	25-30224	1
18-2826	Water Pump Base to Gear Housing Gasket	27-85610-1	1
18-2915	Water Pump Gasket	27-85609-1	1
18-3117	Plate	32435	1
18-7162	O-Ring	25-33145	1
18-2919	Water Pump Gasket	27-42631-1	1
NSS	Water Pump Gasket	27-32438	1
18-7426	O-Ring	35-30271	1
18-2945	Drain Screw Gasket	26-20260, 12-19183	2
18-3110	Grommet	26-38970	1
18-2013	Seal	26-16977	1
18-2014	Seal	26-89238	1



**18-8370
COMPLETE LOWER GEAR CASE REBUILD KIT**
Includes Water Pump and Complete Seal Kit
For: Mercuriser R/MR/ALPHA 1

Model	Year	Beginning Serial #	Ending Serial #	Driveshaft Hsg Seal Kit	J-Joint Seal	U-Joint Carrier Seal	Gear Hsg Seal & Brg Kit	Gear Hsg Seal Kit	Brg Carrier O-Ring	Brg Carrier Seal
60 / 80 / 90	1965-1972	1830753	3225967	N/A	N.L.A.	N/A	N/A	N/A	18-7160	18-2011
IA / IB / IC / EZ SHIFT	1964-1966	1684188	2065186	18-2648	18-2003	18-0577	N/A	18-2652	18-7159	18-2002
120 / 140	1967-1982	2062141	6225576	18-2648	18-2003	18-0577	N/A	18-2652	18-7159	18-2002
470 / 485	1976-1982	4208730	6225575	18-2648	18-2003	18-0577	N/A	18-2652	18-7159	18-2002
160 / 165	1967-1981	2065190	& UP	18-2648	18-2003	18-0577	N/A	18-2652	18-7159	18-2002
888	1971-1977	3106717	& UP	18-2648	18-2003	18-0577	N/A	18-2652	18-7159	18-2002
225 / 233	1974-1977	3856268	& UP	18-2648	18-2003	18-0577	N/A	18-2652	18-7159	18-2002
888 / 228 / 250 / 260	1977-1982	4782330	6225576	18-2648	18-2003	18-0577	N/A	18-2652	18-7159	18-2002
R	1983	6225577	& UP	18-2648	18-2003	18-0577	N/A	18-2652	18-7159	18-2002
MR ALPHA ONE	1984-1990	6225577	D469858	18-2648	18-2003	18-0577	18-8208	18-2652	18-7159	18-2002 ③
MR ALPHA ONE	1984-1990	6225577	D469858	18-2648	18-2003	18-0577	18-8208	18-2652	18-7159	18-2077 ①
MR ALPHA ONE	1984-1990	6225577	D469858	18-2648	18-2003	18-0577	18-8208	18-2652	18-7159	18-2076 ②
MR ALPHA ONE (CR)	1984-1990	6225577	D469858	18-2648	18-2003	18-0577	N.L.A.	18-2652	18-7159	18-2077 ①
MR ALPHA ONE (CR)	1984-1990	6225577	D469858	18-2648	18-2003	18-0577	N.L.A.	18-2652	18-7159	18-2076 ②
ALPHA ONE SS	1986-1989	A545004	& UP	18-2648	18-2003	18-0577	N/A	18-2652	18-7159	18-2002 ③
ALPHA ONE SS	1986-1989	A545004	& UP	18-2648	18-2003	18-0577	N/A	18-2652	18-7159	18-2077 ①
ALPHA ONE SS	1986-1989	A545004	& UP	18-2648	18-2003	18-0577	N/A	18-2652	18-7159	18-2076 ②
APLHA ONE GEN II	1991-1995	D469859	F679999	18-2644	18-2003	18-0577	N/A	18-2646-1	18-7159	18-2077 ①
APLHA ONE GEN II	1991-1995	D469859	F679999	18-2644	18-2003	18-0577	N/A	18-2646-1	18-7159	18-2076 ②
APLHA ONE GEN II (CR)	1991-1995	D469859	F679999	18-2644	18-2003	18-0577	N.L.A.	18-2646-1	18-7159	18-2077 ①
APLHA ONE GEN II (CR)	1991-1995	D469859	F679999	18-2644	18-2003	18-0577	N.L.A.	18-2646-1	18-7159	18-2076 ②
APLHA ONE GEN II	1996-1997	F680000	K999999	18-2644	18-2003	18-0577	N/A	18-2646-1	18-7159	18-2077 ①
APLHA ONE GEN II	1996-1997	F680000	K999999	18-2644	18-2003	18-0577	N/A	18-2646-1	18-7159	18-2076 ②
APLHA ONE GEN II (CR)	1996-2010	F680000	& UP	18-2644	18-2003	18-0577	N.L.A.	18-2646-1	18-7159	18-2077 ①
APLHA ONE GEN II (CR)	1996-2010	F680000	& UP	18-2644	18-2003	18-0577	N.L.A.	18-2646-1	18-7159	18-2076 ②
APLHA ONE GEN II	1998-2010	L100040	& UP	18-2644	18-2003	18-0577	N/A	18-2646-1	18-7159	18-2077 ①
APLHA ONE GEN II	1998-2010	L100040	& UP	18-2644	18-2003	18-0577	N/A	18-2646-1	18-7159	18-2076 ②
BRAVO I	1988-2010	B664190	& UP	18-2643	N/A	N/A	N/A	18-2645-1	18-7159	18-2002
BRAVO I X	2000-2010	M100001	& UP	18-2643	N/A	N/A	N/A	18-2645-1	18-7159	18-2002
BRAVO I XR/XZ	2000-2010	M100001	& UP	18-2643	N/A	N/A	N/A	N/A	18-7159	N/A
BRAVO II	1988-2010	B664190	& UP	18-2643	N/A	N/A	N/A	18-2645-1	N/A	N/A ②
BRAVO II	1988-2010	B664190	& UP	18-2643	N/A	N/A	N/A	18-2645-1	N/A	N/A ①
BRAVO II X	2000-2010	M100001	& UP	18-2643	N/A	N/A	N/A	18-2645-1	N/A	N/A ②
BRAVO II X	2000-2010	M100001	& UP	18-2643	N/A	N/A	N/A	18-2645-1	N/A	N/A ①
BRAVO III	1988-2010	B664190	& UP	18-2643	N/A	N/A	N/A	18-2645-1	N/A	N/A
BRAVO III X	2000-2010	M100001	& UP	18-2643	N/A	N/A	N/A	18-2645-1	N/A	N/A
BLACKHAWK	1994-1995	F186717	& UP	18-2643	N/A	N/A	N/A	N/A	N/A	N/A
I	1963	1534570	1684187	18-2648	N/A	18-0577	18-2652	N/A	18-7157	18-2002
II	1962-1969	1474909	2671321	N/A	N/A	N/A	N/A	N/A	18-7159	N.L.A.
III	1968-1972	2373127	3002613	N/A	N/A	N/A	N/A	N/A	N/A	N/A
215E/H	1970-1972	2909035	2915034	N/A	N/A	N/A	N/A	N/A	N/A	N/A
TR	1973-1993	3377316	& UP	N/A	N/A	N/A	N/A	N/A	N/A	N/A
TRS	1973-1993	3377316	& UP	N/A	N/A	N/A	N/A	N/A	18-7159	N/A

① Inner ② Outer ③ w/o Fishline Cutter Seal

<p>②18-4456D </p> <p>18-4456 EXHAUST PROTECTOR VALVE Replaces: 34765A1, 34765A2 INCLUDES STAINLESS STEEL CLAMP 3"</p>	<p>②18-4457D </p> <p>18-4457 EXHAUST PROTECTOR VALVE Replaces: 12644A1, 12644Q01 INCLUDES STAINLESS STEEL CLAMP 4"</p>	<p>②18-4458D </p> <p>18-4458 EXHAUST PROTECTOR VALVE (Fits both 5" & 6" Exhaust) INCLUDES STAINLESS STEEL CLAMP</p>
--	--	---

② Items ending in "D" are Display Packaged - Regular number is Non-Display

OIL SEALS

Part #	O.E. #	Shaft Size (in.)	Dimensions (in.)	
			O.D.	Width
18-0172	26-97530	0.845	1.500	0.315
18-0515	26-30530	0.540	1.004	0.303
18-0517	26-32911	1.100	1.260	0.127
18-0519	26-14240	3.792	4.536	0.482
18-0522	26-43036	1.045	1.474	0.187
18-0523	26-43993	1.640	2.132	0.282
18-0525	26-45587	0.390	0.628	0.124
18-0526	26-48443	0.750	1.379	0.256
18-0527	26-56397	0.750	1.127	0.343
18-0529	26-62818	1.640	2.256	0.319
18-0531	26-72785	0.790	1.880	0.248
18-0537	26-85107	1.020	1.507	0.251
18-0578	26-67388	1.800	3.100	0.500
18-2002	26-76868, 26-70019	1.188	1.692	0.25
18-2004	26-20070	0.625	1	0.25
18-2003	26-32080, 26-68493, 26-823894	2.25	3	0.437
18-2004	26-20070	0.625	1	0.25
18-2006	26-897154	0.625	1.125	0.312
18-2007	26-94038, 26-30727, 26-31489	1	1.5	0.312
18-2008	26-56788	0.875	1.25	0.375
18-2009	26-892361, 26-25776, 26-31249, 26-46021	0.375	0.75	0.25
18-2010	26-897153	0.437	0.875	0.25
18-2011	26-23300, 26-90562, 26-29595	0.75	1.25	0.312



Part #	O.E. #	Shaft Size (in.)	Dimensions (in.)	
			O.D.	Width
18-2013	802276, 26-16977, 26-20465, 26-31507, 26-79884	0.875	1.25	0.188
18-2014	26-33144, 26-77634, 26-89238, 26-F694305	0.875	1.5	0.312
18-2015	20250, 26-23517	0.75	1.25	0.25
18-2016	26-20079, 26-25837, 26-29476, 26-41953	1.187	1.875	0.25
18-2017	26-32121, 26-35025	0.75	1	0.125
18-2019	26-27163	0.688	1.124	0.25
18-2026 ①	802276, 26-16977, 26-20465, 26-31507, 26-79884	0.875	1.25	0.188
18-2048	26-24590	0.4	0.566	0.094
18-2049	26-32511	1.25	2.005	0.388
18-2050	26-55682	1	1.253	0.125
18-2051	26-69188	0.875	1.253	0.278
18-2052	26-69189	0.875	1.314	0.322
18-2053	26-70081	1.185	1.754	0.36
18-2054	26-76384, 26-8164641	0.375	0.75	0.243
18-2055	26-21642, 26-26782, 26-79831	0.75	1.127	0.149
18-2056	26-37259, 26-89237, 26-96503, 26-965031	0.875	1.375	0.250
18-2076 ①	26-F697118, 26-12224	1.188	1.690	0.360
18-2077	26-F697555, 26-14077	1.188	1.689	0.247

① Line Cutter Seal

DRIVESHAFT HOUSING

Stern Drive Model	Beg. S/N	End S/N	Oil Seal	Desc.	Qty.
R/MR/Alpha I	6225577	UP	18-2003	BC	1
Alpha I SS		ALL	18-2003	BC	1
Alpha I SS		ALL	18-2056	LDS	1
Alpha I SS		ALL	18-2049	GC	1
IA,IB,IC	1684188	2065189	18-2003	BC	1
I,IA,IB,IC	1534570	2065189	18-2049	GC	1
IA,IB,IC	1749276	2065189	18-2056	LDS	1
II	1474909	2671321	18-2003	BC	1
120/140	2062141	6225576	18-2003	BC	1
120/140	2062141	6225576	18-2056	LDS	1
120/140	2062141	6225576	18-2049	GC	1
160/165	2065190	UP	18-2003	BC	1
160/165	2065190	UP	18-2049	GC	1
160/165	2065190	UP	18-2056	LDS	1
225-S	3856268	4200499	18-2056	LDS	1
225-S	3856268	4200499	18-2049	GC	1
225-S	3856268	4200499	18-2003	BC	1
233	4200500	UP	18-2049	GC	1
233	4200500	UP	18-2003	BC	1
233	4200500	UP	18-2056	LDS	1

Stern Drive Model	Beg. S/N	End S/N	Oil Seal	Desc.	Qty.
250	4791300	4898729	18-2049	GC	1
250	4791300	4898729	18-2003	BC	1
250	4791300	4898729	18-2056	LDS	1
260	4898730	6225576	18-2049	GC	1
260	4898730	6225576	18-2056	LDS	1
260	4898730	6225576	18-2003	BC	1
470	4208730	6225576	18-2056	LDS	1
470	4208730	6225576	18-2003	BC	1
470	4208730	6225576	18-2049	GC	1
485	4893835	UP	18-2003	BC	1
485	4893835	UP	18-2049	GC	1
485	4893835	UP	18-2056	LDS	1
888	3106717	UP	18-2056	LDS	1
888	3106717	UP	18-2049	GC	1
888	3106717	UP	18-2003	BC	1
898/228	4782330	6225576	18-2049	GC	1
898/228	4782330	6225576	18-2003	BC	1
898/228	4782330	6225576	18-2056	LDS	1

BC Bearing Carrier Seal
GC Gear Chamber Seal
LDS Lower Driveshaft Seal

GEAR HOUSING

Stern Drive Model	Beg. S/N	End S/N	Oil Seal	Desc.	Qty.
MR/Alpha I	6225577	UP	18-2002	PS	2
R/MR/Alpha I	6225577	UP	18-2009	SSB	1
R/MR/Alpha I	6225577	UP	18-2014	WPB,L	1
MR/Alpha I	6225577	UP	18-2013	WPB,U	1
R	6225577	UP	18-2013	WPB,U	1
Alpha I SS	ALL		18-2014	WPB,L	1
Alpha I SS	ALL		18-2009	SSB	1

Stern Drive Model	Beg. S/N	End S/N	Oil Seal	Desc.	Qty.
Alpha I SS	ALL		18-2013	WPB,U	1
Alpha I SS	ALL		18-2002	PS	2
BRAVO I	B664190	UP	18-2002	PS	2
I	1534570	1536617	18-2009	WPB	1
I	1534570	1684187	18-2009	SSB	1
I	1534570	1684187	18-2002	PS	2
I	1534570	1684187	18-2013	WP	1

GEAR HOUSING (Cont.)

Stern Drive Model	Beg. S/N	End S/N	Oil Seal	Desc.	Qty.
I	1536618	1684187	18-2014	WPB	1
I	1563354	1684187	18-2013	WPB	1
IA,IB,IC	1684188	2065189	18-2014	WPB	1
IA,IB,IC	1684188	2065189	18-2002	PS	2
IA,IB,IC	1684188	2065189	18-2013	WPB	1
IA,IB,IC	1684188	2065189	18-2013	WP	1
IA,IB,IC	1684188	2065189	18-2009	SSB	1
TRS	4794900	UP	18-2002	PS	2
60	1830753	2063740	18-2009	SSB	1
60	1830753	2063740	18-2011	WPB,L	1
60	1830753	2063740	18-2055	WPB,U	1
60	1830753	2063740	18-2015	PS,O	1
60	1830753	2063740	18-2011	PS,I	1
80	2063741	2898029	18-2002	PS	2
80	2063741	2898029	18-2009	SSB	1
80	2063741	2898029	18-2055	WPB,U	1
80	2063741	2898029	18-2011	WPB,L	1
90	2898020	3225967	18-2009	SSB	1
90	2898020	3225967	18-2002	PS	2
90	2898020	3225967	18-2011	WPB,L	1
90	2898020	3225967	18-2055	WPB,U	1
120/140	2062141	6225576	18-2013	WPB,U	1
120/140	2062141	4893634	18-2013	WP	1
120/140	2062141	6225576	18-2014	WPB,L	1
120/140	2062141	6225576	18-2009	SSB	1
120/140	2062141	6225576	18-2002	PS	2
160/165	2065190	UP	18-2009	SSB	1
160/165	2065190	UP	18-2014	WPB,L	1
160/165	2065190	UP	18-2002	PS	2
160/165	2065190	4890459	18-2013	WP	1
160/165	2065190	UP	18-2013	WPB,U	1
225-S	3856268	4200499	18-2013	WPB,U	1
225-S	3856268	4200499	18-2014	WPB,L	1
225-S	3856268	4200499	18-2002	PS	2
225-S	3856268	4200499	18-2009	SSB	1

Stern Drive Model	Beg. S/N	End S/N	Oil Seal	Desc.	Qty.
233	4200500	UP	18-2009	SSB	1
233	4200500	UP	18-2013	WPB,U	1
233	4200500	UP	18-2002	PS	2
233	4200500	UP	18-2014	WPB,L	1
250	4791300	4898729	18-2013	WPB,U	1
250	4791300	4898729	18-2014	WPB,L	1
250	4791300	4898729	18-2002	PS	2
250	4791300	4898729	18-2009	SSB	1
255-TRS	3377316	4203749	18-2002	PS	2
260	4898730	6225576	18-2009	SSB	1
260	4898730	6225576	18-2002	PS	2
260	4898730	6225576	18-2013	WPB,U	1
260	4898730	6225576	18-2014	WPB,L	1
280-TRS	4203750	4895399	18-2002	PS	2
470	4208730	6225576	18-2009	SSB	1
470	4208730	6225576	18-2014	WPB,L	1
470	4208730	6225576	18-2002	PS	2
470	4208730	6225576	18-2013	WPB,U	1
485	4893835	UP	18-2002	PS	2
485	4893835	UP	18-2009	SSB	1
485	4893835	UP	18-2013	WPB,U	1
485	4893835	UP	18-2014	WPB,L	1
888	3106717	UP	18-2014	WPB,L	1
888	3106717	UP	18-2009	SSB	1
888	3106717	UP	18-2013	WP	1
888	3106717	UP	18-2013	WPB,U	1
888	3106717	UP	18-2002	PS	2
898/228	4782330	6225576	18-2014	WPB,L	1
898/228	4782330	6225576	18-2013	WPB,U	1
898/228	4782330	6225576	18-2009	SSB	1
898/228	4782330	6225576	18-2002	PS	2

PS Prop Shaft Seal WPB Water Pump Base Seal
 PS,I Prop Shaft, Inner Seal WPB,L Water Pump Base, Lower Seal
 PS,O Prop Shaft, Outer Seal WPB,U Water Pump Base, Upper Seal
 SSB Shift Shaft Bushing Seal WP Water Pump Body Seal

O-RINGS

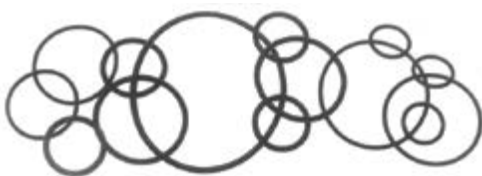

Part #	O.E. #	DIMENSIONS (in.)	
		O.D.	Width
18-0858 ③ ⑤	25-54029	2.8	0.103
18-0860 ③ ⑤	25-62700	3.237	0.103
18-7103 ②	25-29845	0.924	0.103
18-7105 ④ ⑤	25-62705, 25-F7848342	0.75	0.065
18-7107 ② ⑤	25-67202	4.75	0.135
18-7114 ② ⑤	25-23145, 25-843315, 25-F702736	1	0.135
18-7115 ①	25-26722	1.735	0.135
18-7116 ①	25-62704, 25-85148, 25-22174, 25-20633, 802206, 25-F24342	0.36	0.1
18-7117 ②	25-35027	1.046	0.139
18-7120 ①	25-38933	0.215	0.065
18-7121 ①	25-35029, 25-882613, 802231	3.1	0.135
18-7127 ①	25-32507, F83404	3.315	0.35
18-7134 ②	25-20195, 25-201951	0.5	0.1
18-7135 ①	25-20365, 25-35276	0.75	0.135

Part #	O.E. #	DIMENSIONS (in.)	
		O.D.	Width
18-7143 ② ⑤	27-58025, 25-65936, 391-5081	1.31	0.1
18-7145 ② ⑤	25-64068	0.25	0.1
18-7146 ② ⑤	25-47632	1.12	0.1
18-7151 ② ⑤	25-20081, 25-39572	3	0.135
18-7152 ② ⑤	25-20863	2.625	0.135
18-7153 ② ⑤	25-25439, 25-20679, 25-F53795-1, F53795	0.862	0.103
18-7155 ② ⑤	25-26855	1.62	0.135
18-7156 ② ⑤	25-29439	1.185	0.1
18-7157 ② ⑤	25-29976	3.5	0.21
18-7158 ② ⑤	25-30613, 25-846357	0.74	0.1
18-7159 ② ⑤	25-31534, 25-48451	3.855	0.21
18-7160 ② ⑤	25-31986	2.635	0.21
18-7161 ② ⑤	25-32546	3.25	0.07
18-7162 ② ⑤	25-32424, 25-33145	2.025	0.135
18-7163 ② ⑤	25-33465, 25-853220, 25-807149	2.415	0.1
18-7164 ② ⑤	25-33466, 25-67675, 25-846356, 27-898101789	1.375	0.1
18-7165-9 ② ⑤	25-32509, 25-806609, 25-F461342	0.5	0.065
18-7166 ② ⑤	25-45254	0.615	0.065
18-7167 ② ⑤	25-861844	3.609	0.139

CONTINUED ON NEXT PAGE

O-RINGS (CONT.)

Part #	O.E. #	DIMENSIONS (in.)		Part #	O.E. #	DIMENSIONS (in.)	
		O.D.	Width			O.D.	Width
18-7168 ② ⑤	25-20587, 25-21720, 25-26834, 25-48171, 25-801334436	0.37	0.065	18-7413 ② ⑤	22-22175, 25-62702, 25-F50342-1, F50342, F17510	0.301	0.07
18-7169 ② ⑤	25-35984, 25-70937	3.5	0.135	18-7419 ④ ⑤	25-69202	2.675	0.103
18-7170 ② ⑤	25-33504	1.365	0.135	18-7420 ③ ⑤	25-21836	0.796	0.139
18-7171 ② ⑤	25-30529	1.92	0.1	18-7421 ① ⑤	25-16524	0.15	0.065
18-7172 ② ⑤	25-31305	3.25	0.135	18-7426 ③ ⑤	25-30271	0.74	0.31
18-7173 ② ⑤	25-27018, 25-30224Q	1.875	0.135	18-7440-1 ③	25-36318	0.799	0.103
18-7174 ② ⑤	25-45711, 25-F455342	0.62	0.1	18-7449 ①	25-97387	4.487	0.103
18-7175 ② ⑤	25-62817	3.75	0.27	18-7459 ①	20311, 25-20826	2.234	0.139
18-7176 ② ⑤	25-896523, 25-F74305, F74305-1, F74305, F694555	2.16	0.1	18-7464 ①	25-39695, 25-846361	4.234	0.139
18-7177 ② ⑤	25-53421, 25-59712	2.625	0.065	18-7467 ③ ⑤	25-54030, 25-F523555, F532555	2.987	0.103
18-7180 ③ ⑤	12-31060, 25-26802, 25-8M2000926	0.445	0.09	18-7474 ①	25-94288	1.239	0.07
18-7188 ②	25-805726	0.361	0.0635	18-7961 ①	25-47254, 25-861844, 785-97386	3.65	0.135
18-7195 ②	25-8M0027717	2.75	0.07				
18-7198 ② ⑤	25-45710	1.43	0.1				
18-7410 ② ⑤	25-36390	0.676	0.07				
18-7411 ② ⑤	25-35480, 25-47386, 25-8M2000816	1.25	0.1				

① PKG. OF 1 ② PKG. OF 5 ③ PKG. OF 2 ④ PKG. OF 3

DRIVESHAFT HOUSING

Stern Drive Model	Beg. S/N	End S/N	Oil Seal	Desc.	Qty.	Stern Drive Model	Beg. S/N	End S/N	Oil Seal	Desc.	Qty.
R/MR/Alpha I	6225577	UP	18-7153	UJ	2	215E □	2909035	2915034	18-7174	FC	1
R/MR/Alpha I	6225577	UP	18-7169	BC	1	215E	2909035	2915034	18-7146	CC	1
R/MR/Alpha I	6225577	UP	18-7161	TC	1	225-S	3856268	4200499	18-7153	UJ	2
Alpha I SS	ALL		18-7161	TC	1	225-S	3856268	4200499	18-7169	BC	1
Alpha I SS	ALL		18-7169	BC	1	225-S	3856268	4200499	18-7161	TC	1
Alpha I SS	ALL		18-7153	UJ	2	233	4200500	UP	18-7161	TC	1
BRAVO (I/II)	B664190	UP	18-7198	DSH	1	233	4200500	UP	18-7153	UJ	2
BRAVO (I/II)	B664190	UP	18-7153	UJ	2	233	4200500	UP	18-7169	BC	1
I	1534570	1684187	18-7127	DG	1	250	4791300	4898729	18-7153	UJ	2
I,IA,IB,IC	1534570	1777798	18-7165-9	USSL	1	250	4791300	4898729	18-7169	BC	1
I,IA,IB,IC	1535212	2065189	18-7170	BH	2	250	4791300	4898729	18-7161	TC	1
IA,IB,IC	1684188	2065189	18-7153	UJ	2	255-TRS	3377316	4203749	18-7175	DSH	1
IA,IB,IC	1684188	2065189	18-7169	BC	1	260	4898730	6225576	18-7169	DG	1
II	2398798	2671321	18-7153	UJ	2	260	4898730	6225576	18-7161	TC	1
II SSM	ALL		18-7175	DSH	1	260	4898730	6225576	18-7170	BH	1
II SSM	ALL		18-7153	UJ	2	260	4898730	6225576	18-7153	UJ	2
II TR	3377316	4794899	18-7175	DSH	1	280-TRS	4203750	4895399	18-7175	DSH	1
III/III SSM	ALL		18-7115	FC	1	470	4208730	6225576	18-7169	BC	1
IV SSM □	ALL		18-7115	FC	1	470	4208730	6225576	18-7161	TC	1
V/IA/IB/IC	1534570	2065189	18-7161	TC	1	470	4208730	6225576	18-7153	UJ	2
TR/TRS ③	4794900	UP	18-7153	UJ	2	470	4893835	6225576	18-7170	BH	1
TR/TRS	4794900	UP	18-7175	DSH	1	485	4893835	UP	18-7161	TC	1
120/140	2062141	6225576	18-7161	TC	1	485	4893835	UP	18-7170	BH	1
120/140	2062141	6225576	18-7170	BH	1	485	4893835	UP	18-7153	UJ	2
120/140	2062141	6225576	18-7169	DG	1	485	4893835	UP	18-7169	DG	1
120/140	2062141	6225576	18-7153	UJ	2	888	3106717	UP	18-7161	TC	1
160/165	2065190	UP	18-7170	BH	1	888	3106717	UP	18-7169	BC	1
160/165	2065190	UP	18-7169	DG	1	888	3106717	UP	18-7153	UJ	2
160/165	2065190	UP	18-7153	UJ	2	898/228	4782330	6225576	18-7169	BC	1
160/165	2065190	UP	18-7161	TC	1	898/228	4782330	6225576	18-7161	TC	1
215H	2782203	2909034	18-7153	UJ	2	898/228	4782330	6225576	18-7153	UJ	2
215H	2782203	2909034	18-7146	PC	1	898/228	4898730	6225576	18-7170	BH	1

- | | |
|--|--|
| <ul style="list-style-type: none"> ① 1 ST Design ② 5/8" ID ③ With Borg Warner Transmission BC Bearing Carrier Seal BH Bell Housing Seal CC Crankshaft Cover Seal DG Drive Gear Seal | <ul style="list-style-type: none"> DSH Driveshaft Housing Seal FC Front Cover Seal PC Plug Cover Seal TC Top Cover Seal USSL Upper Shift Shaft Lever Seal UJ U-Joint Yoke Seal |
|--|--|

GEAR HOUSING

Stern Drive Model	Beg. S/N	End S/N	Oil Seal	Desc.	Qty.
R/MR/Alpha I	6225577	UP	18-7162	WPB	1
MR/Alpha I	6225577	UP	18-7176	WPB	1 ②
R/MR/Alpha I	6225577	UP	18-7158	UDS	1
R/MR/Alpha I	6225577	UP	18-7159	PBH	1
R/MR/Alpha I	6225577	UP	18-7153	SSB	1
Alpha I SS	ALL		18-7159	PBH	1
Alpha I SS	ALL		18-7158	UDS	1
Alpha I SS	ALL		18-7153	SSB	1
Alpha I SS	ALL		18-7176	WPB	1 ②
BRAVO I	B664190	UP	18-7159	PBH	1
BRAVO I/II	B664190	UP	18-7163	GH	1
I	1534570	1684187	18-7157	PBH	1
I	1534570	1536617	18-7153	WPB	1
I	1534570	1684187	18-7153	SSB	1
I,IA,IB,IC	1534570	2065189	18-7158	UDS	1
I,IA,IB,IC	1536618	2065189	18-7162	WPB	1
IA,IB,IC	1684188	2065189	18-7159	PBH	1
IA,IB,IC	1684188	1777798	18-7153	WPB	1
IA,IB,IC	1684188	2065189	18-7153	SSB	1
II	1474909	2671321	18-7159	PBH	1
III	ALL		18-7151	BRL	1
III	ALL		18-7174	BRS	1
TRS	4794900	UP	18-7159	PBH	1
60	1830753	2063740	18-7153	SSB	1
60	1830753	2063740	18-7160	PBH	1
60	1830753	2063740	18-7155	WOAL	1
60	1830753	2063740	18-7114	WOAS	1
80	2063741	2898029	18-7157	PBH	1
80	2063741	2898029	18-7155	WOAL	1
80	2063741	2898029	18-7114	WOAS	1
80	2063741	2898029	18-7153	SSB	1
90	2898020	3225967	18-7114	WOAS	1
90	2898020	3225967	18-7157	PBH	1
90	2898020	3225967	18-7153	SSB	1
90	2898020	3225967	18-7155	WOAL	1
120/140	2062141	6225576	18-7153	SSB	1
120/140	2062141	6225576	18-7158	UDS	1
120/140	2062141	6225576	18-7159	PBH	1
120/140	2062141	6225576	18-7162	WPB	1
120/140	4893635	6225576	18-7114	GH	1 ③
160/165	2065190	UP	18-7162	WPB	1
160/165	2065190	UP	18-7153	SSB	1

Stern Drive Model	Beg. S/N	End S/N	Oil Seal	Desc.	Qty.
160/165	2065190	UP	18-7158	UDS	1
160/165	2065190	UP	18-7159	PBH	1
165	4890460	UP	18-7114	GH	1 ③
225-S	3856268	4200499	18-7153	SSB	1
225-S	3856268	4200499	18-7162	WPB	1
225-S	3856268	4200499	18-7158	UDS	1
225-S	3856268	4200499	18-7159	PBH	1
233	4200500	UP	18-7162	WPB	1
233	4200500	UP	18-7158	UDS	1
233	4200500	UP	18-7159	PBH	1
233	4200500	UP	18-7153	SSB	1
250	4791300	4898729	18-7159	PBH	1
250	4791300	4898729	18-7158	UDS	1
250	4791300	4898729	18-7162	WPB	1
250	4791300	4898729	18-7153	SSB	1
255-TRS	3377316	4203749	18-7159	PBH	1
260	4898730	6225576	18-7162	WPB	1
260	4898730	6225576	18-7159	PBH	1
260	4898730	6225576	18-7153	SSB	1
260	4898730	6225576	18-7158	UDS	1
260	4898730	6225576	18-7114	GH	1 ③
280-TRS	4203750	4895399	18-7159	PBH	1
470	4208730	6225576	18-7159	PBH	1
470	4208730	6225576	18-7162	WPB	1
470	4208730	6225576	18-7158	UDS	1
470	4208730	6225576	18-7153	SSB	1
470	4893835	6225576	18-7114	GH	1 ①
485	4893835	UP	18-7158	UDS	1
485	4893835	UP	18-7162	WPB	1
485	4893835	UP	18-7153	SSB	1
485	4893835	UP	18-7114	GH	1 ①
485	4893835	UP	18-7159	PBH	1
888	3106717	UP	18-7162	WPB	1
888	3106717	UP	18-7158	UDS	1
888	3106717	UP	18-7153	SSB	1
888	3106717	UP	18-7159	PBH	1
898/228	4782330	6225576	18-7158	UDS	1
898/228	4782330	6225576	18-7153	SSB	1
898/228	4782330	6225576	18-7159	PBH	1
898/228	4782330	6225576	18-7162	WPB	1
898/228	4898730	6225576	18-7114	GH	1 ①

- ① 2.019 ID
- ② 2.17 ID
- ③ V-8 Engines Only
- BRL Bearing Retainer Large Seal
- BRS Bearing Retainer Small Seal
- GH Gear Housing Seal

- PGH Prop Bearing Housing Seal
- SSB Shift Shaft Bushing
- UDS Upper Driveshaft Seal
- WOAL Water & Oil Adapter Large Seal
- WOAS Water & Oil Adapter Small Seal
- WPB Water Pump Base Seal

GIMBAL HOUSING

Stern Drive Model	Beg. S/N	End S/N	Oil Seal	Desc.	Qty.
R/MR/Alpha I	6225577	UP	18-7170	BH	1
BRAVO (I/II)	B664190	UP	18-7168	V	2 ①
I	1534570	1641940	18-7165-9	GHB	2
II	1474909	1475005	18-7151	SL	1

Stern Drive Model	Beg. S/N	End S/N	Oil Seal	Desc.	Qty.
II	1602186	2671321	18-7162	GHAS	1
II	1732380	2671321	18-7172	GHAL	1
III/III SSM/IV		ALL	18-7159	BH	1
60	1830753	2063740	18-7172	BH	1

- ① With Oil Reservoir
- BH Bell Housing Seal
- EE Exhaust Elbow Seal
- GH Gimbal Housing Seal
- GHAL Gimbal Housing Adapter Large Seal

- GHAS Gimbal Housing Adapter Small Seal
- GHB Gimbal Housing Bolt Seal
- SL Steering Lever Seal
- V Valve Seal

⑤ This product is priced per piece. To order priced per package, please add -9 to the part number.

GIMBAL HOUSING (CONT.)

Stern Drive Model	Beg. S/N	End S/N	Oil Seal	Desc.	Qty.
80	2063741	2898029	18-7172	BH	1
90	2898020	3225967	18-7172	BH	1
120/140	2062141	6225576	18-7152	EE	1
160/165	2065190	UP	18-7152	EE	1
225-S	3856268	4200499	18-7170	BH	1
225-S	3856268	4200499	18-7152	EE	1
225-S	3856268	4200499	18-7114	GH	1
233	4200500	UP	18-7152	EE	1
233	4200500	UP	18-7114	GH	1
233	4200500	UP	18-7170	BH	1
250	4791300	4898729	18-7152	EE	1
250	4791300	4898729	18-7114	GH	1
250	4791300	4898729	18-7170	BH	1
260	4898730	6225576	18-7152	EE	1
470	4208730	6225576	18-7152	EE	1

Stern Drive Model	Beg. S/N	End S/N	Oil Seal	Desc.	Qty.
470	4208730	4893934	18-7170	BH	1
485	4893835	UP	18-7152	EE	1
888	3106717	UP	18-7170	BH	1
888	3106717	UP	18-7114	GH	1
888	3106717	UP	18-7152	EE	1
898/228	4782330	4898729	18-7170	BH	1
898/228	4782330	4898729	18-7114	GH	1
898/228	4782330	6225576	18-7152	EE	1

- ① With Oil Reservoir
- BH Bell Housing Seal
- EE Exhaust Elbow Seal
- GH Gimbal Housing Seal
- GHAL Gimbal Housing Adapter Large Seal
- GHAS Gimbal Housing Adapter Small Seal
- GHB Gimbal Housing Bolt Seal
- SL Steering Lever Seal
- V Valve Seal

HYDRAULIC PUMP ASSY

Stern Drive Model	Beg. S/N	End S/N	Oil Seal	Desc.	Qty.
R/MR/Alpha I	6225577	UP	18-7168	CV	4
BRAVO (I/II)	B664190	UP	18-7134	ORC	1
BRAVO (I/II)	B664190	UP	18-7158	ORS	1
II	2398798	2671321	18-7168	CV	4
II TR	3377316	4794899	18-7168	CV	4
III/III SSM/IV		ALL	18-7168	CV	4
TR/TRS	4794900	UP	18-7168	CV	4
90	2898020	3225967	18-7168	CV	4
120/140	2062141	6225576	18-7168	CV	4
160/165	2065190	UP	18-7168	CV	4

Stern Drive Model	Beg. S/N	End S/N	Oil Seal	Desc.	Qty.
215H/E	2782203	2915034	18-7168	CV	4
225-S	3856268	4200499	18-7168	CV	4
233	4200500	UP	18-7168	CV	4
255-TRS	3377316	4203749	18-7168	CV	4
260	4898730	6225576	18-7168	CV	4
280-TRS	4203750	4895399	18-7168	CV	4
470	4208730	6225576	18-7168	CV	4
485	4893835	UP	18-7168	CV	4
888	3106717	UP	18-7168	CV	4
898/228	4898730	6225576	18-7168	CV	4

CV - Control Valve ORC - Oil Reservoir Connector ORS - Oil Reservoir Switch

REVERSE LOCK VALVE

Stern Drive Model	Beg. S/N	End S/N	Oil Seal	Desc.	Qty.
R/MR/Alpha I	6225577	UP	18-7174	VC	1
R/MR/Alpha I	6225577	UP	18-7198	V	1
II	2398798	2671321	18-7198	V	1
II	2398798	2671321	18-7174	VC	1
120/140	2062141	6225576	18-7198	V	1
120/140	2062141	6225576	18-7174	VC	1
160/165	2065190	UP	18-7198	V	1
160/165	2065190	UP	18-7174	VC	1
250	4791300	4898729	18-7198	V	1

Stern Drive Model	Beg. S/N	End S/N	Oil Seal	Desc.	Qty.
250	4791300	4898729	18-7174	VC	1
260	4898730	6225576	18-7198	V	1
260	4898730	6225576	18-7174	VC	1
470	4208730	6225576	18-7198	V	1
470	4208730	6225576	18-7174	VC	1
485	4893835	UP	18-7174	VC	1
485	4893835	UP	18-7198	V	1
898/228	4782330	6225576	18-7174	VC	1
898/228	4782330	6225576	18-7198	V	1

V - Valve Seal VC - Valve Cover Seal





**18-5001
TUNE-UP KIT**
Replaces: 172525

—CONTAINS—

Part #	O.E. #	Description
18-5157	580290	Contact Set
18-5200	580256	Condenser



**18-5250
TUNE-UP KIT**
Replaces: 172527

—CONTAINS—

Part #	O.E. #	Description
18-5311	380538	Contact Set
18-5345	380537	Condenser
18-5418	384735	Rotor

Delco 4 & 6 cyl.



**18-5251
TUNE-UP KIT**
Replaces: 173619

—CONTAINS—

Part #	O.E. #	Description
18-5314	382135	Contact Set
18-5338	382136	Condenser
18-5404-1	982211	Rotor

18-5376 cap



**18-5256
TUNE-UP KIT**
Replaces: 172531

—CONTAINS—

Part #	O.E. #	Description
18-5314	382135	Contact Set
18-5338	382136	Condenser
18-5411	982342	Rotor

Mallory 8 cyl. Flat Cap



**18-5258
TUNE-UP KIT**
Replaces: 173690, 987925

—CONTAINS—

Part #	O.E. #	Description
18-5303	980893	Contact Set
18-5347	980894	Condenser
18-5407	980892	Rotor

Prestolite 8 cyl.



**18-5260
TUNE-UP KIT**
Replaces: 173829, 987926

—CONTAINS—

Part #	O.E. #	Description
18-5303	980893	Contact Set
18-5347	980894	Condenser
18-5403	982880	Rotor



**18-5266
TUNE-UP KIT**

Fits: Flame Thrower Distributors 18-5481, 18-5482, 18-5483, 18-5477, 18-5478 and 18-5479



**18-5268
TUNE-UP KIT**

—CONTAINS—

Part #	O.E. #	Description
18-5311	380538	Contact Set
18-5345	380537	Condenser
18-5418	384735	Rotor
18-5385	380541	Distributor Cap

Delco In-Line 4 - Single Point



**18-5269
TUNE-UP KIT**

—CONTAINS—

Part #	O.E. #	Description
18-5311	380538	Contact Set
18-5345	380537	Condenser
18-5418	384735	Rotor
18-5386	980152	Distributor Cap

Delco In-Line 6 - Single Point



**18-5252
TUNE-UP KIT**

—CONTAINS—

Part #	Description
18-5310	Contact Set
18-5344	Condenser
-	Rotor

Delco 8 cyl.



**18-5271
TUNE-UP KIT**

—CONTAINS—

Part #	O.E. #	Description
18-5314	382135	Contact Set
18-5338	382136	Condenser
18-5404-1	982211	Rotor
18-5376	982209	Distributor Cap

Mallory V-8 - Single Point - Top Terminal



**18-5272
TUNE-UP KIT**

—CONTAINS—

Part #	O.E. #	Description
18-5314	382135	Contact Set
18-5338	382136	Condenser
18-5411	982342	Rotor
18-5375	382133	Distributor Cap

Mallory Flat V-8 - Single Point - Side Terminal - Flat Cap



**18-5275
TUNE-UP KIT**

—CONTAINS—





















Part #	O.E. #	Description
18-5303	980893, 987136,	Contact Set
	987894	
18-5347	980894, 987895	Condenser
18-5403	982880	Rotor
18-5352	984401	Distributor Cap





Prestolite V-8 - Single Point - Screw Cap

APPLICATION BEGINS ON PAGE 881

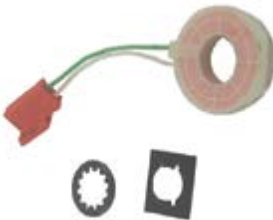
① Items ending in "D" are Display Packaged - Regular number is Non-Display

 <p>18-5276 TUNE-UP KIT —CONTAINS— Part # O.E. # Description 18-5303 980893, 987136, Contact Set 987894 18-5347 980894, 987895 Condenser 18-5403 982880 Rotor 18-5353 984398 Distributor Cap Prestolite V-6 - Single Point - Screw Cap</p>	 <p>18-5277 TUNE-UP KIT —CONTAINS— Part # O.E. # Description 18-5303 980893, 987136, 987894 Contact Set 18-5347 980894, 987895 Condenser 18-5407 980892 Rotor 18-5369 982336 Distributor Cap Prestolite V-8 - Single Point - Clip Cap</p>	 <p>18-5278 TUNE-UP KIT For: Delco EST V-6</p>	 <p>18-5279 TUNE-UP KIT For: Prestolite Electronic V-8 —CONTAINS— Part # Description O.E.# Qty. 18-5352 Distributor Cap 392-9766 1 18-5403 Rotor 392-9089 1</p>	
 <p>18-5280 TUNE-UP KIT For: Delco EST In-Line 4 —CONTAINS— Part # Description O.E.# Qty. 18-5361 Distributor Cap 986643 1 18-5406 Rotor, Delco 986651 1</p>	 <p>18-5281 TUNE-UP KIT For: Delco EST • V-8</p>	 <p>18-5283 TUNE-UP KIT For: Mallory Single Point In-Line 4 —CONTAINS— Part # Description 18-5397 Distributor Cap 18-5404-1 Rotor 18-5314 Contact Set 18-5338 Condenser</p>	 <p>18-5157 CONTACT SET Replaces: 580290</p>	
 <p>18-5303 CONTACT SET Replaces: 980893, 987136, 987894</p>	 <p>18-5310 CONTACT SET Replaces: 380543</p>	 <p>18-5311 CONTACT SET Replaces: 380538</p>	 <p>18-5314 CONTACT SET Replaces: 382135</p>	 <p>18-5200 CONDENSER Replaces: 580256</p>
 <p>18-5338 CONDENSER Replaces: 382136</p>	 <p>18-5344 CONDENSER Replaces: 382125</p>	 <p>18-5345 CONDENSER Replaces: 380537</p>	 <p>18-5347 CONDENSER Replaces: 980894, 987895</p>	 <p>18-5403 ROTOR Replaces: 982880</p>
 <p>18-5404-1 ROTOR Replaces: 982211</p>	 <p>18-5405 ROTOR Replaces: 3854549 V-8 Fits new GM style "Module in Cap"</p>	 <p>18-5406 ROTOR Replaces: 986651 Use with 18-5361 Distributor Cap</p>	 <p>18-5407 ROTOR Replaces: 980892</p>	 <p>18-5408 ROTOR Replaces: 3854311 V-6 Fits new GM style "Module in Cap"</p>

 <p>18-5411 ROTOR Replaces: 982342</p>	 <p>18-5413 ROTOR Replaces: 987986</p>	 <p>18-5418 ROTOR Replaces: 384735</p>	 <p>18-5419 ROTOR Replaces: 380542</p>	
 <p>18-5302 TUNE-UP KIT Fits: Male cap v-8 flamethrower distributors</p>	 <p>18-5473 DISTRIBUTOR CAP Black Distributor Cap with Male Terminals for Flamethrower Distributors</p>	 <p>18-5248 DISTRIBUTOR CAP Replaces: 3854217 Fits: OMC 5.0L(1994-96), 5.8L(1994-96)</p>	 <p>18-5352 DISTRIBUTOR CAP Replaces: 984401 Prestolite</p>	
 <p>18-5353 DISTRIBUTOR CAP Replaces: 984398 Prestolite</p>	 <p>18-5354 DISTRIBUTOR CAP Replaces: 3854548 V-8 Fits new GM style "module in cap"</p>	 <p>18-5361 DISTRIBUTOR CAP Replaces: 986643</p>	 <p>18-5362 DISTRIBUTOR CAP Replaces: 3854331 V-6 Fits new GM style "Module in Cap"</p>	 <p>18-5369 DISTRIBUTOR CAP Replaces: 982336 w/Gasket 18-5399</p>
 <p>18-5375 DISTRIBUTOR CAP Replaces: 382133</p>	 <p>18-5376 DISTRIBUTOR CAP Replaces: 982209 Mallory</p>	 <p>18-5384 DISTRIBUTOR CAP Replaces: 383587</p>	 <p>18-5385 DISTRIBUTOR CAP Replaces: 380541</p>	 <p>18-5386 DISTRIBUTOR CAP Replaces: 980152</p>
 <p>18-5397 DISTRIBUTOR CAP Replaces: 985218 Mallory 9-29418 Fits: Ford 2.3L w/Mallory Distributor (87-90)</p>	 <p>18-5107-1 IGNITION MODULE Replaces: 3854003 4/6/8 cyl</p>	 <p>18-5108 SENSOR (PICK-UP COIL) Replaces: 3854001, 986642 4, V-6 and V-8 cyl</p>		

 <p>18-26810 GM HEI 4 TERMINAL PIGTAIL Fits: GM HEI Distributors w/4 terminals</p>	 <p>18-26811 GM HEI 2 TERMINAL PIGTAIL Fits: GM HEI Distributors w/2 terminals</p>	 <p>18-26812 HEI COIL GRAY CONNECTOR</p>	 <p>18-26813 HEI COIL BLACK CONNECTOR</p>	 <p>18-29322 CAP & ROTOR KIT Fits: Ford HEI Distributors</p>
---	--	---	---	--

FEATURES



- ★ Oil filled for better cooling and long life
- ★ Low resistance and improved turn ratios produces the higher voltage needed to run larger spark plug gaps for added power and better fuel economy
- ★ More windings maximize energy and reliability over the full RPM range
- ★ Fits existing brackets for easy installation

 <p>18-5466 HI-PERFORMANCE IGNITION COIL 1.5 ohm (oil filled), black - 8 cylinder: Flame-Thrower 40,000 volt coil. ★ Designed for use with the original Ignitor Electronic Conversion Kits ★ Can be used with other inductive ignition systems</p>	 <p>18-5469 HI-PERFORMANCE IGNITION COIL 3.0 ohm (oil filled), black - 4 & 6 cylinder: Flame-Thrower 40,000 volt coil. ★ Designed for use with the original Ignitor Electronic Conversion Kits ★ Can be used with other inductive ignition systems</p>	 <p>18-5472 HI-PERFORMANCE IGNITION COIL 0.6 ohm (oil filled), black - 4, 6, & 8 cylinder: Flame-Thrower 45,000 volt coil. ★ Super low 0.6 ohm resistance coil designed for use with the Ignitor II Hi Performance Electronic Conversion Kits ★ Compatible with capacitive discharge systems</p>
---	---	---

Part #	Description	Recommended Coil	Resistance Ohms	Part #	Description	Recommended Coil	Resistance Ohms
18-5293-1	Electronic Conversion Kit	18-5469	3.0	18-5288-1	Hi Performance Electronic Conversion Kit	18-5472	0.6
18-5294	Electronic Conversion Kit	18-5469	3.0	18-5289	Hi Performance Electronic Conversion Kit	18-5472	0.6
18-5295	Electronic Conversion Kit	18-5469	3.0	18-5290	Hi Performance Electronic Conversion Kit	18-5472	0.6
18-5296-2	Electronic Conversion Kit	18-5466	1.5	18-5481	Flame-Thrower Distributor	18-5472	0.6
18-5298-1	Electronic Conversion Kit	18-5466	1.5	18-5483	Flame-Thrower Distributor	18-5472	0.6
18-5299	Electronic Conversion Kit	18-5466	1.5				

 <p>18-5433 IGNITION COIL Replaces: 915735 Uses External Resistor For: 3.0L (1991 & up), 5.7 EFI (1996 & up) and 7.4L EFI (1995 & up)</p>	 <p>18-5437 IGNITION COIL Replaces: 383444, 378231 Metal Encased - 12 Volt Uses External Resistor (For All Applications) For: 1990 & prior stern drives with breaker point ignition</p>	 <p>18-5443 IGNITION COIL Replaces: 3854002 4 cyl./V-8 For: 3.0L (1991 & up), 5.7 EFI (1996 & up) & 7.4 EFI (1995 & up)</p>
--	--	--

 <p>18-5888 SHIFT ASSIST MODULE & HARNESS Replaces: 987738 For: V-8 Sterndrives Fits: 5.0, 5.7 GM (1986-90) 7.5 460 Ford (1987-91)</p>	 <p>18-5889 SHIFT ASSIST MODULE & HARNESS Replaces: 987739 For: V-8 Sterndrives Fits: 5.0, 5.8 Ford (1986-90)</p>	 <p>18-5890 SHIFT ASSIST MODULE & HARNESS Replaces: 987740, 985902 Fits: 2.3, 3.0, 4.3 (1986-90) & 2.5 (1986)</p>
--	---	--

APPLICATION BEGINS ON PAGE 881

- ★ Senses current levels in the coil and adjusts the dwell to maintain peak energy throughout the entire RPM range.
- ★ Develops, on average, 4 times more available energy between 3000 and 5000 RPM's and twice as much plug voltage as point-type systems.
- ★ Ignition energy is sustained and coil life is increased when peak current level is reached just prior to spark.
- ★ More stable timing.
- ★ Use with 18-5472 "Flame Thrower II" Coil for optimum performance



18-5285
HI-PERFORMANCE
ELECTRONIC CONVERSION KIT
Fits: 4 Cylinder Delco Distributors



18-5287-1
HI-PERFORMANCE
ELECTRONIC CONVERSION KIT
Fits: Fits: 6 Cylinder Prestolite Distributors



18-5288-1
HI-PERFORMANCE
ELECTRONIC CONVERSION KIT
Fits: Most Prestolite V-8 Distributors with snap down cap



18-5289
HI-PERFORMANCE
ELECTRONIC CONVERSION KIT
Fits: Most Prestolite V-8 Distributors with screw down cap



18-5290
HI-PERFORMANCE
ELECTRONIC CONVERSION KIT
Fits: Most Mallory YL or YD 8 cylinder Distributors with clockwise and counter clockwise rotation

- ★ Replaces points & condensers for true solid state ignition.
- ★ Uses standard coil, cap and rotor.
- ★ Easy to install, one-piece, 2-wire hook-up.
- ★ Accurate to within 1/4° timing accuracy 0 to 6000 RPM range.

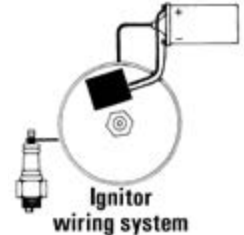

Not compatible with shift assist modules



18-5293-1
ELECTRONIC CONVERSION KIT
For: All Chevrolet V-6 Prestolite with screw down caps



18-5294
ELECTRONIC CONVERSION KIT
Fits: 6 Cyl. Delco distributors



18-5295
ELECTRONIC CONVERSION KIT
Fits: Most 4 Cyl. Prestolite distributors (except IBM 7026)
For: Onan, Universal, Waukesha, Wisconsin

Not compatible with shift assist modules

APPLICATION BEGINS ON PAGE 881

①18-5296-2D

Display Package



**18-5296-2
ELECTRONIC
CONVERSION KIT**
Fits: Most Mallory YL & YD 8 cyl.
Distributors with clockwise and counter
clockwise rotation

①18-5297D

Display Package



**18-5297
ELECTRONIC
CONVERSION KIT**
For 4 Cyl. Delco Distributors

①18-5299D

Display Package



**18-5299
ELECTRONIC
CONVERSION KIT**
(with screw down cap)
For: Most Prestolite V-8 Distributors
Use with 18-5403 style rotor

Not compatible with shift assist modules



FEATURES

- ★ *Distributors feature the Ignitor II ignition module with adaptive dwell control adjusts the spark timing over the entire RPM range to maximize performance*
- ★ *Upper roller bearing and oil impregnated bronze sintered bottom bushing are installed and aligned bored for accuracy for maximum durability*
- ★ *Machined heat treated gear with tight tolerances insures durability and consistent timing to maximize horsepower and performance. Complete with high dielectric strength cap and rotor for years of performance*

Standard Rotation

CCW Rotation

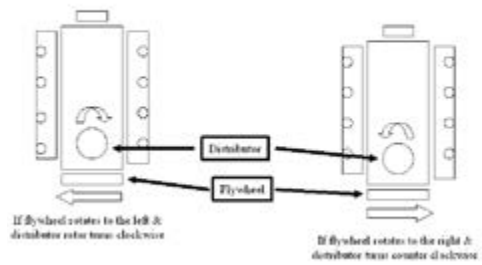

**18-5477
ELECTRONIC DISTRIBUTOR**
Fits: Ford 302 V-8 engines
Replacement Cap/Rotor Kit 18-5266



**18-5480
COMPLETE
IGNITION CONVERSION KIT**
Fits: GM SB & BB with Standard Deck Height
—CONTAINS—
Part # Description
18-5472 Coil
18-8803-2 Wire Set
18-5483 Distributor



**18-5481
HI-PERFORMANCE ELECTRONIC DISTRIBUTOR**
Fits: Ford V-8 351 Windsor
Replacement cap/rotor kit: 18-5266



**18-5483
HI-PERFORMANCE ELECTRONIC DISTRIBUTOR**
Fits: Chevrolet Marine Small and Big Block engines (Standard Deck Height)
Replacement cap/rotor kit: 18-5266



APPLICATION BEGINS ON PAGE 881

① Items ending in "D" are Display Packaged - Regular number is Non-Display



18-5476
DISTRIBUTOR
 Fits: GM V-6 engines with Delco EST ignition HEI
 Tune-Up Kit 18-5278



18-5479
ELECTRONIC DISTRIBUTOR
 GM V-8 engines-reverse rotation
 Replacement Cap/Rotor Kit 18-5266



18-5489-2
ELECTRONIC DISTRIBUTOR
 Replaces: Mallory YLM554CV
 Conventional Rotation
 For: Ford V8 351W CID
 —CONTAINS—

Part #	Description
18-5376	Distributor Cap
18-5488	Module
18-5404-1	Rotor



18-5486-2
ELECTRONIC DISTRIBUTOR
 Superseded from 18-5486
 Replaces: Mallory YLM673AV
 Conventional Rotation
 For: Chevrolet L4, 153 & 181 CID
 —CONTAINS—

Part #	Description
18-5397	Distributor Cap
18-5488	Module
18-5404-1	Rotor



18-5496-2
ELECTRONIC DISTRIBUTOR
 Replaces: Mallory YLM567CV
 Conventional Rotation
 For: Ford V8 351C — 460 CID
 —CONTAINS—

Part #	Description
18-5376	Distributor Cap
18-5488	Module
18-5404-1	Rotor



18-5495-2
ELECTRONIC DISTRIBUTOR
 Replaces: Mallory YLM512CV
 Conventional Rotation
 For: Ford V8 302 CID
 —CONTAINS—

Part #	Description
18-5376	Distributor Cap
18-5488	Module
18-5404-1	Rotor



18-5494-2
ELECTRONIC DISTRIBUTOR
 Replaces: Mallory YLM624AV
 Conventional Rotation
 For: Chevrolet all V8 includes 482, 502, 540 CID
 (Except 348,409 & Tall Deck Big Block)
 —CONTAINS—

Part #	Description
18-5376	Distributor Cap
18-5488	Module
18-5404-1	Rotor

**18-5484-1
ELECTRONIC
DISTRIBUTOR**

Replaces: 3857400, 3850399

Late HEI

Conventional Rotation

V8 262-454 & 502 except 348/409 and tall block engines

• Designed as a plug-in replacement for GM-style fuel injection system distributors



—CONTAINS—

Description	Part #
Distributor Cap	18-5354
Rotor	18-5405

Tune-Up Kit 18-5281

18-5498-2

ELECTRONIC DISTRIBUTOR

Replaces: 9-26307; Mallory YLM624BV

For GM V8, 482, 502, 540 CID (Except 348, 409 & Tall Deck Big Block) (Reverse Rotation)



18-5339-1

DISTRIBUTOR

Replaces: 9-26103; Mallory YL566AV

For GM V8 327



**18-5475
DISTRIBUTOR**

Fits: 4 Cyl. GM Engines with Delco EST Ignition HEI
Tune-Up Kit 18-5280



**18-5309-1
DISTRIBUTOR**

Contact Controlled

Replaces: 980902; Mallory YL512CV

For most Ford 302 CID V-8 Eng.
Tune-Up Kit 18-5251



**18-5316-1
DISTRIBUTOR**

Replaces: Mallory YL624BV
Fits Most GM V8 (Reverse Rotation)



**18-5312-1
DISTRIBUTOR**

Contact Controlled

Replaces: 981080; Mallory YL554CV

For most Ford 351 CID V-8 Eng.
Tune-Up Kit 18-5251



**18-5313-1
DISTRIBUTOR**

Contact Controlled

Replaces: 985560; Mallory YL624MW

For most GM V-8 Eng. (small & large blocks)
Tune-Up Kit 18-5251



**18-5315-1
DISTRIBUTOR**

Contact Controlled

Replaces: Mallory YL673AV

For most GM 4 Cyl. Engines (120 & 140 HP)
Tune-Up Kit 18-5251



**18-26110-1
DISTRIBUTOR**

Replaces: 9-26110; Mallory YL579AV

For Chrysler V8, 273, 318 (1967 & Up), 340 and 360 "LA" Engines



**18-26104-1
DISTRIBUTOR**

Replaces: 9-26104; Mallory YL567EV

For Ford V8 351C



**18-26112-1
DISTRIBUTOR**

Replaces: 9-26112; Mallory YL676AV

Fits GM L6, 194, 230, 250, 292 CID (Conventional Rotation)

OMC IGNITION APPLICATION CHART

Model	Year Start	Year Stop	Cylinder	Distributor	Contact Set	Condenser	Dist. Cap	Rotor	Tune-Up Kit w/o Cap	Tune-Up Kit w/ Cap	Plug Wire Set
2.3L	1987	1990	4	Mallory	18-5314	18-5338	18-5397	18-5404-1	-	18-5283	18-8807-1
2.3L	1990	1990	4	Prestolite	18-5303	18-5347	-	18-5403	18-5260	-	18-8807-1
2.5L	1981	1986	4	Delco	18-5311	18-5345	18-5385	18-5418	18-5250	18-5268	18-8800-1
3.0L	1982	1990	4	Delco	18-5311	18-5345	18-5385	18-5418	18-5250	18-5268	18-8800-1
3.0L	1990	1998	4	Delco EST	N/A	N/A	18-5361	18-5406	-	18-5280	18-8833-1
3.8L	1981	1985	6	Prestolite	18-5303	18-5347	18-5353	18-5403	18-5262	18-5276	18-8801-1
4.3L	1985	1990	6	Prestolite ②	18-5303	18-5347	18-5353	18-5403	18-5262	18-5276	18-8801-1
4.3L	1991	1993	6	Prestolite	N/A	N/A	18-5353	18-5403	-	-	18-8801-1
4.3L	1994	1998	6	Delco EST	N/A	N/A	18-53626	18-5408	-	18-5278	18-8835-1
5.0L (GM)	1979	1982	8	Prestolite ①	18-5303	18-5347	18-5369	18-5407	18-5258	18-5277	18-8802-1
5.0L (GM)	1981	1988	8	Mallory	18-5314	18-5338	18-5376	18-5404-1	18-5251	18-5271	18-8802-1
5.0L (GM)	1983	1988	8	Prestolite ②	18-5303	18-5347	18-5352	18-5403	18-5262	18-5275	18-8802-1
5.0L (Ford)	1989	1990	8	Prestolite ②	18-5303	18-5347	18-5352	18-5403	18-5262	18-5275	18-8806-1
5.0L (Ford)	1991	1996	8	Prestolite	N/A	N/A	18-5352	18-5403	-	18-5279	18-8806-1
5.0L (Ford)	1993	1996	8	Ford HEI	N/A	N/A	18-5248	18-5413	-	18-29322	18-8820-1
5.0L (GM)	1998	1998	8	Prestolite	N/A	N/A	18-5352	18-5403	-	18-5279	18-8801-1
5.0L (GM)	1998	1998	8	Delco EST	N/A	N/A	18-5354	18-5405	-	18-5281	18-8822-1
5.7L	1982	1990	8	Mallory	18-5314	18-5338	18-5376	18-5404-1	18-5251	18-5271	18-8802-1
5.7L	1982	1990	8	Prestolite ②	18-5303	18-5347	18-5352	18-5403	18-5262	18-5275	18-8802-1
5.7L	1991	1998	8	Prestolite ②	N/A	N/A	18-5352	18-5403	-	18-5279	18-8802-1
5.7L	1996	1998	8	Delco EST	N/A	N/A	18-5354	18-5405	-	18-5281	18-8822-1
5.8L	1989	1990	8	Prestolite ②	18-5303	18-5347	18-5352	18-5403	18-5262	18-5275	18-8842-1
5.8L	1991	1996	8	Prestolite ②	N/A	N/A	18-5352	18-5403	-	18-5279	18-8842-1
5.8L	1993	1996	8	Ford HEI	N/A	N/A	18-5248	18-5413	-	18-29322	18-8820-1
7.4L	1988	1988	8	Mallory	18-5314	18-5338	18-5376	18-5404-1	18-5251	18-5271	18-8802-1
7.4L	1988	1988	8	Prestolite ②	18-5303	18-5347	18-5352	18-5403	18-5262	18-5275	18-8802-1
7.4L	1990	1991	8	Distributorless	-	-	-	-	-	-	18-8843-1
7.4L	1995	1998	8	Delco EST	N/A	N/A	18-5354	18-5405	-	18-5281	18-8832-1
7.5L	1987	1987	8	Prestolite ①	18-5303	18-5347	18-5369	18-5407	18-5258	18-5277	18-8803-2
7.5L	1987	1989	8	Prestolite ①	18-5303	18-5347	18-5352	18-5407	18-5258	18-5277	18-8803-2
8.2L	1984	1985	8	Mallory	18-5314	18-5338	18-5376	18-5404-1	18-5251	18-5271	18-8802-1
8.2L	1984	1985	8	Prestolite ②	18-5303	18-5347	18-5352	18-5403	18-5262	18-5275	18-8802-1
8.2L	1998	1998	8	Delco EST	N/A	N/A	18-5354	18-5405	-	18-5281	18-8832-1
80	1962	1968	4	ALL	18-5157	18-5200	-	-	18-5001	-	18-8800-1
90	1962	1968	4	ALL	18-5157	18-5200	-	-	18-5001	-	18-8800-1
100	1972	1973	4	Delco	18-5311	18-5345	18-5385	18-5418	18-5250	18-5268	18-8800-1
110	1964	1964	4	Delco	18-5311	18-5345	18-5385	18-5418	18-5250	18-5268	18-8800-1
120	1965	1981	4	Delco	18-5311	18-5345	18-5385	18-5418	18-5250	18-5268	18-8800-1
140	1973	1981	4	Delco	18-5311	18-5345	18-5385	18-5418	18-5250	18-5268	18-8800-1
150	1964	1966	6	Delco	18-5310	18-5345	-	18-5419	-	-	-
155	1967	1972	6	Delco	18-5310	18-5344	-	18-5419	-	-	-
165	1972	1976	6	Delco	18-5311	18-5345	18-5386	18-5418	18-5250	18-5269	-
170	1974	1974	8	Prestolite ①	18-5303	18-5347	18-5369	18-5407	18-5258	18-5277	18-8802-1
175	1975	1977	8	Prestolite ①	18-5303	18-5347	18-5369	18-5407	18-5258	18-5277	18-8802-1
185	1967	1968	8	Mallory	18-5314	18-5338	18-5375	18-5411	18-5256	18-5272	18-8802-1
185	1978	1980	8	Mallory	18-5314	18-5338	18-5376	18-5404-1	18-5251	18-5271	18-8802-1
185	1978	1980	8	Prestolite ①	18-5303	18-5347	18-5369	18-5407	18-5258	18-5277	18-8802-1
190	1974	1977	8	Prestolite ①	18-5303	18-5347	18-5369	18-5407	18-5258	18-5277	18-8802-1
200	1966	1966	8	Delco	18-5310	18-5345	18-5384	18-5300	-	-	-
200	1967	1968	8	Delco	18-5310	18-5344	18-5384	18-5300	18-5252	-	-
200	1979	1988	8	Mallory	18-5314	18-5338	18-5376	18-5404-1	18-5251	18-5271	18-8802-1









① Clip down distributor cap ② Screw down distributor cap

APPLICATION CONTINUED ON NEXT PAGE

OMC IGNITION APPLICATION CHART

Model	Year Start	Year Stop	Cylinder	Distributor	Contact Set	Condenser	Dist. Cap	Rotor	Tune-Up Kit w/o Cap	Tune-Up Kit w/ Cap	Plug Wire Set
200	1979	1981	8	Prestolite ①	18-5303	18-5347	18-5369	18-5407	18-5258	18-5277	18-8802-1
210	1968	1970	8	Mallory	18-5314	18-5338	18-5375	18-5411	18-5256	18-5272	18-8802-1
215	1971	1971	8	Mallory	18-5314	18-5338	18-5375	18-5411	18-5256	18-5272	18-8802-1
225	1972	1976	8	Mallory	18-5314	18-5338	18-5375	18-5411	18-5256	18-5272	18-8802-1
225	1978	1978	8	Mallory	18-5314	18-5338	18-5376	18-5404-1	-	18-5271	18-8802-1
230	1979	1981	8	Mallory	18-5314	18-5338	18-5376	18-5404-1	18-5251	18-5271	18-8802-1
230	1979	1981	8	Prestolite ①	18-5303	18-5347	18-5369	18-5407	18-5258	18-5277	18-8802-1
230	1975	1976	8	Mallory	18-5314	18-5338	18-5375	18-5411	18-5256	18-5272	18-8802-1
235	1971	1971	8	Mallory	18-5314	18-5338	18-5375	18-5411	18-5256	18-5272	18-8802-1
235	1975	1977	8	Prestolite ①	18-5303	18-5347	18-5369	18-5407	18-5258	18-5277	18-8802-1
240	1978	1978	8	Prestolite ①	18-5303	18-5347	18-5369	18-5407	18-5258	18-5277	18-8802-1
245	1975	1975	8	Mallory	18-5314	18-5338	18-5375	18-5411	18-5256	18-5272	18-8802-1
250	1970	1974	8	Mallory	18-5314	18-5338	18-5375	18-5411	18-5256	18-5272	18-8802-1
250	1979	1979	8	Prestolite ①	18-5303	18-5347	18-5369	18-5407	18-5258	18-5277	18-8802-1
260	1975	1976	8	Mallory	18-5314	18-5338	18-5375	18-5411	18-5256	18-5272	18-8802-1
260	1979	1981	8	Mallory	18-5314	18-5338	18-5376	18-5404-1	18-5251	18-5271	18-8802-1
260	1979	1981	8	Prestolite ①	18-5303	18-5347	18-5369	18-5407	18-5258	18-5277	18-8802-1
290 JET	1974	1975	8	Mallory	18-5314	18-5338	18-5375	18-5411	18-5256	18-5272	18-8802-1
305	1977	1979	8	Mallory	18-5314	18-5338	18-5375	18-5411	18-5256	18-5272	18-8802-1
305	1980	1981	8	Mallory	18-5314	18-5338	18-5376	18-5404-1	18-5251	18-5271	18-8802-1
305	1981	1981	8	Prestolite ①	18-5303	18-5347	18-5369	18-5407	18-5258	18-5277	18-8802-1
350	1977	1979	8	Mallory	18-5314	18-5338	18-5375	18-5411	18-5256	18-5272	18-8802-1
350	1980	1981	8	Mallory	18-5314	18-5338	18-5376	18-5404-1	18-5251	18-5271	18-8802-1
350	1981	1981	8	Prestolite ①	18-5303	18-5347	18-5369	18-5407	18-5258	18-5277	18-8802-1
454	1977	1979	8	Mallory	18-5314	18-5338	18-5375	18-5411	18-5256	18-5272	18-8803-2
454	1980	1981	8	Mallory	18-5314	18-5338	18-5376	18-5404-1	18-5251	18-5271	18-8803-2
454	1981	1981	8	Prestolite ①	18-5303	18-5347	18-5369	18-5407	18-5258	18-5277	18-8803-2

① Clip down distributor cap ② Screw down distributor cap

 <p>MP28890 IGNITION LANAYARD Replaces: 176288 Fits: 1996 - Up</p>	 <p>MP28880 IGNITION LANAYARD Replaces: 432230 Fits: 1995-Older</p>	 <p>18-5225 SPARK PLUG WIRE KIT Kit Includes 25 ft. Roll of 7 MM Hypalon Ignition Wire With a Metallic Core and a Large Assortment of Three Different End Fittings.</p>	 <p>18-5222 IGNITION WIRE Silicone Core 100' Spool 8mm</p>
 <p>18-5226 IGNITION WIRE Metallic Core 100' Spool 7mm Hypalon</p>	 <p>PKG. OF 10 18-5224 18-5224-9② SPARK PLUG WIRE TERMINAL Replaces: Mercury 20121 OMC 510364</p>	 <p>PKG. OF 10 18-5750 18-5750-9② UNIVERSAL SPARK PLUG BOOT Supplied complete w/Terminal Connector Replaces: OMC 581027, 580339</p>	 <p>18-5752 UNIVERSAL SPARK PLUG BOOT 8mm</p>

② Priced per Package

PREMIUM MARINE IGNITION WIRES

Sierra's MAGFORCE Ignition Wires are "Electronics Friendly" protecting all of your electronic devices and electronic engine controls from RFI and EMI while delivering the maximum amount of voltage. Exact fit design ensures easy installation and years of trouble - free service.

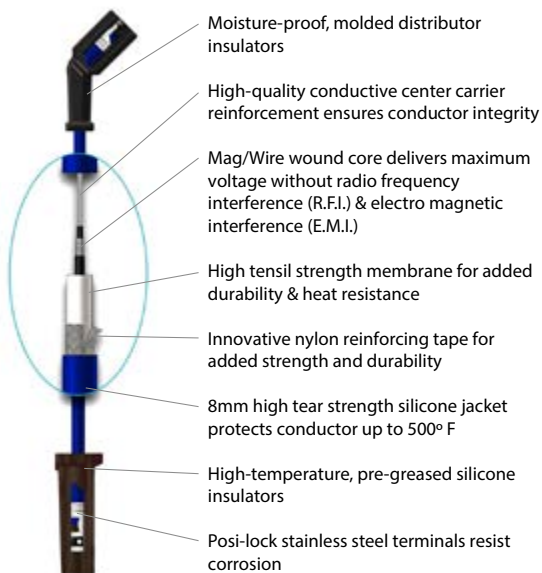

APPLICATION CONTINUED ON NEXT PAGE

OMC MARINE IGNITION WIRES APPLICATION					
Model	Cyl.	Distributor	Year Start	Year End	Plug Wire Set
2.3L	4	Mallory	1987	1990	18-8807-1
2.3L	4	Prestolite	1990	1990	18-8807-1
2.5L	4	Delco	1981	1986	18-8800-1
3.0L	4	Delco	1982	1990	18-8800-1
3.0L	4	Delco EST	1990	1998	18-8833-1
3.8L	6	Prestolite	1981	1985	18-8801-1
4.3L	6	Prestolite ②	1985	1990	18-8801-1
4.3L	6	Prestolite	1991	1993	18-8801-1
4.3L	6	Delco EST	1994	1998	18-8835-1
5.0L (GM)	8	Prestolite ①	1979	1982	18-8802-1
5.0L (GM)	8	Mallory	1981	1988	18-8802-1
5.0L (GM)	8	Prestolite ②	1983	1988	18-8802-1
5.0L (Ford)	8	Prestolite ②	1989	1990	18-8806-1
5.0L (Ford)	8	Prestolite	1991	1996	18-8806-1
5.0L (Ford)	8	Ford HEI	1993	1996	18-8820-1
5.0L (GM)	8	Prestolite	1998	1998	18-8801-1
5.0L (GM)	8	Delco EST	1998	1998	18-8822-1
5.7L	8	Mallory	1982	1990	18-8802-1
5.7L	8	Prestolite ②	1982	1990	18-8802-1
5.7L	8	Prestolite ②	1991	1998	18-8802-1
5.7L	8	Delco EST	1996	1998	18-8822-1
5.8L	8	Prestolite ②	1989	1990	18-8842-1
5.8L	8	Prestolite ②	1991	1996	18-8842-1
5.8L	8	Ford HEI	1993	1996	18-8820-1
7.4L	8	Mallory	1988	1988	18-8802-1
7.4L	8	Prestolite ②	1988	1988	18-8802-1
7.4L	8	Distributorless	1990	1991	18-8843-1
7.4L	8	Delco EST	1995	1998	18-8832-1
7.5L	8	Prestolite ②	1987	1987	18-8803-2
7.5L	8	Prestolite ②	1987	1989	18-8803-2
8.2L	8	Mallory	1984	1985	18-8802-1
8.2L	8	Prestolite ②	1984	1985	18-8802-1
8.2L	8	Delco EST	1998	1998	18-8832-1

OMC MARINE IGNITION WIRES APPLICATION					
Model	Cyl.	Distributor	Year Start	Year End	Plug Wire Set
80	4	ALL	1962	1968	18-8800-1
90	4	ALL	1962	1968	18-8800-1
100	4	Delco	1972	1973	18-8800-1
110	4	Delco	1964	1964	18-8800-1
120	4	Delco	1965	1981	18-8800-1
140	4	Delco	1973	1981	18-8800-1
170	8	Prestolite ①	1974	1974	18-8802-1
175	8	Prestolite ①	1975	1977	18-8802-1
185	8	Mallory	1967	1968	18-8802-1
185	8	Mallory	1978	1980	18-8802-1
185	8	Prestolite ①	1978	1980	18-8802-1
190	8	Prestolite ①	1974	1977	18-8802-1
200	8	Mallory	1979	1988	18-8802-1
200	8	Prestolite ①	1979	1981	18-8802-1
210	8	Mallory	1968	1970	18-8802-1
215	8	Mallory	1971	1971	18-8802-1
225	8	Mallory	1972	1976	18-8802-1
225	8	Mallory	1978	1978	18-8802-1
230	8	Mallory	1979	1981	18-8802-1
230	8	Prestolite ①	1979	1981	18-8802-1
230	8	Mallory	1975	1976	18-8802-1
235	8	Mallory	1971	1971	18-8802-1
235	8	Prestolite ①	1975	1977	18-8802-1
240	8	Prestolite ①	1978	1978	18-8802-1
245	8	Mallory	1975	1975	18-8802-1
250	8	Mallory	1970	1974	18-8802-1
250	8	Prestolite ①	1979	1979	18-8802-1
260	8	Mallory	1975	1976	18-8802-1
260	8	Mallory	1979	1981	18-8802-1
260	8	Prestolite ①	1979	1981	18-8802-1
290 JET	8	Mallory	1974	1975	18-8802-1
305	8	Mallory	1977	1979	18-8802-1

① Clip down cap ② Snap down cap

OMC MARINE IGNITION WIRES APPLICATION					
Model	Cyl.	Distributor	Year Start	Year End	Plug Wire Set
305	8	Mallory	1980	1981	18-8802-1
305	8	Prestolite ①	1981	1981	18-8802-1
350	8	Mallory	1977	1979	18-8802-1
350	8	Mallory	1980	1981	18-8802-1

OMC MARINE IGNITION WIRES APPLICATION					
Model	Cyl.	Distributor	Year Start	Year End	Plug Wire Set
350	8	Prestolite ①	1981	1981	18-8802-1
454	8	Mallory	1977	1979	18-8803-2
454	8	Mallory	1980	1981	18-8803-2
454	8	Prestolite ①	1981	1981	18-8803-2

① Clip down cap ② Snap down cap



STARTER SOLENOIDS

Starter solenoids take extreme abuse during their life which is a main reason why they so commonly require replacement. Sierra's replacement starter solenoids are built to EXCEED OEM specifications and feature many extras not available on many competitors' products today.

- Anti-corrosion coating for maximum corrosion resistance.
- Additional sealing to prevent ingress of water around mating surfaces.
- Upgraded design and materials for increased reliability.
- Longer battery stud for easier installation of multiple connections.

PART NO.	REPLACES
18-6447	Solenoid for Sierra Starter 18-55510
18-6458	Solenoid for Sierra Starters 18-55505 and 18-55506
18-6459	Solenoid for Sierra Starter 18-6447; Delco PG260

**18-5920
STARTER, PMGR, FORD**
PMGR Replacement for 18-5903; 302CID, 351CID Ford Engines
Clockwise/Standard Rotation

**18-5927
STARTER, PMGR, FORD**
PMGR Replacement for 18-5917, 2.3L Ford Starter.

**18-6270
PERMANENT MAGNET
I/O STARTER**
Replaces: 988013, 984536
• Permanent Magnet
• Heavy Duty
• 12 Volt
• 2 Bolt Mount
• 1 Threaded Hole
• CW Rotation
• SAE J1171
For: 460 Ford, OMC King Cobra

**18-5919-1
STARTER
Permanent magnet
I/O starter**
For: Late model GM - 12 3/4" flywheel
Replaces: 988217
SAEJ1171
1.7 KW

**18-5920
STARTER**
Permanent Magnet
For: 5.0 & 5.8 litre Ford engines.
Clockwise/Standard Rotation
Replaces: 987811, 3854190
Replacement Solenoid: 18-6291

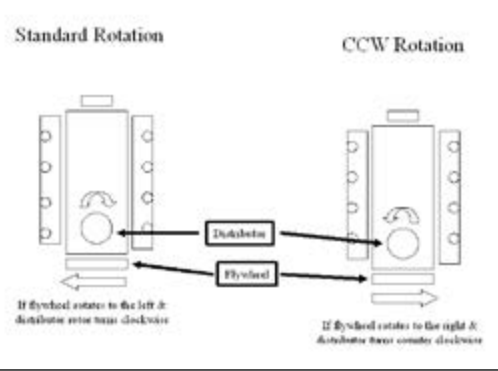

**18-6276
STARTER**
Replaces: 984536, 988013
• 12 Volt
• CW Rotation
• Threaded Top Hole in Housing
• 460 Ford, OMC King Cobra

**18-5911
STARTER
(Heavy-Duty) (No Core)**
For GM engines, bottom mount straight across bolt pattern.
Standard rotation clockwise. 100-245 HP — 1970-1978 (GM)
Replaces: 981078, 982121, 983444, 983790, 985966
Replacement Solenoid: 18-5837
SAEJ1171

**18-5907
STARTER
(Heavy-Duty) (No Core)**
Top mount front entry starter for standard rotation
GM and Ford engines.
Replaces: 981289, 982202
Replacement Solenoid: 18-5837
SAEJ1171



**18-5908
STARTER**
(Heavy-Duty) (No Core)
Top mount front entry starter for reverse rotation GM and Ford engines. Counter-clockwise.
Replaces: 981288, 982195, 984982, 986007
Replacement Solenoid: 18-5837
SAEJ1171



**18-5910
STARTER**
(Heavy-Duty) (No Core)
Small block GM V-6 & V-8 Engine with 14 1/4" flywheel and bottom mount, offset bolt pattern. For standard rotation engines. Clockwise. 1986-1992 - V-6, V-8 (GM) and 1990-1993 OMC King Cobra
Replaces: 984456, 986505
Replacement Solenoid: 18-5837
SAEJ1171



**18-5917
STARTER**
Replaces: 984628
3 bolt mount - Late style 4" diameter case.
Standard rotation engines
For: Late model Ford V-8.
Replacement Solenoid: 18-5801



**18-5903
STARTER**
(No Core) (Clockwise)
Bottom mount, two bolt pattern for standard rotation. Ford engines. Clockwise. Non-threaded top mounting hole. For threaded top, order 18-6276.
Replaces: 980803, 981821
Replacement Solenoid: 18-5801



**18-5913-1
STARTER**
(Clockwise)
Delco permanent magnet gear reduction 2 bolt starter 12V - 11 Tooth - Offset bolt pattern. Fits: Chevy Engines with 14" flywheels. 1.7 KW
Replaces: 3854751 SAEJ1171



OMC STERNDRIVE/OMC COBRA STARTERS

ENGINE	YEAR	STARTER #	ENGINE	YEAR	STARTER #	ENGINE	YEAR	STARTER #
3.0L	1982-92	18-5911	165	1972-76	18-5911	245 JET	1972-74	18-5911
5.0L	1982-86	18-5911 ④	170	1974	18-5903	250	1979	18-5903
5.0L	1986-88	18-5910 ⑤	175	1975-77	18-5903	260	1975-76	18-5908 ①
2.5L	1982-86	18-5911	185	1967-68, 1978-80	18-5911	260	1975-76	18-5907 ②
3.8L	1981-86	18-5911	190	1974-77	18-5903	260	1979-81	18-5911
4.3L	1985-86	18-5911	200	1966-68, 1979-81	18-5911	262 CID	1989	18-5910
4.3L	1986-92	18-5910	210	1968-72	18-5911 ①	290	1975	18-5908 ③
5.7L	1982-86	18-5911	215	1971	18-5911	305 CID	1977-80,82	18-5908 ①
5.7L	1986-92	18-5910	225	1972-76, 1978	18-5911 ①	305 CID	1977-80,82	18-5907 ②
100	1972-73	18-5911	230	1975-76	18-5908 ①	350 CID	1977-80,82	18-5908 ①
110	1964	18-5911	230	1975-76	18-5907 ②	350 CID	1977-80,82	18-5907 ②
120	1965-81	18-5911	230	1979-81	18-5911	350 CID	1988-91	18-5910
140	1973-81	18-5911	235	1971	18-5911	370 CID	1988	18-5908
140 JET	1973	18-5911	235	1975-77	18-5903	454 CID	1977-80,82	18-5908 ①
150	1964-66	18-5911	240	1978	18-5903	454 CID	1977-80,82	18-5907 ②
155	1967-72	18-5911	245	1972-75	18-5911	454 CID	1990-92	18-5910
						502 CID	1992	18-5910

① Standard rotation engines. ③ Engines with model number suffix "R2" or "R3"
 ② Opposite (Reverse) rotation engines. ④ '86 Model engines with model number suffix "WB"
 ⑤ '86 Model engines with model number suffix "XS"



**18-5717
STARTER BRUSH SET**
Replaces: Delco 1984462



**18-8412
STARTER STUD EXTENDER**
Extends the solenoid stud on PMGR starters for applications that require more accessory wire connections.
Threads: Female M8x1.25, Male 3/8"x16 UNC



**18-5811-1
STARTER SOLENOID**
Replaces: 3850216
For: PG 260 series starters, GM V6 & V8 (1983-Up)



**18-5801
SOLENOID**
Replaces: 985064, 586842, 586730
Grounded Base

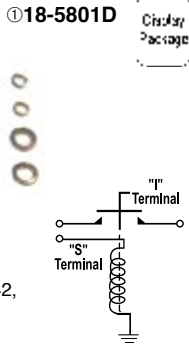

**18-5803
SOLENOID**
Replaces: 979774

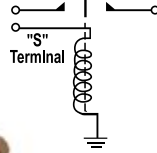

**18-5807
SOLENOID**
Replaces: 378444
Prestolite SAW4206

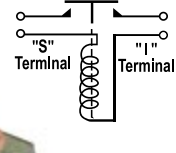

**18-6291
SOLENOID**
Replaces: 3854194 and Volvo Penta 3854194-2
Fits: Ford Gear Reduction Starters on Late Model 5.0L, 5.8L, OMC and Volvo Penta



**18-5814
SOLENOID**
Replaces: 172869, 581528
12 Volt, Isolated Base

①18-5814D Display Package



**18-5808
SOLENOID**
Replaces: 395419, 582708

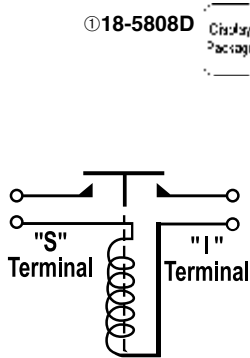

**18-5812
SOLENOID**
Replaces: 985063

①18-5812D Display Package

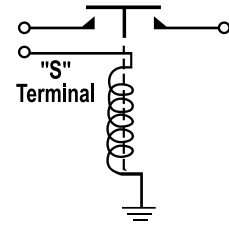

**18-5837
SOLENOID**
Replaces: 985799, 986620
Delco 1114531

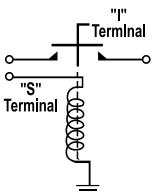

**18-5838
SOLENOID**
Replaces:
Delco 1114356, 1114458

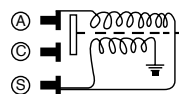

BATTERY CABLES
Gauge cable with soldered lug terminals on each end to accept a 3/8" stud

Part No.	Size	Color	Gauge	Part No.	Size	Color	Gauge
BC88523	2'	red	4	BC88563	6'	red	2
BC88533	2'	black	4	BC88573	6'	black	2
BC88543	4'	red	2	BC88583	8'	red	1
BC88553	4'	black	2	BC88593	8'	black	1

① Items ending in "D" are Display Packaged - Regular number is Non-Display

STRINGER SOLENOID APPLICATION

HP	Year	Starter Brush	Starter Mounted Solenoid	Starter Solenoid	Tilt Solenoid	Trim Solenoid
80	1969	—	N/A	18-5808	N/A	18-5808
88	1964	—	N/A	18-5807	N/A	18-5807
90	1965-71	—	N/A	18-5808	N/A	18-5808
100	1972-73	18-5717	18-5838	18-5803	N/A	18-5803
110	1964	18-5717	18-5838	18-5807	N/A	18-5807
120	1965-71	18-5717	18-5838	18-5808	N/A	18-5808
120	1972-77	18-5717	18-5838	18-5803	18-5803	18-5803
120	1978-81	18-5717	18-5838	—	—	—
140	1973-77	18-5717	18-5838	18-5803	18-5803	18-5803
140	1978-81	18-5717	18-5838	—	—	—
145 ①	1973	—	18-5838	18-5803	N/A	N/A
150	1964	18-5717	18-5838	18-5807	N/A	18-5807
150	1965-66	18-5717	18-5838	18-5808	N/A	18-5808
155	1967-72	18-5717	18-5838	18-5808	N/A	18-5808
165	1972-76	18-5717	18-5838	18-5803	18-5803	18-5803
170	1974	—	N/A	18-5801	N/A	18-5803
175	1975-78	—	N/A	18-5801	N/A	18-5803
185	1967-68	18-5717	18-5838	18-5808	N/A	18-5808
185	1978-80	18-5717	18-5838	—	—	—
190	1974-78	—	N/A	18-5801	N/A	18-5803
200	1966-78	18-5717	18-5838	18-5808	N/A	18-5808
200	1979-81	—	18-5838	—	—	—
210	1968-70	18-5717	18-5838	18-5808	N/A	18-5808
210 ②	1970-72	18-5717	18-5838	18-5808	N/A	N/A
215	1971	18-5717	18-5838	18-5808	N/A	18-5808
225	1972	18-5717	18-5838	18-5808	N/A	18-5808
225	1973	18-5717	18-5838	18-5803	N/A	18-5808
225	1974-76	18-5717	18-5838	18-5803	N/A	18-5803
225	1978	18-5717	18-5838	—	—	—
225 ②	1973-74	18-5717	18-5838	18-5808	N/A	N/A
230 ②	1975-76	18-5717	18-5838	18-5803	N/A	N/A
230	1979-81	18-5717	18-5838	—	—	—
235	1971	18-5717	18-5838	18-5808	N/A	18-5808
235	1975-78	—	N/A	18-5801	N/A	18-5803
245	1972	18-5717	18-5838	18-5808	N/A	18-5808
245	1973	18-5717	18-5838	18-5803	N/A	18-5808
245	1974-75	18-5717	18-5838	18-5803	N/A	18-5803
245 ①	1972-75	18-5717	18-5838	18-5808	N/A	N/A
250 ②	1970-74	—	18-5838	18-5808	N/A	N/A
260 ②	1975-76	18-5717	18-5838	18-5803	N/A	N/A
260	1979-81	18-5717	18-5838	—	—	—
290 ①	1974-75	18-5717	18-5838	18-5808	N/A	N/A
305 ②	1977-82	18-5717	18-5838	—	N/A	N/A
350 ②	1977-82	18-5717	18-5838	—	N/A	N/A
454 ②	1977-82	18-5717	18-5838	—	N/A	N/A
2.5	1982	18-5717	18-5838	—	—	—
2.5	1983-86	18-5717	18-5837	—	—	—
3	1982	18-5717	18-5838	—	—	—
3	1983-86	18-5717	18-5837	—	—	—
3.8	1981-82	18-5717	18-5838	—	N/A	—
3.8	1983-86	18-5717	18-5837	—	N/A	—
4.3	1985-86	18-5717	18-5837	—	N/A	—
5	1982	18-5717	18-5838	—	—	—
5	1983-86	18-5717	18-5837	—	—	—
5.7	1982	18-5717	18-5838	—	—	—
5.7	1983-86	18-5717	18-5837	—	—	—

① Jet Drive

② Inboard

OMC COBRA SOLENOID APPLICATION

HP	Year	Starter Brush	Starter Mounted Solenoid	Starter Solenoid	Trim Solenoid
262	1989	N/A	18-5837	18-5812	N/A
350	1988	N/A	18-5837	18-5812	18-5812
350	1989	N/A	18-5837	18-5812	N/A
350	1990-91	N/A	18-5837	18-5801	N/A
351	1992	—	—	18-5801	N/A
370	1988	N/A	—	18-5812	18-5812
370	1989	N/A	—	18-5812	N/A
454	1990	—	—	18-5801	N/A
454	1991-92	N/A	18-5837	18-5801	N/A
460	1989-90	N/A	—	18-5801	N/A
502	1992	N/A	18-5837	18-5801	N/A
2.3	1987-88	N/A	—	18-5801	18-5812
2.3	1989-90	N/A	—	18-5801	N/A
2.5	1986	18-5717	18-5837	18-5812	18-5812
3	1986-88	18-5717	18-5837	18-5812	18-5812
3	1989-90	18-5717	18-5837	18-5812	N/A
3	1991-92	18-5717	18-5837	18-5801	N/A
4.3	1986-88	18-5717	18-5837	18-5812	18-5812
4.3 ^①	1989-90	18-5717	18-5837	18-5812	N/A
4.3 ^②	1990-92	18-5717	18-5837	18-5801	N/A
5	1986-88	18-5717	18-5837	18-5812	18-5812
5	1989-92	18-5717	—	18-5801	N/A
5.7	1986-88	18-5717	18-5837	18-5812	18-5812
5.7	1989	18-5717	18-5837	18-5812	N/A
5.7	1990-92	18-5717	18-5837	18-5801	N/A
5.8	1989-92	N/A	—	18-5801	N/A
7.5	1987	18-5717	—	18-5801	18-5812

① 1990 Models with 2 barrel carbs

② 1990 Models with 4 barrel carbs.

**18-5711
VOLTAGE REGULATOR**

Replaces: 383440
Prestolite: VSH-6201 AFY
12 Volt



**18-6261
ALTERNATOR**

Replaces: 987774, 3857561,
3854182, 3854809, 3856600, 3860171
Fits: 3.0L, 4.3L, 5.7L, 7.4L (1995-98), 5.0L, 5.8L, 8.2L
(1993-98)
For: Delco



Years	Model	Alternator or Generator
1964-66	110, 150 HP	ALK-6222, A, AYS
1967-81	80, 90, 120, 140, 155, 165, 175, 185, 190, 200, 210, 225, 230, 235, 250, 260 HP & 305, 350, 454 CID	ALK-6222, A, AY, Y, AYS ANK-65201S, Y ALK-6210, A

**18-6260
ALTERNATOR**

OMC Cobra 12 Volt, 51 Amp, Internal Regulator, Negative Ground, Single Groove Pulley
For: Prestolite/Motorola



**18-6841
ALTERNATOR**

Replaces: 983424, 836, 247
For: 37-63A Marine Applications



**18-5957
ALTERNATOR**

Replaces: 982364
(3-Wire) (68 AMP)
Replaces Mando, Motorola and original equipment Delco. Uses same electrical connections and mounting method. Equipped with fan and drive pulley.
SAEJ1171







18-2192
ELECTRIC SHIFT CABLE
Replaces: 379628

ELECTRIC SHIFT CABLE APPLICATION	
Year	HP
1964	110 ②, 150
1965	120 ①, 150
1966	120 ①, 150, 200
1967	120 ①, 155, 185, 200
1968	120, 155, 185, 200, 210
1969-70	120, 155, 210
1971	120, 155, 215, 235
1972-73	100, 120, 155, 165, 225, 245
1974	120, 140, 165, 170, 190, 225, 245
1975	120, 140, 165, 175, 190, 225, 235, 245
1976	120, 140, 165, 175, 190, 225, 235
1977	120, 140, 175, 190, 235

① Heavy Duty ② SU12M, SUE 12M

③ 18-5705D 



18-5705
POWER TRIM/FUEL PUMP RELAY
Replaces: 582472, 584416, 586224
5 Terminal
Single Pull - Double Throw - 12 Volt
Open Contact: 40 Amps Resistive
30 Amps Conductive
Closed Contact: 20 Amps Resistive
15 Amps Conductive



18-6257
TILT/TRIM MOTOR
Replaces: 983195, 982957
1982-85 Models with hydraulic engine lifts for pump assembly



18-6754
TILT MOTOR
Replaces: 382138
Prestolite ETK 4102, ETK 4001, ETK 4101
(All Models 1963-77)



18-6755
TILT MOTOR
Replaces: 982706, 982058
Prestolite EVD 4001, EVD 4002
(All Models Except 2.5L, 3.0L - 1978-85)



18-6764
TILT/TRIM MOTOR
Replaces: 982073, 983318, 982069
For: OMC Stringer and Cobra "Select Trim" 3-Wire Connection
1979-85 Stern Drive (2.5L & 3.0L)



18-6779
TRIM MOTOR
Replaces: 986280, 3853945
For: 1990 & 1994 King Cobra Trim System



18-6814
TRIM MOTOR
Replaces: 984356
OMC Cobra

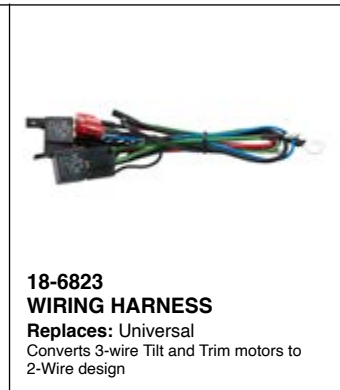

18-6823
WIRING HARNESS
Replaces: Universal
Converts 3-wire Tilt and Trim motors to 2-Wire design



18-6950
18-6950-9①
POWER TILT FUSE
(50 amp)
Replaces: 982019



18-9802
TIMING LIGHT
Self-powered accurate up to 10,000 RPM's



18-7684
MAP SENSOR
Replaces: 3850396
For: 4.3L TBI(1996-98), 5.0L TBI(1998), 5.7L TBI(1996-98), 7.4L(1995-98), 8.2L(1998)



18-7677
KNOCK SENSOR
Replaces: 3850357



18-7679
KNOCK SENSOR
Replaces: 3854905



18-7703
KNOCK SENSOR
Replaces: 3854512



18-7689
FUEL INJECTOR
Replaces: 3855182

③ Items ending in "D" are Display Packaged - Regular number is Non-Display

ALL SIERRA CARBURETORS INCLUDE BASE GASKET

- Precision remanufactured to meet or exceed OEM specifications
- Re-calibrated and re-engineered to maximize fuel efficiency and performance
- All carburetors are flow tested throughout the entire throttle range
- Fuel mixture and idle settings are pre-set to ensure that only minor idle and choke adjustments are necessary during installation
- All bases are resurfaced and throttle shaft bushings replaced



**18-7635
CARBURETOR
(REMANUFACTURED)**
300 CFM Holley 2V
Use replacement gasket **18-0360**



**18-7636
CARBURETOR
(REMANUFACTURED)**
500 CFM Holley 2V
Use replacement gasket **18-0994**



**18-7637
CARBURETOR
(REMANUFACTURED)**
600 CFM Holley 4V
(Includes gasket)



**18-7638
CARBURETOR
(REMANUFACTURED)**
600 CFM Holley 4V-side inlet



**18-7640
CARBURETOR
(REMANUFACTURED)**
Universal Q-jet with electric choke
Use replacement gasket **18-0462**



**18-7605-1
CARBURETOR**
4 Barrel Rochester
Replaces: 382821, 383766, 384194
Remanufactured
Use replacement gasket **18-2948**
Use Carb Replacement Kit **18-7095**



**18-7609-1
CARBURETOR**
2 Barrel Rochester
Replaces: 382733, 980530, 982217, 984180, 381494, 772831
Remanufactured
Use replacement gasket **18-0356**
Use Carb Replacement Kit **18-7070**



**18-7615-1
CARBURETOR**
4 Barrel Rochester
Replaces: 981705, 982223, 983855, 981359, 981564, 985822, 981803, 981428
Remanufactured
Use replacement gasket **18-2948**
Use Carb Replacement Kit **18-7095**



OMC STERN DRIVE CARBURETOR APPLICATION

I/O - OMC STERN DRIVE/COBRA - FUEL SYSTEM

Model	Year	OMC Carburetor #	MFG Carburetor #	Carb Code & Model	Part #
80	1968-69	382733, 772831	7028085, 17059053, 17086064, 17087311	R2, 2GC	18-7609-1
90	1970-71	382733, 772831	7028085, 17059053, 17086064, 17087311	R2, 2GC	18-7609-1
120 (400 Series)	1972-86	381668, 980528, 982219	7044186, 17059056	R2, 2GC	18-7608-1
140 (400 Series)	1973-85	979821, 980530, 982217, 984180	17086107	R2, 2GC	18-7608-1
155	1967-72	772831	7026180	R2, 2GC	18-7609-1
165	1972-76	979821, 980530	17086107	R2, 2GC	18-7609-1
185	1989	984180	17086064	R2, 2GC	18-7609-1
200	1966-68	381494	7025187	R2, 2GC	18-7609-1
210	1968-72	382821, 383766	7028282, 7028280	R4, 4MV	18-7605-1
215, 225, 230	1971-76	382821	7028280	R4, 4MV	18-7605-1
230 (800 Series)	1979-89	981705, 982223	17057290, 17059285, 17059286, 17086117	R4, 4MV	18-7615-1
245	1972-75	384194	7040284	R4, 4MV	18-7605-1
250	1970-74	384194	7040284	R4, 4MV	18-7605-1
260 (800 Series)	1975-76	384194	7040284	R4, 4MV	18-7605-1
260 (800 Series)	1979-89	982223	17057290, 17059285, 17059286, 17086117	R4, 4MV	18-7615-1
2.5L, 3.0L	1982-86	982219, 982217	17059056, 17059053	R2, 2GC	18-7608-1
3.0L	1987-90	984180	17086064	R2, 2GC	18-7608-1
3.8L (4V)	1979-85	983855	17082515, 17085010	R4, 4MV	18-7615-1
4.3L (4V)	1979-89	983855	17082515, 17085010	R4, 4MV	18-7615-1
5.0L (GM)(4V)	1979-89	982223	17057290, 17059285, 17059286, 17086117	R4, 4MV	18-7615-1
5.7L (4V)	1979-89	982223	17057290, 17059285, 17059286, 17086117	R4, 4MV	18-7615-1
305, 350 CI, I/B	1977-83	981359, 982215, 981564, 982223	17057290, 17059285, 17059286, 17086117	R4, 4MV	18-7615-1
350 (4V)	1988-89	985822	17057290, 17059285, 17059286, 17086117	R4, 4MV	18-7615-1
454 CI, I/B	1977-78	981803, 981428	17057290, 17059285, 17059286, 17086117	R4, 4MV	18-7615-1



**18-7017
CARB KIT**
Replaces: 985052
235 (5.8L Ford) 1989 7.5L/460 C.I. 1987-89
(Contains Non-adjustable needles and seats)



**18-7070
CARB KIT**
Replaces: 383615, 982384



**18-7071
CARB KIT**
Replaces: 380186



**18-7072
CARB KIT**
Replaces: 979659, 384743



**18-7080
CARB KIT**
Replaces: 979719



**18-7081
CARB KIT**
Replaces: 982537, 982538
(Contains adjustable needles and seats)



**18-7086
CARB KIT**
Replaces: 984487

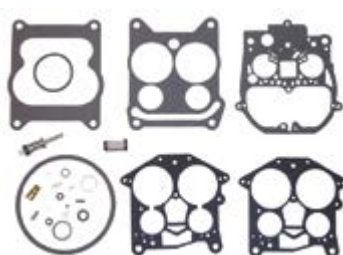

**18-7095
CARB KIT**
Replaces: 983864, 383918

APPLICATION BEGINS ON PAGE 893



18-7096
CARB KIT
 Replaces: 982539, 85R-4541
 (Contains adjustable needles and seats)



18-7235
CARB KIT
 Replaces: 986783



18-7236
CARB KIT
 Replaces: 986782



18-7237
CARB KIT
 Replaces: 986784, 986799



18-7238
CARB KIT
 Replaces: 986796



18-7239
CARB KIT
 Replaces: 986800



18-7241
CARB KIT
 Replaces: 986804



18-7242
CARB KIT
 Replaces: 987313

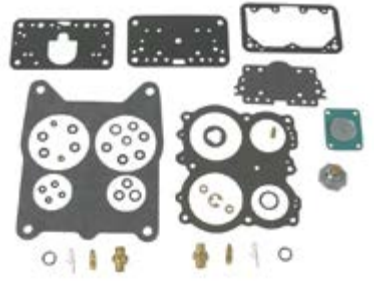

18-7243
CARB KIT
 Replaces: 987315

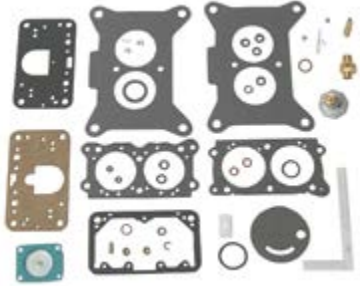

18-7244
CARB KIT
 Replaces: 987317



18-7245
CARB KIT
 Replaces: 987319



18-7246
CARB KIT
 Replaces: 987438, 987440, 987485



18-7727
CARB KIT



18-7729
CARB KIT



**18-7200
FLOAT**
(Alcohol Resistant)
Replaces: 381389
Plastic



**18-7201
FLOAT**
(Alcohol Resistant)
Replaces: 383087, 983871
Brass



**18-7206
NITROPHYL FLOAT**
Nitrophenyl

CARBURETOR KIT/FLOAT APPLICATION

Model	Years	Mfg. Code	Carb. Model	Carb Kit	Float
80	1968-69	R2	2GC	18-7070	18-7200
90	1970-71	R2	2GC	18-7070	18-7200
100	1972-73	C1	RBS	18-7080	—
110	1964	R1	BC	18-7071	—
120	1965-71 (Dual Carb)	C1	RBS	18-7080	—
120	1972-85	R2	2GC	18-7070	18-7200
140	1973-85	R2	2GC	18-7070	18-7200
150	1964-65	R1	BC	18-7071	—
150	1965-66	C1	RBC	18-7080	—
155	1967-72	R2	2GC	18-7070	—
165	1972-76	R2	2GC	18-7070	18-7200
170	1974	H2	2300	18-7081	18-7206
175	1975-77	H2	2300	18-7081	18-7206
185	1978-81	R2	2GE	18-7086	18-7200
185	1989	H2	2300	18-7081	18-7206
190	1974-77	H2	2300	18-7081	18-7206
200	1966-68	R2	2GC,V	18-7070	—
200	1979-85	R2	2GE	18-7086	18-7200
200	1989	H2	2300	18-7081	18-7206
210	1968-72	R4	4MV	18-7072	18-7201
215	1971	R4	4MV	18-7072	18-7201
225	1972-76	R4	4MV	18-7072	18-7201
230	1975-76	R4	4MV	18-7072	18-7201
230	1979-89	R4	4MV	18-7095	18-7201
235	1975-77	H4	4160	18-7096	18-7206
235	1989	H4	4160	18-7017	—
240	1978	H4	4160	18-7017	—
245	1972-75	R4	4MV	18-7072	18-7201
250	1970-74	R4	4MV	18-7072	18-7201
250	1979	H4	4160	18-7017	—
260	1975-76	R4	4MV	18-7072	18-7201
260	1979-89	R4	4MV	18-7095	18-7201
290 JET	1974-75	R4	4MV	18-7072	18-7201
2.3L	1987-89	R2	2GE	18-7086	18-7200
2.5L	1982-85	R2	2GC	18-7070	18-7200
2.5L	1986-90	R2	2GE	18-7086	18-7200
2.5L	1986	R2	2GC	18-7070	18-7200
3.0L ⑥	1982-90	R2	2GC	18-7070	18-7200
3.0L/3.0L H.O.	1991-92	H-2	2300	18-7246	—
3.8L	1979-85	R2	2GE	18-7086	18-7200
4.3L	1986-89	R2	2GE	18-7086	18-7200
4.3L	1979-89	R4	4MV	18-7095	18-7201
4.3,4.3 H.O. ②	1990-92	H2	2300	18-7238	—
4.3,4.3 H.O. ③	1990-92	H4	4160	18-7237	—
4.3/262 ②	1989	R2	2GE	18-7086	18-7200
5.0L (GM)	1979-85	R2	2GE	18-7086	18-7200
5.0L (GM)	1979-89	R4	4MV	18-7095	18-7201

② For 2V Carburetors
③ For 4V Carburetors
④ For Engine Model 574APEPWS

⑥ For 1990 PWC Suffix Only
⑨ For Engine Model 574APERGD

① For Engine Model 744DPEAMH, 744DPPAMH
② For Engine Model 744CPEAMH, 824BPEAM

CARBURETOR KIT/FLOAT APPLICATION

Model	Years	Mfg. Code	Carb. Model	Carb Kit	Float
5.0L (FORD)	1989	H2	2300	18-7081	18-7206
5.0,5.0 H.O. ③	1989-90	H4	4160	18-7237	—
5.0,5.0 H.O. ②	1989-90	H2	2300	18-7236	—
5.0,5.0 H.O. ③	1991	H4	4160	18-7245	—
5.0,5.0 H.O. ②	1991	H4	4175	18-7244	—
5.0,5.0 H.O. ①	1992	H4	4150	18-7242	—
5.7L	1979-89	R4	4MV	18-7095	18-7201
5.7	1990-92	H4	4175	18-7239	—
5.7 LE ⑨	1991-92	H4	4175	18-7243	—
5.7 LE ④	1990	H4	4175	18-7239	—
5.8L	1989	H4	4160	18-7017	—
7.5L	1987-88	H4	4160	18-7017	—
305 C.I./B	1977-79	R2	2GE	18-7086	18-7200
305 C.I./B	1977-78	R4	4MV	—	18-7201
305 C.I./B	1979-83	R4	4MV	18-7095	18-7201
350 C.I./B	1977-78	R4	4MV	—	18-7201
350 C.I./B	1979-83	R4	4MV	18-7095	18-7201
350 ④ ③	1988-89	R4	4MV	18-7095	18-7201
350 ②	1988	R2	2GE	18-7086	18-7200
351 CID/5.8L H.O.	—	H4	4010, R50483A, R84046A (F1JL-9510-EA)	18-7727	—
351 CID/5.8L	—	H4	4160, R9393A, R9394A, R50399A, R50399-1A	18-7729	—
351 CID/5.8L	—	H4	4160C, R80434A	—	—
454 C.I./B	1977-78	R4	4MV	18-7072	18-7201
454,454 H.O. ①	1991-92	H4	4150	18-7242	—
454,454 H.O. ②	1990-92	H4	4150	18-7241	—
460 C.I.	1987-88	H4	4160	18-7017	—
460	1989-90	H4	4160	18-7235	—

- ② For 2V Carburetors
- ③ For 4V Carburetors
- ④ For Engine Model 574APEPWS
- ⑥ For 1990 PWC Suffix Only
- ⑨ For Engine Model 574APERGD
- ① For Engine Model 744DPEAMH, 744DPPAMH
- ② For Engine Model 744CPEAMH, 824BPEAM

18-8114 FUEL LINE HOSE
 For fuel pump to carburetor connection. Replaces copper or steel tubing 3/8" X 31" PTFE composite hose with 5/8"-18 male inverted flare straight one end, 5/8"-18 90° one end. SAE J1527 type A1

18-8115 FUEL LINE HOSE
 For fuel pump to carburetor connection. Replaces copper or steel tubing 3/8" X 25" PTFE composite hose with 5/8"-18 male inverted flare straight one end, 5/8"-18 90° one end. SAE J1527 type A1

ALL SIERRA FUEL PUMPS INCLUDE MOUNTING GASKET

18-7256 FUEL PUMP
 Flange I.D. # 6790
 For: GM (4 & 6 cyl.)153, 230, 250, 292

18-7258 FUEL PUMP
 Replaces: 380986
 Flange I.D. # 40001, M643
 For: GM (V-6) 225, PB-V215

18-7265 FUEL PUMP
 Flange I.D. # 41412, M73018
 For: GM (V-8) 305, 350, 400

18-7267 FUEL PUMP
 Replaces: 982063
 Flange I.D. # 40778, M73016
 (Includes gasket)
 For: Ford (V-8) 302

18-7268 FUEL PUMP
 Replaces: 981650
 Flange I.D. #41415
 For: GM (V-8) 305, 307, 350, 400
 Dual diaphragm sight glass required.

18-7278 FUEL PUMP
 Replaces: 985602, 985603, 982240
 Flange I.D. #M60032
 Uses filter 18-7860
 For: GM (4 & 6 cyl.) 153, 181, 250, 224, 225

18-7289 FUEL PUMP
 Replaces: 982997
 Flange I.D. # 60201
 (Includes gasket)
 For: GM (V-6) 262/4.36

FUEL PUMP APPLICATION

Model	Years	Pump #	Model	Years	Pump #
2.5	1982-85	18-7278	185	1978-80	18-7268
5	1982-88	18-7268	190	1974-77	—
5.7	1982-92	18-7268	200	1979-81	18-7268
100	1972-73	18-7278	225	1978	18-7268
110	1964	18-7278	230	1979-81	18-7268
120	1965-80	18-7278	235	1975-77	—
140	1973-81	18-7278	240	1978	—
140 Jet Drive	1973	18-7278	245 Jet Drive	1973	18-7278
150	1964	—	250	1979	—
150 Model HU-13EM	1965	—	260	1979-81	18-7268
150 Except HU-13EM	1965	—	305 CID IB	1979-82	18-7268
165	1972-76	18-7278	350 CID IB	1979-82	18-7268
170	1974	—	350	1988-91	18-7268
175	1975-77	—			



18-7326
ELECTRIC FUEL PUMP
 Replaces: 3858261, 3857986, 3850809, 3854620



18-7330
ELECTRIC FUEL PUMP
 Replaces: 3857650, 3855958, 3854280, 987620, 988037



18-7331
ELECTRIC FUEL PUMP
 Replaces: 3850810



18-7229
FLAME ARRESTOR
 Replaces: 986865, 981566

ELECTRIC FUEL PUMP APPLICATION

Year	Engine	Application	OE #	#s Superseded from	Part #
1992-94	262/4.3L	Low Pressure	3858261	3850809, 3850810, 3857985	18-7326
1997-98	350/5.7L, 454/7.4L, & 502/8.2L	Engines w/MPI - High Pressure	3857650		18-7330
1996	454/7.4L & 502/8.2L	Engines w/MPI - High Pressure	3857650		18-7330
1993-94	4.3L thru 5.8L	Low pressure electric fuel pump	3858261	3850809	18-7326
1992-1994	454/7.4L & 502/8.2L	GM Mark V Eng. - Low Pressure	3858714	3850810, 3857985	18-7331

- UNIVERSAL DESIGN -

FUEL WATER SEPARATOR BRACKETS



Bracket Type	Part #
1/4" Stainless Steel	18-7777
3/8" Stainless Steel	18-7776

Bracket Type	Part #
1/4" Aluminum	18-7853-1
3/8" Aluminum	18-7775

FUEL WATER SEPARATOR KITS



21 MICRON FILTER KITS FOR CARBURETED ENGINES

Kit Type	Part #	Micron Rating	Contents
1/4" Aluminum (Short Filter)	18-7848-1 •	21	1 - 18-7844 filter & 1 18-7853-1 bracket, 2 - 18-4256 1/4" pipe plugs
1/4" Aluminum Bonus Pack (Contains spare filter)	18-7848-2 •	21	2 - 18-7844 filter & 1 18-7853-1 bracket, 2 - 18-4256 1/4" pipe plugs
1/4" Aluminum (Tall Filter)	18-7852-1 •	21	1 - 18-7845 filter & 1 18-7853-1 bracket, 2 - 18-4256 1/4" pipe plugs
1/4" Aluminum Bonus Pack (Contains spare filter)	18-7852-2 •	21	2 - 18-7845 filter & 1 18-7853-1 bracket, 2 - 18-4256 1/4" pipe plugs
3/8" Aluminum (Tall Filter)	18-7775-1 •	21	1 - 18-7845 filter & 1 18-7775 bracket, 2 - 18-4264 3/8" pipe plugs
1/4" Stainless Steel (Tall Filter)	18-7777-1 •	21	1 - 18-7845 filter & 1 18-7777 bracket, 2 - 18-4256 1/4" pipe plugs
3/8" Stainless Steel (Tall Filter)	18-7776-1 •	21	1 - 18-7845 filter & 1 18-7776 bracket, 2 - 18-4264 3/8" pipe plugs

10 MICRON FILTER KITS FOR FUEL INJECTED ENGINES



Kit Type	Part #	Micron Rating	Contents
1/4" Aluminum (Short Filter)	18-7983-1 •	10	1 - 18-7944 filter & 1 18-7853-1 bracket 2 - 18-4256 1/4" pipe plugs
1/4" Aluminum Bonus Pack Contains spare filter	18-7983-2 •	10	2 - 18-7944 filter & 1 18-7853-1 bracket 2 - 18-4256 1/4" pipe plugs
1/4" Aluminum (Tall Filter)	18-7982-1 •	10	1 - 18-7945 filter & 1 18-7853-1 bracket 2 - 18-4256 1/4" pipe plugs
1/4" Aluminum Bonus Pack Contains spare filter	18-7982-2 •	10	2 - 18-7945 filter & 1 18-7853-1 bracket 2 - 18-4256 1/4" pipe plugs
1/4" Aluminum (High Capacity Filter)	18-7966-1 •	10	1 - 18-7866 filter & 1 18-7853-1 bracket 2 - 18-4256 1/4" pipe plugs
3/8" Aluminum (Tall Filter)	18-7986-1 •	10	1 - 18-7945 filter & 1 18-7775 bracket 2 - 18-4264 3/8" pipe plugs
1/4" Stainless Steel (Tall Filter)	18-7984-1 •	10	1 - 18-7945 filter & 1 18-7777 bracket 2 - 18-4256 1/4" pipe plugs
3/8" Stainless Steel (Tall Filter)	18-7985-1 •	10	1 - 18-7945 filter & 1 18-7776 bracket 2 - 18-4264 3/8" pipe plugs



10 MICRON FILTER KITS WITH DRAIN BOWLS

Sierra AquaVue™ and metal bowl separator filters allow water to be drained from the filter to extend service life. Use the AquaVue™ bowl for outboard, above deck installations. USCG regulations require the use of the flame resistant metal bowl below deck.

Kit Type	Part #	Micron Rating	Contents
1/4" Aluminum w/ metal drain bowl	18-7951 •	10	1 - 18-7919 filter & 1 18-7853-1 bracket 1 - 18-7924 metal bowl 2 - 18-4256 1/4" pipe plugs
1/4" Stainless Steel w/ metal drain bowl	18-7938 •	10	1 - 18-7919 filter & 1 18-7777 bracket 1 - 18-7924 metal bowl 2 - 18-4256 1/4" pipe plugs

• Display Packaged

COMPACT BRACKET AND SEPARATOR KIT - FOR SMALL OUTBOARDS AND FRESH WATER APPLICATIONS

18-7774
COMPACT ALUMINUM BRACKET



18-7965-1
10 MICRON COMPACT SEPARATOR KIT
 Contains:
 1 - 18-7774 bracket
 1 - 18-7865 filter



REPLACEMENT FILTERS



UNIVERSAL DESIGN

10 MICRON REPLACEMENT FILTERS			21 MICRON REPLACEMENT FILTERS			
Part #	Description		Part #	Description		
18-7944	Short - 3.875"		18-7844	Short - 3.875"		
18-7945	Long - 4.35"			Long - 4.35"		
18-7866	High Capacity - 6"			18-7845	Long - 4.35"	
18-7865	Compact 10 Micron					

REPLACEMENT FILTERS FOR OMC

10 MICRON REPLACEMENT FILTERS			21 MICRON REPLACEMENT FILTERS		
Part #	Description	Replaces	Part #	Description	Replaces
18-7946	OMC thread	OMC 502905	18-7846	OMC thread	OMC 502905
18-7989	Cobra EFI	OMC 502906	18-7789	Cobra EFI	OMC 502906



10 MICRON REPLACEMENT FILTERS AND KITS WITH DRAIN BOWLS

REPLACEMENT FILTERS			FILTER & BOWL KITS		
Part #	Description	Replaces	Part #	Description	
18-7919	Spin on replacement	Racor S3213	18-7929 •	Filter & Metal Bowl	
18-7920	Spin on replacement	OMC 771839 Racor S3214		Contains: 18-7919 filter, 18-7924 bowl	
18-7947	Spin on replacement Fits - 120RRAC01	Racor S3240	18-7941-1 •	Filter & AquaVue™ Bowl	
18-7948	Spin on replacement Fits - 320RRAC01	Racor S3227		OMC style	
18-7949	Spin on replacement Fits - 660RRAC02	Racor S3232	18-7943 •	Filter & Metal Bowl	
				OMC style	
			Contains: 18-7920 filter, 18-7924 bowl		
REPLACEMENT BOWLS			REPLACEMENT ELEMENTS		
Part #	Description		Part #	Description	Replaces
18-7924	Metal Collection Bowl		18-7930	1977-83 Fuel system with add on filter kit	OMC 173326



18-7792
FUEL FILTER
 Replaces: 910641, 3855104
 Fits: OMC 3.0L (1996-98), 3.8L/170 (1981)



18-7854
FUEL FILTER
 Replaces: 984491, 311684
 Rochester 17078904



18-7855
FUEL FILTER
 Replaces: 983870, 910139
 Rochester 17068453

• Display Packaged



18-7717
FILTER ELEMENT
For: Rochester 2 bbl & 4 bbl Carburetors



18-7859
FUEL FILTER
Replaces: 908034
For: Most GM Inline 4 & 6 cycle:
Ford and GM V-8's up to 400 HP



18-7860
FUEL FILTER
Replaces: 381690, 312456
with AC Fuel Pumps
For: Inline 4 & 6 cycle engines



18-7861
REPLACEMENT CANISTER AND FILTER
Replaces: 981911



18-7862
FUEL FILTER ELEMENT
For Fuel Filter
(Includes Gasket)
Replaces: 982230



18-7964-1
TRANSMISSION FILTER KIT



18-8072
FUEL ELBOW
3/8" Hose Barb with
3/8" NPT Thread
Replaces: 174177
90°



HOSE BARB
NPT Thread

18-8074 3/8" with 1/4"
Replaces: 173312
18-8055 3/16" with 1/4"
Replaces: 173311

PKG. OF 10

SNAPPER CLAMPS

Part No.	O.E. No.	Range	Size
18-8020 ①	322652	.538 - .608	8
18-8021 ①	911616	.597 - .665	10
18-8034 ①	329654	.670 - .780	12
18-8200 ①	322653	.360 - .406	2
18-8201 ①	124249	.410 - .468	4
18-8202 ①	322654	.475 - .536	6
18-8203 ①	329653	.750 - .875	14
18-8204 ①	324825	.875 - .975	19



18-5894
OIL PRESSURE LIGHT SWITCH
Replaces: 0379948

ALL SIERRA WATER PUMPS ARE BI-DIRECTIONAL



18-3593
CIRCULATING WATER PUMP
Replaces: 0984360, 0986779, 380640, 3854017, 3858340
Uses gasket **18-0327 (Included)**
For: GM Inline (4 & 6 Cylinder)



18-3577-2
CIRCULATING WATER PUMP
Replaces: GM 6269358, OMC 987447,
983296, 986074, 3854118
For: GM Big Block



18-3599-2
CIRCULATING WATER PUMP
Replaces: 382218, 980477, 985429, 3853850
For: GM V-6 & small block V-8 engines
Uses gasket **18-0981 (included)**

① This product is priced per piece. To order priced per package, please add -9 to the part number.

WATER CIRCULATING PUMP APPLICATION

Model	Year	Part #	Model	Year	Part #	Model	Year	Part #
2.3	1987-90	-	165	1972-76	18-3593	Inboard	1970-74	18-3599-2
2.5	1982-86	18-3593	185	1967-80	18-3599-2	250	1979	18-3593
3	1982-92	18-3593	200	1979-81	18-3599-2	260		
3.8	1981-86	18-3599-2	210	1968-70	18-3599-2	Inboard	1975-76	18-3599-2
4.3	1985-92	18-3599-2	210			260	1979-81	18-3599-2
5	1982-88	18-3599-2	Inboard	1970-72	18-3599-2	262	1989	18-3599-2
5	1989-92	18-3593	215	1971	18-3599-2	290		
5.7	1982-92	18-3599-2	225	1972-78	18-3599-2	Jet Drive	1974-75	18-3599-2
5.8	1989-92	18-3593	225			305 CID IB	1977-82	18-3599-2
100	1972	18-3593	Inboard	1973-74	18-3599-2	350 CID IB	1977-82	18-3599-2
100	1973	18-3599-2	230			350	1988-92	18-3599-2
120	1965-69	18-3593	Inboard	1975-76	18-3599-2	454 CID IB	1977-80	18-3577-2
120	1972	18-3593	230	1979-81	18-3599-2	454 CID IB	1982	18-3599-2
120	1973-74	18-3599-2	235	1971	18-3599-2			
120	1975-81	18-3593	245	1972-75	18-3599-2			
140			245					
Jet Drive	1973	18-3593	Jet Drive	1972-75	18-3599-2			
140	1973-81	18-3593	250					

 <p>18-3058 IMPELLER Replaces: 983895</p>	 <p>18-3086 IMPELLER Replaces: 379475, 777130</p>	 <p>18-30585 IMPELLER Replaces: 3854072 Fits: King Cobra (1992-1995)</p>
---	--	--

IMPELLER APPLICATION

Model	Years	Impeller	Model	Years	Impeller
2.3	1987-1990	18-3058 ①	170	1974	18-3086
2.5	1986	18-3058	175	1975-1977	18-3086
3	1986-1992	18-3058 ①	185	1967-1968	18-3086
4.3	1986-1992	18-3058	185	1978-1984	18-3086
5	1986-1992	18-3058	190	1974-1977	18-3086
5.7	1986-1992	18-3058 ②	200	1966-1968	18-3086
5.8	1989-1992	18-3058	200	1979-1984	18-3086
50FAPLJVB, 50FAPJVN	1993	18-3058	210	1968-1972	18-3086
50FAPRJVB	1993	18-3058	215	1971	18-3086
50FACPMDA, 50FACPMDM	1994	18-3060	225	1972-1976	18-3086
50FAGPMDA, 50FAGPMDM	1994	18-3060	225	1978	18-3086
50FAGPMDM	1994	18-3060	230	1975-1976	18-3086
58FACPMDA, 58FACPMDM	1994	18-3060	230	1979-1981	18-3086
58FAGPMDA, 58FAGPMDM	1994	18-3060	232AMFTC	1987	18-3086
58FAPLJVB, 58FAPLJVN	1993	18-3058	232AMRGDE, 232AMRGDP	1988	18-3058
58FAPRJVB, 58APRJVN	1993	18-3058	232APFTC	1987	18-3058
7.5	1987	18-3058	232APRGDE, 232APRGDP	1988	18-3058
80	1968-1969	—	232APSRC	1987	18-3058
88	1964	—	232BMRMED, 232BMRMEF	1989	18-3058
90	1965-1968	—	232BPRMED, 232BPRMEF	1989	18-3058
90	1970-1971	—	235	1971	18-3088
100	1972-1973	18-3086	235	1975-1977	18-3088
110	1964	— ③	240	1978	18-3088
110	1964	18-3086 ④	245	1972-1975	18-3086
120	1965-1967	— ③	250	1970-1974	18-3086
120	1965-1967	18-3086 ④	250	1979	18-3086
120	1968-1984	18-3086	252AMKWB, 252APKWB	1986	18-3058
140	1973-1984	18-3086	260	1975-1976	18-3086
150	1964-1966	18-3086	260	1979-1984	18-3086
155	1967-1972	18-3086	262	1989	18-3058
165	1972-1976	18-3086	262AMLMED, 262APRMED	1989	18-3058

① Except models originally equipped with short impeller or retrofitted with short impeller kit

② Except 1992 5.7LE models ③ Standard pump ④ Heavy duty pump

Model	Years	Impeller	Model	Years	Impeller
302AMARJ, 302AMARY	1987	18-3058	434AMKWB	1986	18-3058
302AMFTC	1987	18-3058	434AML PWS	1990	18-3058
302AMKWB	1986	18-3058	434AMWXS	1986	18-3058
302AMRGDP	1988	18-3058	434AMLGDP	1988	18-3058
302AMRMED	1989	18-3058	434APARY, 434APFTC	1987	18-3058
302APARY, 302APFTC	1987	18-3058	434APKWB	1986	18-3058
302APKWB	1986	18-3058	434APLAMH	1992	18-3058
302APRGDP	1988	18-3058	434APLJVB, 434APLJVN	1993	18-3058
302APRMED	1989	18-3058	434APLRGD	1991	18-3058
302APSRC, 302ARSRY	1987	18-3058	434APRAMH	1992	18-3058
302BMRAMH, 302BMRAMK	1992	18-3058	434APRGDP	1988	18-3058
302BMRJVB	1993	18-3058	434APRJVB, 434APRJVN	1993	18-3058
302BMRRGD	1991	18-3058	434APRPWS	1990	18-3058
302CCPMDA, 302CGPMDA	1994	18-3060	434APRRGD	1991	18-3058
302CMHUB	1995	18-3060	434APSRC, 434APSR Y	1987	18-3058
302CMNCA, 302CMNCS	1996	18-3060	434APWXS	1986	18-3058
302CMRAMH, 302CMRRAMK	1992	18-3058	454	1977	18-3086
302CMRJVB	1993	18-3058	454	1990-1991	18-3058
302CMRRGD	1991	18-3058	460	1988-1990	18-3058
302CPHUB	1995	18-3060	460AML MED	1989	18-3058
302CPNCA "A" SUFFIX MODELS	1996	18-3060	460APRMED	1989	18-3058
302CPNCS "A" SUFFIX MODELS	1996	18-3060	502ACPMDA	1994	18-3060
302CPRAMH, 302CPRAMK	1992	18-3058	502AGPMDA	1994	18-3060
302CPRJVB	1993	18-3058	502AMLGDP	1988	18-3058
302CPRRGD	1991	18-3058	502AML MED	1989	18-3058
302DCMMDA, 302DGMMDA	1994	18-3060	502AML PWS, 502ANLPWS	1990	18-3058
305	1977-1978	18-3086	502APLAMH, 502APLAMK	1992	18-3058
350	1977-1978	18-3086	502APLJVB	1993	18-3058
350	1988-1991	18-3058	502APLRGD	1991	18-3058
350AML MED, 350APRMED	1989	18-3058	502APRAMH, 502APRAMK	1992	18-3058
370	1988	18-3058	502APRGDP	1988	18-3058
432ACMMDA, 432ACPMDA	1994	18-3060	502APRJVB	1993	18-3058
432AGMMDA, 432AGPMDA	1994	18-3060	502APRMED	1989	18-3058
432AMARY, 432AMFTC	1987	18-3058	502APRPWS	1990	18-3058
432AMKWB	1986	18-3058	502APRRGD	1991	18-3058
432AMLGDP	1988	18-3058	502BPRAMH, 502BPRAMK	1992	18-3058
432AML MED	1989	18-3058	502BPRJVB	1993	18-3058
432AML PWS	1990	18-3058	502BPRMED	1989	18-3058
432AMWXS	1986	18-3058	502BPRPWS	1990	18-3058
432APARY, 432APFTC	1987	18-3058	502BPRRGD	1991	18-3058
432APKWB	1986	18-3058	504AMARY, 504AMFTC	1987	18-3058
432APLAMH	1992	18-3058	504AMKWB	1986	18-3058
432APLJVB, 432APLJVN	1993	18-3058	504AMLGDP	1988	18-3058
432APLRGD	1991	18-3058	504AMWXS	1986	18-3058
432APRAMH	1992	18-3058	504APARY, 504APFTC	1987	18-3058
432APRGDE, 432APRGDP	1988	18-3058	504APKWB	1986	18-3058
432APRJVB, 432APRJVN	1993	18-3058	504APRGDP	1988	18-3058
432APRMED	1989	18-3058	504APWXS	1986	18-3058
432APRPWS	1990	18-3058	572ACPMDA, 572AGPMDA	1994	18-3060
432APRRGD	1991	18-3058	574AMFTC	1987	18-3058
432APSRC, 432APSR Y	1987	18-3058	574AMKWB	1986	18-3058
432APWXS	1986	18-3058	574AMLGDP	1988	18-3058
434AMARY, 434AMFTC	1987	18-3058	574AML MED	1989	18-3058

① Except models originally equipped with short impeller or retrofitted with short impeller kit

② Except 1992 5.7LE models ③ Standard pump ④ Heavy duty pump

Model	Years	Impeller	Model	Years	Impeller
574AML PWS	1990	18-3058	584AML MED	1989	18-3058
574AMWXS	1986	18-3058	584AML PWS	1990	18-3058
574APARY	1987	18-3058	584APL AMH, 584APL AMK	1992	18-3058
574APEPWS	1990	18-3058	584APL JVB	1993	18-3058
574APERGD	1991	18-3058	584APLRGD	1991	18-3058
574APFTC	1987	18-3058	584APR AMH, 584APR AMK	1992	18-3058
574APKWB	1986	18-3058	584APR JVB	1993	18-3058
574APL AMH	1992	18-3058	584APR MED	1989	18-3058
574APLRGD	1991	18-3058	584APR PWS	1990	18-3058
574APR AMH	1992	18-3058	584APR RGD	1991	18-3058
574APR GDP	1988	18-3058	744APEPWS	1990	18-3058
574APR MED	1989	18-3058	744APERGD, 744APERGF	1991	18-3058
574APR PWS	1990	18-3058	744BPERGD	1991	18-3058
574APR RGD	1991	18-3058	754APEPWS	1990	18-3058
574APSRC	1987	18-3058	754APFTC, 754APSRC	1987	18-3058
574APWXS	1986	18-3058	754BPFTC, 754BPSRC	1987	18-3058
574BML GDP	1988	18-3058	① Except models originally equipped with short impeller or retrofitted with short impeller kit ② Except 1992 5.7LE models ③ Standard pump ④ Heavy duty pump		
574BPEPWS	1990	18-3058			
574BPERGD	1991	18-3058			
574BPR GDP	1988	18-3058			
584ACPMDA, 584AGPMDA	1994	18-3060			



**18-3108
IMPELLER KEY**
Replaces: 308928
Fits: Stern drive models (1968-85)
For: Stringer Drive Impeller 18-3086



**18-4837
WATER PASSAGE COVER**
Replaces: 911734
Fits: OMC Cobra (1986-93) without cone clutch



**18-3119
WATER PUMP HOUSING**
Replaces: 983298



**18-3206
WATER PUMP HOUSING**
Replaces: 984744
For: OMC Cobra

① 18-3212-1D Display Package



**18-3212-1
IMPELLER
REPAIR KIT**
Replaces: 984461

— CONTAINS —

Part #	Description	O.E.M. #	Qty.
18-2541	O-Ring	911704	1
18-2916	Water Pump Housing Gasket	911702	1
18-3058	Impeller	983895	1
NSS	Impeller Plate	911703	1
NSS	Pump Liner	911844	1



**18-3286
IMPELLER
REPAIR KIT**
1964-86
EXCEPT COBRA

— CONTAINS —

Part #	Description	O.E.M. #	Qty.
18-7135	O-Ring	310584	1
NSS	Plate	313176	1
18-7129	O-Ring	314491	1
NSS	Rubber Seal	907774	1
18-3086	Impeller	379475	1
18-7158	O-Ring	310585, 310967	1



**18-3386
WATER PUMP KIT**
Replaces: 983218
1964-86
EXCEPT COBRA

— CONTAINS —

Part #	Description	O.E.M. #	Qty.
18-7135	O-Ring	310584	1
NSS	Plate	313176	1
18-7129	O-Ring	314491	1
18-3086	Impeller	379475	1
NSS	Rubber Seal	907774	1
18-3119	Impeller Housing	983298	1
18-7158	O-Ring	310585, 310967	1



**18-3348
COMPLETE WATER PUMP KIT**
Replaces: 984461

For: All OMC Cobra Drives-2.3 (1987-90), 2.5 (1986), 3.0(1986-93), 4.3(1986-93), 4.6(1989), 5.0(1986-93), 5.7(1986-93), 5.8 (1989-93), 7.5(1987-89)
Uses impeller **18-3058**



**18-3469
WATER PUMP REPAIR KIT**
Replaces: 3854661

For: King Cobra Drives (1992-1995)



**18-3349
WATER PUMP HOUSING KIT**

For: All OMC Cobra Drives-2.3 (1987-90), 2.5 (1986), 3.0(1986-93), 4.3(1986-93), 4.6(1989), 5.0(1986-93), 5.7(1986-93), 5.8 (1989-93), 7.5(1987-89)



**18-5897
SENDER**
Replaces: 980613
3/8" — 18 NPT
For: Mercruiser Vazer



**18-5898
SENDER**
Replaces: 171960
1/2" — 14 NPT



**18-5899
OIL PRESSURE
SENDER**
Replaces: 982650



**18-3554
THERMOSTAT**
Replaces: 383307
160°



**18-3558
THERMOSTAT**
Replaces: 982554,
3853799
160°

① 18-3653D Display Package



**18-3653
THERMOSTAT KIT**

— CONTAINS —

Part #	O.E. #	Desc.
18-3554	383307	Thermostat
18-2858	314809	Manifold Gasket
18-2917	3701777 (GM)	Thermostat Gasket
18-0398	3852111	Thermostat Gasket

APPLICATION FOR THERMOSTATS/KITS ON NEXT PAGE

① Items ending in "D" are Display Packaged - Regular number is Non-Display

① 18-3670D Display Package

18-3670 THERMOSTAT KIT
Fits: 2.5L & 3.0L (1982-88)

— CONTAINS —

Part #	O.E.#	Desc.
18-3558	982554	Thermostat
18-2858	314809	Thermostat Housing Cover Gasket
18-0929	313416	Thermostat Gasket

18-3676 THERMOSTAT KIT
Superseded from 18-3676D
140°
For: 7.4L (1994-98), 8.2L (1998)

— CONTAINS —

Part #	O.E.#	Desc.
18-7170	3852071	O-Ring
18-0398	3852111	Thermostat Gasket
—	3853983	Thermostat

① 18-3677D Display Package

18-3677 THERMOSTAT KIT
160°

— CONTAINS —

Part #	O.E.#	Desc.
18-7170	3852071	O-Ring
18-0398	3852111	Thermostat Gasket
—	3856961	Thermostat

HP	Year	HP	Year
4.3L	1994-97	5.8L	1994-97
4.3 HO	1991-97	5.8 (EFI)	1993-97
5.0 L	1994-97		

THERMOSTAT AND THERMOSTAT KIT APPLICATION

Model	Years	Thermostat	Thermostat Kit	Model	Years	Thermostat	Thermostat Kit
90	1970	18-3554	18-3653	250	1970-73	18-3554	18-3653
100	1972-73	18-3554	18-3653	250	1979	18-3554	18-3653
120	1969-80	18-3554	18-3653 ①	260	1979-81	18-3554	18-3653
120	1980-81	18-3558	18-3670 ②	262	1989	18-3554	—
140	1973-80	18-3554	18-3653 ①	305	1977-82	18-3554	18-3653
140	1980-81	18-3558	18-3670 ②	350	1977-82	18-3554	18-3653
155	1969-72	18-3554	18-3653	350	1989	18-3554	—
165	1972-76	18-3554	18-3653	351	1992	18-3554	—
170	1974	18-3554	18-3653	454	1977-82	18-3554	18-3653
175	1975-77	18-3554	18-3653	460	1989	18-3554	—
185	1978-80	18-3554	18-3653	2.5L	1982-88	18-3558	18-3670
190	1974-77	18-3554	18-3653	3.0L	1982-88	18-3558	18-3670
200	1979-81	18-3554	18-3653	3.8L	1981-85	18-3554	18-3653
210	1969-72	18-3554	18-3653	4.3L	1985-86	18-3554	18-3653
215	1971	18-3554	18-3653	4.3L	1989-92	18-3554	—
225	1971	18-3554	18-3653	5.0L	1982-88	18-3554	18-3653
230	1979-81	18-3554	18-3653	5.0L	1989-92	18-3554	—
235	1971	18-3554	18-3653	5.7L	1982-88	18-3554	18-3653
235	1975-77	18-3554	18-3653	5.7L	1989	18-3554	—
240	1978	18-3554	18-3653	5.8L	1989-92	18-3554	—
245	1972-75	18-3554	18-3653	7.5L	1988	18-3554	18-3653

① 1980 Models with "C" suffix only ② 1980 Models with "C1" suffix only

SINGLE DIAMETER HOSE

18-70021 MOLDED HOSE
3/4" ID

18-70704 MOLDED HOSE
1 1/4" ID

18-70924 MOLDED HOSE
1 3/4" ID

18-71218 MOLDED HOSE
1" ID

18-71337 MOLDED HOSE
1 3/4" ID

STRAIGHT HOSE

18-75100 MOLDED HOSE
Straight 48"
1" ID

18-75125 MOLDED HOSE
Straight 48"
1 1/4" ID

① Items ending in "D" are Display Packaged - Regular number is Non-Display

V-BELTS

- 1** High strength synthetic cords resist shockload failure. Their low stretch properties assure uniform performance over the life of the belt.
- 2** The compression section is a special rubber compound that assures smooth and even transfer of load forces to the cords.
- 3** Cogs are molded to precise engineering tolerances to improve flexibility and maintain cord support. Cog geometry provides a large area for air circulation to keep the belt cool and prevent damaging heat build up in the cushion section.
- 4** Rubber edges maintain positive, no-slip contact with pulley grooves for reliable energy transfer.



BELT SIZE LISTING BY NUMBER

Part #	Effective Length (Inches)	Top Width (Inches)	Part #	Effective Length (Inches)	Top Width (Inches)	Part #	Effective Length (Inches)	Top Width (Inches)
18-15290	29	29/64	18-15405	40 1/2	29/64	18-15460	46	29/64
18-15300	30	29/64	18-15410	41	29/64	18-15470	47	29/64
18-15325	32 1/2	29/64	18-15415	41 1/2	29/64	18-15480	48	29/64
18-15345	34 1/2	29/64	18-15430	43	29/64	18-15495	49 1/2	29/64
18-15370	37	29/64	18-15435	43 1/2	29/64	18-15500	50	29/64
18-15380	38	29/64	18-15440	44	29/64	18-15520	52	29/64
18-15390	39	29/64	18-15450	45	29/64	18-15550	55	29/64
18-15400	40	29/64	18-15455	45 1/2	29/64			

V-BELT INTERCHANGE

HOSE INTERCHANGE

OMC #	Part #	Part #	OMC #	Sierra #	Part #	Sierra #	Part #
310953	18-15460	18-15380	910414	18-71337	312781	18-75100	913488
311046	18-15440	18-15400	311606	18-75100	910305	18-75125	912793
311606	18-15400	18-15415	910343	18-75100	912424		
908929	18-15455	18-15435	912509				
909818	18-15500	18-15440	311046				
909971	18-15460	18-15450	914787				
910343	18-15415	18-15455	908929				
910414	18-15380	18-15460	310953				
912418	18-15500	18-15460	909971				
912509	18-15435	18-15500	909818				
912714	18-15520	18-15500	912418				
914787	18-15450	18-15520	912714				

V-BELT APPLICATION

Model	Year	Water Alternator	Pump	Power Steering	Model	Year	Water Alternator	Pump	Power Steering
100	1972-73	18-15400	18-15400	—	262 KING COBRA	1989	—	*18-15380	18-15455
110	ALL	18-15440	18-15440	—	305	1977-84	18-15440	18-15440/	—
120	1965-81	18-15400	18-15400	—				*18-15455	
140	1982-87	18-15400	18-15400	—	350	1977-84	18-15440	18-15440/	—
165	1972-76	18-15400	18-15400	—				*18-15455	
170	1974	18-15400	18-15400	—				or *18-15500	
175	1975-77	18-15400	18-15400	—					
185 W/O PS	1978-84	18-15440	18-15440	—	350 KING COBRA	1988-90	18-15455	18-15455	—
185 W/ PS	1978-84	18-15460	18-15460	18-15460	350 KING COBRA	1988-90	18-15470	*18-15380	18-15455
190	1974-77	18-15400	18-15400	—	454	1977-82	18-15455	18-15455/	—
200 W/O PS	1979-81	18-15440	18-15440	—				*18-15500	
200 W/ PS	1979-81	18-15460	18-15460	18-15460	454 KING COBRA	—	—	18-15470	18-15380
210	1970-71	18-15440	18-15440	—	460 KING COBRA	1988	18-15460	18-15460	18-15520
215	1971	18-15440	18-15440	—	888	—	18-15435	18-15435	—
225	1972-84	18-15440	18-15440	—	2.3L	1987-90	18-15435	18-15435	18-15435
230,260	1975	18-15440	18-15440/	—	2.5L W/O PS	1982-87	18-15415	18-15415	—
			*18-15455		2.5L W/ PS	1982-87	18-15400	18-15400	18-15460
230,260	1979-81	18-15440	18-15440	—	3.8L W/O PS	1982-90	18-15400	18-15400	—
230,260	1979-81	18-15460	18-15460	18-15460	3.8L W/ PS	1982-90	—	*18-15380	18-15455
235	1971	18-15440	18-15440	—	5.0L W/O PS	1982-90	18-15455	18-15455	—
235	1975-77	18-15400	18-15400	—	5.0L W/ PS	1982-90	—	*18-15380	18-15455
240	1978-84	18-15400	18-15400	—	5.0L	1988	18-15400	18-15400	18-15450
250	1979	18-15400	18-15400	—	7.5L	1987	18-15460	18-15460	18-15520
262 KING COBRA	1989	18-15400	18-15400	—					

* W/ SEA WATER PUMP

Fits GM 181 CID 3.0L, 4 Cylinder Fits Most 141 Models

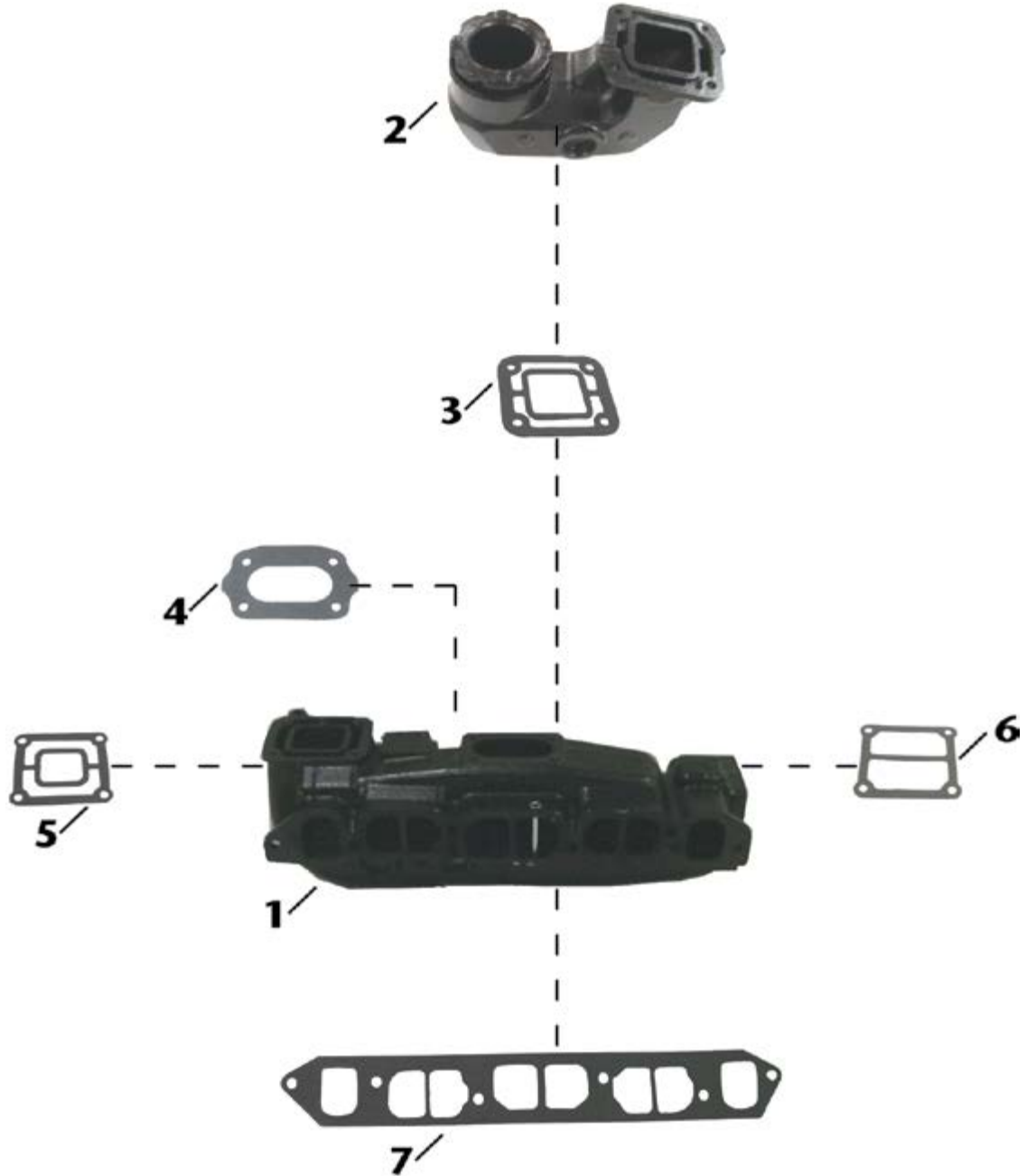

Item No	Description	OE No.	Application
1	18-1901 MANIFOLD	982490, 980083, 984054	GM 181 cu.in. 3.0L , 4 Cylinder. Fits most 140 models.
2	18-1922 MANIFOLD ELBOW	987784	Use with Manifold: 18-1901; Elbow Gasket: 18-2875-1
3	18-2875-1 ELBOW GASKET	3850495	Use with Elbow: 18-1922
4	18-0937 CARBURETOR GASKET	315055	Use with Manifold: 18-1901
5	18-2861-1 END PLATE GASKET	311121	Use with Manifold: 18-1901
6	18-0114-1 END PLATE GASKET	907761	Use with Manifold: 18-1901
7	18-1204-1 MANIFOLD GASKET	912164	Use with Manifold: 18-1901

Fits GM Small Block V8 305-350 cu. in. 1979-1989

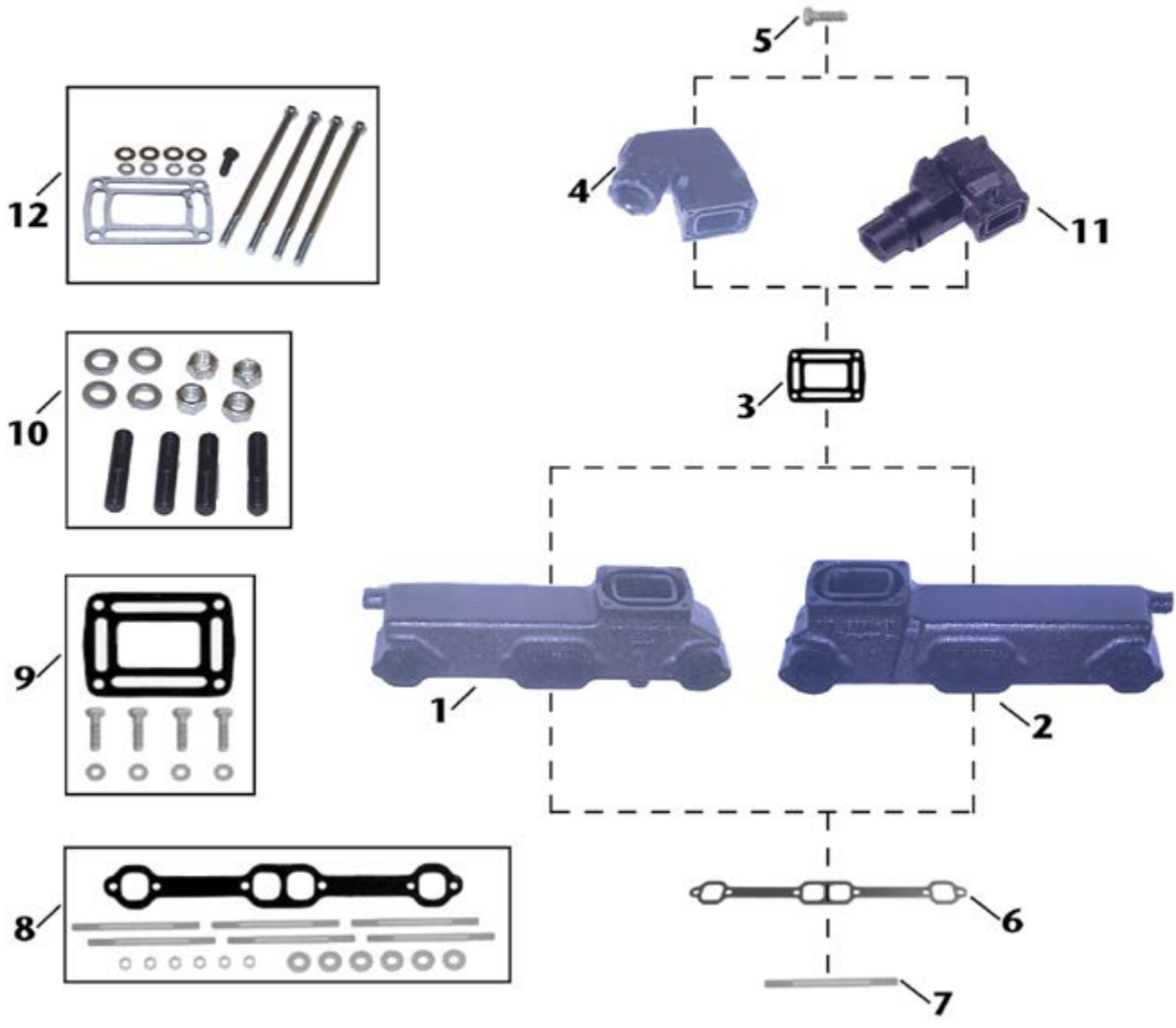

Item No	Description	OE No.	Application
1	18-1902	MANIFOLD (STARBOARD) 912441	GM Small Block (V8) 305-350 cu.in. (1979-1989)(Starboard) Use with Manifold Gasket: 18-2949. Mounting Kit: 18-8502
2	18-1903	MANIFOLD (PORT) 912442	GM Small Block (V8) 305-350 cu.in. (1979-1989)(Port). Use with Manifold Gasket: 18-2949. Mounting Kit: 18-8502
3	—	ELBOW GASKET 909786	Use with Elbow: 18-1921; Mounting Kit: 18-8534.
4	18-1921	MANIFOLD ELBOW 909863	Use with Manifold: 18-1902, 18-1903. Mounting Kit: 18-8534.
5	NSS	MOUNTING BOLT N/A	Included in 18-8534 mounting kit.
6	18-2949	MANIFOLD GASKET 96306	Use with Manifold: 18-1902, 18-1903. Included in 18-8502 mounting kit.
7	NSS	MOUNTING STUD N/A	Included in 18-8502 mounting kit.
8	18-8502	MOUNTING KIT N/A	Use with Manifold: 18-1902, 18-1903. Includes 18-2949 manifold gasket.
9	18-8534	MOUNTING KIT N/A	Use with Elbow: 18-1921.
10	18-8553	HARDWARE KIT N/A	Hardware only for Elbow 18-1921.
11	18-1909-1	MANIFOLD ELBOW N/A	Use with Elbow Gasket: 18-0943-2
12	18-8507	MOUNTING KIT N/A	Use with Manifold Elbow: 18-1909-1

Fits GM Small Block V8 305-350 cu. in.

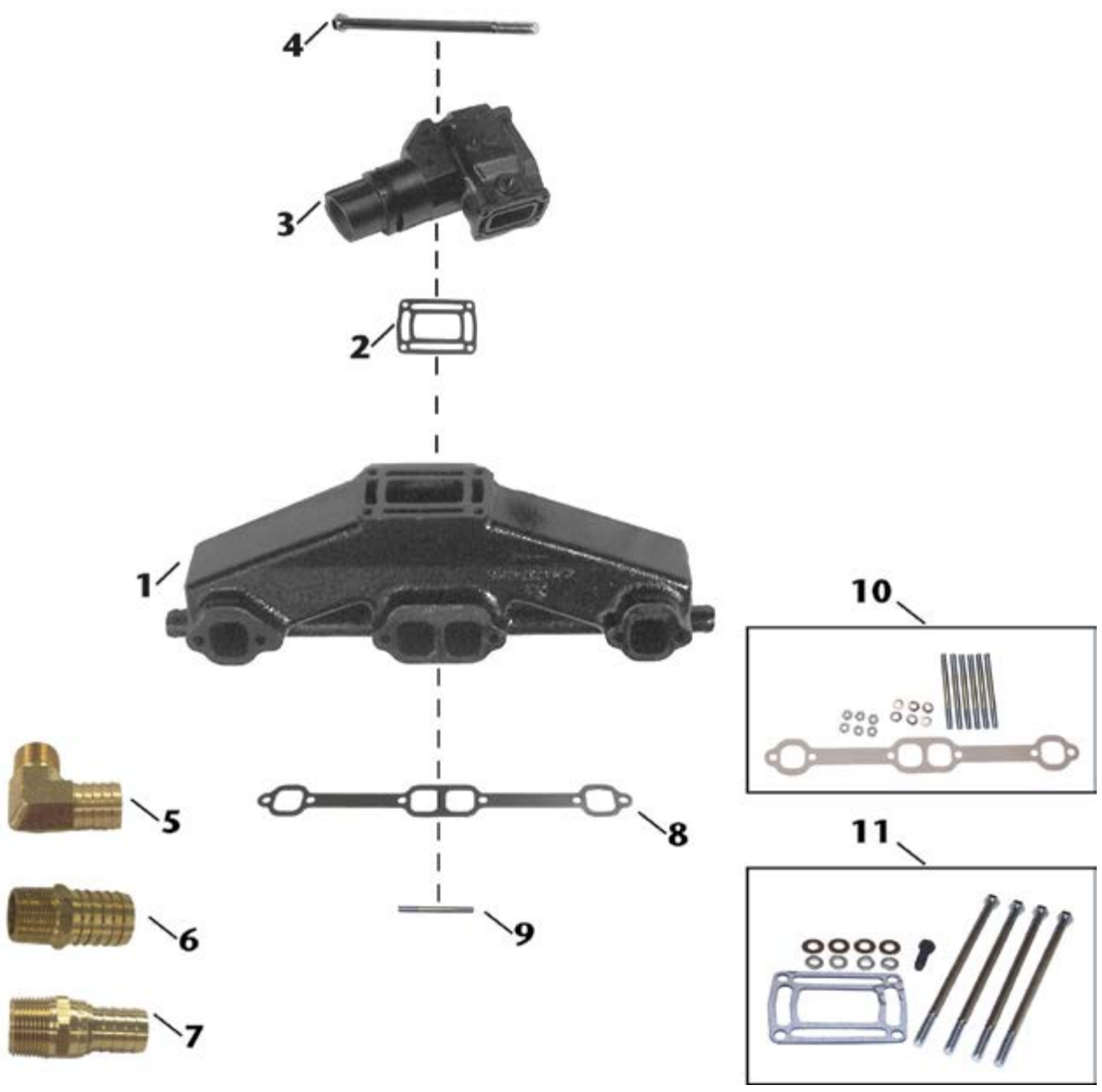

Item No	Description	OE No.	Application
1	18-1986-1 MANIFOLD	3857723	GM Small Block (V8) 305-350 cu.in. Use with Manifold Gasket: 18-2949; Mounting Kit: 18-8502.
2	— ELBOW GASKET	909786	Use with Elbow: 18-1909-1. Included in 18-8507 mounting kit.
3	18-1909-1 MANIFOLD ELBOW	913784, 3855270, 3850459, 3857944	Use with Manifold: 18-1986-1; Mounting Kit: 18-8507.
4	NSS MOUNTING BOLT	N/A	Included in 18-8507 mounting kit.
5	18-8216 HOSE FITTING	N/A	3/4" - 14NPT X 1" Hose (Corrosion Resistant Brass Fitting)
6	18-4461 HOSE FITTING	N/A	3/4" - 14NPT X 1" Hose (Corrosion Resistant Brass Fitting)
7	18-8215 HOSE FITTING	N/A	3/4" - 14NPT X 3/4" Hose (Corrosion Resistant Brass Fitting)
8	18-2949 MANIFOLD GASKET	96306	Use with Manifold: 18-1986-1. Included in 18-8502
9	NSS MOUNTING STUD	N/A	Included in 18-8502 mounting kit.
10	18-8502 MOUNTING KIT	N/A	Use with Manifold 18-1986-1. Includes 18-2949 manifold gasket.
11	18-8507 MOUNTING KIT	N/A	Use with Elbow: 18-1909-1. Includes 18-0943-2 elbow gasket.

**SIERRA MANIFOLDS
ARE PAINTED, PACKAGED AND LEAK TESTED**



**18-1901
MANIFOLD**
Replaces: 984054
Fits 181 CID model 140
and 3.0L (1973 - 1989)
Use with: Exhaust Manifold Gasket **18-1204-1** &
Elbow Gasket **18-2875-1**
***For Exploded View - See PAGE 905**



**18-1898
MANIFOLD**
Port & Starboard
Replaces: Barr CHVA-1-84, Marine Power 0991-110
Fits 454 cu.in. GM big block V8 engines
Use with:
Exhaust Manifold Gasket: 18-0418
***For Exploded View - See Pages 656-657**



**18-1997-1
EXHAUST MANIFOLD**
Port & Starboard
Replaces Barr CHV-1-83 Universal Center Riser Manifold
FITS: GM 283, 305, 307 and 350 CID engines
Use with:
Exhaust Manifold Gasket Set: 18-0604
***For Exploded View - See Pages 658-659**

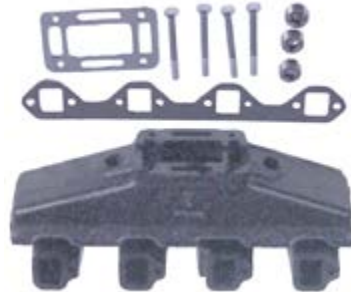

**18-1998-1
EXHAUST MANIFOLD**
Port & Starboard
Replaces: Barr FM-1-83
Universal Center Riser Manifold
FITS: Ford 302 and 351 CID engines
Use with:
Exhaust Manifold Gasket Set: 18-0603
***For Exploded View - See Pages 660-661**



**18-1986-1
MANIFOLD**
Port & Starboard
Replaces: 3852374, 3857723
For: GM Small Block V8 305-350 ci
Use with:
Exhaust Manifold Gasket: 18-2949
Mounting Kit: 18-8502



**18-1902
MANIFOLD**
Replaces: 912441
V-8 - STARBOARD SIDE
Fits most GM V-8 small blocks with end riser
Use with:
Mounting Kit: 18-8502



**18-1903
MANIFOLD**
Replaces: 912442 V-8 - PORT SIDE
Fits most GM V-8 small blocks with end riser
Use with:
Mounting Kit: 18-8502



**18-1904
MANIFOLD**
Port & Starboard
Replaces: 980959, 980572 V-8 - EITHER SIDE
Fits most Ford V-8 302 & 351W with end riser
Use with:
Exhaust Manifold Gasket: 18-0183-1 or 18-2896-1
(See Application Chart)



**18-1848
MANIFOLD**
Replaces: 3852338, 3857656, 914899
Fits: 4.3L V-6



**18-1991
30° EXHAUST ELBOW ADAPTER**
Replaces: Barr 200089P
For use with 3" I.D. Exhaust Hose
Use with:
Manifold Riser: 18-1999



**18-1992-1
80° EXHAUST ELBOW**
Replaces: Barr 200087P
For 3" I.D. Exhaust Hose (As used in 18-1987 Exhaust Manifold Conversion Kit)



**18-1921
ELBOW MANIFOLD**
Replaces: 909863
V-8
Fits most GM V-8 small blocks
Use with:
Manifold: 18-1902, 18-1903
Elbow Gasket: 18-0943-2
Mounting Kit: 18-8534



**18-1922
ELBOW MANIFOLD**
Replaces: 987784, 916096, 0740120, 3850799, 910380
4 CYL.
Fits most 140 HP 3.0L (181 CID)
Use with:
Manifold: 18-1901
Elbow Gasket: 18-2875-1



**18-1909-1
RISER**
Replaces:
OMC 913784, 3855270, 3850456, 3857944
VOLVO 3855270-9, 3857944-7, 3863061, 3856444
OMC Riser, 4" outlet 7°: Fits many GM & Ford center rise manifolds.
Use with:
Manifold: 18-1986-1
Riser Gasket: 18-0943-2
Mounting Kit: 18-8507



**18-1939
RISER**
Replaces: Barr 20-0100, Marine Power 0992-593 Barr, Indmar and Marine Power Ford Small Block V8 302-351cu.in., GM Small Block V8 305-350cu.in., GM Big Block V8 454cu.in.
Use with:
Manifold: 18-1997-1, 18-1998-1
Riser Gasket: 18-2854-1 open or 18-0476-1 blocked
Mounting Kit: 18-4364 open or 18-8535 blocked
4" hose



**18-1907
RISER**
Replaces: Barr 20-0102, Indmar 53-2009, 53-2018, Barr and Indmar Ford Small Block V8 302-351cu.in.
Use with:
Manifold: 18-1997-1, 18-1998-1
Riser Gasket: 18-2854-1 open or 18-0476-1 blocked
Mounting Kit: 18-4364 open or 18-8535 blocked
3" hose



**18-1999
EXHAUST MANIFOLD RISER**
Replaces: Barr 20-0082
Use with:
Manifold: 18-1997-1 or 18-1998-1
Riser Gasket: 18-2854-1 open
3 1/2" hose
Comes with 18-4364 open
If blocked mounting kit is required use 18-8535
Replaces: Barr 20-0082-P



**18-4009
MANIFOLD END PLATE**
Replaces: 910384



PIPE PLUGS

Part #	Thread Size
18-4256	1/4"
18-4257	1/4"
18-4258	3/4"
18-4263	1/8" - 27 NPT
18-4264	3/8" - 18 NPT



**18-4461
HOSE BARB**
3/4" - 14 NPT X 1" Hose
Corrosion Resistant Brass Fitting



**18-8216
HOSE BARB**
3/4" - 14 NPT X 1" hose barb
Fits: OMC - In-Line 6 Cylinders



① 18-4218 Display Package
**18-4218
BRASS DRAIN COCK**
Replaces: 379957
1/4"
18-3223-9 Bulk Pack of 12

① Items ending in "D" are Display Packaged - Regular number is Non-Display



18-4364 (Open) MOUNTING PACKAGE
 Replaces: Barr 20-0082-P
 Use with: Riser: 18-1999, 18-1939, 18-1907

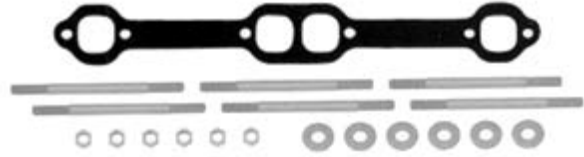

18-8502 MOUNTING KIT
 OMC GM Small Block V8 305-350cu.in. (1979-89) OMC/
 Volvo GM Small Block 305-350cu.in.
 Used with: Manifolds: 18-1931-1, 18-1902 & 18-1903



18-8507 MOUNTING KIT
 Replaces: Barr CM-20-6674JP
 OMC/Volvo GM
 Small Block V8 305-350cu.in.
 Used with:
 Riser: 18-1909-1



18-8534 MOUNTING KIT
 OMC GM Small Block V8 305-350cu.in.
 (1979-1989) and multiple application Ford
 and GM Risers
 Used with:
 Riser: 18-1921



18-8535 (Blocked) MOUNTING KIT
 Barr, Indmar and Marine Power Ford Small
 Block V8 302-351cu.in., GM Small Block V8
 305-350cu.in., GM Big Block V8 454cu.in.
 Used with:
 Risers: 18-1939, 18-1999, and 18-1907



18-8536 MOUNTING KIT
 Barr, Indmar and Marine Power GM
 Small Block V8 305-350cu.in.
 Used with:
 Manifold: 18-1997-1



18-8538 MOUNTING KIT
 Barr and Indmar Ford Small
 Block V8 302-351cu.in.
 Used with:
 Manifold: 18-1998-1, 18-1904



18-8553 MOUNTING KIT
 Used with:
 Exhaust Elbow: 18-1921



18-2779 EXHAUST HOSE
 Replaces: 3852696



18-2781 EXHAUST HOSE
 Replaces: 3852742



18-0114-1 MANIFOLD END GASKET
 Replaces: 907761



18-0183-1 EXHAUST MANIFOLD GASKET
 Replaces: 908717, 916262,
 3852455, 3853742
 Use with:
 Manifold: 18-1958, 18-1962, 18-1904,
 18-1998-1, 18-1996, 18-1979







18-0476-1 (Blocked) RISER GASKET
 Replaces: Barr 01-0105
 Indmar & Marine Power
 Ford Small Block V8 302-351cu.in.
 Used with:
 Risers: 18-1939, 18-1999 and 18-1907



PKG. OF 2



18-0943-2 EXHAUST ELBOW GASKET
 Replaces: 909786, 3850496
 Used with:
 Riser: 18-1909-1

<p>PKG. OF 2</p>  <p>18-2850-1 18-2850-9① EXHAUST ELBOW GASKET Replaces: 908935</p>	<p>PKG. OF 2</p>  <p>18-2854-1 18-2854-9① EXHAUST RISER GASKET Replaces: Barr 01-0107 Use with: Mounting Kit: 18-8535 Risers: 18-1999, 18-1939, 18-1907</p>	<p>PKG. OF 2</p>  <p>18-2861-1 18-2861-9① EXHAUST ELBOW GASKET Replaces: 311121</p>
--	---	--

<p>PKG. OF 2</p>  <p>18-2875-1 18-2875-1-9① EXHAUST ELBOW GASKET Replaces: 3850495, 908013 Used with: Elbow: 18-1922</p>	 <p>18-2896-1 MANIFOLD GASKET Replaces: 311068 For GM 4 cyl. 153 cu.in. Early models 110/120 where the carb. linkage mounts to the rear of the engine Use with: Manifold: 18-1904</p>
--	--

<p>PKG. OF 2</p>  <p>18-2902-1 18-2902-1-9① MANIFOLD GASKET Replaces: 909314 Use with: Manifold: 18-1997-1, 18-1986-1, 18-1902, 18-1903</p>	<p>PKG. OF 2</p>  <p>18-2949 18-2949-9① MANIFOLD GASKET Replaces: Barr CHV-47-000 Use with: Manifold: 18-1997-1</p>
---	--

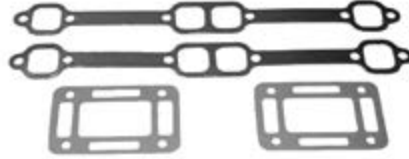
 <p>18-0603 EXHAUST MANIFOLD GASKET SET For: Ford 302/351 CID Eng. Use with: Manifold: 18-1998-1</p>	 <p>18-0604 EXHAUST MANIFOLD GASKET SET For: GM 305/350 CID Eng. Use with: Manifold: 18-1997-1</p>
---	---

① Priced per Package

MANIFOLD/MANIFOLD GASKET APPLICATION

Year	Horsepower	Exhaust Manifold	Exhaust Elbow	Manifold Mount Kit	Elbow Mount Kit	Manifold Gasket	Elbow Gasket
1997-98	5.0/5.7L	18-1986-1	18-1909-1	18-8502	18-8507	18-2902-1	18-0943-2
1994-97	5.8L (Ford)	—	—	—	—	18-0183-1	18-0943-2
1994-97	7.4L (GM)	—	—	—	—	18-0418	18-0943-2
1991-93	3.0 Liter	—	18-1922	—	—	—	18-2875-1
1992-93	4.3/4.3 HO	—	18-1909-1	—	18-8507	—	18-0943-2
1993	5.0/5.0 HO/5.8 Liter	—	18-1909-1	—	18-8507	18-0183-1	18-0943-2
1993	5.0 & 5.8 EFI	—	18-1909-1	—	18-8507	18-0183-1 ②	18-0943-2
1993	5.0 & 5.8 EFI	—	18-1909-1	—	18-8507	—	18-0943-2
1993	5.8L (Ford)	—	18-1909-1	—	18-8507	18-0183-1	18-0943-2
1993	7.4L (GM), 8.2L (GM)	—	18-1909-1	—	18-8507	18-0418	18-0943-2
1993	351 King, 454/454 HO/502	—	—	—	—	—	18-0943-2
1992	5.0/5.0 HO/5.8 Liter	—	18-1909-1	—	18-8507	18-0183-1	18-0943-2
1992	5.8L (Ford)	—	—	—	—	18-0183-1	18-0943-2
1992	7.4L (GM), 8.2L (GM)	—	—	—	—	18-0418	18-0943-2
1992	351 King Cobra	—	—	—	—	18-0183-1	18-0943-2
1992	454/454 HO/502	—	—	—	—	—	18-0943-2
1991	4.3/4.3 HO	—	—	—	—	—	18-0943-2
1991	5.8L (Ford), 5.0/5.0HO/5.8 Liter	—	18-1909-1	—	18-8507	18-0183-1	18-0943-2

② 5.0L only

APPLICATION CONTINUED ON NEXT PAGE

MANIFOLD/MANIFOLD GASKET APPLICATION

Year	Horsepower	Exhaust Manifold	Exhaust Elbow	Manifold Mount Kit	Elbow Mount Kit	Manifold Gasket	Elbow Gasket
1991	454/454 HO	—	18-1909-1	—	18-8507	—	18-0943-2
1991	7.4L (GM)	—	18-1909-1	—	18-8507	18-0418	18-0943-2
1990-91	8.2L (GM)	—	18-1909-1	—	18-8507	—	—
1982-83,1985-90	3.0 Liter	18-1901	18-1922	—	—	—	18-2875-1
1990	4.3 Liter	—	18-1909-1	—	18-8507	—	—
1990	5.0/5.0 HO/5.8 Liter	—	18-1921	—	—	18-0183-1	18-0943-2
1990	5.0/5.7L	18-1986-1	18-1909-1	18-8502	18-8507	18-2902-1	18-0943-2
1990	7.4L (GM)	—	—	—	—	18-0418	18-0943-2
1990	7.5L (Ford)	—	—	—	—	18-0992	18-0943-2
1990	454 King Cobra	—	—	—	—	—	18-0943-2
1987-90	460 King Cobra	—	—	—	—	—	18-0943-2
1989	5.0/5.0 HO/5.8 Liter	—	18-1921	—	18-8534	18-0183-1	18-0943-2
1989	5.7/350 King Cobra	—	—	—	—	18-2902-1	18-0943-2
1988	5.0/5.7/350 King Cobra	18-1902 #	18-1921	18-8502	18-8534	18-2902-1	18-0943-2
1988	5.0/5.7/350 King Cobra	18-1903 *	18-1921	18-8502	18-8534	18-2902-1	18-0943-2
1988	370 King Cobra	—	—	—	—	—	18-0943-2
1982-87	5.0/5.7 Liter	18-1902 #	18-1921 ①	18-8502	18-8534	18-2902-1	18-0943-2
1982-87	5.0/5.7 Liter	18-1903 *	18-1921	18-8502	18-8534	18-2902-1	18-0943-2
1982-86	2.5 Liter	18-1901	18-1922	—	—	18-2896-1	18-2875-1
1984	3.0 Liter	18-1901	18-1921	—	18-8534	—	18-2875-1
1978-81	400 Series, 120 HP	—	—	—	—	18-2896-1	18-2861-1
1978-81	400 Series, 140 HP	—	18-1922	—	—	—	18-2875-1
1981	800 Series, 200,230,260 HP	18-1902 #	18-1921	18-8502	18-8534	18-2902-1	18-0943-2
1981	800 Series, 200,230,260 HP	18-1903 *	18-1921	18-8502	18-8534	18-2902-1	18-0943-2
1980	800 Series, 185-260 HP	18-1902 #	18-1921	18-8502	18-8534	18-2902-1	18-0943-2
1980	800 Series, 185-260 HP	18-1903 *	18-1921	18-8502	18-8534	18-2902-1	18-0943-2
1979	800 Series,185-230 HP	18-1902 #	18-1921	18-8502	18-8534	18-2902-1	18-0943-2
1979	800 Series,185-230 HP	18-1903 *	18-1921	18-8502	18-8534	18-2902-1	18-0943-2
1979	800 Series, 260 HP	18-1902 #	18-1921	18-8502	18-8534	18-2902-1	18-0943-2
1979	800 Series, 260 HP	18-1903 *	18-1921	18-8502	18-8534	18-2902-1	18-0943-2
1978	800 Series, 185-225 HP	18-1902 #	18-1921	18-8502	18-8534	18-2902-1	18-0943-2
1978	800 Series, 185-225 HP	18-1903 *	18-1921	18-8502	18-8534	18-2902-1	18-0943-2
1978	800 Series, 240 HP	—	18-1921	—	18-8534	—	—
1977	120 HP	—	—	—	—	18-2896-1	18-0943-2
1977	140 HP	—	18-1922	—	—	—	18-2861-1
1977	175 THRU 235 HP	—	18-1921	—	18-8534	18-0183-1	18-2875-1
1976	120 HP	18-1904	—	—	—	18-0183-1	18-0943-2
1974-76	140 HP	18-1904	18-1922	—	—	—	18-2861-1
1976	165 HP	18-1904	18-1922	—	—	18-2830-1	18-2875-1
1976	175 THRU 235 HP	18-1904	—	—	—	18-0183-1	18-2875-1
1974-75	120 HP	18-1904	—	—	—	18-2896-1	18-2850-1
1974-75	165 HP	18-1904	18-1922	—	—	—	18-2875-1
1975	175 THRU 235 HP	18-1904	—	—	—	18-0183-1	18-2875-1
1974	170 & 190 HP	18-1904	—	—	—	18-0183-1	18-2875-1
1974	175 THRU 235 HP	18-1904	—	—	—	18-0183-1	18-2850-1
1973	100,120,140 HP	—	—	—	—	18-2896-1	18-2861-1
1973	165 HP	—	18-1922	—	—	18-2896-1	18-2861-1
1972-73	225 & 245 HP	—	—	—	—	—	18-2883
1972	100,120 HP	—	—	—	—	18-2896-1	18-2861-1
1972	155 HP	—	—	—	—	N/A	18-2883
1972	165 HP S MODEL, C MODEL	—	—	—	—	—	18-2875-1
1971	215 & 235 HP	—	—	—	—	—	—
1965-71	120 HP	—	—	—	—	—	18-2861-1
1967-71	155 HP	—	—	—	—	N/A	—
1968-70	210 HP	—	—	—	—	—	—
1967-68	185 HP	—	—	—	—	—	—
1966-68	200 HP	—	—	—	—	N/A	—
1964-66	150 HP	—	—	—	—	N/A	—
1964	110 HP	—	—	—	—	N/A	—

Starboard

* Port

① High rise applications only for 1985

② 5.0L only

OIL FILTERS



Display
Package

Part #	Fits:	O.E.M #
18-7824-2	GM Engines (Short Filter)	173232, 502902
18-7875	Ford Engines (Long Filter)	173231, 502900
18-7876-1	GM Engines (Long Filter)	173233, 502901
18-7878-1	M-100, M200 (Short Filter)	502904
18-7879-1	GM V-6 Engines	173834, 502903

SEE PAGES 203-205 & 1155-11830 FOR ADDITIONAL INFORMATION

CYLINDER HEAD ASSEMBLIES



18-4486HP CYLINDER HEAD ASSEMBLY

Fits: Vortec GM small block 5.7L high performance
Completely assembled with revised runner and combustion chambers. Add 30hp to stock motor with no additional modifications.



18-4501HP CYLINDER HEAD

Fits: Vortec GM small block 5.0L
Completely assembled with revised runners and combustion chambers.
Add 30hp to stock motor with no additional modifications.



18-1400
HYDRAULIC LIFTER
 Replaces: 3856127
 GM 4.3L/V-6 Late/5.0L/5.7L



18-1401
HYDRAULIC LIFTER
 Replaces: 3853847, 985316
 Ford 5.0L & 5.8L



18-1402
HYDRAULIC LIFTER
 Replaces: 3854033, 502036
 GM 2.5L/120
 For: OMC & Volvo 3.0L/181 CID

**ALL PISTONS
 ARE SUPPLIED COMPLETE WITH PISTON RINGS AND WRIST PIN.**



RINGS		PISTONS	
Std.	REPLACES OMC/VOLVO	18-4173	*14077948
18-3937	*14089025	18-4173	3911020
18-3937	328506	0.03	
18-3937	3853960	18-4164	*14077949, 3911023
18-3937	914555	* OMC References GM Number	
18-3937	3853268		
18-3937	985083, 986336		
18-3944	370409		
0.02			
18-3939	3854252		
18-3939	914556		

PISTON / RING APPLICATION

Model	PISTONS			RINGS			Qty. per Eng.
	Std.	.020	.030	Std.	.020	.030	
OMC							
GM							
2.5L/153 CID	-	-	-	18-3942	-	-	4
3.0L/181 CID	-	-	18-4191	18-3937	18-3939	-	4
I-6/250 CID	-	-	-	18-3942	-	-	6
4.3L/V-6	18-4173	18-4188	18-4164	18-3937	18-3939	-	6
5.0L/305 CID	-	-	18-4178	18-3944	-	-	8
5.7L/350 CID	18-4173	18-4188	18-4164	18-3937	18-3939	-	8
7.4L/454 CID	18-4171	18-4189	18-4172	-	-	-	8
FORD							
5.0L/302 CID	-	-	-	18-3937	18-3939	-	8



ROD BEARINGS

Part #	Size
18-1308	Std.
18-1309	.010
18-1327	Std.
18-1333	.010
18-1334	Std.
18-1337	.010



MAIN BEARINGS

Part #	Per Eng.	Size
18-1317	②	Std.

Rod bearings sold individually, 1 per rod

BEARING APPLICATION

Model	ROD BEARING			MAIN BEARING			CAM BEARING
	Std.	.010	.020	Std.	.010	.020	
OMC							
GM							
2.5L/153 CID	-	18-1330	-	18-1317	-	-	-
3.0L/181 CID	18-1308	18-1309	-	18-1317	-	-	-
I-6/230 CID	-	18-1330	-	-	-	-	-
I-6/250 CID	18-1308	18-1309	-	-	-	-	-
4.3L/V-6	18-1327	18-1337	-	-	-	-	-
5.0L/305 CID	18-1308	18-1309	-	-	-	-	-
5.7L/350 CID	18-1308	18-1309	-	-	-	-	-
7.4L/454 CID	18-1334	18-1333	18-1332	-	-	-	-
FORD							
5.0L/302 CID	-	-	-	-	-	-	-



One Piece Rear Main Seals
18-1234
 Replaces: 3853528
18-0519
 Replaces 3852657, 912957



Two Piece Rear Main Seals
18-0528
 Replaces: 913745
18-1211
 Replaces: 473424



Timing Cover Seals
18-1213
 Replaces: 3853341, 912989, 914817
18-1230
 Replaces: 3853827, 984884
18-1233
 Replaces: 3860095

OMC SEAL APPLICATION

Engine Model	2 Piece Rear Main Crankshaft Seal Conv. Rotation (LH)	Timing Cover Seal
GM		
2.5L/153 CID	18-1211 ②	18-1213
3.0L/181 CID	18-1211 ②	18-1213
I-6/230CID	18-1211 ②	18-1213
I-6/250CID	18-1211 ②	18-1213
4.3L/V-6	18-1211 ②	18-1213
5.0L/305 CID	18-1211 ①	18-1213
5.7L/350 CID	18-1211 ①	18-1213
7.4L/454 CID	③	18-1233
FORD		
5.0L/302 CID	18-0528	
5.8L/351 CID	-	18-1230

① Large Journal Crankshaft GM Engines ② For One Piece Seal (LH) Models Use 18-0519 ③ For One Piece Seal (LH) Models Use 18-1234

FOR MODULAR GASKET SETS SEE PAGES 671-677

MISCELLANEOUS GASKETS/GASKET SETS



18-0465
INTAKE MANIFOLD GASKET SET
 Replaces: 352670
 For: GM 454 CID Engines, 325, 330, 340, 350 HP
 and 454 Magnums, 7.4L

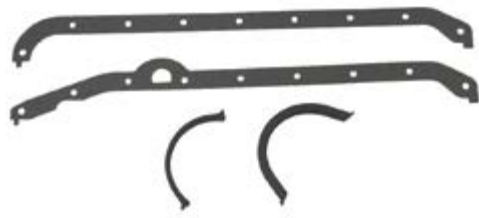

18-0153
OIL PAN GASKET SET
 Replaces:
 393159, 458625, 357159
 For: OMC 5.7L



18-1239
OIL PAN GASKET
 Replaces: 914820
 For: OMC 3.0L



18-0348
OIL PAN GASKET SET
 Replaces: 3931593, 508871



18-1237
OIL PAN GASKET
 Replaces: 3856138
 For: GM 5.7L



18-0466
OIL PAN GASKET SET
 Replaces: 393061, 3923440, 3921473



18-1238
INTAKE GASKET SET
 Replaces: 3850379, 912979
 For: OMC 4.3L 1993-96



18-1231
INTAKE GASKET
 Replaces: 3854095



18-0405
OIL PAN GASKET
 Replaces: 3852655, 912955
 For: OMC 4.3L



18-0411
OIL PAN GASKET SET
 Replaces: 458625, 357159, 508876



18-1232
OIL PAN GASKET
 Replaces: 3853510



18-0868
INTAKE MANIFOLD GASKET SET
 Replaces: 985630, 3854269
 For: OMC 5.7L 1994, 1996-97

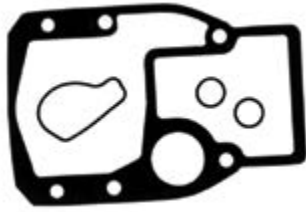

18-2613
OUTDRIVE GASKET SET
 Replaces: 508105

— CONTAINS —

Part #	Description	O.E. #	Qty.
18-2918	Outdrive Gasket	911836	1
18-2996	Outdrive Seal	911823	1
18-7153	O-Ring	911851	2

Display
Package



18-2699
OUTDRIVE GASKET
 For: SX Drives

Use 18-3721 Mounting Nuts

— CONTAINS —

Part #	Description	O.E. #	Qty.
18-7153	O-Ring	911851	2
18-2996	Outdrive Seal	911823	1

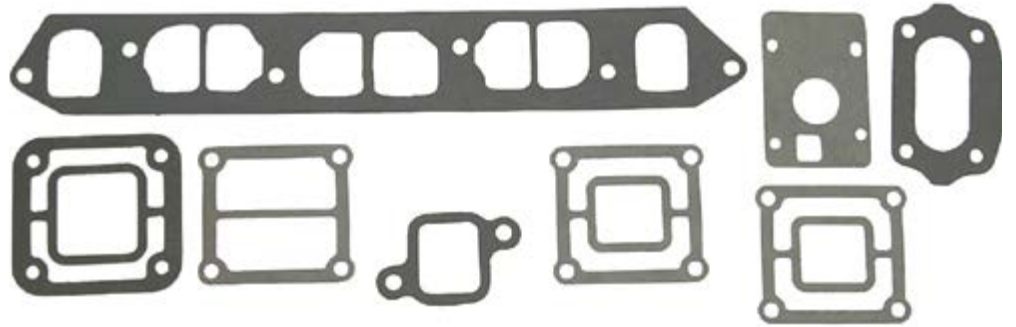

18-4369
EXHAUST MANIFOLD GASKET SET
 For: 2.5L (1985-86) and 3.0L (1985-88)

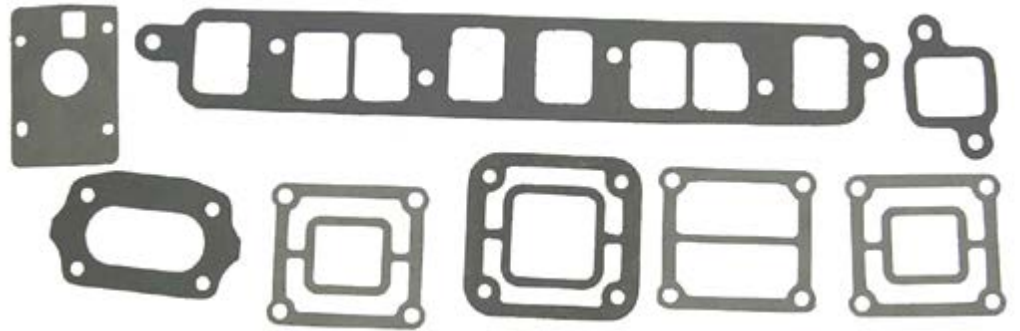



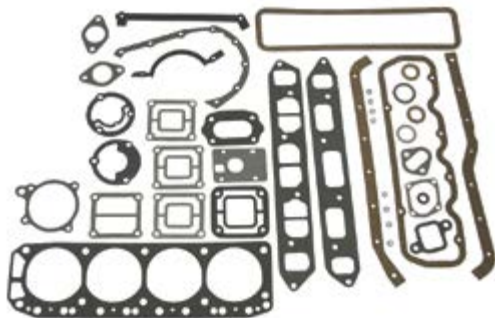



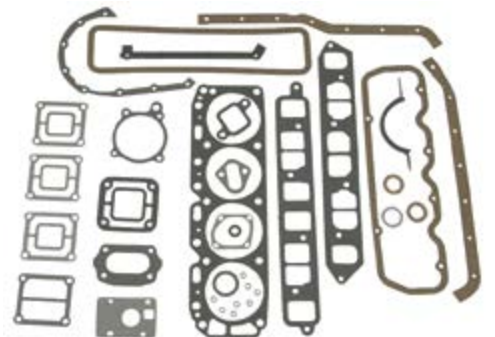









18-4371
EXHAUST MANIFOLD GASKET SET
 For: 140 HP and 3.0L (1973-84)





















18-4373
OVERHAUL GASKET SET
 For: 110, 120 HP and 2.5L (1965-86)









18-4374
OVERHAUL GASKET SET
 For: 140 HP and 3.0L (1973-88)

 <p>18-2946 HEAD GASKET Superseded from 18-3880 Replaces: 3853336, 908611 For: GM 181 (3.0L) CID Eng.</p>	 <p>18-3874 HEAD GASKET Replaces: 3853511 For: (8.2L) 502 CID</p>	 <p>18-3876 HEAD GASKET Replaces: 3853380, 914971 For: GM 305 (5.0L)/350 (5.7L) CID Eng.</p>	 <p>18-3877 HEAD GASKET Replaces: 914849 For: GM 454 (7.4L) CID Eng.</p>
 <p>18-3878 HEAD GASKET Replaces: 912766 For: 460 Ford</p>	 <p>18-3879 HEAD GASKET Replaces: 3854299, 912227, 914930 For: GM 262 (4.3L) CID Eng.</p>	 <p>18-3881 HEAD GASKET Replaces: 908237 For: GM 250 (4.1L) CID (6 cyl) Eng.</p>	
 <p>18-3883 HEAD GASKET Replaces: 3853732 For: Ford 302 (5.0L) 351 (5.8L) CID Eng.</p>	 <p>18-3887 HEAD GASKET Replaces: 915325 For: (7.4L) 454 CID GEN V</p>	 <p>18-0434 CARB MOUNTING GASKET Replaces: 909758</p>	<p>PKG. of 2</p>  <p>18-5399 DISTRIBUTOR CAP GASKET Replaces: 910169</p>
<p>PKG. OF 2</p>  <p>18-0874 18-0874-9① DISTRIBUTOR GASKET For GM V6 & V8 Replaces: 3852109, 312780 For: 2.6L (1989), 3.5L (1989), 4.3L (1987-93), 5.0L (1987-88), 5.7L (1987-92), 7.4L (1988-93), 8.2L (1992-93)</p>	<p>PKG. OF 2</p>  <p>18-0937 18-0937-9① CARB MOUNTING GASKET Replaces: 315055</p>	<p>PKG. OF 2</p>  <p>18-0435 CARB MOUNTING GASKET Replaces: 908765</p>	<p>PKG. OF 2</p>  <p>18-0876 18-0876-9① FUEL PUMP GASKET For GM 4.3L, 5.0L & 5.7L Replaces: 3852113, 312800</p>
<p>PKG. OF 2</p>  <p>18-0164 18-0164-9① THERMOSTAT GASKET 4 & 6 Cyl. Replaces: 311069 GM 3789161</p>	<p>PKG. OF 2</p>  <p>18-0929 18-0929-9① THERMOSTAT GASKET Replaces: 313416</p>	<p>PKG. OF 2</p>  <p>18-2858 18-2858-9① THERMOSTAT GASKET Replaces: 314809</p>	<p>PKG. OF 2</p>  <p>18-2917 18-2917-9① THERMOSTAT GASKET Replaces: 312797, 3701777 (GM)</p>

① Priced per Package

<p>PKG. OF 2</p>  <p>18-2947 18-2947-9① THERMOSTAT GASKET Replaces: 310913</p>	<p>PKG. OF 2</p>  <p>18-0398 18-0398-9① THERMOSTAT GASKET Replaces: 312797, 3852111</p>	 <p>18-0114-1 MANIFOLD END GASKET Replaces: 907761 For GM 4 Cyl.</p>	<p>PKG. OF 2</p>  <p>18-0104 18-0104-9① EXHAUST ELBOW GASKET Replaces: 907764</p>
 <p>18-0430 EXHAUST ELBOW GASKET Replaces: 912477</p>	<p>PKG. OF 2</p>  <p>18-0673 18-0673-9① EXHAUST ELBOW GASKET Replaces: 910113</p>	<p>PKG. OF 2</p>  <p>18-0943-2 18-0943-2-9① EXHAUST ELBOW GASKET Replaces: 913783, 909786, 3850496</p>	<p>PKG. OF 2</p>  <p>18-2850-1 18-2850-9① MANIFOLD END CAP GASKET Replaces: 908935</p>
<p>PKG. OF 2</p>  <p>18-2860 MANIFOLD END CAP GASKET Replaces: 311130</p>	<p>PKG. OF 2</p>  <p>18-2861-1 18-2861-9① MANIFOLD END CAP GASKET Replaces: 311121</p>	<p>PKG. OF 2</p>  <p>18-2875-1 18-2875-1-9① EXHAUST ELBOW GASKET Replaces: 908013, 3850495</p>	<p>PKG. OF 2</p>  <p>18-2883-1 MANIFOLD END CAP GASKET Replaces: 907775</p>
 <p>18-2541 RUBBER SEAL Replaces: 911704</p>	 <p>18-0401 EXHAUST MANIFOLD GASKET Replaces: 913393 For Ford 140 CID (2.3L)</p>	 <p>18-0956-1 EXHAUST MANIFOLD GASKET Replaces: 912405 460 CID</p>	 <p>18-2912-1 EXHAUST MANIFOLD GASKET Replaces: 908079</p>
 <p>18-2830-1 EXHAUST MANIFOLD GASKET Inline 6 cyl. Replaces: 907932</p>		 <p>18-2896-1 EXHAUST MANIFOLD GASKET Replaces: 311068</p>	

<p>PKG. OF 2</p>  <p>18-2909 18-2909-9① EXHAUST MANIFOLD GASKET Replaces: 915025 GM V-6</p>	 <p>18-0183-1 EXHAUST MANIFOLD GASKET Replaces: 3853742, 3852455, 908717, 916262 For: OMC 5.0L & 5.8L (1993-96)</p>	 <p>18-0680 EXHAUST MANIFOLD GASKET Replaces: 3853256</p>	 <p>18-0418 EXHAUST MANIFOLD GASKET Replaces: 909613</p>
<p>PKG. OF 2</p>  <p>18-1204-1 18-1204-1-9① EXHAUST MANIFOLD GASKET Replaces: 912164</p>	 <p>18-0892 DEFLECTOR HOSE Replaces: 322411</p>	 <p>18-0664 VALVE COVER GASKET Replaces: 913270, 3852687 For: GM 305/350, 5.0 & 5.7L</p>	 <p>18-2845 VALVE COVER GASKET Replaces: 912965 For GM 305/350 CID (5.0L and 5.7L)</p>
 <p>18-0311 VALVE COVER GASKET Replaces: 3854942 For: 4.3 Litre 262 CID</p>	 <p>18-0346 VALVE COVER GASKET Replaces: 3930912 For: GM 250 CID (4.1L), 160/165/200 (6 cyl.)</p>	 <p>18-0347 VALVE COVER GASKET Replaces: 3852693, 912981, 913277 For: GM 153 & 181 CID (2.5L & 3.0L)</p>	<p>PKG. OF 2</p>  <p>18-0464-9① VALVE COVER GASKET Replaces: 912768 For: GM 454/502 CID (7.4L & 8.2L)</p>
 <p>18-0352 VALVE COVER GASKET Replaces: 913758 For: Ford 302/351 CID (5.0L & 5.8L)</p>	 <p>18-0548 ADAPTER TO INTERMEDIATE HOUSING GASKET Replaces: 909515</p>	<p>PKG. OF 2</p>  <p>18-0947 18-0947-9① PIVOT CAP COVER GASKET Replaces: 909529</p>	<p>PKG. OF 2</p>  <p>18-0440 18-0440-9① WATER PASSAGE GASKET Replaces: 915719</p>
 <p>18-0911 WATER PUMP GASKET Replaces: 911698</p>	<p>PKG. OF 2</p>  <p>18-0903 18-0903-9① WATER PUMP GASKET Replaces: 3853361 454 CID</p>	 <p>18-0147 WATER PUMP GASKET For Ford V-8 Replaces: 3852824</p>	 <p>18-0327 WATER PUMP GASKET Replaces: 3853342 4 & 6 Cyl.</p>

① Priced per Package

<p>PKG. OF 2</p>  <p>18-2916 18-2916-9① WATER PUMP HOUSING GASKET Replaces: 911702</p>	<p>18-0939 18-0939-9① UPPER GEARCASE DIPSTICK GASKET Replaces: 315189</p> 	<p>18-0468 TIMING COVER GASKET Replaces: 3853512, 912954, 3852654, 915326 For: OMC 2.6L, 3.5L (1989), 4.3L (1987-93), 5.0L (1987-88), 5.7L (1987-92, 1994, 1996)</p> 	<p>PKG. OF 2</p>  <p>18-0891 18-0891-9① WATER PUMP MOUNTING GASKET Replaces: 3852477, 909835 For: GM 4.3L, 5.0L & 5.8L</p>
<p>PKG. OF 2</p>  <p>18-0893 18-0893-9① WATER PUMP BACK-IN PLATE GASKET Replaces: 3850595 GM 4.3L, 5.0L & 5.7L</p>	<p>PKG. OF 2</p>  <p>18-0322 18-0322-9① REAR SEAL GASKET Replaces: 3852656 GM 5.0L & 5.7L</p>	 <p>18-0329 PUSH ROD/LIFTER COVER GASKET</p>	<p>PKG. OF 2</p>  <p>18-0887 18-0887-9① TIMING COVER GASKET Replaces: 3852691, 912988, 913275 4 & 6 Cyl.</p>
 <p>18-0980 TIMING COVER GASKET Replaces: 3935449 GM 7.4L</p>	<p>PKG. OF 2</p>  <p>18-0880 18-0880-9① SHIFT COVER GASKET Replaces: 911878</p>	<p>PKG. OF 2</p>  <p>18-0166 18-0166-9① GROMMET Replaces: 911705</p>	 <p>18-2815 PUSH ROD COVER GASKET Replaces: 3852692, 913276 For: 3.0L</p>
 <p>18-0190 WIPER GASKET Replaces: 912157</p>	<p>PKG. OF 2</p>  <p>18-2851 SWIVEL BEARING GASKET Replaces: 313368</p>	<p>PKG. OF 2</p>  <p>18-2863 18-2863-9① TILT CLUTCH COVER GASKET Replaces: 308799</p>	<p>PKG. OF 2</p>  <p>18-2911 18-2911-9① SWIVEL BEARING HOUSING GASKET Replaces: 910236</p>

<p>PKG. OF 5</p>  <p>18-2918 18-2918-9① OUTDRIVE GASKET Replaces: 911836, 915840</p>	<p>PKG. OF 5</p>  <p>18-2996 18-2996-9① OUTDRIVE SEAL Replaces: 911823, 3852560</p>	<p>PKG. OF 2</p>  <p>18-0923 18-0923-9① RUBBER SEAL Replaces: 313244</p>	<p>PKG. OF 2</p>  <p>18-0188 18-0188-9① WASHER Replaces: 909748</p>
 <p>18-1236 DRAIN SCREW Replaces: 309243 For Cobra Drives & V-6 40-50HP (1989-97)</p>	 <p>18-2387 18-23871-9① (PKG. OF 50) LOWER UNIT DRAIN SCREW Replaces: 307551 Fits: OMC V-6, V-4(1979 & Up), 60-75hp 3 cylinder, 20-35hp (1985-97)</p>	 <p>18-2378 MAGNETIC DRAIN SCREW Replaces: 318544 Fits: Cobra 2.3, 3.0, 3.8 & 5.8L (1986-92), V-6, V-4(1979 & Up), 60-75hp 3 cyl, 40/50hp (1989-98)</p>	<p>PKG. OF 5</p>  <p>18-4253-9① 18-42531-9① (PKG. OF 50) DRAIN SCREW O-RING Replaces: 336982 Used w/ 18-1236 Drain Screw</p>
<p>PKG. OF 2</p>  <p>18-2945 18-2945-9① DRAIN SCREW GASKET Replaces: 307552</p>	 <p>18-8369 OIL INDICATOR WITH WASHER Replaces: 914488 Uses o-ring 18-7116 Fits: OMC Cobra (1986-93) without cone clutch</p>	<p>PKG. OF 5</p>  <p>18-4248 18-4248-9① 18-42481-9① (PKG. OF 50) DRAIN/FILL PLUG WASHER (Plastic) Replaces: 311598</p>	<p>PKG. OF 5</p>  <p>18-4250 18-4250-9① WASHER Replaces: 911820</p>
 <p>18-0549 PLUG OFF CAP Replaces: 909829 I.D. 1" For V-8 Model Stern Drives and Inboards (1977 to present)</p>	 <p>18-0550 PLUG OFF CAP Replaces: 909830 I.D. 1 1/4" For V-8 Model Stern Drives and Inboards 1977 to present</p>	 <p>18-0518 VALVE STEM SEAL Replaces: 3854956, 914323, 3853132 For: most inline 4 and 6 cyl. GM (Early) and 305-350 CID GM</p>	<p>PKG. OF 8</p>  <p>18-4024 18-4024-9① VALVE STEM SEAL Replaces: 3853226, 914445 For: Chevy 4.3L/5.0L/5.7L</p>

① Priced per Package

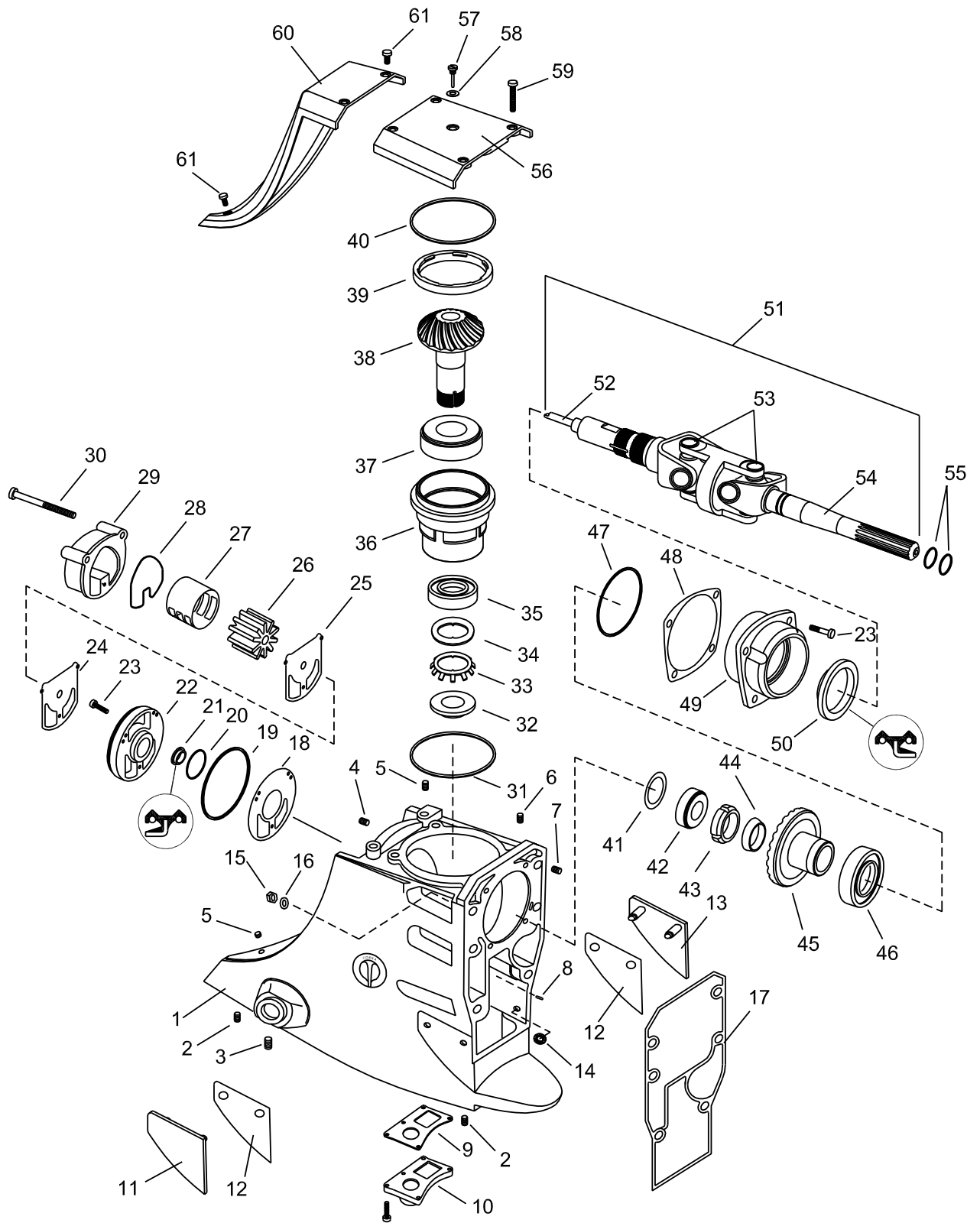

Figure #	Description	Part #	O.E.M. #	Qty.	Figure #	Description	Part #	O.E.M. #	Qty.	
1	Upper Gear Housing, Basic w/ Inserts	~	984518	1	32	Pinion Nut	18-3769	911753	1	
				5	33	Nut Retainer	18-3610	911752	1	
2	Gearcase Insert	NSS	910935	5	34	Pinion Washer	NSS	911697	1	
3	Gearcase Insert	NSS	911779,	5	35	Pinion Bearing, Lower	18-1170	983892	1	
			3852541		36	Bearing Carrier, Pinion	18-4828	911750	1	
4	Gearcase Insert	NSS	910901	5	37	Pinion Bearing, Upper	18-1161	983891	1	
5	Gearcase Insert	NSS	911858,	3	38	Gear Set, 21:16 (includes 38 & 45)	18-1600	983825	AR	
			3852567		38	Gear Set, 21:18 (includes 38 & 45)	NSS	983826	AR	
6	Gearcase Insert	NSS	910901	4	38	Gear Set, 21:19 (includes 38 & 45)	NSS	984012	AR	
7	Gearcase Insert	NSS	910901	4						
8	Shift Rod Guide	NSS	912137	1	38	Gear Set, 21:19 (includes 38 & 45)	NSS	984012	AR	
9	Gasket, Water Passage Cover	18-0884	911733	1						
10	Water Passage Cover	18-4837	911734	1	39	Retainer Ring, Pinion Housing	18-3768	911751	1	
11	Thrust Plate, Starboard	NSS	911838,	1	40	O-Ring, Gear Housing Cover	18-7107	313175	1	
			3852562		41	Shim, Gear Position, 0.003"	NSS	911662	AR	
12	Shim, Thrust Plate, 0.015"	18-1713	911839,	AR	41	Shim, Gear Position, 0.005"	NSS	911663	AR	
			3852563		41	Shim, Gear Position, 0.007"	NSS	911664	AR	
13	Thrust Plate, Port	NSS	911837,	1	41	Shim, Gear Position, 0.010"	18-02065	911665	AR	
			3852561		41	Shim, Gear Position, 0.012"	NSS	911666	AR	
14	Retainer Ring, Thrust Plate	NSS	910953	4	41	Shim, Gear Position, 0.015"	18-02067	911667	AR	
15	Nut	18-3730	912920,	6	42	Bearing, U-Joint Shaft	18-1171	983878	1	
			3852648		43	Nut, Gear to U-Joint	18-3770	911937	1	
16	Washer	NSS	911833	6	44	Centering Cone	NSS	912029	1	
17	Gasket, Outdrive Mounting	18-2918	911836,	1	45	Gear Set, 21:16 (includes 38 & 45)	18-1600	983825	AR	
			915840		45	Gear Set, 21:18 (includes 38 & 45)	NSS	983826	AR	
18	Gasket, Adapter to Gear Housing	18-0911	911698	1	45	Gear Set, 21:19 (includes 38 & 45)	NSS	984012	AR	
19	O-Ring, Adapter, Large	18-7407	911700	1						
20	O-Ring, Adapter, Small	18-7403	909316	1	46	Bearing, Bearing Carrier	18-1172	983877	1	
21	Water Pump Shaft Seal	18-2068	911701,	1						47
22	Adapter, Water Pump to Gear Housing	18-4836	915702,		1	48	Shim, Bearing Carrier, 0.003", Green	18-0227	911678	AR
			916058,	48		Shim, Bearing Carrier, 0.004", Tan	18-0229	911679	AR	
23	Screw	18-1598	908668,	6	48	Shim, Bearing Carrier, 0.005", Blue	18-02060	911680	AR	
24	Gasket, Plate to Adapter	18-2916	341013		1	48	Shim, Bearing Carrier, 0.010", Brown	18-02061	911681	AR
25	Plate, Water Pump	NSS	911703	1	49	Gear Bearing Carrier	18-4838	911683	1	
26	Impeller	18-3058	983895,	1	50	Seal, Bearing Carrier	18-2067	911685	1	
27	Liner, Water Pump Cover	NSS	777128		1	51	U-Joint & Water Pump Shaft Assy	18-2338	983880	1
28	Seal, Water Pump Housing	18-2541	911704	1	52	Stub & Water Pump Shaft	18-6399	984264	1	
29	Impeller Housing	18-3206	984744	1	53	U-Joint Assy	18-2104	912214	2	
30	Screw	NSS	912238	3	54	Yoke Shaft	18-2146	912212	1	
31	Shim, Bearing Carrier 0.010	18-0207	911668	AR	55	O-Ring, U-Joint Shaft	18-7153	911851,	2	
31	Shim, Bearing Carrier 0.001	18-0209	911669,	AR	56	Gear Housing Cover	18-4838	3852565		
			911670,		57	Oil Indicator	18-8369	914488	1	
			611671,		58	O-Ring, Oil Indicator	18-7116	303067	1	
			911672,		59	Screw, Gear Housing Cover	18-1599	123018	4	
			911673,		60	Cover, Water Pump Access	18-4750	983967	1	
			911674,		61	Screw, Water Pump Access Cover	18-4749-9	911859,	3852568	3
			911675,							
			911676,		AR	984744	1			
911677										

AR As required

NSS Not Sold Seperate



GEAR HOUSINGS

Part No.	OE No.	Description	Application
18-4804	984770, 986381	Upper Gear Housing Complete, 21: 16 Ratio	5.7L(1986-93), 5.8L(1986-89,1991-93)
18-4805	984771, 986382	Upper Gear Housing Complete, 21: 18 Ratio	2.5L (1986-89),3.0L(1986-93),5.0L(1989-93)



SCREWS

Part No.	OE No.	Application
18-1279	317624	20, 25, 35 HP (1976-86) 120, 140, 275, 300 HP (1985-86) Cobra Drives
18-1598	341013	Fits: OMC Cobra (1986-93) without cone clutch
18-1599	123018	Fits: OMC Cobra (1986-93) without cone clutch
18-4749-9 ^①	3852568	For Cover Assembly: (3 Pack)Fits: 2.3L (1987-90), 2.5L (1986), 2.6L (1989), 3.0L (1986-93), 4.3L (1986-93),5.0L (1986-94), 5.7L (1986-92), 5.8L (1989-93), 7.4L (1988)

^① PKG of 3, priced per package



18-4801
COMPLETE LOWER UNIT ASSEMBLY
Replaces: 5000356
Fits: 85-140hp Crossflow (1978-94) w/o Upper Driveshaft
Primered only



SHIMS

Part No.	O.E. No.	Size	Part No.	O.E. No.	Size
18-0207 ^①	911668	0.010	18-02065 ^①	911665	0.010
18-0209 ^①	911669, 911670, 911671, 911672, 911673, 911674, 911675, 911676, 911677	0.001	18-02067 ^①	911667	0.015
18-0211 ^①	911669, 911670, 911671, 911672, 911673, 911674, 911675, 911676, 911678	0.003	18-2229	323362	0.003
18-0227 ^{① ②}	911678	0.003	18-2230	323361	0.004
18-0229 ^{① ③}	911679	0.004	18-2231	314745	0.005
18-1713 ^①	3852563	0.015			
18-02060 ^{① ④}	911680	0.005			
18-02061 ^{① ⑤}	911681	0.010			
—	911662	0.003			
NSS ^①	911663	0.005			

^① Fits: OMC Cobra (1986-93) without cone clutch
^② Green
^③ Tan
^④ Blue
^⑤ Brown
^⑥ Kit includes 1 each of 18-2229, 18-2230 & 18-2231

NOTE: For shim sizes larger than .010" use shim 18-0207 and appropriate combination of .001" shim (18-0209), and .003" shim (18-0211) to reach desired shim thickness.



18-9876
SHIM GAUGE TOOL
Replaces: 349957

MARINE GRADE 316 STAINLESS STEEL WORM GEAR HOSE CLAMPS

All components are manufactured from Marine Grade 316 stainless steel.
These clamps are designed to fit many applications from 5/16" to 7" diameter hoses.



STAINLESS STEEL CLAMPS

Part #	Diameter Size	Std. #	Part #	Diameter Size	Std. #
18-710-06-2	5/16" to 7/8"	006	118-710-32-2	1 9/16" to 2 1/2"	032
118-710-10-2	9/16" to 1 1/16"	010	118-710-48-2	2 9/16" to 3 1/2"	048
18-710-12-2	9/16" to 1 1/4"	012	18-710-64-2	2 1/2" to 4 1/2"	064
18-710-16-2	1 1/16" to 1 1/2"	016	18-710-72-2	3" to 5"	072
118-710-20-2	3/4" to 1 3/4"	020	118-710-104-2	5" to 7"	104
118-710-24-2	1 1/16" to 2"	024			



18-4442
ENGINE ALIGNMENT TOOL
Used to verify engine alignment on Cobra models.



18-2100
LINK BELT HEAVY DUTY GIMBAL BEARING
Replaces: 983937
Uses seal 18-8349
Fits all OMC Cobra and King Cobra Drives



18-3763
SHIFT SHAFT
Replaces: 322941
For: V-4/V-6, Cobra, Stringer



18-2337
STUB SHAFT
Replaces: 3850814
Fits: All Cobra 1994-Up except King Cobra



18-6399
SHAFT & STUB ASSEMBLY
Replaces: 984264
For: Cobra Drives- 232, 302(1986-90), 252(1986), 262, 350, 460(1989), 432, 434, 502(1986-92), 504(1986-88), 574(1986-92), 584(1989-93), 754(1987-88)



18-2104
U-JOINT
Heavy Duty
Replaces: 912214, 915716
Fits OMC Cobra Drives (1986-89) Includes straight grease fitting and 90° fitting



18-2174
U-JOINT
Heavy Duty
Replaces: 915717, 3850812
Fits OMC Cobra and King Cobra Drives (1990 & ABOVE)
Includes straight grease fitting and 90° fitting.



18-2338
U-JOINT
Replaces: 983880
For: 1986-93 OMC Cobra



18-2339
U-JOINT ASSEMBLY
Replaces: 3852384
Fits: All Cobra 1994-Up except King Cobra



18-2146
UNIVERSAL YOKE ASSEMBLY
Replaces: 912212, 3850815
For: All Cobra (1986-Up)



18-3770
U-JOINT NUT
Replaces: 911937
For: 232, 252, 262, 302, 350, 432, 434, 460, 502, 504, 574, 584, 744, 754, (1987-93)

Model	Year	U-Joint #	U-Joint Assy. OE #	Long Yoke #	Long Yoke OE #	Short Yoke #	Short Yoke OE #
2.3L	1986 ①	18-2338	983880	18-2146	812212	18-6399	984264
3.0L	1986 ①	18-2338	983880	18-2146	812212	18-6399	984264
4.3L	1986 ①	18-2338	983880	18-2146	812212	18-6399	984264
5.7L	1986 ①	18-2338	983880	18-2146	812212	18-6399	984264
2.3L	1987-1988 ①	18-2338	983880	18-2146	912212	18-6399	984264
3.0L	1987-1988 ①	18-2338	983880	18-2146	912212	18-6399	984264
4.3L	1987-1988 ①	18-2338	983880	18-2146	912212	18-6399	984264
5.0L	1987-1988 ①	18-2338	983880	18-2146	912212	18-6399	984264
5.7L	1987-1988 ①	18-2338	983880	18-2146	912212	18-6399	984264
7.5L	1987-1988 ①	18-2338	983880	18-2146	912212	18-6399	984264
2.3L	1989 ①	18-2338	983880	18-2146	912212	18-6399	984264
3.0L	1989 ①	18-2338	983880	18-2146	912212	18-6399	984264
4.3L	1989 ①	18-2338	983880	18-2146	912212	18-6399	984264
5.0L	1989 ①	18-2338	983880	18-2146	912212	18-6399	984264
5.7L	1989 ①	18-2338	983880	18-2146	912212	18-6399	984264
5.8L	1989 ①	18-2338	983880	18-2146	912212	18-6399	984264
7.5L	1989 ①	18-2338	983880	18-2146	912212	18-6399	984264
2.3L	1990 ②	18-2338	983880	18-2146	912212	18-6399	984264
3.0L	1990 ②	18-2338	983880	18-2146	912212	18-6399	984264
4.3L	1990 ②	18-2338	983880	18-2146	912212	18-6399	984264
5.0L	1990 ②	18-2338	983880	18-2146	912212	18-6399	984264
5.7L	1990 ②	18-2338	983880	18-2146	912212	18-6399	984264
5.8L	1990 ②	18-2338	983880	18-2146	912212	18-6399	984264

APPLICATION CONTINUED ON NEXT PAGE

① Used where raw w/p is located on outdrive ② Used where raw w/p is located on engine ③ Excludes Model 58FBDPMDA, used where raw w/p is located on engine
④ Used where raw w/p is located on engine, incl. Model 58FBDPMDA

Model	Year	U-Joint #	U-Joint Assy. OE #	Long Yoke #	Long Yoke OE #	Short Yoke #	Short Yoke OE #
5.7L	1990 ①	18-2338	983880	18-2146	912212	18-6399	984264
7.4L	1990 ①	18-2338	983880	18-2146	912212	18-6399	984264
7.5L	1990 ①	18-2338	983880	18-2146	912212	18-6399	984264
3.0L	1991 ①	18-2338	983880	18-2146	912212	18-6399	984264
4.3L	1991 ①	18-2338	983880	18-2146	912212	18-6399	984264
5.7L	1991 ①	18-2338	983880	18-2146	912212	18-6399	984264
5.8L	1991 ①	18-2338	983880	18-2146	912212	18-6399	984264
7.4L	1991 ②	N/A	986191	18-2146	912212	N/A	914646
3.0L	1992-1993 ①	18-2338	983880	18-2146	912212	18-6399	984264
3.2L	1992-1993 ①	18-2338	983880	18-2146	912212	18-6399	984264
4.3L	1992-1993 ①	18-2338	983880	18-2146	912212	18-6399	984264
5.0L	1992-1993 ①	18-2338	983880	18-2146	912212	18-6399	984264
5.7L	1992-1993 ①	18-2338	983880	18-2146	912212	18-6399	984264
5.8L	1992-1993 ①	18-2338	983880	18-2146	912212	18-6399	984264
3.0L	1992-1993 ②	N/A	986191	18-2146	912212	N/A	914646
3.2L	1992-1993 ②	N/A	986191	18-2146	912212	N/A	914646
4.3L	1992-1993 ②	N/A	986191	18-2146	912212	N/A	914646
5.0L	1992-1993 ②	N/A	986191	18-2146	912212	N/A	914646
5.7L	1992-1993 ②	N/A	986191	18-2146	912212	N/A	914646
5.8L	1992-1993 ②	N/A	986191	18-2146	912212	N/A	914646
7.4L	1992-1993 ②	N/A	986191	18-2146	912212	N/A	914646
8.2L	1992-1993 ②	N/A	986191	18-2146	912212	N/A	914646
3.0L	1994 ③	18-2339	3852384	18-2146	3850815	18-2337	3850814
4.3L	1994 ③	18-2339	3852384	18-2146	3850815	18-2337	3850814
5.0L	1994 ③	18-2339	3852384	18-2146	3850815	18-2337	3850814
5.7L	1994 ③	18-2339	3852384	18-2146	3850815	18-2337	3850814
5.8L	1994 ③	18-2339	3852384	18-2146	3850815	18-2337	3850814
5.8L	1994 ④	N/A	3853937	18-2146	3850815	N/A	3853563
7.4L	1994 ④	N/A	3853937	18-2146	3850815	N/A	3853563
3.0L	1995 ②	18-2339	3852384	18-2146	3850815	18-2337	3850814
4.3L	1995 ②	18-2339	3852384	18-2146	3850815	18-2337	3850814
5.0L	1995 ②	18-2339	3852384	18-2146	3850815	18-2337	3850814
5.8L	1995 ②	18-2339	3852384	18-2146	3850815	18-2337	3850814
7.4L	1995 ②	N/A	3853937	18-2146	3850815	N/A	3853563
3.0L	1996 ②	18-2339	3852384	18-2146	3850815	18-2337	3850814
4.3L	1996 ②	18-2339	3852384	18-2146	3850815	18-2337	3850814
5.0L	1996 ②	18-2339	3852384	18-2146	3850815	18-2337	3850814
5.7L	1996 ②	18-2339	3852384	18-2146	3850815	18-2337	3850814
5.8L	1996 ②	18-2339	3852384	18-2146	3850815	18-2337	3850814
7.4L	1996 ②	18-2339	3852384	18-2146	3850815	18-2337	3850814
3.0L	1997 ②	18-2339	3852384	18-2146	3850815	18-2337	3850814
4.3L	1997 ②	18-2339	3852384	18-2146	3850815	18-2337	3850814
5.7L	1997 ②	18-2339	3852384	18-2146	3850815	18-2337	3850814
7.4L	1997 ②	18-2339	3852384	18-2146	3850815	18-2337	3850814
3.0L	1998 ②	18-2339	3852384	18-2146	3850815	18-2337	1850814
4.3L	1998 ②	18-2339	3852384	18-2146	3850815	18-2337	1850814
5.0L	1998 ②	18-2339	3852384	18-2146	3850815	18-2337	1850814
5.7L	1998 ②	18-2339	3852384	18-2146	3850815	18-2337	1850814
7.4L	1998 ②	18-2339	3852384	18-2146	3850815	18-2337	1850814
8.2L	1998 ②	18-2339	3852384	18-2146	3850815	18-2337	1850814
43APHUB	1995	18-2339	3852384	18-2146	3850815	18-2337	3850814
43FAPNCA	1996	18-2339	3852384	18-2146	3820815	18-2337	3850814
43FBPBYC	1998	18-2339	3852384	18-2146	3820815	18-2337	3850814
43FBPLKD	1997	18-2339	3852384	18-2146	3820815	18-2337	3850814
43FBPNCS	1996	18-2339	3852384	18-2146	3820815	18-2337	3850814
50FBPBYC	1998	18-2339	3852384	18-2146	3820815	18-2337	3850814
50FACPMDA	1994	18-2339	3852384	18-2146	3820815	18-2337	3850814

APPLICATION CONTINUED ON NEXT PAGE

① Used where raw w/p is located on outdrive ② Used where raw w/p is located on engine ③ Excludes Model 58FBPMDA, used where raw w/p is located on engine
 ④ Used where raw w/p is located on engine, incl. Model 58FBPMDA

Model	Year	U-Joint #	U-Joint Assy. OE #	Long Yoke #	Long Yoke OE #	Short Yoke #	Short Yoke OE #
50FACPMMDM	1994	18-2339	3852384	18-2146	3820815	18-2337	3850814
50FAGPMDA	1994	18-2339	3852384	18-2146	3820815	18-2337	3850814
50FAGPMMDM	1994	18-2339	3852384	18-2146	3820815	18-2337	3850814
50FAPHUB	1995	18-2339	3852384	18-2146	3850815	18-2337	3850814
50FAPHUE	1995	18-2339	3852384	18-2146	3850815	18-2337	3850814
50FAPNCA	1996	18-2339	3852384	18-2146	3820815	18-2337	3850814
50FAPNCS	1996	18-2339	3852384	18-2146	3820815	18-2337	3850814
50FBPBYC	1998	18-2339	3852384	18-2146	3820815	18-2337	3850814
57FAPLKD	1997	18-2339	3852384	18-2146	3850815	18-2337	3850814
57FAPNCA	1996	18-2339	3852384	18-2146	3850815	18-2337	3850814
57FAPNCS	1996	18-2339	3852384	18-2146	3850815	18-2337	3850814
57FCPBYC	1998	18-2339	3852384	18-2146	3820815	18-2337	3850814
57FCPBYD	1998	18-2339	3852384	18-2146	3820815	18-2337	3850814
57FCPLKD	1997	18-2339	3852384	18-2146	3850815	18-2337	3850814
57FDPLKD	1997	18-2339	3852384	18-2146	3850815	18-2337	3850814
58FACPMDA	1994	18-2339	3852384	18-2146	3820815	18-2337	3850814
58FACPMMDM	1994	18-2339	3852384	18-2146	3820815	18-2337	3850814
58FAGPMDA	1994	18-2339	3852384	18-2146	3820815	18-2337	3850814
58FAGPMMDM	1994	18-2339	3852384	18-2146	3820815	18-2337	3850814
58FAPHUB	1995	18-2339	3852384	18-2146	3820815	18-2337	3850814
58FAPHUE	1995	18-2339	3852384	18-2146	3820815	18-2337	3850814
58FBDMDA	1994	18-2339	3852384	18-2146	3820815	18-2337	3850814
58FBPHUB	1995	18-2339	3852384	18-2146	3820815	18-2337	3850814
58FBPHUE	1995	18-2339	3852384	18-2146	3820815	18-2337	3850814
58FBPNCA	1996	18-2339	3852384	18-2146	3820815	18-2337	3850814
58FBPMDA	1994	18-2339	3852384	18-2146	3820815	18-2337	3850814
58FCPNCA	1996	18-2339	3852384	18-2146	3820815	18-2337	3850814
58FCPNCS	1996	18-2339	3852384	18-2146	3820815	18-2337	3850814
74FEPHUB	1995	18-2339	3852384	18-2146	3820815	18-2337	3850814
74FFPNCA	1996	18-2339	3852384	18-2146	3850815	18-2337	3850814
74FGPLKD	1997	18-2339	3852384	18-2146	3820815	18-2337	3850814
74FGPNCS	1996	18-2339	3852384	18-2146	3850815	18-2337	3850814
74FHPYIC	1998	18-2339	3852384	18-2146	3820815	18-2337	3850814
74FHPBYC	1998	18-2339	3852384	18-2146	3820815	18-2337	3850814
74FJPBYC	1998	18-2339	3852384	18-2146	3820815	18-2337	3850814
74FJPBYD	1998	18-2339	3852384	18-2146	3820815	18-2337	3850814
74FJPYD	1998	18-2339	3852384	18-2146	3820815	18-2337	3850814
82FCPBYC	1998	18-2339	3852384	18-2146	3820815	18-2337	3850814
302CCPMDA	1994	18-2339	3852384	18-2146	3820815	18-2337	3850814
302CGPMDA	1994	18-2339	3852384	18-2146	3820815	18-2337	3850814
302CMBYIC	1998	18-2339	3852384	18-2146	3820815	18-2337	3850814
302CMBYD	1998	18-2339	3852384	18-2146	3820815	18-2337	3850814
302CMHUB	1995	18-2339	3852384	18-2146	3820815	18-2337	3850814
302CMLKD	1997	18-2339	3852384	18-2146	3850815	18-2337	3850814
302CMNCA	1996	18-2339	3852384	18-2146	3820815	18-2337	3850814
302CMNCS	1996	18-2339	3852384	18-2146	3820815	18-2337	3850814
302CPBYC	1998	18-2339	3852384	18-2146	3820815	18-2337	3850814
302CPBYD	1998	18-2339	3852384	18-2146	3820815	18-2337	3850814
302CPHUB	1995	18-2339	3852384	18-2146	3820815	18-2337	3850814
302CPLKD	1997	18-2339	3852384	18-2146	3850815	18-2337	3850814
302CPNCA	1996	18-2339	3852384	18-2146	3820815	18-2337	3850814
302CPNCS	1996	18-2339	3852384	18-2146	3820815	18-2337	3850814
302DCMMDA	1994	18-2339	3852384	18-2146	3820815	18-2337	3850814
302DGMMDA	1994	18-2339	3852384	18-2146	3820815	18-2337	3850814
432ACMMDA	1994	18-2339	3852384	18-2146	3820815	18-2337	3850814
432ACPMDA	1994	18-2339	3852384	18-2146	3820815	18-2337	3850814
432AGMMDA	1994	18-2339	3852384	18-2146	3820815	18-2337	3850814

APPLICATION CONTINUED ON NEXT PAGE

① Used where raw w/p is located on outride ② Used where raw w/p is located on engine ③ Excludes Model 58FBPMDA, used where raw w/p is located on engine
 ④ Used where raw w/p is located on engine, incl. Model 58FBPMDA

Model	Year	U-Joint #	U-Joint Assy. OE #	Long Yoke #	Long Yoke OE #	Short Yoke #	Short Yoke OE #
432AGPMDA	1994	18-2339	3852384	18-2146	3820815	18-2337	3850814
432APNCA	1996	18-2339	3852384	18-2146	3820815	18-2337	3850814
432BPLKD	1997	18-2339	3852384	18-2146	3820815	18-2337	3850814
432BPNC	1996	18-2339	3852384	18-2146	3820815	18-2337	3850814
502APHUB	1995	18-2339	3852384	18-2146	3820815	18-2337	3850814
502APHUE	1995	18-2339	3852384	18-2146	3820815	18-2337	3850814
432ACMMDA	1994	18-2339	3852384	18-2146	3820815	18-2337	3850814
432ACPMDA	1994	18-2339	3852384	18-2146	3820815	18-2337	3850814
432AGMMDA	1994	18-2339	3852384	18-2146	3820815	18-2337	3850814
432AGPMDA	1994	18-2339	3852384	18-2146	3820815	18-2337	3850814
432BPBYC	1998	18-2339	3852384	18-2146	3820815	18-2337	3850814
432BPLKD	1997	18-2339	3852384	18-2146	3820815	18-2337	3850814
434APNCA	1996	18-2339	3852384	18-2146	3820815	18-2337	3850814
434BPBYC	1998	18-2339	3852384	18-2146	3820815	18-2337	3850814
434BPLKD	1997	18-2339	3852384	18-2146	3820815	18-2337	3850814
434BPNC	1996	18-2339	3852384	18-2146	3820815	18-2337	3850814
502ACPMDA	1994	18-2339	3852384	18-2146	3820815	18-2337	3850814
502AGPMDA	1994	18-2339	3852384	18-2146	3820815	18-2337	3850814
502APHUB	1995	18-2339	3852384	18-2146	3850815	18-2337	3850814
502APHUE	1995	18-2339	3852384	18-2146	3850815	18-2337	3850814
502APNCA	1996	18-2339	3852384	18-2146	3820815	18-2337	3850814
502APNC	1996	18-2339	3852384	18-2146	3820815	18-2337	3850814
502BPBYC	1998	18-2339	3852384	18-2146	3820815	18-2337	3850814
572ACPMDA	1994	18-2339	3852384	18-2146	3820815	18-2337	3850814
572AGPMDA	1994	18-2339	3852384	18-2146	3820815	18-2337	3850814
572BPBYC	1998	18-2339	3852384	18-2146	3820815	18-2337	3850814
572BPLKD	1997	18-2339	3852384	18-2146	3820815	18-2337	3850814
572BPLKR	1997	18-2339	3852384	18-2146	3820815	18-2337	3850814
572BPNC	1996	18-2339	3852384	18-2146	3820815	18-2337	3850814
574BPLKD	1997	18-2339	3852384	18-2146	3820815	18-2337	3850814
584ACPMDA	1994	18-2339	3852384	18-2146	3820815	18-2337	3850814
584AGPMDA	1994	18-2339	3852384	18-2146	3820815	18-2337	3850814
584APHUB	1995	18-2339	3852384	18-2146	3820815	18-2337	3850814
584APHUE	1995	18-2339	3852384	18-2146	3820815	18-2337	3850814
584APNCA	1996	18-2339	3852384	18-2146	3820815	18-2337	3850814
584APNC	1996	18-2339	3852384	18-2146	3820815	18-2337	3850814
744DCPMDM	1994	18-2339	3852384	18-2146	3820815	18-2337	3850814
744DCPMDA	1994	18-2339	3852384	18-2146	3820815	18-2337	3850814
744DDPMDA	1994	18-2339	3852384	18-2146	3820815	18-2337	3850814
744DDPMDM	1994	18-2339	3852384	18-2146	3820815	18-2337	3850814
744DGPMDA	1994	18-2339	3852384	18-2146	3820815	18-2337	3850814
744DGPMDM	1994	18-2339	3852384	18-2146	3820815	18-2337	3850814
744DJPMDA	1994	18-2339	3852384	18-2146	3820815	18-2337	3850814
744DJPMDM	1994	18-2339	3852384	18-2146	3820815	18-2337	3850814
744DPHUB	1995	18-2339	3852384	18-2146	3820815	18-2337	3850814
744EPNCA	1996	18-2339	3852384	18-2146	3850815	18-2337	3850814
744FPLKD	1997	18-2339	3852384	18-2146	3850815	18-2337	3850814
744FPNC	1996	18-2339	3852384	18-2146	3850815	18-2337	3850814

① Used where raw w/p is located on outdrive ② Used where raw w/p is located on engine
 ③ Excludes Model 58FBPMDA, used where raw w/p is located on engine ④ Used where raw w/p is located on engine, incl. Model 58FBPMDA



**18-2772-1
TRANSOM
SEAL KIT**
For: SX Cobra Drives with cone clutch

— CONTAINS —

Part #	Description	O.E. #	Qty.
18-2100	Gimbal Bearing	3853807	1
18-2765	Bellows	3854127	1
18-1074	Bellows	3850426-2	1
18-2996	Seal	3852560, 911823	1
18-710-64-2	Hose Clamp	853012-3	1



**18-2771
BELLOWS KIT**
Replaces: 3854270
For: OMC Cobra without cone clutch

— CONTAINS —

Part #	Description	O.E. #
18-2613	Outdrive Gasket Set	—
18-2765	U-Joint Bellows	983973, 987467
18-2764	Exhaust Bellows	914036
18-2763	Shift Cable Bellows	911826
18-2100	Gimbal Bearing	983937
18-710-64-2	Hose Clamp	—



**18-2128
CENTER SOCKET**
Replaces: 912213, 3850813
Fits all OMC Cobra



**18-2745
EXHAUST BOOT**
Replaces: 912374
Fits 5.7L & 7.5L (1986 & later)



**18-1074
EXHAUST BELLOW**
I.D. 2 5/8" x O.D. 3" x L 7.5"
Replaces: 3850426
All cone clutch models (1994-up)
not using exhaust boot



**18-2763
SHIFT CABLE
BELLOWS**
Replaces: 911826
ALL COBRA



**18-2764
EXHAUST BELLOWS**
Replaces: 914036
All clutch dog Cobra models
(1986-93)



**18-2765
U-JOINT BELLOWS**
I.D. 3 1/2" x O.D. 4" x L 6"
Replaces: 983973,
987467, 3854127
All clutch dog Cobra models (1986-93)



**18-9031-1
BELLOWS ADHESIVE**
Securely seals ALL Universal
and Exhaust Bellows to provide
maximum coverage across
OEMs. Oil, Gasoline, Water and
Grease Resistant for Premier
Application and Hold
Replaces: Mercury 92-86166Q1



**18-21754
ENGINE COUPLER**
Replaces: 986232, 984537
Fits: 7.5L / 460 King Cobra 1987-90



**18-21751
ENGINE COUPLER**
Replaces: 3853962,
983902, 986338
Fits: 2.5L (1986), 3.0L (1986-90), (4.3L,
5.0L, 5.7L) (1986) KW & KWB suffix only,
7.4L (1990-98), 8.2L (1992-93, 1998)



**18-21752-1
ENGINE COUPLER**
Replaces: 3858437, 984290,
986120, 3853917
Fits: 4.3L (1986-98), 5.0L (1986-88, 1998)
5.7 (1986-92, 1994, 1996-98)



**18-21753
ENGINE COUPLER**
Replaces: 3853862
Fits: 5.0L & 5.8L (1989-96)



**18-21755
ENGINE COUPLER**
Replaces: 984629
2.3L Cobra



**18-2533
TRANSOM SEAL**
Replaces: 911797



**18-2767
TRANSOM SEAL
16 hole**
Replaces: 313080
(1967-77) 120 HP and UP



**18-2768
TRANSOM SEAL
22 hole**
Replaces: 909527
(1978-86) — ALL

 <p>18-2245-1 SHIFT CABLE ASSEMBLY Replaces: 987661 Wire: 68" • Jacket: 58 1/2" For: 1988-1993 OMC Cobra (except King) without cone clutch</p>	 <p>18-2246 SHIFT CABLE ASSEMBLY Replaces: 987678 Wire: 59" For: King Cobra</p>	 <p>18-3769 PINION NUT Replaces: 911753 For: 115 (1994-97), 232 (1987-90), 252 (1986), 262, 350, 460 (1989), 302, 574 (1986-92), 432 (1986-93), 502 (1988-93), 504, 754 (1986-88), .584 (1989-93), 744 (1988), 90 Jet (1994-95)</p>	 <p>18-3719 PINION NUT Replaces: 314730 (⁵/₈ - 18)</p>	
<p>PKG. OF 5</p>  <p>18-3725 18-3725-9① BALL GEAR NUT Replaces: 908064</p>	<p>PKG. OF 5</p>  <p>18-4251 18-4251-9① PLUG Replaces: 908062 O.D. 1.748</p>	 <p>18-1154 BALL BEARING Replaces: 377139</p>	 <p>18-1161 TAPERED ROLLER BEARING Replaces: 983891</p>	
 <p>18-1170 LOWER PINION BEARING Replaces: 983892</p>	 <p>18-1171 U-JOINT SHAFT BEARING Replaces: 983878</p>	 <p>18-1172 CARRIER BEARING Replaces: 983877 For: 1986-95 Cobra</p>	 <p>18-1158 CARRIER BEARING Replaces: 387247</p>	
 <p>18-1350 CARRIER BEARING Replaces: 379504</p>	 <p>18-1351 CARRIER BEARING Replaces: 382407 COBRA</p>	 <p>18-1117 PINION BEARING Replaces: 387817</p>	 <p>18-1357 PINION BEARING Replaces: 384195 COBRA</p>	
 <p>18-1358 REVERSE GEAR BEARING Replaces: 389039 COBRA</p>	 <p>18-1365 THRUST BEARING Replaces: 387656 COBRA DRIVE SHAFT</p>	 <p>18-1366 THRUST BEARING Replaces: 382408 COBRA REVERSE GEAR</p>	 <p>18-1370 THRUST FORWARD BEARING Replaces: 389042</p>	 <p>18-1371 THRUST FORWARD BEARING Replaces: 385043 COBRA</p>

① Priced per Package

OMC 400 & 800 SERIES GEARCASE BEARINGS

HP	Year	Pinion Bearing	Drive Shaft Bearing	Carrier Aft Bearing	Carrier Fore Bearing	Forward Thrust Bearing	Reverse Thrust Bearing	Housing Bearing
120	1978-81	18-1357	18-1365	18-1350	18-1351	18-1371	18-1366	—
2.5L	1982-86	18-1357	18-1365	18-1350	18-1351	18-1371	18-1366	18-1351
140	1978-81	18-1357	18-1365	18-1350	18-1351	18-1371	18-1366	—
3.0L	1982-86	18-1357	18-1365	18-1350	18-1351	18-1371	18-1366	18-1351
185/3.8L	1978-85	18-1117	18-1365	18-1158	18-1351	18-1370	18-1366	18-1358
4.3L	1985-86	18-1117	18-1365	18-1158	18-1351	18-1370	18-1366	18-1358
200/5.0L	1979-86	18-1117	18-1365	18-1158	18-1351	18-1370	18-1366	18-1358
225	1978	18-1117	18-1365	18-1158	18-1351	18-1370	18-1366	18-1358
230/530L	1979-86	18-1117	18-1365	18-1158	18-1351	18-1370	18-1366	18-1358
240	1978	18-1117	18-1365	18-1158	18-1351	18-1370	18-1366	18-1358
250	1979	18-1117	18-1365	18-1158	18-1351	18-1370	18-1366	18-1358
260/5.7L	1979-86	18-1117	18-1365	18-1158	18-1351	18-1370	18-1366	18-1358

OMC COBRA GEAR HOUSING BEARINGS

Model	Liter	Year	Pinion Bearing	Drive Shaft Bearing	Carrier Aft Bearing	Carrier Fore Bearing	Forward Thrust Bearing	Reverse Thrust Bearing	Housing Bearing
2.3L	2.3L	1987	18-1357	18-1365	18-1350	18-1351	18-1371	18-1366	18-1351
2.3L	2.3L	1988-1990	18-1357	18-1365	18-1350	18-1351	18-1371	18-1366	N/A
2.5L	2.5L	1986	18-1357	18-1365	18-1350	18-1351	18-1371	18-1366	18-1351
3.0L	3.0L	1986-1987	18-1357	18-1365	18-1350	18-1351	18-1371	18-1366	18-1351
3.0L	3.0L	1988-1989	18-1357	18-1365	18-1350	18-1351	18-1371	18-1366	N/A
3.0L	3.0L	1990-1991	18-1117	18-1365	18-1158	18-1351	18-1370	18-1366	N/A
3.0L	3.0L	1992-1993	18-1117	18-1365	N/A	18-1351	18-1370	18-1366	N/A
3.0L HO	3.0L	1992-1993	18-1117	18-1365	N/A	18-1351	18-1370	18-1366	N/A
4.3L	4.3L	1986-1987	18-1117	18-1365	18-1158	18-1351	18-1370	18-1366	18-1358
4.3L	4.3L	1988-1991	18-1117	18-1365	18-1158	18-1351	18-1370	18-1366	N/A
4.3L	4.3L	1992-1993	18-1117	18-1365	N/A	18-1351	18-1370	18-1366	N/A
4.3L HO	4.3L	1992-1993	18-1117	18-1365	N/A	18-1351	18-1370	18-1366	N/A
5.0L	5.0L	1986-1987	18-1117	18-1365	18-1158	18-1351	18-1370	18-1366	18-1358
5.0L	5.0L	1988-1991	18-1117	18-1365	18-1158	18-1351	18-1370	18-1366	N/A
5.0L	5.0L	1992-1993	18-1117	18-1365	N/A	18-1351	18-1370	18-1366	N/A
5.0L HO	5.0L	1992-1993	18-1117	18-1365	N/A	18-1351	18-1370	18-1366	N/A
5.7L	5.7L	1986-1987	18-1117	18-1365	18-1158	18-1351	18-1370	18-1366	18-1358
5.7L	5.7L	1988-1991	18-1117	18-1365	N/A	18-1351	18-1370	18-1366	N/A
5.7L	5.7L	1992-1993	18-1117	18-1365	N/A	18-1351	18-1370	18-1366	N/A
5.8L	5.8L	1989-1991	18-1117	18-1365	N/A	18-1351	18-1370	18-1366	N/A
5.8L	5.8L	1992-1993	18-1117	18-1365	N/A	18-1351	18-1370	18-1366	N/A



18-0195
THRUST WASHER
Replaces: 314731
COBRA



18-0198
FORWARD GEAR THRUST WASHER
Replaces: 324766



18-2243-9
DETENT BALL
Replaces: 316506
For: V-4 & V-6 gearcase
OMC Sterndrive 400 Series (1978-79);
800 Series (1978)



18-2183
DRIVE SHAFT
Replaces: 909121



18-1701
LOWER DRIVE SHAFT
Replaces: 911693
For: Cobra Drives 262, 302, 350,
432, 434, 502, 504, 574, 584

① Priced per Package



18-2184
DRIVE SHAFT
 Replaces: 908087



18-2185
DRIVE SHAFT
 Replaces: 909753



18-2186
DRIVE SHAFT
 Replaces: 982424
 800 Drives



18-2187
PROP SHAFT
 Replaces: 395209
 Cobra & Late Model 800 Drives



18-2251
PROP SHAFT
 Replaces: 435022, 433017, 436740



18-2252
PROP SHAFT
 Replaces: 387818, 436888



18-2216
SLIDING CLUTCH
 Replaces: 337772, 337774,
 334516, 336562, 910995



18-2220
SLIDING CLUTCH
 Replaces: 323664, 320630



18-2383
SLIDING CLUTCH
 Replaces: 914716, 915272
 For: 3.0L (GM), 4.3L (GM), 5.0L (Ford), 5.7L (Ford),
 5.8L (Ford) (1990-91)



18-2218
FORWARD GEAR SET
 Replaces: 434063, 987966,
 985050, 436746



18-2219
REVERSE GEAR
 Replaces: 333077,
 317838, 340490



18-1600
UPPER GEAR KIT
 with bearing
 Replaces: 983825
 For: 5.7, 5.8L V-8 Cobra drives (21:16 ratio)

SHAFT/GEAR/SLIDING CLUTCH APPLICATION

Model	Year	Bearing Carrier Shaft	Short/Long Water Pump Shaft	Drive Shaft	Prop Shaft	Forward Gear	Reverse Gear	Sliding Clutch
100 thru 165	1973	—	18-2185	—	—	—	—	—
120 thru 190	1974-75	—	18-2185	—	—	—	—	—
120 thru 235 ⑥	1976-77	—	18-2184	—	—	—	—	—
120 thru 190 ⑤	1976	—	18-2185	—	—	—	—	—
120/140 ⑤	1977	—	18-2185	—	—	—	—	—
120/140	1978-81	18-2183	18-2185	—	18-2252	—	—	18-2220
120 thru 235 ⑥	1977	—	18-2184	—	—	—	—	—
175/190/235 ⑤	1977	18-2183	18-2185	—	—	—	—	—
185	1978	18-2183	18-2185	18-2186	—	—	—	—
185	1980-81	18-2183	18-2185	18-2186	—	—	—	—
200	1979	18-2183	18-2185	18-2186	—	—	—	—
200	1980-81	18-2183	18-2185	18-2186	—	—	—	—
225/245	1973-75	—	18-2184	—	—	—	—	—
225	1978	18-2183	18-2185	18-2186	—	—	—	—
225	1979	—	—	18-2186	—	—	—	—
225	1980	—	—	18-2186	—	—	—	—
225	1981	—	—	18-2186	—	—	—	—
230	1979	18-2183	18-2185	18-2186	—	—	—	—
230	1980-81	18-2183	18-2185	18-2186	—	—	—	—
235	1975	18-2183	18-2185	—	—	—	—	—
235 ⑤	1976-77	18-2183	18-2185	—	—	—	—	—
240	1978	18-2183	18-2185	18-2186	—	—	—	—
240	1979	—	—	18-2186	—	—	—	—
240	1980-81	—	—	18-2186	—	—	—	—
250	1979	18-2183	18-2185	18-2186	—	—	—	—
260	1979	18-2183	18-2185	18-2186	—	—	—	—
260	1980-81	18-2183	18-2185	—	—	—	—	—
262	1989	—	—	—	18-2187	—	—	—
2.3/3.0	1987-89	—	—	—	18-2252	—	18-2219	—
2.3	1990	—	—	—	18-2252	—	—	—
2.5	1986	18-2183	18-2185	—	18-2252	—	18-2219	—
2.5	1982-87	18-2183	18-2185	—	18-2252	18-2218	18-2219	—
350 ③	1988-89	—	—	—	18-2187	18-2218	—	—
3 ①	1982-86	18-2183	18-2185	—	18-2252	18-2218	18-2219	18-2216
3.0/4.3 ③	1990-91	—	—	—	18-2187	—	—	18-2383
3.0/4.3	1992-93	—	—	—	18-2251	—	—	18-2383
3.0 H.O.	1990-91	—	—	—	18-2187	—	—	18-2383
3.0 H.O.	1992-93	—	—	—	18-2251	—	—	18-2383
3.8	1982-86	18-2183	18-2185	18-2186	18-2187	—	—	18-2216
460 ③	1988-89	—	—	—	18-2187	—	—	18-2216
4.3 ①	1985-86	18-2183	18-2185	18-2186	18-2187	—	—	18-2216
4.3 ②	1986-87	—	—	—	18-2187	—	—	—
4.3 ③	1988-91	—	—	—	18-2187	—	—	18-2383 ⑨
4.3 H.O.	1990-91	—	—	—	18-2187	—	—	18-2383
4.3 H.O.	1992-93	—	—	—	18-2251	—	—	18-2383
5.0/5.7	1982-83	18-2183	18-2185	18-2186	—	—	—	18-2216
5.0/5.7 ①	1984-86	18-2183	18-2185	18-2186	18-2187	—	—	18-2216
5 ②	1986-87	—	—	—	18-2187	—	—	—
5	1988	—	—	—	18-2187	—	—	—
5 ③	1988-91	—	—	—	18-2187	—	—	18-2383 ⑨
5.0/5.7	1992	—	—	—	18-2251	—	—	18-2383
5.0 H.O.	1990-91	—	—	—	18-2187	—	—	18-2383
5.0 H.O.	1992-93	—	—	—	18-2251	—	—	18-2383
5.7	1987-88	—	—	—	18-2187	—	—	—
5.7 ③	1988-89	—	—	—	18-2187	—	—	—
5.7 ⑧ ③	1990-92	—	—	—	18-2187	—	—	18-2383
5.8 ③	1989-90	—	—	—	18-2187	—	—	18-2383 ⑨
5.8	1991	—	—	—	18-2187	—	—	18-2383
5.8	1992-93	—	—	—	18-2251	—	—	18-2383
7.5	1987	—	—	—	18-2187	—	—	18-2216

① Except Cobra
② Cobra

③ Right hand rotation drive
⑤ Low profile

⑥ High profile
⑧ Except L.E. models

⑨ 1990-93 models only



**18-1702
CARRIER BEARING**

Replaces: 438039, 5000074
For: 1 3/16" diameter prop shaft-Cobra drives (1986-90) Fits all stringer mounts except 2.5L & 3.0L (1978-85)



**18-1703
CARRIER BEARING**

Replaces: 434400, 435096, 438040, 5000363, 5004257
For: 1 1/4" diameter prop shaft Cobra drives (1991-93)



18-4828
PINION BEARING CARRIER
 Replaces: 911750
 Fits: OMC Cobra (1986-93) without cone clutch



18-1099
BEARING HOUSING & SEAL ASSEMBLY
 Replaces: 982422
 For: OMC Stringer Drive-120, 140, 170, 200, 230, 260, (1981), 252, 302, 382, 502, 504 & 574 (1982-85), 432 (1985)



18-0647
SHIFT ROD ASSEMBLY
 Replaces: 986658
 3.0L (1990-1993), 4.3L, 5.0L, 5.7L, 5.8L (1986-1993)



18-0652
ROD END, SHIFT
 Replaces: 914723
 3.0L (1990-1993), 4.3L, 5.0L, 5.7L, 5.8L (1986-1993)



18-0653
SCREW, SHIFT ROD END
 Replaces: 308825
 3.0L (1990-1993), 4.3L, 5.0L, 5.7L, 5.8L (1986-1993)



18-0654
NUT, SHIFT ROD END
 Replaces: 914743
 3.0L (1990-1993), 4.3L, 5.0L, 5.7L, 5.8L (1986-1993)



18-3766
SHIFT CRADLE
 Replaces: 334163
 For: V-4/V-6, Cobra, Stringer



18-3610
RETAINER NUT
 Replaces: 911752
 Fits: OMC Cobra (1986-93)
 without cone clutch



18-3768
COVER NUT
 Replaces: 911751
 For: Cobra Drives 115 (1994-97), 232 (1987-90), 252 (1986) 262 (1989), 302 (1987)



18-1500
INTAKE WATER SCREEN
 Replaces: 337778
 For: 100, 120, 125, 140, 150, 175, 200, 225 (1993) (OMC Cobra & V6)



18-4750
COVER ASSEMBLY
 Replaces: 983967
 Fits: 2.3L (1987-90), 2.5L (1986), 2.6L (1989), 3.0L (1986-93), 4.3L (1986-93), 5.0L (1986-94), 5.7L (1986-92), 5.8L (1989-93), 7.4L (1988)



18-1714
CLUTCH DOG PIN
 Replaces: 313448
 For: 50-85, 100, 135, 140, 150, 175, 200, 235 (1969-82) (OMC Stringer drive)



18-2399
CLUTCH DOG
Replaces: 324369
For: V-4 & V-6



18-4222
THRUST WASHER
Replaces: 318841



18-4223
THRUST WASHER
Replaces: 333592



18-4228
PROP SPACER
Replaces: 315810



18-4194
PROP SPACER
Replaces: 3852350
For: 1994 King Cobra Lower Units



18-4231
PROP SPACER
Replaces: 320570



18-3705
18-3705-9^①
PROP NUT
Replaces: 314503



18-3708-1
PROP NUT & KEEPER
Replaces: 398042

② **18-3733D** Display Package



18-3733
PROP NUT KIT
For: SX Cobra

② **18-3715D** Display Package



18-3715
PROP NUT KIT

— CONTAINS —

Part #	O.E. #	Description
18-3708-1	398042	Prop Nut/Keeper
18-3741	309955	Cotter Pin
18-4231	320570	Prop Spacer



18-3730
LOCK NUT
Replaces: 3852648
For: Cobra & King Cobra 1987-94

② **18-3716D** Display Package



18-3716
PROP NUT KIT
Replaces: 175267

— CONTAINS —

Part #	O.E. #	Description
18-3705	314503	Prop Nut
18-3742	314502	Cotter Pin
18-4238	315810	Prop Spacer



18-4444
PROP WRENCH
FOR ALL COBRA



18-2156
TILT SHAFT
Replaces: 980183
I/O 1964-86
EXCEPT COBRA

PKG. OF 10



COTTER PINS
18-3741 **18-3742**
18-3741-9^① **18-3742-9^①**
Replaces: 309955 314502



18-9098
TRAILERING CLIPS
Replaces: 174448
Set of 2
For all Cobra Stern Drives

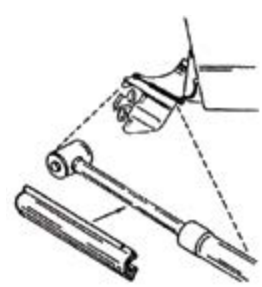

APPLICATION BEGINS ON NEXT PAGE

① Priced per Package

② Items ending in "D" are Display Packaged - Regular number is Non-Display

NUT/SPACER/WASHER/COTTER PIN/PROP NUT KIT APPLICATION

Model	Year	Nut	Spacer	Washer	Cotter Pin	Prop Nut Kit	Model	Year	Nut	Spacer	Washer	Cotter Pin	Prop Nut Kit
120	1978-81	18-3705	18-4228	18-4222	18-3742	18-3716	460	1989-90	18-3708-1	18-4231	18-4223	18-3741	18-3715
140	1978-81	18-3705	18-4228	18-4222	18-3742	18-3716	502	1992	18-3708-1	18-4231	18-4223	18-3741	18-3715
185	1978-80	18-3708-1	18-4231	18-4223	18-3741	18-3715	2.3	1987-90	18-3705	18-4228	18-4222	18-3742	18-3716
200	1979-81	18-3708-1	18-4231	18-4223	18-3741	18-3715	2.5	1982-86	18-3705	18-4228	18-4222	18-3742	18-3716
225	1978	18-3708-1	18-4231	18-4223	18-3741	18-3715	3	1982-89	18-3705	18-4228	18-4222	18-3742	18-3716
230	1979	18-3708-1	18-4231	18-4223	18-3741	18-3715	3	1990-92	18-3708-1	18-4231	18-4223	18-3741	18-3715
240	1978	18-3708-1	18-4231	18-4223	18-3741	18-3715	3.8	1981-85	18-3708-1	18-4231	18-4223	18-3741	18-3715
260	1979-81	18-3708-1	18-4231	18-4223	18-3741	18-3715	4.3	1985-92	18-3708-1	18-4231	18-4223	18-3741	18-3715
262	1987-89	18-3708-1	18-4231	18-4223	18-3741	18-3715	5	1982-92	18-3708-1	18-4231	18-4223	18-3741	18-3715
350	1988-91	18-3708-1	18-4231	18-4223	18-3741	18-3715	5.7	1979-92	18-3708-1	18-4231	18-4223	18-3741	18-3715
351	1992	18-3708-1	18-4231	18-4223	18-3741	18-3715	5.8	1989-92	18-3708-1	18-4231	18-4223	18-3741	18-3715
454	1990-92	18-3708-1	18-4231	18-4223	18-3741	18-3715	7.5	1987	18-3708-1	18-4231	18-4223	18-3741	18-3715

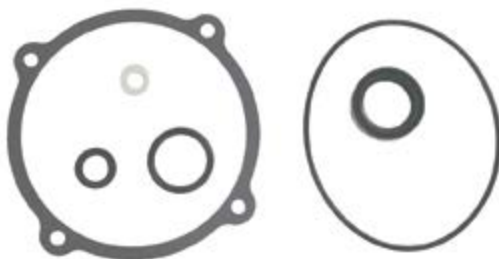

**18-2698
CLUTCH HOUSING SEAL KIT**

Fits: All models 1977 & below

-- CONTAINS --

Part #	Desc.	O.E. #	Qty.
18-7114	O-RING	302540	1
18-7400	O-RING	908194	1
18-7952	OIL SEAL	911019	1
18-2863	GASKET, COVER	308799	1
18-4248	GASKET, OIL DRAIN	311598	1
18-0939	GASKET, DIPSTICK	315189	1



**18-8360
CLUTCH HOUSING SEAL KIT**

Fits: All models 1978 & above

-- CONTAINS --

Part #	Desc.	O.E. #	Qty.
18-2060	OIL SEAL	321467	2
18-7114	O-RING	302540	1
18-7168	O-RING	202893	2
18-7400	O-RING	908194	1
18-2863	GASKET, COVER	308799	1
18-4248	GASKET, OIL DRAIN	311598	2
18-0939	GASKET, DIPSTICK	315189	1

HP	Year	Clutch Pack Seal Kit	HP	Year	Clutch Pack Seal Kit	HP	Year	Clutch Pack Seal Kit	HP	Year	Clutch Pack Seal Kit
80	1968-1969	18-2698	140	1980-1981	18-8360 ^③	190	1974-1977	18-2698	230	1980-1981	18-8360 ^②
90	All	18-2698	3.0L	1982-1985	18-8360	200	1966-1968	18-2698	235	All	18-2698
100	1972-1973	18-2698	155	1967-1972	18-2698	200	1979-1980	18-2698 ^①	240	1978	18-2698
120	1965-1978	18-2698	165	1972-1976	18-2698	200	1980-1981	18-8360 ^②	245	1972-1975	18-2698
120	1979-1980	18-2698 ^①	3.8L	1981-1983	18-8360	5.0L	1982-1985	18-8360	250	1979	18-2698
120	1980-1985	18-8360 ^③	170	1974	18-2698	210	1968-1970	18-2698	260	1979-1980	18-2698 ^①
2.5L	1982-1985	18-8360	175	1975-1977	18-2698	215	1971	18-2698	260	1980-1981	18-8360 ^②
140	1973-1978	18-2698	185	1967-1968	18-2698	225	All	18-2698	5.7L	1982-1985	18-8360
140	1979-1980	18-2698 ^①	185	1978	18-2698	230	1979-1980	18-2698 ^①			

① 1980 Models with the "C" suffix

② 1980 Models with "K" or "U" suffix

③ 1980 Models with "C1" suffix

**Zinc is for saltwater only applications.
Magnesium is for fresh water only applications.
Aluminum is for brackish water, or if boat is used in both fresh and salt environments.**



**⑤ 18-6019
ANODE**
Replaces: 982277, 982438
For intermediate housing on
Stringer Drive models



**⑤ 18-6020
ANODE**
Replaces: 976669
For Stringer Drive models with central
grounding point on boat hull



**⑤ 18-6024
④ 18-6024A
ANODE**
Replaces: 393023, 436745
(1982-87) For use on gearcases

④ Aluminum

⑤ Zinc



⑤ **18-6025**
ANODE
 Replaces: 433458, 398331



③ **18-6027**
ANODE
 Replaces: 392123
 For exhaust housing,
 V4 & V6 (1983-90)



③ **18-6028**
 ① **18-6028A**
 ② **18-6102**
ANODE
 Replaces: 984513,
 3853818, 3855412
 For use on Gearcases: 2.3L (1987-90),
 2.6L/3.5L/4.6L (1989), 3.0L /4.3L/5.0L/5.8L
 (1987-93), 5.7L (1987-92), 7.4L (1987-88)



③ **18-6029**
ANODE
 Replaces: 397768



③ **18-6095**
 ① **18-6095A**
ANODE
 Replaces: 431708
 For use on gearcases (1988-90)



③ **18-6101**
ANODE
 Replaces: 983494
 For: Cobra Lower Unit (1987)
 2.5, 3.0, 4.3, 5.0, 5.7



③ **18-6103**
 ① **18-6103A**
ANODE
 Replaces: 984547
 For use on Transom Mounts:
 2.3L/3.0L (1987-89), 2.6L (1989)



③ **18-6155Z**
ANODE KIT
 For: Cobra Drives except King Cobra

PKG. OF 5



18-3722
18-3722-9④
STAINLESS STEEL LOCKNUT
 Replaces: 121731
 (1/4" — 28)



18-2454
DRAIN PLUG
 Replaces: 3854539
 3/8" - 16 thread
 Uses O-ring 18-7145
 For: Cobra SX drives



18-2138
PIVOT PIN BEARING
 Replaces: 911787
COBRA
(2 per Drive)



18-7634
TRIM SENDER
 Replaces: 984748
 Fits: OMC Cobra



18-2663
LOWER UNIT SEAL KIT
 Replaces: 981797
 100-245 Stringer Unit (1968-77)

— CONTAINS —

Part #	Desc.	O.E. #	Qty.
18-0168	Grommet	908594	1
18-2012	Oil Seal	310599	4
18-2020	Oil Seal	310649	1
18-2058	Oil Seal	313353	2
18-2851	Swivel Bearing To Lower Gear Case Gsk.	313368	1
18-4248	Washer	311598	2
18-7120	O-Ring	307853, 322598	4
18-7129	O-Ring	314491	1
18-7135	O-Ring	310584	1
18-7167	O-Ring	310414	1



18-2666
UPPER UNIT SEAL KIT
 Replaces: 981799
 100-245 Stringer Unit (1968-72)

— CONTAINS —

Part #	Desc.	O.E. #	Qty.
18-0939	Upper Gearcase Gasket	315189	1
18-2073	Oil Seal	981268	4
NSS	Rubber Seal	907774	1
18-4248	Washer	311598	2
18-7103	O-Ring	308624	4
18-7107	O-Ring	313175	1
18-7121	O-Ring	308621	1
18-7134	O-Ring	303059	1
18-7146	O-Ring	554545	1
18-7173	O-Ring	910582	1
18-7198	O-Ring	308626	2
18-7158	O-Ring	310585, 310967	1
18-7172	O-Ring	553126	1



18-2671
LOWER UNIT SEAL KIT
 Replaces: 985612
 All 4 cyl. Cobra (1986-89)

— CONTAINS —

Part #	Desc.	O.E. #	Qty.
18-0880	Shift Cover Gasket	911878	1
18-0166	Grommet	911705	2
18-0190	Wiper	912157	1
18-4248	Washer	311598	2
18-7127	O-Ring	313446	1
18-7130	O-Ring	314728	1
18-7137	O-Ring	318372	1
18-7138	O-Ring	318717	3
18-7145	O-Ring	333572	2
18-7475	Quad Ring	332584	5
18-2001	Oil Seal	330137	2



18-2672
LOWER UNIT SEAL KIT
 Replaces: 984458, 985613, 439967
 All V6/V8 Cobra (1986-1991)

— CONTAINS —

Part #	Desc.	O.E. #	Qty.
18-0880	Shift Cover Gasket	911878	1
18-0166	Grommet	911705	2
18-0190	Wiper	912157	1
18-2002	Oil Seal	320862	2
18-4248	Washer	311598	2
18-7130	O-Ring	314728	1
18-7137	O-Ring	318372	1
18-7138	O-Ring	318717	3
18-7142	O-Ring	322119	1
18-7145	O-Ring	333572	2
18-7475	Quad Ring	332584	5
18-0440	Water Passage Gasket	915719	1

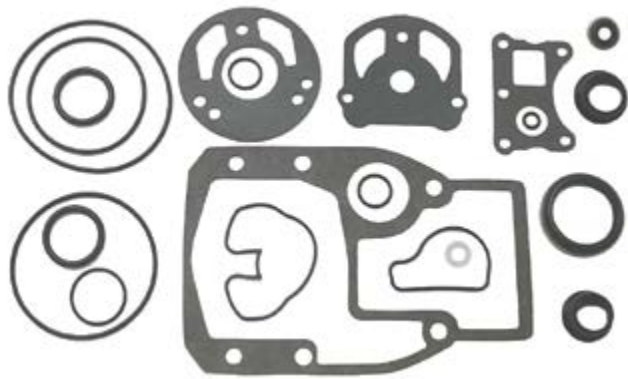

18-2673
UPPER UNIT SEAL KIT
 Replaces: 984459, 986364, 987603
 All Cobra (1986-89)

— CONTAINS —

Part #	Desc.	O.E. #	Qty.
18-0911	Water Pump Base Gasket	911698	1
18-0884	Water Cover Gasket	911733	1
18-0166	Grommet	911705	2
18-2067	Oil Seal	911685	1
18-2068	Oil Seal	3853655	1
18-2541	Rubber Seal	911704	1
18-2916	Water Pump Housing Gasket	911702	1
18-2918	Outdrive Gasket	915840	1
18-2996	Seal	911823	1
18-7107	O-Ring	313175	1
18-7116	O-Ring	303067	1
18-7138	O-Ring	318717	2
18-7153	O-Ring	—	2
18-7169	O-Ring	911686	1
18-7403	O-Ring	909316	1
18-7407	O-Ring	911700	1



18-2674
TRANSOM MOUNT SEAL KIT
 Replaces: 985518, 986423
 All Cobra (1986-89)

— CONTAINS —

Part #	Desc.	O.E. #	Qty.
18-2070	Oil Seal	911795	1
18-2138	Bearing	911787	3
18-2139	Bearing	911794	1
18-2533	Foam Seal	911797	1
18-2918	Outdrive Gasket	915840, 911836	1
18-2996	Seal	911823	1
18-4250	Washer	911820	2
18-7141	O-Ring	321117	12
18-7143	O-Ring	322501	1
18-7162	O-Ring	302337	1
18-7165	O-Ring	304174	1
18-7406	O-Ring	911311	3
18-7408	O-Ring	911718	2
18-7409	O-Ring	911871	1
18-7168	O-Ring	202893	1
18-8349	Seal	3852548	1



18-2783
LOWER UNIT SEAL KIT
 Replaces: 986629
 King Cobra Lower Unit - 1990



18-2791
GEARCASE SEAL KIT
 Replaces: 987251, 3850597
 Fits: 3.0L, 4.3L, 5.0L (1994), 3.2L (1992-93),
 5.7L (1992-94), 7.4L (1992-95), 8.2L (1992-93)

APPLICATION ON NEXT PAGE



SEAL KIT APPLICATION

Model	Year	Lower Gearcase Seal Kit	Upper Gearcase Seal Kit	Intermediate Housing Seal Kit	Transom Mount Seal Kit	Model	Year	Lower Gearcase Seal Kit	Upper Gearcase Seal Kit	Intermediate Housing Seal Kit	Transom Mount Seal Kit
2.3	1987-90	18-2671	18-2673	N/A	18-2674	165	1972	18-2663	18-2666	18-2668	N/A
2.5 ①	1982-86	—	—	N/A	N/A	165	1973-76	18-2663	—	N/A	N/A
2.5 ②	1986	18-2671	18-2673	N/A	18-2674	170	1974	18-2663	—	N/A	N/A
3 ①	1982-86	—	—	N/A	N/A	175	1975-77	18-2663	—	N/A	N/A
3 ②	1986-91	18-2671	—	N/A	N/A	185	1968	18-2663	18-2666	18-2668	N/A
4.3 ①	1985-86	—	—	N/A	N/A	185	1978-80	—	—	N/A	N/A
4.3 ②	1986-91	18-2672	18-2673	N/A	18-2674	190	1974-77	18-2663	—	N/A	N/A
3.8	1981-86	—	—	N/A	N/A	200	1968	18-2663	18-2666	18-2668	N/A
5 ①	1982-86	—	—	N/A	N/A	200	1979-81	—	—	N/A	N/A
5 ②	1986-91	18-2672	18-2673	N/A	18-2674	210	1968-70	18-2663	18-2666	18-2668	N/A
5.7 ①	1982-86	—	—	N/A	N/A	215	1971	18-2663	18-2666	18-2668	N/A
5.7 ②	1986-89	18-2672	18-2673	N/A	18-2674	225	1972	18-2663	18-2666	18-2668	N/A
5.7 ③	1990-91	18-2672	18-2673	N/A	18-2674	225	1973-76	18-2663	—	N/A	N/A
5.8	1989-90	18-2672	18-2673	N/A	18-2674	225	1978	—	—	N/A	N/A
7.5	1987	—	18-2673	N/A	18-2674	230	1979-81	—	—	N/A	N/A
80	1969	18-2663	18-2666	18-2668	N/A	235	1971	18-2663	18-2666	18-2668	N/A
90	1970	18-2663	18-2666	18-2668	N/A	235	1975-77	18-2663	—	N/A	N/A
100	1972	18-2663	18-2666	18-2668	N/A	240	1978	—	—	N/A	N/A
100	1973	18-2663	—	N/A	N/A	245	1972	18-2663	18-2666	18-2668	N/A
120	1968-72	18-2663	18-2666	18-2668	N/A	245	1973-75	18-2663	—	N/A	N/A
120	1973-77	18-2663	—	N/A	N/A	250	1979	—	—	N/A	N/A
120	1978-81	N/A	—	N/A	N/A	260	1979-81	—	—	N/A	N/A
140	1973-77	18-2663	—	N/A	N/A	262	1989	18-2672	18-2673	N/A	18-2674
140	1978-81	N/A	—	N/A	N/A	350	1988-89	18-2672	18-2673	N/A	18-2674
155	1968-72	18-2663	18-2666	18-2668	N/A	460	1988-89	—	18-2673	N/A	18-2674

① Except Cobra ② Cobra ③ Except L.E. N/A Not Applicable

OIL SEALS



Part #	O.E. #	Shaft Size	Dimensions (in)		Part #	O.E. #	Shaft Size	Dimensions (in)	
			O.D.	Width				O.D.	Width
18-0543	321895, 313507	1.540	1.926	0.243	18-2064	332205	0.730	1.130	0.194
18-0559	332585	0.285	0.357	0.940	18-2065	332261	0.625	1.375	0.195
18-2000	309989	1.375	2.000	0.313	18-2066	911019	1.000	1.375	0.435
18-2001	330137	1.125	1.624	0.250	18-2067	911685	2.000	2.509	0.315
18-2002	320862	1.188	1.692	0.250	18-2068	3853655	0.500	0.905	0.250
18-2005	313284	0.625	1.128	0.250	18-2068	915702	0.500	0.905	0.250
18-2012	310599	1.000	1.499	0.250	18-2068	916058	0.500	0.905	0.250
18-2016	0764337	1.187	1.875	0.250	18-2068	3853655	0.500	0.905	0.200
18-2018	0767970	1.000	1.375	0.250	18-2071	908065, 908852	1.500	2.125	0.250
18-2020	310649	2.500	3.000	0.250	18-2072	0765461, 908894, 908070	1.750	2.502	0.250
18-2022	303345	0.554	1.000	0.375	18-2073	907967, 981268	1.625	2.502	0.250
18-2023	313282	0.554	1.062	0.312	18-8349	3852548	1.375	2.186	0.500
18-2024	314167	0.425	0.937	0.312					
18-2025	318972	0.500	0.875	0.250					
18-2027	305306, 321459	0.625	1.125	0.250					
18-2030	321786	0.625	1.125	0.188					
18-2031	321787	0.625	1.125	0.312					
18-2033	321928	0.625	1.375	0.250					
18-2034	324639	0.437	0.937	0.188					
18-2058	313353	1.938	2.438	0.250					
18-2059	318223	0.750	1.126	0.200					
18-2060	321467	1.000	1.375	0.250					
18-2061	329922	0.822	1.375	0.195					
18-2062	329923	0.875	1.375	0.207					
18-2063	330327	0.625	1.124	0.188					



UPPER GEARCASE (Cobra)				
ENGINE	YEAR	OIL SEAL	DESC.	QTY
262 - 460	1988-89	18-2067	BC	1
262 - 460	1988-90	18-2068	WPS	1
2.3 - 7.5	1986-90	18-2068	WPS	1
2.3 - 7.5 ①	1986-90	18-2067	BC	1
① 5.7 '90 574 AMPWS, ARPWS BC Bearing Carrier Seal WPS Water Pump Seal				
LOWER GEARCASE (Stringer)				
ENGINE	YEAR	OIL SEAL	DESC.	QTY
80/90	1968-71	18-2066	BR,L	2
80/90	1968-71	18-2066	PS	2
88/90	1964-68	18-2012	BR	1
80 - 260	1968-81	18-2020	BR,U	1
80 - 260	1968-81	18-2058	BR,M	2
110 - 200 ①	1964-67	18-2012	BR	2
110 - 245 ①	1964-77	18-2012	PS	2
110/120 ②	1964-67	18-2012	BR	1
120 - 245	1968-77	18-2012	BR,L	2
120 - 260	1978-81	18-2060	BR,L	2
120/140	1978-81	18-2001	PS	2
155 ③	1967	18-2058	BR,M	2
155 ③	1967	18-2020	BR,U	1
185 - 260	1978-81	18-2002	PS	2
210 - 260 ④	1972-75	18-2066	IH	1
230/260 ④	1976	18-2060	IH	1
305/350/454 ④	1977-78	18-2060	IH	1
2.5/3.0	1982-86	18-2001	PS	2
2.5 - 5.7	1981-86	18-2020	BR,U	1
2.5 - 5.7	1981-86	18-2058	BR,M	2
2.5 - 5.7	1981-86	18-2060	BR,L	2
3.8 - 5.7	1981-86	18-2002	PS	2
① 110, 120 HP '64-67 Hvy. Duty Dr. ② Standard Drive ③ HU, HUE 16 C Models ④ Inboard BR Driveshaft Bearing Retainer Seal BR,U Driveshaft Bearing Retainer Upper Seal BR,M Driveshaft Bearing Retainer Middle Seal BR,L Driveshaft Bearing Retainer Lower Seal IH Impeller Housing Seal PS Prop Shaft Seal				

UPPER GEARCASE (Stringer)				
ENGINE	YEAR	OIL SEAL	DESC.	QTY
80 - 245	1968-72	18-2073	BGS	1
80 - 260	1969-81	18-2073	IH	2
88 - 200	1964-66	18-2000	BGS	1
90 ③	1967	18-2000	BGS	1
90 ④	1967	18-2073	BGS	1
100 - 245	1972-73	18-2073	BGS	1
100 - 260	1973-81	18-2072	BGS	2
120 ①	1967	18-2073	BGS	1
120 ②	1967	18-2000	BGS	1
120 ①	1967	18-2073	IH	2
120 - 210	1968	18-2073	IH	2
155	1967	18-2073	IH	2
155 ⑤	1967	18-2000	BGS	1
155	1967	18-2073	BGS	1
185	1967	18-2000	BGS	1
200 ⑥	1967	18-2000	BGS	1
200 ⑦	1967	18-2073	IH	2
200 ⑦	1967	18-2073	BGS	1
2.5 - 5.7	1981-86	18-2072	BGS	2
2.5 - 5.7	1981-86	18-2073	IH	2
① CU, CUE 16C Models ⑥ TU, TUE 15S Models ② CU15S Models ⑦ TU, TUE 16C Models ③ DU, DUE 14D Models BGS Ball Gear Shaft Seal ④ DU, DUE 15S Models IH Impeller Housing Seal ⑤ HU, HUE 15S Models				
LOWER GEARCASE (Cobra)				
ENGINE	YEAR	OIL SEAL	DESC.	QTY
262 - 460	1988-89	18-2002	PS	2
2.3	1990	18-2001	PS	2
2.3 - 3.0	1986-89	18-2001	PS	2
3	1990	18-2002	PS	2
4.3 - 7.5	1986-90	18-2002	PS	2
PS Prop Shaft Seal				
INTERMEDIATE HOUSING (Stringer)				
ENGINE	YEAR	OIL SEAL	DESC.	QTY
80 - 235	1964-71	18-2000	BG,O	1
80 - 245	1964-72	18-2001	BG,I	1
80 - 260 ②	1964-80	18-2066	CL	1
100 - 245	1972	18-2000	BG,O	2
100 - 260	1973-79	18-2016	BG,I	1
100 - 260	1973-81	18-2071	BG,O	2
120 - 260	1980-81	18-2016	BG,I	2
120 - 260 ①	1980-81	18-2060	CL	2
2.5 - 5.7	1981-86	18-2060	CL	2
2.5 - 5.7	1981-86	18-2016	BG,I	2
2.5 - 5.7	1981-86	18-2071	BG,O	2
CL Clutch ① 120, 140 '80C Models/185-260 '80 K&U Models ② C Models in '80 BG,I Driveshaft Ball Gear Inner Seal BG,O Driveshaft Ball Gear Outer Seal				



O-RINGS

I/O - OMC STERNDRIVE/COBRA - O-RINGS

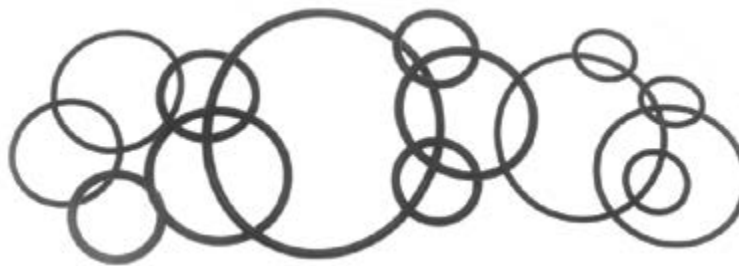

Part #	O.E. #	Dimensions (in)		Part #	O.E. #	Dimensions (in)	
		I.D.	Width			I.D.	Width
18-7100	② ⑤ 301877	.245	.155	18-7150	③ ⑤ 331380	.225	.115
18-7101	② ⑤ 305739	.250	.065	18-7150	③ ⑤ 334913	.225	.115
18-7102	② ⑤ 307450	.430	.065	18-7152	② ⑤ 307082	2.625	.135
18-7103	② ⑤ 308624	.920	.100	18-7153	① 3852565,		
18-7104	② ⑤ 308627	2.210	.135		911851	.0860	.100
18-7105	② ⑤ 311338	.750	.065	18-7155	② ⑤ 305270	1.620	.135
18-7107	② ⑤ 313175	4.750	.135	18-7156	② ⑤ 309731	1.185	.100
18-7108	② ⑤ 313893	2.550	.100	18-7158	② ⑤ 310585	.740	.100
18-7108	② ⑤ 338518	2.550	.100	18-7162	② ⑤ 302337	2.025	.135
18-7109	② ⑤ 317178	.214	.048	18-7164	② ⑤ 302537	1.375	.100
18-7111	① 301824	.197	.113	18-7165-9	② ⑤ 304174	.500	.065
18-7112	① 302493	1.170	.135	18-7167	② ⑤ 310414	3.625	.135
18-7114	② ⑤ 302540	1.000	.135	18-7168	② ⑤ 202893	.370	.065
18-7115	① 302588	1.735	.135	18-7169	② ⑤ 911686	3.500	.135
18-7116	① 303067	.360	.100	18-7170	① 307239	1.365	.135
18-7117	① 303360	1.060	.135	18-7172	② ⑤ 553126	3.250	.135
18-7118	② ⑤ 305242	.300	.135	18-7173	② ⑤ 310327	1.875	.135
18-7120	① 307853	.215	.065	18-7174	② ⑤ 326649	.620	.100
18-7120	① 332598	.215	.065	18-7178	② ⑤ 320140	.920	.135
18-7121	① 308621	3.100	.135	18-7180	② ⑤ 303347	.445	.090
18-7123	① 308876	2.235	.100	18-7198	② ⑤ 308626	1.430	.100
18-7126	① 313340	1.690	.100	18-7400	② ⑤ 908194	4.000	.100
18-7127	① 313446	3.315	.135	18-7401	② ⑤ 908383	2.485	.100
18-7128	① 313754	1.835	.100	18-7403	② ⑤ 909316	1.500	.100
18-7129	② ⑤ 314491	.970	.065	18-7404	② ⑤ 909747	.300	.100
18-7130	① 314728	2.125	.100	18-7406	② ⑤ 911311	0.250	.065
18-7133	② ⑤ 305123	3.780	.135	18-7407	② ⑤ 911700	4.125	.135
18-7134	② ⑤ 303059	.500	.100	18-7407	② ⑤ 3852531	4.125	.135
18-7135	① 310584	.750	.135	18-7408	② ⑤ 911718	1.060	.100
18-7137	② ⑤ 318372	0.320	.155	18-7409	② ⑤ 911871	1.175	.100
18-7138	② ⑤ 318717	1.500	.210	18-7413	② ⑤ 303191	.301	.070
18-7139	② ⑤ 319085	1.080	.210	18-7416	② ⑤ 329380	.612	.103
18-7140	② ⑤ 320303	2.750	.135	18-7417	② ⑤ 329381	.362	.103
18-7141	② ⑤ 321117	.180	.065	18-7440-1	④ 301967	.799	.103
18-7142	② ⑤ 322119	3.940	.135	18-7457	① 319662	1.799	.103
18-7143	② ⑤ 322501, 331188	1.310	.100	18-7461	① 308458	1.612	.103
18-7144	② ⑤ 326849	4.250	.135	18-7475	② ⑤ 332584	.250	.065
18-7145	② ⑤ 333572	.250	.100	18-7477	② ⑤ 909048	.480	.100
18-7146	② ⑤ 554545	1.120	.100	18-7510	① 321163	2.750	.070
18-7150	③ ⑤ 303598	.225	.115				

① Pkg. of 1 ② Pkg. of 5 ③ Pkg. of 10 ④ Indicates Quad Rings rather than O-Rings

TRANSOM MOUNT (Cobra)

TRANSOM MOUNT (Cobra) (Cont.)

ENGINE	YEAR	O-RING	DESC.	QTY.	ENGINE	YEAR	O-RING	DESC.	QTY.
262 - 460	1988-89	18-7165-9	SCS	1	2.3 - 7.5 ①	1986-90	18-7165-9	SCS	1
262 - 460	1988-89	18-7408	NP	2	2.3 - 7.5 ①	1986-90	18-7409	SC	1
262 - 460	1988-89	18-7409	SC	1	2.3 - 7.5	1986-90	18-7143	MB	1
262 - 460	1988-89	18-7406	PL	1					
262 - 460	1988-89	18-7168	BC	1					
262 - 460	1988-90	18-7162	UG	1					
262 - 460	1988-90	18-7143	MB	1					
2.3 - 7.5 ①	1986-90	18-7168	BC	1					
2.3 - 7.5	1986-90	18-7162	UG	1					
2.3 - 7.5 ①	1986-90	18-7406	PL	1					
2.3 - 7.5 ①	1986-90	18-7408	NP	2					

① 5.7 '90 574 AMPWS, ARPWS
BC Bell Crank Seal
MB Manifold Block Seal
UG Upper Gimbal Seal
SCS Shift Cable Seal
PL Plug Seal
NP Nipple Seal
SC Sleeve and Connector Seal

⑤ This product is priced per piece. To order priced per package, please add -9 to the part number.

UPPER GEARCASE (Cobra)				
ENGINE	YEAR	O-RING	DESC.	QTY
262 - 460	1988-89	18-7403	A,S	1
262 - 460	1988-89	18-7107	GHC	1
262 - 460	1988-89	18-7407	A,L	1
262 - 460	1988-90	18-7169	BC	1
350 - 460	1990	18-7116	OPF	1
350 - 460	1990	18-7407	BC	1
350 - 460	1990	18-7406	WDP	1
370	1988	18-7407	AB	1
460	1990	18-7407	BC	1
2.3 - 5.8	1990	18-7116	OPF	1
2.3 - 7.5	① 1986-90	18-7107	GHC	1
2.3 - 7.5	① 1986-90	18-7407	A,L	1
2.3 - 7.5	1986-90	18-7169	BC	1
2.3 - 7.5	① 1986-90	18-7403	A,S	1
5.7	② 1990	18-7406	WDP	1
5.7	② 1990	18-7407	BC	1

- ① 5.7 '90 574 AMPWS, ARPWS
- ② 574 PEPWS
- GHC** Gear Hsg. Cover Seal
- OPF** Oil Fill Plug Seal
- BC** Bearing Carrier Seal
- A,S** Adaptor, Small Seal
- A,L** Adaptor, Large Seal
- WDP** Water Drain Plug Seal
- AB** Anchor Block Seal

LOWER GEARCASE (Cobra)				
ENGINE	YEAR	O-RING	DESC.	QTY
262/350	1988-89	18-7475	PBHS	4
262/350	1988-89	18-7142	PBH	1
262 - 460	1988-89	18-7130	DS B	1
262 - 460	1988-89	18-7475	BSS	1
262 - 460	1988-89	18-7138	DS BH	3
262 - 460	1988-89	18-7137	SR	1
350 - 460	1990	18-7145	PL	1
370	1988	18-7130	SL	2
370/460	1988-89	18-7145	D&F S	2
2.3	1987	18-7145	D&F S	2
2.3	1990	18-7127	PBH	1
2.3 - 3.0	1986-89	18-7127	PBH	1
2.3/3.0	1988-90	18-7145	D&F S	2
2.5 - 5.7	1986	18-7145	D&F S	2
2.3 - 5.8	① 1986-90	18-7475	PBHS	4
2.3 - 7.5	① 1986-90	18-7475	BSS	1
2.3 - 7.5	① 1986-90	18-7138	DS BH	3
2.3 - 7.5	① 1986-90	18-7137	SR	1
2.3 - 7.5	① 1986-90	18-7130	DS B	1
3.0 - 5.8	① 1990	18-7142	PBH	1
4.3 - 5.8	1989-89	18-7142	PBH	1
5.7	② 1990	18-7145	PLUG	1

- ① 5.7 '90 574 AMPWS, ARPWS
- ② 574 PEPWS
- BSS** Bearing Setscrew Seal
- DS BH** Driveshaft Bearing Hsg. Seal
- DS B** Driveshaft Bearing Seal
- D&F S** Drain & Fill Screw Seal
- PBH** Prop Bearing Hsg. Seal
- PBHS** Prop Bearing Hsg. Screw Seal
- PL** Plug Seal
- SR** Shift Rod Seal
- SL** Sleeve Seal

POWER TILT AND TRIM (Cobra)				
ENGINE	YEAR	O-RING	DESC.	QTY
262 - 460	1988-90	18-7141	OL	12
262 - 460	1988-90	18-7102	PL	1
350 - 460	1988	18-7174	VSH	1
350 - 460	1988	18-7168	VS	4
350 - 460	1988	18-7174	VA,L	2
350 - 460	1988	18-7165-9	VA,S	2
2.3 - 7.5	1986-88	18-7174	VSH	1
2.3 - 7.5	1986-88	18-7168	VS	4
2.3 - 7.5	1986-88	18-7174	VA,L	2
2.3 - 7.5	1986-88	18-7165-9	VA,S	2
2.3-7.5	1986-90	18-7102	PL	1
2.3-7.5	1986-90	18-7141	OL	12

- PL** Plug Seal
- VS** Valve Seat Assy. Seal
- VA,L** Valve Assy., Large Seal
- VA,S** Valve Assy., Small Seal
- VSH** Valve Seat Hsg. Seal
- OL** Oil Line Seal

OIL AND COOLING SYSTEM (Cobra)				
ENGINE	YEAR	O-RING	DESC.	QTY
262/454	1989-90	18-7135	AR	1
262 - 460	1988-90	18-7116	ODF	1
350/460	1988-90	18-7135	AR	1
370	1988	18-7162	THERM	1
2.3 - 5.8	1988-90	18-7116	ODF	1
4.3	① 1990	18-7135	AR	1
7.5	1987	18-7135	AR	1

- ① V-4 Only
- ODF** Oil Drain Fitting Seal
- AR** Adapter Retainer Seal
- THERM** Thermostat Seal

POWERHEAD (Stringer)				
ENGINE	YEAR	O-RING	DESC.	QTY
80/90	1969-71	18-7108	WP	1
88	1964	18-7133	CCH	3
88/90	1964-68	18-7120	CCHS	4
90	1965-68	18-7133	CCH	4
120/140	1977-80	18-7114	CP	1
120 - 235	1976	18-7114	CP	1

- WP** Water Pump Seal
- CCH** Crankcase Head Seal
- CCHS** Crankcase Head Screw Seal
- CP** Coupling Seal

INTERMEDIATE HOUSING (Stringer)				
ENGINE	YEAR	O-RING	DESC.	QTY
80	1968	18-7162	SL	1
80 - 90	1964-68	18-7174	WT	1
80 - 210	1964-70	18-7123	BGR	1
80 - 245	① 1964-72	18-7174	PS	1
80 - 260	1964-81	18-7198	COV	2
80 - 260	1964-81	18-7114	WR	1
80 - 260	1969-81	18-7162	SL	1
88	1964	18-7104	TH	1
88	1964	18-7174	TC	1

INTERMEDIATE HOUSING (Stringer) (Cont.)				
ENGINE	YEAR	O-RING	DESC.	QTY
90 - 235	1970-71	18-7158	DS	1
90 - 235	② 1971	18-7123	BGR	1
100 - 260	1973-81	18-7401	BGR	1
100 - 260	1973-81	18-7400	TUC	1
120	③ 1967	18-7162	SL	1
120 - 210	1968	18-7162	SL	1
120/140	1981	18-7168	FS	3
155	④ 1967	18-7162	SL	1
2.5 - 5.7	1981-86	18-7400	TUC	1
2.5 - 5.7	1981-86	18-7198	COV	2
2.5 - 5.7	1981-86	18-7114	WR	1
2.5 - 5.7	1981-86	18-7401	BGR	1
2.5 - 5.7	1981-86	18-7162	SL	1
2.5 - 5.7	1982	18-7168	FS	3

- ① Rope or Pull-Pull Steering Models
- ② All 90/120, 155, 210 EX Models/235 XUFM20S prior to S/N 202880 and 235 XUFM20S prior to S/N 204600
- ③ CU, CUE 16C
- ④ 120, 155, 215, 20D Models/235 XUFR20S S/N 202880 & up and 235 XUFM20S S/N 204600 & up 235 20D all Models
- COV** Pivot Cap Cover Seal
- BGR** Ball Gear Retainer Seal
- DS** Driveshaft to Hsg. Seal
- TC** Driveshaft Tube Cover Seal
- TH** Driveshaft Tube to Hsg.
- FS** Fill Screw Seal
- PS** Pulley Shaft
- SL** Sleeve to Hsg. Seal
- TUC** Tilt Unit Cover Seal
- WT** Water Tube Seal
- WR** Worm Gear Retainer Seal

UPPER GEARCASE (Stringer)

ENGINE	YEAR	O-RING	DESC.	QTY
80 - 90	1968-71	18-7158	BG	1
80 - 90	1964-68	18-7174	IH	1
80 - 245	① 1964-72	18-7103	WG	1
80 - 245	① 1964-74	18-7134	G	1
80 - 260	1964-81	18-7172	IH	1
80 - 260	1964-81	18-7121	BGR	1
80 - 260	1968-80	18-7173	WW	1
80 - 260	② 1968-81	18-7107	WW	1
90	③ 1967	18-7107	WW	1
90 - 200	1964-67	18-7128	CAP	1
90 - 200	1965-67	18-7173	WW	2
90 - 245	④ 1967-72	18-7146	BG	1
100 - 245	1973-75	18-7114	WS	1
100 - 260	1973-81	18-7129	DS IH	1
110 - 120	⑤ 1964-67	18-7158	IH	1
110 - 120	⑥ 1964-67	18-7174	IH	1
120 - 200	⑦ 1967	18-7107	WW	1
120 - 235	1968-71	18-7158	IH	1
120 - 260	1975-81	18-7477	G	1
150 - 210	1964-67	18-7158	IH	1
2.5/3.0	1982	18-7168	OP	1
2.5 - 5.7	1981-86	18-7477	G	1
2.5 - 5.7	1981-86	18-7172	IH	1
2.5 - 5.7	1981-86	18-7107	WW	1
2.5 - 5.7	1981-86	18-7121	BGR	1
2.5 - 5.7	1981-86	18-7129	DS IH	1

UPPER GEARCASE (Stringer) (Cont.)

- ① Rope or Pull-Pull Steering Models
- ② 155 HP 1968 HU, HUE 16C
- ③ DU, DUE 15S
- ④ 90 HP '67 DU, DUE 15S/120 and 200 '67 16C Models
- ⑤ Heavy Duty Drive
- ⑥ Standard Gearcase
- ⑦ 16C Models
- BG** Ball Gear Seal
- BGR** Ball Gear Retainer Seal
- DS IH** Driveshaft Impeller Hsg. Seal
- IH** Impeller Hsg. Seal
- CAP** Gear Hsg. Cap Seal
- OP** Oil Plug Seal
- WR** Steering Worm Wheel Retainer Seal
- WS** Steering Worm Wheel Spacer Seal
- WG** Steering Worm Wheel Gear Seal
- WW** Steering Worm Wheel Seal
- G** Gear Seal

LOWER GEARCASE (Stringer)

ENGINE	YEAR	O-RING	DESC.	QTY
80 - 90	1964-69	18-7120	PBH S	4
80 - 90	1964-71	18-7152	PBH	1
80 - 90	1964-71	18-7115	BR	1
80 - 90	1964-71	18-7174	DS	1
88/90	1964-68	18-7173	DSB	2
90 - 245	1970-77	18-7120	PBH S	4
100 - 245	1968-72	18-7135	BR	1
100 - 245	1969-77	18-7167	PBH	1
110/120	② 1964-67	18-7167	PBH	1
110/120	① 1964-67	18-7174	DS	1
110/120	② 1964-67	18-7135	BR	1
110/120	① 1964-67	18-7152	PBH	1
110/120	① 1964-67	18-7173	DSB	2
110/120	① 1964-67	18-7115	BR	1
120	① 1964-67	18-7120	PBH S	4
120/140	1978-81	18-7127	PBH	1
120/140	1978	18-7156	SA,L	2
120 - 235	1977	18-7129	DS	1
120 - 240	1978	18-7178	SA,S	1
120 - 260	1978-81	18-7130	BR	1
120 - 260	1978-81	18-7102	PIN	1
120 - 260	1978-81	18-7109	PBH S	4
120 - 260	1978-81	18-7404	PIN	1
120 - 260	1979-81	18-7120	BSS	1
120 - 260	1981	18-7168	D&F S	1
150 - 200	1964-67	18-7135	BR	1
150 - 210	1964-68	18-7167	PBH	1
185 - 240	1978	18-7403	SA,L	2
185 - 260	1978-81	18-7142	PBH	1
2.5 - 5.7	1981-82	18-7168	D&F S	1
2.5 - 5.7	1981-83	18-7109	PBH S	4
2.5 - 5.7	1981-86	18-7130	BR	1
2.5 - 5.7	1981-86	18-7102	PIN	1
2.5 - 5.7	1981-86	18-7404	PIN	1
2.5 - 5.7	1981-86	18-7120	BSS	1
2.5 - 5.7	1981-86	18-7142	PBH	1
2.5/3.0	1982-86	18-7127	PBH	1
3.8	1981	18-7101	OSV	1

- ① Standard Drive
- ② Heavy Duty Drive
- OSV** Oil Stem Valve Seal
- PIN** Pinion Shaft Seal
- BR** Driveshaft Bearing Retainer Seal
- DS** Driveshaft Seal
- PBH** Prop Bearing Hsg. Seal
- DSB** Driveshaft Bushing Seal
- PBH S** Prop Bearing Hsg. Screw Seal
- D&F S** Drain & Fill Screw Seal
- SA,L** Shift Assy., Large Seal
- SA,S** Shift Assy., Small Seal
- BSS** Bearing Set Screw Seal

TUNE-UP APPLICATION FOR GAS ENGINE MODELS



Model No.	Oil Filter	Fuel Filter	Impeller	Drive Belt
MB 10 A	18-7878-1	—	18-3080	—
BB 30	18-7878-1	—	18-3080	—
BB 100	18-7878-1	—	18-3080	—
MB 18	18-7878-1	—	18-3080	—
AQ 60 F	18-7878-1	—	18-3080	—
MB 18 F	18-7878-1	—	18-3080	—
AQ 90	18-7878-1	—	18-3080	—
AQ 95	18-7878-1	—	18-3080	—
AQ 100	18-7878-1	—	18-3080	—
AQ 95A	18-7878-1	—	18-3080	—
AQ 110	18-7878-1	—	18-3080	—
AQ 120	18-7878-1	—	18-3080	—
BB 115 A	18-7878-1	—	18-3080	—
BB 115 B	18-7878-1	—	18-3080	—
BB 115 C	18-7878-1	—	18-3080	—
MB 20 A	18-7878-1	—	18-3080	—
MB 20 B	18-7878-1	—	18-3080	—
MB 20 C	18-7878-1	—	18-3080	—
AQ 115 A	18-7878-1	—	18-3080	—
AQ 115 B	18-7878-1	—	18-3080	—
AQ 130 A	18-7878-1	—	18-3080	—
AQ 130 B	18-7878-1	—	18-3080	—
AQ 130 C	18-7878-1	—	18-3080	—
AQ 130 D	18-7878-1	—	18-3080	—
BB 165 A	18-7878-1	—	18-3075	18-4044
BB 170 A	18-7878-1	—	18-3075	18-4044
BB 170 B	18-7878-1	—	18-3075	18-4044
BB 170 C	18-7878-1	—	18-3075	18-4044
AQ 165 A	18-7878-1	—	18-3075	18-4044
AQ 170 A	18-7878-1	—	18-3075	18-4044
AQ 170 B	18-7878-1	—	18-3075	18-4044
AQ 170 C	18-7878-1	—	18-3075	18-4044
AQ 120 B	18-7878-1	18-7862 18-7858	18-3075	18-4044
AQ 125 A	18-7878-1	18-7862 18-7858	18-3075	18-4044
AQ 125 B	18-7878-1	18-7862 18-7858	18-3075	18-15435
AQ 131 A	18-7878-1	18-7862 18-7858	18-3075	18-15435
AQ 131 B	18-7878-1	18-7862 18-7858	18-3075	18-15435
AQ 131 C	18-7878-1	18-7862 18-7858	18-3075	18-15435
AQ 131 D	18-7878-1	18-7862 18-7858	18-3075	18-15435
230A	18-7878-1	18-7862 18-7858	18-3075	18-15435
230B	18-7878-1	18-7862 18-7858	18-3075	18-4044

Model No.	Oil Filter	Fuel Filter	Impeller	Drive Belt
BB 140 A	18-7878-1	18-7862 18-7858	18-3075	18-4044
AQ 140 A	18-7878-1	18-7862 18-7858	18-3075	18-4044
BB 145 A	18-7878-1	18-7862 18-7858	18-3075	18-4044
AQ 145 A	18-7878-1	18-7862 18-7858	18-3075	18-4044
AQ 145 B	18-7878-1	18-7862 18-7858	18-3075	18-15435
AQ 151 A	18-7878-1	18-7862 18-7858	18-3075	18-15435
AQ 151 B	18-7878-1	18-7862 18-7858	18-3075	18-15435
AQ 151 C	18-7878-1	18-7862 18-7858	18-3075	18-15435
250 A	18-7878-1	18-7862 18-7858	18-3075	18-4044
250 B	18-7878-1	18-7862 18-7858	18-3075	18-4044
AQ 171 A	18-7878-1	18-7862 18-7858	18-3075	18-15435
AQ 171 C	18-7878-1	18-7862 18-7858	18-3075	18-15435
251 A	18-7878-1	18-7862 18-7858	18-3075	18-4044
3.0 GL	18-7824-2	—	18-3060	—
3.0 GS	18-7824-2	—	18-3060	—
AQ 175 A	18-7879-1	18-7862 18-7858	18-3081	18-4046
430 A	18-7879-1	18-7862 18-7858	18-3081	18-4046
430 B	18-7879-1	18-7862 18-7858	18-3081	18-4046
AQ 190A	18-7875	—	18-3061	—
AQ 200 B	18-7824-2	18-7862 18-7858	18-3060	18-4046 Ⓢ
AQ 200 C	18-7824-2	18-7862 18-7858	18-3060	18-4046 Ⓢ
AQ 200 D	18-7824-2	18-7862 18-7858	18-3081	18-4046
AQ 200 F	18-7824-2	18-7862 18-7858	18-3081	18-4046
AQ 205 A	18-7879-1	18-7845 18-7858 18-7845	—	18-4046
431 A	18-7879-1	18-7858	—	18-4046
431 B	18-7879-1	18-7845 18-7858	18-3081	18-4046
432 A	18-7879-1	18-7845 18-7858	18-3081	—
434 A	18-7879-1	18-7845 18-7858	18-3081	—
4.3 GL	18-7879-1	—	18-3060	—

Ⓢ Alternator

TUNE-UP APPLICATION FOR GAS ENGINE MODELS



Model No.	Oil Filter	Fuel Filter	Imeller	Drive Belt
4.3 GS	18-7879-1	—	18-3060	—
4.3 GI	18-7879-1	—	18-3081	—
AQ 211 A	18-7824-2	18-7858	18-3081	18-4046
500 A	18-7824-2	18-7845 18-7858	18-3081	18-4046
500 B	18-7824-2	18-7845 18-7858	18-3081	18-4046
AQ 225 B	18-7824-2	18-7862	18-3060	18-4046 ⓐ
AQ 225 C	18-7824-2	18-7862 18-7858	18-3060	18-4046 ⓐ
AQ 225 D	18-7824-2	18-7862 18-7858	—	18-4046
AQ 225 E	18-7824-2	18-7862 18-7858	—	18-4046
AQ 225 F	18-7824-2	18-7862 18-7858	—	18-4046
BB 225 A	18-7824-2	18-7862 18-7858	18-3081	—
BB 225 B	18-7824-2	18-7862 18-7858	18-3081	18-4046
BB 225 C	18-7824-2	18-7845 18-7858	18-3081	18-4046
AQ 231 A	18-7824-2	18-7845 18-7858	18-3081	18-4046
AQ 231 B	18-7824-2	18-7845 18-7858	18-3081	18-4046
BB 231 A	18-7824-2	18-7845 18-7858	—	18-4046
501 A	18-7824-2	18-7845 18-7858	18-3081	18-4046
501 B	18-7824-2	18-7845 18-7858	18-3081	18-4046
5.0 FL	18-7875	—	18-3060	18-3081
5.0 FI	18-7875	—	18-3060	18-3081
5.7 GL	18-7824-2	—	18-3060	—
5.7 GI	18-7824-2	—	18-3060	—
5.8 FL	18-7875	—	18-3060	18-3081
5.8 FI	18-7875	—	18-3060	18-3081
5.8 FSI	18-7875	—	18-3060	18-3081
AQ 240 A	18-7875	—	18-3061	—
AQ 255 A	18-7824-2	18-7862 18-7858	—	18-4046
AQ 255 B	18-7824-2	18-7862 18-7858	18-3081	18-4046

Model No.	Oil Filter	Fuel Filter	Imeller	Drive Belt
AQ 260 A	18-7824-2	18-7862 18-7858	18-3081	18-4046
AQ 260 B	18-7824-2	18-7862 18-7858	—	18-4046
BB 260 A	18-7824-2	18-7862 18-7858	18-3081	18-4046
BB 260 B	18-7824-2	18-7862 18-7858	18-3081	18-4046
BB 260 C	18-7824-2	18-7862 18-7858	18-3081	18-4046
BB 261 A	18-7824-2	18-7845 18-7858	18-3081	18-4046
AQ 271 A	18-7824-2	18-7845 18-7858	18-3081	18-4046
AQ 271 B	18-7824-2	18-7845 18-7858	18-3081	18-4046
AQ 271 C	18-7824-2	18-7845 18-7858	18-3081	18-4046
AQ 271 D	18-7824-2	18-7845 18-7858	18-3081	18-4046
570 A	18-7824-2	18-7845 18-7858	18-3081	18-4046
572 A	18-7824-2	18-7845 18-7858	18-3081	18-4046
570 A/MS 4A	18-7824-2	18-7845 18-7858	18-3081	18-4046
AQ 280 A	18-7824-2	18-7862 18-7858	18-3081	18-4046
AQ 290 A	18-7824-2	18-7862 18-7858	18-3081	18-4046
AQ 311 A	18-7824-2	18-7845 18-7858	18-3081	18-4046
AQ 311 B	18-7824-2	18-7845 18-7858	18-3081	—
571 A	18-7824-2	18-7858	18-3081	18-4046
740 A	—	18-7845	—	—
740 B	18-7824-2	18-7845	—	—
7.4 GL	18-7824-2	—	18-3081 18-3060	—
7.4 GI	18-7824-2	—	18-3081	—
7.4 GSI	18-7824-2	—	18-3081	—
8.2 GL	18-7824-2	—	18-3081 18-3060	—

ⓐ Alternator

VOLVO PENTA APPLICATION GUIDE

TUNE-UP APPLICATION FOR DIESEL ENGINE MODELS



Model No.	Oil Filter	Fuel Filter	Imeller	Drive Belt
2001, B	18-7884	18-7858	18-3076	—
2002, B	18-7884	18-7858	18-3076	—
2003, B	18-7884	18-7858	18-3076	—
2003 T,TB	18-7884	18-7858	18-3081	—
MD 2010 A,B	—	18-7858	18-3079	—
MD 2020 A,B	—	18-7858	18-3079	—
MD 2030 A,B	—	18-7858	18-3080	—
MD 2040 A,B	—	18-7858	18-3080	—
MD 1	—	—	18-3079 ②	—
MD 1 B	18-7884	—	18-3079	—
MD 2	18-7884	—	18-3079 ③	—
MD 2 B	18-7884	—	18-3079	—
AQD 2 B	18-7884	—	18-3079	—
MD 3 B	18-7884	—	18-3080	—
MD 5 A	18-7884	—	18-3076	—
MD 5 B	18-7884	—	18-3076	—
MD 5 C	18-7884	—	18-3076	—
MD 6 A	18-7884	—	18-3079	—
MD 6 B	18-7884	—	18-3076	—
MD 7 A	18-7884	—	18-3076	—
MD 7 B	18-7884	—	18-3076	—
MD 11 C	18-7884	—	18-3076	—
MD 11 D	18-7884	—	18-3076	—
MD 17 C	18-7884	—	18-3080	—
MD 17 D	18-7884	—	18-3080	—
MD 22 A	—	—	18-3081	—
MD 22 L-A	—	—	18-3081	—
TMD 22 A	—	—	18-3081	—
AQD 21 A	—	18-7858	18-3081 ④ 18-3075 ⑤	— 18-15460
MD 21 A	—	18-7858	18-3081 ④ 18-3075 ⑤	— 18-15460
AQD 21 B	—	18-7858	18-3081 ④ 18-3075 ⑤	— 18-15460
MD 21 B	—	18-7858	18-3081 ④ 18-3075 ⑤	— 18-15460
AQD 32 A	—	18-7858	18-3077	—
MD 32 A	—	18-7858	18-3077	—
MD 30 A	18-7878-1	—	18-3077	—
TMD 30 A	18-7878-1	—	18-3077	—
TAMD 30 A	18-7878-1	—	18-3077	—
AQAD 30 A	18-7878-1	—	18-3077	—
MD 31 A	18-7878-1	—	18-3077	—
TMD 31 A	18-7878-1	—	18-3077	—
AQAD 31 A	18-7878-1	—	18-3077	—
AD 31 A	18-7878-1	—	18-3077	—
TMD 31 B	18-7878-1	—	18-3077	—
TAMD 31 B	18-7878-1	—	18-3077	—
AD 31 B	18-7878-1	—	18-3077	—

Model No.	Oil Filter	Fuel Filter	Imeller	Drive Belt
TMD 31 D	18-7878-1	—	18-3077	—
TAMD 31 D	18-7878-1	—	18-3077	—
AD 31 D	18-7878-1	—	18-3077	—
AD 31 XD	18-7878-1	—	18-3077	—
TMD 31 L-A	18-7878-1	—	18-3077	—
TAMD 31 P,L,M-A	18-7878-1	—	18-3077	—
AD 31 P,L-A	18-7878-1	—	18-3077	—
MD 40 A	—	—	18-3077	—
TMD 40 A	—	—	18-3077	—
AQD 40 A	—	—	18-3077	—
TAMD 40 A	—	—	18-3078	—
AQAD 40 A	—	—	18-3078	—
TMD 40 B	—	—	18-3077	—
TAMD 40 B	—	—	18-3078	—
AQAD 40 B	—	—	18-3078	—
TMD 40 C	—	—	18-3077	—
TMD 41 A	—	—	18-3077	—
AQD 41 A	—	—	18-3077	—
D 41 A	—	—	18-3077	—
TAMD 41 A	—	—	18-3077	—
AQAD 41 A	—	—	18-3077	—
AD 41 A	—	—	18-3077	—
TMD 41 B	—	—	18-3077	—
D 41 B	—	—	18-3077	—
TAMD 41 B	—	—	18-3077	—
AD 41 B	—	—	18-3077	—
KAMD 42 A	—	—	18-3077	—
KAD 42 A	—	—	18-3077	—
TMD 41 D	—	—	18-3077	—
D 41 D	—	—	18-3077	—
TAMD 41 D	—	—	18-3077	—
AD 41 D	—	—	18-3077	—
TMD 41 L-A	—	—	18-3077	—
D 41 L-A	—	—	18-3077	—
TAMD 41 P,L,M,H-A	—	—	18-3077	—
KAMD 42 B	—	—	18-3077	—
KAD 42 B	—	—	18-3077	—
KAMD 42 P-A	—	—	18-3077	—
KAD 42 P-A	—	—	18-3077	—

② S/N 14016 & up
 ③ S/N 4211- & up
 ④ S/N 103386 & below
 ⑤ S/N 103387 & up



**18-5246
TUNE-UP KIT**
For: Delco HVS V-6 Distributors



**18-5247
TUNE-UP KIT**
Replaces: 898253T29
For: Delco HVS V-8 Distributors



**18-5256
TUNE-UP KIT**
— CONTAINS —

Part #	O.E. #	Description
18-5314	835304	Contact Set
18-5338	835308-8	Condenser
18-5411	841243	Rotor



**18-5260
TUNE-UP KIT**
— CONTAINS —

Part #	O.E. #	Description
18-5303	835705, 855846-2	Contact Set
18-5345	835704	Condenser
18-5403	855845	Rotor

Prestolite



**18-5264
TUNE-UP KIT**
— CONTAINS —

Part #	O.E. #	Description
18-5303	835705, 855846-2	Contact Set
18-5345	835704	Condenser
18-5425	834975	Rotor

V-8 with Prestolite clip-down cap



**18-5265
TUNE-UP KIT**
— CONTAINS —

Part #	O.E. #	Description
18-5305	243799, 1306169,	Contact Set
	243460	
18-5348	834560	Condenser
18-5428	243903	Rotor



**18-5266
TUNE-UP KIT**
Fits: Flame Thrower Distributors 18-5481, 18-5482, 18-5483, 18-5477, 18-5478, 18-5479



**18-5284
TUNE-UP KIT**
— CONTAINS —

Part #	O.E. #	Description
18-5305	243799, 1306169,	Contact Set
	243460	
18-5349	841262	Condenser
18-5428	243903	Rotor

Bosch 4 cyl.



**18-5303
CONTACT SET**
Replaces: 835705, 855846-2



**18-5305
CONTACT SET**
Replaces: 241664, 243460, 243799, 1306169



**18-5306
CONTACT SET**
Replaces: 240149



**18-5310
CONTACT SET**
Replaces: 818701-5



**18-5314
CONTACT SET**
Replaces: 835304



**18-5338
CONDENSER**
Replaces: 835308



**18-5345
CONDENSER**
Replaces: 835704



**18-5349
CONDENSER**
Replaces: 841262
For: Bosch Distributors



**18-5348
CONDENSER**
Replaces: 834560



**18-5245
ROTOR**
Replaces: 3858977
For: Delco HVS Distributors



**18-5402
ROTOR**
Replaces: 3862014
For: Delco EST V-8 Distributors



**18-5403
ROTOR**
Replaces: 855845, 841907, 3853801



**18-5404-1
ROTOR**

SEE PAGES 946-948 FOR APPLICATION

① Items ending in "D" are Display Packaged - Regular number is Non-Display

 <p>18-5405 ROTOR Replaces: 33854549, 3862014 V-8 Fits new GM style "Module in Cap"</p>	 <p>18-5406 ROTOR Replaces: 3854261 For: 3.0L Delco EST "Module in Cap"</p>	 <p>18-5408 ROTOR Replaces: 3854311 For: 4.3L V6 Delco EST "Module in Cap"</p>	 <p>18-5411 ROTOR Replaces: 841243</p>	 <p>18-5413 ROTOR Replaces: 3854218 For: 5.0L FI, FL, 5.8L FL, FI, FSI</p>
 <p>18-5419 ROTOR Replaces: 818525</p>	 <p>18-5425 ROTOR Replaces: 834975</p>	 <p>18-5428 ROTOR Replaces: 243903</p>	 <p>18-29322 CAP & ROTOR KIT Replaces: 3854217, 3854215 Fits: Ford HEI Distributors</p>	 <p>18-5248 DISTRIBUTOR CAP Replaces: 3854217 For: 5.0FIPMDA, 5.0FIPMDM, 5.8FIPMDA, 5.8FIPMDM, 5.0FIPHUCE, 5.0FIPHUCE, 5.0FIPHUCE, 5.0FIPHURCE, 5.0FIPHURCE, 5.0FLPHUB, 5.0FLPHUC, 5.0FLPHUE, 5.0FLPHUR, 5.0FLPHUS, 5.8FIHU, 5.8FIP</p>
 <p>18-5352 DISTRIBUTOR CAP Replaces: 841070, 3853815</p>	 <p>18-5353 DISTRIBUTOR CAP Replaces: 841926</p>	 <p>18-5354 DISTRIBUTOR CAP Replaces: 3854548 For: V-8 GM Delco EST "Module in Cap"</p>	 <p>18-5356 DISTRIBUTOR CAP Replaces: 243797 Bosch</p>	
 <p>18-5357 DISTRIBUTOR CAP Replaces: 243632, 870690, 1243632</p>	 <p>18-5358 DISTRIBUTOR CAP Replaces: 841263 Bosch</p>	 <p>18-5361 DISTRIBUTOR CAP Replaces: 3854260 For: 3.0L Delco EST "Module in Cap"</p>	 <p>18-5362 DISTRIBUTOR CAP Replaces: 3854331 For: 4.3L V6 Delco EST "Module in Cap"</p>	
 <p>18-5369 DISTRIBUTOR CAP Replaces: 835702 with 18-5399 Gasket</p>	 <p>18-5375 DISTRIBUTOR CAP Replaces: 841244</p>	 <p>18-5393 DISTRIBUTOR CAP Replaces: 241669</p>	 <p>18-5394 DISTRIBUTOR CAP Replaces: 243658</p>	 <p>18-5473 DISTRIBUTOR CAP Black Distributor Cap with Male Terminals for Flamethrower Distributors</p>

SEE PAGES 946-948 FOR APPLICATION

 <p>18-5243 DISTRIBUTOR CAP Replaces: 3859019 For: Delco HVS V-6 Distributors</p>	 <p>18-5244 DISTRIBUTOR CAP Replaces: 3858975 For: Delco HVS V-8 Distributors</p>	 <p>18-7492 COIL Replaces: 3854161 For: 1996 applications</p>	 <p>18-7493 COIL Replaces: 3859078 For: 8.1L 2001-2007</p>
 <p>18-5745 IGNITION COIL Replaces: 3287677 Fits: AQ171A, AQ171C 251A (1988-92)</p>	 <p>18-7648 IGNITION COIL Replaces: 3861267 Fits: 8.1Gi-A, 8.1Gi-B, 8.1Gi-BF, 8.1Gi-C, 8.1Gi-CF, 8.1Gi-D, 8.1Gi-DF, 8.1GSi-A, 8.1GXi-A, 8.1GXi-AF, 8.1GXi-B, 8.1GXi-BF, 8.1GXi-C</p>	 <p>18-5433 IGNITION COIL Replaces: 835998 Uses External Resistor</p>	 <p>18-5436 IGNITION COIL 3.0 ohm Replaces: 35254 Has Internal Resistor</p>
<div style="display: flex; justify-content: space-between;"> <div data-bbox="196 806 553 1157">  <p>18-5437 IGNITION COIL Replaces: 3852217 Metal Encased - 12 Volt Uses External Resistor (For All Applications) For: 1990 & prior stern drives with breaker point ignition</p> </div> <div data-bbox="553 806 873 1157">  <p>18-5443 IGNITION COIL Replaces: 3854002 3.0L/4.3L/5.7L/7.4L</p> </div> <div data-bbox="873 806 1203 1157">  <p>18-5107-1 IGNITION MODULE Replaces: 3854003</p> </div> </div>			
 <p>18-5108 PICK-UP COIL SENSOR Replaces 3854001 For: GM EST</p>	 <p>18-7757 THROTTLE POSITION SENSOR Replaces: 3855296 Fits: 1995-2001</p>	 <p>18-7642 PICK-UP ASSEMBLY Replaces: 3863130 Fits: 3.0, 4.3, 5.0, 5.7L models (2002-07)</p>	 <p>18-7706 CRANKSHAFT POSITION SENSOR Replaces: 3858979 Fits: 4.3, 5.0, 5.7L models</p>

FEATURES

- ★ Oil filled for better cooling and long life
- ★ Low resistance and improved turn ratios produces the higher voltage needed to run larger spark plug gaps for added power and better fuel economy
- ★ More windings maximize energy and reliability over the full RPM range
- ★ Fits existing brackets for easy installation

 <p>18-5466 HI-PERFORMANCE IGNITION COIL 1.5 ohm (oil filled), black - 8 cylinder: Flame-Thrower 40,000 volt coil. ★ <i>Designed for use with the original Ignitor Electronic Conversion Kits</i> ★ <i>Can be used with other inductive ignition systems</i></p>	 <p>18-5469 HI-PERFORMANCE IGNITION COIL 3.0 ohm (oil filled), black - 4 & 6 cylinder: Flame-Thrower 40,000 volt coil. ★ <i>Designed for use with the original Ignitor Electronic Conversion Kits</i> ★ <i>Can be used with other inductive ignition systems</i></p>	 <p>18-5472 HI-PERFORMANCE IGNITION COIL 0.6 ohm (oil filled), black - 4, 6, & 8 cylinder: Flame-Thrower 45,000 volt coil. ★ <i>Super low 0.6 ohm resistance coil designed for use with the Ignitor II Hi Performance Electronic Conversion Kits</i> ★ <i>Compatible with capacitive discharge systems</i></p>
--	---	--

Part #	Description	Recommended Coil	Resistance Ohms	Part #	Description	Recommended Coil	Resistance Ohms
18-5294	Electronic Conversion Kit	18-5469	3.0	18-5289	Hi Performance Electronic Conversion Kit	18-5472	0.6
18-5295	Electronic Conversion Kit	18-5469	3.0	18-5483	Flame-Thrower Distributor	18-5472	0.6
18-5299	Electronic Conversion Kit	18-5466	1.5				



FEATURES

- ★ *Distributors feature the Ignitor II ignition module with adaptive dwell control adjusts the spark timing over the entire RPM range to maximize performance*
- ★ *Upper roller bearing and oil impregnated bronze sintered bottom bushing are installed and aligned bored for accuracy for maximum durability*
- ★ *Machined heat treated gear with tight tolerances insures durability and consistent timing to maximize horsepower and performance. Complete with high dielectric strength cap and rotor for years of performance*

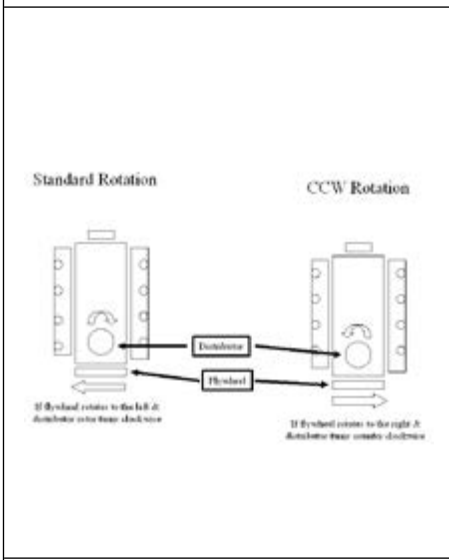

18-5483
HI-PERFORMANCE ELECTRONIC DISTRIBUTOR
Fits: Chevrolet Marine Small and Big Block engines (Standard Deck Height)
Replacement cap/rotor kit 18-5266

18-5498-2
DISTRIBUTOR
Replaces: 9-26307; Mallory YLM624BV
For GM V8, 482, 502, 540 CID (Except 348, 409 & Tall Deck Big Block)

18-5475
DISTRIBUTOR
Fits: 4 Cyl GM w/ Delco EST Ignition
Tune-Up Kit 18-5280

18-5476
DISTRIBUTOR
Fits: GM V6 Engines with Delco EST Ignition HEI
Tune-Up Kit 18-5278

18-5484-1
ELECTRONIC DISTRIBUTOR (Late HEI)
Replaces: 3857449
For Conventional Rotation V8/LH 262-454 & 502 (Except 348/409 and Tall Block Engines)
• Designed as plug-in replacement for GM-style fuel ignition system distributor
Tune-Up Kit 18-5281

—CONTAINS—

Description	Part #
Distributor Cap	18-5354
Rotor	18-5405

18-5494-2
ELECTRONIC DISTRIBUTOR
Replaces: Mallory YLM624AV
Conventional Rotation
For Chevrolet all V8 includes 482, 502, 540 CID (Except 348, 409 & Tall Deck Big Block)

—CONTAINS—

Part #	Description
18-5376	Distributor Cap
18-5488	Module
18-5404-1	Rotor

18-5480
COMPLETE IGNITION CONVERSION KIT
Fits: GM SB & BB with Standard Deck Height

—CONTAINS—

Part #	Description
18-5472	Coil
18-8803-2	Wire Set
18-5483	Distributor

18-5477
ELECTRONIC DISTRIBUTOR
Fits: Ford 302 V-8 engines
Replacement Cap/Rotor Kit 18-5266



18-5479
ELECTRONIC DISTRIBUTOR
 Fits: GM V-8 engines-reverse rotation
 Replacement Cap/Rotor Kit 18-5266

Ignitor® II FEATURES

ELECTRONIC IGNITION

- ★ Senses current levels in the coil and adjusts the dwell to maintain peak energy throughout the entire RPM range.
- ★ Develops, on average, 4 times more available energy between 3000 and 5000 RPM's and twice as much plug voltage as point-type systems.
- ★ Ignition energy is sustained and coil life is increased when peak current level is reached just prior to spark.
- ★ More stable timing.
- ★ Use with 18-5472 "Flame Thrower II" Coil for optimum performance



18-5240
HI-PERFORMANCE ELECTRONIC CONVERSION KIT
 Fits: Prestolite IDU-7801 Distributors



18-5288-1
HI-PERFORMANCE ELECTRONIC CONVERSION KIT
 Fits: Most Prestolite V-8 Distributors with snap down cap



18-5289
HI-PERFORMANCE ELECTRONIC CONVERSION KIT
 Fits: Most Prestolite V-8 Distributors with screw down cap

IGNITOR® FEATURES

ELECTRONIC IGNITION

- ★ Replaces points & condensers for true solid state ignition.
- ★ Uses standard coil, cap and rotor.
- ★ Easy to install, one-piece, 2-wire hook-up.
- ★ Accurate to within 1/4° timing accuracy 0 to 6000 RPM range.

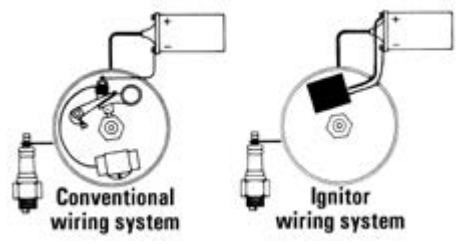

18-5239
ELECTRONIC CONVERSION KIT
 Fits: Prestolite IDU-7801 Distributors



18-5292
ELECTRONIC CONVERSION KIT
 Fits: 4 Cylinder Volvo AQ Models with Bosch Ignition(Dist # 0231178017)



18-5294
ELECTRONIC CONVERSION KIT
 Fits: (6 Cyl.) Delco distributors



18-5295
ELECTRONIC CONVERSION KIT
 Fits: Most 4 Cyl. Prestolite distributors (except IBM7026) For: Onan, Universal, Waukesha, Wisconsin



18-5299
ELECTRONIC CONVERSION KIT
 Fits: 8 (Cyl.) AQ200A, B, AQ225A, B and All 8 Cyl. w/Prestolite Dist # IBM-7013A
 Use with 18-5403 style rotor

① 18-5299D Display Package

① Items ending in "D" are Display Packaged - Regular number is Non-Display

PREMIUM MARINE IGNITION WIRES

Sierra's MAGFORCE Ignition Wires are "Electronics Friendly" protecting all of your electronic devices and electronic engine controls from RFI and EMI while delivering the maximum amount of voltage. Exact fit design ensures easy installation and years of trouble - free service.

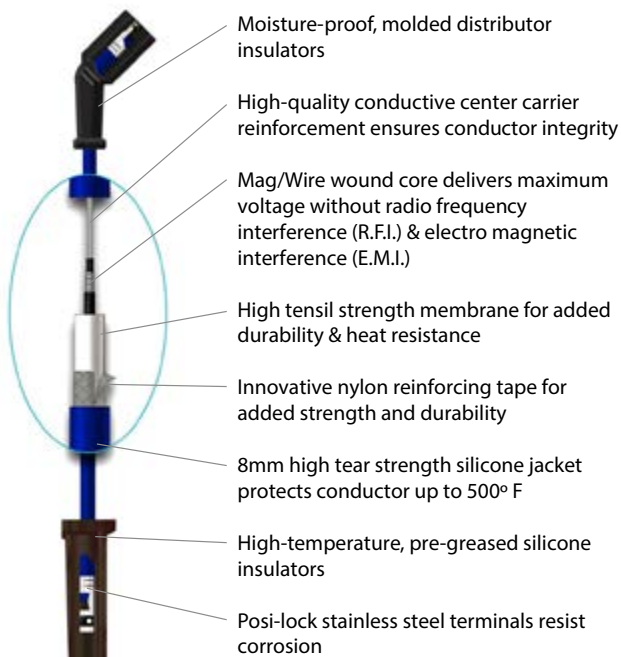

VOLVO MARINE IGNITION WIRES APPLICATION						VOLVO MARINE IGNITION WIRES APPLICATION					
Model	Cyl.	Distributor	Year Start	Year End	Plug Wire Set	Model	Cyl.	Distributor	Year Start	Year End	Plug Wire Set
AQ115A, B	4	Volvo	1969	1975	18-28050	AQ231A, B	8	Volvo	1986	1989	18-8802-1
AQ120B	4	Volvo	1977	1980	18-8813-1	AQ240A	8	Volvo	1976	1977	18-8802-1
AQ125A, B	4	Volvo	1981	1985	18-8813-1	AQ255A	8	Mallory (Flat Cap)	1977	1978	18-8823-1
AQ130A, B, C, D	4	Volvo	1968	1977	18-28050	AQ255B	8	Mallory (Tall Cap)	1978	1978	18-8802-1
AQ131A, B, C, D	4	Volvo	1985	1989	18-8813-1	AQ255B	8	Mallory (Flat Cap)	1978	1978	18-8823-1
AQ140A	4	Volvo	1975	1979	18-8813-1	AQ260A	8	Mallory (Tall Cap)	1979	1985	18-8802-1
AQ145A, B	4	Volvo	1979	1985	18-8813-1	AQ260A	8	Mallory (Flat Cap)	1979	1985	18-8823-1
AQ151A, B, C	4	Volvo	1985	1989	18-8813-1	AQ260B	8	Mallory (Tall Cap)	1985	1986	18-8802-1
AQ175A	6	Volvo	1981	1985	18-8801-1	AQ271A, B, C, D	8	Volvo	1986	1989	18-8802-1
AQ190A	8	Volvo	1976	1977	18-8802-1	AQ280A	8	Mallory (Tall Cap)	1978	1979	18-8802-1
AQ200B	8	Mallory (Tall Cap)	1974	1976	18-8802-1	AQ280A	8	Mallory (Flat Cap)	1978	1979	18-8823-1
AQ200B	8	Mallory (Flat Cap)	1974	1976	18-8823-1	AQ290A	8	Mallory (Tall Cap)	1979	1985	18-8802-1
AQ200C	8	Mallory (Tall Cap)	1976	1977	18-8802-1	AQ290A	8	Mallory (Flat Cap)	1979	1985	18-8823-1
AQ200C	8	Mallory (Flat Cap)	1976	1977	18-8823-1	AQ311A, B	8	Volvo	1986	1989	18-8802-1
AQ205A	6	Volvo	1988	1989	18-8801-1	BB140A	4	Volvo	1975	1979	18-8813-1
AQ211A	8	Volvo	1986	1989	18-8802-1	BB145A	4	Volvo	1979	1985	18-8813-1
AQ225B	8	Mallory (Tall Cap)	1974	1976	18-8802-1	BB225A, AV, B, C	8	Volvo	1973	1977	18-8802-1
AQ225B	8	Mallory (Flat Cap)	1974	1976	18-8823-1	BB231A	8	Volvo	1987	1987	18-8802-1

APPLICATION CONTINUED ON NEXT PAGE

VOLVO MARINE IGNITION WIRES APPLICATION					
Model	Cyl.	Distributor	Year Start	Year End	Plug Wire Set
BB260A, AV, B, C	8	Volvo	1978	1985	18-8802-1
BB261A	8	Volvo	1988	1989	18-8802-1
230A, B	4	Volvo	1989	1992	18-8813-1
250A, B	4	Volvo	1989	1992	18-8813-1
432A	6	Delco EST	1992	1993	18-8835-1
434A	6	Delco EST	1992	1993	18-8835-1
3.0GLM	4	Delco EST	1993	1994	18-8833-1
3.0GLM	4	Delco EST	2002	2004	18-8833-1
3.0GLP	4	Delco EST	2002	2010	18-8833-1
3.0GSM	4	Delco EST	1994	2002	18-8833-1
3.0GSP	4	Delco EST	1993	2002	18-8833-1
3.0GX1	4	Delco EST	2008	2009	18-8833-1
4.3GI	6	Delco EST	1994	2000	18-8835-1
4.3GL	6	Delco EST	1993	2010	18-8835-1
4.3GS	6	Delco EST	1993	1999	18-8835-1
4.3GX1	6	Delco HVS	2001	2015	18-8829-1
4.3GX1	6	Delco EST	2001	2002	18-8835-1
4.3GXIE	6	Delco HVS	2009	2015	18-8829-1
4.3SI	6	Delco HVS	2001	2009	18-8829-1
4.3SI-BF	6	Delco HVS	2001	2002	18-8829-1
5.0FI	8	Ford	1994	1996	18-8820-1
5.0FL	8	Prestolite	1994	1996	18-8802-1
5.0GI	8	Delco EST	1997	2000	18-8836-1
5.0GL	8	Prestolite	1997	2001	18-8802-1
5.0GL	8	Delco EST	2001	2006	18-8836-1
5.0GX1	8	Delco HVS	2001	2015	18-8828-1
5.0GX1-A	8	Delco EST	2001	2002	18-8836-1
5.0GXIC	8	Delco HVS	2007	2009	18-8828-1
5.0GXIE	8	Delco HVS	2007	2015	18-8828-1
5.0OSI	8	Delco HVS	2001	2009	18-8828-1
5.0OSIE	8	Delco HVS	2008	2009	18-8828-1
5.7GI	8	Delco EST	1993	1997	18-8836-1
5.7Gi	8	Delco HVS	2001	2015	18-8828-1
5.7GI	8	Delco EST	2004	2005	18-8836-1
5.7GiC	8	Delco HVS	2008	2009	18-8828-1
5.7GiCE	8	Delco HVS	2008	2009	18-8828-1
5.7GiE	8	Delco HVS	2007	2015	18-8828-1
5.7GIL	8	Delco HVS	2002	2009	18-8828-1
5.7GIL-A	8	Delco EST	2001	2001	18-8836-1
5.7GL	8	Prestolite	1993	1997	18-8802-1
5.7GL	8	Delco EST	1993	1997	18-8836-1
5.7GL	8	Delco EST	2001	2004	18-8836-1
5.7GL-A	8	Mallory	2001	2001	18-8802-1
5.7GSI	8	Delco EST	1996	2001	18-8836-1
5.7GSP	8	Prestolite	1996	2000	18-8802-1

VOLVO MARINE IGNITION WIRES APPLICATION					
Model	Cyl.	Distributor	Year Start	Year End	Plug Wire Set
5.7GX1	8	Delco HVS	2001	2015	18-8828-1
5.7GX1-A, B	8	Delco EST	2000	2002	18-8836-1
5.7GXIC	8	Delco HVS	2007	2008	18-8828-1
5.7GXICE	8	Delco HVS	2007	2010	18-8828-1
5.7GXIE	8	Delco HVS	2007	2015	18-8828-1
5.7GXIL	8	Delco HVS	2001	2008	18-8828-1
5.7GXIL-A, B	8	Delco EST	2000	2002	18-8836-1
5.7OSI	8	Delco HVS	2001	2009	18-8828-1
5.7OSIE	8	Delco HVS	2008	2009	18-8828-1
5.7OSXI	8	Delco HVS	2001	2009	18-8828-1
5.7OSXIE	8	Delco HVS	2008	2009	18-8828-1
5.8FI	8	Ford	1994	1996	18-8820-1
5.8FL	8	Prestolite	1994	1996	18-8803-1
5.8FSI	8	Prestolite	1994	1996	18-8803-1
7.4GI	8	Delco EST	1994	2000	18-8836-1
7.4GL	8	Prestolite	1993	1997	18-8802-1
7.4GLI	8	Prestolite	1993	1996	18-8802-1
7.4GLP	8	Prestolite	1993	1997	18-8802-1
7.4GLP	8	Prestolite	1994	1997	18-28051
7.4GLP	8	Delco EST	1995	1996	18-8836-1
7.4GSI	8	Delco EST	1994	2000	18-8836-1
8.1Gi-A	8	Distributorless	1999	2015	18-8838-1
8.1GiC	8	Distributorless	2007	2015	18-8838-1
8.1GiCE	8	Distributorless	2007	2015	18-8838-1
8.1GiE	8	Distributorless	2007	2015	18-8838-1
8.1GiL	8	Distributorless	2000	2008	18-8838-1
8.1GSI	8	Distributorless	2000	2001	18-8838-1
8.1GX1	8	Distributorless	2001	2015	18-8838-1
8.1GXIE	8	Distributorless	2007	2015	18-8838-1
8.1GXil	8	Distributorless	2001	2008	18-8838-1
8.1IPSCE	8	Distributorless	2008	2015	18-8838-1
8.1OSI	8	Distributorless	2003	2009	18-8838-1
8.1OSIE	8	Distributorless	2008	2009	18-8838-1
8.2GLI	8	Prestolite	1993	1994	18-8803-1
8.2GLP	8	Prestolite	1993	1994	18-8803-1
8.2GSI	8	Delco EST	1995	2000	18-8836-1
DPX375	8	Distributorless	2000	2002	18-8838-1
DPX385	8	Delco EST	1996	2000	18-8836-1
DPX415	8	Delco EST	1996	2000	18-8836-1
DPX420	8	Distributorless	2000	2002	18-8838-1
V6-200	6	Delco HVS	2012	2015	18-8828-1
V6-225	6	Delco HVS	2012	2015	18-8828-1
V8-270	8	Delco HVS	2012	2015	18-8829-1
V8-300	8	Delco HVS	2012	2015	18-8829-1
V8-320	8	Delco HVS	2012	2015	18-8829-1



BATTERY CABLES
Gauge cable with soldered lug terminals on each end to accept a 3/8" stud.

Part No.	Size	Color	Gauge
BC88523	2'	red	4
BC88533	2'	black	4
BC88543	4'	red	2
BC88553	4'	black	2
BC88563	6'	red	2
BC88573	6'	black	2
BC88583	8'	red	1
BC88593	8'	black	1



18-5225 SPARK PLUG WIRE KIT
Replaces: Mercury 84-99215A26, 84-813706A26
Kit includes 25 ft. roll of 7mm Hypalon Ignition Wire With a Metallic Core and a large assortment of three different end fittings.

 18-5226 IGNITION WIRE Metallic Core 100' Spool 7mm Hypalon	 18-26810 GM HEI 4 TERMINAL PIGTAIL Fits: GM HEI Distributors w/4 terminals	 18-26811 GM HEI 2 TERMINAL PIGTAIL Fits: GM HEI Distributors w/2 terminals	 18-26812 HEI COIL GRAY CONNECTOR	 18-26813 HEI COIL BLACK CONNECTOR
--	--	--	---	--

PKG. OF 10  18-5224 18-5224-9① SPARK PLUG WIRE TERMINAL Replaces: Mercury 20121 OMC 510364	PKG. OF 10  18-5750 18-5750-9① UNIVERSAL SPARK PLUG BOOTS Supplied complete w/Terminal Connector Replaces: OMC 581027, 580339	 18-5752 UNIVERSAL SPARK PLUG BOOT 8mm	 18-5657 PROTECTING SLEEVE Replaces: 855798 Fits: Most Volvo gas & diesel engines
--	--	---	--

① Priced per Package

VOLVO PENTA IGNITION APPLICATION

Model	Distributor	Spark Plug Wire Set	Distributor Cap	Rotor	Pick-Up Coil	ICM	Ignition Coil	Condenser	Contact Points	Tune-Up Kit
AQ100	BOSCH	-	18-5357	18-5428	N/A	N/A	18-5436	-	18-5306	-
AQ110	BOSCH	-	18-5357	18-5428	N/A	N/A	18-5436	-	18-5306	-
AQ115A	0231153010	18-28050	18-5357	18-5428	N/A	N/A	18-5436	-	18-5305	-
AQ115A	0231153012	18-28050	18-5356	18-5428	N/A	N/A	18-5436	-	18-5305	-
AQ115B	0231153010	18-28050	18-5357	18-5428	N/A	N/A	18-5436	-	18-5305	-
AQ115B	0231153012	18-28050	18-5356	18-5428	N/A	N/A	18-5436	-	18-5305	-
AQ120	BOSCH	-	18-5357	18-5428	N/A	N/A	18-5436	-	18-5306	-
AQ120B	0231178017	18-8813-1	18-5358	18-5428	N/A	N/A	18-5436	18-5349	18-5305	18-5284
AQ120B	0231178016	18-8813-1	18-5356	18-5428	N/A	N/A	18-5436	18-5349	18-5305	18-5284
AQ120B	0231178018	18-8813-1	18-5356	18-5428	N/A	N/A	18-5436	18-5349	18-5305	18-5284
AQ125A	ALL	18-8813-1	18-5358	18-5428	N/A	N/A	18-5436	18-5349	18-5305	18-5284
AQ125B	ALL	18-8813-1	18-5358	18-5428	N/A	N/A	18-5436	18-5349	18-5305	18-5284
AQ130A	0231153010	18-28050	18-5357	18-5428	N/A	N/A	18-5436	-	18-5305	-
AQ130A	0231153012	18-28050	18-5356	18-5428	N/A	N/A	18-5436	-	18-5305	-
AQ130B	0231153010	18-28050	18-5357	18-5428	N/A	N/A	18-5436	-	18-5305	-
AQ130B	0231153012	18-28050	18-5356	18-5428	N/A	N/A	18-5436	-	18-5305	-
AQ130C	0231153010	18-28050	18-5357	18-5428	N/A	N/A	18-5436	-	18-5305	-
AQ130C	0231153012	18-28050	18-5356	18-5428	N/A	N/A	18-5436	-	18-5305	-
AQ130D	0231153010	18-28050	18-5357	18-5428	N/A	N/A	18-5436	-	18-5305	-
AQ130D	0231153012	18-28050	18-5356	18-5428	N/A	N/A	18-5436	-	18-5305	-
AQ131A	ALL	18-8813-1	18-5358	18-5428	N/A	N/A	18-5436	-	18-5305	-
AQ131B	ALL	18-8813-1	18-5358	18-5428	N/A	N/A	18-5436	-	18-5305	-
AQ131C	ALL	18-8813-1	18-5358	18-5428	N/A	N/A	18-5436	-	18-5305	-
AQ131D	ALL	18-8813-1	18-5358	18-5428	N/A	N/A	18-5436	-	18-5305	-
AQ140A	0231178017	18-8813-1	18-5358	18-5428	N/A	N/A	18-5436	18-5349	18-5305	18-5284
AQ140A	0231178016	18-8813-1	18-5356	18-5428	N/A	N/A	18-5436	18-5349	18-5305	18-5284
AQ140A	0231178018	18-8813-1	18-5356	18-5428	N/A	N/A	18-5436	18-5349	18-5305	18-5284
AQ145A	ALL	18-8813-1	18-5358	18-5428	N/A	N/A	18-5436	18-5349	18-5305	18-5284
AQ145B	ALL	18-8813-1	18-5358	18-5428	N/A	N/A	18-5436	18-5349	18-5305	18-5284
AQ151A	ALL	18-8813-1	18-5358	18-5428	N/A	N/A	18-5436	18-5349	18-5305	18-5284
AQ151B	ALL	18-8813-1	18-5358	18-5428	N/A	N/A	18-5436	18-5349	18-5305	18-5284
AQ151C	ALL	18-8813-1	18-5358	18-5428	N/A	N/A	18-5436	18-5349	18-5305	18-5284

APPLICATION CONTINUED ON NEXT PAGE

VOLVO PENTA IGNITION APPLICATION (Cont.)

Model	Distributor	Spark Plug Wire Set	Distributor Cap	Rotor	Pick-Up Coil	ICM	Ignition Coil	Condenser	Contact Points	Tune-Up Kit
AQ165A	0231116054		18-5393	18-5428	N/A	N/A	-	-	-	-
AQ165A	0231116060		18-5393	18-5428	N/A	N/A	-	-	-	-
AQ165A	0231121008		18-5393	18-5428	N/A	N/A	-	-	18-5305	-
AQ165A	0231311002		18-5394	18-5428	N/A	N/A	-	-	-	-
AQ170A	0231116054		-	18-5428	N/A	N/A	-	-	-	-
AQ170A	0231116060		-	18-5428	N/A	N/A	-	-	-	-
AQ170A	0231121008		-	18-5428	N/A	N/A	-	-	18-5305	-
AQ170A	0231311002		-	-	N/A	N/A	-	-	-	-
AQ170B	0231116054		-	18-5428	N/A	N/A	-	-	-	-
AQ170B	0231116060		-	18-5428	N/A	N/A	-	-	-	-
AQ170B	0231121008		-	18-5428	N/A	N/A	-	-	18-5305	-
AQ170B	0231311002		-	-	N/A	N/A	-	-	-	-
AQ170C	0231116054		18-5393	18-5428	N/A	N/A	-	-	-	-
AQ170C	0231121008		-	18-5428	N/A	N/A	-	-	18-5305	-
AQ171A	ALL		-	-	N/A	N/A	N/A	N/A	N/A	-
AQ171C	ALL		-	-	N/A	N/A	N/A	N/A	N/A	-
AQ175A	ALL	18-8801-1	18-5369	18-5425	N/A	N/A	18-5433	18-5345	18-5303	18-5264
AQ190A	ALL	18-8802-1	18-5369	18-5425	N/A	N/A	18-5345	18-5345	18-5303	18-5264
AQ200B	MALLORY FLAT CAP	18-8823-1	18-5375	18-5411	N/A	N/A	18-5338	18-5338	18-5314	18-5256
AQ200B	MALLORY TALL CAP	18-8802-1	18-5352	18-5403	N/A	N/A	18-5345	18-5345	18-5303	18-5260
AQ200C	MALLORY FLAT CAP	18-8823-1	18-5375	18-5411	N/A	N/A	18-5433	18-5338	18-5314	18-5256
AQ200C	MALLORY TALL CAP	18-8802-1	18-5352	18-5403	N/A	N/A	18-5433	18-5345	18-5303	18-5260
AQ200D	S/N 20459 & BELOW		18-5369	18-5425	N/A	N/A	18-5433	18-5345	18-5303	18-5264
AQ200D	S/N 20460 & UP		18-5352	18-5403	N/A	N/A	18-5433	18-5345	18-5303	18-5260
AQ200F	ALL		18-5352	18-5403	N/A	N/A	18-5433	18-5345	18-5303	18-5260
AQ205A	ALL	18-8801-1	18-5353	18-5403	N/A	N/A	-	-	-	-
AQ211A	ALL	18-8802-1	18-5352	18-5403	N/A	N/A	18-5433	18-5345	18-5303	18-5260
AQ225B	MALLORY FLAT CAP	18-8823-1	18-5375	18-5411	N/A	N/A	18-5338	18-5338	18-5314	18-5256
AQ225B	MALLORY TALL CAP	18-8802-1	18-5352	18-5403	N/A	N/A	18-5345	18-5345	18-5303	18-5260
AQ225C	ALL		18-5375	18-5411	N/A	N/A	18-5433	18-5338	18-5314	18-5256
AQ225D	S/N 20459 & BELOW		18-5369	18-5425	N/A	N/A	18-5433	18-5345	18-5303	18-5264
AQ225D	S/N 20460 & UP		18-5352	18-5403	N/A	N/A	18-5433	18-5345	18-5303	18-5260
AQ225E	ALL		18-5352	18-5403	N/A	N/A	18-5433	18-5345	18-5303	18-5260
AQ225F	ALL		18-5352	18-5403	N/A	N/A	18-5433	18-5345	18-5303	18-5260
AQ231A	ALL	18-8802-1	18-5352	18-5403	N/A	N/A	18-5433	18-5345	18-5303	18-5260
AQ231B	ALL	18-8802-1	18-5352	18-5403	N/A	N/A	18-5433	18-5345	18-5303	18-5260
AQ240A	ALL	18-8802-1	18-5369	18-5403	N/A	N/A	18-5345	18-5345	18-5303	18-5260
AQ255A	MALLORY FLAT CAP	18-8823-1	18-5375	18-5411	N/A	N/A	18-5433	18-5338	18-5314	18-5256
AQ255B	MALLORY FLAT CAP	18-8823-1	18-5375	18-5411	N/A	N/A	18-5433	18-5338	18-5314	18-5256
AQ255B	MALLORY TALL CAP	18-8802-1	18-5352	18-5403	N/A	N/A	18-5433	18-5345	18-5303	18-5260
AQ260A	MALLORY FLAT CAP	18-8823-1	18-5375	18-5411	N/A	N/A	18-5433	18-5338	18-5314	18-5256
AQ260A	MALLORY TALL CAP	18-8802-1	18-5352	18-5403	N/A	N/A	18-5433	18-5345	18-5303	18-5260
AQ260B	MALLORY TALL CAP	18-8802-1	18-5352	18-5403	N/A	N/A	18-5433	18-5345	18-5303	18-5260
AQ271A	ALL	18-8802-1	18-5352	18-5403	N/A	N/A	18-5433	-	-	-
AQ271B	ALL	18-8802-1	18-5352	18-5403	N/A	N/A	-	-	-	-
AQ271C	ALL	18-8802-1	18-5352	18-5403	N/A	N/A	-	-	-	-
AQ271D	ALL	18-8802-1	18-5352	18-5403	N/A	N/A	-	-	-	-
AQ280A	MALLORY FLAT CAP	18-8823-1	18-5375	18-5411	N/A	N/A	-	18-5338	18-5314	18-5256
AQ280A	MALLORY TALL CAP	18-8802-1	18-5352	18-5403	N/A	N/A	-	18-5345	18-5303	18-5260
AQ290A	MALLORY FLAT CAP	18-8823-1	18-5375	18-5411	N/A	N/A	18-5433	18-5338	18-5314	18-5256
AQ290A	MALLORY TALL CAP	18-8802-1	18-5352	18-5403	N/A	N/A	18-5433	18-5345	18-5303	18-5260
AQ311A	ALL	18-8802-1	18-5352	18-5403	N/A	N/A	-	-	-	-
AQ311B	ALL	18-8802-1	18-5352	18-5403	N/A	N/A	-	-	-	-
AQ60F	BOSCH	-	18-5357	18-5428	N/A	N/A	18-5436	-	18-5306	-

APPLICATION CONTINUED ON NEXT PAGE

VOLVO PENTA IGNITION APPLICATION (Cont.)

Model	Distributor	Spark Plug Wire Set	Distributor Cap	Rotor	Pick-Up Coil	ICM	Ignition Coil	Condenser	Contact Points	Tune-Up Kit
AQ90	BOSCH	-	18-5357	18-5428	N/A	N/A	18-5436	-	18-5306	-
AQ95	BOSCH	-	18-5357	18-5428	N/A	N/A	18-5436	-	18-5306	-
AQ95A	BOSCH	-	18-5357	18-5428	N/A	N/A	18-5436	-	18-5306	-
BB100	BOSCH	-	18-5357	18-5428	N/A	N/A	18-5436	-	18-5306	-
BB115A	0231153010	18-28050	18-5357	18-5428	N/A	N/A	18-5436	-	18-5305	-
BB115A	0231153012	18-28050	18-5356	18-5428	N/A	N/A	18-5436	-	18-5305	-
BB115B	0231153010	18-28050	18-5357	18-5428	N/A	N/A	18-5436	-	18-5305	-
BB115B	0231153012	18-28050	18-5356	18-5428	N/A	N/A	18-5436	-	18-5305	-
BB115C	0231153010	18-28050	18-5357	18-5428	N/A	N/A	18-5436	-	18-5305	-
BB115C	0231153012	18-28050	18-5356	18-5428	N/A	N/A	18-5436	-	18-5305	-
BB140A	0231178017	18-8813-1	18-5358	18-5428	N/A	N/A	18-5436	18-5349	18-5305	18-5284
BB140A	0231178016	18-8813-1	18-5356	18-5428	N/A	N/A	18-5436	18-5349	18-5305	18-5284
BB140A	0231178018	18-8813-1	18-5356	18-5428	N/A	N/A	18-5436	18-5349	18-5305	18-5284
BB145A	ALL	18-8813-1	18-5358	18-5428	N/A	N/A	18-5436	18-5349	18-5305	18-5284
BB165A	0231116054		18-5393	18-5428	N/A	N/A		-	-	-
BB165A	0231116060		18-5393	18-5428	N/A	N/A		-	-	-
BB165A	0231121008		18-5393	18-5428	N/A	N/A		-	18-5305	-
BB165A	0231311002		18-5394	18-5428	N/A	N/A		-	-	-
BB170A	0231116054		18-5393	18-5428	N/A	N/A		-	-	-
BB170A	0231116060		18-5393	18-5428	N/A	N/A		-	-	-
BB170A	0231121008		18-5393	18-5428	N/A	N/A		-	18-5305	-
BB170A	0231311002		18-5394	18-5428	N/A	N/A		-	-	-
BB170B	0231116054		18-5393	18-5428	N/A	N/A		-	-	-
BB170B	0231116060		18-5393	18-5428	N/A	N/A		-	-	-
BB170B	0231121008		18-5393	18-5428	N/A	N/A		-	18-5305	-
BB170B	0231311002		18-5394	18-5428	N/A	N/A		-	-	-
BB170C	0231116054		18-5393	18-5428	N/A	N/A		-	-	-
BB170C	0231116060		18-5393	18-5428	N/A	N/A		-	-	-
BB170C	0231121008		18-5393	18-5428	N/A	N/A		-	18-5305	-
BB170C	0231311002		18-5394	18-5428	N/A	N/A		-	-	-
BB225A	ALL	18-8802-1	18-5352	18-5403	N/A	N/A	18-5433	18-5345	18-5303	18-5260
BB225AV	ALL	18-8802-1	18-5352	18-5403	N/A	N/A	18-5433	18-5345	18-5303	18-5260
BB225B	ALL	18-8802-1	18-5352	18-5403	N/A	N/A	18-5433	18-5345	18-5303	18-5260
BB225C	ALL	18-8802-1	18-5352	18-5403	N/A	N/A	18-5433	18-5345	18-5303	18-5260
BB231A	ALL	18-8802-1	18-5352	18-5403	N/A	N/A	18-5433	18-5345	18-5303	18-5260
BB260A	ALL	18-8802-1	18-5352	18-5403	N/A	N/A	18-5433	18-5345	18-5303	18-5260
BB260AV	ALL	18-8802-1	18-5352	18-5403	N/A	N/A	18-5433	18-5345	18-5303	18-5260
BB260B	ALL	18-8802-1	18-5352	18-5403	N/A	N/A	18-5433	18-5345	18-5303	18-5260
BB260C	ALL	18-8802-1	18-5352	18-5403	N/A	N/A	18-5433	18-5345	18-5303	18-5260
BB261A	ALL	18-8802-1	18-5352	18-5403	N/A	N/A	18-5433	18-5345	18-5303	18-5260
BB30	BOSCH	-	18-5357	18-5428	N/A	N/A	18-5436	-	18-5306	-
MB10A	ALL		-	18-5428	N/A	N/A	18-5436	-	18-5305	-
MB18	BOSCH	-	18-5357	18-5428	N/A	N/A	18-5436	-	18-5306	-
MB18F	BOSCH	-	18-5357	18-5428	N/A	N/A	18-5436	-	18-5306	-
MB20A	ALL		18-5356	18-5428	N/A	N/A	18-5436	-	18-5305	-
MB20B	0231110043	-	18-5357	18-5428	N/A	N/A	18-5436	-	18-5306	-
MB20B	0231178005		18-5356	18-5428	N/A	N/A	18-5436	-	18-5305	-
MB20C	0231110043	-	18-5357	18-5428	N/A	N/A	18-5436	-	18-5306	-
MB20C	0231178005		18-5356	18-5428	N/A	N/A	18-5436	-	18-5305	-
230A	ALL	18-8813-1	18-5358	18-5428	N/A	N/A	18-5436	18-5349	18-5305	18-5265
230B	ALL	18-8813-1	18-5358	18-5428	N/A	N/A	18-5436	18-5349	18-5305	18-5265
250A	ALL	18-8813-1	18-5358	18-5428	N/A	N/A	18-5436	18-5349	18-5305	18-5265
250B	ALL	18-8813-1	18-5358	18-5428	N/A	N/A	18-5436	18-5349	18-5305	18-5265
251A	ALL		-	-	N/A	N/A	-	N/A	N/A	N/A

APPLICATION CONTINUED ON NEXT PAGE

VOLVO PENTA IGNITION APPLICATION (Cont.)

Model	Distributor	Spark Plug Wire Set	Distributor Cap	Rotor	Pick-Up Coil	ICM	Ignition Coil	Condenser	Contact Points	Tune-Up Kit
430A	ALL		18-5353	18-5403	-	N/A	-	N/A	N/A	N/A
430B	ALL		18-5353	18-5403	-	N/A	-	N/A	N/A	N/A
431A	ALL		18-5353	18-5403	-	N/A	-	N/A	N/A	N/A
431B	ALL		18-5353	18-5403	-	N/A	-	N/A	N/A	N/A
432A	DELCO EST	18-8835-1	18-5362	18-5408	18-5108	18-5107-1	-	N/A	N/A	18-5278
434A	DELCO EST	18-8835-1	18-5362	18-5408	18-5108	18-5107-1	-	N/A	N/A	18-5278
500A	ALL		18-5352	18-5403	-	N/A	-	N/A	N/A	N/A
500B	ALL		18-5352	18-5403	-	N/A	-	N/A	N/A	N/A
501A	ALL		18-5352	18-5403	-	N/A	-	N/A	N/A	N/A
501A/MS4	ALL		18-5352	18-5403	-	N/A	-	N/A	N/A	N/A
501B	ALL		18-5352	18-5403	-	N/A	-	N/A	N/A	N/A
570A	ALL		18-5352	18-5403	-	N/A	-	N/A	N/A	N/A
571A	ALL		18-5352	18-5403	-	N/A	-	N/A	N/A	N/A
572A	ALL		18-5352	18-5403	-	N/A	-	N/A	N/A	N/A
740A	ALL		18-5352	18-5403	-	N/A	-	N/A	N/A	N/A
740A/MS5	ALL		18-5352	18-5403	-	N/A	-	N/A	N/A	N/A
740B	ALL		18-5352	18-5403	-	N/A	-	N/A	N/A	N/A
3.0GL	DELCO EST	18-8841-1	18-5361	18-5406	18-5108	18-5107-1	18-5443	N/A	N/A	18-5280
3.0GS	DELCO EST	18-8841-1	18-5361	18-5406	18-5108	18-5107-1	18-5443	N/A	N/A	18-5280
3.0GXi	DELCO EST	18-8841-1	18-5361	18-5406	18-5108	18-5117	18-5465	N/A	N/A	18-5280
4.3Gi	DELCO HVS	18-8829-1	18-5243	18-5245	18-7642	18-5117	-	N/A	N/A	18-5246
4.3Gi	DELCO EST	18-8835-1	18-5362	18-5408	18-5108	18-5107-1	18-7648	N/A	N/A	18-5278
4.3GL	DELCO EST	18-8835-1	18-5362	18-5408	18-5108	18-5107-1	18-7648	N/A	N/A	18-5278
4.3GS	DELCO EST	18-8835-1	18-5362	18-5408	18-5108	18-5107-1	18-7648	N/A	N/A	18-5278
4.3GXi	DELCO EST	18-8835-1	18-5362	18-5408	18-5108	18-5107-1	18-7648	N/A	N/A	18-5278
4.3GXi	DELCO HVS	18-8829-1	18-5243	18-5245	18-7642	18-5117	-	N/A	N/A	18-5246
4.3Si	DELCO HVS	18-8829-1	18-5243	18-5245	18-7642	18-5117	-	N/A	N/A	18-5246
5.0Fi	FORD	18-8820-1	18-5248	18-5413	-	N/A	18-7492	N/A	N/A	N/A
5.0FL	PRESTOLITE	18-8802-1	18-5352	18-5403	-	N/A	18-5437	N/A	N/A	N/A
5.0GIC	DELCO HVS	18-8828-1	18-5244	18-5245	18-7642	18-5117	-	N/A	N/A	18-5247
5.0GI	DELCO EST	18-8836-1	18-5354	18-5405	18-5108	18-5107-1	18-7648	N/A	N/A	18-5281
5.0GL	PRESTOLITE	18-8802-1	18-5352	18-5403	-	N/A	18-5437	N/A	N/A	N/A
5.0GL	DELCO EST	18-8836-1	18-5354	18-5405	18-5108	18-5107-1	18-5443	N/A	N/A	18-5281
5.0GXi	DELCO EST	18-8836-1	18-5354	18-5405	18-5108	18-5107-1	18-7648	N/A	N/A	18-5281
5.0GXi	DELCO HVS	18-8828-1	18-5244	18-5245	18-7642	18-5117	-	N/A	N/A	18-5247
5.0GXIE	DELCO HVS	18-8828-1	18-5244	18-5245	18-7642	18-5117	-	N/A	N/A	18-5247
5.0OSIE	DELCO HVS	18-8828-1	18-5244	18-5245	18-7642	18-5117	-	N/A	N/A	18-5247
5.0OSi	DELCO HVS	18-8828-1	18-5244	18-5245	18-7642	18-5117	-	N/A	N/A	18-5247
5.7GI	DELCO EST	18-8836-1	18-5354	18-5405	18-5108	18-5107-1	18-7648	N/A	N/A	18-5281
5.7GIC	DELCO HVS	18-8828-1	18-5244	18-5245	18-7642	18-5117	-	N/A	N/A	18-5247
5.7GICE	DELCO HVS	18-8828-1	18-5244	18-5245	18-7642	18-5117	-	N/A	N/A	18-5247
5.7GIE	DELCO HVS	18-8828-1	18-5244	18-5245	18-7642	18-5117	-	N/A	N/A	18-5247
5.7Gi	DELCO HVS	18-8828-1	18-5244	18-5245	18-7642	18-5117	-	N/A	N/A	18-5247
5.7Gi	DELCO EST	18-8836-1	18-5354	18-5405	18-5108	18-5107-1	18-5443	N/A	N/A	18-5281
5.7GL	MALLORY	18-8802-1	18-5352	18-5403	-	-	-	N/A	N/A	N/A
5.7GL	DELCO EST	18-8836-1	18-5354	18-5405	18-5108	18-5107-1	18-5443	N/A	N/A	18-5281
5.7GL	PRESTOLITE	18-8802-1	18-5352	18-5403	-	N/A	18-5437	N/A	N/A	N/A
5.7GSi	DELCO EST	18-8836-1	18-5354	18-5405	18-5108	18-5107-1	18-5443	N/A	N/A	18-5281
5.7GSii	DELCO EST	18-8836-1	18-5354	18-5405	18-5108	18-5107-1	18-5443	N/A	N/A	18-5281
5.7GSP	PRESTOLITE	18-8802-1	18-5352	18-5403	-	N/A	18-5437	N/A	N/A	N/A
5.7GXi	DELCO EST	18-8836-1	18-5354	18-5405	18-5108	18-5107-1	18-7648	N/A	N/A	18-5281
5.7GXICE	DELCO HVS	18-8828-1	18-5244	18-5245	18-7642	18-5117	-	N/A	N/A	18-5247
5.7GXiC	DELCO HVS	18-8828-1	18-5244	18-5245	18-7642	18-5117	-	N/A	N/A	18-5247
5.7GXIE	DELCO HVS	18-8828-1	18-5244	18-5245	18-7642	18-5117	-	N/A	N/A	18-5247

APPLICATION CONTINUED ON NEXT PAGE

VOLVO PENTA IGNITION APPLICATION (Cont.)

Model	Distributor	Spark Plug Wire Set	Distributor Cap	Rotor	Pick-Up Coil	ICM	Ignition Coil	Condenser	Contact Points	Tune-Up Kit
5.7GXi	DELCO HVS	18-8828-1	18-5244	18-5245	18-7642	18-5117	-	N/A	N/A	18-5247
5.7GXii	DELCO HVS	18-8828-1	18-5244	18-5245	18-7642	18-5117	-	N/A	N/A	18-5247
5.7GXii	DELCO EST	18-8836-1	18-5354	18-5405	18-5108	18-5107-1	18-5443	N/A	N/A	18-5281
5.7OSi	DELCO HVS	18-8828-1	18-5244	18-5245	18-7642	18-5117	-	N/A	N/A	18-5247
5.7OSXi	DELCO HVS	18-8828-1	18-5244	18-5245	18-7642	18-5117	-	N/A	N/A	18-5247
5.8Fi	FORD	18-8820-1	18-5248	18-5413	-	N/A	18-7492	N/A	N/A	N/A
5.8FL	PRESTOLITE	18-8803-1	18-5352	18-5403	-	N/A	18-5437	N/A	N/A	N/A
5.8FSi	PRESTOLITE	18-8803-1	18-5352	18-5403	-	N/A	18-5437	N/A	N/A	N/A
7.4Gi	DELCO EST	18-8836-1	18-5354	18-5405	18-5108	18-5107-1	18-5443	N/A	N/A	18-5281
7.4GL	PRESTOLITE	18-8802-1	18-5352	18-5403	-	N/A	18-5437	N/A	N/A	N/A
7.4GL	DELCO EST	18-8836-1	18-5354	18-5405	18-5108	18-5107-1	18-5443	N/A	N/A	18-5281
7.4GSi	DELCO EST	18-8836-1	18-5354	18-5405	18-5108	18-5107-1	18-5443	N/A	N/A	18-5281
8.1Gi	DELCO	18-8838-1	N/A	N/A	N/A	N/A	18-7493	N/A	N/A	N/A
8.1Gi-A	DELCO	18-8838-1	N/A	N/A	N/A	N/A	18-7648	N/A	N/A	N/A
8.1Gi-B	DELCO	18-8838-1	N/A	N/A	N/A	N/A	18-7648	N/A	N/A	N/A
8.1Gi-BF	DELCO	18-8838-1	N/A	N/A	N/A	N/A	18-7648	N/A	N/A	N/A
8.1Gi-C	DELCO	18-8838-1	N/A	N/A	N/A	N/A	18-7493	N/A	N/A	N/A
8.1GiC-400	DELCO	18-8838-1	N/A	N/A	N/A	N/A	18-7493	N/A	N/A	N/A
8.1GiCE	DELCO	18-8838-1	N/A	N/A	N/A	N/A	18-7493	N/A	N/A	N/A
8.1GiE	DELCO	18-8838-1	N/A	N/A	N/A	N/A	18-7493	N/A	N/A	N/A
8.1Gii-A	DELCO	18-8838-1	N/A	N/A	N/A	N/A	18-7648	N/A	N/A	N/A
8.1Gii-B	DELCO	18-8838-1	N/A	N/A	N/A	N/A	18-7648	N/A	N/A	N/A
8.1Gii	DELCO	18-8838-1	N/A	N/A	N/A	N/A	18-7493	N/A	N/A	N/A
8.1GSi-A	DELCO	18-8838-1	N/A	N/A	N/A	N/A	18-7648	N/A	N/A	N/A
8.1GXi	DELCO	18-8838-1	N/A	N/A	N/A	N/A	18-7493	N/A	N/A	N/A
8.1GXii	DELCO	18-8838-1	N/A	N/A	N/A	N/A	18-7493	N/A	N/A	N/A
8.1GXi-A	DELCO	18-8838-1	N/A	N/A	N/A	N/A	18-7648	N/A	N/A	N/A
8.1GXi-AF	DELCO	18-8838-1	N/A	N/A	N/A	N/A	18-7648	N/A	N/A	N/A
8.1GXii-A	DELCO	18-8838-1	N/A	N/A	N/A	N/A	18-7648	N/A	N/A	N/A
8.1IPS	DELCO	18-8838-1	N/A	N/A	N/A	N/A	18-7493	N/A	N/A	N/A
8.1OSi	DELCO	18-8838-1	N/A	N/A	N/A	N/A	18-7493	N/A	N/A	N/A
8.2GL	PRESTOLITE	18-8803-1	18-5352	18-5403	-	N/A	18-5437	N/A	N/A	N/A
8.2GSi	DELCO EST	18-8836-1	18-5354	18-5405	18-5108	18-5107-1	18-5443	N/A	N/A	18-5281
DPX375	DELCO	18-8838-1	N/A	N/A	N/A	N/A	18-7648	N/A	N/A	N/A
DPX375-CF	DELCO	18-8838-1	N/A	N/A	N/A	N/A	18-7493	N/A	N/A	N/A
DPX385	DELCO EST	18-8836-1	18-5354	18-5405	18-5108	18-5107-1	18-5443	N/A	N/A	18-5281
DPX415	DELCO EST	18-8836-1	18-5354	18-5405	18-5108	18-5107-1	18-5443	N/A	N/A	18-5281
DPX420	DELCO	18-8838-1	N/A	N/A	N/A	N/A	18-7648	N/A	N/A	N/A
DPX420-CF	DELCO	18-8838-1	N/A	N/A	N/A	N/A	18-7493	N/A	N/A	N/A
V6-200	DELCO HVS	18-8829-1	18-5243	18-5245	18-7642	18-5117	-	N/A	N/A	18-5246
V6-225	DELCO HVS	18-8829-1	18-5243	18-5245	18-7642	18-5117	-	N/A	N/A	18-5246
V8-225	DELCO HVS	18-8828-1	18-5244	18-5245	18-7642	18-5117	-	N/A	N/A	18-5247
V8-270	DELCO HVS	18-8828-1	18-5244	18-5245	18-7642	18-5117	-	N/A	N/A	18-5247
V8-300	DELCO HVS	18-8828-1	18-5244	18-5245	18-7642	18-5117	-	N/A	N/A	18-5247
V8-320	DELCO HVS	18-8828-1	18-5244	18-5245	18-7642	18-5117	-	N/A	N/A	18-5247
V8-350	N/A	18-8838-1	N/A	N/A	N/A	N/A	-	N/A	N/A	N/A
V8-380	N/A	18-8838-1	N/A	N/A	N/A	N/A	-	N/A	N/A	N/A
V8-430	N/A	18-8838-1	N/A	N/A	N/A	N/A	-	N/A	N/A	N/A

APPLICATION CONTINUED ON NEXT PAGE



STARTER SOLENOIDS

Starter solenoids take extreme abuse during their life which is a main reason why they so commonly require replacement. Sierra's replacement starter solenoids are built to EXCEED OEM specifications and feature many extras not available on many competitors' products today.

- Anti-corrosion coating for maximum corrosion resistance.
- Additional sealing to prevent ingress of water around mating surfaces.
- Upgraded design and materials for increased reliability.
- Longer battery stud for easier installation of multiple connections.

PART NO. REPLACES

18-6447	Solenoid for Sierra Starter 18-55510
18-6458	Solenoid for Sierra Starters 18-55505 and 18-55506
18-6459	Solenoid for Sierra Starter 18-6447; Delco PG260

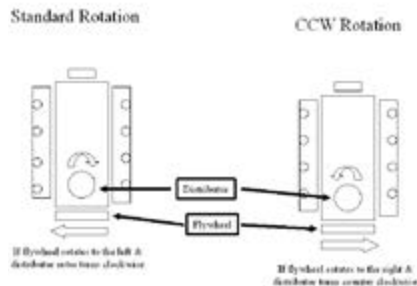

**18-5920
STARTER**
PMGR, Ford



**18-5927
STARTER**
PMGR, Ford



**18-5911
STARTER**
(Heavy-Duty) (No Core) Clockwise
For GM engines, bottom mount straight
across bolt pattern. Standard rotation.
Replaces: 834893, 855326
Replacement Solenoid: 18-5837
SAEJ1171



**18-5903
STARTER**
Replaces: 841066-4
(No Core)Clockwise
Bottom mount two bolt pattern for
standard rotation FORD engines.
Replacement Solenoid: 18-5801



**18-5906
STARTER**
Replaces: 840808, 872241
• Inboard
• Gear Reduction Starter
• Permanent Magnet, 12 Volt
• CW Rotation
• Aluminum Pinion Housing w/2 Threaded
Mounting Holes
Fits : Volvo Penta 4 Cylinder and 6 Cylin-
der Gas Engines



**18-5913-1
STARTER**
Replaces: 3856004, 3860764,
3587625, 3853982, 3854751, 3885317
(Clockwise)
Delco permanent magnet gear reduction 2
bolt starter. 12V - 11 Tooth Offset Bolt Pattern
For: Late model GM 14" Flywheel
SAEJ1171
1.7 KW



**18-5919-1
STARTER**
Replaces: 3856003
Permanent magnet I/O starter
Fits: Chevy Engines with 12 3/4" flywheels
Straight across bolt pattern
SAEJ1171
For: 3.0 GS
1.7 KW



**18-5920
STARTER**
Replaces: 3854190
Clockwise/Standard rotation
Permanent magnet starter
Replacement Solenoid: 18-6291
For: 5.0 & 5.8 litre Ford engines



**18-6275-1
STARTER**
Replaces: 3857747, 3860566
• Inboard
• Permanent Magnet Gear Reduction Starter
• 2 Long Bolt Offset Pattern
• CW Rotation
• Use w/ Late Model 3.0L Engines with 14"
Flywheel
Replacement Solenoid: **18-5811-1**
Fits : Volvo Penta, Mercuriser, Marine Power



**18-6834
STARTER**
Replaces: GM Engines Universal
Used on all GM Engines with either 14 1/4"
or 12 3/4" flywheels



**18-6835
STARTER**
Replaces: GM Engines Universal
Used on all GM Engines with either 14 1/4" or 12 3/4"
flywheels



**18-6839
STARTER**
Replaces: 1357199, -7, 3523301, -4,
5003564, -1
Fits: 240,740,760,780,940 series 2.3L



**18-6872
STARTER**
(12 Volt)
Replaces: 233991, 240501, 837924,
842775, 843511, 847306-8, 881681
Fits: 12V; TAMD, MD, AQD Models



**18-6956
STARTER**
Replaces: 3803227, -2, 834625-6,
841378-3, 841380, 841762, 63, 65, 66,



**18-6958
STARTER**
(24 Volt)
Replaces: 847308-4, 870998, 881682
Fits: 24V; MD, TMD, TAMD Models



**18-59710
ALTERNATOR**
Replaces: 820652, 822454, 827303,
847651, 849561, 849602
Fits: 24V; AQ Series gas and diesel
24V systems



**18-5882
ALTERNATOR**
Superseded from 18-6845
Replaces: 3884950
75A, 12V, Serpentine
3.0L, 4.3L, 5.0L, 5.7L, 8.1L (2007 - Current)



**18-5957
ALTERNATOR**
Replaces: 3860769
(3-Wire) (68 AMP)
Replaces Mando, Motorola and Original Equipment Delco.
Uses same electrical connections and mounting method.
Equipped with fan and drive pulley.
SAEJ1171



**18-59700
ALTERNATOR**
Replaces: 3803227, -2, 834625-6,
841378-3, 841380, 841762, 63, 65, 66



**18-5979
ALTERNATOR**
Replaces: 3860082, Mando AC165622,
Lester 12391
65 amp, 3.0GSM-A/B/C, 3.0GSP-A/B/C, 3.0GLM-A/B,
3.0GLP-A/B, 4.3GXl-A/B/BF/C.CF.D.DF, 4.3OSl-B/BF/C/
CF/DF/Df, 5.0GXl-A



**18-5959
ALTERNATOR**
Superseded from 18-5943
Replaces: 826495, 834609,
834963, 841762, 841765, 841766.
Valeo A13N1M, 2M, 147M, 148M
14V/50 AMP: AQ120-AQ145, AQ200D-AD290-TMD40-
MD21-8070-MD5C, MD18-7D-MD30-TMD30-TAM30,
MD18-MD2B-MD2BHY-MD3B-MD21A, MD32A-
AQD32A/270D (Mot V8S), MD5-MD7-MD11-MD17-B21-
B22 Mot. TMD40), Series 2002-2003-R,V,S.



**18-6261
ALTERNATOR**
Replaces: 3856600-6, 3857561
Mando for Late Model Volvo
Penta, 12 Volt, 65 Amp,
Internal Regulator, Single
Groove Pulley



**18-6265
ALTERNATOR**
Replaces: 3857813
Mando for Late Model Volvo Penta, 12 Volt,
65 Amp, Internal Regulator, Single Groove
Pulley



**18-5939
ALTERNATOR**
Replaces: 872235, 3803260, 873770
Valeo: A13N234, 2541451
14V/60 AMP: AQ115, AQ120B, AQ125, AQ130, AQ140,
AQ145, AQ165, AQ170, AQ200, AQ225, AQ256,
AQ260, AQ280, AQ290, BB115, BB145, MB20; Diesel
Engine Application: AQD2B, AQD21A, AQD21B,
AQD27, AQD29, AQD32A, MD11C, MD11D, MD17C,
MD17D, MD2B, MD2010A, MD2010B, MD2030A,
MD2030B, MD2040A, MD2040B, MD21A, MD21B,
MD27, MD29, MD3B, MD32A, MD6A, MD6B, MD7,
TAM71A, TAM71B, TAM72A, TAMD72WI-A.



**18-6846
ALTERNATOR**
Replaces: Volvo Penta 1502272,
3803270-2, 5001677, 845940,
72021, 872022, 872757, 873635,
873757, 873757-9, 873771,



**18-6847
ALTERNATOR**
Replaces: 3862613, 2655301,
Fits: 2000-07 3.0GLP, GSP, GSM, 4.3GXi,
5.0GXi, Si, 5.7Gi, GXi, Osi, Sxi



**18-5976
ALTERNATOR**
Replaces: Motorola 9AR3743G,
510-821, 510-802, 510-835, 510-836,
510-856, 510-861, 510-862
Valeo 2937430
28V/45 AMP: TAMD120, TMD100, TMD120



**18-6975
ALTERNATOR (Universal)**
Fits: High amp 160A alternator, universal
mounting pattern based on Delco CS1300
design, v-belt and 6 groove serpentine
pulley included



**18-6848
ALTERNATOR**
Replaces: Volvo 3862612,
2656299, Valeo A0002655299
Fits: 2000 and on Volvo Penta Models
w/ 4.3, 5.0, and 5.7 GM engines



**18-6953
ALTERNATOR**
Replaces: Volvo
Fits: Diesel D3 Models



**18-6955
ALTERNATOR**
Replaces: Caterpillar
3001117, 10-258, Prestolite
110-258, 110-258A, Volvo
849748-9
Fits: Volvo Diesel 6 cylinder models

ALTERNATOR/STARTER APPLICATION

GASOLINE ENGINES

Model	Engine	Year	Starter	Alternator	Model	Engine	Year	Starter	Alternator
AQ115			18-5918	N/A	AQ131D	4 cyl	1985-1989	18-5906	18-5959
AQ120B			18-5918 ①	N/A	AQ140A			18-5918 ③	18-5959
AQ120B			18-5906	N/A	AQ140A			18-5906 ②	18-5959
AQ125A			18-5918 ①	18-5959	AQ145			18-5918	18-5959
AQ125A	4 cyl	1981-1985	18-5906 ②	18-5959	AQ145A	4 cyl	1979-1985	18-5918 ③	18-5959
AQ125B	4 cyl	1981-1985	18-5906 ②	18-5959	AQ145A	4 cyl	1979-1985	18-5906 ⑤	18-5959
AQ130			18-5918	N/A	AQ145B	4 cyl	1979-1985	18-5906 ⑤	18-5959
AQ131A	4 cyl	1985-1989	18-5906	18-5959	AQ151A	4 cyl	1985-1989	18-5906	18-5959
AQ131B	4 cyl	1985-1989	18-5906	18-5959	AQ151B	4 cyl	1985-1989	18-5906	18-5959
AQ131C	4 cyl	1985-1989	18-5906	18-5959	AQ151C	4 cyl	1985-1989	18-5906	18-5959

① Below SN 7679/013489

② AQ125A beginning with S/N 7679/013489

③ Below SN 7705/001557

⑤ AQ145A & BB145A beginning with SN 7705/001557

⑥ 18-5959 14V/50AMP

⑦ Mounting screw threads into bracket

⑧ 18-5939 14V 50 AMP

Model	Engine	Year	Starter	Alternator	Model	Engine	Year	Starter	Alternator
AQ165			18-5918	N/A	BB115			18-5918	N/A
AQ170			18-5918	N/A	BB140A			18-5918 ③	18-5959
AQ171A	4 cyl	1986-1994	18-5906	18-5959 ⑥	BB140A			18-5906	N/A
AQ171C	4 cyl	1986-1994	18-5906	18-5959 ⑥	BB145			18-5918	N/A
AQ175A			18-5911 ⑤	N/A	BB145A	4 cyl	1979-1985	18-5918 ③	18-5959
AQ190A			18-5903	N/A	BB145A			18-5906 ⑤	N/A
AQ200B			18-5911	18-5959	BB165			18-5918	N/A
AQ200C			18-5911	18-5959	BB170			18-5918	N/A
AQ200D			18-5911	18-5959	BB225A			18-5911	18-5959
AQ200F			18-5911	18-5959	BB225B			18-5911	18-5959
AQ205A			18-5911	N/A	BB225C			18-5911	18-5959
AQ211A			18-5911	N/A	BB260A			18-5911	18-5959
AQ225A			18-5911	18-5959	BB260B			18-5911	18-5959
AQ225B			18-5911	18-5959	BB260C			18-5911	18-5959
AQ225C			18-5911	18-5959	230			18-5906	18-5959
AQ225D			18-5911	18-5959	250			18-5906	18-5959 ⑦ 18-5939 ⑧
AQ225E			18-5911	18-5959	251A			18-5906	N/A
AQ225F			18-5911	18-5959	430			18-5911	18-5959 ⑦
AQ231A			18-5911	N/A	431			18-5911	18-5959 ⑦
AQ231B			18-5911	N/A	432			18-5911	18-5959 ⑦
AQ240A			18-5903	N/A	434			N/A	N/A ⑦ 18-5939 ⑧
AQ255A			18-5911	N/A	500-570			18-5911	18-5959 ⑦ 18-5939 ⑧
AQ255B			18-5911	N/A	571A			18-5911	N/A N/A
AQ260A			18-5911	18-5959	572			18-5911	18-5959 18-5939 ⑧
AQ260B			18-5911	18-5959	740B			18-5911	18-5959 18-5939 ⑧
AQ271A			18-5911	N/A	3.0L			18-5919-1	N/A
AQ271B			18-5911	N/A	4.3L			18-5913-1	N/A
AQ271C			18-5911	N/A	5.0L (GM)	V-8	1994-2007	18-5913-1	N/A
AQ271D			18-5911	N/A	5.7L (GM)	V-8	1994-2007	18-5913-1	N/A
AQ280			18-5911	N/A	7.4L (GM)	V-8	1994-2007	18-5913-1	N/A
AQ290A			18-5911	18-5959	8.2L (GM)	V-8	1994-2007	18-5913-1	N/A
AQ311A			18-5911	N/A	5.0L (FORD)	V-8	1994	18-5920	N/A
AQ311B			18-5911	N/A	5.8L (FORD)	V-8	1994	18-5920	N/A

① Below SN 7679/013489 ② AQ125A beginning with S/N 7679/013489 ③ Below SN 7705/001557 ⑤ AQ145A & BB145A beginning with SN 7705/001557
 ⑥ 18-5959 14V/50AMP ⑦ Mounting screw threads into bracket ⑧ 18-5939 14V 50 AMP



18-6291
SOLENOID
 Replaces: 3854194-2, OMC 3854194
 Fits: Ford Gear Reduction
 Starters on Late Model 5.0L, 5.8L,
 OMC and Volvo Penta



18-5806
SOLENOID
 Replaces: 834520
 BOSCH 0331-302-050, 0331-302-081,
 0331-302-085, 0331-302-581, 0331-302-585
 For starters with aluminum nose.
 Slot in end of solenoid shaft is 13/32" long.



18-5811-1
STARTER SOLENOID
 Replaces: 3850216, 3859054
 For: PG 260 series starters, GM V6 & V8 (1983-Up)



18-5837
SOLENOID
 Replaces: 3853869, 3853998
 For: 3.0 ; GL, GS, 4.3L GL, GS, 5.7L GL, GI,
 7.4L GL, 8.2L GL



18-9802
TIMING LIGHT
 Self-powered accurate up to 10,000 RPM's



18-69550
CIRCUIT BREAKER
 Replaces: 3854164
 Fits: Volvo Multiple Gasoline Engine Applications



**18-6271
RELAY**
Replaces: 870670, 6643474,
876038, 241812
12 Volt, 30 Amp



**18-6268
RELAY**
Replaces: 841177, 872272
12 Volt, 30 Amp



**18-6266
RELAY**
Replaces: 876040, 872300
12 Volt, 30 Amp/20 Amp continuous



①18-5705D Display Package

**18-5705
POWER TRIM RELAY**
Replaces: 876039
5 Terminal
For: AQ 175, 200, 225D,
260, 290A



**18-5700
TRIM RELAY**
Replaces:
3858081, 3858809
For: (1998 SX-M-MAC, MDA, MLT), 3.0GLP-D,
4.3GL-E, 4.3GL-EF, 4.3GXl-F, 4.3GXl-FF, 4.3OSl-F,
4.3OSl-FF, 5.0GL-F, 5.0GL-FF, 5.0GXl-FF, 5.0GXl-FF,
5.0Si-F, 5.0Si-FF, 5.7Gi-F/FF, 5.7GXl-G/GF, 5.7OSl-E/
EF, 5.7OXl-E/EF, 5.7Gil-F, 5.7GXl-G, 8.1Gi-G/GF,
8.1GXl-F/FF, 8.1OSl-C/CF, 8.1Gil-G, 8.1GXl-F, DPH-A,
DPH-B, DPR-A, DPH-B, EF drives, SX-M TSKs 1998-
05, SX-M, DP-SM, (WT drives, PJX-C, PJX-S SX-M,
-MACLT, -MDA, -MDB, -MHP, -MTD, DP-E, DP-S, -S1,
-S2, DP-SM, -SM)XDP-B



**18-5704
POWER TRIM RELAY**
Replaces: 876037
20 Amps Resistive
15 Amps Inductive
Single Pull 5 Terminal
For: AQ270, 280

PKG. OF 5



**18-6951
18-6951-9②
POWER TILT FUSE
(30 Amp)**
Replaces: 851120



**18-6770
TILT/TRIM
PUMP**
Replaces: 854346
Oil-dyne
For: Early Version SX Drive with 2.5" bolt centers and
fine threads
Motor **18-6817**



**18-6806
TRIM PUMP ASSEMBLY**
Replaces: 3587079, 3857489, 3860879
For: SX - Late Model with Coarse Thread
Motor **18-6804**



**18-6822
TRIM PUMP**
Replaces: Volvo Penta 852928, 820545,
OMC 172543, 382715
Motor **18-6838**



**18-6804
TRIM MOTOR**
Replaces: 3861575
For: SX Drives - Later Version / 2.3" Bolt Centers w/
Coarse Thread



**18-6817
TRIM MOTOR**
Replaces: 854525-3, 3858071
Fits: Late model Volvo Penta
For: SX - Early Version / Fine thread & 2.5" bolt centers



**18-6838
TRIM MOTOR**
Replaces: 3586765, 852928, 872449,
873051
Fits: DP, DPX Drives
Replacement pump **18-6822**



**18-6881
TRIM MOTOR WITH PUMP**
Replaces: Volvo 852928, 872449, 873051,
Fits: DP, DPX Drives
Motor **18-6838**
Pump **18-6822**



**18-6823
WIRING HARNESS**
Replaces: Universal
Converts 3-wire Tilt and Trim motors to 2-Wire design

① Items ending in "D" are Display Packaged - Regular number is Non-Display
② Priced per package



**18-6274
TILT/TRIM MOTOR**
Replaces: 852928, 3857265
Replaces : Prestolite HYK4001
Includes Hydraulic Valve Body



**18-6758
TILT/TRIM MOTOR**
Replaces: 850834
Electrolux KP5024/120



**18-6779
TRIM MOTOR**
Replaces: 986280, 3853945
For: PJX, SX, DPS, DP, DPX, 3.0L GS,
GL, 4.3L GL, GS, GI, 5.0L FL, FI, 5.7L
GL, GI, 5.8L FL, FI, FSI



**18-6790
TILT MOTOR**
Replaces: 839430,
Electrolux KS3448/290
Fits: Older model Volvo



**18-6791
TILT MOTOR**
Replaces: 850046, 853520
Fits: Older model Volvo



**18-6792
TILT MOTOR**
Replaces: 897720, 854329
Fits: Older model Volvo



**18-7641
CARBURETOR
(Remanufactured)**
Replaces: 841047-4, 841313-0, 3856393
AQ225B, C, D, E, F; 225A, B; AQ260A, B; 290A; BB225A, AV,
BB225B, C; 260A, AV, B, C; 501A, 501A/MS4A; 570/MS4A
Use Replacement Carb Kit **18-7095**



**18-79998
CARBURETOR
(Remanufactured)**
Replaces: R80316
Fits: 3.0L GL, GS



**18-80008
CARBURETOR
(Remanufactured)**
Replaces: R7044289
Fits: 7.4L w/ 4bbl Rochester



**18-7000
CARB KIT**
Replaces: 841836-0, 841292
SOLEX DOWN DRAFT
(856471 + 856472 = 18-7000)



**18-7001
CARB KIT**
Replaces: 841293-4
SOLEX SIDE DRAFT



**18-7040
CARB KIT**
Contains adjustable needle & seats



**18-7072
CARB KIT**
Replaces: 855889



**18-7085
CARB KIT**
Replaces: 875407



**18-7086
CARB KIT**
Replaces: 841994



**18-7095
CARB KIT**
Replaces: 834985-4



**18-7237
CARB KIT**



**18-7238
CARB KIT**
Replaces: 3854020
For: 4.3L GL, GS, 5.0L GL, 5.7L GL



**18-7241
CARB KIT**
Replaces: 3855017
For: 7.4L GL, 8.2L GL



**18-7242
CARB KIT**
Replaces: 3854105



**18-7244
CARB KIT**
Replaces: 3854106



**18-7245
CARB KIT**
Replaces: 3854107



**18-7246
CARB KIT**
Replaces: 3854116
For: 3.0L GLM, GLP, GSM, GSP, GS, GL



**18-7099
CARB GASKET SET**
Replaces: 824803, 856470



**18-7200
FLOAT**
Replaces: 841634-9
(ALCOHOL RESISTANT)
Plastic



**18-7201
FLOAT**
(ALCOHOL RESISTANT)
Brass



**18-7202
FLOAT**
(ALCOHOL RESISTANT)
Brass



**18-36905
FLOAT**
Replaces: 3854018
Fits: 3.0L GLM, GLP w/2 bbl Holley Carb

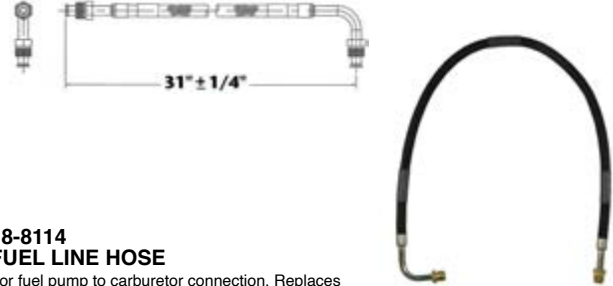

**18-8114
FUEL LINE HOSE**
For fuel pump to carburetor connection. Replaces copper or steel tubing 3/8" X 31" PTFE composite hose with 5/8"-18 male inverted flare straight one end, 5/8"-18 90° one end. SAE J1527 type A1



**18-8115
FUEL LINE HOSE**
For fuel pump to carburetor connection. Replaces copper or steel tubing 3/8" X 25" PTFE composite hose with 5/8"-18 male inverted flare straight one end, 5/8"-18 90° one end. SAE J1527 type A1

CARBURETOR KIT/FLOAT/CARBURETOR GASKET KIT APPLICATION

Model	Cyl.	Mfg Code	Carb Model	Carburetor #	Carb Kit ①	Carb Float	Carb Gasket Kit
AQ115A,B,125A,B,130C,D, AQ131A,B,C,D,145A,B AQ151A,B,C,171A,C BB115B,C,145A	4	—	—	SOLEX 44 PA1	18-7000	—	18-7099
AQ120B,140A,BB140A	4	—	—	SOLEX 44 PHN-3	18-7001	—	—
AQ80	4	—	—	ZENITH 34VN	—	—	—
AQ95,95A,100,105A,110, 115 W/109", (1780cc) Dual Carb. Installation	4	ZS-1	150CD	150CD-SE (C1865F,R, C304D,F,R)	18-7085	—	—
AQ120, AQ130A,B,BB115A,w. 121" (1986cc) Dual Carb. Installation	4	ZS-1	175CD	175CD-2S, (C3098F,R, C3200 F,R,C,3231 F,R)	18-7085	—	—
3.0L GL,GS	4	H-2	2300	R-80316A,R-80316-1A	18-7246	—	—
AQ170A,B,C,BB170A,B,C	6	—	—	SOLEX 44 PA1	18-7000	—	18-7099
AQ165A,BB165A (3 Carb. Installation)	6	ZS-1	175CD	175CD-2S, (C3201F,M, R,C 3232F,M,R)	18-7085	—	—
AQ175A	6	R-2	2GE	17059059	18-7086	18-7200	—
4.3L GL,GS	6	H-2	2300	R-80312A,R-80312-1A	18-7238	—	—
4.3L GL,GS	6	H-4	4160	R-80403A,R-80403-1A	18-7237	—	—
AQ200D,F and 500A AQ225B,C,D,E,F,255A,B, AQ260A,B,290A,BB225A,AV, BB225B,C,260A,AV,B,C 501A,501A/MS4A,570/MS4A	8	R-2	2GE	17057133, 17059059	18-7086	18-7200	—
305" (5.0L),307" (5.0L),350" (5.7),	8	R-4	4ME	17059283,296, 298	18-7095	18-7201	—
5.0L, 5.8L (Fi, FL,SX) (Ford)	8	R-4	4MC, 4MV	7044288,7044289, 1705,628717,057,290	18-7072	18-7201	—
5.0L, 5.8L (Fi, FL) (Ford)	8	H-2	2300	R-80382A,R-80382-1A	18-7244	—	—
740A/MS5A	8	H-4	4150	R-80383A,R-80383-1A	18-7245	—	—
454" (7.4L)	8	H-4	4011	R84026AA	18-7040	—	—
7.4L GL	8	R-4	4MC, 4MV	7044288,7044289, 1705,628717,057,290	18-7072	18-7201	—
8.2L GL	8	H-4	4150	R-80378A,R-80378-1A	18-7242	—	—
	8	H-4	4150	R-80378A,R-80378-1A	18-7242	—	—

① Does not include metering rods



**18-7326
ELECTRIC FUEL PUMP**
Replaces: 3850809,
3858261, 3854620, 3857986



**18-7330
ELECTRIC FUEL PUMP**
Replaces: 3857650, 3855958



**18-7331
ELECTRIC FUEL PUMP**
Replaces: 3850810,
3857985, 3858714

ELECTRIC FUEL PUMP APPLICATION

Year	Engine	Application	OE #	#'s Superseded from	Part #
1994-99	262/4.3L (HU-WT)	High Pressure pump	3857650		18-7330
1994-99	262/4.3L GL/GS (All)	Carbureted - Low Pressure	3858261	3850809	18-7326
1994-99	262/4.3L GI (HU-WT)	W.Elec. Pump - Low Pressure	3858261	3850809	18-7326
1994-99	454/7.4L & 502/8.2L (HU-WT)	Low pressure system	3858714	3850810, 3857985	18-7331
1993-99	350/5.7L, 454/7.4L, & 502/8.2L	Engines w/MPI - High Pressure	3857650		18-7330
1996-99	454/7.4L & 502/8.2L (HU-WT)	Engines w/MPI - High Pressure	3857650		18-7330
1994-99	5.0L thru 5.8L	Low pressure electric fuel pump	3858261	3850809	18-7326
1994-99	454/7.4L & 502/8.2L (HU-WT)	GM Mark V Eng. - Low Pressure	3858714	3850810, 3857985	18-7331
1992-93	454/7.4L	GM Mark V Eng. - Low Pressure	3858714	3850810, 3857985	18-7331



**18-7268
FUEL PUMP**
Replaces: 3855276
For: 5.7L Liter Engines
Dual Diaphragm requires sight glass



**18-7281
FUEL PUMP**
Replaces: 826493
For: GM (V-8) 305, 350
(Includes gasket)



**18-7286
FUEL PUMP**
Replaces: 841161
For: XP stamped steel pump
AQ120B (spec# 867465), AQ125A/B, AQ131A/B/C/D,
AQ140A (spec# 867464), BB140A, AQ145A, BB145A,
AQ151A/B/C, AQ171A/C, AQ230A/B, AQ250A/B, AQ251A



**18-35442
FUEL PUMP**
Replaces: 859428
Fits: Volvo Late 2000 Series Engines



**18-7229
FLAME ARRESTOR**
Replaces: 3854026
For: 3.0L GS, GL, 4.3L GL, GS, GSI, 5.0L
FL, FI, 5.7L GL, GI, 5.8L FL, FI, FSI

- UNIVERSAL DESIGN -

FUEL WATER SEPARATOR BRACKETS



Bracket Type	Part #	Bracket Type	Part #
1/4" Stainless Steel	18-7777	1/4" Aluminum	18-7853-1
3/8" Stainless Steel	18-7776	3/8" Aluminum	18-7775

FUEL WATER SEPARATOR KITS



21 MICRON FILTER KITS FOR CARBURETED ENGINES

Kit Type	Part #	Micron Rating	Contents
1/4" Aluminum (Short Filter)	18-7848-1 •	21	1 - 18-7844 filter & 1 18-7853-1 bracket 2 - 18-4256 1/4" pipe plugs
1/4" Aluminum Bonus Pack Contains spare filter	18-7848-2 •	21	2 - 18-7844 filter & 1 18-7853-1 bracket 2 - 18-4256 1/4" pipe plugs
1/4" Aluminum (Tall Filter)	18-7852-1 •	21	1 - 18-7845 filter & 1 18-7853-1 bracket 2 - 18-4256 1/4" pipe plugs
1/4" Aluminum Bonus Pack Contains spare filter	18-7852-2 •	21	2 - 18-7845 filter & 1 18-7853-1 bracket 2 - 18-4256 1/4" pipe plugs
3/8" Aluminum (Tall Filter)	18-7775-1 •	21	1 - 18-7845 filter & 1 18-7775 bracket 2 - 18-4264 3/8" pipe plugs
1/4" Stainless Steel (Tall Filter)	18-7777-1 •	21	1 - 18-7845 filter & 1 18-7777 bracket 2 - 18-4256 1/4" pipe plugs
3/8" Stainless Steel (Tall Filter)	18-7776-1 •	21	1 - 18-7845 filter & 1 18-7776 bracket 2 - 18-4264 3/8" pipe plugs

10 MICRON FILTER KITS FOR FUEL INJECTED ENGINES



Kit Type	Part #	Micron Rating	Contents
1/4" Aluminum (Short Filter)	18-7983-1 •	10	1 - 18-7944 filter & 1 18-7853-1 bracket 2 - 18-4256 1/4" pipe plugs
1/4" Aluminum Bonus Pack Contains spare filter	18-7983-2 •	10	2 - 18-7944 filter & 1 18-7853-1 bracket 2 - 18-4256 1/4" pipe plugs
1/4" Aluminum (Tall Filter)	18-7982-1 •	10	1 - 18-7945 filter & 1 18-7853-1 bracket 2 - 18-4256 1/4" pipe plugs
1/4" Aluminum Bonus Pack Contains spare filter	18-7982-2 •	10	2 - 18-7945 filter & 1 18-7853-1 bracket 2 - 18-4256 1/4" pipe plugs
1/4" Aluminum (High Capacity Filter)	18-7966-1 •	10	1 - 18-7866 filter & 1 18-7853-1 bracket 2 - 18-4256 1/4" pipe plugs
3/8" Aluminum (Tall Filter)	18-7986-1 •	10	1 - 18-7945 filter & 1 18-7775 bracket 2 - 18-4264 3/8" pipe plugs
1/4" Stainless Steel (Tall Filter)	18-7984-1 •	10	1 - 18-7945 filter & 1 18-7777 bracket 2 - 18-4256 1/4" pipe plugs
3/8" Stainless Steel (Tall Filter)	18-7985-1 •	10	1 - 18-7945 filter & 1 18-7776 bracket 2 - 18-4264 3/8" pipe plugs

• Display Packaged



10 MICRON FILTER KITS WITH DRAIN BOWLS

Sierra AquaVue™ and metal bowl separator filters allow water to be drained from the filter to extend service life. Use the AquaVue™ bowl for outboard, above deck installations. USCG regulations require the use of the flame resistant metal bowl below deck.

Kit Type	Part #	Micron Rating	Contents
1/4" Aluminum w/ metal drain bowl	18-7951 •	10	1 - 18-7919 filter & 1 18-7853-1 bracket 1 - 18-7924 metal bowl 2 - 18-4256 1/4" pipe plugs
1/4" Stainless Steel w/ metal drain bowl	18-7938 •	10	1 - 18-7919 filter & 1 18-7777 bracket 1 - 18-7924 metal bowl 2 - 18-4256 1/4" pipe plugs

VOLVO STYLE BRACKETS AND SEPARATOR KITS

18-7778
VOLVO ALUMINUM
REPLACEMENT BRACKET
Replaces: 3850861



COMPACT BRACKET AND SEPARATOR KIT - FOR SMALL OUTBOARDS AND FRESH WATER APPLICATIONS

18-7774
COMPACT ALUMINUM BRACKET



18-7965-1
10 MICRON COMPACT
SEPARATOR KIT
Contains:
1 - 18-7774 bracket
1 - 18-7865 filter



REPLACEMENT FILTERS



UNIVERSAL DESIGN

10 MICRON REPLACEMENT FILTERS		21 MICRON REPLACEMENT FILTERS	
Part #	Description	Part #	Description
18-7944	Short - 3.875"	18-7844	Short - 3.875"
18-7945	Long - 4.35"	18-7845	Long - 4.35"
18-7866	High Capacity - 6"		
18-7865	Compact 10 Micron		

REPLACEMENT FILTERS FOR VOLVO

10 MICRON REPLACEMENT FILTERS			21 MICRON REPLACEMENT FILTERS		
Part #	Description	Replaces	Part #	Description	Replaces
18-7946	OMC thread		18-7846	OMC thread	
18-7989	Volvo SX/EFI Cobra EFI	Volvo 3851218-2, 3852413, 3862228	18-7789	Volvo SX/EFI Cobra EFI	Volvo 3851218-2, 3852413



10 MICRON REPLACEMENT FILTERS AND KITS WITH DRAIN BOWLS

REPLACEMENT FILTERS			REPLACEMENT BOWLS	
Part #	Description	Replaces	Part #	Description
18-7919	Spin on replacement	Racor S3213	18-7924	Metal Collection Bowl
18-7920	Spin on replacement	Racor S3214		
18-7947	Spin on replacement Fits - 120RRAC01	Racor S3240	FILTER & BOWL KITS	
18-7948	Spin on replacement Fits - 320RRAC01	Racor S3227	Part #	Description
18-7949	Spin on replacement Fits - 660RRAC02	Racor S3232	18-7929	Filter & Metal Bowl Contains: 18-7919 filter, 18-7924 bowl

**18-8125
DIESEL FUEL FILTER**

Replaces: 3583443

D4-180i-B, D4-180i-C, D4-210A-A, D4-210A-B, D4-210i-A, D4-210i-B, D4-225A-B, D4-225A-C, D4-225i-B, D4-225i-C, D4-260A-A, D4-260A-B, D4-260A-C, D4-260D-B, D4-260D-C, D4-260i-A, D4-260i-B, D4-260i-C, D4-300A-A, D4-300A-C, D4-300D-A, D4-300D-C, D4-300i-A, D4-300i-C, D6-280A-A, D6-280A-B, D6-280i-A, D6-280i-B, D6-310A-A, D6-310A-B, D6-310D-A, D6-310D-B, D6-310i-A, D6-310i-B, D6-330A-B, D6-330A-C, D6-330D-B, D6-330D-C, D6-330i-B, D6-330i-C, D6-350A-A, D6-350A-B, D6-370A-B, D6-370A-C, D6-370D-A, D6-370D-B, D6-370D-C, D6-370i-A, D6-370i-B, D6-370i-C, D6-435D-A, D6-435D-C, D6-435i-A, D6-435i-C



**18-7862
FUEL FILTER
ELEMENT**

Replaces: 841162
(Includes Gasket)



**18-7858
FUEL FILTER**

Replaces: 858201

For CAV Type Unit

AQ120B, 125A, B, 131A, 140A, 145A,B, 151, BB, 140, 145A



18-8149

HIGH CAPACITY FUEL WATER SEPARATING FILTER

Replaces: Volvo 3847644

Fits most gasoline applications with electric fuel pump.
(some height restrictions may occur when using with 18-7778, Volvo 3850861)



**18-7942
FUEL FILTER**

Replaces:

466987, 3825133

For: MD100A, TMD100A, MD100B, MD120A, TMD120A, TAMD120A, MD120B, TMD120B, TAMD120B, MD70B, TM-D70B, TAMD70B, THAMD70B, AQAD70B, MD70C, TMD70C, TAMD70C, AQD70C, TAMD60A, TAMD60B, TAMD60C, D5/ D7 MARINE GENSET, D5A-T, D5A-TA, D7A-T, D7A-TA, D7C-TA, D63 MARINE, D71/73 MARINE, KAD32P, TAMD42WJ, KAD43P/44P/300, KAMD43P/44P/300, TAMD103A, TAMD61A, TAMD62A, TAMD71A, TAMD72A, TAMD72P, TAMD72WJ, TAMD74, TAMD75 MARINE, TMD102A, TAMD102A, TAMD102D, TMD122A, TAMD122A, TAMD122P, TMD31L, TAMD31P/L/M/S, AD31P/L, TMD41L, TAMD41P/L/M/H



18-7709

FUEL FILTER

Replaces: 3840335

Fits: KAD42P-A, KAMD42P-1, KAD44P-B, KAD44P-C, KAMD44P-A, KAMD44P-B, KAMD44P-C, TAMD42WJ-A, KAD43P-A, KAMD43P-A, KAT44P-C, KAD300-A, KAMD300-A, MD6A, MD6B, MD7A, MD7B, D41L-A, TAMD41H-B, TMD41L-A, AD41L-A, AD41P-A, TAMD41H-A, TAMD41P-A, MD22A, MD22A-A, MD22L-A, TMD22A, TMD22-A, D3-110i-A, D3-130A-A, D3-130i-A, D3-160A-A, D3-160i-A, D3-110i-B, D3-110i-C, D3-130A-B, D3-130i-B, D3-130A-C, D3-130i-C, D3-160A-B, D3-160i-B, D30160A-B, D3-160A-C, D3-160i-C, D3-190A-B, D3-190i-B, D3-190A-C, D3-190i-C, KKAD42A, KAMD42A, AD41D, D41D, TAMD41D, TMD41D, MD22L-B, MD22P-B, TMD22-B, TMD22P-C, TAMD22P-B



18-7859

FUEL FILTER

Replaces: 835576

For: AQ175, 200, 226, 266, 290
BB200, 225, 260



18-8124

DIESEL FUEL FILTER

Replaces: 829913

Fits: 2001, 2001B, 2002, 2002B, 2003, 2003B/T/TB, AQD2B, MD11C/D, MD17C/D, MD1B, MD2B, MD3B, MD5A/B/C, MD7/B



18-7792

FUEL FILTER

Replaces: 3855104

For: Volvo 3.0L (1994-99), OMC 3.0L (1995-98)





**18-7964-1
TRANSMISSION
FILTER KIT**
For: Mercruiser V-8 Inboard
with Hurth Transmission



**18-7717
FILTER ELEMENT**
For: Rochester 2 bbl &
4 bbl Carburetors



**18-7689
FUEL INJECTOR**
Replaces: 3855182
Fits: 5.7GLPMDA, 5.7GIPMDA, 5.7GIPMDACE, 5.7GLIMDA, 5.7GIIMDA, 4.3GLPHUB, 4.3GSPHUB, 4.3GSPHUS, 4.3GIPHUSCE, 5.7GIPHUS, 4.3GLPNCA, 4.3GLPNCB, 4.3GLPNCS, 4.3GSJNCC, 4.3GSJNCS, 4.3GSPNCA, 4.3GSPNCB, 4.3GSPNCM, 4.3GSPNCS, 4.3GIPNCA, 4.3GIPNCB, 4.3, 5.7GLPNCS, 5.7GIPNCA, 5.7GIPNCSCE, 5.7GIPNCMCE, 5.7GIPNCBCE, 5.7GIINCSC, 4.3GLPLKD, 4.3GLPLKE, 4.3GSPDK, 4.3GSPDKE, 4.3GIPLKDC, 4.3GIPLKCE, 4.3GSJLKD, 5.7GLPLKA, 5.7GLPLKE, 5.7GLPLKE, 5.7GLPLKR, 5.7GSPDK, 5.7GSPDKE, 5.7GIPLKDC, 5.7GIPLKCE, 5.7GICPLKD, 5.7GICPLKE, 4.3GLPBYC, 4.3GSPBYC, 4.3GIPBYC, 4.3GSJBYA, 4.3GIJBYA (1994-07)



**18-7685
TBI INJECTOR**
Replaces: 3858941
Fits: 4.3GXi-A, 4.3GLPWTC, 4.3GLPWTR, 4.3GSPWTC, 4.3GSPWTR, 4.3GIPWTC, 4.3GIPWTR, 4.3GIJWTR, 4.3GSJWTR, 4.3GLPEFS, 4.3GIPEFS



**18-7702
AIR CHARGE
TEMPERATURE SENDER**
Replaces: 3854527
Fits: 5.0L Gxi-A(2001-02), 5.7L GiL-A (2001), 5.7L Gi-A(2000-01), 5.7L GSIL-A (2000-01), 5.7L Gxi-A(00-01), 5.7L XiL-A (00-01), 5.7L Gxi-B(01-02), Many 7.4L (1994-00), Many 8.1L (2005-Current)



**18-7513
TEMPERATURE SENSOR**
Replaces: 3862500



**18-5897
TEMPERATURE
SENDER**
Replaces: 3853787
For: 5.0L FL, FI, 5.8L FL, FI, FSI



**18-7647
TEMPERATURE SENDER**
Replaces: 872066
Fits: 4.3GL-A, 4.3GL-B, 4.3GL-C, 4.3GL-D, 5.7GL-A, 5.7GL-B, 5.7GL-C, 5.7GL-D, 5.7GL-E, 5.0GL-A, 5.0GL-B, 5.0GL-C, 5.0GL-D, 5.0GL-E, 3.0GLP-A, 3.0GLP-B, 3.0GLM-A, 3.0GLM-B, 3.0GSP-A, 3.0GSP-B, 3.0GSP-C, 3.0GSM-A, 3.0GSM-B, 3.0GSM-C, 3.0GLP-C, 3.0GLP-D, 4.3GL-E, 4.3GL-EF, 5.0GL-F, 5.0GL-FF, 3.0GLP-E, 4.3GL-G, 4.3GL-GF, 4.3GL-J, 4.3GL-JF, 5.0GL-H, 5.0GL-HF, 3.0GLP-J, 3.0GLP-N, 5.0GL-J, 5.0GL-JF (1998-2007)



**18-5894
OIL PRESSURE LIGHT
SWITCH**
Replaces: 3852215



**18-7700
THROTTLE
POSITION SENSOR**
Replaces: 3857487
Fits: 4.3, 5.0, 5.7, 8.1, 8.2L models



**18-5899
OIL PRESSURE SENDER**
Replaces: 3857532
For: 230, 250, 3.0L GLM, GLP, GSM, GSP, 4.3L GL, GXI, OSI, 5.0L GL, GXI, OSI, 5.7L GL, GI, GXI, GIL, GXIL, OSI, OSXI, 8.1L GI, GXI, OSI, GIL



**18-7704
IAC MOTOR**
Replaces: 3855194



**18-7705
IAC MOTOR**
Replaces: 3843751



**18-7684
MAP SENSOR**
Replaces: 3850396
Fits: 4.3, 5.0, 5.7, 7.4L models (1994-2007)



**18-7677
KNOCK SENSOR**
Replaces: 3850357
Fits: 4.3, 5.0, 5.7L models (2002-07)



**18-7703
KNOCK SENSOR**
Replaces: 3854512
Fits: 7.4, 8.2L (1999-2001)



**18-7679
KNOCK SENSOR**
Replaces: 3854905
Fits: 4.3L (1994-2002), 5.0L Gxi-A (2001-02), 5.7L GiL-A(2001), 5.7Gi-A, 5.7GXi-A, 5.7GXi-B, 5.7GiL-A, 5.7GSiL-A, 5.7GXi-A, 5.7GXii-B(2000-03), 5.7GLPNCS, 5.7GIPNCA, 5.7GIPNCSCE, 5.7GIPNCSCE, 5.7GIPNCSCE, 5.7GIINCCE, 5.7GIINCCE(1995-96)

 <p>18-7888 DRAIN PLUG & GASKET Replaces: 826648, 862293 For CAV Filter</p>	<p>PKG OF 10</p>  <p>SNAPPER CLAMPS</p> <table border="1"> <thead> <tr> <th>Part #</th> <th>Range</th> <th>Size</th> </tr> </thead> <tbody> <tr> <td>18-8200 ①</td> <td>.360 - .406</td> <td>2</td> </tr> <tr> <td>18-8201 ①</td> <td>.410 - .468</td> <td>4</td> </tr> <tr> <td>18-8202 ①</td> <td>.475 - .536</td> <td>6</td> </tr> <tr> <td>18-8020 ①</td> <td>.538 - .608</td> <td>8</td> </tr> <tr> <td>18-8021 ①</td> <td>.597 - .665</td> <td>10</td> </tr> <tr> <td>18-8034 ①</td> <td>.670 - .780</td> <td>12</td> </tr> <tr> <td>18-8203 ①</td> <td>.750 - .875</td> <td>14</td> </tr> <tr> <td>18-8204 ①</td> <td>.875 - .975</td> <td>19</td> </tr> </tbody> </table>	Part #	Range	Size	18-8200 ①	.360 - .406	2	18-8201 ①	.410 - .468	4	18-8202 ①	.475 - .536	6	18-8020 ①	.538 - .608	8	18-8021 ①	.597 - .665	10	18-8034 ①	.670 - .780	12	18-8203 ①	.750 - .875	14	18-8204 ①	.875 - .975	19	 <p>18-3506-1 CIRCULATING PUMP Superseded from 18-3506 Replaces: 21124846</p>
Part #	Range	Size																											
18-8200 ①	.360 - .406	2																											
18-8201 ①	.410 - .468	4																											
18-8202 ①	.475 - .536	6																											
18-8020 ①	.538 - .608	8																											
18-8021 ①	.597 - .665	10																											
18-8034 ①	.670 - .780	12																											
18-8203 ①	.750 - .875	14																											
18-8204 ①	.875 - .975	19																											
 <p>18-3513 CIRCULATING PUMP Replaces: 22844837 (Stainless Steel Impeller) Fits: 5.3L and 6.2L GM Engines</p>	 <p>18-3586-1 WATER PUMP Replaces: 841640 (Crank Shaft Mounted) Fits: 431A, 500A/B, 501A, 570A, 571A, AQ180, AQ200, AQ200B/C/D/F, AQ250A, AQ211A, AQ225, AQ231A/B, AQ260, AQ255B, AQ260A, AQ271A/B/C/D/, AQ280A, AQ290A</p>	 <p>18-3577-2 CIRCULATING WATER PUMP Replaces: 3855991, 856609 For: GM Big Block V8 Uses gasket 18-0903 (included) (Bi-Directional)</p>																											
 <p>18-3593 CIRCULATING WATER PUMP Replaces: 3854017, 3858340 Fits: 3.0L 4 cyl. engines, GM 4 cyl. & in-line 6 cyl. Uses gasket 18-0327 (included) (Bi-Directional)</p>	 <p>18-3599-2 CIRCULATING WATER PUMP Replaces: 3853850, 835390, 856364 For GM V-6 & small block V-8 engines Uses gasket 18-0981 (included)</p>	 <p>18-0187 EXHAUST TUBE Replaces: 860396 Fits Engines: AD31B, AD31D, AD31L-A, AD31P-A, AD31XD, AD41B, AD41D, AD41L-A, AD41P-A, D41B, D41D, DP-D, DP-D1, DP-E, DP-G, DPX, DRIVE DP-D, DRIVE SP-C, KAD300-A, KAD32P-A, KAD42A, KAD42B, KAD42P-A, KAD43P-A, KAD44P-B, KAD44P-C, KAMD300-A, KAMD42A, KAMD42B</p>																											
 <p>18-2779 EXHAUST HOSE Replaces: 3852696 I.D. 4" x For: 4.3L GL, GS, GI, GXI, OSI, 5.0L FI, GL, FL, GXI, OSI, 5.7L GL, GI, GIL, OSI, GXI, OSXI, 5.8L FL, FI, FSI, 7.4L GL, GI, 8.1L GI, GXI, OSI, 8.2L GL</p>	 <p>18-2780-1 HOSE Replaces: 3852741, 3863450 I.D. 4" x For: 3.0L GL, GS, GI, GLM, GLP, GSM, GSP, GS, 4.3L GL, GS, GI, GXI, OSI, 5.0L FL, FI, GL, GXI, OSI, 5.7L GL, GI, GXI, OSI, OSXI, GIL, GXIL, 5.8L FL, FI, FSI, 7.4L GL, GI, GSI, 8.2L GSI</p>	 <p>18-2781 EXHAUST HOSE Replaces: 3852742 I.D. 4" x For: 5.0L FL, GL, GXI, OSI, 5.7L GL, GI, GXI, GIL, GXIL, OSI, OSXI, 5.8L FL, FSI, 7.4L GL, GI, GSI, 8.1L, 8.2L GL, GSI</p>	 <p>18-31602 PUMP, SEA WATER Replaces: 3593654, 3580944 For: MD, D1</p>																										
 <p>18-31604 SEA WATER PUMP Replaces: 3583115, 3581558 For: KAD, KAMD, AD, TAMD</p>	 <p>18-3106 WATER PUMP COUPLER Replaces: 806256, 831009 AQ90, 95, 100, 110, 120A, 115, 130, MB3B, 17C, D</p>	 <p>18-3175 WATER PUMP COUPLER Replaces: 858467 Fits: D31, D32, D41, D42, D43, D44, D300, AD31A, AD31B, AD31D, AD31L-A, AD31P-A, AD31XD, AQAD31A, MD31A, TAMD31A, TAMD31B, TAMD31D, TAMD31L-A, TAMD31M-A, TAMD31P-A, TMD31A, TMD31B, TMD31D, TMDL-A, KAD32P-A, AD41A, AD41B, AD41D, AD41L-A, AD41P-A, AQAD41A, D41A, D41B, D41D, D41L-A, TAMD41A, TAMD41B, TAMD41D, TAMD41H-A, TAMD41L-A, TAMD41M-A, TAMD41P-A, TMD41A, TMD41B, TMD41D, TMD41L-A, KAD42A, KAD42B, KAD42P-A, TAMD42B, TAMD42WJ-A, KAD43P-A, KAMD43P-A, KAD44P-B, KAD44P-C, KAMD44P-A, KAMD44P-B, KAMD44P-C, KAD300A, KAMD300A</p>																											

① This product is priced per piece. To order priced per package, please add -9 to the part number.



18-3275
IMPELLER KIT
Volvo 877066

Fits: TAMD74A, A-A, A-B (2000-2005); TAMD74C-A, C-B (2000-2005); TAMD74L-A, B (1999-2005); TAMD74P-A, P-B (1998-2005); TAMD75P-A (1998-2005); TAMD71B (1989-2000); TAMD73P-A (1997-1998); TAMD73WJ-A (1997-1999).



18-3504
IMPELLER KIT
Volvo 3588475

Fits: D4-180I-B, D4-180I-C, D4-180I-D, D4-210A-A, D4-210A-B, D4-210I-A, D4-210I-B, D4-225A-B, D4-225A-C, D4-225A-D, D4-225I-B, D4-225I-C, D4-225I-D, D4-260A-A, D4-260A-B, D4-260A-C, D4-260A-D, D4-260D-B, D4-260D-C, D4-260D-D, D4-260I-A, D4-260I-B, D4-260I-C, D4-260I-D, D4-300A-A, D4-300A-C, D4-300A-D, D4-300D-A, D4-300D-C, D4-300D-D, D4-300I-A, D4-300I-C, D4-300I-D



18-3276-1
IMPELLER KIT

Replaces: 3862567, 21213660
Fits: Volvo (1999 and Later)



18-3277
IMPELLER KIT

Replaces: 3862281, Yanmar 192470-42530, 192470-42532
Fits: Volvo (1998 and Earlier), Johnson Pump 09-812B-1



18-3047
IMPELLER KIT

Replaces: 835874
Sherwood 10615K,
Jabsco 18948-0001
12 FINS



18-3060
IMPELLER

Replaces: 835512, 3854286
Sherwood 9959,
Jabsco 18838-0001
Oberdorfer 132-0317
OMC 3854286
Neoprene, 12 FINS



18-3046
IMPELLER

Replaces: 3854286

① **18-3046D** Display Package



18-3061
IMPELLER

Replaces: 835874,
Sherwood 0615K,
Jabsco 18948-0001
Neoprene
12 FINS
For: GM engines with V-Belt



18-30778
IMPELLER

Replaces: 21213664
Fits: Gas GM engines 2005 & Up



① **18-3075D** Display Package

18-3075
IMPELLER KIT

Replaces: 875575, Jabsco 2877-0001, 4568-0001, Johnson 09-801B, Oberdorfer B6620
12 FINS
Neoprene



18-3076
IMPELLER KIT

Replaces: 875583, 833995
Jabsco 22405-0001
Johnson Pump 09-45589, 09-808B
6 FINS, Neoprene



18-3077 (Neoprene) **18-3038** (Nitrile)
WATER PUMP KIT

Replaces: 877061-2, 3841697
For: AQ 30, 31, 40, 41 AQD 19, 27, 29, 32, KAD/KAMD 42A, B, P, MD, 19, 27, 29, 32, TAMD 60A, B, C



18-3078 (Neoprene) **18-3037** (Nitrile)
WATER PUMP KIT

Replaces: 875736, 875660, 2430184
Jabsco 836-0003,
Johnson Pump 09-1029B-9
For: AQ, AD 40 A, B, TAMD 40 A, B, TAMD 61-62 A, 71-72A



18-3287
IMPELLER KIT

Replaces: 876120
Fits: 431A, BB231A, 570A, 571A, 572A, 740A, 740B, AQ200D, AQ205A, AQ225D, AQ255B, AQ260A, AQ260B, AQ271A, AQ271B, AQ271C, AQ271D, AQ280A, AQ290A, AQ311A, AQ311B, BB225A, BB225AV, BB225B, BB260A, BB260AV, BB261A

① Items ending in "D" are Display Packaged - Regular number is Non-Display



**18-3079
IMPELLER KIT**
Replaces: 875807-0, 3586498
Johnson Pump 09-806B Sherwood 9979K
6 FINS
Neoprene
Jabsco 4528-0001
Side Width 3/4" Dia. 1 9/16"



**18-3080
(Neoprene)
WATER PUMP KIT**
Volvo 875808, 3593659
Jabsco 673-0001
Johnson Pump 09-1026B-1
For: AQ 60, 80, 90, 95, 100, 105, 110, 115, 120A, 130, B 16, BB 25, 30, 70, 100, MB 18, 20, MD 3B, 17C, D, ND2010B, 2020B, 2030B, 2040BC

**18-3036
(Nitrile)
WATER PUMP KIT**
Volvo 875808-8
Jabsco 673-0003
Johnson Pump 09-1026B-9



**18-3081
IMPELLER KIT**
Replaces: 875811-2, 3858256, 3862281
OMC 3858256
Johnson Pump 09-1027B
Neoprene
12 SPLINES 12 FINS
Jabsco 1210-0001

18-3081D 



**18-3089
WATER PUMP KIT**
Replaces: 09-45825
Johnson Pump
For 18-3587-1 Pump



**18-3208
WATER PUMP REPAIR KIT**
Replaces: 875584
MD5A, B, C, MD6B, MD7A, B, MD11C, D



**18-3205
WATER PUMP REPAIR KIT**
Replaces: 875574
AQ120B, 125A, B, 131A, 140A, 145A, B, 151A, B



**18-3261
WATER PUMP REPAIR KIT**
Replaces: 875769
Fits: D40, AD40B, AQAD40A, AQAD40B, TAMD40A, TAMD40B

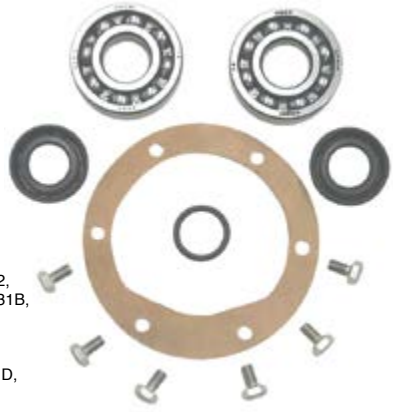

**18-3262
WATER PUMP REPAIR KIT**
Replaces: 875759
For sea water pumps: Fits: D30, D31, D32, D40, D41, D42, D43, D44, AD30A, AQAD30A, TAMD30A, TMD30A, AD31A, AD31B, AD31D, AD31XD, AQAD31A, MD31A, TAMD31A, TAMD31B, TAMD31D, TMD31A, TMD31B, TMD31D, KAD32P-A, AQD40A, MD40A, TMD40A, TMD40B, TMD40C, AD41A, AD41B, AD41D, AQAD41A, D41A, D41B, D41D, TAMD41A, TAMD41B, TAMD41D, TMD41A, TMD41B, TMD41D, KAD42A, KAD42B, KAD42P-A, KAMD42A, KAMD42B, KAMD42P-A, TAMD42B, TAMD42WJ-A, KAD43P-A, KAMD43P-A, KAD44P-A, KAMD44P-A



**18-3263
WATER PUMP REPAIR KIT**
Replaces: 875698
For sea water pumps: Fits: B18, B20, D3, D17, AQ60F, AQ90, AQ95A, AQ110, AQ120, BB30, BB100, MB18, AQ105A, AQ115A, AQ115B, AQ130A, AQ130B, AQ130C, AQ130D, BB115, BB115B, BB115C, MB20A, MB20B, MB20C, MD3B, MD17C, MD17D,

① Items ending in "D" are Display Packaged - Regular number is Non-Display

SINGLE DIAMETER HOSE

18-70924
MOLDED HOSE
 1 3/4" ID



5"

18-70704
MOLDED HOSE
 1 1/4" ID



5"

18-71218
MOLDED HOSE
 1" ID



12 1/2"

18-71337
MOLDED HOSE
 1 3/4" ID



12 3/4"

STRAIGHT HOSE

18-75100
MOLDED HOSE
 Straight 48"
 1" ID



18-75125
MOLDED HOSE
 Straight 48"
 1 1/4" ID



V-BELTS



- ❶ High strength synthetic cords resist shockload failure. Their low stretch properties assure uniform performance over the life of the belt.
- ❷ The compression section is a special rubber compound that assures smooth and even transfer of load forces to the cords.
- ❸ Cogs are molded to precise engineering tolerances to improve flexibility and maintain cord support. Cog geometry provides a large area for air circulation to keep the belt cool and prevent damaging heat build up in the cushion section.
- ❹ Rubber edges maintain positive, no-slip contact with pulley grooves for reliable energy transfer.

BELT SIZE LISTING BY NUMBER

Part #	Effective Length (Inches)	Top Width (Inches)	Part #	Effective Length (Inches)	Top Width (Inches)	Part #	Effective Length (Inches)	Top Width (Inches)
18-15290	29	29/64	18-15405	40 1/2	29/64	18-15460	46	29/64
18-15300	30	29/64	18-15410	41	29/64	18-15470	47	29/64
18-15325	32 1/2	29/64	18-15415	41 1/2	29/64	18-15480	48	29/64
18-15345	34 1/2	29/64	18-15430	43	29/64	18-15495	49 1/2	29/64
18-15370	37	29/64	18-15435	43 1/2	29/64	18-15500	50	29/64
18-15380	38	29/64	18-15440	44	29/64	18-15520	52	29/64
18-15390	39	29/64	18-15450	45	29/64	18-15550	55	29/64
18-15400	40	29/64	18-15455	45 1/2	29/64			

V-BELT INTERCHANGE

Part #	Volvo #	Part #	Volvo #	Volvo #	Part #	Volvo #	Part #
18-15325	958303	18-15460	829207	829207	18-15460	985357	18-15415
18-15390	958310	18-15460	950818	841821	18-15430	958498	18-4046
18-15405	958311	18-15495	958320	950813	18-15410	966694-2	18-4044
18-15410	950813	18-15500	952141	950818	18-15460	966857	18-4046
18-15415	985357	18-4046	958498	952141	18-15500		
18-4044	966694-2	18-4046	966857	958303	18-15325		
18-15430	841821			958310	18-15390		
18-15435	958314			958311	18-15405		
18-15435	966382			958314	18-15435		
18-15450	3858462			958320	18-15495		
18-15455	3852464			966382	18-15435		

HOSE INTERCHANGE

Part #	Volvo #	Part #	Volvo #	Volvo #	Part #	Volvo #	Part #
18-70704	838513	18-75125	826423	826423	18-75125	845792	18-75125
18-70704	856306	18-75125	845792	838513	18-70704	856306	18-70704

**Fits GM Small Block V8 305-350 cu. in.
Models AQ & BB 200, 205, 211, 231, 225,
260, 271, 290, 311, 500, 501, 570, 571 & 572**

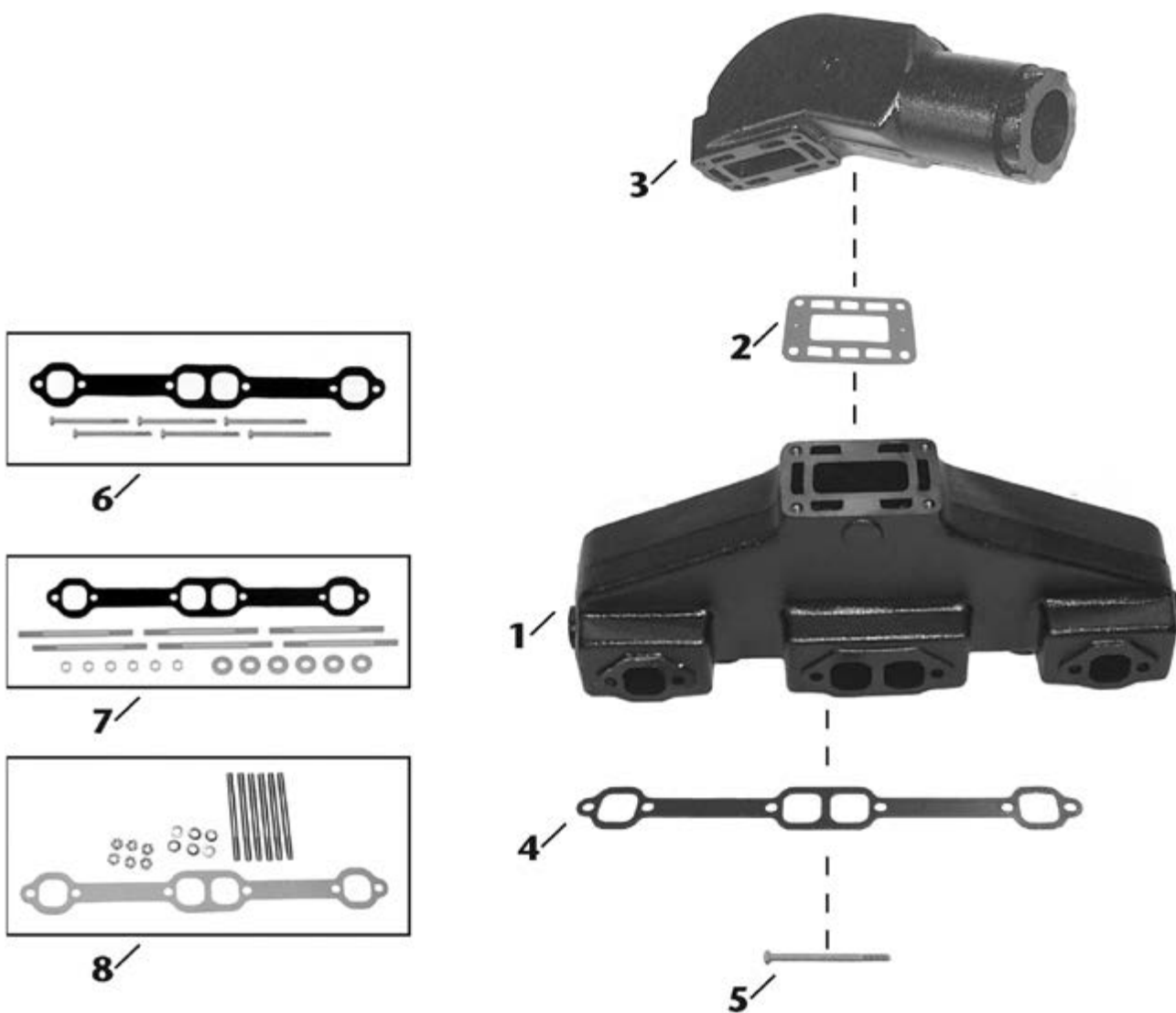

Item No	Description	OE No.	Application
1	18-1931-1 MANIFOLD	835804-6	GM Small Block (V8) 305-350 cu.in. Model AQ & BB 200, 205, 231, 225, 260, 271, 290, 311, 500, 501, 570, 571, & 572. Use with Manifold Gasket: 18-2949; Mounting Kit: 18-8511.
2	18-2971-1 ELBOW GASKET	856039-3	Use with Manifold: 18-1931-1; Elbow: 18-1935-1
3	18-1935-1 ELBOW	855384-4	Use with Manifold: 18-1931-1; Elbow Gasket: 18-2971-1.
4	18-2949 MANIFOLD GASKET	N/A	Use with Manifold: 18-1931-1; Included in 18-8511 mounting kit.
5	NSS MOUNTING BOLT	N/A	Included in 18-8511 mounting kit.
6	18-8511 MOUNTING KIT	N/A	Use with Manifold: 18-1931-1.
7	18-8502 MOUNTING KIT	N/A	Use with Manifold: 18-1931-1. Includes mounting studs and hardware.
8	18-8502 MOUNTING KIT	N/A	Use with Manifold: 18-1931-1. Includes mounting studs and hardware.

Fits GM V6 (1993 & Before) AQ 175, 205, 430A/B, 431, 434

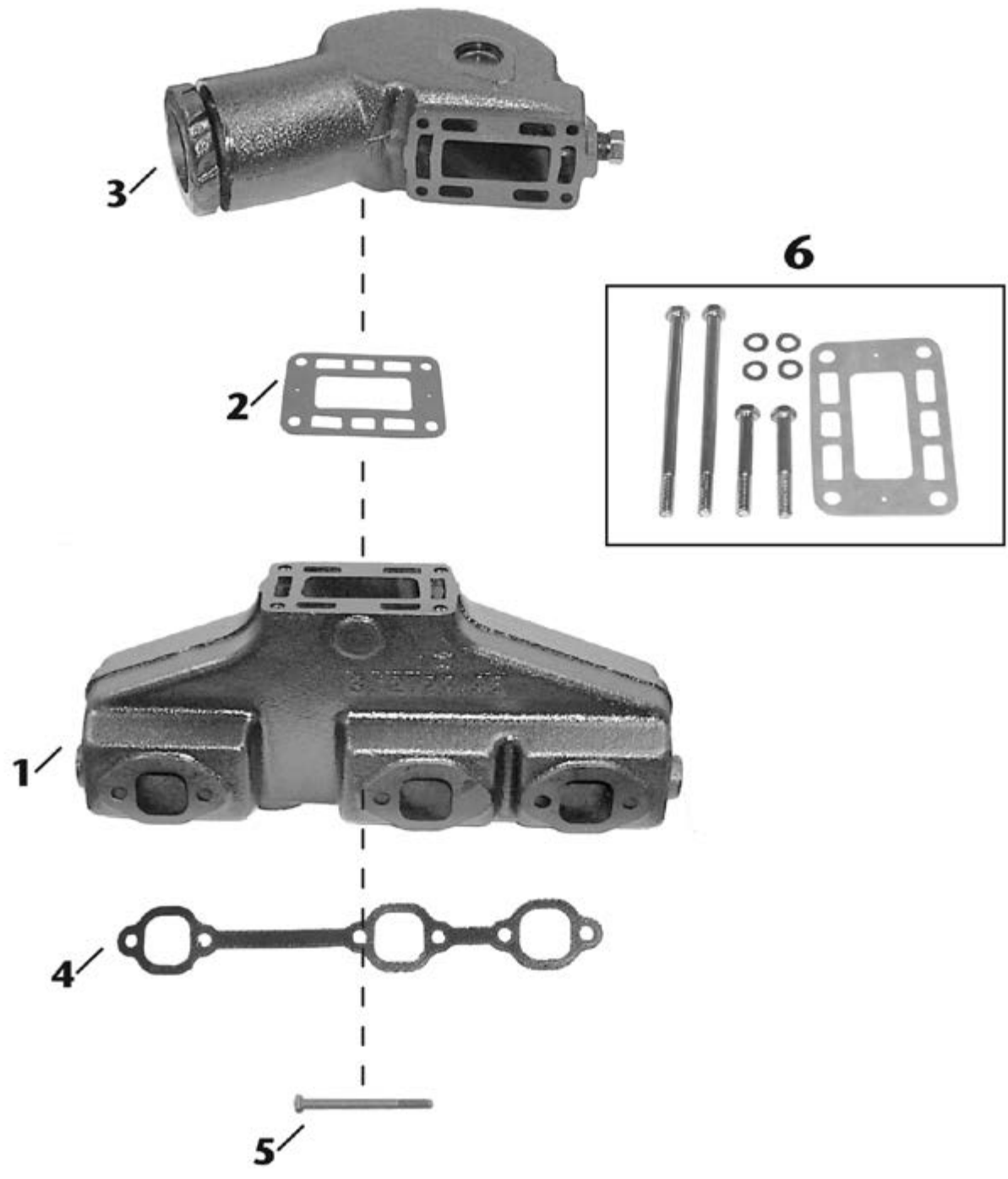

Item No	Description	OE No.	Application
1	18-1932 MANIFOLD	856894-1	GM (V6) (1993 & Before) Model AQ 175, 205, 430 A/B, 432, 434. Use with 18-2909 Manifold Gasket.
2	18-2971-1 ELBOW GASKET	856039-3	Use with Manifold: 18-1932; Elbow: 18-1936.
3	18-1936 ELBOW	857037-6	Use with Manifold: 18-1932; Elbow Gasket: 18-2971-1
4	18-2909 MANIFOLD GASKET	N/A	Use with Manifold: 18-1932.
5	NSS MOUNTING BOLT	N/A	Use to secure 18-2909 to 18-1932.
6	18-19360 HARDWARE KIT	N/A	Use with 18-1936 Elbow

SIERRA MANIFOLDS ARE PAINTED, PACKAGED & LEAK TESTED



**18-1848
MANIFOLD**
Replaces: 3857656, 3847499
Fits: Volvo 4.3L V-6



**18-1898
MANIFOLD**
Port & Starboard
Replaces: Barr CHVA-1-84, Marine Power 0991-110
Fits 454 cu.in. GM big block V8 engines
Use with:
Exhaust Manifold Gasket: 18-0418
***For Exploded View - See Pages 656-657**



**18-1930-2
MANIFOLD**
Replaces: 855387, 834438-4
FITS: Volvo AQ120B, 125A, 140A, 145A, BB140A, 145A
Supplied with Mounting Package
Use with:
Exhaust Manifold Gasket: 18-2991-1
Mounting Kit: 18-8539



**18-1931-1
MANIFOLD**
Port & Starboard
Replaces: 835804, 856883
FITS: Volvo AQ200D, 200F, 225D, 225E, 225F, 255B, 260A, 271A, 280A, 290A, 311A, AQ500, 570: BB225, 225AV, 225B, 260A, 260AV, 260B, 260C
Supplied with Mounting Package
Use with:
Mounting Kit: 18-8511



**18-1986-1
MANIFOLD**
Port & Starboard
Replaces: 3852374-2, 3857723, 3847501
Barr OMC-1-914035
For: 5.0L & 5.7L GM (New Style)
Use with:
Exhaust Manifold Gasket: 18-2949
Mounting Kit: 18-8502



**18-1932
MANIFOLD**
Port & Starboard
Replaces: 856894
For: 4.3L Fits: AQ175, AQ430, AQ431A, AQ431B, AQ432, AQ434
Use with:
Exhaust Manifold Gasket: 18-2909



**18-1997-1
MANIFOLD**
Port & Starboard
Replaces: Barr CHV-1-83
Universal Center Riser Manifold
FITS: GM 283, 305, 307 and 350 CID engines
Use with:
Exhaust Manifold Gasket Set: 18-0604
***For Exploded Kit - See Pages 658-659**



**18-1936
RISER**
Replaces: 857037
For: 4.3L Fits: AQ175, AQ430, AQ431A, AQ431B, AQ432, AQ434
Use with:
Riser Gasket: 18-2971-1
Mounting Kit: 18-19360



**18-1999
ELBOW**
Replaces: Barr 20-0082
Comes with 18-4364 Exhaust Elbow Kit (open)
If blocked mounting kit is required use 18-8535
Replaces: Barr 20-0082-P
Use with:
Manifold: 18-1997-1
Riser Gasket: 18-2854-1 open or 18-0476-1 blocked



**18-1935-1
RISER**
Replaces: 855384-4, 856891
Use with:
Manifold: 18-1931-1
Exhaust Riser Gasket: 18-2971-1
Mounting Kit: 18-8510



**18-1909-1
RISER**
Replaces: OMC 913784,
3855270, 3850456,
Volvo 3855270-9, 3863061
OMC Riser, 4" outlet 7°
Fits many GM & Ford center rise manifolds.
Use with:
Manifold: 18-1986-1 & 18-1848
Riser Gasket: 18-0943-2 open
Mounting Kit: 18-8507 open



**18-1939
RISER**
For use with 4" I.D. exhaust hose
Replaces: Barr 20-0100, Marine Power 0992-593 Barr, Indmar,
and Marine Power Ford Small Block V8 302-351cu.in., GM
Small Block V8 305-350cu.in., GM Big Block V8 454cu.in.
Use with:
Manifold: 18-1997-1, 18-1998-1
Riser Gasket: 18-2854-1 open or 18-0476-1 blocked
Mounting Kit: 18-4364 open or 18-8535 blocked



**18-1907
RISER**
For use with 3" I.D. exhaust hose
Replaces: Barr 20-0102, Indmar 53-2009, 53-2018 Barr
and Indmar Ford Small Block V8 302-351cu.in.
Use with:
Manifold: 18-1997-1, 18-1998-1
Riser Gasket: 18-2854-1 open or 18-0476-1 blocked
Mounting Kit: 18-4364 open or 18-8535 blocked



**18-1876
RISER**
Replaces: 980617
Use with:
Manifold: 18-1904
Riser Gasket: 18-2850
Fits: 170 (1974), 175 (1975-76), 190 (1974-76), 235 (1975-76)



**18-1991
ELBOW ADAPTER**
Replaces: Barr 200089P
For use with 3" I.D. Exhaust Hose
Use with:
Manifold Riser: 18-1999
30°



**18-1992-1
ELBOW ADAPTER**
Replaces: Barr 200087P
For 3" I.D. Exhaust Hose
(As used in 18-1987 Exhaust Manifold
Conversion Kit)
80°

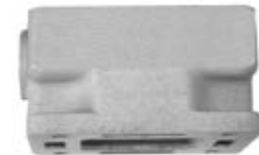

**18-1949
MANIFOLD SPACER**
Barr CM 20-0097
Barr, Indmar and Marine Power Ford Small
Block V8 302-351cu.in., GM Small Block
V8 305-350cu.in., GM Big Block V8 454cu.
in.
Used with:
Manifolds: 18-1998-1, 18-1997-1,
18-1898



**18-4364 (Open)
EXHAUST ELBOW KIT**
Replaces: Barr 20-0082-P
Use with:
Riser: 18-1999, 18-1907, 18-1939



PKG. OF 2
**18-0943-2
18-0943-2-9①
EXHAUST ELBOW GASKET**
Replaces: 3850496
Used with:
Riser: 18-1909-1



PKG. OF 2
**18-2909
18-2909-9①
EXHAUST
MANIFOLD GASKET**
Replaces: 856116, 3853412
For: Volvo 4.3GL, GS, GI, GXI, OSI

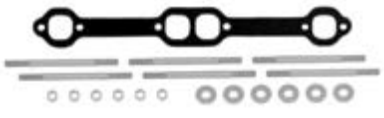

18-8502
EXHAUST MANIFOLD MOUNTING KIT
 OMC GM Small Block V8 305-350cu.in.
 (1979-89) OMC/Volvo GM Small Block
 305-350cu.in.
 Used with:
 Manifold: 18-1931-1, 18-1902, 18-1903
 & 18-1986-1



18-8507
EXHAUST ELBOW MOUNTING KIT
 Replaces: Barr 20 6674JP
 OMC/Volvo GM Small Block V8
 305-350cu.in.
 Used with:
 Riser: 18-1909-1



18-8510
EXHAUST ELBOW MOUNTING KIT
 Volvo GM Small Block V8 305-350cu.in.
 (Models: AQ and BB200, 205, 211, 231, 225,
 260, 271, 290, 311, 500, 501, 570, 571, 572)
 Used with:
 Riser: 18-1935-1



18-8511
EXHAUST MANIFOLD MOUNTING KIT
 Volvo GM Small Block V8 305-350cu.in.
 (Models: AQ and BB200, 205, 211, 231,
 225, 260, 271, 290, 311, 500, 501, 570,
 571, 572)
 Used with:
 Manifold 18-1931-1



18-8535 (Blocked)
EXHAUST ELBOW MOUNTING KIT
 Barr, Indmar and Marine Power Ford Small
 Block V8 302-351cu.in., GM Small Block V8
 305-350cu.in., GM Big Block V8 454cu.in.
 Used with:
 Riser: 18-1939, 18-1999, and 18-1907



18-8536
EXHAUST ELBOW MOUNTING KIT
 Barr, Indmar and Marine Power
 GM Small Block V8 305-350cu.in.
 Used with:
 Manifold: 18-1997-1



18-8538
EXHAUST MANIFOLD MOUNTING KIT
 Barr and Indmar Ford Small Block
 V8 302-351cu.in.
 Used with:
 Manifold: 18-1998-1



18-8539
EXHAUST MANIFOLD MOUNTING KIT
 Volvo 4 Cylinder B20 2.3 and 2.5L (Models:
 AQ 120, 125, 131, 140, 145, and 151.
 BB140, 145, 230, and 250) Volvo 4 Cylinder
 B20 2.3 and 2.5L (Models: AQ 120, 125,
 131, 140, 145, and 151. BB140, 145, 230,
 and 250)
 Used with:
 Manifold: 18-1930-2



18-19360
HARDWARE KIT
 Used with:
 Riser: 18-1936



18-0146
HEAT EXCHANGER GASKET SET
 Fits: B21, B23, AQ120B, AQ125A, AQ140A,
 BB140A, AQ125B, AQ145A, AQ145B, BB145A



18-0337
HEAT EXCHANGER GASKET SET
 Fits: AD40B, AQAD40A, AQAD40B, TAMD40A,
 TAMD40B, TMD40B, TMD40C



18-0476-1 (Blocked)
RISER BLOCKOFF GASKET
 Replaces: Barr 01-0105
 Indmar & Marine Power Ford
 Small Block V8 302-351cu.in.
 Used with:
 Riser: 18-1939, 18-1999 &
 18-1907

PKG. OF 2



18-2854-1 (Open)
18-2854-9①
EXHAUST ELBOW GASKET
 Replaces: Barr 01-0107
 Used with: Manifold: 18-1999, 18-1939, 18-1907

PKG. OF 2



18-2875-1
18-2875-1-9①
EXHAUST ELBOW GASKET
 Replaces: 3850495
 For: 3.0L GS, GL, GLM, GLP, GSM, GSP

① Priced per Package



**18-0418
EXHAUST
MANIFOLD GASKET**
Replaces: 3852472
For: Volvo 7.4L GL, GI, GSI,
8.2L GL, GI, GSI



**18-0680
EXHAUST
MANIFOLD GASKET**
Replaces: 3853256

PKG. OF 2



**18-2902-1
18-2902-1-9①
MANIFOLD GASKET**
Replaces: 3852468
For: 5.0L GL, GXI, OSI, 5.7L GL, GI, GXI,
GIL, GXIL, OSI, GXIL, OSXI

PKG. OF 2



**18-2949
18-2949-9①
EXHAUST MANIFOLD GASKET**
Replaces:
Barr CHV-47-000
Used with:
Manifold: 18-1986-1,
18-1997-1 and 18-1931-1
AQ200, 225, 260, 271, 290, 311



**18-2971-1
EXHAUST MANIFOLD GASKET**
Replaces: 835908-5, 856039-3
Used with:
Riser: 18-1935-1

PKG. OF 4



**18-2991-1
18-2991-1-9①
EXHAUST MANIFOLD GASKET**
Replaces: 855967, 855383
Used with:
Manifold: 18-1930-2
AQ200, 225, 260, 271, 290, 311



**18-4461
HOSE BARB**
3/4" - 14 NPT x 1" Hose
Corrosion Resistant Brass Fitting



PIPE PLUGS

Part #	Thread Size
18-4256	1/4"
18-4257	1/4"
18-4258	3/4"
18-4263	1/8" - 27 NPT
18-4264	3/8" - 18 NPT

DRAIN TAPS

Part #	Replaces:
18-4216	807036
18-4218	82745
18-4218D②	
18-4697	



18-3223-9 ③
Bulk pack of 12 (18-4218)
Use with most OEM manifolds

















DRAIN TAP APPLICATION

Model	Thread Size	Location	Tap
MD1A,B,2A,B,3B,5A,B,MD6A	10 x 1	Cyl Block	18-4216
AQ90,95,100,110,115,120,125A,B,130,131A,140A,145A,B, 151A,B,171A,MB18,MB20,BB30,100,AQD40,AQAD40,TMD40	1/4" NPT	Cyl Block	18-4218
MD5C,11C,D,17C,D	1/8" NPT	Cyl Block	-
D40, 2001, 2002, 2003 V6, B23, B25, D30, D31, D40, D41	1/4" NPT	Oil Cooler	18-4697

① Priced per Package
② Items ending in "D" are Display Packaged - Regular number is Non-Display
③ This product is priced per piece. To order priced per package, please add -9 to the part number

Model	Exhaust Manifold	Exhaust Elbow	Manifold Mounting Kits	Exhaust Elbow Kits	Manifold Gasket	Elbow Gasket
230	18-1930-2	-	18-8539	-	18-2991-1	-
250	18-1930-2	-	18-8539	-	18-2991-1	-
AQ120B	18-1930-2	-	18-8539	-	18-2991-1	-
AQ125A	18-1930-2	-	18-8539	-	18-2991-1	-
AQ131A,B,C,D	18-1930-2	-	18-8539	-	18-2991-1	-
AQ140A	18-1930-2	-	18-8539	-	18-2991-1	-
AQ145A,B	18-1930-2	-	18-8539	-	18-2991-1	-
AQ151A,B,C	18-1930-2	-	18-8539	-	18-2991-1	-
AQ200C,D/280	18-1931-1	18-1935-1	18-8511⑤/18-8502⑥	18-8510	18-2949	18-2971-1
AQ200D,F	18-1931-1	18-1935-1	18-8511⑤/18-8502⑥	18-8510	18-2949	18-2971-1
AQ225C,D/280	18-1931-1	18-1935-1	18-8511⑤/18-8502⑥	18-8510	18-2949	18-2971-1
AQ225D,E,F	18-1931-1	18-1935-1	18-8511⑤/18-8502⑥	18-8510	18-2949	18-2971-1
AQ255A,B/280	18-1931-1	18-1935-1	18-8511⑤/18-8502⑥	18-8510	18-2949	18-2971-1
AQ260A,B	18-1931-1	18-1935-1	18-8511⑤/18-8502⑥	18-8510	18-2949	18-2971-1
AQ290A	18-1931-1	18-1935-1	18-8511⑤/18-8502⑥	18-8510	18-2949	18-2971-1
AQ430	18-1932	18-1936	-	-	18-2909	18-2971-1
AQ431	18-1932	18-1936	-	-	18-2909	18-2971-1
AQ432	18-1932	18-1936	-	-	18-2909	18-2971-1
AQ434	18-1932	18-1936	-	-	18-2909	18-2971-1
BB140A	18-1930-2	-	18-8539	-	18-2991-1	-
BB145A	18-1930-2	-	18-8539	-	18-2991-1	-
BB225A,B,C	18-1931-1	18-1935-1	18-8511⑤/18-8502⑥	18-8510	18-2949	18-2971-1
BB260A,B,C	18-1931-1	18-1935-1	18-8511⑤/18-8502⑥	18-8510	18-2949	18-2971-1
500B	-	18-1936	-	-	18-2909	18-2971-1
501B	-	18-1936	-	-	18-2909	18-2971-1
570	18-1931-1	18-1935-1	-	-	18-2909	18-2971-1
572	-	18-1936	-	-	18-2909	18-2971-1
740B	-	18-1936	-	-	18-2909	18-2971-1
LK 4.3L	-	18-1936	-	-	18-2909	18-2971-1
LK 5.7L	18-1986-1	18-1909-1	18-8502	18-4364⑦/18-8535⑧	18-2949	18-2854-1⑦/18-0476-1⑧
HU 5.7 Gi	18-1986-1	18-1909-1	18-8502	18-4364⑦/18-8535⑧	18-2949	18-2854-1⑦/18-0476-1⑧
MD 5.7GL / 5.7Gi	18-1986-1	18-1909-1	18-8502	18-4364⑦/18-8535⑧	18-2949	18-2854-1⑦/18-0476-1⑧
NC5.7 GL / 5.7Gi	18-1986-1	18-1909-1	18-8502	18-4364⑦/18-8535⑧	18-2949	18-2854-1⑦/18-0476-1⑧

⑤ Volvo Configuration Match (Bolts Used in Hardware Kit) ⑦ Open Gasket
⑥ OMC Configuration Match (Studs Used in Hardware Kit) ⑧ Closed Gasket

<p>PKG. OF 5</p>  <p>18-4236 18-4236-9① WASHER Replaces: 941907</p>	 <p>18-2774 MOLDED HOSE Replaces: 875847 AQ290, AQ290DP Includes (2) 18-7306-9 Clamps</p>	 <p>18-2775 MOLDED HOSE Replaces: 875822 AQDRIVE UNITS 200, 250, 270, 270T, 275, 280, 280T, 280PT, DP UNIT: 280 Includes (2) 18-7306-9 Clamps</p>	
 <p>18-2776 MOLDED HOSE Replaces: 832831 AQ270T, 280T Includes (2) 18-7306-9 Clamps</p>	 <p>18-0377 COOLING PIPE GASKET SET Fits: B21, B23, AQ120B, AQ125A, AQ140A, BB140A, AQ125B, AQ145A, AQ145B, BB145A</p>	 <p>18-0590 COOLING PIPE GASKET SET Fits: B20, AQ125A, AQ115B, AQ130A, AQ130B, AQ130C, AQ130D, BB115A, BB115B, BB115C</p>	
 <p>18-0648 COOLING PIPE GASKET SET Fits: D11, D17, MD11C, MD11D, MD17C, MD17D</p>	 <p>18-3889 COOLING PIPE GASKET SET Fits: B23, B25, 230A, 230B, AQ131A, AQ131B, AQ131C, AQ131D, 250A, 250B, 251A, AQ151A, AQ151B, AQ151C, AQ171A, AQ171C</p>	 <p>18-0907 OIL DRAIN PLUG GASKET SET For oil plugs: Fits: 200, 250, 270, 270T, 275, 275A</p>	
 <p>18-2777 WATER HOSE CONNECTION Replaces: 854031 *AQ120B, *AQ125A, B, AQ130A, B, D, *AQ130C, *AQ131A, AQ140A, AQ145A, *AQ165A, *AQ170A, B, C, *AQ175A, AQ200D, AQ225D, *AQ225E, AQ260A, AQ260B, AQ290A, *AQAD31A, AQD40A, AQD21A, AQAD40A * Models with Power Trim</p>	 <p>18-2778 WATER HOSE CONNECTION Replaces: 832846 AQ140A, AQ145A, AQ165A, AQ170A, *AQ175D, AQ200D, AQ225D, AQ260A, AQ290A, *AQ280, *AQ280L, AQAD30A, AQAD40A, B *Models with Power Trim</p>	 <p>18-3557 THERMOSTAT Replaces: 21148403 143°</p>	
 <p>18-3558 THERMOSTAT Replaces: 3853799 160°</p>	 <p>18-3679 THERMOSTAT Replaces: 3840816, 3584474 For: D3</p>	 <p>18-3680 THERMOSTAT Replaces: 3580365 For: MD, D2</p>	 <p>18-3681 THERMOSTAT Replaces: 8149182 For: DH, TD, TAD, TWD, D4, D6, TAMD</p>

① Priced per Package



18-3682
THERMOSTAT KIT
 Replaces: 21613426,
 21412639, 21237213
 For: TAD, TWD, , D12, D13, D9, D16



18-3683
THERMOSTAT KIT
 Replaces: 3839110, 1661993
 For: TD, TWD, TAMD



18-3539
THERMOSTAT KIT
Closed Cooling System
(Includes sealing ring)
 Replaces: 3831426
160°



18-3538
THERMOSTAT KIT
(Includes sealing ring)
 Replaces: 3831424



18-3676
THERMOSTAT KIT
 Superseded from 18-3676D
 Replaces: 3853983
140°

— **Contains** —

Part #	OE#	Description
18-7170	3852071	O-Ring
18-0398	835417	Gasket
—	3853983	Thermostat



18-3670D Display Package

18-3670
THERMOSTAT KIT
160°
 — **CONTAINS** —

Part #	O.E.#	Desc.
18-3558	3853799	Thermostat
18-2858	3852127	Thermostat Housing
—	—	Cover Gasket
18-0929	3852120	Thermostat Gasket



18-3677D Display Package

18-3677
THERMOSTAT KIT
 Replaces: 3856961
160°
 — **Contains** —

Part #	OE#	Description
18-7170	3852071	O-Ring
18-0398	835417	Gasket
—	3856961	Thermostat



18-3658
THERMOSTAT KIT
165°
 Replaces: 875784, 877349



18-3659
THERMOSTAT KIT
160°
 Replaces: 875785



18-3660
THERMOSTAT KIT
170°
 Replaces: 875787, 3831425



18-3662
THERMOSTAT KIT
145°
 Replaces: 875794, 876305



18-3664
THERMOSTAT KIT
165°
 Replaces: 875795



18-3665
THERMOSTAT KIT
140°
 Replaces: 875796



18-3615
THERMOSTAT - RAW WATER
 Replaces: 3587597
150°



18-3617
THERMOSTAT KIT



18-3620
THERMOSTAT KIT
180°



18-3621
THERMOSTAT KIT
160°



18-3626
THERMOSTAT KIT
145°



18-3618
THERMOSTAT KIT -
RAW WATER COOLED
150°



18-3619
THERMOSTAT KIT -
FRESH WATER COOLED
150°

THERMOSTAT APPLICATION ON NEXT PAGE

① Items ending in "D" are Display Packaged - Regular number is Non-Display

RAW WATER (OPEN) COOLING SYSTEM - RAW (RIVER, LAKE, SEA) WATER RUNS THROUGH CYLINDER BLOCK								
Model	Version	Identifier	Model Year	Thermostat	Seal	Gasket	Thermostat & Seal Kit	Complete Kit Thermostat Seal Gasket
AQ90			1962-1964	NSS	18-2933			
AQ95			1964-1968	NSS	18-2933			
AQ100			1961-1963	NSS	18-2933			
AQ130	A, B, C, D		1968-1977	NSS	18-2933			
AQ115	A, B		1969-1975	NSS	18-2933			
AQ140	A		1975-1979	NSS	18-2933	18-7181		18-3620
AQ120	B		1977-1980	NSS	18-2933	18-7181		18-3620
AQ145	A, B		1979-1985	NSS	18-2933	18-7181		18-3620
AQ125	A, B		1981-1985	NSS	18-2933	18-7181		18-3620
AQ131	A, B, C, D		1985-1989	NSS	18-2933	18-7181		18-3620
230	A, B		1989-1993	NSS	18-2933	18-7181		18-3620
AQ151	A, B, C		1985-1989	NSS	18-2933	18-7181		18-3620
AQ171	A, C		1986-1989	NSS	18-2933	18-7181		18-3620
250	A, B		1986-1993	NSS	18-2933	18-7181		18-3620
251	A		1989-1992	NSS	18-2933	18-7181		18-3620
3.0 GL, GS		MD,HU,NC	1993-1996	18-3558	18-0929	18-2858		18-3670
3.0 GL, GL, GSP, GLP, GLM		LK,BY,WT,EF	1996-2000	18-3558	NSS	18-0164		18-3621
3.0 GLP, GLM, GSP, GSM	A, B, C, D, E, J		2000-Current	18-3558	NSS	18-0164		18-3621
3.0 GXi, 3.0GXiC	J		2009-Current	18-3557	NSS	18-0164		18-3626
AQ175			1981-1985	18-3551	18-2933	18-0398		18-3662
AQ205	A		1988-1989	18-3551	18-2933	18-0398		18-3662
431	A, B		1989-1991	18-3551	18-2933	18-0398		18-3662
430	A, B		1990-1991	18-3551	18-2933	18-0398		18-3662
432	A		1992-1993	18-3551	18-2933	18-0398		18-3662
434	A		1992-1993	18-3551	18-2933	18-0398		18-3662
4.3 (All Models)		MD,HU,NC,LK, BY,WT,EF	1993-2000	NSS	18-7170	18-2917		18-3677
4.3 (All Models)	A, B		2001-2002	NSS	18-7170	18-2917		18-3677
4.3 (All Models)	C, D, E, F, G, J		2002-Current	NSS	NSS	18-2917	18-3615	18-3618
AQ190	A		1976-1977	18-3551		18-0398		18-3662
AQ200	B,C		1974-1976	18-3551		18-0398		18-3662
AQ225	B, C		1974-1976	18-3551		18-0398		18-3662
AQ200	D, F		1977-1986	18-3551		18-0398		18-3662
AQ225			1977-1986	18-3551	18-2933	18-0398		18-3662
AQ211	A		1986-1989	18-3551	18-2933	18-0398		18-3662
AQ231			1986-1989	18-3551	18-2933	18-0398		18-3662
500			1989-1993	18-3551	18-2933	18-0398		18-3662
501			1989-1993	18-3551	18-2933	18-0398		18-3662
5.0 FiP, FLP		MD,HU,NC	1993-1996	NSS	18-7170	18-2917		18-3677
5.0 GiP, GLP		BY,WT,EF	1997-2000	NSS	18-7170	18-2917		18-3677
5.0 GL, GXi, OSi	A, B		2001-2003	NSS	18-7170	18-2917		18-3677
5.0 (All Models)	C, D, E, F, G, H, J, K		2002-Current	NSS	NSS	18-2917	18-3615	18-3618
AQ271	A, B		1986	18-3551	18-2933	18-0398		18-3662
AQ260	A, B		1979-1985	18-3551	18-2933	18-0398		18-3662
AQ311	A		1986-1987	18-3551	18-2933	18-0398		18-3662
AQ271	C		1986-1989	18-3551	18-2933	18-0398		18-3662
AQ255	A, B		1977-1978			18-0398		
571	A		1989-1992	18-3551	18-2933	18-0398		18-3662
5.7 (All Models)		MD, HU, NC, LK, BY, WT, EF	1993-2000	NSS	18-7170	18-2917		18-3677
5.7 (All Models Except OSi)	A, B, C		2001-2003	NSS	18-7170	18-2917		18-3677
5.7 OSi, OSXi	B, C		2001-2003	NSS	NSS	18-2917	18-3615	18-3618
5.7 (All Models)	D, E, F, G, H, J, K		2002-Current	NSS	NSS	18-2917	18-3615	18-3618
5.8 (All Models)		HU, NC	1993-1996	NSS	18-7170	18-2917		18-3677
740	A, B		1991-1993	18-3551	18-2933	18-0398		18-3662
7.4 (All Models)		MD, HU, NC, LK, BY, WT, EF	1993-2000	NSS	18-7170	18-2917		18-3676
8.1 (All Models)			2000-Current	NSS	18-7170	NSS		18-3617
8.2 (All Models)		MD, HU, NC, LK, BY, WT, EF	1993-2000	NSS	18-7170	18-2917		18-3676
FRESH WATER (CLOSED) COOLING SYSTEM - ENGINE IS EQUIPPED WITH RESEVOIR TO HOLD ANTI-FREEZE								
4.3, 5.0, 5.7 (All Models)			1993 - Current	NSS	18-2933	18-2917	18-3539	18-3619
5.8 (All Models)			1993 - 1996	NSS	18-2933	18-2917	18-3539	18-3619
7.4 (All Models)			1991 - 2000	NSS	18-2933	18-2917	18-3539	18-3619
8.1 (All Models)			2000-Current	NSS	18-2933	18-2917	18-3539	18-3619
8.2 (All Models)			1993 - 2000	NSS	18-2933	18-2917	18-3539	18-3619



**18-1476
CAMSHAFT KIT**

Fits: AQ165A, AQ170A, AQ170B, AQ170C, BB165A, BB170A, BB170B, BB170C



**18-1477
CAMSHAFT KIT**

Fits: B18, B20, AQ60F, AQ90, AQ95, AQ110, AQ120, BB30, BB100, MB18, AQ105, AQ115A, AQ115B, AQ130A, AQ130B, AQ130C, AQ130D, BB115A, BB115B, BB115C, MB20A, MB20B, MB20C



**18-1478
CAMSHAFT**

Replaces: 1218674
Fits: B18, B20, AQ60F, AQ90, AQ95, AQ95A, AQ110, AQ120, BB30, BB100, MB18, AQ105A, AQ115A, AQ115B, AQ130A, AQ130B, AQ130C, AQ130D, BB115A, BB115B, BB115C, MB20A, MB20B, MB20C



**18-1479
CAMSHAFT**

Replaces: 461511
Fits: B30, AQ165A, AQ170A, AQ170B, AQ170C, BB165A, BB170A, BB170B, BB170C



VALVES

Part #	Type	O.E. #	Application
18-4464	Exhaust	829620	D1, D2, D3, 3AA, D17, AQD2B, MD1B, MD2B, MD3B, MD11C, MD11D, MD17C, MD17D
18-4469	Exhaust	1542389	D40, AD40B, AQAD40A, AQAD40B, AQD40A, MD40A, TAMD40A, TAMD40B, TMD40A, TMD40B, TMD40C
18-4463	Intake	833188	D1, D2, D3, 3AA, D17, AQD2B, MD1B, MD2B, MD3B, MD11C, MD11D, MD17C, MD17D
18-4467	Intake	1542472	D40, AD40B, AQAD40A, AQAD40B, AQD40A, MD40A, TAMD40A, TAMD40B, TMD40A, TMD40B, TMD40C
18-4468	Intake	419734	B20, B30, AQ105A, AQ115A, AQ115B, AQ130A, AQ130B, AQ130C, AQ130D, BB115A, BB115B, BB115C, MB20A, MB20B, MB20C



**18-4465
VALVE GUIDE**

Replaces: 3582609
for exhaust, 230, 250, AQ115, BB115, MB20, AQ130, AQ165, BB165, AQ170, BB170, AQD21A, MD21A, AQ120B, AQ125A, AQ140A, BB140A, AQ125B, AQ131A, AQ131B, AQ131C, AQ131D, AQ145A, BB145A, AQ145B, AQ151A, AQ151B, AQ151C, MB10



**18-4472
VALVE LIFTER**

Replaces: 1218630
Fits: B18, B20, B30, AQ120, AQ90, AQ95, AQ110, AQ120, BB30, BB100, MB18, AQ105A, AQ115A, AQ115B, AQ130A, AQ130B, AQ130C, AQ130D, BB115A, BB115B, BB115C, MB20A, MB20B, MB20C, AQ165A, AQ170A, AQ170C, BB165A, BB170A, BB170B, BB170C



**18-4044
DRIVE BELT**

Replaces: 834548, 966694-2
Generator: AQ120B, 125A, 140A, 145A, 165, 170A, B, C



**18-4046
DRIVE BELT**

Replaces: 958498, 966857
Generator: AQ175A, 200A, B, C, D, 225A, B, 260A, B, 280A, 290A
Water Pump AQ210
V-6, V-8

TIMING BELTS

Part #	Replaces	Fits
18-4029	463377	4AQ120B, 125A, B, 131A, B, C, D 140, 145, 151A, B, C, 230, 250, BB140A, 145A, B 4 Cyl.
18-4030	31359568, 31258305	D3-110I-G, D3-140A-G, D3-140I-G, D3-150I-G, D3-170A-G, D3-170I-G, D3-200A-G, D3-200I-G, D3-220A-G, D3-220I-G, D3-110I-H, D3-140I-H, D3-150I-H, D3-170I-H, D3-200I-H, D3-220I-H, D3-140A-H, D3-170A-H, D3-200A-H, D3-220A-H, D3-110I-A, D3-110I-B, D3-110I-C, D3-130A-A, D3-130I-A, D3-130A-B, D3-130I-B, D3-130A-C, D3-130I-C, D3-160A-A, D3-160I-A, D3-160A-B, D3-160I-B, D3-160A-C, D3-160I-C, D3-190A-B, D3-190I-B, D3-190A-C, D3-190I-C, D3-190I-A, D3-110I-D, D3-110I-E, D3-110I-F, D3-140I-E, D3-140I-F, D3-140A-D, D3-140A-E, D3-140A-F, D3-150I-D, D3-150I-E, D3-150I-F, D3-170I-D, D3-170I-E, D3-170I-F, D3-170A-D, D3-170A-E, D3-170A-F, D3-200I-D, D3-200I-E, D3-200I-F, D3-200A-D, D3-200A-E, D3-200A-F, D3-220I-D, D3-220I-E, D3-220I-F, D3-220A-D, D3-220A-E, D3-220A-F, D3-140I-D





18-7514

POWER STEERING PUMP

Replaces: 22797780

Fits: Early Production. SN-2004033423 D4-180I-B, D4-210A-A, D4-210A-B, D4-210I-A, D4-210I-B, D4-225I-B, D4-260A-A, D4-260A-B, D4-260I-A, D4-260I-B, D4-300A-A, D4-300I-A

Sierra power steering pumps are built to meet or exceed OEM performance.

All pumps are leak and efficiency tested to ensure a quality performance."



EXPANSION PLUGS

Part #	Pkg.	O.E. #	Size
18-4200 ① ②	5	477024	35MM (1.375")
18-4201 ① ②	5	192212	45MM (1.770")
18-4245 ②	5	463902	42MM (1.655")
18-4246 ②	5	463903-5	35MM (1.375")

① Stainless Steel

② This product is priced per piece. To order priced per package, please add -9 to the part number.



18-2367

CYLINDER HEAD NUT

Replaces: 943414

For cylinder head: Fits: D1, D2, D3, D11, D17, MD1B, AQD2B, MD2B, MD11C, MD11D, MD3B, MD17C, MD17D



18-4005

ENGINE MOUNT

Replaces: 833950

Fits: D5, D6, D7, D11, D17, MB10, MB10A, MD5A, MD5B, MD5C, MD6A, MD6B, MD7A, MD7B, MD11C, MD11D, MD17C, MD17D



18-57702

CRANKCASE FILTER

Replaces: 876069

Fits: Volvo MD30A, TMD30A, TAMD30A, MD31A, TMD31A, TAMD31A, MD40A, TMD40A, TMD40B, TAMD40A, TAMD40B, TMD41A, TAMD41A



18-1727

RUBBER CUSHION

Replaces: 803762

For propeller shaft coupler: Fits: B18, B20, B30, MB10, 2001, 2002, 2003, 2010, 2020, 2030, 2040, D1, D2, D3, D5, D6, D7, D11, D17, D21, D22, D29, D32, BB30, BB100, BB115, BB165, BB170, MB10A, MB18, MB20, MD1, MD2, MD3, MD5, MD6, MD7, MD11, MD17, MD21, MD22, MD29, MD32



18-7907

AIR FILTER

Replaces: 858488

Fits: D31, D41, D42, AD31A, AD31B, AD31D, AD31L-A, AD31P-A, AD31XD, AQAD31A, MD31A, TAMD31A, TAMD31B, TAMD31D, TAMD31L-A, TAMD31M-A, TAMD31P-A, TMD31A, TMD31B, TMD31D, TMD31L-A, AD41A, AD41B, AD41D, AD41L-A, AD41P-A, AQAD41A, D41A, D41B, D41D, D41L-A, TAMD41A, TAMD41B, TAMD41D, TAMD41H-A, TAMD41L-A, TAMD41M-A, TAMD41P-A, TMD41A, TMD41B, TMD41D, TMD41L-A, TAMD42B, TAMD42WJ-A



18-7908

AIR FILTER

Replaces: 3582358

Fits: D31, D41, AD31A, AD31B, AD31D, AD31L-A, AD31P-A, AD31XD, AQAD31A, TAMD31A, TAMD31B, TAMD31D, TAMD31L-A, TAMD31M-A, TAMD31P-A, TMD31A, TMD31B, TMD31D, TMD31L-A, AD41D, AD41L-A, AD41P-A, AQAD41A, AQD41A, D41A, D41B, D41D, D41L-A, TAMD41A, TAMD41B, TAMD41D, TAMD41H-A, TAMD41L-A, TAMD41M-A, TAMD41P-A, TMD41A, TMD41B, TMD41D, TMD41L-A



18-7890

AIR FILTER

Replaces:

463505, 876185
MD30, MD40, KAD42A, KAMD42A
Diesel



18-0035

DIESEL OIL FILTER, FULL FLOW

Replaces: 3582732

Fits: D4-180i-B, D4-180I-C, D4-210A-A, D4-210A-B, D4-210I-A, D4-210I-B, D4-225A-B, D4-225A-C, D4-225I-B, D4-225I-C, D4-260A-A, D4-260A-B, D4-260A-C, D4-260D-B, D4-260D-C, D4-260I-A, D4-260I-B, D4-260I-C, D4-300A-A, D4-300A-C, D4-300D-A, D4-300D-C, D4-300I-A, D4-300I-C, D6-280A-A, D6-280A-B, D6-280I-A, D6-280I-B, D6-310A-A, D6-310A-B, D6-310D-A, D6-310D-B, D6-310I-A, D6-310I-B, D6-330A-B, D6-330A-C, D6-330D-B, D6-330D-C, D6-330I-B, D6-330I-C, D6-350A-A, D6-350A-B, D6-370A-B, D6-370A-C, D6-370D-A, D6-370D-B, D6-370D-C, D6-370I-A, D6-370I-B, D6-370I-C, D6-435D-A, D6-435D-C, D6-435I-A, D6-435I-C



18-0036

DIESEL OIL FILTER, BYPASS

Replaces: 3582733

Fits: D4-180i-B, D4-180I-C, D4-210A-A, D4-210A-B, D4-210I-A, D4-210I-B, D4-225A-B, D4-225A-C, D4-225I-B, D4-225I-C, D4-260A-A, D4-260A-B, D4-260A-C, D4-260D-B, D4-260D-C, D4-260I-A, D4-260I-B, D4-260I-C, D4-300A-A, D4-300A-C, D4-300D-A, D4-300D-C, D4-300I-A, D4-300I-C, D6-280A-A, D6-280A-B, D6-280I-A, D6-280I-B, D6-310A-A, D6-310A-B, D6-310D-A, D6-310D-B, D6-310I-A, D6-310I-B, D6-330A-B, D6-330A-C, D6-330D-B, D6-330D-C, D6-330I-B, D6-330I-C, D6-350A-A, D6-350A-B, D6-370A-B, D6-370A-C, D6-370D-A, D6-370D-B, D6-370D-C, D6-370I-A, D6-370I-B, D6-370I-C, D6-435D-A, D6-435D-C, D6-435I-A, D6-435I-C



18-7974

OIL FILTER

Replaces: 3827069

Thread Specs: 18mm x 1.5

Fits: Diesel Models AQD21A-B, AQD32A, MD21A/B, MD32A, TAMD61A, TAMD62A, TAMD63L-A, TAMD63P-A, TAMD71A/B, TAMD72A, TAMD73P-A, TAMD73WJ-A, TAMD74A-A, TAMD74A-B, TAMD74C-A, TAMD74C-B, TAMD74P-B, TAMD75P-A

OIL FILTERS

SEE PAGES 203-205 & 1155-11 FOR ADDITIONAL INFORMATION

OIL FILTERS

PART #	O.E. #	APPLICATION
18-8003-1	8692305	—
18-7824-2	835440	Short GM Filter
18-7876-1	3850559	Long GM Filter
18-7878-1	430143, 1266286, 3517857	Short Ford Filter
18-7879-1	841750	V-6 GM

DIESEL OIL FILTER

18-0033	21707133	—
18-0034	477556	—
18-7880	466634	TAMD100, TMD102, TMD121, TMD122, TAMD122 & TAMD162
18-7884	834337	—
18-7974	3827069	—



18-7962
OIL FILTER
 Replaces: 3840525
 Anti-Drain Back Valve
 Engineered with premium grade materials that will excel in the extreme marine environment
 Fits: D1-30A, D2-40A, D2-55A, D2-55B, D2-55C, D2-75A



18-8701
OIL FILTER
 Replaces: 861476
 Anti-Drain Back Valve
 Engineered with premium grade materials that will excel in the extreme marine environment
 Fits: MD22A, L-A, TMD22



18-7960
OIL FILTER
 Replaces: Volvo Penta 861473, D1-13 A B F, D1-20 A B F, MD2010 A B C / D, MD2020 A B C / D

18-8702
OIL FILTER

Replaces: 30788490
 Anti-Drain Back Valve. Epoxy coated for corrosion resistance.
 Heavy-wall steel canister for further corrosion protection
 Fits: D3-110I-G, D3-140A-G, D3-140I-G, D3-150I-G, D3-170A-G, D3-170I-G, D3-200A-G, D3-200I-G, D3-220A-G, D3-220I-G, D3-110I-H, D3-140I-H, D3-150I-H, D3-170I-H, D3-200I-H, D3-220I-H, D3-140A-H, D3-170A-H, D3-200A-H, D3-220A-H, D3-110I-D, D3-110I-E, D3-110I-F, D3-140I-E, D3-140I-F, D3-140A-D, D3-140A-E, D3-140A-F, D3-150I-D, D3-150I-E, D3-150I-F, D3-170I-D, D3-170I-E, D3-170I-F, D3-170A-D, D3-170A-E, D3-170A-F, D3-200I-D, D3-200I-E, D3-200I-F, D3-200A-D, D3-200A-E, D3-200A-F, D3-220I-D, D3-220I-E, D3-220I-F, D3-220A-D, D3-220A-E, D3-220A-F, D3-140I-D



CYLINDER HEAD ASSEMBLIES

All cylinder heads are new castings and complete assemblies with new - stainless steel valves, hardened steel exhaust seats, valve springs, valve locks, and retainers.
All GM cylinder heads utilize high performance screw-in rocker arm studs in place of factory press in rocker arm studs.



18-4486HP
CYLINDER HEAD ASSEMBLY
 Fits: Vortec GM small block 5.7L high performance
 Completely assembled with revised runner and combustion chambers. Add 30hp to stock motor with no additional modifications.



18-4501HP
CYLINDER HEAD
 Fits: Vortec GM small block 5.0L
 Completely assembled with revised runner and combustion chambers. Add 30hp to stock motor with no additional modifications.



18-1400
HYDRAULIC LIFTER
 Replaces: 3856127
 GM 4.3L/V-6 Late/5.0L/5.7L



18-1401
HYDRAULIC LIFTER
 Replaces: 3853847, 985316
 Ford 302/351
 Ford 5.0L & 5.8L



18-1402
HYDRAULIC LIFTER
 Replaces: 3854033, 502036
 GM 2.5L/120
 For: Volvo 3.0L/181 CID GM 3.0L, 4.3L, 5.0L & 5.7L

**ALL PISTONS
 ARE SUPPLIED COMPLETE WITH PISTON RINGS AND WRIST PIN.**



PISTONS	
STD	OMC / VOLVO #
18-4173	*14077948
18-4173	3911020
0.03	
18-4164	*14077949, 3911023

* OMC References GM Number

PISTON RINGS	
STD	OMC / VOLVO #
18-3937	*14089025
18-3937	328506
18-3937	3853960
18-3937	914555
18-3937	3853268
18-3937	985083, 986336
18-3944	370409

PISTON RINGS	
0.02	
18-3939	3854252
18-3939	914556

PISTON / RING APPLICATION

VOLVO		PISTONS			RINGS			Qty.
Model	Serial Number	Std.	.020	.030	Std.	.020	Per .030	Eng.
GM								
2.5L/153 CID		-	-	-	18-3942	-	-	4
3.0L/181 CID		-	-	18-4191	18-3937	18-3939	-	4
4.3L/V-6		18-4173	18-4188	18-4164	18-3937	18-3939	-	6
5.0L/305 CID		-	-	18-4178	18-3944	-	-	8
5.7L/350 CID		18-4173	18-4188	18-4164	18-3937	18-3939	-	8
7.4L/454 CID		18-4171	18-4189	18-4172	-	-	-	8
FORD								
5.0L/302 CID		-	-	-	18-3937	18-3939	-	8



ROD BEARINGS

Part #	Size
18-1308	Std.
18-1309	.010
18-1327	Std.
18-1332	.020
18-1333	.010
18-1334	Std.
18-1337	.010

Rod bearings sold individually,
1 per rod.



MAIN BEARINGS

Part #	Per Eng.	Size
18-1311	②	Std.
18-1317	②	Std.

BEARING APPLICATION

Model	ROD BEARING			MAIN BEARING			CAM BEARING
	Std.	.010	.020	Std.	.010	.020	
VOLVO							
GM							
3.0L/181 CID	18-1308	18-1309	-	18-1317	-	-	-
4.3L/V-6	18-1327	18-1337	-	18-1311	-	-	-
5.0L/305 CID	18-1308	18-1309	-	-	-	-	-
5.7L/350 CID	18-1308	18-1309	-	-	-	-	-
7.4L/454 CID	18-1334	18-1333	18-1332	-	-	-	-
FORD							
5.0L/302 CID	-	-	-	-	-	-	-



18-0518
VALVE STEM SEAL
Replaces: 3854956,
914323, 3853132
For: most inline 4 and 6 cyl. GM (Early)
and 305-350 CID GM

PKG. OF 8



18-4024
18-4024-9①
VALVE STEM SEAL
Replaces:
3853226, 914445
For: Chevy 4.3L/5.0L/5.7L



ONE PIECE REAR MAIN SEALS
18-1234
Replaces: 3853528
For: 7.4L, GL, GI, GSI: 8.2L, GL
18-0519
Replaces: 3852657, 912957
4.3L/3.0L/5.0L 5.7L



TWO PIECE REAR MAIN SEALS
18-0528 **18-1211**
Replaces:
3852805



TIMING COVER SEALS
18-1213 **18-1230**
Replaces:
3853341 Replaces:
3853827

① Priced per Package

② Complete Engine Set

VOLVO SEAL APPLICATION

Engine Model	2 Piece Rear Main Crankshaft Seal Conv. Rotation (LH)	Timing Cover Seal
GM		
3.0L/181 CID	18-1211 ②	18-1213
4.3L/V-6	18-1211 ②	18-1213
5.0L/305 CID	18-1211 ①	18-1213
5.7L/350 CID	18-1211 ①	18-1213
7.4L/454 CID	③	18-1233
FORD		
5.0L/302 CID	18-0528	18-1230
5.8L/351 CID	—	18-1230

① Large Journal Crankshaft GM Engine ② For one piece seal (LH) models use 18-0519 ③ For one piece seal (LH) models use 18-1234

FOR MODULAR GASKET SETS SEE PAGES 671-677

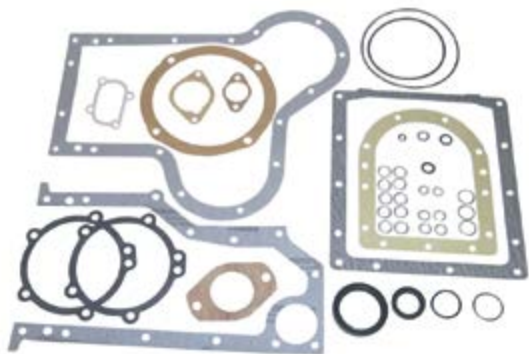

**18-0252
CONVERSION GASKET SET**
Replaces: 876314
Fits: D6, D7, MD6A, MD6B, MD7A, MD7B



**18-2699
OUTDRIVE GASKET**
For: SX and DP-SM Drives thru 2006

— CONTAINS —

Part #	Description	O.E. #	Qty.
18-7153	O-Ring	911851	2
18-2996	Outdrive Seal	911823	1



**18-2596
HEAD GASKET SET**
Replaces: 875422
Fits: D1, D2, D1A, MD1A, D2A, MD2, MD2A:
NOTE: Model MD2A requires two 18-2596

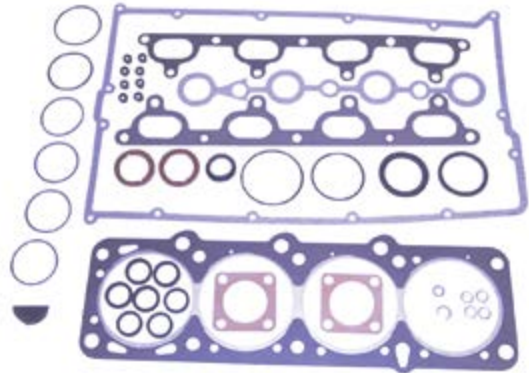

**18-3870
HEAD GASKET SET**
Replaces: 876303
Fits: B25, 251A, AQ171A, AQ171C

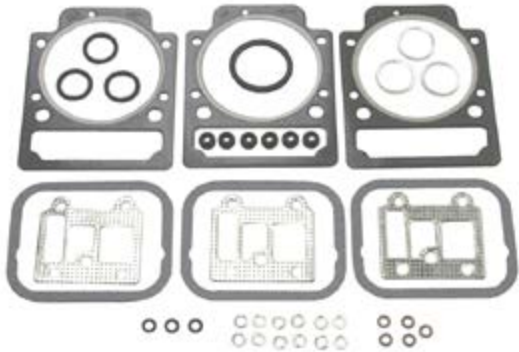

**18-4341
HEAD GASKET SET**
Replaces: 876380
Fits: D17, MD17C, MD17D



**18-2813
HEAD GASKET SET**
Replaces: 876302
(4 CYL.)

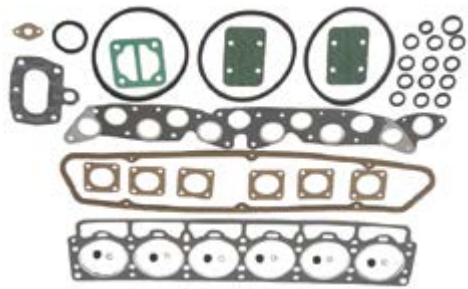

**18-2817
HEAD GASKET SET**
Replaces: 876359
(6 CYL.)



**18-2818
OIL PAN GASKET SET**
Replaces: 876433
(4 CYL.)



**18-2982
HEAD GASKET SET**
Replaces: 875569 (Old), 876358
(4 CYL.)



**18-2983
SHORT BLOCK GASKET SET**
Replaces: 875400 (Old), 876342
(4 CYL.)



**18-2998
HEAD GASKET SET**
Replaces: 876300
(4 CYL.)



**18-0410
INTAKE MANIFOLD
GASKET SET**
Replaces: 3853912, 3853913, 3854406
For: Volvo 5.0L FL, FI, 5.8L FL, FI, FSI



**18-0868
INTAKE MANIFOLD
GASKET SET**
Replaces: 3854269

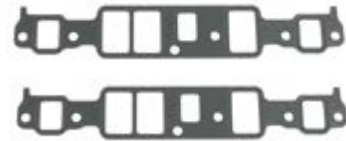

**18-1238
INTAKE GASKET SET**
Replaces: 3850379, 912979
For: Volvo 4.3GL/GS 1994-96, 4.3Gi 1995-97



**18-0498
HEAD GASKET**
Replaces: 3580309
Fits: MD2030A, MD2030B



**18-2946
HEAD GASKET**
Replaces: 3853336, 908611
Fits: GM 181 (3.0L) CID Eng.



**18-2965
HEAD GASKET**
Replaces: 419310, 419763-8
(4 CYL.)



**18-2966
HEAD GASKET**
Replaces: 462623
(4 CYL.)



**18-2968
HEAD GASKET**
Replaces: 1378645
(4 CYL.)



**18-2970
HEAD GASKET**
Replaces: 1378646
(4 CYL.)



18-3868

HEAD GASKET

Replaces: 3583786

Fits: D41, D42, D43, D44, AD41A, AD41B, AD41D, AD41L-A, AD41P-A, AQAD41A, D41A, D41B, D41D, D41L-A, TAM41A, TAM41B, TAM41D, TAM41H-A, TAM41L-A, TAM41M-A, TAM41P-A, TMD41A, TMD41B, TMD41D, TMD41LA, KAD42A, KAD42B, KAD42P-A, KAMD42A, KAMD42B, KAMD42P-A, TAM42B, TAM42WJ-A, KAD43P-A, KAMD43P-A, KAD44P-A, KAD44P-B, KAD44P-C, KAMD44P-A, KAMD44P-B, KAMD44P-C



18-3867

HEAD GASKET

Replaces: 859647

Fits: MD22A, MD22L-A, MD22L-B, MD22P-B, TAM42P-B, TMD22A, TMD22B



18-3876

HEAD GASKET

Replaces: 841207-4, 856474-2

Fits: GM 305 (5.0L)/350 (5.7L) CID Eng.

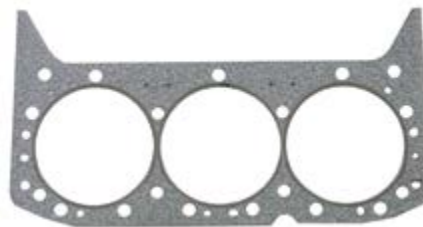

18-3879

HEAD GASKET

Replaces: 3854299, 912227, 914930

Fits: GM 262 (4.3L) CID Eng.



18-3883

HEAD GASKET

Replaces: 3853732

Fits: Ford 302 (5.0L) 351 (5.8L) CID Eng.

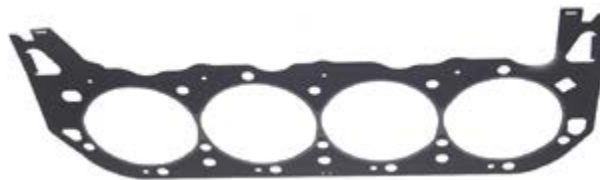

18-3887

HEAD GASKET

Replaces: 3853511



















For: Volvo 7.4L

HEAD GASKET SET/GASKET SET/HEAD GASKET APPLICATION

Model	Head Gasket Set	Gasket Set	Head Gasket	Model	Head Gasket Set	Gasket Set	Head Gasket	Model	Head Gasket Set	Gasket Set	Head Gasket
AQ60	—	18-2983	—	AQ151A,B,C	18-2813	—	18-2970	MB20	—	18-2983	—
AQ90	—	18-2983	—	AQ165	—	—	—	MB20A	18-2981	—	—
AQ95	—	18-2983	—	AQ170A	—	—	—	MB20B	—	—	18-2965
AQ100	—	18-2983	—	AQ170B	—	—	—	MB20C	18-2982	—	18-2966
AQ105	—	18-2983	—	AQ170C	18-2817	—	18-2811	MD11C,D	—	—	—
AQ110	—	18-2983	—	AQD2B	18-2985	—	18-3833	MD17C,D	—	—	—
AQ115	—	18-2983	—	B20 (0.8MM)	—	—	18-2965	MD1B	—	—	—
AQ115A	—	—	18-2965	B20 (1.2MM)	—	—	18-2966	MD2B	18-2985	—	—
AQ115B,C	—	18-2982	18-2966	B21	—	—	18-2968	MD3B	—	—	—
AQ120A	—	18-2983	—	B23	—	—	18-2970	230A,B	18-2813	—	—
AQ120B	18-2998	18-2818	18-2968	B30 (0.8MM)	—	—	—	250A,B	18-2813	—	—
AQ125A	18-2998	18-2818	18-2968	B30 (1.2MM)	—	—	18-2811				
AQ125B	18-2813	—	18-2970	BB30	—	18-2983	—				
AQ130	—	18-2983	—	BB100	—	18-2983	—				
AQ130A	—	—	18-2965	BB115A,B	—	—	—				
AQ130B	—	—	—	BB115C	—	—	18-2966				
AQ130C	—	—	18-2965	BB140A	18-2998	18-2818	18-2968				
AQ130D	18-2982	—	18-2966	BB145A	18-2999	18-2818	—				
AQ131A,B,C,D	18-2813	—	18-2970	BB165	—	—	—				
AQ140A	18-2998	18-2818	18-2968	BB170C	18-2817	—	18-2811				
AQ145A	—	18-2818	18-2970	BB30	—	18-2983	—				
AQ145B	18-2813	—	18-2970	MB18	—	18-2983	—				

<p>PKG. OF 2</p>  <p>18-0876 18-0876-9① FUEL PUMP GASKET For GM 4.3L, 5.0L & 5.7L Replaces: 3852113</p>	<p>PKG. OF 2</p>  <p>18-0889 18-0889-9① FUEL PUMP GASKET For GM 4.3L, 5.0L & 5.7L Replaces: 3852095</p>	<p>PKG. OF 2</p>  <p>18-2989 18-2989-9① CARB MOUNTING GASKET Replaces: 824677 AQ115, 125A, B, 130C, D, 131A, 145A, B, 151A, B, 170, 171A</p>	<p>PKG. OF 2</p>  <p>18-0398 18-0398-9① THERMOSTAT GASKET Replaces: 835417</p>
<p>PKG. OF 2</p>  <p>18-2933 THERMOSTAT GASKET Replaces: 416033, 1317466 Used with most Volvo thermostats (Except AQ175, V-8, MD1A)</p>	<p>PKG. OF 2</p>  <p>18-2858 18-2858-9① THERMOSTAT HOUSING COVER GASKET Replaces: 3852127 For: 3.0L GS, GL, GLM, GLP, GSM, GSP</p>	<p>PKG. OF 2</p>  <p>18-0164 18-0164-9① THERMOSTAT HOUSING GASKET Replaces: 3852096 For: 3.0L GS, GL</p>	<p>PKG. OF 2</p>  <p>18-0929 18-0929-9① THERMOSTAT GASKET Replaces: 3852120 For: 3.0L GS, GL</p>
 <p>18-0183-1 EXHAUST MANIFOLD GASKET Replaces: 3853742, 3852455</p>	 <p>18-2971-1 EXHAUST MANIFOLD GASKET Replaces: 856039, 835908 AQ200, 225, 260, 271, 290, 311</p>	 <p>18-2925 EXHAUST MANIFOLD GASKET Replaces: 461092 (Old), 1378913 AQ165, 170B, BB165, 170 6 Cyl.</p>	
 <p>18-2815 PUSH ROD COVER GASKET Replaces: 3852692 For: 3.0L</p>	 <p>18-1231 INTAKE GASKET Replaces: 3854095 For: Volvo 7.4L GL, GI, GSI, 8.2L GL</p>	<p>PKG. OF 2</p>  <p>18-2995 18-2995-9① HEAT EXCHANGE GASKET Replaces: 856037 AQ120B, 125A, B, 140A, 145A,B</p>	 <p>18-2928 EXHAUST MANIFOLD GASKET Replaces: 824633, 856044 AQ105, 115, 130, BB115, MB20 4 Cyl.</p>
 <p>18-2930 EXHAUST MANIFOLD GASKET Replaces: 1266796 (Old), 1378879 AQ125A, B, 145A, B, 131A, 151A, B, 120B, 140A</p>	<p>PKG. OF 2</p>  <p>18-2949 18-2949-9① EXHAUST MANIFOLD GASKET Replaces: 835966, 856034 AQ200, 225, 260, 271, 290, 311 V-8</p>	<p>PKG. OF 4</p>  <p>18-2991-1 18-2991-1-9① EXHAUST MANIFOLD GASKET Replaces: 855967, 855383 AQ120B, 125A, B, 131, 140, 145, 151, B21, B23</p>	<p>PKG. OF 2</p>  <p>18-2974 DISTRIBUTOR GASKET Replaces: 418265 AQ90, 95, 100, 105, 110, 115, 120, 130, 165, 170, MB18, 20, BB30, 100</p>

① Priced per Package

 <p>18-0311 VALVE COVER GASKET Replaces: 3854942 For: 4.3 Litre 262 CID</p>	 <p>18-0347 VALVE COVER GASKET Replaces: 3852693 For: GM 153 & 181 CID (2.5L & 3.0L)</p>	 <p>18-0352 VALVE COVER GASKET Replaces: 3852818 For: Ford 302/351 CID (5.0L & 5.8L)</p>	 <p>18-0664 VALVE COVER GASKET Replaces: 3852687 For: GM 305/350, 5.0 & 5.7L</p>
 <p>18-2923 VALVE COVER GASKET Replaces: 419678 AQ105, 115, 120, 130, BB115, MB20 4 Cyl.</p>	 <p>18-2924 VALVE COVER GASKET Replaces: 430039 AQ165, 170, BB165, 170 6 Cyl.</p>	 <p>18-2927 VALVE COVER GASKET Replaces: 463999 (Old), 1378909 AQ120B, 125A, 140A, 145A, BB140, 145A 4Cyl.</p>	 <p>18-2972 VALVE COVER GASKET Replaces: 1378870 AQ125B, 145B, 131A, 151A, B</p>
 <p>18-2926 OIL PAN GASKET Replaces: 463587 (Old), 1378864 AQ90, 95, 100, 105, 110, 115, 120, 120B, 125A, B, 130, 131A, 140A, 145A, B, 151A, B, 171A</p>		 <p>18-0307 OIL PAN GASKET Replaces: 861250 Fits: D30, D31, D32, AD300A, AQAD30A, MD30A, TAMD30A, TMD30A, AD31A, AD31B, AD31D, AD31L-A, AD31P-A, AD31XD, AQAD31A, MD31A, TAMD31A, TAMD31B, TAMD31D, TAMD31L-A, TAMD31M-A, TAMD31P-A, TMD31A, TMD31B, TMD31D, TMD31L-A, KAD32P-A</p>	
 <p>18-1237 OIL PAN GASKET Replaces: 3856138 For: GM 5.7L</p>	 <p>18-1239 OIL PAN GASKET Replaces: 3853343 For: Volvo 3.0L</p>	 <p>18-0405 OIL PAN GASKET Replaces: 3852655 For: Volvo 4.3L</p>	 <p>18-1232 OIL PAN GASKET Replaces: 3853510 For: Volvo 7.4L GL, GI, GSI, 8.2L GL</p>
 <p>18-2518 CIRCULATION PUMP GASKET Replaces: 430017 For: Volvo AQ165A, 170A, B, C</p>	<p>PKG. OF 2</p>  <p>18-0903 18-0903-9① WATER PUMP GASKET Replaces: 3853361 454 CID</p>	 <p>18-0327 WATER PUMP GASKET Replaces: 3853342 4 & 6 Cyl.</p>	<p>PKG. OF 2</p>  <p>18-0891 18-0891-9① WATER PUMP MOUNTING GASKET Replaces: 3852477 For: GM 4.3L, 5.0L & 5.8L</p>

① Priced per Package

<p>PKG. OF 2</p>  <p>18-0893 18-0893-9① WATER PUMP BACK-IN PLATE GASKET Replaces: 3850595 GM 4.3L, 5.0L & 5.7L</p>	<p>PKG. OF 2</p>  <p>18-0147 WATER PUMP GASKET For Ford V-8 Replaces: 3852824</p>	<p>PKG. OF 2</p>  <p>18-2979-9① WATER PUMP GASKET Replaces: 1378906 AQ120B, 125A, 140A, 145A</p>	 <p>18-0468 TIMING COVER GASKET Replaces: 3852654, 3853512 GM 4.3L, 5.0L & 5.7L</p>
<p>PKG. OF 2</p>  <p>18-0887 18-0887-9① TIMING COVER GASKET Replaces: 3852691 4 & 6 Cyl.</p>	 <p>18-2531 CLAMP RING Replaces: 834476 Fits: AQ120B, 125A, B, 140A, 145A, B</p>	 <p>18-25250 SEALING RING Replaces: 3863085 Fits: Volvo SX-A/DPS-A (2007 & Up)</p>	 <p>18-25251 SEALING RING Replaces: 853868 Fits: Volvo SX Thru 2006</p>
<p>PKG. OF 2</p>  <p>18-2519 18-2519-9① SEAL RING Replaces: 831622 For cooling water pipe 120B, 125A, B, 131A, 140A, 145A, B, 151A, B, 171A</p>	<p>PKG. OF 5</p>  <p>18-2525 SEAL RING Replaces: 430018 Circulation pump to cylinder head AQ165A, 170A, B, C</p>	<p>PKG. OF 5</p>  <p>18-252 SEAL RING Replaces: 831617 For cooling water pipe AQ165A, 170A, B, C, MD21A (S/N MD-103387 & UP), MD21B</p>	<p>PKG. OF 5</p>  <p>18-2528 SUPPORT RING Replaces: 831891 AQ120B, 125A, B, 140A, 145A, B</p>
<p>PKG. OF 5</p>  <p>18-2529 SEAL RING Replaces: 831892 AQ120B, 125A, B, 140A, 145A, B</p>	<p>PKG. OF 5</p>  <p>18-4259 WASHER Replaces: 804261</p>	<p>PKG. OF 5</p>  <p>18-2530 SEAL RING Replaces: 1336255, 3547991 Circulation pump to cylinder head AQ120B, 125A, B, 131A, 140A, 145A, B, 151A, B, 171A</p>	<p>PKG. OF 2</p>  <p>18-2934 18-2934-9① RUBBER SEAL Replaces: 829714 AQ90, 95, 100, 105, 110, 115, 120, 130, MD5A, B, C, 7A, B, 11D, MD2001, 2002, 2003T</p>
<p>PKG. OF 2</p>  <p>18-2935 18-2935-9① RUBBER SEAL Replaces: 418411 AQ90, 95, 100, 105, 110, 115, 120, 130, MB18, 20, BB30, 100, MD11C, D, 17C, D, MD2001, 2002, 2003, 2003T</p>	<p>PKG. OF 2</p>  <p>18-2936 18-2936-9① RUBBER SEAL Replaces: 418445 AQ90, 95, 100, 105, 110, 115, 120, 130, MB18, 20, BB30, 100, MD11C, D, 17C, D, 2001, 2002, 2003, 2003T</p>	<p>PKG. OF 2</p>  <p>18-2937 18-2937-9① RUBBER SEAL Replaces: 418412 AQ90, 95, 100, 110, 120B, 125A, B, 131A, 140A, 145A, B, 151A, B, 165A, 170, 171A, MD21A, B</p>	

① Priced per Package

<p>PKG. OF 5</p>  <p>18-2996 18-2996-9^① OUTDRIVE SEAL Replaces: 3852560 3.0L GL, GS, 4.3L GL, GS, GI, 5.0L FL, FI, 5.7L GL, GI, 5.8L FL, FI, FSI</p>	<p>PKG. OF 2</p>  <p>18-0322 18-0322-9^① REAR SEAL GASKET Replaces: 3852656 GM 5.0L & 5.7L</p>	
<p>PKG. OF 2</p>  <p>18-2929 18-2929-9^① COVER PLATE GASKET Replaces: 856028 AQ105, 115, 130, BB115, MB20</p>	<p>PKG. OF 2</p>  <p>18-2939 18-2939-9^① RUBBER SEAL Replaces: 814356 AQ200, 250, 270, 275, 280, 290</p>	<p>PKG. OF 2</p>  <p>18-0874 18-0874-9^① DISTRIBUTOR GASKET For GM V6 & V8 Replaces: 3852109</p>
<p>PKG. OF 2</p>  <p>18-0943-2 18-0943-2-9^① EXHAUST ELBOW GASKET Replaces: 3850496 Late Model Volvo Applications</p>	<p>PKG. OF 2</p>  <p>18-2990 18-2990-9^① UPPER GEAR HOUSING GASKET Replaces: 832669 AQ270, 275, 280, 290</p>	<p>PKG. OF 2</p>  <p>18-2199 SHORT YOKE SPACER Replaces: 832675 AQ270, 275, 280, 290</p>
 <p>18-2945 18-29451-9^① (PKG. OF 50) DRAIN SCREW GASKET For: use with 18-2944 drain screw</p>	 <p>18-2432 POWER TRIM HOSE Replaces: 873228 For: DP, DPX</p>	 <p>18-2433 POWER TRIM HOSE Replaces: 873229 For: DP, DPX</p>
 <p>18-21751 ENGINE COUPLER Replaces: 3853962-3 Fits: 2.5L (1986), 3.0L (1986-90), 4.3L, 5.0L, 5.7L (1986) KW & KWB suffix only, 7.4L (1990-98), 8.2L (1992-93,1998)</p>	 <p>18-21752-1 ENGINE COUPLER Replaces: 3858437-1 Fits: 4.3L (1986-Current), 5.0L (1986-88, 1998-Current), 5.7 (1986-92,1994, 1996-Current)</p>	 <p>18-21753 ENGINE COUPLER Replaces: 985727, 3853862-5 Fits: Ford Engines 5.0L & 5.8L (1989-96)</p>

① Priced per Package



18-9096
TRAWLING CLIP
 Volvo 3847547
 Fits: Volvo SX-A, DPS-A (2007-Up)



18-9098
TRAWLING CLIPS
 Replaces: 174448
 Set of 2
 For all SX Models thru 2006



Double
 Package



STAINLESS STEEL CLAMPS

Part #	Sizes	O.E. #
18-7300 ① ②	50MM	—
18-7306-9 ① ②	38MM	853548
118-710-48-2	—	3852604
18-710-64-2	122MM	853012



18-2772-1
TRANSOM SEAL KIT
 For: SX Drives

— CONTAINS —

Part #	Description	O.E. #	Qty.
18-2100	Gimbal Bearing	3853807	1
18-2765	Bellows	3854127	1
18-1074	Bellows	3850426-2	1
18-2996	Seal	3852560, 911823	1
18-710-64-2	Hose Clamp	853012-3	1



18-2744
DRIVE BELLOWS KIT
 Replaces: 875826, 876294
 (with ridge)
 AQ200, 250, 270, 270T, 275, 280, 280T,
 PT, 290 DP UNIT: 280, 290



18-2755
DRIVE BELLOWS KIT
 Replaces: 875827
 SAIL DRIVE: 100S, AQ DRIVE: 100, 100B



18-2757
EXHAUST BELLOWS KIT
 with flapper valve
 Replaces: 875828, 876633
 AQ175, 280, 280DP, T, PT, AQD40,
 AQAD40, V-8



18-2758
EXHAUST BELLOWS KIT
 Replaces: 875848, 876631
 AQ200, 250, 270, 275, 280, 280DP,
 290, 290DP



18-1074
EXHAUST BELLOWS
 Replaces: 3850426
 For: SX Drives includes 302, 432,
 434, 502, 572, 584, 744 (1994-98)
 Uses 18-710-48-2 Clamp



18-2765
U-JOINT BELLOWS
 Replaces: 3854127
 For: DP-S, SX



18-2766
EXHAUST HOSE
 Replaces: 834751
 (I.D. 95MM, LENGTH 160 MM)
 V-8

① This product is priced per piece. To order priced per package, please add -9 to the part number.

② Priced per Package



**18-6523
SPRING SET**
For reverse tilt lock: Fits: AQ250, 270, 275, 275A, 280, 280DP, 280L, 285A, 290, 290A, 290DP, SP-A, SP-A/MT, SP-A1, SP-A2, DP-A, DP-A1, DP-A2, DP-B, DP-B1



**18-0184
RUBBER RING**
Replaces: 804190
For clamp ring: Fits: 230A/SP-A/MT, 250A/SP-A/MT, 500A, 501A, 571A, 740A, AQ100, AQ105, AQ110, AQ115A, AQ110B, AQ120A, AQ120B, AQ125A/B, AQ130A/B, AQ131A/D, AQ175A, AQ190A, AQ200A/C/D/F, AQ210A, AQ211A, AQ225A/B/C/D/E/F, AQ231A/B, AQ240A, AQ255A/B, AQ260A/B, AQ271A/B/C/D, AQ280A, AQ290A, AQ311A/B, AQ60F, AQ80, AQ90, AQ95, AQD19, AQD29A, AQD32A



**18-8368
RUBBER RING**
Replaces: 813967
For clamp ring: 230A/SP-A/SP, A1, 230B, 250A/B, 251A, 430A/B, 431A/B, 432A, 434A, 500B, 501B, 570A, 572A, 740B, AD31A/B/D/XD, AD40B, AD41A/B/D, AQ100, AQ105, AQ110, AQ115A/B, AQ130A/B, AQ131B/C, AQ140A, AQ145A/B, AQ151A/B/C, AQ171A/C, AQ205A, AQ60F, AQ90, AQ95, AQAD30A, AQAD31A, AQAD40A/B, AQAD41A, AQD19, AQD21A/B, AQD40A, D41A/B/D, KAD32, KAD42A/B/P, KAD43P, KAD44P, KAMD42A, TAMD41A



**HEAVY DUTY U-JOINTS
(Rockwell Style)**

Part #	O.E. #	Application
18-2104	897707,	AQ200,250,270,
	853255	280,290
18-2174	3850812	3.0L GS, GL, 4.3L GL, GS, GI, 5.0L GL, GI, 5.7L GL, GI, 5.8L FL, FI, FSI



**18-6406
U-JOINT**
Replaces: 3860232
GKN new style with external clips.



**18-2100
LINK BELT
GIMBAL BEARING**
Replaces: 3853807
Fits: OMC/Volvo- 3.0L, 4.3L, 5.0L, 5.7L, 7.4L (1994-1998), 5.8L (1994-1996), 8.2L(1998)



**18-2146
UNIVERSAL U-JOINT
ASSEMBLY**
Replaces: 3850815



**18-2339
U-JOINT ASSEMBLY**
Replaces: 3852384



**18-2337
YOKE**
Replaces: 3850814
Fits: 3.0L GS, GL, 4.3L GS, GL, GI, 5.0L FL, FI, 5.7L GL, GI, 5.8L FL, FI, FSI



**18-2128
CENTER SOCKET**
Replaces: 3850813, 912213

Drive Model	U-joint Assy. #	O.E. U-joint Assy. #	Long Yoke #	O.E. Long Yoke #	Short Yoke #	O.E.Short Yoke #	Double Yoke #	O.E. Double Yoke #
SX, DP-SM	18-2339	3852384	18-2146	3850815	18-2337	3850814	18-2128	3850813



**18-4204
PLASTIC BUSHING**
Replaces: 826341, 876278
AQ200, 250, 270, 275, 280, 280DP,290DP,
NOT FOR 270T, 280T, AND 290



**18-2366
LOWER
GEARCASE SEAL**
Replaces: 876279
290, 290A, 290DP, SP-A, SP-A1 & SP-A2



**18-4205
PLASTIC BUSHING**
Replaces: 832820
A270T, 280T



**18-4206
STERNDRIVE COVER**
Replaces: 832570
AQ200, 250, 270, 275, 280, 290



**FISH LINE
PROTECTOR SPACER**

Part #	O.E. #	Application
18-4208	839423	AQ280, 290
18-4209	839534	AQ250, 270, 275
18-4234	832965	AQ110S, 200



**18-4210
PROP CONE**
Replaces: 850785, 854045
AQ200, 250, 270, 270T, 275, 280, 280T, 280PT, 290



**18-4211
PLASTIC WASHER**
Replaces: 850888



**18-3730
LOCK NUT**
Replaces: 3852648-9
For: SX Drives



**18-4212
PROP CONE SCREW**
Replaces: 850889
(5/16" - 18 thread)



**18-4213
SPACER**
Replaces: 851261,
854047
AQ275, 280, 290



**18-4214
LOCKING WASHER**
Replaces: 897367
AQ Drive Units: 200, 250,
270, 270T (TID UTF) 275, 280,
280T, 280PT (TID UTF)



**18-4215
COVER SCREW**
Replaces: 941816
(1/4" — 20)



**18-2153
SETTING PIVOT PIN**
Replaces: 814301
AQ200, 250, 270, 275, 280



**18-2454
DRAIN PLUG**
3/8" - 16 thread
Replaces: 3854539
For: Volvo SX drives
Use o-ring **18-7145**



**18-3733
PROP NUT KIT**
For: SX Cobra
— Contains —

Part #	Description	Qty.
18-4194	Spacer	1
18-3708-1	Nut & Keeper	1
18-3741	Cotter Pin	1

② **18-3733D** Display Package



**18-4194
PROP SPACER**
Replaces: 3852350
For: Lower gearcase models SX-M (1994)



**18-3708-1
PROP NUT & KEEPER**
Replaces: 3850984



**18-3744
18-3744-9^①
COTTER PIN**
Replaces: 3852255
For: XDP, MDSSL, MD22P, TMD22,
TMD22P, TAMD22P, PJX, SX, DPS,
DP, 3.0L GS, GL, 4.3L GL, GS, GI,
5.0L FL, FI, 5.7L GL, GI, 5.8L FL, FI, FSI



**18-3745
18-3745-9^①
COTTER PIN**
Replaces: 17253-6



**18-4238
LOCK CATCH SCREW**
For Stern Drive Cover 18-4206
Replaces: 943218
AQ200, 250, 270, 275, 280, 290



**18-4239
LOCK CATCH**
For Stern Drive Cover 18-4206
Replaces: 897873
AQ200, 250, 270, 275, 280, 290



**18-4241
ROLL PIN**
Replaces: 951924
AQ200, 250, 270, 275, 280, 290



**18-1501
DETENT BALL**
Replaces: 3852023
For: 3.0L GS, GL, 4.3L GL, GS, GI,
5.0L FL, FI, 5.7L GL, GI, 5.8L FL, FI, FSI



**18-3722
18-3722-9^①
STAINLESS STEEL LOCKNUT**
Replaces: 3852005
For: PJX, SX, DPS, DP, DPX, 3.0L GL, GS,
4.3L GL, GS, GI, 5.0L FL, FI, 5.7L GL, GI,
5.8L FL, FI, FSI, 7.4L GL, GI, GSI, 8.2L GL



**18-0549
PLUG OFF CAP
1"**
Replaces: 3852476
For: 4.3L GL, GS, GI, GSI, 5.0L FL, FI, 5.7L GL,
GI, 5.8L FL, FI, FSI, 7.4L GL, GI, GSI, 8.3L GI,
GSI, GXI, 8.2L GL, GSI



**18-2138
PIVOT PIN BEARING**
Replaces: 3852544
For: 3.0L GS, GL, 4.3L GL, GS, GI,
5.0L FL, FI, 5.7L GL, GI, 5.8L FL, FI, FSI

① Priced per Package
② Items ending in "D" are Display Packaged - Regular number is Non-Display

Zinc is for saltwater only applications.
 Magnesium is for fresh water only applications.
 Aluminum is for brackish water, or if boat is used in both fresh and salt environments.



③ **18-6123Z**
ANODE
 Replaces: 873395
 Transom Shield



③ **18-6124Z**
ANODE
 Replaces: 872793
 DPS Steering Arm



① **18-6125A**
 ② **18-6125M**
 ③ **18-6125Z**
TRANSOM PLATE
 Replaces:
 3586461 (Alumuminum)
 3855610 (Magnesium)
 3854130 (Zinc)



① **18-6126A**
 ② **18-6126M**
 ③ **18-6126Z**
TRANSOM ANODE
(with bolt)
 Replaces:
 3888816 (Alumuminum)
 3888818 (Magnesium)
 3888817 (Zinc)
 SX-A, DPS-A, DPS-A Oxi



① **18-6127A**
 ② **18-6127M**
TRANSOM ANODE
(with bolt)
 Replaces:
 3888813 (Alumuminum)
 3888815 (Magnesium)
 3888814 (Zinc)
 SX-A, DPS-A, DPS-A Oxi



③ **18-6000**
 ① **18-6000A**
 ② **18-6104**
ANODE
 Replaces: 832598,
 873179
 For 200, 250, 250C, 250D, 270,
 270B, 270C, 270D, 275, 280,
 280C, 280D, 280DP, 280L, 280PT



③ **18-6001**
ANODE
 Replaces: 838929
 AQ200 (For shield), MD19, 21,
 27, 29, 32, 2003, AQ30, 31, 40, 41
 For Fresh Water Cooler



③ **18-6004**
 ① **18-6004A**
 ② **18-6105**
ANODE
 Replaces: 852835,
 873178
 For 290, 290A, 290ADP, 290B



③ **18-6005**
ANODE
 Replaces: 875805
 AQ250, 270, 270T, 275



③ **18-6009**
 ① **18-6009A**
ANODE
 Replaces: 875815



③ **18-6028**
 ① **18-6028A**
 ② **18-6102**
ANODE
 Replaces: 3855411, 984513
 (18-6028), 3863193 (18-6028A),
 3855412 (18-6102)
 For use on Gearcases: 2.3L (1987-90), 2.6L/
 3.5L/4.6L (1989), 3.0L/4.3L/5.0L/5.8L (1987-
 93), 5.7L (1987-92), 7.4L (1987-88)



③ **18-6010**
 ① **18-6010A**
 ② **18-6106**
ANODE
 Replaces: 875821
 280DP, 290DP



18-6130
ANODE
Replaces: Volvo
Fits: Volvo IPS Drives



18-6131
ANODE
Replaces: Volvo
Fits: Volvo IPS Drives



18-6128A
ANODE KIT
Replaces: Volvo
Fits: Volvo SX-A & DPS Drives

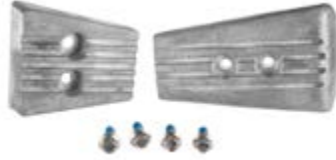

18-6128M
ANODE KIT
Replaces: Volvo
Fits: Volvo SX-A & DPS Drives

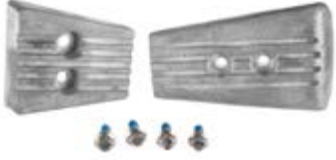

18-6128Z
ANODE KIT
Replaces: Volvo
Fits: Volvo SX-A & DPS Drives



18-6129A
ANODE KIT
Replaces: Volvo
Fits: Volvo DPH Drives



18-6129M
ANODE KIT
Replaces: Volvo
Fits: Volvo DPH Drives



18-6129Z
ANODE KIT
Replaces: Volvo
Fits: Volvo DPH Drives



18-1076
BELLOWS
Replaces: Volvo 3888916
Fits: Volvo SX-A & DPS-A Drives



③ **18-6021**
ANODE PLUG
Replaces: 838928
AQ30, 31, 40, 41, MD10, 21, 27, 29, 32, 2003



18-2598
LOWER UNIT SEAL KIT
Replaces: 3855275
Fits: Volvo SX Thru 2006



18-2586
UPPER UNIT SEAL KIT
Replaces: 3850594
Fits: Volvo SX Thru 2006



18-3893
GEAR SHIFT MECHANISM GASKET SET
Fits: 275A, 280, 280DP, 280T, 285A, 290, 290A, 290DP, SP-A, SP-A/MT, SP-A1, SP-A2, SP-C, SP-C1, DP-A, DP-A1, DP-A2, DP-B, DP-B1, DP-C, DP-C1, DP-D, DP-D1, DP-E, DP-G, DPX, DPX-S, XDP-B

① Aluminum ② Magnesium ③ Zinc



**18-2597
UPPER GEAR
UNIT SEAL KIT**

For intermediate housing: Fits: 200, 250, 270, 270T, 275, 275A, 280, 280DP, 280T, 285A, 290, 290A, 290DP, SP-A, SP-A/MT, SP-A1, SP-A2, SP-C, SP-C1, DP-A, CP-A1, DP-B, DP-B1, DP-C, DP-C1, DP-D, DP-D1, DP-E, DP-G, DPX, DPX-S, DPX-S1



**18-3888
LOWER GEAR
UNIT SEAL KIT**

For intermediate housing: Fits: 200, 250, 270, 270T, 275, 275A, 280, 280DP, 280T, 285A, 290, 290A, 290DP, SP-A, SP-A/MT, SP-A1, SP-A2, SP-C, SP-C1, DP-A, CP-A1, DP-B, DP-B1, DP-C, DP-C1, DP-D



**18-8357
COMPLETE
GEARCASE SEAL KIT**

Replaces: 875741
For: 280DP/290DP

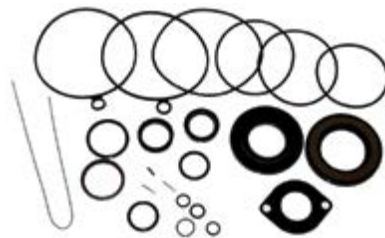

**18-8361
UPPER SEAL KIT**

Replaces: 576266-8
For: AQ200-AQ290

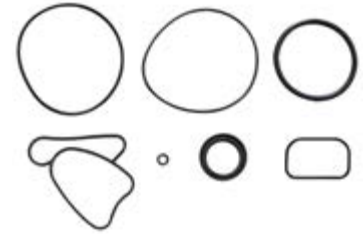

**18-2583
LOWER UNIT SEAL KIT**

Replace: 3888821
Fits: SX-A Drives (2007 and UP)



**18-2584
LOWER UNIT SEAL KIT**

Replaces: 3888822
Fits: DPS-A Drives (2007 and UP)

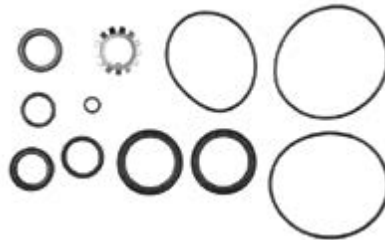

**18-8358
LOWER UNIT SEAL KIT**

Replaces: 876267
For: 280DP/290DP



**18-8359
LOWER GEARCASE
SEAL KIT**

Replaces: 876268
For: AQ200-AQ290



**18-2791
LOWER UNIT SEAL KIT**

Replaces: 3850597



**18-32882
WATER TUBE SEAL**

Replaces: 3852315



OIL SEALS

Part #	O.E. #	Dimensions (mm)		
		I.D.	O.D.	Width
18-0558	851407	44	58.33	7
18-2039	804695	13	25.4	6
18-2040	853670	45	75	8
18-2041	897426	33	45.25	7
18-2044	833996	12	24	7
18-2045	827247	16	28	7
18-2046	946242	35	55	10
18-2047	958860	35	62	7
18-2057	181620	34	42	4

O-RINGS

Part #	Pkg.	O.E. #	Dimensions (mm)		Part #	Pkg.	O.E. #	Dimensions (mm)	
			I.D.	Width				I.D.	Width
18-7122		925095	—	—	18-7181	5	925091, 975672	50.5	3
18-7154		949656	—	—	18-7182	5	925092	55	3
18-7102	5	3852073	.430	.065	18-7183	5	925093	69.5	3
18-7116		3852045	.360	.10	18-7184	5	925256	79	3
18-7135		3852089	.750	.135	18-7186	5	925259	102	3
18-7141	5	3852165	.180	.065	18-7187	5	925261	106	3
18-7143	5	3852169	1.310	.100	18-7188	5	955983	9.1	1.6
18-7147-9	5	949658-9	24	3	18-7190	5	925065	34	3
18-7149	5	955989	15	1.5	18-7192	5	955995	25.1	1.6
18-7162	5	3852044	2.025	.135	18-7193	5	955974	10.3	2.4
18-7168	5	3852033	.370	.065	18-7194	5	956000	37.1	1.6
18-7178	5	125017	23.5	3.5	18-7406	5	3852523	.250	.065
18-7179	5	925054	9.3	2.4	18-7407	5	3852531	4.125	.135
18-7180	5	925055	11.3	2.4					



① This product is priced per piece. To order priced per package, please add -9 to the part number.



**18-3060
IMPELLER**
Replaces: 835512, 3854286
Sherwood 9959,
Jabsco 18838-0001
Oberdorfer 132-0317
OMC 3854286
Neoprene, 12 FINS



**18-5280
COMPLETE TUNE-UP KIT**
For: In-line 4

— CONTAINS —

Part #	Description	Qty.
18-5361	DISTRIBUTOR CAP	1
18-5406	ROTOR	1



**18-5278
COMPLETE TUNE-UP KIT**
For: V-6



**18-59640
ALTERNATOR**
Replaces: Prestolite



**18-6843
ALTERNATOR**
Replaces: Mando A000B0341, TA000B0341,
Yamaha 19-1400-10
Fits: Crusader and Yamaha Sterndrive engines



**18-6834
STARTER**
Replaces: GM Engines Universal
Used on all GM Engines with either 14 1/4"
or 12 3/4" flywheels



**18-6835
STARTER**
Replaces: GM Engines Universal
Used on all GM Engines with either 14 1/4" or 12 3/4"
flywheels

PREMIUM MARINE SPARK PLUG WIRE LEADS

Sierra's **MAGFORCE** Ignition Wires are "Electronics Friendly" protecting all of your electronic devices and electronic engine controls from RFI and EMI while delivering the maximum amount of voltage. Exact fit design ensures easy installation and years of trouble - free service.

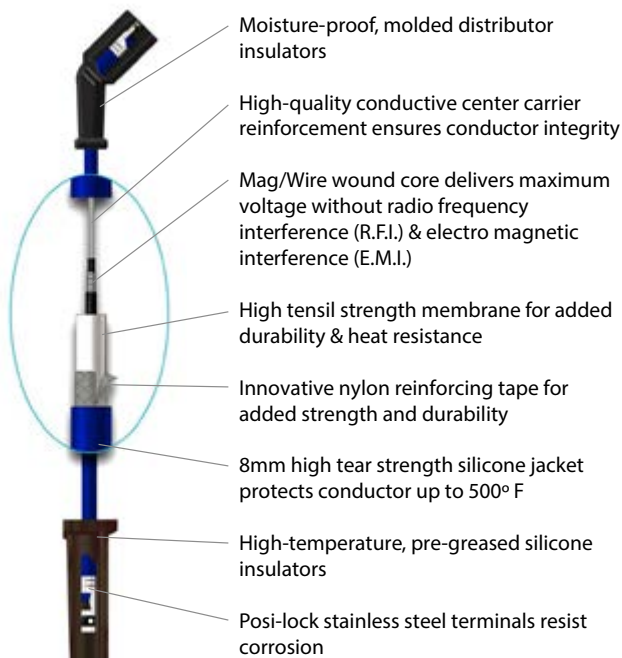

YAMAHA STERNDRIVE APPLICATION					
Model	Cyl.	Distributor	Year Start	Year End	Plug Wire Set
3.0L	4	Delco EST	1990	1993	18-8835-1
4.3L	6	YEMS	1989	1989	18-8835-1
4.3L	6	Delco EST	1990	1990	18-8835-1
5.0L	8	YEMS	1989	1989	18-8836-1
5.7L	8	Delco EST	1989	1990	18-8836-1
7.4L	8	Delco EST	1992	1992	18-8836-1



FUEL WATER SEPARATORS



Sierra offers a complete line of 10 and 21 micron fuel water separating filters including drainable bowl filters to protect your carbureted and fuel injected engine.

Refer to pages 156-160 for a complete listing of OEM and universal applications.

Sierra fuel water separators remove over 99.8% of emulsified water from your gasoline. Sierra's 10 micron filters are over 90% efficient at removing particles as small as 10 micron. All filters flow @ 90 GPH to feed even the hungriest motor. Sierra 10 micron filters are recommended to prevent damage to sensitive inboard and outboard fuel injection systems.



STERNDRIVE & INBOARD OIL FILTERS

All 3.0L	YSC-13231-20-0C	18-7824-2
All V-8 5.0L, 5.7L (Spin on Lube)	YSC-14231-20-0C	18-7876-1
All V-8 5.0L, 5.7L, 7.4L	YSC-16231-20-0C	18-7875

SEE PAGES 203-205 & 1155-1183 FOR ADDITIONAL INFORMATION



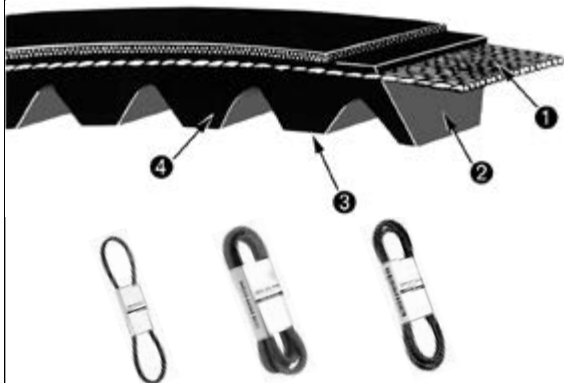







V-BELTS



- 1 High strength synthetic cords resist shockload failure. Their low stretch properties assure uniform performance over the life of the belt.
- 2 The compression section is a special rubber compound that assures smooth and even transfer of load forces to the cords.
- 3 Cogs are molded to precise engineering tolerances to improve flexibility and maintain cord support. Cog geometry provides a large area for air circulation to keep the belt cool and prevent damaging heat build up in the cushion section.
- 4 Rubber edges maintain positive, no-slip contact with pulley grooves for reliable energy transfer.

Part #	OE #	Application
18-15111	YSC-10260-00-0C	V-6 Sterndrive 4.3L/V-8 5, 5.7L (For: crank/pump alternator)

YAMAHA STERNDRIVE GASKETS

<p>PKG. OF 2</p>  <p>18-0164 18-0164-9① THERMOSTAT GASKET Replaces: YSC-13080-00-0C, GM 3789161</p>	<p>PKG. OF 2</p>  <p>18-0876 18-0876-9① FUEL PUMP GASKET Replaces: YSG-10108-43-8G</p>	<p>PKG. OF 2</p>  <p>18-0889 18-0889-9① FUEL PUMP GASKET Replaces: YSG-10114-14-1G</p>	<p>PKG. OF 2</p>  <p>18-0891 18-0891-9① WATER PUMP MOUNTING GASKET Replaces: YSG-37545-87-G0</p>	<p>PKG. OF 2</p>  <p>18-0874 18-0874-9① DISTRIBUTOR GASKET Replaces: YSG-10108-44-5G</p>
<p>PKG. OF 2</p>  <p>18-2909 18-2909-9① EXHAUST MANIFOLD GASKET Replaces: YSC-12190-00-AC For: 262 CID (4.3L)</p>	<p>PKG. OF 2</p>  <p>18-0903 18-0903-9① WATER PUMP GASKET Replaces: YSG-38600-39-G0</p>	<p>PKG. OF 2</p>  <p>18-0887 18-0887-9① TIMING COVER GASKET Replaces: YSG-14096-15-6G</p>	<p>PKG. OF 2</p>  <p>18-0905 18-0905-9① OIL PAN DRAIN PLUG GASKET Replaces: YSG-14090-90-8G</p>	<p>PKG. OF 2</p>  <p>18-4698 18-46981-9① (PKG. OF 50) DRAIN FILL WASHER Replaces: 90430-08020-00</p>

① Priced per Package

MALLORY DISTRIBUTOR PARTS GUIDE

Distributor No.	Cyl. & Rotation	Description	Contact Set	Condenser	Dist. Cap	Rotor	Tune-Up Kit
ZD345A, B	8RH	Crusader	18-5314	18-5344	18-5376	18-5404-1	—
ZD347A	8LH	Crusader	18-5314	18-5344	18-5375	18-5411	—
ZD347B	8RH	Crusader	—	18-5344	18-5375	18-5411	—
YD349A	4LH	Burmeister & Wain	18-5314	18-5338	18-5355	18-5427	—
YD350A	8LH	Dearborn	18-5314	18-5338	18-5375	18-5411	18-5256 ①
YL350A	8LH	262, 272, 292, 312 Eng.	18-5314	18-5338	18-5376	18-5404-1	18-5251 ②
ZD352	8RH	Crusader	18-5314	18-5344	18-5375	18-5411	—
YD356A	8RH	Flagship Owens	18-5314	18-5338	18-5375	18-5411	18-5256 ①
YL356A	8RH	Flagship Owens	18-5314	18-5338	18-5375	18-5411	18-5256 ①
YL356A-2	8RH	Flagship	18-5314	18-5338	18-5375	18-5411	18-5256 ①
ZD358A	8LH	Crusader	18-5314	18-5344	18-5375	18-5411	—
YD359C, D, E, F	8LH	Gray (250, 327) AM Mtrs.	18-5314	18-5338	18-5376	18-5404-1	18-5251 ②
YL362A, B	8LH	Dearborn 390 Eng.	18-5314	18-5338	18-5375	18-5411	18-5256 ①
YD362A, B	8LH	Dearborn 390 Eng.	18-5314	18-5338	18-5375	18-5411	18-5256 ①
YL362C, D, E, F, G, H	8LH	390, 427 Eng.	18-5314	18-5338	18-5375	18-5411	18-5256 ①
YL362AV, BV, CV, DV	8LH	Dearborn 390 Eng.	18-5314	18-5338	18-5375	18-5411	18-5256 ①
ZD366A, B	8LH	Crusader (Cadillac 275 Eng.)	18-5314	18-5344	18-5375	18-5411	—
YD370A	4RH	Universal Mts.	18-5314	18-5338	18-5355	18-5427	—
YD370B	6RH	Universal Mts.	18-5314	18-5338	—	18-5427	—
YD370C	4RH	Universal Mts.	18-5314	18-5338	18-5355	18-5427	—
YL370A	4RH	Universal Mts.	18-5314	18-5338	18-5355	18-5427	—
YL370B	6RH	Universal Mts.	18-5314	18-5338	—	18-5427	—
YD372A, B, C, D	8LH	Chris Craft 430 Eng.	18-5314	18-5338	18-5375	18-5411	18-5256 ①
YL372C, D	8LH	Chris Craft 430 Eng.	18-5314	18-5338	18-5375	18-5411	18-5256 ①
YD372F-2	8LH	431 Eng.	18-5314	18-5338	18-5375	18-5411	18-5256 ①
YD375A	8RH	Chrysler M80	18-5314	18-5338	18-5376	18-5404-1	18-5251 ②
YD377A	6LH	Palmer	18-5314	18-5338	—	18-5427	—
YL387A	8LH	Dearborn	18-5314	18-5338	18-5376	18-5404-1	18-5251 ②
YD396A	6RH	Palmer 308 Eng.	18-5314	18-5338	—	18-5427	—
YD397A	6RH	Palmer 308 Eng.	18-5314	18-5338	—	18-5427	—
YD410A	4RH	Gray	18-5314	18-5338	18-5355	18-5427	—
YD410C	6RH	Gray	18-5314	18-5338	—	18-5427	—
YD411A	4RH	Gray	18-5314	18-5338	18-5355	18-5427	—
YD411B	4LH	Gray	18-5314	18-5338	18-5355	18-5427	—
YD411C	6RH	Gray	18-5314	18-5338	—	18-5427	—
YD411D	6LH	Gray	18-5314	18-5338	—	18-5427	—
YL411A	4RH	F-4 Turbo	18-5314	18-5338	18-5355	18-5427	—
YL411B	4LH	F-4 Turbo	18-5314	18-5338	18-5355	18-5427	—
YL411C	6RH	F-6 Turbo	18-5314	18-5338	—	18-5427	—
YL411D	6LH	F-6 Turbo	18-5314	18-5338	—	18-5427	—
YL414D, E, J, K	6RH	Dearborn	18-5314	18-5338	—	18-5427	—
YD420A, B, C, D	8RH	Palmer 345 Eng.	18-5314	18-5338	18-5375	18-5411	18-5256 ①
YL420E	8RH	IHC 304, 345, 392 Eng.	18-5314	18-5338	18-5375	18-5411	18-5256 ①
YD429A, B	8LH	Gray	18-5314	18-5338	18-5376	18-5404-1	18-5251 ②
YD429C, D	8LH	Gray	18-5314	18-5338	18-5375	18-5411	18-5256 ①
YL429C, D	8LH	138, 175 Eng.	18-5314	18-5338	18-5375	18-5411	18-5256 ①
ZD430A	8RH	170, 220, 225 HP	—	18-5338	18-5375	18-5411	—
YL431A	8RH	Crusader	18-5314	18-5338	18-5375	18-5411	18-5256 ①
ZYLD431A	8RH	185, 220, 230 HP	18-5314	18-5338	18-5375	18-5411	18-5256 ①
YL436A,B	6RH	Dorsett	18-5314	18-5338	—	18-5427	—

① 18-5272 Kit with distributor cap

② 18-5271 Kit with distributor cap

MALLORY DISTRIBUTOR PARTS GUIDE (CONT.)

Distributor No.	Cyl. & Rotation	Description	Contact Set	Condenser	Dist. Cap	Rotor	Tune-Up Kit
YL445A, B, BD, JV, KV	8LH	Dearborn	18-5314	18-5338	18-5375	18-5411	18-5256 ①
YP451A, B, C, D, E, F, G, H	6 RH	Chrysler M170 & M225 Engs.	18-5314	18-5338	—	—	—
YL455A, B,	8RH	Gray	18-5314	18-5338	18-5376	18-5404-1	18-5251 ②
YL457AC,AV, BV, CV, DV	8LH	Dearborn	18-5314	18-5338	18-5375	18-5411	18-5256 ①
YL458B	8RH	Gray	18-5314	18-5338	18-5376	18-5404-1	18-5251 ②
YL459A	8RH	Gray	18-5314	18-5338	18-5375	18-5411	18-5256 ①
YL461A, B	8RH	Crusader 409 Eng.	18-5314	18-5338	18-5376	18-5404-1	18-5251 ②
YL461A-2, B-2	8RH	427 Eng.	18-5314	18-5338	18-5376	18-5404-1	18-5251 ②
YL467A	8RH	Daytona (283, 327 Chevy Eng.)	18-5314	18-5338	18-5376	18-5404-1	18-5251 ②
YL469A	8RH	Chris-Craft (283, 327 Chevy Eng.)	18-5314	18-5338	18-5375	18-5411	18-5256 ①
YL474D, E	6RH	Dearborn (200 Ford Eng.)	18-5314	18-5338	—	18-5427	—
YL481A, B	6RH	Chevy 230, 292 Engs.	18-5314	18-5338	—	18-5427	—
YL486A,B,	6RH	Crusader (230, 292 Chevy Eng.	18-5314	18-5338	—	18-5427	—
YL486C,D,	4 RH	Crusader 153 Eng.	18-5314	18-5338	18-5355	18-5427	—
YL487A	8RH	Crusader (283, 327 Chevy Eng.	18-5314	18-5338	18-5376	18-5404-1	18-5251 ②
YL494A, BO	8LH	Dearborn	18-5314	18-5338	18-5376	18-5404-1	18-5251 ②
YL494A-2, B-2	8LH	427 Eng.	18-5314	18-5338	18-5376	18-5404-1	18-5251 ②
YL495A,B	6RH	Dearborn (170 Ford Eng.)	18-5314	18-5338	—	18-5427	—
YL496A, B,	8LH	Holman & Moody	18-5314	18-5338	18-5375	18-5411	18-5256 ①
YL501AV, CV, EV, GV	8LH	Oldsmobile Eng.	18-5314	18-5338	18-5375	18-5404-1	18-5251 ②
YL502A, B	8LH	Chris-Craft (427 Ford Eng.)	18-5314	18-5338	18-5375	18-5411	18-5256 ①
YL512A	8LH	289 Eng.	18-5314	18-5338	18-5376	18-5404-1	18-5251 ②
YL512CV, DV	8LH	Ford 302 Eng.	18-5314	18-5338	18-5376	18-5404-1	18-5251 ②
YL513A, B	8LH	Dearborn (289 Ford Eng.)	18-5314	18-5338	18-5376	18-5404-1	18-5251 ②
YL513CV, DV	8LH	Ford 289, 302 Engs.	18-5314	18-5338	18-5376	18-5404-1	18-5251 ②
YL514A, B, C, D	8LH	352, 390, 427, 428 Engs.	18-5314	18-5338	18-5376	18-5404-1	18-5251 ②
YL515A, B	8RH	283, 327 Engs.	18-5314	18-5338	18-5375	18-5411	18-5256 ①
YL519A, B, AV, BV	8LH	Dearborn (289 Ford Eng.)	18-5314	18-5338	18-5375	18-5411	18-5256 ①
YL520AV, BV, CV, CV2, DV, EV, JV	8RH	OMC	18-5314	18-5338	18-5375	18-5411	18-5256 ①
YL524AV, BV	6RH	300 Eng.	18-5314	18-5338	—	18-5427	—
YL529A, B	8RH	Crusader (283, 327 Engs.)	18-5314	18-5338	18-5375	18-5411	18-5256 ①
YL539AV	8RH	Chris-Craft (327 Chevy Eng.)	18-5314	18-5338	18-5375	18-5411	18-5256 ①
YL554CV, DV, EV, FV	8LH	Ford 351W Eng.	18-5314	18-5338	18-5376	18-5404-1	18-5251 ②
YL555CV, DV	8LH	Ford 351W Eng.	18-5314	18-5338	18-5376	18-5404-1	18-5251 ②
YL558AV, BV	8LH	Ford 351C Eng.	18-5314	18-5338	18-5375	18-5411	18-5256 ①
YL566AV	8RH	Chris-Craft (327 Chevy Eng.)	18-5314	18-5338	18-5375	18-5411	18-5256 ①
YL567CV, DV	8LH	Ford 351 Eng.	18-5314	18-5338	18-5376	18-5404-1	18-5251 ②
YL585AV, CV-2	8RH	Chris-Craft	18-5314	18-5338	18-5375	18-5411	18-5256 ①
YL623AV	8	Chris-Craft Thermo-Electron	18-5314	18-5338	18-5376	18-5404-1	18-5251 ②
YL623AV-2	8	Chris-Craft, Mercury	18-5314	18-5338	18-5375	18-5404-1	18-5251 ②
YL624AV	8	Gale Banks, Maritec,Mercury	18-5314	18-5338	18-5375	18-5404-1	18-5251 ②
YL624AV-2	8	Harmin	18-5314	18-5338	18-5375	18-5404-1	18-5251 ②
YL624JV	8	O.M.C.	18-5314	18-5338	18-5376	18-5404-1	18-5251 ②
YL624MV	8	Mercury (Mercuriser)	18-5314	18-5338	18-5376	18-5404-1	18-5251 ②
YL670AV	8	Chevy - Exc 348, 409 Eng.	18-5314	18-5338	18-5376	18-5404-1	18-5251 ②
YL673AV	4	Chevy 153 Eng.	18-5314	18-5338	18-5397	18-5404-1	18-5251 ②
YL676AV	6	Chevy In Line	18-5314	18-5338	—	—	18-5251 ②
YL677AV	6	Chevy Odd Fire	18-5314	18-5338	—	18-5404-1	—
YL/YS700AV	6	Chevy Even Fire	18-5314	18-5338	—	18-5404-1	18-5251 ②
YL703AV	8	Crusader/Thermo-Electron	18-5314	18-5338	18-5376	18-5404-1	18-5251 ②

① 18-5272 Kit with distributor cap

② 18-5271 Kit with distributor cap

PRESTOLITE DISTRIBUTOR PARTS GUIDE

Distributor Number	Contact Set	Condenser ③	Rotor	Cap	Ignition Coil	Tune-Up Kit
IAD-6004-2F, 2N, 2P	18-5307	18-5345	—	—	18-5435 ①	—
IAO-4109-1M	18-5307	18-5345	18-5430	18-5392	18-5435 ①	—
IAO-4113-1M	18-5307	18-5345	18-5430	18-5392	18-5435 ①	—
IAO-4114-1M	18-5307	18-5345	18-5430	18-5392	18-5435 ①	—
IAY-4010, A	18-5307	18-5345	18-5427	—	18-5435 ①	—
IAY-4014	18-5307	—	18-5427	—	18-5435 ①	—
IAY-4014C	18-5307	18-5345	18-5427	—	18-5435 ①	—
IBB-4205	18-5303 ②	—	18-5407	—	18-5435 ①	—
IBB-4301B	18-5303 ②	18-5345	18-5407	18-5369	18-5433	18-5255 ⑦
IBB-7003	18-5303 ②	18-5345	18-5407	18-5369	18-5435 ①	18-5255 ⑦
IBM-4106	18-5303	18-5345	18-5407	18-5369	—	18-5255 ⑦
IBM-4107, A	18-5303	18-5345	18-5407	18-5369	18-5435 ①	18-5255 ⑦
IBM-4108, A, B, C	18-5303	18-5345	18-5407	—	—	18-5255 ⑦
IBM-4109, A	18-5303	18-5345	18-5407	18-5369	—	18-5255 ⑦
IBM-4110	18-5303	18-5345	18-5429	18-5391	—	18-5259
IBM-4112	18-5303	18-5345	18-5429	18-5391	18-5435 ①	18-5259
IBM-4115	18-5303	18-5345	18-5429	18-5391	18-5435	18-5258
IBM-4116	18-5303	18-5345	18-5429	18-5391	18-5435	18-5258
IBM-4117A	18-5303	18-5345	18-5407	18-5369	18-5435 ①	18-5255 ⑦
IBM-4118A	18-5303	18-5345	18-5429	18-5391	18-5435 ①	18-5259
IBM-4119, A	18-5303	18-5345	18-5429	18-5391	18-5435 ①	18-5259
IBM-4120	18-5303	18-5347	18-5429	18-5391	18-5433	18-5259
IBM-4122	18-5303	18-5347	18-5407	18-5369	18-5435 ①	18-5258 ⑦
IBM-7003B, BS	18-5303	18-5345	18-5407	18-5369	18-5433	18-5255 ⑦
IBM-7004A, AS, B, BS	18-5303	18-5345	18-5407	18-5369	18-5435 ①	18-5255 ⑦
IBM-7007, A, AS, S	18-5303	18-5345	18-5407	18-5369	18-5435 ①	18-5255 ⑦
IBM-7008, A, AS, B, BS, C, CS, S	18-5303	18-5345	18-5407	18-5369	18-5435 ①	18-5255 ⑦
IBM-7010	—	18-5345	18-5407	18-5369	18-5433	—
IBM-7011	18-5303	18-5345	18-5407	18-5369	18-5433	18-5255 ⑦
IBM-7011A	18-5303	18-5345	18-5407	18-5369	18-5435 ①	18-5255 ⑦
IBM-7011B	—	18-5345	18-5407	18-5369	18-5435 ①	—
IBM-7011C, D	18-5303	18-5345	18-5407	18-5369	18-5435 ①	18-5255 ⑦
IBM-7013	18-5303	18-5345	18-5403	18-5352	—	18-5260 ④
IBM-7013A	18-5303	18-5345	18-5403	18-5352	18-5433	18-5260 ④
IBM-7013B	—	18-5345	18-5403	18-5352	—	—
IBM-7013C, D, E	18-5303	18-5345	18-5403	18-5352	—	18-5260 ④
IBM-7014	18-5303	18-5345	18-5403	18-5353	—	18-5260 ⑥
IBM-7014A	18-5303	18-5347	18-5403	18-5353	18-5433	18-5258 ⑥
IBM-7016	18-5303	18-5345	18-5409	18-5352	—	18-5260 ④
IBM-7017	18-5303	18-5345	18-5409	18-5352	—	18-5260 ④
IBM-7018	18-5303	18-5345	18-5409	18-5353	—	18-5260 ⑥
IBM-7019, A, AS, S	18-5303	18-5345	18-5403	18-5352	18-5435 ①	18-5260 ④
IBM-7020, A, AS, B, BS, C, CS, S	18-5303	18-5345	18-5403	18-5352	18-5435 ①	18-5260 ④
IBM-7021	18-5303	18-5345	18-5403	18-5353	—	18-5260
IBP-4105, A	—	18-5345	18-5407	18-5369	18-5435 ①	—
IBP-4110, A, B	—	18-5345	18-5429	18-5391	18-5435 ①	—
IBP-4111A	—	18-5345	18-5407	18-5369	18-5435 ①	—
IBP-4112A, B	—	18-5345	18-5429	18-5391	18-5435 ①	—
IBP-4113A, B, C	—	18-5345	18-5429	18-5391	18-5435 ①	—
IBR-4205, A, S	—	18-5347	—	—	18-5435 ①	—
IBR-7002, A, AS, S	18-5307	18-5345	18-5430	18-5392	18-5433	—
IDD-7001	N/A	N/A	18-5407	18-5369	—	N/A
IDH-7001, S	N/A	N/A	18-5407	18-5369	—	N/A
IDH-7002, S	N/A	N/A	18-5407	18-5369	—	N/A
IDH-7003, A, AS, S	N/A	N/A	18-5407	18-5369	—	N/A
IDH-7004	N/A	N/A	18-5409	18-5352	—	N/A
IDH-7005	N/A	N/A	18-5409	18-5352	—	N/A
IDH-7006, A	N/A	N/A	18-5403	18-5352	—	N/A
IDH-7802	N/A	N/A	18-5403	—	18-5433	N/A
IDU-7601	N/A	N/A	18-5403	18-5353	—	N/A
IDU-7801, A, B	N/A	N/A	18-5403	18-5352	18-5433	N/A
IGC-5501A	18-5307	18-5345	18-5430	—	18-5435 ①	—
IGW-4056	—	—	—	—	18-5433	—
IGW-4118A	—	—	—	—	18-5435 ①	—
IGW-4199B, C	—	—	—	—	18-5435 ①	—
IGW-4301	—	—	—	—	18-5435 ①	—
IGW-4409A	—	—	—	—	18-5435 ①	—

N/A Not Applicable ① 12 Volt System Only ② 2 Required ③ Condensers 18-5340 (Wire Conductor) and 18-5347 (Strap Conductor) are interchangeable.

④ 18-5275 Kit with distributor cap ⑥ 18-5276 Kit with distributor cap ⑦ 18-5277 Kit with distributor cap

Evinrude Outboards 1950-1979			Evinrude Outboards 1950-1979			Evinrude Outboards 1950-1979			Evinrude Outboards 1950-1979		
MODEL NO.	HP	YEAR	MODEL NO.	HP	YEAR	MODEL NO.	HP	YEAR	MODEL NO.	HP	YEAR
3402	3	1964	6203	6	1972	10925	9.9	1979	25702	25	1977
3412	3	1964	6302	6	1973	10935	9.9	1979	25703	25	1977
3432	3	1964	6303	6	1973	10954	9.9	1979	25752	25	1977
3433	3	1964	6402	6	1974	10955	9.9	1979	25753	25	1977
3502	3	1965	6403	6	1974	15032	18	1960	25802	25	1978
3512	3	1965	6502	6	1965	15033	18	1960	25803	25	1978
3532	3	1965	6503	6	1965	15034	18	1961	25852	25	1978
3533	3	1965	6504	6	1975	15035	18	1961	25853	25	1978
3602	3	1966	6505	6	1975	15036	18	1962	25902	25	1969
3603	3	1966	6602	6	1966	15037	18	1962	25903	25	1969
3606	3	1966	6603	6	1966	15404	15	1974	25904	25	1979
3612	3	1966-67	6604	6	1976	15405	15	1974	25905	25	1979
3632	3	1966	6605	6	1976	15454	15	1974	25952	25	1979
3633	3	1966	6702	6	1967	15455	15	1974	25953	25	1979
3636	3	1966	6703	6	1967	15504	15	1975	28202	28	1962
3702	3	1967	6704	6	1977	15505	15	1975	28203	28	1962
3703	3	1967	6705	6	1977	15554	15	1975	28302	28	1963
3706	3	1967	6802	6	1968	15555	15	1975	28303	28	1963
3707	3	1967	6803	6	1968	15604	15	1976	28352	28	1963
3712	3	1967	6804	6	1978	15605	15	1975	28402	28	1964
3716	3	1967	6805	6	1978	15654	15	1976	28403	28	1964
3732	3	1967	6902	6	1969	15655	15	1976	28452	28	1964
3733	3	1967	6903	6	1969	15704	15	1977	33002	33	1970
3736	3	1967	6904	6	1979	15705	15	1977	33003	33	1970
3737	3	1967	6905	6	1979	15754	15	1977	33052	33	1970
3802	3	1968	9022	9.5	1970	15755	15	1977	33053	33	1970
3803	3	1968	9023	9.5	1970	15804	15	1978	33502	33	1965
3806	3	1968	9122	9.5	1971	15805	15	1978	33503	33	1965
3807	3	1968	9123	9.5	1971	15854	15	1978	33552	33	1965
3832	3	1968	9222	9.5	1972	15855	15	1978	33553	33	1965
3833	3	1968	9223	9.5	1972	15904	15	1979	33602	33	1966
3836	3	1968	9322	9.5	1973	15905	15	1979	33603	33	1966
3837	3	1968	9323	9.5	1973	15954	15	1979	33652	33	1966
4006	4	1970	9422	9.5	1964	15955	15	1979	33653	33	1966
4036	4	1970	9423	9.5	1964	18002	18	1970	33702	33	1967
4106	4	1971	9522	9.5	1965	18003	18	1970	33703	33	1967
4136	4	1971	9523	9.5	1965	18102	18	1971	33752	33	1967
4206	4	1972	9622	9.5	1966	18103	18	1971	33753	33	1967
4236	4	1972	9623	9.5	1966	18202	18	1972	33802	33	1968
4306	4	1973	9722	9.5	1967	18203	18	1972	33803	33	1968
4336	4	1973	9723	9.5	1967	18302	18	1963	33852	33	1968
4406	4	1974	9822	9.5	1968	18303	18	1963	33853	33	1968
4436	4	1974	9823	9.5	1968	18304	18	1973	33902	33	1969
4506	4	1975	9922	9.5	1969	18305	18	1973	33903	33	1969
4536	4	1975	9923	9.5	1969	18402	18	1964	33952	33	1969
4606	4	1976	10020	10	1960	18403	18	1964	33953	33	1969
4636	4	1976	10021	10	1960	18502	18	1965	35018	40	1960
4706	4	1977	10022	10	1961	18503	18	1965	35019	40	1960
4736	4	1977	10023	10	1961	18602	18	1966	35022	40	1961
4806	4	1978	10024	10	1962	18603	18	1966	35023	40	1961
4836	4	1978	10025	10	1962	18702	18	1967	35028	40	1962
4837	4	1978	10302	10	1963	18703	18	1967	35029	40	1962
4902	4	1969	10303	10	1963	18802	18	1968	35520	40	1960
4904	4	1979	10422	9.5	1964	18803	18	1968	35521	40	1960
4906	4	1969	10424	9.9	1974	18902	18	1969	35524	40	1961
4932	4	1979	10425	9.9	1974	18903	18	1969	35525	40	1961
4933	4	1979	10454	9.9	1974	25002	25	1970	35530	40	1962
4936	4	1969	10455	9.9	1974	25003	25	1970	35531	40	1962
5302	5.5	1963	10522	9.5	1965	25102	25	1971	35602	35	1976
5303	5.5	1963	10524	9.9	1975	25103	25	1971	35603	35	1976
5402	5.5	1964	10525	9.9	1975	25202	25	1972	35652	35	1976
5403	5.5	1964	10554	9.9	1975	25203	25	1972	35653	35	1976
5502	5	1965	10555	9.9	1975	25252	25	1972	35702	35	1977
5503	5	1965	10622	9.5	1966	25253	25	1972	35703	35	1977
5520	5.5	1960	10624	9.9	1976	25302	25	1973	35752	35	1977
5521	5.5	1960	10625	9.9	1976	25303	25	1973	35753	35	1977
5522	5.5	1961	10654	9.9	1976	25352	25	1973	35802	35	1978
5523	5.5	1961	10655	9.9	1976	25353	25	1973	35803	35	1978
5524	5.5	1962	10722	9.5	1967	25402	25	1974	35852	35	1978
5525	5.5	1962	10724	9.9	1977	25403	25	1974	35853	35	1978
5602	5	1966	10725	9.9	1977	25452	25	1974	35902	35	1979
5603	5	1966	10754	9.9	1977	25453	25	1974	35903	35	1979
5702	5	1967	10755	9.9	1977	25502	25	1975	35932	40	1962
5703	5	1967	10822	9.5	1968	25503	25	1975	35933	40	1962
5802	5	1968	10824	9.9	1978	25552	25	1975	35952	35	1979
5803	5	1968	10825	9.9	1978	25553	25	1975	35953	35	1979
6002	6	1970	10835	9.9	1978	25602	25	1976	40002	40	1970
6003	6	1970	10854	9.9	1978	25603	25	1976	40003	40	1970
6102	6	1971	10855	9.9	1978	25652	25	1976	40052	40	1970
6202	6	1972	10924	9.9	1979	25653	25	1976	40053	40	1970

Evinrude Outboards 1950-1979			Evinrude Outboards 1950-1979			Evinrude Outboards 1950-1979			Evinrude Outboards 1950-1979		
MODEL NO.	HP	YEAR	MODEL NO.	HP	YEAR	MODEL NO.	HP	YEAR	MODEL NO.	HP	YEAR
40072	40	1970	50272	50	1972	70573	70	1975	100693	100	1966
40073	40	1970	50273	50	1972	70673	70	1976	100782	100	1967
40102	40	1971	50302	50	1973	70773	70	1977	100783	100	1967
40103	40	1971	50303	50	1973	70873	70	1978	100882	100	1968
40152	40	1971	50372	50	1973	70973	70	1979	100883	100	1968
40153	40	1971	50373	50	1973	75352	75	1963	100990	100	1979
40202	40	1972	50442	50	1974	75353	75	1963	100993	100	1979
40203	40	1972	50443	50	1974	75382	75	1963	100999	100	1979
40252	40	1972	50472	50	1974	75383	75	1963	115083	115	1970
40253	40	1972	50473	50	1974	75392	75	1963	115393	115	1973
40302	40	1963	50522	75	1960	75393	75	1963	115493	115	1974
40303	40	1963	50523	75	1960	75432	75	1964	115499	115	1974
40304	40	1973	50524	75	1961	75433	75	1964	115593	115	1975
40305	40	1973	50525	75	1961	75452	75	1964	115693	115	1976
40352	40	1963	50528	75	1962	75453	75	1964	115699	115	1976
40353	40	1963	50529	75	1962	75482	75	1964	115742	115	1967-68
40354	40	1973	50542	50	1975	75483	75	1964	115790	115	1977
40355	40	1973	50543	50	1975	75492	75	1964	115793	115	1977
40362	40	1963	50572	50	1975	75493	75	1964	115799	115	1977
40363	40	1963	50573	50	1975	75532	75	1965	115890	115	1978
40372	40	1963	50802	50	1978	75533	75	1965	115893	115	1978
40373	40	1963	50803	50	1978	75542	75	1975	115899	115	1978
40402	40	1964	50902	50	1979	75543	75	1975	115983	115	1969
40403	40	1964	50903	50	1979	75552	75	1965	115990	115	1979
40404	40	1974	50926	75	1961	75553	75	1965	115993	115	1979
40405	40	1974	50927	75	1961	75582	75	1965	115999	115	1979
40452	40	1964	50930	75	1962	75583	75	1965	125183	125	1971
40453	40	1964	50931	75	1962	75592	75	1965	125283	125	1972
40454	40	1974	55642	55	1976	75593	75	1965	135342	135	1973
40455	40	1974	55643	55	1976	75642	75	1976	135383	135	1973
40462	40	1964	55672	55	1976	75643	75	1976	135443	135	1974
40463	40	1964	55673	55	1976	75742	75	1977	135483	135	1974
40472	40	1964	55772	55	1977	75743	75	1977	135489	135	1974
40473	40	1964	55773	55	1977	75842	75	1978	135543	135	1975
40502	40	1965	55872	55	1968	75843	75	1978	135583	135	1975
40503	40	1965	55873	55	1968	75942	75	1979	135589	135	1975
40504	40	1975	55874	55	1978	75943	75	1979	135643	135	1976
40505	40	1975	55875	55	1978	80652	80	1966	135683	135	1976
40552	40	1965	55902-55903	55	1979	80653	80	1966	140740	140	1977
40553	40	1965	55972	55	1969	80682	80	1966	140743	140	1977
40554	40	1975	55973	55	1969	80683	80	1966	140783	140	1977
40555	40	1975	55974	55	1979	80692	80	1966	140840	140	1978
40562	40	1965	55975	55	1979	80693	80	1966	140843	140	1978
40563	40	1965	60062	60	1970	80752	80	1967	140883	140	1978
40572	40	1965	60063	60	1970	80753	80	1967	140940	140	1979
40573	40	1965	60072	60	1970	80792	80	1967	140943	140	1979
40602	40	1966	60073	60	1970	80793	80	1967	140983	140	1979
40603	40	1966	60162	60	1971	85093	85	1970	150840	150	1978
40604	40	1976	60163	60	1971	85193	85	1971	150849	150	1978
40605	40	1976	60172	60	1971	85293	85	1972	150940	150	1979
40652	40	1966	60173	60	1971	85393	85	1973	150949	150	1979
40653	40	1966	60432	60	1964	85493	85	1974	175740	175	1977
40654	40	1976	60433	60	1964	85593	85	1975	175749	175	1977
40655	40	1976	60452	60	1964	85693	85	1976	175840	175	1978
40662	40	1966	60453	60	1964	85699	85	1976	175849	175	1978
40663	40	1966	60532	60	1965	85790	85	1977	175940	175	1979
40672	40	1966	60533	60	1965	85793	85	1977	175949	175	1979
40673	40	1966	60552	60	1965	85799	85	1977	200640	200	1976
40702	40	1967	60553	60	1965	85852	85	1968	200649	200	1976
40703	40	1967	60632	60	1966	85853	85	1968	200740	200	1977
40752	40	1967	60633	60	1966	85890	85	1978	200749	200	1977
40753	40	1967	60652	60	1966	85892	85	1968	200840	200	1978
40772	40	1967	60653	60	1966	85893	85	1968	200849	200	1978
40773	40	1967	60732	60	1967	85895	85	1978	200940	200	1979
40802	40	1968	60733	60	1967	85899	85	1978	200949	200	1979
40803	40	1968	60752	60	1967	85990	85	1979	235840	235	1978
40852	40	1968	60753	60	1967	85993	85	1969	235849	235	1978
40853	40	1968	65272	65	1972	85995	85	1979	235940	235	1979
40872	40	1968	65273	65	1972	85999	85	1979	235949	235	1979
40873	40	1968	65372	65	1973	90482	90	1964			
40902	40	1969	65373	65	1973	90483	90	1964			
40903	40	1969	65832	65	1968	90492	90	1964			
40952	40	1969	65833	65	1968	90493	90	1964			
40953	40	1969	65852	65	1968	90582	90	1965			
40972	40	1969	65853	65	1968	90583	90	1965			
40973	40	1969	70442	70	1974	90592	90	1965			
50172	50	1971	70443	70	1974	90593	90	1965			
50173	50	1971	70472	70	1974	100193	100	1971			
50202	50	1972	70473	70	1974	100293	100	1972			
50203	50	1972	70572	70	1975	100683	100	1966			
									Johnson Outboards 1960-1979		
									1R69	1.5	1969
									1R70	1.5	1970
									2R71	2	1971
									2R72	2	1972
									2R73	2	1973
									2R74	2	1974
									2R75	2	1975

Johnson Outboards 1960-1979			Johnson Outboards 1960-1979			Johnson Outboards 1960-1979			Johnson Outboards 1960-1979		
MODEL NO.	HP	YEAR	MODEL NO.	HP	YEAR	MODEL NO.	HP	YEAR	MODEL NO.	HP	YEAR
2R76	2	1976	25E75-25EL75	25	1975	85EL76	85	1976	235TXL79	235	1979
2R77	2	1977	25E76-25EL76	25	1976	85EL77	85	1977	CD-17	5.5	1960
2R78	2	1978	25E77-25EL77	25	1977	85ESL69	85	1969	CD-18	5.5	1961
2R79	2	1979	25E78-25EL78	25	1978	85ESL70	85	1970	CD-19	5.5	1962
4R69-4RL69	4	1969	25E79-25EL79	25	1979	85ESL71	85	1971	CD-20	5.5	1963
4R70-4RL70	4	1970	25R69-25RL69	25	1969	85ESL72	85	1972	CD-21	5.5	1964
4R71-4RL71	4	1971	25R70-25RL70	25	1970	85ESL73	85	1973	CD-22	6	1965
4R72-4RL72	4	1972	25R71-25RL71	25	1971	85ESL74	85	1974	CD-23	6	1966
4R73-4RL73	4	1973	25R72-25RL72	25	1972	85ESL75	85	1975	CD-24	6	1967
4R74-4RL74	4	1974	25R73-25RL73	25	1973	85ETLR76	85	1976	CD-25	6	1968
4R75-4RL75	4	1975	25R74-25RL74	25	1974	85ETLR77	85	1977	FD-14	18	1960
4R76-4RL76	4	1976	25R75-25RL75	25	1975	85ETLR78	85	1978	FD-15	18	1961
4R77-4RL77	4	1977	25R76-25RL76	25	1976	85ML78	85	1978	FD-16	18	1962
4R78-4RL78	4	1978	25R77-25RL77	25	1977	85ML79	85	1979	FD-17	18	1963
4R79-4RL79	4	1979	25R78-25RL78	25	1978	85TL79	85	1979	FD-18	18	1964
4W69	4	1969	25R79-25RL79	25	1979	85TXL79	85	1979	FD-19	18	1965
4W70-4WL70	4	1970	33E69-33EL69	33	1969	85TXLR77	85	1977	FD-20	20	1966
4W71-4WL71	4	1971	33E70-33EL70	33	1970	85TXLR78	85	1978	FD-21	20	1967
4W72	4	1972	33R69-33RL69	33	1969	100ESL71	100	1971	FD-22	20	1968
4W73	4	1973	33R70-33RL70	33	1970	100ESL72	100	1972	JH-19	3	1964
4W74	4	1974	35E76-35EL76	35	1976	100ML79	100	1979	JH-20	3	1965
4W75	4	1975	35E77-35EL77	35	1977	100TLR79	100	1979	JH-21	3	1966
4W76	4	1976	35E78-35EL78	35	1978	100TXLR79	100	1979	JH-22	3	1967
4W77	4	1977	35E79-35EL79	35	1979	115EL76	115	1976	JH-23	3	1968
4W78	4	1978	35R76-35RL76	35	1976	115EL77	115	1977	JHF-21	3	1967
4W79	4	1979	35R77-35RL77	35	1977	115ESL69	115	1969	JHF-22	3	1967
6R69-6RL69	6	1969	35R78-35RL78	35	1978	115ESL70	115	1970	JHF-23	3	1968
6R70-6RL70	6	1970	35R79-35RL79	35	1979	115ESL73	115	1973	JW-16	3	1960
6R71-6RL71	6	1971	40E69-40EL69	40	1969	115ESL74	115	1974	JW-17	3	1961-62
6R72-6RL72	6	1972	40E70-40EL70	40	1970	115ESL75	115	1975	JW-18	3	1963
6R73-6RL73	6	1973	40E71-40EL71	40	1971	115ETL74	115	1974	JW-19	3	1964
6R74-6RL74	6	1974	40E72-40EL72	40	1972	115ETL75	115	1975	JW-20	3	1965
6R75-6RL75	6	1975	40E73-40EL73	40	1973	115ETL76	115	1976	JW-21	3	1966
6R76-6RL76	6	1976	40E74-40EL74	40	1974	115ETL77	115	1977	JW-22	3	1967
6R77-6RL77	6	1977	40E75-40EL75	40	1975	115ETL78	115	1978	JW-23	3	1968
6R78-6RL78	6	1978	40E76-40EL76	40	1976	115ML78	115	1978	JWF-21	3	1967
6R79-6RL79	6	1979	40ES69-40ESL69	40	1969	115ML79	115	1979	JWF-23	3	1968
8RCI-8RLCI	7.5	1981	40ES70-40ESL70	40	1970	115TL79	115	1979	LD-10	5	1965
8RCN-8RLCN	7.5	1982	40R69-40RL69	40	1969	115TXL77	115	1977	LD-11	5	1966
8RCS-8RLCS	7.5	1980	40R70-40RL70	40	1970	115TXL78	115	1978	LD-12	5	1967
8RCT-8RLCT	7.5	1983	40R71-40RL71	40	1971	115TXL79	115	1979	LD-13	5	1968
9R69-9RL69	9.5	1969	40R72-40RL72	40	1972	125ESL71	125	1971	MQ-10	9.5	1964
9R70-9RL70	9.5	1970	40R73-40RL73	40	1973	125ESL72	125	1972	MQ-11	9.5	1965
9R71-9RL71	9.5	1971	40R74-40RL74	40	1974	135EL76	135	1976	MQ-12	9.5	1966
9R72-9RL72	9.5	1972	40R75-40RL75	40	1975	135ESL73	135	1973	MQ-13	9.5	1967
9R73-9RL73	9.5	1973	40R76-40RL76	40	1976	135ESL74	135	1974	MQ-14	9.5	1968
10E74-10EL74	9.9	1974	50ES71-50ESL71	50	1971	135ESL75	135	1975	QD-21	10	1960
10E75-10EL75	9.9	1975	50ES72-50ESL72	50	1972	135ETL74	135	1974	QD-22	10	1961
10E76-10EL76	9.9	1976	50ES73-50ESL73	50	1973	135ETL75	135	1975	QD-23	10	1962
10E77-10EL77	9.9	1977	50ES74-50ESL74	50	1974	135ETL76	135	1976	QD-24	10	1963
10E78-10EL78	9.9	1978	50ES75-50ESL75	50	1975	140ML77	140	1977	RD-22	40	1960
10E79-10EL79	9.9	1979	50R72-50RL72	50	1972	140ML78	140	1978	RD-23	40	1961
10R74-10RL74	9.9	1974	50R73-50RL73	50	1973	140ML79	140	1979	RD-24	40	1962
10R75-10RL75	9.9	1975	50R77-50RL77	50	1977	140TL77	140	1977	RD-25	40	1963
10R76-10RL76	9.9	1976	50R78-50RL78	50	1978	140TL78	140	1978	RD-26	40	1964
10R77-10RL77	9.9	1977	50R79-50RL79	50	1979	140TL79	140	1979	RD-27	40	1965
10R78-10RL78	9.9	1978	55E76-55EL76	55	1976	140TXL77	140	1977	RD-28	40	1966
10R79-10RL79	9.9	1979	55E77-55EL77	55	1977	140TXL78	140	1978	RD-29	40	1967
10SEL78	9.9	1978	55E78-55EL78	55	1978	140TXL79	140	1979	RD-30	40	1968
10SEL79	9.9	1979	55E79-55EL79	55	1979	150TL78	150	1978	RDS-22	40	1960
15E74-15EL74	15	1974	55ES69-55ESL69	55	1969	150TL79	150	1979	RDS-23	40	1961
15E75-15EL75	15	1975	55R79-55RL79	55	1979	150TXL78	150	1978	RDS-24	40	1962
15E76-15EL76	15	1976	60ES70-60ESL70	60	1970	150TXL79	150	1979	RDS-25	40	1963
15E77-15EL77	15	1977	60ES71-60ESL71	60	1971	175TL77	175	1977	RDS-26	40	1964
15E78-15EL78	15	1978	65ES72-65ESL72	65	1972	175TL78	175	1978	RDS-27	40	1965
15E79-15EL79	15	1979	65ES73-65ESL73	65	1973	175TL79	175	1979	RDS-28	40	1966
15R74-15RL74	15	1974	65ESLR72	65	1972	175TXL77	175	1977	RDS-29	40	1967
15R75-15RL75	15	1975	65ESR73-65ESLR73	65	1973	175TXL78	175	1978	RDS-30	40	1968
15R76-15RL76	15	1976	70EL76	70	1976	175TXL79	175	1979	RK-24	40	1962
15R77-15RL77	15	1977	70EL77	70	1977	200TL76	200	1976	RK-25	40	1963
15R78-15RL78	15	1978	70EL78	70	1978	200TL77	200	1977	RK-26	40	1964
15R79-15RL79	15	1979	70EL79	70	1979	200TL78	200	1978	RK-27	40	1965
20R69-20RL69	20	1969	70ES74-70ESL74	70	1974	200TL79	200	1979	RK-28	40	1966
20R70-20RL70	20	1970	70ES75-70ESL75	70	1975	200TXL76	200	1976	RK-29	40	1967
20R71-20RL71	20	1971	70ESLR74	70	1974	200TXL77	200	1977	RK-30	40	1968
20R72-20RL72	20	1972	75ER76-75ELR76	75	1976	200TXL78	200	1978	RX-10	28	1962
20R73-20RL73	20	1973	75ER77-75ELR77	75	1977	200TXL79	200	1979	RX-11	28	1963
25E72-25EL72	25	1972	75ER78-75ELR78	75	1978	235TL78	235	1978	RX-12	28	1964
25E73-25EL73	25	1973	75ER79-75ELR79	75	1979	235TL79	235	1979	RX-13	33	1965
25E74-25EL74	25	1974	75ESR75-75ESLR75	75	1975	235TXL78	235	1978	RX-14	33	1966

Johnson Outboards 1980 & Later			Johnson Outboards 1980 & Later			Johnson Outboards 1980 & Later			Johnson Outboards 1980 & Later		
MODEL NO.	HP	YEAR	MODEL NO.	HP	YEAR	MODEL NO.	HP	YEAR	MODEL NO.	HP	YEAR
25RCI-25RLCI	25	1981	35RCU-35RLCU	35	1987	60ELCD	60	1986	100MLCS	100	1980
25RCN-25RLCN	25	1982	35RELECT	35	1983	60ELCE	60	1989	100SLES	100	1990
25RCO-25RLCO	25	1985	35RES-35RELES	35	1990	60ELCU	60	1987	100STLCC	100	1988
25RCR-25RLCR	25	1984	35TELCN	35	1982	60ELES	60	1990	100STLCE	100	1989
25RCS-25RLCS	25	1980	35TELCR	35	1984	60TLCC	60	1988	100STLES	100	1990
25RCT-25RLCT	25	1983	40AELCC	40	1988	60TLCD	60	1986	100TLCS	100	1980
25RCU-25RLCU	25	1987	40ARLCC	40	1988	60TLCE	60	1989	100TXCS	100	1980
25RES-25RLES	25	1990	40ATLCC	40	1988	60TLCI	60	1981	110MLCC	110	1988
25SECC-25SELCC	25	1988	40BACC-40BALCC	40	1988	60TLCN	60	1982	110MLCD	110	1986
25SECE-25SELCE	25	1989	40BACD-40BALCD	40	1986	60TLCO	60	1985	110MLCE	110	1989
25SEES-25SELES	25	1990	40BACE-40BALCE	40	1989	60TLCR	60	1984	110MLCU	110	1987
25SRCC-25SRLCC	25	1988	40BACO-40BALCO	40	1985	60TLCT	60	1983	110TLAE	110	1989
25SRCE-25SRLCE	25	1989	40BACU-40BALCU	40	1987	60TLCO	60	1987	110TLCC-110TXCC	110	1988
25SRES-25SRLSES	25	1990	40BAES-40BALES	40	1990	60TLCS	60	1990	110TLCD	110	1986
25TECC-25TELCC	25	1988	40ECC-40ELCC	40	1988	60TLCE	60	1989	110TLCE-110TXCE	110	1989
25TECD-25TELCD	25	1986	40ECD-40ELCD	40	1986	60TLLES	60	1990	110TLCO-110TXCU	110	1987
25TECE-25TELCE	25	1989	40ECE-40ELCE	40	1989	60TLLCC	60	1988	115MLCI	115	1981
25TECI-25TELCI	25	1981	40ECO-40ELCO	40	1985	70ELCC	70	1988	115MLCN	115	1982
25TECN-25TELCN	25	1982	40ECL-40ELCL	40	1984	70ELCD	70	1986	115MLCO	115	1985
25TECO-25TELCO	25	1985	40ECL-40ELCL	40	1984	70ELCE	70	1989	115MLCR	115	1984
25TECR-25TELCR	25	1984	40EES-40ELES	40	1990	70ELCI	70	1981	115MLCS	115	1980
25TECS-25TELCS	25	1980	40RCC-40RLCC	40	1988	70ELCN	70	1982	115MLCT	115	1983
25TECT-25TELTCT	25	1983	40RCD-40RLCD	40	1986	70ELCO	70	1985	115MLES	115	1990
25TECU-25TELCU	25	1987	40RCE-40RLCE	40	1989	70ELCR	70	1984	115TLCI-115TXCI	115	1981
25TEES-25TELES	25	1990	40RCO-40RLCO	40	1985	70ELCS	70	1980	115TLCN-115TXCN	115	1982
28ELCD	28	1986	40RCU-40RLCU	40	1987	70ELCT	70	1983	115TLCO	115	1985
28ESLCC	28	1988	40RES-40RLES	40	1990	70ELCU	70	1987	115TLCR-115TXCR	115	1984
28ESLCE	28	1989	40TECC-40TELCC	40	1988	70ELES	70	1990	115TLCS-115TXCS	115	1980
28ESLCU	28	1987	40TECD-40TELCD	40	1986	70TLCC	70	1988	115TLCT-115TXCT	115	1983
28ESLES	28	1990	40TECE-40TELCE	40	1989	70TLCD	70	1986	115TLCE-115TXES	115	1990
30BACC-30BALCC	30	1988	40TECO-40TELCO	40	1985	70TLCE	70	1989	120TLAE	120	1989
30BACD-30BALCD	30	1986	40TECR-40TELCR	40	1984	70TLCI	70	1981	120TLAS	120	1990
30BACO-30BALCO	30	1985	40TECU-40TELCU	40	1987	70TLCN	70	1982	120TLCC-120TXCC	120	1988
30BACU-30BALCU	30	1987	40TEES-40TELES	40	1990	70TLCO	70	1985	120TLCD-120TXCD	120	1986
30BAES-30BALES	30	1990	40TLCC	40	1988	70TLCR	70	1984	120TLCE-120TXCE	120	1989
30ECC-30ELCC	30	1988	40TLCD	40	1986	70TLCT	70	1983	120TLCO-120TXCO	120	1985
30ECD-30ELCD	30	1986	40TLCE	40	1989	70TLCS	70	1990	120TLCO-120TXCU	120	1987
30ECE-30ELCE	30	1989	40TLCO	40	1987	75ECC	75	1988	120TLCS-120TXES	120	1990
30ECO-30ELCO	30	1985	40TLCS	40	1990	75ECD	75	1986	140CXCC	140	1988
30ECL-30ELCL	30	1984	40TLLCC	40	1988	75ECO	75	1985	140CXCE	140	1989
30ECU-30ELCU	30	1987	40TLCE	40	1989	75ECL	75	1984	140CXES	140	1990
30EES-30ELES	30	1990	40TTLES	40	1990	75ECU	75	1987	140MLCI	140	1981
30RCC-30RLCC	30	1988	48ESLCC	48	1988	75ELCO	75	1985	140MLCN	140	1982
30RCD-30RLCD	30	1986	48ESLCE	48	1989	75ELCR	75	1984	140MLCR	140	1984
30RCE-30RLCE	30	1989	48ESLCU	48	1987	75ERCI-75ERLCI	75	1981	140MLCS	140	1980
30RCO-30RLCO	30	1985	48ESLES	48	1990	75ERCN-75ERLCN	75	1982	140MLCT	140	1983
30RCU-30RLCU	30	1987	50BECC-50BELCC	50	1988	75ERCS-75ERLCS	75	1980	140TLAE	140	1989
30RES-30RLES	30	1990	50BECD-50BELCD	50	1986	75ERCT-75ERLCT	75	1983	140TLAS	140	1990
30TECC-30TELCC	30	1988	50BECE-50BELCE	50	1989	75TLCO	75	1985	140TLCC-140TXCC	140	1988
30TECD-30TELCD	30	1986	50BECL-50BELCI	50	1981	75TLCR	75	1984	140TLCE-140TXCE	140	1989
30TECE-30TELCE	30	1989	50BECL-50BELCI	50	1981	75TRLCI	75	1981	140TLCO-140TXCO	140	1985
30TECO-30TELCO	30	1985	50BECL-50BELCI	50	1981	75TRLCS	75	1980	140TLCR-140TXCR	140	1984
30TECU-30TELCU	30	1987	50BECL-50BELCI	50	1981	75TRLCT	75	1983	140TLCO-140TXCU	140	1987
30TEES-30TELES	30	1990	50BECS-50BELCS	50	1980	85MLCS	85	1980	140TLCS-140TXES	140	1990
35AECD-35AELCD	35	1986	50BECT-50BELCT	50	1983	85TLCS-85TXCS	85	1980	140TRLCI-140TRXCI	140	1981
35AELCU	35	1987	50BECL-50BELCI	50	1981	88MSLCC	88	1988	140TRLCN-140TRXCN	140	1982
35ARCD-35ARLCD	35	1986	50BECL-50BELCI	50	1981	88MSLCE	88	1989	140TRLCS-140TRXCS	140	1980
35ARLCU	35	1987	50BECS-50BELCS	50	1990	88MSLCU	88	1987	140TRLCI-140TRXCI	140	1983
35ATECD-35ATELCD	35	1986	50TELC	50	1988	88MSLES	88	1990	150ANCO	150	1985
35ATECU-35ATELCU	35	1987	50TELCD	50	1986	90MLCC	90	1988	150CXCC	150	1988
35ATLCU	35	1987	50TELCE	50	1989	90MLCD	90	1986	150CXCE	150	1989
35BACI-35BALCI	35	1981	50TELCO	50	1985	90MLCE	90	1989	150CXES	150	1990
35BACN-35BALCN	35	1982	50TELCR	50	1984	90MLCI	90	1981	150GTLCU	150	1987
35BACR-35BALCR	35	1984	50TELCR	50	1984	90MLCN	90	1982	150SLCE	150	1989
35BACS-35BALCS	35	1980	50TELCR	50	1984	90MLCO	90	1985	150SLES	150	1990
35BACT-35BALCT	35	1983	50TELCU	50	1987	90MLCR	90	1984	150STLCC	150	1988
35ECI-35ELCI	35	1981	50TELES	50	1990	90MLCT	90	1983	150STLCD	150	1986
35ECN-35ELCN	35	1982	50TLCC	50	1988	90MLCO	90	1987	150STLCE	150	1989
35ECL-35ELCL	35	1984	50TLCD	50	1986	90TLAE	90	1990	150STLCO	150	1985
35ECL-35ELCL	35	1984	50TLCE	50	1989	90TLAS	90	1989	150STLCR	150	1984
35ECS-35ELCS	35	1980	50TLCO	50	1985	90TLCC-90TXCC	90	1988	150STLCT	150	1983
35ECT-35ELCT	35	1983	50TLCO	50	1985	90TLCD-90TXCD	90	1986	150STLCU	150	1987
35RCC-35RLCC	35	1988	50TLCR	50	1984	90TLCE-90TXCE	90	1989	150STLES	150	1990
35RCD-35RLCD	35	1986	50TLCO	50	1985	90TLCS	90	1990	150TLAE	150	1989
35RCE-35RLCE	35	1989	50TLCO	50	1985	90TLCT	90	1983	150TLAS	150	1990
35RCI-35RLCI	35	1981	60ECI-60ELCI	60	1981	90TLCO	90	1985	150TLCC-150TXCC	150	1988
35RCN-35RLCN	35	1982	60ECN-60ELCN	60	1982	90TLCO-90TXCO	90	1985	150TLCD-150TXCD	150	1986
35RCO-35RLCO	35	1985	60ECO-60ELCO	60	1985	90TLCR-90TXCR	90	1984	150TLCE-150TXCE	150	1989
35RCR-35RLCR	35	1984	60ECL-60ELCL	60	1984	90TLCT-90TXCT	90	1983	150TLCO-150TXCO	150	1985
35RCS-35RLCS	35	1980	60ECS-60ELCS	60	1980	90TLCO	90	1987	150TLCR-150TXCR	150	1984
35RCT-35RLCT	35	1983	60ECT-60ELCT	60	1983	90TLCS	90	1990			
			60ELCC	60	1988	90TLCS	90	1990			

Johnson Outboards 1980 & Later			Johnson Outboards 1980 & Later			Johnson Evinrude Commercial			Johnson Evinrude Commercial		
MODEL NO.	HP	YEAR	MODEL NO.	HP	YEAR	MODEL NO.	HP	YEAR	MODEL NO.	HP	YEAR
150TLCU-150TXCU	150	1987	300CXES	300	1990	10RSC-M	10	1983	25RWA-25RWLA	25	1988
150TLES-150TXES	150	1990	300PLCC-300PXCC	300	1988	10RSD-10RSLD	10	1985	25RWCD-25RWLCD	25	1986
150TRLCI-150TRXCI	150	1981	300PLCE-300PXCE	300	1989	10RSE-10RSL	10	1987	25RWCI-25RWLCI	25	1981
150TRLCN-150TRXCN	150	1982	300PLCU-300PXCU	300	1987	10RSG-2-10RSLG-2	10	1981	25RWCN-25RWLCN	25	1982
150TRLCS-150TRXCS	150	1980	300PLES-300PXES	300	1990	10RSJ-10RSLJ	10	1989	25RWCO-25RWLCO	25	1985
150TRLCT-150TRXCT	150	1983	300PTLCD-300PTXCDC	300	1986	10RSL-10RSL	10	1983	25RWCR-25RWLCR	25	1984
175STLAC	175	1988	300TLCO-300TXCO	300	1985	10RSN-10RSLN	10	1990	25RWCT-25RWLCT	25	1983
175STLCC	175	1988	C-275TLCO	275	1985	10RSR-10RSLR	10	1986	25RWCU-25RWLCU	25	1987
175STLCE	175	1990	C-275TXCO	275	1985	10RSU-10RSLU	10	1988	25RWES-25RWLES	25	1990
175TLCC-175TXCC	175	1988	C-300TLCO	300	1985	10RSW-10RSLW	10	1982	25RWFC-25RWLFC	25	1989
175TLCD-175TXCD	175	1986	C-300TXCO	300	1985	10RSY-10RSLY	10	1983	35RSP-35RSLP	35	1981
175TLCE-175TXCE	175	1989	C-E275PTLCD	275	1986	10RSYD	10	1985	40R78B-40R78B	40	1978
175TLCO-175TXCO	175	1985	C-E275PTXCD	275	1986	10RSYR	10	1986	40R79E-40R79E	40	1979
175TLCU-175TXCU	175	1987	C-E300PTLCD	300	1986	10RSYZ	10	1984	40RCA-40RCLA	40	1989
175TLES-175TXES	175	1990	C-E300PTXCD	300	1986	10RSZ-10RSLZ	10	1984	40RCB-40RCLB	40	1986
175TRLCI-175TRXCI	175	1981	CO-CC	1.2	1988	11KCA-11KCLA	11	1983	40RCH-40RCLH	40	1985
175TRLCN-175TRXCN	175	1982	CO-CD	1.2	1986	11KCG-11KCLG	11	1985	40RCK-40RCLK	40	1990
175TRLCS-175TRXCS	175	1980	CO-CE	1.2	1990	11KCS-11KCLS	11	1984	40RCP-40RCLP	40	1984
175TRLCT-175TRXCT	175	1983	CO-CU	1.2	1987	11KCW-11KCLW	11	1986	40RCT-40RCLT	40	1987
185ESXES	185	1990	CO-ES	1.2	1990	11KSLW-11KSYW	11	1986	40RCV-40RCLV	40	1983
185ESXW	185	1989	JR-CC	1.2	1988	12K79S	12	1979	40RCY-40RCLY	40	1988
185TLCO-185TXCO	185	1985	JR-CD	1.2	1986	12KCCSC	12	1980	40RCYA	40	1989
185TLCR-185TXCR	185	1984	JR-CE	1.2	1989	12KCLCSC	12	1980	40RCYB	40	1986
200CXCE	200	1989	JR-CU	1.2	1987	12KXCXSC	12	1980	40RCYH	40	1985
200CXES	200	1990	JR-ES	1.2	1990	12KXL79S	12	1979	40RCYK	40	1990
200SLES	200	1990	KT-11C	15A	1987	12LK79S	12	1979	40RCYP	40	1984
200STLAC	200	1988	KT-12R	15A	1988	12R78S	12	1978	40RCYT	40	1987
200STLCC	200	1988	KT-13A	15A	1989	12RL78S	12	1978	40RCYV	40	1983
200STLCD	200	1986	KT-14M	15A	1990	12RL79C-R	12	1979	40RCYY	40	1988
200STLCE	200	1989	RTE-11C	45SS	1987	12RSCSA	12	1980	40RSCSD	40	1980
200STLCU	200	1987	RTE-12R	45SS	1988	12RSLCSA	12	1980	40RSD-R	40	1981
200STLES	200	1990	RTE-13A	45SS	1989	12RSXCSA	12	1980	40RSLCSD	40	1980
200TLCT-200TRXCT	200	1983	RTE-14M	45SS	1990	12RXL78S	12	1978	40RSLD-R	40	1981
200TRLCI-200TRXCI	200	1981	STE-13A	SST-60	1989	12RXL79R	12	1979	40RSLR-40RSLR	40	1982
200TRLCN-200TRXCN	200	1982	STE-14M	SST-60	1990	14RSB-14RSLB	14	1990	40RWCD-40RWLCD	40	1986
200TRLCS-200TRXCS	200	1980				14RSE-14RSL	14	1982	40RWCI-40RWLCI	40	1981
200TXCC	200	1988				14RSF-14RSLF	14	1985	40RWCN-40RWLCN	40	1982
200TXCD	200	1986				14RSH-14RSLH	14	1989	40RWCO-40RWLCO	40	1985
200TXCE	200	1989				14RSLR-2	14	1981	40RWCR-40RWLCR	40	1984
200TXCU	200	1987				14RSLU-J	14	1983	40RWCT-40RWLCT	40	1983
200TXES	200	1990				14RSN-14RSLN	14	1984	45RCCD-45RCLCD	45	1986
225CLCU-225CXCU	225	1987				14RSP-14RSLP	14	1988	45RCCU-45RCLCU	45	1987
225CXCC	225	1988				14RSQ-14RSLQ	14	1986	45RCE-45RCL	45	1989
225CXCE	225	1989				14RSR-2	14	1981	45RCR-45RCLR	45	1988
225CXES	225	1990				14RSU-J	14	1983	45RSD-45RSLD	45	1986
225PLAE	225	1989				14RSV-14RSLV	14	1987	45RSE-45RSL	45	1988
225PLAS	225	1990				14RSYF	14	1985	45RSJ-45RSLJ	45	1990
225PLCC-225PXCC	225	1988				14RSYN	14	1984	45RSR-45RSLR	45	1987
225PLCU-225PXCU	225	1987				14RSYQ	14	1986	45RSU-45RSLU	45	1989
225PLES-225PXES	225	1990				14RSYU-J	14	1983	45RSYD	45	1986
225PLES-225SPXES	225	1990				15RSH-B	15	1983	45RSYE	45	1988
225PTLCD-225PTXCD	225	1986				15RSLH-B	15	1983	45RSYJ	45	1990
225SCXES	225	1990				15RSP-15RSLP	15	1982	45RSYR	45	1987
225SLES	225	1990				23R79C-R	12	1979	45RSYU	45	1989
225STLES	225	1990				25KCG-25KCLG	25	1986	45RSYZ	45	1985
225TLAE	225	1989				25KCS-25KCLS	25	1985	45RSZ-45RSLZ	45	1985
225TLAS	225	1990				25KCW-25KCLW	25	1987	45RWD-45RWLD	45	1986
225TLCC-225TXCC	225	1988				25RPL-25RPL	25	1984	45RWLE-45RWYE	45	1988
225TLCD-225TXCD	225	1986				25RPD	25	1989	45RWLJ-45RWYJ	45	1990
225TLCE-225TXCE	225	1989				25RPH-25RPLH	25	1982	45RWLR-45RWYR	45	1987
225TLCO-225TXCO	225	1987				25RPR	25	1990	45RWLU-45RWYU	45	1989
225TLCS-225TXCS	225	1990				25R78C-25RSL78C	25	1978	45RWYD	45	1986
235STLCO	235	1985				25R79R-25RSL79R	25	1979	45RWZ-45RWLZ	45	1985
235STLCR	235	1984				25RSA-25RSLA	25	1981	45WMLE	45	1989
235STLCT	235	1983				25RSC-25RSLC	25	1986	45WMLES	45	1990
235TLCO-235TXCO	235	1985				25RSCSA-25RSLCSA	25	1980	50RS78C-G	50	1978
235TLCR-235TXCR	235	1984				25RSG-2-25RSLG-2	25	1984	50RS79R-50RSL79R	50	1979
235TRLCI-235TRXCI	235	1981				25RSK-25RSLK	25	1982	50RSL78C-G	50	1978
235TRLCN-235TRXCN	235	1982				25RSM-25RSLM	25	1987	55AWQ-55AWLQ	55	1985
235TRLCS-235TRXCS	235	1980				25RSP-25RSLR	25	1990	55RCI-55RLCI	55	1981
235TRLCT-235TRXCT	235	1983				25RSS-25RSLS	25	1983	55RCN-55RLCN	55	1982
275CLCU-275CXCU	275	1987				25RSW-25RSLW	25	1985	55RCT-55RLCT	55	1983
275CXCC	275	1988				25RSY-25RSLY	25	1986	55RLCS	55	1980
275PLCC-275PXCC	275	1988				25RSYD	25	1989	55RSB-55RSLB	55	1989
275PLCU-275PXCU	275	1987				25RSYG-2	25	1984	55RSCS-55RSLCS	55	1980
275PTLCD-275PTXCD	275	1986				25RSYM	25	1987	55RSF-55RSLF	55	1984
275TLCO-275TXCO	275	1985				25RSYS	25	1983	55RSH-55RSLH	55	1988
300CLCUR-300CXCU	300	1987				25RSYW	25	1985	55RSJ-55RSLJ	55	1982
300CXCC	300	1988				25RSYZ	25	1988	55RSN-55RSLN	55	1983
300CXCE	300	1989				25RSZ-25RSLZ	25	1988	55RSP-55RSLP	55	1987
			Johnson Evinrude Commercial								
			4RST-4RSLT	4	1981						
			4RSY-4RSLY	4	1982						
			6K79S-6KL79S	6	1979						
			6KCB-6KCLB	6	1983						
			6KCCSC	6	1980						
			6KCH-6KCLH	6	1981						
			6KCLCSC	6	1980						
			6KCT-6KCLT	6	1984						
			6RS78B-6RSL78B	6	1978						
			6RS79E-6RSL79E	6	1979						
			6RSCSD-6RSLCSD	6	1980						
			6RSM-6RSLM	6	1981						
			6RSZ-6RSLZ	6	1983						
			7RSA-7RSLA	6.5	1989						
			7RSB-7RSLB	7	1986						
			7RSF-7RSLF	6.5	1981						
			7RSH-7RSLH	6.5	1985						
			7RSK-7RSLK	7	1990						
			7RSP-7RSLP	6.5	1984						
			7RSQ-7RSLQ	6.5	1982						
			7RST-7RSLT	7	1987						
			7RSV-7RSLV	6.5	1983						
			7RSY-7RSLY	7	1988						
			9K79S	9	1979						
			9KCCSC	9	1980						
			9KCLCSC	9	1980						
			9KXCXSC	9	1980						
			9KL79S	9	1979						
			9KXL79S	9	1979						
			9R78S	9	1978						
			9R79C-R	9	1979						
			9RL78S	9	1978						
			9RL79C-R	9	1979						
			9RSCSA	9	1980						
			9RSLCSA	9	1980						
			9RSXCSA	9	1980						
			9RXL78S	9	1978						
			9RXL79R	9	1979						
			10KCC-10KCLC	10	1987						
			10KCLD	10	1990						
			10KSLC	10	1987						

Johnson Evinrude Commercial			Johnson Evinrude Commercial			McCulloch Outboard			McCulloch Outboard			
MODEL NO.	HP	YEAR	MODEL NO.	HP	YEAR	MODEL NO.	HP	YEAR	MODEL NO.	HP	YEAR	
55RSQ-55RSLQ	55	1985	125WPLG-125WTPXG	125	1988	80355	7.5	1966-68	65302810	28	1965	
55RST-55RSLT	55	1990	125WPLS-125WTPXS	125	1987	80370	14	1966-67	65302830	28	1965	
55RSU-55RSLU	55	1981	125WPLW-125WTPXW	125	1989	80373	14	1966-67	65304510	45	1965	
55RSV-55RSLV	55	1986	155WTALA	155	1990	80378	45	1966-69	65304511	45	1965	
55RSYB	55	1989	155WTALY	155	1989	80382	45	1966-69	65304520	45	1965	
55RSYF	55	1984	155WTLCD-155WTXCD	155	1986	80386	45	1966-67	65304521	45	1965	
55RSYH	55	1988	155WTLCO-155WTXCO	155	1985	80450	75	1966-68	65304530	45	1965	
55RSYN	55	1983	155WTLCR-155WTXCR	155	1984	80454	75	1966-68	65304531	45	1965	
55RSYP	55	1987	155WTLCO-155WTXCO	155	1987	80914	28	1966-67	65304540	45	1965	
55RSYQ	55	1985	155WTLES-155WTXEX	155	1990	80915	28	1966-67	65304541	45	1965	
55RSYT	55	1990	155WTLM-155WTXM	155	1988	80916	45	1966-67	65307530	75	1965	
55RSYV	55	1986	155WTLZ-155WTXZ	155	1989	81605	7.5	1968	65307531	75	1965	
55RWCR-55RWLRCR	55	1984	155WTPLA-155WTPXA	155	1990	81635	7.5	1969	65307540	75	1965	
55RWLCO	55	1985	155WTPLB-155WTPXB	155	1987	81660	9	1967-69	661301210-20	14	1961	
55RWLCU	55	1987	155WTPLH-155WTPXH	155	1986	81680	9	1967-69	Mercury Outboard			
55RWLE	55	1989	155WTPLT-155WTPXT	155	1988	81700	9	1967-69				
55RWLES	55	1990	155WTPLV-155WTPXV	155	1984	81710	4	1966-68	HP	CYL	BEG.S/N	YEAR
55RWLR	55	1988	155WTPLY-155WTPXY	155	1989	6530310	3.5	1965	2.2	1	8075603	1984
65RELCR	65	1984	200WTPLV-200WTPXV	200	1990	6530710	7.5	1965	2.2	1	8087123	1985
65RSLA-65RSYA	65	1990	6834B	6	1978	6530720	7.5	1965	2.2	1	A800761	1986
65RSLB-65RSYB	65	1987	6835B	6	1978	6530750	7.5	1965	2.2	1	A805221	1987
65RSLH	65	1986	6912S	6	1979	6530760	7.5	1965	2.2	1	A817421	1988
65RSLP-65RSYP	65	1985	6913S	6	1979	10700305C	4	1969	2.2	1	A837101	1989
65RSLT-65RSYT	65	1988	6934E	6	1979	10700325D	7.5	1969	3	1	A855097	1990
65RSLV-65RSYV	65	1984	6935E	6	1979	10700395D	75	1969	3.4 L	6	6436883	1984
65RSLY-65RSYY	65	1989	9800S	9	1978	10800305C	4	1969	3.4 L	6	A129445	1985
65RWLCD	65	1986	9802S	9	1978	10800395D	75	1969	3.4 L	6	A912426	1986
65RWLCO	65	1985	9803S	9	1978	61300310	3.6	1961	3.5	1	6202173	1983
65RWLCR	65	1984	9900R	9	1979	61300610-710	7.5	1961	3.5	1	6434771	1984
65TELCD	65	1986	9901S	9	1979	61302510-20	27	1961	3.5	1	6594744	1985
65TELCO	65	1985	9902C-R	9	1979	61302530-40	27	1961	3.6	1	5404657	1980-81
65WMLA-65WMYA	65	1990	9903C-R	9	1979	61304010-11	43	1961	3.6	1	5910968	1982
65WMLB-65WMYB	65	1987	9912S	9	1979	61304020-21	43	1961	3.9	1	1655013	1964
65WMLCD	65	1986	9913S	9	1979	61304030-31	43	1961	3.9	1	1738941	1965
65WMLCO	65	1985	12800S	12	1978	61304040-41	43	1961	3.9	1	1865633	1966
65WMLCU	65	1987	12800S	12	1978	61304050-51	43	1961	3.9	1	2098037	1967
65WMLCUM	65	1990	12803S	12	1978	61307030-40	75	1961	3.9	1	2278851	1968
65WMLH	65	1986	12900R	12	1979	61307050-70	75	1961	4	1	2498136	1969
65WMLM	65	1988	12902C-R	12	1979	61307080-90	75	1961	4	1	2771662	1970
65WMLP-65WMP	65	1985	12903C-R	12	1979	62300310	3.6	1962	4	1	3028361	1971
65WMLT-65WMYT	65	1988	12910S	12	1979	62300610-710	7.5	1962	4	1	3296137	1972
65WMLY-65WMYT	65	1989	12912S	12	1979	62301410-20	14	1962	4	1	3529446	1973
65WMLZ	65	1990	12913S	12	1979	62302810-20	27	1962	4	1	3764825	1974
65WTLCO	65	1985	25832C	25	1978	62302830-40	27	1962	4	2	5589202	1980-81
65WTLCR	65	1984	25833C	25	1978	62304411-21	43	1962	4	2	9075839	1976
100TEMLH-100TEMX	100	1986	25932R	25	1979	62304431-41	43	1962	4	2	9172806	1978
100WMLCD	100	1986	25933R	25	1979	62304450-60	43	1962	4	1	A818721	1988
100WMLCO	100	1985	40804B	40	1978	62307030-40	75	1962	4	1	A837101	1989
100WMLCR	100	1984	40805B	40	1978	62307530-40	75	1962	4	1	A855097	1990
100WMPLA	100	1990	40904E	40	1979	63104060-61	43	1961	4	1	A906702	1986
100WMPLB	100	1987	40905E	40	1979	63300311	3.5	1963	4	1	B114109	1987
100WMPLH	100	1986	50832C-G	50	1978	63300411	3.5	1963	4.5	1	4108120	1975
100WMPLP	100	1985	50833C-G	50	1978	63300711	7.5	1963	4.5	1	4377557	1976
100WMPLT	100	1988	50932R	50	1979	63300712	7.5	1963	4.5	1	4597262	1977
100WMPLV	100	1984	50933R	50	1979	63301411	14	1963	4.5	1	4869518	1978
100WMPLY	100	1989			63301412	14	1963	4.5	1	5270784	1979	
100WTLCD-100WTXCD	100	1986	McCulloch Outboard			63302811	28	1963	4.5	1	5595532	1980-81
100WTLCO	100	1985	A3BB	3.6	1960	63302821	28	1963	4.5	1	6025119	1982
100WTLCR	100	1984	A3EB	7.5	1960	63302831	28	1963	4.5	1	6232381	1983
100WTLCU-100WTXCU	100	1987	A3FB	12	1960	63302831	28	1963	4.5	1	6428076	1984
100WTLES-100WTXES	100	1990	A3GB	25	1960	63302841	28	1963	4.5	1	6608536	1985
100WTLM-100WTXM	100	1988	A3HB	40	1960	63304511	45	1963	5	1	A819951	1988
100WTLZ-100WTXZ	100	1989	A3KB	7.5	1960	63304521	45	1963	5	1	A837101	1989
100WTPLA	100	1990	B3GB	25	1960	63304531	45	1963	5	1	A855097	1990
100WTPLB	100	1987	B3HB	40	1960	63304541	45	1963	6	2	1408611	1961
100WTPLH	100	1986	C3GB	25	1960	63307531	75	1963	6	2	1485612	1962
100WTPLP	100	1985	C3HB	40	1960	63307541	75	1963	6	2	1551443	1963
100WTPLT	100	1988	C3JB	60	1960	63507541	75	1965	6	2	1607513	1964
100WTPLV	100	1984	D3GB	25	1960	64300310	3.5	1964	6	2	1745521	1965
100WTPLY	100	1989	D3HB	40	1960	64300710	7.5	1964	6	2	1958278	1966
125ESXES	125	1990	D3JB	60	1960	64300720	7.5	1964	6	2	2096171	1967
125ESXW	125	1989	E3HB	40	1960	64301410	14	1964	6	2	2284857	1968
125RWLC-125RWYC	125	1990	F3HB	40	1960	64301420	14	1964	6	2	A910596	1986
125RWLG-125RWXG	125	1988	1410-20	14	1962	64302810	28	1964	6	2	B114231	1987
125RWLS-125RWXS	125	1987	78500	4	1966-67	64302830	28	1964	6	2	B233200	1988
125RWLW-125RWYW	125	1989	80000	7.5	1966-67	64304510	45	1964	6	2	B385500	1989
125RWYX	125	1988	80351	7.5	1966-67	64304530	45	1964	7.5	2	2529895	1969
125RWYS	125	1987			64304540	45	1964	7.5	2	2810637	1970	
125WTPLC-125WTPXC	125	1990			64307530	75	1964	7.5	2	3016581	1971	
					65301410	14	1965	7.5	2	3274633	1972	
					65301420	14	1965	7.5	2	3488153	1973	
								7.5	2	3801458	1974	

Mercury Outboard				Mercury Outboard				Mercury Outboard				Mercury Outboard			
HP	CYL	BEG.S/N	YEAR	HP	CYL	BEG.S/N	YEAR	HP	CYL	BEG.S/N	YEAR	HP	CYL	BEG.S/N	YEAR
7.5	2	4087015	1975	25	2	6593849	1985	65	4	2119749	1967	115	6	4112635	1975
7.5	2	4314385	1976	25	2	A911346	1986	65	4	2309311	1968	115	6	4310785	1976
7.5	2	4691222	1977	25	2	B114231	1987	65	4	2503991	1969	115	6	4567952	1977
7.5	2	4851693	1978	25	2	B238464	1988	65	4	2803562	1970	115	6	4855153	1978
7.5	2	5226935	1979	25	2	B385500	1989	65	4	2997339	1971	115	6	5168574	1979
7.5	2	5524660	1980-81	25	2	C221500	1990	65	3	3293184	1972	115	6	5600967	1980-81
7.5	2	5936301	1982	35	4	1570507	1963	65	3	3547987	1973	115	6	6006834	1982
7.5	2	6239857	1983	35	2	1628795	1964	65	3	3807833	1974	115	6	6262961	1983
7.5	2	6430041	1984	35	2	1755799	1965	65	3	4136685	1975	115	6	6440183	1984
7.5	2	6611886	1985	35	2	1960827	1966	65	3	4382057	1976	115	6	6630171	1985
8	2	A197112	1986	35	2	2097800	1967	70	3	1296411	1960	115	6	A907777	1986
8	2	B114231	1987	35	2	2300972	1968	70	3	1413611	1961	115	6	B117567	1987
8	2	B233200	1988	35	2	2487558	1969	70	3	1503459	1962	115	6	B239242	1988
8	2	B385500	1989	35	2	6445653	1984	70	3	4382057	1976	115	4	C100000	1989
8	2	C221500	1990	35	2	6626696	1985	70	3	4571652	1977	115	4	C221500	1990
9.8	2	5206550	1979	35	2	A922171	1986	70	3	4825249	1978	125	6	2314956	1968
9.8	2	5541280	1980-81	35	2	B110789	1987	70	3	5128280	1979	125	6	2536210	1969
9.8	2	5965263	1982	35	2	B238644	1988	70	3	5579017	1980-81	135	6	2839369	1970
9.8	2	6263906	1983	35	2	B393190	1989	70	3	5974683	1982	135	6	3036066	1971
9.8	2	6438338	1984	35 (300)	4	1271885	1960	70	3	6279960	1983	V-135	6	A909997	1986
9.8	2	6620196	1985	40	2	2874704	1970	70	3	B110054	1987	V-135	6	B116662	1987
9.8 (100)	2	1397581	1961	40	2	3043031	1971	70	3	B240451	1988	V-135	6	B241881	1988
9.8 (110)	2	1455240	1962	40	2	3219678	1972	70	3	C100000	1989	V-135	6	C100861	1989
9.8 (110)	2	1474328	1963	40	2	3474578	1973	75	4	6432901	1984	V-135	6	C221500	1990
9.8 (110)	2	1607083	1964	40	2	3859435	1974	75	4	6613221	1985	140	6	3293234	1972
9.8 (110)	2	1742746	1965	40	2	4118385	1975	75	4	A197882	1986	140	6	4865678	1978
9.8 (110)	2	1865779	1966	40	2	4362215	1976	75	3	C100000	1989	140	6	5189788	1979
9.8 (110)	2	2098352	1967	40	2	4564002	1977	75	3	C221500	1990	140	6	5625108	1980-81
9.8 (110)	2	2290663	1968	40	2	4860103	1978	80	4	1335465	1960	150	6	3502806	1973
9.8 (110)	2	2508759	1969	40	2	5174089	1979	80	4	1398630	1961	150	6	3752620	1974
9.8 (110)	2	2798057	1970	40	2	5562306	1980-81	80	4	2559001	1969	150	6	4125985	1975
9.8 (110)	2	3002814	1971	40	2	5991215	1982	80	4	2783253	1970	150XS	6	4319880	1976
9.8 (110)	2	3263263	1972	40	2	6228285	1983	80	4	2986444	1971	150XS	6	4602012	1977
9.8 (110)	2	3482753	1973	40	4	C159200	1989	80	4	3186263	1972	150XS	6	4868648	1978
9.8 (110)	2	3795658	1974	40	4	C221500	1990	80	4	4831999	1978	V-150	6	4868998	1978
9.8 (110)	2	4079675	1975	40 350	2	1356948	1961	80	4	5141097	1979	V-150	6	5129480	1979
9.8 (110)	2	4304785	1976	45	4	1476510	1962	80	4	5582562	1980-81	V-150	6	5503247	1980-81
9.8 (110)	2	4605112	1977	45	4	A914859	1986	80	4	5987161	1982	V-150	6	5944791	1982
9.8 (110)	2	4839254	1978	45	4	B110789	1987	80	4	6232941	1983	V-150	6	6220254	1983
9.9	2	A918999	1986	45	4	B238644	1988	80	3	A966142	1987	V-150	6	6443213	1984
9.9	2	B114231	1987	45	4	B393190	1989	80	3	B240451	1988	V-150	6	6616991	1985
9.9	2	B233200	1988	45 (400)	4	1279685	1960	80	3	C100000	1989	V-150	6	A904646	1986
9.9	2	B385500	1989	45 (400)	4	1384806	1961	85	6	1460999	1963	V-150	6	B116662	1987
9.9	2	C221500	1990	50	4	1421113	1961	85	6	1648888	1964	V-150	6	B242881	1988
10	2	1290910	1960	50	4	1477910	1962	85	4	3493913	1973	V-150	6	C100861	1989
15	2	1288910	1960	50	4	1552535	1963	85	4	3865695	1974	V-150	6	C221500	1990
15	2	1346448	1961	50	4	1605952	1964	85	4	4092965	1975	V-150XR2	6	A905191	1986
15	2	B293117	1988	50	4	1755549	1965	85	4	4590512	1977	V-150XR2	6	B289430	1988
15	2	B385500	1989	50	4	1870389	1966	85XS	4	4366802	1976	V-150XR4	6	B242885	1988
15	2	C221500	1990	50	4	2097445	1967	90	6	1755444	1965	V-175	6	4301235	1976
18	2	5860332	1980-81	50	4	2305101	1968	90	6	4854301	1978	V-175	6	4563802	1977
18	2	5954911	1982	50	4	2514919	1969	90	6	5160324	1979	V-175	6	4838074	1978
18	2	6171607	1983	50	4	2736807	1970	90	6	5594657	1980-81	V-175	6	5180109	1979
18	2	6443973	1984	50	4	3009934	1971	90	6	5996390	1982	V-175	6	5488752	1980-81
18	2	6617631	1985	50	4	3235063	1972	90	6	6246856	1983	V-175	6	6618751	1985
20	2	1558310	1963	50	4	3478003	1973	90	6	6436123	1984	V-175	6	A918329	1986
20	2	1606903	1964	50	4	3816308	1974	90	6	6623151	1985	V-175	6	B116662	1987
20	2	1755849	1965	50	4	4141450	1975	90	6	A902436	1986	V-175	6	B241881	1988
20	2	1866496	1966	50	4	4357650	1976	90	3	B110054	1987	V-175	6	C100861	1989
20	2	1997990	1967	50	4	4576237	1977	90	3	B240451	1988	V-175	6	C221500	1990
20	2	2296267	1968	50	4	4962056	1978	90	3	C100000	1989	V-200	6	4839034	1978
20	2	2550065	1969	50	4	5193259	1979	90	3	C221500	1990	V-200	6	5158929	1979
20	2	2827677	1970	50	4	5531630	1980-81	90cc	2	A907702	1986	V-200	6	5464486	1980-81
20	2	2991679	1971	50	4	5949386	1982	90cc	2	B114221	1987	V-200	6	6073192	1982
20	2	3226958	1972	50	4	6275323	1983	95	6	1869776	1966	V-200	6	6203991	1983
20	2	3537531	1973	50	4	6448808	1984	95	6	2097280	1967	V-200	6	6435503	1984
20	2	3755885	1974	50	4	6586624	1985	100	6	1503332	1962	V-200	6	6625221	1985
20	2	4103290	1975	50	3	A912478	1986	100	6	1518384	1963	V-200	6	A913228	1986
20	2	4293920	1976	50	3	B110789	1987	100	6	1665002	1964	V-200	6	B116662	1987
20	2	4580036	1977	50	3	B239242	1988	100	6	1755459	1965	V-200	6	B241881	1988
20	2	4819249	1978	50	3	B396036	1989	100	6	2318586	1968	V-200	6	C100861	1989
20	2	5183393	1979	50	3	C221500	1990	100	6	2484633	1969	V-200	6	C221500	1990
20	2	5606492	1980-81	60	3	1303411	1960	100	4	B209468	1988	210cc	2	A918999	1986
20	2	A910971	1986	60	3	6428681	1984	100	4	C100000	1989	210cc	2	B114231	1987
20	2	B114231	1987	60	3	6609651	1985	100	4	C221500	1990	210cc	2	B233405	1988
20	2	B238464	1988	60	3	A197392	1986	102cc	2	A819211	1988	210cc	2	B385500	1989
20	2	B385500	1989	60	3	B110789	1987	102cc	2	A837101	1989	V-220	6	B241881	1988
20	2	C221500	1990	60	3	B239242	1988	110	6	1870204	1966	V-225	6	5615282	1980-81
22 (200)	2	1292910	1960	60	3	B396036	1989	110	6	2097385	1967	V-250	6	C139860	1989
22 (200)	2	1339948	1961	60	3	C221500	1990	115	6	2836019	1970	V-250	6	C221500	1990
25	2	1467499	1962	65	4	1542745	1963	115	6	3023086	1971	V-275	6	C139860	1989
25	2	5705532	1980-81	65	4	1606282	1964	115	6	3270480	1972	V-275	6	C221500	1990
25	2	5942041	1982	65	4	1765044	1965	115	6	3525441	1973	V-300	6	5611648	1980-81
25	2	6185159	1983	65	4	1869564	1966	115	6	3761035	1974	V-300	6	6239853	1983
25	2	6453343	1984												

Mercruiser Inboard/Outdrive				Mercruiser Inboard/Outdrive				Mercruiser Inboard/Outdrive			
Sea Ray				GM Inline 6 Cylinder (Stern Drive)				GM V8 283, 327, 305 & 350 CID (Stern Drive)			
MODEL NO.	MERC. NO.	S/N	YEAR	MODEL	S/N	YEAR	MODEL	S/N	YEAR		
3.0L	3.0L	B787205-B917529	88	140	1538930-1725960	63	190	1564539-1730903	63-64		
4.3L2	4.3L	B785483-B921276	88	150	1666495-2048046	64-66	898 (2bbl.)	4762210-6218461	77-82		
4.3L4	4.3LX	B785981-B922330	88	160	2048022-2770031	67-69	898 (2bbl.)	6218462-B525981	83-84		
5.7L	5.7L	B784799-B917017	88	165	2770032-5178958	70-78	200/5.0L (2bbl.)	6218462-F600999	85-95		
SRX5.7L	350 Mag	B785241-B919012	88	165	5178959-5813433	79-81	5.0L (2bbl.)	L015751-UP	98-		
SRX7.4L	454 Mag			200	2453769-2712072	69	5.0L EFI	L012052-L340000	98-99		
SRX7.4L-H	Alpha	B785149-B924857	88				228 (4bbl.)	4765100-5170008	77-78		
	Bravo	B721206-B919343	88				228 (4bbl.)	5170009-6218461	79-82		
							228 (4bbl.)	6218462-B525981	82-84		
							230 (4bbl.)	6218462-B525981	85-86		
Stern Drives				GM V6 (Stern Drive)							
3.0L-SRX7.4L	Alpha	B803866-C348032	88				230/5.0LX (4bbl.)	B525982-F600999	87-95		
SRX7.4L-H	Bravo	B803872-B999972	88				225	1539620-2694014	63-69		
Inboard Engines							250	2314301-2639854	68-69		
5.7L	5.7L	B788204-B919356	88	185 (4bbl.)	6330183-6919655	83-84	255	4175500-4767999	75-76		
7.4L	7.4L	B788179-B913769	88	185 (2bbl.)	A331455-B527954	85-87	250	4768000-4908849	77		
				175/4.3L (2bbl.)	B527955-D714106	87-92	260/5.7L	4908850-6218461	78-82		
				4.3L (GEN II)(2bbl.)	D714107-F000877	92-93	260/5.7L	621462-B525981	82-86		
				4.3L (GEN II)(2bbl.)	F000878-F601126	93-95	260/5.7L	B525982-F600999	87-95		
				4.3L (GEN II)(2bbl.)	F601127-F000878	96	5.7L (2bbl.)	F601000-UP	96-98		
				4.3LX (GEN+)(2bbl.)	F803000-K999999	96-97	5.7L EFI	F225560-UP	95-		
				4.3L (GEN+)(2bbl.)	L010044-UP	98-	5.7LX (4bbl.)	F601000-K999999	96-97		
				4.3L EFI (GEN+)(TBI)	L012009-UP	98-	5.7LX EFI	F752400-K999999	96-97		
				205 (4bbl.)	A331455-B527954	85-87	5.7LX	Bravo EFI	F800300-K999999	96-97	
				205/4.3LX (4bbl.)	B527955-D714369	87-91	350 Mag. Alpha	A635178-B525981	86-87		
				4.3LX (GEN II)(4bbl.)	D714370-F001219	92-93	350 Mag. Alpha	B525982-F600999	87-95		
				4.3LX (GEN II)(4bbl.)	F001220-F601126	93-95	350 Mag. Alpha	F601000-K001526	96		
				4.3LX (GEN II)(4bbl.)	F601127-F802999	96	350 Mag. Alpha	K001527-K999999	97		
				4.3LXH (GEN+)(4bbl.)	F803114-UP	96-97	350 Mag. Alpha EFI	F800300-K999999	96-97		
				4.3LH(GEN+)(4bbl.)	L010044-UP	98	350 Mag. Bravo MPI	F415189-K999999	95-97		
				262 Mag. (TBI)(GEN+)	F803800-K999999	96-97	350 Mag. MPI (GEN +)	F602000-K999999	96-97		
							350 Mag. MPI (GEN+)	L010019-UP	98-		
							270	2851074-3385720	69-72		
							280TRS	4176250-4770199	75-76		
							300 Tempest	6668677-B430367	85-86		
							320 (EFI)	A543604-C622418	87-89		
Mercury Marine 4 Cylinder (Stern Drive)				Ford V8 (Stern Drive)							
MODEL	S/N	YEAR		MODEL	S/N	YEAR					
470 (2bbl.)	4208730-5520114	76-79		888 (2bbl.)	3108723-4887829	71-77					
470 (2bbl.)	5520115-6218036	80-82		215 (4bbl.)	2781153-3385720	70-72					
470 (2bbl.)	6218037-6916778	83-84		225 (4bbl.)	3385721-4166999	73-74					
170 (2bbl.)	6916779-UP	85-86		225-S (4bbl.)	3385721-4166999	73-74					
165/3.7L (2bbl.)	6916779-UP	87-89		233	4173000-4902304	75-77					
485 (2bbl.)	5685394-6218036	80-82		255	3258728-4175499	71-74					
488 (4bbl.)	6170297-6916778	83-84									
190 (4bbl.)	6916779-UP	85-86									
180/3.7LX (4bbl.)	6916779-UP	87-89									

MerCruiser Inboard/Outdrive			MerCruiser Inboard/Outdrive				MerCruiser Inboard/Outdrive		
GM V8 427, 454, 502, 540 & 572 (Stern Drive)			MCM 4, 5, 6 & V8 Cylinder Diesel Stern Drive Engines				GM MIE V8 427, 454, 482 & 502 CID (Inboard)		
MODEL	S/N	YEAR	MODEL	HP	S/N	YEAR	MODEL	S/N	YEAR
325	2278747-3780449	69-72	Rover	60	31400000F-UP	65-67	325	2278747-3780449	68-74
330	4623115-6083144	77-81	530 D-TA	150	B993000-B993492	89	330	4623115-5889913	77-80
330	6083145-B816450	82-87	636 D-TA	180	B993500-C696047	89	340/7.4L		
7.4L Bravo	B771113-D603117	88-91	D183	140	B993493-D725149	90-93	w/B/W MK4	5889914-UP	81-92
7.4L Bravo (Gen.V)	D603118-F800699	92-96	D219	170	C696048-D850124	90-93	7.4L w/Hurth (LH) MK4	C391564-D715493	89-92
7.4L Bravo (Gen. VI)	F800700-K999999	96-97	D254	200	C849484-D554729	90-93	7.4L (LH)	D715494-K999999	92-97
7.4LX Bravo (MPI)(Gen.V)	F602010-F801999	96	D3.0L	140	D725150-UP	94-	7.4L MPI (LH)	F563052-K999999	95-97
7.4LX Bravo (MPI)(Gen.VI)	F802000-K999999	96-97	D3.6L	170	D850125-UP	94-	7.4L MPI (L29) Gen VI	L002006-UP	98
7.4L MPI (Gen. VI)	L010003-UP	98	D4.2L	200	D554730-UP	94-	7.4L TBI (LH) Gen VI	F874815-K999999	96-97
7.4LX Bravo (TBI)(Gen.VI)	F820000-K999999	96-97	D7.3L	238	F060000-UP	94-	454 Mag. MPI Horizon	L002200-L086049	98-99
454 Mag. Alpha	A631894-UP	86-88	Mercury Marine MIE 4 Cylinder (Inboard)				454 Mag. MPI (Gen.V)	F215800-F820099	95-96
454 Mag. Bravo (Gen.V)	D805069-F304999	92-94	MODEL	S/N	YEAR	470	5520115-6218036	80-81	
454 Mag. Bravo (Gen.V)	F305000-F801699	95-96	Ford MIE V8 (Inboard)				454 Mag. MPI (SKI)(Gen.VI)	F820100-K999999	96-97
454 Mag. Bravo (Gen.VI)	F801700-K999999	96-97	MODEL	S/N	YEAR	215	2781153-3563181	70-72	
454 EFI (Gen.V)	F115700-F802349	94-96	225	3385721-4176999	70-72	225	4173000-4775784	75-76	
454 Mag. MPI (Gen.VI)	F802350-K999999	96-97	233	4173000-4775784	75-76	255	3258728-4178299	73-74	
454 Mag. MPI (Gen.VI)	L010029-L085399	98	GM MIE V8 305,327,350 CID (Inboard)				350	9780450-4623109	74-76
454 Mag. MPI (Gen.VI)	L085400-UP	99-	MODEL	S/N	YEAR	390	2781129-2825059	69-70	
370 TRS	4179554-6721527	78-85	198	4762210-6218461	77	8.2L w/ Hurth	C878221-D857199	90-92	
370 TRS	6721528-B714586	85-87	228	4765100-5170008	77-78	8.2L (Gen.V)	D857200-F819619	93-96	
400 TRS	4179554-B457644	80-86	228	5170009-5907057	79-80	8.2L MPI (LH) Gen VI	F819620-K999999	96-97	
420	A398941-D937011	87-89	230/5.0L (4bbl.)	5907058-B788151	81-87	8.2L MPI (LH) Gen VI	L002450-L0086012	98	
425	A398941-D937011	90-93	225	2278647-2694014	68	8.2L MPI (LH) Gen VI	L0086013-UP	99	
440 TRS	4179554-B485220	83-86	250	2314301-2639854	68-69				
450 (Gen. V)	F347100-F347277	95-96	255	4175500-5907057	75-80				
525 SC	D456000-F348963	91-92	260/5.7L	5907058-F024999	81-93				
525 SC (Gen.V)	D456000-F348963	92-95	270	2851074-3077735	69-72				
525 SC (Gen.V)	F615814-F745215	96	5.7L	F025000-K999999	94-97				
525 SC (Gen.VI)	F745260-UP	96-97	5.7L (Gen+)	L002003-UP	98				
390	2781129-3042731	69-70	5.7L MPI	K040300-K999999	97				
460 TRS	4719554-6181046	83-86	350 Mag. MPI (Gen+)	L002008-L304499	98				
465	C849992-F213244	90-92	350 Mag. MPI (Gen+)	L304500-UP	99				
465 (Gen.V)	C849992-F213244	92-94	350 Horizon	L304700-UP	99-				
500 (Gen.V)	F213293-F745159	94-96	5.7L Ski	A338533-B514626	85-87				
500 (Gen.VI)	F745195-L001772	97-98	5.7L Competition Ski	B514627-F775199	87-95				
502 Mag. Bravo	C878221-D824588	90-92	5.7L Competition Ski	F775200-K040003	96				
502 Mag. Bravo (Gen.V)	D824589-F114528	92-93	5.7L Competition Ski (Gen+)	L002005-UP	98-				
502 EFI (Gen.V)	D840650-F802599	93-96	350 Mag. Ski	D505450-K999999	91-97				
502 Mag. MPI (Gen.VI)	F802600-K999999	96-97	350 Mag. EFI Ski	F215561-K999999	94-97				
500 EFI	L001477-UP	99-	350 Mag. MPI Ski	F350583-F799999	95-98				
502 Mag. MPI (Gen.VI)	L085433-UP	98	Black Scorpion Ski	F800000-UP	96-98				
600 SC	D456489-F877642	91-92							
600 SC (Gen.V)	D456489-F877642	92-96							
600 SC (Gen.VI)	K000227-UP	97							
500 Bulldog	C577254-F745405	90-96							
500 Bulldog	K000248-UP	97							
575	A677429-D763716	86-92							
800 SC (Gen.V)	D763836-UP	93-96							

Mercuriser Inboard/Outdrive			
MIE 5, 6 & V8 Cylinder Diesel Inboard Engines			
MODEL	HP	S/N	YEAR
530 D-TA	150	B993002-C539258	89
636 D-TA	180	B993750-C696011	89
D183	150	C539259-D725149	90-93
D219	180	C696012-D850124	90-93
D254	210	C849461-D554729	90-93
D3.0L	150	D725150-UP	94-
D3.6L	180	D850125-UP	94-
D4.2L	210	D554730-UP	94-
D7.3L	262	F060000-UP	94-

MC 60, 80 & 90 Stern Drives & Transom Plates		
MODEL	S/N	YEAR
60 (O)	1830753-2063740	65-66
80	2063741-2898029	66-69
90	2898020-3225967	70-72

MC I, II & III		
MODEL	S/N	YEAR
I	1534570-1684187	63
II (1.33:1)	1474909-2278488	62-67
II (1.78:1)	2398798-2671321	68-69
III	2373127-3002613	68-72
III	5128065-UP	78-

MC 1A, 1B & 1C		
MODEL	S/N	YEAR
1A, 1B & 1C	1684188-1777798	64
1A, 1B & 1C (E-Z Shift)	1776349-2065189	65-66

Mercuriser Inboard/Outdrive		
MC 120, 140, 160 & 165		
MODEL	S/N	YEAR
120/140	2062141-378049	67-73
120/140	3780850-4893634	74-77
120/140	4893635-6225576	78-82
160	2065190-2763441	67-69
165	2763442-3780849	70-73
165	3780849-4890459	74-77
165	4890460-6268064	78-82

MC470 & 485		
MODEL	S/N	YEAR
470	4208730-4893834	76-77
470	4893835-6225576	78-82
485	5487437-6225576	80-82

MC 888, 225S & 233		
MODEL	S/N	YEAR
888	3106717-3784374	71-73
888	3784375-4782329	74-77
225S	3856268-4200499	74
233	4200500-4782329	75-77

MC 898, 228, 250 & 260		
MODEL	S/N	YEAR
898/228	4782330-4898729	77
898/228	4898730-6229157	78-82
250	4791300-4898729	77
260	4898730-6229157	78-82

MC R, MR, Alpha One, Alpha One SS & Alpha One Gen II		
MODEL	S/N	YEAR
R	6152230-6847029	83-84
MR	6810538-A479506	85
Alpha One	A470165-UP	86-90
Alpha One SS	A545004-UP	86-89
Alpha One Gen II	D469859-UP	91-

Mercuriser Inboard/Outdrive		
MC Bravo & Blackhawk		
MODEL	S/N	YEAR
Bravo One	B664190-UP	88-
Bravo Two	C564952-UP	89-
Bravo Three	D763691-UP	93-
Blackhawk	F186717-UP	94-

MC 215E & 215H		
MODEL	S/N	YEAR
215H	2782203-2909034	70
215E	2782203-2909034	70-72

MC TR & TRS		
MODEL	S/N	YEAR
TR	3377316-3787239	73
TR	3787240-4794899	74-76
TR	4794900-5009866	77
TR	5009867-UP	78-
TRS	3787240-4203749	74-75
TRS	4203750-4795399	76
TRS	4795400-UP	77-

MC II, III, IV & V SSM		
MODEL	S/N	YEAR
II SSM	Z2021100C-Z2021313C	82-84
	A544504Z-C576702Z	85-90
III SSM	Z38022378C-X38092085C	78-84
	A568120-UP	86-
IV SSM	A568120-UP	86-
V SSM	C576812-UP	89-
VI SSM	D456231-UP	91-

BARR (Cont.)		CDI/RAPAIR (Cont.)		COLE-HERSEE (Cont.)		COLE-HERSEE (Cont.)	
BARR No.	Sierra No.	CDI/RAPAIR No.	Sierra No.	COLE-HERSEE No.	Sierra No.	COLE-HERSEE No.	Sierra No.
MC47-27-89657	18-0111	114-7778	18-5775	5520BP	TG21020-2	M482-BP	MP39380
MC47-27-92720	18-0954	114-9052	18-5791	5582-30-BP	TG19560	M484-BP	TG21160
MC472796429	18-1204	123-9898-P	18-5888	56027-01BP	RK40140	M485-BP	MP39320
MC47-27-97542	18-0113	123-9898-P	18-5889	56327-01BP	RK19650	M489-BP	MP39020
MC47-27-99757	18-2909	123-9898-P	18-5890	57000-23	RK40140W	M490-BP	MP39420
MC472799777	18-2833	134-6453	18-5797	57001-15	RK40150W	M491-BP	MP39410
MC47-27-99777A1	18-4367	134-6456	18-5795	57003-16	RK40170W	M492-BP	MP39310
OMC-1-912441	18-1902	134-6456	18-5798	58027-02BP	RK40150	M493-BP	TG21030-1
OMC-1-912442	18-1903	153-1778	18-5709	58027-03BP	RK40170	M527-BP	MP39600
OMC-1-980959	18-1904	153-3408	18-5708	58027-04BP	RK40350	M531-BP	MP39640
OMC-1-984054	18-1901	154-6770	18-5707	58027-07BP	RK40480	M532-BP	MP39620
OMC-20-913784	18-1909	173-3117	18-5869	58027-11BP	RK40470	M54111-01BP	TG40300
OMC-20-982680	18-1921	173-3668	18-5868	58327-01BP	RK19660	M54111-02-BP	TG40320
OMC47308799	18-2863	174-3996	18-5855	58327-06BP	RK40110	M550-14-BP	MP39080
OMC47311121	18-2861	174-5255	18-5856	58328-01-BP	RK19510R	M550-BP	MP39060
OMC47311130	18-2860	174-5454K1	18-5859	58328-02	RK19510G	M58031-01BP	RK19400S
OMC47311131	18-2859	174-5456	18-5854	58328-04	RK19500R	M58031-02BP	RK19420S
OMC47313368	18-2851	174-5456-16	18-5860	58328-05	RK19530RC	M58031-04BP	RK19560S
OMC47314809	18-2858	174-6617K1	18-5863	58328-06	RK19520RC	M58031-07BP	RK19410S
OMC47315055	18-0937	174-6617K1	18-5864	58328-07	RK19520GC	M584-BP	TG21050-1
OMC47907761	18-0114	174-832075K1	18-5874	58328-08	RK19580K	M-597	MP40970-1
OMC47907775	18-2883-1	174-832075K2	18-5870	58328-09	RK19510C	M-598	MP40990
OMC47908013	18-2875	174-9610K2	18-5875	58328-10	RK19510A	M606-BP	MP39390B
OMC47-908079	18-2912	174-9610K2	18-5876	58328-100BP	RK19500K	M608-BP	MP39350
OMC47908935	18-2850	183-2091	18-5192	58328-101BP	RK19510K	M612-BP	MP39360
OMC-47-909314	18-2902	183-2508	18-5179	58328-102BP	RK19580K	M626-BP	UN42000
OMC47909515	18-0548	183-3737	18-5176	58328-103BP	RK19520K	M628-BP	MP39530
OMC-47-909786	18-0943	183-4632	18-5194	58328-104BP	RK19530K	M630-BP	MP39400
VO-1-835804	18-1931-1	193-3689	18-5832	58328-11	RK19500G	M-641-01-BP	FS40600-1
VO-1-855387	18-1930-1	193-4093	18-5828	58328-12	RK19500C	M-643-01	FS40610-1
VO-20-855384	18-1935-1	193-4476	18-5827	58328-13	RK19500A	M-649-04-BP	FS40670
VO47-835908	18-2971	193-4641	18-5831	58328-14	RK19580K	M-649-06BP	FS40680
VO47855383	18-2991	193-5204	18-5825	58328-15	RK19580K	M-649-08BP	FS40690
		193-6048	18-5829	58328-16	RK19580K	M656-BP	FS40560-1
		194-5279	18-5741	58328-17	RK19580K	M674-BP	FS40550-1
		194-5279	18-5743	58328-18	RK19580K	M676-BP	MP39010
		194-8736K1	18-5824	58328-19	RK19580K	M712-09BP	MP39070
		832-9809	18-6774	58328-20	RK19580K	M712-BP	MP41020
		R584642	18-5773	58328-21	RK19580K	M832BP	MP39090
				58328-22	RK19580K	M850BP	MP39200
				58328-25	RK19520K		
				58328-26	RK19520K		
				58328-33	RK19520AG		
				58328-34	RK19520K		
				58328-35	RK19520K		
				58328-36	RK19520K		
				58328-39	RK19530K		
				58328-40	RK19530K		
				58328-47	RK19530AG		
				58328-48	RK19530GC		
				58328-49	RK19530K		
				58328-50	RK19530K		
				58328-51	RK19530K		
				81255-BP	MP39220		
				81264-BP	MP39030		
				82065-BP	UN19690		
				82159-02BP	UN19750		
				82159-03BP	UN19730		
				82159-1-BP	UN19740		
				82159-2	UN19750		
				83280-03BP	MP39260		
				9187-01BP	MP39670		
				9187-BP	MP39680		
				9187-Q2BP	MP39690		
				96101-BP	MP39300		
				M-115BP	TC43624		
				M-121BP	TC43604		
				M200-BP	BA58050		
				M284-01BP	MP39050		
				M284-09 BP	MP38910		
				M320-RCBP	UN22190		
				M40177BP	MP41400		
				M412BP	FS40500		
				M-414-01	FS40590		
				M414BP	FS40510-1		
				M-426BP	FS45620		
				M-427BP	FS45630		
				M-429BP	FS45650		
				M-449	FS40750		
				M476-BP	MP39580		

CDI/RAPAIR		COLE-HERSEE		FRAM	
CDI/RAPAIR No.	Sierra No.	COLE-HERSEE No.	Sierra No.	FRAM No.	Sierra No.
113-1397	18-5755	4099	MC33501	C1110PL	18-7930
113-2115	18-5762	24059	BA58003	C1175PL	18-7931
113-2125	18-5759	11134BP	TC43654	C1191A	18-7858
113-2138	18-5760	11172BP	TC43634	CC1133PL	18-7934
113-2285	18-5763	11173BP	WH10320	CCS1136	18-7935
113-2285	18-5765	24059-08BP	BA58060	CG11	18-7855
113-2453	18-5758	24106-BP	18-5840	CG20DP	18-7862
113-2556	18-5760	24106-BP	BA58040	CG7	18-7860
113-2651	18-5769	24117-01	BA58010	CH33APL	18-7920
113-2705	18-5782	24117-01BP	BA58010	CH836PL	18-7921
113-2811	18-5783	26100-BP	UN22200	G12	18-7830
113-3101	18-5892	30147BP	FS45410	G15	18-7831
113-3110	18-5784	3031-0BP	FS45400	G15(Plastic)	18-7857-1
113-3114	18-5761	30410-10 BP	CB42100	G2	18-7856-1
113-3241	18-5764	30410-15 BP	CB42110	G3	18-7831
113-3605	18-5891	30410-20 BP	CB42120	G3(Plastic)	18-7857-1
113-3748	18-5766-1	30410-25 BP	CB42130	G3870	18-7936
113-3865	18-5885	30410-30 BP	CB42140	G8174	18-7830
113-4028	18-5770-1	407-01-BP	MP39170	P1115	18-7937
113-4032	18-5771	407-03-BP	MP39140	P1116	18-7938
113-4037	18-5893	46377-10BP	FS40740	P1146G	18-7829
113-4041	18-5772-1	46377-14	FS40440	P1146G	18-7867
113-4489	18-5794-1	46377-6BP	FS40420	P3726	18-7939
113-4767	18-5768	46377-8	FS40450	P4102A	18-7942
113-4783	18-5767	46379-10-BP	FS40740	P8043	18-7940
113-4808	18-5774-1	54003-BP	RK19630	P8263	18-7802
113-4985	18-5887	54010-BP	RK19640	PH16	18-7878
113-5316	18-5785	54100-01	TG40020-1	PH25	18-7923
113-6212	18-5781	54101-01	TG40030-1	PH2821	18-7886
113-6367	18-5886	54103-01	TG40040-1	PH2821A	18-7886
113-7123	18-5747	54104-01	TG40050-1	PH2870A	18-7925
113-7123	18-5749	54107-01-BP	TG40450-1	PH30	18-7824
114-2986	18-5779	54109-01	TG40060	PH3306A	18-7926
114-4911	18-5786	54110-01	TG40010	PH3545	18-7927
114-4911	18-5787	55020-11-BP	TG19540	PH3593A	18-7910
114-4953	18-5790	55036-14-BP	TG19550		

FRAM (Cont.)		GLM (Cont.)		GLM (Cont.)		GLM (Cont.)	
FRAM No.	Sierra No.	GLM No.	Sierra No.	GLM No.	Sierra No.	GLM No.	Sierra No.
PH3612	18-7874	11500	18-2171	12501	Obsolete	13050	18-3552
PH3614	18-7884	11510	18-2173	12502	18-3351	13060	18-3554
PH3614	18-7915	11520	18-2172	12510	18-3117	13070	18-3558
PH3980	18-7879-1	11610	18-5967	12520	18-3107	13080	18-3557
PH43	18-7878	11620	18-2372	12540	18-3139	13100	18-3649
PH4743	18-7886	11800	18-8210	12550	18-3127	13101	18-3647
PH4967	18-7906	11810	18-8211	12560	18-3126	13120	18-3549
PH4967	18-7916	12000	18-3315-2	12590	Obsolete	13124	18-3569
PH49A	18-7880	12010	18-3507	12610	18-3178	13150	18-3561
PH5046	18-7917	12020	18-3423	12620	18-3343	13170	18-3500
PH6017A	18-7902	12030	18-3424	12670	18-6011	13200	18-3556
PH6017A	18-7910	12041	18-3151	12675	18-6068	13220	18-1977-1
PH6017A	18-7911	12042	18-3214	12680	18-6014	13230	18-1994
PH6607	18-7910	12043	18-3154	12690	18-6249	13270	18-3673
PH6607	18-7911	12050	18-3327	12700	18-6015-9	13280	18-3674
PH7317	18-7914	12060	18-3383	12702	18-6093	13350	18-3672
PH7575	18-7884	12061	18-3401	12703	18-6067	13370	18-3650
PH7575	18-7915	12070	18-3382	12703	18-6114	13380	18-3646
PH8842	18-7880	12071	18-3381	12704	18-6089	13380	18-3651
PH8A	18-7875	12082	18-3216	12704	18-6092	13381	18-3662
PH977A	18-7887	12084	18-3237	12710	18-6016	13390	18-3668
PH977A	18-7899	12085	18-3309	12711	18-6080	13400	18-3652
PS3808	18-7844	12088	18-3150	12712	18-6094	13410	18-3671
PS3808	18-7845	12091	18-3212-1	12713	18-6066	13420	18-3667
		12100	18-3324	12730	18-6017	13430	18-3653
		12101	18-3393	12731	18-6018	13440	18-3670
		12102	18-3392	12733	18-6027	13450	18-3669
		12103	18-3391	12736	18-6025	13520	18-3678
		12104	18-3390	12737	18-6095	13540	18-3531
		12105	18-3211	12738	18-6026	13550	18-3532
		12106	18-3210	12739	18-6115	13950	18-8112
		12107	18-3215	12740	18-6012	13984	18-4461
		12108	18-3201	12741	18-6029	13990	18-4224
		12110	18-3317	12743	18-6113	13991	18-4227
		12120	18-3320	12744	18-6097	13992	18-4226
		12130	18-3321	12745	18-6034	13993	18-4218
		12140	18-3314	12750	18-6013	14010	18-4500
		12150	18-3316	12760	Obsolete	14020	18-4505
		12170	18-3322	12770	18-6020	14030	18-4515
		12180	18-3323	12772	18-6019	14040	18-4520
		12190	18-3386	12773	18-6101	14110	18-4510
		12200	18-3219	12774	18-6028	14115	18-4010
		12202	18-3220	12775	18-6103	14120	18-4545
		12210	18-3378	12776	18-6024	14125	18-4011
		12211	18-3380	12780	18-6000	14130	18-4525
		12221	18-3385	12781	18-6023	14135	18-4012
		12243	18-3994	12782	18-6004	14140	18-4560
		12244	18-3388	12784	18-6005	14145	18-4013
		12246	18-3387	12787	18-6009	14160	18-4575
		12250	18-3207	12788	18-6010	14165	18-4015
		12251	18-3400	12789	18-6001	14190	18-4090
		12260	18-3252	12810	18-3114	14210	18-3918
		12270	18-3239	12812	18-3358	14220	18-3919
		12280	18-3517	12813	18-3179	14230	18-3920
		12290	18-3217	12817	18-3113	14240	18-3921
		12305	18-3149-1	12820	18-3109	14250	18-3922
		12310	18-3417	12821	Obsolete	14260	18-3923
		12320	18-3420	12822	18-3197	14270	18-3924
		12330	18-3421	12824	18-3151	14275	18-3927
		12341	18-2354	12825	18-3222	14280	18-3925
		12350	18-3416	12826	18-2722	14315	18-4600
		12352	18-3445	12829	18-3221	14320	18-4555
		12360	18-3419	12830	18-3110	14330	18-4565
		12370	18-3414	12836	18-2728	14410	18-4635
		12380	18-3422	12840	18-3106	14430	18-4637
		12390	18-3119	12860	18-3115	14440	18-4636
		12391	Obsolete	12880	18-3346	14470	18-4626
		12395	18-3405	12881	18-6070	14480	18-4627
		12400	18-3129	12883	18-6112	14490	18-4628
		12405	18-3206	12884	18-6091	14600	18-4055
		12410	18-3116	12885	18-6090	14610	18-4056
		12415	18-3571	12886	18-6036	14640	18-4059
		12416	18-3572	12887	18-6032	14650	18-4060
		12420	18-3118	12888	18-6098	14660	18-4623
		12430	18-3130	12889	18-6033	14670	18-4624
		12440	18-3363	12930	18-2715	14680	18-4625
		12450	18-3336	13010	18-3553	14910	18-3979
		12460	18-3180	13020	18-3550	14920	18-3980
		12470	18-3367	13030	18-3551	14930	18-3981
		12500	18-3122	13040	18-3555	14940	18-3982

GLM (Cont.)		GLM (Cont.)		GLM (Cont.)		GLM (Cont.)	
GLM No.	Sierra No.	GLM No.	Sierra No.	GLM No.	Sierra No.	GLM No.	Sierra No.
14950	18-3983	21360	18-3714	21894	18-4264	22616	18-2290
14960	18-3984	21370	18-2462	21896	18-4265	22620	18-2217
15100	18-3575	21380	18-2463	21900	18-2100	22625	18-2216
15201	18-3583	21419	18-3749	21910	18-2461	22630	18-2221
15201	18-3599	21420	18-2169	21930	18-2148	22631	18-2218
15301	18-3574	21421	18-2322	21951	18-8205	22633	18-2220
15400	18-3584-1	21423	18-3236	21960	18-8206	22661	18-2310
15500	18-3581	21424	18-2395	21961	18-8212	22662	18-2309
15600	18-3582	21425	18-2464	21962	18-2771	22663	18-2308
15700	18-3578	21430	18-2149	21980	18-2142	22670	18-2210
16100	18-4035	21432	18-3754	22010	18-2176	22671	18-2207
16120	18-4036	21433	18-2303	22020	18-2177	22672	18-2208
16150	18-4037	21440	18-2600	22030	18-4251	22673	18-2209
16200	18-1194	21450	18-2603	22031	18-4273	22681	18-2289
16210	18-4038	21451	18-2190	22040	18-2156	22683	18-2287
16220	18-1374	21453	18-2604	22050	18-2178	22700	18-1362
16230	18-1376	21460	18-2159	22090	18-2380	22710	18-1377
16240	18-1375	21480	18-2396	22100	18-3740	22720	18-1099
16300	18-1366	21481	18-2397	22110	18-3741	22750	18-1112
16310	18-1371	21510	18-1165	22120	18-3742	22760	18-1113
16320	18-1367	21511	18-1179	22130	18-3743	22770	18-1114
16330	18-1365	21512	18-1129	22140	18-3744	22780	18-1115
16340	18-1370	21520	18-1160	22150	18-3705	22800	18-1352
16350	18-1363	21540	18-1161	22160	18-3706	22810	18-1353
16360	18-1364	21541	18-1170	22170	18-3707	22820	18-1361
16370	18-1368	21542	18-1172	22185	18-3708-1	22830	18-1378
16400	18-4039	21543	18-1171	22190	18-4231	22840	18-1359
16470	18-1347	21560	18-1142	22191	18-4274	22850	18-1360
16520	18-1196	21570	18-1164	22200	18-3715	22860	18-1350
17000	18-2402	21580	18-1143	22220	18-4223	22870	18-1351
18000	18-2401	21584	18-1193	22230	18-4222	22880	18-1357
18100	18-2443	21590	18-1159	22240	18-4230	22890	18-1354
19100	18-2450	21591	18-1173	22250	18-4228	22900	18-1355
19200	18-2451	21592	18-1130	22252	18-4194	22910	18-1358
19300	18-2452	21593	18-1197	22260	18-4232	22920	18-1372
19310	18-3729	21610	18-1117	22280	18-0550	22930	18-1373
19350	18-3728	21620	18-1155	22290	18-0549	22940	18-1369
19400	18-2453	21622	18-1346	22300	18-2377	22960	18-1118
21010	18-2154	21623	18-1345	22317	18-4244	22980	18-1121
21015	18-2353	21625	18-1398	22320	18-3153	22990	18-1122
21020	18-2155	21630	18-1162	22321	18-4276	23010	18-2778
21030	18-2150	21641	18-0193	22322	18-4277	23011	18-2777
21031	18-2320	21642	18-0195	22323	18-3133	23020	18-2939
21032	18-0647	21643	18-0194	22325	18-3365	23030	18-2199
21033	18-0655	21644	18-0198	22330	18-3725	23040	18-4210
21040	18-2193	21645	18-0200	22340	18-3717	23050	18-4213
21060	18-2164	21646	18-0199	22350	18-3716	23060	18-4214
21070	18-2165	21647	18-0196	22360	18-3369	23070	18-4211
21080	18-2141	21648	18-0197	22370	18-3135	23080	18-2153
21090	18-2163	21649	18-0201	22380	18-3136	23090	18-4204
21100	18-2151	21710	18-2157	22388	18-0653	23100	18-4206
21110	18-3750	21711	18-2145	22390	18-0190	23110	18-2194
21111	18-3768	21715	18-2245-1	22391	18-3233	23140	18-2342
21120	18-3751	21725	18-4236	22407	18-9219	23141	18-3759
21130	18-2152	21731	18-2375	22408	18-2279	23150	18-4208
21131	18-2357	21731	18-23751-9	22409	18-2277	23160	18-4209
21136	18-4295	21731	18-2378	22410	18-2185	23200	18-2346
21140	18-2161	21731	18-23781-9	22411	18-2184	23203	18-7296
21160	18-3720	21740	Obsolete	22412	18-2183	23210	18-2294
21161	18-2344	21740	18-6245	22413	18-2186	23220	18-2285
21170	18-3721	21750	18-2170	22414	18-2187	23230	18-4215
21180	18-3722	21770	18-4289	22416	18-2252	23240	18-4212
21190	18-3723	21771	18-2345	22417	18-2251	23260	18-2283
21210	18-3200	21780	18-2160	22420	18-2244	23261	18-2282
21220	18-3204-9	21790	18-7321	22420	18-22441-9	23270	18-2293
21230	18-3700	21791	18-7311	22420	18-2387	23280	18-2292
21231	18-3737	21800	18-4267	22420	18-23871-9	23300	18-2295
21240	18-3704	21811	18-2140	22421	18-2288	23510	18-2231
21241	18-3726	21820	18-1156	22430	Obsolete	23580	18-2230
21242	18-3703	21830	18-1166	22433	18-2326	23590	18-2229
21245	18-0654	21840	18-1153	22435	18-2327	23710	18-3931
21250	18-3701	21850	18-2101	22436	18-2330	23800	18-4122
21251	18-3782	21860	18-1154	22440	Obsolete	23810	18-4121
21260	18-3702	21870	18-3199	22445	18-8551	23810	18-4294
21261	18-3781	21880	18-3198	22490	18-2243-9	23820	18-4112
21290	18-4233	21885	18-1500	22491	18-1501	23830	18-4111
21300	18-4220	21887	18-8111	22500	18-4040	23840	18-4102
21321	18-8348	21890	18-3232	22520	18-1600	23850	18-4101
21330	18-7426	21892	18-4258	22560	18-1601	23910	18-4107
21350	18-4221	21893	18-4263	22612	18-2217	23930	18-4127

GLM (Cont.)		GLM (Cont.)		GLM (Cont.)		GLM (Cont.)	
GLM No.	Sierra No.	GLM No.	Sierra No.	GLM No.	Sierra No.	GLM No.	Sierra No.
23940	18-4123	26490	18-2466-9	30740	18-0359	31640	18-0988
23950	18-4113	27700	18-3767	30760	18-0918	31650	18-2572
23960	18-4103	27720	18-1731	30770	18-0131	31660	18-0356
24010	18-4120	27782	18-1712	30790	18-0410	31670	18-2552
24020	18-4110	27931	18-2192	30800	18-0922	31680	18-2501
24030	18-4100	28020	18-2104	30850	18-4366	31690	18-2509
24040	18-4124	28030	18-2174	30860	18-0868	31710	18-0992
24050	18-4065	28040	18-2097	30870	18-0363	31720	18-2835
24060	18-4114	28050	18-9218	30880	18-0926	31730	18-2573
24080	18-4104	28060	18-6401	30890	18-2513	31740	18-0434
24090	18-4067	28100	18-2128	30900	18-0133	31750	18-0158
24100	18-4066	28180	18-1152	30920	18-0928	31770	18-0903
24110	18-4125	28190	18-1151	30930	18-2512	31780	18-0942
24112	18-4115	28300	Obsolete	30940	18-0932	31790	18-0137
24130	18-4105	28310	18-2125	30970	18-0866	31810	18-2804
24140	18-4068	28315	18-2146	30980	18-0372	31820	18-0685
24210	18-3904	28317	18-2337	30990	18-0103	31830	18-0389
24240	18-3910	28318	18-2339	31000	18-0938	31840	18-2843
24250	18-3975	28325	18-2338	31010	18-2914	31850	18-0365
24260	18-3911	28330	18-3712	31020	18-2915	31860	18-2800
24280	18-3912	28340	18-6400	31030	18-2801	31870	18-0369
24290	18-3974	28350	18-3752	31040	18-2826	31880	18-0151
24300	18-3905	28360	18-3713	31050	18-2919	31890	18-2507
24310	18-3913	28370	18-0577	31060	18-2823	31900	18-0147
24330	18-3915	28380	18-2296	31070	18-2824	31900	18-0747
24410	18-4106	28390	18-4296	31080	18-2825	31920	18-2805
24430	18-3933	28400	18-2381	31090	18-2827	31930	18-2836
24430	18-4126	28402	18-2382	31100	18-0872	31940	18-0934
24570	18-3907	30010	18-2340	31100	18-2949	31950	18-2837
24590	18-3908	30020	18-0681	31101	18-2902	31960	18-0371
24830	18-7826	30030	18-2316	31105	18-8536	31970	18-0373
24840	18-7859	30050	18-0123	31110	18-2829	31980	18-0139
24841	18-7869	30060	18-0870	31120	18-2847	31990	18-0936
24880	18-7860	30090	18-2564-1	31130	18-2820	32000	18-2561
24900	18-7861	30100	18-0328	31141	18-2743	32010	18-2500
24910	18-7862	30120	18-0329	31150	18-0894	32030	18-5399
24930	18-7846	30160	18-0895	31160	18-2840	32040	18-0422
24940	18-7845	30170	18-0333	31170	18-29451-9	32050	18-2839
24941	18-7844	30180	18-0334	31171	18-42481-9	32070	18-0946
24950	18-7852-1	30190	18-1209	31180	18-2948	32080	18-2849
24951	18-7848-1	30220	18-0672	31190	18-2841	32090	18-2504
24970	18-7854	30230	18-0893	31200	18-2828	32100	18-2555
24980	18-7855	30240	18-0897	31210	18-2560	32110	18-0385
25000	18-7853-1	30260	18-2810	31220	18-2558	32120	18-2803
25110	18-8207	30270	18-2809	31230	18-2559	32130	18-0357
25115	18-2404	30290	18-2563	31260	18-2568	32140	18-0360
25120	18-8208	30290	18-2566	31270	18-2569	32150	18-2502
25125	18-2405	30300	18-4380	31280	18-2570	32160	18-0667
26030	18-2119	30320	18-2565	31300	18-2571-9	32170	18-2909
26040	18-2105	30330	18-0344	31310	18-2567	32175	18-8533
26050	18-2106	30350	18-0464-9	31330	18-4261	32180	18-0994
26060	18-2107	30351	18-1238	31340	18-0164	32190	18-2575
26070	18-2108	30353	18-0428	31350	18-0327	32200	18-2910
26080	18-2109	30353	18-2845	31360	18-0889	32210	18-0347
26090	18-2120	30354	18-0322	31370	18-0874	32220	18-0320
26100	18-2103	30357	18-0664	31380	18-0891	32280	18-2574
26110	18-2112	30359	18-0311	31390	18-0332	32300	18-0948
26120	18-2113	30360	18-0887	31400	18-0879	32320	18-2807
26130	18-2110	30363	18-0740	31410	18-2819	32330	18-0952
26140	18-2111	30370	18-0905	31420	18-1210	32350	18-0384
26170	18-2123	30380	18-2848	31430	18-2831	32360	18-2562
26180	18-2124	30381	18-0435	31440	18-2830	32370	18-0111
26190	18-2114	30390	18-0419	31450	18-2846	32390	18-0185
26200	18-2134	30410	18-0867	31460	18-2553	32400	18-0160
26200	18-2137	30430	18-2514	31470	18-0342	32420	18-2505
26210	18-2116	30440	18-0980	31480	18-0885	32440	18-2808
26220	18-2126	30450	18-0350	31490	18-2832	32450	18-2510
26240	18-2115	30470	18-0352	31500	18-2802	32460	18-0113
26250	18-2136	30480	18-0982	31510	18-2844	32470	18-0881
26310	18-2701	30490	18-0898	31520	18-2833	32480	18-0950
26320	18-2336	30510	18-0353	31530	18-0378	32500	18-0388
26330	18-2702-1	30530	18-0976	31540	18-0462	32510	18-2511
26340	18-4288	30570	18-0904	31550	18-2896	32520	18-2506
26350	18-2341	30580	18-0354	31560	18-2917	32530	18-2503
26400	18-2427	30610	18-0182	31570	18-2912	32540	18-2508-1
26410	18-2426	30640	18-0910	31580	18-2515	32560	18-0945
26440	18-0652	30670	18-0129	31590	18-0568	32580	18-0114
26460	18-2425	30680	18-2806	31600	18-2838	32600	18-0318
26470	18-2424	30700	18-0912	31620	18-2834	32630	18-0954
26480	18-2465-9	30730	18-0149	31630	18-2554	32640	18-2815

COMPETITIVE INTERCHANGE

GLM (Cont.)		GLM (Cont.)		GLM (Cont.)		GLM (Cont.)	
GLM No.	Sierra No.	GLM No.	Sierra No.	GLM No.	Sierra No.	GLM No.	Sierra No.
32650	18-7106	33770	18-2875	34790	18-0424	36820	18-0476
32680	18-0431	33780	18-0401	34800	18-1218	36830	18-2854
32730	18-0386	33790	18-0183-1	34850	18-1224	36840	18-0475
32740	18-0916	33795	18-8509	34870	18-0953	37000	18-4313
32750	18-0876	33800	18-0956	34880	18-0957	37010	18-4312
32760	18-0323	33810	18-0943	34890	18-0397	37020	18-4314
32770	18-0324	33820	18-0673	34910	18-3827	37100	18-2991
32780	18-0336	33830	18-2961	34920	18-3829	37110	18-0962
32800		33840	18-2947	34930	18-3830	37120	18-0869
18-2343-9		33850	18-2884	34940	18-3831	37130	18-0154
32820	18-0339	33860	18-2888-9	34950	18-3805	37150	18-0960
32830	18-0670	33870	18-2964	34960	18-3832	37190	18-0968
32840	18-0341	33880	18-3804	34970	18-0959	37200	18-0119
32870	18-0930	33890	18-3828	34980	18-0961	37210	18-0853
32880	18-0135	33900	18-0548	34990	18-0967	37220	18-0855
32890	18-0374	33910	18-0884	35020	18-2929	37240	18-0857
32920	18-0380	33930	18-0104	35030	18-0391	37250	18-0861
32930	18-0940	33950	18-0913	35060	18-0398	37260	18-0141
32940	18-0944	33960	18-0880	35070	18-0346	37290	18-0863
32950	18-0107	33970	18-0440	35070	18-0349	37310	18-0873
32960	18-0970	34000	18-0679	35080	18-2971	37320	18-0314
32980	18-2850	34010	18-3841-2	35090	18-2729	37330	18-0115
32990	18-2883-1	34020	18-2889	35180	18-0983	37360	18-0958
33010	18-2851	34030	18-2959	35190	18-0112	37370	18-0915
33020	18-0110	34040	18-2891	35200	18-0120	37400	18-0315
33030	18-0430	34050	18-2892	35320	18-0122	37410	18-0854
33050	18-0939	34080	18-0850	35330	18-0126	37430	18-0415
33060	18-2863	34090	18-2893-9	35340	18-0128	37470	18-0622
33080	18-2907	34120	18-0882	35360	18-0136	37490	18-0345
33090	18-2862	34140	18-2963	35370	18-0138	37500	18-0416
33100	18-2890	34150	18-2895	35380	18-0140	37520	18-0624
33110	18-2879	34200	18-2897	35390	18-0142	37530	18-0644
33120	18-2908	34220	18-2881	35400	18-0144	37540	18-0645
33130	18-2903	34230	18-0917	35410	18-0441	37550	18-0646
33140	18-2906	34240	18-3801	35420	18-0851	37560	18-0642
33150	18-2709	34250	18-3802	35430	18-1205	37570	18-0643
33170	18-2901	34260	18-0929	35440	18-1202	37590	18-0641
33180	18-2867	34280	18-3836	35460	18-0150	37630	18-2942
33190	18-2904	34290	18-2866	35480	18-0157	37640	18-2621
33210	18-2887	34300	18-0117	35540	18-0161	37650	18-2741
33220	18-2880	34310	18-2543	35620	18-0633	37660	18-2740
33230	18-2871	34320	18-2853	35650	Obsolete	37670	18-2943
33280	18-2876	34330	18-0969	35730	18-0978	37680	18-2611
33330	18-2861	34340	18-0971	35740	18-0130	37690	18-2610
33340	18-2860	34350	18-2878	35750	18-0987	37760	18-2582
33370	18-2900	34370	18-2544	35780	18-0965	37795	18-0626
33400	18-2960	34380	18-0979	35800	18-0963	37796	18-0628
33410	18-2865	34390	18-0981	35830	18-3895	37797	18-0627
33420	18-2855	34400	18-3837	35840	18-2954	39010	18-4386
33430	18-2877	34410	18-0189	35850	18-3861	39020	18-4387
33440	18-2858	34420	18-0975	35860	18-3862	39030	18-4385
33450	18-2874	34430	18-0989	35870	18-3864	39040	18-4381
33460	18-0973	34440	18-0675	35880	18-3863	39050	18-4383
33470	18-0947	34450	18-2547	35890	18-3871	39060	18-4384
33480	18-0949	34460	18-2550	35900	18-3872	39080	18-4303-1
33500	18-0677	34470	18-0995	35930	18-3866	39090	18-4304-1
33510	18-0955	34480	18-0997	35940	18-3896	39100	18-4358
33511	18-0108	34490	18-0999	35950	18-3838	39110	18-4382
33530	18-2873-9	34520	18-0124	35960	18-3897	39130	18-0340
33540	18-2956	34530	18-1212	35990	18-2957	39140	18-4350
33560	18-2856	34540	18-0134	36080	18-2968	39150	18-4351
33570	18-1204	34550	18-2865	36090	18-2970	39160	18-0407
33580	18-0680	34560	18-3360	36100	18-3879	39170	18-0465
33590	18-2545	34570	18-3803	36100	18-7879-1	39180	18-4352
33600	18-2546	34580	18-2905	36110	18-3877	39190	18-4353
33610	18-0148	34590	18-3839	36120	18-3878	39230	18-0153
33620	18-2549	34610	18-2913	36130	18-3880	39240	18-4357
33630	18-0985	34620	18-2938	36140	18-3881	39250	18-4319
33640	18-2864	34630	18-2548	36150	18-2946	39260	18-0411
33650	18-0977	34640	18-0933	36160	18-3876	39270	18-4396
33660	18-0991	34650	18-0927	36170	18-3883	39280	18-4394
33680	18-0102	34700	18-0937	36180	18-3887	39290	18-4395
33690	18-0106	34710	18-0188	36200	18-3825	39300	18-4398
33700	18-3899	34720	18-2911	36220	18-3822	39310	18-4399
33710	18-2852	34730	18-2918	36230	18-3823	39320	18-4367
33730	18-2557	34740	18-0935	36240	18-3824	39330	18-4355
33740	18-0118	34750	18-0923	36250	18-3820	39331	18-4340
33750	18-2857	34770	18-2916	36260	18-3814	39332	18-4339
33760	18-0418	34771	18-0911	36290	18-3855	39333	18-4336
33765	18-8532	34780	18-0941	36300	18-3857	39335	18-4334

GLM (Cont.)		GLM (Cont.)		GLM (Cont.)		GLM (Cont.)	
GLM No.	Sierra No.	GLM No.	Sierra No.	GLM No.	Sierra No.	GLM No.	Sierra No.
39336	18-4326	40580	18-7220	51420	18-1903	71530	18-5386
39337	18-4325	40600	18-7219	51430	18-1986	71540	18-5385
39338	18-4338	40610	18-7212	51442	18-1901	71550	18-5389
39340	18-4315	40620	18-7213	51480	18-1848	71560	18-5352
39350	18-4300	40630	18-7214	51510	18-1935-1	71570	18-5369
39350	18-4302	40640	18-7215	51520	18-1936	71580	18-5375
39354	18-4310	40650	18-7750-1	51610	18-1930-1	71590	18-5376
39355	18-4324	40651	18-7226	51630	18-1931-1	71600	18-5353
39360	18-4301	40710	18-7093	51640	18-1932	71710	18-5269
39370	18-4305	40720	18-7094	52080	18-1938	71720	18-5268
39380	18-4306	40800	18-7801	52090	18-1984	71730	18-5275
39390	18-4321	40810	18-7823	52230	18-1983	71740	18-5277
39400	18-4322	40820	18-7820	52240	18-1982	71750	18-5276
39410	18-4323	40830	18-7821	53100	18-4362	71760	18-5271
39420	18-4307	40840	18-7822	53300	18-8529	71770	18-5267
39430	18-4309	40850	18-7800	53330	18-8554	71780	18-5273
39440	18-4317	40860	18-7805	53360	18-8556	71790	18-5274
39470	18-0466	40870	18-7806-1	53430	18-8555	71800	18-5272
39490	18-0348	40900	18-7233	53770	18-8539	71810	18-5281
39500	18-0611	40910	18-7061	54110	18-1899	71820	18-5278
39520	18-4359	40920	18-7057	54250	18-1996	71830	18-5280
39550	18-4356	40930	18-7041	56030	18-1949	72010	18-5179
39560	18-4316	40950	18-7062	56110	18-1999	72020	18-5196
39590	18-2614	40970	18-7295	56120	18-1907	72030	18-5172
39600	18-2620	41120	18-7477	56140	18-1939	72040	18-5192
39620	18-2619-1	44990	18-7956	56230	18-1997-1	72050	18-5194
39630	18-2613	45010	18-4217	56240	18-1898	72060	18-5170
39640	18-2615	45020	18-7179	56250	18-1998-1	72080	18-5176
39650	18-4388	45030	18-7180	70010	18-5303	72100	18-5181
39660	18-4389	45050	18-7190	70020	18-5311	72110	18-5433
39670	18-4390	45060	18-7181	70030	18-5310	72113	18-5443
39690	18-4392	45080	18-7183	70040	18-5318	72114	18-5442
39700	18-4393	45090	18-7184	70050	18-5317	72115	18-5434
39710	18-4375	45100	18-7186	70060	18-5314	72120	18-5178
39720	18-4376	45160	18-7194	70070	18-5156	72130	18-5108
39730	18-4337	45170	18-7185	70080	18-5157	72240	18-5740
39750	18-4379	45180	18-7187	70082	18-5305	72260	18-5711
39770	18-4369	45200	18-7137	70100	18-5306	72310	18-5707
39790	18-4371	45230	18-7100	70110	18-5148	72320	18-5708
39800	18-4372	45250	18-0298	70160	18-5153	72350	18-5709
39810	18-4373	45280	18-7405	70170	18-5140	72360	18-5801
39820	18-4374	46100	18-1219	70200	18-5141	72370	18-5815
39830	18-4368	46110	18-1221	70500	18-5349	72380	18-5820
39840	18-0405	46120	18-3562	70510	18-5347	72390	18-5816
39850	18-1237	46130	18-1222	70520	18-5344	72400	18-5817
39870	18-4347-1	46140	18-3567	70530	18-5345	72402	18-5819
39880	18-4349	46150	18-1243	70540	18-5346	72403	18-5812
39890	18-4348	46160	18-3565	70570	18-5199	72410	18-5802
39910	18-0604	46170	18-3564	70580	18-5338	72420	18-5807
39920	18-0603	46180	18-3563	70590	18-5200	72430	18-5808
40130	18-7832	47110	18-3602	70591	18-5348	72440	18-5814
40130	18-7838	47120	18-3601	70640	18-5205	72460	18-5837
40140	18-7829	47130	18-3603	70660	18-5169	72480	18-5836
40150	18-7830	50006	18-4008	70670	18-5212	72490	18-5838
40160	18-7831	50310	18-1908K	70680	18-5206	72500	18-5834
40280	18-7818-1	50330	18-1906	71000	18-5428	72510	18-5297
40290	18-7817	50610	18-1985	71020	18-5418	72520	18-5296-2
40310	18-7804	51010	18-4009	71030	18-5420	72530	18-5298-1
40320	18-7807	51030	18-1990	71040	18-5404-1	72540	18-5299
40330	18-7808	51110	18-1970-2	71050	18-5407	72550	18-5295
40340	18-7809	51120	18-1971	71050	18-5425	72570	18-5294
40350	18-7811	51130	18-1972	71060	18-5403	72590	18-5265
40360	18-7812	51140	18-1976-1	71070	18-5432	72600	18-5284
40370	18-7813	51160	18-1975-1	71080	18-5431	72610	18-5250
40380	18-7814	51180	18-1937	71090	18-5411	72620	18-5251
40390	18-7810	51190	18-1978	71100	18-5405	72630	18-5252
40410	18-7004	51210	18-1956-1	71110	18-5408	72640	18-5253
40420	18-7005	51212	18-1955-1	71120	18-5406	72650	18-5260
40435	18-7006-1	51220	18-1952-1	71130	18-5403	72660	18-5258
40460	18-7007	51224	18-1960-1	71400	18-5354	72660	18-5264
40470	18-7013	51230	18-1953-2	71410	18-5362	72670	18-5254
40480	18-7021	51237	18-1950-1	71420	18-5361	72680	18-5256
40490	18-7211-1	51238	18-1951-1	71450	18-5393	72800	18-5011
40500	18-7033	51240	18-1957-1	71460	18-5394	72810	18-5006
40501	18-7037	51250	18-1958-1	71470	18-5356	72820	18-5002
40510	18-7043	51252	18-1962-1	71480	18-5358	72830	18-5003
40530	18-7024	51320	18-1921	71490	18-5357	72840	18-5001
40550	18-7223	51330	18-1909	71500	18-5396	72970	18-5012
40560	18-7042	51340	18-1922	71510	18-5395	72980	18-5008
40570	18-7046	51410	18-1902	71520	18-5384	73010	18-5705

COMPETITIVE INTERCHANGE

GLM (Cont.)		GLM (Cont.)		GLM (Cont.)		GLM (Cont.)	
GLM No.	Sierra No.	GLM No.	Sierra No.	GLM No.	Sierra No.	GLM No.	Sierra No.
73020	18-5704	79210	18-7603	82310	18-7152	86090	18-2073
73110	18-5116-1	80070	18-7421	82320	18-7140	86100	18-3111
73120	18-5115-1	80080	18-7141	82340	18-7151	86120	18-2025
73180	18-6769-1	80090	18-7120	82350	18-7121	86130	18-2536
73190	18-5107-1	80100	18-7101	82360	18-7172	86140	18-2532
74000	18-5750	80100	18-7109	82370	18-7127	86150	18-2027
74000	18-5950	80100	18-7406	82380	18-7169	86160	18-2059
74000	18-5956	80110	18-7413	82390	18-7167	86170	18-2028
74001	18-5951	80120	18-7168	82400	18-7133	86180	18-2029
74001	18-5957	80130	18-7102	82430	18-7407	86190	18-2031
74100	18-5903	80140	18-7165	82440	18-7144	86200	18-2033
74110	18-5904	80160	18-7166	82460	18-7418	86210	18-2537
74140	18-5905	80160	18-7466	82480	18-7107	86230	18-2539
74140	18-5910	80170	18-7410	82900	18-7957	86240	18-2061
74150	18-5900	80180	18-7105	83200	18-7139	86250	18-2062
74150	18-5911	80220	18-7129	83250	18-7138	86270	18-2063
74170	18-5902	80330	18-7414	83340	18-7160	86300	18-2996
74170	18-5908	80350	18-7412	83410	18-7157	86310	18-2516
74180	18-5901	80380	18-7177	83440	18-7159	86350	18-2021
74180	18-5907	80390	18-7195	84026	18-7474	86360	18-2022
74190	18-5913-1	80420	18-7161	85010	18-2016	86370	18-2000
75370	18-5755	81030	18-7197	85020	18-2049	86380	18-2018
75380	18-5759	81070	18-7111	85030	18-2003	86390	18-2023
75390	18-5760	81080	18-7145	85040	18-2013	86400	18-2024
75400	18-5758	81090	18-7404	85040	18-2026	86410	18-2005
76068	18-7070	81100	18-7116	85050	18-2009	86420	18-2030
76068	18-7746	81100	18-7417	85060	18-2056	86430	18-2032
76081	18-7081	81120	18-7134	85070	18-2014	86440	18-2074
76082	18-7080	81140	18-7174	85080	18-2011	86450	18-2035
76082	18-7089	81140	18-7416	85090	18-0523	86460	18-2064
76083	18-7076	81160	18-7158	85100	18-2019	86470	18-2075
76084	18-7078	81170	18-7440-1	85110	18-2012	86480	18-2704
76085	18-7097	81180	18-7153	85120	18-2051	86481	18-2391
76086	18-7098	81190	18-7103	85130	18-2002	86490	18-2703
76088	18-7017	81210	18-7408	85130	18-2077	86491	18-2705-9
76096	18-7096	81220	18-7146	85140	18-2944	86492	18-3329
76101	18-7000	81230	18-7156	85150	18-0521	86494	18-3337
76102	18-7001	81230	18-7409	85160	18-0583	86496	18-2392
76103	18-7008	81240	18-7411	85170	18-0522	86497	18-2708
76104	18-7040	81250	18-7143	85200	18-0563	86500	18-2706
76105	18-7085	81260	18-7164	85210	18-2015	86510	18-2034
76107	18-7075	81270	18-7198	85230	18-0514	86520	18-2065
76111	18-7071	81280	18-7403	85260	18-0515	86530	18-2067
76120	18-7086	81290	18-7461	85270	18-0516	86540	18-2769
76123	18-7077	81310	18-7126	85290	18-2017	86570	18-7481
76150	18-7095	81320	18-7457	85330	18-2006	86610	18-2068
76160	18-7072	81340	18-7128	85380	18-0525	86620	18-0166
77010	18-1256	81360	18-7171	85440	18-0517	86630	18-2541
77010	18-7256	81380	18-7130	85460	18-0527	86640	18-7475
77011	18-7286	81390	18-7176	85480	18-2008	86654	18-8352
77040	18-7267	81400	18-7123	85490	18-1211	86660	18-7963
77050	18-7266	81430	18-0858	85520	18-2052	86700	18-2767
77060	18-7265	81430	18-7163	85530	18-2053	86710	18-2768
77070	18-7274	81440	18-7401	85580	18-2055	86711	18-2724
77080	18-7269	81450	18-7108	85581	18-2054	86712	18-2692
77090	18-7275	81470	18-7419	85590	18-2599	86720	18-1240
77101	18-7263	81510	18-7467	85600	18-2007	86740	18-0173
77102	18-7268	81520	18-0860	85610	18-2010	86750	18-0174
77103	18-7270	81540	18-7110	85630	18-0539	86760	18-0542
77105	18-7260	81550	18-7400	85680	18-2048	86760	18-0592
77106	18-7272	81570	18-7449	85700	18-2076	86770	18-0543
77108	18-7271	82030	18-7118	85790	18-0519	86790	18-8307
77113	18-7284	82050	18-7472	85800	18-0526	86810	18-8367
77114	18-7278	82060	18-7959	85810	18-0531	86840	18-0584
77115	18-7289	82080	18-7490	85830	18-0540	87010	18-2990
77116	18-7288	82100	18-7135	85840	18-8353	87020	18-2047
77200	18-4200	82110	18-7420	85850	18-2349	87030	18-2040
77200	18-7200	82130	18-7178	85860	18-1508	87050	18-2043
77220	18-7201	82140	18-7114	85910	18-2094	87060	18-2041
77230	18-7202	82150	18-7117	85960	18-0520	87070	18-2057
77250	18-7208	82170	18-7112	86010	18-2071	87120	18-2093
77260	18-72000	82200	18-7170	86011	18-8300	87130	18-8351
77290	18-7210	82230	18-7155	86012	18-8301	87140	18-8350
79110	18-7605	82240	18-7115	86013	18-8325	87400	18-2649
79120	18-7615	82240	18-7464	86030	18-2001	87410	18-2291
79120	18-7618	82250	18-7173	86040	18-2020	87480	18-2643
79140	18-7616	82260	18-7162	86050	18-2058	87490	18-2645-1
79150	18-7617	82270	18-7196	86060	18-2060	87500	18-2648
79180	18-7609	82280	18-7104	86070	18-2066	87501	18-2644
79190	18-7608	82280	18-7459	86080	18-2072	87510	18-2652

GLM (Cont.)		GLM (Cont.)		MALLORY		MALLORY (Cont.)	
GLM No.	Sierra No.	GLM No.	Sierra No.	MALLORY No.	Sierra No.	MALLORY No.	Sierra No.
87511	18-2646-1	89224	18-2779	9-01102	18-01000	9-15042	18-6282
87513	18-2642	89230	18-2781	9-01103	18-01100	9-15043	18-5627
87520	18-2653	89240	18-4456	9-01208	18-01302	9-15044	18-6828
87530	18-2654	89250	18-4457	9-01209	18-01308	9-15045	18-6829
87540	18-2655	89260	18-4458	9-01210	18-01311	9-15046	18-6422
87550	18-2590	89450	18-3030	9-01211	18-01312	9-15048	18-6432
87561	18-2622	89451	18-3062	9-01212	18-01313	9-15049	18-6411
87562	18-3760	89480	18-3006	9-01213	18-01314	9-15050	18-6421
87573	18-2627	89490	18-3090	9-01214	18-01301	9-15051	18-6416
87574	18-2628	89500	18-3091	9-01301	18-01200	9-15052	18-6410
87575	18-2629	89510	18-3079	9-01302	18-01202	9-15053	18-6430
87576	18-2697-1	89520	18-3080	9-01412	18-01404	9-15054	18-6417
87580	18-8371	89530	18-3075	9-01413	18-01406	9-15055	18-6425
87590	18-2626	89540	18-3081	9-01414	18-01408	9-15056	18-6414
87600	18-2623	89550	18-3077	9-01416	18-01402	9-15057	18-3423
87601	18-2660	89560	18-3078	9-01417	18-01416	9-15058	18-6427
87602	18-2656	89570	18-3059	9-01418	18-01418	9-15059	18-6426
87603	18-2659	89580	18-3001	9-01419	18-01707	9-15060	18-6433
87604	18-2679	89590	18-3299	9-01420	18-01422	9-15061	18-15061
87605	18-2682	89592	18-3138	9-01504	18-03200	9-15062	18-6418
87606	18-2684	89593	18-3295	9-01505	18-03206	9-15063	18-6833
87607	18-2686	89595	18-3108	9-01506	18-03208	9-15070	18-6873
87608	18-2689	89596	18-3326	9-01601	18-01500	9-15074	18-6868
87609	18-2690	89600	18-3012	9-01703	18-03400	9-15075	18-6868
87611	18-2691	89610	18-3060	9-01704	18-03404	9-15076	18-6908
87614	18-2694	89611	18-3061	9-01805	18-01600	9-15077	18-6867
87616	18-2680	89612	18-3044	9-01806	18-01602	9-15078	18-6862
87617	18-2681	89614	18-8903	9-02003	18-03600	9-15080	18-15080
87618	18-2683	89615	18-8901	9-02004	18-03602	9-15100	BA58003
87619	18-2685	89620	18-3046	9-02005	18-03606	9-15101	18-5806
87620	18-2663	89621	18-3047	9-02006	18-03608	9-15102	18-5837
87621	18-2687	89630	18-3056	9-02108	18-01701	9-15103	18-5836
87622	18-2688	89640	18-3057	9-02109	18-01703	9-15104	18-5808
87630	18-2665	89650	18-3002	9-02110	18-01705	9-15104-10	18-5808
87640	18-2664	89660	18-3083	9-02201	18-07400	9-15105	18-5801
87650	18-2667	89680	18-3043	9-02412	18-09200	9-15106	18-5802
87651	18-2666	89690	18-3055	9-02413	18-09202	9-15107	18-5812
87652	18-2669	89710	18-3053	9-02416	18-09400	9-15108	18-5814
87653	18-2670	89740	18-3087	9-02418	18-09602	9-15109	18-5807
87654	18-2673	89750	18-3051	9-02419	18-09606	9-15110	18-5810
87655	18-2671	89760	18-3086	9-15000	18-5640	9-15111	18-5815
87656	18-2672	89770	18-3050	9-15001	18-5601	9-15112	18-5817
87660	18-2698	89780	18-3368	9-15002	18-5642	9-15112-10	18-5817
87670	18-8360	89790	18-3104	9-15003	18-5608	9-15113	18-5816
87680	18-2658	89800	18-3054	9-15004	18-5613	9-15115	18-5819
87690	18-2657	89810	18-3039	9-15005	18-5629	9-15116	18-5820
87700	18-2625	89820	18-3052	9-15006	18-5630	9-15117	18-5834
87800	18-2630	89830	18-3007	9-15007	18-5634	9-15118	18-5823
87802	18-2637	89840	18-3017	9-15008	18-5648	9-15119	18-5833
87803	18-2632	89850	18-3072	9-15009	18-5636	9-15120	18-5853
87804	18-2638	89860	18-3073	9-15010	18-6441	9-15121	18-5821
87805	18-2639	89870	18-3066	9-15011	18-5617	9-15122	18-5879
87806	18-2633	89880	18-3074	9-15012	18-6439	9-15125	18-5811
87807	18-2640	89890	18-3067	9-15013	18-5622	9-15200	18-5705
87808	18-2624	89900	18-3068	9-15014	18-5618	9-15200-10	18-5705
87809	18-2635	89910	18-3069	9-15015	18-5622	9-15201	18-6271
87810	18-2636	89920	18-3070	9-15016	18-5621	9-15202	18-6268
88170	18-7175	89930	18-3071	9-15017	18-6437	9-15203	18-5821
89010	18-2757	89940	18-3082	9-15018	18-6438	9-15210	18-5849
89020	18-2758	89950	18-3058	9-15019	18-6436	9-15211	18-5851
89030	18-2744	89990	18-3366	9-15020	18-5619	9-15212	18-5852
89040	18-2752	90050	18-4442	9-15021	18-6434	9-15213	18-5850
89050	18-2751	90065	18-4446	9-15022	18-5611	9-15214	18-15214
89060	18-2759	90070	18-9099	9-15023	18-6415	9-15450	18-65450
89070	18-2762	90100	18-9803	9-15024	18-5602	9-15500	18-69550
89080	18-2753-2	90110	18-9806E	9-15025	18-5605	9-15501	18-15501
89090	18-2761	90140	18-9817	9-15026	18-5605	9-15510	18-8220
89100	18-2750	90160	18-9853	9-15027	18-5610	9-15900	18-5913-1
89120	18-2748	90170	18-9855	9-15028	18-5620	9-15901	18-5919-1
89130	18-2746	90180	18-9856	9-15029	18-5636	9-15902	18-5962-9
89140	18-2756	90190	18-9858	9-15030	18-6825	9-15903	18-5910
89150	18-2760	90200	18-9861	9-15031	18-6283	9-15904	18-5910
89160	18-2733	90210	18-9857	9-15032	18-5612	9-15905	18-5907
89170	18-2732	90220	18-9854	9-15034	18-5624	9-15906	18-6937
89180	18-2747	90230	18-9868	9-15036	18-5628	9-15907	18-6275-1
89190	18-2764	90240	18-9842	9-15037	18-6826	9-15908	18-5603
89200	18-2765	90260	18-9837	9-15038	18-6413	9-17100	18-5707
89210	18-2763	90270	18-9829	9-15039	18-6440	9-17101	18-5743
89220	18-2745	90280	18-9819	9-15040	18-5631	9-17200	18-5708
89222	18-2780			9-15041	18-6863	9-17201	18-5709

MALLORY (Cont.)		MALLORY (Cont.)		MALLORY (Cont.)		MALLORY (Cont.)	
MALLORY No.	Sierra No.	MALLORY No.	Sierra No.	MALLORY No.	Sierra No.	MALLORY No.	Sierra No.
9-17202	18-5827	9-19109	18-5983	9-25510	18-5874	9-28029	18-8820-1
9-17203	18-5825	9-19110	18-6293	9-25511	18-5875	9-28030	18-8802-1
9-17204	18-5829	9-19111	18-6298	9-25512	18-5876	9-28031	18-8838-1
9-17205	18-5831	9-19112	18-6454	9-25601	18-5183	9-28032	18-8801-1
9-17206	18-5828	9-19113	18-5957	9-25602	18-25602	9-28035	18-8807-1
9-17207	18-5832	9-19114	18-5943	9-25604	18-25604	9-28039	18-8817-1
9-17208	18-5830	9-19115	18-5959	9-25605	18-25605	9-28042	18-28042
9-17300	18-17300	9-19116	18-19116	9-25650	18-25650	9-28043	18-8823-1
9-18100	18-6756	9-19200	18-6960	9-25651	18-25651	9-28044	18-28044
9-18101	18-6767-1	9-19201	18-6455	9-25652	18-25652	9-28046	18-28046
9-18102	18-6761	9-19202	18-5929	9-26000	18-5480	9-28050	18-28050
9-18103	18-6780	9-19203	18-6844	9-26002	18-26002	9-28056	18-8833-1
9-18104	18-6759	9-19204	18-6455	9-26101	18-5309-1	9-28057	18-8829-1
9-18105	18-6285	9-23100	18-5192	9-26102	18-5312-1	9-28060	18-8818-1
9-18106	18-6281	9-23101	18-5196	9-26103	18-5339-1	9-28080	18-28080
9-18107	18-6277	9-23102	18-5181	9-26104	18-26104-1	9-28081	18-28081
9-18108	18-6816	9-23103	18-5176	9-26105	18-5313-1	9-28082	18-28082
9-18110	18-5632	9-23104	18-5170	9-26106	18-5315-1	9-28083	18-28083
9-18200	18-6279	9-23105	18-5194	9-26107	18-26107-1	9-28084	18-28084
9-18201	18-6774	9-23106	18-5172	9-26110	18-26110-1	9-28085	18-28085
9-18202	18-6775	9-23107	18-5179	9-26111	18-26111-1	9-28086	18-28086
9-18203	18-6777	9-23200	18-5186	9-26112	18-26112-1	9-28090	18-8840-1
9-18204	18-6773	9-23201	18-5187	9-26301	18-5495-2	9-28091	18-8810-1
9-18205	18-6273-1	9-23204	18-5185	9-26302	18-5489-2	9-28092	18-8839-1
9-18206	18-6273-1	9-23206	18-5180	9-26303	18-5496-2	9-28100	18-28100
9-18207	18-6772	9-23250	18-23250	9-26305	18-5497-2	9-28101	18-28101
9-18208	18-18208	9-23251	18-23251	9-26306	18-5494-2	9-28102	18-28102
9-18209	18-6279	9-24500	18-5888	9-26307	18-5498-1	9-28120	18-5225
9-18210	18-6799	9-24501	18-5889	9-26308	18-5486-2	9-28122	18-5224
9-18211	18-6286	9-24502	18-5890	9-26309	18-5487-2	9-28123	18-5752
9-18212	18-6765	9-25000	18-5759	9-26310	18-26310-2	9-28124	18-5750
9-18213	18-6273-1	9-25001	18-5760	9-26311	18-26311-2	9-28150	18-28150
9-18214	18-6757	9-25002	18-5758	9-26700	18-5484-1	9-28151	18-28151
9-18215	18-6774	9-25004	18-5782	9-26702	18-5476	9-28175	18-28175
9-18300	18-6785	9-25005	18-5783	9-26750	18-5350	9-29000	18-5317
9-18301	18-6786-1	9-25006	18-5784-1	9-26751	18-5351	9-29001	18-5148
9-18302	18-6793	9-25007	18-5761	9-26800	18-26800	9-29002	18-5307
9-18303	18-18303	9-25008	18-5762	9-26804	18-26804	9-29003	18-5310
9-18304	18-18304	9-25009	18-5763	9-26807	18-26807	9-29004	18-5303
9-18305	18-18305	9-25010	18-5764	9-26810	18-26810	9-29005	18-5314
9-18306	18-6822	9-25011	18-5766-1	9-26811	18-26811	9-29006	18-5311
9-18400	18-6782	9-25012	18-5767	9-26812	18-26812	9-29008	18-5156
9-18401	18-6789	9-25013	18-5785	9-26813	18-26813	9-29009	18-5318
9-18402	18-6783-1	9-25017	18-5772-1	9-26815	18-26815	9-29100	18-5345
9-18403	18-6821	9-25018	18-5773	9-26820	18-26820	9-29101	18-5338
9-18405	18-6760	9-25019	18-5781	9-26821	18-26821	9-29102	18-5169
9-18406	18-6259	9-25020	18-5893	9-26823	18-26823	9-29103	18-5344
9-18407	18-6781	9-25021	18-5770-1	9-26825	18-26825	9-29104	18-5345
9-18408	18-6788	9-25022	18-5891	9-26900	18-5297	9-29107	18-5348
9-18409	18-18409	9-25023	18-5892	9-26901	18-5294	9-29108	18-5347
9-18410	18-6787	9-25024	18-5885	9-26902	18-5299	9-29109	18-5206
9-18411	18-6798	9-25026	18-5794-1	9-26903	18-5298-1	9-29110	18-5207
9-18412	18-6836	9-25027	18-5887	9-26904	18-5296-2	9-29114	18-5346
9-18500	18-6769-1	9-25028	18-5774-1	9-28000	18-8803-2	9-29200	18-5431
9-18540	18-6823	9-25029	18-5780	9-28001	18-8804-1	9-29201	18-5407
9-18600	18-6755	9-25030	18-5884	9-28002	18-8804-1	9-29202	18-5418
9-18601	18-6257	9-25100	18-5775	9-28003	18-8802-1	9-29203	18-5403
9-18602	18-6779	9-25101	18-5776	9-28004	18-8811-1	9-29204	18-5419
9-18603	18-6758	9-25102	18-5777	9-28005	18-5228-1D	9-29205	18-5428
9-18604	18-6274	9-25103	18-5778	9-28006	18-5231-1	9-29206	18-5102
9-18607	18-6754	9-25104	18-5881	9-28009	18-8828-1	9-29207	18-5404-1
9-18608	18-6790	9-25105	18-5787	9-28010	18-8803-2	9-29208	18-5430
9-18609	18-6791	9-25107	18-5790	9-28011	18-8832-1	9-29209	18-5405
9-18610	18-6792	9-25108	18-5791	9-28012	18-8803-2	9-29210	18-5411
9-18611	18-6771	9-25109	18-5793	9-28013	18-8813-1	9-29211	18-5427
9-18612	18-6778	9-25110	18-5792	9-28014	18-8808-2	9-29212	18-5428
9-18613	18-6822	9-25200	18-25200	9-28015	18-8801-1	9-29213	18-5429
9-18614	18-6804	9-25201	18-25201	9-28016	18-8810-1	9-29214	18-5403
9-18615	18-6806	9-25300	18-25300	9-28017	18-8809-1	9-29217	18-5245
9-18616	18-6274	9-25302	18-5132	9-28018	18-28018	9-29218	18-5432
9-18618	18-18618	9-25400	18-25400	9-28019	18-8845-1	9-29220	18-5406
9-19100	18-5956	9-25500	18-5854	9-28020	18-8800-1	9-29221	18-5408
9-19101	18-5966	9-25502	18-5857	9-28021	18-8803-2	9-29222	18-5402
9-19102	18-5967	9-25503	18-5859	9-28022	18-8823-1	9-29223	18-5413
9-19103	18-5965	9-25504	18-5860	9-28023	18-8835-1	9-29300	18-5250
9-19104	18-5960	9-25505	18-5864	9-28024	18-8830-1	9-29301	18-5251
9-19105	18-6927	9-25506	18-5865	9-28025	18-8805-1	9-29303	18-5256
9-19106	18-5959	9-25507	18-5870	9-28026	18-8806-1	9-29304	18-5260
9-19107	18-6299	9-25508	18-5871	9-28027	18-8814-1	9-29305	18-5264
9-19108	18-5984	9-25509	18-5873	9-28028	18-8811-1	9-29307	18-5284

MALLORY (Cont.)		MALLORY (Cont.)		MALLORY (Cont.)		MALLORY (Cont.)	
MALLORY No.	Sierra No.	MALLORY No.	Sierra No.	MALLORY No.	Sierra No.	MALLORY No.	Sierra No.
9-29308	18-5281	9-32100	18-7655	9-34602	18-34602	9-37107	18-7222
9-29309	18-5260	9-32101	18-7656	9-34603	18-34603	9-37108	18-7221
9-29310	18-5258	9-32150	18-32150	9-34604	18-34604	9-37109	18-7219
9-29311	18-5268	9-32151	18-32151	9-34605	18-34605	9-37110	18-7220
9-29312	18-5272	9-32201	18-7658	9-35000	18-35000	9-37300	18-7005
9-29313	18-5271	9-33100	18-33100	9-35102	18-35102	9-37302	18-7013
9-29314	18-5276	9-33102	18-7688	9-35300	18-7334	9-37303	18-7211-1
9-29315	18-5275	9-33104	18-33104	9-35301	18-7349	9-37304	18-7212
9-29316	18-5277	9-33105	18-7686	9-35302	18-35302	9-37305	18-7213
9-29317	18-5274	9-33106	18-7685	9-35305	18-7334	9-37306	18-7007
9-29318	18-5247	9-33107	18-7689	9-35325	18-7839	9-37307	18-7007
9-29319	18-5246	9-33200	18-7652	9-35326	18-7843	9-37308	18-7006-1
9-29320	18-5280	9-33201	18-33201	9-35327	18-7788	9-37309	18-7354
9-29321	18-5278	9-33202	18-7683	9-35328	18-7787	9-37310	18-7355
9-29323	18-5012	9-33207	18-33207	9-35329	18-7822	9-37311	18-7356
9-29324	18-5283	9-33208	18-7663	9-35345	18-0849	9-37400	18-7752
9-29330	18-5012	9-33209	18-33209	9-35350	18-7350	9-37401	18-7773
9-29350	18-5273	9-33210	18-7662	9-35351	18-7351	9-37402	18-7753
9-29351	18-5012	9-33211	18-33211	9-35352	18-7352	9-37403	18-7754
9-29400	18-5396	9-33301	18-7695	9-35353	18-7353	9-37404	18-7755
9-29401	18-5385	9-33302	18-7692	9-35400	18-7254	9-37500	18-7293
9-29402	18-5376	9-33303	18-7696	9-35401	18-7255	9-37501	18-7291
9-29403	18-5395	9-33304	18-7693	9-35402	18-7256	9-37502	18-7766
9-29404	18-5393	9-33305	18-7690	9-35404	18-7258	9-37503	18-7768
9-29405	18-5394	9-33306	18-7694	9-35405	18-7260	9-37504	18-7747
9-29406	18-5356	9-33400	18-7697	9-35408	18-7264	9-37505	18-7765
9-29407	18-5386	9-33401	18-7632	9-35409	18-7265	9-37506	18-7769
9-29408	18-5384	9-33402	18-7704	9-35410	18-7266	9-37507	18-7772
9-29409	18-5357	9-33403	18-7705	9-35411	18-7267	9-37508	18-7737
9-29410	18-5358	9-33500	18-7703	9-35412	18-7268	9-37509	18-7756
9-29411	18-5354	9-33503	18-7677	9-35414	18-7270	9-37510	18-7738
9-29412	18-5352	9-33504	18-7679	9-35416	18-7272	9-37511	18-7736
9-29413	18-5369	9-33600	18-7668	9-35417	18-7274	9-37512	18-7743
9-29414	18-5359	9-33601	18-7684	9-35418	18-7275	9-37513	18-7741
9-29416	18-5375	9-33602	18-7682	9-35419	18-7278	9-37514	18-7747
9-29417	18-29417	9-33603	18-7668	9-35421	18-7281	9-37515	18-7742
9-29418	18-5397	9-33604	18-7660	9-35422	18-7282	9-37516	18-7759
9-29419	18-5244	9-33700	18-7757	9-35423	18-7283	9-37517	18-7739
9-29420	18-5243	9-33701	18-7630	9-35424	18-7284	9-37518	18-7744
9-29421	18-5389	9-33702	18-7700	9-35425	18-7286	9-37519	18-7740
9-29423	18-5248	9-33800	18-33800	9-35426	18-7288-1	9-37600	18-7000
9-29424	18-5361	9-33850	18-7513	9-35427	18-7289	9-37601	18-7001
9-29425	18-5362	9-34000	18-7609-1	9-35428	18-7326	9-37602	18-7008
9-29426	18-5353	9-34001	18-7608-1	9-35429	18-7326	9-37603	18-7085
9-29700	18-5433	9-34002	18-7610-1	9-35430	18-7330	9-37604	18-7071
9-29701	18-5438	9-34003	18-7603-1	9-35431	18-7331	9-37605	18-7075
9-29702	18-5434	9-34004	18-7615-1	9-35433	18-35433	9-37606	18-7076
9-29703	18-5435	9-34005	18-7616-1	9-35434	18-7333	9-37607	18-7078
9-29704	18-7492	9-34006	18-7617-1	9-35435	18-35435	9-37608	18-7081
9-29705	18-5437	9-34007	18-7605-1	9-35436	18-35436	9-37610	18-7086
9-29707	18-5436	9-34008	18-7618-1	9-35437	18-35437	9-37611	18-7096
9-29708	18-5443	9-34009	18-7604-1	9-35438	18-35438	9-37612	18-7098-1
9-29709	18-7648	9-34010	18-7619-1	9-35439	18-35439	9-37613	18-7727
9-29710	18-7493	9-34011	18-7613-1	9-35440	18-35440	9-37614	18-7728
9-29711	18-5465	9-34013	18-7611-2	9-36700	18-8115	9-37615	18-7729
9-29716	18-29716	9-34040	18-7665	9-36800	18-7094	9-37616	18-7070
9-29717	18-29717	9-34041	18-7664	9-36801	18-7093	9-37617	18-7077
9-29720	18-29720	9-34064	18-7609-1	9-36802	18-7061	9-37618	18-7097
9-29722	18-29722	9-34066	18-7611-2	9-36803	18-7296	9-37619	18-7080
9-29723	18-29723	9-34068	18-7611-2	9-36850	18-36850	9-37620	18-7072
9-29800	18-5107-1	9-34069	18-7605-1	9-36900	18-7210	9-37621	18-7095
9-29801	18-5488	9-34070	18-7604-1	9-36901	18-7201	9-37622	18-7236
9-29804	18-5116-1	9-34071	18-7618-1	9-36903	18-7202	9-37623	18-7237
9-29806	18-7642	9-34074	18-7618-1	9-36905	18-36905	9-37624	18-7238
9-29807	18-5117	9-34075	18-34075	9-36906	18-36906	9-37625	18-7239
9-29808	18-5103	9-34076	18-7615-1	9-36950	18-7209	9-37626	18-7241
9-29809	18-5105	9-34077	18-7615-1	9-36951	18-7381	9-37627	18-7242
9-29820	18-7706	9-34078	18-7615-1	9-36952	18-7380	9-37628	18-7243
9-29821	18-7646	9-34081	18-7489	9-36953	18-36953	9-37629	18-7244
9-29822	18-7643	9-34082	18-7605-1	9-36954	18-7382	9-37630	18-7245
9-29900	18-5450	9-34084	18-7640	9-36955	18-7208	9-37631	18-7246
9-29901	18-5451	9-34085	18-7640	9-36956	18-36956	9-37632	18-7017
9-29904	18-29904	9-34086	18-7604-1	9-37000	18-7037	9-37633	18-7040
9-31100	18-7228	9-34100	18-34100	9-37100	18-7046	9-37637	18-79900
9-31101	18-7234	9-34110	18-34110	9-37101	18-7223	9-37638	18-79901
9-31102	18-31102	9-34120	18-34120	9-37102	18-7247	9-37639	18-7748
9-31103	18-31103	9-34140	18-34140	9-37103	18-7248	9-37640	18-7749
9-31107	18-31107	9-34500	18-34500	9-37104	18-7024	9-37700	18-7821
9-31108	18-7231	9-34600	18-34600	9-37105	18-7042	9-37701	18-7800
9-31109	18-7232	9-34601	18-34601	9-37106	18-7043	9-37702	18-7820

MALLORY (Cont.)		MALLORY (Cont.)		MALLORY (Cont.)		MALLORY (Cont.)	
MALLORY No.	Sierra No.	MALLORY No.	Sierra No.	MALLORY No.	Sierra No.	MALLORY No.	Sierra No.
9-37750	18-7808	9-38011	18-8091	9-40473	18-8524	9-42500	18-1989
9-37751	18-7812	9-38012	18-80402	9-40475	18-8536	9-42501	18-3531
9-37752	18-7813	9-38013	18-8062	9-40476	18-8519	9-42502	18-1994
9-37753	18-7814	9-38014	18-8056	9-40477	18-8523	9-42503	18-1977-1
9-37754	18-7818-1	9-38015	18-8092	9-40478	18-8547	9-42506	18-1977-1
9-37755	18-7810	9-38016	18-8055	9-40479	18-8547	9-42601	18-3573
9-37756	18-7811	9-38016-25	18-8055	9-40500	18-1960-1	9-42602	18-3581
9-37800	18-7844	9-38017	18-8042	9-40501	18-1962-1	9-42604	18-3574
9-37801	18-7845	9-38017-25	18-8042	9-40502	18-1958-1	9-42605	18-3575
9-37803	18-7846	9-38018	18-8074	9-40503	18-1950-1	9-42606	18-3583
9-37804	18-7789	9-38018-25	18-8074	9-40504	18-1951-1	9-42607	18-3584-1
9-37805	18-7967	9-38019	18-8054	9-40505	18-1952-1	9-42608	18-42608
9-37806	18-7968	9-38020	18-8073	9-40506	18-1957-1	9-42700	18-2766
9-37807	18-7866	9-38021	18-8109	9-40507	18-1953-2	9-42720	18-0549
9-37808	18-7865	9-38022	18-8108	9-40530	18-1908	9-42721	18-0550
9-37810	18-7948	9-38023	18-8043	9-40531	18-1985	9-42800	18-2727
9-37811	18-7919	9-38030	18-80403	9-40532	18-1906	9-42801	18-2733
9-37812	18-7947	9-38031	18-8070	9-40540	18-4008	9-42802	18-2732
9-37815	18-7861	9-38032	18-8069	9-40541	18-4009	9-43000	18-3552
9-37820	18-7860	9-38033	18-8082	9-40543	18-1995	9-43001	18-3555
9-37821	18-7784	9-38034	18-8068	9-40545	18-4256	9-43002	18-3649
9-37822	18-7854	9-38039	18-8078	9-40546	18-4264	9-43004	18-3662
9-37823	18-7859	9-38040	18-8075	9-40550	18-1905	9-43005	18-3663
9-37825	18-7717	9-38041	18-8083	9-40551	18-1937	9-43006	18-3658
9-37826	18-7721	9-38100	18-8004EP-1	9-40552	18-1972	9-43007	18-3654
9-37827	18-7977	9-38120	18-8013EP-1	9-40553	18-1973	9-43008	18-3660
9-37850	18-7848-1	9-38121	18-8032EP-1	9-40554	18-1974-1	9-43009	18-3539
9-37851	18-7852-1	9-38140	18-8015EP-1	9-40555	18-1975-1	9-43010	18-3666
9-37852	18-7775-1	9-40100	18-1999	9-40556	18-1978	9-43011	18-3664
9-37853	18-7848-1	9-40102	18-1898	9-40557	18-1970-2	9-43012	18-3659
9-37855	18-7777-1	9-40110	18-1997-1	9-40558	18-1971	9-43013	18-3551
9-37856	18-7776-1	9-40111	18-1998-1	9-40559	18-1976-1	9-43014	18-3549
9-37857	18-7965-1	9-40112	18-1907	9-40570	18-8512	9-43015	18-43015
9-37860	18-7853-1	9-40113	18-1939	9-40573	18-8520	9-43016	18-3555
9-37861	18-7775	9-40120	18-1992-1	9-40574	18-8531	9-43017	18-43017
9-37862	18-7777	9-40130	18-1949	9-40575	18-8532	9-43018	18-3656
9-37863	18-7776	9-40170	18-4362	9-40576	18-8533	9-43019	18-3553
9-37880	18-7932	9-40171	18-4364	9-40577	18-8500	9-43020	18-3550
9-37881	18-7951	9-40172	18-8538	9-40578	18-8505	9-43021	18-3554
9-37882	18-7928	9-40173	18-8535	9-40579	18-8514	9-43022	18-3559
9-37883	18-7929	9-40174	18-8536	9-40580	18-8529	9-43023	18-3561
9-37884	18-7922	9-40200	18-1914	9-40581	18-8530	9-43024	18-3557
9-37885	18-7924	9-40270	18-8516	9-40582	18-8554	9-43025	18-3556
9-37886	18-7937	9-40300	18-1915	9-40583	18-8555	9-43026	18-3676
9-37887	18-7938	9-40301	18-1941	9-40584	18-8556	9-43027	18-3560
9-37903	18-8124	9-40302	18-1942	9-40585	18-8551	9-43028	18-3677
9-37905	18-7942	9-40303	18-1940	9-40586	18-4362	9-43029	18-3534
9-37906	18-7940	9-40310	18-1913	9-40601	18-1903	9-43030	18-3546
9-37907	18-37907	9-40311	18-1944	9-40602	18-1902	9-43031	18-3545
9-37908	18-7858	9-40312	18-1945	9-40610	18-1921	9-43032	18-3544
9-37950	18-7828-1	9-40313	18-1946	9-40611	18-1922	9-43035	18-3540
9-37951	18-7720	9-40314	18-1948	9-40670	18-8534	9-43036	18-3544
9-37952	18-7786	9-40315	18-6600	9-40671	18-8502	9-43037	18-3541
9-37952-10	18-7786	9-40340	18-1911	9-40672	18-8507	9-43038	18-3609
9-37953	18-7785	9-40370	18-8517	9-40770	18-8535	9-43051	18-43051
9-37954	18-7790	9-40371	18-8526	9-40800	18-1996	9-43052	18-43052
9-37955	18-7791	9-40372	18-8527	9-40810	18-1899	9-43100	18-3648
9-37956	18-7712	9-40373	18-4360	9-40870	18-8503	9-43101	18-3672
9-37957	18-8226	9-40375	Obsolete	9-40871	18-8504	9-43150	18-3668
9-37958	18-7829	9-40376	18-8506	9-40900	18-1930-1	9-43151	18-3646
9-37959	18-7830	9-40377	18-8518	9-40901	18-1931-1	9-43152	18-3651
9-37960	18-7831	9-40400	18-1926	9-40902	18-1986-1	9-43153	18-3650
9-37961	18-7979	9-40401	18-1927	9-40910	18-1935-1	9-43154	18-3671
9-37965	18-79910	9-40402	18-1933	9-40911	18-1909-1	9-43155	18-3569
9-37966	18-79907	9-40403	18-1982	9-40970	18-8511	9-43156	18-3653
9-37967	18-79900	9-40404	18-1983	9-40971	18-8539	9-43157	18-3647
9-37968	18-79901	9-40410	18-1916	9-40972	18-8510	9-43175	18-43175
9-37969	18-7713	9-40411	18-1918	9-41100	18-9010	9-43176	18-3624
9-37970	18-7981	9-40412	18-1919	9-41200	18-4224	9-43177	18-3608
9-37980	18-7113-9	9-40413	18-1924	9-41201	18-4218	9-43178	18-3609
9-38001	18-80406	9-40414	18-1925	9-41202	18-4227	9-43200	18-3206
9-38002	18-8079	9-40415	18-1928	9-41203	18-4226	9-43201	18-3119
9-38003	18-8085	9-40416	18-1929	9-41203-10	18-4226	9-43202	18-3118
9-38004	18-8076	9-40417	18-1934	9-41205	18-4258	9-43203	18-3405
9-38005	18-80420	9-40418	18-8112	9-42400	18-5897	9-43204	18-3336
9-38006	18-8071	9-40419	18-1938	9-42401	18-5898	9-43205	18-3367
9-38007	18-80400	9-40430	18-1984	9-42402	18-7600	9-43206	18-3363
9-38008	18-38008	9-40440	18-1917	9-42404	18-7601	9-43208	18-3129
9-38009	18-80401	9-40470	18-8515	9-42406	18-7702	9-43209	18-3180
9-38010	18-8063	9-40471	18-8521	9-42407	18-7647	9-43211	18-3116

MALLORY (Cont.)		MALLORY (Cont.)		MALLORY (Cont.)		MALLORY (Cont.)	
MALLORY No.	Sierra No.	MALLORY No.	Sierra No.	MALLORY No.	Sierra No.	MALLORY No.	Sierra No.
9-43212	18-43212	9-44066	18-75125	9-45309	18-3062	9-48220	18-3400
9-43220	18-1398	9-44067	18-70945	9-45309-10	18-3062	9-48222	18-3388
9-43250	18-3170	9-44068	18-70946	9-45310	18-3016-1	9-48300	18-3207
9-43251	18-3171	9-44069	18-70947	9-45310-10	18-3016-1	9-48301	18-3507
9-43252	18-3173	9-44070	18-70948	9-45311	18-3052	9-48302	18-3323
9-43254	18-3356	9-44072	18-71218	9-45312	18-45312	9-48303	18-3322
9-43262	18-3185	9-44073	18-70957	9-45375	18-3087	9-48304	18-3217
9-43263	18-43263	9-44074	18-70958	9-45375-10	18-3087	9-48305	18-3317
9-43300	18-3424	9-44075	18-70949	9-45400	18-8923	9-48306	18-3319
9-43301	18-3423	9-44077	18-70950	9-45401	18-8920	9-48307	18-3320
9-43302	18-3422	9-44079	18-70952	9-45402	18-8924	9-48308	18-3321
9-43304	18-3414	9-44080	18-70953	9-45404	18-45404	9-48309	18-3314
9-43305	18-3416	9-44081	18-70954	9-45500	18-3099	9-48310	18-3316
9-43306	18-3417	9-44083	18-70955	9-45501	18-3094	9-48311	18-3517
9-43307	18-3419	9-44084	18-70956	9-45502	18-3095	9-48312	18-3324
9-43308	18-3420	9-44092	18-44092	9-45503	18-3023	9-48313	18-3214
9-43309	18-3421	9-45000	18-8901	9-45504	18-3097	9-48314	18-3571
9-43330	18-3445	9-45001	18-3030	9-45507	18-3035	9-48315	18-3147
9-43400	18-3117	9-45001-10	18-3030	9-45600	18-3067	9-48316	18-3237
9-43401	Obsolete	9-45003	18-45003	9-45601	18-3068	9-48317	18-48317
9-43403	18-3343	9-45004	18-8903	9-45601-10	18-3068	9-48350	18-3150
9-43404	18-3178	9-45100	Obsolete	9-45602	18-3069	9-48600	18-3148
9-43407	18-3107	9-45101	18-3246	9-45602-10	18-3069	9-48601	18-3310
9-43408	18-3126	9-45102	18-3247	9-45603	18-3070	9-48602	18-3370
9-43413	18-3122	9-45103	18-3248	9-45603-10	18-3070	9-48603	18-3395
9-43500	Obsolete	9-45104	18-3250	9-45604	18-3072	9-48604	18-3397
9-43502	18-3114	9-45105	18-3249	9-45605	18-3074	9-48605	18-3148
9-43504	18-3358	9-45106	18-3031	9-45606	18-3088	9-48606	18-3370
9-43505	18-3346	9-45200	18-3051	9-45607	18-3040	9-48608	18-3451
9-43508	18-3182	9-45200-10	18-3051	9-45608	18-3063	9-48609	18-3433
9-43525	18-3179	9-45201	18-3050	9-45609	18-3071	9-48610	18-3440
9-43601	18-3113	9-45201-10	18-3050-10	9-45609-10	18-3071	9-48611	18-3442
9-43603	18-3329	9-45202	18-3055	9-45610	18-3066	9-48612	18-3430
9-43604	18-3110	9-45203	18-3043	9-45611	18-3073	9-48613	18-3450
9-43612	18-2705-9	9-45204	18-3104	9-45612	18-3042	9-48614	18-3311
9-43613	18-3337	9-45204-10	18-3104	9-45613	18-3065	9-48615	18-3313
9-43615	18-2392	9-45205	18-3091	9-45614	18-8910	9-48616	18-3371
9-43622	18-7139	9-45206	18-3059	9-45615	18-8911	9-48617	18-3433
9-43623	18-3109	9-45206-10	18-3059-10	9-45616	18-9825	9-48618	18-3396
9-43624	18-2708	9-45207	18-3053	9-45617	18-45617	9-48619	18-48619
9-43628	18-2599	9-45207-10	18-3053	9-45700	18-3089	9-48700	18-3279
9-43629	18-2948	9-45208	18-3368	9-45701	18-3075	9-48701	18-3280
9-43631	18-7116	9-45209	18-3083	9-45702	18-3080	9-48702	18-3282
9-43632	18-7481	9-45209-10	18-3083	9-45703	18-3081	9-48703	18-3278
9-43700	18-3326	9-45210	18-3090	9-45704	18-3306	9-50000	18-50000
9-43702	18-3293	9-45211	18-3104	9-45705	18-3205	9-50001	18-50001
9-43703	18-3108	9-45212	18-3366	9-45706	18-3047	9-51000	18-51000
9-43711	18-9075	9-45213	18-3082	9-45707	18-3060	9-51001	18-51001
9-43712	18-9076	9-45214	18-3091	9-45707-10	18-3060	9-51002	18-51002
9-43713	18-9078	9-45215	18-3002	9-45708	18-3061	9-51003	18-51003
9-43714	18-9077	9-45215-10	18-3002	9-45709	18-3076	9-51100	18-1361
9-43715	18-9079	9-45216	18-3001	9-45710	18-3077	9-51103	18-1374
9-43716	18-43716	9-45216-10	18-3001	9-45711	18-3078	9-51104	18-1360
9-43720	18-3293	9-45217	18-3006	9-45712	18-45712	9-51105	18-1391
9-43801	18-3136	9-45219	18-3096	9-45713	18-45713	9-51106	18-1395
9-43813	18-2379	9-45220	18-3044	9-45714	18-45714	9-51200	18-1346
9-43814	18-2377	9-45221	18-45221	9-45715	18-3078	9-51202	18-1154
9-44000	18-4456	9-45222	18-3006	9-45716	23-2000	9-51204	18-1345
9-44001	18-4457	9-45280	18-3058	9-45717	18-3079	9-51207	18-1347
9-44002	18-4458	9-45281	18-3086	9-45800	18-3586	9-51209	18-1196
9-44003	18-2778	9-45283	18-3212-1	9-48200	18-3315-2	9-51211	18-4038
9-44004	18-2775	9-45284	18-3286	9-48201	18-3327	9-51300	18-1414
9-44005	18-2774	9-45285	18-3348	9-48202	18-3211	9-51302	18-1415
9-44010	18-3221	9-45286	18-3386	9-48203	18-3392	9-51303	18-1412
9-44050	18-70931	9-45300	18-3007	9-48204	18-3378	9-51304	18-1417
9-44051	18-70934	9-45300-10	18-3007-10	9-48205	18-3381	9-51306	18-1416
9-44052	18-71337	9-45301	18-8900	9-48206	18-3384	9-51401	18-1411
9-44053	18-70944	9-45301-10	18-8900	9-48207	18-3399	9-51403	18-4077
9-44054	18-70935	9-45302	18-3098	9-48208	18-3393	9-51406	Obsolete
9-44055	18-70933	9-45302-10	18-3098	9-48209	18-3394	9-52100	18-1752
9-44056	18-70925	9-45303	18-3057	9-48210	18-3390	9-52101	18-1753
9-44057	18-70938	9-45303-10	18-3057	9-48211	18-3382	9-52300	18-1757
9-44058	18-70940	9-45304	18-3054	9-48212	18-3383	9-52301	18-1759
9-44059	18-70932	9-45305	18-3039	9-48213	18-3389	9-52302	18-1758
9-44060	18-70939	9-45305-10	18-3039	9-48214	18-2704	9-52400	18-1755
9-44061	18-70941	9-45306	18-3017	9-48215	18-2706	9-52401	18-1756
9-44062	18-75100	9-45306-10	18-3017-10	9-48216	18-2703	9-52404	18-4157
9-44063	18-70942	9-45307	18-3056	9-48217	18-7963	9-53200	18-4620
9-44064	18-70943	9-45307-10	18-3056-10	9-48218	18-3133	9-53202	18-4622
9-44065	18-70930	9-45308	18-3012	9-48219	18-3135	9-53210	18-4018

MALLORY (Cont.)		MALLORY (Cont.)		MALLORY (Cont.)		MALLORY (Cont.)	
MALLORY No.	Sierra No.	MALLORY No.	Sierra No.	MALLORY No.	Sierra No.	MALLORY No.	Sierra No.
9-53224	18-4530	9-54417	18-3906	9-60005	18-2553	9-60324	18-99021
9-53232	18-4635	9-54418	18-3905	9-60006	18-2554	9-60325	18-99023
9-53233	18-4636	9-54420	18-3901	9-60007	18-2917	9-60326	18-99024
9-53246	18-4623	9-54422	18-3905	9-60007-10	18-2917	9-60328	18-99032
9-53248	18-4625	9-54424	18-4088	9-60008	18-2552	9-60329	18-99033
9-53250	18-4626	9-54425	18-4089	9-60009	18-0398	9-60330	18-99034
9-53252	18-4628	9-54426	18-4090	9-60010	18-2844	9-60335	18-99005
9-53256	18-4643	9-54432	18-3975	9-60011	18-2834	9-60336	18-99009
9-53257	18-4644	9-54434	18-3974	9-60012	18-2831	9-60339	Obsolete
9-53260	18-4639	9-54436	18-3907	9-60016	18-2858	9-60340	18-99020
9-53261	18-4640	9-54438	18-3908	9-60017	18-2947	9-60341	18-99026
9-53265	18-4575	9-54804	18-3963	9-60020	18-2564-1	9-60342	18-0618
9-53401	18-4115	9-54808	18-3960	9-60021	18-2563	9-60343	18-0656
9-53412	18-4107	9-54812	18-3969	9-60022	18-2565	9-60344	18-99047
9-53413	18-4117	9-54816	18-3934	9-60023	18-2566	9-60345	18-99047
9-53416	18-4124	9-54817	18-3936	9-60026	18-2593	9-60346	18-99028
9-53417	18-4114	9-54904	18-4294	9-60027	18-0622	9-60347	18-99028
9-53418	18-4104	9-55000	18-15550	9-60028	18-2801	9-60348	18-99028
9-53420	18-4120	9-55001	18-15520	9-60029	18-2824	9-60353	18-99001
9-53421	18-4110	9-55002	18-15460	9-60030	18-2825	9-60354	18-99004
9-53422	18-4100	9-55003	18-15480	9-60031	18-2919	9-60356	18-99013
9-53424	18-4112	9-55004	18-15410	9-60033	18-2841	9-60357	18-99079
9-53425	18-4111	9-55005	18-15370	9-60034	18-2914	9-60358	18-99015
9-53426	18-4102	9-55006	18-15440	9-60035	18-2915	9-60360	18-99022
9-53427	18-4101	9-55007	18-15490	9-60036	18-2826	9-60361	18-99025
9-53430	18-4122	9-55020	18-18000	9-60037	18-0894	9-60362	18-99030
9-53432	18-4063	9-55021	18-18100	9-60038	18-2562	9-60365	18-99045
9-53434	18-4064	9-55022	18-15113	9-60039	18-2823	9-60366	18-99046
9-53436	18-4195	9-55023	18-15115	9-60040	18-0315	9-60378	18-0239
9-53437	18-4086	9-55025	18-15113	9-60041	18-0115	9-60380	18-0756-1
9-53438	18-4165	9-55026	18-15102	9-60042	18-0879	9-60382	18-0240
9-53439	18-4087	9-55027	18-15104	9-60043	18-0670	9-60395	18-0785
9-53442	18-4190	9-56000	18-95560	9-60044	18-2835	9-60396	18-0813
9-53443	18-4079	9-56005	18-95605	9-60045	18-0378	9-60398	18-99037
9-53445	18-4058	9-56006	18-95606	9-60046	18-2506-1	9-60399	18-99038
9-53462	18-4067	9-56481	18-56481	9-60047	18-2807	9-60400	18-0880
9-53463	18-4068	9-56482	18-56482	9-60048	18-0324	9-60401	18-2557
9-53466	18-4065	9-56871	18-4514	9-60049	18-2513	9-60402	18-0969
9-53467	18-4066	9-57700	18-7907	9-60050	18-2513	9-60404	18-2855
9-53468	18-4123	9-57701	18-7890	9-60051	18-0642	9-60406	18-0882
9-53469	18-4113	9-57702	18-57702	9-60052	18-0131	9-60408	18-4248
9-53470	18-4103	9-57725	18-7997	9-60053	18-0918	9-60408-50	18-42481-9
9-53805	18-4144	9-57726	18-7999	9-60054	18-0970	9-60409	18-2709
9-53806	18-4145	9-57800	18-7913	9-60056	18-0645	9-60410	18-2911
9-53807	18-4146	9-57801	18-7824-2	9-60057	18-0936	9-60413	18-2864
9-53810	18-4141	9-57802	18-7875	9-60058	18-0988	9-60414	18-0965
9-53811	18-4142	9-57803	18-7879-1	9-60059	18-0139	9-60415	18-0933
9-53812	18-4143	9-57804	18-7911-1	9-60060	18-2501	9-60416	18-0979
9-53815	Obsolete	9-57806	18-7878-1	9-60061	18-0320	9-60417	18-0985
9-53817	18-4099	9-57807	18-7903	9-60062	18-0129	9-60418	18-0989
9-53820	18-4128	9-57808	18-7906-2	9-60063	18-0870	9-60419	18-0975
9-53821	18-4129	9-57809	18-7902	9-60065	18-0891	9-60420	18-2550
9-53822	Obsolete	9-57810	18-7910-1	9-60066	18-0903	9-60421	18-0128
9-53823	18-4131	9-57814	18-7896	9-60067	18-0327	9-60422	18-0136
9-53825	18-4133	9-57815	18-7897	9-60074	18-0164	9-60423	18-0138
9-53830	18-4080	9-57816	18-7918	9-60100	18-4698	9-60424	18-2865
9-53831	18-4081	9-57817	18-7915-1	9-60100-50	18-46981-9	9-60425	18-1205
9-54200	18-3966	9-57818	18-7905-1	9-60101	18-2945	9-60426	18-2876
9-54202	18-3968	9-57819	18-7905	9-60101-50	18-29451-9	9-60427	18-0118
9-54208	18-4019	9-57820	18-8003-1	9-60102	18-2945	9-60428	18-0134
9-54210	18-4021	9-57821	18-7921	9-60102-50	18-29451-9	9-60429	18-0983
9-54216	18-3927	9-57822	18-7758	9-60103	18-60103	9-60430	18-2913
9-54217	18-3902	9-57823	18-7918	9-60103-50	18-60103-50	9-60431	18-2938
9-54219	18-3916	9-57824	18-57824	9-60104	18-0905	9-60432	18-1207
9-54225	18-3982	9-57825	18-7824-2	9-60105	18-2430	9-60433	18-2545
9-54229	18-3979	9-57826	18-57826	9-60202	18-8331	9-60434	18-2866
9-54231	18-3981	9-57902	18-7871	9-60202-50	18-8331	9-60435	18-0117
9-54233	18-3921	9-57905	18-7926	9-60301	18-99027	9-60436	18-0850
9-54235	18-3923	9-57906	18-0032	9-60309	18-0757	9-60437	18-0424
9-54237	18-4050	9-57907	18-7878-1	9-60312	18-99000	9-60438	18-2867
9-54239	18-4052	9-57908	18-7974	9-60313	18-99002	9-60439	18-1212
9-54400	18-3913	9-57909	18-7926	9-60314	18-99003	9-60440	18-0963
9-54401	18-3914	9-57910	18-7880	9-60315	18-99006	9-60441	18-0148
9-54402	18-3915	9-57911	18-7884	9-60317	18-99008	9-60442	18-0142
9-54404	18-3931	9-58000	18-2193	9-60318	18-99010	9-60443	18-0161
9-54406	18-3933	9-59020	18-4495	9-60319	18-99012	9-60444	18-0122
9-54412	18-3910	9-60001	18-2933	9-60320	18-99014	9-60445	18-2852
9-54413	18-3911	9-60002	18-0182	9-60321	18-99016	9-60446	18-0130
9-54414	18-3912	9-60003	18-0844	9-60322	18-99018	9-60447	18-0144
9-54416	18-3904	9-60004	18-0339	9-60323	18-99019	9-60448	18-0977

MALLORY (Cont.)		MALLORY (Cont.)		MALLORY (Cont.)		MALLORY (Cont.)	
MALLORY No.	Sierra No.	MALLORY No.	Sierra No.	MALLORY No.	Sierra No.	MALLORY No.	Sierra No.
9-60449	18-2546	9-61308	18-0609	9-63700	18-2946	9-64213	18-4356
9-60450	18-0987	9-61311	18-25001	9-63701	18-3877	9-64214	18-4325
9-60451	18-0941	9-61312	18-2815	9-63702	18-3878	9-64215	18-4326
9-60452	18-2544	9-61313	18-0685	9-63703	18-3874	9-64216	18-4338
9-60453	18-0440	9-61315	18-25002	9-63704	18-3880	9-64217	18-64217
9-60454	18-2873-9	9-61316	18-0311	9-63705	18-3881	9-64401	18-4419
9-60455	18-0110	9-61317	18-0347	9-63706	18-3876	9-64402	18-4427
9-60463	18-2857	9-61318	18-0346	9-63707	18-3879	9-64404	Obsolete
9-60464	18-2549	9-61319	18-61319	9-63708	18-3883	9-64406	18-4403
9-60501	18-99040	9-61400	18-0418	9-63709	18-3860	9-64407	18-4415
9-60503	18-99039	9-61401	18-0872	9-63711	18-3878	9-64410	18-4400
9-60505	18-99091	9-61402	18-4394	9-63800	18-3855	9-64411	18-4411
9-60508	18-60508	9-61403	18-4395	9-63801	18-3857	9-64412	18-99103
9-60510	18-0829	9-61404	18-4396	9-63803	18-3852	9-64415	18-64415
9-60511	18-99124	9-61405	18-4398	9-63804	18-3854	9-64418	18-99073
9-60512	18-60512	9-61406	18-4367	9-63805	18-3853	9-65100	18-2875
9-60513	18-60513	9-61407	18-2833	9-63806	18-3858	9-65200	18-0470
9-60518	18-60518	9-61409	18-1210	9-63807	18-3851	9-65300	18-2941
9-60519	18-60519	9-61411	18-0113	9-63820	18-3837	9-65301	18-0471
9-60520	18-60520	9-61412	18-0881	9-63821	18-3836	9-65302	18-0472
9-60521	18-60521	9-61413	18-0897	9-63822	18-3838	9-65400	18-0305
9-60522	18-60522	9-61414	18-2849-1	9-63823	18-2888-9	9-65401	18-0309
9-60523	18-60523	9-61415	18-0954	9-63825	18-3839	9-65402	18-0475
9-60525	18-99075	9-61416	18-2830	9-63826	18-3866	9-65500	18-0476
9-60526	18-99070	9-61417	18-2912	9-63827	18-2960	9-65501	18-2854
9-60527	18-60527	9-61418	18-0956	9-63828	18-2956	9-65700	18-0677
9-60528	18-60528	9-61419	18-1204	9-63829	18-2964	9-65800	18-2971
9-60529	18-60529	9-61420	18-0183-1	9-63830	18-3803	9-65801	18-2991
9-60530	18-60530	9-61421	18-2909	9-63832	18-2963	9-71102	18-71102
9-60532	18-60532	9-61422	18-0672	9-63833	18-3802	9-71500	18-2103
9-60534	18-60534	9-61423	18-2819	9-63834	18-7110	9-71501	18-2105
9-60535	18-60535	9-61424	18-2832	9-63850	18-7400	9-71502	18-2106
9-60536	18-99069	9-61426	18-2896	9-63851	18-3861	9-71503	18-2107
9-60537	18-99074	9-61428	18-0680	9-63852	18-3872	9-71504	18-2108
9-60538	18-0754	9-61450	18-4369	9-63853	18-3862	9-71505	18-2109
9-60539	18-0836	9-61451	18-4371	9-63854	18-3864	9-71506	18-2112
9-60540	18-60540	9-61452	18-0943-1	9-63855	18-3863	9-71507	18-2113
9-60541	18-60541	9-61453	18-4347-1	9-63856	18-3871	9-71508	18-2114
9-60915	18-60915	9-61455	18-4349	9-63900	18-3808	9-71509	18-2115
9-60916	18-60916	9-61500	18-1239	9-63902	18-3810	9-71510	18-2116
9-60917	18-60917	9-61501	18-0348	9-63903	18-3809	9-71512	18-2436
9-60918	18-60918	9-61502	18-0407	9-63950	18-3891	9-71514	18-2136
9-60919	18-60919	9-61503	18-0340	9-63951	18-3894	9-71515	18-2137
9-60920	18-60920	9-61504	18-1237	9-63952	18-3831	9-71516	18-2435
9-61001	18-0467	9-61505	18-0405	9-63953	18-3830	9-71702	18-2432
9-61003	18-0462	9-61507	18-1235	9-63955	18-99140	9-71703	18-2433
9-61004	18-2848	9-61508	18-1232	9-63956	18-3892	9-72001	18-3722
9-61005	18-0353	9-61509	18-0466	9-63958	18-3805	9-72001-10	18-3722
9-61006	18-0354	9-61511	18-0322	9-63959	18-3832	9-72002	18-3720
9-61007	18-0356	9-61513	18-61513	9-63960	18-3804	9-72002-10	18-3720
9-61008	18-0360	9-61600	18-0976	9-63961	18-3848	9-72003	18-3723
9-61009	18-0357	9-61602	18-0887	9-63962	18-3828	9-72003-10	18-3723
9-61010	18-4380	9-61603	18-4375	9-63963	18-99062	9-72004	18-3721
9-61011	18-0994	9-61610	18-1213	9-63964	18-3827	9-72004-10	18-3721
9-61012	18-2743	9-61612	18-1233	9-63965	18-3829	9-72005	18-72005
9-61041	18-0889	9-61620	18-1211	9-63966	18-63966	9-72009	18-2560
9-61042	18-0876	9-61621	18-0519	9-64002	18-4312	9-72100	18-2603
9-61051	18-61051	9-61622	18-1234	9-64006	18-4314	9-72101	18-2604
9-61100	18-4374	9-61623	18-0864	9-64100	18-4402	9-72140	18-2192
9-61101	18-4384	9-61650	18-4024	9-64101	18-4321	9-72150	18-2149
9-61102	18-4387	9-61652	18-4022	9-64102	18-4302	9-72151	18-2162
9-61103	18-4383	9-61653	18-4024	9-64106	18-4428	9-72152	18-2163
9-61104	18-4385	9-61700	18-1271	9-64107	18-4406	9-72153	18-2161
9-61105	18-4373	9-61701	18-1270	9-64108	18-4323	9-72154	18-3752
9-61200	18-0868	9-61702	18-1275	9-64109	18-4322	9-72155	18-3751
9-61201	18-0465	9-61703	18-1256	9-64110	18-4310	9-72156	18-2145
9-61202	18-1231	9-61704	18-1273	9-64111	18-4304-1	9-72157	18-2190
9-61204	18-0410	9-61705	18-1274	9-64112	18-4303-1	9-72158	18-2158
9-61208	18-0607	9-61706	18-1265	9-64113	18-4305	9-72159	18-2159
9-61210	18-4388	9-61707	18-1266	9-64114	18-4307	9-72160	18-2157
9-61211	18-4365	9-61708	18-1267	9-64115	18-4309	9-72161	18-2622
9-61212	18-4389	9-62601	18-2619-1	9-64117	18-4301	9-72162	18-3760
9-61213	18-0488	9-62601-25	18-2619-1	9-64200	18-4317	9-72164	18-2303
9-61214	18-0487	9-62602	18-2614	9-64201	18-4319	9-72200	18-2176
9-61217	18-0403	9-62602-25	18-2614	9-64204	18-4359	9-72201	18-2177
9-61221	18-61221	9-62603	18-2617	9-64207	18-4337	9-72202	18-6399
9-61300	18-2845	9-62604	18-2615	9-64209	18-4336	9-72203	18-3725
9-61302	18-0464-9	9-62605	18-2613	9-64210	18-4339	9-72204	18-2178
9-61305	18-0664	9-62606	18-2699	9-64211	18-4340	9-72352	18-2239
9-61307	18-0352	9-62650	18-2918	9-64212	18-4319	9-72400	18-2125

MALLORY (Cont.)		MALLORY (Cont.)		MALLORY (Cont.)		MALLORY (Cont.)	
MALLORY No.	Sierra No.	MALLORY No.	Sierra No.	MALLORY No.	Sierra No.	MALLORY No.	Sierra No.
9-72401	18-2146	9-72901	18-8205	9-73991	18-3781	9-75113	18-1153
9-72402	18-6400	9-72902	18-2601-1	9-73992	18-3782	9-75114	18-1155
9-72403	18-2128	9-72903	18-8219	9-73994	18-73994	9-75115	18-1173
9-72404	18-2104	9-72904	18-8206-1	9-74000	18-8366	9-75117	18-1165
9-72405	18-2174	9-72905	18-8212-1	9-74001	18-8365	9-75118	18-1156
9-72406	18-2097	9-72906	18-8218	9-74002	18-8362-1	9-75119	18-1197
9-72408	18-6402	9-72907	18-8219	9-74100	18-2656	9-75120	18-1159
9-72409	18-9218	9-72930	18-2771	9-74101	18-2658	9-75121	18-1117
9-72410	18-2100	9-72931	18-2772-1	9-74102	18-2659	9-75122	18-1161
9-72412	18-21005	9-73001	18-3601	9-74103	18-2660	9-75123	18-1160
9-72413	18-6406	9-73002	18-3602	9-74104	18-2694	9-75125	18-1193
9-72414	18-6406	9-73003	18-3603	9-74105	18-2684	9-76100	18-2016
9-72415	18-21006	9-73100	18-7311	9-74106	18-2623	9-76101	18-2076
9-72420	18-2724	9-73101	18-7314	9-74107	18-8341	9-76102	18-2003
9-72425	18-21005K	9-73102	18-7316	9-74108	18-74108	9-76103	18-2007
9-72426	18-2100K	9-73103	18-7315	9-74109	18-8373	9-76104	18-2008
9-72450	18-2166	9-73104	18-7312	9-74110	18-8374	9-76105	18-2009
9-72460	18-2180	9-73115	18-7321	9-74111	18-8337	9-76106	18-2010
9-72462	18-2324	9-73117	18-1728	9-74112	18-2657	9-76107	18-2011
9-72463	18-2331	9-73118	18-1710	9-74113	18-2692	9-76108	18-2013
9-72475	18-2169	9-73130	18-1705	9-74114	18-2691	9-76109	18-2014
9-72476	18-2150	9-73131	18-73131	9-74115	18-2685	9-76110	18-2048
9-72477	18-2320	9-73410	18-1551	9-74200	18-2626	9-76111	18-2049
9-72500	18-2172	9-73420	18-1550	9-74201	18-2655	9-76112	18-2050
9-72501	18-2173	9-73431	18-1550	9-74202	18-2654	9-76113	18-2051
9-72502	18-2171	9-73432	18-1560	9-74203	18-2653	9-76114	18-2052
9-72503	18-2412	9-73450	18-1551	9-74204	18-2635	9-76115	18-2053
9-72504	18-2413	9-73451	18-1564	9-74205	18-2624	9-76116	18-2054
9-72505	18-2414	9-73452	18-1566	9-74206	18-2646-1	9-76117	18-2055
9-72506	18-2321	9-73454	18-1565	9-74207	18-2640	9-76119	18-2077
9-72507	18-2323	9-73464	18-2236	9-74208	18-8382	9-76127	18-0579
9-72510	18-72510	9-73474	18-2202	9-74209	18-2642	9-76128	18-0580
9-72600	18-2370	9-73500	18-2210	9-74210	18-2697-1	9-76129	18-0583
9-72601	18-2191	9-73501	18-2207	9-74212	18-2628	9-76130	18-2056
9-72602	18-2376	9-73502	18-2208	9-74300	18-2645-1	9-76131	18-0500
9-72640	18-2298	9-73504	18-2209	9-74301	18-2643	9-76133	18-2154
9-72641	18-2299	9-73510	18-2315	9-74302	18-2644	9-76134	18-2155
9-72642	18-2354	9-73511	18-2310	9-74303	18-2648	9-76136	18-2353
9-72643	18-2298	9-73512	18-2309	9-74304	18-2652	9-76200	18-2018
9-72644	18-0557	9-73514	18-2308	9-74400	18-2665	9-76201	18-2025
9-72650	18-2244	9-73520	18-2289	9-74401	18-2671	9-76202	18-2002
9-72650-10	18-22441-9	9-73530	18-2290	9-74402	18-2672	9-76203	18-2026
9-72651	18-2375	9-73534	18-2216	9-74501	18-74501	9-76204	18-2027
9-72652	18-2374	9-73540	18-1293	9-74502	18-0021	9-76205	18-2059
9-72653	18-2371	9-73541	18-1287	9-74503	18-0028	9-76206	18-2060
9-72654	18-2378	9-73542	18-1288	9-74504	18-74504	9-76207	18-2028
9-72655	18-2387	9-73543	18-1289	9-74507	18-74507	9-76208	18-2030
9-72656	18-72656	9-73544	18-1290	9-74510	18-74510	9-76209	18-2031
9-72657	18-8331	9-73550	18-1291	9-74511	18-99073	9-76210	18-2032
9-72659	18-1236	9-73560	18-2221	9-74512	18-74512	9-76211	18-2033
9-72660	18-4249	9-73561	18-2218	9-74513	18-74513	9-76212	18-2001
9-72700	18-2752	9-73564	18-2220	9-74514	18-0023	9-76213	18-2064
9-72701	18-2751	9-73890	18-73890	9-74515	18-74515	9-76214	18-2065
9-72702	18-2756	9-73891	18-73891	9-74516	18-0024	9-76217	18-8326
9-72703	18-2750	9-73892	18-73892	9-74518	18-99104	9-76218	18-2029
9-72704	18-2747	9-73900	18-3200	9-74526	18-74526	9-76219	18-2061
9-72705	18-2753-2D	9-73901	18-3704	9-74527	18-74527	9-76220	18-2062
9-72706	18-2764	9-73902	18-3714	9-74528	18-0030	9-76221	18-8300
9-72707	18-2765	9-73903	18-3705	9-74529	18-0031	9-76227	18-2058
9-72708	18-2758	9-73904	18-4194	9-74530	18-0027	9-76228	18-2020
9-72709	18-2763	9-73905	18-4231	9-74531	18-0026	9-76230	18-2094
9-72710	18-2744	9-73906	18-3773	9-74534	18-0025	9-76410	18-0554
9-72711	18-1074	9-73907	18-73907	9-74535	18-74535	9-76411	18-0296
9-72721	18-8368	9-73908	18-3732	9-74539	18-2794-1	9-76412	18-0265
9-72800	18-2780-1	9-73909	18-3726	9-74540	18-74540	9-76413	18-0297
9-72801	18-2781	9-73911	18-2380	9-74544	18-74544	9-76414	18-0587
9-72802	18-2779	9-73912	18-3735	9-74546	18-74546	9-76421	18-0265
9-72803	18-2757	9-73914	18-73914	9-74700	18-8335	9-76422	18-0266
9-72804	18-2770	9-73915	18-4274	9-74701	18-8338	9-76423	18-0267
9-72805	18-2748	9-73918	18-73918	9-74702	18-8339	9-76500	18-7145
9-72806	18-2745	9-73951	18-3717	9-74703	18-8340	9-76501	18-7173
9-72807	18-2759	9-73952	18-3716	9-74805	18-74805	9-76502	18-7170
9-72808	18-2762	9-73953	18-3715	9-75100	18-1190	9-76503	18-2516
9-72809	18-2761	9-73960	18-3701	9-75104	18-1397	9-76504	18-7198
9-72810	18-2760	9-73961	18-3702	9-75106	18-1179	9-76505	18-7153
9-72811	18-2746	9-73963	18-3703	9-75107	18-1143	9-76506	18-7105
9-72812	18-2768	9-73964	18-73964	9-75108	18-1162	9-76507	18-7117
9-72813	18-2767	9-73978	18-73978	9-75110	18-1166	9-76508	18-2996
9-72814	18-2780-1	9-73979	18-73979	9-75111	18-1157	9-76509	18-7100
9-72900	18-8218	9-73990	18-73990	9-75112	18-1158	9-76511	18-7134

MALLORY (Cont.)		MALLORY (Cont.)		MALLORY (Cont.)		MOELLER (Cont.)	
MALLORY No.	Sierra No.	MALLORY No.	Sierra No.	MALLORY No.	Sierra No.	MOELLER No.	Sierra No.
9-76512	18-2944	9-77902	18-8361	9-81006	18-81006	33421-10	18-8084
9-76516	18-0858	9-77903	18-8358	9-81102	18-81102	33430-10	18-8055
9-76517	18-2536	9-77904	18-8359	9-81103	18-81103	33432-10	18-8054
9-76518	18-2769	9-78001	18-1240	9-82100	18-9550-0	33434-10	18-8073
9-76519	18-7101	9-78002	18-4261	9-82101	18-9550-3	33436-10	18-8040
9-76520	18-7102	9-78003	18-2742	9-82150	18-9750-0	33450-10	18-8078
9-76521	18-7104	9-78005	18-2715	9-82151	18-9750-0	33451-10	18-8088
9-76522	18-7108	9-78007	18-2534	9-82200	18-9013	33461-10	18-8071
9-76525	18-7118	9-78009	18-2539	9-82201	18-9024	33463-10	18-8078
9-76526	18-7120	9-78013	18-4251	9-82202	18-9080	33464-10	18-8062
9-76527	18-7127	9-78100	18-0577	9-82250	18-9570-0	33467-10	18-8079
9-76528	18-7130	9-78103	18-3719	9-82275	18-9775	33470-10	18-8077
9-76529	18-7133	9-78105	18-4296	9-82276	18-9065	33473-10	18-8070
9-76530	18-7135	9-78106	18-2342	9-82300	18-9500-1	33475-10	18-8069
9-76531	18-7137	9-78107	18-3712	9-82301	18-9500-2	33476-10	18-8094
9-76532	18-7128	9-78108	18-2343-9	9-82302	18-9500-3	33477-10	18-80402
9-76533	18-7138	9-78109	18-4295	9-82303	18-9500-4	33480-10	18-8092
9-76535	18-7140	9-78110	18-3151	9-82305	18-9500-7	33481-10	18-8076
9-76536	18-7142	9-78111	18-2357	9-82311	18-9798	33482-10	18-8076
9-76537	18-7143	9-78112	18-2261	9-82350	18-9420-2	33484-10	18-8062
9-76539	18-7146	9-78114	18-3198	9-82351	18-9420-3	33485-10	18-4462
9-76540	18-7151	9-78115	18-3199	9-82352	18-9420-7	33486-10	18-8085
9-76541	18-7155	9-78117	18-3713	9-82360	18-9410-2	33487-10	18-80405
9-76542	18-7157	9-78120	18-2382	9-82361	18-9410-4	33491-10	18-8078
9-76543	18-7158	9-78121	18-2381	9-82363	18-9410-7	33492-10	18-8088
9-76544	18-7159	9-78126	18-2346	9-82380	18-9400-2	33496-10	18-80406
9-76545	18-7160	9-78127	Obsolete	9-82382	18-9400-4	33497-10	18-80403
9-76546	18-7161	9-78129	Obsolete	9-82383	18-9400-7	33498-10	18-80401
9-76547	18-7162	9-78130	18-3197	9-82390	18-9440-2	33501-10	18-80400
9-76549	18-7167	9-78132	18-2130	9-82391	18-9440-3	33502-10	18-80401
9-76550	18-7168	9-78133	18-2286	9-82392	18-9440-4	33503-10	18-8071
9-76551	18-7169	9-78134	18-2349	9-82393	18-9440-7	34391-10	18-8058
9-76552	18-7172	9-78135	18-2348	9-82400	18-9600-0	34394-10	18-8017
9-76553	18-7174	9-78137	18-4267	9-82401	18-9600-2	34395-10	18-8013
9-76554	18-7176	9-78138	18-4270	9-82402	18-9600-5	34590-10	18-8005
9-76555	18-7178	9-78139	18-3219	9-82403	Obsolete	34690-10	18-8004
9-76556	18-7180	9-78140	18-3220	9-82404	18-9600-7	99076-10	18-9010
9-76557	18-7183	9-78141	18-4273	9-82500	18-9650-0	99077-00	18-8998
9-76559	18-7188	9-78212	18-0605	9-82501	18-9650-2	99082-00	18-8999
9-76562	18-7426	9-78213	18-0619	9-82502	18-9650-5	106	18-1941
9-76564	18-7419	9-79000	18-9098	9-82503	18-9650-6	121	18-0471
9-76565	18-7420	9-79001	18-9099	9-82504	18-9650-7	150	18-1911
9-76567	18-7403	9-79101	18-2411	9-82601	18-9620-2	188	18-1922
9-76569	18-7961	9-79126	18-2415	9-82602	18-9620-5	402	18-6600
9-76571	18-7475	9-79127	18-2401	9-82700	18-9200	480	18-2941
9-76573	18-7485	9-79200	18-2405	9-82750	18-9710-1	639	18-1913
9-76574	18-7440-1	9-79202	18-2256	9-82751	18-9710-0	689	18-1945
9-76578	18-7956	9-79203	18-2259	9-82752	18-9700-2	794	18-1946
9-76579	18-7956	9-79800	18-4442	9-82801	18-9680-2	826	18-1940
9-76581	18-7449	9-79801	18-9803	9-82802	18-9680-5	879	18-1905
9-76586	18-8325	9-79802	18-9802	9-82804	18-9680-7	992	18-1999
9-76615	18-7436	9-79803	18-9801			994	18-1997-1
9-76651	18-7121	9-79804	18-9800			1851	18-1906
9-76652	18-7401	9-79805	18-9861			2018	18-1907
9-76653	18-4253-9	9-79806	18-9806-1			2076	18-1975-1
9-76654	18-7404	9-79807	18-9842			2441	18-1902
9-76689	18-76689	9-79808	18-9868			2442	18-1903
9-76690	18-76690	9-79809	18-9854			3320	18-1908
9-76691	18-76691	9-79810	18-9809			3322	18-1985
9-76692	18-76692	9-79811	18-9847			4354	18-1976-1
9-76693	18-76693	9-79812	18-9872			5538	18-1973
9-76694	18-76694	9-79813	18-79813			5603	18-1962-1
9-76695	18-76695	9-79814	18-79814			5604	18-1958-1
9-77000-20	18-2702	9-79815	18-79815			5639	18-1944
9-77001	18-4288	9-79816	18-79816			5805	18-1931-1
9-77001-20	18-4288	9-79816-24	18-79816-24			5862	18-1954-1
9-77002	18-2341-1	9-79817	18-79817			5944	18-0470
9-77002-20	18-2341-1	9-79820	18-79820			6022	18-0473
9-77003	18-2701	9-79821	18-9870			6108	18-0305
9-77004	18-2701-04	9-79822	18-9896			6325	18-1972
9-77100	18-2461	9-79823	18-79823			6351	18-1971
9-77101	18-2464	9-79824	18-9141			6562	18-0309
9-77102	18-2462	9-79825	18-79825			6705	18-1955-1
9-77103	18-2463	9-79833	18-79833			6771	18-1978
9-77200	18-2465-9	9-79834	18-79834			7056	18-1914
9-77200-20	18-2465	9-81000	18-9783			7081	18-1915
9-77201	18-2466-9	9-81001	18-9782-1			7169	18-1916
9-77201-20	18-2466	9-81002	18-9781			7296	18-1917
9-77900	18-8357	9-81003	18-9794			7386	18-1918
9-77901	18-2625	9-81004	18-9788			7387	18-1919

MOELLER

MOELLER No.	Sierra No.
33418	18-8083
33421	18-8084
33480	18-8092
33481	18-8076
33482	18-8085
33484	18-8106
33485	18-4462
33486	18-8085
34313	18-8000
34375	18-8049
33212-10	18-7307
33319-10	18-7790
33320-10	18-7775-1
33321-10	18-7776-1
33323-10	18-7844
33324-10	18-7845
33325-10	18-7789
33389-10	18-8032
33400-10	18-8063
33401-10	18-8042
33405-10	18-8074
33418-10	18-8083
33419-10	18-8082
33420-10	18-8068

WISECO (Cont.)		WISECO (Cont.)			
WISECO No.	Sierra No.	WISECO No.	Sierra No.		
3023P2	18-4530	3530KD	18-3905		
3023P3	18-4515	3544KD	18-3934		
3023PS	18-4500	3625KD	18-3907		
3027P3	18-4127	3685KD	18-3975		
3027PS	18-4107	3715KD	18-3974		
3030KD	18-3912	B1029	18-1375		
3030KD	18-3912	CW24	18-4292		
3030P2	18-4142	S474	18-4281		
3030P3	18-4143	S493	18-4280		
3030PS	18-4141	W4958	18-4294		
3031P3	18-4099	W5217	18-1374		
3031PS	Obsolete	W5263	18-4290		
3032PS	Obsolete				
3036P3	18-4126				
3036PS	18-4106				
3072P3	18-4064				
3072PS	18-4063				
3073P3	18-4100				
3073PS	18-4120				
3102PS	18-4600				
3108P2	18-4525				
3108P3	18-4540				
3108PS	18-4510				
3108S2	18-4560				
3108S3	18-4575				
3108SS	18-4545				
3109P2	18-4520				
3109PS	18-4505				
3111P3	18-4105				
3111PS	18-4125				
3115P2	18-4114				
3115P3	18-4104				
3115PS	18-4124				
31164P4	Obsolete				
3116PS	18-4128				
3116S4	18-4133				
3116SS	18-4129				
3118P3	18-4102				
3118PS	18-4122				
3118S3	18-4101				
3118SS	18-4121				
3119P3	18-4067				
3119PS	18-4065				
3119S3	18-4068				
3119SS	18-4066				
3121P3	18-4103				
3121PS	18-4123				
3123P2	18-4530				
3123P3	18-4515				
3123PS	18-4500				
3125KD	18-3921				
3127P3	18-4127				
3127PS	18-4107				
3130P2	18-4142				
3130P3	18-4143				
3130PS	18-4141				
3131P3	18-4099				
3131PS	Obsolete				
3132PS	Obsolete				
3136P3	18-4126				
3136PS	18-4106				
3145KD	18-3922				
3155KD	18-3923				
3172P3	18-4064				
3172PS	18-4063				
3173P3	18-4100				
3173PS	18-4120				
3184P2	18-4139				
3184P3	18-4140				
3184PS	18-4138				
3187KD	18-3913				
3190P2	18-4136				
3190P3	Obsolete				
3190PS	18-4135				
3217KD	18-3915				
3228KD	18-3969				
3312KD	18-3951				
3375KD	18-3927				
3500KD	18-3904				
3520KD	18-3906				

WIX

WIX No.	Sierra No.
33003	18-7857-1
33012	18-7830
33031	18-7829
33032	18-7856-1
33033	18-7831
33044	18-7855
33118	18-7867
33225	18-7844
33225	18-7845
33398	18-7802
33943	18-7860
51036	18-7879-1
51064	18-7910
51068	18-7878
51069	18-7824
51307	18-7878
51334	18-7910
51348	18-7884
51348	18-7915
51356	18-7914
51358	18-7902
51365	18-7911
51394	18-7916
51515	18-7875
51773	18-7887
51791	18-7880
51806	18-7886
51970	18-7874
51970	18-7899

GENERATOR PRODUCTS								
FISCHER PANDA			NORTHERN LIGHTS			WESTERBEKE (Cont.)		
O.E. #	SIERRA #	PAGE #	O.E. #	SIERRA #	PAGE #	O.E. #	SIERRA #	PAGE #
FISCHER PANDA			24-22009	23-1102	130	34440	23-3307	133
IC78.460.000A	23-1105	130	24-28003	23-1103	130	35109	23-5840	131
IC78.460.000B	23-1104	130	25-12009	23-3315	133	35595	23-7801	Obsolete
J009-1027B-1	23-3312	133	25-12009	23-2005	132	35608	23-2702	137
J009-46840	23-3311	133	25-12031	23-0400	133	35736	23-3601	134
JABSCO			ONAN			35828	23-7825	139
22799-0001	23-2003	132	122-0185	23-7841	139	35920	23-7720	131
JOHNSON PUMP			122-0810	23-7840	139	36450	23-7200	130
09-808B-1	23-2001	132	130-4434	23-6401	140	36918	23-7800	138
KOHLER			130-6228	23-6402	140	37387	23-3602	134
26987	23-7762	131	132-0349	23-3300	132	37922	23-0808	135
229432	23-0810	135	132-0436	23-3309	133	38100	23-7201	130
229433	23-0812	136	149-0428	23-7750	131	39181	23-4000	140
229678	23-7822	139	149-1445	23-7720	131	39378	23-3603	134
229715	23-7751	130	149-2106	23-7760	131	39705	23-1101	130
229826	23-2002	132	185-5835	23-7842	139	40154	23-7826	139
229826	23-3303	132	185-7444	23-7804	138	40434	23-0805	135
229955	23-3304	132	309-0130	23-3606	134	40859	23-2700	137
229963	23-0813	136	541-1519	23-3310	133	40860	23-2802	138
249433	23-7771	131	A026K278	23-7760	131	42260	23-0800	135
249865	23-0811	135	SHERWOOD			43050	23-2803	138
249930	23-3608	134	09000K	23-2002	132	43060	23-4500	Obsolete
250872	23-2003	132	10077K	23-2000	132	45232	23-4003	140
252896	23-3609	134	WESTERBEKE			46097	23-3604	134
252898	23-7740	130	11672	23-4001	140	46124	23-0801	135
260085	23-6400	140	11885	23-6400	140	46592	23-2703	137
267709	23-1100	130	11907	23-3301	132	46596	23-4501	138
267714	23-7823	139	13810	23-4005	133	46622	23-3306	133
267718	23-0809	135	24132	23-5880	131	47060	23-7770	131
278857	23-1130	130	24323	23-0806	135	48076	23-7802	138
279449	23-7820	138	24353	23-1000	131	24688 & 24323	23-3650	136
326817	23-7803	Obsolete	24363	23-7764	131	24688 & 33966	23-3658	137
352018	23-3607	134	24639	23-5800	140	24688 & 34196	23-3653	136
352031	23-0814	136	24690	23-3605	134	24688 & 40434	23-3662	137
352122	23-3308	133	26488	23-3600	134	24690 & 33373	23-3660	137
359771	23-7821	139	30200	23-7770	131	24690 & 33417	23-3657	136
359978	23-2004	132	30376	23-4007	134	35736 & 33417	23-3652	136
249930 & 29963	23-3664	137	30475	23-4004	140	35736 & 34196	23-3651	136
252896 & 229432	23-3665	137	30592	23-4002	Obsolete	35736 & 40434	23-3661	137
267717 & 267718	23-3663	Obsolete	30593	23-5600	140	37387 & 37922	23-3659	137
352018 & 352031	23-3666	137	30594	23-5900	#N/A	39378 & 42260	23-3654	136
GM24510	23-7202	130	31152	23-4006	134	39378 & 46124	23-3655	136
GM32359	23-7761	131	32620	23-3305	132	46097 & 33417	23-3656	136
GM34570	23-7780	131	33104	23-3313	133			
GM47465	23-7824	139	33112	23-3302	132			
KOHLER / SHERWOOD			33373	23-0804	135			
359978	23-3314	133	33417	23-0803	135			
NORTHERN LIGHTS			33966	23-0807	135			
11-10015	23-0830	136	34196	23-0802	135			

SIERRA MARINE PRODUCTS

A.C. DELCO			BARR (cont.)			BARR (cont.)		
O.E. #	SIERRA #	PAGE #	O.E. #	SIERRA #	PAGE #	O.E. #	SIERRA #	PAGE #
GF-61	18-7856-1	161	20-0102	18-1907	794	CM-20-9232P	18-8518	Obsolete
GF-61P	18-7857-1	161	20-0082-P	18-4364	629	CM-20-9234	18-1948	607
ARCTIC CAT			200087P	18-1992-1	589, 628, 650, 793, 909, 980	FM-1-83	18-1998-1	662
0436-879	72-5100-3	215				FM-1-83	18-1996	650
0436-880	72-5100-2	215	200089P	18-1991	589, 628, 650, 793, 909, 980	FM-1-83-P	18-4363	661
0436-901	72-5102-4	216				MC 1 58759	18-1960-1	792
1436-159	72-5102-2	216	CHV-1-83	18-1997-1	662	MC 1 96705	18-1955-1	792
1436-434	72-5101-2	215	CHV-1-83	18-1964	659	MC 1 99798	18-1956-3	792
1436-435	72-5101-3	215	CHV-47-000	18-2949	591, 631, 651, 659, 663, 797, 911, 982	MC-1-65603	18-1962-1	792
4639-349	72-5103-2	215				MC-1-65604	18-1958-1	791
5639-469	72-5103-3	215	CHVA-1-84	18-1898	589, 606, 627, 657, 662, 791, 908, 979	MC-1-77234	18-1950-1	791
ARCTIC CAT PWC			CM 20-0097	18-1949	629	MC-1-77235	18-1951-1	791
3008-093	18-6919	572	CM-1-6672-B	18-1941	607	MC-1-99746	18-1952-1	791
3008-327	18-6919	572	CM-1-6672-H	18-1942	607	MC-20-44354	18-1976-2	794
3008-462	18-6919	572	CM-1-6677A	18-1940	606	MC-20-55538	18-1973	793
3008-536	18-6919	572	CM-1-6677SS P	18-8527	608	MC-20-60207	18-4008	795
BARR			CM-20-414211	18-1944	606	MC20-60426P	18-4362	793, 795
01-0105	18-0476-1	631	CM-20-6672	18-1946	606	MC-20-76325	18-1972	793
01-0107	18-2854-1	663	CM206672JP	18-4360	607	MC-20-76771	18-1978	793
160252	18-4009	795	CM-20-6674	18-1945	606	MC-20-93322A3	18-1985	794
1-73813	18-1990	795	CM-20-6674JP	18-8506	608	MC-20-98502	18-1974-1	794
20-0082	18-1999	662	CM-20-6674JP	18-8507	608, 910	MC-20-98504	18-1970-2	793
20-0100	18-1939	662	CM-20-6674P	18-4361	607	OMC-1-914035	18-1986-1	979
20-0100	18-1907	794						

BARR (cont.)			CHRYSLER FORCE (cont.)			CHRYSLER FORCE (cont.)		
O.E. #	SIERRA #	PAGE #	O.E. #	SIERRA #	PAGE #	O.E. #	SIERRA #	PAGE #
BORG-WARNER			26-99325	18-0586	261	27-F85154-1	18-0119	257
A4876HA	18-2590	579	27-19701	18-0622	258	27-F85168-2	18-0855	257
BOSCH			3745414	18-7254	598	27-F85748-2	18-0861	257
0-001-109-035	18-6944	679	3745415	18-7255	598	27-F85762	18-0141	257
0331-302-050	18-5806	964	449541-3	18-6762	247	27-F85906	18-0960	257
0331-302-081	18-5806	964	47-19453	18-8900	253	27-F97067	18-0873	258
0331-302-085	18-5806	964	8152792	18-5742	Obsolete	332-5772A5	18-5881	244
0331-302-581	18-5806	964	8152794	18-5744	247	332-5772A7	18-5881	244
0331-302-585	18-5806	964	8174111	18-5744	247	332-7778A12	18-5775	244
BRP			11-826375	18-3719	260	339-7370A13	18-5186	244
5007987	18-8387	365	25-201951	18-7134	261	339-7370B13	18-5186	244
420956741	18-8880	572	26-817472	18-0500	261	339-832757B4	18-5186	244
CAN-AM			26-819396	18-0502	261	39-817869A1	18-39010	256
XPS #779139	72-5101-2	215	26-828627	18-8354	261	39-820457A2	18-3998	256
XPS #779140	72-5101-3	215	27-819377	18-0873	258	39-820641A1	18-3999	256
CATERPILLAR			27-820438	18-3855	256	398-832075A4	18-5870	244
10-258	18-6955	678	27-824615	18-3857	257	398-832075A6	18-5873	244
163-3361	18-6944	679	27-828316	18-0314	257	46-43024A7	18-3214	253
3001117	18-6955	678	47-42038-2	18-3062	253	47-803630T	18-3030	252
1R-0658	18-7880	203	47-430262	18-3056	252	47-803631T	18-3017	252
1R-0714	18-7927	Obsolete	47-85089-3	18-3057	252	47-89984T4	18-3017	252
CERLIST DIESEL			50-819968	18-5618	247	47-F40065-2	18-3084	253
1512903	18-7970	160	50-820193	18-5622	247, 248	47-F433065	18-45003	253
1512904	18-7934	160	27-819138-2	18-3859	257	47-F436065-2	18-8903	253
CHRIS-CRAFT			27-824615-2	18-3857	257	47-F462065	18-8901	253
16.69-00100	18-5375	581	50-8199681	18-5618	247	47-F694065	18-3017	252
1869704	18-5346	581	50-819968-2	18-5618	247, 248	47-F84065	18-3085	253
16.50-00250	18-3876	591	50-8199683	18-5618	247	50-803900T	18-6441	247
16.69-00040	18-5338	581	50-8199684	18-5618	247	50-803903T	18-6439	247
16.69-00050	18-5345	581	50-898265003	18-5618	247	50-820193T1	18-5622	247, 248
16.69-0022	18-5427	581	11-F694188	18-3719	260	50-F514955	18-6441	247, 248
16.11-01236	18-2845	591	18495A26	18-5790	244	50-F575955	18-6439	247
16.50-00074	18-0889	591	19217A1	18-6777	247	700-834794A4	18-4630	256
16.50-00078	18-0891	591	19217A5	18-6777	247	700-834794A5	18-4631	256
16.50-00162	18-0874	591	19291A3	18-2370	258	700-834794T3	18-4629	Obsolete
16.50-00204	18-2946	591	21-42990A10	18-7817	248	700-834800A4	18-4632	256
16.50-00232	18-0868	591	21-42990A7	18-7817	248	700-834800A5	18-4633	256
16.50-00259	18-3877	591	21-42990A8	18-7817	248	700-834800A6	18-4634	256
16.50-05756	18-0876	591	21-42990A9	18-7817	248	815279T2	18-5742	Obsolete
16.61-00042	18-5911	585	21-857005A1	18-7817	248	815279T3	18-5742	Obsolete
16.69-00039	18-5314	581	25-F24278	18-7169	261	815279T4	18-5744	247
16.69-00042	18-5411	581	25-F45530	18-7457	261	815279T5	18-5744	247
16.69-00049	18-5311	581	25-F498618	18-7120	869	818903A1	18-6777	247, 384
16.69-00051	18-5418	581	25-F74305	18-7176	261	819479A1	18-6777	247, 384
16.69-00052	18-5385	581	25-F84305	18-7127	261	819480A1	18-6777	247, 384
16.69-00148	18-5376	581	26-41365A3	18-2697-1	259	819762A4	18-6777	247
16.69-00149	18-5404-1	581	26-43035A4	18-2626	258	819762A7	18-6777	247
16.81-06536	18-7875	591	26-814669A1	18-2635	259	81977A8	18-6777	247
16.81-08746	18-7824-2	591	26-814669A2	18-2635	259	81977A9	18-6777	247
16.83-08758	18-7265	587	26-820645A	18-2636	Obsolete	822870A1	18-6777	247, 384
16.83-90006	18-7860	588	26-85090A1	18-2629	259	827675A1	18-6286	247
FI6900165	18-5375	581	26-85090A2	18-2624	258	830179A1	18-5744	247
FI8308762	18-7265	587	26-F318307	18-0592	Obsolete	830179A2	18-5742	Obsolete
CHRYSLER FORCE			26-F346118	18-0584	261	830250A3	18-6777	247
75384	18-5697	247	26-F40307-2	18-0503	261	830250T3	18-6777	247
455541	18-6762	247	26-F84307-1	18-0512	Obsolete	832021A1	18-6777	247
811902	18-5677	248	26-F901307-2	18-0593	Obsolete	832021A2	18-6777	247
817411	18-5742	Obsolete	27-820500A3	18-0869	257	832021T2	18-6777	247
820545	18-6279	247	27-F178168	18-0314	257	832021T4	18-6777	247
824051	18-6775	247	27-F178168-1	18-0314	257	854514A1	18-5744	247
11-35921	18-3719	260	27-F201529-1	18-3856	256	855654A1	18-6777	247
11-47411	18-3719	260	27-F286529-3	18-3851	256	855654T2	18-6777	248
1736073	18-7264	Obsolete	27-F307279-2	18-0115	257	856747T1	18-5744	247
197787-3	18-8062	252	27-F372154-1	18-0958	257	883071A1	18-5744	247
2279913	18-7264	Obsolete	27-F40223	18-0869	257	89-803822T	18-5835	244
25-20195	18-7134	261	27-F40279-1	18-0154	258	89-817109A2	18-5834	244
25-32507	18-7127	261	27-F406406	18-0915	257	89-817109A3	18-5835	244
25-45258	18-7950	261	27-F440906	18-0315	257	89-F460917-1	18-5835	244
25-85549	18-7956	261	27-F476067	18-0854	258	F010790	18-7057	248
25-85594	18-7100	258	27-F476529-4	18-3857	257	F12042-1	18-5169	244
25-88657	18-7952	261	27-F513529	18-3852	256	F12044	18-5149	245
26-41131	18-0579	261	27-F523031	18-0415	258	F12181-1	18-5241	244
26-41132	18-0580	261	27-F658529	18-3854	256	F15150	18-5655	248
26-43035	18-0583	261	27-F691529-1	18-3853	256	F15164	18-5697	247
26-66022	18-0584	261	27-F694830	18-0416	258	F177917	18-5803	244

CHRYSLER FORCE (cont.)			CHRYSLER INBOARD (cont.)			CHRYSLER INBOARD (cont.)		
O.E. #	SIERRA #	PAGE #	O.E. #	SIERRA #	PAGE #	O.E. #	SIERRA #	PAGE #
F178168	18-0314	257	1818757	18-5347	592	20129	18-0976	632
F184122-1	18-2534	258	1851658	18-7875	599	20222	18-5376	613
F24747-1	18-7805	248	2084074	18-5307	592	20223	18-5404-1	612
F335068	18-3557	252	2095946	18-5723	597	20300	18-3061	620
F438955-1	18-5613	247	2098058	18-5345	592	20318	18-3599-2	621
F460917-1	18-5835	244	2098300	18-5710	596	20502	18-3140	620
F476529	18-3857	257	2098611	18-5429	592	21140	18-7270	620
F476529-1	18-3857	257	2279913	18-7264	Obsolete	21141	18-7271	173
F476529-2	18-3857	257	2279949	18-5345	592	22212	18-3060	578
F480955	18-5613	247	2421173	18-5303	592	22687	18-7852-1	620
F490955	18-5613	247	2421178	18-5307	592	30103	18-3577-2	621
F523065	18-3030	252	2421820	18-5314	592	30266	18-3877	632
F523065-1	18-3030	252	2463441	18-3645	598	31136	18-3887	632
F528068	18-3559	Obsolete	2469556	18-1913	607	31137	18-3874	632
F616955	18-5613	247, 248	2469559	18-2941	608	32722	18-7256	619
F694541-1	18-6279	247	2469639	18-1913	607	33393	18-4408	Obsolete
F697140	18-3200	260	2495531	18-5433	594	33408	18-3879	632
F718470	18-5742	Obsolete	2808870	18-5303	592	33628	18-7232	619
F746470	18-5742	Obsolete	2846106	18-1941	607	37061	18-5313-1	613
F83404	18-7127	261	2846689	18-1945	606	37068	18-5433	616
F84068-2	18-3550	252	2847404	18-1944	606	37068	18-5438	616
F85068	18-3550	252	2847405	18-1913	607	38070	18-5354	612
F85068-1	18-3550	252	2847480	18-2941	608	38071	18-5405	612
F85068-2	18-3550	252	2847527	18-5710	596	41052	18-5369	612
F85955-1	18-5613	247	2847623	18-1944	606	41057	18-5345	611
F97068-2	18-3556	252	3004886	18-3581	599	41058	18-5303	611
FA663260	18-39010	256	3420600	18-5347	592	41059	18-5407	612
FA85955	18-5613	247	3527501	18-5954	597	41061	18-5399	613
FK10003	18-7033	248	3527502	18-5954	597	41069	18-5353	612
FK10004	18-7037	248	3527794	18-1946	606	41074	18-5403	611
FK10005	18-7037	248	3549957	18-7878-1	599	41076	18-5352	612
FK10007	18-7037	248	3619542	18-3581	599	41080	18-5435	616
FK10008	18-7037	248	3619859	18-3582	Obsolete	41089	18-5403	611
FK10026	18-7033	248	3656017	18-5102	594	42001	18-5717	617
FK10027	18-7037	248	3675826	18-1940	606	42090	18-5907	617
FK10053	18-7033	248	3675826	18-1942	607	42091	18-5908	617
FK10057	18-7037	248	3744870	18-5954	597	45303	18-7200	619
FK10102-1	18-7033	248	3745215	18-28019	193	45334	18-7095	618
FK10108	18-7037	248	3745217	18-0607	607	47002	18-7600	618
FK1060	18-2630	259	3745220	18-4346	607	47032	18-7630	618
FK1061	18-2631	259	3745414	18-7254	598	47033	18-7632-1	618
FK1063-1	18-2632	259	3745415	18-7255	598	51080	18-5433	616
FK1063-2	18-2632	259	3745639	18-1944	606	91351	18-2845	632
FK1064	18-2637-1	259	3745985	18-3581	599	91606	18-7862	620
FK1065	18-2638	Obsolete	3780600	18-5103	595	96108	18-0305-1	631
FK1068	18-2639	259	3874020	18-5105	595	96120	18-1925	628
FK1074	18-2636	Obsolete	3874767	18-5451	594	96121	18-1926	627
FK1127	18-2633	Obsolete	4106140	18-5450	594	96216	18-0306-1	631
FK1203	18-2640	259	4142322	18-1940	606	96306	18-2949	631
FK1203-1	18-2640	259	4142408	18-5369	592	96319	18-3551	621
FK1234	18-2635	259	4142817	18-5352	592	96358	18-3552	621
FK616955	18-5613	247, 248	4142880	18-3860	599	96562	18-0309-1	631
FO10790	18-7041	248	4142885	18-3551	598	96653	18-0418	631
FO16311	18-7041	248	4142886	18-7230	598	96938	18-2434	617
FP2437A	18-5149	245	4273129	18-0609	599	97039	18-7272	620
FRK739	18-7037	248	4417375	18-3878	599	97114	18-1929	627
FS409752	18-8011EP-2	163, 252	4417905	18-3581	599	97115	18-1933	627
FS438955	18-5613	247	24695566	18-1942	607	97169	18-1916	628
FS438955	18-5613	247	E9234M	18-1948	607	97214	18-7231	619
FS480955	18-5613	247	E9923M	18-1944	606	97296	18-1917	631
FS489955	18-5613	247	F724002	18-7875	599	97361	18-3671	621
FS490955	18-5613	247	L-1008	18-7878-1	599	97386	18-1918	628
L-319	18-7879-1	599	L-19	18-7878-1	599	97387	18-1919	628
CHRYSLER INBOARD			398-176	18-5206	246	97498	18-2909	638
10612	18-0499	Obsolete	44-850308	18-2254	260	97595	18-7231	619
56874	18-7875	599	31-F523143	18-1113	261	97624	18-1924	628
118-614	18-0956-1	607	31-F523901	18-1112	261	97686	18-0311	632
200691	18-5435	594	CRUSADER			97752	18-1925	628
201522	18-5433	594	12525	18-5310	611	97753	18-1926	627
868095	18-5430	592	12526	18-5344	611	97772	18-1927	628
868096	18-5404-1	592	12528	18-5384	613	97854	18-8112	629
1274092	18-5307	592	12530	18-5338	611	97895	18-3649	621
1658535	18-5407	592	12531	18-5411	612	97924	18-1928	628
1692658	18-5841	Obsolete	12532	18-5375	613	97992	18-1929	627
1736073	18-7264	Obsolete	20117	18-5314	611	97993	18-1933	627

CRUSADER (cont.)			FISHER PANDA (cont.)			HONDA (cont.)		
O.E. #	SIERRA #	PAGE #	O.E. #	SIERRA #	PAGE #	O.E. #	SIERRA #	PAGE #
98041	18-7846	620	FISHER PANDA			16221-ZV4-610	18-2470	270
98068	18-1934	628	IC78.460.000A	23-1105	130	16221-ZW1-000	18-2472	270
98125	18-1982	627	IC78.460.000B	23-1104	130	16221-ZW9-000	18-2471	270
98126	18-1938	628	J009-1027B-1	23-3312	133	16900-SA5-004	18-7786	264
98128	18-1984	629	J009-46840	23-3311	133	16900-SR3-004	18-7720	264
201104	18-7876-1	632	FRAM			16901-ZY3-003	18-79909	265
201104	18-7824-2	632	CCS 1136	18-7935	687	16910-GB2-005	18-7712	264
700425	18-5899	621	GLM			16910-ZV4-015	18-8226	264
700427	18-5898	621	21090	18-2163E-9	845	16910-ZVL-003	18-7521	264
705786	18-5427	612	GM			16911-ZY3-010	18-79908	265
705787	18-5345	611	3701777	18-2917	918	16977-ZV5-900	18-80406	264
705788	18-5307	611	6269358	18-3577-2	898	16977-ZV5-A00	18-80400	264
707125	18-5717	617	6269577	18-3876	652	17105-ZY3-004	18-0390	Obsolete
1003026	18-3060	620	6414989	18-7258	894	17105-ZY6-000	18-0300	270
1003062	18-3046	620	10482803	18-5117	696	17109-XY6-000	18-0382	270
1003317	18-5375	613	14077948	18-4173	914	17109-ZY3-004	18-0396	270
1003318	18-5411	612	14077949	18-4164	914	17151-ZW5-00	18-0248	270
3000121	18-5389	613	14089025	18-3937	914	17650-921-003ZB	18-80420	264
3000122	18-5420	612	14089026	18-3938	Obsolete	17650-ZW9-003	18-80408	264
3000124	18-5318	611	HITACHI			17660-ZV5-902	18-38008	264
7057500	18-3876	632	129470-77200	18-6929	678	17670-ZW1-030GH	18-7947	264
7142520	18-3599-2	621	LR135-105	18-6925	678	17670-ZW1-801AH	18-7948	264
7243110	18-5107-1	616	LR135-74	18-6928	678	17700-ZW9-010	18-81042EP-2	163, 264
7243200	18-5443	616	LR135-74B	18-6928	678	17700-ZW9-020	18-81042EP-2	163, 264
9002514	18-7875	632	LR180-03A	18-6929	678	17710-ZW9-033	18-80407	264
R130012	18-15214	617	LR180-03B	18-6929	678	19021-ZW1-003	18-3214	266
RO29015	18-1938	628	LR180-03C	18-6929	678	19210-881-A01	18-3245	267
RP061022	18-8926	620	S114-257	18-6880	679	19210-881-A02	18-3245	267
CUMMINS			S114-257G	18-6880	679	19210-ZV4-013	18-3246	266
160596	18-3078	575	S114-303	18-6937	679	19210-ZV4-651	18-3246	266
166758	18-3078	575	S114-303A	18-6937	679	19210-ZV4-651	18-3247	266, 267
214169	18-6952	678	S114-483	18-6880	679	19210-ZV5-003	18-3248	266
216040	18-5982	678	S114-483A	18-6880	679	19210-ZV7-003	18-3249	266
556540	18-3078	575	S114-559B	18-6861	500	19210-ZW1-003	18-3056	266
556850	18-3078	575	S114-682	18-6942	500	19210-ZW1-B04	18-3250	266, 267
650607	18-3077	576	S114-837	18-6831	482	19210-ZW9-003	18-3100	266
3920618	18-6952	678	S114-837A	18-6831	482	19210-ZW9-013	18-3100	266, 267
21601R	18-3078	575	S13-68	18-6934	679	19210-ZW9-A02	18-3245	267
3603853RX	18-6952	678	S13-68A	18-6934	679	19210-ZW9-A31	18-32455	266
3604234RX	18-5982	678	S13-68C	18-6934	679	19210-ZW9-A32	18-32455	266, 267
DELCO			S13-86	18-6934	679	19210-ZY3-003	18-3031	266
1100077	18-6952	678	HONDA			19231-ZW1-003	18-3122	266
1100093	18-6952	678	08208-0080	72-5102-2	216	19232-ZV1-A10	18-2524	269
1100211	18-6952	678	16010-881-003	18-2482	270	19232-ZV4-610	18-2495	269
1100274	18-6952	678	16011-881-741	18-7048	265	19232-ZW1-003	18-2563	269
1105474	18-6952	678	16201-881-850	18-2473	270	19233-ZV5-000	18-2496	269
1105475	18-6952	678	19232-881-850	18-2608	269	19234-ZW1-003	18-2564-1	269
1105476	18-6952	678	19234-881-850	18-2609	269	19234-ZW1-003	18-2564	269
1114356	18-5838	886	19300-881-761	18-3627	532	19234-ZW1-B00	18-0481	Obsolete
1114458	18-5838	886	91252-935-004	18-8298	270	19234-ZX2-C00	18-99154	267
1115202	18-5433	378, 584, 594, 616, 635, 645, 654, 696, 876, 951	06192-881-C00	18-3279	267	19234-ZY3-000	18-2499	269
10459244	18-6952	678	06192-ZV1-C00	18-3278	Obsolete	19242-ZV5-000	18-0176	269
DENSO			06192-ZV4-000	18-3280	267	19242-ZW1-003	18-2565	269
995435	18-6868	571	06192-ZV4-A00	18-4536	267	19242-ZW1-B00	18-0482	Obsolete
101211-3020	18-6960	719	06192-ZV5-003	18-3282	267	19300-ZV5-043	18-3630	266
101211-3021	18-6960	719	06192-ZV7-000	18-3281	267	19300-ZW9-003	18-3628-1	266
101211-3460	18-6844	719	06192-ZW1-000	18-3283	267	30520-PNA-007	18-7494	262
101211-9940	18-6849	678	06192-ZW1-305	18-3187	266	30520-PWC-003	18-23251	262
128000-4860	18-6868	571	06192-ZW1-B04	18-3492	267	30530-P8F-A01	18-7559	265
128000-4861	18-6868	571	06192-ZW9-000	18-3493	267	30530-PPL-A01	18-7558	265
128000-4862	18-6868	571	06192-ZW9-A30	18-3478	267	31200-ZV5-013	18-6433	263
128000-4863	18-6868	571	06192-ZX2-C00	18-3489	267	31200-ZW1-004	18-15061	263
128000-4864	18-6868	571	06192-ZY3-000	18-3285	267	31200-ZW9-802	18-6445	263
228000-4550	18-6867	571	06192-ZY6-000	18-3284	267	31200-ZY6-003	18-6959	263
428000-0081	18-6873	571	15400-PFB-007	18-7911-1	205	31200-ZY9-003	18-6959	263
DETROIT DIESEL			15400-PFB-014	18-7913	271	31200-ZY9A-0031	18-6959	263
5574508	18-7931	160	15400-PLM-A01PE	18-7909	205	31630-ZW5-003	18-6475	262
ELECTROLUX			15400-POH-305	18-7909	205	31630-ZY6-003	18-6476	262
5024/120	18-6758	966	15400-POH-305PE	18-7909	205	35655-ZY3-C01	18-32153	265
KS3448/290	18-6790	966	15400-ZJI-004	18-7909	205	35655-ZY6-013	18-7659	265
EVINRUDE			16010-ST5-993	18-7785	264	35655-ZY9-003	18-7658	265
587078	18-5909	286	16010-ZV4-005	18-2480	269	35655-ZZ5-004	18-32153	265
587291	18-5909	286	16010-ZW9-003	18-2481	269	36120-ZV5-821	18-6258	263
			16011-ZV4-005	18-7047	265	36120-ZV5-822	18-6793	263
			16176-POA-004	18-0737	270	36120-ZY3-023	18-6742	263

HONDA (cont.)			JABSCO (cont.)			JOHNSON/EVINRUDE (cont.)		
O.E. #	SIERRA #	PAGE #	O.E. #	SIERRA #	PAGE #	O.E. #	SIERRA #	PAGE #
36120-ZY6-013	18-6745	263	1210-0001	18-3081	575	355209	18-5703	Obsolete
36120-ZY9-003	18-6743	263	1210-0003	18-3020	576	360347	18-4571	301
37500-PNB-003	18-25200	265	2877-0001	18-3075	575	586768	18-6826	288
37510-PNB-003	18-25201	265	3101-0000	18-3125	576	5005034	18-3753	349
37830-PGK-A01	18-7552	265	4528-0001	18-3079	575	5005831	18-6815	282
41107-ZV5-00-00	18-6165A	272	4568-0001	18-3075	575	5007554	18-4568	Obsolete
41107-ZW1-003ZA	18-6241	272	4598-0001	18-3021	576	5007770	18-1823	306
41107-ZW1-003ZA	18-6011	272	6760-0001	18-3304	Obsolete	5008967	18-4539	299
41107-ZW1-003ZA	18-6011A	272	13554-0001	18-3306	575	KAWASAKI		
41109-ZW1-003	18-6068	271	17636-0001	18-45712	576	21163-3715	18-6873	571
90508-ZW1-003	18-3200	272	17935-0001	18-3275	575	21163-3719	18-6873	571
90752-ZV4-650	18-3268	266	17937-0003	18-3038	575	21163-3720	18-6904	571
90752-ZV5-003	18-3270	266	18653-0001	18-45713	575	21163-3720	18-6904	571
90752-ZV7-000	18-3269	266	18838-0001	18-3046	576	K61021-208A	72-5103-2	215
90752-ZW1-B02	18-3271	266	18838-0001	18-3060	974	21174-3703	18-6875	571
90752-ZW9-A30	18-3022	267	18948-0001	18-3047	576	KOHLER		
90752-ZW9-A30	18-3025	267	18948-0001	18-3061	577	26987	23-7762	131
90752-ZY3-003	18-3273	Obsolete	21676-0001	18-45712	576	229432	23-0810	135
91051-ZW1-003	18-1156	271	22405-0001	18-3076	575	229433	23-0812	136
91053-ZW1-003	18-1158	271	22799-0001	23-2003	132	229678	23-7822	139
91057-ZW1-003	18-1157	271	92700-0060	18-2005	576	229715	23-7751	130
91251-ZW1-003	18-0583	272	14510-46090	18-3075	575	229826	23-3303	132
91251-ZW1-B04	18-1820	Obsolete	124310-46090	18-3075	575	229826	23-2002	132
91252-ZV1-003	18-3288	Obsolete	JOHNSON			229955	23-3304	132
91252-ZW1-003	18-2002	272	5036972	18-6945	284	229963	23-0813	136
91253-ZW1-003	18-2054	272	JOHNSON PUMP			249433	23-7771	131
91254-ZW1-003	18-0522	467	01-42401	18-3303	Obsolete	249865	23-0811	135
91255-ZW1-003	18-2053	272	09-45589	18-3510	Obsolete	249930	23-3608	134
91301-ZG3-000	18-71335	Obsolete	09-45589	18-3076	577	250872	23-2003	132
91353-ZW1-003	18-7198	272	09-45825	18-3089	578	252896	23-3609	134
91356-ZY3-003	18-8299	270	10-24228-1	18-3586-1	577	252898	23-7740	130
HP2	72-5103-2	215	10-24232-1	18-3587-1	577	260085	23-6400	140
HP2	72-5103-3	215	3298-0000	18-3125	577	267709	23-1100	130
HP2	72-5103-4	215	09-1026B	18-3080	576	267714	23-7823	139
HP2	72-5103-5	215	09-1026B-1	18-3080	975	267718	23-0809	135
HP2	72-5103-7	215	09-1026B-9	18-3036	575	278857	23-1130	130
HP4	72-5100-2	215	09-1026B-9	18-3080	576	279449	23-7820	138
HONDA PWC			09-1027B	18-3081	576	326817	23-7803	Obsolete
31200-HW1-671	18-6877	571	09-1027B-9	18-3020	576	352018	23-3607	134
ILMOR			09-1028B	18-3077	576	352031	23-0814	136
MV8V1021	18-57824	204	09-1028B-9	18-3038	576	352122	23-3308	133
S556162	18-32152	635	09-1029B	18-3078	576	359771	23-7821	139
550022689	18-9558-2	212	09-1029B-9	18-3037	576	359978	23-2004	132
550046126	18-9558-4	212	09-102BB	18-3277	974	249930 & 29963	23-3664	137
INDMAR			09-801B	18-3075	576	252896 & 229432	23-3665	137
0170-000	18-5603	635	09-802-B	18-3304	Obsolete	267717 & 267718	23-3663	Obsolete
50-1001	18-7824-2	204	09-806B	18-3079	576, 975	352018 & 352031	23-3666	137
53-2009	18-1907	589, 606, 629, 659, 661, 662, 794, 909, 980	09-808B	18-3076	577	GM24510	23-7202	130
53-2018	18-1907	589, 606, 629, 659, 661, 662, 794, 909, 980	09-808B-1	23-2001	132	GM32359	23-7761	131
573001	18-5603-1	638	09-810B	18-45713	577	GM34570	23-7780	131
575010	18-6288	635	09-812B	18-3306	575	GM47465	23-7824	139
575011	18-5984	635	09814B	18-45712	577	359978	23-3314	133
575014	18-6451	635	09-819B	18-3275	575	MALIBU		
685001	18-3587-1	636	JOHNSON/EVINRUDE			S556162	18-32152	635
685011	18-3586-1	636	302035	18-71336	306, 307	MALLORY		
751007	18-5303	633	302325	18-1597	306, 307	670	18-26800	186
755017	18-5345	633	321129	18-1827	Obsolete	29217	18-29717	Obsolete
755021	18-5277	633	324640	18-4578	307	29349	18-26815	186
872003	18-9555-2	212	324641	18-4551	306, 307, 308	29716	18-29716	664
872005	18-9554-2	212	328725	18-1596	307	54212	18-35102	667
872006	18-9554-4	212	328754	18-2147	306, 307	9-26103	18-5339-1	701, 880
872025	18-8779	204, 636	331130	18-3026	Obsolete	9-29418	18-5397	695, 875
872004 (7QT)	18-9555-4	212	331894	18-3566	311	9-72152	18-2163E-9	845
S556050	18-42608	636	338485	18-4579	307	29440M	18-29720	664
S556162	18-32152	635	338486	18-4549	Obsolete	4110M	18-34110	Obsolete
S985009	18-43017	636	338601	18-1826	306	4140M	18-34140	667
JABSCO			339720	18-4569	301	5110MFI	18-34120	667
673-0001	18-3080	575	340811	18-1825	Obsolete	YL512CV	18-5309-1	186, 615, 642, 700, 880
673-0003	18-3036	575	342370	18-71340	307	YL554CV	18-5312-1	186, 642, 700, 880
836-0001	18-3078	575	346865	18-71338	306	YL566AV	18-5339-1	186, 701, 880
836-0003	18-3037	575	349354	18-1824	306	YL567EV	18-26104-1	186
920-0001	18-3077	575	353690	18-1821	307	YL579AV	18-26110-1	186
920-0003	18-3038	575	354578	18-9084	306	YL624AV	18-5313-1	186, 700
			354580	18-1822	Obsolete	YL624BV	18-5316-1	186, 701, 880
			355169	18-5701	Obsolete	YL624MW	18-5313-1	584, 615, 642, 880

MALLORY (cont.)			MERCUISER (cont.)			MERCURY (cont.)		
O.E. #	SIERRA #	PAGE #	O.E. #	SIERRA #	PAGE #	O.E. #	SIERRA #	PAGE #
YL648AV	18-26111-1	186	50-801333980	18-6957	679	684311	18-7083	407
YL673AV	18-5315-1	186, 700, 800	50-831001562	18-6949	679	802632	18-33104	726
YL700AV	18-26107-1	186	50-831001961	18-6949	679	804184	18-7382	399
YLM512CV	18-5495-2	185, 643, 879	1389-815396A2	18-7370N	730	804540	18-3638	412
YLM554CV	18-5489-2	185, 879	1389-8490A2	18-7370N	730	807057	18-5851	389
YLM566AV	18-26311-2	185	1389-9350A2	18-7370N	730	809569	18-7380	399
YLM567CV	18-5496-2	185, 700, 879	1389-9562A1	18-7370N	730	811536	18-36906	737
YLM624BV	18-5498-2	185, 700, 880, 952	14336A15	18-6747	717	816877	18-7083	407
YLM673AV	18-5486-2	185, 879	14336A15	18-6813	718	858763	18-7083	407
YLM673AV	18-5486-2	185, 879	14336A17	18-6747	717	859168	18-6829	394
YLM676AV	18-5487-2	Obsolete	14336A20	18-6813	718	861249	18-7550	725
YLM700AV	18-26310-2	185	14336A22	18-6747	717	861425	18-7551	726
MANDO			14336A28	18-6747	717	864493	18-43015	755
A000B0341	18-6843	1004	14336A6	18-6747	717	878187	18-7554	726
TA000B0341	18-6843	1004	14336A6	18-6813	718	882571	18-6948	678
MARINCO			14336A8	18-6813	718	892681	18-33211	725
199116	AC12340	79	14336A9	18-6747	717	27-87105	18-2849-1	823
199117	AC12350	79	14336A9	18-6813	718	47-95289	18-45312	414
199120	AC12360	79	22-88847A1	18-2460	858	50-41583	18-6828	394
104SPP	AC12480	80	27-75611A03	18-1254	821	50-86976	18-6825	394
117A	AC12500	80	27-864547A02	18-0721	798	8168771	18-7083	407
121A	AC12440	80	27-864547A1	18-0721	798	8168772	18-7083	407
12VBP	WH10620P	71	27-864547A1	18-0722	798	8168773	18-7083	407
12VBR	WH10620R	71	27-864549A02	18-0720	798	8213542	18-4577	Obsolete
153AY	AC12430	79	27-864549A1	18-0720	798	8235471	18-1839	Obsolete
157AY	AC12460	79	27-864850A02	18-0722	798	88-93582	18-15501	718
301EL-B	AC12520	80	30-803097T1	18-8213	845, 846	91-75132	18-9896	228
305CRCN	AC12490	80	30-803098T1	18-8217	845, 846	91-90455	18-9896	228
6152SPP	AC12380	79	30-803099T1	18-8218	845, 846	1395-7826	18-97357	399
6152SPP-25	AC12370	79	30-803100T1	18-8219	845, 846	1395-9023	18-97358	399
6364CRN	AC12470	80	3310-806077A2	18-7370N	730	1395-9267	18-36956	399
P30-15	AC12510	80	3310-806078A2	18-7370N	730	1399-8153	18-97355	399
RY504-2-30	AC12450	79	3310-860070A2	18-7370N	730	1399-8154	18-97359	399
MARINE POWER			3310-861245A1	18-7376N	730	16066004	18-25400	Obsolete
0100-000	18-2434	578	3310-861448A1	18-7375N	730	21-806118	18-33800	Obsolete
0170-000	18-5603-1	638	3310-861448A1	18-7375N	730	22-424254	18-8958	403
402001	18-6299	638	3310-864941A01	18-7373N	730	22-818994	18-8957	403
612011	18-1985	794	3310-864942A01	18-7375N	730	27-860232	18-2849-1	823
0991-110	18-1898	589, 606, 627, 657, 662, 791, 908, 979	3310-864943A01	18-7376N	170	27-863726	18-2849-1	823
0992-593	18-1939	662	392-863704T	18-5465	696	32-861635	18-44092	768
0994-000	18-8536	608	46-807151A12	18-36001	751	47-952892	18-45312	414
50-808011A4	18-5603	712, 714	50-60594A	18-6824	394	50-805833	18-6870	679
27-99049M	18-74501	465	50-60594A1	18-6824	394	50-819271	18-6864	394
MCCULLOCH			50-60594T01	18-6824	394	50-852570	18-6829	394
1340135	18-5153	374	50-8M8021116	18-6946	715	50-857065	18-6829	394
36550135	18-5153	374	65L-13915-00-00	18-79901	514, 748	50-859168	18-6829	394
38850115	18-5241	374	78403A1	18-6841	719	50-893894	18-6943	394
75101A	18-5153	374	78403A1	18-6842	719	91-878232	18-9896	228
MERC/EVINRUDE			78403A2	18-6841	719	91-896661	18-79814	228
881150K1	18-9895	225	78403A2	18-6842	719	91-904551	18-9896	228
MERCUISER			807252Q4	18-3668	756	1395-51091	18-97352	399
13220	18-7751	666	807252T4	18-3668	756	1399-51991	18-97353	399
56045	18-6841	719	821663A1	18-6960	719	22-8189941	18-8957	403
56045	18-6842	719	834832T2	18-6844	719	46-8037502	18-43212	415
59755	18-6841	719	857006A3	18-6844	719	855676002	18-43175	411
59755	18-6842	719	864308T01	18-1843	792	864297001	18-7556	696
69729	18-6841	719	864591T02	18-1845	792	1395-811287	18-97354	399
69729	18-6842	719	865049T01	18-1843	792	25-803513007	18-76695	470
78385	18-5724	720	865380A02	18-6747	717	27-803508017	18-60917	443
78477	18-6841	719	865380A05	18-6747	717	27-834952001	18-60919	444
78477	18-6842	719	865380A13	18-6813	718	27-835427003	18-60918	444
90794	18-6841	719	865380A15	18-6747	717	27-850836001	18-60916	Obsolete
90794	18-6842	719	865380A25	18-6747	717	27-853702005	18-60920	444
821663	18-6960	719	865735A02	18-1843	792	50-831001671	18-6954	679
834832	18-6844	719	88183A12	18-6747	717	50-831001672	18-6954	679
11-88462	18-2460	858	88183A12	18-6813	718	50-831002050	18-6954	679
26-11973	18-1213	815	88183A3	18-6747	717	50-831002051	18-6954	679
26-42750	18-1213	815	88183A5	18-6813	718	50-831002052	18-6954	679
26-54799	18-1213	815	88183A8	18-6813	718	728374-92605	18-55503	688
26-97335	18-1213	815	8M0054588	18-5465	696	1399-879194026	18-97356	399
8216631	18-6960	719	92-802841A1	18-9400-7P	210, 214	50-859168T	18-6829	394
50-805991	18-6947	679	92-858057K01	18-9440-7P	210, 214	1395-9844A1	18-97351	399
50-854178	18-6957	679	MERCURY			14586A3	18-43052	411
50-855507	18-6957	679	16253	18-7381	399	22-8M0001721	18-8956	403
			43023	18-1838	Obsolete	27-815791A00	18-64217	437

MERCURY (cont.)			MERCURY (cont.)			MERCURY MARINE (cont.)		
O.E. #	SIERRA #	PAGE #	O.E. #	SIERRA #	PAGE #	O.E. #	SIERRA #	PAGE #
3310-866142A03	18-79994N	731	91-895343T01	18-9897	228	33981	18-2162	844
3310-866142A04	18-79994N	731	91-895343T02	18-9897	228	34127	18-6012	864
35-789884T	18-79965	410	91-90455T	18-9896	228	34235	18-5311	693
35-866594K01	18-7596	410	91-90455T1	18-9896	228	34282	18-1402	806
35-880084T01	18-7523	411	92-802833Q1	18-9420-2P	209, 214	34623	18-5899	766
35-8M0079962	18-79911	409	92-802835Q1	18-9420-30	209	34625	18-5898	766
35-8M0082290	18-79912	156	92-802835Q1	18-9420-3P	209, 214	35329	18-4492	Obsolete
42725A3	18-35437	741	92-802835Q1	18-9420-30P	209, 214	35341	18-3599-2	621, 648, 749, 898, 973
46-803750A02	18-43212	415	92-802836A1	18-9420-7P	209, 214	35583	18-1402	806
46-803750A03	18-48317	419	92-802863A1	18-9240-1	219, 852	35884	18-3551	598, 621, 648, 755
50-805833T	18-6870	679	92-8M0062765	18-8606	222	35915	18-3759	854
50-820193A1	18-6864	394	98230A1	18-73131	843	35957	18-3593	749, 898, 899, 973
50-825991A2	18-6940	394	99798A18	18-1966-1	792	35983	18-4296	844
50-852570T	18-6829	394	MERCURY MARINE			35992	18-3752	844
50-897755T	18-6840	392	6325	18-5345	694	36147	18-2101	843
75962A10	18-43052	411	12415	18-5896	412	36223	18-2752	846, 847
75962A11	18-43052	411	12449	18-5957	719	36312	18-2104	833, 843, 926, 999
75962A9	18-43052	411	12449	18-5965	719	36312	18-2174	833, 843, 926, 999
802632T	18-33104	726	12449	18-5966	719	36525	18-5897	766
806867A12	18-1966-1	792	12708	18-1240	825	37369	18-3593	749, 898, 899, 973
806867A2	18-1966-1	792	12784	18-6400	842	37721	18-0539	446
806867A3	18-1966-1	792	13037	18-5804	716	37951	18-3599-2	621, 648, 749, 898, 973
806867A8	18-1966-1	792	14244	18-0616	805	37967	18-2196	854
806867A9	18-1966-1	792	14259	18-0612	805	37973	18-2150	855
807057T	18-5851	389	14586	18-3549	412	38463	18-7878-1	805
808015T	18-7553	726	14760	18-0615	805	38547	18-5433	696
811536T	18-36906	737	14957	18-7824-2	805	39383	18-2128	831, 833, 842, 930, 999
812966A12	18-3690	418	14957	18-7876-1	805	39384	18-2125	831, 833, 842
816329A3	18-1966-1	792	16755	18-2615	828	39920	18-1973	793
821354A2	18-4531	419	16755	18-2516	825	41431	18-2104	833, 843, 926, 999
823547A2	18-1699	465	17437	18-3599-2	621, 648, 749, 898, 973	41431	18-2174	833, 843, 926, 999
84-813706A56	18-28081	383	17646	18-6771	383, 718	41639	18-7230	740
84-813715A8	18-28082	383	17649	18-6772	718	41815	18-7879-1	805
84-821945A56	18-28080	383	17670	18-3577-2	621, 648, 749, 898, 973	42785	18-5740	720
84-881908T	18-28083	192	18525	18-6771	383, 718	42838	18-8305	446
84-881908T	18-28084	192	18717	18-8309	446	43433	18-2149	848
84-881908T	18-28085	192	19273	18-7249	399	43436	18-3754	848
84-881908T	18-28086	192	19643	18-4261	446	43557	18-5395	695
855676A1	18-3642	412	20121	18-5224	383	43585	18-1730	414
859168T	18-6829	394	20175	18-2146	842	43713	18-2724	845
860235A03	18-1966-1	792	20250	18-2015	868	45523	18-2148	Obsolete
860349A1	18-33207	725	20311	18-7459	470	46020	18-2125	831, 833, 842
861249A1	18-7550	725	22879	18-2149	848	46472	18-1402	806
861676A1	18-35437	741	25661	18-5836	717	46692	18-7878-1	805
861676T09	18-35437	741	29196	18-8084	407	46744	18-1402	806
863358T	18-43017	755	29196	18-8070	407	46860	18-7275	741
864612T01	18-1842	792	29880	18-2149	848	46895	18-3139	414
865202T	18-5851	389	30605	18-3117	414, 750	47441	18-1977-1	756
880596T55	18-7338	402	31640	18-6011	461	47585	18-7278	741
880596T58	18-7346	402	31640	18-6011A	461	47587	18-1910	757
888733T02	18-7336	402	31640	18-6241	461	47588	18-1910	757
892864T04	18-3631	412	31659	18-2753-2	846, 847, 848	47594	18-3557	252, 311, 755, 983
892864T06	18-3635	412	32170	18-6013	864	47638	18-1995	795
893640T01	18-5732	388	32435	18-3117	414, 750	47886	18-5808	388
897755T	18-6840	392	32489	18-3219	844	48045	18-1990	795
8M0065218	18-7347	402	32716	18-7824-2	805	48752	18-3114	414, 749
8M0073435	18-35437	741	32716	18-7876-1	805	48753	18-3115	414
8M0074922	18-43017	755	32717	18-7824-2	805	49117	18-1402	806
8M0076464	18-43017	755	32717	18-7876-1	805	49139	18-3577-2	621, 648, 749, 898, 973
8M0081917	18-9229	220	32722	18-7256	741	52022	18-7824-2	805
8M0084523	18-6948	719	32728	18-3551	598, 621, 648, 755	52022	18-7876-1	805
8M0090809	18-79967	410	32734	18-2750	845, 846, 847	52226	18-3599-2	621, 648, 749, 898, 973
8M0090819	18-3633	412	32768	18-3107	412	52352	18-5315-1	700
8M0094529	18-3691	418	33149	18-2193	827	52353	18-3593	749, 898, 899, 973
8M0113799	18-3688	419	33261	18-5838	716	52444	18-7848-1	408
8M0113801	18-3689	419	33266	18-5315-1	700	52731	18-7824-2	805
8M0117413	18-3640	412	33270	18-5717	716	52731	18-7876-1	805
8M0137769	18-55505	394	33316	18-5838	716	52999	18-4009	795
8M0142679	18-55505	394	33662	18-5345	694	53114	18-2759	846
8M0169547	18-9230	220	33667	18-5385	695	54111	18-7824-2	805
8M0182227	18-9234	220	33700	18-5310	693	54111	18-7876-1	805
8M0182228	18-9235	220	33706	18-5344	694	54534	18-3577-2	621, 648, 749, 898, 973
91-47448A1	18-9896	228	33707	18-5300	694	54552	18-7267	741
91-879172T28	18-79816	221	33708	18-5384	695	54705	18-3107	414
91-895343A02	18-9897	228	33765	18-5386	695	54793	18-3599-2	621, 648, 749, 898, 973

MERCURY MARINE (cont.)			MERCURY MARINE (cont.)			MERCURY MARINE (cont.)		
O.E. #	SIERRA #	PAGE #	O.E. #	SIERRA #	PAGE #	O.E. #	SIERRA #	PAGE #
54870	18-1990	795	76214	18-60161	461	802231	18-7121	470
54981	18-5802	388	76214	18-6016A	461	802276	18-2013	868
55481	18-7853-1	746	76214	18-6244	461	802276	18-2026	868
55989	18-60151-9	864	76270	18-3552	755	802464	18-5107-1	696
56045	18-5957	719	76865	18-2130	855	803148	18-7757	726
56045	18-5956	719	77123	18-1705	843	803149	18-7697	725
56153	18-1401	806	77326	18-2144	428	803470	18-7878-1	805
56879	18-3584-1	648	77443	18-2148	Obsolete	804412	18-5107-1	696
57380	18-5650	395	77481	18-2150	855	804418	18-5354	694
57882	18-7232	740	77594	18-7278	741	804424	18-5408	694
58033	18-5318	693	78016	18-5420	694	805100	18-3784	858
58034	18-5346	694	78458	18-2760	846	805629	18-5021	Obsolete
58086	18-3584	648	78477	18-5957	719	806105	18-6079	865
58217	18-5418	694	78477	18-5956	719	806105	18-6093A	865
58231	18-5315-1	700	78485	18-7274	741	806105	18-6093	839, 865
58749	18-2104	833, 843, 926, 999	78687	18-2144	428	806189	18-6114	865
58749	18-2174	833, 843, 926, 999	78820	18-7275	741	806190	18-6092	865
59078	18-3550	755	79448	18-3751	459	806190	18-6092A	865
59137	18-3551	755	85552	18-2742	462	806490	18-5897	766
59755	18-5957	719	86177	18-5658	395	808483	18-5354	694
59755	18-5956	719	86234	18-7278	741	808484	18-5405	694
59972	18-3577-2	621, 648, 749, 898, 973	86246	18-7274	741	809064	18-7748	736
60207	18-4008	795	86247	18-7275	741	809065	18-7749	736
60252	18-4009	795	86459	18-9099	862	809066	18-7664	737
60565	18-7875	805	86814	18-1710	846	809462	18-5811	S/S to 18-5811-1
60658	18-3599-2	621, 648, 749, 898, 973	87581	18-5315-1	700	809463	18-5811	S/S to 18-5811-1
60687	18-5838	716	88035	18-2372	862	809910	18-0612	805
60930	18-2727	750	88726	18-8305	446	811091	18-5897	766
61073	18-2196	854	89876	18-7853-1	746	811549	18-0614	805
61851	18-1906	794	89902	18-5838	716	811573	18-3577-2	621, 648, 749, 898, 899, 973
62092	18-7267	741	90794	18-5957	719	811618	18-6751	383
62092	18-7267	741	90794	18-5956	719	811628	18-6774	384
62104	18-2322	844	90806	18-5899	766	811635	18-5361	694
62424	18-5315-1	700	90880	18-1905	794	811636	18-5406	694
62981	18-3553	412	92497	18-5957	719	811637	18-5107-1	696
63196	18-7275	741	92497	18-5965	719	811639	18-5108	696
64850	18-5317	Obsolete	92497	18-5966	719	811841	18-3599-2	621, 648, 749, 898, 899, 973
65028	18-2150	855	92802	18-2733	750	814472	18-6275	S/S to 18-6275-1
65057	18-5802	388	93320	18-1908	794	814755	18-3593	749, 898, 899, 973
65142	18-3593	749, 898, 899, 973	93322	18-1985	794	815425	18-5899	766
65547	18-1705	843	93423	18-3199	835, 855	815471	18-2145E	848
65864	18-5420	694	93424	18-3198	855	816597	18-3151	419
66062	18-2130	855	93476	18-0613	805	816607	18-1728	846
66066	18-2150	855	93477	18-0615	805	816685	18-3749	Obsolete
66067	18-2286	854	94318	18-5817	388	816770	18-5707	388
66071	18-3752	844	94576	18-3350	Obsolete	817276	18-3122	750
66850	18-3553	412	94916	18-3351	Obsolete	817377	18-5475	699
67209	18-2144	428	97257	18-5897	766	817378	18-5443	696
67859	18-3577-2	621, 648, 749, 898, 899, 973	97258	18-5898	766	821509	18-5852	389
68100	18-2342	854	97399	18-7288-1	741	821629	18-6080A	865
68575	18-5656	395, 396	97401	18-7283	741	821630	18-6094A	865
69668	18-8305	446	99186	18-6273-1	384	821630	18-6240	865
69729	18-5957	719	110990	18-0980	824	822777	18-6014	461
69729	18-5956	719	1399-99	18-2575	441	823034	18-5793	379
70125	18-7665	737	195141	18-5315-1	700	823728	18-7749	736
70977	18-3113	414	256611	18-5836	717	824519	18-2346	854
70981	18-2762	846	316403	18-6011	461	826134	18-6068	461
71327	18-7278	741	316404	18-6011	461	828151	18-5849	389
71464	18-7667	737	324351	18-3117	414, 750	828708	18-6773	384
71646	18-7274	741	393831	18-2128	831, 833, 842, 930, 999	834832	18-6454	392
71683	18-3584-1	648	397-359	18-5169	377	835076	18-7749	736
72625	18-7667	737	397-741	18-5169	377	846070	18-5817	388
72638	18-1402	806	398-174	18-5153	377	849934	18-7682	725
72777	18-3351	Obsolete	398-693	18-5206	377	850399	18-3599-2	621, 648, 749, 898, 899, 973
72778	18-3350	Obsolete	398-713	18-5207	377	850454	18-3577-2	621, 648, 749, 898, 899, 973
73345	18-4233	461	428381	18-8305	446	850458	18-0614	805
73813	18-1990	795	460201	18-2125	831, 833, 842	850484	18-5362	694
74639	18-2753-2	846, 847, 848	573001	18-5603	645	850485	18-5408	694
75384	18-5697	395	621041	18-2322	844	850487	18-5107-1	696
75639	18-0615	805	681001	18-2342	854	853292	18-5852	389
75661	18-5674	395	758321	18-2104	833, 843, 926, 999	854445	18-7668	726
75692	18-3553	412	758321	18-2174	833, 843, 926, 999	85785-2	18-7229	740
75832	18-2104	833, 843, 926, 999	762142	18-6016	461			
75832	18-2174	833, 843, 926, 999	774811	18-2150	855			
76214	18-6016	461	802206	18-7116	470			

MERCURY MARINE (cont.)			MERCURY MARINE (cont.)			MERCURY MARINE (cont.)		
O.E. #	SIERRA #	PAGE #	O.E. #	SIERRA #	PAGE #	O.E. #	SIERRA #	PAGE #
861260	18-7692	727	11-99298	18-3728	827	23-43045	18-0568-9	Obsolete
861578	18-8297	806	12-12577	18-1191	Obsolete	23-44165	18-4288	827, 831
862132	18-1711	842	12-13171	18-4220	461	23-45736	18-2701-04	864
862209	18-1710	846	12-19183	18-2945	446	23-45736	18-2701	864
862998	18-7701	725				23-47392	18-2336	864
878341	18-3599-2	621, 648, 749, 898, 899, 973	12-20260	18-2945	415, 416, 417, 418, 433, 446, 462, 463, 464, 826, 831, 833, 835, 837, 866	23-48351	18-1329	Obsolete
878342	18-3577-2	621, 648, 749, 898, 899, 973	12-22388	18-4275	446	23-49168	18-1334	810
879036	18-2830-1	823	12-23245	18-2948	446	23-49171	18-1333	810
879078	18-9099	862	12-25410	18-0203	827	23-52221	18-1308	810
879366	18-1194	427	12-25945	18-4275	446	23-52224	18-1309	810
880817	18-3593	749, 898, 899, 973	12-29245	18-4275	446	23-52225	18-1341	Obsolete
881540	18-7979	410	12-29395	18-4267	827	23-52242	18-1329	Obsolete
881731	18-7660	725	12-31060	18-7180	470	23-52261	18-1317	810
883514	18-3573	749	12-31211	18-3714	460, 859	23-52270	18-1308	810
883885	18-3584-1	648	12-31266	18-2340	827	23-52273	18-1309	810
883925	18-3573	749	12-31266	18-2340	827	23-52274	18-1341	Obsolete
884727	18-3593	749	12-32733	18-4275	446	23-52928	18-3109	414, 749
884790	18-5245	694	12-32834	18-0681	827	23-61290	18-2701-04	864
884792	18-5244	694	12-35935	18-0203	827	23-61290	18-2701	864
885176	18-7688	726	12-36001	18-4270	Obsolete	23-61291	18-2336	864
888731	18-5243	694	12-38753	18-4275	446	23-61291	18-2336	864
893409	18-3607	461	12-45176	18-4858-9	446	23-67370	18-2349	858
895338	18-3556	412	12-45176	18-4858-9	446	23-67484	18-1340	810
934231	18-3199	835, 855	12-45810	18-3712	844	23-69884	18-1334	810
934233	18-3199	835, 855	12-49221	18-2948	446	23-69887	18-1333	810
934241	18-3198	855	12-77674	18-2316	827	23-85669	18-1317	810
934243	18-3198	855	12-77987	18-4220	461	23-85677	18-1329	Obsolete
99186-1	18-6273-1	384	12-86645	18-2560	446	23-85684	18-1305	810
10-14834	18-2375	456, 858	12-92721	18-2343-9	827	23-85691	18-1333	810
10-20259	18-2244	456, 858	12-93416	18-0681	827	23-85701	18-1308	810
10-20518	18-2303	848	14-17460	18-2298	459	23-85704	18-1309	810
10-28634	18-2244	456, 858	14-18323	18-2298	459	23-85705	18-1341	Obsolete
10-28668	18-3229	795	14-31210	18-3200	460	23-85715	18-1317	810
10-30206	18-2361	827	14-34817	18-3788-9	859	23-85726	18-1334	810
10-30720	18-3226	Obsolete	14-52833	18-2299	459	23-89574	18-2701-04	864
10-31700	18-2163E-9	845, 848	14-76281	18-3204	460	23-89574	18-2701	864
10-31700	18-2163	845, 848	14-79447	18-2299	459	23-90203	18-2336	864
10-32470	18-6245	462	15-45811	18-2296	840	23-99291	18-2702-04	864
10-36289	18-3729	827	15-71013	18-2296	833, 840	23-99291	18-2702-1	864
10-43749	18-8410	795	17-14872	18-2393	862	24-30893	18-2348	Obsolete
10-44387	18-8411	795	17-14873	18-2394	863	24-38191	18-4161	Obsolete
10-45590	18-2170	844	17-30632	18-2357	450, 837, 839, 853	24-46312	18-4252	863
10-67373	18-3197	750	17-35973	18-3227-9	448, 754, 837	25-16524	18-7421	470
10-76156	18-3197	750	17-44166	18-2396	863	25-20081	18-7151	470
10-79953	18-2244	448, 450, 452, 456, 858	17-44167	18-2397	863	25-20195	18-7134	869
10-86801	18-1706	843	17-45735	18-2152	863	25-20365	18-7135	470
10-97934	18-3729	827	17-45738	18-2151	863	25-20587	18-7168	470
10-98794	18-3231	Obsolete	17-85056	18-2462	862	25-20633	18-7116	470
1100990	18-0980	824	17-99207	18-2463	862	25-20679	18-7153	470
11-20361	18-3722	459	18-52457	18-2848	822	25-20826	18-7459	470
11-21298	18-3721	459	19-14842	18-2465-9	862	25-20863	18-7152	470
11-22178	18-3721	459	19-32652	18-4272	827	25-21720	18-7168	470
11-22339	18-3713	844	19-42682	18-4273	827	25-21836	18-7420	470
11-24648	18-3721	459	19-47579	18-3232	863	25-22174	18-7116	470
11-29241	18-3721	459	22-22175	18-7413	470	25-23145	18-7114	470
11-33962	18-3721	459	22-30139	18-4263	795	25-25439	18-7153	470
11-34932	18-3720	459	22-32802	18-4263	795	25-26543	18-0175	Obsolete
11-34933	18-3721	459	22-32803	18-4264	795	25-26722	18-7115	470
11-35888	18-3722	459	22-33198	18-4258	663	25-26802	18-7180	470
11-35921	18-3719	457	22-36305	18-8216	798	25-26834	18-7168	470
11-36084	18-3713	844	22-36392	18-8111	795	25-26855	18-7155	470
11-39823	18-3785	859	22-41622	18-4258	663, 795	25-27018	18-7173	470
11-39907	18-3785	859	22-41622	18-4258	663, 795	25-29439	18-7156	470
11-42633	18-2346	854	22-42861	18-4265	795	25-29845	18-7103	470
11-45592	18-3723	459	22-46754	18-4258	663	25-29976	18-7157	470
11-46355	18-3721	459	22-63186	18-8054	406	25-30224	18-7173	470
11-47411	18-3719	457	22-63187	18-8055	406	25-30271	18-7426	470
11-52707	18-3700	460	22-64426	18-4218	798	25-30529	18-7171	470
11-54034	18-3785	859	22-67892	18-2375	456, 858	25-30613	18-7158	470
11-69578	18-3704	460	22-87238	18-4218	798	25-31305	18-7172	470
11-88228	18-3703	460	22-87543	18-4264	795	25-31534	18-7159	470
11-95702	18-3721	459	23-11992	18-1327	810	25-31986	18-7160	470
11-97522	18-3713	844	23-15961	18-1308	810	25-32424	18-7162	470
			23-29804	18-3109	414, 749	25-32507	18-7127	869
			23-32632	18-3236	864	25-32509	18-7165	470
			23-34464	18-1317	810	25-32546	18-7161	470

MERCURY MARINE (cont.)			MERCURY MARINE (cont.)			MERCURY MARINE (cont.)		
O.E. #	SIERRA #	PAGE #	O.E. #	SIERRA #	PAGE #	O.E. #	SIERRA #	PAGE #
25-33145	18-7162	470	26-32080	18-2003	865	27-11987	18-4408	Obsolete
25-33465	18-7163	470	26-32121	18-2017	868	27-11988	18-0311	824
25-33466	18-7164	470	26-32511	18-2049	868	27-11999	18-2845	824
25-33466	18-7164	470	26-32911	18-0517	467	27-13218	18-3877	821
25-33504	18-7170	470	26-33144	18-2014	868	27-13687	18-3877	821
25-35027	18-7117	470	26-34217	18-0518	467	27-13709	18-3878	821
25-35029	18-7121	470	26-35025	18-2017	868	27-13865	18-1237	819
25-35276	18-7135	470	26-36054	18-2003	865	27-14241	18-0322	826
25-35480	18-7411	470	26-36143	18-2094	826	27-14247	18-0405	819
25-35984	18-7169	470	26-36556	18-0563	446	27-14250	18-0976	824
25-36318	18-7440-1	470	26-36557	18-0521	446	27-14765	18-25001	824
25-36390	18-7410	870	26-37259	18-2056	868	27-14901	18-0466	819
25-38933	18-7120	470	26-38970	18-3110	414, 749	27-15172	18-0324	440
25-39572	18-7151	470	26-41131	18-0579	467	27-17145	18-0868	820
25-39695	18-7464	470	26-41132	18-0580	467	27-17467	18-0664	824
25-45254	18-7166	470	26-41365	18-0581	467	27-18272	18-0881-1	797
25-45710	18-7198	470	26-41953	18-2016	868	27-18937	18-3828	437
25-45711	18-7174	470	26-42102	18-2728	446	27-19050	18-0642	442
25-47254	18-7961	470	26-43035	18-0583	467	27-19138	18-3804	437
25-47386	18-7411	470	26-43036	18-0522	467	27-19202	18-2559	444
25-47632	18-7146	470	26-43993	18-0523	467	27-19206	18-0633	440
25-48171	18-7168	470	26-45577	18-2944	826	27-19315	18-3877	821
25-48451	18-7159	470	26-45587	18-0525	467	27-19551	18-2824	445
25-53421	18-7177	470	26-46021	18-2009	868	27-19552	18-2841	445
25-54029	18-0858	470	26-48443	18-0526	467	27-19553	18-2823	445
25-54030	18-7467	470	26-49131	18-4022	815	27-19701	18-0622	445
25-59712	18-7177	470	26-49154	18-1233	815	27-22023	18-2572	440
25-62700	18-0860	470	26-49947	18-1211	815	27-25848	18-2568	440
25-62702	18-7413	470	26-55682	18-2050	868	27-25849	18-2569	441
25-62704	18-7116	470	26-56397	18-0527	467	27-25851	18-2570	441
25-62705	18-7105	470	26-56788	18-2008	467	27-26891	18-2800	440
25-62706	18-7102	470	26-56866	18-1230	815	27-27936	18-0870	442
25-62817	18-7175	470	26-56868	18-0528	815	27-30603	18-2914	446
25-64068	18-7145	470	26-58094	18-0518	815	27-30604	18-2915	446
25-65936	18-7143	470	26-58094	18-4023	815	27-30803	18-0385	443
25-67202	18-7107	470	26-58203	18-1211	815	27-31402	18-2571	435, 440
25-67675	18-7164	470	26-62818	18-0529	467	27-31436	18-2837	443
25-69202	18-7419	470	26-66022	18-0584	467	27-31439	18-2836	442
25-70937	18-7169	470	26-66303	18-0595	467	27-31557	18-0385	443
25-85148	18-7116	470	26-67388	18-0578	815	27-32433	18-2914	446
25-85549	18-7956	470	26-67863	18-4022	815	27-32434	18-2915	446
25-85594	18-7100	470	26-69188	18-2051	868	27-32438	18-2801	Obsolete
25-94288	18-7474	470	26-69189	18-2052	868	27-32769	18-2823	445
25-97387	18-7449	470	26-70019	18-2002	467	27-32770	18-2824	445
25-98277	18-7113-9	411	26-70081	18-2053	467	27-32771	18-2825	445
26-12224	18-2076	868	26-72564	18-0518	815	27-32816	18-2896-1	797
26-14077	18-2077	868	26-72564	18-4023	815	27-32910	18-0356	821
26-14240	18-0519	467	26-72785	18-0531	467	27-33121	18-2830-1	823
26-16977	18-2026	868	26-75413	18-0518	815	27-33179	18-2917	822
26-16977	18-2013	868	26-75413	18-4023	815	27-33395	18-2949	797
26-20070	18-2004	467	26-75624	18-0518	815	27-33918	18-0398	823
26-20079	18-2016	868	26-75624	18-4023	815	27-33956	18-0327	825
26-20465	18-2013	868	26-75982	18-4022	815	27-34041	18-0347	824
26-20465	18-2026	868	26-75988	18-4022	815	27-34042	18-0346	824
26-21642	18-2055	868	26-76384	18-2054	467	27-34043	18-2845	824
26-23300	18-2011	868	26-76868	18-2002	467	27-34208	18-0328	825
26-23517	18-2015	868	26-77634	18-2014	868	27-34209	18-0329	825
26-24590	18-2048	868	26-79831	18-2055	868	27-34213	18-0889	824
26-25329	18-0514	Obsolete	26-79831	18-2055	868	27-34216	18-0887	824
26-25776	18-2009	868	26-79884	18-2013	868	27-34273	18-3880	821
26-25837	18-2016	868	26-79884	18-2026	868	27-34278	18-3876	821
26-27163	18-2019	868	26-85107	18-0537	467	27-34486	18-0874	822
26-29476	18-2016	868	26-88416	18-2094	826	27-34502	18-0905	827
26-29595	18-2011	868	26-89237	18-2056	868	27-34614	18-2570	441
26-29677	18-3110	414, 749	26-89238	18-2014	868	27-34891	18-0874	822
26-30530	18-0515	467	26-90562	18-2011	868	27-34895	18-0976	824
26-30550	18-2002	467	26-90925	18-0864	815	27-34896	18-0891	825
26-30696	18-8308	467	26-94038	18-2007	868	27-34897	18-0891	825
26-30727	18-2007	868	26-96503	18-2056	868	27-34898	18-0876	821
26-30900	18-8310	467	26-97530	18-0172	467	27-35380	18-0893	825
26-30913	18-0516	Obsolete	26-97664	18-4024	815	27-35982	18-2840	825
26-31249	18-2009	868	26-99325	18-0586	467	27-35996	18-2617	828
26-31489	18-2007	868	27-11338	18-2513	441	27-35996	18-2556	825
26-31507	18-2013	868	27-11977	18-4408	Obsolete	27-37724	18-0879	443
26-31507	18-2026	868	27-11986	18-3879	821	27-37725	18-0103	443

MERCURY MARINE (cont.)			MERCURY MARINE (cont.)			MERCURY MARINE (cont.)		
O.E. #	SIERRA #	PAGE #	O.E. #	SIERRA #	PAGE #	O.E. #	SIERRA #	PAGE #
27-37816	18-2507	442	27-52584	18-2830-1	823	27-72487	18-2507	442
27-37976	18-0988	444	27-52892	18-0133	441	27-72496	18-0103	443
27-38501	18-0879	443	27-52893	18-2500	442	27-72505	18-2500	442
27-39164	18-3881	821	27-53045	18-2917	822	27-72506	18-2807	442
27-39316	18-0371	441	27-53354	18-2912-1	797	27-72507	18-2574	442
27-39401	18-0333	443	27-53650	18-2514	441	27-72508	18-0944	442
27-39402	18-0334	443	27-53863	18-2807	442	27-72509	18-2839	442
27-39623	18-2827	445	27-54014	18-2620	828	27-72510	18-0107	441
27-39625	18-2828	445	27-54014	18-2847	825	27-72622	18-3881	821
27-39915	18-2819-1	797	27-54529	18-0980	824	27-72627	18-0153	819
27-39923	18-1210-1	797	27-54566	18-0183-1	796	27-72637	18-0868	820
27-41382	18-2837	443	27-55279	18-2838	442	27-72779	18-0916	825
27-41417	18-2710	441	27-55308	18-0940	442	27-72780	18-0386	825
27-41418	18-2712	441	27-55810	18-0894	825	27-72915	18-0371	441
27-41449	18-0633	440	27-56110	18-3883	821	27-72916	18-0372	442
27-41475	18-2717	443	27-56173	18-0352	824	27-72917	18-0373	441
27-41499	18-2716	443	27-56304	18-0982-1	444	27-72918	18-2837	443
27-41610	18-0467	822	27-56859	18-0898	826	27-72919	18-2836	442
27-41811	18-0672	797	27-56880	18-0147	825	27-73377	18-2804	440
27-41812	18-2554	822	27-56883	18-0889	821	27-73645	18-0926	442
27-41813	18-0897	797	27-56884	18-0357	821	27-73665	18-0133	441
27-42178	18-0633	440	27-58025	18-7143	470	27-73666	18-0685	821
27-42206	18-2559	444	27-58764	18-0353	796	27-73814	18-0928-1	823
27-42631	18-2919	446	27-60208	18-2834	815	27-73866	18-0183-1	796
27-42744	18-3879	821	27-60286	18-2512	Obsolete	27-74264	18-3878	821
27-43007	18-0670	443	27-60310	18-2504	442	27-74511	18-2504	442
27-43008	18-0341	443	27-60317	18-0904	Obsolete	27-74830	18-2843	822
27-43033	18-2564-1	445	27-60475	18-2573	442	27-75450	18-0365	823
27-43033	18-2564	445	27-60476	18-2574	442	27-75483	18-0611	Obsolete
27-43034	18-2563	445	27-60477	18-2839	442	27-75611	18-3876	821
27-43047	18-2565	445	27-60479	18-2835	444	27-75646	18-3883	821
27-43337	18-2713	443	27-60715	18-0354	821	27-75647	18-3883	821
27-43777	18-2810	443	27-60721	18-0905	827	27-75648	18-0410	820
27-43779	18-2809	444	27-60945	18-0912	444	27-75791	18-2800	440
27-45088	18-0373	441	27-61224	18-3877	821	27-75909	18-0369	443
27-45588	18-2622	844	27-61782	18-0403	816	27-75952	18-0151	442
27-45748	18-0385	443	27-62386	18-0182	334	27-76401	18-2504	442
27-45821	18-2614	828	27-62860	18-0988	444	27-76589	18-0139	443
27-45821	18-2820	825, 828	27-63309	18-2572	440	27-76636	18-0151	442
27-46110	18-0942	442	27-64173	18-2835	444	27-76862	18-0932	442
27-46233	18-2836	442	27-64203	18-0107	441	27-77417	18-2841	445
27-46401	18-2830-1	823	27-64204	18-0944	442	27-78026	18-2507	442
27-46820	18-0418	797	27-64692	18-0356	821	27-78027	18-0940	442
27-47453	18-3881	821	27-64763	18-3883	821	27-78035	18-2836	442
27-47510	18-2553	822	27-64798	18-0407	Obsolete	27-78068	18-2503	444
27-47590	18-2831	822	27-64818	18-2820	825, 828, 842, 848	27-78069	18-0934-1	444
27-47644	18-0342	826	27-64818	18-2614	828	27-78087	18-2837	443
27-47644	18-0342	826	27-64857	18-0131	441	27-78246	18-0135	443
27-48042	18-0885-1	797	27-64940	18-2807	442	27-78409	18-0371	441
27-48043	18-2832-1	816, 823	27-65184	18-0465	821	27-78410	18-0372	442
27-48043	18-2832-1-9	816, 823	27-65577	18-0357	821	27-78411	18-0373	441
27-48164	18-2802	440	27-65744	18-0129	441	27-78623	18-0139	443
27-48330	18-3876	821	27-65788	18-2806	442	27-78690	18-0936	444
27-48399	18-0462	822	27-66101	18-2835	444	27-79373	18-2622	844
27-48713	18-0982-1	444	27-66102	18-0912	444	27-79650	18-0103	443
27-48818	18-2844	822	27-66358	18-2837	443	27-79986	18-3878	821
27-49104	18-3877	821	27-67208	18-2513	441	27-81084	18-2946	821
27-49107	18-0348	819	27-67275	18-0359	441	27-81987	18-4698	446
27-49109	18-0980	824	27-67389	18-0864	815	27-85087	18-2561	Obsolete
27-49110	18-0903	825	27-67738	18-2501	441	27-85487	18-2507	442
27-49121	18-0464	824	27-67751	18-2509	440	27-85488	18-0940	442
27-49814	18-0467	822	27-68714	18-4380	820	27-85491	18-0942	442
27-49936	18-0346	824	27-68715	18-0956-1	824	27-85493	18-2500	442
27-49953	18-0887	824	27-69238	18-2835	444	27-85494	18-2807	442
27-49955	18-0905	827	27-69524	18-0918	441	27-85495	18-2574	442
27-52076	18-2833	823	27-69525	18-0131	441	27-85496	18-0944	442
27-52144	18-0466	819	27-69659	18-2800	440	27-85497	18-2839	442
27-52145	18-0347	824	27-70142	18-0360	822	27-85498	18-0107	441
27-52184	18-0874	822	27-70143	18-0994	822	27-85608	18-2914	446
27-52202	18-2845	824	27-70335	18-0922	442	27-85609	18-2915	446
27-52364	18-2946	821	27-70905	18-0158	823	27-85610	18-2826	445
27-52546	18-2896-1	797	27-72098	18-4380	820	27-85653	18-0946	Obsolete
27-52550	18-0348	819	27-72142	18-2573	442	27-85978	18-2710	441
27-52571	18-0403	816	27-72479	18-4366	820	27-85979	18-2712	441
27-52579	18-0372	442	27-72486	18-0942	442	27-87396	18-2502	442

MERCURY MARINE (cont.)			MERCURY MARINE (cont.)			MERCURY MARINE (cont.)		
O.E. #	SIERRA #	PAGE #	O.E. #	SIERRA #	PAGE #	O.E. #	SIERRA #	PAGE #
27-87707	18-0948	824	31-30956	18-1158	453	391-5090	18-5314	693
27-88046	18-0950	826	31-32898	18-1115	453	391-5092	18-5338	694
27-88449	18-2504	442	31-35246	18-1120	855	391-5092	18-5338	694
27-88451	18-0139	443	31-42647	18-1117	453	391-5093	18-5338	694
27-88907	18-0952	444	31-54928	18-1356	855	391-7057	18-5404-1	694
27-89221	18-0384	440	31-67526	18-1194	427	39-17464	18-3937	806
27-89656	18-2555	822	31-73363	18-1122	Obsolete	39-17465	18-3938	Obsolete
27-89657	18-0111	Obsolete	31-74248	18-1196	427	392-6318	18-5369	695
27-89937	18-0385	443	32-14358	18-2746	846	392-6324	18-5347	694
27-90430	18-2803	440	32-16011	18-70955	767	392-6325	18-5303	693
27-90458	18-0411	820	32-16012	18-70956	767	392-6326	18-5407	694
27-90484	18-2502	442	32-16021	18-70925	769, 770	392-6329	18-5399	695
27-90556	18-2554	822	32-32461	18-3601	768, 770, 845	392-8263	18-6799	718
27-91831	18-0464	824	32-38377	18-2160	847	392-8263	18-6768	718
27-91892	18-0185	819, 825	32-43437	18-3603	769, 770, 845	392-8989	18-6255	Obsolete
27-92166	18-3878	821	32-44348	18-2748	846	392-9086	18-5353	694
27-92331	18-2717	443	32-45327	18-2110	460	392-9089	18-5403	694
27-92332	18-2716	443	32-45959	18-2111	460	392-9766	18-5352	694
27-92720	18-0954	823	32-45973	18-2105	Obsolete	392-9767	18-5403	694
27-93214	18-0324	440	32-45974	18-2106	860	393-3230	18-5389	695
27-93536	18-2501	441	32-47373	18-2103	859	39-34479	18-3942	806
27-94914	18-0386	825	32-47640	18-70931	769	393-4988	18-5389	695
27-94915	18-0916	825	32-48131	18-71218	770	39-34988	18-3937	806
27-94996	18-2619-1	828	32-48132	18-71218	770	393-9459	18-5385	695
27-94996	18-2743	825, 828	32-48418	18-2126	861	394-1130	18-5169	377
27-96171	18-2505	442	32-52481	18-70930	769	39-48344	18-3939	806
27-96278	18-2808	442	32-54236	18-3220	750	39-48345	18-3938	Obsolete
27-96286	18-2713	443	32-55816	18-2107	860	39-58096	18-3942	806
27-96429	18-1204-1	797	32-59841	18-2108	860	39-65153	18-3937	806
27-96429	18-1204-1-9	788, 797, 824	32-59842	18-2109	860	39-66217	18-3939	806
27-96440	18-2508-1	444	32-66073	18-2103	859	39-67119	18-3942	806
27-96483	18-2810	443	32-68676	18-2103	859	39-67123	18-3937	806
27-96485	18-2809	444	32-71613	18-70928	770	39-67126	18-3938	Obsolete
27-96761	18-2510	441	32-73004	18-2103	859	39-67132	18-3942	806
27-97529	18-3877	821	32-73005	18-2109	860	39-75422	18-3928	806
27-97542	18-0113-1	819, 823	32-73123	18-2108	860	39-75609	18-3944	806
27-97863	18-0881-1	797	32-73794	18-70929	Obsolete	398-2202	18-5140	376
27-98185	18-2807	442	32-73795	18-70927	769	398-5255	18-5856	386
27-98769	18-0970	441	32-73796	18-70926	Obsolete	39-88392	18-3917	424
27-98823	18-0388	826	32-79431	18-2103	859	39-97125	18-3939	806
27-99176	18-2506-1	444	32-86036	18-2103	859	40-52035	18-4294	Obsolete
27-99177	18-2503	444	32-87116	18-70925	769	43-61027	18-2200	852
27-99326	18-2562	445	32-87117	18-70932	769	43-92320	18-2409	852
27-99506	18-0667	822	32-87234	18-2112	860	44-17915	18-2260	457
27-99757	18-2909	824	32-87235	18-2113	Obsolete	44-55857	18-2166	853
27-99776	18-2508-1	444	32-88005	18-2110	460	44-66060	18-2166	835, 837, 853
27-99777	18-2833	823	32-88006	18-2111	460	44-94148	18-2239	457
27-99960	18-0389	823	32-89653	18-70704	770	44-98418	18-2260	457
28-43037	18-3293	414, 450, 750, 839	32-90949	18-2761	846	45-42634	18-2180	835, 854
29-47270	18-4036	427	32-95858	18-2435	860	4602002	18-2125	831, 833, 842
29-71422	18-4037	427	32-95859	18-2436	861	46-96148	18-3116	414, 750
30-17927	18-1155	453	32-96246	18-70958	768	47-16154	18-3098	413
30-20066	18-1151	Obsolete	32-96879	18-70931	769	47-19453	18-8900	414
30-20464	18-1153	427, 453, 857	32-99902	18-2136	860	47-20813	18-3008	413
30-20839	18-1190	453	32-99903	18-2137	860	47-22748	18-3012	413
30-20861	18-1398	427	32-99904	18-2116	861	47-25287	18-3008	413
30-23679	18-1152	379	35-16248	18-7712	410	47-30221	18-3017	413
30-35914	18-1155	453	35-16494	18-7829	161	47-39074	18-3039	413
30-36056	18-2101	843	35-49088	18-7860	748	47-56780	18-3052	413
30-36418	18-2101	843	35-52456	18-7944	410	47-59362	18-3087	749, 751
30-41421	18-1345	427	35-52456	18-7945	747	47-65957	18-3039	413
30-43011	18-1346	Obsolete	35-53336	18-7859	748	47-65958	18-3052	413
30-49313	18-1153	427, 453, 857	35-55501	18-7944	410	47-65960	18-3017	413
30-54215	18-1153	427, 453, 857	35-55501	18-7845	747	47-68988	18-3054	413
30-62699	18-1190	453	35-55501	18-7945	747	47-85460	18-3017	413
30-63326	18-1153	427, 453, 857	35-57250	18-7944	410	47-89980	18-3054	413
30-63742	18-1154	453	35-57250	18-7845	747	47-89981	18-3039	413
30-67923	18-1345	427	35-57250	18-7945	747	47-89982	18-3052	413
30-72961	18-1398	427	35-60494	18-7944	410	47-89983	18-3007	412
30-88957	18-1155	453	35-60494	18-7945	747	47-89984	18-3017	413
31-12576	18-1112	453	35-93568	18-7717	748	50-12872	18-5903	713
31-12578	18-1113	453	391-5075	18-5376	695	50-44369	18-5606	Obsolete
31-17514	18-1194	427	391-5076	18-0422	822	50-44414	18-5608	393
31-29982	18-1115	453	391-5081	18-7143	470	50-44414	18-5608	393
31-30895	18-1157	453	391-5088	18-5404-1	694	50-44415	18-5608	393

MERCURY MARINE (cont.)			MERCURY MARINE (cont.)			MERCURY MARINE (cont.)		
O.E. #	SIERRA #	PAGE #	O.E. #	SIERRA #	PAGE #	O.E. #	SIERRA #	PAGE #
50-44415	18-5608	393	815279-3	18-5743	388	10-816601	18-3230	833
50-45093	18-4915	396	815279-5	18-5743	388	10-853163	18-2361	827
50-47455	18-5908	714	81-64851	18-5346	694	11-13439-1	18-3721	827
50-55601	18-5601	393	8168111	18-3752	844	11-805092	18-3783	859
50-56886	18-5903	713	8168112	18-3752	844	11-805093	18-3786	859
50-57867	18-5636	394	8172761	18-3122	750	11-826375	18-3719	457
50-60315	18-5606	395	8172763	18-3122	750	11-827614	18-3700	460
50-64975	18-5636	394	8227731	18-0202-9	Obsolete	11-859116	18-3721	827
50-66015	18-5642	393, 395	8227772	18-6014	461	11-859131	18-3783	859
50-67341	18-5602	393	8503991	18-3599-2	621, 648, 749, 898, 899, 973	11-862907	18-3786	859
50-72467	18-5636	394				11-863332	18-3728	827
50-73521	18-5605	393, 395	8504541	18-3577-2	621, 648, 749, 898, 899, 973	12-191832	18-2945	446
50-77141	18-5608	393				12-191833	18-2945	446
50-77141	18-5608	393	8504541	18-3577-2	621, 648, 749, 898, 899, 973	12-492211	18-2948	446, 448, 826
50-79472	18-5608	393				12-815472	18-0318	827
50-79472	18-5608	393	8504851	18-5408	694	12-824793	18-4275	446
52-12777	18-2236	457	8507521	18-2162	844	12-835467	18-4220	461
52-34239	18-2236	457	8507522	18-2162	844	12-866451	18-2560	446
52-66063	18-2202	853	87-18211	18-5729	389	12-934161	18-0681	827
53-29641	18-4295	855	87-19761	18-5737	389	1337-2103	18-7078	Obsolete
54-31765	18-710-72-2	849	87-71831	18-5317	Obsolete	1337-2604	18-7078	Obsolete
54-32533	18-710-48-2	849	87-88107	MP41000	383	1346-2770	18-7080	736
54-38863	18-7321	847	89-15857	18-5815	388, 717	1356-4066	18-7096	736
57-13457	18-15290	771	89-18080	18-5837	716	1356-4092	18-7096	736
57-13458	18-15550	771	89-61053	18-5815	388	1356-5155	18-7096	736
57-32850	18-15410	771	89-65258	18-5815	388, 717	1356-5169	18-7096	736
57-32850	18-15400	771	89-76545	18-5815	388, 717	1395-4808	18-7006-1	397
57-33170	18-15520	771	89-91975	18-5816	388	1395-6200	18-7004	397
57-36356	18-15415	771	89-96054	18-5816	388	1395-6452	18-7005	397
57-45856	18-15440	771	89-96158	18-5817	388	1395-7824	18-7233	399
57-48120	18-15460	771	89-99253	18-5838	716	1395-8318	18-7061	399
57-48122	18-15480	771	91-12037	18-9806E	229	1395-8506	18-7354	397
57-49043	18-15410	771	91-12427	18-9807	229	1395-8673	18-7208	399
57-49211	18-15430	771	91-15755	18-9808	229	1395-8983	18-7208	399
57-49211	18-15435	771	91-17256	18-9803	229, 852	1395-9022	18-7295	397
57-49756	18-15300	771	91-17257	18-9809	229	1395-9024	18-7215	397
57-52692	18-15390	771	91-23033	18-9817	229	1395-9179	18-7212	397
57-53215	18-15290	771	91-24150	18-9817	229	1395-9258	18-7057	399
57-64032	18-15410	771	91-30500	18-9785	224	1395-9293	18-7209	399
57-64416	18-15430	771	91-31107	18-9817	229	1395-9377	18-7212	397
57-64416	18-15435	771	91-31109	18-9808	229	1395-9594	18-72000	399
57-65607	18-15370	771	91-31229	18-9819	235	1395-9599	18-7750-1	399
57-74271	18-15345	771	91-32336	18-9822	230, 235	1395-9645	18-7212	397
57-76269	18-15405	771	91-33489	18-9823	229	1395-9650	18-7226	397
57-77274	18-15345	771	91-33491	18-9824	229	1395-9725	18-7212	399
57-78200	18-15470	771	91-33492	18-9825	229	1395-9761	18-7212	399
57-91035	18-15495	771	91-33493	18-9826	229	1395-9803	18-7212	399
57-96834	18-15550	771	91-36235	18-9803	852	1396-4148	18-7227	Obsolete
733-2278	18-4180	Obsolete	91-36379	18-9828	235	1396-4656	18-7081	736
733-3818	18-4160	Obsolete	91-37263	18-9808	229	1396-5222	18-7096	736
733-3819	18-4191	806	91-37292	18-9832	230, 235	1396-5238	18-7096	736
733-3819	18-4161	Obsolete	91-37311	18-9833	230, 235	1397-2060	18-7200	737
733-4028	18-4191	806	91-37312	18-9834	230, 235	1397-2067	18-7746	736
733-4028	18-4161	Obsolete	91-37323	18-9835	230	1397-2072	18-7070	586
735-6370	18-4173	806	91-37324	18-9815	235	1397-2133	18-7078	Obsolete
735-6370	18-4173	806	91-37350	18-9836	230	1397-2150	18-7855	748
735-6371	18-4164	806	91-37384	18-4442	234, 852	1397-2605	18-7078	Obsolete
735-9431	18-4164	806	91-38756	18-9838	230	1397-2631	18-7746	736
735-9686	18-4173	806	91-43579	18-9844	230	1397-2634	18-7746	736
735-9687	18-4164	806	91-48347	18-4442	234, 852	1397-2637	18-7070	586
735-9703	18-4173	806	91-52393	18-9848	230, 235	1397-2637	18-7746	736
735-9704	18-4164	806	91-52394	18-9849	230	1397-3306	18-7072	736
735-9715	18-4178	806	91-53459	18-9850	230	1397-3327	18-7201	737
736-2343	18-4180	Obsolete	91-55916	18-9851	230	1397-3458	18-7071	735
737-6523	18-4189	806	91-55918	18-9852	231	1397-3459	18-7746	736
8052732	18-3649	755	91-60523	18-9855	231	1397-3462	18-7078	Obsolete
8055361	18-2097	833, 842	91-63616	18-9859	231	1397-3464	18-7070	586
8072521	18-3551	755	91-78310	18-9861	231	1397-3464	18-7746	736
8072522	18-3649	755	91-87119	18-9862	234	1397-4329	18-7072	736
8072531	18-3551	755	91-89865	18-9863	232	1397-5635	18-7072	736
8094621	18-5811	S/S to 18-5811-1	91-89897	18-9866	232	1397-5830	18-7075	735
8094631	18-5811	S/S to 18-5811-1	91-90774	18-9865	232	1397-5831	18-7075	735
8107492	18-7213	397	91-95830	18-4444	460, 859	1397-5837	18-7202	737
8107493	18-7214	397	91-99379	18-9802	385	1397-6367	18-7076	736
815279-1	18-5741	388	10-805763	18-2361	827	1397-6638	18-7072	736

MERCURY MARINE (cont.)			MERCURY MARINE (cont.)			MERCURY MARINE (cont.)		
O.E. #	SIERRA #	PAGE #	O.E. #	SIERRA #	PAGE #	O.E. #	SIERRA #	PAGE #
1397-7099	18-7075	735	26-455771	18-2944	826	27-430053	18-2740	442
1397-7539	18-7095	736	26-814622	18-1211	815	27-430055	18-2740	442
1397-7540	18-7095	736	26-814754	18-8305	446	27-430056	18-2740	442
1397-7542	18-7070	586	26-821309	18-3013	414	27-430057	18-2740	442
1397-7542	18-7746	736	26-821310	18-3014	414	27-43006-2	18-0339	444
1397-7543	18-7070	586	26-821928	18-0585	467	27-430066	18-0339	444
1397-7543	18-7746	736	26-821947	18-1233	815	27-430073	18-0670	443
1397-7544	18-7095	736	26-823894	18-2003	868	27-430075	18-0670	443
1397-7547	18-7746	736	26-830749	18-2430	446	27-430082	18-0341	443
1397-8535	18-7095	736	26-830749	18-24301-9	446	27-430083	18-0341	443
1397-8545	18-7869	748	26-864319	18-3289	826	27-430085	18-0341	443
1397-8546	18-7201	737	26-888483	18-0564	467	27-430086	18-0341	443
1397-8582	18-7666	737	26-892361	18-2009	868	27-430331	18-2564-1	445
1397-8760	18-7075	735	26-896600	18-0560	467	27-430331	18-2564	445
1397-8767	18-7869	748	26-897153	18-2010	467	27-430341	18-2563	445
1397-8872	18-7070	586	26-897154	18-2006	467	27-430471	18-2565	445
1397-8872	18-7746	736	26-965031	18-2056	868	27-430472	18-2565	445
1397-8873	18-7746	736	26-976641	18-4024	815	27-433371	18-2713	443
1397-8952	18-7077	736	27-138651	18-1237	819	27-433372	18-2713	443
1397-8959	18-7201	737	27-13937-6	18-0320	441	27-433373	18-2713	443
1397-9723	18-7095	736	27-139581	18-2621	441	27-433374	18-2713	443
1398-3089	18-7080	736	27-14318-2	18-0323	444	27-437771	18-2810	443
1399-1136	18-7832	410	27-146972	18-0644	441	27-437772	18-2810	443
1399-1138	18-7057	399	27-15172-3	18-0324	440	27-437791	18-2809	444
1399-1473	18-7057	399	27-151724	18-0324	440	27-437792	18-2809	444
1399-1717	18-7006-1	397	27-167371	18-0645	441	27-443281	18-2943	442
1399-1754	18-7832	410	27-18307-1	18-0643	443	27-443282	18-2943	442
1399-2015	18-7006-1	397	27-183076	18-0643	443	27-443283	18-2943	442
1399-3523	18-7006-1	397	27-187851	18-3861	437	27-443284	18-2943	442
1399-3938	18-7832	410	27-187853	18-3861	437	27-475901	18-2831	822
1399-5135	18-7007	397	27-18786-1	18-3871	438	27-476441	18-0342	826
1399-5137	18-7815	399	27-188891	18-0624	441	27-480431	18-2832-1	797, 823
1399-5198	18-7007	397	27-190502	18-0642	442	27-480431	18-2832-1-9	797, 823
14-816629	18-3200	460	27-190503	18-0642	442	27-481641	18-2802	440
17-815953	18-2395	863	27-190505	18-0642	442	27-488181	18-2844	822
18-524571	18-2848	822	27-190506	18-2735	443	27-524572	18-2848	822
19-148421	18-2465-9	862	27-19204-2	18-2558	444	27-530451	18-2917	822
19-475791	18-3232	831, 864	27-192061	18-0633	440	27-552791	18-2838	442
19-815951	18-2466-9	862	27-194541	18-2593	445	27-558101	18-0894	825
22-328021	18-4263	795	27-279361	18-0870	442	27-628601	18-0988	444
22-328022	18-4263	795	27-331791	18-2552	822	27-657441	18-0129	441
22-428611	18-4265	795, 831	27-331792	18-2552	822	27-657442	18-0129	441
22-806926	18-4227	798	27-342731	18-3880	821	27-657443	18-0129	441
22-807155	18-4461	663, 798	27-344861	18-0874	822	27-661021	18-0912	444
22-841908	18-4263	795	27-344863	18-0874	822	27-672751	18-0359	441
22-861187	18-4265	795	27-385011	18-0879	443	27-692381	18-2835	444
22-862210	18-4227	798	27-41245-1	18-3872	438	27-695241	18-0918	441
23-801793	18-1311	990	27-41246-1	18-3862	434, 435, 438	27-695242	18-0918	441
23-801803	18-1320	810	27-414171	18-2710	441	27-695251	18-0131	441
23-807073	18-4288	864	27-414172	18-2710	441	27-695252	18-0131	441
23-811858	18-1337	810	27-414181	18-2712	441	27-701431	18-0994	822
23-815950	18-2341-1	864	27-414491	18-0633	440	27-703351	18-0922	442
23-816583	18-3222	750	27-414751	18-2717	443	27-721421	18-2573	442
23-818469	18-1317	810	27-414752	18-2717	443	27-733771	18-2804	440
23-853853	18-1148	Obsolete	27-414753	18-2717	443	27-738141	18-0928-1	823
23-888690	18-9075	461	27-414754	18-2717	443	27-757911	18-2800	440
24-801879	18-1234	815	27-414755	18-2717	443	27-768621	18-0932	442
24-811554	18-1234	815	27-414756	18-2717	443	27-782461	18-0135	443
25-201951	18-7134	869	27-414757	18-2717	443	27-796501	18-0103	443
25-805726	18-7188	470	27-414758	18-2717	443	27-801853	18-4387	821
25-806609	18-7165	470	27-414991	18-2716	443	27-801855	18-4365	821
25-807149	18-7163	470	27-414992	18-2714	443	27-803508	18-3844	438
25-809086	18-0715	399	27-414993	18-2714	443	27-805215	18-0916	825
25-818573	18-7400	438	27-414994	18-2714	443	27-805396	18-0740-1	441
25-843315	18-7114	470	27-414995	18-2714	443	27-806452	18-0347	824
25-846356	18-7164	470	27-41670-3	18-0336	443	27-807218	18-0928-1	823
25-846357	18-7158	470	27-41670-5	18-0336	443	27-807982	18-0994	822
25-846361	18-7464	470	27-426311	18-2919	446	27-810846	18-1239	819
25-853220	18-7163	470	27-430041	18-2741	443	27-811546	18-3874	821
25-861844	18-7167	470	27-430042	18-2741	443	27-811547	18-3887	821
25-861844	18-7961	470	27-430043	18-2741	443	27-811566	18-1232	819
25-882613	18-7121	470	27-430045	18-2741	443	27-811572	18-0468	824
25-896523	18-7176	470	27-430047	18-2741	443	27-811588	18-25002	824
25-897536	18-7113-9	411	27-430051	18-2740	442	27-812712	18-0403	816
26-421021	18-2728	446	27-430052	18-2740	442	27-812755	18-2610	443

MERCURY MARINE (cont.)			MERCURY MARINE (cont.)			MERCURY MARINE (cont.)		
O.E. #	SIERRA #	PAGE #	O.E. #	SIERRA #	PAGE #	O.E. #	SIERRA #	PAGE #
27-812867	18-2749	442	27-99173-2	18-2511	444	46020002	18-2125	831, 833, 842
27-813859	18-0646	Obsolete	27-991762	18-2506-1	444	47-161543	18-3098	413
27-814210	18-0463	822	27-991763	18-2506-1	444	47-420381	18-3062	413
27-814703	18-2815	825	27-991764	18-2506-1	444	47-420382	18-3062	413
27-815528	18-0680	824	27-991771	18-2503	444	47-430261	18-3056	413
27-816460	18-3879	821	27-991772	18-2503	444	47-430262	18-3056	413
27-817277	18-2566	445	27-993261	18-2562	445	47-430264	18-3056	413
27-817533	18-0384	440	27-995061	18-0667	822	47-85089-3	18-3057	413
27-818188	18-1231	819	27-997761	18-2508-1	444	47-899842	18-3017	413
27-818832	18-2849-1	823	27-997771	18-2833	823	47-899844	18-3017	413
27-822189	18-0345	445	27-997772	18-2833	797, 823	50-660151	18-5610	393
27-823142	18-0378	443	32-160211	18-70925	769	50-660153	18-5610	393
27-824326	18-1238	819	32-806825	18-71337	770	50-822462	18-5621	394, 395
27-824853	18-0835	444	32-806856	18-70935	768	50-834749	18-6436	392
27-825032	18-3845	437	32-807407	18-70949	767	52-814756	18-2236	457
27-825482	18-3827	438	32-808033	18-70948	767	52-822539	18-2236	457
27-827284	18-2721	441	32-814384	18-3221	750	52-824112	18-2202	853
27-828292	18-0641	440	32-860089	18-70954	767	52-853594	18-2202	853
27-828553	18-0319	443	32-860144	18-70940	768, 770	53-805272	18-4289	864
27-845628	18-1232	819	32-860205	18-70951	767	53-815949	18-2345	864
27-850283	18-2737	441	32-860220	18-3221	750	54-41582-7	18-8020	167
27-850318	18-3675	442	32-861127	18-2435	860	54-866507	18-7321	847
27-850470	18-3887	821	32-861128	18-2436	861	57-816544	18-15410	771
27-852957	18-7690	727	32-862124	18-70947	767	57-861049	18-15114	777
27-854881	18-0940	442	32-862139	18-70945	767	57-861050	18-15103	777
27-854882	18-0940	442	32-864588	18-2137	860	57-861757	18-15115	777
27-85490-2	18-2805	442	32-864589	18-2136	860	57-861758	18-15116	777
27-854911	18-0942	442	32-864959	18-2115	860	57-862086	18-15101	777
27-85491-2	18-0942	442	32-864960	18-2114	860	57-862089	18-15104	777
27-854913	18-0942	442	32-871171	18-70932	769	57-862807	18-15100	777
27-85492-2	18-0137	441	32-887952	18-70952	767	57-864639	18-15123	Obsolete
27-854951	18-2574	442	32-897181	18-70934	768	57-892318	18-18000	392
27-854952	18-2574	442	32-897491	18-70943	768	57-895120	18-15149	432
27-854961	18-0944	442	32-99902-1	18-2114	860	733-38181	18-4160	Obsolete
27-854971	18-2839	442	32-99903-1	18-2115	860	733-38191	18-4191	806
27-854972	18-2839	442	3302-9031	18-7202	737	733-66217	18-4180	Obsolete
27-85498-1	18-0107	434, 441	3302-9033	18-7859	748	735-97151	18-4178	806
27-856081	18-2914	446	3302-9437	18-7097	736	785-97386	18-7961	470
27-856091	18-2915	446	35-134301	18-7830	161	84-881698	18-8838-1	705
27-856101	18-2826	445	35-164941	18-7830	161	88245191	18-2346	854
27-85653-1	18-0946	Obsolete	35-184585	18-7968	410	89-818864	18-5818	388
27-856704	18-2826	445	35-604941	18-7944	410	91-813653	18-9873	234
27-856705	18-0113-1	823	35-604941	18-7845	747	91-818162	18-9870	231
27-856730	18-0946	Obsolete	35-604941	18-7945	747	92-809820	37479	224
27-858524	18-2915	446	35-805369	18-7944	410	97-762145	18-6016	461
27-858524	18-2915	446	35-805369	18-7945	747	97-806189	18-6067	865
27-858935	18-0649	443	35-805809	18-7871	203	97-806189	18-6067A	865
27-860231	18-0672	797	35-806771	18-7944	410	97-806190	18-6089	865
27-860233	18-0897	797	35-806771	18-7845	747	10-8053432	18-8402-1	716
27-863724	18-0897	797	35-806771	18-7945	747	10-8053432	18-8402	716
27-863725	18-0672	797	35-807172	18-7944	410	10-8083434	18-8404-1	716
27-863891	18-2736	437	35-807172	18-7845	747	11-8267089	18-3722	459
27-863893	18-2736	437	35-807172	18-7945	747	12-8354671	18-4220	461
27-863895	18-2736	437	35-807172	18-7844	747	12-855682-2	18-9078	461
27-871051	18-2849-1	823	35-809097	18-7919	432	13-888363-2	18-9077	461
27-880729	18-0791	443	35-809099	18-7920	747	1395-83181	18-7061	399
27-881715	18-0322	826	35-809100	18-7929	158	1395-95951	18-7062	399
27-883964	18-0405	819	35-813405	18-7964-1	748	1395-97611	18-7212	399
27-884511	18-0139	443	35-815419	18-7964-1	748	23-1596110	18-1309	810
27-892157	18-2714	443	35-816296	18-7829	161	23-1596120	18-1341	Obsolete
27-892158	18-2717	443	35-853333	18-7997	411	23-1761515	18-0208	Obsolete
27-892211	18-0384	440	35-864572	18-7721	748	23-1761516	18-0210	840
27-896561	18-2555	822	35-886638	18-7948	160	23-1761517	18-0212	Obsolete
27-904301	18-2803	440	35-892665	18-7715	748	23-1761518	18-0214	840
27-904841	18-2502	442	35-896247	18-7999	411	23-1761519	18-0216	Obsolete
27-921661	18-3878	821	43-850036	18-1560	457	23-1761520	18-0218	Obsolete
27-935361	18-2501	441	44-660602	18-2166	853	23-1761522	18-0222	840
27-949962	18-2743	825	44-660603	18-2166	853	23-1761523	18-0224	Obsolete
27-961711	18-2505	442	44-824110	18-2166	839, 853	23-1761524	18-0226	Obsolete
27-96542-1	18-3863	434, 438	44-850308	18-2254	457	23-1761526	18-0230	Obsolete
27-967611	18-2510	441	45-440001	18-1737	457	23-8159501	18-2341-1	864
27-981851	18-2807	442	45-557961	18-2324	Obsolete	23-888690-1	18-9076	461
27-981853	18-2807	442	45-816919	18-2261	839, 854	25-8071341	18-1508	756
27-987691	18-0970	441	45-853647	18-2331	Obsolete	26-8164641	18-2054	467
27-988231	18-0388	826	45-853648	18-2331	Obsolete	26-8219471	18-1233	815

MERCURY MARINE (cont.)			MERCURY MARINE (cont.)			MERCURY MARINE (cont.)		
O.E. #	SIERRA #	PAGE #	O.E. #	SIERRA #	PAGE #	O.E. #	SIERRA #	PAGE #
27-8052151	18-0916	825	879150150	18-7682	725	10-8M0084649	18-2170	844
27-8079821	18-0994	822	879194024	18-7006-1	397	10-97934A1	18-2141	827
27-8127551	18-2611	443	879194241	18-7964-1	748	10-F50109	18-2244	456, 858
27-8127754	18-2610	443	885599004	18-3535	411	11497M	18-7833	403
27-8127755	18-2611	443	898253003	18-5345	694	11502M	18-7765	399
27-8128671	18-2749	442	898253005	18-5345	694	11-52707A1	18-3701	460, 859
27-8128672	18-2729	441	898253007	18-5318	693	11-52707A2	18-3701	460, 859
27-8172771	18-2566	445	898253008	18-5418	694	11-52707Q1	18-3701	460, 859
27-8181881	18-1231	819	898253009	18-5402	694	11-69578A1	18-3702	460
27-822844-1	18-3864	438	898253010	18-5405	694	11-69578Q1	18-3702	460
27-8243261	18-0487	820	898253011	18-5406	694	11-69578T1	18-3702	460
27-8248531	18-0835	444	898253012	18-5408	694	11-805092T	18-3783	859
27-8254821	18-3827	438	898253013	18-5245	694	11-F694188	18-3719	457
27-8329331	18-2739	443	938-883490	18-4485	668	12076A1	18-1975-1	794
27-8329332	18-2739	443	11-82671015	18-3721	459	12076A2	18-1972	793
27-8329333	18-2739	443	11-82671127	18-3785	859	12076A2	18-1975-1	794
27-8329334	18-2739	443	1347-818619	18-7609-1	730	12-31211A2	18-3714	460, 859
27-8329335	18-2739	443	1347-818620	18-7608-1	732	12-31211A3	18-3714	460, 859
27-8503181	18-3675	442	1347-818621	18-7610-1	730	12-31211Q03	18-3714	460, 859
27-8637251	18-0672	797	1347-818622	18-7603-1	730	12449A1	18-5957	719
27-9818512	18-2807	442	1395-811222	18-7750-1	399	12449A1	18-5965	719
32-4172533	18-3602	769	1395-811357	18-7212	399	12449A1	18-5966	719
32-5346170	18-75125	770	1395-823635	18-7750-1	399	12449A1	18-5966	719
32-8066351	18-70938	768	23-11992001	18-1327	810	12632A3	18-2195	849
32-8066361	18-70939	768	23-85726001	18-1334	810	12632A4	18-2175	849
32-8066362	18-70946	768	27-43004009	18-2741	443	12632A6	18-2321	849
32-8078961	18-70951	767	27-75611001	18-3876	821	12632A7	18-2195	849
32-8078962	18-70951	767	31-14358001	18-2746	846	12644A1	18-4457	126
32-8080441	18-70953	767	31-44348001	18-2748	846	12644Q01	18-4457	867
32-8600891	18-70954	767	3302-804844	18-7098-1	736	12-77987A1	18-4220	461
339-850227	18-5187	378	3302-804845	18-7097	736	12784A10	18-6401	842
35-8053691	18-7944	410	1395-8112231	18-7211-1	397	12784A4	18-6401	842
35-8053691	18-7845	747	1395-8236351	18-7750-1	399	12784T	18-6400	842
35-8053691	18-7945	747	1395-8236352	18-7750-1	399	12-835467Q01	18-4220	461
35-816296-1	18-7830	161	1395-8236353	18-7750-1	399	12886A6	18-1800	432
35-8162961	18-7830	161	1395-8236354	18-7750-1	399	12-8M0042641	18-4267	827
35-8226267	18-7906-1	432	23-811858001	18-1337	810	12-8M2001219	18-0681	827
392-881732	18-7648	696	23-818469001	18-1317	810	12-92647M	18-4233	461
392889925	18-7493	696	23-853853002	18-1148	Obsolte	13191A1	18-4221	461
50-818445-2	18-5620	393, 396	25-801334436	18-7168	470	13310T1	18-5674	395
50-818445-3	18-5620	393, 396	27-824326002	18-0487	820	13330A3	18-8005S	169
50-8184455	18-5620	393, 396	27-832933006	18-2739	443	13330A3	18-8005EP-1	406
50-8329972	18-6282	393	27-879150139	18-3874	821	13330Q	18-8005S	168
50-8331535	18-6283	393	27-879150140	18-3879	821	13447A1	18-5313-1	700
57-8077554	18-15112	777	27-879150141	18-3887	821	1347-804623A1	18-7605-1	730
57-8077555	18-15113	Obsolte	32-865672070	18-75125	770	1347-804623R02	18-7604-1	730
57-8610491	18-15102	777	46-879194401	18-3506	748	1347-804623R02	18-7605-1	730
57-8620861	18-15101	777	50-898265005	18-5605	393, 395	1347-804623R1	18-7604-1	730
57-8623523	18-15119	777	54-815504348	18-710-48-2	849	1347-804624 R02	18-7615-1	730
57-8638761	18-15119	777	57-865423005	18-15121	777	1347-804624 R1	18-7618-1	730
57-8638763	18-15100	777	57-865615001	18-15119	777	1347-804624R02	18-7618-1	730
57-8638764	18-15101	777	57-865615003	18-15100	777	1347-804624R1	18-7615-1	730
57-8638765	18-15121	777	57-865615004	18-15101	777	1347-804625R02	18-7617-1	730
57-8638766	18-15102	777	57-865615005	18-15121	777	1347-804625R1	18-7617-1	730
57-8638767	18-15103	777	57-865615006	18-15102	777	1347-804626 R02	18-7616-1	730
57-8638768	18-15104	777	57-865615007	18-15103	777	1347-816373A4	18-7615-1	730
735-808661	18-4173	806	57-865615008	18-15104	777	1347-818619 1	18-7609-1	730
735-808674	18-4173	806	57-880566014	18-15128	392	1347-818619 1R02	18-7609-1	730
735-850097	18-4173	806	57-895120002	18-15150	432	1347-818620 1	18-7608-1	732
735-850098	18-4164	806	1623-81582243	18-2400	840	1347-818620R02	18-7608-1	731
759-592010	18-4109	Obsolte	391-898253001	18-5338	694	1347-818621 1	18-7610-1	730
759-592012	18-4134	Obsolte	391-898253004	18-5314	693	1347-818621 1R02	18-7610-1	730
759-661010	18-4109	Obsolte	391-898253029	18-5404-1	694	1347-818622 1	18-7603-1	730
759-661012	18-4134	Obsolte	392-898253002	18-5347	694	1347-818622R02	18-7603-1	730
759-831210	18-4109	Obsolte	392-898253005	18-5303	693	1347-8288A1	18-7616-1	730
759-831212	18-4134	Obsolte	737-879194035	18-4189	806	1347-8289A1	18-7618-1	730
811637001	18-5107-1	696	1395-879194024	18-7006-1	397	1347-8460A3	18-7619-1	731
811637002	18-5107-1	696	3302-804844001	18-7098-1	736	1347-9142A2	18-7619-1	731
833072002	18-3537	411	3302-804844002	18-7098-1	736	1347-9661A3	18-7605-1	175
833072003	18-3536	411	10-14834A1	18-2375	456, 858	1347-9863A3	18-7617-1	730
833072004	18-3537	411	10-14834A1	18-23751-9	456, 858	13524A4	18-5432	694
850399002	18-3599-2	621, 648, 749, 898, 899, 973	10-28634A1	18-2244	456, 858	13524A5	18-5431	694
			10-79953A2	18-2244	259, 456, 831, 833, 835, 837, 858	13524A6	18-5432	694
850454002	18-3577-2	621, 648, 749, 898, 899, 973	10-79953Q04	18-2244	456, 858	13524Q06	18-5432	694
			10-79953Q2	18-2244	456	13524T1	18-5431	694

MERCURY MARINE (cont.)			MERCURY MARINE (cont.)			MERCURY MARINE (cont.)		
O.E. #	SIERRA #	PAGE #	O.E. #	SIERRA #	PAGE #	O.E. #	SIERRA #	PAGE #
13753A2	18-5396	695	16755A1	18-2615	828	22-14213Q	18-8075	407
1376-5659A1	18-7603-1	730	16755A1	18-2516	825	22-16610M	18-8084	407
1395-811691 2	18-7355	397	16755Q1	18-2615	828	22-16951A1	18-4218	798
1395-811691 3	18-7356	397	16755Q1	18-2516	825	22-16951Q1	18-4218	798
1395-9258 1	18-7057	399	16755T1	18-2615	828	22-16951T1	18-4218	798
1397-6367A1	18-7076	736	16792A33	18-7508	806	22-33198A1	18-4258	663, 795
14244T	18-0616	805	16792A39	18-7508	806	22-36305T	18-8216	798
14336A15	18-6752	717	17-14872A1	18-2463	862	22-67892A05	18-2375	456, 858
14336A17	18-6752	717	17-14873A1	18-2462	862	22-67892A06	18-2375	456, 858
14336A20	18-6274	385	17177A1	18-5313-1	700	22-67892A1	18-2375	450, 452, 839, 858
14336A20	18-6746	718	17340T	18-1400	806	22-67892A1	18-2375-1-9	450, 452, 839, 858
14336A20	18-6746	718	17-44166T1	18-2461	862	22-806608A02	18-4226	798
14336A22	18-6752	717	17-44167A1	18-2397	863	22-806608A1	18-4226	798
14336A25	18-6746	718	17649T	18-6772	718	22-806926A1	18-4224	798
14336A28	18-6752	717	17693A2	18-7633	862	22-81042M	18-8075	407
14336A31	18-6746	718	17-815953A1	18-2395	863	22-816856T2	18-80412	407
14336A6	18-6752	717	17-815953T1	18-2464	862	22831A1	18-8069	407
14336A8	18-6746	718	17-828507 1	18-15129	392	22831A3	18-8069	407
14336A8	18-6769-1	718	17-8M0020941	18-2357	853	22831A4	18-8069	407
14336A9	18-6752	717	17-8M0084681	18-2357	853	22831B3	18-8069	407
14336A9	18-6753	717	17-8M0100263	18-2357	853	22831Q3	18-8069	407
14505A2	18-2172	849	18309A2	18-2412-1	849	22-862210A01	18-4224	798
14-816629Q	18-3200	460, 859	18311A17	18-2412-1	849	23014A1	18-7804	403
14-F697140	18-3200	460, 859	18311A2	18-2412-1	849	23-29804T	18-3109	414, 749
15103A3	18-1137	810	18312A3	18-2382	844	23-30617A1	18-2154	855
15-23097A1	18-2293	840	18495A12	18-5790	379	23-30617A2	18-2154	855
15-32563A1	18-2282	833, 840	18495A19	18-5790	379	23-37428A1	18-2155	456
15-33143A1	18-2295	840	18495A26	18-5790	379	23-55419A1	18-2155	456
15-35931A1	18-2285	840	18525A1	18-6771	383, 718	23-77631A2	18-2155	448, 452, 456, 464
15-35980A1	18-2292	840	18643A5	18-2323	849	23-79373A1	18-2622	844
15-36178A02	18-2293	840	18654A1	18-2750	845, 846	23-805041A2	18-2622	844
15-36178A1	18-2293	840	19052A3	18-5791	379	23-806036A1	18-3760	844
15-39899A1	18-2293	840	19052A5	18-5791	379	23-815921A10	18-2353	855
15-42637A1	18-2294	835, 839	19052A8	18-5791	379	23-815921A17	18-2353	855
15-45691A1	18-2283	831, 833, 840	19217A1	18-6777	384	23-815921A21	18-2353	839, 855
1547-3917A13	18-2450	Obsolete	19217A5	18-6777	384	23-815921A6	18-2353	855
15-47397A1	18-2285	840	19291A3	18-2370	258	23-815921A8	18-2353	855
1547-5523A49	18-2453	Obsolete	19297A3	18-2145	847	23-815950Q01	18-2341-1	864
1547-815930A13	18-2419	840	19405A4	18-5432	694	23-853853A1	18-1148	Obsolete
1547-815930A16	18-2416	840	19543A10	18-2190	847	23-99291T	18-2702-04	864
1547-815930A3	18-2419	840	19543A10	18-2190E	847	23-99291T	18-2702-1	864
1547-815930A6	18-2416	840	19543A10	18-2157	847	24-17057A1	18-1234	815
1547-861063A12	18-2416	840	19543A10	18-2159	847	24-17997A1	18-2715	833, 845, 865
1547-861063A4	18-2411	840	19543A2	18-2190	847	24-29340A1	18-6506	396
1547-861063A6	18-2419	840	19543A2	18-2190E	847	24-29340T1	18-6506	396
1547-9412A36	18-2452	Obsolete	19543A2	18-2190E	847	24-801879T	18-1234	815
15-57007A1	18-2295	452, 840	19543A2	18-2157	847	25-60342A1	18-2291	Obsolete
15-8M0063267	18-2294	835, 839, 840, 853, 866	19543A2	18-2159	847	25-60342A2	18-2291	Obsolete
16061T	18-5792	379	19543A4	18-2190	847	25661T1	18-5836	717
1623-4110A13	18-2443	Obsolete	19543A4	18-2157	847, 848	25-82275M	18-0298	470
1623-4110A4	18-2443	Obsolete	19543A4	18-2159	847, 848	25-82289M	18-0299	Obsolete
1623-4110A6	18-2443	Obsolete	19543A8	18-2190	847	25-85491A87	18-4325	435
1623-5356A18	18-2443	Obsolete	19543A8	18-2190E	847	25-87400A2	18-2649	862
1623-5356A19	18-2443	Obsolete	19543A8	18-2157	847	25-8M0027717	18-7195	870
1623-5356A20	18-2443	Obsolete	19543A8	18-2159	847	25-8M2000816	18-7411	470
1623-5356A3	18-2443	Obsolete	19543T1	18-2603	848	25-8M2000926	18-7180	470
1623-5356A4	18-2402	841	19543T1	18-2603E	848	25-F24342	18-7116	470
1623-815822A32	18-2400	840	19543T2	18-2603	848	25-F455342	18-7174	870
1623-815822A36	18-2415	840	19543T2	18-2603E	848	25-F461342	18-7165	470
1623-815822A5	18-2400	840	19755A08	18-2196	854	25-F50342-1	18-7413	470
1623-815822A53	18-2400	840	19755A2	18-2286	854	25-F523555	18-7467	470
1623-8951A14	18-2443	Obsolete	19755A4	18-2196	854	25-F53795-1	18-7153	470
1623-8951A15	18-2401	841	21-42990A10	18-7817	399	25-F702736	18-7114	470
1623-8951A19	18-2443	Obsolete	21-42990A7	18-7817	399	25-F74305	18-7176	470
1623-8951A2	18-2443	Obsolete	21-42990A8	18-7817	399	25-F7848342	18-7105	470
1623-8951A23	18-2443	Obsolete	21-42990A9	18-7817	399	25-F84305	18-7127	869
1623-8951A27	18-2401	841	21-857005A1	18-7817	399	26-16709A1	18-2643	865
1623-8951A37	18-2401	841	22-13563A3	18-8076	405	26-16709A2	18-2643	865
1623-8951A43	18-2443	Obsolete	22-13563A6	18-8091	407	26-32511A1	18-2648	866
1623-8951A5	18-2401	841	22-13563A7	18-8091	407	26-33144A1	18-2652	866
16457A4	18-5395	695	22-13563Q3	18-8076	405	26-33144A2	18-2652	866
1647-9148T93	18-4832	458	22-13563Q7	18-8091	407	26-36557A1	18-3110	414, 749
16610M	18-8070	407	22-13563T3	18-80410-1	407	26-41365A3	18-2697-1	464
1667-9011G59	18-4830	458	22-13563T7	18-8091	407	26-43034A1	18-2626	462
1667-9011R6	18-4850	Obsolete	22-14213M	18-8075	407	26-43034A2	18-2626	462

MERCURY MARINE (cont.)			MERCURY MARINE (cont.)			MERCURY MARINE (cont.)		
O.E. #	SIERRA #	PAGE #	O.E. #	SIERRA #	PAGE #	O.E. #	SIERRA #	PAGE #
26-43034A3	18-2626	462	27-47453A1	18-4389	821	27-83899M	18-3828	437
26-43035A4	18-2626	462	27-47510Q	18-2553	822	27-83940M	18-0380	441
26-55682A1	18-2653	464	27-48818Q1	18-2844	822	27-84733M	18-3804	437
26-66303A1	18-2627	462	27-53354A1	18-4398	817	27-85491A90	18-4325	435
26-76868A04	18-2645	465, 866	27-54014A1	18-2620	828	27-85653A32	18-4356	436
26-76868A1	18-2645	866	27-54014A1	18-2847	825	27-85653A79	18-4356	436
26-76868A2	18-2645	866	27-54014Q1	18-2620	828	27-85653A87	18-4356	436
26-77066A1	18-2628	Obsolete	27-54014Q1	18-2847	825	27-85817A1	18-0153	819
26-79831A1	18-2654	464	27-54014T1	18-2620	828	27-883964T	18-0405	819
26-814669A2	18-2635	463	27-54014T1	18-2847	825	27-88449A32	18-4357	Obsolete
26-81607M	18-2731	446	27-54566A1	18-4399	817	27-88449A80	18-4357	Obsolete
26-816575A1	18-2646-1	463	27-55306A72	18-4355	436	27-89221A32	18-4319	435
26-816575A2	18-2599	462	27-55306A73	18-4355	436	27-89221A84	18-4319	435
26-816575A3	18-2646-1	463	27-55306A74	18-4355	436	27-89221A85	18-4319	435
26-816575A4	18-8382	465	27-55306A75	18-4355	436	27-89221A88	18-4319	435
26-816575A5	18-2642	463	27-56870A1	18-0407	Obsolete	27-89656A1	18-4381	819
26-82234M	18-0297	567	27-60476A72	18-4356	436	27-8M0027781	18-0384	440
26-82257M	18-0267	467	27-60476A73	18-4356	436	27-8M0049045	18-3877	821
26-830749A01	18-2725	465	27-60476A74	18-4356	436	27-8M0050224	18-0465	821
26-84813M	18-0554	467	27-60476A75	18-4356	436	27-8M0077608	18-0905	827
26-85090A1	18-2629	463	27-64203A73	18-4351	434	27-8M0090319	18-2914	446
26-85090A2	18-2624	462	27-64203A74	18-4351	434	27-8M2021920	18-0398	823
26-854017M	18-0296	467	27-64203A75	18-4351	434	27-90458A1	18-0411	820
26-88397A1	18-2644	865	27-64818A1	18-2614	828	27-90484A32	18-4317	434
26-89238A1	18-2652	866	27-64818A1	18-2820	825, 828	27-90484A86	18-4317	434
26-89238A2	18-2655	464	27-64818A2	18-2619-1	828	27-90484A88	18-4317	434
26-8M0050563	18-4024	815	27-64818A2	18-2743	825	27-92648M	18-2787	Obsolete
26-F694305	18-2014	868	27-64818A20	18-2614	828	27-94996A1	18-2619-1	828
26-F697118	18-2076	868	27-64818A20	18-2820	825, 828	27-94996A1	18-2743	825
26-F697555	18-2077	868	27-64818A3	18-2619-1	828	27-94996A2	18-2619-1	828
2704-812896A2	18-4626	424	27-64818A3	18-2619-1	828	27-94996A2	18-2743	825
2704-821896A3	18-4627	424	27-64818A4	18-2614	828	27-94996A20	18-2619-1	828
2704-821896A4	18-4628	424	27-64818A4	18-2820	825, 828	27-94996A20	18-2743	825
2704-821896A6	18-4626	424	27-64818Q4	18-2614	828	27-94996A3	18-2743	825
2704-826191A4	18-4626	424	27-64818Q4	18-2820	828	27-94996Q2	18-2619-1	828
2704-826191A6	18-4626	424	27-64818T1	18-2614	828	27-94996Q2	18-2743	825
2704-826191T4	18-4626	424	27-68714A6	18-4380	820	27-94996T2	18-2619-1	828
27-11338A85	18-4319	435	27-68714A7	18-4380	820	27-98990M	18-3828	437
27-11338A88	18-4319	435	27-70143B1	18-0994	822	27-99777A1	18-4367	816
27-11977A88	18-4388	818	27-72479A5	18-4366	819, 820	28-81912M	18-3305	414
27-11977A92	18-4388	821	27-72479T	18-4366	820	28-83444M	18-3300	414
27-13461A88	18-4340	Obsolete	27-72486A32	18-4353	435	28-83701M	18-3305	414
27-13461A89	18-4340	Obsolete	27-72486A76	18-4353	435	28-8M0058389	18-2375	456
27-13461A90	18-4340	Obsolete	27-72486A78	18-4353	435	30185A1	18-8084	405
27-13461A99	18-4340	Obsolete	27-72486A79	18-4353	435	30185A1	18-8070	407
27-13709T	18-3878	824	27-73440A76	18-4357	Obsolete	30185A3	18-8084	406
27-14318 3	18-0323	444	27-74264A1	18-4382	819	30185A3	18-8070	407
27-14697A87	18-4339	434	27-74830A1	18-4382	819	30185B3	18-8070	407
27-14901A1	18-0466	819	27-74830A3	18-4382	819	30185B3	18-8084	407
27-18785T	18-3861	437	27-75611A1	18-4392	821	30185Q3	18-8084	407
27-18937M	18-3828	437	27-75611A2	18-4392	821	30185Q3	18-8070	407
27-19138M	18-3804	437	27-76589A77	18-4357	Obsolete	30-20839T	18-1190	453
27-33395A1	18-4394	816	27-76589A78	18-4357	Obsolete	30-43011T	18-1346	Obsolete
27-33395A2	18-4394	816	27-76589A79	18-4357	Obsolete	30-562540A3	18-21005	843
27-34213A1	18-4375	820	27-78028A78	18-4355	436	30-60794A2	18-2100K	843, 845
27-34213A2	18-4375	820	27-805403A1	18-0404	816	30-60794A2	18-2100	843, 845
27-35898A2	18-4395	817	27-805722A1	18-0403	816	30-60794A2	18-21001	843, 845
27-35898A3	18-4395	817	27-807473A1	18-0488	820	30-60794A4	18-2100K	843, 845
27-35898A4	18-4395	817	27-807982B	18-0994	822	30-60794A4	18-2100	843, 845
27-35996A1	18-2617	828	27-81031M	18-0232	442	30-60794A4	18-21001	843, 845
27-35996A1	18-2556	828	27-810846T	18-1239	819	30-63326T	18-1153	427, 453, 857
27-41499A87	18-4334	Obsolete	27-812755A01	18-2611	443	30-63742T	18-1154	453
27-41636A1	18-4381	819	27-812867A91	18-4337	433	30-67923T	18-1345	427
27-41812Q	18-2554	822	27-812867A96	18-4337	433	30-803097T1	18-2601-1	845
27-41899M	18-2785	465	27-812867A97	18-4337	433	30-803098T1	18-8205	845, 846
27-43004A86	18-4336	433	27-81417M	18-0292	444	30-803099T1	18-8206-1	845, 846
27-43004A90	18-4336	433	27-81421M	18-0294	444	30-803100T1	18-8212-1	845, 846
27-43004A99	18-4336	433	27-814754A00	18-4338	433	30-862540A04	18-21005	843
27-43186A1	18-4381	819	27-815791A92	18-4359	437	30-862540A04	18-21005K	843
27-43337A1	18-2713	443	27-815792A90	18-4359	437	30-862540A04	18-21006	843
27-43779A87	18-4326	433	27-815809A90	18-4359	437	30-862540A3	18-21005K	843, 845
27-46110A1	18-4353	435	27-815810A90	18-4359	437	30-862540A3	18-21006	843, 845
27-46110A2	18-4353	435	27-81987M	18-4698	446	30-862540T1	18-21005	843
27-46110A72	18-4353	435	27-81987M	18-46981-9	446	30-862540T1	18-21005K	843
27-46401A1	18-4396	817	27-823142 2	18-0378	443	30-862540T1	18-21006	843

MERCURY MARINE (cont.)			MERCURY MARINE (cont.)			MERCURY MARINE (cont.)		
O.E. #	SIERRA #	PAGE #	O.E. #	SIERRA #	PAGE #	O.E. #	SIERRA #	PAGE #
30-879194A01	18-21005	843	32193A2	18-5433	696	339-7452A2	18-5776	378
30-879194A01	18-21005K	843	32-32461A1	18-3601	768	339-7452A21	18-5778	378
30-879194A01	18-21006	843	32-44348T	18-2748	788, 846	339-7452A3	18-5776	378
30-879194A02	18-2100K	843	32489A2	18-3219	795	339-7452A7	18-5777	378
30-879194A02	18-2100	843	32492A2	18-2171	849	339-7452A8	18-5778	378
30-879194A02	18-21001	843	32492A3	18-2171	849	339-7452A9	18-5777	378
30-88957A1	18-1155	453	32492A5	18-2171	849	33981T	18-2162	844
30-88957T	18-1155	453	32-52951A1	18-2126	861	33981T1	18-2162	844
31-12578T	18-1113	453	32-59841A1	18-2108	860	339-832757A4	18-5186	378
31-17514A1	18-1194	427	32657A3	18-9099	862	339-856991A1	18-5187	378
31-17514A2	18-1194	427	32657A4	18-9099	862	339-880615T01	18-5154	378
31-17514A2	18-4039	Obsolete	32734A3	18-2750	845, 846, 847	34086A1	18-2189	847
31-30894A1	18-1156	453	32-802885Q	18-7876-1	805	34127A1	18-6012	864
31-30894A5	18-1182	856	32-807458T	18-2770	846	34127A2	18-6012	864
31-30895T	18-1157	453	32-858104K08	18-8024EP-2	164, 405	34127T1	18-6012	864
31-30956T	18-1158	453	32-858104Q08	18-8024EP-2	164, 405	34127T2	18-6012	864
31-32573A1	18-1142	855	32-858105K08	18-8025EP-2	165, 406	34235Q1	18-5250	692
31-32575A1	18-1179	856	32-858105Q08	18-8025EP-2	165, 406	34235T	18-5311	693
31-32575T1	18-1179	856	32-858109K12	18-8016S-1	169	34235T1	18-5250	692
31-32898T	18-1115	453	32-858109K12	18-8016EP-2	165, 169, 406	34762A1	18-6013	864
31-33138A1	18-1193	856	32-858109Q12	18-8016EP-2	165, 169, 406	34765A1	18-4456	126
31-35928A1	18-1159	453	32-858114K08	18-8012EP-2	164, 405	34765A2	18-4456	867
31-35928T1	18-1159	453	32-858114Q08	18-8012EP-2	164, 405	35-11004A1	18-7784	748
31-35988A12	18-1160	857	32-86036A1	18-2103	859	35-14571A1	18-7967	410
31-35988A2	18-1160	857	32-86036Q	18-2103	859	35-17808A1	18-7967	410
31-35990A1	18-1161	856	32-861590A05	18-71337	770	35-18458A2	18-7967	410
31-36387A1	18-1143	453	32-861590A1	18-71337	770	35-18458A3	18-7967	410
31-38356A1	18-1162	454, 856	32-861590A2	18-71337	770	35-18458Q3	18-7967	410
31-42647A1	18-1117	453	32-883702K	18-7879-1	805	35-18458Q4	18-7968	410
31-42677A1	18-1118	453	32-883702Q	18-7879-1	805	35187A1	18-2248	847
31-47245A1	18-4038	427	32-8M0062309	18-3602	769	35187A2	18-2248	847
31-48941A1	18-1163	454, 856	32-8M0062614	18-75100	770	35187A4	18-2248	847
31-54036A1	18-1126	453	32-8M0062665	18-75125	770	35-49088A2	18-7860	748
31-54038A1	18-1127	Obsolete	32-8M0071007	18-70931	769	35-49088Q2	18-7860	748
31-55332A1	18-4038	427	32-8M0090859	18-3603	769	35-52456A1	18-7983-1	409
31-58859A1	18-4038	427	32-90949T	18-2761	846	35-52456A1	18-7848-1	408
31-61100A1	18-1165	856	32-96246A1	18-70958	768	35-53336Q	18-7859	748
31-61424A2	18-4038	427	32-96246A4	18-70958	768	35-55501A1	18-7983-1	409
31-62596A1	18-4038	427	32-97153A1	18-2110	460	35-55501A1	18-7848-1	408
31-62799A1	18-1111	453	32-97154A1	18-2111	460	35-57250A1	18-7983-1	409
31-63075A1	18-4038	427	32992A1	18-2189	847	35-57250A1	18-7848-1	408
31640A1	18-6011	461	32-99904Q	18-2116	861	35-60494A1	18-7983-1	409
31640A1	18-6011A	461	3304-9354A2	18-7604-1	175	35-60494A1	18-7848-1	408
31640A1	18-6241	461	3310-806969 R01	18-7613-1	Obsolete	35-60494A4	18-7983-1	409
31640A2	18-6011	461	3310-806969A1	18-7613-1	Obsolete	35-60494A4	18-7848-1	410
31640A4	18-6011	461	3310-807312A1	18-7611-2	730	35-60494A4	18-7845	747
31640Q4	18-6011A	461	3310-807312R02	18-7611-2	730	35-802884Q	18-7879-1	805
31640Q4	18-6241	461	3310-864943A01	18-7639	730	35-802885Q	18-7824-2	805
31640T6	18-6011	461	332-4911A5	18-5787	378	35-802886Q	18-7875	805
31640T6	18-6241	461	332-4911A8	18-5787	378	35-802893A4	18-7983-1	409
31640T6	18-6011A	461	332-5524A1	18-5775	378	35-802893Q	18-7944	410
31-67526A1	18-1194	427	332-5772A1	18-5881	379	35-802893Q	18-7844	747
31-67526A2	18-1194	427	332-5772A2	18-5881	379	35-802893Q	18-7945	747
31-73363T	18-1122	Obsolete	332-5772A3	18-5881	379	35-802893Q4	18-7983-1	409
31-74248T	18-1196	427	332-5772A5	18-5881	379	35-802893Q4	18-7848-1	408
31-78172A1	18-1166	452, 454	332-7778A1	18-5775	378	35-80365M	18-7713	410
31-803090T1	18-8208	866	332-7778A12	18-5775	378	35-803897Q1	18-7784	748
31-812767A1	18-1170	454	332-7778A3	18-5775	378	35-805369A4	18-7848-1	408
31-814337A1	18-1194	427	332-7778A6	18-5775	378	35-805809T	18-7871	805
31-821146A1	18-1194	427	332-7778A7	18-5775	378	35-807172A4	18-7983-1	409
31-828437A2	18-1173	856	332-7778A9	18-5775	378	35-807172A4	18-7848-1	4008
31-828439A2	18-1197	453	336-3948A2	18-5139	376	35-813405A1	18-7964-1	748
31-86748A1	18-1129	856	336-3948A3	18-5139	376	35-816296B1	18-7830	161
31-88269T	18-1347	Obsolete	336-3996A7	18-5855	386	35-816296B2	18-7830	161
31-8M0045428	18-1194	427	336-4318A2	18-5139	376	35-816296K03	18-7829	161
31-8M0045430	18-4039	Obsolete	336-4318A3	18-5139	376	35-816296Q	18-7829	161
31-8M0103473	18-1129	856	336-4318A4	18-5139	376	35-816296Q2	18-7830	161
31-8M0103474	18-1126	856	33662Q	18-5345	694	35-816296T	18-7829	161
31-F506818	18-1129	856	33765T	18-5386	695	35-816296T1	18-7830	161
31-F523058	18-1158	453	339-7370A13	18-5186	378	35-816396Q1	18-7830	161
31-F694057	18-1117	453	339-7452A1	18-5776	378	35-822626K04	18-7914	432
31-F84901	18-1162	454, 856	339-7452A11	18-5778	378	35-822626Q03	18-7913	432
31-M8004528	18-1194	427	339-7452A14	18-5778	378	35-822626Q04	18-7914	432
32-14358T	18-2746	846	339-7452A15	18-5777	378	35-822626Q1	18-7913	432
32170A1	18-6013	864	339-7452A19	18-5777	378	35-822626Q15	18-7906-1	432

MERCURY MARINE (cont.)			MERCURY MARINE (cont.)			MERCURY MARINE (cont.)		
O.E. #	SIERRA #	PAGE #	O.E. #	SIERRA #	PAGE #	O.E. #	SIERRA #	PAGE #
35-822626Q2	18-7914	432	39-78811A12	18-3916	424, 426, 427	43557A1	18-5395	695
35-822626T2	18-7914	432	39-78816A12	18-3902	424, 426, 427	43-59832A2	18-2201	841
35-822626T7	18-7906-1	432	39-78918A4	18-3922	426, 427	43-59832A4	18-2201	841
35-853333T	18-7997	411	39-81096M	18-3986	424	43-75325A2	18-2204	841
35-866171A01	18-7977	748	39-813011A12	18-3927	426, 427	43-75325A3	18-2204	831, 833, 841
35-866340K01	18-7824-2	805	39-815267A4	18-3925	426, 427	43-803069T1	18-2369	Obsolete
35-866340Q	18-7824-2	805	39-817096A16	18-3919	424, 426, 427	43-803071T1	18-2368	Obsolete
35-866340Q02	18-7824-2	805	39-817096A26	18-3920	424, 426, 427	43-803079T1	18-2404	853
35-866340Q02	18-7824-2	805	39-817096A6	18-3918	424, 426, 427	43-803091T1	18-2405	853
35-866340Q02	18-7876-1	805	39-822321A12	18-3982	424	43-803101T1	18-2259	Obsolete
35-866340Q03	18-7824-2	805	39-822321A2	18-3984	424	43-803102T1	18-2358	Obsolete
35-866340Q03	18-7876-1	805	39-824905A12	18-3982	424	43-803103T1	18-6351K	Obsolete
35-877565T	18-7714	410	39-826293A12	18-4051	Obsolete	43-803105T1	18-6353K	Obsolete
35-877565T1	18-7714	410	39-826297A12	18-4052	Obsolete	43-803106T1	18-6352K	Obsolete
35-877761K01	18-7758	432	39-827179A12	18-4050	426, 427	43-803112T1	18-2257	831, 842
35-877761Q01	18-7758	432	39-83196M	18-3992	424	43-803114T1	18-2258	Obsolete
35-877767K01	18-7921	205, 432	398-5454A17	18-5854	386	43-803116T1	18-2256	Obsolete
35-877768K01	18-7914	432	398-5454A21	18-5874	385	43-803118T1	18-2363	Obsolete
35-877769K01	18-7918	432	398-5454A22	18-5859	386	43-803119T1	18-2364	841
35-87946A3	18-7802	410	398-5454A25	18-5874	385	43-803120T1	18-2365	Obsolete
35-87946Q3	18-7802	410	398-5454A32	18-5871	385	43-803615T1	18-1564	457
35-87946Q4	18-7802	410	398-5454A35	18-5860	386	43-803615T2	18-1551	457
35-879885T	18-7718	410	398-5454A63	18-5874	385	43-803615T2	18-1564	457
35-883701K01	18-7918	432	398-5454A7	18-5857	386	43-823072A2	18-2407	853
35-884380T	18-7981	410	39-85636A4	18-3923	426, 427	43-828072A2	18-2206-1	839, 852
35-888289T2	18-7936	410	398-5704A7	18-5865	385	43-828072A3	18-2360	852
35-896546T	18-7921	205, 432	398-5919A2	18-5874	385	43-828073A1	18-2408	852
35-8M0008397	18-7914	432	398-5919A3	18-5859	386	43-828073A1	18-2206-1	852
35-8M0020349	18-7981	410	398-5919A6	18-5874	385	43-828175A1	18-1566	Obsolete
35-8M0064104	18-7914	432	398-5919A7	18-5859	386	43-850036T	18-1560	457
35-8M0103095	18-7919	432	398-5919A8	18-5874	385	43-853641A2	18-6351	Obsolete
35993A1	18-0577	844	398-818535A15	18-5874	385	43-853642A2	18-6352	833, 841
36223A1	18-2752	846	398-832075A14	18-5874	385	43-853643A2	18-6353	833, 841
36223A2	18-2752	846	398-832075A20	18-5874	385	43-878072A3	18-2406	Obsolete
37611A1	18-2189	847	398-832075-A21	18-5870	385	43-878087A2	18-2406	Obsolete
38399A2	18-2189	847	398-832075A4	18-5870	385	43-878087A2	18-2360	852
38965A1	18-2171	849	398-832075A6	18-5873	385	43-878087A2	18-2206-1	852
38965A2	18-2171	849	39-88392A12	18-3917	424, 426, 427	43-878087A4	18-2407	853
391-5075Q1	18-5376	695	398-9610A19	18-5876	385	43-881260A3	18-1550	457
39-15320M	18-3976	Obsolete	39920A1	18-1973	793	43-92320T	18-2409	852
39-15320T	18-3976	Obsolete	39-93481A12	18-3921	426, 427	43-96084A4	18-2200	837, 852, 853
39-15322M	18-3978	424	39-96170A12	18-3979	424	43-96084A5	18-2410	852
391-7057T	18-5404-1	694	39-96170A4	18-3981	424	43-96084A7	18-2410	852
39-18487A12	18-3924	426, 427	41141A2	18-7284	741	43994A2	18-6066	864
39-18653A1	18-3967	424, 426, 427	41155A1	18-9099	862	43994A2	18-6066A	864
39-18653A12	18-3966	424, 426, 427	41155A2	18-9099	862	43994A2	18-6243	864
39-18653A2	18-3968	424, 426, 427	41639A1	18-7230	740	44354A10	18-1976-2	794
39-18939M	18-3977	424	41951A1	18-2190	847	44354A13	18-1976-2	794
39-19721A1	18-4020	424	41951A1	18-2190E	847	44354A3	18-1976-2	794
39-19721A2	18-4021	Obsolete	41951A1	18-2157	847	44354A9	18-1976-2	794
39-19721A6	18-4019	424	41951A1	18-2159	847	45-43031A1	18-1736	457
392-6318T	18-5369	695	42419A1	18-6749	717	45518A1	18-2161	844
392-6326T	18-5407	694	42419A1	18-6749	717	45518A2	18-2161	844
392-7803A4	18-5438	696	42419A1	18-6750	717	45518A3	18-2161	844
392-805570A2	18-5438	696	42431M	18-3426	Obsolete	45589A1	18-2169	844
392-806529A1	18-5433	696	42724A3	18-3219	795, 831	45589A3	18-2169	844
392-8261A1	18-6799	718	42725A3	18-7282	741	45706A1	18-2142	Obsolete
392-8261A1	18-6768	718	42909A1	18-7818-1	403	45706A12	18-2142	Obsolete
392-9086T	18-5353	694	42909A2	18-7818-1	403	45706A14	18-2142	Obsolete
392-9089Q	18-5403	694	42909A3	18-7818-1	403	45706A3	18-2142	Obsolete
392-9089T	18-5403	694	42909A4	18-7818-1	403	45706A4	18-2148	Obsolete
392-9766Q1	18-5352	694	43-17064A3	18-2407	853	45706A6	18-2142	Obsolete
392-9766T	18-5352	694	43-18410A2	18-2201	831, 833, 841	45706A8	18-2142	Obsolete
393-4988T	18-5389	695	43-18411A2	18-2201	833, 841	46020T	18-2125	831, 833, 842
393-4988T2	18-5389	695	43396A2	18-6249	462	46-32437A1	18-3517	417
39383T	18-2128	831, 833, 842	43396A2	18-6249A	462	46-32437A3	18-3316	417
393-9459Q1	18-5385	695	43-42933A2	18-2407	853	463999A2	18-6014	461
393-9459T	18-5385	695	43-42933A3	18-2407	853	46399A1	18-6014	461
394-1100A2	18-5148	377	43432A2	18-2145	847	46399A1	18-6014A	461
394-1100A3	18-5148	377	43-45814A5	18-2203	831, 833, 841, 842	46-42040A1	18-3149-2	415
394-1130A1	18-5169	377	43-55765A2	18-2203	841	46-42040A3	18-3149-2	415
394-352A1	18-5148	377	43-55765A3	18-2203	841	46-42040A5	18-3149-2	415
39-45155A12	18-3902	424	43-55766A2	18-2205	841	46-42579A3	18-3419	415
39-45204A12	18-3916	424	43-55766A3	18-2205	841	46-42579A4	18-3517	417
39-74381A1	18-3928	806	43-55778A3	18-2205	831, 833, 841	46-42579A4	18-3319	417

MERCURY MARINE (cont.)			MERCURY MARINE (cont.)			MERCURY MARINE (cont.)		
O.E. #	SIERRA #	PAGE #	O.E. #	SIERRA #	PAGE #	O.E. #	SIERRA #	PAGE #
46-43024A3	18-3572	418	47-81242M	18-3063	413	50-812604A2	18-5913-1	714
46-44292A3	18-3420	750	47-81423M	18-3069	413	50-812604A2	18-6275	S/S to 18-6275-1
46-44292A4	18-3517	417	47-81604M	18-3067	413	50-822330A2	18-5913-1	714
46-44292Q03	18-3420	750	47-82824M	18-3069	413	50-822330A2	18-6275	S/S to 18-6275-1
46-44292T1	18-3420	750	47-84027M	18-3074	413	50-822462T1	18-5621	394
46-48743A1	18-3116	414, 750	47-84027T	18-3074	413	50-830308T	18-6437	392
46-48744A3	18-3448	419	47-84797M	18-3067	413	50-853329T	18-6440	393
46-48745A1	18-3422	415	47-85089T7	18-3215	415	50-854636T	18-6438	392
46-48746A1	18-3118	414	47-862232A2	18-3016-1	749	50-859169T	18-6437	392
46-48746A3	18-3118	414	47886T	18-5808	388	50-859170T	18-6438	392
46-48747A3	18-3517	417	47-89982T1	18-3252	421	50-859171T	18-6436	392
46-48748A1	18-3421	750	47-89983Q1	18-3207	415	50-859377T	18-6435	392
46-57234A1	18-3417	750	47-89983T	18-3007	412	50-863007A1	18-6275	S/S to 18-6275-1
46-57234A3	18-3517	417	47-89983T2	18-3207	415	50-864340A2	18-5913-1	714
46-58618A4	18-3517	417	47-89984T3	18-3017	413	50-864340A2	18-6275	S/S to 18-6275-1
46-59112A2	18-3600	751	47-89984T4	18-3017	413	50-884044T	18-6435	392
46-60366A1	18-3507	417	47-8M0100526	18-3265	416	50-884045T	18-6438	392
46-60367A4	18-3517	417	47-95611M	18-3063	413	50-888151T	18-6437	392
46-63450A2	18-3600	751	47-96305M	18-3073	413	50-888160T	18-6438	392
46-64141A1	18-3116	414, 750	47-96619M	18-3074	413	50-888161T	18-6435	392
46-64141A11	18-3517	417	47-97108M	18-3069	413	50-892339T	18-6440	393
46-65498A1	18-3422	415	48752T	18-3114	414, 749, 753	50-893890T	18-5621	394, 395
46-68390A1	18-3422	415	49518A1	18-2248	847	50-893891T	18-5642	393, 395
46-69222A3	18-3517	417	49964A1	18-1971	793	50-893891T	18-5602	393
46-70941A3	18-3446	418	49964A2	18-1971	793	50-893892T	18-5610	393, 395
46-72774A11	18-3600	751	50-12066A1	18-4915	396	50-8M003398A	18-5611	393, 395
46-72774A32	18-3600	751	50-12066A9	18-4915	396	50-90983A1	18-5611	395
46-73640A1	18-3423	415	50-12066Q9	18-4915	396	50-90983T1	18-5611	393
46-73640A2	18-3323	418	50-12121A2	18-6275	S/S to 18-6275-1	50-97499A2	18-5907	713
46-73802A2	18-3416	415	50-12177A2	18-5910	714	50-97499R4	18-5907	713
46-73802A3	18-3517	417	50-12177A2	18-6275	S/S to 18-6275-1	50-99417A2	18-5911	713
46-73804A1	18-3414	415	50-17251A2	18-5908	714	50-99418A2	18-5910	714
46-73804A3	18-3517	417	50-17251A3	18-5911	713	50-99418A2	18-6275	S/S to 18-6275-1
46-73823A7	18-3600	751	50-17251A3	18-5908	714	50-99419A3	18-5911	713
46-73842A2	18-3422	415	50-22791A1	18-4915	396	50-99419A3	18-5908	714
46-77177A1	18-3424	415	50-28985A2	18-4915	396	52073A1	18-1960-1	792
46-77177A3	18-3324	418, 448	50-38890A1	18-5601	393	52390A1	18-1955-1	792
46-77516A1	18-3422	415	50-44369A1	18-5642	393, 395	52731A1	18-7824-2	805
46-77516A3	18-3322	417	50-44369A1	18-5606	393, 395	52731A1	18-7876-1	805
46-77822A1	18-3118	414	50-44369A1	18-5602	393	52-822539T	18-2236	457
46-78400A1	18-3416	415	50-55601A2	18-5601	393	52-853594T	18-2202	853
46-78400A2	18-3517	417	50-57465A1	18-5636	394	52-859340T	18-1565	458
46-78400A2	18-3316	417	50-58788A3	18-5602	393	52969A1	18-1960-1	792
46-807151A14	18-3150	751	50-58788A3	18-5636	394	53114A1	18-2759	846
46-807151A7	18-3150	751	50-65784A1	18-5908	714	53779A1	18-1978	793
46-812966A7	18-3445	415	50-66015T	18-5610	393	53779A2	18-1978	793
46-812996A3	18-3445	415	50-66015T1	18-5642	393, 395	54099A1	18-1962-1	792
46-812996A9	18-3445	415	50-69865A1	18-5903	713	54099A5	18-1962-1	792
46-84277M	18-3148	418	50-72550A2	18-5907	713	54100A1	18-1958-1	791
46-84277T	18-3148	418	50-73521T	18-5605	393	54100A5	18-1958-1	791
46-862914A13	18-3160-1	751	50-76965A3	18-5908	714	54293A10	18-5822	Obsolete
46-96146A2	18-3416	415	50-76965A4	18-5911	713	54293A13	18-5822	Obsolete
46-96146A5	18-3414	415, 417	50-76967A1	18-5908	714	54293A4	18-5822	Obsolete
46-96146A6	18-3416	415	50-76967A4	18-5908	714	54-8M0090424	18-7321	847
46-96148A1	18-3116	414, 750	50-77328A1	18-6275	S/S to 18-6275-1	55278A1	18-7807	403
46-96148A5	18-3517	752	50-77328A3	18-5911	713	55278A3	18-7809	403
46-96148A8	18-3517	752	50-77328A3	18-6275	S/S to 18-6275-1	55278A4	18-7809	403
46-96148A8	18-3316	417	50-79472 1	18-5608	393	55278A5	18-7808	403
46-96148T1	18-3116	414, 750	50-79472 1	18-5608	393	55538A2	18-1973	793
47-11590M	18-3066	413	50-79604A3	18-5907	713	55989A3	18-60151-9	864
47-42038Q02	18-3062	413	50-804312T1	18-6425	392	55989A3	18-6015-9	864
47-43026Q06	18-3265	416	50-806963A4	18-5919	714	55989A3	18-6242-9	864
47-43026T11	18-3214	415, 416, 753	50-806964A2	18-6275	S/S to 18-6275-1	55989A3	18-6015A-9	Obsolete
47-43026T11	18-3265	416	50-806964A3	18-6275	S/S to 18-6275-1	55989A4	18-60151-9	864
47-43026T2	18-3056	413	50-806964A4	18-6275	S/S to 18-6275-1	55989A9	18-60151-9	864
47-43026T6	18-3214	415, 751	50-806965A2	18-5919	714	55989Q9	18-60151-9	864
47-43026T8	18-3214	415	50-806965A4	18-5919	714	55989Q9	18-6015-9	864
47441A1	18-1977-1	756	50-807904A1	18-6275	S/S to 18-6275-1	55989Q9	18-6242-9	864
47587A2	18-1910	757	50-808011A05	18-5908	714	55989Q9	18-6015A-9	Obsolete
47-59362A4	18-3216	751	50-808011A1	18-5908	714	55989T9	18-60151-9	864
47-59362Q08	18-3318	751	50-808011A3	18-5908	714	55989T9	18-6015-9	864
47-59362T	18-3087	749	50-808011A4	18-5908	714	55989T9	18-6242-9	864
47638A1	18-1995	795	50-808011A4	18-5603-1	638	55989T9	18-6015A-9	Obsolete
47-72774A89	18-3155	751	50-812428A3	18-5913-1	714	56-18541A75	18-2464	862
47-80395M	18-3072	413	50-812428A3	18-6275	S/S to 18-6275-1	56211A1	18-2191	854

MERCURY MARINE (cont.)			MERCURY MARINE (cont.)			MERCURY MARINE (cont.)		
O.E. #	SIERRA #	PAGE #	O.E. #	SIERRA #	PAGE #	O.E. #	SIERRA #	PAGE #
56-864641A24	18-2464	862	65057A1	18-5802	388	75832A2	18-2104	831, 833, 843
57-13457Q	18-15290	771	65057T1	18-5802	388	75832A2	18-2174	843
57-13457T	18-15290	771	65142A1	18-3593	749	75832A3	18-2104	843
57-13458Q	18-15550	771	65603A12	18-1962-1	792	75832A3	18-2174	843
57-13458T	18-15550	771	65603A4	18-1962-1	792	75832T	18-2104	843
57-33170Q	18-15520	771	65604A12	18-1958-1	791	75832T	18-2174	843
57-37619T	18-15520	771	65604A4	18-1958-1	791	75832T1	18-2104	843
57-48120A1	18-15460	771	66065A1	18-2190	847	75832T1	18-2174	843
57-48120Q1	18-15460	771	66065A1	18-2190E	847	759-80661A3	18-4109	Obsolete
57-48122Q	18-15480	771	66065A1	18-2157	847	759-80661A7	18-4109	Obsolete
57-49043A1	18-15410	771	66065A1	18-2159	847	759-80661A8	18-4134	Obsolete
57-49213A1	18-15440	771	66067T	18-2286	854	759-806661A5	18-4134	Obsolete
57-53215T	18-15290	771	66069A2	18-2190	847	759-8312A2	18-4109	Obsolete
57-64032A1	18-15410	771	66069A2	18-2190E	847	759-8312A6	18-4134	Obsolete
57-64032Q1	18-15410	771	66069A2	18-2157	847	759-9015A4	18-4134	Obsolete
57-65607Q	18-15370	771	66069A2	18-2159	847	761-7131M	18-4135	424
57-65607T	18-15370	771	66081A1	18-0577	844	761-7133M	18-4135	424
57-69143Q	18-15400	771	66081A2	18-0577	831, 833, 844	761-7134M	18-4135	424
57-69143T	18-15400	771	66081A4	18-0577	844	761-7196M	18-4138	424
57-74271Q	18-15345	771	66599A1	18-7811	403	761-7197M	18-4138	424
57-74271T	18-15345	771	66599A2	18-7812	403	761-7198M	18-4138	424
57-76269Q	18-15405	771	66599A3	18-7813	403	761-7982M	18-4135	424
57-77274A1	18-15325	771	67914A2	18-6763	718	761-7982T	18-4135	424
57-78200A1	18-15470	771	68162A1	18-5798	386	761-8484M	18-4138	424
57-78200Q1	18-15470	771	68162A3	18-5797	386	762142A1	18-6016	461
57-807755Q04	18-15112	777	68162A5	18-5798	386	76214A5	18-6016	461
57-816295Q	18-15490	771	68162A6	18-5797	386	76214Q5	18-60161	461
57-816295T	18-15490	771	68162A8	18-5798	386	76214Q5	18-6016A	461
57-828507Q4	18-18100	392	68521A3	18-5313-1	700	76214Q5	18-6244	461
57-861049Q	18-15114	777	68521A4	18-5313-1	700	76214T3	18-60161	461
57-861757Q	18-15115	777	68704A1	18-1148	Obsolete	76214T3	18-6016A	461
57-861758Q	18-15116	777	69354A1	18-2413	849	76214T3	18-6244	461
57-862086A1	18-15101	777	69354A2	18-2413	849	76270T	18-3552	755
57-862087A1	18-15100	777	700-858294T1	18-4639	427	76325A2	18-1972	793
57-862089A1	18-15104	777	700-858295T1	18-4640	427	76351A04	18-1971	793
57-865615Q01	18-15119	777	700-878571A2	18-4641	427	76351A1	18-1971	793
57-865615Q03	18-15100	777	700-878572A2	18-4642	427	76351A2	18-1971	793
57-865615Q04	18-15101	777	700-878573A2	18-4643	427	765-7443A11	18-4013	426
57-865615Q05	18-15121	777	700-878574A2	18-4644	427	765-7443A12	18-4560	427
57-865615Q06	18-15102	777	70125A02	18-7665	737	765-7443A2	18-4560	427
57-865615Q07	18-15103	777	70125A1	18-7665	737	765-7446A11	18-4014	Obsolete
57-865615Q08	18-15104	777	70981A3	18-2762	846	766-8667A36	18-4565	427
57882T	18-7232	740	71464A01	18-7667	737	766-8667A43	18-4565	427
57-91035A1	18-15495	771	71683A1	18-3584-1	648	76771A2	18-1978	793
57-91035Q1	18-15495	771	72436A1	18-6011	461	76771A3	18-1978	793
57-96834Q	18-15500	771	73020A1	18-2191	854	76850A2	18-2171	849
57-96834T	18-15500	771	73020A14	18-2191	854	77123A1	18-1705	843
58217Q	18-5418	694	73020A20	18-2376	855	77234A2	18-1950-1	791
58397A2	18-6749	717	73345A1	18-4233	461	77234A7	18-1950-1	791
58397A3	18-6749	717	733-803850T	18-4191	806	77235A2	18-1951-1	791
58759A1	18-1960-1	792	733-803850T	18-4161	Obsolete	77235A8	18-1951-1	791
58759A10	18-1960-1	792	735-808674A1	18-4173	806	77442A1	18-2148	Obsolete
58759A13	18-1960-1	792	735-9715T1	18-4178	806	774-9137A10	18-4515	424
58759A14	18-1960-1	792	73679A2	18-2190	847	776-9096A1	18-4156	424
59078A1	18-3550	755	73679A2	18-2190E	847	777-815965A4	18-4623	Obsolete
59078T3	18-3650	755	73679A2	18-2157	847	777-815965A5	18-4624	Obsolete
59137A1	18-3551	755	73679A2	18-2159	847	777-815965A6	18-4625	Obsolete
59826A1	18-2173	849	73723A01	18-2248	847	777-815965T4	18-4623	Obsolete
59826A3	18-2173	849	73723A1	18-2248	847, 848	778-9015A2	18-4109	Obsolete
59829A1	18-9218	842	73813A1	18-1990	795	778-9441A3	18-4109	Obsolete
59830A1	18-2146	831, 833, 842	73813F1	18-1990	795	778-9441A5	18-4134	Obsolete
59830A5	18-9218	831, 842	74313A4	18-1131	810	780-9229A10	18-4621	424
59830A7	18-2146	842	743-3193A2	18-4620	Obsolete	780-9229A11	18-4622	424
60252A2	18-4009	780, 784, 786, 788, 795	743-3193A4	18-4620	Obsolete	780-9229A7	18-4620	Obsolete
60372A1	18-1910	757	743-3366A1	18-4621	424	783-9613A2	18-4017	424
60372A2	18-1910	757	743-3366A2	18-4621	424	783-9613A3	18-4018	424
60426A1	18-1971	793	743-5172A6	18-4620	Obsolete	783-9613T2	18-4017	424
60427A2	18-1978	793	743-7716A2	18-4622	424	783-9613T3	18-4018	424
60932A1	18-2751	846	74436A9	18-6799	718	78403A1	18-5957	719
60932A4	18-2751	845, 846	74436A9	18-6768	718	78403A1	18-5956	719
62092T	18-7267	741	74639A2	18-2753-2	846	78403A2	18-5957	719
62351A1	18-5707	388	74905A3	18-5313-1	700	78403A2	18-5956	719
62351A2	18-5707	388	75282A1	18-4221	461	78458A1	18-2760	846
63115A12	18-7633	862	75832A1	18-2104	843	785-9737A10	18-4637	Obsolete
63908A2	18-1910	757	75832A1	18-2174	843	785-9737T9	18-4635	Obsolete

MERCURY MARINE (cont.)			MERCURY MARINE (cont.)			MERCURY MARINE (cont.)		
O.E. #	SIERRA #	PAGE #	O.E. #	SIERRA #	PAGE #	O.E. #	SIERRA #	PAGE #
785-9738T10	18-4638	427	807252T1	18-3551	755	818298A1	18-6249	462
785-9738T9	18-4636	427	807252T2	18-3649	755	818298A1	18-6249A	462
786214A2	18-6016	461	807252T6	18-3646	755	818298Q1	18-6249	462
78687T	18-2144	428	807252T8	18-3647	755	818298Q1	18-6249A	462
79271A4	18-6799	718	807476A6	18-1908K	794	818349A1	18-2286	854
79271A4	18-6768	718	807652T	18-5967	719	818349T1	18-2286	854
79271A4	18-6763	718	807653T	18-5960	719	818763A10	18-2376	855
802128A1	18-7831	411	807757T	18-6457	749	818763A4	18-2376	855
802371A1	18-5181	378	807914A1	18-1976-2	794	818903A1	18-6777	384
802706A1	18-7738	397	807929A1	18-2354	855	819479A1	18-6777	384
803061T1	18-3569	411	807929A2	18-2354	855	819480A1	18-6777	384
803470Q	18-7878-1	805	807964A1	18-5476	699	819762A4-A7	18-6777	384
804346T1	18-7743	397	807988A03	18-1976-2	794	81977A8-A9	18-6777	384
804483T	18-5354	694	807988A2	18-1976-2	794	821509T1	18-5852	389
805016A1	18-7234	740	808064A1	18-3531	756	821629A1	18-6080A	865
805025A2	18-7326	741	808483K2	18-5291	692	821629A1	18-6099	865
805101T	18-3787	859	808483Q2	18-5281	693	821629A1	18-6080	833, 865
805185A36	18-5471	699	808483T3	18-5354	694	821629Q1	18-6080A	865
805185A37	18-5470	699	808484 1	18-5405	694	821630A1	18-6094	865
805217A1	18-7684	725	809463A1	18-5811	388, 717	821630A1	18-6094A	865
805218T	18-7600	725	811618A1	18-6751	383	821630A1	18-6240	865
805222A1	18-5484-1	699	811635Q2	18-5280	693	821630C2	18-6094	865
805223T	18-7702	766	811635T3	18-5361	694	821630Q1	18-6094A	865
805224A1	18-7632-1	725	811636 1	18-5406	694	821630Q1	18-6240	865
805226A1	18-7630	725	811637T	18-5107-1	696	821630T1	18-6094A	865
805320A03	18-7633	862	811639T	18-5108	696	821630T1	18-6240	865
805320A1	18-7633	862	811673 1	18-6775	384	821631A1	18-6066	864
805536A1	18-2097	833, 842	81242M	18-3427	Obsolete	821631B1	18-6066	864
805536A2	18-2097	833, 842	812454A1	18-7288-1	741	821631C	18-6066	864
805544T	976	726	812454A3	18-7288-1	741	821631Q1	18-6066	864
805656A2	18-7326	741	812843A1	18-6751	383	821631Q1	18-6066A	864
805656A5	18-7326	741	812964A2	18-2412-1	849	821631Q1	18-6243	864
805656A6	18-7326	741	813442A1	18-6751	383	821759A1	18-2354	855
805759A1	18-5395	695	813442A2	18-6751	383	821759A2	18-2354	839, 855
805759A2	18-5395	695	814309A1	18-2434	715	821759A3	18-2354	855
805759A5	18-5395	695	814481M	18-7769	399	821759A4	18-2354	855
805759Q3	18-5273	693	814819A2	18-9218	833, 842	822777A1	18-6014	461
805759T	18-5395	695	815279A2	18-5741	388	822777A1	18-6014A	461
805759T1	18-5395	695	815407A2	18-5396	695	822777A3	18-6014	461
805759T3	18-5273	693	815425T	18-5899	766	822777A4	18-6014	461
805884T	18-5965	719	815471A3	18-2145	847, 848	822777Q1	18-6014	461
80606M	18-7839	403	815471A3	18-2145E	848	822777Q1	18-6014A	461
806105A1	18-6079	865	815471A6	18-2145E	847	822870A1	18-6777	384
806105A1	18-6093A	865	815471A6	18-2145	847	823034T	18-5793	379
806105A1	18-6093	839, 865	815471T1	18-2604	848	823426A1	18-7077	736
806105Q1	18-6079	865	815471T1	18-2604E	848	823426A1	18-7072	736
806105Q1	18-6093A	865	815919A1	18-2320	855	823427A1	18-7746	736
806105Q1	18-6093	865	815921A2	18-2353	855	823653A5	18-6765	384
806105T1	18-6079	865	815922A1	18-2354	855	823653A9	18-6765	384
806105T1	18-6093A	865	815922A5	18-2354	855	825096T01	18-5821	388
806105T1	18-6093	865	815933A1	18-6099	865	825467A1	18-7901	204
806189A1	18-6067	865	815933A1	18-6080	865	825467T1	18-7901	432
806189A1	18-6067A	865	816148A1	18-5313-1	700	826134A1	18-6068	865
806189A1	18-6114	865	816431A1	18-2747	845, 846	826763A	18-3154	414
806189Q1	18-6114	865	816610A1	18-2244	456, 858	828151A1	18-5849	389
806189T1	18-6114	865	816610A2	18-2244	456, 858	828692A1	18-2382	833, 844
806190A1	18-6089	865	816770T	18-5707	388	828708A1	18-6774	384
806190A1	18-6092	865	817019A1	18-9099	862	830250A3	18-6777	384
806190A1	18-6092A	865	817019A2	18-9099	862	830250T3	18-6777	384
806190Q1	18-6092	865	817019Q2	18-9099	862	832021A1	18-6777	384
806190Q1	18-6092A	865	817119A1	18-5957	719	832021A2	18-6777	384
806190T1	18-6089	865	817119A1	18-5965	719	832021T2	18-6777	384
806190T1	18-6092	865	817119A1	18-5966	719	832021T4	18-6777	384
806190T1	18-6092A	865	817119A4	18-5957	719	833232E	18-4173	806
806490T	18-5897	766	817119A4	18-5965	719	835392Q	18-15147	432
806612T	18-7677	647	817119A4	18-5966	719	84141M	18-7840	403
806673T	18-5442	696	817275A08	18-3406	416	84188M	18-3425	419
806673T1	18-5442	696	817275A09	18-3407	416	84188T	18-3425	419
806867A 8	18-1956-3	792	817275A1	18-3571	418, 419, 753, 839	84262M	18-7837	403
807074A1	18-3531	756	817275A2	18-3572	418, 419, 450	84265M	18-7838	403
807078Q07	18-1957-2	792	817275K05	18-3147	751	84419M	18-7290	397
807078T08	18-1957-2	792	817275T4	18-3147	751	84-43376A12	18-8802-1	705
807166A3	18-2732	750	817373A1	18-6094	865	84-43376A7	18-8800-1	709
807252Q3	18-3646	755	817377T	18-5475	699	84-43376A8	18-8809-1	709
807252Q5	18-3647	755	817378T	18-5443	696	84-43376A9	18-8803-2	637

MERCURY MARINE (cont.)			MERCURY MARINE (cont.)			MERCURY MARINE (cont.)		
O.E. #	SIERRA #	PAGE #	O.E. #	SIERRA #	PAGE #	O.E. #	SIERRA #	PAGE #
84456M	18-7770	506	854472A4	18-6777	384	878265A4	18-6773	384
84475M	18-7291	397	855654A1	18-6777	384	878265A6	18-6774	384
845668T	18-0614	805	855654T2	18-6777	384	87-861780A2	18-5116-1	696
84-813706A26	18-5225	383	857006T	18-6454	392	87-861780Q4	18-5116-1	696
84-813715A1	18-5228-1	382	85784A1	18-7228	740	87-88107A5	MP52000	25, 31, 383
84-813715A1	18-5227-1	382	85785A2	18-7231	740	87-892150A02	18-5116-1	696
84-813720A10	18-8803-2	637	85785T	18-7229	740	881247A1	18-6455	392
84-813720A11	18-8810-1	709	860235A04	18-1956-3	792	881248T	18-6454	392
84-813720A12	18-8802-1	705	860246Q11	18-1953-2	791	88183A11	18-6752	717
84-813720A13	18-8811-1	709	861006A1	18-1989	667	88183A12	18-6752	717
84-813720A2	18-8804-1	198	861155A5	18-7326	741	88183A12	18-6753	717
84-813720A3	18-8804-1	198	861155A6	18-7326	741	88183A5	18-6746	718
84-813720A3	18-8821-1	705	861156A1	18-35433	Obsolete	88183A5	18-6769-1	718
84-813720A4	18-8804-1	198	861188A1	18-3531	756	88183A6	18-6752	717
84-813720A4	18-8821-1	705	861245A1	18-7639	730	882751A04	18-5850	389
84-813720A5	18-8800-1	709	861260T	18-7692	727	882751A1	18-5849	389
84-813720A6	18-8808-2	709	861493A07	18-1910	757	882751A2	18-5849	389
84-813720A7	18-8801-1	709	861493A3	18-1910	757	883072T	18-5743	388
84-813720A8	18-8809-1	709	861523A9	18-2412-1	849	883166A1	18-6778	718
84-813720A9	18-8803-2	637	861676T09	18-7282	741	883166A2	18-6778	718
84-816608A14	18-8833-1	705	861677T	18-8860	741	88475A4	18-6799	718
84-816608A68	18-8832-1	705	861678A1	18-7283	741	88475A4	18-6768	718
84-816608A71	18-8836-1	705	861678A1	18-7283	741	884794A02	18-5351	699
84-816608A81	18-8822-1	705	86177 1	18-5658	395	884794A1	18-5351	699
84-816608A83	18-8834-1	705	862030T	18-5983	719	88553A1	18-6749	717
84-816608K68	18-8832-1	705	862031T	18-6293	719	88678A4	18-7633	862
84-816608Q14	18-8833-1	705	862031T1	18-6293	719	88678A5	18-7633	862
84-816608Q61	18-8804-1	198	862048A1	18-7288-1	741	88-79023A91	18-8220	720
84-816608Q68	18-8832-1	705	862077A1	18-7284	741	888751A02	18-5350	699
84-816608Q71	18-8836-1	705	862132T	18-1711	842	888751A03	18-5350	699
84-816608Q78	18-8824-1	705	86234A05	18-7278	741	888751A1	18-5350	699
84-816608Q80	18-8830-1	705	86234A3	18-7278	741	888755A1	18-6158M	864
84-816608Q81	18-8822-1	705	86234A4	18-7278	741	888755Q01	18-6158M	864
84-816608Q82	18-8835-1	705	86246A1	18-7274	741	888756A2	18-6150A	865
84-816608Q83	18-8834-1	705	86246T	18-7274	171	888756A2	18-6150M	865
84-816761A12	18-8802-1	705	86247A2	18-7275	741	888756A2	18-6150Z	865
84-816761A17	18-8821-1	705	86247T	18-7275	741	888756Q01	18-6158A	864
84-816761A4	18-8804-1	198	862548A1	18-6749	717	888756Q02	18-6150A	865
84-816761A4	18-8821-1	705	862548A1	18-6750	717	888756Q02	18-6150M	865
84-816761A7	18-8800-1	709	863077T	18-6298	719	888756Q02	18-6150Z	865
84-816761A8	18-8809-1	709	86459A1	18-9099	862	888756Q4	18-6150A	865
84-816761A9	18-8803-2	637	86459A2	18-9099	862	888756Q4	18-6150M	865
84-816761K14	18-8833-1	705	864856A1	18-7684	725	888756Q4	18-6150Z	865
84-816761Q10	18-8803-2	637	865380A03	18-6746	718	888757Q01	18-6159M	864
84-816761Q12	18-8802-1	705	865380A13	18-6746	718	888758A1	18-6159A	864
84-816761Q13	18-8811-1	709	865436A02	18-2190	847	888758Q01	18-6159A	864
84-816761Q16	18-8810-1	709	865436A02	18-2190E	847	888759A1	18-6159M	864
84-816761Q17	18-8821-1	705	865436A02	18-2157	847	888760A1	18-6160M	864
84-816761Q3	18-8804-1	703	865436A02	18-2159	847	888760Q01	18-6160M	864
84-816761Q3	18-8821-1	705	865436A03	18-2603	848	888761A1	18-6160A	864
84-816761Q4	18-8804-1	198	865436A03	18-2603E	848	888761Q01	18-6160A	864
84-816761Q4	18-8821-1	705	865437A02	18-2145	847	888909A1	18-0557	454
84-816761Q5	18-8800-1	709	865493A01	18-6406	843	88893A4	18-6749	717
84-816761Q6	18-8808-2	709	865496A01	18-6406	843	889955A03	18-6454	392
84-816761Q7	18-8801-1	709	865496A01	18-6406	843	89031A1	18-7811	403
84-816761Q8	18-8809-1	709	865503T	18-6404	Obsolete	89031A2	18-7812	403
84-816761Q9	18-8803-2	637	865510T	18-6406	843	89031A3	18-7813	403
84829M	18-3426	Obsolete	865511T	18-6406	843	89031A4	18-7814	403
84-847701A7	18-8837-1	705	866169A01	18-8864	740	891736T	18-6772	718
84-847701Q7	18-8837-1	705	866169T01	18-8864	740	892874T01	18-8866	403
84-863656A1	18-8828-1	705	866170A01	18-8865	740	892940T	18-5929	392
84-863656A2	18-8829-1	705	86617A20	18-5864	385	893929A01	18-6751	383
84-881262A2	18-6500	392	86840A05	18-2756	846	89396A38	18-8004EP-1	406
84-90816A26	18-5225	383	86840A3	18-2756	845, 846	89396A38	18-8004S	406
84-93212A1	18-5225	383	87-17009A2	MP41070-2	383	89396Q38	18-8004EP-1	406
84-93475A26	18-5225	383	87-17009A5	MP51090	25, 31, 383	89396Q38	18-8004S	406
84-99215A26	18-5225	383	87-17009A5	MP51092	25, 31, 383	89-68258A4	18-5815	388
850484T	18-5362	694	87290A4	18-1994	Obsolete	89-76416A1	18-5801	716
850484T2	18-5362	694	87399A1	18-2428	Obsolete	89-76545T	18-5815	388
850484T3	18-5278	693	87399A2	18-2428	Obsolete	89-817109A2	18-5834	389
85147A5	18-2145	847	87399A3	18-2429	Obsolete	89-818864T	18-5818	388
852956A1	18-7685	726	875285T1	18-6454	392	89-818997A1	18-5819	388
853678T	18-7700	725	875286A1	18-6455	392	89-818997A2	18-5819	388
854472A2	18-6777	384	875286T	18-6455	392	89-818997T1	18-5819	388
854472A3	18-6777	384	87581T	18-5315-1	700	89-818999A2	18-5820	717

MOTOROLA (cont.)			Mercury Marine (cont.)			Mercury Marine (cont.)		
O.E. #	SIERRA #	PAGE #	O.E. #	SIERRA #	PAGE #	O.E. #	SIERRA #	PAGE #
89-825096T	18-5821	388	91823A3	18-5313-1	700	938-883297 1	18-4486	805
898253T22	18-5244	694	91-850730Q01	18-9781	223	938-883490R1	18-4485	668
898253T23	18-5243	694	91-859046Q4	18-4459	460, 859	938-883490R50	18-4485	668
898253T24	18-5433	696	91-859046T4	18-4459	460, 859	938-884741R	18-4485	668
898253T27	18-5443	696	91-883704Q03	18-9794	223	938-884741R50	18-4485	668
898253T28	18-5246	692	91-8M0067546	18-4442	234, 852	94998A1	18-2381	844
898253T29	18-5247	692	91-8M0072133	18-9781	223	94998A2	18-2381	831, 844
89-825842A1	18-5820	717	91-8M0101435	18-9650-2QP	218	94998A3	18-2381	844
89-850188T1	18-5820	717	91-95830A1	18-4444	460, 859	94998A4	18-2381	844
89-853654A1	18-5815	388	91-99750A1	18-9801	232, 385	95661M	18-3427	Obsolete
89876A3	18-7853-1	746	91-99750A1	18-9801	232, 385	95755A2	18-1970-2	793
899106T01	18-8866	403	92459A4	18-6765	384	95862A5	18-1954-1	Obsolete
89-96054T	18-5816	388	92497A3	18-5957	719	95864A2	18-1975-1	794
89-96158T	18-5817	388	92497A3	18-5965	719	96455A1	18-5797	386
8M0027721	18-2560	446	92520M	18-7293	397	96455A6	18-5798	386
8M0054726	18-7660	725	92-78383A12	18-9080	221	96455A8	18-5797	386
8M0058164	18-7283	741	92-802833Q1	18-9420-2	209, 214	96455A9	18-5798	386
8M0058677	18-6157A	461	92-802835Q1	18-9420-3	209, 214	96477A3	18-6752	717
8M0060495	18-5247	692	92-802836A1	18-9420-7	209, 214	96705A1	18-1955-1	792
8M0061335	18-5247	692	92-802837Q1	18-9400-2	210, 214	96863A15	18-7633	862
8M0061381	18-1989	667	92-802841A1	18-9400-7	210, 214	97257A1	18-5897	766
8M0062084	18-5408	694	92-802844Q02	18-9600-0	218	97258A1	18-5898	766
8M0062406	18-2756	846	92-817529A12	18-9080	221	97-31640B4	18-6011	461
8M0064021	18-6454	392	92-857389A1	18-9400-4	210, 214	97-31640Q4	18-6011	461
8M0065179	18-15148	432	92-858007Q01	18-9600-5	224	97-34672C	18-6013	864
8M0068784	18-5899	766	92-858008Q01	18-9650-5	218	97399A2	18-7288-1	741
8M0072670	18-15146	432	92-858037K01	18-9530-3	208, 214	97401A2	18-7283	741
8M0084600	18-5224	383	92-858039K01	18-9530-7	208, 214	97401A8	18-7283	741
8M0089715	18-3551	755	92-858042K01	18-9553-3	209, 214	97432A2	18-2414	849
8M0091470	18-3649	755	92-858042Q01	18-9553-3	209, 214	97-76214Q5	18-6016	461
8M0095485	18-8212-1	845	92-858057K01	18-9440-7	210, 214	97793M	18-3426	Obsolete
8M0098795	18-2412-1	849	92-858058Q01	18-9600-2	218	97793T	18-3426	Obsolete
8M0104229	18-3016-1	749	92-858062Q01	18-9600-7	218	97-806188A1	18-6117A	864
8M0708280	18-2425	862	92-858064Q01	18-9650-2	218	97-806188A1	18-6117Z	864
8M2009865	18-2130	855	92-858067Q01	18-9650-6	218	97-806188A1	18-6117M	Obsolete
8M6001217	18-5338	694	92-858067Q01	18-9650-6P	218	97-806188Q01	18-6117A	864
8M6001218	18-5345	694	92-858068Q01	18-9650-7	218	97-806188Q01	18-6117Z	864
8M6001219	18-5303	693	92-858084K01	18-9552-3	209, 214	97-806188Q01	18-6117M	Obsolete
8M6001224	18-5404-1	694	92-883722K01	18-9440-8	211, 214	97-806189Q1	18-6067	865
8M6001249	18-5347	694	92-883723K01	18-9440-3	211, 214	97-806189Q1	18-6067A	865
8M6001250	18-5314	693	92-883724K01	18-9440-2	210, 214	97-806190B4	18-6089	865
90363A1	18-7810	403	92-883724K01	18-9440-2P	210, 214	97-806190Q1	18-6089	865
90576A4	18-5432	694	92-883725K01	18-9440-4	210, 214	97-821629Q1	18-6099	865
90746A1	18-5395	695	92-883725K01	18-9440-4P	210, 214	97-821629Q1	18-6080	865
90796A41	18-5476	699	92-8M0071837	18-9200-2	219	97-821630Q1	18-6094	865
90806A1	18-5899	766	92-8M0071837	18-9200-4	219	97-826134Q	18-6068	461
91-12427T	18-9807	229	92-8M0071838	18-9200-0	219	97-888755Q03	18-6158M	864
91-14311A04	18-9874	229	92-8M0071841	18-9200-1	219	97-888756Q03	18-6158A	864
91-14311A1	18-9874	229	92-8M0078618	18-9420CAT-7	213, 214	97-888758Q03	18-6159A	864
91-14311A2	18-9874	229	92-8M0078618	18-9420CAT-7P	213, 214	97-888759Q03	18-6159M	864
91-15755T	18-9808	229	92-8M0078621	18-9400CAT-7	213, 214	97-888760Q03	18-6160M	864
91-17262A1	18-9810	229	92-8M0078621	18-9400CAT-7P	213, 214	97-888761Q03	18-6160A	864
91-17275A1	18-9812	229	92-8M0078624	18-9440CAT-7	213, 214	98502A2	18-1974-1	794
91-23033T	18-9817	229	92-8M0078624	18-9440CAT-7P	213, 214	98503A2	18-1970-2	793
91-30366T1	18-9816	235	92-8M0078625	18-9420CAT-2	213, 214	98504A3	18-1970-2	793
91-31107T	18-9817	229	92-8M0078625	18-9420CAT-2P	213, 214	98555A1	18-5957	719
91-31229A7	18-9820-1	230	92-8M0078626	18-9420CAT-3	213, 214	98555A1	18-5965	719
91-33492T	18-9825	229	92-8M0078626	18-9420CAT-3P	213, 214	98555A1	18-5966	719
91-33493T	18-9826	229	92-8M0078627	18-9400CAT-2	213, 214	98562A6	18-1937	794
91-34379T	18-9827	229	92-8M0078627	18-9400CAT-2P	213, 214	98703A11	18-2424	862
91-38277A1	18-4444	460, 859	92-8M0078629	18-9440CAT-2	213, 214	98703A12	18-2424	862
91-38918T	18-9839	230	92-8M0078629	18-9440CAT-2P	213, 214	98703A17	18-2424	862
91-43506T	18-9842	230	92975A28	18-6763	384	98703A26	18-2424	862
91-43591T	18-9845	230	92975A32	18-6763	384	98703A3	18-2426	862
91-44307A1	18-9874	229	92975A6	18-6763	718	98704A11	18-2425	862
91-45497A1	18-9847	230	93247A4	18-6799	718	98704A12	18-2425	862
91-57797A1	18-4442	234, 852	93247A7	18-6799	718	98704A17	18-2425	862
91-57797A2	18-4442	234, 852	93247A7	18-6768	718	98704A26	18-2425	862
91-57797A3	18-4442	234, 852	93320A13	18-1908K	794	98704A3	18-2427	862
91-60526T	18-9856	231	93320A2	18-1908K	794	99155A1	18-3555	755, 756
91-61069T	18-9858	231	93320A3	18-1908K	794	99155T1	18-3568	755
91-63638T	18-9860	231	93320A5	18-1908K	794	99155T2	18-3555	755
91-74057Q6	18-9783	224	93320A6	18-1908K	794	99186T	18-6273-1	384
91748M	18-7834	403	93477T	18-0615	805	99297A1	18-2193	827
91-821887A1	18-4459	460, 859	938-803860T	18-4486	805	99297A2	18-2193	827

MERCURY MARINE (cont.)			MERCURY MARINE (cont.)			MERCURY MARINE (cont.)		
O.E. #	SIERRA #	PAGE #	O.E. #	SIERRA #	PAGE #	O.E. #	SIERRA #	PAGE #
993247A4	18-6768	718	FI1100785	18-3593	749	FI6900190	18-5403	694
99356A2	18-2587	578	FI1100862	18-1402	806	FI6900198	18-5898	766
99370A2	18-2733	750	FI1100954	18-1402	806	FI6901224	18-5404-1	694
99660A1	18-6751	383	FI1100968	18-4022	815	FI8390006	18-7860	748
99746A17	18-1952-1	791	FI1100980	18-1334	810	FI9608751	18-7964-1	748
99746A8	18-1952-1	791	FI1100986	18-1233	815	MC 1 95862	18-1954-1	Obsolete
99798A16	18-1956-3	792	FI1100997	18-3577-2	749	RA122009	18-5603	645
99798A18	18-1956-3	792	FI1101000	18-0903	825	YLM579AV	18-5497-2	185, 700
99798A3	18-1956-3	792	FI1101053	18-3577-2	749	MERCURY/MERCUISER		
99798A9	18-1956-3	792	FI1101057	18-3944	806	339-883778A01	18-5159	378
F10077105	18-2917	822	FI1101101	18-4189	806	339-883778A02	18-5159	378
F1348	18-3713	844	FI1101117	18-4022	815	339-8M0077473	18-5159	378
F17510	18-7413	470	FI1101134	18-3939	806	879984A1	18-5158	378
F1881	18-3713	844	FI1101184	18-4173	806	879984T00	18-5158	378
F2769931	18-1402	806	FI1101185	18-4164	806	879984T01	18-5158	378
F2774666	18-3593	749	FI1101200	18-4024	815	8M0077471	18-5158	378
F328506	18-3937	806	FI1101208	18-3599-2	749	MOTOROLA		
F328516	18-3938	Obsolete	FI1101222	18-1402	806	510-802	18-5976	963
F3746241	18-4492	Obsolete	FI1101236	18-2845	824	510-821	18-5976	963
F3860315	18-25001	824	FI1101276	18-2917	822	510-835	18-5976	963
F3866612	18-4022	815	FI1101281	18-1237	819	510-836	18-5976	963
F3892364	18-3937	806	FI1101287	18-0664	824	510-845	18-5975	678
F3910555	18-1308	810	FI1101291	18-2917	822	510-856	18-5976	963
F3916351	18-1308	810	FI1101292	18-3599-2	749	510-860	18-5975	678
F3932344	18-0874	822	FI1101295	18-0612	805	510-861	18-5976	963
F40109	18-2244	456, 858	FI1101296	18-0868	820	510-862	18-5976	963
F50342	18-7413	470	FI1101297	18-0976	824	510-864	18-5975	678
F50556	18-2945	446	FI1101300	18-0519	467	9AR3743G	18-5976	963
F508814	18-1129	856	FI1101317	18-4178	806	9AR3855G	18-5975	678
F5232670	18-1402	806	FI1101318	18-4173	806	9AR3959G	18-5975	678
F532555	18-7467	470	FI1101320	18-4164	806	9AR6000G	18-5975	678
F53795	18-7153	470	FI1101321	18-3937	806	NISSAN		
F6269358	18-3577-2	749	FI1101322	18-3938	Obsolete	3G3060211M	18-5165	476
F694555	18-7176	470	FI1101334	18-4173	806	NISSAN/TOHATSU		
F694961	18-2346	854	FI1101336	18-4164	806	346-01032-0	18-60920	480
F700633	18-4263	795	FI1101656	18-0322	826	65750-95500	18-8079	478
F7040	18-3700	460, 859	FI1110294	18-25001	824	332600052M	18-72656	480
F720301	18-5881	379	FI1110958	18-25001	824	332600060M	18-72656	480
F724102	18-1401	806	FI5000074	18-0889	821	332600060M	18-60103	480
F74305	18-7176	470	FI5000077	18-0891	825	334650210M	18-8921	479
F74305-1	18-7176	470	FI5000078	18-0891	825	345650210M	18-8923	479
F749301	18-5775	378	FI5000096	18-2917	822	345871224M	18-7290	478
F7778A9	18-5775	378	FI5000119	18-2815	825	346760100M	18-6431	Obsolete
F8077	18-2945	446	FI5000161	18-2845	824	346871220M	18-7291	478
F8186	18-2945	446	FI5000162	18-0874	822	346873217M	18-74611	479
F84903	18-1162	454, 856	FI5000178	18-0411	820	353650210M	18-45404	479
FA84901	18-1162	454, 856	FI5000183	18-0411	820	353760104M	18-6418	477
FFF001138	18-7964-1	748	FI5000199	18-2815	825	369022300M	18-7712	478
FI000034	18-1190	453	FI5000200	18-0327	825	369871221M	18-7765	505
FI1001079	18-3593	749	FI5000201	18-0887	824	398873213M	18-74610	479
FI1100014	18-4492	Obsolete	FI5000204	18-2946	821	3AA050040M	18-51000	480
FI1100229	18-0348	819	FI5000219	18-0327	825	3B2650160M	18-43212	479
FI110026	18-1211	815	FI5000229	18-0348	819	3B2650211M	18-8920	479
FI110027	18-1211	815	FI5000232	18-0868	820	3B2702501M	18-8088	478
FI1100305	18-1308	810	FI5000245	18-0348	819	3B2-70260-0	18-8089	478
FI1100349	18-1402	806	FI5000263	18-0868	820	3B2702810M	18-8079	478
FI1100381	18-1309	810	FI5005756	18-0876	821	3B2873222M	18-48317	479
FI1100382	18-1341	Obsolete	FI5110032	18-0153	819	3B7650212M	18-8924	479
FI1100386	18-3937	806	FI5110037	18-0153	819	3B7871218M	18-4436	479
FI1100387	18-3939	806	FI5810151	18-4263	795	3C7650211M	18-8924	479
FI1100399	18-1402	806	FI5880010	18-4264	795	3C8010055M	18-3850	480
FI110041	18-1211	815	FI6900023	18-5347	694	3C8650212M	18-8922	479
FI1100495	18-4492	Obsolete	FI6900031	18-5303	693	3C8760101M	18-6432	477
FI1100570	18-1308	810	FI6900031	18-5345	694	3C8-87121-4	18-4434	479
FI1100573	18-1309	810	FI6900032	18-5347	694	3F3010051M	18-4299	480
FI1100692	18-3937	806	FI6900044	18-5338	694	3F3871210M	18-4435	479
FI1100694	18-3938	Obsolete	FI6900040	18-5407	694	3G2-06040-2	18-5166	476
FI1100742	18-3599-2	749	FI6900052	18-5385	695	3GR702500M	18-80410-1	407, 478
FI1100779	18-4191	806	FI6900083	18-5347	694	3M3060482M	18-5166	476
FI1100779	18-4161	Obsolete	FI6900148	18-5376	695	3R0074220M	18-76695	470
FI1100780	18-4191	806	FI6900152	18-5898	766	3R0-07615-0	18-7911-1	205
FI1100780	18-4161	Obsolete	FI6900184	18-5369	695	3R3010300M	18-43175	479
FI1100781	18-4160	Obsolete	FI6900185	18-5352	694	3T9010050M	18-3886	480
FI1100783	18-3939	806	FI6900186	18-5403	694	3V1010050M	18-60916	Obsolete
			FI6900189	18-5347	694	3V1010240M	18-60917	480

NISSAN - TOHATSU (cont.)			OMC (cont.)			OMC (cont.)		
O.E. #	SIERRA #	PAGE #	O.E. #	SIERRA #	PAGE #	O.E. #	SIERRA #	PAGE #
3V1013030M	18-60918	480	173619	18-5251	873	306048	18-2959	327
3V1023050M	18-60919	480	173690	18-5258	873	306205	18-2901	334
B29A-90500A	18-6430	Obsolete	173829	18-5260	873	306643	18-3135	Obsolete
NOCO			173834	18-7879-1	913	307069	18-2957	327
GCP1	AC12390	79	173944	18-6816	282	307082	18-7152	370
GCP1E	AC12400	79	174177	18-8072	898	307103	18-7428	335
GCP1EX	AC12410	79	174275	18-9080	221	307133	18-2876	334
GCP2	AC12420	79	174448	18-9098	936	307239	18-7170	370
NORCROSS			174508	18-8056	297	307257	18-2872-9	334
26000P	26000P	19	174509	18-8014S-1	169	307450	18-7102	943
NORTHERN LIGHTS			174509	18-8014EP-2	164, 297	307551	18-4255	348
11-10015	23-0830	136	174511	18-8004EP-1	297	307551	18-23871-9	348
24-22009	23-1102	130	174511	18-8004S	168, 170	307551	18-2387	348
24-28003	23-1103	130	174512	18-8005S	169	307552	18-2945	348, 922
25-12009	23-2005	132	174512	18-8005EP-1	297	307573	18-6501	337
25-12009	23-3315	133	175068	18-9080	221	307583	18-7106	290
OBERDORFER			175158	18-0871	290	307853	18-7120	943
6603	18-3021	576	175266	18-3715	349	308186	18-4075	317
7054	18-3078	577	175267	18-3716	349	308458	18-7461	370
8922	18-3061	577	175268	18-3717	349	308500	18-8351	367, 941
132-0317	18-3060	974	176288	MP28890	32, 281, 882	308621	18-7121	943
B6620	18-3075	577	176445	18-8092	297	308624	18-7103	370
C7441	18-3077	577	202893	18-7168	370, 943, 1003	308626	18-7198	370
OETIKER			203034	18-2952	327	308627	18-7104	943
787133	18-9125	225	203130	18-3841-2	328	308799	18-2863	921
14100082	18-9141	225	203171	18-2886	333	308825	18-0653	935
16700004	18-9126-9	225	203698	18-6513	337	308876	18-7123	370
16700006	18-9127-9	225	277181	18-3001	298	308928	18-3108	901
16700007	18-9128-9	225	300599	18-2035	367, 941	309044	18-2534	336
16700010	18-9129-9	225	300611	18-3326	300	309243	18-1236	348
16700011	18-9130-9	225	301824	18-7111	370, 943, 1003	309612	18-2950	327
16700012	18-9131-9	225	301877	18-7100	370, 943, 1003	309731	18-7156	370
16700013	18-9132-9	225	301967	18-7440-1	943	309955	18-3741	349
16700016	18-9133-9	225	302325	18-3369	330	309956	18-2898	333
16700017	18-9134-9	225	302337	18-7162	370	309989	18-2000	367, 941
16700020	18-9140-9	225	302493	18-7112	943	310058	18-0182	334
16700024	18-9135-9	225	302497	18-3329	336	310137	18-2868	Obsolete
16700031	18-9136-9	225	302537	18-7164	370	310327	18-7173	370
16700037	18-9137-9	225	302540	18-7114	943	310414	18-7167	943
16700040	18-9138-9	225	302557	18-2887	337	310584	18-7135	943
16700053	18-9139-9	225	302588	18-7115	943	310585	18-7158	370
OMC			302675	18-2889	331	310599	18-2012	367, 941
114812	18-45312	299	302804	18-3740	349	310649	18-2020	367, 941
121731	18-3722	938	302994	18-2890	330	310913	18-2947	919
122838	18-8052	168, 297	303059	18-7134	370	310953	18-15460	904
123009	18-6017	363	303067	18-7116	943	310967	18-7158	370
123009	18-6017A	363	303069	18-3103	299	311046	18-15440	904
123009	18-6100	363	303191	18-7413	943	311068	18-2896-1	911
123018	18-1599	924	303339	18-2891	336	311069	18-0164	994
124249	18-8201	298	303345	18-2022	367, 941	311121	18-2861-1	919
125530	18-2881	337	303347	18-7180	370	311130	18-2860	919
127084	18-4222	349	303355	18-2892	331	311131	18-2859	Obsolete
171960	18-5898	901	303360	18-7117	943	311145	18-0679	335
172521	18-5011	274	303438	18-2885	327	311210	18-3880	918
172522	18-5006	274	303598	18-7150	370	311338	18-7105	943
172523	18-5002	274	303615	18-0850	330	311508	18-0917	336
172525	18-5001	274	303750	18-2893-9	330	311598	18-4248	348, 922
172527	18-5250	873	303804	18-2060	367, 941	311598	18-42481-9	348, 922
172531	18-5256	873	304023	18-2880	335	311606	18-15400	904
172543	18-6822	965	304026	18-3332	336	311684	18-7854	897
172543	18-6762	247, 282	304174	18-7165	943	312456	18-7860	898
172588	18-6816	282	304314	18-2894	333	312634	18-2879	331
172806	18-5003	274	304720	18-2951	327	312679	18-2900	331
172850	18-6767-1	282	304762	18-2871	332	312780	18-0874	918
172869	18-5814	886	304764	18-0882	335	312781	18-71337	904
173029	18-6017	363	305123	18-7133	370	312797	18-2917	918
173029	18-6017A	363	305185	18-7826	296	312797	18-0398	919
173029	18-6100	363	305242	18-7118	943	312800	18-0876	918
173231	18-7875	913	305270	18-7155	370	312932	18-6511	337
173233	18-7876-1	913	305303	18-3102	299	313065	18-2901	334
173311	18-8055	297	305306	18-2027	367, 941	313080	18-2767	930
173312	18-8074	297	305312	18-2869	336	313175	18-7107	370
173326	18-7930	159	305739	18-7101	370	313176	18-3141	Obsolete
173564	18-6767-1	282	305762	18-2532	336	313244	18-0923	922
173596	18-6767-1	282	305987	18-2018	367, 941	313258	18-2021	367

OMC (cont.)			OMC (cont.)			OMC (cont.)		
O.E. #	SIERRA #	PAGE #	O.E. #	SIERRA #	PAGE #	O.E. #	SIERRA #	PAGE #
313282	18-2023	367, 941	318841	18-4222	936	321692	18-2391	336
313283	18-0173	367, 941	318914	18-2963	327	321722	18-0985	331
313284	18-2005	367, 941	318917	18-0397	334	321724	18-70936	323
313340	18-7126	370	318924	18-0959	331	321727	18-2864	333
313353	18-2058	367, 941	318925	18-2853	332	321786	18-2030	367, 941
313368	18-2851	921	318932	18-0961	330	321787	18-2031	367, 941
313413	18-2960	327	318940	18-1505	337	321788	18-2032	367, 941
313416	18-0929	334	318944	18-6503	337	321794	18-0989	331
313446	18-7127	943	318971	18-3706	349	321830	18-8304	367
313448	18-1714	935	318972	18-2025	367, 941	321831	18-0542	Obsolete
313507	18-0543	367, 941	318973	18-2028	367, 941	321886	18-3290	297
313754	18-7128	370	318995	18-3178	300	321895	18-0543	367, 941
313763	18-2865	333	319085	18-7139	370	321907	18-0991	332
313782	18-2884	327	319097	18-2913	333	321921	18-7411	370
313893	18-7108	943	319126	18-3369	301	321928	18-2033	367, 941
313992	18-2016	367, 941	319174	18-2867	333	321932	18-0675	334
314008	18-2703	336	319256	18-2029	367, 941	321940	18-3126	300
314082	18-2855	335	319275	18-3127	300	322119	18-7133	370
314115	18-0933	331	319332	18-0967	334	322119	18-7142	370
314167	18-2024	367, 941	319348	18-2904	334	322236	18-4911	235, 337
314322	18-0935	331	319586	18-0969	335	322332	18-2962	327
314421	18-2877	333	319633	18-2954	327	322411	18-0892	334
314491	18-7129	370	319661	18-0971	325	322501	18-7143	943
314502	18-3742	349	319662	18-7457	370	322652	18-8020	298
314503	18-3705	349	319664	18-2093	354	322653	18-8200	298
314728	18-7130	370	319665	18-2856	334	322654	18-8202	298
314730	18-3719	931	319710	18-2878	333	322656	18-8051	168, 297
314731	18-0195	351	319771	18-2857	331	322858	18-2547	335
314745	18-2231	361	319890	18-4229	339	322941	18-3763	925
314809	18-2858	918	319891	18-3707	349	323214	18-2550	333
314832	18-2389	336	319895	18-2287	356	323217	18-0945	332
314876	18-2874	335	320041	18-2379	348	323222	18-0995	333
315052	18-0973	332	320140	18-7178	370	323312	18-0445	335
315055	18-0937	918	320166	18-2224	361	323361	18-2230	361
315189	18-0939	921	320167	18-2225	361	323362	18-2229	361
315232	18-7296	290	320168	18-2226	361	323459	18-0999-9	Obsolete
315288	18-0542	Obsolete	320169	18-2227	361	323469	18-0102	332
315538	18-0941	334	320170	18-2228	361	323582	18-8372	336
315539	18-2958	327	320303	18-7140	370	323626	18-3136	330
315748	18-2705	S/S to 18-2705-9	320305	18-4230	341	323653	18-6522	337
315810	18-4228	349	320311	18-2398	357	323664	18-2220	356
315837	18-3337	336	320499	18-1377	317	323889	18-2232	361
315868	18-1218	332	320533	18-2963	327	323890	18-2233	361
315869	18-1224	332	320570	18-4231	349	323943	18-4232	339
316499	18-0949	Obsolete	320630	18-2220	356	324097	18-3179	Obsolete
316506	18-2243	Obsolete	320658	18-3802	328	324323	18-0106	325
316563	18-2377	348	320745	18-2964	328	324324	18-3803	328
316705	18-4913	235, 337	320785	18-3743	349	324334	18-4276	307, 330
316706	18-4914	235, 337	320862	18-2002	367, 941	324369	18-2399	357
317178	18-7109	943	320880	18-1219	336	324430	18-4277	307, 330
317232	18-2234	361	320936	18-0540	336	324449	18-0108	306
317245	18-1243	310	320943	18-2704	336	324639	18-2034	367, 941
317624	18-1279	925	320961	18-8353	336	324670	18-0110	335
317831	18-4290	314	320981	18-3343	300	324701	18-2557	335
317838	18-2219	356	321008	18-2706	336	324717	18-0112	325
317841	18-3182	Obsolete	321027	18-3563	312	324766	18-0198	351
317843	18-2026	367	321028	18-2544	334	324825	18-8204	298
317914	18-2866	333	321117	18-7141	370	324937	18-2537	336
317951	18-0953	Obsolete	321120	18-2536	335	324981	18-7481	335
317955	18-0117	332	321163	18-7510	370	325092	18-0118	330
318156	18-0955	332	321182	18-2545	332	325211	18-0120	332
318223	18-2059	367, 941	321183	18-0979	331	325260	18-0122	331
318303	18-2209	Obsolete	321184	18-2546	335	325273	18-3800	328
318304	18-2208	356	321220	18-3565	311	325398	18-3352	308
318334	18-2872-9	334	321221	18-3567	311	325537	18-0124	335
318335	18-2873-9	334	321222	18-3562	Obsolete	325647	18-3801	328
318358	18-2956	327	321435	18-2549	332	325721	18-2907	334
318372	18-7137	370	321459	18-2027	367, 941	326260	18-2862	332
318373	18-0957	333	321467	18-2060	367, 941	326264	18-0126	332
318395	18-3564	312	321479	18-0981	332	326468	18-0128	333
318544	18-4249	349	321481	18-2029	367, 941	326649	18-7174	370
318544	18-23781-9	Obsolete	321497	18-0983	331	326716	18-0174	367, 941
318544	18-2378	922	321504	18-8351	367, 941	326741	18-7418	325
318609	18-2543	334	321573	18-2862	332	326751	18-2075	367
318717	18-7138	370	321648	18-5655	284	326765	18-4292	Obsolete

OMC (cont.)			OMC (cont.)			OMC (cont.)		
O.E. #	SIERRA #	PAGE #	O.E. #	SIERRA #	PAGE #	O.E. #	SIERRA #	PAGE #
326849	18-7144	943	331979	18-3133	Obsolete	338882	18-2579	330
326877	18-6509	337	331980	18-1704	Obsolete	338884	18-2906	330
326926	18-1212	332	331999	18-4826	Obsolete	338886	18-2890	330
326953	18-2888	S/S to 18-2888-9	332000	18-2769	336	339620	18-2074	367
327031	18-2035	367, 941	332010	18-2888	S/S to 18-2888-9	340115	18-3866	328
327035	18-2392	336	332108	18-2548	335	340490	18-2219	356
327606	18-6018	363	332205	18-2064	367, 941	340619	18-3455	300
327655	18-1289	356	332253	18-8352	330	340975	18-70936	323
327656	18-0200	351	332261	18-2065	367, 941	340976	18-70937	323
327674	18-3899	334	332266	18-0130	331	341013	18-1598	924
327707	18-0134	330	332319	18-0987	332	341280	18-8300	367, 941
327795	18-3802	328	332369	18-0977	334	341281	18-8301	367, 941
327861	18-4280	314	332403	18-2881	337	341440	18-9892	228
328283	18-0136	333	332489	18-2309	357	341501	18-0628	330
328313	18-1288	356	332491	18-2308	356	342786	18-8325	367
328360	18-9885	228	332584	18-7475	943	342787	18-8326	367
328361	18-9886	228	332585	18-0559	367, 941	343863	18-1207	332
328363	18-9887	228	332598	18-7120	869	344470	18-3295	300
328364	18-9888	228	332694	18-2900	331	346004	18-1723	354
328365	18-9889	228	332696	18-2903	330	346150	18-9140-9	298
328366	18-9890	228	332816	18-3895	328	346151	18-9135-9	298
328367	18-9891	228	332817	18-3896	328	346152	18-9136-9	298
328506	18-3937	914	332819	18-3898	Obsolete	346153	18-9137-9	298
328516	18-3938	Obsolete	333008	18-0975	331	346785	18-9132-9	298
328590	18-0138	333	333077	18-2219	356	346786	18-9133-9	298
328604	18-0140	333	333096	18-2093	354	346930	18-9126-9	298
328622	18-0142	331	333418	18-2906	330	346931	18-9131-9	298
328623	18-3837	328	333572	18-7145	943	347107	18-9129-9	298
328626	18-0144	331	333592	18-4223	349	347108	18-9130-9	298
328751	18-3358	300	333670	18-3839	328	348838	18-9127-9	298
328753	18-2539	335	333725	18-0197	351	348839	18-9134-9	298
329076	18-0441	334	333758	18-2708	336	349516	18-9128-9	298
329103	18-2961	327	333771	18-0201	351	349729	18-9139-9	298
329380	18-7416	943	333879	18-0965	333	349759	18-9138-9	298
329381	18-7417	943	333957	18-1343	Obsolete	349957	18-9876	229, 925
329390	18-3360	334	334163	18-3766	363	352165	18-0313	335
329419	18-3803	328	334353	18-0437	330	352670	18-0465	916
329653	18-8203	298	334516	18-2216	356	353076	18-2075	367
329654	18-8034	898	334665	18-4197	Obsolete	357159	18-0153	916
329718	18-0148	331	334726	18-3839	328	357159	18-0411	916
329826	18-0851	335	334742	18-1734	311	370409	18-3944	914
329828	18-1205	333	334897	18-3138	300	375638	18-3002	298
329830	18-1202	334	334913	18-7150	370	377139	18-1154	931
329833	18-1207	332	334950	18-8367	367	377230	18-3083	299
329836	18-3836	328	335334	18-7796	293	378065	18-3543	311
329920	18-2905	334	335359	18-3802	328	378231	18-5437	876
329922	18-2061	367, 941	335360	18-2964	328	378444	18-5807	283
329923	18-2062	367, 941	335361	18-3801	328	378891	18-3006	298
330081	18-4076	317	335403	18-1285	333	378895	18-7093	290
330137	18-2001	367, 941	335523	18-7110	328	379312	18-7093	290
330273	18-1221	336	335633	18-0963	331	379313	18-7094	290
330327	18-2063	367, 941	335679	18-2279	354	379475	18-3086	899
330412	18-0155	335	335722	18-2277	354	379504	18-1350	931
330525	18-6512	S/S to 18-6512-9	335818	18-1283	333	379628	18-2192	889
330560	18-3363	301	335819	18-1284	333	379763	18-3201	301
330619	18-3295	300	335981	18-1507	311	379766	18-3203	301
330621	18-2852	333	336232	18-1286	322	379777	18-7801	292
330698	18-0157	Obsolete	336430	18-0945	332	379957	18-4218	909
330818	18-2963	327	336530	18-2709	335	380186	18-7071	891
330854	18-1391	318	336562	18-2216	356	380537	18-5345	874
330909	18-0159	331	336982	18-4253-9	348, 922	380538	18-5311	874
331103	18-8307	367, 941	336982	18-42531-9	348, 922	380541	18-5385	875
331107	18-3299	300	337020	18-1290	357	380542	18-5419	875
331188	18-7143	943	337068	18-0412	334	380543	18-5310	874
331203	18-2890	330	337772	18-2216	356	380640	18-3593	898
331211	18-3838	328	337774	18-2216	356	380986	18-7258	894
331353	18-7963	336	337778	18-1500	357	381389	18-7200	893
331363	18-2879	331	338484	18-2557	335	381494	18-7609-1	178
331380	18-7150	370	338518	18-7108	943	381538	18-3059	302
331499	18-2908	330	338534	18-6522	337	381668	18-7608-1	178
331532	18-0161	331	338813	18-2582	330	381690	18-7860	898
331598	18-0978	331	338876	18-2879	331	382045	18-7043	289
331880	18-3765	357	338878	18-2908	330	382046	18-7043	289
331916	18-2913	333	338879	18-2900	331	382047	18-7043	289
331917	18-2938	333	338880	18-2903	330	382049	18-7043	289

OMC (cont.)			OMC (cont.)			OMC (cont.)		
O.E. #	SIERRA #	PAGE #	O.E. #	SIERRA #	PAGE #	O.E. #	SIERRA #	PAGE #
382050	18-7010	289	387277	18-6761	282	393159	18-0153	916
382051	18-7010	289	387284	18-4124	314	393271	18-4120	316
382052	18-7024	289	387285	18-4114	314	393279	18-9894	228
382053	18-7024	289	387326	18-3325	302	393301	MP39760	30, 281
382054	18-7010	289	387361	18-3090	299	393433	18-4305	324
382125	18-5344	874	387610	18-3327	302	393509	18-3381	303
382133	18-5375	875	387656	18-1365	352	393561	18-0927	Obsolete
382135	18-5314	874	387661	18-4062	314	393566	18-4122	314
382136	18-5338	874	387683	18-5674	288	393570	18-5628	287
382138	18-6754	889	387684	18-5630	287	393612	18-4102	314
382218	18-3599-2	898	387684	18-5630	287	393630	18-3382	303
382221	18-45221	299	387787	18-1361	317	393632	18-3367	301
382296	18-3402	Obsolete	387817	18-1117	931	393659	18-3543	311
382343	18-1356	352	387818	18-2252	355	393924	18-4120	316
382354	18-7352	292	387879	18-2250	355	393988	18-6759	282
382363	18-7210	290	388268	18-7352	292	394176	18-6759	282
382385	18-3557	311	388344	18-1378	317	394394	18-3401	306
382407	18-1351	931	388602	18-4301	323	394408	18-1222	311
382408	18-1366	352	388644	18-3393	305	394409	18-3500	311
382468	18-3377	302	388644	18-3403	306	394411	18-1506	311
382547	18-3082	299	389039	18-1358	931, 932	394461	18-4063	Obsolete
382715	18-6822	965	389042	18-1370	352	394462	18-1752	317
382733	18-7609-1	178	389112	18-3327	302	394488	18-4148-1	317
382821	18-7605-1	178	389143	18-3388	304	394534	18-3059	302
383052	18-7043	289	389206	18-4307	325	394543	18-7352	292
383067	18-7043	289	389275	18-5630	287	394546	18-4306	325
383087	18-7201	893	389275	18-5630	287	394711	18-3327	302
383307	18-3554	902	389289	18-3059	302	394711	18-3400	305
383440	18-5711	888	389556	18-4303-1	324	394885	18-4309	Obsolete
383444	18-5437	876	389576	18-3091	299	394930	18-3904	314
383587	18-5384	875	389589	18-3055	299	395060	18-3390	304
383615	18-7070	891	389642	18-3043	517	395072	18-3391	305
383766	18-7605-1	178	389954	18-5634	287	395073	18-3393	305
383918	18-7095	891	390055	18-7046	289	395091	18-7350	292
384087	18-3336	300	390076	18-4318	325	395204	18-5825	Obsolete
384163	18-5630	287	390078	18-4302	324	395207	18-5640	286
384163	18-5630	287	390082	18-3972	315	395209	18-2187	355
384194	18-7605-1	178	390286	18-3366	299	395270	18-3383	303
384195	18-1357	352	390381	18-3379	Obsolete	395270	18-3401	306
384719	18-3560	Obsolete	390509	18-3907	Obsolete	395271	18-3401	306
384735	18-5418	581, 612, 653, 694, 875	390510	18-3908	314	395289	18-3051	298
384743	18-7072	891	390770	18-3380	303	395419	18-5808	886
384777	18-5648	287	390905	22355	224	395460	18-6501	337
384781	18-5671	288	390928	79040	224	395627	18-1374	317
384956	18-3376	302	391170	18-3913	314	395713	18-7352	292
385043	18-1371	352	391264	18-6759	282	395861	18-1753	317
385068	18-1367	352	391300	18-4303-1	324	395864	18-3059	302
385072	18-3044	298	391305	18-7223	289	395867	18-7821	292
385356	18-7024	289	391416	18-3915	314	396041	18-1360	317
385416	18-4300	323	391472	18-2187	933	396235	18-5619	287
385503	18-1395	318	391511	18-5619	287	396349	18-2660	364
385529	18-5634	287	391635	18-3378	303	396350	18-2656	363
385662	18-3906	314	391638	18-7350	292	396351	18-2658	364
385781	18-7352	292	391653	18-4101	314	396352	18-2657	Obsolete
385952	18-5697	288	391698	18-3327	302	396355	18-2659	364
386084	18-3050	298	391698	18-3400	305	396377	18-3910	314
386124	18-3384	304	391735	18-5648	287	396378	18-3911	314
386280	18-3933	314	391937	18-7223	289	396379	18-3912	314
386430	18-6434	286	391988	18-4304-1	324	396503	18-3906	314
386533	18-3388	304	392061	18-7042	289	396504	18-3905	314
386545	MP39830	31, 281	392061	18-7222	289	396520	18-7093	290
386545	MP39100	31, 281	392123	18-6027	363, 938	396521	18-7093	290
386573	18-2857	331	392133	18-5629	287	396522	18-7094	290
386591	18-5629	287	392455	18-4123	316	396583	18-4104	314
386657	18-5648	287	392462	18-6026	363	396585	18-4100	314
386659	18-2355	355	392475	18-1287	356	396587	18-4103	314
386697	18-3327	302	392550	18-7046	289	396588	18-4100	314
386764	18-1354	352	392567	18-4307	325	396644	18-4529	306
386765	18-1355	352	392615	18-4307	325	396701	18-7042	289
387041	18-1353	317	392621	18-4107	314	396701	18-7222	289
387094	18-5640	286	393023	18-6024	491	396725	18-3053-1	299
387139	18-4040	318	393023	18-6024A	363, 937	396750	18-4310	325
387142	18-4040	318	393061	18-0466	916	396809	18-3368	299
387247	18-1158	931	393088	18-7823	293	396852	18-3015	298
387262	18-7093	290	393103	18-7820	292	396932	18-3385	304

OMC (cont.)			OMC (cont.)			OMC (cont.)		
O.E. #	SIERRA #	PAGE #	O.E. #	SIERRA #	PAGE #	O.E. #	SIERRA #	PAGE #
396933	18-3399	305	434107	18-3913	314	438592	18-3454	302
396987	18-3557	311	434109	18-3915	314	438592	18-3394	305
397004	18-6526	Obsolete	434137	18-3500	311	438616	18-7800	292
397023	18-5619	287	434381	18-4309	Obsolete	438786	18-6281	282
397131	18-3059	302	434400	18-1703	934	438996	18-7247	290
397274	18-7350	292	434421	18-3390	304	439015	18-4195	314
397537	18-1363	352	434421	18-3392	305	439071	18-7043	289
397538	18-1364	352	434424	18-3001	298	439072	18-7223	289
397541	18-2288	355	434496	18-6780	282	439073	18-7219	289
397627	18-2310	Obsolete	434839	18-7916	205, 323	439076	18-7046	289
397768	18-6029	938	434841	18-3543	311	439077	18-3378	303
397839	18-7350	292	434844	18-1376	317	439077	18-3399	305
398042	18-3708-1	936	434888	18-7046	289	439078	18-7248	290
398047	18-4321	Obsolete	435022	18-2251	355	439079	18-7248	290
398051	18-2093	354	435027	18-3346	300	439138	18-2288	355
398319	18-7831	296	435096	18-1703	934	439141	18-2623	363
398327	18-7830	296	435276	18-4841	348	439476	18-4807	357
398331	18-6025	363, 938	435277	18-4840	348	439515	18-4165	314
398338	18-7352	292	435279	18-4843	348	439516	18-4086	314
398387	18-7352	292	435390	18-3180	301	439517	18-4087	314
398452	18-7223	289	435442	18-7221	289	439538	18-3947	314
398453	18-7223	289	435442	18-7247	290	439561	18-5828	Obsolete
398483	18-4064	Obsolete	435443	18-7046	289	439937	18-6281	282
398514	18-7821	292	435447	18-3390	304	439948	18-3059	302
398526	18-7046	289	435491	18-3544	311	439967	18-2672	939
398532	18-7043	289	435548	18-6277	282	458625	18-0153	916
398549	18-8009S-1	169	435673	18-3129	301	458625	18-0411	916
398549	18-8009EP-2	163, 297	435676	18-7248	290	473424	18-1211	915
398602	18-1282	32, 281	435677	18-7248	290	500423	37479	224
398729	18-7042	289	435678	18-7248	290	502036	18-1402	914
398729	18-7222	289	435748	18-3059	302	502867	18-8063	297
398901	18-1368	352	435752	18-7248	290	502880	18-5196	275
431708	18-6095	363, 938	435760	18-2325	354	502881	18-5172	275
431708	18-6095A	363, 938	435761	18-2328	354	502888	18-5192	275
431844	18-3974	Obsolete	435821	18-3059	302	502890	18-5194	275
431870	18-3975	314	435929	18-3315-2	306	502900	18-7875	913
431897	18-7219	289	435957	18-3501	300	502901	18-7876-1	913
432072	18-4065	314	435959	18-3405	301	502903	18-7879-1	913
432073	18-4066	314	436137	18-8906	299	502904	18-7878-1	913
432077	18-4067	314	436195	18-3561	311	502905	18-7846	897
432078	18-4068	Obsolete	436232	18-2326	354	502905	18-7946	897
432230	MP28880	32, 281, 882	436234	18-2327	354	502906	18-7789	897
432230	MP28900	32, 282	436235	18-2330	354	502906	18-7989	897
432230	MP28902-1	32, 282	436254	18-3901	314	503747	18-8807-1	193-198, 614
432264	18-1369	352	436353	18-4088	316	503748	18-8800-1	881
432451	18-7352	292	436354	18-4090	Obsolete	503749	18-8814-1	193
432570	18-4322	329	436367	18-5886	278	503749	18-8811-1	193
432803	18-4069	Obsolete	436740	18-2251	355	503749	18-8841-1	193, 959
432925	18-5612	287	436745	18-6024	491	503750	18-8801-1	193
432941	18-3104-1	299	436745	18-6024A	363, 937	503751	18-8810-1	193
432955	18-3129	301	436746	18-2218	356	503752	18-8823-1	194
432955	18-3389	304	436834	18-1725	355	503752	18-8802-1	193
432956	18-3387	304	436859	18-4079	Obsolete	503752	18-8803-2	194
432962	18-7822	292	436860	18-4190	314	503753	18-8842-1	198
432969	18-4065	314	436888	18-2252	355	503754	18-8820-1	194
432970	18-4066	314	436891	18-4323	Obsolete	503755	18-8823-1	194
433003	18-4067	314	436954	18-3129	301	503755	18-8802-1	195
433004	18-4068	Obsolete	436957	18-3389	304	503755	18-8803-2	194
433017	18-2251	355	437059	18-3104-1	299	503756	18-8843-1	198
433067	18-1721	341	437090	18-3545	311	508105	18-2613	917
433190	18-79781	296	437228	18-0993	290	508180	MP39760	30, 281
433226	18-6285	282	437327	18-7248	290	508626	18-3543	311
433379	18-3643	311	437409	18-4063	Obsolete	508871	18-0348	916
433386	18-7353	292	437801	18-6280	282	508872	18-0407	Obsolete
433387	18-7352	292	437907	18-3491	307	508876	18-0411	916
433458	18-6025	363, 938	438039	18-1702	934	509395	18-7278	171
433503	18-1299	352	438040	18-1703	934	509404	18-7283	171
433519	18-7800	292	438399	18-1722	354	509407	18-7282	171
433548	18-3394	305	438529	18-6780	282	509408	18-7284	171
433549	18-3394	305	438531	18-6780	282	509409	18-7274	171
433550	18-2694	365	438555	18-7353	292	509410	18-7275	171
433580	18-6115	363	438556	18-7352	292	510364	18-5224	281
433935	18-3015	298	438562	18-7351	292	510883	18-5226	882
433941	18-4307	325	438591	18-3129	301	552906	18-3744	349
434063	18-2218	356	438591	18-3389	304	553126	18-7172	370

OMC (cont.)			OMC (cont.)			OMC (cont.)		
O.E. #	SIERRA #	PAGE #	O.E. #	SIERRA #	PAGE #	O.E. #	SIERRA #	PAGE #
554545	18-7146	943	584424	18-5832	Obsolete	765012	18-3803	328
580148	18-5156	274	584476	18-5827	Obsolete	765350	18-3104-1	299
580256	18-5200	874	584477	18-5181	275	766779	18-2964	328
580290	18-5157	376	584489	18-5794	S/S to 18-5794-1	766870	18-2950	327
580321	18-5199	274	584561	18-5176	275	771839	18-7920	897
580339	18-5750	246, 262, 281, 383,	584580	18-5823	283	772577	18-4911	235, 337
		476, 481, 497, 582,	584632	18-5194	275	772578	18-4913	235, 337
		596, 615, 644, 712,	584636	18-5781-1	278	772579	18-4914	235, 337
		882, 956	584641	18-5831	Obsolete	772584	18-5226	882
581027	18-5750	246, 262, 281, 383,	584642	18-5773	278	772681	18-8063	297
		476, 481, 497, 582,	584643	18-5877	282	772681	18-8063	297
		596, 615, 644, 712,	584783	18-5767	277	772831	18-7609-1	178
		882, 956	584799	18-5619	287	775518	18-3002	298
581032	18-5194	275	584818	18-5631	287	775521	18-3006	298
581130	18-5163	275	584890	18-5826	285	775613	18-9080	221
581207	18-5141	274	584908	18-5768	277	775640	18-8056	297
581397	18-5755	Obsolete	584980	18-5632	287	775641	18-8092	297
581407	18-5196	275	584981	18-5878	282	777120	18-9540-7	208, 214
581419	18-5205	275	584985	18-5887	278	777130	18-3086	899
581528	18-5814	886	585001	18-5827	Obsolete	777213	18-3083	299
581610	18-5192	275	585050	18-5648	287	777228	18-9530-7	208, 214
581778	18-5709	285	585051	18-5634	287	778885	18-7915-1	323
581786	18-5172	275	585056	18-5624	287	778886	18-7896	323
581805	18-5759	279	585057	18-5634	287	778887	18-7897	491
582048	18-6761	282	585058	18-5648	287	778888	18-7895	205
582091	18-5192	275	585059	18-5627	287	778992	18-5640	286
582125	18-5759	279	585060	18-5628	287	778994	18-5628	287
582138	18-5760	279	585061	18-5629	287	778995	18-5617	287
582155	18-6761	282	585062	18-5640	286	778996	18-5631	287
582160	18-5194	275	585063	18-5630	287	787133	18-9125	298
582261	18-5764	279	585114	18-5781-1	278	787145	18-9125	298
582285	18-5763	279	585134	MP28870	32, 281	787145	18-9141	225
582365	18-5231-1	280	585145	18-5774-1	278	797407	18-3015	298
582365	18-8815-1	280	585189	18-5780	Obsolete	907761	18-0114-1	910
582365	18-8818-1	280	585219	18-5828	Obsolete	907764	18-0104	919
582366	18-5176	275	585261	18-5785	278	907774	18-3111	Obsolete
582399	18-5708	285	585267	18-5679	286	907775	18-2883-1	919
582400	18-5760	279	585269	18-5678	288	907866	18-3731	Obsolete
582452	18-5758	279	585459	18-5627	287	907932	18-2830-1	823
582453	18-5758	279	585995	18-5831	Obsolete	907967	18-2073	941
582472	18-5705	889	586000	18-5832	Obsolete	908013	18-2875-1-9	919
582508	18-5179	275	586048	18-5829	Obsolete	908013	18-2875-1	921
582556	18-5760	279	586075	18-5830	Obsolete	908034	18-7859	898
582642	18-5760	279	586212	18-5781-1	278	908062	18-4251	931
582705	18-5782	278	586217	18-5893	278	908063	18-2176	Obsolete
582708	18-5808	886	586224	18-5705	889	908064	18-3725	931
582811	18-5784-1	278	586271	18-5831	Obsolete	908065	18-2071	941
582811	18-5783	279	586274	18-5617	287	908069	18-2177	Obsolete
582995	18-5181	275	586277	18-5631	287	908070	18-2072	941
583110	18-5784-1	278	586279	18-5624	287	908079	18-2912-1	919
583114	18-5761	279	586281	18-5648	287	908087	18-2184	933, 934
583170	18-5763	279	586284	18-5632	287	908158	18-3153	307
583266	18-5832	Obsolete	586285	18-5628	287	908194	18-7400	943
583298	18-5170	275	586286	18-5612	287	908237	18-3881	918
583380	18-5758	279	586287	18-5612	287	908383	18-7401	943
583408	18-5708	285	586288	18-5640	286	908611	18-2946	918
583473	18-5627	287	586343	18-5884	278	908717	18-0183-1	910
583476	18-5893	278	586661	18-5781-1	278	908765	18-0435	918
583482	18-5624	287	586667	18-5893	278	908852	18-2071	941
583605	18-5891	278	586696	18-5764	279	908894	18-2072	941
583689	18-5832	Obsolete	586730	18-5801	886	908929	18-15455	904
583737	18-5176	275	586731	18-5619	287	908935	18-2850-1	921
583740	18-5170	275	586774	18-5833	283	909048	18-7477	943
583748	18-5766	S/S to 18-5766-1	586842	18-5801	886	909121	18-2183	932, 934
583865	18-5885	278	678882	18-7093	290	909314	18-2902-1-9	911
583896	18-5794	S/S to 18-5794-1	740120	18-1922	909	909314	18-2902-1	921
584028	18-5770-1	277	763364	18-7903	205	909316	18-7403	943
584032	18-5771	277	763735	18-3090	299	909515	18-0548	920
584037	18-5893	278	763793	18-5782	278	909527	18-2768	930
584041	18-5772-1	278	763794	18-5784-1	278	909529	18-0947	920
584107	18-6761	282	763794	18-5783	279	909533	18-3365	307, 330
584122	18-5886	278	763803	18-5774-1	278	909613	18-0418	920
584128	18-5813	283	764354	18-9530-3	208, 214	909747	18-7404	943
584329	18-5794	S/S to 18-5794-1	764357	18-9540-3	208, 214	909748	18-0188	922
584331	18-5794	S/S to 18-5794-1	764708	18-5755	Obsolete	909753	18-2185	933, 934
584416	18-5705	889						

OMC (cont.)			OMC (cont.)			OMC (cont.)		
O.E. #	SIERRA #	PAGE #	O.E. #	SIERRA #	PAGE #	O.E. #	SIERRA #	PAGE #
909758	18-0434	918	911851	18-7153	370	915840	18-2918	922
909786	18-0943-2	910	911871	18-7409	943	916058	18-2068	367, 941
909818	18-15500	904	911878	18-0880	921	916096	18-1922	909
909829	18-0549	922	911937	18-3770	926	916262	18-0183-1	910
909830	18-0550	922	912029	18-4835	Obsolete	976669	18-6020	363, 937
909835	18-0891	921	912157	18-0190	921	979659	18-7072	891
909863	18-1921	909	912164	18-1204-1-9	920	979719	18-7080	891
909971	18-15460	904	912164	18-1204-1	920	979774	18-5803	886
910113	18-0673	919	912212	18-2146	926	980014	18-1712	357
910139	18-7855	897	912213	18-2128	930	980152	18-5386	581, 612, 653, 694, 875
910169	18-5399	918	912214	18-2104	926	980183	18-2156	936
910236	18-2911	921	912227	18-3879	918	980477	18-3599-2	898
910305	18-75100	904	912374	18-2745	930	980528	18-7608-1	178
910343	18-15415	904	912405	18-0956-1	919	980530	18-7609-1	178
910380	18-1922	909	912418	18-15500	904	980613	18-5897	902
910384	18-4009	909	912424	18-75100	904	980617	18-1876	988
910414	18-15380	904	912441	18-1902	908	980803	18-5903	961
910582	18-7174	370	912442	18-1903	908	980892	18-5407	874
910641	18-7792	897	912471	18-0431	Obsolete	980893	18-5303	874
910995	18-2216	356	912477	18-0430	919	980894	18-5347	874
911019	18-2066	367, 941	912509	18-15435	904	980902	18-5309-1	880
911311	18-7406	943	912614	18-3502	Obsolete	980959	18-1904	908
911616	18-8021	898	912714	18-15520	904	981078	18-5911	884
911662	18-02062	Obsolete	912766	18-3878	918	981080	18-5312-1	880
911663	18-02063	Obsolete	912768	18-0464	675	981195	18-2071	941
911665	18-02065	924	912793	18-75125	904	981196	18-2072	367, 941
911666	18-02066	Obsolete	912954	18-0468	921	981268	18-2073	367, 941
911667	18-02067	924	912955	18-0405	916	981288	18-5908	885
911668	18-0207	924	912965	18-2845	920	981289	18-5907	884
911669	18-0209	924	912978	18-4408	Obsolete	981359	18-7615-1	178
911669	18-0211	924	912979	18-1238	916	981428	18-7615-1	178
911670	18-0209	924	912981	18-0347	920	981564	18-7615-1	178
911670	18-0211	924	912988	18-0887	921	981566	18-7229	895
911671	18-0209	924	912989	18-1213	915	981650	18-7268	894
911671	18-0211	924	913270	18-0664	920	981705	18-7615-1	178
911672	18-0209	924	913275	18-0887	921	981797	18-2663	939
911672	18-0211	924	913276	18-2815	921	981799	18-2666	939
911673	18-0209	924	913277	18-0347	920	981801	18-2669	Obsolete
911673	18-0211	924	913393	18-0401	919	981803	18-7615-1	178
911674	18-0209	924	913488	18-75100	904	981821	18-5903	885
911674	18-0211	924	913745	18-0528	915	981911	18-7861	898
911675	18-0209	924	913758	18-0352	920	982019	18-6950	889
911675	18-0211	924	913783	18-0943-2	910	982058	18-6755	889
911676	18-0209	924	913783	18-0943-2-9	919	982063	18-7267	894
911676	18-0211	924	913784	18-1909-1	909	982069	18-6764	889
911677	18-0209	924	914036	18-2764	930	982073	18-6764	889
911678	18-0211	924	914323	18-0518	922	982121	18-5911	884
911678	18-0227	924	914445	18-4024	922	982132	18-2595	367
911679	18-0229	924	914488	18-8369	924	982195	18-5908	885
911680	18-02060	924	914555	18-3937	914	982202	18-5907	884
911681	18-02061	924	914556	18-3939	914	982209	18-5376	875
911685	18-2067	367, 941	914557	18-3938	Obsolete	982211	18-5404-1	874
911686	18-7169	370	914716	18-2383	933, 934	982217	18-7608-1	178
911693	18-1701	932	914723	18-0652	935	982217	18-7609-1	178
911698	18-0911	920	914736	18-0655	Obsolete	982219	18-7608-1	178
911700	18-7407	943	914743	18-0654	935	982223	18-7615-1	178
911701	18-2068	367, 941	914787	18-15450	904	982230	18-7862	898
911702	18-2916	921	914816	18-4161	Obsolete	982240	18-7278	894
911703	18-3121	Obsolete	914817	18-1213	915	982277	18-6019	937
911704	18-2541	919	914820	18-1239	916	982336	18-5369	875
911705	18-0166	921	914849	18-3877	918	982342	18-5411	875
911718	18-7408	943	914899	18-1848	909	982364	18-5957	888
911734	18-4837	901	914930	18-3879	918	982384	18-7070	891
911750	18-4828	924	914971	18-3876	918	982422	18-1099	935
911751	18-3768	349	915025	18-2909	920	982424	18-2186	933, 934
911752	18-3610	935	915236	18-4160	Obsolete	982438	18-6019	937
911753	18-3769	924, 931	915272	18-2383	933, 934	982515	18-3584-1	648
911787	18-2138	938	915325	18-3887	918	982517	18-3584-1	648
911795	18-8349	367, 941	915326	18-0468	921	982537	18-7081	894
911797	18-2533	930	915702	18-2068	367, 941	982539	18-7096	892
911820	18-4250	922	915716	18-2104	926	982554	18-3558	902
911823	18-2996	922	915717	18-2174	926	982650	18-5899	902
911826	18-2763	930	915719	18-0440	920	982706	18-6755	889
911836	18-2918	922	915720	18-4833	Obsolete	982880	18-5403	874
911844	18-3145	Obsolete	915735	18-5433	876			

OMC (cont.)			OMC (cont.)			OMC (cont.)		
O.E. #	SIERRA #	PAGE #	O.E. #	SIERRA #	PAGE #	O.E. #	SIERRA #	PAGE #
982946	18-2665	Obsolete	985429	18-3599-2	898	3850379	18-1238	916
982947	18-2664	Obsolete	985518	18-2674	940	3850396	18-7684	889
982949	18-2667	Obsolete	985560	18-5313-1	880	3850426	18-1074	929
982957	18-6257	889	985602	18-7278	894	3850456	18-1909-1	909
982997	18-7289	171	985603	18-7278	894	3850495	18-2875-1-9	911
983195	18-6257	889	985612	18-2671	939	3850495	18-2875-1	911
983218	18-3386	902	985613	18-2672	939	3850496	18-0943-2	910
983247	18-6842	666	985630	18-0868	916	3850595	18-0893	921
983296	18-3577-2	898	985822	18-7615-1	178	3850597	18-2791	940
983298	18-3119	901	985902	18-5890	876	3850799	18-1922	909
983318	18-6764	889	985966	18-5911	884	3850809	18-7326	894
983424	18-6842	666	986007	18-5908	885	3850810	18-7331	895
983424	18-6841	888	986074	18-3577-2	898	3850812	18-2174	926
983444	18-5911	884	986103	18-0410	820	3850813	18-2128	930
983494	18-6101	938	986104	18-0410	820	3850814	18-2337	926
983538	18-7081	891	986120	18-21752-1	930	3850815	18-2146	926
983790	18-5911	884	986232	18-21754	930	3852109	18-0874	918
983825	18-1600	924	986280	18-6779	889	3852111	18-0398	919
983826	18-1601	Obsolete	986336	18-3937	914	3852113	18-0876	918
983836	18-6842	666	986338	18-21751	930	3852215	18-5894	898
983836	18-6841	888	986364	18-2673	940	3852338	18-1848	909
983855	18-7615-1	178	986380	18-4806	Obsolete	3852350	18-4194	936
983864	18-7095	891	986381	18-4804	925	3852374	18-1986-1	908
983870	18-7855	897	986382	18-4805	925	3852384	18-2339	926
983871	18-7201	893	986423	18-2674	940	3852455	18-0183-1	910
983877	18-1172	924, 931	986505	18-5910	885	3852477	18-0891	921
983878	18-1171	924, 931	986629	18-2783	940	3852531	18-7407	943
983880	18-2338	926	986642	18-5108	875	3852548	18-8349	941
983891	18-1161	931	986643	18-5361	875	3852560	18-2996	922
983892	18-1170	931	986651	18-5406	874	3852563	18-1713	924
983895	18-3058	899	986658	18-0647	174	3852565	18-7153	370
983902	18-21751	930	986779	18-3593	898	3852568	18-4749-9	924
983937	18-2100	925	986782	18-7236	891	3852648	18-3730	936
983967	18-4750	924	986783	18-7235	892	3852654	18-0468	921
983973	18-2765	930	986784	18-7237	892	3852655	18-0405	916
984054	18-1901	908	986796	18-7238	892	3852656	18-0322	921
984180	18-7609-1	178	986799	18-7237	892	3852657	18-0519	915
984264	18-6399	926	986800	18-7239	892	3852687	18-0664	920
984290	18-21752-1	930	986804	18-7241	892	3852691	18-0887	921
984356	18-6814	889	986865	18-7229	895	3852692	18-2815	921
984360	18-3593	898	987136	18-5303	693	3852693	18-0347	920
984398	18-5353	875	987251	18-2791	940	3852696	18-2779	910
984401	18-5352	875	987313	18-7242	892	3852741	18-2780-1	973
984456	18-5910	885	987315	18-7243	892	3852742	18-2781	910
984458	18-2672	939	987317	18-7244	892	3852824	18-0147	996
984459	18-2673	940	987319	18-7245	892	3853132	18-0518	922
984461	18-3212-1	902	987438	18-7246	892	3853226	18-4024	922
984461	18-3348	902	987440	18-7246	892	3853256	18-0680	920
984487	18-7086	891	987447	18-3577-2	898	3853268	18-3937	914
984491	18-7854	897	987467	18-2765	930	3853336	18-2946	918
984513	18-6102	938	987485	18-7246	892	3853340	18-4161	Obsolete
984513	18-6028	938	987603	18-2673	940	3853341	18-1213	915
984513	18-6028A	938	987661	18-2245-1	931	3853342	18-0327	920
984536	18-6270	884	987678	18-2246	931	3853361	18-0903	920
984536	18-6276	884	987738	18-5888	876	3853380	18-3876	918
984537	18-21754	930	987739	18-5889	876	3853477	18-4160	Obsolete
984547	18-6103	938	987740	18-5890	876	3853510	18-1232	916
984547	18-6103A	938	987774	18-6261	888	3853511	18-3874	918
984628	18-5917	885	987784	18-1922	909	3853512	18-0468	921
984629	18-21755	930	987811	18-5920	884	3853528	18-1234	990
984744	18-3206	901	987894	18-5303	693	3853655	18-2068	367, 941
984748	18-7634	938	987895	18-5347	874	3853732	18-3883	918
984765	18-4806	Obsolete	987925	18-5258	873	3853742	18-0183-1	910
984770	18-4804	925	987926	18-5260	873	3853796	18-3584-1	648
984771	18-4805	925	987986	18-5413	875	3853799	18-3558	902
984876	18-3578	Obsolete	988013	18-6270	884	3853818	18-6102	938
984982	18-5908	885	988013	18-6276	884	3853818	18-6028	938
985050	18-2218	356	988037	18-7330	895	3853818	18-6028A	938
985052	18-7017	891	988162	18-0410	820	3853827	18-1230	990
985063	18-5812	886	988217	18-5919	714	3853847	18-1401	914
985064	18-5801	886	988247	18-6841	888	3853850	18-3599-2	898
985083	18-3937	914	989966	18-2218	356	3853862	18-21753	930
985218	18-5397	875	1984462	18-5717	886	3853912	18-0410	916
985237	18-6759	282	3850216	18-5811-1	886	3853913	18-0410	916
985316	18-1401	914	3850357	18-7677	889	3853917	18-21752-1	930

OMC (cont.)			OMC (cont.)			PLEASURECRAFT (cont.)		
O.E. #	SIERRA #	PAGE #	O.E. #	SIERRA #	PAGE #	O.E. #	SIERRA #	PAGE #
3853945	18-6779	889	5001594	18-3390	304	R017066	18-3700	652
3853960	18-3937	914	5001594	18-3392	305	R020027	18-7677	647
3853962	18-21751	930	5001595	18-3315-2	306	R026002E	18-3551	648
3854001	18-5108	616, 696, 875, 951, 959, 960	5004257	18-1703	934	R047111	18-7480	648
3854002	18-5443	876	5004705	18-4148-1	317	R077001	18-7875	652
3854003	18-5107-1	616, 696, 875, 951, 959, 960	5005113	18-6802	Obsolete	R077002	18-7824-2	652
3854017	18-3593	898	5005114	18-6801	Obsolete	R084003	18-7697	647
3854033	18-1402	914	5005115	18-6803	Obsolete	R094020A	18-2702-1	652
3854072	18-30585	899	5005254	18-6281	282	R096116	18-4220	461
3854095	18-1231	916	5005266	18-7722	296	R096117	18-3200	652
3854118	18-3577-2	898	5005440	18-3543	311	R103001	18-5404-1	640
3854127	18-2765	930	5006319	18-6744	282	R103003	18-5407	640
3854182	18-6261	888	5006373	18-8384	366	R103004	18-5403	640
3854190	18-5920	884	5006511	18-3453	302	R103011	18-5245	640
3854194	18-6291	886	5007556	18-3476	307	R108001	18-5376	185, 643, 700, 706, 879
3854217	18-5248	875, 881, 950, 959, 960	5007662	18-6803	Obsolete	R114001	18-5314	640
3854252	18-3939	914	5007972	18-3472	306	R114002	18-5303	640
3854269	18-0868	916	5008968	18-8905	298	R114004	18-5314	640
3854280	18-7330	895	5008972	18-4537	306	R115001	18-5338	640
3854286	18-3060	889	5030087	18-3735	349	R115002	18-5345	640
3854299	18-3879	918	5030699	18-3499	293	R117001	18-5433	644
3854311	18-5408	874	5031411	18-7915-1	323	R117012	18-7648	645
3854331	18-5362	612, 693, 694, 703, 875, 950, 959	5031456	18-8337	493	R119001	18-5450	645
3854406	18-0410	916	5032238	18-7719	296	R130001	18-5801	646
3854512	18-7703	889	5032323	18-7716	296	R130012	18-15214	646
3854539	18-2454	938	5032424	18-7773	289	R142006	18-2434	652
3854548	18-5354	612, 653, 694, 875, 950	5033102	18-7903	205	RA057004	18-3584-1	648
3854549	18-5405	874	5033112	18-3099	299	RA057018	18-3599-2	648
3854620	18-7326	895	5033372	18-3497	293	RA057019	18-3577-2	648
3854661	18-3469	902	5033539	18-7896	323	RA057023	18-3586-1	648
3854751	18-5913-1	961	5033542	18-8907	299	RA057024	18-3587-1	648
3854809	18-6261	888	5033919	18-7897	491	RA057036	18-42608	648
3854905	18-7679	889	5035703	18-7895	205	RA097002	18-5957	646
3854942	18-0311	920	5035974	18-7953	296	RA097003	18-5957	646
3854956	18-0518	922	5036216	18-3498	293	RA097006	18-5957	646
3855104	18-7792	897	173232, 502902	18-7824-2	913	RA097007B	18-6288	635
3855182	18-7689	889	173232, 502902	18-7824-2	913	RA097007B	18-5984	646
3855270	18-1909-1	909	584605, 586275	18-6863	288	RA097007C	18-6453	646
3855412	18-6102	938	85R-4541	18-7096	892	RA097009	18-6452	646
3855412	18-6028	938	5031417	18-3096	299	RA107001	18-5309-1	642
3855412	18-6028A	938	OMC/BOMBARDIER			RA108002	18-5369	641
3855958	18-7330	895	336226	18-0694	333	RA108003	18-5352	641
3856127	18-1400	914	336227	18-0693	333	RA108009	18-5244	641
3856138	18-1237	916	336388	18-0696	333	RA122001	18-5903	646
3856444	18-1909-1	909	336389	18-0695	333	RA122001	18-5920	646
3856600	18-6261	888	339601	18-0692	333	RA122008	18-5907	645
3857561	18-6261	888	340919	18-0492	328	RA122009	18-5908	645
3857650	18-7330	895	346007	18-0491	328	RA122009	18-5603-1	638
3857656	18-1848	909	347205	18-0690	333	RA122019	18-6443	645
3857723	18-1986-1	908	437155	18-4406	Obsolete	RK122014	18-5920	646
3857944	18-1909-1	909	437725	18-4428	326	RM0002	18-0677-1	651
3857985	18-7331	895	437779	18-4402	326	RM0003	18-0878	651
3857986	18-7326	895	439202	18-4420	326	RM0007	18-0183-1	651
3858261	18-7326	895	5000400	18-4421	326	RM0017	18-0898	651
3858340	18-3593	898	ONAN			RM0032	18-3883	652
3858437	18-21752-1	930	122-0185	23-7841	139	RM0099	18-0676-1	651
3858714	18-7331	895	122-0810	23-7840	139	RN0067	18-7227	Obsolete
3860095	18-1233	915	130-4434	23-6401	140	RN0116	18-7081	647
3860171	18-6261	888	130-6228	23-6402	140	RN0116-2	18-7081	647
3911020	18-4173	914	132-0349	23-3300	132	RN0118	18-7096	647
3911023	18-4164	989	132-0436	23-3309	133	RN0118-1	18-7017	647
3921473	18-0466	916	149-0428	23-7750	131	RN0120	18-7096	647
3923440	18-0466	916	149-1445	23-7720	131	RN0120-1	18-7017	647
3930912	18-0346	824, 920	149-2106	23-7760	131	RO20001	18-5899	648
3931593	18-0348	822	185-5835	23-7842	139	RO28001	18-1996	650
3935449	18-0980	921	185-7444	23-7804	138	RO29001	18-1899	650
5000074	18-1702	934	309-0130	23-3606	134	RO85035	18-2103	652
5000309	18-8383	366	541-1519	23-3310	133	RO96081	18-4214	652
5000356	18-4801	925	A026K278	23-7760	131	RP026002E	18-3671	648
5000363	18-1703	934	PERKINS			RP061015	18-3060	648
5001036	18-3546	311	2654403	18-7886	203, 689	RP061017	18-3061	648
5001344	18-5768	277	185086600	18-6944	679	RP080026	18-8127-1	648
5001593	18-3059	302	2871A651	18-5975	678	POLARIS		
			PLEASURECRAFT			3240120	18-15080	572
			3705042	18-0889	651	PS-4	72-5104-2	216

POLARIS (cont.)			ROCHESTER (cont.)			SUZUKI (cont.)		
O.E. #	SIERRA #	PAGE #	O.E. #	SIERRA #	PAGE #	O.E. #	SIERRA #	PAGE #
PS-4	72-5104-3	216	17059052	18-7608-1	175	57630-92E00	18-3775	492
VES	72-5103-2	215	17059054	18-7609-1	175	17471-87E01	18-3192	Obsolete
VES	72-5103-3	215	17059057	18-7608-1	175	31100-9810	18-6962	482
VES	72-5103-4	215	17059280	18-7615-1	175	09141-14008	18-3710	Obsolete
VES	72-5103-5	215	17059280	18-7617-1	175	09141-18005	18-3726	492
VES	72-5103-7	215	17059283	18-7619-1	175	09168-10022	18-8331-9	491
POWER POLE			17059287	18-7616-1	175	09204-02004	18-3737	492
PUMP PRO-F	18-6819	76	17059288	18-7615-1	175	09204-03003	18-3735	492
PUMP SPN-F	18-6818	76	17059289	18-7618-1	175	09204-03004	18-3735	492
PRESTOLITE			17059290	18-7616-1	175	09263-14022	18-1414	490
15-79	18-5840	585, 596, 617, 716	17059291	18-7605-1	175	09263-18016	18-1415	Obsolete
110-258	18-6955	678	17059292	18-7605-1	175	09263-20051	18-1412	Obsolete
873051	18-6881	965	17059298	18-7619-1	175	09263-20072	18-1417	490
110-258A	18-6955	678	17068453	18-7855	897	09263-27005	18-1416	Obsolete
ETK 4001	18-6754	889	17078904	18-7854	897	09280-08008	18-7118	494
ETK 4101	18-6754	889	17080560	18-7616-1	175	09280-75002	18-7140	494
ETK 4102	18-6754	889	17080561	18-7615-1	175	09282-24004	18-0544	494
EVD 4001	18-6755	889	17080561	18-7618-1	175	09283-10011	18-0551	Obsolete
EVD 4002	18-6755	889	17080562	18-7618-1	175	09284-08003	18-0569	Obsolete
HYK4001	18-6274	966	17080564	18-7605-1	175	09289-10002	18-0545	Obsolete
SAW4201	18-5840	585, 596, 617	17080565	18-7605-1	175	09289-22007	18-8345	494
SAW4206	18-5807	283, 886	17081060	18-7610-1	175	09381-18002	18-42950-9	489
SAW4207	18-5840	585, 596, 617, 716	17081299	18-7619-1	175	09381-20003	18-42960-9	Obsolete
SAW4210	18-5840	585, 596, 617, 716	17082403	18-7607-1	175	09420-03005	18-3292	486
VSH-6201 AFY	18-5711	888	17083522	18-7619-1	175	09420-04009	18-3404	Obsolete
VSH-6201JY	18-5710	585, 596, 618	17085013	18-7615-1	175	09420-05005	18-3296	486
RACOR			SEA-DOO			09420-05006	18-3291	Obsolete
2010PM-OR	18-99183	159	278-000-123	18-6878	572	09420-05009	18-3291	Obsolete
2010SM-OR	18-99186	159	278-000-186	18-6868	571	11141-93901	18-3808	490
2010TM-OR	18-99182	159	278-000-311	18-6868	571	11141-93960	18-3808	490
2020N-02	18-99187	159	278-000-316	18-6868	571	11141-94401	18-3810	490
2020N-10	18-99181	159	278-000-484	18-6867	571	11141-94450	18-3810	490
2020N-30	18-99180	159	278-000-485	18-6867	571	11141-94506	18-3823	490
2040N-02	18-99191	159	278-000-576	18-6866	571	11141-94600	18-3824	491
2040N-10	18-99185	159	278-000-577	18-6866	571	11141-94620	18-3824	491
2040N-30	18-99184	159	278-001-038	18-6866	571	11141-94620	18-3823	490
6H3-W0001-02	18-99176	541	278-001-239	18-6879	572	11141-94701	18-3820	490
B32013	18-7928-1	158	278-001-292	18-6871	Obsolete	11141-94702	18-3820	490
B32020MAM	18-7929	158	278-001-300	18-6867	571	11141-94720	18-3820	490
R12P	18-99199	159, 160	278-001-301	18-6866	571	11141-95305	18-3813	Obsolete
R12S	18-99194	159, 160	278-001-376	18-6859	571	11141-95320	18-3813	Obsolete
R12T	18-99193	159, 160	278-001-497	18-6869	571	11141-95505	18-3814	490
R20P	18-99200	159	278-001-554	18-6876	572	11141-95512	18-3814	490
R20S	18-99196	159	278-001-581	18-6874	Obsolete	11141-96303	18-3809	490
RK10215	18-99201	160	278-001-802	18-6859	571	11141-96344	18-3809	490
RK10222	18-7987	158	278-001-935	18-6867	571	11141-98101	18-3807	490
RK22244	18-0179	158	278-001-936	18-6869	571	11141-98130	18-3807	490
RK22368	18-99203	160	278-002-199	18-1294	Obsolete	11141-98401	18-3806	490
RK22628	18-9884	158, 160, 162, 223	290-888-993	18-6905	571	11141-98411	18-3806	490
S3213	18-7919	158, 296, 410, 512, 747, 748, 897, 971	290-888-999	18-6905	571	11141-98504	18-3816	490
			420-888-994	18-6905	571	11141-98510	18-3816	490
S3214	18-7920	158, 296, 410, 512, 747, 897, 971	420-888-996	18-6905	571	11141-98522	18-3816	490
			420-888-9933	18-6905	571	12110-93120	18-40140	489
S3227	18-7948	160	SHERWOOD			12110-94400	18-40110	489
S3232	18-7949	160	09000K	23-2002	132	12140-93121	18-39480	Obsolete
S3240	18-7947	160	10077K	23-2000	132	12140-94400	18-39540	489
ROCHESTER			SHERWOOD PUMP			12151-92502	18-42870	Obsolete
1708563	18-7616-1	175	9959	18-3060	578	12151-93100	18-42860	Obsolete
7036543	18-7609-1	175	10615	18-3061	578	12151-94400	18-42850	Obsolete
7040080	18-7608-1	175	10931	18-3140	620	12161-93902	18-1757K	490
7040082	18-7609-1	175	18200	18-3077	577	12161-93902	18-1757	Obsolete
7040083	18-7608-1	175	10615K	18-3047	575	12161-94400	18-1759K	490
7040089	18-7608-1	175	9959K	18-3046	575	12161-94400	18-1759	Obsolete
7041369	18-7609-1	175	9979K	18-3079	975	12161-96300	18-1758	Obsolete
7042183	18-7608-1	175	SKI-DOO			13910-94400	18-7753	483
7043182	18-7609-1	175	XPS 779126	72-5103-2	215	13910-94701	18-7754	483
7043183	18-7608-1	175	XPS 779127	72-5103-3	215	15170-93911	18-3495	483
7043184	18-7608-1	175	SUZUKI			15170-94320	18-3496	483
7044182	18-7609-1	175	15170-99E00	18-3499	483	15410-94400	18-7735	484
7044185	18-7603-1	175	17685-99E00	18-0796	489	15410-98500	18-7719	484
7044291	18-7618-1	175	25700-99E00	18-8381	494	16510-05240	18-7903	491
17057283	18-7605-1	175	31100-92E00	18-6417	482	16510-82703	18-7897	491
17057285	18-7605-1	175	31173-99E00	18-56009	482	17400-87E03	18-3254	487
17057287	18-7616-1	175	37110-99-E00	MP51010	25, 481	17400-93951	18-3256	487
17057298	18-7615-1	175	37110-99-E00	MP51012	25, 481	17400-94611	18-3257	487

SUZUKI (cont.)			SUZUKI (cont.)			SUZUKI (cont.)		
O.E. #	SIERRA #	PAGE #	O.E. #	SIERRA #	PAGE #	O.E. #	SIERRA #	PAGE #
17400-94700	18-3243	487	65750-98505	18-8062	485	31100-95J01	18-6945	482
17400-94701	18-3243	487	99105-00192	18-8071	485	31100-96J00	18-6941	482
17400-95350	18-3244	487	99105-00193	18-8078	485	31100-96J01	18-6941	482
17400-95351	18-3244	487	99105-20005	18-7948	484	33410-92L10	18-5151	481
17400-95550	18-3244	487	99105-20006	18-7947	160	34830-87J20	18-1799	489
17400-96350	18-3242	487	17400-87E04	18-3254	487	37100-87J00-OEP	18-18304	Obsolete
17400-96351	18-3242	487	12410-96351-050	18-39530	Obsolete	38100-87000-OIT	18-6785	Obsolete
17400-96353	18-3242	487	11141-87E10	18-3822	490	38100-87D10-OED	18-6786-1	483
17400-98551	18-3259	487	17461-87E11	18-3049	486	38100-87D10-OIT	18-6786-1	483
17400-98652	18-3260	487	17461-87E12	18-3049	486	38100-87D10-35J	18-6786-1	483
17400-98661	18-3266	487	11141-87E90	18-3822	490	38100-87E10-OED	18-6785	Obsolete
17411-93901	18-3480	488	11141-87D60	18-3825	491	38100-87E20-OED	18-6785	Obsolete
17411-94421	18-3481	488	11141-87D90	18-3825	491	38100-87J0EP	18-18304	Obsolete
17461-93001	18-3092	486	11141-95D10	18-3819	490	38100-87J11	18-6793	483
17461-93003	18-3092	486	11141-95D90	18-3819	490	38100-87J20	18-6793	483
17461-93004	18-3092	486	12161-91L00	18-1758	Obsolete	38100-92E00-OED	18-6786-1	483
17461-93901	18-3099	486	12161-92L00	18-1759	Obsolete	38100-92J02	18-18303	483
17461-93902	18-3099	486	13119-91J00	18-0792	488	38100-92J10	18-18303	483
17461-93903	18-3099	486	13910-87D00	18-7752	483	38100-93J01	18-18303	483
17461-94500	18-3023	486	13910-89J01	18-7773	483	38100-93J02	18-18303	483
17461-94501	18-3023	486	13910-95D00	18-7755	483	38100-96J00	18-18303	483
17461-94502	18-3023	486	15170-91J00	18-3497	483	38860-76F01	18-5731	483
17461-94503	18-3023	486	15170-94J00	18-3498	483	55125-87D00	18-6033	492
17461-94504	18-3023	486	15170-94J0V	18-3498	483	56132-95J00	18-0650	491
17461-94505	18-3023	486	15410-87J10	18-7716	484	65720-986B0	18-80425	485
17461-94506	18-3023	486	15410-87J30	18-7953	484	65750-87J10	18-80419	485
17461-94510	18-3023	486	15410-88L00	18-79949	484	65750-87J11	18-80419	485
17461-94511	18-3023	486	15410-96J00	18-7711	484	990C0-10W40-1GL	18-9551-3	209
17461-94520	18-3023	486	15412-93J00	18-7936	484	990C0-10W40-1QT	18-9551-2	209
17461-94700	18-3094	486	16510-45H10	18-8870	491	99105-20004-BWL	18-7922-1	484
17461-94701	18-3094	486	16510-61A20-MHL	18-7896	491	99105-20006-BWL	18-7987	484
17461-95300	18-3095	486	16510-87J00	18-7915-1	491	TOHATSU		
17461-95301	18-3095	486	16510-93J00	18-7895	205	369060210M	18-5143	476
17461-95302	18-3095	486	16510-96J00	18-7905-1	491	3A0060401M	18-5133	476
17461-96301	18-3096	486	17400-87D11	18-3253	487	3A0060481M	18-5133	476
17461-96311	18-3096	486	17400-90J11	18-3258	487	3G2060602M	18-5134	476
17461-96312	18-3096	486	17400-90J20	18-3258	487	UNIVERSAL		
17461-98501	18-3097	486	17400-92D01	18-3255	487	88-831	18-8613	232
17461-98502	18-3097	486	17400-92J00	18-4553	487	288182	18-6263	654
17461-98503	18-3097	486	17400-92J23	18-4554	487	288759	18-6263	654
17462-93990	18-3292	486	17400-93J00	18-3264	487	299381	18-7884	689
17471-93902	18-3190	486	17400-93J02	18-3264	487	301068	18-6140	579
17471-94501	18-3191	486	17400-94J00	18-4556	487	301069	18-6141	579
17471-98503	18-3188	486	17400-94L21	18-4557	488	VALEO		
17472-93911	18-0478	488	17400-98J00	18-3267	487	541663	18-5943	S/S to 18-5959
17472-95200	18-0459	488	17400-98J01	18-3267	487	2541451	18-5939	962
17472-95310	18-0460	488	17461-90J00	18-3023	486	2937430	18-5976	962
17472-96301	18-0461	488	17461-90J01	18-3023	486	2939590	18-5975	678
17472-98503	18-0477-9	488	17461-92D02	18-3000	486	A0002655299	18-6848	963
25223-94400	18-8334	491	17461-93J00	18-3035	486	A13N147M	18-5959	962
25700-94400	18-8337	494	17461-985M0	18-3097	486	A13N148M	18-5959	962
25700-94500	18-8338	494	17471-87D01	18-3189	486	A13N1M	18-5959	962
25700-94700	18-8339	494	17471-92D10	18-3193	486	A13N234	18-5939	963
25700-95500	18-8340	494	17471-92J00	18-3192	Obsolete	A13N259	18-5943	962
31100-94600	18-6827	482	17472-91J00	18-0761	488	A13N2M	18-5959	962
31100-94601	18-6827	482	17472-92D10	18-0479	Obsolete	VEETHREE INSTRUMENTS		
31100-94610	18-6827	482	17472-93J00	18-0778	488	71691P	20000P	19
31100-94610	18-6416	482	17472-98J00	18-0651	491	71692P	20010P	19
31100-94702	18-6429	482	17582-93J00	18-0793	488	71693P	21000P	19
31100-95313	18-6428	Obsolete	17670-90J11	18-3687	488	71694P	21010P	19
31100-95600	18-6414	482	17685-87D10	18-0797	489	71695P	22000P	20
32140-93900	18-5152	481	17685-97J00	18-0794	488	71696P	22010P	20
32900-93911	18-5144	481	17685-98J00	18-0795	489	71697P	22020P	20
33410-94400	18-5151	481	18213-98J00	18-32154	484	VOLVO		
55125-96310	18-6098	492	25700-87D00	18-8335	494	35254	18-5436	951
55320-95310	18-6032	492	25700-90J01	18-8373	493	82745	18-4218	982
57630-94300	18-3777	492	25700-92J00	18-8374	493	125017	18-7178	1003
57630-94500	18-3774	492	25700-93J00	18-8380	494	17253-6	18-3745	1000
57630-96300	18-3778	492	25700-95D00	18-8341	494	174448	18-9098	998
65720-94401	18-80409	485	25700-95J00	18-8385	494	181620	18-2057	1003
65720-94411	18-8087	485	25700-98J00	18-8386	494	192212	18-4201	987
65740-95500	18-8078	485	31100-89J00	18-6419	482	233991	18-6872	679, 962
65750-94404	18-80418	485	31100-90J00	18-6831	482	240149	18-5306	949
65750-95500	18-8079	485	31100-93J00	18-6941	482	240501	18-6872	679, 962
65750-95510	18-8079	485	31100-95J00	18-6945	482	241669	18-5393	950

VOLVO (cont.)			VOLVO (cont.)			VOLVO (cont.)		
O.E. #	SIERRA #	PAGE #	O.E. #	SIERRA #	PAGE #	O.E. #	SIERRA #	PAGE #
241812	18-6271	965	832570	18-4206	999	842775	18-6872	679, 962
243460	18-5305	949	832598	18-6000	1001	843511	18-6872	679, 962
243632	18-5357	950	832598	18-6000A	1001	845363	18-28050	954, 956, 958
243658	18-5394	950	832598	18-6104	1001	845792	18-75125	976
243797	18-5356	950	832669	18-2990	997	847651	18-59710	962
243799	18-5305	949	832675	18-2199	997	847741	18-0032	Obsolete
243801	18-5319	Obsolete	832820	18-4205	999	849561	18-59710	962
243903	18-5428	950	832831	18-2776	983	849602	18-59710	962
324825	18-8204	973	832846	18-2778	983	850046	18-6791	966
328516	18-3938	Obsolete	832965	18-4234	999	850785	18-4210	999
329653	18-8203	973	833188	18-4463	986	850834	18-6758	966
370409	18-3944	989	833274	18-3842	Obsolete	850888	18-4211	999
416033	18-2933	994	833453	18-3834	Obsolete	850889	18-4212	1000
418265	18-2974	994	833950	18-4005	987	851120	18-6951	965
418411	18-2935	996	833995	18-3076	974	851261	18-4213	1000
418412	18-2937	996	833996	18-2044	1003	851407	18-0558	1003
418445	18-2936	996	834337	18-7884	689	852520	18-6791	966
419310	18-2965	992	834476	18-2531	996	852835	18-6004	1001
419652	18-4474	Obsolete	834520	18-5806	964	852835	18-6004A	1001
419653	18-4473	Obsolete	834548	18-4044	986	852835	18-6105	1001
419678	18-2923	995	834560	18-5348	949	852928	18-6838	965
419734	18-4468	986	834609	18-5959	962	852928	18-6274	966
419735	18-4470	Obsolete	834751	18-2766	998	852928	18-6881	965
423135	18-7926	Obsolete	834893	18-5911	961	853012	18-710-64-2	998
430017	18-2518	995	834963	18-5959	962	853255	18-2104	999
430018	18-2525	996	834975	18-5425	950	853670	18-2040	1003
430039	18-2924	995	835304	18-5314	949	853868	18-25251	996
430143	18-7878-1	988	835308	18-5338	949	854031	18-2777	983
430172	18-2526	Obsolete	835390	18-3599-2	973	854045	18-4210	999
461092	18-2925	994	835417	18-0398	994	854047	18-4213	1000
461511	18-1479	986	835440	18-7824-2	988	854329	18-6792	966
462623	18-2966	992	835512	18-3060	974	854346	18-6770	965
463377	18-4029	986	835576	18-7859	971	855326	18-5911	961
463505	18-7890	987	835702	18-5369	950	855383	18-2991-1	994
463587	18-2926	995	835704	18-5345	949	855383	18-2991-1-9	982
463902	18-4245	987	835705	18-5303	949	855387	18-1930-2	979
463999	18-2927	995	835804	18-1931-1	979	855798	18-5657	956
466634	18-7880	689	835874	18-3061	974	855845	18-5403	593
466987	18-7942	687	835874	18-3047	974	855889	18-7072	586
477024	18-4200	987	835966	18-2949	994	855967	18-2991-1	982
477556	18-0034	988	835998	18-5433	951	855967	18-2991-1-9	982
502036	18-1402	989	837924	18-6872	679, 962	856028	18-2929	997
803762	18-1727	987	838513	18-70704	976	856034	18-2949	994
804190	18-0184	999	838637	18-4466	Obsolete	856037	18-2995	994
804261	18-4259	996	838638	18-4471	Obsolete	856044	18-2928	994
804695	18-2039	1003	838928	18-6021	1002	856116	18-2909	980
806256	18-3106	973	838929	18-6001	1001	856306	18-70704	976
807036	18-4216	982	839423	18-4208	999	856364	18-3599-2	973
808007	18-3274	Obsolete	839430	18-6790	966	856470	18-7099	968
812994	18-4150	Obsolete	839534	18-4209	999	856471	18-7000	966
813967	18-8368	999	840808	18-5906	961	856472	18-7000	966
814301	18-2153	1000	841070	18-5352	950	856474	18-3876	993
814356	18-2939	997	841161	18-7286	968	856609	18-3577-2	973
818525	18-5419	950	841162	18-7862	971	856883	18-1931-1	979
820652	18-59710	962	841177	18-6268	965	856891	18-1935-1	980
822454	18-59710	962	841207	18-3876	993	856894	18-1932	979
824633	18-2928	994	841243	18-5411	950	857037	18-1936	981
824677	18-2989	994	841244	18-5375	950	858201	18-7858	971
824803	18-7099	967	841262	18-5349	593	858459	18-35444	Obsolete
826341	18-4204	999	841263	18-5358	950	858467	18-3175	973
826423	18-75125	976	841292	18-7000	966	858488	18-7907	987
826493	18-7281	968	841380	18-59700	962	859428	18-35442	968
826495	18-5959	962	841640	18-3586-1	973	859647	18-3867	993
826648	18-7888	973	841750	18-7879-1	988	861250	18-0307	995
827247	18-2045	1003	841762	18-5959	962	861251	18-0310	Obsolete
827303	18-59710	962	841762	18-59700	962	862293	18-7888	973
829207	18-15460	976	841763	18-59700	962	870670	18-6271	965
829620	18-4464	986	841765	18-5959	962	870690	18-5357	950
829714	18-2934	996	841765	18-59700	962	870998	18-6958	679, 962
829913	18-8124	687	841766	18-5959	962	872066	18-7647	972
831009	18-3106	973	841766	18-59700	962	872235	18-5939	963
831617	18-2527	Obsolete	841821	18-15430	976	872241	18-5906	961
831622	18-2519	996	841907	18-5403	593	872272	18-6268	965
831891	18-2528	996	841926	18-5353	950	872300	18-6266	965
831892	18-2529	996	841994	18-7086	968	872449	18-6838	965

VOLVO (cont.)			VOLVO (cont.)			VOLVO (cont.)		
O.E. #	SIERRA #	PAGE #	O.E. #	SIERRA #	PAGE #	O.E. #	SIERRA #	PAGE #
872449	18-6881	965	876306	18-2814	Obsolete	1141679	18-9680-2	218
872793	18-6124Z	1001	876314	18-0252	991	1141681	18-9680-5	218
872926	18-5943	962	876342	18-2983	992	1141682	18-9680-7	218
873051	18-6838	965	876356	18-2980	Obsolete	1218630	18-4472	986
873178	18-6004	1001	876358	18-2982	992	1218674	18-1478	986
873178	18-6004A	1001	876359	18-2817	993	1243632	18-5357	950
873178	18-6105	1001	876376	18-4342	Obsolete	1266286	18-7878-1	988
873179	18-6000	1001	876380	18-4341	991	1266796	18-2930	994
873179	18-6000A	1001	876384	18-0489	Obsolete	1306169	18-5305	949
873179	18-6104	1001	876433	18-2818	993	1306630	18-4031	Obsolete
873228	18-2432	997	876631	18-2758	998	1317466	18-2933	994
873229	18-2433	997	876633	18-2757	998	1336255	18-2530	996
873395	18-6123Z	1001	877066	18-3275	974	1357199	18-6839	962
873770	18-5939	963	877349	18-3658	984	1378645	18-2968	992
875192	18-2625	Obsolete	881681	18-6872	679, 962	1378646	18-2970	992
875383	18-3209	Obsolete	881682	18-6958	679, 962	1378864	18-2926	995
875400	18-2983	992	897367	18-4214	652	1378870	18-2972	995
875401	18-2980	Obsolete	897426	18-2041	1003	1378879	18-2930	994
875407	18-7085	966	897707	18-2104	999	1378909	18-2927	995
875422	18-2596	991	897720	18-6792	966	1378913	18-2925	994
875550	18-2793	Obsolete	897873	18-4239	1000	1542389	18-4469	986
875569	18-2982	992	908611	18-2946	992	1542472	18-4467	986
875571	18-8813-1	954, 955, 956, 958	912213	18-2128	999	2430184	18-3037	974
875574	18-3205	975	912227	18-3879	993	2430184	18-3078	974
875575	18-3075	974	912957	18-0519	990	2655301	18-6847	963
875580	18-3666	Obsolete	912979	18-1238	992	2656299	18-6848	963
875583	18-3076	974	914323	18-0518	990	3287677	18-5745	951
875584	18-3208	975	914445	18-4024	990	3517857	18-7878-1	988
875660	18-3037	974	914556	18-3939	989	3523301	18-6839	962
875660	18-3078	974	914557	18-3938	Obsolete	3547991	18-2530	996
875698	18-3263	974	914816	18-4161	Obsolete	3580309	18-0498	992
875736	18-3037	974	914930	18-3879	993	3582310	18-35443	687
875736	18-3078	974	915236	18-4160	Obsolete	3582358	18-7908	987
875741	18-8357	1003	925054	18-7179	1003	3582561	18-4473	Obsolete
875759	18-3262	974	925055	18-7180	1003	3582606	18-4474	Obsolete
875769	18-3261	974	925065	18-7190	1003	3582609	18-4465	986
875779	18-3654	Obsolete	925091	18-7181	1003	3582732	18-0035	987
875781	18-3656	Obsolete	925092	18-7182	493	3582733	18-0036	987
875784	18-3658	984	925093	18-7183	493	3583443	18-8125	687
875785	18-3659	984	925095	18-7122	1003	3583555	18-6944	679
875787	18-3660	984	925256	18-7184	1003	3583786	18-3868	993
875791	18-3663	Obsolete	925259	18-7186	1003	3586461	18-6125A	1001
875794	18-3662	984, 985	925261	18-7187	1003	3586498	18-3079	975
875795	18-3664	984	941816	18-4215	1000	3586765	18-6838	965
875796	18-3665	984	941907	18-4236	983	3587079	18-6806	965
875805	18-6005	1001	943218	18-4238	936	3587597	18-3615	984
875808	18-3080	975	943414	18-2367	987	3587625	18-5913-1	961
875815	18-6009	1001	946242	18-2046	1003	3588475	18-3504	974
875815	18-6009A	1001	949656	18-7154	1003	3803227	18-5943	S/S to 18-5959
875821	18-6010	1001	950813	18-15410	976	3803227	18-5970	962
875821	18-6106	1001	950818	18-15460	976	3803260	18-5939	963
875821	18-6010A	1001	951924	18-4241	1000	3803645	18-6953	678
875822	18-2775	983	952141	18-15500	976	3825133	18-7942	687
875826	18-2744	998	955974	18-7193	1003	3827069	18-7974	205, 987, 988
875827	18-2755	998	955983	18-7188	1003	3831424	18-3538	984
875828	18-2757	998	955989	18-7149	1003	3831425	18-3660	984
875847	18-2774	983	955995	18-7192	1003	3831426	18-3539	984
875848	18-2758	998	956000	18-7194	1003	3840335	18-7709	971
876037	18-5704	965	958303	18-15325	976	3841697	18-3038	974
876038	18-6271	965	958310	18-15390	976	3841697	18-3077	974
876039	18-5705	965	958311	18-15405	976	3842343	18-9410-2	139, 211, 214
876040	18-6266	965	958314	18-15435	976	3842344	18-9410-4	211, 214
876069	18-57702	204, 987	958320	18-15495	976	3843751	18-7705	972
876097	18-3656	Obsolete	958357	18-15415	976	3847501	18-1986-1	982
876120	18-3287	974	958498	18-4046	986	3847547	18-9096	998
876185	18-7890	987	958838	18-2043	Obsolete	3847644	18-8149	970
876267	18-8358	1003	958860	18-2047	1003	3850216	18-5811	Obsolete
876268	18-8359	1003	966382	18-15435	976	3850357	18-7677	889
876278	18-4204	999	966857	18-4046	986	3850379	18-1238	992
876279	18-2366	999	975672	18-7181	1003	3850379	18-4408	Obsolete
876294	18-2744	998	984513	18-6028	938	3850396	18-7684	972
876300	18-2998	992	985316	18-1401	989	3850426	18-1074	998
876302	18-2813	991	985727	18-21753	930	3850495	18-2875-1-9	981
876303	18-3870	991	986280	18-6779	966	3850495	18-2875-1	981
876305	18-3662	984	988037	18-7330	968	3850496	18-0943-2	910

VOLVO (cont.)			VOLVO (cont.)			VOLVO (cont.)		
O.E. #	SIERRA #	PAGE #	O.E. #	SIERRA #	PAGE #	O.E. #	SIERRA #	PAGE #
3850496	18-0943-2-9	997	3853510	18-1232	995	3855991	18-3577-2	973
3850559	18-7876-1	913	3853511	18-3887	993	3856003	18-5919	714
3850594	18-2586	1002	3853512	18-0468	996	3856004	18-5913-1	695
3850595	18-0893	996	3853528	18-1234	990	3856127	18-1400	989
3850597	18-2791	1003	3853732	18-3883	993	3856138	18-1237	995
3850809	18-7326	968	3853742	18-0183-1	663, 796	3856393	18-7641	966
3850810	18-7331	968	3853787	18-5897	972	3856884	18-33800	Obsolete
3850812	18-2174	999	3853796	18-3584-1	648	3856961	18-3677	984
3850813	18-2128	999	3853799	18-3558	983	3857265	18-6274	966
3850814	18-2337	999	3853801	18-5403	593	3857487	18-7700	972
3850815	18-2146	999	3853807	18-2100	999	3857489	18-6806	965
3850861	18-7778	971	3853815	18-5352	950	3857532	18-5899	972
3850984	18-3708-1	1000	3853827	18-1230	990	3857561	18-6261	963
3852005	18-3722	1000	3853847	18-1401	989	3857650	18-7330	968
3852023	18-1501	1000	3853850	18-3599-2	973	3857656	18-1848	979
3852033	18-7168	1003	3853912	18-0410	992	3857723	18-1986-1	979
3852044	18-7162	1003	3853913	18-0410	992	3857747	18-6275	S/S to 18-6275-1
3852045	18-7116	943	3853945	18-6779	966	3857813	18-6265	963
3852073	18-7102	1003	3853960	18-3937	989	3857985	18-7331	968
3852089	18-7135	1003	3853982	18-5913-1	961	3857986	18-7326	968
3852095	18-0889	994	3853983	18-3676	984	3858061	18-9410-7	211, 214
3852096	18-0164	918	3854001	18-5108	616	3858071	18-6817	965
3852109	18-0874	997	3854002	18-5443	951	3858081	18-5700	965
3852113	18-0876	994	3854003	18-5107-1	951	3858256	18-3081	975
3852120	18-0929	994	3854017	18-3593	973	3858261	18-7326	968
3852127	18-2858	994	3854018	18-36905	967	3858340	18-3593	973
3852165	18-7141	1003	3854020	18-7238	967	3858462	18-15450	976
3852169	18-7143	1003	3854026	18-7229	968	3858714	18-7331	968
3852170	18-8020	973	3854033	18-1402	989	3858809	18-5700	965
3852171	18-8200	973	3854095	18-1231	994	3858941	18-7685	972
3852172	18-8202	973	3854105	18-7242	967	3858979	18-7706	951
3852255	18-3744	1000	3854106	18-7244	967	3859054	18-5811	Obsolete
3852315	18-32882	1003	3854107	18-7245	967	3859078	18-7493	950
3852350	18-4194	1000	3854116	18-7246	967	3860082	18-5979	962
3852384	18-2339	999	3854127	18-2765	998	3860566	18-6275	S/S to 18-6275-1
3852413	18-7989	970	3854130	18-6125Z	1001	3860764	18-5913-1	695
3852413	18-7789	970	3854161	18-7492	951	3860769	18-5957	962
3852455	18-0183-1	663, 796	3854164	18-69550	964	3860879	18-6806	965
3852464	18-15455	976	3854190	18-5920	961	3861267	18-7648	951
3852468	18-2902-1	982	3854202	18-3869	Obsolete	3861575	18-6804	965
3852468	18-2902-1-9	982	3854215	18-29322	950	3862014	18-5405	950
3852472	18-0418	982	3854217	18-29322	950	3862228	18-7989	970
3852476	18-0549	922	3854217	18-5248	950	3862281	18-3277	974
3852477	18-0891	995	3854218	18-5413	950	3862281	18-3081	975
3852523	18-7406	943	3854252	18-3939	989	3862500	18-7513	20, 972
3852529	18-8021	973	3854261	18-5406	950	3862567	18-3276-1	974
3852531	18-7407	943	3854269	18-0868	916	3862612	18-6848	963
3852544	18-2138	1000	3854280	18-7330	968	3862613	18-6845	962
3852560	18-2996	997	3854286	18-3046	974	3862613	18-6847	963
3852604	18-710-48-2	998	3854286	18-3060	974	3862665	18-6845	962
3852654	18-0468	996	3854299	18-3879	993	3863061	18-1909-1	906, 907, 909, 910, 911, 912, 980, 981, 982
3852655	18-0405	995	3854311	18-5408	950	3863061	18-1909-1	906, 907, 909, 910, 911, 912, 980, 981, 982
3852656	18-0322	997	3854331	18-5362	950	3863085	18-25250	996
3852657	18-0519	990	3854406	18-0410	992	3863130	18-7642	960
3852687	18-0664	995	3854512	18-7703	972	3863193	18-6028A	1001
3852691	18-0887	996	3854527	18-7702	972	3863450	18-2780-1	973
3852692	18-2815	994	3854539	18-2454	938	3863450	18-2780-1	973
3852693	18-0347	920	3854548	18-5354	950	3884950	18-5882	962
3852696	18-2779	973	3854549	18-5405	950	3884950	18-6845	962
3852741	18-2780-1	973	3854620	18-7326	968	3885317	18-5913-1	695
3852742	18-2781	973	3854751	18-5913-1	695	3888813	18-6127A	1001
3852805	18-0528	990	3854905	18-7679	972	3888814	18-6127Z	Obsolete
3852818	18-0352	995	3854942	18-0311	995	3888815	18-6127M	1001
3852824	18-0147	996	3854956	18-0518	990	3888816	18-6126A	1001
3853132	18-0518	990	3855017	18-7241	967	3888817	18-6126Z	1001
3853226	18-4024	990	3855104	18-7792	971	3888818	18-6126M	1001
3853268	18-3937	989	3855182	18-7689	972	3888821	18-2583	1003
3853336	18-2946	992	3855194	18-7704	972	3888822	18-2584	1003
3853340	18-4161	Obsolete	3855275	18-2598	1002	3888916	18-1076	1002
3853341	18-1213	990	3855276	18-7268	968	3888917	18-2726	Obsolete
3853342	18-0327	995	3855296	18-7757	951	3911020	18-4173	989
3853343	18-1239	995	3855411	18-6028	938	3911023	18-4164	806, 807, 808, 914, 989
3853361	18-0903	995	3855412	18-6102	938	419763-8	18-2965	992
3853412	18-2909	980	3855610	18-6125M	1001			
3853477	18-4160	Obsolete	3855958	18-7330	968			

VOLVO (cont.)			VOLVO PENTA (cont.)			WESTERBEKE (cont.)		
O.E. #	SIERRA #	PAGE #	O.E. #	SIERRA #	PAGE #	O.E. #	SIERRA #	PAGE #
463903-5	18-4246	987	872757	18-6846	678	24690 & 33373	23-3660	137
4785974	18-7926	Obsolete	873635	18-6846	678	24690 & 33417	23-3657	136
5003564	18-6839	962	873757	18-6846	678	35736 & 33417	23-3652	136
576266-8	18-8361	1003	1502272	18-6846	678	35736 & 34196	23-3651	136
6209190	18-6956	962	3840525	18-7962	988	35736 & 40434	23-3661	137
6643474	18-6271	965	3852215	18-5894	972	37387 & 37922	23-3659	137
818701-5	18-5310	949	5001677	18-6846	678	39378 & 42260	23-3654	136
834438-4	18-1930-2	979	854525-3	18-6817	965	39378 & 46124	23-3655	136
834625-6	18-59700	962	873757-9	18-6846	678, 963	46097 & 33417	23-3656	136
834985-4	18-7095	967	22797780	18-7514	987	YAMAHA		
835908-5	18-2971-1	982	22844837	18-3513	973	19-1400-10	18-6843	1004
841047-4	18-7641	966	30788490	18-8702	988	626-14390-90	18-7079	506
841066-4	18-5903	961	3803270-2	18-6846	963	647-44366-00	18-1833	520
841293-4	18-7001	966	873771,	18-6846	678	647-45616-02	18-3709	555
841313-0	18-7641	966	WESTERBEKE			650-24431-00	18-0849	544
841378-3	18-59700	962	11672	23-4001	140	663-44311-02	18-3408	522
841634-9	18-7200	967	11885	23-6400	140	663-44366-00	18-1828	519
841836-0	18-7000	966	11907	23-3301	132	663-44366-00	18-1830	519
847306-8	18-6872	679, 962	13810	23-4005	133	676-45127-00	18-99084	547
847308-4	18-6958	679, 962	21235	18-7925	Obsolete	676-45128-00	18-99085	547
849748-9	18-6955	678	24132	23-5880	131	677-14384-01	18-99146	507
855384-4	18-1935-1	980	24323	23-0806	135	682-44365-00	18-1834	520
855846-2	18-5303	949	24353	23-1000	131	682-44366-00	18-1831	520
856039-3	18-2971-1	982	24363	23-7764	131	682-44367-00	18-1832	520
8602629	18-6953	678	24639	23-5800	140	688-41133-00	18-99023	545
8602710	18-6953	678	24690	23-3605	134	688-45123-00	18-99026	545
8602714	18-6953	678	26488	23-3600	134	689-81800-11	18-6410	499
8676496	18-6953	678	30200	23-7770	131	689-81800-12	18-6410	499
8676498	18-6953	678	30220	18-7910-1	689	697-81800-12	18-6412	499
8676499	18-6953	678	30376	23-4007	134	93210-05001	18-71330	527
8692305	18-8003-1	205, 988	30475	23-4004	140	93210-44704	18-71331	Obsolete
8757166	18-8802-1	954, 955, 956, 958	30592	23-4002	Obsolete	93210-45161	18-71332	Obsolete
8757166	18-8823-1	954, 957	30593	23-5600	140	93210-49046	18-71333	526
875807-0	18-3079	975	31152	23-4006	134	97080-06045	18-0261	526
875808-8	18-3036	974	32620	23-3305	132	97595-06535	18-8406	527
875811-2	18-3081	975	33104	23-3313	133	97595-06540	18-8407	527
876532-3	18-8801-1	954, 957	33112	23-3302	132	646-24251-02-00	18-7713	513
877061-2	18-3038	974	33373	23-0804	135	646-44322-00-00	18-3328	Obsolete
877061-2	18-3077	974	33417	23-0803	135	646-44323-00-00	18-3357	525
966694-2	18-4044	986	33966	23-0807	135	646-44352-01-00	18-3072	517, 525
1357199-7	18-6839	962	34196	23-0802	135	647-14385-00-00	18-7065	507
21124846	18-3506	973	34440	23-3307	133	648-14385-00-00	18-7066	507
21148403	18-3557	983	35109	23-5840	131	648-24411-00-00	18-7839	510
21213660	18-3276-1	974	35595	23-7801	Obsolete	650-11651-04-00	18-1755	Obsolete
21213664	18-30778	974	35608	23-2702	137	650-11651-04-00	18-1755K	Obsolete
21323043	18-6944	679	35736	23-3601	134	662-44352-01-00	18-3063	517
21436799	18-5467	Obsolete	35828	23-7825	139	663-13622-00-00	18-0242	Obsolete
21707133	18-0033	988	35920	23-7720	131	663-24410-00-00	18-7334	509
3523301-4	18-6839	962	36450	23-7200	130	663-24411-00-00	18-7840	510
3803227-2	18-59700	962	36918	23-7800	138	663-44322-00-00	18-3435	522
3851218-2	18-7989	159	37387	23-3602	134	663-44323-00-00	18-3436	522
3851218-2	18-7789	970	37922	23-0808	135	663-45331-00-94	18-2773	553
3852374-2	18-1986-1	979	38100	23-7201	130	664-45371-01-00	18-6096	554
3852648-9	18-3730	999	39181	23-4000	140	670-45997-02-00	18-73914	554
3853862-5	18-21753	997	39378	23-3603	134	676-14984-00-00	18-0840-1	550
3853962-3	18-21751	997	39705	23-1101	130	676-14985-01-00	18-7392	507
3854194-2	18-6291	886, 964	40154	23-7826	139	677-24411-02-00	18-7837	510
3855270-9	18-1909-1	980	40434	23-0805	135	677-24471-01-00	18-7838	510
3855270-9	18-1909-1	980	40859	23-2700	137	680-85570-00-00	18-5138	495
3856600-6	18-6261	963	40860	23-2802	138	680-85570-02-00	18-5138	495
3857846-4	18-2434	578	42260	23-0800	135	680-85570-09-00	18-5112	495
3858437-1	18-21752-1	997	43050	23-2803	138	682-11610-01-00	18-3976	Obsolete
40005011	18-9553-2	139, 209, 214	43060	23-4500	Obsolete	682-11610-11-00	18-3977	537
40005012	18-9553-3	209, 214	45232	23-4003	140	682-44352-01-00	18-3074	517, 520
5003564-1	18-6839	962	46097	23-3604	134	682-82556-00-00	MP28860	32, 497
R7044289	18-80008	966	46124	23-0801	135	688-11181-02-00	18-3805	542
R80316	18-79998	966	46592	23-2703	137	688-11193-01-00	18-0767	551
949658-9	18-7147-9	1003	46596	23-4501	138	688-11650-03-00	18-1756	538
VOLVO PENTA			46622	23-3306	133	688-43880-11-00	18-6821	504
72021	18-6846	678	47060	23-7770	131	688-44311-01-00	18-3171	518
820545	18-6822	965	48076	23-7802	138	688-44352-03-00	18-3070	517
845940	18-6846	678	24688 & 24323	23-3650	136	688-45331-00-94	18-2782	553
852928	18-6822	965	24688 & 33966	23-3658	137	688-45341-00-00	18-2374	553
861476	18-8701	988	24688 & 34196	23-3653	136	688-45341-10-00	18-2374	553
872022	18-6846	678	24688 & 40434	23-3662	137	688-45371-02-00	18-6111	554

YAMAHA (cont.)			YAMAHA (cont.)			YAMAHA (cont.)		
O.E. #	SIERRA #	PAGE #	O.E. #	SIERRA #	PAGE #	O.E. #	SIERRA #	PAGE #
688-45371-02-00	18-6070	554	5GH-13440-20	18-8700	539	61N-W0078-11-00	18-3432	525
688-45611-00-00	18-2388	553	5GH-13440-50-00	18-8700	539	61N-W0093-00-00	18-7737	505
688-45997-01-00	18-4274	553	5JW-13400-00-00	18-8700	539	61T-11193-A1	18-99057	546
688-81800-12-00	18-6423	500	60E-81950-00-00	18-1525	504	62L-85570-00-00	18-5129	572
688-81941-00-00	18-5879	499	60V-12411-00	18-3525	532	62T-85520-00-00	18-5147	572
688-81950-10-00	18-5879	499	60V-12414-A0-00	18-60508	548	62T-85520-01-00	18-5147	572
688-85540-16-00	18-5130	495	60V-13621-A0	18-99049	546	62T-85533-00-00	18-5146	572
689-11181-02-00	18-3804	542	60V-13645-00	18-99050	546	62X-43880-00-00	18-6811	503
689-11631-00-95	18-4138	537	60V-13907-00-00	18-7343	509	62X-43880-00-00	18-6812	503
689-15755-01-00	18-50000	503	60V-24251-01-00	18-79907	514	62X-43880-01-00	18-6811	503
689-44352-02-00	18-3067	517	60V-43880-00-00	18-6798	503	62X-43880-01-00	18-6812	503
689-81311-40-00	18-5195	495	60V-46241-00-00	18-15143	540	62X-43880-09-00	18-6789	503
689-81800-13-00	18-6410	499	60V-81800-00-00	18-6832	500	62X-43880-09-00	18-6812	503
692-14590-00-00	18-7060	506	60X-43315-A0-00	18-0406	544	62Y-12414-00-00	18-0835	551
692-14590-01-00	18-7060	506	60X-44323-00-00	18-3520	Obsolete	62Y-14392-00-00	18-7049	506
692-24410-00-00	18-7334	509	60X-81800-00-00	18-6832	500	62Y-41133-00	18-99002	544
692-24411-00-00	18-7391	509	60X-W0078-00	18-3522-1	524	62Y-43800-11-00	18-6811	503
695-85540-12-00	18-5131	495	60X-W0078-00-00	18-3516	524	62Y-43880-00-00	18-6811	503
695-85570-10-00	18-5112	495	61A-11181-A0-00	18-3891	542	62Y-46241-00-00	18-15144	540
697-44352-00-00	18-3069	517	61A-11181-A1-00	18-3891	542	62Y-W0001-20-00	18-74540	569
697-85570-11-00	18-5111	495	61A-11193-A1	18-99051	546	63D-11181-A1	18-99060	542
703-82510-12-00	MP51020	25, 496	61A-12414-A0-00	18-0829	551	63D-11193-A0	18-99059	542
703-82510-12-00	MP51022	25, 496	61A-13411-00	18-79976	538	63D-44312-00	18-9083	519
703-82510-43-00	MP51040	25, 497	61A-13621-A0	18-99053	546	63D-44316-00-00	18-0483	551
703-82510-43-00	MP51042	25, 497	61A-13645-00	18-99054	546	63D-44322-00-00	18-3449	523
90171-14056-00	18-3792	555	61A-13646-00	18-99055	546	63D-44323-00-00	18-3186	523
90171-14056-00	18-73907	555	61A-24563-00-00	18-7782	513	63D-45114-A0	18-99004	544
90171-16011-00	18-3732	555	61A-24564-00-00	18-7486	513	63D-45123-00	18-99005	544
90280-03003-00	18-3305	519	61A-41134-A0	18-99000	544	63D-W0001-00	18-99061	541
90280-03024-00	18-3305	519	61A-43880-01-00	18-6782	503	63D-W0078-01-00	18-3415	523
90340-08002-00	18-23711-9	553	61A-43880-02-00	18-6782	503	63D-W0078-01-00	18-3434	523
90340-08002-00	18-2371	553	61A-44311-00-00	18-3173-1	518	63P-12414-00-00	18-99127	551
90430-08020-00	18-46981-9	446	61A-44311-01	18-3523-1	523	63P-13915-00-00	18-79902	515
90430-08020-00	18-4698	553	61A-44311-01	18-3522-1	524	63P-14984-00	18-0712	507
90430-14115-00	18-0826	553	61A-44311-01-00	18-3173-1	518	63P-45987-00-00	18-73918	554
904-30142-28-00	18-0755	544	61A-44322-00-00	18-3333	520	63P-46241-00-00	18-15140	540
90430-14228-00	18-0755	544	61A-44322-02-00	18-3519	523	63P-81950-00	18-1522	504
91401-30028-00	18-2380	554	61A-45113-A0	18-99056	546	63V-11181-A2	18-99140	548
91401-30030-00	18-2380	554	61A-45114-A0	18-99001	544	63V-14301-00-00	18-34603	Obsolete
91402-30022-00	18-2380	554	61A-45371-00-00	18-6119A	554	63V-14985-00	18-7064	507
91402-30022-09	18-2380	554	61A-45371-00-00	18-6119Z	554	63V-15713-00-00	18-51001	553
91402-30028-00	18-2380	554	61A-45527-00-00	18-9076	519	63V-24411-00-00	18-7390	509
91402-30028-09	18-2380	554	61A-45527-00-00 +	18-9079	519	63V-41133-A1	18-99006	544
91490-30030-00	18-2380	554	61A-45538-00-00	18-9075	519	63V-44301-00	18-3412	522
91490-30045-00	18-3748	554	61A-45538-00-00 +	18-9079	519	63V-44301-00-00	18-3356	518, 522, 523
91490-40030-00	18-3735	554, 561, 563, 565	61A-81800-01-00	18-6861	500	63V-44322-00-00	18-3444	522
92900-10600-00	18-0192	538	61A-81840-00-00	18-56007	Obsolete	63V-44323-00-00	18-3195	522
92901-10600-00	18-0192	538	61A-81941-00-00	18-5853	499	63V-44328-01	18-9090	526
92902-10600-00	18-0192	538	61A-81950-01	18-1523	504	63V-44352-01-00	18-3040	517
92903-10600-00	18-0192	538	61A-W0001-01-00	18-4400	540	63V-44365-10-00	18-3505	520
92990-06600-00	18-0191	538	61A-W0001-21-00	18-2799	568	63V-45113-A1	18-99150	550
92990-10600-00	18-0192	538	61A-W0001-A1-00	18-4400	540	63V-45315-A0	18-99063	547
92995-10600-00	18-0192	538	61A-W0001-C1-00	18-2799	568	63V-85520-00	18-5183	495
93101-22067-00	18-0296	570	61A-W0078-01-00	18-3395	521	63V-85520-01	18-5183	495
93101-23070-00	18-0297	570	61A-W0078-A2-00	18-3396-1	521	63V-85533-00-00	18-25604	496
93102-23096-00	18-0570	570	61A-W0078-A3-00	18-3396-1	521	63V-85540-00-00	18-5132	495
93106-09014-00	18-0267	570	61A-W0093-00-00	18-7772	506	63V-85540-01-00	18-5132	495
93210-16716-00	18-7511-9	570	61A-W0093-01-00	18-7772	506	63V-85540-02-00	18-5132	495
93210-19123-00	18-7463	570	61B-82510-00-00	MP51030	25, 496	63V-85580-01-00	18-25652	496
93210-32738-00	18-7432	570	61B-82510-01-00	MP51030	25, 496	63V-W0001-01	18-99175	541
93210-41042-00	18-0298	570	61B-82510-01-00	MP51032	25, 496	63V-W0001-21-00	18-74507	569
93210-46044-00	18-7436	570	61N-11603-00-00	18-3957	537	63V-W0078-01	18-3412	522
93211-04384-00	18-7444	570	61N-11635-00-00	18-4145	537	63V-W0078-01-00	18-3433	522
93310-32337-00	18-1410	538	61N-11636-00-00	18-4146	537	63V-W0093-00-00	18-7058	504
93604-18080-00	18-43716	519	61N-14392-00-00	18-7049	506	64B-14198-A0-00	18-0775	550
95307-16900-00	18-3732	555	61N-24560-10	18-79910	515	64D-14384-01-00	18-0856-1	544
97080-08045-00	18-0256	520	61N-24563-00-00	18-7781	513	64D-W0093-00-00	18-7756	505
97095-06040-00	18-2607	Obsolete	61N-44311-00-00	18-3185	518	64E-13645-A0	18-99064	547
97095-08045-00	18-0256	520	61N-44311-01-00	18-3185	518, 525	64E-43822-00-00	18-2081	504
99999-03249-00	18-6412	499	61N-44322-01-00	18-3443	525	64E-4384J-00-00	18-2082	504
1WD-E3440-00-00	18-8700	539	61N-44323-00	18-3194	Obsolete	64E-43869-00-00	18-7469	570
2MB-E3440-00-00	18-8700	539	61N-45251-01-00	18-6120A	554	64E-43880-00-00	18-6783	Obsolete
3FV-13440-00-00	18-7902	539	61N-45251-01-00	18-6120Z	554	64E-43880-01-00	18-6783	Obsolete
3FV-13440-20-00	18-7902	539	61N-85570-00-00	18-5113	495	64J-41133-10	18-99008	545
5GH-13440-00-00	18-7911-1	271	61N-85570-10-00	18-5113	495	64X-81800-00-00	18-6862	571

YAMAHA (cont.)			YAMAHA (cont.)			YAMAHA (cont.)		
O.E. #	SIERRA #	PAGE #	O.E. #	SIERRA #	PAGE #	O.E. #	SIERRA #	PAGE #
650-24431-A0-00	18-0849	544	676-44324-A0	18-99083	547	688-45114-A1	18-99025	545
655-12414-A1-00	18-0232	442	676-45114-A0	18-99015	545	688-W0001-00-00	18-4415	540
65L-13645-00	18-99066	547	677-14198-A1	18-99145	549	688-W0001-20-00	18-2798	Obsolete
65L-13646-00	18-99067	547	677-W0093-00-00	18-7059	504	688-W0001-22-00	18-0021	567
65L-13915-00-00	18-79901	514, 748	677-W0093-04-00	18-7059	504	688-W0001-A0-00	18-4415	540
65L-14984-00	18-0715	399	679-44316-A0	18-99086	547	688-W0001-C0-00	18-2798	Obsolete
65L-24563-00-00	18-7517	513	679-45315-A0	18-99087	547	689-45113-A1-00	18-0739	551
65L-W0001-C0-00	18-74510	569	679-W0078-00-00	18-3397	522	689-W0001-21-00	18-2785	567
65N-44315-A0	18-0453	527	679-W0078-A0-00	18-3397	522	689-W0001-23-00	18-0022	567
65N-44323-00	18-0408	527	67C-11356-00	18-99088	547	689-W0001-A1-00	18-3804	542
65N-W0078-A0-00	18-4533	527	67C-41114-00	18-99089	548	689-W0001-C1-00	18-2785	567
65W-11169-00	18-99068	547	67C-41133-00	18-99016	545	689-W0001-C2-00	18-0023	567
65W-11351-00	18-99069	547	67C-43880-00-00	18-6748	503	689-W0078-04-00	18-3426	Obsolete
65W-11356-00	18-99070	547	67C-43880-01-00	18-6748	503	689-W0078-A4-00	18-3426	Obsolete
65W-13645-00-00	18-60535	552	67C-45113-00	18-99091	548	689-W0078-A6-00	18-3427	Obsolete
65W-14198-00-00	18-76689	570	67C-W0001-00	18-99092	541	689-W0093-02-00	18-7770	506
65W-14457-10	18-99071	547	67C-W0001-20	18-99093	541	68D-11351-A0-00	18-60518	Obsolete
65W-24251-10-00	18-7830	513	67D-14301-13-00	18-34601	506	68D-E1169-A0-00	18-60512	Obsolete
65W-41114-00	18-99072	547	67D-15713-00-00	18-51002	553	68D-E1193-A0-00	18-60519	Obsolete
65W-43865-00-00	18-7470	570	67D-45113-A0-00	18-60527	552	68D-E2414-A0-00	18-0754	551
65W-43871-00-00	18-7484	504	67D-W0093-00-00	18-7736	505	68D-G4311-01-00	18-43263	518, 526
65W-46241-00-00	18-15135	540	67F-11181-02	18-99094	542	68D-G5987-00-00	18-73891	554
65W-81941-00-00	18-5819	499	67F-12411-01-00	18-3632	532	68D-WG078-00-00	18-48619	526
65W-W0001-20	18-99073	541	67F-13415-00-00	18-0486	538	68F-11181-00	18-99062	542
663-13622-A0-00	18-0242	Obsolete	67F-14371-01	18-79972	513	68F-11193-01	18-99099	548
663-44315-A0-00	18-0292	552	67F1439A-00-00	18-7056	506	68F-11381-00	18-99100	548
663-44316-A0	18-99149	549	67F-24251-02-00	18-7516	513	68F-13440-00	18-79971	538
663-44324-A0-00	18-0294	552	67F-41133-A1	18-99018	545	68F-13907-00-00	18-7342	509
663-W0078-00-00	18-3425	525	67F-41134-A0	18-99019	545	68F-13907-01-00	18-7342	509
663-W0078-A0-00	18-3425	525	67F-41138-00-00	18-0605	544	68F-13915-00-00	18-79904	515
664-41114-A0-00	18-0250	551	67F-43880-00-00	18-6787	503	68F-24563-00	18-79980	514
664-41134-A0	18-99010	545	67F-44311-01	18-3409	524	68F-24563-10-00	18-7955	513
66K-13907-00-00	18-7341	509	67F-44322-00-00	18-3162	Obsolete	68F-41114-00	18-99101	548
66K-13915-00-00	18-79900	514, 515	67F-44323-00-00	18-3143	524	68F-45113-00	18-99102	548
66K-14984-00	18-0711	507	67F-44352-00-00	18-3042	517	68F-46241-10-00	18-15145	540
66K-W0001-20-00	18-74512	569	67F-45113-00-00	18-99164	545	68F-81800-01-00	18-6426	500
66M-11181-10-00	18-63966	Obsolete	67F-45123-00	18-99020	545	68F-W0001-01	18-99103	541
66M-11351-10	18-99074	547	67F-45127-00-00	18-0617	544	68F-W1135-00-00	18-64415	550
66M-11356-00	18-99075	547	67F-46241-00-00	18-15131	540	68T-13475-00	18-99027	545
66M-11357-00-00	18-60513	Obsolete	67F-81800-02-00	18-6425	500	68T-24251-00-00	18-7710-1	513
66M-12411-01-00	18-3541	532, 533	67F-82341-00-00	18-5217-1	496	68T-44323-00-00	18-3142	523
66M-13329-10	18-99076	547	67F-82341-00-00 +	18-8847-1	496	68T-44352-00-00	18-8910	518
66M-13645-00-00	18-60534	552	67F-82342-00-00	18-5218-1	496	68T-44366-00-00	18-3176	520
66M-14301-00-00	18-34600	Obsolete	67F-82342-00-00 +	18-8847-1	496	68T-46241-00-00	18-15138	540
66M-14301-12-00	18-34600	Obsolete	67F-82343-00-00	18-5219-1	496	68T-W0078-00-00	18-3410	523
66M-24410-10-00	18-35302	509	67F-82343-00-00 +	18-8847-1	496	68T-W0078-00-00	18-3450	523
66M-41114-01-00	18-60530	552	67F-82344-00-00	18-5220-1	496	68V-11325-01-00	18-6118A	554
66M-41138-00	18-99078	547	67F-82344-00-00	18-8847-1	496	68V-13766-00-00	18-2083	503
66M-45113-00	18-99013	545	67F-W0001-20-00	18-74535	569	68V-13907-00-00	18-7340	509
66M-45115-00	18-99079	547	67F-W0078-00	18-3409	524	68V-13907-01-00	18-7340	509
66M-46241-00-00	18-15137	540	67F-W0078-00-00	18-3451	524	68V-13907-02-00	18-7340	509
66M-81800-01-00	18-6943	500	67F-W0093-00-00	18-7743	505	68V-13907-03-00	18-7340	509
66M-81800-02-00	18-6943	500	67H-8592A-00-00	18-7655	516	68V-13915-00-00	18-79903	515
66M-85540-01-00	18-25300	Obsolete	67H-8592A-01-00	18-7655	516	68V-14984-00	18-0710	507
66M-85580-00-00	18-25650	Obsolete	682-11351-A0	18-99095	548	68V-15312-00	18-99028	545
66M-W0093-00-00	18-7738	505	682-12414-A1-00	18-0836	551	68V-24502-00-00	18-79986	514
66M-W0093-01-00	18-7738	505	682-41112-A1	18-99096	548	68V-24502-01-00	18-79986	514
66T-11181-A0-00	18-60522	552	682-41133-A0	18-99021	545	68V-24502-02	18-79986	514
66T-11193-A0-00	18-60520	552	682-44315-A0-00	18-0768	553	68V-24502-20-00	18-79985	514
66T-14301-00-00	18-34605	Obsolete	682-45113-A1	18-99022	545	68V-24502-30	18-79985	514
66T-15713-00-00	18-51003	553	682-W0001-06	18-99097	541	68V-24563-00-00	18-7979	513
66T-41114-A0-00	18-60532	552	682-W0078-A1-00	18-3148	520	68V-44323-00-00	18-3521	523
66T-41133-A0-00	18-60529	552	682-W0078-A1-00	18-3411	520	68V-45123-00-00	18-0618	544
66T-44311-00	18-3413	523	683-45315-A0	18-99152	550	68V-81800-01-00	18-6427	500
66T-44323-00-00	18-3196	523	683-W0001-C1-00	18-74501	569	68V-W0001-20-00	18-74515	569
66T-45113-A0-00	18-60528	Obsolete	688-11181-A1-00	18-3805	542	68V-W0078-00	18-3523-1	523
66T-W0078-00	18-3413	523	688-11603-A0-00	18-3969	537	68V-W0078-00-00	18-3442	523
66T-W0078-00-00	18-3440	523	688-12414-A1-00	18-0844	551	692-W0078-00-00	18-3370	521
66V-81960-00-00	18-6651	572	688-13621-A1	18-99098	548	692-W0078-01-00	18-3370	521
676-11181-A0-00	18-3892	542	688-41112-A0-00	551	551	692-W0078-A0-00	18-3371	521
676-11181-A1-00	18-3892	542	688-41114-A0	18-99148	549	692-W0078-A0-00	18-3370	521
676-12414-A0-00	18-60540	Obsolete	688-41134-A0	18-99024	545	695-11181-A0-00	18-3849	542
676-13646-A0	18-99080	547	688-44315-A0-00	18-0239	521	695-11181-A1-00	18-3849	542
676-41133-A0	18-99014	545	688-44316-A0-00	18-0240	521	695-W0001-01-00	18-4417	543
676-44315-A1	18-99082	547	688-45113-A0	18-99151	550	695-W0001-02-00	18-4417	543

YAMAHA (cont.)			YAMAHA (cont.)			YAMAHA (cont.)		
O.E. #	SIERRA #	PAGE #	O.E. #	SIERRA #	PAGE #	O.E. #	SIERRA #	PAGE #
695-W0001-A2-00	18-4417	543	6C5-43880-01-00	18-6836	504	6E5-81941-10-00	18-5853	499
696-W0093-02-00	18-7290	505	6C5-46241-00-00	18-15130	540	6E5-81941-11-00	18-5853	499
697-11181-A0-00	18-3848	542	6CB-12411-10-00	18-3637	532	6E5-85540-10-00	18-5135	496
697-11181-A1-00	18-3848	542	6CB-13016-00	18-0707	507	6E5-85540-11-00	18-5135	496
697-45114-A0	18-99030	546	6CB-13915-00	18-79978	515	6E5-85540-12-00	18-5135	496
698-W0001-20-00	18-2787	Obsolete	6CB-14984-00	18-0716	507	6E5-85570-11-00	18-5110	495
698-W0001-21-00	18-0024	567	6CB-24501-00	18-79979	514	6E5-W0001-51-00	18-2794-1	568
698-W0001-C0-00	18-2787	Obsolete	6CB-44315-00-00	18-0451	526	6E5-W0001-F1-00	18-2794-1	568
69G-W0001-20-00	18-0025	Obsolete	6CB-44323-00-00	18-4572	526	6E5-W0078-01-00	18-3372	521
69G-W0078-00	18-3475	526	6CB-81800-00-00	18-6961	500	6E5-W0078-A1-00	18-3373	521
69J-13440-00-00	18-7906-1	432	6CB-W0078-00-00	18-3474	526	6E5-W0093-06-00	18-7002	505
69J-13440-01-00	18-7906-1	432	6CB-W4624-00-00	18-15134	540	6E7-11181-00-00	18-3828	542
69J-13907-04-00	18-7339	509	6CE-12411-00-00	18-3524	532	6E7-11181-A1-00	18-3828	542
69J-13907-04-00	18-7345	509	6CE-44311-01-00	18-3482	518	6E7-11631-00-97	18-4135	537
69J-24501-00	18-79981	514	6CE-44315-00-00	18-3458	Obsolete	6E7-14227-00	18-99144	549
69J-24501-10-00	18-79905	513	6CE-44323-01-00	18-3459	Obsolete	6E7-14385-00-00	18-7393	507
69J-24502-00	18-79982	514	6CE-44352-00-00	18-45617-1	518	6E7-14390-12-00	18-7073	506
69J-41134-A0	18-99032	546	6CE-W0078-01	18-3470	524	6E7-85570-10-00	18-5112	495
69J-41135-A0	18-99033	546	6CE-W0078-01 + 6CE-44311-01	18-3471	524	6E7-85570-19-00	18-5112	495
69J-41136-A0	18-99034	546	6CJ-44311-00-00	18-3485	518	6E7-W0093-04-00	18-7769	506
69J-41138-00-00	18-0619	Obsolete	6CJ-44315-00	18-0448	Obsolete	6E8-14380-12-00	18-7073	506
69J-43880-00-00	18-6798	503	6CJ-44316-00	18-0449	526	6E9-11193-A0	18-99106	548
69J-45123-00-00	18-0656	544	6CJ-44324-00	18-0450	526	6E9-12414-A1	18-99142	549
69J-46241-00-00	18-15141	540	6CJ-W0078-00-00	18-3494	526	6E9-41114-A0	18-99107	548
69J-81800-00-00	18-6833	500	6D8-WS24A-00-00	18-79799	513	6E9-82575-02-00	18-65450	Obsolete
69L-45371-00-00	18-6122A	554	6DA-12411-01-00	18-3636	532	6E9-W0093-02-00	18-7740	505
69L-45371-00-00	18-6122Z	554	6DA-W4624-00-00	18-15142	540	6E9-W0093-03-00	18-7741	505
69L-81800-00-00	18-6861	500	6E0-24411-00-00	18-7389	509	6EE-G4311-00	18-4567	526
69M-11181-00-00	18-60523	Obsolete	6E0-24471-00-00	18-7834	510	6EE-G4322-00	18-4546	526
69M-11196-A0-00	18-60521	552	6E0-44352-00-00	18-3073	517	6EE-G4323-00	18-4573	526
69M-12411-01-00	18-3624	532	6E0-44366-00-00	18-3166	520	6EE-G4366-00	18-1840	519
69M-14301-11-00	18-34604	Obsolete	6E0-W0001-C1-00	18-0028	568	6EE-W0078-00-00	18-3473	526
69M-G4323-00	18-0409	527	6E5-11181-02-00	18-3832	542	6EG-G4315-00	18-99157	527
69M-G4328-00	18-9091	527	6E5-11181-A1-00	18-3832	542	6EG-G4322-00	18-4547	527
69M-WG078-00-00	18-4534	527	6E5-11193-A0-00	18-0781	551	6EG-G4323-00	18-4574	527
69W-43880-00-00	18-6811	503	6E5-11381-A1-00	18-0782	551	6EG-G4328-00	18-9089	527
69W-81800-00	18-6861	500	6E5-11610-03-00	18-3934	537	6EG-W0078-00-00	18-4532	527
69W-81800-00-00	18-6942	500	6E5-11610-23-00	18-3936	538	6EK-12411-00-00	18-3639	532
6A0-24410-00-00	18-7334	509	6E5-12411-02-00	18-3623	532	6EM-81800-01-00	18-6963	500
6A0-24410-01-00	18-7334	509	6E5-12411-30-00	18-3540	532, 533	6F3-W0001-04-00	18-4403	Obsolete
6A0-24410-02-00	18-7334	509	6E5-13411-00	18-79975	538	6F3-W0001-21-00	18-2794-1	568
6A0-24410-03-00	18-7334	509	6E5-13621-A1	18-99105	548	6F3-W0001-AA-00	18-4403	Obsolete
6A0-24410-04-00	18-7334	509	6E5-13645-A1-00	18-0823	551	6F3-W0001-C1-00	18-2794-1	568
6A0-24410-05-00	18-7334	509	6E5-14198-A1-00	18-0785	550	6F5-12411-03-00	18-3625	532
6A0-W0001-21	18-99104	541	6E5-14384-02-00	18-0786	550	6F5-24563-00-00	18-7780	513
6A1-W0001-22-00	18-0026	Obsolete	6E5-14384-03-00	18-2592	550	6F5-44352-00-00	18-3088	517, 522
6A1-W0001-23-00	18-0027	567	6E5-14385-00-00	18-7068	507	6F5-81800-11	18-6421	500
6A1-W0078-01-00	18-3463	525	6E5-14385-01-00	18-7068	507	6F5-85540-21-00	18-5136	496
6A1-W0078-02-00	18-3462	525	6E5-14385-02-00	18-7069	507	6F5-85540-22-00	18-5136	496
6A1-W0093-01-00	18-7293	505	6E5-14546-00-00	18-7055	506	6F5-W0078-00-00	18-3398	522
6AH-44311-00-00	18-3484	518	6E5-24305-05	18-80415	517	6F5-W0078-A0-00	18-3398	522
6AH-46241-00-00	18-15136	540	6E5-24410-00-00	18-7349	509	6FM-44323-01	18-4576	527
6AH-W0078-00	18-3479	526	6E5-24410-01-00	18-7349	509	6FM-W0078-00-00	18-4527	527
6AW-12411-00-00	18-3634	532	6E5-24410-02-00	18-7349	509	6FP-12411-00-00	18-3641	532
6AW-14984-00	18-0714	507	6E5-24410-03-00	18-7349	509	6G1-11193-A1	18-99108	548
6AW-24502-00-00	18-79984	514	6E5-24410-04-00	18-7349	509	6G1-13621-A1	18-99109	548
6AW-24502-10	18-79984	514	6E5-24410-10-00	18-7349	509	6G1-13645-A1	18-99110	548
6AW-44311-01-00	18-3483	518	6E5-24411-00-00	18-7843	510	6G1-14198-A1	18-99111	548
6AW-44312-00-00	18-9082	519	6E5-24471-00-00	18-7842	403	6G1-14546-00-00	18-7054	506
6AW-44315-00	18-0452	526	6E5-41112-A1-00	18-0799	551	6G1-14546-01-00	18-7054	506
6AW-44322-00-00	18-3457	Obsolete	6E5-41134-A0	18-99037	546	6G1-14985-00-00	18-7067	507
6AW-44323-00	18-0421	526	6E5-41135-A0	18-99038	546	6G1-15755-00-00	18-50001	503
6AW-44336-00	18-3028	526	6E5-43880-01-00	18-6821	504	6G1-15779-00-00	18-50000	503
6AW-44352-00-00	18-8925	518	6E5-43880-02-00	18-6821	504	6G1-15779-00-00	18-50001	503
6AW-44365-00-00	18-1829	519	6E5-44311-00-00	18-3170	518	6G1-24305-04	18-80414	517
6AW-W0078-00-00	18-3477	526	6E5-44312-00-00	18-9081	519	6G1-24305-05-00	18-80414	517
6AW-W4624-00-00	18-15139	540	6E5-44315-A0-00	18-0244	552	6G1-24411-00-00	18-7388	509
6BG-13915-00	18-79970	513	6E5-44323-00-00	18-3344	521	6G1-24431-01	18-99147	549
6BG-81800-00-00	18-6964	500	6E5-44352-01-00	18-3071	517	6G1-24471-00-00	18-7833	510
6BG-W0078-00-00	18-3490	526	6E5-44365-00-00	18-1835	520	6G1-41112-A1	18-99112	548
6BX-G4315-01-00	18-60541	552	6E5-45371-01-00	18-6097	554	6G1-41114-A0	18-99113	548
6C5-13915-00	18-79973	513	6E5-45611-01-00	18-2385	Obsolete	6G1-41133-A0	18-99114	548
6C5-14984-00	18-0717	507	6E5-81800-11-00	18-6413	500	6G1-44315-A0-00	18-0753	551
6C5-24251-00	18-79983	514	6E5-81800-12-00	18-6413	500	6G1-44322-00-00	18-3456	Obsolete
6C5-43880-00-00	18-6836	504	6E5-81840-10-00	18-56005	503	6G1-44352-00-00	18-3066	517

YAMAHA (cont.)			YAMAHA (cont.)			YAMAHA (cont.)		
O.E. #	SIERRA #	PAGE #	O.E. #	SIERRA #	PAGE #	O.E. #	SIERRA #	PAGE #
6G1-45113-A1	18-99115	548	6H3-45123-00	18-99047	546	6L2-44322-00	18-4548	Obsolete
6G1-45315-A0	18-99116	548	6H3-81800-10	18-6411	499	6L2-44328-00	18-9092	527
6G1-81941-10-00	18-5821	499	6H3-81800-11-00	18-6411	499	6L2-44352-00-00	18-3065	517
6G1-W0001-A2	18-99117	541	6H3-85510-A1	18-5746	499	6L2-44367-00	18-1836	519
6G1-W0001-C1-00	18-0029	568	6H3-W0001-21-00	18-2788	Obsolete	6L2-44367-10	18-1837	519
6G1-W0078-01-00	18-3460	525	6H3-W0001-22-00	18-74504	569	6L2-45315-A0	18-99138	549
6G1-W0078-A1-00	18-3460	525	6H3-W0001-A0-00	18-4427	541	6L2-81800-20-00	18-6420	500
6G1-W0093-00-00	18-7765	505	6H3-W0001-C1-00	18-2788	Obsolete	6L2-W0001-C3-00	18-0030	568
6G5-11181-00-00	18-3894	542	6H3-W0078-00-00	18-3428-1	522	6L2-W0078-00-00	18-3431	525
6G5-11181-A0-00	18-3894	542	6H3-W0078-00-00	18-3461	522	6L2-W0093-00-00	18-7739	505
6G5-11193-A0-00	18-0779	551	6H3-W0078-01	18-3466	524	6L5-24251-00	18-79977	514
6G5-11382-A1-00	18-0808	550	6H3-W0078-01-00	18-3465	524	6L5-44322-00-00	18-3164	526
6G5-11631-00-93	18-4129	537	6H3-W0078-02-00	18-3465	524	6L5-44323-00-00	18-3163	529
6G5-11636-00-00	18-4133	Obsolete	6H3-W0078-02-00	18-3466	524	6L5-44352-00-00	18-8911	518
6G5-11642-00-93	18-4128	Obsolete	6H3-W0078-A0-00	18-3428-1	522	6M6-81800-10-00	18-8862	571
6G5-13645-A1-00	18-0809	550	6H3-W0078-A0-00	18-3461	522	6M6-8183E00-00	18-15080	572
6G5-14483-A1	18-99118	548	6H3-W0093-02-00	18-7766	506	6M6-81960-A0-00	18-6650	572
6G5-41112-A1-00	18-0812	551	6H4-11181-00-00	18-3830	542	6N0-W0001-C0-00	18-0031	568
6G5-41134-A1	18-99039	546	6H4-11181-A1-00	18-3830	542	6N0-W0078-A0-00	18-3460	525
6G5-43864-00-00	18-7468	570	6H4-11193-A1-00	18-0815	551	6N6-W0001-03-00	18-4411	Obsolete
6G5-43880-02-00	18-6760	503	6H4-11610-00-00	18-3960	537	6N6-W0001-A3-00	18-4411	Obsolete
6G5-44323-00-00	18-3345	520	6H4-11610-10-00	18-3961	Obsolete	6N6-W0078-00-00	18-3312	521
6G5-45113-A0-00	18-0813	551	6H4-11610-20-00	18-3962	537	6N6-W0078-01-00	18-3313-1	521
6G5-45114-A1	18-99040	546	6H4-11631-00-96	18-4141	537	6N6-W0093-02-00	18-7744	505
6G5-45251-01-00	18-6090	554	6H4-11635-01-00	18-4142	Obsolete	6N7-81800-10-00	18-6415	500
6G5-W0001-21-00	18-2794-1	568	6H4-13621-A1	18-99132	549	6OV-13646-00	18-99139	549
6G5-W0001-C1-00	18-2794-1	568	6H4-14198-01	18-99133	549	6P2-14984-00	18-0713	507
6G5-W0078-01-00	18-3310	520	6H4-15369-A1	18-99134	549	6P2-44323-00-00	18-3518	525
6G5-W0078-A1-00	18-3311	520	6H4-41112-A0	18-99135	549	6P2-46241-02-00	18-15132	540
6G5-W0093-08-00	18-7747	505	6H4-41114-A0-00	18-0798	551	6P2-W0078-00-00	18-3515	525
6G5-W4599-00-00	18-3782	555	6H4-44352-02-00	18-3068	517	6P2-WS245-00-00	18-7518	513
6G8-11181-00-00	18-3827	542	6H4-81800-12-00	18-6422	500	6P3-24564-00-00	18-7488	513
6G8-11181-A1-00	18-3827	542	6H4-W0001-02-00	18-4419	543	6P3-WS24A-00-00	18-79809	513
6G8-11351-A0	18-99119	548	6H4-W0001-20-00	18-2792	Obsolete	6R3-85570-01-00	18-5128	495
6G8-12414-A0	18-99120	548	6H4-W0001-21-00	18-2792	Obsolete	6R5-11603-00	18-39320	537
6G8-13440-00-00	18-7901	539	6H4-W0001-A2-00	18-4419	543	6R5-11631-11-93	18-4081	Obsolete
6G8-13646-A0	18-99121	549	6H4-W0078-00	18-3408	522	6R5-11635-11-00	18-4083	537
6G8-14198-A0	18-99122	549	6H4-W0078-00-00	18-3429	522	6R5-11636-11-00	18-4085	537
6G8-15374-00	18-99123	Obsolete	6H4-W0078-A0	18-3408	522	6R5-11642-11-93	18-4080	537
6G8-45113-A1	18-99045	546	6H4-W0078-A0-00	18-3429	522	6R5-11645-11-00	18-4082	537
6G8-46241-00-00	18-15133	540	6H4-W0093-01-00	18-7767	506	6R5-11646-11-00	18-4084	537
6G9-W0001-C6-00	18-74527	569	6H4-W0093-03-00	18-7768	506	6R5-11650-10-00	18-4157	538
6H0-W0093-00-00	18-7742	505	6H4-W4599-00-00	18-73990	554	6R6-W0001-01-00	18-4413	Obsolete
6H1-11631-03-95	18-4097	537	6H5-43880-02-00	18-6788	Obsolete	6Y1-24305-04	18-80413	517
6H1-11636-03-00	18-4099	Obsolete	6J4-81800-01-00	18-6421	500	6Y2-24305-05	18-80415	517
6H1-13411-00	18-79961	538	6J8-11181-00-00	18-3829	542	6YL-24306-60-00	18-8017EP-2	516
6H1-43880-00-00	18-6259	503	6J8-11181-A1-00	18-3829	542	6YL-24306-60-00	18-8017S-1	170, 516
6H1-43880-02-00	18-6781	503	6J8-12414-A0-00	18-0829	551	90105-10M00-00	18-6246	554
6H1-45251-02-00	18-6091	554	6J8-13411-00	18-79974	538	90119-08M13-00	18-2606	Obsolete
6H1-81950-01-00	18-1524	504	6J8-14546-00-00	18-7055	506	90119-08M15-00	18-8400-9	523
6H1-W0001-00-00	18-4405	Obsolete	6J8-24471-00-00	18-7841	510	90119-08M33	18-0260	526
6H1-W0001-01-00	18-4405	Obsolete	6J8-W0001-21-00	18-2789	568	90119-08M87-00	18-2605	Obsolete
6H1-W0001-A0-00	18-4405	Obsolete	6J8-W0001-C2-00	18-2789	568	90171-10M01	18-3773	555
6H1-W0093-01-00	18-7291	505	6J8-W0078-A1-00	18-3430	525	90201-22M01	18-9078	519
6H1-W4599-00-00	18-3781	555	6J9-45371-01-00	18-6112	554	90201-22M01	18-9079	519
6H2-14591-00-00	18-7056	506	6J9-45371-01-00	18-6035	554	90206-22M19	18-9077	519
6H3-11181-01-00	18-3831	542	6K1-45371-00-00	18-6034	554	90206-22M19 +	18-9079	519
6H3-11181-A1-00	18-3831	542	6K1-45371-02-00	18-6121A	554	90280-03M03-00	18-3297	519
6H3-11193-A1	18-99141	549	6K1-45371-02-00	18-6121Z	554	90280-04M00-00	18-3300	519
6H3-11631-01-96	18-4091	Obsolete	6K1-82510-06-00	MP51050	25, 497	90280-04M04-00	18-3301	519
6H3-12411-11-00	18-3622	532	6K1-82510-06-00	MP51052	25, 497	90280-04M05-00	18-3302	519
6H3-12414-A1	18-99124	549	6K5-11601-02-00	18-3963	Obsolete	90340-08M04-00	18-23711-9	553
6H3-13621-A1	18-99143	549	6K5-11636-03-00	18-4096	#Obsolete	90340-08M04-00	18-2371	553
6H3-13622-00	18-99125	549	6K7-13645-A1-00	18-0807-1	550	90340-14M06-00	18-2456	539
6H3-14198-01	18-99126	549	6K7-13686-A1	18-99136	549	90430-14M09-00	18-0755	544
6H3-14590-00-00	18-7056	506	6K7-W0093-09-00	18-7759	505	93101-20M07-00	18-0554	570
6H3-14590-01-00	18-7056	506	6K8-81960-A0-00	18-6652	572	93101-22M15-00	18-2079	570
6H3-41112-A0	18-99128	549	6L2-11181-A1-00	18-3847	542	93101-25M03-00	18-0587	570
6H3-41114-A0	18-99129	549	6L2-11181-A2-00	18-3847	542	93101-28M16-00	18-0265	570
6H3-44311-00	18-3466	524	6L2-14384-00-00	18-0765	550	93101-30M17-00	18-0266	570
6H3-44315-A0-00	18-0756-1	552	6L2-14385-00-00	18-7063	506	93102-25M28-00	18-0588	570
6H3-44324-A0-00	18-0757	553	6L2-14392-00-00	18-7049	506	93102-35M13-00	18-2085	570
6H3-44352-00-00	18-3069	517	6L2-41114-A1-00	18-0744	551	93102-40M36-00	18-2087	Obsolete
6H3-45113-A0	18-99130	549	6L2-41133-A2	18-99137	549	93104-22M07-00	18-2091	570
6H3-45114-A1	18-99046	546	6L2-44311-01-00	18-3486	518	93210-24M79	18-76694	570

YAMAHA (cont.)			YAMAHA (cont.)			YANMAR (cont.)		
O.E. #	SIERRA #	PAGE #	O.E. #	SIERRA #	PAGE #	O.E. #	SIERRA #	PAGE #
93210-27ME3-00	18-76691	570	YSG-10108-43-8G	18-0876	1005	124520-77010	18-6931	679
93210-31MJ5-00	18-76693	570	YSG-10108-44-5G	18-0874	1005	124520-77011	18-6931	679
93210-33M85-00	18-7119	570	YSG-10114-14-1G	18-0889	1005	124610-77010	18-6934	679
93210-33MG4-00	18-0335	550	YSG-14090-90-8G	18-0905	1005	124610-77019	18-6934	679
93210-37M67-00	18-7483	570	YSG-14096-15-6G	18-0887	1005	127610-42200	18-3077	576
93210-46M16-00	18-76690	570	YSG-37545-87-G0	18-0891	1005	128170-01331	18-55600	688
93210-59MG7	18-71334	526	YSG-38600-39-G0	18-0903	1005	128170-11310	18-56000	688
93210-66M98-00	18-0299	Obsolete	YAMAHA PWC			128170-42090	18-56602	688
93210-74M35-00	18-7442	570	60E-81800-00-00	18-6921	572	128170-77010	18-6937	679
93210-86M38-00	18-7485	570	63M-81800-00-00	18-6908	571	128170-77200	18-6928	678
93210-97M55-00	18-0275	570	63M-81960-00-00	18-6857	572	128170-77201	18-6928	678
93310-620V5-00	18-1411	538	64X-81800-00-00	18-6906	571	128170-77202	18-6928	678
93310-730V8-00	18-4077	538	6D3-81800-00-00	18-6907	571	128171-01911	18-55601	688
93310-836V2-00	18-4078	Obsolete	6H2-81960-00-00	18-6858	Obsolete	128171-12540	18-57704	687
93604-10M03-00	18-43717	Obsolete	6S5-81800-00-00	18-6909	571	128176-42071	18-8951	687
ABA-FBARB-90-DG	18-8040	516	YANMAR			128270-12540	18-57703	687
ABA-FLINE-BA-RB	18-8055	516	104211-42070	18-3079	576	128270-77200	18-6925	678
ABB-FUELF-IL-TR	18-7945	512	104211-42071	18-8952	688	128271-01911	18-55602	688
ABB-FUELF-IL-TR	18-7845	512	104211-49160	18-56601	688	128374-01911	18-55603	688
ABB-SPRTR-HD-SS	18-7777-1	511	104211-77010	18-6930	679	129242-77010	18-6932	679
LUB-20W40-FC-12	18-9450-2	208, 214	104211-77011	18-6930	679	129429-77010	18-6939	679
LUB-2STRK-M1-4	18-9530-3	208, 214	104500-55710	18-79960	161, 687	129429-77011	18-6939	679
LUB-2STRK-M1-55	18-9530-7	208, 214	114361-77011	18-6936	679	129470-77200	18-6927	678
LUB-MRNLG-KT-10	18-9393	539	114362-77010	18-6936	679	129470-77200	18-6970	Obsolete
LUB-MRNMD-KT-10	18-9391	539	114362-77011	18-6936	679	129573-77010	18-6880	679
LUB-MRNMR-KT-10	18-9392	539	114399-77010	18-6936	679	129612-77230	18-6926	678
LUB-MRNSM-KT-10	18-9390	539	119209-77010	18-6931	679	129698-77010	18-6932	679
MAR-10171-00-10	18-7924	512	119225-77010	18-6935	679	171008-77010	18-6880	679
MAR-10171-30-00	18-7606	516	119225-77011	18-6935	679	192470-42530	18-3277	974
MAR-24563-00-00	18-7919	512	119226-77010	18-6935	679	192470-42532	18-3277	974
MAR-FLTHD-AL-12	18-7853-1	511	119350-35150	18-7910-1	203, 689	27210-200200	18-6200	688
MAR-FLTHD-SS-12	18-7777	511	119350-35151	18-7910-1	203, 689	27210-200300	18-6201	688
MAR-FUELF-IL-TR	18-7866	512	119573-77200	18-6927	678	424610-77010	18-6934	679
MAR-MINIF-IL-TR	18-7865	512	119573-77200	18-6929	678	728170-92600	18-55500	688
MAR-MINIF-LT-AS	18-7965-1	512	119573-77201	18-6927	678	728171-92601	18-55501	688
MAR-SEPAR-AT-OR	18-7852-1	511	119573-77201	18-6929	678	728271-92605	18-55502	688
MAR-SEPAR-AT-OR	18-7966-1	511	119574-42550	18-45714	688	119836-77200-2	18-6926	678
MAR-SPRTR-HD-SS	18-7984-1	511	119574-42552	18-45714	688	119836-77200-3	18-6926	678
N26-13440-00-00	18-7954	538	119773-77010	18-6938	679	119773-42600-00	18-3306	575
N26-13440-02-00	18-7954	538	119773-77200	18-6849	678	128170-77010D	18-6937	679
YB-6AW04-1	18-9133-9	225, 517	119836-77200	18-6926	678	8M0095471	18-55510	713
YB-6AW04-3	18-9146-9	225, 517	121120-77010	18-6931	679	34093	23-2800	138
YB-6AW04-A	18-9145	225, 517	121120-77011	18-6931	679	34113	23-2701	Obsolete
YB-ACC04	18-79815	228	121120-77012	18-6931	679	35610	23-2801	138
YSC-10231-20-0C	18-7824-2	204, 667	121254-77010	18-6939	679	42201	23-2804	138
YSC-10260-00-0C	18-15111	1005	121254-77011	18-6939	679	140, 275	18-8005-10EP-1	162
YSC-12190-00-AC	18-2909	1005	121254-77012	18-6939	679	140, 275, 464	18-8004-10EP-1	162
YSC-13080-00-0C	18-0164	1005	121254-77019	18-6939	679	175158+437228	18-7044-1	290
YSC-13231-20-0C	18-7824-2	1005	121370-77010	18-6932	679	RK350-02	18-99202	160
YSC-14231-20-0C	18-7876-1	204, 1005	123500-77010	18-6934	679			
YSC-16231-20-0C	18-7875	204, 1005	124223-42092	18-8950	687			
YSC-22260-00-0C	18-15109	Obsolete	124450-35100	18-7910-1	203, 689			

SIERRA #	PAGE #	SIERRA #	PAGE #	SIERRA #	PAGE #	SIERRA #	PAGE #
GAUGES							
1507678P	22	62542P	2, 7	65670P	2, 10	69073FP	14
1508370P	Obsolete	62543P	2, 7	65670PH	10	69074FP	14
1827871P	23	62546P	2, 7	65671P	2, 10	69268P	Obsolete
18-5896	20, 412	62546PH	7	65692P	2, 10	69269P	21
18-5897	20	62547P	2, 7	65693P	2, 10	69270P	21
18-5898	20	62548P	2, 7	66956P	3, 12	69380P	21
18-5899	20	62549P	2, 7	67019P	3, 14	69381P	21
18-7513	20, 972	62550P	2, 7	67020P	3, 14	69703P	12
20000P	19	62551P	2, 7	67021P	3, 14	69704P	12
20010P	19	62555P	2, 7	67022P	3, 14	69708P	15
21000P	19	62561P	2, 7	67023P	3, 14	69709P	15
21010P	19	62565P	2, 7	67285P	3, 14	69710P	16
22000P	20	62715P	6	67363P	3, 14	69711P	16
22010P	20	62718P	2, 6	67364P	3, 14	69712P	17
22020P	20	62719P	2, 6	67365P	3, 14	69713P	17
26000P	19	62720P	2, 6	67382P	3, 14	69716P	12
56353P	22	62721P	2, 6	67437P	22	69717P	12
56966P	21, 139	62722P	2, 6, 7	67457P	22	69721P	15
56967P	21, 139	62723PH	6	67653P	9	69722P	15
56968P	21	62724P	2, 6, 7	67654P	7	69723P	16
56969P	21	62725P	2, 6	67657P	2, 7	69724P	16
56973P	22	62726P	2, 6, 7	67669P	9	69725P	17
57897P	15	62727P	2, 6	67855P	3, 14	69726P	17
57898P	3, 15	62728P	2, 6, 7	68356P	3, 15	69743P	Obsolete
57898PH	15	62729P	2, 6, 7	68357P	3, 15	69870P	3, 12
57899P	3, 15	62730P	2, 6	68358P	3, 15	69992D	Obsolete
57899PH	15	62748P	2, 6	68359P	3, 15	69993D	4
57900P	3, 15	62952P	2, 11	68361P	3, 15	69994D	4
57900PH	15	62960P	2, 11	68362P	15	69995K	4
57901P	3, 15	63076P	3, 12	68363P	15	69996K	4
57902P	3, 15	63076PH	12	68364P	3, 16	69997K	4
57903P	3, 15	63473P	3, 13	68365P	3, 16	69998K	Obsolete
57904P	3, 15	63474P	3, 13	68366P	3, 16	69999K	4
57905P	3, 15	63475P	3, 13	68367P	3, 16	70000D	4
57929P	3, 15	63475PH	13	68369P	16	70001D	4
58255P	3, 15	63476P	3, 13	68370P	3, 16	70002D	4
58342P	3, 15	63476PH	13	68371P	3, 16	70003D	4
58342PH	15	63477P	3, 13	68372P	3, 16	70004D	4
58431P	3, 15	63478P	3, 13	68373P	3, 16	70005D	4
58862P	3, 15	63479P	3, 13	68374P	3, 16	70006D	4
58935P	3, 15	63480P	3, 13	68375P	3, 16	781-294-060P	2, 5, 8
59416P	2, 9	63481P	3, 13	68376P	3, 16	781-310-035P	2, 5, 9
59653P	2, 9	63482P	3, 13	68377P	3, 16	781-310-060P	2, 5, 9
59654P	2, 9	63483P	3, 13	68378P	3, 16	781-579-035P	3, 5, 15
59655P	2, 9	63523P	2, 9	68379P	3, 16	781-579-060P	3, 5, 15
59656P	2, 9	63585P	3, 13	68380P	3, 16	781-579-080P	3, 5, 15
59657P	2, 9	64475P	3, 13	68381P	3, 16	781-625-035P	2, 5, 7
59677P	22	64477FP	2, 10	68383P	3, 16	781-625-080P	2, 5, 7
59703P	3, 12	65129P	2, 10	68384P	3, 16	781-625-120P	2, 5, 7
59704P	3, 12	65205P	3, 15	68385P	3, 16	781-627-035P	2, 5, 6, 7
59704PH	12	65206SSP	2, 10	68387P	16	781-627-060P	2, 5, 6
59705P	3, 12	65481P	12	68388P	16	781-627-080P	2, 5, 6
59706P	3, 12	65485P	12	68389P	3, 17	781-627-120P	2, 5, 6
59707P	3, 12	65495P	2, 10	68390P	3, 17	781-683-035P	3, 5, 16
59708P	3, 12	65496P	2, 10	68391P	3, 17	781-683-060P	3, 5, 16
59709P	3, 12	65497P	2, 10	68392P	3, 17	781-683-080P	3, 5, 16
59713P	2, 9	65498P	2, 10	68393P	3, 17	781-684-035P	3, 5, 17
59737P	2, 9	65501P	2, 10	68394P	3, 17	781-684-060P	3, 5, 17
61163P	3, 12	65502P	2, 10	68395P	3, 17	781-684-080P	3, 5, 17
61238P	3, 15	65503P	2, 10	68396P	3, 17	80131P	3, 18
61546P	2, 11	65504P	2, 10	68397P	3, 17	80134P	3, 18
61547P	2, 11	65505P	2, 10	68398P	3, 17	80150P	3, 18
61548P	2, 11	65506P	2, 10	68399P	3, 17	80180P	3, 18
61549P	2, 11	65507P	2, 10	68400P	3, 17	80181P	3, 18
61550P	2, 11	65508P	2, 10	68401P	3, 17	80514P	Obsolete
61551P	2, 11	65509P	2, 10	68402P	3, 17	80514PH	Obsolete
61552P	2, 11	65510P	2, 10	68403P	3, 17	80590P	3, 18
61748P	3, 15	65524P	2, 8	68404P	3, 17	80593P	18
61751P	2, 10	65525P	2, 8	68405P	3, 17	80596P	18
61751PH	10	65526P	2, 8	68406P	3, 17	80710P	3, 18
61752FP	2, 9	65529P	2, 8	68408P	3, 17	80712P	18
61752P	2, 10	65530P	2, 8	68409P	3, 17	80730P	Obsolete
61752PH	10	65531P	2, 8	68410P	3, 17	82288P	3, 18
61826P	3, 12	65535P	2, 8	68412P	17	82301P	18
61826PH	12	65536P	2, 8	68413P	17	82302P	3, 18
61886P	23	65537P	2, 8	68443P	3, 15	82303P	3, 18
61901P	3, 12	65545P	2, 8	68755P	5	82760P	3, 18
61908P	3, 12	65547P	2, 8	68960P	3, 14	84760P	3, 15
62369P	3, 12	65548P	2, 8	68960PH	14	FS45430	23, 64
62375P	2, 11	65550P	2, 8	68982P	5	IA55009	23
62538P	2, 7	65551P	2, 8, 10	69044P	15	IA62995	23
62540P	2, 7	65553P	2, 8, 10	69053P	5	IA65476	Obsolete

SIERRA #	PAGE #	SIERRA #	PAGE #	SIERRA #	PAGE #	SIERRA #	PAGE #
GAUGES							
IA65477	21	OP22900	20	TS25101	20	TS26641	20
IH14767	22	OP24301	20	TS26611	20	TS26651	20
IH15105	22	OP24891	20	TS26621	20		
OP22891	20	OP72533	20	TS26631	20		
SIERRA SWITCH & ELECTRICAL							
95001	76	CB40250	64	EA01090	77	EC10250	74
95002	76	CB40260	64	EA01100	77	EC63120	73
95004	76	CB40270	64	EC01310	75	EC63130	73
95005	76	CB40280	64	EC01350	75	EC63140	73
95006	76	CB41100	64	EC01360	S/S to EC1380	EC63190	73
95011	76	CB41200	64	EC01370	74	EC63200	73
95013	76	CB41210	64	EC01380	74	EC63720	73
95016	76	CB41210B	64	EC01440	74	EC63240	73
95026	76	CB41220	64	EC01450	74	EC63250	73
18-1100	Obsolete	CB41230	64	EC01460	74	EC63260	73
18-1105	72	CB41240	Obsolete	EC01570	74	EC63300	73
18-1106	72	CB42240	64	EC01620	74	EC63720	73
18-1107	72	CB41250	64	EC01630	74	EC64000	73
18-1109	72	CB41260	64	EC01750	74	EC64110	73
18-1110	Obsolete	CB41270	64	EC04000	74	EC64110-100	73
18-1175	72	CB42250-1	64	EC04000-100	74	EC64230	73
18-1176	72	CB43240	64	EC04010	73	EC64230-100	73
18-1177	Obsolete	CB43250	64	EC04010-100	73	FS22080	Obsolete
18-1178	Obsolete	CB45240	Obsolete	EC04020	73	FS22082	64
18-1199	72	CB45250	64	EC04020-100	73	FS35870	63
18-1282	32, 281	CB50300	65	EC04030-100	73	FS35872	63
18-1294	Obsolete	CB50310	65	EC04040-100	Obsolete	FS40410	58
18-3746	72	CB50320	65	EC04050	74	FS40412	58
18-3747	72	CB50330	65	EC04050-100	74	FS40420	58
18-3748	554	CB50340	65	EC04070-100	74	FS40422	58
18-5840	585, 596, 617,	CB50350	65	EC04080	74	FS40430	58
18-5894	716, 898	CB50360	65	EC04080-100	74	FS40432	58
18-79987	Obsolete	CB50370	65	EC04090	74	FS40440	58
18-79988	Obsolete	CB50380	65	EC04090-100	74	FS40442	58
AP10010	78	CB50390	65	EC04100	74	FS40450	58
AP10020	78	CB50400	65	EC04100-100	74	FS40452	58
AV10030	50	CB50410	65	EC04110	74	FS40500-1	56
AV10030B	50	CB50420	65	EC04110-100	74	FS40502-1	56
AV10030G	50	CB50430	65	EC04120	73	FS40510-1	56
AV10030R	50	CB50440	65	EC04120-100	73	FS40512-1	56
AV10030W	50	CB50450	65	EC04130	73	FS40520-1	56
AV10040	50	CB50460	65	EC04130-100	73	FS40522-1	56
AV10040B	50	CB50470	65	EC04140	73	FS40530-1	56
AV10040G	50	CB50480	65	EC04140-100	73	FS40540-1	57
AV10040R	50	CB50490	65	EC04150	74	FS40542-1	57
AV10040W	50	CB50500	65	EC04150-100	74	FS40550-1	57
AV10050R	50	CB50510	65	EC04160-100	74	FS40552-1	57
AV10060R	50	CB50520	65	EC04170	74	FS40560-1	57
AV10060B	50	CB50530	65	EC04170-100	74	FS40562-1	57
AV10060G	50	CB50540	65	EC04180	74	FS40570-1	57
AV10060W	50	CB50550	65	EC04180-100	74	FS40572-1	57
AV10100R	50	CB50560	65	EC04190	73	FS40590-1	56
AV10100B	50	CB50570	65	EC04190-100	73	FS40592-1	56
AV10120B	50	CB50580	65	EC04200	73	FS40600-1	56
AV10130B	50	CB50590	65	EC04200-100	73	FS40602-1	56
BA58003	78	CB50600	65	EC04210	74	FS40610-1	56
BA58010	78	CB50610	65	EC04210-100	74	FS40612-1	56
BA58020	78	CB50620	65	EC04220	74	FS40630-1	57
BA58050	Obsolete	CB50630	65	EC04220-100	74	FS40632-1	57
BC88523	78	CB50640	65	EC04230	74	FS40640-1	57
BC88533	78	CB50650	65	EC04230-100	74	FS40642-1	57
BC88543	78	CB50660	65	EC04240	73	FS40650-1	57
BC88553	78	CB50670	65	EC04240-100	73	FS40652-1	57
BC88563	78	CB60000-1	65	EC04250	73	FS40660	59
BC88573	78	CB60002-1	65	EC04250-100	73	FS40662	59
BC88583	78	CB60012	Obsolete	EC04260	73	FS40670	59
BC88593	78	CL49300	76	EC04260-100	73	FS40672	59
BS11000	72	CL49310	76	EC04280	74	FS40680	59
BS11010	72	CL49320	76	EC04280-100	Obsolete	FS40682	59
BS11020	72	CL49330	76	EC04300	73	FS40690	59
BS11030	72	CL49330KA	76	EC04300-100	73	FS40692	59
BS11040	71	CL52422	76	EC04490	74	FS40720	62
BS11050	71	EA01000	77	EC04490-100	74	FS40722	62
BT44430	78	EA01010	77	EC04500	74	FS40730	58
CB40190	64	EA01020	77	EC04500-100	74	FS40732	58
CB40200	64	EA01040	77	EC04710-100	73	FS40740	58
CB40220	64	EA01050	77	EC04720-100	73	FS40742	58
CB40230	64	EA01070	77	EC06230	Obsolete	FS40750	62
CB40240	64	EA01080	Obsolete	EC09040	75, 234	FS40752	62
				EC09090	Obsolete	FS40830	57

SIERRA #	PAGE #	SIERRA #	PAGE #	SIERRA #	PAGE #	SIERRA #	PAGE #
SIERRA SWITCH & ELECTRICAL							
FS40840	57	FS79060	53	MP39012	28	MP39670	52
FS40800	57	FS79070	53	MP39020	28	MP39672	52
FS40820	57	FS79090	53	MP39022	28	MP39680	52
FS40810	57	FS79100	53	MP39030	48	MP39682	52
FS40900	58	FS79110	53	MP39032	48	MP39690	52
FS40910	58	FS79120	53	MP39040	31	MP39692	52
FS40920	58	FS79130	53	MP39042	31	MP39700-1	26
FS45350	63	FS79140	53	MP39060-1	27	MP39702-1	26
FS45352	63	FS79150	53	MP39062-1	27	MP39710-1	29
FS45360	63	FS79160	53	MP39070	26	MP39712-1	29
FS45362	63	FS79170	53	MP39072	26	MP39720-1	29
FS45380	63	FS79180	53	MP39080-1	27	MP39722-1	29
FS45382	63	FS79190	53	MP39082-1	27	MP39730	29
FS45390	63	FS79200	53	MP39090	31	MP39732	29
FS45392	63	FS79210	53	MP39092	31	MP39740-1	30
FS45400	63	FS79220	53	MP39100	31, 281	MP39742-1	30
FS45402	63	FS79270	53	MP39102	31	MP39760	30
FS45410	63	FS79280	53	MP39120	27	MP39762	30
FS45412	63	FS79470	53	MP39122	27	MP39770	28
FS45430	23, 64	FS79480	54	MP39140	53	MP39772	28
FS45432	64	FS79490	54	MP39142	53	MP39780	27
FS45440	63	FS79500	54	MP39160	50, 496	MP39782	27
FS45442	63	FS79510	54	MP39162	50	MP39800	26
FS45460	63	FS79520	54	MP39180	Obsolete	MP39802	26
FS45462	63	FS79530	54	MP39182	50	MP39820-1	28
FS45470	63	FS79540	54	MP39190	32	MP39822-1	28
FS45472	63	FS79550	54	MP39200	28	MP39830	31
FS45620	61	FS79560	54	MP39202	28	MP39832	31
FS45622	61	FS79570	54	MP39210	68	MP40950	32
FS45630	61	FS79580	54	MP39220	48	MP40960	32
FS45632	61	FS79590	54	MP39222	48	MP40962	32
FS45640	61	FS79600	Obsolete	MP39240-1	48	MP40970-1	32
FS45642	61	FS79630	53	MP39242	48	MP40972-1	32
FS45650	61	FS79680	54	MP39260	53	MP40980	32
FS45652	61	FS79690	54	MP39262	53	MP40982	32
FS46100	60	FS79820	53	MP39270	32	MP40990	32
FS46102	60	FS79870	53	MP39280	48	MP40992	32
FS46150	60	FS80000	54	MP39282	48	MP41000	383
FS46152	60	FS80010	54	MP39300	52	MP41002	30
FS46200	60	FS80030	54	MP39302	52	MP41010	29
FS46202	60	FS80040	54	MP39310	51	MP41012	29
FS46250	60	FS80050	54	MP39312	51	MP41020	27
FS46252	60	FS80060	54	MP39320	51	MP41022	27
FS46300	61	FS80070	54	MP39322	51	MP41030	28
FS46302	61	FS80080	54	MP39340	51	MP41032	28
FS46350	61	FS80090	54	MP39342	51	MP41040	26
FS46352	61	FS81000	Obsolete	MP39350	53	MP41042	26
FS46400	60	FS81010	54	MP39352	53	MP41070-2	383
FS46402	60	FS81020	54	MP39360	52	MP41072-2	30
FS46450	60	FS81030	54	MP39362	52	MP41080	29
FS46452	60	FS81040	54	MP39380	49	MP41082	29
FS46551	61	FS81050	54	MP39382	49	MP41090-1	30
FS46552	61	FS81060	Obsolete	MP39390	49	MP41092-1	30
FS46540	62	FS81080	54	MP39390B	49	MP41400	68
FS46561	61	FS81082	54	MP39392	49	MP49410-1	75
FS46562	61	FS82000	56	MP39392B	49	MP49412	75
FS46570	62	FS82010	56	MP39410	52	MP49430	75
FS46580	62	FS82020	56	MP39412	52	MP49432	75
FS46590	62	FS82030	56	MP39420	52	MP49500	76
FS46600	59	FS82040	56	MP39422	52	MP50560	Obsolete
FS46610	59	FS82050	56	MP39510	51	MP50562	75
FS46620	59	FS82060	56	MP39512	51	MP51010	25, 481
FS46630	59	FS82070	56	MP39520	51	MP51012	25, 481
FS46660	59	FSC46100	62	MP39522	51	MP51020	25, 496
FS46670	59	FSC46200	62	MP39530	51	MP51022	25, 496
FS46680	60	FSC46300	62	MP39532	51	MP51030	25, 496
FS46690	60	FSC46400	62	MP39540	51	MP51032	25, 496
FS46700	60	FSC46550	62	MP39542	51	MP51040	25, 497
FS46710	60	FSC46560	62	MP39570	51	MP51042	25, 497
FS56152	59	MC33502	68	MP39572	51	MP51050	25, 497
FS56232	58	MP21460	50	MP39580	49	MP51052	25, 497
FS56242	58	MP21462	50	MP39582	49	MP51090	25, 31, 383
FS56252	58	MP28850	32	MP39590	49	MP51092	25, 31, 383
FS69100	63	MP28860	32, 497	MP39592	49	MP52000	25, 31, 383
FS69110	Obsolete	MP28870	32	MP39600	49	MP52002	25, 31, 383
FS69120	63	MP28872-1	32	MP39602	49	MP59012	33
FS69130	63	MP28880	32	MP39610	51	MP59032	33
FS69140	63	MP28890	32	MP39612	51	MP59042	33
FS69150	63	MP28900	32	MP39620	Obsolete	MP59102	33
FS69160	63	MP28902-1	32	MP39622	49	MP59122	33
FS69170	63	MP38910	71	MP39640	49	MP59132	33
FS69180	63	MP39010	28	MP39642	49	MP59162	33

SIERRA #	PAGE #	SIERRA #	PAGE #	SIERRA #	PAGE #	SIERRA #	PAGE #
SIERRA SWITCH & ELECTRICAL							
MP78372	33	RK19500K	43	RK40402	43	TG19542-1	47
MP78710	33	RK19510K	43	RK40470	42	TG19560-1	47
MP78712	33	RK19520K	43	RK40472	42	TG19562-1	47
MP78720	33	RK19530K	43	RK40480	42	TG21020-2	47
MP78722	33	RK19540-1	41	RK40482	42	TG21022-1	Obsolete
MP78730	33	RK19550-1	41	RK40610B	36	TG21040	47
MP78740	33	RK19570	42	RK40610G	36	TG21042	47
MP78800	33	RK19572	42	RK40620B	36	TG21050-1	47
MP78802	33	RK19630	44	RK40620G	36	TG21052-1	47
MP78820	33	RK19632	44	RK40630B	36	TG21070	47
MP78822	33	RK19640	44	RK40630G	36	TG21072	47
MP78830	33	RK19642	44	RK40640B	36	TG21080	47
MP78860	33	RK19680	39	RK40640G	36	TG21082	47
MP78870	33	RK19680TP	39	RK40650B	36	TG21130	48
MP78872	33	RK19690	39	RK40650G	36	TG21132	48
MP78910	33	RK19690TP	39	RK40660B	36	TG21140	48
MP78912	33	RK19700	40	RK40660G	36	TG21142	48
MP78942	33	RK19700TP	40	RK40670B	36	TG21360	48
MP78950	33	RK19710TP	39	RK40670G	36	TG21362	48
MP78952	33	RK19720	39	RK40680B	36	TG21390	48
MP78960	33	RK19730TP	40	RK40680G	36	TG21392	48
MP78962	33	RK19740	40	RK40690B	36	TG21500	47
MP79740	33	RK19750TP	39	RK40690G	36	TG21502	47
MP79742	33	RK19760	39	RK40700B	36	TG21590	Obsolete
MP79760	33	RK19770TP	40	RK40700G	36	TG21592	47
MP79762	33	RK19780	40	RK40800	34	TG21600	47
N-186913	63	RK19810TP	40	RK40810	34	TG21602	47
OP22891	20	RK19820	40	RK40820	34	TG22000	46
OP22900	20	RK19830TP	40	RK40830	34	TG22002	46
PC51000	67	RK19840	40	RK40840	34	TG22010	46
PC51010	67	RK19850TP	39	RK40850	34	TG22012	46
PC51020	67	RK19860	39	RK40860	34	TG22020	46
PC51030	67	RK19870TP	39	RK40870	34	TG22022	46
PC51040	67	RK19880	39	RS20000	34	TG22030	46
PC51050	67	RK19890TP	40	RS20010	34	TG22032	46
PC51060	67	RK19910	40	RS20020	34	TG22040	46
PC51070	67	RK19920-1	Obsolete	RS20030	34	TG22042	46
PC51080	67	RK19930-1	41	RS20040	34	TG23000	46
PC51090	67	RK19940-1	41	RS20050	34	TG23002	46
PC51100	67	RS20180	35	RS20060	34	TG23010	46
PC51110	67	RS20190	35	RS20180	35	TG23012	46
PC51120	67	RS20200	35	RS20190	35	TG23020	46
PC51130	67	RK21420	44	RS20200	35	TG23022	46
PC51140	67	RK21430	44	SP21000	35	TG23030	46
PC51150	67	RK21880	44	SP21002	35	TG23032	46
PC51160	67	RK22100	39	SP21010	35	TG23040	46
PC51170	67	RK22110	39	SP21012	35	TG23042	46
RK19000	37	RK22120	40	SP21020	35	TG23050	46
RK19010	37	RK22130	40	SP21022	35	TG23052	46
RK19020	37	RK22140	40	SP21030	35	TG40000	47
RK19030	37	RK22150	40	SP21032	35	TG40002	47
RK19040	37	RK22160	41	TC42834	69	TG40010	46
RK19050	37	RK22170	41	TC42884	Obsolete	TG40012	46
RK19060	37	RK22180	38	TC42894	69	TG40020-1	45
RK19070	37	RK22190	38	TC42904	69	TG4002252	45
RK19080	37	RK22200	38	TC42914	Obsolete	TG40030-1	45
RK19090	37	RK22290	38	TC43504	69	TG4003252	45
RK19100	37	RK40100	42	TC43604	69	TG40040-1	45
RK19110	37	RK40102	42	TC43614	Obsolete	TG4004252	45
RK19120	37	RK40110	42	TC43624	69	TG40050-1	45
RK19130	37	RK40112	42	TC43634	69	TG4005252	45
RK19140	37	RK40120	42	TC43654	68	TG40060	45
RK19150	37	RK40122	42	TC43744	68	TG40062	45
RK19160	37	RK40130	42	TC43754	68	TG40070	45
RK19170	37	RK40132	42	TC43904	Obsolete	TG40072	45
RK19210	38	RK40140	42	TC43944	69	TG40080	45
RK19220	38	RK40142	42	TC44054	68	TG40082	45
RK19230	38	RK40150	42	TC44094	68	TG40090	45
RK19240	38	RK40152	42	TC44224	68	TG40092	45
RK19310	38	RK40170	42	TC44254	68	TG40160-1	45
RK19320	38	RK40172	42	TC44984	69	TG4016252	45
RK19400-1	41	RK40350	42	TC50000	69	TG40300	45
RK19410-1	41	RK40352	42	TC51000	68	TG40302	45
RK19410-RED	41	RK40360	42	TC51100	68	TG40310	45
RK19420-1	41	RK40362	42	TC51200	Obsolete	TG40312	45
RK19430-1	41	RK40370	43	TC51300	69	TG40320	45
RK19440-1	41	RK40372	43	TC52000	Obsolete	TG40322	45
RK19450-1	41	RK40380	Obsolete	TG19520	45	TG40330	45
RK19460-1	41	RK40382	43	TG19522	45	TG40332	45
RK19480-1	41	RK40390	43	TG19530	45	TG40340	45
RK19490-1	41	RK40392	43	TG19532	45	TG40342	45
		RK40400	43	TG19540-1	47		

SIERRA #	PAGE #	SIERRA #	PAGE #	SIERRA #	PAGE #	SIERRA #	PAGE #
SIERRA SWITCH & ELECTRICAL							
TG40450-1	45	UN42000	53				
TG4045252	45	UN42002	53				
TG40460-1	45	UN77310	71				
TG4046252	45	WH10003	68				
TG40490	45	WH10040	71				
TG40492	45	WH10220	71				
TS25101	20	WH10230	71				
UN12140	27	WH10240	71				
UN12142	27	WH10300	69				
UN19700	44	WH10310	69				
UN19710	44	WH10320	Obsolete				
UN19720	44	WH10350	68				
UN19730	44	WH10470-1	70				
UN19740	44	WH10480-1	70				
UN19750	44	WH10490-1	70				
UN21280	52	WH10500-1	70				
UN21282	52	WH10520-1	70				
UN21290	52	WH10530-1	70				
UN21292	52	WH10540-1	70				
UN21320	52	WH10550-1	70				
UN21322	52	WH10560	70				
UN22100	52	WH10570	70				
UN22102	52	WH10600-1	70				
UN22110	52	WH10602-1	70				
UN22112	52	WH10610-1	70				
UN22120	52	WH10612-1	70				
UN22122	52	WH10640	70				
UN22150	52	WH10650	70				
UN22152	52						
UN22160	52						
UN22162	52						

SHIELDS

16-14X1X10	129	SERIES 150	99				
16-14X2X10	129	SERIES 151	129				
16-18X1X10	129	SERIES 157	86				
16-18X2X10	129	SERIES 160	91				
16-38X1X10	129	SERIES 162	91				
16-38X2X10	129	SERIES 163	91				
18-4456	867	SERIES 164	101				
18-4457	867	SERIES 168	101				
18-4458	126	SERIES 200	92, 116				
18-800-1120	110	SERIES 202	93, 117				
18-801-1120	110	SERIES 220	124				
18-802-1120	110	SERIES 220S	122				
18-803-1120	110	SERIES 221	124				
18-806-1120	110	SERIES 245	124				
18-9093	112	SERIES 245S	123				
18-9095	112	SERIES 250	94, 113, 118				
18-9761B	128	SERIES 252	95, 119				
18-9761G	128	SERIES 254	85				
18-9761W	128	SERIES 262	91, 119				
18-9883B	128	SERIES 272	122				
18-9883G	128	SERIES 274	122				
18-9883W	128	SERIES 290	125				
18-J662-XXX	108	SERIES 290S	123				
18-J664-XXX	108	SERIES 291	125				
N14NEO60	129	SERIES 309	102				
18-4456	867	SERIES 315	102				
18-4457	867	SERIES 321	107				
18-4458	126	SERIES 337	103				
N18NEO60	129	SERIES 350	104				
N316NEO60	129	SERIES 351	104				
N38NEO60	129	SERIES 355	105				
SERIES 101	110	SERIES 365	105				
SERIES 105	110	SERIES 357	86				
SERIES 120	87	SERIES 368	106				
SERIES 123	87	SERIES 369	106				
SERIES 126	128	SERIES 375	86				
SERIES 128	127	SERIES 400	114				
SERIES 129	127	SERIES 402	114				
SERIES 130	91	SERIES 420	114				
SERIES 135	91	SERIES 450	115				
SERIES 140	91	SERIES 460	115				
SERIES 141	89, 98	SERIES 500	108				
SERIES 142	88	SERIES 502	108				
SERIES 144	111	SERIES 600	108				
SERIES 146	89, 111	SERIES 601	108				
SERIES 147	88	SERIES 700	108				
SERIES 148	90, 100, 112	SERIES 710	126				
SERIES 149	90, 99	SERIES 720	126				

SIERRA #	O.E.M.	O.E. #	PAGE #	SIERRA #	O.E.M.	O.E. #	PAGE #
GENERATOR PARTS							
18-9400-2			139	23-3658	Westerbeke	24688 & 33966	137
18-9410-2			139	23-3659	Westerbeke	37387 & 37922	137
18-9420-2			139	23-3660	Westerbeke	24690 & 33373	137
18-9553-2			139	23-3661	Westerbeke	35736 & 40434	137
23-0400	Northern Lights		133	23-3662	Westerbeke	24688 & 40434	137
23-0800	Westerbeke	42260	135	23-3663	Kohler	267717 & 267718	Obsolete
23-0801	Westerbeke	46124	135	23-3664	Kohler	249930 & 29963	137
23-0802	Westerbeke	34196	135	23-3665	Kohler	252896 & 229432	137
23-0803	Westerbeke	33417	135	23-3666	Kohler	352018 & 352031	137
23-0804	Westerbeke	33373	135	23-4000	Westerbeke	39181	140
23-0805	Westerbeke	40434	135	23-4001	Westerbeke	11672	140
23-0806	Westerbeke	24323	135	23-4002	Westerbeke	30592	Obsolete
23-0807	Westerbeke	33966	135	23-4003	Westerbeke	45232	140
23-0808	Westerbeke	37922	135	23-4004	Westerbeke	30475	140
23-0809	Kohler	267718	135	23-4005	Westerbeke	13810	133
23-0810	Kohler	229432	135	23-4006	Westerbeke	31152	134
23-0811	Kohler	249865	135	23-4007	Westerbeke	30376	134
23-0812	Kohler	229433	136	23-4500	Westerbeke	43060	Obsolete
23-0813	Kohler	229963	136	23-4501	Westerbeke	46596	138
23-0814	Kohler	352031	136	23-5600	Westerbeke	30593	140
23-0830	Northern Lights	11-10015	136	23-5800	Westerbeke	24639	140
23-1000	Westerbeke	24353	131	23-5840	Westerbeke	35109	131
23-1100	Kohler	267709	130	23-5880	Westerbeke	24132	131
23-1101	Westerbeke	39705	130	23-6400	Kohler	260085	140
23-1102	Northern Lights	24-22009	130	23-6400	Westerbeke	11885	140
23-1103	Northern Lights	24-28003	130	23-6401	Onan	130-4434	140
23-1104	Fischer Panda	IC78.460.000B	130	23-6402	Onan	130-6228	140
23-1105	Fischer Panda	IC78.460.000A	130	23-7200	Westerbeke	36450	130
23-1130	Kohler	278857	130	23-7201	Westerbeke	38100	130
23-2000	Sherwood	10077K	132	23-7202	Kohler	GM24510	130
23-2001	Johnson Pump	09-808B-1	132	23-7720	Onan	149-1445	131
23-2002	Kohler	229826	132	23-7720	Westerbeke	35920	131
23-2002	Sherwood	09000K	132	23-7740	Kohler	252898	130
23-2003	Jabsco	22799-0001	132	23-7750	Onan	149-0428	131
23-2003	Kohler	250872	132	23-7751	Kohler	229715	130
23-2004	Kohler	359978	132	23-7760	Onan	149-2106	131
23-2005	Northern Lights	25-12009	132	23-7760	Onan	A026K278	131
23-2700	Westerbeke	40859	137	23-7761	Kohler	GM32359	131
23-2701		34113	Obsolete	23-7762	Kohler	26987	131
23-2702	Westerbeke	35608	137	23-7764	Westerbeke	24363	131
23-2703	Westerbeke	46592	137	23-7770	Westerbeke	30200	131
23-2800		34093	138	23-7770	Westerbeke	47060	131
23-2801		35610	138	23-7771	Kohler	249433	131
23-2802	Westerbeke	40860	138	23-7780	Kohler	GM34570	131
23-2803	Westerbeke	43050	138	23-7800	Westerbeke	36918	138
23-2804		42201	138	23-7801	Westerbeke	35595	Obsolete
23-3300	Onan	132-0349	132	23-7802	Westerbeke	48076	138
23-3301	Westerbeke	11907	132	23-7803	Kohler	326817	Obsolete
23-3302	Westerbeke	33112	132	23-7804	Onan	185-7444	138
23-3303	Kohler	229826	132	23-7820	Kohler	279449	138
23-3304	Kohler	229955	132	23-7821	Kohler	359771	139
23-3305	Westerbeke	32620	132	23-7822	Kohler	229678	139
23-3306	Westerbeke	46622	133	23-7823	Kohler	267714	139
23-3307	Westerbeke	34440	133	23-7824	Kohler	GM47465	139
23-3308	Kohler	352122	133	23-7825	Westerbeke	35828	139
23-3309	Onan	132-0436	133	23-7826	Westerbeke	40154	139
23-3310	Onan	541-1519	133	23-7840	Onan	122-0810	139
23-3311	Fischer Panda	J009-46840	133	23-7841	Onan	122-0185	139
23-3312	Fischer Panda	J009-1027B-1	133	23-7842	Onan	185-5835	139
23-3313	Westerbeke	33104	133	56966P			21, 139
23-3314	Kohler / Sherwood	359978	133	56967P			21, 139
23-3315	Northern Lights	25-12009	133				
23-3600	Westerbeke	26488	134				
23-3601	Westerbeke	35736	134				
23-3602	Westerbeke	37387	134				
23-3603	Westerbeke	39378	134				
23-3604	Westerbeke	46097	134				
23-3605	Westerbeke	24690	134				
23-3606	Onan	309-0130	134				
23-3607	Kohler	352018	134				
23-3608	Kohler	249930	134				
23-3609	Kohler	252896	134				
23-3650	Westerbeke	24688 & 24323	136				
23-3651	Westerbeke	35736 & 34196	136				
23-3652	Westerbeke	35736 & 33417	136				
23-3653	Westerbeke	24688 & 34196	136				
23-3654	Westerbeke	39378 & 42260	136				
23-3655	Westerbeke	39378 & 46124	136				
23-3656	Westerbeke	46097 & 33417	136				
23-3657	Westerbeke	24690 & 33417	136				

1 This product is priced per piece. To order, priced per package, please add -9 to the part number
 2 Items ending in "D" are display packaged - regular number is non-display - 3 For discount shop pack of 10, please add -10 to the part number

SIERRA #	O.E.M.	O.E. #	PAGE #	SIERRA #	O.E.M.	O.E. #	PAGE #
4701			579	18-01312			236
4702			Obsolete	18-01313			236
4703			Obsolete	18-01314			236
4705			Obsolete	18-0133	Mercury Marine	27-52892	441
4711			579	18-0133	Mercury Marine	27-73665	441
4712			579	1 18-0134	OMC	327707	330
4713			579	18-0135	Mercury Marine	27-78246	443
4714			Obsolete	18-0135	Mercury Marine	27-782461	443
4715			Obsolete	18-0136	OMC	328283	333
4720			579	18-0137	Mercury Marine	27-85492-2	441
4721			579	18-0138	OMC	328590	333
4722			Obsolete	18-0139	Mercury Marine	27-76589	443
4723			Obsolete	18-0139	Mercury Marine	27-78623	443
4724			Obsolete	18-0139	Mercury Marine	27-88451	443
4725			Obsolete	18-0139	Mercury Marine	27-884511	443
4730			Obsolete	18-0140	OMC	328604	333
4731			Obsolete	18-01402			236
4732			579	18-01404			236
4733			Obsolete	18-01406			236
4734			579	18-01408			236
4735			579	1 18-0141	Chrysler Force	27-F85762	257
22355	OMC	390905	224	18-01416			236
37467			Obsolete	18-01418			236
37479	Mercury Marine	92-809820	224	18-0142	OMC	328622	331
37479	OMC	500423	224	18-01422			236
37566			Obsolete	1 18-0144	OMC	328626	331
37701			224	18-0146			981
79040	OMC	390928	224	18-0147	Mercury Marine	27-56880	996
18-0021	Yamaha	688-W0001-22-00	567	18-0147	OMC	3852824	996
18-0022	Yamaha	689-W0001-23-00	567	18-0147	Volvo	3852824	996
18-0023	Yamaha	689-W0001-C2-00	567	18-0148	OMC	329718	331
18-0024	Yamaha	698-W0001-21-00	567	18-01500			236
18-0025	Yamaha	69G-W0001-20-00	Obsolete	18-0151	Mercury Marine	27-75952	442
18-0026	Yamaha	6A1-W0001-22-00	Obsolete	18-0151	Mercury Marine	27-76636	442
18-0027	Yamaha	6A1-W0001-23-00	567	18-0153	Mercury Marine	27-72627	819
18-0028	Yamaha	6E0-W0001-C1-00	568	18-0153	Mercury Marine	27-85817A1	819
18-0029	Yamaha	6G1-W0001-C1-00	568	18-0153	Mercury Marine	FI5110032	819
18-0030	Yamaha	6L2-W0001-C3-00	568	18-0153	Mercury Marine	FI5110037	819
18-0031	Yamaha	6N0-W0001-C0-00	568	18-0153	OMC	357159	819
18-0032	Volvo	847741	Obsolete	18-0153	OMC	393159	819
18-0033	Volvo	21707133	988	18-0153	OMC	458625	819
18-0034	Volvo	477556	988	18-0154	Chrysler Force	27-F40279-1	258
18-0035	Volvo	3582732	987	1 18-0155	OMC	330412	335
18-0036	Volvo	3582733	987	18-0157	OMC	330698	Obsolete
18-00534			238	18-0158	Mercury Marine	27-70905	823
18-00535			237	18-0159	OMC	330909	331
18-0102	OMC	323469	332	18-01600			236
18-0103	Mercury Marine	27-37725	443	18-01602			236
18-0103	Mercury Marine	27-72496	443	18-0161	OMC	331532	331
18-0103	Mercury Marine	27-79650	443	18-0163			Obsolete
18-0103	Mercury Marine	27-796501	443	1 18-0164	OMC	311069	994
1 18-0104	OMC	907764	919	1 18-0164	Volvo	3852096	994
1 18-0106	OMC	324323	325	1 18-0164	Yamaha	YSC-13080-00-0C	994
18-0107	Mercury Marine	27-64203	441	1 18-0166	OMC	911705	921
18-0107	Mercury Marine	27-72510	441	18-01701			236
18-0107	Mercury Marine	27-85498	441	18-01703			236
18-0107	Mercury Marine	27-85498-1	441	18-01705			236
1 18-0108	OMC	324449	306	18-01707			237
1 18-0110	OMC	324670	335	18-0172	Mercury Marine	26-97530	467
18-01101			236	18-0173	OMC	313283	367, 941
18-0111	Mercury Marine	27-89657	Obsolete	18-0174	OMC	326716	367, 941
18-0112	OMC	324717	325	1 18-0175	Mercury Marine	25-26543	Obsolete
18-0113-1	Mercury Marine	27-856705	819, 823	18-0176	Honda	19242-ZV5-000	269
18-0113-1	Mercury Marine	27-97542	819, 823	18-0179	Racor	RK22244	158
18-0114-1	OMC	907761	910	1 18-0182	Mercury Marine	27-62386	334
1 18-0115	Chrysler Force	27-F307279-2	257	1 18-0182	OMC	310058	334
18-0116			224	18-0183-1	Mercury Marine	27-54566	651
18-0117	OMC	317955	332	18-0183-1	Mercury Marine	27-73866	651
1 18-0118	OMC	325092	330	18-0183-1	OMC	908717	651
1 18-0119	Chrysler Force	27-F85154-1	257	18-0183-1	OMC	916262	651
18-0120	OMC	325211	332	18-0183-1	OMC	3852455	651
18-01200			236	18-0183-1	OMC	3853742	651
18-01202			236	18-0183-1	Pleasurecraft	RM0007	651
1 18-0122	OMC	325260	331	18-0183-1	Volvo	3852455	651
1 18-0124	OMC	325537	335	18-0183-1	Volvo	3853742	651
1 18-0126	OMC	326264	332	18-0184	Volvo	804190	999
18-0128	OMC	326468	333	1 18-0185	Mercury Marine	27-91892	819, 825
18-0129	Mercury Marine	27-65744	441	1 18-0188	OMC	909748	922
18-0129	Mercury Marine	27-657441	441	18-0190	OMC	912157	921
18-0129	Mercury Marine	27-657442	441	18-0191	Yamaha	92990-06600-00	538
18-0129	Mercury Marine	27-657443	441	18-0192	Yamaha	92990-10600-00	538
1 18-0130	OMC	332266	331	18-0192	Yamaha	92901-10600-00	538
18-01301			236	18-0192	Yamaha	92902-10600-00	538
18-01302			236	18-0192	Yamaha	92903-10600-00	538
18-01308			236	18-0192	Yamaha	92995-10600-00	538
18-0131	Mercury Marine	27-64857	441	18-0195	OMC	314731	351
18-0131	Mercury Marine	27-69525	441	18-0197	OMC	333725	351
18-0131	Mercury Marine	27-695251	441	18-0198	OMC	324766	351
18-0131	Mercury Marine	27-695252	441	18-0200	OMC	327656	351
18-01311			236				

1 This product is priced per piece. To order, priced per package, please add -9 to the part number
 2 Items ending in "D" are display packaged - regular number is non-display • 3 For discount shop pack of 10, please add -10 to the part number

SIERRA #	O.E.M.	O.E. #	PAGE #	SIERRA #	O.E.M.	O.E. #	PAGE #
SIERRA							
18-0201	OMC	333771	351	18-0319	Mercury Marine	27-828553	443
18-0202-9	Mercury Marine	8227731	Obsolete	18-0320	Mercury Marine	27-13937-6	441
1 18-0203	Mercury Marine	12-25410	827	18-03200			237
1 18-0203	Mercury Marine	12-35935	827	18-03206			237
18-02060	OMC	911680	924	18-03208			237
18-02061	OMC	911681	924	1 18-0322	Mercury Marine	27-14241	997
18-02062	OMC	911662	Obsolete	1 18-0322	Mercury Marine	27-881715	997
18-02063	OMC	911663	Obsolete	1 18-0322	Mercury Marine	F11101656	997
18-02065	OMC	911665	924	1 18-0322	OMC	3852656	997
18-02066	OMC	911666	Obsolete	1 18-0322	Volvo	3852656	997
18-02067	OMC	911667	924	18-0323	Mercury Marine	27-14318-3	444
18-0207	OMC	911668	924	18-0323	Mercury Marine	27-14318-2	444
18-0208	Mercury Marine	23-1761515	Obsolete	18-0324	Mercury Marine	27-15172	440
18-0209	OMC	911669	924	18-0324	Mercury Marine	27-15172-3	440
18-0209	OMC	911670	924	18-0324	Mercury Marine	27-151724	440
18-0209	OMC	911671	924	18-0324	Mercury Marine	27-93214	440
18-0209	OMC	911672	924	18-0327	Mercury Marine	27-33956	995
18-0209	OMC	911673	924	18-0327	Mercury Marine	F15000200	995
18-0209	OMC	911674	924	18-0327	Mercury Marine	F15000219	995
18-0209	OMC	911675	924	18-0327	OMC	3853342	995
18-0209	OMC	911676	924	18-0327	Volvo	3853342	995
18-0209	OMC	911677	924	1 18-0328	Mercury Marine	27-34208	825
18-0210	Mercury Marine	23-1761516	840	18-0329	Mercury Marine	27-34209	825
18-0211	OMC	911669	924	18-0329			825
18-0211	OMC	911670	924	18-0333	Mercury Marine	27-39401	443
18-0211	OMC	911671	924	18-0334	Mercury Marine	27-39402	443
18-0211	OMC	911672	924	18-0336	Mercury Marine	27-41670-3	443
18-0211	OMC	911673	924	18-0336	Mercury Marine	27-41670-5	443
18-0211	OMC	911674	924	18-0337			981
18-0211	OMC	911675	924	18-0339	Mercury Marine	27-43006-2	444
18-0211	OMC	911676	924	18-0339	Mercury Marine	27-430066	444
18-0211	OMC	911678	924	18-03400			237
18-0212	Mercury Marine	23-1761517	Obsolete	18-03404			237
18-0214	Mercury Marine	23-1761518	840	18-0341	Mercury Marine	27-43008	443
18-0216	Mercury Marine	23-1761519	Obsolete	18-0341	Mercury Marine	27-430082	443
18-0218	Mercury Marine	23-1761520	Obsolete	18-0341	Mercury Marine	27-430083	443
18-0222	Mercury Marine	23-1761522	840	18-0341	Mercury Marine	27-430085	443
18-0224	Mercury Marine	23-1761523	Obsolete	18-0341	Mercury Marine	27-430086	443
18-0226	Mercury Marine	23-1761524	Obsolete	18-0342	Mercury Marine	27-47644	826
18-0227	OMC	911678	924	18-0342	Mercury Marine	27-47644	826
18-0229	OMC	911679	924	18-0342	Mercury Marine	27-476441	826
18-0230	Mercury Marine	23-1761526	Obsolete	18-0345	Mercury Marine	27-822189	445
18-0232	Mercury Marine	27-81031M	442	18-0346	Mercury Marine	27-34042	824
18-0232	Yamaha	655-12414-A1-00	442	18-0346	Mercury Marine	27-49936	824
18-0239	Yamaha	688-44315-A0-00	521	18-0346	OMC	3930912	824
18-0240	Yamaha	688-44316-A0-00	521	18-0347	Mercury Marine	27-34041	824
18-0242	Yamaha	663-13622-00-00	Obsolete	18-0347	Mercury Marine	27-52145	824
18-0242	Yamaha	663-13622-A0-00	Obsolete	18-0347	Mercury Marine	27-806452	824
18-0244	Yamaha	6E5-44315-A0-00	552	18-0347	OMC	912981	824
18-0248	Honda	17151-ZW5-00	270	18-0347	OMC	913277	824
18-0250	Yamaha	664-41114-A0-00	551	18-0347	OMC	3852693	824
18-0252	Volvo	876314	991	18-0347	Volvo	3852693	824
18-0256	Yamaha	97080-08045-00	520	18-0348	Mercury Marine	27-49107	819
18-0256	Yamaha	97095-08045-00	520	18-0348	Mercury Marine	27-52550	819
18-0260	Yamaha	90119-08M33	526	18-0348	Mercury Marine	F11100229	819
18-0261	Yamaha	97080-06045	526	18-0348	Mercury Marine	F15000229	819
18-0265	Yamaha	93101-28M16-00	570	18-0348	Mercury Marine	F15000245	819
18-0266	Yamaha	93101-30M17-00	570	18-0348	OMC	508871	819
18-0267	Mercury Marine	26-82257M	467	18-0348	OMC	3931593	819
18-0267	Yamaha	93106-09014-00	467	18-0352	Mercury Marine	27-56173	824
18-0275	Yamaha	93210-97M55-00	570	18-0352	OMC	913758	824
18-0292	Mercury Marine	27-81417M	444	18-0352	Volvo	3852818	824
18-0292	Yamaha	663-44315-A0-00	444	18-0353	Mercury Marine	27-58764	796
1 18-0294	Mercury Marine	27-81421M	444	18-0354	Mercury Marine	27-60715	821
1 18-0294	Yamaha	663-44324-A0-00	444	18-0356	Mercury Marine	27-32910	821
18-0296	Mercury Marine	26-854017M	467	18-0356	Mercury Marine	27-64692	821
18-0296	Yamaha	93101-22067-00	467	18-0357	Mercury Marine	27-56884	821
18-0297	Mercury Marine	26-82234M	567	18-0357	Mercury Marine	27-65577	821
18-0297	Yamaha	93101-23070-00	567	18-0359	Mercury Marine	27-67275	441
18-0298	Mercury Marine	25-82275M	470	18-0359	Mercury Marine	27-672751	441
18-0298	Yamaha	93210-41042-00	470	18-0360	Mercury Marine	27-70142	822
18-0299	Mercury Marine	25-82289M	Obsolete	18-03600			237
18-0299	Yamaha	93210-66M98-00	Obsolete	18-03602			237
18-0300	Honda	17105-ZY6-000	270	18-03606			237
18-0305-1	Crusader	96108	631	18-03608			237
18-0306-1	Crusader	96216	631	18-0365	Mercury Marine	27-75450	823
18-0307	Volvo	861250	995	18-0368			Obsolete
18-0309-1	Crusader	96562	631	18-0369	Mercury Marine	27-75909	443
18-0310	Volvo	861251	Obsolete	18-0371	Mercury Marine	27-39316	441
18-0311	Crusader	97686	995	18-0371	Mercury Marine	27-72915	441
18-0311	Mercury Marine	27-11988	995	18-0371	Mercury Marine	27-78409	441
18-0311	OMC	3854942	995	18-0372	Mercury Marine	27-52579	442
18-0311	Volvo	3854942	995	18-0372	Mercury Marine	27-72916	442
18-0313	OMC	352165	335	18-0372	Mercury Marine	27-78410	442
18-0314	Chrysler Force	27-828316	257	18-0373	Mercury Marine	27-45088	441
18-0314	Chrysler Force	27-F178168	257	18-0373	Mercury Marine	27-72917	441
18-0314	Chrysler Force	27-F178168-1	257	18-0373	Mercury Marine	27-78411	441
18-0314	Chrysler Force	F178168	257	18-0376			Obsolete
1 18-0315	Chrysler Force	27-F440906	257	18-0377			983
18-0318	Mercury Marine	12-815472	827	18-0378	Mercury Marine	27-823142	443

1 This product is priced per piece. To order, priced per package, please add -9 to the part number
 2 Items ending in "D" are display packaged - regular number is non-display • 3 For discount shop pack of 10, please add -10 to the part number

SIERRA #	O.E.M.	O.E. #	PAGE #	SIERRA #	O.E.M.	O.E. #	PAGE #
SIERRA							
18-0378	Mercury Marine	27-823142 2	443	18-0465	Mercury Marine	27-65184	821
18-0380	Mercury Marine	27-83940M	441	18-0465	Mercury Marine	27-8M0050224	821
18-0382	Honda	17109-XY6-000	270	18-0465	OMC	352670	821
18-0384	Mercury Marine	27-817533	440	18-0466	Mercury Marine	27-14901	819
18-0384	Mercury Marine	27-89221	440	18-0466	Mercury Marine	27-14901A1	819
18-0384	Mercury Marine	27-892211	440	18-0466	Mercury Marine	27-52144	819
18-0384	Mercury Marine	27-8M0027781	440	18-0466	OMC	393061	819
18-0385	Mercury Marine	27-30803	443	18-0466	OMC	3921473	819
18-0385	Mercury Marine	27-31557	443	18-0466	OMC	3923440	819
18-0385	Mercury Marine	27-45748	443	18-0467	Mercury Marine	27-41610	822
18-0385	Mercury Marine	27-89937	443	18-0467	Mercury Marine	27-49814	822
18-0386	Mercury Marine	27-72780	825	18-0468	Mercury Marine	27-811572	824
18-0386	Mercury Marine	27-94914	825	18-0468	OMC	912954	824
18-0388	Mercury Marine	27-98823	826	18-0468	OMC	915326	824
18-0388	Mercury Marine	27-988231	826	18-0468	OMC	3852654	824
18-0389	Mercury Marine	27-99960	823	18-0468	OMC	3853512	824
18-0390	Honda	17105-ZY3-004	Obsolete	18-0468	Volvo	3852654	824
18-0396	Honda	17109-ZY3-004	270	18-0468	Volvo	3853512	824
18-0397	OMC	318917	334	18-0471			607
1 18-0398	Mercury Marine	27-33918	994	18-0472-1			607
1 18-0398	Mercury Marine	27-8M2021920	994	18-0474-1			Obsolete
1 18-0398	OMC	312797	994	18-0475-1			631
1 18-0398	OMC	3852111	994	18-0476-1	Barr	01-0105	636
1 18-0398	Volvo	835417	994	18-0476-1			636
18-0401	OMC	913393	919	18-0477-9	Suzuki	17472-98503	488
18-0403	Mercury Marine	27-52571	816	18-0478	Suzuki	17472-93911	488
18-0403	Mercury Marine	27-61782	816	18-0479	Suzuki	17472-92D10	Obsolete
18-0403	Mercury Marine	27-805722A1	816	18-0481	Honda	19234-ZW1-B00	Obsolete
18-0403	Mercury Marine	27-812712	816	18-0482	Honda	19242-ZW1-B00	Obsolete
18-0404	Mercury Marine	27-805403A1	816	18-0483	Yamaha	63D-44316-00-00	551
18-0405	Mercury Marine	27-14247	819	18-0487	Mercury Marine	27-824326002	820
18-0405	Mercury Marine	27-883964	819	18-0487	Mercury Marine	27-8243261	820
18-0405	Mercury Marine	27-883964T	819	18-0488	Mercury Marine	27-807473A1	820
18-0405	OMC	912955	819	18-0489	Volvo	876384	Obsolete
18-0405	OMC	3852655	819	18-0491	OMC/Bombardier	346007	328
18-0405	Volvo	3852655	819	18-0492	OMC/Bombardier	340919	328
18-0406	Yamaha	60X-43315-A0-00	544	18-0498	Volvo	3580309	992
18-0407	Mercury Marine	27-56870A1	Obsolete	1 18-0499	Chrysler Inboard	10612	Obsolete
18-0407	Mercury Marine	27-64798	Obsolete	18-0500	Chrysler Force	26-817472	261
18-0407	OMC	508872	Obsolete	18-05002			238
18-0408	Yamaha	65N-44323-00	527	18-05004			Obsolete
18-0409	Yamaha	69M-G4323-00	527	18-0502	Chrysler Force	26-819396	261
18-0410	Mercury Marine	27-75648	820	18-0503	Chrysler Force	26-F40307-2	261
18-0410	OMC	986103	820	18-0512	Chrysler Force	26-F84307-1	Obsolete
18-0410	OMC	986104	820	18-0514	Mercury Marine	26-25329	Obsolete
18-0410	OMC	988162	820	18-0515	Mercury Marine	26-30530	467
18-0410	OMC	3853912	820	18-0516	Mercury Marine	26-30913	Obsolete
18-0410	OMC	3853913	820	18-0517	Mercury Marine	26-32911	467
18-0410	OMC	3854406	820	18-0518	Mercury Marine	26-34217	815
18-0410	Volvo	3853912	820	18-0518	Mercury Marine	26-58094	815
18-0410	Volvo	3853913	820	18-0518	Mercury Marine	26-72564	815
18-0410	Volvo	3854406	820	18-0518	Mercury Marine	26-75413	815
18-0411	Mercury Marine	27-90458	820	18-0518	Mercury Marine	26-75624	815
18-0411	Mercury Marine	27-90458A1	820	18-0518	OMC	914323	815
18-0411	Mercury Marine	F15000178	820	18-0518	OMC	3853132	815
18-0411	Mercury Marine	F15000183	820	18-0518	OMC	3854956	815
18-0411	OMC	357159	820	18-0518	Volvo	914323	815
18-0411	OMC	458625	820	18-0518	Volvo	3853132	815
18-0411	OMC	508876	820	18-0518	Volvo	3854956	815
1 18-0412	OMC	337068	334	18-0519	Mercury Marine	26-14240	467
1 18-0415	Chrysler Force	27-F523031	258	18-0519	Mercury Marine	F1101300	467
18-0416	Chrysler Force	27-F694830	258	18-0519	OMC	3852857	467
18-0418	Crusader	96653	631	18-0519	Volvo	912957	467
18-0418	Mercury Marine	27-46820	631	18-0519	Volvo	3852657	467
18-0418	Volvo	3852472	631	18-0521	Mercury Marine	26-36557	446
18-0418	OMC	909613	631	18-0522	Honda	91254-ZW1-003	467
18-0421	Yamaha	6AW-44323-00	526	18-0522	Mercury Marine	26-43036	467
18-0422	Mercury Marine	391-5076	822	18-0523	Mercury Marine	26-43993	467
18-0430	OMC	912477	919	18-0525	Mercury Marine	26-45587	467
18-0431	OMC	912471	Obsolete	18-0526	Mercury Marine	26-48443	467
18-0434	OMC	909758	918	18-0527	Mercury Marine	26-56397	467
18-0435	OMC	908765	918	18-0528	Mercury Marine	26-56868	815
18-0437	OMC	334353	330	18-0528	OMC	913745	815
1 18-0440	OMC	915719	920	18-0528	Volvo	3852805	815
1 18-0441	OMC	329076	334	18-0529	Mercury Marine	26-62818	467
1 18-0445	OMC	323312	335	18-0531	Mercury Marine	26-72785	467
18-0448	Yamaha	6CJ-44315-00	Obsolete	18-0537	Mercury Marine	26-85107	467
18-0449	Yamaha	6CJ-44316-00	526	18-0539	Mercury Marine	37721	446
18-0450	Yamaha	6CJ-44324-00	526	18-0540	OMC	320936	336
18-0451	Yamaha	6CB-44315-00-00	526	18-0542	OMC	315288	Obsolete
18-0452	Yamaha	6AW-44315-00	526	18-0542	OMC	321831	Obsolete
18-0453	Yamaha	65N-44315-A0	527	18-0543	OMC	313507	367, 941
18-0459	Suzuki	17472-95200	488	18-0543	OMC	321895	367, 941
18-0460	Suzuki	17472-95310	488	18-0544	Suzuki	09282-24004	494
18-0461	Suzuki	17472-96301	488	18-0545	Suzuki	09289-10002	Obsolete
18-0462	Mercury Marine	27-48399	822	18-0548	OMC	909515	920
18-0463	Mercury Marine	27-814210	822	18-0549	OMC	909829	922
1 18-0464	Mercury Marine	27-49121	824	18-0549	Volvo	3852476	922
1 18-0464	Mercury Marine	27-91831	824	18-0550	OMC	909830	922
1 18-0464	OMC	912768	824	18-05500			238

1 This product is priced per piece. To order, priced per package, please add -9 to the part number
 2 Items ending in "D" are display packaged - regular number is non-display • 3 For discount shop pack of 10, please add -10 to the part number

SIERRA #	O.E.M.	O.E. #	PAGE #	SIERRA #	O.E.M.	O.E. #	PAGE #
SIERRA							
18-0551	Suzuki	09283-10011	Obsolete	18-0653	OMC	308825	935
18-0554	Mercury Marine	26-84813M	467	18-0654	OMC	914743	935
18-0554	Yamaha	93101-20M07-00	467	18-0655	OMC	914736	Obsolete
18-0557	Mercury Marine	888909A1	454	18-0656	Yamaha	69J-45123-00-00	544
18-0558	Volvo	851407	1003	18-0663			433, 542
18-0559	OMC	332585	367, 941	18-0664	Mercury Marine	27-17467	995
18-0560	Mercury Marine	26-896600	467	18-0664	Mercury Marine	F1101287	995
18-0563	Mercury Marine	26-36556	446	18-0664	OMC	913270	995
18-0564	Mercury Marine	26-888483	467	18-0664	OMC	3852687	995
18-0568-9	Mercury Marine	23-43045	Obsolete	18-0664	Volvo	3852687	995
18-0569	Suzuki	09284-08003	Obsolete	1 18-0665			636
18-0570	Yamaha	93102-23096-00	570	1 18-0667	Mercury Marine	27-99506	822
18-0577	Mercury Marine	35993A1	844	1 18-0667	Mercury Marine	27-995061	822
18-0577	Mercury Marine	66081A1	844	18-0670	Mercury Marine	27-43007	443
18-0577	Mercury Marine	66081A2	844	18-0670	Mercury Marine	27-430073	443
18-0577	Mercury Marine	66081A4	844	18-0670	Mercury Marine	27-430075	443
18-0578	Mercury Marine	26-67388	815	1 18-0672	Mercury Marine	27-41811	797
18-0579	Chrysler Force	26-41131	261	1 18-0672	Mercury Marine	27-860231	797
18-0579	Mercury Marine	26-41131	261	1 18-0672	Mercury Marine	27-863725	797
18-0580	Chrysler Force	26-41132	261	1 18-0672	Mercury Marine	27-8637251	797
18-0580	Mercury Marine	26-41132	261	1 18-0673	OMC	910113	919
18-0581	Mercury Marine	26-41365	467	18-0675	OMC	321932	334
18-0583	Chrysler Force	26-43035	261	18-0676-1	Pleasurecraft	RM0099	651
18-0583	Honda	91251-ZW1-003	261	1 18-0677-1	Pleasurecraft	RM0002	651
18-0583	Mercury Marine	26-43035	261	18-0679	OMC	311145	335
18-0584	Chrysler Force	26-66022	261	18-0680	Mercury Marine	27-815528	824
18-0584	Chrysler Force	26-F346118	261	18-0680	OMC	3853256	824
18-0584	Mercury Marine	26-66022	261	1 18-0681	Mercury Marine	12-32834	827
18-0585	Mercury Marine	26-821928	467	1 18-0681	Mercury Marine	12-8M2001219	827
18-0586	Chrysler Force	26-99325	261	1 18-0681	Mercury Marine	12-93416	827
18-0586	Mercury Marine	26-99325	261	1 18-0681	Mercury Marine	12-934161	827
18-0587	Yamaha	93101-25M03-00	570	18-0685	Mercury Marine	27-73666	821
18-0588	Yamaha	93102-25M28-00	570	18-0690	OMC/Bombardier	347205	333
18-0590			983	18-0691	OMC/Bombardier		333
18-0592	Chrysler Force	26-F318307	Obsolete	18-0692	OMC/Bombardier	339601	333
18-0593	Chrysler Force	26-F901307-2	Obsolete	18-0693	OMC/Bombardier	336227	333
18-0595	Mercury Marine	26-66303	467	18-0694	OMC/Bombardier	336226	333
18-0601			630	18-0695	OMC/Bombardier	336389	333
18-0602			630	18-0696	OMC/Bombardier	336388	333
18-0602-1			630	18-0707	Yamaha	6CB-13016-00	507
18-0603			590, 631, 636, 651, 663, 797, 816, 911	18-0710	Yamaha	68V-14984-00	507
18-0604			590, 631, 636, 651, 663, 797, 816, 911	18-0711	Yamaha	66K-14984-00	507
18-0605	Yamaha	67F-41138-00-00	544	18-0712	Yamaha	63P-14984-00	507
18-0606			Obsolete	18-0713	Yamaha	6P2-14984-00	507
18-0607	Chrysler Inboard	3745217	607	18-0714	Yamaha	6AW-14984-00	507
18-0609	Chrysler Inboard	4273129	599	18-0715	Mercury Marine	25-809086	399
18-0611	Mercury Marine	27-75483	Obsolete	18-0715	Yamaha	65L-14984-00	399
18-0612	Mercury Marine	14259	805	18-0716	Yamaha	6CB-14984-00	507
18-0612	Mercury Marine	809910	805	18-0717	Yamaha	6C5-14984-00	507
18-0612	Mercury Marine	F11101295	805	18-0720	Mer cruiser	27-864549A02	798
18-0613	Mercury Marine	93476	805	18-0720	Mer cruiser	27-864549A1	798
18-0614	Mercury Marine	811549	805	18-0721	Mer cruiser	27-864547A02	798
18-0614	Mercury Marine	850458	805	18-0721	Mer cruiser	27-864547A1	798
18-0614	Mercury Marine	845668T	805	18-0722	Mer cruiser	27-864547A1	798
18-0615	Mercury Marine	14760	805	18-0722	Mer cruiser	27-864850A02	798
18-0615	Mercury Marine	75639	805	18-0737	Honda	16176-POA-004	270
18-0615	Mercury Marine	93477	805	18-0739	Yamaha	689-45113-A1-00	551
18-0615	Mercury Marine	93477T	805	18-0740-1	Mercury Marine	27-805396	441
18-0616	Mercury Marine	14244	805	18-0743	Yamaha	6L2-41112-A1-00	Obsolete
18-0616	Mercury Marine	14244T	805	18-0744	Yamaha	6L2-41114-A1-00	551
18-0617	Yamaha	67F-45127-00-00	544	18-0753	Yamaha	6G1-44315-A0-00	551
18-0618	Yamaha	68V-45123-00-00	544	18-0754	Yamaha	68D-E2414-A0-00	551
18-0619	Yamaha	69J-41138-00-00	Obsolete	18-0755	Yamaha	90430-14228-00	544
18-0622	Chrysler Force	27-19701	258	18-0755	Yamaha	90430-14M09-00	544
18-0622	Mercury Marine	27-19701	258	18-0756-1	Yamaha	6H3-44315-A0-00	552
18-0624	Mercury Marine	27-188891	441	18-0757	Yamaha	6H3-44324-A0-00	553
18-0628	OMC	341501	330	18-0761	Suzuki	17472-91J00	488
1 18-0633	Mercury Marine	27-19206	440	18-0765	Yamaha	6L2-14384-00-00	550
1 18-0633	Mercury Marine	27-192061	440	1 18-0767	Yamaha	688-11193-01-00	551
1 18-0633	Mercury Marine	27-41449	440	1 18-0768	Yamaha	682-44315-A0-00	553
1 18-0633	Mercury Marine	27-414491	440	18-0775	Yamaha	648-14198-A0-00	550
1 18-0633	Mercury Marine	27-42178	440	18-0778	Suzuki	17472-93J00	488
18-0641	Mercury Marine	27-828292	440	18-0779	Yamaha	6G5-11193-A0-00	551
18-0642	Mercury Marine	27-19050	442	18-0781	Yamaha	6E5-11193-A0-00	551
18-0642	Mercury Marine	27-190502	442	18-0782	Yamaha	6E5-11381-A1-00	551
18-0642	Mercury Marine	27-190503	442	18-0785	Yamaha	6E5-14198-A1-00	550
18-0642	Mercury Marine	27-190505	442	18-0786	Yamaha	6E5-14384-02-00	550
18-0643	Mercury Marine	27-18307-1	443	18-0791	Mercury Marine	27-880729	443
18-0643	Mercury Marine	27-183076	443	18-0792	Suzuki	13119-91J00	488
18-0644	Mercury Marine	27-146972	441	18-0793	Suzuki	17582-93J00	488
18-0645	Mercury Marine	27-167371	441	18-0794	Suzuki	17685-97J00	488
18-0646	Mercury Marine	27-813859	Obsolete	18-0795	Suzuki	17685-98J00	489
18-0647	OMC	986658	174	18-0796	Suzuki	17685-99E00	489
18-0648			983	18-0797	Suzuki	17685-87D10	489
18-0649	Mercury Marine	27-858935	443	18-0798	Yamaha	6H4-41114-A0-00	551
18-0650	Suzuki	56132-95J00	491	18-0799	Yamaha	6E5-41112-A1-00	551
18-0651	Suzuki	17472-98J00	491	18-0807-1	Yamaha	6K7-13645-A1-00	550
18-0652	OMC	914723	935	18-0808	Yamaha	6G5-11382-A1-00	550
				18-0809	Yamaha	6G5-13645-A1-00	550

1 This product is priced per piece. To order, priced per package, please add -9 to the part number
 2 Items ending in "D" are display packaged - regular number is non-display • 3 For discount shop pack of 10, please add -10 to the part number

SIERRA #	O.E.M.	O.E. #	PAGE #	SIERRA #	O.E.M.	O.E. #	PAGE #
SIERRA							
18-0812	Yamaha	6G5-41112-A1-00	551	1 18-0891	OMC	909835	825
18-0813	Yamaha	6G5-45113-A0-00	551	1 18-0891	OMC	3852477	825
18-0815	Yamaha	6H4-11193-A1-00	551	1 18-0891	Volvo	3852477	825
18-0823	Yamaha	6E5-13645-A1-00	551	1 18-0891	Yamaha	YSG-37545-87-G0	825
18-0826	Yamaha	90430-14115-00	553	18-0892	OMC	322411	334
18-0829	Yamaha	61A-12414-A0-00	551	1 18-0893	Mercury Marine	27-35380	996
18-0829	Yamaha	6J8-12414-A0-00	551	1 18-0893	OMC	3850595	996
18-0835	Mercury Marine	27-824853	444	1 18-0893	Volvo	3850595	996
18-0835	Mercury Marine	27-8248531	444	1 18-0894	Mercury Marine	27-55810	825
18-0835	Yamaha	62Y-12414-00-00	444	1 18-0894	Mercury Marine	27-558101	825
18-0836	Yamaha	682-12414-A1-00	551	18-0897	Mercury Marine	27-41813	797
18-0840-1	Yamaha	676-14984-00-00	550	18-0897	Mercury Marine	27-860233	797
18-0844	Yamaha	688-12414-A1-00	551	18-0897	Mercury Marine	27-863724	797
18-0847	Yamaha	688-41112-A0-00	551	18-0898	Mercury Marine	27-56859	826
18-0849	Yamaha	650-24431-00	544	18-0898	Pleasurecraft	RM0017	826
18-0849	Yamaha	650-24431-A0-00	544	18-09006			237
1 18-0850	OMC	303615	330	1 18-0903	Mercury Marine	27-49110	995
1 18-0851	OMC	329826	335	1 18-0903	Mercury Marine	F1101000	995
1 18-0854	Chrysler Force	27-F476067	258	1 18-0903	OMC	3853361	995
1 18-0855	Chrysler Force	27-F85168-2	257	1 18-0903	Volvo	3853361	995
18-0856-1	Yamaha	64D-14384-01-00	544	1 18-0903	Yamaha	YSG-38600-39-G0	995
18-0858	Mercury Marine	25-54029	470	18-0904	Mercury Marine	27-60317	Obsolete
1 18-0860	Mercury Marine	25-82700	470	1 18-0905	Mercury Marine	27-34502	1005
1 18-0861	Chrysler Force	27-F85748-2	257	1 18-0905	Mercury Marine	27-49955	1005
18-0864	Mercury Marine	26-90925	815	1 18-0905	Mercury Marine	27-60721	1005
18-0864	Mercury Marine	27-67389	815	1 18-0905	Mercury Marine	27-8M0077608	1005
18-0868	Chris-Craft	16.50-00232	591	1 18-0905	Yamaha	YSG-14090-90-8G	1005
18-0868	Mercury Marine	27-17145	591	18-0907			983
18-0868	Mercury Marine	27-72637	591	18-0911	OMC	911698	920
18-0868	Mercury Marine	F11101296	591	18-0912	Mercury Marine	27-60945	444
18-0868	Mercury Marine	F15000232	591	18-0912	Mercury Marine	27-66102	444
18-0868	Mercury Marine	F15000263	591	18-0912	Mercury Marine	27-661021	444
18-0868	OMC	985630	591	1 18-0915	Chrysler Force	27-F406406	257
18-0868	OMC	3854269	591	18-0916	Mercury Marine	27-72779	825
18-0868	Volvo	3854269	591	18-0916	Mercury Marine	27-805215	825
18-0869	Chrysler Force	27-820500A3	257	18-0916	Mercury Marine	27-8052151	825
1 18-0869	Chrysler Force	27-F40223	257	18-0916	Mercury Marine	27-94915	825
1 18-0870	Mercury Marine	27-27936	442	18-0917	OMC	311508	336
1 18-0870	Mercury Marine	27-279361	442	18-0918	Mercury Marine	27-69524	441
18-0871	OMC	175158	290	18-0918	Mercury Marine	27-695241	441
18-0873	Chrysler Force	27-819377	258	18-0918	Mercury Marine	27-695242	441
1 18-0873	Chrysler Force	27-F97067	258	18-09200			237
1 18-0874	Chris-Craft	16.50-00162	997	18-09202			237
1 18-0874	Mercury Marine	27-34486	997	1 18-0922	Mercury Marine	27-70335	442
1 18-0874	Mercury Marine	27-344861	997	1 18-0922	Mercury Marine	27-703351	442
1 18-0874	Mercury Marine	27-344863	997	1 18-0923	OMC	313244	922
1 18-0874	Mercury Marine	27-34891	997	18-0926	Mercury Marine	27-73645	442
1 18-0874	Mercury Marine	27-52184	997	18-0927	OMC	393561	Obsolete
1 18-0874	Mercury Marine	F3932344	997	1 18-0928-1	Mercury Marine	27-73814	823
1 18-0874	Mercury Marine	F15000162	997	1 18-0928-1	Mercury Marine	27-738141	823
1 18-0874	OMC	312780	997	1 18-0928-1	Mercury Marine	27-807218	823
1 18-0874	OMC	3852109	997	1 18-0929	OMC	313416	994
1 18-0874	Volvo	3852109	997	1 18-0929	Volvo	3852120	994
1 18-0874	Yamaha	YSG-10108-44-5G	997	18-0932	Mercury Marine	27-76862	442
1 18-0875			632, 648, 651	18-0932	Mercury Marine	27-768621	442
1 18-0876	Chris-Craft	16.50-05756	994	18-0933	OMC	314115	331
1 18-0876	Mercury Marine	27-34898	994	18-0934-1	Mercury Marine	27-78069	444
1 18-0876	Mercury Marine	F15005756	994	18-0935	OMC	314322	331
1 18-0876	OMC	312800	994	1 18-0936	Mercury Marine	27-78690	444
1 18-0876	OMC	3852113	994	1 18-0937	OMC	315055	918
1 18-0876	Volvo	3852113	994	1 18-0939	OMC	315189	921
1 18-0876	Yamaha	YSG-10108-43-8G	994	18-0940	Mercury Marine	27-55308	442
1 18-0878	Pleasurecraft	RM0003	651	18-0940	Mercury Marine	27-78027	442
18-0879	Mercury Marine	27-37724	443	18-0940	Mercury Marine	27-85488	442
18-0879	Mercury Marine	27-38501	443	18-0940	Mercury Marine	27-854881	442
18-0879	Mercury Marine	27-385011	443	18-0940	Mercury Marine	27-854882	442
1 18-0880	OMC	911878	921	18-09400			237
18-0881-1	Mercury Marine	27-18272	797	18-0941	OMC	315538	334
18-0881-1	Mercury Marine	27-97863	797	18-0942	Mercury Marine	27-46110	442
1 18-0882	OMC	304764	335	18-0942	Mercury Marine	27-72486	442
1 18-0885-1	Mercury Marine	27-48042	797	18-0942	Mercury Marine	27-85491	442
1 18-0887	Mercury Marine	27-34216	1005	18-0942	Mercury Marine	27-854911	442
1 18-0887	Mercury Marine	27-49953	1005	18-0942	Mercury Marine	27-85491-2	442
1 18-0887	Mercury Marine	F15000201	1005	18-0942	Mercury Marine	27-854913	442
1 18-0887	OMC	912988	1005	1 18-0943-2	OMC	909786	910
1 18-0887	OMC	913275	1005	1 18-0943-2	OMC	913783	910
1 18-0887	OMC	3852691	1005	1 18-0943-2	OMC	3850496	910
1 18-0887	Volvo	3852691	1005	18-0943-2	Volvo	3850496	910
1 18-0887	Yamaha	YSG-14096-15-6G	1005	18-0943-2-9	OMC	913783	919
1 18-0889	Chris-Craft	16.50-00074	651	18-0943-2-9	Volvo	3850496	919
1 18-0889	Mercury Marine	27-34213	651	18-0944	Mercury Marine	27-64204	442
1 18-0889	Mercury Marine	27-56883	651	18-0944	Mercury Marine	27-72508	442
1 18-0889	Mercury Marine	F15000074	651	18-0944	Mercury Marine	27-85496	442
1 18-0889	Pleasurecraft	3705042	651	18-0944	Mercury Marine	27-854961	442
1 18-0889	Volvo	3852095	651	18-0945	OMC	323217	332
1 18-0889	Yamaha	YSG-10114-14-1G	651	18-0945	OMC	336430	332
1 18-0891	Chris-Craft	16.50-00078	825	18-0946	Mercury Marine	27-85653	Obsolete
1 18-0891	Mercury Marine	27-34896	825	18-0946	Mercury Marine	27-85653-1	Obsolete
1 18-0891	Mercury Marine	27-34897	825	18-0946	Mercury Marine	27-856730	Obsolete
1 18-0891	Mercury Marine	F15000077	825	1 18-0947	OMC	909529	920
1 18-0891	Mercury Marine	F15000078	825	1 18-0948	Mercury Marine	27-87707	824

1 This product is priced per piece. To order, priced per package, please add -9 to the part number

2 Items ending in "D" are display packaged - regular number is non-display • 3 For discount shop pack of 10, please add -10 to the part number

SIERRA #	O.E.M.	O.E. #	PAGE #	SIERRA #	O.E.M.	O.E. #	PAGE #
SIERRA							
1 18-0949	OMC	316499	Obsolete	18-1129	Mercury Marine	F508814	856
18-0950	Mercury Marine	27-88046	826	18-1131	Mercury Marine	74313A4	810
1 18-0952	Mercury Marine	27-88907	444	18-1137	Mercury Marine	15103A3	810
1 18-0953	OMC	317951	Obsolete	18-1142	Mercury Marine	31-32573A1	855
18-0954	Mercury Marine	27-92720	823	18-1143	Mercury Marine	31-36387A1	453
18-0955	OMC	318156	332	18-1148	Mercury Marine	23-853853	Obsolete
18-0956-1	Chrysler Inboard	118-614	607	18-1148	Mercury Marine	23-853853002	Obsolete
18-0956-1	Mercury Marine	27-68715	607	18-1148	Mercury Marine	23-853853A1	Obsolete
18-0956-1	OMC	912405	607	18-1148	Mercury Marine	68704A1	Obsolete
18-0957	OMC	318373	333	18-1151	Mercury Marine	30-20066	Obsolete
18-0958	Chrysler Force	27-F372154-1	257	18-1152	Mercury Marine	30-23679	379
1 18-0959	OMC	318924	331	18-1153	Mercury Marine	30-20464	427, 453, 857
1 18-0960	Chrysler Force	27-F85906	257	18-1153	Mercury Marine	30-49313	427, 453, 857
18-09602			237	18-1153	Mercury Marine	30-54215	427, 453, 857
18-09606			237	18-1153	Mercury Marine	30-63326	427, 453, 857
1 18-0961	OMC	318932	330	18-1153	Mercury Marine	30-63326T	427, 453, 857
1 18-0963	OMC	335633	331	18-1154	Mercury Marine	30-63742	453
18-0965	OMC	333879	333	18-1154	Mercury Marine	30-63742T	453
1 18-0967	OMC	319332	334	18-1154	OMC	377139	453
1 18-0969	OMC	319586	335	18-1155	Mercury Marine	30-17927	453
1 18-0970	Mercury Marine	27-98769	441	18-1155	Mercury Marine	30-35914	453
1 18-0970	Mercury Marine	27-987691	441	18-1155	Mercury Marine	30-88957	453
18-0971	OMC	319661	325	18-1155	Mercury Marine	30-88957A1	453
1 18-0973	OMC	315052	332	18-1155	Mercury Marine	30-88957T	453
1 18-0975	OMC	333008	331	18-1156	Honda	91051-ZW1-003	271
1 18-0976	Crusader	20129	632	18-1156	Mercury Marine	31-30894A1	271
1 18-0976	Mercury Marine	27-14250	632	18-1157	Honda	91057-ZW1-003	271
1 18-0976	Mercury Marine	27-34895	632	18-1157	Mercury Marine	31-30895	271
1 18-0976	Mercury Marine	F11101297	632	18-1157	Mercury Marine	31-30895T	271
1 18-0977	OMC	332369	334	18-1158	Honda	91053-ZW1-003	271
18-0978	OMC	331598	331	18-1158	Mercury Marine	31-30956	271
18-0979	OMC	321183	331	18-1158	Mercury Marine	31-30956T	271
18-0980	Mercury Marine	110990	824	18-1158	Mercury Marine	31-F523058	271
18-0980	Mercury Marine	1100990	824	18-1158	OMC	387247	271
18-0980	Mercury Marine	27-49109	824	18-1159	Mercury Marine	31-35928A1	453
18-0980	Mercury Marine	27-54529	824	18-1159	Mercury Marine	31-35928T1	453
18-0980	OMC	3935449	824	18-1160	Mercury Marine	31-35988A12	857
1 18-0981	OMC	321479	332	18-1160	Mercury Marine	31-35988A2	857
18-0982-1	Mercury Marine	27-48713	444	18-1161	Mercury Marine	31-35990A1	856
18-0982-1	Mercury Marine	27-56304	444	18-1161	OMC	983891	856
1 18-0983	OMC	321497	331	18-1162	Mercury Marine	31-38356A1	454, 856
18-0985	OMC	321722	331	18-1162	Mercury Marine	31-F84901	454, 856
1 18-0987	OMC	332319	332	18-1162	Mercury Marine	F84903	454, 856
18-0988	Mercury Marine	27-37976	444	18-1162	Mercury Marine	FA84901	454, 856
18-0988	Mercury Marine	27-62860	444	18-1163	Mercury Marine	31-48941A1	454, 856
18-0988	Mercury Marine	27-628601	444	18-1165	Mercury Marine	31-61100A1	856
18-0989	OMC	321794	331	18-1166	Mercury Marine	31-78172A1	452, 454
1 18-0991	OMC	321907	332	18-1170	Mercury Marine	31-812767A1	454
18-0993	OMC	437228	290	18-1170	OMC	983892	454
1 18-0994	Mercury Marine	27-70143	822	18-1171	OMC	983878	924, 931
1 18-0994	Mercury Marine	27-701431	822	18-1172	OMC	983877	924, 931
1 18-0994	Mercury Marine	27-70143B1	822	18-1173	Mercury Marine	31-828437A2	856
1 18-0994	Mercury Marine	27-807982	822	18-1175			72
1 18-0994	Mercury Marine	27-8079821	822	18-1176			72
1 18-0994	Mercury Marine	27-807982B	822	18-1177			Obsolete
18-0995	OMC	323222	333	18-1178			Obsolete
18-0999-9	OMC	323459	Obsolete	18-1179	Mercury Marine	31-32575A1	856
18-1074	OMC	3850426	929	18-1179	Mercury Marine	31-32575T1	856
18-1074	Volvo	3850426	929	18-1180	Mercury Marine	31-54042T	Obsolete
18-1076	Volvo	3888916	1002	18-1182	Mercury Marine	31-30894A5	856
18-1099	OMC	982422	935	18-1190	Mercury Marine	30-20839	453
18-1100			Obsolete	18-1190	Mercury Marine	30-20839T	453
18-1105			72	18-1190	Mercury Marine	30-62699	453
18-1106			72	18-1190	Mercury Marine	F1000034	453
18-1107			72	18-1191	Mercury Marine	12-12577	Obsolete
18-1109			72	18-1193	Mercury Marine	31-33138A1	856
18-1110			Obsolete	18-1194	Mercury Marine	879366	427
18-1111	Mercury Marine	31-62799A1	453	18-1194	Mercury Marine	31-17514	427
18-1112	Chrysler/Force	31-F523901	261	18-1194	Mercury Marine	31-17514A1	427
18-1112	Mercury Marine	31-12576	261	18-1194	Mercury Marine	31-17514A2	427
18-1113	Chrysler/Force	31-F523143	261	18-1194	Mercury Marine	31-67526	427
18-1113	Mercury Marine	31-12578	261	18-1194	Mercury Marine	31-67526A1	427
18-1113	Mercury Marine	31-12578T	261	18-1194	Mercury Marine	31-67526A2	427
18-1115	Mercury Marine	31-29982	453	18-1194	Mercury Marine	31-814337A1	427
18-1115	Mercury Marine	31-32898	453	18-1194	Mercury Marine	31-821146A1	427
18-1115	Mercury Marine	31-32898T	453	18-1194	Mercury Marine	31-8M0045428	427
18-1117	Mercury Marine	31-42647	453	18-1194	Mercury Marine	31-M8004528	427
18-1117	Mercury Marine	31-42647A1	453	18-1196	Mercury Marine	31-74248	427
18-1117	Mercury Marine	31-F694057	453	18-1196	Mercury Marine	31-74248T	427
18-1117	OMC	387817	453	18-1197	Mercury Marine	31-828439A2	453
18-1118	Mercury Marine	31-42677A1	453	18-1199			72
18-1120	Mercury Marine	31-35246	855	1 18-1199			72
18-1122	Mercury Marine	31-73363	Obsolete	1 18-1202	OMC	329830	334
18-1122	Mercury Marine	31-73363T	Obsolete	1 18-1204-1	Mercury Marine	27-96429	797
18-1126	Mercury Marine	31-54036A1	453	18-1204-1	OMC	912164	797
18-1126	Mercury Marine	31-8M0103474	453	18-1204-1-9	Mercury Marine	27-96429	920
18-1127	Mercury Marine	31-54038A1	Obsolete	18-1204-1-9	OMC	912164	920
18-1129	Mercury Marine	31-86748A1	856	18-1205	OMC	329828	333
18-1129	Mercury Marine	31-8M0103473	856	18-1206			671
18-1129	Mercury Marine	31-F506818	856	18-1207	OMC	329833	332

1 This product is priced per piece. To order, priced per package, please add -9 to the part number
 2 Items ending in "D" are display packaged - regular number is non-display • 3 For discount shop pack of 10, please add -10 to the part number

SIERRA #	O.E.M.	O.E. #	PAGE #	SIERRA #	O.E.M.	O.E. #	PAGE #
SIERRA							
18-1207	OMC	343863	332	18-1287	OMC	392475	356
18-1210-1	Mercury Marine	27-39923	797	18-1288	OMC	328313	356
1 18-1211	Mercury Marine	26-49947	815	18-1289	OMC	327855	356
1 18-1211	Mercury Marine	26-58203	815	18-1290	OMC	337020	357
18-1211	Mercury Marine	26-814622	815	18-1291			356
18-1211	Mercury Marine	F110026	815	18-1292			356
18-1211	Mercury Marine	F110027	815	18-1293			356
18-1211	Mercury Marine	F110041	815	18-1294	Sea-Doo	278-002-199	Obsolete
18-1211	OMC	473424	815	18-1299	OMC	433503	352
18-1211			815	18-1305	Mercury Marine	23-85684	810
18-1212	OMC	326926	332	18-1308	Mercury Marine	23-15961	810
18-1213	Mercuriser	26-11973	815	18-1308	Mercury Marine	23-52221	810
18-1213	Mercuriser	26-42750	815	18-1308	Mercury Marine	23-52270	810
18-1213	Mercuriser	26-54799	815	18-1308	Mercury Marine	23-85701	810
18-1213	Mercuriser	26-97335	815	18-1308	Mercury Marine	F3910555	810
18-1213	OMC	912989	815	18-1308	Mercury Marine	F3916351	810
18-1213	OMC	914817	815	18-1308	Mercury Marine	F1100305	810
18-1213	OMC	3853341	815	18-1308	Mercury Marine	F1100570	810
18-1213	Volvo	3853341	815	18-1308			810
18-1218	OMC	315868	332	18-1309	Mercury Marine	23-1596110	810
18-1219	OMC	320880	336	18-1309	Mercury Marine	23-52224	810
1 18-1221	OMC	330273	336	18-1309	Mercury Marine	23-52273	810
18-1222	OMC	394408	311	18-1309	Mercury Marine	23-85704	810
18-1224	OMC	315869	332	18-1309	Mercury Marine	F1100381	810
18-1230	Mercury Marine	26-56866	815	18-1309	Mercury Marine	F1100573	810
18-1230	OMC	3853827	815	18-1309			810
18-1230	Volvo	3853827	815	18-1311	Mercury Marine	23-801793	990
18-1231	Mercury Marine	27-818188	819	18-1311			990
18-1231	Mercury Marine	27-8181881	819	18-1317	Mercury Marine	23-34464	810
18-1231	OMC	3854095	819	18-1317	Mercury Marine	23-52261	810
18-1231	Volvo	3854095	819	18-1317	Mercury Marine	23-818469	810
18-1232	Mercury Marine	27-845628	819	18-1317	Mercury Marine	23-818469001	810
18-1232	Mercury Marine	27-811566	819	18-1317	Mercury Marine	23-85669	810
18-1232	OMC	3853510	819	18-1317	Mercury Marine	23-85715	810
18-1232	Volvo	3853510	819	18-1317			810
18-1233	Mercury Marine	26-49154	815	18-1320	Mercury Marine	23-801803	810
18-1233	Mercury Marine	26-821947	815	18-1327	Mercury Marine	23-11992	810
18-1233	Mercury Marine	26-8219471	815	18-1327	Mercury Marine	23-11992001	810
18-1233	Mercury Marine	F1100986	815	18-1327			810
18-1233	OMC	3860095	815	18-1329	Mercury Marine	23-48351	Obsolete
18-1234	Mercury Marine	24-17057A1	815	18-1329	Mercury Marine	23-52242	Obsolete
18-1234	Mercury Marine	24-801879	815	18-1329	Mercury Marine	23-85677	Obsolete
18-1234	Mercury Marine	24-801879T	815	18-1333	Mercury Marine	23-49171	810
18-1234	Mercury Marine	24-811554	815	18-1333	Mercury Marine	23-69887	810
18-1234	OMC	3853528	815	18-1333	Mercury Marine	23-85691	810
18-1234	Volvo	3853528	815	18-1333			810
18-1236	OMC	309243	348	18-1334	Mercury Marine	23-49168	810
18-1237	Mercury Marine	27-13865	819	18-1334	Mercury Marine	23-69884	810
18-1237	Mercury Marine	27-138651	819	18-1334	Mercury Marine	23-85726	810
18-1237	Mercury Marine	F1101281	819	18-1334	Mercury Marine	23-85726001	810
18-1237	OMC	3856138	819	18-1334	Mercury Marine	F1100980	810
18-1237	Volvo	3856138	819	18-1334			810
18-1238	Mercury Marine	27-824326	819	18-1337	Mercury Marine	23-811858	810
18-1238	OMC	912979	819	18-1337	Mercury Marine	23-811858001	810
18-1238	OMC	3850379	819	18-1337			810
18-1238	Volvo	912979	819	1 18-1340	Mercury Marine	23-67484	810
18-1238	Volvo	3850379	819	18-1341	Mercury Marine	23-1596120	Obsolete
18-1239	Mercury Marine	27-810846	819	18-1341	Mercury Marine	23-52225	Obsolete
18-1239	Mercury Marine	27-810846T	819	18-1341	Mercury Marine	23-52274	Obsolete
18-1239	OMC	914820	819	18-1341	Mercury Marine	23-85705	Obsolete
18-1239	Volvo	3853343	819	18-1341	Mercury Marine	F1100382	Obsolete
18-1240	Mercury Marine	12708	825	18-1341			Obsolete
18-1241			330	18-1343	OMC	333957	Obsolete
18-1243	OMC	317245	310	18-1344			352
18-1254	Mercuriser	27-75611A03	821	18-1345	Mercury Marine	30-41421	427
18-1255			Obsolete	18-1345	Mercury Marine	30-67923	427
18-1256			Obsolete	18-1345	Mercury Marine	30-67923T	427
18-1257			675	18-1346	Mercury Marine	30-43011	Obsolete
18-1258			675	18-1346	Mercury Marine	30-43011T	Obsolete
18-1259			675	18-1347	Mercury Marine	31-88269T	Obsolete
18-1261			675	18-1350	OMC	379504	931
18-1263			674	18-1351	OMC	382407	931
18-1264			672	18-1353	OMC	387041	317
18-1265			Obsolete	18-1354	OMC	386764	352
18-1266			672	18-1355	OMC	386765	352
18-1267			673	18-1356	Mercury Marine	31-54928	352
18-1270			Obsolete	18-1356	OMC	382343	352
18-1271			671	18-1357	OMC	384195	352
18-1273			677	18-1358	OMC	389039	931, 932
18-1274			671	18-1360	OMC	396041	317
18-1275			Obsolete	18-1361	OMC	387787	317
18-1276			671	18-1363	OMC	397537	352
18-1277			671	18-1364	OMC	397538	352
18-1278			672	18-1365	OMC	387656	352
18-1279	OMC	317624	925	18-1366	OMC	382408	352
18-1282	OMC	398602	32, 281	18-1367	OMC	385068	352
18-1283	OMC	335818	333	18-1368	OMC	398901	352
18-1284	OMC	335819	333	18-1369	OMC	432264	352
18-1285	OMC	335403	333	18-1370	OMC	389042	352
18-1286	OMC	336232	322	18-1371	OMC	385043	352

1 This product is priced per piece. To order, priced per package, please add -9 to the part number

2 Items ending in "D" are display packaged - regular number is non-display • 3 For discount shop pack of 10, please add -10 to the part number

SIERRA #	O.E.M.	O.E. #	PAGE #	SIERRA #	O.E.M.	O.E. #	PAGE #
SIERRA							
18-1374	OMC	395627	317	18-15116	Mercury Marine	57-861758	777
18-1376	OMC	434844	317	18-15116	Mercury Marine	57-861758Q	777
18-1377	OMC	320499	317	18-15119	Mercury Marine	57-8623523	777
18-1378	OMC	388344	317	18-15119	Mercury Marine	57-8638761	777
18-1386			318	18-15119	Mercury Marine	57-865615001	777
18-1389			318	18-15119	Mercury Marine	57-865615001	777
18-1391	OMC	330854	318	18-15121	Mercury Marine	57-8638765	777
18-1395	OMC	385503	318	18-15121	Mercury Marine	57-865423005	777
18-1398	Mercury Marine	30-20861	427	18-15121	Mercury Marine	57-865615005	777
18-1398	Mercury Marine	30-72961	427	18-15121	Mercury Marine	57-865615005	777
18-1400	Mercury Marine	17340T	806	18-15123	Mercury Marine	57-864639	Obsolete
18-1400	OMC	3856127	806	18-15128	Mercury Marine	57-880566014	392
18-1400	Volvo	3856127	806	18-15129	Mercury Marine	17-828507 1	392
18-1401	Mercury Marine	56153	806	18-15130	Yamaha	6C5-46241-00-00	540
18-1401	Mercury Marine	F724102	806	18-15131	Yamaha	67F-46241-00-00	540
18-1401	OMC	985316	806	18-15132	Yamaha	6P2-46241-02-00	540
18-1401	OMC	3853847	806	18-15133	Yamaha	6G8-46241-00-00	540
18-1401	Volvo	985316	806	18-15134	Yamaha	6CB-W4624-00-00	540
18-1401	Volvo	3853847	806	18-15135	Yamaha	65W-46241-00-00	540
18-1402	Mercury Marine	34282	806	18-15136	Yamaha	6AH-46241-00-00	540
18-1402	Mercury Marine	35583	806	18-15137	Yamaha	66M-46241-00-00	540
18-1402	Mercury Marine	46472	806	18-15138	Yamaha	68T-46241-00-00	540
18-1402	Mercury Marine	46744	806	18-15139	Yamaha	6AW-W4624-00-00	540
18-1402	Mercury Marine	49117	806	18-15140	Yamaha	63P-46241-00-00	540
18-1402	Mercury Marine	72638	806	18-15141	Yamaha	69J-46241-00-00	540
18-1402	Mercury Marine	F2769931	806	18-15142	Yamaha	6DA-W4624-00-00	540
18-1402	Mercury Marine	F5232670	806	18-15143	Yamaha	60V-46241-00-00	540
18-1402	Mercury Marine	F11100349	806	18-15144	Yamaha	62Y-46241-00-00	540
18-1402	Mercury Marine	F11100399	806	18-15145	Yamaha	68F-46241-10-00	540
18-1402	Mercury Marine	F11100862	806	18-15146	Mercury Marine	8M0072670	432
18-1402	Mercury Marine	F11100954	806	18-15147	Mercury Marine	835392Q	432
18-1402	Mercury Marine	F11101222	806	18-15148	Mercury Marine	8M0065179	432
18-1402	OMC	502036	806	18-15149	Mercury Marine	57-895120	432
18-1402	OMC	3854033	806	18-15150	Mercury Marine	57-895120002	432
18-1402	Volvo	502036	806	18-1522	Yamaha	63P-81950-00	504
18-1402	Volvo	3854033	806	18-1523	Yamaha	61A-81950-01	504
18-1410	Yamaha	93310-32337-00	538	18-1524	Yamaha	6H1-81950-01-00	504
18-1411	Yamaha	93310-620V5-00	538	18-1525	Yamaha	60E-81950-00-00	504
18-1412	Suzuki	09263-20051	Obsolete	18-15214	Crusader	R130012	617
18-1414	Suzuki	09263-14022	490	18-15214	Pleasurecraft	R130012	617
18-1415	Suzuki	09263-18016	Obsolete	18-15290	Mercury Marine	57-13457	771
18-1416	Suzuki	09263-27005	Obsolete	18-15290	Mercury Marine	57-13457Q	771
18-1417	Suzuki	09263-20072	490	18-15290	Mercury Marine	57-13457T	771
18-1476			986	18-15290	Mercury Marine	57-53215	771
18-1477			986	18-15290	Mercury Marine	57-53215T	771
18-1478	Volvo	1218674	986	18-15290			771
18-1479	Volvo	461511	986	18-15300	Mercury Marine	57-49756	771
18-1500	OMC	337778	357	18-15300			771
18-1501	OMC	160084	1000	18-15325	Mercury Marine	57-77274A1	771
18-1501	Volvo	3852023	1000	18-15325	Volvo	958303	771
18-1505	OMC	318940	337	18-15325			771
18-1506	OMC	394411	311	18-15345	Mercury Marine	57-74271	771
18-15061	Honda	31200-ZW1-004	263	18-15345	Mercury Marine	57-74271Q	771
18-1507	OMC	335981	311	18-15345	Mercury Marine	57-74271T	771
18-1508	Mercury Marine	25-8071341	756	18-15345	Mercury Marine	57-77274	771
18-15080	Polaris	3240120	572	18-15345			771
18-15080	Yamaha	6M6-8183E00-00	572	18-15370	Mercury Marine	57-65607	771
18-15100	Mercury Marine	57-862087A1	777	18-15370	Mercury Marine	57-65607Q	771
18-15100	Mercury Marine	57-862807	777	18-15370	Mercury Marine	57-65607T	771
18-15100	Mercury Marine	57-8638763	777	18-15370			771
18-15100	Mercury Marine	57-865615003	777	18-15380	OMC	910414	771, 904, 976
18-15100	Mercury Marine	57-865615003	777	18-15380			771, 904, 976
18-15101	Mercury Marine	57-862086	777	18-15390	Mercury Marine	57-52692	771
18-15101	Mercury Marine	57-8620861	777	18-15390	Volvo	958310	771
18-15101	Mercury Marine	57-862086A1	777	18-15390			771
18-15101	Mercury Marine	57-8638764	777	18-15400	Mercury Marine	57-32850	771
18-15101	Mercury Marine	57-865615004	777	18-15400	Mercury Marine	57-69143Q	771
18-15101	Mercury Marine	57-865615004	777	18-15400	Mercury Marine	57-69143T	771
18-15102	Mercury Marine	57-8610491	777	18-15400	OMC	311606	771
18-15102	Mercury Marine	57-8638766	777	18-15400			771
18-15102	Mercury Marine	57-865615006	777	18-15405	Mercury Marine	57-76269	771
18-15102	Mercury Marine	57-865615006	777	18-15405	Mercury Marine	57-76269Q	771
18-15103	Mercury Marine	57-861050	777	18-15405	Volvo	958311	771
18-15103	Mercury Marine	57-8638767	777	18-15405			771
18-15103	Mercury Marine	57-865615007	777	18-15410	Mercury Marine	57-32850	771
18-15103	Mercury Marine	57-865615007	777	18-15410	Mercury Marine	57-49043	771
18-15104	Mercury Marine	57-862089	777	18-15410	Mercury Marine	57-49043A1	771
18-15104	Mercury Marine	57-862089A1	777	18-15410	Mercury Marine	57-64032	771
18-15104	Mercury Marine	57-8638768	777	18-15410	Mercury Marine	57-64032A1	771
18-15104	Mercury Marine	57-865615008	777	18-15410	Mercury Marine	57-64032Q1	771
18-15104	Mercury Marine	57-865615008	777	18-15410	Mercury Marine	57-816544	771
18-15109	Yamaha	YSC-22260-00-OC	Obsolete	18-15410	Volvo	950813	771
18-15111	Yamaha	YSC-10260-00-OC	1005	18-15410			771
18-15112	Mercury Marine	57-8077554	777	18-15415	Mercury Marine	57-36356	771
18-15112	Mercury Marine	57-807755Q04	777	18-15415	OMC	910343	771
18-15113	Mercury Marine	57-8077555	Obsolete	18-15415	Volvo	958357	771
18-15114	Mercury Marine	57-861049	777	18-15430	Mercury Marine	57-49211	771
18-15114	Mercury Marine	57-861049Q	777	18-15430	Mercury Marine	57-64416	771
18-15115	Mercury Marine	57-861757	777	18-15430	Volvo	841821	771
18-15115	Mercury Marine	57-861757Q	777	18-15430			771

1 This product is priced per piece. To order, priced per package, please add -9 to the part number
 2 Items ending in "D" are display packaged - regular number is non-display • 3 For discount shop pack of 10, please add -10 to the part number

SIERRA #	O.E.M.	O.E. #	PAGE #	SIERRA #	O.E.M.	O.E. #	PAGE #
SIERRA							
18-15435	Mercury Marine	57-49211	771	18-1712	OMC	980014	357
18-15435	Mercury Marine	57-64416	771	18-1713	OMC	3852563	924
18-15435	OMC	912509	771	18-1714	OMC	313448	935
18-15435	Volvo	958314	771	18-1721	OMC	433067	341
18-15435	Volvo	966382	771	18-1722	OMC	438399	354
18-15440	Mercury Marine	57-45856	771	18-1723	OMC	346004	354
18-15440	Mercury Marine	57-49213A1	771	18-1725	OMC	436834	355
18-15440	OMC	311046	771	18-1727	Volvo	803762	987
18-15440			771	18-1728	Mercury Marine	816607	846
18-15450	OMC	914787	771	18-1730	Mercury Marine	43585	414
18-15450	Volvo	3858462	771	18-1734	OMC	334742	311
18-15450			771	18-1736	Mercury Marine	45-43031A1	457
18-15455	OMC	908929	771, 904, 976	18-1737	Mercury Marine	45-440001	457
18-15455	Volvo	3852464	771, 904, 976	18-1750			Obsolete
18-15455			771, 904, 976	18-1752	OMC	394462	317
18-15460	Mercury Marine	57-48120	771	18-1753	OMC	395861	317
18-15460	Mercury Marine	57-48120A1	771	18-1755	Yamaha	650-11651-04-00	Obsolete
18-15460	Mercury Marine	57-48120Q1	771	18-1755K	Yamaha	650-11651-04-00	Obsolete
18-15460	OMC	310953	771	18-1756	Yamaha	688-11650-03-00	538
18-15460	OMC	909971	771	18-1757	Suzuki	12161-93902	Obsolete
18-15460	Volvo	829207	771	18-17570			Obsolete
18-15460	Volvo	950818	771	18-1757K	Suzuki	12161-93902	490
18-15470	Mercury Marine	57-78200	771	18-1758	Suzuki	12161-91L00	Obsolete
18-15470	Mercury Marine	57-78200A1	771	18-1758	Suzuki	12161-96300	Obsolete
18-15470	Mercury Marine	57-78200Q1	771	18-1759	Suzuki	12161-92L00	Obsolete
18-15470			771	18-1759	Suzuki	12161-94400	Obsolete
18-15480	Mercury Marine	57-48122	771	18-1759K	Suzuki	12161-94400	490
18-15480	Mercury Marine	57-48122Q	771	18-1800	Mercury Marine	12886A6	432
18-15480			771	18-18000	Mercury Marine	57-892318	392
18-15490	Mercury Marine	57-816295Q	771	18-18100	Mercury Marine	57-828507Q4	392
18-15490	Mercury Marine	57-816295T	771	18-1820	Honda	91251-ZW1-B04	Obsolete
18-15495	Mercury Marine	57-91035	771	18-1821	Johnson/Evinrude	353690	307
18-15495	Mercury Marine	57-91035A1	771	18-1822	Johnson/Evinrude	354580	Obsolete
18-15495	Mercury Marine	57-91035Q1	771	18-1823	Johnson/Evinrude	5007770	306
18-15495	Volvo	958320	771	18-1824	Johnson/Evinrude	349354	306
18-15495			771	18-1825	Johnson/Evinrude	340811	Obsolete
18-1550	Mercury Marine	43-881260A3	457	18-1826	Johnson/Evinrude	338601	306
18-15500	Mercury Marine	57-96834Q	771	18-1827	Johnson/Evinrude	321129	Obsolete
18-15500	Mercury Marine	57-96834T	771	18-1828	Yamaha	663-44366-00	519
18-15500	OMC	909818	771	18-1829	Yamaha	6AW-44365-00-00	519
18-15500	OMC	912418	771	18-1830	Yamaha	663-44366-00	519
18-15500	Volvo	952141	771	18-18303	Suzuki	38100-92J02	483
18-15501	Mercury	88-93582	718	18-18303	Suzuki	38100-92J10	483
18-1551	Mercury Marine	43-803615T2	457	18-18303	Suzuki	38100-93J01	483
18-15520	Mercury Marine	57-33170	771	18-18303	Suzuki	38100-93J02	483
18-15520	Mercury Marine	57-33170Q	771	18-18303	Suzuki	38100-96J00	483
18-15520	Mercury Marine	57-37619T	771	18-18304	Suzuki	37100-87J00-OEP	Obsolete
18-15520	OMC	912714	771	18-18304	Suzuki	38100-87J0EP	Obsolete
18-15520			771	18-1831	Yamaha	682-44366-00	520
18-15550	Mercury Marine	57-13458	771	18-1832	Yamaha	682-44367-00	520
18-15550	Mercury Marine	57-13458Q	771	18-1833	Yamaha	647-44366-00	520
18-15550	Mercury Marine	57-13458T	771	18-1834	Yamaha	682-44365-00	520
18-15550	Mercury Marine	57-96834	771	18-1835	Yamaha	6E5-44365-00-00	520
18-15550			771	18-1836	Yamaha	6L2-44367-00	519
18-1560	Mercury Marine	43-850036	457	18-1837	Yamaha	6L2-44367-10	519
18-1560	Mercury Marine	43-850036T	457	18-1838	Mercury	43023	Obsolete
18-1564	Mercury Marine	43-803615T1	457	18-1839	Mercury	8235471	Obsolete
18-1564	Mercury Marine	43-803615T2	457	18-1840	Yamaha	6EE-G4366-00	519
18-1565	Mercury Marine	52-859340T	458	18-1842	Mercury	864612T01	792
18-1566	Mercury Marine	43-828175A1	Obsolete	18-1843	Mercury	864308T01	792
18-1596	Johnson/Evinrude	328725	307	18-1843	Mercury	865049T01	792
18-1597	Johnson/Evinrude	302325	306, 307	18-1843	Mercury	865735A02	792
18-1598	OMC	341013	924	18-1845	Mercury	864591T02	792
18-1599	OMC	123018	924	18-1848	OMC	3852338	909
18-1600	OMC	983825	924	18-1848	OMC	3857656	909
18-1601	OMC	983826	Obsolete	18-1848	OMC	914899	909
18-1650	Universal		167	18-1848	Volvo	3857656	909
18-1651	Universal		167	18-1876	OMC	980617	988
18-1652	Universal		167				
18-1653	Universal		167	18-1898	Barr	CHVA-1-84	589, 606, 627, 657, 662, 791, 908, 979
18-1654	Universal		167				
18-1655	Universal		167	18-1898	Marine Power	0991-110	589, 606, 627, 657, 662, 791, 908, 979
18-1656	Universal		167	18-1899	Pleasurecraft	RO29001	650
18-1701	OMC	911693	932	18-1901	OMC	984054	908
18-1702	OMC	438039	934	18-1902	OMC	912441	908
18-1702	OMC	5000074	934	18-1903	OMC	912442	908
18-1703	OMC	434400	934	18-1904	OMC	980959	908
18-1703	OMC	435096	934	18-1905	Mercury Marine	90880	794
18-1703	OMC	438040	934	18-1906	Mercury Marine	61851	794
18-1703	OMC	5000363	934				
18-1703	OMC	5004257	934	18-1907	Barr	20-0100	589, 606, 629, 659, 661, 662, 794, 909, 980
18-1704	OMC	331980	Obsolete				
18-1705	Mercury Marine	65547	843	18-1907	Barr	20-0102	589, 606, 629, 659, 661, 662, 794, 909, 980
18-1705	Mercury Marine	77123	843				
18-1705	Mercury Marine	77123A1	843	18-1907	Indmar	53-2009	589, 606, 629, 659, 661, 662, 794, 909, 980
18-1706	Mercury Marine	10-86801	843				
18-1710	Mercury Marine	86814	846	18-1907	Indmar	53-2018	589, 606, 629, 659, 661, 662, 794, 909, 980
18-1710	Mercury Marine	862209	846				
18-1711	Mercury Marine	862132	842	18-1908	Mercury Marine	93320	794
18-1711	Mercury Marine	862132T	842	18-1908K	Mercury Marine	807476A6	794

1 This product is priced per piece. To order, priced per package, please add -9 to the part number
 2 Items ending in "D" are display packaged - regular number is non-display • 3 For discount shop pack of 10, please add -10 to the part number

SIERRA #	O.E.M.	O.E. #	PAGE #	SIERRA #	O.E.M.	O.E. #	PAGE #
SIERRA							
18-1908K	Mercury Marine	93320A13	794	18-1952-1	Mercury Marine	99746A8	791
18-1908K	Mercury Marine	93320A2	794	18-1953-2	Mercury Marine	860246Q11	791
18-1908K	Mercury Marine	93320A3	794	18-1954-1	Mercury Marine	MC 1 95862	Obsolete
18-1908K	Mercury Marine	93320A5	794	18-1954-1	Mercury Marine	95862A5	Obsolete
18-1908K	Mercury Marine	93320A6	794	18-1955-1	Barr	MC 1 96705	792
18-1909-1	OMC	913784	909	18-1955-1	Mercury Marine	52390A1	792
18-1909-1	OMC	3850456	909	18-1955-1	Mercury Marine	96705A1	792
18-1909-1	OMC	3855270	909	18-1956-3	Barr	MC 1 99798	792
18-1909-1	OMC	3857944	909	18-1956-3	Mercury Marine	806867A 8	792
18-1909-1	OMC	3856444	909	18-1956-3	Mercury Marine	860235A04	792
18-1909-1	Volvo	3863061	909	18-1956-3	Mercury Marine	99798A16	792
18-1909-1	Volvo	3863061	909	18-1956-3	Mercury Marine	99798A18	792
18-1909-1	Volvo	3855270-9	909	18-1956-3	Mercury Marine	99798A3	792
18-1909-1	Volvo	3855270-9	909	18-1956-3	Mercury Marine	99798A9	792
18-1910	Mercury Marine	47587	757	18-1957-2	Mercury Marine	807078T08	792
18-1910	Mercury Marine	47588	757	18-1957-2	Mercury Marine	807078Q07	792
18-1910	Mercury Marine	47587A2	757	18-1958-1	Mercury Marine	54100A1	791
18-1910	Mercury Marine	60372A1	757	18-1958-1	Mercury Marine	54100A5	791
18-1910	Mercury Marine	60372A2	757	18-1958-1	Barr	MC-1-65604	791
18-1910	Mercury Marine	63908A2	757	18-1958-1	Mercury Marine	65604A12	791
18-1910	Mercury Marine	861493A07	757	18-1958-1	Mercury Marine	65604A4	791
18-1910	Mercury Marine	861493A3	757	18-1960-1	Mercury Marine	58759A13	792
18-1911			603, 607	18-1960-1	Mercury Marine	58759A1	792
18-1913	Chrysler Inboard	2469556	607	18-1960-1	Mercury Marine	52969A1	792
18-1913	Chrysler Inboard	2469639	607	18-1960-1	Mercury Marine	52073A1	792
18-1913	Chrysler Inboard	2847405	607	18-1960-1	Barr	MC 1 58759	792
18-1916	Crusader	97169	628	18-1960-1	Mercury Marine	58759A10	792
18-1917	Crusader	97296	631	18-1960-1	Mercury Marine	58759A14	792
18-1918	Crusader	97386	628	18-1962-1	Barr	MC-1-65603	792
18-1919	Crusader	97387	628	18-1962-1	Mercury Marine	54099A5	792
18-1921	OMC	909863	909	18-1962-1	Mercury Marine	54099A1	792
18-1922	OMC	987784	909	18-1962-1	Mercury Marine	65603A12	792
18-1922	OMC	916096	909	18-1962-1	Mercury Marine	65603A4	792
18-1922	OMC	740120	909	18-1964	Barr	CHV-1-83	659
18-1922	OMC	3850799	909	18-1966-1	Mercury	806867A12	792
18-1922	OMC	910380	909	18-1966-1	Mercury	806867A2	792
18-1924	Crusader	97624	628	18-1966-1	Mercury	806867A3	792
18-1925	Crusader	96120	628	18-1966-1	Mercury	806867A8	792
18-1925	Crusader	97752	628	18-1966-1	Mercury	806867A9	792
18-1926	Crusader	96121	627	18-1966-1	Mercury	816329A3	792
18-1926	Crusader	97753	627	18-1966-1	Mercury	860235A03	792
18-1927	Crusader	97772	628	18-1966-1	Mercury	99798A18	792
18-1928	Crusader	97924	628	18-1970-2	Mercury Marine	95755A2	793
18-1929	Crusader	97114	627	18-1970-2	Mercury Marine	98503A2	793
18-1929	Crusader	97992	627	18-1970-2	Mercury Marine	98504A3	793
18-1930-2	Volvo	855387	979	18-1970-2	Barr	MC-20-98504	793
18-1930-2	Volvo	834438-4	979	18-1971	Mercury Marine	49964A1	793
18-1931-1	Volvo	835804	979	18-1971	Mercury Marine	49964A2	793
18-1931-1	Volvo	856883	979	18-1971	Mercury Marine	60426A1	793
18-1932	Volvo	856894	979	18-1971	Mercury Marine	76351A04	793
18-1933	Crusader	97115	627	18-1971	Mercury Marine	76351A1	793
18-1933	Crusader	97993	627	18-1971	Mercury Marine	76351A2	793
18-1934	Crusader	98068	628	18-1972	Barr	MC-20-76325	793
18-1935-1	Volvo	856891	980	18-1972	Mercury Marine	12076A2	793
18-1935-1	Volvo	855384-4	980	18-1972	Mercury Marine	76325A2	793
18-1936	Volvo	857037	981	18-1973	Barr	MC-20-55538	793
18-19360			981	18-1973	Mercury Marine	39920	793
18-1937	Mercury Marine	98562A6	794	18-1973	Mercury Marine	39920A1	793
18-1938	Crusader	98126	628	18-1973	Mercury Marine	55538A2	793
18-1938	Crusader	RO29015	628	18-1974-1	Barr	MC-20-98502	794
18-1939	Barr	20-0100	662	18-1974-1	Mercury Marine	98502A2	794
18-1939	Marine Power	0992-593	662	18-1975-1	Mercury Marine	12076A1	794
18-1940	Barr	CM-1-6677A	606	18-1975-1	Mercury Marine	12076A2	794
18-1940	Chrysler Inboard	3675826	606	18-1975-1	Mercury Marine	95864A2	794
18-1940	Chrysler Inboard	4142322	606	18-1976-2	Barr	MC-20-44354	794
18-1941	Barr	CM-1-6672-B	607	18-1976-2	Mercury Marine	44354A10	794
18-1941	Chrysler Inboard	2846106	607	18-1976-2	Mercury Marine	44354A13	794
18-1942	Barr	CM-1-6672-H	607	18-1976-2	Mercury Marine	44354A3	794
18-1942	Chrysler Inboard	3675826	607	18-1976-2	Mercury Marine	44354A9	794
18-1942	Chrysler Inboard	24695566	607	18-1976-2	Mercury Marine	807914A1	794
18-1944	Barr	CM-20-414211	606	18-1976-2	Mercury Marine	807988A03	794
18-1944	Chrysler Inboard	2847404	606	18-1976-2	Mercury Marine	807988A2	794
18-1944	Chrysler Inboard	2847623	606	18-1977-1	Mercury Marine	47441	756
18-1944	Chrysler Inboard	3745639	606	18-1977-1	Mercury Marine	47441A1	756
18-1944	Chrysler Inboard	E9923M	606	18-1978	Mercury Marine	60427A2	793
18-1945	Barr	CM-20-6674	606	18-1978	Mercury Marine	53779A2	793
18-1945	Chrysler Inboard	2846689	606	18-1978	Mercury Marine	53779A1	793
18-1946	Barr	CM-20-6672	606	18-1978	Barr	MC-20-76771	793
18-1946	Chrysler Inboard	3527794	606	18-1978	Mercury Marine	76771A2	793
18-1948	Barr	CM-20-9234	607	18-1978	Mercury Marine	76771A3	793
18-1948	Chrysler Inboard	E9234M	607	18-1982	Crusader	98125	627
18-1949	Barr	CM 20-0097	629	18-1984	Crusader	98128	629
18-1950-1	Barr	MC-1-77234	791	18-1985	Barr	MC-20-93322A3	794
18-1950-1	Mercury Marine	77234A2	791	18-1985	Marine Power	612011	794
18-1950-1	Mercury Marine	77234A7	791	18-1985	Mercury Marine	93322	794
18-1951-1	Barr	MC-1-77235	791	18-1986-1	OMC	3852374	908
18-1951-1	Mercury Marine	77235A2	791	18-1986-1	OMC	3857723	908
18-1951-1	Mercury Marine	77235A8	791	18-1986-1	Barr	OMC-1-914035	908
18-1952-1	Barr	MC-1-99746	791	18-1986-1	Volvo	3847501	908
18-1952-1	Mercury Marine	99746A17	791	18-1986-1	Volvo	3857723	908

1 This product is priced per piece. To order, priced per package, please add -9 to the part number
 2 Items ending in "D" are display packaged - regular number is non-display • 3 For discount shop pack of 10, please add -10 to the part number

SIERRA #	O.E.M.	O.E. #	PAGE #	SIERRA #	O.E.M.	O.E. #	PAGE #
SIERRA							
18-1986-1	Volvo	3852374-2	908	18-2039	Volvo	804695	1003
18-1989	Mercury Marine	861006A1	667	18-2040	Volvo	853670	1003
18-1989	Mercury Marine	8M0061381	667	18-2041	Volvo	897426	1003
18-1989K			667, 756	18-2043	Volvo	958838	Obsolete
18-1990	Barr	1-73813	795	18-2044	Volvo	833996	1003
18-1990	Mercury Marine	48045	795	18-2045	Volvo	827247	1003
18-1990	Mercury Marine	54870	795	18-2046	Volvo	946242	1003
18-1990	Mercury Marine	73813	795	18-2047	Volvo	958860	1003
18-1990	Mercury Marine	73813A1	795	18-2048	Mercury Marine	26-24590	868
18-1990	Mercury Marine	73813F1	795	18-2049	Mercury Marine	26-32511	868
18-1991	Barr	200089P	589, 628, 650, 793, 909, 980	18-2050	Mercury Marine	26-55682	868
18-1992-1	Barr	200087P	589, 628, 650, 793, 909, 980	18-2051	Mercury Marine	26-69188	868
18-1994	Mercury Marine	87290A4	Obsolete	18-2052	Mercury Marine	26-69189	868
18-1995	Mercury Marine	47638	795	18-2053	Honda	91255-ZW1-003	272
18-1995	Mercury Marine	47638A1	795	18-2053	Mercury Marine	26-70081	272
18-1996	Barr	FM-1-83	650	18-2054	Honda	91253-ZW1-003	272
18-1996	Pleasurecraft	RC28001	650	18-2054	Mercury Marine	26-76384	272
18-1997-1	Barr	CHV-1-83	662	18-2054	Mercury Marine	26-8164641	272
18-1998-1	Barr	FM-1-83	662	18-2055	Mercury Marine	26-21642	868
18-1999	Barr	20-0082	662	18-2055	Mercury Marine	26-79831	868
18-2000	OMC	309989	367, 941	18-2055	Mercury Marine	26-79831	868
18-2001	OMC	330137	367, 941	18-2056	Mercury Marine	26-37259	868
18-2002	Honda	91252-ZW1-003	272	18-2056	Mercury Marine	26-89237	868
18-2002	Mercury Marine	26-30550	272	18-2056	Mercury Marine	26-96503	868
18-2002	Mercury Marine	26-70019	272	18-2056	Mercury Marine	26-965031	868
18-2002	Mercury Marine	26-76868	272	18-2057	Volvo	181620	1003
18-2002	OMC	320862	272	18-2058	OMC	313353	367, 941
18-2003	Mercury Marine	26-32080	865	18-2059	OMC	318223	367, 941
18-2003	Mercury Marine	26-36054	865	18-2060	OMC	303804	367, 941
18-2003	Mercury Marine	26-823894	865	18-2060	OMC	321467	367, 941
18-2004	Mercury Marine	26-20070	467	18-2061	OMC	329922	367, 941
18-2005	Jabco	92700-0060	367, 941	18-2062	OMC	329923	367, 941
18-2005	OMC	313284	367, 941	18-2063	OMC	330327	367, 941
18-2006	Mercury Marine	26-897154	467	18-2064	OMC	332205	367, 941
18-2007	Mercury Marine	26-30727	868	18-2065	OMC	332261	367, 941
18-2007	Mercury Marine	26-31489	868	18-2066	OMC	911019	367, 941
18-2007	Mercury Marine	26-94038	868	18-2067	OMC	911685	367, 941
18-2008	Mercury Marine	26-56788	467	18-2068	OMC	911701	367, 941
18-2009	Mercury Marine	26-25776	868	18-2068	OMC	915702	367, 941
18-2009	Mercury Marine	26-31249	868	18-2068	OMC	916058	367, 941
18-2009	Mercury Marine	26-46021	868	18-2068	OMC	3853655	367, 941
18-2009	Mercury Marine	26-892361	868	18-2071	OMC	908065	941
18-2010	Mercury Marine	26-897153	467	18-2071	OMC	908852	941
18-2011	Mercury Marine	26-23300	868	18-2071	OMC	981195	941
18-2011	Mercury Marine	26-29595	868	18-2072	OMC	908070	367, 941
18-2011	Mercury Marine	26-90562	868	18-2072	OMC	908894	367, 941
18-2012	OMC	310599	367, 941	18-2072	OMC	981196	367, 941
18-2013	Mercury Marine	802276	868	18-2073	OMC	907967	367, 941
18-2013	Mercury Marine	26-20465	868	18-2073	OMC	981268	367, 941
18-2013	Mercury Marine	26-31507	868	18-2074	OMC	339620	367
18-2013	Mercury Marine	26-79884	868	18-2075	OMC	326751	367
18-2014	Mercury Marine	26-33144	868	18-2075	OMC	353076	367
18-2014	Mercury Marine	26-77634	868	18-2076	Mercury Marine	26-12224	868
18-2014	Mercury Marine	26-89238	868	18-2076	Mercury Marine	26-F697118	868
18-2014	Mercury Marine	26-F694305	868	18-2077	Mercury Marine	26-14077	868
18-2015	Mercury Marine	20250	868	18-2077	Mercury Marine	26-F697555	868
18-2015	Mercury Marine	26-23517	868	18-2079	Yamaha	93101-22M15-00	570
18-2016	Mercury Marine	26-20079	367, 941	18-2081	Yamaha	64E-43822-00-00	504
18-2016	Mercury Marine	26-25837	367, 941	18-2082	Yamaha	64E-4384J-00-00	504
18-2016	Mercury Marine	26-29476	367, 941	18-2083	Yamaha	68V-13766-00-00	503
18-2016	Mercury Marine	26-41953	367, 941	18-2085	Yamaha	93102-35M13-00	570
18-2016	OMC	313992	367, 941	18-2087	Yamaha	93102-40M36-00	Obsolete
18-2017	Mercury Marine	26-32121	868	18-2091	Yamaha	93104-22M07-00	570
18-2017	Mercury Marine	26-35025	868	18-2093	OMC	319664	354
18-2018	OMC	305987	367, 941	18-2093	OMC	333096	354
18-2019	Mercury Marine	26-27163	868	18-2093	OMC	398051	354
18-2020	OMC	310649	367, 941	18-2094	Mercury Marine	26-36143	826
18-2021	OMC	313258	367	18-2094	Mercury Marine	26-88416	826
18-2022	OMC	303345	367, 941	18-2097	Mercury Marine	8055361	833, 842
18-2023	OMC	313282	367, 941	18-2097	Mercury Marine	805536A1	833, 842
18-2024	OMC	314167	367, 941	18-2097	Mercury Marine	805536A2	833, 842
18-2025	OMC	318972	367, 941	18-2100	Mercury Marine	30-60794A2	999
18-2026	Mercury Marine	802276	367	18-2100	Mercury Marine	30-60794A4	999
18-2026	Mercury Marine	26-16977	367	18-2100	Mercury Marine	30-879194A02	999
18-2026	Mercury Marine	26-20465	367	18-2100	OMC	983937	999
18-2026	Mercury Marine	26-31507	367	18-2100	Volvo	3853807	999
18-2026	Mercury Marine	26-79884	367	18-21001	Mercury Marine	30-60794A2	843, 845
18-2026	OMC	317843	367	18-21001	Mercury Marine	30-60794A4	843, 845
18-2027	OMC	305306	367, 941	18-21001	Mercury Marine	30-879194A02	843, 845
18-2027	OMC	321459	367, 941	18-21005	Mercury Marine	30-562540A3	843
18-2028	OMC	318973	367, 941	18-21005	Mercury Marine	30-862540A04	843
18-2029	OMC	319256	367, 941	18-21005	Mercury Marine	30-862540T1	843
18-2029	OMC	321481	367, 941	18-21005	Mercury Marine	30-879194A01	843
18-2030	OMC	321786	367, 941	18-21005K	Mercury Marine	30-862540A04	843
18-2031	OMC	321787	367, 941	18-21005K	Mercury Marine	30-862540A3	843
18-2032	OMC	321788	367, 941	18-21005K	Mercury Marine	30-862540T1	843
18-2033	OMC	321928	367, 941	18-21005K	Mercury Marine	30-879194A01	843
18-2034	OMC	324639	367, 941	18-21006	Mercury Marine	30-862540A04	843
18-2035	OMC	300599	367, 941	18-21006	Mercury Marine	30-862540A3	843
18-2035	OMC	327031	367, 941	18-21006	Mercury Marine	30-862540T1	843

1 This product is priced per piece. To order, priced per package, please add -9 to the part number

2 Items ending in "D" are display packaged - regular number is non-display • 3 For discount shop pack of 10, please add -10 to the part number

SIERRA #	O.E.M.	O.E. #	PAGE #	SIERRA #	O.E.M.	O.E. #	PAGE #	
SIERRA								
18-21006	Mercury Marine	30-879194A01	843	18-2145	Mercury Marine	815471A3	847	
18-2100K	Mercury Marine	30-60794A2	843, 845	18-2145	Mercury Marine	815471A6	847	
18-2100K	Mercury Marine	30-60794A4	843, 845	18-2145	Mercury Marine	85147A5	847	
18-2100K	Mercury Marine	30-879194A02	843, 845	18-2145	Mercury Marine	865437A02	847	
18-2101	Mercury Marine	36147	843	18-2145E	Mercury Marine	815471	847	
18-2101	Mercury Marine	30-36056	843	18-2145E	Mercury Marine	815471A3	847	
18-2101	Mercury Marine	30-36418	843	18-2145E	Mercury Marine	815471A6	847	
18-2103	Mercury Marine	32-47373	859	18-2146	Mercury Marine	20175	999	
18-2103	Mercury Marine	32-66073	859	18-2146	Mercury Marine	59830A1	999	
18-2103	Mercury Marine	32-68676	859	18-2146	Mercury Marine	59830A7	999	
18-2103	Mercury Marine	32-73004	859	18-2146	OMC	912212	999	
18-2103	Mercury Marine	32-79431	859	18-2146	OMC	3850815	999	
18-2103	Mercury Marine	32-86036	859	18-2146	Volvo	3850815	999	
18-2103	Mercury Marine	32-86036A1	859	18-2147	Johnson/Evinrude	328754	306, 307	
18-2103	Mercury Marine	32-86036Q	859	18-2148	Mercury Marine	45523	Obsolete	
18-2103	Pleasurecraft	FO85035	859	18-2148	Mercury Marine	77443	Obsolete	
18-2104	Mercury Marine	36312	843	18-2148	Mercury Marine	45706A4	Obsolete	
18-2104	Mercury Marine	41431	843	18-2148	Mercury Marine	77442A1	Obsolete	
18-2104	Mercury Marine	58749	843	18-2149	Mercury Marine	22879	848	
18-2104	Mercury Marine	75832	843	18-2149	Mercury Marine	29880	848	
18-2104	Mercury Marine	758321	843	18-2149	Mercury Marine	43433	848	
18-2104	Mercury Marine	75832A1	843	18-2150	Mercury Marine	37973	855	
18-2104	Mercury Marine	75832A2	843	18-2150	Mercury Marine	65028	855	
18-2104	Mercury Marine	75832A3	843	18-2150	Mercury Marine	66066	855	
18-2104	Mercury Marine	75832T	843	18-2150	Mercury Marine	77481	855	
18-2104	Mercury Marine	75832T1	843	18-2150	Mercury Marine	774811	855	
18-2104	OMC	912214	843	18-2151	Mercury Marine	17-45738	863	
18-2104	OMC	915716	843	18-2152	Mercury Marine	17-45735	863	
18-2104	Volvo	853255	843	18-2153	Volvo	814301	1000	
18-2104	Volvo	897707	843	18-2154	Mercury Marine	23-30617A1	855	
18-2105	Mercury Marine	32-45973	Obsolete	18-2154	Mercury Marine	23-30617A2	855	
18-2106	Mercury Marine	32-45974	860	18-2155	Mercury Marine	23-37428A1	456	
18-2107	Mercury Marine	32-55816	860	18-2155	Mercury Marine	23-55419A1	456	
18-2108	Mercury Marine	32-59841	860	18-2155	Mercury Marine	23-77631A2	456	
18-2108	Mercury Marine	32-59841A1	860	18-2156	OMC	980183	936	
18-2108	Mercury Marine	32-73123	860	18-2157	Mercury Marine	19543A10	847	
18-2109	Mercury Marine	32-59842	860	18-2157	Mercury Marine	19543A2	847	
18-2109	Mercury Marine	32-73005	860	18-2157	Mercury Marine	19543A4	847	
18-2110	Mercury Marine	32-45327	460	18-2157	Mercury Marine	19543A8	847	
18-2110	Mercury Marine	32-88005	460	18-2157	Mercury Marine	41951A1	847	
18-2110	Mercury Marine	32-97153A1	460	18-2157	Mercury Marine	66065A1	847	
18-2111	Mercury Marine	32-45959	460	18-2157	Mercury Marine	66069A2	847	
18-2111	Mercury Marine	32-88006	460	18-2157	Mercury Marine	73679A2	847	
18-2111	Mercury Marine	32-97154A1	460	18-2157	Mercury Marine	865436A02	847	
18-2112	Mercury Marine	32-87234	860	18-2158			847	
18-2113	Mercury Marine	32-87235	Obsolete	18-2159	Mercury Marine	19543A10	847	
18-2114	Mercury Marine	32-864960	860	18-2159	Mercury Marine	19543A2	847	
18-2114	Mercury Marine	32-99902-1	860	18-2159	Mercury Marine	19543A4	847	
18-2115	Mercury Marine	32-864959	860	18-2159	Mercury Marine	19543A8	847	
18-2115	Mercury Marine	32-99903-1	860	18-2159	Mercury Marine	41951A1	847	
18-2116	Mercury Marine	32-99904	861	18-2159	Mercury Marine	66065A1	847	
18-2116	Mercury Marine	32-99904Q	861	18-2159	Mercury Marine	66069A2	847	
18-2125	Mercury Marine	39384	831, 833, 842	18-2159	Mercury Marine	73679A2	847	
18-2125	Mercury Marine	46020	831, 833, 842	18-2159	Mercury Marine	865436A02	847	
18-2125	Mercury Marine	460201	831, 833, 842	18-2160	Mercury Marine	32-38377	847	
18-2125	Mercury Marine	4602002	831, 833, 842	18-2161	Mercury Marine	45518A1	844	
18-2125	Mercury Marine	46020002	831, 833, 842	18-2161	Mercury Marine	45518A2	844	
18-2125	Mercury Marine	46020T	831, 833, 842	18-2161	Mercury Marine	45518A3	844	
18-2126	Mercury Marine	32-48418	861	18-2162	Mercury Marine	33981	844	
18-2126	Mercury Marine	32-52951A1	861	18-2162	Mercury Marine	8507521	844	
18-2128	Mercury Marine	39383	999	18-2162	Mercury Marine	8507522	844	
18-2128	Mercury Marine	393831	999	18-2162	Mercury Marine	33981T	844	
18-2128	Mercury Marine	39383T	999	18-2162	Mercury Marine	33981T1	844	
18-2128	OMC	912213	999	1	18-2163	Mercury Marine	10-31700	845, 848
18-2128	OMC	3850813	999	18-2163E-9	GLM	21090	845, 848	
18-2128	Volvo	912213	999	18-2163E-9	Mallory	9-72152	845, 848	
18-2128	Volvo	3850813	999	18-2163E-9	Mercury Marine	10-31700	845, 848	
18-2130	Mercury Marine	66062	855	18-2166	Mercury Marine	44-55857	853	
18-2130	Mercury Marine	76865	855	18-2166	Mercury Marine	44-66060	853	
18-2130	Mercury Marine	8M2009865	855	18-2166	Mercury Marine	44-660602	853	
18-2136	Mercury Marine	32-864589	860	18-2166	Mercury Marine	44-660603	853	
18-2136	Mercury Marine	32-99902	860	18-2166	Mercury Marine	44-824110	853	
18-2137	Mercury Marine	32-864588	860	18-2169	Mercury Marine	45589A1	844	
18-2137	Mercury Marine	32-99903	860	18-2169	Mercury Marine	45589A3	844	
18-2138	OMC	911787	938	18-2170	Mercury Marine	10-45590	844	
18-2138	Volvo	3852544	938	18-2170	Mercury Marine	10-8M0084649	844	
18-2140			827	18-2171	Mercury Marine	32492A2	849	
18-2141	Mercury Marine	10-97934A1	827	18-2171	Mercury Marine	32492A3	849	
18-2142	Mercury Marine	45706A1	Obsolete	18-2171	Mercury Marine	32492A5	849	
18-2142	Mercury Marine	45706A12	Obsolete	18-2171	Mercury Marine	38965A1	849	
18-2142	Mercury Marine	45706A14	Obsolete	18-2171	Mercury Marine	38965A2	849	
18-2142	Mercury Marine	45706A3	Obsolete	18-2171	Mercury Marine	76850A2	849	
18-2142	Mercury Marine	45706A6	Obsolete	18-2172	Mercury Marine	14505A2	849	
18-2142	Mercury Marine	45706A8	Obsolete	18-2173	Mercury Marine	59826A1	849	
18-2144	Mercury Marine	67209	428	18-2173	Mercury Marine	59826A3	849	
18-2144	Mercury Marine	77326	428	18-2174	Mercury Marine	36312	999	
18-2144	Mercury Marine	78687	428	18-2174	Mercury Marine	41431	999	
18-2144	Mercury Marine	78687T	428	18-2174	Mercury Marine	58749	999	
18-2145	Mercury Marine	19297A3	847	18-2174	Mercury Marine	75832	999	
18-2145	Mercury Marine	43432A2	847	18-2174	Mercury Marine	758321	999	

1 This product is priced per piece. To order, priced per package, please add -9 to the part number
 2 Items ending in "D" are display packaged - regular number is non-display • 3 For discount shop pack of 10, please add -10 to the part number

SIERRA #	O.E.M.	O.E. #	PAGE #	SIERRA #	O.E.M.	O.E. #	PAGE #
SIERRA							
18-2174	Mercury Marine	75832A1	999	18-2208	OMC	318304	356
18-2174	Mercury Marine	75832A2	999	18-2209	OMC	318303	Obsolete
18-2174	Mercury Marine	75832A3	999	18-2216	OMC	334516	356
18-2174	Mercury Marine	75832T	999	18-2216	OMC	336562	356
18-2174	Mercury Marine	75832T1	999	18-2216	OMC	337772	356
18-2174	OMC	915717	999	18-2216	OMC	337774	356
18-2174	OMC	3850812	999	18-2216	OMC	910995	356
18-2174	Volvo	3850812	999	18-2217			356
18-2175	Mercury Marine	12632A4	849	18-2218	OMC	434063	356
18-21751	OMC	983902	997	18-2218	OMC	436746	356
18-21751	OMC	986338	997	18-2218	OMC	985050	356
18-21751	OMC	3853962	997	18-2218	OMC	989966	356
18-21751	Volvo	3853962-3	997	18-2219	OMC	317838	356
18-21752-1	OMC	984290	997	18-2219	OMC	333077	356
18-21752-1	OMC	986120	997	18-2219	OMC	340490	356
18-21752-1	OMC	3853917	997	18-2220	OMC	320630	356
18-21752-1	OMC	3858437	997	18-2220	OMC	323664	356
18-21752-1	Volvo	3858437-1	997	18-2221			356
18-21753	OMC	3853862	997	1 18-2224	OMC	320166	361
18-21753	Volvo	985727	997	1 18-2225	OMC	320167	361
18-21753	Volvo	3853862-5	997	1 18-2226	OMC	320168	361
18-21754	OMC	984537	930	1 18-2227	OMC	320169	361
18-21754	OMC	986232	930	18-2228	OMC	320170	361
18-21755	OMC	984629	930	1 18-2229	OMC	323362	361
18-2176	OMC	908063	Obsolete	18-2230	OMC	323361	361
18-2177	OMC	908069	Obsolete	18-2231	OMC	314745	361
18-2180	Mercury Marine	45-42634	835, 854	18-2232	OMC	323889	361
18-2183	OMC	909121	932, 934	18-2233	OMC	323890	361
18-2184	OMC	908087	933, 934	1 18-2234	OMC	317232	361
18-2185	OMC	909753	933, 934	18-2236	Mercury Marine	52-12777	457
18-2186	OMC	982424	933, 934	18-2236	Mercury Marine	52-34239	457
18-2187	OMC	391472	933	18-2236	Mercury Marine	52-814756	457
18-2187	OMC	395209	933	18-2236	Mercury Marine	52-822539	457
18-2189	Mercury Marine	32992A1	847	18-2236	Mercury Marine	52-822539T	457
18-2189	Mercury Marine	34086A1	847	18-2239	Mercury Marine	44-94148	457
18-2189	Mercury Marine	37611A1	847	1 18-2243	OMC	316506	Obsolete
18-2189	Mercury Marine	38399A2	847	18-2244	Mercury Marine	10-20259	456
18-2190	Mercury Marine	19543A10	847	18-2244	Mercury Marine	10-28634	456
18-2190	Mercury Marine	19543A2	847	18-2244	Mercury Marine	10-28634A1	456
18-2190	Mercury Marine	19543A4	847	18-2244	Mercury Marine	10-79953	456
18-2190	Mercury Marine	19543A8	847	18-2244	Mercury Marine	10-79953A2	456
18-2190	Mercury Marine	41951A1	847	18-2244	Mercury Marine	10-79953Q04	456
18-2190	Mercury Marine	66065A1	847	18-2244	Mercury Marine	10-79953Q2	456
18-2190	Mercury Marine	66069A2	847	18-2244	Mercury Marine	10-F50109	456
18-2190	Mercury Marine	73679A2	847	18-2244	Mercury Marine	816610A1	456
18-2190	Mercury Marine	865436A02	847	18-2244	Mercury Marine	816610A2	456
18-2190E	Mercury Marine	19543A10	847	18-2244	Mercury Marine	F40109	456
18-2190E	Mercury Marine	19543A2	847	18-22441-9			456, 858
18-2190E	Mercury Marine	19543A2	847	18-2245-1	OMC	987661	931
18-2190E	Mercury Marine	19543A8	847	18-2246	OMC	987678	931
18-2190E	Mercury Marine	41951A1	847	18-2248	Mercury Marine	35187A1	847
18-2190E	Mercury Marine	66065A1	847	18-2248	Mercury Marine	35187A2	847
18-2190E	Mercury Marine	66069A2	847	18-2248	Mercury Marine	35187A4	847
18-2190E	Mercury Marine	73679A2	847	18-2248	Mercury Marine	49518A1	847
18-2190E	Mercury Marine	865436A02	847	18-2248	Mercury Marine	73723A01	847
18-2191	Mercury Marine	56211A1	854	18-2248	Mercury Marine	73723A1	847
18-2191	Mercury Marine	73020A1	854	18-2250	OMC	387879	355
18-2191	Mercury Marine	73020A14	854	18-2251	OMC	433017	355
18-2192	OMC	379628	889	18-2251	OMC	435022	355
18-2193	Mercury Marine	33149	827	18-2251	OMC	436740	355
18-2193	Mercury Marine	99297A1	827	18-2252	OMC	387818	355
18-2193	Mercury Marine	99297A2	827	18-2252	OMC	436888	355
18-2195	Mercury Marine	12632A3	849	18-2254	Chrysler/Force	44-850308	260
18-2195	Mercury Marine	12632A7	849	18-2254	Mercury Marine	44-850308	260
18-2196	Mercury Marine	37967	854	18-2256	Mercury Marine	43-803116T1	Obsolete
18-2196	Mercury Marine	61073	854	18-2257	Mercury Marine	43-803112T1	831, 842
18-2196	Mercury Marine	19755A08	854	18-2258	Mercury Marine	43-803114T1	Obsolete
18-2196	Mercury Marine	19755A4	854	18-2259	Mercury Marine	43-803101T1	Obsolete
18-2199	Volvo	832675	997	18-2260	Mercury Marine	44-17915	457
18-2200	Mercury Marine	43-61027	852	18-2260	Mercury Marine	44-98418	457
18-2200	Mercury Marine	43-96084A4	852	18-2261	Mercury Marine	45-816919	839, 854
18-2201	Mercury Marine	43-18410A2	831, 833, 841	18-2277	OMC	335722	354
18-2201	Mercury Marine	43-18411A2	831, 833, 841	18-2279	OMC	335679	354
18-2201	Mercury Marine	43-59832A2	831, 833, 841	18-2282	Mercury Marine	15-32563A1	833, 840
18-2201	Mercury Marine	43-59832A4	831, 833, 841	18-2283	Mercury Marine	15-45691A1	831, 833, 840
18-2202	Mercury Marine	52-66063	853	18-2285	Mercury Marine	15-35931A1	840
18-2202	Mercury Marine	52-824112	853	18-2286	Mercury Marine	66067	854
18-2202	Mercury Marine	52-853594	853	18-2286	Mercury Marine	19755A2	854
18-2202	Mercury Marine	52-853594T	853	18-2286	Mercury Marine	66067T	854
18-2203	Mercury Marine	43-45814A5	841	18-2286	Mercury Marine	818349A1	854
18-2203	Mercury Marine	43-55765A2	841	18-2286	Mercury Marine	818349T1	854
18-2203	Mercury Marine	43-55765A3	841	18-2287	OMC	319895	356
18-2204	Mercury Marine	43-75325A2	841	18-2288	OMC	397541	355
18-2204	Mercury Marine	43-75325A3	841	18-2288	OMC	439138	355
18-2205	Mercury Marine	43-55766A2	841	18-2290			Obsolete
18-2205	Mercury Marine	43-55766A3	841	18-2291	Mercury Marine	25-60342A1	Obsolete
18-2205	Mercury Marine	43-55778A3	841	18-2291	Mercury Marine	25-60342A2	Obsolete
18-2206-1	Mercury Marine	43-828072A2	839, 852	18-2292	Mercury Marine	15-35980A1	840
18-2206-1	Mercury Marine	43-828073A1	839, 852	18-2293	Mercury Marine	15-23097A1	840
18-2206-1	Mercury Marine	43-878087A2	839, 852	18-2293	Mercury Marine	15-36178A02	840

1 This product is priced per piece. To order, priced per package, please add -9 to the part number
 2 Items ending in "D" are display packaged - regular number is non-display • 3 For discount shop pack of 10, please add -10 to the part number

SIERRA #	O.E.M.	O.E. #	PAGE #	SIERRA #	O.E.M.	O.E. #	PAGE #
SIERRA							
18-2293	Mercury Marine	15-36178A1	840	18-2370	Mercury Marine	19291A3	258
18-2293	Mercury Marine	15-39899A1	840	18-2371	Yamaha	90340-08002-00	553
18-2294	Mercury Marine	15-42637A1	835, 839	18-2371	Yamaha	90340-08M04-00	553
18-2294	Mercury Marine	15-8M0063267	835, 839	18-23711-9	Yamaha	90340-08002-00	553
18-2295	Mercury Marine	15-33143A1	840	18-23711-9	Yamaha	90340-08M04-00	553
18-2295	Mercury Marine	15-57007A1	840	18-2372	Mercury Marine	88035	862
18-2296	Mercury Marine	15-45811	840	18-2374	Yamaha	688-45341-00-00	553
18-2296	Mercury Marine	15-71013	840	18-2374	Yamaha	688-45341-10-00	553
18-2298	Mercury Marine	14-17460	459	2 18-2375	Mercury Marine	10-14834	456
18-2298	Mercury Marine	14-18323	459	2 18-2375	Mercury Marine	10-14834A1	456
18-2299	Mercury Marine	14-52833	459	2 18-2375	Mercury Marine	22-67892	456
18-2299	Mercury Marine	14-79447	459	2 18-2375	Mercury Marine	22-67892A05	456
1 18-2303	Mercury Marine	10-20518	848	2 18-2375	Mercury Marine	22-67892A06	456
18-2308	OMC	332491	356	2 18-2375	Mercury Marine	22-67892A1	456
18-2309	OMC	332489	357	2 18-2375	Mercury Marine	28-8M0058389	456
18-2310	OMC	397627	Obsolete	2 18-2375			456
18-2315			Obsolete	18-23751-9	Mercury Marine	10-14834A1	258, 456, 858
1 18-2316	Mercury Marine	12-77674	827	18-23751-9	Mercury Marine	22-67892A1	258, 456, 858
18-2320	Mercury Marine	815919A1	855	18-23751-9			258, 456, 858
18-2321	Mercury Marine	12632A6	849	18-2376	Mercury Marine	73020A20	855
18-2322	Mercury Marine	62104	844	18-2376	Mercury Marine	818763A10	855
18-2322	Mercury Marine	621041	844	18-2376	Mercury Marine	818763A4	855
18-2323	Mercury Marine	18643A5	849	1 18-2377	OMC	316563	348
18-2324	Mercury Marine	45-557961	Obsolete	18-2378	OMC	318544	922
18-2325	OMC	435760	354	18-23781-9	OMC	318544	Obsolete
18-23251	Honda	30520-PWC-003	262	1 18-2379	OMC	320041	348
18-2326	OMC	436232	354	1 18-2380	Yamaha	91401-30028-00	554
18-2327	OMC	436234	354	1 18-2380	Yamaha	91401-30030-00	554
18-2328	OMC	435761	354	1 18-2380	Yamaha	91402-30022-00	554
18-2330	OMC	436235	354	1 18-2380	Yamaha	91402-30022-09	554
18-2331	Mercury Marine	45-853647	Obsolete	1 18-2380	Yamaha	91402-30028-00	554
18-2331	Mercury Marine	45-853648	Obsolete	1 18-2380	Yamaha	91402-30028-09	554
18-2334			579	1 18-2380	Yamaha	91490-30030-00	554
1 18-2336	Mercury Marine	23-47392	864	18-2381	Mercury Marine	94998A1	844
1 18-2336	Mercury Marine	23-61291	864	18-2381	Mercury Marine	94998A2	844
1 18-2336	Mercury Marine	23-90203	864	18-2381	Mercury Marine	94998A3	844
18-2337	OMC	3850814	999	18-2381	Mercury Marine	94998A4	844
18-2337	Volvo	3850814	999	18-2382	Mercury Marine	18312A3	844
18-2338	OMC	983880	926	18-2382	Mercury Marine	828692A1	844
18-2339	OMC	3852384	999	18-2383	OMC	914716	933, 934
18-2339	Volvo	3852384	999	18-2383	OMC	915272	933, 934
1 18-2340	Mercury Marine	12-31266	827	18-2385	Yamaha	6E5-45611-01-00	Obsolete
12 18-2341-1	Mercury Marine	23-815950	864	18-2387	OMC	307551	348
12 18-2341-1	Mercury Marine	23-8159501	864	18-23871-9	OMC	307551	348
12 18-2341-1	Mercury Marine	23-815950Q01	864	18-2388	Yamaha	688-45611-00-00	553
18-2342	Mercury Marine	68100	854	18-2389	OMC	314832	336
18-2342	Mercury Marine	681001	854	18-2391	OMC	321692	336
1 18-2343-9	Mercury Marine	12-92721	827	18-2392	OMC	327035	336
1 18-2345	Mercury Marine	53-815949	864	18-2393	Mercury Marine	17-14872	862
18-2346	Mercury Marine	824519	854	18-2394	Mercury Marine	17-14873	863
18-2346	Mercury Marine	88245191	854	18-2395	Mercury Marine	17-815953	863
18-2346	Mercury Marine	11-42633	854	18-2395	Mercury Marine	17-815953A1	863
18-2346	Mercury Marine	F694961	854	18-2396	Mercury Marine	17-44166	863
18-2346	Mercury Marine	F694961-1	854	18-2397	Mercury Marine	17-44167	863
1 18-2348	Mercury Marine	24-30893	Obsolete	18-2397	Mercury Marine	17-44167A1	863
18-2349	Mercury Marine	23-67370	858	18-2398	OMC	320311	357
18-2353	Mercury Marine	23-815921A10	855	18-2399	OMC	324369	357
18-2353	Mercury Marine	23-815921A17	855	18-2400	Mercury Marine	1623-815822A3	840
18-2353	Mercury Marine	23-815921A21	855	18-2400	Mercury Marine	1623-815822A32	840
18-2353	Mercury Marine	23-815921A6	855	18-2400	Mercury Marine	1623-815822A5	840
18-2353	Mercury Marine	23-815921A8	855	18-2400	Mercury Marine	1623-815822A53	840
18-2353	Mercury Marine	815921A2	855	18-2401	Mercury Marine	1623-8951A15	841
18-2354	Mercury Marine	807929A1	855	18-2401	Mercury Marine	1623-8951A27	841
18-2354	Mercury Marine	807929A2	855	18-2401	Mercury Marine	1623-8951A37	841
18-2354	Mercury Marine	815922A1	855	18-2401	Mercury Marine	1623-8951A5	841
18-2354	Mercury Marine	815922A5	855	18-2402	Mercury Marine	1623-5356A4	841
18-2354	Mercury Marine	821759A1	855	18-2404	Mercury Marine	43-803079T1	853
18-2354	Mercury Marine	821759A2	855	18-2405	Mercury Marine	43-803091T1	853
18-2354	Mercury Marine	821759A3	855	18-2406	Mercury Marine	43-878072A3	Obsolete
18-2354	Mercury Marine	821759A4	855	18-2406	Mercury Marine	43-878087A2	Obsolete
18-2355	OMC	386659	355	18-2407	Mercury Marine	43-17064A3	853
18-2357	Mercury Marine	17-30632	450, 837, 839, 853	18-2407	Mercury Marine	43-42933A2	853
18-2357	Mercury Marine	17-8M0020941	450, 837, 839, 853	18-2407	Mercury Marine	43-42933A3	853
18-2357	Mercury Marine	17-8M0084681	450, 837, 839, 853	18-2407	Mercury Marine	43-823072A2	853
18-2357	Mercury Marine	17-8M0100263	450, 837, 839, 853	18-2407	Mercury Marine	43-878087A4	853
18-2358	Mercury Marine	43-803102T1	Obsolete	18-2408	Mercury Marine	43-828073A1	852
18-2359	Mercury Marine		854	18-2409	Mercury Marine	43-92320	852
18-2360	Mercury Marine	43-828072A3	852	18-2409	Mercury Marine	43-92320T	852
18-2360	Mercury Marine	43-878087A2	852	18-2410	Mercury Marine	43-96084A5	852
1 18-2361	Mercury Marine	10-30206	827	18-2410	Mercury Marine	43-96084A7	852
1 18-2361	Mercury Marine	10-805763	827	18-2411	Mercury Marine	1547-861063A4	840
1 18-2361	Mercury Marine	10-853163	827	18-2412-1	Mercury Marine	18309A2	849
18-2363	Mercury Marine	43-803118T1	Obsolete	18-2412-1	Mercury Marine	18311A17	849
18-2364	Mercury Marine	43-803119T1	841	18-2412-1	Mercury Marine	18311A2	849
18-2365	Mercury Marine	43-803120T1	Obsolete	18-2412-1	Mercury Marine	812964A2	849
18-2366	Volvo	876279	999	18-2412-1	Mercury Marine	861523A9	849
18-2367	Volvo	943414	987	18-2412-1	Mercury Marine	8M0098795	849
18-2368	Mercury Marine	43-803071T1	Obsolete	18-2413	Mercury Marine	69354A1	849
18-2369	Mercury Marine	43-803069T1	Obsolete	18-2413	Mercury Marine	69354A2	849
18-2370	Chrysler Force	19291A3	258	18-2414	Mercury Marine	97432A2	849

1 This product is priced per piece. To order, priced per package, please add -9 to the part number
 2 Items ending in "D" are display packaged - regular number is non-display • 3 For discount shop pack of 10, please add -10 to the part number

SIERRA #	O.E.M.	O.E. #	PAGE #	SIERRA #	O.E.M.	O.E. #	PAGE #
SIERRA							
18-2415	Mercury Marine	1623-815822A36	840	18-2464	Mercury Marine	17-815953T1	862
18-2416	Mercury Marine	1547-815930A16	840	18-2464	Mercury Marine	56-18541A75	862
18-2416	Mercury Marine	1547-815930A6	840	18-2464	Mercury Marine	56-864641A24	862
18-2416	Mercury Marine	1547-861063A12	840	18-2465-9	Mercury Marine	19-14842	862
18-2419	Mercury Marine	1547-815930A13	840	18-2465-9	Mercury Marine	19-148421	862
18-2419	Mercury Marine	1547-815930A3	840	18-2466-9	Mercury Marine	19-815951	862
18-2419	Mercury Marine	1547-861063A6	840	18-2470	Honda	16221-ZV4-610	270
18-2424	Mercury Marine	98703A11	862	18-2471	Honda	16221-ZW9-000	270
18-2424	Mercury Marine	98703A12	862	18-2472	Honda	16221-ZW1-000	270
18-2424	Mercury Marine	98703A17	862	18-2473	Honda	16201-881-850	270
18-2424	Mercury Marine	98703A26	862	18-2480	Honda	16010-ZV4-005	269
18-2425	Mercury Marine	8M0708280	862	18-2481	Honda	16010-ZW9-003	269
18-2425	Mercury Marine	98704A11	862	18-2482	Honda	16010-881-003	270
18-2425	Mercury Marine	98704A12	862	18-2495	Honda	19232-ZV4-610	269
18-2425	Mercury Marine	98704A17	862	18-2496	Honda	19233-ZV5-000	269
18-2425	Mercury Marine	98704A26	862	18-2499	Honda	19234-ZY3-000	269
18-2426	Mercury Marine	98703A3	862	1 18-2500	Mercury Marine	27-52893	442
18-2427	Mercury Marine	98704A3	862	1 18-2500	Mercury Marine	27-72505	442
18-2428	Mercury Marine	87399A1	Obsolete	1 18-2500	Mercury Marine	27-85493	442
18-2428	Mercury Marine	87399A2	Obsolete	18-25001	Mercury Marine	27-14765	824
18-2429	Mercury Marine	87399A3	Obsolete	18-25001	Mercury Marine	F3860315	824
1 18-2430	Mercury Marine	26-830749	446	18-25001	Mercury Marine	FI1110294	824
18-24301-9	Mercury Marine	26-830749	446	18-25001	Mercury Marine	FI1110958	824
18-2432	Volvo	873228	997	18-25002	Mercury Marine	27-811588	824
18-2433	Volvo	873229	997	1 18-2501	Mercury Marine	27-67738	441
18-2434	Crusader	96938	578	1 18-2501	Mercury Marine	27-93536	441
18-2434	Marine Power	0100-000	578	1 18-2501	Mercury Marine	27-935361	441
18-2434	Mercury Marine	814309A1	578	1 18-2502	Mercury Marine	27-87396	442
18-2434	Pleasurecraft	R142006	578	1 18-2502	Mercury Marine	27-90484	442
18-2434	Volvo	3857846-4	578	1 18-2502	Mercury Marine	27-904841	442
18-2435	Mercury Marine	32-861127	860	1 18-2503	Mercury Marine	27-78068	444
18-2435	Mercury Marine	32-95858	860	1 18-2503	Mercury Marine	27-99177	444
18-2436	Mercury Marine	32-861128	861	1 18-2503	Mercury Marine	27-991771	444
18-2436	Mercury Marine	32-95859	861	1 18-2503	Mercury Marine	27-991772	444
18-2443	Mercury Marine	1623-4110A13	Obsolete	1 18-2504	Mercury Marine	27-60310	442
18-2443	Mercury Marine	1623-4110A4	Obsolete	1 18-2504	Mercury Marine	27-74511	442
18-2443	Mercury Marine	1623-4110A6	Obsolete	1 18-2504	Mercury Marine	27-76401	442
18-2443	Mercury Marine	1623-5356A18	Obsolete	1 18-2504	Mercury Marine	27-88449	442
18-2443	Mercury Marine	1623-5356A19	Obsolete	1 18-2505	Mercury Marine	27-96171	442
18-2443	Mercury Marine	1623-5356A20	Obsolete	1 18-2505	Mercury Marine	27-961711	442
18-2443	Mercury Marine	1623-5356A3	Obsolete	1 18-2506-1	Mercury Marine	27-99176	444
18-2443	Mercury Marine	1623-8951A14	Obsolete	1 18-2506-1	Mercury Marine	27-991762	444
18-2443	Mercury Marine	1623-8951A19	Obsolete	1 18-2506-1	Mercury Marine	27-991763	444
18-2443	Mercury Marine	1623-8951A2	Obsolete	1 18-2506-1	Mercury Marine	27-991764	444
18-2443	Mercury Marine	1623-8951A23	Obsolete	1 18-2507	Mercury Marine	27-37816	442
18-2443	Mercury Marine	1623-8951A43	Obsolete	1 18-2507	Mercury Marine	27-72487	442
18-2446	Mercury / BRP		219	1 18-2507	Mercury Marine	27-78026	442
18-2447			219	1 18-2507	Mercury Marine	27-85487	442
18-2448			219, 271, 480, 553	1 18-2508-1	Mercury Marine	27-96440	444
18-2450	Mercury Marine	1547-3917A13	Obsolete	1 18-2508-1	Mercury Marine	27-99776	444
18-2450	Mercury Marine	1547-3917A21	Obsolete	1 18-2508-1	Mercury Marine	27-997761	444
18-2450	Mercury Marine	1547-3917A32	Obsolete	1 18-2509	Mercury Marine	27-67751	440
18-2450	Mercury Marine	1547-3917A37	Obsolete	1 18-2510	Mercury Marine	27-96761	441
18-2450	Mercury Marine	1547-5523A12	Obsolete	1 18-2510	Mercury Marine	27-967611	441
18-2450	Mercury Marine	1547-5523A2	Obsolete	1 18-2511	Mercury Marine	27-99173-2	444
18-2450	Mercury Marine	1547-5523A68	Obsolete	1 18-2512	Mercury Marine	27-60286	Obsolete
18-2450	Mercury Marine	1547-5523A9	Obsolete	1 18-2513	Mercury Marine	27-11338	441
18-2450	Mercury Marine	1547-8265A15	Obsolete	1 18-2513	Mercury Marine	27-67208	441
18-2450	Mercury Marine	1547-9412A20	Obsolete	1 18-2514	Mercury Marine	27-53650	441
18-2450	Mercury Marine	1547-9412A30	Obsolete	1 18-2516	Mercury Marine	16755	825
18-2450	Mercury Marine	1547-9412A35	Obsolete	1 18-2516	Mercury Marine	16755A1	825
18-2451	Mercury Marine	1547-3917A16	Obsolete	1 18-2516	Mercury Marine	16755Q1	825
18-2451	Mercury Marine	1547-3917A30	Obsolete	18-2518	Volvo	430017	995
18-2451	Mercury Marine	1547-3917A38	Obsolete	1 18-2519	Volvo	831622	996
18-2451	Mercury Marine	1547-3917A4	Obsolete	18-25200	Honda	37500-PNB-003	265
18-2451	Mercury Marine	1547-3917A8	Obsolete	18-25201	Honda	37510-PNB-003	265
18-2451	Mercury Marine	1547-5523A11	Obsolete	18-2524	Honda	19232-ZV1-A10	269
18-2451	Mercury Marine	1547-5523A8	Obsolete	1 18-2525	Volvo	430018	996
18-2451	Mercury Marine	1547-8265A16	Obsolete	18-25250	Volvo	3863085	996
18-2451	Mercury Marine	1547-9412A21	Obsolete	18-25251	Volvo	853868	996
18-2452	Mercury Marine	1547-5523A67	Obsolete	1 18-2526	Volvo	430172	Obsolete
18-2452	Mercury Marine	1547-8265A17	Obsolete	1 18-2527	Volvo	831617	Obsolete
18-2452	Mercury Marine	1547-9412A22	Obsolete	1 18-2528	Volvo	831891	996
18-2452	Mercury Marine	1547-9412A36	Obsolete	1 18-2529	Volvo	831892	996
18-2453	Mercury Marine	1547-5523A49	Obsolete	1 18-2530	Volvo	1336255	996
18-2453	Mercury Marine	1547-5523A67	Obsolete	1 18-2530	Volvo	3547991	996
18-2453	Mercury Marine	1547-8265A17	Obsolete	18-25300	Yamaha	66M-85540-01-00	Obsolete
18-2453	Mercury Marine	1547-9412A23	Obsolete	18-2531	Volvo	834476	996
18-2454	OMC	3854539	938	18-2532	OMC	305762	336
18-2454	Volvo	3854539	938	18-2533	OMC	911797	930
18-2455			225	18-2534	Chrysler Force	F184122-1	258
18-2456	Yamaha	90340-14M06-00	539	18-2534	OMC	309044	258
18-2460	MerCruiser	11-88462	858	1 18-2536	OMC	321120	335
18-2460	MerCruiser	22-88847A1	858	18-2537	OMC	324937	336
18-2461	Mercury Marine	17-44166T1	862	1 18-2539	OMC	328753	335
18-2462	Mercury Marine	17-14873A1	862	18-25400	Mercury	16066004	Obsolete
18-2462	Mercury Marine	17-85056	862	18-2541	OMC	911704	919
18-2463	Mercury Marine	17-14872A1	862	1 18-2543	OMC	318609	334
18-2463	Mercury Marine	17-99207	862	1 18-2544	OMC	321028	334

1 This product is priced per piece. To order, priced per package, please add -9 to the part number

2 Items ending in "D" are display packaged - regular number is non-display • 3 For discount shop pack of 10, please add -10 to the part number

SIERRA #	O.E.M.	O.E. #	PAGE #	SIERRA #	O.E.M.	O.E. #	PAGE #
SIERRA							
1 18-2545	OMC	321182	332	18-2605	Yamaha	90119-08M87-00	Obsolete
1 18-2546	OMC	321184	335	18-2606	Yamaha	90119-08M13-00	Obsolete
1 18-2547	OMC	322858	335	18-2607	Yamaha	97095-06040-00	Obsolete
1 18-2548	OMC	332108	335	18-2608	Honda	19232-881-850	269
1 18-2549	OMC	321435	332	18-2609	Honda	19234-881-850	269
1 18-2550	OMC	323214	333	18-2610	Mercury Marine	27-812755	443
1 18-2552	Mercury Marine	27-331791	822	18-2610	Mercury Marine	27-8127754	443
1 18-2552	Mercury Marine	27-331792	822	18-26104-1	Mallory	YL567EV	186
1 18-2553	Mercury Marine	27-47510	822	18-26107-1	Mallory	YL700AV	186
1 18-2553	Mercury Marine	27-47510Q	822	18-2611	Mercury Marine	27-8127551	443
1 18-2554	Mercury Marine	27-41812	822	18-2611	Mercury Marine	27-812755A01	443
1 18-2554	Mercury Marine	27-41812Q	822	18-2611	Mercury Marine	27-8127755	443
1 18-2554	Mercury Marine	27-90556	822	18-26110-1	Mallory	YL579AV	186
1 18-2555	Mercury Marine	27-89656	822	18-26111-1	Mallory	YL648AV	186
1 18-2555	Mercury Marine	27-896561	822	18-2613	OMC	508105	917
1 18-2556	Mercury Marine	27-35996	825	2 18-2614	Mercury Marine	27-45821	828
1 18-2556	Mercury Marine	27-35996A1	825	2 18-2614	Mercury Marine	27-64818A1	828
1 18-2557	OMC	324701	335	2 18-2614	Mercury Marine	27-64818A20	828
1 18-2557	OMC	338484	335	2 18-2614	Mercury Marine	27-64818A4	828
1 18-2558	Mercury Marine	27-19204-2	444	2 18-2614	Mercury Marine	27-64818O4	828
1 18-2559	Mercury Marine	27-19202	444	2 18-2614	Mercury Marine	27-64818T1	828
1 18-2559	Mercury Marine	27-42206	444	18-2615	Mercury Marine	16755	828
1 18-2560	Mercury Marine	12-86645	446	18-2615	Mercury Marine	16755A1	828
1 18-2560	Mercury Marine	12-866451	446	18-2615	Mercury Marine	16755Q1	828
1 18-2560	Mercury Marine	8M0027721	446	18-2615	Mercury Marine	16755T1	828
18-25604	Yamaha	63V-85533-00-00	496	18-2617	Mercury Marine	27-35996	828
1 18-2561	Mercury Marine	27-85087	Obsolete	18-2617	Mercury Marine	27-35996A1	828
1 18-2562	Mercury Marine	27-99326	445	2 18-2619-1	Mercury Marine	27-64818A2	828
1 18-2562	Mercury Marine	27-993261	445	2 18-2619-1	Mercury Marine	27-64818A3	828
1 18-2563	Honda	19232-ZW1-003	269	2 18-2619-1	Mercury Marine	27-64818A3	828
1 18-2563	Mercury Marine	27-43034	269	2 18-2619-1	Mercury Marine	27-94996	828
1 18-2563	Mercury Marine	27-430341	269	2 18-2619-1	Mercury Marine	27-94996A1	828
1 18-2564	Honda	19234-ZW1-003	445	2 18-2619-1	Mercury Marine	27-94996A2	828
1 18-2564-1	Honda	19234-ZW1-003	269	2 18-2619-1	Mercury Marine	27-94996A20	828
1 18-2564	Mercury Marine	27-43033	445	2 18-2619-1	Mercury Marine	27-94996Q2	828
1 18-2564-1	Mercury Marine	27-43033	269	2 18-2619-1	Mercury Marine	27-94996T2	828
1 18-2564	Mercury Marine	27-430331	445	18-2620	Mercury Marine	27-54014	828
1 18-2564-1	Mercury Marine	27-430331	269	18-2620	Mercury Marine	27-54014A1	828
1 18-2565	Honda	19242-ZW1-003	269	18-2620	Mercury Marine	27-54014O1	828
1 18-2565	Mercury Marine	27-43047	269	18-2620	Mercury Marine	27-54014T1	828
1 18-2565	Mercury Marine	27-430471	269	18-2621	Mercury Marine	27-139581	441
1 18-2565	Mercury Marine	27-430472	269	18-2622	Mercury Marine	23-79373A1	844
18-25650	Yamaha	66M-85580-00-00	Obsolete	18-2622	Mercury Marine	23-805041A2	844
18-25652	Yamaha	63V-85580-01-00	496	18-2622	Mercury Marine	27-45588	844
1 18-2566	Mercury Marine	27-8172771	445	18-2622	Mercury Marine	27-79373	844
1 18-2568	Mercury Marine	27-25848	440	18-2623	OMC	439141	363
1 18-2569	Mercury Marine	27-25849	441	18-2624	Chrysler Force	26-85090A2	258
1 18-2570	Mercury Marine	27-25851	441	18-2624	Mercury Marine	26-85090A2	258
1 18-2570	Mercury Marine	27-34614	441	18-2625	Volvo	875192	Obsolete
1 18-2571	Mercury Marine	27-31402	435, 440	18-2626	Chrysler Force	26-43035A4	258
1 18-2572	Mercury Marine	27-22023	440	18-2626	Mercury Marine	26-43034A1	258
1 18-2572	Mercury Marine	27-63309	440	18-2626	Mercury Marine	26-43034A2	258
1 18-2573	Mercury Marine	27-60475	442	18-2626	Mercury Marine	26-43034A3	258
1 18-2573	Mercury Marine	27-72142	442	18-2626	Mercury Marine	26-43035A4	258
1 18-2573	Mercury Marine	27-721421	442	18-2627	Mercury Marine	26-66303A1	462
1 18-2574	Mercury Marine	27-60476	442	18-2628	Mercury Marine	26-77066A1	Obsolete
1 18-2574	Mercury Marine	27-72507	442	18-2629	Chrysler Force	26-85090A1	259
1 18-2574	Mercury Marine	27-85495	442	18-2629	Mercury Marine	26-85090A1	259
1 18-2574	Mercury Marine	27-854951	442	18-2630	Chrysler Force	FK1060	259
1 18-2574	Mercury Marine	27-854952	442	18-2631	Chrysler Force	FK1061	259
1 18-2575	Mercury Marine	1399-99	441	18-26310-2	Mallory	YLM700AV	185
18-2579	OMC	338882	330	18-26311-2	Mallory	YLM566AV	185
18-2582	OMC	338813	330	18-2632	Chrysler Force	FK1063-1	259
18-2583	Volvo	3888821	1003	18-2632	Chrysler Force	FK1063-2	259
18-2584	Volvo	3888822	1003	18-2633	Chrysler Force	FK1127	Obsolete
18-2586	Volvo	3850594	1002	18-2635	Chrysler Force	26-814669A1	259
18-2587	Mercury Marine	99356A2	578	18-2635	Chrysler Force	26-814669A2	259
18-2588			578	18-2635	Chrysler Force	FK1234	259
18-2589			578	18-2635	Mercury Marine	26-814669A2	259
18-2590	Borg-Warner	A4876HA	579	18-2636	Chrysler Force	26-820645A	Obsolete
18-2591			579	18-2636	Chrysler Force	FK1074	Obsolete
18-2592	Yamaha	6E5-14384-03-00	550	18-2637-1	Chrysler Force	FK1064	259
18-2593	Mercury Marine	27-194541	445	18-2638	Chrysler Force	FK1065	Obsolete
18-2595	OMC	982132	367	18-2639	Chrysler Force	FK1068	259
18-2596	Volvo	875422	991	18-2640	Chrysler Force	FK1203	259
18-2597			1003	18-2640	Chrysler Force	FK1203-1	259
18-2598	Volvo	3855275	1002	18-2642	Mercury Marine	26-816575A5	463
18-2599	Mercury Marine	26-816575A2	462	18-2643	Mercury Marine	26-16709A1	865
18-2600			848	18-2643	Mercury Marine	26-16709A2	865
18-26002-1			699	18-2644	Mercury Marine	26-88397A1	865
18-2601-1	Mercury Marine	30-803097T1	845	18-2645	Mercury Marine	26-76868A04	465, 866
18-2603	Mercury Marine	19543T1	848	18-2645	Mercury Marine	26-76868A1	465, 866
18-2603	Mercury Marine	19543T2	848	18-2645	Mercury Marine	26-76868A2	465, 866
18-2603	Mercury Marine	865436A03	848	18-2646-1	Mercury Marine	26-816575A1	463
18-2603E	Mercury Marine	19543T1	848	18-2646-1	Mercury Marine	26-816575A3	463
18-2603E	Mercury Marine	19543T2	848	18-2648	Mercury Marine	26-32511A1	866
18-2603E	Mercury Marine	865436A03	848	18-2649	Mercury Marine	25-87400A2	862
18-2604	Mercury Marine	815471T1	848	18-2652	Mercury Marine	26-33144A1	866
18-2604E	Mercury Marine	815471T1	848	18-2652	Mercury Marine	26-33144A2	866

1 This product is priced per piece. To order, priced per package, please add -9 to the part number
 2 Items ending in "D" are display packaged - regular number is non-display • 3 For discount shop pack of 10, please add -10 to the part number

SIERRA #	O.E.M.	O.E. #	PAGE #	SIERRA #	O.E.M.	O.E. #	PAGE #
SIERRA							
18-2652	Mercury Marine	26-89238A1	866	18-2716	Mercury Marine	27-92332	443
18-2653	Mercury Marine	26-55682A1	464	18-2717	Mercury Marine	27-41475	443
18-2654	Mercury Marine	26-79831A1	464	18-2717	Mercury Marine	27-414751	443
18-2655	Mercury Marine	26-89238A2	464	18-2717	Mercury Marine	27-414752	443
18-2656	OMC	396350	363	18-2717	Mercury Marine	27-414753	443
18-2657	OMC	396352	Obsolete	18-2717	Mercury Marine	27-414754	443
18-2658	OMC	396351	364	18-2717	Mercury Marine	27-414755	443
18-2659	OMC	396355	364	18-2717	Mercury Marine	27-414756	443
18-2660	OMC	396349	364	18-2717	Mercury Marine	27-414757	443
18-2663	OMC	981797	939	18-2717	Mercury Marine	27-414758	443
18-2664	OMC	982947	Obsolete	18-2717	Mercury Marine	27-892158	443
18-2665	OMC	982946	Obsolete	18-2717	Mercury Marine	27-92331	443
18-2666	OMC	981799	939	18-2721	Mercury Marine	27-827284	441
18-2667	OMC	982949	Obsolete	18-2724	Mercury Marine	43713	845
18-2669	OMC	981801	Obsolete	18-2725	Mercury Marine	26-830749A01	465
18-2671	OMC	985612	939	18-2726	Volvo	3888917	Obsolete
18-2672	OMC	439967	939	18-2727	Mercury Marine	60930	750
18-2672	OMC	984458	939	18-2728	Mercury Marine	26-42102	446
18-2672	OMC	985613	939	18-2728	Mercury Marine	26-421021	446
18-2673	OMC	984459	940	18-2729	Mercury Marine	27-8128672	441
18-2673	OMC	986364	940	18-2731	Mercury Marine	26-81607M	446
18-2673	OMC	987603	940	1 18-2732	Mercury Marine	807166A3	750
18-2674	OMC	985518	940	18-2733	Mercury Marine	92802	750
18-2674	OMC	986423	940	18-2733	Mercury Marine	99370A2	750
18-2679			364	18-2735	Mercury Marine	27-190506	443
18-2680			364	18-2736	Mercury Marine	27-863891	437
18-26800	Mallory	670	186	18-2736	Mercury Marine	27-863893	437
18-2681			364	18-2736	Mercury Marine	27-863895	437
18-26810			616	18-2737	Mercury Marine	27-850283	441
18-26811			616	18-2739	Mercury Marine	27-832933006	443
18-26812			616	18-2739	Mercury Marine	27-8329331	443
18-26813			616	18-2739	Mercury Marine	27-8329332	443
18-26815	Mallory	29349	186	18-2739	Mercury Marine	27-8329333	443
18-2682			187	18-2739	Mercury Marine	27-8329334	443
18-26820			Obsolete	18-2739	Mercury Marine	27-8329335	443
18-26821			187	18-2740	Mercury Marine	27-430051	442
18-2683			364	18-2740	Mercury Marine	27-430052	442
18-2684			364	18-2740	Mercury Marine	27-430053	442
18-2685			364	18-2740	Mercury Marine	27-430055	442
18-2686			365	18-2740	Mercury Marine	27-430056	442
18-2687			Obsolete	18-2740	Mercury Marine	27-430057	442
18-2688			Obsolete	18-2741	Mercury Marine	27-43004009	443
18-2689			365	18-2741	Mercury Marine	27-430041	443
18-2690			365	18-2741	Mercury Marine	27-430042	443
18-2691			365	18-2741	Mercury Marine	27-430043	443
18-2692			365	18-2741	Mercury Marine	27-430045	443
18-2694	OMC	433550	365	18-2741	Mercury Marine	27-430047	443
18-2697-1	Chrysler Force	26-41365A3	259	18-2742	Mercury Marine	85552	462
18-2697-1	Mercury Marine	26-41365A3	259	18-2743	Mercury Marine	27-64818A2	825
18-2698			937	18-2743	Mercury Marine	27-94996	825
18-2699			917, 991	18-2743	Mercury Marine	27-949962	825
1 18-2701	Mercury Marine	23-45736	864	18-2743	Mercury Marine	27-94996A1	825
1 18-2701	Mercury Marine	23-61290	864	18-2743	Mercury Marine	27-94996A2	825
1 18-2701	Mercury Marine	23-89574	864	18-2743	Mercury Marine	27-94996A20	825
2 18-2701-04	Mercury Marine	23-45736	864	18-2743	Mercury Marine	27-94996A3	825
2 18-2701-04	Mercury Marine	23-61290	864	18-2743	Mercury Marine	27-94996Q2	825
2 18-2701-04	Mercury Marine	23-89574	864	18-2744	Volvo	875826	998
2 18-2702-04	Mercury Marine	23-99291	864	18-2744	Volvo	876294	998
2 18-2702-04	Mercury Marine	23-99291T	864	18-2745	OMC	912374	930
1 18-2702-1	Mercury Marine	23-99291	652	18-2746	Mercury Marine	31-14358001	846
1 18-2702-1	Mercury Marine	23-99291T	652	18-2746	Mercury Marine	32-14358	846
1 18-2702-1	Pleasurecraft	R094020A	652	18-2746	Mercury Marine	32-14358T	846
1 18-2703	OMC	314008	336	18-2747	Mercury Marine	816431A1	845, 846
18-2704	OMC	320943	336	18-2748	Mercury Marine	31-44348001	846
1 18-2705	OMC	315748	S/S to 18-2705-9	18-2748	Mercury Marine	32-44348	846
1 18-2706	OMC	321008	336	18-2748	Mercury Marine	32-44348T	846
1 18-2708	OMC	333758	336	18-2749	Mercury Marine	27-812867	442
1 18-2709	OMC	336530	335	18-2749	Mercury Marine	27-8128671	442
18-2710	Mercury Marine	27-41417	441	18-2750	Mercury Marine	32734	845, 846
18-2710	Mercury Marine	27-414171	441	18-2750	Mercury Marine	18654A1	845, 846
18-2710	Mercury Marine	27-414172	441	18-2750	Mercury Marine	32734A3	845, 846
18-2710	Mercury Marine	27-85978	441	18-2751	Mercury Marine	60932A1	846
18-2712	Mercury Marine	27-41418	441	18-2751	Mercury Marine	60932A4	846
18-2712	Mercury Marine	27-414181	441	18-2752	Mercury Marine	36223	846, 847
18-2712	Mercury Marine	27-85979	441	18-2752	Mercury Marine	36223A1	846, 847
18-2713	Mercury Marine	27-43337	443	18-2752	Mercury Marine	36223A2	846, 847
18-2713	Mercury Marine	27-433371	443	2 18-2753-2	Mercury Marine	31659	846, 847, 848
18-2713	Mercury Marine	27-433372	443	2 18-2753-2	Mercury Marine	74639	846, 847, 848
18-2713	Mercury Marine	27-433373	443	2 18-2753-2	Mercury Marine	74639A2	846, 847, 848
18-2713	Mercury Marine	27-433374	443	18-2755	Volvo	875827	998
18-2713	Mercury Marine	27-43337A1	443	18-2756	Mercury Marine	86840A05	845, 846
18-2713	Mercury Marine	27-96286	443	18-2756	Mercury Marine	86840A3	845, 846
18-2714	Mercury Marine	27-414992	443	18-2756	Mercury Marine	8M0062406	845, 846
18-2714	Mercury Marine	27-414993	443	18-2757	Volvo	875828	998
18-2714	Mercury Marine	27-414994	443	18-2757	Volvo	876633	998
18-2714	Mercury Marine	27-414995	443	18-2758	Volvo	875848	998
18-2714	Mercury Marine	27-892157	443	18-2758	Volvo	876631	998
18-2715	Mercury Marine	24-17997A1	833, 845, 865	18-2759	Mercury Marine	53114	846
18-2716	Mercury Marine	27-41499	443	18-2759	Mercury Marine	53114A1	846
18-2716	Mercury Marine	27-414991	443				

1 This product is priced per piece. To order, priced per package, please add -9 to the part number
 2 Items ending in "D" are display packaged - regular number is non-display • 3 For discount shop pack of 10, please add -10 to the part number

SIERRA #	O.E.M.	O.E. #	PAGE #	SIERRA #	O.E.M.	O.E. #	PAGE #
SIERRA							
18-2760	Mercury Marine	78458	846	1 18-2807	Mercury Marine	27-9818512	442
18-2760	Mercury Marine	78458A1	846	1 18-2807	Mercury Marine	27-981853	442
18-2761	Mercury Marine	32-90949	846	1 18-2808	Mercury Marine	27-96278	442
18-2761	Mercury Marine	32-90949T	846	18-28080	Mercury	84-821945A56	383
18-2762	Mercury Marine	70981	846	18-28081	Mercury	84-813706A56	383
18-2762	Mercury Marine	70981A3	846	18-28082	Mercury	84-813715A8	383
2 18-2763	OMC	911826	930	18-28083	Mercury	84-881908T	192
18-2764	OMC	914036	930	18-28084	Mercury	84-881908T	192
18-2765	OMC	983973	998	18-28085	Mercury	84-881908T	192
18-2765	OMC	987467	998	18-28086	Mercury	84-881908T	192
18-2765	OMC	3854127	998	1 18-2809	Mercury Marine	27-43779	444
18-2765	Volvo	3854127	998	1 18-2809	Mercury Marine	27-437791	444
18-2766	Volvo	834751	998	1 18-2809	Mercury Marine	27-437792	444
18-2767	OMC	313080	930	1 18-2809	Mercury Marine	27-96485	444
18-2768	OMC	909527	930	18-28090	Johnson/Evinrude		192
1 18-2769	OMC	332000	336	18-28092	Johnson/Evinrude		280
18-2770	Mercury Marine	32-807458T	846	1 18-2810	Mercury Marine	27-43777	443
18-2771			929	1 18-2810	Mercury Marine	27-437771	443
18-2772-1			929, 998	1 18-2810	Mercury Marine	27-437772	443
18-2773	Yamaha	663-45331-00-94	553	1 18-2810	Mercury Marine	27-96483	443
18-2774	Volvo	875847	983	18-28100			654
18-2775	Volvo	875822	983	18-28101			654
18-2776	Volvo	832831	983	18-28102			654
18-2777	Volvo	854031	983	18-2813	Volvo	876302	991
18-2778	Volvo	832846	983	18-2814	Volvo	876306	Obsolete
18-2779	OMC	3852696	910	18-2815	Mercury Marine	27-814703	994
18-2779	Volvo	3852696	910	18-2815	Mercury Marine	F15000119	994
18-2780-1	OMC	3852741	973	18-2815	Mercury Marine	F15000199	994
18-2780-1	Volvo	3852741	973	18-2815	OMC	913276	994
18-2780-1	Volvo	3863450	973	18-2815	OMC	3852692	994
18-2780-1	Volvo	3863450	973	18-2815	Volvo	3852692	994
18-2781	OMC	3852742	910	18-28150			187
18-2781	Volvo	3852742	910	18-28151			187
18-2782	Yamaha	688-45331-00-94	553	18-2817	Volvo	876359	993
18-2783	OMC	986629	940	18-28175			187
18-2785	Mercury Marine	27-41899M	465	18-2818	Volvo	876433	993
18-2785	Yamaha	689-W0001-21-00	465	1 18-2819-1	Mercury Marine	27-39915	797
18-2785	Yamaha	689-W0001-C1-00	465	1 18-2820	Mercury Marine	27-45821	828
18-2787	Mercury Marine	27-92648M	Obsolete	1 18-2820	Mercury Marine	27-64818	828
18-2787	Yamaha	698-W0001-20-00	Obsolete	1 18-2820	Mercury Marine	27-64818A1	828
18-2787	Yamaha	698-W0001-C0-00	Obsolete	1 18-2820	Mercury Marine	27-64818A20	828
18-2788	Yamaha	6H3-W0001-21-00	Obsolete	1 18-2820	Mercury Marine	27-64818A4	828
18-2788	Yamaha	6H3-W0001-C1-00	Obsolete	1 18-2820	Mercury Marine	27-64818Q4	828
18-2789	Yamaha	6J8-W0001-21-00	568	1 18-2823	Mercury Marine	27-19553	445
18-2789	Yamaha	6J8-W0001-C2-00	568	1 18-2823	Mercury Marine	27-32769	445
18-2791	OMC	987251	1003	1 18-2824	Mercury Marine	27-19551	445
18-2791	OMC	3850597	1003	1 18-2824	Mercury Marine	27-32770	445
18-2791	Volvo	3850597	1003	1 18-2825	Mercury Marine	27-32771	445
18-2792	Yamaha	6H4-W0001-20-00	Obsolete	1 18-2826	Mercury Marine	27-85610	445
18-2792	Yamaha	6H4-W0001-21-00	Obsolete	1 18-2826	Mercury Marine	27-856101	445
18-2793	Volvo	875550	Obsolete	1 18-2826	Mercury Marine	27-856704	445
18-2794-1	Yamaha	6E5-W0001-51-00	568	1 18-2827	Mercury Marine	27-39823	445
18-2794-1	Yamaha	6E5-W0001-F1-00	568	1 18-2828	Mercury Marine	27-39625	445
18-2794-1	Yamaha	6F3-W0001-21-00	568	18-2830-1	Mercury Marine	879036	823
18-2794-1	Yamaha	6F3-W0001-C1-00	568	18-2830-1	Mercury Marine	27-33121	823
18-2794-1	Yamaha	6G5-W0001-21-00	568	18-2830-1	Mercury Marine	27-46401	823
18-2794-1	Yamaha	6G5-W0001-C1-00	568	18-2830-1	Mercury Marine	27-52584	823
18-2798	Yamaha	688-W0001-20-00	Obsolete	18-2830-1	OMC	907932	823
18-2798	Yamaha	688-W0001-C0-00	Obsolete	1 18-2831	Mercury Marine	27-47590	822
18-2799	Yamaha	61A-W0001-21-00	568	1 18-2831	Mercury Marine	27-475901	822
18-2799	Yamaha	61A-W0001-C1-00	568	18-2832-1	Mercury Marine	27-48043	797, 823
1 18-2800	Mercury Marine	27-26891	440	18-2832-1	Mercury Marine	27-480431	797, 823
1 18-2800	Mercury Marine	27-69659	440	18-2832-1-9	Mercury Marine	27-48043	797, 823
1 18-2800	Mercury Marine	27-75791	440	18-2832-1-9	Mercury Marine	27-480431	797, 823
1 18-2800	Mercury Marine	27-757911	440	1 18-2833	Mercury Marine	27-52076	823
1 18-2801	Mercury Marine	27-32438	Obsolete	1 18-2833	Mercury Marine	27-99777	823
18-28019	Chrysler Inboard	3745215	193	1 18-2833	Mercury Marine	27-997771	823
1 18-2802	Mercury Marine	27-48164	440	1 18-2833	Mercury Marine	27-997772	823
1 18-2802	Mercury Marine	27-481641	440	1 18-2834	Mercury Marine	27-60208	815
1 18-2803	Mercury Marine	27-90430	440	1 18-2835	Mercury Marine	27-60479	444
1 18-2803	Mercury Marine	27-904301	440	1 18-2835	Mercury Marine	27-64173	444
18-28033	Mercuriser		193	1 18-2835	Mercury Marine	27-66101	444
1 18-2804	Mercury Marine	27-73377	440	1 18-2835	Mercury Marine	27-69238	444
1 18-2804	Mercury Marine	27-733771	440	1 18-2835	Mercury Marine	27-692381	444
18-28042	Universal		193	1 18-2836	Mercury Marine	27-31439	442
18-28043	Pleasurecraft		193	1 18-2836	Mercury Marine	27-46233	442
18-28044	Pleasurecraft		582	1 18-2836	Mercury Marine	27-72919	442
18-28044	Volvo Penta		582	1 18-2836	Mercury Marine	27-78035	442
18-28046	OMC		193	1 18-2837	Mercury Marine	27-31436	443
18-28046	Pleasurecraft		193	1 18-2837	Mercury Marine	27-41382	443
1 18-2805	Mercury Marine	27-85490-2	442	1 18-2837	Mercury Marine	27-66358	443
18-28050	Volvo	845363	954, 956, 958	1 18-2837	Mercury Marine	27-72918	443
1 18-2806	Mercury Marine	27-65788	442	1 18-2837	Mercury Marine	27-78087	443
1 18-2807	Mercury Marine	27-53863	442	1 18-2838	Mercury Marine	27-55279	442
1 18-2807	Mercury Marine	27-64940	442	1 18-2838	Mercury Marine	27-552791	442
1 18-2807	Mercury Marine	27-72506	442	1 18-2839	Mercury Marine	27-60477	442
1 18-2807	Mercury Marine	27-85494	442	1 18-2839	Mercury Marine	27-72509	442
1 18-2807	Mercury Marine	27-98185	442	1 18-2839	Mercury Marine	27-85497	442
1 18-2807	Mercury Marine	27-981851	442	1 18-2839	Mercury Marine	27-854971	442

1 This product is priced per piece. To order, priced per package, please add -9 to the part number
 2 Items ending in "D" are display packaged - regular number is non-display • 3 For discount shop pack of 10, please add -10 to the part number

SIERRA #	O.E.M.	O.E. #	PAGE #	SIERRA #	O.E.M.	O.E. #	PAGE #
SIERRA							
1 18-2839	Mercury Marine	27-854972	442	1 18-2898	OMC	309956	333
1 18-2840	Mercury Marine	27-35982	825	1 18-2900	OMC	312679	331
1 18-2841	Mercury Marine	27-19552	445	1 18-2900	OMC	332694	331
1 18-2841	Mercury Marine	27-77417	445	1 18-2900	OMC	338879	331
1 18-2843	Mercury Marine	27-74830	822	1 18-2901	OMC	306205	334
1 18-2844	Mercury Marine	27-48818	822	1 18-2901	OMC	313065	334
1 18-2844	Mercury Marine	27-488181	822	18-2902-1	OMC	909314	921
1 18-2844	Mercury Marine	27-48818Q1	822	18-2902-1	Volvo	3852468	921
18-2845	Chris-Craft	16.11-01236	591	18-2902-1-9	OMC	909314	911
18-2845	Crusader	91351	591	18-2902-1-9	Volvo	3852468	911
18-2845	Mercury Marine	27-11999	591	1 18-2903	OMC	332696	330
18-2845	Mercury Marine	27-34043	591	1 18-2903	OMC	338880	330
18-2845	Mercury Marine	27-52202	591	1 18-2904	OMC	319348	334
18-2845	Mercury Marine	F11101236	591	1 18-2905	OMC	329920	334
18-2845	Mercury Marine	F15000161	591	1 18-2906	OMC	333418	330
18-2845	OMC	912965	591	1 18-2906	OMC	338884	330
1 18-2847	Mercury Marine	27-54014	825	1 18-2907	OMC	325721	334
1 18-2847	Mercury Marine	27-54014A1	825	1 18-2908	OMC	331499	330
1 18-2847	Mercury Marine	27-54014Q1	825	1 18-2908	OMC	338878	330
1 18-2847	Mercury Marine	27-54014T1	825	1 18-2909	Crusader	97498	1005
1 18-2848	Mercury Marine	18-52457	822	1 18-2909	Mercury Marine	27-99757	1005
1 18-2848	Mercury Marine	18-524571	822	1 18-2909	OMC	915025	1005
1 18-2848	Mercury Marine	27-524572	822	1 18-2909	Volvo	856116	1005
1 18-2849-1	Mercury	27-860232	823	1 18-2909	Volvo	3853412	1005
1 18-2849-1	Mercury	27-863726	823	1 18-2909	Yamaha	YSC-12190-00-AC	1005
1 18-2849-1	Mercury	27-87105	823	1 18-2909			1005
1 18-2849-1	Mercury Marine	27-818832	823	1 18-2911	OMC	910236	921
1 18-2849-1	Mercury Marine	27-871051	823	18-2912-1	Mercury Marine	27-53354	797
1 18-2850-1	OMC	908935	921	18-2912-1	OMC	908079	797
1 18-2851	OMC	313368	921	1 18-2913	OMC	319097	333
1 18-2852	OMC	330621	333	1 18-2913	OMC	331916	333
1 18-2853	OMC	318925	332	1 18-2914	Mercury Marine	27-30603	446
1 18-2854-1	Barr	01-0107	663	1 18-2914	Mercury Marine	27-32433	446
1 18-2855	OMC	314082	335	1 18-2914	Mercury Marine	27-85608	446
1 18-2856	OMC	319665	334	1 18-2914	Mercury Marine	27-856081	446
1 18-2857	OMC	319771	331	1 18-2914	Mercury Marine	27-8M0090319	446
1 18-2857	OMC	386573	331	1 18-2915	Mercury Marine	27-30604	446
1 18-2858	OMC	314809	994	1 18-2915	Mercury Marine	27-32434	446
1 18-2858	Volvo	3852127	994	1 18-2915	Mercury Marine	27-85609	446
1 18-2859	OMC	311131	Obsolete	1 18-2915	Mercury Marine	27-856091	446
1 18-2860	OMC	311130	919	1 18-2915	Mercury Marine	27-858524	446
1 18-2861-1	OMC	311121	919	1 18-2915	Mercury Marine	27-858524	446
1 18-2862	OMC	321573	332	1 18-2916	OMC	911702	921
1 18-2862	OMC	326260	332	1 18-2917	GM	3701777	822
1 18-2863	OMC	308799	921	1 18-2917	Mercury Marine	27-33179	822
1 18-2864	OMC	321727	333	1 18-2917	Mercury Marine	27-53045	822
1 18-2865	OMC	313763	333	1 18-2917	Mercury Marine	27-530451	822
1 18-2866	OMC	317914	333	1 18-2917	Mercury Marine	F10077105	822
1 18-2867	OMC	319174	333	1 18-2917	Mercury Marine	F11101276	822
1 18-2868	OMC	310137	Obsolete	1 18-2917	Mercury Marine	F11101291	822
1 18-2869	OMC	305312	336	1 18-2917	Mercury Marine	F15000096	822
1 18-2871	OMC	304762	332	1 18-2917	OMC	312797	822
1 18-2872	OMC	307257	334	1 18-2918	OMC	911836	922
1 18-2872	OMC	318334	334	1 18-2918	OMC	915840	922
1 18-2873-9	OMC	318335	334	1 18-2919	Mercury Marine	27-42631	446
1 18-2874	OMC	314876	335	1 18-2919	Mercury Marine	27-426311	446
18-2875-1	OMC	908013	911	18-2923	Volvo	419678	995
18-2875-1	OMC	3850495	911	18-2924	Volvo	430039	995
18-2875-1	Volvo	3850495	911	18-2925	Volvo	461092	994
18-2875-1-9	OMC	908013	911	18-2925	Volvo	1378913	994
18-2875-1-9	OMC	3850495	911	18-2926	Volvo	463587	995
18-2875-1-9	Volvo	3850495	911	18-2926	Volvo	1378864	995
1 18-2876	OMC	307133	334	18-2927	Volvo	463999	995
1 18-2877	OMC	314421	333	18-2927	Volvo	1378909	995
1 18-2878	OMC	319710	333	18-2928	Volvo	824633	994
1 18-2879	OMC	312634	331	18-2928	Volvo	856044	994
1 18-2879	OMC	331363	331	18-2929	Volvo	856028	997
1 18-2879	OMC	338876	331	18-2930	Volvo	1266796	994
1 18-2880	OMC	304023	335	1 18-2930	Volvo	1378879	994
1 18-2881	OMC	125530	337	18-29322	Volvo	3854215	185, 643, 644, 700, 879
1 18-2881	OMC	332403	337	18-29322	Volvo	3854217	185, 643, 644, 700, 879
1 18-2883-1	OMC	907775	919	18-29322			185, 643, 644, 700, 879
1 18-2884	OMC	313782	327	1 18-2933	Volvo	416033	994
1 18-2885	OMC	303438	327	1 18-2933	Volvo	1317466	994
1 18-2886	OMC	203171	333	1 18-2934	Volvo	829714	996
1 18-2887	OMC	302557	337	1 18-2935	Volvo	418411	996
1 18-2888	OMC	326953	S/S to 18-2888-9	1 18-2936	Volvo	418445	996
1 18-2888	OMC	332010	S/S to 18-2888-9	1 18-2937	Volvo	418412	996
1 18-2889	OMC	302675	331	1 18-2938	OMC	331917	333
1 18-2890	OMC	302994	330	1 18-2939	Volvo	814356	997
1 18-2890	OMC	331203	330	1 18-2941	Chrysler Inboard	2469559	608
1 18-2890	OMC	338886	330	1 18-2941	Chrysler Inboard	2847480	608
1 18-2891	OMC	303339	336	18-2943	Mercury Marine	27-443281	442
1 18-2892	OMC	303355	331	18-2943	Mercury Marine	27-443282	442
1 18-2893-9	OMC	303750	330	18-2943	Mercury Marine	27-443283	442
1 18-2894	OMC	304314	333	18-2943	Mercury Marine	27-443284	442
18-2896-1	Mercury Marine	27-32816	797	1 18-2944	Mercury Marine	26-45577	826
18-2896-1	Mercury Marine	27-52546	797	1 18-2944	Mercury Marine	26-455771	826
18-2896-1	OMC	311068	797	1 18-2945	Mercury Marine	12-19183	270, 348, 446, 826, 922, 997

1 This product is priced per piece. To order, priced per package, please add -9 to the part number

2 Items ending in "D" are display packaged - regular number is non-display • 3 For discount shop pack of 10, please add -10 to the part number

SIERRA #	O.E.M.	O.E. #	PAGE #	SIERRA #	O.E.M.	O.E. #	PAGE #
SIERRA							
1 18-2945	Mercury Marine	12-191832	270, 348, 446, 826, 922, 997	18-3015	OMC	433935	298
1 18-2945	Mercury Marine	12-191833	270, 348, 446, 826, 922, 997	18-3015	OMC	797407	298
1 18-2945	Mercury Marine	12-20260	270, 348, 446, 826, 922, 997	18-3016-1	Mercury Marine	47-862232A2	749
1 18-2945	Mercury Marine	F50556	270, 348, 446, 826, 922, 997	18-3016-1	Mercury Marine	8M0104229	749
1 18-2945	Mercury Marine	F8077	270, 348, 446, 826, 922, 997	3 18-3017	Chrysler Force	47-803631T	252
1 18-2945	Mercury Marine	F8186	270, 348, 446, 826, 922, 997	3 18-3017	Chrysler Force	47-89984T4	252
1 18-2945	OMC	307552	270, 348, 446, 826, 922, 997	3 18-3017	Chrysler Force	47-F694065	252
1 18-2945			270, 348, 446, 826, 922, 997	3 18-3017	Mercury Marine	47-30221	252
18-2945-9			270, 348, 446, 826, 922, 997	3 18-3017	Mercury Marine	47-65960	252
18-2946	Chris-Craft	16.50-00204	992	3 18-3017	Mercury Marine	47-85460	252
18-2946	Mercury Marine	27-52364	992	3 18-3017	Mercury Marine	47-89984	252
18-2946	Mercury Marine	27-81084	992	3 18-3017	Mercury Marine	47-899842	252
18-2946	Mercury Marine	F15000204	992	3 18-3017	Mercury Marine	47-899844	252
18-2946	OMC	908611	992	3 18-3017	Mercury Marine	47-89984T3	252
18-2946	OMC	3853336	992	3 18-3017	Mercury Marine	47-89984T4	252
18-2946	Volvo	908611	992	18-3020	Jabsco	1210-0003	576
18-2946	Volvo	3853336	992	18-3020	Johnson Pump	09-1027B-9	576
1 18-2947	OMC	310913	919	18-3021	Jabsco	4598-0001	576
1 18-2948	Mercury Marine	12-23245	446, 448, 826	18-3021	Oberdorfer	6603	576
1 18-2948	Mercury Marine	12-49221	446, 448, 826	18-3022	Honda	90752-ZW9-A30	267
1 18-2948	Mercury Marine	12-492211	446, 448, 826	18-3023	Suzuki	17461-90J00	486
1 18-2949	Barr	CHV-47-000	994	18-3023	Suzuki	17461-90J01	486
1 18-2949	Crusader	96306	994	18-3023	Suzuki	17461-94500	486
18-2949	Mercury Marine	27-33395	994	18-3023	Suzuki	17461-94501	486
1 18-2949	Volvo	835966	994	18-3023	Suzuki	17461-94502	486
1 18-2949	Volvo	856034	994	18-3023	Suzuki	17461-94503	486
18-2950	OMC	309612	327	18-3023	Suzuki	17461-94504	486
18-2950	OMC	766870	327	18-3023	Suzuki	17461-94505	486
18-2951	OMC	304720	327	18-3023	Suzuki	17461-94506	486
18-2952	OMC	203034	327	18-3023	Suzuki	17461-94510	486
18-2954	OMC	319633	327	18-3023	Suzuki	17461-94511	486
18-2956	OMC	318358	327	18-3023	Suzuki	17461-94520	486
18-2957	OMC	307069	327	18-3025	Honda	90752-ZW9-A30	267
18-2958	OMC	315539	327	18-3026	Johnson/Evinrude	331130	Obsolete
18-2959	OMC	306048	327	18-3028	Yamaha	6AW-44336-00	526
18-2960	OMC	313413	327	18-3030	Chrysler Force	47-803630T	252
18-2961	OMC	329103	327	18-3030	Chrysler Force	F523065	252
18-2962	OMC	322332	327	18-3030	Chrysler Force	F523065-1	252
18-2963	OMC	318914	327	18-3031	Honda	19210-ZY3-003	266
18-2963	OMC	320533	327	18-3035	Suzuki	17461-93J00	486
18-2963	OMC	330818	327	18-3036	Jabsco	673-0003	575
18-2964	OMC	320745	328	18-3036	Johnson Pump	09-1026B-9	575
18-2964	OMC	335360	328	18-3036	Volvo	875808-8	575
18-2964	OMC	766779	328	18-3037	Jabsco	836-0003	575
18-2965	Volvo	419310	992	18-3037	Johnson Pump	09-1026B-9	575
18-2965	Volvo	419763-8	992	18-3037	Volvo	875860	575
18-2966	Volvo	462623	992	18-3037	Volvo	875736	575
18-2968	Volvo	1378645	992	18-3037	Volvo	2430184	575
18-2970	Volvo	1378646	992	18-3038	Jabsco	17937-0003	575
18-2971-1	Volvo	835908-5	982	18-3038	Jabsco	920-0003	575
18-2971-1	Volvo	856039-3	982	18-3038	Johnson Pump	09-1026B-9	575
18-29716	Mallory	29716	664	18-3038	Volvo	3841897	575
18-29717	Mallory	29217	Obsolete	18-3038	Volvo	877061-2	575
18-2972	Volvo	1378870	995	18-3039	Mercury Marine	47-39074	413
18-29720	Mallory	29440M	664	18-3039	Mercury Marine	47-65957	413
18-29723			664	18-3039	Mercury Marine	47-89981	413
18-2974	Volvo	418265	994	18-3040	Yamaha	63V-44352-01-00	517
18-2980	Volvo	875401	Obsolete	18-3042	Yamaha	67F-44352-00-00	517
18-2980	Volvo	876356	Obsolete	18-3043	OMC	389642	517
18-2982	Volvo	875569	992	18-3044	OMC	385072	298
18-2982	Volvo	876358	992	2 18-3046	Crusader	1003062	576
18-2983	Volvo	875400	992	2 18-3046	Jabsco	18838-0001	576
18-2983	Volvo	876342	992	2 18-3046	Sherwood Pump	9959K	576
1 18-2989	Volvo	824677	994	2 18-3046	Volvo	3854286	576
1 18-2990	Volvo	832669	997	18-3047	Jabsco	18948-0001	576
18-2991-1	Volvo	855383	994	18-3047	Sherwood Pump	10615K	576
18-2991-1	Volvo	855967	994	18-3047	Volvo	835874	576
18-2991-1-9	Volvo	855383	982	18-3047			576
18-2991-1-9	Volvo	855967	982	18-3049	Suzuki	17461-87E11	486
1 18-2995	Volvo	856037	994	18-3049	Suzuki	17461-87E12	486
1 18-2996	OMC	911823	997	3 18-3050	OMC	386084	298
1 18-2996	OMC	3852560	997	18-3051	OMC	395289	298
1 18-2996	Volvo	3852560	997	18-3052	Mercury Marine	47-56780	413
18-2998	Volvo	876300	992	18-3052	Mercury Marine	47-65958	413
18-3000	Suzuki	17461-92D02	486	18-3052	Mercury Marine	47-89982	413
18-3001	OMC	277181	298	18-3053-1	OMC	396725	299
18-3001	OMC	434424	298	18-3054	Mercury Marine	47-68988	413
18-3002	OMC	375638	298	18-3054	Mercury Marine	47-89980	413
18-3002	OMC	775518	298	18-3055	OMC	389589	299
18-3006	OMC	378891	298	3 18-3056	Chrysler Force	47-430262	252
18-3006	OMC	775521	298	3 18-3056	Honda	19210-ZW1-003	252
3 18-3007	Mercury Marine	47-89983	412	3 18-3056	Mercury Marine	47-430261	252
3 18-3007	Mercury Marine	47-89983T	412	3 18-3056	Mercury Marine	47-430262	252
18-3008	Mercury Marine	47-20813	413	3 18-3056	Mercury Marine	47-430264	252
18-3008	Mercury Marine	47-25287	413	3 18-3056	Mercury Marine	47-43026T2	252
18-3012	Mercury Marine	47-22748	413	18-3057	Chrysler Force	47-85089-3	252
18-3013	Mercury Marine	26-821309	414	18-3057	Mercury Marine	47-85089-3	252
18-3014	Mercury Marine	26-821310	414	18-3058	OMC	983895	899
18-3015	OMC	396852	298	18-30585	OMC	3854072	899

1 This product is priced per piece. To order, priced per package, please add -9 to the part number
 2 Items ending in "D" are display packaged - regular number is non-display • 3 For discount shop pack of 10, please add -10 to the part number

SIERRA #	O.E.M.	O.E. #	PAGE #	SIERRA #	O.E.M.	O.E. #	PAGE #		
SIERRA									
3	18-3059	OMC	381538	302	18-3080	Jabsco	673-0001	575	
3	18-3059	OMC	389289	302	18-3080	Johnson Pump	09-1026B	575	
3	18-3059	OMC	394534	302	18-3080	Johnson Pump	09-1026B-1	575	
3	18-3059	OMC	395864	302	18-3080	Johnson Pump	09-1026B-9	575	
3	18-3059	OMC	397131	302	18-3080	Volvo	875808	575	
3	18-3059	OMC	435748	302	18-3081	Jabsco	1210-0001	575	
3	18-3059	OMC	435821	302	2	18-3081	Johnson Pump	09-1027B	575
3	18-3059	OMC	439948	302	2	18-3081	Volvo	3858256	575
3	18-3059	OMC	5001593	302	2	18-3081	Volvo	3862281	575
18-3060	Crusader		22212	578	2	18-3081	Volvo	875811-2	575
18-3060	Crusader		1003026	578	2	18-3081		575	
18-3060	Jabsco		18838-0001	578	2	18-3082	OMC	382547	299
18-3060	Oberdorfer		132-0317	578	18-3083	OMC	377230	299	
18-3060	OMC		3854286	578	18-3083	OMC	777213	299	
18-3060	Pleasurecraft		RP061015	578	18-3084	Chrysler Force	47-F40065-2	253	
18-3060	Sherwood Pump		9959	578	18-3085	Chrysler Force	47-F84065	253	
18-3060	Volvo		835512	578	18-3086	OMC	379475	899	
18-3060	Volvo		3854286	578	18-3086	OMC	777130	899	
18-3061	Crusader		20300	577	18-3087	Mercury Marine	47-59362	749, 751	
18-3061	Jabsco		18948-0001	577	18-3087	Mercury Marine	47-59362T	749, 751	
18-3061	Oberdorfer		8922	577	18-3088	Yamaha	6F5-44352-00-00	517, 522	
18-3061	Pleasurecraft		RP061017	577	18-3089	Johnson Pump	09-45825	578	
18-3061	Sherwood Pump		10615	577	18-3090	OMC	387361	299	
18-3061	Volvo		835874	577	18-3090	OMC	763735	299	
18-3062	Chrysler Force		47-42038-2	253	18-3091	OMC	389576	299	
18-3062	Mercury Marine		47-420381	253	18-3092	Suzuki	17461-93001	486	
18-3062	Mercury Marine		47-420382	253	18-3092	Suzuki	17461-93003	486	
18-3062	Mercury Marine		47-42038Q02	253	18-3092	Suzuki	17461-93004	486	
18-3063	Mercury Marine		47-81242M	413	18-3094	Suzuki	17461-94700	486	
18-3063	Mercury Marine		47-95611M	413	18-3094	Suzuki	17461-94701	486	
18-3063	Yamaha		662-44352-01-00	413	18-3095	Suzuki	17461-95300	486	
18-3065	Yamaha		6L2-44352-00-00	517	18-3095	Suzuki	17461-95301	486	
18-3066	Mercury Marine		47-11590M	413	18-3095	Suzuki	17461-95302	486	
18-3066	Yamaha		6G1-44352-00-00	413	18-3096	Suzuki	17461-96301	299	
18-3067	Mercury Marine		47-81604M	413	18-3096	Suzuki	17461-96311	299	
18-3067	Mercury Marine		47-84797M	413	18-3096	Suzuki	17461-96312	299	
18-3067	Yamaha		689-44352-02-00	413	18-3096	OMC	5031417	299	
18-3068	Yamaha		6H4-44352-02-00	517	18-3097	Suzuki	17461-98501	486	
18-3069	Mercury Marine		47-81423M	413	18-3097	Suzuki	17461-98502	486	
18-3069	Mercury Marine		47-82824M	413	18-3097	Suzuki	17461-98503	486	
18-3069	Mercury Marine		47-97108M	413	18-3097	Suzuki	17461-985M0	486	
18-3069	Yamaha		697-44352-00-00	413	18-3098	Mercury Marine	47-16154	413	
18-3069	Yamaha		6H3-44352-00-00	413	18-3098	Mercury Marine	47-161543	413	
18-3070	Yamaha		688-44352-03-00	517	18-3099	OMC	5033112	486	
18-3071	Yamaha		6E5-44352-01-00	517	18-3099	Suzuki	17461-93901	486	
18-3072	Mercury Marine		47-80395M	413	18-3099	Suzuki	17461-93902	486	
18-3072	Yamaha		646-44352-01-00	413	18-3099	Suzuki	17461-93903	486	
18-3073	Mercury Marine		47-96305M	413	18-3100	Honda	19210-ZW9-003	266	
18-3073	Yamaha		6E0-44352-00-00	413	18-3100	Honda	19210-ZW9-013	266	
18-3074	Mercury Marine		47-84027M	413	18-3102	OMC	305303	299	
18-3074	Mercury Marine		47-84027T	413	18-3103	OMC	303069	299	
18-3074	Mercury Marine		47-96619M	413	18-3104-1	OMC	432941	299	
18-3074	Yamaha		682-44352-01-00	413	18-3104-1	OMC	437059	299	
2	18-3075	Jabsco	124310-46090	575	18-3104-1	OMC	765350	299	
2	18-3075	Jabsco	14510-46090	575	18-3106	Volvo	806256	973	
2	18-3075	Jabsco	2877-0001	575	18-3106	Volvo	831009	973	
2	18-3075	Jabsco	4568-0001	575	18-3107	Mercury Marine	32768	412	
2	18-3075	Johnson Pump	09-801B	575	18-3107	Mercury Marine	54705	412	
2	18-3075	Oberdorfer	B6620	575	18-3108	OMC	308928	901	
2	18-3075	Volvo	875575	575	18-3109	Mercury Marine	23-29804	414, 749	
18-3076	Jabsco		22405-0001	575	18-3109	Mercury Marine	23-29804T	414, 749	
18-3076	Johnson Pump		09-45589	575	18-3109	Mercury Marine	23-52928	414, 749	
18-3076	Johnson Pump		09-808B	575	18-3110	Mercury Marine	26-29677	414, 749	
18-3076	Volvo		833995	575	18-3110	Mercury Marine	26-36557A1	414, 749	
18-3076	Volvo		875583	575	18-3110	Mercury Marine	26-38970	414, 749	
18-3077	Cummins		650607	575	18-3111	OMC	907774	Obsolete	
18-3077	Jabsco		920-0001	575	18-3113	Mercury Marine	70977	414	
18-3077	Johnson Pump		09-1028B	575	18-3114	Mercury Marine	48752	414, 749	
18-3077	Oberdorfer		C7441	575	18-3114	Mercury Marine	48752T	414, 749	
18-3077	Sherwood Pump		18200	575	18-3115	Mercury Marine	48753	414	
18-3077	Volvo		3841697	575	18-3116	Mercury Marine	46-48743A1	414, 750	
18-3077	Volvo		877061-2	575	18-3116	Mercury Marine	46-64141A1	414, 750	
18-3077	Yanmar		127610-42200	575	18-3116	Mercury Marine	46-96148	414, 750	
18-30778	Volvo		21213664	974	18-3116	Mercury Marine	46-96148A1	414, 750	
18-3078	Cummins		160596	575	18-3116	Mercury Marine	46-96148T1	414, 750	
18-3078	Cummins		166758	575	18-3117	Mercury Marine	30605	414, 750	
18-3078	Cummins		556540	575	18-3117	Mercury Marine	32435	414, 750	
18-3078	Cummins		556850	575	18-3117	Mercury Marine	324351	414, 750	
18-3078	Cummins		21601R	575	18-3118	Mercury Marine	46-48746A1	414	
18-3078	Jabsco		836-0001	575	18-3118	Mercury Marine	46-48746A3	414	
18-3078	Johnson Pump		09-1029B	575	18-3118	Mercury Marine	46-77822A1	414	
18-3078	Oberdorfer		7054	575	18-3119	OMC	983298	901	
18-3078	Volvo		875660	575	18-3121	OMC	911703	Obsolete	
18-3078	Volvo		875736	575	18-3122	Honda	19231-ZW1-003	266	
18-3078	Volvo		2430184	575	18-3122	Mercury Marine	817276	266	
18-3079	Jabsco		4528-0001	575	18-3122	Mercury Marine	8172761	266	
18-3079	Sherwood Pump		9979K	575	18-3122	Mercury Marine	8172763	266	
18-3079	Volvo		3586498	575	1	18-3125	Jabsco	3101-0000	576
18-3079	Volvo		875807-0	575	1	18-3125	Johnson Pump	3298-0000	576
18-3079	Yanmar		104211-42070	575	18-3126	OMC	321940	300	

1 This product is priced per piece. To order, priced per package, please add -9 to the part number

2 Items ending in "D" are display packaged - regular number is non-display • 3 For discount shop pack of 10, please add -10 to the part number

SIERRA #	O.E.M.	O.E. #	PAGE #	SIERRA #	O.E.M.	O.E. #	PAGE #
SIERRA							
18-3127	OMC	319275	300	2 18-3214	Mercury Marine	47-43026T6	415
18-3129	OMC	432955	301	2 18-3214	Mercury Marine	47-43026T8	415
18-3129	OMC	435673	301	2 18-3215	Mercury Marine	47-85089T7	415
18-3129	OMC	436954	301	2 18-3215			415
18-3129	OMC	438591	301	18-32150			635, 647
18-3133	OMC	331799	Obsolete	18-32151			635, 647
1 18-3135	OMC	306643	Obsolete	18-32152	Ilmor	S556162	635
1 18-3136	OMC	323626	330	18-32152	Indmar	S556162	635
1 18-3138	OMC	334897	300	18-32152	Malibu	S556162	635
18-3139	Mercury Marine	46895	414	18-32153	Honda	35655-ZY3-C01	265
1 18-3140	Crusader	20502	620	18-32153	Honda	35655-ZZ5-004	265
1 18-3140	Sherwood Pump	10931	620	18-32154	Suzuki	18213-98J00	484
18-3141	OMC	313176	Obsolete	18-3216	Mercury Marine	47-59362A4	751
18-3142	Yamaha	68T-44323-00-00	523	2 18-3217			416
18-3143	Yamaha	67F-44323-00-00	524	18-3219	Mercury Marine	32489	844
18-3145	OMC	911844	Obsolete	18-3219	Mercury Marine	32489A2	844
18-3147	Mercury Marine	817275K05	751	18-3219	Mercury Marine	42724A3	844
18-3147	Mercury Marine	817275T4	751	18-3220	Mercury Marine	32-54236	750
18-3148	Mercury Marine	46-84277M	418	18-3221	Mercury Marine	32-814384	750
18-3148	Mercury Marine	46-84277T	418	18-3221	Mercury Marine	32-860220	750
18-3148	Yamaha	682-W0078-A1-00	418	18-3222	Mercury Marine	23-816583	750
18-3149-2	Mercury Marine	46-42040A1	415	18-3223-9			590, 608, 630, 651, 663, 795, 909, 982
18-3149-2	Mercury Marine	46-42040A3	415	1 18-3226	Mercury Marine	10-30720	Obsolete
18-3149-2	Mercury Marine	46-42040A5	415	1 18-3227-9	Mercury Marine	17-35973	448, 754, 837
18-3150	Mercury Marine	46-807151A14	751	1 18-3229	Mercury Marine	10-28668	795
18-3150	Mercury Marine	46-807151A7	751	18-3230	Mercury Marine	10-816601	833
18-3151	Mercury Marine	816597	419	18-3231	Mercury Marine	10-98794	Obsolete
18-3153	OMC	908158	307	12 18-3232	Mercury Marine	19-47579	863
18-3154	Mercury Marine	826763A	414	12 18-3232	Mercury Marine	19-475791	863
18-3155	Mercury Marine	47-72774A89	751	18-3236	Mercury Marine	23-32632	864
18-3160-1	Mercury Marine	46-862914A13	751	18-3237			751
18-3162	Yamaha	67F-44322-00-00	Obsolete	2 18-3239			416
18-3163	Yamaha	6L5-44323-00-00	529	18-3240			253
18-3164	Yamaha	6L5-44322-00-00	526	18-3242	Suzuki	17400-96350	487
18-3166	Yamaha	6E0-44366-00-00	520	18-3242	Suzuki	17400-96351	487
18-3170	Yamaha	6E5-44311-00-00	518	18-3242	Suzuki	17400-96353	487
18-3171	Yamaha	688-44311-01-00	518	18-3243	Suzuki	17400-94700	487
18-3173-1	Yamaha	61A-44311-00-00	518	18-3243	Suzuki	17400-94701	487
18-3173-1	Yamaha	61A-44311-01-00	518	18-3243	Suzuki	17400-94701	487
18-3175	Volvo	858467	973	18-3244	Suzuki	17400-95350	487
18-3176	Yamaha	68T-44366-00-00	520	18-3244	Suzuki	17400-95351	487
18-3178	OMC	318995	300	18-3244	Suzuki	17400-95550	487
18-3179	OMC	324097	Obsolete	18-3245	Honda	19210-881-A01	267
18-3180	OMC	435390	301	18-3245	Honda	19210-881-A02	267
18-3182	OMC	317841	Obsolete	18-3245	Honda	19210-ZW9-A02	267
18-3185	Yamaha	61N-44311-00-00	518	18-32455	Honda	19210-ZW9-A31	266
18-3185	Yamaha	61N-44311-01-00	518	18-32455	Honda	19210-ZW9-A32	266
18-3186	Yamaha	63D-44323-00-00	523	18-3246	Honda	19210-ZV4-013	266
18-3187	Honda	06192-ZW1-305	266	18-3246	Honda	19210-ZV4-651	266
18-3188	Suzuki	17471-98503	486	18-3247	Honda	19210-ZV4-651	266, 267
18-3189	Suzuki	17471-87D01	486	18-3248	Honda	19210-ZV5-003	266
18-3190	Suzuki	17471-93902	486	18-3249	Honda	19210-ZV7-003	266
18-3191	Suzuki	17471-94501	486	18-3250	Honda	19210-ZW1-B04	266, 267
18-3192	Suzuki	17471-87E01	Obsolete	2 18-3251			253
18-3192	Suzuki	17471-92J00	Obsolete	18-3252	Mercury Marine	47-89982T1	421
18-3193	Suzuki	17471-92D10	486	18-3253	Suzuki	17400-87D11	487
18-3194	Yamaha	61N-44323-00	Obsolete	18-3254	Suzuki	17400-87E03	487
18-3195	Yamaha	63V-44323-00-00	522	18-3254	Suzuki	17400-87E04	487
18-3196	Yamaha	66T-44323-00-00	523	18-3255	Suzuki	17400-92D01	487
18-3197	Mercury Marine	10-67373	750	18-3256	Suzuki	17400-93951	487
18-3197	Mercury Marine	10-76156	750	18-3257	Suzuki	17400-94611	487
18-3198	Mercury Marine	93424	855	18-3258	Suzuki	17400-90J11	487
18-3198	Mercury Marine	934241	855	18-3258	Suzuki	17400-90J20	487
18-3198	Mercury Marine	934243	855	18-3259	Suzuki	17400-98551	487
18-3199	Mercury Marine	93423	835, 855	18-3260	Suzuki	17400-98652	487
18-3199	Mercury Marine	934231	835, 855	18-3261	Volvo	875769	974
18-3199	Mercury Marine	934233	835, 855	18-3262	Volvo	875759	974
1 18-3200	Chrysler Force	F697140	272	18-3263	Volvo	875698	974
1 18-3200	Honda	90508-ZW1-003	272	18-3264	Suzuki	17400-93J00	487
1 18-3200	Mercury Marine	14-31210	272	18-3264	Suzuki	17400-93J02	487
1 18-3200	Mercury Marine	14-816629	272	18-3265	Mercury Marine	47-43026Q06	416
1 18-3200	Mercury Marine	14-816629Q	272	18-3265	Mercury Marine	47-43026T11	416
1 18-3200	Mercury Marine	14-F697140	272	18-3265	Mercury Marine	47-8M0100526	416
1 18-3200	Pleasurecraft	R096117	272	18-3266	Suzuki	17400-98661	487
18-3201	OMC	379763	301	18-3267	Suzuki	17400-98J00	487
18-3202			301	18-3267	Suzuki	17400-98J01	487
18-3203	OMC	379766	301	18-3268	Honda	90752-ZV4-650	266
1 18-3204	Mercury Marine	14-76281	460	18-3269	Honda	90752-ZV7-000	266
18-3205	Volvo	875574	975	18-3270	Honda	90752-ZV5-003	266
18-3206	OMC	984744	901	18-3271	Honda	90752-ZW1-B02	266
2 18-3207	Mercury Marine	47-89983Q1	415	18-3273	Honda	90752-ZY3-003	Obsolete
2 18-3207	Mercury Marine	47-89983T2	415	18-3274	Volvo	808007	Obsolete
18-3208	Volvo	875584	975	18-3275	Jabsco	17935-0001	575
18-3209	Volvo	875383	Obsolete	18-3275	Johnson Pump	09-819B	575
18-3210			Obsolete	18-3275	Volvo	877066	575
2 18-3211			302	18-3276-1	Volvo	3862567	974
2 18-3212-1	OMC	984461	902	18-3276-1	Volvo	21213660	974
2 18-3214	Chrysler Force	46-43024A7	415	18-3277	Johnson Pump	09-102BB	974
2 18-3214	Honda	19021-ZW1-003	415	18-3277	Volvo	3862281	974
2 18-3214	Mercury Marine	47-43026T11	415	18-3277	Yanmar	192470-42530	974

1 This product is priced per piece. To order, priced per package, please add -9 to the part number
 2 Items ending in "D" are display packaged - regular number is non-display • 3 For discount shop pack of 10, please add -10 to the part number

SIERRA #	O.E.M.	O.E. #	PAGE #	SIERRA #	O.E.M.	O.E. #	PAGE #
SIERRA							
18-3277	Yanmar	192470-42532	974	18-3363	OMC	330560	301
18-3278	Honda	06192-ZV1-C00	Obsolete	18-3365	OMC	909533	307, 330
18-3279	Honda	06192-881-C00	267	18-3366	OMC	390286	299
18-3280	Honda	06192-ZV4-000	267	18-3367	OMC	393632	301
18-3281	Honda	06192-ZV7-000	267	18-3368	OMC	396809	299
18-3282	Honda	06192-ZV5-003	267	18-3369	OMC	302325	301
18-3283	Honda	06192-ZW1-000	267	18-3369	OMC	319126	301
18-3284	Honda	06192-ZY6-000	267	18-3370	Yamaha	692-W0078-00-00	521
18-3285	Honda	06192-ZY3-000	267	18-3370	Yamaha	692-W0078-01-00	521
18-3286			902	18-3370	Yamaha	692-W0078-A0-00	521
18-3287	Volvo	876120	974	18-3371	Yamaha	692-W0078-A0-00	521
18-3288	Honda	91252-ZV1-003	Obsolete	18-3372	Yamaha	6E5-W0078-01-00	521
18-32882	Volvo	3852315	1003	18-3373	Yamaha	6E5-W0078-A1-00	521
18-3289	Mercury Marine	26-864319	826	18-3376	OMC	384956	302
18-3290	OMC	321886	297	18-3377	OMC	382468	302
18-3291	Suzuki	09420-05006	Obsolete	18-3378	OMC	391635	303
18-3291	Suzuki	09420-05009	Obsolete	18-3378	OMC	439077	303
18-3292	Suzuki	09420-03005	486	18-3379	OMC	390381	Obsolete
18-3292	Suzuki	17462-93990	486	18-3380	OMC	390770	303
18-3293	Mercury Marine	28-43037	414, 450, 750, 839	18-33800	Mercury	21-806118	Obsolete
1 18-3295	OMC	330619	300	18-33800	Volvo	3856884	Obsolete
1 18-3295	OMC	344470	300	18-3381	OMC	393509	303
18-3296	Suzuki	09420-05005	486	18-3382	OMC	393630	303
18-3297	Yamaha	90280-03M03-00	519	18-3383	OMC	395270	303
1 18-3299	OMC	331107	300	18-3384	OMC	386124	304
18-3300	Mercury Marine	28-83444M	414	18-3385	OMC	396932	304
18-3300	Yamaha	90280-04M00-00	414	18-3386	OMC	983218	902
18-3301	Yamaha	90280-04M04-00	519	18-3387	OMC	432956	304
18-3302	Yamaha	90280-04M05-00	519	18-3388	OMC	386533	304
18-3303	Johnson Pump	01-42401	Obsolete	18-3388	OMC	389143	304
18-3304	Jabsco	6760-0001	Obsolete	18-3389	OMC	436957	304
18-3304	Johnson Pump	09-802-B	Obsolete	18-3389	OMC	438591	304
18-3305	Mercury Marine	28-81912M	414	18-3389	OMC	432955	304
18-3305	Mercury Marine	28-83701M	414	18-3390	OMC	395060	304
18-3305	Yamaha	90280-03003-00	414	18-3390	OMC	435447	304
18-3305	Yamaha	90280-03024-00	414	18-3390	OMC	434421	304
18-3306	Jabsco	13554-0001	575	18-3390	OMC	5001594	304
2 18-3306	Johnson Pump	09-812B	575	18-3391	OMC	395072	305
2 18-3306	Yanmar	119773-42600-00	575	18-3392	OMC	434421	305
2 18-3309			751	18-3392	OMC	5001594	305
18-3310	Yamaha	6G5-W0078-01-00	520	18-3393	OMC	388644	305
18-33104	Mercury	802632	726	18-3393	OMC	395073	305
18-33104	Mercury	802632T	726	18-3394	OMC	433548	305
18-3311	Yamaha	6G5-W0078-A1-00	520	18-3394	OMC	433549	305
18-3312	Yamaha	6N6-W0078-00-00	521	18-3394	OMC	438592	305
18-3313-1	Yamaha	6N6-W0078-01-00	521	18-3395	Yamaha	61A-W0078-01-00	521
18-3314			417	18-3396-1	Yamaha	61A-W0078-A2-00	521
18-3315-2	OMC	435929	306	18-3396-1	Yamaha	61A-W0078-A3-00	521
18-3315-2	OMC	5001595	306	18-3397	Yamaha	679-W0078-00-00	522
18-3316	Mercury Marine	46-32437A3	417	18-3397	Yamaha	679-W0078-A0-00	522
18-3316	Mercury Marine	46-78400A2	417	18-3398	Yamaha	6F5-W0078-00-00	522
18-3316	Mercury Marine	46-96148A8	417	18-3398	Yamaha	6F5-W0078-A0-00	522
18-3317	Mercury Marine		752	18-3399	OMC	396933	305
18-3318	Mercury Marine	47-59362Q08	751	18-3399	OMC	439077	305
18-3319	Mercury Marine	46-42579A4	417	18-3400	OMC	391698	305
18-3320			752	18-3400	OMC	394711	305
18-33207	Mercury	860349A1	725	18-3401	OMC	394394	306
18-3321			752	18-3401	OMC	395271	306
18-33211	Mercury	892681	725	18-3401	OMC	395270	306
18-3322	Mercury Marine	46-77516A3	417	18-3402	OMC	382296	Obsolete
18-3323	Mercury Marine	46-73640A2	418	18-3403	OMC	388644	306
18-3324	Mercury Marine	46-77177A3	418, 448	18-3404	Suzuki	09420-04009	Obsolete
18-3325	OMC	387326	302	18-3405	OMC	435959	301
18-3326	OMC	300611	300	18-3406	Mercury Marine	817275A08	416
18-3327	OMC	386697	302	18-3407	Mercury Marine	817275A09	416
18-3327	OMC	387610	302	18-3408	Yamaha	663-44311-02	522
18-3327	OMC	389112	302	18-3408	Yamaha	6H4-W0078-00	522
18-3327	OMC	391698	302	18-3408	Yamaha	6H4-W0078-A0	522
18-3327	OMC	394711	302	18-34080	Universal		670
18-3328	Yamaha	646-44322-00-00	Obsolete	18-34081	Universal		670
18-3329	OMC	302497	336	18-34082	GM		Obsolete
18-3332	OMC	304026	336	18-34083	GM		670
18-3333	Yamaha	61A-44322-00-00	520	18-34084	GM		670
18-3336	OMC	384087	300	18-3409	Yamaha	67F-44311-01	524
18-3337	OMC	315837	336	18-3409	Yamaha	67F-W0078-00	524
18-3343	OMC	320981	300	18-3410	Yamaha	68T-W0078-00-00	523
18-3344	Yamaha	6E5-44323-00-00	521	18-3411	Yamaha	682-W0078-A1-00	520
18-3345	Yamaha	6G5-44323-00-00	520	18-34110	Mallory	4110M	Obsolete
18-3346	OMC	435027	300	18-3412	Yamaha	63V-44301-00	522
18-3348	OMC	984461	902	18-3412	Yamaha	63V-W0078-01	522
18-3349			902	18-34120	Mallory	5110MFI	667
18-3350	Mercury Marine	72778	Obsolete	18-3413	Yamaha	66T-44311-00	523
18-3350	Mercury Marine	94576	Obsolete	18-3413	Yamaha	66T-W0078-00	523
18-3351	Mercury Marine	72777	Obsolete	18-3414	Mercury Marine	46-73804A1	415
18-3351	Mercury Marine	94916	Obsolete	18-3414	Mercury Marine	46-96146A5	415
18-3352	OMC	325398	308	18-34140	Mallory	4140M	667
18-3356	Yamaha	63V-44301-00-00	518, 522, 523	18-3415	Yamaha	63D-W0078-01-00	523
18-3357	Yamaha	646-44323-00-00	525	18-3416	Mercury Marine	46-73802A2	415
18-3358	OMC	328751	300	18-3416	Mercury Marine	46-78400A1	415
18-3360	OMC	329390	334	18-3416	Mercury Marine	46-96146A2	415

1 This product is priced per piece. To order, priced per package, please add -9 to the part number

2 Items ending in "D" are display packaged - regular number is non-display • 3 For discount shop pack of 10, please add -10 to the part number

SIERRA #	O.E.M.	O.E. #	PAGE #	SIERRA #	O.E.M.	O.E. #	PAGE #
SIERRA							
18-3416	Mercury Marine	46-96146A6	415	18-3482	Yamaha	6CE-44311-01-00	518
18-3417	Mercury Marine	46-57234A1	750	18-3483	Yamaha	6AW-44311-01-00	518
18-3419	Mercury Marine	46-42579A3	415	18-3484	Yamaha	6AH-44311-00-00	518
18-3420	Mercury Marine	46-44292A3	750	18-3485	Yamaha	6CJ-44311-00-00	518
18-3420	Mercury Marine	46-44292Q03	750	18-3486	Yamaha	6L2-44311-01-00	518
18-3420	Mercury Marine	46-44292T1	750	18-3489	Honda	06192-ZX2-C00	267
18-3421	Mercury Marine	46-48748A1	750	18-3490	Yamaha	6BG-W0078-00-00	526
18-3422	Mercury Marine	46-48745A1	415	18-3491	OMC	437907	307
18-3422	Mercury Marine	46-65498A1	415	18-3492	Honda	06192-ZW1-B04	267
18-3422	Mercury Marine	46-68390A1	415	18-3493	Honda	06192-ZW9-000	267
18-3422	Mercury Marine	46-73842A2	415	18-3494	Yamaha	6CJ-W0078-00-00	526
18-3422	Mercury Marine	46-77516A1	415	18-3495	Suzuki	15170-93911	483
18-3423	Mercury Marine	46-73640A1	415	18-3496	Suzuki	15170-94320	483
18-3424	Mercury Marine	46-77177A1	415	18-3497	OMC	5033372	293
18-3425	Mercury Marine	84188M	419	18-3497	Suzuki	15170-91J00	293
18-3425	Mercury Marine	84188T	419	18-3498	OMC	5036216	293
18-3425	Yamaha	663-W0078-00-00	419	18-3498	Suzuki	15170-94J00	293
18-3425	Yamaha	663-W0078-A0-00	419	18-3498	Suzuki	15170-94J0V	293
18-3426	Mercury Marine	42431M	Obsolete	18-3499	OMC	5030699	293
18-3426	Mercury Marine	84829M	Obsolete	18-3499	Suzuki	15170-99E00	293
18-3426	Mercury Marine	97793M	Obsolete	18-3500	OMC	394409	311
18-3426	Mercury Marine	97793T	Obsolete	18-3500	OMC	434137	311
18-3426	Yamaha	689-W0078-04-00	Obsolete	18-3501	OMC	435957	300
18-3426	Yamaha	689-W0078-A4-00	Obsolete	18-3502	OMC	912614	Obsolete
18-3427	Mercury Marine	81242M	Obsolete	18-3504	Volvo	3588475	974
18-3427	Mercury Marine	95661M	Obsolete	18-3505	Yamaha	63V-44365-10-00	520
18-3427	Yamaha	689-W0078-A6-00	Obsolete	18-3506	Mercury Marine	46-879194401	748
18-3428-1	Yamaha	6H3-W0078-00-00	522	18-3506	Volvo	21124846	748
18-3428-1	Yamaha	6H3-W0078-A0-00	522	18-3507	Mercury Marine	46-60366A1	417
18-3429	Yamaha	6H4-W0078-00-00	522	18-3510	Johnson Pump	09-45589	Obsolete
18-3429	Yamaha	6H4-W0078-A0-00	522	18-35102	Mallory	54212	667
18-3430	Yamaha	6J8-W0078-A1-00	525	18-3513	Volvo Penta	22844837	973
18-3431	Yamaha	6L2-W0078-00-00	525	18-3515	Yamaha	6P2-W0078-00-00	525
18-3432	Yamaha	61N-W0078-11-00	525	18-3516	Yamaha	60X-W0078-00-00	524
18-3433	Yamaha	63V-W0078-01-00	522	18-3517	Mercury Marine	46-32437A1	417
18-3434	Yamaha	63D-W0078-01-00	523	18-3517	Mercury Marine	46-42579A4	417
18-3435	Yamaha	663-44322-00-00	414	18-3517	Mercury Marine	46-44292A4	417
18-3435			414	18-3517	Mercury Marine	46-48747A3	417
18-3436	Yamaha	663-44323-00-00	414	18-3517	Mercury Marine	46-57234A3	417
18-3436			414	18-3517	Mercury Marine	46-58618A4	417
18-3440	Yamaha	66T-W0078-00-00	523	18-3517	Mercury Marine	46-60367A4	417
18-3442	Yamaha	68V-W0078-00-00	523	18-3517	Mercury Marine	46-64141A11	417
18-3443	Yamaha	61N-44322-01-00	525	18-3517	Mercury Marine	46-69222A3	417
18-3444	Yamaha	63V-44322-00-00	522	18-3517	Mercury Marine	46-73802A3	417
18-3445	Mercury Marine	46-812966A7	415	18-3517	Mercury Marine	46-73804A3	417
18-3445	Mercury Marine	46-812996A3	415	18-3517	Mercury Marine	46-78400A2	417
18-3445	Mercury Marine	46-812996A9	415	18-3517	Mercury Marine	46-96148A5	417
18-3446	Mercury Marine	46-70941A3	418	18-3517	Mercury Marine	46-96148A8	417
18-3448	Mercury Marine	46-48744A3	419	18-3518	Yamaha	6P2-44323-00-00	525
18-3449	Yamaha	63D-44322-00-00	523	18-3519	Yamaha	61A-44322-02-00	523
18-3450	Yamaha	68T-W0078-00-00	523	18-3520	Yamaha	60X-44323-00-00	Obsolete
18-3451	Yamaha	67F-W0078-00-00	524	18-3521	Yamaha	68V-44323-00-00	523
18-3453	OMC	5006511	302	18-3522-1	Yamaha	60X-W0078-00	524
18-3454	OMC	438592	302	18-3522-1	Yamaha	61A-44311-01	524
18-3455	OMC	340619	300	18-3523-1	Yamaha	61A-44311-01	523
18-3456	Yamaha	6G1-44322-00-00	Obsolete	18-3523-1	Yamaha	68V-W0078-00	523
18-3457	Yamaha	6AW-44322-00-00	Obsolete	18-3524	Yamaha	6CE-12411-00-00	532
18-3458	Yamaha	6CE-44315-00-00	Obsolete	18-3525	Yamaha	60V-12411-00	532
18-3459	Yamaha	6CE-44323-01-00	Obsolete	18-35302	Yamaha	66M-24410-10-00	509
18-3460	Yamaha	6G1-W0078-01-00	525	18-3531	Mercury Marine	807074A1	756
18-3460	Yamaha	6G1-W0078-A1-00	525	18-3531	Mercury Marine	808064A1	756
18-3460	Yamaha	6N0-W0078-A0-00	525	18-3531	Mercury Marine	861188A1	756
18-34600	Yamaha	66M-14301-00-00	Obsolete	18-3535	Mercury Marine	885599004	411
18-34600	Yamaha	66M-14301-12-00	Obsolete	18-3536	Mercury Marine	833072003	411
18-34601	Yamaha	67D-14301-13-00	506	18-3537	Mercury Marine	833072002	411
18-34603	Yamaha	63V-14301-00-00	Obsolete	18-3537	Mercury Marine	833072004	411
18-34604	Yamaha	69M-14301-11-00	Obsolete	18-3538	Volvo	3831424	984
18-34605	Yamaha	66T-14301-00-00	Obsolete	18-3539	Volvo	3831426	984
18-3461	Yamaha	6H3-W0078-00-00	522	18-3540	Yamaha	6E5-12411-30-00	532, 533
18-3461	Yamaha	6H3-W0078-A0-00	522	18-3541	Yamaha	66M-12411-01-00	532, 533
18-3462	Yamaha	6A1-W0078-02-00	525	18-3543	OMC	378065	311
18-3463	Yamaha	6A1-W0078-01-00	525	18-3543	OMC	393659	311
18-3465	Yamaha	6H3-W0078-01-00	524	18-3543	OMC	434841	311
18-3465	Yamaha	6H3-W0078-02-00	524	18-3543	OMC	508626	311
18-3466	Yamaha	6H3-44311-00	524	18-3543	OMC	5005440	311
18-3466	Yamaha	6H3-W0078-01	524	18-35433	Mercury Marine	861156A1	Obsolete
18-3466	Yamaha	6H3-W0078-02-00	524	18-35435			667
18-3469	OMC	3854661	902	18-35436			667
18-3470	Yamaha	6CE-W0078-01	524	18-35437	Mercury	42725A3	741
18-3471	Yamaha	6CE-W0078-01 + 6CE-44311-01 5007972	524	18-35437	Mercury	861676A1	741
18-3472	OMC		306	18-35437	Mercury	861676T09	741
18-3473	Yamaha	6EE-W0078-00-00	526	18-35437	Mercury	8M0073435	741
18-3474	Yamaha	6CB-W0078-00-00	526	18-3544	OMC	435491	311
18-3475	Yamaha	69G-W0078-00	526	18-35442	Volvo	859428	968
18-3476	OMC	5007556	307	18-35443	Volvo	3582310	687
18-3477	Yamaha	6AW-W0078-00-00	526	18-35444	Volvo	858459	Obsolete
18-3478	Honda	06192-ZW9-A30	267	18-3545	OMC	437090	311
18-3479	Yamaha	6AH-W0078-00	526	18-3546	OMC	5001036	311
18-3480	Suzuki	17411-93901	488	18-3549	Mercury Marine	14586	412
18-3481	Suzuki	17411-94421	488	18-3550	Chrysler Force	F84068-2	252

1 This product is priced per piece. To order, priced per package, please add -9 to the part number
 2 Items ending in "D" are display packaged - regular number is non-display • 3 For discount shop pack of 10, please add -10 to the part number

SIERRA #	O.E.M.	O.E. #	PAGE #	SIERRA #	O.E.M.	O.E. #	PAGE #
SIERRA							
18-3550	Chrysler Force	F85068	252	18-3584-1	Volvo	3853796	648
18-3550	Chrysler Force	F85068-1	252	18-3584-1			648
18-3550	Chrysler Force	F85068-2	252	18-3586-1	Indmar	685011	577
18-3550	Mercury Marine	59078	252	18-3586-1	Johnson Pump	10-24228-1	577
18-3550	Mercury Marine	59078A1	252	18-3586-1	Pleasurecraft	RA057023	577
18-3551	Chrysler Inboard	4142885	598	18-3586-1	Volvo	841640	577
18-3551	Crusader	96319	598	18-3587-1	Indmar	685001	577
18-3551	Mercury Marine	32728	598	18-3587-1	Johnson Pump	10-24232-1	577
18-3551	Mercury Marine	35884	598	18-3587-1	Pleasurecraft	RA057024	577
18-3551	Mercury Marine	59137	598	18-3593	Mercury Marine	35957	749, 898, 899, 973
18-3551	Mercury Marine	8072521	598	18-3593	Mercury Marine	37369	749, 898, 899, 973
18-3551	Mercury Marine	8072531	598	18-3593	Mercury Marine	52353	749, 898, 899, 973
18-3551	Mercury Marine	59137A1	598	18-3593	Mercury Marine	65142	749, 898, 899, 973
18-3551	Mercury Marine	807252T1	598	18-3593	Mercury Marine	65142A1	749, 898, 899, 973
18-3551	Mercury Marine	8M0089715	598	18-3593	Mercury Marine	814755	749, 898, 899, 973
18-3551	Pleasurecraft	R026002E	598	18-3593	Mercury Marine	880817	749, 898, 899, 973
18-3552	Crusader	96358	621	18-3593	Mercury Marine	884727	749, 898, 899, 973
18-3552	Mercury Marine	76270	621	18-3593	Mercury Marine	F2774666	749, 898, 899, 973
18-3552	Mercury Marine	76270T	621	18-3593	Mercury Marine	F11001079	749, 898, 899, 973
18-3553	Mercury Marine	62981	412	18-3593	Mercury Marine	F11100785	749, 898, 899, 973
18-3553	Mercury Marine	66850	412	18-3593	OMC	984360	749, 898, 899, 973
18-3553	Mercury Marine	75692	412	18-3593	OMC	986779	749, 898, 899, 973
18-3554	OMC	383007	902	18-3593	OMC	380640	749, 898, 899, 973
18-3555	Mercury Marine	99155A1	755, 756	18-3593	OMC	3854017	749, 898, 899, 973
18-3555	Mercury Marine	99155T2	755, 756	18-3593	OMC	3858340	749, 898, 899, 973
18-3556	Chrysler Force	F97068-2	252	18-3593	Volvo	3854017	749, 898, 899, 973
18-3556	Mercury Marine	895338	252	18-3593	Volvo	3858340	749, 898, 899, 973
18-3557	Chrysler Force	F335068	252	18-3599-2	Crusader	20318	621
18-3557	Mercury Marine	47584	252	18-3599-2	Crusader	7142520	621
18-3557	OMC	382385	252	18-3599-2	Mercury Marine	17437	621
18-3557	OMC	396987	252	18-3599-2	Mercury Marine	35341	621
18-3557	Volvo	21148403	252	18-3599-2	Mercury Marine	37951	621
18-3558	OMC	982554	902	18-3599-2	Mercury Marine	52226	621
18-3558	OMC	3853799	902	18-3599-2	Mercury Marine	54793	621
18-3558	Volvo	3853799	902	18-3599-2	Mercury Marine	60658	621
18-3559	Chrysler Force	F528068	Obsolete	18-3599-2	Mercury Marine	811841	621
18-3560	OMC	384719	Obsolete	18-3599-2	Mercury Marine	850399	621
18-3561	OMC	436195	311	18-3599-2	Mercury Marine	878341	621
18-3562	OMC	321222	Obsolete	18-3599-2	Mercury Marine	8503991	621
18-3563	OMC	321027	312	18-3599-2	Mercury Marine	850399002	621
18-3564	OMC	318395	312	18-3599-2	Mercury Marine	F11100742	621
18-3565	OMC	321220	311	18-3599-2	Mercury Marine	F11101208	621
18-3566	Johnson/Evinrude	331894	311	18-3599-2	Mercury Marine	F11101292	621
18-3567	OMC	321221	311	18-3599-2	OMC	382218	621
18-3568	Mercury Marine	99155T1	755	18-3599-2	OMC	980477	621
18-3569	Mercury Marine	803061T1	411	18-3599-2	OMC	985429	621
18-3570			419	18-3599-2	OMC	3853850	621
18-3571	Mercury Marine	817275A1	418, 419, 753, 839	18-3599-2	Pleasurecraft	RA057018	621
18-3572	Mercury Marine	46-43024A3	418	18-3599-2	Volvo	835390	621
18-3572	Mercury Marine	817275A2	418	18-3599-2	Volvo	856364	621
18-3573	Mercury Marine	883514	749	18-3599-2	Volvo	3853850	621
18-3573	Mercury Marine	883925	749	18-3600	Mercury Marine	46-59112A2	751
18-3577-2	Crusader	30103	621	18-3600	Mercury Marine	46-63450A2	751
18-3577-2	GM	6269358	621	18-3600	Mercury Marine	46-72774A11	751
18-3577-2	Mercury Marine	17670	621	18-3600	Mercury Marine	46-72774A32	751
18-3577-2	Mercury Marine	49139	621	18-3600	Mercury Marine	46-73823A7	751
18-3577-2	Mercury Marine	54534	621	18-36001	Mercuriser	46-807151A12	751
18-3577-2	Mercury Marine	59972	621	18-3601	Mercury Marine	32-32461	768
18-3577-2	Mercury Marine	67859	621	18-3601	Mercury Marine	32-32461A1	768
18-3577-2	Mercury Marine	811573	621	18-3602	Mercury Marine	32-4172533	769
18-3577-2	Mercury Marine	850454	621	18-3602	Mercury Marine	32-8M0062309	769
18-3577-2	Mercury Marine	878342	621	18-3603	Mercury Marine	32-43437	769, 770, 845
18-3577-2	Mercury Marine	8504541	621	18-3603	Mercury Marine	32-8M0090859	769, 770, 845
18-3577-2	Mercury Marine	8504541	621	18-3605			411
18-3577-2	Mercury Marine	850454002	621	18-3606			411
18-3577-2	Mercury Marine	F6269358	621	18-3607	Mercury Marine	893409	461
18-3577-2	Mercury Marine	F11100997	621	2 18-3608			533
18-3577-2	Mercury Marine	F11101053	621	2 18-3609			533
18-3577-2	OMC	983296	621	18-3610	OMC	911752	935
18-3577-2	OMC	986074	621	18-3611			533
18-3577-2	OMC	987447	621	18-3615	Volvo	3587597	984
18-3577-2	OMC	3854118	621	18-3617			984
18-3577-2	Pleasurecraft	RA057019	621	18-3618			984
18-3577-2	Volvo	856609	621	18-3619			984
18-3577-2	Volvo	3855991	621	18-3620			984
18-3578	OMC	984876	Obsolete	18-3621			984
18-3581	Chrysler Inboard	3004886	599	18-3622	Yamaha	6H3-12411-11-00	532
18-3581	Chrysler Inboard	3619542	599	18-3623	Yamaha	6E5-12411-02-00	532
18-3581	Chrysler Inboard	3745985	599	18-3624	Yamaha	69M-12411-01-00	532
18-3581	Chrysler Inboard	4417905	599	18-3625	Yamaha	6F5-12411-03-00	532
18-3582	Chrysler Inboard	3619859	Obsolete	18-3626			984
18-3584-1	Mercury Marine	56879	648	18-3627	Honda	19300-881-761	532
18-3584	Mercury Marine	58086	648	18-3628-1	Honda	19300-ZW9-003	266
18-3584-1	Mercury Marine	71683	648	18-3630	Honda	19300-ZV5-043	266
18-3584-1	Mercury Marine	883885	648	18-3631	Mercury	892864T04	412
18-3584-1	Mercury Marine	71683A1	648	18-3632	Yamaha	67F-12411-01-00	532
18-3584-1	OMC	982515	648	18-3633	Mercury	8M0090819	412
18-3584-1	OMC	982517	648	18-3634	Yamaha	6AW-12411-00-00	532
18-3584-1	OMC	3853796	648	18-3635	Mercury	892864T06	412
18-3584-1	Pleasurecraft	RA057004	648	18-3636	Yamaha	6DA-12411-01-00	532

1 This product is priced per piece. To order, priced per package, please add -9 to the part number

2 Items ending in "D" are display packaged - regular number is non-display • 3 For discount shop pack of 10, please add -10 to the part number

SIERRA #	O.E.M.	O.E. #	PAGE #	SIERRA #	O.E.M.	O.E. #	PAGE #
SIERRA							
18-3637	Yamaha	6CB-12411-10-00	532	2 18-3717	OMC	175268	349
18-3638	Mercury	804540	412	18-3719	Chrysler Force	11-35921	260
18-3639	Yamaha	6EK-12411-00-00	532	18-3719	Chrysler Force	11-47411	260
18-3640	Mercury	8M0117413	412	18-3719	Chrysler Force	11-826375	260
18-3641	Yamaha	6FP-12411-00-00	532	18-3719	Chrysler Force	11-F694188	260
18-3642	Mercury	855676A1	412	18-3719	Mercury Marine	11-35921	260
18-3643	OMC	433379	311	18-3719	Mercury Marine	11-47411	260
18-3644			755	18-3719	Mercury Marine	11-826375	260
18-3645	Chrysler Inboard	2463441	598	18-3719	Mercury Marine	11-F694188	260
2 18-3646	Mercury Marine	807252Q3	755	18-3719	OMC	314730	260
2 18-3646	Mercury Marine	807252T6	755	1 18-3720	Mercury Marine	11-34932	459
2 18-3647	Mercury Marine	807252Q5	755	1 18-3721	Mercury Marine	11-13439-1	827
2 18-3647	Mercury Marine	807252T8	755	1 18-3721	Mercury Marine	11-21298	827
2 18-3648			755	1 18-3721	Mercury Marine	11-22178	827
18-3649	Crusader	97895	755	1 18-3721	Mercury Marine	11-24648	827
18-3649	Mercury Marine	8052732	755	1 18-3721	Mercury Marine	11-29241	827
18-3649	Mercury Marine	8072522	755	1 18-3721	Mercury Marine	11-33962	827
18-3649	Mercury Marine	807252T2	755	1 18-3721	Mercury Marine	11-34933	827
18-3649	Mercury Marine	8M0091470	755	1 18-3721	Mercury Marine	11-46355	827
2 18-3650	Mercury Marine	59078T3	755	1 18-3721	Mercury Marine	11-82671015	827
2 18-3651			755	1 18-3721	Mercury Marine	11-859116	827
18-3652			755	1 18-3721	Mercury Marine	11-95702	827
2 18-3653			903, 984	1 18-3722	Mercury Marine	11-20361	1000
18-3654	Volvo	875779	Obsolete	1 18-3722	Mercury Marine	11-35888	1000
18-3656	Volvo	875781	Obsolete	1 18-3722	Mercury Marine	11-8267089	1000
18-3656	Volvo	876097	Obsolete	1 18-3722	OMC	121731	1000
18-3658	Volvo	875784	984	1 18-3722	Volvo	3852005	1000
18-3658	Volvo	877349	984	1 18-3723	Mercury Marine	11-45592	459
18-3659	Volvo	875785	984	1 18-3725	OMC	908064	931
18-3660	Volvo	875787	984	18-3726	Suzuki	09141-18005	492
18-3660	Volvo	3831425	984	18-3728	Mercury Marine	11-863332	827
18-3662	Volvo	875794	984, 985	18-3728	Mercury Marine	11-99298	827
18-3662	Volvo	876305	984, 985	18-3729	Mercury Marine	10-36289	827
18-3663	Volvo	875791	Obsolete	18-3729	Mercury Marine	10-97934	827
18-3664	Volvo	875795	984	18-3730	OMC	3852648	999
18-3665	Volvo	875796	984	18-3730	Volvo	3852648-9	999
2 18-3666	Volvo	875580	Obsolete	1 18-3731	OMC	907866	Obsolete
18-3667			756	18-3732	Yamaha	90171-16011-00	555
2 18-3668	Mercuriser	807252Q4	756	18-3732	Yamaha	95307-16900-00	555
2 18-3668	Mercuriser	807252T4	756	2 18-3733			936, 1000
2 18-3669			311	1 18-3735	OMC	5030087	349
2 18-3670			903, 984	1 18-3735	Suzuki	09204-03003	349
2 18-3671	Crusader	97361	621	1 18-3735	Suzuki	09204-03004	349
2 18-3671	Pleasurecraft	RP026002E	621	1 18-3735	Yamaha	91490-40030-00	349
2 18-3672			311	1 18-3737	Suzuki	09204-02004	492
2 18-3673			311	1 18-3740	OMC	302804	349
2 18-3674			311	1 18-3741	OMC	309955	349
18-3675	Mercury Marine	27-850318	442	1 18-3742	OMC	314502	349
18-3675	Mercury Marine	27-8503181	442	1 18-3743	OMC	320785	349
2 18-3676	Volvo	3853983	903, 984	1 18-3744	OMC	552906	1000
2 18-3676			903, 984	1 18-3744	Volvo	3852255	1000
2 18-3677	Volvo	3856961	903, 984	1 18-3745	Volvo	17253-6	1000
2 18-3677			903, 984	1 18-3746			72
18-36850			399	1 18-3747			72
18-36905	Volvo	3854018	967	1 18-3748	Yamaha	91490-30045-00	554
18-36906	Mercury	811536	737	1 18-3748			554
18-36906	Mercury	811536T	737	18-3749	Mercury Marine	816685	Obsolete
18-36956	Mercury	1395-9267	399	18-3751	Mercury Marine	79448	459
18-3700	Mercury Marine	11-52707	460	18-3752	Mercury Marine	35992	844
18-3700	Mercury Marine	11-827614	460	18-3752	Mercury Marine	66071	844
18-3700	Mercury Marine	F7040	460	18-3752	Mercury Marine	8168111	844
18-3700	Pleasurecraft	R017066	460	18-3752	Mercury Marine	8168112	844
2 18-3701	Mercury Marine	11-52707A1	260, 272, 460, 652, 859	18-3753	Johnson/Evinrude	5005034	349
2 18-3701	Mercury Marine	11-52707A2	260, 272, 460, 652, 859	18-3754	Mercury Marine	43436	848
2 18-3701	Mercury Marine	11-52707Q1	260, 272, 460, 652, 859	18-3755			859
2 18-3701			260, 272, 460, 652, 859	18-3756			859
2 18-3702	Mercury Marine	11-69578A1	460	18-3759	Mercury Marine	35915	854
2 18-3702	Mercury Marine	11-69578Q1	460	18-3760	Mercury Marine	23-806036A1	844
2 18-3702	Mercury Marine	11-69578T1	460	18-3763	OMC	322941	925
18-3703	Mercury Marine	11-88228	460	18-3765	OMC	331880	357
18-3704	Mercury Marine	11-69578	460	18-3766	OMC	334163	363
1 18-3705	OMC	314503	349	18-3768	OMC	911751	349
1 18-3706	OMC	318971	349	18-3769	OMC	911753	924, 931
1 18-3707	OMC	319891	349	18-3770	OMC	911937	926
18-3708-1	OMC	398042	1000	18-3771			555
18-3708-1	Volvo	3850984	1000	18-3773	Yamaha	90171-10M01	555
18-3709	Yamaha	647-45616-02	555	18-3774	Suzuki	57630-94500	492
18-3710	Suzuki	09141-14008	Obsolete	18-3775	Suzuki	57630-92E00	492
18-3712	Mercury Marine	12-45810	844	18-3777	Suzuki	57630-94300	492
18-3713	Mercury Marine	11-22339	844	18-3778	Suzuki	57630-96300	492
18-3713	Mercury Marine	11-36084	844	2 18-3781	Yamaha	6H1-W4599-00-00	555
18-3713	Mercury Marine	11-97522	844	2 18-3782	Yamaha	6G5-W4599-00-00	555
18-3713	Mercury Marine	F1348	844	18-3783	Mercury Marine	11-805092	859
18-3713	Mercury Marine	F1881	844	18-3783	Mercury Marine	11-805092T	859
18-3714	Mercury Marine	12-31211	460, 859	18-3783	Mercury Marine	11-859131	859
18-3714	Mercury Marine	12-31211A2	460, 859	18-3784	Mercury Marine	805100	858
18-3714	Mercury Marine	12-31211A3	460, 859	18-3785	Mercury Marine	11-39823	859
18-3714	Mercury Marine	12-31211Q03	460, 859	18-3785	Mercury Marine	11-39907	859
2 18-3715	OMC	175266	349	18-3785	Mercury Marine	11-54034	859
2 18-3716	OMC	175267	349	18-3785	Mercury Marine	11-82671127	859

1 This product is priced per piece. To order, priced per package, please add -9 to the part number
 2 Items ending in "D" are display packaged - regular number is non-display • 3 For discount shop pack of 10, please add -10 to the part number

SIERRA #	O.E.M.	O.E. #	PAGE #	SIERRA #	O.E.M.	O.E. #	PAGE #
SIERRA							
18-3786	Mercury Marine	11-805093	859	18-3852	Chrysler Force	27-F513529	256
18-3786	Mercury Marine	11-862907	859	18-3853	Chrysler Force	27-F691529-1	256
18-3787	Mercury Marine	805101T	859	18-3854	Chrysler Force	27-F658529	256
18-3788-9	Mercury Marine	14-34817	859	18-3855	Chrysler Force	27-820438	256
18-3791			Obsolete	18-3856	Chrysler Force	27-F201529-1	256
18-3792	Yamaha	90171-14056-00	555	18-3857	Chrysler Force	27-824615	257
18-3792			555	18-3857	Chrysler Force	27-824615-2	257
18-3800	OMC	325273	328	18-3857	Chrysler Force	27-F476529-4	257
18-38008	Honda	17660-ZV5-902	264	18-3857	Chrysler Force	F476529	257
18-3801	OMC	325647	328	18-3857	Chrysler Force	F476529-1	257
18-3801	OMC	335361	328	18-3857	Chrysler Force	F476529-2	257
18-3802	OMC	320658	328	18-3859	Chrysler Force	27-819138-2	257
18-3802	OMC	327795	328	18-3860	Chrysler Inboard	4142880	599
18-3802	OMC	335359	328	18-3861	Mercury Marine	27-187851	437
18-3803	OMC	324324	328	18-3861	Mercury Marine	27-187853	437
18-3803	OMC	329419	328	18-3861	Mercury Marine	27-18785T	437
18-3803	OMC	765012	328	18-3862	Mercury Marine	27-41246-1	434, 435, 438
18-3804	Mercury Marine	27-19138	437	18-3863	Mercury Marine	27-96542-1	434, 438
18-3804	Mercury Marine	27-19138M	437	18-3864	Mercury Marine	27-822844-1	438
18-3804	Mercury Marine	27-84733M	437	18-3866	OMC	340115	328
18-3804	Yamaha	689-11181-02-00	437	18-3867	Volvo	859647	993
18-3804	Yamaha	689-W0001-A1-00	437	18-3868	Volvo	3583786	993
18-3805	Yamaha	688-11181-02-00	542	18-3869	Volvo	3854202	Obsolete
18-3805	Yamaha	688-11181-A1-00	542	18-3870	Volvo	876303	991
18-3806	Suzuki	11141-98401	490	18-3871	Mercury Marine	27-18786-1	438
18-3806	Suzuki	11141-98411	490	18-3872	Mercury Marine	27-41245-1	438
18-3807	Suzuki	11141-98101	490	18-3874	Crusader	31137	821
18-3807	Suzuki	11141-98130	490	18-3874	Mercury Marine	27-811546	821
18-3808	Suzuki	11141-93901	490	18-3874	Mercury Marine	27-879150139	821
18-3808	Suzuki	11141-93960	490	18-3874	OMC	3853511	821
18-3809	Suzuki	11141-96303	490	18-3876	Chris-Craft	16.50-00250	821
18-3809	Suzuki	11141-96344	490	18-3876	Crusader	7057500	821
18-3810	Suzuki	11141-94401	490	18-3876	GM	6269577	821
18-3810	Suzuki	11141-94450	490	18-3876	Mercury Marine	27-34278	821
18-3813	Suzuki	11141-95305	Obsolete	18-3876	Mercury Marine	27-48330	821
18-3813	Suzuki	11141-95320	Obsolete	18-3876	Mercury Marine	27-75611	821
18-3814	Suzuki	11141-95505	490	18-3876	Mercury Marine	27-75611001	821
18-3814	Suzuki	11141-95512	490	18-3876	OMC	914971	821
18-3816	Suzuki	11141-98504	490	18-3876	OMC	3853380	821
18-3816	Suzuki	11141-98510	490	18-3876	Volvo	841207	821
18-3816	Suzuki	11141-98522	490	18-3876	Volvo	856474	821
18-3819	Suzuki	11141-95D10	490	18-3877	Chris-Craft	16.50-00259	821
18-3819	Suzuki	11141-95D90	490	18-3877	Crusader	30266	821
18-3820	Suzuki	11141-94701	490	18-3877	Mercury Marine	27-13218	821
18-3820	Suzuki	11141-94702	490	18-3877	Mercury Marine	27-13687	821
18-3820	Suzuki	11141-94720	490	18-3877	Mercury Marine	27-19315	821
18-3822	Suzuki	11141-87E10	490	18-3877	Mercury Marine	27-49104	821
18-3822	Suzuki	11141-87E90	490	18-3877	Mercury Marine	27-61224	821
18-3823	Suzuki	11141-94506	490	18-3877	Mercury Marine	27-8M0049045	821
18-3823	Suzuki	11141-94620	490	18-3877	Mercury Marine	27-97529	821
18-3824	Suzuki	11141-94600	491	18-3877	OMC	914849	821
18-3824	Suzuki	11141-94620	491	18-3878	Chrysler Inboard	4417375	599
18-3825	Suzuki	11141-87D60	491	18-3878	Mercury Marine	27-13709	599
18-3825	Suzuki	11141-87D90	491	18-3878	Mercury Marine	27-13709T	599
18-3827	Mercury Marine	27-825482	438	18-3878	Mercury Marine	27-74264	599
18-3827	Mercury Marine	27-8254821	438	18-3878	Mercury Marine	27-79986	599
18-3827	Yamaha	6G8-11181-00-00	438	18-3878	Mercury Marine	27-92166	599
18-3827	Yamaha	6G8-11181-A1-00	438	18-3878	Mercury Marine	27-921661	599
18-3828	Mercury Marine	27-18937	437	18-3878	OMC	912766	599
18-3828	Mercury Marine	27-18937M	437	18-3879	Crusader	33408	632
18-3828	Mercury Marine	27-83899M	437	18-3879	Mercury Marine	27-11986	632
18-3828	Mercury Marine	27-98990M	437	18-3879	Mercury Marine	27-42744	632
18-3828	Yamaha	6E7-11181-00-00	437	18-3879	Mercury Marine	27-816460	632
18-3828	Yamaha	6E7-11181-A1-00	437	18-3879	Mercury Marine	27-879150140	632
18-3829	Yamaha	6J8-11181-00-00	542	18-3879	OMC	912227	632
18-3829	Yamaha	6J8-11181-A1-00	542	18-3879	OMC	914930	632
18-3830	Yamaha	6H4-11181-00-00	542	18-3879	OMC	3854299	632
18-3830	Yamaha	6H4-11181-A1-00	542	18-3879	Volvo	912227	632
18-3831	Yamaha	6H3-11181-01-00	542	18-3879	Volvo	914930	632
18-3831	Yamaha	6H3-11181-A1-00	542	18-3879	Volvo	3854299	632
18-3832	Yamaha	6E5-11181-02-00	542	18-3880	Mercury Marine	27-34273	821
18-3832	Yamaha	6E5-11181-A1-00	542	18-3880	Mercury Marine	27-342731	821
18-3834	Volvo	833453	Obsolete	18-3880	OMC	311210	821
18-3836	OMC	329836	328	18-3881	Mercury Marine	27-34274	821
18-3837	OMC	328623	328	18-3881	Mercury Marine	27-39164	821
18-3838	OMC	331211	328	18-3881	Mercury Marine	27-47453	821
18-3839	OMC	333670	328	18-3881	Mercury Marine	27-72622	821
18-3839	OMC	334726	328	18-3881	OMC	908237	821
18-3841-2	OMC	203130	328	18-3883	Mercury Marine	27-56110	821
18-3842	Volvo	833274	Obsolete	18-3883	Mercury Marine	27-64763	821
18-3844	Mercury Marine	27-803508	438	18-3883	Mercury Marine	27-75646	821
18-3845	Mercury Marine	27-825032	437	18-3883	Mercury Marine	27-75647	821
18-3847	Yamaha	6L2-11181-A1-00	542	18-3883	OMC	3853732	821
18-3847	Yamaha	6L2-11181-A2-00	542	18-3883	Pleasurecraft	RM0032	821
18-3848	Yamaha	697-11181-A0-00	542	18-3883	Volvo	3853732	821
18-3848	Yamaha	697-11181-A1-00	542	18-3886	Nissan/Tohatsu	3T9010050M	480
18-3849	Yamaha	695-11181-A0-00	542	18-3887	Crusader	31136	821
18-3849	Yamaha	695-11181-A1-00	542	18-3887	Mercury Marine	27-811547	821
18-3850	Nissan/Tohatsu	3C8010055M	480	18-3887	Mercury Marine	27-850470	821
18-3851	Chrysler Force	27-F286529-3	256	18-3887	Mercury Marine	27-879150141	821

1 This product is priced per piece. To order, priced per package, please add -9 to the part number

2 Items ending in "D" are display packaged - regular number is non-display • 3 For discount shop pack of 10, please add -10 to the part number

SIERRA #	O.E.M.	O.E. #	PAGE #	SIERRA #	O.E.M.	O.E. #	PAGE #
SIERRA							
18-3887	OMC	915325	821	18-3939	OMC	3854252	806
18-3887	Volvo	3853511	821	18-3939	Volvo	914556	806
18-3888			1003	18-3939	Volvo	3854252	806
18-3889			983	18-3942	Mercury Marine	39-34479	806
18-3890			Obsolete	18-3942	Mercury Marine	39-58096	806
18-3891	Yamaha	61A-11181-A0-00	542	18-3942	Mercury Marine	39-67119	806
18-3891	Yamaha	61A-11181-A1-00	542	18-3942	Mercury Marine	39-67132	806
18-3892	Yamaha	676-11181-A0-00	542	18-3944	Mercury Marine	39-75609	806
18-3892	Yamaha	676-11181-A1-00	542	18-3944	Mercury Marine	F11101057	806
18-3893			1002	18-3944	OMC	370409	806
18-3894	Yamaha	6G5-11181-00-00	542	18-3944	Volvo	370409	806
18-3894	Yamaha	6G5-11181-A0-00	542	18-3947	OMC	439538	314
18-3895	OMC	332816	328	18-39480	Suzuki	12140-93121	Obsolete
18-3896	OMC	332817	328	18-39530	Suzuki	12410-96351-050	Obsolete
18-3898	OMC	332819	Obsolete	18-39540	Suzuki	12140-94400	489
18-3899	OMC	327674	334	18-3957	Yamaha	61N-11603-00-00	537
18-3901	OMC	436254	314	18-3960	Yamaha	6H4-11610-00-00	537
18-39010	Chrysler Force	39-817869A1	256	18-3961	Yamaha	6H4-11610-10-00	Obsolete
18-39010	Chrysler Force	FA663260	256	18-3962	Yamaha	6H4-11610-20-00	537
18-3902	Mercury Marine	39-45155A12	424	18-3963	Yamaha	6K5-11601-02-00	Obsolete
18-3902	Mercury Marine	39-78816A12	424	18-3966	Mercury Marine	39-18653A12	424, 426, 427
18-3904	OMC	394930	314	18-3967	Mercury Marine	39-18653A1	424, 426, 427
18-3905	OMC	396504	314	18-3968	Mercury Marine	39-18653A2	424, 426, 427
18-3906	OMC	385662	314	18-3969	Yamaha	688-11603-A0-00	537
18-3906	OMC	396503	314	18-3972	OMC	390082	315
18-3907	OMC	390509	Obsolete	18-3974	OMC	431844	Obsolete
18-3908	OMC	390510	314	18-3975	OMC	431870	314
18-3910	OMC	396377	314	18-3976	Mercury Marine	39-15320M	Obsolete
18-3911	OMC	396378	314	18-3976	Mercury Marine	39-15320T	Obsolete
18-3912	OMC	396379	314	18-3976	Yamaha	682-11610-01-00	Obsolete
18-3913	OMC	391170	314	18-3977	Mercury Marine	39-18939M	424
18-3913	OMC	434107	314	18-3977	Yamaha	682-11610-11-00	424
18-3914			315	18-3978	Mercury Marine	39-15322M	424
18-3915	OMC	391416	314	18-3979	Mercury Marine	39-96170A12	424
18-3915	OMC	434109	314	18-3981	Mercury Marine	39-96170A4	424
18-3916	Mercury Marine	39-45204A12	424	18-3982	Mercury Marine	39-822321A12	424
18-3916	Mercury Marine	39-78811A12	424	18-3982	Mercury Marine	39-824905A12	424
18-3917	Mercury Marine	39-88392	424	18-3984	Mercury Marine	39-822321A2	424
18-3917	Mercury Marine	39-88392A12	424	18-3986	Mercury Marine	39-81096M	424
18-3918	Mercury Marine	39-817096A6	424, 426, 427	18-3992	Mercury Marine	39-83196M	424
18-3919	Mercury Marine	39-817096A16	424, 426, 427	18-3998	Chrysler Force	39-820457A2	256
18-3920	Mercury Marine	39-817096A26	424, 426, 427	18-3999	Chrysler Force	39-820641A1	256
18-3921	Mercury Marine	39-93481A12	426, 427	18-4005	Volvo	833950	987
18-3922	Mercury Marine	39-78918A4	426, 427	18-4008	Barr	MC-20-60207	795
18-3923	Mercury Marine	39-85636A4	426, 427	18-4008	Mercury Marine	60207	795
18-3924	Mercury Marine	39-18487A12	426, 427	18-4009	Barr	160252	795
18-3925	Mercury Marine	39-815267A4	426, 427	18-4009	Mercury Marine	52999	795
18-3927	Mercury Marine	39-813011A12	426, 427	18-4009	Mercury Marine	60252	795
18-3928	Mercury Marine	39-74381A1	806	18-4009	Mercury Marine	60252A2	795
18-3928	Mercury Marine	39-75422	806	18-4009	OMC	910384	795
18-39320	Yamaha	6R5-11603-00	537	18-40110	Suzuki	12110-94400	489
18-3933	OMC	386280	314	18-4013	Mercury Marine	765-7443A11	426
18-3934	Yamaha	6E5-11610-03-00	537	18-4014	Mercury Marine	765-7446A11	Obsolete
18-3936	Yamaha	6E5-11610-23-00	538	18-40140	Suzuki	12110-93120	489
18-3937	GM	14089025	806	18-4017	Mercury Marine	783-9613A2	424
18-3937	Mercury Marine	39-17464	806	18-4017	Mercury Marine	783-9613T2	424
18-3937	Mercury Marine	39-34988	806	18-4018	Mercury Marine	783-9613A3	424
18-3937	Mercury Marine	39-65153	806	18-4018	Mercury Marine	783-9613T3	424
18-3937	Mercury Marine	39-67123	806	18-4019	Mercury Marine	39-19721A6	424
18-3937	Mercury Marine	F328506	806	18-4020	Mercury Marine	39-19721A1	424
18-3937	Mercury Marine	F3892364	806	18-4021	Mercury Marine	39-19721A2	Obsolete
18-3937	Mercury Marine	F11100386	806	18-4022	Mercury Marine	26-49131	815
18-3937	Mercury Marine	F11100692	806	18-4022	Mercury Marine	26-67863	815
18-3937	Mercury Marine	F11101321	806	18-4022	Mercury Marine	26-75982	815
18-3937	OMC	328506	806	18-4022	Mercury Marine	26-75988	815
18-3937	OMC	914555	806	18-4022	Mercury Marine	F3866612	815
18-3937	OMC	985083	806	18-4022	Mercury Marine	F11100968	815
18-3937	OMC	986336	806	18-4022	Mercury Marine	F11101117	815
18-3937	OMC	3853268	806	18-4023	Mercury Marine	26-58094	815
18-3937	OMC	3853960	806	18-4023	Mercury Marine	26-72564	815
18-3937	Volvo	3853268	806	18-4023	Mercury Marine	26-75413	815
18-3937	Volvo	3853960	806	18-4023	Mercury Marine	26-75624	815
18-3938	GM	14089026	Obsolete	1 18-4024	Mercury Marine	26-8M0050563	815
18-3938	Mercury Marine	39-17465	Obsolete	1 18-4024	Mercury Marine	26-97664	815
18-3938	Mercury Marine	39-48345	Obsolete	1 18-4024	Mercury Marine	26-976641	815
18-3938	Mercury Marine	39-67126	Obsolete	1 18-4024	Mercury Marine	F11101200	815
18-3938	Mercury Marine	F328516	Obsolete	1 18-4024	OMC	914445	815
18-3938	Mercury Marine	F11100694	Obsolete	1 18-4024	OMC	3853226	815
18-3938	Mercury Marine	F11101322	Obsolete	1 18-4024	Volvo	914445	815
18-3938	OMC	328516	Obsolete	1 18-4024	Volvo	3853226	815
18-3938	OMC	914557	Obsolete	18-4029	Volvo	463377	986
18-3938	Volvo	328516	Obsolete	18-4031	Volvo	1306630	Obsolete
18-3938	Volvo	914557	Obsolete	1 18-4036	Mercury Marine	29-47270	427
18-3939	Mercury Marine	39-48344	806	1 18-4037	Mercury Marine	29-71422	427
18-3939	Mercury Marine	39-66217	806	18-4038	Mercury Marine	31-47245A1	427
18-3939	Mercury Marine	39-97125	806	18-4038	Mercury Marine	31-55332A1	427
18-3939	Mercury Marine	F11100387	806	18-4038	Mercury Marine	31-58859A1	427
18-3939	Mercury Marine	F11100783	806	18-4038	Mercury Marine	31-61424A2	427
18-3939	Mercury Marine	F11101134	806	18-4038	Mercury Marine	31-62596A1	427
18-3939	OMC	914556	806	18-4038	Mercury Marine	31-63075A1	427

1 This product is priced per piece. To order, priced per package, please add -9 to the part number
 2 Items ending in "D" are display packaged - regular number is non-display • 3 For discount shop pack of 10, please add -10 to the part number

SIERRA #	O.E.M.	O.E. #	PAGE #	SIERRA #	O.E.M.	O.E. #	PAGE #
SIERRA							
18-4039	Mercury Marine	31-17514A2	Obsolete	18-4138	Mercury Marine	761-7198M	424
18-4039	Mercury Marine	31-8M0045430	Obsolete	18-4138	Mercury Marine	761-8484M	424
18-4040	OMC	387139	318	18-4138	Yamaha	689-11631-00-95	424
18-4040	OMC	387142	318	18-4141	Yamaha	6H4-11631-00-96	537
18-4044	Volvo	834548	986	18-4142	Yamaha	6H4-11635-01-00	Obsolete
18-4044	Volvo	966694-2	986	18-4145	Yamaha	61N-11635-00-00	537
18-4046	Volvo	958498	986	18-4146	Yamaha	61N-11636-00-00	537
18-4046	Volvo	966857	986	18-4148-1	OMC	394488	317
18-4050	Mercury Marine	39-827179A12	426, 427	18-4148-1	OMC	5004705	317
18-4051	Mercury Marine	39-826293A12	Obsolete	18-4150	Volvo	812994	Obsolete
18-4052	Mercury Marine	39-826297A12	Obsolete	18-4156	Mercury Marine	776-9096A1	424
18-4058			316	18-4157	Yamaha	6R5-11650-10-00	538
18-4062	OMC	387661	314	18-4160	Mercury Marine	733-3818	Obsolete
18-4063	OMC	394461	Obsolete	18-4160	Mercury Marine	733-38181	Obsolete
18-4063	OMC	437409	Obsolete	18-4160	Mercury Marine	F11100781	Obsolete
18-4064	OMC	398483	Obsolete	18-4160	OMC	915236	Obsolete
18-4065	OMC	432072	314	18-4160	OMC	3853477	Obsolete
18-4065	OMC	432969	314	18-4160	Volvo	915236	Obsolete
18-4066	OMC	432073	314	18-4160	Volvo	3853477	Obsolete
18-4066	OMC	432970	314	18-4161	Mercury Marine	24-38191	Obsolete
18-4067	OMC	432077	314	18-4161	Mercury Marine	733-3819	Obsolete
18-4067	OMC	433003	314	18-4161	Mercury Marine	733-4028	Obsolete
18-4068	OMC	432078	Obsolete	18-4161	Mercury Marine	733-803850T	Obsolete
18-4068	OMC	433004	Obsolete	18-4161	Mercury Marine	F11100779	Obsolete
18-4069	OMC	432803	Obsolete	18-4161	Mercury Marine	F11100780	Obsolete
1 18-4075	OMC	308186	317	18-4161	OMC	914816	Obsolete
18-4076	OMC	330081	317	18-4161	OMC	3853340	Obsolete
18-4077	Yamaha	93310-730V8-00	538	18-4161	Volvo	914816	Obsolete
18-4078	Yamaha	93310-836V2-00	Obsolete	18-4161	Volvo	3853340	Obsolete
18-4079	OMC	436859	Obsolete	18-4164	GM	14077949	806
18-4080	Yamaha	6R5-11642-11-93	537	18-4164	Mercury Marine	735-6371	806
18-4081	Yamaha	6R5-11631-11-93	Obsolete	18-4164	Mercury Marine	735-850098	806
18-4082	Yamaha	6R5-11645-11-00	537	18-4164	Mercury Marine	735-9431	806
18-4083	Yamaha	6R5-11635-11-00	537	18-4164	Mercury Marine	735-9687	806
18-4084	Yamaha	6R5-11646-11-00	537	18-4164	Mercury Marine	735-9704	806
18-4085	Yamaha	6R5-11636-11-00	537	18-4164	Mercury Marine	F11101185	806
18-4086	OMC	439516	314	18-4164	Mercury Marine	F11101320	806
18-4087	OMC	439517	314	18-4164	Mercury Marine	F11101336	806
18-4088	OMC	436353	316	18-4164	OMC	3911023	806
18-4089			Obsolete	18-4164	Volvo	3911023	806
18-4090	OMC	436354	Obsolete	18-4165	OMC	439515	314
18-4091	Yamaha	6H3-11631-01-96	Obsolete	18-4173	GM	14077948	806
18-4096	Yamaha	6K5-11636-03-00	#Obsolete	18-4173	Mercury Marine	735-6370	806
18-4097	Yamaha	6H1-11631-03-95	537	18-4173	Mercury Marine	735-6370	806
18-4099	Yamaha	6H1-11636-03-00	Obsolete	18-4173	Mercury Marine	735-808661	806
18-4100	OMC	396585	314	18-4173	Mercury Marine	735-808674	806
18-4100	OMC	396588	314	18-4173	Mercury Marine	735-808674A1	806
18-4101	OMC	391653	314	18-4173	Mercury Marine	735-850097	806
18-4102	OMC	393612	314	18-4173	Mercury Marine	735-9686	806
18-4103	OMC	396587	314	18-4173	Mercury Marine	735-9703	806
18-4104	OMC	396583	314	18-4173	Mercury Marine	833232E	806
18-4107	OMC	392621	314	18-4173	Mercury Marine	F11101184	806
18-4109	Mercury Marine	759-592010	Obsolete	18-4173	Mercury Marine	F11101318	806
18-4109	Mercury Marine	759-861010	Obsolete	18-4173	Mercury Marine	F11101334	806
18-4109	Mercury Marine	759-80661A3	Obsolete	18-4173	OMC	3911020	806
18-4109	Mercury Marine	759-80661A7	Obsolete	18-4173	Volvo	3911020	806
18-4109	Mercury Marine	759-831210	Obsolete	18-4178	Mercury Marine	735-9715	806
18-4109	Mercury Marine	759-8312A2	Obsolete	18-4178	Mercury Marine	735-97151	806
18-4109	Mercury Marine	778-9015A2	Obsolete	18-4178	Mercury Marine	735-9715T1	806
18-4109	Mercury Marine	778-9441A3	Obsolete	18-4178	Mercury Marine	F11101317	806
18-4110			315	18-4180	Mercury Marine	733-2278	Obsolete
18-4111			315	18-4180	Mercury Marine	733-66217	Obsolete
18-4113			315	18-4180	Mercury Marine	736-2343	Obsolete
18-4114	OMC	387285	314	18-4183			Obsolete
18-4118			Obsolete	18-4188			914
18-4120	OMC	393271	316	18-4189	Mercury Marine	737-6523	806
18-4120	OMC	393924	316	18-4189	Mercury Marine	737-879194035	806
18-4122	OMC	393566	314	18-4189	Mercury Marine	F11101101	806
18-4123	OMC	392455	316	18-4189			806
18-4124	OMC	387284	314	18-4190	OMC	436860	314
18-4128	Yamaha	6G5-11642-00-93	Obsolete	18-4191	Mercury Marine	733-3819	806
18-4129	Yamaha	6G5-11631-00-93	537	18-4191	Mercury Marine	733-38191	806
18-4130			Obsolete	18-4191	Mercury Marine	733-4028	806
18-4133	Yamaha	6G5-11636-00-00	Obsolete	18-4191	Mercury Marine	733-803850T	806
18-4134	Mercury Marine	759-592012	Obsolete	18-4191	Mercury Marine	F11100779	806
18-4134	Mercury Marine	759-861012	Obsolete	18-4191	Mercury Marine	F11100780	806
18-4134	Mercury Marine	759-80661A8	Obsolete	18-4191			806
18-4134	Mercury Marine	759-80661A5	Obsolete	18-4194	OMC	3852350	1000
18-4134	Mercury Marine	759-831212	Obsolete	18-4194	Volvo	3852350	1000
18-4134	Mercury Marine	759-8312A6	Obsolete	18-4195	OMC	439015	314
18-4134	Mercury Marine	759-9015A4	Obsolete	18-4197	OMC	334665	Obsolete
18-4134	Mercury Marine	778-9441A5	Obsolete	1 18-4200	Volvo	477024	987
18-4135	Mercury Marine	761-7131M	424	1 18-4201	Volvo	192212	987
18-4135	Mercury Marine	761-7133M	424	18-4204	Volvo	826341	999
18-4135	Mercury Marine	761-7134M	424	18-4204	Volvo	876278	999
18-4135	Mercury Marine	761-7982M	424	18-4205	Volvo	832820	999
18-4135	Mercury Marine	761-7982T	424	18-4206	Volvo	832570	999
18-4135	Yamaha	6E7-11631-00-97	424	18-4208	Volvo	839423	999
18-4138	Mercury Marine	761-7196M	424	18-4209	Volvo	839534	999
18-4138	Mercury Marine	761-7197M	424	18-4210	Volvo	850785	999

1 This product is priced per piece. To order, priced per package, please add -9 to the part number

2 Items ending in "D" are display packaged - regular number is non-display • 3 For discount shop pack of 10, please add -10 to the part number

SIERRA #	O.E.M.	O.E. #	PAGE #	SIERRA #	O.E.M.	O.E. #	PAGE #
SIERRA							
18-4210	Volvo	854045	999	18-4264			109
18-4211	Volvo	850888	999	18-4265	Mercury Marine	22-42861	795
18-4212	Volvo	850889	1000	18-4265	Mercury Marine	22-428611	795
18-4213	Volvo	851261	1000	18-4265	Mercury Marine	22-861187	795
18-4213	Volvo	854047	1000	1 18-4267	Mercury Marine	12-29395	827
18-4214	Pleasurecraft	RO96081	652	1 18-4267	Mercury Marine	12-8M0042641	827
18-4214	Volvo	897367	652	1 18-4270	Mercury Marine	12-36001	Obsolete
18-4215	Volvo	941816	1000	18-4272	Mercury Marine	19-32652	827
18-4216	Volvo	807036	982	18-4273	Mercury Marine	19-42682	827
2 18-4218	Mercury Marine	22-16951A1	798	18-4274	Yamaha	688-45997-01-00	553
2 18-4218	Mercury Marine	22-16951Q1	798	18-4275	Mercury Marine	12-22388	446
2 18-4218	Mercury Marine	22-16951T1	798	18-4275	Mercury Marine	12-25945	446
2 18-4218	Mercury Marine	22-64426	798	18-4275	Mercury Marine	12-29245	446
2 18-4218	Mercury Marine	22-87238	798	18-4275	Mercury Marine	12-32733	446
2 18-4218	OMC	379957	798	18-4275	Mercury Marine	12-38753	446
2 18-4218	Volvo	82745	798	18-4275	Mercury Marine	12-824793	446
2 18-4218			798	1 18-4276	OMC	324334	307, 330
2 18-4220	Mercury Marine	12-13171	461	18-4277	OMC	324430	307, 330
2 18-4220	Mercury Marine	12-77987	461	18-4280	OMC	327861	314
2 18-4220	Mercury Marine	12-77987A1	461	18-42850	Suzuki	12151-94400	Obsolete
2 18-4220	Mercury Marine	12-835467	461	18-42860	Suzuki	12151-93100	Obsolete
2 18-4220	Mercury Marine	12-8354671	461	18-4287			Obsolete
2 18-4220	Mercury Marine	12-835467Q01	461	18-42870	Suzuki	12151-92502	Obsolete
2 18-4220	Pleasurecraft	RO96116	461	1 18-4288	Mercury Marine	23-44165	827, 831
18-4221	Mercury Marine	13191A1	461	1 18-4288	Mercury Marine	23-807073	827, 831
18-4221	Mercury Marine	75282A1	461	1 18-4289	Mercury Marine	53-805272	864
18-4222	OMC	127084	349	1 18-4290	OMC	317831	314
18-4222	OMC	318841	349	1 18-4292	OMC	326765	Obsolete
18-4223	OMC	333592	349	1 18-4294	Mercury Marine	40-52035	Obsolete
2 18-4224	Mercury Marine	22-806926A1	798	18-42940-9	Suzuki	09381-14001	489
2 18-4224	Mercury Marine	22-862210A01	798	1 18-4295	Mercury Marine	53-29641	855
18-4226	Mercury Marine	22-806608A02	798	18-42950-9	Suzuki	09381-18002	489
18-4226	Mercury Marine	22-806608A1	798	18-4296	Mercury Marine	35983	844
18-4227	Mercury Marine	22-806926	798	18-42960-9	Suzuki	09381-20003	Obsolete
18-4227	Mercury Marine	22-862210	798	18-4299	Nissan/Tohatsu	3F3010051M	480
18-4228	OMC	315810	349	18-4300	OMC	385416	323
18-4229	OMC	319890	339	18-4301	OMC	388602	323
18-4230	OMC	320305	341	18-43015	Mercury	864493	755
18-4231	OMC	320570	349	18-43017	Indmar	S985009	755
18-4232	OMC	323943	339	18-43017	Mercury	863358T	755
18-4233	Mercury Marine	73345	461	18-43017	Mercury	8M0074922	755
18-4233	Mercury Marine	12-92647M	461	18-43017	Mercury	8M0076464	755
18-4233	Mercury Marine	73345A1	461	18-4302	OMC	390078	324
18-4234	Volvo	832965	999	18-4303-1	OMC	389556	324
1 18-4236	Volvo	941907	983	18-4303-1	OMC	391300	324
1 18-4238	Volvo	943218	936	18-4304-1	OMC	391988	324
18-4239	Volvo	897873	1000	18-4305	OMC	393433	324
1 18-4241	Volvo	951924	1000	18-43051			412
1 18-4245	Volvo	463902	987	18-43052	Mercury	14586A3	411
1 18-4246	Volvo	463903-5	987	18-43052	Mercury	75962A10	411
1 18-4248	OMC	311598	348, 922	18-43052	Mercury	75962A11	411
18-42481-9	OMC	311598	348, 922	18-43052	Mercury	75962A9	411
18-4249	OMC	318544	349	18-4306	OMC	394546	325
1 18-4250	OMC	911820	922	18-4307	OMC	389206	325
1 18-4251	OMC	908062	931	18-4307	OMC	392567	325
1 18-4252	Mercury Marine	24-46312	863	18-4307	OMC	392615	325
18-42531-9	OMC	336982	348, 922	18-4307	OMC	433941	325
18-4253-9	OMC	336982	348, 922	18-4309	OMC	394885	Obsolete
18-4255	OMC	307551	348	18-4309	OMC	434381	Obsolete
18-4256			109	18-4310	OMC	396750	325
18-4257			590, 608, 630, 651, 663, 795, 909, 982	18-4312			Obsolete
18-4258	Mercury Marine	22-33198	590, 608, 630, 651, 663, 795, 909, 982	18-4313			Obsolete
18-4258	Mercury Marine	22-33198A1	590, 608, 630, 651, 663, 795, 909, 982	18-4317	Mercury Marine	27-90484A32	434
18-4258	Mercury Marine	22-41622	590, 608, 630, 651, 663, 795, 909, 982	18-4317	Mercury Marine	27-90484A86	434
18-4258	Mercury Marine	22-41622	590, 608, 630, 651, 663, 795, 909, 982	18-4317	Mercury Marine	27-90484A88	434
18-4258	Mercury Marine	22-46754	590, 608, 630, 651, 663, 795, 909, 982	18-43175	Mercury	855676002	411
18-4258			590, 608, 630, 651, 663, 795, 909, 982	18-43175	Nissan/Tohatsu	3R3010300M	411
18-4259	Volvo	804261	996	18-4318	OMC	390076	325
18-42608	Indmar	S556050	636	18-4319	Mercury Marine	27-11338A85	435
18-42608	Pleasurecraft	RA057036	636	18-4319	Mercury Marine	27-11338A88	435
18-4261	Mercury Marine	19643	446	18-4319	Mercury Marine	27-89221A32	435
18-4263	Mercury Marine	22-30139	795	18-4319	Mercury Marine	27-89221A84	435
18-4263	Mercury Marine	22-32802	795	18-4319	Mercury Marine	27-89221A85	435
18-4263	Mercury Marine	22-328021	795	18-4319	Mercury Marine	27-89221A88	435
18-4263	Mercury Marine	22-328022	795	18-4321	OMC	398047	Obsolete
18-4263	Mercury Marine	22-841908	795	18-43212	Mercury	46-8037502	415
18-4263	Mercury Marine	F700633	795	18-43212	Mercury	46-803750A02	415
18-4263	Mercury Marine	FI5810151	795	18-43212	Nissan/Tohatsu	3B2650160M	415
18-4263			795	18-4322	OMC	432570	329
18-4264	Mercury Marine	22-32803	109	18-4323	OMC	436891	Obsolete
18-4264	Mercury Marine	22-87543	109	18-4325	Mercury Marine	25-85491A87	435
18-4264	Mercury Marine	FI5880010	109	18-4325	Mercury Marine	27-85491A90	435
				18-4326	Mercury Marine	27-43779A87	433
				18-43263	Yamaha	68D-G4311-01-00	518, 526
				18-4329			322
				18-4330			322
				18-4331			322
				18-4332			Obsolete
				18-4334	Mercury Marine	27-41499A87	Obsolete

1 This product is priced per piece. To order, priced per package, please add -9 to the part number
 2 Items ending in "D" are display packaged - regular number is non-display • 3 For discount shop pack of 10, please add -10 to the part number

SIERRA #	O.E.M.	O.E. #	PAGE #	SIERRA #	O.E.M.	O.E. #	PAGE #
SIERRA							
18-4336	Mercury Marine	27-43004A86	433	18-4395	Mercury Marine	27-35898A2	817
18-4336	Mercury Marine	27-43004A90	433	18-4395	Mercury Marine	27-35898A3	817
18-4336	Mercury Marine	27-43004A99	433	18-4395	Mercury Marine	27-35898A4	817
18-4337	Mercury Marine	27-812867A91	433	18-4396	Mercury Marine	27-46401A1	817
18-4337	Mercury Marine	27-812867A96	433	18-4398	Mercury Marine	27-53354A1	817
18-4337	Mercury Marine	27-812867A97	433	18-4399	Mercury Marine	27-54566A1	817
18-4338	Mercury Marine	27-814754A00	433	18-4400	Yamaha	61A-W0001-01-00	540
18-4339	Mercury Marine	27-14697A87	434	18-4400	Yamaha	61A-W0001-A1-00	540
18-4340	Mercury Marine	27-13461A88	Obsolete	18-4402	OMC/Bombardier	437779	326
18-4340	Mercury Marine	27-13461A89	Obsolete	18-4403	Yamaha	6F3-W0001-04-00	Obsolete
18-4340	Mercury Marine	27-13461A90	Obsolete	18-4403	Yamaha	6F3-W0001-A4-00	Obsolete
18-4340	Mercury Marine	27-13461A99	Obsolete	18-4405	Yamaha	6H1-W0001-00-00	Obsolete
18-4341	Volvo	876380	991	18-4405	Yamaha	6H1-W0001-01-00	Obsolete
18-4342	Volvo	876376	Obsolete	18-4405	Yamaha	6H1-W0001-A0-00	Obsolete
18-4346	Chrysler Inboard	3745220	607	18-4406	OMC/Bombardier	437155	Obsolete
18-4347-1			816	18-4408	Crusader	33393	Obsolete
18-4348			816	18-4408	Mercury Marine	27-11977	Obsolete
18-4349			677, 816	18-4408	Mercury Marine	27-11987	Obsolete
18-4351	Mercury Marine	27-64203A73	434	18-4408	OMC	912978	Obsolete
18-4351	Mercury Marine	27-64203A74	434	18-4408	Volvo	3850379	Obsolete
18-4351	Mercury Marine	27-64203A75	434	18-44092	Mercury	32-861635	768
18-4353	Mercury Marine	27-46110A1	435	18-4411	Yamaha	6N6-W0001-03-00	Obsolete
18-4353	Mercury Marine	27-46110A2	435	18-4411	Yamaha	6N6-W0001-A3-00	Obsolete
18-4353	Mercury Marine	27-46110A72	435	18-4413	Yamaha	6R6-W0001-01-00	Obsolete
18-4353	Mercury Marine	27-72486A32	435	18-4415	Yamaha	688-W0001-00-00	540
18-4353	Mercury Marine	27-72486A76	435	18-4415	Yamaha	688-W0001-A0-00	540
18-4353	Mercury Marine	27-72486A78	435	18-4417	Yamaha	695-W0001-01-00	543
18-4353	Mercury Marine	27-72486A79	435	18-4417	Yamaha	695-W0001-02-00	543
18-4355	Mercury Marine	27-55306A72	436	18-4417	Yamaha	695-W0001-A2-00	543
18-4355	Mercury Marine	27-55306A73	436	18-4419	Yamaha	6H4-W0001-02-00	543
18-4355	Mercury Marine	27-55306A74	436	18-4419	Yamaha	6H4-W0001-A2-00	543
18-4355	Mercury Marine	27-55306A75	436	18-4420	OMC/Bombardier	439202	326
18-4355	Mercury Marine	27-78028A78	436	18-4421	OMC/Bombardier	5000400	326
18-4356	Mercury Marine	27-60476A72	436	18-4427	Yamaha	6H3-W0001-A0-00	541
18-4356	Mercury Marine	27-60476A73	436	18-4428	OMC/Bombardier	437725	326
18-4356	Mercury Marine	27-60476A74	436	18-4429	OMC/Bombardier		326
18-4356	Mercury Marine	27-60476A75	436	18-4434	Nissan/Tohatsu	3C8-87121-4	479
18-4356	Mercury Marine	27-85653A32	436	18-4435	Nissan/Tohatsu	3F3871210M	479
18-4356	Mercury Marine	27-85653A79	436	18-4436	Nissan/Tohatsu	3B7871218M	479
18-4356	Mercury Marine	27-85653A87	436	18-4442	Mercury Marine	91-37384	234, 852
18-4357	Mercury Marine	27-73440A76	Obsolete	18-4442	Mercury Marine	91-48347	234, 852
18-4357	Mercury Marine	27-76589A77	Obsolete	18-4442	Mercury Marine	91-57797A1	234, 852
18-4357	Mercury Marine	27-76589A78	Obsolete	18-4442	Mercury Marine	91-57797A2	234, 852
18-4357	Mercury Marine	27-76589A79	Obsolete	18-4442	Mercury Marine	91-57797A3	234, 852
18-4357	Mercury Marine	27-88449A32	Obsolete	18-4442	Mercury Marine	91-8M0067546	234, 852
18-4357	Mercury Marine	27-88449A90	Obsolete	18-4444	Mercury Marine	91-38277A1	460, 859
18-4359	Mercury Marine	27-815791A92	437	18-4444	Mercury Marine	91-95830	460, 859
18-4359	Mercury Marine	27-815792A90	437	18-4444	Mercury Marine	91-95830A1	460, 859
18-4359	Mercury Marine	27-815809A90	437	18-4444			460, 859
18-4359	Mercury Marine	27-815810A90	437	18-4446			260, 460, 652, 859
18-4360	Barr	CM206672JP	607	18-4454-1			129, 235
18-4361	Barr	CM-20-6674P	607	18-4455			129, 235
18-4362	Barr	MC20-60426P	793, 795	2 18-4456	Mercury Marine	34765A1	867
18-4363	Barr	FM-1-83-P	661	2 18-4456	Mercury Marine	34765A2	867
18-4364	Barr	20-0082-P	629	2 18-4456			867
18-4365	Mercury Marine	27-801855	821	2 18-4457	Mercury Marine	12644A1	867
18-4366	Mercury Marine	27-72479	820	2 18-4457	Mercury Marine	12644Q01	867
18-4366	Mercury Marine	27-72479A5	820	2 18-4457			867
18-4366	Mercury Marine	27-72479T	820	2 18-4458			126
18-4367	Mercury Marine	27-99777A1	816	18-4459	Mercury Marine	91-821887A1	460, 859
18-4369			917	18-4459	Mercury Marine	91-859046Q4	460, 859
18-4371			917	18-4459	Mercury Marine	91-859046T4	460, 859
18-43716	Yamaha	93604-18080-00	519	18-4461	Mercury Marine	22-807155	590, 608, 630, 652, 663, 798, 909, 982
18-43717	Yamaha	93604-10M03-00	Obsolete				
18-4373			917				
18-4374			917	18-4461			590, 608, 630, 652, 663, 798, 909, 982
18-4375	Mercury Marine	27-34213A1	820	18-4463	Volvo	833188	986
18-4375	Mercury Marine	27-34213A2	820	18-4464	Volvo	829620	986
18-4380	Mercury Marine	27-68714	820	18-4465	Volvo	3582609	986
18-4380	Mercury Marine	27-68714A6	820	18-4466	Volvo	838637	Obsolete
18-4380	Mercury Marine	27-68714A7	820	18-4467	Volvo	1542472	986
18-4380	Mercury Marine	27-72098	820	18-4468	Volvo	419734	986
18-4381	Mercury Marine	27-41636A1	819	18-4469	Volvo	1542389	986
18-4381	Mercury Marine	27-43186A1	819	18-4470	Volvo	419735	Obsolete
18-4381	Mercury Marine	27-89656A1	819	18-4471	Volvo	838638	Obsolete
18-4382	Mercury Marine	27-74264A1	819	18-4472	Volvo	1218630	986
18-4382	Mercury Marine	27-74830A1	819	18-4473	Volvo	419653	Obsolete
18-4382	Mercury Marine	27-74830A3	819	18-4473	Volvo	3582561	Obsolete
18-4383			820	18-4474	Volvo	419652	Obsolete
18-4384			820	18-4474	Volvo	3582606	Obsolete
18-4385			818	18-4484HP	GM		668
18-4386			820	18-4485	Mercury Marine	938-883490	S/S to 18-4485HP
18-4387	Mercury Marine	27-801853	821	18-4485	Mercury Marine	938-883490R1	S/S to 18-4485HP
18-4388	Mercury Marine	27-11977A88	818	18-4485	Mercury Marine	938-883490R50	S/S to 18-4485HP
18-4388	Mercury Marine	27-11977A92	818	18-4485	Mercury Marine	938-884741R	S/S to 18-4485HP
18-4389	Mercury Marine	27-47453A1	821	18-4485	Mercury Marine	938-884741R50	S/S to 18-4485HP
18-4392	Mercury Marine	27-75611A1	821	18-4485			S/S to 18-4485HP
18-4392	Mercury Marine	27-75611A2	821	18-4485HP	GM		668
18-4394	Mercury Marine	27-33395A1	816	18-4486	Mercury Marine	938-803860T	805
18-4394	Mercury Marine	27-33395A2	816	18-4486	Mercury Marine	938-883297 1	805

1 This product is priced per piece. To order, priced per package, please add -9 to the part number

2 Items ending in "D" are display packaged - regular number is non-display • 3 For discount shop pack of 10, please add -10 to the part number

SIERRA #	O.E.M.	O.E. #	PAGE #	SIERRA #	O.E.M.	O.E. #	PAGE #
SIERRA							
18-4486			805	18-4633	Chrysler Force	700-834800A5	256
18-4486HP	GM		805, 913, 988	18-4634	Chrysler Force	700-834800A6	256
18-4492	Mercury Marine	35329	Obsolete	18-4635	Mercury Marine	785-9737T9	Obsolete
18-4492	Mercury Marine	F3746241	Obsolete	18-4636	Mercury Marine	785-9738T9	427
18-4492	Mercury Marine	F11100014	Obsolete	18-4637	Mercury Marine	785-9737A10	Obsolete
18-4492	Mercury Marine	F11100495	Obsolete	18-4638	Mercury Marine	785-9738T10	427
18-4493HP	GM		668	18-4639	Mercury Marine	700-858294T1	427
18-4497	GM		Obsolete	18-4640	Mercury Marine	700-858295T1	427
18-45003	Chrysler Force	47-F433065	253	18-4641	Mercury Marine	700-878571A2	427
18-4501			S/S to 18-4501HP	18-4642	Mercury Marine	700-878572A2	427
18-4501HP	GM		805, 913, 988	18-4643	Mercury Marine	700-878573A2	427
18-4503			669	18-4644	Mercury Marine	700-878574A2	427
18-4506			667	18-4697			982
18-4507			667	18-4698	Mercury Marine	27-81987	446
18-4515	Mercury Marine	774-9137A10	424	18-4698	Mercury Marine	27-81987M	446
18-4516			669	18-4698	Yamaha	90430-08020-00	446
18-4517			Obsolete	18-46981-9	Mercury Marine	27-81987M	446
18-4518			Obsolete	18-46981-9	Yamaha	90430-08020-00	446
18-4519			669	18-4712			317
18-4521			Obsolete	18-4735			669
18-4522			669	18-4737			669
18-4529	OMC	396644	306	18-4749-9	OMC	3852568	924
18-45221	OMC	382221	299	18-4750	OMC	983967	924
18-4523			Obsolete	18-4801	OMC	5000356	925
18-4527	Yamaha	6FM-W0078-00-00	527	18-4804	OMC	986381	925
18-4531	Mercury	821354A2	419	18-4804	OMC	984770	925
18-45312	Mercury	47-95289	414	18-4805	OMC	984771	925
18-45312	Mercury	47-952892	414	18-4805	OMC	986382	925
18-45312	OMC	114812	414	18-4806	OMC	984765	Obsolete
18-4532	Yamaha	6EG-W0078-00-00	527	18-4806	OMC	986380	Obsolete
18-4533	Yamaha	65N-W0078-A0-00	527	18-4807	OMC	439476	357
18-4534	Yamaha	69M-WG078-00-00	527	18-4826	OMC	331999	Obsolete
18-4536	Honda	06192-ZV4-A00	267	18-4828	OMC	911750	924
18-4537	OMC	5008972	306	18-4830	Mercury Marine	1667-9011G59	458
18-4539	Johnson/Evinrude	5008967	299	18-48317	Mercury	46-803750A03	479
18-45404	Nissan/Tohatsu	353650210M	479	18-48317	Nissan/Tohatsu	3B2873222M	479
18-4546	Yamaha	6EE-G4322-00	526	18-4832	Mercury Marine	1647-9148T93	458
18-4547	Yamaha	6EG-G4322-00	527	18-4833	OMC	915720	Obsolete
18-4548	Yamaha	6L2-44322-00	Obsolete	18-4835	OMC	912029	Obsolete
18-4549	Johnson/Evinrude	338486	Obsolete	18-4837	OMC	911734	901
18-4551	Johnson/Evinrude	324641	306, 307, 308	18-4840	OMC	435277	348
18-4560	Mercury Marine	765-7443A12	427	18-4841	OMC	435276	348
18-4560	Mercury Marine	765-7443A2	427	18-4843	OMC	435279	348
18-4565	Mercury Marine	766-8667A36	427	18-4858-9	Mercury Marine	12-45176	446
18-4565	Mercury Marine	766-8667A43	427	18-48619	Yamaha	68D-WG078-00-00	526
18-4567	Yamaha	6EE-G4311-00	526	18-4901			235, 337
18-4568	Johnson/Evinrude	5007554	Obsolete	18-4904			235, 337
18-45617-1	Yamaha	6CE-44352-00-00	518	18-4911	OMC	322236	235, 337
18-4569	Johnson/Evinrude	339720	301	18-4911	OMC	772577	235, 337
18-4571	Johnson/Evinrude	360347	301	18-4913	OMC	316705	235, 337
18-45712	Jabsco	17636-0001	576	18-4913	OMC	772578	235, 337
18-45712	Jabsco	21676-0001	576	18-4914	OMC	316706	235, 337
18-45712	Johnson Pump	09814B	576	18-4914	OMC	772579	235, 337
18-45713	Jabsco	18653-0001	575	18-4915	Mercury Marine	50-12066A1	396
18-45713	Johnson Pump	09-810B	575	18-4915	Mercury Marine	50-12066A9	396
18-45714	Yanmar	119574-42550	688	18-4915	Mercury Marine	50-12066Q9	396
18-45714	Yanmar	119574-42552	688	18-4915	Mercury Marine	50-22791A1	396
18-4572	Yamaha	6CB-44323-00-00	526	18-4915	Mercury Marine	50-28985A2	396
18-4573	Yamaha	6EE-G4323-00	526	18-4915	Mercury Marine	50-45093	396
18-4574	Yamaha	6EG-G4323-00	527	18-50000	Yamaha	689-15755-01-00	503
18-4575			426, 427	18-50000	Yamaha	6G1-15779-00-00	503
18-4576	Yamaha	6FM-44323-01	527	18-50001	Yamaha	6G1-15755-00-00	503
18-4577	Mercury	8213542	Obsolete	18-50001	Yamaha	6G1-15779-00-00	503
18-4578	Johnson/Evinrude	324640	307	2 18-5001	OMC	172525	274
18-4579	Johnson/Evinrude	338485	307	18-500-1212			108
18-4580			Obsolete	18-500-1238			108
18-4620	Mercury Marine	743-3193A2	Obsolete	18-500-1414			108
18-4620	Mercury Marine	743-3193A4	Obsolete	18-500-1418			108
18-4620	Mercury Marine	743-5172A6	Obsolete	2 18-5002	OMC	172523	274
18-4620	Mercury Marine	780-9229A7	Obsolete	2 18-5003	OMC	172806	274
18-4621	Mercury Marine	743-3366A1	424	18-500-3814			108
18-4621	Mercury Marine	743-3366A2	424	18-500-3818			108
18-4621	Mercury Marine	780-9229A10	424	18-500-3838			108
18-4622	Mercury Marine	743-7716A2	424	18-500-5614			108
18-4622	Mercury Marine	780-9229A11	424	18-500-5618			108
18-4623	Mercury Marine	777-815965A4	Obsolete	18-500-5838			108
18-4623	Mercury Marine	777-815965T4	Obsolete	2 18-5006	OMC	172522	274
18-4624	Mercury Marine	777-815965A5	Obsolete	18-5007			376
18-4625	Mercury Marine	777-815965A6	Obsolete	18-5011	OMC	172521	274
18-4626	Mercury Marine	2704-812896A2	424	18-5012			Obsolete
18-4626	Mercury Marine	2704-821896A6	424	18-5013			Obsolete
18-4626	Mercury Marine	2704-826191A4	424	18-5021	Mercury Marine	805629	Obsolete
18-4626	Mercury Marine	2704-826191A6	424	18-502-1234			108
18-4626	Mercury Marine	2704-826191T4	424	18-502-1278			108
18-4627	Mercury Marine	2704-821896A3	424	18-502-1476			108
18-4628	Mercury Marine	2704-821896A4	424	18-502-3858			108
18-4629	Chrysler Force	700-834794T3	Obsolete	18-502-5612			Obsolete
18-4630	Chrysler Force	700-834794A4	256	18-502-5658			Obsolete
18-4631	Chrysler Force	700-834794A5	256	18-51000	Nissan/Tohatsu	3AA050040M	480
18-4632	Chrysler Force	700-834800A4	256	18-51001	Yamaha	63V-15713-00-00	553

1 This product is priced per piece. To order, priced per package, please add -9 to the part number
 2 Items ending in "D" are display packaged - regular number is non-display • 3 For discount shop pack of 10, please add -10 to the part number

SIERRA #	O.E.M.	O.E. #	PAGE #	SIERRA #	O.E.M.	O.E. #	PAGE #
SIERRA							
18-51002	Yamaha	67D-15713-00-00	553	18-5169	Mercury Marine	394-1130A1	244
18-51003	Yamaha	66T-15713-00-00	553	18-5169	Mercury Marine	397-359	244
18-5102	Chrysler Inboard	3656017	594	18-5169	Mercury Marine	397-741	244
18-5103	Chrysler Inboard	3780600	595	18-5170	OMC	583298	275
18-5105	Chrysler Inboard	3874020	595	18-5170	OMC	583740	275
18-5107-1	Crusader	7243110	616	18-5172	OMC	502881	275
18-5107-1	Mercury Marine	802464	616	18-5172	OMC	581786	275
18-5107-1	Mercury Marine	804412	616	2 18-5176	OMC	582366	275
18-5107-1	Mercury Marine	811637	616	2 18-5176	OMC	583737	275
18-5107-1	Mercury Marine	850487	616	2 18-5176	OMC	584561	275
18-5107-1	Mercury Marine	811637001	616	2 18-5179	OMC	582508	275
18-5107-1	Mercury Marine	811637002	616	2 18-5181	Mercury Marine	802371A1	275
18-5107-1	Mercury Marine	811637T	616	2 18-5181	OMC	582995	275
18-5107-1	OMC	3854003	616	2 18-5181	OMC	584477	275
18-5107-1	Volvo	3854003	616	18-5183	Yamaha	63V-85520-00	495
18-5108	Mercury Marine	811639	616	18-5183	Yamaha	63V-85520-01	495
18-5108	Mercury Marine	811639T	616	2 18-5186	Chrysler Force	339-7370A13	244
18-5108	OMC	986642	616	2 18-5186	Chrysler Force	339-7370B13	244
18-5108	OMC	3854001	616	2 18-5186	Chrysler Force	339-832757B4	244
18-5108	Volvo	3854001	616	2 18-5186	Mercury Marine	339-7370A13	244
18-5108			616	2 18-5186	Mercury Marine	339-832757A4	244
18-5110	Yamaha	6E5-85570-11-00	495	18-5187	Mercury Marine	339-850227	378
18-5111	Yamaha	697-85570-11-00	495	18-5187	Mercury Marine	339-856991A1	378
18-5112	Yamaha	680-85570-09-00	495	18-5192	OMC	502888	275
18-5112	Yamaha	695-85570-10-00	495	18-5192	OMC	581610	275
18-5112	Yamaha	6E7-85570-10-00	495	18-5192	OMC	582091	275
18-5112	Yamaha	6E7-85570-19-00	495	18-5194	OMC	502890	275
18-5113	Yamaha	61N-85570-00-00	495	18-5194	OMC	581032	275
18-5113	Yamaha	61N-85570-10-00	495	18-5194	OMC	582160	275
18-5116-1	Mercury Marine	87-861780A2	696	18-5194	OMC	584632	275
18-5116-1	Mercury Marine	87-861780Q4	696	18-5195	Yamaha	689-81311-40-00	495
18-5116-1	Mercury Marine	87-892150A02	696	18-5196	OMC	502880	275
18-5117	GM	10482803	696	18-5196	OMC	581407	275
18-5128	Yamaha	6R3-85570-01-00	495	18-5199	OMC	580321	274
18-5129	Yamaha	62L-85570-00-00	572	18-5200	OMC	580256	874
18-5130	Yamaha	688-85540-16-00	495	18-5206	Chrysler/Force	398-176	246
18-5131	Yamaha	695-85540-12-00	495	18-5206	Mercury Marine	398-693	246
18-5132	Yamaha	63V-85540-00-00	495	18-5207	Mercury Marine	398-713	377
18-5132	Yamaha	63V-85540-01-00	495	18-52104			223
18-5132	Yamaha	63V-85540-02-00	495	18-5217-1	Yamaha	67F-82341-00-00	496
18-5133	Tohatsu	3A0060401M	476	18-5218-1	Yamaha	67F-82342-00-00	496
18-5133	Tohatsu	3A0060481M	476	18-5219-1	Yamaha	67F-82343-00-00	496
18-5134	Tohatsu	3G2060602M	476	18-5220-1	Yamaha	67F-82344-00-00	496
18-5135	Yamaha	6E5-85540-10-00	496	18-52204			223
18-5135	Yamaha	6E5-85540-11-00	496	18-52205	Universal		223
18-5135	Yamaha	6E5-85540-12-00	496	18-52206	Universal		223
18-5136	Yamaha	6F5-85540-21-00	496	18-52207	Universal		223
18-5136	Yamaha	6F5-85540-22-00	496	18-5222			246
18-5138	Yamaha	680-85570-00-00	495	1 18-5224	Mercury Marine	20121	246
18-5138	Yamaha	680-85570-02-00	495	1 18-5224	Mercury Marine	8M0084600	246
18-5139	Mercury Marine	336-3948A2	376	1 18-5224	OMC	510364	246
18-5139	Mercury Marine	336-3948A3	376	1 18-5224			246
18-5139	Mercury Marine	336-4318A2	376	18-5225	Mercury Marine	84-813706A26	476
18-5139	Mercury Marine	336-4318A3	376	18-5225	Mercury Marine	84-90816A26	476
18-5139	Mercury Marine	336-4318A4	376	18-5225	Mercury Marine	84-93212A1	476
18-5140	Mercury Marine	398-2202	376	18-5225	Mercury Marine	84-93475A26	476
18-5141	OMC	581207	274	18-5225	Mercury Marine	84-99215A26	476
18-5143	Tohatsu	369060210M	476	18-5225			476
18-5144	Suzuki	32900-93911	481	18-5226	OMC	510883	246, 262, 281, 374, 383, 476, 481, 497, 582, 595, 615, 644, 712, 882, 956
18-5146	Yamaha	62T-85533-00-00	572	18-5226	OMC	772584	246, 262, 281, 374, 383, 476, 481, 497, 582, 595, 615, 644, 712, 882, 956
18-5147	Yamaha	62T-85520-00-00	572	18-5226	OMC		246, 262, 281, 374, 383, 476, 481, 497, 582, 595, 615, 644, 712, 882, 956
18-5147	Yamaha	62T-85520-01-00	572	18-5226	OMC		246, 262, 281, 374, 383, 476, 481, 497, 582, 595, 615, 644, 712, 882, 956
18-5148	Mercury Marine	394-1100A2	377	18-5226	OMC		246, 262, 281, 374, 383, 476, 481, 497, 582, 595, 615, 644, 712, 882, 956
18-5148	Mercury Marine	394-1100A3	377	18-5226	OMC		246, 262, 281, 374, 383, 476, 481, 497, 582, 595, 615, 644, 712, 882, 956
18-5148	Mercury Marine	394-352A1	377	18-5226	OMC		246, 262, 281, 374, 383, 476, 481, 497, 582, 595, 615, 644, 712, 882, 956
18-5149	Chrysler Force	F12044	245	18-5226	OMC		246, 262, 281, 374, 383, 476, 481, 497, 582, 595, 615, 644, 712, 882, 956
18-5149	Chrysler Force	FP2437A	245	18-5226	OMC		246, 262, 281, 374, 383, 476, 481, 497, 582, 595, 615, 644, 712, 882, 956
18-5151	Suzuki	33410-92L10	481	2 18-5227-1	Mercury Marine	84-813715A1	382
18-5151	Suzuki	33410-94400	481	2 18-5228-1	Mercury Marine	84-813715A1	382
18-5152	Suzuki	32140-93900	481	2 18-5228-1	Mercury Marine	84-813715A1	382
18-5153	McCulloch	1340135	374	18-5229-9-1			246, 280, 382
18-5153	McCulloch	36550135	374	2 18-5230-9-1			246, 280, 382
18-5153	McCulloch	75101A	374	2 18-5231-1	OMC	582365	280
18-5153	Mercury Marine	398-174	374	18-5239			953
18-5154	Mercury Marine	339-880615T01	378	18-5240			953
18-5156	OMC	580148	274	18-5241	Chrysler Force	F12181-1	374
18-5157	OMC	580290	376	18-5241	McCulloch	38850115	374
18-5158	Mercury/Mercruiser	879984A1	378	18-5243	Mercury Marine	888731	694
18-5158	Mercury/Mercruiser	879984T00	378	18-5243	Mercury Marine	898253T23	694
18-5158	Mercury/Mercruiser	879984T01	378	18-5244	Mercury Marine	884792	694
18-5158	Mercury/Mercruiser	8M0077471	378	18-5244	Mercury Marine	898253T22	694
18-5159	Mercury/Mercruiser	339-883778A01	378	18-5244	Pleasurecraft	RA108009	694
18-5159	Mercury/Mercruiser	339-883778A02	378	18-5245	Mercury Marine	884790	694
18-5159	Mercury/Mercruiser	339-8M0077473	378	18-5245	Mercury Marine	898253013	694
18-5163	OMC	581130	275	18-5245	Pleasurecraft	R103011	694
18-5165	NISSAN	3G3060211M	476	18-5246	Mercury Marine	898253T28	692
18-5166	Nissan/Tohatsu	3G2-06040-2	476	18-5247	Mercury Marine	898253T29	692
18-5166	Nissan/Tohatsu	3M3060482M	476	18-5247	Mercury Marine	8M0060495	692
18-5169	Chrysler Force	F12042-1	244	18-5247	Mercury Marine	8M0061335	692
18-5169	Mercury Marine	394-1130	244	18-5248	OMC	3854217	875, 881, 950, 959, 960

1 This product is priced per piece. To order, priced per package, please add -9 to the part number

2 Items ending in "D" are display packaged - regular number is non-display • 3 For discount shop pack of 10, please add -10 to the part number

SIERRA #	O.E.M.	O.E. #	PAGE #	SIERRA #	O.E.M.	O.E. #	PAGE #
SIERRA							
18-5248	Volvo	3854217	875, 881, 950, 959, 960	18-5309-1	Pleasurecraft	RA107001	186, 615, 642, 700, 880
2 18-5250	Mercury Marine	34235Q1	580, 609, 692, 873	18-5310	Crusader	12525	581, 611, 653, 693, 874, 949
2 18-5250	Mercury Marine	34235T1	580, 609, 692, 873	18-5310	Mercury Marine	33700	581, 611, 653, 693, 874, 949
2 18-5250	OMC	172527	580, 609, 692, 873	18-5310	OMC	380543	581, 611, 653, 693, 874, 949
2 18-5250			580, 609, 692, 873	18-5310	Volvo	818701-5	581, 611, 653, 693, 874, 949
2 18-5251	OMC	173619	580, 592, 609, 639, 692, 873,	18-5310			581, 611, 653, 693, 874, 949
2 18-5251			580, 592, 609, 639, 692, 873,	18-5311	Chris-Craft	16.69-00049	581
18-5252			580, 609, 696, 882	18-5311	Mercury Marine	34235	581
18-5253			692	18-5311	Mercury Marine	34235T	581
2 18-5254			692	18-5311	OMC	380538	581
18-5255			580, 592, 609, 639	18-5311			581
18-5256	OMC	172531	580, 609, 692, 873, 949	18-5312-1	Mallory	YL554CV	186, 642, 700, 880
18-5256			580, 609, 692, 873, 949	18-5312-1	OMC	981080	186, 642, 700, 880
2 18-5258	OMC	173690	580, 592, 610, 696	18-5313-1	Crusader	37061	700
2 18-5258	OMC	987925	580, 592, 610, 696	18-5313-1	Mallory	YL624AV	700
2 18-5258			580, 592, 610, 696	18-5313-1	Mallory	YL624MW	700
18-5259			580, 592, 610	18-5313-1	Mercury Marine	13447A1	700
2 18-5260	OMC	173829	580, 592, 609, 639, 692, 873,	18-5313-1	Mercury Marine	17177A1	700
2 18-5260	OMC	987926	580, 592, 609, 639, 692, 873,	18-5313-1	Mercury Marine	68521A3	700
2 18-5260			580, 592, 609, 639, 692, 873,	18-5313-1	Mercury Marine	68521A4	700
18-5264			949	18-5313-1	Mercury Marine	74905A3	700
18-5265			949	18-5313-1	Mercury Marine	816148A1	700
18-5267			Obsolete	18-5313-1	Mercury Marine	91823A3	700
18-5268			580, 633, 653, 692, 873	18-5313-1	OMC	985560	700
18-5269			580, 610, 692, 873	18-5314	Chris-Craft	16.69-00039	693
18-5271			580, 610, 633, 639, 693, 873	18-5314	Chrysler Inboard	2421820	693
18-5272			580, 610, 873	18-5314	Crusader	20117	693
18-5273	Mercury Marine	805759Q3	693	18-5314	Mercury Marine	391-5090	693
18-5273	Mercury Marine	805759T3	693	18-5314	Mercury Marine	391-898253004	693
18-5274			693	18-5314	Mercury Marine	8M6001250	693
18-5275			580, 610, 633, 639, 693, 873	18-5314	OMC	382135	693
18-5276			610, 633, 640, 693, 874	18-5314	Pleasurecraft	R114001	693
18-5277	Indmar	755021	580, 610, 633, 640, 693, 874	18-5314	Pleasurecraft	R114004	693
18-5277			580, 610, 633, 640, 693, 874	18-5314	Volvo	835304	693
18-5278	Mercury Marine	850484T3	693	18-5315-1	Mallory	YL673AV	700
18-5278			693	18-5315-1	Mercury Marine	33266	700
18-5279			611, 633, 640, 693, 874, 1004	18-5315-1	Mercury Marine	52352	700
18-5280	Mercury Marine	811635Q2	693	18-5315-1	Mercury Marine	58231	700
18-5280			693	18-5315-1	Mercury Marine	62424	700
18-5281	Mercury Marine	808483Q2	693	18-5315-1	Mercury Marine	87581	700
18-5281			693	18-5315-1	Mercury Marine	195141	700
18-5282			Obsolete	18-5315-1	Mercury Marine	87581T	700
18-5283			633, 693, 874	18-5316-1	Mallory	YL624BV	186, 701, 880
2 18-5284			949	18-5317	Mercury Marine	64850	Obsolete
18-5285			665, 697, 877	18-5317	Mercury Marine	87-71831	Obsolete
18-5287-1			187, 877	18-5317			Obsolete
18-5288			583, 613, 641, 665, 697, 877	18-5318	Crusader	3000124	611
18-5289			877, 953	18-5318	Mercury Marine	58033	611
18-5290			583, 613, 641, 665, 697, 877	18-5318	Mercury Marine	898253007	611
18-5291	Mercury Marine	808483K2	692	18-5319	Volvo	243801	Obsolete
18-5292			953	18-5338	Chris-Craft	16.69-00040	694
18-5293-1			877	18-5338	Crusader	12530	694
18-5294			583, 594, 614, 641, 697, 877, 953	18-5338	Mercury Marine	391-5092	694
18-5295			583, 594, 614, 641, 697, 877, 953	18-5338	Mercury Marine	391-5092	694
2 18-5296-2			583, 614, 641, 697, 878	18-5338	Mercury Marine	391-5093	694
2 18-5297			697, 878	18-5338	Mercury Marine	391-5093	694
18-5298			614, 642	18-5338	Mercury Marine	391-898253001	694
2 18-5299			583, 614, 641, 697, 878	18-5338	Mercury Marine	8M6001217	694
18-5300	Mercury Marine	33707	581, 592, 612, 640, 694	18-5338	Mercury Marine	F16900040	694
18-5300			581, 592, 612, 640, 694	18-5338	OMC	382136	694
18-5301			Obsolete	18-5338	Pleasurecraft	R115001	694
18-5302			592, 611, 612, 640, 693, 875	18-5338	Volvo	835308	694
18-5303	Chrysler Inboard	2421173	592, 611, 633, 693, 874	18-5338			694
18-5303	Chrysler Inboard	2808870	592, 611, 633, 693, 874	18-5339-1	Mallory	YL568AV	186, 701, 880
18-5303	Crusader	41058	592, 611, 633, 693, 874	18-5344	Crusader	12526	581, 611, 694, 874
18-5303	Indmar	751007	592, 611, 633, 693, 874	18-5344	Mercury Marine	33706	581, 611, 694, 874
18-5303	Mercury Marine	392-6325	592, 611, 633, 693, 874	18-5344	OMC	382125	581, 611, 694, 874
18-5303	Mercury Marine	392-898253005	592, 611, 633, 693, 874	18-5345	Chris-Craft	16.69-00050	581
18-5303	Mercury Marine	8M6001219	592, 611, 633, 693, 874	18-5345	Chrysler Inboard	2098058	581
18-5303	Mercury Marine	F16900031	592, 611, 633, 693, 874	18-5345	Chrysler Inboard	2279949	581
18-5303	OMC	980893	592, 611, 633, 693, 874	18-5345	Crusader	41057	581
18-5303	OMC	987136	592, 611, 633, 693, 874	18-5345	Crusader	705787	581
18-5303	OMC	987894	592, 611, 633, 693, 874	18-5345	Indmar	755017	581
18-5303	Pleasurecraft	R114002	592, 611, 633, 693, 874	18-5345	Mercury Marine	6325	581
18-5303	Volvo	835705	592, 611, 633, 693, 874	18-5345	Mercury Marine	33662	581
18-5303	Volvo	855846-2	592, 611, 633, 693, 874	18-5345	Mercury Marine	898253003	581
18-5303			592, 611, 633, 693, 874	18-5345	Mercury Marine	898253005	581
18-5305	Volvo	243460	949	18-5345	Mercury Marine	33662Q	581
18-5305	Volvo	243799	949	18-5345	Mercury Marine	8M6001218	581
18-5305	Volvo	1306169	949	18-5345	Mercury Marine	F16900031	581
18-5306	Volvo	240149	949	18-5345	OMC	380537	581
18-5307	Chrysler Inboard	1274092	580, 592, 611, 653	18-5345	Pleasurecraft	R115002	581
18-5307	Chrysler Inboard	2084074	580, 592, 611, 653	18-5345	Volvo	835704	581
18-5307	Chrysler Inboard	2421178	580, 592, 611, 653	18-5345			581
18-5307	Crusader	705788	580, 592, 611, 653	18-5346	Chris-Craft	1869704	581
18-5307			580, 592, 611, 653	18-5346	Mercury Marine	58034	581
18-5309-1	Mallory	YL512CV	186, 615, 642, 700, 880	18-5346	Mercury Marine	81-64851	581
18-5309-1	OMC	980902	186, 615, 642, 700, 880	18-5347	Chrysler Inboard	1818757	694

1 This product is priced per piece. To order, priced per package, please add -9 to the part number
 2 Items ending in "D" are display packaged - regular number is non-display • 3 For discount shop pack of 10, please add -10 to the part number

SIERRA #	O.E.M.	O.E. #	PAGE #	SIERRA #	O.E.M.	O.E. #	PAGE #
SIERRA							
18-5347	Chrysler Inboard	3420600	694	18-5385	OMC	380541	695
18-5347	Mercury Marine	392-6324	694	18-5385			695
18-5347	Mercury Marine	392-898253002	694	18-5386	Mercury Marine	33765	695
18-5347	Mercury Marine	8M6001249	694	18-5386	Mercury Marine	33765T	695
18-5347	Mercury Marine	F16900023	694	18-5386	OMC	980152	695
18-5347	Mercury Marine	F16900032	694	18-5386			695
18-5347	Mercury Marine	F16900083	694	18-5389	Crusader	3000121	695
18-5347	Mercury Marine	F16900189	694	18-5389	Mercury Marine	393-3230	695
18-5347	OMC	980894	694	18-5389	Mercury Marine	393-4988	695
18-5347	OMC	987895	694	18-5389	Mercury Marine	393-4988T	695
18-5347			694	18-5389	Mercury Marine	393-4988T2	695
18-5348	Volvo	834560	949	18-5389			695
18-5349	Volvo	841262	593	18-5393	Volvo	241669	950
18-5350	Mercury Marine	888751A02	699	18-5394	Volvo	243658	950
18-5350	Mercury Marine	888751A03	699	18-5395	Mercury Marine	43557	695
18-5350	Mercury Marine	888751A1	699	18-5395	Mercury Marine	16457A4	695
18-5351	Mercury Marine	884794A02	699	18-5395	Mercury Marine	43557A1	695
18-5351	Mercury Marine	884794A1	699	18-5395	Mercury Marine	805759A1	695
18-5352	Chrysler Inboard	4142817	581, 592, 612, 641, 694, 875	18-5395	Mercury Marine	805759A2	695
18-5352	Crusader	41076	581, 592, 612, 641, 694, 875	18-5395	Mercury Marine	805759A5	695
18-5352	Mercury Marine	392-9766	581, 592, 612, 641, 694, 875	18-5395	Mercury Marine	805759T	695
18-5352	Mercury Marine	392-9766Q1	581, 592, 612, 641, 694, 875	18-5395	Mercury Marine	805759T1	695
18-5352	Mercury Marine	392-9766T	581, 592, 612, 641, 694, 875	18-5395	Mercury Marine	90746A1	695
18-5352	Mercury Marine	F16900185	581, 592, 612, 641, 694, 875	18-5396	Mercury Marine	13753A2	695
18-5352	OMC	984401	581, 592, 612, 641, 694, 875	18-5396	Mercury Marine	815407A2	695
18-5352	Pleasurecraft	RA108003	581, 592, 612, 641, 694, 875	18-5397	Mallory	9-29418	695, 875
18-5352	Volvo	841070	581, 592, 612, 641, 694, 875	18-5397	OMC	985218	695, 875
18-5352	Volvo	3853815	581, 592, 612, 641, 694, 875	1 18-5399	Crusader	41061	613
18-5352			581, 592, 612, 641, 694, 875	1 18-5399	Mercury Marine	392-6329	613
18-5353	Crusader	41069	612	1 18-5399	OMC	910169	613
18-5353	Mercury Marine	392-9086	612	18-5402	Mercury Marine	898253009	694
18-5353	Mercury Marine	392-9086T	612	18-5403	Crusader	41074	611
18-5353	OMC	984398	612	18-5403	Crusader	41089	611
18-5353	Volvo	841926	612	18-5403	Mercury Marine	392-9089	611
18-5354	Crusader	38070	694	18-5403	Mercury Marine	392-9089Q	611
18-5354	Mercury Marine	804418	694	18-5403	Mercury Marine	392-9089T	611
18-5354	Mercury Marine	808483	694	18-5403	Mercury Marine	392-9767	611
18-5354	Mercury Marine	804483T	694	18-5403	Mercury Marine	F16900186	611
18-5354	Mercury Marine	808483T3	694	18-5403	Mercury Marine	F16900190	611
18-5354	OMC	3854548	694	18-5403	OMC	982880	611
18-5354	Volvo	3854548	694	18-5403	Pleasurecraft	R103004	611
18-5354			694	18-5403	Volvo	841907	611
18-5356	Volvo	243797	950	18-5403	Volvo	855845	611
18-5357	Volvo	243632	950	18-5403	Volvo	3853801	611
18-5357	Volvo	870690	950	18-5404-1	Chris-Craft	16.69-00149	581
18-5357	Volvo	1243632	950	18-5404-1	Chrysler Inboard	868096	581
18-5358	Volvo	841263	950	18-5404-1	Crusader	20223	581
18-5359			581, 641, 653	18-5404-1	Mercury Marine	391-5088	581
18-5361	Mercury Marine	811635	694	18-5404-1	Mercury Marine	391-7057	581
18-5361	Mercury Marine	811635T3	694	18-5404-1	Mercury Marine	391-7057T	581
18-5361	OMC	986643	694	18-5404-1	Mercury Marine	391-898253029	581
18-5361			694	18-5404-1	Mercury Marine	8M6001224	581
18-5362	Mercury Marine	850484	612, 694, 875, 950	18-5404-1	Mercury Marine	F16901224	581
18-5362	Mercury Marine	850484T	612, 694, 875, 950	18-5404-1	OMC	982211	581
18-5362	Mercury Marine	850484T2	612, 694, 875, 950	18-5404-1	Pleasurecraft	R103001	581
18-5362	OMC	3854331	612, 694, 875, 950	18-5404-1			581
18-5362	Volvo	3854331	612, 694, 875, 950	18-5405	Crusader	38071	612
18-5362			612, 694, 875, 950	18-5405	Mercury Marine	808484	612
18-5369	Chrysler Inboard	4142408	695	18-5405	Mercury Marine	898253010	612
18-5369	Crusader	41052	695	18-5405	Mercury Marine	808484 1	612
18-5369	Mercury Marine	392-6318	695	18-5405	OMC	3854549	612
18-5369	Mercury Marine	392-6318T	695	18-5405	Volvo	3854549	612
18-5369	Mercury Marine	F16900184	695	18-5405	Volvo	3862014	612
18-5369	OMC	982336	695	18-5406	Mercury Marine	811636	612, 694, 874, 950
18-5369	Pleasurecraft	RA108002	695	18-5406	Mercury Marine	898253011	612, 694, 874, 950
18-5369	Volvo	835702	695	18-5406	Mercury Marine	811636 1	612, 694, 874, 950
18-5369			695	18-5406	OMC	986651	612, 694, 874, 950
18-5375	Chris-Craft	16.69-00100	581	18-5406	Volvo	3854261	612, 694, 874, 950
18-5375	Chris-Craft	F16900165	581	18-5406			612, 694, 874, 950
18-5375	Crusader	12532	581	18-5407	Chrysler Inboard	1658535	581, 592, 612, 633, 640, 694, 874
18-5375	Crusader	1003317	581	18-5407	Crusader	41059	581, 592, 612, 633, 640, 694, 874
18-5375	OMC	382133	581	18-5407	Mercury Marine	392-6326	581, 592, 612, 633, 640, 694, 874
18-5375	Volvo	841244	581	18-5407	Mercury Marine	392-6326T	581, 592, 612, 633, 640, 694, 874
18-5376	Chris-Craft	16.69-00148	695	18-5407	Mercury Marine	F16900044	581, 592, 612, 633, 640, 694, 874
18-5376	Crusader	20222	695	18-5407	OMC	980892	581, 592, 612, 633, 640, 694, 874
18-5376	Mercury Marine	391-5075	695	18-5407	Pleasurecraft	R103003	581, 592, 612, 633, 640, 694, 874
18-5376	Mercury Marine	391-5075Q1	695	18-5407			581, 592, 612, 633, 640, 694, 874
18-5376	Mercury Marine	F16900148	695	18-5408	Mercury Marine	804424	612, 694, 874, 950
18-5376	OMC	982209	695	18-5408	Mercury Marine	850485	612, 694, 874, 950
18-5376	Pleasurecraft	R108001	695	18-5408	Mercury Marine	8504851	612, 694, 874, 950
18-5376			695				
18-5384	Crusader	12528	695				
18-5384	Mercury Marine	33708	695				
18-5384	OMC	383587	695				
18-5385	Chris-Craft	16.69-00052	695				
18-5385	Mercury Marine	33667	695				
18-5385	Mercury Marine	393-9459	695				
18-5385	Mercury Marine	393-9459Q1	695				
18-5385	Mercury Marine	393-9459T	695				
18-5385	Mercury Marine	F16900052	695				

1 This product is priced per piece. To order, priced per package, please add -9 to the part number

2 Items ending in "D" are display packaged - regular number is non-display • 3 For discount shop pack of 10, please add -10 to the part number

SIERRA #	O.E.M.	O.E. #	PAGE #	SIERRA #	O.E.M.	O.E. #	PAGE #
SIERRA							
18-5408	Mercury Marine	898253012	612, 694, 874, 950	18-5475	Mercury Marine	817377T	699
18-5408	Mercury Marine	8M0062084	612, 694, 874, 950	18-5475			699
18-5408	OMC	3854311	612, 694, 874, 950	18-5476	Mercury Marine	807964A1	699
18-5408	Volvo	3854311	612, 694, 874, 950	18-5476	Mercury Marine	907964A1	699
18-5408			612, 694, 874, 950	18-5476			699
18-5411	Chris-Craft	16.69-00042	581	18-5477			183, 642, 665, 698, 878, 952
18-5411	Crusader	12531	581	18-5478			580, 610, 639, 692, 873, 949
18-5411	Crusader	1003318	581	18-5479			183, 642, 665, 698, 878, 952
18-5411	OMC	982342	581	18-5480			584, 616, 634, 643, 665, 698, 878, 952
18-5411	Volvo	841243	581	18-5481			183, 642, 665, 692, 698
18-5413	OMC	987986	875	18-5482			580, 610, 639, 692, 873, 949
18-5413	Volvo	3854218	875	18-5483			183, 583, 615, 616, 642, 666, 698, 878, 952
18-5418	Chris-Craft	16.69-00051	581	18-5484-1	Mercury Marine	805222A1	699
18-5418	Mercury Marine	58217	581	18-5484-1			699
18-5418	Mercury Marine	898253008	581	18-5486-2	Mallory	YLM673AV	185, 879
18-5418	Mercury Marine	58217Q	581	18-5486-2	Mallory	YLM673AV	185, 879
18-5418	OMC	384735	581	18-5487-2	Mallory	YLM676AV	Obsolete
18-5418			581	18-5488			696
18-5419	OMC	380542	581, 653, 875, 950	18-5489-2	Mallory	YLM554CV	185, 879
18-5419	Volvo	818525	581, 653, 875, 950	18-5489-2			185, 879
18-5419			581, 653, 875, 950	18-5494-2			700, 879, 952
18-5420	Crusader	3000122	612	18-5495-2	Mallory	YLM512CV	185, 643, 879
18-5420	Mercury Marine	65864	612	18-5495-2			185, 643, 879
18-5420	Mercury Marine	78016	612	18-5496-2	Mallory	YLM567CV	185, 700, 879
18-5425	Volvo	834975	950	18-5496-2			185, 700, 879
18-5427	Chris-Craft	16.69-0022	581	18-5497-2	Mercury Marine	YLM579AV	185, 700
18-5427	Crusader	705786	581	18-5497-2			185, 700
18-5427			581	18-5498-2	Mallory	YLM624BV	185, 700, 880, 952
18-5428	Volvo	243903	950	18-5512			184, 701
18-5429	Chrysler Inboard	2098611	581, 592, 612	18-5513			184, 701
18-5429			581, 592, 612	18-5514			184, 701
18-5430	Chrysler Inboard	868095	592	18-5515			186
18-5430			592	18-5516			186
2 18-5431	Mercury Marine	13524A5	694	18-5517			186
2 18-5431	Mercury Marine	13524T1	694	18-5518			185, 701
2 18-5432	Mercury Marine	13524A4	694	18-5519			Obsolete
2 18-5432	Mercury Marine	13524A6	694	18-5520			185, 701
2 18-5432	Mercury Marine	13524Q06	694	18-55500	Yanmar	728170-92600	688
2 18-5432	Mercury Marine	19405A4	694	18-55501	Yanmar	728171-92601	688
2 18-5432	Mercury Marine	90576A4	694	18-55502	Yanmar	728271-92605	688
18-5433	Chrysler Inboard	201522	696	18-55503	Mercury	728374-92605	688
18-5433	Chrysler Inboard	2495531	696	18-55505	Mercury	8M0142679	394
18-5433	Crusader	37068	696	18-55505	Mercury	8M0137769	394
18-5433	Crusader	51080	696	18-55510	Yanmar	8M0095471	713
18-5433	Delco	1115202	696	18-55600	Yanmar	128170-01331	688
18-5433	Mercury Marine	38547	696	18-55601	Yanmar	128171-01911	688
18-5433	Mercury Marine	32193A2	696	18-55602	Yanmar	128271-01911	688
18-5433	Mercury Marine	392-806529A1	696	18-55603	Yanmar	128374-01911	688
18-5433	Mercury Marine	898253T24	696	18-56000	Yanmar	128170-11310	688
18-5433	OMC	915735	696	18-56001			Obsolete
18-5433	Pleasurecraft	R117001	696	18-56005	Yamaha	6E5-81840-10-00	503
18-5433	Volvo	835998	696	18-56007	Yamaha	61A-81840-00-00	Obsolete
18-5433			696	18-56009	Suzuki	31173-99E00	482
18-5435	Chrysler Inboard	200691	594	18-5601	Mercury Marine	50-38890A1	393
18-5435	Crusader	41080	594	18-5601	Mercury Marine	50-55601	393
18-5435			594	18-5601	Mercury Marine	50-55601A2	393
18-5436	Volvo	35254	616, 645, 951	18-5602	Mercury Marine	50-44369A1	393
18-5436			616, 645, 951	18-5602	Mercury Marine	50-58788A3	393
18-5437	OMC	378231	876	18-5602	Mercury Marine	50-67341	393
18-5437	OMC	383444	876	18-5602	Mercury Marine	50-893891T	393
18-5438	Crusader	37068	696	18-5603	Mercury Marine	573001	635
18-5438	Mercury Marine	392-7803A4	696	18-5603-1	Indmar	573001	638
18-5438	Mercury Marine	392-805570A2	696	18-5603	Indmar	0170-000	635
18-5442	Mercury Marine	806673T	696	18-5603-1	Marine Power	0170-000	638
18-5442	Mercury Marine	806673T1	696	18-5603	Marine Power	50-808011A4	635
18-5443	Crusader	7243200	696	18-5603-1	Mercury Marine	50-808011A4	638
18-5443	Mercury Marine	817378	696	18-5603	Mercury Marine	RA122009	635
18-5443	Mercury Marine	817378T	696	18-5603-1	Pleasurecraft	RA122009	638
18-5443	Mercury Marine	898253T27	696	18-5605	Mercury Marine	50-73521	393, 395
18-5443	OMC	3854002	696	18-5605	Mercury Marine	50-73521T	393, 395
18-5443	Volvo	3854002	696	18-5605	Mercury Marine	50-898265005	393, 395
18-5450	Chrysler Inboard	4106140	594	18-5606	Mercury Marine	50-44369	Obsolete
18-5450	Pleasurecraft	R119001	594	18-5606	Mercury Marine	50-44369A1	Obsolete
18-5450			594	18-5606	Mercury Marine	50-60315	Obsolete
18-5451	Chrysler Inboard	3874767	594	18-5608	Mercury Marine	50-44414	393
18-5465	Mercuriser	392-863704T	696	18-5608	Mercury Marine	50-44414	393
18-5465	Mercuriser	8M0054588	696	18-5608	Mercury Marine	50-44414	393
18-5466			584, 616, 644, 664, 695, 876, 951	18-5608	Mercury Marine	50-44415	393
18-5467	Volvo	21436799	Obsolete	18-5608	Mercury Marine	50-44415	393
18-5469			584, 594, 616, 644, 664, 695, 876, 951	18-5608	Mercury Marine	50-77141	393
18-5470	Mercury Marine	805185A37	699	18-5608	Mercury Marine	50-77141	393
18-5471	Mercury Marine	805185A36	699	18-5608	Mercury Marine	50-79472	393
18-5472			584, 616, 634, 643, 665, 698, 878, 952	18-5608	Mercury Marine	50-79472	393
18-5473			666, 695, 875, 950	18-5608	Mercury Marine	50-79472 1	393
18-5474			Obsolete	18-5610	Mercury Marine	50-79472 1	393
18-5475	Mercury Marine	817377	699	18-5610	Mercury Marine	50-660151	393
				18-5610	Mercury Marine	50-660153	393
				18-5610	Mercury Marine	50-66015T	393
				18-5610	Mercury Marine	50-893892T	393

1 This product is priced per piece. To order, priced per package, please add -9 to the part number
 2 Items ending in "D" are display packaged - regular number is non-display • 3 For discount shop pack of 10, please add -10 to the part number

SIERRA #	O.E.M.	O.E. #	PAGE #	SIERRA #	O.E.M.	O.E. #	PAGE #
SIERRA							
18-5611	Mercury Marine	50-8M0033984	393, 395	18-5655	Chrysler Force	F15150	248
18-5611	Mercury Marine	50-90983A1	393, 395	18-5655	OMC	321648	248
18-5611	Mercury Marine	50-90983T1	393, 395	18-5656	Mercury Marine	68575	395, 396
18-5612	OMC	432925	287	18-5657	Volvo	855798	956
18-5612	OMC	586286	287	18-5658	Mercury Marine	86177	395
18-5612	OMC	586287	287	18-5658	Mercury Marine	86177 1	395
18-5613	Chrysler Force	F438955-1	247	18-56601	Yanmar	104211-49160	688
18-5613	Chrysler Force	F480955	247	18-56602	Yanmar	128170-42090	688
18-5613	Chrysler Force	F490955	247	18-5671	OMC	384781	288
18-5613	Chrysler Force	F616955	247	18-5674	Mercury Marine	75661	288
18-5613	Chrysler Force	F85955-1	247	18-5674	Mercury Marine	13310T1	288
18-5613	Chrysler Force	FA85955	247	18-5674	OMC	387683	288
18-5613	Chrysler Force	FK616955	247	18-5677	Chrysler Force	811902	248
18-5613	Chrysler Force	FS438955	247	18-5678	OMC	585269	288
18-5613	Chrysler Force	FS438955	247	18-5679	OMC	585267	286
18-5613	Chrysler Force	FS480955	247	18-5697	Chrysler Force	75384	247
18-5613	Chrysler Force	FS489955	247	18-5697	Chrysler Force	F15164	247
18-5613	Chrysler Force	FS490955	247	18-5697	Mercury Marine	75384	247
18-5617	OMC	586274	287	18-5697	OMC	385952	247
18-5617	OMC	778995	287	18-5700	Volvo	3858081	965
18-5618	Chrysler Force	50-819968	247	18-5700	Volvo	3858809	965
18-5618	Chrysler Force	50-8199681	247	18-5701	Johnson/Evinrude	355169	Obsolete
18-5618	Chrysler Force	50-819968-2	247	18-5703	Johnson/Evinrude	355209	Obsolete
18-5618	Chrysler Force	50-8199683	247	18-5704	Volvo	876037	965
18-5618	Chrysler Force	50-8199684	247	2 18-5705	OMC	582472	889
18-5618	Chrysler Force	50-898265003	247	2 18-5705	OMC	584416	889
18-5619	OMC	391511	287	2 18-5705	OMC	586224	889
18-5619	OMC	396235	287	2 18-5705	Volvo	876039	889
18-5619	OMC	397023	287	18-5707	Mercury Marine	816770	388
18-5619	OMC	584799	287	18-5707	Mercury Marine	62351A1	388
18-5619	OMC	586731	287	18-5707	Mercury Marine	62351A2	388
18-5620	Mercury Marine	50-818445-2	393, 396	18-5707	Mercury Marine	816770T	388
18-5620	Mercury Marine	50-818445-3	393, 396	18-5708	OMC	582399	285
18-5620	Mercury Marine	50-8184455	393, 396	18-5708	OMC	583408	285
18-5621	Mercury Marine	50-822462	394, 395	18-5709	OMC	581778	285
18-5621	Mercury Marine	50-822462T1	394, 395	18-5710	Chrysler Inboard	2098300	585, 596, 618
18-5621	Mercury Marine	50-893890T	394, 395	18-5710	Chrysler Inboard	2847527	585, 596, 618
18-5622	Chrysler Force	50-820193	247, 248	18-5710	Prestolite	VSH-6201JY	585, 596, 618
18-5622	Chrysler Force	50-820193T1	247, 248	18-5711	OMC	383440	888
18-5624	OMC	583482	287	18-5711	Prestolite	VSH-6201 AFY	888
18-5624	OMC	585056	287	18-5717	Crusader	42001	585, 617, 716, 886
18-5624	OMC	586279	287	18-5717	Crusader	707125	585, 617, 716, 886
18-5627	OMC	583473	287	18-5717	Mercury Marine	33270	585, 617, 716, 886
18-5627	OMC	585059	287	18-5717	OMC	1984462	585, 617, 716, 886
18-5627	OMC	585459	287	18-5717	OMC		585, 617, 716, 886
18-5628	OMC	393570	287	18-5723	Chrysler Inboard	2095946	597
18-5628	OMC	585060	287	18-5724	Mercuriser	78385	720
18-5628	OMC	586285	287	18-5729	Mercury Marine	87-18211	389
18-5628	OMC	778994	287	18-5731	Suzuki	38860-76F01	483
18-5629	OMC	386591	287	18-5732	Mercury	893640T01	388
18-5629	OMC	392133	287	18-5737	Mercury Marine	87-19761	389
18-5629	OMC	585061	287	18-5740	Mercury Marine	42785	720
18-5630	OMC	384163	287	18-5741	Mercury Marine	815279-1	388
18-5630	OMC	384163	287	18-5741	Mercury Marine	815279A2	388
18-5630	OMC	387684	287	18-5742	Chrysler Force	817411	Obsolete
18-5630	OMC	387684	287	18-5742	Chrysler Force	8152792	Obsolete
18-5630	OMC	389275	287	18-5742	Chrysler Force	81527912	Obsolete
18-5630	OMC	389275	287	18-5742	Chrysler Force	815279T3	Obsolete
18-5630	OMC	585063	287	18-5742	Chrysler Force	830179A2	Obsolete
18-5631	OMC	584818	287	18-5742	Chrysler Force	F718470	Obsolete
18-5631	OMC	586277	287	18-5742	Chrysler Force	F746470	Obsolete
18-5631	OMC	778996	287	18-5743	Mercury Marine	815279-3	388
18-5632	OMC	584980	287	18-5743	Mercury Marine	815279-5	388
18-5632	OMC	586284	287	18-5743	Mercury Marine	883072T	388
18-5634	OMC	385529	287	18-5744	Chrysler Force	8152794	247
18-5634	OMC	389954	287	18-5744	Chrysler Force	8174111	247
18-5634	OMC	585051	287	18-5744	Chrysler Force	815279T4	247
18-5634	OMC	585057	287	18-5744	Chrysler Force	815279T5	247
18-5636	Mercury Marine	50-57465A1	394	18-5744	Chrysler Force	830179A1	247
18-5636	Mercury Marine	50-57867	394	18-5744	Chrysler Force	854514A1	247
18-5636	Mercury Marine	50-58788A3	394	18-5744	Chrysler Force	856747T1	247
18-5636	Mercury Marine	50-64975	394	18-5744	Chrysler Force	883071A1	247
18-5636	Mercury Marine	50-72467	394	18-5745	Volvo	3287677	951
18-5640	OMC	387094	286	18-5746	Yamaha	6H3-85510-A1	499
18-5640	OMC	395207	286				
18-5640	OMC	585062	286	18-5750	OMC	580339	246, 262, 281, 383, 476, 481, 497, 582, 596, 615, 644, 712, 882, 956
18-5640	OMC	586288	286				
18-5640	OMC	778992	286				
18-5642	Mercury Marine	50-44369A1	393, 395	18-5750	OMC	581027	246, 262, 281, 383, 476, 481, 497, 582, 596, 615, 644, 712, 882, 956
18-5642	Mercury Marine	50-86015	393, 395				
18-5642	Mercury Marine	50-66015T1	393, 395				
18-5642	Mercury Marine	50-893891T	393, 395	1 18-5750			246, 262, 281, 383, 476, 481, 497, 582, 596, 615, 644, 712, 882, 956
18-5648	OMC	384777	287				
18-5648	OMC	386657	287				
18-5648	OMC	391735	287	1 18-5752			246, 262, 281, 383, 476, 481, 497, 582, 596, 615, 644, 712, 882, 956
18-5648	OMC	585050	287				
18-5648	OMC	585058	287	18-5755	OMC	581397	Obsolete
18-5648	OMC	586281	287	18-5755	OMC	764708	Obsolete
18-56481			669	18-5758	OMC	582452	279
18-5650	Mercury Marine	57380	395	18-5758	OMC	582453	279

1 This product is priced per piece. To order, priced per package, please add -9 to the part number

2 Items ending in "D" are display packaged - regular number is non-display • 3 For discount shop pack of 10, please add -10 to the part number

SIERRA #	O.E.M.	O.E. #	PAGE #	SIERRA #	O.E.M.	O.E. #	PAGE #
SIERRA							
18-5758	OMC	583380	279	2 18-5802	Mercury Marine	65057	388
18-5759	OMC	581805	279	2 18-5802	Mercury Marine	65057A1	388
18-5759	OMC	582125	279	2 18-5802	Mercury Marine	65057T1	388
18-5760	OMC	582138	279	18-5803	Chrysler Force	F177917	244
18-5760	OMC	582400	279	18-5803	OMC	979774	244
18-5760	OMC	582556	279	18-5804	Mercury Marine	13037	654, 716
18-5760	OMC	582642	279	18-5804			654, 716
18-5761	OMC	583114	279	18-5806	Bosch	0331-302-050	964
18-5763	OMC	582285	279	18-5806	Bosch	0331-302-081	964
18-5763	OMC	583170	279	18-5806	Bosch	0331-302-085	964
18-5764	OMC	582261	279	18-5806	Bosch	0331-302-581	964
18-5764	OMC	586696	279	18-5806	Bosch	0331-302-585	964
18-5766	OMC	583748	S/S to 18-5766-1	18-5806	Volvo	834520	964
18-5767	OMC	584783	277	18-5807	OMC	378444	283
18-5768	OMC	584908	277	18-5807	Prestolite	SAW4206	283
18-5768	OMC	5001344	277	2 18-5808	Mercury Marine	47886	886
18-5770-1	OMC	584028	277	2 18-5808	Mercury Marine	47886T	886
18-57702	Volvo	876069	204, 987	2 18-5808	OMC	395419	886
18-57703	Yanmar	128270-12540	687	2 18-5808	OMC	582708	886
18-57704	Yanmar	128171-12540	687	2 18-5810			388, 717
18-5771	OMC	584032	277	18-5811	Mercury Marine	809462	S/S to 18-5811-1
18-5772-1	OMC	584041	278	18-5811	Mercury Marine	809463	S/S to 18-5811-1
18-5773	OMC	584642	278	18-5811	Mercury Marine	8094621	S/S to 18-5811-1
18-5774-1	OMC	585145	278	18-5811	Mercury Marine	8094631	S/S to 18-5811-1
18-5774-1	OMC	763803	278	18-5811	Mercury Marine	809463A1	S/S to 18-5811-1
18-5775	Chrysler Force	332-7778A12	378	18-5811	OMC	3850216	S/S to 18-5811-1
18-5775	Mercury Marine	332-5524A1	378	18-5811	Volvo	3850216	S/S to 18-5811-1
18-5775	Mercury Marine	332-7778A1	378	18-5811	Volvo	3859054	S/S to 18-5811-1
18-5775	Mercury Marine	332-7778A12	378	2 18-5812	OMC	985063	886
18-5775	Mercury Marine	332-7778A3	378	18-5813	OMC	584128	283
18-5775	Mercury Marine	332-7778A6	378	2 18-5814	OMC	172869	886
18-5775	Mercury Marine	332-7778A7	378	2 18-5814	OMC	581528	886
18-5775	Mercury Marine	332-7778A9	378	2 18-5815	Mercury Marine	89-15857	388, 717
18-5775	Mercury Marine	F749301	378	2 18-5815	Mercury Marine	89-61053	388, 717
18-5775	Mercury Marine	F7778A9	378	2 18-5815	Mercury Marine	89-65258	388, 717
18-5776	Mercury Marine	339-7452A1	378	2 18-5815	Mercury Marine	89-68258A4	388, 717
18-5776	Mercury Marine	339-7452A2	378	2 18-5815	Mercury Marine	89-76545	388, 717
18-5776	Mercury Marine	339-7452A3	378	2 18-5815	Mercury Marine	89-76545T	388, 717
18-5777	Mercury Marine	339-7452A15	378	2 18-5815	Mercury Marine	89-853654A1	388, 717
18-5777	Mercury Marine	339-7452A19	378	2 18-5816	Mercury Marine	89-91975	388
18-5777	Mercury Marine	339-7452A7	378	2 18-5816	Mercury Marine	89-96054	388
18-5777	Mercury Marine	339-7452A9	378	2 18-5816	Mercury Marine	89-96054T	388
18-5778	Mercury Marine	339-7452A11	378	2 18-5817	Mercury Marine	94318	388
18-5778	Mercury Marine	339-7452A14	378	2 18-5817	Mercury Marine	846070	388
18-5778	Mercury Marine	339-7452A21	378	2 18-5817	Mercury Marine	89-96158	388
18-5778	Mercury Marine	339-7452A8	378	2 18-5817	Mercury Marine	89-96158T	388
18-5780	OMC	585189	Obsolete	18-5818	Mercury Marine	89-818864	388
18-5781-1	OMC	584636	278	18-5818	Mercury Marine	89-818864T	388
18-5781-1	OMC	585114	278	18-5819	Mercury Marine	89-818997A1	388
18-5781-1	OMC	586212	278	18-5819	Mercury Marine	89-818997A2	388
18-5781-1	OMC	586661	278	18-5819	Mercury Marine	89-818997T1	388
18-5782	OMC	582705	278	18-5819	Yamaha	65W-81941-00-00	388
18-5782	OMC	763793	278	18-5820	Mercury Marine	89-818999A2	717
18-57824	Ilmor	MV8V1021	204	18-5820	Mercury Marine	89-825842A1	717
18-5783	OMC	582811	279	18-5820	Mercury Marine	89-850188T1	717
18-5783	OMC	763794	279	18-5821	Mercury Marine	825096T01	388
18-5784-1	OMC	582811	278	18-5821	Mercury Marine	89-825096T	388
18-5784-1	OMC	763794	278	18-5821	Yamaha	6G1-81941-10-00	388
18-5784-1	OMC	583110	278	2 18-5822	Mercury Marine	54293A10	Obsolete
18-5785	OMC	585261	278	2 18-5822	Mercury Marine	54293A13	Obsolete
18-5787	Mercury Marine	332-4911A5	378	2 18-5822	Mercury Marine	54293A4	Obsolete
18-5787	Mercury Marine	332-4911A8	378	2 18-5823	OMC	584580	283
18-5790	Chrysler Force	18495A26	379	18-5825	OMC	395204	Obsolete
18-5790	Mercury Marine	18495A12	379	18-5826	OMC	584890	285
18-5790	Mercury Marine	18495A19	379	18-5827	OMC	584476	Obsolete
18-5790	Mercury Marine	18495A26	379	18-5827	OMC	585001	Obsolete
18-5791	Mercury Marine	19052A3	379	18-5828	OMC	439561	Obsolete
18-5791	Mercury Marine	19052A5	379	18-5828	OMC	585219	Obsolete
18-5791	Mercury Marine	19052A8	379	18-5829	OMC	586048	Obsolete
18-5792	Mercury Marine	16061T	379	18-5830	OMC	586075	Obsolete
18-5793	Mercury Marine	823034	379	18-5831	OMC	584641	Obsolete
18-5793	Mercury Marine	823034T	379	18-5831	OMC	585995	Obsolete
18-5794	OMC	583896	S/S to 18-5794-1	18-5831	OMC	586271	Obsolete
18-5794	OMC	584329	S/S to 18-5794-1	18-5832	OMC	583266	Obsolete
18-5794	OMC	584331	S/S to 18-5794-1	18-5832	OMC	583689	Obsolete
18-5794	OMC	584489	S/S to 18-5794-1	18-5832	OMC	584424	Obsolete
18-5797	Mercury Marine	68162A3	386	18-5832	OMC	586000	Obsolete
18-5797	Mercury Marine	68162A6	386	2 18-5833	OMC	586774	283
18-5797	Mercury Marine	96455A1	386	18-5834	Chrysler Force	89-817109A2	244
18-5797	Mercury Marine	96455A8	386	18-5834	Mercury Marine	89-817109A2	244
18-5798	Mercury Marine	68162A1	386	18-5835	Chrysler Force	89-803822T	244
18-5798	Mercury Marine	68162A5	386	18-5835	Chrysler Force	89-817109A3	244
18-5798	Mercury Marine	68162A8	386	18-5835	Chrysler Force	89-F460917-1	244
18-5798	Mercury Marine	96455A6	386	18-5835	Chrysler Force	F460917-1	244
18-5798	Mercury Marine	96455A9	386	2 18-5836	Mercury Marine	25661	717
2 18-5801	Mercury Marine	89-76416A1	716	2 18-5836	Mercury Marine	256611	717
2 18-5801	OMC	586730	716	2 18-5836	Mercury Marine	25661T1	717
2 18-5801	OMC	586842	716	18-5837	Mercury Marine	89-18080	716
2 18-5801	OMC	985064	716	18-5838	Delco	1114356	716
18-5801	Pleasurecraft	R130001	716	18-5838	Delco	1114458	716
2 18-5802	Mercury Marine	54981	388				

1 This product is priced per piece. To order, priced per package, please add -9 to the part number
 2 Items ending in "D" are display packaged - regular number is non-display • 3 For discount shop pack of 10, please add -10 to the part number

SIERRA #	O.E.M.	O.E. #	PAGE #	SIERRA #	O.E.M.	O.E. #	PAGE #
SIERRA							
18-5838	Mercury Marine	33261	716	18-5897			20
18-5838	Mercury Marine	33316	716	18-5898	Crusader	700427	20
18-5838	Mercury Marine	60687	716	18-5898	Mercury Marine	34625	20
18-5838	Mercury Marine	89902	716	18-5898	Mercury Marine	97258	20
18-5838	Mercury Marine	89-99253	716	18-5898	Mercury Marine	97258A1	20
18-5838			716	18-5898	Mercury Marine	F16900152	20
18-5840	Prestolite	15-79	585, 596, 617, 716	18-5898	Mercury Marine	F16900198	20
18-5840	Prestolite	SAW4201	585, 596, 617, 716	18-5898	OMC	171960	20
18-5840	Prestolite	SAW4207	585, 596, 617, 716	18-5898			20
18-5840	Prestolite	SAW4210	585, 596, 617, 716	18-5899	Crusader	700425	20
18-5840			585, 596, 617, 716	18-5899	Mercury Marine	34623	20
18-5841	Chrysler Inboard	1692658	Obsolete	18-5899	Mercury Marine	90806	20
18-5849	Mercury Marine	828151	389	18-5899	Mercury Marine	815425	20
18-5849	Mercury Marine	828151A1	389	18-5899	Mercury Marine	815425T	20
18-5849	Mercury Marine	882751A1	389	18-5899	Mercury Marine	8M0068784	20
18-5849	Mercury Marine	882751A2	389	18-5899	Mercury Marine	90806A1	20
18-5850	Mercury Marine	882751A04	389	18-5899	OMC	982650	20
18-5851	Mercury	807057	389	18-5899	Pleasurecraft	RO20001	20
18-5851	Mercury	807057T	389	18-5899	Volvo	3857532	20
18-5851	Mercury	865202T	389	18-5899			20
18-5852	Mercury Marine	821509	389	18-5903	Mercury Marine	50-12872	713
18-5852	Mercury Marine	853292	389	18-5903	Mercury Marine	50-56886	713
18-5852	Mercury Marine	821509T1	389	18-5903	Mercury Marine	50-69865A1	713
18-5853	Yamaha	61A-81941-00-00	499	18-5903	OMC	980803	713
18-5853	Yamaha	6E5-81941-10-00	499	18-5903	OMC	981821	713
18-5853	Yamaha	6E5-81941-11-00	499	18-5903	Pleasurecraft	RA122001	713
18-5854	Mercury Marine	398-5454A17	386	18-5903	Volvo	841066-4	713
18-5855	Mercury Marine	336-3996A7	386	18-5906	Volvo	840808	961
18-5856	Mercury Marine	398-5255	386	18-5906	Volvo	872241	961
18-5857	Mercury Marine	398-5454A7	386	18-5907	Crusader	42090	713
18-5859	Mercury Marine	398-5454A22	386	18-5907	Mercury Marine	50-72550A2	713
18-5859	Mercury Marine	398-5919A3	386	18-5907	Mercury Marine	50-79604A3	713
18-5859	Mercury Marine	398-5919A7	386	18-5907	Mercury Marine	50-97499A2	713
18-5860	Mercury Marine	398-5454A35	386	18-5907	Mercury Marine	50-97499R4	713
18-5864	Mercury Marine	86617A20	385	18-5907	OMC	981289	713
18-5865	Mercury Marine	398-5704A7	385	18-5907	OMC	982202	713
18-5870	Chrysler Force	398-832075A4	244	18-5907	Pleasurecraft	RA122008	713
18-5870	Mercury Marine	398-832075-A21	244	18-5908	Crusader	42091	617
18-5870	Mercury Marine	398-832075A4	244	18-5908	Mercury Marine	50-17251A2	617
18-5871	Mercury Marine	398-5454A32	385	18-5908	Mercury Marine	50-17251A3	617
18-5873	Chrysler Force	398-832075A6	244	18-5908	Mercury Marine	50-47455	617
18-5873	Mercury Marine	398-832075A6	244	18-5908	Mercury Marine	50-65784A1	617
18-5874	Mercury Marine	398-5454A21	385	18-5908	Mercury Marine	50-76965A3	617
18-5874	Mercury Marine	398-5454A25	385	18-5908	Mercury Marine	50-76967A1	617
18-5874	Mercury Marine	398-5454A63	385	18-5908	Mercury Marine	50-76967A4	617
18-5874	Mercury Marine	398-5919A2	385	18-5908	Mercury Marine	50-808011A05	617
18-5874	Mercury Marine	398-5919A6	385	18-5908	Mercury Marine	50-808011A1	617
18-5874	Mercury Marine	398-5919A8	385	18-5908	Mercury Marine	50-808011A3	617
18-5874	Mercury Marine	398-818535A15	385	18-5908	Mercury Marine	50-808011A4	617
18-5874	Mercury Marine	398-832075A14	385	18-5908	Mercury Marine	50-99419A3	617
18-5874	Mercury Marine	398-832075A20	385	18-5908	OMC	981288	617
18-5876	Mercury Marine	398-9610A19	385	18-5908	OMC	982195	617
18-5877	OMC	584643	282	18-5908	OMC	984982	617
18-5878	OMC	584981	282	18-5908	OMC	986007	617
18-5879	Yamaha	688-81941-00-00	499	18-5908	Pleasurecraft	RA122009	617
18-5879	Yamaha	688-81950-10-00	499	18-5909	Evinrude	587078	286
18-5881	Chrysler Force	332-5772A5	379	18-5909	Evinrude	587291	286
18-5881	Chrysler Force	332-5772A7	379	18-5910	Mercury Marine	50-12177A2	714
18-5881	Mercury Marine	332-5772A1	379	18-5910	Mercury Marine	50-99418A2	714
18-5881	Mercury Marine	332-5772A2	379	18-5910	OMC	984456	714
18-5881	Mercury Marine	332-5772A3	379	18-5910	OMC	986505	714
18-5881	Mercury Marine	332-5772A5	379	18-5911	Chris-Craft	16.61-00042	585
18-5881	Mercury Marine	F720301	379	18-5911	Mercury Marine	50-17251A3	585
18-5882	Volvo	3884950	962	18-5911	Mercury Marine	50-76965A4	585
18-5884	OMC	586343	278	18-5911	Mercury Marine	50-77328A3	585
18-5885	OMC	583865	278	18-5911	Mercury Marine	50-99417A2	585
18-5886	OMC	436367	278	18-5911	Mercury Marine	50-99419A3	585
18-5886	OMC	584122	278	18-5911	OMC	981078	585
18-5887	OMC	584985	278	18-5911	OMC	982121	585
18-5888	OMC	987738	876	18-5911	OMC	983444	585
18-5889	OMC	987739	876	18-5911	OMC	983790	585
18-5890	OMC	987740	876	18-5911	OMC	985966	585
18-5890	OMC	985902	876	18-5911	Volvo	834893	585
18-5891	OMC	583605	278	18-5911	Volvo	855326	585
18-5893	OMC	583476	278	18-5913-1	Mercury Marine	50-812428A3	714
18-5893	OMC	584037	278	18-5913-1	Mercury Marine	50-812604A2	714
18-5893	OMC	586217	278	18-5913-1	Mercury Marine	50-822330A2	714
18-5893	OMC	586667	278	18-5913-1	Mercury Marine	50-864340A2	714
18-5894	OMC	3852215	898	18-5913-1	OMC	3854751	714
18-5894	Volvo Penta	3852215	898	18-5913-1	Volvo	3587625	714
18-5896	Mercury Marine	12415	20, 412	18-5913-1	Volvo	3853982	714
18-5896			20, 412	18-5913-1	Volvo	3854751	714
18-5897	Mercury Marine	36525	20	18-5913-1	Volvo	3856004	714
18-5897	Mercury Marine	97257	20	18-5913-1	Volvo	3860764	714
18-5897	Mercury Marine	806490	20	18-5913-1	Volvo	3885317	714
18-5897	Mercury Marine	811091	20	18-5917	OMC	984628	885
18-5897	Mercury Marine	806490T	20	18-5919	Mercury Marine	50-806963A4	714
18-5897	Mercury Marine	97257A1	20	18-5919	Mercury Marine	50-806965A2	714
18-5897	OMC	980613	20	18-5919	Mercury Marine	50-806965A4	714
18-5897	Volvo	3853787	20	18-5919	OMC	988217	714

1 This product is priced per piece. To order, priced per package, please add -9 to the part number
 2 Items ending in "D" are display packaged - regular number is non-display • 3 For discount shop pack of 10, please add -10 to the part number

SIERRA #	O.E.M.	O.E. #	PAGE #	SIERRA #	O.E.M.	O.E. #	PAGE #
SIERRA							
18-5919	Volvo	3856003	714	18-59710	Volvo	820652	962
18-5920	OMC	987811	646	18-59710	Volvo	822454	962
18-5920	OMC	3854190	646	18-59710	Volvo	827303	962
18-5920	Pleasurecraft	RA122001	646	18-59710	Volvo	847651	962
18-5920	Pleasurecraft	RK122014	646	18-59710	Volvo	849561	962
18-5920	Volvo	3854190	646	18-59710	Volvo	849602	962
18-5923			713	18-5975	Motorola	510-845	678
18-5927			884, 961	18-5975	Motorola	510-860	678
18-5929	Mercury Marine	892940T	392	18-5975	Motorola	510-864	678
18-5939	Valeo	2541451	962	18-5975	Motorola	9AR3855G	678
18-5939	Valeo	A13N234	962	18-5975	Motorola	9AR6000G	678
18-5939	Volvo	872235	962	18-5975	Motorola	9AR3959G	678
18-5939	Volvo	873770	962	18-5975	Perkins Marine Engine	2871A651	678
18-5939	Volvo	3803260	962	18-5975	Valeo	2939590	678
18-5943	Valeo	541663	S/S to 18-5959	18-5976	Motorola	9AR3743G	962
18-5943	Valeo	A13N259	S/S to 18-5959	18-5976	Motorola	510-821	962
18-5943	Volvo	872926	S/S to 18-5959	18-5976	Motorola	510-802	962
18-5943	Volvo	3803227	S/S to 18-5959	18-5976	Motorola	510-835	962
18-5945			718	18-5976	Motorola	510-836	962
18-5946			718	18-5976	Motorola	510-856	962
18-5953-1			720	18-5976	Motorola	510-861	962
18-5954	Chrysler Inboard	3527501	597	18-5976	Motorola	510-862	962
18-5954	Chrysler Inboard	3527502	597	18-5976	Valeo	2937430	962
18-5954	Chrysler Inboard	3744870	597	18-5979	Volvo	3860082	962
18-5956	Mercury Marine	56045	719	18-5982	Cummins	216040	678
18-5956	Mercury Marine	59755	719	18-5982	Cummins	3604234RX	678
18-5956	Mercury Marine	69729	719	18-5983	Mercury Marine	862030T	719
18-5956	Mercury Marine	78477	719	18-5984	Indmar	575011	635
18-5956	Mercury Marine	90794	719	18-5984	Pleasurecraft	RA097007B	635
18-5956	Mercury Marine	78403A1	719	18-6000	Volvo	832598	1001
18-5956	Mercury Marine	78403A2	719	18-6000	Volvo	873179	1001
18-5957	Mercury Marine	12449	646	18-6000A	Volvo	832598	1001
18-5957	Mercury Marine	56045	646	18-6000A	Volvo	873179	1001
18-5957	Mercury Marine	59755	646	18-6001	Volvo	838929	1001
18-5957	Mercury Marine	69729	646	18-600-1212			108
18-5957	Mercury Marine	78477	646	18-600-1414			108
18-5957	Mercury Marine	90794	646	18-600-1418			Obsolete
18-5957	Mercury Marine	92497	646	18-600-3814			108
18-5957	Mercury Marine	12449A1	646	18-600-3818			Obsolete
18-5957	Mercury Marine	78403A1	646	18-600-3838			108
18-5957	Mercury Marine	78403A2	646	18-6004	Volvo	852835	1001
18-5957	Mercury Marine	817119A1	646	18-6004	Volvo	873178	1001
18-5957	Mercury Marine	817119A4	646	18-6004A	Volvo	852835	1001
18-5957	Mercury Marine	92497A3	646	18-6004A	Volvo	873178	1001
18-5957	Mercury Marine	98555A1	646	18-6005	Volvo	875805	1001
18-5957	OMC	982364	646	18-600-5618			Obsolete
18-5957	Pleasurecraft	RA097002	646	18-6009	Volvo	875815	1001
18-5957	Pleasurecraft	RA097003	646	18-6009A	Volvo	875815	1001
18-5957	Pleasurecraft	RA097006	646	18-6010	Volvo	875821	1001
18-5957	Volvo	3860769	646	18-60103	Nissan/Tohatsu	332600060M	480
18-5959	Valeo	A13N147M	962	18-60103-50			480
18-5959	Valeo	A13N148M	962	18-6010A	Volvo	875821	1001
18-5959	Valeo	A13N1M	962	18-6011	Honda	41107-ZW1-003ZA	272
18-5959	Valeo	A13N2M	962	18-6011	Mercury Marine	31640	272
18-5959	Volvo	826495	962	18-6011	Mercury Marine	316403	272
18-5959	Volvo	834609	962	18-6011	Mercury Marine	316404	272
18-5959	Volvo	834963	962	18-6011	Mercury Marine	31640A1	272
18-5959	Volvo	841762	962	18-6011	Mercury Marine	31640A2	272
18-5959	Volvo	841765	962	18-6011	Mercury Marine	31640A4	272
18-5959	Volvo	841766	962	18-6011	Mercury Marine	31640T6	272
18-5960	Mercury Marine	807653T	719	18-6011	Mercury Marine	72436A1	272
1 18-5961			588, 608, 618, 648	18-6011	Mercury Marine	97-31640B4	272
1 18-5962			588, 608, 618, 648	18-6011	Mercury Marine	97-31640Q4	272
18-59640	Prestolite		1004	18-6011A	Honda	41107-ZW1-003ZA	272
18-5965	Mercury Marine	12449	719	18-6011A	Mercury Marine	31640	272
18-5965	Mercury Marine	92497	719	18-6011A	Mercury Marine	31640A1	272
18-5965	Mercury Marine	12449A1	719	18-6011A	Mercury Marine	31640Q4	272
18-5965	Mercury Marine	805884T	719	18-6011A	Mercury Marine	31640T6	272
18-5965	Mercury Marine	817119A1	719	18-6012	Mercury Marine	34127	864
18-5965	Mercury Marine	817119A4	719	18-6012	Mercury Marine	34127A1	864
18-5965	Mercury Marine	92497A3	719	18-6012	Mercury Marine	34127A2	864
18-5965	Mercury Marine	98555A1	719	18-6012	Mercury Marine	34127T1	864
18-5966	Mercury Marine	12449	719	18-6012	Mercury Marine	34127T2	864
18-5966	Mercury Marine	92497	719	18-6013	Mercury Marine	32170	864
18-5966	Mercury Marine	12449A1	719	18-6013	Mercury Marine	32170A1	864
18-5966	Mercury Marine	12449A1	719	18-6013	Mercury Marine	34762A1	864
18-5966	Mercury Marine	817119A1	719	18-6013	Mercury Marine	97-34672C	864
18-5966	Mercury Marine	817119A4	719	18-601-3814			108
18-5966	Mercury Marine	98555A1	719	18-6014	Mercury Marine	822777	461
18-5967	Mercury Marine	807652T	719	18-6014	Mercury Marine	8227772	461
18-5968			720	18-6014	Mercury Marine	463999A2	461
18-59700	Volvo	841380	962	18-6014	Mercury Marine	46399A1	461
18-59700	Volvo	841762	962	18-6014	Mercury Marine	822777A1	461
18-59700	Volvo	841763	962	18-6014	Mercury Marine	822777A3	461
18-59700	Volvo	841765	962	18-6014	Mercury Marine	822777A4	461
18-59700	Volvo	841766	962	18-6014	Mercury Marine	822777Q1	461
18-59700	Volvo	3803227	962	18-6014A	Mercury Marine	46399A1	461
18-59700	Volvo	3803227-2	962	18-6014A	Mercury Marine	822777A1	461
18-59700	Volvo	834625-6	962	18-6014A	Mercury Marine	822777Q1	461
18-59700	Volvo	841378-3	962	18-60151-9	Mercury Marine	55989	864

1 This product is priced per piece. To order, priced per package, please add -9 to the part number
 2 Items ending in "D" are display packaged - regular number is non-display • 3 For discount shop pack of 10, please add -10 to the part number

SIERRA #	O.E.M.	O.E. #	PAGE #	SIERRA #	O.E.M.	O.E. #	PAGE #
SIERRA							
18-60151-9	Mercury Marine	55989A3	864	18-6066A	Mercury Marine	43994A2	864
18-60151-9	Mercury Marine	55989A4	864	18-6066A	Mercury Marine	821631Q1	864
18-60151-9	Mercury Marine	55989A9	864	18-6067	Mercury Marine	806189A1	865
18-60151-9	Mercury Marine	55989Q9	864	18-6067	Mercury Marine	97-806189	865
18-60151-9	Mercury Marine	55989T9	864	18-6067	Mercury Marine	97-806189Q1	865
18-6015-9	Mercury Marine	55989A3	864	18-6067A	Mercury Marine	806189A1	865
18-6015-9	Mercury Marine	55989Q9	864	18-6067A	Mercury Marine	97-806189	865
18-6015-9	Mercury Marine	55989T9	864	18-6067A	Mercury Marine	97-806189Q1	865
18-6015A-9	Mercury Marine	55989A3	Obsolete	18-6068	Honda	41109-ZW1-003	271
18-6015A-9	Mercury Marine	55989Q9	Obsolete	18-6068	Mercury Marine	826134	271
18-6015A-9	Mercury Marine	55989T9	Obsolete	18-6068	Mercury Marine	826134A1	271
18-6016	Mercury Marine	76214	461	18-6068	Mercury Marine	97-826134Q	271
18-6016	Mercury Marine	762142	461	18-6070	Yamaha	688-45371-02-00	554
18-6016	Mercury Marine	762142A1	461	18-6079	Mercury Marine	806105	865
18-6016	Mercury Marine	76214A5	461	18-6079	Mercury Marine	806105A1	865
18-6016	Mercury Marine	786214A2	461	18-6079	Mercury Marine	806105Q1	865
18-6016	Mercury Marine	97-762145	461	18-6079	Mercury Marine	806105T1	865
18-6016	Mercury Marine	97-76214Q5	461	18-6080	Mercury Marine	815933A1	865
18-60161	Mercury Marine	76214	461	18-6080	Mercury Marine	821629A1	865
18-60161	Mercury Marine	76214Q5	461	18-6080	Mercury Marine	97-821629Q1	865
18-60161	Mercury Marine	76214T3	461	18-6080A	Mercury Marine	821629	865
18-6016A	Mercury Marine	76214	461	18-6080A	Mercury Marine	821629A1	865
18-6016A	Mercury Marine	76214Q5	461	18-6080A	Mercury Marine	821629Q1	865
18-6016A	Mercury Marine	76214T3	461	18-6089	Mercury Marine	806190A1	865
18-6017	OMC	123009	363	18-6089	Mercury Marine	806190T1	865
18-6017	OMC	173029	363	18-6089	Mercury Marine	97-806190	865
18-6017A	OMC	123009	363	18-6089	Mercury Marine	97-806190B4	865
18-6017A	OMC	173029	363	18-6089	Mercury Marine	97-806190Q1	865
18-6018	OMC	327606	363	18-6090	Yamaha	6G5-45251-01-00	554
18-6019	OMC	982277	937	18-6091	Yamaha	6H1-45251-02-00	554
18-6019	OMC	982438	937	18-60916	Mercury	27-850836001	Obsolete
18-6020	OMC	976669	363, 937	18-60916	Mercury	27-850836001	Obsolete
18-6021	Volvo	838928	1002	18-60916	Nissan/Tohatsu	3V1010050M	443
18-6024	OMC	393023	491	18-60917	Mercury	27-803508017	443
18-6024	OMC	436745	491	18-60917	Nissan/Tohatsu	3V1010240M	443
18-6024A	OMC	393023	363, 937	18-60918	Mercury	27-835427003	444
18-6024A	OMC	436745	363, 937	18-60918	Nissan/Tohatsu	3V1013030M	444
18-6025	OMC	398331	363, 938	18-60919	Mercury	27-834952001	444
18-6025	OMC	433458	363, 938	18-60919	Nissan/Tohatsu	3V1023050M	444
18-6026	OMC	392462	363	18-6092	Mercury Marine	806190	865
18-6027	OMC	392123	363, 938	18-6092	Mercury Marine	806190A1	865
18-6028	OMC	984513	938	18-6092	Mercury Marine	806190Q1	865
18-6028	OMC	3853818	938	18-6092	Mercury Marine	806190T1	865
18-6028	OMC	3855412	938	18-60920	Mercury	27-853702005	444
18-6028	Volvo	984513	938	18-60920	Nissan/Tohatsu	346-01032-0	444
18-6028	Volvo	3855411	938	18-6092A	Mercury Marine	806190	865
18-6028A	OMC	984513	1001	18-6092A	Mercury Marine	806190A1	865
18-6028A	OMC	3853818	1001	18-6092A	Mercury Marine	806190Q1	865
18-6028A	OMC	3855412	1001	18-6092A	Mercury Marine	806190T1	865
18-6028A	Volvo	3863193	1001	18-6093	Mercury Marine	806105	865
18-6029	OMC	397768	938	18-6093	Mercury Marine	806105A1	865
18-6032	Suzuki	55320-95310	492	18-6093	Mercury Marine	806105Q1	865
18-6033	Suzuki	55125-87D00	492	18-6093	Mercury Marine	806105T1	865
18-6034	Yamaha	6K1-45371-00-00	554	18-6093A	Mercury Marine	806105	865
18-6035	Yamaha	6J9-45371-01-00	554	18-6093A	Mercury Marine	806105A1	865
18-6040			579	18-6093A	Mercury Marine	806105Q1	865
18-6041-1			Obsolete	18-6093A	Mercury Marine	806105T1	865
18-6043-1			Obsolete	18-6094	Mercury Marine	806105	865
18-6045			579	18-6094	Mercury Marine	817373A1	865
18-6046			579	18-6094	Mercury Marine	821630A1	865
18-6047			579	18-6094	Mercury Marine	821630C2	865
18-6050			Obsolete	18-6094	Mercury Marine	97-821630Q1	865
18-60508	Yamaha	60V-12414-A0-00	548	18-6094A	Mercury Marine	821630	865
18-60512	Yamaha	68D-E1169-A0-00	Obsolete	18-6094A	Mercury Marine	821630A1	865
18-60513	Yamaha	66M-11357-00-00	Obsolete	18-6094A	Mercury Marine	821630Q1	865
18-60518	Yamaha	68D-11351-A0-00	Obsolete	18-6094A	Mercury Marine	821630T1	865
18-60519	Yamaha	68D-E1193-A0-00	Obsolete	18-6095	OMC	431708	363, 938
18-6052			Obsolete	18-6095A	OMC	431708	363, 938
18-60520	Yamaha	66T-11193-A0-00	552	18-6096	Yamaha	664-45371-01-00	554
18-60521	Yamaha	69M-11196-A0-00	552	18-6097	Yamaha	6E5-45371-01-00	554
18-60522	Yamaha	66T-11181-A0-00	552	18-6098	Suzuki	55125-96310	492
18-60523	Yamaha	69M-11181-00-00	Obsolete	18-6099	Mercury Marine	815933A1	865
18-60527	Yamaha	67D-45113-A0-00	552	18-6099	Mercury Marine	821629A1	865
18-60528	Yamaha	66T-45113-A0-00	Obsolete	18-6099	Mercury Marine	97-821629Q1	865
18-60529	Yamaha	66T-41133-A0-00	552	18-6100	OMC	123009	363
18-6053			579	18-6100	OMC	173029	363
18-60530	Yamaha	66M-41114-01-00	552	18-6101	OMC	983494	938
18-60532	Yamaha	66T-41114-A0-00	552	18-6102	OMC	984513	938
18-60534	Yamaha	66M-13645-00-00	552	18-6102	OMC	3853818	938
18-60535	Yamaha	65W-13645-00-00	552	18-6102	Volvo	3855412	938
18-60540	Yamaha	676-12414-A0-00	Obsolete	18-6103	OMC	984547	938
18-60541	Yamaha	6BX-G4315-01-00	552	18-6103A	OMC	984547	938
18-6059			579	18-6104	Volvo	832598	1001
18-6060			579	18-6104	Volvo	873179	1001
18-6062			579	18-6105	Volvo	852835	1001
18-6063			579	18-6105	Volvo	873178	1001
18-6066	Mercury Marine	43994A2	864	18-61051			187, 696
18-6066	Mercury Marine	821631A1	864	18-6106	Volvo	875821	1001
18-6066	Mercury Marine	821631B1	864	18-6107			579
18-6066	Mercury Marine	821631C	864	18-6108			579
18-6066	Mercury Marine	821631Q1	864	18-6109			579
				18-6111	Yamaha	688-45371-02-00	554

1 This product is priced per piece. To order, priced per package, please add -9 to the part number

2 Items ending in "D" are display packaged - regular number is non-display • 3 For discount shop pack of 10, please add -10 to the part number

SIERRA #	O.E.M.	O.E. #	PAGE #	SIERRA #	O.E.M.	O.E. #	PAGE #
SIERRA							
18-6112	Yamaha	6J9-45371-01-00	554	18-6162M	Yamaha		554
18-6114	Mercury Marine	806189	865	18-6163A	Honda		272
18-6114	Mercury Marine	806189A1	865	18-6163M	Honda		272
18-6114	Mercury Marine	806189Q1	865	18-6165A	Honda	41107-ZV5-00-00	272
18-6114	Mercury Marine	806189T1	865	18-6200	Yanmar	27210-200200	688
18-6115	OMC	433580	363	18-6201	Yanmar	27210-200300	688
18-6117A	Mercury Marine	97-806188A1	864	18-6240	Mercury Marine	821630	865
18-6117A	Mercury Marine	97-806188Q01	864	18-6240	Mercury Marine	821630A1	865
18-6117M	Mercury Marine	97-806188A1	Obsolete	18-6240	Mercury Marine	821630Q1	865
18-6117M	Mercury Marine	97-806188Q01	Obsolete	18-6240	Mercury Marine	821630T1	865
18-6117Z	Mercury Marine	97-806188A1	864	18-6241	Honda	41107-ZW1-003ZA	272
18-6117Z	Mercury Marine	97-806188Q01	864	18-6241	Mercury Marine	31640	272
18-6118A	Yamaha	68V-11325-01-00	554	18-6241	Mercury Marine	31640A1	272
18-6119A	Yamaha	61A-45371-00-00	554	18-6241	Mercury Marine	31640Q4	272
18-6119Z	Yamaha	61A-45371-00-00	554	18-6241	Mercury Marine	31640T6	272
18-6120A	Yamaha	61N-45251-01-00	554	18-6242-9	Mercury Marine	55989A3	864
18-6120Z	Yamaha	61N-45251-01-00	554	18-6242-9	Mercury Marine	55989Q9	864
18-6121A	Yamaha	6K1-45371-02-00	554	18-6242-9	Mercury Marine	55989T9	864
18-6121Z	Yamaha	6K1-45371-02-00	554	18-6243	Mercury Marine	43994A2	864
18-6122A	Yamaha	69L-45371-00-00	554	18-6243	Mercury Marine	821631Q1	864
18-6122Z	Yamaha	69L-45371-00-00	554	18-6244	Mercury Marine	76214	461
18-6123Z	Volvo	873395	1001	18-6244	Mercury Marine	76214Q5	461
18-6124Z	Volvo	872793	1001	18-6244	Mercury Marine	76214T3	461
18-6125A	Volvo	3586461	1001	2 18-6245	Mercury Marine	10-32470	462
18-6125M	Volvo	3855610	1001	18-6246	Yamaha	90105-10M00-00	554
18-6125Z	Volvo	3854130	1001	18-6249	Mercury Marine	43396A2	462
18-6126A	Volvo	3888816	1001	18-6249	Mercury Marine	818298A1	462
18-6126M	Volvo	3888818	1001	18-6249	Mercury Marine	818298Q1	462
18-6126Z	Volvo	3888817	1001	18-6249A	Mercury Marine	43396A2	462
18-6127A	Volvo	3888813	1001	18-6249A	Mercury Marine	818298A1	462
18-6127M	Volvo	3888815	1001	18-6249A	Mercury Marine	818298Q1	462
18-6127Z	Volvo	3888814	Obsolete	18-6250			Obsolete
18-6128A	Volvo		1002	18-6251			288
18-6128M	Volvo		1002	18-6252			282
18-6128Z	Volvo		1002	18-6253			718
18-6129A	Volvo		1002	18-6255	Mercury Marine	392-8989	Obsolete
18-6129M	Volvo		1002	18-6257	OMC	983195	889
18-6129Z	Volvo		1002	18-6258	Honda	36120-ZV5-821	263
18-6130	Volvo		1002	18-6259	Yamaha	6H1-43880-00-00	503
18-6131	Volvo		1002	18-6260			888
18-6132A	Yamaha		554	18-6261	OMC	987774	888
18-6132M	Yamaha		554	18-6261	OMC	3854182	888
18-6133A	Yamaha		554	18-6261	OMC	3854809	888
18-6133M	Yamaha		554	18-6261	OMC	3856600	888
18-6134			579	18-6261	OMC	3857561	888
18-6135			Obsolete	18-6261	OMC	3860171	888
18-6136			579	18-6261	Volvo	3857561	888
18-6137			579	18-6261	Volvo	3856600-6	888
18-6140	Universal	301068	579	18-6263	Universal	288182	654
18-6141	Universal	301069	579	18-6263	Universal	288759	654
18-6150A	Mercury Marine	888756A2	865	18-6264	Un		654
18-6150A	Mercury Marine	888756Q02	865	18-6265	Volvo	3857813	963
18-6150A	Mercury Marine	888756Q4	865	18-6266	Volvo	872300	965
18-6150M	Mercury Marine	888756A2	865	18-6266	Volvo	876040	965
18-6150M	Mercury Marine	888756Q02	865	18-6268	Volvo	841177	965
18-6150M	Mercury Marine	888756Q4	865	18-6268	Volvo	872272	965
18-6150Z	Mercury Marine	888756A2	865	18-6270	OMC	984536	597
18-6150Z	Mercury Marine	888756Q02	865	18-6270	OMC	988013	597
18-6150Z	Mercury Marine	888756Q4	865	18-6270			597
18-6154A			864	18-6271	Volvo	241812	965
18-6154M			864	18-6271	Volvo	870670	965
18-6154Z			864	18-6271	Volvo	876038	965
18-6155Z			938	18-6271	Volvo	6643474	965
18-6156A			461	18-6273-1	Mercury Marine	99186	384
18-6156M			461	18-6273-1	Mercury Marine	99186-1	384
18-6157A	Mercury Marine	8M0058677	461	18-6273-1	Mercury Marine	99186T	384
18-6157M			461	18-6274	Mercury Marine	14336A20	385
18-6158A	Mercury Marine	888756Q01	864	18-6274	Prestolite	HYK4001	385
18-6158A	Mercury Marine	97-888756Q03	864	18-6274	Volvo	852928	385
18-6158M	Mercury Marine	888755A1	864	18-6274	Volvo	3857265	385
18-6158M	Mercury Marine	888755Q01	864	18-6275	Mercury Marine	814472	S/S to 18-6275-1
18-6158M	Mercury Marine	97-888755Q03	864	18-6275	Mercury Marine	50-12121A2	S/S to 18-6275-1
18-6158Z			864	18-6275	Mercury Marine	50-12177A2	S/S to 18-6275-1
18-6159A	Mercury Marine	888758A1	864	18-6275	Mercury Marine	50-77328A1	S/S to 18-6275-1
18-6159A	Mercury Marine	888758Q01	864	18-6275	Mercury Marine	50-77328A3	S/S to 18-6275-1
18-6159A	Mercury Marine	97-888758Q03	864	18-6275	Mercury Marine	50-806964A2	S/S to 18-6275-1
18-6159M	Mercury Marine	888757Q01	864	18-6275	Mercury Marine	50-806964A3	S/S to 18-6275-1
18-6159M	Mercury Marine	888759A1	864	18-6275	Mercury Marine	50-806964A4	S/S to 18-6275-1
18-6159M	Mercury Marine	97-888759Q03	864	18-6275	Mercury Marine	50-807904A1	S/S to 18-6275-1
18-6159Z			864	18-6275	Mercury Marine	50-812428A3	S/S to 18-6275-1
18-6160A	Mercury Marine	888761A1	864	18-6275	Mercury Marine	50-812604A2	S/S to 18-6275-1
18-6160A	Mercury Marine	888761Q01	864	18-6275	Mercury Marine	50-822330A2	S/S to 18-6275-1
18-6160A	Mercury Marine	97-888761Q03	864	18-6275	Mercury Marine	50-863007A1	S/S to 18-6275-1
18-6160M	Mercury Marine	888760A1	864	18-6275	Mercury Marine	50-864340A2	S/S to 18-6275-1
18-6160M	Mercury Marine	888760Q01	864	18-6275	Mercury Marine	50-99418A2	S/S to 18-6275-1
18-6160M	Mercury Marine	97-888760Q03	864	18-6275	Volvo	3857747	S/S to 18-6275-1
18-6160Z			864	18-6275	Volvo	3860566	S/S to 18-6275-1
18-6161A	Suzuki		492	18-6276	OMC	984536	884
18-6161M	Suzuki		492	18-6276	OMC	988013	884
18-6162A	Yamaha		554	18-6277	OMC	435548	282
				18-6279	Chrysler Force	820545	247

1 This product is priced per piece. To order, priced per package, please add -9 to the part number
 2 Items ending in "D" are display packaged - regular number is non-display • 3 For discount shop pack of 10, please add -10 to the part number

SIERRA #	O.E.M.	O.E. #	PAGE #	SIERRA #	O.E.M.	O.E. #	PAGE #
SIERRA							
18-6279	Chrysler Force	F694541-1	247	18-6452	Pleasurecraft	RA097009	646
18-6280	OMC	437801	282	18-6453	Pleasurecraft	RA097007C	646
18-6281	OMC	438786	282	18-6454	Mercury Marine	834832	392
18-6281	OMC	439937	282	18-6454	Mercury Marine	857006T	392
18-6281	OMC	5005254	282	18-6454	Mercury Marine	875285T1	392
18-6282	Mercury Marine	50-8329972	393	18-6454	Mercury Marine	881248T	392
18-6283	Mercury Marine	50-8331535	393	18-6454	Mercury Marine	889955A03	392
18-6284			654	18-6454	Mercury Marine	8M0064021	392
18-6285	OMC	433226	282	18-6455	Mercury Marine	875286A1	392
18-6286	Chrysler Force	827675A1	247	18-6455	Mercury Marine	875286T	392
18-6288	Indmar	575010	635	18-6455	Mercury Marine	881247A1	392
18-6288	Pleasurecraft	RA097007B	635	18-6457	Mercury Marine	807757T	749
18-6291	OMC	3854194	886	18-6475	Honda	31630-ZW5-003	262
18-6291	Volvo	3854194-2	886	18-6476	Honda	31630-ZY6-003	262
18-6293	Mercury Marine	862031T	719	18-6500	Mercury Marine	84-881262A2	392
18-6293	Mercury Marine	862031T1	719	18-6501	OMC	307573	337
18-6298	Mercury Marine	863077T	719	18-6501	OMC	395460	337
18-6299	Marine Power	402001	638	18-6503	OMC	318944	337
18-6351	Mercury Marine	43-853641A2	Obsolete	18-6506	Mercury Marine	24-29340A1	396
18-6351K	Mercury Marine	43-803103T1	Obsolete	18-6506	Mercury Marine	24-29340T1	396
18-6352	Mercury Marine	43-853642A2	833, 841	18-6509	OMC	326877	337
18-6352K	Mercury Marine	43-803106T1	Obsolete	18-6511	OMC	312932	337
18-6353	Mercury Marine	43-853643A2	833, 841	1 18-6512	OMC	330525	S/S to 18-6512-9
18-6353K	Mercury Marine	43-803105T1	Obsolete	1 18-6513	OMC	203698	337
18-63966	Yamaha	66M-11181-10-00	Obsolete	18-6522	OMC	323653	337
18-6399	OMC	984264	926	18-6522	OMC	338534	337
18-6400	Mercury Marine	12784	842	18-6523			999
18-6400	Mercury Marine	12784T	842	18-6526	OMC	397004	Obsolete
18-6401	Mercury Marine	12784A10	842	18-65450	Yamaha	6E9-82575-02-00	Obsolete
18-6401	Mercury Marine	12784A4	842	18-6650	Yamaha	6M6-81960-A0-00	572
18-6404	Mercury Marine	865503T	Obsolete	18-6651	Yamaha	66V-81960-00-00	572
18-6406	Mercury Marine	865493A01	843	18-6652	Yamaha	6K8-81960-A0-00	572
18-6406	Mercury Marine	865496A01	843	18-6742	Honda	36120-ZY3-023	263
18-6406	Mercury Marine	865496A01	843	18-6743	Honda	36120-ZY9-003	263
18-6406	Mercury Marine	865510T	843	18-6745	Honda	36120-ZY6-013	263
18-6406	Mercury Marine	865511T	843	18-6744	OMC	5006319	282
18-6410	Yamaha	689-81800-11	499	18-6746	Mercury Marine	14336A20	718
18-6410	Yamaha	689-81800-12	499	18-6746	Mercury Marine	14336A20	718
18-6410	Yamaha	689-81800-13-00	499	18-6746	Mercury Marine	14336A25	718
18-6411	Yamaha	6H3-81800-10	499	18-6746	Mercury Marine	14336A31	718
18-6411	Yamaha	6H3-81800-11-00	499	18-6746	Mercury Marine	14336A8	718
18-6412	Yamaha	697-81800-12	499	18-6746	Mercury Marine	865380A03	718
18-6412	Yamaha	99999-03249-00	499	18-6746	Mercury Marine	865380A13	718
18-6413	Yamaha	6E5-81800-11-00	500	18-6746	Mercury Marine	88183A5	718
18-6413	Yamaha	6E5-81800-12-00	500	18-6747	Mercuriser	14336A15	717
18-6414	Suzuki	31100-95600	482	18-6747	Mercuriser	14336A17	717
18-6415	Yamaha	6N7-81800-10-00	500	18-6747	Mercuriser	14336A22	717
18-6416	Suzuki	31100-94610	482	18-6747	Mercuriser	14336A28	717
18-6417	Suzuki	31100-92E00	482	18-6747	Mercuriser	14336A6	717
18-6418	Nissan/Tohatsu	353760104M	477	18-6747	Mercuriser	14336A9	717
18-6419	Suzuki	31100-89J00	482	18-6747	Mercuriser	865380A02	717
18-6420	Yamaha	6L2-81800-20-00	500	18-6747	Mercuriser	865380A05	717
18-6421	Yamaha	6F5-81800-11	500	18-6747	Mercuriser	865380A15	717
18-6421	Yamaha	6J4-81800-01-00	500	18-6747	Mercuriser	865380A25	717
18-64217	Mercury	27-815791A00	437	18-6747	Mercuriser	88183A12	717
18-6422	Yamaha	6H4-81800-12-00	500	18-6747	Mercuriser	88183A3	717
18-6423	Yamaha	688-81800-12-00	500	18-6748	Yamaha	67C-43880-00-00	503
18-6425	Mercury Marine	50-804312T1	392	18-6748	Yamaha	67C-43880-01-00	503
18-6425	Yamaha	67F-81800-02-00	392	18-6749	Mercury Marine	42419A1	717
18-6426	Yamaha	68F-81800-01-00	500	18-6749	Mercury Marine	42419A1	717
18-6427	Yamaha	68V-81800-01-00	500	18-6749	Mercury Marine	58397A2	717
18-6428	Suzuki	31100-95313	Obsolete	18-6749	Mercury Marine	58397A3	717
18-6429	Suzuki	31100-94702	482	18-6749	Mercury Marine	862548A1	717
18-6430	Nissan/Tohatsu	B29A-90500A	Obsolete	18-6749	Mercury Marine	88553A1	717
18-6431	Nissan/Tohatsu	346760100M	Obsolete	18-6749	Mercury Marine	88893A4	717
18-6432	Nissan/Tohatsu	3C8760101M	477	18-6750	Mercury Marine	42419A1	717
18-6433	Honda	31200-ZV5-013	263	18-6750	Mercury Marine	862548A1	717
18-6434	OMC	386430	286	18-6751	Mercury Marine	811618	383
18-6435	Mercury Marine	50-859377T	392	18-6751	Mercury Marine	811618A1	383
18-6435	Mercury Marine	50-884044T	392	18-6751	Mercury Marine	812843A1	383
18-6435	Mercury Marine	50-888161T	392	18-6751	Mercury Marine	813442A1	383
18-6436	Mercury Marine	50-834749	392	18-6751	Mercury Marine	813442A2	383
18-6436	Mercury Marine	50-859171T	392	18-6751	Mercury Marine	893929A01	383
18-6437	Mercury Marine	50-830308T	392	18-6751	Mercury Marine	99660A1	383
18-6437	Mercury Marine	50-859169T	392	18-6752	Mercury Marine	14336A15	717
18-6437	Mercury Marine	50-888151T	392	18-6752	Mercury Marine	14336A17	717
18-6438	Mercury Marine	50-854636T	392	18-6752	Mercury Marine	14336A22	717
18-6438	Mercury Marine	50-859170T	392	18-6752	Mercury Marine	14336A28	717
18-6438	Mercury Marine	50-884045T	392	18-6752	Mercury Marine	14336A6	717
18-6438	Mercury Marine	50-888160T	392	18-6752	Mercury Marine	14336A9	717
18-6439	Chrysler Force	50-803903T	247	18-6752	Mercury Marine	88183A11	717
18-6439	Chrysler Force	50-F575955	247	18-6752	Mercury Marine	88183A12	717
18-6440	Mercury Marine	50-853329T	393	18-6752	Mercury Marine	88183A6	717
18-6440	Mercury Marine	50-892339T	393	18-6752	Mercury Marine	96477A3	717
18-6441	Chrysler Force	50-803900T	247	18-6753	Mercury Marine	14336A9	717
18-6441	Chrysler Force	50-F514955	247	18-6753	Mercury Marine	88183A12	717
18-64415	Yamaha	68F-W1135-00-00	550	18-6754	OMC	382138	889
18-6443	Pleasurecraft	RA122019	645	18-6754	Prestolite	ETK 4001	889
18-6445	Honda	31200-ZW9-802	263	18-6754	Prestolite	ETK 4101	889
18-6448			385, 477	18-6754	Prestolite	ETK 4102	889
18-6451	Indmar	575014	635	18-6755	OMC	982058	889

1 This product is priced per piece. To order, priced per package, please add -9 to the part number

2 Items ending in "D" are display packaged - regular number is non-display • 3 For discount shop pack of 10, please add -10 to the part number

SIERRA #	O.E.M.	O.E. #	PAGE #	SIERRA #	O.E.M.	O.E. #	PAGE #
SIERRA							
18-6755	OMC	982706	889	18-6777	Mercury Marine	855654T2	247
18-6755	Prestolite	EVD 4001	889	18-6778	Mercury Marine	883166A1	718
18-6755	Prestolite	EVD 4002	889	18-6778	Mercury Marine	883166A2	718
18-6756			282	18-6779	OMC	986280	889
18-6757			384	18-6779	OMC	3853945	889
18-6758	Electrolux	5024/120	966	18-6779	Volvo	986280	889
18-6758	Volvo	850834	966	18-6779	Volvo	3853945	889
18-6759	OMC	391264	282	18-6780	OMC	434496	282
18-6759	OMC	393988	282	18-6780	OMC	438529	282
18-6759	OMC	394176	282	18-6780	OMC	438531	282
18-6759	OMC	985237	282	18-6781	Yamaha	6H1-43880-02-00	503
18-6760	Yamaha	6G5-43880-02-00	503	18-6782	Yamaha	61A-43880-01-00	503
18-6761	OMC	387277	282	18-6782	Yamaha	61A-43880-02-00	503
18-6761	OMC	582048	282	18-6783	Yamaha	64E-43880-00-00	Obsolete
18-6761	OMC	582155	282	18-6783	Yamaha	64E-43880-01-00	Obsolete
18-6761	OMC	584107	282	18-6785	Suzuki	38100-87000-01T	Obsolete
18-6762	Chrysler Force	455541	247	18-6785	Suzuki	38100-87E10-0ED	Obsolete
18-6762	Chrysler Force	449541-3	247	18-6785	Suzuki	38100-87E20-0ED	Obsolete
18-6762	OMC	172543	247	18-6786-1	Suzuki	38100-87D10-0ED	483
18-6763	Mercury Marine	67914A2	384	18-6786-1	Suzuki	38100-87D10-01T	483
18-6763	Mercury Marine	79271A4	384	18-6786-1	Suzuki	38100-87D10-35J	483
18-6763	Mercury Marine	92975A32	384	18-6786-1	Suzuki	38100-92E00-0ED	483
18-6763	Mercury Marine	92975A6	384	18-6787	Yamaha	67F-43880-00-00	503
18-6764	OMC	982069	889	18-6788	Yamaha	6H5-43880-02-00	Obsolete
18-6764	OMC	982073	889	18-6789	Yamaha	62X-43880-09-00	503
18-6764	OMC	983318	889	18-6790	Electrolux	KS3448/290	966
18-6765	Mercury Marine	823653A5	384	18-6790	Volvo	839430	966
18-6765	Mercury Marine	823653A9	384	18-6791	Volvo	850046	966
18-6765	Mercury Marine	92459A4	384	18-6791	Volvo	852520	966
18-6767-1	OMC	172850	282	18-6792	Volvo	854329	966
18-6767-1	OMC	173564	282	18-6792	Volvo	897720	966
18-6767-1	OMC	173596	282	18-6793	Honda	36120-ZV5-822	263
18-6768	Mercury Marine	392-8261A1	718	18-6793	Suzuki	38100-87J11	263
18-6768	Mercury Marine	392-8263	718	18-6793	Suzuki	38100-87J20	263
18-6768	Mercury Marine	74436A9	718	18-6798	Yamaha	60V-43880-00-00	503
18-6768	Mercury Marine	79271A4	718	18-6798	Yamaha	69J-43880-01-00	503
18-6768	Mercury Marine	88475A4	718	18-6799	Mercury Marine	392-8261A1	718
18-6768	Mercury Marine	93247A7	718	18-6799	Mercury Marine	392-8263	718
18-6768	Mercury Marine	993247A4	718	18-6799	Mercury Marine	74436A9	718
18-6769-1	Mercury Marine	14336A8	718	18-6799	Mercury Marine	79271A4	718
18-6769-1	Mercury Marine	88183A5	718	18-6799	Mercury Marine	88475A4	718
18-6770	Volvo	854346	965	18-6799	Mercury Marine	93247A4	718
18-6771	Mercury Marine	17646	383, 718	18-6799	Mercury Marine	93247A7	718
18-6771	Mercury Marine	18525	383, 718	18-6801	OMC	5005114	Obsolete
18-6771	Mercury Marine	18525A1	383, 718	18-6802	OMC	5005113	Obsolete
18-6772	Mercury Marine	17649	718	18-6803	OMC	5005115	Obsolete
18-6772	Mercury Marine	17649T	718	18-6803	OMC	5007662	Obsolete
18-6772	Mercury Marine	891736T	718	18-6804	Volvo	3861575	965
18-6773	Mercury Marine	828708	384	18-6806	Volvo	3587079	965
18-6773	Mercury Marine	878265A4	384	18-6806	Volvo	3857489	965
18-6774	Mercury Marine	811628	384	18-6806	Volvo	3860879	965
18-6774	Mercury Marine	828708A1	384	18-6811	Yamaha	62X-43880-00-00	503
18-6774	Mercury Marine	878265A6	384	18-6811	Yamaha	62X-43880-01-00	503
18-6775	Chrysler Force	824051	247	18-6811	Yamaha	62Y-43880-11-00	503
18-6775	Mercury Marine	811673 1	247	18-6811	Yamaha	62Y-43880-00-00	503
18-6777	Chrysler Force	19217A1	247	18-6811	Yamaha	69W-43880-00-00	503
18-6777	Chrysler Force	19217A5	247	18-6812	Yamaha	62X-43880-00-00	503
18-6777	Chrysler Force	818903A1	247	18-6812	Yamaha	62X-43880-01-00	503
18-6777	Chrysler Force	819479A1	247	18-6812	Yamaha	62X-43880-09-00	503
18-6777	Chrysler Force	819480A1	247	18-6813	Mer cruiser	14336A15	718
18-6777	Chrysler Force	819762A4	247	18-6813	Mer cruiser	14336A20	718
18-6777	Chrysler Force	819762A7	247	18-6813	Mer cruiser	14336A6	718
18-6777	Chrysler Force	81977A8	247	18-6813	Mer cruiser	14336A8	718
18-6777	Chrysler Force	81977A9	247	18-6813	Mer cruiser	14336A9	718
18-6777	Chrysler Force	822870A1	247	18-6813	Mer cruiser	865380A13	718
18-6777	Chrysler Force	830250A3	247	18-6813	Mer cruiser	88183A12	718
18-6777	Chrysler Force	830250T3	247	18-6813	Mer cruiser	88183A5	718
18-6777	Chrysler Force	832021A1	247	18-6813	Mer cruiser	88183A8	718
18-6777	Chrysler Force	832021A2	247	18-6814	OMC	984356	889
18-6777	Chrysler Force	832021T2	247	18-6815	Johnson/Evinrude	5005831	282
18-6777	Chrysler Force	832021T4	247	18-6816	OMC	172588	282
18-6777	Chrysler Force	855654A1	247	18-6816	OMC	173944	282
18-6777	Chrysler Force	855654T2	247	18-6817	Volvo	3858071	965
18-6777	Mercury Marine	19217A1	247	18-6817	Volvo Penta	854525-3	965
18-6777	Mercury Marine	19217A5	247	18-6818	Power Pole	PUMP SPN-F	76
18-6777	Mercury Marine	818903A1	247	18-6819	Power Pole	PUMP PRO-F	76
18-6777	Mercury Marine	819479A1	247	18-6821	Yamaha	688-43880-11-00	504
18-6777	Mercury Marine	819480A1	247	18-6821	Yamaha	6E5-43880-01-00	504
18-6777	Mercury Marine	819762A4-A7	247	18-6821	Yamaha	6E5-43880-02-00	504
18-6777	Mercury Marine	81977A8-A9	247	18-6822	OMC	172543	965
18-6777	Mercury Marine	822870A1	247	18-6822	OMC	382715	965
18-6777	Mercury Marine	830250A3	247	18-6822	Volvo Penta	820545	965
18-6777	Mercury Marine	830250T3	247	18-6822	Volvo Penta	852928	965
18-6777	Mercury Marine	832021A1	247	18-6823	Universal		263, 282, 384, 477, 483, 504, 718, 889, 965
18-6777	Mercury Marine	832021A2	247	18-6824	Mer cruiser	50-60594A	394
18-6777	Mercury Marine	832021T2	247	18-6824	Mer cruiser	50-60594A1	394
18-6777	Mercury Marine	832021T4	247	18-6824	Mer cruiser	50-60594T01	394
18-6777	Mercury Marine	854472A2	247	18-6825	Mercury	50-86976	394
18-6777	Mercury Marine	854472A3	247	18-6826	Johnson/Evinrude	586768	288
18-6777	Mercury Marine	854472A4	247				
18-6777	Mercury Marine	855654A1	247				

1 This product is priced per piece. To order, priced per package, please add -9 to the part number
 2 Items ending in "D" are display packaged - regular number is non-display • 3 For discount shop pack of 10, please add -10 to the part number

SIERRA #	O.E.M.	O.E. #	PAGE #	SIERRA #	O.E.M.	O.E. #	PAGE #
SIERRA							
18-6827	Suzuki	31100-94600	482	18-6860	Sea-Doo		571
18-6827	Suzuki	31100-94601	482	18-6861	Hitachi	S114-559B	500
18-6827	Suzuki	31100-94610	482	18-6861	Yamaha	61A-81800-01-00	500
18-6828	Mercury	50-41583	394	18-6861	Yamaha	69L-81800-00-00	500
18-6829	Mercury	859168	394	18-6861	Yamaha	69W-81800-00	500
18-6829	Mercury	50-859168T	394	18-6862	Yamaha	64X-81800-00-00	571
18-6829	Mercury	50-852570	394	18-6862	Yamaha	6M6-81800-10-00	571
18-6829	Mercury	50-852570T	394	18-6863	OMC	584605, 586275	288
18-6829	Mercury	50-857065	394	18-6864	Mercury	50-819271	394
18-6829	Mercury	50-859168	394	18-6864	Mercury	50-820193A1	394
18-6829	Mercury	859168T	394	18-6866	Sea-Doo	278-000-576	571
18-6831	Hitachi	S114-837	482	18-6866	Sea-Doo	278-000-577	571
18-6831	Hitachi	S114-837A	482	18-6866	Sea-Doo	278-001-038	571
18-6831	Suzuki	31100-90J00	482	18-6866	Sea-Doo	278-001-301	571
18-6832	Yamaha	60V-81800-00-00	500	18-6867	Denso	228000-4550	571
18-6832	Yamaha	60X-81800-00-00	500	18-6867	Sea-Doo	278-000-484	571
18-6833	Yamaha	69J-81800-00-00	500	18-6867	Sea-Doo	278-000-485	571
18-6834	GM Engines		666	18-6867	Sea-Doo	278-001-300	571
18-6835	GM Engines		666	18-6867	Sea-Doo	278-001-935	571
18-6836	Yamaha	6C5-43880-00-00	504	18-6868	Denso	995435	571
18-6836	Yamaha	6C5-43880-01-00	504	18-6868	Denso	128000-4860	571
18-6838	Volvo	852928	965	18-6868	Denso	128000-4861	571
18-6838	Volvo	872449	965	18-6868	Denso	128000-4862	571
18-6838	Volvo	873051	965	18-6868	Denso	128000-4863	571
18-6838	Volvo	3586765	965	18-6868	Denso	128000-4864	571
18-6839	Volvo	1357199	962	18-6868	Sea-Doo	278-000-186	571
18-6839	Volvo	3523301	962	18-6868	Sea-Doo	278-000-311	571
18-6839	Volvo	5003564	962	18-6868	Sea-Doo	278-000-316	571
18-6839	Volvo	1357199-7	962	18-6869	Sea-Doo	278-001-497	571
18-6839	Volvo	3523301-4	962	18-6869	Sea-Doo	278-001-936	571
18-6839	Volvo	5003564-1	962	18-6870	Mercury	50-805833	679
18-6840	Mercury	50-897755T	392	18-6870	Mercury	50-805833T	679
18-6840	Mercury	897755T	392	18-6871	Sea-Doo	278-001-292	Obsolete
18-6841	Mer cruiser	56045	719	18-6872	Volvo	233991	679, 962
18-6841	Mer cruiser	59755	719	18-6872	Volvo	240501	679, 962
18-6841	Mer cruiser	69729	719	18-6872	Volvo	837924	679, 962
18-6841	Mer cruiser	78477	719	18-6872	Volvo	842775	679, 962
18-6841	Mer cruiser	90794	719	18-6872	Volvo	843511	679, 962
18-6841	Mer cruiser	78403A1	719	18-6872	Volvo	881681	679, 962
18-6841	Mer cruiser	78403A2	719	18-6872	Volvo	847306-8	679, 962
18-6841	OMC	983424	719	18-6873	Denso	428000-0081	571
18-6841	OMC	983836	719	18-6873	Kawasaki	21163-3715	571
18-6841	OMC	988247	719	18-6873	Kawasaki	21163-3719	571
18-6842	Mer cruiser	56045	666	18-6874	Sea-Doo	278-001-581	Obsolete
18-6842	Mer cruiser	59755	666	18-6875	Kawasaki PWC	21174-3703	571
18-6842	Mer cruiser	69729	666	18-6876	Sea-Doo	278-001-554	572
18-6842	Mer cruiser	78477	666	18-6877	Honda PWC	31200-HW1-671	571
18-6842	Mer cruiser	90794	666	18-6878	Sea-Doo	278-000-123	572
18-6842	Mer cruiser	78403A1	666	18-6879	Sea-Doo	278-001-239	572
18-6842	Mer cruiser	78403A2	666	18-6880	Hitachi	S114-257	679
18-6842	OMC	983247	666	18-6880	Hitachi	S114-257G	679
18-6842	OMC	983424	666	18-6880	Hitachi	S114-483	679
18-6842	OMC	983836	666	18-6880	Hitachi	S114-483A	679
18-6843	Mando	A000B0341	1004	18-6880	Yanmar	129573-77010	679
18-6843	Mando	TA000B0341	1004	18-6880	Yanmar	171008-77010	679
18-6843	Yamaha	19-1400-10	1004	18-6881	Prestolite	873051	965
18-6844	Denso	101211-3460	719	18-6881	Volvo	852928	965
18-6844	Mer cruiser	834832	719	18-6881	Volvo	872449	965
18-6844	Mer cruiser	834832T2	719	18-6904	Kawasaki	21163-3720	571
18-6844	Mer cruiser	857006A3	719	18-6904	Kawasaki	21163-3720	571
18-6845	Volvo	3862613	962	18-6905	Sea-Doo	290-888-993	571
18-6845	Volvo	3862665	962	18-6905	Sea-Doo	290-888-999	571
18-6845	Volvo	3884950	962	18-6905	Sea-Doo	420-888-9933	571
18-6846	Volvo Penta	72021	678	18-6905	Sea-Doo	420-888-994	571
18-6846	Volvo Penta	845940	678	18-6905	Sea-Doo	420-888-996	571
18-6846	Volvo Penta	872022	678	18-6906	Yamaha PWC	64X-81800-00-00	571
18-6846	Volvo Penta	872757	678	18-6907	Yamaha PWC	6D3-81800-00-00	571
18-6846	Volvo Penta	873635	678	18-6908	Yamaha PWC	63M-81800-00-00	571
18-6846	Volvo Penta	873757	678	18-6909	Yamaha PWC	6S5-81800-00-00	571
18-6846	Volvo Penta	1502272	678	18-6919	Arctic Cat PWC	3008-093	572
18-6846	Volvo Penta	5001677	678	18-6919	Arctic Cat PWC	3008-327	572
18-6846	Volvo Penta	3803270-2	678	18-6919	Arctic Cat PWC	3008-462	572
18-6846	Volvo Penta	873757-9	678	18-6919	Arctic Cat PWC	3008-536	572
18-6846	Volvo Penta	873771,	678	18-6921	Yamaha PWC	60E-81800-00-00	572
18-6847	Volvo	2655301	963	18-6925	Hitachi	LR135-105	678
18-6847	Volvo	3862613	963	18-6925	Yanmar	128270-77200	678
18-6848	Valeo	A0002655299	963	18-6926	Yanmar	119836-77200	678
18-6848	Volvo	2656299	963	18-6926	Yanmar	119836-77200-2	678
18-6848	Volvo	3862612	963	18-6926	Yanmar	119836-77200-3	678
18-6849	Denso	101211-9940	678	18-6926	Yanmar	129612-77230	678
18-6849	Yanmar	119773-77200	678	18-6927	Yanmar	119573-77200	678
18-6851	Universal	Universal	72	18-6927	Yanmar	119573-77201	678
18-6852	Universal	Universal	72	18-6927	Yanmar	129470-77200	678
18-6853	Universal	Universal	Obsolete	18-6928	Hitachi	LR135-74	678
18-6854	Universal	Universal	72	18-6928	Hitachi	LR135-74B	678
18-6855	Universal	Universal	72	18-6928	Yanmar	128170-77200	678
18-6856	Universal	Universal	72	18-6928	Yanmar	128170-77201	678
18-6857	Yamaha PWC	63M-81960-00-00	572	18-6928	Yanmar	128170-77202	678
18-6858	Yamaha PWC	6H2-81960-00-00	Obsolete	18-6929	Hitachi	129470-77200	678
18-6859	Sea-Doo	278-001-376	571	18-6929	Hitachi	LR180-03A	678
18-6859	Sea-Doo	278-001-802	571	18-6929	Hitachi	LR180-03B	678

1 This product is priced per piece. To order, priced per package, please add -9 to the part number

2 Items ending in "D" are display packaged - regular number is non-display • 3 For discount shop pack of 10, please add -10 to the part number

SIERRA #	O.E.M.	O.E. #	PAGE #	SIERRA #	O.E.M.	O.E. #	PAGE #
SIERRA							
18-6929	Hitachi	LR180-03C	678	18-6955	Prestolite	110-258A	678
18-6929	Yanmar	119573-77200	678	18-6955	Volvo	849748-9	678
18-6929	Yanmar	119573-77201	678	18-69550	Volvo	3854164	964
18-6930	Yanmar	104211-77010	679	18-6956	Volvo	6209190	962
18-6930	Yanmar	104211-77011	679	18-6957	Mer cruiser	50-801333980	679
18-6931	Yanmar	119209-77010	679	18-6957	Mer cruiser	50-854178	679
18-6931	Yanmar	121120-77010	679	18-6957	Mer cruiser	50-855507	679
18-6931	Yanmar	121120-77011	679	18-6958	Volvo	870998	679, 962
18-6931	Yanmar	121120-77012	679	18-6958	Volvo	881682	679, 962
18-6931	Yanmar	124520-77010	679	18-6958	Volvo	847308-4	679, 962
18-6931	Yanmar	124520-77011	679	18-6959	Honda	31200-ZY6-003	263
18-6932	Yanmar	121370-77010	679	18-6959	Honda	31200-ZY9-003	263
18-6932	Yanmar	129242-77010	679	18-6959	Honda	31200-ZY9A-0031	263
18-6932	Yanmar	129698-77010	679	18-6960	Denso	101211-3020	719
18-6934	Hitachi	S13-68	679	18-6960	Denso	101211-3021	719
18-6934	Hitachi	S13-68A	679	18-6960	Mer cruiser	821663	719
18-6934	Hitachi	S13-68C	679	18-6960	Mer cruiser	8216631	719
18-6934	Hitachi	S13-86	679	18-6960	Mer cruiser	821663A1	719
18-6934	Yanmar	123500-77010	679	18-6961	Yamaha	6CB-81800-00-00	500
18-6934	Yanmar	124610-77010	679	18-6970	Yanmar	129470-77200	Obsolete
18-6934	Yanmar	124610-77019	679	18-6971	Yanmar		678
18-6934	Yanmar	424610-77010	679	18-6975	Universal		666, 719, 963
18-6935	Yanmar	119225-77010	679	18-7000	Volvo	841292	966
18-6935	Yanmar	119225-77011	679	18-7000	Volvo	856471	966
18-6935	Yanmar	119226-77010	679	18-7000	Volvo	856472	966
18-6936	Yanmar	114361-77011	679	18-7000	Volvo	841836-0	966
18-6936	Yanmar	114362-77010	679	18-7001	Volvo	841293-4	966
18-6936	Yanmar	114362-77011	679	18-7002	Yamaha	6E5-W0093-06-00	505
18-6936	Yanmar	114399-77010	679	18-70021			903
18-6937	Hitachi	S114-303	679	18-7004	Mercury Marine	1395-6200	397
18-6937	Hitachi	S114-303A	679	18-7005	Mercury Marine	1395-6452	397
18-6937	Yanmar	128170-77010	679	18-700-5500			108
18-6937	Yanmar	128170-77010D	679	18-7006-1	Mercury Marine	879194024	397
18-6938	Yanmar	119773-77010	679	18-7006-1	Mercury Marine	1395-4808	397
18-6939	Yanmar	121254-77010	679	18-7006-1	Mercury Marine	1395-879194024	397
18-6939	Yanmar	121254-77011	679	18-7006-1	Mercury Marine	1399-1717	397
18-6939	Yanmar	121254-77012	679	18-7006-1	Mercury Marine	1399-2015	397
18-6939	Yanmar	121254-77019	679	18-7006-1	Mercury Marine	1399-3523	397
18-6939	Yanmar	129429-77010	679	18-700-6250			108
18-6939	Yanmar	129429-77011	679	18-700-6500			Obsolete
18-6940	Mercury	50-825991A2	394	18-700-6750			108
18-6941	Suzuki	31100-93J00	482	18-7007	Mercury Marine	1399-5135	397
18-6941	Suzuki	31100-96J00	482	18-7007	Mercury Marine	1399-5198	397
18-6941	Suzuki	31100-96J01	482	18-700-7000			108
18-6942	Hitachi	S114-682	500	18-700-7250			Obsolete
18-6942	Yamaha	69W-81800-00-00	500	18-700-7500			Obsolete
18-6943	Mercury	50-893894	394	18-700-7750			108
18-6943	Yamaha	66M-81800-01-00	394	18-7008			Obsolete
18-6943	Yamaha	66M-81800-02-00	394	18-700-8000			Obsolete
18-6944	Bosch	0-001-109-035	679	18-700-8250			108
18-6944	Caterpillar	163-3361	679	18-700-8500			108
18-6944	Perkins	185086600	679	18-700-9000A			Obsolete
18-6944	Volvo	3583555	679	18-700-9250			108
18-6944	Volvo	21323043	679	18-700-9500			108
18-6945	Johnson	5036972	284	18-7010	OMC	382050	289
18-6945	Suzuki	31100-95J00	284	18-7010	OMC	382051	289
18-6945	Suzuki	31100-95J01	284	18-7010	OMC	382054	289
18-6946	Mer cruiser	50-8M8021116	715	18-7013			397
18-6947	Mer cruiser	50-805991	679	18-7017	OMC	985052	647
18-6948	Mercury	882571	719	18-7017	Pleasurecraft	RN0118-1	647
18-6948	Mercury	8M0084523	719	18-7017	Pleasurecraft	RN0120-1	647
18-6949	Mer cruiser	50-831001562	679	18-7019			586, 618
18-6949	Mer cruiser	50-831001961	679	18-7021			397
1 18-6950	OMC	982019	889	18-7022			586, 618
1 18-6951	Volvo	851120	965	18-7023			179, 586, 587
18-6952	Cummins	214169	678	18-7024	OMC	382052	289
18-6952	Cummins	3920618	678	18-7024	OMC	382053	289
18-6952	Cummins	3603853RX	678	18-7024	OMC	385356	289
18-6952	Delco	1100077	678	18-7025			179, 586, 587
18-6952	Delco	1100093	678	18-7033	Chrysler Force	FK10003	248
18-6952	Delco	1100211	678	18-7033	Chrysler Force	FK10026	248
18-6952	Delco	1100274	678	18-7033	Chrysler Force	FK10053	248
18-6952	Delco	1105474	678	18-7033	Chrysler Force	FK10102-1	248
18-6952	Delco	1105475	678	18-7037	Chrysler Force	FK10004	248
18-6952	Delco	1105476	678	18-7037	Chrysler Force	FK10005	248
18-6952	Delco	10459244	678	18-7037	Chrysler Force	FK10007	248
18-6953	Volvo	3803645	678	18-7037	Chrysler Force	FK10008	248
18-6953	Volvo	8602629	678	18-7037	Chrysler Force	FK10027	248
18-6953	Volvo	8602710	678	18-7037	Chrysler Force	FK10057	248
18-6953	Volvo	8602714	678	18-7037	Chrysler Force	FK10108	248
18-6953	Volvo	8676496	678	18-7037	Chrysler Force	FRK739	248
18-6953	Volvo	8676498	678	18-7093	OMC	379312	290
18-6953	Volvo	8676499	678	18-7093	OMC	387262	290
18-6954	Mercury	50-831001671	679	18-7093	OMC	396520	290
18-6954	Mercury	50-831001672	679	18-7039			179
18-6954	Mercury	50-831002050	679	18-7040			966
18-6954	Mercury	50-831002051	679	18-7041	Chrysler Force	FO10790	248
18-6954	Mercury	50-831002052	679	18-7041	Chrysler Force	FO16311	248
18-6955	Caterpillar	3001117	678	18-7042	OMC	392061	289
18-6955	Caterpillar	10-258	678	18-7042	OMC	396701	289
18-6955	Prestolite	110-258	678				

1 This product is priced per piece. To order, priced per package, please add -9 to the part number
 2 Items ending in "D" are display packaged - regular number is non-display • 3 For discount shop pack of 10, please add -10 to the part number

SIERRA #	O.E.M.	O.E. #	PAGE #	SIERRA #	O.E.M.	O.E. #	PAGE #
SIERRA							
18-7042	OMC	398729	289	18-7078	Mercury Marine	1397-2133	Obsolete
18-7043	OMC	382045	289	18-7078	Mercury Marine	1397-2605	Obsolete
18-7043	OMC	382046	289	18-7078	Mercury Marine	1397-3462	Obsolete
18-7043	OMC	382047	289	18-7078			Obsolete
18-7043	OMC	382049	289	18-7079	Yamaha	626-14390-90	506
18-7043	OMC	383052	289	18-7080	Mercury Marine	1346-2770	736
18-7043	OMC	383067	289	18-7080	Mercury Marine	1398-3089	736
18-7043	OMC	398532	289	18-7080	OMC	979719	736
18-7043	OMC	439071	289	18-7081	Mercury Marine	1396-4656	891
18-7044-1		175158+437228	290	18-7081	OMC	982537	891
18-7046	OMC	390055	289	18-7081	OMC	983538	891
18-7046	OMC	392550	289	18-7081	Pleasurecraft	RN0116	891
18-7046	OMC	398526	289	18-7081	Pleasurecraft	RN0116-2	891
18-7046	OMC	434888	289	18-7083	Mercury	684311	407
18-7046	OMC	435443	289	18-7083	Mercury	816877	407
18-7046	OMC	439076	289	18-7083	Mercury	858763	407
18-7047	Honda	16011-ZV4-005	265	18-7083	Mercury	8168771	407
18-7048	Honda	16011-881-741	265	18-7083	Mercury	8168772	407
18-7049	Yamaha	61N-14392-00-00	506	18-7083	Mercury	8168773	407
18-7049	Yamaha	62Y-14392-00-00	506	18-7085	Volvo	875407	966
18-7049	Yamaha	6L2-14392-00-00	506	18-7086	OMC	984487	618, 891, 967
18-7050	Honda		265	18-7086	Volvo	841994	618, 891, 967
18-7051	Honda		265	18-7086			618, 891, 967
18-7052	Honda		265	18-7089			179, 597
18-7053	Honda		265	18-7091			179, 597
18-7054	Yamaha	6G1-14546-00-00	506	18-70924			771, 904, 976
18-7054	Yamaha	6G1-14546-01-00	506	18-70925	Mercury Marine	32-16021	769, 770
18-7055	Yamaha	6E5-14546-00-00	506	18-70925	Mercury Marine	32-160211	769, 770
18-7055	Yamaha	6J8-14546-00-00	506	18-70925	Mercury Marine	32-87116	769, 770
18-7056	Yamaha	67F-1439A-00-00	506	18-70926	Mercury Marine	32-73796	Obsolete
18-7056	Yamaha	6H2-14591-00-00	506	18-70927	Mercury Marine	32-73795	769
18-7056	Yamaha	6H3-14590-00-00	506	18-70928	Mercury Marine	32-71613	770
18-7056	Yamaha	6H3-14590-01-00	506	18-70929	Mercury Marine	32-73794	Obsolete
18-7057	Chrysler Force	F010790	399	18-7093	OMC	378895	290
18-7057	Mercury Marine	1395-9258	399	18-7093	OMC	396521	290
18-7057	Mercury Marine	1395-9258 1	399	18-7093	OMC	678882	290
18-7057	Mercury Marine	1399-1138	399	18-70930	Mercury Marine	32-52481	769
18-7057	Mercury Marine	1399-1473	399	18-70931	Mercury Marine	32-47640	769
18-7058	Yamaha	63V-W0093-00-00	504	18-70931	Mercury Marine	32-8M0071007	769
18-7059	Yamaha	677-W0093-00-00	504	18-70931	Mercury Marine	32-96879	769
18-7059	Yamaha	677-W0093-04-00	504	18-70932	Mercury Marine	32-87117	769
18-7060	Yamaha	692-14590-00-00	506	18-70932	Mercury Marine	32-871171	769
18-7060	Yamaha	692-14590-01-00	506	18-70934	Mercury Marine	32-897181	768
18-7061	Mercury Marine	1395-8318	399	18-70935	Mercury Marine	32-806856	768
18-7061	Mercury Marine	1395-83181	399	18-70936	OMC	321724	323
18-7062	Mercury Marine	1395-95951	399	18-70936	OMC	340975	323
18-7063	Yamaha	6L2-14385-00-00	506	18-70937	OMC	340976	323
18-7064	Yamaha	63V-14985-00	507	18-70938	Mercury Marine	32-8066351	768
18-7065	Yamaha	647-14385-00-00	507	18-70939	Mercury Marine	32-8066361	768
18-7066	Yamaha	648-14385-00-00	507	18-7094	OMC	379313	290
18-7067	Yamaha	6G1-14985-00-00	507	18-7094	OMC	396522	290
18-7068	Yamaha	6E5-14385-00-00	507	18-70940	Mercury Marine	32-860144	768, 770
18-7068	Yamaha	6E5-14385-01-00	507	18-70943	Mercury Marine	32-897491	768
18-7069	Yamaha	6E5-14385-02-00	507	18-70945	Mercury Marine	32-862139	767
18-7070	Mercury Marine	1397-2072	586	18-70946	Mercury Marine	32-8066362	768
18-7070	Mercury Marine	1397-2637	586	18-70947	Mercury Marine	32-862124	767
18-7070	Mercury Marine	1397-3464	586	18-70948	Mercury Marine	32-808033	767
18-7070	Mercury Marine	1397-7542	586	18-70949	Mercury Marine	32-807407	767
18-7070	Mercury Marine	1397-7543	586	18-7095	Crusader	45334	736
18-7070	Mercury Marine	1397-8872	586	18-7095	Mercury Marine	1397-7539	736
18-7070	OMC	383615	586	18-7095	Mercury Marine	1397-7540	736
18-7070	OMC	982384	586	18-7095	Mercury Marine	1397-7544	736
18-7070			586	18-7095	Mercury Marine	1397-8535	736
18-70704	Mercury Marine	32-89653	770	18-7095	Mercury Marine	1397-9723	736
18-70704	Volvo	838513	770	18-7095	OMC	383918	736
18-70704	Volvo	856306	770	18-7095	OMC	983864	736
18-70704			770	18-7095	Volvo	834985-4	736
18-7071	Mercury Marine	1397-3458	655	18-7095			736
18-7071	OMC	380186	655	18-70951	Mercury Marine	32-8078961	767
18-7071			655	18-70951	Mercury Marine	32-8078962	767
18-7072	Mercury Marine	1397-3306	736	18-70951	Mercury Marine	32-860205	767
18-7072	Mercury Marine	1397-4329	736	18-70952	Mercury Marine	32-887952	767
18-7072	Mercury Marine	1397-5635	736	18-70953	Mercury Marine	32-8080441	767
18-7072	Mercury Marine	1397-6638	736	18-70954	Mercury Marine	32-860089	767
18-7072	Mercury Marine	823426A1	736	18-70954	Mercury Marine	32-8600891	767
18-7072	OMC	384743	736	18-70955	Mercury Marine	32-16011	767
18-7072	OMC	979659	736	18-70956	Mercury Marine	32-16012	767
18-7072	Volvo	855889	736	18-70958	Mercury Marine	32-96246	768
18-7072			736	18-70958	Mercury Marine	32-96246A1	768
18-7073	Yamaha	6E7-14390-12-00	506	18-70958	Mercury Marine	32-96246A4	768
18-7073	Yamaha	6E8-14380-12-00	506	18-7096	Mercury Marine	1356-4066	647
18-7075	Mercury Marine	1397-5830	735	18-7096	Mercury Marine	1356-4092	647
18-7075	Mercury Marine	1397-5831	735	18-7096	Mercury Marine	1356-5155	647
18-7075	Mercury Marine	1397-7099	735	18-7096	Mercury Marine	1356-5169	647
18-7075	Mercury Marine	1397-8760	735	18-7096	Mercury Marine	1396-5222	647
18-7076	Mercury Marine	1397-6367	736	18-7096	Mercury Marine	1396-5238	647
18-7076	Mercury Marine	1397-6367A1	736	18-7096	OMC	982539	647
18-7077	Mercury Marine	1397-8952	736	18-7096	OMC	85R-4541	647
18-7077	Mercury Marine	823426A1	736	18-7096	Pleasurecraft	RN0118	647
18-7078	Mercury Marine	1337-2103	Obsolete	18-7096	Pleasurecraft	RN0120	647
18-7078	Mercury Marine	1337-2604	Obsolete	18-7097	Mercury Marine	3302-804845	736

1 This product is priced per piece. To order, priced per package, please add -9 to the part number

2 Items ending in "D" are display packaged - regular number is non-display • 3 For discount shop pack of 10, please add -10 to the part number

SIERRA #	O.E.M.	O.E. #	PAGE #	SIERRA #	O.E.M.	O.E. #	PAGE #
SIERRA							
18-7097	Mercury Marine	3302-9437	736	18-7127	Chrysler Force	25-32507	261
18-7098-1	Mercury Marine	3302-804844	736	18-7127	Chrysler Force	25-F84305	261
18-7098-1	Mercury Marine	3302-804844001	736	18-7127	Chrysler Force	F83404	261
18-7098-1	Mercury Marine	3302-804844002	736	18-7127	Mercury Marine	25-32507	261
18-7099	Volvo	824803	967	18-7127	Mercury Marine	25-F84305	261
18-7099	Volvo	856470	967	18-7127	OMC	313446	261
1 18-7100	Chrysler Force	25-85594	258	18-7128	OMC	313754	370
1 18-7100	Mercury Marine	25-85594	258	1 18-7129	OMC	314491	370
1 18-7100	OMC	301877	258	18-7130	OMC	314728	370
18-710-06-2			126	1 18-7133	OMC	305123	370
18-710-08-2			126	1 18-7133	OMC	322119	370
1 18-7101	OMC	305739	370	18-71330	Yamaha	93210-05001	527
18-710-10-2			126	18-71331	Yamaha	93210-44704	Obsolete
18-710-104-2			126	18-71332	Yamaha	93210-45161	Obsolete
18-710-12-2			126	18-71333	Yamaha	93210-49046	526
18-710-16-2			126	18-71334	Yamaha	93210-59MG7	526
1 18-7102	Mercury Marine	25-62706	1003	18-71335	Honda	91301-ZG3-000	Obsolete
1 18-7102	OMC	307450	1003	18-71336	Johnson/Evinrude	302035	306, 307
1 18-7102	Volvo	3852073	1003	18-71337	Mercury Marine	32-806825	770
18-710-20-2			126	18-71337	Mercury Marine	32-861590A05	770
18-710-24-2			126	18-71337	Mercury Marine	32-861590A1	770
18-710-28-2			126	18-71337	Mercury Marine	32-861590A2	770
1 18-7103	Mercury Marine	25-29845	370	18-71337	OMC	312781	770
1 18-7103	OMC	308624	370	18-71337			770
18-710-32-2			126	18-71338	Johnson/Evinrude	346865	306
18-710-36-2			126	18-71340	Johnson/Evinrude	342370	307
1 18-7104	OMC	308627	943	1 18-7134	Chrysler Force	25-20195	261
18-710-40-2			126	1 18-7134	Chrysler Force	25-201951	261
18-710-44-2			126	1 18-7134	Mercury Marine	25-20195	261
18-710-48-2	Mercury Marine	54-32533	849	1 18-7134	Mercury Marine	25-201951	261
18-710-48-2	Mercury Marine	54-815504348	849	1 18-7134	OMC	303059	261
18-710-48-2	Volvo	3852604	849	18-7135	Mercury Marine	25-20365	1003
18-710-48-2			849	18-7135	Mercury Marine	25-35276	1003
1 18-7105	Mercury Marine	25-62705	943	18-7135	OMC	310584	1003
1 18-7105	Mercury Marine	25-F7848342	943	18-7135	Volvo	3852089	1003
1 18-7105	OMC	311338	943	1 18-7137	OMC	318372	370
18-710-52-2			126	1 18-7138	OMC	318717	370
18-710-56-2			126	1 18-7139	OMC	319085	370
1 18-7106	OMC	307583	290	1 18-7140	OMC	320303	370
18-710-60-2			126	1 18-7140	Suzuki	09280-75002	370
18-710-64-2	Volvo	853012	998	1 18-7141	OMC	321117	1003
18-710-64-2			998	1 18-7141	Volvo	3852165	1003
1 18-7107	Mercury Marine	25-67202	370	1 18-7142	OMC	322119	370
1 18-7107	OMC	313175	370	1 18-7143	Mercury Marine	25-65936	943
18-710-72-2	Mercury Marine	54-31765	126	1 18-7143	Mercury Marine	27-58025	943
18-710-72-2	OMC		126	1 18-7143	Mercury Marine	391-5081	943
1 18-710-72-2			126	1 18-7143	OMC	322501	943
1 18-7108	OMC	313893	943	1 18-7143	OMC	331188	943
18-7108	OMC	338518	943	1 18-7143	Volvo	3852169	943
18-710-80-2			126	1 18-7144	OMC	326849	943
1 18-710-88-2			126	1 18-7145	Mercury Marine	25-64068	943
18-7109	OMC	317178	943	1 18-7145	OMC	333572	943
1 18-710-96-2			126	1 18-7146	Mercury Marine	25-47632	943
18-7110	OMC	335523	328	1 18-7146	OMC	554545	943
18-71102	OMC		357	18-7147-9	Volvo	949658-9	1003
18-7111	OMC	301824	370, 943, 1003	1 18-7149	Volvo	955989	1003
18-7112	OMC	302493	943	1 18-7150	OMC	303598	370
18-7113-9	Mercury Marine	25-897536	411	1 18-7150	OMC	331380	370
18-7113-9	Mercury Marine	25-98277	411	1 18-7150	OMC	334913	370
1 18-7114	Mercury Marine	25-23145	943	1 18-7151	Mercury Marine	25-20081	470
1 18-7114	Mercury Marine	25-843315	943	1 18-7151	Mercury Marine	25-39572	470
1 18-7114	Mercury Marine	25-F702736	943	1 18-7152	Mercury Marine	25-20863	370
1 18-7114	OMC	302540	943	1 18-7152	OMC	307082	370
18-7115	Mercury Marine	25-26722	943	1 18-7153	Mercury Marine	25-20679	370
18-7115	OMC	302588	943	1 18-7153	Mercury Marine	25-25439	370
18-7116	Mercury Marine	802206	943	1 18-7153	Mercury Marine	25-F53795-1	370
18-7116	Mercury Marine	25-20633	943	1 18-7153	Mercury Marine	F53795	370
18-7116	Mercury Marine	25-22174	943	1 18-7153	OMC	911851	370
18-7116	Mercury Marine	25-62704	943	1 18-7153	OMC	3852565	370
18-7116	Mercury Marine	25-85148	943	18-7154	Volvo	949656	1003
18-7116	Mercury Marine	25-F24342	943	1 18-7155	Mercury Marine	25-26855	370
18-7116	OMC	303067	943	1 18-7155	OMC	305270	370
18-7116	Volvo	3852045	943	1 18-7156	Mercury Marine	25-29439	370
18-7117	Mercury Marine	25-35027	943	1 18-7156	OMC	309731	370
18-7117	OMC	303360	943	1 18-7157	Mercury Marine	25-29976	470
1 18-7118	OMC	305242	943	1 18-7158	Mercury Marine	25-30613	370
18-7120	Mercury Marine	25-38933	943	1 18-7158	Mercury Marine	25-846357	370
18-7120	OMC	307853	943	1 18-7158	OMC	310585	370
18-7120	OMC	332598	943	1 18-7158	OMC	310967	370
18-7121	Mercury Marine	802231	943	1 18-7159	Mercury Marine	25-31534	470
18-7121	Mercury Marine	25-35029	943	1 18-7159	Mercury Marine	25-48451	470
18-7121	Mercury Marine	25-882613	943	1 18-7160	Mercury Marine	25-31986	470
18-7121	OMC	308621	943	1 18-7161	Mercury Marine	25-32546	470
18-71218	Mercury Marine	32-48131	770	1 18-7162	Mercury Marine	25-32424	1003
18-71218	Mercury Marine	32-48132	770	1 18-7162	Mercury Marine	25-33145	1003
18-71218			770	1 18-7162	OMC	302337	1003
18-7122	Volvo	925095	1003	1 18-7162	Volvo	3852044	1003
18-7123	OMC	308876	370	1 18-7163	Mercury Marine	25-33465	470
18-7124			470	1 18-7163	Mercury Marine	25-807149	470
18-7125			470	1 18-7163	Mercury Marine	25-853220	470
18-7126	OMC	313340	370	1 18-7164	Mercury Marine	25-33466	370

1 This product is priced per piece. To order, priced per package, please add -9 to the part number
 2 Items ending in "D" are display packaged - regular number is non-display • 3 For discount shop pack of 10, please add -10 to the part number

SIERRA #	O.E.M.	O.E. #	PAGE #	SIERRA #	O.E.M.	O.E. #	PAGE #
SIERRA							
1 18-7164	Mercury Marine	25-33466	370	18-7212	Mercury Marine	1395-9179	399
1 18-7164	Mercury Marine	25-67675	370	18-7212	Mercury Marine	1395-9377	399
1 18-7164	Mercury Marine	25-846356	370	18-7212	Mercury Marine	1395-9645	399
1 18-7164	OMC	302537	370	18-7212	Mercury Marine	1395-9725	399
1 18-7165	Mercury Marine	25-32509	943	18-7212	Mercury Marine	1395-9761	399
1 18-7165	Mercury Marine	25-806609	943	18-7212	Mercury Marine	1395-97611	399
1 18-7165	Mercury Marine	25-F461342	943	18-7212	Mercury Marine	1395-9803	399
1 18-7165	OMC	304174	943	18-7213	Mercury Marine	8107492	397
1 18-7166	Mercury Marine	25-45254	470	18-7214	Mercury Marine	8107493	397
1 18-7167	Mercury Marine	25-861844	943	18-7215	Mercury Marine	1395-9024	397
1 18-7167	OMC	310414	943	18-7219	OMC	431897	289
1 18-7168	Mercury Marine	25-20587	1003	18-7219	OMC	439073	289
1 18-7168	Mercury Marine	25-21720	1003	18-7221	OMC	435442	289
1 18-7168	Mercury Marine	25-26834	1003	18-7222	OMC	392061	289
1 18-7168	Mercury Marine	25-48171	1003	18-7222	OMC	396701	289
1 18-7168	Mercury Marine	25-801334436	1003	18-7222	OMC	398729	289
1 18-7168	OMC	202893	1003	18-7223	OMC	391305	289
1 18-7168	Volvo	3852033	1003	18-7223	OMC	391937	289
1 18-7169	Chrysler Force	25-F24278	261	18-7223	OMC	398452	289
1 18-7169	Mercury Marine	25-35984	261	18-7223	OMC	398453	289
1 18-7169	Mercury Marine	25-70937	261	18-7223	OMC	439072	289
1 18-7169	OMC	911686	261	18-7226	Mercury Marine	1395-9650	397
1 18-7170	Mercury Marine	25-33504	370	18-7227	Mercury Marine	1396-4148	Obsolete
1 18-7170	OMC	307239	370	18-7227	Pleasurecraft	RN0067	Obsolete
1 18-7171	Mercury Marine	25-30529	470	18-7228	Mercury Marine	85784A1	740
1 18-7172	Mercury Marine	25-31305	370	18-7229	Mercury Marine	85785-2	740
1 18-7172	OMC	553126	370	18-7229	Mercury Marine	85785T	740
1 18-7173	Mercury Marine	25-27018	370	18-7229	OMC	981566	740
1 18-7173	Mercury Marine	25-30224	370	18-7229	OMC	986865	740
1 18-7173	OMC	310327	370	18-7229	Volvo	3854026	740
1 18-7174	Mercury Marine	25-45711	870	18-7230	Chrysler Inboard	4142886	740
1 18-7174	Mercury Marine	25-F455342	870	18-7230	Mercury Marine	41639	740
1 18-7174	OMC	326649	870	18-7230	Mercury Marine	41639A1	740
1 18-7174	OMC	910582	870	18-7231	Crusader	97214	740
1 18-7175	Mercury Marine	25-62817	470	18-7231	Crusader	97595	740
1 18-7176	Chrysler Force	25-F74305	261	18-7231	Mercury Marine	85785A2	740
1 18-7176	Mercury Marine	25-896523	261	18-7232	Crusader	33628	619
1 18-7176	Mercury Marine	25-F74305	261	18-7232	Mercury Marine	57882	619
1 18-7176	Mercury Marine	F694555	261	18-7232	Mercury Marine	57882T	619
1 18-7176	Mercury Marine	F74305	261	18-7233	Mercury Marine	1395-7824	399
1 18-7176	Mercury Marine	F74305-1	261	18-7234	Mercury Marine	805016A1	740
1 18-7177	Mercury Marine	25-53421	470	18-7235	OMC	986783	892
1 18-7177	Mercury Marine	25-59712	470	18-7236	OMC	986782	891
1 18-7178	OMC	320140	1003	18-7237	OMC	986784	892
1 18-7178	Volvo	125017	1003	18-7237	OMC	986799	892
1 18-7179	Volvo	925054	1003	18-7237	OMC	986799	892
1 18-7180	Mercury Marine	12-31060	1003	18-7238	OMC	986796	892
1 18-7180	Mercury Marine	25-26802	1003	18-7238	Volvo	3854020	892
1 18-7180	Mercury Marine	25-8M2000926	1003	18-7239	OMC	986800	892
1 18-7180	OMC	303347	1003	18-7241	OMC	986804	892
1 18-7180	Volvo	925055	1003	18-7241	Volvo	3855017	892
1 18-7181	Volvo	925091	1003	18-7242	OMC	987313	892
1 18-7181	Volvo	975672	1003	18-7242	Volvo	3854105	892
1 18-7182	Volvo	925092	493	18-7243	OMC	987315	892
1 18-7183	Volvo	925093	493	18-7244	OMC	987317	892
1 18-7184	Volvo	925256	1003	18-7244	Volvo	3854106	892
1 18-7186	Volvo	925259	1003	18-7245	OMC	987319	892
1 18-7187	Volvo	925261	1003	18-7245	Volvo	3854107	892
1 18-7188	Mercury Marine	25-805726	1003	18-7246	OMC	987438	892
1 18-7188	Volvo	955983	1003	18-7246	OMC	987440	892
1 18-7190	Volvo	925065	1003	18-7246	OMC	987485	892
1 18-7192	Volvo	955995	1003	18-7246	Volvo	3854116	892
1 18-7193	Volvo	955974	1003	18-7247	OMC	435442	290
1 18-7194	Volvo	956000	1003	18-7247	OMC	438996	290
1 18-7195	Mercury Marine	25-8M0027717	870	18-7248	OMC	435676	290
1 18-7198	Honda	91353-ZW1-003	272	18-7248	OMC	435677	290
1 18-7198	Mercury Marine	25-45710	272	18-7248	OMC	435678	290
1 18-7198	OMC	308626	272	18-7248	OMC	435752	290
18-7200	Crusader	45303	737	18-7248	OMC	437327	290
18-7200	Mercury Marine	1397-2060	737	18-7248	OMC	439078	290
18-7200	OMC	381389	737	18-7248	OMC	439079	290
18-7200	Volvo	841634-9	737	18-7249	Mercury Marine	19273	399
18-7200			737	18-7250			859
18-72000	Mercury Marine	1395-9594	399	18-725-2000			126
18-72005			858	18-7254	Chrysler Force	3745414	598
18-7201	Mercury Marine	1397-3327	737	18-7254	Chrysler Inboard	3745414	598
18-7201	Mercury Marine	1397-8546	737	18-725-4000			Obsolete
18-7201	Mercury Marine	1397-8959	737	18-7255	Chrysler Force	3745415	598
18-7201	OMC	383087	737	18-7255	Chrysler Inboard	3745415	598
18-7201	OMC	983871	737	18-7256	Crusader	32722	619
18-7201			737	18-7256	Mercury Marine	32722	619
18-7202	Mercury Marine	1397-5837	737	18-7256			619
18-7202	Mercury Marine	3302-9031	737	18-7258	GM	6414989	894
18-7202			737	18-7258	OMC	380986	894
18-7208	Mercury Marine	1395-8673	399	18-7260			171, 173, 587, 619
18-7208	Mercury Marine	1395-8983	399	18-7264	Chrysler Force	1736073	Obsolete
18-7209	Mercury Marine	1395-9293	399	18-7264	Chrysler Force	2279913	Obsolete
18-7210	OMC	382363	290	18-7264	Chrysler Inboard	1736073	Obsolete
18-7211-1	Mercury Marine	1395-8112231	397	18-7264	Chrysler Inboard	2279913	Obsolete
18-7212	Mercury Marine	1395-811357	399	18-7265	Chris-Craft	16.83-08758	587

1 This product is priced per piece. To order, priced per package, please add -9 to the part number
 2 Items ending in "D" are display packaged - regular number is non-display • 3 For discount shop pack of 10, please add -10 to the part number

SIERRA #	O.E.M.	O.E. #	PAGE #	SIERRA #	O.E.M.	O.E. #	PAGE #
SIERRA							
18-7265	Chris-Craft	F18308762	587	18-7326	Volvo	3850809	741
18-7265			587	18-7326	Volvo	3854620	741
18-72656	Nissan/Tohatsu	332600052M	480	18-7326	Volvo	3857986	741
18-72656	Nissan/Tohatsu	332600060M	480	18-7326	Volvo	3858261	741
18-7266			741	18-7328	Mercury	14307T01	Obsolete
18-7267	Mercury Marine	54552	741	18-7330	OMC	988037	895
18-7267	Mercury Marine	62092	741	18-7330	OMC	3854280	895
18-7267	Mercury Marine	62092	741	18-7330	OMC	3855958	895
18-7267	Mercury Marine	62092T	741	18-7330	OMC	3857650	895
18-7267	OMC	982063	741	18-7330	Volvo	988037	895
18-7267			741	18-7330	Volvo	3854280	895
18-7268	OMC	981650	894	18-7330	Volvo	3855958	895
18-7268	Volvo	3855276	894	18-7330	Volvo	3857650	895
18-7268			894	18-7331	OMC	3850810	895
18-7270	Crusader	21140	620	18-7331	OMC	3857985	895
18-7271	Crusader	21141	173	18-7331	OMC	3858714	895
18-7272	Crusader	97039	620	18-7331	Volvo	3850810	895
18-7272			620	18-7331	Volvo	3857985	895
18-7274	Mercury Marine	71646	171	18-7331	Volvo	3858714	895
18-7274	Mercury Marine	78485	171	18-7332			172, 667
18-7274	Mercury Marine	86246	171	18-7333			172
18-7274	Mercury Marine	86246A1	171	18-7334	Yamaha	663-24410-00-00	509
18-7274	Mercury Marine	86246T	171	18-7334	Yamaha	692-24410-00-00	509
18-7274	OMC	509409	171	18-7334	Yamaha	6A0-24410-00-00	509
18-7275	Mercury Marine	46860	171	18-7334	Yamaha	6A0-24410-01-00	509
18-7275	Mercury Marine	63196	171	18-7334	Yamaha	6A0-24410-02-00	509
18-7275	Mercury Marine	78820	171	18-7334	Yamaha	6A0-24410-03-00	509
18-7275	Mercury Marine	86247	171	18-7334	Yamaha	6A0-24410-04-00	509
18-7275	Mercury Marine	86247A2	171	18-7334	Yamaha	6A0-24410-05-00	509
18-7275	Mercury Marine	86247T	171	18-7336	Mercury	888733T02	402
18-7275	OMC	509410	171	18-7337	Mercury	898101T67	Obsolete
18-7278	Mercury Marine	47585	171	18-7338	Mercury	880596T55	402
18-7278	Mercury Marine	71327	171	18-7339	Yamaha	69J-13907-04-00	509
18-7278	Mercury Marine	77594	171	18-7340	Yamaha	68V-13907-00-00	509
18-7278	Mercury Marine	86234	171	18-7340	Yamaha	68V-13907-01-00	509
18-7278	Mercury Marine	86234A05	171	18-7340	Yamaha	68V-13907-02-00	509
18-7278	Mercury Marine	86234A3	171	18-7340	Yamaha	68V-13907-03-00	509
18-7278	Mercury Marine	86234A4	171	18-7341	Yamaha	66K-13907-00-00	509
18-7278	OMC	509395	171	18-7342	Yamaha	68F-13907-00-00	509
18-7278	OMC	982240	171	18-7342	Yamaha	68F-13907-01-00	509
18-7278	OMC	985602	171	18-7343	Yamaha	60V-13907-00-00	509
18-7278	OMC	985603	171	18-7344	Yamaha	6AW-13907-00-00	Obsolete
18-7278			171	18-7345	Yamaha	69J-13907-04-00	509
18-7281	Volvo	826493	968	18-7346	Mercury	880596T58	402
18-7282	Mercury Marine	42725A3	171	18-7347	Mercury	8M0065218	402
18-7282	Mercury Marine	861676T09	171	18-7348	Suzuki	15200-96J00	Obsolete
18-7282	OMC	509407	171	18-7349	Yamaha	6E5-24410-00-00	509
18-7283	Mercury Marine	97401	171	18-7349	Yamaha	6E5-24410-01-00	509
18-7283	Mercury Marine	861678A1	171	18-7349	Yamaha	6E5-24410-02-00	509
18-7283	Mercury Marine	861678A1	171	18-7349	Yamaha	6E5-24410-03-00	509
18-7283	Mercury Marine	8M0058164	171	18-7349	Yamaha	6E5-24410-04-00	509
18-7283	Mercury Marine	97401A2	171	18-7349	Yamaha	6E5-24410-10-00	509
18-7283	Mercury Marine	97401A8	171	18-7350	OMC	391638	292
18-7283	OMC	509404	171	18-7350	OMC	395091	292
18-7284	Mercury Marine	41141A2	171	18-7350	OMC	397274	292
18-7284	Mercury Marine	862077A1	171	18-7350	OMC	397839	292
18-7284	OMC	509408	171	18-7351	OMC	438562	292
18-7286	Volvo	841161	968	18-7352	OMC	382354	292
18-7288-1	Mercury Marine	97399	741	18-7352	OMC	385781	292
18-7288-1	Mercury Marine	812454A1	741	18-7352	OMC	388268	292
18-7288-1	Mercury Marine	812454A3	741	18-7352	OMC	394543	292
18-7288-1	Mercury Marine	862048A1	741	18-7352	OMC	395713	292
18-7288-1	Mercury Marine	97399A2	741	18-7352	OMC	398338	292
18-7289	OMC	982997	171	18-7352	OMC	398387	292
18-7290	Mercury Marine	84419M	397	18-7352	OMC	432451	292
18-7290	Nissan/Tohatsu	345871224M	397	18-7352	OMC	433387	292
18-7290	Yamaha	696-W0093-02-00	397	18-7352	OMC	438556	292
18-7291	Mercury Marine	84475M	397	18-7353	OMC	433386	292
18-7291	Nissan/Tohatsu	346871220M	397	18-7353	OMC	438555	292
18-7291	Yamaha	6H1-W0093-01-00	397	18-7354	Mercury Marine	1395-8506	397
18-7293	Mercury Marine	92520M	397	18-7355	Mercury Marine	1395-811691 2	397
18-7293	Yamaha	6A1-W0093-01-00	397	18-7356	Mercury Marine	1395-811691 3	397
18-7295	Mercury Marine	1395-9022	397	18-7367	Yamaha		509
1 18-7296	OMC	315232	290	18-7368	Yamaha		509
1 18-7300			998	18-7369	Yamaha		509
1 18-7306-9	Volvo	853548	998	18-7370N	Mer cruiser	1389-815396A2	730
18-73131	Mercury	98230A1	843	18-7370N	Mer cruiser	1389-8490A2	730
1 18-7321	Mercury Marine	54-38863	847	18-7370N	Mer cruiser	1389-9350A2	730
1 18-7321	Mercury Marine	54-866507	847	18-7370N	Mer cruiser	1389-9562A1	730
1 18-7321	Mercury Marine	54-8M0090424	847	18-7370N	Mer cruiser	3310-806077A2	730
18-7326	Mercury Marine	805025A2	741	18-7370N	Mer cruiser	3310-806078A2	730
18-7326	Mercury Marine	805656A2	741	18-7370N	Mer cruiser	3310-860070A2	730
18-7326	Mercury Marine	805656A5	741	18-7373N	Mer cruiser	3310-864941A01	730
18-7326	Mercury Marine	805656A6	741	18-7375N	Mer cruiser	3310-861448A1	730
18-7326	Mercury Marine	861155A5	741	18-7375N	Mer cruiser	3310-861448A1	730
18-7326	Mercury Marine	861155A6	741	18-7375N	Mer cruiser	3310-864942A01	730
18-7326	OMC	3850809	741	18-7376N	Mer cruiser	3310-861245A1	730
18-7326	OMC	3854620	741	18-7376N	Mer cruiser	3310-864943A01	730
18-7326	OMC	3857986	741	18-7380	Mercury	809569	399
18-7326	OMC	3858261	741	18-7381	Mercury	16253	399

1 This product is priced per piece. To order, priced per package, please add -9 to the part number
 2 Items ending in "D" are display packaged - regular number is non-display • 3 For discount shop pack of 10, please add -10 to the part number

SIERRA #	O.E.M.	O.E. #	PAGE #	SIERRA #	O.E.M.	O.E. #	PAGE #
SIERRA							
18-7382	Mercury	804184	399	18-7471	Yamaha	93210-94003-00	Obsolete
18-7388	Yamaha	6G1-24411-00-00	509	18-7474	Mercury Marine	25-94288	470
18-7389	Yamaha	6E0-24411-00-00	509	1 18-7475	OMC	332584	943
18-73891	Yamaha	68D-G5987-00-00	554	1 18-7477	OMC	909048	943
18-73892	Yamaha	6L5-45616-00-00	Obsolete	18-7480	Pleasurecraft	R047111	648
18-73893	Yamaha	91490-25030-00	Obsolete	1 18-7481	OMC	324981	335
18-7390	Yamaha	63V-24411-00-00	509	18-7483	Yamaha	93210-37M67-00	570
18-73907	Yamaha	90171-14065-00	555	1 18-7484	Yamaha	65W-43871-00-00	504
18-7391	Yamaha	692-24411-00-00	509	18-7485	Yamaha	93210-86M38-00	570
18-73914	Yamaha	670-45997-02-00	554	18-7486	Yamaha	61A-24564-00-00	513
18-73918	Yamaha	63P-45987-00-00	554	18-7487	Yamaha	65L-24564-00-00	Obsolete
18-7392	Yamaha	676-14985-01-00	507	18-7488	Yamaha	6P3-24564-00-00	513
18-7393	Yamaha	6E7-14385-00-00	507	18-7489	Mallory	9-34081	Obsolete
18-7394	Racor	RK10012	Obsolete	18-7492	Volvo	3854161	951
18-73964	Nissan/Tohatsu		480	18-7493	Mercury Marine	392889925	696
18-73978	Yamaha	90201-08M54-00	Obsolete	18-7493	Volvo	3859078	696
18-73979	Yamaha	6L2-45987-01-00	Obsolete	18-7494	Honda	30520-PNA-007	262
18-73990	Yamaha	6H4-W4599-00-00	554	18-7508	Mercury Marine	16792A33	806
18-73994	Yamaha		Obsolete	18-7508	Mercury Marine	16792A39	806
18-73995	Yamaha	66T-W4599-00-00	555	18-7510	OMC	321163	370
18-73996	Yamaha	67F-W4599-00-00	555	18-75100	Mercury Marine	32-8M0062614	770
1 18-7400	Mercury Marine	25-818573	438	1 18-75100	OMC	910305	770
1 18-7400	OMC	908194	438	18-75100	OMC	912424	770
1 18-7401	OMC	908383	943	18-75100	OMC	913488	770
1 18-7403	OMC	909316	943	18-75100			770
1 18-7404	OMC	909747	943	18-7511-9	Yamaha	93210-16716-00	570
1 18-7406	OMC	911311	943	18-75125	Mercury Marine	32-5346170	770
1 18-7406	Volvo	3852523	943	18-75125	Mercury Marine	32-865672070	770
1 18-7407	OMC	911700	943	18-75125	Mercury Marine	32-8M0062665	770
1 18-7407	OMC	3852531	943	18-75125	OMC	912793	770
1 18-7407	Volvo	3852531	943	18-75125	Volvo	826423	770
1 18-7408	OMC	911718	943	18-75125	Volvo	845792	770
1 18-7409	OMC	911871	943	18-7513	Volvo	3862500	20, 972
18-7410	Mercury Marine	25-36390	870	18-7514	Volvo Penta	22797780	987
18-74108	OMC	5030973	Obsolete	18-7516	Yamaha	67F-24251-02-00	513
1 18-7411	Mercury Marine	25-35480	370	18-7517	Yamaha	65L-24563-00-00	513
1 18-7411	Mercury Marine	25-47386	370	18-7518	Yamaha	6P2-WS245-00-00	513
1 18-7411	Mercury Marine	25-8M2000816	370	18-7521	Honda	16910-ZVL-003	264
1 18-7411	OMC	321921	370	18-7523	Mercury	35-880084T01	411
1 18-7413	Mercury Marine	22-22175	943	18-7550	Mercury	861249	725
1 18-7413	Mercury Marine	25-62702	943	18-7550	Mercury	861249A1	725
1 18-7413	Mercury Marine	25-F50342-1	943	18-7551	Mercury	861425	726
1 18-7413	Mercury Marine	F17510	943	18-7552	Honda	37830-PGK-A01	265
1 18-7413	Mercury Marine	F50342	943	18-7553	Mercury	808015T	726
1 18-7413	OMC	303191	943	18-7554	Mercury	878187	726
1 18-7414	Mercury Marine	25-62384	Obsolete	18-7556	Mercury	864297001	696
1 18-7414	Mercury Marine	25-823683	Obsolete	18-7558	Honda	30530-PPL-A01	265
1 18-7416	OMC	329380	943	18-7559	Honda	30530-P8F-A01	265
1 18-7417	OMC	329381	943	18-7596	Mercury	35-866594K01	410
1 18-7418	OMC	326741	325	18-7598			167
1 18-7419	Mercury Marine	25-69202	470	18-7599			167, 265, 406
1 18-7420	Mercury Marine	25-21836	470	18-7600	Crusader	47002	618
1 18-7421	Mercury Marine	25-16524	470	18-7600	Mercury Marine	805218T	618
1 18-7426	Mercury Marine	25-30271	470	18-7601	OMC	3854158	Obsolete
1 18-7428	OMC	307103	335	18-7601	Volvo	3854158	Obsolete
1 18-7432	Yamaha	93210-32738-00	570	18-7603-1	Mercury Marine	1347-818622	175
18-7436	Yamaha	93210-46044-00	570	18-7603-1	Mercury Marine	1347-818622 1	175
18-7439-9	Yamaha	93210-54M54-00	Obsolete	18-7603-1	Mercury Marine	1347-818622R02	175
1 18-7440-1	Mercury Marine	25-36318	943	18-7603-1	Mercury Marine	1376-5659A1	175
1 18-7440-1	OMC	301967	943	18-7603-1	Rochester	7044185	175
18-7442	Yamaha	93210-74M35-00	570	18-7604-1	Mercury Marine	1347-804623R02	730
18-7444	Yamaha	93211-04384-00	570	18-7604-1	Mercury Marine	1347-804623R1	730
18-7449	Mercury Marine	25-97387	470	18-7604-1	Mercury Marine	3304-9354A2	730
18-74501	Mariner	27-99049M	465	18-7605-1	Mercury Marine	1347-804623A1	175
18-74501	Yamaha	683-W0001-C1-00	465	18-7605-1	Mercury Marine	1347-804623R02	175
18-74504	Yamaha	6H3-W0001-22-00	569	18-7605-1	Mercury Marine	1347-9661A3	175
18-74507	Yamaha	63V-W0001-21-00	569	18-7605-1	OMC	382821	175
18-74510	Yamaha	65L-W0001-C0-00	569	18-7605-1	OMC	383766	175
18-74512	Yamaha	66K-W0001-20-00	569	18-7605-1	OMC	384194	175
18-74515	Yamaha	68V-W0001-20-00	569	18-7605-1	Rochester	17057283	175
18-74527	Yamaha	6G9-W0001-C6-00	569	18-7605-1	Rochester	17057285	175
18-74535	Yamaha	67F-W0001-20-00	569	18-7605-1	Rochester	17059291	175
18-74540	Yamaha	62Y-W0001-20-00	569	18-7605-1	Rochester	17059292	175
18-74544	Yamaha	68T-W0001-20-00	Obsolete	18-7605-1	Rochester	17080564	175
18-74546	Yamaha		569	18-7605-1	Rochester	17080565	175
18-7457	Chrysler Force	25-F45530	261	18-7606	Yamaha	MAR-10171-30-00	516
18-7457	OMC	319662	261	18-7607-1	Rochester	17082403	175
18-7459	Mercury Marine	20311	470	18-7608-1	Mercury Marine	1347-818620	175
18-7459	Mercury Marine	25-20826	470	18-7608-1	Mercury Marine	1347-818620 1	175
18-7461	OMC	308458	370	18-7608-1	Mercury Marine	1347-818620R02	175
18-74610	Nissan/Tohatsu	398873213M	479	18-7608-1	OMC	381668	175
18-74611	Nissan/Tohatsu	346873217M	479	18-7608-1	OMC	980528	175
18-7463	Yamaha	93210-19123-00	570	18-7608-1	OMC	982217	175
18-7464	Mercury Marine	25-39695	470	18-7608-1	OMC	982219	175
18-7464	Mercury Marine	25-846361	470	18-7608-1	Rochester	7040080	175
1 18-7467	Mercury Marine	25-54030	470	18-7608-1	Rochester	7040083	175
1 18-7467	Mercury Marine	25-F523555	470	18-7608-1	Rochester	7040089	175
1 18-7467	Mercury Marine	F532555	470	18-7608-1	Rochester	7042183	175
18-7468	Yamaha	6G5-43864-00-00	570	18-7608-1	Rochester	7043183	175
18-7469	Yamaha	64E-43869-00-00	570	18-7608-1	Rochester	7043184	175
18-7470	Yamaha	65W-43865-00-00	570	18-7608-1	Rochester	17059052	175

1 This product is priced per piece. To order, priced per package, please add -9 to the part number

2 Items ending in "D" are display packaged - regular number is non-display • 3 For discount shop pack of 10, please add -10 to the part number

SIERRA #	O.E.M.	O.E. #	PAGE #	SIERRA #	O.E.M.	O.E. #	PAGE #
SIERRA							
18-7608-1	Rochester	17059057	175	18-7646	Mercury Marine	892615001	Obsolete
18-7609-1	Mercury Marine	1347-818619	175	18-7646	Mercury Marine	892615002	Obsolete
18-7609-1	Mercury Marine	1347-818619 1	175	18-7646	Pleasurecraft	R020035A	Obsolete
18-7609-1	Mercury Marine	1347-818619 1R02	175	18-7647	Volvo	872066	972
18-7609-1	OMC	381494	175	18-7648	Mercury Marine	392-881732	645
18-7609-1	OMC	382733	175	18-7648	Pleasurecraft	R117012	645
18-7609-1	OMC	772831	175	18-7648	Volvo	3861267	645
18-7609-1	OMC	980530	175	18-7655	Yamaha	67H-8592A-00-00	516
18-7609-1	OMC	982217	175	18-7655	Yamaha	67H-8592A-01-00	516
18-7609-1	OMC	984180	175	18-7656	Yamaha	68F-8592A-00-00	Obsolete
18-7609-1	Rochester	7036543	175	18-7658	Honda	35655-ZY9-003	265
18-7609-1	Rochester	7040082	175	18-7659	Honda	35655-ZY6-013	265
18-7609-1	Rochester	7041369	175	18-7660	Mercury Marine	881731	725
18-7609-1	Rochester	7043182	175	18-7660	Mercury Marine	8M0054726	725
18-7609-1	Rochester	7044182	175	18-7663	Mercury Marine	802630	Obsolete
18-7609-1	Rochester	17059054	175	18-7663	Mercury Marine	802630001	Obsolete
18-7610-1	Mercury Marine	1347-818621	175	18-7663	Mercury Marine	802630T	Obsolete
18-7610-1	Mercury Marine	1347-818621 1	175	18-7663	Mercury Marine	802630T01	Obsolete
18-7610-1	Mercury Marine	1347-818621 1R02	175	18-7663	Mercury Marine	8M0069803	Obsolete
18-7610-1	Rochester	17081060	175	18-7664	Mercury Marine	809066	737
18-7611-2	Mercury Marine	3310-807312R02	730	18-7665	Mercury Marine	70125	737
18-7611-2	Mercury Marine	3310-807312A1	730	18-7665	Mercury Marine	70125A02	737
18-7613-1	Mercury Marine	3310-806969 R01	Obsolete	18-7665	Mercury Marine	70125A1	737
18-7613-1	Mercury Marine	3310-806969A1	Obsolete	18-7666	Mercury Marine	1397-8582	737
18-7615-1	Mercury Marine	1347-804624 R02	175	18-7667	Mercury Marine	71464	737
18-7615-1	Mercury Marine	1347-804624R1	175	18-7667	Mercury Marine	72625	737
18-7615-1	Mercury Marine	1347-816373A4	175	18-7667	Mercury Marine	71464A01	737
18-7615-1	OMC	981359	175	18-7668	Mercury Marine	854445	726
18-7615-1	OMC	981428	175	18-76689	Yamaha	65W-14198-00-00	570
18-7615-1	OMC	981564	175	18-76690	Yamaha	93210-46M16-00	570
18-7615-1	OMC	981705	175	18-76691	Yamaha	93210-27ME3-00	570
18-7615-1	OMC	981803	175	18-76692	Yamaha	93210-75M51-00	Obsolete
18-7615-1	OMC	982223	175	18-76693	Yamaha	93210-31MJ5-00	570
18-7615-1	OMC	983855	175	18-76694	Yamaha	93210-24M79	570
18-7615-1	OMC	985822	175	18-76695	Mercury	25-803513007	470
18-7615-1	Rochester	17057298	175	18-76695	Nissan/Tohatsu	3R0074220M	470
18-7615-1	Rochester	17059280	175	18-7677	Mercury Marine	806612T	647
18-7615-1	Rochester	17059288	175	18-7677	OMC	3850357	647
18-7615-1	Rochester	17080561	175	18-7677	Pleasurecraft	R020027	647
18-7615-1	Rochester	17085013	175	18-7677	Volvo	3850357	647
18-7615N	Mercuriser		Obsolete	18-7679	OMC	3854905	889
18-7616-1	Mercury Marine	1347-804626 R02	175	18-7679	Volvo	3854905	889
18-7616-1	Mercury Marine	1347-8288A1	175	18-7682	Mercury Marine	849934	725
18-7616-1	Rochester	1708563	175	18-7682	Mercury Marine	879150150	725
18-7616-1	Rochester	17057287	175	18-7683	Mercury Marine	849899	Obsolete
18-7616-1	Rochester	17059287	175	18-7684	Mercury Marine	805217A1	725
18-7616-1	Rochester	17059290	175	18-7684	Mercury Marine	864856A1	725
18-7616-1	Rochester	17080560	175	18-7684	OMC	3850396	725
18-7617-1	Mercury Marine	1347-804625R02	175	18-7684	Volvo	3850396	725
18-7617-1	Mercury Marine	1347-804625R1	175	18-7685	Mercury Marine	852956A1	726
18-7617-1	Mercury Marine	1347-9863A3	175	18-7685	Volvo	3858941	726
18-7617-1	Rochester	17059280	175	18-7688	Mercury Marine	885176	726
18-7618-1	Mercury Marine	1347-804624 R1	175	18-7689	OMC	3855182	889
18-7618-1	Mercury Marine	1347-804624R02	175	18-7689	Volvo	3855182	889
18-7618-1	Mercury Marine	1347-8289A1	175	18-7690	Mercury Marine	27-852957	727
18-7618-1	Rochester	7044291	175	18-7692	Mercury Marine	861260	727
18-7618-1	Rochester	17059289	175	18-7692	Mercury Marine	861260T	727
18-7618-1	Rochester	17080561	175	18-7693			727
18-7618-1	Rochester	17080562	175	18-7694			Obsolete
18-7619-1	Mercury Marine	1347-8460A3	175	18-7695			727
18-7619-1	Mercury Marine	1347-9142A2	175	18-7696			727
18-7619-1	Rochester	17059283	175	18-7697	Mercury Marine	803149	647
18-7619-1	Rochester	17059298	175	18-7697	Pleasurecraft	R084003	647
18-7619-1	Rochester	17081299	175	18-7700	Mercury Marine	853678T	972
18-7619-1	Rochester	17083522	175	18-7700	Volvo	3857487	972
18-7628			174, 667	18-7701	Mercury Marine	862998	725
18-7630	Crusader	47032	725	18-7702	Mercury Marine	805223T	766
18-7630	Mercury Marine	805226A1	725	18-7702	Volvo	3854527	766
18-7632-1	Crusader	47033	725	18-7703	Mercury Marine	805544T	972
18-7632-1	Mercury Marine	805224A1	725	18-7703	OMC	3854512	972
18-7633	Mercury Marine	17693A2	862	18-7703	Volvo	3854512	972
18-7633	Mercury Marine	63115A12	862	18-7704	Volvo	3855194	972
18-7633	Mercury Marine	805320A03	862	18-7705	Volvo	3843751	972
18-7633	Mercury Marine	805320A1	862	18-7706	Volvo	3858979	951
18-7633	Mercury Marine	88678A4	862	18-7709	Volvo	3840335	971
18-7633	Mercury Marine	88678A5	862	18-7710-1	Yamaha	68T-24251-00-00	513
18-7633	Mercury Marine	96863A15	862	18-7711	Suzuki	15410-96J00	484
18-7634	OMC	984748	938	18-7712	Honda	16910-GB2-005	264
18-7635			174	18-7712	Mercury Marine	35-16248	264
18-7636			174	18-7712	Nissan/Tohatsu	369022300M	264
18-7637			174, 666, 890	18-7713	Mercury Marine	35-80365M	410
18-7638			174, 666, 890	18-7713	Yamaha	646-24251-02-00	410
18-7639	Mercury Marine	3310-864943A01	730	18-7714	Mercury Marine	35-877565T	410
18-7639	Mercury Marine	861245A1	730	18-7714	Mercury Marine	35-877565T1	410
18-7640			174	18-7715	Mercury Marine	35-892665	748
18-7641	Volvo	3856393	966	18-7716	OMC	5032323	484
18-7641	Volvo	841047-4	966	18-7716	Suzuki	15410-87J10	484
18-7641	Volvo	841313-0	966	18-7717	Mercury Marine	35-93568	748
18-7642	Volvo	3863130	960	18-7717			748
18-7643	Volvo	3859082	Obsolete	18-7718	Mercury Marine	35-879885T	410
18-7646	Mercury Marine	892615	Obsolete	18-7719	OMC	5032238	484

1 This product is priced per piece. To order, priced per package, please add -9 to the part number
 2 Items ending in "D" are display packaged - regular number is non-display • 3 For discount shop pack of 10, please add -10 to the part number

SIERRA #	O.E.M.	O.E. #	PAGE #	SIERRA #	O.E.M.	O.E. #	PAGE #
SIERRA							
18-7719	Suzuki	15410-98500	484	18-7778	Volvo	3850861	971
18-7720	Honda	16900-SR3-004	264	18-7780	Yamaha	6F5-24563-00-00	513
18-7721	Mercury Marine	35-864572	748	18-7781	Yamaha	61N-24563-00-00	513
18-7722	OMC	5005266	296	18-7782	Yamaha	61A-24563-00-00	513
18-7723			161	18-7784	Mercury Marine	35-11004A1	748
18-7724			161	18-7784	Mercury Marine	35-803897Q1	748
18-7726			Obsolete	18-7785	Honda	16010-ST5-993	264
18-7727			892	18-7786	Honda	16900-SA5-004	264
18-7728			179, 736, 740	18-7787			509
18-7729			892	18-7788			509
18-7730			Obsolete	18-7789	OMC	502906	897
18-7732	Zenith	K-2035	Obsolete	18-7789	Volvo	3852413	897
18-7732	Zenith	K-2036	Obsolete	18-7789	Volvo	3851218-2	897
18-7735	Suzuki	15410-94400	484	18-7790			668
18-7736	Yamaha	67D-W0093-00-00	505	18-7791			668
18-7737	Yamaha	61N-W0093-00-00	505	18-7792	OMC	910641	897
18-7738	Mercury Marine	802706A1	397	18-7792	OMC	3855104	897
18-7738	Yamaha	66M-W0093-00-00	397	18-7792	Volvo	3855104	897
18-7738	Yamaha	66M-W0093-01-00	397	18-7796	OMC	335334	293
18-7739	Yamaha	6L2-W0093-00-00	505	18-7797			510
18-7740	Yamaha	6E9-W0093-02-00	505	18-7798			510
18-7741	Yamaha	6E9-W0093-03-00	505	18-7799			510
18-7742	Yamaha	6H0-W0093-00-00	505	18-7800	OMC	433519	292
18-7743	Mercury Marine	804346T1	397	18-7800	OMC	438616	292
18-7743	Yamaha	67F-W0093-00-00	397	18-7801	OMC	379777	292
18-7744	Yamaha	6N6-W0093-02-00	505	18-7802	Mercury Marine	35-87946A3	410
18-7746	Mercury Marine	1397-2067	736	18-7802	Mercury Marine	35-87946G3	410
18-7746	Mercury Marine	1397-2631	736	18-7802	Mercury Marine	35-87946Q4	410
18-7746	Mercury Marine	1397-2634	736	18-7804	Mercury Marine	23014A1	403
18-7746	Mercury Marine	1397-2637	736	18-7805	Chrysler Force	F24747-1	248
18-7746	Mercury Marine	1397-3459	736	18-7806-1			403
18-7746	Mercury Marine	1397-3464	736	18-7807	Mercury Marine	55278A1	403
18-7746	Mercury Marine	1397-7542	736	18-7808	Mercury Marine	55278A5	403
18-7746	Mercury Marine	1397-7543	736	18-7809	Mercury Marine	55278A3	403
18-7746	Mercury Marine	1397-7547	736	18-7809	Mercury Marine	55278A4	403
18-7746	Mercury Marine	1397-8872	736	18-7810	Mercury Marine	90363A1	403
18-7746	Mercury Marine	1397-8873	736	18-7811	Mercury Marine	66599A1	403
18-7746	Mercury Marine	823427A1	736	18-7811	Mercury Marine	89031A1	403
18-7747	Yamaha	6G5-W0093-08-00	505	18-7812	Mercury Marine	66599A2	403
18-7748	Mercury Marine	809064	736	18-7812	Mercury Marine	89031A2	403
18-7749	Mercury Marine	809065	736	18-7813	Mercury Marine	66599A3	403
18-7749	Mercury Marine	823728	736	18-7813	Mercury Marine	89031A3	403
18-7749	Mercury Marine	835076	736	18-7814	Mercury Marine	89031A4	403
18-7750-1	Mercury Marine	1395-811222	399	18-7815	Mercury Marine	1399-5137	399
18-7750-1	Mercury Marine	1395-823635	399	18-7817	Chrysler Force	21-42990A10	248
18-7750-1	Mercury Marine	1395-8236351	399	18-7817	Chrysler Force	21-42990A7	248
18-7750-1	Mercury Marine	1395-8236352	399	18-7817	Chrysler Force	21-42990A8	248
18-7750-1	Mercury Marine	1395-8236353	399	18-7817	Chrysler Force	21-42990A9	248
18-7750-1	Mercury Marine	1395-8236354	399	18-7817	Chrysler Force	21-857005A1	248
18-7750-1	Mercury Marine	1395-9599	399	18-7817	Mercury Marine	21-42990A10	248
18-7751	Mercuriser	13220	666	18-7817	Mercury Marine	21-42990A7	248
18-7752	Suzuki	13910-87D00	483	18-7817	Mercury Marine	21-42990A8	248
18-7753	Suzuki	13910-94400	483	18-7817	Mercury Marine	21-42990A9	248
18-7754	Suzuki	13910-94701	483	18-7817	Mercury Marine	21-857005A1	248
18-7755	Suzuki	13910-95D00	483	18-7818-1	Mercury Marine	42909A1	403
18-7756	Yamaha	64D-W0093-00-00	505	18-7818-1	Mercury Marine	42909A2	403
18-7757	Mercury Marine	803148	726	18-7818-1	Mercury Marine	42909A3	403
18-7757	Volvo	3855296	726	18-7818-1	Mercury Marine	42909A4	403
18-7758	Mercury Marine	35-877761K01	432	18-7820	OMC	393103	292
18-7758	Mercury Marine	35-877761Q01	432	18-7821	OMC	395867	292
18-7759	Yamaha	6K7-W0093-09-00	505	18-7821	OMC	398514	292
18-7761			289	18-7822	OMC	432962	292
18-7765	Mercury Marine	11502M	399	18-7823	OMC	393088	293
18-7765	Nissan/Tohatsu	369871221M	399	18-7824-2	Chris-Craft	16.81-08746	1005
18-7765	Yamaha	6G1-W0093-00-00	399	18-7824-2	Crusader	201104	1005
18-7766	Yamaha	6H3-W0093-02-00	506	18-7824-2	Indmar	50-1001	1005
18-7767	Yamaha	6H4-W0093-01-00	506	18-7824-2	Mercury Marine	14957	1005
18-7768	Yamaha	6H4-W0093-03-00	506	18-7824-2	Mercury Marine	32716	1005
18-7769	Mercury Marine	814481M	399	18-7824-2	Mercury Marine	32717	1005
18-7769	Yamaha	6E7-W0093-04-00	399	18-7824-2	Mercury Marine	52022	1005
18-7770	Mercury Marine	84456M	506	18-7824-2	Mercury Marine	52731	1005
18-7770	Yamaha	689-W0093-02-00	506	18-7824-2	Mercury Marine	54111	1005
18-7772	Yamaha	61A-W0093-00-00	506	18-7824-2	Mercury Marine	35-802885Q	1005
18-7772	Yamaha	61A-W0093-01-00	506	18-7824-2	Mercury Marine	35-866340K01	1005
18-7773	OMC	5032424	483	18-7824-2	Mercury Marine	35-866340Q	1005
18-7773	Suzuki	13910-89J01	483	18-7824-2	Mercury Marine	35-866340Q02	1005
18-7774			109	18-7824-2	Mercury Marine	35-866340Q02	1005
18-7775			109	18-7824-2	Mercury Marine	35-866340Q03	1005
18-7775-1			109,157, 295, 408, 511, 666, 895	18-7824-2	Mercury Marine	52731A1	1005
18-7775-1			109,157, 295, 408, 511, 666, 895	18-7824-2	OMC	173232, 502902	1005
18-7776			109,157, 295, 408, 511, 666, 895	18-7824-2	OMC	173232, 502902	1005
18-7776-1			109,157, 295, 408, 511, 666, 895	18-7824-2	Pleasurecraft	R077002	1005
18-7777	Yamaha	MAR-FLTHD-SS-12	109	18-7824-2	Volvo	835440	1005
18-7777			109	18-7824-2	Yamaha	YSC-10231-20-0C	1005
18-7777-1	Yamaha	ABB-SPRTR-HD-SS	511	18-7824-2	Yamaha	YSC-13231-20-0C	1005
18-7777-1			511	18-7824C-2			667
				18-7826	OMC	305185	296
				18-7828-1			161
				18-7829	Mercury Marine	35-16494	161
				18-7829	Mercury Marine	35-816296	161
				18-7829	Mercury Marine	35-816296K03	161

1 This product is priced per piece. To order, priced per package, please add -9 to the part number
 2 Items ending in "D" are display packaged - regular number is non-display • 3 For discount shop pack of 10, please add -10 to the part number

SIERRA #	O.E.M.	O.E. #	PAGE #	SIERRA #	O.E.M.	O.E. #	PAGE #
SIERRA							
18-7829	Mercury Marine	35-816296Q	161	18-7860	Mercury Marine	35-49088Q2	588
18-7829	Mercury Marine	35-816296T	161	18-7860	Mercury Marine	F18390006	588
18-7829			161	18-7860	OMC	312456	588
18-7830	Mercury Marine	35-134301	296	18-7860	OMC	381690	588
18-7830	Mercury Marine	35-8162961	296	18-7861	OMC	981911	898
18-7830	Mercury Marine	35-816296-1	296	18-7862	Crusader	91606	620
18-7830	Mercury Marine	35-816296B1	296	18-7862	OMC	982230	620
18-7830	Mercury Marine	35-816296B2	296	18-7862	Volvo	841162	620
18-7830	Mercury Marine	35-816296Q2	296	18-7865	Yamaha	MAR-MINIF-IL-TR	109
18-7830	Mercury Marine	35-816296T1	296	18-7865			109
18-7830	Mercury Marine	35-816396Q1	296	18-7866	Yamaha	MAR-FUELF-IL-TR	109
18-7830	OMC	398327	296	18-7866			109
18-7830	Yamaha	65W-24251-10-00	296	18-7869	Mercury Marine	1397-8545	748
18-7830			296	18-7869	Mercury Marine	1397-8767	748
18-7831	Mercury Marine	802128A1	296	18-7871	Mercury Marine	35-805809	805
18-7831	OMC	398319	296	18-7871	Mercury Marine	35-805809T	805
18-7831			296	18-7873	Mercury Marine	35-808275	Obsolete
18-7832	Mercury Marine	1399-1136	410	18-7875	Chris-Craft	16.81-06536	204, 1005
18-7832	Mercury Marine	1399-1754	410	18-7875	Chrysler Inboard	56874	204, 1005
18-7832	Mercury Marine	1399-3938	410	18-7875	Chrysler Inboard	1851658	204, 1005
18-7833	Mercury Marine	11497M	403	18-7875	Chrysler Inboard	F724002	204, 1005
18-7833	Yamaha	6G1-24471-00-00	403	18-7875	Crusader	9002514	204, 1005
18-7834	Mercury Marine	91748M	403	18-7875	Mercury Marine	60565	204, 1005
18-7834	Yamaha	6E0-24471-00-00	403	18-7875	Mercury Marine	35-802886Q	204, 1005
18-7837	Mercury Marine	84262M	403	18-7875	OMC	173231	204, 1005
18-7837	Yamaha	677-24411-02-00	403	18-7875	OMC	502900	204, 1005
18-7838	Mercury Marine	84265M	403	18-7875	Pleasurecraft	F077001	204, 1005
18-7838	Yamaha	677-24471-01-00	403	18-7875	Yamaha	YSC-16231-20-0C	204, 1005
18-7839	Mercury Marine	80606M	403	18-7876-1			913
18-7839	Yamaha	648-24411-00-00	403	18-7876-1	Crusader	201104	913
18-7840	Mercury Marine	84141M	403	18-7876-1	Mercury Marine	14957	913
18-7840	Yamaha	663-24411-00-00	403	18-7876-1	Mercury Marine	32716	913
18-7841	Yamaha	6J8-24471-00-00	510	18-7876-1	Mercury Marine	32717	913
18-7842	Yamaha	6E5-24471-00-00	403	18-7876-1	Mercury Marine	52022	913
18-7843	Yamaha	6E5-24411-00-00	510	18-7876-1	Mercury Marine	52731	913
18-7844	Mercury Marine	35-802893Q	109	18-7876-1	Mercury Marine	54111	913
18-7844	Mercury Marine	35-807172	109	18-7876-1	Mercury Marine	32-802885Q	913
18-7844			109	18-7876-1	Mercury Marine	35-866340Q02	913
18-7845	Mercury Marine	35-55501	109	18-7876-1	Mercury Marine	35-866340Q03	913
18-7845	Mercury Marine	35-57250	109	18-7876-1	Mercury Marine	52731A1	913
18-7845	Mercury Marine	35-604941	109	18-7876-1	OMC	173233	913
18-7845	Mercury Marine	35-60494A4	109	18-7876-1	OMC	502901	913
18-7845	Mercury Marine	35-8053691	109	18-7876-1	Volvo	3850559	913
18-7845	Mercury Marine	35-806771	109	18-7876-1	Yamaha	YSC-14231-20-0C	913
18-7845	Mercury Marine	35-807172	109	18-7876-1			913
18-7845	Yamaha	ABB-FUELF-IL-TR	109	18-7878-1	Chrysler Inboard	3549957	599
18-7845			109	18-7878-1	Chrysler Inboard	L-1008	599
18-7846	Crusader	98041	620	18-7878-1	Chrysler Inboard	L-19	599
18-7846	OMC	502905	620	18-7878-1	Mercury Marine	38463	599
18-7846			620	18-7878-1	Mercury Marine	46692	599
18-7847			403	18-7878-1	Mercury Marine	803470	599
18-7848-1	Mercury Marine	52444	408	18-7878-1	Mercury Marine	803470Q	599
18-7848-1	Mercury Marine	35-52456A1	408	18-7878-1	OMC	502904	599
18-7848-1	Mercury Marine	35-55501A1	408	18-7878-1	Volvo	430143	599
18-7848-1	Mercury Marine	35-57250A1	408	18-7878-1	Volvo	1266286	599
18-7848-1	Mercury Marine	35-60494A1	408	18-7878-1	Volvo	3517857	599
18-7848-1	Mercury Marine	35-60494A4	408	18-7878-1			599
18-7848-1	Mercury Marine	35-802893Q4	408	18-7879-1	Chrysler Force	L-319	599
18-7848-1	Mercury Marine	35-805369A4	408	18-7879-1	Mercury Marine	41815	599
18-7848-1	Mercury Marine	35-807172A4	408	18-7879-1	Mercury Marine	32-883702K	599
18-7848-1			408	18-7879-1	Mercury Marine	32-883702Q	599
18-7848-2		157, 295, 409, 512, 747, 896, 970		18-7879-1	Mercury Marine	35-802884Q	599
				18-7879-1	OMC	173834	599
18-7852-1	Crusader	22687	511	18-7879-1	OMC	502903	599
18-7852-1	Yamaha	MAR-SEPAR-AT-OR	511	18-7879-1	Volvo	841750	599
18-7852-1			511	18-7880	Caterpillar	1R-0658	203
18-7852-2			156, 408, 511, 746, 896, 969	18-7880	Volvo	466634	203
18-7853-1	Mercury Marine	55481	970	18-7884	Universal	299381	689
18-7853-1	Mercury Marine	89876	970	18-7884	Volvo	834337	689
18-7853-1	Mercury Marine	89876A3	970	18-7886	Perkins	2654403	203, 689
18-7853-1	Yamaha	MAR-FLTHD-AL-12	970	18-7888	Volvo	826648	973
18-7853-1			970	18-7888	Volvo	862293	973
18-7854	OMC	311684	897	18-7890	Volvo	463505	987
18-7854	OMC	984491	897	18-7890	Volvo	876185	987
18-7854	Rochester	17078904	897	18-7891			219
18-7855	Mercury Marine	1397-2150	748	18-7894			219
18-7855	OMC	910139	748	18-7895	OMC	778888	205
18-7855	OMC	983870	748	18-7895	OMC	5035703	205
18-7855	Rochester	17068453	748	18-7895	Suzuki	16510-93J00	205
18-7856-1	A.C. Delco	GF-61	161	18-7896	OMC	778886	323
18-7857-1	A.C. Delco	GF-61P	161	18-7896	OMC	5033539	323
18-7858	Volvo	858201	971	18-7896	Suzuki	16510-61A20-MHL	323
18-7859	Mercury Marine	3302-9033	748	18-7897	OMC	778887	491
18-7859	Mercury Marine	35-53336	748	18-7897	OMC	5033919	491
18-7859	Mercury Marine	35-53336Q	748	18-7897	Suzuki	16510-82703	491
18-7859	OMC	908034	748	18-79007	Volvo	3825038	Obsolete
18-7859	Volvo	835576	748	18-7901	Mercury Marine	825467A1	432
18-7860	Chris-Craft	16.83-90006	588	18-7901	Mercury Marine	825467T1	432
18-7860	Mercury Marine	35-49088	588	18-7901	Yamaha	6G8-13440-00-00	432
18-7860	Mercury Marine	35-49088A2	588	18-7902	Yamaha	3FV-13440-00-00	539

1 This product is priced per piece. To order, priced per package, please add -9 to the part number
 2 Items ending in "D" are display packaged - regular number is non-display • 3 For discount shop pack of 10, please add -10 to the part number

SIERRA #	O.E.M.	O.E. #	PAGE #	SIERRA #	O.E.M.	O.E. #	PAGE #
SIERRA							
18-7902	Yamaha	3FV-13440-20-00	539	18-7943			158, 296, 747, 897
18-7903	OMC	763364	205	18-7944	Mercury Marine	35-52456	109
18-7903	OMC	5033102	205	18-7944	Mercury Marine	35-55501	109
18-7903	Suzuki	16510-05240	205	18-7944	Mercury Marine	35-57250	109
18-7905-1	Suzuki	16510-96J00	491	18-7944	Mercury Marine	35-60494	109
18-7906-1	Mercury Marine	35-8226267	432	18-7944	Mercury Marine	35-604941	109
18-7906-1	Mercury Marine	35-822626Q15	432	18-7944	Mercury Marine	35-802893Q	109
18-7906-1	Mercury Marine	35-822626T7	432	18-7944	Mercury Marine	35-805369	109
18-7906-1	Yamaha	69J-13440-00-00	432	18-7944	Mercury Marine	35-8053691	109
18-7906-1	Yamaha	69J-13440-01-00	432	18-7944	Mercury Marine	35-806771	109
18-7907	Volvo	858488	987	18-7944	Mercury Marine	35-807172	109
18-7908	Volvo	3582358	987	18-7944			109
18-7909	Honda	15400-PLM-A01PE	205	18-7945	Mercury Marine	35-52456	109
18-7909	Honda	15400-POH-305	205	18-7945	Mercury Marine	35-55501	109
18-7909	Honda	15400-POH-305PE	205	18-7945	Mercury Marine	35-57250	109
18-7909	Honda	15400-ZJI-004	205	18-7945	Mercury Marine	35-60494	109
18-7910-1	Westerbeke	30220	203, 689	18-7945	Mercury Marine	35-604941	109
18-7910-1	Yanmar	119350-35150	203, 689	18-7945	Mercury Marine	35-802893Q	109
18-7910-1	Yanmar	119350-35151	203, 689	18-7945	Mercury Marine	35-805369	109
18-7910-1	Yanmar	124450-35100	203, 689	18-7945	Mercury Marine	35-8053691	109
18-7911-1	Honda	15400-PFB-007	205	18-7945	Mercury Marine	35-806771	109
18-7911-1	Nissan/Tohatsu	3R0-07615-0	205	18-7945	Mercury Marine	35-807172	109
18-7911-1	Yamaha	5GH-13440-00-00	205	18-7945	Yamaha	ABB-FUELF-IL-TR	109
18-7913	Honda	15400-PFB-014	271	18-7945			109
18-7913	Mercury Marine	35-822626Q03	271	18-7945C			667
18-7913	Mercury Marine	35-822626Q1	271	18-7946	OMC	502905	897
18-7914	Mercury Marine	35-822626K04	432	18-7946			897
18-7914	Mercury Marine	35-822626Q04	432	18-7947	Honda	17670-ZW1-030GH	264
18-7914	Mercury Marine	35-822626Q2	432	18-7947	Racor	S3240	264
18-7914	Mercury Marine	35-822626T2	432	18-7947	Suzuki	99105-20006	264
18-7914	Mercury Marine	35-877768K01	432	18-7948	Honda	17670-ZW1-801AH	264
18-7914	Mercury Marine	35-8M0008397	432	18-7948	Mercury Marine	35-886638	264
18-7914	Mercury Marine	35-8M0064104	432	18-7948	Racor	S3227	264
18-7915-1	OMC	778885	323	18-7948	Suzuki	99105-20005	264
18-7915-1	OMC	5031411	323	18-7949	Racor	S3232	160
18-7915-1	Suzuki	16510-87J00	323	18-7950	Chrysler Force	25-45258	261
18-7916	OMC	434839	205, 323				
18-7917	Yanmar	124085-35113	Obsolete	18-7951			157, 295, 409, 512, 747, 896, 970
18-7917	Yanmar	124450-35110	Obsolete	1 18-7952	Chrysler Force	25-88657	261
18-7917	Yanmar	124550-35110	Obsolete	18-7953	OMC	5035974	484
18-7917	Yanmar	171056-35110	Obsolete	18-7953	Suzuki	15410-87J30	484
18-7917	Yanmar	171056-35111	Obsolete	18-7954	Yamaha	N26-13440-00-00	538
18-7918	Mercury Marine	35-877769K01	432	18-7954	Yamaha	N26-13440-02-00	538
18-7918	Mercury Marine	35-883701K01	432	18-7955	Yamaha	68F-24563-10-00	513
18-7919	Mercury Marine	35-809097	158, 296, 410, 512, 747, 748, 897, 971	1 18-7956	Chrysler Force	25-85549	261
18-7919	Mercury Marine	35-8M0103095	158, 296, 410, 512, 747, 748, 897, 971	1 18-7956	Mercury Marine	25-85549	261
18-7919	Racor	S3213	158, 296, 410, 512, 747, 748, 897, 971	18-7958	Crusader	47047	Obsolete
18-7919	Yamaha	MAR-24563-00-00	158, 296, 410, 512, 747, 748, 897, 971	18-7961	Mercury Marine	25-47254	470
18-7920	Mercury Marine	35-809099	158, 296, 410, 512, 747, 897, 971	18-7961	Mercury Marine	25-861844	470
18-7920	OMC	771839	158, 296, 410, 512, 747, 897, 971	18-7961	Mercury Marine	785-97386	470
18-7920	Racor	S3214	158, 296, 410, 512, 747, 897, 971	18-7962	Volvo Penta	3840525	988
18-7921	Mercury Marine	35-877767K01	205, 432	18-7963	OMC	331353	336
18-7921	Mercury Marine	35-896546T	205, 432	18-7964-1	Mercury Marine	879194241	748
18-7922-1	Suzuki	99105-20004-BWL	484	18-7964-1	Mercury Marine	35-813405	748
18-7922-1			484	18-7964-1	Mercury Marine	35-813405A1	748
18-7924	Yamaha	MAR-10171-00-10	158, 296, 410, 512, 747, 897, 971	18-7964-1	Mercury Marine	35-815419	748
18-7924			158, 296, 410, 512, 747, 897, 971	18-7964-1	Mercury Marine	FFF001138	748
18-7925	Westerbeke	21235	Obsolete	18-7964-1	Mercury Marine	FI9608751	748
18-7926	Volvo	423135	Obsolete	18-7965-1	Yamaha	MAR-MINIF-LT-AS	512
18-7926	Volvo	4785974	Obsolete	18-7965-1			512
18-7927	Caterpillar	1R-0714	Obsolete	18-7966-1	Yamaha	MAR-SEPAR-AT-OR	511
18-7928-1	Racor	B32013	158	18-7966-1			511
18-7928-1			158	18-7967	Mercury Marine	35-14571A1	410
18-7929	Mercury Marine	35-809100	158	18-7967	Mercury Marine	35-17808A1	410
18-7929	Racor	B32020MAM	158	18-7967	Mercury Marine	35-18458A2	410
18-7929			158	18-7967	Mercury Marine	35-18458A3	410
18-7930	OMC	173326	159	18-7967	Mercury Marine	35-18458Q3	410
18-7931	Detroit Diesel	5574508	160	18-7968	Mercury Marine	35-184585	410
18-7932-1			157, 295, 409, 512	18-7968	Mercury Marine	35-18458Q4	410
18-7934	Cerlist Diesel	1512904	160	18-7969			160, 410, 747
18-7935	FRAM	CCS 1136	687	18-7970	Cerlist Diesel	1512903	160
18-7936	Mercury Marine	35-888289T2	410	18-7974	Volvo	3827069	205, 987, 988
18-7936	Suzuki	15412-93J00	410	18-7977	Mercury Marine	35-866171A01	748
18-7937-1			157, 295, 409, 512	18-79781	OMC	433190	296
18-7938			157, 295, 409, 512, 747, 896, 970	18-7979	Mercury Marine	881540	513
18-7941-1			158, 296, 897	18-7979	Yamaha	68V-24563-00-00	513
18-7942	Volvo	466987	687	18-79799	Yamaha	6D8-WS24A-00-00	513
18-7942	Volvo	3825133	687	18-79809	Yamaha	6P3-WS24A-00-00	513
				18-7981	Mercury Marine	35-884380T	410
				18-7981	Mercury Marine	35-8M0020349	410
				18-79813			228
				18-79814	Mercury	91-896661	228
				18-79815	Yamaha	YB-ACC04	228
				18-79816	Mercury	91-879172T28	221
				18-79816-24			221
				18-79817			228
				18-79820-1			228
				18-7982-1			109, 157, 295, 408, 511, 666, 895

1 This product is priced per piece. To order, priced per package, please add -9 to the part number

2 Items ending in "D" are display packaged - regular number is non-display • 3 For discount shop pack of 10, please add -10 to the part number

SIERRA #	O.E.M.	O.E. #	PAGE #	SIERRA #	O.E.M.	O.E. #	PAGE #
SIERRA							
18-7982-2			109,157, 295, 408, 511, 666, 895	3 18-8002EP-1			109
18-79823			228	18-8002S			168
18-79825			228	18-8003-1	Volvo	8692305	205, 988
18-7983-1	Mercury Marine	35-52456A1	409	18-8004-10EP-1		140, 275, 464	162
18-7983-1	Mercury Marine	35-55501A1	409	3 18-8004EP-1	Mercury Marine	89396A38	109
18-7983-1	Mercury Marine	35-57250A1	409	3 18-8004EP-1	Mercury Marine	89396C38	109
18-7983-1	Mercury Marine	35-60494A1	409	3 18-8004EP-1	OMC	174511	109
18-7983-1	Mercury Marine	35-60494A4	409	3 18-8004EP-1	Mercury Marine	89396A38	109
18-7983-1	Mercury Marine	35-802893A4	409	18-8004S	Mercury Marine	89396C38	406
18-7983-1	Mercury Marine	35-802893Q4	409	18-8004S	Mercury Marine	89396C38	406
18-7983-1	Mercury Marine	35-807172A4	409	18-8004S	OMC	174511	406
18-7983-1	Mercury Marine		409	3 18-8005-10EP-1		140, 275	162
18-7983-2			109,157, 295, 408, 511, 666, 895	3 18-8005EP-1	Mercury Marine	13330A3	406
18-79833-1	Mercury		228	3 18-8005EP-1	OMC	174512	406
18-79834	OMC		228	18-8005EP-1			406
18-7984-1	Yamaha	MAR-SPRTR-HD-SS	109,157, 295, 408, 511, 666, 895	18-8005S	Mercury Marine	13330A3	169
18-7984-1			109,157, 295, 408, 511, 666, 895	18-8005S	Mercury Marine	13330Q	169
18-7985-1			109,157, 295, 408, 511, 666, 895	18-8005S	OMC	174512	169
18-7986-1			109,157, 295, 408, 511, 666, 895	18-8009EP-2	OMC	398549	163, 297
18-7987	Racor	RK10222	158	18-8009S-1	OMC	398549	169
18-7987	Suzuki	99105-20006-BWL	158	18-8010EP-2			164, 405
18-7988			66, 156, 158, 160	18-8011EP-2	Chrysler Force	FS409752	163, 252
18-7989	OMC	502906	159	18-8012EP-2	Mercury Marine	32-858114K08	164, 405
18-7989	Volvo	3852413	159	18-8012EP-2	Mercury Marine	32-858114Q08	164, 405
18-7989	Volvo	3862228	159	18-8013EP-2			166, 374
18-7989	Volvo	3851218-2	159	18-8013S-1			170
18-79900	Yamaha	66K-13915-00-00	514, 515	18-8014EP-2	OMC	174509	164, 297
18-79901	Mercuriser	65L-13915-00-00	514, 748	18-8014S-1	OMC	174509	169
18-79901	Yamaha	65L-13915-00-00	514, 748	18-8015EP-2			166, 374
18-79902	Yamaha	63P-13915-00-00	515	18-8015S-1			170
18-79903	Yamaha	68V-13915-00-00	515	18-8016EP-2	Mercury Marine	32-858109K12	165, 169, 406
18-79904	Yamaha	68F-13915-00-00	515	18-8016EP-2	Mercury Marine	32-858109Q12	165, 169, 406
18-79905	Yamaha	69J-24501-10-00	513	18-8016S-1	Mercury Marine	32-858109K12	169
18-79906			158	18-8017EP-2	Yamaha	6YL-24306-60-00	516
18-79907	Yamaha	60V-24251-01-00	514	18-8017S-1	Yamaha	6YL-24306-60-00	170, 516
18-79908	Honda	16911-ZY3-010	265	1 18-8020	Mercury Marine	54-41582-7	167
18-79909	Honda	16901-ZY3-003	265	1 18-8020	OMC	322652	167
18-79910	Yamaha	61N-24560-10	515	1 18-8020	Volvo	3852170	167
18-79911	Mercury	35-8M0079962	409	1 18-8020			167
18-79912	Mercury	35-8M0082290	156	1 18-8021	OMC	911616	898
18-7994-1			160, 410	1 18-8021	Volvo	3852529	898
18-79950	Yamaha		515	1 18-8021			898
18-79951	Yamaha		515	18-8024EP-2	Mercury Marine	32-858104K08	164, 405
18-79952	Yamaha		515	18-8024EP-2	Mercury Marine	32-858104Q08	164, 405
18-79953	Yamaha		515	18-8025EP-2	Mercury Marine	32-858105K08	165, 406
18-79954	Yamaha		515	18-8025EP-2	Mercury Marine	32-858105Q08	165, 406
18-79955	Yamaha		515	18-8032EP-2			166, 374
18-79956	Yamaha		515	18-8032S-1			170
18-79957	Yamaha		515	1 18-8034	OMC	329654	898
18-79960	Yanmar	104500-55710	161, 687	1 18-8034	Volvo		898
18-79961	Yamaha	6H1-13411-00	538	18-8040	Yamaha	ABA-FBARB-90-DG	516
18-7997	Mercury Marine	35-853333	411	18-80400	Honda	16977-ZV5-A00	264
18-7997	Mercury Marine	35-853333T	411	18-80401			163, 264
18-79970	Yamaha	6BG-13915-00	513	18-80402			407
18-79971	Yamaha	68F-13440-00	538	18-80403			163, 264
18-79972	Yamaha	67F-14371-01	513	18-80404			485
18-79973	Yamaha	6CS-13915-00	513	18-80405			485
18-79974	Yamaha	6J8-13411-00	538	18-80406	Honda	16977-ZV5-900	264
18-79975	Yamaha	6E5-13411-00	538	18-80407	Honda	17710-ZW9-033	264
18-79976	Yamaha	61A-13411-00	538	18-80408	Honda	17650-ZW9-003	264
18-79977	Yamaha	6L5-24251-00	514	18-80409	Suzuki	65720-94401	485
18-79978	Yamaha	6CB-13915-00	515	18-8041			108
18-79979	Yamaha	6CB-24501-00	514	18-80410-1	Mercury Marine	22-13563T3	407
18-79980	Yamaha	68F-24563-00	514	18-80410-1	Nissan/Tohatsu	3GR702500M	407
18-79981	Yamaha	69J-24501-00	514	18-80412	Mercury Marine	22-816856T2	407
18-79982	Yamaha	69J-24502-00	514	18-80413	Yamaha	6Y1-24305-04	517
18-79983	Yamaha	6CS-24251-00	514	18-80414	Yamaha	6G1-24305-04	517
18-79984	Yamaha	6AW-24502-00-00	514	18-80414	Yamaha	6G1-24305-05-00	517
18-79984	Yamaha	6AW-24502-10	514	18-80415	Yamaha	6E5-24305-05	517
18-79985	Yamaha	68V-24502-20-00	514	18-80415	Yamaha	6Y2-24305-05	517
18-79985	Yamaha	68V-24502-30	514	18-80418	Suzuki	65750-94404	485
18-79986	Yamaha	68V-24502-00-00	514	18-80419	Suzuki	65750-87J10	485
18-79986	Yamaha	68V-24502-01-00	514	18-80419	Suzuki	65750-87J11	485
18-79986	Yamaha	68V-24502-02	514	18-8042			108
18-79987			Obsolete	18-80420	Honda	17650-921-003ZB	264
18-79988			Obsolete	18-80425	Suzuki	65720-986B0	485
18-79989	Universal		Obsolete	18-8043			108
18-7999	Mercury Marine	35-896247	411	18-8045			167
18-79994N	Mercury	3310-866142A03	731	18-8046			167
18-79994N	Mercury	3310-866142A04	731	18-8047			167
18-79998	Volvo	R80316	966	18-8048			168, 297
18-80008	Volvo	R7044289	966	18-8050			168, 297
				18-8051	OMC	322656	168, 297
				18-8052	OMC	122838	168, 297
				18-8054	Mercury Marine	22-63186	108, 167, 406
				18-8054			108, 167, 406
				18-8055	Mercury Marine	22-63187	516
				18-8055	OMC	173311	516
				18-8055	Yamaha	ABA-FLINE-BA-RB	516
				18-8055			516
				3 18-8056	OMC	174508	297

1 This product is priced per piece. To order, priced per package, please add -9 to the part number
 2 Items ending in "D" are display packaged - regular number is non-display • 3 For discount shop pack of 10, please add -10 to the part number

SIERRA #	O.E.M.	O.E. #	PAGE #	SIERRA #	O.E.M.	O.E. #	PAGE #
SIERRA							
3 18-8056	OMC	775640	297	1 18-8203	OMC	329653	298
18-8062	Chrysler Force	197787-3	252	1 18-8203	Volvo	329653	298
18-8062	Suzuki	65750-98505	252	1 18-8204	OMC	324825	298
3 18-8063	OMC	502867	297	1 18-8204	Volvo	324825	298
3 18-8063	OMC	772681	297	18-8205	Mercury Marine	30-803098T1	845, 846
3 18-8063	OMC	772681	297	18-8206-1	Mercury Marine	30-803099T1	845, 846
18-8067			167	18-8208	Mercury Marine	31-803090T1	866
18-8068			164, 165, 405, 406, 407	18-8212-1	Mercury Marine	30-803100T1	845, 846
18-8069	Mercury Marine	22831A1	407	18-8212-1	Mercury Marine	8M0095485	845, 846
18-8069	Mercury Marine	22831A3	407	18-8213	Mercuriser	30-803097T1	845, 846
18-8069	Mercury Marine	22831A4	407	18-8215			608, 636, 652
18-8069	Mercury Marine	22831B3	407	18-8216	Mercury Marine	22-36305	798
18-8069	Mercury Marine	22831Q3	407	18-8216	Mercury Marine	22-36305T	798
18-8070	Mercury Marine	29196	407	18-8216			798
18-8070	Mercury Marine	16610M	407	18-8217	Mercuriser	30-803098T1	845, 846
18-8070	Mercury Marine	30185A1	407	18-8218	Mercuriser	30-803099T1	845, 846
18-8070	Mercury Marine	30185A3	407	18-8219	Mercuriser	30-803100T1	845, 846
18-8070	Mercury Marine	30185B3	407	18-8220	Mercury Marine	88-79023A91	720
18-8070	Mercury Marine	30185Q3	407	18-8226	Honda	16910-ZV4-015	264
18-8071	Suzuki	99105-00192	485	18-8227	Mercury Marine	73873	Obsolete
18-8071			485	18-8227	Mercury Marine	73873A1	Obsolete
18-8072	OMC	174177	898	18-8297	Mercury Marine	861578	806
18-8073			108	18-8298	Honda	91252-935-004	270
18-8074	OMC	173312	108	18-8299	Honda	91356-ZY3-003	270
18-8074			108	18-8300	OMC	341280	367, 941
18-8075	Mercury Marine	22-14213M	407	18-8301	OMC	341281	367, 941
18-8075	Mercury Marine	22-14213Q	407	18-8304	OMC	321830	367
18-8075	Mercury Marine	22-81042M	407	18-8305	Mercury Marine	42838	446
3 18-8076	Mercury Marine	22-13563A3	405	18-8305	Mercury Marine	69668	446
3 18-8076	Mercury Marine	22-13563Q3	405	18-8305	Mercury Marine	88726	446
3 18-8077-1			407	18-8305	Mercury Marine	428381	446
18-8078	Suzuki	65740-95500	478	18-8305	Mercury Marine	26-814754	446
18-8078	Suzuki	99105-00193	478	18-8307	OMC	331103	367, 941
18-8078			478	18-8308	Mercury Marine	26-30696	467
18-8079	Nissan/Tohatsu	3B2702810M	478	18-8309	Mercury Marine	18717	446
18-8079	Nissan/Tohatsu	65750-95500	478	18-8310	Mercury Marine	26-30900	467
18-8079	Suzuki	65750-95500	478	18-8311			843
18-8079	Suzuki	65750-95510	478	18-8312			843
18-8082			407	18-8313			843
18-8083			407	18-8325	OMC	342786	367
18-8084	Mercury Marine	29196	407	18-8326	OMC	342787	367
18-8084	Mercury Marine	22-16610M	407	18-8331-9	Suzuki	09168-10022	491
18-8084	Mercury Marine	30185A1	407	18-8334	Suzuki	25223-94400	491
18-8084	Mercury Marine	30185A3	407	18-8335	Suzuki	25700-87D00	494
18-8084	Mercury Marine	30185B3	407	18-8337	OMC	5031456	493
18-8084	Mercury Marine	30185Q3	407	18-8337	Suzuki	25700-94400	493
3 18-8085			407	18-8338	Suzuki	25700-94500	494
18-8087	Suzuki	65720-94411	485	18-8339	Suzuki	25700-94700	494
18-8088	Nissan/Tohatsu	3B2702501M	478	18-8340	Suzuki	25700-95500	494
18-8089	Nissan/Tohatsu	3B2-70260-0	478	18-8341	Suzuki	25700-95D00	494
18-8090			485	18-8345	Suzuki	09289-22007	494
18-8091	Mercury Marine	22-13563A6	407	18-8347	Chrysler Force	26-76384	Obsolete
18-8091	Mercury Marine	22-13563A7	407	18-8347	Chrysler Force	26-816464	Obsolete
18-8091	Mercury Marine	22-13563Q7	407	18-8347	Chrysler Force	26-8164641	Obsolete
18-8091	Mercury Marine	22-13563T7	407	18-8347	Mercury Marine	26-76384	Obsolete
18-8092	OMC	176445	297	18-8347	Mercury Marine	26-816464	Obsolete
18-8092	OMC	775641	297	18-8347	Mercury Marine	26-8164641	Obsolete
18-8093			167	18-8349	OMC	911795	367, 941
18-8094			167	18-8349	OMC	3852548	367, 941
18-8095			167	18-8350	OMC	328603	Obsolete
18-81006	OMC		224	18-8351	OMC	308500	367, 941
18-81042EP-2	Honda	17700-ZW9-010	163, 264	18-8351	OMC	321504	367, 941
18-81042EP-2	Honda	17700-ZW9-020	163, 264	18-8352	OMC	332253	330
18-8108			108	18-8353	OMC	320961	336
18-8108			108	18-8354	Chrysler Force	26-828627	261
18-8109			167	18-8355			Obsolete
1 18-8110			Obsolete	18-8357	Volvo	875741	1003
18-81103			223	18-8358	Volvo	876267	1003
1 18-8111	Mercury Marine	22-36392	795	18-8359	Volvo	876268	1003
18-8112	Crusader	97854	629	18-8360			937
18-8114			176, 587, 598, 619, 635, 655, 667, 735, 894, 967	18-8361	Volvo	576266-8	1003
18-8115			176, 587, 598, 619, 635, 655, 667, 735, 894, 967	18-8362-1			272
18-8124	Volvo	829913	687	18-8363			272
18-8125	Volvo	3583443	687	18-8365			Obsolete
18-8126	Volvo	861477	Obsolete	18-8366			Obsolete
18-8127-1	Pleasurecraft	RP080026	648	18-8367	OMC	334950	367
18-8149	Volvo	3847644	970	18-8368	Volvo	813967	999
18-8150			167	18-8369	OMC	914488	924
18-8150-10			167	18-8370			866
18-8151			167	18-8372	OMC	323582	336
18-8151-10			167	18-8373	Suzuki	25700-90J01	493
18-8152			167	18-8374	Suzuki	25700-92J00	493
18-8152-10			167	18-8375			494
1 18-8200	OMC	322653	298	18-8378			Obsolete
1 18-8200	Volvo	3852171	298	18-8380	Suzuki	25700-93J00	494
1 18-8201	OMC	124249	298	18-8381	Suzuki	25700-99E00	494
1 18-8202	OMC	322654	298	18-8382	Mercury Marine	26-816575A4	465
1 18-8202	Volvo	3852172	298	18-8383	OMC	5000309	366
				18-8384	OMC	5006373	366
				18-8385	Suzuki	25700-95J00	494
				18-8386	Suzuki	25700-98J00	494

1 This product is priced per piece. To order, priced per package, please add -9 to the part number

2 Items ending in "D" are display packaged - regular number is non-display • 3 For discount shop pack of 10, please add -10 to the part number

SIERRA #	O.E.M.	O.E. #	PAGE #	SIERRA #	O.E.M.	O.E. #	PAGE #
SIERRA							
18-8387	BRP	5007987	365	18-8802-1	Mercury Marine	84-816761A12	193
18-8400-9	Yamaha	90119-08M15-00	523	18-8802-1	Mercury Marine	84-816761Q12	193
18-8402	Mercury Marine	10-8053432	716	18-8802-1	OMC	503752	193
18-8402-1	Mercury Marine	10-8053432	716	18-8802-1	OMC	503755	193
18-8404-1	Mercury Marine	10-8083434	716	18-8802-1	Volvo	8757166	193
18-8406	Yamaha	97595-06535	527	18-8803-2	Mercury Marine	84-43376A9	194
18-8407	Yamaha	97595-06540	527	18-8803-2	Mercury Marine	84-813720A10	194
18-8410	Mercury Marine	10-43749	795	18-8803-2	Mercury Marine	84-813720A9	194
18-8411	Mercury Marine	10-44387	795	18-8803-2	Mercury Marine	84-816761A9	194
18-8412			715, 886	18-8803-2	Mercury Marine	84-816761Q10	194
18-8500			794	18-8803-2	Mercury Marine	84-816761Q9	194
18-8502			910	18-8803-2	OMC	503752	194
18-8503			650	18-8803-2	OMC	503755	194
18-8504			650	18-8803-2	OMC	503755	194
18-8505			796	18-8804-1	Mercury Marine	84-813720A2	198
18-8506	Barr	CM-20-6674JP	608	18-8804-1	Mercury Marine	84-813720A3	198
18-8507	Barr	CM-20-6674JP	608, 910	18-8804-1	Mercury Marine	84-813720A4	198
18-8510			981	18-8804-1	Mercury Marine	84-816608Q61	198
18-8511			981	18-8804-1	Mercury Marine	84-816761A4	198
18-8512			795	18-8804-1	Mercury Marine	84-816761Q3	198
18-8514			795	18-8804-1	Mercury Marine	84-816761Q4	198
18-8515			629	18-8805-1			193
18-8516			Obsolete	18-8806-1			190-199
18-8518	Barr	CM-20-9232P	Obsolete	18-8807-1	OMC	503747	193-198, 614
18-8519			629	18-8808-2	Mercury Marine	84-813720A6	709
18-8520			796	18-8808-2	Mercury Marine	84-816761Q6	709
18-8521			629	18-8809-1	Mercury Marine	84-43376A8	709
18-8523			629	18-8809-1	Mercury Marine	84-813720A8	709
18-8524			630	18-8809-1	Mercury Marine	84-816761A8	709
18-8526			601, 605, 608	18-8809-1	Mercury Marine	84-816761Q8	709
18-8527	Barr	CM-1-6677SS P	608	18-8810-1	Mercury Marine	84-813720A11	193
18-8529			796	18-8810-1	Mercury Marine	84-816761Q16	193
18-8530			796	18-8810-1	OMC	503751	193
18-8531			796	18-8811-1	Mercury Marine	84-813720A13	193
18-8532			796	18-8811-1	Mercury Marine	84-816761Q13	193
18-8533			796	18-8811-1	OMC	503749	193
18-8534			910	18-8811-1			193
18-8535		590, 608, 630, 638, 650, 663, 796, 910, 981		18-8813-1	Volvo	875571	954, 955, 956, 958
18-8536	Marine Power	0994-000	608	18-8814-1	OMC	503749	193
18-8536			608	18-8815-1	OMC	582365	280
18-8538		590, 608, 630, 638, 650, 663, 796, 910, 981		18-8816-1	OMC	582365	280
18-8539			981	18-8817-1			193, 194, 582
18-8547			630	18-8818-1	OMC	582365	280
18-8548			791	18-8819-1			192, 246, 382
18-8549			788, 796	18-8820-1	OMC	503754	190-199
18-8551			796	18-8820-1			190-199
18-8553			910	18-8821-1	Mercury Marine	84-813720A3	705
18-8554			796	18-8821-1	Mercury Marine	84-813720A4	705
18-8555			796	18-8821-1	Mercury Marine	84-816761A17	705
18-8555			796	18-8821-1	Mercury Marine	84-816761A4	705
18-8556			796	18-8821-1	Mercury Marine	84-816761Q17	705
18-8600			222	18-8821-1	Mercury Marine	84-816761Q3	705
18-8601			222	18-8821-1	Mercury Marine	84-816761Q4	705
18-8602			222	18-8822-1	Mercury Marine	84-816608A81	705
18-8603			222	18-8822-1	Mercury Marine	84-816608Q81	705
18-8604			222	18-8823-1	OMC	503752	194
18-8605			222	18-8823-1	OMC	503755	194
18-8606	Mercury	92-8M0062765	222	18-8823-1	Volvo	8757166	194
18-8607			222	18-8823-1			194
18-8608			222	18-8824-1	Mercury Marine	84-816608Q78	705
18-8609			222	18-8824-1			705
18-8610			222	18-8825-1			Obsolete
18-8611			232	18-8826-1			193, 194, 593
18-8612			232	18-8827-1			193, 194, 593
18-8613	Universal	88-831	232	18-8828-1	Mercury Marine	84-863656A1	705
18-8614			232	18-8829-1	Mercury Marine	84-863656A2	705
18-8615			232	18-8830-1	Mercury Marine	84-816608Q80	705
18-8616			232	18-8832-1	Mercury Marine	84-816608A68	705
18-8617			232	18-8832-1	Mercury Marine	84-816608K68	705
18-8700	Yamaha	1WD-E3440-00-00	539	18-8832-1	Mercury Marine	84-816608Q68	705
18-8700	Yamaha	2MB-E3440-00-00	539	18-8833-1	Mercury Marine	84-816608A14	705
18-8700	Yamaha	5GH-13440-20	539	18-8833-1	Mercury Marine	84-816608Q14	705
18-8700	Yamaha	5GH-13440-50-00	539	18-8833-1	Mercury Marine	84-816761K14	705
18-8700	Yamaha	5JW-13400-00-00	539	18-8834-1	Mercury Marine	84-816608A83	705
18-8701	Volvo Penta	861476	988	18-8834-1	Mercury Marine	84-816608Q83	705
18-8702	Volvo Penta	30788490	988	18-8835-1	Mercury Marine	84-816608Q82	705
18-8779	Indmar	872025	204, 636	18-8836-1	Mercury Marine	84-816608A71	705
18-8800-1	Mercury Marine	84-43376A7	881	18-8836-1	Mercury Marine	84-816608Q71	705
18-8800-1	Mercury Marine	84-813720A5	881	18-8837-1	Mercury Marine	84-847701A7	705
18-8800-1	Mercury Marine	84-816761A7	881	18-8837-1	Mercury Marine	84-847701Q7	705
18-8800-1	Mercury Marine	84-816761Q5	881	18-8838-1	Mercury Marine	84-881698	705
18-8800-1	OMC	503748	881	18-8839-1			192
18-8800-1			881	18-8840-1			92, 280
18-8801-1	Mercury Marine	84-813720A7	193	18-8841-1	OMC	503749	193, 959
18-8801-1	Mercury Marine	84-816761Q7	193	18-8842-1	OMC	503753	198
18-8801-1	OMC	503750	193	18-8843-1	OMC	503756	198
18-8801-1	Volvo	876532-3	193	18-8844-1	Crusader		193
18-8802-1	Mercury Marine	84-43376A12	193	18-8847-1	Yamaha	67F-82341-00-00 +	496
18-8802-1	Mercury Marine	84-813720A12	193	18-8847-1	Yamaha	67F-82342-00-00 +	496
				18-8847-1	Yamaha	67F-82343-00-00 +	496

1 This product is priced per piece. To order, priced per package, please add -9 to the part number
 2 Items ending in "D" are display packaged - regular number is non-display • 3 For discount shop pack of 10, please add -10 to the part number

SIERRA #	O.E.M.	O.E. #	PAGE #	SIERRA #	O.E.M.	O.E. #	PAGE #
SIERRA							
18-8847-1	Yamaha	67F-82344-00-00	496	18-9095			112
18-8860	Mercury Marine	861677T	741	18-9096	Volvo	3847547	998
18-8864	Mercury Marine	866169A01	740	18-9098	OMC	174448	998
18-8864	Mercury Marine	866169T01	740	18-9098	Volvo	174448	998
18-8865	Mercury Marine	866170A01	740	18-9099	Mercury Marine	86459	862
18-8866	Mercury Marine	892874T01	403	18-9099	Mercury Marine	879078	862
18-8866	Mercury Marine	899106T01	403	18-9099	Mercury Marine	32657A3	862
18-8870	Suzuki	16510-45H10	491	18-9099	Mercury Marine	32657A4	862
18-8880	BRP	420956741	572	18-9099	Mercury Marine	41155A1	862
18-8898			664	18-9099	Mercury Marine	41155A2	862
18-8899			664	18-9099	Mercury Marine	817019A1	862
18-8900	Chrysler Force	47-19453	253	18-9099	Mercury Marine	817019A2	862
18-8900	Mercury Marine	47-19453	253	18-9099	Mercury Marine	817019Q2	862
18-8901	Chrysler Force	47-F462065	253	18-9099	Mercury Marine	86459A1	862
18-8903	Chrysler Force	47-F436065-2	253	18-9099	Mercury Marine	86459A2	862
18-8904	OMC	5031417	Obsolete	18-9125	Oetiker	787133	225
18-8905	OMC	5008968	298	18-9125	OMC	787133	225
18-8906	OMC	436137	299	18-9125	OMC	787145	225
18-8907	OMC	5033542	299	18-9126-9	Oetiker	16700004	225
18-8910	Yamaha	68T-44352-00-00	518	18-9126-9	OMC	346930	225
18-8911	Yamaha	6L5-44352-00-00	518	18-9127-9	Oetiker	16700006	225
18-8920	Nissan/Tohatsu	3B2650211M	479	18-9127-9	OMC	348838	225
18-8921	Nissan/Tohatsu	334650210M	479	18-9128-9	Oetiker	16700007	225
18-8922	Nissan/Tohatsu	3C8650212M	479	18-9128-9	OMC	349516	225
18-8923	Nissan/Tohatsu	345650210M	479	18-9129-9	Oetiker	16700010	225
18-8924	Nissan/Tohatsu	3B7650212M	479	18-9129-9	OMC	347107	225
18-8924	Nissan/Tohatsu	3C7650211M	479	18-9130-9	Oetiker	16700011	225
18-8925	Yamaha	6AW-44352-00-00	518	18-9130-9	OMC	347108	225
18-8926	Crusader	RP061022	620	18-9131-9	Oetiker	16700012	225
18-8950	Yanmar	124223-42092	687	18-9131-9	OMC	346931	225
18-8951	Yanmar	128176-42071	687	18-9132-9	Oetiker	16700013	225
18-8952	Yanmar	104211-42071	688	18-9132-9	OMC	346785	225
18-8953			512	18-9133-9	Oetiker	16700016	298
18-8954			512	18-9133-9	OMC	346786	298
18-8955			157, 410, 748	18-9133-9	Yamaha	YB-6AW04-1	298
18-8956	Mercury	22-8M0001721	403	18-9134-9	Oetiker	16700017	225
18-8957	Mercury	22-818994	403	18-9134-9	OMC	348839	225
18-8957	Mercury	22-8189941	403	18-9135-9	Oetiker	16700024	225
18-8958	Mercury	22-424254	403	18-9135-9	OMC	346151	225
18-8960			234	18-9136-9	Oetiker	16700031	225
18-8962	GM		Obsolete	18-9136-9	OMC	346152	225
18-8963	GM		Obsolete	18-9137-9	Oetiker	16700037	225
18-8964	Volvo	3853804	Obsolete	18-9137-9	OMC	346153	225
18-8997			225	18-9138-9	Oetiker	16700040	225
18-8998-1			225	18-9138-9	OMC	349759	225
18-8999			225	18-9139-9	Oetiker	16700053	225
18-9009			225	18-9139-9	OMC	349729	225
18-9010			225, 461, 861	18-9140-9	Oetiker	16700020	225
18-9013	Mercury Marine	92-78383A12	Obsolete	18-9140-9	OMC	346150	225
18-9013	Mercury Marine	92-817529A12	Obsolete	18-9141	Oetiker	14100082	225
18-9013	OMC	174275	Obsolete	18-9141	OMC	787145	225
18-9013	OMC	175068	Obsolete	18-9145	Yamaha	YB-6AW04-A	225, 517
18-9013	OMC	775613	Obsolete	18-9146-9	Yamaha	YB-6AW04-3	225, 517
18-9024	Mercury Marine	92-78383A12	Obsolete	18-9182			222
18-9024	Mercury Marine	92-817529A12	Obsolete	18-9183			222
18-9024	OMC	174275	Obsolete	18-9200-0	Mercury Marine	92-8M0071838	219
18-9024	OMC	175068	Obsolete	18-9200-1	Mercury Marine	92-8M0071841	219
18-9024	OMC	775613	Obsolete	18-9200-2	Mercury Marine	92-8M0071837	219
18-9065	Mercury Marine	92-78383A12	Obsolete	18-9200-4	Mercury Marine	92-8M0071837	219
18-9065	Mercury Marine	92-817529A12	Obsolete	18-9218	Mercury Marine	59829A1	842
18-9065	OMC	174275	Obsolete	18-9218	Mercury Marine	59830A5	842
18-9065	OMC	175068	Obsolete	18-9218	Mercury Marine	814819A2	842
18-9065	OMC	775613	Obsolete	18-9219	OMC	335677	Obsolete
18-9066			224	18-9240-0	Mercury	92-802859A1	Obsolete
18-9067			Obsolete	18-9240-1	Mercury	92-802863A1	219, 852
18-9075	Mercury Marine	23-888690	461	18-9320			Obsolete
18-9075	Yamaha	61A-45538-00-00	461	18-9350			217
18-9076	Mercury Marine	23-888690-1	461	18-9390	Yamaha	LUB-MRNSM-KT-10	539
18-9076	Yamaha	61A-45527-00-00	461	18-9391	Yamaha	LUB-MRNMD-KT-10	539
18-9077	Mercury Marine	13-888363-2	461	18-9392	Yamaha	LUB-MRNMR-KT-10	539
18-9077	Yamaha	90206-22M19	461	18-9393	Yamaha	LUB-MRNLG-KT-10	539
18-9078	Mercury Marine	12-855682-2	461	18-9400-2	Mercury Marine	92-802837Q1	139
18-9078	Yamaha	90201-22M01	461	18-9400-2P	Mercuriser	92-802837Q1	Obsolete
18-9079	Yamaha	61A-45538-00-00 +	519	18-9400-30			210, 214
18-9079	Yamaha	61A-45527-00-00 +	519	18-9400-30P			Obsolete
18-9079	Yamaha	90206-22M19 +	519	18-9400-4	Mercury Marine	92-857389A1	210, 214
18-9079	Yamaha	90201-22M01	519	18-9400-4P	Mercuriser	92-857389A1	Obsolete
18-9080	Mercury Marine	92-78383A12	221	18-9400-7	Mercury Marine	92-802841A1	210, 214
18-9080	Mercury Marine	92-817529A12	221	18-9400-7P	Mercuriser	92-802841A1	210, 214
18-9080	OMC	174275	221	18-9400CAT-2	Mercury Marine	92-8M0078627	213, 214
18-9080	OMC	175068	221	18-9400CAT-2P	Mercury Marine	92-8M0078627	213, 214
18-9080	OMC	775613	221	18-9400CAT-4	Mercury Marine		213, 214
18-9081	Yamaha	6E5-44312-00-00	519	18-9400CAT-4P	Mercury Marine		Obsolete
18-9082	Yamaha	6AW-44312-00-00	519	18-9400CAT-7	Mercury Marine	92-8M0078621	213, 214
18-9083	Yamaha	63D-44312-00	519	18-9400CAT-7P	Mercury Marine	92-8M0078621	213, 214
18-9084	Johnson/Evinrude	354578	306	18-9410-2	Volvo	3842343	139
18-9089	Yamaha	6EG-G4328-00	527	18-9410-4	Volvo	3842344	211, 214
18-9090	Yamaha	63V-44328-01	526	18-9410-7	Volvo	3858061	211, 214
18-9091	Yamaha	69M-G4328-00	527	18-9420-2	Mercury Marine	92-802833Q1	139
18-9092	Yamaha	6L2-44328-00	527	18-9420-2P	Mercury	92-802833Q1	209, 214
18-9093			112	18-9420-3	Mercury Marine	92-802835Q1	209, 214

1 This product is priced per piece. To order, priced per package, please add -9 to the part number

2 Items ending in "D" are display packaged - regular number is non-display • 3 For discount shop pack of 10, please add -10 to the part number

SIERRA #	O.E.M.	O.E. #	PAGE #	SIERRA #	O.E.M.	O.E. #	PAGE #
SIERRA							
18-9420-3P	Mercury	92-802835Q1	209, 214	18-9600-5P	Mercury Marine	92-858007Q01	Obsolete
18-9420-30	Mercury	92-802835Q1	209	18-9600-6	Mercury Marine	92-858061Q01	Obsolete
18-9420-30P	Mercury	92-802835Q1	209, 214	18-9600-7	Mercury Marine	92-858062Q01	218
18-9420-7	Mercury Marine	92-802836A1	209, 214	18-9600-7P	Mercury Marine	92-858062Q01	Obsolete
18-9420-7P	Mercury	92-802836A1	209, 214	18-9600-9			218
18-9420CAT-2	Mercury Marine	92-8M0078625	213, 214	18-9650-0			218
18-9420CAT-2P	Mercury Marine	92-8M0078625	213, 214	18-9650-2	Mercury Marine	92-858064Q01	218
18-9420CAT-3	Mercury Marine	92-8M0078626	213, 214	18-9650-2P	Mercury Marine	92-858064Q01	Obsolete
18-9420CAT-3P	Mercury Marine	92-8M0078626	213, 214	18-9650-2QP	Mercury Marine	91-8M0101435	218
18-9420CAT-7	Mercury Marine	92-8M0078618	213, 214	18-9650-5	Mercury Marine	92-858008Q01	218
18-9420CAT-7P	Mercury Marine	92-8M0078618	213, 214	18-9650-5P	Mercury Marine	92-858008Q01	Obsolete
18-9440-2	Mercury Marine	92-883724K01	210, 214	18-9650-6	Mercury Marine	92-858067Q01	218
18-9440-2P	Mercury Marine	92-883724K01	210, 214	18-9650-6P	Mercury Marine	92-858067Q01	218
18-9440-3	Mercury Marine	92-883723K01	211, 214	18-9650-7	Mercury Marine	92-858068Q01	218
18-9440-4	Mercury Marine	92-883725K01	210, 214	18-9650-7P	Mercury Marine	92-858068Q01	Obsolete
18-9440-4P	Mercury Marine	92-883725K01	210, 214	18-9680-2	Volvo	1141679	218
18-9440-7	Mercury Marine	92-858057K01	210, 214	18-9680-5	Volvo	1141681	218
18-9440-7P	Mercuriser	92-858057K01	210, 214	18-9680-7	Volvo	1141682	218
18-9440-8	Mercury Marine	92-883722K01	211, 214	18-9690-2			211, 214
18-9440CAT-2	Mercury Marine	92-8M0078629	213, 214	18-9690-3			211, 214
18-9440CAT-2P	Mercury Marine	92-8M0078629	213, 214	18-9730-1			222
18-9440CAT-4	Mercury Marine		213	18-9750-0			222
18-9440CAT-4P	Mercury Marine		Obsolete	18-9751-0			Obsolete
18-9440CAT-7	Mercury Marine	92-8M0078624	213, 214	18-9751-2			221
18-9440CAT-7P	Mercury Marine	92-8M0078624	213, 214	18-9775			221
18-9450-2	Yamaha	LUB-20W40-FC-12	208, 214	18-9776			221
18-9490-1			207	18-9777			221
18-9493			221	18-9778			223
18-9494			Obsolete	18-9779			223
18-9495			Obsolete	18-9780			223
18-9499			Obsolete	18-9781	Mercury Marine	91-850730Q01	223
18-9500-1			208, 214	18-9781	Mercury Marine	91-8M0072133	223
18-9500-1P			208, 214	18-9782	Mercury Marine	91-74057Q6	Obsolete
18-9500-2			208, 214	18-9783	Mercury Marine	91-74057Q6	224
18-9500-2P			Obsolete	18-9784			224
18-9500-3			208, 214	18-9785	Mercury Marine	91-30500	224
18-9500-3P			208, 214	18-9786			218
18-9500-4			208, 214	18-9787			223
18-9500-4P			Obsolete	18-9788			224
18-9500-6			208, 214	18-9789			223
18-9500-7			208, 214	18-9790			223
18-9500-7P			Obsolete	18-9794	Mercury Marine	91-883704Q03	223
18-9530-3	Mercury Marine	92-858037K01	208, 214	18-9795			224
18-9530-3	OMC	764354	208, 214	18-9798			208, 222
18-9530-3	Yamaha	LUB-2STRK-M1-4	208, 214	18-9800			232, 385
18-9530-3P			Obsolete	18-9801	Mercury Marine	91-99750A1	232, 385
18-9530-4			208, 214	18-9801	Mercury Marine	91-99750A1	232, 385
18-9530-4P			Obsolete	18-9802	Mercury Marine	91-99379	385
18-9530-6			208, 214	18-9802			385
18-9530-7	Mercury Marine	92-858039K01	208, 214	18-9803	Mercury Marine	91-17256	852
18-9530-7	OMC	777228	208, 214	18-9803	Mercury Marine	91-36235	852
18-9530-7	Yamaha	LUB-2STRK-M1-55	208, 214	18-9804			224
18-9530-7P			Obsolete	18-9805	Mercury Marine	12-34961	Obsolete
18-9540-2			208, 214	18-9806E	Mercury Marine	91-12037	229
18-9540-3	OMC	764357	208, 214	18-9806E			229
18-9540-3P			Obsolete	18-9807	Mercury Marine	91-12427	229
18-9540-7	OMC	777120	208, 214	18-9807	Mercury Marine	91-12427T	229
18-9550-0			221	18-9808	Mercury Marine	91-15755	229
18-9550-3			221	18-9808	Mercury Marine	91-15755T	229
18-9551-2	Suzuki	990C0-10W40-1QT	209	18-9808	Mercury Marine	91-31109	229
18-9551-3	Suzuki	990C0-10W40-1GL	209	18-9808	Mercury Marine	91-37263	229
18-9551-6			209, 214	18-9809	Mercury Marine	91-17257	229
18-9551-7			209, 214	18-9810	Mercury Marine	91-17262A1	229
18-9552-3	Mercury Marine	92-858084K01	209, 214	18-9812	Mercury Marine	91-17275A1	229
18-9552-8			209, 214	18-9814	Mercury Marine	91-29310	Obsolete
18-9553-2	Volvo	40005011	139	18-9815	Mercury Marine	91-37324	235
18-9553-2			139	18-9816	Mercury Marine	91-30366T1	235
18-9553-3	Mercury Marine	92-858042K01	209, 214	18-9817	Mercury Marine	91-23033	229
18-9553-3	Mercury Marine	92-858042Q01	209, 214	18-9817	Mercury Marine	91-23033T	229
18-9553-3	Volvo	40005012	209, 214	18-9817	Mercury Marine	91-24150	229
18-9553-5	Volvo	40005013	Obsolete	18-9817	Mercury Marine	91-31107	229
18-9553-6			Obsolete	18-9817	Mercury Marine	91-31107T	229
18-9553-7	Volvo	40005014	Obsolete	18-9819	Mercury Marine	91-31229	235
18-9554-2	Indmar	872005	212	18-9820-1	Mercury Marine	91-31229A7	230
18-9554-4	Indmar	872006	212	18-9821	Mercury Marine	91-32325	Obsolete
18-9554-5	Indmar		209	18-9821	Mercury Marine	91-32325T	Obsolete
18-9554-7	Indmar		212	18-9822	Mercury Marine	91-32336	230, 235
18-9555-2	Indmar	872003	212	18-9823	Mercury Marine	91-33489	229
18-9555-4	Indmar	872004 (7QT)	212	18-9824	Mercury Marine	91-33491	229
18-9555-7	Indmar		212	18-9825	Mercury Marine	91-33492	229
18-9558-2	Ilmor/MasterCraft	550022689	212	18-9825	Mercury Marine	91-33492T	229
18-9558-4	Ilmor/MasterCraft	550046126	212	18-9826	Mercury Marine	91-33493	229
18-9558-7	Ilmor/MasterCraft		212	18-9826	Mercury Marine	91-33493T	229
18-95560			228	18-9827	Mercury Marine	91-34379T	229
18-9570-0			222	18-9828	Mercury Marine	91-36379	235
18-9580-3			222	18-9829	Mercury Marine	91-36569	Obsolete
18-9600-0	Mercury Marine	92-802844Q02	218	18-9829	Mercury Marine	91-36569T	Obsolete
18-9600-2	Mercury Marine	92-858058Q01	218	18-9830	Mercury Marine	91-36571	Obsolete
18-9600-2P	Mercury Marine	92-858058Q01	Obsolete	18-9830	Mercury Marine	91-36571T	Obsolete
18-9600-5	Mercury Marine	92-858007Q01	224	18-9831	Mercury Marine	91-36577	Obsolete
				18-9831	Mercury Marine	91-36577T	Obsolete

1 This product is priced per piece. To order, priced per package, please add -9 to the part number
 2 Items ending in "D" are display packaged - regular number is non-display • 3 For discount shop pack of 10, please add -10 to the part number

SIERRA #	O.E.M.	O.E. #	PAGE #	SIERRA #	O.E.M.	O.E. #	PAGE #
SIERRA							
18-9832	Mercury Marine	91-37292	230, 235	18-99025	Yamaha	688-45114-A1	545
18-9833	Mercury Marine	91-37311	230, 235	18-99026	Yamaha	688-45123-00	545
18-9834	Mercury Marine	91-37312	230, 235	18-99027	Yamaha	68T-13475-00	545
18-9835	Mercury Marine	91-37323	230	18-99028	Yamaha	68V-15312-00	545
18-9836	Mercury Marine	91-37350	230	18-9903			233
18-9837	Mercury Marine	91-38628T	Obsolete	18-99030	Yamaha	697-45114-A0	546
18-9838	Mercury Marine	91-38756	230	18-99032	Yamaha	69J-41134-A0	546
18-9839	Mercury Marine	91-38918T	230	18-99033	Yamaha	69J-41135-A0	546
18-9841	Mercury Marine	91-42840T	Obsolete	18-99034	Yamaha	69J-41136-A0	546
18-9842	Mercury Marine	91-43506T	230	18-99037	Yamaha	6E5-41134-A0	546
18-9844	Mercury Marine	91-43579	230	18-99038	Yamaha	6E5-41135-A0	546
18-9845	Mercury Marine	91-43591T	230	18-99039	Yamaha	6G5-41134-A1	546
18-9847	Mercury Marine	91-45497A1	230	18-9904			233
18-9848	Mercury Marine	91-52393	230, 235	18-99040	Yamaha	6G5-45114-A1	546
18-9849	Mercury Marine	91-52394	230	18-99045	Yamaha	6G8-45113-A1	546
18-9850	Mercury Marine	91-53459	230	18-99046	Yamaha	6H3-45114-A1	546
18-9851	Mercury Marine	91-55916	230	18-99047	Yamaha	6H3-45123-00	546
18-9852	Mercury Marine	91-55918	231	18-99048	Yamaha	60V-11181-00	Obsolete
18-9853	Mercury Marine	91-56048001	Obsolete	18-99049	Yamaha	60V-13621-A0	546
18-9853	Mercury Marine	91-56048T	Obsolete	18-9905			233
18-9854	Mercury Marine	91-56775T	Obsolete	18-99050	Yamaha	60V-13645-00	546
18-9855	Mercury Marine	91-60523	231	18-99051	Yamaha	61A-11193-A1	546
18-9856	Mercury Marine	91-60526T	231	18-99052	Yamaha	61A-11381-A0	Obsolete
18-9857	Mercury Marine	91-61067A3	Obsolete	18-99053	Yamaha	61A-13621-A0	546
18-9858	Mercury Marine	91-61069T	231	18-99054	Yamaha	61A-13645-00	546
18-9859	Mercury Marine	91-63616	231	18-99055	Yamaha	61A-13646-00	546
18-9860	Mercury Marine	91-63638T	231	18-99056	Yamaha	61A-45113-A0	546
18-9861	Mercury Marine	91-78310	231	18-99057	Yamaha	61T-11193-A1	546
18-9862	Mercury Marine	91-87119	234	18-99059	Yamaha	63D-11193-A0	542
18-9863	Mercury Marine	91-89865	232	18-9906			233
18-9865	Mercury Marine	91-90774	232	18-99060	Yamaha	63D-11181-A1	542
18-9866	Mercury Marine	91-89897	232	18-99061	Yamaha	63D-W0001-00	541
18-9868	Mercury Marine	91-61077	Obsolete	18-99062	Yamaha	68F-11181-00	542
18-9869	Mercury Marine	91-817570T	Obsolete	18-99063	Yamaha	63V-45315-A0	547
18-9870	Mercury Marine	91-818162	231	18-99064	Yamaha	64E-13645-A0	547
18-9871	Mercury Marine	91-818169T	Obsolete	18-99066	Yamaha	65L-13645-00	547
18-9872	Mercury Marine	91-821571A1	Obsolete	18-99067	Yamaha	65L-13646-00	547
18-9873	Mercury Marine	91-813653	234	18-99068	Yamaha	65W-11169-00	547
18-9874	Mercury Marine	91-14311A04	229	18-99069	Yamaha	65W-11351-00	547
18-9874	Mercury Marine	91-14311A1	229	18-9907			233
18-9874	Mercury Marine	91-14311A2	229	18-99070	Yamaha	65W-11356-00	547
18-9874	Mercury Marine	91-44307A1	229	18-99071	Yamaha	65W-14457-10	547
18-9876	OMC	349957	229, 925	18-99072	Yamaha	65W-41114-00	547
18-9879	Mercury		228	18-99073	Yamaha	65W-W0001-20	541
18-9884	Racor	RK22628	158, 160, 162, 223	18-99074	Yamaha	66M-11351-10	547
18-9885	OMC	328360	228	18-99075	Yamaha	66M-11356-00	547
18-9886	OMC	328361	228	18-99076	Yamaha	66M-13329-10	547
18-9887	OMC	328363	228	18-99078	Yamaha	66M-41138-00	547
18-9888	OMC	328364	228	18-99079	Yamaha	66M-45115-00	547
18-9889	OMC	328365	228	18-9908			233
18-9890	OMC	328366	228	18-99080	Yamaha	676-13646-A0	547
18-9891	OMC	328367	228	18-99082	Yamaha	676-44315-A1	547
18-9892	OMC	341440	228	18-99083	Yamaha	676-44324-A0	547
18-9894	OMC	393279	228	18-99084	Yamaha	676-45127-00	547
18-9895	Merc/Evinrude	881150K1	225	18-99085	Yamaha	676-45128-00	547
18-9896	Mercury	91-47448A1	228	18-99086	Yamaha	679-44316-A0	547
18-9896	Mercury	91-75132	228	18-99087	Yamaha	679-45315-A0	547
18-9896	Mercury	91-878232	228	18-99088	Yamaha	67C-11356-00	547
18-9896	Mercury	91-90455	228	18-99089	Yamaha	67C-41114-00	548
18-9896	Mercury	91-904551	228	18-9909			234
18-9896	Mercury	91-90455T	228	18-99091	Yamaha	67C-45113-00	548
18-9896	Mercury	91-90455T1	228	18-99092	Yamaha	67C-W0001-00	541
18-9897	Mercury	91-895343A02	228	18-99093	Yamaha	67C-W0001-20	541
18-9897	Mercury	91-895343T01	228	18-99094	Yamaha	67F-11181-02	542
18-9897	Mercury	91-895343T02	228	18-99095	Yamaha	682-11351-A0	548
18-9898			223	18-99096	Yamaha	682-41112-A1	548
18-9900	Universal		232	18-99097	Yamaha	682-W0001-06	541
18-99000	Yamaha	61A-41134-A0	544	18-99098	Yamaha	688-13621-A1	548
18-99001	Yamaha	61A-45114-A0	544	18-99099	Yamaha	68F-11193-01	548
18-99002	Yamaha	62Y-41133-00	544	18-9910			234
18-99003	Yamaha	62Y-41134-01	Obsolete	18-99100	Yamaha	68F-11381-00	548
18-99004	Yamaha	63D-45114-A0	544	18-99101	Yamaha	68F-41114-00	548
18-99005	Yamaha	63D-45123-00	544	18-99102	Yamaha	68F-45113-00	548
18-99006	Yamaha	63V-41133-A1	544	18-99103	Yamaha	68F-W0001-01	541
18-99008	Yamaha	64J-41133-10	545	18-99104	Yamaha	6A0-W0001-21	541
18-99009	Yamaha	663-45123-00	Obsolete	18-99105	Yamaha	6E5-13621-A1	548
18-99010	Yamaha	664-41134-A0	545	18-99106	Yamaha	6E9-11193-A0	548
18-99012	Yamaha	66M-41133-00	Obsolete	18-99107	Yamaha	6E9-41114-A0	548
18-99013	Yamaha	66M-45113-00	545	18-99108	Yamaha	6G1-11193-A1	548
18-99014	Yamaha	676-41133-A0	545	18-99109	Yamaha	6G1-13621-A1	548
18-99015	Yamaha	676-45114-A0	545	18-9911			233
18-99016	Yamaha	67C-41133-00	545	18-99110	Yamaha	6G1-13645-A1	548
18-99017	Yamaha	67C-45123-00	Obsolete	18-99111	Yamaha	6G1-14198-A1	548
18-99018	Yamaha	67F-41133-A1	545	18-99112	Yamaha	6G1-41112-A1	548
18-99019	Yamaha	67F-41134-A0	545	18-99113	Yamaha	6G1-41114-A0	548
18-9902	Universal		232	18-99114	Yamaha	6G1-41133-A0	548
18-99020	Yamaha	67F-45123-00	545	18-99115	Yamaha	6G1-45113-A1	548
18-99021	Yamaha	682-41133-A0	545	18-99116	Yamaha	6G1-45315-A0	548
18-99022	Yamaha	682-45113-A1	545	18-99117	Yamaha	6G1-W0001-A2	541
18-99023	Yamaha	688-41133-00	545	18-99118	Yamaha	6G5-14483-A1	548
18-99024	Yamaha	688-41134-A0	545	18-99119	Yamaha	6G8-11351-A0	548

1 This product is priced per piece. To order, priced per package, please add -9 to the part number

2 Items ending in "D" are display packaged - regular number is non-display • 3 For discount shop pack of 10, please add -10 to the part number

SIERRA #	O.E.M.	O.E. #	PAGE #	SIERRA #	O.E.M.	O.E. #	PAGE #
SIERRA							
18-9912			Obsolete	18-SD115			Obsolete
18-99120	Yamaha	6G8-12414-A0	548	18-SD115SUB			Obsolete
18-99121	Yamaha	6G8-13646-A0	549	18-SD116			Obsolete
18-99122	Yamaha	6G8-14198-A0	549	18-SD116SUB			Obsolete
18-99123	Yamaha	6G8-15374-00	Obsolete	18-SD117			Obsolete
18-99124	Yamaha	6H3-12414-A1	549	18-SD117SUB			Obsolete
18-99125	Yamaha	6H3-13622-00	549	18-SD405			Obsolete
18-99126	Yamaha	6H3-14198-01	549	18-SD406			Obsolete
18-99127	Yamaha	63P-12414-00-00	551	18-SD406SUB			Obsolete
18-99128	Yamaha	6H3-41112-A0	549	18-SD407			Obsolete
18-99129	Yamaha	6H3-41114-A0	549	18-SD407SUB			Obsolete
18-9913			234	18-SD410			Obsolete
18-99130	Yamaha	6H3-45113-A0	549	18-SD413			Obsolete
18-99132	Yamaha	6H4-13621-A1	549	18-SD413SUB			Obsolete
18-99133	Yamaha	6H4-14198-01	549	18-SD414			Obsolete
18-99134	Yamaha	6H4-15369-A1	549	18-SD415			Obsolete
18-99135	Yamaha	6H4-41112-A0	549	18-SD500			Obsolete
18-99136	Yamaha	6K7-13686-A1	549	18-SD501			Obsolete
18-99137	Yamaha	6L2-41133-A2	549	35-SS605			Obsolete
18-99138	Yamaha	6L2-45315-A0	549	35-SS610			Obsolete
18-99139	Yamaha	6OV-13646-00	549	35-SS615			Obsolete
18-9914			233	35-SS620			Obsolete
18-99140	Yamaha	63V-11181-A2	548	35-SS625			Obsolete
18-99141	Yamaha	6H3-11193-A1	549	35-SS630			235
18-99142	Yamaha	6E9-12414-A1	549	35-SS645			Obsolete
18-99143	Yamaha	6H3-13621-A1	549	35-SS650			Obsolete
18-99144	Yamaha	6E7-14227-00	549	35-SS695			Obsolete
18-99145	Yamaha	677-14198-A1	549	35-SS700			Obsolete
18-99146	Yamaha	677-14384-01	507	35-SS715	Mercury		Obsolete
18-99147	Yamaha	6G1-24431-01	549	35-SSKIT1			Obsolete
18-99148	Yamaha	688-41114-A0	549	72-5100-2	Arctic Cat	0436-880	215
18-99149	Yamaha	663-44316-A0	549	72-5100-2	Honda	HP4	215
18-99150	Yamaha	63V-45113-A1	550	72-5100-2			215
18-99151	Yamaha	688-45113-A0	550	72-5100-3	Arctic Cat	0436-879	215
18-99152	Yamaha	683-45315-A0	550	72-5100-7			215
18-99153	Honda	19232-ZW9-000	Obsolete	72-5101-2	Arctic Cat	1436-434	215
18-99154	Honda	19234-ZX2-C00	267	72-5101-2	Can-Am	XPS #779139	215
18-99155	Mercury	27-822217	Obsolete	72-5101-3	Arctic Cat	1436-435	215
18-99156	Johnson/Evinrude	325040	Obsolete	72-5101-3	Can-Am	XPS #779140	215
18-99157	Yamaha	6EG-G4315-00	527	72-5101-7			215
18-99175	Yamaha	63V-W0001-01	541	72-5102-2	Arctic Cat	1436-159	216
18-99176	RACOR	6H3-W0001-02	541	72-5102-2	Honda	08208-0080	216
18-99186	RACOR	2010SM-OR	159	72-5102-2			216
18-99182	RACOR	2010TM-OR	159	72-5102-4	Arctic Cat	0436-901	216
18-99183	RACOR	2010PM-OR	159	72-5102-4			216
18-99184	RACOR	2040N-30	159	72-5102-5			216
18-99185	RACOR	2040N-10	159	72-5102-7			216
18-99191	RACOR	2040N-02	159	72-5103-2	Arctic Cat	4639-349	215
18-99180	RACOR	2020N-30	159	72-5103-2	Honda	HP2	215
18-99181	RACOR	2020N-10	159	72-5103-2	Yamaha		215
18-99187	RACOR	2020N-02	159	72-5103-2	Ski-Doo	XPS 779126	215
18-99193	RACOR	R12T	159, 160	72-5103-2	Polaris	VES	215
18-99194	RACOR	R12S	159, 160	72-5103-2	Kawasaki	K61021-208A	215
18-99196	RACOR	R20S	159	72-5103-3	Arctic Cat	5639-469	215
18-99199	RACOR	R12P	159, 160	72-5103-3	Honda	HP2	215
18-99200	RACOR	R20P	159	72-5103-3			215
18-99201	RACOR	RK10215	160	72-5103-3	Ski-Doo	XPS 779127	215
18-99203	RACOR	RK22368	160	72-5103-3	Polaris	VES	215
18-99202		RK350-02	160	72-5103-4	Honda	HP2	215
18-ADC400			Obsolete	72-5103-4	Yamaha		215
18-ADC401			Obsolete	72-5103-4	Polaris	VES	215
18-ADC402			Obsolete	72-5103-5	Honda	HP2	215
18-ADC403			Obsolete	72-5103-5	Polaris	VES	215
18-ADC404			Obsolete	72-5103-7	Honda	HP2	215
18-ADC406			Obsolete	72-5103-7	Polaris	VES	215
18-ADC407			Obsolete	72-5104-2	Polaris	PS-4	216
18-ADC408			Obsolete	72-5104-3	Polaris	PS-4	216
18-ADC409			Obsolete	72-5104-7	Polaris	PS-4	Obsolete
18-ADC410			Obsolete	72-5105-2			216
18-ADC411			Obsolete	72-5105-3			216
18-ADC412			Obsolete	72-5105-7			216
18-ADC414			Obsolete	56966P			21, 139
18-ADC415			Obsolete	56967P			21, 139
18-ADC416			Obsolete	BC88523			78
18-ADC417			Obsolete	BC88533			78
18-ADC418			Obsolete	BC88543			78
18-ADC419			Obsolete	BC88553			78
18-ADC420			Obsolete	BC88563			78
18-ADC421			Obsolete	BC88573			78
18-ADC422			Obsolete	BC88583			78
18-ADC423			Obsolete	BC88593			78
18-ADC424			Obsolete	EC01350			75
18-ADC425			Obsolete	EC09040			75, 234
18-ADC427			Obsolete	EC09090			Obsolete
18-ADC428			Obsolete	GS62600			226
18-ADC450			Obsolete	GS62610			226
18-SD111			Obsolete	GS62620			226
18-SD112			Obsolete	GS62630			226
18-SD113			Obsolete	GS62640			226
18-SD114			Obsolete	GS62650			226

1 This product is priced per piece. To order, priced per package, please add -9 to the part number
 2 Items ending in "D" are display packaged - regular number is non-display • 3 For discount shop pack of 10, please add -10 to the part number

SIERRA #	O.E.M.	O.E. #	PAGE #	SIERRA #	O.E.M.	O.E. #	PAGE #
SIERRA							
GS62660			226				
GS62670			226				
GS62680			226				
GS62690			226				
GS62700			226				
GS62710			226				
GS62720			226				
GS62730			226				
GS62740			226				
GS62750			226				
GS62760			226				
GS62770			226				
GS62780			226				
GS62790			226				
GS62800			226				
GS62810			226				
GS62820			226				
GS62830			226				
GS62840			227				
GS62850			227				
GS62860			227				
GS62870			227				
GS62880			227				
GS62890			227				
GS62900			227				
GS62910			227				
GS62920			227				
GSS62600			227				
GSS62610			227				
GSS62630			227				
GSS62640			227				
GSS62670			227				
GSS62680			227				
GSS62700			227				
GSS62710			227				
GSS62720			227				
GSS62740			227				
GSS62750			227				
GSS62760			227				
GSS62770			227				
GSS62780			227				
GSS62790			227				
GSS62800			227				
GSS62820			227				
GSS62830			227				
MP28860	Yamaha	682-82556-00-00	32, 497				
MP28860			32, 497				
MP28870	OMC	585134	32				
MP28870			32				
MP28880	OMC	432230	32				
MP28890	OMC	176288	32				
MP28900	OMC	432230	32				
MP28902-1	OMC	432230	32				
MP39100	OMC	386545	31, 281				
MP39160			50, 496				
MP39760	OMC	393301	30				
MP39760	OMC	508180	30				
MP39830	OMC	386545	31				
MP41000	Mercury Marine	87-88107	383				
MP41070-2	Mercury Marine	87-17009A2	383				
MP51010	Suzuki	37110-99-E00	25, 481				
MP51012	Suzuki	37110-99-E00	25, 481				
MP51020	Yamaha	703-82510-12-00	25, 496				
MP51022	Yamaha	703-82510-12-00	25, 496				
MP51030	Yamaha	61B-82510-00-00	25, 496				
MP51030	Yamaha	61B-82510-01-00	25, 496				
MP51032	Yamaha	61B-82510-01-00	25, 496				
MP51040	Yamaha	703-82510-43-00	25, 497				
MP51042	Yamaha	703-82510-43-00	25, 497				
MP51050	Yamaha	6K1-82510-06-00	25, 497				
MP51052	Yamaha	6K1-82510-06-00	25, 497				
MP51090	Mercury Marine	87-17009A5	25, 31, 383				
MP51092	Mercury Marine	87-17009A5	25, 31, 383				
MP52000	Mercury Marine	87-88107A5	25, 31, 383				
PC51000			67				
PC51010			67				
PC51020			67				
PC51030			67				
PC51040			67				
PC51050			67				
PC51060			67				
PC51070			67				
PC51080			67				
PC51090			67				
PC51100			67				
PC51110			67				
PC51120			67				
PC51130			67				

1 This product is priced per piece. To order, priced per package, please add -9 to the part number
 2 Items ending in "D" are display packaged - regular number is non-display • 3 For discount shop pack of 10, please add -10 to the part number

OIL FILTER QUICK-REFERENCE GUIDE

All listed oil capacities are approximate amounts only and may or may not include the oil filter capacity.
ALWAYS follow proper crankcase drain and fill procedures. Check engine dipstick for proper crankcase oil level.

ALBIN

Model	Year	Oil Filter	Replaces	Crankcase Capacity	Recommended Oil
AD-21		18-7878-1	3875827	See Owners Manual	See Owners Manual

B & W LATHROP

Model	Year	Oil Filter	Replaces	Crankcase Capacity	Recommended Oil
130155		18-7875		See Owners Manual	See Owners Manual

CATERPILLAR

Model	Year	Oil Filter	Replaces	Crankcase Capacity	Recommended Oil
3304, 3306, D330		18-7880	1R-0658	See Owners Manual	See Owners Manual
3116, 3116TA, 3208, 3208T, 3208TA		18-7927	1R-0714	See Owners Manual	See Owners Manual

CHRIS-CRAFT

Model	Year	Oil Filter	Replaces	Crankcase Capacity	Recommended Oil
307G, 305K, 307K		18-7824-2	16.81-08746	See Owners Manual	See Owners Manual

CHRYSLER

Model	Year	Oil Filter	Replaces	Crankcase Capacity	Recommended Oil
(Chrysler-Volvo) 100, 110, 120, 130,		18-7878-1		See Owners Manual	See Owners Manual
165, 170		18-7878-1		See Owners Manual	See Owners Manual
125, 150, 155, 175, Fury 190, 195, 200,		18-7875	1851658	See Owners Manual	See Owners Manual
210, 225, 235, 250, 260, 280, 300, 330,		18-7875	1851658	See Owners Manual	See Owners Manual
335, 375, 525, CM6-55, CMC-55NA,		18-7875	1851658	See Owners Manual	See Owners Manual
M-170A, M-225A, M-225D, M-273A,		18-7875	1851658	See Owners Manual	See Owners Manual
M-273B, M-273BO/D, LM-318, LM-318A,		18-7875	1851658	See Owners Manual	See Owners Manual
LM-318B, M-318B, M-318C, M-383B,		18-7875	1851658	See Owners Manual	See Owners Manual
M-413B, M-413D, M-413E, M-440B,		18-7875	1851658	See Owners Manual	See Owners Manual
M-440D, Model 340, M-80, M-81,		18-7875	1851658	See Owners Manual	See Owners Manual
Super Crown 145, 150, Imperial 290,		18-7875	1851658	See Owners Manual	See Owners Manual
325, Jet II, Jet III, Jet IV, Super Bee,		18-7875	1851658	See Owners Manual	See Owners Manual
Super Bee II, Super Bee III,		18-7875	1851658	See Owners Manual	See Owners Manual
V-8 Engines 1962-on		18-7875	1851658	See Owners Manual	See Owners Manual
V-6 GM		18-7879-1	L-319	See Owners Manual	See Owners Manual
3.7L, 5.2L		18-7878-1	3549957, L-19, L1008	See Owners Manual	See Owners Manual

COMMANDER

Model	Year	Oil Filter	Replaces	Crankcase Capacity	Recommended Oil
225, 340 Clevor		18-7875		See Owners Manual	See Owners Manual

CRUSADER

Model	Year	Oil Filter	Replaces	Crankcase Capacity	Recommended Oil
150, 160, 165, CH185, 210, CH220,		18-7824-2	201104	See Owners Manual	See Owners Manual
CH270, 350, CH350		18-7824-2	201104	See Owners Manual	See Owners Manual
SS330		18-7876-1 (Long), 18-7824-2 (Short)	201104	See Owners Manual	See Owners Manual
220 Conqueror, 255 Conqueror,		18-7875	9002514	See Owners Manual	See Owners Manual
255 Conqueror Jet, 250 ('71),		18-7875	9002514	See Owners Manual	See Owners Manual
300 Scorpion, 460		18-7875	9002514	See Owners Manual	See Owners Manual
220, 300, 320, 325		18-7878-1		See Owners Manual	See Owners Manual
5.0L Carbureted (Classic)	1999 - 2008	18-7875	22679	See Owners Manual	Start with 4 Quarts - Fill to full level
1999 - 2010	1999 - 2010	18-7875	22679	See Owners Manual	Start with 4 Quarts - Fill to full level
5.0L MPI (Captain's Choice)	2004 - 2013	18-7875	22679	5.67L / 6.0 Qt.	Start with 4 Quarts - Fill to full level
5.7L MPI (Captain's Choice)	2005 - 2013	18-7875	22679	5.67L / 6.0 Qt.	Start with 4 Quarts - Fill to full level

CRUSADER CONTINUED ON NEXT PAGE

OIL FILTER QUICK-REFERENCE GUIDE

CRUSADER

Model	Year	Oil Filter	Replaces	Crankcase Capacity	Recommended Oil
6.0L MPI (Captain's Choice)	2006 - 2013	18-7875	22679	4.75L / 5.0 Qt.	API 15W-40 SM or Higher
7.4L MPI (Captain's Choice)	All	18-7875	22679	See Owners Manual	API 15W-40 SM or Higher
8.1L MPI (Captain's Choice)	2001 - 2010	18-7875	22679	6.65 L / 7.0 Qt.	API 15W-40 SM or Higher
8.1L MPI HO (Captain's Choice)	2009 - 2010	18-7875	22679	6.65 L / 7.0 Qt.	API 15W-40 SM or Higher

DETROIT DIESEL

Model	Year	Oil Filter	Replaces	Crankcase Capacity	Recommended Oil
2-71 (142), 3-71 (213), 4-53 (212), 4-71 (284), 6V-53 (318), 6-71 (426), 6-71E (426), 671N (426), 6-71T (426), 6V-71 (426), 6V-71T (426), 6V-92 (552), 6V-92T (522), 8V-71 (568), 8V-71T (568), 8V-92 (736), 8V-92T (736), 12V-71 (1788), 12V-71T (1788), 12V-149 (1788), 16V-71 (1136), 16V-71T (1136), 16V-92 (1472), 16V-92T (1472), 16V-149 (2384) Series		N/A	25010495	See Owners Manual	See Owners Manual

EVINRUDE / JOHNSON

Model	Year	Oil Filter	Replaces	Crankcase Capacity	Recommended Oil
9.9 HP	1995-2001	18-7916	434839	1272 ml. / 43 oz.	10W40 Synthetic Blend FC-W
9.9 HP	2002-2007	18-7903	5033102; 763364	1.1 L / 1.2 Qt.	10W40 Synthetic Blend FC-W
15 HP	1995-2001	18-7916	434839	1272 ml. / 43 oz.	10W40 Synthetic Blend FC-W
15 HP	2002-2007	18-7903	5033102; 763364	1.1 L / 1.2 Qt.	10W40 Synthetic Blend FC-W
25 HP	2000-2001	18-7915-1	5031411; 778885	3.2 L / 3.4 Qt.	10W40 Synthetic Blend FC-W
25 HP	2004-2007	18-7915-1	5031411; 778885	3.2 L / 3.4 Qt.	10W40 Synthetic Blend FC-W
30 HP	2000-2001	18-7915-1	5031411; 778885	3.2 L / 3.4 Qt.	10W40 Synthetic Blend FC-W
30 HP	2004-2007	18-7915-1	5031411; 778885	3.2 L / 3.4 Qt.	10W40 Synthetic Blend FC-W
40 HP	1999-2006	18-7915-1	5031411; 778885	2.4 L / 2.5 Qt.	10W40 Synthetic Blend FC-W
50 HP	1999-2006	18-7915-1	5031411; 778885	2.4 L / 2.5 Qt.	10W40 Synthetic Blend FC-W
60 HP	2002-2006	18-7915-1	5031411; 778885	4.5 L / 4.8 Qt.	10W40 Synthetic Blend FC-W
70 HP	1998-2000	18-7916	434839	4.5 L / 4.8 Qt.	10W40 Synthetic Blend FC-W
70 HP	2001-2006	18-7915-1	5031411; 778885	4.5 L / 4.8 Qt.	10W40 Synthetic Blend FC-W
90 HP	2003-2006	18-7896	5033539; 778886	5.7 L / 6.0 Qt.	25W40 Synthetic Blend FC-W
115 HP	2003-2006	18-7896	5033539; 778886	5.7 L / 6.0 Qt.	25W40 Synthetic Blend FC-W
140 HP	2003-2006	18-7897	5033919; 778887	5.7 L / 6.0 Qt.	25W40 Synthetic Blend FC-W
200 HP	2004-2006	18-7905-1	5035703; 778888	8.2 L / 8.7 Qt.	25W40 Synthetic Blend FC-W
225 HP	2004-2006	18-7905-1	5035703; 778888	8.2 L / 8.7 Qt.	25W40 Synthetic Blend FC-W

FISCHER PANDA

Model	Year	Oil Filter	Replaces	Crankcase Capacity	Recommended Oil
PMS 8 Mini		23-7804	SE15853-99170	2.5L / 2.64 Qt.	15W-40 API CF or Higher
PMS 8 DP		23-7804	SE15853-99170	2.5L / 2.64 Qt.	15W-40 API CF or Higher
PMS 4200		23-7804	SE15853-99170	1L / 1.05 Qt.	15W-40 API CF or Higher
PMS 6500		23-7804	SE15853-99170	2.5L / 2.64 Qt.	15W-40 API CF or Higher
PMS 12 DP		23-7804	SE15853-99170	3.8L / 4.0 Qt.	15W-40 API CF or Higher
PMS 12 Mini		23-7804	SE15853-99170	3.8L / 4.0 Qt.	15W-40 API CF or Higher
PMS 16 DP		23-7842		See Owners Manual	15W-40 API CF or Higher
PMS 22		23-7842		See Owners Manual	15W-40 API CF or Higher
16V-92T (1472), 16V-149 (2384) Series		N/A	25010495	See Owners Manual	See Owners Manual

OIL FILTER QUICK-REFERENCE GUIDE

FLAGSHIP

Model	Year	Oil Filter	Replaces	Crankcase Capacity	Recommended Oil
150FA, 220FF, 250FA, 400FA,		18-7824-2		See Owners Manual	See Owners Manual
425FAJ, 650FAJ, 950FAJ		18-7824-2		See Owners Manual	See Owners Manual
292, 300, 307, 327, 350, 482		18-7824-2 (Short) 18-7876-1-1 (Long)		See Owners Manual	See Owners Manual

FORD

Model	Year	Oil Filter	Replaces	Crankcase Capacity	Recommended Oil
CSG850M, WSG858M, LSG875M,		18-7875		See Owners Manual	See Owners Manual
SSD-655,-655M, -655MT, (5.5 Liter),		18-7875		See Owners Manual	See Owners Manual
140(2.3L) FOUR, 170, 200 Six, 240 Six,		18-7875		See Owners Manual	See Owners Manual
300 Six, 302 (5.0L),351 (5.8L),		18-7875		See Owners Manual	See Owners Manual
460 (7.5L),2711E, 2712E, 2713E,		18-7875		See Owners Manual	See Owners Manual
2714E, 2715E (diesel)		18-7875		See Owners Manual	See Owners Manual
254 (DSD-442 4.2 Liter), 362		18-7875		See Owners Manual	See Owners Manual
(DSD-659 5.9 Liter)		18-7875		See Owners Manual	See Owners Manual
91—V4, 104 V4, 380 (DSD-662 6.2 Liter)		18-7878-1		See Owners Manual	See Owners Manual

GM

Model	Year	Oil Filter	Replaces	Crankcase Capacity	Recommended Oil
IL6-194	1962 - 1967	18-7876-1		See Owners Manual	See Owners Manual
IL6-230	1963 - 1968	18-7876-1		See Owners Manual	See Owners Manual
267	1979 - 1981	18-7876-1		See Owners Manual	See Owners Manual
305	1976 - 1987	18-7876-1		See Owners Manual	See Owners Manual
307	1970 - 1973	18-7876-1		See Owners Manual	See Owners Manual
350	1970 - 1987	18-7876-1		See Owners Manual	See Owners Manual
366	1970 - 1987	18-7876-1		See Owners Manual	See Owners Manual
400	1971 - 1972	18-7876-1		See Owners Manual	See Owners Manual
400	1975 - 1983	18-7876-1		See Owners Manual	See Owners Manual
454	1973 - 1987	18-7876-1		See Owners Manual	See Owners Manual
400	1974 - 1977	18-7824-2		See Owners Manual	See Owners Manual

GREENWICH

Model	Year	Oil Filter	Replaces	Crankcase Capacity	Recommended Oil
Porpoise (w/IH V8-275B)		18-7875		See Owners Manual	See Owners Manual

HONDA

Model	Year	Oil Filter	Replaces	Crankcase Capacity	Recommended Oil
BF2A	All	----	----	0.40 L / 0.42 Qt.	10W-30 FC-W
BF2D	All	----	----	0.25 L / 0.26 Qt.	10W-30 FC-W
BF5	All	----	----	0.55 L / 0.58 Qt.	10W-30 FC-W
BF75 (7.5hp)	All	----	----	0.76 L / 0.80 Qt.	10W-30 FC-W
BF8 / BFP8	2001 - Current	18-7913	15400-PFB-014 15400-PFB-004	0.76 L / 0.80 Qt.	10W-30 FC-W
BF9.9 / BFP9.9	2001 - Current	18-7913	15400-PFB-014 15400-PFB-004	1.1L / 1.2 Qt.	10W-30 FC-W
BF100 (10 hp.)		----	----	0.76 L / 0.80 Qt.	10W-40 FC-W
BF15 / BFP15	2003 - Current	18-7913	15400-PFB-014 15400-PFB-004	1.1L / 1.2 Qt.	10W-30 FC-W
BF20	2003 - Current	18-7913	15400-PFB-014 15400-PFB-004	1 L / 1.1 Qt.	10W-30 FC-W

All listed oil capacities are approximate amounts only and may or may not include the oil filter capacity. ALWAYS follow proper crankcase drain and fill procedures. Check engine dipstick for proper crankcase oil level.

HONDA CONTINUED ON NEXT PAGE

OIL FILTER QUICK-REFERENCE GUIDE

HONDA

Model	Year	Oil Filter	Replaces	Crankcase Capacity	Recommended Oil
BF25	1998 & Earlier	18-7913	15400-PFB-014 15400-PFB-004 15400-PM3-004 15400-PJ7-015	1.6L / 1.7 Qt.	10W-30 FC-W
BF25 (Up to serial number 1003206)	1999 - 2005	18-7911-1	15400-PFB-007	1.6L / 1.7 Qt.	10W-30 FC-W
BF25 (Starting serial number 1003207)	2005 - Current	18-7913	15400-PFB-014	1.6L / 1.7 Qt.	5W-30 FC-W
BF30	1998 & Earlier	18-7913	15400-PFB-014 15400-PFB-004 15400-PM3-004 15400-PJ7-015	1.6L / 1.7 Qt.	10W-30 FC-W
BF30 (Up to serial number 1005016)	1999 - 2005	18-7911-1	15400-PFB-007	1.6L / 1.7 Qt.	10W-30 FC-W
BF30 (Starting serial number 1005017)	2005 - Current	18-7913	15400-PFB-014	1.6L / 1.7 Qt.	5W-30 FC-W
BF35	1997	18-7913	15400-PFB-014 15400-PFB-004 15400-PM3-004 15400-PJ7-015	2.4L / 2.5 Qt.	10W-30 FC-W
BF40	1998 & Earlier	18-7913	15400-PFB-014		
			15400-PFB-004	2.4L / 2.5 Qt.	10W-30 FC-W
BF40 (Up to serial number 3007642)	1999 - 2005	18-7911-1	15400-PFB-007	2.4L / 2.5 Qt.	10W-30 FC-W
BF40 (Starting serial number 3007643)	2005 - Current	18-7913	15400-PFB-014	2.0L / 2.1 Qt.	5W-30 FC-W
BF45	1997	18-7913	15400-PFB-014 15400-PFB-004 15400-PM3-004 15400-PJ7-015	2.4L / 2.5 Qt.	10W-30 FC-W
BF50	1998 & Earlier	18-7913	15400-PFB-014 15400-PFB-004 15400-PM3-004 15400-PJ7-015	2.4L / 2.5 Qt.	10W-30 FC-W
BF50 (Up to serial number 3014456)	1999 - 2005	18-7911-1	15400-PFB-007	2.4L / 2.5 Qt.	10W-30 FC-W
BF50 (Starting serial number 301457)	2005 - Current	18-7913	15400-PFB-014	2.0L / 2.1 Qt.	5W-30 FC-W
BF60 / BFP60	All	18-7913	15400-PFB-014 15400-PFB-004	2.6L / 2.7 Qt.	10W-30 FC-W
BF75	1997 - Current	18-7909	15400-PLM-A01PE 15400-POH-305PE 15400-ZJ1-004	4.2L / 4.4 Qt.	10W-30 FC-W
BF90	1997 - Current	18-7909	15400-PLM-A01PE 15400-POH-305PE 15400-ZJ1-004	4.2L / 4.4 Qt.	10W-30 FC-W
BF115	1999 - 2009	18-7909	15400-PLM-A01PE 15400-POH-305PE 15400-ZJ1-004	5.6L / 5.9 Qt.	10W-30 FC-W
BF115	2010 - Current	18-7909	15400-PLM-A01PE 15400-POH-305PE 15400-ZJ1-004	6.5L / 6.9Qt.	10W-30 FC-W
BF130	1999 - 2004	18-7909	15400-PLM-A01PE 15400-POH-305PE 15400-ZJ1-004	5.6L / 5.9 Qt.	10W-30 FC-W
BF135	2004 - Current	18-7909	15400-PLM-A01PE 15400-POH-305PE 15400-ZJ1-004	6.5L / 6.9Qt.	10W-30 FC-W
BF150	2004 - Current	18-7909	15400-PLM-A01PE 15400-POH-305PE 15400-ZJ1-004	6.5L / 6.9Qt.	10W-30 FC-W

HONDA CONTINUED ON NEXT PAGE

OIL FILTER QUICK-REFERENCE GUIDE

HONDA

Model	Year	Oil Filter	Replaces	Crankcase Capacity	Recommended Oil
BF200	2002 - Current	18-7909	15400-PLM-A01PE 15400-P0H-305PE 15400-ZJ1-004	7.6L / 8.0 Qt.	10W-30 FC-W
BF225	2002 - Current	18-7909	15400-PLM-A01PE 15400-P0H-305PE 15400-ZJ1-004	7.6L / 8.0 Qt.	10W-30 FC-W
BF250A	All	18-7909	15400-PLM-A01PE, 15400-P0H-305PE, 15400-ZJ1-004	7.6L / 8.0 Qt.	7.6L / 8.0 Qt.

HYDRO-MARINE

Model	Year	Oil Filter	Replaces	Crankcase Capacity	Recommended Oil
All Models (Knecht F0335/1)		18-7875		See Owners Manual	See Owners Manual

INDMAR

Model	Year	Oil Filter	Replaces	Crankcase Capacity	Recommended Oil
200, 225, 250, 275 (SP), 300 (SP), 350-2, 350-4,	1993 & OLDER	18-7875			
350(SP), 454-2, 454-4, 400 (SP)		18-7824-2 (Short) 18-7876-1 (Long)		See Owners Manual	See Owners Manual
454 Carb	2003 - 2006	18-7824-2	872023	6.62L / 7.0 Qt.	15W-40 API SL/SJ/C14/
5.7 HO	2007 - 2009	18-7824-2	872023	See Owners Manual	15W-40 API SL/SJ/C14/
5.7 Vortec	2007 - 2012	18-7824-2	872023	5.25L / 5.5 Qt.	15W-40 API SL/SJ/C14/
5.7L MPFI	2007 - 2012	18-7824-2	872023	5.25L / 5.5 Qt.	15W-40 API SL/SJ/C14/
502 Carb	2003 - 2006	18-7824-2	872023	6.62L / 7.0 Qt.	15W-40 API SL/SJ/C14/
6.0 PFI	2003 - 2006	18-7824-2	872023	See Owners Manual	15W-40 API SL/SJ/C14/
8.1L Vortec (Remote Oil Filter)	2007 - 2009	18-7824-2	872023	9.5L / 10 Qt.	15W-40 API SL/SJ/C14/
Assault 310, 325, 340, 385	2003 - 2007	18-7824-2	872023	See Owners Manual	15W-40 API SL/SJ/C14/
Malibu 350 Vortec Carbureted	2003 - 2005	18-7824-2	872023	5.25L / 5.5 Qt.	15W-40 API SL/SJ/C14/
Malibu Anniversary Edition LS6	2007	18-7824-2	872023	5.25L / 5.5 Qt.	15W-40 API SL/SJ/C14/
Malibu Hammerhead	2003 - 2007	18-7824-2	872023	5.25L / 5.5 Qt.	15W-40 API SL/SJ/C14/
Malibu LC2	2003 - 2006	18-7824-2	872023	See Owners Manual	15W-40 API SL/SJ/C14/
Malibu LS1	2003 - 2006	18-7824-2	872023	5.25L / 5.5 Qt.	15W-40 API SL/SJ/C14/
Malibu Monsoon	2003 - 2007	18-7824-2	872023	See Owners Manual	15W-40 API SL/SJ/C14/
MasterCraft 5.7L LCR	2007 - 2009	18-7824-2	872023	See Owners Manual	15W-40 API SL/SJ/C14/
MasterCraft 6.0L (LY5, LY6)	2007 - 2009	18-7824-2	872023	5.25L / 5.5 Qt.	15W-40 API SL/SJ/C14/
MasterCraft LQ9	2003 - 2006	18-7824-2	872023	5.25L / 5.5 Qt.	15W-40 API SL/SJ/C14/
MasterCraft MCX	2003 - 2007	18-7824-2	872023	See Owners Manual	15W-40 API SL/SJ/C14/C14Plus
MasterCraft RTP-1	2003 - 2007	18-7824-2	872023	6.62L / 7.0 Qt.	15W-40 API SL/SJ/C14/
5.7L - Serial Number 174786 & Below	2013 - 2015	18-7824-2	872023	5.25L / 5.5 Qt.	15W-40 API SL/SJ/C14/
L96 (6.0L - Serial Number 174786 & Below, GM)	2014 - 2015	18-7824-2	872023	5.7L / 6.0 Qt.	15W-40 API SL/SJ/C14/
LS3, LSA (6.2L - Serial Number 174786 & Below, GM)	2015 - 2015	18-7824-2	872023	8.0L / 8.5 Qt.	5W-30 Full Synthetic

All listed oil capacities are approximate amounts only and may or may not include the oil filter capacity.
 ALWAYS follow proper crankcase drain and fill procedures. Check engine dipstick for proper crankcase oil level.

OIL FILTER QUICK-REFERENCE GUIDE

INTERCEPTOR

Model	Year	Oil Filter	Replaces	Crankcase Capacity	Recommended Oil
IV4-80, OV4-80, OV6-100 (Taurus), 80, 85, 100, 110, 120, 140, 190, 200, 210, Interceptor 160, Interceptor 165	1960 & UP	18-7878-1		See Owners Manual	See Owners Manual

KOHLER

Model	Cyl.	Year	Oil Filter	Replaces	Crankcase Capacity	Recommended Oil
4CZ	2	ALL	23-7823	267714	1.4L / 1.48 Qt.	10W-40
4EF	2	ALL	23-7821	359771	1.36L / 1.44 Qt.	
4ESZ	2	ALL	23-7823	267714	Refer to Owners Manual	10W-40
5E	2	ALL	23-7821	359771	1.36L / 1.44 Qt.	
6.5CZ	2	ALL	23-7823	267714	1.4L / 1.48 Qt.	10W-40
6.5ESZ	2	ALL	23-7823	267714	Refer to Owners Manual	10W-40
7.3E	2	ALL	23-7821	359771	1.36L / 1.44 Qt.	10W-40
10EOZ	3	ALL	23-7824	GM47465 252834	5.2L / 5.5 Qt.	15W-40 API CI-4, CI-4 Plus
10EOZD	3	ALL	23-7824 (Variation 1)	GM47465 252834	3.6L / 3.8 Qt.	15W-40 API CI-4, CI-4 Plus
13.5CCOZ	3	ALL	23-7824	GM47465 252834	5.8L / 6.1 Qt.	15W-40 API CI-4, CI-4 Plus
13EOZ	3	ALL	23-7824	GM47465 252834	4.7L / 5.0 Qt.	15W-40 API CI-4, CI-4 Plus
13EOZD	3	ALL	23-7824	GM47465 252834	4.7L / 5.0 Qt.	15W-40 API CI-4, CI-4 Plus
14CCOZ	3	ALL	23-7824	GM47465 252834	Refer to Owners Manual	15W-40 API CI-4, CI-4 Plus
14EOZ	3	ALL	23-7824	GM47465 252834	4.7L / 5.0 Qt.	15W-40 API CI-4, CI-4 Plus
14EOZD	3	ALL	23-7824	GM47465 252834	4.7L / 5.0 Qt.	15W-40 API CI-4, CI-4 Plus
15.5EOZ	3	ALL	23-7824	GM47465 252834	4.7L / 5.0 Qt.	15W-40 API CI-4, CI-4 Plus
15.5EOZD	3	ALL	23-7824	GM47465 252834	4.7L / 5.0 Qt.	15W-40 API CI-4, CI-4 Plus
5CCOZ	3	ALL	23-7822	229678	Refer to Owners Manual	Refer to Owners Manual
5EOZ	3	ALL	23-7822	229678	3.0L / 3.2 Qt.	15W-40 API CI-4, CI-4 Plus
8EOZ	3	ALL	23-7822	229678	2.3L / 2.4 Qt.	15W-40 API CI-4, CI-4 Plus
9CCOZ	3	ALL	23-7824	GM47465 252835	Refer to Owners Manual	Refer to Owners Manual
9EOZ	3	ALL	23-7824	GM47465 252835	Refer to Owners Manual	15W-40 API CI-4, CI-4 Plus
9EOZD	3	ALL	23-7824 (Variation 1)	GM47465 252835	3.6L / 3.8 Qt.	15W-40 API CI-4, CI-4 Plus
10E	4	ALL	23-7803		3.25L / 3.50 Qt.	10W-40
12.5E	4	ALL	23-7803	326817	3.25L / 3.50 Qt.	10W-40
15C	4	ALL	23-7820	279449	4.7L / 5.0 Qt.	10W-40
16CF	4	ALL	23-7820	279449	Refer to Owners Manual	Refer to Owners Manual

OIL FILTER QUICK-REFERENCE GUIDE

KOHLER

Model	Cyl.	Year	Oil Filter	Replaces	Crankcase Capacity	Recommended Oil
18.5CCOZ	4	ALL	23-7824	GM47465 252834	5.8L / 6.1 Qt.	Refer to Owners Manual
20C	4	ALL	23-7820	279449	4.7L / 5.0 Qt.	10W-40
20EOZ	4	ALL	23-7824	GM47465 252834	5.8L / 6.1 Qt.	15W-40 API CI-4, CI-4 Plus
20EOZD	4	ALL	23-7824	GM47465 252834	5.8L / 6.1 Qt.	15W-40 API CI-4, CI-4 Plus
23EOZ	4	ALL	23-7824	GM47465 252834	5.8L / 6.1 Qt.	15W-40 API CI-4, CI-4 Plus
23EOZD	4	ALL	23-7824	GM47465 252834	5.8L / 6.1 Qt.	15W-40 API CI-4, CI-4 Plus
24CCOZ	4	ALL	23-7824	GM47465 252834	5.8L / 6.1 Qt.	Refer to Owners Manual
24EOZ	4	ALL	23-7824	GM47465 252834	5.8L / 6.1 Qt.	15W-40 API CI-4, CI-4 Plus
24EOZD	4	ALL	23-7824	GM47465 252834	5.8L / 6.1 Qt.	15W-40 API CI-4, CI-4 Plus
28EOZ	4	ALL	23-7824	GM47465 252834	10.2L / 10.78 Qt.	15W-40 API CI-4, CI-4 Plus
28EOZD	4	ALL	23-7824	GM47465 252834	10.2L / 10.78 Qt.	15W-40 API CI-4, CI-4 Plus
32EOZ	4	ALL	23-7824	GM47465 252834	10.2L / 10.78 Qt.	15W-40 API CI-4, CI-4 Plus
32EOZD	4	ALL	23-7824	GM47465 252835	10.2L / 10.78 Qt.	15W-40 API CI-4, CI-4 Plus
8E	4	ALL	23-7803	326817	3.25L / 3.50 Qt.	10W-40

LEHMAN

Model	Oil Filter	Replaces	Crankcase Capacity	Recommended Oil
Models (w/ Ford 242), (w/ Ford 254), (w/ Ford 363), (w/ Ford 380), (Lehman 2N50)	18-7875		See Owners Manual	See Owners Manual

MERCURUISER

Model	Cyl.	CID/Litre	Year	Oil Filter	Replaces	Crankcase Capacity	Recommended Oil
ALL CYLINDER BLOCKS MANUFACTURED BY GENERAL MOTORS (GM) UNLESS NOTED IN MODEL COLUMN							
Vazer	4	1.6L	2007 - 2010	18-7824-2	35-866340K01, 35-866340Q03	4.02L / 4.25 Qt.	25W-40 FC-W
Vazer	4	1.6L	2011 - Current	18-7824-2	35-866340K01, 35-866340Q03	4.02L / 4.25 Qt.	20W-40 Synthetic Catalyst (1)
60 (Renault)	4	68 / 1.1L	1965 - 1968	-----	38463	2.6L / 2.75 Qt.	See Owners Manual
80 (Renault)	4	80 / 1.3L	1966 - 1969	-----	-----	4.7L / 5.0 Qt.	See Owners Manual
90 (Renault)	4	96 / 1.6L	1970 - 1972	-----	-----	4.7L / 5.0 Qt.	See Owners Manual
110	4	153 / 2.5L	1963 - 1966	18-7824-2	35-866340K01, 35-866340Q03	3.8L / 4.0 Qt.	See Owners Manual
120	4	153 / 2.5L	1964 - 1986	18-7824-2	35-866340K01, 35-866340Q03	3.8L / 4.0 Qt.	25W-40 FC-W
140	4	181 / 3.0L	1968 - 1986	18-7824-2	35-866340K01, 35-866340Q03	3.8L / 4.0 Qt.	25W-40 FC-W

All listed oil capacities are approximate amounts only and may or may not include the oil filter capacity.
ALWAYS follow proper crankcase drain and fill procedures. Check engine dipstick for proper crankcase oil level.

MERCURUISER CONTINUED ON NEXT PAGE

OIL FILTER QUICK-REFERENCE GUIDE

MERCUISER

Model	Cyl.	CID/Litre	Year	Oil Filter	Replaces	Crankcase Capacity	Recommended Oil
165	4	224 / 3.7L	1987	18-7824-2	35-866340K01, 35-866340Q03	5.2L / 5.5 Qt.	25W-40 FC-W
170	4	224 / 3.7L	1985 - 1986	18-7824-2	35-866340K01, 35-866340Q03	5.2L / 5.5 Qt.	25W-40 FC-W
180	4	224 / 3.7L	1987	18-7824-2	35-866340K01, 35-866340Q03	6.1L / 6.5 Qt.	25W-40 FC-W
190	4	224 / 3.7L	1985 - 1986	18-7824-2	35-866340K01, 35-866340Q03	6.1L / 6.5 Qt.	25W-40 FC-W
2.5L	4	153 / 2.5L	1987 - 1989	18-7824-2	35-866340K01, 35-866340Q03	3.8L / 4.0 Qt.	25W-40 FC-W
3.0L / LX	4	181 / 3.0L	1987 - 2010	18-7824-2	35-866340K01, 35-866340Q03	3.8L / 4.0 Qt.	25W-40 FC-W
3.0L MPI EC (Catalyzed)	4	182 / 3.0L, 3.0LX	2011 - 2020	18-7824-2	35-866340K01, 35-866340Q03	3.8L / 4.0 Qt.	20W-40 Synthetic Catalyst (1)
3.7L	4	224 / 3.7L	1988 - 1989	18-7824-2	35-866340K01, 35-866340Q03	5.2L / 5.5 Qt.	25W-40 FC-W
3.7LX	4	224 / 3.7L	1983 - 1989	18-7824-2	35-866340K01, 35-866340Q03	6.1L / 6.5 Qt.	25W-40 FC-W
470	4	224 / 3.7L	1976 - 1984	18-7824-2	35-866340K01, 35-866340Q03	5.2L / 5.5 Qt.	25W-40 FC-W
485	4	224 / 3.7L	1980 - 1982	18-7824-2	35-866340K01, 35-866340Q03	5.4L / 5.75 Qt.	25W-40 FC-W
488	4	224 / 3.7L	1983 - 1984	18-7824-2	35-866340K01, 35-866340Q03	6.1L / 6.5 Qt.	25W-40 FC-W
140	6 IL	194 / 3.2L	1963	18-7876-1	35-99894	4.7L / 5.0 Qt.	25W-40 FC-W
150	6 IL	230 / 3.8L	1964 - 1966	18-7876-1	35-99894	4.7L / 5.0 Qt.	25W-40 FC-W
160	6 IL	250 / 4.1L	1967 - 1969	18-7876-1	35-99894	4.7L / 5.0 Qt.	25W-40 FC-W
165	6 IL	250 / 4.1L	1970 - 1981	18-7876-1	35-99894	4.7L / 5.0 Qt.	25W-40 FC-W
175	V6	262 / 4.3L	1987	18-7879-1*	35-883702	4.3L / 4.5 Qt.	25W-40 FC-W
185	V6	262 / 4.3L	1985 - 1987	18-7879-1*	35-883702	4.3L / 4.5 Qt.	25W-40 FC-W
200	6 IL	292 / 4.8L	1969	18-7876-1	35-99894	5.7L / 6.0 Qt.	25W-40 FC-W
205	V6	262 / 4.3L	1985 - 1987	18-7879-1*	35-883702	4.3L / 4.5 Qt.	25W-40 FC-W
262 Mag EFI	V6	263 / 4.3L	1996 - 1997	18-7879-1*	35-883702	4.3L / 4.5 Qt.	25W-40 FC-W
4.3L / LX / LH / LXH	V6	264 / 4.3L	1988 - 2001	18-7879-1*	35-883702	4.3L / 4.5 Qt.	25W-40 FC-W
4.3L	V6	265 / 4.3L	2002 - 2010	18-7879-1*	35-883702	4.3L / 4.5 Qt.	25W-40 FC-W
4.3L EFI	V6	266 / 4.3L	1998 - 2001	18-7879-1*	35-883702	4.3L / 4.5 Qt.	25W-40 FC-W
4.3L MPI	V6	267 / 4.3L	2002 - 2010	18-7879-1*	35-883702	3.8L / 4.0 Qt.	25W-40 FC-W
4.3L MPI (Catalyzed)	V6	268 / 4.3L	2011 - 2020	18-7824-2	35-866340K01, 35-866340Q03	3.8L / 4.0 Qt.	20W-40 Synthetic Catalyst (1)
*NOTE: V6 engines equipped with the oil filter relocation option will use filter 18-7824-2.							
190	V8	283 / 4.6L	1963 - 1964	18-7824-2	35-866340K01, 35-866340Q03	4.7L / 5.0 Qt.	25W-40 FC-W
198	V8	305 / 5.0L	1977 - 1988	18-7876-1	35-99894	5.7L / 6.0 Qt.	25W-40 FC-W
200	V8	305 / 5.0L	1985 - 1987	18-7824-2	35-866340K01, 35-866340Q03	4.7L / 5.0 Qt.	25W-40 FC-W
215 (Ford)	V8	302 / 5.0L	1970 - 1972	18-7875	35-802886	6.6L / 7.0 Qt.	25W-40 FC-W
225 (Ford)	V8	302 / 5.0L	1973 - 1974	18-7875	35-802886	5.7L / 6.0 Qt.	25W-40 FC-W

MERCUISER CONTINUED ON NEXT PAGE

OIL FILTER QUICK-REFERENCE GUIDE

MERCUISER							
Model	Cyl.	CID/Litre	Year	Oil Filter	Replaces	Crankcase Capacity	Recommended Oil
225	V8	327 / 5.4L	1963 - 1966	18-7824-2	35-866340K01, 35-866340Q03	4.7L / 5.0 Qt.	25W-40 FC-W
225	V8	327 / 5.4L	1967 - 1969	18-7824-2	35-866340K01, 35-866340Q03	6.6L / 7.0 Qt.	25W-40 FC-W
228	V8	305 / 5.0L	1977 - 1978	18-7824-2	35-866340K01, 35-866340Q03	4.7L / 5.0 Qt.	25W-40 FC-W
230	V8	305 / 5.0L	1985 - 1987	18-7824-2	35-866340K01, 35-866340Q03	5.2L / 5.5 Qt.	25W-40 FC-W
233 (Ford)	V8	351 / 5.8L	1975 - 1977	18-7875	35-802886	4.7L / 5.0 Qt.	25W-40 FC-W
233 (Ford) Inboard	V8	351 / 5.8L	1973 - 1976	18-7875	35-802886	6.6L / 7.0 Qt.	25W-40 FC-W
250	V8	327 / 5.4L	1969	18-7876-1	35-99894	6.6L / 7.0 Qt.	25W-40 FC-W
250	V8	327 / 5.4L	1968	18-7876-1	35-99894	5.7L / 6 Qt.	25W-40 FC-W
250	V8	350 / 5.7L	1975 - 1977	18-7876-1	35-99894	4.7L / 5.0 Qt.	25W-40 FC-W
255	V8	350 / 5.7L	1975 - 1977	18-7876-1	35-99894	4.7L / 5.0 Qt.	25W-40 FC-W
255 (Ford)	V8	351 / 5.8L	1973 - 1974	18-7875	35-802886	4.7L / 5.0 Qt.	25W-40 FC-W
255 (Ford) Inboard	V8	351 / 5.8L	1973 - 1976	18-7875	35-802886	6.6L / 7.0 Qt.	25W-40 FC-W
260	V8	350 / 5.7L	1975 - 1987	18-7824-2	35-866340K01, 35-866340Q03	5.2L / 5.5 Qt.	25W-40 FC-W
270	V8	350 / 5.7L	1969 - 1972	18-7876-1	35-99894	6.6L / 7.0 Qt.	25W-40 FC-W
280 TRS	V8	350 / 5.7L	1975 - 1976	18-7876-1	35-99894	6.0L / 6.5 Qt.	25W-40 FC-W
300 Tempest	V8	350 / 5.7L	1985 - 1986	18-7876-1	35-99894	6.0L / 6.5 Qt.	25W-40 FC-W
320 EFI	V8	350 / 5.7L	1987 - 1989	18-7824-2	35-866340K01, 35-866340Q03	6.0L / 6.5 Qt.	25W-40 FC-W
325	V8	427 / 7.0L	1969 - 1972	18-7876-1	35-99894	7.6L / 8.0 Qt.	25W-40 FC-W
325 Inboard	V8	427 / 7.0L	1968 - 1974	18-7824-2	35-866340K01, 35-866340Q03	6.6L / 7.0 Qt.	25W-40 FC-W
330	V8	454 / 7.4L	1977 - 1981	18-7876-1	35-866340K01, 35-866340Q03	5.7L / 6.0 Qt.	25W-40 FC-W
330	V8	454 / 7.4L	1982 - 1987	18-7824-2	35-866340K01, 35-866340Q03	6.6L / 7.0 Qt.	25W-40 FC-W
350 Mag.	V8	350 / 5.7L	1986 - 1997	18-7824-2	35-866340K01, 35-866340Q03	5.2L / 5.5 Qt.	25W-40 FC-W
350 Mag. EFI	V8	350 / 5.7L	1996 - 1997	18-7824-2	35-866340K01, 35-866340Q03	5.2L / 5.5 Qt.	25W-40 FC-W
350 Mag. MPI	V8	350 / 5.7L	1996 - 2001	18-7824-2	35-866340K01, 35-866340Q03	5.2L / 5.5 Qt.	25W-40 FC-W
350 Mag. MPI	V8	350 / 5.7L	2002 - 2010	18-7824-2	35-866340K01, 35-866340Q03	4.25L / 4.5 Qt.	25W-40 FC-W
350 Mag. MPI (Catalyzed)	V8	350 / 5.7L	2011 - Current	18-7824-2	35-866340K01, 35-866340Q03	4.25L / 4.5 Qt.	20W-40 Synthetic Catalyst (1)
370 TRS	V8	454 / 7.4L	1978 - 1987	18-7824-2	35-866340K01, 35-866340Q03	5.7L / 6.0 Qt.	25W-40 FC-W
377 Scorpion	V8	377 / 6.2L	1997 - 2010	18-7824-2		4.7L / 5.0 Qt.	25W-40 FC-W
390	V8	482 / 7.9L	1969 - 1970	18-7876-1	35-99894	7.6L / 8.0 Qt.	25W-40 FC-W
390 Inboard	V8	482 / 7.9L	1969 - 1970	18-7876-1	35-99894	6.6L / 7.0 Qt.	25W-40 FC-W
400 TRS	V8	454 / 7.4L	1978 - 1987	18-7824-2	35-866340K01, 35-866340Q03	6.6L / 7.0 Qt.	25W-40 FC-W

All listed oil capacities are approximate amounts only and may or may not include the oil filter capacity.
ALWAYS follow proper crankcase drain and fill procedures. Check engine dipstick for proper crankcase oil level.

MERCUISER CONTINUED ON NEXT PAGE

OIL FILTER QUICK-REFERENCE GUIDE

MERCUISER

Model	Cyl.	CID/Litre	Year	Oil Filter	Replaces	Crankcase Capacity	Recommended Oil
420	V8	454 / 7.4L	1987 - 1989	18-7824-2	35-866340K01, 35-866340Q03	5.7L / 6.0 Qt.	25W-40 FC-W
425	V8	454 / 7.4L	1990 - 1993	18-7824-2	35-866340K01, 35-866340Q03	7.6L / 8.0 Qt.	25W-40 FC-W
440 TRS Cyclone	V8	454 / 7.4L	1983 - 1986	18-7876-1	35-99894	6.6L / 7.0 Qt.	25W-40 FC-W
450	V8	454 / 7.4L	1995 - 1996	18-7876-1	35-99894	7.6L / 8.0 Qt.	25W-40 FC-W
454 Mag. Alpha	V8	454 / 7.4L	1986 - 1988	18-7824-2	35-866340K01, 35-866340Q03	6.6L / 7.0 Qt.	25W-40 FC-W
454 Mag.	V8	454 / 7.4L	1989 - 1991	18-7824-2	35-866340K01, 35-866340Q03	7.6L / 8.0 Qt.	25W-40 FC-W
454 Mag.	V8	454 / 7.4L	1992 - 1997	18-7824-2	35-866340K01, 35-866340Q03	6.6L / 7.0 Qt.	25W-40 FC-W
454 Mag. EFI	V8	454 / 7.4L	1994 - 1996	18-7824-2	35-866340K01, 35-866340Q03	6.6L / 7.0 Qt.	25W-40 FC-W
454 Mag. MPI	V8	454 / 7.4L	1996 - 2001	18-7824-2	35-866340K01, 35-866340Q03	6.6L / 7.0 Qt.	25W-40 FC-W
460 TRS	V8	482 / 7.9L	1983 - 1986	18-7876-1	35-99894	9.4L / 10 Qt.	25W-40 FC-W
465	V8	502 / 8.2L	1990 - 1994	18-7824-2	35-866340K01, 35-866340Q03	7.6L / 8.0 Qt.	25W-40 FC-W
496 Mag.	V8	496 / 8.1L	2001 - 2010	18-7824-2	35-866340K01, 35-866340Q03	8.5L / 9.0 Qt.	25W-40 FC-W
496 Mag. HO	V8	496 / 8.1L	2001 - 2010	18-7824-2	35-866340K01, 35-866340Q03	8.5L / 9.0 Qt.	25W-40 FC-W
496 Mag. (Catalyzed)	V8	496 / 8.1L	2011 - 2020	18-7824-2	35-866340K01, 35-866340Q03	8.5L / 9.0 Qt.	20W-40 Synthetic Catalyst (1)
496 Mag. HO (Catalyzed)	V8	496 / 8.1L	2011 - 2020	18-7824-2	35-866340K01, 35-866340Q03	8.5L / 9.0 Qt.	20W-40 Synthetic Catalyst (1)
5.0L	V8	305 / 5.0L	1988 - 1995	18-7824-2	35-866340K01, 35-866340Q03	4.7L / 5.0 Qt.	25W-40 FC-W
5.0L	V8	305 / 5.0L	1998 - 2002	18-7824-2	35-866340K01, 35-866340Q03	5.2L / 5.5 Qt.	25W-40 FC-W
5.0L	V8	305 / 5.0L	2003 - 2010	18-7824-2	35-866340K01, 35-866340Q03	4.25L / 4.5 Qt.	25W-40 FC-W
5.0LX	V8	305 / 5.0L	1988 - 1995	18-7824-2	35-866340K01, 35-866340Q03	5.2L / 5.5 Qt.	25W-40 FC-W
5.0 EFI	V8	305 / 5.0L	1998 - 2001	18-7824-2	35-866340K01, 35-866340Q03	5.2L / 5.5 Qt.	25W-40 FC-W
5.0 MPI	V8	305 / 5.0L	2002 - 2010	18-7824-2	35-866340K01, 35-866340Q03	4.25L / 4.5 Qt.	25W-40 FC-W
5.0 MPI (Catalyzed)	V8	305 / 5.0L	2011 - 2020	18-7824-2	35-866340K01, 35-866340Q03	4.25L / 4.5 Qt.	20W-40 Synthetic Catalyst (1)
5.7L	V8	350 / 5.7L	1978 - 2002	18-7824-2	35-866340K01, 35-866340Q03	5.2L / 5.5 Qt.	25W-40 FC-W
5.7L	V8	350 / 5.7L	2003 - 2010	18-7824-2	35-866340K01, 35-866340Q03	4.25L / 4.5 Qt.	25W-40 FC-W
5.7LX	V8	350 / 5.7L	1996 - 1997	18-7824-2	35-866340K01, 35-866340Q03	5.2L / 5.5 Qt.	25W-40 FC-W
5.7 EFI	V8	350 / 5.7L	1995 - 2001	18-7824-2	35-866340K01, 35-866340Q03	5.2L / 5.5 Qt.	25W-40 FC-W

MERCUISER CONTINUED ON NEXT PAGE

OIL FILTER QUICK-REFERENCE GUIDE

MERCUISER							
Model	Cyl.	CID/Litre	Year	Oil Filter	Replaces	Crankcase Capacity	Recommended Oil
5.7 MPI (Catalyzed)	V8	350 / 5.7L	2011 - 2020	18-7824-2	35-866340K01, 35-866340Q03	4.25L / 4.5 Qt.	25W-40 Synthetic Catalyst
5.7L Black Scorpion Ski	V8	350 / 5.7L	1996 - 1997	18-7824-2	35-866340K01, 35-866340Q04	4.7L / 5.0 Qt.	25W-40 FC-W
5.7L Black Scorpion Ski	V8	351 / 5.7L	1998 - 2001	18-7824-2	35-866340K01, 35-866340Q05	5.2L / 5.5 Qt.	25W-40 FC-W
5.7L Black Scorpion Ski	V8	352 / 5.7L	2002 - 2010	18-7824-2	35-866340K01, 35-866340Q06	4.25L / 4.5 Qt.	25W-40 FC-W
5.7L Black Scorpion Ski (Catalyzed)	V8	352 / 5.7L	2011 - 2020	18-7824-2	35-866340K01, 35-866340Q06	4.25L / 4.5 Qt.	25W-40 Synthetic Catalyst
500	V8	502 / 8.2L	1994 - 1999	18-7824-2	35-866340K01, 35-866340Q03	7.6L / 8.0 Qt.	25W-40 FC-W
500 EFI	V8	502 / 8.2L	1999 - 2005	18-7824-2	35-866340K01, 35-866340Q03	6.6L / 7.0 Qt.	25W-40 FC-W
502 Mag.	V8	502 / 8.2L	1990 - 1993	18-7824-2	35-866340K01, 35-866340Q03	7.6L / 8.0 Qt.	25W-40 FC-W
502 Mag. EFI	V8	502 / 8.2L	1993 - 1995	18-7824-2	35-866340K01, 35-866340Q03	6.6L / 7.0 Qt.	25W-40 FC-W
502 Mag. MPI	V8	502 / 8.2L	1996 - 2001	18-7824-2	35-866340K01, 35-866340Q03	6.6L / 7.0 Qt.	25W-40 FC-W
6.2 MPI (up to OM299999)	V8	377 / 6.2L	2000 - 2002	18-7824-2	35-866340K01, 35-866340Q03	5.2L / 5.5 Qt.	25W-40 FC-W
6.2MPI (OM300000 & up)	V8	377 / 6.2L	2002 - 2010	18-7824-2	35-866340K01, 35-866340Q03	4.25L / 4.5 Qt.	25W-40 FC-W
6.2MPI (OM300000 & up) (Catalyzed)	V8	377 / 6.2L	2011 - 2020	18-7824-2	35-866340K01, 35-866340Q03	4.25L / 4.5 Qt.	25W-40 Synthetic Catalyst
6.2 Black Scorpion (OM391599 & up)	V8	377 / 6.2L	2001 - 2003	18-7824-2	35-866340K01, 35-866340Q03	5.2L / 5.5 Qt.	25W-40 FC-W
6.2 Black Scorpion (OM391599 & up)	V8	377 / 6.2L	2003 - 2010	18-7824-2	35-866340K01, 35-866340Q03	4.25L / 4.5 Qt.	25W-40 FC-W
6.2 Black Scorpion (OM391599 & up) (Catalyzed)	V8	377 / 6.2L	2011 - 2020	18-7824-2	35-866340K01, 35-866340Q03	4.25L / 4.5 Qt.	25W-40 Synthetic Catalyst
7.4L	V8	454 / 7.4L	1988 - 1991	18-7824-2	35-866340K01, 35-866340Q03	7.6L / 8.0 Qt.	25W-40 FC-W
7.4L with Borg Warner	V8	454 / 7.4L	1981 - 1992	18-7824-2	35-866340K01, 35-866340Q03	6.6L / 7.0 Qt.	25W-40 FC-W
7.4L with Hurth	V8	454 / 7.4L	1988 - 1992	18-7824-2	35-866340K01, 35-866340Q03	7.6L / 8.0 Qt.	25W-40 FC-W
7.4L	V8	454 / 7.4L	1992 - 1997	18-7824-2	35-866340K01, 35-866340Q03	6.6L / 7.0 Qt.	25W-40 FC-W
7.4LX TBI	V8	454 / 7.4L	1996 - 1997	18-7824-2	35-866340K01, 35-866340Q03	6.6L / 7.0 Qt.	25W-40 FC-W
7.4LX MPI	V8	454 / 7.4L	1996 - 1997	18-7824-2	35-866340K01, 35-866340Q03	6.6L / 7.0 Qt.	25W-40 FC-W
7.4L MPI	V8	454 / 7.4L	1998 - 2001	18-7824-2	35-866340K01, 35-866340Q03	6.6L / 7.0 Qt.	25W-40 FC-W
8.1L	V8	496 / 8.1L	2001 - 2010	18-7824-2	35-866340K01, 35-866340Q03	8.5L / 9.0 Qt.	25W-40 FC-W
8.1L (Catalyzed)	V8	496 / 8.1L	2011 - 2020	18-7824-2	35-866340K01, 35-866340Q03	8.5L / 9.0 Qt.	20W-40 Synthetic Catalyst (1)

All listed oil capacities are approximate amounts only and may or may not include the oil filter capacity.
ALWAYS follow proper crankcase drain and fill procedures. Check engine dipstick for proper crankcase oil level.

MERCUISER CONTINUED ON NEXT PAGE

OIL FILTER QUICK-REFERENCE GUIDE

MERCUISER

Model	Cyl.	CID/Litre	Year	Oil Filter	Replaces	Crankcase Capacity	Recommended Oil
8.1L HO	V8	496 / 8.1L	2001 - 2010	18-7824-2	35-866340K01, 35-866340Q03	8.5L / 9.0 Qt.	25W-40 FC-W
8.1L HO (Catalyzed)	V8	496 / 8.1L	2011 - 2020	18-7824-2	35-866340K01, 35-866340Q03	8.5L / 9.0 Qt.	20W-40 Synthetic Catalyst (1)
8.2L	V8	502 / 8.2L	1992 - 1996	18-7824-2	35-866340K01, 35-866340Q03	7.6L / 8.0 Qt.	25W-40 FC-W
8.2L Mag. MPI (Catalyzed)	V8	502 / 8.2L	2010 - 2020	18-7824-2	35-866340K01, 35-866340Q04	7.6L / 8.0 Qt.	25W-40 Synthetic Catalyst
8.2L MPI	V8	502 / 8.2L	1996 - 2001	18-7824-2	35-866340K01, 35-866340Q03	6.6L / 7.0 Qt.	25W-40 FC-W
888 (Ford)	V8	302 / 5.0L	1971 - 1977	18-7875	35-802886	5.7L / 6.0 Qt.	25W-40 FC-W
898	V8	305 / 5.0L	1977 - 1984	18-7876-1	35-99894	4.7L / 5.0 Qt.	25W-40 FC-W

MERCURY OUTBOARD

Model	Year	Oil Filter	Replaces	Crankcase Capacity	Recommended Oil
2.5HP / 3.5HP	2006 - 2020	----		0.30 L / 0.31 Qt.	10W-30 FC-W
4HP / 5HP / 6 HP	1999 - 2020	----		0.45L / 0.48 Qt.	10W-30 FC-W
8HP (232cc)	1995-2000	18-7901	825467T1, A1	1.0L / 1.05 Qt.	10W-30 FC-W
8HP (323cc)	2001-2004	18-7913	35-822626Q1, Q3, K03	1.0L / 1.05 Qt.	10W-30 FC-W
8HP (209cc)	2005-2020	----	35-895152, 35-895152002	0.80L / 0.85 Qt.	10W-30 FC-W
9.9HP (232cc)	1995-1998	18-7901	825467T1, A1	1.0L / 1.05 Qt.	10W-30 FC-W
9.9HP (323cc)	1999-2004	18-7913	35-822626Q1, Q3, K03	1.0L / 1.05 Qt.	10W-30 FC-W
9.9HP (209cc)	2005-2020	----	35-895152, 35-895152002	0.80L / 0.85 Qt.	10W-30 FC-W
15HP (323cc)	1998-2020	18-7913	35-822626Q1, Q3, K03	1.0L / 1.05 Qt.	10W-30 FC-W
20HP (351cc)	2008-2020	18-7913	35-822626Q1, Q3, K03	1.0L / 1.05 Qt.	10W-30 FC-W
25HP (OT800999 and lower)	1998-2006	18-7914	35-822626Q2, Q04, K04	3.0L / 3.17 Qt.	10W-30 FC-W
25HP (OT801000 and up)	2006-2011	18-7913	35-822626Q1, Q3, K03	1.8L / 1.90 Qt.	10W-30 FC-W
30HP (OT800999 and lower)	1999-2006	18-7914	35-822626Q2, Q04, K04	3.0L / 3.17 Qt.	10W-30 FC-W
30HP (OT801000 and up)	2006-2020	18-7913	35-822626Q1, Q3, K03	1.8L / 1.90 Qt.	10W-30 FC-W
40HP (3 cyl)	1999-2011	18-7914	35-822626Q2, Q04, K04	3.0L / 3.17 Qt.	10W-30 FC-W
40HP (4 cyl)	2001-2011	18-7914	35-822626Q2, Q04, K04	3.0L / 3.17 Qt.	10W-30 FC-W
50HP (996cc)	2001-2011	18-7914	35-822626Q2, Q04, K04	3.0L / 3.17 Qt.	10W-30 FC-W
50HP (935cc)	1995-2000	18-7914	35-822626Q2, Q04, K04	3.0L / 3.17 Qt.	10W-30 FC-W
60HP	2001-2011	18-7914	35-822626Q2, Q04, K04	3.0L / 3.17 Qt.	10W-30 FC-W
75HP Carbureted	2000-2005	18-7914	35-822626Q2, Q04, K04	5.0L / 5.28 Qt.	10W-30 FC-W
75HP EFI (1B366822 & Below)	1999-2006	18-7914	35-822626Q2, Q04, K04	4.5L / 4.80 Qt.	10W-30 FC-W
75HP EFI (1B366822 & Above)	2006-2011	18-7758	35-877761K01	5.0L / 5.28 Qt.	10W-30 FC-W
80HP	2006-UP	18-7914	35-822626Q2, Q04, K04	4.5L / 4.80 Qt.	10W-30 FC-W
90HP Carbureted	2000-2005	18-7914	35-822626Q2, Q04, K04	5.0L / 5.28 Qt.	10W-30 FC-W
90HP EFI (1B366822 & Below)	1999-2006	18-7914	35-822626Q2, Q04, K04	4.5L / 4.80 Qt.	10W-30 FC-W
90HP EFI (1B366822 & Above)	2006-2011	18-7758	35-877761K01	5.0L / 5.28 Qt.	10W-30 FC-W
115HP EFI (1B366822 & Below)	2001-2006	18-7914	35-822626Q2, Q04, K04	5.0L / 5.28 Qt.	10W-30 FC-W
115HP EFI (1B366822 & Above)	2006-2011	18-7758	35-877761K01	5.0L / 5.28 Qt.	10W-30 FC-W
135 Verado L4	2006-2020	18-7921	35-877767K01, 35-877767Q01	6.0L / 6.34 Qt.	25W-40 Synthetic Blend FC-W
150 (4-Stroke)	2011-2020	18-7758	35-877761K01, 35-877761Q01	6.0L/6.34 Qt	25W-40 Synthetic Blend FC-W
150 Verado L4	2006-2020	18-7921	35-877767K01, 35-877767Q01	6.0L / 6.34 Qt.	25W-40 Synthetic Blend FC-W
175 Verado L4	2006-2020	18-7921	35-877767K01, 35-877767Q01	6.0L / 6.34 Qt.	25W-40 Synthetic Blend FC-W
200 Verado L4	2007-2020	18-7921	35-877767K01, 35-877767Q01	6.0L / 6.34 Qt.	25W-40 Synthetic Blend FC-W
200 Verado L6	2005-2020	18-7918	35-877769K01, 35-877769Q01	7.0L / 7.40 Qt.	25W-40 Synthetic Blend FC-W

MERCURY OUTBOARD CONTINUED ON NEXT PAGE

OIL FILTER QUICK-REFERENCE GUIDE

MERCURY OUTBOARD

Model	Year	Oil Filter	Replaces	Crankcase Capacity	Recommended Oil
225HP EFI	2003-2020	18-7906-2	35-822626T7, Q15	6.0L / 6.34 Qt.	25W-40 Synthetic Blend FC-W
225 Verado L6	2005-2020	18-7918	35-8777769K01, 35-877769Q01	7.0L / 7.40 Qt.	25W-40 Synthetic Blend FC-W
250 Verado L6	2005-2020	18-7918	35-8777769K01, 35-877769Q01	7.0L / 7.40 Qt.	25W-40 Synthetic Blend FC-W
275 Verado L6	2005-2020	18-7918	35-8777769K01, 35-877769Q01	7.0L / 7.40 Qt.	25W-40 Synthetic Blend FC-W
300 Verado L6	2007-2020	18-7918	35-8777769K01, 35-877769Q01	7.0L / 7.40 Qt.	25W-40 Synthetic Blend FC-W
350 Verado	2015-2020	18-7918	35-8777769K01, 35-877769Q01	7.0L / 7.40 Qt.	25W-40 Synthetic Blend FC-W
400R Verado	2015-2020	18-7918	35-8777769K01, 35-877769Q01	7.0L / 7.40 Qt.	25W-40 Synthetic Blend FC-W

MOHAWK

Model	Year	Oil Filter	Replaces	Crankcase Capacity	Recommended Oil
V8-302, V8-351		18-7875		See Owners Manual	25W-40 FC-W

NISSAN TOHATSU

Model	Year	Oil Filter	Replaces	Crankcase Capacity	Recommended Oil
F2	2006	----	----	300 ml. / 10 oz.	10W-40 FC-W
F2.5	2006 - Current	----	----	300 ml. / 10 oz.	10W-40 FC-W
F3.5	2006 - Current	----	----	300 ml. / 10 oz.	10W-40 FC-W
F4	1999 - Current	----	3H6-07413-0	450 ml. / 16 oz.	10W-40 FC-W
F5	1998 - Current	----	3H6-07413-0	450 ml. / 16 oz.	10W-40 FC-W
F6	2002 - Current	----	3H6-07413-0	450 ml. / 16 oz.	10W-40 FC-W
F8	2003 - Current	----	3V1-07410-1	800 ml. / 27 oz.	10W-40 FC-W
F9.8	2003 - Current	----	3V1-07410-1	800 ml. / 27 oz.	10W-40 FC-W
F9.9	2000 - 2008	18-7911-1	3R007-6150M 3RO-07615-0	1.0L / 1.06 Qt.	10W-40 FC-W
F15	2000 - Current	18-7911-1	3R007-6150M 3RO-07615-0	1.0L / 1.06 Qt.	10W-40 FC-W
F18	2001 - 2006	18-7911-1	3R007-6150M 3RO-07615-0	1.0L / 1.06 Qt.	10W-40 FC-W
F20	2008 - Current	18-7911-1	3R007-6150M 3RO-07615-0	1.0L / 1.06 Qt.	10W-40 FC-W
F25	2002 - Current	18-7911-1	3R007-6150M 3RO-07615-0	1.8L / 1.9 Qt.	10W-40 FC-W
F30	2002 - Current	18-7911-1	3R007-6150M 3RO-07615-0	1.8L / 1.9 Qt.	10W-40 FC-W

NORTHERN LIGHTS

Model	Year	Oil Filter	Replaces	Crankcase Capacity	Recommended Oil
M753		23-7801	140516190	3.5L / 3.7 Qt.	15W-40 API CF or Higher
M753G		23-7801	140516190	3.5L / 3.7 Qt.	15W-40 API CF or Higher
M753K		23-7801	140516190	3.5L / 3.7 Qt.	15W-40 API CF or Higher
M753W		23-7801	140516190	3.5L / 3.7 Qt.	15W-40 API CF or Higher
M753w2		23-7801	140516190	3.5L / 3.7 Qt.	15W-40 API CF or Higher
M773L		23-7801	140516190	4.0L / 4.2 Qt.	15W-40 API CF or Higher
M773LW2		23-7801	140516190	4.9L / 4.75 Qt.	15W-40 API CF or Higher
M773LW3: 9/7Kw		23-7801	140516190	4.9L / 4.75 Qt.	15W-40 API CF or Higher
M843		23-7801	140516190	5.5L / 5.8 Qt.	15W-40 API CF or Higher
M843N		23-7801	140516190	5.5L / 5.8 Qt.	15W-40 API CF or Higher
M843NK		23-7801	140516190	5.5L / 5.8 Qt.	15W-40 API CF or Higher
M843NK2		23-7801	140516190	5.5L / 5.8 Qt.	15W-40 API CF or Higher
M843NW		23-7801	140516190	5.5L / 5.8 Qt.	15W-40 API CF or Higher
M843NW2		23-7801	140516190	5.5L / 5.8 Qt.	15W-40 API CF or Higher
M844		23-7801	140516190	8.2L / 8.66 Qt.	15W-40 API CF or Higher

All listed oil capacities are approximate amounts only and may or may not include the oil filter capacity.
ALWAYS follow proper crankcase drain and fill procedures. Check engine dipstick for proper crankcase oil level.

NORTHERN LIGHTS CONTINUED ON NEXT PAGE

OIL FILTER QUICK-REFERENCE GUIDE

NORTHERN LIGHTS

Model	Year	Oil Filter	Replaces	Crankcase Capacity	Recommended Oil
M844K		23-7801	140516190	8.2L / 8.66 Qt.	15W-40 API CF or Higher
M844L		23-7801	140516190	8.2L / 8.66 Qt.	15W-40 API CF or Higher
M844LK		23-7801	140516190	8.2L / 8.66 Qt.	15W-40 API CF or Higher
M844LW		23-7801	140516190	8.2L / 8.66 Qt.	15W-40 API CF or Higher
M844LW2		23-7801	140516190	8.2L / 8.66 Qt.	15W-40 API CF or Higher
M844W		23-7801	140516190	8.2L / 8.66 Qt.	15W-40 API CF or Higher
M844W2		23-7801	140516190	8.2L / 8.66 Qt.	15W-40 API CF or Higher
M844W3: 16/12KW		23-7801	140516190	8.2L / 8.66 Qt.	15W-40 API CF or Higher
M844LW3: 20/16Kw		23-7801	140516190	8.2L / 8.66 Qt.	15W-40 API CF or Higher
M844NK2		23-7801	140516190	8.2L / 8.66 Qt.	15W-40 API CF or Higher
M844LK2		23-7801	140516190	8.2L / 8.66 Qt.	15W-40 API CF or Higher
M844NW2		23-7801	140516190	8.2L / 8.66 Qt.	15W-40 API CF or Higher
M844NW3		23-7801	140516190	8.2L / 8.66 Qt.	15W-40 API CF or Higher
ML844		23-7801	140516190	8.2L / 8.66 Qt.	15W-40 API CF or Higher
ML844K		23-7801	140516190	8.2L / 8.66 Qt.	15W-40 API CF or Higher
ML844L		23-7801	140516190	8.2L / 8.66 Qt.	15W-40 API CF or Higher
ML844LK		23-7801	140516190	8.2L / 8.66 Qt.	15W-40 API CF or Higher
M864K		23-7801	140516190	7.4L / 7.8 Qt.	15W-40 API CF or Higher
M864W		23-7801	140516190	7.4L / 7.8 Qt.	15W-40 API CF or Higher
M864W3: 25/20Kw		23-7801	140516190	7.4L / 7.8 Qt.	15W-40 API CF or Higher
M16C		23-7801	140516190	Refer to Owner's Manual	15W-40 API CF or Higher
M20CL		23-7801	140516190	8.2L / 8.66 Qt.	15W-40 API CF or Higher
M20CR		23-7801	140516190	8.2L / 8.66 Qt.	15W-40 API CF or Higher

OMC

Model	Cyl.	Year	Oil Filter	Replaces	Crankcase Capacity	Recommended Oil
100	4	1972 - 1973	18-7824	502902	3.3L / 3.5 Qt.	25W-40 FC-W
120	4	1965 - 1981	18-7824	502902	3.3L / 3.5 Qt.	25W-40 FC-W
140	4	1973 - 1981	18-7824	502902	3.3L / 3.5 Qt.	25W-40 FC-W
2.3L (Ford)	4	1987 - 1990	18-7875	502900	3.8L / 4.0 Qt.	25W-40 FC-W
2.5L	4	1982 - 1986	18-7824	502902	3.3L / 3.5 Qt.	25W-40 FC-W
3.0L / GL / GS	4	1982 - 1998	18-7824	502902	3.8L / 4.0 Qt.	25W-40 FC-W
165	6	1972 - 1976	18-7876-1	502901	3.8L / 4.0 Qt.	25W-40 FC-W
3.8L	6	1981 - 1985	18-7879-1	502903	3.8L / 4.0 Qt.	25W-40 FC-W
4.3L	6	1985 - 1998	18-7879-1	502903	3.8L / 4.0 Qt.	25W-40 FC-W
4.3 HO (Remote Oil Filter)	6	1989 - 1991	18-7876-1	502901	4.0L / 4.5 Qt.	25W-40 FC-W
175 (Ford)	8	1975 - 1977	18-7875	502900	4.7L / 5.0 Qt.	25W-40 FC-W
185 (Ford)	8	1978 - 1980	18-7875	502900	3.8L / 4.0 Qt.	25W-40 FC-W
190 (Ford)	8	1974 - 1977	18-7875	502900	4.7L / 5.0 Qt.	25W-40 FC-W
200	8	1978 - 1981	18-7876-1	502901	3.8L / 4.0 Qt.	25W-40 FC-W
225	8	1972 - 1978	18-7876-1	502901	4.7L / 5.0 Qt.	25W-40 FC-W
230	8	1978 - 1981	18-7876-1	502901	4.7L / 5.0 Qt.	25W-40 FC-W
235	8	1971 - 1977	18-7876-1	502901	4.7L / 5.0 Qt.	25W-40 FC-W
245	8	1972 - 1975	18-7876-1	502901	4.7L / 5.0 Qt.	25W-40 FC-W
250 (Ford)	8	1979	18-7875	502900	4.7L / 5.0 Qt.	25W-40 FC-W
260	8	1978 - 1981	18-7876-1	502901	4.7L / 5.0 Qt.	25W-40 FC-W
262 King Cobra	8	1989	18-7876-1	502901	3.8L / 4.0 Qt.	25W-40 FC-W
350 King Cobra	8	1986 - 1989	18-7876-1	502901	4.7L / 5.0 Qt.	25W-40 FC-W
351 EFI	8	1994 - 1995	18-7875	502900	3.8L / 4.0 Qt.	25W-40 FC-W

OMC CONTINUED ON NEXT PAGE

OIL FILTER QUICK-REFERENCE GUIDE

OMC						
Model	Cyl.	Year	Oil Filter	Replaces	Crankcase Capacity	Recommended Oil
351 King	8	1992	18-7875	502900	4.7L / 5.0 Qt.	25W-40 FC-W
351 King	8	1993	18-7875	502900	3.8L / 4.0 Qt.	25W-40 FC-W
454 HO	8	1991 - 1993	18-7876-1	502901	5.7L / 6.0 Qt.	25W-40 FC-W
454 King Cobra	8	1989 - 1990	18-7876-1	502901	5.7L / 6.0 Qt.	25W-40 FC-W
460 King Cobra	8	1986 - 1989	18-7878-1	502904	5.7L / 6.0 Qt.	25W-40 FC-W
5.0L	8	1986-1996, 1998	18-7876-1	502901	4.7L / 5.0 Qt.	25W-40 FC-W
5.0L EFI (Ford)	8	1993 - 1996	18-7875	502900	4.7L / 5.0 Qt.	25W-40 FC-W
502 King Cobra (8.2L)	8	1992 - 1993	18-7876-1	502901	5.7L / 6.0 Qt.	25W-40 FC-W
5.7L	8	1982 - 1985	18-7876-1	502901	5.7L / 6.0 Qt.	25W-40 FC-W
5.7L / GL / Gi	8	1986 - 1998	18-7876-1	502901	4.7L / 5.0 Qt.	25W-40 FC-W
5.8L (Ford)	8	1989 - 1991	18-7875	502900	4.7L / 5.0 Qt.	25W-40 FC-W
5.8L (Ford) / FL / EFI	8	1992 - 1995	18-7875	502900	3.8L / 4.0 Qt.	25W-40 FC-W
5.8L HO EFI	8	1995	18-7875	502900	3.8L / 4.0 Qt.	25W-40 FC-W
7.4L / GL	8	1988, 1991-1998	18-7876-1	502901	5.7L / 6.0 Qt.	25W-40 FC-W
7.4L Gi	8	1996 - 1998	18-7876-1	502901	7.6L / 8.0 Qt.	25W-40 FC-W
7.5L (Ford)	8	1987 - 1990	18-7878-1	502904	4.7L / 5.0 Qt.	25W-40 FC-W
8.2L	8	1984 - 1985	18-7876-1	502901	5.7L / 6.0 Qt.	25W-40 FC-W
8.2L GSi	8	1998	18-7876-1	502901	7.6L / 8.0 Qt.	25W-40 FC-W
ONAN						
Model	Year	Oil Filter	Replaces	Crankcase Capacity	Recommended Oil	
MDKAU		23-7804	185-744	2.1L / 2.2 Qt.	15W-40 API CF or Higher	
MDKAV		23-7842	185-5835	4.0L / 4.2 Qt.	15W-40 API CF or Higher	
MDKBG		23-7842	185-5835	4.0L / 4.2 Qt.	15W-40 API CF or Higher	
MDKAW (Spacesaver)		23-7842	185-5835	4.3L / 4.5 Qt.	15W-40 API CF or Higher	
MDKAZ		23-7842	185-5835	4.3L / 4.5 Qt.	15W-40 API CF or Higher	
MDKBD		23-7840	122-0810	7.6L / 8.0 Qt.	15W-40 API CF or Higher	
MDKBE		23-7840	122-0810	7.6L / 8.0 Qt.	15W-40 API CF or Higher	
MDKBF		23-7840	122-0810	12L / 12.7 Qt.	15W-40 API CF or Higher	
MDKBD (w/ Isolated Ground)		23-7840	122-0810	7.6L / 8.0 Qt.	15W-40 API CF or Higher	
MDKBE (w/ Isolated Ground)		23-7840	122-0810	7.6L / 8.0 Qt.	15W-40 API CF or Higher	
MDKBF (w/ Isolated Ground)		23-7840	122-0810	12L / 12.7 Qt.	15W-40 API CF or Higher	
MDKBH		23-7804	185-744	2.1L / 2.2 Qt.	15W-40 API CF or Higher	
MDJB		23-7841	122-0185	3.3L / 3.5 Qt.	15W-40 API CF or Higher	
MDJC		23-7841	122-0185	6.2L / 6.5 Qt.	15W-40 API CF or Higher	
MDJE		23-7841	122-0185	3.3L / 3.5 Qt.	15W-40 API CF or Higher	
MDJF		23-7841	122-0185	6.2L / 6.5 Qt.	15W-40 API CF or Higher	
MJA		23-7841	122-0185	Refer to Owners Manual	15W-40 API CF or Higher	
MJB		23-7841	122-0185	Refer to Owners Manual	15W-40 API CF or Higher	
MJC		23-7841	122-0185	Refer to Owners Manual	15W-40 API CF or Higher	
MDKAD/E/F		23-7840	122-0810	7.6L / 8.0 Qt.	15W-40 API CF or Higher	
MDKAL/A/B		23-7842	185-5835	4.0L / 4.2 Qt.	15W-40 API CF or Higher	
PCM PLEASURECRAFT						
Model	Year	Oil Filter	Replaces	Crankcase Capacity	Recommended Oil	
200		18-7875	R077001	Refer to Owners Manual	Refer to Owners Manual	
220		18-7875	R077001	Refer to Owners Manual	Refer to Owners Manual	
8200		18-7875	R077001	Refer to Owners Manual	Refer to Owners Manual	
8240		18-7875	R077001	Refer to Owners Manual	Refer to Owners Manual	

All listed oil capacities are approximate amounts only and may or may not include the oil filter capacity.
 ALWAYS follow proper crankcase drain and fill procedures. Check engine dipstick for proper crankcase oil level.

PCM PLEASURECRAFT CONTINUED ON NEXT PAGE

OIL FILTER QUICK-REFERENCE GUIDE

PCM PLEASURECRAFT

Model	Year	Oil Filter	Replaces	Crankcase Capacity	Recommended Oil
230		18-7824	R077002	Refer to Owners Manual	Refer to Owners Manual
280		18-7824	R077002	Refer to Owners Manual	Refer to Owners Manual
300		18-7824	R077002	Refer to Owners Manual	Refer to Owners Manual
350		18-7824	R077002	Refer to Owners Manual	Refer to Owners Manual
5.0L MPI (Remote Oil Filter)	2007 & Older	18-7875	R077001	3.8L / 4.0 Qt.	15W-40 API SL or Higher
5.7L MPI (Remote Oil Filter)	2007 & Older	18-7875	R077001	3.8L / 4.0 Qt.	15W-40 API SL or Higher
6.0L MPI (Remote Oil Filter)	2007 & Older	18-7875	R077001	4.75L / 5.0 Qt.	15W-40 API SL or Higher
5.0L MPI (Serial 473065 & UP) (Remote Oil Filter)	2007 - 2009	18-7875	R077001	3.8L / 4.0 Qt.	15W-40 API SL or Higher
EX 343 (Serial 473065 & UP) (Remote Oil Filter)	2007 - 2012	18-7875	R077001	3.8L / 4.0 Qt.	15W-40 API SL or Higher
ZR6 390 (Serial 470365 & UP) (Remote Oil Filter)	2007	18-7875	R077001	4.75L / 5.0 Qt.	15W-40 API SL or Higher
5.0L Pro Sport Catanium™ CES (Remote Oil Filter)	2008 - 2010	18-7875	R077001	4.5L / 4.75 Qt.	15W-40 API SM or Higher
5.7L EX343 Catanium™ CES (Remote Oil Filter)	2008 - 2016	18-7875	R077001	4.5L / 4.75 Qt.	"Below 50° 5W-30 Semi-Synth Above 50° 15W-40 SM or Higher"
6.0L ZR-409 Catanium™ CES (Remote Oil Filter)	2011 - 2016	18-7875	R077001	4.75L / 5.0 Qt.	15W-40 API SM or Higher
6.0L MPI - ZR409 (Remote Oil Filter)	2009 - 2010	18-7875	R077001	4.75L / 5.0 Qt.	15W-40 API SM or Higher
HO303 MPI	2010 - Older	18-7875	R077001	3.8L / 4.0 Qt. (Starting Amount)	15W-40 API SM or Higher
HO303 Catanium™ CES	2011 - 2016	18-7875	R077001	3.8L / 4.0 Qt. (Starting Amount)	"Below 50° 5W-30 Semi-Synth Above 50° 15W-40 SM or Higher"
ZR450 Catanium™ CES	2011 - 2012	18-7875	R077001	3.8L / 4.0 Qt. (Starting Amount)	15W-40 API SM or Higher
ZR550 6.2L MPI	2011 - 2012	18-7875	R077001	3.8L / 4.0 Qt. (Starting Amount)	5W-30 Full Synthetic

SUZUKI

Model	Year	Oil Filter	Replaces	Crankcase Capacity	Recommended Oil
DF9.9A	2011 - 2020	18-7903	16510-05240	0.8L / 0.85 Qt.	10W-40 Synthetic Blend FC-W
DF9.9-DF15 (9.9 hp. serial 110001 and below)	1996 - 2010	18-7903	16510-05240 16510-45H10	1.0 L / 1.1 Qt.	10W-40 Synthetic Blend FC-W
DF9.9T / DF9.9TH / DF9.9B	2011 - 2020	18-8870	16510-45H10	1.0 L / 1.1 Qt.	10W-40 Synthetic Blend FC-W
DF15 / DF15A	2011 - 2020	18-8870	16510-45H10	1.0 L / 1.1 Qt.	10W-40 Synthetic Blend FC-W
DF20A	2011 - 2020	18-8870	16510-45H10	1.0 L / 1.1 Qt.	10W-40 Synthetic Blend FC-W
DF25	2000 - 2006	18-7915-1	16510-87J00	3.0 L / 3.2 Qt.	10W-40 Synthetic Blend FC-W
DF25 V-Twin	2006 - 2010	18-7915-1	16510-87J00	1.5L / 1.6 Qt.	10W-40 Synthetic Blend FC-W
DF25A	2011 - 2020	18-7915-1	16510-87J00	3.0 L / 3.2 Qt.	10W-40 Synthetic Blend FC-W
DF30	2000 - 2007	18-7915-1	16510-87J00	3.0 L / 3.2 Qt.	10W-40 Synthetic Blend FC-W
DF30A	2011 - 2020	18-7915-1	16510-87J00	3.0 L / 3.2 Qt.	10W-40 Synthetic Blend FC-W
DF40	1999 - 2010	18-7915-1	16510-87J00	2.2 L / 2.3 Qt.	10W-40 Synthetic Blend FC-W
DF40A	2011 - 2020	18-7915-1	16510-87J00	2.7 L / 3.0 Qt.	10W-40 Synthetic Blend FC-W
DF50	1999 - 2010	18-7915-1	16510-87J00	2.2 L / 2.3 Qt.	10W-40 Synthetic Blend FC-W
DF50A	2011 - 2020	18-7915-1	16510-87J00	2.7 L / 3.0 Qt.	10W-40 Synthetic Blend FC-W
DF60	1998 - 2009	18-7915-1	16510-87J00	4.5 L / 4.8 Qt.	10W-40 Synthetic Blend FC-W
DF70	1998 - 2009	18-7915-1	16510-87J00	4.5 L / 4.8 Qt.	10W-40 Synthetic Blend FC-W
DF60A	2010	18-7915-1	16510-87J00	2.7 L / 3.0 Qt.	10W-40 Synthetic Blend FC-W
DF70A	2009 - 2010	18-7896	16510-61A20-MHL	4.2 L / 4.0 Qt.	10W-40 Synthetic Blend FC-W
DF80A	2009 - 2010	18-7896	16510-61A20-MHL	4.2 L / 4.0 Qt.	10W-40 Synthetic Blend FC-W
DF90A	2009 - 2010	18-7896	16510-61A20-MHL	4.2 L / 4.0 Qt.	10W-40 Synthetic Blend FC-W
DF90	2001 - 2008	18-7896	16510-61A20-MHL	5.5 L / 5.8 Qt.	10W-40 Synthetic Blend FC-W
DF115	2001 - 2010	18-7896	16510-61A20-MHL	5.5 L / 5.8 Qt.	10W-40 Synthetic Blend FC-W
DF140	2002 - 2010	18-7897	16510-82703	5.5 L / 5.8 Qt.	10W-40 Synthetic Blend FC-W
DF150-DF175	2006 - 2010	18-7905	16510-96J00	8.0 L / 8.5 Qt.	10W-40 Synthetic Blend FC-W

All listed oil capacities are approximate amounts only and may or may not include the oil filter capacity.
 ALWAYS follow proper crankcase drain and fill procedures. Check engine dipstick for proper crankcase oil level.

SUZUKI CONTINUED ON NEXT PAGE

OIL FILTER QUICK-REFERENCE GUIDE

SUZUKI

Model	Year	Oil Filter	Replaces	Crankcase Capacity	Recommended Oil
DF200 / DF225 / DF250	2004 - 2010	18-7905	16510-96J00	8.0 L / 8.5 Qt.	10W-40 Synthetic Blend FC-W
DF300	2007 - 2010	18-7905	16510-96J00	8.0 L / 8.5 Qt.	10W-40 Synthetic Blend FC-W
DF300A	2011 - 2020	18-7905-1	16510-96J10	8.0 L / 8.5 Qt.	10W-40 Synthetic Blend FC-W
DF300B	2017 - 2020	18-7905-1	16510-96J10	7.8L / 8.2 Qt.	10W-40 Synthetic Blend FC-W
DF350A	2018 - 2020	18-7905-1	16510-96J10	7.8L / 8.2 Qt.	10W-40 Synthetic Blend FC-W

VOLVO GASOLINE

Model	Cyl.	Year	Oil Filter	Replaces	Crankcase Capacity	Recommended Oil
230 A/B	4	1989 - 1993	18-7878-1	3517857	4.5L / 4.75 Qt.	10W-40 FC-W
250 A/B	4	1989 - 1993	18-7878-1	3517857	4.5L / 4.75 Qt.	10W-40 FC-W
251A	4	1989 - 1992	18-7878-1	3517857	4.5L / 4.75 Qt.	10W-40 FC-W
3.0L	4	1993 - Current	18-7824	835440	3.8L / 4.0 Qt.	Synthetic SAE 30 (1)
AQ100	4	1961 - 1963	18-7878-1	3517857	3.8L / 4.0 Qt.	10W-40 FC-W
AQ110	4	1963 - 1966	18-7878-1	3517857	3.8L / 4.0 Qt.	10W-40 FC-W
AQ115 A/B	4	1969 - 1975	18-7878-1	3517857	3.8L / 4.0 Qt.	10W-40 FC-W
AQ120 A/B	4	1966 - 1980	18-7878-1	3517857	3.8L / 4.0 Qt.	10W-40 FC-W
AQ125 A/B	4	1981 - 1985	18-7878-1	3517857	4.2L / 4.5 Qt.	10W-40 FC-W
AQ130 A/B/C/D	4	1968 - 1977	18-7878-1	3517857	3.8L / 4.0 Qt.	10W-40 FC-W
AQ131 A/B/C/D	4	1985 - 1989	18-7878-1	3517857	3.8L / 4.0 Qt.	10W-40 FC-W
AQ140A	4	1975 - 1979	18-7878-1	3517857	3.8L / 4.0 Qt.	10W-40 FC-W
AQ145 A/B	4	1979 - 1985	18-7878-1	3517857	4.2L / 4.5 Qt.	10W-40 FC-W
AQ151 A/B/C	4	1985 - 1989	18-7878-1	3517857	3.8L / 4.0 Qt.	10W-40 FC-W
AQ170 A/B/C	4	1969 - 1980	18-7878-1	3517857	3.8L / 4.0 Qt.	10W-40 FC-W
AQ171 A/C	4	1986 - 1989	18-7878-1	3517857	3.8L / 4.0 Qt.	10W-40 FC-W
AQ60F	4	1962 - 1968	18-7878-1	3517857	Check Owners Manual	10W-40 FC-W
AQ90	4	1962 - 1964	18-7878-1	3517857	3.8L / 4.0 Qt.	10W-40 FC-W
AQ95 /A	4	1964 - 1966	18-7878-1	3517857	3.8L / 4.0 Qt.	10W-40 FC-W
BB100	4	1963 - 1969	18-7878-1	3517857	Check Owners Manual	10W-40 FC-W
BB115 A/B/C	4	1969 - 1977	18-7878-1	3517857	Check Owners Manual	10W-40 FC-W
BB140A	4	1975 - 1979	18-7878-1	3517857	Check Owners Manual	10W-40 FC-W
BB145A	4	1979 - 1985	18-7878-1	3517857	Check Owners Manual	10W-40 FC-W
BB165A	4	1965 - 1969	18-7878-1	3517857	Check Owners Manual	10W-40 FC-W
BB170 A/B/C	4	1969 - 1978	18-7878-1	3517857	Check Owners Manual	10W-40 FC-W
BB30	4	1963 - 1969	18-7878-1	3517857	Check Owners Manual	10W-40 FC-W
MB10A	4	1971 - 1977	18-7878-1	3517857	Check Owners Manual	10W-40 FC-W
MB20 A/B/C	4	1969 - 1980	18-7878-1	3517857	Check Owners Manual	10W-40 FC-W
4.3L	V6	1993 - 2006	18-7879-1	841750	4.2L / 4.5 Qt.	Synthetic SAE 30 (1)
4.3L	V6	2007 - Current	18-8003-1	8692305	4.7L / 5.0 Qt.	Synthetic SAE 30 (1)
430 A/B	V6	1990 - 1992	18-7879-1	841750	4.2L / 4.5 Qt.	10W-40 FC-W
431 A/B	V6	1989 - 1992	18-7879-1	841750	4.2L / 4.5 Qt.	10W-40 FC-W
432A/B	V6	1992 - 1998	18-7879-1	841750	4.2L / 4.5 Qt.	10W-40 FC-W
434A/B	V6	1992 - 1997	18-7879-1	841750	4.2L / 4.5 Qt.	10W-40 FC-W
AQ175A	V6	1981 - 1985	18-7879-1	841750	6.0L / 6.5 Qt.	10W-40 FC-W
AQ205A	V6	1988 - 1989	18-7879-1	841750	6.0L / 6.5 Qt.	10W-40 FC-W
5.0L (Ford)	V8	1993 - 1999	18-7875	835779	5.7L / 6.0 Qt.	Synthetic SAE 30 (1)
5.0L (GM)	V8	1997 - 2006	18-7824	835440	5.7L / 6.0 Qt.	Synthetic SAE 30 (1)
5.0L (GM)	V8	2007 - Current	18-8003-1	8692305	5.2L / 5.5 Qt.	Synthetic SAE 30 (1)
5.7L	V8	1993 - 2006	18-7824	835440	5.7L / 6.0 Qt.	Synthetic SAE 30 (1)
5.7L	V8	2007 - Current	18-8003-1	8692305	5.2L / 5.5 Qt.	Synthetic SAE 30 (1)

VOLVO GASOLINE CONTINUED ON NEXT PAGE

OIL FILTER QUICK-REFERENCE GUIDE

VOLVO GASOLINE

Model	Cyl.	Year	Oil Filter	Replaces	Crankcase Capacity	Recommended Oil
5.8L	V8	1993 - 1996	18-7875	835779	5.7L / 6.0 Qt.	Synthetic SAE 30 (1)
500 A/B	V8	1989 - 1993	18-7824	835440	5.7L / 6.0 Qt.	10W-40 FC-W
501 A/B	V8	1989 - 1993	18-7824	835440	5.7L / 6.0 Qt.	10W-40 FC-W
570 A/MS4A	V8	1989 - 1993	18-7824	835440	5.7L / 6.0 Qt.	10W-40 FC-W
571A	V8	1989 - 1992	18-7824	835440	5.7L / 6.0 Qt.	10W-40 FC-W
572A	V8	1991 - 1993	18-7824	835440	5.7L / 6.0 Qt.	10W-40 FC-W
7.4L	V8	1993 - 2000	18-7876-1	3850559	6.6L / 7.0 Qt.	Synthetic SAE 30 (1)
740 A/B	V8	1992 - 1993	18-7876-1	3850559	6.6L / 7.0 Qt.	10W-40 FC-W
8.1L	V8	1999 - 2006	18-7824	835440	8.0L / 8.5 Qt.	Synthetic SAE 30 (1)
8.1L	V8	2007 - Current	18-8003-1	8692305	8.0L / 8.5 Qt.	Synthetic SAE 30 (1)
8.2L	V8	1993 - 2000	18-7876-1	3850559	6.6L / 7.0 Qt.	Synthetic SAE 30 (1)
AQ190A	V8	1976 - 1977	18-7875	835779	4.0L / 4.2 Qt.	10W-40 FC-W
AQ211A	V8	1986 - 1989	18-7824	835440	4.0L / 4.2 Qt.	10W-40 FC-W
AQ225 B/C/D/E/F	V8	1973 - 1976	18-7824	835440	4.4L / 4.7 Qt.	10W-40 FC-W
AQ231A	V8	1986 - 1989	18-7824	835440	4.4L / 4.7 Qt.	10W-40 FC-W
AQ231B	V8	1987 - 1989	18-7824	835440	4.4L / 4.7 Qt.	10W-40 FC-W
AQ240A	V8	1976 - 1977	18-7875	835779	4.4L / 4.7 Qt.	10W-40 FC-W
AQ255 A/B	V8	1977 - 1978	18-7824	835440	5.7L / 6.0 Qt.	10W-40 FC-W
AQ260 A/B	V8	1979 - 1986	18-7824	835440	5.7L / 6.0 Qt.	10W-40 FC-W
AQ271 A/B/C/D	V8	1986 - 1989	18-7824	835440	5.4L / 5.7 Qt.	10W-40 FC-W
AQ280A	V8	1978 - 1979	18-7824	835440	5.4L / 5.7 Qt.	10W-40 FC-W
AQ290A	V8	1979 - 1985	18-7824	835440	5.4L / 5.7 Qt.	10W-40 FC-W
AQ311 A/B	V8	1986 - 1987	18-7824	835440	5.4L / 5.7 Qt.	10W-40 FC-W
BB225 A/B/C	V8	1973 - 1977	18-7824	835440	4.4L / 4.7 Qt.	10W-40 FC-W
BB231A	V8	1987	18-7824	835440	4.4L / 4.7 Qt.	10W-40 FC-W
BB260 A/B/C	V8	1978 - 1987	18-7824	835440	5.7L / 6.0 Qt.	10W-40 FC-W
BB261A	V8	1988 - 1989	18-7824	835440	5.7L / 6.0 Qt.	10W-40 FC-W

VOLVO DIESEL

Model	Cyl.	Year	Oil Filter	Replaces	Crankcase Capacity	Recommended Oil
2001 / B	1	1984 - 1993	18-7884	834337	1.4L / 1.5 Qt.	15W-40 VDS-2 or VDS-3 / API CI-4 or higher
MD1B	1	1970 - 1973	18-7884	834337	1.5L / 1.8 Qt.	15W-40 VDS-2 or VDS-3 / API CI-4 or higher
MD5A / B / C	1	1975 - 1982	18-7884	834337	2.0L / 2.10 Qt.	15W-40 VDS-2 or VDS-3 / API CI-4 or higher
2002 / B	2	1983 - 1993	18-7884	834337	2.75L / 2.9 Qt.	15W-40 VDS-2 or VDS-3 / API CI-4 or higher
AQD2B	2	1972 - 1975	18-7884	834337	See Owners Manual	15W-40 VDS-2 or VDS-3 / API CI-4 or higher
MD11C / D	2	1975 - 1983	18-7884	834337	2.6L / 2.7 Qt.	15W-40 VDS-2 or VDS-3 / API CI-4 or higher
MD2	2	1964 - 1967	18-7884	834337	See Owners Manual	15W-40 VDS-2 or VDS-3 / API CI-4 or higher
MD2B	2	1970 - 1975	18-7884	834337	2.6L / 2.7 Qt.	15W-40 VDS-2 or VDS-3 / API CI-4 or higher
MD6A / B	2	1971 - 1976	18-7884	834337	2.8L / 2.9 Qt.	15W-40 VDS-2 or VDS-3 / API CI-4 or higher
MD7A / B	2	1976 - 1983	18-7884	834337	2.8L / 2.9 Qt.	15W-40 VDS-2 or VDS-3 / API CI-4 or higher
2003 / B / TB	3	1983 - 1993	18-7884	834337	4.1L / 4.3 Qt.	15W-40 VDS-2 or VDS-3 / API CI-4 or higher
MD17C / D	3	1975 - 1984	18-7884	834337	4.2L / 4.4 Qt.	15W-40 VDS-2 or VDS-3 / API CI-4 or higher
MD3B	3	1971 - 1975	18-7884	834337	4.8L / 5.8 Qt.	15W-40 VDS-2 or VDS-3 / API CI-4 or higher
AD31A / L-A / P-A / D / X	4	1986 - 2004	18-7878-1	3517857	8.5L / 9.0 Qt.	15W-40 VDS-2 or VDS-3 / API CI-4 or higher
AQAD30A	4	1983 - 1986	18-7878-1	3517857	8.5L / 9.0 Qt.	15W-40 VDS-2 or VDS-3 / API CI-4 or higher
AQAD31A	4	1986 - 1989	18-7878-1	3517857	8.5L / 9.0 Qt.	15W-40 VDS-2 or VDS-3 / API CI-4 or higher
AQD21A / B	4	1969 - 1981	18-7974	3827069	5.5L / 5.8 Qt.	15W-40 VDS-2 or VDS-3 / API CI-4 or higher
D4-180iB / C / D / E	4	2005 - Current	18-0035	3582732 Full Flow	12.5L / 13.2 Qt.	15W-40 VDS-2 or VDS-3 / API CI-4 or higher

All listed oil capacities are approximate amounts only and may or may not include the oil filter capacity.
 ALWAYS follow proper crankcase drain and fill procedures. Check engine dipstick for proper crankcase oil level.

VOLVO DIESEL CONTINUED ON NEXT PAGE

OIL FILTER QUICK-REFERENCE GUIDE

VOLVO DIESEL						
Model	Cyl.	Year	Oil Filter	Replaces	Crankcase Capacity	Recommended Oil
D4-180iB / C / D / E	4	2005 - Current	18-0036	3582733 Bypass	12.5L / 13.2 Qt.	15W-40 VDS-2 or VDS-3 / API CI-4 or higher
D4-210A / A-B	4	2003 - 2006	18-0035	3582732 Full Flow	12.5L / 13.2 Qt.	15W-40 VDS-2 or VDS-3 / API CI-4 or higher
D4-210A / B	4	2003 - 2006	18-0036	3582733 Bypass	12.5L / 13.2 Qt.	15W-40 VDS-2 or VDS-3 / API CI-4 or higher
D4-210i-A / B	4	2003 - 2006	18-0035	3582732 Full Flow	12.5L / 13.2 Qt.	15W-40 VDS-2 or VDS-3 / API CI-4 or higher
D4-210i-A / B	4	2003 - 2006	18-0036	3582733 Bypass	12.5L / 13.2 Qt.	15W-40 VDS-2 or VDS-3 / API CI-4 or higher
D4-225A-B	4	2005 - 2008	18-0035	3582732 Full Flow	12.5L / 13.2 Qt.	15W-40 VDS-2 or VDS-3 / API CI-4 or higher
D4-225A-B	4	2005 - 2008	18-0036	3582733 Bypass	12.5L / 13.2 Qt.	15W-40 VDS-2 or VDS-3 / API CI-4 or higher
D4-225i-B	4	2005 - 2008	18-0035	3582732 Full Flow	12.5L / 13.2 Qt.	15W-40 VDS-2 or VDS-3 / API CI-4 or higher
D4-225i-B	4	2005 - 2008	18-0036	3582733 Bypass	12.5L / 13.2 Qt.	15W-40 VDS-2 or VDS-3 / API CI-4 or higher
D4-260A / A-B / D-B	4	2004 - 2008	18-0036	3582733 Bypass	12.5L / 13.2 Qt.	15W-40 VDS-2 or VDS-3 / API CI-4 or higher
D4-260A / A-B / D-B (IPS)	4	2004 - 2008	18-0035	3582732 Full Flow	12.5L / 13.2 Qt.	15W-40 VDS-2 or VDS-3 / API CI-4 or higher
D4-260i-A / B	4	2004 - 2008	18-0035	3582732 Full Flow	12.5L / 13.2 Qt.	15W-40 VDS-2 or VDS-3 / API CI-4 or higher
D4-260i-A / B	4	2004 - 2008	18-0036	3582733 Bypass	12.5L / 13.2 Qt.	15W-40 VDS-2 or VDS-3 / API CI-4 or higher
D4-300A / A-E / D-A	4	2007 - Current	18-0035	3582732 Full Flow	12.5L / 13.2 Qt.	15W-40 VDS-2 or VDS-3 / API CI-4 or higher
D4-300A / A-E / D-A	4	2007 - Current	18-0036	3582733 Bypass	12.5L / 13.2 Qt.	15W-40 VDS-2 or VDS-3 / API CI-4 or higher
D4-300i-A / C / D	4	2007 - 2010	18-0035	3582732 Full Flow	12.5L / 13.2 Qt.	15W-40 VDS-2 or VDS-3 / API CI-4 or higher
D4-300i-A / C / D	4	2007 - 2010	18-0036	3582733 Bypass	12.5L / 13.2 Qt.	15W-40 VDS-2 or VDS-3 / API CI-4 or higher
KAD32P	4	1997 - 2005	18-7926		8.5L / 9.0 Qt.	15W-40 VDS-2 or VDS-3 / API CI-4 or higher
MD21A / B	4	1969 - 1981	18-7974	3827069	5.5L / 5.8 Qt.	15W-40 VDS-2 or VDS-3 / API CI-4 or higher
MD30A	4	1983 - 1986	18-7878-1	3517857	8.5L / 9.0 Qt.	15W-40 VDS-2 or VDS-3 / API CI-4 or higher
MD31A	4	1986 - 1994	18-7878-1	3517857	8.5L / 9.0 Qt.	15W-40 VDS-2 or VDS-3 / API CI-4 or higher
TAMD30A	4	1983 - 1986	18-7878-1	3517857	8.5L / 9.0 Qt.	15W-40 VDS-2 or VDS-3 / API CI-4 or higher
TAMD31B / D / PL	4	1989 - 2003	18-7878-1	3517857	8.5L / 9.0 Qt.	15W-40 VDS-2 or VDS-3 / API CI-4 or higher
TMD30A	4	1983 - 1986	18-7878-1	3517857	8.5L / 9.0 Qt.	15W-40 VDS-2 or VDS-3 / API CI-4 or higher
TMD31A / B / D	4	1986 - 1994	18-7878-1	3517857	8.5L / 9.0 Qt.	15W-40 VDS-2 or VDS-3 / API CI-4 or higher
TMD31L-A	4	1994 - 1997	18-7878-1	3517857	8.5L / 9.0 Qt.	15W-40 VDS-2 or VDS-3 / API CI-4 or higher
D3-110i-A / B / C	5	2004 - 2006	18-8003-1	8692305	5.65L / 6.0 Qt.	15W-40 VDS-2 or VDS-3 / API CI-4 or higher
D3-130A / A-B	5	2005 - 2006	18-8003-1	8692305	5.65L / 6.0 Qt.	15W-40 VDS-2 or VDS-3 / API CI-4 or higher
D3-130i-A / B / C	5	2004 - 2006	18-8003-1	8692305	5.65L / 6.0 Qt.	15W-40 VDS-2 or VDS-3 / API CI-4 or higher
D3-160A / A-B / A-C	5	2004 - 2006	18-8003-1	8692305	5.65L / 6.0 Qt.	15W-40 VDS-2 or VDS-3 / API CI-4 or higher
D3-160i-A / B / C	5	2004 - 2006	18-8003-1	8692305	5.65L / 6.0 Qt.	15W-40 VDS-2 or VDS-3 / API CI-4 or higher
D3-190A-B	5	2005 - 2007	18-8003-1	8692305	5.65L / 6.0 Qt.	15W-40 VDS-2 or VDS-3 / API CI-4 or higher
D3-190i-B / C	5	2005 - Current	18-8003-1	8692305	5.65L / 6.0 Qt.	15W-40 VDS-2 or VDS-3 / API CI-4 or higher
AQD70B / C	6	1972 - 1978	18-7926	423135	20L / 5.28 Gal.	15W-40 VDS-2 or VDS-3 / API CI-4 or higher
D11A-A / B / C / D	6	2007 - Current	18-0033	478736	38L / 10 Gal.	15W-40 VDS-2 or VDS-3 / API CI-4 or higher
D11A-A / B / C / D	6	2007 - Current	18-0034	477556	38L / 10 Gal.	15W-40 VDS-2 or VDS-3 / API CI-4 or higher
D11A-C (IPS) / D11A-D (IPS)	6	2009 - Current	18-0033	478736	38L / 10 Gal.	15W-40 VDS-2 or VDS-3 / API CI-4 or higher
D11A-C (IPS) / D11A-D (IPS)	6	2009 - Current	18-0034	477556	38L / 10 Gal.	15W-40 VDS-2 or VDS-3 / API CI-4 or higher
D12D-AMP / B / C / E / F / G / H	6	1999 - 2009	18-0033	478736	44L / 11.62 Gal.	15W-40 VDS-2 or VDS-3 / API CI-4 or higher
D12D-AMG / EMG (Gen Set)	6	2002 - 2008	18-0034	477556	44L / 11.62 Gal.	15W-40 VDS-2 or VDS-3 / API CI-4 or higher
D12D-AMH / B / C / E / G	6	2002 - 2008	18-0033	478736	44L / 11.62 Gal.	15W-40 VDS-2 or VDS-3 / API CI-4 or higher
D13AMP / B / C / G / H	6	2009 - Current	18-0033	478736	45L / 11.89 Gal.	15W-40 VDS-2 or VDS-3 / API CI-4 or higher
D13AMP / B / C / G / H	6	2009 - Current	18-0034	477556	45L / 11.89 Gal.	15W-40 VDS-2 or VDS-3 / API CI-4 or higher
D16C-AMG / B / C (Gen Set)	6	2006 - 2009	18-0034	477556	49L / 13 Gal.	15W-40 VDS-2 or VDS-3 / API CI-4 or higher
D16C-AMH / B / C	6	2006 - 2009	18-0033	478736	49L / 13 Gal.	15W-40 VDS-2 or VDS-3 / API CI-4 or higher
D6-280A / A-B / A-C / A-D	6	2004 - 2010	18-0035	3582732 Full Flow	20L / 5.28 Gal.	15W-40 VDS-2 or VDS-3 / API CI-4 or higher
D6-280i-A / B	6	2004 - 2008	18-0035	3582732 Full Flow	20L / 5.28 Gal.	15W-40 VDS-2 or VDS-3 / API CI-4 or higher

VOLVO DIESEL CONTINUED ON NEXT PAGE

OIL FILTER QUICK-REFERENCE GUIDE

VOLVO DIESEL

Model	Cyl.	Year	Oil Filter	Replaces	Crankcase Capacity	Recommended Oil
D6-280i-A / B	6	2004 - 2008	18-0036	3582733 Bypass	20L / 5.28 Gal.	15W-40 VDS-2 or VDS-3 / API CI-4 or higher
D6-310i-A / B / C / D	6	2003 - 2010	18-0035	3582732 Full Flow	20L / 5.28 Gal.	15W-40 VDS-2 or VDS-3 / API CI-4 or higher
D6-310i-A / B / C / D	6	2003 - 2010	18-0036	3582733 Bypass	20L / 5.28 Gal.	15W-40 VDS-2 or VDS-3 / API CI-4 or higher
D6-330A-B / D-B	6	2004 - 2008	18-0035	3582732 Full Flow	20L / 5.28 Gal.	15W-40 VDS-2 or VDS-3 / API CI-4 or higher
D6-330A-B / D-B	6	2004 - 2008	18-0036	3582733 Bypass	20L / 5.28 Gal.	15W-40 VDS-2 or VDS-3 / API CI-4 or higher
D6-330i-B / C / D	6	2007 - 2010	18-0035	3582732 Full Flow	20L / 5.28 Gal.	15W-40 VDS-2 or VDS-3 / API CI-4 or higher
D6-330i-B / C / D	6	2007 - 2010	18-0036	3582733 Bypass	20L / 5.28 Gal.	15W-40 VDS-2 or VDS-3 / API CI-4 or higher
D6-370A-B / A-C / A-D / D-B / D-C / D-D	6	2007 - 2010	18-0035	3582732 Full Flow	20L / 5.28 Gal.	15W-40 VDS-2 or VDS-3 / API CI-4 or higher
D6-370A-B / A-C / A-D / D-B / D-C / D-D	6	2007 - 2010	18-0036	3582733 Bypass	20L / 5.28 Gal.	15W-40 VDS-2 or VDS-3 / API CI-4 or higher
D6-400A-E	6	2011 - Current	18-0035	3582732 Full Flow	20L / 5.28 Gal.	15W-40 VDS-2 or VDS-3 / API CI-4 or higher
D6-400A-E	6	2011 - Current	18-0036	3582733 Bypass	20L / 5.28 Gal.	15W-40 VDS-2 or VDS-3 / API CI-4 or higher
D6-435D-C / D-D / D-E	6	2006 - Current	18-0035	3582732 Full Flow	20L / 5.28 Gal.	15W-40 VDS-2 or VDS-3 / API CI-4 or higher
D6-435D-C / D-D / D-E	6	2006 - Current	18-0036	3582733 Bypass	20L / 5.28 Gal.	15W-40 VDS-2 or VDS-3 / API CI-4 or higher
D6-435i-A / C / D / E	6	2006 - Current	18-0035	3582732 Full Flow	20L / 5.28 Gal.	15W-40 VDS-2 or VDS-3 / API CI-4 or higher
D6-435i-A / C / D / E	6	2006 - Current	18-0036	3582733 Bypass	20L / 5.28 Gal.	15W-40 VDS-2 or VDS-3 / API CI-4 or higher
D9A2A	6	2004 - 2006	18-0033	478736	31L / 32.75 Qt.	15W-40 VDS-2 or VDS-3 / API CI-4 or higher
D9A2A MG (Gen Set)	6	2004 - Current	18-0033	478736	31L / 32.75 Qt.	15W-40 VDS-2 or VDS-3 / API CI-4 or higher
KAD300-A	6	2001 - 2005	18-7926		11L / 11.6 Qt.	15W-40 VDS-2 or VDS-3 / API CI-4 or higher
KAD42B/P/PA	6	1993 - 1997	18-7926		10.5L / 11.0 Qt.	15W-40 VDS-2 or VDS-3 / API CI-4 or higher
KAD43P-A	6	1997 - 2005	18-7926		10.5L / 11.0 Qt.	15W-40 VDS-2 or VDS-3 / API CI-4 or higher
KAD44P-A/B/C	6	1997 - 2004	18-7926		11L / 11.6 Qt.	15W-40 VDS-2 or VDS-3 / API CI-4 or higher
KAMD300-A	6	2001 - 2004	18-7926		11L / 11.6 Qt.	15W-40 VDS-2 or VDS-3 / API CI-4 or higher
KAMD42A/B/P/PA	6	1991 - 1997	18-7926		10.5L / 11.0 Qt.	15W-40 VDS-2 or VDS-3 / API CI-4 or higher
KAMD43P-A	6	1997 - 2005	18-7926		10.5L / 11.0 Qt.	15W-40 VDS-2 or VDS-3 / API CI-4 or higher
KAMD44P-B/C	6	1999 - 2004	18-7926		11L / 11.6 Qt.	15W-40 VDS-2 or VDS-3 / API CI-4 or higher
MD100A/B	6	1965 - 1984	18-7926		50L / 13.21 Gal.	15W-40 VDS-2 or VDS-3 / API CI-4 or higher
MD120A/B	6	1970 - 1980	18-7926		50L / 13.21 Gal.	15W-40 VDS-2 or VDS-3 / API CI-4 or higher
MD32A	6	1970 - 1977	18-7974	3827069	8L / 8.4 Qt.	15W-40 VDS-2 or VDS-3 / API CI-4 or higher
MD70B	6	1970 - 1978	18-7926		15L / 16 Qt.	15W-40 VDS-2 or VDS-3 / API CI-4 or higher
TAMD102A (Long Filter)	6	1991 - 2000	18-0033	478736	50L / 13.21 Gal.	15W-40 VDS-2 or VDS-3 / API CI-4 or higher
TAMD102A / D (Short Filter)	6	1991 - 2000	-----	847741	50L / 13.21 Gal.	15W-40 VDS-2 or VDS-3 / API CI-4 or higher
TAMD103A-A (Long Filter)	6	2000 - 2004	18-0033	478736	50L / 13.2 Gal.	15W-40 VDS-2 or VDS-3 / API CI-4 or higher
TAMD103A-A, AUX (Short Filter)	6	2000 - 2004	-----	847741	50L / 13.2 Gal.	15W-40 VDS-2 or VDS-3 / API CI-4 or higher
TAMD120A / B	6	1972 - 1983	18-7926		50L / 13.2 Gal.	15W-40 VDS-2 or VDS-3 / API CI-4 or higher
TAMD122D	6	1989 - 1996	-----	847741	50L / 13.2 Gal.	15W-40 VDS-2 or VDS-3 / API CI-4 or higher
TAMD122P-A, B, C	6	1995 - 2002	18-0033	478736	50L / 13.2 Gal.	15W-40 VDS-2 or VDS-3 / API CI-4 or higher
TAMD162A / B / C	6	1988 - 1996	18-0033	478736	73L / 19.3 Gal.	15W-40 VDS-2 or VDS-3 / API CI-4 or higher
TAMD162C-C	6	1999 - 2001	18-0033	478736	Refer to Owners Manual	15W-40 VDS-2 or VDS-3 / API CI-4 or higher
TAMD163A-A / PA	6	1994 - 2001	18-0033	478736	73L / 19.3 Gal.	15W-40 VDS-2 or VDS-3 / API CI-4 or higher
TAMD165A-A / C-A / P-A	6	2002 - 2005	18-0033	478736	73L / 19.3 Gal.	15W-40 VDS-2 or VDS-3 / API CI-4 or higher
TAMD40A / B	6	1980 - 1986	18-7926	423135	10.5L / 11.0 Qt.	15W-40 VDS-2 or VDS-3 / API CI-4 or higher
TAMD41A/B/D	6	1986 - 1994	18-7926	423135	10.5L / 11.0 Qt.	15W-40 VDS-2 or VDS-3 / API CI-4 or higher
TAMD42 B/WJ-A	6	1993 - 2003	18-7926	423135	10.5L / 11.0 Qt.	15W-40 VDS-2 or VDS-3 / API CI-4 or higher
TAMD60A/B/C	6	1976 - 1987	18-7926	423135	20L / 5.28 Gal.	15W-40 VDS-2 or VDS-3 / API CI-4 or higher

All listed oil capacities are approximate amounts only and may or may not include the oil filter capacity.
 ALWAYS follow proper crankcase drain and fill procedures. Check engine dipstick for proper crankcase oil level.

VOLVO DIESEL CONTINUED ON NEXT PAGE

OIL FILTER QUICK-REFERENCE GUIDE

VOLVO DIESEL						
Model	Cyl.	Year	Oil Filter	Replaces	Crankcase Capacity	Recommended Oil
TAMD61A	6	1986 - 1999	----	847741	20L / 5.28 Gal.	15W-40 VDS-2 or VDS-3 / API CI-4 or higher
TAMD62A	6	1992 - 1994	----	847741	20L / 5.28 Gal.	15W-40 VDS-2 or VDS-3 / API CI-4 or higher
TAMD63LA, 63PA	6	1994 - 2005	18-7974	3827069	20L / 5.28 Gal.	15W-40 VDS-2 or VDS-3 / API CI-4 or higher
TAMD63P-A	6	1994 - 2005	----	847741	20L / 5.28 Gal.	15W-40 VDS-2 or VDS-3 / API CI-4 or higher
TAMD70B/C	6	1970 - 1978	18-7926	423135	20L / 5.28 Gal.	15W-40 VDS-2 or VDS-3 / API CI-4 or higher
TAMD71A	6	1986 - 1994	----	847741	20L / 5.28 Gal.	15W-40 VDS-2 or VDS-3 / API CI-4 or higher
TAMD71B	6	1989 - 2000	18-1974	3827069	20L / 5.28 Gal.	15W-40 VDS-2 or VDS-3 / API CI-4 or higher
TAMD72A	6	1991 - 1994	----	847741	20L / 5.28 Gal.	15W-40 VDS-2 or VDS-3 / API CI-4 or higher
TAMD72P-A	6	1995 - 1997	----	847741	27L / 7.1 Gal.	15W-40 VDS-2 or VDS-3 / API CI-4 or higher
TAMD72WJ-A	6	1993 - 1997	----	847741	20L / 5.28 Gal.	15W-40 VDS-2 or VDS-3 / API CI-4 or higher
TAMD73P-A/WJ-A	6	1997 - 1999	18-7926	423135	28L / 7.4 Gal.	15W-40 VDS-2 or VDS-3 / API CI-4 or higher
TAMD74A	6	2000 - 2001	----	847741	29L / 7.7 Gal.	15W-40 VDS-2 or VDS-3 / API CI-4 or higher
TAMD74A-A / A-B / P-B	6	2000 - 2005	18-7926		24L / 6.3 Gal.	15W-40 VDS-2 or VDS-3 / API CI-4 or higher
TAMD74C-A, B	6	2000 - 2001	----	847741	25L / 6.6 Gal.	15W-40 VDS-2 or VDS-3 / API CI-4 or higher
TAMD74L-A, B	6	2000 - 2005	----	847741	25L / 6.6 Gal.	15W-40 VDS-2 or VDS-3 / API CI-4 or higher
TAMD74P-A, B	6	1998 - 2005	----	847741	25L / 6.6 Gal.	15W-40 VDS-2 or VDS-3 / API CI-4 or higher
TAMD75P-A	6	1998 - 2005	18-7926		24L / 6.3 Gal.	15W-40 VDS-2 or VDS-3 / API CI-4 or higher
THAMD70B/C	6	1972 - 1979	18-7926		24L / 6.3 Gal.	15W-40 VDS-2 or VDS-3 / API CI-4 or higher
TMD100A	6	1965 - 1983	18-7926		50L / 13.2 Gal.	15W-40 VDS-2 or VDS-3 / API CI-4 or higher
TMD102A	6	1988 - 2000	18-0033	478736	50L / 13.2 Gal.	15W-40 VDS-2 or VDS-3 / API CI-4 or higher
TMD120A/B	6	1970 - 1983	18-7878-1	3517857	50L / 13.2 Gal.	15W-40 VDS-2 or VDS-3 / API CI-4 or higher
TMD41B	6	1989 - 1993	18-7926		8.5L / 9 Qt.	15W-40 VDS-2 or VDS-3 / API CI-4 or higher
TMD41L-A	6	1994 - 1997	18-7926		10.5L / 11.0 Qt.	15W-40 VDS-2 or VDS-3 / API CI-4 or higher
TMD70B/C	6	1972 - 1985	----	847741	20L / 5.28 Gal.	15W-40 VDS-2 or VDS-3 / API CI-4 or higher
WESTERBEKE						
Model	Cyl.	Year	Oil Filter	Replaces	Crankcase Capacity	Recommended Oil
PROPULSION ENGINES						
11A One	1	2001 - Current	23-7800	036918	1.6L / 1.7 Qt.	SAE 10W-30
12B Two	2	1983 - 1992	23-7800	036918	2.8L / 3.0 Qt.	SAE 10W-30
12C Two	2	1992 - Current	23-7800	036918	2.8L / 3.0 Qt.	SAE 10W-30
12D Two	2	Current	23-7800	036918	2.8L / 3.0 Qt.	15W-40 API CI-4, CI-4 Plus, CJ-4
20B Two	2	1987 - Current	23-7800	036918	2.8L / 3.0 Qt.	15W-40 API CI-4, CI-4 Plus, CJ-4
W13	2	1980 - 1984	23-7800	036918	2.8L / 3.0 Qt.	SAE 10W-30
W13A	2	1984 - 1988	23-7800	036918	2.8L / 3.0 Qt.	SAE 10W-30
30B Three	3	1987 - Current	23-7800	036918	2.8L / 3.0 Qt.	15W-40 API CI-4, CI-4 Plus, CJ-4
30C Three	3	Current	23-7800	036918	2.8L / 3.0 Qt.	15W-40 API CI-4, CI-4 Plus, CJ-4
35B Three	3	1987 - 2000	23-7800	036918	4.5L / 4.75 Qt.	SAE 10W-30
35C Three	3	2000 - 2002	23-7800	036918	4.5L / 4.75 Qt.	15W-40 API CI-4, CI-4 Plus, CJ-4
35D Three	3	2002 - Current	23-7800	036918	4.5L / 4.75 Qt.	15W-40 API CI-4, CI-4 Plus, CJ-4
35E Three	3	Current	23-7800	036918	4.5L / 4.75 Qt.	15W-40 API CI-4, CI-4 Plus, CJ-4
W18	3	1985 - 1989	23-7800	036918	3.78L / 4.0 Qt.	SAE 10W-30
W21	3	1980 - 1984	23-7800	036918	3.78L / 4.0 Qt.	SAE 10W-30
W21A	3	1984 - 1987	23-7800	036918	3.78L / 4.0 Qt.	SAE 10W-30
38B Four	4	1987 - 2001	23-7825	035828	4.5L / 4.75 Qt.	SAE 10W-30
42B Four	4	1987 - 1999	23-7825	035828	4.5L / 4.75 Qt.	SAE 10W-30

All listed oil capacities are approximate amounts only and may or may not include the oil filter capacity.
 ALWAYS follow proper crankcase drain and fill procedures. Check engine dipstick for proper crankcase oil level.

WESTERBEKE CONTINUED ON NEXT PAGE

OIL FILTER QUICK-REFERENCE GUIDE

WESTERBEKE

Model	Cyl.	Year	Oil Filter	Replaces	Crankcase Capacity	Recommended Oil
44A Four	4	1999 - 2002	23-7800	036918	4.5L / 4.75 Qt.	15W-40 API CI-4, CI-4 Plus, CJ-4
44B Four	4	2002 - Current	23-7800	036918	4.5L / 4.75 Qt.	15W-40 API CI-4, CI-4 Plus, CJ-4
44C Four	4	Current	23-7800	036918	4.5L / 4.75 Qt.	15W-40 API CI-4, CI-4 Plus, CJ-4
55A Four	4	1995 - 2002	23-7825	035828	5.0L / 5.28 Qt.	SAE 30 CF
55B Four	4	2002 - 2005	23-7800	036918	7.6L / 8.0 Qt.	SAE 30 CF
55C Four	4	2005 - Current	23-7800	036918	7.6L / 8.0 Qt.	SAE 30 CF
55D Four	4	Current	23-7800	036918	7.6L / 8.0 Qt.	SAE 30 CF
63B Four	4	1990 - 1994	23-7825	035828	11.3L / 12 Qt.	15W-40 API CI-4, CI-4 Plus, CJ-4
63C Four	4	1994 - 2000	23-7825	035828	11.3L / 12 Qt.	15W-40 API CI-4, CI-4 Plus, CJ-4
63D Four	4	2001 - 2003	23-7825	035828	5.0L / 5.28 Qt.	15W-40 API CI-4, CI-4 Plus, CJ-4
64A Four	4	2003 - Current	23-7826	040154	6.15L / 6.5 Qt.	15W-40 API CI-4, CI-4 Plus, CJ-4
71B Four	4	1991 - 1994	23-7825	035828	11.3L / 12 Qt.	15W-40 API CI-4, CI-4 Plus, CJ-4
71C Four	4	1994 - Current	23-7826	040154	11.3L / 12 Qt.	15W-40 API CI-4, CI-4 Plus, CJ-4
82B Four	4	1991 - Current	23-7826	040154	11.3L / 12 Qt.	15W-40 API CI-4, CI-4 Plus, CJ-4
90A Four	4	1999 - Current	23-7826	040154	6.0L / 6.3 Qt.	15W-40 API CI-4, CI-4 Plus, CJ-4
W27	4	1980 - 1984	23-7800	036918	3.78L / 4.0 Qt.	SAE 10W-30
W27A	4	1984 - 1988	23-7800	036918	3.78L / 4.0 Qt.	SAE 10W-30
W33	4	1980 - 1984	23-7825	035828	3.78L / 4.0 Qt.	SAE 10W-30
W33A	4	1984 - 1988	23-7825	035828	3.78L / 4.0 Qt.	SAE 10W-30
W41G	4	1986 - 1993	23-7800	036918	-	-
W46	4	1985 - 1990	23-7825	035828	6.15L / 6.5 Qt.	SAE 10W-30
W70	4	1982 - 1991	23-7826	040154	6.15L / 6.5 Qt.	SAE 10W-30
W70G	4	1988 - 2001	23-7800	036918	-	-
W70GA	4	2003 - Current	23-7800	036918	-	-
108B Six	6	1991 - 1994	23-7826	040154	11.3L / 12 Qt.	15W-40 API CI-4, CI-4 Plus, CJ-4
108C Six	6	1994 - Current	23-7826	040154	11.3L / 12 Qt.	15W-40 API CI-4, CI-4 Plus, CJ-4
W100	6	1982 - 1991	23-7826	040154	11.3L / 12 Qt.	-
GEN SET (ALL MODELS ARE 60HZ. USA / NORTH AMERICAN)						
10.0 BTD	3	1984 - 2000	23-7800	036918	3.3 Qt.	15W-40 API CI-4, CI-4 Plus, CJ-4
10.0 BTDA	3	2000 - Current	23-7800	036918	3.8L / 4.0 Qt.	15W-40 API CI-4, CI-4 Plus, CJ-4
10.0 EDT D-NET	3	-	23-7800	036918	3.8L / 4.0 Qt.	15W-40 API CI-4, CI-4 Plus, CJ-4
10.0 SBEG Low-CO	4	2005 - Current	23-7800	036918	3.5 Qt.	SAE 10W-30
11.0 TWG	4	1984 - 1987	23-7800	036918	-	SAE 10W-30
11.0 WMD	4	1980 - 1987	23-7800	036918	6.15 Qt.	15W-40 API CI-4, CI-4 Plus, CJ-4
11.5 BTD	3	-	23-7800	036918	4.7L / 5.0 Qt.	15W-40 API CI-4, CI-4 Plus, CJ-4
11.5 EDT D-NET	3	-	23-7800	036918	4.7L / 5.0 Qt.	15W-40 API CI-4, CI-4 Plus, CJ-4
12.06 EDT D-NET	3	-	23-7800	036918	4.7L / 5.0 Qt.	15W-40 API CI-4, CI-4 Plus, CJ-4
12.5 BEG	4	2002 - Current	23-7800	036918	3.5 Qt.	SAE 10W-30
12.5 BTDB	4	-	23-7800	036918	5.2L / 5.5 Qt.	15W-40 API CI-4, CI-4 Plus, CJ-4
12.5 BTG	4	1987 - 2001	23-7800	036918	3.8L / 4.0 Qt.	SAE 10W-30
12.5 BTGA	4	2001 - 2002	23-7800	036918	-	SAE 10W-30
12.5 EDT D-NET	4	-	23-7800	036918	5.2L / 5.5 Qt.	15W-40 API CI-4, CI-4 Plus, CJ-4
12.5 SBEG Low-CO	4	2005 - Current	23-7800	036918	3.5 Qt.	SAE 10W-30
12.6 BTD	3	2002 - Current	23-7800	036918	3.8L / 4.0 Qt.	15W-40 API CI-4, CI-4 Plus, CJ-4
14.0 SBEG Low-CO	4	2005 - Current	23-7800	036918	3.5 Qt.	SAE 10W-30
15.0 BEG	4	2002 - Current	23-7800	036918	3.5 Qt.	SAE 10W-30

All listed oil capacities are approximate amounts only and may or may not include the oil filter capacity.
 ALWAYS follow proper crankcase drain and fill procedures. Check engine dipstick for proper crankcase oil level.

WESTERBEKE CONTINUED ON NEXT PAGE

OIL FILTER QUICK-REFERENCE GUIDE

15.0 BTDC	4	2000 - Current	23-7800	036918	5.2L / 5.5 Qt.	15W-40 API CI-4, CI-4 Plus, CJ-4
15.0 BTG	4	1987 - 2001	23-7800	036918	3.8L / 4.0 Qt.	SAE 10W-30
15.0 EDT D-NET	4	-	23-7800	036918	5.2L / 5.5 Qt.	15W-40 API CI-4, CI-4 Plus, CJ-4
20.0 BEG	4	1995 - 2004	23-7800	036918	4.5 Qt.	SAE 10W-30
20.0 BEGA	4	2004 - Current	23-7800	036918	-	SAE 10W-30
20.0 SBEG Low-CO	4	2005 - Current	23-7800	036918	4.5 Qt.	SAE 10W-30
20.0 SBEGA Low-CO	4	-	23-7800	036918	-	SAE 10W-30
22.5 SBEG Low-CO	4	2005 - Current	23-7800	036918	-	SAE 10W-30
22.5 SBEGA Low-CO	4	-	23-7800	036918	4.5 Qt.	SAE 10W-30
25.0 BEG	4	1999 - 2004	23-7800	036918	4.5 Qt.	SAE 10W-30
3.0 WMD	2	1982 - 1988	23-7800	036918	2.0 Qt.	15W-40 API CI-4, CI-4 Plus, CJ-4
4.0 BCD (60 Hz.) ONLY	3	2002 - Current	23-7800	036918	3.05L / 3.2 Qt.	15W-40 API CI-4, CI-4 Plus, CJ-4
4.0 BCDA 60Hz. ONLY	3	2008 - Current	23-7800	036918	3.05L / 3.2 Qt.	15W-40 API CI-4, CI-4 Plus, CJ-4
4.4 BCD	2	1986 - 1989	23-7800	036918	2.4L / 2.5 Qt.	15W-40 API CI-4, CI-4 Plus, CJ-4
4.4 WMD	2	1980 - 1986	23-7800	036918	2.4L / 2.5 Qt.	15W-40 API CI-4, CI-4 Plus, CJ-4
4.5 BCG	3	1988 - 1997	23-7800	036918	2.8L / 3.0 Qt.	SAE 10W-30
4.5 BCGA	3	1997	23-7800	036918	2.4L / 2.5 Qt.	SAE 10W-30
4.5 BCGB	3	1999 - 2002	23-7800	036918	2.4L / 2.5 Qt.	SAE 10W-30
4.5 BCGTC	3	1997 - 2002	23-7800	036918	2.6L / 2.7 Qt.	SAE 10W-30
4.5 BCGTE	3	1997 - 2001	23-7800	036918	2.6L / 2.7 Qt.	SAE 10W-30
5.0 BCD	3	1989 - 1996	23-7800	036918	3.0L / 3.2 Qt.	15W-40 API CI-4, CI-4 Plus, CJ-4
5.0 BCDA	3	1996	23-7800	036918	3.0L / 3.2 Qt.	15W-40 API CI-4, CI-4 Plus, CJ-4
5.0 BCDB(60Hz)	3	1996 - Current	23-7800	036918	3.0L / 3.2 Qt.	15W-40 API CI-4, CI-4 Plus, CJ-4
5.0 BCG low profile	3	2002 - Current	23-7800	036918	2.4L / 2.5 Qt.	SAE 40 SJ
5.0 BCGA	3	2002	23-7800	036918	2.4L / 2.5 Qt.	SAE 40 SJ
5.0 SBEG Low-CO	3	2005 - Current	23-7800	036918	2.8L / 3.0 Qt.	SAE 40 SJ
5.5 BCD	3	-	23-7800	036918	3.0L / 3.2 Qt.	15W-40 API CI-4, CI-4 Plus, CJ-4
5.5 EDC D-NET	3	-	23-7800	036918	3.6L / 3.8 Qt.	15W-40 API CI-4, CI-4 Plus, CJ-4
6.0 BCD	3	1986 - 1989	23-7800	036918	3.0L / 3.2 Qt.	15W-40 API CI-4, CI-4 Plus, CJ-4
GEN SET (ALL MODELS ARE 60HZ. USA / NORTH AMERICAN)						
6.0 WMD	3	-	23-7800	036918	3.0L / 3.2 Qt.	15W-40 API CI-4, CI-4 Plus, CJ-4
6.5 SBEG Low-CO	3	2005 - Current	23-7800	036918	2.8L / 3.0 Qt.	SAE 40 SJ
6.5 TWG	4	1984 - 1987	23-7800	036918	3.0L / 3.2 Qt.	SAE 10W-30
7.0 BCG / BCGA	3	1989 - 1997	23-7800	036918	2.8L / 3.0 Qt.	SAE 10W-30
7.0 BCGB	3	1999 - 2002	23-7800	036918	2.4L / 2.5 Qt.	SAE 10W-30
7.0 BCGC Low Profile	3	2002 - 2004	23-7800	036918	2.4L / 2.5 Qt.	SAE 40 SJ
7.0 BCGD Low Profile	3	2004 - Current	23-7800	036918	2.4L / 2.5 Qt.	SAE 40 SJ
7.2 BCGTC	3	1997 - 2002	23-7800	036918	2.6L / 2.7 Qt.	SAE 10W-30
7.2 BCGTE	3	1997 - 2001	23-7800	036918	2.6L / 2.7 Qt.	SAE 10W-30
7.6 BTD	3	1993 - Current	23-7800	036918	3.6L / 3.8 Qt.	15W-40 API CI-4, CI-4 Plus, CJ-4
7.6 EDT D-NET	3	-	23-7800	036918	3.6L / 3.8 Qt.	15W-40 API CI-4, CI-4 Plus, CJ-4
7.7 WMD	3	1980 - 1984	23-7800	036918	3.0L / 3.2 Qt.	15W-40 API CI-4, CI-4 Plus, CJ-4
8.0 BCDD	2	2002 - 2004	23-7800	036918	2.9L / 3.1 Qt.	15W-40 API CI-4, CI-4 Plus, CJ-4
8.0 BTD	3	1984 - 2000	23-7800	036918	3.0L / 3.2 Qt.	15W-40 API CI-4, CI-4 Plus, CJ-4
8.0 BTDA	3	2000 - Current	23-7800	036918	3.0L / 3.2 Qt.	15W-40 API CI-4, CI-4 Plus, CJ-4
8.0 EDT D-NET	3	-	23-7800	036918	3.8L / 4.0 Qt.	15W-40 API CI-4, CI-4 Plus, CJ-4
8.0 SGE Low-CO	4	2005 - Current	23-7800	036918	3.3L / 3.5 Qt.	SAE 10W-30
8.0 TWG	4	1983 - 1987	23-7800	036918	3.0L / 3.2 Qt.	SAE 10W-30
8.0 WMD	3	1980 - 1984	23-7800	036918	3.0L / 3.2 Qt.	15W-40 API CI-4, CI-4 Plus, CJ-4
8.5 BTG	4	1987 - 1993	23-7800	036918	3.7L / 3.9 Qt.	SAE 10W-30

WESTERBEKE CONTINUED ON NEXT PAGE

OIL FILTER QUICK-REFERENCE GUIDE

8.5 BTGA	4	1993 - 2002	23-7800	036918	3.8L / 4.0 Qt.	SAE 10W-30
9.6 BCGTC	3	1997 - 2002	23-7800	036918	2.6L / 2.7 Qt.	SAE 10W-30
9.6 BCGTE	3	-	23-7800	036918	2.6L / 2.7 Qt.	SAE 10W-30
11.0 BTD	4	1987 - 2001	23-7825	035828	4.0L / 4.2 Qt.	15W-40 API CI-4, CI-4 Plus, CJ-4
12.5 BTDA	4	1988 - 2000	23-7825	035828	4.5L / 4.7 Qt.	15W-40 API CI-4, CI-4 Plus, CJ-4
12.5 WMD	4	1980 - 1987	23-7825	035828	4.5L / 4.7 Qt.	15W-40 API CI-4, CI-4 Plus, CJ-4
15.0 BTD	4	1987 - 1990	23-7825	035828	6.6L / 7.0 Qt.	15W-40 API CI-4, CI-4 Plus, CJ-4
15.0 BTDA	4	1990 - 1994	23-7825	035828	5.0L / 5.3 Qt.	15W-40 API CI-4, CI-4 Plus, CJ-4
15.0 BTDB	4	1994 - 2000	23-7825	035828	5.0L / 5.3 Qt.	15W-40 API CI-4, CI-4 Plus, CJ-4
20.0 BED	4	1990 - 1995	23-7825	035828	6.15L / 6.5 Qt.	15W-40 API CI-4, CI-4 Plus, CJ-4
25.0 BED PTO	4	1992 - Current	23-7826	040154	6.15L / 6.5 Qt.	15W-40 API CI-4, CI-4 Plus, CJ-4
25.0 WTA	4	1982 - 1985	23-7826	040154	6.0L / 6.3 Qt.	15W-40 API CI-4, CI-4 Plus, CJ-4
32.0 BED	6	1993 - 1994	23-7826	040154	Refer to Owners Manual	15W-40 API CI-4, CI-4 Plus, CJ-4
32.0 BEDA	4	1994 - Current	23-7826	040154	6.0L / 6.3 Qt.	15W-40 API CI-4, CI-4 Plus, CJ-4
32.0 BEDB	6	1994	23-7826	040154	11.3L / 12 Qt.	15W-40 API CI-4, CI-4 Plus, CJ-4
20.0 BEDA	4	1995 - Current	23-7826	040154	6.15L / 6.5 Qt.	15W-40 API CI-4, CI-4 Plus, CJ-4
25.0 BED	4	1992 - Current	23-7826	040154	6.15L / 6.5 Qt.	15W-40 API CI-4, CI-4 Plus, CJ-4

YAMAHA

Model	Year	Oil Filter	Replaces	Crankcase Capacity	Recommended Oil
F2.5	2003 - 2011	----		0.35 L / 0.35 Qt.	10W-30 FC-W
F4	1999 - 2011	----		0.50 L / 0.53 Qt.	10W-30 FC-W
F6, F/T8	2001 - 2011	----		0.80 L / 0.84 Qt.	10W-30 FC-W
F8S / F8L	2015 - 2020	----		0.27 oz.	10W-30 FC-W
T9.9 (Model 6G8)	1991 - 04/2005	18-7901	6G8-13440-00-00	1.0 L / 1.06 Qt.	10W-30 FC-W
F9.9 (Model 6G8)	1990 - 04/2005	18-7901	6G8-13440-00-00	1.0 L / 1.06 Qt.	10W-30 FC-W
T9.9 (Model 66R)	2005 - 04/2006	18-7911-1	5GH-13440-00-00	0.80 L / 0.84 Qt.	10W-30 FC-W
F9.9 (Model 66R)	2005 - 04/2006	18-7911-1	5GH-13440-00-00	0.80 L / 0.84 Qt.	10W-30 FC-W
F9.9F / F9.9G	2008 - 2020	----		0.27 oz.	10W-30 FC-W
F15	1998 - 1999	18-7902	3FV-13440-10-00	1.0 L / 1.06 Qt.	10W-30 FC-W
F15	2000 - 2006	18-7911-1	5GH-13440-00-00	1.8 L / 1.9 Qt.	10W-30 FC-W
F15C	2007 - 2020	18-8700	5GH-13440-20-00	1.8 L / 1.9 Qt.	10W-30 FC-W
F20	2007 - 2020	18-8700	5GH-13440-20-00	1.8 L / 1.9 Qt.	10W-30 FC-W
F25	1998 - 1999	18-7902	3FV-13440-10-00	1.7 L / 1.8 Qt.	10W-30 FC-W
F25 / T25	2000 - 04/2006	18-7911-1	5GH-13440-00-00	1.7 L / 1.8 Qt.	10W-30 FC-W
F25	2009 - 2020	18-8700	5GH-13440-20-00	1.7 L / 1.8 Qt.	10W-30 FC-W
F30	2017 - 2020	18-7911-1	5GH-13440-00-00	2.0 L / 2.1 Qt.	10W-30 FC-W
F40	1999 - 2000	18-7902	3FV-13440-10-00	2.0 L / 2.1 Qt.	10W-30 FC-W
F40 / F40B (International)	2001 - 2008	18-7911-1	5GH-13440-00-00	2.0 L / 2.1 Qt.	10W-30 FC-W
F40A	2001 - Current	18-8700	5GH-13440-20-00	2.0 L / 2.1 Qt.	10W-30 FC-W
T50	1996 - 1999	18-7902	3FV-13440-10-00	2.0 L / 2.1 Qt.	10W-30 FC-W
T50	2000 - 2004	18-7911-1	5GH-13440-00-00	2.0 L / 2.1 Qt.	10W-30 FC-W
T50	2005 - Current	18-8700	5GH-13440-20-00	2.0 L / 2.1 Qt.	10W-30 FC-W
F50	1995 - 1999	18-7902	3FV-13440-10-00	2.0 L / 2.1 Qt.	10W-30 FC-W
F50	1999 - 2004	18-7911-1	5GH-13440-00-00	2.0 L / 2.1 Qt.	10W-30 FC-W
F50	2005 - Current	18-8700	5GH-13440-20-00	2.0 L / 2.1 Qt.	10W-30 FC-W
T60	1999 - 2004	18-7911-1	5GH-13440-00-00	2.0 L / 2.1 Qt.	10W-30 FC-W
T60	2005 - Current	18-8700	5GH-13440-20-00	2.0 L / 2.1 Qt.	10W-30 FC-W
F60	1999 - 2004	18-7911-1	5GH-13440-00-00	2.0 L / 2.1 Qt.	10W-30 FC-W
F60	2005 - Current	18-8700	5GH-13440-20-00	2.0 L / 2.1 Qt.	10W-30 FC-W

All listed oil capacities are approximate amounts only and may or may not include the oil filter capacity.
 ALWAYS follow proper crankcase drain and fill procedures. Check engine dipstick for proper crankcase oil level.

YAMAHA CONTINUED ON NEXT PAGE

OIL FILTER QUICK-REFERENCE GUIDE

YAMAHA

Model	Year	Oil Filter	Replaces	Crankcase Capacity	Recommended Oil
F70	All Years	18-8700	5GH-13440-20-00	2.0 L / 2.1 Qt.	10W-30 FC-W
F75	All Years	18-7911-1	5GH-13440-00-00	4.3 L / 4.5 Qt.	10W-30 FC-W
F80	1999	18-7902	3FV-13440-10-00	4.3 L / 4.5 Qt.	10W-30 FC-W
F80	2000 - Current	18-7911-1	5GH-13440-00-00	4.3 L / 4.5 Qt.	10W-30 FC-W
F90	All Years	18-7911-1	5GH-13440-00-00	4.3 L / 4.5 Qt.	10W-30 FC-W
F100	1999	18-7902	3FV-13440-10-00	4.3 L / 4.5 Qt.	10W-30 FC-W
F100	2000 - Current	18-7911-1	5GH-13440-00-00	4.3 L / 4.5 Qt.	10W-30 FC-W
F115	All Years	18-7911-1	5GH-13440-00-00	4.3 L / 4.5 Qt.	10W-30 FC-W
F150	2004 - Current	18-7906-2	69J-13440-01-00	5.4 L / 5.7 Qt.	10W-30 FC-W
F200 (3.3L)	All Years	18-7906-2	69J-13440-01-00	5.8 L / 6.13 Qt.	10W-30 FC-W
F200 (4.2L SHO)	2009 - Current	18-7954	N26-13440-00-00	7.1L / 7.5 Qt.	5W-30 FC-W Full Synthetic
F225 (3.3L)	All Years	18-7906-2	69J-13440-01-00	5.8 L / 6.13 Qt.	10W-30 FC-W
F225 (4.2L)	2009 - Current	18-7954	N26-13440-00-00	7.1L / 7.5 Qt.	10W-30 FC-W
F250 (3.3L)	All Years	18-7906-2	69J-13440-01-00	5.8 L / 6.13 Qt.	10W-30 FC-W
F250 (4.2L)	2009 - Current	18-7954	N26-13440-00-00	7.1L / 7.5 Qt.	10W-30 FC-W
F300 (V8)	2007 - Current	18-7954	N26-13440-00-00	8.0 L / 8.45 Qt.	10W-30 FC-W
F350 (V8)	2007 - Current	18-7954	N26-13440-00-00	8.0 L / 8.45 Qt.	10W-30 FC-W

YANMAR

Model	Cyl.	Year	Oil Filter	Replaces	Crankcase Capacity	Recommended Oil
1GM	1	1980 - 1983	18-7910-1	124450-35100 119660-35150 119660-35150	1.6 Qt.	SAE 15W-40 CI-4 Refer to owners manual
1GM10	1	1983 - 2009	18-7910-1	124450-35100 119660-35150 119305-35151	1.6 Qt.	SAE 15W-40 CI-4 Refer to owners manual
2GM	2	1980 - 1983	18-7910-1	124450-35100 119660-35150 119305-35151	2.1 Qt.	SAE 15W-40 CI-4 Refer to owners manual
2GM20	2	1983 - 2005	18-7910-1	124450-35100 119660-35150 119305-35151	2.1 Qt.	SAE 15W-40 CI-4 Refer to owners manual
2GM20-YEU (Serial No. Starts w/ E)	2	1997 - Current	18-7910-1	119660-35150 119305-35151	2.1 Qt.	SAE 15W-40 CI-4 Refer to owners manual
2GM20F	2	1983 - 2005	18-7910-1	124450-35100 119660-35150 119305-35151	2.1 Qt.	SAE 15W-40 CI-4 Refer to owners manual
2GMF	2	1980 - 1983	18-7910-1	124450-35100 119660-35150 119305-35151	2.1 Qt.	SAE 15W-40 CI-4 Refer to owners manual
2QM15	2	1977 - 1980	18-7910-1	124450-35100 119660-35150 119305-35151	2.1 Qt.	SAE 15W-40 CI-4 Refer to owners manual
2QM20 (Serial #81181 and Higher)	2	1975 - 1980	18-7917	124550-35110 124085-35113	2.1 Qt.	SAE 15W-40 CI-4 Refer to owners manual
2YM15	2	2004 - Current	18-7910-1	119305-35151	2.1 Qt.	SAE 15W-40 CI-4 Refer to owners manual
3GM30	3	1983 - Current	18-7910-1	124450-35100 119660-35150 119305-35151	2.7 Qt.	SAE 15W-40 CI-4 Refer to owners manual
3GM30-YEU (Serial No. Starts w/ E)	3	1997 - Current	18-7910-1	119660-35150 119305-35151	2.7 Qt.	SAE 15W-40 CI-4 Refer to owners manual
3GM30F	3	1983 - 2005	18-7910-1	124450-35100 119660-35150 119305-35151	2.7 Qt.	SAE 15W-40 CI-4 Refer to owners manual

YANMAR CONTINUED ON NEXT PAGE

OIL FILTER QUICK-REFERENCE GUIDE

YANMAR

Model	Cyl.	Year	Oil Filter	Replaces	Crankcase Capacity	Recommended Oil
3GM	3	1980 - 1983	18-7910-1	124450-35100 119660-35150 119305-35151	2.7 Qt.	SAE 15W-40 CI-4 Refer to owners manual
3GMD	3	1980 - 1983	18-7910-1	119660-35150 119305-35151	2.7 Qt.	SAE 15W-40 CI-4 Refer to owners manual
3GMF	3	1980 - 1983	18-7910-1	124450-35100 119660-35150 119305-35151	2.7 Qt.	SAE 15W-40 CI-4 Refer to owners manual
3HM	3	1980 - 1983	18-7917	124550-35110 124085-35113		Refer to owners manual
3HM35	3	1983 - 1992	18-7917	124550-35110 124085-35113		SAE 15W-40 CI-4 Refer to owners manual
3HM35F	3	1983 - 1992	18-7917	124550-35110 124085-35113		SAE 15W-40 CI-4 Refer to owners manual
3HMF	3	1980 - 1983	18-7917	124550-35110 124085-35113		SAE 15W-40 CI-4 Refer to owners manual
3JH2TBE	3	1991-1999	18-7910-1	119305-35151		SAE 15W-40 CI-4 Refer to owners manual
3JH2BE	3	1989-1999	18-7910-1	119305-35151		SAE 15W-40 CI-4 Refer to owners manual
3JH2	3	1992-1999	18-7910-1	119305-35151		SAE 15W-40 CI-4 Refer to owners manual
3JH3	3	1999 - 2004	18-7910-1	119305-35150 119305-35151		SAE 15W-40 CI-4 Refer to owners manual
3JH3E-YEU	3	2004 - Current	18-7910-1	119305-35150 119305-35151	5.2 Qt.	SAE 15W-40 CI-4 Refer to owners manual
3JH4E (40hp.)	3	2004 - Current	18-7910-1	119305-35150 119305-35151		SAE 15W-40 CI-4 Refer to owners manual
3QM30	3	1976 - 1980	18-7917	124550-35110 124085-35113		SAE 15W-40 CI-4 Refer to owners manual
3QM30F	3	1976 - 1980	18-7917	124550-35110 124085-35113		SAE 15W-40 CI-4 Refer to owners manual
3YM20	3	2004 - Current	18-7910-1	119305-35151	2.6 Qt.	SAE 15W-40 CI-4 Refer to owners manual
3YM30	3	2004 - Current	18-7910-1	119305-35151	2.6 Qt.	SAE 15W-40 CI-4 Refer to owners manual

ALPHA CROSS REFERENCE

AC	
PF1250	18-7758
PF1267	18-0034
PF454	18-7824
PF2	18-7875
PF1218	18-7876-1
PF13	18-7878-1
PF857F	18-7880
PF2210	18-7884
PF939	18-7886
PF881F	-----
SPF53	18-7897
PF911F	N/A
PF1127	18-7910-1
PF1237*	18-7911-1
PF1237*	18-7913
PF2057	18-7914
PF1233	18-7916
PF60	18-7925
PF2207	18-7926
PF2203	18-7927
PF2257	18-8003-1
PF1127	23-7800
* Refer to Engine Mfg. Section	

BALDWIN	
B131	23-7801
B134	18-7871
B1400*	18-7902
B1400*	18-7911-1
B1400*	18-7913
B1402*	18-7909
B1402*	18-7914
B161-S	23-7842
B163	23-7841
B167	18-7926
B168	18-7917
B178	18-7925
B179*	18-7910-1
B179*	23-7800
B179*	23-7824
B2	18-7875
B202	23-7825
B233*	18-7878-1
B233*	23-7840
B33*	18-7916
B33*	23-7821
B35-S	18-7879-1
B360	18-7824
B37*	18-7905-1
B37*	18-7896
B43-S	18-7974
B6	18-7876-1
B7165	18-7884

BALDWIN	
B7333	18-7897
B75*	-----
B75*	18-7927
B76	18-7880
B7685	18-0034
B76-SS	18-0033
BT216	18-7886
BT223	18-7915-1
BT237	-----
P7417	18-8003-1
* Refer to Engine Mfg. Section	

BRP	
See Evinrude / Johnson / OMC	

CATERPILLAR	
1R-0658	18-7880

CHRYSLER INBOARD	
1851658	18-7885
3549957	18-7878-1
L-1108	18-7878-1
L-19	18-7878-1
L-319	18-7879-1

CRUSADER	
22679	18-7875
201101	18-7824
201104	18-7876-1

DETROIT DIESEL	
25010495	N/A

EVINRUDE / JOHNSON / OMC	
173232	18-7824
173233	18-7876-1
173834	18-7879-1
434839	18-7916
502901	18-7876-1
502902	18-7824
502903	18-7879-1
502904	18-7878-1
763364	18-7903
778885	18-7915-1
778886	18-7896
778887	18-7897
5031411	18-7915-1
5033102	18-7903
5033539	18-7896
5033919	18-7897
5035703	18-7905-1

FRAM	
CH9954	18-8003-1
P9407	18-0034
PH10809	23-7823

FRAM	
PH13	18-7876-1
PH16*	18-7878-1
PH16*	23-7841
PH2821A	18-7886
PH2870A	18-7925
PH2921	23-7825
PH2951*	18-7897
PH2951*	23-7801
PH30	18-7824
PH3306A	18-7926
PH3387A	18-7974
PH3545*	-----
PH3545*	18-7927
PH3593A*	18-7910-1
PH3593A*	23-7800
PH3612	N/A
PH3614	18-7884
PH3766	18-7871
PH3980	18-7879-1
PH4386*	18-7905-1
PH4386*	18-7896
PH4967*	18-7897
PH4967*	18-7906-2
PH4967*	18-7916
PH4967*	23-7821
PH49A*	18-0033
PH49A*	18-7880
PH5	18-7876-1
PH5046	18-7917
PH6017A*	18-7902
PH6017A*	18-7909
PH6017A*	18-7911-1
PH6017A*	18-7913
PH6017A*	18-8700
PH6811	23-7842
PH7317	18-7914
PH7328	23-7841
PH7575*	18-7884
PH7575*	18-7915-1
PH8842	18-0033
PH8A	18-7875
PH9688	23-7842
PH977A	-----
* Refer to Engine Mfg. Section	

HONDA	
15400-PFB-007	18-7911-1
15400-PFB-014	18-7913
15400-PLM-A01PE	18-7909
15400-POH-305PE	18-7909
15400-POH-305PE	18-7909
15400-ZJ1-004	18-7909

All listed oil capacities are approximate amounts only and may or may not include the oil filter capacity.
 ALWAYS follow proper crankcase drain and fill procedures. Check engine dipstick for proper crankcase oil level.

ALPHA CROSS REFERENCE

INDMAR

501001	18-7824
50-1101	18-7824

KOHLER

229678	23-7822
252834	23-7824
267714	23-7823
279449	23-7820
326817	23-7803
359771	23-7821
GM47465	23-7824

LUBER-FINER

LFP2234	18-7926
LFP2274	18-7824
LFP3191	18-0033
LFP3191	18-7880
LFP5522	18-7917
LFP6007	-----
LFP8642	18-0034
LFP911	N/A
P3986	18-8003-1
PH1218	18-7876-1
PH208	18-7910-1
PH253	18-7878-1
PH2801	23-7825
PH2808	23-7800
PH2808	23-7822
PH2808	23-7824
PH2835	18-7884
PH2835	18-7915-1
PH2840	18-7905-1
PH2840	18-7896
PH2840	18-7897
PH2840	18-7916
PH2840	23-7821
PH2867	18-7914
PH2876	18-7913
PH299	-----
PH4403	18-7886
PH47	18-7974
PH51A	18-7879-1
PH561	18-7925
PH7028	18-7911-1
PH820	18-7758
PH8A	18-7875

MALLORY

9-57800	18-7913
9-57801	18-7824
9-57802	18-7875
9-57803	18-7879-1
9-57804	18-7911-1
9-57806	18-7878-1

MALLORY

9-57807	18-7903
9-57808	18-7906-2
9-57810	18-7910-1
9-57811	18-7876-1
9-57813	18-7916
9-57814	18-7896
9-57815	18-7897
9-57816	18-7918
9-57817	18-7915-1
9-57818	18-7905-1
9-57819	18-7905
9-57820	18-8003-1
9-57821	18-7921
9-57822	18-7758
9-57902	18-7871
9-57905	18-7926
9-57908	18-7974
9-57910	18-7880
9-57911	18-7884

MERCURY / QUICKSILVER

14957	18-7876-1
32717	18-7876-1
38463	18-7878-1
41815	18-7879-1
46692	18-7878-1
52731	18-7876-1
54111	18-7824
56874	18-7875
60565	18-7875
803470	18-7878-1
35-16595T1	18-7876-1
35-802884Q	18-7879-1
35-802885	18-7824
35-802885T	18-7824
35-802886Q	18-7875
35-805809	18-7871
35-822626Q03	18-7913
35-822626Q04	18-7914
35-822626Q1	18-7913
35-822626Q15	18-7906-2
35-822626Q2	18-7914
35-866340K01	18-7824
35-866340Q02	18-7824
35-866340Q03	18-7824
35-877761K01	18-7758
35-877761Q01	18-7758
35-877767K01	18-7921
35-877769K01	18-7918
35-883701K01	18-7918
35-883702Q	18-7879-1
35-896549T	18-7921
803470Q	18-7878-1

NAPA

1036	18-7879-1
1040	18-7974
1061	18-7876-1
1064	23-7822
1068	23-7840
1069	18-7824
1084	23-7841
1307	18-7878-1
1334	18-7910-1
1342	18-7925
1344	23-7842
1347	18-7917
1348	18-7915-1
1358	18-8700
1365	18-7911-1
1394	18-7916
1660	18-0034
1773	-----
1791	18-0033
1798	-----
1806	18-7886
1820	18-7926
1970	N/A
6644	23-7825
7000	18-7906-2
7145	18-7896
7186	18-8003-1
21036	18-7879-1
21061	18-7876-1
21069	18-7824
21334	23-7800
21342	18-7925
21348	18-7884
21358	18-7902
21394	23-7801
21515	18-7875
21521	18-7878-1
27145	18-7896
31358	18-8700
31515	18-7875

NISSAN / TOHATSU

3R0076150M	18-7911-1
------------	-----------

NORTHERN LIGHTS

140516190	23-7801
-----------	---------

ONAN

122-0185	23-7841
122-0810	23-7840
185-5835	23-7842
185-7444	23-7804

All listed oil capacities are approximate amounts only and may or may not include the oil filter capacity. ALWAYS follow proper crankcase drain and fill procedures. Check engine dipstick for proper crankcase oil level.

ALPHA CROSS REFERENCE

PCM / PLEASURECRAFT

R077001	18-7875
R077022	18-7824

PERKINS

2654347	-----
2654403	18-7886
2654407	-----

SUZUKI

16510-05240	18-7903
16510-61A20-MHL	18-7896
16510-82703	18-7897
16510-87J00	18-7915-1
16510-93J00	18-7905-1
16510-96J00	18-7905

UNIVERSAL

299381	18-7884
--------	---------

VOLVO PENTA

423135	18-7926
430143	18-7878-1
466634	18-7880
477556	18-0034
478736	18-0033
834337	18-7884
835440	18-7824
841750	18-7879-1
847741	-----
1266286	18-7878-1
3517857	18-7878-1
3582732	18-0035
3582733	18-0036
3827069	18-7974
3850559	18-7876-1
3852412	18-7824
4785974	18-7926
8692305	18-8003-1

WIX

46644	23-7825
51036	18-7879-1
51040	18-7974
51061	18-7876-1
51064	23-7822
51068	23-7840
51069	18-7824
51084	23-7841
51215	23-7803
51307	18-7878-1
51334	18-7910-1
51342	18-7925
51344	23-7842
51347	18-7917
51348	18-7915-1
51358	18-7911-1
51365	18-7913
51365	23-7804
51394	18-7916
51452	18-7875
51459	-----
51630	18-7897
51660	18-0034
51791	18-0033
51798	-----
51806	18-7886
51820	18-7926
57000	18-7906-2
57145	18-7905-1
57145	18-7896
57186	18-8003-1
57356	18-7909
51742MP	18-7871

WESTERBEKE

21235	18-7925
30220	18-7910-1
35595	23-7801
35828	23-7825
36918	23-7800
36920	23-7800
40154	23-7826
48076	23-7802

YAMAHA

3FV-13440-00-00	18-7902
5GH-13440-00-00	18-7911-1
5GH-13440-20-00	18-8700
69J-13440-01-00	18-7906-2
6G8-13440-00-00	18-7901
N26-13440-00-00	18-7954
YSC-10231-20-0C	18-7824
YSC-13231-20-0C	18-7824

YANMAR

119305-35151	18-7910-1
119660-35150	18-7910-1
124450-35100	18-7910-1
124550-35110	18-7917
171056-35111	18-7917

All listed oil capacities are approximate amounts only and may or may not include the oil filter capacity.

ALWAYS follow proper crankcase drain and fill procedures. Check engine dipstick for proper crankcase oil level.



GEAR LUBE CAPACITY CHARTS

GEAR LUBE CAPACITY CHART - HONDA ENGINES

Model	Oil Capacity		Model	Oil Capacity	
	Std. (Oz.)	Notes		Std. (Oz.)	Notes
BF2A/BF20	1.7		BF50A	17.6	UP to 3213356
BF5A/BF50	3.4		BF50A	13.9	FROM 3213357
BF8A/BF80	7.8		BF50D	13.9	
BF75/BF100	7.8		BF(P)60A	16	
BF(P)8D	9.6		BF75AT-AW	22.3	
BF9.9A	8.1		BF75AX	33.8	
BF(P)9.9D	9.6		BF75D	32.1	
BF15A	8.1		BF90AT-AW	22.3	
BF(P)15D	9.6		BF90AX	33.8	
BF(P)20D	9.6		BF90D	32.1	
BF25A	9.8		BF115A	33.8	
BF25D	9.1		BF115D	33.1	
BF30A	9.8		BF130A	33.8	
BF30D	9.1		BF135A	33.1	
BF35A	17.6		BF150A	33.1	
BF40A	17.6	UP to 3212165	BF200A	39.6	
BF40A	13.9	FROM 3212166	BF225A	39.6	
BF40D	13.9		BF250A	49.6	
BF45A	17.6				

GEAR LUBE CAPACITY CHART - JOHNSON/EVINRUDE/OMC ENGINES

Evinrude-Johnson Outboards			Evinrude-Johnson Outboards		
Model	Year	Capacity (Oz.)	Model	Year	Capacity (Oz.)
1.5	1968-70	1	14	1988-90	8
2	1971-85	2	15	1953-55	10
Colt®/Junior®	1986-91	2	15	1956	9
2.0,2.3,3.3	1991-Thru	3	15	1974-Thru	9
2.5	1987-88	3	18	1957-73	9
3	1952-72	3	20	1966-73	9
3	1990-Thru	3	20	1985-Thru	11
4 (8110)	1969-82	4	25	1951-1955	14
4 (90)	1973-Thru	3	25	1969-84	9
Ultra 4, Excel 4	1987-91	3	25 Comm.	1985-Thru	9
4 Deluxe	1986-Thru	11	25 Comm. Thru Hub	1991-Thru	11
4 4-Stroke	2003	7	25	1985-Thru	11
4.5	1980-83	11	25, 30 4-Stroke	2000-01	8
5	1965-68	3	28	1962-64	14
5	1998	6.4	28	1986-Thru	9
5.5	1954-64	9	30	1956	14
6	1965-79	9	30	1984-Thru	11
6	1984-Thru	11	33	1965-70	14
6 4-Stroke	1997-Thru	11	35	1957-59	14
7.5	1951-53	4	35	1976-82	10
7.5	1954-58	9	35	1983-84	11
7.5	1980-83	11	35 45 Cu. In./737 CC	1987	22
8	1984-Thru	11	40	1960-76	14
8 4-Stroke	1995-Thru	9	40 Elec. Shift	1962-70	15
9.5	1964-73	10	40 Comm.	1981-90	14
9.9 2-Stroke	1974-Thru	9	40 Comm. (RS)	1991-Thru	16
9.9, 15 4-Stroke	1995-01	9	40 Comm. (RP,RW)	1993	22
9.9, 15 4-Stroke	2002-Thru	6	40	1984-88	22
10	1956-57	9	40	1989-Thru	16
10	1958-63	10			
14	1951-52	10			

*Sierra Premium Gear Lube (18-9600 series) recommended for under 75 HP • Sierra Hi-Performance Gear Lube (18-9650 series) recommended for 75 HP and above

GEAR LUBE CAPACITY CHARTS

GEAR LUBE CAPACITY CHART - JOHNSON/EVINRUDE/OMC ENGINES (CONT.)

Evinrude-Johnson Outboards			Evinrude-Johnson Outboards		
Model	Year	Capacity (Oz.)	Model	Year	Capacity (Oz.)
45 Comm.	1986-Thru	22	110	1986-89	26
48	1987-88	22	112	1994-Thru	26
48	1989-Thru	16	115 Elec. Shift	1969-70	27
40, 50 4-Stroke	1999-Thru	21	115	1973-76	28
50	1958-59	35	115 20"	1977	29
50 1971-72 Electric	1971-74	26	115 25"	1977	35
50	1975-88	22	115	1978	38
50	1989-Thru	16	115	1979-85	27
50 Comm.	1977-79	26	115	1990-Thru	26
50 3 cyl. 56 Cu.In.	1995-Thru	22	115 4-Stroke	2003-Thru	36
55 Electric Shift 3 Cyl	1968-69	26	115 60V4 EL, GL, SL	1995-Thru	31
55	1976-79	22	115 60V4 EX, SX V6 G/C	1995-Thru	34
55 Comm.	1980-Thru	22	120 V6 G/C	1985	34
60 Std.	1964-67	20	120	1986-1993	26
60 Heavy-Duty	1964-67	35	120 20"	1994	26
60 Electric Shift	1970-71	26	120 25" V6 G/C	1994	34
60	1980-85	22	125 Elec. Shift	1971-1972	27
60	1986-Thru	22	130 V6 G/C	1995-Thru	34
60 4-Stroke	2002-Thru	19	135	1973-74	28
65 Standard	1968	20	135	1975-76	29
65 Heavy-Duty	1968	35	140	1977	35
65 1972 Electric	1972-73	26	140	1978	38
65 Comm.	1984-Thru	22	140	1979-84	27
70	1974-Thru	22	140 4-Stroke	2003-Thru	36
70 4-Stroke	1998-Thru	19	140 V6 G/C	1985	34
75	1960	22	140 V4 Loop	1986-87	26
75 Man. Shift	1961-65	20	140 20" V4 Loop	1988-94	26
75 Elec. Shift	1962-65	18	140 25" V6 G/C	1988-94	34
75 15" Small G/C	1975-88	22	150	1978	43
75 20"	1975-84	25	150	1979-82	29
80 Man. Shift	1966-67	20	150 V6 Cross	1983-91	34
80 Heavy-Duty	1966-67	35	150 60V6	1991-Thru	34
80 Elec. Shift	1966-67	18	150 DI	1997-Thru	34
85 Man. Shift - Std.	1968	20	150 Comm.	1993-Thru	34
85 Elec. Shift	1968	18	155 Comm.	1984-90	77
85 Elec. Shift	1969-71	27	155 Comm.	1991-92	34
85 1972 Elec. Shift	1972-76	28	175	1977	44
85 20"	1977	29	175	1978	43
85 25"	1977	35	175	1979-82	29
85	1978	38	175	1983	34
85	1979-80	27	175 V6 Cross	1986-91	34
85	1991-Thru	26	175 60V6	1991-Thru	34
88	1987-Thru	26	175 DI	1998-Thru	34
90 Elec. Shift	1964-65	18	185	1984-85	34
90 Cross V4	1981-Thru	26	200	1976-77	44
90 60V4 EL, SL	1995-Thru	31	200	1978	43
90 60V4 EX, SX V6 G/C	1995-Thru	34	200	1979-82	29
90 4-Stroke	2003-Thru	36	200	1983	34
100* Elec. Shift	1966	28	200 V6 Loop	1986-Thru	34
100 Elec. Shift	1967-68	38	200/225 4-Stroke	2004	37
100 Elec. Shift	1971-72	27	225 V6 Loop	1986-Thru	34 V6 Coro 31
100	1979-80	27	235	1978	43
100	1988-Thru	26	235	1979-82	28
100 Comm. V6 G/C	1984-Thru	34	235	1983-85	34

GEAR LUBE CAPACITY CHARTS

GEAR LUBE CAPACITY CHART - JOHNSON/EVINRUDE/OMC ENGINES (cont.)

Evinrude-Johnson Outboards			Evinrude-Johnson Outboards		
Model	Year	Capacity (Oz.)	Model	Year	Capacity (Oz.)
2.6L	1984-85	34	V4/V6 w/ Type O	2002-Thru	34
250 V8 Loop	1991-Thru	77	V4/V6 w/ Type O - Counter Rot.	2002-Thru	31
275 V8 Loop	1985-87	77 V8 Coro 72	V6 Type L Gearcase	2002-Thru	34
300 V8 Loop	1985-Thru	77	V6 Type L2 - CLE	2009-Thru	32.5
3.6L V8 Loop	1985-87	77	V6 Type M	2002-Thru	44
4.0 V8 Loop	1988-92	77	V6 Type M - Counter Rot.	2002-Thru	41
Turbo Jet	1994-Thru	84.6	V6 Type M2	2009-Thru	38.9
Magnum	2002-Thru	44	V6 Type M2 - Counter Rot.	2009-Thru	35.8
Magnum CX	2002-Thru	41	* Gearcase with Fill Plug Above Cavitation Plate 32 Oz.		

GEAR LUBE CAPACITY CHART - JOHNSON/EVINRUDE/OMC ENGINES

OMC Cobra®		OMC Cobra®	
Model	Capacity (Oz.)	Model	Capacity (Oz.)
2.3L, 128 Model	60	262 OMC King Cobra	64
2.5L	60	350 OMC King Cobra	64
3.0L, (1990-93)	64	460 OMC King Cobra	108
3.0L 130 Model	60	460 OMC King Cobra (Cone Clutch)	103
4.3L 175 Model	64	1990-94 King Cobra (Cone Clutch)	103
5.0L	64	1994-Thru Cobra (Cone Clutch)	71
5.7L, 260 Model	64	1996-Thru Dual Prop	81
7.5L	108	OMC Sail Drive	—
1990-93 3.0L, 3.0L HO	64	1977-86	20
185, 200, 235 Models	64		

GEAR LUBE CAPACITY CHART - MERCURY ENGINES

Brand	Model	Cycle	Model Note	Oz.	mL.
Mercury/Mariner	2.2, 2.5, 3.3	2 Cycle		4.5	135
Mercury/Mariner	4.5	2 Cycle		6.8	200
Mercury/Mariner	6, 8, 9.9, 15	2 Cycle		6.8	200
Mercury/Mariner	20, 25	2 Cycle		8.8	260
Mercury/Mariner	30, 40	2 Cycle	2 cylinder	14.9	440
Mercury/Mariner	40, 50	2 Cycle	3 cylinder, std. Gearcase	14.9	440
Mercury/Mariner	55, 60	2 Cycle	Standard Gearcase	11.5	340
Mercury/Mariner	60	2 Cycle	Big Foot	22.5	665
Mercury/Mariner	75, 90	2 Cycle	3 cylinder	22.5	665
Mercury/Mariner	100, 115, 125	2 Cycle	4 cylinder	22.5	665
Mercury/Mariner	115	2 Cycle	3 cylinder Optimax	22.5	665
Mercury/Mariner	135, 150	2 Cycle	2.0L	22.5	665
Mercury/Mariner	150, 175, 200	2 Cycle	2.5L Carb/EFI/Optimax	22.5	665
Mercury/Mariner	200, 225, 250	2 Cycle	3.0L Carb/EFI/Optimax	27	798
Force	5	2 Cycle		4	120
Force	9.9, 15	2 Cycle		6.8	200
Force	25	2 Cycle		8.8	260
Force	40, 50	2 Cycle		14.9	440
Force	75	2 Cycle		12	355
Force	90, 120	2 Cycle		22.5	655
Mercury/Mariner	4.5	FourStroke		6.8	200
Mercury/Mariner	8, 9.9	FourStroke	MY 2004 & prior Standard Gearcase	6.8	200
Mercury/Mariner	8, 9.9	FourStroke	MY 2005 & newer	10.8	320
Mercury/Mariner	9.9	FourStroke	MY 2004 & prior Big Foot	8.8	260
Mercury/Mariner	9.9	FourStroke	MY 2005 & newer Big Foot	12.5	370

GEAR LUBE CAPACITY CHARTS

GEAR LUBE CAPACITY CHART - MERCURY ENGINES (cont.)					
Brand	Model	Cycle	Model Note	Oz.	mL.
Mercury/Mariner	15	FourStroke	Standard Gearcase	6.8	200
Mercury/Mariner	15	FourStroke	Big Foot	8.8	260
Mercury/Mariner	25	FourStroke	Big Foot	14.9	440
Mercury/Mariner	30, 40	FourStroke	3 cylinder, standard Gearcase	14.9	440
Mercury/Mariner	30, 40	FourStroke	3 cylinder, Big Foot	22.5	665
Mercury/Mariner	40, 45, 50	FourStroke	4 cylinder, 935 cc, standard Gearcase	14.9	440
Mercury/Mariner	40, 45, 50	FourStroke	4 cylinder, 935 cc, Big Foot	22.5	655
Mercury/Mariner	40	FourStroke	4 cylinder, 996 cc, Big Foot	24	710
Mercury/Mariner	50, 60	FourStroke	4 cylinder, 996 cc, standard Gearcase	11.5	340
Mercury/Mariner	50, 60	FourStroke	4 cylinder, 996 cc, Big Foot	24	710
Mercury/Mariner	75, 90	FourStroke		22.5	665
Mercury/Mariner	115	FourStroke		24	710
Mercury/Mariner	200	FourStroke	Verado (RH Rotation)	32.8	970
Mercury/Mariner	225	FourStroke	Standard Gearcase	39	1.15L
Mercury/Mariner	225/250/275	FourStroke	Verado (RH Rotation)	32.8	970

GEAR LUBE CAPACITY CHART - MERCUISER STERNDRIIVE					
Brand	Model	Cycle	Model Note	Oz.	mL.
MerCruiser	Vazer Drive	4 cycle	with Gear Lube Monitor	2.0 US Quarts	1.9L
MerCruiser	Alpha One Gen II	4 cycle	without Gear Lube Monitor	1.22 US Quarts	1.16L
MerCruiser	Alpha One Gen II	4 cycle	with Round Gear Lube Monitor	2.0 US Quarts	1.9L
MerCruiser	Alpha One Gen II	4 cycle	with Rectangular Gear Lube Monitor	1.75 US Quarts	1.66L
MerCruiser	Bravo One	4 cycle	without Gear Lube Monitor	2.0 US Quarts	1.9L
MerCruiser	Bravo One	4 cycle	with Round Gear Lube Monitor	3.25 US Quarts	3.07L
MerCruiser	Bravo One	4 cycle	with Rectangular Gear Lube Monitor	2.75 US Quarts	2.6L
MerCruiser	Bravo Two	4 cycle	without Gear Lube Monitor	2.5 US Quarts	2.4L
MerCruiser	Bravo Two	4 cycle	with Round Gear Lube Monitor	3.75 US Quarts	3.55L
MerCruiser	Bravo Two	4 cycle	with Rectangular Gear Lube Monitor	3.25 US Quarts	3.07L
MerCruiser	Bravo Three	4 cycle	without Gear Lube Monitor	2.0 US Quarts	1.9L
MerCruiser	Bravo Three	4 cycle	with Rectangular Gear Lube Monitor	3.0 US Quarts	2.84L
MerCruiser	Blackhawk	4 cycle	without Gear Lube Monitor	1.75 US Quarts	1.66L
MerCruiser	Blackhawk	4 cycle	with Rectangular Gear Lube Monitor	2.25 US Quarts	2.1L

GEAR LUBE CAPACITY CHART - NISSAN ENGINES			
Model	Approximate Fluid Ounces Required	Model	Approximate Fluid Ounces Required
2A & 3.5A (4-Stroke)	6.1	25 (4-Stroke)	9.5
2.5A & 3.5A (2-Stroke)	3	30 (2-Stroke)	14.5
3.5B (2-Stroke)	6	30 (4-Stroke)	9.5
4 (4-Stroke)	6.6	40C (2 cyl)	15.9
5 (2-str/4-str)	6.6	40D (3 cyl)	16.9
6 (4-Stroke)	6.6	NSD40 (TLDI) / NSF40	16.9
8 (2-str/4-str)	10.8	50D (3 cyl)	16.9
9.8 (2-str/4-str)	10.8	NSD50 (TLDI) / NSF50	16.9
9.9 (2-Stroke)	12.5	70B (3 cyl)	23.7
9.9A (4-Stroke)	6.8	70C (3 cyl)	30.4
9.9B (4-Stroke)	12.5	NSD70 / 75 (TLDI)	30.4
15 (2-Stroke)	12.5	90A (2-Stroke)	30.4
15A (4-Stroke)	6.8	NSD90 (TLDI)	30.4
15B (4-Stroke)	12.5	115A (2-Stroke)	30.4
18 (2-str/4-str)	12.5	NSD115 (TLDI)	30.4
20 (4-Stroke)	12.5	140A (2-Stroke)	30.4
25 (2-Stroke)	14.5		

*Sierra Premium Gear Lube (18-9600 series) recommended for under 75 HP • Sierra Hi-Performance Gear Lube (18-9650 series) recommended for 75 HP and above

GEAR LUBE CAPACITY CHARTS

GEAR LUBE CAPACITY CHART - SUZUKI ENGINES

Model	Gear Case Oil Capacity (CC)	Gear Case Oil Capacity (Oz.)	Model	Gear Case Oil Capacity (CC)	Gear Case Oil Capacity (Oz.)
DT2 (Short Shaft)	70	2.4	DT40	610	20.6
DT2 (Long Shaft)	120	4	DF40/50	610	20.6
DT3.5	85	2.9	DT50/55/60/65	650	22
DT4	190	6.4	DF60/70	600	20.3
DF4/6	190	6.4	DT75/85	700	23.7
DT5/6/8	240	11.5	DT90/100	560	18.9
DT8C/9.9C/9.9CN	175	5.9	DT115/140	1100	37.2
DF9.9/15	175	5.9	DF90/115/140	1050	35.5
DT9.9/15/15C	170	5.7	DT150/175/200/225	1050	35.5
DT20/25/30/30C/35C	230	7.8	DF150/175/200/225/250/300	1100	37.2
DF25/30	230	7.8			

GEAR LUBE CAPACITY CHART - YAMAHA ENGINES

Model	CC	Oz.	Model	CC	Oz.
2	45	1.5	F50	430	14.5
F2.5	75	2.5	T50 (1996-00)	430	14.5
3	75	2.5	T50 (2001-02)	610	20.6
4	105	3.6	C55	500	16.9
F4	100	3.5	60	610	20.6
5	105	3.6	E60	610	20.6
6	160	5.4	F60	430	14.5
8	160	5.4	P60	610	20.6
F8	150	5.1	T60	670	23
T8	320	10.9	70	610	20.6
9.9	185	6	C70	610	20.6
F9.9	185	6	C75	610	20.6
T9.9	320	10.8	E75	610	20.6
15 (1984-97)	185	6.03	F75	670	23
15 (1998-02)	250	8.5	P75	610	20.6
F15	250	8.5	C80	610	20.6
20	370	12.7	F80	670	23
25 (1984-87)	180	6.1	C85	610	20.6
25 (1988-02)	370	12.7	90/B90/C90	610	20.6
25 3cyl.	200	6.8	F90	670	23
C25	180	6.1	F100	670	23
F25	320	10.8	115	760	25.7
T25	430	14.5	B115/C115	760	25.7
30	200	6.8	F115	760	25.7
30 (1984-86) 3cyl.	180	6.1	LF115	715	24.2
30 (1987-02) 3cyl.	200	6.8	P115/S115	760	25.7
C30 (1989-92)	180	6.1	130	760	25.7
C30 (1993-97)	320	10.8	L130	715	24.2
F30	430	14.5	S130	760	25.7
40 (1984-94)	415	14	150	980	33.1
40 (1995-02)	430	14.5	C150	980	33.1
C40 (1989-97)	315	10.6	D150 (1997-99)	900	30.4
C40 (1997-02) 3cyl.	430	14.5	DX150 (1999)	980	33.1
F40	430	14.5	L150	870	29.4
E48	500	16.9	SX150 (1999-02)	980	33.1
50/P50 (1984-94)	415	14	V150 (1998-99)	980	33.1
50/P50 (1995-02)	430	14.5			
C50	430	14.5			

GEAR LUBE CAPACITY CHARTS

GEAR LUBE CAPACITY CHART - YAMAHA ENGINES (cont.)					
Model	CC	Oz.	Model	CC	Oz.
VX150	980	34.5	Model	CC	OZ
VZ150	980	33.1	LX225	1000	33.8
Z150	980	33.1	S225 3.1L	1150	38.9
175 (1984-99)	980	33.1	SX225	1000	33.8
P175	980	33.1	V225 3.1L	1150	38.9
S175	980	33.1	VX225	1150	38.9
V175	980	33.1	VZ225 3.3L	1000	33.8
VZ175	980	33.1	250	1150	38.9
Z175	980	33.1	L250	1000	33.8
200 (1984-99)	980	33.1	Model	CC	OZ
F200	1150	38.9	LX250	1000	33.8
L200 (1986-95)	900	30.4	S250	1150	38.9
L200 (1996-99)	870	30.4	LZ250 3.3L	1150	38.9
LF200	1000	33.8	SX250	1150	38.9
LX200 (1999-02)	980	33.1	VX250	1150	38.9
LZ200	870	29.4	VZ250 3.3L	1000	33.8
P200	980	33.1	Z250 3.3L	1000	33.8
LF225	1000	33.8			

*Sierra Premium Gear Lube (18-9600 series) recommended for under 75 HP • Sierra Hi-Performance Gear Lube (18-9650 series) recommended for 75 HP and above



Sierra Customer Satisfaction Warranty (Professional Installer)

Limited Warranty (to include Sierra, Shields and Instrumentation Product Groups):

SIERRA INTERNATIONAL INC. ("SIERRA") warrants its products to be free of defects in workmanship and materials for useful life of the product (the "Warranty"). If a SIERRA product fails to comply with the warranty, SIERRA will repair or replace the defective product free of charge. The Warranty is subject to the additional terms, conditions and limitations set forth below.

Warranty Claims for Professionally Installed Products:

For any SIERRA product that was originally installed on a vessel by a dealer or other professional installer that fails to comply with the Warranty, in addition to repairing or replacing the product free of charge, SIERRA will also reimburse the customer for reasonable labor charges incurred to replace the product, and reasonable towing and other similar incidental expenses incurred as a result of the failure of the product to comply with the Warranty. Labor will be calculated based on the installer's posted shop rate that is competitive with their local market rates. The original work order along with the original invoice and a copy of the new re-work order must be provided to SIERRA to file a claim for reimbursement of labor expenses. Towing charges will also be paid based on reasonable and customary rates in the local trading area. A copy of the original invoice for the towing service must be provided to SIERRA to file a claim for reimbursement of towing expenses.

ALL PROFESSIONAL INSTALLER WARRANTY CLAIMS MUST BE SUBMITTED IN ACCORDANCE WITH THE FOLLOWING PROCEDURE:

Dealers may file all warranty claims on our SIERRA Catalog website at catalog.sierraparts.com
A free user account is required, Dealers may also continue to use the options below.

WITHOUT LABOR CLAIM - The dealer may return any allegedly defective SIERRA product to the distributor from whom it was purchased for analysis. The product shall be tagged with the SIERRA part number, date of purchase and the alleged cause of failure. The Distributor will then forward the product to SIERRA with a request for credit. If SIERRA determines that the part failed to comply with the Warranty and otherwise qualifies for Warranty coverage under the terms hereof, SIERRA will issue credit for the product to the distributor. The distributor will reimburse the dealer. SIERRA will not issue credit for any products that are not returned to SIERRA. Products not manufactured or distributed by SIERRA will be held for disposition for 30 days.

WITH LABOR CLAIM - All warranty claims for which reimbursement of labor and/or towing expenses is sought are subject to prior authorization. In addition to SIERRA Catalog, dealers may call (800) 730-4082 (Option 2) to discuss any such claim with a SIERRA representative. In order to process all claims quickly and efficiently, the following must be shipped directly to SIERRA via a traceable and insurable method (i.e. UPS, Federal Express, Registered U.S. Mail, etc.):

1. The allegedly defective product and any related damaged parts.
2. A written estimate detailing the following information
 - a. A complete list, including part numbers, of all products required for the warranty repair.
 - b. The shop labor rate and a breakdown of the time required for the repair
 - c. The year, model and serial number of the warranted engine or drive.
 - d. The name and address of the distributor the products were purchased from.
 - e. The name, address and phone number of the end consumer.
3. The original work order or receipt detailing the initial installation of the allegedly defective product.
4. Any receipts detailing addition expenses.

Failure to provide required documentation and information may void all or part of the Warranty coverage.

Proof of delivery will be required on all lost shipments.

NOTE: Concerning labor claims on older products that cannot be rectified due to the unavailability of OEM replacement parts; SIERRA reserves the right to extend only the market value of the OEM product.

Send claims to:

TECHNICAL SERVICE
DOMETIC
1 Sierra Place
Litchfield, IL 62058-3029
(800) 730-4082 (Option 2)

Limitations:

THE EXPRESS WARRANTY SET FORTH ABOVE IS IN LIEU OF ALL OTHER WARRANTIES, EXPRESS OR IMPLIED, INCLUDING BUT NOT LIMITED TO THE IMPLIED WARRANTIES OF MERCHANTABILITY AND FITNESS FOR PARTICULAR PURPOSE. SIERRA does not warrant against, and the Warranty shall be void with respect to, damages or defects arising out of any of the following:

- Improper or abnormal use or handling of SIERRA's products;
- Installation or use of SIERRA product in a manner that is inconsistent with SIERRA's application information, guidelines, instructions and/or specifications;
- defects in products or components not manufactured by SIERRA;
- non-SIERRA made products or components;
- Sierra products transferred from a vessel on which they were originally installed;
- SIERRA products transferred from the engine on which they were originally installed;
- failure to maintain SIERRA product in accordance with SIERRA's application information, guidelines, instructions and/or specifications;
- ordinary wear and tear resulting from operation and/or use of SIERRA product.

This warranty also does not apply to products which have been altered or upon which repairs have been affected or attempted by persons other than pursuant to written authorization by SIERRA.

THIS STATEMENT OF LIMITED WARRANTY IS NOT A STATEMENT OF THE USEFUL LIFE OF ANY SIERRA PRODUCT. WHEN SIERRA WARRANTS IT PRODUCTS FOR THE USEFUL LIFE OF THE PRODUCT, THIS DOES NOT GUARANTEE THAT THE PRODUCT WILL LAST FOREVER OR FOR THE LIFE OF THE VESSEL. THE LENGTH OF THE USEFUL LIFE OF SIERRA'S PRODUCTS WILL VARY DEPENDING ON THE TYPE OF PRODUCT, AS SPECIFIED IN SIERRA'S APPLICATION INFORMATION, GUIDELINES, INSTRUCTIONS AND SPECIFICATIONS FOR EACH PARTICULAR PRODUCT. PLEASE REFER TO THE INFORMATION PROVIDED WITH YOU SIERRA PRODUCT IN ORDER TO DETERMINE THE USEFUL LIFE OF THAT PRODUCT.

The sole and exclusive obligation of SIERRA shall be to repair or replace the defective products in the manner set forth above. SIERRA shall not have any other obligation with respect to the products or any part thereof, whether based on contract, tort, strict liability or otherwise. Under no circumstances, whether based on this Warranty or otherwise, shall SIERRA be liable for any special, punitive or consequential damages.

SIERRA'S employees or representatives' ORAL OR OTHER WRITTEN STATEMENTS DO NOT CONSTITUTE WARRANTIES, shall not be relied upon by customer, and are not a part of the warranty stated herein.

If any part of this Limited Warranty is determined to be void or illegal, the remainder shall remain in full force and effect.

W
A
R
R
A
N
T
Y

SIERRA[®]

PARTS THAT KEEP YOU MOVING

© Copyright January 2023 Sierra International
Sierra International, 1 Sierra Place, Litchfield IL 62056
Phone: 877-663-8396 | Fax 217-441-8340
www.sierraparts.com

