



Trade Safety LTD

Hire • Sales • Servicing • Training

CATALOGUE 2025



FALL ARREST



CONFINED SPACE



GAS DETECTION

Confined Space & Working at Height Specialists

Asbestos Decontamination & Removal Equipment



Honeywell

3M

CONTENTS

Safety Store	4
Asbestos Decontamination	5
Atex/Non Atex Lighting	10
Anchorage	15
Temporary Anchors	18
Overnet	20
Air Movers	21
Breathing Apparatus	23
Connectors	27
Confined Space Kits	30
Fall Arrest Blocks	35
Gas Monitors	38
Harnesses	43
Lanyards	48
Fall Arresters	52
Portable Gantries	53
Rescue Davits	56
Rescue Equipment	70
Respiratory	73
Safety Accessories	78
Skyhook	83
Tripods	85
Winches	88
Servicing	90
Training	92
Consultancy	95

SAFETY STORE



Come visit our safety store located here in Tullamore, Co. Offaly, where there is a wide range of working at heights, confined space and rescue equipment on display. We have recently opened up our new office and warehouse in Belfast. See back of catalogue for location details.

Our servicing team and sales staff will be available to help with any enquiries and show products relevant to your safety needs.



ASBESTOS DECONTAMINATION

Trade Safety are associated partners with Thermanc and suppliers of Decontamination, and Surface Preparation Equipment, providing Equipment, Consumables, RPE, PPE, Equipment Servicing and RPE Face fitting to a wide range of industries and sectors



POLYTHENE BAGS

*Polythene
Stretch Wrapping (Clear)
Orange retardent*

CODE **4300223**



ENCAPSULANT

*10ltr
Grey or White*

CODE **1051022**



ASBESTOS BAGS

*200 and 300 gauge
Clear and Red
Various Sizes 900 X 600 , 900 X
1200
Printed and Non Printed available*

CODE **1011003**



TEXTURE COATING REMOVER

15ltr

CODE **1051042**



TRIMAX PROTECTION LIQUID

5ltr

CODE **4300553**



PVA SEALER CONTRACT

5ltr

CODE **1051021**



SILICONE SEALANT

295ml



INSTANT NAILS GRAB ADHESIVE

295ml



TAPES

*Hazard /Asbestos Warning Tape,
Foil Tape
PCL Tape etc.*

CODE 3200550

CODE 1051479

CODE 1051201



SIGNS

*Warning Labels
Multi Warning Signs 3 in 1*



M SERIES VACUUM BAGS

*Vacuum Duo Dust Bags
Hepa Flow Vacuum Bags*



DUCTING

Rigid and Flexible Available

CODE 1071000

CODE 1800230

CODE 1041108

Decontamination Units



Modular Decontamination Unit



Twin Shower Decontamination Unit



Welfare Decontamination Unit

Decontamination is a combination of processes that removes or destroys contamination so that infectious agents or other contaminants cannot reach a susceptible site in sufficient quantities to initiate infection, or other harmful response

Negative Pressure Units



A Negative Pressure Unit (NPU) creates a negative pressure that minimizes the spread of dust from the construction work. In this way, the work environment is improved and the need for final cleaning is reduced.

H Type Vacuums



H Type Vac 17.5l & 35.0l

H Type Wet Vac

Thermac H Type Vacuums are efficient, reliable, fully-compliant solution for use in the asbestos removal and construction sectors.

They remove potentially contaminated water and debris from asbestos enclosures or flooded sites

Blast Units



Blast & Breathe Trailer



Trailer Mounted Blast Unit



Dustless Blasting System

Blasting is generally a dry process. However, depending on the method, it is classified into several types such as sandblasting, blower blasting, and shot blasting. It is also used for various purposes such as rust removal, cleaning, and polishing



ATEX LIGHTING

Atex Generally refers to the hazard of explosive atmospheres occurring in the workplace due to the presence of flammable gasses or combustible dust mixed in air, which can give rise to the risk of explosion.

Any area that is not classified as zone 0, 1 or 2 is deemed to be non-hazardous, as flammable atmospheres are not expected to be present. Special precautions for the construction and use of electrical apparatus or for the control of non-electrical ignition sources are therefore not required although such an area may still be part of a greater restricted area.

ATEX RATED



SAFE LED HEAD TORCH

Zone 0
200 Lumens
2.5hr - 4.5hr

CODE EXHT220



NETWON X HEADLAMP

Zone 0
216 Lumens
10hr - 12hr

CODE HL 1010400



SIGMA RECHARGEABLE SEARCHLIGHT

Zone 1
890 Lumens
15hr - 20hr

CODE SA-SIGMA-RSL 100



EX ZOOM LED FLASHLIGHT

Zone 0,1,2
160 Lumens
6hr - 13hr

CODE NSEXZOOM



SAFE LED FLASHLIGHT

Zone 0,1,2
270 Lumens
6.5hr - 13hr

CODE EXHT220



RECHARGEABLE LED SEARCHLIGHT

Zone 0
370 Lumens
60hr - 80hr

CODE NSSAFA-SL



SHINDAIWA M1 SERIES

Zone 1,2
9000 Lumens
Run Time - Always

CODE M1



SITE BRIGHT ULTRA RECHARGEABLE

Zone 1
3200 Lumens
8hr
Stand Available

CODE ULTRA



RECHARGEABLE PORTABLE FLOODLIGHT

Zone 1,2
1400 Lumens
10hr
Magnetic or Stand Available

CODE SAFETEX FLR



2M TRIPOD ULTRA

Accessory

CODE ULTRA



SUBFRAME FOR SITE BRIGHT ULTRA RECHARGEABLE

Accessory

CODE ULTRA



EXPLOSION PROOF TORCH

Zone 1,2
220 Lumens
9Hr-13hr

CODE EXMP31R



**EXPLOSION PROOF
RECHARGEABLE HANDLAMP**

*ZONE 1,2
410 Lumens
14hr - 25hr*

CODE

EXHT220



EXPLOSION PROOF TORCH

*Zone 1,2
160 Lumens
12hr - 18hr*

CODE

EXMP21R



EXPLOSION PROOF TORCH

*Zone 0,1,2
200 Lumens
9hr - 14hr*

CODE

EXMP32N



ATEX RADIO

Intrinsically Safe Land Portables

CODE

DT 952

NON-ATEX



RAINBOW 1 HEADLAMP

Zone 1
350 Lumens
2hr - 8hr

CODE HL1000100



NEWTON 4 HEADLAMP

Zone 4
600 Lumens
5hr - 30hr

CODE HL 1010300



RAINBOW 2 HEADLAMP

Zone 2
250 Lumens
3hr - 20hr

CODE HL 1000200



NEWTON 2 HEADLAMP

Zone 2
400 Lumens
60hr - 80hr

CODE HL1010100



SITE BRIGHT SERIES SPHERE

Non Atex
2600 Lumens
Run Time - Always

CODE SITE



TRIPOD STAND GALAXY PRO

Zone 0,1,2
6000 Lumens
2.5hr - 13hr

CODE GALAXYPRO



ANCHORAGE

An anchor point is a point of attachment for a fall arrest system. They are usually found at the top or on the side of a building and serve as a secure and safe way to ensure that those who are working on elevated surfaces will be protected from any potential falls.

Anchor points are important as they allow for the installation of fall arrest systems. These are systems that prevent injuries and fatalities when working at height.



MOBILE ANCHOR

1550mm X 1550mm X 260mm
220Kg
12 Weights

CODE IM 100



MOBILE ANCHOR

3020mm X 3020mm
374Kg
12 Weights

CODE IM 200



DEADWEIGHT TROLLEY

1470mm x 610mm x 524mm
208Kg
2 Users

CODE DW 100



DEADWEIGHT TROLLEY

Galvanized Steel
2420mm x 1766mm x 2486mm
3 Users

CODE DW 200



CROSSLOOP ANCHOR

Simple, light and easy to install, it is designed to be installed on platforms, bridges, horizontal surfaces made up of pressed steel gratings

CODE FA6000400



HYDRA JAWS

Is for medium duty fixing testers enable engineers to confirm the holding power of anchors in most construction materials

CODE HYDRA



WING SINGLE ANCHOR POINT

158mm Thick
1 Person



KITE ANCHOR POINT

140mm Thick
1 Person

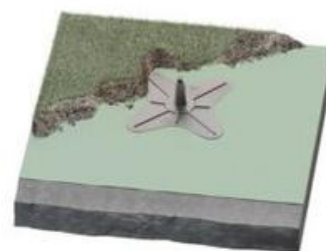

GREEN POINT ANCHOR WITH BALLAST

80KG/M2
2 person

CODE

ANCH1

CODE

ANCH2

CODE

ANCH3



GLUE ANCHOR POINT

Equipped with a 360 degree swivel eyelet to facilitate work operations. Designed for installaion on flat roofs.



ANCHOR POINTS FOR SUPPORT

Suitable for installation on concrete and sheet metal structres, also on green roofs and non drillable flat roofs.



BLOCK ANCHOR POINT

Designed for flat roofs with inclines up to 5 degrees with OVC or bituminous final covering.

CODE

ANCH4

CODE

ANCHP

CODE

ANCH5

TEMPORARY ANCHORS



AT250

Anchor device AT 250 is a portable anchor point, suitable for use with an I-beam rail. The rail must be fixed to a permanent structure

CODE

ST030



BEAM ANCHOR TROLLEY

80mm-250mm

CODE

FA600303



VERTIGRAB

Anchor point for vertical & horizontal metal beam

CODE

FA6000805



GRAB AND SLIDE ANCHOR

Beam Anchor

CODE

FA6000800



CONCRETE ANCHOR

Temporary Concrete Anchor
23kN Breaking Strength

CODE

FA6001800



CONCRETE ANCHOR

Temporary Toggle Anchor
20cm/50cm Available
12kN Breaking Strength

CODE

FA6001900



DETACHABLE ANCHOR

Detachable anchorage with chemical fixing

CODE FA6003800



WEBBING SLING

*Fall protection equipment
Available 0.3M 0.6M, 0.8M, 1.2M,
1.5M & 2M*

CODE AZ910



ANCHORAGE ROUND SLING

Available in 0.8M, 1M, 1.2M & 1.5M

CODE FA 6000508/10/12/15



WEBBING ANCHORAGE SLING

*Available in 0.5M, 1M & 1.5M
Heavy duty tubular wear sleeve*

CODE IKAB50



ANTI SLIP WEBBING CONNECTOR

*Anchor Device with Saphook.
Available in 0.9M, 1.4M, 2M*

CODE AZ700



Overnet



Installing OVERNET is convenient: it is easily installed outdoors on trapezoidal metal sheets or trapezoidal sandwich panels and is supplied in 25 m rolls.

OVERNET is a complete system composed of: fall protection net, fastening plates, EPDM gaskets and rivets. Its strength and durability are made excellent by the combination of zinc plating, primer and PVC.

A large, dark-colored industrial air mover unit is shown. It features a prominent circular fan grille on the front and a handle on top. The unit is positioned in a dimly lit environment, possibly a confined space.

AIR MOVERS

This can be used as a stand-alone item to simply cause a through airflow or be linked to trunking to introduce clean air into the system from outside of the confined space.

These units can be much more productive than a traditional fan and do not pose the same electrical issues.



VENT TB 3850

110V
Airflow - 3850 m3/h



VENT TB 7550

110V
7560 m3/h



AIR MOVER DUCTING

Available in 5m, 7.5m & 10m

CODE TB3850

CODE TB7550

CODE AMD

Atex Air Mover



SA ATEX AIR MOVER

Airflow - 5179 m3/hr



ANTI STATIC DUCTING

Diameter 10cm, 20cm, 30cm, 40cm
Available in 5m & 10m



SA CYCLONE FILTRATION UNIT

Creates clean, breathable air
Zone 1&2

CODE SAF35

CODE SAFD1

CODE SAFD2



BREATHING APPARATUS

Breathing apparatus is provided to help you safely evacuate a confined space if the gas monitoring equipment indicates a problem within the atmosphere

It will also help sustain life if you get into difficulties whilst in a confined space, until you can be rescued by the emergency services.



PROPAK SIGMA

The 3M™ Scott™ ProPak Sigma is a Type 2 open-circuit self-contained compressed-air breathing apparatus with an unpadded carrying harness

CODE TYPE2



HOENYWELL AERIS COMFORT TYPE 2

Is a black harness – with Zenith demand valve and Panoramasque. Full-face mask with 5-point head strap without air cylinder

CODE 1825216



SCOTT VISION 3

Breathing Air Mask

CODE 1710650



HONEYWELL ESCAPE SET

15 Min

CODE 1815732



ELSA B ESCAPE SET

10/15 Min

CODE ELSA15



BREATHING AIR CYLINDERS

Available in 2 litres up to 9 litres with a charging capacity of 300bar

CODE SCBA



SCOTT BREATHING AIR TROLLEY

2 Person Load Limit.

The Airline trolley used with 2 cylinders and can supply two users at a distance of 50 meters

CODE

SCOTTBAT



SCOTT FLITE BANDOLIER

10 or 15-minute compressed air cylinder supply for escape from the most hazardous environments.

CODE

3M FLITE



BREATHING AIR TROLLEY

12 Hours Breathing Air Time

CODE

BATROLLEY



BREATHING AIR TRAILER

TS Trade Safety LTD
 Confined Space & Working at Height Specialists
 Contact: 057 9330782 Email: info@tradesafety.ie Web: www.tradesafety.ie
 CONFINED SPACE RESCUE TEAM

Provide quality clean air.
 Provides 37.5hr of air for 1 Person when full.



BREATHING AIR COMPRESSOR

Provide a portable, trailer mounted air source for breathing quality air.
 Available in 2 sizes - 4 & 8 personnes





CONNECTORS

A connector is designed to be weighted along its primary axis, with the gate closed and locked. This is the connector's strongest position. All other positions increase the risk of a break or accidental opening, and therefore present a danger to the user.

Connectors move around when used, are pulled by the rope, bump up against the rock, and vibrate when you are on the move. Regularly check that the carabiner has not moved into a dangerous position and that the locking system stays closed in spite of vibrations.



AZ011

Detectable Connection
160g
18mm



AZ011T

Twist Lock Karabiner
173g
17mm



AZ014T

Connection with Twist Lock
100g
24mm

CODE

AZ011

CODE

AZ011T

CODE

AZ014T



AZ014DT

Triple Lock Karabiner
105g
24mm



AZ111

Light Twist Lock Karabiner
205g
45mm



AZ022

Scaffold Hook
500g
50mm

CODE

AZ014DT

CODE

AZ111

CODE

AZ022



RGK15

Karabiner with Captive Pin
215g
12mm



RGK2P

Karabiner with Retainer Pin
197g
17mm



FA 50101117T

Screw Locking Karabiner
160g
18mm

CODE

RGK15

CODE

RGK2P

CODE

FA50101117T



FA 5030222

Triple Action Locking
80g
21mm



FA 5021460

Rebar Hook with Latch
100g
60mm

CODE

FA5030222

CODE

FA5021460

A worker wearing a red protective suit, a respirator mask, and gloves is positioned inside a confined space, likely a large industrial tank or vessel. The worker is looking towards the camera. The environment is filled with metal structures, pipes, and equipment. The text "CONFINED SPACE" is overlaid in large white letters across the center of the image.

CONFINED SPACE

Confined Space Kits provided basic equipment to assist in confined space entry and egress. The presence of a hazardous atmosphere is a major threat to workers in confined spaces.

KIT 1



KRATOS TRIPOD

*Single Pulley
7ft*



KRATOS WINCH

20m Available



P10 R NIZE

Rescue Harness with leg padding

CODE FA6000100

CODE FA6000320

CODE P10RNIZE



BW MICRO CLIP XL

Gas Monitor (H2S,O2,LEL,O2)



HONEYWELL ESCAPE SET

15 Minute

CODE BWMICRO

CODE 1815732

KIT 2



KRATOS TRIPOD

*Double Pulley
7ft*



KRATOS WINCH

It is a revolutionary skincare product that is designed to provide a luxurious and nourishing experience for your skin.



P10 R NIZE

Rescue Harness with Leg Padding

CODE

FA6000100

CODE

FA2040110

CODE

P10RNIZE



GMI PS200

Gas Monitor (H2S,O2,LEL,O2)



ELSA ESCAPE SET

10/15 Minute

CODE

PS200

CODE

ELSA

KIT 3



GLOBESTOCK TRIPOD

*Triple Pulley
9ft*



GLOBESTOCK FAB C/W RESCUE

*Fall Arrest Block with Integrated
Rescue Winch*



P10 R NIZE

Rescue Harness with Leg Padding

CODE

GSE230

CODE

GSE414G

CODE

P10RNIZE



WATCHGAS SST4

Gas Monitor (H2S,O2,LEL,O2)



HONEYWELL ESCAPE SET

15 Minute

CODE

SST4

CODE

1815732



NEW CONFINED SPACE UNIT **NEW**

New Addition to Our Training Fleet!

We are excited to announce the addition of a state-of-the-art vehicle designed specifically for confined space training and working at heights training. This versatile training unit is equipped with the latest technology and safety features, offering a realistic and hands-on experience for participants to enhance their skills and confidence in challenging environments.

Whether you're looking to upskill your team or meet compliance requirements, this new vehicle is the perfect solution to deliver comprehensive, practical training.

Contact us today to book your training session and take advantage of this cutting-edge resource!



FALL ARREST

Fall arrestors are anchored above the user, it gives the user a safe area of work.

The retracting line pays in and out of the device as the user moves. In the event of a fall, a brake engages, arresting the fall of the user with a controlled deceleration force.



PROTEKT RETRACTABLE FALL ARREST

2.35m

CODE

WR025



KRATOS MINI BLOCK

2m

CODE

FA2050302



KRATOS TWIN MINI BLOCK

2m

CODE

FA2050002



PROTEKT TWIN BLOCK

2m

CODE

DWR0402



KRATOS

6m/12m
Vertical & Horizontal Use
Sharp Edge Protection

CODE

FA5020320



KRATOS

10m/15m
Vertical Use
Sharp Edge Protection

CODE

FA5020320

FALL ARRESTER WITH RESCUE



GLOBESTOCK

14m & 34m Available
Integrated Rescue Winch

CODE

GSE414/34G



KRATOS

10m/20m/30m
Integrated Rescue Winch

CODE

FA 2040110



HONOR DESCENDER

15m/33m
Integrated Rescue Winch

CODE

FPED15/33



IKAR

Sizes available 9 / 18 / 30m
Integrated Rescue Winch

CODE

HAS9/18/30



GAS DETECTION

Confined space gas detectors are designed to ensure occupational health and safety compliance and to protect personnel from exposure to harmful fues, gases, vapours or lack of oxygen.

A personal multi gas monitor can also be used to track the concentration of combustibile gases amd alert users if concentrations approach the Lower Explosive Limit (LEL). Therefore, mititgating the risk of potentially fatal ignition



13%
bigger screen



29 grams
lighter



5dB louder
audible alarm



48% longer
battery run time



wider
sensor ranges



simpler
connectivity



improved
robustness



faster T90
response time

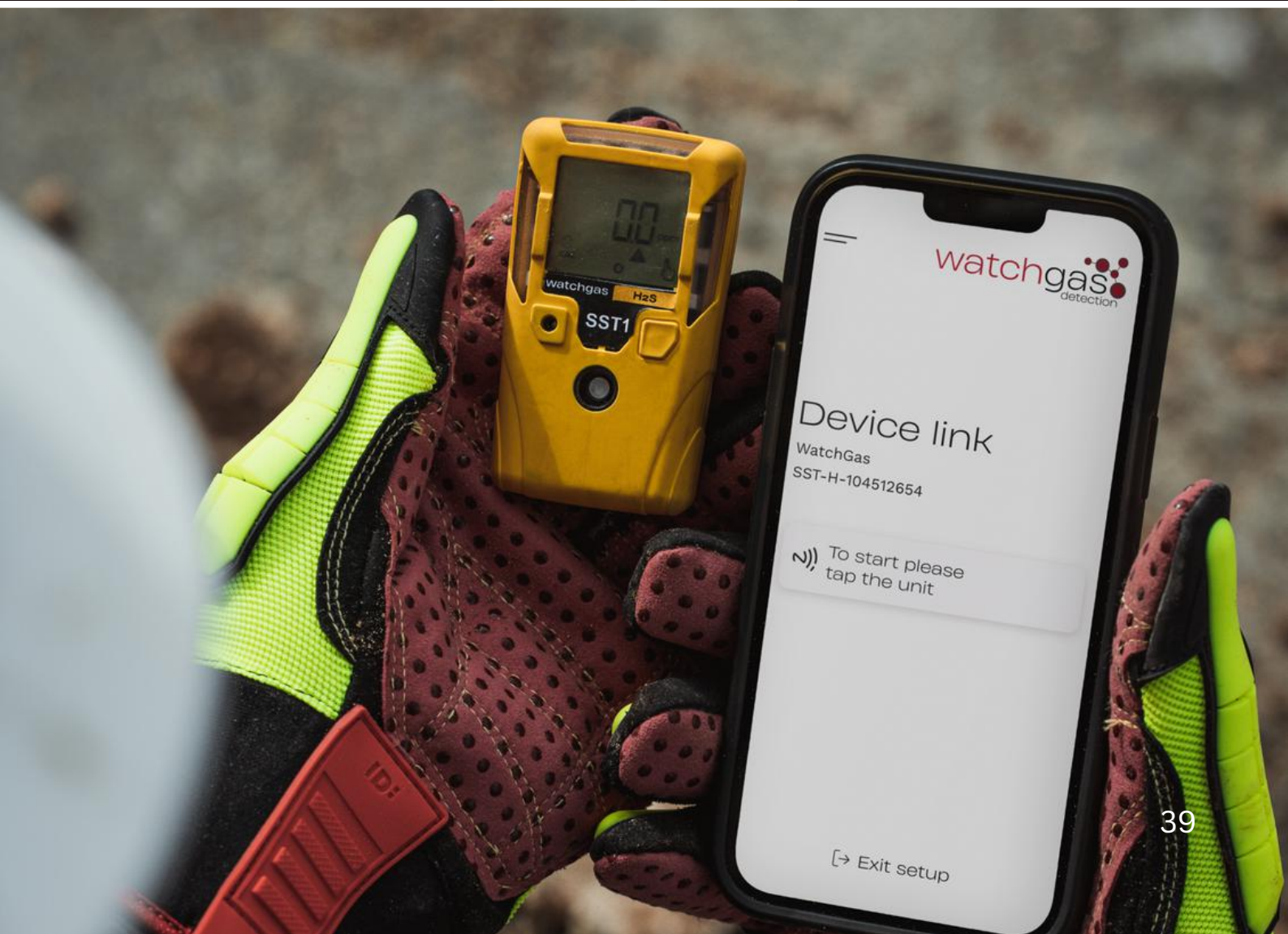

4 GAS MONITOR

NEW



WATCHGAS SST4

(LEL, H2S, O2, CO)
Pumped Option Available
IR Version Available
Online Tracking

CODE SST4



GMI PS200

(LEL, H2S, O2, CO)

CODE PS200



BW MICRO CLIP XL

(LEL, H2S, O2, CO)

CODE BWXL



WATCHGAS QGM

(LEL, H2S, O2, CO)

CODE QGM



SOFT AND GRAINY SERUM N₂

(LEL, H2S, O2, CO)

CODE POLI



BW MAX XT

(LEL, H2S, O2, CO)

CODE MAX XT



BW QUATTRO

(LEL, H2S, O2, CO)

CODE

QUATTRO



SST Range:
committed to
ensuring your safety

SST RANGE™ 

SINGLE GASES



WATCHGAS SST1

2 Yr Disposable
Various Single Gases Available

CODE

SST1



WATCHGAS PDM

Various Single Gases Available

CODE

PDM



TOXIRAE PRO PID

VOC Monitor

CODE

RAEPRO



BWSOLO

H2S/CO2 Available



WATCHGAS UNI

Various Single Gases Available



WATCHGAS PDM+

Various Single Gases Available

CODE

SOLO

CODE

UNI

CODE

PDM+



PDM PRO CO2

CO2



GMI PS500

*(O2, H2S, LEL, CO, NH3)
5 Gas*

CODE

PDMPRO

CODE

PS500



HARNESSES

Harnesses are used in almost all types of confined space work because safety teams are required to have a method of removing an injured worker in the event of an accident.

Harnesses can also be utilized as fall protection device. Wearing the harness, comprised of a system of straps and restraints, the risk of injury caused by potential fall is reduced



PROTEKT SAFETY HARNESS

*Manual Buckles
2 Front + Rear*

CODE

P11



KRATOS FULL BODY HARNESS

*Adjustable Shoulder + Thigh
Straps
2 Front + Rear*

CODE

FA1010500



PROTEKT RESCUE HARNESS

*Click Buckles
2 Chest + Rear*

CODE

P10 R NIZE



KRATOS RESCUE HARNESS

*Click Buckles
2 W/ Rescue Extension Loop*

CODE

FA1010600



ARESTA

*2pt Harness
Standard Buckles*

CODE

AR-01024S



ARESTA

*3pt Harness
Eeze Klick Buckles*

CODE

AR-01025





ARESTA MEWP

AR-01024 S + Lanyard



MEWP KIT

FA1010200 Harness
1.5m Lanyard



SCAFFOLD KIT

Body harness FA1010200
Kermantle rope lanyard length
1.50 m FA 40 500 15

CODE AK-MO1B-15A

CODE FA8000100

CODE FA8000200



ARESTA

Comfort Plus Harness
Eeze Klick Buckles



PROTEKT SAFETY HARNESS

Automatic Buckles
1 Rear



PROEKT WORK POSITIONING HARNESS

Automatic Buckles
3 Front + Rear + Front (Rail)

CODE AR-01130

CODE P500

CODE P600



KRATOS RESCUE HARNESS

*Combination Buckles
3 Shoulder + Rear*

CODE **FA1011400A**



**PROTEKT SUSPENSION + WORK
POSITIONING HARNESS**

*Automatic Buckles
2 Chest + Rear*

CODE **P70 MX**



SKYLOTEC ION

*Click Buckles
2 Front + Rear*

CODE **G1130**



SKYLOTEC TRION

*Click Buckles
4 Allow Individual Adjustments*

CODE **G1131**



SKYLOTEC IGNITE

*Click Buckles
4 Dorsal + Sternal + Pole + Frontal*

CODE **G1161**



HARNESS BACKPACK

2 in 1 harness and backpack

CODE **FA1030501**



KRATOS BACKPACK

*Automatic Buckles
2 Chest*

CODE

FA 9011500

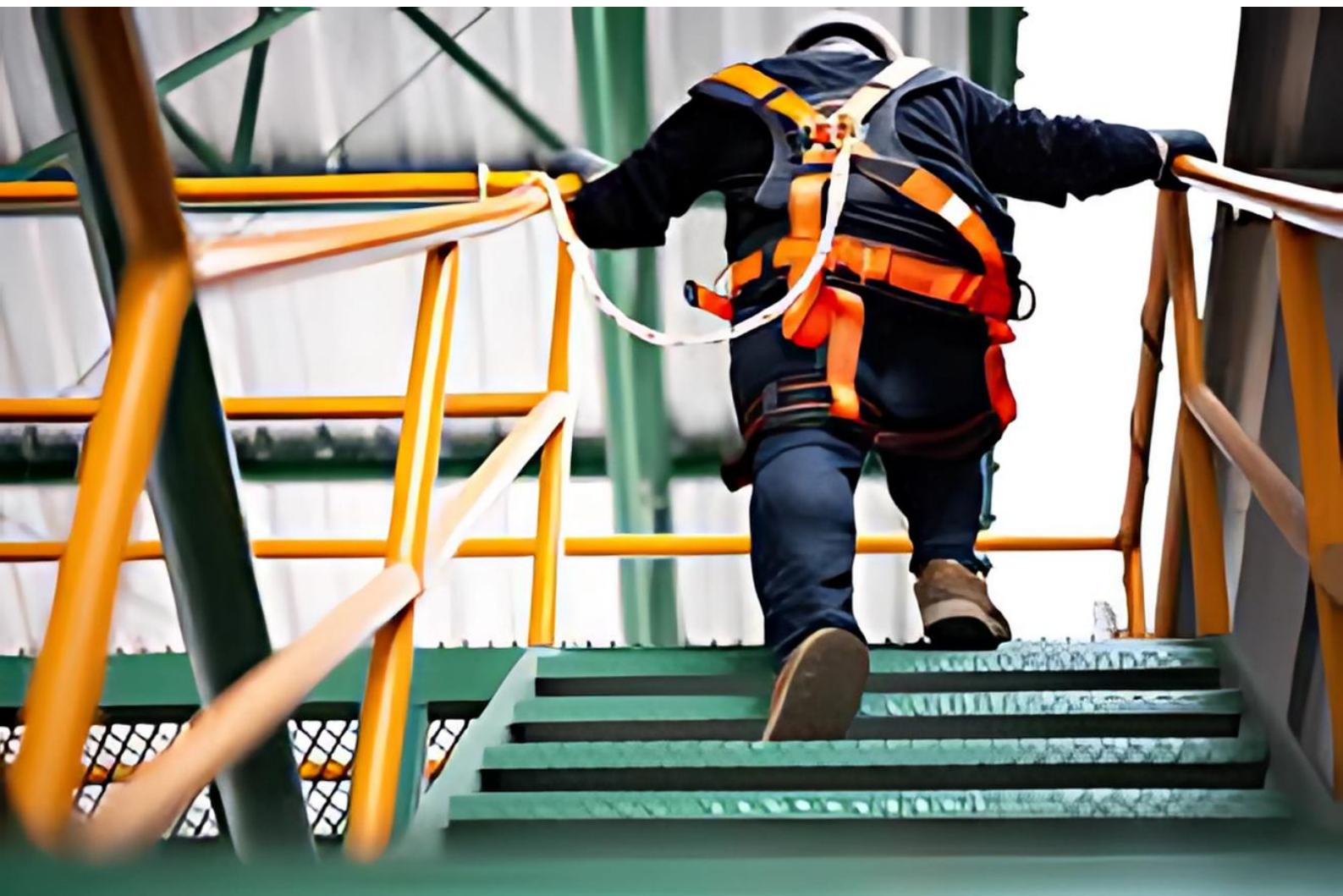



LANYARDS

Lanyards and energy absorbers are connected to an anchorage point and to the back D-Ring of a harness

Their Role is to prevent injuries in the event of a fall. Lanyard with the shock pack, these lanyards are made from resistant nylon fibres to which are attached a shock absorbing pack

FALL ARREST



**KRATOS ENERGY ABSORBING
WEBBING LANYARD**

*Polyester Webbing
1.8-2m
1 x 50mm Scaffhook + 1 18mm
Karabiner*

CODE FA3030418



KRATOS FIRE RETARDANT

*Webbing
2m
1 x 50mm Scaffhook + 1 18mm
Karabiner*

CODE FA3030520



**KRATOS ANTISTATIC ENERGY
ABSORBING**

*Polyester Webbing
2m
1 x 60mm Scaffhook + 1 22mm
Karabiner*

CODE FA3030620



ARESTA

*1.8m
Scaffhook
Elasticated*

CODE AR-03908/18



SKYLOTEC PRO TIE BACK

*Polyester Webbing
Rescue Loop
1.8m
1 x 22mm Scaffhook + 1 x 22mm
Karabiner*

CODE L0574



PROTEKT ROPE LANYARD

*Kermantle
2m
1 x 50mm Scaffhook + 1 18mm
Karabiner*

CODE LB101

NEW



ARESTA TWIN LANYARD

Elasticated Webbing Lanyard
2 Scaffold Hooks, a Carabiner and
Shock Absorber,
1.5m

CODE AR-03701/15



**KRATOS FORKED ENERGY
ABSORBING LANYARD**

Polyester Webbing
1.8m
2 x 50mm Scaffhook + 1 x 18mm
Karabiner

CODE FA3040018



SKYLOTEC TWIN ROPE

Polyamide
Rescue Loop
12mm
1 x 60mm Scaffhook + 2 x 29mm
Karabiner

CODE L013



PROTEKT TWIN ROPE

Kermantle
2m
2 x 50mm Scaffhook + 1 x 18mm
Karabiner

CODE LB102



SKYLOTEC PROFLEX Y TWIN

Polyester / Aluminium
Rescue Loop
1.8m
2 x 60mm Scaffhook + 1 22mm
Karabiner

CODE L055

WORK POSITION/RESTRAINT



KRATOS LANYARD

Work Positioning Webbing
Lanyard & ring adjuster
2m

CODE FA4090120



NEW

ARESTA

1m & 2m
Scaffhook
Work Position

CODE AR-02076-10/20



PROTEKT LANYARD

Kernmantle
2m
Karabiners?

CODE AF500



SKYLOTEC ERGO GRIP

Rope Polyamide
2m
1 x 20mm Karabiner

CODE SK20



SKYLOTEC ERGO GRIP

Rope Polyamide
1.8m
1 x 50mm Scaffhook

CODE SK18



**KRATOS WORK POSITIONING W/
GRIP ADJUSTER**

Polyamide Webbing
2m
1 x 22mm Scaffhook + 1 x 18mm
Karabiner

CODE FA4090320

LIFELINES

Horizontal



CODE FA6000700

Adjustable length from 5m - 20m
Secures an operator throughout his travels

Horizontal Lifeline in 30mm polyester webbing

Forked ends in order to:

- Either anchor to a structure without the need to add anchorage sling
- Hand directly on adapted anchorage point



CODE FA6003318

Retractable wire rope horizontal lifeline, max. length 18 m, extremely easy to install, lightweight, ready to use.

- Quick dismantling and re-installation on a new site thanks to the inbuilt winch.
- Durable and high strength polymer casings, with carrying handle having a tension indicator.
- Inbuilt shock absorption mechanism to limit the impact forces during fall arrest.
- The cable has a swivel snap hook in order to avoid the twisting of the rope.
- Can be simultaneously used by 1 or 2 people.



CODE FA20110210/20

Vertical

- Kratos Guided Fall Arrester
- Length of the rope: 10 metres
- Breaking strength : > 15 kN
- Works on 12 mm Diameter Polyester Kermantle Rope Anchorage Line

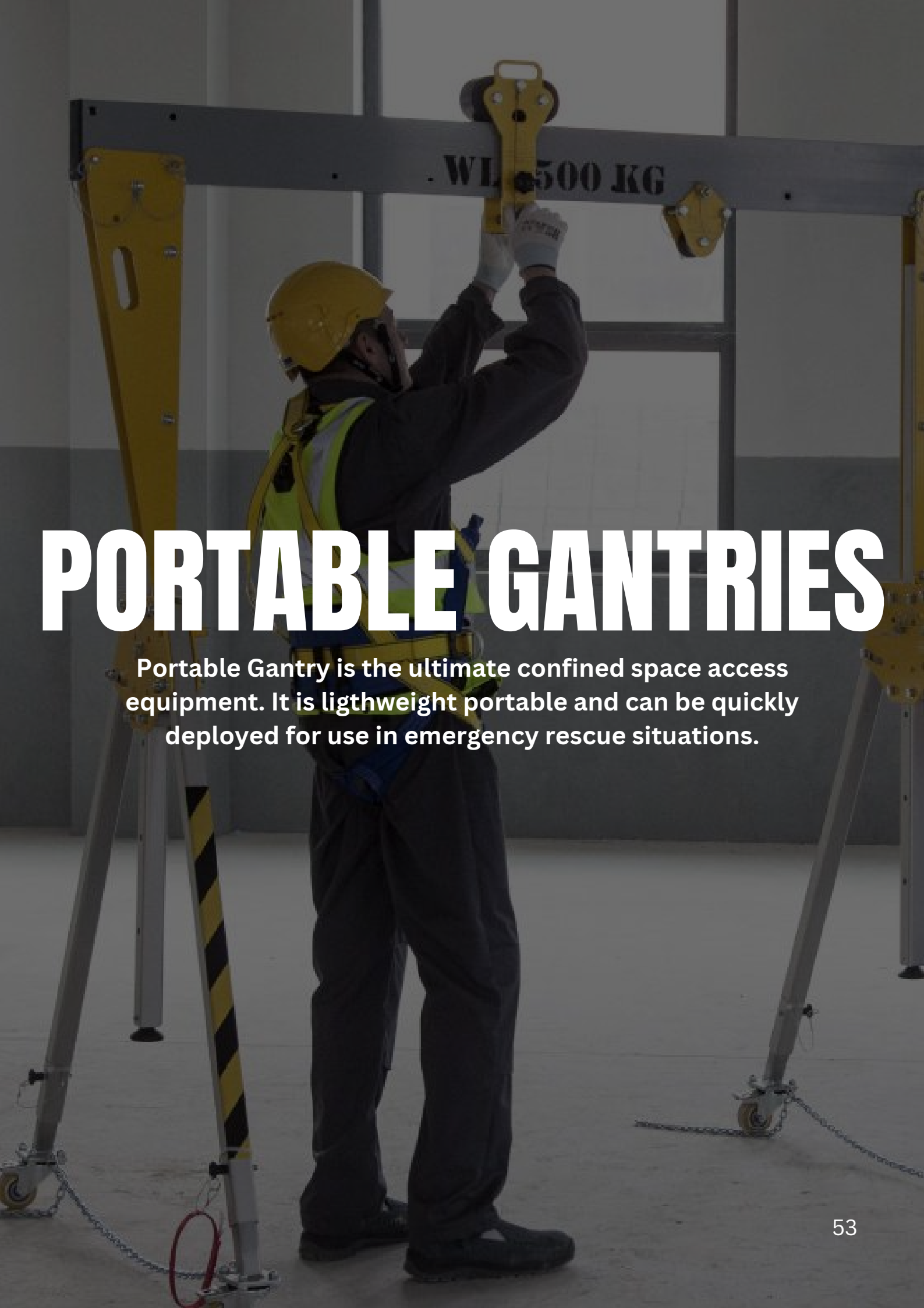

PORTABLE GANTRIES

Portable Gantry is the ultimate confined space access equipment. It is lightweight portable and can be quickly deployed for use in emergency rescue situations.

KSB SERIES



Aluminium Gantry Crane “KSB Series” is a complete, lightweight, fully customizable, portable device designed for lifting loads up to the related working load limit (WLL).

These Gantries is ideal for lifting applications such as confined spaces, silos, rooftops, lift-shafts, water treatment works and clean environments

SWL KSB: 500kg
 Total weight of Gantry KSB: 58kg
 Beam Length: 2m/3m
 Trolley Included

LSB SERIES



Aluminium gantry crane “LSB series” is a complete, lightweight, fully customizable (modular design), portable and flexible device designed to be used in variety of lifting applications such as, drainage wells, reservoirs, wells, silos, rooftop, lift-shaft, waste water and many more.

For faster device installation additional tools are not needed (device installation.

Beam LSB: from 2 to 7 meters.

Trolley Available

LSB Working Load Limit (WLL): from 500kg up to 2000kg (depends on configuration - please see LSB Technical Data Table).

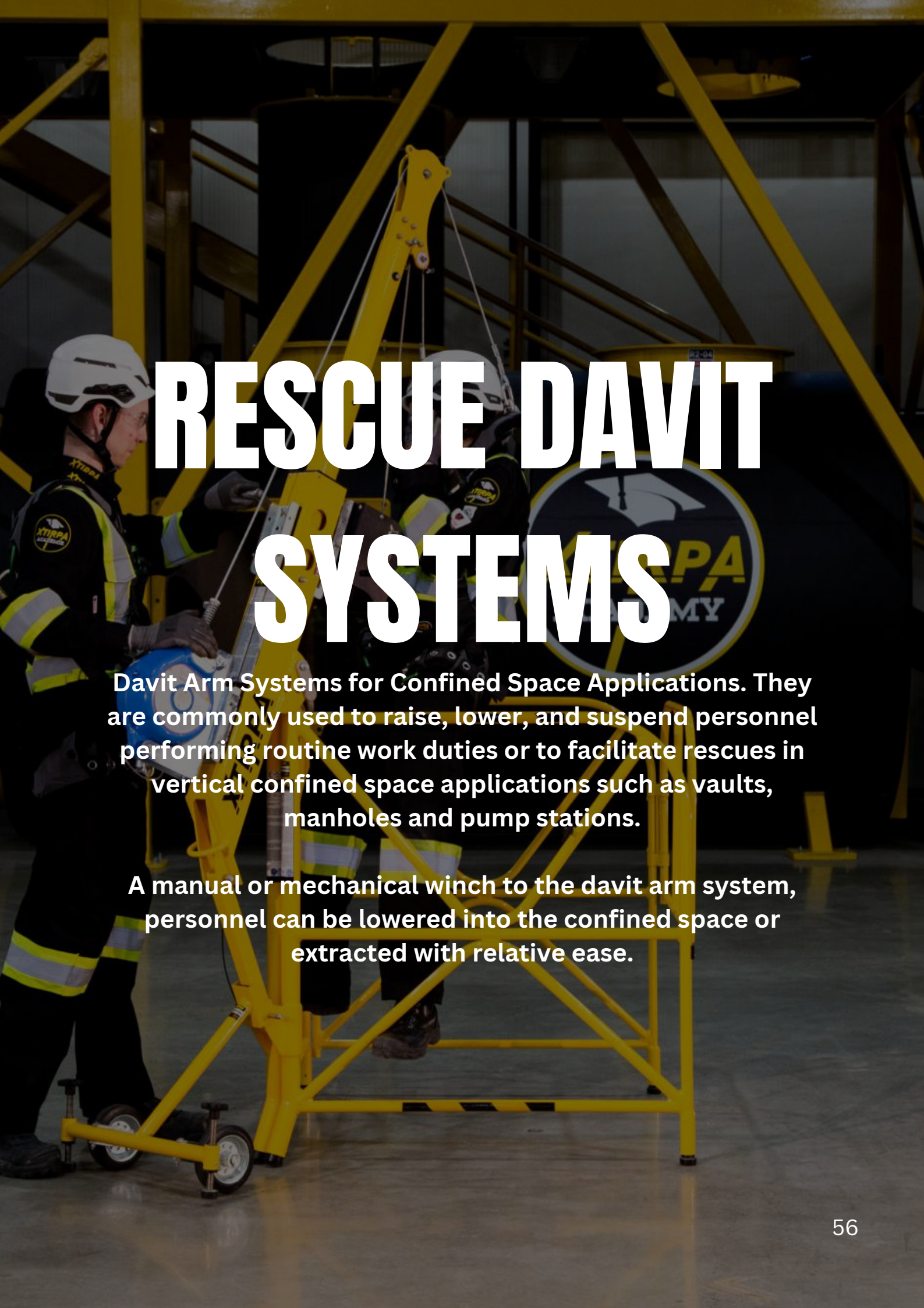

RESCUE DAVIT SYSTEMS

Davit Arm Systems for Confined Space Applications. They are commonly used to raise, lower, and suspend personnel performing routine work duties or to facilitate rescues in vertical confined space applications such as vaults, manholes and pump stations.

A manual or mechanical winch to the davit arm system, personnel can be lowered into the confined space or extracted with relative ease.

COUNTERWEIGHT SYSTEM



610mm

A counterweight system is built for when you need to move and access various confined space entry points in the same area.



1200mm

Consisting of a central base unit with a number of options for anchoring, positioning, leg adjustment and extension, this is a system designed for versatility.

We also have the static counterweight trolley available .

H BASE DAVIT SYSTEM



A free-standing system is perfect when you need to move the davit and access different confined space entry points in the same area.

The portable wheeled lower base allows for adjustment to accommodate the width and lengths of most standard confined spaces, offering a versatile confined space access solution.

The extendable legs allow for access to wider entries and increase stability.



POLE HOIST SYSTEM



Pole Hoist System is a vertical confined space entry and retrieval fall arrest system. A versatile pole hoist for confined space access

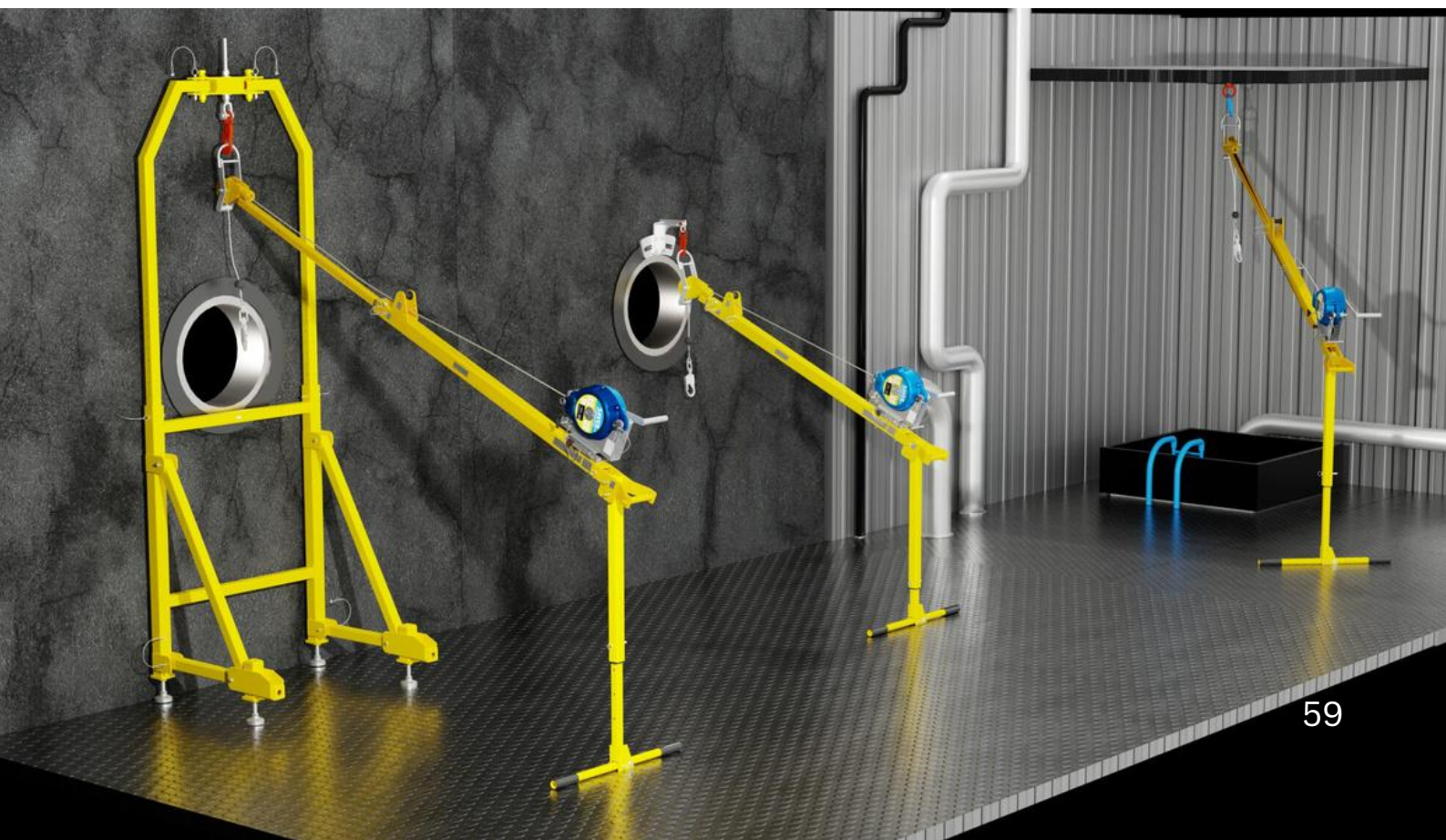

HITCH MOUNT SYSTEM



Hitch Mount System

Hitch mount davit system provides a portable confined space access system with a hitch mount attachment for vehicles, plus other anchor points.

Ideal for use in a sandwich plate anchor and using a “C” clamp for concrete or steel mezzanine floor anchors.



Hitch Mount C Clamp 610mm



Hitch Mount J Clamp 610mm

Hitch mount “J” is a system commonly used for rescue in confined spaces



GUARD RAIL



Guard rail systems are used when an exposed entry point needs to be guarded

This portable system has an integrated mast which is used in conjunction with a davit arm to provide fall protection, entry and retrieval capabilities.

The manhole guard system facilitates access to underground chambers or any other type of confined space where an entry point should be protected

Davit arm is equipped with (2268 kg) anchor point

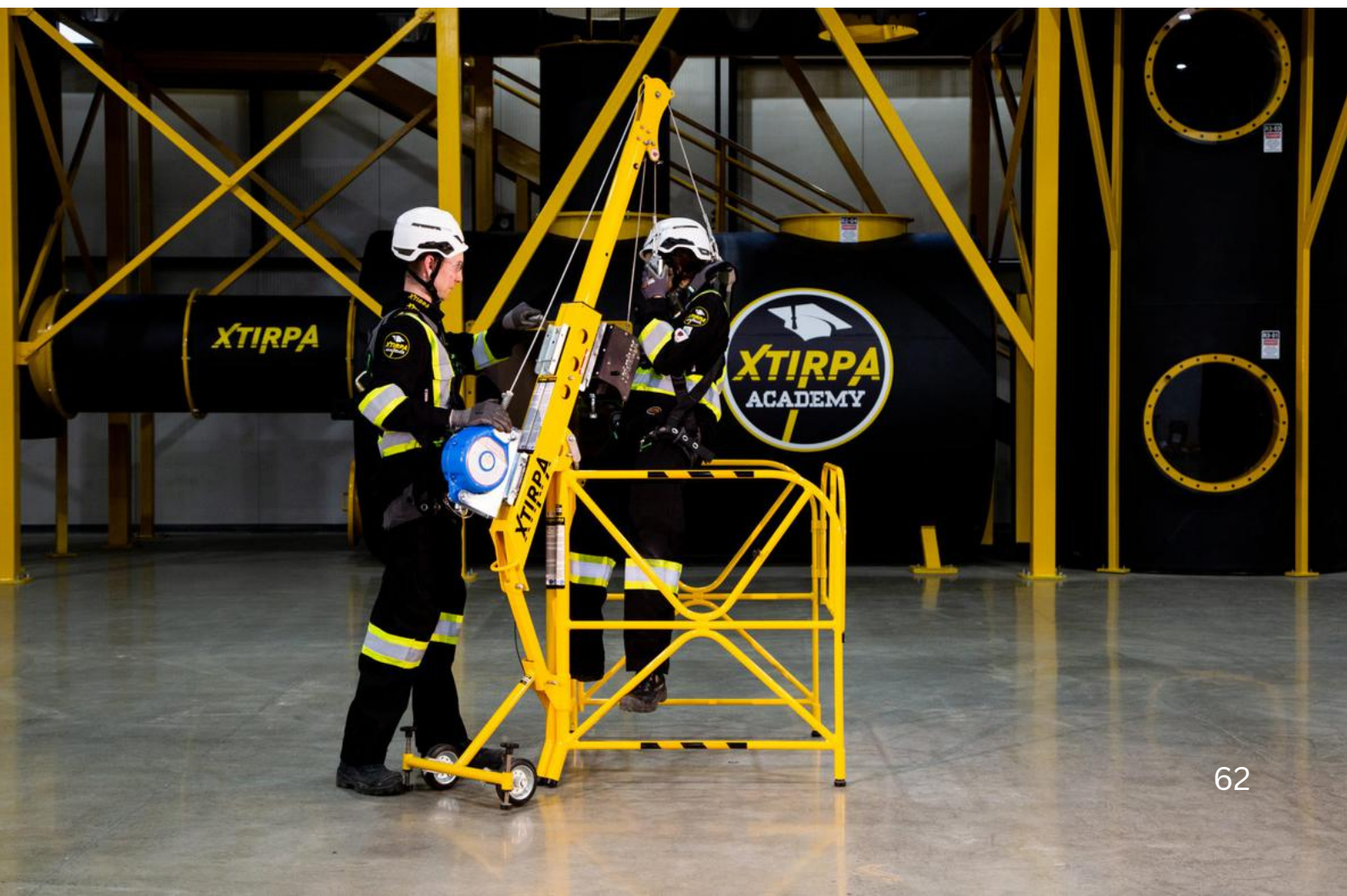

MANHOLE COLLAR SYSTEM



This system also offers a good solution in situations where there is little space around the manhole. Since the system is mounted on the manhole, very little space is required around the manhole.

In addition to the standard system, a Davit arm with a limited height is also available for situations with limited space above the manhole

DAVIT ARMS



610mm Davit

The Xtirpa 610mm fixed Davit system is used in conjunction with mast IN-2003 and appropriate socket base or manhole guard. Quick and easy 3 pin assembly.

Davit Arm 1200mm is ideal for work areas that require regular set-up and tear-down and where a base can be permanently affixed to an existing structure



1200mm Davit



2400mm Davit

Davit Arm 2400mm is ensuring easy and safe access into a wide variety of confined spaces. This davits versatility offers a solution where other conventional systems are impractical.

DAVIT BASES



IN 2105
76mm Centre Floor Base



IN 2005
76mm Floor Base

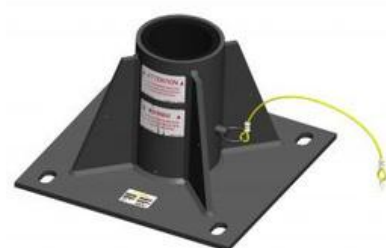

IN 2137
76mm Centre Floor Base



IN 2129
76mm Wall Base



IN 2315
51-127mm Barrel Base
(Zinc Plated)



IN 2021
51-127mm Barrel Base
(304 SS)



IN 2482
51-267mm Shoring Box



IN 2008/2168/2075/2125
Adjustable Wall Bases
105-1143mm

GENESI



Genesi SC6NW

- Genesi SC6NW is a mobile anchor device consisting of an extendable arm with a reach of about 600 mm and SC6-PNW support mast, the system is designed to ensure safe vertical access in confined spaces and with limited access and exit

- Genesi SC12NW is a mobile anchor device consisting of an extendable arm with a reach of over 1200 mm and SC12-PNW support pole, the system is designed to make vertical access safe in confined spaces and with limited access and exit



Genesi SC12NW



Genesi SC6F

- Genesi SC6F is a mobile anchor device consisting of a fixed arm with a reach of over 600 mm and an integrated pole

- Genesi SC3 is a compact mobile anchor device, consisting of a fixed arm with a reach of about 300 mm and an integrated mast, particularly suitable for making safe vertical access in confined spaces that have limited space outside



Genesi SC3



Genesi SCTY

- The system has been designed for great flexibility and, depending on the geometry of the access, can be configured or installed to allow for optimum stability to ensure safe access within the confined space or environment with restricted access. The Genesi SCTY system can be set in three different configurations without the need to use specific tools

- BUMP73 is the patented solution that can be used for both wall and floor installation, is made from a single aluminum body to ensure exceptional mechanical and chemical resistance. This base is ideal for all Genesi SC systems. Its light weight and robustness facilitate installation in any context while ensuring a high level of safety and durability.

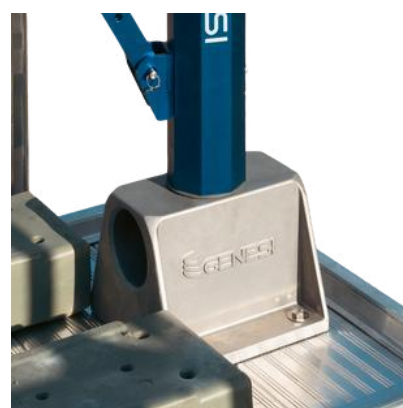

BUMP



Ground Fixing Configuration

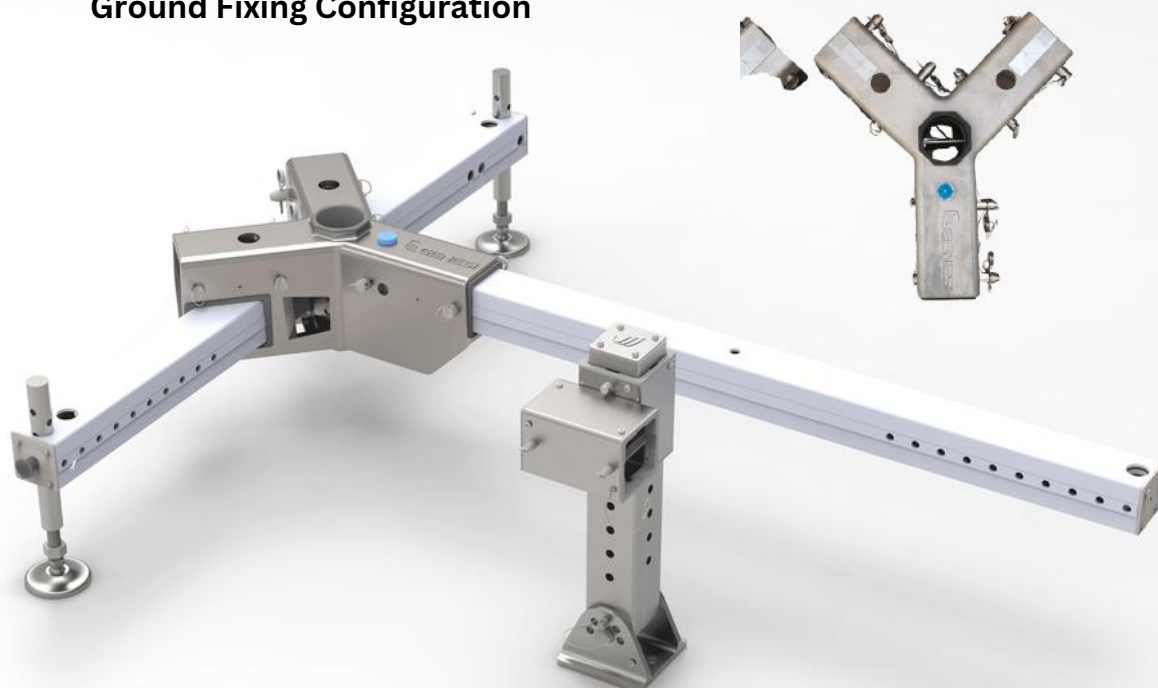



Self-Supporting Configuration

Mounting the elements in a self-supporting configuration allows you to obtain a stable and safe support for installing one of the mobile devices provided and fixing the elements with security PINs



Ground Fixing Configuration

The assembly of the elements in a T configuration with fixing to the ground allows, using the GNSSC-FIXM16 accessory, to fasten the system to the ground via an M16 fixing, the rear extension fixed to the structure by means of an M16 fixing. To mount in this configuration you need an adjustable ground fixing GNSSC-FIXM16



Configuration with Tow Hook Fixing

Mounting the elements in a T configuration with tow hook fixing allows, using the GNSSC-FIXVAN accessory, to attach the system to the tow hook of a suitable vehicle

A collection of safety equipment including a life preserver, ropes, and gear. The background is a dark, slightly blurred image of various safety items like a life preserver, ropes, and gear, with a semi-transparent dark overlay.

RESCUE EQUIPMENT

Confined space equipment is any tool or system that protects, aids or rescues someone who is working inside of a confined space

This can include simple tools like signs, radios, and helmets as well as more complex equipment like gas monitors, manhole pumps, and retrieval gear.



LIFT RESCUE

20m - 40m

CODE FA 7020120



NEW

SKYLOTEC MILANO

2 Persons
280 Kg Max Working Load

CODE A-029



NEW

ABS PLASTIC STRETCHER

2 Slings
2 Piece

CODE SKUFA24754



FLEXIBLE SKED RESCUE STRETCHER

2435mm x 920mm

CODE DX020



BASKET STRETCHER 2.1M ALLOY

2125mm x 585mm
Slings on request

CODE DX030



FOLDING RESCUE STRETCHER

1925mm x 393mm

CODE DX040



EVE.2 LAD

6m

CODE

FA7002906



EVE.2 LAD + DESCENDER

6m
Integrated belaying System

CODE

FA7002906R





KRATOS SAFETY
 SOLUTIONS FOR LIFE

EVA'LAD 2

Fast Rescue System

FA 70 029 06R



RESPIRATORY

Hazardous conditions can include oxygen deficiency and atmospheric concentrations which make a confined space and immediately dangerous to life and health. This makes proper respiratory protection critical to helping keep workers protected in these environments

HALF / FULL / DISPOSABLE FACE MASKS



3M HALF FACE MASK



3M FULL FACE MASK



DISPOSABLE MASK

CODE

3MHALF

CODE

3MFULL

CODE

FFP2



DISPOSBALE MASK

CODE

FFP3



FILTERS



**GAS AND VAPOUR
COMBINATION FILTERS**

CODE

ABEK1



PARTICULATE FILTER

CODE

P1/2/3



PARTICULATE FILTER

CODE

P2/3R

BREATHING AIR MASK



SCOTT PHANTOM

CODE

PHANTOM



SCOTT PROFLOW

CODE

RFF400

SWISS AIR



Safety never felt so comfortable



Ventilated half mask made of flame-retardant material covers mouth and nose area completely. Positive pressure supports breathing and avoids fatigue.

Infinitely adjustable headband for all sizes from XS to XL.

Y-hose with adjustable neck strap and flexible hose elements guides the air directly into the half mask.

Shoulder harness for ergonomically perfect weight distribution of the super-light filter system (only 550 g).

Powerful TH3 filter unit with innovative, ultra-flat design. Lightweight and comfortable to carry, highly efficient in use.

Blower unit with automatic air flow calibration and Power battery for an uninterrupted working day.

Face Fit Testing



Face Fit testing is a method of ensuring that a facepiece or mask is tight-fitting and seals adequately to the wearer's face. The performance of tight-fitting facepieces depends on achieving continuous contact between the wearer's skin and the seal of the mask

Before The Face Fit Testing Commences

1. Are clean-Shaven for the Face Fit test - this includes any hair growth between the skin and the mask seal
2. Don't smoke or vape, eat, chew gum or drink anything (other than water) for the 30 minutes prior to the test
3. Bring the facepiece, including any filters if used. Trade Safety can supply a mask if not

The Face Fit Test

The test will consist of 7 different exercises, that are simple but will test the mask to make sure there are no leaks present. The test will take 20 minutes in total



A collection of safety equipment including a yellow hard hat, a pair of safety glasses, and a pair of work boots.

SAFETY ACCESSORIES

Confined space equipment is any tool or system that protects, aids or rescues someone who is working inside of a confined space. This can include simple tools like tags, radios, and helmets as well as more complex equipment like gas monitors, manhole pumps, and retrieval gear.



PROTEKT HELMET



FOX SAFETY HELMET



ROTHOBLAAS PROTECTOR HELMET

CODE ATRA40V

CODE HP1020000

CODE PRO



LIFEJACKETS



EXTENDABLE BARRIERS



BARRIER

Available in Red

CODE 165N

CODE BAR1

CODE BAR2



FIRE EXTINGUISHERS



TAG KIT

20 Holders
20 Inserts
40 Cable Ties
2 Mark Pen



TAG

Different Colours Available
Option for Logo Design

CODE

FIREEXT

CODE

TAGKIT1

CODE

TAG1



TAG

Different Colours Available
Option for Logo Design



TAG

Different Colours Available
Option for Logo Design



RETRACTABLE TOOL LANYARD

120mm

CODE

TAG2

CODE

TAG3

CODE

TS9000108



STRETCH LANYARD

14mm



WRISTBAND LANYARD

120mm



**HARNES TOOL HOLFIG
KARABINER**

24mm

CODE TS9000106

CODE TS9000103

CODE TS9000114



EYE PROTECTION



MANHOLE GUARDIAN

CODE EYE1

CODE GUARDIAN



MANHOLE GUARDIAN

Protects open manholes, whilst still allowing full access for the workforce
Designed & Manufactured in the UK

Quick and easy to install



Protects, whilst allowing access to the manhole

- STRONG BUT LIGHT WEIGHT
- QUICK & EASY TO INSTALL & REMOVE
- FITS SQUARE, RECTANGULAR & CIRCULAR MANHOLES
- TESTED & APPROVED BY CERTEX
- UK LTD TO 440kg (PC99)
- CLOSES FOR EASY TRANSPORT



Compact & light weight for easy transportation

- COST EFFECTIVE PROTECTION FOR OPEN MANHOLES
- MANUFACTURED FROM GALVANISED & POWDER COATED STEEL FOR FULL WEATHER PROTECTION
- FULLY ADJUSTABLE, FITS MANHOLES FROM

Adjustable positioning posts to secure Manhole Guardian into place



- 370 TO 900 mm
- PROTECTS THE PUBLIC & YOUR WORKFORCE

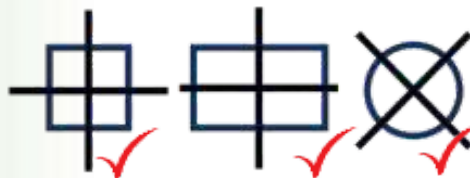

Suitable for Square, Rectangle & Round manholes

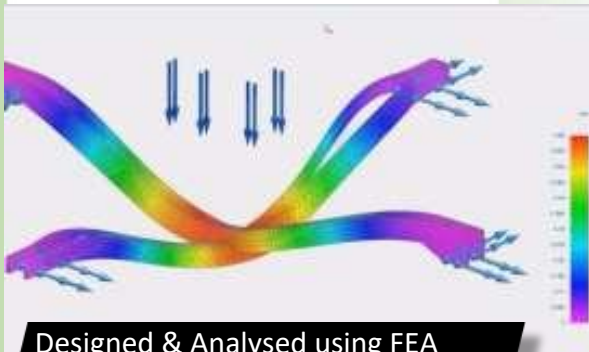

Designed & Analysed using FEA



Designed & Manufactured in the UK



Tested and certified to 440kg



SKYHOOK

The Skyhook is a mobile fall arrest system that provides overhead anchor points anywhere, any time

The Skyhook offers three overhead anchor points and adding an extendable mast that provides one worker overhead tie-off up to 10.4m in height. Both support a maximum anchor capacity of 140kg



X1000

Max. Working Height	6.7m
Min. Working Height	5.2m
Max. Folded Height	2.4m
Frame Width	1.8m
Overall Length	2.9m
Total Weight	998kg
Max. Anchor Point	141kg
Max. Allowable Users	2



X1250

Max. Working Height	10m
Min. Working Height	0.6m
Max. Folded Height	2.6m
Frame Width	1.7m
Overall Length	4.7m
Total Weight	2676kg
Max. Anchor Point	141kg
Max. Allowable Users	3

A green and grey tripod is the central focus, standing on a grey carpeted floor. It has a blue generator attached to its left leg and a black bag hanging from its right leg. The background is a white brick wall with various tools and equipment hanging on it, including a blue ladder on the left and a blue tool on the right.

TRIPODS

One of the main purposes of tripods is to simplify access and escape for workers that are set to operate within hazardous areas



GLOBESTOCK TRIPOD

3 Pulleys
Compact unit also available
136Kg Max Working Load

CODE GSE230S+C



KRATOS TRIPOD

Single Pulley and Double Pulley
available.
7ft,

CODE FA6000100



HONOR TRIPOD

1700cm - 2800cm
2 Person

CODE HONORT



IKAR ALUMINIUM TRIPOD

144cm - 242cm
2 Person

CODE DBA2



TM15 TRIPOD

313cm
3 Person

CODE TM15



PROTEKT LIFTING GOOD TRIPOD

147cm - 229cm
1000kg MWL

CODE TM7-T



PROTEKT SPIDER TRIPOD

189cm - 221cm
2 Person

CODE

TM12



PROTEKT HEXAPOD

139cm - 221cm
2 Person

CODE

TM12-2



G TRIPOD BAG

CODE

GSETB230



TRIPOD BAG

CODE

BAG1



HOLD ALL BAG

CODE

BAG2



WINCHES

Winches are used for safe, easy entry and escape, and they can be used to prevent falling from height. Winches are manually operated and come in various lengths



GLOBESTOCK G WINCH

Available in 20m /40m
Galvanized and Stainless Steel.

CODE **GWINCH**



KRATOS RESCUE WINCH

Safe Working Load - 135kg
20m Available

CODE **FA6000320**



KRATOS PERSONEL WINCH

Personel Lifting Winch
20m Available

CODE **FA6002320**



HONOR PERSONNEL WINCH

15m Available

CODE **MRW**



SALA WINCH

18m/26 Available

CODE **8518560**

A workshop table with various pieces of equipment including a laptop, a gas detector, a breathing apparatus, and other tools. The table is white with a marble top and has several drawers underneath. The background is a brick wall.

SERVICING

We have specialised workshops with qualified technicians to cater for gas detection, breathing apparatus, tripods, winches, fall arrest blocks and much more.

WHAT WE SERVICE

We provide service for a wide range of
Gas Detection, Breathing Apparatus,
Confined Space and Working at Heights
Equipment.

Call us today to book in your service
057 933 0782

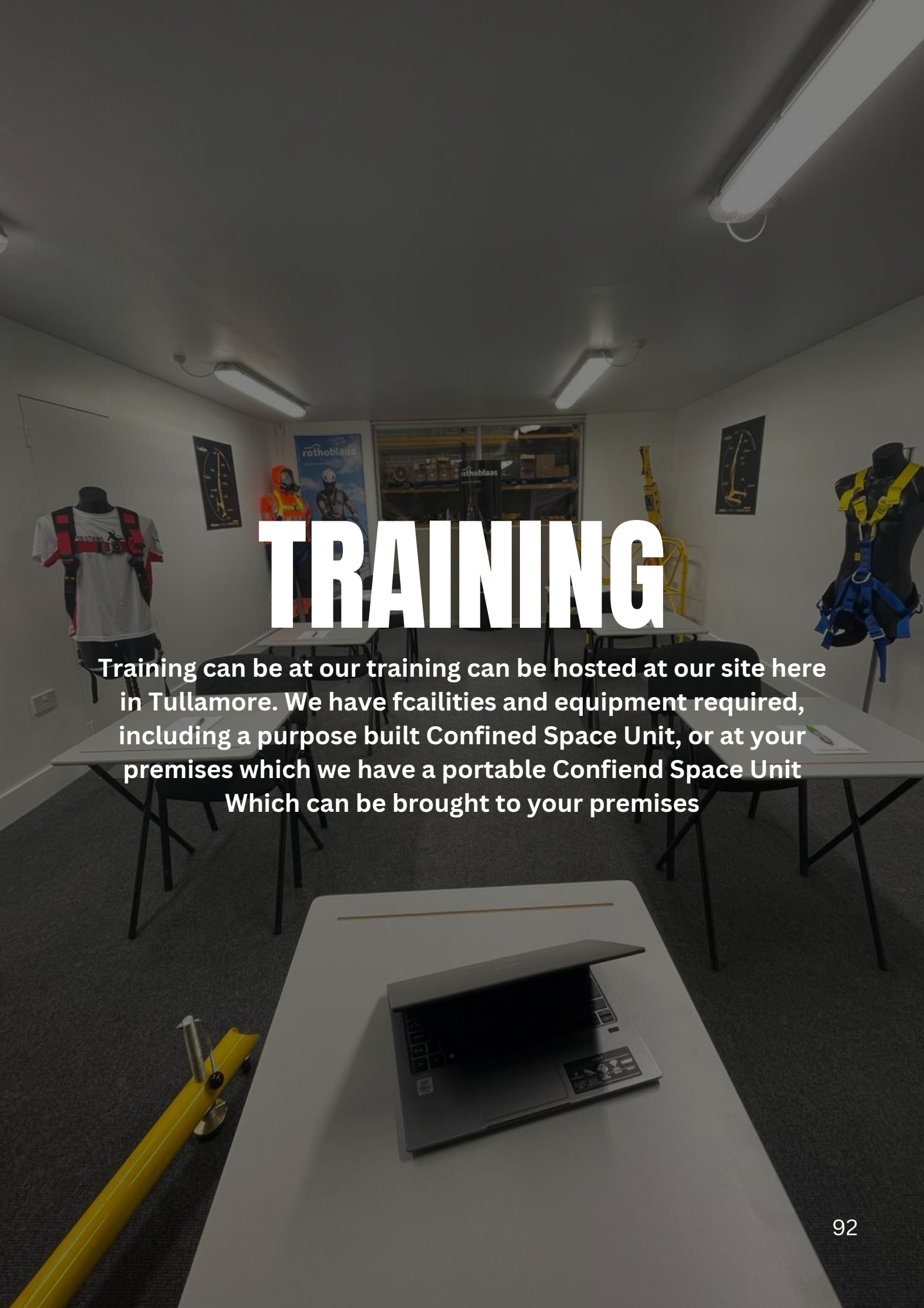

A training room with several white tables and black chairs. On the left, a mannequin wears a red and black safety harness. On the right, another mannequin wears a blue and yellow safety harness. In the background, there are posters on the wall, one of which says 'rothoblaas'. A yellow crane-like structure is visible in the background. In the foreground, a laptop is open on a table. A yellow tool is on the floor in the bottom left corner.

TRAINING

Training can be at our training can be hosted at our site here in Tullamore. We have facilities and equipment required, including a purpose built Confined Space Unit, or at your premises which we have a portable Confined Space Unit Which can be brought to your premises



**CONFINED SPACE
MEDIUM & HIGH RISK**



MANUAL HANDLING



FIRST AID



ABRASIVE WHEELS



WORKING AT HEIGHTS



MEWP



FIRE WARDEN



FIRE EXTINGUISHER

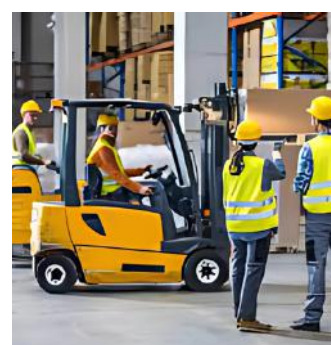

FORKLIFT



EHS



ASBESTOS AWARENESS

Training Room



Training Equipment



Confined Space Training Area



CONSULTANCY

Acting as Health and Safety Coordinator Design &
Construction

Safety Statements

Method Statement

Preliminary Health & Safety Plan

Health & Safety Plan for Construction Stage

Development of a Safety Management Systems

Provision of Site Safety Officers

Provision of Confined Space Rescue Team

Carry out Noise Assessments, Risk Assessments & Safety
Audits

Carry out Ergonomics, VDU & DSE Assessments

Carry out Noise & Dust Monitoring

For further information, please contact info@tradesafety.ie



**Unit 4, Sragh Business Park,
Sragh Avenue,
Tullamore, Co. Offaly
R35 X2N5
www.tradesafety.ie
+353 57 933 0782**

**Unit 9, The Foundry,
Sanda Road,
Belfast,
BT37 9UB,
www.tradesafetyni.com
+44 289 5757 981**