











# 20 24

 **Beta**

# SHOP

*in Shop*



-  Soluzioni espositive per il punto vendita
-  Display solutions for sales points
-  Solutions d'exposition pour le point de vente
-  Soluciones expositivas para el punto de venta
-  Ausstellungslösungen für den Verkaufspunkt
-  Display's VOOR de verkooppunten
-  Rozwiązania wystawiennicze dla punktów sprzedaży
-  Állványok értékesítési helyekre
-  Soluções de expositores para pontos de venda
-  Λύσεις προβολής για σημεία πώλησης

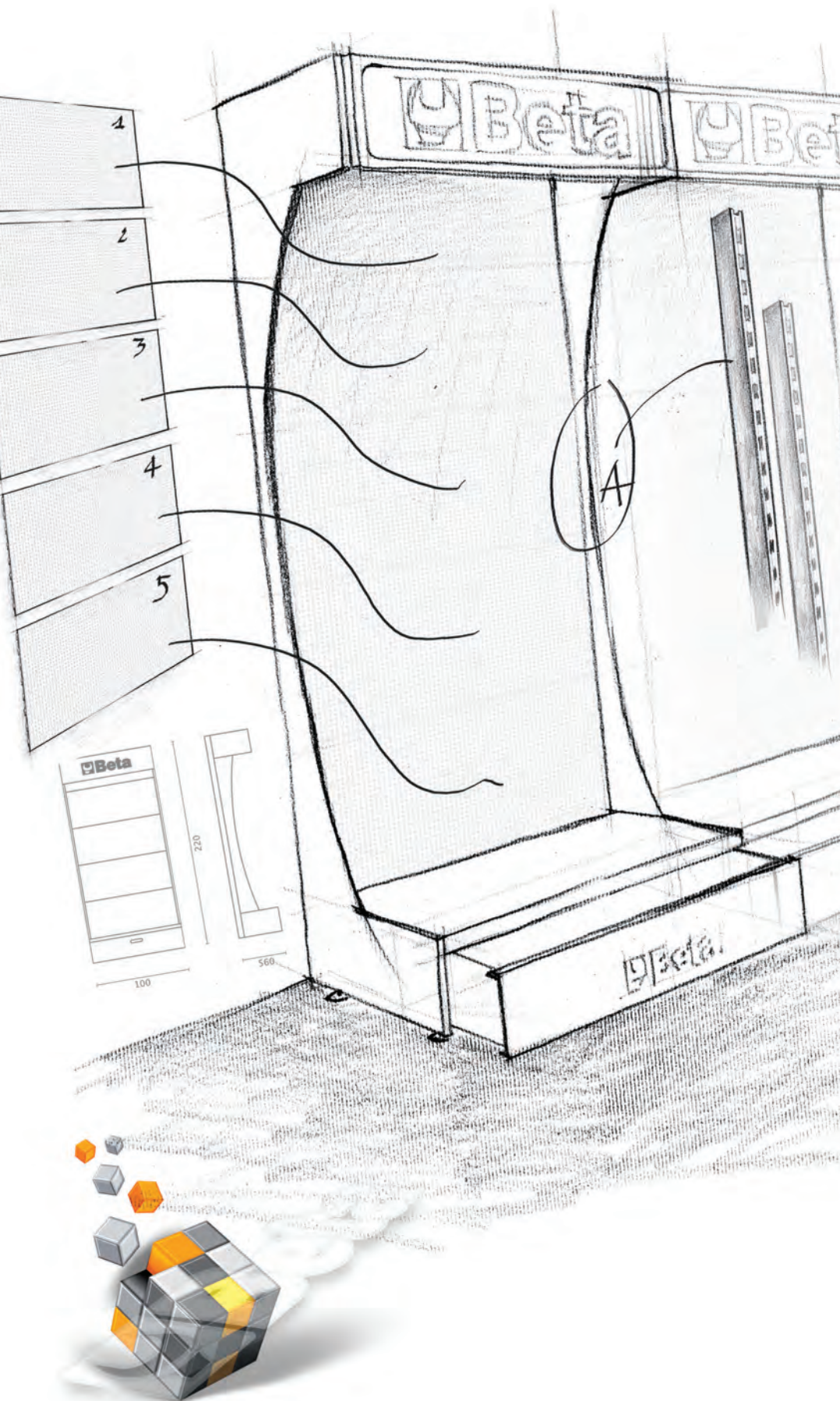

Le immagini riprodotte sono indicative.

Beta Utensili S.p.A. si riserva il diritto di apportare aggiornamenti e migliorie alla propria gamma produttiva senza preavviso.



The pictures are given by way of example.

Beta Utensili reserve the right to update and enhance their product range without notice.



Les renseignements et photos figurant dans ce chapitre sont donnés à titre indicatifs et n'ont aucune valeur contractuelle.

Beta Utensili se réserve le droit de mettre à jour ou d'accroître sa gamme de produits sans préavis, et sans obligation d'effectuer les modifications sur les modèles vendus antérieurement.



Las fotos que se reproducen sirven tan sólo de indicación.

Beta Utensili se reserva el derecho de aportar actualizaciones y mejoras a su gama de productos sin previo aviso.



Die dargestellten Bilder dienen zur Orientierung.

Die Firma Beta Utensili behält sich das Recht vor, ihre Produktpalette ohne Vorankündigung anzupassen oder zu verbessern.



De afbeeldingen dienen uitsluitend als voorbeeld.

Beta utensili behoudt zich het recht voor de producten te wijzigen en te verbeteren zonder voorafgaand bericht.



Zamieszczone zdjęcia narzędzi należy traktować jako przykładowe.

Beta zastrzega sobie prawo do wprowadzania zmian oraz udoskonaleń w swoich produktach bez powiadomienia.



A nyomtatott képek tájékoztató jellegűek. Beta Utensili cég fenntartja magának azt a jogot,

hogy áruválasztékán előzetes bejelentés nélkül változtatást hajtson végre.



Todas as informações e imagens que aparecem neste catálogo são meramente indicativas e sem qualquer valor contratual.

A Beta Utensili reserva-se ao direito de alterar ou actualizar a sua gama de produtos sem aviso prévio, e sem obrigação de efectuar qualquer modificação sobre os modelos vendidos anteriormente.













Οι απεικονίσεις παρατίθενται σαν παράδειγμα.

Η Beta Utensili διατηρεί το δικαίωμα να τροποποιεί και να βελτιώνει την σειρά προϊόντων της χώρας χωρίς άλλη ειδοποίηση.











4

-  Introduzione
-  Introduction
-  Introduction
-  Introducción
-  Einleitung
-  Introductie
-  Wstęp
-  Bevezetés
-  Introdução
-  Εισαγωγή

19

-  Proposte espositive: moduli singoli
-  Display suggestions: individual modules
-  Propositions d'exposition : modules simples
-  Propuestas expositivas: módulos individuales
-  Ausstellungsangebote: Einzelmodule
-  Display suggesties: individuele modules
-  Propozycje ekspozycji - pojedyncze moduły
-  Állvány ajánlatok: egyedi modulok
-  Sugestão de expositores: módulos individuais
-  Προτάσεις προβολής: αυτόνομες μονάδες











105

-  Proposte espositive: espositori completi
-  Display suggestions: complete displays
-  Propositions d'exposition : présentoirs complets
-  Propuestas expositivas: expositores completos
-  Ausstellungsangebote: Komplette Ständer
-  Display suggesties: complete displays
-  Propozycje ekspozycji - kompletne zestawy
-  Állvány ajánlatok: komplett állványok
-  Sugestão de expositores: expositores completos
-  Προτάσεις προβολής: πλήρη εκθετήρια

113

-  Accessori
-  Accessories
-  Accessoires
-  Accesorios
-  Zubehör
-  Accessoires
-  Akcesoria
-  Tartozékok
-  Acessórios
-  Εξαρτήματα

126

-  Strumenti di comunicazione
-  Communication
-  Outils de communication
-  Instrumentos de comunicación
-  Kommunikationsinstrumente
-  Communicatie mediums
-  Środki i pomoce reklamowe
-  Kommunikációs eszközök
-  Meios de comunicação
-  Μέσα προβολής





## **Introduzione**

L'esposizione del prodotto nei punti vendita è l'aspetto strategico per la conoscenza e l'acquisto degli articoli da parte dell'utente finale. Beta Utensili ha da sempre dedicato molte risorse nella ricerca e sviluppo di nuovi supporti e strumenti di comunicazione in grado, non solo di aumentare la visibilità del prodotto e stimolare l'interesse della clientela, ma anche di razionalizzarne e ottimizzarne l'esposizione.

Oggi Beta Utensili introduce un moderno sistema espositivo in linea con le nuove strategie di vendita, in grado di soddisfare le molteplici e differenti necessità dei propri clienti.

I concetti cardine del nuovo sistema espositivo sono:

- **Modularità:** massima flessibilità nella composizione degli assortimenti e dell'area espositiva.
- **Redditività:** assortimenti ad alta rotazione e adeguati alle reali esigenze del mercato.
- **Efficienza espositiva:** organizzazione e ottimizzazione dello spazio di vendita secondo criteri merceologici e di utilizzo.

A completamento del nuovo sistema espositivo, Beta Utensili ha sviluppato una serie completa di strumenti di comunicazione visiva (insegne luminose, banner, pannelli grafici) in grado di personalizzare, identificare ed enfatizzare al meglio i prodotti e l'area Beta.

## **Introduction**

Product displays in sales points play a strategic role: end users directly appreciate and purchase goods on show. Beta Utensili has always invested massively in rationalising and optimising displays, in the research and development of new communication approaches and sales support designed to gain product visibility and encourage/stimulate customer interest.

Beta Utensili today launches a modern display system that satisfies new sales strategies as well as all our customers' various requirements.

The new display system relies on the following quality features:

- **Modularity:** unparalleled flexibility in assembling assortments and in the display area;
- **Cost-effectiveness:** fast-moving products to suit actual market needs;
- **Display efficiency:** sales space organisation and optimisation to meet product visibility and individual needs.

In addition, Beta Utensili supplements the new display system with a wide range of visual communication (luminous signs, banners, graphic panels) designed to effectively customise, identify and emphasise Beta products and area.



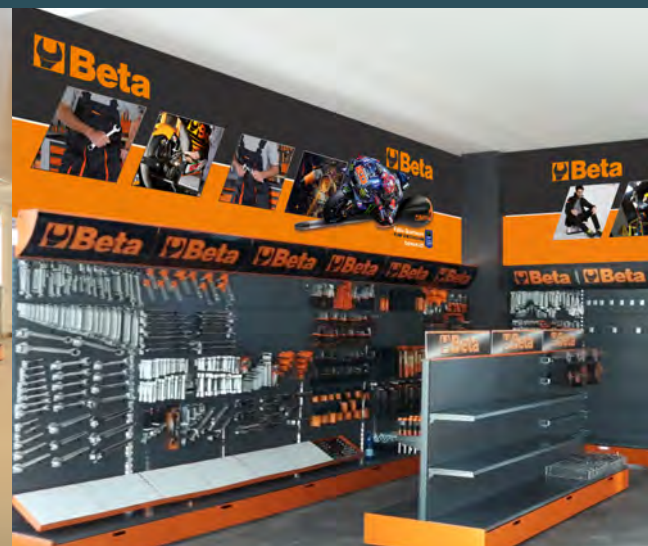

## Introduction

L'exposition du produit dans les points de vente est l'aspect stratégique pour la découverte et l'achat des articles par l'utilisateur final. Beta Utensili a depuis toujours consacré d'importantes ressources pour la recherche et le développement de nouveaux supports et outils de communication capables non seulement d'augmenter la visibilité du produit et de stimuler l'intérêt de la clientèle, mais également d'en rationaliser et d'en optimiser l'exposition.

Aujourd'hui Beta Utensili présente un système d'exposition moderne parfaitement aligné aux nouvelles stratégies de vente qui est à même de répondre aux exigences nombreuses et variées de sa clientèle. Les concepts clés du nouveau système d'exposition sont les suivants :

- **Modularité** : flexibilité maximale dans la constitution des compositions et de l'espace d'exposition
- **Rentabilité** : compositions constamment renouvelées et adaptées aux exigences réelles du marché
- **Efficacité d'exposition** : organisation et optimisation de l'espace de vente en fonction des critères commerciaux et d'utilisation.

Pour compléter son nouveau système d'exposition, Beta Utensili a mis au point une série complète d'outils de communication visuelle (enseignes lumineuses, bannières, panneaux graphiques) pour personnaliser, identifier et mettre en valeur au mieux les produits et l'espace Beta.

## Introducción

La exposición del producto en el punto de venta es el aspecto clave para el conocimiento y la compra de los artículos por parte del usuario final. Beta Utensili siempre ha dedicado recursos importantes a la investigación y desarrollo de nuevos soportes e instrumentos de comunicación capaces no sólo de aumentar la visibilidad del producto y estimular el interés de la clientela, sino también de racionalizar y optimizar su exposición.

Hoy Beta Utensili introduce un moderno sistema expositivo consecuente con sus nuevas estrategias de ventas, capaz de atender el sinfín de necesidades diferentes de sus clientes.

Los conceptos básicos del nuevo sistema expositivo son:

- **Modularidad**: máxima flexibilidad en la composición de los surtidos y del área expositiva.
- **Rentabilidad**: surtidos de alta rotación y adecuados para atender las necesidades reales del mercado.
- **Eficiencia expositiva**: organización y optimización del espacio de ventas conforme a criterios de mercancía y utilización.

Para completar su nuevo sistema expositivo, Beta Utensili ha desarrollado una serie completa de instrumentos de comunicación visual (rótulos, letreros luminosos, banners, paneles gráficos) capaces de personalizar, identificar y resaltar perfectamente los productos y el área Beta.





## Einleitung

Die Ausstellung des Produkts in den Verkaufspunkten repräsentiert einen strategischen Aspekt hinsichtlich Bekanntmachung und Kauf der einzelnen Artikel durch den Endkunden. Beta Utensili hat immer viele Ressourcen für die Erforschung und Entwicklung neuer Kommunikationsträger und -systeme, die nicht nur die Produktsichtbarkeit verbessern, sondern auch die Ausstellung an sich rationalisieren und optimieren, aufgebracht. Nun führt Beta Utensili ein modernes und auf die neuen Verkaufsstrategien abgestimmtes Ausstellungssystem ein, das den zahlreichen und unterschiedlichen Kundenansprüchen bestens entspricht. Die Angelpunkte des neuen Ausstellungssystems sind:

- **Modularität:** maximale Flexibilität bei der Zusammensetzung der Sortimente und des Ausstellungsbereichs.
- **Rentabilität:** hoher Umschlag des Sortiments in Übereinstimmung mit den realen Marktanforderungen.
- **Ausstellungseffizienz:** Organisation und Optimierung des Verkaufsraums nach Waren- und Nutzungskriterien.

Zur Vervollständigung des Ausstellungssystems hat Beta Utensili eine vollständige Serie an visuellen Kommunikationsinstrumenten (Leuchtschilder, Banner, Grafik-Paneele) entwickelt, mit deren Hilfe die Produkte und der Bereich Beta personalisiert, identifiziert und hervorgehoben werden.

## Introductie

Product displays spelen een grote strategische rol bij de verkooppunten. Ze zorgen ervoor dat de klant bekend wordt met de identiteit van Beta en geven een impuls tot aanschaf van Beta producten. Wij van Beta, blijven daarom zwaar investeren op het gebied van innovatieve communicatiemediums om de klant zoveel mogelijk te informeren over de kwaliteit en diversiteit van onze producten en optimalisatie van de displays.

We zijn daarom ook trots dat we u een nieuw display systeem kunnen presenteren dat nieuwe verkoop strategieën toepast en voldoet aan de meest uiteenlopende eisen van het verkooppunt. Het nieuwe display systeem heeft de volgende kenmerken als basis:

- **Modulair:** ongekende flexibiliteit in de zowel de assortimenten als de displays zelf;
- **Kosten effectiviteit:** snel lopende producten die voldoen aan de vraag uit de markt;
- **Display effectiviteit:** organisatie en optimalisatie van de verkoopruimte naar product en gebruikswijze.

Als toevoeging, hebben wij van Beta het nieuwe display systeem aangevuld met een uitgebreid assortiment van visuele communicatie mediums (wand lampen, banners en grafische panelen) om de klanten zo goed mogelijk te informeren over de identiteit en kwaliteit van Beta.





## Wstęp

Sposób eksponowania produktów w punktach sprzedaży odgrywa bardzo ważną rolę podczas zapoznawania użytkowników z ofertą i zachęcania ich do nabycia towarów. Beta Utensili zawsze dążyła do ulepszania i racjonalizacji regałów wystawienniczych oraz angażowała się w badania i rozwój nowych środków i pomocy reklamowych w celu uzyskania jak największej widoczności produktów służącej zwiększaniu zainteresowania klientów.

Beta Utensili wprowadza obecnie nowoczesny system wystawienniczy dopasowany do najnowszych strategii sprzedaży i zdolny spełnić różnorodne wymagania klientów.

Nowy system wystawiennictwa oparty jest na następujących oryginalnych cechach:

- **Modułowość:** niezrównana elastyczność zarówno w zakresie wyboru towarów jak i układu ekspozycji;
- **Oszczędność:** towary szybko rotujące odpowiadające bieżącym potrzebom rynku;
- **Wydajność:** organizowanie i optymalizacja powierzchni handlowej według kryteriów użytkowych z uwzględnieniem specyfiki poszczególnych towarów.

Dodatkowo Beta Utensili zaopatrzyła nowy system wystawienniczy w pełny zakres wizualnych środków reklamowych (podświetlane szyldy, banery, panele graficzne) o dużej przystosowalności montażowej przeznaczonych do identyfikacji i zwracania uwagi na produkty Bety i ich powierzchnie wystawiennicze.

## Bevezetés

A termékek bemutatása az értékesítési helyeken azt a stratégiát képviseli, melynek célja a termékek közvetlen ismertetése és értékesítése a végfelhasználók számára. Beta Utensili folyamatosan újításokat kezdeményez a kommunikációs hordozók és rendszer, valamint annak fejlesztése érdekében, mivel ezzel nemcsak a termékek megismertetését segíti elő, hanem a bemutatást is racionalizálja és optimalizálja. Beta Utensili modern és új eladási stratégiát dolgozott ki a bemutató rendszert illetően, mely a különböző vevők eltérő igényeinek maximálisan megfelel.

A bemutató rendszerek fő jellemzői:

- **Alkalmazkodási képesség:** maximális rugalmasság a bemutatott választék/terület arányának kialakításánál.
- **Gazdaságosság:** a választék gyors változtatása a tényleges piaci igényeknek megfelelően.
- **A bemutatás hatékonysága:** Az eladótér berendezéseinek optimalizálása az áru/felhasználási terület szerint.

A bemutató rendszer kiegészítésére a Beta Utensili a vizuális kommunikációs eszközök teljes skáláját (fényreklám, zászlók, grafikák, panelek) fejlesztette ki, melyek segítségével a termékek azonnal a Beta márkánévvel azonosulnak.





## **Introdução**

A disposição de produtos nos postos de venda é uma estratégia fundamental para os utilizadores finais se familiarizarem com os produtos e assim os adquirirem. Nós, Beta Utensili, investimos maciçamente na pesquisa e desenvolvimento de novos meios de promoção e de novos projectos que aumentem a visibilidade dos produtos de forma a encorajar o interesse dos clientes, racionalizando e optimizando os expositores. Nós, Beta Utensili, procedemos com agrado ao lançamento de um novo e moderno sistema de expositores para uma nova estratégia de vendas, capaz de satisfazer as mais diversas exigências dos nossos clientes.

O novo sistema de expositores tem as seguintes imagens de marca:

- **Modularidade:** flexibilidade inigualável em jogos de ferramentas e área de exposição;
- **Rentabilidade:** produtos de elevada rotatividade para responderem às necessidades do mercado;
- **Exposição eficiente:** organizando e optimizando espaços de venda de acordo com os produtos e critérios de utilização.

Adicionalmente, nós, Beta Utensili, completamos os novos sistemas de expositores com uma polivalente gama de meios visuais (sinais luminosos, banners, painéis gráficos) projectados para efectivamente personalizar, identificar e realçar a área e os produtos Beta.

## **ΕΙΣΑΓΩΓΗ**

Τα εκθετήρια προϊόντων στα σημεία πώλησης παίζουν στρατηγικό ρόλο αν θέλουμε οι τελικοί χρήστες να γνωρίσουν και να αγοράζουν κάποιο προϊόν. Στην Beta Utensili ανέκαθεν επενδύαμε έντονα στην έρευνα και ανάπτυξη νέων μέσων προβολής και βοηθημάτων, με στόχο να κάνουμε γνωστά τα προϊόντα και να προσελκύσουμε το ενδιαφέρον της πελατειακής βάσης, προσπαθώντας ταυτόχρονα να εκλογικεύουμε και να βελτιστοποιούμε τα εκθετήρια. Εμείς στην Beta Utensili είμαστε τώρα στην ευχάριστη θέση να παρουσιάσουμε ένα νέο, μοντέρνο σύστημα εκθετηρίων προσαρμοσμένο σε σύγχρονες στρατηγικές πώλησης και ικανό να καλύψει τις διαφοροποιημένες απαιτήσεις των πελατών μας.

Το νέο σύστημα εκθετηρίων προσφέρει τα παρακάτω πλεονεκτήματα:

- **Ευελιξία:** απaráμιλλη ευελιξία σε συλλογές αλλά και σε επιφάνεια παρουσίασης
- **Οικονομική αποδοτικότητα:** προϊόντα με μεγάλη κινητικότητα που συμβαδίζουν με τις ανάγκες τις αγοράς
- **Προβολή:** οργάνωση και βέλτιστη εκμετάλλευση του χώρου των πωλήσεων με κριτήρια βασισμένα στο ποιόν και τη χρήση του

Επιπλέον, εμείς στην Beta Utensili συμπληρώσαμε το νέο σύστημα εκθετηρίων με μια περιεκτική σειρά μέσων οπτικής προβολής (φωτεινές επιγραφές, πανό, πινακίδες με γραφικά) σχεδιασμένα να ξεχωρίζουν και να τονίζουν τα προϊόντα Beta μέσα στο χώρο του κάθε πελάτη.





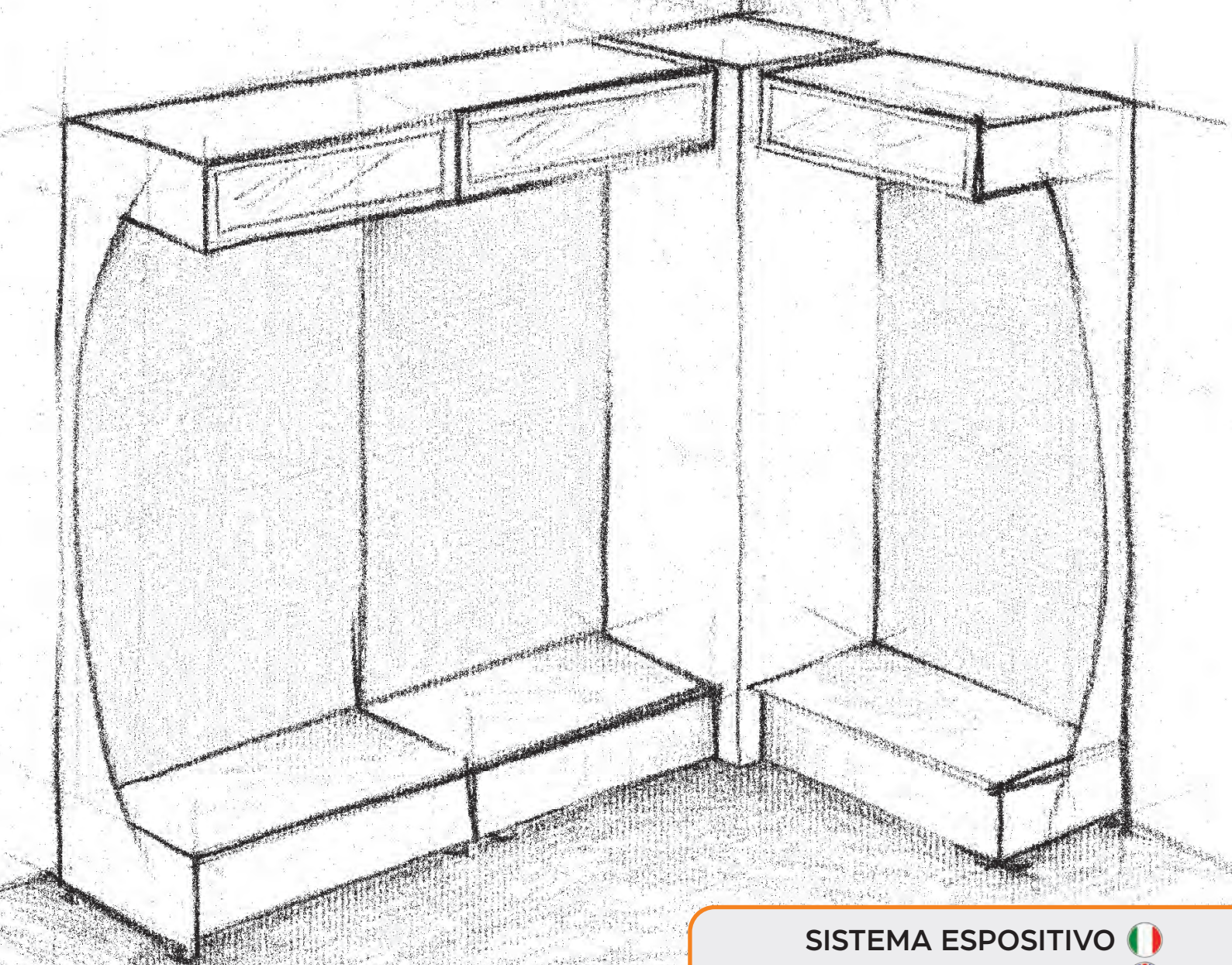

- SISTEMA ESPOSITIVO 
- DISPLAY SYSTEM 
- SYSTÈME D'EXPOSITION 
- SISTEMA EXPOSITIVO 
- AUSSTELLUNGSSYSTEM 
- DISPLAY SYSTEEM 
- SYSTEM WYSTAWIENNICZY 
- BEMUTATÓ RENDSZER 
- SISTEMA DE EXPOSITORES 
- ΣΥΣΤΗΜΑ ΕΚΘΕΤΗΡΙΩΝ 



 **SISTEMA ESPOSITIVO**

La nuova struttura è costituita da diversi elementi (montanti, pannelli, basamento) studiati e realizzati secondo gli standard attualmente applicati nei negozi di utensileria/ferramenta. Ne risulta un sistema pratico e funzionale in grado di adattarsi a qualsiasi esigenza espositiva. La struttura è autoportante e non richiede fissaggio a parete. Ogni componente evidenzia colori ed elementi caratteristici in grado di enfatizzare l'immagine Beta. Nove diversi ganci, progettati appositamente, permettono di esporre in maniera pratica e razionale tutti i prodotti Beta.

 **DISPLAY SYSTEM**

The new system is composed of several different parts (uprights, panels, base) designed and built according to the standards currently applied to tool/hardware shops. The result is a both practical and functional system that can adapt to any display requirement. The frame is self-supporting therefore does not have to be fixed to the wall. Each part displays typical colours and features designed to emphasise Beta image. Nine different specially designed hooks ensure a practical, rational display of all of Beta products.

 **SYSTÈME D'EXPOSITION**

Cette nouvelle structure est constituée de plusieurs éléments (montants, panneaux, base) conçus et réalisés selon les standards actuellement adoptés dans les magasins d'outillage/quincaillerie. Ce système pratique et fonctionnel répond parfaitement à toutes les exigences d'exposition. Cette structure est autoportante et ne nécessite aucune fixation au mur. Chaque composant souligne des couleurs et des éléments caractéristiques qui permettent de renforcer l'image Beta. Neuf différents crochets de conception spéciale permettent d'exposer de façon pratique et rationnelle tous les produits Beta.

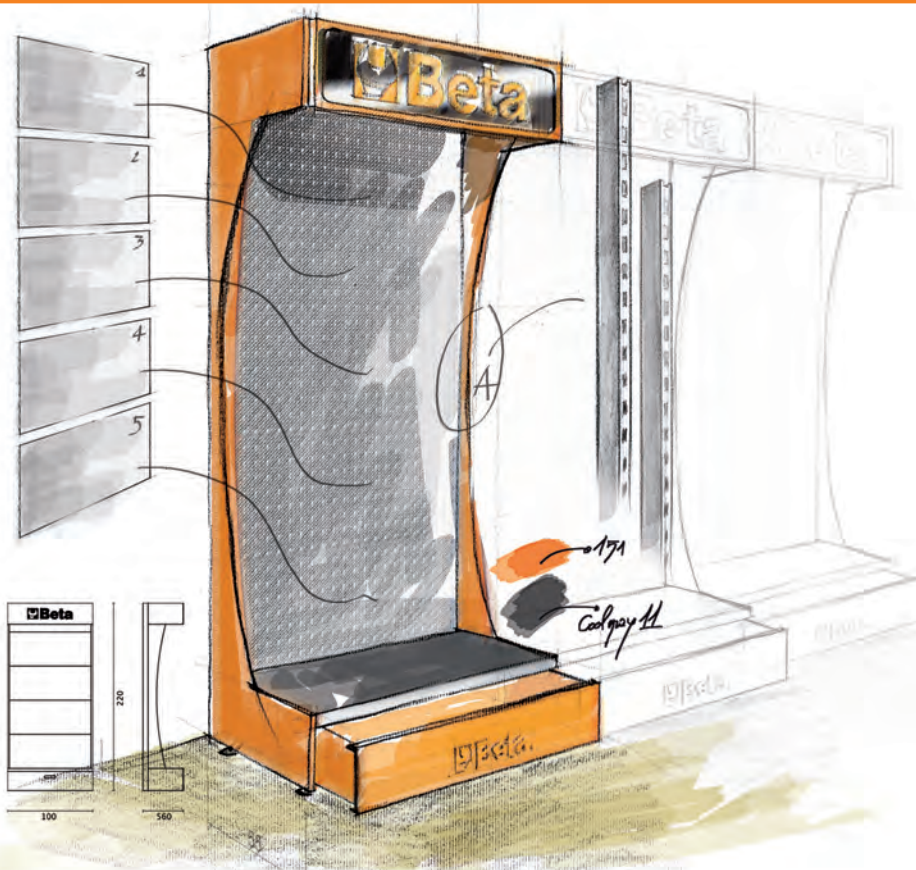

 **SISTEMA EXPOSITIVO**

La nueva estructura se compone de diferentes elementos (montantes, paneles, base) estudiados y realizados conforme a los estándares actualmente aplicados en las tiendas de herramientas/ferretería. De ello se desprende un sistema práctico y funcional capaz de adaptarse a cualquier necesidad expositiva. La estructura es autoportante y no precisa de fijación en la pared. Cada componente destaca colores y elementos característicos capaces de resaltar la imagen Beta. Nueve ganchos diferentes, diseñados especialmente, permiten exponer de manera práctica y racional todos los productos Beta.

 **AUSSTELLUNGSSYSTEM**

Die neue Struktur setzt sich aus verschiedenen Elementen (Ständer, Paneel, Grundgestell) zusammen, die auf der Grundlage der derzeit von Eisenwaren- und Werkzeuggeschäften angewendeten Standards entwickelt und hergestellt wurden. Die selbsttragende Struktur bedarf keiner Wandbefestigung. Jede Komponente hebt zur Unterstreichung des Images Beta charakteristische Farben und Elemente hervor. Neun unterschiedliche und eigens entwickelte Haken garantieren eine praktische und rationale Ausstellung aller Produkte Beta.

 **DISPLAY SYSTEEM**

Het display systeem bestaat uit verschillende onderdelen (Basis frame, panelen en zijwanden). Het is gebaseerd op de standaard die momenteel wordt gebruikt in de gereedschap/ijszwaren zaken. Het display systeem is dus zowel praktisch als functioneel en voldoet aan alle eisen. Het display systeem is zelfdragend en hoeft dus niet vast gezet te worden aan een muur. Elk onderdeel bevat de typische kleuren van Beta's identiteit. Negen verschillende unieke haken zorgen voor een praktische en functionele indeling van alle Beta producten.



 **SYSTEM WYSTAWIENNICZY**

Nowy system wystawienniczy składa się z wielu części (wsporniki pionowe, panele, podstawy) zaprojektowanych i wytworzonych wg aktualnych standardów stosowanych w sklepach narzędziowych, dzięki czemu jest praktyczny i wyróżnia się pod względem funkcjonalnym, zaspakajając wszelkie wymagania w zakresie wystawiennictwa. Samonośna rama nie wymaga zamocowania do ściany. Każda część posiada charakterystyczne kolory i oznaczenia podkreślające wizerunek firmy Beta. Dziewięć różnych, specjalnie zaprojektowanych haków pozwala na sprawne i racjonalne prezentowanie towarów Bety.

 **BEMUTATÓ RENDSZER**

Az új struktúra felöleli a különböző elemeket (állványok, panelek, alapállvány), melyeket jelenleg a vasáru- és szerszámüzletekben található standard alapján fejlesztettek ki és gyártottak le. Az önhordó szerkezetnél a falhoz való rögzítés nem szükséges. Minden egyes alkotó elem a Beta image-t hangsúlyozza a jellegzetes színekkel és elemekkel. Új, különböző és külön erre a célra fejlesztett szerelvények garantálják a Beta valamennyi termékének praktikus és racionális bemutatását.

 **SISTEMA DE EXPOSITORES**

O novo sistema é composto por várias partes diferentes (colunas, painéis, base) projectado e construído de acordo com os padrões actuais requeridos pelas lojas de ferramentas. Assim salienta-se as suas formas práticas e funcionais que respondem a qualquer exigência de exposição. A estrutura de apoio não tem que ser fixada à parede. Cada parte do expositor tem cores e formas que realçam a imagem Beta. Nove tipos de ganchos diferentes especialmente projectados, asseguram uma exposição de todos os produtos Beta de forma prática e racional.

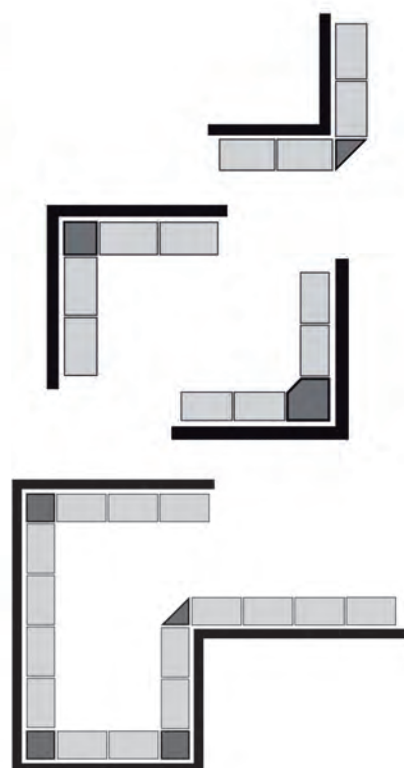
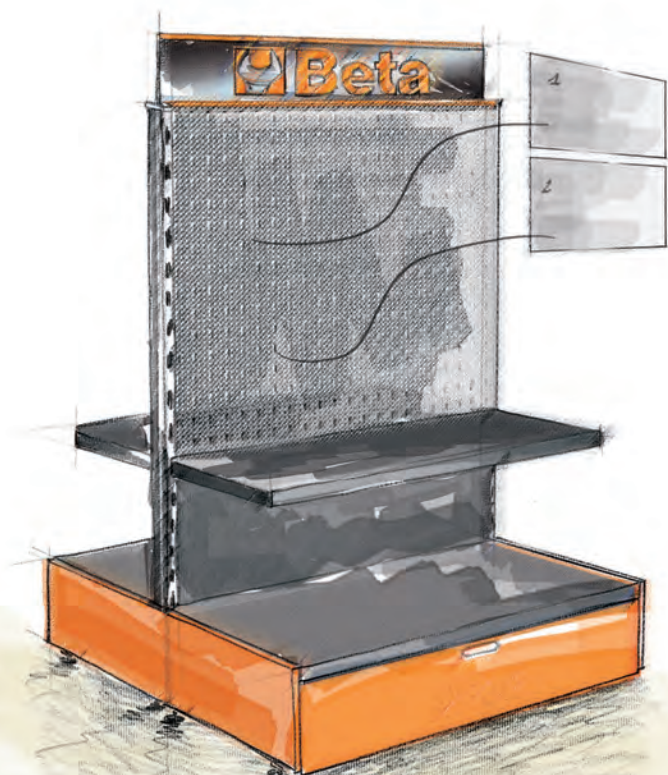

 **ΣΥΣΤΗΜΑ ΕΚΘΕΤΗΡΙΩΝ**

Το νέο σύστημα απαρτίζεται από αρκετά διαφορετικά κομμάτια (όρθια, πίνακες, βάση) σχεδιασμένα και κατασκευασμένα σύμφωνα με τα πρότυπα που επικρατούν σήμερα στα καταστήματα εργαλείων/σιδηρικών. Έτσι, είναι πρακτικά και συγχρόνως λειτουργικά, ικανοποιώντας οποιαδήποτε ανάγκη παρουσίασης. Ο αυτοφερόμενος σκελετός δεν χρειάζεται να στερεωθεί σε τείχος. Κάθε κομμάτι παρουσιάζει χαρακτηριστικά χρώματα και αντικείμενα με στόχο την προβολή της εικόνας Beta. Εννέα διαφορετικά, ειδικά σχεδιασμένα στηρίγματα/γάντζοι βοηθάνε σε πρακτική και εκλογικευμένη παρουσίαση όλων των προϊόντων Beta.

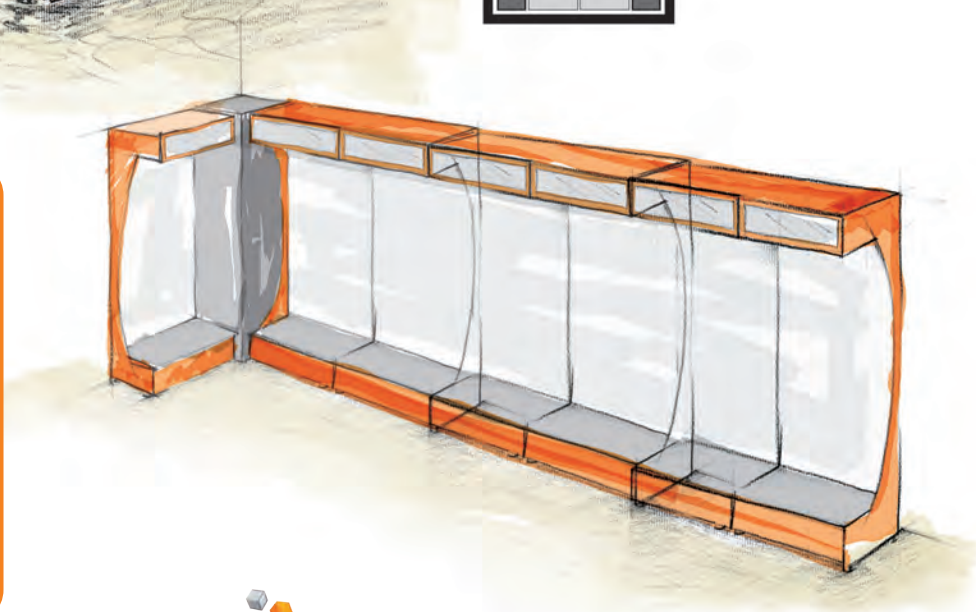

# C68 / C68N

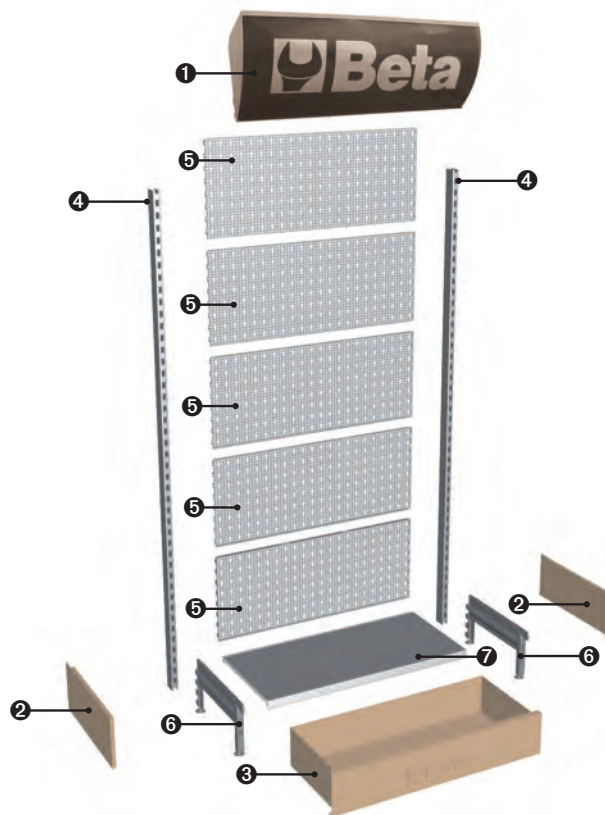
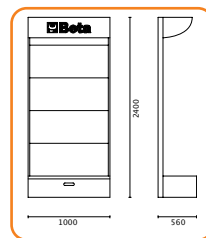
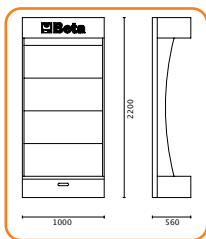
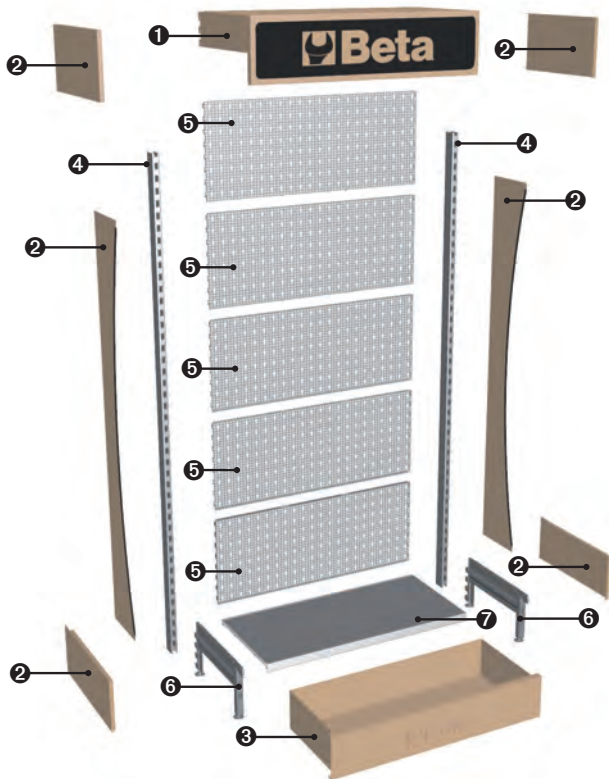

## Espositore a parete

- 1 Insegna luminosa
- 2 Spalle
- 3 Cassetto base
- 4 Montante
- 5 Modulo espositivo
- 6 Piede base
- 7 Ripiano base



## Wall display

- 1 Luminous sign
- 2 Side panels
- 3 Base drawer
- 4 Upright
- 5 Display module
- 6 Support
- 7 Base shelf



## Présentoir mural

- 1 Enseigne lumineuse
- 2 Flancs
- 3 Tiroir de base
- 4 Montant
- 5 Module d'exposition
- 6 Piètement
- 7 Étagère de base



## Expositor de pared

- 1 Letrero luminoso
- 2 Laterales
- 3 Cajón base
- 4 Montante
- 5 Módulo expositivo
- 6 Pie base
- 7 Estante base



## Wandständer

- 1 Leuchtschild
- 2 Seitenteile
- 3 Basiskasten
- 4 Ständer
- 5 Ausstellungsmodul
- 6 Basisfuß
- 7 Basisbord



## Muur display

- 1 Lichtbak
- 2 Zij panelen
- 3 Vloer lade
- 4 Verticale paneelhouder
- 5 Wand paneel
- 6 Voeten
- 7 Bodem plank



## Regał przyścienny

- 1 Sztyld z logo podświetlany
- 2 Osłony boczne
- 3 Szuflada w podstawie
- 4 Wspornik pionowy
- 5 Panel wystawienniczy
- 6 Wspornik podstawy
- 7 Półka dolna



## Faliállvány

- 1 Világítótest
- 2 Oldal panelek
- 3 Basis fiókok
- 4 Állványok
- 5 Bemutató modulok
- 6 Basis lábazat
- 7 Basis fedlap



## Expositor de parete

- 1 Sinal luminos
- 2 Painéis laterais
- 3 Base com gaveta
- 4 Coluna
- 5 Módulo expositor
- 6 Suporte
- 7 Estante base



## Εκθετήριο τοίχου

- 1 Φωτεινή επιγραφή
- 2 Πλευρικά
- 3 Συρτάρι βάσης
- 4 Κατακόρυφο
- 5 Εκθετήριο
- 6 Στήριγμα
- 7 Ράφι βάσης

# C68 G

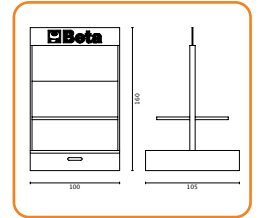
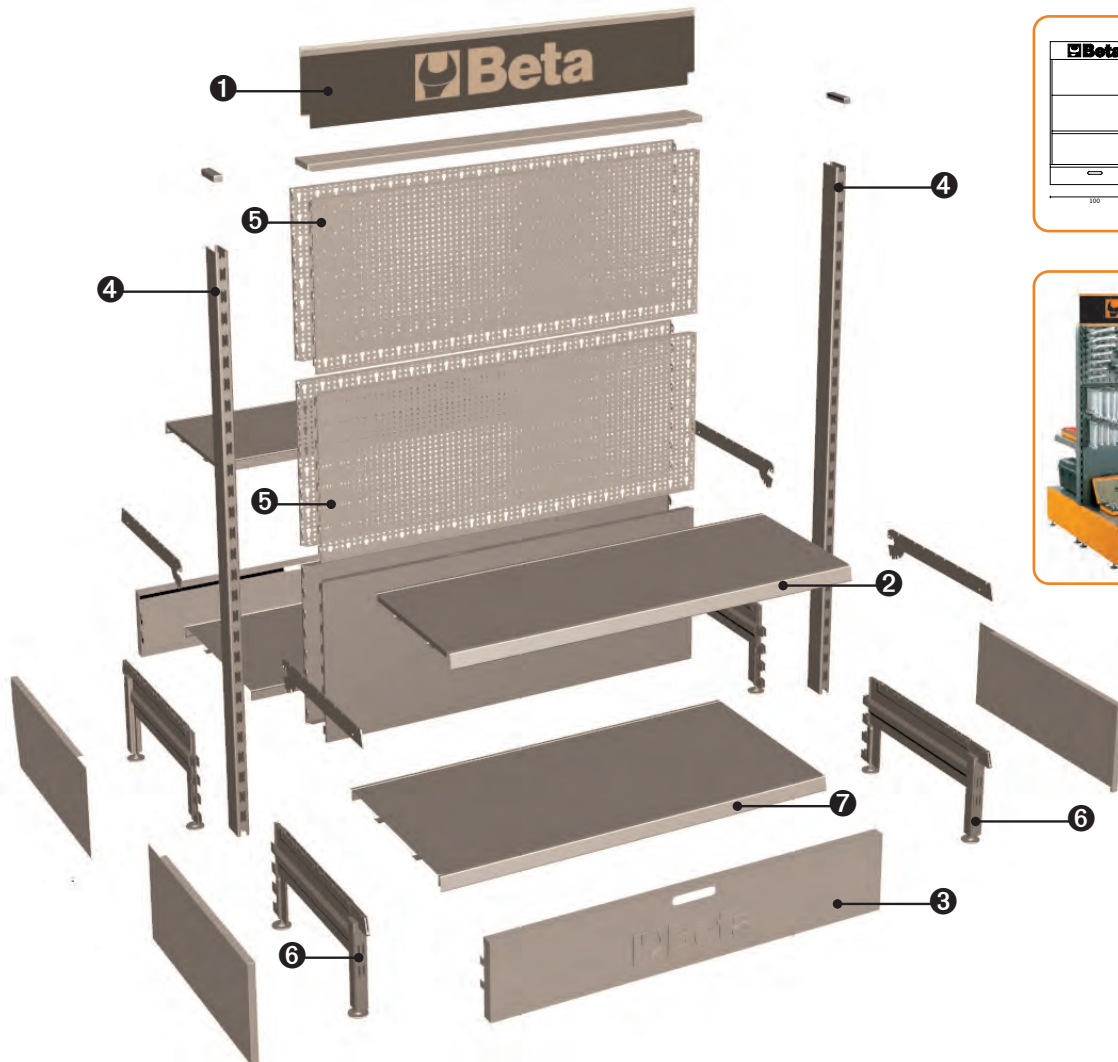

## Espositore gondola

- 1 Crowner bifacciale
- 2 Ripiano parete
- 3 Frontalino base
- 4 Montante
- 5 Modulo espositivo
- 6 Piede base
- 7 Ripiano base



## Gondola display

- 1 Double-faced crowner
- 2 Wall shelf
- 3 Base front
- 4 Upright
- 5 Display module
- 6 Support
- 7 Base shelf



## Présentoir gondole

- 1 Crowner double face
- 2 Étagère murale
- 3 Façade de base
- 4 Montant
- 5 Module d'exposition
- 6 Piètement
- 7 Étagère de base



## Expositor gondola

- 1 Crowner bifacial
- 2 Estante de pared
- 3 Carátula base
- 4 Montante
- 5 Módulo expositivo
- 6 Pie base
- 7 Estante base



## Gondelaussteller

- 1 Doppelseitiger Crowner
- 2 Wandbord
- 3 Basis-Stirnteil
- 4 Ständer
- 5 Ausstellungsmodul
- 6 Basisfuß
- 7 Basisbord



## "Gondel" vloer display

- 1 Top indicatie
- 2 Achterpaneel
- 3 Plank
- 4 Ständer
- 5 Ausstellungsmodul
- 6 Basisfuß
- 7 Basisbord



## Regał wolnostojący

- 1 Szyld dwustronny z logo
- 2 Półka wisząca
- 3 Osłona przednia podstawy
- 4 Wspornik pionowy
- 5 Panel wystawienniczy
- 6 Wspornik podstawy
- 7 Półka dolna



## Bemutató gondola

- 1 Kétoldalt polc
- 2 Fali fedlap
- 3 Basis-homlokfal
- 4 Állványok
- 5 Bemutató modulok
- 6 Basis lábazat
- 7 Basis fedlap



## Expositor gondola

- 1 Painel de dupla face
- 2 Estante de parede
- 3 Base frontal
- 4 Coluna
- 5 Módulo expositor
- 6 Suporte
- 7 Estante base



## Εκθετήριο Γόνδολα

- 1 Πινακίδα διπλής όψης
- 2 Ράφι τοίχου
- 3 Μπροστινή βάση
- 4 Κατακόρυφο
- 5 Εκθετήριο
- 6 Στήριγμα
- 7 Ράφι Βάσης

# C64



Espositore per abbigliamento con predisposizione per calzature



Workwear and safety shoes display



Présentoir pour vêtements et chaussures



Expositor para prendas con predisposición para calzado



Kleider- und Schuhständer

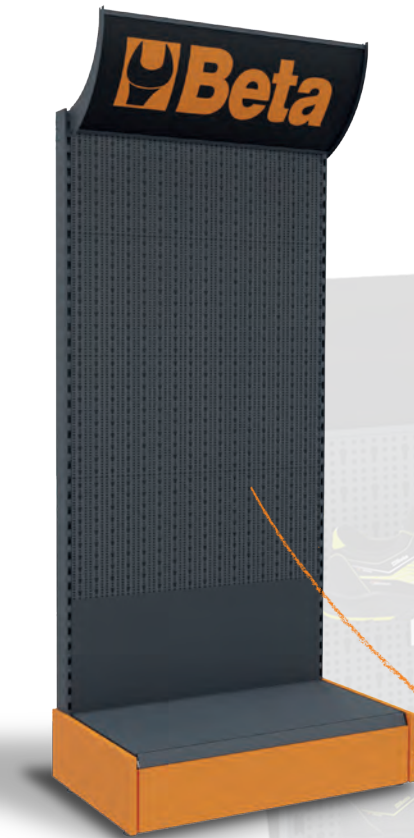

2500 mm  
560 mm  
1000 mm



## C64

064000021	1 m
064000022	2 m
064000023	3 m
064000024	4 m

**Beta**

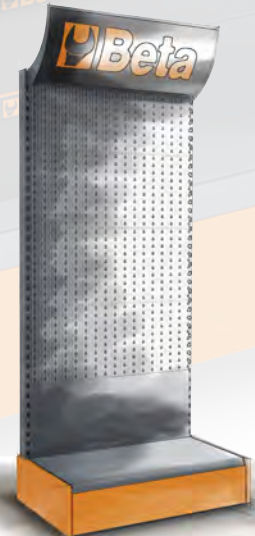

# C64G



Werkkleding en  
veiligheidsschoenen  
display



Regał wystawienny  
na buty i ubrania



Munkaruha és  
védőcipő bemutatófal



Expositor de roupa e  
calçado de segurança



Εκθετήριο δαπέδου  
για ρούχα εργασίας  
και υποδήματα  
ασφαλείας

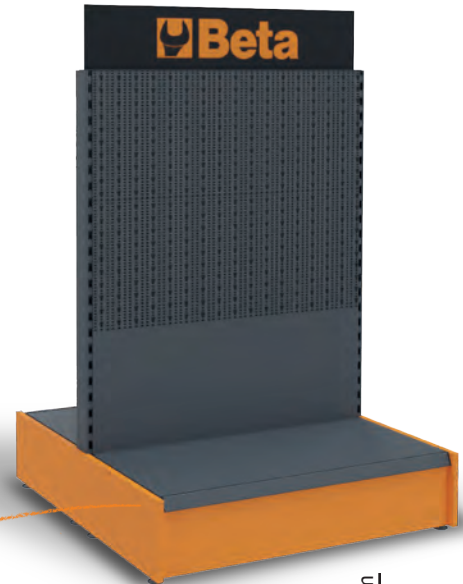

1600 mm  
1200 mm  
1000 mm

## C64G

064000051  
064000052

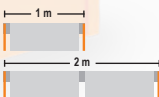

**Beta**



## C62M/WW

062000362



-  Espositore a manichino
-  Mannequin
-  Présentoir mannequin
-  Expositor maniquí
-  Kleiderständer
-  Werkkleding display
-  Manekin postaciowy
-  Állvány ruhák részére
-  Manequim
-  Mavekév



185 cm

## C62EVC/IT

062000210

-  Espositore durevole da terra con predisposizione per calzature
-  Safety shoes floor display

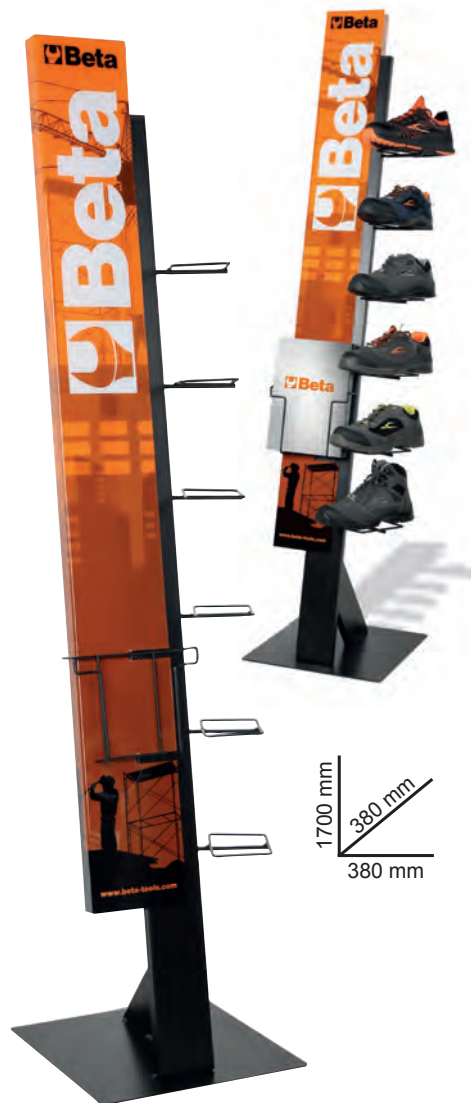

## C64CW

064000610

-  Espositore a manichino
-  Mannequin
-  Présentoir mannequin
-  Expositor maniquí
-  Kleiderständer
-  Werkkleding display
-  Manekin postaciowy
-  Állvány ruhák részére
-  Manequim
-  Mavekév













1000x2100x1070 mm



## 9562TB

095620500











-  Tappeto prova calzature
-  Mat for trying on shoes
-  Tapis pour essuyage chaussures
-  Alfombra prueba calzado
-  Schuhanprobe-Teppich
-  Vloermat voor het passen van schoenen
-  Mata do przymierzania butów
-  SZÖNYEG
-  Tapete de teste de calçados
-  Ταπί για δοκιμή υποδημάτων



800x600 mm

## 9565S

095650300











-  Seduta in lamiera
-  Sheet steel
-  Fût en tôle d'acier
-  Barril en chapa de acero
-  Stahlblechtonne
-  Plaatstalen vat
-  Taboret z beczki
-  LEMEZACÉL HORDÓSZÉK KIVEHETŐ
-  Tambor em chapa de aço
-  Χαλύβδινο βαρέλι



h600 mm Ø 380 mm

## 9565K

095650500

-  Tavolo 9565T con due sedute 9565S
-  Drum table with two seats
-  Table fût avec deux assises
-  Barril mesa con dos asientos
-  Tonnentisch mit zwei Sitzplätzen
-  Vat tafel met twee krukjes
-  Stół z dwoma taboretami
-  Hordóasztal két székkal
-  Mesa bidão com dois assentos
-  Τραπέζι και δύο θέσεις











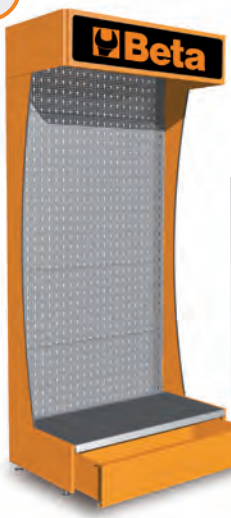

9565T  
h 95 → 108 cm - Ø 70 cm

9565S  
h 60 cm - Ø 38 cm



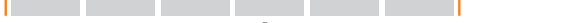
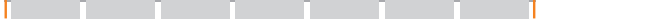
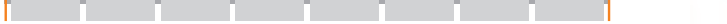





-  Codici espositori lineari vuoti
-  Linear empty display codes
-  Codes des présentoirs linéaires vides
-  Códigos de expositores lineales vacíos
-  Artikelnummern für leere Linearständer
-  Lineare code voor lege displays
-  Kody zestawów regałów bez wyposażenia
-  Lineáris üres állványok cikkszámá
-  Códigos de expositores lineares vazios
-  Κωδικοί για γραμμικά άδεια εκθετήρια

			
068000001	068000031		
068000002	068000032		
068000003	068000033		
068000004	068000034		
068000005	068000035		
068000006	068000036		
068000007	068000037		
068000008	068000038		
068000009	068000039		
068000010	068000040		



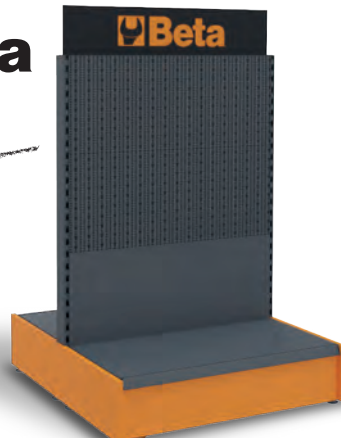







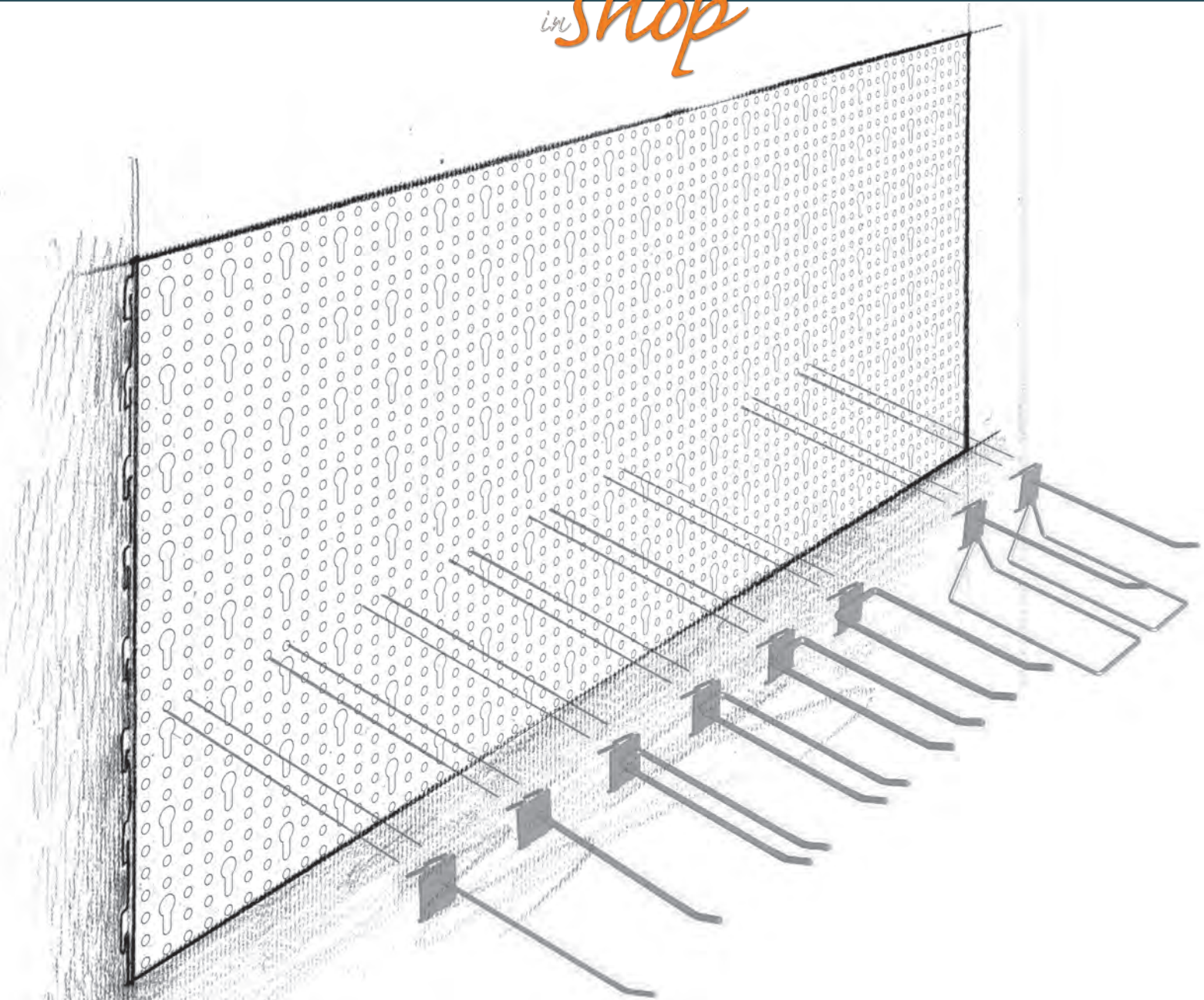

			
088000001	088000031		













			
068000051			
068000052			
068000053			
068000054			















- PROPOSTE ESPOSITIVE: MODULI SINGOLI** 
- DISPLAY SUGGESTIONS: INDIVIDUAL MODULES** 
- PROPOSITIONS D'EXPOSITION: MODULES SIMPLES** 
- PROPUESTAS EXPOSITIVAS: MÓDULOS INDIVIDUALES** 
- AUSSTELLUNGSANGEBOTE: EINZELMODULE** 
- DISPLAY SUGGESTIES: INDIVIDUELE MODULES** 
- PROPOZYCJE EKSPOZYCJI: POJEDYNCZE MODUŁY** 
- ÁLLVÁNY AJÁNLATOK: EGYEDI MODULOK** 
- SUGESTÕES DE EXPOSITORES: MÓDULOS INDIVIDUAIS** 
- ΠΡΟΤΑΣΕΙΣ ΠΡΟΒΟΛΗΣ: ΑΥΤΟΝΟΜΕΣ ΜΟΝΑΔΕΣ** 



-  Legenda
-  Legend
-  Légende
-  Leyenda
-  Zeichenerklärung
-  Legenda
-  Opis
-  Jelmagyarázat
-  Legenda
-  Υπόμνημα













-  Gli assortimenti comprendono utensili + ganci
-  Assortments include tools + hooks
-  Les compositions sont constituées d'outils + crochets
-  Los surtidos incluyen herramientas + ganchos
-  Die Sortimente beinhalten Werkzeuge + Haken
-  Een assortiment bestaat uit gereedschappen + haken
-  Moduły składają się wyłącznie z narzędzi i elementów mocujących
-  Ajánlatok tartalmazzák a szerszámokat + kampókat
-  Jogos incluem ferramentas + ganchos
-  Οι συλλογές περιλαμβάνουν εργαλεία + γάντζους



-  Numero utensili
-  Number of tools
-  Nombre d'outils
-  Número de herramientas
-  Anzahl der werkzeuge
-  Aantal Gereedschappen
-  Liczba narzędzi
-  Szerszámok száma
-  Número De ferramentas
-  Πλήθος εργαλείων



-  Numero ganci
-  Number of hooks
-  Nombre de crochets
-  Número de ganchos
-  Anzahl der haken
-  Aantal haken
-  Liczba haków
-  Kampók száma
-  Número de ganchos
-  Πλήθος γάντζων

-  Pannello non incluso
-  Panels not included
-  Panneaux non fournis
-  Paneles no incluidos
-  Paneel nicht mitgeliefert
-  Exclusief de wandpanelen
-  Panele nie wchodzą w skład zestawów
-  Panel nélkül szállítva
-  Painéis não incluídos
-  Δεν περιλαμβάνονται πίνακες

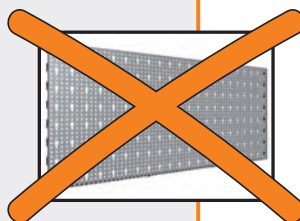

6600 M/14





066000014

154

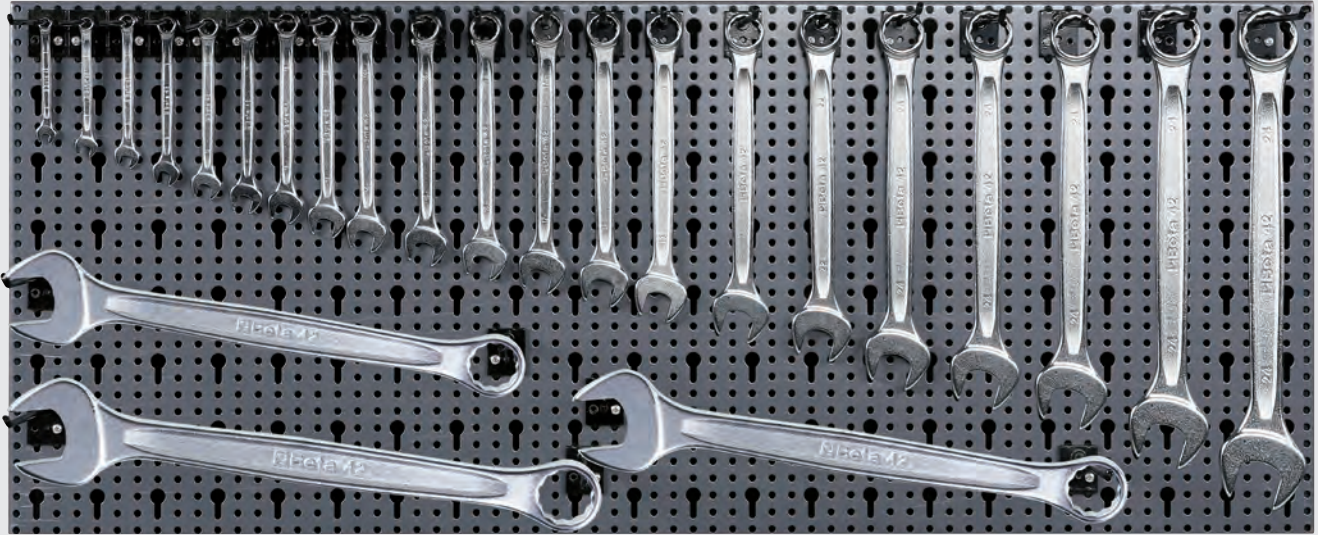
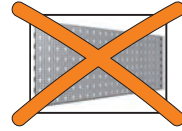
27



		 N°
42		6x6 mm
		7x7 mm
		8x8 mm
		9x9 mm
		10x10 mm
		11x11 mm
		12x12 mm
		13x13 mm
		14x14 mm
		15x15 mm
		16x16 mm
		17x17 mm
		18x18 mm
		19x19 mm
		21x21 mm
		22x22 mm
		24x24 mm
		27x27 mm
		28x28 mm
		30x30 mm
		32x32 mm
		36x36 mm
		38x38 mm
		41x41 mm

6600 M/22





066000022

108

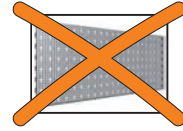
34



			N°
55		6x7 mm	10
		8x9 mm	
		10x11 mm	
		12x13 mm	
		14x15 mm	
		16x17 mm	
		18x19 mm	
		20x22 mm	
		21x23 mm	
		24x26 mm	
		25x28 mm	
		27x29 mm	
		30x32 mm	
		32x36 mm	
		34x36 mm	2
		36x41 mm	
41x46 mm			

6600 M/27



066000027

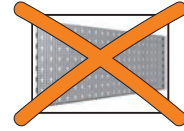

		PROFESIONALE	N°
52		17 mm	5
		24-27-30 mm	
		32-36-38 mm	
		41-46-50-55 mm	2

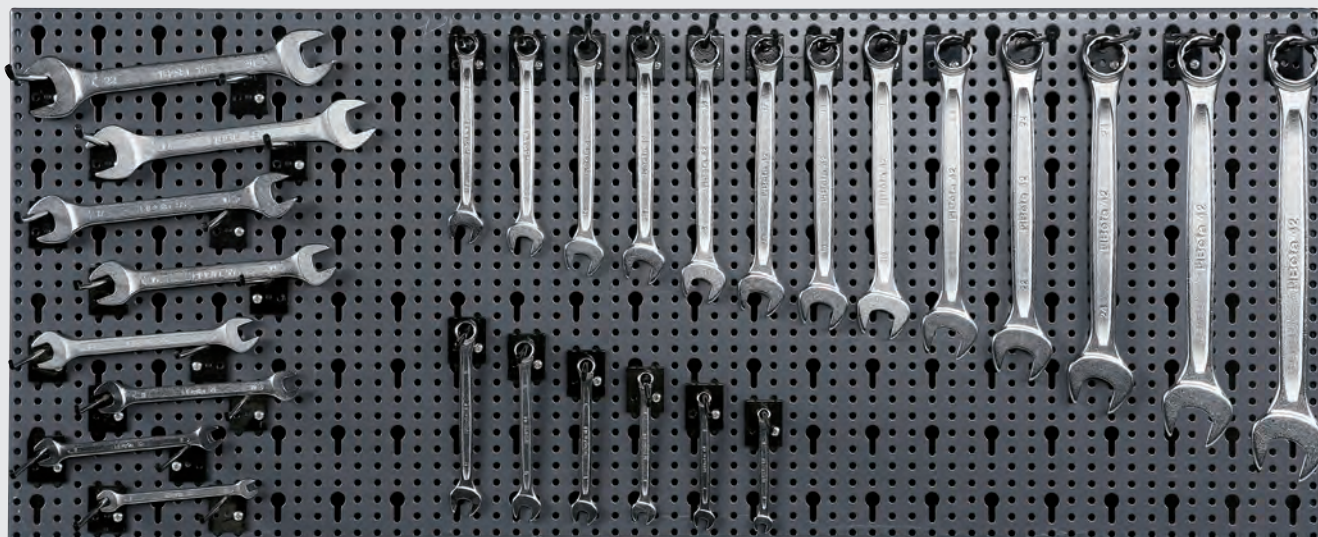
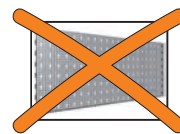

			N°
42		6x6 mm	5
		7x7 mm	5
		8x8 mm	10
		9x9 mm	5
		10x10 mm	10
		11x11 mm	5
		12x12 mm	5
		13x13 mm	10
		14x14 mm	5
		15x15 mm	5
		16x16 mm	10
		17x17 mm	5
		18x18 mm	5
		19x19 mm	10
		22x22 mm	5
24x24 mm	8		
27x27 mm	5		
30x30 mm	5		
32x32 mm	5		
55		6x7 mm	5
		8x9 mm	5
		10x11 mm	10
		12x13 mm	10
		14x15 mm	5
		16x17 mm	5
		18x19 mm	5
20x22 mm	5		



6600 M/33



066000033

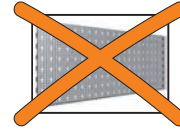





		N°	
111E		100-150	5
		200-250 mm	3
		300 mm	3
		380-450 mm	2
111CM		200-250 mm	3
		300 mm	2
186		8-32 mm	2

6600 M/40

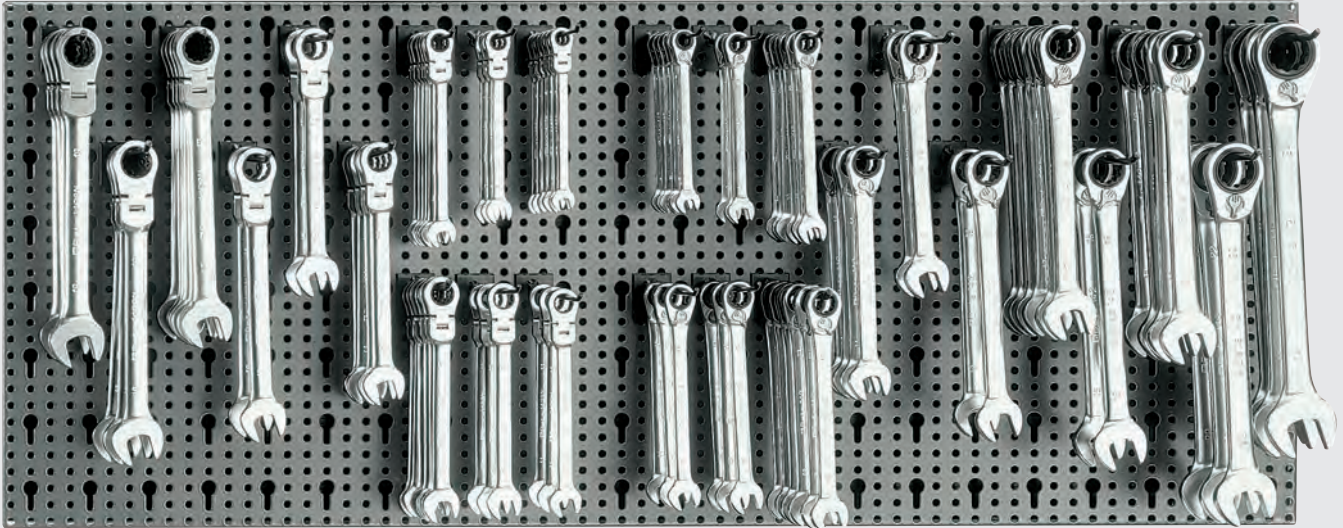
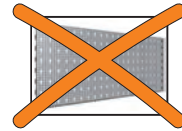

066000040



		N°
142		8 mm 6
		9 mm 3
		10 mm 6
		11-12 mm 3
		13 mm 6
		14 mm 4
		15-16 mm 2
		17 mm 6
		18 mm 2
		19 mm 4
		22-24 mm 3
142SN		8 mm 6
		9 mm 3
		10 mm 6
		11-12 mm 3
		13 mm 6
		14 mm 4
		15-16 mm 2
		17 mm 6
		18 mm 2
19 mm 4		

# 6600 M/42



066000042

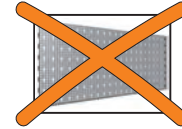

			N°
141		8 mm	6
		9 mm	3
		10 mm	6
		11-12 mm	3
		13 mm	6
		14 mm	4
		15-16 mm	2
		17 mm	6
		18 mm	2
		19 mm	4
192/S2		8x10	4
		12x13	
		16x17	
		18x19 mm	
195		8x10	2
		12x13	
		14x15	
		16x18	
		17x19 mm	

6600 M/44



066000044

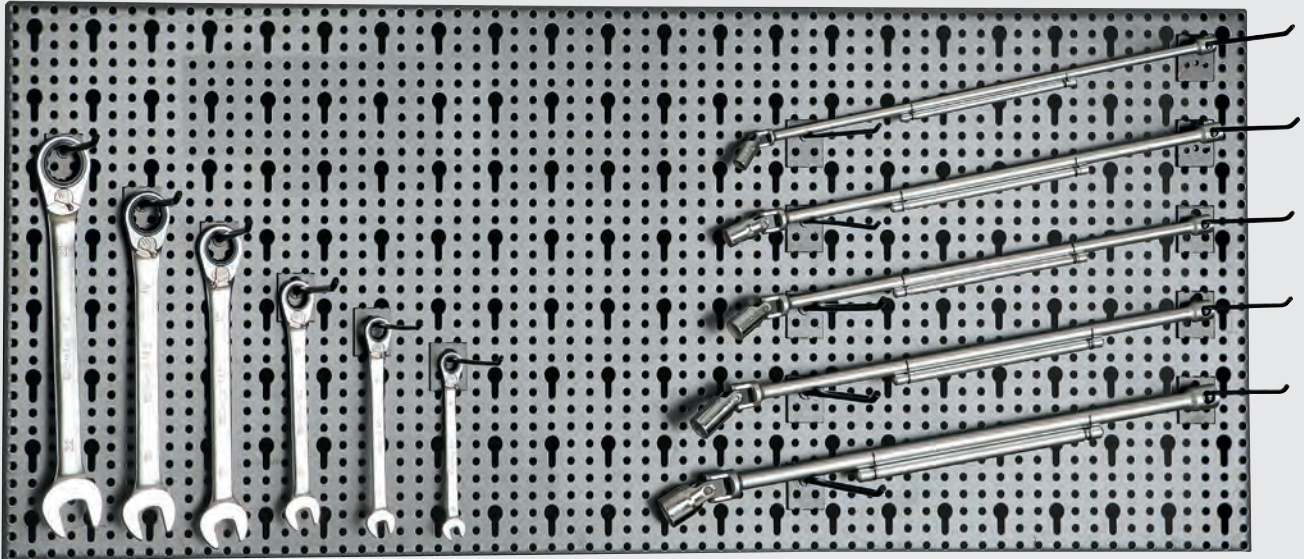
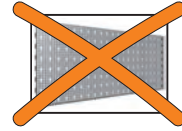

			N°
142		8 mm	3
		10 mm	5
		13 mm	5
		17 mm	4
		19 mm	3
		22 mm	5
952		8 mm	
		10 mm	5
		12 mm	
		13 mm	
		17 mm	3

6600 M/47



066000047

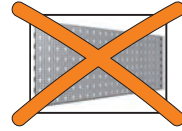

		GROUP	N°
99		12-14 mm	5
		16-18-20 mm	
		22-25-28 mm	
		30-32 mm	
		34-36-38 mm	
		40-42 mm	3
		45-50 mm	
		52-55-58 mm	
		62-65 mm	
		68-70-75 mm	
		80-85-90 mm	3
		92-95 mm	
		98-100 mm	
		105-110-115 mm	
		120-125-130 mm	

6600 M/51



066000051

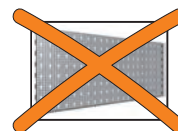

			N°
96T ○		2 mm	5
		2,5-3-4	10
		5-6 mm	
		7-8-10 mm	5
96/BG7 ○		2,5-3-4-5	2
		6-8-10 mm	
96/SC9 ○		1,5-2-2,5	5
		3-4-5-6-8	
		10 mm	
96ST6 ○		2,5-3-4-5	3
		6-8 mm	
96BPC/SC9 ○		1,5-2-2,5	5
		3-4-5-6-8	
		10 mm	
951 ○		2 mm	5
		2,5-3-4	10
		5-6 mm	
		8-10 mm	5

# 6600 M/52



066000052

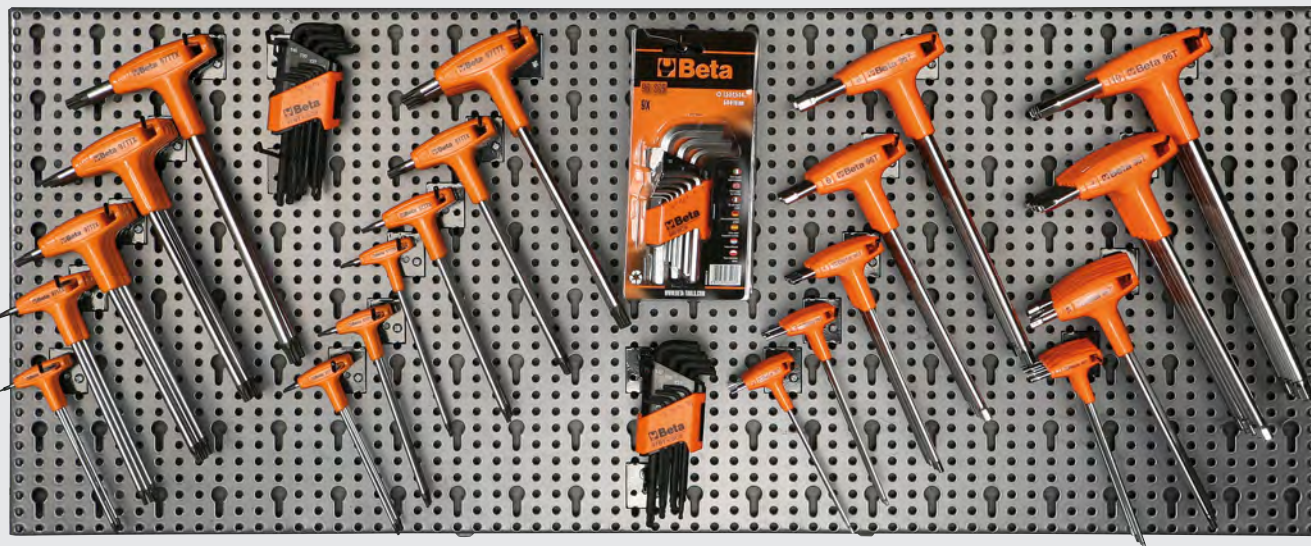
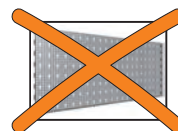

		N°
96T ○		2-2,5-3 4-5-6-7 8-10 mm 5
96/SC9 ○		1,5-2-2,5 3-4-5-6 8-10 mm 5
97TTX ⊗		T8-T9-T10 3
		T15-T20-T25 5
		T27-T30-T40 5
		T45 3
		T50 2
97BTX/SC8 ⊗		T9-T10-T15 T20-T25 3 T27-T30-T40
97RTX/SC8 ⊕		T9-T10-T15 T20-T25-T27 3 T30-T40

6600 M/58



066000058

150

25

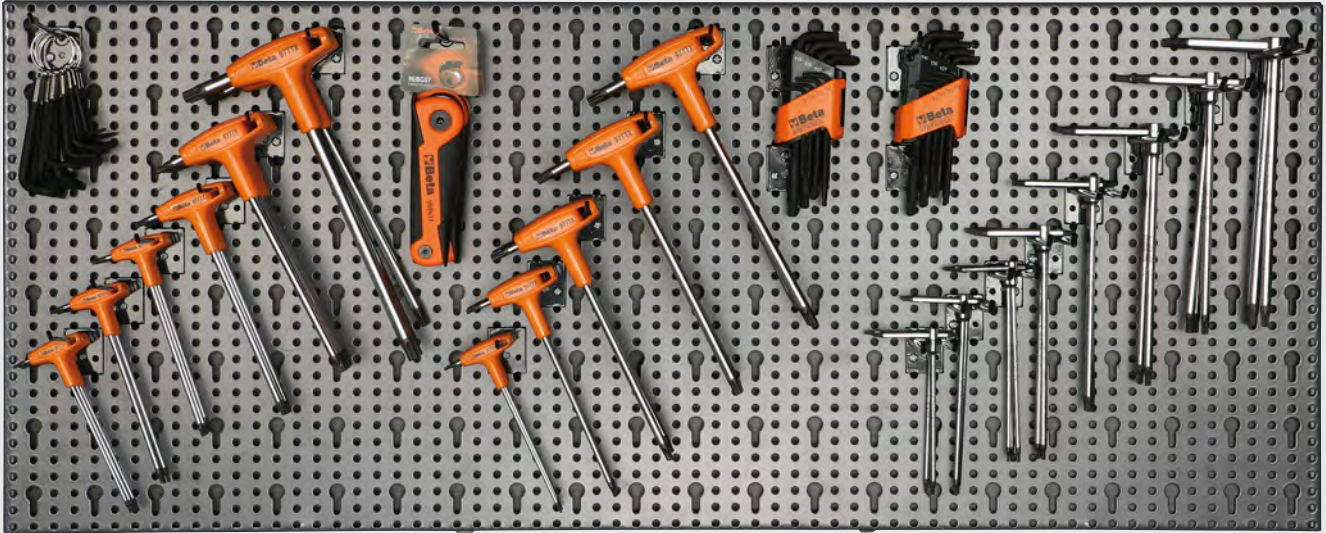
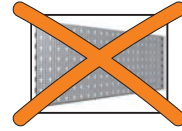

		N°
97TX/BG8 ⊙		T9-T10 T15-T20 T25-T27 T30-T40 2
97TX/ST8 ⊙		T9-T10 T15-T20 T25-T27 T30-T40 3
97BTX/SC8 ⊙		T9-T10 T15-T20 T25-T27 T30-T40 3
97TTX ⊙		T8-T9-T10 T15-T20-T25 3
		T27-T30-T40 5
		T45 3
		T50 2
97RTX/SC8 ⊙		T9-T10 T15-T20 T25-T27 T30-T40 3
951TX ⊙		T9-T10 T15-T20 T25-T27 T30-T40 3



# 6600 M/59



066000059

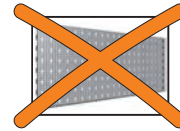





			N°
96T ○		2-2.5 mm	5
		3-4-5 mm	10
		6 mm	5
96/SC9 ○		1,5-2-2,5	5
		3-4-5-6-8	
		10 mm	
96BPC/SC9 ○		1,5-2-2,5	10
		3-4-5-6	
		8-10 mm	
951 ○		2,5-3-4-5	5
		6-8 mm	
111E		200-250 mm	4
		300 mm	2

# 6600 M/61

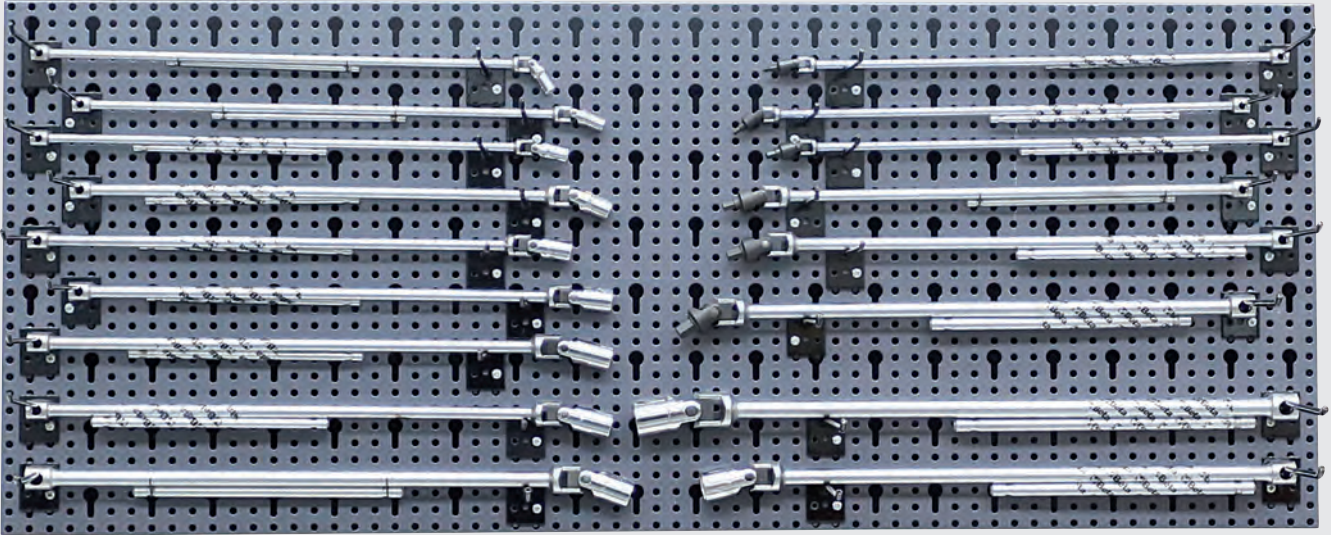
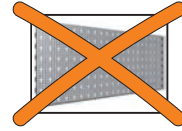

066000061



			N°
952 ○		6 mm	
		7 mm	5
		8 mm	
		10 mm	5
		11 mm	3
		12 mm	
		13 mm	5
		14 mm	
		15 mm	3
		17 mm	
953 ○		3 mm	
		4 mm	5
		5 mm	
		6 mm	
		8 mm	3
		10 mm	

# 6600 M/62



066000062

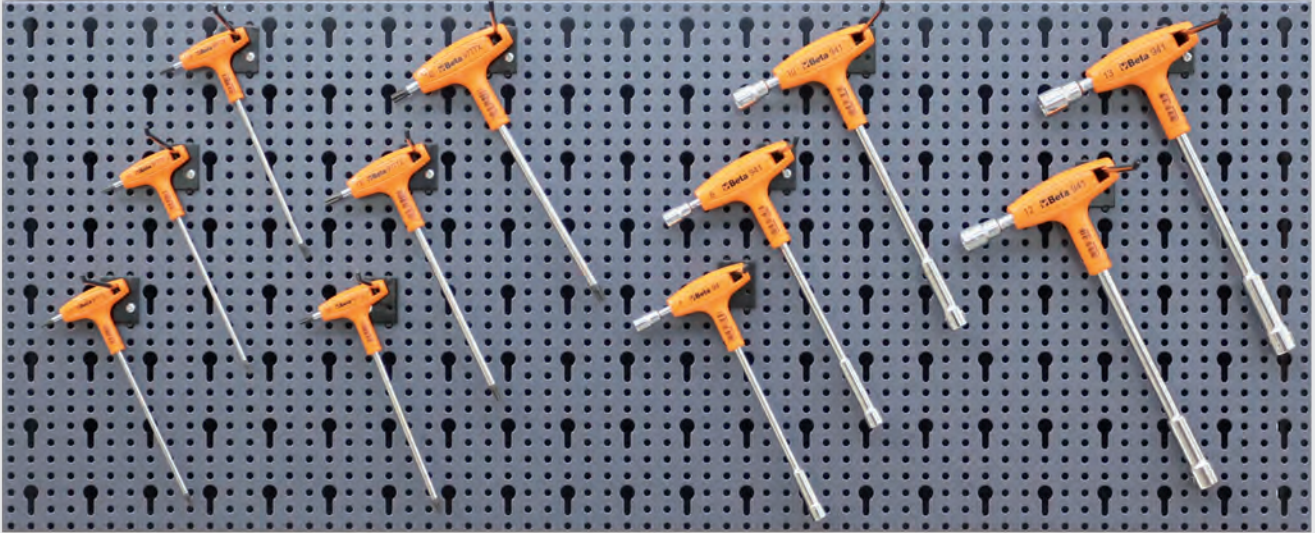
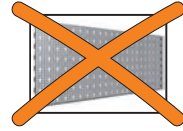

		N°
97TTX ♻️		T10-T15 T20-T25 T30-T40 3
941 ⊙		7x7 mm 8x8 mm 10x10 mm 12x12 mm 13x13 mm 2



# 6600 M/63



066000063

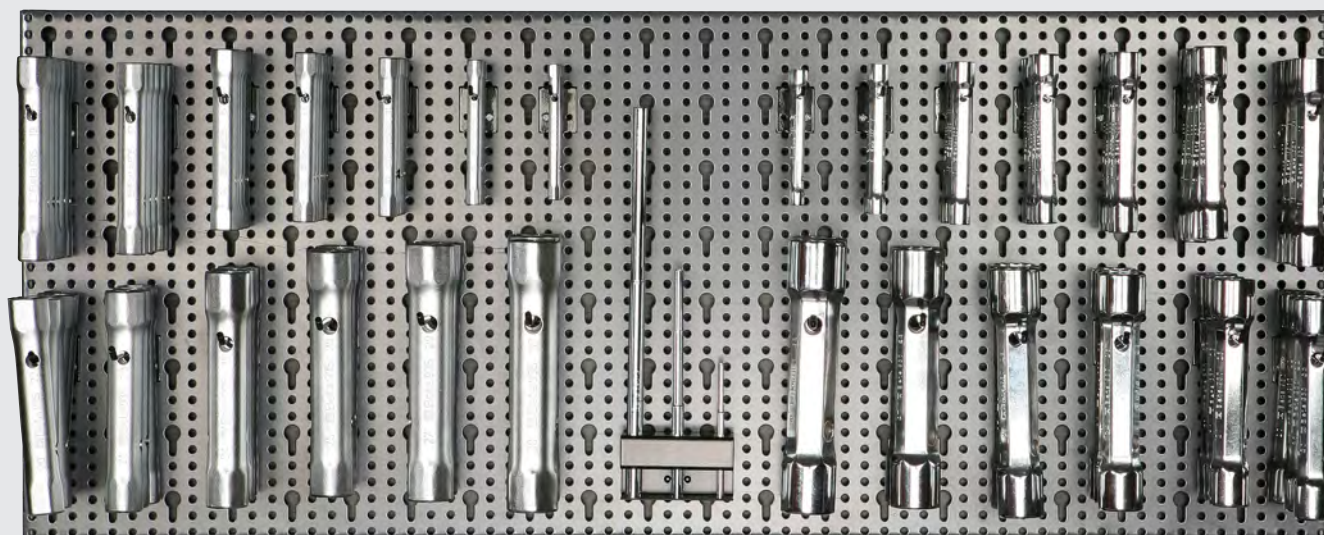
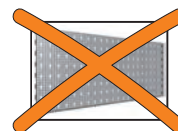

		N°		
930 		6x7 8x9 mm	5	
		10x11-12x13 14x15-16x17 18x19-20x22 mm	5	
		21x23 24x26 mm	3	
		25x28-27x29 30x32 mm	2	
935 		6x7-8x9 mm	5	
		10x11 mm		
		12x13 mm		
		14x15 mm		
		16x17 mm		
		18x19 mm	3	
		20x22 mm		
		21x23 mm		
		24x26 mm	2	
		25x28 mm		
27x29 mm				
30x32 mm				
940/1		930-935: 6+13 mm	2	
940/2		930-935: 14+22 mm	2	
940/3		930-935: 21+32 mm	2	

6600 M/73



066000073

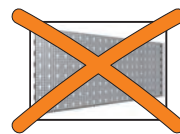

		N°
933		6x6 mm
		7x7 mm
		8x8 mm
		9x9 mm
		10x10 mm
		11x11 mm
		12x12 mm
		13x13 mm
		14x14 mm
		15x15 mm
		16x16 mm
		17x17 mm
		18x18 mm
		19x19 mm
		20x20 mm
		21x21 mm
		22x22 mm
		24x24 mm

# 6600 M/112



066000112

**329**

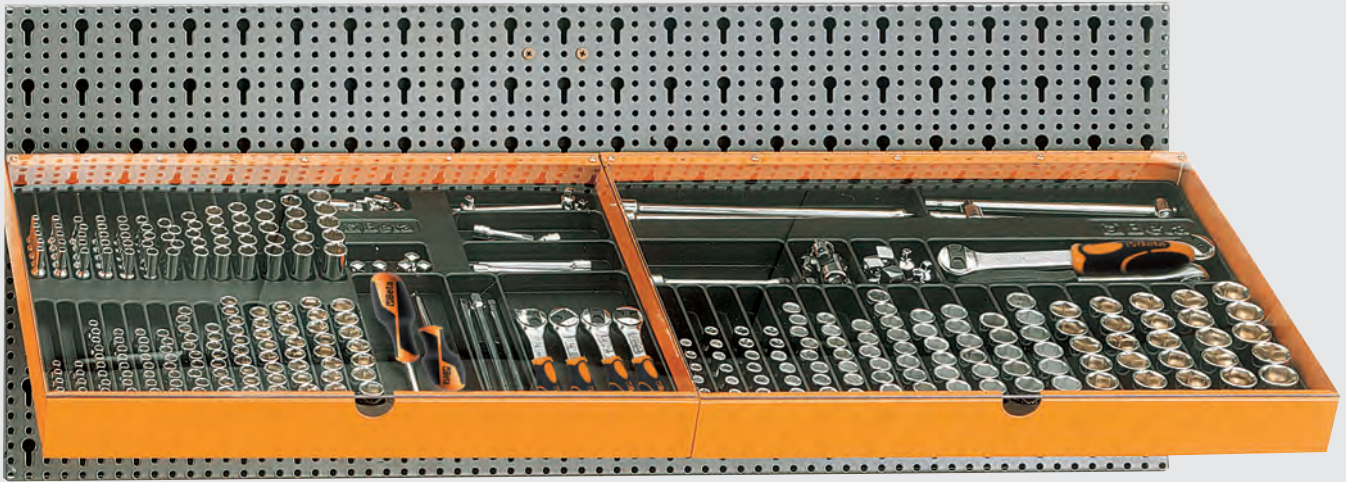
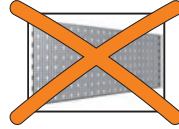

			N°
900 14"		4-4,5-5	10
		5,5-6-7-8	
		9-10 mm	
		11-12 13 mm 14 mm	
900L 14"		4-4,5-5-5,5 6-7-8-9-10 11-12-13 14 mm	5
900/16 14"		□1/4"x□3/8"	5
900/20 14"		50 mm	3
900/20L 14"		100 mm	3
900/21 14"		150 mm	3

			N°
900/25 14"			3
900BG /30 14"		176 mm	2
900/42 14"			3
900/55 14"			5



			N°
910A 38"		6-7 mm	5
		8 mm	8
		9 mm	5
		10 mm	8
		11-12 mm	5
		13 mm	8
		14-15-16 mm	5
		17 mm	8
		18 mm	5
		19 mm	8
20-21-22 mm	5		

			N°
910/15 38"		□3/8"x□1/4"	3
910/16 38"		□3/8"x□1/2"	3
910/21 38"		125 mm	2
910/22 38"		250 mm	2
910/25 38"			2
910/42 38"			2
910/55 38"			2

# 6600 M/116



066000116

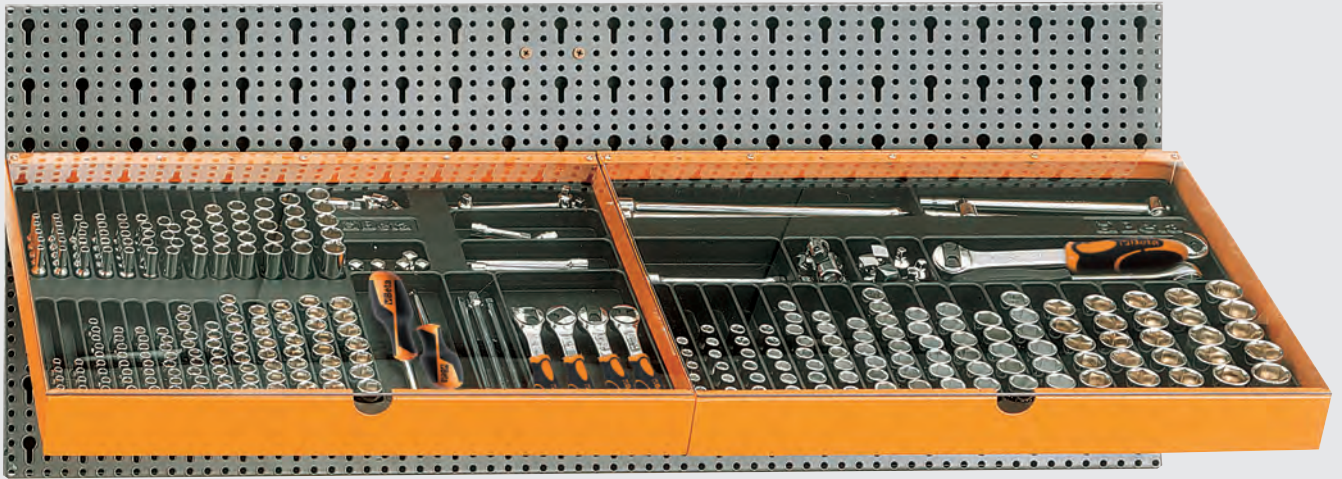
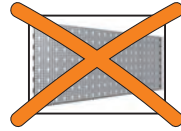

			N°
900 14"		4-4,5-5	10
		5,5-6-7-8	
		9-10 mm	
		11-12	
		13 mm	
900L 14"		4-4,5-5-5,5	5
		6-7-8-9-10 11-12-13 14 mm	
900/16 14"		□1/4" x ■3/8"	5
900/20 14"		50 mm	3
900/20L 14"		100 mm	3
900/21 14"		150 mm	3

			N°
900/25 14"			3
900BG /30 14"		176 mm	2
900/42 14"			3
900/55 14"			5



			N°
910B 38"		6-7 mm	4
		8 mm	5
		9 mm	4
		10 mm	6
		11-12 mm	5
		13 mm	6
		14-15-16 mm	4
		17 mm	6
		18-19-20	4
		21-22 mm	

			N°
910/15 38"		□3/8" x ■1/4"	3
910/16 38"		□3/8" x ■1/2"	3
910/21 38"		125 mm	2
910/22 38"		250 mm	2
910/25 38"			2
910/42 38"			2
910/55 38"			2

# 6600 M/120



066000120

163

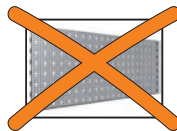

		N°
<b>920A</b>  12" ○	8 mm	6
	9 mm	5
	10 mm	9
	11 mm	5
	12 mm	6
	13 mm	9
	14-15 mm	8
	16 mm	6
	17 mm	8
	18-19 mm	7
	20-21 mm	5
	22 mm	6
23-24-25 mm		
26-27-28 mm	5	
29 mm		
30-32 mm	4	
<b>920/15</b> 12" 	□1/2"x■3/8"	2
<b>920/16</b> 12" 	□1/2"x■3/4"	2
<b>920/20</b> 12" 	75 mm	2
<b>920/21</b> 12" 	125 mm	2
<b>920/22</b> 12" 	255 mm	2

		N°
<b>900/25</b> 12" 		2
<b>920/42</b> 12" 		2
<b>920/50</b> 12" 		2
<b>920/55</b> 12" 		4







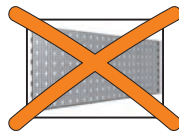

# 6600 M/125



066000125



		N°
<b>920B</b> 	8 mm	4
	9 mm	3
	10 mm	8
	11 mm	3
	12 mm	4
	13 mm	8
	14-15 mm	6
	16 mm	4
	17 mm	8
	18 mm	6
	19 mm	8
	20-21 mm	3
	22 mm	6
	23 mm	3
	24 mm	6
	25-26 mm	3
27 mm	4	
28-29 mm	3	
30-32 mm	4	
<b>920/15</b> 	$\square 1/2 \times \blacksquare 3/8$	2
<b>920/16</b> 	$\square 1/2 \times \blacksquare 3/4$	2
<b>920/20</b> 	75 mm	2
<b>920/21</b> 	125 mm	2

		N°
<b>920/22</b> 	255 mm	2
<b>920/25</b> 		2
<b>920/42</b> 		2
<b>920/50</b> 		2
<b>920/55</b> 		4

# 6600 M/126



066000126

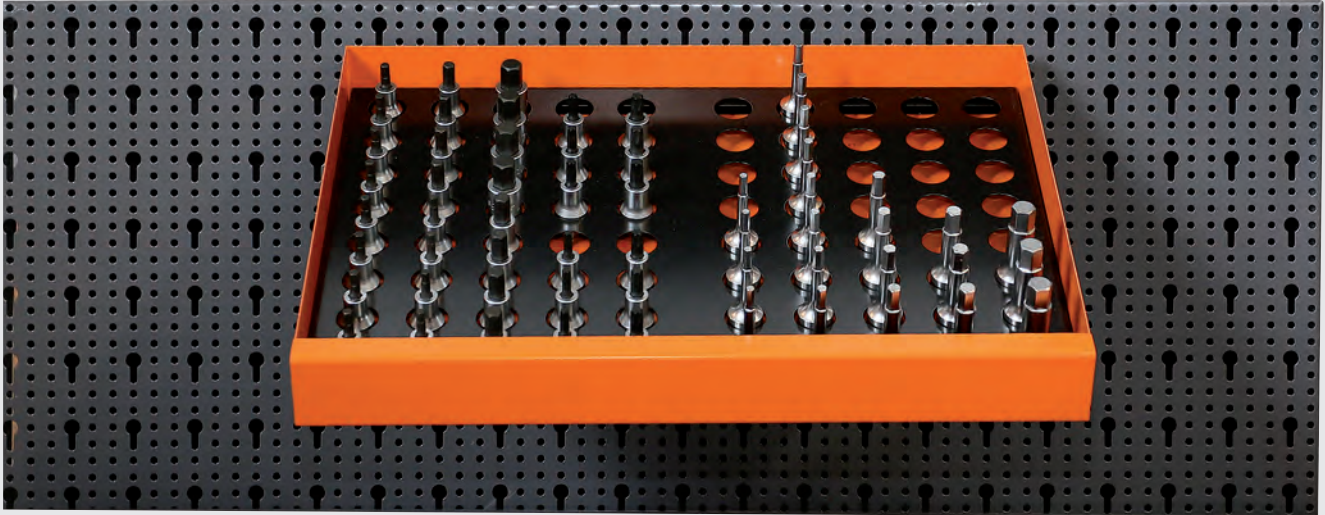
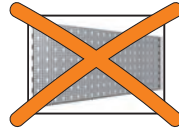

			N°
<b>920PE</b>  ○		5 mm	4
		6 mm	8
		8 mm	4
		10 mm	4
		14 mm	4
<b>920ME</b>  ○		5 mm	4
		6 mm	8
		8 mm	4
		10 mm	3
		14 mm	3
<b>920TX</b>  ⊗		T30	3
		T40	
		T45	
		T50	

# 6600 M/131



066000131

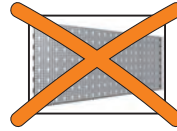

			N°
<b>928A</b> 		19-22 mm	4
		23 mm	2
		24 mm	6
		26 mm	2
		27 mm	6
		28 mm	4
		29 mm	2
		30-32 mm	6
		33-34 mm	4
		35 mm	2
		36 mm	6
		38-41-46 mm	4
		50 mm	2
	55-60 mm	4	
<b>928/15</b> 		□3/4"x1"	2
<b>928/21</b> 		200 mm	2
<b>928/22</b> 		380 mm	2
<b>928/25</b> 			2

			N°
<b>928/42</b> 		450 mm	2
<b>928/55</b> 		510 mm	2

# 6600 M/174



066000174

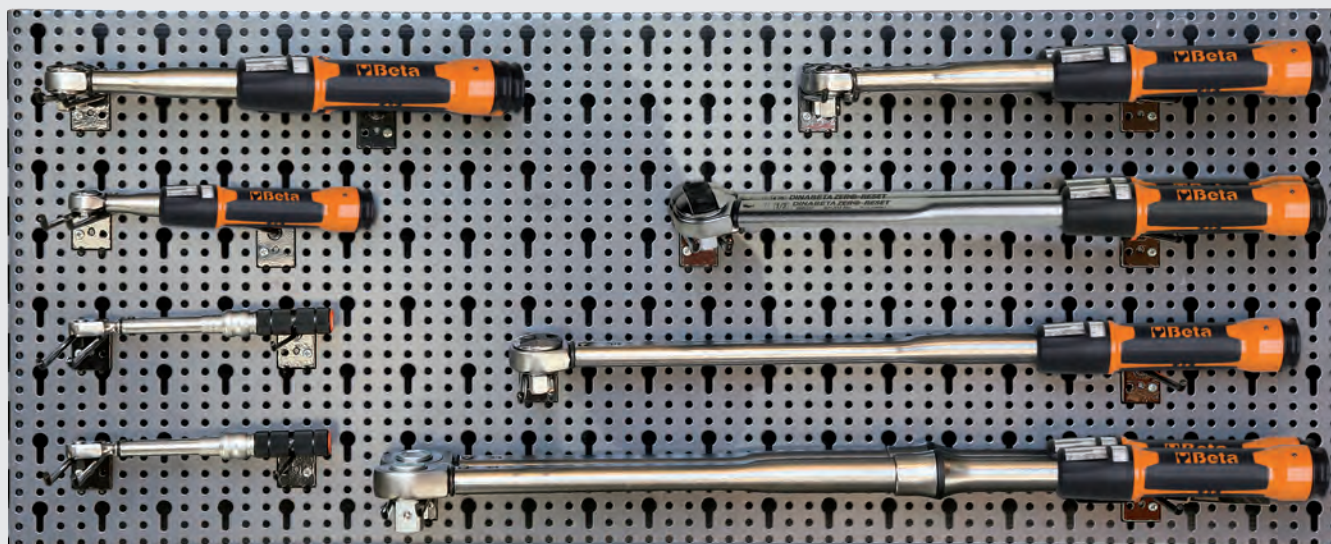
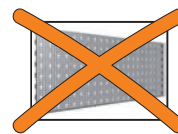

			N°
605E/5		■ 1/4" 1÷5 Nm	1
605E/10		■ 1/4" 2÷10 Nm	1
666/2		■ 1/4" 5÷25 Nm	1
666/5		■ 3/8" 10÷50 Nm	2
666/10X		■ 1/2" 20÷100 Nm	2

			N°
666/20		■ 1/2" 40÷200 Nm	2
666/30		■ 1/2" 60÷300 Nm	2
667/40		■ 3/4" 80÷400 Nm	2

# 6600 M/175





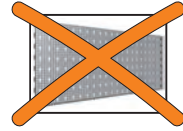



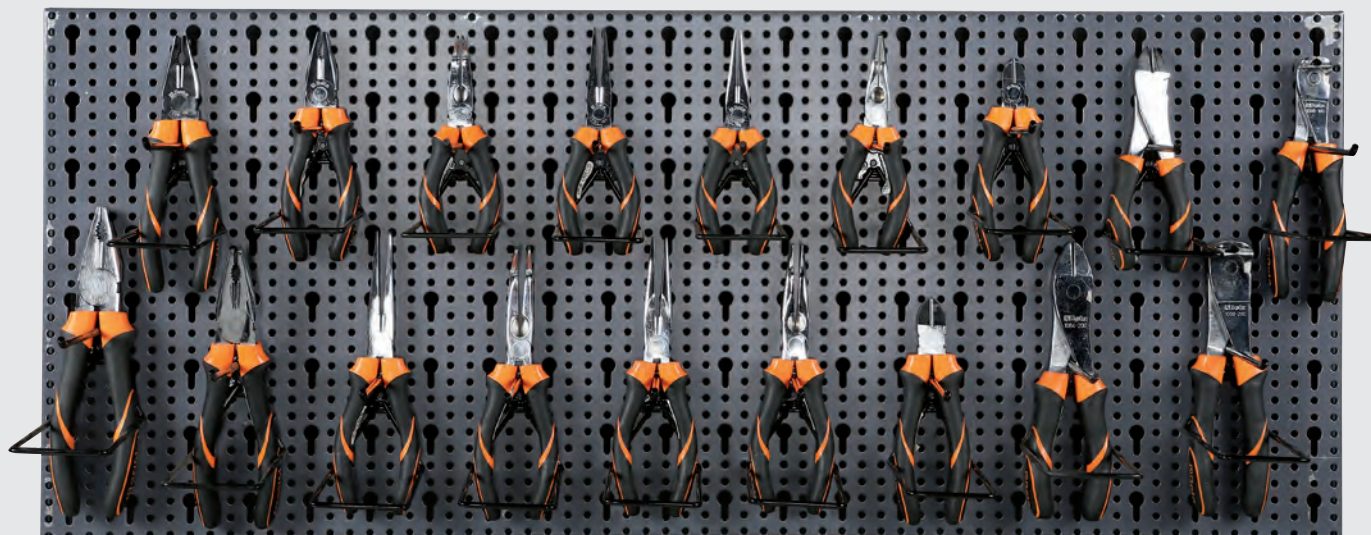
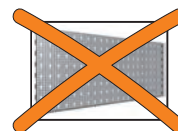

066000175







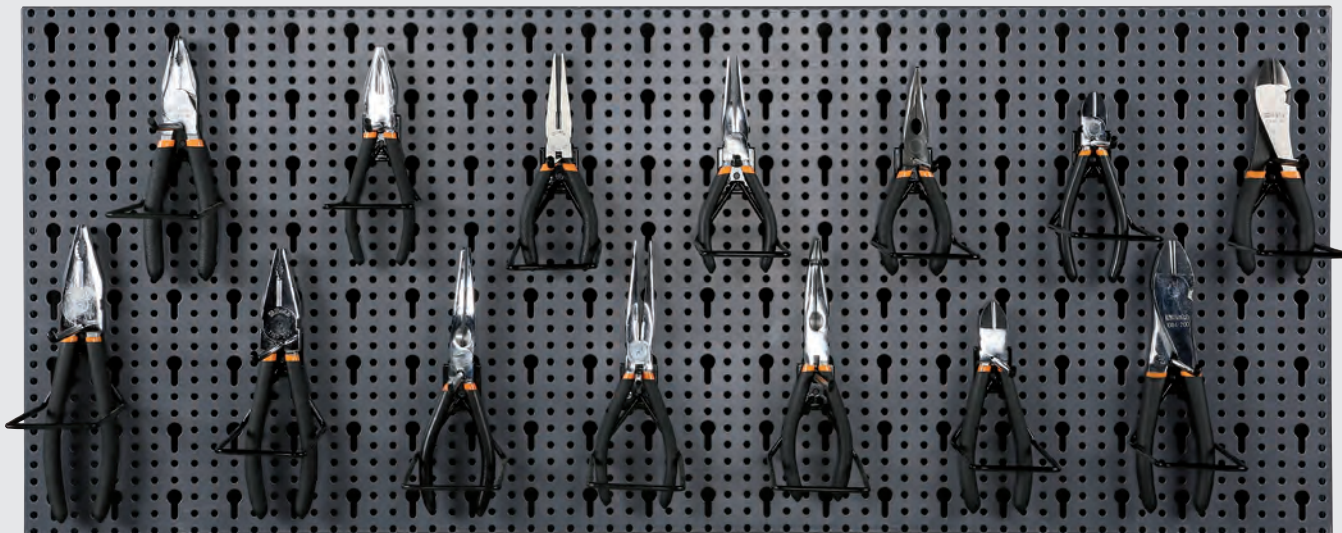
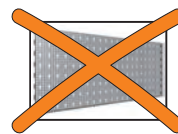

		N°
605E/5		■ 1/4" 1+5 Nm 1
605E/10		■ 1/4" 2+10 Nm 1
665/6		■ 3/8" 10+60 Nm 2
665/10		■ 3/8" 20+100 Nm 2
665/10X		■ 1/2" 20+100 Nm 2
665/20		■ 1/2" 40+200 Nm 2
665/30		■ 1/2" 60+300 Nm 2











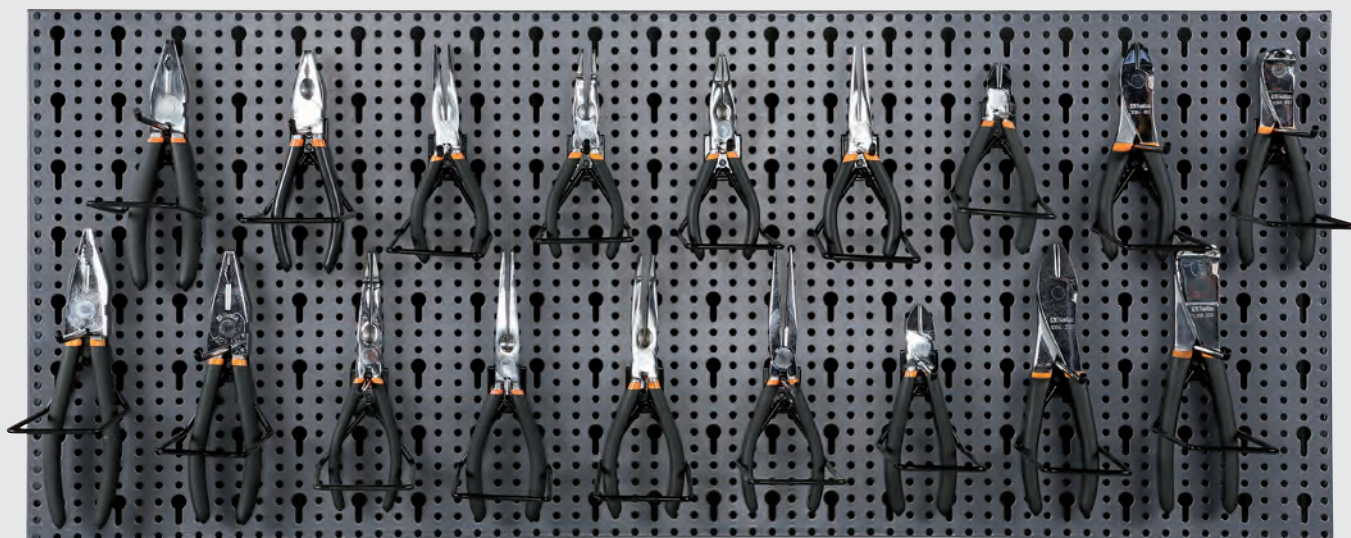
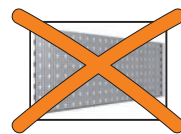

			N°
1082BM		140 mm	3
		160 mm	5
1084BM		160 mm	5
		200 mm	3
1088BM		160 mm	5
		200 mm	3
1150BM		160 mm	5
		180 mm	5
		200 mm	3
		220 mm	3
1162BM		160 mm	5
		200 mm	3
1164BM		160 mm	5
		200 mm	3
1166BM		160 mm	5
		200 mm	3
1168BM		160 mm	5
		200 mm	3



			N°
1082G		140 mm	3
		160 mm	5
1084G		160 mm	5
		200 mm	3
1150G		160 mm	5
		180 mm	
		200 mm	3
		220 mm	
1162G		160 mm	5
		200 mm	3
1166G		160 mm	5
		200 mm	3
1168G		160 mm	5
		200 mm	3





		N°
1082		140 mm 3
		160 mm 5
1084		160 mm 5
		200 mm 3
1088		160 mm 5
		200 mm 3
1150		160 mm 5
		180 mm 5
		200 mm 3
		220 mm 3
1162		160 mm 5
		200 mm 3
1164		160 mm 5
		200 mm 3
1166		160 mm 5
		200 mm 3
1168		160 mm 5
		200 mm 3







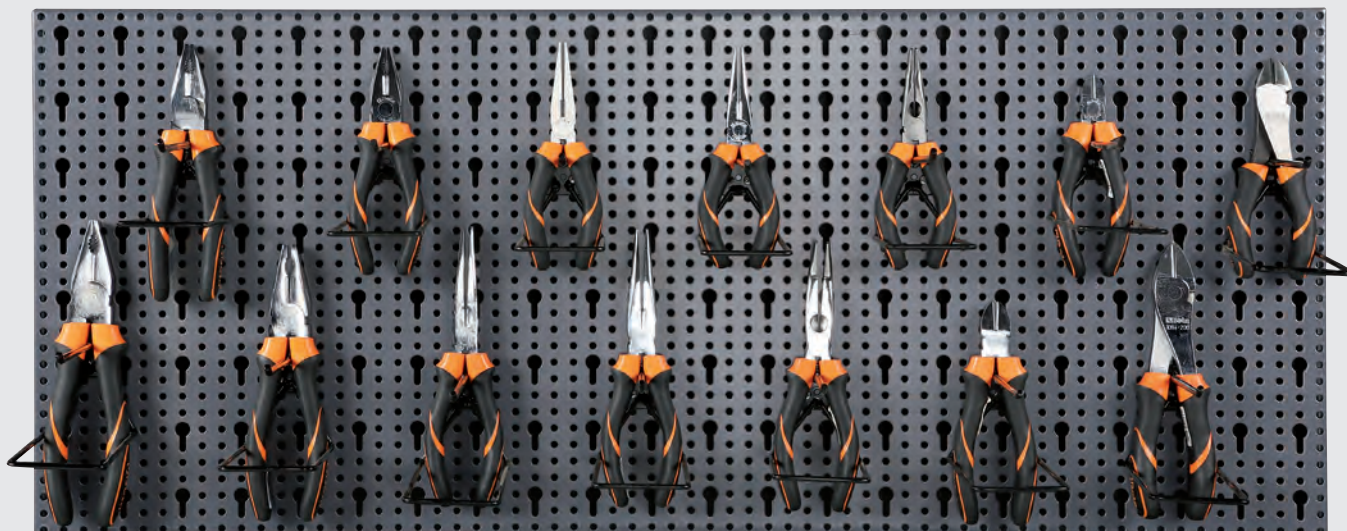
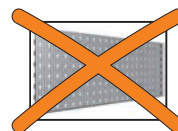

6600 M/223



066000223



		N°
1082GBM		140 mm 3
		160 mm 5
1084GBM		160 mm 5
		200 mm 3
1150GBM		160 mm 5
		180 mm 5
		200 mm 3
		220 mm 3
1162GBM		160 mm 5
		200 mm 3
1166GBM		160 mm 5
		200 mm 3
1168GBM		160 mm 5
		200 mm 3



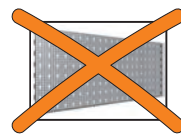





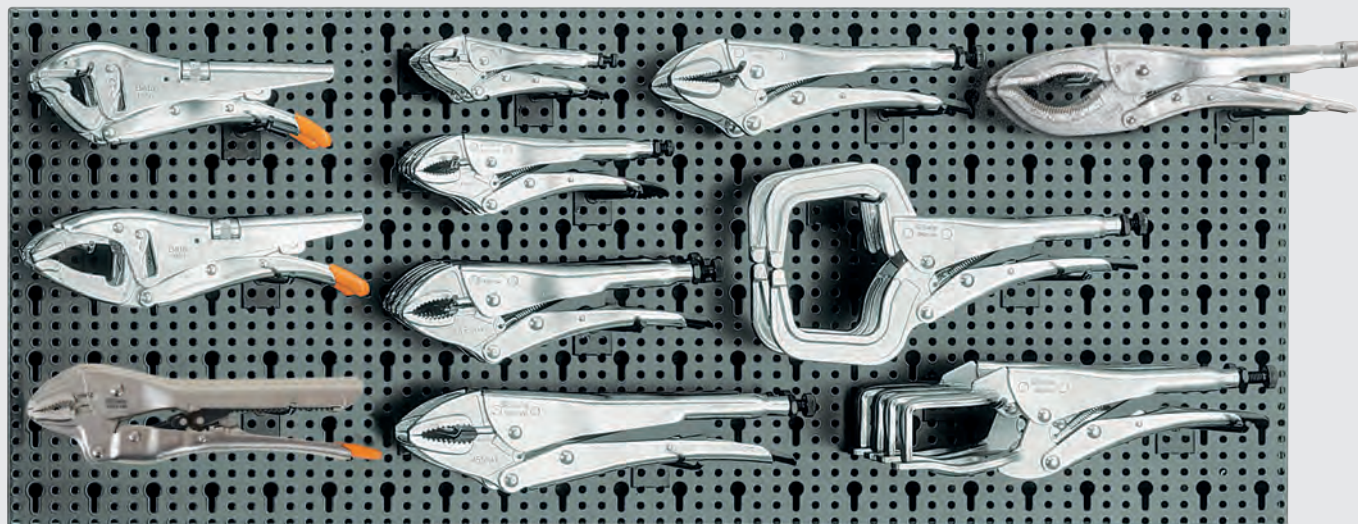
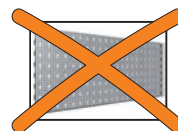

		N°
1032		140 mm 180 mm 225 mm    5
1033		225 mm    2
1034		130 mm 170 mm 210 mm    5
1036		140x0,9 mm 140x1,3 mm 175 mm 225 mm    5
1038		135x0,9 mm 135x1,3 mm 175 mm 220 mm    5
1037		175 mm 225 mm    2

		N°
1039		150 mm    2



		N°
1050		220 mm 2
1051		255 mm 2
1052		140 mm 3
		180 mm 6
		200 mm 6
		220 mm 2
1054		235 mm 2
1055		270 mm 2
1057A		240 mm 2



		N°
1060		280 mm 2
1062		290 mm 2

6600 M/241



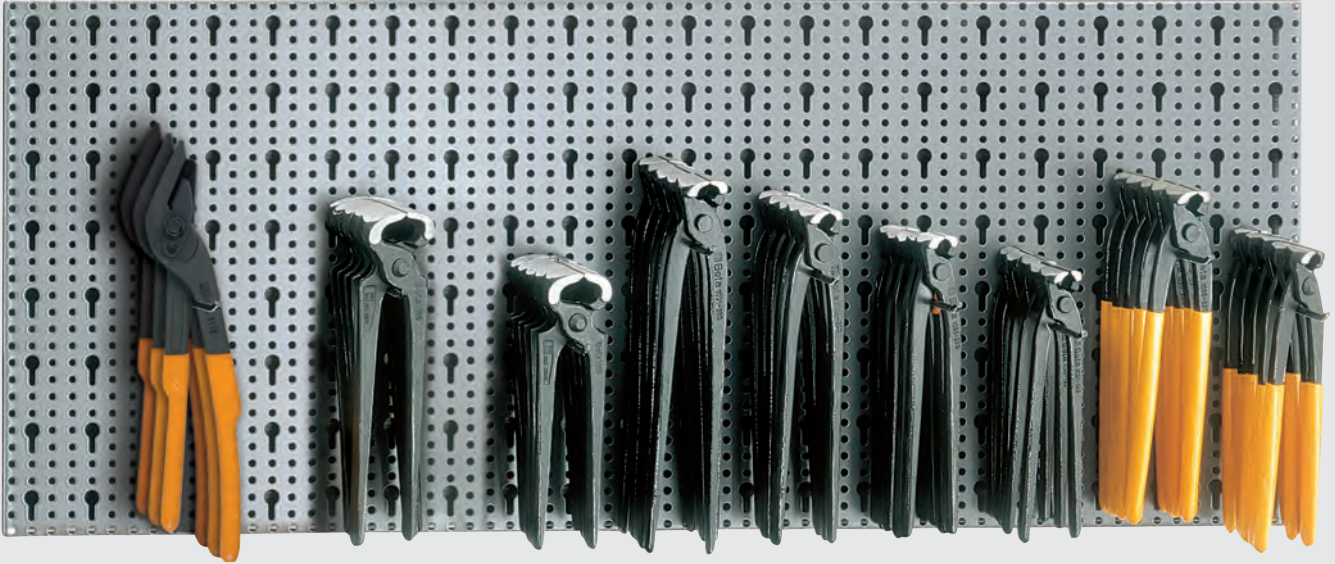
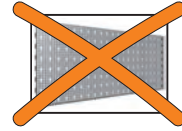



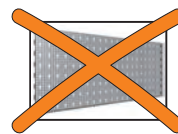

066000241



		N°
1096	 200 mm 250 mm	5
1098	 190 mm 220 mm 250 mm 280 mm	5
1098PL	 200 mm 250 mm	5
1118	 310 mm	3



		N°
1032 ⊙	 140 mm 180 mm	5
1034 ⊙	 130 mm 170 mm	5
1036 ●	 140x1,3 mm 175 mm	5
1038 ●	 135x1,3 mm 175 mm	5
1048N	 250 mm	5
1052	 240 mm	3

		N°
1082	140 mm	5
	160 mm	3
1088BM	 160 mm	5
1150BM	 180 mm 200 mm	5
1162BM	 160 mm	5
1164BM	 160 mm	5
1166BM	 160 mm	5
1168BM	 160 mm	5

# 6600 M/253



066000253

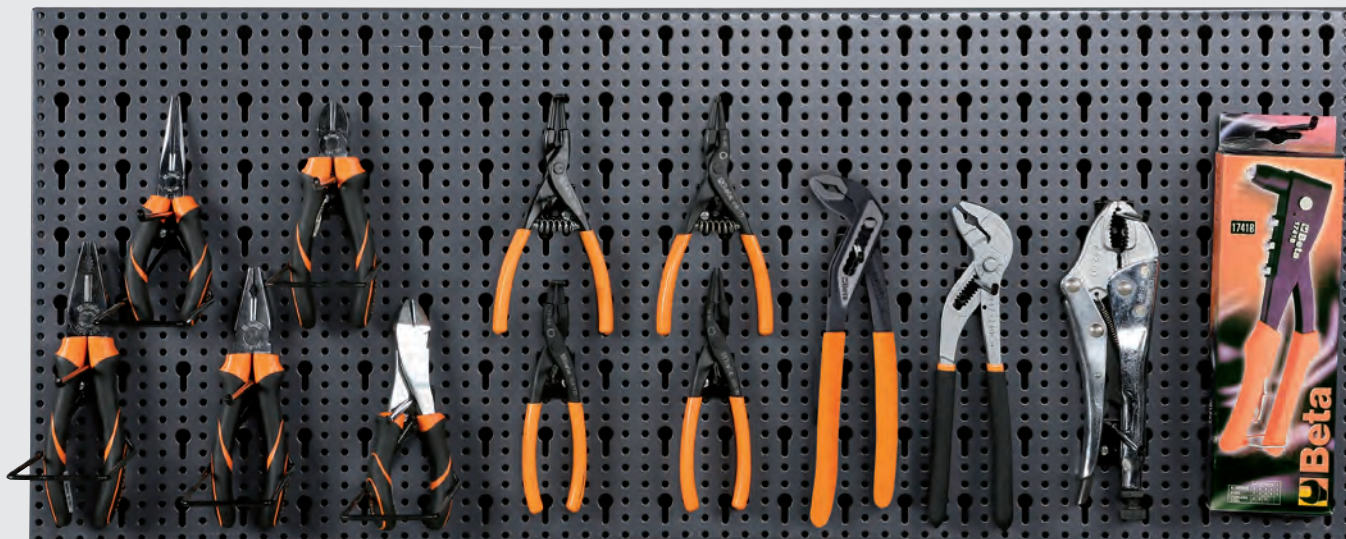
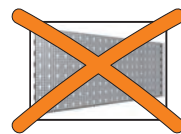

			N°
1032 ⊖		180 mm	5
1034 ⊖		170 mm	5
1036 ●		175 mm	5
1038 ●		175 mm	5
1047		240 mm	4
1048N		250 mm	5
1052		240 mm	4

			N°
1082BM		160 mm	5
1084BM		160 mm	3
1150BM		180 mm 200 mm	5
1166BM		160 mm	5
1741B			4

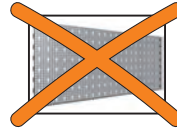

1293BX/DA



1293INOX/D8

3X



BETA		N°
1293 ●		3x75 mm
		3,5x100 mm
		4x100 mm
		4x125 mm
		5,5x100 mm
		5,5x150 mm
1290N ●		4x30 mm
		6,5x30 mm
		6,5x150 mm
		10x200 mm
1292 ●		PH0x60 mm
		PH1x80 mm
		PH2x100 mm
1292N +		PH1x30 mm
		PH2x30 mm

BETA		N°
1290 INOX ●		2,5x50 mm
		3x75 mm
		4x100 mm
		5,5x150 mm
		6,5x150 mm
1292 INOX +		PH0x60 mm
		PH1x80 mm
		PH2x100 mm

# 6600 M/315



066000315

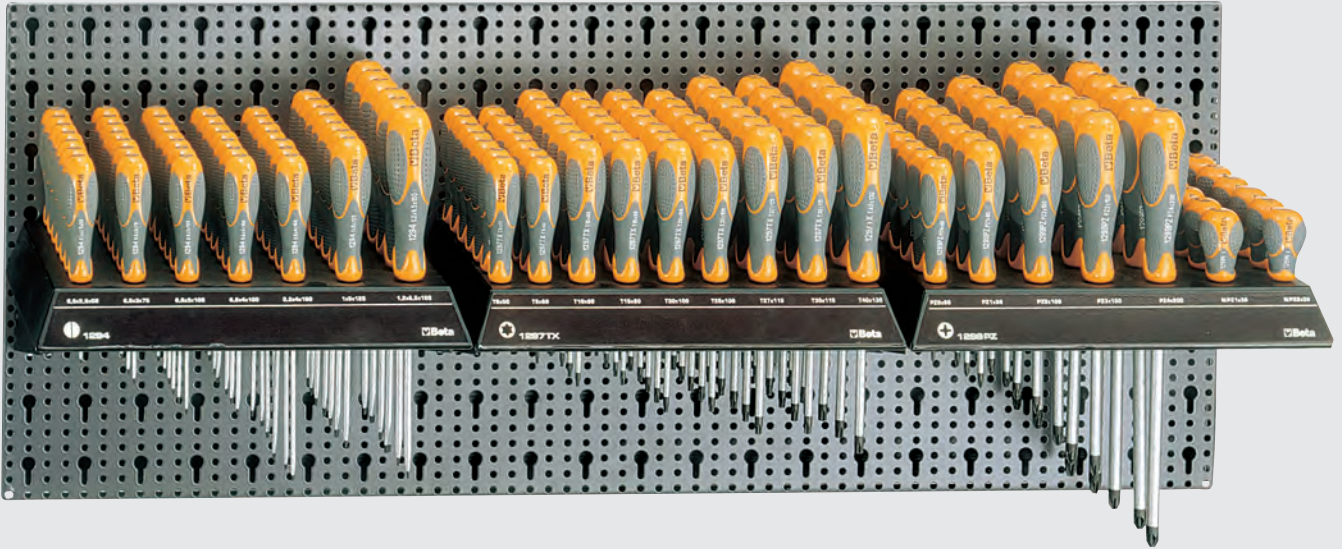
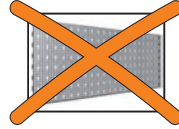

1293BX/DD



1293BX/DF



1293BX/DE



		N°	
1294		2,5x60 mm	7
		3x75 mm	
		3x100 mm	
		4x100 mm	
		4x150 mm	
5x125 mm	6		
6,5x150 mm			

		N°	
1297TX		T6-T8-T10	7
		T15-T20	
		T25	
		T27-T30	6
		T40	5

		N°	
1299PZ		PZ0	7
		PZ1	
		PZ2	5
		PZ3 PZ4	
1299N/ PZ		PZ1	6
		PZ2	



# 6600 M/320



066000320

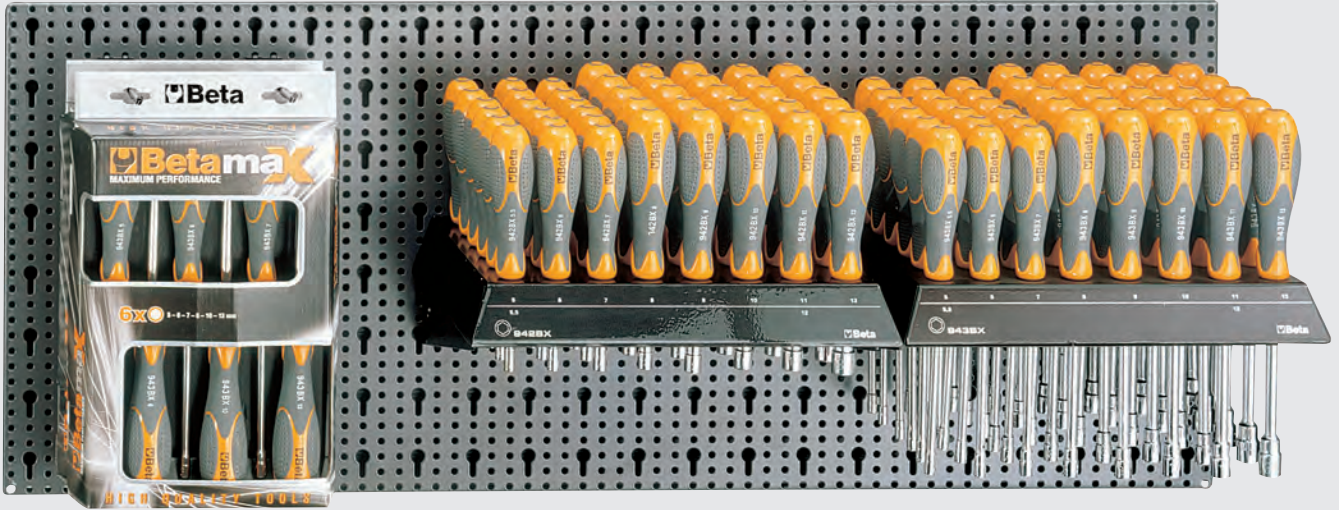
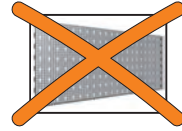

943BX/D6

2X



942BX/DG

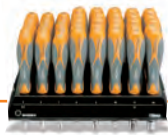

943BX/DG



			N°
943BX 		5 mm	1
		6 mm	
		7 mm	
		8 mm	
		10 mm	
		13 mm	

			N°
942BX 		5-5,5 mm	3
		6-7 mm	6
		8-9-10	5
		13 mm	2
		11 mm	2
		12 mm	3

			N°
943BX 		5-5,5 mm	3
		6-7 mm	6
		8-9-10	5
		13 mm	2
		11 mm	2
		12 mm	3

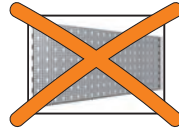

1263/E85



1263/E70



			N°
1260		2,5x50 mm	7
		2,5x75 mm	6
		3x75 mm	7
		3x100 mm	
		3,5x100 mm	6
		4x100 mm	
		4x125 mm	
		5,5x125 mm	
		5,5x150 mm	4
		6,5x150 mm	
8x150 mm	3		
10x200 mm			
1260E		12x250 mm	2
1260N		4x30 mm	6
		6,5x30 mm	

			N°
1262		PH0x60 mm	7
		PH0x100 mm	
		PH1x80 mm	6
		PH1x120 mm	
		4x100 mm	9
1262E		PH2x150 mm	5
		PH3x150 mm	4
		PH4x200 mm	
1262E		PH2x150 mm	5
		PH3x175 mm	4
1262N		PH1x30 mm	6
		PH2x30 mm	

# 6600 M/327



066000327

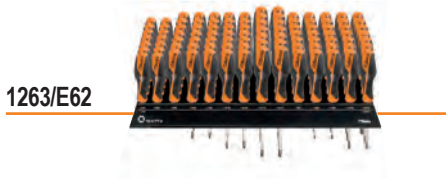
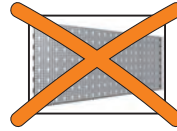

		1267TX	N°
1267TX		T5	5
		T6	6
		T7	5
		T8	6
		T9	5
		T10	
		T15	6
		T20	
		T25	5
		T27	4
		T30	
		T40	2
T45			

		1268RTX	N°
1268RTX		T9	
		T10	
		T15	6
		T20	
		T25	
		T27	4
		T30	3
T40	2		

# 6600 M/330



066000330

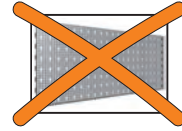

1263/D10

2X



1263/E50



1263/E40



			N°
1260		2,5x75 mm 3x100 mm 4x125 mm 5,5x150 mm 6,5x150 mm	1
1260N		4x30 mm	1
1262		PH0x60 mm PH1x80 mm PH2x100 mm	1
1262N		PH1x30 mm	1

			N°
1264		2,5x60 mm 3x75 mm 3x100 mm 4x100 mm 4x125 mm 5x125 mm 5x150 mm 6,5x150 mm	7 6 5

			N°
1269PZ		PZ0 PZ1 PZ2 PZ3 PZ4	7 6 5
1269N /PZ		PZ1 PZ2	6

# 6600 M/371



066000371

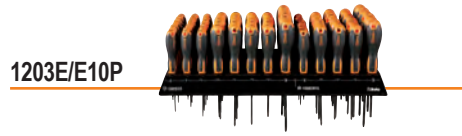
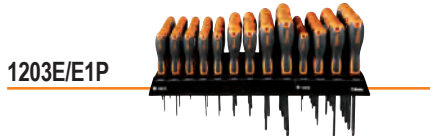
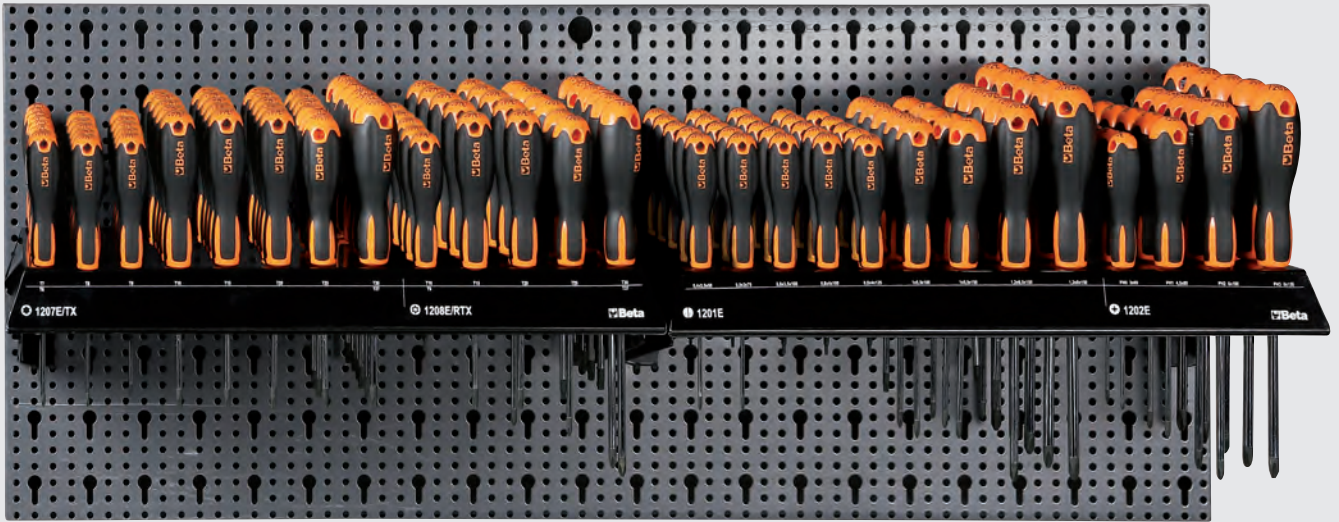
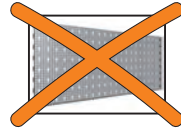

			N°	
1201E ●		2,5x50 mm	7	
		3x75 mm		
		3,5x100 mm		
		4x100 mm		
		4x125 mm		
1202E ⊕		5,5x100 mm		6
		5,5x150 mm		
		6,5x150 mm		
		8x150 mm	5	
		PH0x60 mm		
1202E ⊕		PH1x80 mm	6	
		PH2x100 mm		
		PH3x150 mm		5

			N°		
1207E/TX ⊕		T6	4		
		T7	3		
		T8	7		
		T9	6		
		T10			
		T15			
		T20			
		T25			
		1208E/RTX ⊕		T27	3
				T30	3
T9-T10					
T15					
1208E/RTX ⊕		T20	6		
		T25			
		T27	3		
		T30			

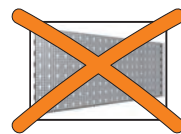

1263MC/D8

2X



1273MQ/F-D6

2X



1273MQ/D6

2X



		N°
1260MC ●	 PH0x60 mm PH1x80 mm PH2x100 mm	1
1262MC ●	 2,5x60 mm 3x100 mm 4x125 mm 5x125 mm	1

		N°
1274MQ/F ● ⚠ 1000 V	 3,5x100 mm 4,5x100 mm 5,5x125 mm 6,5x150 mm	1
1272MQ/F ● ⚠ 1000 V	 PH1x80 mm PH2x100 mm	1

		N°
1274MQ ● ⚠ 1000 V	 3x100 mm 4x100 mm 5,5x125 mm	1
1272MQ ● ⚠ 1000 V	 PH0x60 mm PH1x80 mm PH2x100 mm	1

1257LPH/S8

2X



		N°
1257LP ●	 0,4x2 mm 0,4x2,5 mm 0,5x3 mm 0,6x3,5 mm 0,8x4 mm	1
1257PH +	 PH00 PH0 PH1	1

		N°
1253 ●	 150/250V	5
1253A + ⚠	 125/150V	5
1254 ●	 6÷24V	5

# 6600 M/406



066000406

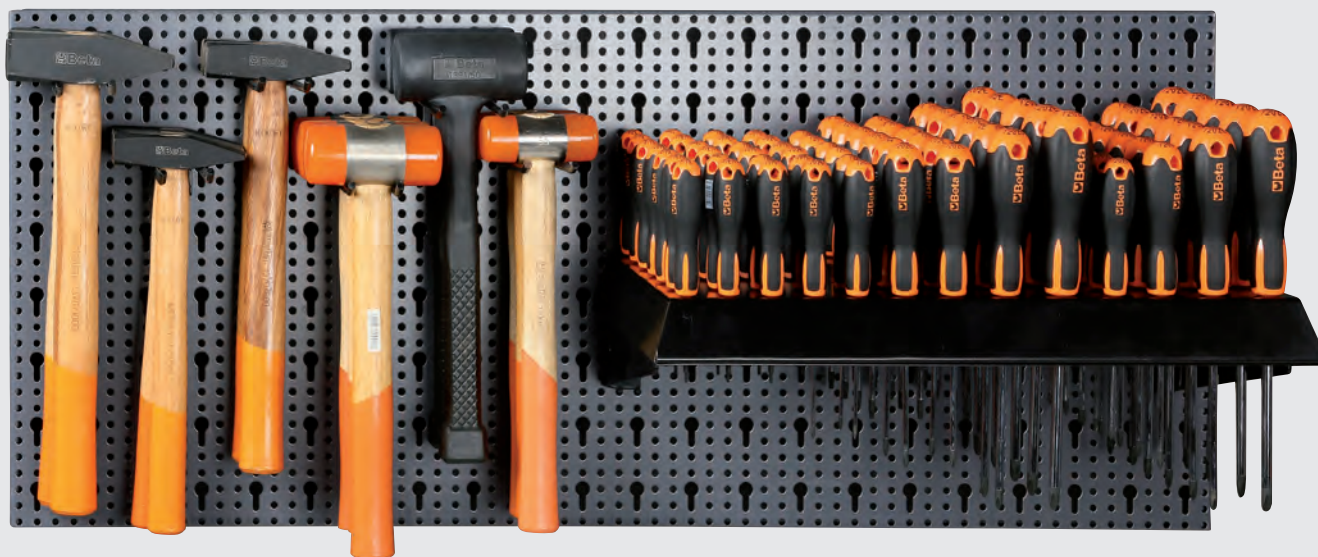
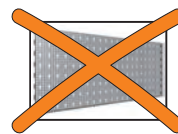

			N°
1370		300 g	5
		500 g	
		1000 g	4
1390		35 mm	5
		45 mm	4
1391		50 mm	2



		N°	
1201E ●		2,5x50 mm	
		3x75 mm	
		3,5x100 mm	7
		4x100 mm	
		4x125 mm	
		5,5x100 mm	6
1202E +		5,5x150 mm	
		6,5x150 mm	
		8x150 mm	5
		PH0x60 mm	7
		PH1x80 mm	
		6	
		5	

# 6600 M/417



066000417

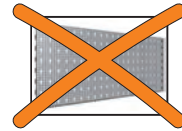

		Capacità Peso (g)	N°
1370		300 g	5
		400 g	
		500 g	
		800 g	4
		1000 g	
		1500 g	
1370T		300 gr	5
		500 gr	4
		800 gr	2
		1000 g	
		1500 g	



# 6600 M/423



066000423

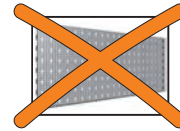

			N°
1370F		30-32 mm	4
		36-40-42 mm	3
1370FT		30-32 mm	3
		36-40-42 mm	2

# 6600 M/424



066000424

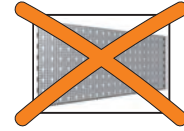

		g	N°
1370T		300 g	5
		500 g	5
		800 g	4
		1000 g	2
		1500 g	2
1377T		340 g	4
		450 g	4
		570 g	4
		680 g	3
		900 g	3

# 6600 M/427



066000427

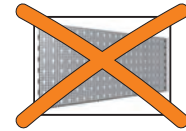

		N°
1380	 1000 g 1500 g 2000 g	2
1380S	 800 g 1000 g	2
1385	 600 g 800 g 1000 g	2
1392	 30 mm 35 mm 40 mm 50 mm	2

# 6600 M/430



066000430

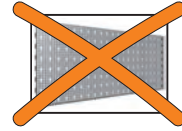

			N°	
1390		22 mm	5	
		28 mm		
		35 mm		
		45 mm		4
		60 mm		2
1391		35 mm	2	
		50 mm		
		55 mm		
		65 mm		

# 6600 M/440



066000440

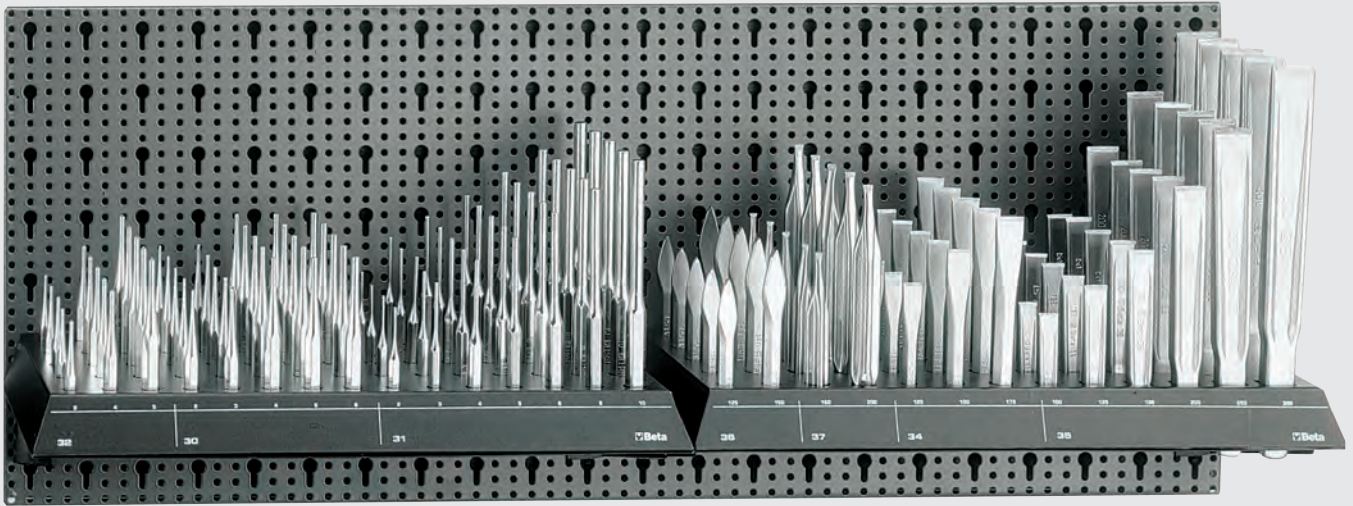
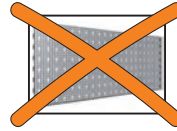







38/DS1



38/DS2



		N°
30		Ø 2-3-4 5-6 mm    5
31		Ø 2-3-4-5 6-8-10 mm    5
32		Ø 3-4-5 mm    5

		N°
34		125 mm 150 mm    5 175 mm
35		100 mm 125 mm 150 mm    5 200 mm 250 mm 300 mm
36		125 mm    5 150 mm
37		150 mm    5 200 mm







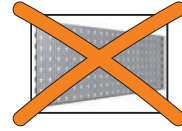

# 6600 M/456



066000456



		N°
1044N	 250 mm	5
1047	 240 mm	5
1047BM	 250 mm	4
1048N	 175 mm	3
	250 mm	5
	300 mm	4
1048VN	 175 mm	3
	250 mm	5
	300 mm	4
1048BM	 250 mm	3

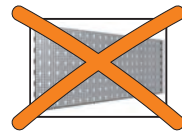

		N°
332		Ø 3÷16 mm 6
334		Ø 3÷30 mm 3
336		Ø 6÷38 mm 3
338		Ø 6÷67 mm 2
340		Ø 0÷26 mm 2
342		Ø 0÷42 mm 2

		N°
342A		Ø 0÷50 mm 2
359		1"÷1.1/4" 2
359CH		1.1/2" 2
388A/1		Ø 6-8 10 mm 2
388A/2		Ø 1/4" 5/16" 3/8" 2
392C		Ø 25÷65 mm 2

		N°
393		270 mm 2
395		15÷32 mm 2
395T		10÷32 mm 2

# 6600 M/480



066000480

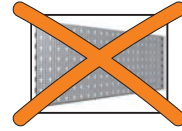

		Kit contenuto	N°
362		350 (Ø 60 mm)	2
		450 (Ø 76 mm)	
363		350 (Ø 60 mm)	2
		450 (Ø 76 mm)	
375		320 (Ø 34 mm)	2
		410 (Ø 49 mm)	
378		320 (Ø 34 mm)	2
		410 (Ø 49 mm)	
384		Ø 115 mm	2



6600 M/485



066000485

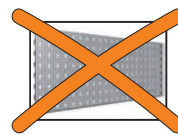





	Dimensioni Lunghezza	N°
374	 320 mm 410 mm 550 mm	2
376	 320 mm 410 mm 550 mm	2

# 6600 M/510

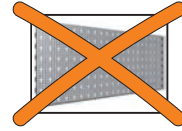

066000510



			N°
1101		300 mm 350 mm 450 mm 600 mm	3
1102		230 mm	4

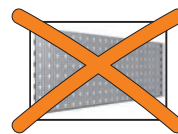

		N°
1112		200 mm 2
		300 mm 2
		250 mm 4
1114		250 mm 2 350 mm 2
1120A		280 mm 2
1122		250 mm 2
1123		250 mm 2
1124		250 mm 2
1125		250 mm 2
1126		250 mm 2

6600 M/534



066000534

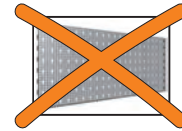

		N°
1128FX		145 mm 5
1128BSX		145 mm 10
1130BMX		190 mm 4
1131CK		203 mm 3
1132		203 mm 4

		N°
1771BM		18 mm 10
1772R		18 mm 5
1772M		18 mm 5
1771HD		18 mm 5

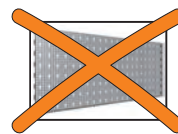

		N°	
1719BM A/M		▷ 200 mm	5
1719BM A/P		┆ 200 mm	5
1719BM A/Q		■ 200 mm	5
1719BM A/R		● 200 mm	5
1719BM A/T		▲ 200 mm	5
1719BM RL		┆ 200 mm	5
1719BM RR		● 200 mm	5

		N°	
1725CR		250 mm	5
1726		440 mm	4
1727		515 mm	4
1727BM		315 mm	5

6600 M/548



066000548

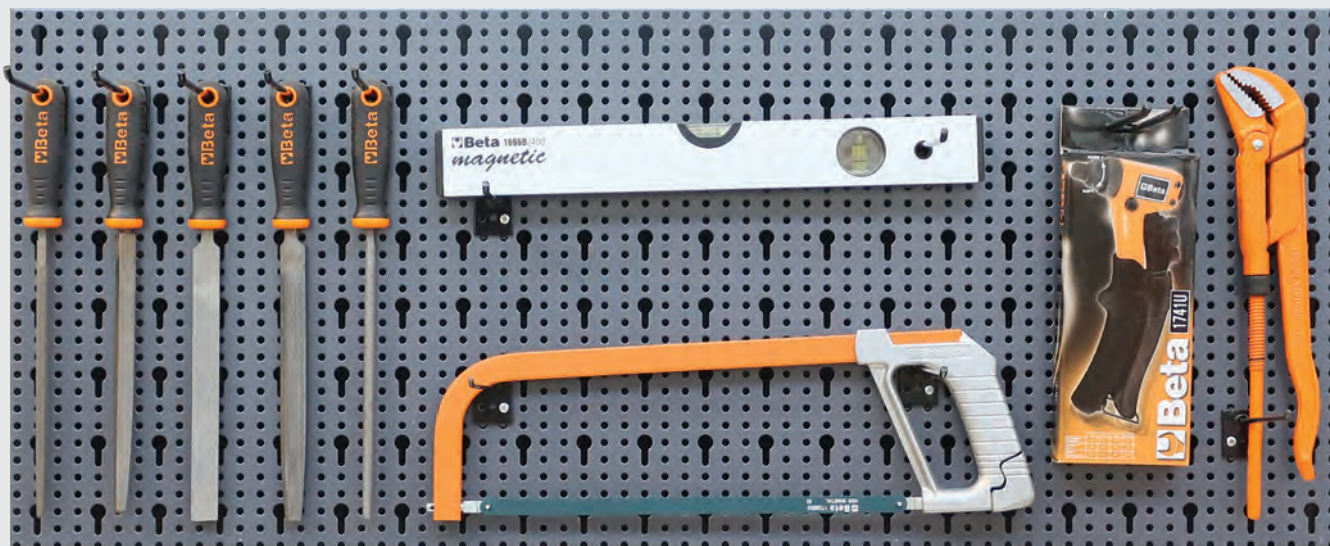
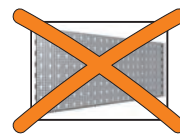

			N°
1719BM A/M		▷ 200 mm	5
1719BM A/P		▮ 200 mm	5
1719BM A/Q		■ 200 mm	5
1719BM A/R		● 200 mm	5
1719BM A/T		▲ 200 mm	5

			N°
1726		440 mm	4
374		320 mm	3
1696B		400 mm	2
1741U			3

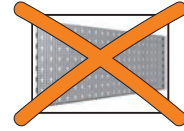

		N°	
435		/0 M2÷M8	5
		/1 M3÷M10	3
		/1,5 M3÷M12	
		/2 M4÷M14	
		/3 M5÷M21	2
436		/1 M3÷M8	5
		/2 M5÷M12	
436L		/1 M3÷M8	2
		/2 M5÷M12	

446/C30



		N°	
430		M3x0,5 mm	1
		M4x0,7 mm	
		M5x0,8 mm	
		M6x1 mm	
		M8x1,25 mm	
		M10x1,5 mm	
M12x1,75 mm			
440		M3x0,5 mm	1
		M4x0,7 mm	
		M5x0,8 mm	
		M6x1 mm	
		M8x1,25 mm	
		M10x1,5 mm	
M12x1,75 mm			
435/1,5		M3÷M12	1
444/1		Ø25,4 mm	1

# 6600 M/583



066000583

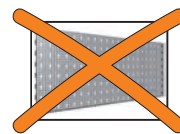

		N°
1650		2
1651DGTB	200 mm	2
1692		5 m 8 m 5
1694A/L		50 m 2
1694B/L		50 m 2
1696B		400 mm 500 mm 2



# 6600 M/643



066000643

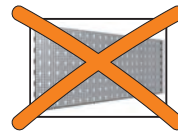

			N°
850MQ △1000 V 		233 mm	3
1082MQ △1000 V 		160 mm	3
1150MQ △1000 V 		180 mm	3
1048MQ △1000 V 		250 mm	2
1166MQ △1000 V 		160 mm	4
1777MQ/U △1000 V		400 mm 500 mm	2

1273MQ/E2









943MQ/BG

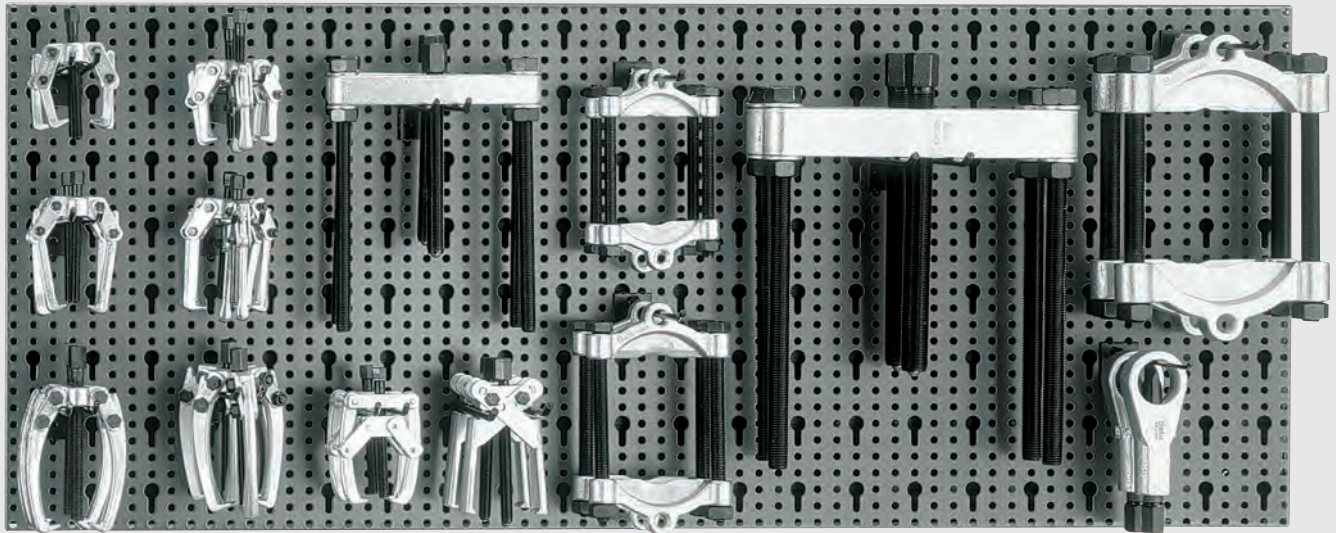
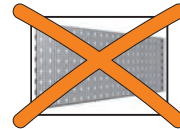



			N°
1272MQ/F △1000 V 		4,5x80 mm 6x100 mm	3
1274MQ/F △1000 V 		3,5x100 mm 4,5x100 mm 5,5x125 mm 6,5x150 mm	3
1275MQ/C △1000 V 		PH1 LPP 4,5x80 mm	5
1276MQ/C △1000 V 		PZ1 LPP 4,5x80 mm	5
		PZ2 LPP 6x100 mm	
1279MQ/F △1000 V 		PZ1 4,5x80 mm	3
		PZ2 6x100 mm	2





			N°
943MQ △1000 V 		5,5 mm 6 mm 7 mm 8 mm 10 mm 13 mm	5

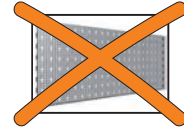

			N°
1506		10÷50 mm	2
1508		6÷100 mm /1	2
1515		0÷60 mm /1	2
		0÷70 mm /2	
		0÷90 mm /3	
1516		0÷60 mm /1	2
		0÷70 mm /2	
		0÷90 mm /3	
1533		45÷134 mm /2	2
		55÷205 mm /3	

			N°
1534		0÷60 mm /1	2
		0÷70 mm /2	
		0÷90 mm /3	
1709/18		0÷25 mm M16	2



			N°
1500N		/0 Ø max 65 mm	3
		/1 Ø max 90 mm	
		/2 Ø max 120 mm	
		/3 Ø max 170 mm	2
		/4 Ø max 220 mm	
/5 Ø max 290 mm			
1518		/1 24÷100 mm	1
1521		/1 0÷110 mm	1

6600 M/658



066000658

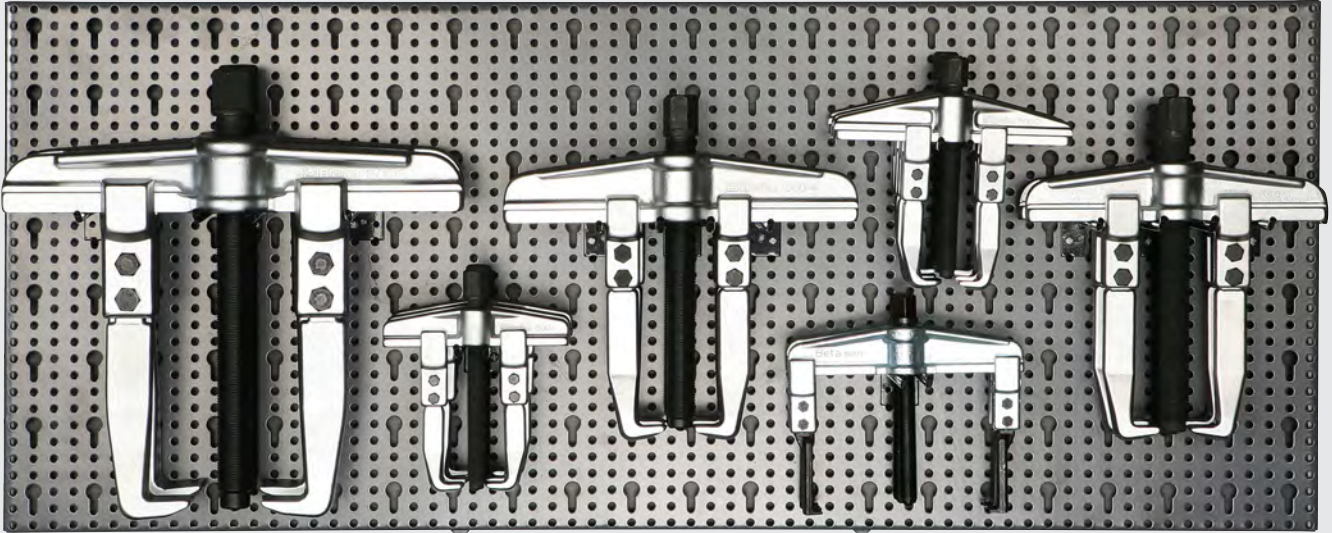
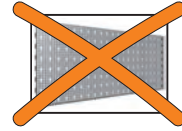

		N°	
1500		/1 25÷80 mm	3
		/2 25÷130 mm	
		/3 50÷160 mm	
		/4 60÷200 mm	2
		/35 80÷250 mm	
1501		/1 25÷130 mm	2

# 6600 M/716



066000716

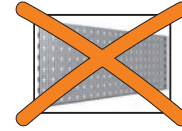

			N°
720 12"		10 mm	4
		11-12 mm	2
		13 mm	4
		14-15-16 mm	2
		17 mm	4
		18 mm	2
		19-21-22 mm	4
		23 mm	2
		24 mm	4
		27 mm	3
30-32-36 mm	2		
720/15 12"		□1/2x■3/8	2
720/16 12"		□1/2x■3/4	2
720/20 12"		75 mm	2
720/21 12"		125 mm	2
720/25 12"			1

			N°
1927XM 12" CE		10.000 rpm 770 Nm	1
1927P 12" CE		7.500 rpm 1.750 Nm	1
1927G 12" CE		8.500 rpm 325 Nm	1
1928XM 3/4" CE		4.800 rpm 1.600 Nm	1

# 6600 M/813



066000813

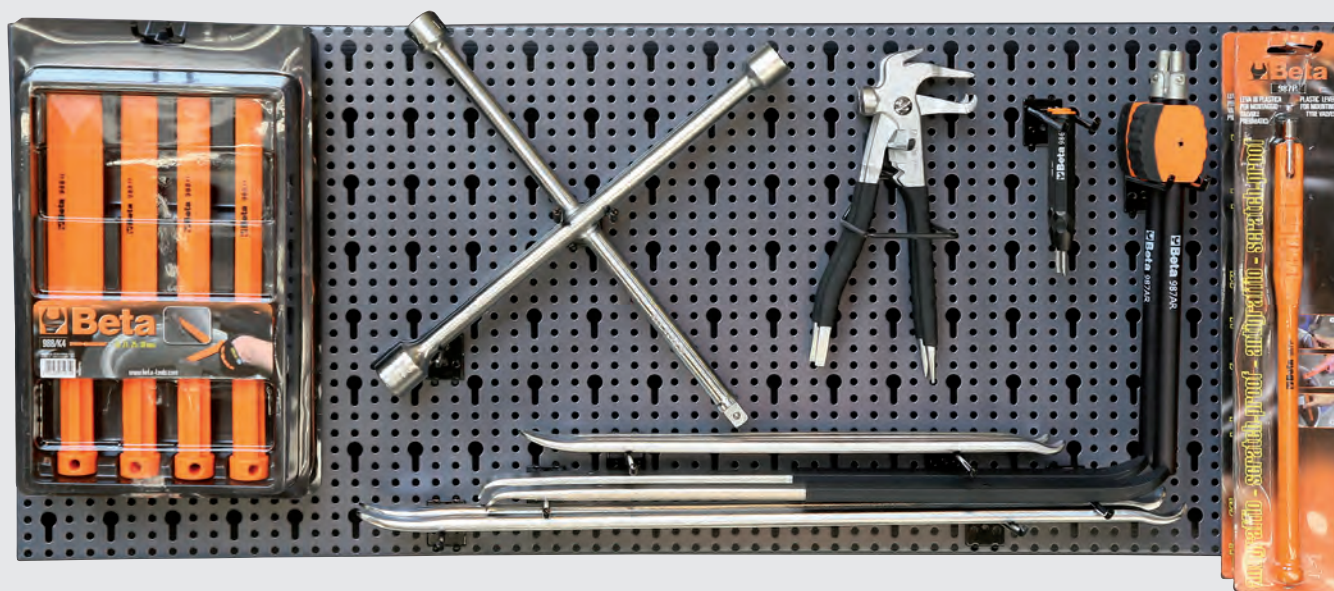
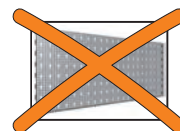

		lunghezza length	N°
962		400 mm	5
		600 mm	3
962P		490 mm	2
979		17x19x22x ■ 1/2 mm	2
986PT		120 mm	2
987AR		305 mm	2
987P		335 mm	5

		lunghezza length	N°
988/K4		19 mm	2
		21 mm	
		25 mm	
		38 mm	
989		250 mm	2

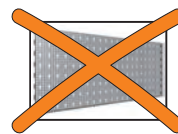

		N°
1482		Ø 89-170 mm 2
1488		Ø 60-110 mm 2
1488L		Ø 60-160 mm 3
1490		Ø max 160 mm /1
		Ø max 240 mm /2
1491		Ø 65-110 mm 3
1491R		10

		N°
1492/2		Ø 80-110 mm 3
1493X/1		Ø 60÷80 mm 2
1496/C		■ 8x ■ 10 mm 3
1758LG		L=365 mm 2

6600 M/852



066000852

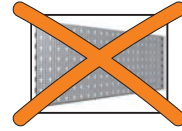

		N°
11001		115x3,2 40
11021		115x3,2 40
11011		115x6,5 20
11011H		230x6,5 20

		N°
11034		115x1,0 100
		115x1,6 100
11038		230x2,0 40
11045		115x1,0 100
		115x1,6 100



6600 M/856



066000856

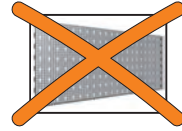

		N°
11001		125x3,2 40
11021		125x3,2 40
11011H		125x6,5 20
		230x6,5 20

		N°
11035		125x1,0 100
		125x1,6 100
11038		230x2,0 40
11046		125x1,0 100
		125x1,6 100

6600 M/857



066000857

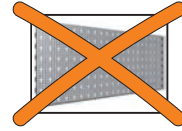

		N°
11001		115x3,2 40
		125x3,2 40
11011H		125x6,5 20
		230x6,5 20

		N°
11034		115x1,0 100
		115x1,6 100
11035		125x1,0 100
		125x1,6 100
11038		230x2,0 40

6600 M/871



066000871

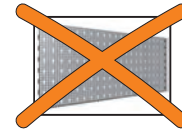

			N°
11200A 40		Ø 115/40 mm	10
11204A 40		Ø 115/40 mm	10
11202A 40		Ø 115/40 mm	10
11212A 40		Ø 115/40 mm	10
11216A 40		Ø 115/40 mm	10
11214A 40		Ø 115/40 mm	10





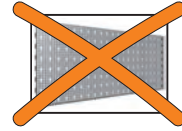

			N°
11230A 40		Ø 115/40 mm	10
11234A 40		Ø 115/40 mm	10
11240A 40		Ø 115/40 mm	10
11242A 40		Ø 115/40 mm	10
11246A 40		Ø 115/40 mm	10
11248A 40		Ø 115/40 mm	10

# 6600 M/878









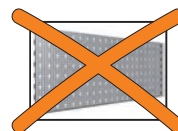

066000878









			N°
11204B 40		Ø 125/40 mm	10
11208B 40		Ø 125/40 mm	10
11210B 40		Ø 125/40 mm	10
11204B 60		Ø 125/40 mm	10
11216B 60		Ø 125/40 mm	10
11216B 40		Ø 125/40 mm	10

			N°
11218B 40		Ø 125/40 mm	10
11220B 40		Ø 125/40 mm	10
11240B 40		Ø 125/40 mm	10
11248B 40		Ø 125/40 mm	10



			N°
11263 15-60		Ø 30x15 mm	40
11263 15-80		Ø 30x15 mm	40
11264 20-40		Ø 40x20 mm	40
11264 20-60		Ø 40x20 mm	40
11265 20-60		Ø 50x20 mm	40
11265 20-80		Ø 50x20 mm	40





			N°
11265 30-60		Ø 50x30 mm	40
11265 30-80		Ø 50x30 mm	40
11266 30-40		Ø 60x30 mm	30
11266 30-60		Ø 60x30 mm	30
11266 30-80		Ø 60x30 mm	30



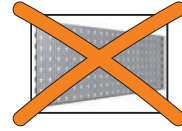



**374**





**34**



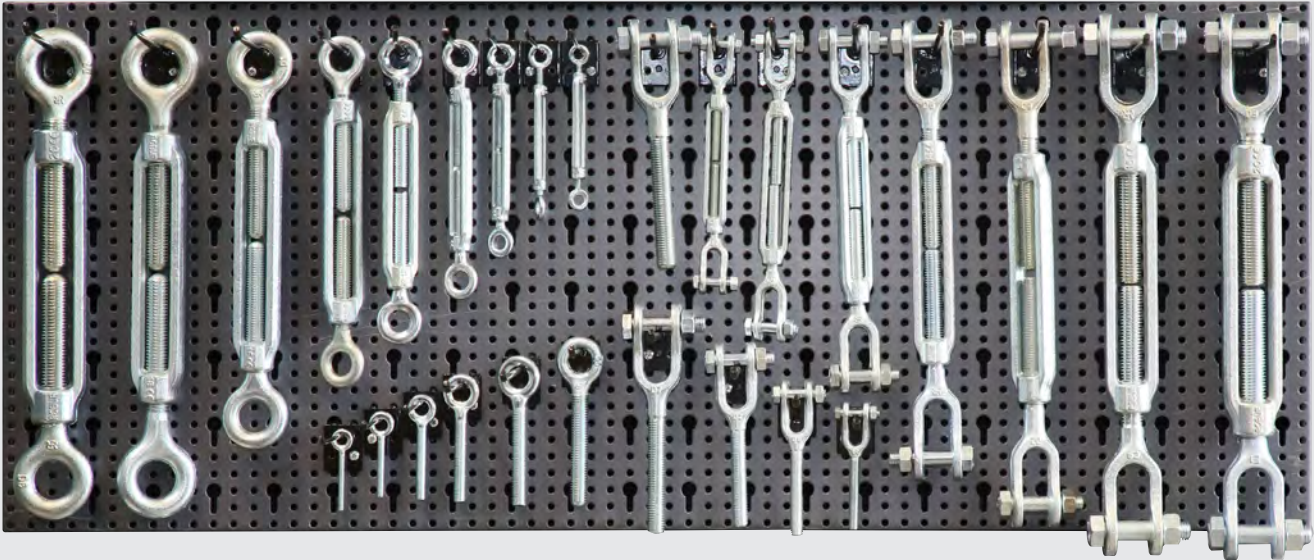
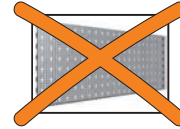



		N°
8002ZD		M5
		M6
		M8
		M10
8003ZD		M5
		M6
		M8
		M10
8005Z €€		M5
		M6
		M8
		M10
		M12
8006Z €€		M5
		M6
		M8
		M10
		M12

		N°
8007Z €€		M5
		M6
		M8
		M10
8009FD		M8
		M10
		M12
8009Z €€		M8
		M10
		M12
		M14

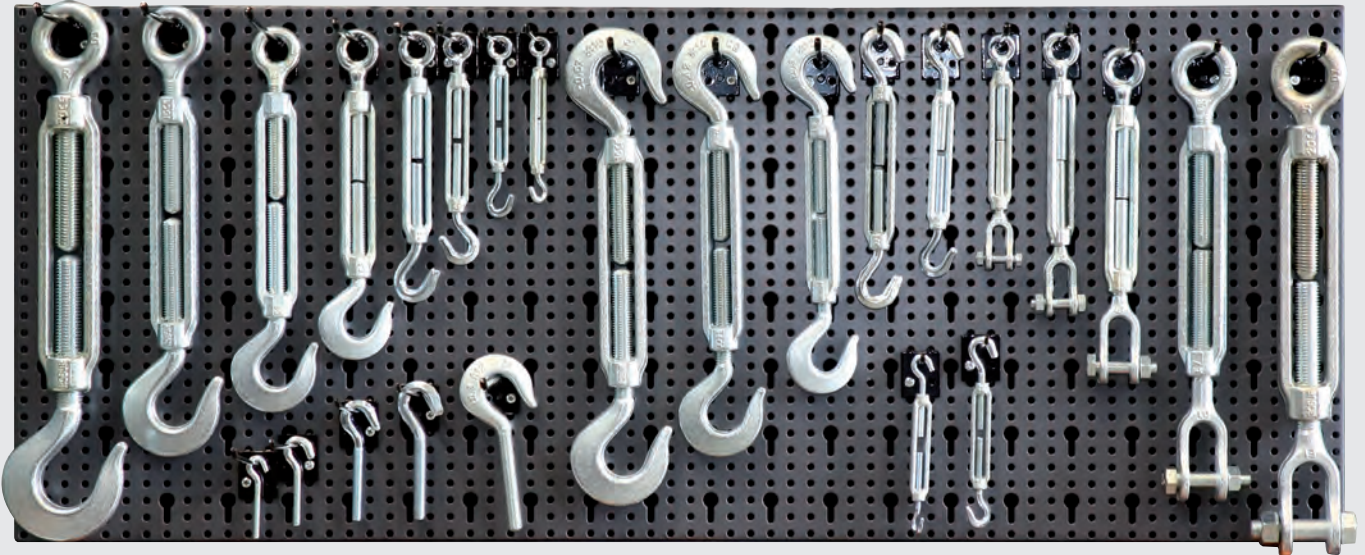
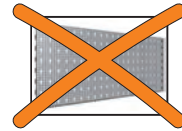

		 N°
8002ZD		M5
		M6
		M8
		M10
		M12
8005Z CE		M14
		M16
		M18
		M20
		M8
		M10
		M12
		M14
8009Z CE		M16
		M18
		M20
		M8
		M10
		M12
8009FD		M8
		M10
		M12
		M14
		M16



		N°
8003ZD		M5 15
		M6 12
		M8 10
		M10 6
		M12 6
8006Z CE		M5 30
		M6 20
		M8 15
		M10 10
		M14 8
		M16 4
		M20 4
8007Z CE		M5 10
		M6 8
		M8 8
		M10 6
		M12 4
		M14 2
8010Z CE		M8 6
		M10 4
		M12 4
		M16 2
		M20 2



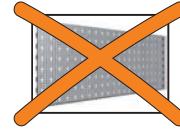

			N°
8016 CE		3 mm	100
		5 mm	50
		6 mm	30
		8 mm	15
		10 mm	15
8020A		4 mm	150
		5 mm	100
		6 mm	50
		8 mm	30
		12 mm	10
8025 CE		5 mm	25
		6 mm	15
		8 mm	12
		12 mm	12
8040EZ CE		M6	30
		M8	20
		M10	2
		M16	2
8042EZ		M6	30
		M8	20
		M10	10
		M12	10
8051S CE		250 kg	15
		500 kg	10

			N°
8074		4x40 mm	50
		5x50 mm	40
		6x60 mm	30
		8x80 mm	20
		10x100 mm	20
8074A		5x50 mm	30
		6x60 mm	20
		8x80 mm	10
		10x100 mm	10
8074G		5x50 mm	30
		6x60 mm	20
		8x80 mm	10
		10x100 mm	10
8080		4x40 mm	50
		5x49 mm	40
		6x57 mm	30
		8x74 mm	30
8083		3 mm	40
		4 mm	30
		5 mm	20
		6 mm	15
8302Z		M5	30
		M6	20
		M8	20
8303Z		M5	30
		M6	20
		M8	20

			N°
8381SL		22 mm	20
		27 mm	15
		34 mm	10
		43 mm	10
8515V		24,5 mm	10
8515Z		24,5 mm	10

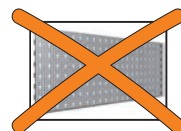

			N°
8016 c€		3 mm	50
		5 mm	25
		6 mm	15
		8 mm	15
		10 mm	15
8020A		2-3 mm	150
		4 mm	150
		5 mm	100
		6 mm	100
		8 mm	50
		10 mm	30
8025 c€		12 mm	10
		5 mm	10
		6 mm	10
		8 mm	10
		10 mm	5
8026A c€		12 mm	10
		14 mm	10
		16 mm	10
		20 mm	5
8029R c€		500 kg	5
		750 kg	5
		1000 kg	10
		2000 kg	8
		3250 kg	5
8031R c€		4750 kg	2
		2000 kg	3
		3250 kg	

			N°
8040EZ c€		M6	20
		M8	10
		M10	10
		M12	10
		M16	5
8041 c€		M8	10
		M10	6
		M12	4
		M16	2
8042EZ c€		M6	20
		M8	10
		M10	10
		M12	10
8043 c€		M16	5
		M8	10
		M10	6
		M12	4
8051S c€		M16	2
		250 kg	10
		500 kg	5

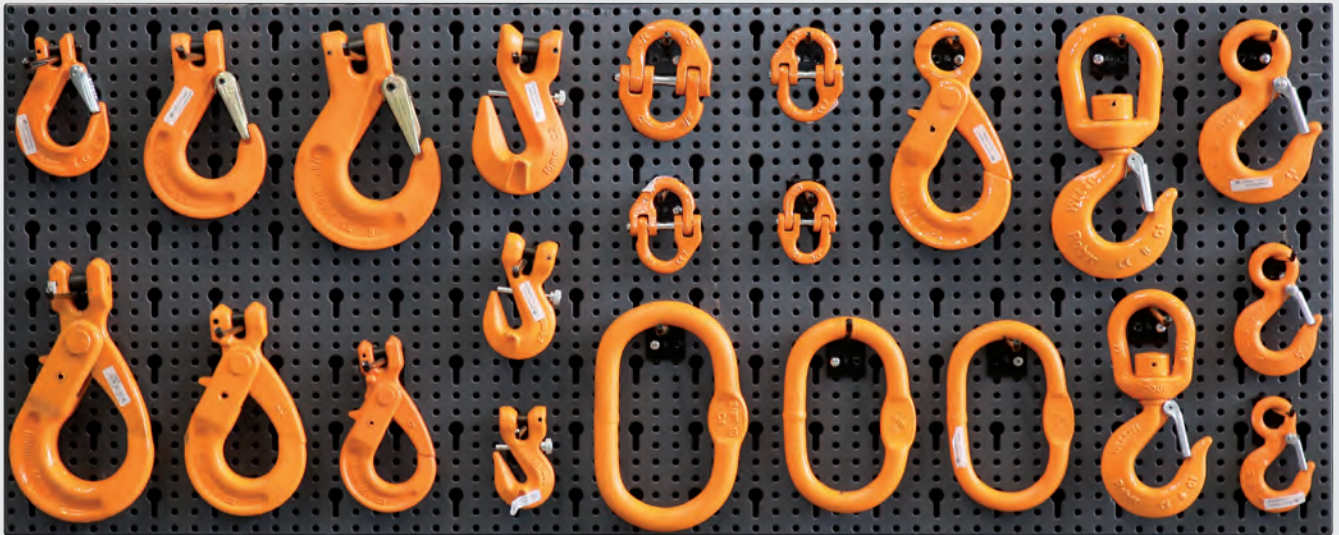
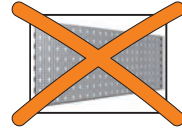

		N°
8052 €€		800 kg 1120 kg 2000 kg    4
8057R €€		2000 kg    2
8058R €€		1120 kg    4
		2000 kg 3150 kg    2
8060R €€		1120 kg    4
		2000 kg 3150 kg    2
8061R €€		1120 kg 2000 kg 3150 kg    2

		N°
8063 €€		1120 kg 2000 kg    2
8085R €€		1500 kg 2000 kg 3150 kg    2
8090R €€		1120 kg    4
		1500 kg 2000 kg 3150 kg    2

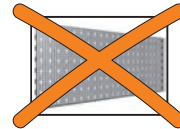

			N°
8205		M4	5
		M5	10
		M6	5
		M8	1
8206		M5	5
		M6	
		M8	
8209		M5	5
		M6	
		M8	
8216 CE		3 mm	15
		4 mm	10
		5 mm	
		6 mm	5
		8 mm	
8220		3 mm	15
		4 mm	10
		5 mm	
		6 mm	5
8225		4 mm	10
		5 mm	
		6 mm	5
		8 mm	
		10 mm	3
8240		M6	5
		M8	
		M10	
		M12	

			N°
8242		M6	5
		M8	
		M10	
		M12	
8249		M5	5
		M6	
		M8	
		M10	
8250		50 mm	5
		70 mm	
8264			5
		12 mm	
8274		4,5x40 mm	10
		5x50 mm	5
		6x60 mm	
		7x70 mm	
		8x80 mm	
8274G		10x100 mm	1
		6x60 mm	3
	10x100 mm		

			N°
8276G		10x100 mm	3
8280		5x49 mm	5
		6x57 mm	
		7x66 mm	
8381SX		8x74 mm	10
		22 mm	
		27 mm	
		34 mm	
		49 mm	5
	61 mm		

# 8600 R/511



086000511

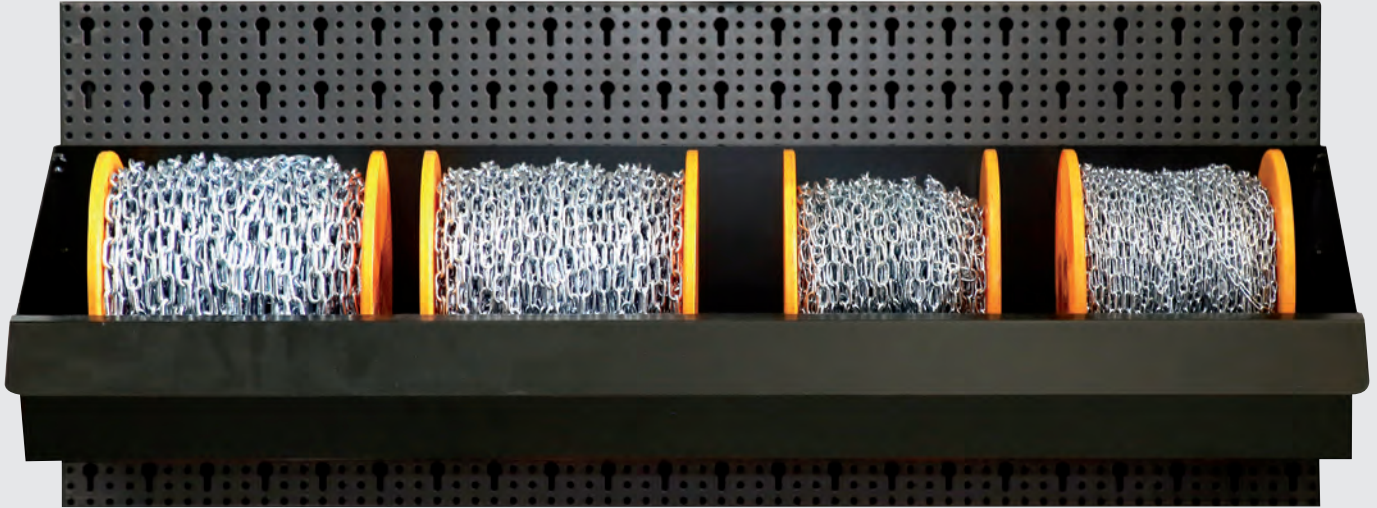
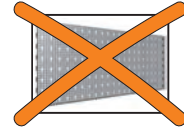

			N°
8120		Ø 2,2 mm x 75 m	2
		Ø 2,7 mm x 75 m	2
		Ø 3,4 mm x 60 m	1
		Ø 4,4 mm x 40 m	1
		Ø 4,8 mm x 30 m	2
		Ø 5,5 mm x 25 m	1
		Ø 6,5 mm x 25 m	2

# 8600 R/601



086000601

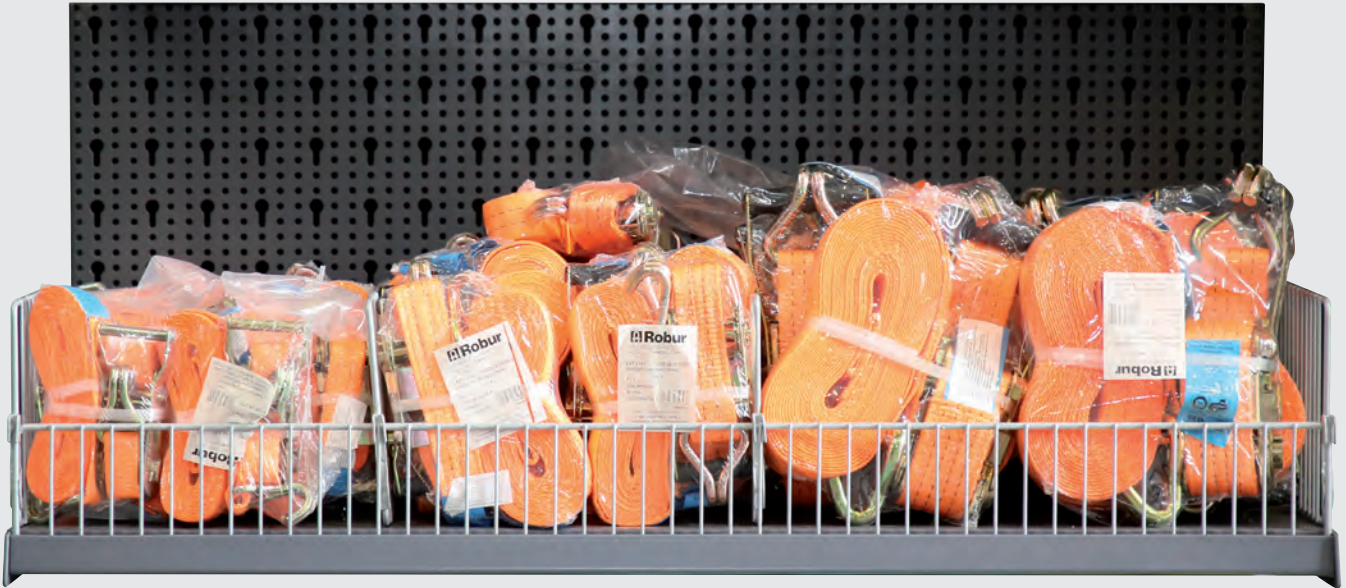
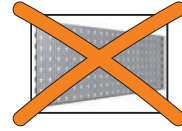

			N°
8180 CE		25 mm - 4 m	15
8181 CE		35 mm - 6 m	15
8182 CE		50 mm - 8,5 m	20

# 8600 R/611



086000611

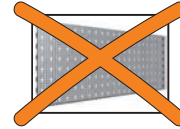

		N°	
8150 c€		1 m - 1000 kg	10
		2 m - 1000 kg	8
		3 m - 1000 kg	6
8153 c€		2 m - 2000 kg	8
		3 m - 2000 kg	6
		4 m - 2000 kg	4
8156 c€		3 m - 3000 kg	6
		4 m - 3000 kg	4

















-  Espositore non incluso
-  Display not included
-  Présentoir non fourni
-  Expositores no incluidos
-  Ständer nicht mitgeliefert
-  Exklusief de display
-  Regał nie wchodzi  
w skład zestawu
-  Állvány nélkül szállítva
-  Expositor não incluído
-  Δεν περιλαμβάνεται  
εκθετήριο



- PROPOSTE ESPOSITIVE: ESPOSITORI COMPLETI** 
- DISPLAY SUGGESTIONS: COMPLETE DISPLAYS** 
- PROPOSITIONS D'EXPOSITION : PRÉSENTOIRS COMPLETS** 
- PROPUESTAS EXPOSITIVAS: EXPOSITORES COMPLETOS** 
- AUSSTELLUNGSANGEBOTE: KOMPLETTE STÄNDER** 
- DISPLAY SUGGESTIES: COMPLETE DISPLAYS** 
- PROPOZYCJE EKSPOZYCJI: KOMPLETNE ZESTAWY** 
- ÁLLVÁNY AJÁNLATOK: KOMPLETT ÁLLVÁNYOK** 
- SUGESTÃO DE EXPOSITORES: EXPOSITORES COMPLETOS** 
- ΠΡΟΤΑΣΕΙΣ ΠΡΟΒΟΛΗΣ: ΠΛΗΡΗ ΕΚΘΕΤΗΡΙΑ** 

8600 E/R1

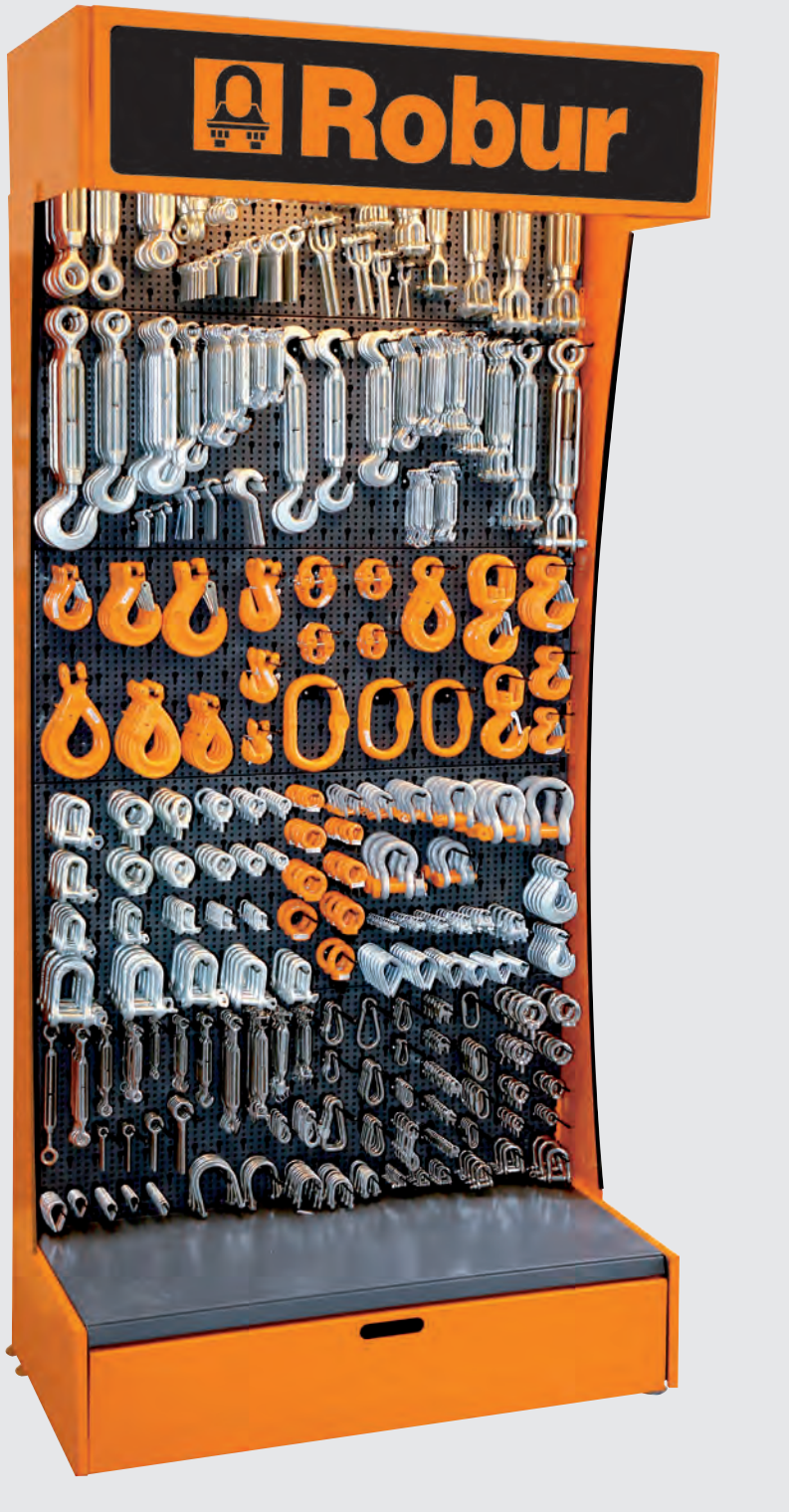

8600 R/12	
8600 R/13	
8600 R/225	
8600 R/114	
8600 R/412	



8600 E/R2



2349



98



8600 R/11	
8600 R/113	
8600 R/511	
8600 R/601	
8600 R/611	



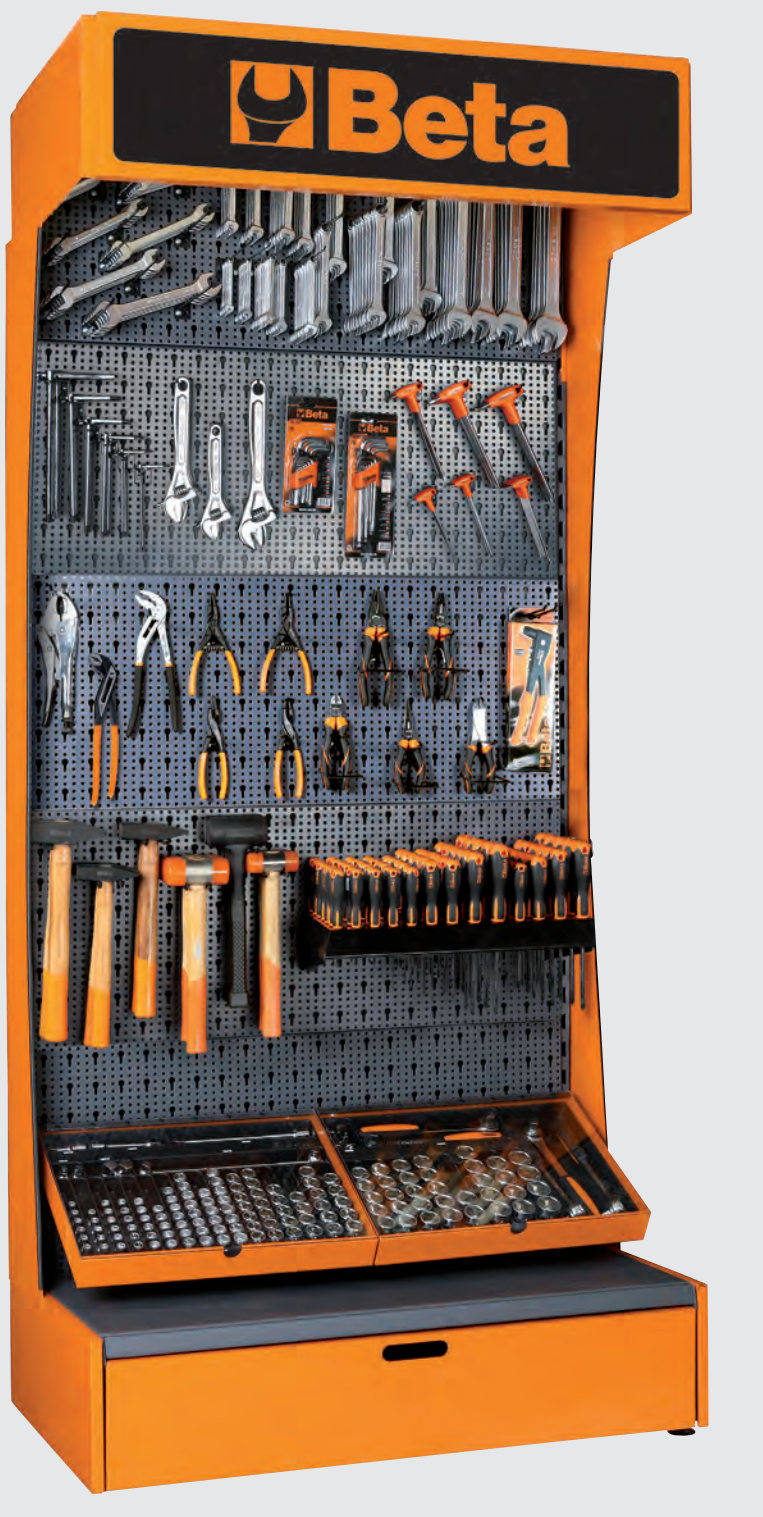

			N°
42		6x6 mm	5
		7x7 mm	10
		8x8 mm	10
		9x9 mm	5
		10x10 mm	10
		11x11 mm	5
		12x12 mm	10
		13x13 mm	10
		14x14 mm	5
		15x15 mm	10
		16x16 mm	5
		17x17 mm	10
		18x18 mm	5
		19x19 mm	10
		22x22 mm	5
24x24 mm	8		
27x27 mm	5		
30x30 mm	5		
32x32 mm	5		
55		6x7 mm	5
		8x9 mm	10
		10x11 mm	10
		12x13 mm	5
		14x15 mm	5
		16x17 mm	5
18x19 mm	5		
20x22 mm	5		
96T ○		2-2,5 mm	5
		3-4-5 mm	10
		6 mm	5
96/SC9 ○		1,5-2-2,5	5
		3-4-5-6-8	
		10 mm	
96BPC/ SC9 ○		1,5-2-2,5	10
		3-4-5-6-8	
		10 mm	
111E		200-250 mm	4
		300 mm	2
951 ○		2,5-3-4-5	5
		6-8 mm	

				N°
1032		180 mm		5
1034		170 mm		5
1036		175 mm		5
1038		175 mm		5
1047		240 mm		4
1048N		250 mm		5
1052		240 mm		4
1082BM		160 mm		5
1084BM		160 mm		3
1150BM		180 mm 200 mm		5
1166BM		160 mm		5
1741B				4

1370		300 g 500 g 1000 g	5 4
1390		35 mm 45 mm	5 4
1391		50 mm	2

1203E/E1P

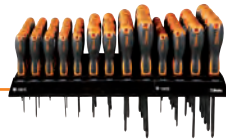

			N°
1201E		2,5x50 mm 3x75 mm 3,5x100 mm 4x100 mm 4x125 mm	7
		5,5x100 mm 5,5x150 mm 6,5x150 mm	6
		8x150 mm	5
1202E		PH0x60 mm PH1x80 mm PH2x100 mm PH3x150 mm	7 6 5





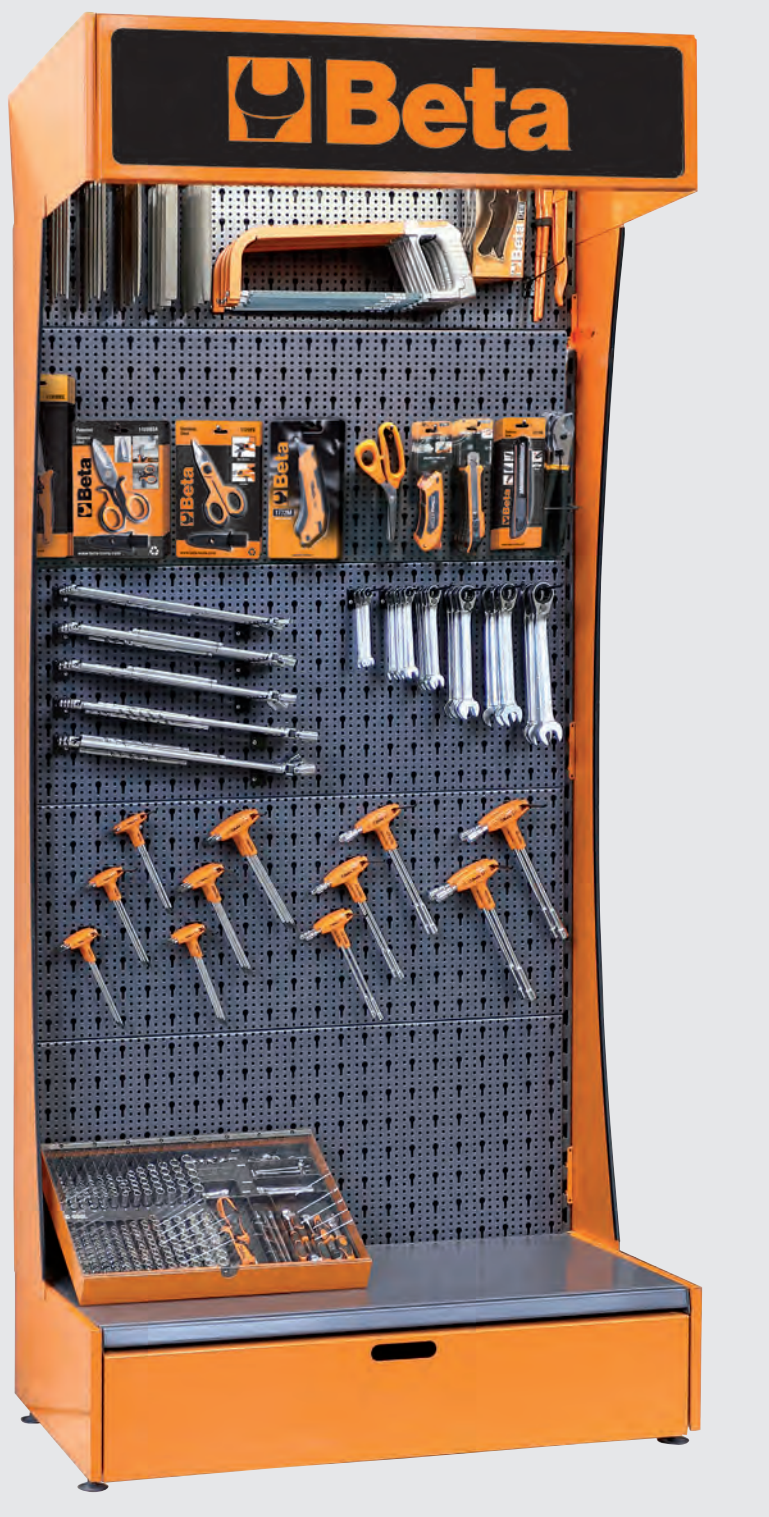

920A		8 mm 9 mm 10 mm 11 mm 12 mm 13 mm 14-15 mm 16 mm 17 mm 18-19 mm 20-21 mm 22 mm 23-24-25 mm 26-27-28 mm 29 mm 30-32 mm	6 5 9 5 6 9 8 6 8 7 5 6 5 5
920/15		□1/2"x■3/8"	2
920/16		□1/2"x■3/4"	2
920/20		75 mm	2
920/21		125 mm	2
920/22		255 mm	2
900/25			2
920/42			2
920/50			2
920/55			4



















			N°
1719BM A/M		▷ 200 mm	5
1719BM A/P		▮ 200 mm	5
1719BM A/Q		■ 200 mm	5
1719BM A/R		● 200 mm	5
1719BM A/T		▲ 200 mm	5
1726		440 mm	4
374		320 mm	3
1696B		400 mm	2
1741U			3

		N°
1128FX		145 mm 5
1128BSX		145 mm 10
1130BMX		190 mm 4
1131CK		203 mm 3
1132		203 mm 4
1771BM		18 mm 10
1772R		18 mm 5
1772M		18 mm 5
1771HD		18 mm 5

		N°
142		8 mm 3
		10 mm 5
		13 mm 4
		17 mm 3
		22 mm 5
952		8 mm 5
		10 mm 3
		12 mm 3
		13 mm 3
		17 mm 3
97TTX		T10-T15 3
		T20-T25 3
		T30-T40 3
941		7x7 mm 2
		8x8 mm 2
		10x10 mm 2
		12x12 mm 2
		13x13 mm 2

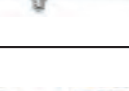
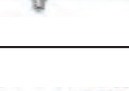
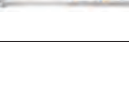
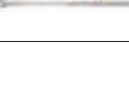

		N°
900 		4-4.5-5 10
		5.5-6-7-8 10
		9-10 mm 8
		11-12 13 mm 7
900L 		4-4.5-5-5.5 5
		6-7-8-9-10 11-12-13 14 mm 5
900/16 		□1/4"x■3/8" 5
900/20 		50 mm 3
900/20L 		100 mm 3
900/21 		150 mm 3
900/25 		3
900BG /30 		176 mm 2
900/42 		150 mm 3
900/55 		5







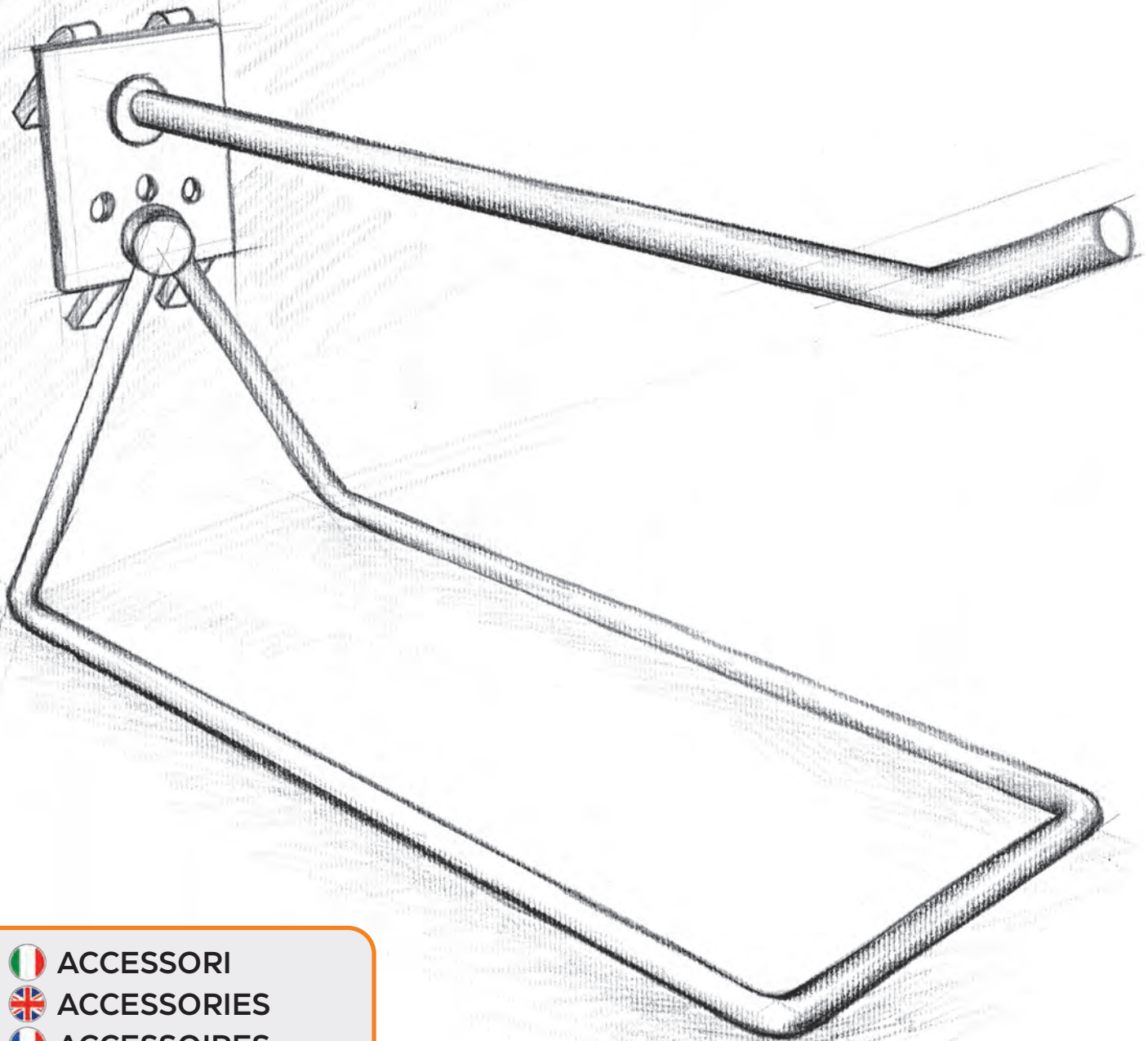



-  ACCESSORI
-  ACCESSORIES
-  ACCESSOIRES
-  ACCESORIOS
-  ZUBEHÖR
-  ACCESSOIRES
-  AKCESORIA
-  TARTOZÉKOK
-  ACESSÓRIOS
-  ΕΞΑΡΤΗΜΑΤΑ



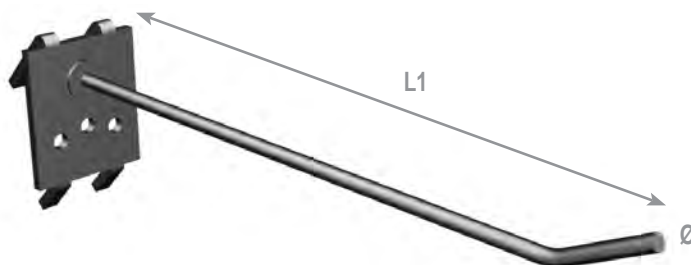

## 6888 S...

-  Ganci singoli
-  Single hooks
-  Crochets simples
-  Ganchos individuales
-  Einzelhaken
-  Enkele haken
-  Haki pojedyncze
-  Kampó
-  Ganchos simples
-  Μόνο γάντζοι





	L1 mm	L2 mm		
S1	150	3,4	10	068880011

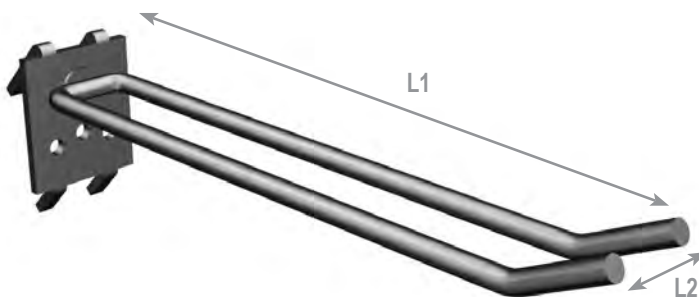

	L1 mm	L2 mm		
S2	150	5,2	10	068880012

## 6888 D...

-  Ganci doppi
-  Double hooks
-  Crochets doubles
-  Ganchos dobles
-  Doppelhaken
-  Dubbele haken
-  Haki podwójne
-  Duplakampó
-  Ganchos duplos
-  Διπλοί γάντζοι





	L1 mm	L2 mm		
D1	150	15	5	068880021
D4	150	32	5	068880024

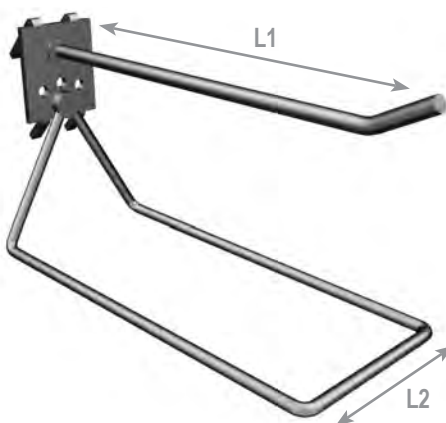

	L1 mm	L2 mm		
D2	150	22	5	068880022
D5	150	44	5	068880025

## 6888 T...

-  Ganci tripli
-  Triple hooks
-  Crochets triples
-  Ganchos triples
-  Dreifachhaken
-  Drie haken
-  Haki potrójne
-  Hármás kampó
-  Ganchos triplos
-  Τριπλοί γάντζοι



	L1 mm	L2 mm		
T1	150	57	5	068880031

	L1 mm	L2 mm		
T2	150	63	5	068880032

## 6888 B

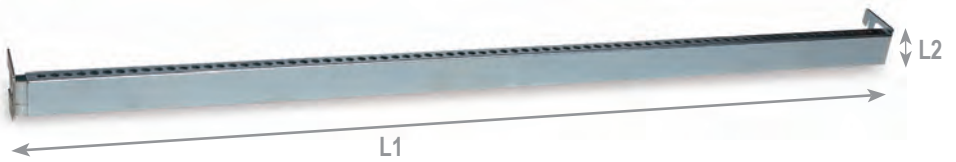

- Barre forate inclinabili per abrasivi
- Steel bar (40x20 mm) complete with fixing plate
- Barre percée basculant pour abrasives
- Barra de acero de 40x20 mm con placa de fijación
- Stahlstange 40x20 mm mit Befestigungsplatte
- Stalen beugel (40x20 mm) compleet met bevestigingsplaat
- Belka stalowa (40x20 mm) z płytka mocującą
- Acél rúd (40x20 mm) rögzítő lemezzel
- Barra em aço (40x20 mm) com placa de fixação
- Χαλύβδινη ράβδος (40x20 mm) πλήρης με πλάκα στερέωσης



L1 mm	L2 mm		
1000	40	1	068880100

## 6888 GA

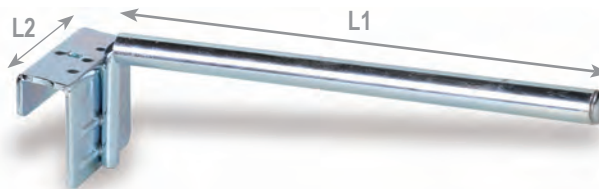

- Gancio per abrasivi
- Disc display hook
- Crochet pour abrasives
- Gancho para exposición discos
- Haken für Scheibenausstellung
- Ophanghaak voor schijven
- Elementy mocujące do regału do ekspozycji tarcz
- Korong bemutató
- Gancho para expositor de discos
- Γάντζοι



L1 mm	L2 mm		
200	50	3	068880120

## 6888 S...

- Gancio
- Hooks
- Crochets
- Ganchos
- Dreifachhaken
- Drie haken
- Haki
- Hármás
- Ganchos triplos
- Γάντζοι



L1 mm	L2 mm	L3 mm		
65	50	50	1	068880605
150	50	50	1	068880610

## 6800 BA

068000130

-  Barra abbigliamento
-  Clothes bar
-  Barre porte-vêtements
-  Barra para prendas de vestuario
-  Kleiderstange
-  Kleding drager
-  Wieszak na odzież
-  Vállfatartó rúd
-  Barra para roupa
-  Κρεμάστρα ρούχων

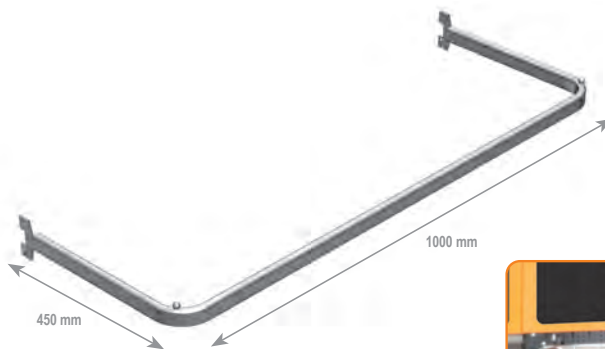

## 6800 RS

068000135

-  Rastrelliera scarpe
-  Shoe rack
-  Porte-chaussures
-  Estantería para calzado
-  Schuhgestell
-  Schoenen rek
-  Półka na obuwie
-  Cipőtartó
-  Prateleira para sapatos
-  Ράφι παπουτσιών

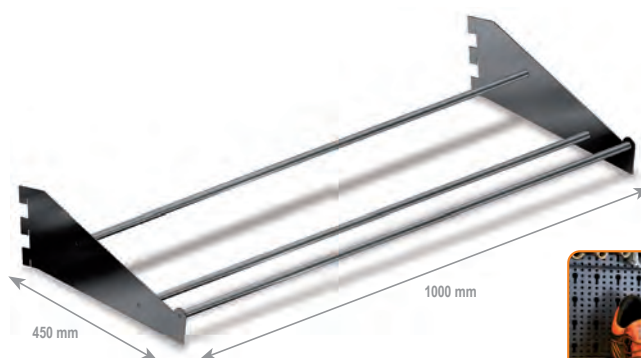

## 6888 GW





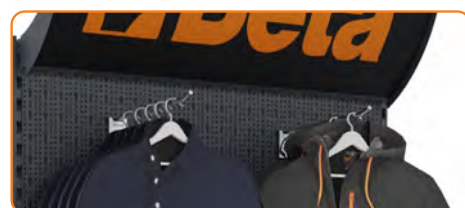





068880121

-  Gancio parete per art C64
-  Clothes bar
-  Barre porte-vêtements
-  Barra para prendas de vestuario
-  Kleiderstange
-  Kleding drager
-  Wieszak na odzież
-  Vállfatartó rúd
-  Barra para roupa
-  Κρεμάστρα ρούχων



## 6888 GS

068880122

-  Gancio parete scarpe per art C64
-  Shoe rack
-  Porte-chaussures
-  Estantería para calzado
-  Schuhgestell
-  Schoenen rek
-  Półka na obuwie
-  Cipőtartó
-  Prateleira para sapatos
-  Ράφι παπουτσιών

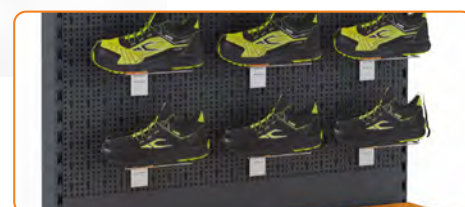

## 6800 MB

068000200

- Espositore polivalente bussole vuoto - 1 mt
- Multi-purpose empty wall-mounted display - 1 meter

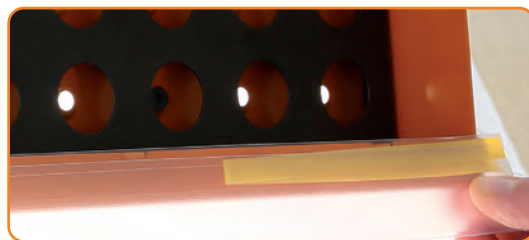
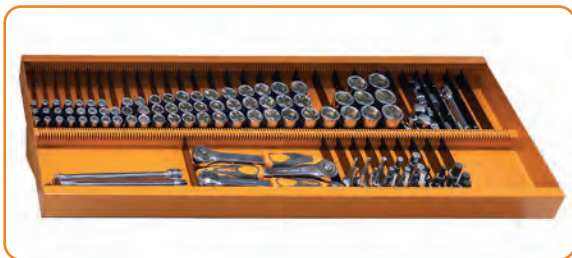
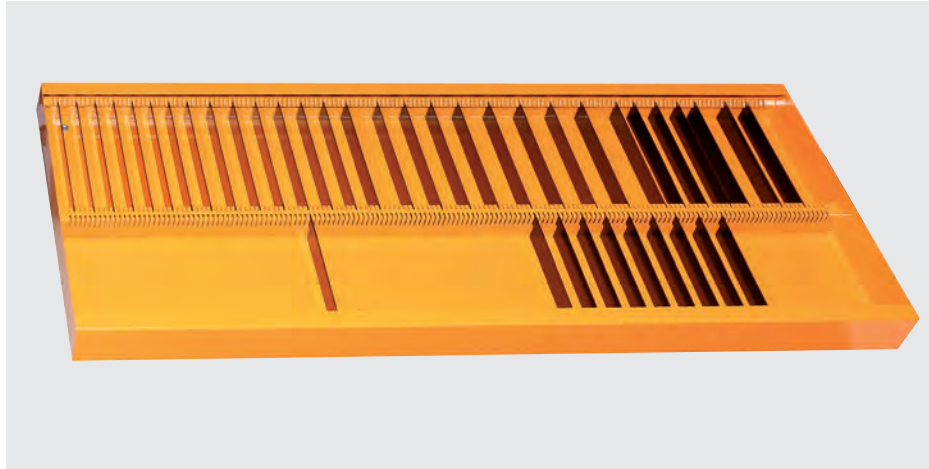

- Portaprezzi
- Price tag

## 6800 BIM

068000201

- Espositore bussole maschio esagonale vuoto - 0,5 mt
- Wall mounted display for Amale-end square drive socket wrenches 0,5 meter

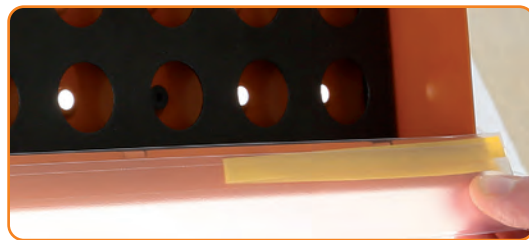
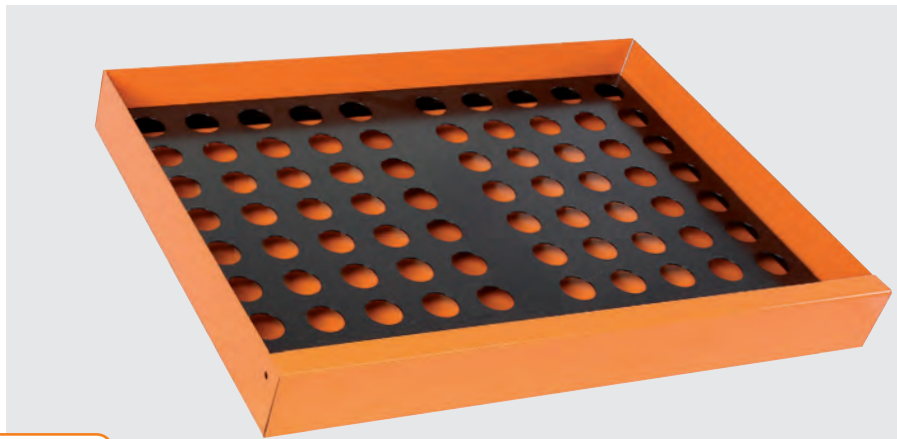











- Portaprezzi
- Price tag



## C88VE

088000120

-  **Vasca espositiva per pareti C88 R/1,**  
adatta ad alloggiare bobine di catena art. 8120
-  **Display tray for display walls C88,**  
suitable for housing coils of chains item 8120
-  **Plateau d'exposition pour présentoir mural C88,**  
apte au rangement de rouleaux de chaîne art. 8120
-  **Bandeja expositiva para paredes C88,**  
adecuada para alojar cadenas en bobina art. 8120
-  **Schale für Ausstellungswand Art. C88,**  
zur Aufnahme von Kettenspulen Art. 8120
-  **Rek voor verkoopstandaard C88,**  
geschikt voor het ophangen van rollen ketting artikel 8120
-  **Pojemnik do ekspozycji łańcuchów na rolkach do regału model C88,**  
odpowiedni do umieszczenia łańcuchów na rolkach model 8120
-  **Kiállító tálcá C88 falhoz,**  
a 8120 cikkszámú lánctekercsek elhelyezésére alkalmas
-  **Tabuleiro para expositor de parede C88,**  
adequado para bobinas das correntes artigo 8120
-  **Δίσκος εκθετήριο για C88,**  
κατάλληλος για ρολά αλυσίδας 8120

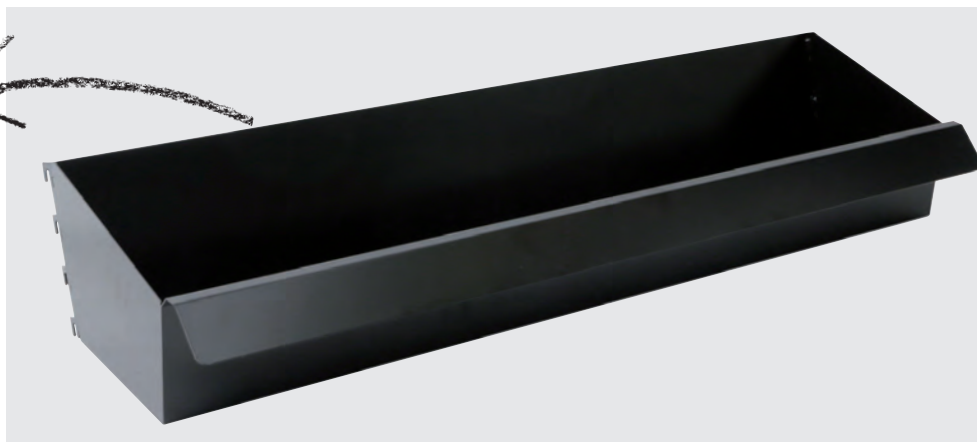

## 6888CG





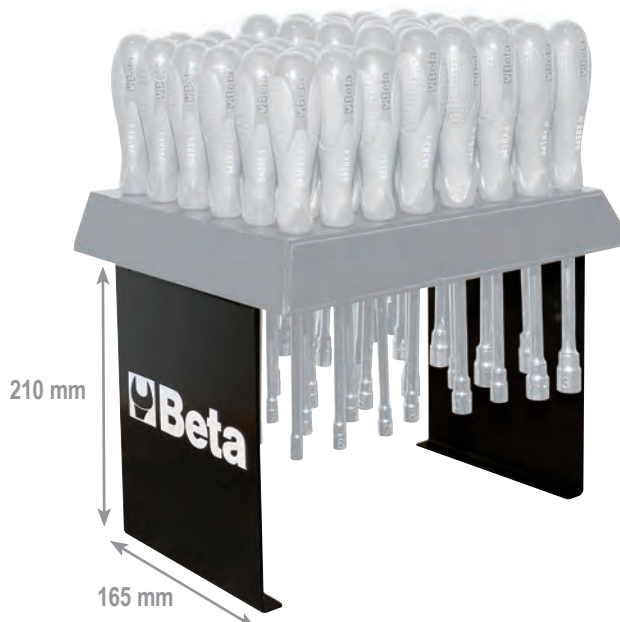





068880002

-  **Coppia spalle per espositori da parete**
-  **Pair of side supports for wall-mounted displays**



## 6800 RP/100





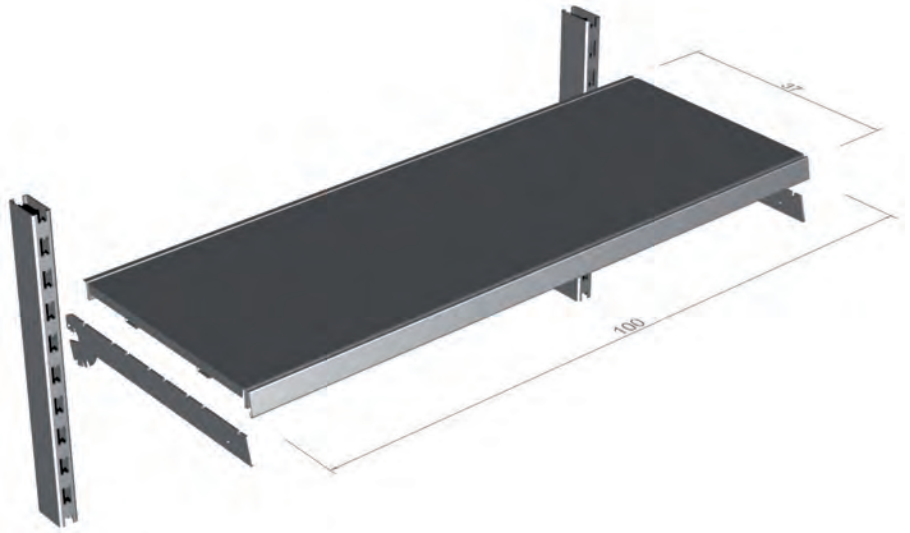





 068000150

-  Ripiano parete: profondità 37 cm
-  Wall shelf: depth 37 cm
-  Étagère murale: profondeur 37 cm
-  Estante de pared: profundidad 37 cm
-  Wandbord: Tiefe 37 cm
-  Wand plank: diepte 37 cm
-  Półka wisząca: głębokość 37 cm
-  Fali: polc 37 cm
-  Prateleira de parede: profundidade 37 cm
-  Ράφι τοίχου: βάθος 37 cm



## 6800 GR/37

 068000159

-  Gancio ripiano: profondità 37 cm
-  Shelf hook: depth 37 cm
-  Crochet étagère: profondeur 37 cm
-  Gancho estante: profundidad 37 cm
-  Haken für Bord: Tiefe 37 cm
-  Wand haak: diepte 37 cm
-  Wspornik: półki 37 cm
-  Ruhaállvány: 37 cm
-  Suporte prateleira: profundidade 37 cm
-  Γάντζος ραφιού: βάθος 37 cm

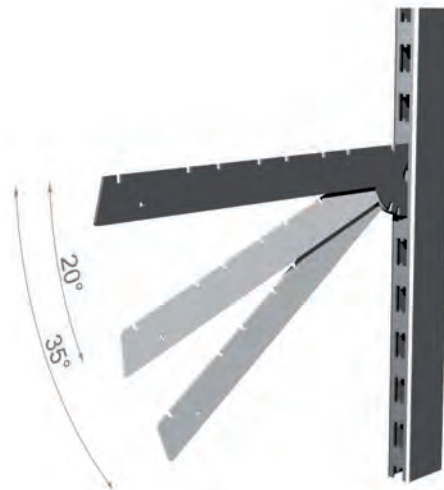

=

1x



+

2x



 068000150

 068000159













## 6800 AE

068000145

-  Angolo esterno
-  Outer corner
-  Angle externe
-  Ángulo externo
-  Außenwinkel
-  Buiten hoekwand, oranje
-  Naróżnik zewnętrzny
-  Külső sarokelem
-  Canto exterior
-  Εξωτερική γωνία











## 6800 AI

068000140

-  Angolo interno
-  Inner corner
-  Angle interne
-  Ángulo interno
-  Innenwinkel
-  Binne hoekwand, zwart
-  Naróżnik wewnętrzny wypełniający
-  Belső sarokelem
-  Canto interior
-  Εσωτερική γωνία

## 6800 AD/P





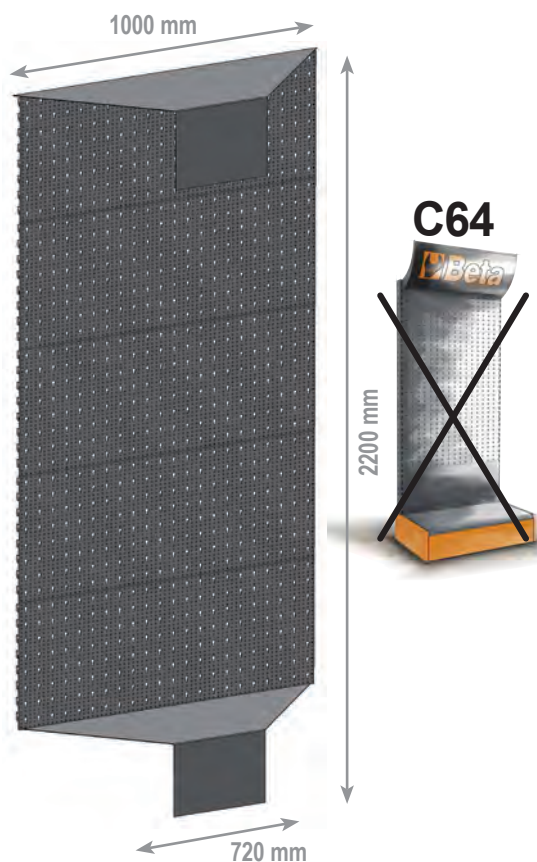
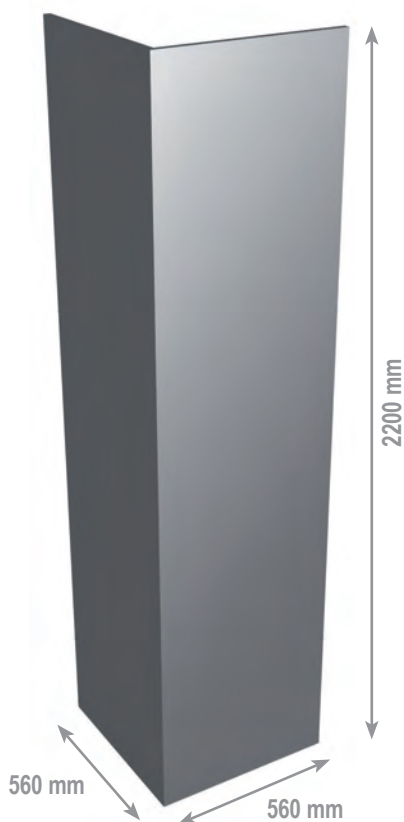





068000143

-  Angolo obliquo
-  Oblique corner
-  Angle oblique
-  Ángulo oblicuo
-  Schrägwinkel
-  Schuine wand
-  Naróżnik wewnętrzny wystawienniczy
-  Átlós sarokelem
-  Canto oblíquo
-  Λοξή γωνία





## 6800 PM

-  Prolunga montante
-  Upright extension
-  Rallonge montant
-  Elemento de prolongación montante
-  Ständerverlängerung
-  Frame verlenging
-  Profil przedłużający
-  Faliállvány hosszabbító
-  Extensão de coluna
-  Κατακόρυφη προέκταση

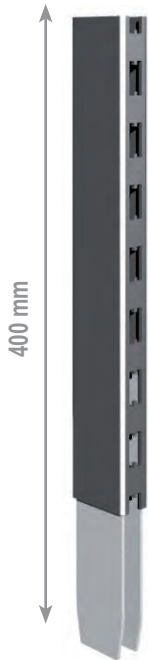

**h 400 mm**

1 m

1 + 2

068000108 068000171

2 m

2 + 3

068000108 068000171

N m

N + N+1 +

068000108 068000171

**6800 PM/40**  
068000171



**h 800 mm**

1 m

2 + 2

068000108 068000172

2 m

4 + 3

068000108 068000172

N m

2N + 2N+1 +

068000108 068000172

**6800 PM/80**  
068000172

## 6800 FR





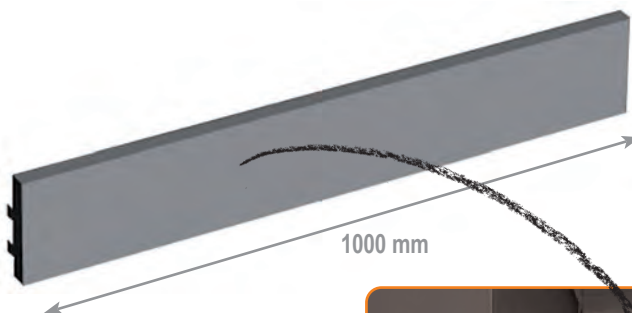





068000173

-  Frontalino soprainsegna
-  Sign front
-  Façade couvre-enseigne
-  Carátula sobre-letrero
-  Schild-Stirnteil
-  Basis logo
-  Osłona dodatkowa szyldu
-  Faliállvány siltes homlokrésszel
-  Painel frontal
-  Μηροστινή πινακίδα



## 6800 P/AI

068000174

-  Prolunga angolo interno 80 cm
-  Inner corner extension 80 cm
-  Rallonge angle interne 80 cm
-  Elemento de prolongación ángulo interno 80 cm
-  Innenwinkelverlängerung 80 cm
-  Verlenging hoekwand 80 cm
-  Przedłużenie narożnika wewnętrzznego 80 cm
-  Belső sarokelem hosszabbító 80 cm
-  Extensão canto interior 80 cm
-  Προέκταση εσωτερικής γωνίας 80 cm

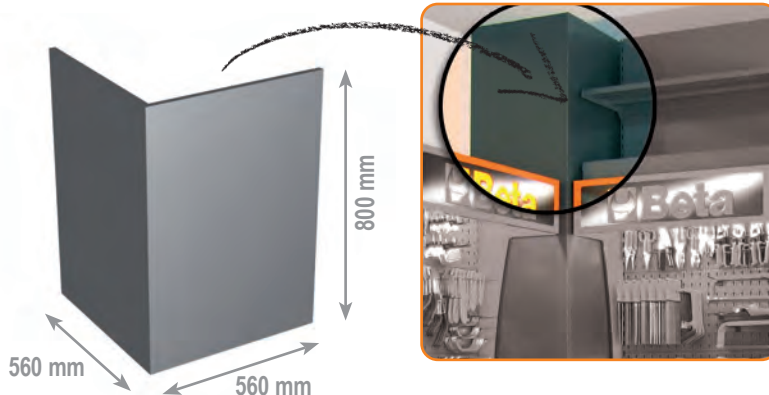

## 6800 FO/100

068000108

-  Pannello parete pieno
-  Smooth wall panel
-  Panneau mural plein
-  Panel de pared lleno
-  Durchgehendes Wandpaneel
-  Glad wand paneel
-  Panel ścienny gładki
-  Hátsó panel
-  Painel de parede liso
-  Πάνελ

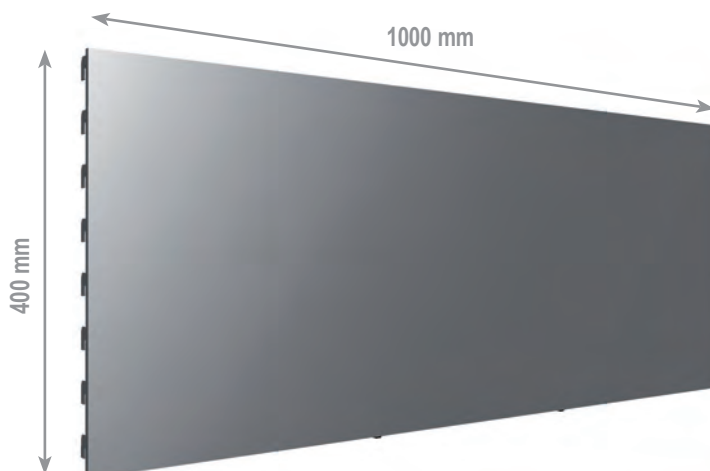

## 6800 PF/100

068000101

-  Pannello parete pieno
-  Smooth wall panel
-  Panneau mural plein
-  Panel de pared lleno
-  Durchgehendes Wandpaneel
-  Glad wand paneel
-  Panel ścienny gładki
-  Hátsó panel
-  Painel de parede liso
-  Πάνελ

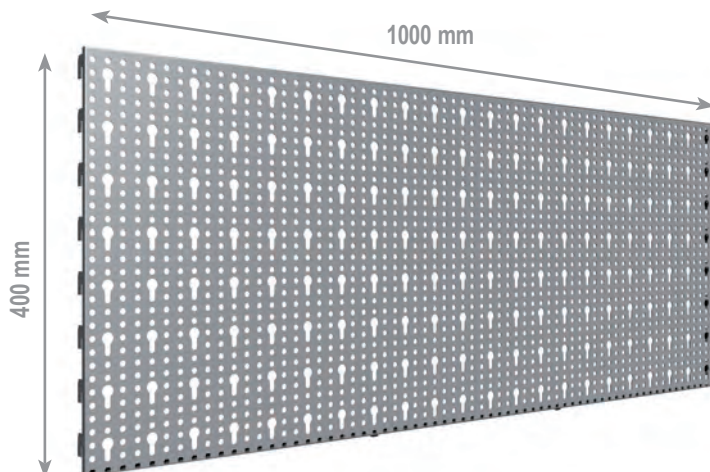

## 6800 CB/100





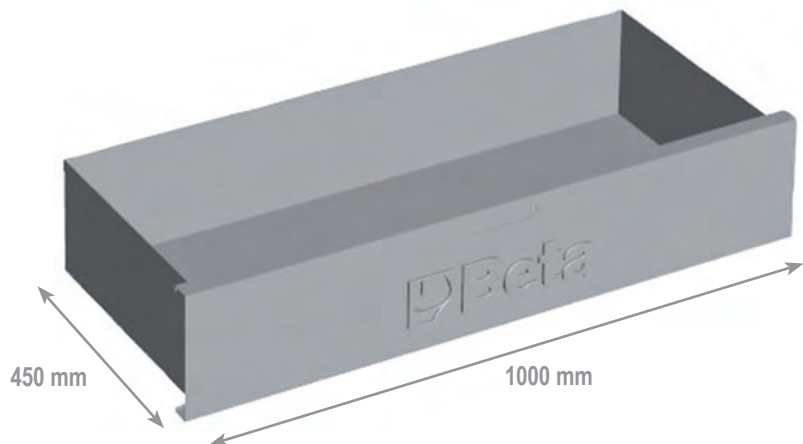





068000104

-  Cassetto base
-  Base drawer
-  Tiroir de base
-  Cajón de base
-  Basisschublade
-  Vloer lade
-  Szuflada do podstawy regału
-  Basis fiók
-  Gaveta base
-  Συρτάρι βάσης



## 6800 FB/100

068000109

-  Frontalino base
-  Base front
-  Façade base
-  Carátula de base
-  Basis-Stirnteil
-  Vloer panel
-  Osłona przednia podstawy regału
-  Basis-homlokfal
-  Base frontal
-  Μπροστινή βάση

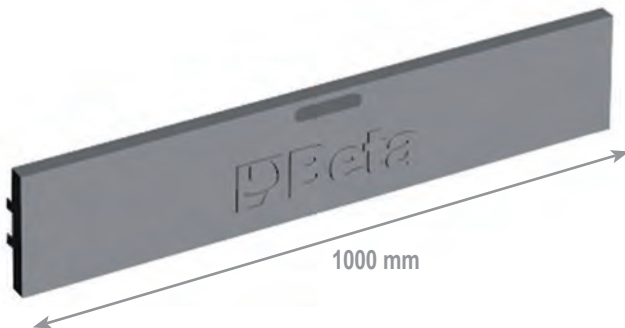

## 6800PL

068000137

-  Pedana
-  Footboard
-  Estrades
-  Plataformas
-  Fußbretter
-  Voettrede
-  Platformy ekspozycyjnej
-  Lábazat
-  Painei inferior
-  Πόδια

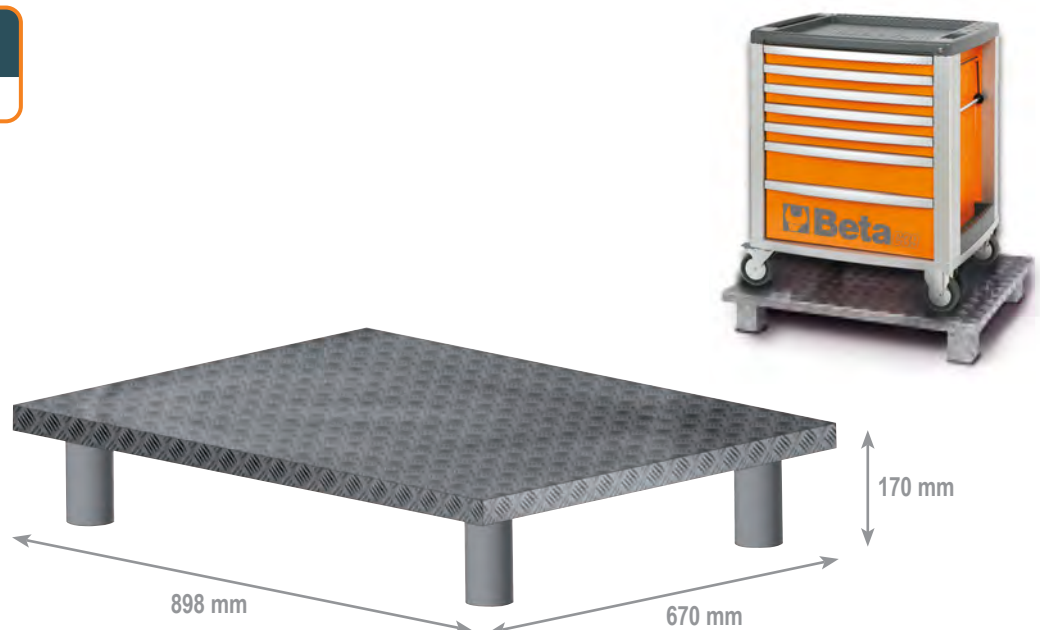

## 6888 VE/...

-  **Vetrinetta espositore parete**, H 180 cm,  
vetro temprato, serratura
-  **Wall-mounted display showcase**, H 180 cm,  
tempered glass, lock
-  **Vitrine présentoir murale**, H 180 cm,  
verre trempé, serrure
-  **Vitrina expositor de pared**, H 180 cm,  
cristal templado, cerradura
-  **Wandständervitrine**, H 180 cm,  
gehärtetes Glas, Verschluss
-  **Muur display met vitrine**, H 180 cm,  
gehard glas, slot
-  **Cablota wystawiennicza**, H 180 cm,  
szkło hartowane, zamek
-  **Fali bemutató vitrin**, 180 cm,  
edzett üveg, zár
-  **Vitrina para expositor de parede**, A 180 cm,  
vidro temperado, fechadura
-  **Εκθετήριο τοίχου βιτρίνα**, H 180 cm,  
ενισχυμένο γυαλί, κλειδαριά

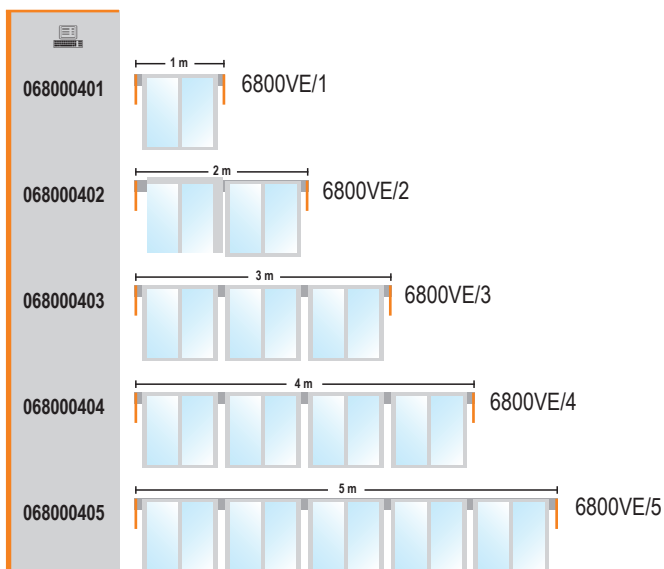
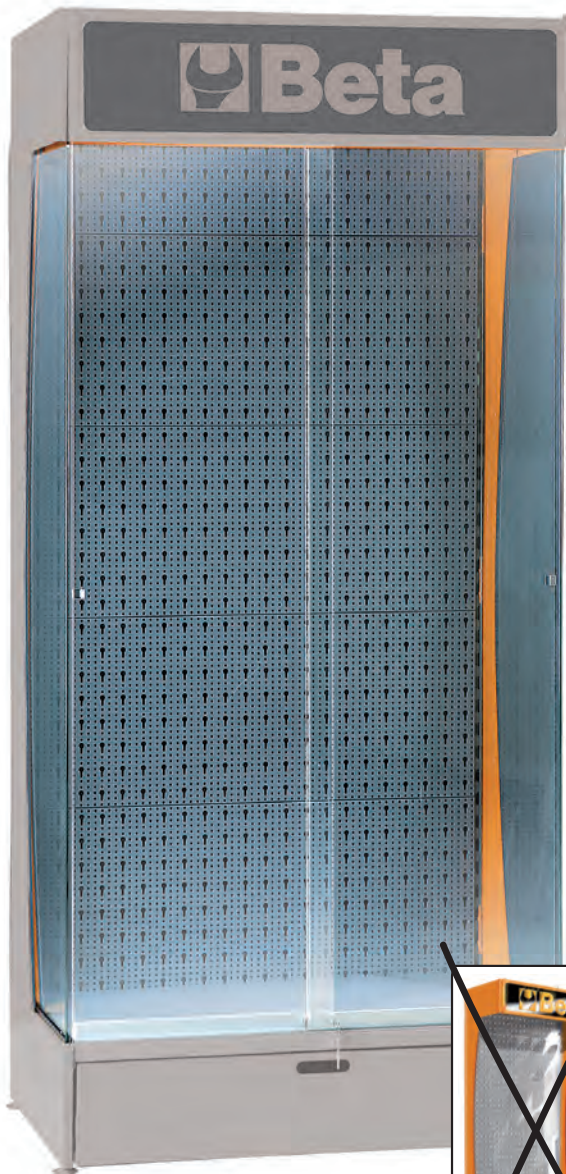

## 6800 L/MT-1

☎ 068000122

-  Insegna luminosa espositore
-  Luminous sign
-  Enseigne lumineuse
-  Letrero luminoso
-  Leuchtschild
-  Lichtbak
-  Szyld z logo podświetlany
-  Világítótest
-  Sinal luminoso
-  Φωτεινή επιγραφή



## 8800 L/Robur

☎ 088000122

-  Insegna luminosa espositore
-  Luminous sign
-  Enseigne lumineuse
-  Letrero luminoso
-  Leuchtschild
-  Lichtbak
-  Szyld z logo podświetlany
-  Világítótest
-  Sinal luminoso
-  Φωτεινή επιγραφή

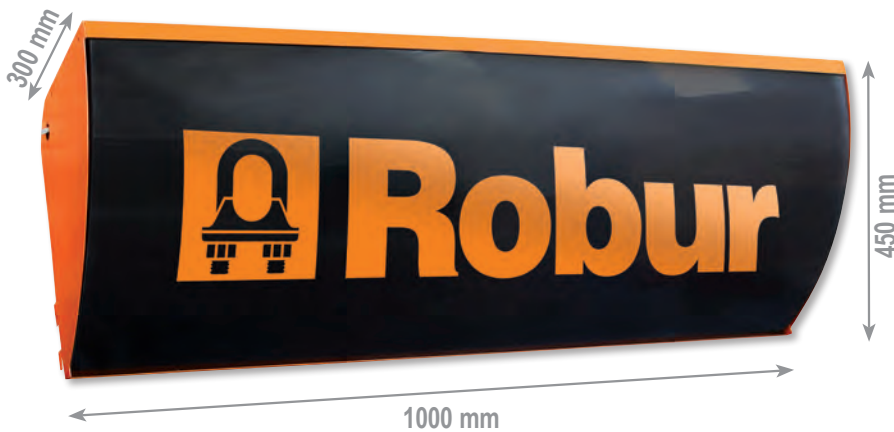

✗ 6888VE...



✗ 6800PM



✗ 6800AE-6800AI-6800AD/P



Beta

il lavoro è la nostra passione

Beta

A1

Beta

Beta



Fabio Quartararo  
MotoGP World Championship  
Partnership 2023



A2

Beta

il lavoro è la nostra **PASSIONE**



Beta  
O-Gravity  
te le meriti!!!

la scarpa più leggera che c'è

[www.beta-tools.com](http://www.beta-tools.com)

A3

Beta

il lavoro è la nostra **PASSIONE**



[www.beta-tools.com](http://www.beta-tools.com)

GRAFICA  
PERSONALIZZATA  
SU MISURA PER IL  
TUO PUNTO VENDITA

A4

Robur





il lavoro  
è la nostra passione



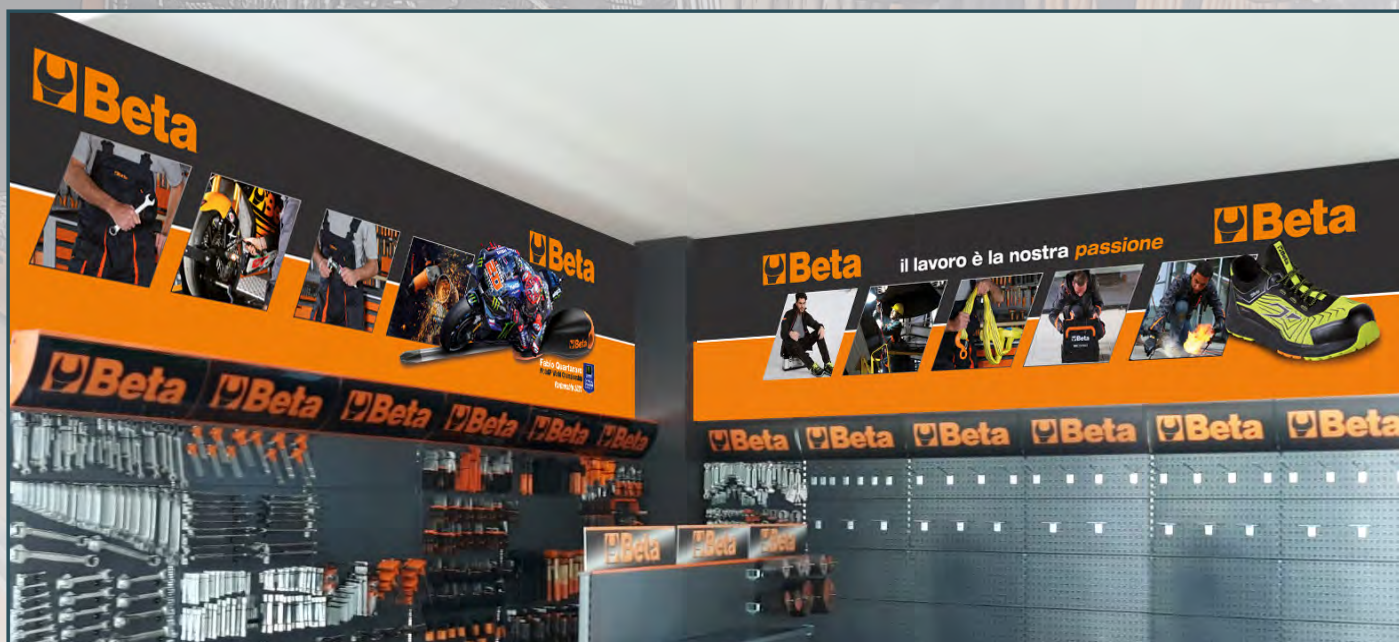



NOVITA  
€ 23,50















-  **Pannelli grafici**  
Misure personalizzate
-  **Graphic panels**  
Customized dimensions
-  **Panneaux graphique**  
Dimensions sur mesure
-  **Paneles gráficos**  
Medidas personalizadas
-  **Grafik-Paneele**  
Personalisierte Abmessungen

-  **Panelen met opdruk**  
Afmetingen op aanvraag
-  **Banery z grafiką reklamową.**  
Możliwość dostosowania wymiarów do potrzeb użytkownika
-  **Grafikus –panel**  
Feliratozott
-  **Παινέις gráficos**  
Dimensões personalizadas
-  **Γραφιστικές πινακίδες**  
Διαστάσεις κατά παραγγελία





# SHOP in Shop

-  Progetta il tuo corner Beta
-  Build your Beta corner
-  Construisez votre corner Beta
-  Construye tu corner Beta
-  Schaffen Sie Ihren Beta Corner
-  Ontwerp je eigen presentatie
-  Zbuduj swoją ekspozycję Beta
-  Készítsd el a saját Beta sarkodat
-  Configure o seu espaço Beta
-  ΦΤΙΑΞΕ ΤΗ ΔΙΚΗ ΣΟΥ ΓΩΝΙΑ ΒΕΤΑ

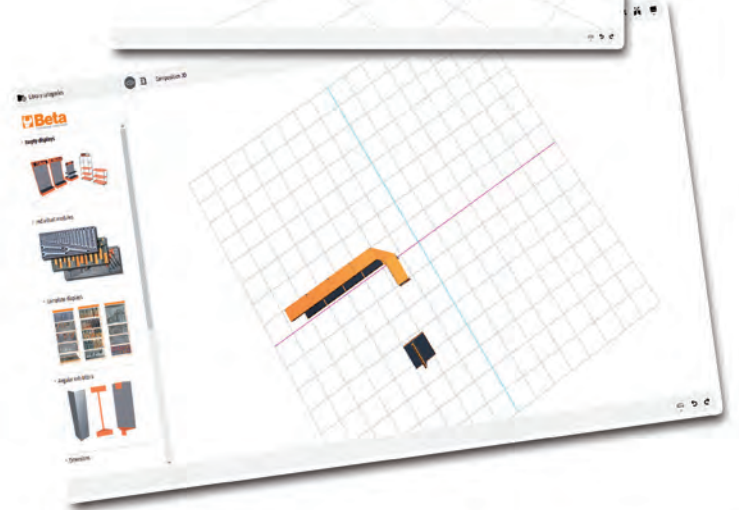
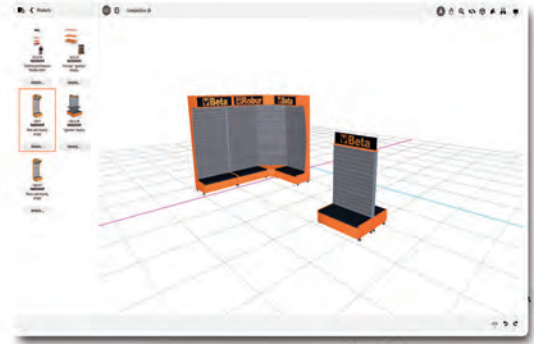

[beta-tools.com/planner3d/shopinshop/](https://beta-tools.com/planner3d/shopinshop/)



360°  
view

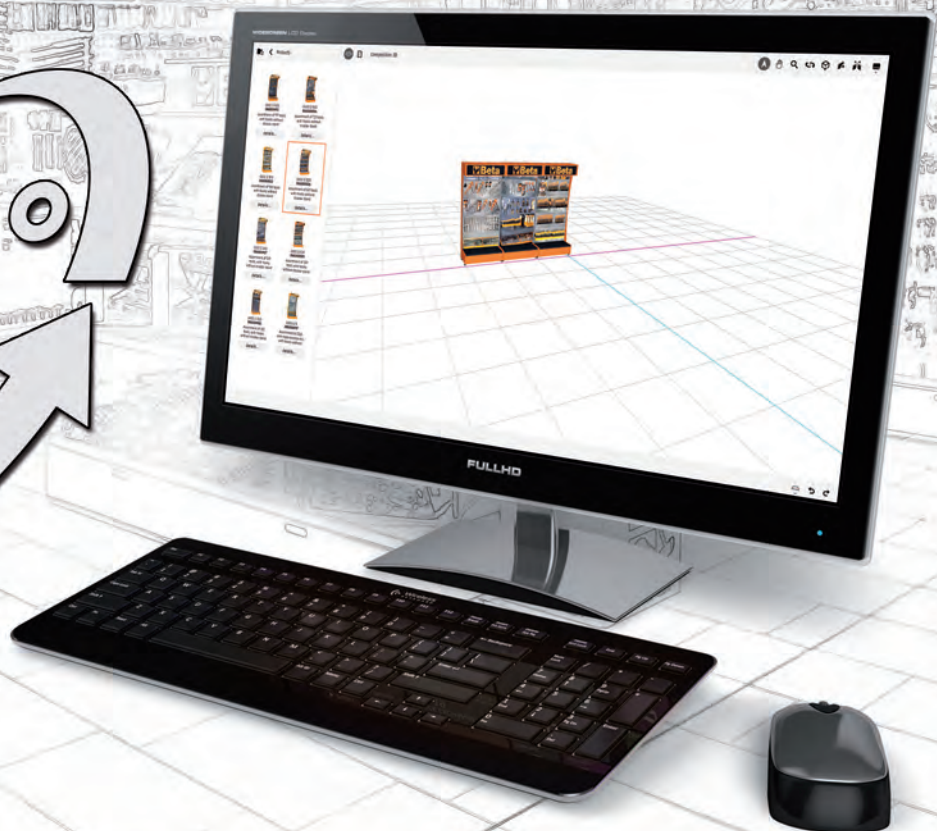



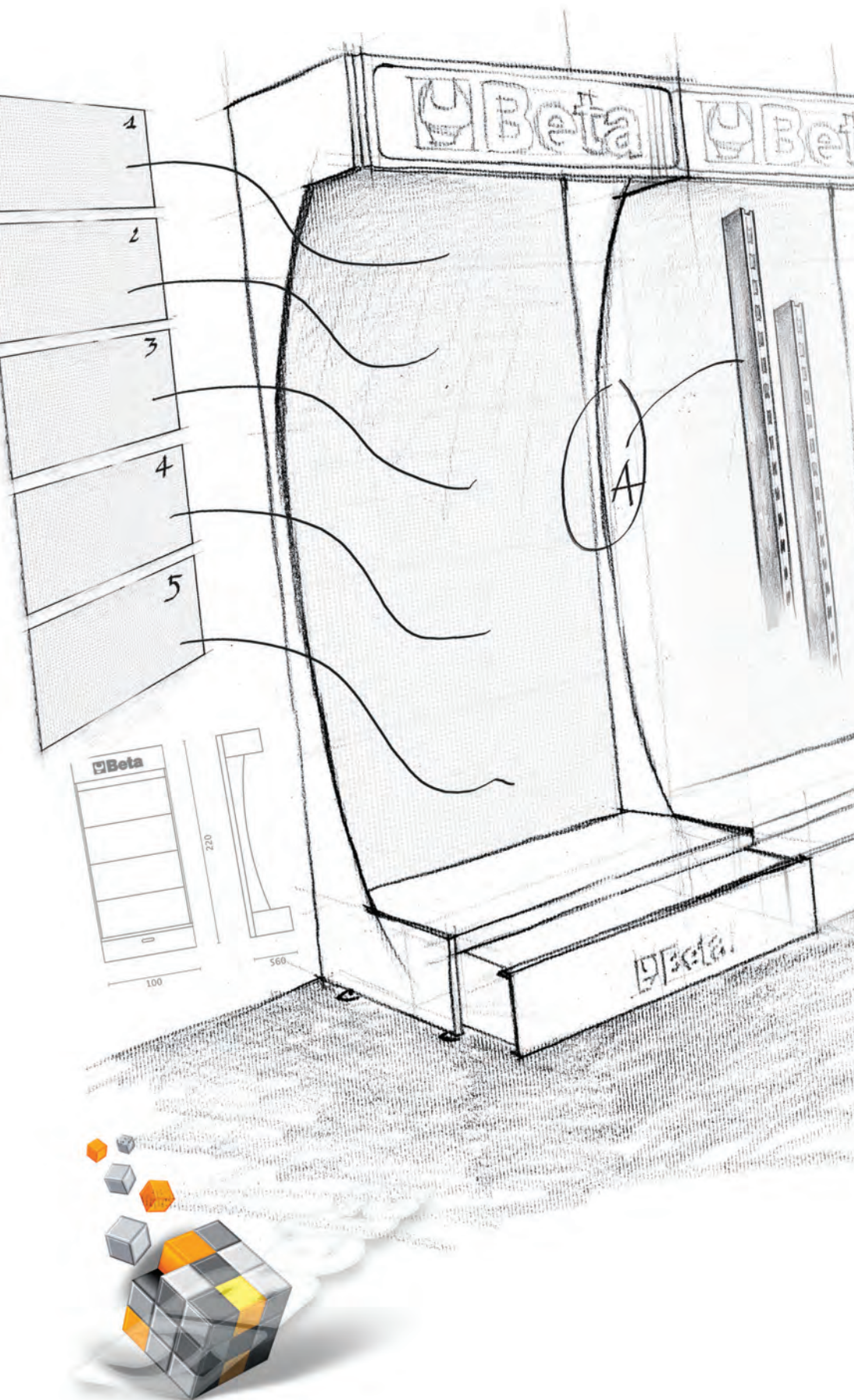



 Le immagini riprodotte sono indicative.

Beta Utensili S.p.A. si riserva il diritto di apportare aggiornamenti e migliorie alla propria gamma produttiva senza preavviso.

 The pictures are given by way of example.

Beta Utensili reserve the right to update and enhance their product range without notice.

 Les renseignements et photos figurant dans ce chapitre sont donnés à titre indicatifs et n'ont aucune valeur contractuelle.

Beta Utensili se réserve le droit de mettre à jour ou d'accroître sa gamme de produits sans préavis, et sans obligation d'effectuer les modifications sur les modèles vendus antérieurement.

 Las fotos que se reproducen sirven tan sólo de indicación.

Beta Utensili se reserva el derecho de aportar actualizaciones y mejoras a su gama de productos sin previo aviso.

 Die dargestellten Bilder dienen zur Orientierung.

Die Firma Beta Utensili behält sich das Recht vor, ihre Produktpalette ohne Vorankündigung anzupassen oder zu verbessern.

 De afbeeldingen dienen uitsluitend als voorbeeld.

Beta utensili behoudt zich het recht voor de producten te wijzigen en te verbeteren zonder voorafgaand bericht.

 Zamieszczone zdjęcia narzędzi należy traktować jako przykładowe.

Beta zastrzega sobie prawo do wprowadzania zmian oraz udoskonalień w swoich produktach bez powiadomienia.

 A nyomtatott képek tájékoztató jellegűek. Beta Utensili cég fenntartja magának azt a jogot, hogy áruválasztékán előzetes bejelentés nélkül változtatást hajtsön végre.

 Todas as informações e imagens que aparecem neste catálogo são meramente indicativas e sem qualquer valor contratual.

A Beta Utensili reserva-se ao direito de alterar ou actualizar a sua gama de produtos sem aviso prévio, e sem obrigação de efectuar qualquer modificação sobre os modelos vendidos anteriormente.

 Οι απεικονίσεις παρατίθενται σαν παράδειγμα.

Η Beta Utensili διατηρεί το δικαίωμα να τροποποιεί και να βελτιώνει την σειρά προϊόντων της χώρας χωρίς άλλη ειδοποίηση.

 **Beta**  
**SHOP**  
*in Shop*



099804694

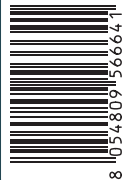

 **Beta**

Beta Utensili S.p.A.  
Via A. Volta, 18  
20845 Sovico (MB) - Italy  
[www.beta-tools.com](http://www.beta-tools.com)