

STORAGE DESIGN LIMITED

01446 772614

www.storage-design.ltd.com
info@storage-design.ltd.uk



GROUP PRODUCTS CATALOGUE 2024

Page 2 Projects

Page 13 Racking, Shelving & Sheet/Bar Racks

Page 68 Lockers, Cupboards & Cloakroom

Page 94 Small Parts Storage & Containers

Page 126 Storage, Security Cages & Hazardous

Page 148 Safety, Security, PPE, Matting & Flooring

Page 166 Signs, Labels & Notice/Whiteboards

Page 186 Barriers, Traffic Management & Mirrors

Page 218 Cycle Storage & Smoking Shelters

Page 224 Workbenches & Drawer Cabinets

Page 260 Tool Storage & Trolleys

Page 268 Drum, Cylinder & Spill Control

Page 296 Pallet Trucks Stackers Lift Tables

Page 320 Sack Trucks

Page 334 Platform & Shelf Trolleys

Page 380 Distribution Trucks & Roll Containers

Page 402 Turntable General Purpose Ackerman Trucks

Page 416 Container Trucks & Trolleys

Page 428 Wheels, Castors & Conveyors

Page 436 Kick, Handy & Low Level Steps

Page 438 Aluminium & Glass Fibre Steps/Ladders

Page 464 Mobile, Safety, Warehouse Steps & Platforms

Page 490 First Aid, Hygiene & Janitorial Equipment

Page 500 Waste Management

Page 528 Winter Management

Page 532 Office Desks, Seating & Canteen Furniture

Page 544 Mailroom, Packaging & Retail Equipment

Welcome to the Storage Design Limited 'Group Products Catalogue'

With 36 years experience in supply and installation of storage systems, we pride ourselves in offering the highest level of service.

From the smallest product like a '**Rhino**' container through to a complete '**Pallet Racking System**' we will be able to maximise your storage facilities and workplace.

Special discounts are available for Projects. Please ask for a quote!

We hope you find this catalogue useful and look forward to hearing from you.

Yours sincerely



TIM BIRD Catalogue Sales Manager
for STORAGE DESIGN LTD

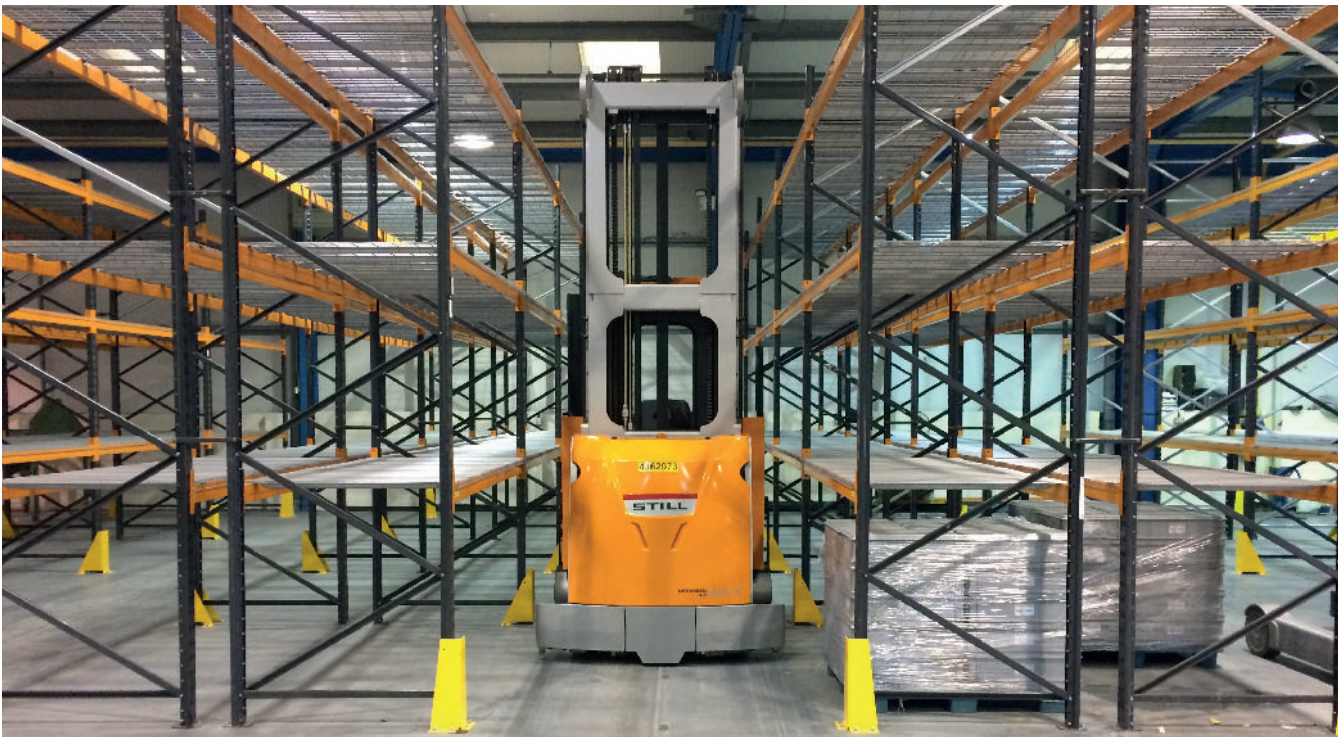

Contents:

Industrial Buildings	2 & 3
Partitions & Guards	4 to 9
Access Equipment	10 & 11
Office Partitions	12



If your storage requires a more bespoke solution, we can help. We can advise you on a wide range of systems which will help increase your storage efficiency

After discussing your requirements with you, we will design, project manage & install your system, helping you implement the new facility with the minimum of disruption.

From mezzanines to conveyors, from drive-in racking to multi-tier structures, we are here to help.

If you have a project brief to take forward or would like to arrange a site survey, just pick up the phone & talk to us.

Mezzanine Floors

A mezzanine floor is a quick & easy way of utilising the available height of a building, by doubling or even tripling the available floor space. Installed quickly & cost effectively, a mezzanine floor can prove to be a rational alternative to relocating your business or expanding your premises. Mezzanine Floors are typically designed as free-standing platforms & comprise cold rolled galvanised secondary floor beams bolted into the main universal beams, in turn supported by rolled hollow section steel columns. This structure is topped with a tough 38mm thick tongue & grooved particle board, although we can provide alternatives when required.

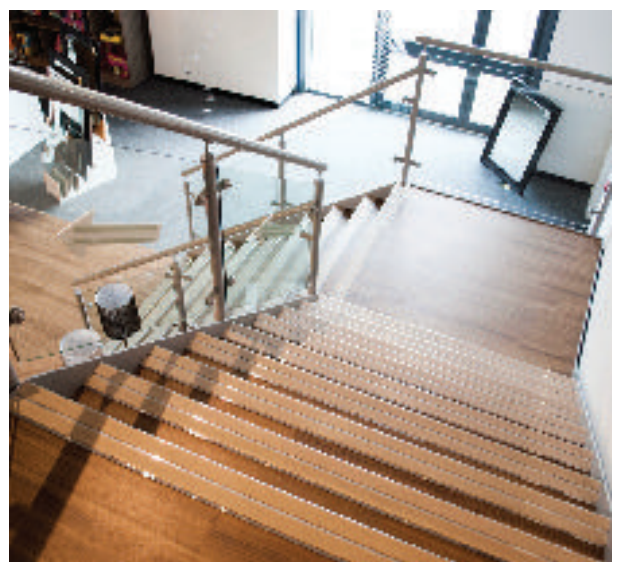

Please call us for further details & advice

Industrial Buildings & Loading Bays

Custom designs & flexible solutions
Made to measure for your business

Creating extra space laterally & vertically is best done with equipment & processes in mind.

Make us part of your team & we will build it for you!

We design industrial fabric buildings which retract, multi-task & integrate with loading & handling systems throughout your workplace.



Purpose built steel framed buildings



Technical internal designs to accommodate processes & machinery



Palletised storage created in goods yards to free up internal manufacturing space



Dry containing decanting facilities



Retractable production space in an open quarry

Allows lifting equipment access



Cover for all weather protection of soft fruits



Raised loading docks

Retractable & Curtain Sided Buildings



Turnkey solutions on all our structures

J.I.T. engine storage for assembly line, heavy duty construction equipment



Raised storage dock with enclosed retractable shelter



50M L retractable drying tunnel for wind tower steel columns prior to shot blasting



Home delivery hygienic marshalling space for van collection of online orders



1500 sqm of engineering workshop space with a 2 x 20T, 1 x 10T & 2 x 5T OET cranes, a mezzanine & loading bay



Gantry mounted retractable workshop



Enclosed testing facilities for container sized compressors - 4 sided for airflow



In floor electrical power conduit for engineering workshop to clear overhead space

Installation service available (subject to a site survey) - CALL FOR DETAILS

Titan - Double Skin Partitions



Please call us for further details & advice



A high quality double skin system that is ideal for cleanroom & office applications where appearance is important. When used in conjunction with the correct HVAC system, Titan is ideal for working toward an ISO 14644-1 class 5 cleanroom environment

- » RAL 9010 - other colours available upon request
- » Flush double glazing with integral magnetic blinds, coved & bull nosed skirting
- » Anti-static/electro-dissipative & anti-microbial powder coating
- » Sound reduction

Ask about our installation service



Price on application



Please call us for further details & advice

Ideal for offices, facility areas, machine enclosures etc, where sound reduction & insulation are important.

- » Standard powder coated colours; sandstone, medium grey, white or light grey
- » Fire rating
- » Double glazing
- » Ceilings
- » Integrated venetian blinds

Ask about our installation service

Available on rapid delivery



Price on application



Single Skin Partitions



**Ask about our
installation service**

Price on application

Bastion - Single Skin Partitions

Heavy duty angle-framed industrial partitioning suitable for harsh environments. It provides secure storage & screening and can feature a combination of full steel, mesh & glazing. 25 x 25mm and expanded metal mesh inserts are also available upon request.

Sigma - Single Skin Partitions

Demountable & relocatable medium duty partitioning, ideal for applications requiring a high quality appearance.



Caelum Industrial Mesh Partitions



Caelum is a modular mesh panel system that is specifically designed for factory & warehouse division. Panels are constructed using strong, durable steel frames. We also offer a variety of posts & fixings for attaching panels to the floor & ceiling.

**Ask about our
installation service**



Price on application

Anti-collapse System



TUV Certified pendulum test method

Troax anti-collapse system is tested and approved by TÜV Rheinland to withstand an impact of 2,500 Joules.



Anti-collapse system prevents any risk of spillage from pallets in warehouse storages. The system is used for safe handling and storing of products in a logistics environment. It is made from fully welded mesh and steel frames and is strong and durable.

The panels are available in three models with different safety levels to suit your specific needs. The Anti-collapse screen can be made from 700mm, 1,200mm and 1,500mm high panels by 1,100mm and 2,200mm wide.

Please call us for further details & advice



Speed Bolt

Speed bolt is developed for the anti-collapse system. The speed bolt is a perfect fastener, especially when you require a fast & safe assembly. It's only one item which you mount from the front and you don't need to reach around the backside of the upright.

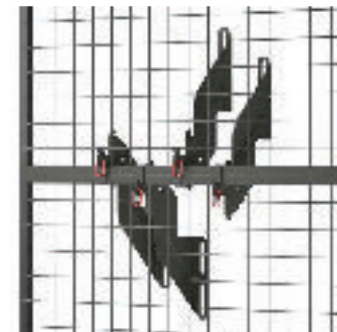

Uni-bracket

Uni-bracket is a versatile bracket which can be mounted in four different positions. The unique kit secure method keeps the panels locked in position. It has a cut-out which eases the removal of pallet racking beams located near the brackets. A user-friendly system as it can be built more logically from the bottom of the screen upwards.



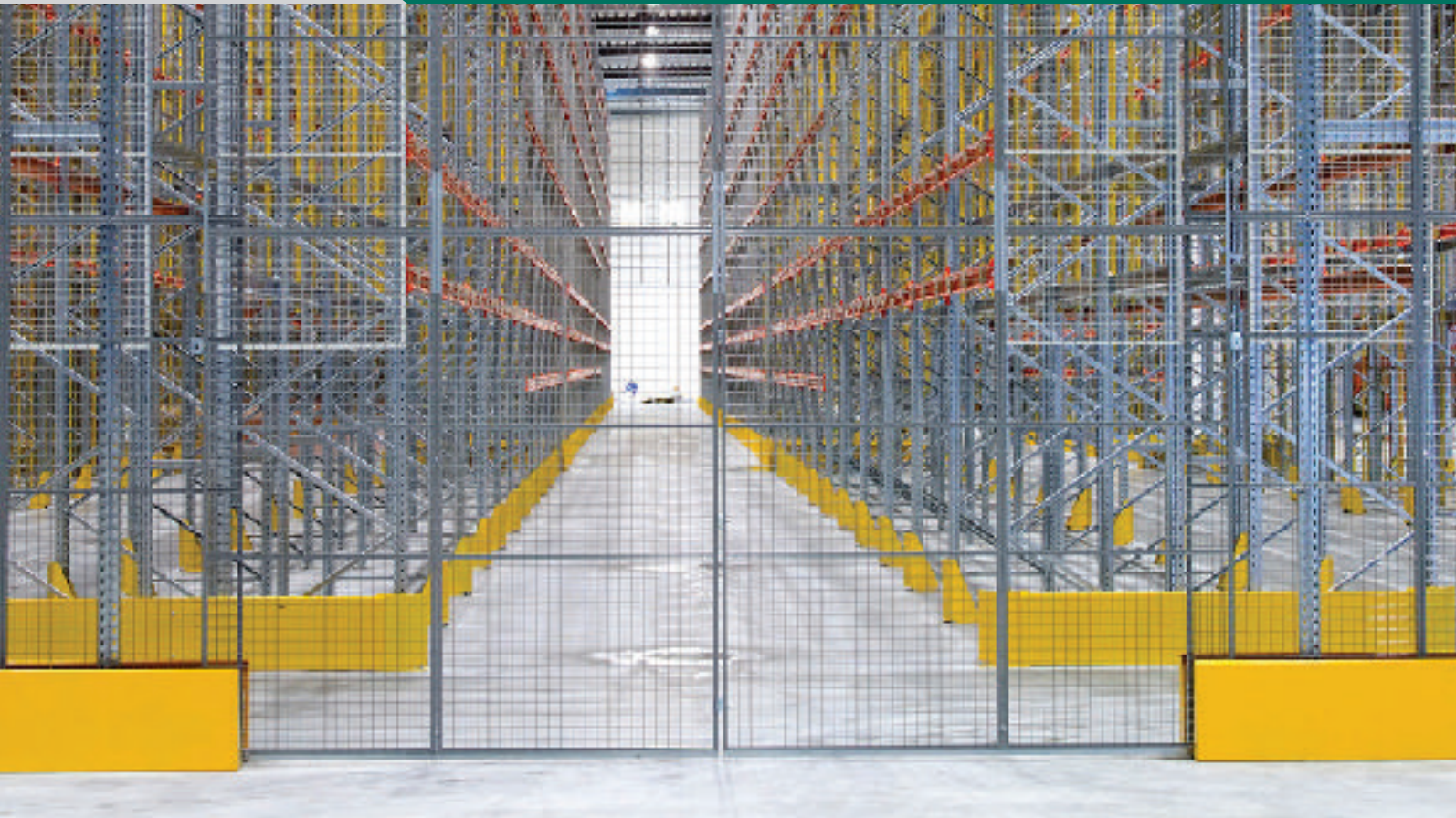

Anti-collapse system prevents any risk of spillage from pallets in warehouse storages. The system is used for safe handling and storing of products in a logistics environment. It is made from fully welded mesh and steel frames and is strong and durable. The panels are available in three models with different safety levels to suit your specific needs. The Anti-collapse screen can be made from 700mm, 1,200mm and 1,500mm high panels by 1,100mm and 2,200mm wide

Mesh Shelves

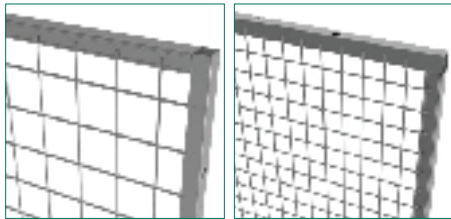

(UR350 & UX450)

50×50 mm mesh panels are an ideal solution for providing a safe working environment that allows natural light and ventilation.

(UR325)

25×25 mm mesh panels are adapted for applications that require a high level of safety, such as storing aerosols, or hazardous or high-value goods. The panels allow natural light and ventilation.

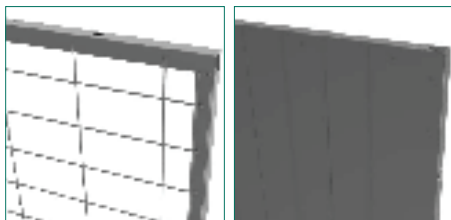

(UR300)

100×50 mm mesh panels are a lighter alternative to 50×50 mm, but still a perfect solution for providing a safe working environment.

(URSP)

Full steel Modular panels are ideal for creating storage areas for storing goods out of sight. They are made from profiled steel sheet and available in a number of different standard widths.

Locks for Doors

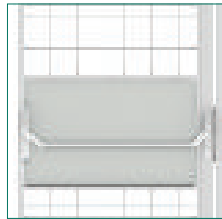

PANIC BAR

For emergency evacuation. Available as a hinged door, fitted with euro profile cylinder. The Troax Panic Bar meets the requirements of norm EN1125



ABLOY EL460

A kit with the electrical lock ABLOY EL460 is combined with split function for emergency exit from the inside

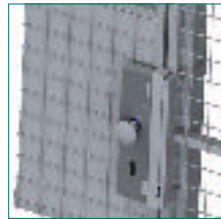

KNOB AND HANDLE

When it shall be possible to open the door from the inside with only the handle and necessary to use a key from the outside



ASSA CYLINDER

A frequently used door, which can be used both locked with a key or unlocked with just the handles.



EURO CYLINDER

A frequently used door, which can be used both locked with a key or unlocked with just the handles.



ELECTRIC STRIKE

When an electric keyless control is needed. For example together with a tag/ code/ card system.



PADLOCK

For less frequent access.

Access Solutions



Bespoke access solutions for all your needs. From design to manufacture we can help

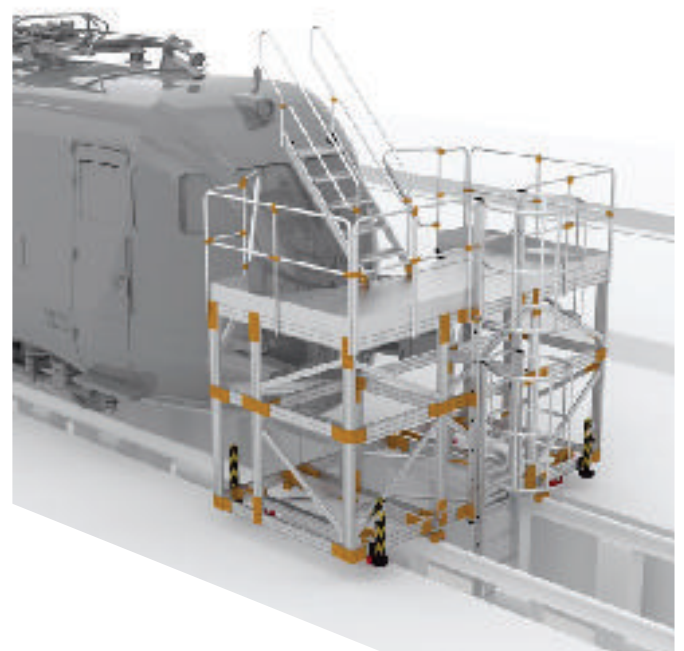
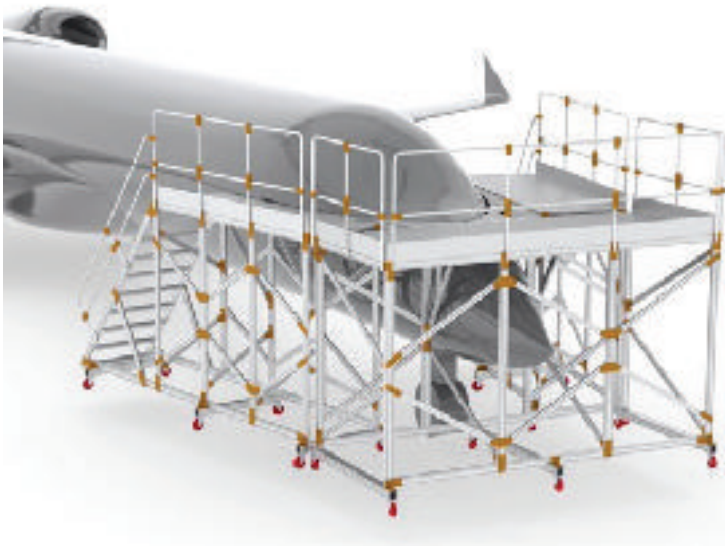



See pages 438 to 463 for our standard Aluminium Access ranges



Office Partitioning

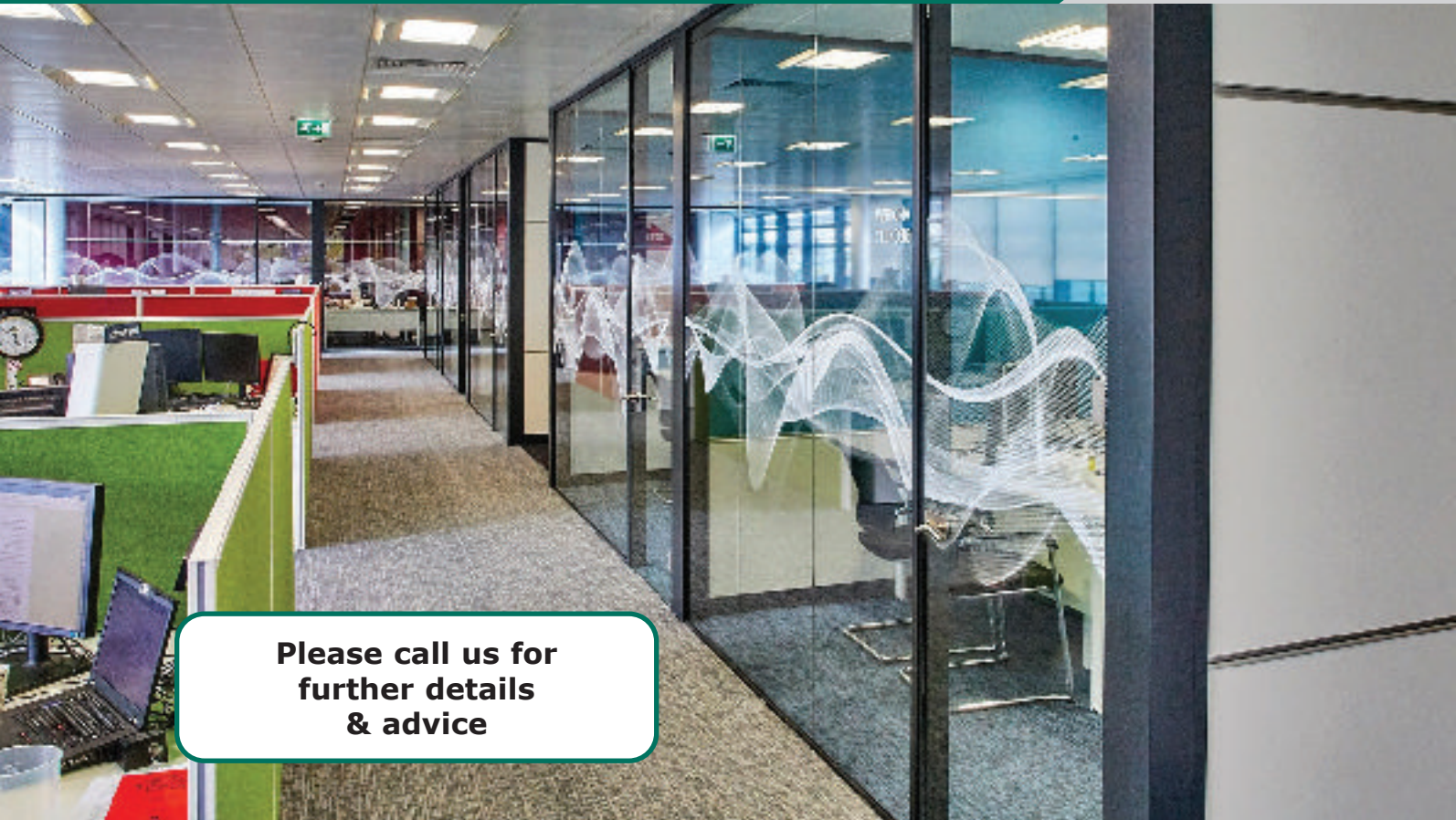

**Please call us for
further details
& advice**

A Partition Wall creates a dynamic, functional working environment. Demountable Partition Walls allow you to reconfigure the space as your business requirements evolve. Glass Partition Walls in an office environment create light, open spaces whilst maintaining privacy, security & control over sound, temperature & lighting needs of individual areas.

Make the most of your space...

You may require a more open plan office or the opposite. Utilising the flexibility that Office Partitioning gives, you are able to create the space & / or individual working areas that you need. Having the option to increase privacy, sound reduction or add fire protection routes.

Whether it is a simple alteration or a complete office refurbishment it needn't be a daunting task. With our expertise, experience & skills in space planning we will endeavour to meet your requirements no matter how big or small the project may be.

- » Quick & easy installations - tailored to your individual requirements
- » Utilise space & create privacy where needed
- » Re-locatable – can be moved or extended to suit your future needs
- » Wide range of designs, finishes & accessories available
- » Fully glazed or partial glazed modules 7 doors
- » Fire resistance of up to 60mins
- » Sound reduction up to 50dB Rw
- » Integral colour co-ordinated blinds & other furnishings are available





Shelving & Racking

Kwikrack Shelving	14 & 15
Rivet Shelving	16 to 25
Delta Plus Shelving	26 & 27
Expo Boltless Shelving	28 to 32
Galvanised Shelving.....	32 & 33
Longspan Racking.....	34 & 35
Pallet Racking	36 to 39
Vertical & Cantilever Racking.....	40 & 41
Tilt Bins	42 & 43
Rhino Tuff Bins.....	44 to 48

Many more products....

Other Shelving	49 to 67
Lockers, Cupboards & Cloakroom.....	68 to 93
Small Parts Storage & Containers	94 to 125
Storage, Security Cages & Hazardous...	126 to 147

Racking, Shelving & Sheet/Bar Racks

Kwikrack Shelving



- » Offers robust, effective storage for any application
- » The unique 6 fold channel beam offers high shelf capacities with a shelf height of only 54mm
- » No nuts & bolts required - the system simply taps together with the use of a hammer/mallet
- » Complete with 5 chipboard shelves
- » Total bay load: up to 1500kg U.D.L.

PRICES HELD

**FROM ONLY
£139.52**

Rubber Mallet

Model	Price
MALLET	£5.51

upto
300kg
evenly
distributed

5 day
delivery

SOME
ASSEMBLY
REQUIRED

INFORMATION *i*
**Takes less than
5 minutes to build!**

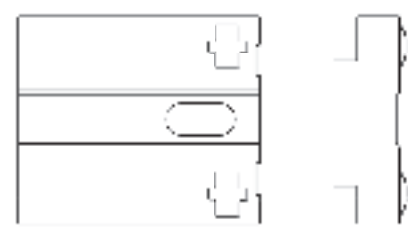

Beam Profile

Size H x W x D mm	Shelf Load kg	Kwikrack Shelving		Extra Shelf	
		Model	Price	Model	Price
2000 x 1000 x 300	300	KWB/20/10/03/5/BGV	£139.52	KWS/10/03/GV	£16.70
2000 x 1000 x 450	300	KWB/20/10/04/5/BGV	£166.81	KWS/10/04/GV	£22.16
2000 x 1000 x 600	300	KWB/20/10/06/5/BGV	£189.41	KWS/10/06/GV	£26.68
2000 x 1200 x 300	250	KWB/20/12/03/5/BGV	£156.89	KWS/12/03/GV	£20.18
2000 x 1200 x 450	250	KWB/20/12/04/5/BGV	£182.52	KWS/12/04/GV	£25.30
2000 x 1200 x 600	250	KWB/20/12/06/5/BGV	£207.88	KWS/12/06/GV	£30.37
2000 x 1500 x 300	200	KWB/20/15/03/5/BGV	£186.93	KWS/15/03/GV	£26.18
2000 x 1500 x 450	200	KWB/20/15/04/5/BGV	£222.76	KWS/15/04/GV	£33.35
2000 x 1500 x 600	200	KWB/20/15/06/5/BGV	£254.46	KWS/15/06/GV	£39.69

For Taller Bays add price

Extra Height	Model	Price
Bays to 2500mm	KWB/25/--/--/5/BGV	£13.45

Kwikrack Shelving



INFORMATION



**Great for
Archive Storage**



Interlocking Deck Supports



Chipboard sits flush within Beam



Racking, Shelving & Sheet/Bar Racks



J Rivet Shelving

- » Offers robust, effective storage for any application
- » J beam profile gives increased storage capacity whilst maintaining excellent strength
- » No nuts & bolts required - the system simply taps together with the use of a hammer/mallet
- » Complete with 5 chipboard shelves
- » Total bay load: up to 2800kg U.D.L.



INFORMATION



Takes less than 10 minutes to build!

Available Heights (mm) (width shown 915mm)

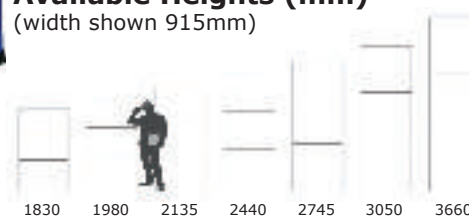

For Taller Bays add price

Size H x W x D mm	Shelf Load kg	J Rivet Shelving		Extra Shelf	
		Model	Price	Model	Price
1830 x 915 x 305	150	JRB/18/09/03/5/BG	£134.73	JRS/09/03/GY	£18.08
1830 x 915 x 457	150	JRB/18/09/04/5/BG	£157.05	JRS/09/04/GY	£22.55
1830 x 915 x 610	150	JRB/18/09/06/5/BG	£179.38	JRS/09/06/GY	£27.01
1830 x 1220 x 305	120	JRB/18/12/03/5/BG	£159.53	JRS/12/03/GY	£23.05
1830 x 1220 x 457	120	JRB/18/12/04/5/BG	£187.09	JRS/12/04/GY	£28.55
1830 x 1220 x 610	120	JRB/18/12/06/5/BG	£214.66	JRS/12/06/GY	£34.07

Extra Height	Model	Price
Bays to 1980mm	JRB/19/--/--/5/BG	£3.97
Bays to 2135mm	JRB/21/--/--/5/BG	£7.06
Bays to 2440mm	JRB/24/--/--/5/BG	£14.33
Bays to 2745mm	JRB/27/--/--/5/BG	£20.51
Bays to 3050mm	JRB/30/--/--/5/BG	£29.55
Bays to 3660mm	JRB/36/--/--/5/BG	£41.90

J Rivet Shelving



Run of 3 x J Rivet Shelving units connected with Tie Plates

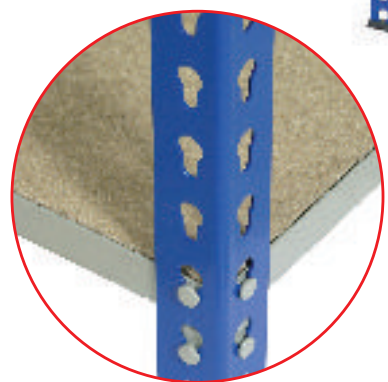
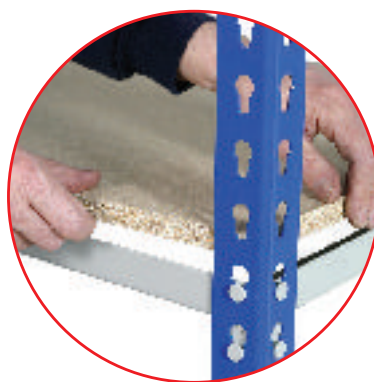

Rubber Mallet



Model	Price
MALLET	£5.51

Tie Plate (set of 4)



Model	Price
RR8/SET4	£5.07

Wall Bracket



Model	Price
RR5/WBKT	£1.43

Metal Feet (set of 4)



Model	Price
RR5/SET4	£5.73

Floor Fixing (M8x50)



Model	Price
FFM8X50	£1.60

Racking, Shelving & Sheet/Bar Racks

Heavy Duty Rivet Shelving (915mm to 1525mm Wide)



COLOUR OPTIONS

- Blue & Grey
- Blue & Orange

specify when ordering

INFORMATION i

Takes less than 10 minutes to build!

- » Offers robust, effective storage for any application
- » No nuts & bolts required - the system simply taps together with the use of a hammer/mallet
- » Complete with 4 chipboard shelves
- » Total bay load: up to 2800kg U.D.L.

Size H x W x D mm	Shelf Load kg	Heavy Duty Rivet Shelving		Extra Shelf	
		Model	Price	Model	Price
1830 x 915 x 305	600	RRB/18/09/03/4	£145.53	RRS/09/03	£27.07
1830 x 915 x 457	600	RRB/18/09/04/4	£166.70	RRS/09/04	£33.41
1830 x 915 x 610	600	RRB/18/09/06/4	£186.54	RRS/09/06	£39.41
1830 x 915 x 762	600	RRB/18/09/07/4	£212.12	RRS/09/07	£46.86
1830 x 915 x 915	600	RRB/18/09/09/4	£245.86	RRS/09/09	£56.28
1830 x 915 x 1220	550	RRB/18/09/12/4	£292.38	RRS/09/12	£69.84
1830 x 1220 x 305	550	RRB/18/12/03/4	£181.25	RRS/12/03	£33.90
1830 x 1220 x 457	550	RRB/18/12/04/4	£211.02	RRS/12/04	£41.34
1830 x 1220 x 610	550	RRB/18/12/06/4	£239.46	RRS/12/06	£48.45
1830 x 1220 x 762	550	RRB/18/12/07/4	£275.18	RRS/12/07	£57.39
1830 x 1220 x 915	550	RRB/18/12/09/4	£317.30	RRS/12/09	£67.91
1830 x 1220 x 1220	550	RRB/18/12/12/4	£380.80	RRS/12/12	£83.79
1830 x 1525 x 305	500	RRB/18/15/03/4	£214.77	RRS/15/03	£42.28
1830 x 1525 x 457	500	RRB/18/15/04/4	£250.27	RRS/15/04	£51.16
1830 x 1525 x 610	500	RRB/18/15/06/4	£284.45	RRS/15/06	£59.70
1830 x 1525 x 762	500	RRB/18/15/07/4	£319.28	RRS/15/07	£68.41
1830 x 1525 x 915	500	RRB/18/15/09/4	£366.03	RRS/15/09	£80.10
1830 x 1525 x 1220	500	RRB/18/15/12/4	£438.80	RRS/15/12	£98.29

Available Heights (mm)

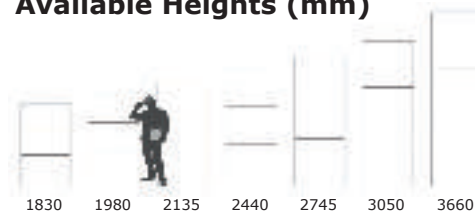

For Taller Bays add price

Extra Height	Model	Price
Bays to 1980mm	RRB/19/--/--/4	£3.97
Bays to 2135mm	RRB/21/--/--/4	£7.06
Bays to 2440mm	RRB/24/--/--/4	£14.33
Bays to 2745mm	RRB/27/--/--/4	£20.51
Bays to 3050mm	RRB/30/--/--/4	£29.55
Bays to 3660mm	RRB/36/--/--/4	£41.90

Heavy Duty Rivet Shelving (1830mm to 2440mm Wide)

Rubber Mallet



Model	Price
MALLET	£5.51

Tie Plate (set of 4)



Model	Price
RR8/SET4	£5.07

Wall Bracket



Model	Price
RR5/WBKT	£1.43

Metal Feet (set of 4)



Model	Price
RR5/SET4	£5.73

Floor Fixing (M8x50)



Model	Price
FFM8X50	£1.60



- » Offers robust, effective storage for any application
- » No nuts & bolts required - the system simply taps together with the use of a hammer/mallet
- » Complete with 4 chipboard shelves
- » Total bay load: up to 2800kg U.D.L.



Size H x W x D mm	Shelf Load kg	Heavy Duty Rivet Shelving		Extra Shelf	
		Model	Price	Model	Price
1830 x 1830 x 305	500	RRB/18/18/03/4	£266.58	RRS/18/03	£55.24
1830 x 1830 x 457	500	RRB/18/18/04/4	£306.94	RRS/18/04	£65.32
1830 x 1830 x 610	500	RRB/18/18/06/4	£345.74	RRS/18/06	£75.03
1830 x 1830 x 762	500	RRB/18/18/07/4	£384.99	RRS/18/07	£84.84
1830 x 1830 x 915	500	RRB/18/18/09/4	£436.37	RRS/18/09	£97.68
1830 x 1830 x 1220	450	RRB/18/18/12/4	£518.40	RRS/18/12	£118.19
1830 x 2135 x 305	450	RRB/18/21/03/4	£300.54	RRS/21/03	£63.72
1830 x 2135 x 457	450	RRB/18/21/04/4	£345.52	RRS/21/04	£74.97
1830 x 2135 x 610	450	RRB/18/21/06/4	£388.74	RRS/21/06	£85.77
1830 x 2135 x 762	450	RRB/18/21/07/4	£432.84	RRS/21/07	£96.80
1830 x 2135 x 915	450	RRB/18/21/09/4	£488.85	RRS/21/09	£110.80
1830 x 2135 x 1220	425	RRB/18/21/12/4	£579.92	RRS/21/12	£133.57
1830 x 2440 x 305	400	RRB/18/24/03/4	£341.55	RRS/24/03	£73.98
1830 x 2440 x 457	400	RRB/18/24/04/4	£395.14	RRS/24/04	£87.37
1830 x 2440 x 610	400	RRB/18/24/06/4	£447.39	RRS/24/06	£100.44
1830 x 2440 x 762	400	RRB/18/24/07/4	£521.04	RRS/24/07	£118.85
1830 x 2440 x 915	400	RRB/18/24/09/4	£589.62	RRS/24/09	£135.99
1830 x 2440 x 1220	400	RRB/18/24/12/4	£705.38	RRS/24/12	£164.93

Available Heights (mm)

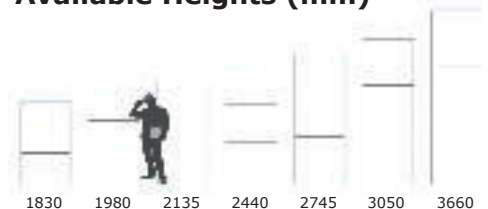

For Taller Bays add price

Extra Height	Model	Price
Bays to 1980mm	RRB/19/--/--/4	£3.97
Bays to 2135mm	RRB/21/--/--/4	£7.06
Bays to 2440mm	RRB/24/--/--/4	£14.33
Bays to 2745mm	RRB/27/--/--/4	£20.51
Bays to 3050mm	RRB/30/--/--/4	£29.55
Bays to 3660mm	RRB/36/--/--/4	£41.90

Racking, Shelving & Sheet/Bar Racks

Heavy Duty Rivet Shelving with Solid Steel Decking

- » Offers robust, effective storage for any application
- » No nuts & bolts required - the system simply taps together with the use of a hammer/mallet
- » Complete with 4 solid steel shelves
- » Total bay load: up to 2800kg U.D.L.

FROM ONLY
£275.63

INFORMATION
Takes less than **10 minutes to build!**

PRICES HELD

Rubber Mallet



Model	Price
MALLET	£5.51

Tie Plate (set of 4)



Model	Price
RR8/SET4	£5.07

Wall Bracket



Model	Price
RR5/WBKT	£1.43

Metal Feet (set of 4)



Model	Price
RR5/SET4	£5.73

COLOUR OPTIONS
 Blue & Grey
 Blue & Orange
 specify when ordering

upto **500kg** evenly distributed
 **5 day delivery**
 **SOME ASSEMBLY REQUIRED**

Size H x W x D mm	Shelf Load kg	Heavy Duty Rivet Shelving		Extra Shelf	
		Model	Price	Model	Price
1830 x 915 x 457	360	RRBSD/18/09/04/4	£275.63	RRSSD/09/04	£57.50
1830 x 915 x 610	360	RRBSD/18/09/06/4	£378.82	RRSSD/09/06	£83.29
1830 x 915 x 762	360	RRBSD/18/09/07/4	£438.80	RRSSD/09/07	£98.29
1830 x 915 x 915	300	RRBSD/18/09/09/4	£512.88	RRSSD/09/09	£116.81
1830 x 915 x 1220	270	RRBSD/18/09/12/4	£596.45	RRSSD/09/12	£137.70
1830 x 1220 x 457	480	RRBSD/18/12/04/4	£339.57	RRSSD/12/04	£73.48
1830 x 1220 x 610	480	RRBSD/18/12/06/4	£473.41	RRSSD/12/06	£106.94
1830 x 1220 x 762	480	RRBSD/18/12/07/4	£549.49	RRSSD/12/07	£125.96
1830 x 1220 x 915	400	RRBSD/18/12/09/4	£640.33	RRSSD/12/09	£148.67
1830 x 1220 x 1220	360	RRBSD/18/12/12/4	£742.86	RRSSD/12/12	£174.31
1830 x 1830 x 457	500	RRBSD/18/18/04/4	£496.13	RRSSD/18/04	£112.62
1830 x 1830 x 610	500	RRBSD/18/18/06/4	£691.27	RRSSD/18/06	£161.41
1830 x 1830 x 762	500	RRBSD/18/18/07/4	£799.53	RRSSD/18/07	£188.47
1830 x 1830 x 915	500	RRBSD/18/18/09/4	£923.90	RRSSD/18/09	£219.56
1830 x 1830 x 1220	450	RRBSD/18/18/12/4	£1064.35	RRSSD/18/12	£254.68
1830 x 2135 x 457	450	RRBSD/18/21/04/4	£567.13	RRSSD/21/04	£130.37
1830 x 2135 x 610	450	RRBSD/18/21/06/4	£792.92	RRSSD/21/06	£186.82
1830 x 2135 x 762	450	RRBSD/18/21/07/4	£917.28	RRSSD/21/07	£217.91
1830 x 2135 x 915	450	RRBSD/18/21/09/4	£1058.40	RRSSD/21/09	£253.19
1830 x 2135 x 1220	425	RRBSD/18/21/12/4	£1217.82	RRSSD/21/12	£293.04
1830 x 2440 x 457	400	RRBSD/18/24/04/4	£647.17	RRSSD/24/04	£150.38
1830 x 2440 x 610	400	RRBSD/18/24/06/4	£907.80	RRSSD/24/06	£215.54
1830 x 2440 x 762	400	RRBSD/18/24/07/4	£1052.45	RRSSD/24/07	£251.70
1830 x 2440 x 915	400	RRBSD/18/24/09/4	£1214.29	RRSSD/24/09	£292.16
1830 x 2440 x 1220	400	RRBSD/18/24/12/4	£1400.40	RRSSD/24/12	£338.69

Floor Fixing (M8x50)



Model	Price
FFM8X50	£1.60

Available Heights (mm)

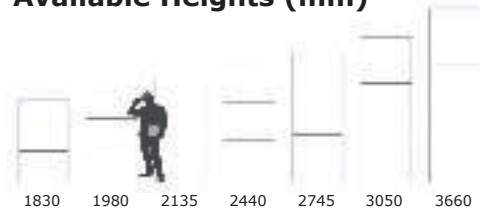

For Taller Bays add price

Extra Height	Model	Price
Bays to 1980mm	RRB/19/--/--/4	£3.97
Bays to 2135mm	RRB/21/--/--/4	£7.06
Bays to 2440mm	RRB/24/--/--/4	£14.33
Bays to 2745mm	RRB/27/--/--/4	£20.51
Bays to 3050mm	RRB/30/--/--/4	£29.55
Bays to 3660mm	RRB/36/--/--/4	£41.90

Heavy Duty Rivet Shelving with Wire Mesh Decking

Rubber Mallet



Model	Price
MALLET	£5.51

Tie Plate (set of 4)



Model	Price
RR8/SET4	£5.07

Wall Bracket



Model	Price
RR5/WBKT	£1.43

Metal Feet (set of 4)



Model	Price
RR5/SET4	£5.73

Floor Fixing (M8x50)



Model	Price
FFM8X50	£1.60

upto
600kg
evenly
distributed



COLOUR OPTIONS

-  Blue & Grey
-  Blue & Orange

specify when ordering



FROM ONLY
£228.44



- » Offers robust, effective storage for any application
- » No nuts & bolts required - the system simply taps together with the use of a hammer/mallet
- » Complete with 4 mesh shelves
- » Total bay load: up to 2800kg U.D.L.

Size H x W x D mm	Shelf Load kg	Heavy Duty Rivet Shelving		Extra Shelf	
		Model	Price	Model	Price
1830 x 915 x 457	600	RRBWD/18/09/04/4	£228.44	RRSWD/09/04	£45.70
1830 x 915 x 610	600	RRBWD/18/09/06/4	£259.75	RRSWD/09/06	£53.53
1830 x 915 x 762	600	RRBWD/18/09/07/4	£295.03	RRSWD/09/07	£62.35
1830 x 915 x 915	600	RRBWD/18/09/09/4	£338.91	RRSWD/09/09	£73.32
1830 x 915 x 1220	550	RRBWD/18/09/12/4	£407.93	RRSWD/09/12	£90.57
1830 x 1220 x 457	550	RRBWD/18/12/04/4	£275.18	RRSWD/12/04	£57.39
1830 x 1220 x 610	550	RRBWD/18/12/06/4	£312.67	RRSWD/12/06	£66.76
1830 x 1220 x 762	550	RRBWD/18/12/07/4	£355.67	RRSWD/12/07	£77.51
1830 x 1220 x 915	550	RRBWD/18/12/09/4	£405.50	RRSWD/12/09	£89.96
1830 x 1220 x 1220	550	RRBWD/18/12/12/4	£490.61	RRSWD/12/12	£111.24
1830 x 1830 x 457	500	RRBWD/18/18/04/4	£401.75	RRSWD/18/04	£89.03
1830 x 1830 x 610	500	RRBWD/18/18/06/4	£453.13	RRSWD/18/06	£101.87
1830 x 1830 x 762	500	RRBWD/18/18/07/4	£512.00	RRSWD/18/07	£116.59
1830 x 1830 x 915	500	RRBWD/18/18/09/4	£575.95	RRSWD/18/09	£132.58
1830 x 1830 x 1220	450	RRBWD/18/18/12/4	£687.30	RRSWD/18/12	£160.41
1830 x 2135 x 457	450	RRBWD/18/21/04/4	£455.55	RRSWD/21/04	£102.48
1830 x 2135 x 610	450	RRBWD/18/21/06/4	£513.10	RRSWD/21/06	£116.87
1830 x 2135 x 762	450	RRBWD/18/21/07/4	£579.69	RRSWD/21/07	£133.51
1830 x 2135 x 915	450	RRBWD/18/21/09/4	£649.59	RRSWD/21/09	£150.99
1830 x 2135 x 1220	425	RRBWD/18/21/12/4	£777.04	RRSWD/21/12	£182.85
1830 x 2440 x 457	400	RRBWD/18/24/04/4	£518.40	RRSWD/24/04	£118.19
1830 x 2440 x 610	400	RRBWD/18/24/06/4	£586.31	RRSWD/24/06	£135.17
1830 x 2440 x 762	400	RRBWD/18/24/07/4	£685.76	RRSWD/24/07	£160.03
1830 x 2440 x 915	400	RRBWD/18/24/09/4	£769.55	RRSWD/24/09	£180.98
1830 x 2440 x 1220	400	RRBWD/18/24/12/4	£928.53	RRSWD/24/12	£220.72

INFORMATION 

Takes less than 10 minutes to build!

Available Heights (mm)

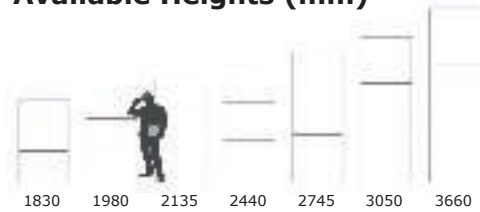

For Taller Bays add price

Extra Height	Model	Price
Bays to 1980mm	RRB/19/--/--/4	£3.97
Bays to 2135mm	RRB/21/--/--/4	£7.06
Bays to 2440mm	RRB/24/--/--/4	£14.33
Bays to 2745mm	RRB/27/--/--/4	£20.51
Bays to 3050mm	RRB/30/--/--/4	£29.55
Bays to 3660mm	RRB/36/--/--/4	£41.90

Racking, Shelving & Sheet/Bar Racks

Medium Duty Rivet Shelving



INFORMATION



Takes less than 10 minutes to build!

Available Heights (mm)

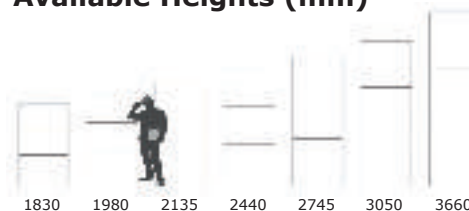

- » Offers robust, effective storage for any application
- » No nuts & bolts required - the system simply taps together with the use of a hammer/mallet
- » Complete with 4 chipboard shelves

Size H x W x D mm	Shelf Load kg	Medium Duty Rivet Shelving		Extra Shelf	
		Model	Price	Model	Price
1830 x 1830 x 305	300	MRB/18/18/03/4/BG	£218.52	MRS/18/03/GY	£43.22
1830 x 1830 x 457	300	MRB/18/18/04/4/BG	£258.87	MRS/18/04/GY	£53.31
1830 x 1830 x 610	300	MRB/18/18/06/4/BG	£297.68	MRS/18/06/GY	£63.01
1830 x 1830 x 762	280	MRB/18/18/07/4/BG	£336.92	MRS/18/07/GY	£72.82
1830 x 1830 x 915	250	MRB/18/18/09/4/BG	£388.30	MRS/18/09/GY	£85.66
1830 x 1830 x 1220	230	MRB/18/18/12/4/BG	£470.33	MRS/18/12/GY	£106.17

For Taller Bays add price

Extra Height	Model	Price
Bays to 1980mm	RRB/19/--/--/4	£3.97
Bays to 2135mm	RRB/21/--/--/4	£7.06
Bays to 2440mm	RRB/24/--/--/4	£14.33
Bays to 2745mm	RRB/27/--/--/4	£20.51
Bays to 3050mm	RRB/30/--/--/4	£29.55
Bays to 3660mm	RRB/36/--/--/4	£41.90

Heavy Duty Rivet Shelving - White Shelves

Rubber Mallet



Model	Price
MALLET	£5.51

Tie Plate (set of 4)



Model	Price
RR8/SET4	£5.07

Wall Bracket



Model	Price
RR5/WBKT	£1.43

Metal Feet (set of 4)



Model	Price
RR5/SET4	£5.73

Floor Fixing (M8x50)



Model	Price
FFM8X50	£1.60



FROM ONLY
£217.85

PRICES HELD

INFORMATION



Takes less than 10 minutes to build!

COLOUR OPTIONS

- Blue & Grey
 - Blue & Orange
- specify when ordering*



- » Offers robust, effective storage for any application
- » No nuts & bolts required - the system simply taps together with the use of a hammer/mallet
- » Complete with 4 white shelves

Available Heights (mm)

(width shown 915mm)

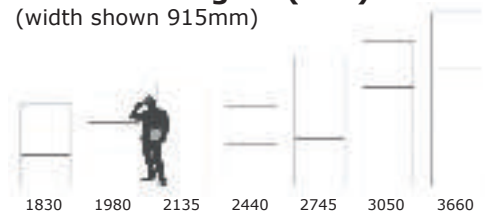

Size H x W x D mm	Shelf Load kg	Heavy Duty Rivet Shelving		Extra Shelf	
		Model	Price	Model	Price
1830 x 915 x 610	600	RRB/M/18/09/06/4	£217.85	RRS/M/09/06	£43.05
1830 x 915 x 762	600	RRB/M/18/09/07/4	£245.86	RRS/M/09/07	£50.05
1830 x 915 x 915	600	RRB/M/18/09/09/4	£285.55	RRS/M/09/09	£59.98
1830 x 1220 x 610	550	RRB/M/18/12/06/4	£258.21	RRS/M/12/06	£53.14
1830 x 1220 x 762	550	RRB/M/18/12/07/4	£291.28	RRS/M/12/07	£61.41
1830 x 1220 x 915	550	RRB/M/18/12/09/4	£336.26	RRS/M/12/09	£72.65
1830 x 1830 x 610	500	RRB/M/18/18/06/4	£364.93	RRS/M/18/06	£79.82
1830 x 1830 x 762	500	RRB/M/18/18/07/4	£408.37	RRS/M/18/07	£90.68
1830 x 1830 x 915	500	RRB/M/18/18/09/4	£463.71	RRS/M/18/09	£104.52
1830 x 2440 x 610	400	RRB/M/18/24/06/4	£472.75	RRS/M/24/06	£106.78
1830 x 2440 x 762	400	RRB/M/18/24/07/4	£530.74	RRS/M/24/07	£121.28
1830 x 2440 x 915	400	RRB/M/18/24/09/4	£600.42	RRS/M/24/09	£138.69

For Taller Bays add price

Extra Height	Model	Price
Bays to 1980mm	RRB/19/--/--/4	£3.97
Bays to 2135mm	RRB/21/--/--/4	£7.06
Bays to 2440mm	RRB/24/--/--/4	£14.33
Bays to 2745mm	RRB/27/--/--/4	£20.51
Bays to 3050mm	RRB/30/--/--/4	£29.55
Bays to 3660mm	RRB/36/--/--/4	£41.90

Racking, Shelving & Sheet/Bar Racks

Rivet Garment Racks

- » Offers a cost effective & flexible way to store hanging garments
- » Comes configured as single or double side garment rails
- » No nuts & bolts required - the system just taps together with the use of a hammer/mallet



FROM ONLY
£126.62



PRICES HELD

Overall Size H x W x D mm	Tube Load kg	Single Rail Garment Bay - 2 Levels		Double Rail Garment Bay - 2 Levels	
		Model	Price	Model	Price
2135 x 915 x 610	70	RRGB/SG/21/09/06/2/BG	£126.62	RRGB/DG/21/09/06/2/BG	£149.01
2135 x 1220 x 610	60	RRGB/SG/21/12/06/2/BG	£151.32	RRGB/DG/21/12/06/2/BG	£181.30

Rivet Archive Storage

- » Offers robust, effective storage for archive boxes
- » No nuts & bolts required - the system simply taps together with the use of a hammer/mallet
- » Complete with chipboard shelves & archive boxes

PRICES HELD

FROM ONLY
£314.21



COLOUR OPTIONS
 Blue & Grey
 Blue & Orange
specify when ordering



RRAK18/100

Archive Boxes - pk of 10

H x W x D mm	Model	Price
270 x 350 x 430	AK0020AB/10	£47.96

Rubber Mallet

Model	Price
MALLET	£5.51

Tie Plate (set of 4)

Model	Price
RR8/SET4	£5.07

Wall Bracket

Model	Price
RR5/WBKT	£1.43

Metal Feet (set of 4)

Model	Price
RR5/SET4	£5.73

Floor Fixing (M8x50)

Model	Price
FFM8X50	£1.60

Size H x W mm	Single Box Deep - 457mm				Double Box Deep - 915mm			
	No of Boxes	No of Shelves	Model	Price	No of Boxes	No of Shelves	Model	Price
1830 x 1525	24	3	RRAK15/24	£314.21	48	3	RRAK15/48	£516.14
2440 x 1525	32	4	RRAK15/32	£418.07	64	4	RRAK15/64	£687.30
3050 x 1525	40	5	RRAK15/40	£522.81	80	5	RRAK15/80	£859.34
1830 x 1830	30	3	RRAK18/30	£385.49	60	3	RRAK18/60	£626.44
2440 x 1830	40	4	RRAK18/40	£513.10	80	4	RRAK18/80	£834.37
3050 x 1830	50	5	RRAK18/50	£641.60	100	5	RRAK18/100	£1043.19

Racking, Shelving & Sheet/Bar Racks

Delta Plus Shelving

- » Ideal for offices, libraries, workshops or warehouses
- » All steel construction
- » Complete with 6 shelves
- » Pure white finish (RAL9010)
- » Shelves adjust every 25mm
- » 362mm deep shelf takes standard 330mm lateral files underneath adding extra versatility

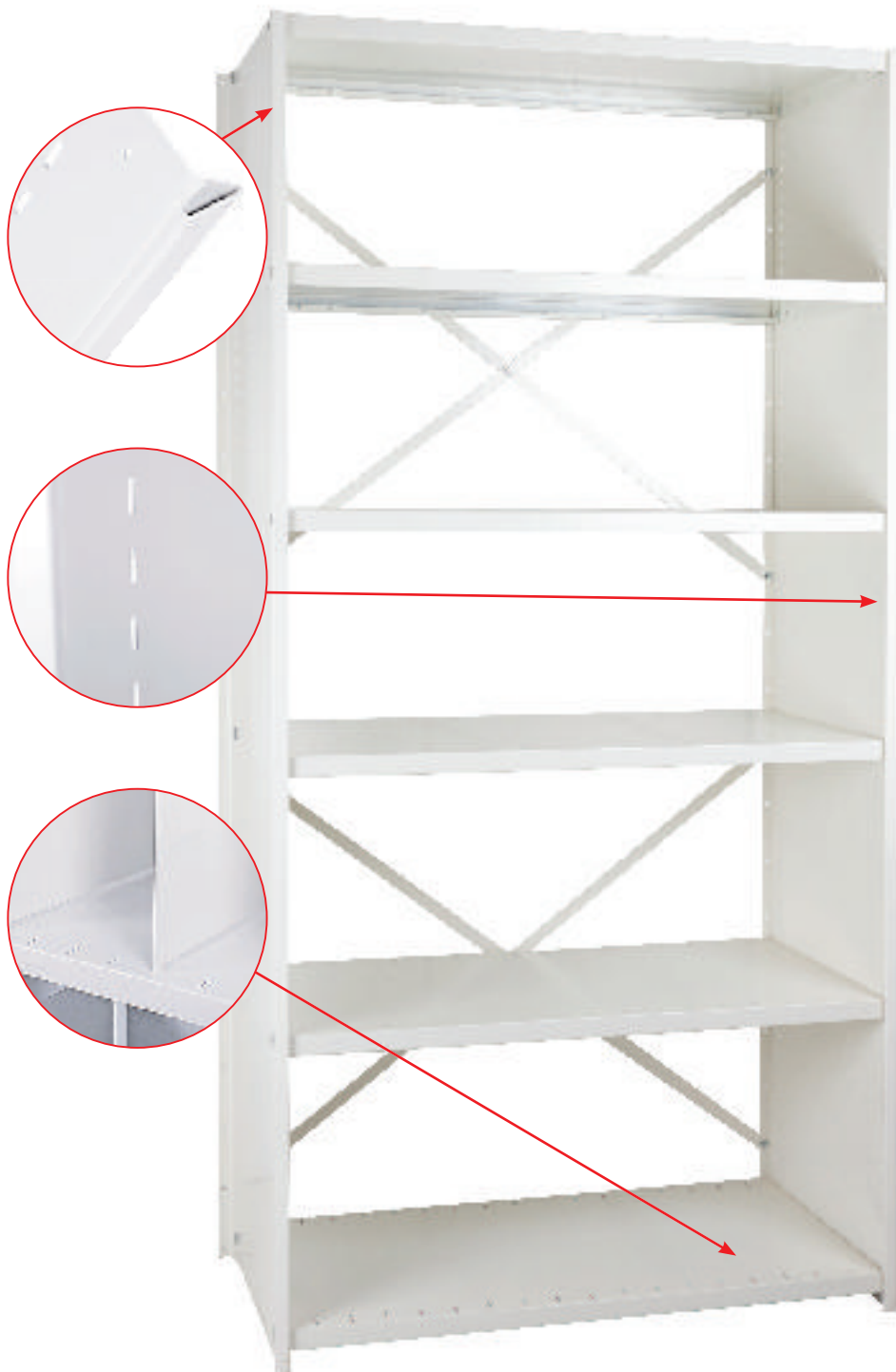

INFORMATION



Takes less than 10 minutes to build!

Overall Size H x W x D mm	Delta Plus Starter Bays		Delta Plus Extension Bays		Extra Shelf		Extra Height	Add Extra Height for Starter Bays		Add Extra Height for Extension Bays	
	Model	Price	Model	Price	Model	Price		Model	Price	Model	Price
1930 x 686 x 300	DTS/19/07/30/6	£172.21	DTE/19/07/30/6	£130.11	DTS/0730SH	£14.67	2230	DTS/22/--/30/6	£11.09	DTE/22/--/30/6	£5.54
1930 x 902 x 300	DTS/19/09/30/6	£189.54	DTE/19/09/30/6	£147.44	DTS/0930SH	£17.56	2530	DTS/25/--/30/6	£22.18	DTE/25/--/30/6	£11.09
1930 x 986 x 300	DTS/19/10/30/6	£205.82	DTE/19/10/30/6	£163.72	DTS/1030SH	£20.27	-	-	-	-	-
1930 x 686 x 362	DTS/19/07/36/6	£195.89	DTE/19/07/36/6	£148.19	DTS/0736SH	£16.75	2230	DTS/22/--/36/6	£12.82	DTE/22/--/36/6	£6.41
1930 x 902 x 362	DTS/19/09/36/6	£216.33	DTE/19/09/36/6	£168.63	DTS/0936SH	£20.15	2530	DTS/25/--/36/6	£25.76	DTE/25/--/36/6	£12.88
1930 x 986 x 362	DTS/19/10/36/6	£234.70	DTE/19/10/36/6	£186.99	DTS/1036SH	£23.22	-	-	-	-	-
1930 x 686 x 400	DTS/19/07/40/6	£210.67	DTE/19/07/40/6	£159.56	DTS/0740SH	£18.08	2230	DTS/22/--/40/6	£13.98	DTE/22/--/40/6	£6.99
1930 x 902 x 400	DTS/19/09/40/6	£232.50	DTE/19/09/40/6	£181.39	DTS/0940SH	£21.71	2530	DTS/25/--/40/6	£27.95	DTE/25/--/40/6	£13.98
1930 x 986 x 400	DTS/19/10/40/6	£252.60	DTE/19/10/40/6	£201.49	DTS/1040SH	£25.06	-	-	-	-	-
1930 x 686 x 450	DTS/19/07/45/6	£229.85	DTE/19/07/45/6	£174.17	DTS/0745SH	£19.75	2230	DTS/22/--/45/6	£15.36	DTE/22/--/45/6	£7.68
1930 x 902 x 450	DTS/19/09/45/6	£253.75	DTE/19/09/45/6	£198.08	DTS/0945SH	£23.74	2530	DTS/25/--/45/6	£30.61	DTE/25/--/45/6	£15.30
1930 x 986 x 450	DTS/19/10/45/6	£275.93	DTE/19/10/45/6	£220.26	DTS/1045SH	£27.43	-	-	-	-	-
1930 x 686 x 500	DTS/19/07/50/6	£249.25	DTE/19/07/50/6	£189.07	DTS/0750SH	£21.48	2230	DTS/22/--/50/6	£16.75	DTE/22/--/50/6	£8.37
1930 x 902 x 500	DTS/19/09/50/6	£275.24	DTE/19/09/50/6	£215.06	DTS/0950SH	£25.81	2530	DTS/25/--/50/6	£33.50	DTE/25/--/50/6	£16.75
1930 x 986 x 500	DTS/19/10/50/6	£299.15	DTE/19/10/50/6	£238.97	DTS/1050SH	£29.80	-	-	-	-	-
1930 x 686 x 600	DTS/19/07/60/6	£287.83	DTE/19/07/60/6	£218.58	DTS/0760SH	£24.89	2230	DTS/22/--/60/6	£19.52	DTE/22/--/60/6	£9.76
1930 x 902 x 600	DTS/19/09/60/6	£317.97	DTE/19/09/60/6	£248.73	DTS/0960SH	£29.91	2530	DTS/25/--/60/6	£39.04	DTE/25/--/60/6	£19.52
1930 x 986 x 600	DTS/19/10/60/6	£345.69	DTE/19/10/60/6	£276.45	DTS/1060SH	£34.53	-	-	-	-	-

Racking, Shelving & Sheet/Bar Racks



PRICES HELD



Size mm	Model	Price
Back Cladding Sets		
1930H x 686W	DT05/1907/WH	£58.56
1930H x 986W	DT05/1910/WH	£83.51
2230H x 686W	DT05/2207/WH	£67.16
2230H x 986W	DT05/2210/WH	£95.92
2530H x 686W	DT05/2507/WH	£75.77
2530H x 986W	DT05/2510/WH	£108.34



Size mm	Model	Price
Fixed Height Dividers		
300D x 300H	DT07/30/30	£3.75
362D x 300H	DT07/36/30	£4.56
450D x 300H	DT07/45/30	£5.83
300D x 400H	DT07/30/40	£4.97
362D x 400H	DT07/36/40	£6.12
450D x 400H	DT07/45/40	£7.80

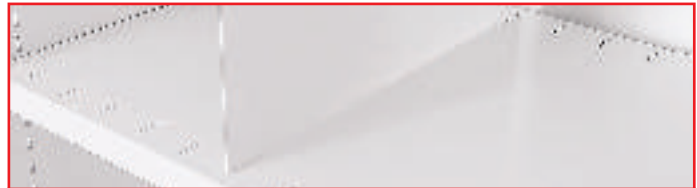

Size mm	Model	Price
Slot-in Dividers		
300D x 95H	DT08/30/09	£1.56
362D x 95H	DT08/36/09	£1.91
450D x 95H	DT08/45/09	£2.37
300D x 195H	DT08/30/19	£2.83
362D x 195H	DT08/36/19	£3.41
450D x 195H	DT08/45/19	£4.33



Size mm	Model	Price
Freestanding Dividers		
300D x 175H	DT06/30/175	£4.04
362D x 175H	DT06/36/175	£4.74
450D x 175H	DT06/45/175	£5.72



Size mm	Model	Price
Base Plinth		
25H x 686W	DT10/07/25	£1.79
25H x 986W	DT10/10/25	£2.48



Size mm	Model	Price
Bin Front		
85H x 686W	DT09/07/85	£3.70
85H x 986W	DT09/10/85	£5.31



Racking, Shelving & Sheet/Bar Racks

Expo 4 Boltless Shelving



Expo 4 Extension Bay

Expo 4 Starter Bay

PRICES HELD

- >> Ideal for many applications
- >> All steel shelves which are easily adjustable on steel shelf clips
- >> Endless versatility with the huge range of accessories available

Expo 4 Starter & Extension Bays

Overall Size H x W x D mm	Shelf Load kg	Expo 4 Open Bays		Expo 4 Extension Bays		Extra Shelf	
		Model	Price	Model	Price	Model	Price
2000 x 700 x 300	140	E4S/200703/6	£229.67	E4E/200703/6	£176.20	E4/0703SH	£20.44
2000 x 1000 x 300	110	E4S/201003/6	£281.99	E4E/201003/6	£228.52	E4/1003SH	£29.16
2000 x 1150 x 300	90	E4S/201103/6	£303.13	E4E/201103/6	£249.65	E4/1103SH	£32.69
2000 x 700 x 400	130	E4S/200704/6	£256.93	E4E/200704/6	£201.95	E4/0704SH	£24.49
2000 x 1000 x 400	200	E4S/201004/6	£316.53	E4E/201004/6	£261.55	E4/1004SH	£34.42
2000 x 1150 x 400	180	E4S/201104/6	£358.45	E4E/201104/6	£303.48	E4/1104SH	£41.41
2000 x 700 x 500	200	E4S/200705/6	£292.27	E4E/200705/6	£235.91	E4/0705SH	£29.91
2000 x 1000 x 500	180	E4S/201005/6	£356.03	E4E/201005/6	£299.66	E4/1005SH	£40.54
2000 x 1150 x 500	150	E4S/201105/6	£381.32	E4E/201105/6	£324.96	E4/1105SH	£44.76
2000 x 700 x 600	180	E4S/200706/6	£298.51	E4E/200706/6	£240.76	E4/0706SH	£30.49
2000 x 1000 x 600	200	E4S/201006/6	£387.21	E4E/201006/6	£329.46	E4/1006SH	£45.28
2000 x 1150 x 600	150	E4S/201106/6	£474.53	E4E/201106/6	£416.78	E4/1106SH	£59.83

For Taller Bays add the below:

Depth mm	To Take Height To	Starter Bay		Extension Bay	
		Model	Price	Model	Price
300	2200mm	E4S/220703/6	£6.70	E4E/220703/6	£3.35
	2500mm	E4S/251003/6	£20.10	E4E/251003/6	£10.05
	3000mm	E4S/301103/6	£57.52	E4E/301103/6	£28.76
400	2200mm	E4S/220704/6	£6.70	E4E/220704/6	£3.35
	2500mm	E4S/251004/6	£21.60	E4E/251004/6	£10.80
	3000mm	E4S/301104/6	£60.52	E4E/301104/6	£30.26
500	2200mm	E4S/220705/6	£6.70	E4E/220705/6	£3.35
	2500mm	E4S/251005/6	£22.98	E4E/251005/6	£11.49
	3000mm	E4S/301105/6	£63.29	E4E/301105/6	£31.65
600	2200mm	E4S/220706/6	£6.70	E4E/220706/6	£3.35
	2500mm	E4S/251006/6	£24.37	E4E/251006/6	£12.19
	3000mm	E4S/301106/6	£66.07	E4E/301106/6	£33.03

Expo 4 Boltless Shelving - Cladding



Expo 4 Solid Side Cladding

Price to clad per frame. Includes multiple panels & a plastic joining rib

Overall Size H x D mm	Model	Price	Overall Size H x D mm	Model	Price
2000 x 300	EX10/2003/GY	£38.58	2500 x 300	EX10/2503/GY	£49.20
2000 x 400	EX10/2004/GY	£50.53	2500 x 400	EX10/2504/GY	£64.33
2000 x 500	EX10/2005/GY	£62.43	2500 x 500	EX10/2505/GY	£79.41
2000 x 600	EX10/2006/GY	£73.98	2500 x 600	EX10/2506/GY	£94.71
2200 x 300	EX10/2203/GY	£42.27	3000 x 300	EX10/3003/GY	£58.50
2200 x 400	EX10/2204/GY	£55.44	3000 x 400	EX10/3004/GY	£76.58
2200 x 500	EX10/2205/GY	£68.49	3000 x 500	EX10/3005/GY	£94.54
2200 x 600	EX10/2206/GY	£81.77	3000 x 600	EX10/3006/GY	£112.79

Expo 4 Mesh Side Cladding

Price to clad per frame. Includes multiple panels

Overall Size H x D mm	Model	Price	Overall Size H x D mm	Model	Price
2000 x 300	EX11/2003/GV	£23.45	2500 x 300	EX11/2503/GV	£28.30
2000 x 400	EX11/2004/GV	£32.57	2500 x 400	EX11/2504/GV	£39.15
2000 x 500	EX11/2005/GV	£42.50	2500 x 500	EX11/2505/GV	£50.47
2000 x 600	EX11/2006/GV	£52.21	2500 x 600	EX11/2506/GV	£62.37
2200 x 300	EX11/2203/GV	£25.87	3000 x 300	EX11/3003/GV	£35.17
2200 x 400	EX11/2204/GV	£35.86	3000 x 400	EX11/3004/GV	£48.86
2200 x 500	EX11/2205/GV	£46.49	3000 x 500	EX11/3005/GV	£63.76
2200 x 600	EX11/2206/GV	£57.29	3000 x 600	EX11/3006/GV	£78.31



Expo 4 Mesh Back Cladding

Price includes multiple panels of 2" x 2" galvanised mesh & ties

Overall Size H x W mm	Model	Price
2000 x 700	EX12/2007/GV	£65.49
2200 x 700	EX12/2207/GV	£71.84
2500 x 700	EX12/2507/GV	£78.19
3000 x 700	EX12/3007/GV	£98.23
2000 x 1000	EX12/2010/GV	£95.17
2200 x 1000	EX12/2210/GV	£104.64
2500 x 1000	EX12/2510/GV	£114.11
3000 x 1000	EX12/3010/GV	£142.76
2000 x 1150	EX12/2011/GV	£108.80
2200 x 1150	EX12/2211/GV	£119.48
2500 x 1150	EX12/2511/GV	£130.17
3000 x 1150	EX12/3011/GV	£163.20

Expo 4 Solid Sheet Back Cladding

Price includes multiple solid steel sheets & screws

Overall Size H x W mm	Model	Price
2000 x 700	EX13/2007/GY	£119.54
2200 x 700	EX13/2207/GY	£134.50
2500 x 700	EX13/2507/GY	£149.46
3000 x 700	EX13/3007/GY	£194.27
2000 x 1000	EX13/2010/GY	£169.44
2200 x 1000	EX13/2210/GY	£189.36
2500 x 1000	EX13/2510/GY	£209.29
3000 x 1000	EX13/3010/GY	£274.08
2000 x 1150	EX13/2011/GY	£193.81
2200 x 1150	EX13/2211/GY	£221.47
2500 x 1150	EX13/2511/GY	£249.13
3000 x 1150	EX13/3011/GY	£318.38

Expo 4 Hook In Back Cladding

Price includes multiple hook in steel panels

Overall Size H x W mm	Model	Price
2000 x 700	EX14/2007/GY	£192.31
2200 x 700	EX14/2207/GY	£222.92
2500 x 700	EX14/2507/GY	£241.97
3000 x 700	EX14/3007/GY	£291.64
2000 x 1000	EX14/2010/GY	£226.15
2200 x 1000	EX14/2210/GY	£267.44
2500 x 1000	EX14/2510/GY	£284.07
3000 x 1000	EX14/3010/GY	£342.00
2000 x 1150	EX14/2011/GY	£248.15
2200 x 1150	EX14/2211/GY	£295.10
2500 x 1150	EX14/2511/GY	£311.56
3000 x 1150	EX14/3011/GY	£374.97

Racking, Shelving & Sheet/Bar Racks

Expo 4D Boltless Shelving



Expo 4D Starter Bay



INFORMATION



Takes less than 10 minutes to build!



Expo 4D Starter Bay with Cladding

Expo 4D Starter & Extension Bays

Overall Size H x W x D mm	Shelf Load kg	Expo 4D Open Bays		Expo 4D Extension Bays		Extra Shelf	
		Model	Price	Model	Price	Model	Price
2000 x 700 x 300	120	E4ST/200703/6/BW	£223.09	E4ET/200703/6/BW	£169.58	E4/0703ST	£19.35
2000 x 1000 x 300	120	E4ST/201003/6/BW	£266.05	E4ET/201003/6/BW	£212.55	E4/1003ST	£26.51
2000 x 700 x 400	120	E4ST/200704/6/BW	£252.43	E4ET/200704/6/BW	£197.42	E4/0704ST	£23.74
2000 x 1000 x 400	120	E4ST/201004/6/BW	£305.44	E4ET/201004/6/BW	£250.43	E4/1004ST	£32.57
2000 x 700 x 500	120	E4ST/200705/6/BW	£280.84	E4ET/200705/6/BW	£224.45	E4/0705ST	£28.01
2000 x 1000 x 500	120	E4ST/201005/6/BW	£344.59	E4ET/201005/6/BW	£288.20	E4/1005ST	£38.63
2000 x 700 x 600	120	E4ST/200706/6/BW	£309.60	E4ET/200706/6/BW	£251.82	E4/0706ST	£32.34
2000 x 1000 x 600	120	E4ST/201006/6/BW	£383.40	E4ET/201006/6/BW	£325.62	E4/1006ST	£44.64

For Taller Bays add the below:

Depth mm	To Take Height To	Starter Bay		Extension Bay	
		Model	Price	Model	Price
300	2200mm	E4ST/22--03/6/BW	£6.70	E4ET/22--03/6/BW	£3.35
	2500mm	E4ST/25--03/6/BW	£20.10	E4ET/25--03/6/BW	£10.05
	3000mm	E4ST/30--03/6/BW	£57.52	E4ET/30--03/6/BW	£28.76
400	2200mm	E4ST/22--04/6/BW	£6.70	E4ET/22--04/6/BW	£3.35
	2500mm	E4ST/25--04/6/BW	£21.60	E4ET/25--04/6/BW	£10.80
	3000mm	E4ST/30--04/6/BW	£60.52	E4ET/30--04/6/BW	£30.26
500	2200mm	E4ST/22--05/6/BW	£6.70	E4ET/22--05/6/BW	£3.35
	2500mm	E4ST/25--05/6/BW	£22.98	E4ET/25--05/6/BW	£11.49
	3000mm	E4ST/30--05/6/BW	£63.29	E4ET/30--05/6/BW	£31.65
600	2200mm	E4ST/22--06/6/BW	£6.70	E4ET/22--06/6/BW	£3.35
	2500mm	E4ST/25--06/6/BW	£24.37	E4ET/25--06/6/BW	£12.19
	3000mm	E4ST/30--06/6/BW	£66.07	E4ET/30--06/6/BW	£33.03

Expo 4D Solid Back Cladding

Overall Size H x W mm	Model	Price
2000 x 700	EX13/2007/WH	£191.27
2200 x 700	EX13/2207/WH	£215.18
2500 x 700	EX13/2507/WH	£239.09
3000 x 700	EX13/3007/WH	£310.81
2000 x 1000	EX13/2010/WH	£270.96
2200 x 1000	EX13/2210/WH	£302.84
2500 x 1000	EX13/2510/WH	£334.72
3000 x 1000	EX13/3010/WH	£438.32

Expo 4D Solid Side Cladding

Overall Size H x W mm	Model	Price
2000 x 300	EX10/2003/WH	£29.74
2000 x 400	EX10/2004/WH	£39.56
2000 x 500	EX10/2005/WH	£49.03
2000 x 600	EX10/2006/WH	£58.91
2200 x 300	EX10/2203/WH	£32.57
2200 x 400	EX10/2204/WH	£43.43
2200 x 500	EX10/2205/WH	£53.82
2200 x 600	EX10/2206/WH	£64.62
2500 x 300	EX10/2503/WH	£37.88
2500 x 400	EX10/2504/WH	£50.53
2500 x 500	EX10/2505/WH	£62.37
2500 x 600	EX10/2506/WH	£75.02
3000 x 300	EX10/3003/WH	£45.05
3000 x 400	EX10/3004/WH	£60.00
3000 x 500	EX10/3005/WH	£74.21
3000 x 600	EX10/3006/WH	£89.22

Expo 4D Boltless Shelving



5 day delivery   **NO ON SITE ASSEMBLY REQUIRED**  **upto 120kg evenly distributed**  **PRICES HELD**

Size D x H mm	Model	Price
1) Slot-in Dividers		
300 x 95	EX32/030/095/WH	£1.96
300 x 195	EX32/030/195/WH	£3.58
400 x 95	EX32/040/095/WH	£2.66
400 x 195	EX32/040/195/WH	£4.85
500 x 95	EX32/050/095/WH	£3.35
500 x 195	EX32/050/195/WH	£6.12
600 x 95	EX32/060/095/WH	£4.04
600 x 195	EX32/060/195/WH	£7.39

Size D x H mm	Model	Price
2) Fixed Height Dividers		
300 x 300	EX33/030/300/WH	£4.74
300 x 400	EX33/030/400/WH	£6.35
400 x 300	EX33/040/300/WH	£6.58
400 x 400	EX33/040/400/WH	£8.78
500 x 300	EX33/050/300/WH	£8.26
500 x 400	EX33/050/400/WH	£11.09
600 x 300	EX33/060/300/WH	£9.93
600 x 400	EX33/060/400/WH	£13.28

Size D x H mm	Model	Price
3) Freestanding Dividers		
300 x 175	EX20/030/175/WH	£5.14
400 x 175	EX20/040/175/WH	£6.58
500 x 175	EX20/050/175/WH	£7.91
600 x 175	EX20/060/175/WH	£9.30
4) Bin Front / Back Stop		
686 x 85	EX31/070/085/WH	£4.74
986 x 85	EX31/100/085/WH	£6.76

Racking, Shelving & Sheet/Bar Racks



Expo 4G Galvanised Shelving

- » Complete with 6 shelves
- » Assemble in minutes
- » Tough hardwearing galvanised finish



INFORMATION



Takes less than 10 minutes to build!

For Taller Bays add the below:

Depth mm	To Take Height To	Starter Bay		Extension Bay	
		Model	Price	Model	Price
300	2200mm	E4SG/22--03/6	£6.01	E4EG/22--03/6	£3.00
	2500mm	E4SG/25--03/6	£22.29	E4EG/25--03/6	£11.15
	3000mm	E4SG/30--03/6	£44.58	E4EG/30--03/6	£22.29
400	2200mm	E4SG/22--04/6	£6.01	E4EG/22--04/6	£3.00
	2500mm	E4SG/25--04/6	£23.91	E4EG/25--04/6	£11.95
	3000mm	E4SG/30--04/6	£47.82	E4EG/30--04/6	£23.91
500	2200mm	E4SG/22--05/6	£6.01	E4EG/22--05/6	£3.00
	2500mm	E4SG/25--05/6	£25.18	E4EG/25--05/6	£12.59
	3000mm	E4SG/30--05/6	£50.36	E4EG/30--05/6	£25.18
600	2200mm	E4SG/22--06/6	£6.01	E4EG/22--06/6	£3.00
	2500mm	E4SG/25--06/6	£26.80	E4EG/25--06/6	£13.40
	3000mm	E4SG/30--06/6	£53.59	E4EG/30--06/6	£26.80

Expo 4G Starter & Extension Bays

Overall Size H x W x D mm	Shelf Load kg	Expo 4G Open Bays		Expo 4G Extension Bays		Extra Shelf	
		Model	Price	Model	Price	Model	Price
2000 x 700 x 300	150	E4SGG/200703/6	£176.48	E4EGG/200703/6	£127.40	E4G/0703SH	£13.05
2000 x 1000 x 300	150	E4SGG/201003/6	£202.47	E4EGG/201003/6	£153.38	E4G/1003SH	£17.38
2000 x 1150 x 300	120	E4SGG/201103/6	£215.64	E4EGG/201103/6	£166.55	E4G/1103SH	£19.58
2000 x 700 x 400	120	E4SGG/200704/6	£193.92	E4EGG/200704/6	£143.22	E4G/0704SH	£15.42
2000 x 1000 x 400	200	E4SGG/201004/6	£248.67	E4EGG/201004/6	£197.97	E4G/1004SH	£24.54
2000 x 1150 x 400	170	E4SGG/201104/6	£267.73	E4EGG/201104/6	£217.02	E4G/1104SH	£27.72
2000 x 700 x 500	200	E4SGG/200705/6	£226.61	E4EGG/200705/6	£174.64	E4G/0705SH	£20.44
2000 x 1000 x 500	200	E4SGG/201005/6	£270.62	E4EGG/201005/6	£218.64	E4G/1005SH	£27.78
2000 x 1150 x 500	160	E4SGG/201105/6	£292.79	E4EGG/201105/6	£240.82	E4G/1105SH	£31.47
2000 x 700 x 600	200	E4SGG/200706/6	£243.71	E4EGG/200706/6	£190.11	E4G/0706SH	£22.75
2000 x 1000 x 600	180	E4SGG/201006/6	£293.60	E4EGG/201006/6	£240.01	E4G/1006SH	£31.07
2000 x 1150 x 600	140	E4SGG/201106/6	£318.20	E4EGG/201106/6	£264.61	E4G/1106SH	£35.17

Midspan Racking

- >> Heavy duty & secure
- >> Shelves easily adjust every 25mm
- >> Easy to build & reconfigure



M50 Upright & C50 Beam

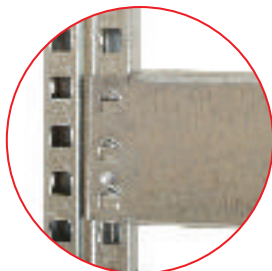

M50 Upright & C70 Beam



M50 Profile Frames - 50mm wide frames which include uprights, metal feet & all necessary bracing & fixings

Size mm	Depth - 400mm		Depth - 600mm		Depth - 800mm		Depth - 1000mm		Depth - 1200mm	
	Model	Price	Model	Price	Model	Price	Model	Price	Model	Price
1950H	MSF/19/04	£64.45	MSF/19/06	£65.95	MSF/19/08	£69.65	MSF/19/10	£73.05	MSF/19/12	£78.83
2550H	MSF/25/04	£84.43	MSF/25/06	£86.97	MSF/25/08	£87.66	MSF/25/10	£91.82	MSF/25/12	£98.87
3000H	MSF/30/04	£98.12	MSF/30/06	£101.64	MSF/30/08	£103.14	MSF/30/10	£107.88	MSF/30/12	£115.90

M70 Profile Frames - 70mm wide frames which include uprights, metal feet & all necessary bracing & fixings

Size mm	Depth - 400mm		Depth - 600mm		Depth - 800mm		Depth - 1000mm		Depth - 1200mm	
	Model	Price	Model	Price	Model	Price	Model	Price	Model	Price
2550H	-	-	MSF70/25/06	£158.87	MSF70/25/08	£160.20	MSF70/25/10	£165.86	MSF70/25/12	£171.52
4500H	-	-	MSF70/45/06	£263.34	MSF70/45/08	£267.79	MSF70/45/10	£275.70	MSF70/45/12	£283.96
5550H	-	-	MSF70/55/06	£321.44	MSF70/55/08	£326.52	MSF70/55/10	£336.22	MSF70/55/12	£346.33
6000H	-	-	MSF70/60/06	£345.69	MSF70/60/08	£348.75	MSF70/60/10	£358.17	MSF70/60/12	£368.16

C50 Profile Beam Levels - 50mm wide beams which include pair of beams, galvanised decking, safety pins & beam ties

Size mm	Depth - 400mm			Depth - 600mm			Depth - 800mm			Depth - 1000mm			Depth - 1200mm		
	Shelf Load kg	Model	Price	Shelf Load kg	Model	Price	Shelf Load kg	Model	Price	Shelf Load kg	Model	Price	Shelf Load kg	Model	Price
1000W	400	MSB/1004C50	£46.03	400	MSB/1006C50	£56.02	400	MSB/1008C50	£73.86	350	MSB/1010C50	£85.41	325	MSB/1012C50	£97.14
1200W	400	MSB/1204C50	£54.81	340	MSB/1206C50	£66.70	340	MSB/1208C50	£88.01	340	MSB/1210C50	£101.81	340	MSB/1212C50	£115.85
1600W	250	MSB/1604C50	£72.25	250	MSB/1606C50	£87.95	250	MSB/1608C50	£116.19	250	MSB/1610C50	£134.50	250	MSB/1612C50	£153.15

C70 Profile Beam Levels - 70mm wide beams which include pair of beams, galvanised decking, safety pins & beam ties

Size mm	Depth - 400mm			Depth - 600mm			Depth - 800mm			Depth - 1000mm			Depth - 1200mm		
	Shelf Load kg	Model	Price	Shelf Load kg	Model	Price	Shelf Load kg	Model	Price	Shelf Load kg	Model	Price	Shelf Load kg	Model	Price
1000W	500	MSB/1004C70	£66.35	500	MSB/1006C70	£76.35	400	MSB/1008C70	£94.19	350	MSB/1010C70	£105.74	325	MSB/1012C70	£117.46
1200W	600	MSB/1204C70	£79.06	600	MSB/1206C70	£90.96	480	MSB/1208C70	£112.27	420	MSB/1210C70	£126.07	390	MSB/1212C70	£140.10
1600W	750	MSB/1604C70	£104.12	750	MSB/1606C70	£119.83	640	MSB/1608C70	£148.07	560	MSB/1610C70	£166.38	520	MSB/1612C70	£185.03
1800W	660	MSB/1804C70	£116.71	660	MSB/1806C70	£134.33	660	MSB/1808C70	£166.03	630	MSB/1810C70	£186.59	585	MSB/1812C70	£207.05
2000W	600	MSB/2004C70	£129.30	600	MSB/2006C70	£148.82	600	MSB/2008C70	£183.99	600	MSB/2010C70	£206.80	600	MSB/2012C70	£230.08
2400W	480	MSB/2404C70	£154.37	480	MSB/2406C70	£177.70	480	MSB/2408C70	£219.80	480	MSB/2410C70	£247.11	480	MSB/2412C70	£275.01

Racking, Shelving & Sheet/Bar Racks

Longspan Heavy Duty Racking



Chipboard Decking

- » Heavy Duty Racking system - store all your heavy & bulk items with ease
- » Adaptable storage solutions simple to add to, as your storage needs grow
- » Strong "Z" profile beam design - unique beam design that offers capacities up to 950kgs
- » Heavy duty shelf levels - shelf levels includes deck supports to match beam capacities



Twin Slot Upright & Beam



Horizontal Deck Supports

Longspan Heavy Duty Racking Starter Bays - Chipboard Decking - 1984Hmm Frames

Includes 2 x frames & 3 Beam Levels complete with Decking

Width mm	Depth - 471mm		Depth - 624mm		Depth - 776mm		Depth - 928mm		Depth - 1233mm	
	Model	Price	Model	Price	Model	Price	Model	Price	Model	Price
1229	TNBS/201204/3/BO	£302.20	TNBS/201206/3/BO	£365.48	TNBS/201207/3/BO	£401.70	TNBS/201209/3/BO	£420.16	TNBS/201212/3/BO	£500.31
1534	TNBS/201504/3/BO	£343.21	TNBS/201506/3/BO	£410.63	TNBS/201507/3/BO	£446.18	TNBS/201509/3/BO	£467.96	TNBS/201512/3/BO	£534.88
1839	TNBS/201804/3/BO	£381.24	TNBS/201806/3/BO	£451.97	TNBS/201807/3/BO	£490.83	TNBS/201809/3/BO	£515.91	TNBS/201812/3/BO	£589.29
2144	TNBS/202104/3/BO	£418.95	TNBS/202106/3/BO	£493.15	TNBS/202107/3/BO	£535.32	TNBS/202109/3/BO	£582.89	TNBS/202112/3/BO	£696.12
2449	TNBS/202404/3/BO	£456.49	TNBS/202406/3/BO	£546.73	TNBS/202407/3/BO	£595.68	TNBS/202409/3/BO	£630.19	TNBS/202412/3/BO	£789.39
2754	TNBS/202704/3/BO	£494.03	TNBS/202706/3/BO	£600.31	TNBS/202707/3/BO	£656.04	TNBS/202709/3/BO	£696.84	TNBS/202712/3/BO	£803.61

Longspan Heavy Duty Racking Extension Bays - Chipboard Decking - 1984Hmm Frames

Includes 1 x frame & 3 Beam Levels complete with Decking

Width mm	Depth - 471mm		Depth - 624mm		Depth - 776mm		Depth - 928mm		Depth - 1233mm	
	Model	Price	Model	Price	Model	Price	Model	Price	Model	Price
1229	TNBE/201204/3/BO	£233.62	TNBE/201206/3/BO	£290.73	TNBE/201207/3/BO	£322.65	TNBE/201209/3/BO	£342.88	TNBE/201212/3/BO	£416.19
1534	TNBE/201504/3/BO	£274.63	TNBE/201506/3/BO	£335.88	TNBE/201507/3/BO	£367.13	TNBE/201509/3/BO	£390.67	TNBE/201512/3/BO	£450.76
1839	TNBE/201804/3/BO	£312.67	TNBE/201806/3/BO	£377.22	TNBE/201807/3/BO	£411.78	TNBE/201809/3/BO	£438.63	TNBE/201812/3/BO	£505.17
2144	TNBE/202104/3/BO	£350.37	TNBE/202106/3/BO	£418.40	TNBE/202107/3/BO	£456.27	TNBE/202109/3/BO	£505.61	TNBE/202112/3/BO	£612.00
2449	TNBE/202404/3/BO	£387.91	TNBE/202406/3/BO	£471.98	TNBE/202407/3/BO	£516.63	TNBE/202409/3/BO	£552.90	TNBE/202412/3/BO	£705.27
2754	TNBE/202704/3/BO	£425.45	TNBE/202706/3/BO	£525.56	TNBE/202707/3/BO	£576.99	TNBE/202709/3/BO	£619.55	TNBE/202712/3/BO	£719.49

Longspan Heavy Duty Racking Extra Levels with Beams & Chipboard Decking

Width mm	Depth - 471mm		Depth - 624mm		Depth - 776mm		Depth - 928mm		Depth - 1233mm	
	Model	Price	Model	Price	Model	Price	Model	Price	Model	Price
1229	TSB/12/04/OR	£55.01	TSB/12/06/OR	£71.99	TSB/12/07/OR	£81.20	TSB/12/09/OR	£88.53	TSB/12/12/OR	£110.69
1534	TSB/15/04/OR	£68.69	TSB/15/06/OR	£87.04	TSB/15/07/OR	£96.03	TSB/15/09/OR	£104.46	TSB/15/12/OR	£122.21
1839	TSB/18/04/OR	£81.36	TSB/18/06/OR	£100.82	TSB/18/07/OR	£110.91	TSB/18/09/OR	£120.45	TSB/18/12/OR	£140.35
2144	TSB/21/04/OR	£93.93	TSB/21/06/OR	£114.55	TSB/21/07/OR	£125.74	TSB/21/09/OR	£142.77	TSB/21/12/OR	£175.96
2449	TSB/24/04/OR	£106.45	TSB/24/06/OR	£132.41	TSB/24/07/OR	£145.86	TSB/24/09/OR	£158.54	TSB/24/12/OR	£207.05
2754	TSB/27/04/OR	£118.96	TSB/27/06/OR	£150.27	TSB/27/07/OR	£165.98	TSB/27/09/OR	£180.75	TSB/27/12/OR	£211.79

Longspan Heavy Duty Racking

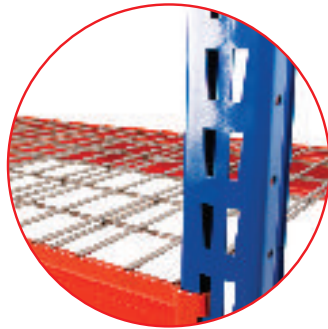

Wire Mesh Decking

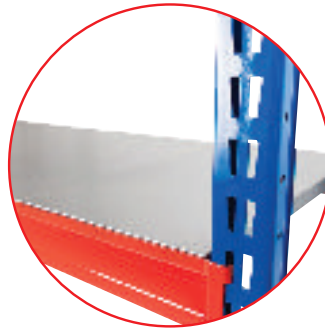

Solid Steel Decking

Longspan Heavy Duty Racking - Beam Levels - Solid Steel Decking

Includes one complete level with 2 beams, solid steel decking, all necessary deck supports & safety pins

Size mm	Depth - 471mm			Depth - 624mm			Depth - 776mm			Depth - 928mm			Depth - 1233mm		
	Shelf Load	Model	Price	Shelf Load	Model	Price	Shelf Load	Model	Price	Shelf Load	Model	Price	Shelf Load	Model	Price
1229W	480kg	TSBSD/12/04/OR	£80.81	480kg	TSBSD/12/06/OR	£118.96	480kg	TSBSD/12/07/OR	£136.71	400kg	TSBSD/12/09/OR	£154.79	360kg	TSBSD/12/12/OR	£177.61
1534W	600kg	TSBSD/15/04/OR	£99.67	600kg	TSBSD/15/06/OR	£145.20	600kg	TSBSD/15/07/OR	£166.81	500kg	TSBSD/15/09/OR	£188.91	450kg	TSBSD/15/12/OR	£216.31
1839W	720kg	TSBSD/18/04/OR	£118.52	720kg	TSBSD/18/06/OR	£171.44	720kg	TSBSD/18/07/OR	£196.91	600kg	TSBSD/18/09/OR	£223.04	540kg	TSBSD/18/12/OR	£255.01
2144W	700kg	TSBSD/21/04/OR	£137.26	700kg	TSBSD/21/06/OR	£197.57	700kg	TSBSD/21/07/OR	£226.89	700kg	TSBSD/21/09/OR	£257.05	630kg	TSBSD/21/12/OR	£293.60
2449W	600kg	TSBSD/24/04/OR	£156.00	600kg	TSBSD/24/06/OR	£223.70	600kg	TSBSD/24/07/OR	£256.88	600kg	TSBSD/24/09/OR	£291.06	600kg	TSBSD/24/12/OR	£332.18
2754W	440kg	TSBSD/27/04/OR	£174.64	440kg	TSBSD/27/06/OR	£249.72	440kg	TSBSD/27/07/OR	£286.76	440kg	TSBSD/27/09/OR	£324.96	440kg	TSBSD/27/12/OR	£370.66

Longspan Heavy Duty Racking - Beam Levels - Wire Mesh Decking

Includes one complete level with 2 beams, wire mesh decking, all necessary deck supports & safety pins

Size mm	Depth - 471mm			Depth - 624mm			Depth - 776mm			Depth - 928mm			Depth - 1233mm		
	Shelf Load	Model	Price	Shelf Load	Model	Price	Shelf Load	Model	Price	Shelf Load	Model	Price	Shelf Load	Model	Price
1229W	350kg	TSBWD/12/04/OR	£67.69	350kg	TSBWD/12/06/OR	£87.54	325kg	TSBWD/12/07/OR	£99.23	300kg	TSBWD/12/09/OR	£109.09	250kg	TSBWD/12/12/OR	£131.25
1839W	700kg	TSBWD/18/04/OR	£99.45	700kg	TSBWD/18/06/OR	£122.82	650kg	TSBWD/18/07/OR	£138.86	600kg	TSBWD/18/09/OR	£152.31	500kg	TSBWD/18/12/OR	£181.47
2144W	700kg	TSBWD/21/04/OR	£114.60	700kg	TSBWD/21/06/OR	£143.99	650kg	TSBWD/21/07/OR	£163.11	600kg	TSBWD/21/09/OR	£179.21	500kg	TSBWD/21/12/OR	£214.82
2449W	600kg	TSBWD/24/04/OR	£129.76	600kg	TSBWD/24/06/OR	£160.85	600kg	TSBWD/24/07/OR	£181.91	600kg	TSBWD/24/09/OR	£199.66	500kg	TSBWD/24/12/OR	£239.46
2754W	440kg	TSBWD/27/04/OR	£146.03	440kg	TSBWD/27/06/OR	£183.24	440kg	TSBWD/27/07/OR	£207.88	440kg	TSBWD/27/09/OR	£228.55	440kg	TSBWD/27/12/OR	£273.42

Longspan Heavy Duty Frames

Height mm	Depth - 471mm		Depth - 624mm		Depth - 776mm		Depth - 928mm		Depth - 1233mm	
	Model	Price	Model	Price	Model	Price	Model	Price	Model	Price
1984	TSF/20/04/BE	£68.58	TSF/20/06/BE	£74.75	TSF/20/07/BE	£79.05	TSF/20/09/BE	£77.29	TSF/20/12/BE	£84.12
2492	TSF/25/04/BE	£85.55	TSF/25/06/BE	£93.16	TSF/25/07/BE	£98.23	TSF/25/09/BE	£97.19	TSF/25/12/BE	£105.90
3000	TSF/30/04/BE	£102.42	TSF/30/06/BE	£111.46	TSF/30/07/BE	£117.31	TSF/30/09/BE	£116.64	TSF/30/12/BE	£126.90
3508	TSF/35/04/BE	£119.40	TSF/35/06/BE	£129.87	TSF/35/07/BE	£136.49	TSF/35/09/BE	£136.54	TSF/35/12/BE	£148.67
4016	TSF/40/04/BE	£134.95	TSF/40/06/BE	£146.85	TSF/40/07/BE	£154.24	TSF/40/09/BE	£148.34	TSF/40/12/BE	£160.14

Longspan Heavy Duty Racking - For Taller Frames - Available on all 3 Deck Options

For Starter Bays please add 2 x extra height price. For Extension Bays please add 1 x extra height price

Height mm	Depth - 471mm		Depth - 624mm		Depth - 776mm		Depth - 928mm		Depth - 1233mm	
	Model	Price	Model	Price	Model	Price	Model	Price	Model	Price
2492	----/25--04/3/BO	£16.98	----/25--06/3/BO	£18.41	----/25--07/3/BO	£19.18	----/25--09/3/BO	£19.90	----/25--12/3/BO	£21.77
3000	----/30--04/3/BO	£33.85	----/30--06/3/BO	£36.71	----/30--07/3/BO	£38.26	----/30--09/3/BO	£39.36	----/30--12/3/BO	£42.78
3508	----/35--04/3/BO	£50.83	----/35--06/3/BO	£55.13	----/35--07/3/BO	£57.44	----/35--09/3/BO	£59.26	----/35--12/3/BO	£64.55
4016	----/40--04/3/BO	£66.37	----/40--06/3/BO	£72.10	----/40--07/3/BO	£75.19	----/40--09/3/BO	£71.06	----/40--12/3/BO	£76.02

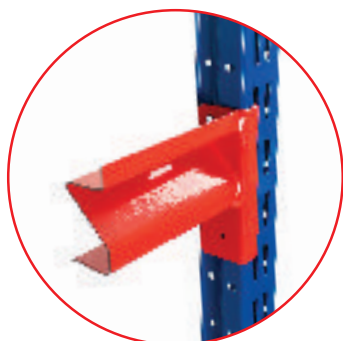

Twin Slot Upright & Beam



Horizontal Deck Supports



Vertical Dividers

Racking, Shelving & Sheet/Bar Racks

Pallet Racking



Pallet Racking



- » A pallet racking solution that will provide you with the perfect storage solution for your business
- » Galvanised frames with steel beams (RAL 1003 Yellow)
- » We will evaluate the type of goods you store, the amount of floor space available for the racking installation, the speed of throughput & the type of equipment you use before recommending the best solution



Frames

Height mm	Depth - 900mm		Depth - 1100mm	
	Model	Price	Model	Price
2500	MPRF/2509/GV	£219.50	MPRF/2511/GV	£229.72
3000	MPRF/3009/GV	£250.72	MPRF/3011/GV	£262.50
4000	MPRF/4009/GV	£307.38	MPRF/4011/GV	£320.49
5000	MPRF/5009/GV	£364.04	MPRF/5011/GV	£378.48
6000	MPRF/6009/GV	£435.90	MPRF/6011/GV	£454.55

Beams

Width mm	Load per Pair kg	Model	Price (pair)
1350	3540	MPRB/1375/YW	£101.52
2225	2800	MPRB/2210/YW	£168.75
2700	3180	MPRB/2712/YW	£218.87
3300 (900mm depth)	3790	MPRB/331709/YW	£358.86
3300 (1100mm depth)	3790	MPRB/331711/YW	£358.86

Pallet Racking Accessories

Description	Model	Price
Visiplas Upright Protector - 50/63mm	AVS1	£22.29
Visiplas Upright Protector - 79/92mm	AVB	£24.09
Visiplas Upright Protector - 92/105mm	AVC	£24.95
Visiplas Cable Tie - 600mm	AVQ	£1.27
Upright Protector Type L - 400mm	RPS/CCG4004	£63.76
Upright Protector Type U - 530mm	RPS/UCG4004	£77.56
200mm Row Spacer	MPRRS/20/GV	£13.86
250mm Row Spacer	MPRRS/25/GV	£16.52
Shim 1mm	MPR01/SHIM10	£2.37
Floor Fixing M12 x 100	FFM12X100	£2.31

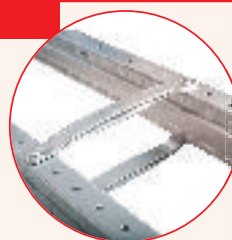

200mm Row Spacer



Visiplas Upright Protector



L-Shaped Upright Protector



U-Shaped Upright Protector

Racking, Shelving & Sheet/Bar Racks

Pallet Racking



PRICES HELD

Open Timber Decking Panels

Wire Decking Panels

W x D mm	Load kg	Model	Price
1350 x 900	1000	MPRMWD/1309	£56.25
2700 x 900	2000	MPRMWD/2709	£112.50
1350 x 1100	1000	MPRMWD/1311	£66.87
2225 x 1100	2000	MPRMWD/2211	£109.15
2700 x 1100	2000	MPRMWD/2711	£133.75
3300 x 1100	3000	MPRMWD/3311	£163.72

W x D mm	Load kg	Model	Price
1350 x 900	500	MPROTD/1309	£48.34
2225 x 900	810	MPROTD/2209	£83.39
2700 x 900	1000	MPROTD/2709	£96.67
3300 x 900	1226	MPROTD/3309	£125.09
1350 x 1100	685	MPROTD/1311	£60.81
2225 x 1100	1120	MPROTD/2211	£105.45
2700 x 1100	1375	MPROTD/2711	£121.62
3300 x 1100	1680	MPROTD/3311	£158.18

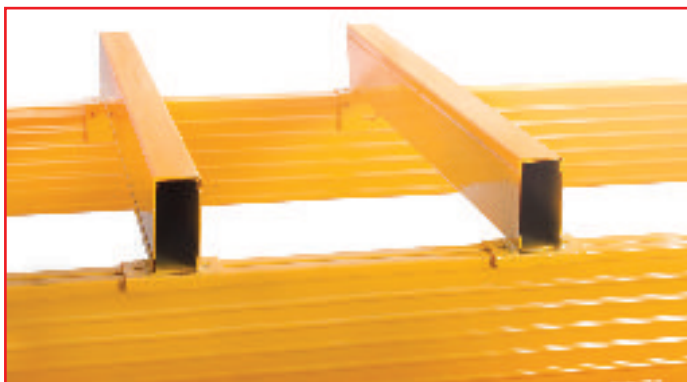

Fork Spacers

Depth mm	Load kg	Model	Price
900 (Pair)	2000 (Pair)	MPRFS/09/YW	£110.53
1100 (Pair)	2000 (Pair)	MPRFS/11/YW	£123.12

Pallet Support Bars

Depth mm	Load kg	Model	Price
900 (Pair)	1700 (Pair)	MPRSP/09/GV	£44.47
1100 (Pair)	1500 (Pair)	MPRSP/11/GV	£50.94

Pallet Racking

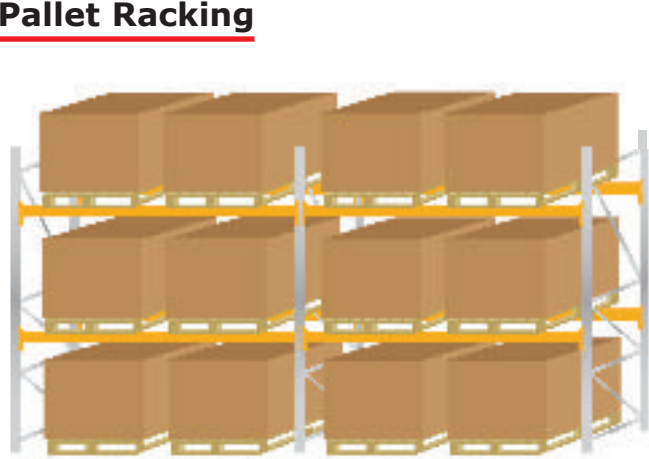

PRICES HELD

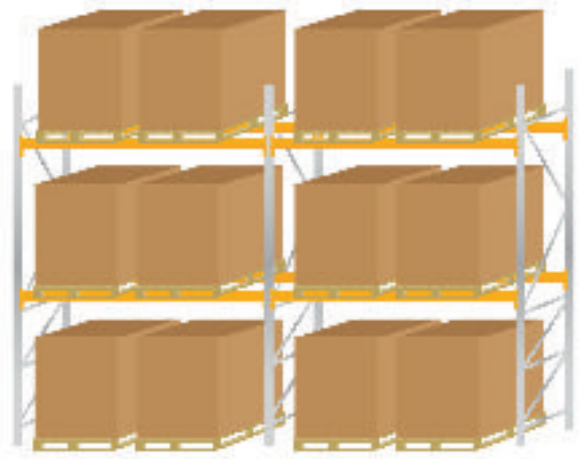

- >> For use with UK Pallets
- >> Pallet Racking Kit for 12 x pallets (Boxes shown 1000H x 1200Wmm)

H x W x D mm	Levels	Pallets Stored	Model	Price
3000 x 5742 x 900	2	12	MPRK1	£1653.63

- >> For use with UK Pallets
- >> Pallet Racking Kit for 12 x pallets (Boxes shown 1500H x 1200Wmm)

H x W x D mm	Levels	Pallets Stored	Model	Price
4000 x 5742 x 900	2	12	MPRK2	£1823.62

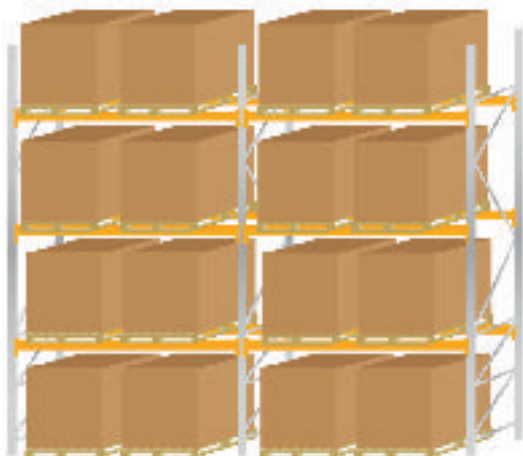

PRICES HELD



- >> For use with UK Pallets
- >> Pallet Racking Kit for 16 x pallets (Boxes shown 1200H x 1200Wmm)

H x W x D mm	Levels	Pallets Stored	Model	Price
5000 x 5742 x 900	3	16	MPRK3	£2431.36

- >> For use with Euro Pallets
- >> Pallet Racking Kit for 18 x pallets (Boxes shown 1000H x 800Wmm)

H x W x D mm	Levels	Pallets Stored	Model	Price
3000 x 5742 x 1100	2	18	MPRK4	£1688.97



PRICES HELD



- >> For use with Euro Pallets
- >> Pallet Racking Kit for 18 x pallets (Boxes shown 1500H x 800Wmm)

H x W x D mm	Levels	Pallets Stored	Model	Price
4000 x 5742 x 1100	2	18	MPRK5	£1862.95

- >> For use with Euro Pallets
- >> Pallet Racking Kit for 24 x pallets (Boxes shown 1200H x 800Wmm)

H x W x D mm	Levels	Pallets Stored	Model	Price
5000 x 5742 x 1100	3	24	MPRK6	£2474.67

Racking, Shelving & Sheet/Bar Racks

Vertical Storage Racks



PRICES HELD

FROM ONLY
£830.05

VRS/2518/3
& VRE/2512/3



INFORMATION

Simple to build
& reconfigure



- » Store all your long awkward items
- » Simple to build and reconfigure
- » Starter and extension bay system
- » Can be secured to the floor

Overall Size H x W x D mm	Starter Bay (c/w right & left fixed & 1 adj. dividers)		Extension Bay (c/w 3 adj. dividers)		Additional Hoop Dividers	
	Model	Price	Model	Price	Model	Price
2550 x 1200 x 810	VRS/2512/3	£830.05	VRE/2512/3	£636.81	VR/DIV1004	£96.90
2550 x 1600 x 810	VRS/2516/3	£865.97	VRE/2516/3	£672.74		
2550 x 1800 x 810	VRS/2518/3	£886.99	VRE/2518/3	£693.76		

Cantilever Racking

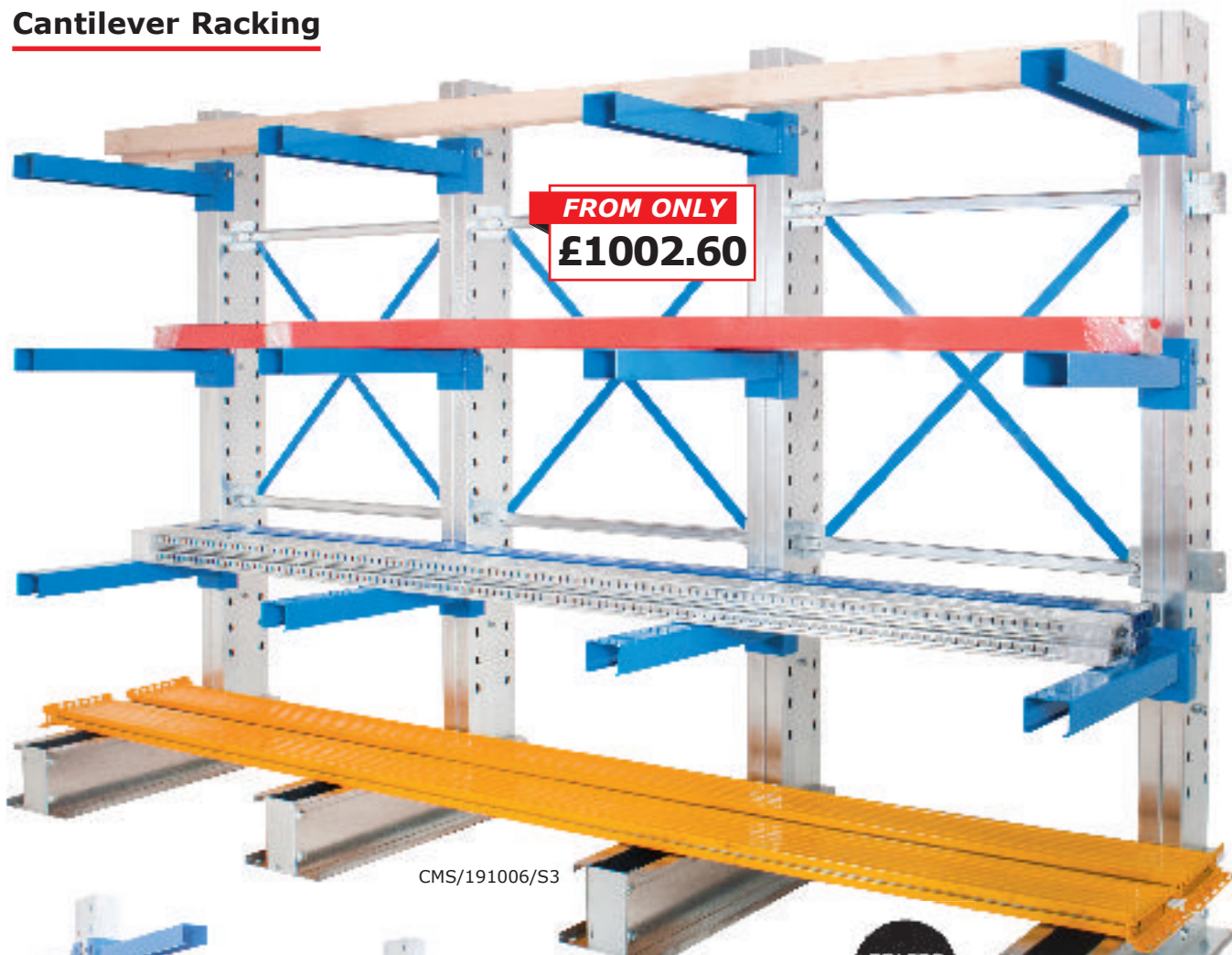

**FROM ONLY
£1002.60**

CMS/191006/S3



CMS/191006/D3

PRICES HELD



INFORMATION *i*
1500mm wide bays available - call for details



Description	Model	Price
Arm End Stop	CMAR/150ES	£11.72

- » Store all your long awkward items
- » Simple to build and reconfigure
- » Complete with 3 arms per upright (6 on double sided)
- » Capacity per arm: up to 1000kg
- » Arms adjust every 75mm

Overall Size H x W x D mm	Arm Length mm	Capacity per Arm kg	Starter Bay Single Sided		Extension Bay Single Sided		Starter Bay Double Sided (add arm length to depth)		Extension Bay Double Sided (add arm length to depth)		Additional Arm	
			Model	Price	Model	Price	Model	Price	Model	Price	Model	Price
1976 x 1000 x 780	600	600	CMS/191006/S3	£1002.60	CME/191006/S3	£528.47	CMS/191006/D3	£1298.86	CME/191006/D3	£676.60	CMAR/06	£40.83
1976 x 1000 x 980	800	400	CMS/191008/S3	£1079.52	CME/191008/S3	£566.93	CMS/191008/D3	£1458.25	CME/191008/D3	£756.29	CMAR/08	£49.84
1976 x 1000 x 1180	1000	250	CMS/191010/S3	£1156.67	CME/191010/S3	£605.51	CMS/191010/D3	£1618.10	CME/191010/D3	£836.22	CMAR/10	£58.91
2432 x 1000 x 780	600	600	CMS/241006/S3	£1125.03	CME/241006/S3	£589.69	CMS/241006/D3	£1421.29	CME/241006/D3	£737.81	CMAR/06	£40.83
2432 x 1000 x 980	800	400	CMS/241008/S3	£1201.95	CME/241008/S3	£628.15	CMS/241008/D3	£1580.68	CME/241008/D3	£817.51	CMAR/08	£49.84
2432 x 1000 x 1180	1000	250	CMS/241010/S3	£1279.10	CME/241010/S3	£666.72	CMS/241010/D3	£1740.53	CME/241010/D3	£897.44	CMAR/10	£58.91
2964 x 1000 x 780	600	600	CMS/291006/S3	£1278.87	CME/291006/S3	£666.61	CMS/291006/D3	£1575.13	CME/291006/D3	£814.74	CMAR/06	£40.83
2964 x 1000 x 980	800	400	CMS/291008/S3	£1355.80	CME/291008/S3	£705.07	CMS/291008/D3	£1734.52	CME/291008/D3	£894.43	CMAR/08	£49.84
2964 x 1000 x 1180	1000	250	CMS/291010/S3	£1432.95	CME/291010/S3	£743.65	CMS/291010/D3	£1894.37	CME/291010/D3	£974.36	CMAR/10	£58.91

Racking, Shelving & Sheet/Bar Racks



Rhino Tilt Bins



- » Complete with louvre panels
- » Large front handles with ergonomic grip
- » Great for space saving & organising small parts

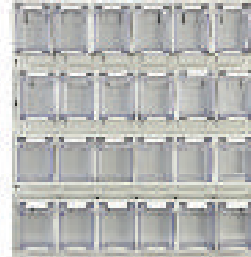

RTBKITA



RTBKITB



RTBKITC



RTBKITD



RTBKITDP

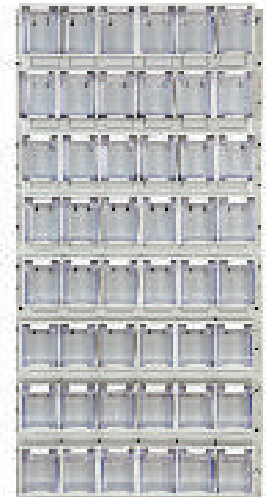

RTBKITAP



RTBKITBP

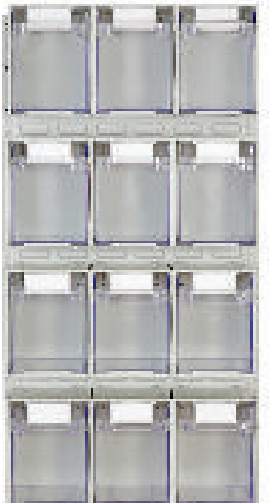

RTBKITCP

INFORMATION

Complete with Louvred Panels



Description	Model	Price
Rhino Tilt Bins with 457W x 457Hmm Square Louvre Panel		
Louvre Panel & 24 off 73W x 50D x 92Hmm Rhino Tilt Bins	RTBKITA	£90.57
Louvre Panel & 12 off 108W x 90D x 141Hmm Rhino Tilt Bins	RTBKITB	£85.94
Louvre Panel & 6 off 144W x 121D x 193Hmm Rhino Tilt Bins	RTBKITC	£83.96
Louvre Panel & 2 off 215W x 167D x 283Hmm Rhino Tilt Bins	RTBKITD	£65.54
Rhino Tilt Bins with 457W x 915Hmm Portrait Louvre Panel		
Louvre Panel & 48 off 73W x 50D x 92Hmm Rhino Tilt Bins	RTBKITAP	£180.31
Louvre Panel & 24 off 108W x 90D x 141Hmm Rhino Tilt Bins	RTBKITBP	£171.05
Louvre Panel & 12 off 144W x 121D x 193Hmm Rhino Tilt Bins	RTBKITCP	£167.08
Louvre Panel & 6 off 215W x 167D x 283Hmm Rhino Tilt Bins	RTBKITDP	£175.35

Rhino Tilt Bin Stands



RTBSSSA



RTBSSSB



RTBSSSC



RTBSSSD



RTBDSSD



RTBDSSC



RTBDSSA



RTBDSSB



Bin Sizes
RTB1 - 73W x 50D x 92H
RTB2 - 108W x 90D x 141H
RTB3 - 144W x 121D x 193H
RTB4 - 215W x 167D x 283H

INFORMATION

Many more configurations available - call for details

Includes	Model	Price
Rhino Tilt Bins with Single Sided 930W x 1920Hmm Louvre Panel		
192 off RTB1	RTBSSSA	£879.52
96 off RTB2	RTBSSSB	£842.48
48 off RTB3	RTBSSSC	£826.60
24 off RTB4	RTBSSSD	£859.67

Includes	Model	Price
Rhino Tilt Bins with Double Sided 930W x 1920Hmm Louvre Panel		
72 off RTB1 48 off RTB2, 36 off RTB3 & 8 off RTB4	RTBDSSA	£1532.03
48 off RTB1 48 off RTB2, 24 off RTB3 & 16 off RTB4	RTBDSSB	£1515.28
48 off RTB1 48 off RTB2, 12 off RTB3 & 24 off RTB4	RTBDSSC	£1568.64
24 off RTB1 32 off RTB2, 12 off RTB3 & 32 off RTB4	RTBDSSD	£1591.57

Racking, Shelving & Sheet/Bar Racks

Rhino Tuff Plastic Bins



PRICES HELD



Bin Features

- 1 Slot dividers for bins ARTB30, 40, 50, 60 & 70
- 2 Full length rear lip for louvre panels
- 3 Reinforced side walls to stop spreading
- 4 Extra wide & reinforced stacking base
- 5 Moulded finger grips for greater comfort
- 6 Large label area for better identification (label provided)
- 7 Stop to prevent stacked bins slipping

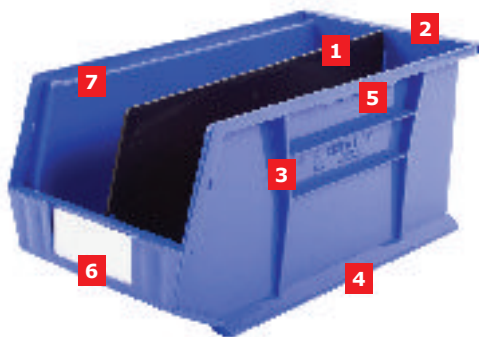

BIN COLOUR OPTIONS

- Red (RD)
- Blue (BE)
- Yellow (YW)
- Grey (GR)

*specify when ordering
(please add colour suffix)*

Louvre Panels & Spigots

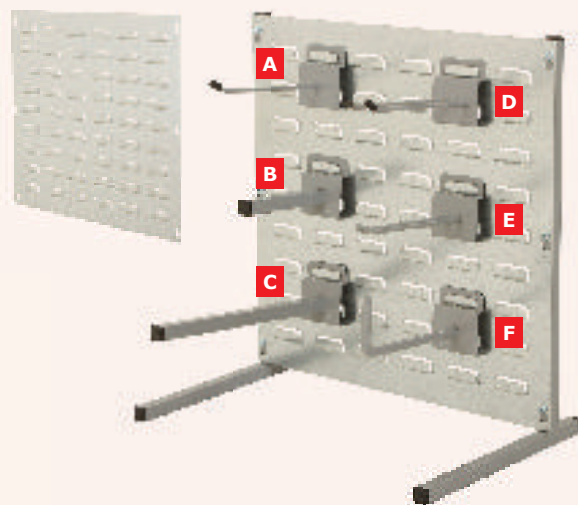

Description	Size H x W mm	Model	Price
Louvre Panel			
Square Louvre Panel	457 x 457	ARTBPLV0505	£20.45
Portrait Louvre Panel	915 x 457	ARTBPLV1005P	£40.08
Landscape Louvre Panel	457 x 915	ARTBPLV0510L	£40.08
Bench Stand Louvre	457 x 457	ARTBBS0505	£44.93
Spigots			
A) Single Prong - 200mm	-	ARTBSPSP200	£3.14
B) Square Tube - 150mm	-	ARTBSPST150	£4.13
C) Square Tube - 300mm	-	ARTBSPST300	£5.18
D) Double Prong - 200mm	-	ARTBSPDP200	£3.91
E) Euro Hook - 200mm	-	ARTBSPEK200	£4.30
F) Steel Hook - 200mm	-	ARTBSPHK200	£4.13

Overall Size W x D x H mm	Colour	Coloured		Grey	
		Model	Price	Model	Price
Plastic Bins					
106 x 106 x 49	Red, Blue or Yellow	ARTB05CO	£1.05	-	-
106 x 136 x 76	Red, Blue, Yellow or Grey	ARTB10CO	£1.27	ARTB10/GR	£1.16
106 x 187 x 76	Red, Blue, Yellow or Grey	ARTB20CO	£1.71	ARTB20/GR	£1.43
140 x 205 x 127	Red, Blue, Yellow or Grey	ARTB25CO	£3.31	ARTB25/GR	£2.76
140 x 274 x 127	Red, Blue, Yellow or Grey	ARTB30CO	£4.30	ARTB30/GR	£3.75
210 x 375 x 179	Red, Blue, Yellow or Grey	ARTB40CO	£10.09	ARTB40/GR	£8.38
280 x 457 x 254	Red, Blue, Yellow or Grey	ARTB50CO	£18.08	ARTB50/GR	£15.66
415 x 375 x 179	Blue	ARTB60CO	£17.36	-	-
415 x 460 x 292	Blue	ARTB70CO	£26.18	-	-
Dividers					
274W x 127D	Black	ARTBDIV3	£1.21	-	-
375W x 179D	Black	ARTBDIV4	£1.93	-	-
457W x 254D	Black	ARTBDIV5	£3.36	-	-
370W x 179D	Black	ARTBDIV6	£1.93	-	-
460W x 292D	Black	ARTBDIV7	£3.58	-	-

Wall Louvre & Bench Stand Kits



**FROM ONLY
£47.80**



ARTBKITBN



ARTBKITWN



ARTBKITWP



ARTBKITWQ



Bin Sizes

ARTB10 - 76H x 106W x 136D
 ARTB20 - 76H x 106W x 187D
 ARTB25 - 127H x 140W x 205D
 ARTB30 - 127H x 140W x 274D



ARTBKITBP



ARTBKITBQ



ARTBKITBT

Overall Size H x W mm	Includes	Model	Price
Wall Kits			
457 x 457	4 x ARTB10, 8 x ARTB20 & 3 x ARTB30	ARTBKITWN	£52.09
457 x 457	4 x ARTB10, 3 x ARTB25 & 3 x ARTB30	ARTBKITWP	£48.34
457 x 457	9 x ARTB30	ARTBKITWQ	£59.15
457 x 457	16 x ARTB20	ARTBKITWT	£47.80

Overall Size H x W mm	Includes	Model	Price
Bench Stand Kits			
457 x 457	4 x ARTB10, 8 x ARTB20 & 3 x ARTB30	ARTBKITBN	£76.57
457 x 457	4 x ARTB10, 3 x ARTB25 & 3 x ARTB30	ARTBKITBP	£72.82
457 x 457	9 x ARTB30	ARTBKITBQ	£83.62
457 x 457	16 x ARTB20	ARTBKITBT	£72.27

Racking, Shelving & Sheet/Bar Racks

Wall Louvre Kits



ARTBKITWAP



ARTBKITWCP



ARTBKITWDP



ARTBKITWEP



ARTBKITWFP



ARTBKITWGP



ARTBKITWHP



ARTBKITWJP

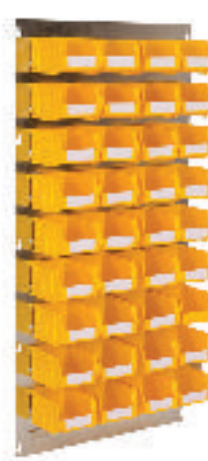

ARTBKITWKP



ARTBKITWLP



ARTBKITWNP



ARTBKITWPP



ARTBKITWQP

Bin Sizes
 ARTB05 - 49H x 106W x 106D
 ARTB10 - 76H x 106W x 136D
 ARTB20 - 76H x 106W x 187D
 ARTB25 - 127H x 140W x 205D
 ARTB30 - 127H x 140W x 274D
 ARTB40 - 179H x 210W x 375D
 ARTB60 - 179H x 415W x 375D
 ARTB70 - 292H x 415W x 460D



Overall Size H x W mm	Includes	Model	Price
915 x 457	6 x ARTB30 & 6 x ARTB40	ARTBKITWAP	£126.40
915 x 457	8 x ARTB10, 12 x ARTB20 & 9 x ARTB30	ARTBKITWBP	£109.42
915 x 457	18 x ARTB30	ARTBKITWCP	£117.47
915 x 457	36 x ARTB20	ARTBKITWDP	£101.60
915 x 457	3 x ARTB25, 3 x ARTB30, 2 x ARTB40 & 2 x ARTB60	ARTBKITWEP	£117.80
915 x 457	8 x ARTB10, 8 x ARTB20, 6 x ARTB25 & 6 x ARTB30	ARTBKITWFP	£109.54
915 x 457	5 x ARTB60	ARTBKITWGP	£126.90
915 x 457	10 x ARTB40	ARTBKITWHP	£140.95
915 x 457	36 x ARTB05	ARTBKITWJP	£77.78
915 x 457	36 x ARTB10	ARTBKITWKP	£85.72
915 x 457	16 x ARTB10 & 20 x ARTB20	ARTBKITWLP	£94.54
915 x 457	18 x ARTB25	ARTBKITWMP	£99.61
915 x 457	9 x ARTB25 & 9 x ARTB30	ARTBKITWNP	£108.54
915 x 457	4 x ARTB10, 4 x ARTB20, 3 x ARTB25, 3 x ARTB30, 2 x ARTB40 & 1 x ARTB60	ARTBKITWPP	£112.35
915 x 457	4 x ARTB40 & 2 x ARTB60	ARTBKITWQP	£115.15
915 x 457	3 x ARTB70	ARTBKITWRP	£118.63



ARTBKITWRP

Wall Louvre Kits



FROM ONLY
£77.78



ARTBKITWMP



ARTBKITWBP

Bin Sizes

- ARTB05 - 49H x 106W x 106D
- ARTB10 - 76H x 106W x 136D
- ARTB20 - 76H x 106W x 187D
- ARTB25 - 127H x 140W x 205D
- ARTB30 - 127H x 140W x 274D
- ARTB40 - 179H x 210W x 375D
- ARTB60 - 179H x 415W x 375D
- ARTB70 - 292H x 415W x 460D

**PRICES
HELD**



Racking, Shelving & Sheet/Bar Racks

Plastic Bin Shelving



- >> J beam profile gives increased storage capacity whilst maintaining excellent strength
- >> No nuts & bolts required - the system simply taps together with the use of a hammer/mallet
- >> Complete with 5 chipboard shelves & plastic bins



ARTBJRRH02

Bin Sizes
 ARTB30 - 127H x 140W x 274D
 ARTB40 - 179H x 210W x 375D
 ARTB50 - 254H x 280W x 457D



ARTBJRRH01



ARTBJRRH03



ARTBJRRH04

Overall Size H x W x D mm	Includes	Model	Price
1830 x 915 x 305	48 x ARTB30	ARTBJRRH01	£341.11
1830 x 915 x 457	32 x ARTB40	ARTBJRRH02	£479.86
1830 x 915 x 457	12 x ARTB50	ARTBJRRH03	£338.96
1830 x 915 x 610	96 x ARTB30	ARTBJRRH04	£592.15

Mesh Shelves

Troax mesh shelves are secure, flexible & relocatable. No fixings are required as the panels are held in place by their own weight with angle sections or formed wire mesh.

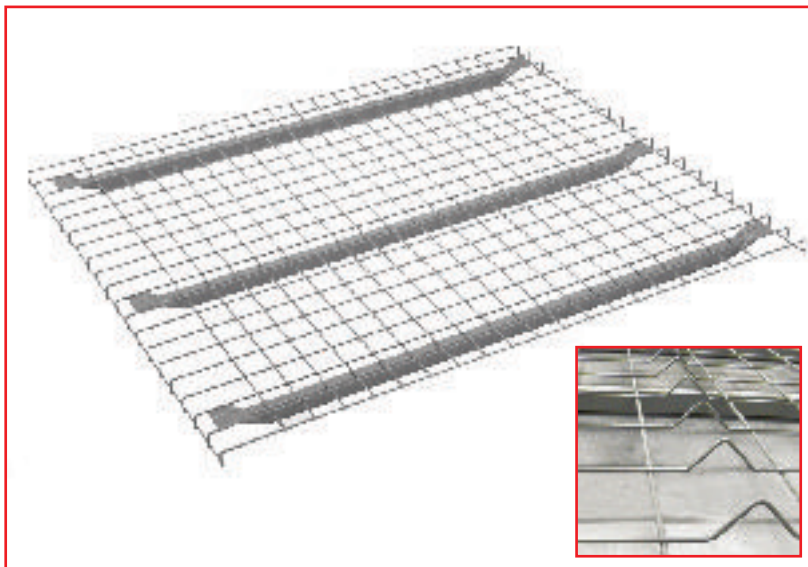

- » Recommended by Fire Authorities & Insurance Companies for premises with Sprinkler Systems installed
- » Dividers optimise storage space
- » Custom made to fit requirements
- » Ideal for underguarding below conveyors

i Information

**CERTAIN SIZES
ARE AVAILABLE
EX-STOCK**

**PLEASE CALL
TO ENQUIRE**

**PRICE ON
APPLICATION**

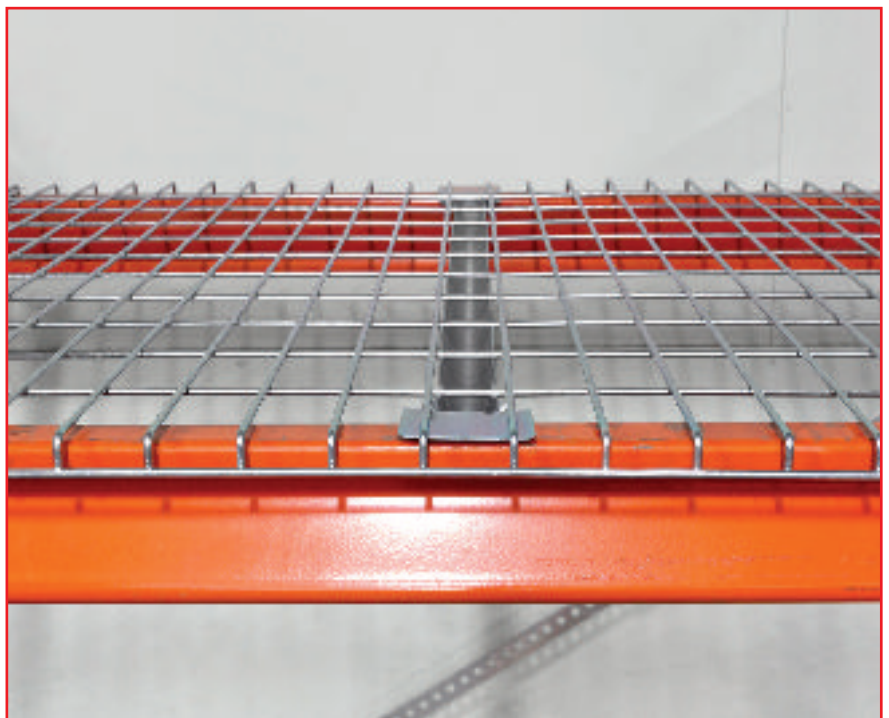

Racking, Shelving & Sheet/Bar Racks

alfer® Hooks



Size	Model	Price
A) Steel Galvanised Bucket Hook		
180	02984	£2.97
B) Steel Galvanised Wall Hook		
115 x 140	02958	£3.93
150 x 210	02961	£6.53
250 x 300	02964	£9.33
C) Steel Galvanised Ladder/Tool Hook		
90 x 120 x 98	02968	£6.93
175 x 120 x 98	02969	£9.27
250 x 120 x 98	02970	£13.73
325 x 120 x 98	02971	£14.83
D) Aluminium J Hook		
110 x 165 x 90	02908	£6.63

Size	Model	Price
E) Steel Galvanised Wall Hook		
175 x 80	02950	£3.30
350 x 165	02952	£8.00
F) Steel Galvanised Wall & Ceiling Hook		
150 x 255 x 155	02976	£11.07
G) Galvanised Wall Hook		
150 x 210	02962	£9.00
250 x 300	02965	£12.10
H) Aluminium Wall & Ceiling Bicycle Hook		
150 x 150 x 120	02909	£7.83
I) Aluminium Wall & Ceiling Hook		
150 x 160	01906	£4.87
170 x 220	01907	£8.67

Adjustable Steel Shelving by ProSolve®



Size	Model	Price
A) Uprights - single sided, wall fixed		
430mm	DU430BC	£4.56
710mm	DU710BC	£7.56
1000mm	DU1000BC	£9.26
1220mm	DU1220BC	£11.15
1600mm	DU1600BC	£13.56
1980mm	DU1980BC	£16.15
2400mm	DU2400BC	£20.56
B) Straight Brackets		
120mm	SDB120BC	£2.58
170mm	SDB170BC	£2.92
220mm	SDB220BC	£3.81
270mm	SDB270BC	£4.22
320mm	SDB320BC	£4.56
370mm	SDB370BC	£5.51
370mm	DMDB370	£8.25
470mm	SDB470BC	£9.26
610mm	SDB610BC	£12.66
C) Steel Shelves		
1m x 170mm	DSS1017	£16.83
1m x 220mm	DSS1022	£18.32
1m x 270mm	DSS1027	£21.11
1m x 320mm	DSS1032	£23.00
1m x 370mm	DSS1037	£25.55
1m x 470mm	DSS1047	£30.99
1m x 610mm	DSS1061	£37.53
500 x 170mm	DSS517	£15.15
500 x 220mm	DSS522	£16.49
500 x 270mm	DSS527	£19.00
500 x 320mm	DSS532	£20.70
500 x 370mm	DSS537	£22.99
500 x 470mm	DSS547	£27.90
500 x 610mm	DSS561	£33.78
D) Shelf Ends		
150mm Shelf End Pair	DSE150	£10.99
200mm Shelf End Pair	DSE200	£12.36
250mm Shelf End Pair	DSE250	£15.63
E) Book Supports - Square		
Square - 150mm	FSB150	£7.06
Square - 200mm	FSB200	£9.41
Square - 250mm	FSB250	£11.84
F) Book Supports - Rods		
150mm Spring Rod (Pairs)	DFB150	£5.31
200mm Spring Rod (Pairs)	DFB200	£6.73
250mm Spring Rod (Pairs)	DFB250	£8.37

- >> Manufactured from high grade steel to ensure maximum weight loading capacity. Uprights are produced from 2mm thick steel & the brackets from 1.6mm thick steel
- >> High quality Dupont™ anti-bacterial coating as standard. Safe, impact scratch resistant, durable & easily maintained
- >> The 'Shelf Lok' safety system ensures that shelves cannot be accidentally dislodged
- >> Also suitable for wood, composite & glass shelves



Brackets

- >> A single shelf support system with high load capability. Suitable for use in hospitals, kitchens, factories, workshops, laboratories, schools & colleges etc.

Size	Model	Price
Reinforced Bracket		
100 x 75mm	DRB10	£2.42
150 x 125mm	DRB15	£3.52
200 x 150mm	DRB20	£4.42
250 x 200mm	DRB25	£5.85
Mitred Bracket		
200 x 200mm	DMB200	£7.33
250 x 250mm	DMB250	£8.10
300 x 300mm	DMB300	£8.78
350 x 350mm	DMB350	£9.51



265kg Shelving with 5 MDF Shelves

Quick Assembly Shelving

- >> Quick & easy to erect - no nuts or bolts
- >> 175 & 265kg shelf capacities
- >> Complete with shelves

INFORMATION

10 minute assembly



Locate beam in position

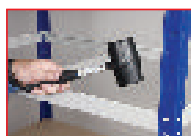

Tap beam to secure



Lay the shelf into the beams



CL3/CLIP Connector connects two bays back to back or side by side to create a run of bays

Description	Model	Price
Connector (set of 4)	CL3/CLIP	£2.76*
Rubber Mallet	MALLET	£5.51*



175kg Shelving with 5 MDF Shelves



265kg Galvanised Shelving with 4 Galvanised Mesh Shelves

NEW

265kg Shelving with 5 MDF Shelves

Overall Size H x W x D mm	Load Capacity	Model	Price
1770 x 900 x 300	265kg U.D.L	CL265A/BG	£82.94
1770 x 900 x 450	265kg U.D.L	CL265B/BG	£106.45
1770 x 900 x 600	265kg U.D.L	CL265C/BG	£126.69
1770 x 1200 x 300	265kg U.D.L	CL265D/BG	£106.78
1770 x 1200 x 450	265kg U.D.L	CL265E/BG	£128.65
1770 x 1200 x 600	265kg U.D.L	CL265F/BG	£153.80

175kg Shelving with 5 MDF Shelves

Overall Size H x W x D mm	Load Capacity	Model	Price
1800 x 900 x 450	175kg U.D.L	CL175A	£49.90
1800 x 900 x 600	175kg U.D.L	CL175B	£58.00

265kg Galv. Shelving with 4 Mesh Galv. Shelves

Overall Size H x W x D mm	Load Capacity	Model	Price
1980 x 1200 x 600	265kg U.D.L	RB350M	£185.00

*prices applicable when ordering with the Quick Assembly Shelving. Order charges will apply if ordered on their own.

Racking, Shelving & Sheet/Bar Racks



Mammoth Shelving



Mammoth Shelving

- » Incredible strength & rigidity with an easy to use interlocking system - no nuts or bolts
- » Hammerite finish powder coated uprights
- » Galvanised beams give a corrosion resistant finish
- » Capacity of each shelf is 175kg U.D.L.

No of Shelves	Overall Size H x W x D mm	Model	Price 1 to 4	Price each 5+	Price each 8+
5	1800 x 1000 x 400	MRS1040Z	£88.30	£77.30	£69.35
5	1800 x 1000 x 600	MRS1060Z	£99.45	£88.45	£79.95

INFORMATION

**Rivet style system
- No nuts or bolts**



Heavy Duty Shelving - 360kg U.D.L.



1800 x 900 x 450



1800 x 1200 x 450



1800 x 1200 x 450/620

- » Designed to provide optimal storage combinations in garage, industrial & commercial environments
- » Extra heavy-duty 360kg UDL capacity per shelf
- » Popular corner shelf unit to seamlessly combine shelving bays with a 250kg UDL capacity per shelf
- » 4 x adjustable shelves (every 4cm) for optimal storage solutions
- » Shelf material: 5mm thick high-density fibreboard

- » Framework: Corrosion-resistant thick steel
- » Cross Beams included for additional weight-support
- » Durable connecting plates designed with Rivet technology
- » Multi-purpose: Ability to assemble horizontally as a workbench
- » Quick boltless assembly

Description	No of Shelves	Overall Size H x W x D mm	Load Capacity	Model	Price
Shelving Unit	4	1800 x 900 x 450	360kg	VS360189045CB	£86.63
Shelving Unit	4	1800 x 1200 x 450	360kg	VS360181245CB	£114.75
Shelving Unit	4	1800 x 1500 x 450	360kg	VS360181545CB	£145.13
Corner Unit	4	1800 x 900 x 450/620	250kg	VS36018904562CB	£130.50

Racking, Shelving & Sheet/Bar Racks



FROM ONLY
£145.53



Colours Available:

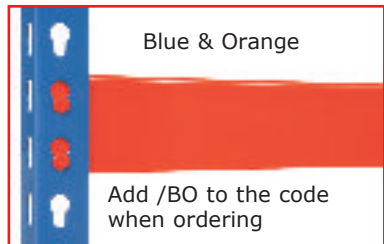

INFORMATION

Takes less than 10 minutes to build!

Rivet Racking

- » Offers amazing strength & rigidity
- » All components are joined via the heavy duty rivet & key hole slot which offers a simple & effective way to assemble the racking
- » Only a hammer/mallet is required to build & the system just taps together
- » No nuts & bolts required
- » Uninterrupted access to all sides

Accessories

Description	Suffix	Price each
Tie Plate (Set of 4)	RR8/SET4	£5.07
Metal Feet (Set of 4)	RR5/SET4	£5.73
Floor Fixing (M8 x 50 Floor Fixings)	FFM8x50	£1.60
Rubber Mallet	MALLET	£5.51

Optional Uprights

Additional Cost per Bay
Add suffix to above codes:

Height extended to:	Suffix	Price
1980 mm	RRB/19/--/--/4	£3.97
2135 mm	RRB/21/--/--/4	£7.06
2440 mm	RRB/24/--/--/4	£14.33
2745 mm	RRB/27/--/--/4	£20.51
3050 mm	RRB/30/--/--/4	£29.55
3660 mm	RRB/36/--/--/4	£41.90

4 Shelf Level Units

Overall Size H x W x D mm	Shelf Loading	Four Shelf Unit		Extra Shelf		
		Model	Price	Model	Price	
1830 x 915 x 305	600 kg per Shelf U.D.L.	RRB/18/09/03/4	£145.53	RRS/09/03	£27.07	
1830 x 915 x 457		RRB/18/09/04/4	£166.70	RRS/09/04	£33.41	
1830 x 915 x 610		RRB/18/09/06/4	£186.54	RRS/09/06	£39.41	
1830 x 915 x 762		RRB/18/09/07/4	£212.12	RRS/09/07	£46.86	
1830 x 915 x 915		RRB/18/09/09/4	£245.86	RRS/09/09	£56.28	
1830 x 915 x 1220	550 kg per Shelf U.D.L.	RRB/18/09/12/4	£292.38	RRS/09/12	£69.84	
1830 x 1220 x 305		RRB/18/12/03/4	£181.25	RRS/12/03	£33.90	
1830 x 1220 x 457		RRB/18/12/04/4	£211.02	RRS/12/04	£41.34	
1830 x 1220 x 610		RRB/18/12/06/4	£239.46	RRS/12/06	£48.45	
1830 x 1220 x 762		RRB/18/12/07/4	£275.18	RRS/12/07	£57.39	
1830 x 1220 x 915		RRB/18/12/09/4	£317.30	RRS/12/09	£67.91	
1830 x 1220 x 1220		RRB/18/12/12/4	£380.80	RRS/12/12	£83.79	
1830 x 1525 x 305		500 kg per Shelf U.D.L.	RRB/18/15/03/4	£214.77	RRS/15/03	£42.28
1830 x 1525 x 457			RRB/18/15/04/4	£250.27	RRS/15/04	£51.16
1830 x 1525 x 610			RRB/18/15/06/4	£284.45	RRS/15/06	£59.70
1830 x 1525 x 762	RRB/18/15/07/4		£319.28	RRS/15/07	£68.41	
1830 x 1525 x 915	RRB/18/15/09/4		£366.03	RRS/15/09	£80.10	
1830 x 1525 x 1220	RRB/18/15/12/4	£438.80	RRS/15/12	£98.29		

Rivet Racking

- >> Offers amazing strength & rigidity
- >> All components are joined via the heavy duty rivet & key hole slot which offers a simple & effective way to assemble the racking
- >> Only a hammer/mallet is required to build & the system just taps together
- >> No nuts & bolts required
- >> Uninterrupted access to all sides



Colours Available:

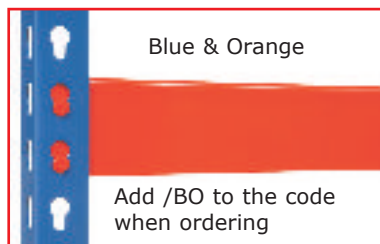

INFORMATION

Takes less than 10 minutes to build!

4 Shelf Level Units

Overall Size H x W x D mm	Shelf Loading	Four Shelf Unit		Extra Shelf	
		Model	Price	Model	Price
1830 x 1830 x 305	500 kg per Shelf U.D.L.	RRB/18/18/03/4	£266.58	RRS/18/03	£55.24
1830 x 1830 x 457		RRB/18/18/04/4	£306.94	RRS/18/04	£65.32
1830 x 1830 x 610		RRB/18/18/06/4	£345.74	RRS/18/06	£75.03
1830 x 1830 x 762		RRB/18/18/07/4	£384.99	RRS/18/07	£84.84
1830 x 1830 x 915		RRB/18/18/09/4	£436.37	RRS/18/09	£97.68
1830 x 1830 x 1220	450 kg per Shelf U.D.L.	RRB/18/18/12/4	£518.40	RRS/18/12	£118.19
1830 x 2135 x 305		RRB/18/21/03/4	£300.54	RRS/21/03	£63.72
1830 x 2135 x 457		RRB/18/21/04/4	£345.52	RRS/21/04	£74.97
1830 x 2135 x 610		RRB/18/21/06/4	£388.74	RRS/21/06	£85.77
1830 x 2135 x 762		RRB/18/21/07/4	£432.84	RRS/21/07	£96.80
1830 x 2135 x 915	425kg	RRB/18/21/09/4	£488.85	RRS/21/09	£110.80
1830 x 2135 x 1220		RRB/18/21/12/4	£579.92	RRS/21/12	£133.57
1830 x 2440 x 305		RRB/18/24/03/4	£341.55	RRS/24/03	£73.98
1830 x 2440 x 457		RRB/18/24/04/4	£395.14	RRS/24/04	£87.37
1830 x 2440 x 610		RRB/18/24/06/4	£447.39	RRS/24/06	£100.44
1830 x 2440 x 762	400 kg per Shelf U.D.L.	RRB/18/24/07/4	£521.04	RRS/24/07	£118.85
1830 x 2440 x 915		RRB/18/24/09/4	£589.62	RRS/24/09	£135.99
1830 x 2440 x 1220		RRB/18/24/12/4	£705.38	RRS/24/12	£164.93

Accessories

Description	Suffix	Price each
Tie Plate (Set of 4)	RR8/SET4	£5.07
Metal Feet (Set of 4)	RR5/SET4	£5.73
Floor Fixing (M8 x 50 Floor Fixings)	FFM8x50	£1.60
Rubber Mallet	MALLET	£5.51

Optional Uprights

Additional Cost per Bay
Add suffix to above codes:

Height extended to:	Suffix	Price
1980 mm	RRB/19/--/--/4	£3.97
2135 mm	RRB/21/--/--/4	£7.06
2440 mm	RRB/24/--/--/4	£14.33
2745 mm	RRB/27/--/--/4	£20.51
3050 mm	RRB/30/--/--/4	£29.55
3660 mm	RRB/36/--/--/4	£41.90

Racking, Shelving & Sheet/Bar Racks



KSR02Z

Kanban Shelving

- >> Complete with sloping chipboard shelves which present containers for easy access
- >> Reduce costs & increase efficiency for operations or inventory management
- >> Simplify stock rotation & replacement
- >> When the front bin is removed the bin behind takes its place, leaving a space that is clearly identified for refilling on the next inspection
- >> Capacity of each shelf is 80kg U.D.L.
- >> KSR01Z - shelving unit
- >> KSR02Z - complete with 60 plastic bins: 140W x 274D x 127H mm
- >> KSR03Z - complete with 70 shelf trays: 117W x 300D x 90H mm



KSR01Z



KSR03Z



No of Shelves	No of Sloping Shelves	Overall Size H x W x D mm	Complete With	Model	Price
5	3	1830 x 915 x 610	-	KSR01Z	£215.20
7	5	1830 x 915 x 610	60 Plastic Bins	KSR02Z	£520.65
7	5	1830 x 915 x 610	70 Shelf Trays	KSR03Z	£642.45

Small Parts Shelving

- » Using the handle/stop allows the tray to be withdrawn & suspended from the shelf which offers around 90% clear picking. It also acts as a handle to enable the trays to be carried
- » All the below are starter bays. Extensions are available - call for details



ASUA13



ASUB13



ASUD13



ASUF13



ASUG13

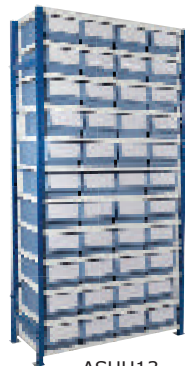

ASUH13

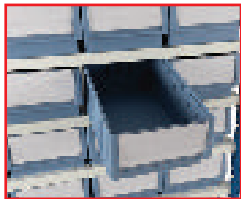

Dividers & Handles/Stops



ASUE13

Shelving with Shelf Trays

Shelf Trays

Overall Size H x W x D mm	Description	Model	Price
90 x 117 x 300	Tray 'A'	ASTA01	£5.25*
90 x 234 x 300	Tray 'B'	ASTB02	£7.55*
140 x 234 x 300	Tray 'C'	ASTC03	£9.70*
90 x 117 x 400	Tray 'D'	ASTD04	£5.95*
90 x 234 x 400	Tray 'E'	ASTE05	£9.20*
140 x 234 x 400	Tray 'F'	ASTF06	£12.15*
90 x 117 x 500	Tray 'G'	ASTG07	£7.35*
90 x 234 x 500	Tray 'H'	ASTH08	£11.25*
140 x 234 x 500	Tray 'I'	ASTI09	£15.30*

Dividers

Overall Size H x W mm	Model	Price
90 x 117	ASTD109	£0.95*
90 x 234	ASTD209	£1.20*
140 x 234	ASTD214	£1.55*

Handles/Stops

Size Width mm	Model	Price
117	ASTH117	£1.50*
234	ASTH234	£1.80*

*price applicable when ordering with the Shelf Units. Order charges will apply if ordered on their own.

Overall Size H x W x D mm	Description	Model	Price
2000 x 1000 x 300	Part Height Unit - c/w 16 x 'A', 12 x 'B' & 12 x 'C' Trays	ASUA13	£764.85
2000 x 1000 x 300	Part Height Unit - c/w 64 x 'A' Trays	ASUB13	£837.55
2000 x 1000 x 300	Part Height Unit - c/w 32 x 'B' Trays	ASUC13	£704.80
2000 x 1000 x 300	Part Height Unit - c/w 28 x 'C' Trays	ASUD13	£700.15
2000 x 1000 x 300	Full Height Unit - c/w 32 x 'A', 16 x 'B' & 20 x 'C' Trays	ASUE13	£1083.40
2000 x 1000 x 300	Full Height Unit - c/w 120 x 'A' Trays	ASUF13	£1352.75
2000 x 1000 x 300	Full Height Unit - c/w 60 x 'B' Trays	ASUG13	£1103.90
2000 x 1000 x 300	Full Height Unit - c/w 44 x 'C' Trays	ASUH13	£938.80
2000 x 1000 x 400	Part Height Unit - c/w 16 x 'D', 12 x 'E' & 12 x 'F' Trays	ASUA14	£882.45
2000 x 1000 x 400	Part Height Unit - c/w 64 x 'D' Trays	ASUB14	£939.15
2000 x 1000 x 400	Part Height Unit - c/w 32 x 'E' Trays	ASUC14	£816.50
2000 x 1000 x 400	Part Height Unit - c/w 28 x 'F' Trays	ASUD14	£822.15
2000 x 1000 x 400	Full Height Unit - c/w 32 x 'D', 16 x 'E' & 20 x 'F' Trays	ASUE14	£1254.40
2000 x 1000 x 400	Full Height Unit - c/w 120 x 'D' Trays	ASUF14	£1517.60
2000 x 1000 x 400	Full Height Unit - c/w 60 x 'E' Trays	ASUG14	£1287.65
2000 x 1000 x 400	Full Height Unit - c/w 44 x 'F' Trays	ASUH14	£1110.30
2000 x 1000 x 500	Part Height Unit - c/w 16 x 'G', 12 x 'H' & 12 x 'I' Trays	ASUA15	£1034.25
2000 x 1000 x 500	Part Height Unit - c/w 64 x 'G' Trays	ASUB15	£1096.65
2000 x 1000 x 500	Part Height Unit - c/w 32 x 'H' Trays	ASUC15	£948.80
2000 x 1000 x 500	Part Height Unit - c/w 28 x 'I' Trays	ASUD15	£971.30
2000 x 1000 x 500	Full Height Unit - c/w 32 x 'G', 16 x 'H' & 20 x 'I' Trays	ASUE15	£1479.80
2000 x 1000 x 500	Full Height Unit - c/w 120 x 'G' Trays	ASUF15	£1783.60
2000 x 1000 x 500	Full Height Unit - c/w 60 x 'H' Trays	ASUG15	£1506.40
2000 x 1000 x 500	Full Height Unit - c/w 44 x 'I' Trays	ASUH15	£1321.50

Racking, Shelving & Sheet/Bar Racks

Inclined Shelving

- » Ideal for euro size containers
- » Galvanised shelves with a 30° incline
- » Inclined position of bins allows a better overview & faster access
- » Complete with 3 shelves as standard which are adjustable in 25mm increments
- » Easy picking as stocked items always move to the picking front
- » Ideal for 3 x 400mm wide containers
- » 100kg evenly distributed capacity per level

INFORMATION

Ideal for stock picking



ISST1852 & ISEX1852



Overall Size H x W x D mm	Shelf Depth mm	Starter Bay (1358mm)		Extension Bay (1308mm)		Additional Shelf	
		Model	Price	Model	Price	Model	Price
1850 x 1358 x 524	570	ISST1852	£318.05	ISEX1852	£283.85	ESAS57	£75.45

Inclined Mobile Shelving

- » Easy to assemble
- » Ideal for euro size containers
- » Galvanised shelves with a 30° incline
- » Inclined position of bins allows a better overview & faster access
- » Easy picking as stocked items always move to the picking front
- » Complete with 4 shelves as standard which are adjustable in 25mm increments
- » Mobile on 2 fixed & 2 swivel braked 125mm castors
- » Blue and red container size: 600L x 400W x 270H mm



IMS1853WOCT



IMS1853CONTBL



Overall Size H x W x D mm	Without Containers		With Blue Containers		With Red Containers	
	Model	Price	Model	Price	Model	Price
1815 x 1368 x 533	IMS1853WOCT	£626.30	IMS1853CONTBL	£888.45	IMS1853CONTRE	£888.45

Plastic or Aluminium Shelving Systems

COLOUR OPTIONS

- Beige
- Red
- Blue
- Grey

specify when ordering



INFORMATION

Bespoke sizes available - call for details

LOWER PRICES



- » Shelving Systems suitable for Food, Pharmaceutical or general factory use
- » Moisture resistant heavy duty plastic that will never rust, rot or corrode
- » 4 tier units (*more or less tiers available*)
- » 400mm clearance between shelves (can be customised - call for details)

up to 360kg
evenly distributed per shelf

- » Height of racks: Static - 1495mm
Mobile - 1560mm
- » L to R clearance between bays:
 - 1000mm Rack - 915mm
 - 1200mm Rack - 1115mm
 - 1500mm Rack - 2 x 687mm
 - 2000mm Rack - 2 x 937mm

1000mm Long Single Bay		Plastic - 180kg per M ² evenly distributed per shelf				Aluminium - 360kg per M ² evenly distributed per shelf			
Depth		Static Model	Price	Mobile Model	Price	Static Model	Price	Mobile Model	Price
400mm	15"	4104	£271.43	4104C	£330.32	4104A	£382.84	4104AC	£431.28
500mm	20"	4105	£304.40	4105C	£358.72	4105A	£423.84	4105AC	£474.85
600mm	24"	4106	£344.03	4106C	£395.61	4106A	£511.71	4106AC	£555.57
1200mm Long Single Bay		Plastic - 180kg per M ² evenly distributed per shelf				Aluminium - 360kg per M ² evenly distributed per shelf			
Depth		Static Model	Price	Mobile Model	Price	Static Model	Price	Mobile Model	Price
400mm	15"	4124	£289.75	4124C	£348.68	4124A	£408.08	4124AC	£492.04
500mm	20"	4125	£325.56	4125C	£381.55	4125A	£489.69	4125AC	£539.01
600mm	24"	4126	£357.72	4126C	£420.19	4126A	£545.61	4126AC	£589.32
1500mm Long Double Bay		Plastic - 180kg per M ² evenly distributed per shelf				Aluminium - 360kg per M ² evenly distributed per shelf			
Depth		Static Model	Price	Mobile Model	Price	Static Model	Price	Mobile Model	Price
400mm	15"	4154	£355.97	4154C	£445.96	4154A	£531.04	4154AC	£628.99
500mm	20"	4155	£414.09	4155C	£504.49	4155A	£579.60	4155AC	£688.93
600mm	24"	4156	£467.81	4156C	£553.35	4156A	£656.35	4156AC	£754.29
2000mm Long Double Bay		Plastic - 180kg per M ² evenly distributed per shelf				Aluminium - 360kg per M ² evenly distributed per shelf			
Depth		Static Model	Price	Mobile Model	Price	Static Model	Price	Mobile Model	Price
400mm	15"	4204	£460.76	4204C	£547.00	4204A	£619.68	4204AC	£689.93
500mm	20"	4205	£513.28	4205C	£598.67	4205A	£692.68	4205AC	£762.93
600mm	24"	4206	£579.28	4206C	£650.25	4206A	£772.51	4206AC	£838.07

Racking, Shelving & Sheet/Bar Racks



PRICES HELD

INFORMATION
 Temperature range from -30°C to +90°C

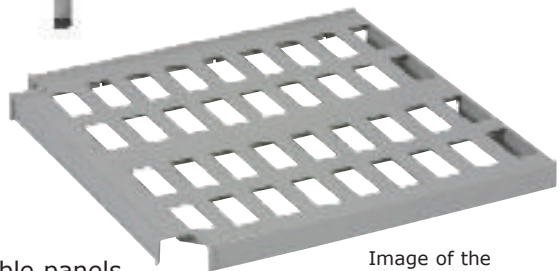

Image of the Vented Shelf

Plastic Plus

- >> Easy to assemble shelving system which can be cleaned by a commercial or utensil dishwasher
- >> Resistant to moisture, grease, acids & alkalis
- >> NSF accreditation
- >> 2 depths & 8 length size variations in both solid & vented removable panels
- >> All models can be made mobile - please see the castor options on the opposite page
- >> Also available in 1820 & 2130mm heights - call for details
- >> Shelf loading: 360kg udl. Bay loading: 1400kg udl.

Shelf Length mm	Solid Shelves - complete with 4 shelves (1625H mm)				Vented Shelves - complete with 4 shelves (1625H mm)			
	460mm Deep Unit		610mm Deep Unit		460mm Deep Unit		610mm Deep Unit	
	Model	Price	Model	Price	Model	Price	Model	Price
610	8168S	£250.91	8184S	£280.00	8168V	£243.64	8164V	£261.82
760	8169S	£280.00	8185S	£309.09	8169V	£280.00	8185V	£294.55
915	8170S	£305.45	8186S	£338.18	8170V	£294.55	8186V	£316.36
1070	8171S	£352.73	8187S	£392.73	8171V	£338.18	8187V	£367.27
1220	8172S	£385.45	8188S	£429.09	8172V	£360.00	8188V	£396.36
1370	8173S	£429.09	8189S	£480.00	8173V	£414.55	8189V	£443.64
1520	8174S	£454.55	8190S	£494.55	8174V	£436.36	8190V	£461.82
1820	8175S	£534.55	8191S	£578.18	8175V	£509.09	8191V	£541.82

Eclipse Shelving

Multi-purpose shelving systems full of advantages:

- >> NSF accreditation
- >> ESD Compliant with optional accessories - *call for details*
- >> Bolt free assembly, fully adjustable & easy to clean
- >> 300kg shelf loading
- >> Static or mobile options
- >> New extra hard wearing Chrome finish
- >> Higher post options available (1820mm & 2130mm) - please call for details
- >> Accessories available - *please call for details*

Chrome

The open wire design offers improved light penetration & better air circulation making it an ideal system for:

- >> Catering & dry stores
- >> Retail Display
- >> Medical Authorities & Hospitals
- >> Electronic
- >> Engineering Industries
- >> Office



Perma Plus

With the **added** bonus of an anti-bacterial additive that will help fight the build up of germs & improve hygiene standards, making it an ideal system for:

- >> Catering
- >> Medical Authorities & Hospitals
- >> Food Production
- >> Walk-In Freezers & Cold Rooms
- >> Damp & Corrosive Environments

INFORMATION
PERMA PLUS -
10 year anti corrosion
guarantee



Complete 4 Shelf Units: 1625 mm High

Shelf Length	Depth 305mm		Depth 355mm		Depth 460mm		Depth 610mm	
	Model	Price	Model	Price	Model	Price	Model	Price
Eclipse Shelving - Chrome								
460mm	-	-	-	-	EC39	£121.90	-	-
610mm	EC31	£118.10	-	-	EC40	£123.64	EC47A	£145.45
760mm	EC32	£121.90	EC35	£129.52	EC43	£141.82	EC47	£156.36
915mm	EC37	£125.71	EC36	£160.00	EC44	£149.09	EC48	£174.55
1070mm	EC34	£137.14	EC33	£168.89	EC51	£156.36	EC54	£189.09
1220mm	EC38	£148.57	EC30	£186.67	EC45	£167.27	EC49	£196.36
1370mm	-	-	EC39A	£204.44	EC53	£196.36	EC56	£232.73
1520mm	-	-	EC41	£213.33	EC46	£203.64	EC50	£240.00
1820mm	-	-	EC42	£227.37	EC52	£225.45	EC55	£272.73
Eclipse Shelving - Perma Plus								
460mm	-	-	-	-	-	-	EPP40	£138.18
610mm	-	-	-	-	EPP40	£138.18	EPP47A	£160.00
760mm	EPP32	£127.27	EPP35	£141.82	EPP43	£156.36	EPP47	£178.18
915mm	EPP37	£134.55	EPP36	£149.09	EPP44	£167.27	EPP48	£189.09
1070mm	EPP34	£141.82	EPP33	£163.64	EPP51	£181.82	EPP54	£207.27
1220mm	EPP38	£163.64	EPP30	£174.55	EPP45	£192.73	EPP49	£225.45
1370mm	-	-	EPP39	£192.73	EPP53	£221.82	EPP56	£254.55
1520mm	-	-	EPP41	£200.00	EPP46	£229.09	EPP50	£265.45
1820mm	-	-	EPP42	£229.09	EPP52	£250.91	EPP55	£298.18

*Units are available with fewer or more shelves. Ask for details & prices.

Castors:

Size (Diameter)	Model	Capacity	Wheel/Housing	Price
75mm unbraked	R75UB	70kg	Rubber/Zinc	£10.00
75mm braked	R75BR	70kg	Rubber/Zinc	£10.91
100mm unbraked	R100UB	80kg	Rubber/Zinc	£10.91
100mm braked	R100BR	80kg	Rubber/Zinc	£12.73
125mm unbraked	R120UB	100kg	Rubber/Zinc	£17.27
125mm braked	R120BR	100kg	Rubber/Zinc	£18.18

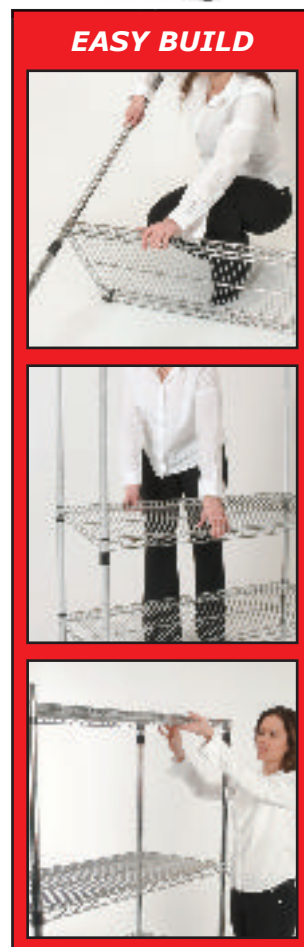

Racking, Shelving & Sheet/Bar Racks

Heavy Duty Bar Pallets

- >> A versatile & flexible bar storage system of an all welded construction, which stacks up to 5 high
- >> Load capacity of 1000kg per unit, max 5000kg

FROM ONLY
£427.35

upto
5000kg
evenly
distributed



4 x BRP01Z



BRP12Z

N.B. A Fork Lift will be needed to unload these units

Internal Size L x W mm	Overall Size L x W x H mm	Weight kg	Model	Price
620 x 400	700 x 480 x 610	19	BRP01Z	£427.35
920 x 400	1000 x 480 x 610	22	BRP02Z	£433.50
620 x 520	700 x 600 x 610	22	BRP11Z	£436.15
920 x 520	1000 x 600 x 610	24	BRP12Z	£442.35



2 x BRP01Z

GVR31

£767.80



GVR31



GSR34



Sheet Racking

- >> Fully welded construction
- >> Intermediate floor bracing for supporting the sheet materials



N.B. A Fork Lift will be needed to unload these units

Overall Size L x D x H mm	No of Bays	Distance between Uprights	Weight kg	Model	Price
1200 x 2040 x 1050	4	260mm	135	GSR34	£1458.30
1400 x 2040 x 1050	5	242mm	160	GSR35	£1737.00
1600 x 2040 x 1050	6	229mm	180	GSR36	£2043.65
1800 x 2040 x 1050	7	221mm	200	GSR37	£2336.70
2000 x 2040 x 1050	8	214mm	215	GSR38	£2716.40
2200 x 2040 x 1050	9	209mm	235	GSR39	£3064.10
2400 x 2040 x 1050	10	205mm	255	GSR40	£3364.00

Variable Height Sheet Rack

- >> Fully welded construction
- >> Distance between uprights: 160mm
- >> 5 Support Bars: 400, 550, 700, 850 & 1000mm

N.B. A Fork Lift will be needed to unload these units

Overall Size L x D x H mm	No of Bays	Weight kg	Model	Price
1400 x 800 x 1000	4	70	GVR31	£767.80

Racking, Shelving & Sheet/Bar Racks

Vertical Sheet Rack



GVR20
£993.25

GVR20

- >> Fully welded construction
- >> Distance between support bars: 310mm
- >> Flat Steel base to accept sheet metal

N.B. A Fork Lift will be needed to unload these units

Overall Size L x D x H mm	No of Bays	Weight kg	Model	Price
1100 x 970 x 1245	3	53	GVR20	£993.25

Vertical Sheet Rack

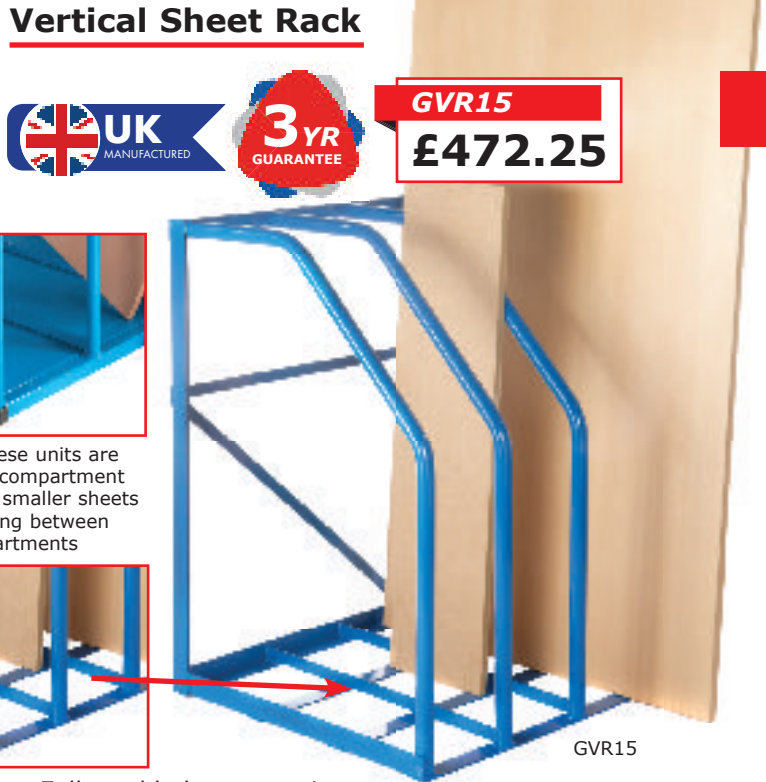

GVR15
£472.25

GVR15

Both of these units are fitted with compartment bars to stop smaller sheets from sliding between compartments

- >> Fully welded construction
- >> Distance between support bars: 230mm

N.B. A Fork Lift will be needed to unload these units

Overall Size L x D x H mm	No of Bays	Weight kg	Model	Price
860 x 860 x 900	3	20	GVR15	£472.25

Vertical Storage Racks

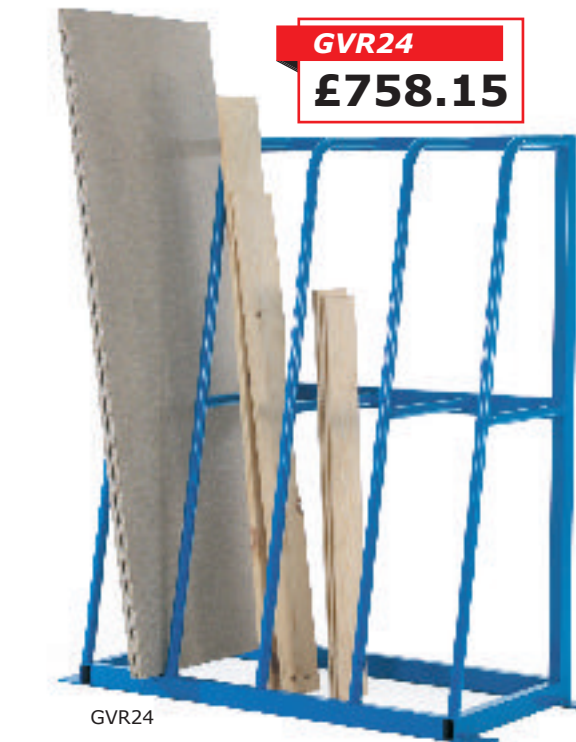

GVR24
£758.15

GVR24

- >> Fully welded construction
- >> Distance between support bars: 250mm
- >> Pre-drilled for bolting to the floor (*fixings not supplied*)

N.B. A Fork Lift will be needed to unload these units

Overall Size L x D x H mm	No of Bays	Weight kg	Model	Price
1200 x 600 x 1500	4	70	GVR24	£758.15
1800 x 600 x 1500	6	100	GVR26	£1006.30
2400 x 600 x 1500	8	120	GVR28	£1163.95

Vertical Sheet Rack



GVR01
£1758.15

GVR01

- >> Bolted & welded construction
- >> Overall Size: 2120L x 1240W x 1530H mm
- >> Flatpack Size: 1240L x 1530W x 120H mm

N.B. A Fork Lift will be needed to unload these units

For use with Sheet Size	Opening mm	Weight kg	Model	Price
2½ m x 1½ m	150	140	GVR01	£1758.15



Racking, Shelving & Sheet/Bar Racks

Bar Storage Racks



2 x GSR62

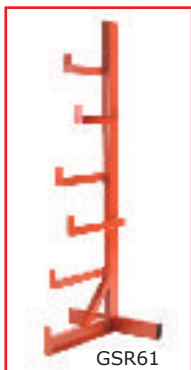

GSR61

- >> Tiers per unit: 6
- >> Units can be drilled to enable you to fix to the floor for stability
- >> Load heavy materials at base

N.B. A Fork Lift will be needed to unload these units



Load Capacity Per Arm

Overall Size L x W x H mm	Type	Weight kg	Model	Price
680 x 680 x 1910	Single	45	GSR61	£605.55
1270 x 680 x 1910	Double	55	GSR62	£883.50

Heavy Duty Bar Storage Racks



2 x GSR11

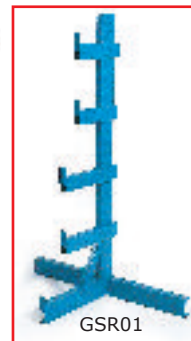

GSR01

- >> Load Capacity per arm: 500kg
 - >> Space between arms: 250mm
 - >> Units can be drilled to enable you to fix to the floor for stability
 - >> Load heavy materials at base
- N.B. A Fork Lift will be needed to unload these units**

Overall Size L x W x H mm	Tiers per unit	Type	Weight kg	Model	Price
1150 x 575 x 1500	5	Single	40	GSR01	£841.15
1150 x 575 x 1870	6		60	GSR02	£939.45
1150 x 1000 x 1500	5	Double	50	GSR11	£1037.50
1150 x 1000 x 1870	6		80	GSR12	£1121.35

Heavy Duty Mobile Bar Storage Rack

- >> Tiers per unit: 3
- >> Space between arms: 330mm
- >> Mobile on 4 x 200mm heavy duty swivel castors, 2 braked
- >> Folded height: 630mm

N.B. A Fork Lift will be needed to unload these units



Removable Central Support Section on the GSR52

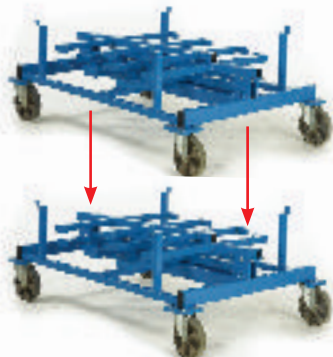

Foldable unit for easy storage & allows them to be stacked



GSR52

Description	Load Capacity	Overall Size L x W x H mm	Weight kg	Model	Price
2 Support Posts	1000kg	1600 x 1100 x 1560	78	GSR51	£1290.00
3 Support Posts	2000kg	1600 x 1100 x 1560	95	GSR52	£1480.40



Heavy Duty Bar CUBI-Rack

- » High capacity storage for flat/round bar, hollow section, angle & channel steel
- » Units can be fixed to the floor for stability
- » Easy to assemble
- » Heavy duty capacity of 3000kg per column
- » Columns are fully welded, with the braces & spacing angles bolted together

N.B. A Fork Lift will be needed to unload these units

INFORMATION

Heavy duty storage solution for long materials

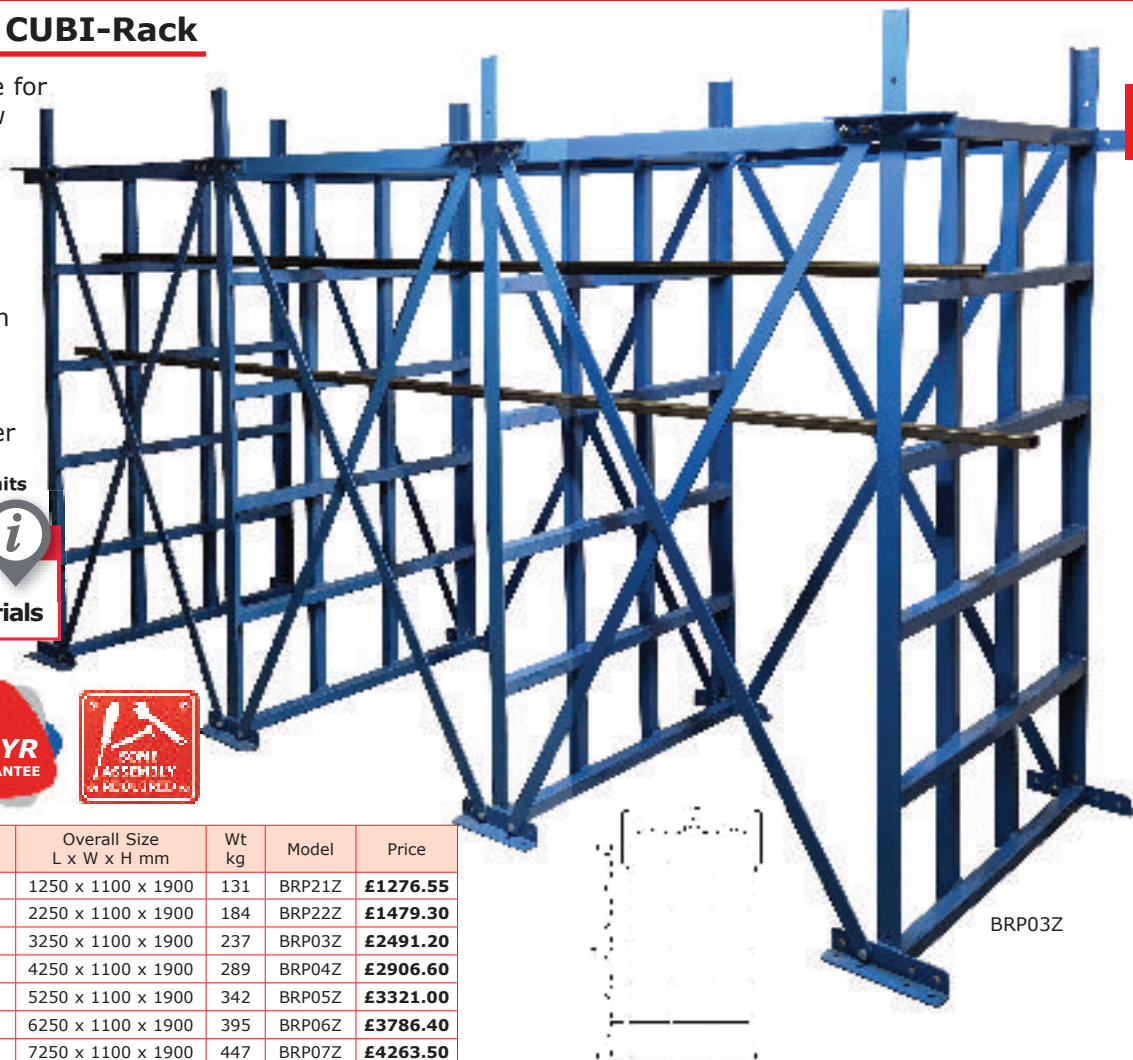

BRP03Z



Description	Overall Size L x W x H mm	Wt kg	Model	Price
2 Columns with Spacers & Angles	1250 x 1100 x 1900	131	BRP21Z	£1276.55
3 Columns with Spacers & Angles	2250 x 1100 x 1900	184	BRP22Z	£1479.30
4 Columns with Spacers & Angles	3250 x 1100 x 1900	237	BRP03Z	£2491.20
5 Columns with Spacers & Angles	4250 x 1100 x 1900	289	BRP04Z	£2906.60
6 Columns with Spacers & Angles	5250 x 1100 x 1900	342	BRP05Z	£3321.00
7 Columns with Spacers & Angles	6250 x 1100 x 1900	395	BRP06Z	£3786.40
8 Columns with Spacers & Angles	7250 x 1100 x 1900	447	BRP07Z	£4263.50

Mobile Variable Height Sheet Rack

- » Fully welded construction
- » Distance between uprights: 160mm
- » 5 Support Bars: 400, 550, 700, 850 & 1000mm
- » Mobile on 100mm swivel castors (2 braked)

N.B. A Fork Lift will be needed to unload these units

GVR99

£773.05



GVR99



Overall Size L x D x H mm	No of Bays	Weight kg	Model	Price
1400 x 800 x 1135	4	71	GVR99	£773.05

Mobile Vertical Sheet Rack

- » Fully welded construction
- » Distance between support bars: 310mm
- » Flat Steel base accepts sheet metal
- » Mobile on 100mm swivel castors (2 braked)

N.B. A Fork Lift will be needed to unload these units

GVR98

£1017.25



GVR98



Overall Size L x D x H mm	No of Bays	Weight kg	Model	Price
1100 x 970 x 1380	3	54	GVR98	£1017.25

Racking, Shelving & Sheet/Bar Racks



Vertical Storage Racks

- » Each starter bay is made up of two uprights & 8 adjustable support dividers
- » Each extension bay is made up of one upright & a further 8 adjustable support dividers
- » Movable dividers enable horizontal adjustment of the storage sections allowing the unit to meet your individual requirements
- » Plywood base offers protection to the ends of the stored items whilst adding stability to the unit
- » Frame has wall mounted fixing points to secure the unit (fixings not included)

N.B. A Fork Lift will be needed to unload these units



Movable Divider

Description	Starter Bay			Extension Bay		
	Overall Size L x D x H mm	Model	Price	Overall Size L x D x H mm	Model	Price
5 Compartments (8 Dividers)	2430 x 650 x 3000	CR3000ST	£1490.00	2430 x 650 x 3000	CR3000EX	£1244.50
Additional Divider	-	CRA20A	£88.65	-	CRA20A	£88.65

Vertical Storage Racks

- » Each starter bay is made up of two uprights & 3 adjustable support arms
- » Each extension bay is made up of one upright & a further 3 adjustable support dividers
- » Movable dividers enable horizontal & vertical adjustment of the storage sections allowing the unit to meet your individual requirements
- » Plywood base offers protection to the ends of the stored items whilst adding stability to the unit
- » Frame has wall mounted fixing points to secure the unit (fixings not included)

N.B. A Fork Lift will be needed to unload these units



Movable dividers enable horizontal & vertical adjustment



CR2575ST & CR2575EX
with 1 x CRA15A

Description	Starter Bay			Extension Bay		
	Overall Size L x D x H mm	Model	Price	Overall Size L x D x H mm	Model	Price
3 Dividers	1633 x 785 x 2575	CR2575ST	£1304.55	1595 x 785 x 2575	CR2575EX	£1071.10
Additional Divider	-	CRA15A	£104.95	-	CRA15A	£104.95

Cantilever Racking

- » Fully welded construction
- » Load capacity per arm: 200kg
- » Each arm has end stops to prevent items falling off
- » Load heavy materials at base

N.B. A Fork Lift will be needed to unload these units



GCR120



GCR110

GCR110
£1484.20

Description	Overall Size L x D x H mm	Weight kg	Model	Price
Parallel Arms				
Single Sided - 2 Bay	2580 x 610 x 2100	106	GCR110	£1484.20
Single Sided Extra Bay - 1 Upright & 3 Support Stays	Increase Length by 1225mm per bay	38	GCR111	£670.45
Double Sided - 2 Bay	2580 x 1100 x 2100	143	GCR210	£1852.60
Double Sided Extra Bay - 1 Upright & 3 Support Stays	Increase Length by 1225mm per bay	51	GCR211	£882.15
Tapered Arms				
Single Sided - 2 Bay	2580 x 650 x 2030	93	GCR120	£1621.40
Single Sided Extra Bay - 1 Upright & 3 Support Stays	Increase Length by 1225mm per bay	34	GCR121	£760.55
Double Sided - 2 Bay	2580 x 1190 x 2030	125	GCR220	£1729.20
Double Sided Extra Bay - 1 Upright & 3 Support Stays	Increase Length by 1225mm per bay	44	GCR221	£875.65

Cantilever Racking

- » Store long & heavy products safely
- » Improve stock accessibility. Ideal for timber, piping, steel, plastic etc
- » The arms are fitted with removable end stops for the ease of loading products on & off
- » Frame has wall & floor fixing points to secure the unit (fixings not included)
- » The arms are height adjustable in increments of 150mm
- » Load capacity per arm: 250kg

N.B. A Fork Lift will be needed to unload these units



Heavy duty, height adjustable arms with removable end stops



CR1003ST

Overall Size L x D x H mm	Starter Bay 12 Arms & 3 Uprights		Starter Bay 15 Arms & 3 Uprights		Extension Bay 4 Arms & 1 Upright		Additional Arm	
	Model	Price	Model	Price	Model	Price	Model	Price
500mm Long Arms								
2490 x 1200 x 3000	CR0503ST	£2437.95	CR0504ST	£2606.50	CR050EX	£926.30	CRA05A	£212.30
1000mm Long Arms								
2490 x 1200 x 3000	CR1003ST	£2641.40	CR1004ST	£2828.25	CR100EX	£998.80	CRA10A	£230.25

Lockers, Cupboards & Cloakroom

Cube Lockers



FROM ONLY
£74.00

» An excellent way of providing secure storage for personal & valuable items in offices, call centres & schools where space is at a premium

- » Fitted with standard mastered cam locks with 2,000 differs
- » Rubber door buffers
- » Powder coated with Germ Guard Active Technology paint
- » Pre-drilled for nesting or wall mounting
- » Available with internal shelf - call for details
- » Reaction to Fire Classification EN 13501-1

DOOR COLOUR OPTIONS

- Dark Blue
- Light Grey

specify when ordering



Overall Size H x W x D mm	Model	Price
300 x 300 x 300	UG303030Z	£74.00
380 x 380 x 380	UG383838Z	£86.81
450 x 450 x 450	UG464646Z	£93.92
Internal Shelf for UG464646Z	UGES4646Z	£39.85

Z-Door Lockers



FROM ONLY
£405.57

An attractive yet extremely robust locker, ideal for when space is at a premium. These lockers are designed so that each compartment can comfortably hang up a coat on the fitted hook. Each locker compartment also has space available to store small personal effects.

- » Doors are available in steel or high quality laminate for extra durability
- » Fitted with standard mastered cam locks, with 2,000 differs.
- » Choice of 300mm or 450mm widths
- » Powder coated with Germ Guard Active Technology Anti-Bacterial paint
- » Reaction to Fire Classification EN13501-1
- » Available in minimum order quantities of 8

LAMINATE DOOR COLOUR OPTIONS

- Spectrum Red
- Campanula
- Spectrum Yellow
- Aquamarine
- Light Grey
- Vibrant Green
- Graphite Grey
- Clementine
- Oak

specify when ordering

STEEL DOOR COLOUR OPTIONS

- Blue
- Light Grey
- Light Blue
- Red
- Yellow
- Green

specify when ordering



Overall Size H x W x D mm	Door Material	Model	Price
1800 x 300 x 450	Steel	LZD183045	£405.57
1800 x 450 x 450	Steel	LZD184545	£445.42
1800 x 300 x 450	Laminate	LZU183045	£573.50
1800 x 450 x 450	Laminate	LZU184545	£623.30

Express Lockers



Our range of Express Lockers comprise of the same high quality design as our Standard Lockers but are available on a 5 Day Delivery lead time. Express Lockers are kept in stock with a selection of four compartment options with a choice of either Light Grey or Dark Blue doors.

- » Choice of 300mm & 450mm depths
- » 1, 2, 4 & 6 door lockers fitted with galvanised security shelf to prevent any unauthorised access to the compartment below
- » Fitted with standard, mastered cam locks with 2,000 differs
- » Single tier lockers fitted with top shelf & coat hook
- » Two tier lockers fitted with coat hook in each compartment
- » Strengthened & ventilated doors with rubber buffers
- » Powder coated with Germ Guard Active Technology paint
- » Order quantities may apply - please contact us for more details
- » Complete with rust resisting galvanised shelves
- » Reaction to Fire Classification EN 13501-1

LOWER PRICES



Tiers	Model	Price
Express Lockers - 1800H x 300W x 300D mm		
1	LQ1830301	£125.73
2	LQ1830302	£154.74
4	LQ1830304	£179.61
6	LQ1830306	£221.06

Tiers	Model	Price
Express Lockers - 1800H x 300W x 450D mm		
1	LQ1830451	£146.45
2	LQ1830452	£172.70
4	LQ1830454	£208.62
6	LQ1830456	£239.02

Lockers, Cupboards & Cloakroom

Standard Lockers



Interior Coat Hook



Door Ventilation



Door Stiffener

DOOR COLOUR OPTIONS

- Green
- Light Blue
- Dark Blue
- Red
- Yellow
- Dark Grey
- Light Grey

specify when ordering



INFORMATION



**Reaction to Fire
Classification EN 13501-1**

- » Choice of 300mm, 380mm & 450mm depths
- » Lockers fitted with galvanised security shelf to prevent any unauthorised access to the compartment below
- » Fitted with standard, mastered cam locks with 2,000 differs
- » Single tier lockers fitted with top shelf & coat hook
- » Two tier lockers fitted with coat hook in each compartment
- » Strengthened & ventilated doors with rubber buffers
- » Powder coated with Germ Guard Active Technology paint
- » Complete with rust resisting galvanised shelves
- » Reaction to Fire Classification EN 13501-1

Overall Size H x W x D mm	1 Tier		2 Tier		3 Tier		4 Tier		5 Tier		6 Tier	
	Model	Price	Model	Price	Model	Price	Model	Price	Model	Price	Model	Price
1800 x 300 x 300	LS1830301	£125.73	LS1830302	£154.74	LS1830303	£174.08	LS1830304	£179.61	LS1830305	£200.33	LS1830306	£221.06
1800 x 300 x 450	LS1830451	£146.45	LS1830452	£172.70	LS1830453	£192.05	LS1830454	£208.62	LS1830455	£223.82	LS1830456	£239.02
1800 x 380 x 380	LS1838381	£151.98	LS1838382	£168.56	LS1838383	£182.37	LS1838384	£207.24	LS1838385	£232.11	LS1838386	£241.78
1800 x 450 x 450	LS1845451	£165.79	LS1845452	£187.90	LS1845453	£215.53	LS1845454	£240.40	LS1845455	£244.55	LS1845456	£250.07

elite Lockers

LOWER PRICES

- >> Anti-bacterial satin gloss finish. BS Class '0' rated product
- >> Robust steel construction with rebated doors
- >> Fitted with standard cam locks with 4,000 differs or padlock fitting - please specify when ordering. Other locks available - please see below



**FROM ONLY
£104.00**

- DOOR COLOUR OPTIONS**
- Green
 - Blue
 - Dark Grey
 - Red
 - Yellow
 - Black
 - Mid Grey
- specify when ordering*



INFORMATION
Constructed from 0.7-0.9mm steel components

Overall Size H x W x D mm	Clear Entry H x W x D mm	Model	Price
Single Door (c/w top shelf & double coat hook)			
1800 x 300 x 300	1410 x 235 x 275	1830301	£104.00
1800 x 300 x 450	1410 x 235 x 425	1830451	£122.00
1800 x 450 x 450	1410 x 385 x 425	1845451	£143.00
Two Door (c/w double coat hook)			
1800 x 300 x 300	835 x 235 x 275	1830302	£127.00
1800 x 300 x 450	835 x 235 x 425	1830452	£139.00
1800 x 450 x 450	835 x 385 x 425	1845452	£166.00
Three Door			
1800 x 300 x 300	540 x 235 x 275	1830303	£138.00
1800 x 300 x 450	540 x 235 x 425	1830453	£158.00
Four Door			
1800 x 300 x 300	400 x 235 x 275	1830304	£152.00
1800 x 300 x 450	400 x 235 x 425	1830454	£171.00
1800 x 450 x 450	400 x 385 x 425	1845454	£201.00
Six Door			
1800 x 300 x 300	260 x 235 x 275	1830306	£184.00
1800 x 300 x 450	260 x 235 x 425	1830456	£199.00

Locker Accessories



Overall Size W x D mm	Model	Price
Factory Fitted Sloping Top (150mm high)		
300 x 300	ST3030	£13.00
300 x 450	ST3045	£14.00
450 x 450	ST4545	£15.00
Locker Stand (150mm high)		
300 Width*	LS30	£34.00
450 Width*	LS45	£44.00
600 Width*	LS60	£49.00
900 Width*	LS90	£67.00
*Supplied to suit locker depth		
Master key for key operated Locks		
-	MKEY	£21.00

Padlock Fitting



Model	Price
PADL	Free of Charge

Premium Combi Lock



Model	Price
PCOML	£34.00

Electronic Combi Lock



Model	Price
ECOML	£56.00

Coin Return



Model	Price
COINL	£26.00

Vinyl Numbering

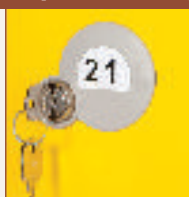

Model	Price
NUM	£2.00

Key Fob



Model	Price
FOB	£2.00

Lockers, Cupboards & Cloakroom

Workwear & Hygiene Lockers

- » Anti-bacterial powder coating
- » Robust steel construction with coloured doors
- » Fitted with standard cam locks with 4,000 differs or padlock fitting - please specify when ordering. Other locks available - please see page 71

Combi Locker

- » Ideal for hanging workwear clothing
- » Vertical hanging compartment with double coat hook & smaller storage compartments
- » Galvanised internal components

Clean & Dirty Locker

- » Two vertical hanging compartments to separate workwear & daywear

Two Person Locker

- » Space saving unit for 2 users
- » Each user has a vertical hanging space & a smaller possession compartment

Twin Locker

- » Space saving unit for 2 users
- » Each user has a slim vertical hanging space with shelf & double coat hook

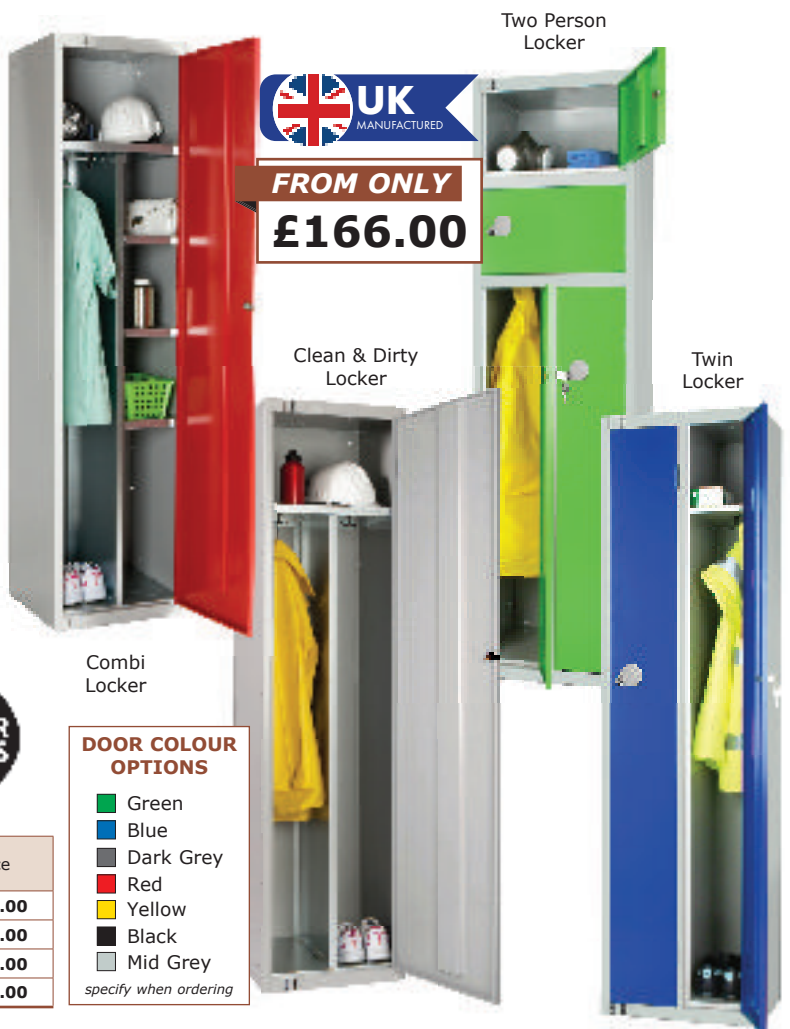

DOOR COLOUR OPTIONS

- Green
- Blue
- Dark Grey
- Red
- Yellow
- Black
- Mid Grey

specify when ordering

Description	Overall Size H x W x D mm	Model	Price
Combi Locker	1800 x 450 x 450	1845N	£184.00
Clean & Dirty Locker	1800 x 450 x 450	1845CD	£166.00
Two Person Locker	1800 x 450 x 450	1845TP	£206.00
Twin Locker	1800 x 450 x 450	1845TW	£194.00

Lockers with Sloping Tops & Stands

- » Ideal choice for changing rooms that demand a neat & tidy environment
- » Robust steel construction with anti-bacterial powder coated paint finish
- » Supplied with either a key cam lock or padlock fitting - please specify when ordering. Additional lock options available on request



DOOR COLOUR OPTIONS

- Grey
- Dark Grey

specify when ordering

Overall Size H x W x D mm	Model	Price
Two Door		
2100 x 300 x 300	ST1830302LS	£174.00
2100 x 300 x 450	ST1830452LS	£187.00
Three Door		
2100 x 300 x 300	ST1830303LS	£185.00
2100 x 300 x 450	ST1830453LS	£206.00
Four Door		
2100 x 300 x 300	ST1830304LS	£199.00
2100 x 300 x 450	ST1830454LS	£219.00
Five Door		
2100 x 300 x 300	ST1830305LS	£220.00
2100 x 300 x 450	ST1830455LS	£235.00



elite White Lockers

- >> Anti-bacterial powder coating - RAL 9010
- >> Robust steel construction with rebated doors
- >> Fitted with standard cam locks with 4,000 differs or padlock fitting - please specify when ordering. Other locks available - please see below

LOWER PRICES

FROM ONLY
£109.00



INFORMATION
Constructed from **0.7 - 0.9mm steel components**



Overall Size H x W x D mm	Clear Entry H x W x D mm	Model	Price
Single Door (c/w top shelf & double coat hook)			
1800 x 300 x 300	1410 x 235 x 275	1830301W	£109.00
1800 x 300 x 450	1410 x 235 x 425	1830451W	£128.00
Two Door (c/w double coat hook)			
1800 x 300 x 300	835 x 235 x 275	1830302W	£133.00
1800 x 300 x 450	835 x 235 x 425	1830452W	£146.00
Three Door			
1800 x 300 x 300	540 x 235 x 275	1830303W	£145.00
1800 x 300 x 450	540 x 235 x 425	1830453W	£166.00
Four Door			
1800 x 300 x 300	400 x 235 x 275	1830304W	£160.00
1800 x 300 x 450	400 x 235 x 425	1830454W	£179.00
1800 x 450 x 450	400 x 385 x 425	1845454W	£211.00
Six Door			
1800 x 300 x 300	260 x 235 x 275	1830306W	£194.00
1800 x 300 x 450	260 x 235 x 425	1830456W	£209.00

Locker Accessories

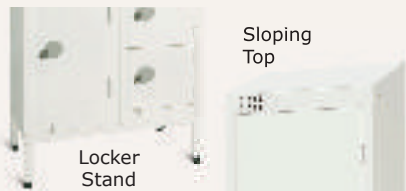

Overall Size W x D mm	Model	Price
Factory Fitted Sloping Top (150mm high)		
300 x 300	ST3030	£13.00
300 x 450	ST3045	£14.00
450 x 450	ST4545	£15.00
Locker Stand (150mm high)		
300 Width*	LS30	£34.00
450 Width*	LS45	£44.00
600 Width*	LS60	£49.00
900 Width*	LS90	£67.00
*Supplied to suit locker depth		
Master key for key operated Locks		
-	MKEY	£21.00

Padlock Fitting



Model	Price
PADL	Free of Charge

Premium Combi Lock



Model	Price
PCOML	£34.00

Electronic Combi Lock



Model	Price
ECOML	£56.00

Coin Return



Model	Price
COINL	£26.00

Vinyl Numbering

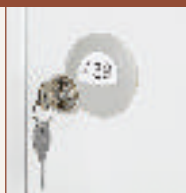

Model	Price
NUM	£2.00

Key Fob



Model	Price
FOB	£2.00

Lockers, Cupboards & Cloakroom

Flat Garment Lockers

- » Enables work clothing to be issued when cleaned, & exchanged when dirty
- » Clothing compartments can be accessed individually or collectively using the master door
- » Fitted with standard, mastered cam locks with 2,000 differs
- » Doors are fitted with rubber buffers to prevent scratching
- » Pre-drilled for nesting
- » Powder coated with Germ Guard Active Technology paint
- » Reaction to Fire Classification EN 13501-1
- » Other door colour options available on minimum order quantity - please call for details

DOOR COLOUR OPTIONS

- Light Grey
- Dark Blue

specify when ordering



FROM ONLY

£331.58



LF183845Y



LF183845W



LF1838455

Overall Size H x W x D mm	5 Tier		10 Tier		12 Tier		15 Tier		20 Tier	
	Model	Price	Model	Price	Model	Price	Model	Price	Model	Price
1800 x 380 x 450	LF1838455	£331.58	LF183845N	£405.57	LF183845W	£441.15	LF183845Q	£483.84	LF183845Y	£562.11
1800 x 450 x 380	LF1845385	£331.58	LF184538N	£405.57	LF184538W	£441.15	LF184538Q	£483.84	-	-

Garment Disposal Lockers

- » Enables dirty work wear to be deposited & collected for cleaning
- » Suitable for use in any industrial environment where a uniform or work wear cleaning service is provided
- » Fitted with 3 point locking cam locks with 2,000 differs
- » Letter box opening to receive approx. 45 garments
- » Door fitted with rubber buffers
- » Powder coated with Germ Guard Active Technology paint
- » Reaction to Fire Classification EN 13501-1
- » Other door colour options available on minimum order quantity - please call for details

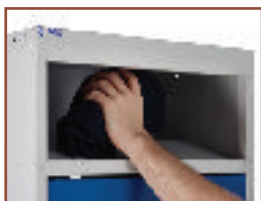

Garment opening



Coat hooks



Cam lock



Ventilated doors



DOOR COLOUR OPTIONS

- Light Grey
- Dark Blue

specify when ordering

FROM ONLY

£304.54



LL1845451

Overall Size H x W x D mm	Model	Price
1800 x 380 x 450	LL1838451	£304.54
1800 x 450 x 450	LL1845451	£318.77

Personal Effect Lockers



Compartment Close Up



Locking Mechanism



LR909038Y



LR184538Y



LR189038F

- » Fitted with standard mastered cam locks with 2,000 differs
- » Through frame shelf for extra security
- » Compartment entry aperture: 150H x 163W x 360D mm
- » Powder coated with Germ Guard Active Technology paint
- » Pre-drilled for nesting
- » Reaction to Fire Classification EN 13501-1
- » Personal Effect lockers are fitted with a security shelf to prevent unauthorised access to the compartment below
- » Order quantities may apply - please speak to sales

FROM ONLY
£473.88



DOOR COLOUR OPTIONS

- Blue
- Light Grey

specify when ordering

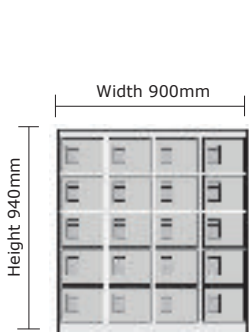

20 Tier

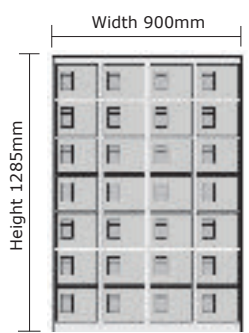

28 Tier

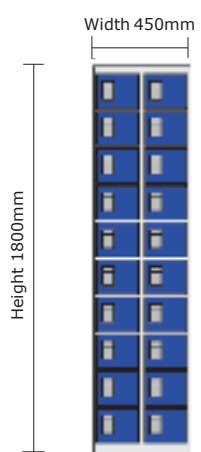

20 Tier

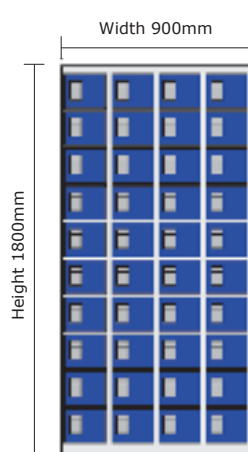

40 Tier

Overall Size H x W x D mm	No of Compartments	Model	Price
940 x 900 x 380	20	LR909038Y	£473.88
1285 x 900 x 380	28	LR129038H	£673.11
1800 x 450 x 380	20	LR184538Y	£473.88
1800 x 900 x 380	40	LR189038F	£912.19

Lockers, Cupboards & Cloakroom

Steel Splash Lockers

These lockers are manufactured from pre-coated galvanised steel for damp environments or where frequent washing down is required.

- » Strengthened & ventilated doors with rubber buffers
- » Single tier lockers fitted with top shelf & coat hook
- » Two tier lockers fitted with coat hook in each compartment
- » Powder coated with Germ Guard Active Technology anti-bacterial paint
- » Hinges are 75mm deep - offers greater quality & durability
- » Ideal for swimming pools, changing rooms, saunas, industrial wet areas & food preparation plants
- » 2, 3 & 4 door lockers fitted with security shelf to prevent unauthorised access to the compartment below
- » Moisture resistant cam locks are fitted as standard for superior lock durability in moist environments
- » Lateral security beam enhances the security of the product



Tiers	Model	Price
Steel Splash Lockers - 1800H x 300W x 300D mm		
1	LW1830301	£193.54
2	LW1830302	£222.00
3	LW1830303	£250.46
4	LW1830304	£278.92

Tiers	Model	Price
Steel Splash Lockers - 1800H x 300W x 450D mm		
1	LW1830451	£204.92
2	LW1830452	£231.96
3	LW1830453	£264.69
4	LW1830454	£294.58



Clothing Cupboards

- » "No Snag" handles with 2-point locking
- » Strengthened doors
- » Top shelf & hanging garment rail
- » Reaction to Fire Classification EN 13501-1

COLOUR OPTIONS

- Light Grey
- Light Blue
- Dark Blue
- Green
- Red
- Yellow



Overall Size H x W x D mm	No of Shelves	Model	Price
1800 x 600 x 450	1	CC180645Z	£479.05
1800 x 900 x 450	1	CC180945Z	£509.30
1800 x 1200 x 450	1	CC181245Z	£635.65

Extra Shelves		
To Fit W x D mm	Model	Price
600 x 450	CC0645ES	£32.90
900 x 450	CC0945ES	£39.50
1200 x 450	CC1245ES	£51.35

Tool Charging Lockers

- » Suitable for the secure charging of batteries & power tools
- » CE tested & meets EU safety requirements
- » Fitted with galvanised security shelf to prevent any unauthorised access to the compartment below
- » Fitted with standard, mastered cam locks with 2,000 differs
- » Strengthened & ventilated doors with rubber buffers
- » Powder coated with Germ Guard Active Technology paint
- » Reaction to Fire Classification EN 13501-1

DOOR COLOUR OPTIONS

- Green
- Light Blue
- Dark Blue
- Red
- Yellow
- Light Grey

specify when ordering



**FROM ONLY
£586.30**

4 x 5 Tier Lockers



Perforated Door Charging Lockers with a Standard plug

Overall Size H x W x D mm	4 Tier		5 Tier		6 Tier		8 Tier	
	Model	Price	Model	Price	Model	Price	Model	Price
1800 x 300 x 450	BL1830454*PX	£586.30	BL1830455*PX	£688.77	BL1830456*PX	£774.15	BL1830458*PX	£929.26
1800 x 450 x 450	BL1845454*PX	£666.00	BL1845455*PX	£785.53	BL1845456*PX	£882.30	BL1845458*PX	£1058.76

Perforated Door Charging Lockers with a RCD plug

Overall Size H x W x D mm	4 Tier		5 Tier		6 Tier		8 Tier	
	Model	Price	Model	Price	Model	Price	Model	Price
1800 x 300 x 450	BR1830454*PX	£819.69	BR1830455*PX	£981.92	BR1830456*PX	£1124.22	BR1830458*PX	£1396.03
1800 x 450 x 450	BR1845454*PX	£900.80	BR1845455*PX	£1077.26	BR1845456*PX	£1233.80	BR1845458*PX	£1525.53

Solid Door Charging Lockers with a Standard plug

Overall Size H x W x D mm	4 Tier		5 Tier		6 Tier		8 Tier	
	Model	Price	Model	Price	Model	Price	Model	Price
1800 x 300 x 450	BL1830454*SX	£586.30	BL1830455*SX	£688.77	BL1830456*SX	£774.15	BL1830458*SX	£929.26
1800 x 450 x 450	BL1845454*SX	£666.00	BL1845455*SX	£785.53	BL1845456*SX	£882.30	BL1845458*SX	£1058.76

Solid Door Charging Lockers with a RCD plug

Overall Size H x W x D mm	4 Tier		5 Tier		6 Tier		8 Tier	
	Model	Price	Model	Price	Model	Price	Model	Price
1800 x 300 x 450	BR1830454*SX	£819.69	BR1830455*SX	£981.92	BR1830456*SX	£1124.22	BR1830458*SX	£1396.03
1800 x 450 x 450	BR1845454*SX	£900.80	BR1845455*SX	£1077.26	BR1845456*SX	£1233.80	BR1845458*SX	£1525.53

Lockers, Cupboards & Cloakroom

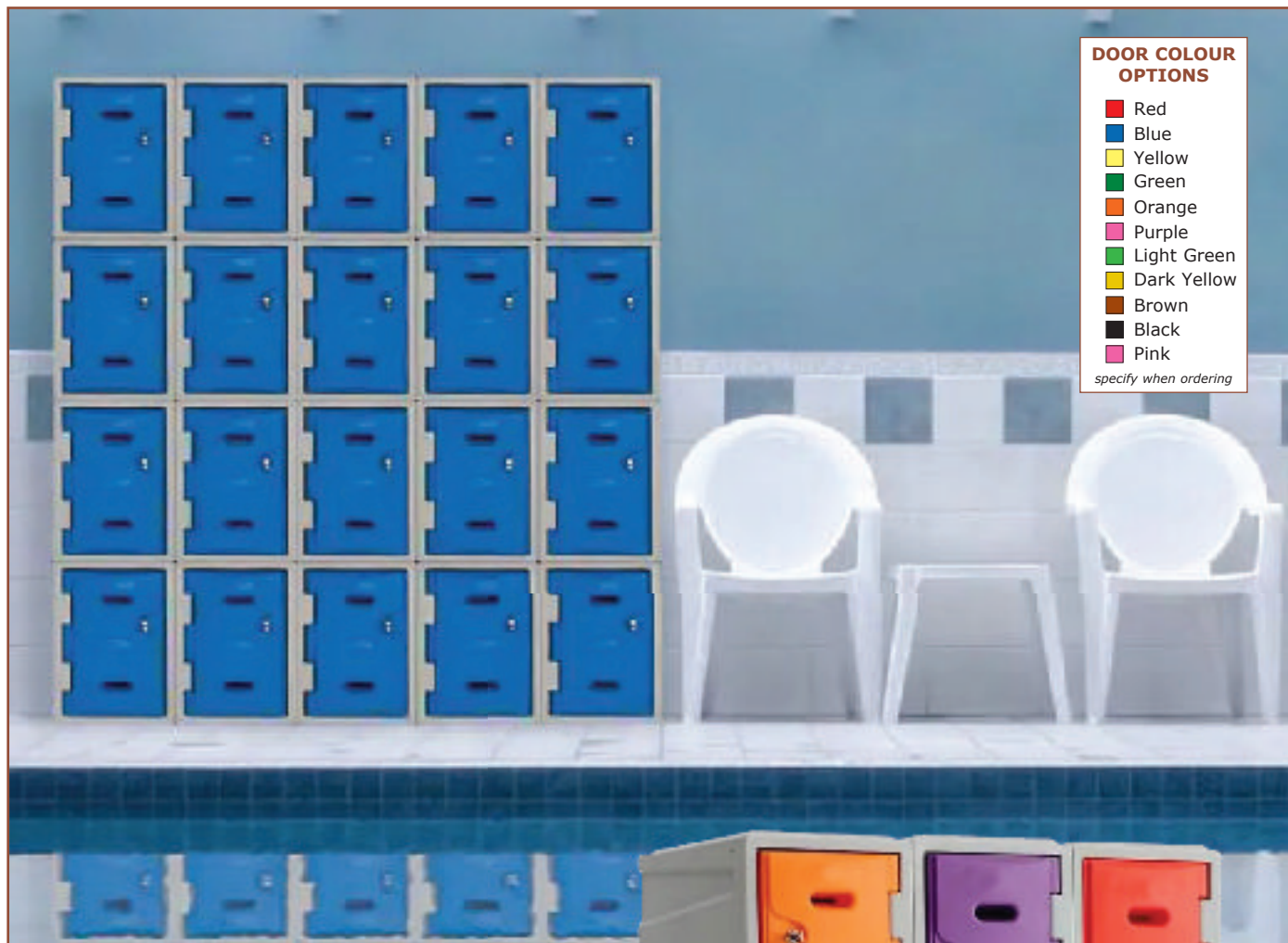

DOOR COLOUR OPTIONS

- Red
- Blue
- Yellow
- Green
- Orange
- Purple
- Light Green
- Dark Yellow
- Brown
- Black
- Pink

specify when ordering

Plastic Lockers

- » Robust, MDPE plastic lockers, built to a robust yet stylish design & are ideal for storage, schools universities, factories, manufacturers, leisure centres, gyms & much more
- » Supplied with an anti-theft double locking feature that helps to keep the contents secure
- » Fitted with standard cam lock or padlock fitting - please specify when ordering (*if not specified Cam Lock will be supplied)
- » Weather resistant for outdoor or swimming pool use

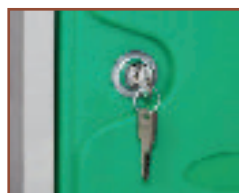

Cam Lock Fitting

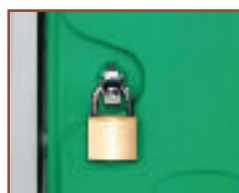

Padlock Fitting



PL453246



4 x PL453246

3 x PL603246

2 x PL903246

Description	Overall Size H x W x D mm	Model	Price
450H Plastic Locker - stackable 4 high	450 x 320 x 460	PL453246	£102.80
600H Plastic Locker - stackable 3 high	600 x 320 x 460	PL603246	£114.60
900H Plastic Locker - stackable 2 high	900 x 320 x 460	PL903246	£126.60
Coin Operated Return Lock (Dry Area) - per lock	-	PLCRLDA	£30.95
Coin Operated Return Lock (Wet Area) - per lock	-	PLCRLWA	£37.30

Laptop & Tablet Storage Lockers

- » High quality & cost effective storage
- » Choice of 10 or 15 compartment units
- » Powder coated with Germ Guard active technology anti-bacterial paint
- » Pre-drilled for nesting
- » Reaction to Fire Classification EN 13501-1
- » Other colours available - call for details

Overall Size H x W x D mm	Configuration	Colour	Code	Price
1800 x 450 x 450	10 Comp 10 Doors	Light Grey	L7184545NLXX	£526.54
		Dark Blue	L7184545NBXX	£526.54
		Red	L7184545NRXX	£526.54
1800 x 380 x 450	15 Comp 15 Doors	Light Grey	L7183845QLXX	£592.00
		Dark Blue	L7183845QBXX	£592.00
		Red	L7183845QRXX	£592.00
	15 Comp 1 Door	Light Grey	L71838451LXX	£475.30
		Dark Blue	L71838451BXX	£475.30
		Red	L71838451RXX	£475.30



Charging Laptop & Tablet Lockers

- » Choice of 8 or 12 compartment units - each equipped with a 3 pin socket
- » Ventilated compartments for dissipation of heat during charge cycle
- » Compartment aperture: 100H x 375W x 470D mm
- » Powder coated with Germ Guard active technology anti-bacterial paint
- » Other colours available - call for details



Internal Charging Point fitted inside the compartments



Overall Size H x W x D mm	Configuration	Colour	Code	Price
1000 x 500 x 500	8 Comp 8 Doors	Light Grey	L7C10505088L	£791.23
		Dark Blue	L7C10505088B	£791.23
		Red	L7C10505088R	£791.23
	8 Comp 1 Door	Light Grey	L7C10505081L	£742.84
		Dark Blue	L7C10505081B	£742.84
		Red	L7C10505081R	£742.84
1460 x 500 x 500	12 Comp 1 Door	Light Grey	L7C145050W1L	£983.34
		Dark Blue	L7C145050W1B	£983.34
		Red	L7C145050W1R	£983.34
	12 Comp 12 Doors	Light Grey	L7C145050WWL	£1035.99
		Dark Blue	L7C145050WWB	£1035.99
		Red	L7C145050WWR	£1035.99

Charging Laptop & Tablet Trolleys

- » Choice of 8 or 16 compartment units - each equipped with a 3 pin socket
- » Ventilated compartments for dissipation of heat during charge cycle
- » "Narrow Aisle" units are 525mm wide & allow easy access between desks
- » Compartment aperture: 100H x 375W x 465D mm
- » Powder coated with Germ Guard active technology anti-bacterial paint
- » Other colours available - call for details



Overall Size H x W x D mm	Configuration	Colour	Code	Price
Narrow Aisle 1200 x 525 x 675	8 Comp 2 Doors	Light Grey	L7M12526782L	£873.76
		Dark Blue	L7M12526782B	£873.76
		Red	L7M12526782R	£873.76
Narrow Aisle 1200 x 525 x 1220	16 Comp 4 Doors	Light Grey	L7M125212X4L	£1565.38
		Dark Blue	L7M125212X4B	£1565.38
		Red	L7M125212X4R	£1565.38
1200 x 1040 x 660	16 Comp 2 Doors	Light Grey	L7M121066X2L	£1565.38
		Dark Blue	L7M121066X2B	£1565.38
		Red	L7M121066X2R	£1565.38



Internal Charging Point fitted inside the compartments



Lockers, Cupboards & Cloakroom

Stainless Steel Lockers



INFORMATION

Manufactured from high quality 304 grade stainless steel

- » Choice of 300mm & 450mm depths
- » Ideal for hygienic areas such as catering, industrial, construction & healthcare environments
- » High quality 304 grade stainless steel units do not rust or tarnish easily
- » Fitted with standard, mastered cam locks with 2,000 differs
- » Strengthened doors
- » Single-tier lockers fitted with top shelf and coat hook
- » Two-tier lockers fitted with coat hook in each compartment
- » Pre-drilled for nesting together
- » Lockers are fitted with a stainless steel security shelf to prevent any unauthorised access to the compartment below

Overall Size H x W x D mm	1 Tier		2 Tier		3 Tier		4 Tier		6 Tier	
	Model	Price	Model	Price	Model	Price	Model	Price	Model	Price
1800 x 300 x 300	LSS1830301SX	£624.61	LSS1830302SX	£674.70	LSS1830303SX	£742.66	LSS1830304SX	£824.74	LSS1830306SX	£978.67
1800 x 300 x 450	LSS1830451SX	£648.74	LSS1830452SX	£698.83	LSS1830453SX	£775.67	LSS1830454SX	£857.76	LSS1830456SX	£1080.58

Wire Mesh Storage Compartments

- » Strong & hard wearing
- » Fully welded tubular steel construction with a 50 x 50mm square mesh outer carcass & 25 x 25mm mesh shelves
- » Fitted with hanging rail & 2 storage shelves per compartment as illustrated
- » Produced with both floor & wall fixing points (fixings not supplied)
- » Easy access for cleaning
- » Contents can easily be visually inspected

N.B. A Fork Lift will be needed to unload these units

INFORMATION



Bespoke models can be made to your specification - call for details



WML01Z
Single sided



WML04Z



WML02Z
Double sided

No. of Compartments	Overall Size H x W x D mm	Weight kg	Model	Price
Wall Mounted Unit				
3	1890 x 1590 x 565	65	WML01Z	£1226.10
Double Sided Unit				
6	1890 x 1590 x 1130	130	WML02Z	£2346.90
Mobile Unit with padlockable doors (<i>padlock not included</i>)				
3	2090 x 1590 x 565	105	WML04Z	£1918.30

Lockers, Cupboards & Cloakroom

Wire Mesh Lockers



INFORMATION

Powder coated lockers available - call for details

INFORMATION

Premium 8mm lockers available - call for details

- » Manufactured from 25 x 25 x 2.5 copper coated welded mesh on a 6mm rod frame.
- » Bright electroplated zinc lockers which offer full through ventilation & high visual security
- » Single Locker is 300W, Nest of 2 is 610W & Nest of 3 is 910W



- » Single tier lockers come complete with a hat shelf & coat hook. Lockers are fitted with a hasp & staple for use with a padlock (*not included*). Also fitted with floor fixing brackets with provision to be fitted back to back, to the wall & to the floor (*fixings not included*)
- » **Premium 8mm lockers available - call for details**

Description	1980H x 305Dmm			1980H x 457Dmm		
	Model	Price (each)	Price (each) 2+	Model	Price (each)	Price (each) 2+
1 Door						
Single Locker	CM0002EC	£163.24	£138.59	CM0014EC	£176.83	£152.18
Nest of 2 Lockers	CM0004EC	£275.25	£250.61	CM0016EC	£290.60	£265.95
Nest of 3 Lockers	CM0006EC	£362.87	£338.22	CM0018EC	£403.56	£378.91
2 Door						
Single Locker	CM0020EC	£167.89	£143.24	CM0032EC	£182.64	£158.00
Nest of 2 Lockers	CM0022EC	£290.29	£265.64	CM0034EC	£308.02	£283.37
Nest of 3 Lockers	CM0024EC	£389.67	£365.02	CM0036EC	£424.87	£400.22
3 Door						
Single Locker	CM0038EC	£172.24	£147.59	CM0050EC	£192.65	£168.00
Nest of 2 Lockers	CM0040EC	£293.69	£269.04	CM0052EC	£324.21	£299.56
Nest of 3 Lockers	CM0042EC	£408.42	£383.77	CM0054EC	£457.59	£432.94

Description	1980H x 305Dmm			1980H x 457Dmm		
	Model	Price (each)	Price (each) 2+	Model	Price (each)	Price (each) 2+
4 Door						
Single Locker	CM0056EC	£180.38	£155.73	CM0068EC	£201.20	£176.55
Nest of 2 Lockers	CM0058EC	£313.10	£288.45	CM0070EC	£352.50	£327.85
Nest of 3 Lockers	CM0060EC	£434.78	£410.13	CM0072EC	£483.34	£458.69
5 Door						
Single Locker	CM0190EC	£192.14	£167.49	CM0196EC	£214.37	£189.73
Nest of 2 Lockers	CM0191EC	£331.47	£306.82	CM0197EC	£369.79	£345.14
Nest of 3 Lockers	CM0192EC	£470.22	£445.57	CM0198EC	£532.34	£507.69
6 Door						
Single Locker	CM0074EC	£200.51	£175.86	CM0086EC	£222.51	£197.86
Nest of 2 Lockers	CM0076EC	£356.07	£331.42	CM0088EC	£386.78	£362.13
Nest of 3 Lockers	CM0078EC	£512.16	£487.51	CM0090EC	£553.20	£528.56

Wire Mesh Compartment Lockers

- » Manufactured from 25 x 25 x 2.5 copper coated welded mesh on a 8mm rod frame
- » Bright electroplated zinc lockers which offer full through ventilation & high visual security
- » Fitted with a hasp & staple for use with a padlock (*not included*)
- » Fitted with floor fixing brackets with provision to be fitted back to back, to the wall & to the floor (*fixings not included*)



FROM ONLY
£209.77

INFORMATION
Powder coated lockers available - call for details



Overall Size H x W x D mm	Compartment Lockers with No Doors				Compartment Lockers with Doors			
	No of Compartments	Model	Price (each)	Price (each) 2+	No of Doors / Compartments	Model	Price (each)	Price (each) 2+
1370 x 610 x 305	8	CM010BZP0129	£234.42	£209.77	8 / 8	CM010BZP0130	£310.85	£286.20
1370 x 610 x 457	8	CM010BZP0141	£265.18	£240.53	8 / 8	CM010BZP0142	£335.92	£311.27
1370 x 910 x 305	12	CM010BZP0145	£272.76	£248.11	12 / 12	CM010BZP0146	£391.86	£367.21
1370 x 910 x 457	12	CM010BZP0151	£299.43	£274.78	12 / 12	CM010BZP0152	£416.36	£391.71
1370 x 1210 x 305	16	CM010BZP0147	£342.77	£318.13	16 / 16	CM010BZP0148	£497.96	£473.31
1370 x 1210 x 457	16	CM010BZP0153	£368.00	£343.35	16 / 16	CM010BZP0154	£523.18	£498.53
1370 x 1510 x 305	20	CM010BZP0149	£409.69	£360.39	20 / 20	CM010BZP0150	£605.56	£556.26
1370 x 1510 x 457	20	CM010BZP0155	£446.90	£397.61	20 / 20	CM010BZP0156	£642.76	£593.46
1370 x 830 x 305	40	CM010BZP0157	£344.22	£319.57	2 / 40	CM010BZP0158	£429.50	£404.86
1370 x 830 x 457	40	CM010BZP0159	£377.97	£353.32	2 / 40	CM010BZP0160	£459.48	£434.83

Wire Mesh Compartment Cupboards

- » Manufactured from 25 x 25 x 2.5 copper coated welded mesh on a 8mm rod frame
- » Bright electroplated zinc lockers which offer full through ventilation & high visual security
- » Fitted with a hasp & staple for use with a padlock (*not included*)
- » Fitted with floor fixing brackets with provision to be fitted back to back, to the wall & to the floor (*fixings not included*)

FROM ONLY
£160.13



INFORMATION
Powder coated lockers available - call for details

Description	Overall Size H x W x D mm	Model	Price (each)	Price (each) 2+
Low Cupboard - Single Door (c/w 2 shelves)	1370 x 450 x 457	CM090BZP0401	£184.78	£160.13
Low Cupboard - Double Door (c/w 2 shelves)	1370 x 910 x 457	CM090BZP0402	£311.65	£287.00
Narrow Cupboard - Single Door (c/w 3 shelves)	1980 x 450 x 457	CM090BZP0403	£221.97	£197.32
Cupboard - Double Door (c/w 3 shelves)	1980 x 910 x 457	CM090BZP0404	£470.80	£446.15
Divided Cupboard - Double Door (c/w 6 shelves)	1980 x 910 x 457	CM090BZP0405	£439.49	£414.85
Divided Cupboard - Double Door (c/w 9 shelves)	1980 x 910 x 457	CM090BZP0406	£485.65	£461.00
Divided Cupboard - Double Door (c/w 12 shelves)	1980 x 910 x 457	CM090BZP0407	£510.45	£485.80
Janitor Cupboard - Double Door (c/w Rail & 3 shelves)	1980 x 910 x 457	CM090BZP0408	£478.13	£453.48
Wardrobe Cupboard - Double Door (c/w Hat Shelf & Rail)	1980 x 910 x 457	CM090BZP0409	£439.49	£414.85

BESPOKE PRODUCTS AVAILABLE UPON REQUEST

Lockers, Cupboards & Cloakroom

Computer Cupboards

- >> Shelves are 650mm / 1050mm wide x 550mm deep
- >> Lockable cupboards with cable routing apertures
- >> Lockable, slide out keyboard tray
- >> Galvanised steel shelves with 75kg U.D.L capacity
- >> Lockable, ventilated monitor housings
- >> Sloping writing surface on 1050mm wide models



Item	Overall Size H x W x D mm	Shelves	Model	Price
A	1650 x 1050 x 550	1	16928022.19	£720.37

Item	Overall Size H x W x D mm	Shelves	Model	Price
B	1650 x 650 x 550	1	16928001.19	£539.32



Item	Overall Size H x W x D mm	Shelves	Model	Price
C	1130 x 1050 x 550	1	16928021.19	£536.29

Item	Overall Size H x W x D mm	Shelves	Model	Price
D	1000 x 650 x 550	1	16928000.19	£429.51

Workplace Cupboards



**FROM ONLY
£277.75**



- DOOR COLOUR OPTIONS**
- Green
 - Grey
 - Blue
 - Yellow
 - Light Blue
 - Red
- specify when ordering*



SCQ090946 & SCQ180946 ARE ON 5 DAY DELIVERY IN BLUE & GREY ONLY

- » Strong construction provides all round robustness
- » 'No snag' handles with 2-point locking
- » Strengthened doors
- » Grey powder coated carcass
- » Powder coated with Germ Guard active technology anti-bacterial paint
- » Wall cupboard is pre-drilled for mounting (fixings not supplied)
- » Shelf capacities: 50kg evenly distributed
- » Shelves can be positioned in 25mm increments
- » Reaction to Fire Classification EN 13501-1

Static Cupboards

Overall Size H x W x D mm	No of Shelves	Cupboard		Extra Shelf	
		Model	Price	Model	Price
900 x 460 x 460	1	SCQ094646	£277.75	SCQ0446ES	£38.20
900 x 900 x 460	2	SCQ090946	£347.50	SCQ0946ES	£50.00
900 x 900 x 610	2	SCQ090961	£430.40	SCQ0961ES	£44.75
1200 x 900 x 460	2	SCQ120946	£429.05	SCQ0946ES	£50.00
1800 x 600 x 460	3	SCQ180646	£425.10	SCQ0646ES	£28.95
1800 x 900 x 460	3	SCQ180946	£469.85	SCQ0946ES	£50.00
1800 x 900 x 610	3	SCQ180961	£626.40	SCQ0961ES	£44.75
1800 x 1200 x 460	3	SCQ181246	£621.15	SCQ1246ES	£57.90
1800 x 1200 x 610	3	SCQ181261	£747.45	SCQ1261ES	£65.80

Mobile Cupboards

Overall Size H x W x D mm	No of Shelves	Cupboard		Extra Shelf	
		Model	Price	Model	Price
1040 x 900 x 460	2	MCQ10946	£501.45	MCQ0946ES	£50.00
1040 x 900 x 610	2	MCQ10961	£702.75	MCQ0961ES	£44.75

Wall Cupboard

Overall Size H x W x D mm	No of Shelves	Cupboard		Extra Shelf	
		Model	Price	Model	Price
570 x 850 x 255	1	WCQ57825	£263.30	-	-

Lockers, Cupboards & Cloakroom

Extra Wide Cupboards

- » Anti-bacterial powder coating
- » Robust steel construction, welded frame with reinforced doors
- » 3 point locking



724818C

COLOUR OPTIONS

- Green
- Blue
- Dark Grey
- Red
- Yellow
- Black
- Mid Grey

specify when ordering



724818CE



724818JAN



724818W

Description	Overall Size H x W x D mm	Model	Price
General Cupboard	1830 x 1220 x 457	724818C	£504.00
Clothing & Equipment Cupboard	1830 x 1220 x 457	724818CE	£597.00
Janitorial Cupboard	1830 x 1220 x 457	724818JAN	£554.00
Wardrobe Cupboard	1830 x 1220 x 457	724818W	£524.00

Slim Cupboards

- » Anti-bacterial powder coating
- » Robust steel construction, welded frame with reinforced doors
- » 3 point locking



722418C



722418N



722418CD



722418W

DOOR COLOUR OPTIONS

- Green
- Blue
- Dark Grey
- Red
- Yellow
- Black
- Mid Grey

specify when ordering

Description	Overall Size H x W x D mm	Model	Price
General Cupboard	1830 x 610 x 457	722418C	£308.00
Clothing & Equipment Cupboard	1830 x 610 x 457	722418N	£342.00
Clothing Cupboard	1830 x 610 x 457	722418CD	£321.00
Wardrobe Cupboard	1830 x 610 x 457	722418W	£296.00

Standard Cupboards

- » Anti-bacterial powder coating
- » Robust steel construction, welded frame with reinforced doors
- » Hardwearing galvanised shelves



No of Shelves	No of Doors	Overall Size H x W x D mm	Model	Price
2	1	910 x 457 x 457	361818C	£172.00
1	2	1000 x 915 x 457	393618C	£275.00
3	2	1830 x 915 x 457	723618C	£375.00

Keyless Locking

» Add-on extra for cupboards. Not available on Slim Cupboards

Model	Price
CUPCOML	£85.00

Tray Cupboards

- » Robust steel construction, welded frame with reinforced doors
- » 3 tray options - 75, 150 & 225mm high



7245181



7245182



7245183

DOOR COLOUR OPTIONS

- Mid Grey
- Blue
- Dark Grey
- Red

specify when ordering

TRAY COLOUR OPTIONS

- Opaque
- Blue
- Red

specify when ordering

No of Trays	Overall Size H x W x D mm	Model	Price
51	1830 x 1120 x 457	7245181	£1280.00
27	1830 x 1120 x 457	7245182	£1027.00
18	1830 x 1120 x 457	7245183	£823.00

Perforated Door Cupboards



PDC090946

- » The perforated doors allows view of contents for greater visual security
- » 'No snag' handles with 2-point locking
- » Powder coated light grey carcass with a variety of door colours
- » Adjustable shelves
- » Reaction to Fire Classification EN 13501-1

FROM ONLY
£417.20



PDC180946

DOOR COLOUR OPTIONS

- Green
- Grey
- Blue
- Yellow
- Light Blue
- Red

specify when ordering

Overall Size H x W x D mm	No of Shelves	Cupboard		Extra Shelf	
		Model	Price	Model	Price
900 x 900 x 460	2	PDC090946	£417.20	PDC0946ES	£50.00
900 x 900 x 610	2	PDC090961	£500.10	PDC0961ES	£44.75
1200 x 900 x 460	2	PDC120946	£498.80	PDC0946ES	£50.00
1800 x 600 x 460	3	PDC180646	£494.85	PDC0646ES	£28.95
1800 x 900 x 460	3	PDC180946	£521.15	PDC0946ES	£50.00
1800 x 900 x 610	3	PDC180961	£694.85	PDC0961ES	£44.75
1800 x 1200 x 460	3	PDC181246	£690.90	PDC1246ES	£57.90
1800 x 1200 x 610	3	PDC181261	£817.20	PDC1261ES	£65.80

Vision Door Cupboards

These cupboards and cabinets bring a combination of storage, mobility, security and a touch of style to the workplace. The perspex doors allow managers and supervisors to be able to see the contents of cupboards whilst the cupboard is locked.

- » Flush "no snag" handles
- » Mobile and static options
- » Strengthened doors
- » Adjustable shelves
- » Secure locks
- » Tough powder coated finish
- » Cupboard shelves have a UDL of 50kg



DOOR COLOUR OPTIONS

- Green
- Grey
- Blue
- Yellow
- Light Blue
- Red

specify when ordering



Overall Size H x W x D mm	No of Shelves	Cupboard		Extra Shelf	
		Model	Price	Model	Price
700 x 350 x 300	2	VDOR073530	£329.05	-	-
700 x 900 x 450	2	VDOR079045	£502.75	VDOR0945ES	£50.00
900 x 460 x 450	2	VDOR094645	£381.70	VDOR0445ES	£38.20
900 x 900 x 450	2	VDOR099045	£584.30	VDOR0945ES	£50.00
1200 x 900 x 450	2	VDOR129045	£673.80	VDOR0945ES	£50.00
1800 x 900 x 450	3	VDOR189045	£814.55	VDOR0945ES	£50.00
1800 x 1200 x 450	3	VDOR181245	£927.70	VDOR1245ES	£57.90

Lockers, Cupboards & Cloakroom

Security Cupboards

- » Provide an extra level of security for the storage of high value equipment & materials
- » Welded all steel structure for extra strength
- » Seven lever safe lock for high security
- » Full length heavy duty hinges with concealed fixings to prevent forced entry
- » Adjustable powder coated shelves
- » Powder coated with Germ Guard Active Technology anti-bacterial paint
- » Made from 1.5mm powder coated mild steel
- » Reaction to Fire Classification EN 13501-1



Full length H.D. hinges



7 Lever Safe Lock



COLOUR OPTIONS

- Red
 - Blue
 - Grey
 - Green
 - Light Blue
 - Yellow
- specify when ordering*



Overall Size H x W x D mm	No of Shelves	Security Cupboards		Extra Shelves	
		Model	Price	Model	Price
900 x 460 x 460	1	SC094646	£739.55	SC4646ES	£44.75
1200 x 900 x 460	2	SC120946	£1030.35	SC0946ES	£69.75
1200 x 1200 x 460	2	SC121246	£1572.40	SC1246ES	£97.40
1800 x 900 x 460	3	SC180946	£1584.25	SC0946ES	£69.75
1800 x 1200 x 460	3	SC181246	£1935.55	SC1246ES	£97.40

Utility Cupboards

- » "No Snag" handles with 2-point locking
- » Strengthened doors
- » Central divider with removable rail on one side & 3 adjustable shelves on the other
- » Reaction to Fire Classification EN 13501-1



COLOUR OPTIONS

- Light Grey
- Light Blue
- Dark Blue
- Green
- Red
- Yellow



Overall Size H x W x D mm	No of Shelves	Model	Price
1800 x 900 x 450	3	UCU180945Z	£533.00
1800 x 1200 x 450	3	UCU181245Z	£702.75

Extra Shelves		
To Fit W x D mm	Model	Price
900 x 450	UCU0945ES	£30.30
1200 x 450	UCU1245ES	£32.90

Stainless Steel Cupboards

- » Corrosion resistant; ideal for food, pharmaceutical & medical environments - where damp is a factor
- » 'No snag' handles with 2-point locking
- » Adjustable stainless steel shelves



STSC180946

Static Cupboards

Overall Size H x W x D mm	No of Shelves	Model	Price
900 x 460 x 460	1	STSC090446	£850.10
900 x 900 x 460	1	STSC090946	£1072.45
1200 x 900 x 460	2	STSC120946	£1297.45
1800 x 900 x 460	3	STSC180946	£1631.65
1800 x 1200 x 460	3	STSC181246	£2139.50

Extra Shelves

To Fit W x D mm	Model	Price
900 x 460	STSC0946ES	£139.50
1200 x 460	STSC1246ES	£157.90

Utility Cupboards

- » Made from robust, high quality plastic
- » Ideal for many applications; kitchens/cafeterias, janitorial closets, schools, offices etc
- » Anti-wear steel hinges that provide a snap closure
- » Hygienic - easy to clean



CLD1634



CLD163U



FROM ONLY
£101.35



CLD163T

INFORMATION



Ideal for many applications; kitchens, cafeterias, schools, offices etc



CLD084D



CLT084T

Doors	Features	Overall Size H x W x D mm	Weight kg	Model	Price
Compact Cupboard					
Double	1 Shelf	840 x 680 x 370	9	CLD084D	£101.35
Triple		840 x 1020 x 370	14.5	CLT084T	£151.30
Large Cupboard					
Double	3 Shelves	1630 x 680 x 370	17	CLD1634	£171.25
Triple		1630 x 1020 x 370	22	CLD163T	£246.85
Utility Cupboard					
Double	3 Half Shelves	1630 x 680 x 370	17	CLD163U	£171.25

Lockers, Cupboards & Cloakroom

Cloakroom Equipment

- » Triple lacquered 70 x 32mm hardwood timber slats with radiused edges fitted to a steel seat support frame
- » Frames come complete with floor fixing brackets on each leg
- » Durable grey plastic coated frame doesn't chip whilst giving a softer & more durable finish - alternative colours are available in a powder coated finish - please call for details
- » Virtually unbreakable 'toughhooks' in mid-grey. Other colours available - call for details

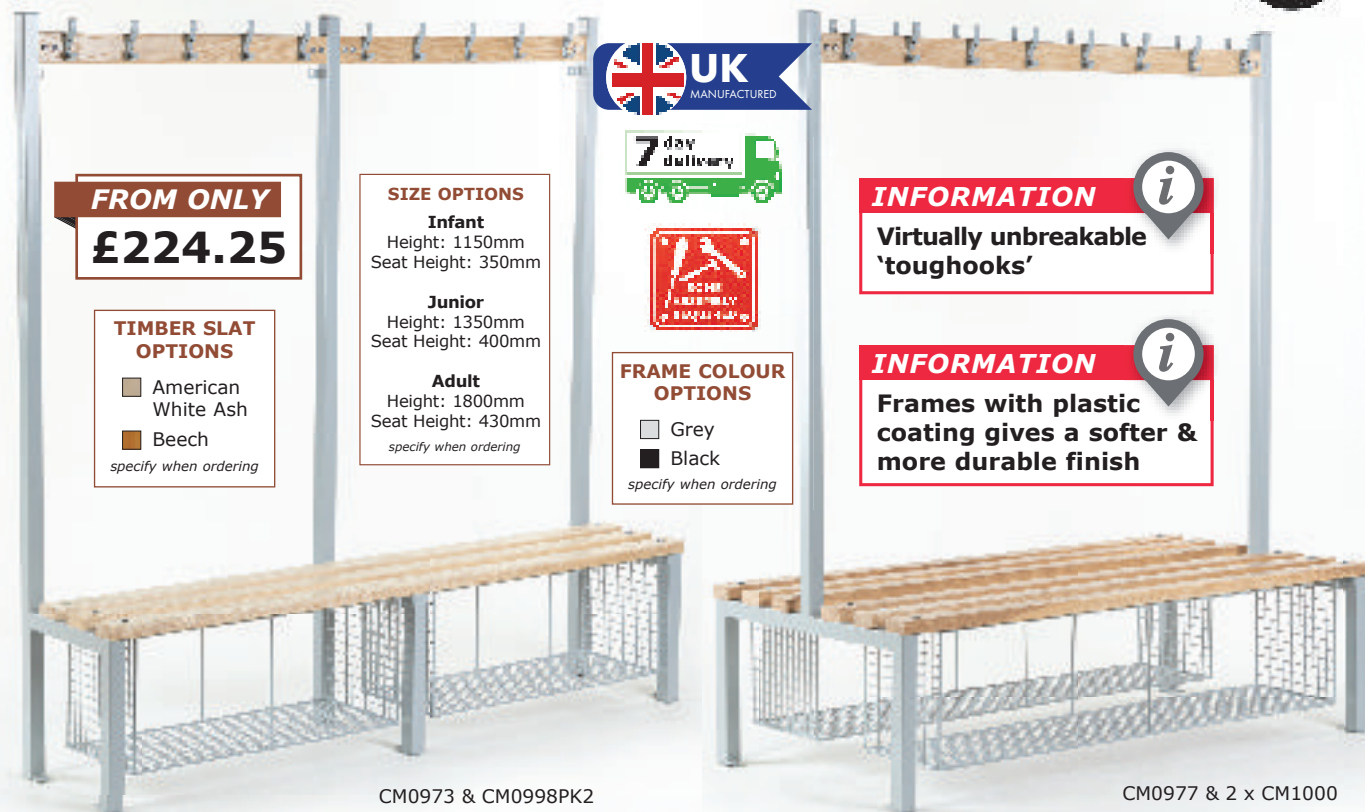

FROM ONLY
£224.25

TIMBER SLAT OPTIONS

- American White Ash
- Beech

specify when ordering

SIZE OPTIONS

Infant
Height: 1150mm
Seat Height: 350mm

Junior
Height: 1350mm
Seat Height: 400mm

Adult
Height: 1800mm
Seat Height: 430mm

specify when ordering

UK MANUFACTURED

7 day delivery

SOFT TOUCH

FRAME COLOUR OPTIONS

- Grey
- Black

specify when ordering

INFORMATION

Virtually unbreakable 'toughhooks'

INFORMATION

Frames with plastic coating gives a softer & more durable finish

CM0973 & CM0998PK2

CM0977 & 2 x CM1000

Single Sided Cloakroom Units

Length mm	Depth mm	No of Hooks	Leg Sets	Single Sided Bench	
				Model	Price
1000	400	5	2	CM0970	£224.25
1200	400	6	2	CM0971	£239.70
1500	400	8	2	CM0972	£274.66
1800	400	10	3	CM0973	£344.75

Double Sided Cloakroom Units

Length mm	Depth mm	No of Hooks	Leg Sets	Double Sided Bench	
				Model	Price
1000	760	10	2	CM0975	£359.88
1200	760	12	2	CM0976	£384.51
1500	760	16	2	CM0977	£435.67
1800	760	20	3	CM0978	£538.65

Cloakroom Bench

- » Triple lacquered 70 x 32mm hardwood timber slats
- » Durable grey plastic coated frame doesn't chip whilst giving a softer & more durable finish
- » Complete with floor fixing brackets on each leg



CM0966

INFORMATION

Timber slats have smooth radiused edges

Shoe Baskets/Shoe Shelves to suit Bench/Cloakroom

- » Grey LDPE dip plastic coated baskets which can be fitted to either the Cloakroom units above or the Cloakroom Benches shown to the left



CM0966 & CM1002SB8

Length mm	Leg Sets	300mm Deep Bench		400mm Deep Bench	
		Model	Price	Model	Price
1000	2	CM0966	£138.38	CM0966XL	£157.88
1200	2	CM0967	£145.85	CM0967XL	£175.07
1500	2	CM0968	£166.05	CM0968XL	£194.75
1800	3	CM0969	£214.39	CM0969XL	£242.37

To Suit Length mm	Shoe Baskets to Suit Bench/Cloakroom			Shoe Shelves to Suit Bench/Cloakroom	
	Model	Compartments	Price	Model	Price
1000	CM1001SB6	6	£94.62	CM0998	£75.93
1200	CM1002SB8	8	£112.76	CM0999	£81.42
1500	CM1003SB10	10	£150.99	CM1000	£92.61
1800	CM1001SB6PK2	12	£189.27	CM0998PK2	£154.91

ECO Cloakroom Equipment

- >> 100% recycled 100 x 30mm plastic slats
- >> Frames come complete with floor fixing brackets on each leg
- >> Durable plastic coated frame doesn't chip whilst giving a softer & more durable finish - please specify when ordering
- >> Virtually unbreakable 'toughhooks' in mid-grey. Other colours available - call for details



FROM ONLY
£219.93

PRICES HELD

INFORMATION

Virtually unbreakable 'toughhooks'

INFORMATION

Frames with plastic coating gives a softer & more durable finish

FRAME COLOUR OPTIONS

- Grey
- Black

specify when ordering



CM0976ECO & 2 x ECO1200BASKET

Single Sided Cloakroom Units

Length mm	Depth mm	No of Hooks	Leg Sets	Single Sided Bench	
				Model	Price
1000	400	5	3	CM0970ECO	£219.93
1200	400	6	3	CM0971ECO	£237.12
1500	400	8	4	CM0972ECO	£276.55
1800	400	10	5	CM0973ECO	£363.68

Double Sided Cloakroom Units

Length mm	Depth mm	No of Hooks	Leg Sets	Double Sided Bench	
				Model	Price
1000	760	10	3	CM0975ECO	£360.18
1200	760	12	3	CM0976ECO	£384.58
1500	760	16	4	CM0977ECO	£435.22
1800	760	20	5	CM0978ECO	£542.15

Cloakroom Bench

- >> 100% recycled 100 x 30mm plastic slats
- >> Frames come complete with floor fixing brackets on each leg
- >> Durable grey plastic coated frame doesn't chip whilst giving a softer & more durable finish



CM0966ECO



Shoe Baskets/Shoe Shelves to suit ECO Bench/Cloakroom

- >> Grey LDPE dip plastic coated baskets which can be fitted to either the Cloakroom units above or the Cloakroom Benches shown to the left



CM0969ECO & ECO1800BASKET



Length mm	Depth mm	Leg Sets	Model	Price
1000	325	3	CM0966ECO	£136.44
1200		3	CM0967ECO	£148.48
1500		4	CM0968ECO	£163.35
1800		5	CM0969ECO	£213.19

To Suit Length mm	Shoe Baskets to Suit ECO Bench/Cloakroom			Shoe Shelves to Suit ECO Bench/Cloakroom	
	Model	Compartments	Price	Model	Price
1000	ECO1000BASKET	8	£112.76	ECO1000SHELF	£75.93
1200	ECO1200BASKET	8	£118.80	ECO1200SHELF	£81.42
1500	ECO1500BASKET	12	£169.14	ECO1500SHELF	£112.76
1800	ECO1800BASKET	12	£179.18	ECO1800SHELF	£120.79

Lockers, Cupboards & Cloakroom

Cloakroom Equipment

- » Manufactured from 304 grade stainless steel with 40mm square legs
- » Sturdy aluminium or stainless steel coat hooks
- » Seat height: 450mm
- » Laminate seats are available in blue or light grey - please specify when ordering
- » Floor fixings, shoe racks, 316 marine grade finish & mono benches are available - call for details
- » Aqua solo benches are most suitable as a perimeter bench. Floor fixing cleats are available for added stability



STD15X in Blue



ASTS15X



Aqua Solo Benches - Stainless Steel Slats & Hooks

Length mm	Depth mm	No of Hooks	Leg Sets	Single Sided Bench	
				Model	Price
1000	400	5	2	ASTS10X	£834.24
1500	400	7	2	ASTS15X	£975.36
2000	400	10	2	ASTS20X	£1111.09
2500	400	12	3	ASTS25X	£1529.08
3000	400	14	3	ASTS30X	£1670.20

Aqua Solo Benches - Laminate Seats & SAA Hooks

Length mm	Depth mm	No of Hooks	Leg Sets	Single Sided Bench	
				Model	Price
1000	400	5	2	STS10X	£837.85
1500	400	7	2	STS15X	£1004.32
2000	400	10	2	STS20X	£1145.45
2500	400	12	3	STS25X	£1606.89
3000	400	14	3	STS30X	£1793.26

Aqua Duo Benches - Stainless Steel Slats & Hooks

Length mm	Depth mm	No of Hooks	Leg Sets	Double Sided Bench	
				Model	Price
1000	800	10	2	ASTD10X	£1243.16
1500	800	14	2	ASTD15X	£1485.66
2000	800	20	2	ASTD20X	£1751.63
2500	800	24	3	ASTD25X	£2388.61
3000	800	28	3	ASTD30X	£2638.29

Aqua Duo Benches - Laminate Seats & SAA Hooks

Length mm	Depth mm	No of Hooks	Leg Sets	Double Sided Bench	
				Model	Price
1000	800	10	2	STD10X	£1239.55
1500	800	14	2	STD15X	£1567.09
2000	800	20	2	STD20X	£1834.89
2500	800	24	3	STD25X	£2538.79
3000	800	28	3	STD30X	£2893.46

Aqua Mezzo Stainless Steel Benches with Laminate Seats

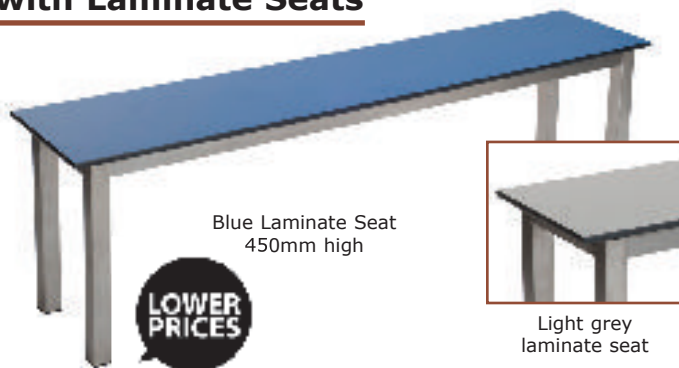

Blue Laminate Seat
450mm high

Light grey
laminate seat



Length mm	Depth mm	Legs Sets	Basic Bench	
			Model	Price
1000	325	2	ST10	£506.69
1500	325	2	ST15	£627.92
2000	325	2	ST20	£749.14
2500	325	3	ST25	£1038.67
3000	325	3	ST30	£1183.46

Aqua Mezzo Stainless Steel Benches with Stainless Steel Slats



Stainless Steel Slats
450mm high



Length mm	Depth mm	Legs Sets	Basic Bench	
			Model	Price
1000	325	2	AST10	£512.13
1500	325	2	AST15	£586.29
2000	325	2	AST20	£716.57
2500	325	3	AST25	£995.26
3000	325	3	AST30	£1092.98

Plastic Cloakroom Equipment

- » Moisture resistant heavy duty plastic that will never rust, rot or corrode
- » Constructed from plastic & aluminium
- » Benches are fully demountable for storage
- » Can be fixed to the floor or supplied with adjustable feet - call for details
- » Can be supplied with standard or theft-proof hangers - call for details



COLOUR OPTIONS

- Beige
- Red
- Blue
- Grey

specify when ordering

LOWER PRICES

Single Standard Bench
O/H 450mm

Size L x D mm	Model	Price
1000 x 400	B1040S	£120.12
1200 x 400	B1240S	£133.83
1500 x 400	B1540S	£167.15
1800 x 400	B1840S	£204.71
2000 x 400	B2040S	£211.75

Double Standard Bench
O/H 450mm

Size L x D mm	Model	Price
1000 x 800	B1080D	£198.44
1200 x 800	B1280D	£210.29
1500 x 800	B1580D	£272.40
1800 x 800	B1880D	£330.91
2000 x 800	B2080D	£342.72

Single Coat Bench
O/H 1800mm

Size L x D mm	No of Hooks	Model	Price
1000 x 400	6	C1040S	£190.20
1200 x 400	7	C1240S	£201.36
1500 x 400	9	C1540S	£254.40
1800 x 400	11	C1840S	£312.53
2000 x 400	12	C2040S	£322.53

Double Coat Bench
O/H 1800mm

Size L x D mm	No of Hooks	Model	Price
1000 x 800	12	C1080D	£357.41
1200 x 800	14	C1280D	£378.33
1500 x 800	18	C1580D	£440.64
1800 x 800	22	C1880D	£469.76
2000 x 800	24	C2080D	£490.99

Wall Rack

» Available in matching colours



Length mm	Depth mm	No of Hooks	Model	Price
1000	40	6	WR1000	£45.43
1200	40	7	WR1200	£51.25
1500	40	9	WR1500	£66.53
1800	40	11	WR1800	£81.03
2000	40	12	WR2000	£87.16

Pool & Sports Equipment



Sports Storage Pen
Designed to hold pool noodles, floats or sporting equipment for easy access. Mobile on 4 castors (2 braked)

Size L x W x H mm	Model	Price
800 x 800 x 850	SPN080	£294.97



Sports Storage Trolley
Ideal for pool or sports equipment. Designed to never rust, rot or corrode. Mobile on 4 castors (2 braked)

Size L x W x H mm	Model	Price
1200 x 600 x 1645	STR120	£294.68



Sports Storage with Lid
Easy open lid for safe storage. Can be fitted with a lock on request. Mobile on 4 castors (2 braked)

Size L x W x H mm	Model	Price
1044 x 690 x 850	SLD1044	£435.96



Lockable Sports Storage Cage
Includes 2 adjustable shelves & 2 lockable doors. Mobile on 4 castors (2 braked)

Size L x W x H mm	Model	Price
1200 x 700 x 1920	SCG120	£937.97

Small Parts Storage & Containers

kbins

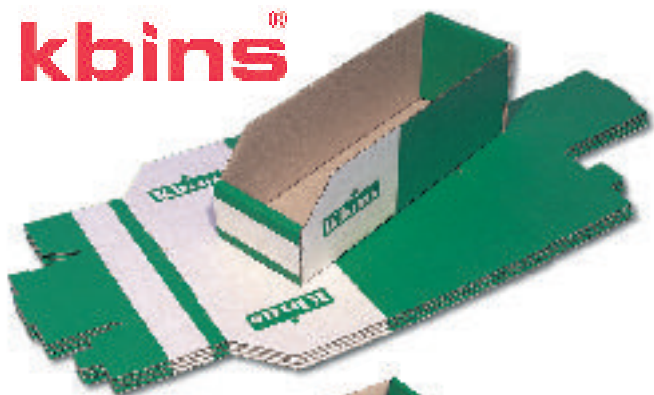

PRICES HELD

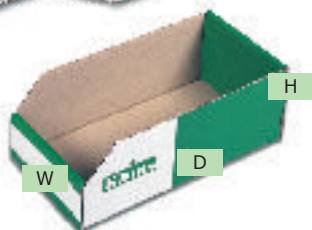

Corrugated Cardboard Storage Bins

- › Manufactured from fully recyclable cardboard
- › Economical storage solutions
- › Supplied flat packed for easy assembly
- › Extensive range of sizes available, all ex-stock

K-Bins are supplied in flat form, saving valuable space prior to use. They are self-locking & assembled in seconds. All bin dimensions shown are external measurements, designed to fit metric & imperial shelf sizes to maximise the use of available space.

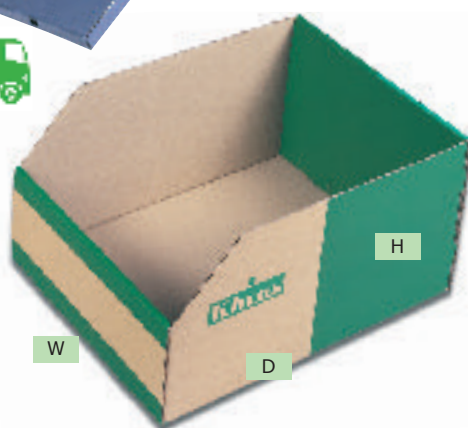

RANGE A - PACKS OF 50 ALL 100MM HIGH



Width mm	Model	Price per pk 50
50	A1505	£38.30
75	A1507	£39.50
100	A1510	£40.30
150	A1515	£46.30



Width mm	Model	Price per pk 50
50	A2005	£42.20
75	A2007	£42.60
100	A2010	£43.20
150	A2015	£50.90
200	A2020	£53.70

**A3010
BESTSELLER
£43.20**



Width mm	Model	Price per pk 50
50	A3005	£42.20
75	A3007	£42.60
100	A3010	£43.20
150	A3015	£50.90
200	A3020	£53.70
250	A3025	£60.70

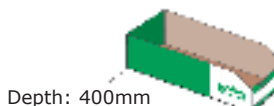

Width mm	Model	Price per pk 50
100	A4010	£52.80
150	A4015	£57.70
200	A4020	£63.30
250	A4025	£65.90

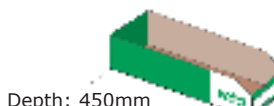

Width mm	Model	Price per pk 50
100	A4510	£55.30
150	A4515	£60.40
200	A4520	£66.30

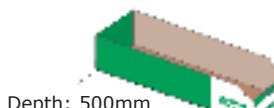

Width mm	Model	Price per pk 50
100	A5010	£62.20
150	A5015	£67.50
200	A5020	£73.10

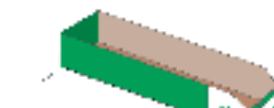

Width mm	Model	Price per pk 50
100	A6010	£66.50
150	A6015	£70.60
200	A6020	£76.60

RANGE B - PACKS OF 25 ALL 200MM HIGH



Width mm	Model	Price per pk 25
150	B3015	£63.80
200	B3020	£67.50
300	B3030	£72.90



Width mm	Model	Price per pk 25
150	B4015	£67.40
200	B4020	£68.40
250	B4025	£69.80
300	B4030	£74.10



Width mm	Model	Price per pk 25
150	B4515	£69.80
200	B4520	£72.00
250	B4525	£73.30
300	B4530	£75.80



Width mm	Model	Price per pk 25
200	B5020	£73.20
250	B5025	£75.20
300	B5030	£77.40

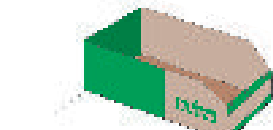

Width mm	Model	Price per pk 25
150	B6015	£72.10
200	B6020	£75.30
250	B6025	£78.50
300	B6030	£80.80

Bioplastic Shelf Bins

Why is bioplastic better for the environment than classic plastic?

When we use renewable raw materials such as wood, which absorbs CO2 during its life, at the end of the production process, more carbon dioxide can be retained than is released into the atmosphere during production. The end product can thus be carbon neutral or carbon negative.

- >> Reduce the environmental impact of industry
- >> Reduce the use of non-renewable resources
- >> Positively affect our planet's well-being



HOW A TREE IS TRANSFORMED INTO AN INDUSTRIAL BIOPLASTIC STORAGE BIN



INFORMATION
Think further.
Act greener



Bioplastic Shelf Bins

Bin	External Dimensions W x D x H mm	Internal Dimensions W x D x H mm	Capacity Litres	Quantity/ package	Model	Price
	92 x 300 x 82	75 x 257 x 70	1.3	30	3010-7 BIOX	£353.28
	92 x 400 x 82	75 x 357 x 70	1.9		4010-7 BIOX	£419.82
	92 x 500 x 82	75 x 457 x 70	2.4		5010-7 BIOX	£545.01
	186 x 300 x 82	167 x 257 x 70	3	15	3020-7 BIOX	£270.79
	186 x 400 x 82	167 x 357 x 70	4.2		4020-7 BIOX	£301.83
	186 x 500 x 82	167 x 457 x 70	5.3		5020-7 BIOX	£371.63

Accessories

Label	Max Amount/bin	Model	Price
1792	4 pcs	D-10 BIOX	£14.41
	6 pcs		
	8 pcs		
	4 pcs	D-20 BIOX	£26.99
	6 pcs		
	8 pcs		

Small Parts Storage & Containers

Shelf Bins

- » Available in four widths & depths & two heights
- » Bin stop available to prevent removal
- » Environmentally friendly recyclable bins
- » Colour: Blue
- » Open front for easy viewing of contents
- » Optimised for shelving - *NO WASTED SPACE*
- » Label holder for improved logistics
- » Anti-static bins available - *please ask for details*



Bin Stop



Showing Open Front & Dividers



Extra Re-inforced Bottom

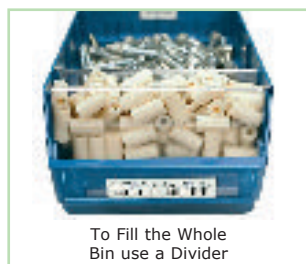

To Fill the Whole Bin use a Divider



Labelling



Shelf Bin



Curved Dividers Facilitate Selection

INFORMATION
Call for more details



Labels (with holder) only available in packs of 100
Model: **LABSTD**
Price: **£22.20 per pack**

Accessories

Description	Overall Size H x W mm	Model	Price each	Per Pack	
				Quantity	Price
Bin Stop	40 x 80	508	£0.40	50	£20.00
Divider	95 x 90	P09	£0.43	50	£21.50
	95 x 120	P12	£0.50	50	£25.00
	95 x 180	P18	£0.85	25	£21.25
	95 x 240	P24	£1.05	25	£26.25
	150 x 240	P24-15	£1.38	10	£13.80

Overall Size H x W x D mm	Model	Price each	Per Pack	
			Quantity	Price
95 x 90 x 300	3009	£2.93	40	£117.20
95 x 120 x 300	3012	£3.25	30	£97.50
95 x 180 x 300	3018	£4.25	20	£85.00
95 x 240 x 300	3024	£4.60	15	£69.00

Overall Size H x W x D mm	Model	Price each	Per Pack	
			Quantity	Price
95 x 90 x 400	4009	£3.73	40	£149.20
95 x 120 x 400	4012	£4.35	30	£130.50
95 x 180 x 400	4018	£5.05	20	£101.00
95 x 240 x 400	4024	£5.98	15	£89.70
150 x 240 x 400	4024/15	£8.75	10	£87.50

Overall Size H x W x D mm	Model	Price each	Per Pack	
			Quantity	Price
95 x 90 x 500	5009	£4.50	40	£180.00
95 x 120 x 500	5012	£5.13	30	£153.90
95 x 180 x 500	5018	£5.90	20	£118.00
95 x 240 x 500	5024	£7.43	15	£111.45
150 x 240 x 500	5024/15	£10.35	10	£103.50

Overall Size H x W x D mm	Model	Price each	Per Pack	
			Quantity	Price
95 x 120 x 600	6012	£6.23	30	£186.90
95 x 240 x 600	6024	£8.08	15	£121.20
150 x 240 x 600	6024/15	£12.13	10	£121.30

Small Parts Storage & Containers

Eco Bins

» Stackable parts bins for use on panels, shelves or stacking

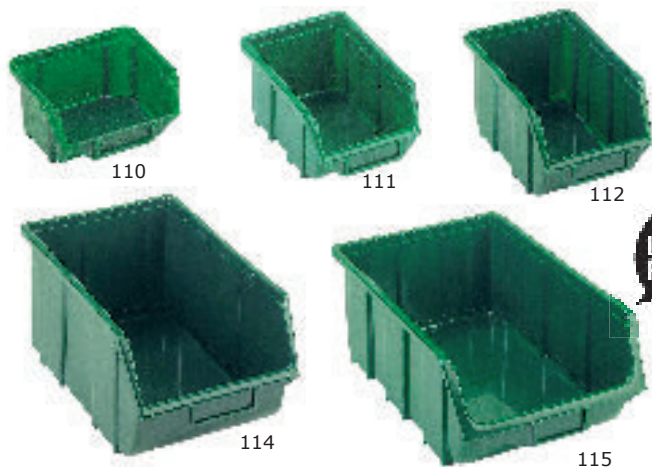

LOWER PRICES

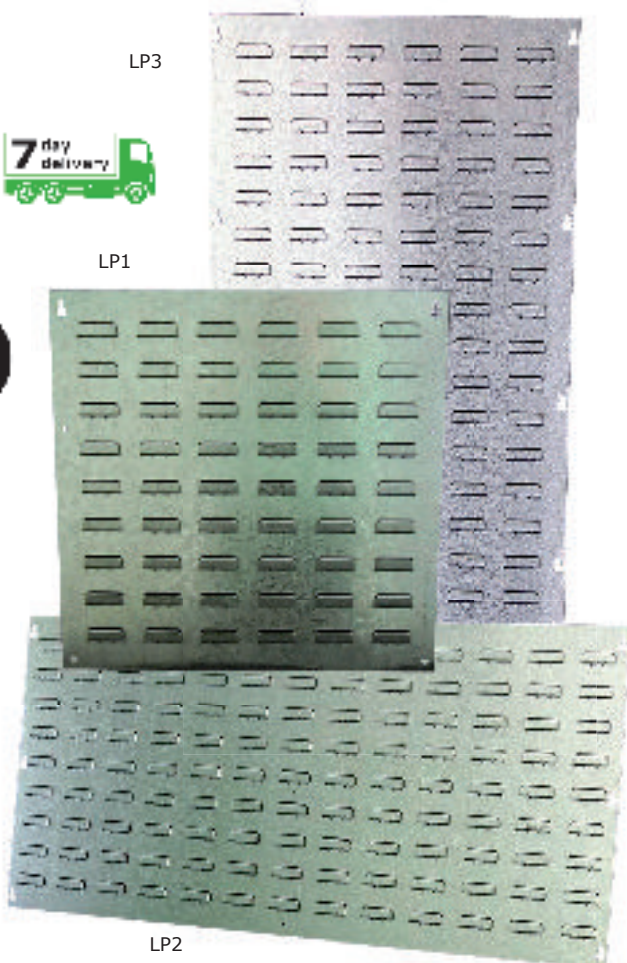

Overall Size W x D x H mm	Colours	Model	Price each	Per Pack	
				Quantity	Price
Eco Bins					
109 x 100 x 53	Red, Blue, Green	Eco110	£0.83	40	£33.20
111 x 168 x 76	Red, Blue, Green	Eco111	£1.26	60	£75.60
160 x 250 x 129	Red, Blue, Green	Eco112	£2.71	30	£81.30
220 x 355 x 167	Red, Blue, Green	Eco114	£5.70	10	£57.00
333 x 505 x 187	Red, Blue, Green	Eco115	£12.77	4	£51.08
Galvanised Backplates					
500 x 500	-	EcoLP1	£19.81	-	-
1000 x 500	-	EcoLP2	£34.37	-	-
500 x 1000	-	EcoLP3	£34.37	-	-

Supra Bins

- » Large heavy duty bin with a strong heavy duty reinforced base, sides and stacking rim
- » Resistant to most industrial solvents
- » Designed so that they can stack one on top of each other
- » Open front design allows clear access to contents and all bins have space on the front for labelling
- » Bins sit flush on top of each other and a stopper prevents the stacked bins from shifting forward

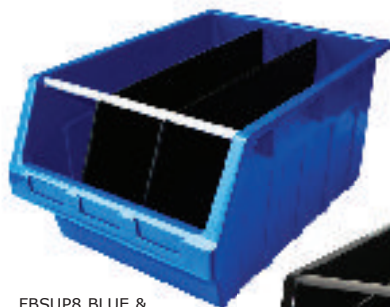

FBSUP8 BLUE & FBSUP8 DIV x 2

INFORMATION
 Create your own strong & stable freestanding storage system



FBSUP8 RECY

Description	Overall Size H x W x D mm	Model	Price each
Supra Bin Black	300 x 425 x 600	FBSUP8 RECY	£12.74
Supra Bin Blue	300 x 425 x 600	FBSUP8 BLUE	£14.97
Supra Bin Divider		FBSUP8 DIV	£3.21

LOWER PRICES

FBSUP8 BLUE x 15

Lower Value Orders May Incur a Handling Charge

Small Parts Storage & Containers

XSTORE Bin

- » Versatile stacking & nesting containers
- » Ideal for industrial or domestic use
- » Large picking space when stacked
- » This range is manufactured from 100% reprocessed polypropylene. Formed from recycled sources, it does not reduce the quality of mechanical properties of the containers



INFORMATION

Ideal for picking wall functionality



20 x XSTORE Grey



XSTORE Black

COLOUR OPTIONS

- Black
- Grey

specify when ordering



Overall Size H x W x D mm	Pack Qty	Cap. L	Model	Price per pack 1 to 9 off	Price per pack 10 to 19 off	Price per pack 20+ off
320 x 490 x 390	5	50	XSTORE	£69.50	£64.80	£60.20



Louvre Panel Wall Kits

- » Wall fixed units make for efficient container storage & product access
- » These units come complete with containers
- » Containers now come inclusive with ID Label Card



ECOWALLKIT 32



ECOWALLKIT 24



Panel Size H x W mm	Containers	Model	Price Each
438 x 914	32 XL2	ECOWALLKIT 32	£98.99
641 x 914	24 XL3	ECOWALLKIT 24	£121.00

Econotainers

- » Our Econotainer range is manufactured from 100% reprocessed polypropylene. Formed from recycled sources, it does not reduce the quality of mechanical properties of the containers. As these are made from recycled materials, there may be a difference in the shade of grey supplied
- » The design incorporates a sturdy base & sides with reinforced front & rims
- » Safe stacking with instant access to contents
- » Compatible for use with louvre panels, shelving, trolleys & benches
- » Containers now come inclusive with ID Label Card

FROM ONLY

£0.78_{each}



DISCOUNTS AVAILABLE FOR VOLUME ORDERS

Overall Size H x W x D mm	Pack Qty	Cap. Litres	Model	Price per pack 1 to 9 off	Price per pack 10 to 19 off	Price per pack 20+ off
50 x 100 x 90	20	0.46	XL1	£20.40	£17.40	£15.60
75 x 100 x 165	20	1.27	XL2	£27.20	£23.60	£20.40
125 x 150 x 240	10	4.6	XL3	£30.60	£26.00	£23.00
125 x 200 x 355	10	9.1	XL4	£37.20	£33.20	£31.40
175 x 200 x 355	10	12.8	XL5	£57.30	£42.90	£37.20
180 x 420 x 370	5	28.3	XL6	£53.70	£40.70	£35.20
200 x 310 x 520	5	31.4	XL7	£66.35	£46.45	£43.15

INFORMATION
100% recycled
polypropylene containers



Small Parts Storage & Containers

Polypropylene Bins

kbins®

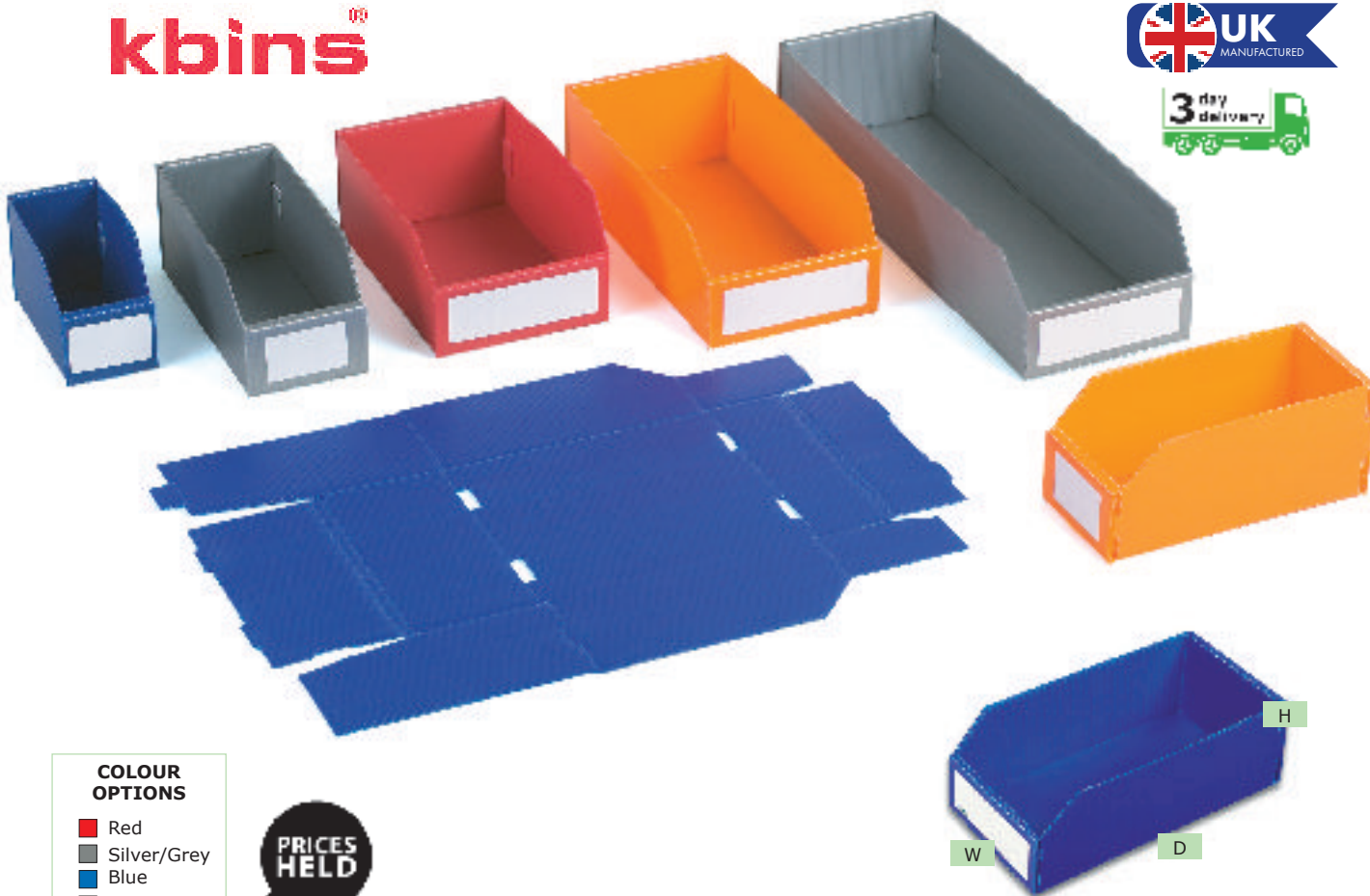

COLOUR OPTIONS

- Red
- Silver/Grey
- Blue
- Orange

specify when ordering



- » Manufactured from fully recyclable strong twinwall fluted polypropylene
- » Wipe clean surfaces (inside & out)
- » Oil, grease & moisture resistant
- » Resistant to most chemicals
- » Supplied flat packed for easy assembly
- » Long shelf life
- » 4 colour options available: red (RD), silver/grey (SG) blue (BE) or orange (OE) - *please specify when ordering please add the following letters to the code to indicate the colour(s) required:*

Red: RD Silver/Grey: SG Blue:BE Orange: OE



RANGE TPA ALL 100MM HIGH

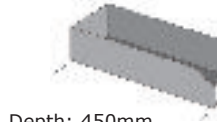
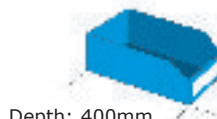
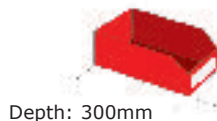
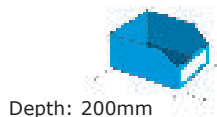

Width mm	Model	Price per pk 25
TPA15 - All Colours		
75	TPA1507	£28.50
TPA20 - Blue Only		
100	TPA2010	£31.70
150	TPA2015	£37.80
200	TPA2020	£42.30
TPA30 - Blue & Silver/Grey Only		
50	TPA3005	£32.60
75	TPA3007	£32.60
TPA30 - All Colours		
100	TPA3010	£36.80
150	TPA3015	£42.80
200	TPA3020	£49.00
TPA40 - Blue Only		
100	TPA4010	£44.10
150	TPA4015	£51.00
200	TPA4020	£57.00
TPA45 - Blue & Silver/Grey Only		
100	TPA4510	£44.10
150	TPA4515	£51.00
200	TPA4520	£57.00

Front Panel Self-adhesive labels - pack of 100

W x H mm	Fits	Model	Price per pk 100
41 x 66	TPA Bins up to 100mm wide	FPL1X100	£3.10
41 x 127	TPA Bins over 100mm wide	FPL2X100	£4.20

Galvanised Stacking Baskets

- » Strong welded construction from 25mm square wire mesh throughout with handgrips; heavy gauge stacking base frame & reinforced top rim; finish - hot dip galvanised; capacity - 75kg



PRICES HELD

INFORMATION



Give instant visibility to stock



Description	Overall Size H x W x D mm	Model	Price
Mesh on all Sides	400 x 300 x 200	GSBM4030	£96.65
Mesh on all Sides	500 x 400 x 300	GSBM5040	£129.05
Mesh on all Sides	600 x 400 x 400	GSBM6040	£158.55
Mesh on all Sides	800 x 600 x 500	GSBM8060	£254.20

Description	Overall Size H x W x D mm	Model	Price
1/2 Open Side	400 x 300 x 200	GSBO4030	£100.65
1/2 Open Side	500 x 400 x 300	GSBO5040	£135.50
1/2 Open Side	600 x 400 x 400	GSBO6040	£166.50
1/2 Open Side	800 x 600 x 500	GSBO8060	£266.80

'The Organiser' Carry Case

- » Ideal for all your D.I.Y. needs: nuts, bolts, fuses, screws etc
- » Complete with 18 individual removable containers which have their own divider & belt clip

**FROM ONLY
£16.70**



Individual containers complete with dividers & belt clip



MSC18H



MSC18H

Overall Size H x W x D mm	Weight kg	Model	Price (each) 1+	Price (each) Pack of 8
330 x 330 x 130	1.6	MSC18H	£23.10	£16.70



Rhino Tuff Plastic Bins

**FROM ONLY
£1.05p**

- » Slot dividers for bins ARTB30, 40, 50, 60 & 70
- » Full length rear lip for louvre panels
- » Reinforced side walls to stop spreading
- » Extra wide & reinforced stacking base
- » Moulded finger grips for greater comfort
- » Large label area for better identification (label provided)
- » Stop to prevent stacked bins slipping

PRICES HELD



5 day delivery



Overall Size W x D x H mm	Colour	Coloured		Grey	
		Model	Price	Model	Price
Plastic Bins					
106 x 106 x 49	Red, Blue or Yellow	ARTB05CO	£1.05	-	-
106 x 136 x 76	Red, Blue, Yellow or Grey	ARTB10CO	£1.27	ARTB10/GR	£1.16
106 x 187 x 76	Red, Blue, Yellow or Grey	ARTB20CO	£1.71	ARTB20/GR	£1.43
140 x 205 x 127	Red, Blue, Yellow or Grey	ARTB25CO	£3.31	ARTB25/GR	£2.76
140 x 274 x 127	Red, Blue, Yellow or Grey	ARTB30CO	£4.30	ARTB30/GR	£3.75
210 x 375 x 179	Red, Blue, Yellow or Grey	ARTB40CO	£10.09	ARTB40/GR	£8.38
280 x 457 x 254	Red, Blue, Yellow or Grey	ARTB50CO	£18.08	ARTB50/GR	£15.66
415 x 375 x 179	Blue	ARTB60CO	£17.36	-	-
415 x 460 x 292	Blue	ARTB70CO	£26.18	-	-

Overall Size W x D x H mm	Colour	Model	Price
Dividers			
274W x 127D	Black	ARTBDIV3	£1.21
375W x 179D	Black	ARTBDIV4	£1.93
457W x 254D	Black	ARTBDIV5	£3.36
370W x 179D	Black	ARTBDIV6	£1.93
460W x 292D	Black	ARTBDIV7	£3.58

Lower Value Orders May Incur a Handling Charge

Small Parts Storage & Containers

High Density Storage Cabinets

- » Freestanding storage units for use in workshop, stores & many other applications
- » A compact storage system, uses a floor area of only 0,25 m²
- » Robust construction: steel frame holding polypropylene bins
- » Backstops prevent the drawers from being pulled out of the frame
- » Steel frame in light grey RAL7035
- » Adjustable feet
- » Load capacity: 240kg (with castors 150kg)

INFORMATION 
Robust & space saving





ESD protected versions - please see below



2440-4840



Cabinet	Outer Size H x W x D mm	Bin Quantity	Bin Type	Model			Price	ESD Version - Black Bins		Divider Pack	
				Red	Blue	Grey		Model	Price	Model	Price
	870 x 605 x 410	24	4020	2440-5	2440-6	2440-3	£711.67	2440 ESD	£1056.09	Coloured D-20	£13.49
										ESD D-20-4-ESD	£20.69
	870 x 605 x 410	48	4010	4840-5	4840-6	4840-3	£787.57	4840 ESD	£1253.14	Coloured D-10	£6.86
										ESD D-10-4-ESD	£9.95
Castor Set	Set of 4 Castors (2 with Brake)			PS-LH			£166.75	PS-LH ESD	£238.54	-	-

Shelf Bins - Coloured & ESD Versions

- » Comprehensive range with depths of 300, 400, 500 & 600 mm
- » Specifically designed for standard metric shelving, automated storage systems & "kanban" trolleys
- » Smooth vertical sides allow maximum use of valuable shelf space.
- » Full width label with protective shield is included with the bin
- » Corrugated base for ease of picking items
- » Polypropylene withstands the effects of most oils, acids & solvents
- » Coloured bins of polypropylene (PP), temperature tolerance of -20 to +80°C.

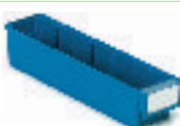
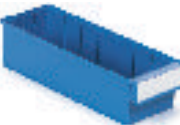
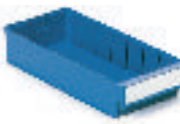

Bin	Outer Size H x W x D mm	Pack	Model			Price per pack	ESD Version - Black Bins		Divider Pack	Model	Price per pack
			Red	Blue	Grey		Model	Price per pack			
	82 x 92 x 300	30	3010-5	3010-6	3010-3	£176.65	3010-4ESD	£320.70	10	Coloured D-10	£6.86
	82 x 92 x 400		4010-5	4010-6	4010-3	£209.91	4010-4ESD	£349.51		ESD D-10-4-ESD	£9.95
	82 x 92 x 500		5010-5	5010-6	5010-3	£271.99	5010-4ESD	£458.58			
	100 x 132 x 300	30	3015-5	3015-6	3015-3	£243.18	-	-	10	Coloured D-15	£9.26
	100 x 132 x 400	20	4015-5	4015-6	4015-3	£195.28	4015-4ESD	£318.98		ESD D-15-4-ESD	£16.23
	100 x 132 x 500	15	5015-5	5015-6	5015-3	£232.54	5015-4ESD	£390.56			
	100 x 132 x 600	15	6015-5	6015-6	6015-3	£203.22	6015-4ESD	£345.05			
	82 x 186 x 300	15	3020-5	3020-6	3020-3	£135.14	3020-4ESD	£219.00	10	Coloured D-20	£13.49
	82 x 186 x 400		4020-5	4020-6	4020-3	£151.77	4020-4ESD	£242.32		ESD D-20-4-ESD	£20.69
	82 x 186 x 500		5020-5	5020-6	5020-3	£185.55	5020-4ESD	£311.27			
	82 x 186 x 600		6020-5	6020-6	6020-3	£205.97	6020-4ESD	£358.59			

Small Parts Storage & Containers

Bin Cabinets

- » Can be wall hung, stood on a worktop or used with space-saving turntables
- » Comprises steel frame, shelf bins, labels & backstops
- » Compact & robust



Cabinet	Type	Outer Size H x W x D mm	Bin Quantity	Model				Price	ESD Version - Black Bins		Divider Pack	
				Clear	Red	Blue	Grey		Model	Price	Model	Price
	Series 300	395 x 400 x 300	8	0830-1	0830-5	0830-6	0830-3	£171.92	0830 ESD	£261.58	D-20	£13.49
			16	1630-1	1630-5	1630-6	1630-3	£194.51	1630 ESD	£305.88	D-10	£6.86
	Series 400	395 x 400 x 400	8	0840-1	0840-5	0840-6	0840-3	£192.26	0840 ESD	£327.98	D-20	£13.49
			16	1640-1	1640-5	1640-6	1640-3	£221.66	1640 ESD	£390.15	D-10	£6.86

Turntable Assemblies

- » Easy assembly without tools
- » Compact storage systems for service, workshop, production & storage areas etc
- » Space saving & practical
- » Assemblies offer storage for up to 1,792 different items
- » This unit holds 16 bin cabinets of series 300 or 400 in four layers, which are ordered separately, see above
- » Steel frame in light grey RAL7035
- » Special offer kits include base unit, 8 x 8 drawer units & 8 x 16 drawer units
please specify colours when ordering

INFORMATION

Offers storage of up to 1792 separate items



Overall Size H x W x D mm	Load capacity	For cabinets (ordered separately)	Model	Price
1680 x 700 x 700	800 kg	0830/1630	16-300	£772.77
1680 x 800 x 800	800 kg	0840/1640	16-400	£838.32

**D16-300 KIT
£3884.93
D16-400 KIT
£4384.88**

Small Parts Storage & Containers

Visible Storage Cabinets

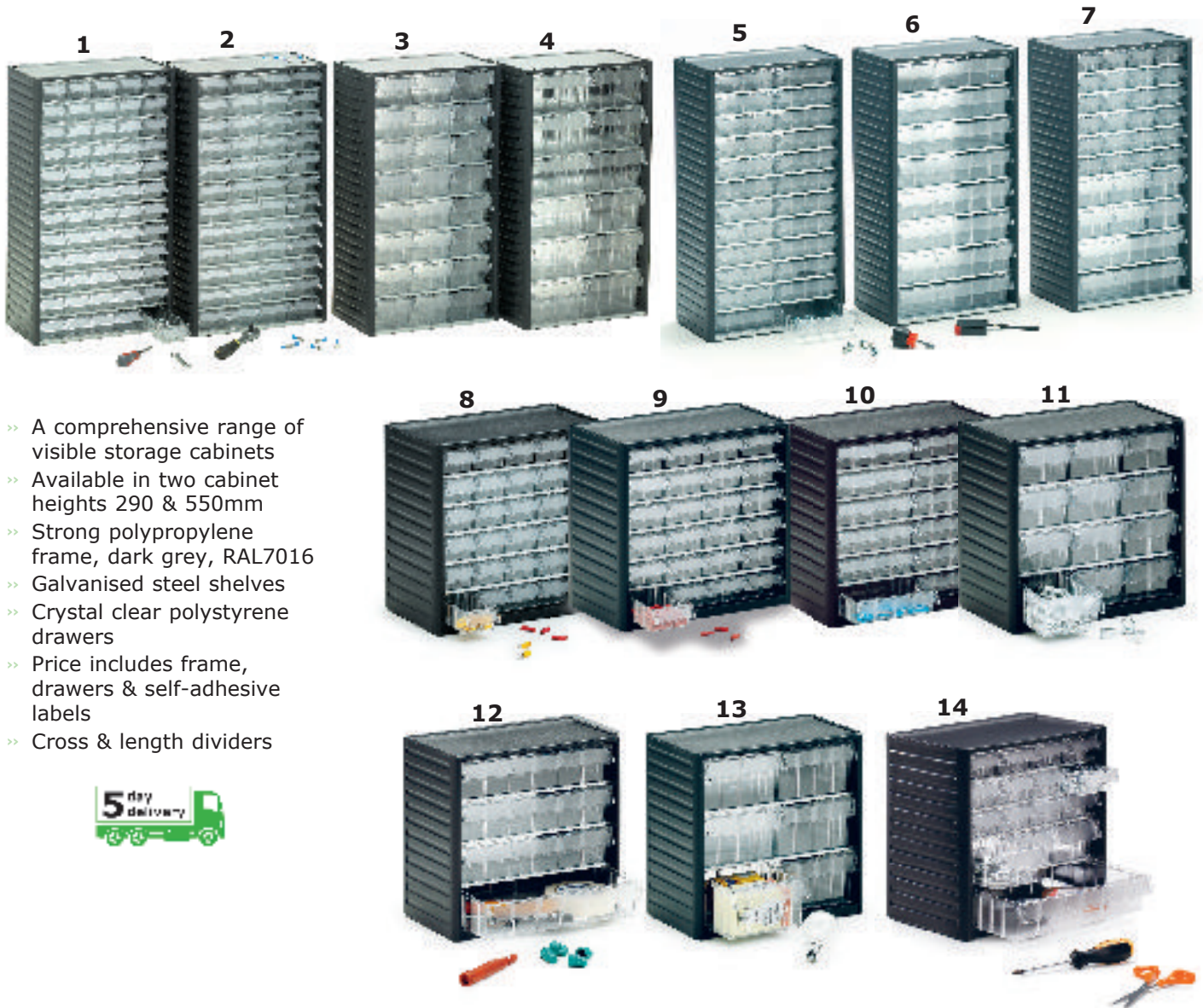

- >> A comprehensive range of visible storage cabinets
- >> Available in two cabinet heights 290 & 550mm
- >> Strong polypropylene frame, dark grey, RAL7016
- >> Galvanised steel shelves
- >> Crystal clear polystyrene drawers
- >> Price includes frame, drawers & self-adhesive labels
- >> Cross & length dividers



No	Frame Size H x W x D mmw	Clear Drawers		Model	Price
		Quantity	Type		
1	550 x 310 x 180	60 pcs	DL-00	D550-3	£99.98
2		48 pcs	DL-01	D551-3	£99.98
3		24 pcs	DL-04	D554-3	£90.76
4		12 pcs	DL-07	D557-3	£90.76
5		24 pcs	DL-02	D552-3	£99.98
6		8 pcs	DL-06	D556-3	£90.76
7		24 pcs, 6 pcs & 2 pcs	DL-01, DL-04 & DL-06	D550C-3	£99.98
8	290 x 310 x 180	30 pcs	DL-00	D290-3	£56.01
9		24 pcs	DL-01	D291-3	£56.01
10		12 pcs	DL-02	D292-3	£56.01
11		12 pcs	DL-04	D294-3	£51.30
12		4 pcs	DL-06	D296-3	£51.30
13		6 pcs	DL-07	D297-3	£51.30
14		12 pcs, 3 pcs & 1 pcs	DL-01, DL-04 & DL-06	D290C-3	£56.01

Extra/Replacement Clear Drawers				Cross Dividers			Length Dividers		
Outer dims H x W x D mm	Pack Size	Model	Price per Pack	Pack drawer	Model each	Price per pack	Pack pieces	Model pack	Price per pack
37 x 55 x 175	120	L-00-Pack	£162.00	10	V-00	£2.98	10	-	-
37 x 69 x 175	96	L-01-Pack	£150.72		V-01	£2.98		-	-
37 x 138 x 175	48	L-02-Pack	£143.04		V-02	£3.88		V-012	£6.29
59 x 92 x 175	45	L-04-Pack	£112.05		V-04	£3.88		V-0456	£6.86
59 x 277 x 175	15	L-06-Pack	£90.00		V-06	£9.95			
81 x 138 x 175	24	L-07-Pack	£98.88		V-07	£7.20			

ESD Protective Storage Systems

- » To complement ESD protected work environments
- » Steel frames have a semi conductive ESD powder coat finish grey
- » Shelf bins are made of semi conductive polypropylene
- » Dividers available please contact for more details

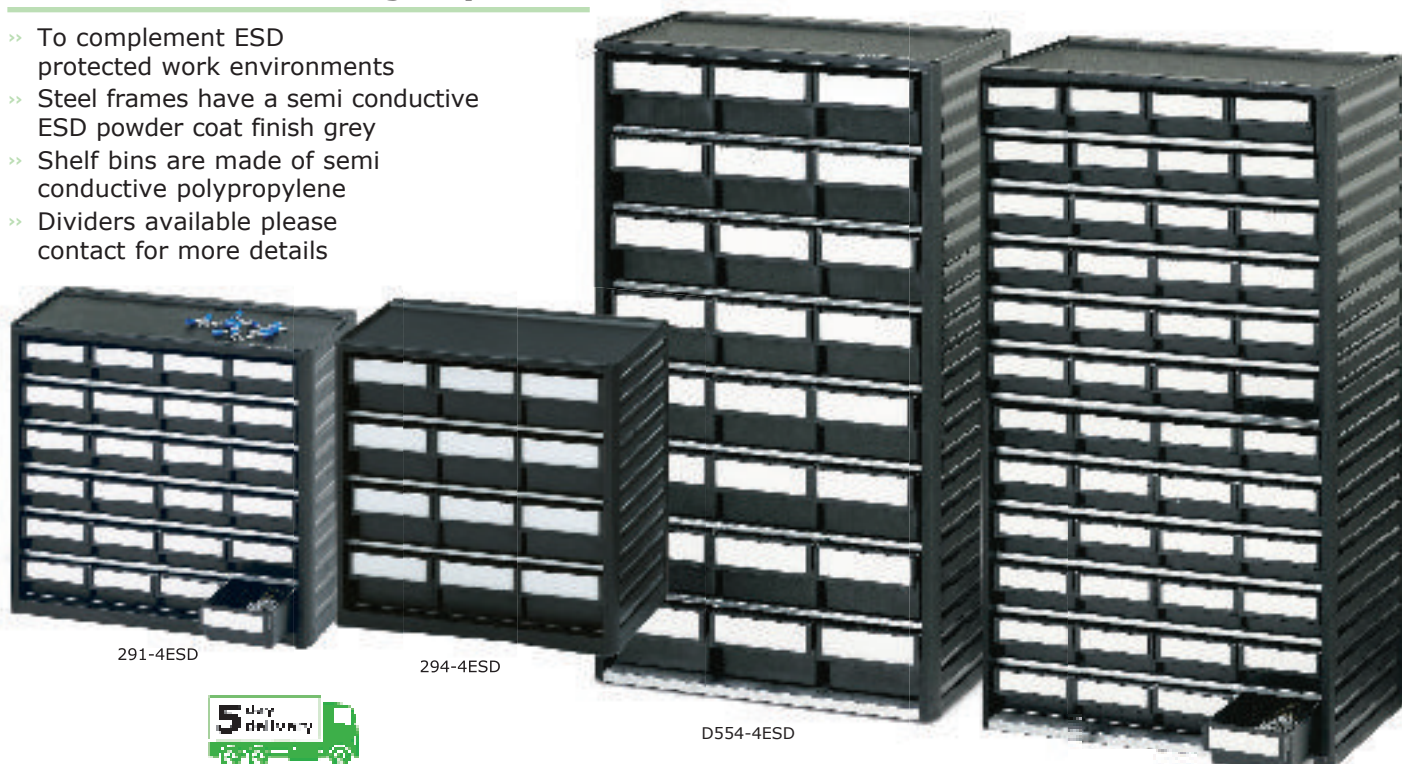

Frame Size H x W x D mm	Bins	Model	Price
290 x 310 x 180	24 pcs	291-4ESD	£131.61
	12 pcs	294-4ESD	£119.54
550 x 310 x 180	48 pcs	D551-4ESD	£205.07
	24 pcs	D554-4ESD	£175.98



Turntable Assemblies

- » Easy assembly without tools
- » Compact storage systems for service, workshop, production & storage areas etc
- » Space saving & practical
- » This unit holds 16 bin cabinets which are ordered separately
- » Steel frame in grey RAL7016
- » Special offer kits include base unit, 4 x 12 drawer units, 4 x 24 drawer units & 4 x 48 drawer units.
- » Special offer ESD kit includes base unit, 8 x 24 drawer units & 4 x 48 drawer units.



Standard Version

Overall Size H x W x D mm	Load capacity	For cabinets (ordered separately)	Model	Price
1730 x 500 x 500	400 kg	D551-3, D554-3 & D557-3	12-550	£384.56

ESD Version

Overall Size H x W x D mm	Load capacity	For cabinets (ordered separately)	Model	Price
1730 x 500 x 500	400 kg	D551-4ESD & D554-4ESD	12-550 ESD	£454.24

**Standard Version
12-550 KIT
£1056.68**

**ESD Version
12-550 ESD KIT
£2798.72**

Small Parts Storage & Containers

Compartment Storage Boxes

- >> Clear compartment boxes for storage of your components in a workshop, production or service area
- >> 4 locating holes on the back of each unit allows them to be hung on the wall



MSB64Z

FROM ONLY
£20.95

MSB24Z

MSB12Z



Description	Drawers	Drawer Size H x W x D mm	Overall Size H x W x D mm	Weight kg	Model	Price
12 Compartment Drawers	8 Small & 4 Large	Small	235 x 265 x 160	1	MSB12Z	£20.95
24 Compartment Drawers	24 Large	38 x 45 x 130	390 x 500 x 160	2.6	MSB24Z	£43.15
64 Compartment Drawers	64 Small	Large 53 x 107 x 130		3.2	MSB64Z	£48.00

Bin Rack

- >> This unit comes complete with 47 polypropylene bins; 32 small & 15 large:
Small Bins: 75H x 100W x 165D mm
Large Bins: 130H x 150W x 235D mm

GIL47Z

£234.15



INFORMATION



**Complete with
polypropylene bins**



GIL47Z

No of Bins	Overall Size H x W x D mm	Weight kg	Model	Price
47	1150 x 930 x 285	17	GIL47Z	£234.15

Bin Trolleys

**FROM ONLY
£258.30**



GIL46Y

GIL90Y

LOWER PRICES

GIL60Y



INFORMATION
Complete with polypropylene bins

- » These units come complete with polypropylene bins. GIL46Y comes with 30 medium bins & 16 large bins, the GIL60Y comes with 24 small bins, 20 medium bins & 16 large bins & the GIL90Y comes with 36 small bins, 30 medium bins & 24 large bins
- » Small Bins: 50H x 90W x 135D mm
Medium Bins: 100H x 120W x 175D mm
Large Bins: 120H x 150W x 240D mm
- » Mobile on 4 x 75mm swivel castors, 2 braked

No of Bins	Overall Size H x W x D mm	Weight kg	Model	Price
46	1120 x 660 x 560	20	GIL46Y	£258.30
60	1120 x 660 x 570	20	GIL60Y	£264.70
90	1320 x 660 x 570	28	GIL90Y	£296.50

Small Parts Storage & Containers

Viewbins

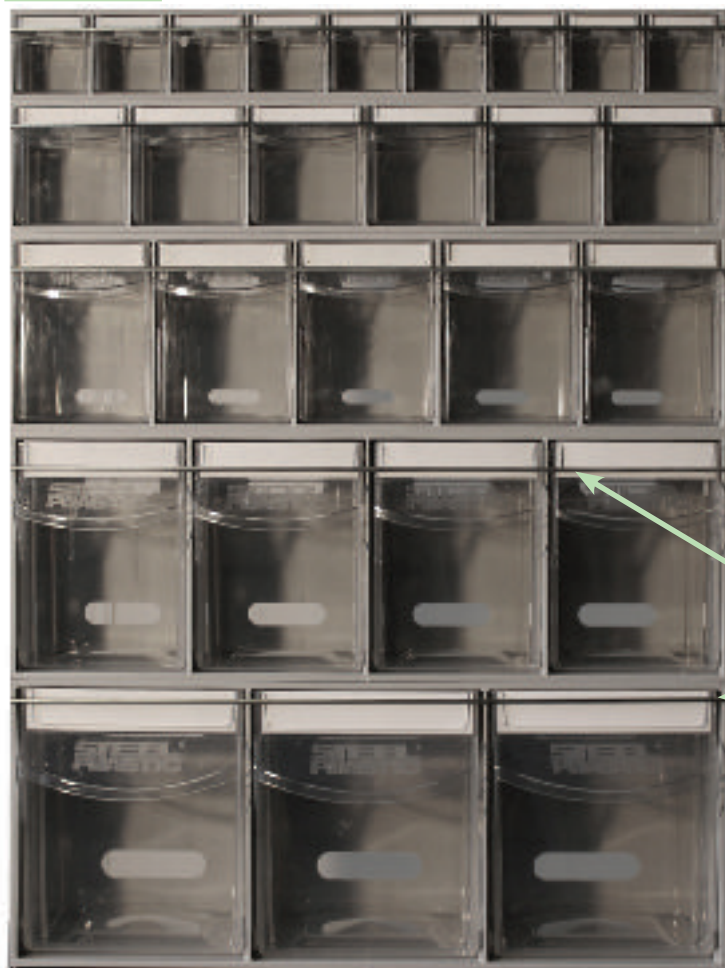

- » Store stock in a flexible, dust free environment
- » High visibility, quality & density system
- » Bins tilt forward for access & are easily removable
- » One width with various heights & depths
- » Incorporates keyhole slots for easy wall mounting
- » Viewbins come complete with locking bars



ViewBin 9



ViewBin 6



ViewBin 5



ViewBin 4



ViewBin 3



INFORMATION

Perfect for van storage when used with the locking bars

Description	Overall Size H x W x D mm	Model	Price
ViewBin 9	76 x 600 x 68	VB9	£13.84
ViewBin 6	112 x 600 x 94	VB6	£16.86
ViewBin 5	164 x 600 x 135	VB5	£24.48
ViewBin 4	203 x 600 x 177	VB4	£32.22
ViewBin 3	240 x 600 x 214	VB3	£39.51

Shelf Units

- » Complete with robust bins
- » Loading per shelf: 60kg UDL
- » Bin sizes: SSU 112
129H x 160W x 250D mm
- » Bin sizes: SSU 114
167H x 220W x 355D mm

BIN COLOUR OPTIONS

- Red
- Blue
- Green

specify when ordering

INFORMATION

Complete with robust bins



SSU 114



SSU 112

Overall Size H x W x D mm	Contents	Model	Price
2000 x 1000 x 300	45 x Eco Bins 112	SSU 112	£290.66
2000 x 1000 x 300	36 x Eco Bins 114	SSU 114	£368.96

Small Parts Storage & Containers

Bin Trolleys

- » Robust light grey frame with tough galvanised louvred panels
- » Complete with ergonomic plastic handle
- » Mobile on 4 swivel castors (2 braked)

PRICES HELD



Bin Sizes

Bin 1 - 76H x 106W x 136D
 Bin 2 - 76H x 106W x 187D
 Bin 3 - 127H x 140W x 274D
 Bin 4 - 179H x 210W x 375D



Bin Trolley Side View

BTC03Y

Description	Bins Included				Overall Size H x W mm	Model	Price
	Bin 1	Bin 2	Bin 3	Bin 4			
Trolley without Bins	-	-	-	-	1425 x 930	BTA01Z	£407.10
Trolley with Bins	-	96	48	-	1425 x 930	BTB02Y	£759.90
Trolley with Bins	32	48	24	16	1425 x 930	BTC03Y	£807.80

Bin Racks

- » Robust light grey frame with tough galvanised louvred panels
- » Single or double sided racks



BRSS09Z

BRSS05Z

PRICES HELD

INFORMATION

Complete with polypropylene bins

Bin Sizes
 Bin 1 - 76H x 106W x 136D
 Bin 2 - 76H x 106W x 187D
 Bin 3 - 127H x 140W x 274D
 Bin 4 - 179H x 210W x 375D
 Bin 5 - 254H x 280W x 457D



BRSS01Z

Description	Bins Included					Overall Size H x W mm	Starter		Extension	
	Bin 1	Bin 2	Bin 3	Bin 4	Bin 5		Model	Price	Model	Price
Single Sided	16	24	12	8	6	1920 x 930	BRSS01Z	£574.45	BRSE02Z	£508.35
Double Sided	32	48	24	16	12	1920 x 930	BRDS03Z	£1016.65	BRDE04Z	£950.55
Single Sided	-	32	24	16	-	1920 x 930	BRSS05Z	£607.50	BRSE06Z	£541.40
Double Sided	-	64	48	32	-	1920 x 930	BRDS07Z	£1082.20	BRDE08Z	£1016.70
Single Sided	24	24	24	12	-	1920 x 930	BRSS09Z	£585.05	BRSE10Z	£518.95
Double Sided	48	48	48	24	-	1920 x 930	BRDS11Z	£1037.85	BRDE12Z	£971.75

Small Parts Storage & Containers

Galvanised Bin Racks

- » Heavy duty parts storage
- » Constructed from welded steel with bin retainers
- » Bin racks can store 4 bins per shelf
- » Other shelf heights available - please call for details

N.B. Steel Bins are sold as separate items



GRH842

COLOUR OPTIONS

- Blue
- Red
- Yellow
- Green
- Grey

specify when ordering



Galvanised Bin Stacking Racks

- » Heavy duty parts storage
- » Constructed from welded steel with bin retainers
- » Bin racks can store 4 bins per shelf
- » Can be stacked up to 3 high

N.B. Steel Bins are sold as separate items



2 x SBH13

Overall Size W x D mm	Shelf Centres	No of Shelves	Suitable for Bin	Model	Price
1350 x 305	200mm	8	32 x SB001	GRH841	£799.15
1350 x 455	200mm	8	32 x SB002	GRH842	£998.85
1350 x 610	200mm	8	32 x SB003	GRH843	£1198.85
1350 x 305	250mm	8	32 x SB004	GRH844	£849.15
1350 x 455	250mm	8	32 x SB005	GRH845	£1048.85
1350 x 610	250mm	8	32 x SB006	GRH846	£1248.55

Overall Size W x D mm	Shelf Centres	No of Shelves	Suitable for Bin	Model	Price
1350 x 305	150mm	3	12 x SB001	SBH11	£323.30
1350 x 455	150mm	3	12 x SB002	SBH12	£399.60
1350 x 610	150mm	3	12 x SB003	SBH13	£474.45
1350 x 305	200mm	3	12 x SB004	SBH14	£343.35
1350 x 455	200mm	3	12 x SB005	SBH15	£418.25
1350 x 610	200mm	3	12 x SB006	SBH16	£493.15

Galvanised Picking Bins

- » Spot welded construction from galvanised steel
- » Units incorporate:
 - » Rear half lift handle
 - » Front handle support bar
 - » Card holder
 - » Re-inforced rim
 - » Stacking runners
- » Semi-open fronted steel bins for easy viewing & instant access to the contents



Overall Size H x W x D mm	Model	Price
150 x 305 x 305	SB001	£40.35*
150 x 305 x 455	SB002	£46.25*
150 x 305 x 610	SB003	£52.20*
200 x 305 x 305	SB004	£47.90*
200 x 305 x 455	SB005	£55.35*
200 x 305 x 610	SB006	£62.70*

Galvanised Bin Trolleys

- » Parts storage trolley with galvanised steel top shelf
- » Constructed from welded steel with bin retainers
- » Mobile on 2 fixed & 2 swivel, 100 nylon castors

N.B. Steel Bins are sold as separate items

COLOUR OPTIONS

- Blue
- Red
- Yellow
- Green
- Grey

specify when ordering



SDBT03



Overall Size H x W x D mm	No of Shelves	Suitable for Bin	Model	Price
930 x 1040 x 455	4	12 x SB002	SDBT02	£862.50
930 x 1040 x 610	4	12 x SB003	SDBT03	£1008.00
930 x 1040 x 455	3	9 x SB005	SDBT05	£768.90
930 x 1040 x 610	3	9 x SB006	SDBT06	£891.90

Small Parts Storage & Containers

Tote Pans & Racks - Tilted Shelf

- >> Heavy duty parts storage
 - >> Constructed from welded steel with bin retainers
 - >> Other shelf heights available - please call for details
- N.B. Steel Bins are sold as separate items**



TPTS1061

Tote Pans & Racks - Horizontal Shelf

- >> Heavy duty parts storage
 - >> Constructed from welded steel with bin retainers
 - >> Other shelf heights available - please call for details
- N.B. Steel Bins are sold as separate items**



TPHO1061

COLOUR OPTIONS

- Blue
- Red
- Yellow
- Green
- Grey

specify when ordering



Overall Size W x D mm	Shelf Centres	No of Shelves	Suitable for Bin	Model	Price
1040 x 305	200mm	6	18 x GTP01	TPTS1030	£566.35
1040 x 455	200mm	6	18 x GTP02	TPTS1045	£707.75
1040 x 610	200mm	6	18 x GTP03	TPTS1061	£849.50
1350 x 305	200mm	6	24 x GTP01	TPTS1330	£629.40
1350 x 455	200mm	6	24 x GTP02	TPTS1345	£786.65
1350 x 610	200mm	6	24 x GTP03	TPTS1361	£944.10

Overall Size W x D mm	Shelf Centres	No of Shelves	Suitable for Bin	Model	Price
1040 x 305	200mm	8	24 x GTP01	TPHO1030	£719.30
1040 x 455	200mm	8	24 x GTP02	TPHO1045	£899.15
1040 x 610	200mm	8	24 x GTP03	TPHO1061	£1078.70
1350 x 305	200mm	8	32 x GTP01	TPHO1330	£799.15
1350 x 455	200mm	8	32 x GTP02	TPHO1345	£998.85
1350 x 610	200mm	8	32 x GTP03	TPHO1361	£1198.85

Galvanised Steel Tote Pans

- >> Strongly constructed from galvanised steel with a reinforced rim
- >> Units incorporate: *Resistant to heat & oil, easy grip handles, card holder, re-inforced rim & 30kg capacity per pan*



Overall Size H x W x D mm	Model	Price
150 x 305 x 305	GTP01	£32.75*
150 x 305 x 455	GTP02	£37.25*
150 x 305 x 610	GTP03	£41.60*
150 x 255 x 305	GTP11	£32.75*
150 x 255 x 455	GTP12	£37.25*
150 x 255 x 610	GTP13	£41.60*

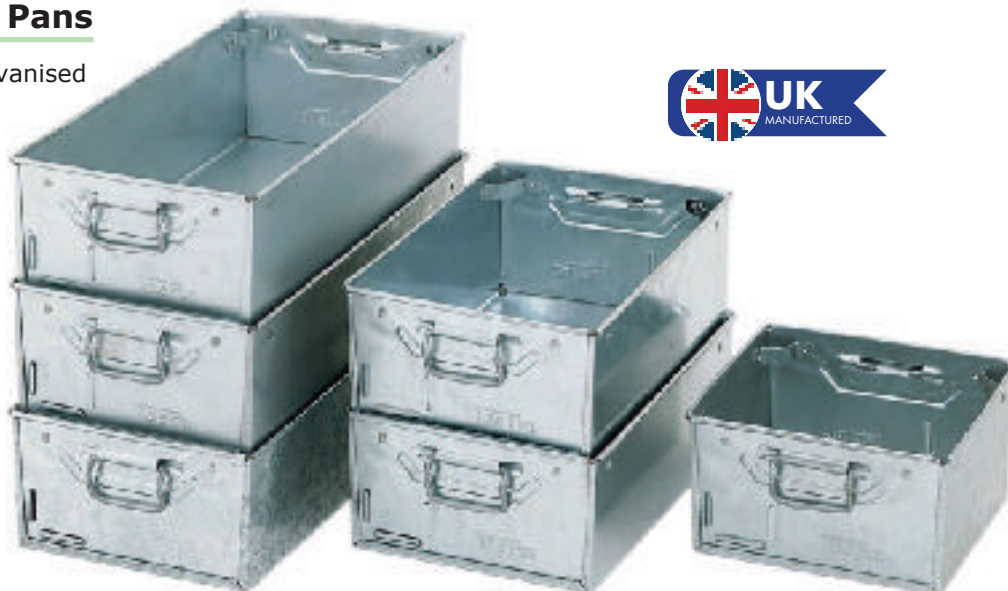

*prices applicable when ordering with Racks.
Order charges will apply if ordered on their own.

Small Parts Storage & Containers

Opening Bins

- » Fully welded steel construction
- » Roll-formed sides for strength & stability
- » Complete with bin fronts for labels & to retain parts



361-95

NEW



330-95

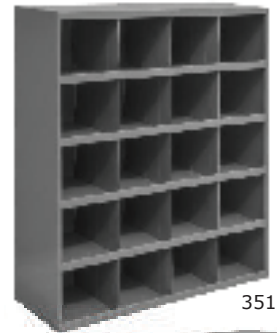

351-95



360-95



356-95

Number of Openings	Overall Size H x W x D mm	Compartment Size H x W x D mm	Model	Price
12	610 x 860 x 303	200 x 200 x 300	330-95	£300.00
20	1066 x 860 x 303	200 x 200 x 300	351-95	£464.29
24	610 x 860 x 303	138 x 136 x 300	356-95	£300.00
42	1066 x 860 x 303	138 x 300 x 136	360-95	£475.71
56	1066 x 860 x 303	130 x 123 x 300	361-95	£475.71

Spool Carts & Wire Storage

- » Fully welded steel construction with louvred panel ends
- » Easily store & organise your spooled items & tools
- » Mobile on 2 fixed & 2 swivel braked 130mm polyurethane castors



MWSR8-LP-95,
4 x DSH-184-95 &
PB30210-21



MWSR8-LP-95



384-95

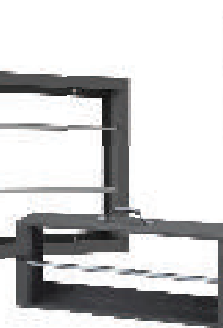

383-95



368-95

Description	Overall Size H x W x D mm	Model	Price
Mobile Spool Cart	1175 x 460 x 825	MWSR8-LP-95	£1142.86
Hook on Bins (pk of 25)	76 x 101 x 127	PB30210-21	£94.29
Hook on Metal Tray	101 x 460	DSH-184-95	£54.29
Wire Spool Rack - 1 Rod	355 x 663 x 147	383-95	£128.57
Wire Spool Rack - 2 Rods	546 x 663 x 147	384-95	£128.57
Wire Spool Rack - 4 Rods	927 x 663 x 147	368-95	£128.57

Small Parts Storage & Containers

'Pigeon Hole' Storage

- >> Fully welded steel construction
- >> Specially designed for heavy duty use
- >> Modular design: allows cabinets to be stacked for added storage capacity



359 (40B)

Description	Overall Size H x W x D mm	Weight kg	Model	Price
Base Unit	150 x 865 x 305	6	364 (BBC-12)	£110.00
40 Compartments	610 x 865 x 305	23	359 (40B)	£300.00
72 Compartments	1067 x 865 x 305	37	363 (72B)	£475.71



364 (BBC-12)
with 1 x 363 (72B)

Drawer Cabinets

- >> Fully welded steel construction
- >> Each drawer is supplied with 2 plastic dividers
- >> Modular design: allows cabinets to be stacked for added storage capacity



005 (18D) & 007 (24D)

Description	Overall Size H x W x D mm	Weight kg	Model	Price
Base Unit	150 x 865 x 305	6	364 (BBC-12)	£110.00
3 Level Drawer Cabinet	298 x 857 x 305	24	005 (18D)	£321.43
4 Level Drawer Cabinet	431 x 857 x 305	32	007 (24D)	£392.86



364 (BBC-12)
with 4 x 007 (24D)

Small Parts Storage & Containers

Balearm Supermarket Crates



- >> From field or food manufacturer to retail point-of-sale Supermarket Crates protect, maintain quality & promote hygiene for many food items
- >> Strong & secure, they stack upto 10 high when loaded
- >> Can carry upto a 16kg load
- >> Ventilated sides promote air flow, speeding cooling & helping to maintain a constant temperature
- >> Empty trays nest by up to 76% of their original height saving valuable space on return transport
- >> A tough & durable design is combined with smooth hygienic surfaces, making them equally at home in heavy duty industrial applications or for food handling & distribution



SC0604019CO in Red

Colours Available	External Size L x W x H mm	Internal Size L x W x H mm	Volume Litres	Model	Price
Black	400 x 300 x 180	364 x 264 x 144	15	SC403018BK	£13.35
Black	600 x 400 x 199	546 x 349 x 172	35	SC604019BK	£14.18
Blue, Green or Red	600 x 400 x 199	546 x 349 x 172	35	SC604019CO	£17.84
Black	600 x 400 x 253	548 x 352 x 226	44	SC604025BK	£17.35
Blue, Green or Red	600 x 400 x 253	548 x 352 x 226	44	SC604025CO	£19.83

Clear Plastic Storage Boxes

- >> Stacking storage boxes complete with lid & locking handles
- >> Can be stacked with or without the lids



INFORMATION

Complete with lid & locking handles



External Size L x W x H mm	Internal Size L x W x H mm	Volume Litres	Model	Price	External Size L x W x H mm	Internal Size L x W x H mm	Volume Litres	Model	Price
245 x 180 x 160	190 x 143 x 120	3	RUB003	£7.25	520 x 440 x 310	405 x 365 x 280	42	RUB042	£35.40
340 x 200 x 125	285 x 160 x 105	5	RUB005	£10.87	600 x 400 x 315	530 x 325 x 289	48	RUB048	£34.84
395 x 255 x 155	335 x 210 x 140	9	RUB009	£13.28	710 x 440 x 230	605 x 370 x 200	50	RUB050	£32.13
465 x 270 x 150	415 x 235 x 140	12	RUB012	£16.43	710 x 440 x 310	605 x 370 x 280	64	RUB064	£36.90
480 x 390 x 200	395 x 355 x 170	18	RUB018	£24.26	810 x 620 x 225	710 x 545 x 190	70	RUB070	£53.05
600 x 400 x 155	535 x 355 x 140	24.5	RUB024	£26.78	710 x 440 x 380	605 x 370 x 355	84	RUB084	£51.40
480 x 390 x 310	405 x 365 x 280	35	RUB035	£34.27	810 x 620 x 430	710 x 545 x 400	145	RUB145	£94.87

Small Parts Storage & Containers

Clear Containers

- >> Manufactured from transparent polypropylene
- >> Perfect for transport, order picking & storage
- >> Food safe & suitable for use in temperature ranges from -20°C to 90°C
- >> Minimum order quantity of 3 containers

HINGED LID COLOURS

- Blue
- Red
- Yellow
- Clear

specify when ordering



**FROM ONLY
£15.90**

PRICES HELD



Plain Container



Stack Rail Container



Hinged Lid Container

External Size L x W x H mm	External Base Size L x W mm	Volume L	Load Cap. kg	Minimum Order Quantity	Plain Container		Stack Rail Container		Hinged Lid Container	
					Model	Price	Model	Price	Model	Price
410 x 300 x 240	318 x 240	17	20	3	-	-	-	-	THL413024	£26.75
400 x 300 x 223	318 x 240	18	20	3	TPC403022	£15.90	TSR403022	£19.10	-	-
610 x 400 x 240	505 x 335	36	30	3	-	-	-	-	THL614024	£35.70
600 x 400 x 223	505 x 335	37	30	3	TPC604022	£22.90	TSR604022	£27.70	-	-
610 x 400 x 340	505 x 335	54	35	3	-	-	-	-	THL614034	£42.20
600 x 400 x 323	505 x 335	55	30	3	TPC603032	£29.15	TSR603032	£35.10	-	-

Stack & Nest Containers

- >> Containers securely stack when loaded & when empty nest by turning 180°. Empty containers nest by up to 76% of their original height saving valuable space on return transport



PRICES HELD

External Size L x W x H mm	Internal Size L x W x H mm	Volume Litres	Nested Height mm	Model	Price
600 x 400 x 150	533 x 368 x 145	27	60	SN604015	£23.47
600 x 400 x 275	530 x 380 x 270	50	90	SN604027	£27.96
600 x 400 x 300	542 x 376 x 295	56	110	SN604030	£32.43
690 x 430 x 317	598 x 412 x 312	70	68	SN694331	£36.92

A delivery consignment charge will apply for Stack & Nest Containers - please call for details

Small Parts Storage & Containers



View & Pick Stacking Containers

- >> Each container is supplied with a label card
- >> Integral label holder on all four sides
- >> Ergonomically designed open hand grips
- >> Minimum order quantity of 3 containers on some sizes



Suits Container	Pack Size	Model	Price
Insertable Window			
400 x 300 x 220	10	IW403022/10	£62.65
400 x 300 x 270	10	IW403027/10	£64.15
600 x 400 x 220	10	IW604022/10	£64.15
600 x 400 x 270	10	IW604027/10	£62.90
600 x 400 x 320	10	IW604032/10	£62.90
600 x 400 x 420	10	IW604042/10	£72.35
800 x 600 x 320	10	IW806032/10	£141.75
800 x 600 x 420	10	IW806042/10	£115.45
Label Cards / Holders			
Label Cards - 210 x 74 mm	50	LC275	£8.25
Label Holders - 209 x 67 mm	10	LHC261	£24.25

External Size L x W x H mm	Pick Opening W x H mm	Volume Litres	Load Cap. kg	Stacking Load kg	Minimum Order Quantity	Colour: Blue		Colour: Red	
						Model	Price	Model	Price
400 x 300 x 220	212 x 106	20.8	20	200	3	XL2110B	£16.00	XL2110R	£17.15
400 x 300 x 270	212 x 131	25.6	20	200	3	XL2113B	£17.75	XL2113R	£17.75
600 x 400 x 220	274 x 106	44.3	15	250	3	XL2710B	£22.90	XL2710R	£22.65
600 x 400 x 270	274 x 131	54.5	15	250	3	XL2713B	£26.55	XL2713R	£26.55
600 x 400 x 320	274 x 156	64.8	20	250	3	XL2715B	£27.45	XL2715R	£27.45
600 x 400 x 420	274 x 206	85.3	20	250	3	XL2720B	£36.60	XL2720R	£36.60
800 x 600 x 320	459 x 153	132	60	500	-	XL4515B	£74.40	-	-
800 x 600 x 420	459 x 203	174	60	500	-	XL4520B	£80.15	-	-
800 x 600 x 520	459 x 253	217	60	500	-	XL4525B	£86.55	-	-



Container Pick Walls

- >> Create a storage & picking area without the need for shelving
- >> Quick & easy to create picking areas
- >> Ideal for NEW products & great sellers
- >> More sizes & options available - call for details
- >> Opening is on the front (width) of the container



INFORMATION

Other sizes available - call for details

Description	Capacity Litres per Container	Overall Size - per Container L x W x H mm	Overall Size - per Wall L x W x H mm	Container Picking Walls	
				Model	Price
16 Containers - 4 x 600W & 4 x 415H	82.5	400 x 600 x 415	400 x 2400 x 1640	PW6442-600W	£642.90
12 Containers - 3 x 600W & 4 x 420H	174	800 x 600 x 420	800 x 1800 x 1640	PW6842-600W	£915.45
12 Containers - 3 x 800W & 4 x 420H	174	600 x 800 x 420	600 x 2400 x 1640	PW8642-800W	£986.30

Small Parts Storage & Containers

Folding Euro Containers

- » Practical footprint (600 x 400) for use with euro pallets
- » Sides lock open with a simple push on the top of the handle
- » Open grip handle for your comfort

**FROM ONLY
£40.85**



4 x FEC32ORWO



4 x FEC32ORWO Folded



FEC32ORWO



FEC32BLWO



FEC32ORLID



FEC32BLLID

Description	External Size L x W x H mm	Weight Cap. kg	Stacking Cap. kg	Volume Litres	Blue Folding Euro Container		Orange Folding Euro Container	
					Model	Price	Model	Price
Without Lid	600 x 400 x 285	20	180	58	FEC28BLWO	£40.85	FEC28ORWO	£42.70
	600 x 400 x 320			65	FEC32BLWO	£41.10	FEC32ORWO	£43.45
With Lid	600 x 400 x 285			57	FEC28BLID	£50.55	FEC28ORLID	£51.60
	600 x 400 x 320			64	FEC32BLID	£50.90	FEC32ORLID	£52.00

Euro Containers with Lids

- » Modular stacking containers with attached hinged lid. All models inter-stack to form a compact handling unit
- » Attached lid protects contents from dust & moisture and inhibits theft when fitted with tamper-evident security ties
- » Containers can also be secured with two mini padlocks



ECLI403013



ECLI403033

External Size L x W x H mm	Internal Size L x W x H mm	Volume Litres	Model	Price	External Size L x W x H mm	Internal Size L x W x H mm	Volume Litres	Model	Price
400 x 300 x 135	370 x 270 x 107	10	ECLI403013	£36.92	600 x 400 x 185	570 x 370 x 157	35	ECLI604018	£62.74
400 x 300 x 185	370 x 270 x 147	15	ECLI403018	£39.17	600 x 400 x 235	570 x 370 x 207	45	ECLI604023	£73.97
400 x 300 x 235	370 x 270 x 197	20	ECLI403023	£44.79	600 x 400 x 285	570 x 370 x 257	56	ECLI604028	£82.95
400 x 300 x 335	370 x 270 x 297	30	ECLI403033	£49.26	600 x 400 x 435	570 x 370 x 407	75	ECLI604043	£89.67

A delivery consignment charge will apply for Euro Containers with Lids - please call for details

117

Small Parts Storage & Containers



Euro Containers

- » Available in both solid & ventilated formats, Euro stacking containers are ideal for a wide variety of industrial storage & handling applications
- » All models inter-stack to form compact handling units.
- » All coloured containers (red, blue & grey) are manufactured in food-safe material & suitable for direct food contact. Black models are manufactured in recycled plastic

External Size L x W x H mm	Internal Size L x W x H mm	Colours Available	Volume Litres	Model	Price
200 x 150 x 118	156 x 107 x 114	Red, Blue & Grey	2	ECSO201511C	£4.94
200 x 150 x 118	156 x 107 x 114	Black	2	ECSO201511B	£4.39
300 x 200 x 118	255 x 155 x 115	Red, Blue & Grey	5	ECSO302011C	£11.10
300 x 200 x 118	255 x 155 x 115	Black	5	ECSO302011B	£9.99
400 x 300 x 70	355 x 255 x 64	Grey	6	ECSO403007G	£17.97
400 x 300 x 118	355 x 255 x 115	Red, Blue & Grey	10	ECSO403011C	£12.24
400 x 300 x 118	355 x 255 x 115	Black	10	ECSO403011B	£11.10
400 x 300 x 175	355 x 255 x 171	Red, Blue & Grey	15	ECSO403017C	£14.48
400 x 300 x 175	355 x 255 x 171	Black	15	ECSO403017B	£13.93
400 x 300 x 230	355 x 255 x 228	Red, Blue & Grey	20	ECSO403023C	£18.18
400 x 300 x 230	355 x 255 x 228	Black	20	ECSO403023B	£17.07
400 x 300 x 320	355 x 255 x 300	Grey	30	ECSO403032G	£27.61

Small Parts Storage & Containers



ECSO806011G

INFORMATION

Coloured containers are food safe

Description	Colours Available	External Size L x W x H mm	Internal Size L x W x H mm	Volume Litres	Model	Price
Solid Euro Container	Grey	600 x 400 x 50	555 x 355 x 40	8	ECSO604005G	£16.28
Solid Euro Container	Grey	600 x 400 x 73	555 x 355 x 62	12	ECSO604007G	£19.85
Solid Euro Container	Red, Blue & Grey	600 x 400 x 118	555 x 355 x 108	21	ECSO604011C	£18.52
Solid Euro Container	Black	600 x 400 x 118	555 x 355 x 108	21	ECSO604011B	£17.84
Solid Euro Container	Grey	600 x 400 x 150	555 x 355 x 139	28	ECSO604015G	£22.33
Solid Euro Container	Red, Blue & Grey	600 x 400 x 175	555 x 355 x 158	30	ECSO604017C	£23.02
Solid Euro Container	Black	600 x 400 x 175	555 x 355 x 158	30	ECSO604017B	£22.33
Solid Euro Container	Red, Blue & Grey	600 x 400 x 230	555 x 355 x 215	42	ECSO604023C	£28.62
Solid Euro Container	Black	600 x 400 x 230	555 x 355 x 215	42	ECSO604023B	£27.51
Solid Euro Container with Open Handles	Grey	600 x 400 x 230	555 x 355 x 215	42	EOH604023G	£28.62
Solid Euro Container	Grey	600 x 400 x 290	555 x 355 x 277	54	ECSO604029G	£36.92
Solid Euro Container with Open Handles	Red, Blue & Grey	600 x 400 x 340	555 x 355 x 325	63	EOH604034C	£42.10
Solid Euro Container with Open Handles	Black	600 x 400 x 340	555 x 355 x 325	63	EOH604034B	£37.60
Solid Euro Container with Open Handles	Grey	600 x 400 x 450	555 x 355 x 440	80	EOH604045G	£54.89
Solid Euro Container	Grey	800 x 600 x 118	750 x 555 x 107	45	ECSO806011G	£35.36
Solid Euro Container with Open Handles	Grey	800 x 600 x 230	750 x 555 x 215	90	ECSO806023G	£71.72
Solid Euro Container with Open Handles	Grey	800 x 600 x 340	750 x 555 x 325	135	ECSO806034G	£76.21
Solid Euro Container with Open Handles	Grey	800 x 600 x 388	750 x 555 x 374	155	ECSO806038G	£93.71
Solid Euro Container with Open Handles	Grey	800 x 600 x 450	750 x 555 x 435	179	ECSO806045G	£96.41

A delivery consignment charge will apply for these products - please call for details

119

Small Parts Storage & Containers

Premium Attached Lid Containers

- » Wholesale & industrial applications
- » Designed for both automated & manual handling
- » Lids are equipped with ribs which hold stacked containers securely
- » Integrated lid accepts strapping & security seals
- » The step design enables nearly vertical walls. This maximises volume & load capacity & saves space during transportation



Colours Available	External Size L x W x H mm	Internal Size L x W x H mm	Volume Litres	Model	Price
Two Tone Green	400 x 300 x 264	325 x 246 x 222	22	ALC403026TG	£23.47
Two Tone Green	400 x 300 x 306	321 x 244 x 282	25	ALC403030TG	£25.26
Two Tone Green	600 x 400 x 250	515 x 343 x 215	40	ALC604025TG	£36.62
Two Tone Green	600 x 400 x 320	508 x 335 x 285	54	ALC604032TG	£35.21
Two Tone Green	600 x 400 x 365	501 x 328 x 330	64	ALC604036TG	£36.21
Two Tone Green	710 x 460 x 368	597 x 374 x 330	80	ALC714636TG	£42.97

Attached Lid Containers

- » Wholesale & industrial applications
- » Designed for both automated & manual handling
- » Lids are equipped with ribs which hold stacked containers securely
- » Integrated lid accepts strapping & security seals
- » The step design enables nearly vertical walls. This maximises volume & load capacity & saves space during transportation



Colours Available	External Size L x W x H mm	Internal Size L x W x H mm	Volume Litres	Model	Price
Blue	300 x 200 x 190	240 x 160 x 153	5.2	ALC302019BU	£19.66
Blue	400 x 300 x 264	325 x 246 x 222	22	ALC403026BU	£23.47
Black	400 x 300 x 264	325 x 246 x 222	22	ALC403026BK	£19.64
Blue	400 x 300 x 306	321 x 244 x 282	25	ALC403030BU	£25.26
Black	400 x 300 x 306	321 x 244 x 282	25	ALC403030BK	£21.22
Black	600 x 400 x 250	515 x 343 x 215	40	ALC604025BK	£28.06
Blue	600 x 400 x 264	530 x 353 x 240	48	ALC604026BU	£35.81
Blue	600 x 400 x 306	514 x 350 x 281	54	ALC604030BU	£39.17
Black	600 x 400 x 306	514 x 350 x 281	54	ALC604030BK	£31.32
Black	600 x 400 x 320	508 x 335 x 285	54	ALC604032BK	£28.47
Black	600 x 400 x 365	501 x 328 x 330	64	ALC604036BK	£28.98
Blue	600 x 400 x 365	508 x 346 x 340	65	ALC604036BU	£42.10
Blue	600 x 400 x 400	521 x 343 x 375	70	ALC604040BU	£44.34
Black	710 x 460 x 368	597 x 374 x 330	80	ALC714636BK	£35.81
Black	1125 x 480 x 360	1000 x 360 x 340	135	ALC114836BK	£80.71
Red	675 x 575 x 615	560 x 430 x 540	160	ALC675761RD	£111.12

Attached Lid Containers with Coloured Lids

- » Up to 78% height saving when nested
- » Lids are equipped with ribs which hold stacked containers securely
- » Integrated lid accepts strapping & security seals
- » Attached lids allow maximum volume & load capacity whilst saving space during transportation
- » Attached lid protects contents from dust & moisture & inhibits theft when fitted with tamper-evident security ties



INFORMATION

Stackable up to 7 high & will carry 35kg each

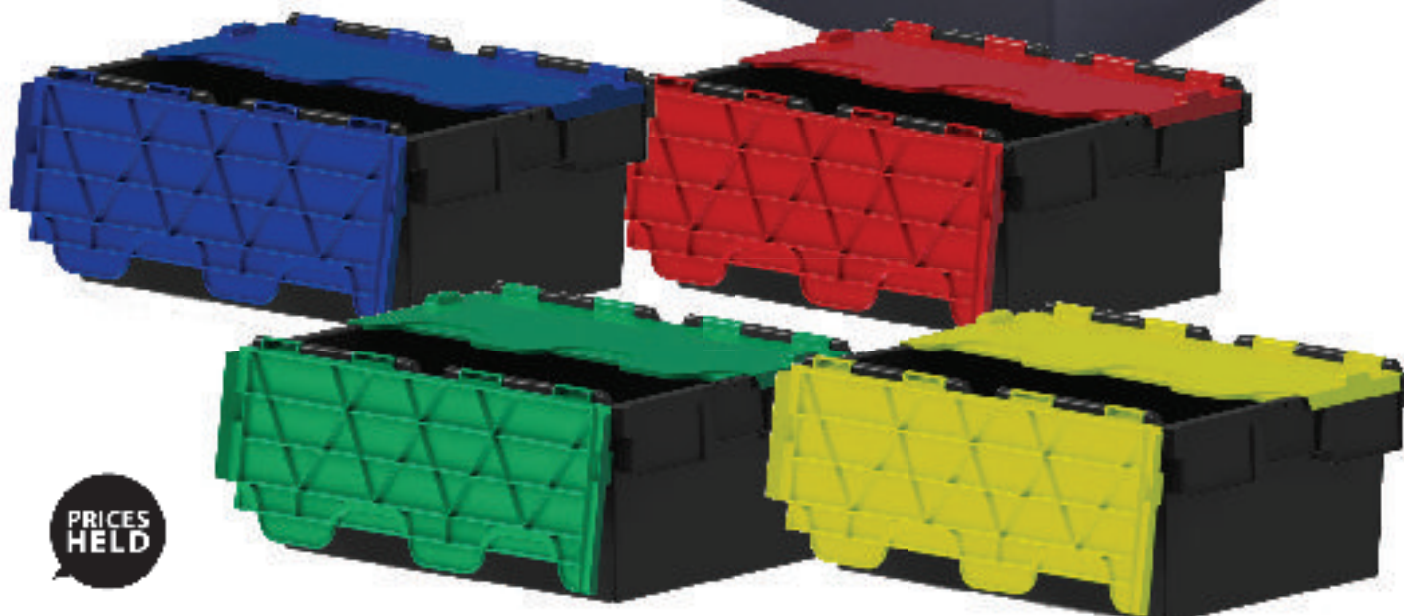

PRICES HELD

External Size L x W x H mm	Internal Size L x W x H mm	Capacity Litres	Colour	Model	Price
400 x 300 x 264	325 x 246 x 222	22	Black with Green Lid	ALC403026BG	£20.09
400 x 300 x 306	321 x 244 x 282	25	Black with Green Lid	ALC403028BG	£21.88
600 x 400 x 250	515 x 343 x 215	40	Black with Blue Lid	ALC604025BB	£30.31
600 x 400 x 250	515 x 343 x 215	40	Black with Green Lid	ALC604025BG	£30.31
600 x 400 x 250	515 x 343 x 215	40	Black with Yellow Lid	ALC604025BY	£30.31
600 x 400 x 250	515 x 343 x 215	40	Black with Red Lid	ALC604025BR	£30.31
600 x 400 x 320	508 x 335 x 285	54	Black with Blue Lid	ALC604032BB	£30.50
600 x 400 x 320	508 x 335 x 285	54	Black with Green Lid	ALC604032BG	£30.50
600 x 400 x 320	508 x 335 x 285	54	Black with Yellow Lid	ALC604032BY	£30.50
600 x 400 x 320	508 x 335 x 285	54	Black with Red Lid	ALC604032BR	£30.50
600 x 400 x 365	501 x 328 x 330	64	Black with Blue Lid	ALC604036BB	£31.02
600 x 400 x 365	501 x 328 x 330	64	Black with Green Lid	ALC604036BG	£31.02
600 x 400 x 365	501 x 328 x 330	64	Black with Yellow Lid	ALC604036BY	£31.02
600 x 400 x 365	501 x 328 x 330	64	Black with Red Lid	ALC604036BR	£31.02
710 x 460 x 368	597 x 374 x 330	80	Black with Blue Lid	ALC714636BB	£36.62
710 x 460 x 368	597 x 374 x 330	80	Black with Green Lid	ALC714636BG	£36.62
710 x 460 x 368	597 x 374 x 330	80	Black with Yellow Lid	ALC714636BY	£36.62
710 x 460 x 368	597 x 374 x 330	80	Black with Red Lid	ALC714636BR	£36.62

A delivery consignment charge will apply for these products - please call for details

Small Parts Storage & Containers

Distribution Pallets

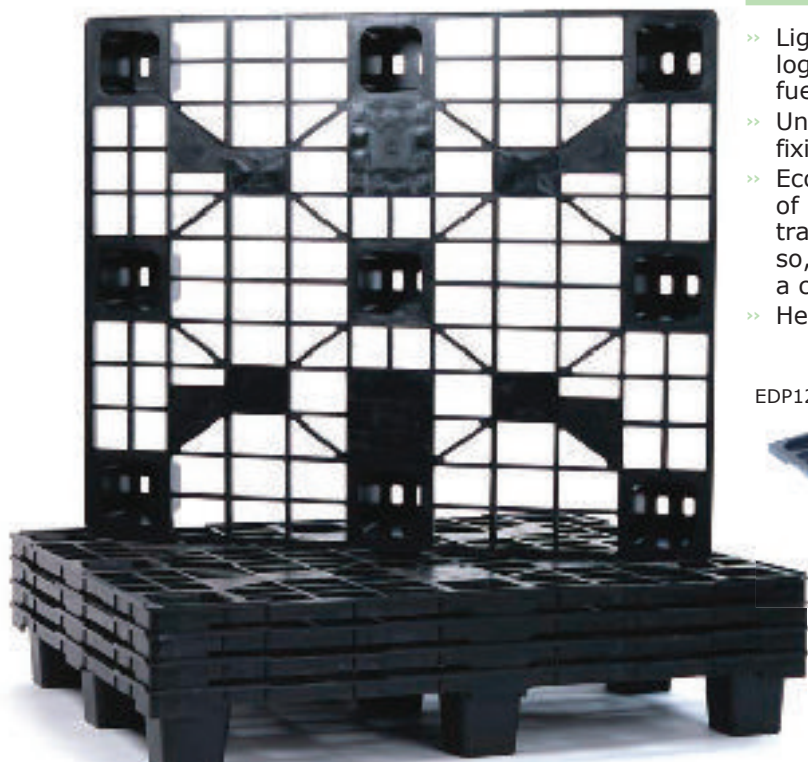

- » Lightweight pallets are ideal for multi-trip logistic operations, making significant fuel savings over heavier pallets
- » Unlike timber pallets there are no splinters or metal fixings that could damage contents or injure personnel
- » Eco Pallets - when not in use, pallets nests by 62% of overall height for even greater savings on return transport. Do not harbour wood-born pests &, so, do not have to be treated for export. Also have a constant tare & do not absorb water or contaminants
- » Heavy Duty Pallets are ideal for heavier loads

EDP120813

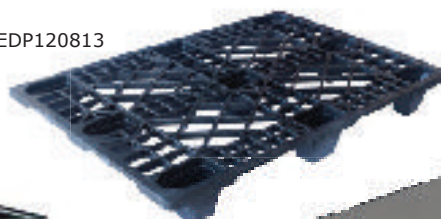

HDP121015

Description	Overall Size L x W x H mm	Static Load Capacity kg	Dynamic Load Capacity kg	Model	Price
Eco Euro Pallet with 9 Feet	1200 x 800 x 130	1500	400	EDP120813	£26.82
Eco UK Pallet with 9 Feet	1200 x 1000 x 130	1500	400	EDP121013	£29.07
Heavy Duty Euro Pallet with 3 Runners	1200 x 800 x 150	5000	1500	HDP120815	£153.05
Heavy Duty UK Pallet with 3 Runners	1200 x 1000 x 155	5000	1500	HDP121015	£163.25

XL Containers with Fork Entry Shoes

- » Each container is supplied with a label card
- » Ergonomically designed open hand grips



Insertable Window

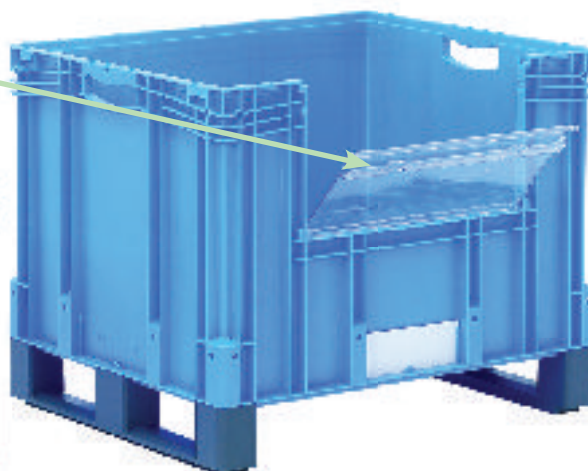

FROM ONLY
£102.65



External Size L x W x H mm	Pick Opening W x H mm	Volume Litres	Load Cap. kg	Container		Insertable Window (pk of 10)	
				Model	Price	Model	Price
Short Side Pick Opening							
800 x 600 x 320	459 x 153	132	200	XLS4515	£102.65	XLW4515/10	£141.75
800 x 600 x 420	459 x 203	174	200	XLS4520	£110.90	XLW4520/10	£115.45
800 x 600 x 520	459 x 253	217	200	XLS4525	£117.75	XLW4525/10	£146.95
Long Side Pick Opening							
800 x 600 x 320	459 x 153	132	200	XLL4515	£105.15	XLW4515/10	£141.75
800 x 600 x 420	459 x 203	174	200	XLL4520	£112.00	XLW4520/10	£115.45
800 x 600 x 520	459 x 253	217	200	XLL4525	£122.30	XLW4525/10	£146.95

INFORMATION



Load capacity of up to 700kg



FBC121080



BCVE121076



BCSO121076



Bulk Containers

- >> Bulk Containers designed for intensive handling & distribution applications
- >> The folding Bulk Container can be assembled & folded by a single operator. Drop-doors allow easy access to contents, preventing users from having to lean into a part empty container. It stacks to five high carrying a 500Kg unit load - a combined load of 2.5 tonnes
- >> Hygienic, strong & stable; rigid Containers are ideal for heavy duty handling applications in both food & non-food industrial environments. Rigid Containers stack to eight high carrying a 700Kg unit load - a combined load of 5.6 tonnes

Description	External Size L x W x H mm	Internal Size L x W x H mm	Folded Height mm	Unit Load	Stacks to	Volume Litres	Model	Price
Folding Bulk Container	1200 x 1000 x 975	1121 x 921 x 775	406	500kg	5 High	800	FBC121080	£662.18
Lid for the Folding Bulk Container	1200 x 1000	-	-	-	-	-	FBL121LID	£117.65
Solid Rigid Bulk Container	1200 x 1000 x 760	1120 x 920 x 610	-	700kg	8 High	625	BCSO121076	£397.20
Ventilated Rigid Bulk Container	1200 x 1000 x 760	1120 x 920 x 610	-	700kg	8 High	625	BCVE121076	£397.20
Lid for the Rigid Bulk Container	1200 x 1000	-	-	-	-	-	BCL1210	£117.65

A delivery consignment charge will apply for these products - please call for details

Small Parts Storage & Containers

Collapsible Mesh Pallets



LCMP1012

- » Collapsible wire storage cages - saves space when not in use
- » Half-drop side along one long side for easy use
- » Stack up to four high when erected
- » Bright zinc plated finish



HEMP0806
Folded

HEMP0806

LCMP1012
Folded

5 x LCMP1012
Stacked

Description	Overall Size L x W x H mm	Internal Height mm	Folded Height mm	Stackable When Folded	Capacity kg	Model	Price
Half Euro Collapsible Mesh Pallet	800 x 600 x 670	540	230	5 High	350	HEMP0806	£128.70
Euro Collapsible Mesh Pallet	800 x 1200 x 1000	850	280	4 High	600	FEMP0812	£232.15
Collapsible Mesh Pallet	1000 x 1200 x 1000	850	280	4 High	600	COMP1012	£250.00
Large Collapsible Mesh Pallet	1000 x 1200 x 890	750	210	4 High	1500	LCMP1012	£431.55
Heavy Duty Collapsible Mesh Pallet	800 x 1000 x 850	700	210	4 High	1200	HDMP0810	£247.60
Heavy Duty Collapsible Mesh Pallet with Fork Guides	1000 x 1200 x 900	750	210	4 High	1500	HDMP1012	£421.45

Collapsible Pallet Retention Cages

- » Collapsible pallet retention cages - saves space when not in use
- » Half-drop side along one long side
- » Stack up to four high when erected
- » Bright zinc plated finish



EPR081210



2 x EPR081210
Stacked

Description	Overall Size L x W x H mm	Folded Size L x W x H mm	Internal Height mm	Capacity kg	Model	Price
Pallet Retention Cage with 1/2 Drop Gate	800 x 1200 x 1000	910 x 2050 x 65	850	800	EPR081210	£179.15
Pallet Retention Cage with 1/2 Drop Gate	1000 x 1200 x 1000	910 x 2250 x 65	850	800	EPR101210	£189.85
Pallet Retention Cage with 1/2 Drop Gate	1000 x 1200 x 1200	1100 x 2250 x 65	1050	800	EPR101212	£217.15
Pallet Retention Cage with 1/2 Drop Gate	1000 x 1200 x 1450	1350 x 2250 x 65	1300	1500	EPR101214	£285.65

Small Parts Storage & Containers

Stackable Pallets - Post Pallets

- >> Stackable up to 4 high
- >> All welded construction with 125mm square feet



COLOUR OPTIONS

- Blue
- Red
- Yellow
- Green
- Grey

specify when ordering

PRICES HELD

Stackable Pallets - Open Front Pallets

- >> Stackable up to 4 high
- >> All welded construction with 125mm square feet



Overall Size W x D x Effective H mm	500kg Load Capacity		1000kg Load Capacity	
	Model	Price	Model	Price
610 x 610 x 455	PP066405	£180.90	PP066410	£239.80
915 x 610 x 455	PP096405	£220.95	PP096410	£286.60
915 x 610 x 610	PP096605	£245.60	PP096610	£312.10
915 x 915 x 610	PP099605	£289.40	PP099610	£360.55
915 x 915 x 760	PP099705	£316.85	PP099710	£387.20
1220 x 915 x 610	PP129605	£335.45	PP129610	£410.05
1220 x 915 x 760	PP129705	£364.60	PP129710	£437.45

Overall Size W x D x Effective H mm	500kg Load Capacity		1000kg Load Capacity	
	Model	Price	Model	Price
610 x 610 x 455	OF066405	£275.00	OF066410	£330.45
915 x 610 x 455	OF096405	£340.60	OF096410	£401.95
915 x 610 x 610	OF096605	£383.70	OF096610	£445.10
915 x 915 x 610	OF099605	£457.80	OF099610	£522.75
915 x 915 x 760	OF099705	£506.90	OF099710	£570.30
1220 x 915 x 610	OF129605	£536.75	OF129610	£603.85
1220 x 915 x 760	OF129705	£589.50	OF129710	£654.05

Stackable Pallets - Half Drop Pallets

- >> Stackable up to 4 high
- >> All welded construction with 125mm square feet

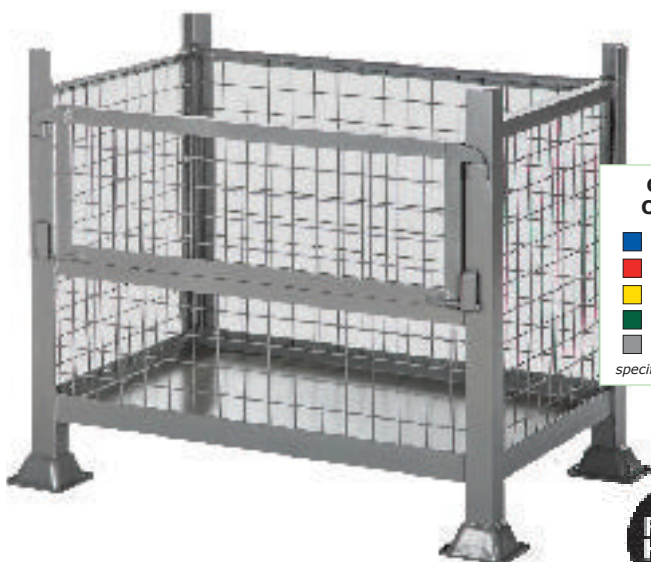

COLOUR OPTIONS

- Blue
- Red
- Yellow
- Green
- Grey

specify when ordering

PRICES HELD

Stackable Pallets - Box Pallets

- >> Stackable up to 4 high
- >> All welded construction with 125mm square feet



Overall Size W x D x Effective H mm	500kg Load Capacity		1000kg Load Capacity	
	Model	Price	Model	Price
610 x 610 x 455	HD066405	£336.05	HD066410	£403.85
915 x 610 x 455	HD096405	£416.35	HD096410	£491.25
915 x 610 x 610	HD096605	£468.95	HD096610	£544.05
915 x 915 x 610	HD099605	£559.55	HD099610	£638.90
915 x 915 x 760	HD099705	£619.60	HD099710	£697.05
1220 x 915 x 610	HD129605	£656.05	HD129610	£738.05
1220 x 915 x 760	HD129705	£720.45	HD129710	£799.80

Overall Size W x D x Effective H mm	500kg Load Capacity		1000kg Load Capacity	
	Model	Price	Model	Price
610 x 610 x 455	FB066405	£305.50	FB066410	£367.15
915 x 610 x 455	FB096405	£378.45	FB096410	£446.60
915 x 610 x 610	FB096605	£426.30	FB096610	£494.55
915 x 915 x 610	FB099605	£508.70	FB099610	£580.80
915 x 915 x 760	FB099705	£563.30	FB099710	£633.65
1220 x 915 x 610	FB129605	£596.35	FB129610	£670.95
1220 x 915 x 760	FB129705	£655.00	FB129710	£726.75

Storage, Security Cages & Hazardous

Hazardous Substance Storage Cupboards



**EXCEPT
FLOOR CHESTS**

**FROM ONLY
£211.50**



INFORMATION



These cabinets can help you comply with COSHH regulations, depending on your own risk assessment

- » Manufactured from 0.7mm steel body & 0.9mm steel doors
- » These units enable separate storage of hazardous substances
- » "No Snag" handles with 2 point locking mechanism
- » Adjustable spill retaining shelves for superior spill management
- » Integral liquid tight sump encourages the correct handling of spills (except wall mounted cupboards)
- » Wall cupboards are pre-drilled for mounting (fixings not included)
- » Floor chests have an integrated welded sump, angled lid to discourage article placement & a hasp & staple lock - padlock not supplied
- » Stands raise cupboards by 543mm with an adjustable foot for uneven surfaces
- » Reaction to Fire Classification EN 13501-1



EFC18Z



ESS02Z

Overall Size H x W x D mm	No of Shelves	No of Doors	Model	Price
Floor Cupboards				
700 x 350 x 300	1	Single	EFC01Z	£211.50
700 x 900 x 460	1	Double	EFC03Z	£291.90
900 x 460 x 460	1	Single	EFC02Z	£249.10
900 x 900 x 460	1	Double	EFC05Z	£319.10
1200 x 900 x 460	2	Double	EFC06Z	£402.10
1800 x 900 x 460	3	Double	EFC08Z	£473.40
1800 x 1200 x 460	3	Double	EFC16Z	£557.70
Mobile Cupboards				
840 x 900 x 460	1	Double	EMC01Z	£464.35
1040 x 900 x 460	1	Double	EMC02Z	£505.80
Wall Cupboards				
570 x 850 x 255	1	Double	EW01Z	£276.30
Floor Chests				
510 x 610 x 340	-	-	EFC18Z	£343.75
610 x 1170 x 460	-	-	EFC19Z	£538.25

To Fit W x D mm	Model	Price
Extra Shelves		
350 x 300	EES01Z	£31.60
460 x 460	EES02Z	£38.20
900 x 460	EES08Z	£50.00
1200 x 460	EES16Z	£57.90
Stands (543mm high)		
350 x 300	ESS01Z	£108.95
460 x 460	ESS02Z	£112.85
900 x 460	ESS08Z	£127.10

Heavy Duty Hazardous Substance Storage Cupboards

- >> Manufactured from 0.9mm sheet steel with formed & welded seams
- >> Supplied with removable galvanised sump tray & shelves
- >> Doors are fitted with vertical reinforcement panels to prevent distortion
- >> Produced with return flange around doors & joints to help prevent the passage of flame
- >> Fitted with security locks & two keys
- >> Shelves can be used as flush shelves or as a tray & are adjustable to 75mm centres
- >> Locks & handles are all metal to eliminate melting under fire attack
- >> Powder coated yellow



HSC05Z



HSC08Z



HSC03Z



HSC02Z

INFORMATION

These cabinets can help you comply with COSHH regulations, depending on your own risk assessment

Overall Size H x W x D mm	No of Shelves	Doors	Weight kg	Model	Price
915 x 458 x 483	1	Single	27	HSC02Z	£514.65
610 x 610 x 306	1	Double	18	HSC03Z	£533.00
915 x 915 x 483	2	Double	50	HSC05Z	£710.10
1830 x 915 x 483	3	Double	83	HSC08Z	£1185.80

N.B - A Fork Lift may be needed to unload these units

Storage, Security Cages & Hazardous

Heavy Duty Hazardous Cabinets



GENERAL SPECIFICATION FOR THE CABINETS SHOWN ON THESE TWO PAGES

- » Designed and manufactured to meet **Fire Classification A2-s2 d0 to EN13501-1:2018**
- » Manufactured from 1.2mm sheet steel for extra strength & improved protection from fire penetration
- » A robustly constructed range of cabinets providing safe storage for flammable liquids
- » Base of each unit is fitted with a large capacity removable sump to contain any spillage
- » All formed welded seams
- » Doors are fitted with vertical reinforcement panels to prevent distortion

**FROM ONLY
£602.80**

- » Produced with return flange around doors & joints to help prevent the passage of flame
- » Fitted with all metal security locks & two keys
- » Adjustable galvanised shelves to 75mm centres. Shelves are also reversible which allows them to be used as a tray
- » Floor stands are available for the five smallest sizes, raising the units by 450 mm

N.B - A Fork Lift may be needed to unload these units

**HEAVY DUTY CABINETS
Made from 1.2mm sheet steel**

FSC Range

INFORMATION



These cabinets can help you comply with COSHH regulations, depending on your own risk assessment



Highly Flammable Storage Cabinets - FSC Range

- » Powder coated Yellow
- » Supplied with appropriate labels to BS5378 standard
- » For pricing details please see opposite page

General Storage Cabinets - GSC Range

- » Powder coated grey
- » Supplied complete with general purpose labelling
- » For pricing details please see opposite page



GSC Range



PSC Range



ASC Range



INFORMATION



Heavy duty cabinets - made from 1.2mm sheet steel

Pesticide/Agrochemical Storage Cabinets - PSC Range

- >> Powder coated red
- >> For your safety the doors of the cabinets are fitted with louvre vents
- >> Supplied with the currently approved labels to BS5378 & EEC directive 92/58
- >> All other details are as per general specification shown on the previous page

Acid Storage Cabinets - ASC Range

- >> Powder coated white which is impervious to most acids
- >> Complete with acid warning label conforming to BS5499/1 & EEC directive 92/58
- >> All other details are as per general specification shown on the previous page

SAFETY NOTE

Before storage of herbicides & petroleum based products takes place the advice of the following should be sought for specific guidance.

- >> Health & Safety Inspector
- >> Trading Standards Officers
- >> Environmental Health Officers
- >> Fire Officers

Overall Size H x W x D mm	No of Shelves	Shelf Depth (as a tray)	Sump Capacity	Doors	Weight kg	Highly Flammable		General		Pesticide/Agrochemical		Acid	
						Model	Price	Model	Price	Model	Price	Model	Price
*765 x 458 x 483	1	38mm	14 litres	1	25	FSC01Z	£610.85	GSC01Z	£602.80	PSC01Z	£651.05	ASC01Z	£651.05
*915 x 458 x 483	1	38mm	14 litres	1	35	FSC02Z	£683.85	GSC02Z	£675.60	PSC02Z	£723.90	ASC02Z	£723.90
*610 x 610 x 306	1	24mm	12 litres	2	23	FSC03Z	£654.10	GSC03Z	£645.95	PSC03Z	£694.00	ASC03Z	£694.00
*710 x 915 x 483	1	34mm	33 litres	2	45	FSC04Z	£849.65	GSC04Z	£841.60	PSC04Z	£889.40	ASC04Z	£889.40
*915 x 915 x 483	2	34mm	33 litres	2	55	FSC05Z	£981.80	GSC05Z	£973.80	PSC05Z	£1021.80	ASC05Z	£1021.80
1220 x 915 x 483	2	34mm	33 litres	2	65	FSC06Z	£1091.35	GSC06Z	£1083.60	PSC06Z	£1131.40	ASC06Z	£1131.40
1500 x 915 x 483	3	34mm	33 litres	2	80	FSC07Z	£1337.80	GSC07Z	£1329.80	PSC07Z	£1377.70	ASC07Z	£1377.70
1830 x 915 x 483	3	34mm	33 litres	2	100	FSC08Z	£1493.40	GSC08Z	£1485.30	PSC08Z	£1533.15	ASC08Z	£1533.15
*Floor stand (available for the 5 smallest sizes)						FSC09Z	£275.35	GSC09Z	£275.35	PSC09Z	£308.10	ASC09Z	£308.10

Storage, Security Cages & Hazardous

CoSHH Cupboards



It is vital that employers and employees comply with the control of hazardous substances in all working environments. This range of cupboards & cabinets enables the separate storage & transportation of hazardous substances as demanded by the CoSHH regulations.

- » Manufactured from 0.7mm steel body & 0.9mm steel doors
 - » Reaction to Fire Classification EN 13501-1
 - » "No snag" handles with 2-point locking
 - » Adjustable spill-retaining galvanized shelves for superior spill management*
 - » Integral liquid-tight sump encourages the correct handling of spills through the use of absorbents*
 - » Wall cupboards are pre-drilled for mounting (fixings not included).
 - » Floor chests have a welded integrated sump, angled lid to discourage article placement & a hasp & staple lock – padlock not supplied
 - » Stands raise cupboards by 543mm with an adjustable foot for uneven surfaces
- *Except wall mounted cupboards

Overall Size H x W x D mm	No of Shelves	No of Doors	Model	Price
Floor Cupboards				
700 x 350 x 300	1	Single	CFC01Z	£214.60
700 x 900 x 460	1	Double	CFC03Z	£296.15
900 x 460 x 460	1	Single	CFC02Z	£252.75
900 x 900 x 460	1	Double	CFC05Z	£323.80
1200 x 900 x 460	2	Double	CFC06Z	£408.00
1800 x 900 x 460	3	Double	CFC08Z	£480.40
1800 x 1200 x 460	3	Double	CFC16Z	£565.90
Mobile Cupboards				
840 x 900 x 460	1	Double	CMC01Z	£471.15
1040 x 900 x 460	1	Double	CMC02Z	£513.25
Wall Cupboards				
570 x 850 x 255	1	Double	CWC01Z	£280.40
Floor Chests				
510 x 610 x 340	-	-	CFC18Z	£348.80
610 x 1170 x 460	-	-	CFC19Z	£546.15

To Fit W x D mm	Model	Price
Stands (543mm high)		
350 x 300	CSS01Z	£110.55
460 x 460	CSS02Z	£114.50
900 x 460	CSS08Z	£128.95

Hazardous Substance & CoSHH Security Cupboards

**FROM ONLY
£765.90**



It is vital that employers & employees comply with the control of hazardous substances in all working environments. This range of cupboards and cabinets enables the separate storage of hazardous substances as demanded by the CoSHH regulations. They are constructed from welded 1.5mm steel for strength combined with a superior anti-pick locking mechanism, to ensure security.

- » Welded all steel structure for extra strength
- » Seven lever safe lock for high security
- » New regulation labels enclosed to be fitted by customer to suit regulations
- » Full length heavy duty hinges with concealed fixings to prevent forced entry
- » Adjustable spill-retaining galvanised shelves for superior spill management
- » Powder coated with Germ Guard Active Technology anti-bacterial paint
- » Integral liquid-tight sump encourages the correct handling of spills through the use of absorbents
- » Reaction to Fire Classification EN 13501-1



Hazardous Substance Security Cupboards (Yellow)

Overall Size H x W x D mm	No of Shelves	Model	Price
900 x 460 x 450	1	HSSC090445	£765.90
1200 x 900 x 450	2	HSSC120945	£1065.85
1200 x 1200 x 450	2	HSSC121245	£1627.70
1800 x 900 x 450	3	HSSC180945	£1639.50
1800 x 1200 x 450	3	HSSC181245	£2004.00

Extra Shelves		
To Fit W x D mm	Model	Price
460 x 450	HSSC0445ES	£44.75
900 x 450	HSSC0945ES	£69.75
1200 x 450	HSSC1245ES	£97.40

CoSHH Security Cupboards (Grey)

Overall Size H x W x D mm	No of Shelves	Model	Price
900 x 460 x 450	1	CSSC090445	£765.90
1200 x 900 x 450	2	CSSC120945	£1065.85
1200 x 1200 x 450	2	CSSC121245	£1627.70
1800 x 900 x 450	3	CSSC180945	£1639.50
1800 x 1200 x 450	3	CSSC181245	£2004.00

Extra Shelves		
To Fit W x D mm	Model	Price
460 x 450	CSSC0445ES	£44.75
900 x 450	CSSC0945ES	£69.75
1200 x 450	CSSC1245ES	£97.40

Storage, Security Cages & Hazardous

Safety Cabinets for Flammable Substances



5 day delivery

10 YR
GUARANTEE

FM
APPROVED



- » Exceed the requirements of HSG51, 2015 (HSE Storage of Flammable Liquids in Containers, 3rd Edition)
- » Meets the requirements of HSG140, 2015 (HSE Safe Use & Handling of Flammable Liquids, 2nd Edition)
- » 10 minute fire tested at up to 1,300°C (independent testing)
- » Internal temperature during fire test kept below the auto ignition temperature of vast majority of flammable liquids
- » Can help justify storage of more volume of flammable liquids than HSG51 would normally allow
- » Fully load tested
- » Self-closing models have fusible links that close the doors at 74°C
- » Dual wall construction with insulating air space
- » Fully welded construction with 1mm steel used throughout
- » 3 point heavy duty stainless bullet self-latching doors – positive door closure without manual rotation to ensure latching
- » Leak proof integrated sump & 2 air vents with flame arresters built-in



- » Concealed self-close mechanism – release doors on self-closing models from any open position & the door will shut & latch
- » Adjustable shelf positions on 76mm centres, each with 156kg UDL rating
- » Continuous piano hinges on doors
- » Shelves direct leaks to back & bottom of cabinet
- » Adjustable levelling feet
- » Built in grounding connector

Description	Overall Size H x W x D mm	No of Doors	No of Shelves	Sump Capacity	Manual Close Doors		Self Close Doors	
					Model	Price	Model	Price
Mini Cabinet	580 x 560 x 230	1	1	2 L	SCF001M	P.O.A.	-	-
Countertop Cabinet	580 x 560 x 460			6.5 L	SCF002M	P.O.A.	SCF011S	P.O.A.
Compact Cabinet	889 x 591 x 457			10 L	SCF003M	P.O.A.	SCF012S	P.O.A.
	1118 x 591 x 457			10 L	SCF004M	P.O.A.	SCF013S	P.O.A.
Slimline Cabinet	1651 x 591 x 457	3	3	10 L	SCF005M	P.O.A.	SCF014S	P.O.A.
Undercounter Cabinet	889 x 889 x 459			20 L	SCF006M	P.O.A.	SCF015S	P.O.A.
Standard Cabinet	1118 x 1092 x 457	2	1	20 L	SCF007M	P.O.A.	SCF016S	P.O.A.
	1651 x 1092 x 457			20 L	SCF008M	P.O.A.	SCF017S	P.O.A.
	1651 x 864 x 864	2	2	20 L	SCF009M	P.O.A.	SCF018S	P.O.A.
	1651 x 1092 x 864			31.5 L	SCF009M	P.O.A.	SCF018S	P.O.A.
				41 L	SCF010M	P.O.A.	SCF019S	P.O.A.

Storage Vaults

- » Designed to comply with the Flammable Liquid Storage Regulations (1972) as appropriate & the Factory Inspection Guide HSG51
- » Adjustable vent meets the requirements of both flammable storage (vents closed) & agrochemicals (vents open)
- » All welded units conforming to the A.P.E.A. construction requirements
- » Provide a half hour protection from collapse & the passage of flame
- » Multi-lockable for high security & fitted with a lift up action lid assisted by gas struts
- » For extra protection & fork lifting the units have skids on the base
- » Middle shelves pivot on models SSV01Z & SSV02Z to enable larger items to be stored on the base level
- » Model SSV03Z has a central partition & four shelves - the two middle shelves fold away & the two top shelves are made in 3 sections - the back section is fixed in position & the front two sections removable
- » All models have a liquid-tight base to contain spillage

N.B. A Fork Lift will be needed to unload these vaults



SSV02Z



SSV01Z



SSV03Z

SAFETY NOTE

Before storage of herbicides & petroleum based products takes place the advice of the following should be sought for specific guidance.

- » Health & Safety Inspector
- » Trading Standards Officers
- » Environmental Health Officers
- » Fire Officers

Overall Size H x W x D mm	Liquid Tight Sealed Base Unit Capacity	Shelves mm	Weight kg	Model	Price
1270 x 700 x 850	120 Litre	2 x Shelves: Top: 690 x 400 fixed Middle: 690 x 400 pivots	180	SSV01Z	£2424.30
1270 x 1370 x 850	250 Litre	2 x Shelves: Top: 1360 x 400 fixed Middle: 1360 x 400 pivots	260	SSV02Z	£3411.95
1270 x 2500 x 1080	550 Litre	4 x Shelves: 1220 x 500	460	SSV03Z	£6103.35

Storage, Security Cages & Hazardous



SSB10Z

Petroleum Storage Chests

- » Suitable for 'CLASS A' Storage (1986) & labelled in accordance with the Petroleum Consolidation Act 1928, conforming to BS5378 & E.C. Directive 92/58 EEC
- » Fully welded units designed & constructed to comply with A.P.E.A requirements
- » Fitted with a hasp & staple to enable padlocking
- » Produced with a sloping roof to aid protection against the weather
- » Each unit is fitted with a removable sump

N.B - A Fork Lift will be needed to unload this unit



Overall Size H front/rear x W x D mm	Weight kg	Capacity (Cubic Metres)	Model	Price
655/810 x 610 x 630	46	0.25	SSB09Z	£1050.65
655/810 x 965 x 630	64	0.34	SSB10Z	£1304.55
655/810 x 1270 x 630	85	0.40	SSB11Z	£1543.25

Storage Cabinet

- » Lockable handle on double doors
- » Clear space between shelves: 550 top & 540 bottom shelf
- » Two removable storage shelves of 25x25mm mesh (1115W x 520Dmm)
- » Designed to comply with the Flammable Liquid Storage Regs. (1972) as appropriate & the Factory Inspection Guide HSG51
- » The adjustable vent meets the requirements of both flammable storage (vent closed) & agrochemicals (vent open)
- » All welded unit conforming to the A.P.E.A. construction requirements
- » The unit helps provide a half hour protection from collapse & the passage of flame

N.B - A Fork Lift will be needed to unload this unit

SSC01Z

£1861.40



SSC01Z

Overall Size H x W x D mm	Base Unit Capacity	Weight kg	Model	Price
1535 x 1125 x 560	85 Litre	120	SSC01Z	£1861.40

Heavy Duty Storage Vault Cabinets

- » Fully welded construction for heavy duty use (complete with handles on the mobile units which are bolt-on)
- » Exterior grade plywood shelves with steel surround for edge protection. Shelves are centrally positioned within the unit
- » Static units are movable with a pallet truck
- » Mobile units are fitted with 2 fixed & 2 swivel braked 200mm castors (125mm on DC5's)
- » Complete with hasp & staple lock with padlock facility (padlock not included)
- » Extra shelves are available - call for details.
- » 500kg load capacity (300kg on the DC5's)



DC30PH



DC10PS

INFORMATION

Secure storage for valuable materials



up to 500kg evenly distributed



DC51PY



Static Units

Overall Size L x W x H mm	Storage Vault Cabinets			Storage Vault Cabinets with 1 Shelf		
	Weight kg	Model	Price	Weight kg	Model	Price
1090 x 730 x 1380	107	DC20PS	£1026.80	123	DC21PS	£1128.60
1090 x 830 x 1180	110	DC40PS	£1027.60	126	DC41PS	£1130.10
1290 x 730 x 1180	110	DC30PS	£1028.95	126	DC31PS	£1132.90
1290 x 830 x 1380	112	DC10PS	£1081.40	128	DC11PS	£1186.35
1310 x 535 x 1060	108	DC50PS	£1011.45	124	DC51PS	£1104.20

Mobile Units

Overall Size L x W x H mm	Storage Vault Cabinets			Storage Vault Cabinets with 1 Shelf		
	Weight kg	Model	Price	Weight kg	Model	Price
1090 x 730 x 1460	109	DC20PH	£1078.10	125	DC21PH	£1179.90
1090 x 830 x 1260	112	DC40PH	£1078.85	128	DC41PH	£1181.45
1290 x 730 x 1260	112	DC30PH	£1080.25	128	DC31PH	£1184.20
1290 x 830 x 1460	114	DC10PH	£1132.75	130	DC11PH	£1235.70
1310 x 535 x 1060	110	DC50PY	£1018.35	126	DC51PY	£1111.30

N.B - A Fork Lift will be needed to unload these units

Storage, Security Cages & Hazardous

Galvanised Secure Stores



Manufactured in accordance with PPG 26 regulations as per the requirement of the Environment Agency

INFORMATION



Hazardous stores to meet all your storage needs

- » Side & roof panels are manufactured from 0.6mm cold rolled corrugated galvanised steel & for additional strength the unit has a structural frame which is fitted at each end & at the centre of the unit
- » The sump is manufactured from 2mm structural grade galvanised steel & is fitted with base plinths to keep the underside of the units out of contact with the ground
- » The double doors, fitted with 3 upper & 3 lower vents in each door, are located on one of the short sides of the unit & are secured with a Kale mortis lock with cylinder (152R)
- » Complete with two sets of shelves (60kg shelf U.D.L.) on each of the long sides of the unit
- » Fork lifting pockets are underneath the units
- » Subject to availability



This unit will be delivered by an articulated vehicle, therefore please ensure that a vehicle of this size can access your premises before ordering and advise us accordingly. You will require an appropriate size-capacity fork lift truck or Hiab unit to offload this item from the delivery vehicle. **IMPORTANT:** our standard delivery doesn't include any offloading due to insurance restrictions - if you require this service then please call for details. The unit must be positioned on a solid level surface, ideally concrete of circa 150mm in depth and 100mm bigger overall than the unit. The purpose of this is to ensure the unit does not settle unevenly when placed in position.

External Size L x W x H mm	Internal Size L x W x H mm	Sump Capacity Litres	Model	Price
2184 x 2928 x 2198	2018 x 2840 x 1935	560	EMDL560	P.O.A.
2184 x 3778 x 2198	2018 x 3690 x 1935	727	EMDL727	P.O.A.

Hazardous Material Stores



ECS2196

Manufactured in accordance with PPG 26 regulations as per the requirement of the Environment Agency

INFORMATION
 Hazardous stores to meet all your storage needs



COLOUR OPTIONS

- Red
- Green
- Blue

specify when ordering



ECS0650



ECS1098



ECS0450



ECS1125

- >> Base is manufactured from 3mm mild steel
- >> Corner posts, main rails & cross members are rolled hollow section
- >> The roof is pressed with suitable bracing & fully welded around the perimeter, while the back, side & door panels are pressed from 2mm mild steel sheet & corrugated where required
- >> Fitted with a single cam door gear which is secured with a padlock (not supplied)
- >> Fully seam welded sump fitted with a removable galvanised grid mesh deck
- >> High & low louvre vents complete with flame arrestor mesh as standard
- >> Shot blasted before being painted (RAL 6029) for greater durability

This unit will be delivered by an articulated vehicle, therefore please ensure that a vehicle of this size can access your premises before ordering and advise us accordingly. You will require an appropriate size-capacity fork lift truck or Hiab unit to offload this item from the delivery vehicle. **IMPORTANT:** our standard delivery doesn't include any offloading due to insurance restrictions - if you require this service then please call for details. The unit must be positioned on a solid level surface, ideally concrete of circa 150mm in depth and 100mm bigger overall than the unit. The purpose of this is to ensure the unit does not settle unevenly when placed in position.

Model	1	2	3	4	5
External Size: H x W x L mm	2658 x 2160 x 2160	2658 x 2440 x 3000	2350 x 800 x 2500	3000 x 1500 x 2403	2625 x 2440 x 5920
Sump Capacity: Litres	650	1098	450	1125	2196
Shelves:	Shelving Units each side of the door	Shelving Units each side of the door	2 Middle Shelves	2 Middle Shelves	3 sets of Double Shelves
Type of Door:	775mm Wing Door	1250mm Wing Door	Sliding Doors	Sliding Doors	1250mm Wing Door
Model:	ECS0650	ECS1098	ECS0450	ECS1125	ECS2196
Price	P.O.A.	P.O.A.	P.O.A.	P.O.A.	P.O.A.

Storage, Security Cages & Hazardous

Grenadier® Heavy Duty Galvanised Security Cage

NEW

500kg
evenly
distributed



Fork
Pockets

GSC1212

Galvanised Roof

- » Manufactured from galvanised, 25 x 25mm mesh & a galvanised sheet panel roof
- » Units have a padlock facility (*padlock not supplied*)
- » Suitable for outdoor use
- » Supplied knock down for easy assembly
- » Incorporates 2 fork lift pockets

N.B. A Fork Lift will be needed to unload these units

INFORMATION



Complete with galvanised sheet panel roof & 2 fork lift pockets - ideal for outdoor use



Overall Size H x W x D mm	Internal Size H x W x D mm	Model	Price
1800 x 1200 x 1200	1390 x 1150 x 1150	GSC1212	£2617.95

Grenadier® Strong Knock Down Cages

- » Knock down cages in a range of sizes, can be easily placed under worktops, or left freestanding
- » Easy assembly
- » Units have a padlock facility (*padlock not supplied*)
- » Red powder coat finish
- » Holes in the base rails allow the cages to be fixed to the floor for additional security (*fixings not supplied*)

N.B. A Fork Lift will be needed to unload these units



FROM ONLY
£453.95



SCK11Z

SCK13Z

INFORMATION

These cages are easily assembled when on site, allowing for easy installation through normal doorways



Overall Size H x W x D mm	Internal Size H x W x D mm	Model	Price
825 x 800 x 825	800 x 750 x 775	SCK11Z	£453.95
825 x 1600 x 825	800 x 1550 x 775	SCK12Z	£675.45
1625 x 800 x 825	1600 x 750 x 775	SCK13Z	£790.50
1625 x 1600 x 825	1600 x 1550 x 775	SCK14Z	£1173.60
1625 x 1600 x 1650	1600 x 1550 x 1600	SCK15Z	£1575.20
1200 x 925 x 1025	1175 x 875 x 975	SCK16Z	£588.20
1200 x 1200 x 1250	1175 x 1150 x 1200	SCK17Z	£680.60
1200 x 1950 x 1025	1175 x 1900 x 975	SCK18Z	£903.70

Storage, Security Cages & Hazardous

Grenadier® Lock Up Security Cage

- » Manufactured from 50 x 50mm mesh panels & galvanised roof
- » Complete with a hasp & staple locking facility (padlock not supplied)



FROM ONLY
£2392.25



N.B. A Fork Lift will be needed to unload these units

Overall Size H x W x D mm	Weight kg	Model	Price
1950 x 1605 x 990	100	GLC12Z	£2392.25
1950 x 2545 x 990	150	GLC15Z	£3304.10
1950 x 3485 x 990	160	GLC18Z	£3843.70

Grenadier® Security Cage with Solid Roof & Base

- » All welded unit constructed from steel angle & 50 x 50mm weld mesh
- » Unit has a padlock facility (*padlock not supplied*)
- » Ideal for the security of both hazardous & valuable materials
- » Blue powder coat finish

N.B. A Fork Lift will be needed to unload this unit



GLC40Z



GLC40Z
£1770.00



GLC40Z

Overall Size H x W x D mm	Internal Size H x W x D mm	No of Doors	Weight kg	Model	Price
1830 x 980 x 980	1710 x 900 x 920	2	75	GLC40Z	£1770.00

Grenadier® Security Cages



**FROM ONLY
£715.20**



SCB01Z

SCB06Z



SCB05Z



SCB02Z

- » Fully assembled units constructed from steel angle & 25 x 25mm weld mesh
- » Units have a padlock facility (*padlock not supplied*)
- » Ideal for the security of both hazardous & valuable materials
- » Blue powder coat finish
- » Optional hazardous chemical sign available - see page 145 for details

N.B. A Fork Lift will be needed to unload these units

Overall Size H x W x D mm	Internal Size H x W x D mm	No of Doors	Weight kg	Model	Price
830 x 700 x 700	790 x 690 x 690	1	37	SCB01Z	£715.20
830 x 1400 x 700	790 x 1380 x 690	2	52	SCB02Z	£1198.75
1630 x 700 x 700	1585 x 690 x 690	1	55	SCB03Z	£1271.35
1630 x 700 x 1000	1585 x 690 x 990	1	58	SCB06Z	£1422.00
1630 x 1400 x 700	1585 x 1380 x 690	2	110	SCB04Z	£1928.00
1630 x 1400 x 1000	1585 x 1380 x 990	2	113	SCB07Z	£2088.55
1630 x 2070 x 700	1585 x 2040 x 690	2	124	SCB05Z	£2424.80
1630 x 2070 x 1000	1585 x 2040 x 990	2	127	SCB08Z	£2554.05

Storage, Security Cages & Hazardous

Grenadier® Security Cage with Lift Up Lid

- » Fully welded construction
- » Hinged lift up lid is assisted by gas struts
- » When the lid is shut the front doors will not open leaving a completely secure & enclosed unit
- » Units have a hasp & staple padlock facility (padlock not included)
- » Incorporates 2 fork lift pockets
- » Optional hazardous chemical sign available - see page 145 for details



FROM ONLY
£1632.30

GBC12Z
N.B. A Fork Lift will be needed to unload these units



GBC12Z

Overall Size H x W x D mm	Internal Height mm	Weight kg	Model	Price
830 x 1260 x 1260	710	150	GBC12Z	£1632.30
1250 x 1860 x 1260	1130	180	GBC18Z	£2068.40

Grenadier® Knock Down Security Cages

- » This unit is supplied knock down for easy access into your premises. Manufactured from 50 x 50mm mesh panels & galvanised roof
 - » Complete with a hasp & staple locking facility (padlock not supplied)
 - » GLC25Z & GLC35Z supplied with a pallet base which incorporates fork lift pockets
- N.B. A Fork Lift will be needed to unload these units



FROM ONLY
£1798.10

GLC25Z



GLC20Z



GLC20Z Folded
(on a pallet)

Description	Overall Size H x W x D mm	Weight kg	Painted		Galvanised	
			Model	Price	Model	Price
Cage Only	1830 x 1260 x 1010	90	GLC20Z	£1798.10	GLC30Z	£2107.90
Cage with Pallet Base	2000 x 1290 x 1010	135	GLC25Z	£2379.75	GLC35Z	£2572.70

Grenadier® Security Cages



SCR05Z

INFORMATION



Industrial galvanised cages with powder coated red doors



SCR06Z



FROM ONLY
£976.65



SCR01Z



SCR02Z

- » Fully assembled constructed from steel angle & 50 x 50mm weld mesh
- » Units have a padlock facility (*padlock not supplied*)
- » Ideal for the security of both hazardous & valuable materials
- » Galvanised cage with powder coated red doors
- » Optional hazardous chemical sign available - see page 145 for details

Overall Size H x W x D mm	Internal Size H x W x D mm	No of Doors	Weight kg	Model	Price
830 x 700 x 700	790 x 690 x 690	1	37	SCR01Z	£976.65
830 x 1400 x 700	790 x 1380 x 690	2	52	SCR02Z	£1491.70
1630 x 700 x 700	1585 x 690 x 690	1	55	SCR03Z	£1604.70
1630 x 700 x 1000	1585 x 690 x 990	1	58	SCR06Z	£1754.65
1630 x 1400 x 700	1585 x 1380 x 690	2	110	SCR04Z	£2460.25
1630 x 1400 x 1000	1585 x 1380 x 990	2	113	SCR07Z	£2588.20
1630 x 2070 x 700	1585 x 2040 x 690	2	124	SCR05Z	£2802.60
1630 x 2070 x 1000	1585 x 2040 x 990	2	127	SCR08Z	£3120.25

N.B. A Fork Lift will be needed to unload these units

Storage, Security Cages & Hazardous

Grenadier® Knock Down Gas Cylinder Cages

- » These units are supplied knock down for easy access into your premises
- » Robust 25 x 25mm mesh panels easily bolt together to create a strong & rigid frame. These units also incorporate a galvanised roof
- » Complete with a locking facility (padlock not supplied)
- » Easy to expand with additional panels



GLC55Z



GLC55Z

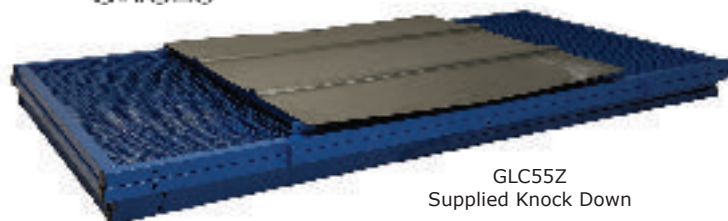

GLC55Z
Supplied Knock Down

N.B. A Fork Lift will be needed to unload these units

Includes	Overall Size H x W x D mm	Weight kg	Model	Price
Knock Down Gas Cylinder Cages				
1 x Back Panel, 2 x Side Panels, 1 x Door Panel & 1 x Roof Panel	1860 x 1007 x 1070	81	GLC50Z	£1274.00
2 x Back Panels, 2 x Side Panels, 2 x Door Panels & 1 x Roof Panel	1860 x 1954 x 1070	125	GLC60Z	£1849.45
2 x Back Panels, 4 x Side Panels, 2 x Door Panels & 1 x Roof Panel	1860 x 1954 x 2045	177	GLC70Z	£2456.50
Knock Down Gas Cylinder Cages with Floor Grid Panel				
1 x Back Panel, 2 x Side Panels, 1 x Door Panel, 1 x Roof Panel & 1 x Floor Grid Panel	1860 x 1007 x 1070	99	GLC55Z	£1383.95
2 x Back Panels, 2 x Side Panels, 2 x Door Panels, 1 x Roof Panel & 1 x Floor Grid Panel	1860 x 1954 x 1070	161	GLC65Z	£2201.55
2 x Back Panels, 4 x Side Panels, 2 x Door Panels, 1 x Roof Panel & 1 x Floor Grid Panel	1860 x 1954 x 2045	249	GLC75Z	£3220.70

Grenadier® Heavy Duty Security Cages

SCS04Z fitted with SCS001

FROM ONLY
£829.85

SCS03Z fitted with SCS003



SCS02S

SCS01Z



SCS01Z



- » Fully assembled constructed from steel angle & 25 x 25mm weld mesh
 - » Units are load tested
 - » Units have a padlock facility (*padlock not supplied*)
 - » Cranage eyes for easy lifting (when lifting using the Cranage eyes, we recommend using a spreader)
 - » A hazardous chemical sign is available as a factory fitted optional extra
 - » Mobile units are fitted with 4 x 100mm nylon, 2 braked swivel castors (*N.B add 115mm to the height*)
 - » Two finishes available: powder coated yellow or galvanised body with powder coated yellow doors
- N.B. A Fork Lift will be needed to unload these units**



SCS05Z fitted with SCS001

Overall Size H x W x D mm	Internal Size H x W x D mm	No of Doors	Wt kg	Powder Coated Yellow				Galvanised - Yellow Doors				Shelf to suit Factory Fitted (one per unit)	
				Static		Mobile		Static		Mobile			
				Model	Price	Model	Price	Model	Price	Model	Price	Model	Price
880 x 700 x 700	790 x 690 x 690	1	37	SCS01Z	£829.85	SCS01S	£909.75	SCG01Z	£1039.55	SCG01S	£1120.70	-	-
880 x 1400 x 700	790 x 1380 x 690	2	52	SCS02Z	£1342.85	SCS02S	£1423.05	SCG02Z	£1591.65	SCG02S	£1672.80	-	-
1680 x 700 x 700	1585 x 690 x 690	1	55	SCS03Z	£1412.80	SCS03S	£1492.95	SCG03Z	£1706.35	SCG03S	£1787.50	SCS003	£114.45
1680 x 1400 x 700	1585 x 1380 x 690	2	110	SCS04Z	£2155.40	SCS04S	£2233.45	SCG04Z	£2613.00	SCG04S	£2694.15	SCS004	£192.40
1680 x 2070 x 700	1585 x 2040 x 690	2	124	SCS05Z	£2604.00	SCS05S	£2683.80	SCG05Z	£3202.40	SCG05S	£3283.55	SCS005	£254.85
Optional Hazardous Sign - Factory Fitted												SCS001	£87.85

Storage, Security Cages & Hazardous



Troax Cage



Troax Cage is a quick and easy theft deterrent, suitable for warehouses or on construction sites. It has a flexible and modular construction, and all depths are possible from 1200mm up to the infinity. Also the depth can be extended as and when needed using additional modular panels and brackets. The unique design of the hinge enables a 270 degrees opening of both doors.



Boxes	Overall Size H x W x D mm	Finish	Model	Price
Mini Box No. 1	2230 x 1200 x 1200	Grey - RAL 7037	UK800298	£1017.81
		Hot Dip Galvanised	UK800299	£1288.07
Maxi Box No. 1	2230 x 2200 x 1200	Grey - RAL 7037	UK800295	£1191.63
		Hot Dip Galvanised	UK800296	£1523.74
Maxi Box No. 2	2230 x 2200 x 2400	Grey - RAL 7037	UK800293	£1581.57
		Hot Dip Galvanised	UK800294	£2061.37
Maxi Box No. 3	2230 x 2200 x 3600	Grey - RAL 7037	UK800290	£2053.40
		Hot Dip Galvanised	UK800291	£2680.90
Maxi Box No. 4	2230 x 2200 x 4800	Grey - RAL 7037	UK800288	£3176.34
		Hot Dip Galvanised	UK800289	£3218.53
Maxi Box No. 5	2230 x 2200 x 6000	Grey - RAL 7037	UK800286	£2833.29
		Hot Dip Galvanised	UK800287	£3756.14

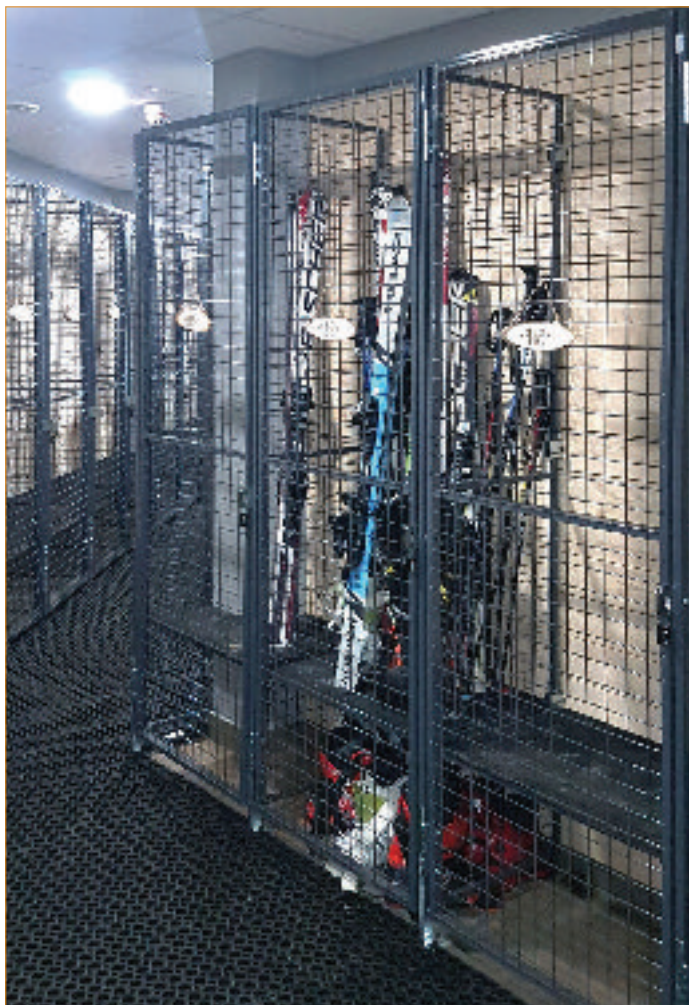

Single & Double Lockers

Single and Double Lockers customise storage spaces depending on the specific need required. The single doors can be created out of eight standard wall panel widths. Both the single and double lockers can be built out of UR350 panels (19x19mm framework) or UX450 panels (20x30mm framework). Securing plates for padlocks are standard.

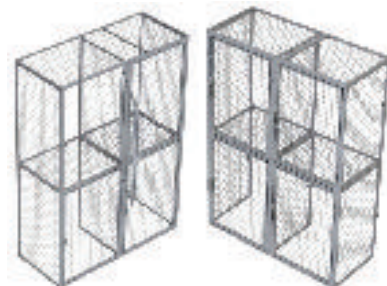

PRICE ON APPLICATION

Storage, Security Cages & Hazardous

Grenadier® Gas Cylinder Cages



FROM ONLY
£1842.85



- » Provision for a padlock
 - » Complete with 'Highly Flammable' sign
 - » Useable distance between shelves: 720mm
 - » Manufactured in angle iron with sides, end & top infilled with metal strip. Base of inverted angle
 - » Mobile models have a push handle at one end
 - » Designed to carry up to 16 'calor gas' type cylinders
 - » Hinged lockable doors
 - » Internal size of 1560W x 840Dmm
- N.B. A forklift will be needed to unload these units



Description	Finish	Overall Size H x W x D mm	Weight kg	Model	Price
Static Unit	Painted	1800 x 1610 x 890	80	GCC02Z	£1842.85
	Galvanised	1800 x 1610 x 890	80	GCC12G	£2478.80
Mobile Unit 200mm Nylon	Painted	1900 x 1610 x 890	80	GCC01N	£1966.80
	Galvanised	1900 x 1610 x 890	80	GCC11G	£2621.75

Grenadier® Cylinder Storage Lock-up Cages



FROM ONLY
£2235.25



Description	Overall Size H x W x D mm	Painted Finish		Galvanised Finish	
		Model	Price	Model	Price
Cage Only	1840 x 1360 x 1095	CS501Z	£2235.25	CS511G	£2831.40
Cage with Pallet Base	1990 x 1360 x 1095	CP601Z	£2848.20	CP611G	£4162.85
Cage Only	1840 x 1360 x 1715	CS502Z	£2592.30	CS512G	£3300.90
Cage with Pallet Base	1990 x 1360 x 1715	CP602Z	£3482.10	CP612G	£4498.90

- » Permanently fixed or pallet base units
 - » Complete with 'Highly Flammable' sign
 - » Manufactured in angle iron infilled with tough iron mesh
 - » Cylinders held by retaining chain
 - » Base is drilled for fixing points
 - » CS512G & CP612G are of a slightly different design as shown in the picture
- N.B. A forklift will be needed to unload these units

Safety, Security, PPE, Matting & Flooring

Poloshirt

- » Available in black, bottle green, heather grey, maroon, navy, red, royal & white - please specify when ordering
- » 50% Polyester 50% Cotton
- » Knitted collar, hemmed sleeve & bottom
- » 3 Self Coloured Button Placket
- » Washable at 60 Degrees



Size Guide:

S	M	L	XL	2XL	3XL	4XL	Price
36-38	40-41	42-44	46-48	50-52	54-55	56-58	P.O.A.

Sweatshirt

- » Available in black, bottle green, heather grey, maroon, navy, red, royal & white - please specify when ordering
- » 50% Polyester 50% Cotton
- » Lycra ribbed cuffs, welt & neck
- » Set in sleeves
- » Twin needle stitching at neck, shoulders, armhole & sleeves
- » Brushed effect for superior comfort & look



Size Guide:

S	M	L	XL	2XL	3XL	4XL	Price
36-38	40-41	42-44	46-48	50-52	54-55	56-58	P.O.A.



Fleece

- » Available in black, bottle green, navy, red & royal - please specify when ordering
- » 100% polyester super anti-pill micro fleece
- » Twin needle stitching & elasticated cuffs
- » Full self coloured zip with zip puller
- » 2 self coloured covered zipped pockets with zip pullers
- » Elasticated pull cords & toggles
- » Hanger loop inside neck
- » Cadet style collar & half moon yoke

Size Guide:

S	M	L	XL	2XL	3XL	4XL	Price
36-38	40-41	42-44	46-48	50-52	54-55	56-58	P.O.A.

Embroidery Services



INFORMATION

All the above products, along with lots more which are available, can be embroidered with your own company details - please call for more details & prices

Fire Extinguishers



INFORMATION

Maintenance, installation, fire risk assessments & training available - call for details



PRICES HELD

INFORMATION

All extinguishers are approved to BS EN 3



Description	Cap.	Fire Rating	Model	Price
Carbon Dioxide	2 kg	55 B	C2/1	£50.71
	5 kg	70 B	C5/1	£100.00
AFF Foam	2L	8 A : 55 B	F2/1	£31.43
	6L	21 A : 183 B	F6/1	£48.57
	9L	27 A : 233 B	F9/1	£57.14
ABC Powder	1 kg	5 A : 55 B	P1/1	£24.29
	2 kg	13 A : 89 B	P2/1	£27.14
	6 kg	43 A : 233 B	P6/1	£41.43
	9 kg	55 A : 233 B	P9/1	£54.29
Water	6L	13 A	W6/1	£45.71
	9L	21 A	W9/1	£55.71
Water Mist	6L	21 A	WM6/1	£50.00
Wet Chemical	6L	21 A : 113 B : 75 F	WC6/1	£98.57

Fire Risks	Water	Water Mist	Carbon Dioxide	AFF Foam	ABC Powder	Wet Chemical
Freely burning materials: Wood, Paper, Textiles etc.	✓	✓		✓	✓	✓
Flammable Liquids: Petrol, Oil, Fats, Paints etc.			✓	✓	✓	✓
Flammable Gases					✓	
Electrical Hazards			✓		✓	
Cooking fats - such as deep fat fryers oils						✓

Fire Control



PRICES HELD

Item	Description	Model	Price
A	Fire Blanket - 1200 x 1200mm	FB12	£25.71
B	Single Extinguishers Polyethylene Cabinet - for wall, floor or post mounting	ECS	£60.00
C	Double Extinguishers Polyethylene Cabinet - for wall, floor or post mounting	ECD	£91.43
D	High Impact Polyethylene & Chemical Resistant Single Extinguisher Stand	ESS	£32.86
E	High Impact Polyethylene & Chemical Resistant Double Extinguisher Stand	ESD	£44.29
F	Mobile FireKart, to hold two fire extinguishers & a fire bucket	MFK	£121.43
F	Mobile FireKart with Rotary Hand Bell, to hold two fire extinguishers & a fire bucket	MFKRHB	£142.86
H	Polypropylene Fire Bucket with Lid & Handle	FBK	£25.71
I	Site Alarm - Diecast Aluminium Hand Bell (65dB at 30M)	RHB	£41.43
J	Site Alert Alarm (118dB & 5 units can be linked)	ESA	£65.71

Safety, Security, PPE, Matting & Flooring

Wall Mounted Key Storage

- » Wall mounted key storage for allowing access to authorised persons only
- » 4 wheel changeable combination
- » Wall mounted - fixings included



PRICES HELD



Overall Size H x W x D mm	Model	Price
115 x 95 x 40	KSC3K	£25.71
142 x 100 x 54	KSC4K	£32.14

Wall Mounted Key Storage

- » Wall mounted key storage for allowing access to authorised persons only
- » 12 digit changeable combination (4000 combination possibilities)
- » Wall mounted - fixings included

PRICE HELD



Overall Size H x W x D mm	Model	Price
120 x 78 x 56	KSC2K	£33.57

Weatherproof Padlocks

- » High security steel padlocks to withstand physical attacks
- » Exclusive cover protects from water, ice, dirt & grime
- » Dual ball bearing locking for added protection from prying & hammering



6121

Combination Padlocks

- » Brass finish padlock with a hardened steel shackle
- » 4 wheel changeable combination with 10,000 potential combinations



175D



PRICES HELD



175LHD

Body Width mm	Shackle Diameter mm	Shackle Length mm	Model	Price
54	8	29	6121	£39.21
61	10	35	6125	£41.71
67	11	35	6127	£46.36

Body Width mm	Shackle Diameter mm	Shackle Length mm	Model	Price
51	8	25	175D	£37.36
51	8	58	175LHD	£39.57

Laminated Steel Padlocks

- » Individually laminated steel body
- » Hardened boron alloy shackle for superior cut resistance
- » Dual Locking levers provide extra pry resistance
- » Hardened steel bottom plates for extra drill resistance



3EURD

5EURD

3LH

PRICES HELD



Body Width mm	Shackle Diameter mm	Shackle Length mm	Model	Price
40	7	19	3EURD	£15.43
51	10	25	5EURD	£18.29
40	7	38	3LF	£17.21
40	7	51	3LH	£18.64

Key Cabinets - Electronic

- » Durable powder coated finish
- » Adjustable hook bars
- » Colour coded hook bars, key tags & removable control index card
- » Four mounting holes in back of cabinet
- » Electronic cam lock

PRICES HELD

Capacity	Overall Size H x W x D mm	Model	Price
20 Keys	250 x 170 x 75	BR20ECAM	£80.29
35 Keys	320 x 230 x 75	BR35ECAM	£87.57
42 Keys	320 x 230 x 75	BR42ECAM	£89.57
58 Keys	320 x 230 x 95	BR58ECAM	£104.07
77 Keys	320 x 230 x 95	BR77ECAM	£109.29



150

Victor Euro Grade I Safes

- » Certified to EN1443-1 (Euro Grade I) & is AiS Approved
- » £10,000 Cash Rating (x10 For Valuables)
- » Comes with double-bit high security lock with 2 keys
- » 3-walled Door with 3-sided bolt locking
- » Running bar behind hinge
- » Door opening angle 180°
- » Double walled body
- » Fixing points in the centre of the rear & floor for fixing



External Size H x W x D mm	Internal Size H x W x D mm	No of Shelves	Key Locking		Electronic Locking	
			Model	Model	Model	Model
400 x 400 x 270	350 x 341 x 157	1	VICTOR1-1	£715.00	VICTOR1-1E	£970.00
400 x 420 x 420	350 x 361 x 307	1	VICTOR1-2	£890.00	VICTOR1-2E	£1145.00
500 x 500 x 420	450 x 441 x 307	1	VICTOR1-3	£990.00	VICTOR1-3E	£1245.00
650 x 500 x 420	600 x 441 x 307	1	VICTOR1-4	£1055.00	VICTOR1-4E	£1310.00
800 x 500 x 420	750 x 441 x 307	1	VICTOR1-5	£1270.00	VICTOR1-5E	£1525.00
1150 x 500 x 420	1100 x 441 x 307	2	VICTOR1-6	£1690.00	VICTOR1-6E	£1945.00

Victor Euro Grade II Safes

- » Certified to EN1443-1 (Euro Grade II) & is AiS Approved
- » £17,500 Cash Rating (x10 For Valuables)
- » Comes with double-bit high security lock with 2 keys
- » 3-walled Door with 3-sided bolt locking
- » Running bar behind hinge
- » Door opening angle 180°
- » Double walled body
- » Fixing points in the centre of the rear & floor for fixing



External Size H x W x D mm	Internal Size H x W x D mm	No of Shelves	Key Locking		Electronic Locking	
			Model	Model	Model	Model
450 x 450 x 465	350 x 340 x 305	1	VICTOR2-1	£1605.00	VICTOR2-1E	£1860.00
550 x 550 x 465	450 x 440 x 305	1	VICTOR2-2	£1895.00	VICTOR2-2E	£2150.00
700 x 550 x 465	600 x 440 x 305	1	VICTOR2-3	£2060.00	VICTOR2-3E	£2315.00
850 x 550 x 465	750 x 440 x 305	1	VICTOR2-4	£2310.00	VICTOR2-4E	£2565.00
1050 x 550 x 465	950 x 440 x 305	2	VICTOR2-5	£2600.00	VICTOR2-5E	£2855.00
1350 x 550 x 465	1250 x 440 x 305	3	VICTOR2-6	£2975.00	VICTOR2-6E	£3230.00

Victor Euro Grade III Safes

- » Certified to EN1443-1 (Euro Grade III) & is AiS Approved
- » £35,000 Cash Rating (x10 For Valuables)
- » Comes with double-bit high security lock with 2 keys
- » 3-walled Door with 3-sided bolt locking
- » Running bar behind hinge
- » Door opening angle 180°
- » Double walled body
- » Fixing points in the centre of the rear & floor for fixing



External Size H x W x D mm	Internal Size H x W x D mm	No of Shelves	Key Locking		Electronic Locking	
			Model	Model	Model	Model
450 x 450 x 465	350 x 340 x 305	1	VICTOR3-1	£1780.00	VICTOR3-1E	£2035.00
550 x 550 x 465	450 x 440 x 305	1	VICTOR3-2	£2165.00	VICTOR3-2E	£2420.00
700 x 550 x 465	600 x 440 x 305	1	VICTOR3-3	£2320.00	VICTOR3-3E	£2575.00

Safety, Security, PPE, Matting & Flooring

Keystor

- » Sturdy steel cabinets with a tough powder coated, light grey finish
- » Fixed coloured & numbered hook bars, with matching key tabs
- » Removable key control index with the 3 larger models
- » Key locking complete with 2 keys

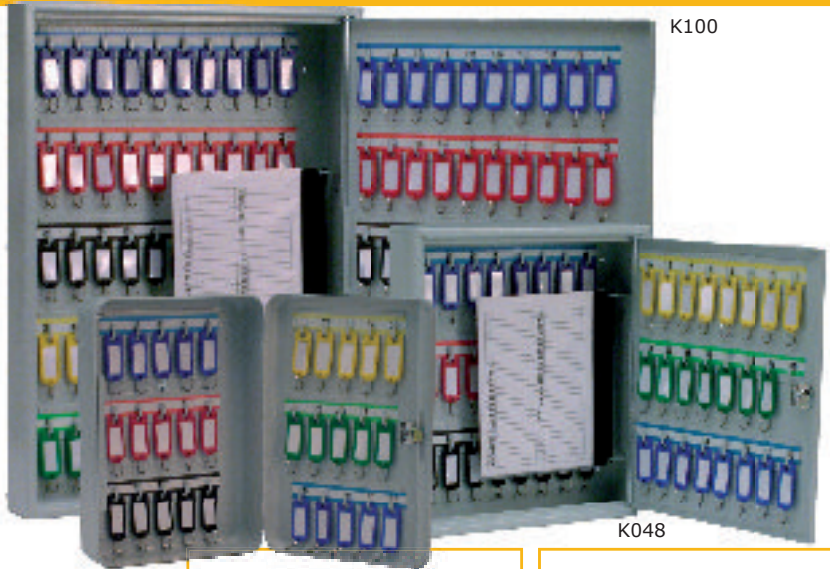

Description	Overall Size H x W x D mm	Model	Price
20 Hook Key Cabinet	255 x 180 x 80	K020	£44.04
30 Hook Key Cabinet	300 x 210 x 80	K030	£55.43
42 Hook Key Cabinet	320 x 245 x 80	K042	£75.49
48 Hook Key Cabinet	350 x 300 x 80	K048	£124.59
64 Hook Key Cabinet	450 x 300 x 80	K064	£159.87
100 Hook Key Cabinet	550 x 380 x 80	K100	£232.10

System Key Cabinets - The total solution for the storage of keys



- » Pressed steel construction (1.5mm thick body & door)
- » Removable control index for added security (except KC020)
- » Adjustable hook bars cater for different key lengths
- » Keytabs are coloured & numbered to match hook bars
- » Supplied with security camlock c/w 2 keys
- » Combination or electronic locks available - *call for details*
- » Closed loops & security seals feature, provides an un-tamperable method of key restriction

Capacity	Overall Size H x W x D mm	Model	Price
20 Keys	260 x 185 x 80	KC020	£85.80
30 Keys	305 x 215 x 80	KC030	£111.16
48 Keys	355 x 300 x 80	KC048	£199.51
64 Keys	450 x 300 x 80	KC064	£261.53
100 Keys	550 x 380 x 80	KC100	£317.58
200 Keys	550 x 380 x 140	KC200	£584.15

'Key Vault' Security Key Cabinets

- » 2.5mm fabricated steel construction
- » Adjustable hook bars cater for different key lengths
- » Removable control index for added security
- » Keytabs are coloured & numbered to match hook bars
- » Supplied with euro profile security deadlock lock c/w 2 keys
- » Combination or electronic locks available - *call for details*
- » Closed loops & security seals feature, provides an un-tamperable method of key restriction

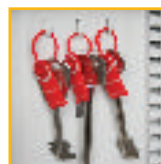

Capacity	Overall Size H x W x D mm	Model	Price
30 Keys	305 x 230 x 70	KV030	£163.07
48 Keys	355 x 300 x 80	KV048	£230.40
100 Keys	550 x 380 x 80	KV100	£396.02
200 Keys	550 x 380 x 140	KV200	£651.33
400 Keys	550 x 730 x 140	KV400	£1084.73
600 Keys	550 x 730 x 205	KV600	£1327.56
48 Bunches	355 x 300 x 140	KVD048	£264.11
100 Bunches	550 x 380 x 140	KVD100	£469.58
200 Bunches	550 x 730 x 140	KVD200	£778.33

Premium Reflective Traffic Mirrors



TMRC60Z



TMR6040Z



- >> Durable casing with reflective strips & impact resistant mirror
- >> Complete with brackets & fixings to fix the mirrors to a post or a wall/flat surface. These mirrors are adjustable for post sizes from 50 to 76mm (2" to 3") dia.

Description	Visibility Distance	Weight kg	Model	Price
Circular Traffic Mirrors with Reflective Edges				
600mm dia.	approx. 15 metres	2.5	TMRC60Z	£109.90
800mm dia.	approx. 15 metres	5	TMRC80Z	£182.25

Description	Visibility Distance	Weight kg	Model	Price
Rectangular Traffic Mirrors with Reflective Edges				
600 x 400mm	approx. 15 metres	2	TMR6040Z	£108.15
800 x 600mm	approx. 15 metres	4	TMR8060Z	£174.95

Indoor Mirrors

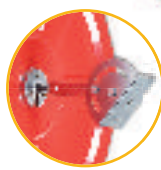

TMN600Z

TMN800Z

- >> TMN600Z - complete with wall/flat surface bracket & fixings
- >> TMN800Z - complete with brackets & fixings to fix the mirrors on to a 76mm (3") dia. post

Description	Visibility Distance	Weight kg	Model	Price
600mm dia.	approx. 11 metres	2	TMN600Z	£50.40
800mm dia.	approx. 15 metres	4.5	TMN800Z	£73.20

Traffic Mirrors with Hoods



Post Fixing Bracket



TMH60Z



- >> Complete with hood for weather protection to help reduce sun glare
- >> Complete with brackets & fixings to fix the mirrors on to a 50mm (2") dia. post



Description	Visibility Distance	Weight kg	Model	Price
450mm dia.	approx. 5 metres	1	TMH45Z	£47.10
600mm dia.	approx. 11 metres	2	TMH60Z	£52.05

Help reduce accident & injuries by eliminating blind spots - These convex traffic mirrors are ideal for outdoor use

Safety, Security, PPE, Matting & Flooring

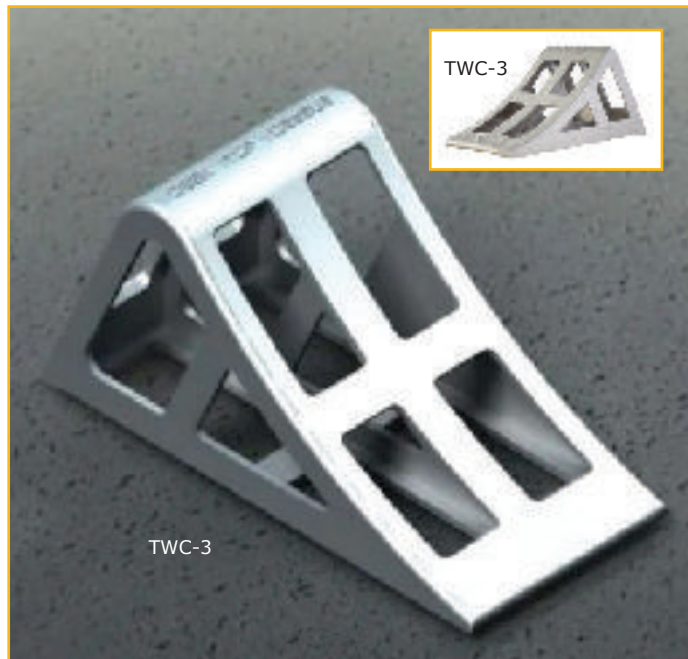

Wheel Chocks



- » Wheel chocks are a low cost effective way of minimising the unexpected movement of vehicles whilst parked or being (un)loaded
- » Moulded rubber units have built-in lifting handles
- » An anti-theft retaining chain is available

TWC-8



TWC-1



TWC-10

Description	Overall Size L x W x H mm	Model	Price each
Rubber Chock	270 x 190 x 190	TWC-1	£46.77
Retaining Chain	5M Long	TWC-2	£56.47
Aluminium Chock	400 x 180 x 180	TWC-3	£109.63
Rubber Chock	150 x 175 x 150	TWC-8	£32.91
Steel Chock	268 x 200 x 230	TWC-10	£42.92

Wheel Chocks with Handle

- » The handle allows operatives to position chocks from a standing position (reducing manual handling effort), whilst also providing a clear visual marker to operatives & drivers that the chock is in place

NEW

TWC-3-HANDLE2-RH



TWC-10-HANDLE2-RH

Description	Orientation	Model	Price each
Cast Aluminium Chock with Handle	Left Hand	TWC-3-HANDLE2-LH	£342.00
Cast Aluminium Chock with Handle	Right Hand	TWC-3-HANDLE2-RH	£342.00
Steel Chock with Handle	Left Hand	TWC-10-HANDLE2-LH	£264.17
Steel Chock with Handle	Right Hand	TWC-10-HANDLE2-RH	£264.17

Dock Lights

- » Ideal for lighting up the inside of HGV's / shipping containers against a loading dock
- » Improve safety by improving visibility for operatives
- » Minimum IP54, for both indoor & outdoor applications
- » Switch included for stand-alone operation
- » Arm length of 1000mm when fully extended
- » Light head swings & pivots to allow optimum positioning
- » Can be mounted either side of the loading bay door



TWDL-5L



TWDL-4L-240



NEW

Description	Voltage	Lamp Type	Model	Price
Deluxe Dock Light	AC 110-240V	18W LED, 900 Lumens	TWDL-4L-240	£368.73
Super Deluxe Dock Light	AC 110-240V	30W LED, 3300 Lumens	TWDL-5L	£409.46

Dock Bumpers

- » Reduce damage to loading docks & buildings caused by vehicle impact
- » The use of rubber dock bumpers, cushions the impact thus minimising ongoing maintenance requirements
- » The correct thickness bumper also helps with the positioning of loading dock equipment such as dock levellers



TWB-E-100-1



TWB-1018-4



TWB-1018-2

TWB-1018-4

TWB-1030-2

TWB-1030-4

Description	Model	Price
D-Section Dock Bumpers		
100 x 100 - 1M length - no fixing holes	TWB-E-100-1	£87.94
100 x 100 - 2M length - no fixing holes	TWB-E-100-2	£176.11
100 x 100 - 3M length - no fixing holes	TWB-E-100-3	£264.17
100 x 100 - 1M length - 3 fixing holes	TWB-E-100-1-H	£106.77
100 x 100 - 2M length - 5 fixing holes	TWB-E-100-2-H	£203.41
100 x 100 - 3M length - 7 fixing holes	TWB-E-100-3-H	£299.72
Optional: 1M length fixing strip	TWB-EST-1	£23.78
Optional: 2M length fixing strip	TWB-EST-2	£47.32
Optional: 3M length fixing strip	TWB-EST-3	£70.44
Fixing: 12mm dia x 135mm long - for concrete	TWB-F1	£3.41

Overall Size mm	Thickness mm	Fixing Holes	Fixing Required	Model	Price
254 x 457	50	2	TWB-F4	TWB-1018-2	£46.01
254 x 457	100	2	TWB-F4	TWB-1018-4	£80.68
254 x 457	150	2	TWB-F5	TWB-1018-6	£97.08
254 x 762	50	3	TWB-F4	TWB-1030-2	£70.99
254 x 762	100	3	TWB-F4	TWB-1030-4	£109.52
Washer to suit all TWB-XXXX-X Bumpers - 2½"				TWB-W	£2.65
Fixing: 16mm dia x 180mm long - for concrete				TWB-F4	£4.62
Fixing: 16mm dia x 220mm long - for concrete				TWB-F5	£8.36

Dockplates

- » Used for (un)loading vehicles from a raised loading area
- » Typically for use with pallet trucks, sack trucks, roll cages & pedestrian access
- » Standard features; manufactured from high tensile aluminium with built in anti-slip finish, loop type handles for movement & one pair of locking legs to prevent movement
- » Options; fork truck handles (FTH-1) for movement by fork truck (recommended for plates marked*) & side curbs with castors (SCC-2) to aid movement

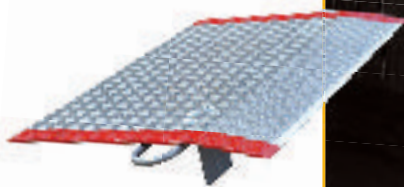

Overall Size W x L mm	Height Differential		Load Cap. kg	Model	Price
	Max Poss.	Max Rec.			
915 x 1220	178	125	770	3648	£987.08
1220 x 610	76	50	2040	4824	£781.89
1220 x 915	127	90	1360	4836	£985.90
1220 x 915	127	90	2450	H4836*	£1146.29
1220 x 1220	178	125	1020	4848*	£1185.20
1220 x 1220	178	125	1810	H4848*	£1408.10
1220 x 1525	228	160	810	4860*	£1389.23
1525 x 1220	178	125	1270	6048*	£1388.04
Fork Truck Lifting Handles (pair)				FTH-1	£215.82
Side Curbs with castors for easy movement (pair)				SCC-2	£340.81

Safety, Security, PPE, Matting & Flooring

PVC Strip Curtains

- » Bespoke-made curtains to fit any location & opening
- » Light to heavy duty use
- » Ambient or freezer grade
- » Pedestrian & forklift friendly
- » Supplied ready to hang



INFORMATION



**Despatched within
2/3 days of ordering**

- » High quality clear PVC
- » DOP & DEHP free
- » Flexible -15°C to +50°C (polar to -25°C)
- » UV stabilisers & high impact resistance

Swivel-hinge

For heavy & frequent use by forklifts. Strips bolted into hinges so they can't be pulled down.

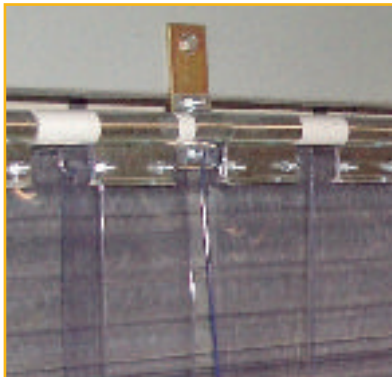

- » Strip widths: 300 & 400mm
- » Strip thickness: 3 & 4mm
- » Overlap options: Min & Max

Hook-on

For pedestrian, pallet truck & occasional forklift use. Available in galvanised or stainless steel.

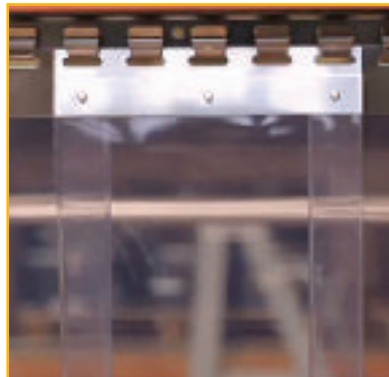

- » Strip widths: 200, 300 & 400mm
- » Strip thickness: 2, 3 & 4mm
- » Overlap options: Min, Med & Max

Quickmount™

For pedestrian areas where safety is key. No steel plates, so no one can be hurt if strips are dislodged.

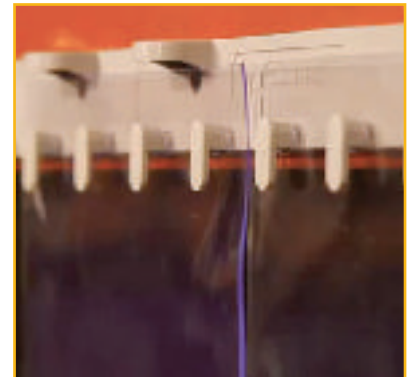

- » Strip widths: 200, 300 & 400mm
- » Strip thickness: 2, 3 & 4mm
- » Overlap options: Min, Med & Max

PVC in standard grade, polar grade, double ribbed & anti-UV

Replacement Strips & Rolls

Available in all sizes & formats. Supplied in 50M rolls or cut to any length & priced per metre



**EXPRESS
DELIVERY**

**ALL CURTAINS
PRICED INDIVIDUALLY
BASED ON HEADRAIL
& PVC OPTIONS**

**CONTACT US
FOR A QUOTE**

CablePRO - Cable Protectors

- » Reduce trip hazards caused by trailing cables
- » Protect cables and wires from being pulled or crushed causing costly damage
- » Hazard strip version for increased visibility



CablePRO GP

- » General purpose cable protectors
- » Hazard strip version for increased visibility

Colour	H x W mm	3M Cable Protector		9M Cable Protector	
		Model	Price	Model	Price
CablePRO GP					
Black	11 x 68	CP010012	£29.38	CP010005	£69.22
Black/Yellow	11 x 68	CP010711	£30.51	CP010701	£72.64
Black	14 x 83	CP010013	£35.69	CP010006	£84.46
Black/Yellow	14 x 83	CP010712	£36.90	CP010702	£91.80

CablePRO Data

- » Multi channel cable protectors for telephone, power or ethernet cables
- » Ideal for keeping multiple cable types separated
- » Seam in base for snapping in cables

Colour	H x W mm	3M Cable Protector		9M Cable Protector	
		Model	Price	Model	Price
CablePRO Data					
Black	14 x 83	CP010010	£39.62	CP010003	£99.97
Black	14 x 108	CP010011	£44.92	CP010004	£115.85

CablePRO HD

- » Tough ramped edges keep cables protected
- » Larger 23mm diameter channels accommodate heavy duty cables
- » CP010009 has a 4.5M length

Colour	H x W mm	3M/4.5M Cable Protector		9M Cable Protector	
		Model	Price	Model	Price
CablePRO Data					
HD1 - Black	28 x 127	CP010007	£80.32	CP010001	£219.01
HD2 - Black	30 x 156	CP010009	£147.84	CP010002	£286.25

CablePRO Mat

- » Special mat for protection from tripping hazards due to loose cables lying around
- » Extremely durable nylon surface in dappled colour shades
- » Cleated non-slip backing made from durable nitrile rubber
- » Integrated cable run underneath the mat
- » Edge in hazard stripe
- » Product height: approx. 11.4 mm
- » 2 year warranty when professionally maintained



CablePRO GP - Black
CP010012 & CP010005
Channel Size: 8mm W x 14mm H

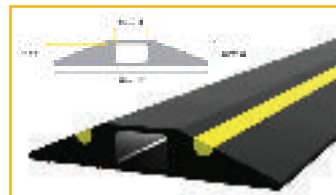

CablePRO GP - Black/Yellow
CP010711 & CP010701
Channel Size: 8mm W x 14mm H



CablePRO GP - Black
CP010013 & CP010006
Channel Size: 30mm W x 10mm H



CablePRO GP - Black/Yellow
CP010712 & CP010702
Channel Size: 30mm W x 10mm H



CablePRO Data
CP010010 & CP010003
2 x Channel Size:
Channel Size: 15mm W x 10mm



CablePRO Data
CP010011 & CP010004
2 x Channel Size:
30mm W x 10mm H & 20mm W x 10mm H



CablePRO HD - HD1
CP010007 & CP010001
Channel Size: 23Ø mm

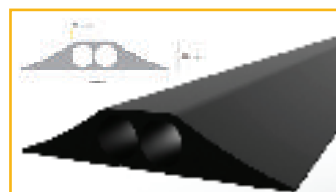

CablePRO HD - HD2
CP010009 & CP010002
2 x Channel Size: 23Ø mm

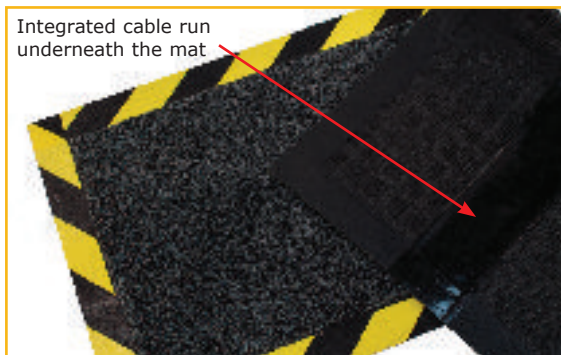

Overall Size L x W mm	Model	Price
1200 x 400	CPM010701	£69.47



Safety, Security, PPE, Matting & Flooring



COBAGRiP

Safety Flooring

- » UV stabilised GRP sheets, treads & stair nosing designed to offer exceptional levels of slip-resistance both indoors & out, while having outstanding wear & tear qualities
- » Ideal for pedestrian & factory walkways, access ramps, gangways & bridges
- » Resistant to most solvents & chemicals
- » Manufactured from a flame retardant silicone carbide 'gritted' top surface
- » Easy to install, simply bond or screw to the existing floor surface

COBAGRiP

- » Suitable for use with forklift traffic
- » Thickness: 5mm overall

COBAGRiP Light

- » Also suitable for food production areas
- » Thickness: 2.4mm overall

COBAGRiP Stair Tread

- » Designed to fully cover the stair area
- » Thickness: 5mm overall

COBAGRiP Stair Nosing

- » Designed to cover the edge of the stair
- » Thickness: 5mm overall

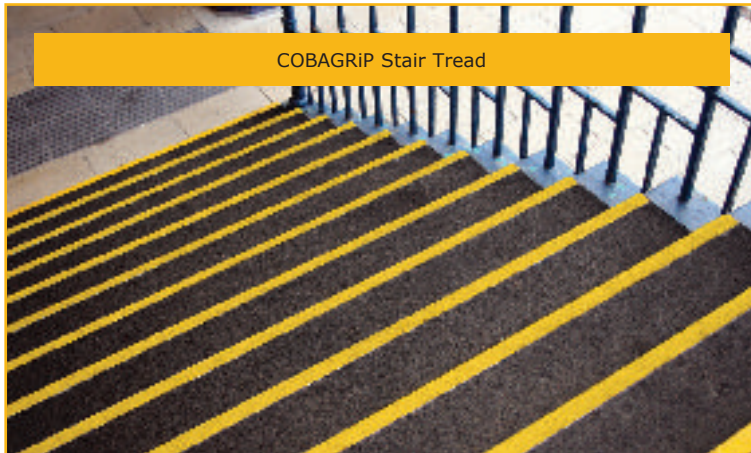

COBAGRiP Stair Tread

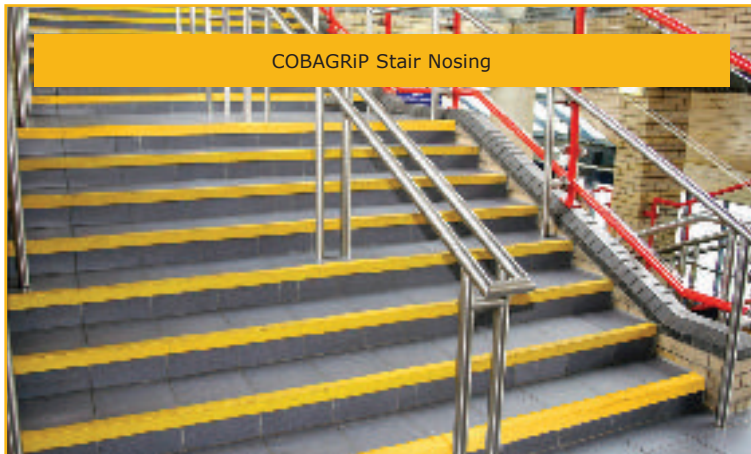

COBAGRiP Stair Nosing

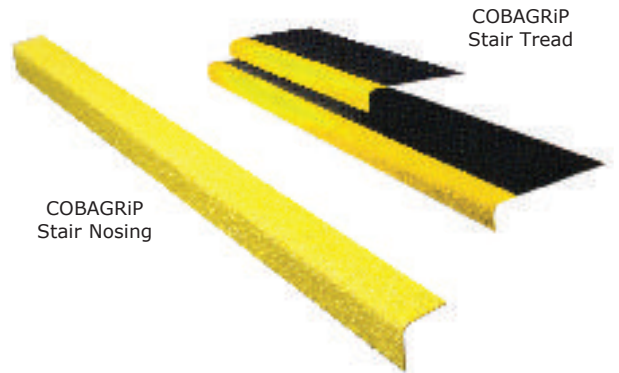

COBAGRiP Stair Nosing

COBAGRiP Stair Tread

Description	Overall Size L x W x H mm	Colour	Model	Price
COBAGRiP	1200 x 1200	Black	GRP010002	£143.88
	1200 x 2400		GRP010001	£266.40
COBAGRiP	1200 x 1200	Grey	GRP060002	£146.37
	1200 x 2400		GRP060001	£266.44
COBAGRiP	1200 x 1200	Yellow	GRP070002	£146.37
	1200 x 2400		GRP070001	£266.44
COBAGRiP Light	1200 x 1200	Black	GRP010002L	£101.37
	1200 x 2400		GRP010001L	£148.99
COBAGRiP Light	1200 x 1200	Grey	GRP060002L	£84.33
	1200 x 2400		GRP060001L	£148.99
COBAGRiP Stair Tread	345 x 1000 x 55	Black/Yellow	GRP010704S	£38.36
	345 x 1500 x 55		GRP010703S	£69.41
	345 x 2000 x 55		GRP010702S	£90.25
	345 x 3000 x 55		GRP010701S	£115.33
COBAGRiP Stair Nosing	55 x 1000 x 55	Yellow	GRP070004N	£12.77
	55 x 1500 x 55		GRP070003N	£21.15
	55 x 2000 x 55		GRP070002N	£28.19
	55 x 3000 x 55		GRP070001N	£38.44

Colours:

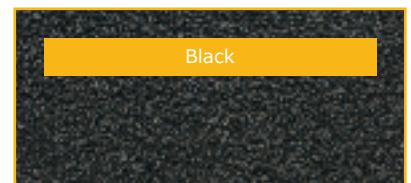

Black



Grey



Yellow

Grip Foot Tape

- » Hard wearing & easy to install
- » Abrasive grip tape with self-adhesive backing
- » Suitable for ladders, stairs, ramps, entrances etc

LOWER PRICES



GF010006



GF010005



Description	Model	Price
Tape Rolls - 18.3m Long		
Black - 25mm wide	GF010001	£14.26
Black - 50mm wide	GF010002	£28.22
Black - 102mm wide	GF010003	£56.37
Black - 152mm wide	GF010004	£84.46
Black/Yellow - 50mm wide	GF010702	£60.68
Red/White - 50mm wide	GF031002	£60.68
Grip Tape Patches		
Black - 140mm x 140mm (Pack of 10)	GF010005	£8.40
Black - 152mm x 610mm (Pack of 10)	GF010006	£32.11

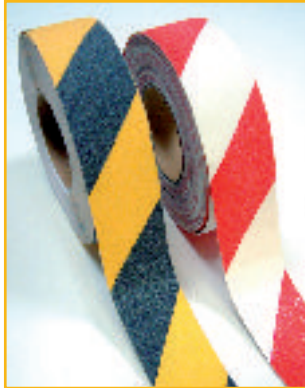

Rampmat

- » An economical anti-fatigue mat for the workplace
- » Raised circular surface for superior slip resistance
- » Conforms to Slip Resistance Test DIN 51130:2014 - R10
- » Open drainage holes for spilt liquids
- » Made from hardwearing NBR rubber
- » Moulded bevelled edges reduce trip hazards
- » Thickness: 10mm

LOWER PRICES

INFORMATION



Help prevent slipping accidents in the workplace

Overall Size L x W mm	Model	Price
1200 x 800	RP010002	£28.38
1500 x 900	RP010001	£35.54

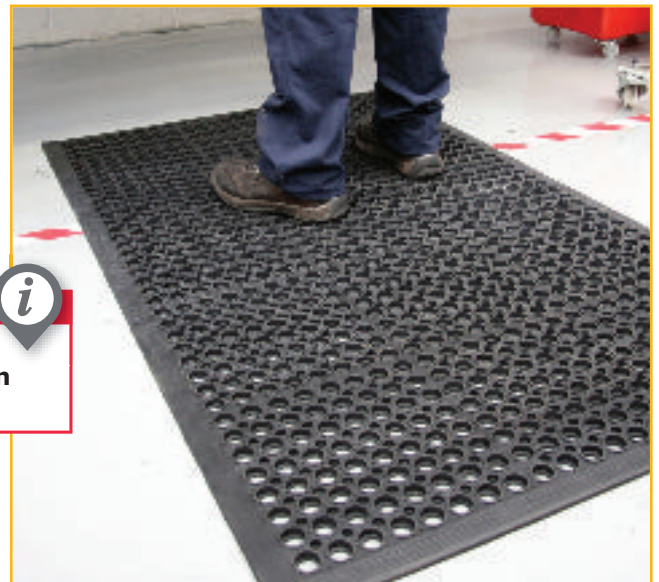

Bubblemat

- » Effective anti-fatigue mat made from 100% natural rubber
- » Raised bubbled surface to stimulate blood circulation
- » Available as complete mats or interlocking sections for longer runs
- » Thickness: 14mm

LOWER PRICES



Overall Size L x W mm	Model	Price
600 x 900 (edged all round)	BF010001	£47.93
900 x 1200 (edged all round)	BF010002	£69.00
600 x 900 (interlocking end piece)	BF010003	£47.93
600 x 900 (interlocking middle piece)	BF010004	£47.93

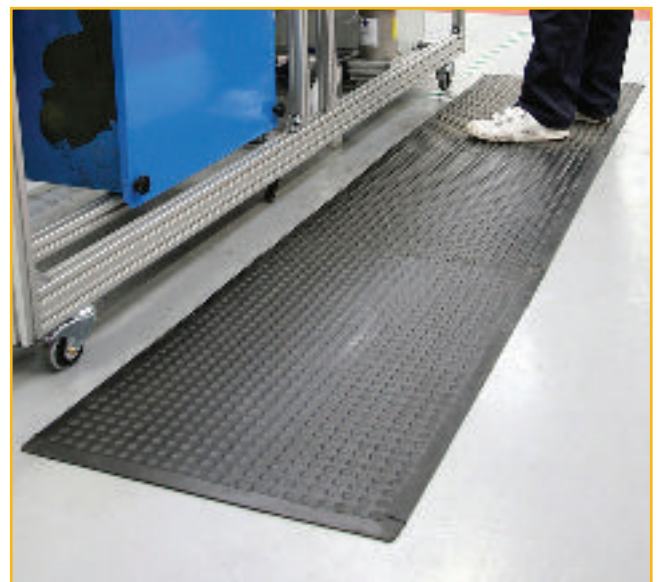

Safety, Security, PPE, Matting & Flooring

Orthomat® Anti Fatigue



- » Extremely comfortable standing surface
- » Reduces fatigue from standing for long periods
- » Pebble surface offers slip resistance
- » Suitable for dry environments only
- » Anti Fatigue - charcoal or grey
- » Safety Fatigue - charcoal with yellow borders
- » Thickness: 9mm



Overall Size L x W mm	Anti Fatigue		Safety Fatigue	
	Model	Price	Model	Price
600 x 900	AF-0001	£31.76	AF-0701	£33.28
900 x 1500	AF-0002	£62.89	AF-0702	£66.73
900 x 18,300	AF-0003	£536.33	AF-0703	£565.98
900 x Linear Metre	AF-0003C	£37.87	AF-0703C	£34.58

Orthomat® Ultimate

- » The mat is encapsulated in revolutionary PolyNit material that is resilient to most oils & chemicals found in engineering
- » Soft foam centre layer creates a very comfortable surface to reduce tiredness & health issues associated with prolonged standing
- » Raised diamond surface provides additional underfoot grip for enhanced safety
- » Fire test classification to BS EN 13501-1:2018 CFL s1
- » Thickness: 10mm



Overall Size L x W mm	Model	Price
600 x 900	OU010001	£49.48
900 x 1500	OU010002	£108.60
900 x 18,300	OU010003	£1165.96
900 x Linear Metre	OU010003C	£75.61

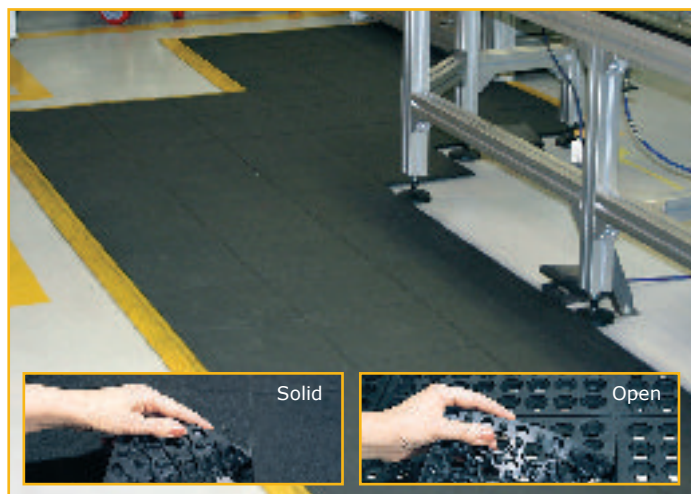

Solid & Open Fatigue Step

- » Premium quality anti-fatigue tiles
- » Available with solid surface or holes for drainage
- » Tiles interlink to provide coverage for any area size
- » Suitable for wet or dry environments
- » Optional extras - male & female bevelled edges in black or yellow
- » Tiles colour black
- » Thickness: 19mm



Overall Size L x W mm	Solid Fatigue Step		Open Fatigue Step	
	Model	Price	Model	Price
900 x 900	ST-0001	£52.87	SS-0001	£52.87
Black Edging/Corner Female	SS010002F	£11.33	SS010002F	£11.33
Black Edging/Corner Male	SS010002M	£11.33	SS010002M	£11.33
Yellow Edging/Corner Female	SS070002F	£15.36	SS070002F	£15.36
Yellow Edging/Corner Male	SS070002M	£15.36	SS070002M	£15.36

Deckplate

- » PVC diamond surface offers wear resistance
- » Foam backing relieves fatigue from standing
- » Supplied complete with all round ramped edges
- » Withstands demanding industrial applications
- » Suitable for dry environments
- » Deckplate - black
- » Safety Deckplate - black with yellow borders
- » Thickness: 14mm



Overall Size L x W mm	Deckplate		Safety Deckplate	
	Model	Price	Model	Price
600 x 900	DP-0609	£82.85	SD-0701	£91.78
900 x 1500	DP-0915	£165.08	SD-0702	£173.04
900 x 3000	DP-0903	£345.43	SD-0703	£405.22
900 x 6000	DP-0906	£690.80	SD-0704	£808.87



INFORMATION



Available in bespoke made to measure lengths up to 18.3M

Cobamat Standard

- » Fights against operator fatigue
- » Slip tested to EN13501-1:2018 EFL s2
- » Flame retardant to DIN 51130:2014 R10
- » Offers slip resistance in both directions
- » Colours: red, black, green or blue
- » Thickness: 12mm
- » Hole size: 22 x 22mm



Overall Size L x W mm	Model	Price
600 x 10,000	CS-0610	£548.38
900 x 10,000	CS-0910	£822.63
1200 x 10,000	CS-1210	£1096.78
Edging per linear metre	XS01	£10.58



Cobamat Inter

- » Easy to clean with detergent & a pressure cleaner
- » Gives added cross grip in wet/oily areas
- » Ideal for heavy duty applications
- » Colours: red, black, green or blue
- » Thickness: 12mm
- » Hole size: 30 x 10mm



Overall Size L x W mm	Model	Price
600 x 10,000	CE-0610	£676.08
900 x 10,000	CE-0910	£1013.96
1200 x 10,000	CE-1210	£1352.18
Edging per linear metre	XE02	£10.58

Workstation Mat

- » Supplied with yellow bevelled edge
- » Cross ribbed to help prevent slipping in wet areas
- » Ideal as a machine operatives mat
- » Slip tested to EN13501-1:2018 EFL s2
- » Flame retardant to DIN 51130:2014 R10
- » Good resistance to the majority of oils & chemicals
- » Thickness: 12mm



Overall Size L x W mm	Model	Price
600 x 1200 - Standard (22 x 22mm Hole Size)	WS-0701	£111.86
1000 x 1500 - Standard (22 x 22mm Hole Size)	WS-0702	£210.23
1200 x 1800 - Standard (22 x 22mm Hole Size)	WS-0703	£287.88
600 x 1200 - Heavy Duty (22 x 10mm Hole Size)	WD-0701	£167.65
1000 x 1500 - Heavy Duty (22 x 10mm Hole Size)	WD-0702	£310.38
1200 x 1800 - Heavy Duty (22 x 10mm Hole Size)	WD-0703	£425.56



Worksafe Mat

- » Manufactured from hard wearing rubber
- » Ideally suited to relieve operator fatigue
- » Bevelled edges help prevent trips over the mat
- » Unique underside design prevents the mat from slipping on the floor



Overall Size L x W mm	Model	Price
900 x 1500 - Black	SW-0001	£168.44
900 x 1500 - Blue (grease/oil resistant)	SW-0002	£221.04

Safety, Security, PPE, Matting & Flooring

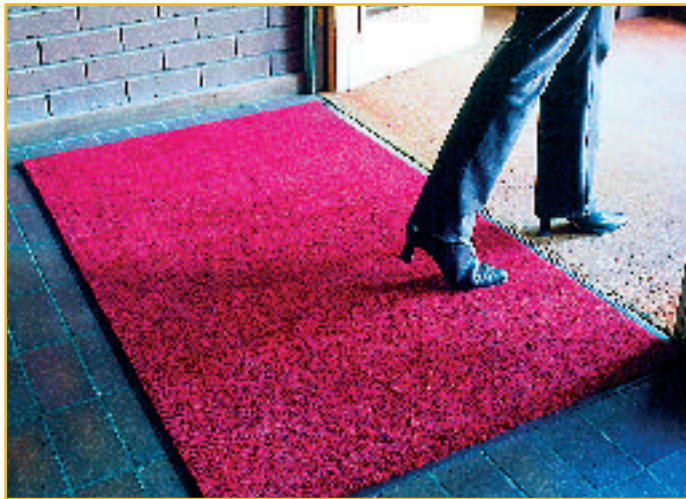

Entraplush

- » Traps dirt & debris protecting internal floors
- » Quick drying 'crush-resistant' carpet surface
- » Slip resistant, stain resistant with PVC backing
- » Colours: grey, brown, blue or red



Overall Size L x W mm	Model	Price
600 x 900	PP-0001	£21.93
900 x 1500	PP-0002	£55.33
1200 x 1800	PP-0003	£91.32

Microfibre Doormat

- » Exceptional multi-action entrance mat using hygienic microfibre technology
- » Superior 'brushing & wiping' with 'rapid dry' properties – even out performs cotton
- » Flexible, ultra-fine fibres provide deep cleaning action on passing footwear
- » Filament structure creates a capillary effect for improved dirt retention/absorbency
- » Environmentally friendly – does not require chemical pre-treatment or washing detergents
- » Colours: beige or black



Overall Size L x W mm	Model	Price
600 x 800	MF-0003	£29.47
900 x 1500	MF-0002	£73.52



INFORMATION
Washable logo mats available - call for details



Coba Wash

- » Machine washable mat
- » Traps up to 90% of tracked-in dirt
- » Traps moisture, grit & grease
- » Bleach & fade resistant - *11 year warranty*
- » Non-slip nitrile rubber backing
- » Colours: black/blue, black/steel, black/brown or black/red



Overall Size L x W mm	Model	Price
600 x 850	LM-0201	£48.41
850 x 1200	LM-0204	£96.78
850 x 1500	LM-0202	£120.99
1150 x 1750	LM-0203	£196.45

Superdry Doormat

- » Heavy duty entrance matting, ideal for office spaces & general workplaces
- » Raised, reinforced 'waffle' pattern scrapes dirt away from footwear, helping to reduce the amount of dirt/debris brought into the building
- » Exceptional moisture wiping properties (able to retain up to 5.4 litres water/m2)
- » Lipped edges to help reduce tripping hazards & rubber backing for slip-resistance
- » Colours: Black, Blue, Red, Brown or Grey



Overall Size L x W mm	Model	Price
600 x 900	WH--0001	£40.56
900 x 1500	WH--0003	£113.86
1200 x 1800	WH--0004	£180.95



Cobascape

- » Hard wearing surface scrapes dirt from your shoes
- » Gives a sure footing grip in wet/oily conditions
- » Bevelled edges to help prevent trips
- » Manufactured from 100% nitrile
- » Ideal for all weather conditions
- » Machine washable
- » Colour: Black



Overall Size L x W mm	Model	Price
850 x 750	CS-0001	£48.36
850 x 1400	CS-0002	£89.16
850 x 3000	CS-0003	£170.91
1100 x 1700	CS-0004	£136.46



Ringmat Octomat

- » Manufactured from hard wearing rubber matting for a long life span even in demanding conditions
- » Conforms to EN-13552 Category R10
- » Connectors available for a larger area coverage
- » Colour: Black



Overall Size L x W mm	Model	Price
1000 x 1500	RM-0003	£70.09
Connector	RM-0004	£0.92

Rampmat

- » Manufactured from durable NBR rubber making this popular doormat suitable for most climates
- » Superior slip resistance conforming to Slip Resistance Test EN-13552 Category R10
- » Raised circular pattern surface provides grip while scraping dirt & moisture
- » Moulded bevelled edging for safety & wheeled access
- » Thickness: 10mm



Overall Size L x W mm	Model	Price
1200 x 800	RP010002	£28.38
1500 x 900	RP010001	£35.54



Superdry Heavy Traffic Mat

- » Waffle pattern absorbs moisture & scrapes away dirt from forklift wheels
- » Reduces slips, forklift skidding & loss of control
- » Easy to install with **Double Sided Adhesive Tape*
- » Mats can be installed individually or laid next to each other to cover vast areas
- » Easy to clean with a vacuum or stiff brush
- » Protects floor from damages
- » Thickness: 10mm



Overall Size L x W mm	Model	Price
Superdry Heavy Traffic Mat		
1800 x 1150	WHT010005	£152.25
*Double Sided Adhesive Tape		
50Wmm x 50LM	DST0001	£51.10

Safety, Security, PPE, Matting & Flooring

Self-adhesive Floor Marking Tape

PROline

- » Floor marking tape for internal surfaces
- » Ideal for demarcation of aisles, traffic ways, pedestrian routes etc
- » Can be removed from most surfaces without leaving residue
- » Tape length: 33M



Description	Colour	50 x 33mm		75 x 33mm	
		Model	Price	Model	Price
Tape Marking Set 1 x TAPEliner 2 x Rolls of PROline Tape 1 x Trimming Knife Marker Line & Chalk	White	261.15.202	£376.50	261.19.212	£382.20
	Yellow	261.17.297	£376.50	261.18.900	£382.20
	Blue	261.14.977	£376.50	261.16.487	£382.20
	Red	261.15.660	£376.50	261.16.560	£382.20
	Green	261.19.541	£376.50	261.17.656	£382.20
	Orange	261.17.130	£376.50	261.13.748	£382.20
TAPEliner (Marker with Trimming Knife)				261.16.528	£337.20

Description	50mm Wide		75mm Wide	
	Model	Price	Model	Price
White	261.16.606	£6.20	261.16.619	£9.20
Yellow	261.13.796	£6.20	261.18.798	£9.20
Blue	261.19.771	£6.20	261.15.989	£9.20
Red	261.13.752	£6.20	261.18.675	£9.20
Green	261.18.249	£6.20	261.16.655	£9.20
Orange	261.16.322	£6.20	261.17.531	£9.20
Red & White (laminated)	261.18.826	£7.80	261.15.954	£11.80
Yellow & Black (laminated)	261.17.941	£7.80	261.13.438	£11.80
Green & White (laminated)	261.17.310	£7.80	261.19.066	£11.80

PROline Vinyl Line Marking Tape

- » Floor marking tape for internal surfaces manufactured in high grade vinyl
- » Suitable for forklift areas
- » For permanent marking
- » 500µ vinyl thickness



Colour	Length M	50mm Wide		75mm Wide	
		Model	Price	Model	Price
White	25	261.27.044	£65.10	261.28.523	£97.30
Yellow	25	261.24.239	£65.10	261.24.227	£97.30
Blue	25	261.26.957	£65.10	261.25.412	£97.30
Red	25	261.21.702	£65.10	261.29.359	£97.30

PROline Paint Marking Systems

- » Floor marking paint for internal & external use
- » Will adhere to concrete, asphalt, tarmac, metal, tiles etc
- » Quick drying - can be walked on in minutes
- » 750ml can will do a 50mm wide line for 50 to 90M approx
- » ENVIRONMENTALLY FRIENDLY
- » Not to be used on sealed floors
- » Conforms to the latest EU Regulations



Description	Colour	Model	Price
Paint Marking Set - 1 PROliner Applicator, 2 Cans of Paint, Marker Line & Chalk	White	260.11.610	£256.90
	Yellow	260.10.795	£256.90
PROliner Applicator for 50 to 75mm Lines		260.10.174	£196.00
ROADliner Applicator for 100 to 130mm Lines		260.10.383	£258.40
HANDliner Applicator for Hand Use		260.10.437	£56.30
PROline Chalk Marker Line		260.11.401	£24.10
Chalk Refill (for Marker Line above)		260.11.117	£6.60

Colour	Model	Price per Can	Colour	Model	Price per Can
Paint Cans					
White	260.11.745	£17.50	Green	260.11.015	£17.50
Yellow	260.11.089	£17.50	Orange	260.17.886	£17.50
Blue	260.12.531	£17.50	Grey	260.11.057	£17.50
Red	260.12.976	£17.50	Black	260.11.954	£17.50

PROline Steel Line Marking Tape

- » Floor marking tape for internal surfaces manufactured in flat steel
- » Forklift resistant
- » For permanent marking
- » 700µ coloured flat steel thickness



Colour	Length M	Model	Price
White	1.5	261.25.551	£22.60
	6	261.24.898	£87.00
Yellow	1.5	261.22.021	£22.60
	6	261.27.500	£87.00

Safety, Security, PPE, Matting & Flooring

Indoor Industrial Floor Paint

PROline-paint

- » Tough & fast drying
- » Dirt repellent, easy to clean
- » Highly resistant to oils, solvents & detergents
- » Easy to use - no mixing of components
- » Suitable for use with forklift trucks
- » 5 Litre container will cover about 20 to 25m²

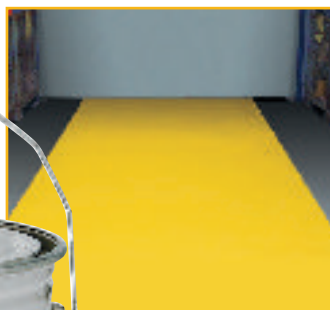

Colour	Weight kg	Model	Price
White	7	263.13.824	£147.20
Yellow		263.14.807	£147.20
Red		263.18.881	£147.20
Blue		263.19.179	£147.20
Silver Grey		263.13.740	£147.20
Stone Grey		263.14.968	£147.20

Anti-Slip Industrial Floor Paint

PROline-paint

- » For indoor use
- » Fast drying with excellent covering properties
- » Wear resistant & durable
- » Resists abrasion & most chemicals
- » Anti-slip to classification R10
- » 5 Litre container will cover about 20 to 25m²



Colour	Weight kg	Model	Price
White	7	263.23.941	£157.30
Yellow		263.24.370	£157.30
Blue		263.25.507	£157.30
Silver Grey		263.26.072	£157.30
Stone Grey		263.24.599	£157.30

Outdoor Industrial Floor Paint

PROline-paint

- » For outdoor use
- » Fast drying with excellent covering properties
- » Wear resistant & durable
- » Highly abrasion resistant
- » Easy to use - no mixing of components
- » 5 Litre container will cover about 20 to 25m²

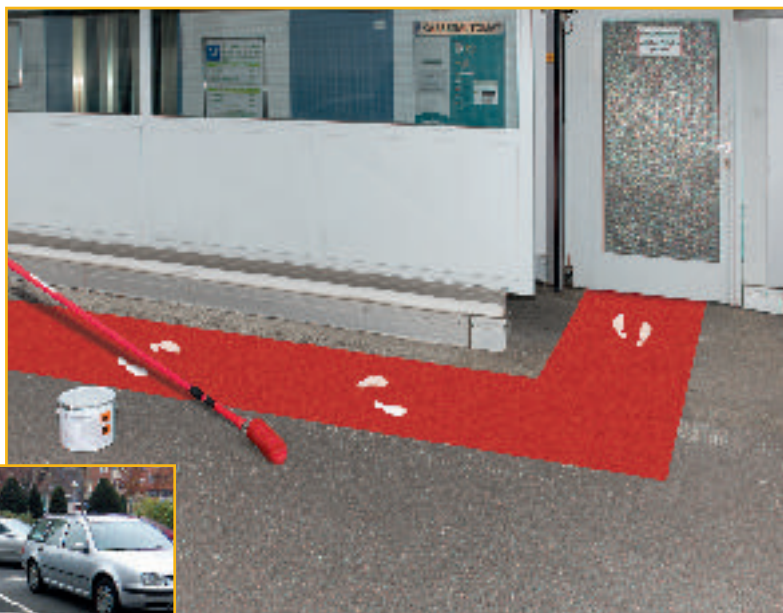

Colour	Weight kg	Model	Price
White	7	263.22.420	£160.70
Yellow		263.25.624	£160.70
Red		263.23.804	£160.70
Blue		263.21.512	£160.70
Grey		263.25.110	£160.70

Signs, Labels & Notice/Whiteboards

Health & Safety Law Poster

- >> Legally required
- >> Clearly marked sections for easy reading
- >> Certified for authenticity with an embedded hologram
- >> Details HSE & incident contact centre helpline numbers
- >> Manufactured using biodegradable material



Overall Size H x W mm	Model	Price
595 x 415	HSLP01	£20.13

Fire Exit & Emergency Signs



150 x 450



100 x 100 mm

150 x 150 mm



FES34

FES35

50 x 100 mm



FES60

FES62

SFES715

420 x 297

297 x 210

297 x 210



FES72

75 x 600 mm

Model	Size H x W mm	Self-Adhesive Vinyl	1mm Rigid Plastic
See below each illustration for the model number & the size that sign is available in	50 x 100	£1.70	£2.79
	75 x 600	£5.61	£9.36
	100 x 100	£2.05	£2.88
	150 x 150	£3.21	£6.14
	150 x 450	£7.39	£10.93
	297 x 210	£6.80	£10.29
	420 x 297	£11.23	£17.32

Prohibition Signs

- >> Available in 210H x 148Wmm or 297H x 210Wmm
- >> Many more sign designs available - *call for details*
- >> 1mm rigid plastic signs have an adhesive back. They can be stuck to smooth & clean surfaces or drilled



Model	Size H x W mm	Self-Adhesive Vinyl	1mm Rigid Plastic
See Below Illustrations	210 x 148	£4.16	£6.52
	294 x 210	£6.80	£10.29

QUALITY SIGNS FOR THE WORKPLACE

Photoluminescent Signs



150 x 450



PLS02

PLS01

PLS07

150 x 300 mm

75 x 600 mm

GLOWS IN THE DARK



PLS20

PLS11

100 x 100 mm

PLS24

PLS09

PLS10

300 x 250 mm

150 x 150 mm

Model	Size H x W mm	Self-Adhesive Vinyl	1mm Rigid Plastic
See below each illustration for the model number & the size that sign is available in	75 x 600	£7.55	£12.63
	100 x 100	£2.77	£5.00
	150 x 150	£5.21	£9.95
	150 x 300	£7.55	£12.63
	150 x 450	£10.13	£14.73
	300 x 250	£13.61	£20.11

Signs, Labels & Notice/Whiteboards

Hazard Signs

>> Available in 210H x 148Wmm or 297H x 210Wmm

>> Many more sign designs available - *call for details*



HZS01



HZS37
A4 Only



HZS23



HZS14



HZS19



HZS29



HZS30



HZS34



Self-Adhesive Vinyl



1mm Rigid Plastic (Undrilled)



HZS26



HZS46



HZS25



HZS36



HZS09



HZS04



HZS44

Model	Size H x W mm	Self-Adhesive Vinyl	1mm Rigid Plastic
See Below Illustrations	210 x 148	£4.16	£6.52
	297 x 210	£6.80	£10.29

Mandatory Signs

>> Available in 210H x 148Wmm or 297H x 210Wmm

>> Many more sign designs available - *call for details*

>> 1mm rigid plastic signs have an adhesive back. They can be stuck to smooth & clean surfaces or drilled



MAS06



MAS04



MAS18



MAS08



MAS03



MAS07



MAS15



MAS36



MAS09



MAS24



MAS17



MAS37



MAS22



MAS02



MAS12



MAS10



MAS43



MAS38



MAS27



MAS33



MAS34



MAS28



MAS29



MAS30



MAS31



MAS35



MAS25



MAS42

QUALITY SIGNS FOR THE WORKPLACE

Model	Size H x W mm	Self-Adhesive Vinyl	1mm Rigid Plastic
See Below Illustrations	210 x 148	£4.16	£6.52
	297 x 210	£6.80	£10.29

Signs, Labels & Notice/Whiteboards

Weight Load Notices

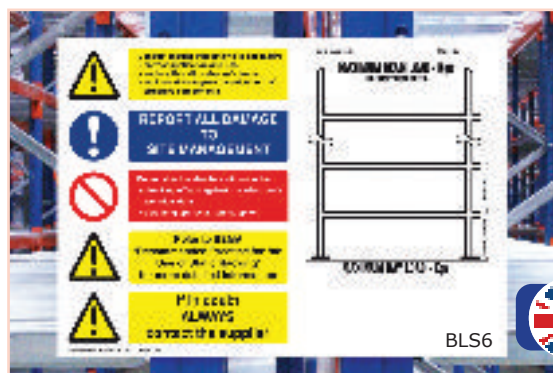

BLS1



BLS2



BLS3



BLS4



BLS5



BLS7

BLS6



Description	Overall Size H x W mm	Model	Price
Shelf/Pallet Racking Weight Load Notice	356 x 254	BLS1	£16.20
Cantilever Racking Weight Load Notice	356 x 254	BLS2	£16.20
Drive Thru' Racking Weight Load Notice	356 x 254	BLS3	£16.20
Landscape Mezzanine Floor Weight Load Notice	210 x 295	BLS4	£16.20
Portrait Pallet Racking Weight Load Notice	470 x 350	BLS5	£19.50
Landscape Pallet Racking Weight Load Notice	297 x 420	BLS6	£19.80
Landscape Shelving Weight Load Notice	215 x 220	BLS7	£13.20

- » Sign to identify weight loadings & procedures
- » Supplied blank or printed with black text at no extra charge
- » Available in horizontal & vertical

Information Labels

- » High visibility individual weight loading labels suitable for both racking & shelving
- » Available in magnetic or self-adhesive & printed black on yellow or white background. *Please state colour required.* *print may appear on two lines
- » *Minimum order value of £25.00*



Overall Size H x W mm	Self Adhesive		Magnetic	
	Model	Price	Model	Price
25 x 200	BL23	£1.50	BL23M	£2.10
50 x 300	BL53	£2.10	BL53M	£3.90
70 x 300	*BL73	£3.00	*BL73M	£5.10
90 x 300	*BL93	£3.60	*BL93M	£6.60



Code Labelling



- » High quality custom made location code labels produced quickly & efficiently
- » They can incorporate alpha-numeric codes, directional arrows, check digits & barcodes
- » Black text on white or yellow background
- » Manufactured to your needs - call to discuss your requirements



Aisle Markers



- » High visibility aisle markers manufactured in rigid styrene in white or yellow with black letters (*Model AM4 is only available in yellow*)



- » Prices include printing
- » Other styles & sizes are available - call for details

Overall Size H x W mm	Type	Fixing	Model	Price
90 x 160 - up to 3 x 60mm Digits	Shelving	-	AM1	£8.70
95 x 130 - up to 3 x 60mm Digits	Flag	Self-adhesive	AM1F	£9.60
95 x 130 - up to 3 x 60mm Digits	Flag	Magnetic	AM1FM	£9.90
95 x 130 x 130 - up to 3 x 60mm Digits	Flag	Self-adhesive	AM1T	£15.00
95 x 130 x 130 - up to 3 x 60mm Digits	Flag	Magnetic	AM1TM	£16.80
220 x 270 - up to 2 x 180mm Digits	I.D. Markers	-	AM2/2	£16.80
220 x 450 - up to 3 x 180mm Digits	I.D. Markers	-	AM3/3	£23.70
300 x 300 - up to 2 x 180mm Digits	I.D. Markers	-	AM3X/2	£18.90
600 x 343 - up to 1 x 450mm Digit	I.D. Markers	-	AM4	£25.80

Ticket Pouches

- » Ideal for 5S & lean manufacturing system
- » Clear front enables barcodes to be scanned
- » Available in 4 sizes & 5 colours
- » Supplied with white card insert



BEAVERSWOOD

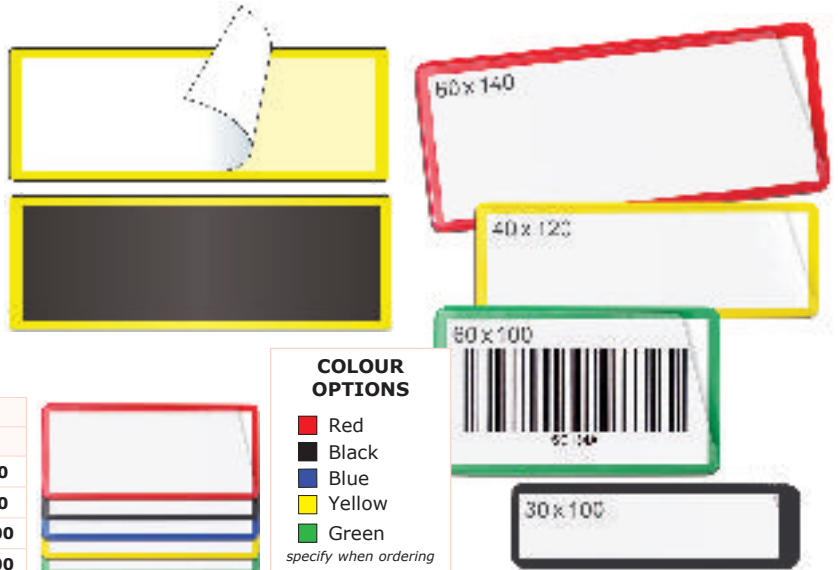

Overall Size H x W mm	Pack Size	Self Adhesive		Magnetic	
		Model	Price	Model	Price
30 x 100	100	SAP310	£67.80	MP310	£76.20
40 x 120	100	SAP412	£72.00	MP412	£90.00
60 x 100	100	SAP610	£75.30	MP610	£105.00
60 x 140	100	SAP614	£84.30	MP614	£121.00

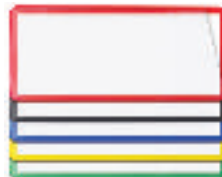

**COLOUR
OPTIONS**

- Red
 - Black
 - Blue
 - Yellow
 - Green
- specify when ordering*



Numbers & Letters

BEAVERSWOOD

- » Self-adhesive vinyl labelling
- » Black characters on yellow backgrounds
- » Individual cards or complete handy packs of numbers or letters
- » Minimum order - 20 individual cards.
These can be mixed numbers, letters or sizes
- » Specify characters required *See table for quantity of characters per card*
- » Cards of identical, individual peel-off numbers 0-9 or letters A-Z
- » Easily applied - cleanly removed



Card Size H x W mm	Digits per card	Arrows	Model	Price
19 x 14	36	✓	F3	£1.32
38 x 21	12	✓	F4	£1.32
56 x 21	12	✓	F5	£1.85
90 x 38	6	✓	F6	£2.55
130 x 45	5		F7	£3.40
230 x 140	1		F8	£3.40

Label Size H x W mm	Digits per card	Number Pack (10 cards)		Letter Pack (26 cards)	
		Model	Price	Model	Price
19 x 14	36	F3PACK0-9	£12.90	F3PACKA-Z	£33.00
38 x 21	12	F4PACK0-9	£12.90	F4PACKA-Z	£33.00
56 x 21	12	F5PACK0-9	£17.40	F5PACKA-Z	£45.30
90 x 38	6	F6PACK0-9	£24.00	F6PACKA-Z	£62.10
130 x 45	5	F7PACK0-9	£31.20	F7PACKA-Z	£81.00
230 x 140	1	F8PACK0-9	£31.20	F8PACKA-Z	£81.00



Lower Value Orders May Incur a Handling Charge

Signs, Labels & Notice/Whiteboards

Ticket Holders

- » Pull forward front allows easy loading & updating
- » Magnetic fixing is suitable for cold stores
- » * White card included

Overall Size H x W mm	Pack Size	Self-Adhesive		Magnetic	
		Model	Price	Model	Price
25 x 100	100	TS210*	£55.50	TS210M*	£96.60
25 x 200	50	TS220*	£52.80	TS220M*	£76.50
25 x 1000	10	TS25/10*	£43.80	TS25M/10*	£67.50
25 x 2000	10	TS25/20	£64.80	TS25M/20	£105.00
38 x 100	100	TS310*	£60.00	TS310M*	£102.00
38 x 200	50	TS320*	£56.40	TS320M*	£82.80
38 x 1000	10	TS38/10*	£50.10	TS38M/10*	£75.30
38 x 2000	10	TS38/20	£75.00	TS38M/20	£122.00
54 x 100	100	TS510*	£82.80	TS510M*	£121.00
54 x 200	50	TS520*	£75.00	TS520M*	£109.00
54 x 1000	10	TS54/10*	£71.40	TS54M/10*	£107.00
54 x 2000	10	TS54/20	£121.00	TS54M/20	£179.00
80 x 100	100	TS810*	£90.00	TS810M*	£133.00
80 x 200	50	TS820*	£83.40	TS820M*	£119.00
80 x 1000	10	TS80/10*	£78.30	TS80M/10*	£111.00
80 x 2000	10	TS80/20	£144.00	TS80M/20	£195.00
125 x 1000	10	TS125/10	£92.00	TS125M/10	£126.00
125 x 200	50	TS125/200	£98.00	TS125M/200	£139.00

BEAVERSWOOD

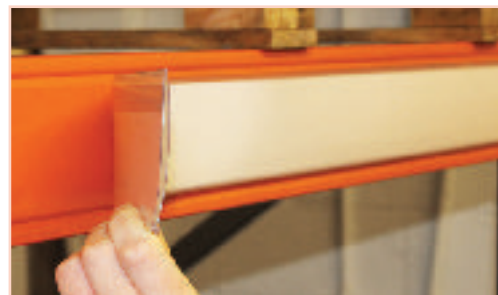
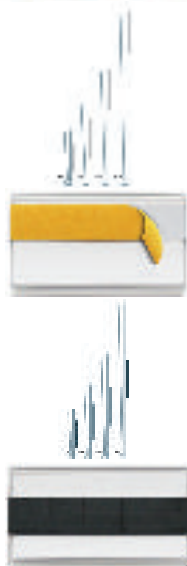

Angled Ticket Holder

- » Angled ticket holder provides the perfect angle to read information & scan barcodes, even on low shelves
- » Strong adhesive tape strip attaches to the shelf
- » Clear PVC front allows barcodes to be scanned through the ticket holder

Overall Size H x W mm	Angle	Pack Size	Model	Price
26 x 100	106°	100	ATS210	£48.60
26 x 200	106°	50	ATS220	£47.00
39 x 100	126°	100	ATS310	£54.60
39 x 200	126°	50	ATS320	£52.20

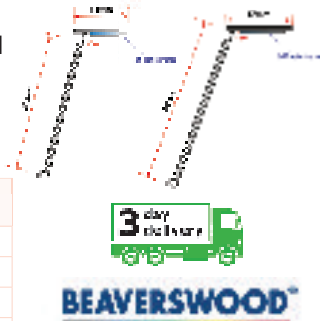

Magnetic & Self-adhesive Label Holders

Magnetic

Height mm	Length mm	Pack Size	Model	Price
15	80	100	ML18	£41.40
	500	20	ML150	£53.40
	50,000	50M Roll	MLR1	£175.00
20	80	100	ML28X	£46.80
	500	20	ML250X	£58.80
	50,000	50M Roll	MLR2X	£193.00
25	80	100	ML28	£50.70
	500	20	ML250	£63.00
	50,000	50M Roll	MLR2	£204.00
30	80	100	ML38	£56.00
	500	20	ML350	£69.00
	5000	5M Roll	MLR3/5	£35.00
	10,000	10M Roll	MLR3/10	£69.00
	50,000	50M Roll	MLR3	£215.00
40	80	100	ML48	£73.80
	500	20	ML450	£86.40
	5000	5M Roll	MLR4/5	£45.60
	10,000	10M Roll	MLR4/10	£90.30
50	50,000	50M Roll	MLR4	£260.00
	80	100	ML58	£91.20
	500	20	ML550	£111.00
	5000	5M Roll	MLR5/5	£56.00
60	10,000	10M Roll	MLR5/10	£111.00
	50,000	50M Roll	MLR5	£301.00
	100	100	ML610	£106.00
	200	50	ML620	£104.00
70	500	20	ML650	£123.00
	1000	10	ML6/10	£123.00
	100	100	ML710	£127.00
	200	50	ML720	£124.00
80	1000	10	ML7/10	£149.00
	10,000	10M Roll	MLR7/10	£149.00
	200	50	ML820	£142.00
	1000	10	ML8/10	£167.00
10,000	10M Roll	MLR8/10	£167.00	

Self-adhesive

Height mm	Length mm	Pack Size	Model	Price
15	80	100	AL18	£51.00
	1000	10	AL1/10	£39.60
30	80	100	AL38	£68.70
	1000	10	AL3/10	£53.70
50	80	100	AL58	£84.90
	1000	10	AL5/10	£63.00



- » Instant identification
- » Steel racking or shelving
- » Supplied complete with white card
- » Easy to update & cut to size
- » Protective transparent PVC strip supplied with each holder
- » Self-adhesive holders are white & magnetic holders are brown



Label Holder Profiles

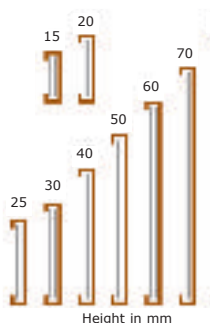

Signs, Labels & Notice/Whiteboards

Magnetic Easy Wipe Racking Strip

- >> Write on - wipe off with wet wipe marker pen
- >> Adheres to most steel surfaces
- >> Cut to suit any length required

Size - L x W	Model	Price
10m x 10mm	MSR1	£15.60
10m x 15mm	MSR15	£22.20
10m x 20mm	MSR2	£27.00
10m x 25mm	MSR25	£32.00
10m x 30mm	MSR3	£36.30
10m x 40mm	MSR4	£46.20
10m x 50mm	MSR5	£55.20
10m x 60mm	MSR6	£56.00
10m x 70mm	MSR7	£64.50
10m x 80mm	MSR8	£69.00
10m x 90mm	MSR9	£74.40
10m x 100mm	MSR10	£80.70

COLOUR OPTIONS

- Red
- Green
- Blue
- Yellow
- Matt Black
- White

specify when ordering

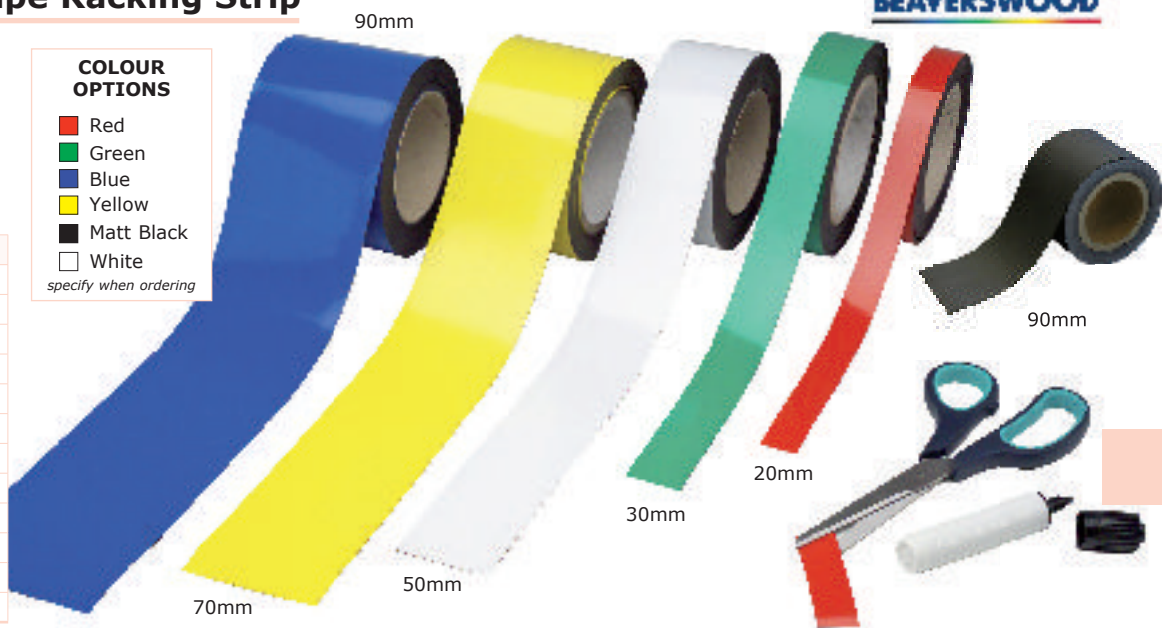

Magnetic Self-adhesive Strip

- >> Locates on any steel surface
- >> Makes anything magnetic
- >> No drilling required



Foam Adhesive

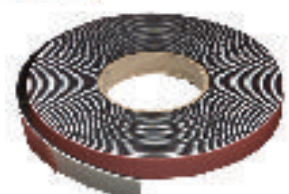

Premium Adhesive



Overall Size H x W mm	Fixing	Pack Size	Model	Price
13mm x 30M	Premium Adhesive	1	MSSA/13	£80.40
20mm x 10M	Foam Adhesive	1	MSSA/20	£43.20
25mm x 10M	Foam Adhesive	1	MSSA/25	£52.50
40mm x 10M	Foam Adhesive	1	MSSA/40	£60.30
50mm x 10M	Foam Adhesive	1	MSSA/50	£66.90
60mm x 10M	Foam Adhesive	1	MSSA/60	£73.50



Mag-Grip

- >> A document clip featuring strong magnets to secure materials within its grip
- >> Easily display documents within the magnetic clip and attach it to a wide range of surfaces using the self-adhesive backing
- >> Fit both A4 & A5 documents in landscape & portrait orientations
- >> Comes in packs of 10 or 50

For Use With	Size H x W mm	Pack Size	Model	Price
A5	26 x 140	10	MC140/10	£17.70
A4	26 x 200	10	MC200/10	£22.50
A5	26 x 140	50	MC140/50	£54.00
A4	26 x 200	50	MC200/50	£79.20



Lower Value Orders May Incur a Handling Charge

Signs, Labels & Notice/Whiteboards

racksack[®] & racksack[®]clear



- » Manage your warehouse waste
- » To be hung onto 900/1100mm end frames of racking
- » Quick & easy 'S' hook locator fixings
- » Manufactured from tough woven polyester
- » Choice of 8 standard designs as shown below
- » Clear design is available in 5 text designs



Clear designs - 5 designs available



SACK COLOUR OPTIONS

- Clear
 - Blue
- specify when ordering



Tough woven polyester 'S' hook locator



8 standard designs available in blue
Specials are available - call for details

Overall Size H x W mm	Sack Colour	Single Unit		Pack of 5		Pack of 10	
		Model	Price	Model	Price	Model	Price
1000 x 920	Clear	RSC/1	£38.40	RSC/5	£176.00	RSC/10	£325.00
	Blue	RSB/1	£33.60	RSB/5	£154.00	RSB/10	£283.00



racksack[®] trolley & racksack[®] rollcage

- » Easily organises waste packaging materials
- » Fits by hooking over the sides or can also be secured via eyelets in the top corner
- » Manufactured from tough, woven polyester

Racksack[®] Trolley - suits trolleys up to 580mm wide

- » Single pocket - 600 x 600 with a capacity of 50L
- » Double pocket - 600 x 600 with a capacity of 55L

Racksack[®] Rollcage - for cages 800mm wide

- » Upper pocket - 700 x 880 with a capacity of 105L
- » Lower pocket - 650 x 880 with a capacity of 95L

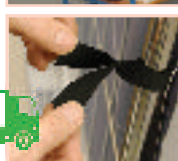

Description	Single Unit		Pack of 5		Pack of 10	
	Model	Price	Model	Price	Model	Price
Racksack [®] Trolley						
Single Pocket	T1B/1	£21.60	T1B/5	£106.00	T1B/10	£211.00
Double Pocket	T2B/1	£29.00	T2B/5	£137.00	T2B/10	£273.00
Racksack [®] Rollcage (Clear or Blue option available)						
Double Pocket (Blue)	C2B/1	£39.00	C2B/5	£187.00	C2B/10	£372.00
Double Pocket (Clear)	C2CL/1	£45.60	C2CL/5	£221.00	C2CL/10	£435.00

Signs, Labels & Notice/Whiteboards

racksack^{mini} **BEAVERSWOOD**



8 standard designs available (please add suffix when ordering)



/GW /MP /P /MR



/GWNT /MPNT /PNT /BK

- » Designed for workstations & workbenches including packing benches, picking stations, assembly stations & desks
- » Manufactured from tough woven polyester
- » Three strong handles are woven into the edge of the sack, one on each side for carrying & one on the base, so the sack can be easily emptied
- » With the fastening options, you can also attach to different fixtures, such as pedestrian barriers & walls

Overall Size H x W mm	Single Unit		Pack of 5		Pack of 10	
	Model	Price	Model	Price	Model	Price
880 x 600	RSMB1	£28.50	RSMB5	£144.00	RSMB10	£273.00
Accessories						
Bungee Loop - price per pair					BU4/1	£11.70
Wall Mounted Hook - price per pair					WMH/1	£10.50
Wall Mounted Hook - price for 5 pairs					WMH/5	£23.40



S Hook (supplied as std)

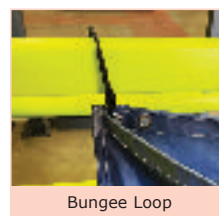

Bungee Loop

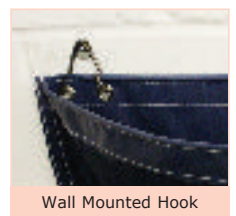

Wall Mounted Hook

racksack^{nano}

NEW



- » Designed for use with forklift trucks & pallet truck handles
- » Hook & loop fastening eliminates chance of snagging
- » Supplied with bungee loop fixing
- » Other designs and special prints available on request

BEAVERSWOOD **3 day delivery** **UK MANUFACTURED**

Overall Size H x W mm	Single Unit		Pack of 5		Pack of 10	
	Model	Price	Model	Price	Model	Price
600 x 450	RSNB1	£28.20	RSNB5	£137.00	RSNB10	£271.00
Accessories						
Small S Hooks - pack of 10					RSNB/HOOK	£10.20



Lower Value Orders May Incur a Handling Charge

173

Signs, Labels & Notice/Whiteboards



Modulean® Shadow Boards

- » Modular system to fit any space
- » Choose from a range of standard 5S boards
- » Various colour options to keep track of tools
- » Customise through title frames
- » Supplied with the products on display

MODULEAN® SHADOW BOARDS

COLOUR OPTIONS*

- Blue
- Green
- Red
- Yellow

specify when ordering



5S Information Board

Notice Board

Cleaning Board - Wet

Cleaning Board - XL

Fire Safety Station



Easy Wipe Board

First Aid Board

Cleaning Board - Dry

Eye Wash & Accident Station



Description	Board Size H x W mm	Model	Price
5S Information Board	750 x 750	SHB001	£101.00
Notice Board*	750 x 750	SHB002	£101.00
Easy Wipe Board	750 x 750	SHB003	£101.00
Cleaning Board - Dry*	750 x 750	SHB004	£132.00
Cleaning Board - Wet*	750 x 750	SHB005	£132.00
Cleaning Board - XL*	1500 x 750	SHB006	£224.00
First Aid Board*	750 x 750	SHB007	£132.00
Eyewash & First Aid Board*	750 x 750	SHB009	£152.00
Fire Safety Board	750 x 750	SHB010	£173.00

Modulean® Rack End Boards

- » Keep your warehouse organised with these Rack End Boards
- » Supplied with the products on display
- » Each board is available with either single or double aisle markers

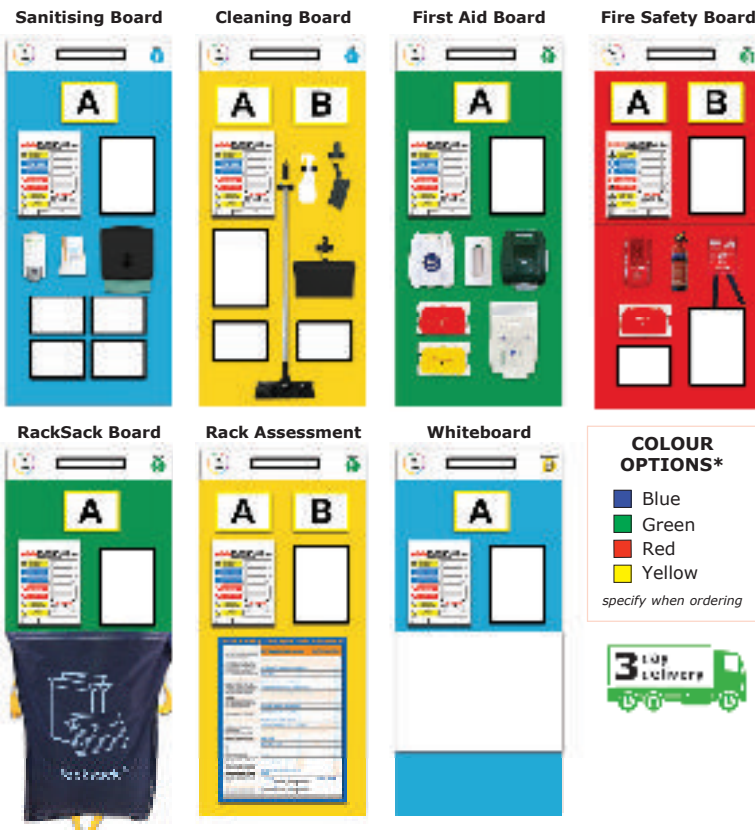

BEAVERSWOOD®
MODULEAN®
RACK END BOARDS



Description	Board Size H x W mm	Model	Price
Sanitising Board - Single Aisle Marker*	2000 x 900	REBS001	£353.00
Sanitising Board - Double Aisle Marker*	2000 x 900	REBD001	£364.00
Cleaning Board - Single Aisle Marker*	2000 x 900	REBS002	£309.00
Cleaning Board - Double Aisle Marker*	2000 x 900	REBD002	£320.00
First Aid Board - Single Aisle Marker*	2000 x 900	REBS003	£393.00
First Aid Board - Double Aisle Marker*	2000 x 900	REBD003	£403.00
Fire Safety Board - Single Aisle Marker	2000 x 900	REBS004	£354.00
Fire Safety Board - Double Aisle Marker	2000 x 900	REBD004	£366.00
RackSack Board - Single Aisle Marker*	2000 x 900	REBS005	£174.00
RackSack Board - Double Aisle Marker*	2000 x 900	REBD005	£186.00
Rack Assessment Board - Single Aisle Marker*	2000 x 900	REBS006	£255.00
Rack Assessment Board - Double Aisle Marker*	2000 x 900	REBD006	£265.00
Whiteboard Board - Single Aisle Marker*	2000 x 900	REBS007	£283.00
Whiteboard Board - Double Aisle Marker*	2000 x 900	REBD007	£295.00

Lower Value Orders May Incur a Handling Charge

Signs, Labels & Notice/Whiteboards

Document Pockets



- >> Self-adhesive pockets have an aggressive tape on reverse for permanent fixing
- >> Magnetic pockets for steel cabinets, racking or shelving
- >> Manufactured in tough clear polypropylene with welded edges, ample room for A3, A4, A5, A6 & A7 documents
- >> Pockets supplied in packs of 10 except A7 size which is supplied in packs of 100

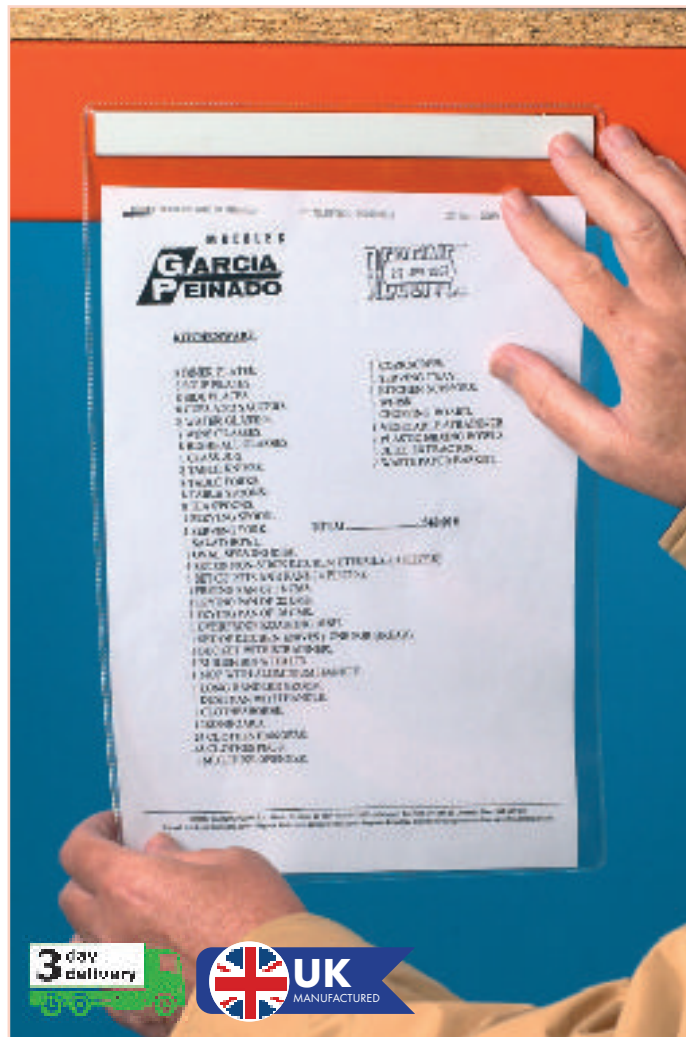

Document Size	Overall Size H x W mm	Self-Adhesive		Magnetic	
		Model	Price	Model	Price
A3	316 x 436	AP3H/10	£69.90	MP3H/10	£77.70
A3	436 x 316	AP3V/10	£69.90	MP3V/10	£77.70
A4	215 x 310	AP4H/10	£25.80	MP4H/10	£36.60
A4	310 x 220	AP4V/10	£25.80	MP4V/10	£36.60
A5	155 x 230	AP5H/10	£21.30	MP5H/10	£30.30
A5	215 x 160	AP5V/10	£21.30	MP5V/10	£30.30
A6	110 x 155	AP6H/10	£28.50	MP6H/10	£29.40
A6	150 x 110	AP6V/10	£28.50	MP6V/10	£29.40
A7	60 x 110	AP7H/100	£77.40	MP7H/100	£103.00
-	110 x 110	AP1111/10	£24.00	MP1111/10	£28.50
-	110 x 220	AP1122/10	£33.60	MP1122/10	£35.00



Weather Resistant Pockets

- >> Keep documents clean & dry
- >> Press seal fastening makes them ideal for use where exposed to wind or rain
- >> Ideal for use on external racking



Size	Pack Size	Magnetic		Self-Adhesive		Tie-On	
		Model	Price	Model	Price	Model	Price
A4 Horizontal	10	WRM4H/10	£45.90	WRA4H/10	£40.20	WRT4H/10	£42.30
A4 Vertical	10	WRM4V/10	£45.90	WRA4V/10	£40.20	WRT4V/10	£42.30
A4 Horizontal	50	WRM4H/50	£208.00	WRA4H/50	£189.00	WRT4H/50	£200.00
A4 Vertical	50	WRM4V/50	£208.00	WRA4V/50	£189.00	WRT4V/50	£200.00

Signs, Labels & Notice/Whiteboards

Floor Graphic Markers

- » High visibility floor signs
- » 430mm diameter
- » Designed to withstand the everyday traffic in a warehouse
- » Independently tested for slip resistance

PRICES HELD



FM05



Model	Price
See codes below each illustration	£24.60

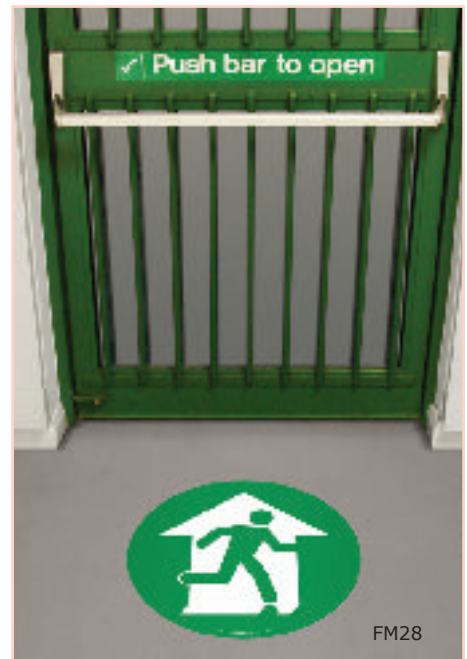

FM28

Floor Signalling

- » Manufactured from tough PVC
- » Easy solution for marking up in your warehouse
- » Designed to withstand traffic in a warehouse
- » FS/F: Pack of 10 - 5 right & 5 left feet

PRICES HELD

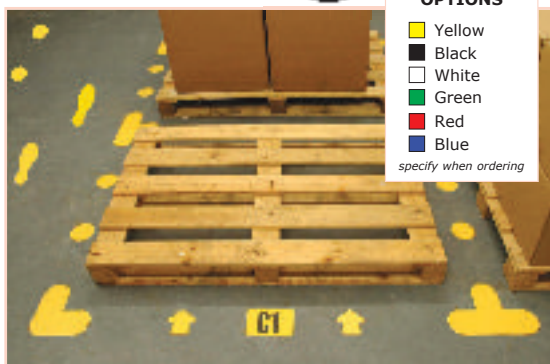

COLOR OPTIONS

- Yellow
- Black
- White
- Green
- Red
- Blue

specify when ordering



Description	Overall Size H x W mm	Pack Size	Model	Price
'T' Floor Signal	200 x 300	10	FS/T	£18.20
'L' Floor Signal	200 x 200	10	FS/L	£18.20
'+' Floor Signal	300 x 300	10	FS/+	£26.50
'O' Floor Signal	90 dia.	100	FS/O	£41.40
↑ Floor Signal	90 x 90	100	FS/A	£41.40
↖ Floor Signal	300 x 100	10	FS/F	£18.20

Frames4floors®

- » Tough, flat, colour coded floor identification frames
- » Available in 2 insert sizes: A4 and DL
- » Choice of 6 stand out colours
- » Permanent industrial strength adhesive to withstand warehouse traffic
- » Ideal for identifying bulk stack locations or to highlight important information



PRICES HELD

Size of Insert	Colours	Model	Price
DL - 210 x 99mm	Blue, Black, Green, Red or Yellow	FFDL/10	£37.70
DL - 210 x 99mm	2 of each of the above colours	FFDLMIX/10	£37.70
DL - 210 x 99mm	Yellow & Black	FFDLBY/10	£46.20
A4 - 210 x 295mm	Blue, Black, Green, Red or Yellow	FFA4/10	£64.10
A4 - 210 x 295mm	2 of each of the above colours	FFA4MIX/10	£64.10
A4 - 210 x 295mm	Yellow & Black	FFA4BY/10	£74.40

Lower Value Orders May Incur a Handling Charge

Signs, Labels & Notice/Whiteboards

Frames4docs®

COLOUR OPTIONS

- Red
- Green
- Blue
- Yellow
- Black
- Black/Yellow
- Green/White
- Red/White

available as a pack of the same colour or a mixed pack of 2 - specify when ordering
Chevron colours only available in A4

BEAVERSWOOD



- >> Frame any sign, chart or document in seconds
- >> Colour coded frames. Colours conform with British Safety Standards
- >> Ideal for displaying important messages in 5S & lean manufacturing
- >> Frames can be used vertically or horizontally
- >> Suitable throughout industry to display all types of literature, certificates & information. Suitable for documents up to 1.5mm thick

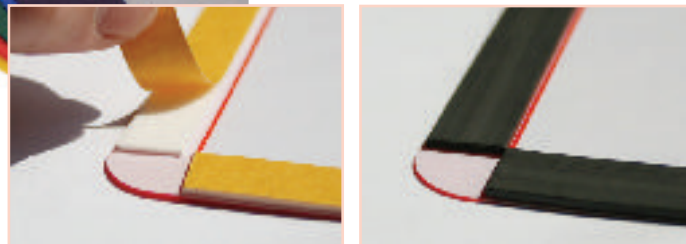

To Suit Documents	Quantity per Pack	Magnetic		Self-Adhesive	
		Model	Price	Model	Price
A5	10	MFD5/10	£60.60	SFD5/10	£59.00
A4		MFD4/10	£74.40	SFD4/10	£72.00
A3		MFD3/10	£114.00	SFD3/10	£111.00
Title Block		MFD6BK/10	£40.50	SFD6BK/10	£40.50

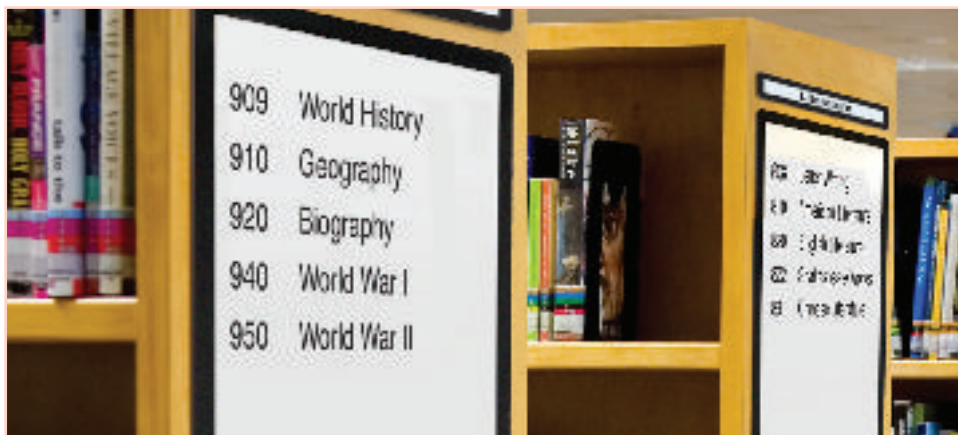

Title Block



Ring Binders & Covers

- >> 2 or 4 hole ring binders
- >> Magnetic or self-adhesive fixings
- >> Available with colour coded PVC covers which can be retrofitted to the ring binders. Covers are available in 5 Lean Manufacturing colours; red, black, blue, yellow or green - please specify when ordering
- >> Creates quick & flexible information centres
- >> Use self-adhesive version for permanent fixing or for heavier files



BEAVERSWOOD



Description	Quantity per Pack	Magnetic		Self-Adhesive	
		Model	Price	Model	Price
2 Ring Binder	3	RBM2/3	£36.00	RBA2/3	£18.30
4 Ring Binder		RBM4/3	£43.50	RBA4/3	£21.90
Coloured cover which can be retrofitted - pack of 5		RBC/5	£33.30		

Signs, Labels & Notice/Whiteboards

Aluminium Framed Noticeboards



COLOUR OPTIONS

DB	RD	GR	BU	LG	CK
Blue	Red	Green	Burgundy	Grey	Cork

**** To order please add colour code to model code**

Fire retardant versions are available, please ask for details

- >> Aluminium framed noticeboards with flushfix conceal corner wall fixings (supplied)
- >> Choice of 5 felt surfaces or traditional cork
- >> Can be mounted portrait or landscape

Description	Overall Size H x W mm	Model	Price
Aluminium Frame Felt Noticeboards	600 x 450	44531/**	£30.50
	900 x 600	44532/**	£40.50
	900 x 1200	44543/**	£59.00
	1200 x 1200	44544/**	£71.75
	1200 x 1500	44554/**	£87.50
	1200 x 1800	44564/**	£109.75
	1200 x 2400	44584/**	£135.25

Tamperproof Felt Noticeboards



COLOUR OPTIONS

DB	RD	GR	BU	LG
Blue	Red	Green	Burgundy	Grey

**** To order please add colour code to model code**

- >> A durable solution to protecting displayed information against casual interference
- >> Single door versions can be mounted with hinge to side, base or top
- >> Matching locks for convenience - fixings supplied

Description	Overall Size H x W mm	Model	Price
Single Door	900 x 600	TP9060/**	£106.75
	900 x 900	TP9090/**	£141.25
	1200 x 900	TP1290/**	£169.00
	1200 x 1200	TP1212/**	£213.00
Double Door	1200 x 1800	TP1812/**	£298.00
	1200 x 2400	TP2412/**	£362.50

Eco-Colour® Fire Resistant Aluminium Framed Noticeboards



COLOUR OPTIONS

DB	RD	CH	NA	LB	LG	GR
Blue	Red	Charcoal	Natural	L. Blue	Grey	Green

**** To order please add colour code to model code**



- >> Fire resistant tested to BS EN 13501 Class B
- >> Made from recyclable eco-friendly materials
- >> Acoustic properties
- >> Self-coloured pinnable core
- >> Mount portrait or landscape
- >> Concealed corner fixings
- >> Bright colours available upon request
- >> Frameless versions available - please call for details

Description	Overall Size H x W mm	Model	Price
Aluminium Framed Noticeboards	900 x 600	22632/**	£56.00
	1200 x 900	22643/**	£91.75
	1200 x 1200	22644/**	£112.50
	1200 x 1500	22654/**	£134.50
	1200 x 1800	22664/**	£173.75
	1200 x 2400	22684/**	£205.50

Eco-Colour® Fire Resistant Tamperproof Lockable Noticeboards



COLOUR OPTIONS

DB	RD	CH	NA	LB	LG	GR
Blue	Red	Charcoal	Natural	L. Blue	Grey	Green

**** To order please add colour code to model code**

- >> Fire resistant tested to BS EN 13501 Class B
- >> Made from recycled materials
- >> Acoustic properties
- >> Self-coloured pinnable core
- >> Protects against casual interference
- >> Concealed corner fixings & matching keys
- >> Ideal for sensitive areas & corridors
- >> Bright colours available upon request

Description	Overall Size H x W mm	Model	Price
Side Hinged Single Door	900 x 600	CBT32/**	£135.67
	1200 x 900	CBT43/**	£188.95
	1200 x 1200	CBT44/**	£224.40
Side Hinged Double Door	1200 x 1800	CBT64/**	£342.72
	1200 x 2400	CBT84/**	£402.65

Signs, Labels & Notice/Whiteboards

Ultrabrite Boards

- » Highly visible aluminium yellow frame
- » Available in Magnetic steel drywipe surface and natural cork surface
- » Magnetic steel surface has a sturdy construction with metal backing
- » Magnetic steel board includes a pen tray that simply clips onto the frame in any position
- » Use accessories to enhance functionality
- » Concealed wall fixings through plastic corners
- » Wall fastening kit included



Magnetic Whiteboards

Corkboards

Overall Size H x W mm	Model	Price
Ultrabrite - Magnetic Whiteboards		
600 x 900	MA0315177	£77.20
900 x 1200	MA0515177	£129.51
Ultrabrite - Corkboards		
600 x 900	CA0311721	£53.53
900 x 1200	CA0511721	£86.50

Ultrabrite Display Cases

- » Highly visible aluminium yellow frame
- » Strong, secure and lightweight solution for a best-selling glazed case
- » Strong acrylic door gives excellent visibility to displayed material
- » Quality & versatility at an affordable price
- » Two versions: lacquered steel or natural cork
- » Lockable & supplied with 2 keys



Magnetic Display Cases

Cork Display Cases

Overall Size H x W x D mm	A4 Pages Stored	Model	Price
Ultrabrite - Magnetic Display Cases			
674 x 720 x 35	6	VT6201601511	£164.29
981 x 720 x 35	9	VT6301601511	£143.89
1288 x 340 x 35	16	VT9501601511	£229.04
Ultrabrite - Cork Display Cases			
981 x 720 x 35	9	VT6301611511	£131.63
981 x 940 x 35	12	VT6601611511	£232.86

Planners

- » High-quality drywipe magnetic surface with slim aluminium frame
- » Supplied with marker pen, pen tray, magnets and wall mounting kit
- » Overall Size H600 x W900 mm



Description	Model	Price
Annual Planner - 365 Days	GA0360170	£139.29
Annual Planner - 52 Weeks	GA0361170	£139.29
Week Planner	GA0333170	£139.29
Annual Planner - 12 Months	GA0375170	£139.29
Monthly Planner	GA0336170	£139.29
Annual Planner - Monthly 16 Lines	GA0337170	£139.29

Mobile Information Boards

- » Highly flexible visual communication board for the factory floor
- » Rotating structure with three or four boards
- » Lacquered steel surface
- » Flexible structure with a large communication area



Description	Board Size H x W mm	Model	Price
Three Sided Boards	910 x 650	EA673217	£695.83
Four Sided Boards	910 x 650	EA673117	£843.93

Signs, Labels & Notice/Whiteboards

Ayda Whiteboards

- » Surface in a choice of Lacquered Steel or Non-Magnetic
- » Anodised aluminium frame inspired in minimalist office trends
- » Easy fixation with improved stability and possibility to be mounted both portrait and landscape
- » Concealed wall fixings through corner covers for a clean look
- » Includes plastic pen tray that can be easily clamped onto the frame



Pen Tray

Overall Size H x W mm	Model	Price
Magnetic <i>(Drywipe magnetic lacquered steel surface with 10 year warranty, for regular use)</i>		
900 x 600	MA03759214	£44.41
1200 x 900	MA05759214	£62.70
1800 x 1200	MA27759214	£123.13
Non-Magnetic <i>(Dry wipe non-magnetic surface with 2 year warranty, for moderate use)</i>		
900 x 600	MA031539214	£29.76
1200 x 900	MA051539214	£48.56
1800 x 1200	MA271539214	£107.29

Ayda Felt Noticeboards

- » Smooth felt surface in blue, green or grey
- » Anodised aluminium frame inspired in minimalist office trends
- » Possibility to be mounted both portrait & landscape
- » Concealed wall fixings through corner covers for a clean look
- » Wall fastening kit included



Colour	Overall Size H x W mm	Model	Price
Blue	900 x 600	FA03439214	£38.57
Green	900 x 600	FA03449214	£38.57
Grey	900 x 600	FA03429214	£38.57
Blue	1200 x 900	FA05439214	£57.26
Green	1200 x 900	FA05449214	£57.26
Grey	1200 x 900	FA05429214	£57.26
Blue	1800 x 1200	FA27439214	£101.31
Green	1800 x 1200	FA27449214	£101.31
Grey	1800 x 1200	FA27429214	£101.31

Ayda Cork Noticeboards

- » Resilient natural cork bulletin surface never shows pin holes
- » Anodised aluminium frame inspired in minimalist office trends
- » Concealed wall fixings through corner covers for a clean look
- » Wall fastening kit included



Overall Size H x W mm	Model	Price
600 x 450	CA02409214	£31.86
900 x 600	CA03409214	£47.91
1200 x 900	CA05409214	£58.04

Enclore Felt Display Cases

- » Strong acrylic door gives excellent visibility to display material
- » Usable internal depth: 18mm; total depth: 35mm
- » Smooth blue felt surface
- » Quality and versatility at an affordable price
- » Lockable and supplied with 2 keys



Overall Size H x W mm	A4 Pages Stored	Model	Price
600 x 450	4	VT610107150	£114.80
600 x 900	9	VT630107150	£164.71
1200 x 900	15	VT640107150	£221.43

Signs, Labels & Notice/Whiteboards

WRITE-ON® Frameless Whiteboards



- >> Contemporary frameless design with white 2mm ABS edging. Available with coloured edging - call for details
- >> A non magnetic ultra smooth drywipe surface (plain on one side & feint grid on the other)
- >> Boards can mount virtually seamlessly side by side
- >> Wall fixings included

Description	Overall Size H x W mm	Model	Price
White Edged Whiteboards	900 x 600	49332/WH	£52.60
	900 x 1200	49343/WH	£74.80
	1200 x 1200	49344/WH	£104.03
	1200 x 1500	49354/WH	£122.17
	1200 x 1800	49364/WH	£138.22
	1200 x 2400	49384/WH	£166.40
Wallet of 4 Assorted Pens		439115	£9.25
Box of 10 Assorted Pens		439116	£17.75
Pack of 10 Assorted Memo Magnets, 20mm diameter		439151	£6.25
Pack of 10 Assorted Memo Magnets, 30mm diameter		439156	£9.25

BUSYGRIP® Poster Frames



- >> Wide range of popular sized poster frames finished in satin anodised aluminium
- >> Simply snap open & closed to change the poster
- >> Protected by anti-glare UV resistant cover
- >> Mounts portrait or landscape with fixings provided
- >> Quantity discounts available - call for details
- >> Coloured frame versions available - call for details
- >> A4 fire resistant version available - call for details

Description	Paper Size	Overall Size H x W mm	Model	Price
'A' Sized Poster Frames	A4	297 x 210	PFA4AL	£15.82
	A3	420 x 297	PFA3AL	£18.57
	A2	594 x 420	PFA2AL	£27.28
	A1	840 x 594	PFA1AL	£37.48
	A0	1189 x 840	PFA0AL	£58.40
'B' Sized Poster Frames	B2	700 x 500	PFB2AL	£30.08
	B1	1000 x 700	PFB1AL	£45.65

WRITE-ON® Aluminium Framed Whiteboards

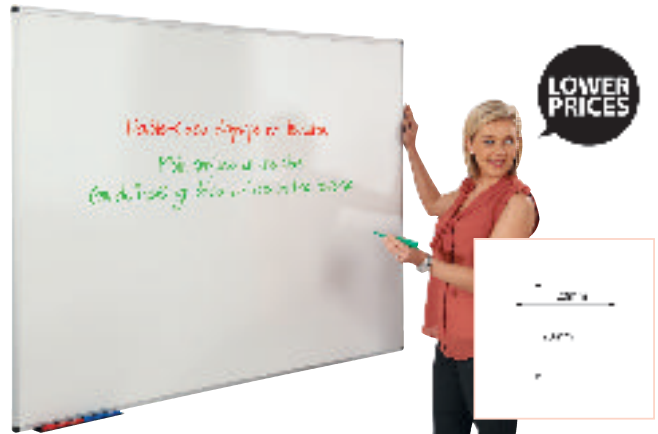

- >> Whiteboards with a plain surface. The non-magnetic has a guideline® gridded surface to the reverse as well
- >> Ultrasmooth to improve erasability & reduce ghosting
- >> Aluminium framed with concealed corner fixings & a dip on tray
- >> Frame styles differ between the non-magnetic & magnetic version

Overall Size H x W mm	Non-magnetic		Magnetic	
	Model	Price	Model	Price
600 x 450	47131	£28.12	49631	£28.35
900 x 600	47132	£38.49	49632	£35.65
900 x 1200	47143	£56.68	49643	£53.45
1200 x 1200	47144	£91.50	49644	£72.00
1200 x 1500	47154	£116.00	49654	£88.00
1200 x 1800	47164	£146.50	49664	£100.70
1200 x 2400	47184	£178.25	49684	£123.55
Wallet of 4 Assorted Pens			439115	£9.25
Box of 10 Assorted Pens			439116	£17.75
Pack of 10 Assorted Memo Magnets, 20mm diameter			439151	£6.25
Pack of 10 Assorted Memo Magnets, 30mm diameter			439156	£9.25

ShowPoint® Sign Frames



- >> Stylish and contemporary design
- >> Sign Frames can be mounted landscape or portrait
- >> Each Sign Frame comes with 4 coloured décor strips

Paper Size	Overall Size H x W mm	Model	Price
A6	164 x 119	SFA6	£13.25
A5	226 x 162	SFA5	£17.25
1/2 A4	313 x 119	SFHA4	£21.75
A4	313 x 224	SFA4	£24.75
A3	313 x 434	SFA3	£31.50
1/2 A4 Flag	119 x 313	SFF297	£38.50

Signs, Labels & Notice/Whiteboards

WRITE-ON® Magnetic Glass Whiteboards

- » Contemporary white glass boards - ideal for meeting or boardrooms
- » Many different colour options available - please call for details
- » A range of attractive glass drywipe boards which also accept super strength magnets
- » Board stands proud of the wall on chrome fixings
- » Made from steel backed 4mm toughened safety glass
- » Optional matching glass pen tray



Description	Overall Size H x W mm	Model	Price
White Glass Whiteboards	500 x 500	G5050/WH	£81.00
	900 x 600	G6090/WH	£131.00
	1000 x 1500	G1015/WH	£284.25
	1000 x 2000	G1020/WH	£383.25
	1200 x 900	G9012/WH	£204.50
	1200 x 1200	G1212/WH	£273.75
	1200 x 1800	G1218/WH	£357.50
	1200 x 2400	G1224/WH	£496.00
Pen tray		G5000	£15.25
Wallet of 5 Assorted Pens		539100	£17.50
25mm Silver Magnets - pack of 2		439158	£18.75

WRITE-ON® Magnetic Revolving Mobile Whiteboards



- » Sturdy white steel frame with a locking pivot mechanism with 4 castors - 2 locking
- » Aluminium framed
- » Simple self-assembly

Description	Overall Size H x W mm	Model	Price
Magnetic Whiteboard	900 x 1200	447433	£191.70
	1200 x 900	447343	£196.70
	1200 x 1200	447443	£226.70
	1200 x 1500	447543	£255.00
	1200 x 1800	447643	£296.70
Wallet of 4 Assorted Pens		439115	£9.25
Box of 10 Assorted Pens		439116	£17.75
30mm Black Magnets - pack of 10		439152	£9.25
Pack of 10 Assorted Memo Magnets, 20mm diameter		439151	£6.25
Pack of 10 Assorted Memo Magnets, 30mm diameter		439156	£9.25

Buzzard Mobile Flipchart Easel



- » Mobile Flipchart easel mounted on a five star base with locking castors
- » Metal pad clamp with hangers to take all standard A1 flipchart pads
- » Magnetic whiteboard is height adjustable with spring loaded assist
- » Two side arms are supplied as standard for hanging completed sheets
- » Full width pen tray

Description	Overall Size H x W mm	Model	Price
Grey/Black	1000 x 700	449505	£153.00
Blue		449510	£153.00
Wallet of 4 Assorted Pens		439115	£9.25
Box of 10 Assorted Pens		439116	£17.75
30mm Black Magnets - pack of 10		439152	£9.25
Pack of 10 Assorted Memo Magnets, 20mm diameter		439151	£6.25
Pack of 10 Assorted Memo Magnets, 30mm diameter		439156	£9.25

Signs, Labels & Notice/Whiteboards

Infini-T Flexible T-Card Panels

- >> Magnetic or adhesive backed polypropylene coloured slotted panels
- >> Multi-application & simple to use
- >> Change of plan? These are modular & easy to rearrange, remove or add extra panels
- >> For use with size 2 T-Cards - please see below

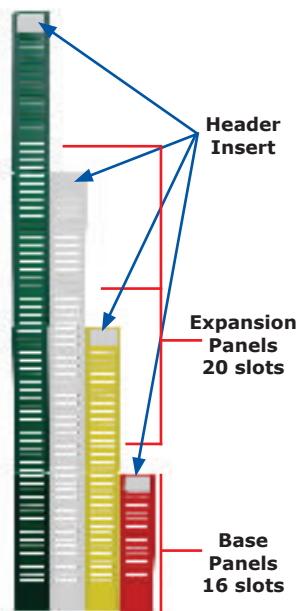

PRICES HELD

INFORMATION
Adhesive & Magnetic backings - no wall rails required



In/Out Boards

Attach to whiteboards, magnetic wallpaper, machines, shelving, furniture, information boards, home offices.....

Backing	Slots	Size	Model	Price
Base Panels (red, yellow, green or white - please specify when ordering)				
Magnetic	16	80W x 340H	ITP2-MB	£6.95
Adhesive	16	80W x 340H	ITP2-AB	£6.45
Expansion Panels (red, yellow, green or white - please specify when ordering)				
Magnetic	20	80W x 340H	ITP2-ME	£6.95
Adhesive	20	80W x 340H	ITP2-AE	£6.45
Accessories				
Panel Header Inserts (White) - pack of 5				£6.00
In/Out Board - one red panel & one green panel				
Magnetic	13	160 x 340	ITK2-MI-13	£29.00
Adhesive	13	160 x 340	ITK2-AI-13	£28.00
Magnetic	33	160 x 680	ITK2-MI-33	£42.00
Adhesive	33	160 x 680	ITK2-AI-33	£40.00

T-Cards & Planning Board Kits

- >> **T-CARDS** - 170gsm card. Available in 10 colours; pink, orange, grey, beige, purple, white, red, yellow, green & pale blue
- >> 20040 is not available in purple or grey
- >> **PRINTER T-CARDS** - 170gsm card. Available in 5 colours - white, yellow, green, blue or pink
- >> **PLASTIC T-CARDS** - Available in 7 colours - black, white, silver, transparent, red, blue or green
- >> PTC-3 is not available pink



T-Cards

Size	Model	Price
T-Cards		
1 - box of 100	20010	£2.00
1.5 - box of 100	20015	£2.10
2 - box of 100	20020	£2.65
3 - box of 100	20030	£3.45
4 - box of 100	20040	£6.30

Printer & Plastic T-Cards

Size	Model	Price
Printer T-Cards		
2 - pack of 180	PTC-2	£14.65
3 - pack of 80	PTC-3	£14.65
Plastic T-Cards		
2 - pack of 50	P-20020	£7.50
3 - pack of 50	P-20030	£12.94



WPDB-32



29112

WPDB-32: T-card stage per stage to produce a production overview board. 12 x 32 slot panels, metal index panel, wall supports, blank title strips, & 5 packs of size 2 T-Cards

29112: Displays a yearly schedule by months & days. 2 x 54 slot panels, metal index panel, wall supports, blank title strips, day/month labels & 10 packs of size 2 T-Cards

Description	Size mm	Model	Price
Workload Production Board Kit	805W x 665H	WPDB-32	£220.00
General Purpose Kit	805W x 960H	29112	£305.00

Magnetic Document Shields

- >> Size A4 or A3 transparent Document Shields with printed coloured frame for colour coding
- >> Backed on 3 edges with magnetic strips
- >> Can be used either portrait or landscape

COLOUR OPTIONS

- Yellow
 - Red
 - Blue
 - Green
 - Black
- specify when ordering*

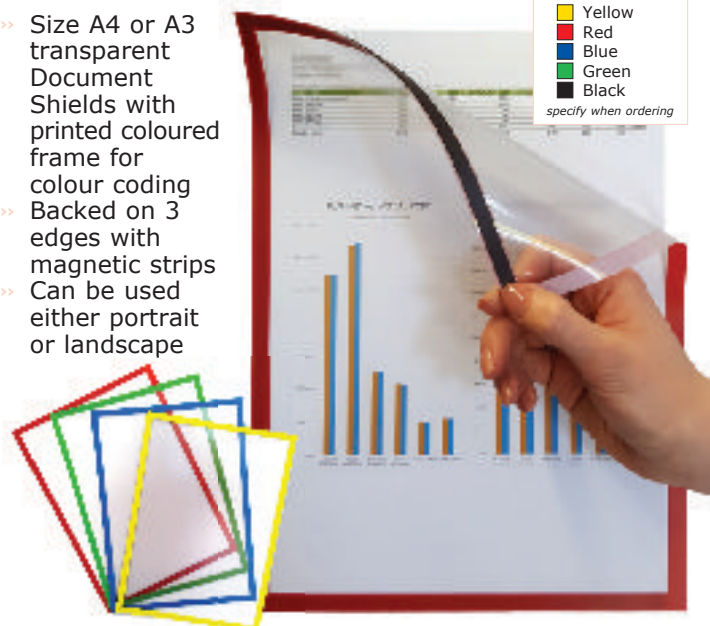

Size	Pack Size	Colours per Pack	Model	Price
A4	5	1	BDS-A4	£17.75
A3	5	1	BDS-A3	£32.95

Cascading Document Display Racks

- >> Modular, wall mounted, document organiser racks
- >> Steel construction for office & industrial environments
- >> Single document rack or combine for complete systems
- >> Choice of colours: Yellow (1), Grey-White (2), Red (3), Blue (4), Green (5), Grey-Aluminium (7) – Add colour code to reference
- >> A5 & A6 pocket formats available – call for details



INFORMATION 
Alternative pocket depth prices on request

No of Pockets	Document Size	Document Format	Model	Price
2	A4 (Visible Edge: Portrait Style 68mm Landscape Style 45mm)	Portrait	CDUA4P2/..	£39.00
		Landscape	CDUA4L2/..	£39.00
Portrait		CDUA4P6/..	£94.50	
Landscape		CDUA4L6/..	£94.50	
6	Portrait	Portrait	CDUA4P10/..	£144.00
		Landscape	CDUA4L10/..	£144.00

Document & Clipboard Racks

- >> High quality, easy-care, Document & Clipboard Racks constructed from tough polypropylene
- >> Designed to hold single or multi page documents & clipboards
- >> Supplied complete with wall fittings
- >> Pocket depth 210 mm. Pocket capacity 12-15 mm

INFORMATION 
Document & clipboard racks - constructed from tough polypropylene

Description	Pockets per Column	No of Column	Overall Size H x W x D mm	Model	Price
Single Column Rack (A4)	10	1	1282 x 315 x 76	DCRS-1-10	£210.00
Double Column Rack (A4)	6	2	900 x 554 x 76	DCRS-2-06	£250.00
Double Column Rack (A4)	10	2	1282 x 554 x 76	DCRS-2-10	£310.00
A4 Flexi-Clipboard	Pack of 3 (1 colour per pack) - Blue, Black, Red or White			CBF-A4	£12.00



DCRS-2-10

DCRS-2-10

Document Display Pockets - professionally display your documentation



- >> No more overloaded, untidy info displays
- >> Colour coded plastic document pockets & optional cover inserts ensure paperwork is secure & protected
- >> Document pocket packs available in white, yellow, red, dark blue, green, blue-grey, grey, black, orange & transparent - please specify



Heavy Duty Metal Document Pockets - A4

- >> Steel Document Pocket, powder coated with an aluminium style finish to store A4 documents.
- >> Edged on 3 sides, with rapid document loading through the 4th side
- >> Loaded through the narrow edge, the metal document pocket may be mounted in portrait or landscape format
- >> Supplied with pre-drilled holes for screw fixing



Pack Size	Model	Price
1	MDP-A4	£19.50

MAGNETIC BACKED DOCUMENT POCKETS

For magnetic whiteboard use, 3 per pack

Size	Style	Model	Price
A3	Portrait	MG3-A3P	£27.45
	Landscape	MG3-A3L	£27.45
	Covers	CVR3-A3	£9.15
A4	Portrait	MG3-A4P	£18.30
	Landscape	MG3-A4L	£18.30
	Covers	CVR3-A4	£5.40

HOOK & LOOP BACKED DOCUMENT POCKETS

For felt noticeboard use, 3 per pack

Size	Style	Model	Price
A3	Portrait	HL3-A3P	£26.70
	Landscape	HL3-A3L	£26.70
	Covers	CVR3-A3	£9.15
A4	Portrait	HL3-A4P	£17.70
	Landscape	HL3-A4L	£17.70
	Covers	CVR3-A4	£5.40

ADHESIVE BACKED DOCUMENT POCKETS

For general use, 3 per pack

Size	Style	Model	Price
A3	Portrait	AD3-A3P	£26.40
	Landscape	AD3-A3L	£26.40
	Covers	CVR3-A3	£9.15
A4	Portrait	AD3-A4P	£17.40
	Landscape	AD3-A4L	£17.40
	Covers	CVR3-A4	£5.40

Barriers, Traffic Management & Mirrors

'Obex Barriers®' Rope Barriers

- » High quality polished stainless steel posts for a durable & aesthetic finish
- » The ropes are manufactured from high quality polyester
- » Ideal where you need to channel traffic; hotels, airports, warehouses, offices, showrooms etc
- » 4 way connectivity



OBEX®
Barriers

3 x SPL11Z &
2 x SRL25B

INFORMATION



Simply buy your post
& add your rope to suit
your requirements



SHL01Z



SPL21Z
& SRL21R

SPL11Z
& SRL22B



SRL21R



SRL22B



SRL25B

Description	Post Size H x W mm	Model	Price
Stainless Steel Post			
Ball Head	987 x 320	SPL11Z	£54.65
Top Hat Head	935 x 320	SPL21Z	£56.00
Ropes			
Red	1500	SRL21R	£35.25*
Blue		SRL22B	£35.25*
Black		SRL25B	£35.25*
Wall Hook			
-	-	SHL01Z	£17.65*

*prices applicable when ordering with the Posts.
Order charges will apply if ordered on their own.

Barriers, Traffic Management & Mirrors

'Obex Barriers®' Belt Barriers

FROM ONLY
£59.05

OBEX®
Barriers



Black Post Belt Barrier
RPLB4R, RPLB5B or RPLB6B

Stainless Steel Post Belt Barrier
RPLS1R, RPLS2B or RPLS3B

Double Belt Barrier
RDLS7B

3 x RPLS1R

Wall Mounted Belt Barrier

RWLS9B

YOUR MESSAGE GOES HERE

RSL8Z



- » The retractable belt is manufactured from nylon
- » Ideal for where you need to channel traffic; hotels, airports, warehouses, offices, showrooms etc
- » 3 way connectivity
- » RWLS9B: comes complete with fixings & wall bracket

Belt Barriers

- » Posts are available in a black coated finish or a high quality polished stainless steel finish for a durable & aesthetic finish
- » Belt size: 50mm high & 2000mm length
- » Belt mechanism incorporates a speed restriction function to prevent the belt retracting too quickly

Belt Colour	Post Size H x W mm	Model	Price
Black Post - Retractable Belt Barrier			
Red	930 x 350	RPLB4R	£59.60
Blue		RPLB5B	£59.60
Black		RPLB6B	£59.60
Receiving End Post		RRLB8P	£57.40
Stainless Steel Post - Retractable Belt Barrier			
Red	930 x 350	RPLS1R	£59.05
Blue		RPLS2B	£59.05
Black		RPLS3B	£59.05
Receiving End Post		RRLS9P	£57.00
Stainless Steel Post - Double Retractable Belt Barrier			
Blue	985 x 320	RDLS7B	£92.35
Wall Mounted Retractable Belt Barrier			
Blue	-	RWLS9B	£33.40
Sign Board			
-	370 x 205	RSL8Z	£48.90*

*prices applicable when ordering with the Barriers. Order charges will apply if ordered on their own.

187

Barriers, Traffic Management & Mirrors

'Obex Barriers®' Wall Mounted Belt Barriers

- » Manufactured with a steel housing
- » Heavy duty nylon construction means the belt won't fray or break even in the toughest conditions
- » Ideal for hallways, doors, factories, warehouses & much more



CHEVRON BELT OPTIONS



please specify when ordering

MESSAGED BELT OPTIONS

CLEANING IN PROGRESS

CAUTION DO NOT ENTER

DANGER - FORKTRUCK TRUCKS

DANGER KEEP OUT

AUTHORISED ACCESS ONLY

DANGER KEEP OUT

AUTHORISED ACCESS ONLY

NO ENTRY

Available with the messages listed above - please specify when ordering

INFORMATION

Complete with receiver clip

PRICES HELD

3 day delivery



Housing Colours	Belt Depth mm	Belt Length mm	Housing Size H x W x D mm	Chevron Belt		Messaged Belt	
				Model	Price each 2+ Off*	Model	Price each 2+ Off*
Polished Chrome, Black, Yellow or Red	50	2300	120 x 114 x 90	WMBB23CH	£42.20	WMBB23ME	£49.10
Polished Chrome, Black, Yellow or Red	50	3000	120 x 114 x 90	WMBB30CH	£47.40	WMBB30ME	£52.60
Polished Chrome, Black, Yellow or Red	50	3900	130 x 114 x 100	WMBB39CH	£55.20	WMBB39ME	£65.55
Polished Chrome, Black, Yellow or Red	50	4600	130 x 114 x 100	WMBB46CH	£58.65	WMBB46ME	£72.50

'Obex Barriers®' Wall Mounted Twin Belt Barriers

- » Manufactured with a steel housing
- » Heavy duty nylon construction means the belt won't fray or break even in the toughest conditions
- » Ideal for hallways, doors, factories, warehouses & much more



CHEVRON BELT OPTIONS



please specify when ordering

MESSAGED BELT OPTIONS

CLEANING IN PROGRESS

CAUTION DO NOT ENTER

DANGER - FORKTRUCK TRUCKS

DANGER KEEP OUT

AUTHORISED ACCESS ONLY

DANGER KEEP OUT

AUTHORISED ACCESS ONLY

NO ENTRY

Available with the messages listed above - please specify when ordering

INFORMATION

Complete with 2 receiver clips

3 day delivery

PRICES HELD



Housing Colours	Belt Depth mm	Belt Length mm	Size H x W x D mm	Chevron Belt		Messaged Belt	
				Model	Price each 2+ Off*	Model	Price each 2+ Off*
Black, Yellow or Red	50	2300	405 x 115 x 90	WMTW23CH	£63.85	WMTW23ME	£77.70
Black, Yellow or Red	50	3000	405 x 115 x 90	WMTW30CH	£66.45	WMTW30ME	£83.75
Black, Yellow or Red	50	3900	405 x 115 x 90	WMTW39CH	£73.35	WMTW39ME	£101.05
Black, Yellow or Red	50	4600	405 x 115 x 90	WMTW46CH	£80.30	WMTW46ME	£114.90

Barriers, Traffic Management & Mirrors

'Obex Barriers®' Safety Belt Barriers



FROM ONLY
£63.40

INFORMATION

Steel base with heavy duty rubber ring



Steel Base

- » Ideal for restricting access to temporary work areas
- » Heavy duty rubber ring provides full contact around the circumference of the base
- » 4 way connectivity



SBBT34CH

SBBS34ME

AUTHORISED ACCESS ONLY

PRICES HELD



4 way connectivity with belt locking mechanism



CHEVRON BELT OPTIONS



please specify when ordering

MESSAGED BELT OPTIONS

- CLEANING IN PROGRESS
- CAUTION DO NOT ENTER
- ANGER - FORKLIFT TRUCKS
- DANGER KEEP OUT
- AUTHORISED ACCESS ONLY
- DANGER KEEP OUT
- AUTHORISED ACCESS ONLY
- NO ENTRY

Available with the messages listed above - please specify when ordering

Post Colours	Belt Depth mm	Belt Length mm	Post Size H x W mm	Chevron Belt		Messaged Belt	
				Model	Price each 2+ Off*	Model	Price each 2+ Off*
Single Belt							
Yellow, Red or Orange	50	3400	1015 x 355	SBBT34CH	£63.40	SBBS34ME	£73.80
Twin Belt							
Yellow or Red	50	3400	1015 x 355	SBBT34CH	£79.00	SBBS34ME	£99.75

*Barriers can be supplied in single units. Additional small order charge will be applied - call for details

Barriers, Traffic Management & Mirrors

OBEX®
Barriers

'Obex Barriers®' Premium Safety Belt Barriers

- » Ideal for restricting access to temporary work areas
- » Solid, cast iron base for extra strength & durability
- » Either 4.9m or 10.6m belt length
- » 4 way connectivity

CHEVRON BELT OPTIONS



please specify when ordering

MESSAGED BELT OPTIONS

CLEANING IN PROGRESS

CAUTION DO NOT ENTER

DANGER - FORKLIFF TRUCKS

DANGER KEEP OUT

AUTHORISED ACCESS ONLY

DANGER KEEP OUT

AUTHORISED ACCESS ONLY

NO ENTRY

Available with the messages listed above - please specify when ordering



PSBB49CH

PSSB10CH

Post Colours	Belt Depth mm	Belt Length mm	Post Size H x W mm	Chevron Belt		Messaged Belt	
				Model	Price each 2+ Off*	Model	Price each 2+ Off*
Black, Yellow, Red or Orange	50	4900	1015 x 355	PSBB49CH	£122.30	PSBB49ME	£142.20
		10,600		PSSB10CH	£130.95	PSSB10ME	£169.05

'Obex Barriers®' Premium Weatherproof Barriers

- » Tough, portable barrier ideal for creating outdoor waiting lines or restricting access to temporary work areas
- » With a recycled rubber base & powder coated stainless steel post, designed for outdoor use
- » Base features convenient carry handles & is tough enough to drive over
- » Designed for creating long run barriers

CHEVRON BELT OPTIONS



please specify when ordering

MESSAGED BELT OPTIONS

CLEANING IN PROGRESS

CAUTION DO NOT ENTER

DANGER - FORKLIFF TRUCKS

DANGER KEEP OUT

AUTHORISED ACCESS ONLY

DANGER KEEP OUT

AUTHORISED ACCESS ONLY

NO ENTRY

Available with the messages listed above - please specify when ordering



WMS106ME

WMS106CH

Post Colours	Belt Depth mm	Belt Length mm	Post Size H x W mm	Chevron Belt		Messaged Belt	
				Model	Price each 2+ Off*	Model	Price each 2+ Off*
Black, Yellow, Red or Orange	50	10,600	1015 x 480	WMS106CH	£127.45	WMS106ME	£165.55

Barriers, Traffic Management & Mirrors

'Obex Barriers®' Weatherproof Barriers



- » Tough, portable barrier ideal for creating outdoor waiting lines or restricting access to temporary work areas
- » With a recycled rubber base & powder coated stainless steel post, designed for outdoor use
- » Base features convenient carry handles & is tough enough to drive over



OBEX®
Barriers

CHEVRON BELT OPTIONS



please specify when ordering

MESSAGED BELT OPTIONS



Available with the messages listed above - please specify when ordering

Post Colours	Belt Depth mm	Belt Length mm	Post Size H x W mm	Chevron Belt		Messaged Belt	
				Model	Price each 2+ Off*	Model	Price each 2+ Off*
Single Belt							
Black, Yellow, Red or Orange	50	3400	1015 x 480	WMS34CH	£73.70	WMS34ME	£84.10
Black, Yellow, Red or Orange	50	4900	1015 x 480	WMS49CH	£93.70	WMS49ME	£113.60
Twin Belt							
Black, Yellow, Red or Orange	50	3400	1015 x 480	WMT34CH	£93.70	WMT34ME	£114.50
Black, Yellow, Red or Orange	50	4900	1015 x 480	WMT49CH	£128.35	WMT49ME	£168.15

*Barriers can be supplied in single units. Additional small order charge will be applied - call for details

191

Barriers, Traffic Management & Mirrors

Guarda - Lightweight Chain Posts

- » For quick & easy cordoning off space in warehouses etc
- » Available in a choice of 3 base styles:
 - » Triangular plastic base filled with concrete for outdoor use
 - » Round plastic hollow base to be filled with sand, water etc
 - » Square hard rubber base



Version	Colour	Height mm	Base mm	Weight kg	Model	Price
Individual Guarda Chain Posts & Bases						
Triangular Plastic Base - Concrete Filled	Red & White	870	300 SL	3.4	175.13.895	£11.60
	Black & Yellow				175.14.011	£11.60
Square Hard Rubber Base	Red & White		265 x 265	2.3	175.19.222	£20.10
	Black & Yellow				175.16.601	£20.10
Round Plastic Hollow Base	Red & White		300 ø	2	175.16.320	£14.00
	Black & Yellow				175.18.711	£14.00
Guarda Chains						
6mm Polyethylene Chain - Red & White (25M Length)					212.10.805	£37.50
6mm Polyethylene Chain - Yellow & Black (25M Length)					212.13.380	£37.50
Set of 6 Guarda Chain Posts & Bases (10M chain, 10 connecting links & 10 hooks)						
Triangular Plastic Base - Concrete Filled	Red & White	870	300 SL	20	175.16.146	£85.30
	Black & Yellow				175.13.735	£85.30
Square Hard Rubber Base	Red & White		265 x 265	12.5	175.19.176	£133.60
	Black & Yellow				175.17.668	£133.60
Round Plastic Hollow Base	Red & White		300 ø	6	175.15.850	£100.70
	Black & Yellow				175.17.247	£100.70



Traffic Line - Belt Posts

- » Flexible system providing demarcation of public areas from traffic routes
- » Powder coated aluminium posts
- » Moulded bases with reflective disks
- » Secure 4 point fixing for permanent installation (*fixings not included*)
- » Self-tensioning belts with retraction feature
- » Overall height: 985mm
- » Post diameter: 60mm



Post Colour	Belt Colour	3000mm Belt Length		4000mm Belt Length	
		Model	Price	Model	Price
Yellow	Black & Yellow	179.14.759	£252.10	179.22.511	£280.40
	Yellow	179.17.353	£252.10	179.26.335	£280.40
Red	Red & White	179.19.970	£252.10	179.28.338	£280.40
	Red	179.15.362	£252.10	179.24.575	£280.40
Wall Clip				179.16.000	£16.60
Belt Link				179.17.430	£9.30

Wall Mounted Belt Cartridges

- » For entrances, doorways, stairs etc
- » Easy to fix bracket
- » Black cartridge
- » Self tensioning



179.13.738

179.27.462

Belt Colour	Belt Length	Wall Mounted		Wall Mounted - Magnetic	
		Model	Price	Model	Price
Black/Yellow Striped	3000mm	179.18.124	£129.00	179.27.462	£160.30
	4000mm	179.23.024	£160.30	179.23.187	£200.40
Red/White Striped	3000mm	179.13.738	£129.00	179.27.835	£160.30
	4000mm	179.23.085	£160.30	179.21.407	£200.40



Barriers, Traffic Management & Mirrors

Traffic Line Heavy Duty Pallet Racking Protectors



- » Conform to DIN 4844 safety guidelines
- » Provide protection from vulnerable frame ends & uprights
- » Made in steel & powder coated yellow with black bands
- » Can effectively be used to protect machines, partitioning, mezzanine support columns, concrete columns etc
- » Right angle - for corner protection (bolted on 2 sides)
- » U-Profile - for three sided protection (bolted on 3 sides)
- » Superior high strength & build quality

LOWER PRICES



197.22.542



197.22.021

Description	Overall Size H x W x Gauge mm	Fixing Bolts required per protector	Weight kg	Model	Price
Right Angle	400 x 160 x 5	4	8	197.15.928	£49.00
	400 x 160 x 6	4	9	197.13.182	£60.70
	800 x 160 x 6	4	16	197.14.605	£109.40
	1200 x 160 x 6	4	22	197.18.380	£162.80
Right Angle with Rollers	400 x 160 x 6	4	9	197.22.542	£131.70
U-Profile	400 x 160 x 6	6	11	197.18.365	£92.90
U-Profile with Rollers	400 x 160 x 6	6	12	197.22.021	£171.80
Fixing Bolts (2 per pack)	12 x 100	-	0.2	109.17.393.2	£3.60

Traffic Line - Collision Protection Bars



- » Protect your shelves, cabinets, machinery etc
- » Low profile design allows easy access to pedestrians
- » Size: 76mm Dia., 3mm wall thickness
- » Surface mounted with extra strength base plates
- » Powder coated in yellow with black bands

LOWER PRICES

Description	Overall Size H x W mm	Weight kg	Model	Price
Protection Bars (needs 4 Bolts)	86 x 400	5	199.13.478	£34.10
	86 x 800	7.5	199.19.220	£48.90
	86 x 1200	10	199.14.143	£69.90
Fixing Bolts (4 per pack)	12 x 100	0.2	109.17.393.4	£7.20



Barriers, Traffic Management & Mirrors

Traffic Line - Protection Guards

- » High impact guards manufactured in 3mm gauge steel, 76mm dia. Superior high strength & build quality
- » Finishes: yellow powder coat with black bands (interior use) or hot dip galvanised & yellow powder coat with black bands (exterior use)
- » Protect your stock, traffic routes & work areas
- » Special size & colours are available - *call for details*
- » Sub-surface fixings are available - *call for details*



Description	Overall Size H x W mm	Weight kg	Powder Coated		Galvanised & Powder Coated	
			Model	Price	Model	Price
Bollards						
Yellow with Black Bands - Surface Fixing Plate	90 x 1200	14.5	-	-	199.19.943	£148.80
Yellow with Black Bands - Sub surface Fixing	90 x 1600	16.5	-	-	199.17.454	£143.60
Yellow with Black Bands - Surface Fixing Plate	159 x 1200	33.5	-	-	199.16.549	£275.00
Yellow with Black Bands - Sub surface Fixing	159 x 1600	35.5	-	-	199.15.852	£320.70
Protection Guards						
Yellow - Surface Fixing Plate	350 x 375	10	195.15.621	£137.20	195.18.233	£198.90
	350 x 750	12	195.14.450	£156.10	195.16.265	£228.10
	350 x 1000	13	195.14.589	£171.80	195.13.499	£249.50
Yellow with Black Bands - Surface Fixing Plate	600 x 750	14	195.18.515	£188.60	195.17.623	£259.00
	600 x 1000	16	195.18.943	£202.10	195.19.157	£277.30
	1200 x 750	20	195.19.573	£238.20	195.17.296	£326.50
	1200 x 1000	22	195.17.903	£255.30	195.18.822	£351.70
Surface Fixing Bolts (8 per guard - price per 8)	12 x 100	0.2	-	-	109.17.393.8	£14.40
Corner Protection Hoops						
Yellow with Black Bands - Surface Fixing Plate	350 x 600	20	195.13.241	£259.90	195.14.708	£407.40
	600 x 600	24	195.14.637	£307.50	195.17.083	£479.10
	1200 x 600	34	195.17.512	£386.70	195.13.874	£603.50
Surface Fixing Bolts (12 per guard - price per 12)	12 x 100	0.2	-	-	109.17.393.12	£21.60

Traffic Line - Steel Hoop Guards

- » Guards manufactured in 2mm gauge high quality steel, 48mm dia.
- » Ideal for the segregation & protection of vulnerable zones such as walkways & machinery
- » Finishes: Yellow powder coat with black bands (interior use)
Hot dip galvanised & yellow powder coat with black bands (exterior use)

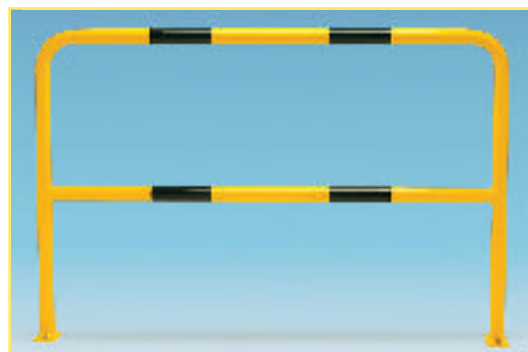

Description	Overall Size H x W mm	Weight kg	Powder Coated		Galvanised & Powder Coated	
			Model	Price	Model	Price
Yellow with Black Bands	1000 x 1000	10	201.14.228	£211.10	201.15.512	£271.90
	1000 x 1500	12	201.15.794	£234.20	201.17.982	£324.20
	1000 x 2000	20	201.14.465	£273.00	201.13.553	£371.20
Surface Fixing Bolts (4 per guard - price per 4)	12 x 100	0.2	-	-	109.17.393.4	£7.20

Barriers, Traffic Management & Mirrors

Heavy Duty Safety Barriers / Machine Guards

- » Constructed from heavy duty 115mm diameter steel pipe, these units are ideal for work areas
- » Bases are pre-drilled with 22mm diameter holes for fixing to the floor (not supplied)
- » These units are powder coated yellow for high visibility



FROM ONLY
£107.75



PRICES HELD

Description	Overall Height mm	Overall Length mm	Mounting Plate Size mm	Weight kg	Model	Price
High Profile Guard	1065	1220	200 x 200	17	SMG10H	£209.35
Low Profile Guard	230	1220		12	SMG02L	£144.90
Safety Bollard	915	-		10	SMG09B	£107.75
Corner Guard	610	610		12	SMG15C	£194.00



Modular Barrier System

- » These units provide isolation for drums & machinery offering protection to products & operators
- » Manufactured from rectangular hollow section steel these units can be bolted together in a line or at right angles
- » Pre-drilled base plates for fixing to the floor with 12mm bolts (not provided)
- » Extension units are supplied with 2 joining bolts
- » Finish: powder coated yellow

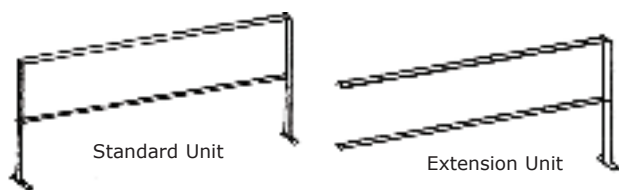

Description	Length mm	Height mm	Model	Price
Standard	1000	1000	SB1000	£208.35
Extension	1000	1000	SE1000	£199.95
Standard	1500	1000	SB1500	£219.80
Extension	1500	1000	SE1500	£206.10



Barriers, Traffic Management & Mirrors

Open & Mesh Infil Barriers

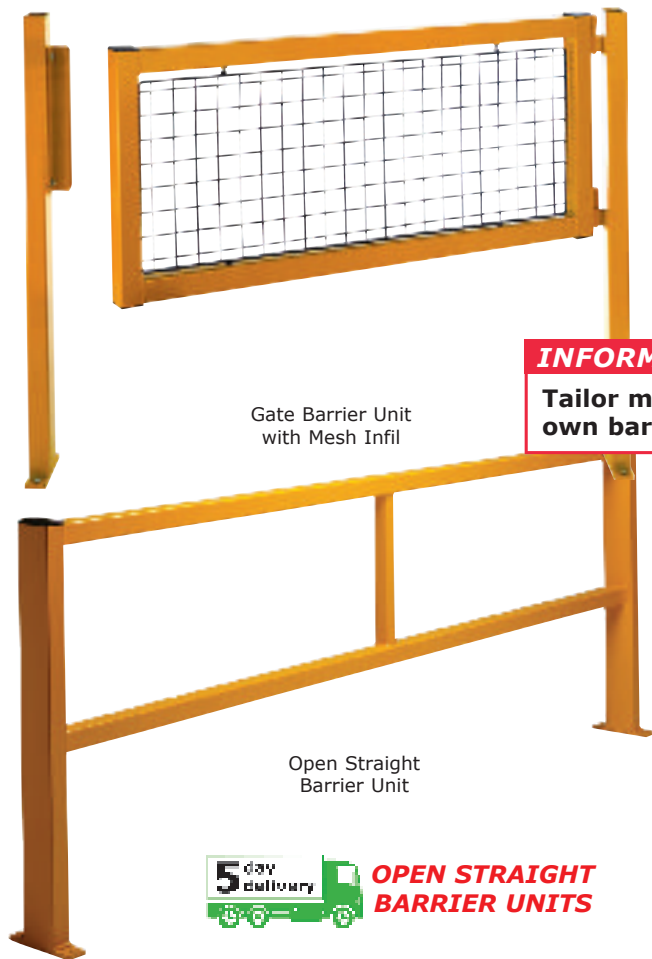

Gate Barrier Unit with Mesh Infil

Open Straight Barrier Unit

Corner Barrier Unit

INFORMATION

Tailor make your own barrier

These safety barriers are designed for creating protective barriers around machinery & equipment and for defining walkways through industrial, manufacturing & warehousing areas.

- » Choice of open or mesh infill panels
- » Fully welded construction
- » Powder coated high visibility yellow
- » Supplied with floor fixings



OPEN STRAIGHT BARRIER UNITS

Overall Size L x H mm	Mesh Infil		Open	
	Model	Price	Model	Price
Gate Barrier Units				
900 x 900	SBG0909M	£277.85	SBG09090	£217.30
900 x 1100	SBG0911M	£289.70	SBG09110	£231.80
1200 x 900	SBG1209M	£304.15	SBG12090	£229.15
1200 x 1100	SBG1211M	£325.25	SBG12110	£247.60
Straight Barrier Units				
1000 x 900	SBS1209M	£308.10	SBS12090	£234.40
1000 x 1100	SBS1211M	£388.40	SBS12110	£300.20
2000 x 900	SBS2409M	£492.40	SBS24090	£347.60
2000 x 1100	SBS2411M	£514.75	SBS24110	£359.45
Corner Barrier Units				
1000 x 900	SBC1209M	£487.10	SBC12090	£330.50
1000 x 1100	SBC1211M	£487.10	SBC12110	£334.45

Guard Barriers

These attractive tubular, safety barriers are ideal for protecting walkways around machinery & shelving and also for defining walkways through industrial, manufacturing & warehouse areas.

- » Fully welded construction
- » Powder coated high visibility yellow
- » Supplied with floor fixings

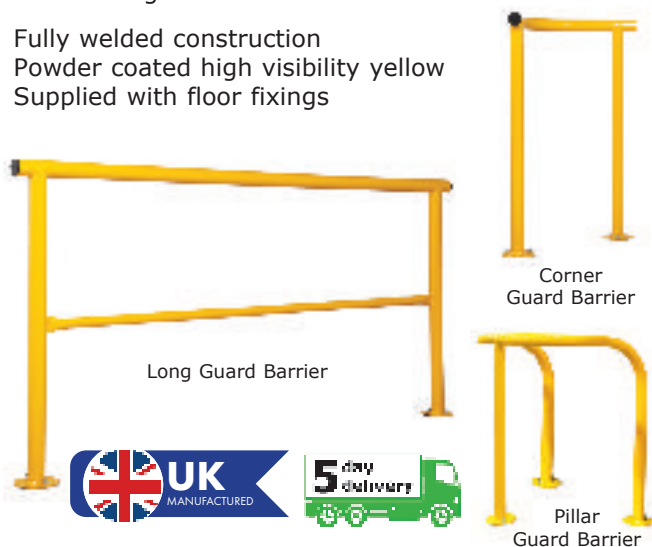

Long Guard Barrier

Corner Guard Barrier

Pillar Guard Barrier



Overall Size H x L mm	Model	Price
Short Guard Barrier		
940 x 1000	GBSG94	£225.20
Corner Guard Barrier		
940H x 530W x 530D	GBCG94	£251.55
Pillar Guard Barrier (Maximum pillar size: W600 x D480mm)		
850H x 750W x 700D	GBPG85	£288.40
Long Guard Barrier		
940 x 2000	GBLG94	£293.65

Pallet Racking Protectors

- » An economical range of protection barriers for the end of pallet racking bays
- » Constructed from heavy gauge steel tube & fully welded - no on-site assembly
- » Powder coated high visibility yellow
- » Heavy duty floor fixing plate with bolts included
- » Sizes to suit single or double bays



MB1900



Length x Height mm	Model	Price
To suit 700 x 620mm	MB0700	£214.65
To suit 900 x 620mm	MB0900	£239.70
To suit 1100 x 620mm	MB1100	£272.60
To suit 1500 x 620mm	MB1500	£296.30
To suit 1900 x 620mm	MB1900	£362.10
To suit 2300 x 620mm	MB2300	£402.90

Barriers, Traffic Management & Mirrors

Protective Posts

- » Designed to protect from accidental damage
- » Fully welded construction for floor mounting - fixings included
- » Extra height posts available on request for embedding into concrete
- » Powder coated in Yellow or Yellow & Black
- » Order quantities may apply, please speak to the sales team



Overall Size: 760H x 90 dia. mm

Colour	Model	Price
Yellow	PP0709YE	£156.75
Yellow & Black	PP0709YB	£156.75

Overall Size: 915H x 115 dia. mm

Colour	Model	Price
Yellow	PP0911YE	£180.45
Yellow & Black	PP0911YB	£180.45

Overall Size: 1100H x 170 dia. mm

Colour	Model	Price
Yellow	PP1117YE	£269.95
Yellow & Black	PP1117YB	£269.95

Protective Rail System

- » Constructed from 100mm welded heavy duty square tubular steel
- » Ideal for dividing manufacturing units & equipment in warehouses etc
- » Square floor plates (200 x 200mm) with pre-drilled fixing holes (approx 12mm) for fixing to the floor (fixings not supplied)
- » The corner rail gives the option of a protective cage around equipment
- » Finish: powder coated yellow



Rail Length	Single Rail Height 380mm			Double Rail Height 750mm			Triple Rail Height 1120mm		
	Weight	Model	Price	Weight	Model	Price	Weight	Model	Price
1220mm	27 kg	SBR104	£419.35	58 kg	SBR204	£796.65	84 kg	SBR304	£1071.55
1830mm	41 kg	SBR106	£476.60	76 kg	SBR206	£895.05	111 kg	SBR306	£1223.20
2440mm	50 kg	SBR108	£529.75	94 kg	SBR208	£1002.05	129 kg	SBR308	£1342.80
Corner Section 1m x 1m	50 kg	SBR100	£671.90	94 kg	SBR200	£1125.95	136 kg	SBR300	£1502.05

Barriers, Traffic Management & Mirrors

Traffic Line - Impact Protection Railing System

- » Extremely strong & versatile protective railing system
- » Interior use - powder coated yellow
- » Exterior use - hot dip galvanised & powder coated yellow
- » Superior high strength & build quality
- » Posts: 100 x 100mm section
Base Plate: 200 x 200mm
Surface fixing (4 bolts)
- » Lateral rails: 120 x 80mm section

LOWER PRICES



Bollards & Posts

Description	Overall Size H x W x D mm	Weight kg	Interior Use		Exterior Use	
			Model	Price	Model	Price
Bollard	1000 x 100 x 100	16	194.15.516	£119.10	194.13.700	£180.30
End Post	500 x 100 x 100	10	194.16.094	£95.40	194.15.765	£145.40
Centre Post	500 x 100 x 100	10.5	194.18.550	£103.40	194.18.142	£157.70
90° Angle Post	500 x 100 x 100	10.5	194.13.760	£104.90	194.15.032	£160.00
End Post	1000 x 100 x 100	17	194.14.244	£140.30	194.13.501	£214.60
Centre Post	1000 x 100 x 100	18	194.17.026	£158.90	194.13.894	£243.80
90° Angle Post	1000 x 100 x 100	18	194.18.205	£164.70	194.15.572	£253.00

Cross Bars

Cross Bar mm	Weight kg	Interior Use		Exterior Use	
		Model	Price	Model	Price
1000	9.5	194.18.997	£99.20	194.16.672	£151.00
1200	11.5	194.16.172	£106.80	194.14.863	£162.30
1500	14	194.15.942	£130.90	194.16.449	£200.20
2000	18	194.13.434	£169.20	194.13.826	£259.70

Traffic Line - Impact Protection Shock Absorbing Pad

- » Shock absorbing pad enables the posts & bollards to deflect by up to 10°. This allows the railing system to absorb shocks & impacts whilst damage is reduced significantly. The pad is UV, weather/temperature resistant & increases the height of the railing system by 40mm (installed by the use of 4 chemical anchor bolts per post/bollard)



Description	Overall Size H x W x D mm	Weight kg	Model	Price
Pad for Post	50 x 200 x 200	0.6	422.21.456	£38.80
Chemical Anchors	300 x 100 x 100	2	109.20.858	£50.70

Traffic Line - Impact Protection Railing Gate

- » Designed to fix to end posts, centre posts or corner posts & can be hung on the left or right hand side
- » Can be manually opened 90° inwards or outwards



Overall Size L x H mm	Gate Size L x H mm	Weight kg	Model	Price
905 x 520	835 x 475	12	194.20.653	£294.90

Barriers, Traffic Management & Mirrors

Steel Barrier System

- » Simple & easy installation
- » Triple ridge barrier for strength & rigidity
- » Rolled top edges help eliminate sharp edges
- » Available with single & double height posts
- » Mounted on square floor plates with pre-drilled fixing holes (fixings not supplied)

PRICES HELD



INFORMATION

Tailor make your own barrier



Barriers

Length mm	Weight kg	Model	Price
508	10	SGR05Z	£96.10
1118	18	SGR11Z	£155.45
1728	26	SGR17Z	£219.80
2337	34.5	SGR23Z	£301.25

Posts - Suitable for use as both 'In-Line' posts & Corner posts

Height mm	Post Size W x D mm	Mounting Plate Size W x D mm	Weight kg	Model	Price
Single - 483	100 x 100	254 x 254	16.5	SGP04Z	£144.85
Double - 1093	100 x 100	254 x 254	27.5	SGP10Z	£225.60

Heavy Duty Barrier System

- » Simple & easy installation
- » Double ridge barrier for strength & rigidity
- » Rolled edges help eliminate sharp edges
- » Available in either a powder coated yellow finish or galvanised for outdoor use
- » Mounted on square floor plates with pre-drilled fixing holes (fixings not supplied)

FROM ONLY
£156.15



Barriers

Length mm	Weight kg	Stove Enamel Yellow		Galvanised	
		Model	Price	Model	Price
610	8	BBY06Z	£156.15	BBG06Z	£213.10
915	10	BBY09Z	£190.60	BBG09Z	£255.45
1220	12	BBY12Z	£198.85	BBG12Z	£266.30
2440	24	BBY24Z	£261.30	BBG24Z	£364.20

Posts - Suitable for use as both 'In-Line' posts & Corner posts

Post Size mm	Mounting Plate Size mm	Post Height mm	Weight kg	Stove Enamel Yellow		Galvanised	
				Model	Price	Model	Price
100 x 100	220 x 220	510	10	BPY04Z	£229.35	BPG04Z	£286.15



Barriers, Traffic Management & Mirrors



INFORMATION 

Ensure safety by segregating traffic & pedestrian routes

BRANDSAFE® Flexi Delineator Range

- >> Polyurethane posts that will flex, bend & return to shape
- >> 80mm diameter posts supplied with 3 floor anchor bolts suitable for tarmac or concrete (1000mm high)
- >> Ideal where demarcation of traffic routes is paramount
- >> Can be used on their own or combined with plastic chains to help segregate traffic & pedestrian routes. When used with chains, please order the chain fixing kit (1 per post) & chain separately

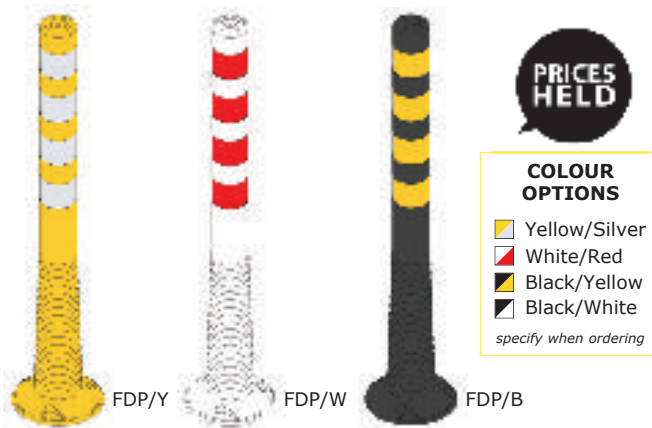

Description	Model	Price
Yellow Post with Silver Reflectors	FDP/Y	£79.00
White Post with Red Reflectors	FDP/W	£79.00
Black Post with Yellow Reflectors	FDP/B	£79.00
Black Post with White Reflectors	FDP/BW	£79.00
Chain Fixing Kit	FDK/FK	£9.00
Black & Yellow 8mm Plastic Chain x 25M	PCH/BY	£54.90
Red & White 8mm Plastic Chain x 25M	PCH/RW	£54.90

BRANDSAFE® Wheel Stops

- >> Suitable for Domestic & HLGV vehicles
- >> Ideal for use where you need to control the parking of vehicles to eliminate clash with vehicles parking against perimeter walls, perimeter fencing, in front of buildings and/or back to back parking



Description	Model	Price
Domestic Wheel Stop (Red) - 900L x 200W x 80Hmm	DWS/R	£84.00
Domestic Wheel Stop (Yellow) - 900L x 200W x 80Hmm	DWS/Y	£84.00
Domestic Wheel Stop (Black) - 900L x 200W x 80Hmm	DWS/B	£84.00
HLGV Wheel Stop (Red) - 1000L x 200W x 130Hmm	CWS/R	£120.00
HLGV Wheel Stop (Yellow) - 1000L x 200W x 130Hmm	CWS/Y	£120.00

BRANDSAFE® Lamp & Sign Post Wrap

- >> Clam-Shell design, manufactured from Polyethylene with a high density foam absorbing impact core
- >> Complete with diamond grade reflective bands for night time visibility by vehicle drivers
- >> Units fit together simply on-site with stainless security bolts



Description	Model	Price
Lamp & Sign Post Protector Kit - Black & Yellow Vis	LPK/BY	£240.00
Lamp & Sign Post Protector Kit - Black & Silver Vis	LPK/BS	£240.00
Lamp & Sign Post Protector Kit - Green & Silver Vis	LPK/GS	£240.00
Lamp & Sign Post Protector Kit - Red & Silver Vis	LPK/RS	£240.00
Lamp & Sign Post Protector Kit - Yellow & Silver Vis	LPK/YS	£240.00

Barriers, Traffic Management & Mirrors

BRANDSAFE® Armco Safety Ends

- >> Polymer moulded ends with single point fixing
- >> Ideal for covering razor sharp Armco cut ends that otherwise present safety issues
- >> Fitted with 2 diamond grade reflectors
- >> Simple & quick to install. Designed to suit Armco 310 x 85mm corrugated rails

PRICES HELD

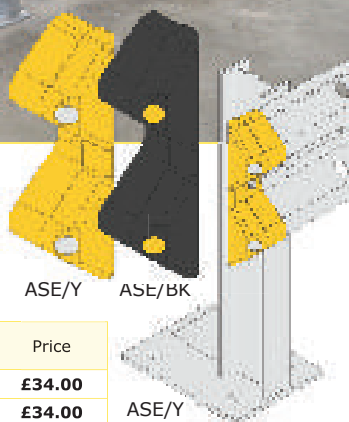
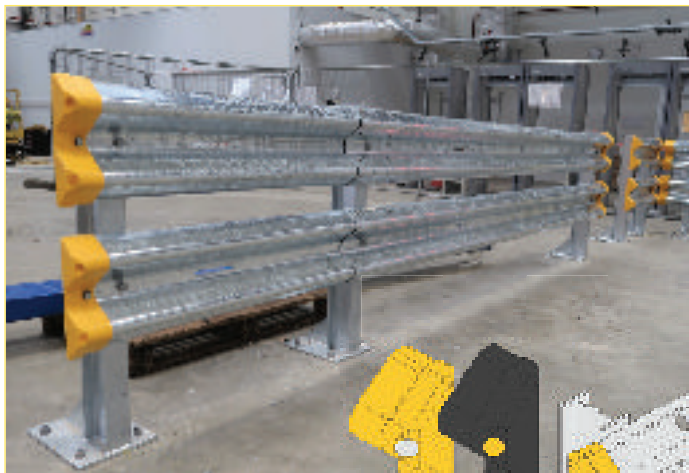

ASE/Y ASE/BK

Description	Model	Price
Yellow Armco Safety End	ASE/Y	£34.00
Black Armco Safety End	ASE/BK	£34.00

ASE/Y

BRANDSAFE® Armco Pedestrian Safety Ends

- >> Provides a safe & visual termination to Armco rails
- >> Retrofit compatibility with all Armco terminals
- >> Quick & easy to install with 2 supplied bolts
- >> Fitted with diamond grade reflectors

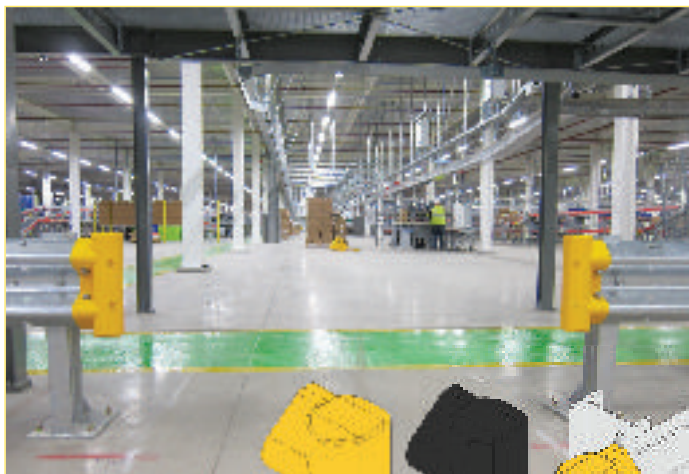

APSE/Y APSE/BK

Description	Model	Price
Yellow Pedestrian Safety End	APSE/Y	£39.00
Black Pedestrian Safety End	APSE/BK	£39.00

APSE/Y

BRANDSAFE® Armco Safety Corners

- >> Safety driven design & development to make your Armco barrier safer & visible to your MHE/PIT operators & HGV drivers
- >> Designed for fitment with a single Armco post, saving costs & install time

PRICES HELD

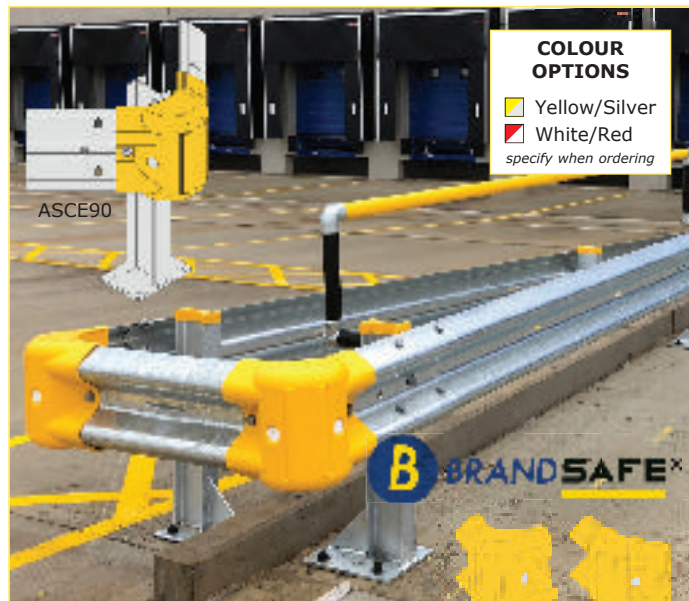

COLOUR OPTIONS
 Yellow/Silver
 White/Red
 specify when ordering

ASCE90



ASCE90 ASCE135
 ASCIN90 ASCIN135

Description	Model	Price
External Corner - 90°	ASCE90	£79.00
External Corner - 135°	ASCE135	£79.00
Internal Corner - 90°	ASCIN90	£79.00
Internal Corner - 135°	ASCIN135	£79.00

BRANDSAFE® Armco Fishtail Safety Ends

- >> Provides a safe & visual termination to Armco rails
- >> Retrofit compatibility with all Armco terminals
- >> Flexible under impact - offers low damage to vehicles
- >> Fitted with diamond grade reflectors



PRICES HELD

AFSE/Y

Description	Model	Price
Yellow Fishtail Safety End	AFSE/Y	£49.00
Black Fishtail Safety End	AFSE/BK	£49.00

AFSE/BK

Lower value orders may incur carriage costs - please call for details

Barriers, Traffic Management & Mirrors

Protect-It XL Rack Guard

Protect-it XL rack guards are large format upright protectors that improve warehouse safety & reduce rack damage caused by forklift trucks, & other vehicles.

- » Overall Height: 500mm
- » Fits uprights with widths to 90mm
- » Easy to fit - no fixing or tools required
- » Easy to remove for rack inspections
- » Passes both front/side impact tests to conform to FEM 10.2.02
- » Fits most pallet racking makes

NEW

INFORMATION

HSE guidelines state that every upright should be protected

Free delivery on orders over £250.00. For orders less than this please add £25.00 per order.

Protection Height	Upright Width	Price
500mm	up to 90mm	£24.95



Protect-It MAXI



Wall Protection: can conform to the shape of the wall (1080L x 500H mm)

Protect-it MAXI is a revolutionary structural column guard designed to minimize damage to building columns especially suited to mezzanine floor columns

- » Reduce vehicle impact damage to columns, walls & structures
- » Low profile, space saving design
- » Quick & easy installation on all column shapes including square, round, H & I beams
- » Inexpensive purchase, installation & replacement costs
- » Suitable for cold stores

Free delivery on orders over £250.00. For orders less than this please add £25.00 per order.

For Column Sizes Between mm	Price 500mm High	Price 1000mm High
Square or 'H' Section		
100 x 100 & 140 x 140	£132.00	£264.00
150 x 150 & 300 x 300	£198.00	£396.00
325 x 325 & 425 x 425	£264.00	£528.00
450 x 450 & 600 x 600	£330.00	£660.00
Round Section		
175	£132.00	£264.00
200		
300		
Protect-It Wall (per linear metre - actual size 1080L x 500H mm)	£264.00	-

Protect-It Stackable

INFORMATION

HSE guidelines state that every upright should be protected



Please specify type of racking if known when ordering or send a photo of the racking

Does your warehouse meet HSE requirements?

HSE document HSG76 states: 'Where racking is likely to be struck by lift trucks & other vehicles it should be protected'

If you are going to conform to HSE requirements make sure you fit a protector that meets the recognised European Standard FEM 10.2.02.

- » Kit includes: 3 x 133mm guards
- » Overall Height: 400mm
- » Fits uprights with widths from 90mm to 120mm
- » Effective in cold stores up to -40 degrees
- » No fixings or tools required
- » Passes both front/side impact tests to conform to FEM 10.2.02
- » Fits most pallet racking makes

Protection Height	Uprights between 90mm x 120mm wide
400mm	£24.95

Free delivery on orders over £250.00. For orders less than this please add £25.00 per order.

Barriers, Traffic Management & Mirrors

Column Protectors

- » Impact protection for columns & girders
- » Easy to assemble with no fixings - fit with velcro straps
- » Manufactured from highly flexible & strong polyethylene
- » Available in a range of sizes which are suitable for warehouses, mezzanine floors & carparks

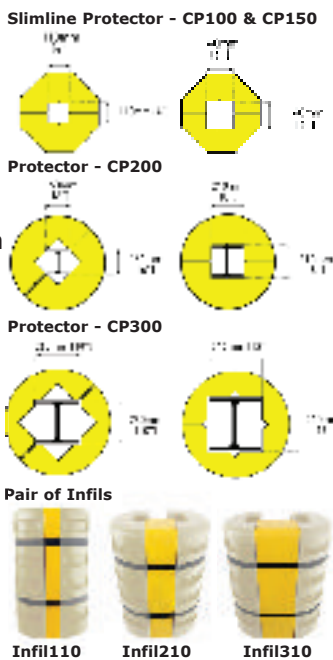
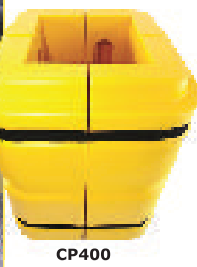

Description	Size mm	Model	Price
Slimline Protector to fit columns 100 x 100mm	1000H x 390W x 435D	CP100	£189.21
Slimline Protector to fit columns 160 x 160mm	1000H x 390W x 435D	CP150	£189.21
Protector to fit columns 160 x 160mm or 210 x 210mm	1100H x 600dia	CP200	£254.40
Protector to fit columns 260 x 260mm or 310 x 310mm	1100H x 600dia	CP300	£254.40
Protector to fit columns 420 x 420mm	1080H x 800W x 800D	CP400	£337.50
Pair of infiles to increase the CP200 or CP300 by 110mm	1100H x 110W	Infil110	£76.32
Pair of infiles to increase the CP200 or CP300 by 210mm	1100H x 210W	Infil210	£93.81
Pair of infiles to increase the CP200 or CP300 by 310mm	1100H x 310W	Infil310	£119.25
Pair of infiles to increase the CP400 by 100mm	1080H x 100W	Infil100	£77.14
Pair of infiles to increase the CP400 by 250mm	1080H x 250W	Infil250	£112.50
Universal Protector to fit columns 200mm to 700mm	1000H x 700W x 700D	UNCP	£225.78

Bollard Sleeves

- » Durable plastic sleeves to protect steel bollards from weathering
- » Manufactured from low density polyethylene which requires no maintenance or re painting & protects the bollard from rust
- » Easy to fit: just slide over existing steel bollard
- » Sleeve is 1200mm high but can be cut to suit bollards which are smaller than this
- » Secure fit with self adhesive foam strip
- » Available in: yellow & black stripe or green, yellow, red, blue with reflective strips



Description	105mm Dia.		120mm Dia.		183mm Dia.		215mm Dia.	
	Model	Price	Model	Price	Model	Price	Model	Price
Yellow with 180mm Black Strip	BS105YB	£60.42	BS120YB	£60.42	BS183YB	£63.60	BS215YB	£63.60
Yellow with 60mm Reflective Strip	BS105Y	£60.42	BS120Y	£60.42	BS183Y	£63.60	BS215Y	£63.60
Green with 60mm Reflective Strip	BS105G	£60.42	BS120G	£60.42	BS183G	£63.60	BS215G	£63.60
Red with 60mm Reflective Strip	BS105R	£60.42	BS120R	£60.42	BS183R	£63.60	BS215R	£63.60
Blue with 60mm Reflective Strip	BS105B	£60.42	BS120B	£60.42	BS183B	£63.60	BS215B	£63.60

Barriers, Traffic Management & Mirrors



SBLR04 &
2 x SBLP11

Lift Out Rail System

- » The rails on this protective barrier system are easy to remove allowing cost efficient access to machinery
- » Posts are constructed from 80mm heavy duty square tubular steel & the rails from 100 x 50mm tubular steel
- » Mounted on square floor plates which are pre-drilled for fixing to the floor (fixings not supplied)
- » Finish: powder coated yellow

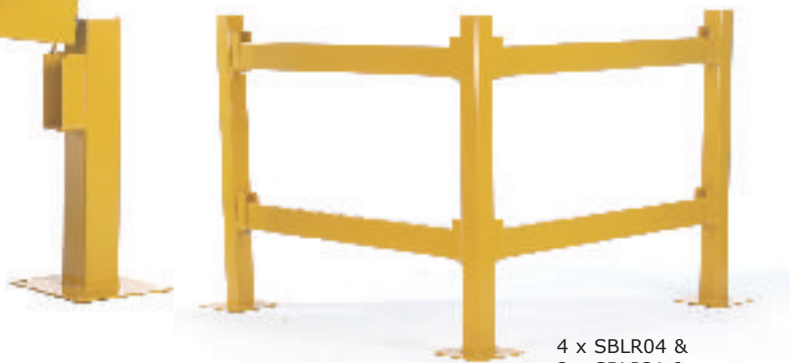

4 x SBLR04 &
2 x SBLP21 &
1 x SBLP22

Lift Out Rails

Rail Length	Weight kg	Model	Price
1220 mm	9	SBLR04	£166.75
1830 mm	13	SBLR06	£185.20
2440 mm	17.5	SBLR08	£229.80
3000 mm	21.5	SBLR10	£265.85

Posts

Description	Single Rail - 500mm High			Double Rail - 1100mm High		
	Wt kg	Model	Price	Wt kg	Model	Price
End Post	5.5	SBLP11	£187.00	10	SBLP21	£263.80
Corner Post	6	SBLP12	£220.25	10.5	SBLP22	£297.15
In Line Post	6	SBLP13	£220.25	10.5	SBLP23	£297.15



Steel Partition System

- » Modular steel partition system which is ideal to segregate areas of your workshop/warehouse
- » Posts are constructed from 50mm heavy duty square tubular steel which are mounted on floor plates which are pre-drilled for fixing to the floor (fixings not supplied)
- » Finish: powder coated yellow

N.B - A Fork Lift may be needed to unload these units



Front View
1 x SPS110, 2 x SPS210 & 3 x SPS250

When ordering please send a drawing showing design layout, including which side is the front & any corner positions

Description	Overall Size H x W x D mm	Model	Price
Single Height Connector Post	1100 x 50 x 50	SPS110	£121.65
Double Height Connector Post	2100 x 50 x 50	SPS210	£147.85
Single Height End Post	1100 x 50 x 50	SPE110	£121.65
Double Height End Post	2100 x 50 x 50	SPE210	£147.85
Single Height Corner Post	1100 x 50 x 50	SPC310	£139.35
Double Height Corner Post	2100 x 50 x 50	SPC410	£159.30
Steel Panel	995 x 2500 x 30	SPS250	£397.00

Barriers, Traffic Management & Mirrors

Rack Armour® Upright Protection

- >> Manufactured from ballistics grade plastic which deflects under impact
- >> Proven to reduce racking damage
- >> Lifespan of 15+ years
- >> Zero maintenance & no floor damage from the impact
- >> Easy installation - no fixings required
- >> Brand & personalise your labels - simply provide us with your logo & contact details



Hi Vis Yellow

Safety Yellow

Description	Upright Width mm	Model	Price
Upright Protector	Small: 70-87mm	RAP70	£22.00
Upright Protector	Medium: 88-100mm	RAP88	£24.00
Upright Protector	Large: 101-110mm	RAP10	£30.00
Upright Protector	XL: 111-120mm	RAP111	£32.00
Installation Tool - Hooks	-	RAIT/S	£25.00
Installation Tool - Arms	-	RAIT/L	£42.00



COLOUR OPTIONS

- Hi Vis Yellow
 - Safety Yellow
- specify when ordering



Other high vis colours available upon request



Patented Interior Foam

Shape of outer shell (curved) is patented

BRANDSAFE® Pedestrian Bumper Barriers

- >> Pedestrian bumper barriers manufactured from a flexible HDPE polymer with a foam diffuser
- >> The bumpers add extra deflection, strength & safety to pedestrian barriers
- >> High visibility colour clearly gives safe working boundaries for MHE drivers & pedestrians



Description	Model	Price
1900mm Wide Single Pedestrian Bumper Barrier	PBBS/19	£562.00
3400mm Wide Single Pedestrian Bumper Barrier	PBBS/34	£858.00
4900mm Wide Single Pedestrian Bumper Barrier	PBBS/49	£1155.00
1900mm Wide Double Pedestrian Bumper Barrier	PBBD/19	£678.00
3400mm Wide Double Pedestrian Bumper Barrier	PBBD/34	£994.00
4900mm Wide Double Pedestrian Bumper Barrier	PBBD/49	£1345.00

BRANDSAFE® Pedestrian Barriers

- >> Pedestrian barriers manufactured from HDPE polymer, making them highly durable
- >> Designed with safety & segregation in mind
- >> High visibility colour highlights safe pedestrian areas
- >> Please note, these pedestrian barriers do not act as impact protection



Description	Model	Price
1500mm Wide 3 Rail Pedestrian Barrier	PB3/15	£336.00
3000mm Wide 3 Rail Pedestrian Barrier	PB3/30	£538.00
4500mm Wide 3 Rail Pedestrian Barrier	PB3/45	£739.00

Lower value orders may incur carriage costs - please call for details

Barriers, Traffic Management & Mirrors



Traffic Line - Impact Protection



- » Manufactured in flexible, age-resistant foam which is free from CFC's & silicones
- » Ideal for interior or exterior use
- » Simply cut to size on site with a knife or fine toothed saw
- » Provide both visual warning & safety cushioning
- » Protect protruding edges in your warehouse or goods in area
- » UV resistant signal colours according to DIN 4844
- » Temperature resistant from -40°C to +90°C
- » Easy to install to dust & grease free surfaces
- » Other colours / profiles available - *call for details*



Edge Protection



Surface Protection

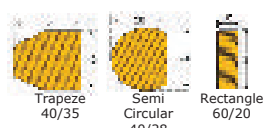

Push-fit Protection

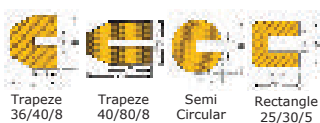

Pipe Protection

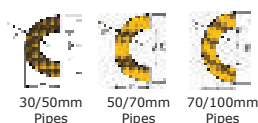

Corner Edge Protection Trapeze

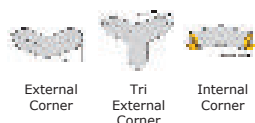

Corner Edge Protection Semi Circular

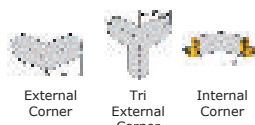

Description	Colour	Length	Self-Adhesive Fitting		Magnetic Fitting	
			Model	Price	Model	Price
Edge Protection						
Trapeze - 40/35	Yellow/Black	1000	422.29.433	£32.80	422.23.243	£37.70
Right Angle - 26/26	Yellow/Black	1000	422.28.546	£30.60	422.24.979	£35.80
	White	1000	422.15.712	£40.90	-	-
Right Angle - 60/60	Yellow/Black	1000	422.18.566	£41.70	422.25.253	£54.70
Semi Circular - 40/40	Yellow/Black	1000	422.23.691	£32.80	422.20.276	£38.20
	White	1000	422.15.039	£42.80	-	-
Surface Protection						
Trapeze - 40/35	Yellow/Black	1000	422.23.025	£32.00	422.26.582	£37.70
Semi Circular - 40/28	Yellow/Black	1000	422.22.446	£32.00	422.27.977	£38.60
	White	1000	422.18.541	£41.70	-	-
Rectangle - 60/20	Yellow/Black	1000	422.19.912	£42.20	422.20.678	£48.80
	White	1000	422.18.163	£52.90	-	-
Push-fit Protection (Push Fit)						
Trapeze - 36/40/8	Yellow/Black	1000	422.21.711	£31.50	-	-
Trapeze - 40/80/8	Yellow/Black	1000	422.15.601	£47.90	-	-
Semi Circular - 40/40/8	Yellow/Black	1000	422.24.672	£31.50	-	-
	White	1000	422.18.250	£40.20	-	-
Rectangle - 25/30/8	Yellow/Black	1000	422.24.758	£31.90	-	-
Pipe Protection						
40: for 30-50mm Pipes	Yellow/Black	1000	422.16.740	£58.90	422.21.293	£64.50
60: for 50-70mm Pipes	Yellow/Black	1000	422.17.049	£63.60	422.22.247	£69.00
85: for 70-100mm Pipes	Yellow/Black	1000	422.17.488	£72.60	422.20.581	£77.90
Corner Edge Protection						
Trapeze External Corner	Black	-	422.18.641	£17.20	-	-
Trapeze External Tri Corner	Black	-	422.16.525	£15.80	-	-
Trapeze Internal Corner	Black	-	422.18.012	£15.70	-	-
Semi Circular External Corner	Black	-	422.19.578	£14.30	-	-
	White	-	422.14.008	£25.20	-	-
Semi Circular External Tri Corner	Black	-	422.18.356	£14.30	-	-
	White	-	422.17.487	£25.20	-	-
Semi Circular Internal Corner	Black	-	422.17.839	£14.40	-	-

Barriers, Traffic Management & Mirrors

Expanding Barricade

- >> Constructed from a sturdy steel frame with aluminium cross bars
- >> Unit is mobile on castors for easy manoeuvrability. The barrier stays in position as the castors are braked
- >> Can be joined with other units for a barrier of any length



COLOUR OPTIONS

- Black & Yellow
 - Red & White
- specify when ordering*

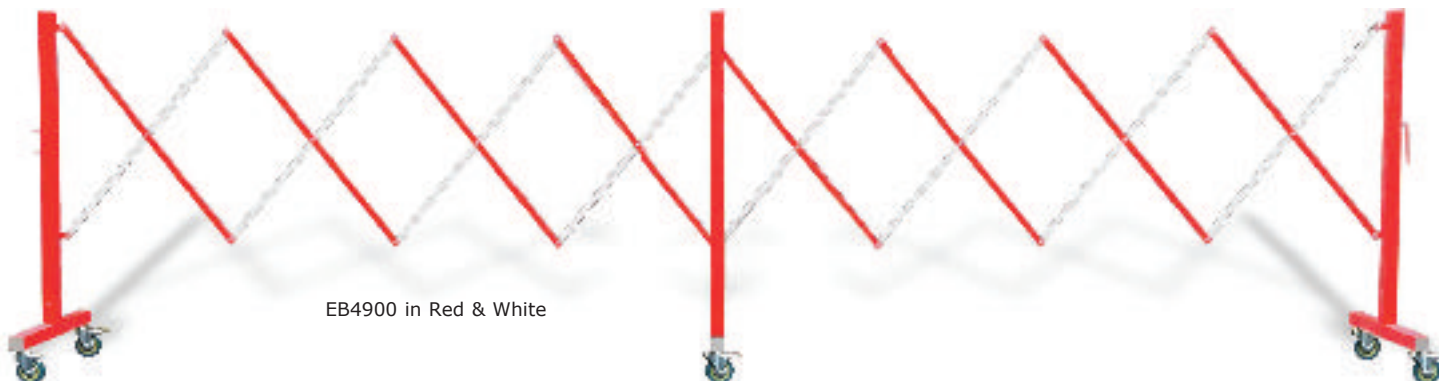
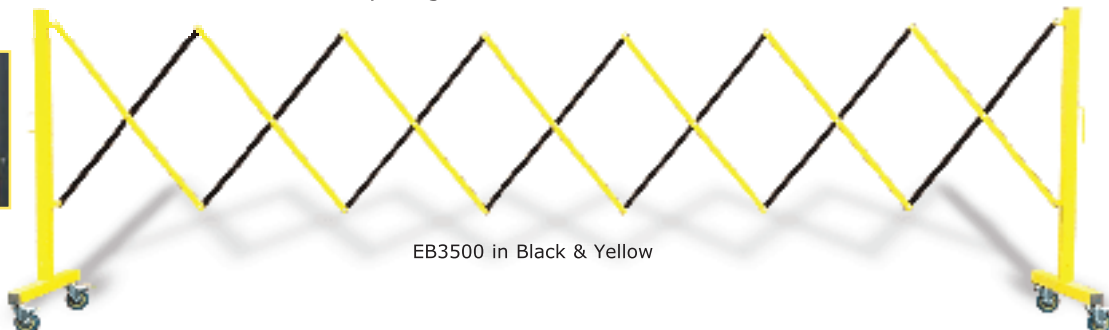

Extended Length mm	Height mm	Model	Price
3500	940	EB3500	£124.40
4900	940	EB4900	£168.00



Stanchions

- >> Robust stanchions which are ideal for displaying signs on a temporary basis
- >> Easily & quickly position near to a potential hazard or danger
- >> Manufactured from steel which is painted in grey primer to discourage rust
- >> Available in single or double sided options
- >> Clips are provided for sign retention into the stanchion

Stanchion Signs

- >> Made from 2mm rigid foam plastic
- >> Suitable for indoor or outdoor use
- >> Other signs available - call for details

INFORMATION



Inform all employees & visitors of risks or temporary rules on site



Description	Model	Price
Single Sided Stanchion	ST4560SS	£35.75
Double Sided Stanchion	ST4560DS	£47.25
450 x 600 Stanchion Sign	See below illustrations	£30.95



A delivery consignment charge will apply for these Stanchions & Stanchion Signs - please call for details

Barriers, Traffic Management & Mirrors

Galvanised Heavy Duty Bollards

- » Constructed from galvanised steel
- ideal for all weather use



Powder coated available upon request

INFORMATION ⓘ

Powder coated versions available upon request

Description	Model	Price
60 dia. x 900mm - Bolt Down	SB10FSM60	£67.31
60 dia. x 1200mm - Concrete In (900mm above ground)	SB10SP60	£50.67
76 dia. x 900mm - Bolt Down	SB10FSM76	£59.93
76 dia. x 1200mm - Concrete In (900mm above ground)	SB10SP76	£78.87
90 dia. x 900mm - Bolt Down	SB10FSM90	£68.89
90 dia. x 1200mm - Concrete In (900mm above ground)	SB10SP90	£85.94
114 dia. x 900mm - Bolt Down	SB10FSM114	£83.51
114 dia. x 1200mm - Concrete In (900mm above ground)	SB10SP114	£96.79
139 dia. x 900mm - Bolt Down	SB10FSM139	£140.70
139 dia. x 1200mm - Concrete In (900mm above ground)	SB10SP139	£170.73
2no. 50mm Yellow Reflective Banding - Per Bollard	SB10HIVISBAND	£9.29
Fixing Bolts - Pack of 4	SB10F	£6.57

Heavy Duty High Vis Bollards

- » A perfect solution to protect buildings, shutter doors, loading bays or anywhere similar. Constructed from 5mm mild steel and either; coated black with two high visibility stripes or coated yellow with two black stripes (available with out black or yellow banding if required)



Removable Bollard - Hi Vis

- » 76mm Dia Removable Post, 1000mm above ground (1240mm overall)
- » Complete with ground socket for padlocking
- » Powder Coated Black with 2 x hi vis yellow stripes
- » Heavy duty & hi visibility, this bollard can be used to protect buildings, around loading bays or similar areas



Description	Black with Yellow Stripes		Yellow with Black Stripes	
	Model	Price	Model	Price
60mm dia. Fixed Surface Mounted - 1000mm high	SB2960SM	£82.91	SB.2760SM	£82.91
60mm dia. Fixed Concrete In - 1500mm high	SB2960	£75.23	SB.2760	£75.23
76mm dia. Fixed Surface Mounted - 1000mm high	SB.2976SM	£87.69	SB.2776SM	£87.69
76mm dia. Fixed Concrete In - 1500mm high	SB2976	£79.93	SB2776	£79.93
90mm dia. Fixed Surface Mounted - 1000mm high	SB.2990SM	£106.90	SB.2790SM	£106.90
90mm dia. Fixed Concrete In - 1500mm high	SB.2990	£93.67	SB.2790	£93.67
139.7mm dia. Fixed Surface Mounted - 900mm High	SB.29FSM9	£175.03	SB.27FSM9	£168.33
139.7mm dia. Fixed Surface Mounted - 1200mm High	SB.29FSM12	£193.50	SB.27FSM12	£175.03
139.7mm dia. Fixed Concrete In - 1500mm High	SB29SP	£168.33	SB27SP	£193.50
90mm dia. Fixed Surface Mounted (Yellow Stripe) - 1000mm High	SB.24SMY	£101.80	-	-
90mm dia. Fixed Surface Mounted (White Stripe) - 1000mm High	SB.24SM	£101.80	-	-
90mm dia. Fixed Sunken Permanent (White Stripe) - 1500mm High	SB.24SP	£91.39	-	-
Accessories				
Description	Model	Price		
Fixings to suit all bollards (pack of 4)	SB.29F	£6.57		

Description	Model	Price
Removable Bollard	SB2976R	£109.00
70mm Discus Padlock (hardened shackle)	SB-DISCUS	£17.13

Barriers, Traffic Management & Mirrors



SB.2P

Parking Posts

- » Fold down parking post, ideal for drive ways or parking spaces
- » Integral lock (c/w 2 keys) or padlock facility (padlock not supplied)
- » Integral lock design can be keyed alike for multiple posts (extra cost)
- » Smart Zinc plated finish or Powder coated Hi Vis Yellow
- » Matching fixed posts for surrounding area available (bolts down and concrete in)
- » Winged design suitable for larger spaces or to deter vehicles from parking between

Description	Model	Price
Hinged Padlock Type (Zinc Plated)	SB11HP	£75.93
Hinged Integral Lock (Zinc Plated) - Concrete In	SB11HISP	£97.41
Hinged Integral Lock (Zinc Plated) - Bolt Down	SB11HI	£115.31
Hinged Integral Lock (Yellow) - Bolt Down	SB11HIY	£97.41
Hinged Integral Lock (Black) - Bolt Down	SB11HIB	£97.41
Hinged Integral Lock (Yellow) - Concrete In	SB11HIYSP	£115.31
Winged Heavy Duty - Padlock Type	SB.2P	£198.16
Winged Heavy Duty - Integral Lock (c/w 2 Keys)	SB.2HI	£225.64
Fixed Surface Mounted	SB11SM	£66.43
Fixed Sunken Permanent	SB11SP	£54.93

Economy Posts

- » Constructed from 50mm square mild steel coated yellow with a quick & easy bolt down design & easy collapsing mechanism
- » Stands 610mm high



SB.28W



SB.28HP

Description	Model	Price
Winged Hinged Post c/w Padlock Facility (padlock not supplied)	SB.28W	£103.43
Hinged Post c/w Padlock Facility (padlock not supplied)	SB.28HP	£92.27
Fixed Surface Mounted	SB.28SM	£56.03
Fixed Sunken Permanent	SB.28SP	£55.37

Removable Security Posts

- » The base is coupled to the steel post by a padlock (not supplied) & stands 1000mm high. The handles create easy lifting for this lightweight, yet strong removable security solution. Powder coated semi matt black with a white or yellow vinyl stripe complete with the ground socket (replacement ground sockets available)



SB.25R

Description	Model	Price
Tough 90mm Square Removable Security Post - Yellow	SB.25RY	£126.97
Tough 90mm Round Removable Security Post - Yellow	SB.24RY	£119.69
Tough 90mm Square Removable Security Post - White	SB.25R	£126.97
Tough 90mm Round Removable Security Post - White	SB.24R	£119.69

Heavy Duty Fold Down Bollard



SB.25HP

- » Padlock facility at the top of the post (padlock not supplied) complete with handles for easy operation
- » 1000mm high with a 230 x 230mm base (fixings not supplied)



2 x SB.24HP
Folded



Description	Model	Price
Tough 90mm Square Hinged Padlock Post	SB.25HP	£177.44
Tough 90mm Round Hinged Padlock Post	SB.24HP	£173.16
Fixings to suit (pack of 4)	SB.24F	£6.57

Pedestrian Street Bollards



SB.32R

- » Hi Visibility Bollard, great for pedestrian areas, paths & driveways
- » 76mm Dia steel post, 1000mm above ground
- » Available as bolt down, concrete in or removable (complete with socket) designs
- » Powder coated Black
- » Choice of Red, White or Yellow Hi Vis Stripes



Description	Model	Price
76mm dia. Fixed Concrete In	SB.32SP	£72.41
76mm dia. Fixed Surface Mounted (bolts not supplied)	SB.32SM	£82.07
76mm Dia Round Removable (c/w Socket)	SB.32R	£109.00
Fixings to suit (Pack of 3)	SB.32F	£4.93

Barriers, Traffic Management & Mirrors



Speed Ramps

- » Quick & easy to install
- » Heavy duty 99% recycled PVC segments which have high UV & chemical resistance. All parts are re-useable & recyclable
- » White reflectors offer excellent visibility
- » Will withstand heavy goods vehicles & will not deform or crack in extreme weather conditions
- » Central channel available for wiring
- » Supplied complete with fixings

Description	50mm Speed Ramp		75mm Speed Ramp	
	Model	Price	Model	Price
2 Metres	SB22(5)20	£128.04	SB22(7.5)20	£148.50
2.5 Metres	SB22(5)25	£168.36	SB22(7.5)25	£176.31
3 Metres	SB22(5)30	£191.73	SB22(7.5)30	£203.90
3.5 Metres	SB22(5)35	£214.77	SB22(7.5)35	£244.79
4 Metres	SB22(5)40	£238.46	SB22(7.5)40	£273.89
4.5 Metres	SB22(5)45	£262.59	SB22(7.5)45	£301.63
5 Metres	SB22(5)50	£285.94	SB22(7.5)50	£343.76
5.5 Metres	SB22(5)55	£314.54	SB22(7.5)55	£371.36
6 Metres	SB22(5)60	£343.14	SB22(7.5)60	£396.93
6.5 Metres	SB22(5)65	£367.20	SB22(7.5)65	£416.19
7 Metres	SB22(5)70	£392.37	SB22(7.5)70	£464.01
7.5 Metres	SB22(5)75	£400.06	SB22(7.5)75	£483.26
8 Metres	SB22(5)80	£440.84	SB22(7.5)80	£502.51
8.5 Metres	SB22(5)85	£470.20	SB22(7.5)85	£520.34

Surface Mounted Flow Plates

- » DON'T BE FOOLED BY FAKE, this original patented design is and has been UK Manufactured for over 25 Years. The Surface Mounted Flow Plate has been designed to offer advantages over the sunken design. This product is strong enough to withstand the heaviest goods vehicle, or with the flap reduced to 115mm, will provide the strength and flexibility to allow all types of vehicles (standard design maximum weight 1 tonne per axle) to travel over them. Another advantage these plates offer is eliminating the problem of piercing roadway surfaces, no more digging holes as these simply bolt down to the surface providing an easy yet effective traffic control solution.



Description	Model	Price
Standard Flow Plate (up to 1 tonne per axle)	SB14S	£209.63
HGV Flow Plate	SB14 HGV	£356.64

Height Restriction Barriers

- » Strong and sturdy design perfect for car parks or anywhere similar
- » Manufactured from 100mm Steel Box Section
- » Fixed & opening designs
- » Bolt down (up to 7m only) or concrete in (recommended)
- » Manufactured to suit your width requirements. E.g. If 5.5m is required order a 6m & specify bespoke size on your order
- » 2.1 Metre height restriction is standard. However, 1.9m, 2.0 & 2.3m is available. Alternative heights will require a quotation.
- » Latch back posts are recommended extra
- » "Maximum Height" Nudge bar is recommended extra
- » Available Powder coated or Galvanised Double Finish (both) is also available extra cost.
- » Low level locking available upon request

Description	Powder Coated		Galvanised	
	Model	Price	Model	Price
3 Metre - Single	SB.23E-3-PCOAT	£1054.81	SB.23E-3-GALV	£906.73
4 Metre - Single	SB.23E-4-PCOAT	£1146.11	SB.23E-4-GALV	£1080.69
5 Metre - Single	SB.23E-5-PCOAT	£1243.14	SB.23E-5-GALV	£1162.99
6 Metre - Single	SB.23E-6S-PCOAT	£1341.54	SB.23E-6S-GALV	£1282.49
7 Metre - Double	SB.23E-7-PCOAT	£1485.01	SB.23E-7-GALV	£1402.03
8 Metre - Double	SB.23E-8-PCOAT	£1531.76	SB.23E-8-GALV	£1438.56
9 Metre - Double	SB.23E-9-PCOAT	£1579.39	SB.23E-9-GALV	£1477.56



Barriers, Traffic Management & Mirrors

Manual Raise Arm Barrier

» Our carefully designed pivot post has the strength to cover up to 9 metre road widths (8 metre for the standard design) and can still be operated by one person alone. Also combined with a strong stainless steel pivot bar and two fully stainless steel, heavy duty bearings. Supplied with a high quality aluminium boom this barrier is a great way of ensuring complete traffic management. Comes complete with Red & White or a Black & Yellow Boom (size to your specification), Traffic Red Pivot post, end rest, padlock & fixings.



Heavy Duty - thicker steel & heavier ballast

Description	Model	Price
6 Metre Boom	SB4-6HD	£1271.96
6.5 Metre Boom	SB4-6.5HD	£1383.59
7 Metre Boom	SB4-7HD	£1560.10
7.5 Metre Boom	SB4-7.5HD	£1585.63
8 Metre Boom	SB4-8HD	£1730.19
8.5 Metre Boom	SB4-8.5HD	£1812.46
9 Metre Boom	SB4-9HD	£1864.61

Standard Duty

Description	Model	Price
3 Metre Boom	SB.43M	£812.73
4 Metre Boom	SB.44M	£866.41
5 Metre Boom	SB.45M	£951.36
6 Metre Boom	SB.46M	£1057.23
7 Metre Boom	SB.47M	£1233.14
8 Metre Boom	SB.48M	£1323.83
Optional Extras: Stop / No Entry Sign		£28.57

Access Gate

- » Robust, durable gate suitable for access control which is manufactured from 100mm box section
- » Available as single (up to 6m) or double leaf. Both options are supplied with hinge posts & can be locked in the open position using an optional latch back post. The single leaf option comes with a latch post for locking in the closed position & the double leaf comes with a central padlockable sliding latch facility
- » Powder coated finish. Available galvanised or double finish (both galvanised & powder coated) at extra cost.

Description	Model	Price
3 Metre - Single Leaf	SB.18-3S-PCOAT	£784.91
4 Metre - Single Leaf	SB.18-4S-PCOAT	£856.03
5 Metre - Single Leaf	SB.18-5S-PCOAT	£969.01
6 Metre - Single Leaf	SB.18-6S-PCOAT	£1064.59
6 Metre - Double Leaf	SB.18-6D-PCOAT	£1465.67
7 Metre - Double Leaf	SB.18-7D-PCOAT	£1599.89
8 Metre - Double Leaf	SB.18-8D-PCOAT	£1665.91
9 Metre - Double Leaf	SB.18-9D-PCOAT	£1731.24



Height Restriction Nudge Bar

- » The perfect solution for warning vehicles of height restrictions ahead. Suitable for car parks, construction sites, warehouses or anywhere that requires restricted access
- » Manufactured from a 76mm Dia aluminium tube & comes with eyebolts to suit
- » Supplied Yellow & Black as standard. Chain not supplied, but available at extra cost - call for details

Description	Model	Price
2 Metre Width	SB.23HRB-2	£169.41
3 Metre Width	SB.23HRB-3	£195.49
4 Metre Width	SB.23HRB-4	£254.79
5 Metre Width	SB.23HRB-5	£280.86
6 Metre Width	SB.23HRB-6	£306.93

Installation services available - please call for details

Barriers, Traffic Management & Mirrors



Cable Protection Ramp - Reel

- » Easily deployed - roll out, cut to length & press cable/hose into the recess
- » Enables you to drive over cables & hoses without causing them damage
- » Manufactured from high strength natural rubber
- » Protects cables/hoses with a dia. of up to 20mm

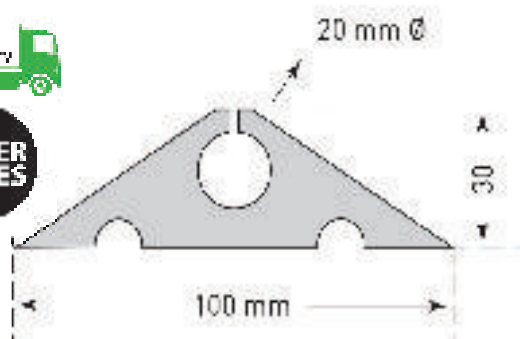

Overall Size L x W x H mm	Weight kg	Model	Price
10,000 x 100 x 30	21	279.26.118	£106.80

Small Cable Protection Ramps

- » Easily & quickly installed
- » Enables you to drive over cables & hoses without causing them damage
- » Manufactured from high strength natural rubber
- » Yellow & black elements provides high visibility
- » Protects cables/hoses with a dia. of up to 40mm

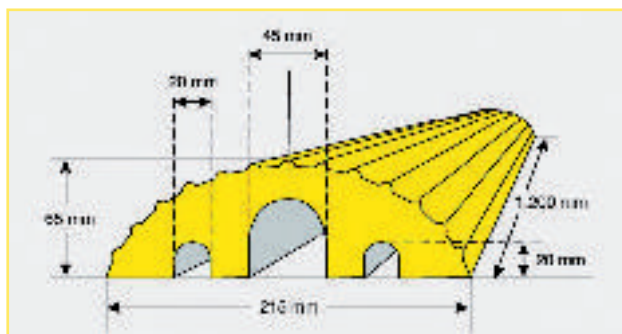

Colour	Overall Size L x W x H mm	Weight kg	Model	Price
Yellow	1200 x 215 x 65	12.8	279.28.720	£68.60
Black			279.21.784	£68.60

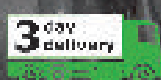

Large Cable Protection Ramps - 3

- » Enables you to drive over cables, hoses & pipes without causing them damage
- » Easily & quickly installed
- » High strength rubber compound ramp with a polypropylene chequer plate, anti-slip, yellow surface moulded cover
- » All sections can be safely interlocked
- » Features 3 cable ducts: 2 cables 68 x 50mm, 1 cable 55 x 50mm
- » End sections & 45° elbow sections are available for corners & curves
- » Tested to 10,000kg axle weights



Description	Colour	Overall Size L x W x H mm	Weight kg	Model	Price
Centre element	Black & Yellow	960 x 600 x 75	26.5	279.23.799	£77.40
Angle - left	Black & Yellow	500/200 x 600 x 75	12	279.29.848	£42.10
Angle - right	Black & Yellow			279.26.562	£42.10
End element - Female	Black	283 x 600 x 75	3	279.20.233	£17.60
End element - Male	Black			279.22.899	£17.60

Barriers, Traffic Management & Mirrors

Traffic Line - Park Aid Wheel Stop

- » Easily & quickly installed
- » Highly visible reflective markings
- » Oil & heat resistant. Also UV stable
- » Fixings included



INFORMATION
Prevent vehicle overruns

Overall Size L x D x H mm	Black & Yellow		Black & White	
	Model	Price	Model	Price
550 x 150 x 100	284.27.207	£30.70	-	-
900 x 150 x 100	284.25.716	£40.90	284.25.032	£40.90
1200 x 150 x 100	284.29.869	£54.90	284.24.168	£54.90
1800 x 150 x 100	284.20.974	£72.40	284.28.572	£72.40
3 part Special Adhesive for Park-AID Wheel Stop - 12kg Activator + 5kg Bonder + 0.2kg Hardner			284.25.975	£187.40



INFORMATION
Mount kerbs easily

Traffic Line Kerb Ramp

- » Enables vehicles, trolleys & wheelchairs to mount kerbs easily
- » Easily & quickly installed
- » All rubber construction
- » Features channels in the base which allow the passage of rainwater or can be used to channel cable through
- » Load capacity up to 40,000kg

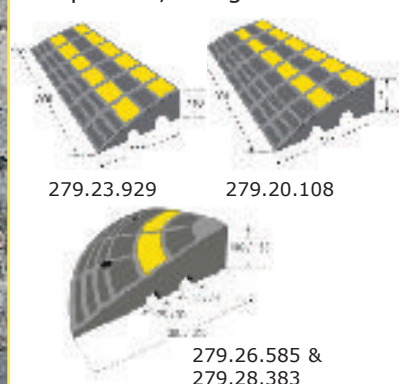

Description	Overall Size W x D x H mm	Weight kg	Model	Price
Centre Section	600 x 300 x 100	11	279.23.929	£52.60
Centre Section	600 x 360 x 150	20	279.20.108	£75.80
Corner Section	300 x 300 x 100	4	279.26.585	£34.70
Corner Section	360 x 360 x 150	7.5	279.28.383	£47.80



Barriers, Traffic Management & Mirrors



Traffic Line Crowd Barrier - HDPE

- » This innovative crowd barrier is manufactured in virgin high density polyethylene with no screws or rivets used in the assembly
- » It is completely recyclable & will not rust, is remarkably durable & strong, ensuring a long productive life-cycle
- » Lighter than traditional metal barriers it is easily handled & deployed on flat or uneven ground
- » No sharp edges
- » Easily stacked for storage due to 360° swivel feet
- » Suitable for crowd control, festivals, events, queue control etc

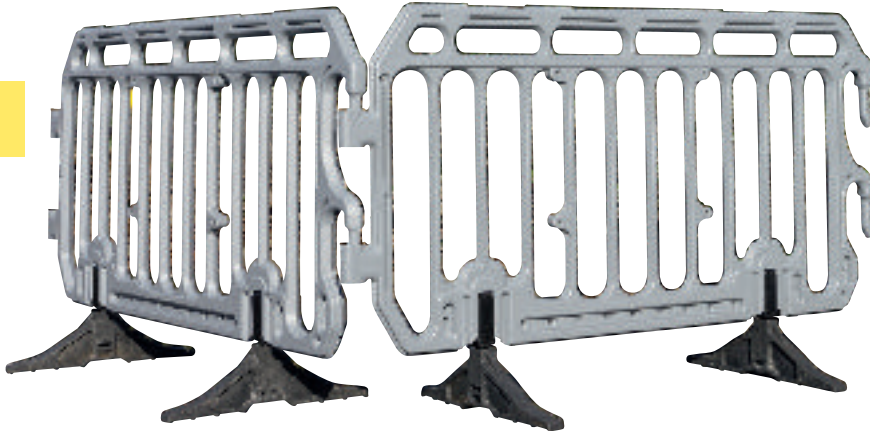

Overall Size W x H x D mm	Weight kg	Model	Price
2000 x 1100 x 50	10	230.31.607	£79.10



Traffic Line Flexible Post in application

Traffic Line Flexible Post

- » These posts have a knuckle joint at the base enabling them to return to a vertical position after being hit or run over
- » Ideal for off-highway applications



Knuckle Joint

Height mm	Red & White		Yellow & Black	
	Model	Price	Model	Price
460	291.10.114	£20.60	291.28.861	£20.60
760	291.12.496	£27.10	291.25.790	£27.10
1000	291.11.558	£32.80	291.27.118	£32.80
60 - Base (Black)			291.11.145	£8.20



TC3 Cone
(Sand Weighted)

Traffic Cones

- » Two piece & one-piece moulded cones with retro-reflective D2 sleeves
- » The cellular construction of the D2 sleeve provides greater tear resistance



TC1 Cone



TC2 Cone

Description	Height mm	Model	Price
TC1-50	500	350.15.478	£14.30
TC1-75	750	350.16.862	£20.60
TC1-100	1000	350.17.100	£25.80
TC2	460	350.18.349	£9.40
TC3 (Sand Weighted)	750	350.13.537	£18.20

Barriers, Traffic Management & Mirrors

Extendable Trellis Barriers

- » Strong steel, expanding trellis barriers which are very quickly deployed to highlight no go areas
- » The units incorporate chain hooks & red reflective warning strips
- » Foot depth of 500mm & overall height of 1000mm
- » 340.11.363 & 340.88.015: trellis bars are 25 x 4mm
- » 340.12.455: trellis bars are 40 x 5mm

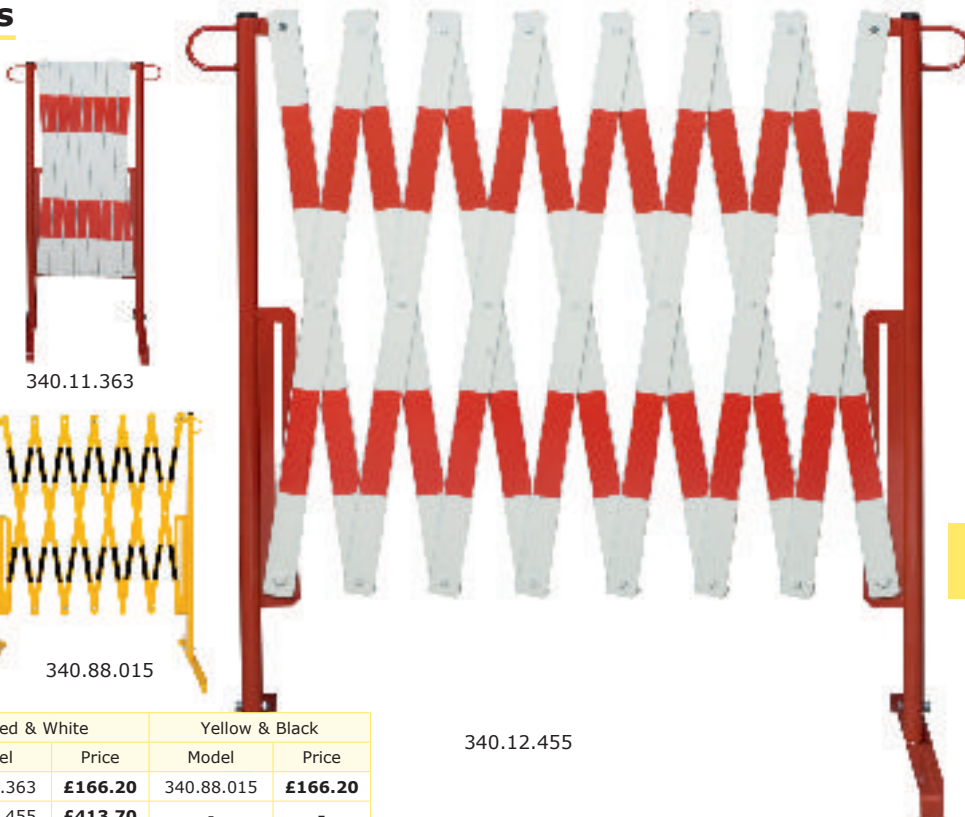

INFORMATION

Extends up to 4M



Description	Max. Extended Width	Weight kg	Red & White		Yellow & Black	
			Model	Price	Model	Price
Flexi-Light Barrier	3600	13	340.11.363	£166.20	340.88.015	£166.20
Flexi Barrier	4000	25	340.12.455	£413.70	-	-

340.12.455

Traffic Line - Blow Moulded Barriers

- » Manufactured in HDPE which is UV resistant
- » Bright orange with red/white reflective panels which make them highly visible, day or night
- » Can be connected to each other using a "hook & eye" system which makes them very adaptable for use on uneven ground
- » Lightweight yet stable barriers which incorporate non-trip 360° swivel feet for compact storage & transportation
- » Conforms to requirements of BS EN 8442 & reflectivity to BS EN 12899-1



Overall Size W x H x D mm	Weight kg	Model	Price
2000 x 1000 x 50	14	230.27.647	£82.10

Barriers, Traffic Management & Mirrors

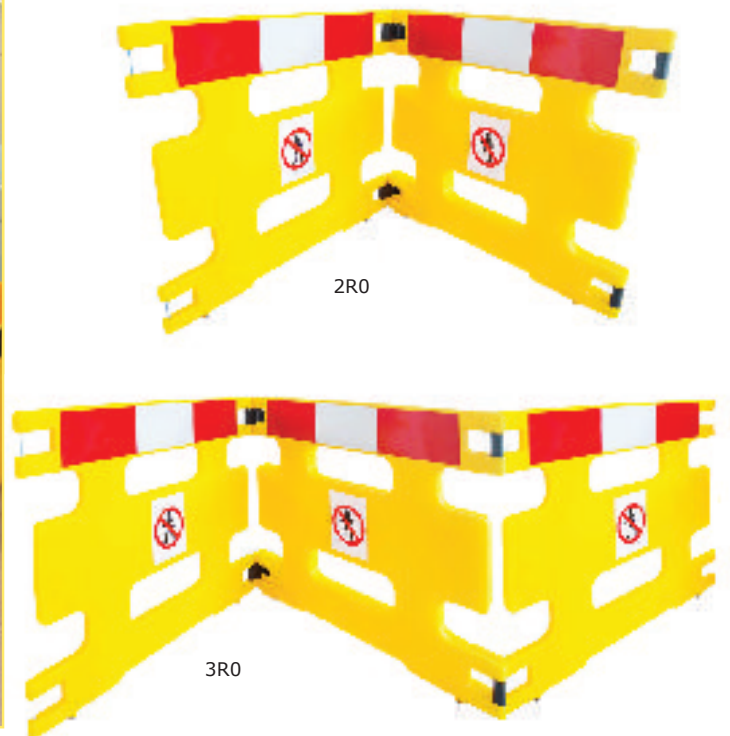

Handigards

- >> Temporary barriers to cordon off areas to make safe & prevent unauthorised access
- >> Rubber Base weight for added stability if used in a long straight line
- >> Lightweight design & their foldable frame makes for easy storage
- >> Choose between a black & yellow top, or a red & white reflective top
- >> Black & yellow comes with a "Caution" symbol
- >> Red & white comes with a "No Entry" sign
- >> The barrier panels are able to link together with snap on hinges to enclose any shaped area, & are made from durable polyethylene



Description	Panel Size H x W mm	Model	Price
2 Panels - Black & Yellow	800 x 1000	2R1	£77.14
2 Panels - Red & White	1100 x 1100	2R0	£77.14
3 Panels - Black & Yellow	800 x 1000	3R1	£114.29
3 Panels - Red & White	1100 x 1100	3R0	£114.29
4 Panels - Black & Yellow	800 x 1000	4R1	£154.29
4 Panels - Red & White	1100 x 1100	4R0	£154.29
Base Weight	-	BMUS1	£15.71

Barriers, Traffic Management & Mirrors

Indoor Mirrors



- >> TMN600Z - complete with wall/flat surface bracket & fixings
- >> TMN800Z - complete with brackets & fixings to fix the mirrors on to a 76mm (3") dia. post

Description	Visibility Distance	Weight kg	Model	Price
600mm dia.	approx. 11 metres	2	TMN600Z	£50.40
800mm dia.	approx. 15 metres	4.5	TMN800Z	£73.20

Traffic Mirrors with Hoods

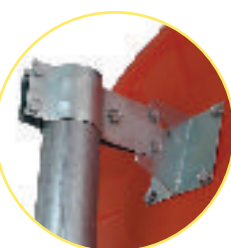

Post Fixing Bracket



TMH60Z



- >> Complete with hood for weather protection to help reduce sun glare
- >> Complete with brackets & fixings to fix the mirrors on to a 50mm (2") dia. post

Description	Visibility Distance	Weight kg	Model	Price
450mm dia.	approx. 5 metres	1	TMH45Z	£47.10
600mm dia.	approx. 11 metres	2	TMH60Z	£52.05

Premium Reflective Traffic Mirrors



TMRC60Z



TMR6040Z

- >> Durable casing with reflective strips & impact resistant mirror
- >> Complete with brackets & fixings to fix the mirrors to a post or a wall/flat surface. These mirrors are adjustable for post sizes from 50 to 76mm (2" to 3") dia.



Description	Visibility Distance	Weight kg	Model	Price
Circular Traffic Mirrors with Reflective Edges				
600mm dia.	approx. 15 metres	2.5	TMRC60Z	£109.90
800mm dia.	approx. 15 metres	5	TMRC80Z	£182.25

Description	Visibility Distance	Weight kg	Model	Price
Rectangular Traffic Mirrors with Reflective Edges				
600 x 400mm	approx. 15 metres	2	TMR6040Z	£108.15
800 x 600mm	approx. 15 metres	4	TMR8060Z	£174.95

Help reduce accident & injuries by eliminating blind spots - These convex traffic mirrors are ideal for outdoor use

Cycle Storage & Smoking Shelters



Wall Mounted Rack

- » Swivels up to 180°
- » Compact & flexible design
- » Suitable for tyre width: 50mm
- » Manufactured in galvanised steel with round tube wheel locators

INFORMATION

Swivels up to 180°



3/4/5 Bicycle Racks

- » Great value for money
- » Suitable for tyre width: 40mm
- » Manufactured in galvanised steel with round tube wheel locators

INFORMATION

Fully assembled ready for immediate use

LOWER PRICES



LOWER PRICES



Sheffield Style Racks

- » Economic, durable & effective bike storage
- » Manufactured in mild steel galvanised
- » 48mm dia. x 2.5mm gauge steel tube
- » Size (above ground): 750W x 850H mm
- » Surface fixing plates: 70 x 160 x 5 mm

Stores	Overall Size H x W x D mm	Model	Price
1 Bike	335 x 90 x 285	169.17.113	£26.20

Stores	Overall Size H x W x D mm	Model	Price
3 Bikes	255 x 725 x 330	169.28.632	£68.20
4 Bikes	255 x 1180 x 330	169.15.334	£82.10
5 Bikes	255 x 1340 x 330	169.19.382	£96.40

Description	Model	Price
Surface Fixing	169.88.041	£99.10
Sub-surface Fixing	169.88.045	£82.00

Hi-hoop Cycle Rack

- » Strong hot dip galvanised steel construction
- » Suitable for tyre width: 55mm
- » Accessible from both sides

LOWER PRICES



Stores	Overall Size H x W x D mm	Model	Price
2 Bikes	415 x 700 x 390	169.13.535	£107.40
3 Bikes	415 x 1050 x 390	169.18.628	£133.30
4 Bikes	415 x 1400 x 390	169.15.104	£184.10
5 Bikes	415 x 1750 x 390	169.14.981	£206.50
6 Bikes	415 x 2100 x 390	169.15.566	£243.90

Lo-hoop Cycle Rack

- » Strong hot dip galvanised steel construction
- » Suitable for tyre width: 55mm
- » Accessible from one side



Stores	Overall Size H x W x D mm	Model	Price
2 Bikes	415 x 700 x 550	169.19.379	£107.90
3 Bikes	415 x 1050 x 550	169.17.164	£122.40
4 Bikes	415 x 1400 x 550	169.14.842	£163.10
5 Bikes	415 x 1750 x 550	169.13.432	£196.70
6 Bikes	415 x 2100 x 550	169.13.416	£225.80

Traditional Cycle Shelters



COLOUR OPTIONS

- Grey
- Blue
- Green
- Red
- Black

specify when ordering

Finish & Installation
Shelters are supplied in knock down sheet form. Installation service is available upon request - *call for details*

- >> Choice of galvanised or powder coated sheet steel side & back panels - light grey panels supplied as standard
- >> Adjustable feet for on-site positioning
- >> Parabolts for surface mounting to concrete included. Must be bolted to 250mm thick concrete for stability
- >> High capacity shelters can be created using runs of initial & extension shelters or double depth shelters
- >> Shelter height - 2180mm

Picture shows Shelter & Bike Rack



Powder Coated Sides With Open Back Frame

Overall Size H x W x D mm	Shelter Model	Price	Extension Model	Price
2180 x 2450 x 1900	SC211924B	£2582.86	SC211924BE	£2320.49
2180 x 2450 x 2500	SC212524B	£2828.31	SC212524BE	£2515.15
2180 x 3060 x 1900	SC211930B	£3114.67	SC211930BE	£2904.49
2180 x 3060 x 2500	SC212530B	£3472.97	SC212530BE	£3188.02

With Closed Back Frame

Shelter Model	Price	Extension Model	Price
SC211924C	£3000.41	SC211924CE	£2673.14
SC212524C	£3231.75	SC212524CE	£2932.70
SC211930C	£3570.30	SC211930CE	£3310.75
SC212530C	£3948.35	SC212530CE	£3628.14

Galvanised Sides With Open Back Frame

Overall Size H x W x D mm	Shelter Model	Price	Extension Model	Price
2180 x 2450 x 1900	SC211924G	£1809.84	SC211924GE	£1567.21
2180 x 2450 x 2500	SC212524G	£1965.01	SC212524GE	£1657.49
2180 x 3060 x 1900	SC211930G	£2327.54	SC211930GE	£2172.37
2180 x 3060 x 2500	SC212530G	£2525.03	SC212530GE	£2352.93

With Closed Back Frame

Shelter Model	Price	Extension Model	Price
SC211924K	£2084.91	SC211924KE	£1784.45
SC212524K	£2210.46	SC212524KE	£1876.14
SC211930K	£2588.51	SC211930KE	£2314.84
SC212530K	£2790.23	SC212530KE	£2400.89

Traditional Racks

- >> Twin level bike racks for use with Traditional Shelters (*see the shelter range above*)
- >> Powder coated dark grey
- >> Fully welded - no assembly required
- >> Simply bolts to the floor (*fixings not supplied*)



Stores	Overall Size H x W x D mm	Model	Price
6 Bikes	935 x 1750 x 600	SRTRADCR6KXX	£396.39
8 Bikes	935 x 2350 x 600	SRTRADCR8KXX	£495.13



Cycle Storage & Smoking Shelters



Information
OFFERS FLOOR TO ROOF LEVEL PROTECTION FROM THE ELEMENTS

- COLOUR OPTIONS**
- Grey
 - Blue
 - Green
 - Red
 - Black
- specify when ordering

PACKAGE DEAL
 SHEFFIELD RACK INCLUDED WITH EVERY DUDLEY SHELTER!

Dudley Cycle Shelters with Sheffield Cycle Rack

The Dudley Shelter combines contemporary design at a competitive price. This Shelter is available with a perspex roof and optional end panels in a galvanised finish or a galvanised with a powder coated finish.

- >> Leg frames can either be bolted to the floor or grouted into the ground
- >> Designed for use with our Sheffield Loops
- >> Initial shelters can be linked side by side to form longer runs
- >> Adjustable feet for on-site positioning
- >> Supplied with a 4mm PETG perspex roof
- >> Powder coated finish in 5 colours; jet black, pine green, traffic blue, red or light grey - *please specify when ordering.*



Sheffield Cycle Rack

>> **2m shelter** includes a 2-loop rack
 >> **4m shelter** includes a 5-loop rack



Overall Size H x D x W mm	Perspex End Panel	Galvanised Unit		Galvanised & Painted Unit	
		Model	Price	Model	Price
2230 x 2150 x 2000	Without	SCDUD2020V2L	£2350.11	SCDUD2020J2	£2602.61
2230 x 2150 x 4000		SCDUD4020V5L	£3327.67	SCDUD4020J5	£3621.09
2230 x 2150 x 2000	With	SCDUD2020VP2	£2770.48	SCDUD2020P2	£3022.98
2230 x 2150 x 4000		SCDUD4020VP5	£3748.04	SCDUD4020P5	£4041.45

Cycle Shelters



INFORMATION

Provide secure storage for bicycles



BCS07Z

£4891.05

- » Constructed from heavy gauge steel framework of bolted components
- » BCS07Z - fitted with 16mm twinwall polycarbonate roof & sides
- » BCS03Z - fitted with galvanised roof & sides
- » Staggered storage to prevent handle contact

N.B. A Fork Lift will be needed to unload the panelled sections

Description	Stores	Overall Size L x W x H mm	Weight kg	Model	Price
Blue Industrial Cycle Shelter	7 Bikes	2600 x 2480 x 2230	285	BCS03Z	£4333.65
Green Cycle Shelter	7 Bikes	2580 x 2430 x 2230	200	BCS07Z	£4891.05



Smoking Shelter

- » Polycarbonate panels provide high impact strength, **200 TIMES STRONGER THAN GLASS**, & is fire resistant
- » Features a curved roof & drainage gutters on a firm & heavy gauge steel skeletal framework of bolted components
- » PVC roof & 16mm twinwall polycarbonate side panels
- » This unit is ideal for keeping smokers in a covered & designated smoking area
- » Powder coated green
- » BSOS7Z is 750mm from the ground

N.B. - A Fork Lift & 1 member of staff are needed to unload the panelled section & this unit must be bolted down on a prepared level concrete base



Description	Overall Size L x W x H mm	Weight kg	Model	Price
Smoking Shelter	2400 x 2000 x 2230	200	BSS27Z	£5062.75
Optional Perch - order with shelter	2580 x 300	30	BSOS7Z	£446.35

Cycle Storage & Smoking Shelters



Frame Colour Options



For required colour please add corresponding suffix to end of code



Smoking Canopy

- » Provides cover for up to 3 smokers
- » Translucent polycarbonate roof provides up to 97% UV protection
- » Simply bolts to a suitable wall (fixings not included)
- » Site survey and erection service available - call for details



Overall Size H x W x D mm	Model	Price
1100 x 2000 x 1000	SS102011WM2	£959.23



Frame Colour Options



For required colour please add corresponding suffix to end of code



Wall Mounted Shelters

- » Aimed at locations where space is at a premium, this shelter provides cover for up to 8 smokers.
- » Robust all-weather construction
- » Greater than 50% open
- » Translucent polycarbonate roof provides up to 97% UV protection
- » Fixes to a suitable wall on one side (fixings not included) while supporting legs can be bolted to the floor (Parabolts included). Must be bolted to 250mm thick concrete for stability
- » Site survey and erection service available - call for details

Overall Size H x W x D mm	Model	Price
2270 x 3000 x 1900	SS241930CWM	£1599.65

Premier Smoking Shelters

- » Adjustable feet for on-site positioning
- » More than 50% open area to allow rapid dispersal of fumes
- » Parabolts for surface mounting to 250mm thick concrete for stability



Shelter With Perspex Sides

Overall Size H x W x D mm	Model	Price
2270 x 3000 x 2100	SS223021X	£5993.76

With Perforated Steel Sides

Overall Size H x W x D mm	Model	Price
2270 x 3000 x 2100	SS223021P	£5502.87



Frame Colour Options



For required colour please add corresponding suffix to end of code

Perch Seat

Finish & Installation

Shelters are supplied in knock down form. Installation service is available upon request - call for details



Description	H x W x D mm	Model	Price
Light Grey Free Standing Perch Seat	900 x 1150 x 300	SSPAPSETZLXX	£301.87

Smoking Shelters

- >> Fabricated from robust heavy duty box section
- >> Available with 16mm twinwall fluted plastic side panels or powder coated punched steel side & back panels. Both have a galvanised sheet steel roof
- >> No fixing required. Simply secure these units by using six 600 x 600mm paving slabs (not supplied)

N.B. A Fork Lift will be needed to unload these units

INFORMATION

Comply to smoking regulations 2007



BSS209

**FROM ONLY
£1474.05**



These units are supplied complete with 2 braces which fit securely over the bottom leg brace. This allows you to place paving slabs directly on top to secure the unit in place



BSS204

Smoking Shelter with Punched Steel Sides

Overall Size L x W x H mm	Model	Price
Smoking Shelter with Punched Steel Sides		
1980 x 1250 x 2040	BSS208	£1474.05
Smoking Shelter with Punched Steel Sides & Back Panel		
1980 x 1250 x 2040	BSS209	£1827.00

Smoking Shelter with 16mm Twinwall Sides

Overall Size L x W x H mm	Model	Price
1980 x 1250 x 2040	BSS204	£1474.05

Wall Mounted Smoking Shelter

- >> Aesthetically pleasing design
- >> Box section construction which makes the unit exceptionally sturdy & durable
- >> The roof is made up of 16mm twinwall polycarbonate sheet & front capping of 1mm galvanised sheet steel
- >> The unit comes with two upright supports & additional option of fill in end panels clad with 16mm twinwall polycarbonate sheeting
- >> Powder coated green

N.B. A Fork Lift will be needed to unload these units. The unit must be securely bolted to the wall & floor. Wall/Floor fixing bolts are not supplied with the unit



BSSW6Z & 2 x BSSP7Z

Description	Overall Size L x W x H mm	Weight kg	Model	Price
Wall Mounted Smoking Shelter	2440 x 1100 x 2250	65	BSSW6Z	£1304.95
Optional Single Side Panel	1220 x 80 x 1085	20	BSSP7Z	£457.65

Workbenches & Drawer Cabinets

Rivet Workbenches

» No nuts & bolts required - the system simply taps together with the use of a hammer/mallet



COLOUR OPTIONS

- Blue & Grey
- Blue & Orange

specify when ordering



Full Undershaft Workbench



T Bar Workbench



Half Undershaft Workbench

INFORMATION

Takes less than 10 minutes to build

Overall Size H x W x D mm	Bench Load kg	Shelf Load kg	Chipboard Top		White MFC Top	
			Model	Price	Model	Price
Full Undershaft Workbench						
915 x 915 x 762	600	400	RRWB/09/09/07	£211.13	RRWB/09/09/07/M	£217.52
915 x 915 x 915	600	400	RRWB/09/09/09	£228.71	RRWB/09/09/09/M	£236.10
915 x 1220 x 762	600	400	RRWB/09/12/07	£237.04	RRWB/09/12/07/M	£245.09
915 x 1220 x 915	600	400	RRWB/09/12/09	£257.76	RRWB/09/12/09/M	£267.25
915 x 1525 x 762	600	400	RRWB/09/15/07	£258.65	-	-
915 x 1525 x 915	600	400	RRWB/09/15/09	£281.69	-	-
915 x 1830 x 762	600	400	RRWB/09/18/07	£290.84	RRWB/09/18/07/M	£302.53
915 x 1830 x 915	600	400	RRWB/09/18/09	£316.20	RRWB/09/18/09/M	£329.87
915 x 2440 x 762	600	400	RRWB/09/24/07	£347.40	RRWB/09/24/07/M	£362.72
915 x 2440 x 915	600	400	RRWB/09/24/09	£379.26	RRWB/09/24/09/M	£397.12
Half Undershaft Workbench						
915 x 915 x 915	600	400	RRWBH/09/09/09	£217.85	RRWBH/09/09/09/M	£221.55
915 x 1220 x 915	600	400	RRWBH/09/12/09	£237.31	RRWBH/09/12/09/M	£242.05
915 x 1830 x 915	600	400	RRWBH/09/18/09	£289.02	RRWBH/09/18/09/M	£295.86
915 x 2440 x 915	600	400	RRWBH/09/24/09	£333.01	RRWBH/09/24/09/M	£341.94
T Bar Workbench						
915 x 915 x 762	600	-	RRWBT/09/09/07	£185.66	RRWBT/09/09/07/M	£188.86
915 x 915 x 915	600	-	RRWBT/09/09/09	£199.77	RRWBT/09/09/09/M	£203.47
915 x 1220 x 762	600	-	RRWBT/09/12/07	£198.01	RRWBT/09/12/07/M	£202.03
915 x 1220 x 915	600	-	RRWBT/09/12/09	£213.22	RRWBT/09/12/09/M	£217.96
915 x 1830 x 762	600	-	RRWBT/09/18/07	£232.35	RRWBT/09/18/07/M	£238.20
915 x 1830 x 915	600	-	RRWBT/09/18/09	£249.88	RRWBT/09/18/09/M	£256.72
915 x 2440 x 762	600	-	RRWBT/09/24/07	£260.80	RRWBT/09/24/07/M	£268.46
915 x 2440 x 915	600	-	RRWBT/09/24/09	£280.64	RRWBT/09/24/09/M	£289.57

Workbenches & Drawer Cabinets

Rivet Workstations

>> No nuts & bolts required - the system simply taps together with the use of a hammer/mallet

PRICES HELD

COLOUR OPTIONS

-  Blue & Grey
 -  Blue & Orange
- specify when ordering*



Full Undershef Workstation



T Bar Workstation



Half Undershef Workstation

INFORMATION



Takes less than 10 minutes to build

Overall Size H x W x D mm	Bench Load kg	Lower Shelf Load kg	Chipboard Top	
			Model	Price
Full Undershef Workstation				
1830 x 915 x 915	600	400	RRWS/18/09/09/03	£314.87
1830 x 1220 x 915	600	400	RRWS/18/12/09/03	£351.81
1830 x 1830 x 915	600	400	RRWS/18/18/09/03	£463.27
1830 x 2440 x 915	600	400	RRWS/18/24/09/03	£542.98
Half Undershef Workstation				
1830 x 915 x 915	600	400	RRWSH/18/09/09/03	£297.79
1830 x 1220 x 915	600	400	RRWSH/18/12/09/03	£331.08
1830 x 1830 x 915	600	400	RRWSH/18/18/09/03	£431.13
1830 x 2440 x 915	600	400	RRWSH/18/24/09/03	£508.42
T Bar Workstation				
1830 x 915 x 915	600	-	RRWST/18/09/09/03	£277.28
1830 x 1220 x 915	600	-	RRWST/18/12/09/03	£304.51
1830 x 1830 x 915	600	-	RRWST/18/18/09/03	£389.24
1830 x 2440 x 915	600	-	RRWST/18/24/09/03	£453.13

Workbenches & Drawer Cabinets



RRMB/09/12/07

Heavy Duty Rivet Mobile Bench

- >> No nuts & bolts required - the system simply taps together with the use of a hammer/mallet
- >> 18mm thick worktops
- >> Mobile on 4 swivel (2 with brakes) castors

PRICES HELD



Allow 10 days for the MFC Top



Chipboard Worktop



White MFC Worktop

Overall Size H x W x D mm	Bench Load kg	Chipboard Top		White MFC Top	
		Model	Price	Model	Price
880 x 915 x 610	300	RRMB/09/09/06	£292.01	RRMB/09/09/06/M	£296.53
880 x 915 x 762	300	RRMB/09/09/07	£307.26	RRMB/09/09/07/M	£310.75
880 x 915 x 915	300	RRMB/09/09/09	£323.39	RRMB/09/09/09/M	£327.73
880 x 1220 x 610	300	RRMB/09/12/06	£309.70	RRMB/09/12/06/M	£316.15
880 x 1220 x 762	300	RRMB/09/12/07	£327.96	RRMB/09/12/07/M	£332.91
880 x 1220 x 915	300	RRMB/09/12/09	£346.32	RRMB/09/12/09/M	£352.54
880 x 1525 x 610	300	RRMB/09/15/06	£331.35	-	-
880 x 1525 x 762	300	RRMB/09/15/07	£349.16	-	-
880 x 1525 x 915	300	RRMB/09/15/09	£369.86	-	-
880 x 1830 x 610	300	RRMB/09/18/06	£355.78	RRMB/09/18/06/M	£362.02
880 x 1830 x 762	300	RRMB/09/18/07	£375.82	RRMB/09/18/07/M	£383.96
880 x 1830 x 915	300	RRMB/09/18/09	£398.86	RRMB/09/18/09/M	£408.76

Rivet Wide Packing Workstations

- >> No nuts & bolts required - the system simply taps together with the use of a hammer/mallet
- >> 18mm thick worktops
- >> Complete with 2 x roll dispensers (bubble wrap, corrugated packaging wrapping & small parts bins are not included)



RRWPS/18/15/09/03



COLOUR OPTIONS

- Blue & Grey
 - Blue & Orange
- specify when ordering

FROM ONLY
£395.44



Chipboard Worktop

PRICES HELD

Overall Size H x W x D mm	Chipboard Top	
	Model	Price
1830 x 1525 x 915	RRWPS/18/15/09/03	£395.44
1830 x 1830 x 915	RRWPS/18/18/09/03	£455.44

Workbenches & Drawer Cabinets

Adjustable Height Workbench



INFORMATION



Height adjustable
in 25mm increments

WBI00Z

- >> 38mm MDF worktop with a rubber edge
- >> Constructed from steel angle
- >> Half depth bottom shelf with rear lip
- >> Available whilst stocks last

PRICE HELD

230kg
evenly distributed

7 day delivery

SAFE ASSEMBLY REQUIRED

Overall Size L x W x H mm	Weight kg	Model	Price
1220 x 760 x 760 to 880	45	WBI00Z	£297.50

Utility Workbenches

UK
MANUFACTURED

STRIP ASSEMBLY REQUIRED

5 day delivery

250kg
evenly distributed



FROM ONLY
£516.45

UWB75180

- >> 20mm high density laminate worktop with 3mm PVC edging
- >> Powder coated, iridium silver finish on the workbench frames
- >> Supplied knock down

Overall Size H x W mm	Depth: 750mm	
	Model	Price
Workbench		
840 x 1500	UWB75150	£516.45
840 x 1800	UWB75180	£526.80

Workbenches & Drawer Cabinets

Taurus Utility Workbenches

FROM STOCK



- » Ideal for factories, labs, retail environments & schools etc
- » 20mm high density laminate worktop with 3mm PVC edging
- » Powder coated, iridium silver finish on the workbench frames
- » Drawer sets come complete with central locking & have a load capacity of 50kg per drawer. Each drawer set can be fitted either on the left or right of the bench. Cupboard sets can only be positioned on the right hand side
- » Supplied knock down



ST1841575

Overall Size H x W mm	Depth: 750mm		Depth: 900mm	
	Model	Price	Model	Price
Workbench				
840 x 1500	ST1841575	£528.60	ST1841590	£617.45
840 x 1800	ST1841875	£539.15	ST1841890	£634.90

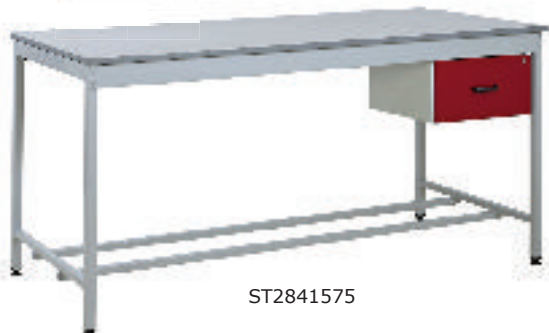

ST2841575



ST3841575

Overall Size H x W mm	Depth: 750mm		Depth: 900mm	
	Model	Price	Model	Price
Workbench with Single Drawer				
840 x 1500	ST2841575	£745.25	ST2841590	£834.10
840 x 1800	ST2841875	£755.85	ST2841890	£851.60

Overall Size H x W mm	Depth: 750mm		Depth: 900mm	
	Model	Price	Model	Price
Workbench with 2 x Single Drawers				
840 x 1500	ST3841575	£961.95	ST3841590	£1050.80
840 x 1800	ST3841875	£972.55	ST3841890	£1068.30

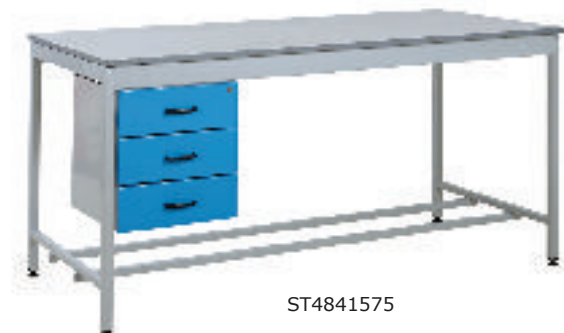

ST4841575



ST5841575

Overall Size H x W mm	Depth: 750mm		Depth: 900mm	
	Model	Price	Model	Price
Workbench with Triple Drawer				
840 x 1500	ST4841575	£940.05	ST4841590	£1028.90
840 x 1800	ST4841875	£950.60	ST4841890	£1046.40

Overall Size H x W mm	Depth: 750mm		Depth: 900mm	
	Model	Price	Model	Price
Workbench with 2 x Triple Drawers				
840 x 1500	ST5841575	£1351.50	ST5841590	£1440.35
840 x 1800	ST5841875	£1362.10	ST5841890	£1457.85



ST6841575



ST7841575

Overall Size H x W mm	Depth: 750mm		Depth: 900mm	
	Model	Price	Model	Price
Workbench with Triple Drawer & Single Drawer				
840 x 1500	ST6841575	£1156.75	ST6841590	£1245.60
840 x 1800	ST6841875	£1167.30	ST6841890	£1263.05

Overall Size H x W mm	Depth: 750mm		Depth: 900mm	
	Model	Price	Model	Price
Workbench with Single Cupboard				
840 x 1500	ST7841575	£722.75	ST7841590	£811.60
840 x 1800	ST7841875	£733.30	ST7841890	£829.05

Workbenches & Drawer Cabinets



**TAURUS WORKBENCHES
FROM STOCK**



**DOOR & DRAWER
COLOUR OPTIONS**

- Red
- Black
- Blue

specify when ordering



ST9841575

ST8841575

- » Single Drawer Set: 220H x 420W x 420D mm
- » Triple Drawer Set: 435H x 420W x 420D mm
- » Cupboard Set: 435H x 420W x 420D mm

Overall Size H x W mm	Depth: 750mm		Depth: 900mm	
	Model	Price	Model	Price
Workbench with Single Drawer & Single Cupboard				
840 x 1500	ST8841575	£939.40	ST8841590	£1028.25
840 x 1800	ST8841875	£950.00	ST8841890	£1045.75

Overall Size H x W mm	Depth: 750mm		Depth: 900mm	
	Model	Price	Model	Price
Workbench with Triple Drawer & Single Cupboard				
840 x 1500	ST9841575	£1134.20	ST9841590	£1223.05
840 x 1800	ST9841875	£1144.75	ST9841890	£1240.55

Taurus Utility Workbench Accessories

DOOR & DRAWER COLOUR OPTIONS



**Red
FROM STOCK**



**Blue
FROM STOCK**



**Black
extended
lead time**

Other colours available - please call for details



INFORMATION

**Complete your
workbench - with
components from stock**

Key	Description	Model	Price
A	760mm Rear Support Posts	ST076RSP	£92.35*
A	1180mm Rear Support Posts	ST118RSP	£111.80*
B	Upper Shelf (300Dmm) for 1500mm Benches	ST3015US	£153.70*
B	Upper Shelf (300Dmm) for 1800mm Benches	ST3018US	£182.95*
C	Light/Tool Rail Support for 1500mm Benches	ST15LTR	£103.35*
C	Light/Tool Rail Support for 1800mm Benches	ST18LTR	£107.00*
D	LED Light - 1200mm Long - please call for details		

Key	Description	Model	Price
E	Louvred back panel (480H mm) with Pinboard for 1500mm Benches	ST15LBP	£194.00*
E	Louvred back panel (480H mm) with Pinboard for 1800mm Benches	ST18LBP	£215.75*
F	Worktop Service Duct for 1500mm Benches**	ST15WSD	£152.30*
F	Worktop Service Duct for 1800mm Benches**	ST18WSD	£159.55*
G	Flat Screen Support Arm	STFSSA	£92.65*

**Worktop Service Ducts are not supplied with cabling and must be fitted by a qualified electrician *Accessories must be ordered with the Workbenches

Workbenches & Drawer Cabinets

Taurus Cantilever Workbenches

FROM STOCK



INFORMATION 

Ideal for assembly, production & light engineering environments

DOOR & DRAWER COLOUR OPTIONS

- Red
- Black
- Blue

specify when ordering



ST18157, STTD444, ST118RSP, ST18WSD, ST18LBP, ST3018US, ST18LTR & LED Light
 (We recommend the 1180mm read support posts are used with the LED light)

- » Workshop bench suitable for use in assembly, production & light engineering environments
- » 20mm high density laminate worktop with 3mm PVC edging
- » Powder coated, iridium silver finish on the workbench frames
- » Cantilever design allows maximum leg room
- » Height adjustable feet for easy levelling
- » Accessories available - see the next page for details
- » Drawer sets come complete with central locking & have a load capacity of 50kg per drawer. Each drawer set can be fitted either on the left or right of the bench. Cupboard sets can only be positioned on the right hand side

Description	Overall Size H x W x D mm	Model	Price
Cantilever Workbench - 20mm Thick Laminate Top			
Cantilever Workbench	840 x 1500 x 750	ST18157	£572.75
	840 x 1500 x 900	ST18159	£576.60
	840 x 1800 x 750	ST18187	£593.15
	840 x 1800 x 900	ST18189	£688.90

Description	Overall Size H x W x D mm	Model	Price
Drawers & Cupboards			
Single Drawer	220 x 420 x 420	STSD244	£216.70*
Triple Drawer	435 x 420 x 420	STTD444	£411.50*
Storage Cupboard	435 x 420 x 420	STSC444	£194.20*

230

900mm deep workbenches are on extended lead time - please call for details

Taurus Cantilever Workbenches

TAURUS WORKBENCHES FROM STOCK



ST18157 & STSC444



DOOR & DRAWER COLOUR OPTIONS

- Red
- Black
- Blue

specify when ordering

Taurus Cantilever Workbench Accessories

DOOR & DRAWER COLOUR OPTIONS



Red FROM STOCK



Blue FROM STOCK



Black extended lead time

Other colours available - please call for details

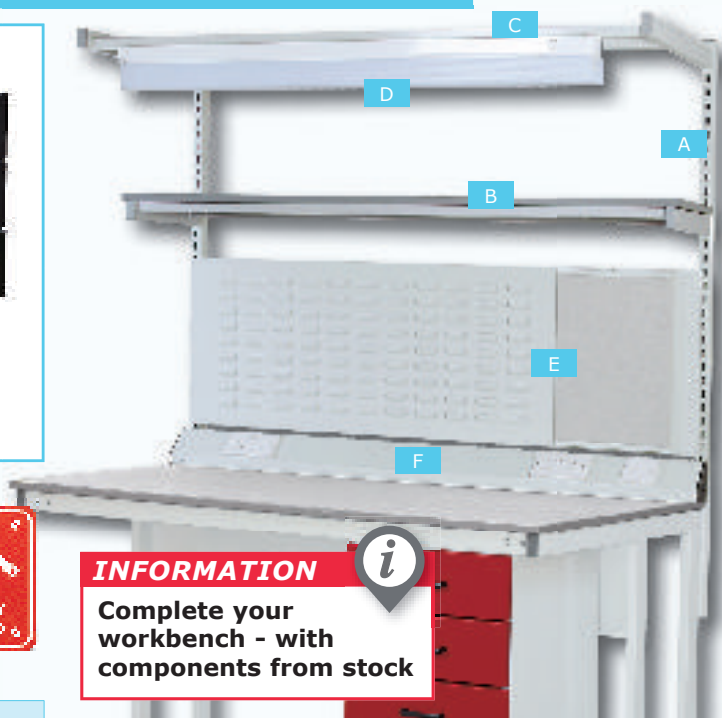

INFORMATION



Complete your workbench - with components from stock

Key	Description	Model	Price
A	760mm Rear Support Posts	ST076RSP	£92.35*
A	1180mm Rear Support Posts	ST118RSP	£111.80*
B	Upper Shelf (300Dmm) for 1500mm Benches	ST3015US	£153.70*
B	Upper Shelf (300Dmm) for 1800mm Benches	ST3018US	£182.95*
C	Light/Tool Rail Support for 1500mm Benches	ST15LTR	£103.35*
C	Light/Tool Rail Support for 1800mm Benches	ST18LTR	£107.00*
D	LED Light - 1200mm Long - please call for details		

Key	Description	Model	Price
E	Louvred back panel (480H mm) with Pinboard for 1500mm Benches	ST15LBP	£194.00*
E	Louvred back panel (480H mm) with Pinboard for 1800mm Benches	ST18LBP	£215.75*
F	Worktop Service Duct for 1500mm Benches**	ST15WSD	£152.30*
F	Worktop Service Duct for 1800mm Benches**	ST18WSD	£159.55*
G	Flat Screen Support Arm	STFSSA	£92.65*

**Worktop Service Ducts are not supplied with cabling and must be fitted by a qualified electrician *Accessories must be ordered with the Workbenches

Workbenches & Drawer Cabinets

All-purpose Heavy Duty Workbenches

FROM ONLY
£809.95



ECO157S, ECS750Z,
ECD100L & ECC204R



INFORMATION

Heavy duty workbenches which are ideal for many different environments



- » Robust all-purpose workbench
 - » Fully welded construction with formed steel worktop
 - » Optional extras available
 - » Worktop height: 840mm
 - » Powder coated grey frame with blue cupboard & drawer fronts
- N.B - A Fork Lift will be needed to unload these units**



ECO157S

Workbench				
Length mm	Depth mm	Weight kg	Model	Price
1500	750	46	ECO157S	£809.95
1800	900	57	ECO189S	£858.25
Optional Extras - Factory Fitted				
Description		Model	Price	
Lower Shelf to Suit ECO157S		ECS750Z	£136.05	
Lower Shelf to Suit ECO189S		ECS900Z	£151.35	
Single Lockable Drawer	Left	ECD100L	£364.40	
	Right	ECD200R	£364.40	
Lockable Cupboard	Left	ECC104L	£341.80	
	Right	ECC204R	£341.80	

Workbenches & Drawer Cabinets

Heavy Duty Workbenches

- » Ideal for factories, laboratories, retail environments & schools etc
- » Heavy duty & robust construction
- » 40mm beech laminated veneer worktop
- » Drawer sets come complete with central locking & have a load capacity of 50kg per drawer



FROM STOCK

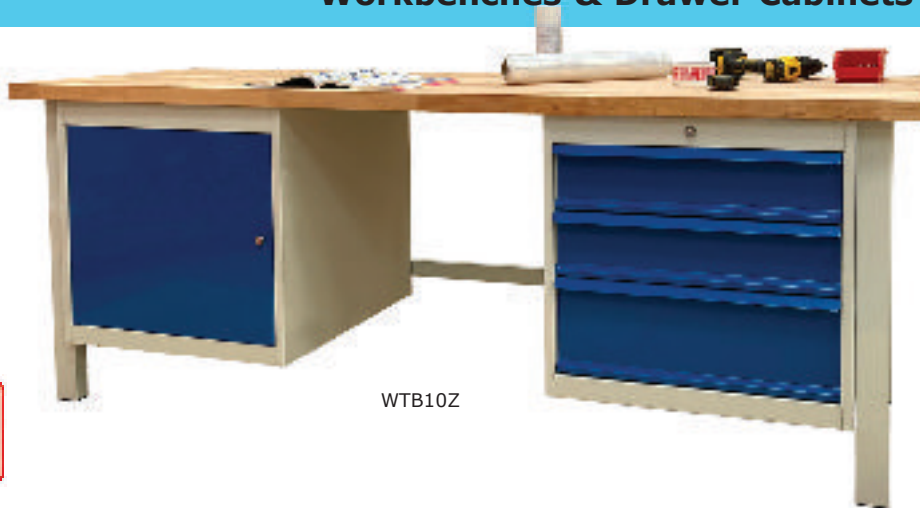

WTB10Z



WTB02Z



WTB04Z



WTB06Z



WTB08Z



WTB12Z



WTB13Z



WTB14Z



WTB15Z



WTB16Z

Top Shelf Kits



- » Top shelf kits are supplied with a pair of support posts with either a 1800mm or 2000mm grey MFC upper shelf

Overall Size L x W mm	Model	Price
1800 x 300	WTBSH01	£331.45
2000 x 300	WTBSH02	£336.15

Configuration	Overall Size L x W x H mm	Model	Price
Workbench	1800 x 650 x 840	WTB01Z	£575.10
	2000 x 650 x 840	WTB02Z	£611.75
Workbench with a Cupboard Unit	1800 x 650 x 840	WTB03Z	£733.60
	2000 x 650 x 840	WTB04Z	£772.70
Workbench with 2 x Cupboard Units	1800 x 650 x 840	WTB05Z	£907.70
	2000 x 650 x 840	WTB06Z	£948.90
Workbench with 3 Drawer Set	1800 x 650 x 840	WTB07Z	£925.65
	2000 x 650 x 840	WTB08Z	£980.30
Workbench with a 3 Drawer Set & a Cupboard Unit	1800 x 650 x 840	WTB09Z	£1112.85
	2000 x 650 x 840	WTB10Z	£1148.75
Workbench with 2 x 3 Drawer Sets	1800 x 650 x 840	WTB11Z	£1318.05
	2000 x 650 x 840	WTB12Z	£1349.35
Workbench with 3 x Cupboard Units	2000 x 650 x 840	WTB13Z	£1148.75
Workbench with a 3 Drawer Set & 2 x Cupboard Units	2000 x 650 x 840	WTB14Z	£1317.25
Workbench with 2 x 3 Drawer Sets & a Cupboard Unit	2000 x 650 x 840	WTB15Z	£1517.80
Workbench with 3 x 3 Drawer Sets	2000 x 650 x 840	WTB16Z	£1716.40

Workbenches & Drawer Cabinets

Industrial Workbenches



CWB1570M



CWB1570M & CWB204ZR

- » Fully welded bench frames meet the requirements of many environments
 - » Fitted with adjustable feet to ensure a level work surface
 - » Worktop height: 840mm
- N.B - A Fork Lift will be needed to unload these units**

Workbenches

Top Options		MDF		Plywood		Steel	
Length mm	Depth mm	Model	Price	Model	Price	Model	Price
1500	750	CWB1570M	£819.30	CWB1570P	£850.05	CWB1570S	£1018.65
	900	CWB1590M	£843.55	CWB1590P	£874.30	CWB1590S	£1045.30
1800	750	CWB1870M	£849.95	CWB1870P	£880.75	CWB1870S	£913.95
	900	CWB1890M	£881.20	CWB1890P	£912.00	CWB1890S	£1072.40



- » Support Legs - must be used with all the optional extras except the rear/side lips & the Worktop Electric Power Point
- » Adjustable Cantilever Shelf - adjustable to 3 positions
- » Tool Rail - runs the length of the bench
- » LED Light - supplied with 3M of core cable & 13 amp plug
- » Worktop Electric Power Point - complete with 2 double 13 amp sockets. Supplied with 3M of core cable & a safety cut out plug

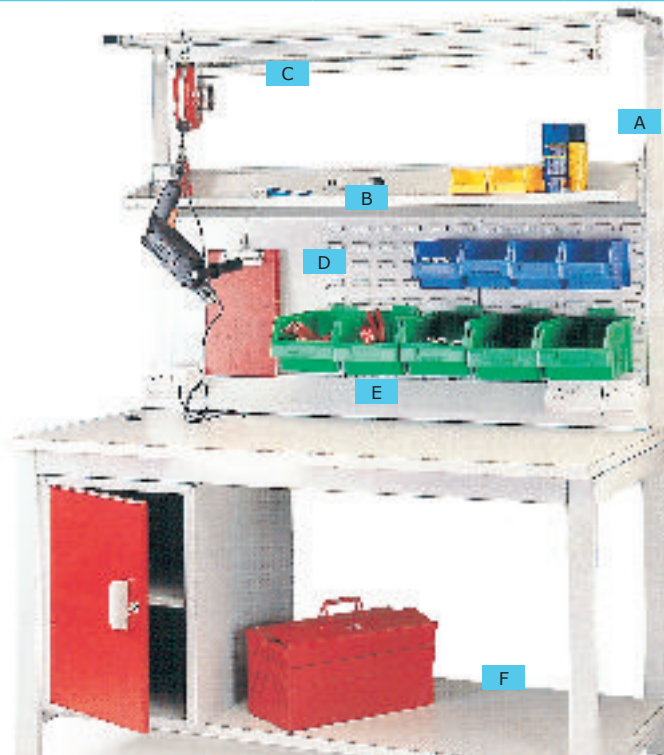

INFORMATION

Complete your workbench with these accessories

Factory Fitted Cupboard

» Cupboard size: 440W x 570D x 590H mm

COLOUR OPTIONS

- Red
- Green
- Blue
- Grey

specify when ordering

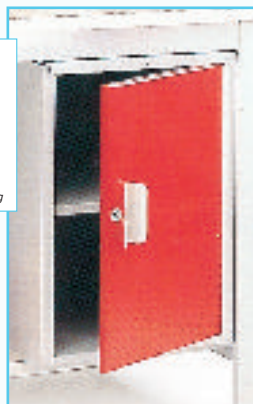

Left Fitting Model	Right Fitting Model	Price
CWB104ZL	CWB204ZR	£341.80*

Accessories

Key	Description	1500mm Benches		1800mm Benches	
		Model	Price	Model	Price
A	Rear Support Legs	CWB106Z	£101.95*	CWB106Z	£101.95*
B	Adjustable Cantilever Shelf	CWB252Z	£221.70*	CWB282Z	£224.60*
C	Tool Rail & LED Light	CWB196Z	£467.30*	CWB197Z	£481.55*
D	Louvred back panel	CWB353Z	£372.60*	CWB383Z	£451.75*
E	Worktop Electric Power Point	CWB195Z	£577.25*	CWB198Z	£577.25*
-	Rear Lips (Vinyl & Plywood Tops only)	CWB454Z	£53.10*	CWB484Z	£90.85*
Key	Description	750mm Deep Benches		900mm Deep Benches	
-	Side Lips (Vinyl & Plywood Tops only)	CWB555Z	£59.80*	CWB585Z	£61.10*

F) Lower Shelf

To Suit		MDF		Plywood		Steel	
Length mm	Depth mm	Model	Price	Model	Price	Model	Price
1500	750	CWB57M	£165.30	CWB57P	£145.85	CWB57S	£140.40
	900	CWB59M	£182.15	CWB59P	£160.90	CWB59S	£151.75
1800	750	CWB87M	£189.55	CWB87P	£165.25	CWB87S	£158.60
	900	CWB89M	£201.80	CWB89P	£182.10	CWB89S	£169.95

*Accessories must be ordered with the Workbenches

Workbenches & Drawer Cabinets

Heavy Duty Modular Workbenches



PR222M fitted with PRS22M, PRE22M & PRSE2M

INFORMATION

Designed to offer indefinite lengths of benching

- » Available up to 1200mm deep to enable working from both sides
- » Worktop height is adjustable in 25mm increments from 840 to 940mm
- » Main benches are supplied fully assembled & extensions knock down. Extension units are not available on their own

Modular Workbenches

Bench mm		Modular Workbench					
		Top Options					
		28mm Vinyl		25mm MDF		25mm Plywood	
Length	Depth	Model	Price	Model	Price	Model	Price
1500	750	PR157L	£1113.65	PR157M	£899.95	PR157P	£1160.20
	900	PR159L	£1132.50	PR159M	£920.40	PR159P	£1176.00
2000	1200	PR222L	£1356.65	PR222M	£1062.90	PR222P	£1241.60



Extension Units

Bench mm		Extension Units - only supplied with the main workbenches					
		Top Options					
		28mm Vinyl		25mm MDF		25mm Plywood	
Length	Depth	Model	Price	Model	Price	Model	Price
1500	750	-	-	PRE57M	£746.90	PRE57P	£954.10
	900	-	-	PRE59M	£767.40	PRE59P	£954.80
2000	1200	-	-	PRE22M	£804.80	PRE22P	£992.20



PR222M

Optional Lower Shelves to suit Benches - factory fitted

To Suit Bench mm		Lower Shelf to suit Bench					
		Top Options					
		28mm Vinyl		25mm MDF		25mm Plywood	
Length	Depth	Model	Price	Model	Price	Model	Price
1500	750	PRS57L	£246.70	PRS57M	£133.55	PRS57P	£192.35
	900	PRS59L	£266.45	PRS59M	£154.05	PRS59P	£259.60
2000	1200	PRS22L	£394.65	PRS22M	£174.70	PRS22P	£288.70

Lower Shelves to suit Extension Units - factory fitted

To Suit Bench mm		Lower Shelf to suit Extension					
		Top Options					
		28mm Vinyl		25mm MDF		25mm Plywood	
Length	Depth	Model	Price	Model	Price	Model	Price
1500	750	-	-	PRSE7M	£133.55	PRSE7P	£192.35
	900	-	-	PRSE9M	£154.05	PRSE9P	£259.60
2000	1200	-	-	PRSE2M	£174.70	PRSE2P	£288.70

Optional Upper Shelves - factory fitted

Description	To Suit	Model	Price
Upper 2 Shelf	1500	PRPT215Z	£299.90
Upper 2 Shelf	2000	PRPT220Z	£310.35



PR222M fitted with PRPT220Z

N.B - A Fork Lift will be needed to unload these units

Workbenches & Drawer Cabinets

Heavy Duty Workbenches



Workbench shown with optional triple drawer, cupboard unit & accessories

- » Heavy duty bench suitable for heavy duty applications such as engineering & manufacturing
- » Fully welded construction for extra strength
- » Powder coated dark grey framework

- » Steel plate, beech, linoleum & laminate worktop options
- » Full range of accessories available including drawers, cupboards, shelves and sliding doors.
- » Standard bench height: 840mm (760 & 920mm also available - call for details)

Drawer & Cupboard Options

Description	Model	Price
Single Drawer - 220 x 420 x 420	BXDR04021	£254.06
Triple Drawer - 435 x 420 x 420	BXDR04043	£436.12
Cupboard Unit - 560 x 420 x 420	BXCU04051	£277.16

Please Note: Only Light Grey Drawers & Cupboards are available on 5 Day Delivery

DOOR & DRAWER COLOUR OPTIONS

- Red
- Blue
- Green
- Light Grey

specify when ordering



Heavy Duty Workbenches

Steel Plate Worktop 2 mm Thick			Linoleum Worktop 20mm Thick			Solid Beech Worktop 27mm Thick		
Size H x W x D mm	Model	Price	Size H x W x D mm	Model	Price	Size H x W x D mm	Model	Price
840 x 1200 x 600	BJ841260SKXX	£480.95	840 x 1200 x 600	BJ8412608KXX	£573.34	840 x 1200 x 600	BJ841260BKXX	£577.41
840 x 1200 x 750	BJ841275SKXX	£536.66	840 x 1200 x 750	BJ8412758KXX	£595.08	840 x 1200 x 750	BJ841275BKXX	£615.46
840 x 1200 x 900	BJ841290SKXX	£550.24	840 x 1200 x 900	BJ8412908KXX	£661.65	840 x 1200 x 900	BJ841290BKXX	£673.88
840 x 1500 x 600	BJ841560SKXX	£552.96	840 x 1500 x 600	BJ8415608KXX	£688.82	840 x 1500 x 600	BJ841560BKXX	£740.45
840 x 1500 x 750	BJ841575SKXX	£654.86	840 x 1500 x 750	BJ8415758KXX	£740.45	840 x 1500 x 750	BJ841575BKXX	£782.57
840 x 1500 x 900	BJ841590SKXX	£668.44	840 x 1500 x 900	BJ8415908KXX	£843.71	840 x 1500 x 900	BJ841590BKXX	£857.29
840 x 1800 x 600	BJ841860SKXX	£586.93	840 x 1800 x 600	BJ8418608KXX	£737.73	840 x 1800 x 600	BJ841860BKXX	£777.13
840 x 1800 x 750	BJ841875SKXX	£688.82	840 x 1800 x 750	BJ8418758KXX	£759.47	840 x 1800 x 750	BJ841875BKXX	£858.65
840 x 1800 x 900	BJ841890SKXX	£714.64	840 x 1800 x 900	BJ8418908KXX	£876.31	840 x 1800 x 900	BJ841890BKXX	£952.40

Laminate Worktop 20mm Thick			Lower Shelves - Fitted Steel Plate		
Size H x W x D mm	Model	Price	To Fit W x D mm	Model	Price
840 x 1200 x 600	BJ841260PKXX	£573.34	1200 x 600	BXLS1206XXXX	£122.28
840 x 1200 x 750	BJ841275PKXX	£595.08	1200 x 750	BXLS1207XXXX	£146.73
840 x 1200 x 900	BJ841290PKXX	£661.65	1200 x 900	BXLS1209XXXX	£146.73
840 x 1500 x 600	BJ841560PKXX	£688.82	1500 x 600	BXLS1506XXXX	£142.66
840 x 1500 x 750	BJ841575PKXX	£740.45	1500 x 750	BXLS1507XXXX	£168.47
840 x 1500 x 900	BJ841590PKXX	£843.71	1500 x 900	BXLS1509XXXX	£168.47
840 x 1800 x 600	BJ841860PKXX	£737.73	1800 x 600	BXLS1806XXXX	£163.03
840 x 1800 x 750	BJ841875PKXX	£759.47	1800 x 750	BXLS1807XXXX	£184.77
840 x 1800 x 900	BJ841890PKXX	£876.31	1800 x 900	BXLS1809XXXX	£184.77

All RED product codes are available on 5 Day Delivery

Workbench Accessories

Heavy Duty Bench Accessories			
Key	Description	Model	Price
A	760mm Rear Support Posts	BESP760SXXXX	£101.90
A	1180mm Rear Support Posts	BESP1180XXXX	£123.63
B	Upper shelf 300mm Laminate for 1200mm bench	BEUS1200PXXX	£142.66
B	Upper shelf 300mm Laminate for 1500mm bench	BEUS1500PXXX	£169.83
B	Upper shelf 300mm Laminate for 1800mm bench	BEUS1800PXXX	£202.43
C	Light/Tool Rail Support for 1200mm bench	BERS1200XLXX	£107.33
C	Light/Tool Rail Support for 1500mm bench	BERS1500XLXX	£114.12
C	Light/Tool Rail Support for 1800mm bench	BERS1800XLXX	£118.20
-	3 Setting LED Light - 1200mm	BE3SETL1200X	£82.88
-	Tilting LED Light - 30 Watt - 1200mm	BELED3012XXX	£220.10
E	Louvred back panel with pinboard for 1200mm bench	BELO4812IXXX	£197.00
E	Louvred back panel with pinboard for 1500mm bench	BELO4815IXXX	£205.15
E	Louvred back panel with pinboard for 1800mm bench	BELO4818IXXX	£239.12
F	Worktop service duct for 1200mm bench	BESDWT122XXX	£164.39
F	Worktop service duct for 1500mm bench	BESDWT15XXX	£168.47
F	Worktop service duct for 1800mm bench	BESDWT18XXX	£176.62
G	Post fitted service duct for 1200mm bench	BESDSP12XXXX	£180.70
G	Post fitted service duct for 1500mm bench	BESDSP15XXXX	£188.85
G	Post fitted service duct for 1800mm bench	BESDSP18XXXX	£201.08
H	Monitor and keyboard Support Arm	BEMONARMFMSG	£239.12
-	Flat Screen Support Arm	BEMONARMLSC	£95.10



Heavy Duty Bench Accessories			
Key	Description	Model	Price
I	Retaining Lip for 1200 x 600mm bench	BXRL1206XXXX	£72.01
I	Retaining Lip for 1200 x 750mm bench	BXRL1208XXXX	£82.88
I	Retaining Lip for 1200 x 900mm bench	BXRL1209XXXX	£92.39
I	Retaining Lip for 1500 x 600mm bench	BXRL1506XXXX	£82.88
I	Retaining Lip for 1500 x 750mm bench	BXRL1507XXXX	£92.39
I	Retaining Lip for 1500 x 900mm bench	BXRL1509XXXX	£99.18
I	Retaining Lip for 1800 x 600mm bench	BXRL1806XXXX	£92.39
I	Retaining Lip for 1800 x 750mm bench	BXRL1807XXXX	£99.18
I	Retaining Lip for 1800 x 900mm bench	BXRL1809XXXX	£110.05
J	Vice Plate	BXVICEPLXXXX	£32.61



Workbenches & Drawer Cabinets

Heavy Duty Workbench Kits with Laminate Tops



Size H x W x D mm	Model	Price
840 x 1200 x 750	BJ841275PX1A	£1123.58
840 x 1500 x 750	BJ841575PX1B	£1268.95
840 x 1800 x 750	BJ841875PX1C	£1287.98

Size H x W x D mm	Model	Price
840 x 1200 x 750	BJ841275PX3A	£1305.64
840 x 1500 x 750	BJ841575PX3B	£1451.01
840 x 1800 x 750	BJ841875PX3C	£1470.03



Size H x W x D mm	Model	Price
840 x 1200 x 750	BJ841275PX5A	£1562.42
840 x 1500 x 750	BJ841575PX5B	£1753.98
840 x 1800 x 750	BJ841875PX5C	£1830.07

Size H x W x D mm	Model	Price
840 x 1200 x 750	BJ841275PX7A	£1744.47
840 x 1500 x 750	BJ841575PX7B	£1936.04
840 x 1800 x 750	BJ841875PX7C	£2012.12



Size H x W x D mm	Model	Price
840 x 1200 x 750	BJ841275PX9A	£1937.40
840 x 1500 x 750	BJ841575PX9B	£2141.19
840 x 1800 x 750	BJ841875PX9C	£2228.14

Size H x W x D mm	Model	Price
840 x 1200 x 750	BJ841275P11A	£2119.45
840 x 1500 x 750	BJ841575P11B	£2323.25
840 x 1800 x 750	BJ841875P11C	£2410.20

Heavy Duty Workbench Kits with Beech Tops



Size H x W x D mm	Model	Price
840 x 1200 x 750	BJ841275BX2A	£1143.96
840 x 1500 x 750	BJ841575BX2B	£1312.43
840 x 1800 x 750	BJ841875BX2C	£1388.51

Size H x W x D mm	Model	Price
840 x 1200 x 750	BJ841275BX4A	£1285.26
840 x 1500 x 750	BJ841575BX4B	£1493.13
840 x 1800 x 750	BJ841875BX4C	£1569.21



Size H x W x D mm	Model	Price
840 x 1200 x 750	BJ841275BX6A	£1582.80
840 x 1500 x 750	BJ841575BX6B	£1797.46
840 x 1800 x 750	BJ841875BX6C	£1929.25

Size H x W x D mm	Model	Price
840 x 1200 x 750	BJ841275BX8A	£1764.85
840 x 1500 x 750	BJ841575BX8B	£1978.16
840 x 1800 x 750	BJ841875BX8C	£2111.30



Size H x W x D mm	Model	Price
840 x 1200 x 750	BJ841275B10A	£1957.78
840 x 1500 x 750	BJ841575B10B	£2183.31
840 x 1800 x 750	BJ841875B10C	£2328.68

Size H x W x D mm	Model	Price
840 x 1200 x 750	BJ841275B12A	£2139.83
840 x 1500 x 750	BJ841575B12B	£2365.36
840 x 1800 x 750	BJ841875B12C	£2509.38

Workbenches & Drawer Cabinets

H.D. Premium Stainless Steel Workbenches

- >> Fully welded construction
- >> Manufactured from food quality grade 304 stainless steel
- >> Ideal for food preparation, healthcare facilities & any other environment where hygiene is essential
- >> Worktop height: 840mm
- >> Hygienic - can be steam cleaned

N.B - A Fork Lift may be needed to unload these units



PB157S shown with PBS57S, PBD03S, PBC04S, PBRL1S, PBPB5P, PBSR6P, PBCS2P & PBLF7P



The bottom shelf has an integral rear lip

INFORMATION



Constructed from food quality 304 stainless steel



Workbench

Overall Size L x D mm	Weight kg	Model	Price
1500 x 750	75	PB157S	£1831.85
1800 x 900	102	PB189S	£2144.35



PB157S fitted with PBC04S & PBD03S

Optional Extras - factory fitted

Description	Model	Price
Bottom Shelf - 1500 x 575	PBS57S	£274.25
Bottom Shelf - 1800 x 575	PBS89S	£308.75
Cantilever Shelf* (Horizontal Fitting)	PBCS2P	£337.50
Rear Retaining Lip	PBRL1S	£120.35
Side Retaining Lip - Each	PBSL2S	£76.15
Single Drawer	PBD03S	£688.55
Lockable Cupboard	PBC04S	£750.75
Electric Powerpoint	PBPB5P	£687.10
Light Fitment*	PBLF7P	£449.65
Support Rails* - for use with the Light Fitment & Cantilever Shelf	PBSR6P	£356.95

* Support Rails are needed for use with Cantilever Shelf & Light Fitment



PB157S shown with PBS57S

Stainless Steel Preparation Workbenches



- » Ideal for food preparation, healthcare facilities & any other environment where hygiene is essential
- » Manufactured from grade 304 stainless steel
- » Worktop height: 875mm
- » Hygienic - can be steam cleaned
- » Complete with undershelf & rear worktop retaining lip



SSB6502

INFORMATION



Constructed from food quality grade 304 stainless steel



Workbench Length mm	650mm Deep		700mm Deep	
	Model	Price	Model	Price
900	SSB6501	£689.10	SSB7501	£739.50
1000	SSB6502	£739.50	SSB7502	£789.95
1200	SSB6503	£764.75	SSB7503	£823.55
1500	SSB6504	£806.75	SSB7504	£857.15
1800	SSB6505	£882.40	SSB7505	£932.80

Stainless Steel Height Adjustable Preparation Workbenches



- » Winch operated, height adjustable, stainless steel preparation workbenches - prevent back strain by bringing the work area to the right height
- » Manufactured from grade 304 stainless steel
- » Worktop height: 720 to 1020mm
- » Hygienic - can be steam cleaned
- » Complete with undershelf & rear worktop retaining lip



SSHAB6516

NEW

INFORMATION



Constructed from food quality grade 304 stainless steel



Workbench Length mm	650mm Deep		700mm Deep	
	Model	Price	Model	Price
900	SSHAB6515	£2226.90	SSHAB7515	£2279.00
1000	SSHAB6516	£2279.00	SSHAB7516	£2329.45
1200	SSHAB6517	£2329.45	SSHAB7517	£2386.60
1500	SSHAB6518	£2386.60	SSHAB7518	£2438.70
1800	SSHAB6519	£2425.25	SSHAB7519	£2479.00

Workbenches & Drawer Cabinets

Binary Electric Height Adjustable Workbenches

INFORMATION



Complete your workbench with these accessories



Binary Workbench Accessories			
Key	Description	Model	Price
A	Aluminium Accessory Frame (to suit 1200mm bench)	BIALBFME12XX	£256.78
A	Aluminium Accessory Frame (to suit 1500mm bench)	BIALBFME15XX	£289.39
A	Aluminium Accessory Frame (to suit 1800mm bench)	BIALBFME18XX	£334.22
B	Laminate Upper Shelf (to suit 1200mm bench) 50H x 1200W x 300Dmm	BIUS3012PLXX	£165.75
B	Laminate Upper Shelf (to suit 1500mm bench) 50H x 1500W x 300Dmm	BIUS3015PLXX	£197.00
B	Laminate Upper Shelf (to suit 1800mm bench) 50H x 1800W x 300Dmm	BIUS3018PLXX	£226.89
C	Peg Back Panel (to suit 1500mm bench) 500H x 450W x 30Dmm	BIBPPEG15LXX	£96.46
C	Peg Back Panel (to suit 1200 & 1800mm bench) 500H x 545W x 30Dmm	BIBPPEG18-12	£100.54
D	Louvre Back Panel (to suit 1500mm bench) 500H x 450W x 30Dmm	BIBPLOV15LXX	£96.46
D	Louvre Back Panel (to suit 1200 & 1800mm bench) 500H x 545W x 30Dmm	BIBPLOV18-12	£100.54
E	Magnetic Back Panel (to suit 1500mm bench) 500H x 450W x 30Dmm	BIBPMAG15LXX	£96.46
E	Magnetic Back Panel (to suit 1200 & 1800mm bench) 500H x 545W x 30Dmm	BIBPMAG18-12	£100.54
F	Shelf Dividers (Pack of 5) - to be fitted to the Upper Shelf	BIDIVPK5LXXX	£85.59
G	Modular Half Shelf (to suit 1200mm bench) 50H x 600W x 150Dmm	BIMDS1200PLX	£120.92
G	Modular Half Shelf (to suit 1500mm bench) 50H x 500W x 150Dmm	BIMDS1500PLX	£111.41
G	Modular Half Shelf (to suit 1800mm bench) 50H x 600W x 150Dmm	BIMDS1800PLX	£120.92

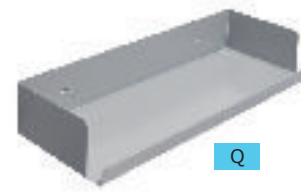
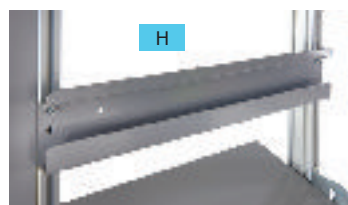

Binary Workbench Accessories			
Key	Description	Model	Price
H	Modular Bin Rail (to suit 1200mm bench) 100H x 600W x 30Dmm (containers sold separately)	BIBINRL12LXX	£43.48
H	Modular Bin Rail (to suit 1500mm bench) 100H x 500W x 30Dmm (containers sold separately)	BIBINRL15LXX	£50.27
H	Modular Bin Rail (to suit 1800mm bench) 100H x 600W x 30Dmm (containers sold separately)	BIBINRL18LXX	£55.70
I	Above Bench Light Rail (to suit 1200mm bench)	BILIGHTRL12LX	£150.81
I	Above Bench Light Rail (to suit 1500mm bench)	BILIGHTRL15LX	£154.88
I	Above Bench Light Rail (to suit 1800mm bench)	BILIGHTRL18LX	£158.96
J	Above Bench LED Light (30 Watt)	BILED30WXXXX	£214.66
K	Worktop Service Duct - 130H x 410W x 55Dmm	BISERVDTLXX	£120.92
L	Side Panel Support Arm (to be fitted with panels or storage shelf) - 530Lmm	BISUPARM530L	£116.84
M	Centre Panel Support Arm (to be fitted with panels or storage shelf) - 305Lmm	BISUPARM305L	£105.97
N	Side Peg Board (to be fitted to panel support arm) 440H x 290W x 30Dmm	BISPPEG4429L	£74.72
O	Side Louvre Panel (to be fitted to panel support arm) 440H x 290W x 30Dmm	BISPLOV4429L	£74.72
P	Side Magnetic Panel (to be fitted to panel support arm) 440H x 290W x 30Dmm	BISPMAG4429L	£72.01
Q	Container Storage Shelf (to be fitted to panel support arm) To suit 80H x 100W x 160Dmm plastic containers	BICONSH51LXX	£105.97
R	Monitor Support Arm (Centre Fitted) - 305Lmm	BIMONARM305L	£111.41
S	Monitor Support Arm (Side Fitted) - 530Lmm	BIMONARM530L	£131.79
T	Adjustable Tilting Shelf (to suit 1200 & 1800mm bench)	BIADJSH18-12	£197.00
T	Adjustable Tilting Shelf (to suit 1500mm bench)	BIADJSH15LXX	£191.57

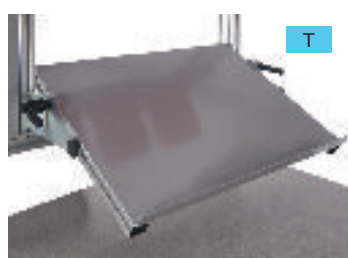
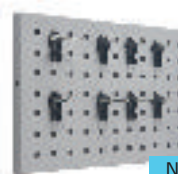

The Electric Height Adjustable Binary Workbench offers a premium solution for your workshop. Each bench comes fitted with a two-button adjustment switch which quickly & effortlessly adjusts the height of the bench.

- >> Adjusts between 660mm & 1300mm high
- >> Available in widths of 1200mm, 1500mm & 1800mm
- >> All above bench accessories are fully modular & adjustable
- >> Available with either a 30mm Laminate top or a 27mm Beech top
- >> UDL of 240kg, evenly distributed



INFORMATION



Complete your workbench with the accessories shown on the opposite page

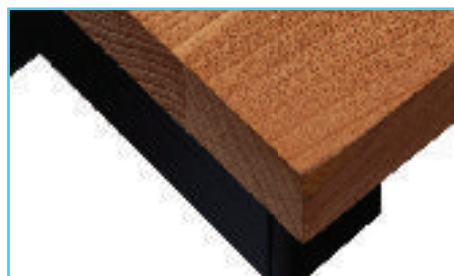

Workbench with Laminate Worktop (30mm Thick)		
Size H x W x D mm	Model	Price
660/1300 x 1200 x 755	BIE661275PLX	£2080.05
660/1300 x 1500 x 755	BIE661575PLX	£2179.23
660/1300 x 1800 x 755	BIE661875PLX	£2290.64

Workbench with Solid Beech Worktop (27mm Thick)		
Size H x W x D mm	Model	Price
660/1300 x 1200 x 755	BIE661275BLX	£2160.21
660/1300 x 1500 x 755	BIE661575BLX	£2249.88
660/1300 x 1800 x 755	BIE661875BLX	£2330.04

Premium Height Adjustment Module		
Description	Model	Price
Memory function which can store up to 3 height positions	BIHADJ3MODXX	£73.37

Workbenches & Drawer Cabinets

Ergonomic Workbenches - Accessories

INFORMATION

Complete your workbench system



ESD Versions are on an extended lead time

No.	Overall Size D x W mm	To Suit TPH bench length	Standard Model	Price
1	Standard Version			
	1115 Length	1200	BP120	£98.15
	1415 Length	1500	BP150	£111.46
	1715 Length	1800	BP180	£121.61
	ESD Version			
	1115 Length	1200	BP120 ESD	£115.25
2	Standard Version			
	310 x 1200	1200	SH120	£241.31
	310 x 1500	1500	SH150	£155.36
	310 x 1800	1800	SH180	£266.27
	ESD Version			
	310 x 1200	1200	SH120 ESD	£353.24
3	Standard Version			
	1200 Length	1200	KT120	£263.70
	1500 Length	1500	KT150	£268.39
	1800 Length	1800	KT180	£209.94
	1500 Length - Bar	1500	SPR150	£54.90
4	ESD Version			
	1800 Length - Bar	1800	SPR180	£61.76
	430 x 120	1200, 1500 & 1800	TNL500W-UK	£509.84
4	900 x 120	1200, 1500 & 1800	TNL900-UK	£717.54
	1180 x 120	1200, 1500 & 1800	TNL1200-UK	£793.04

1) Bin Rail BP

- » For picking/stacking bins
- » Aluminium profile
- » Load capacity: 15kg
- » For TPH bench

2) Auxiliary Shelf SH

- » For more than one shelf on your bench
- » Load capacity: 50kg
- » For TPH bench

3) Tool & Lighting Support Kit KT

- » Includes 1 x C-profile & sliding hook
- » Order extra bar to mount tools & light - SPR
- » For TPH bench

4) LED NaturLite

- » Pre-wired 3 metre cable to UK plug
- » Built in diffuser

5) 4 x UK Power Sockets

Available - please call for details

Ergonomic Workbenches



ESD Versions are on an extended lead time

Frames are epoxy powder coated steel in light grey RAL 7035. The worktops are either 25mm melamine-laminate or volume conductive melamine-laminate on particle board. ESD benches are earthed via a protective 1 mega-ohm resistor. Supplied knock down for self-assembly

Workbench TP

- » Height adjustable from 650 to 900mm (by allen key)
- » Can be also supplied as a line or angle extension
- » Steel frame in light grey RAL7035

Worktop D x W mm	Model	Price	ESD Model	Price
500 x 700	TP507	£436.82	TP507 ESD	£461.31
500 x 1000	TP510	£477.65	TP510 ESD	£560.75
700 x 1000	TP710	£509.72	TP710 ESD	£640.04
700 x 1200	TP712	£545.79	TP712 ESD	£743.36
700 x 1500	TP715	£580.07	TP715 ESD	£811.99
700 x 1800	TP718	£623.31	TP718 ESD	£962.11
900 x 1500	TP915	£632.38	TP915 ESD	£1028.52
900 x 1800	TP918	£686.80	TP918 ESD	£1182.83

Workbench with Shelf TPH

- » Construction as TP with upright profiles & a 310 mm deep laminate shelf
- » Upper shelf is height adjustable from 1080 to 1550mm

Worktop D x W mm	Model	Price	ESD Model	Price
700 x 1200	TPH712	£869.05	TPH712 ESD	£1129.64
700 x 1500	TPH715	£923.48	TPH715 ESD	£1248.88
700 x 1800	TPH718	£1023.83	TPH718 ESD	£1487.23
900 x 1500	TPH915	£1010.04	TPH915 ESD	£1425.51
900 x 1800	TPH918	£1078.28	TPH918 ESD	£1672.45

Mobile Bench SAP

- » Construction as TP but with 100mm swivel castors, 2 braked
- » Height adjustable from 650 to 900mm
- » Lower shelf & push handles are optional extras

Worktop D x W mm	Model	Price	ESD Model	Price
500 x 700	SAP507	£514.10	SAP507 ESD	£595.93
700 x 1000	SAP710	£609.92	SAP710 ESD	£794.39
700 x 1500	SAP715	£714.33	SAP715 ESD	£1003.82
Lower Shelf				
500 x 700	AT507	£104.16	AT507 ESD	£238.35
700 x 1000	AT710	£163.78	AT710 ESD	£434.69
Push Handle				
Push Handle for 500mm deep benches			PUSH50	£117.95
Push Handle for 700mm deep benches			PUSH70	£121.33

ESD protected workbenches are for use in the electronics industry & comply with EN61340-5-1



Workbench TP



Workbench with shelf TPH



Mobile Bench SAP with Push Handle

Workbenches & Drawer Cabinets

Ergonomic Adjustable Workbenches

- » An ergonomic modular & adaptable industrial workbench
- » Various sizes & combinations
- » Height adjustable electrically or with an allen key
- » Easy to customise with a wide range of accessories & add-ons
- » Very stable steel frame giving a load capacity of up to 500kg
- » Frame, table top & accessories available with ESD protection

INFORMATION



400+ accessories available - call for details



Workbench - Allen Key Adjustable

How to configure your workbench

- » Select the bench frame & the height adjustment method: allen key or motor
- » Select a bench top to suit the frame: HPL Laminate, LPL Laminate or ESD

NEW



Workbench with full accessories - please call for more details



Workbench - Allen Key Adjustable

Bench height steplessly adjustable - 670 to 1100mm

Workbench Frame Size W x D mm	Bench Frame Capacity kg	Model	Price
1200 x 750	500	100 49 031P	£722.64
1200 x 900	500	100 49 063P	£829.48
1500 x 750	500	100 49 032P	£787.93
1500 x 900	500	100 49 064P	£895.45
1800 x 750	500	100 49 033P	£795.11
1800 x 900	500	100 49 065P	£902.64

Workbench - Electrically Adjustable

Bench height adjustable - 700 to 1000mm (13mm per second)

Workbench Frame Size W x D mm	Bench Frame Capacity kg	Model	Price
1200 x 750	400	103 49 031P	£2905.41
1200 x 900	400	103 49 063P	£3033.84
1500 x 750	400	103 49 032P	£2964.07
1500 x 900	400	103 49 064P	£3093.07
1800 x 750	400	103 49 033P	£3043.06
1800 x 900	400	103 49 065P	£3172.85

Workbench Top - HPL Laminate



- » 25mm thick, plastic edged light grey, high pressure laminate

Size W x D mm	Model	Price
1200 x 750	TT12075-HPL	£247.40
1200 x 900	TT12090-HPL	£286.14
1500 x 750	TT15075-HPL	£293.86
1500 x 900	TT15090-HPL	£341.14
1806 x 750	TT18075-HPL	£340.51
1806 x 900	TT18090-HPL	£385.56

Workbench Top - LPL Laminate



- » 25mm thick, plastic edged light grey, low pressure laminate

Size W x D mm	Model	Price
1200 x 750	TT12075-LPL	£199.83
1200 x 900	TT12090-LPL	£228.87
1500 x 750	TT15075-LPL	£237.49
1500 x 900	TT15090-LPL	£275.66
1806 x 750	TT18075-LPL	£275.12
1806 x 900	TT18090-LPL	£311.46

Workbench Top - ESD



- » 25mm thick, plastic edged light grey laminate

Size W x D mm	Model	Price
1200 x 750	TT12075-ESD	£343.99
1200 x 900	TT12090-ESD	£430.19
1500 x 750	TT15075-ESD	£427.72
1500 x 900	TT15090-ESD	£466.59
1806 x 750	TT18075-ESD	£495.06
1806 x 900	TT18090-ESD	£550.42

Ergo Chairs

- >> Fabric upholstery chairs which are recommended for use in clean working environments
- >> High quality fabric upholstery which is breathable & can absorb & expel moisture
- >> Easily cleaned by using commercially available upholstery cleaning products



Soft dual-wheel safety castors with load sensitive brakes

Conductive soft dual-wheel safety castors with load sensitive brakes

High version with foot ring & glides

High ESD version with foot ring & glides

Model	Price
C30BL	£508.37

Model	Price
C30BL-ESD	£679.95

Model	Price
C35BL	£667.21

Model	Price
C35BL-ESD	£838.75

For your safety: Did you know that according to standard DIN 68877, any chair with a seat height over 650mm needs to have glides & a foot ring? That is why our high chair models are equipped with glides & a foot ring as standard



Ergo Chair Accessories



NEW **INFORMATION** **Complete your chair with these accessories**

Product	Description	Model	Price	ESD Model	Price
High Glide Set	Abrasion-resistant plastic glides have large surface area & offer a superb level of stability. The glides can be retrofitted to all our chairs	CGLIH	£69.21	CGLIH-ESD	£123.05
Soft castor set for hard floors	The castors will brake when unloaded. As standard, we supply soft castors for hard floors, but hard castors for soft floors needs to be ordered separately	CSCAS	£79.32	CSCAS-ESD	£137.86
Hard castor set for soft floors		CHCAS	£80.89	CHCAS-ESD	£140.55
Soft Stop&Go castor set for hard floors	In case the high chair needs to be moved around the workplace, Stop&Go castors will provide the safe solution. These castors will brake as soon as they are loaded, but when not loaded the chair is easy to move around	CSTOP	£161.65	CSTOP-ESD	£221.45
4D Armrests	Adjustment of height, width & depth with the possibility to swivel	ARE	£176.37	ARE-ESD	£265.33
Chrome Plated Foot Ring	Foot ring can also be fitted to our lower chair models by attaching it to the chair column. The height can easily be adjusted without the use of any tools	CRING	£120.62	CRING	£120.62

Workbenches & Drawer Cabinets

Cubio Storage Benches

- » Storage framework design allows easy cleaning beneath
- » Up to 800kg U.D.L. capacity

- » Full extension 75kg U.D.L. capacity drawers
- » Mobile models have 125mm castors & 300kg U.D.L. capacity



41002022.**V



41002025.**V

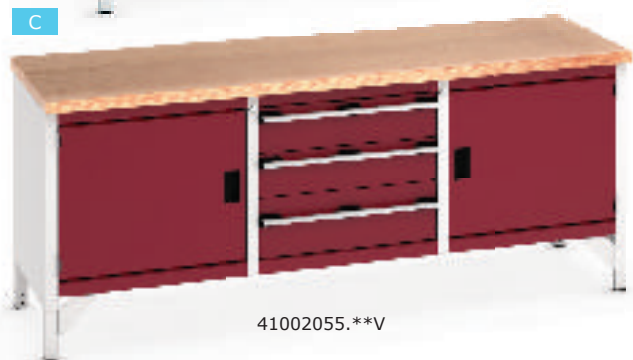

41002055.**V

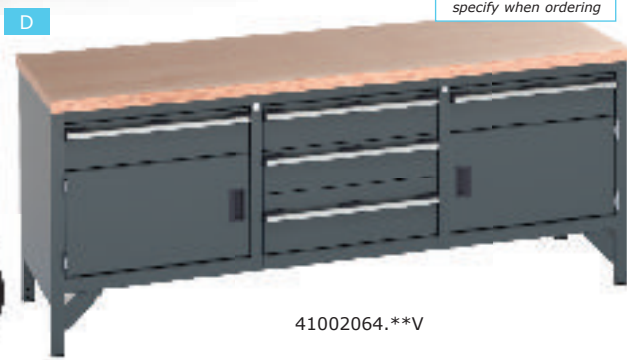

41002064.**V

PRICES HELD

LIGHT GREY HOUSING TOP, BOTTOM & FRONT COLOUR OPTIONS

- Dark Grey
- Blue
- Light Grey
- Crimson

specify when ordering

DARK GREY HOUSING TOP, BOTTOM & FRONT COLOUR

- Dark Grey

specify when ordering

Item	Configuration - Static Models	Overall Size W x D x H mm	Model	Price
A	2 x 500mm cupboards each with adjustable shelves	1500 x 750 x 840	41002022.**V	£1014.47
B	2 x 150mm, 1 x 200mm drawers, 1 x 500mm cupboard with adjustable shelf	1500 x 750 x 840	41002025.**V	£1137.05
C	2 x 150mm, 1 x 200mm drawers, 2 x 500mm cupboards each with adjustable shelf	2000 x 750 x 840	41002055.**V	£1471.68
D	4 x 150mm, 1 x 200mm drawers with 2 x 350mm cupboards	2000 x 750 x 840	41002064.**V	£1626.00



41002097.**V

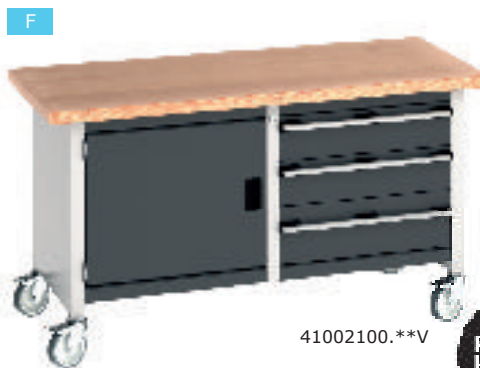

41002100.**V

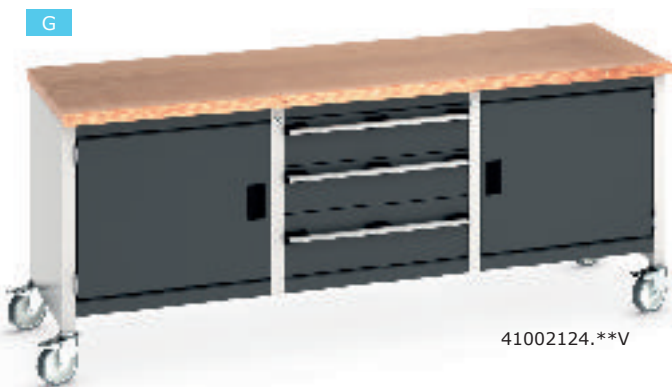

41002124.**V

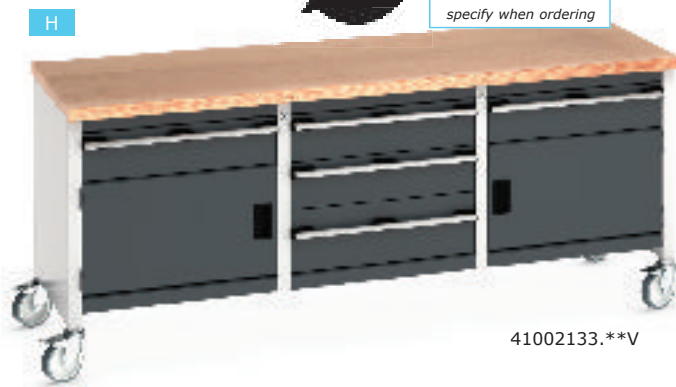

41002133.**V

PRICES HELD

LIGHT GREY HOUSING TOP, BOTTOM & FRONT COLOUR OPTIONS

- Dark Grey
- Blue
- Light Grey
- Crimson

specify when ordering

DARK GREY HOUSING TOP, BOTTOM & FRONT COLOUR

- Dark Grey

specify when ordering

Item	Configuration - Mobile Models	Overall Size W x D x H mm	Model	Price
E	2 x 500mm cupboards each with adjustable shelves	1500 x 750 x 840	41002097.**V	£1035.17
F	2 x 150mm, 1 x 200mm drawers, 1 x 500mm cupboard with adjustable shelf	1500 x 750 x 840	41002100.**V	£1174.70
G	2 x 150mm, 1 x 200mm drawers, 2 x 500mm cupboards each with adjustable shelf	2000 x 750 x 840	41002124.**V	£1564.55
H	4 x 150mm, 1 x 200mm drawers with 2 x 350mm cupboards	2000 x 750 x 840	41002133.**V	£1664.93

Workbenches & Drawer Cabinets

Framework Benches

- >> Heavy duty braced framework
- >> 40mm multiplex or lino worktops
- >> Maximum load capacity: 800kg UDL
- >> Multiplex worktop: resin bonded layered beech ply with a cross laminated construction. A tough general duty worktop suitable for most applications
- >> Lino worktop: chipboard core with 3mm industrial linoleum top surface & plastic edge banding. Resistant to oils & greases
- >> Suspended cabinets with 75kg UDL capacity drawers with 100% extensions



41003082.16v



41003397.11v



41003396.11v

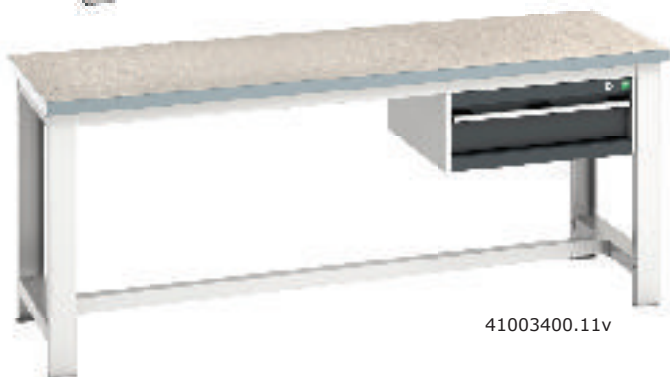

41003400.11v

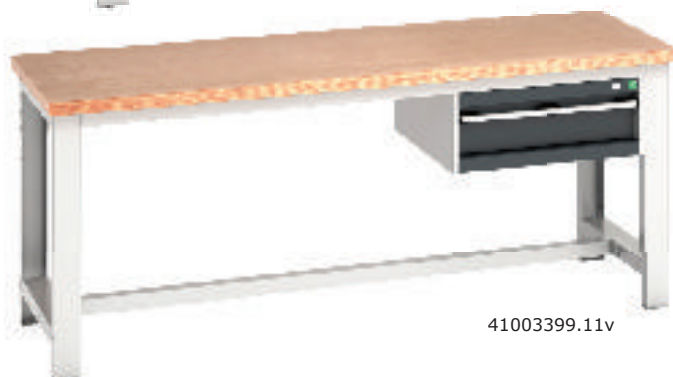

41003399.11v

Configuration	Overall Size L x D x H mm	Worktop Type	Model	Price
Frame Bench	1500 x 750 x 840	Multiplex	41003082.16v	£395.96
		Lino	41003084.16v	£444.36
	2000 x 750 x 840	Multiplex	41003178.16v	£486.17
		Lino	41003180.16v	£537.24

Configuration	Overall Size L x D x H mm	Worktop Type	Model	Price
Bench with 1 x 150mm Drawer	1500 x 750 x 840	Multiplex	41003396.11v	£777.98
		Lino	41003397.11v	£813.15
	2000 x 750 x 840	Multiplex	41003399.11v	£868.19
		Lino	41003400.11v	£979.38



Item	To Suit Bench (mm)	Description	Model	Price
A	1500	Overhead light, fixed shelf, perfo panel	41010183.16	£529.93
B	1500	Overhead light, adjustable shelf, perfo panels, louvre panel, power rail, 4 socket strip, monitor holder, swivel tray	41010187.16	£1438.38
C	2000	Overhead light, fixed shelf, perfo panel	41010193.16	£574.07
D	2000	Overhead light, fixed shelf, adjustable shelf, louvre panel, bin rail	41010195.16	£664.51

Workbenches & Drawer Cabinets

Euroslide Superbench



INFORMATION

Add your cabinet from the opposite page to complete your workbench

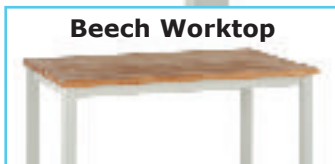

Beech Worktop

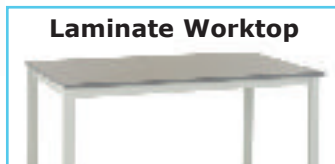

Laminate Worktop

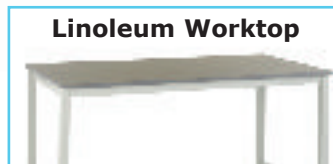

Linoleum Worktop



Steel Worktop

Overall Size H x W x D mm	Beech Top		Laminate Top		Linoleum Top		Steel Top	
	Model	Price	Model	Price	Model	Price	Model	Price
840 x 1200 x 750	BSE841275BLX	£478.84	BSE841275PLX	£502.41	BSE8412758LX	£502.41	BSE841275SLX	£480.99
840 x 1200 x 900	BSE841290BLX	£524.91	BSE841290PLX	£554.90	BSE8412908LX	£554.90	BSE841290SLX	£533.48
840 x 1500 x 750	BSE841575BLX	£609.54	BSE841575PLX	£614.89	BSE8415758LX	£614.89	BSE841575SLX	£595.61
840 x 1500 x 900	BSE841590BLX	£667.38	BSE841590PLX	£692.02	BSE8415908LX	£692.02	BSE841590SLX	£607.39
840 x 1800 x 750	BSE841875BLX	£669.52	BSE841875PLX	£693.09	BSE8418758LX	£693.09	BSE841875SLX	£639.53
840 x 1800 x 900	BSE841890BLX	£741.30	BSE841890PLX	£839.85	BSE8418908LX	£839.85	BSE841890SLX	£665.24

Euroslide Superbench - Drawer Cabinets

B

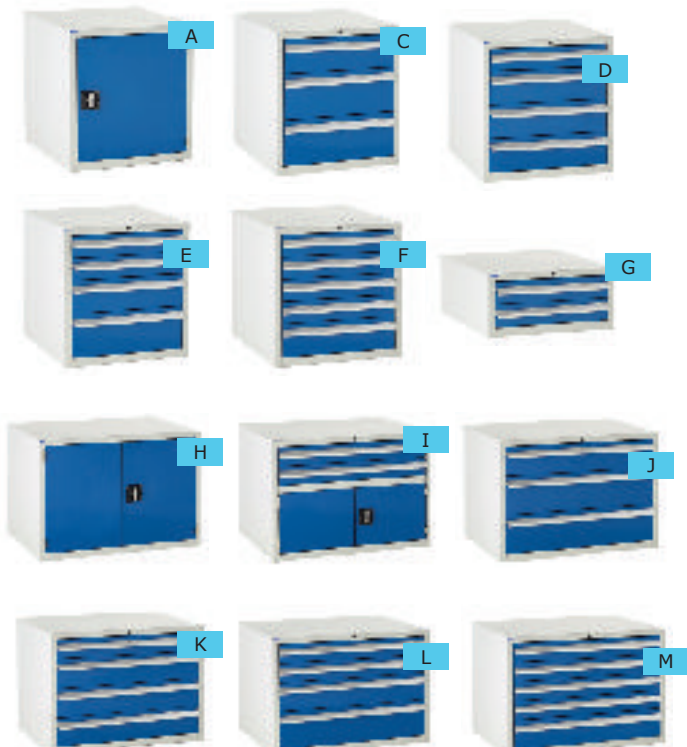

DOOR & DRAWER COLOUR OPTIONS

- Red
- Green
- Blue
- Dark Grey

specify when ordering

INFORMATION



Complete your workbench with these cabinets

Cabinet Size - 620H x 600W x 650D mm

Key	Description	Model	Price
A	Single Cupboard	EUC6760651	£183.18
B	2 x 100mm Drawers & Cupboard	EUC6760652	£421.00
C	1 x 150mm & 2 x 200mm Drawers	EUC6760653	£528.12
D	1 x 100mm & 3 x 150mm Drawers	EUC676065A	£612.75
E	2 x 100mm, 1 x 150mm & 1 x 200mm Drawers	EUC6760654	£613.82
F	4 x 100mm & 1 x 150mm Drawers	EUC676065C	£696.31
G	2 x 100mm Drawers (275mm High)	EUC276065DS	£335.30

Cabinet Size - 620H x 900W x 650D mm

Key	Description	Model	Price
H	Double Cupboard	EUC6790651	£252.81
I	2 x 100mm Drawers & Cupboard	EUC6790652	£465.99
J	1 x 150mm & 2 x 200mm Drawers	EUC6790653	£554.90
K	1 x 100mm & 3 x 150mm Drawers	EUC679065A	£639.53
L	2 x 100mm, 1 x 150mm & 1 x 200mm Drawers	EUC6790655	£640.60
M	4 x 100mm & 1 x 150mm Drawers	EUC679065C	£723.09

Above Bench Accessories

Key	Description	Model	Price
A	760mm Rear Support Posts	BESP760SXXXX	£101.90
A	1180mm Rear Support Posts	BESP1180XXXX	£123.63
B	Upper Shelf 300mm Laminate for 1200 Bench	BEUS1200PXXX	£142.66
B	Upper Shelf 300mm Laminate for 1500 Bench	BEUS1500PXXX	£169.83
B	Upper Shelf 300mm Laminate for 1800 Bench	BEUS1800PXXX	£202.43
B	Upper Shelf 300mm Beech for 1200 Bench	BEUS1200BXXX	£164.39
B	Upper Shelf 300mm Beech for 1500 Bench	BEUS1500BXXX	£199.72
B	Upper Shelf 300mm Beech for 1800 Bench	BEUS1800BXXX	£241.83
C	Light/Tool Rail Support for 1200mm Bench	BERS1200XLXX	£107.33
C	Light/Tool Rail Support for 1500mm Bench	BERS1500XLXX	£114.12
C	Light/Tool Rail Support for 1800mm Bench	BERS1800XLXX	£118.20
D	3 Setting LED Light - 1200mm	BE3SETL1200X	£82.88
E	Combi Panel for 1200mm Bench	BECP4812I3XX	£214.66
E	Combi Panel for 1500mm Bench	BECP4815I3XX	£229.61
E	Combi Panel for 1800mm Bench	BECP4818I3XX	£255.42
F	Worktop service duct for 1200mm Bench	BESDWT122XXX	£164.39
F	Worktop service duct for 1500mm Bench	BESDWT15XXX	£168.47
F	Worktop service duct for 1800mm Bench	BESDWT18XXX	£176.62
G	Post fitted service duct for 1200mm Bench	BESDSP12XXXX	£180.70
G	Post fitted service duct for 1500mm Bench	BESDSP15XXXX	£188.85
G	Post fitted service duct for 1800mm Bench	BESDSP18XXXX	£201.08

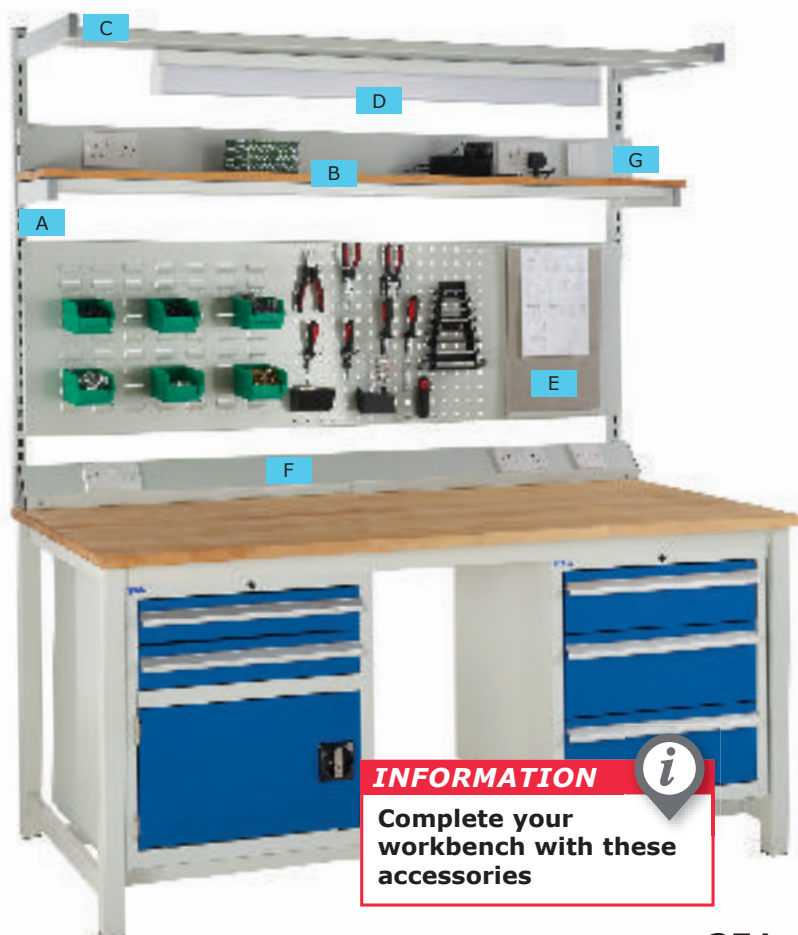

INFORMATION



Complete your workbench with these accessories

Workbenches & Drawer Cabinets

Euroslide Cabinets



Supplied with 1 Galvanised shelf as standard

Description	Model	Price
Overall Cabinet Size - 825H x 600W x 650D mm		
Single Cupboard	EUC18260651	£216.39



Supplied with 1 Galvanised shelf as standard

Description	Model	Price
Overall Cabinet Size - 825H x 600W x 650D mm Drawer Sizes: 2 x 100mm & 1 x 500mm Cupboard		
2 Drawers & Cupboard	EUC18260652	£454.21



Description	Model	Price
Overall Cabinet Size - 825H x 600W x 650D mm Drawer Sizes: 1 x 150mm & 3 x 200mm		
4 Drawers	EUC1826065A	£675.95



Description	Model	Price
Overall Cabinet Size - 825H x 600W x 650D mm Drawer Sizes: 5 x 150mm		
5 Drawers	EUC1826065C	£764.87



Description	Model	Price
Overall Cabinet Size - 825H x 600W x 650D mm Drawer Sizes: 2 x 100mm, 2 x 150mm & 1 x 200mm		
5 Drawers	EUC18260655	£750.94



Description	Model	Price
Overall Cabinet Size - 825H x 600W x 650D mm Drawer Sizes: 4 x 100mm, 1 x 150mm & 1 x 200mm		
6 Drawers	EUC1826065E	£845.21



Description	Model	Price
Overall Cabinet Size - 825H x 600W x 650D mm Drawer Sizes: 7 x 100mm		
7 Drawers	EUC1826065V	£918.05

DOOR & DRAWER COLOUR OPTIONS

- Red
- Green
- Blue
- Dark Grey

specify when ordering



INFORMATION

Ideal for storing all your tools

LOWER PRICES



Description	Worktop Thickness	Model	Price
Worktop Options			
Beech	27mm	ESBEETOP6065	£83.56
Laminate	20mm	ESLAMTOP6065	£138.19
Tool Tray	24mm (lip)	ESTLTTOP6065	£32.14

Euroslide Cabinets



Supplied with 1 Galvanised shelf as standard

Description	Model	Price
Overall Cabinet Size - 825H x 900W x 650D mm		
Double Cupboard	EUC18290651	£280.66



Supplied with 1 Galvanised shelf as standard

Description	Model	Price
Overall Cabinet Size - 825H x 900W x 650D mm Drawer Sizes: 2 x 100mm & 1 x 500mm Cupboard		
2 Drawers & Double Cupboard	EUC18290653	£505.63



Description	Model	Price
Overall Cabinet Size - 825H x 900W x 650D mm Drawer Sizes: 1 x 150mm & 3 x 200mm		
4 Drawers	EUC1829065A	£701.66



Description	Model	Price
Overall Cabinet Size - 825H x 900W x 650D mm Drawer Sizes: 5 x 150mm		
5 Drawers	EUC1829065C	£804.50



Description	Model	Price
Overall Cabinet Size - 825H x 900W x 650D mm Drawer Sizes: 2 x 100mm, 2 x 150mm & 1 x 200mm		
5 Drawers	EUC18290655	£786.29



Description	Model	Price
Overall Cabinet Size - 825H x 900W x 650D mm Drawer Sizes: 4 x 100mm, 1 x 150mm & 1 x 200mm		
6 Drawers	EUC1829065E	£883.77



Description	Model	Price
Overall Cabinet Size - 825H x 900W x 650D mm Drawer Sizes: 7 x 100mm		
7 Drawers	EUC1829065V	£961.97

DOOR & DRAWER COLOUR OPTIONS

- Red
- Green
- Blue
- Dark Grey

specify when ordering



INFORMATION

Ideal for storing all your tools



Description	Worktop Thickness	Model	Price
Worktop Options			
Beech	27mm	ESBEETOP9065	£125.34
Laminate	20mm	ESLAMTOP9065	£161.76
Tool Tray	24mm (lip)	ESTLTTOP9065	£46.06

Workbenches & Drawer Cabinets

System Tek Workbenches



DOOR & DRAWER COLOUR OPTIONS

- Red
- Green
- Blue
- Dark Grey

specify when ordering

1 - Choose your Cabinet

Key	Description	Model	Price
A	Single Cupboard	EUC18260651	£216.39
B	2 x 100mm Drawers & Cupboard	EUC18260652	£454.21
C	1 x 150mm & 3 x 200mm Drawers	EUC1826065A	£675.95
D	5 x 150mm Drawers	EUC1826065C	£764.87
E	2 x 100mm, 2 x 150mm & 1 x 200mm Drawers	EUC18260655	£750.94
F	4 x 100mm, 1 x 150mm & 1 x 200mm Drawers	EUC1826065E	£845.21
G	7 x 100mm Drawers	EUC1826065V	£918.05

2 - Choose your Worktop

Description	Size H x W x D mm	Model	Price
Beech Top	27 x 1500 x 650	ESBEETOP1565	£201.39
Laminate Top	19 x 1500 x 650	ESLAMTOP1565	£224.96
Beech Top	27 x 1880 x 650	ESBEETOP1865	£241.03
Laminate Top	19 x 1880 x 650	ESLAMTOP1865	£226.03
Support Leg & Modesty Panel (required)		E2LEGMOD6560	£94.27



3 - Choose your Accessories

Description	Model	Price
760mm Rear Support Posts	BESP760SXXXX	£101.90
1180mm Rear Support Posts	BESP1180XXXX	£123.63
Upper Shelf 300mm Laminate for 1500 Bench	BEUS1500PXXX	£169.83
Upper Shelf 300mm Laminate for 1800 Bench	BEUS1800PXXX	£202.43
Upper Shelf 300mm Beech for 1500 Bench	BEUS1500BXXX	£199.72
Upper Shelf 300mm Beech for 1800 Bench	BEUS1800BXXX	£241.83
Light/Tool Rail Support for 1500mm Bench	BERS1500XLXX	£114.12
Light/Tool Rail Support for 1800mm Bench	BERS1800XLXX	£118.20
3 Setting LED Light - 1200mm	BE3SETL1200X	£82.88
Louvred/Perforated Back Panel - 1500mm	BECP4815IXXX	£214.66
Louvred/Perforated Back Panel - 1800mm	BECP4818IXXX	£239.12
Louvred/Pin Back Panel - 1500mm	BELO4815IXXX	£205.15
Louvred/Pin Back Panel - 1800mm	BELO4818IXXX	£239.12
Combi Panel for 1500mm Bench	BECP4815I3XX	£229.61
Combi Panel for 1800mm Bench	BECP4818I3XX	£255.42
Worktop Service Duct 1500mm Bench	BESDWT15XXXX	£168.47
Post Fitted Service Duct 1500mm Bench	BESDSP15XXXX	£188.85

Mobile Euroslide Cabinets



Mobile Cabinet Size - 980H x 600W x 650D mm

Key	Description	Model	Price
A	Cupboard	EUC9860651M	£382.43
B	2 x 100mm Drawers & Cupboard	EUC9860652M	£620.25
C	2 x 100mm, 2 x 150mm & 1 x 200mm Drawers	EUC9860655M	£893.41
D	4 x 100mm, 1 x 150mm & 1 x 200mm Drawers	EUC986065EM	£988.75
E	1 x 150mm & 3 x 200mm Drawers	EUC986065AM	£819.50
F	5 x 150mm Drawers	EUC986065CM	£907.34
G	7 x 100mm Drawers	EUC986065VM	£1061.60

DOOR & DRAWER COLOUR OPTIONS

- Red
 - Green
 - Blue
 - Dark Grey
- specify when ordering*

LOWER PRICES



Description	Size H x W x D mm	Model	Price
Beech Top	27 x 600 x 650	ESBEETOP6065	£83.56
Laminate Top	20 x 600 x 650	ESLAMTOP6065	£138.19
Tool Tray	24 x 600 x 650	ESTLTTOP6065	£32.14

Workbenches & Drawer Cabinets

Euroslide Modular Workshop Kits



NEW



DOOR & DRAWER COLOUR OPTIONS

- Red
 - Green
 - Blue
 - Dark Grey
- specify when ordering*



- » Includes;
- 1 x 600mm width 2 drawer & cupboard,
 - 1 x 600mm width storage cupboard,
 - 1 x 600mm width 5 drawer unit,
 - 1 x 1800mm width service duct,
 - 3 x 600mm width perforated back panels,
 - 3 x 600mm width overhead storage cupboards
- Mix pack of 84 clips (for perforated back panels)

- » Includes;
- 1 x 1200mm width, 2M tall storage cupboard,
 - 1 x 600mm width disposal unit cupboard,
 - 1 x 600mm width 7 drawer unit,
 - 1 x 1200mm width service duct,
 - 2 x 600mm width perforated back panels,
 - 2 x 600mm width overhead storage cupboards
- Mix pack of 84 clips (for perforated back panels)

Description	Overall Size H x W x D mm	Worktop Type	Model	Price
Kit 1	2000 x 1800 x 650	Beech	EUCMODKTBS1	£3123.10
		Laminate	EUCMODKTPS1	£3108.10

Description	Overall Size H x W x D mm	Worktop Type	Model	Price
Kit 2	2000 x 2400 x 650	Beech	EUCMODKTBS2	£3099.19
		Laminate	EUCMODKTPS2	£3140.97



NEW



DOOR & DRAWER COLOUR OPTIONS

- Red
 - Green
 - Blue
 - Dark Grey
- specify when ordering*



- » Includes;
- 1 x 1200mm width, 2M tall storage cupboard,
 - 1 x 900mm width 5 drawer unit,
 - 1 x 900mm width service duct,
 - 1 x 900mm width perforated back panels,
 - 1 x 900mm width overhead storage cupboards
- Mix pack of 84 clips (for perforated back panels)

- » Includes;
- 1 x 600mm width, 2M tall storage cupboard,
 - 1 x 600mm width storage cupboard,
 - 1 x 600mm width 2 drawer & cupboard,
 - 1 x 600mm width 5 drawer unit,
 - 1 x 1800mm width service duct,
 - 3 x 600mm width perforated back panels,
 - 3 x 600mm width overhead storage cupboards
- Mix pack of 84 clips (for perforated back panels)

Description	Overall Size H x W x D mm	Worktop Type	Model	Price
Kit 3	2000 x 2100 x 650	Beech	EUCMODKTBS3	£2235.88
		Laminate	EUCMODKTPS3	£2272.31

Description	Overall Size H x W x D mm	Worktop Type	Model	Price
Kit 4	2000 x 2400 x 650	Beech	EUCMODKTBP4	£3701.13
		Laminate	EUCMODKTTP4	£3686.13

Euroslide Modular Workshop Kits



NEW



DOOR & DRAWER COLOUR OPTIONS

- Red
 - Green
 - Blue
 - Dark Grey
- specify when ordering*



- » Includes;
- 1 x 1200mm width, 2M tall storage cupboard,
 - 1 x 600mm width, 2M tall storage cupboard,
 - 1 x 600mm width 2 drawer & cupboard,
 - 1 x 900mm width 6 drawer unit,
 - 1 x 1500mm width service duct,
 - 1 x 600mm & 1 x 900mm width perforated back panels,
 - 1 x 600mm & 1 x 900mm width overhead storage cupboards
- Mix pack of 84 clips (for perforated back panels)

- » Includes;
- 2 x 1200mm width, 2M tall storage cupboard,
 - 1 x 600mm width storage cupboard,
 - 1 x 600mm width 2 drawer & cupboard,
 - 1 x 600mm width 5 drawer unit,
 - 1 x 1800mm width service duct,
 - 3 x 600mm width perforated back panels,
 - 3 x 600mm width overhead storage cupboards
- Mix pack of 84 clips (for perforated back panels)

Description	Overall Size H x W x D mm	Worktop Type	Model	Price
Kit 5	2000 x 3300 x 650	Beech	EUCMODKTBP5	£3788.60
		Laminate	EUCMODKTPP5	£3812.16

Description	Overall Size H x W x D mm	Worktop Type	Model	Price
Kit 6	2000 x 4200 x 650	Beech	EUCMODKTBP6	£4544.59
		Laminate	EUCMODKTPP6	£4529.59

Euroslide Modular Workshop Kits - Corner Units

- » Includes;
- 1 x 600mm width 2 drawer & cupboard,
 - 1 x 600mm width 4 drawer unit,
 - 1 x 600mm width 7 drawer unit,
 - 2 x service ducts with corner piece,
 - Perforated back panels,
 - 2 x 900mm width overhead storage cupboards,
 - 2 x 600mm width overhead storage cupboards
- Mix pack of 84 clips (for perforated back panels)



Description	Overall Size H x D mm	Worktop Type	Model	Price
Corner Kit 1	2000 x 650	Laminate	EUCMODSCR1	£5593.20

DOOR & DRAWER COLOUR OPTIONS

- Red
 - Green
 - Blue
 - Dark Grey
- specify when ordering*

NEW



- » Includes;
- 1 x 1200mm width, 2M tall storage cupboard,
 - 1 x 600mm width, 2M tall storage cupboard,
 - 1 x 600mm width 6 drawer unit,
 - 1 x 600mm width 2 drawer & cupboard,
 - 1 x 600mm width 5 drawer unit,
 - 1 x 600mm width 7 drawer unit,
 - 1 x 600mm width disposal unit cupboard,
 - Service ducts with corner piece,
 - Perforated back panels,
 - Overhead storage cupboards,
- Mix pack of 84 clips (for perforated back panels)



Description	Overall Size H x D mm	Worktop Type	Model	Price
Corner Kit 2	2000 x 650	Laminate	EUCMODSCPP2	£9345.72

Workbenches & Drawer Cabinets



Team Leader Workstations

A range of robustly constructed workstations designed for Team Leaders, Supervisors or Line Managers. Fully-welded steel framework ideal for tough environments. The compact design recognises the pressure on factory workspace but still allows the team leader to have a workstation with everything they need. Colour coordinated range of tops for area segregation are available.



TLS1010469LX

Description	Overall Size H x W x D mm	Workstation with Flat Top		Workstation with Sloping Top	
		Model	Price	Model	Price
Workstation Only	920 x 1000 x 460	TLF9210461LX	£324.46	TLS1010461LX	£324.46
	920 x 1000 x 600	TLF9210601LX	£342.96	TLS1010601LX	£342.96
Workstation with Single Drawer	920 x 1000 x 460	TLF9210462LX	£542.19	TLS1010462LX	£542.19
	920 x 1000 x 600	TLF9210602LX	£560.69	TLS1010602LX	£560.69
Workstation with 2 x Single Drawers	920 x 1000 x 460	TLF9210463LX	£759.92	TLS1010463LX	£759.92
	920 x 1000 x 600	TLF9210603LX	£778.42	TLS1010603LX	£778.42
Workstation with Cupboard	920 x 1000 x 460	TLF9210464LX	£519.42	TLS1010464LX	£519.42
	920 x 1000 x 600	TLF9210604LX	£572.07	TLS1010604LX	£572.07
Workstation with Single Drawer & Cupboard	920 x 1000 x 460	TLF9210465LX	£737.15	TLS1010465LX	£737.15
	920 x 1000 x 600	TLF9210605LX	£755.65	TLS1010605LX	£755.65
Workstation with Triple Drawer	920 x 1000 x 460	TLF9210466LX	£738.57	TLS1010466LX	£738.57
	920 x 1000 x 600	TLF9210606LX	£755.65	TLS1010606LX	£755.65
Workstation with Triple Drawer & Single Drawer	920 x 1000 x 460	TLF9210467LX	£956.30	TLS1010467LX	£956.30
	920 x 1000 x 600	TLF9210607LX	£974.80	TLS1010607LX	£974.80
Workstation with Double Cupboard	920 x 1000 x 460	TLF9210468LX	£653.19	TLS1010468LX	£653.19
	920 x 1000 x 600	TLF9210608LX	£670.27	TLS1010608LX	£670.27
Workstation with Triple Drawer & Cupboard	920 x 1000 x 460	TLF9210469LX	£933.53	TLS1010469LX	£933.53
	920 x 1000 x 600	TLF9210609LX	£952.03	TLS1010609LX	£952.03

Team Leader Workstations

- » Designed for team leaders, supervisors or line managers - ideal for standing at to improve health & fitness, but can be used in conjunction with an industrial stool or chair
- » Fully welded steel frame
- » Drawer sets come complete with central locking & have a load capacity of 50kg per drawer. Each drawer set can be fitted either on the left or right of the bench. Cupboard sets can only be positioned on the right hand side
- » Sloping top units add 140mm to the overall height
- » Red, blue & dark grey sloping tops available and red & black drawer & cupboard fronts available - call for details



TLS1010469LX



TLF9210461LX



TLS1010461LX



TLF9210462LX



TLF9210463LX



TLF9210464LX



TLS1010465LX



TLF9210466LX



TLF9210467LX



TLS1010468LX

Tool Storage & Trolleys



'ProPlaz® Handy' Tool Trolley

- » Hardwearing black plastic shelves with aluminium uprights
- » Complete with optional shelf dividers to keep your tools tidy
- » Ideal for use in warehouses, workshops, garages etc
- » Lightweight & easy to clean
- » Mobile on 4 x 100mm swivel castors, 2 with brakes



ProPlaz®
Handy



Complete with optional shelf dividers to easily keep your tools & fixings tidy & organised

LOWER PRICE

HI663Y

Overall Size H x W x D mm	Weight kg	Model	Price
1310 x 550 x 460	8	HI663Y	£128.75

Reversible Tray/Shelf Trolleys

- » Reversible shelves - either a smooth shelf or a tray with surrounding lip
- » The height of the centre shelf on the 3 shelf model is adjustable
- » Mobile on 2 fixed, 2 swivel braked 100mm polyurethane red castors



TI246Y



TI357Y

LOWER PRICES

Description	Overall Size L x W x H mm	Weight kg	Model	Price
2 Shelf	670 x 400 x 910	17	TI246Y	£207.05
	820 x 500 x 910	20	TI257Y	£236.60
3 Shelf	670 x 400 x 910	20	TI346Y	£233.80
	820 x 500 x 910	23.5	TI357Y	£289.90

Tray Trolleys



WI203Y

FROM ONLY
£208.25



PRICES HELD



WI202Y



- » 85mm deep sides on the shelves
- » Easy to manoeuvre with a push/pull handle & 2 swivel 125mm rubber castors

No of Shelves	Overall Size L x W x H mm	Shelf Heights mm	Weight kg	Model	Price
2	1015 x 635 x 805	150, 720	25	WI202Y	£208.25
3	1015 x 635 x 805	150, 435, 720	32.5	WI203Y	£254.70

260

Plastic Multi Purpose Trolleys

- » Super strong polyethylene moulded trolleys
- » Easy to clean, versatile - will not rust, dent or chip
- » Ideal for use in workshops, storerooms, warehouses, chemical & pharmaceutical industries
- » Manufactured from a non conductive polyethylene which will not pass an electrical current & is unaffected by battery acid, solvents & cleaning solutions
- » Mobile on 4 x 100mm non marking rubber swivel castors, 2 with brakes

ProPlaz
SUPER STRENGTH



FROM ONLY
£162.30



GI335L



GI334L



GI341L



Description	Overall Size L x W x H mm	Size Between Shelves Top / Bottom mm	Weight kg	Model	Price
3 Shelf (3 flat shelves)	610 x 458 x 840	305 / 305	11	GI341L	£162.30
2 Shelf Trolley	890 x 610 x 880	650	16	GI334L	£250.40
3 Shelf Trolley	890 x 610 x 865	292 / 292	22	GI335L	£307.85

'ProPlaz' Shelf Trolleys



FROM ONLY
£233.85

HI291Y



HI292Y



HI393Y with the cupboard closed

ProPlaz



- » High quality hardwearing black plastic shelves with grey aluminium uprights
- » Ideal for most environments including warehouses, garages, workshops, laboratories etc
- » Lightweight & easy to clean
- » Mobile on 4 x 100mm swivel castors (2 with brakes)
- » Incorporates smooth running grey drawers & model HI393Y also has a black plastic cupboard

Description	Overall Size L x W x H mm	Size between Shelves Top / Bottom mm	Load Capacity kg	Weight kg	Model	Price
2 Shelf Trolley with a Lockable Steel Drawer	750 x 460 x 940	560	150	16	HI291Y	£233.85
2 Shelf Trolley with 2 x Steel Drawers				20	HI292Y	£303.90
3 Shelf Trolley with a Lockable Steel Drawer & Cupboard	750 x 460 x 980	280	150	24	HI393Y	£334.15

Tool Storage & Trolleys

Mobile Work Benches



WTS20Y



WTP12Y



WTS30Y



WTP42Y

- >> Strong welded construction, constructed from 40mm steel square section
- >> Worktops have a steel retaining rear lip
- >> Mobile, on 2 fixed, 2 swivel braked 100mm nylon castors
- >> Tubular steel push handle to aid manoeuvrability
- >> Bottom shelf comes complete with a 40mm surround to 3 sides & a 40mm drop edge to the front

Description	Overall Size W x D x H	2mm Steel Work Top			18mm Plywood Work Top		
		Weight	Model	Price	Weight	Model	Price
Mobile Work Bench	1130 x 670 x 1000 mm	39 kg	WTS10Y	£791.80	49 kg	WTP12Y	£887.00
Mobile Work Bench with Single Drawer		50 kg	WTS20Y	£947.30	60 kg	WTP22Y	£1117.65
Mobile Work Bench with Cupboard		55 kg	WTS30Y	£935.20	65 kg	WTP32Y	£1109.55
Mobile Work Bench with Single Drawer & Cupboard		66 kg	WTS40Y	£1169.55	76 kg	WTP42Y	£1342.60

System Flow Trolleys



System Flow Trolley

- COLOUR OPTIONS**
- Red
 - Green
 - Blue
 - Dark Grey
 - Light Grey
- specify when ordering*

Perforated Panel

Louvre Panel

Shelf



1 - Choose your Trolley

Description	Overall Size H x W mm	Model	Price
Static	1520 x 680	RTSYF1668U*X	£295.66
Static	1520 x 1000	RTSYF1610U*X	£347.08
Mobile	1650 x 680	RTSYF1668M*X	£347.08
Mobile	1650 x 1000	RTSYF1610M*X	£398.50

2 - Choose your Accessories

Description	Size H x W x D mm	Model	Price
Perforated Panel	910 x 630 x 60	RTPERF12*XX	£72.84
Perforated Panel	910 x 930 x 60	RTPERF16*XX	£78.20
Louvred Panel	910 x 630 x 60	RTLQVR12*XX	£76.06
Louvred Panel	910 x 930 x 60	RTLQVR16*XX	£82.49
Shelf	20 x 600 x 350	RTSHLU80LXX	£35.35
Shelf	20 x 900 x 350	RTSHLU10LXX	£42.85

Tool Storage & Trolleys

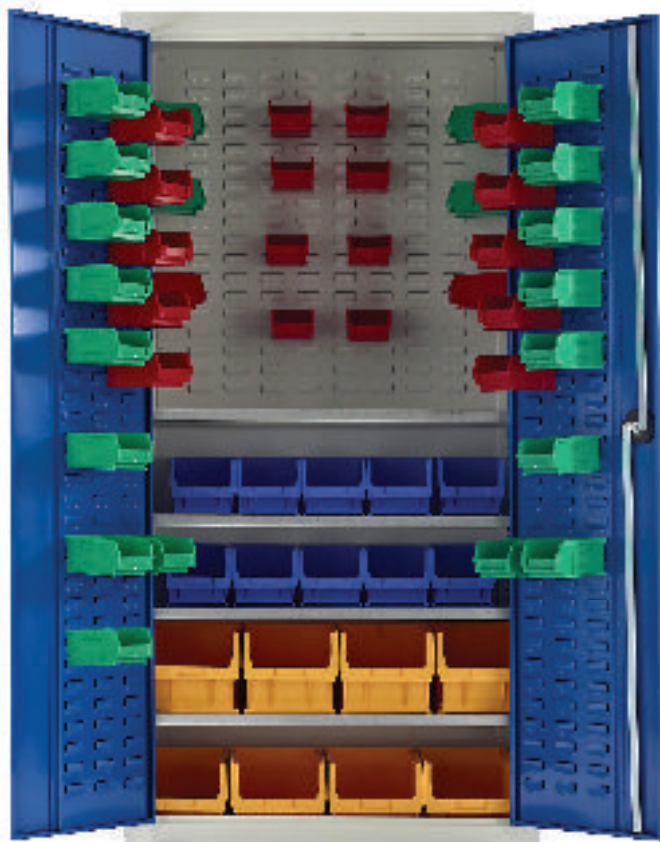

CYD189046461

Container Storage Cupboards

- » These storage container cupboards can be used for a multitude of storage options
- » Louvre panels on the doors & carcass enables you to conveniently store containers close to hand
- » A weld & rivet construction provides all-round robustness, with reinforced doors & "No Snag" handles with 2-point locking
- » 50kg UDL capacity galvanised shelves
- » Overall size: 1800H x 900W x 460D mm
- » More containers available - *call for details*



CYD189046BBX



CYD189046457



CYD189046151

Description	Container Sizes L x W x H mm	Model	Price
Cupboard			
Cupboard with 4 Shelves & 59 Containers (10 x Size 3, 8 x Size 5 & 41 Size 2)	Size 2 - 165 x 100 x 75 Size 3 - 240 x 150 x 132 Size 4 - 350 x 205 x 132	CYD189046BBX	£845.01
Cupboard with 4 Shelves & 57 Containers (16 x Size 4 & 41 x Size 2)	Size 5 - 350 x 205 x 182 Size 6 - 375 x 420 x 182	CYD189046457	£1245.87
Cupboard with 1 Shelf & 51 Containers (10 x Size 6 & 41 x Size 2)		CYD189046151	£1217.94

Multi-Storage Cupboards

- » The welded construction offers high strength & durability
- » 1825H x 940W x 710D mm gives a very large storage capacity
- » The cupboards are available with a combination of accessories including drawer, shelves & perforated/louvre rear panels
- » Either with solid doors or vision doors which allow you to inspect the contents of cupboards
- » Each cupboard comes with adjustable feet for levelling
- » Drawers have a heavy duty slide system giving 100% extension & a capacity of 100kg UDL
- » Reaction to Fire Classification EN 13501-1



DOOR COLOUR OPTIONS

- Red
- Dark Grey
- Blue
- Green

specify when ordering

Description	Model	Price
Solid Door Cupboard	C6MSS181065X	£1069.88
Vision Door Cupboard	C6MSV181065X	£1324.09
Accessories		
100mm Deep Drawer	C6MSDRW100DX	£153.64
150mm Deep Drawer	C6MSDRW150DX	£169.00
200mm Deep Drawer	C6MSDRW200DX	£191.35
Tool Panel (tools not included)	C6MSTOOLPANX	£60.06
Square Louvre Panel	C6MSLOUVREPX	£60.06
Square Perforated Panel	C6MSDUALPANX	£60.06
Noticeboard Panel	C6MSNOTICEBX	£50.28
Shelf	C6MSSHELFXXX	£47.49

C6MSV181065X, C6MSDRW100DX,
4 x C6MSDRW200DX, C6MSSHELFXXX,
C6MSTOOLPANX & C6MSLOUVREPX
(Tools/Containers not included)

Cubio Modular Workshops

- » Cabinets and cupboards with 1 tonne overall capacity
- » 100% extension with safety drawer blocking as standard
- » Fully lockable
- » Incorporates heavy duty worktop & rear perfo tool storage



45010003.**V

Item	Overall Size W x D x H mm	Overall Depth inc. backstraps mm	Model	Price
A	3550 x 525 x 2000	565	45010003.**V	£6419.22

LIGHT GREY HOUSING TOP, BOTTOM & FRONT COLOUR OPTIONS

- Dark Grey
- Blue
- Light Grey
- Crimson

specify when ordering

DARK GREY HOUSING TOP, BOTTOM & FRONT COLOUR

- Dark Grey

specify when ordering



B

45010001.**V



C

45010002.**V



Item	Overall Size W x D x H mm	Overall Depth inc. backstraps mm	Model	Price
B	2100 x 525 x 2000	565	45010001.**V	£3882.18
C	2400 x 525 x 2000	565	45010002.**V	£4555.37

Tool Storage & Trolleys

Cubio Mini Workshop

- » Lockable steel doors with perfo liner panels
- » Galvanised steel shelves with 75kg U.D.L. capacity
- » Roller bearing drawers with 75kg U.D.L. capacity & 100% extension
- » Internal panel options in perfo & louvre styles
- » 25mm multiplex shelf / worktop makes an enclosed mini workshop



40021162.**V



40021160.**V

PRICES HELD

Overall Size H x W x D mm	Back Panels	Drawer Sizes mm	No of Worktops	No of Shelves	Model	Price
2000 x 1050 x 650	Perfo / Louvre	2 x 125	1	1	40021162.**V	£1267.71
2000 x 1300 x 650	Perfo / Louvre	2 x 125	1	1	40022091.**V	£1474.76
2000 x 1050 x 650	Perfo / Louvre	4 x 125	1	1	40021160.**V	£1464.25
2000 x 1300 x 650	Perfo / Louvre	4 x 125	1	1	40022092.**V	£1765.80



40021204.**V



PRICES HELD

LIGHT GREY HOUSING TOP, BOTTOM & FRONT COLOUR OPTIONS

- Dark Grey
- Blue
- Light Grey
- Crimson

specify when ordering

DARK GREY HOUSING TOP, BOTTOM & FRONT COLOUR

- Dark Grey

specify when ordering

Overall Size H x W x D mm	Back Panels	Drawer Sizes mm	No of Worktops	No of Shelves	Model	Price
2000 x 1050 x 650	Perfo / Louvre	9 x 125	1	-	40021204.**V	£1905.32
2000 x 1300 x 650	Perfo / Louvre	9 x 125	1	-	40022093.**V	£2422.91

Perfo Panels

- » Manufactured to withstand the most rigorous conditions, giving a long service life
- » The fully flanged metal panels are reinforced with channel backstrips & fixing points
- » All hooks lock into the panel with the perfo locking clip, positioned quickly but securely

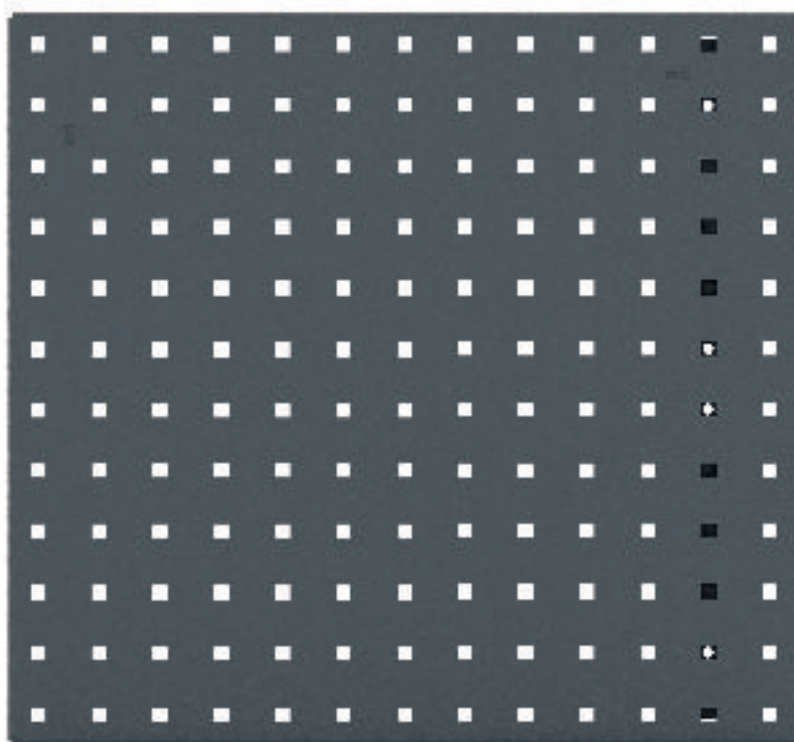

Overall Size W x H mm	Model	Price
495 x 457	14025115.19	£26.94
525 x 457	14025391.19	£32.47
620 x 457	14025392.19	£34.67
750 x 457	14025393.19	£36.42
800 x 457	14025394.19	£36.47
990 x 457	14025117.19	£39.01
1050 x 457	14025395.19	£50.75
1300 x 457	14025396.19	£56.86
1486 x 457	14025118.19	£57.02

Hook Kits

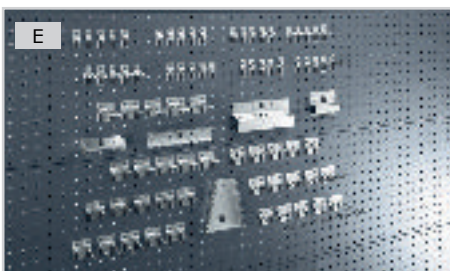

Item	Amount of Hooks	Usage/approx Panel Area M2	Model	Price
A	11	Doors-	14030064	£21.81
B	15	0.25	14031427	£18.69
C	30	1.50	14031413	£39.33
D	40	1.75	14031414	£86.04
E	80	4	14031416	£156.53

Lift-up Wall Cupboard

- » Sturdy lockable wall cabinets with lift up door for secure storage
- » Fully welded construction with perfo or louvre backpanels
- » The double skinned doors provide extra storage area & are secured by 2-point locking
- » Hooks & accessories not included



Backpanel Type	Overall Size W x D x H mm	Model	Price
Perfo	800 x 325 x 700	40031088.19V	£437.60
Perfo	1050 x 325 x 700	40031085.19V	£525.05

Drum, Cylinder & Spill Control

Drum Dolly

- » Design allows loading by overhead lifting
- » Suitable for moving standard 210L drums
- » Fitted with 4 x 75mm rubber swivel castors



DID16Y

PRICE HELD



Overall Size Dia. mm	Weight kg	Model	Price
616	7.5	DID16Y	£119.10

Drum Stands for 210 Litre Drums



FROM ONLY
£194.05

DH440Z

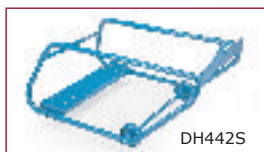

DH442S

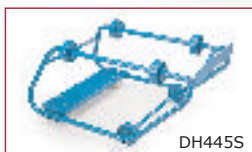

DH445S



DH443Z & DH439Z

- » Fully welded tubular steel construction for strength & durability
- » Model DH443Z: with nylon top rollers to allow drainage from the side bung
- » Models DH442S & DH445S: mobile on 2 x 100mm fixed wheels & 2 x 75mm swivel castors
- » Model DH445S: as per DH442S but with nylon top rollers to allow drainage from the side bung

Description	Overall Size L x W x H mm	Height Under Side of Drum mm	Roller Dia. mm	Weight kg	Model	Price
Static	865 x 595 x 350	280	-	5.4	DH440Z	£194.05
Mobile	865 x 595 x 385	315	-	14	DH442S	£376.15
Static	865 x 595 x 350	290	75mm	7.2	DH443Z	£285.90
Mobile	865 x 595 x 385	325	75mm	15.4	DH445S	£469.55
Drum Handle Lever - Designed for use with the above stands					DH439Z	£116.95

Drum Dolly

- » Design allows loading by overhead lifting
- » Quick & easy assembly
- » DID09Y handle height: 750mm. Suitable for moving standard 210 litre drums
- » Fitted with 4 x 75mm polyethylene swivel castors.

ONLY
£122.75



PRICE HELD

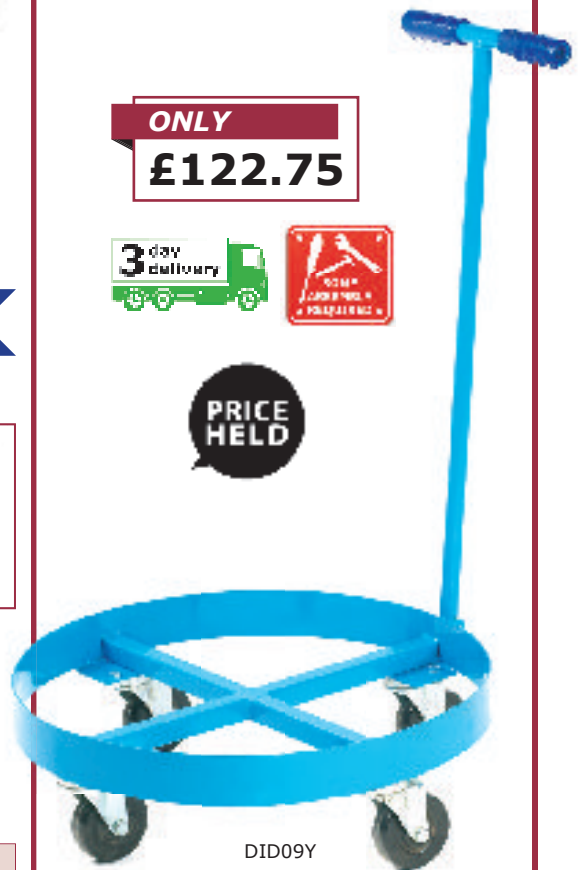

DID09Y

Overall Size L x W mm	Weight kg	Model	Price
615 x 615	10	DID09Y	£122.75

Drum, Cylinder & Spill Control

Drum Transporter



400kg
evenly distributed

7 day delivery

DH140Y
£277.95

LOWER PRICE

- » U shaped handle which incorporates knuckle guard hand grips
- » Drum is held in position by an adjustable hook
- » Designed to carry 210 Litre steel drums
- » Mobile on 2 x 250mm solid rubber wheels & features a third supporting 125mm braked solid rubber castor

Overall Size L x W x H mm	Weight kg	Model	Price
1550 x 680 x 880	21	DH140Y	£277.95

Drum Handler



DH145Y
£317.55

450kg
evenly distributed

7 day delivery

LOWER PRICE

- » U shaped handle
- » Eagle grip ensures drum stays in place when being transported, the mechanism can also easily be adjusted for varying drum heights
- » Suitable for use with 210L steel drums
- » Mobile on 2 x 400mm pneumatic wheels, perfect for traversing rough ground

Overall Size L x W x H mm	Weight kg	Model	Price
1600 x 800 x 880	30	DH145Y	£317.55

Mobile Drum Truck



7 day delivery

DT350Y
£359.35

350kg
evenly distributed

LOWER PRICE

- » Looped ergonomic handle
- » Large toe prongs to allow drum off loading onto a pallet and loading from a pallet
- » Cradle design allows the unit to be used in a horizontal manner for dispensing drum contents
- » 45° design allows the unit to take the full weight of the drum whilst transporting
- » Suitable for use with a 210L steel & certain plastic drums
- » Mobile on 4 x 200mm nylon wheels

Overall Size in Mobile Position - L x W x H mm	Weight kg	Model	Price
1300 x 565 x 950	21	DT350Y	£359.35

Mobile Drum Cradle



270kg
evenly distributed

7 day delivery

DC270Y
£232.35

LOWER PRICE

- » Cradle system, allows the drum to be loaded in a horizontal position
- » Loading handles allow for easy tipping & drainage
- » Suitable for use with 210L steel & certain plastic drums
- » Mobile on 2 x 125mm wheels & 2 x 100mm white nylon castors

Overall Size L x W x H mm	Weight kg	Model	Price
1200 x 400 x 451	17	DC270Y	£232.35

Drum, Cylinder & Spill Control



DL388Y

Hydraulic Drum Lifter

- » Designed to allow you to pick up & transport full or empty 210 litre steel & plastic drums
- » Hydraulic pump smoothly lifts the drum, held firm by the top rim clamp
- » The retractable clamp holds the drum securely & releases automatically
- » Mobile on 2 x 180mm polyurethane wheels & a rear 125mm swivel polyurethane castor

DL388Y
£507.95



DL388Y



Overall Size L x W x H mm	Maximum Lift Height mm	Weight kg	Model	Price
820 x 800 x 1050	250	43	DL388Y	£507.95

Drum Tilter

- » Designed to allow you to pick up, transport & rotate full or empty 210L steel drums
- » The saddle secures the drum
- » Mobile on 2 x 180mm polyurethane wheels & a rear 75mm swivel castor



Drum locking mechanism



DT300P
£617.50



DT300P

INFORMATION

Ideal for low level pouring



DT300P

Overall Size L x W x H mm	Weight kg	Model	Price
921 x 870 x 1676	50	DT300P	£617.50

Drum Handler

- » Designed to carry full or empty 210 litre steel drums
- » This unit smoothly lifts the drum (in 20mm increments) which is held firm by the clamp
- » Mobile on 2 fixed 130mm polyurethane wheels & 2 swivel 120mm polyurethane castors
- » Lifting height: 250mm



Drum locking mechanism



DL250Y
£863.50

PRICE HELD

INFORMATION

Ideal for moving drums from euro & UK pallets

Overall Size L x W x H mm	Weight kg	Model	Price
812 x 1219 x 1200	50	DL250Y	£863.50

DL250Y

Drum Lifter

- » Designed to carry full or empty 210 litre steel drums
- » Foot operated hydraulic pump
- » Lifts a drum up to 740mm off the ground
- » This unit smoothly lifts the drum which is held firm by the clamp
- » Mobile on 2 fixed & 2 swivel 125mm nylon castors (1 braked)

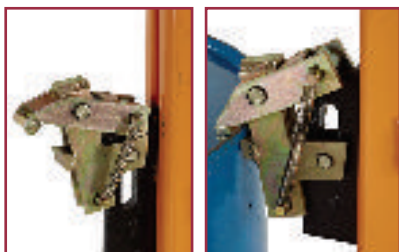

Drum locking mechanism



Hydraulic pump action



Release mechanism



DL300Y
£936.55

INFORMATION

Ideal for moving drums from euro & UK pallets



Overall Size L x W x H mm	Weight kg	Model	Price
952 x 1200 x 1560	72	DL300Y	£936.55

DL300Y

Drum, Cylinder & Spill Control

Drum Carrier & Lifters



NEW

- » Foot operated hydraulic pump
- » DLL03Z - the grip holds the top rim of the drum & will load/unload steel drums from pallets/ground with ease
- » DLL04Z - will lift, transport, tilt & stack 210L steel or plastic drums from pallets/ground with ease
- » The foot pedal hinges up helping to prevent knocked shins whilst mobile
- » Easily manoeuvrable on 2 fixed, 2 swivel braked wheels



up to
450kg
evenly
distributed

FROM ONLY
£1479.40

INFORMATION

DLL04Z - ideal for moving steel or plastic drums from euro & UK pallets



DLL03Z



DLL04Z

Lifting Height mm	Capacity up to 500mm	Wheels	Weight kg	Model	Price
500	450kg	130mm	165	DLL03Z	£1479.40
800	350kg	200mm	180	DLL04Z	£1974.65



PRICE HELD

DLF05Z

INFORMATION

Easy operation from your fork lift cab



Fork Lift Drum Tilter

- » CE marked & plated
- » Can be operated without leaving the fork lift truck
- » Enables your fork truck to be used as a drum handler
- » Can easily lift, transport & tilt loaded drums
- » The 3 metre pull chain loop allows simple control from the driver seat
- » Fork distance: 620mm apart
- » Fork pockets: 65H x 180W mm



350kg
evenly
distributed

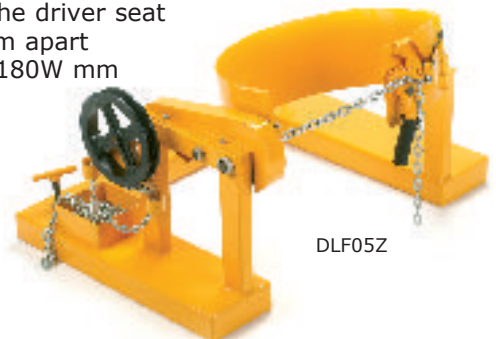

DLF05Z

Overall Size L x W x H mm	Weight kg	Model	Price
1000 x 770 x 510	76	DLF05Z	£848.75

Drum Lifters

- » One person operation
- » CE marked & plated
- » Simply attach/hang the lifter on a hook from an overhead hoist or crane, saddle around the drum & raise to the desired height & position
- » For use with 210 litre steel drums
- » Model DLV02Z has a geared chain control. The 3 metre control chain can be locked to secure the drum in any position during transit & dispensing



INFORMATION
Ideal for low level pouring

Description	Overall Size L x W x H mm	Weight kg	Model	Price
Standard	990 x 725 x 205	22	DLV01Z	£473.05
Geared	990 x 725 x 205	40	DLV02Z	£635.30

Taper Grip Drum Clamp

- » CE marked & plated
- » Suitable for use with 210 Litre steel drums
- » The steel jaws grip the rim of the drum, allowing the drums to be picked up or set down without spaces between them
- » Automatic grip lock will not open & ensures safe drum transportation
- » Grip head has different positions to fit different heights

N.B. It is important for the safe use of this unit that the drum ring is not damaged & is strong enough to support its own weight



No. of Drums Held	Fork Spread	Overall Size L x W x H mm	Weight kg	Model	Price
1	560 mm	830 x 710 x 1000	60	DLC01Z	£752.95
2	605 mm	1030 x 850 x 1000	96	DLC02Z	£932.80

Drum, Cylinder & Spill Control

Maintenance Spill Berms



- » Compact & flexible spill containment which deploys instantly in the shop or field
- » No assembly required - simply unfold & use
- » Encased urethane foam sidewalls offer easy roll-through access without the need for a ramp



INFORMATION



Ideal for compact & flexible spill containment

Capacity Litres	Overall Size W x L x H mm	Folded Size W x L x H mm	Model	Price
19	600 x 600 x 51	762 x 762 x 51	MSB606005	P.O.A.
38	600 x 1200 x 51	762 x 1372 x 51	MSB601205	P.O.A.
76	600 x 1200 x 102	406 x 762 x 406	MSB601210	P.O.A.
227	1200 x 1800 x 102	610 x 610 x 406	MSB121810	P.O.A.
151	1200 x 2400 x 51	762 x 762 x 305	MSB122405	P.O.A.
167	1800 x 1800 x 51	610 x 610 x 406	MSB181851	P.O.A.
341	1800 x 1800 x 102	965 x 965 x 406	MSB181810	P.O.A.

Rigid-Lock QuickBerm®

- » Safe, drive-in spill containment for drums, IBC totes & tanks
- » Single piece construction - patented rigid-lock wall support system integral to berm provides unobstructed work space
- » Quick & easy setup - no assembly required
- » Durable PVC coated fabric withstands long term UV exposure - great for outdoor use



Capacity Litres	Overall Size W x L x H mm	Folded Size W x L x H mm	Model	Price
662	1200 x 1800 x 305	610 x 610 x 127	RLB00662	£908.65
890	1200 x 2400 x 305	610 x 610 x 152	RLB00890	£1059.75
1344	1800 x 2400 x 305	610 x 610 x 305	RLB01344	£1327.15
1798	2400 x 2400 x 305	660 x 660 x 305	RLB01798	£1499.00

Capacity Litres	Overall Size W x L x H mm	Folded Size W x L x H mm	Model	Price
2820	3000 x 3000 x 305	711 x 711 x 305	RLB02820	£1840.25
5432	3700 x 4900 x 305	660 x 660 x 406	RLB05432	£2687.20
7230	4900 x 4900 x 305	914 x 914 x 406	RLB07230	£3128.90

Leak Diverters

- » Redirect roof or pipe leaks to prevent water damage
- » Deal with your nuisance ceiling leaks without disruption to the workplace until a permanent repair can be made. This device can be hung from the roof directly under leaks to catch rainwater & divert it to a convenient collection point, keeping it off the floor, reducing the potential for slips & falls whilst minimising damage to goods & machinery.
- » Adjustable hanging straps (not included) ensure easy levelling & positioning - call for details. Standard UK Hozelock fittings ensure water can be safely channelled into a suitable receptacle or other convenient area
- » Can be connected to a garden hose - not included



Overall Size W x L mm	Colour: Yellow		Colour: White	
	Model	Price	Model	Price
1000 x 1000	LD1X1Y	£39.35	LD1X1W	£39.35
2000 x 2000	LD2X2Y	£73.08	LD2X2W	£73.08
3000 x 3000	LD3X3Y	£123.65	LD3X3W	£123.65
1000 x 3000	LD1X3Y	£78.69	LD1X3W	£78.69



Instabund® with Deck Tiles

- » Lightweight, flexible & portable secondary containment bunds to contain spills & leaks
- » Complies with environmental legislation – ISO14001 & Oil Storage Regulations (OSR)
- » Corrosion resistant & easy to clean
- » No tools required for easy on site assembly
- » Instabund is easily carried in its own bag (tiles are loose)

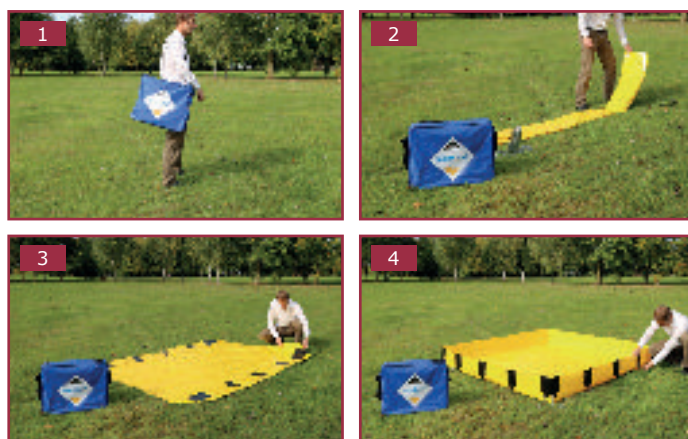

Capacity Litres	Overall Size W x L x H mm	No of Decking Tiles	Model	Price
250	1000 x 1000 x 250	4	INB-22/DK22	£293.89
500	1000 x 2000 x 250	8	INB-24/DK24	£430.41
562	1500 x 1500 x 250	9	INB-33/DK33	£439.24
1000	2000 x 2000 x 250	16	INB-44/DK44	£669.71
1750	2000 x 3500 x 250	28	INB-47/DK47	£944.36
1875	2500 x 3000 x 250	30	INB-56/DK56	£1029.47
3000	3000 x 4000 x 250	48	INB-68/DK68	£1166.05
3937	3500 x 4500 x 250	63	INB-79/DK79	£1326.69
3750	2500 x 6000 x 250	60	INB-512/DK512	£1429.45



Drum, Cylinder & Spill Control

Flexi-trays

- » Made from rubberised plastic which gives strength & flexibility
- » Easy to wheel equipment into - the sides will just pop back up
- » Easily folded & stored. Contains any spilled liquid & is easily cleaned
- » SpillTector® Mats are available - please call for details



STW1212



SDT5252



SDT1212

SDT1252

INFORMATION

Drive over the tray & the sides pop back up



DTW7013 shown with SpillTector® Mat which is also available - call for details



DTW7013 shown with a SpillTector® Mat which is also available - call for details

Description	Minimum Order Qty	Overall Size L x W x H mm	Model	Price each
Shallow Trays / Workmats				
-	4	520 x 520 x 50	STW5252	£31.15
-	3	1020 x 520 x 50	STW1252	£39.20
-	2	1020 x 1020 x 50	STW1212	£54.10
Shallow Dispensing Trays				
1 Grid	3	520 x 520 x 50	SDT5252	£39.00
2 Grids	2	1020 x 520 x 50	SDT1252	£54.45
4 Grids	2	1020 x 1020 x 50	SDT1212	£77.20
Deep Trays (SpillTector® Mats not included)				
-	3	520 x 700 x 100	DTW5270	£44.70
-	2	700 x 1030 x 100	DTW7013	£59.00

Container Drip Trays

- » Made from 100% recycled polypropylene
- » Tough enough for all working environments
- » Re-usable drip & leak containment
- » Can be ordered in smaller quantities - call for details



CDT18Z



CDT40Z



CDT28Z

Overall Size L x W x H mm	Capacity Litres	Minimum Order Qty	Model	Price each
410 x 310 x 45	5	5	CDT05Z	£12.30
560 x 400 x 40	9	5	CDT09Z	£15.50
790 x 400 x 40	12	5	CDT12Z	£20.10
1000 x 400 x 40	15	5	CDT15Z	£21.55
1170 x 400 x 40	18	5	CDT18Z	£24.40
600 x 600 x 70	28	5	CDT28Z	£20.10
1100 x 550 x 40	25	4	CDT25Z	£32.80
8500 x 60	40	5	CDT40Z	£27.75

Container Bunded Storage

- » Integral grid allows the contents to be raised above the container base
- » Made from 100% recycled polypropylene
- » Tough enough for all work environments
- » Can be ordered in smaller quantities - call for details



PSP25Z



PSP22Z

PSP28Z



PSP31Z

Overall Size L x W x H mm	Capacity Litres	Minimum Order Qty	Model	Price
640 x 490 x 120	28	3	PSP22Z	£39.70
1000 x 550 x 150	60	2	PSP25Z	£62.90
1010 x 1000 x 120	100	2	PSP28Z	£86.85
1200 x 1200 x 120	120	-	PSP31Z	£114.55



Integral grid allows the contents to be raised above the container base

Container Spill Trays

- » Made from PE - 100% recyclable
- » Can be used with / without platform
- » Stackable for easy transportation & storage
- » Non slip platform surface
- » Designed to fit on Euro pallets
- » Easy to clean
- » Can be ordered in smaller quantities - call for details

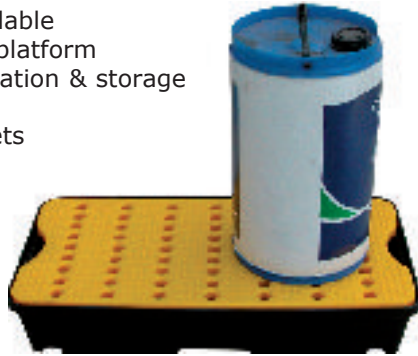

PSP99Z



PSP102Z

Overall Size L x W x H mm	Capacity Litres	Minimum Order Qty	Model	Price each
600 x 400 x 150	20	2	PSP98Z	£78.50
800 x 400 x 150	30	2	PSP99Z	£85.85
800 x 600 x 150	40	2	PSP100Z	£102.05
1000 x 600 x 170	60	-	PSP101Z	£129.90
1200 x 800 x 170	100	-	PSP102Z	£206.25

Low Level Bunded Work Floors

- » 2 & 4 drum Work Floors
- » Easy low level loading - 160mm
- » Removable grate allows easy access to sump contents
- » Easy to relocate & compliant to Oil Storage Regulations
- » Reduces the risk of ground contamination from leaks & spills
- » Ideal as a quarantine point for leaking or damaged drums

FROM ONLY
£130.15

INFORMATION



Ideal for use with both 25 & 205 litre drums

INFORMATION



Comply to all UK oil storage regulations

BWF02Z



BWF04Z



Description	Overall Size L x W x H mm	Capacity Litre	Model	Price
2 Drum	1270 x 870 x 160	135	BWF02Z	£130.15
4 Drum	1220 x 1620 x 160	250	BWF04Z	£208.15

Drum, Cylinder & Spill Control

Bunded Drum Rack System

- » Drum rack to be used with drum rack base only
- » Ideal for easy dispensing & storage
- » Can store up to four 210 litre drums
- » Compatible with most forklifts

INFORMATION



Comply to all UK oil storage regulations



PSP06Z



PSP05Z



PSP07Z

Description	Overall Size L x W x H mm	Capacity Litres	Model	Price
Base Unit	1350 x 1370 x 630	500	PSP05Z	£684.30
Stacker Unit	940 x 1370 x 390	-	PSP06Z	£295.75
Base & Stacker Unit	1350 x 1370 x 1580	500	PSP07Z	£967.25

Covered Drum Storage System

- » Made from PE - 100% recyclable
- » Ideal for easy dispensing & storage
- » Compatible with most forklifts



PSP21Z



PSP21Z

INFORMATION



Comply to all UK oil storage regulations



PSP21Z

Description	Overall Size L x W x H mm	Capacity Litre	Model	Price
2 Drum	1565 x 995 x 2110	250	PSP21Z	£1585.35
4 Drum	1565 x 1620 x 2110	245	PSP41Z	£2065.60

Sump Storage

- >> Of polyethylene construction, these pallets are highly resistant to most chemicals & corrosion
- >> Fork pockets allowing easy positioning



INFORMATION



Comply to oil storage regulations (England) 2001



PSP04Z



PSP02Z



PSP02Z

No of Drums Held	Overall Size L x W x H mm	Capacity Litre	Model	Price
Two	1300 x 750 x 400	250	PSP02Z	£315.75
Four	1380 x 1290 x 280	245	PSP04Z	£364.65

Drum, Cylinder & Spill Control

Polyethylene Storage Cabinets

- >> Rotationally moulded from medium density polyethylene
- >> Lightweight yet robust
- >> Lockable
- >> Broad band chemical compatibility
- >> Polyethylene shelves & grids



PEC25Z



PEC07Z



PEC03Z



Description	External Size L x W x H mm	Sump Capacity	Weight kg	Model	Price
1 Door & 2 Shelves	534 x 540 x 990	17 Litres	15	PEC03Z	£287.10
1 Door & 2 Shelves	650 x 570 x 1650	70 Litres	44	PEC07Z	£486.50
1 Door & Mesh Grid	920 x 740 x 1520	100 Litres	55	PEC10Z	£637.50
1 Door & Mesh Grid	920 x 720 x 1835	225 Litres	50	PEC25Z	£572.20
1 Door, 1 Shelf & Mesh Grid			50	PEC25ZS	£624.45

Polyethylene Vaults

>> Roller shutter doors for ease of accessing your drums



PEC27Z

INFORMATION
Comply to oil storage regulations (England) 2001



LOWER PRICES



PEC27S

Description	Overall Size L x W x H mm	Sump Capacity	Weight kg	Model	Price
Vault for 2 x 205L drums stored vertically	1490 x 999 x 1690	230 Litres	85	PEC27Z	£1004.30
Vault with steel cradle for 1 x 205L drum			95	PEC27H	£1242.65
Vault with shelving (ideal for 5 & 25 Litre Drums)			90	PEC27S	£1057.35

IBC Containment Pallets

- >> Manufactured from polyethylene
- >> Excellent chemical resistance
- >> Fork pockets allowing easy positioning
- >> Optional grid available for the PSP01Z - call for details



INFORMATION



Store IBC's in a safe environment



INFORMATION



IBC's available - please call for details

PSP09Z

PSP01Z

Description	Overall Size L x W x H mm	Capacity Litre	Model	Price
Single	1490 x 2000 x 770	1100	PSP01Z	£1107.60
Double	2450 x 1450 x 580	1140	PSP09Z	£1661.30

Drum & IBC Storage

- >> Weatherproof for outside storage
- >> RHS frame galvanised sheet cladding
- >> Padlockable dual sliding doors for ease of access (padlock not included)
- >> Benches & spill trays are available - see below for details

N.B. A forklift will be needed to unload these units



WCI03Z

INFORMATION



Comply to oil storage regulations (England) 2001



WCD02Z



Storage Units

Overall Size L x W x H mm	Sump Cap. Litres	Weight kg	Model	Price
Drum Storage Unit - with Sump Base				
3150 x 2250 x 2360	780	950	WCD02Z	£8660.80
IBC Storage Unit - with Deep Sump Base				
3150 x 2250 x 2360	1200	970	WCI03Z	£8925.20

Optional Accessories

Overall Size L x W x H mm	Weight kg	Model	Price
Bench (priced individually)			
1990 x 500 x 960	62	WCG02Z	£606.10
Spill Tray which sits on top of the above bench (priced individually) - Capacity - 48 Litres			
1990 x 500 x 50	-	WCG03Z	£206.35

Drum, Cylinder & Spill Control

Galvanised Sump Pallets

- » Fully welded galvanised steel construction with removable galvanised grid for ease of cleaning
- » Complete with 150mm wide fork hoops which are used to move the unit and keep the sump off the ground



GDSP04

INFORMATION

Comply to oil storage regulations (England) 2001



GDSP10



Description	Overall Size L x W x H mm	Sump Capacity	Weight kg	Model	Price
2 Drum Units	1220 x 815 x 393	225.5 litres	51	GDSP02	£530.45
4 Drum Units	1220 x 1220 x 463	440 litres	82	GDSP04	£704.25
8 Drum Units	2450 x 1220 x 550	1100 litres	164	GDSP08	£1316.00
1 IBC Unit	1220 x 1220 x 1005	1100 litres	121	GDSP10	£943.15

Polyethylene Spill Pallets with Steel Covers

- » Medium density polyethylene spill pallet with a 0.6mm galvanised steel powder coated cover with hinged doors
- » Hinged doors have retaining catches to hold them open & are lockable



PSP1140



PSP1100



Description	Overall Size W x L x H mm	Door Aperture H x W mm	Sump Capacity	Weight kg	Model	Price
Stores 4 Drums	1480 x 1385 x 1865	1390 x 1225	410 Litres	221	PSP0410	P.O.A.
Stores 1 IBC	1425 x 1840 x 2320	1590 x 1165	1100 Litres	223	PSP1100	P.O.A.
Stores 8 Drums or 2 IBC's	2625 x 1430 x 2110	1200 x 1410	1140 Litres	285	PSP1140	P.O.A.

Drum, Cylinder & Spill Control

Sump Flooring

- » Versatile sump flooring to meet your requirements
- » Flush fitting seam welded floor panels
- » Safeguard the contents of the drums from potentially contaminating work areas should a drum fail



UK
MANUFACTURED

3 YR
GUARANTEE

2 x SF1001,
SF2301 & SR1051

INFORMATION



Comply to oil storage regulations (England) 2001

Sump Capacity	Overall Size L x W x H mm	Model	Price
Sump Flooring			
263 Litres	1400 x 1250 x 160	*SF1001	£1251.20
347 Litres	2200 x 1050 x 160	*SF2301	£1978.85
525 Litres	2800 x 1250 x 160	*SF2831	£2537.25
Optional Ramp			
-	1000 x 500 x 160	SR1051	£446.70
Optional Safety Rail			
-	1000 x 40 x 1000	SR1000	£174.75
-	1250 x 40 x 1000	SR1250	£196.85

*A fork lift will be needed to unload these units



SF1001, SR1051
& 2 x SR1000

Heavy Duty Sump Pallets

- » Fully welded construction providing secure sump containment
- » Fitted with removable galvanised grid for ease of cleaning
- » Drum Storage Sump Pallets - when not in use the fork guides give a safe & secure lift

A fork lift will be needed to unload these units



DSP04G

INFORMATION



Comply to oil storage regulations (England) 2001



DSP08Z

Description	Overall Size L x W x H mm	Sump Capacity	Weight kg	Model	Price
Floor Sump Pallets					
2 Drum Units	Without Grid	1400 x 625 x 300	230 litres	DSP02Z	£529.25
	With Grid	1400 x 625 x 300	230 litres	DSP02G	£756.55
4 Drum Units	Without Grid	1400 x 1250 x 175	260 litres	DSP04Z	£617.60
	With Grid	1400 x 1250 x 175	260 litres	DSP04G	£1075.25
Drum Storage Sump Pallets					
2 Drum Units	With Grid	1400 x 625 x 445	230 litres	DSP06Z	£905.35
4 Drum Units	With Grid	1400 x 1250 x 330	260 litres	DSP08Z	£1231.00

Drum, Cylinder & Spill Control

Vertical Drum Store

- » Manufactured from heavy duty corrugated steel
 - » Enclosed on 3 sides to stop splash contamination
- A fork lift will be needed to unload these units



DH941Z



Horizontal Drum Store

- » Manufactured from heavy duty corrugated steel
 - » Enclosed on 3 sides to stop splash contamination
 - » Can be stacked 2 high
- A fork lift will be needed to unload these units



DH274Z

Sump Capacity	Overall Size W x D x H mm	Weight kg	Model	Price
250 Litres	820 x 820 x 1375	110	DH941Z	£1478.60

Sump Capacity	Overall Size W x D x H mm	Weight kg	Model	Price
490 Litres	1645 x 1360 x 1900	175	DH274Z	£2382.30

Drum Storage Units

- » Ground clearance: 150mm
 - » Fork centres: 760mm
 - » Heavy duty drum storage units of fully welded construction
 - » Safe storage for 8, 10, 16 or 20 standard 210 litre drums, either palletised or loose loaded
 - » The 8 & 10 drum units are single tier & the 16 & 20 drum units are double tier
 - » Swaged & re-inforced robust sheet steel walls on 3 sides
 - » The sump units can be removed for steam cleaning & have removable galvanised grid floor panels
 - » Fork guides ensure safe & secure movement
 - » Blue powder coated finish
- N.B. A Forklift will be needed to unload these units.**



DH916Z

INFORMATION



Control of pollution (oil storage) (England) regulations 2001



No of Drums	Overall Size W x D x H mm	Sump Capacity Litres	Weight kg	Model	Price
8	3000 x 1275 x 1535	865	420	DH908Z	£4049.50
10	3715 x 1275 x 1535	1112	440	DH910Z	£5235.20
16	3000 x 1275 x 3070	1729	830	DH916Z	£7944.15
20	3715 x 1275 x 3070	2223	860	DH920Z	£9410.45



DH910Z

Fully Enclosed Drum Stores



DH244Z

DH204Z

- » For use outside or where security is of importance. Doors have high & low level venting. 1 drum units are fitted with 1 door & 2 & 4 drum units have 2 doors - all with 3 point locking
 - » Vertical units are fitted with galvanised grid floors & horizontal units have an open topped sump
- N.B. A Forklift will be needed to unload these units.**

No of Drums Stored	Storage Type	Sump Capacity Litres	Overall Size W x D X H mm	Weight kg	Model	Price
1	Vertical	234	800 x 800 x 1470	80	DH241Z	£2186.70
2		263	1510 x 750 x 1470	125	DH242Z	£2467.40
4		439	1510 x 1250 x 1470	150	DH244Z	£3755.75
1	Horizontal	233	1250 x 800 x 1280	80	DH201Z	£2488.40
2		439	1510 x 1250 x 1280	110	DH202Z	£3072.35
4		439	1510 x 1250 x 2170	150	DH204Z	£3301.80

INFORMATION



Comply to oil storage regulations (England) 2001

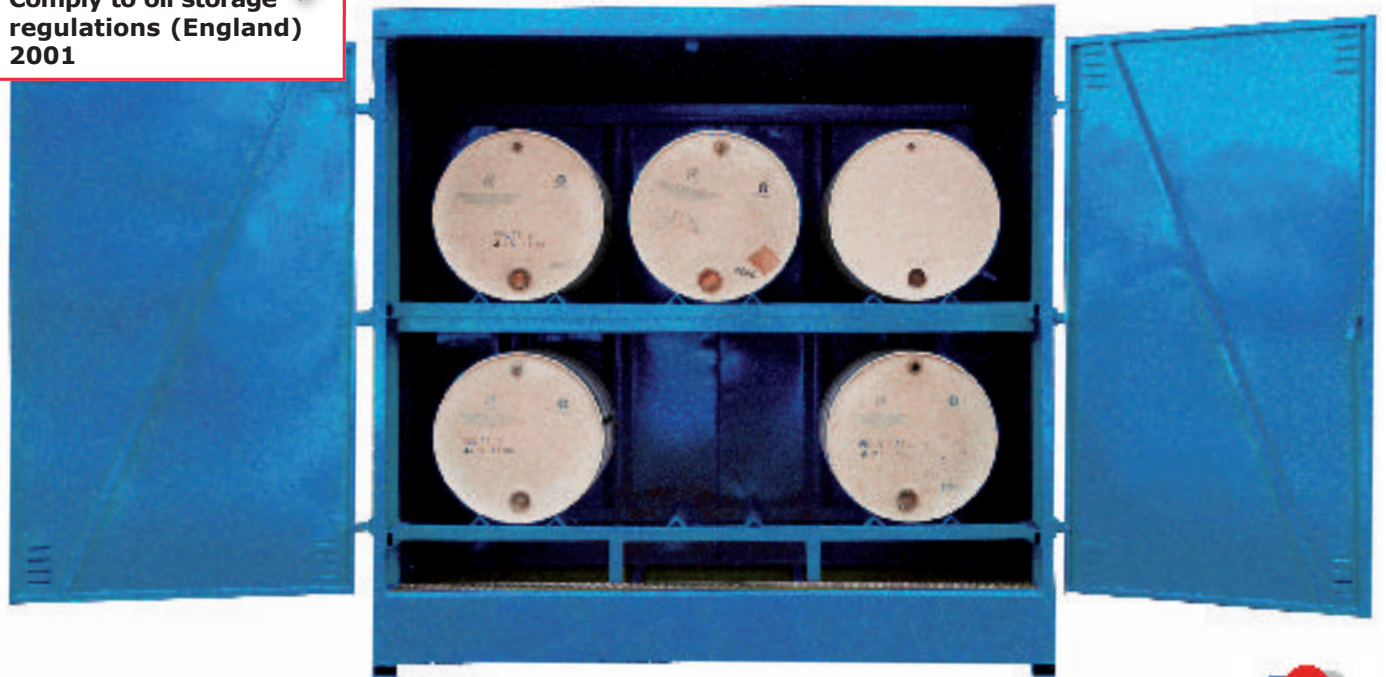

DH296Z



Drum Stores

- » For use outside or where security is of importance. Doors have high & low level venting - with 3 point locking
 - » Drums are set back to allow space to dispense liquids
- N.B. A Forklift will be needed to unload these units.**

No of Drums Stored	Sump Capacity Litres	Overall Size W x D x H mm	Weight kg	Model	Price
6	631	2250 x 1350 x 2275	220	DH296Z	£6952.05

Drum, Cylinder & Spill Control

Drum & IBC Secure Stores



Manufactured in accordance with PPG 26 regulations
as per the requirement of the Environment Agency

EDRIB1604

- » Base is manufactured from 3mm mild steel with RHS cross members & pressed ribs
- » Corner posts, shelf frames & main rails are rolled hollow section
- » The roof is pressed with suitable bracing & fully welded around the perimeter, while the back, side & door panels are pressed from 2mm mild steel sheet & corrugated where required
- » Fitted with crane lifting points (maximum 2000kg per lift point) & sliding doors
- » The floor area above the sump is covered with galvanised steel channel sections so that loose drums or pallets can be stored directly onto it, whilst the upper shelf is an open box section which is designed to support pallets. Grid mesh shelving is available - please call for details
- » Shot blasted before being painted (RAL 6029) for greater durability
- » EDRIB9624 - push back system above the sump, allowing the units to be pushed to the back of the units

Model	1	2	3	4
External Size: H x W x L mm	3295 x 1500 x 3000	3295 x 1500 x 5920	3275 x 1500 x 8840	3325 x 2800 x 8840
Sump Capacity: Litres	1125	2200	3300	6100
Capacity - 205 litre drums	16	32	48	96
or Capacity - 1000 litre IBC's	4	8	12	24
Doors	Double Sliding	Double Sliding	Triple Sliding	Triple Sliding
Model:	EDRIB1604	EDRIB3208	EDRIB4812	EDRIB9624
Price	P.O.A.	P.O.A.	P.O.A.	P.O.A.

Drum & IBC Secure Stores



EDRIB3208



Push Back Loading System on the EDRIB9624



Manufactured in accordance with PPG 26 regulations as per the requirement of the Environment Agency



EDRIB9624

This unit will be delivered by an articulated vehicle, therefore please ensure that a vehicle of this size can access your premises before ordering and advise us accordingly. You will require an appropriate size-capacity fork lift truck or Hiab unit to offload this item from the delivery vehicle. **IMPORTANT:** our standard delivery doesn't include any offloading due to insurance restrictions - if you require this service then please call for details. The unit must be positioned on a solid level surface, ideally concrete of circa 150mm in depth and 100mm bigger overall than the unit. The purpose of this is to ensure the unit does not settle unevenly when placed in position.

Drum, Cylinder & Spill Control



Heavy Duty Cylinder Trolleys with Puncture Proof & REACH Compliant Wheels

- » Mobile on 260mm, REACH compliant & puncture proof pneumatic wheels
- » High quality steel with a hardwearing powder coated anthracite grey finish
- » Cylinders are held in place with a retaining chain for added security when in use



PACT802Y

PACT801Y

NEW

300kg
evenly distributed

3 day
delivery

3 YR
GUARANTEE



PACT801Y

INFORMATION



Units complete with puncture proof wheels "Will not let you down"

Holds / Transports Cylinder Dia. mm	Overall Size H x W x D mm	Model	Price
Up to 240	1120 x 540 x 420	PACT801Y	£282.35
Up to 400	1120 x 700 x 420	PACT802Y	£291.30



Heavy Duty Cylinder Trolleys with Solid Rubber Wheels & Support Castors

- » Mobile on 350mm solid rubber wheels & supporting castors (PACT803Y & PACT805Y)
- » High quality steel with a hardwearing powder coated anthracite grey finish
- » Cylinders are held in place with a retaining chain for added security when in use



PACT805Y



PACT803Y

10 day
delivery

Up to 400kg
evenly distributed

NEW

3 YR
GUARANTEE

Description	Holds / Transports Cylinder Dia. mm	Capacity kg	Overall Size H x W x D mm	Model	Price
Single Cylinder Trolley with Support Castors	Up to 400	300	1120 x 540 x 700	PACT803Y	£360.05
Double Cylinder Trolley	240 & 300	400	1120 x 860 x 500	PACT804Y	£319.25
Double Cylinder Trolley with Support Castors	240 & 300	400	1120 x 860 x 700	PACT805Y	£400.90

Cylinder Trolleys

- » Easily converts from a trolley to a 4 wheel trolley which gives extra support & stability
- » Designed to transport oxygen & acetylene cylinders
- » Complete with chain to secure the cylinders to the trolley
- » Mobile on 2 x 200mm wheels & 2 x 75mm swivel braked castors



CTF12Y
as a Trolley



CTF20Y
as a Trolley



CTF12Y as 4
Wheel Trolley

LOWER
PRICES

INFORMATION



Carry oxygen & acetylene cylinders easily & safely



CTF20Y as 4
Wheel Trolley

FROM ONLY

£243.70



Holds / Transports	Overall Size L x W x H mm	Folded Size H x W x D mm	Weight kg	Model	Price
1 x 140 to 300mm Cylinder	1010 x 430 x 910	1165 x 430 x 480	18	CTF12Y	£243.70
2 x 140 to 300mm Cylinder	1010 x 720 x 910	1165 x 720 x 480	25	CTF20Y	£340.75

Cylinder Pallet Cages

- » Fully welded construction with supporting sides & central sections
- » Non-slip steel floor to aid the safe loading & unloading of cylinders
- » Complete with retaining chain/strap
- » Models GCP01/2Z are suitable for transporting cylinders by pallet truck with width across forks of 680mm. Model GCP03Z is suitable for transportation by fork lift only



GCP01Z

N.B. A Fork Lift will be needed to unload these units

Overall Size L x W x H mm	No of Cylinders held	Weight kg	Model	Price
555 x 480 x 1010	2 - Max Dia. 275mm	20	GCP01Z	£650.10
1100 x 480 x 1010	4 - Max Dia. 275mm	40	GCP02Z	£812.65
1200 x 1050 x 995	9 x 286mm / 12 x 229mm / 20 x 178mm	120	GCP03Z	£1747.10

Drum, Cylinder & Spill Control

Grenadier® Heavy Duty Security Cages

SCS04Z fitted with SCS001

FROM ONLY
£829.85

SCS03Z fitted with SCS003



SCG02S

SCG01Z

- » Fully assembled units constructed from steel angle & 25 x 25mm weld mesh
- » Units are load tested
- » Units have a padlock facility (*padlock not supplied*)
- » Cranage eyes for easy lifting (when lifting using the Cranage eyes, we recommend using a spreader)
- » A hazardous chemical sign is available as a factory fitted optional extra
- » Mobile units are fitted with 4 x 100mm nylon, 2 braked swivel castors (*N.B add 115mm to the height*)
- » Two finishes available: powder coated yellow or galvanised body with powder coated yellow doors

N.B. A Fork Lift will be needed to unload these units

Overall Size H x W x D mm	Internal Size H x W x D mm	No of Doors	Wt kg	Powder Coated Yellow				Galvanised - Yellow Doors				Shelf to suit Factory Fitted (one per unit)	
				Static		Mobile		Static		Mobile			
				Model	Price	Model	Price	Model	Price	Model	Price	Model	Price
880 x 700 x 700	790 x 690 x 690	1	37	SCS01Z	£829.85	SCS01S	£909.75	SCG01Z	£1039.55	SCG01S	£1120.70	-	-
880 x 1400 x 700	790 x 1380 x 690	2	52	SCS02Z	£1342.85	SCS02S	£1423.05	SCG02Z	£1591.65	SCG02S	£1672.80	-	-
1680 x 700 x 700	1585 x 690 x 690	1	55	SCS03Z	£1412.80	SCS03S	£1492.95	SCG03Z	£1706.35	SCG03S	£1787.50	SCS003	£114.45
1680 x 1400 x 700	1585 x 1380 x 690	2	110	SCS04Z	£2155.40	SCS04S	£2233.45	SCG04Z	£2613.00	SCG04S	£2694.15	SCS004	£192.40
1680 x 2070 x 700	1585 x 2040 x 690	2	124	SCS05Z	£2604.00	SCS05S	£2683.80	SCG05Z	£3202.40	SCG05S	£3283.55	SCS005	£254.85
Optional Hazardous Sign - Factory Fitted											SCS001	£87.85	

Cylinder Floor Racks

- » Fully welded cylinder racks with a securing chain equipped to keep the cylinders secure



COLOUR OPTIONS

- Red
- Blue
- Grey

specify when ordering

NEW

Description	No of Cylinders	Overall Size L x W x H mm	Model	Price
Single Sided	2	900 x 740 x 350	CFRS02Z	£317.85
Single Sided	3	900 x 1110 x 350	CFRS03Z	£375.95
Double Sided	4	900 x 740 x 660	CFRD04Z	£428.65
Double Sided	6	900 x 1110 x 660	CFRD06Z	£514.65

Cylinder Wall Racks

- » Fully welded cylinder rack with a securing chain equipped to keep the cylinders secure



COLOUR OPTIONS

- Red
- Blue
- Grey

specify when ordering

NEW

No of Cylinders	Overall Length mm	Model	Price
2	660	CWR02Z	£145.65
3	1210	CWR03Z	£182.85

290

SDL

TEL:01446772614

www.storagedesignltd.com

info@storage-design.ltd.uk

VIRAWIPE® Sanitiser Wipes

- >> EN14476 Antiviral certified, EN1276 Antibacterial Certified & EN14348 Antifungal certified
- >> Approved protection against formation of bacteria & superbugs - proven to kill at least 99.99% of disease causing micro-organisms including COVID-19, MRSA, C-Dif, E.Coli, Salmonella, Listeria, Norovirus & more



VIRAWIPE®

Description	Model	Price
Case of 6 x 2 litre tubs of 80 VIRAWIPE™	AVW80/6	£32.10
Point of Sale Case of 9 x 2 litre tubs of 80 VIRAWIPE™	AVW80/9	£51.39
Point of Sale Case of 12 x 2 litre tubs of 80 VIRAWIPE™	AVW80/12	£55.71
2 Litre Tub Holster complete with shoulder strap	A2L-HOL	£6.03
Case of 2 x 3 litre tubs of 225 VIRAWIPE™	AVW-225/2	£24.01
Case of 4 x 3 litre tubs of 225 VIRAWIPE™	AVW-225/4	£42.87
75 x single 3 litre tubs of 225 VIRAWIPE™	AVW-225/75	£747.55
150 x single 3 litre tubs of 225 VIRAWIPE™	AVW-225/150	£1438.96

MUCKYZ® Wipes

- >> Hand & machinery wipes remove grime, oil, grease & muck from hands & machinery - quick, clean & solvent free
- >> Kills viruses & bacteria
- >> Designed for tough stains
- >> Not tested on animals

INFORMATION



All tubs feature the easy pop-top



MUCKYZ



TSS80

TWW80

Description	Model	Price
Case of 6 x 2 litre tubs of 80 MUCKYZ™ Smooth Wipes (Smooth wipes for wiping tasks)	TSS80/6	£32.12
Point of Sale Case of 9 x 2 litre tubs of 80 MUCKYZ™ Smooth Wipes (Smooth wipes for wiping tasks)	TSS80/9	£50.10
Case of 6 x 2 litre tubs of 80 MUCKYZ™ Scrub Wipes (Rough wipes for harder wiping tasks)	TWW80/6	£32.92
Point of Sale Case of 9 x 2 litre tubs of 80 MUCKYZ™ Scrub Wipes (Rough wipes for harder wiping tasks)	TWW80/9	£50.59

Drum, Cylinder & Spill Control

Dispensing Bottle

- » Heavy duty polyethylene bottles, use to dispense liquids directly on to work single handed
- » The brass valves are self closing & leak proof
- » The body of the bottle is contoured & textured to aid grip



Capacity Litres	Overall Size Dia x H mm	Model	Price
1	102 x 267	DC010Z	£89.00

Plunger Cans

- » Manufactured from chemically resistant Ryton® & brass
- » Used to safely moisten wipes, cleaning wipes etc with solvent
- » Any surplus solvent drains back into the can



Capacity Litres	Overall Size Dia x H mm	Model	Price
0.5	125 x 133	PC115Z	£105.45
1	185 x 143	PC118Z	£113.60
2	185 x 187	PC218Z	£113.60
4	185 x 267	PC418Z	£126.30

Polyethylene Cans

- » Resistant to tough acids & corrosives as well as heat
- » Self close lid, pressure relief mechanism & dual density flame arrester



Capacity Litres	Overall Size L x W x H mm	Model	Price
2	117 x 194 x 241	PC120Z	£139.00
4	117 x 194 x 324	PC140Z	£151.10

All products on this page are:



Type I Steel Cans

- » Cans upto 1L size have a trigger release handle & 4L onwards have a swinging handle for easier carrying
- » Suitable for corrosive flammable liquids

Capacity Litres	Overall Size Dia x H mm	Model	Price
0.5	117 x 172	MC050Z	£184.85
1	117 x 210	MC100Z	£169.75
7.5	241 x 349	MC750Z	£98.75
9.5	298 x 292	MC950Z	£107.45
19	298 x 429	MC190Z	£109.85



Type II Accuflow™ Steel Cans

- » Innovative manifold automatically vents for smooth, slug free pouring
- » Safe-squeeze trigger gives you maximum control when pouring
- » Stainless steel flame arrester dissipates heat to prevent flashback ignition

Capacity Litres	Overall Size Dia x H mm	Hose Dia x L mm	Model	Price
4	241 x 267	16 x 229	AC004Z	£190.00
7.5	241 x 337		AC075Z	£188.40
9.5	298 x 305		AC095Z	£191.60
19	298 x 445	25 x 229	AC190Z	£194.75

Oily Waste Cans

- » Foot operated self closing lid
- » Safe disposal of used wipes, rags & cloths
- » Lid opens no more than 60° & closes when released. This ensures that flammable liquids present on the wipes or rags are not in contact with ignition sources

Capacity Litres	Overall Size Dia x H mm	Model	Price
20	302 x 403	WC100Z	£139.60
34	354 x 464	WC250Z	£157.05
52	408 x 514	WC500Z	£175.30
80	467 x 595	WC700Z	£267.45



INFORMATION

Perforated base for good air circulation

Liquid Disposal Safety Cans

- >> High density polyethylene disposal cans provide superior chemical resistance & leak protection
- >> Spring loaded sealed cap, normally closed, automatically vents between 3 & 5 psig (0.2 & 0.35 bar)
- >> Stainless steel handle & hardware with latch-catch system hold the cap in the open position for easy filling & pouring
- >> Large mouth opening features a built-in stainless steel flame arrester to guard against outside ignition
- >> Current carrying, patented carbon insert embedded in the container allows for proper grounding
- >> Broad base design provides stability & resists accidental tip over



Capacity Litres	Overall Size Dia x H mm	Model	Price
7.5	305 x 375	LDS075	£331.30
19	305 x 508	LDS190	£361.45

All products on this page are:







Bench Cans

- >> Easy means of cleaning small parts in solvent
- >> Simply place work on spring loaded, perforated dasher plate, press down, agitate, then release to return dasher to drain position
- >> Plated steel dasher also works as an effective flame arrester to reduce the risk of fire flashback
- >> Hinged cover minimizes evaporation losses & protected rim reduces the possibility of hand injury



Capacity Litres	Overall Size Dia x H mm	Model	Price
1	124 x 140	BC001	£122.15
2	238 x 83	BC002	£134.25
4	238 x 114	BC004	£131.85
8	292 x 149	BC008	£218.60



Dip Tanks

- >> For cleaning parts & sub-assemblies where the volume of work does not warrant a larger rinse tank
- >> Dip tank covers stay open for convenient access; self-closing mechanism & fusible link metals at 74°C to snap the cover shut in case of fire



Capacity Litres	Overall Size Dia x H mm	Model	Price
4	238 x 140	DT004	£166.00
8	238 x 254	DT008	£170.15
19	349 x 330	DT019	£213.80
30	397 x 362	DT030	£268.60

All products on this page are Prompt Delivery, FM Approved & TUV/GS Approved

Drum, Cylinder & Spill Control

EVO Recycled® Absorbents



- » Made in the UK from 85% recycled natural fibres
- » Weight for weight the most Oil absorbent pad in Europe
- » Lowest carbon footprint of any absorbent pad in Europe
- » Tough & soft, high loft construction for maximum usability
- » Low linting construction for bench top use



EVO-P15



EVO-S08



EVO-S20



EVO-P100



EVO-P100X

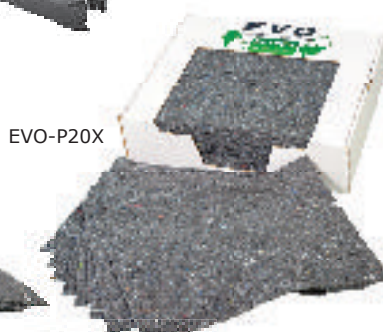

EVO-P20X



EVO-D5

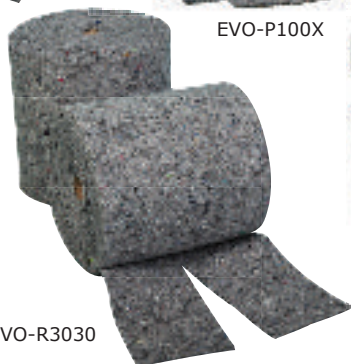

EVO-R3030



EVO-R3820X

INFORMATION
Ideal for oil spills



Sheet/Roll Size L x W x H mm	Pack Quantity	Packaging	Model	Price
Socks				
1200 x 80	20	Poly-wrapped	EVO-S20	£51.06
3000 x 80	8	Poly-wrapped	EVO-S08	£51.06
Pads (Triple Loft, Oil preferential)				
400 x 500 x 10	50	Poly-wrapped	EVO-P50	£29.89
400 x 500 x 10	50	Dispenser Box	EVO-P50X	£32.33
400 x 500 x 10	100	Poly-wrapped	EVO-P100	£55.38
400 x 500 x 10	100	Poly-wrapped	EVO-P100X	£57.80
400 x 500 x 10	20	Dispenser Box	EVO-P20X	£16.86
400 x 500 x 10	15	Clip-Top Bag	EVO-P15	£9.65
Drum-top Pads (with cutout for drum pump)				
560 dia.	5	Clip-Top Bag	EVO-D5	£12.09
Rolls (Quick Rip Perforated)				
300 x 30M	1	Poly-wrapped	EVO-R3030	£28.46
380 x 20M	1	Dispenser Box	EVO-R3820X	£31.73
380 x 40M	1	Poly-wrapped	EVO-R3840	£41.13
500 x 40M	1	Poly-wrapped	EVO-R5040	£53.40

Evo Wood Fibre

- » Green loose absorbents made from environmentally friendly recycled materials which are harmless to plants, animals & humans



Description	Pack Quantity	Packaging	Model	Price
15L	1	Dispenser Box	LW15	£6.99
15L	5	Dispenser Box	LW15/5	£45.72
30L	70	Pallet	LW30	£602.00

Spill Kits



ABK25

ABK50

ABK100



INFORMATION

Ideal for oil spills



OSK20CT

OSK30CT



OSK50

OSK90RY

OSK240

Description	Contents	Oil & Fuel Kit		General Kit		Chemical Kit	
		Model	Price	Model	Price	Model	Price
AdBlue Spill Kits							
25 Litre Kit	3 x 120cm socks, 10 pads & 1 disposable bag	-	-	ABK25	£25.29	-	-
50 Litre Kit	2 x 120cm socks, 25 pads & 1 disposable bag	-	-	ABK50	£68.86	-	-
100 Litre Kit	5 x 120cm socks, 40 pads & 3 disposable bags	-	-	ABK100	£119.82	-	-
Tanker & Vehicle Spill Kit							
20 Litre Kit	2 x 120cm socks, 10 pads & 1 disposable bag	OSK20CT	£18.65	GSK20CT	£18.65	CSK20CT	£26.14
30 Litre Kit	3 x 120cm socks, 40 pads & 3 disposable bags	OSK30CT	£28.01	GSK30CT	£28.01	CSK30CT	£31.76
Shoulder Bag Spill Kit complete with Shoulder Bag							
50 Litre Kit	2 x 300cm socks, 25 pads & 1 disposable bag	OSK50	£61.74	GSK50	£61.74	CSK50	£71.11
Workshop Spill Kit complete with Clip-top Bin							
90 Litre Kit	4 x 300cm socks, 40 pads & 3 disposable bags	OSK90RY	£117.95	GSK90RY	£117.95	CSK90RY	£142.30
Workshop Spill Kit complete with Wheeled Bin							
240 Litre Kit	12 x 300cm socks, 100 double-weight pads & 4 disposable bags	OSK240	£259.49	GSK240	£259.49	CSK240	£310.92

Lower Value Orders May Incur a Handling Charge

Pallet Trucks, Stackers, Lift Tables & Equipment



Premium Pallet Trucks



Ergonomically designed handle with 3 position control lever

CAN BE USED WITH

GKN/CHEP/UK
1000 x 1200mm
Closed Pallets

Euro
800 x 1200mm
Open Pallets

- » Premium model features upgraded handle, pump & tandem front rollers
- » Conform to EN 1757-2
- » Fork width: 160mm
- » Raised height of forks: 205mm
- » Lowered height of forks: 85mm
- » Complete with entry & exit rollers
- » Ergonomically designed handle with a 3 position control lever
- » Manufactured to the recognised European GS standard
- » Mobile on 200mm nylon steering wheels & 85mm nylon tandem rollers



GPT1554P



In accordance with HSE HS (9) it is recommended that all lifting equipment supplied must have a minimum of one service per annum
 One service visit per annum & a PUWER inspection
 Price: **£40.00** per truck & per annum (any parts are extra)
 PLEASE NOTE: In order for us to offer a 2 year guarantee your Pallet Truck must be serviced within the above agreement
FULL NATIONWIDE COVERAGE OF UK MAINLAND

GPT1054P



Close up of Entry/Exit Rollers & Tandem Rollers

Fork Length mm	Width over Forks mm	Pallet Type	Weight kg	Model	Price (each) 1 Off	Price (each) 2+
1000	540	Euro & GKN/CHEP/UK	55.5	GPT1054P	£358.80	£353.95
1150	540	Euro & GKN/CHEP/UK	60.5	GPT1554P	£358.80	£353.95
1000	680	GKN/CHEP/UK	57.5	GPT1068P	£376.60	£371.75
1150	680	GKN/CHEP/UK	62.5	GPT1568P	£376.60	£371.75

Narrow Aisle Pallet Trucks



- » 2000kg capacity
- » Fork width: 160mm
- » Overall height: 1160mm
- » Raised height of forks: 200mm
- » Lowered height of forks: 85mm
- » Highly manoeuvrable through full 180°

INFORMATION

Ideal for narrow aisle applications

Fork Length mm	Width over Forks mm	Weight kg	Model	Price
800	450	58	GX205N	£499.45
900	450	58	GX206N	£499.45
1000	450	59	GX207N	£499.45

Pro Pallet Trucks



- » Conform to EN 1757-2
- » Fork width: 160mm
- » Raised height of forks: 200mm & lowered height of forks: 85mm
- » Complete with entry & exit rollers
- » Ergonomically designed handle with a 3 position control lever
- » Manufactured to the recognised European GS standard
- » Mobile on 200mm nylon steering wheels & 85mm nylon single front rollers

In accordance with HSE HS (9) it is recommended that all lifting equipment supplied must have a minimum of one service per annum

One service visit per annum & a PUWER inspection
 Price: **£40.00** per truck & per annum (any parts are extra)

PLEASE NOTE: In order for us to offer a 2 year guarantee your Pallet Truck must be serviced within the above agreement

FULL NATIONWIDE COVERAGE OF UK MAINLAND

Fork Length mm	Width over Forks mm	Pallet Type	Weight kg	Model	Price (each) 1+	Price (each) 3+
1000	540	Euro & GKN/CHEP/UK	55.5	GPT1054S	£332.95	£328.10
1150	540	Euro & GKN/CHEP/UK	60.5	GPT1154S	£332.95	£328.10
1000	680	GKN/CHEP/UK	57.5	GPT1068S	£352.35	£347.50
1150	680	GKN/CHEP/UK	62.5	GPT1168S	£352.35	£347.50

GPT1154S



Pallet Trucks, Stackers, Lift Tables & Equipment

Low Profile Pallet Trucks

- » Conform to EN 1757-2
- » Fork width: 160mm
- » Raised height of forks: 165mm
- » Lowered height of forks: 55mm
- » Manufactured to the recognised European GS standard



- » Mobile on 180 x 50mm red polyurethane steering wheels & 50 x 70mm tandem front rollers
- » Ideal for moving crates, vending machines, appliances etc



Fork Length mm	Width over Forks mm	Pallet Type	Model	Price
1000	540	Euro & GKN/CHEP/UK	LPPT1054	£695.80
	680	GKN/CHEP/UK	LPPT1068	£731.10
1150	540	Euro & GKN/CHEP/UK	LPPT1554	£695.80
	680	GKN/CHEP/UK	LPPT1568	£731.10

Printers Pallet Trucks

- » Conform to EN 1757-2
- » Fork width: 160mm
- » Raised height of forks: 200mm
- » Lowered height of forks: 85mm
- » Mobile on 200mm nylon steering wheels & 85mm nylon front rollers (picture shows tandem front rollers which are available upon request)
- » 3 position trigger (lift, lower & neutral)



Fork Length mm	Width over Forks mm	Pallet Type	Model	Price
600	450	Printers	GN0645	£515.90
800	450	Printers	GN0845	£515.90
1000	450	Printers	GN1045	£515.90

Braked Pallet Trucks

- » Conform to EN 1757-2
- » Fork width: 160mm
- » Raised height of forks: 200mm
- » Lowered height of forks: 85mm
- » Complete with entry & exit rollers
 - » Mobile on 200mm nylon steering wheels & 80mm nylon front rollers
 - » Progressive braking system & parking brake facility. With the braking device, the walking speed can be controlled by hand. When you pull the brake lever in upward direction, the brake works. You can use the brake no matter if the truck is moving or not
 - » Other sizes available - call for details



Fork Length mm	Width over Forks mm	Pallet Type	Model	Price
1000	550	Euro & GKN/CHEP/UK	GN550BPT	£707.15
	685	GKN/CHEP/UK	GN685BPT	£726.80

Quick Lift Pallet Trucks

- » Conform to EN 1757-2
- » Fork width: 160mm
- » Raised height of forks: 200mm
- » Lowered height of forks: 85mm
- » Mobile on 200mm polyurethane steering wheels & 85mm nylon front rollers
 - » 3 position trigger (lift, lower & neutral) with a comfortable rubber gripped handle
 - » Quick lift pump action speeds up pallet movement in busy work places like parcel/pallet distribution & couriers etc
 - » Quick lift function up to 300kg weight



Fork Length mm	Width over Forks mm	Pallet Type	Model	Price
1150	540	Euro & GKN/CHEP/UK	QLPT1554	£463.50
	685	GKN/CHEP/UK	QLPT1568	£479.40

Long Fork Pallet Trucks

- » Conform to EN 1757-2
- » Raised height of forks: 200mm
- » Lowered height of forks: 85mm
- » Mobile on 200mm nylon steering wheels & 85mm nylon front rollers
- » 3 position trigger (lift, lower & neutral) with a comfortable rubber gripped handle



CAN BE USED WITH



GKN/CHep/UK
1000 x 1200mm
Closed Pallets



Euro
800 x 1200mm
Open Pallets

Fork Length mm	Width over Forks mm	Pallet Type	Fork Spacing mm	Model	Price
1500	540	Euro & GKN/CHep/UK	220	GN1554	£669.85
1500	685	GKN/CHep/UK	365	GN1568	£695.25
1800	540	Euro & GKN/CHep/UK	220	GN1854	£784.15
1800	685	GKN/CHep/UK	365	GN1868	£811.15
2000	540	Euro & GKN/CHep/UK	220	GN2054	£812.70
2000	685	GKN/CHep/UK	365	GN2068	£842.90

Heavy Duty Pallet Trucks

- » Conform to EN 1757-2
- » Fork width: 160mm
- » Raised height of forks: 200mm
- » Lowered height of forks: 85mm
- » Mobile on 200mm nylon steering wheels & 85mm nylon front rollers
- » 3 position trigger (lift, lower & neutral) with a comfortable rubber gripped handle



Fork Length mm	Width over Forks mm	Pallet Type	Model	Price
1150	540	Euro & GKN/CHep/UK	HDPT301554	£614.30
1150	680	GKN/CHep/UK	HDPT301568	£647.65

Extra Heavy Duty Pallet Truck

- » Conform to EN 1757-2
- » Fork width: 210mm
- » Raised height of forks: 200mm
- » Lowered height of forks: 90mm
- » Mobile on 200mm steel steering wheels & 80mm steel front rollers
- » 3 position trigger (lift, lower & neutral)



Fork Length mm	Width over Forks mm	Pallet Type	Model	Price
1150	580	Euro & GKN/CHep/UK	HDPT501558	£1550.80

PLEASE NOTE: In order for us to offer a 2 year guarantee your Pallet Truck must be serviced with the agreement on page 296 & 297 299

Pallet Trucks, Stackers, Lift Tables & Equipment

Robust Ultra Accurate Pallet Truck Scale

- » Large 25mm LCD display for easy reading, keyboard with zero & tare functions
- » Operating time of approximately 80 hours in continuous use or 3 months in normal use thanks to its auto switch-off function
- » **Rubber steering wheels & polyurethane tandem front load wheels for more accurate weighing**



G2TPWN Indicator

G2TPWN

INFORMATION

Ultra accurate 2000kg by 0.2kg increments

INFORMATION

Optional traceable ISO:9000 calibration certificate available

Fork Length mm	Width over Forks mm	Weight kg	Model	Price
1150	550	120	G2TPWN	£1345.00
Optional ISO:9000 Calibration Certificate Calibration Certificates must be ordered at the time of purchase of the scale			ISO-CERT	£35.00

Heavy Duty Pallet Truck Scale

- » The ultimate heavy duty pallet truck scale is extremely accurate - 2000kg x 0.2kg increments
- » Large 25mm LCD display, IP68 rated indicator housing in stainless steel
- » **Fitted with extractable rechargeable battery**
- » **Optional spare battery gives 24/7 use**
- » Supplied with battery charger which gives an operating time of approx. 60 hours in continuous use, thanks to its auto switch-off function
- » **Rubber steering wheels & polyurethane tandem loading front rollers for more accurate weighing**

INFORMATION

Optional traceable ISO:9000 calibration certificate available



G2TPWLK

INFORMATION

Ultra accurate 2000kg by 0.2kg increments

Fork Length mm	Width over Forks mm	Weight kg	Model	Price
1150	550	120	G2TPWLK	£1495.00
Optional spare battery pack for 24/7 use			GTPWBKB	£145.00
Optional ISO:9000 Calibration Certificate Calibration Certificates must be ordered at the time of purchase of the scale			ISO-CERT	£35.00



STAINLESS STEEL & ATEX MODELS ARE AVAILABLE - CALL FOR DETAILS

Weigh Scale Pallet Truck

- » Conform to EN 1757-2
- » CE marked & plated
- » Fork width: 182mm
- » Raised height of forks: 200mm
- » Lowered height of forks: 85mm
- » Mobile on 200 x 50mm polyurethane steering wheels & 74 x 70mm tandem rollers
- » Accuracy (+/- 0.5% and in 2kg increments)
- » Electronic lifting height indication in display
- » Highly reliable - all components are compact, designed for mobile use & low power usage
- » Water & dust proof to IP65. IP65 allows the pallet truck to be used outside or on lorries & can be cleaned with water (under normal pressure). The load cells in the forks have an even protection level
- » Power supply - built in rechargeable batteries give up to 70 hours use from one charge

INFORMATION

Weighing accuracy to +/- 0.5% & in 2kg increments



PRICE HELD



WPT57H Weigh Scale Display



WPT57H

Fork Length mm	Width over Forks mm	Pallet Type	Model	Price
1150	545	Euro & GKN/CHEP/UK	WPT57H	£914.30

Premium Weigh Scale Pallet Truck

- » Conform to EN 1757-2
- » CE marked & plated
- » Fork width: 160mm
- » Raised height of forks: 200mm
- » Lowered height of forks: 85mm
- » Mobile on 180 x 50mm polyurethane steering wheels & 74 x 70mm tandem rollers
- » High accuracy (+/- 0.1% and in 0.5kg increments)
- » Electronic lifting height indication in display
- » Highly reliable - all components are compact, designed for mobile use & low power usage
- » Water & dust proof to IP65. IP65 allows the pallet truck to be used outside or on lorries & can be cleaned with water (under normal pressure). The load cells in the forks have an even protection level
- » Power supply - fitted with rechargeable batteries. The battery will last 70-80 hours & to re-charge simply plug to the mains (cable included). Charging takes approx. 4hrs.



INFORMATION

High weighing accuracy to +/- 0.1% & in 0.5kg increments



PRICES HELD



Weigh Scale Display



PWS1270

Load Capacity	Fork Length mm	Width over Forks mm	Pallet Type	Model	Price
2000kg	1150	540	Euro & GKN/CHEP/UK	PWS1157	£1411.15
2000kg	1220	690	GKN/CHEP/UK	PWS1270	£1485.75
2500kg	1150	540	Euro & GKN/CHEP/UK	PWS1125	£1488.90

PLEASE NOTE: In order for us to offer a 2 year guarantee your Pallet Truck must be serviced within the below agreement
One service visit per annum, a PUWER inspection & Calibration - Price: **£96.00** per truck & per annum (any parts are extra)

Pallet Trucks, Stackers, Lift Tables & Equipment

Semi Powered Pallet Truck

- » Conform to EN 1757-1
- » Fork width: 160mm
- » Raised height of forks: 205mm
- » Lowered height of forks: 85mm
- » Modern, compact & light design makes this unit suitable for application in a variety of warehouses, supermarkets & even on large lorries
- » Brand new Lithium maintenance-free, pollution free battery that is slower discharging & requires significantly shorter time to recharge
- » 400W motor driven without the need for pushing or pulling.
- » Maximum driving speed of 4.8 km/h
- » CURTIS controller unit with a nonpolar speed controller
- » Incorporates stabilising wheels either side of the drive wheel arrangement
- » Mobile on 150mm polyurethane steering wheels & 80 x 60mm polyurethane tandem rollers
- » Power supply: 24V/30A. Complete with 13amp single phase 3 pin charging plug
- » 8 hours average runtime and 3 hours runtime for continuous use
- » Spare battery available - call for details



INFORMATION
Fast charge of only 3.5 hours



PRICE HELD

CAN BE USED WITH

GKN/CHep/UK
1000 x 1200mm
Closed Pallets

Euro
800 x 1200mm
Open Pallets



BATTERY IS EXCLUDED FROM THE GUARANTEE



Fork Length mm	Width over Forks mm	Pallet Type	Model	Price
1150	540	Euro & GKN/CHep/UK	SPPT40	£1307.95

In accordance with HSE HS (9) it is recommended that all lifting equipment supplied must have a minimum of one service per annum
 One service visit per annum & a PUWER inspection
 Price: **£140.00** per truck & per annum (any parts are extra)
 PLEASE NOTE: In order for us to offer a 2 year guarantee your Pallet Truck must be serviced within the above agreement
FULL NATIONWIDE COVERAGE OF UK MAINLAND

Fully Powered Electric Pallet Truck with Lithium Battery

- » Conform to EN 1757-1
- » Fork width: 150mm
- » Raised height of forks: 115mm
- » Lowered height of forks: 80mm
- » Modern, compact & light design makes these units suitable for application in a variety of warehouses, supermarkets & even on large lorries
- » Incredibly smooth travel & lift combined with multi-functional controls greatly help reduce product damage & increase productivity
- » Open design of the truck makes battery removal & installation easier
- » Electric lifting function saves operator effort; manual lowering function can adjust lowering speed through handle angle
- » Auxiliary wheels on two sides increases truck stability
- » CURTIS controller unit with a nonpolar speed controller

PRICES HELD



INFORMATION
 Curtis controller unit & a nonpolar speed controller



FPPT40

CAN BE USED WITH



GKN/CHEP/UK
1000 x 1200mm
Closed Pallets



Euro
800 x 1200mm
Open Pallets



BATTERY IS EXCLUDED FROM THE GUARANTEE

FPPT30 - Premium

Capacity kg	Fork Length mm	Width over Forks mm	Pallet Type	Model	Price
Fully Powered Pallet Trucks with Lithium Battery					
1500	1150	540	Euro & GKN/CHEP/UK	FPPT40	£1733.35
2000	1150	540	Euro & GKN/CHEP/UK	FPPT50	£1874.65
Premium Fully Powered Pallet Trucks with Lithium Battery					
1200	1150	540	Euro & GKN/CHEP/UK	FPPT30	£2047.65
1500	1150	540	Euro & GKN/CHEP/UK	FPPT60	£2341.30
2000	1150	540	Euro & GKN/CHEP/UK	FPPT70	£3076.20

In accordance with HSE HS (9) it is recommended that all lifting equipment supplied must have a minimum of one service per annum
 One service visit per annum & a POWER inspection
 Price: **£185.00** per truck & per annum (any parts are extra)
 PLEASE NOTE: In order for us to offer a 2 year guarantee your Pallet Truck must be serviced within the above agreement
FULL NATIONWIDE COVERAGE OF UK MAINLAND

Pallet Trucks, Stackers, Lift Tables & Equipment

Fully Powered Pallet Truck

INFORMATION 
Curtis controller unit & a nonpolar speed controller

- » Conform to EN 1757-1
- » Fork width: 167mm
- » Raised height of forks: 205mm
- » Lowered height of forks: 85mm
- » 400W motor driven without the need for pushing or pulling. Maximum driving speed of 4.5 km/h
- » CURTIS controller unit with a nonpolar speed controller
- » Incorporates stabilising wheels either side of the drive wheel arrangement
- » Mobile on 250mm polyurethane steering wheels & 80 x 70mm polyurethane tandem rollers
- » Power supply: 2 x 12/80Ah. Complete with 13amp single phase 3 pin charging plug
- » Other fork lengths & widths available - please call for details



1500kg
evenly distributed

7 day
delivery

2 YR
GUARANTEE

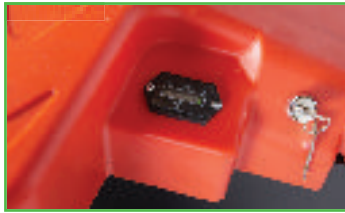

Battery Life Indicator & Key



FPPT10



Control Panel

CAN BE USED WITH



GKN/CHEP/UK
1000 x 1200mm
Closed Pallets



Euro
800 x 1200mm
Open Pallets

In accordance with HSE HS (9) it is recommended that all lifting equipment supplied must have a minimum of one service per annum
 One service visit per annum & a PUWER inspection
 Price: **£185.00** per truck & per annum (any parts are extra)
 PLEASE NOTE: In order for us to offer a 2 year guarantee your Pallet Truck must be serviced within the above agreement
FULL NATIONWIDE COVERAGE OF UK MAINLAND

Fork Length mm	Width over Forks mm	Pallet Type	Model	Price
1150	540	Euro & GKN/CHEP/UK	FPPT10	£2330.20

PRICE HELD

FPPT10

Premium Fully Powered Pallet Trucks

- >> Conform to EN 1757-1
- >> Raised height of forks: 200mm
- >> Lowered height of forks: 85mm
- >> Approved acceleration enhances efficient pallet entry & exit. Nonpolar control is programmable for specific tasks or operator skill levels
- >> High quality hydraulic pump ensures little noise & maximum durability
- >> Drive unit incorporates an electro magnetic brake that is spring applied & electrically released. The brake is activated by the control handle
- >> Ergonomically designed control handle
- >> Mobile on 252mm steering wheels & 84mm tandem rollers
- >> 3000kg option available - please call for details

In accordance with HSE HS (9) it is recommended that all lifting equipment supplied must have a minimum of one service per annum
 One service visit per annum & a PUWER inspection
 Price: **£185.00** per truck & per annum (any parts are extra)
 PLEASE NOTE: In order for us to offer a 2 year guarantee your Pallet Truck must be serviced within the above agreement
FULL NATIONWIDE COVERAGE OF UK MAINLAND



CAN BE USED WITH



GKN/CHP/UK
1000 x 1200mm
Closed Pallets



Euro
800 x 1200mm
Open Pallets



FPPT20 & FPPTPLSA



Control Panel



FPPT20 & FPPTPLSA

2 YR
GUARANTEE

2000kg
evenly distributed

7 day delivery

Load Cap. kg	Fork Length mm	Fork Width mm	Width over Forks mm	Pallet Type	Model	Price
2000	1150	160	540	Euro & GKN/CHP/UK	FPPT20	£6727.00
Optional Driver Platform & Side Protection Bars					FPPTPLSA	£841.30

Pallet Trucks, Stackers, Lift Tables & Equipment

Galvanised Pallet Trucks

- » Conform to EN 1757-2
- » Raised height of forks: 200mm
- » Lowered height of forks: 85mm
- » Complete with entry & exit rollers
- » Mobile on 200 x 50mm nylon steering wheels & 80 x 70mm nylon front rollers
- » Corrosion resistant - ideal for use in wet & damp conditions
- » Fork width: 160mm
- » Stainless steel version available - call for details



GAPT1154

Fork Length mm	Width over Forks mm	Pallet Type	Model	Price
1150	540	Euro & GKN/CHEP/UK	GAPT1154	£853.35
	680	GKN/CHEP/UK	GAPT1168	£887.45

Wet Spec Pallet Trucks

- » Conform to EN 1757-2
- » Raised height of forks: 200mm
- » Lowered height of forks: 85mm
- » Suitable for use in moderately wet conditions, in chilled temperatures & in the food industries
- » Mobile on 200mm nylon steering wheels & 85mm nylon front rollers
- » 3 position trigger (lift, lower & neutral)



WSPT1054

Fork Length mm	Width over Forks mm	Pallet Type	Model	Price
1000	540	Euro & GKN/CHEP/UK	WSPT1054	£595.25
1150	540	Euro & GKN/CHEP/UK	WSPT1154	£595.25
1000	685	GKN/CHEP/UK	WSPT1068	£619.05
1150	685	GKN/CHEP/UK	WSPT1168	£619.05

Rough Terrain Pallet Truck

- » Conform to EN 1757-2
- » CE marked & plated
- » Lowered height of forks: 50mm
- » Adjustable forks (up to 580mm wide) adapt to a maximum pallet width of 1200mm
- » Ideal for rough terrain outdoor applications such as building sites, agricultural environments etc
- » Mobile on pneumatic wheels mounted on hubs with sealed bearings
- » Hydraulic lifting system with integrated hand pump
- » 1200kg electric version available - please call for details



GZR11N

Overall Size W x L x H mm	Fork Length mm	Weight kg	Model	Price
1640 x 1413 x 800	890	173	GZR11N	£1546.05

Reel Handling Pallet Trucks

- » Conform to EN 1757-2
- » CE marked & plated
- » Designed to carry horizontal loads such as rolls, reels, cable drums etc
- » Strong & robust chassis which is reinforced at the 'A' frame & the legs are strengthened along their length
- » Hydraulic pump with a slow lowering hand control valve. A 3 position control lever provides fingertip control of all hydraulic system functions with the handle in any position
- » Mobile on 200 x 50mm steering wheels & 82 x 70mm roller tandems
- » Other fork lengths available - call for details

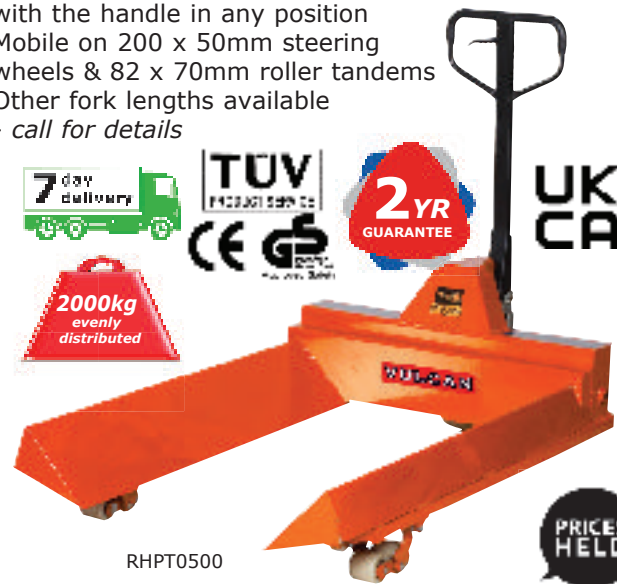

RHPT0500

To Suit Reel Size	Fork Length mm	Fork Width mm	Model	Price
400/600	1000	760	RHPT0500	£1068.30
600/800		850	RHPT0700	£1095.25
800/1200		1000	RHPT1000	£1139.70
1200/1600		1150	RHPT1500	£1233.35

Pallet Trucks, Stackers, Lift Tables & Equipment

High Lift Pallet Trucks

- » Conform to EN 1757-2
- » Fork width: 160mm
- » Raised height of forks: 800mm
- » Lowered height of forks: 85mm
- » Mobile on 180 x 50mm nylon steering wheels & 74 x 50mm front rollers
- » Stabilising bars automatically come into operation to prevent the unit moving
- » Automatically slow descending speed to prevent damage of your goods



HLPT1755
Half Height



HLPT1755
Full Height



Load Capacity	Fork Length mm	Width over Forks mm	Pallet Type	Weight kg	Model	Price
1000kg	1170	540	Euro & GKN/CHEP/UK	95	HLPT1755	£857.15
1000kg	1170	685	GKN/CHEP/UK	115	HLPT1768	£857.15
1500kg	1170	540	Euro & GKN/CHEP/UK	110	HLPT1555	£973.60
1500kg	1170	685	GKN/CHEP/UK	130	HLPT1568	£973.60

PLEASE NOTE: In order for us to offer a 2 year guarantee your High Lift Pallet Truck must be serviced within the agreement below:
One service visit per annum & a LOLER inspection - Price: **£115.00** per truck & per annum (any parts are extra)

Electric High Lift Pallet Trucks

- » Conform to EN 1757-2
- » Fork width: 160mm
- » Raised height of forks: 800mm
- » Lowered height of forks: 85mm
- » Mobile on 180 x 55mm steering wheels & 75 x 50mm front rollers
- » Adjustable stabilising bars come into operation to prevent the unit moving
- » Battery & charger included: Battery - 12v/60Ah
- » Lifting motor power: 0.8kw
- » Manual operation included



Stabilising bars prevent the unit moving whilst in use



PHL54H
Lowered

INFORMATION
Manual or electric lift/lower for precise positioning



PHL54H
Full Height

Load Capacity	Fork Length mm	Width over Forks mm	Pallet Type	Weight kg	Model	Price
1000kg	1170	540	Euro & GKN/CHEP/UK	125	PHL54H	£1923.85
1000kg	1170	680	GKN/CHEP/UK	136	PHL68H	£2049.25
1500kg	1170	540	Euro & GKN/CHEP/UK	140	PHL60H	£2182.55
1500kg	1170	685	GKN/CHEP/UK	151	PHL70H	£2325.40

PLEASE NOTE: In order for us to offer a 2 year guarantee your Electric High Lift Pallet Truck must be serviced within the agreement below:
One service visit per annum & a LOLER inspection - Price: **£115.00** per truck & per annum (any parts are extra)

Pallet Trucks, Stackers, Lift Tables & Equipment

Large Load Movers



- » Load is raised & can be easily moved around in any direction, even in the tightest of areas
- » Incorporates a 5M securing strap to secure your loads to the units



LLM18H

PRICES HELD

INFORMATION
Ideal for bulky & heavy weight items



LLM06M

Load Capacity kg	Lift	Max Lift Height mm	Toe Plate Size D x W mm	Wheels	Overall Size L x W x H mm	Weight kg	Model (pairs)	Price (pairs)
600	Manual	300	120 x 225	125mm Polyurethane	570 x 390 x 780	25	LLM06M	£744.05
1800	Hydraulic	250	60 x 600	150mm Polyurethane	680 x 420 x 1070	86	LLM18H	£1006.00

Static Lift Tables - Mains Operated

- » Comply to BS EN 1570 & BS EN 60204-1
- » Remote power system, easy for controlling, convenient for maintenance
- » Electronic control box with up, down & emergency buttons
- » PSL82U: specially designed in 'U' shape for handling pallets & boxes
Platform cut out - 1050L x 585Wmm
- » Lifting speed with load: 42mm/sec
- » Three phase (414V) power supply required & units need to be installed by an electrician



PSL80F



PSL82U

PRICES HELD



PSL80F Lowered
Ramp Size:
1140L x 890W mm

Load Capacity kg	Lowered Platform Height mm	Raised Platform Height mm	Platform Size L x W mm	Lifting Time	Motor kw	Weight kg	Model	Price
1000	80	760	1450 x 1140	18 secs.	0.75	235	PSL80F	£2419.05
	82					PSL82U	£2419.05	

Scissor Lift Tables



- >> Comply to EN1570:2011
- >> These units are elevated by winch (WLT30/50Y) or pump action foot pedal & lowered by either a hand operated release trigger (Single Scissor Pump Operated Lift Tables) or foot pedal (Double Scissor Pump Operated Lift Tables)
- >> Mobile on 2 fixed & 2 swivel braked castors with wheel guards

Load Capacity	Platform Size mm	Lowered Height mm	Max Lift Height mm	Wheels	Model	Price
Single Scissor Winch Operated Lift Table						
300 kg	950 x 600	440	1000	2 fixed & 2 swivel braked 125mm castors	WLT30Y	£556.35
500 kg	950 x 600	550	1000	2 fixed & 2 swivel braked 125mm castors	WLT50Y	£756.35
Single Scissor Pump Operated Lift Tables						
150 kg	700 x 450	255	720	100 x 25mm Polyurethane Castor	MLTS15Y	£500.85
300 kg	850 x 500	280	880	125 x 40mm Polyurethane Castor	MLTS30Y	£556.35
500 kg	850 x 500	280	880	125 x 40mm Polyurethane Castor	MLTS50Y	£660.55
Double Scissor Pump Operated Lift Tables						
350 kg	910 x 500	350	1300	125 x 40mm Polyurethane Castor	MLTD35Y	£752.95
500 kg	910 x 500	360	1500	125 x 40mm Polyurethane Castor	MLTD50Y	£813.45
800 kg	1200 x 610	450	1500	125 x 40mm Polyurethane Castor	MLTD80Y	£1095.80
1000 kg	1200 x 610	500	1700	125 x 40mm Polyurethane Castor	MLTD100Y	£1361.35

Mini Lifters

- >> Conforms to EN1757:1
- >> Strong chromium plated frame complete with adjustable forks & removable platform
- >> Mobile on 2 fixed 75mm front castors & 2 swivel braked 125mm steering castors with wheel guards
- >> Electric version available - call for details



INFORMATION 

Complete with removable platform (660 x 580mm)

Platform Size mm	Lowered Height mm	Max Lift Height mm	Model	Price
660 x 580	90	1200	ML1200Y	£1019.05
660 x 580	90	1500	ML1500Y	£1058.75

PLEASE NOTE: We are able to offer servicing & a LOLER inspection on the above so please call for details

Pallet Trucks, Stackers, Lift Tables & Equipment



Forklift Caddy & Mini Wrap Caddy

- » Handy tool to store & carry pallet wrapping
- » Easy 'click & release' to remove & replace roll on to Fork lift trucks or hand pallet trucks
- suitable for all makes
- » Pack of 10



Model	Price (per pk of 10) 1+	Price (per pk of 10) 20+	Price (per pk of 10) 50+
Forklift Caddy - Clip & Wrap Holder with Divider & can be used to hold accessories such as scanners, phones, tape, shrink wrap etc			
FKCAD10	£200.00	£192.86	£171.43
Pallet Truck Caddy - Mini Cup & Clip			
PTCAD10	£157.14	£150.00	£122.86

Lifters/Transporters

- » Conform to EN 1757-2
- » Carry out a range of functions in production, warehousing environments
- » Simple controls all mounted within easy reach of the operator
- » Attachments are easily & quickly changed with simple tools
- » Built in battery allows the truck to be charged from any convenient 13 amp socket
- » Mobile on 100mm steering wheels (fitted with foot pedal brakes) & 80mm tandem rollers
- » Load centre: 300mm
- » Lift motor: 24v / 0.37Kw
- » N.B load capacities may alter depending on what accessories are used wth the Lifter



Roll & Coil Handler



Roller Bed Platform



Work Platform

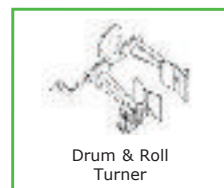

Drum & Roll Turner



Jib Crane Arm

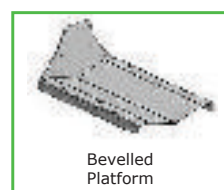

Bevelled Platform

Description	Model	Price
Roll & Coil Handler	LTMLRCH	£249.25
Work Platform	LTMLWP	£423.85
Jib Crane Arm	LTMLJCA	£438.10
Roller Bed Platform	LTMLRBP	£846.05
Drum & Roll Turner	LTMLDRT	£2292.10
Bevelled Platform	LTMLBP	£587.35



LTML115

Load Cap. kg	Lift Height mm	Overall Size H x W x L mm	Lift Speed cm / sec	Battery v / Ah	Weight kg	Model	Price
100	1500	1920 x 560 x 1045	8.3 / 6	2 x 12 / 17	86	LTML086	£4651.90
100	2000	2420 x 560 x 1045	8.3 / 6	2 x 12 / 17	115	LTML115	£5474.10
100	2300	2920 x 560 x 1045	8.3 / 6	2 x 12 / 17	144	LTML144	£5537.80
200	1500	1920 x 560 x 1045	8.3 / 4.2	2 x 12 / 40	106	LTML106	£5665.20
200	2000	2420 x 560 x 1045	8.3 / 4.2	2 x 12 / 40	135	LTML135	£5866.70
200	2300	2920 x 560 x 1045	8.3 / 4.2	2 x 12 / 40	164	LTML164	£6340.75

310

PLEASE NOTE: We are able to offer servicing & a LOLER inspection on the above so please call for details

Mini Lifters

- >> Conform to EN 1757-2
- >> Designed for ultimate flexibility & able to carry out a huge range of functions
- >> Complete with a removable work platform (removable with the use of simple tools leaving two forks underneath)
- >> Electric models: automatic electronic overload protection systems
- >> Manual model: operated via hand winch, with auto brake system
- >> Choice of easy to change options available: bevelled platform, drum & roll turner, roll & coil handler & roller bed - *please call for details*
- >> Mobile on 125mm steering wheels with foot guards & 75mm rollers
- >> 24v/20Ah battery with a built-in charger



Winch System for the MLM01Y



Remote Control for the MLE03Y



PRICES HELD



INFORMATION

Many accessories available - please call for details & prices

Model	Load Capacity kg	Load Centre mm	Lift Height mm	Platform Size W x L mm	Overall Size L x W x H mm	Model	Price
Manual	100	235	1500	470 x 600	840 x 600 x 1830	MLM01Y	£981.00
Manual	200	235	1500		870 x 600 x 1920	MLM02Y	£1047.65
Electric	150	235	1500		870 x 600 x 1790	MLE03Y	£1530.20
Electric	100	200	1700		870 x 740 x 1990	MLE04Y	£1504.80

PLEASE NOTE: We are able to offer servicing & a LOLER inspection on the above so please call for details

Pallet Trucks, Stackers, Lift Tables & Equipment

Semi Electric Straddle Stackers with Adjustable Forks

- » Conform to EN 1757-2
- » Brake & pulling handle
- » Tandem lift chains with full guarding
- » Manual push/electric lift
- » Load centre: 600mm
- » Turning radius: 1350mm
- » Adjustable forks & straddle legs giving an overall width of: 1100 to 1380mm
- » Mobile on 180mm steering wheels with foot guards & 100mm load wheels
- » 12v 150Ah battery with built-in automatic charger



INFORMATION



Adjustable straddle legs suitable for most pallets

PRICES HELD



PSS30E

Fork Length mm	Lowered Fork Height mm	Raised Fork Height mm	Fork Width mm	Overall Size H x L mm	Model	Price
Semi Electric Straddle Stackers with Adjustable Forks						
915	75	1600	220 to 850	2020 x 1550	PSS16E	£3944.45
		2000		2020 x 1550	PSS20E	£4269.85
1150	70	2500		1854 x 1800	PSS30E	£4411.15
		3000		2104 x 1800	PSS35E	£4865.10

Hydraulic Stackers

- >> Conform to CE Standard EN1757-1
- >> Controlled lifting by a hydraulic pump which can be either hand or foot operated
- >> Mobile on 2 swivel 180mm rear castors & 75mm front rollers

N.B. Appropriate facilities will be required to unload these units on delivery



VULCAN®

INFORMATION



Easily lift & manoeuvre palletised loads at height

STHI27Y

STHI23Y



In accordance with HSE HS (9) it is recommended that all lifting equipment supplied must have a minimum of one service per annum
HYDRAULIC STACKER

One service visit per annum & a LOLER inspection
Price: **£185.00** per truck, per annum

FULL NATIONWIDE COVERAGE OF UK MAINLAND

Load Cap. kg	Lifting Height mm	Overall Size H x W x L mm	Fork Length mm	Width over Forks mm	Load Centre mm	Model	Price
Manual Fixed Fork Hydraulic Stackers							
1000	1600	2010 x 740 x 1660	1150	550	600	STHI21Y	£1695.25
1000	2500	1830 x 740 x 1668	1150	550	600	STHI23Y	£1819.05
1000	3000	2060 x 740 x 1668	1150	550	600	STHI24Y	£1920.65
1500	1600	2010 x 740 x 1660	1150	550	600	STHI25Y	£1909.55
Manual Adjustable Fork Straddle Hydraulic Stackers							
1000	1600	2020 x 1100/1370 x 1420	915	210 to 800	500	STHI26Y	£2188.90
1000	2500	1770 x 1100/1370 x 1420	915	210 to 800	500	STHI27Y	£2320.65
1000	3000	2020 x 1100/1370 x 1420	915	210 to 800	500	STHI28Y	£2377.80

Pallet Trucks, Stackers, Lift Tables & Equipment

Semi Electric Stackers

- » Conform to EN 1757-1
- » CE marked & plated
- » Effortless manual push & pull movement
- » Easy control powered lifting
- » Steering & pulling handle
- » Mobile on 180mm steering wheels with foot guards & 74mm tandem rollers
- » 12v/150Ah battery with a built-in charger



Key, Battery Life Indicator & the Fork Operating Lever on the Semi Electric Stacker



In accordance with HSE HS (9) it is recommended that all lifting equipment supplied must have a minimum of one service per annum

One service visit per annum & a LOLER inspection
Price: **£250.00** per truck & per annum (any parts are extra)

PLEASE NOTE: In order for us to offer a 2 year guarantee your Pallet Truck must be serviced within the above agreement

FULL NATIONWIDE COVERAGE OF UK MAINLAND



SESCT15

INFORMATION

Adjustable fork units available - call for details



Load Capacity kg	Fork Length mm	Lift Height mm	Lowered Fork Height mm	Fork Width mm	Overall Size H x L mm	Model	Price
1000	1100	1600	85	570	1980 x 1720	SESCT10	£2950.80
		2500			3070 x 1720	SESCT15	£3238.10
		3000			3570 x 1720	SESCT20	£3525.40

Fully Powered Stackers

- » Conform to EN 1757-1
- » CE marked & plated
- » Turning radius: 1485mm
- » Battery voltage: 2 x 12/85 V/Ah powerful maintenance free batteries (large 2 x 12/106 V/ah are available - call for details)
- » Built in charger as standard, together with battery discharge indicator with automatic lift cut off function, ensure high battery lifetime
- » Fully powered stacker, with duplex mast lifting, that provide smooth travel & lift with easy to operate controls
- » High quality hydraulic pump ensures very little noise, maximum efficiency, durability & shortens the lifting time



LOWER PRICES

FPSCC1030

- » Four wheel supporting design at the driving end, with offset tiller for perfect view, allows stable & safe operation when the truck is used for high position stacking
- » Compact & ergonomic design improves operator performance
- » 1500kg & 2000kg models available - call for details

Load Capacity kg	Fork Length mm	Lift Height mm	Height of Mast Lowered mm	Height of Mast Raised mm	Fork Width mm	Model	Price
1000	1150	1600	2014	2014	570	FPSCC1016	£3887.45
1000	1150	2000	1494	2424	570	FPSCC1020	£3998.55
1000	1150	3000	1994	3424	570	FPSCC1030	£4085.95
1000	1150	3200	2144	3724	570	FPSCC1032	£4364.45

PLEASE NOTE: It is recommended that your equipment must have a minimum of one service per annum. Please see page 314 for more details

Pallet Trucks, Stackers, Lift Tables & Equipment



FPST1016



Fully Powered Straddle Stackers

- » Conform to EN 1757-1
- » CE marked & plated
- » Turning radius: 1485mm
- » Battery voltage: 2 x 12/85 V/Ah
Powerful maintenance free batteries (large 2 x 12/106 V/ah are available - call for details)
- » Built in charger as standard, together with battery discharge indicator with automatic lift cut off function, ensure high battery lifetime
- » Fully powered stacker, with duplex mast lifting, that provide smooth travel & lift with easy to operate controls
- » High quality hydraulic pump ensures very little noise, maximum efficiency, durability & shortens the lifting time
- » Four wheel supporting design at the driving end, with offset tiller for perfect view, allows stable & safe operation when the truck is used for high position stacking
- » Compact & ergonomic design improves operator performance
- » More load capacity options available - call for details



Load Capacity kg	Fork Length mm	Lift Height mm	Height of Mast Lowered mm	Height of Mast Raised mm	Fork Width mm	Model	Price
1000	1150	1600	2099	2099	570	FPST1016	£4720.00
1000	1150	2000	1580	2549	570	FPST1020	£4874.10
1000	1150	2500	1830	3049	570	FPST1025	£5007.45
1000	1150	3000	2080	3549	570	FPST1030	£5140.75
1000	1150	3200	2230	3849	570	FPST1032	£5287.45



CBS1501

Fully Powered Counterbalance Stackers

- » Conform to EN 1757-1
- » Duplex mast configuration allows good sight through the mast uprights
- » Short wheel base, compact & low noise
- » Adjustable fork spread to handle all pallet types
- » Uses latest AC control technology for superior control & battery life
- » External battery charger means that the truck can be charged from any convenient UK 3-pin socket
- » Heavy duty traction battery for 8 to 9 hours continuous work
- » Smooth step less drive controls
- » Power steering & full free lift
- » Can pick up closed board pallets, standard UK pallets & Euro pallets



INFORMATION

Ideal for getting the unit close to racking or where space is a premium



Load Capacity kg	Fork Length mm	Lowered Fork Height mm	Raised Fork Height mm	Height of Mast Lowered mm	Height of Mast Raised mm	Adjustable Width over Forks mm	Model	Price
600	1070	80	1600	2100	2100	200 / 690	CBS0600	£8040.00
600	1070	80	2600	2020	3705	200 / 690	CBS0602	£8322.96
1200	1070	80	1600	1230	2400	200 / 690	CBS1201	£10,411.85
1200	1070	80	3000	2030	4000	200 / 690	CBS1202	£10,992.59
1500	1070	80	1600	1230	2500	200 / 690	CBS1501	£12,234.07
1500	1070	80	4000	1817	4350	200 / 690	CBS1502	£13,324.44

Pallet Level Loader

- » Comply to Machinery Directive 2006/42/EC
- » Heavy duty springs allows the platform to move heavy loads easily, keeping the load at a comfortable working height
- » Helps reduce injuries associated with loading pallets at the floor level & will also improve productivity
- » Maximum lift height: 710mm
- » Galvanised version available - call for details



PLL1211

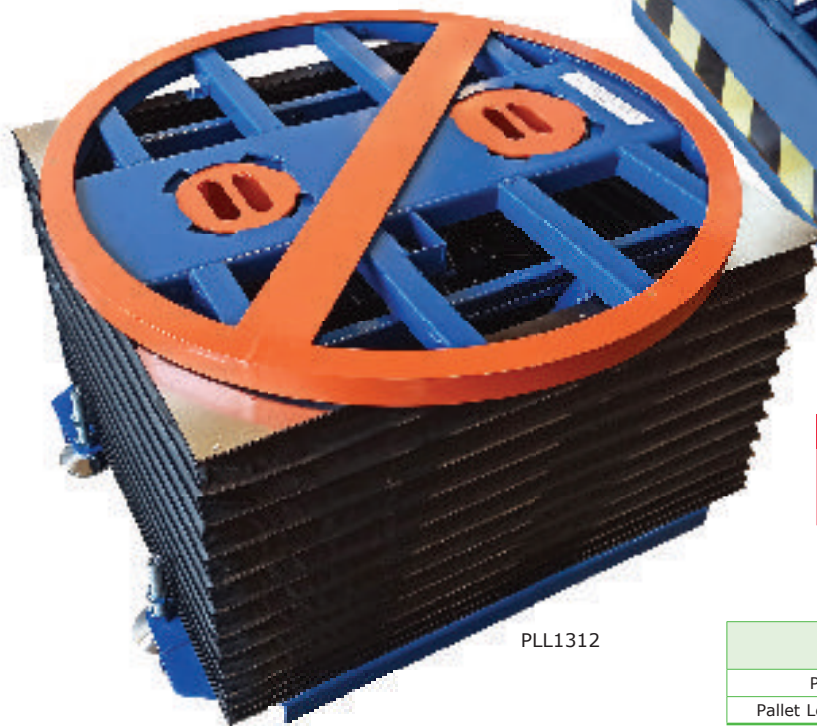

PLL1312

INFORMATION
Load a pallet without bending or stretching



PRICE HELD

Description	Overall Size W x D mm	Model	Price
Pallet Level Loader	1220 x 1110	PLL1211	£2009.55
Pallet Level Loader with Bellows	1220 x 1110	PLL1312	£2387.35

PalletDisc

- » Comply to Machinery Directive 2006/42/EC
- » Free-rotating ramped edge for easy pallet truck loading
- » Lock prevents accidental rotation
- » Ideal for many environments

PRICE HELD



PLD1100



Overall Size Dia. x H mm	Turntable Dia. mm	Model	Price
1100 x 22	1100	PLD1100	£1477.80

PalletRing

- » Comply to Machinery Directive 2006/42/EC
- » Strong, lightweight & simple to use
- » Free turning - does not tighten or bind under load
- » Ideal for many environments



PRICE HELD



Overall Size Dia. x H mm	Inner Dia. mm	Model	Price
1016 x 60	960	PLR1016	£438.10

PLEASE NOTE: We are able to offer servicing & a LOLER inspection on the above so please call for details

Pallet Trucks, Stackers, Lift Tables & Equipment

Fork Extensions



- >> Tip thickness 6mm for ease of splitting packs
- >> Fully pressed profile with rounded corners
- >> Zinc plated heel pins for safe attachment to truck

C of G mm	Fork Length mm	Model	Price per Pair
610	1829	IFE472HDBO-N/F	£312.00
762	1981	IFE478HDBO-N/F	£320.00
825	2134	IFE484HDBO-N/F	£336.00
914	2438	IFE496HDBO-N/F	£346.67
1219	3000	IFE4118HDBO-N/F	£434.67

Fork Mounted Hook

- >> Two fixed lifting points along the fork blade
- >> Supplied complete with single swivel hook & bow shackle
- >> Maximum fork section 150 x 50mm at 481mm centres
- >> Zinc plated heel pins for safe attachment to truck

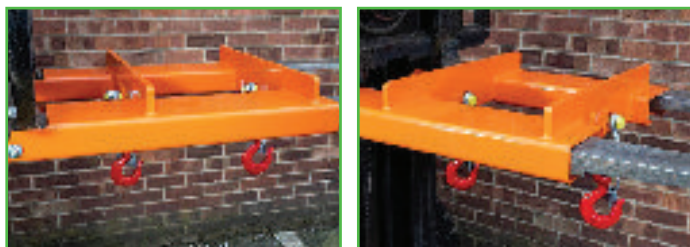

C of G mm	Capacity kg	Model	Price
350	1000	IFH-1	£428.00
350	2000	IFH-2	£461.33
350	3000	IFH-3	£502.67
350	4000	IFH-4	£532.00
350	5000	IFH-5	£552.00

Low Profile Jib



- >> Multi hook positioning from 500-1750 load centres
- >> Supplied complete with swivel hook & bow shackles
- >> Four way pocket entry for ease of storage
- >> Max. fork section 150 x 50 mm at 281 mm centres
- >> Zinc plated heel pins for safe attachment to truck

C of G mm	Capacity at 500mm Centres	Model	Price
750	1000kg	ILP-1.0-OP	£650.67
750	1500kg	ILP-1.5-OP	£685.33
750	2000kg	ILP-2.0-OP	£722.67
750	3000kg	ILP-3.0-OP	£754.67
750	4000kg	ILP-4.0-OP	£808.00

Load Buffers

- >> Specifically designed to reduce damage to fragile finished loads from the fork back height when being loaded or unloaded via a forklift truck
- >> Magnetically attaches to the fork uprights
- >> Easily swapped between trucks on site
- >> 25mm thick encapsulated foam pad



Max Fork Section mm	Length mm	Model	Price
100 x 50	460	ILPB/100/50	£440.00
100 x 50	560	ILPB/100/50-2	£460.00
130 x 60	560	ILPB/130/60	£501.33
150 x 60	720	ILPB/150/60	£509.33

Fork Mounted Sweepers



- >> Quick & easy solution for re-heaping your loose granule products such as sand, top soil, grain or similar
- >> Interchangeable blue nylon brushes
- >> Facility to hang Fork Mounted Magnet from the frame
- >> Maximum fork section 150 x 60mm at 683mm centres
- >> Zinc plated twist screws for safe attachment to truck

C of G mm	Brush Width mm	Model	Price
5 Row Bristle Sweeper			
125	1200	IFMS-1200-ECO	£544.00
125	1500	IFMS-1500-ECO	£668.00
125	1800	IFMS-1800-ECO	£805.33
Heavy Duty 8 Row Bristle Sweeper			
185	1500	IFMS-1500	£905.33
185	1800	IFMS-1800	£1128.00
185	2450	IFMS-2450	£1308.00

Boot Wash Station

- >> The Boot Wash Station is an easy to install unit which helps to keep your site buildings clean & safe
- >> Easier than ever to clean site boots & footwear
- >> The in-line version (IL) covers usage of up to 3 workers at a time whereas the back to back version (BTB) covers two men at a time. The BTB is advantageous when space is at a minimum
- >> Plumbing Waste System to sump to remove internal waste water
- >> Lightweight robust plastic sub-frame
- >> Water flow through each brush with individual isolator
- >> Heavy duty galvanised foot grid



Overall Size H x W x L mm	Description	Model	Price
1100 x 710 x 1460	2 Man (BTB)	IBWS-BTB	£862.67
1100 x 710 x 1460	3 Man (IL)	IBWS-IL	£1034.67

Sack Trucks



Heavy Duty Sack Trucks with Puncture Proof Wheels

- » Mobile on REACH compliant & puncture proof pneumatic wheels
- » High quality steel with a hardwearing aqua blue powder coated finish
- » Complete with strong, riveted knuckle guard hand grips
- » GI701R - high back unit with wheel guards & robust plastic covered skids
- » GI702R - extra wide unit with wheel guards
- » GI703R - standard unit
- » GI704R - complete with wheel guards. This unit also comes with a fixed (250kg capacity) & folding toe plate (150kg capacity). The folding toe plate stays in the folded position by the use of a magnet
- » GI705R - complete with wheel guards & 'P' handle. The 'P' handle allows the unit to be laid horizontally for ease of loading or unloading
- » GI706R - strong angle iron unit complete with wheel guards



INFORMATION



Units complete with puncture proof wheels "Will not let you down"



LOWER PRICES

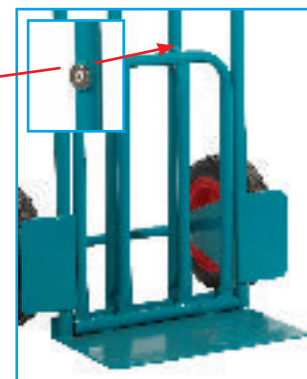
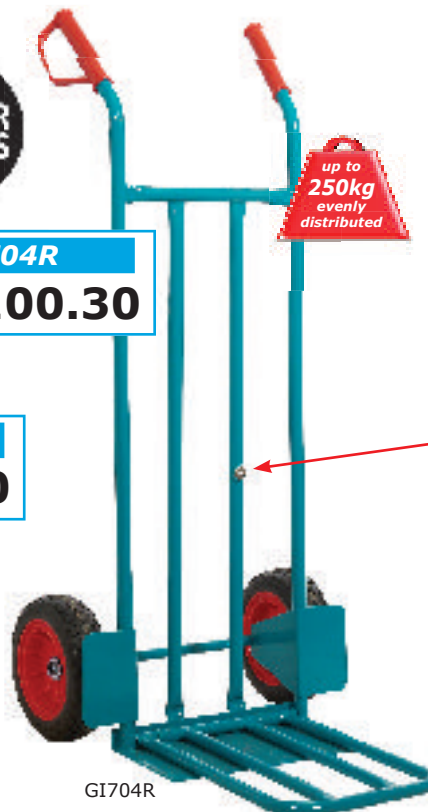

Folding Toe Plate stays in folded position by the use of a magnet

Capacity kg	Overall Size H x W x D mm	Fixed Toe Plate Size W x D mm	Folding Toe Plate Size W x D mm	Wheel Size mm	Weight kg	Model	Price
300	1320 x 510 x 630	285 x 280	-	250	13	GI701R	£147.80
250	1085 x 610 x 585	475 x 240	-	250	12.5	GI702R	£125.60
200	1110 x 515 x 490	360 x 250	-	200	8.5	GI703R	£87.50
up to 250	1240 x 535 x 710	390 x 165	320 x 430	250	11.5	GI704R	£100.30
250	1310 x 520 x 460	366 x 220	-	250	10	GI705R	£104.65
300	1185 x 580 x 600	385 x 300	-	250	14.5	GI706R	£121.95



Heavy Duty Sack Trucks with Puncture Proof Wheels



GI706R

£121.95

300kg
evenly
distributed

INFORMATION



Units complete with
puncture proof wheels
"Will not let you down"



250kg
evenly
distributed

GI702R

£125.60

GI706R

REACH COMPLIANT WHEELS

REACH (Registration, Evaluation, Authorisation & Restriction of Chemicals) is a European regulation that addresses the production & use of chemical substances, & their potential impacts on both human health & the environment

GI702R

Sack Trucks



Heavy Duty Sack Trucks with Puncture Proof & REACH compliant Wheels



SBA101R

SBA102R

- » Mobile on 260mm, REACH compliant & puncture proof pneumatic wheels
- » High quality steel with a hardwearing powder coated anthracite grey finish
- » Complete with strong, riveted knuckle guard hand grips
- » SBA101R - standard unit with wheel guards
- » SBA102R - extra wide unit with wheel guards
- » SBA103R - looped handle with wheel guards & curved back
- » SBA104R - complete with wheel guards. This unit also comes with a fixed (300kg cap.) & folding toe plate (200kg cap.)
- » SBA105R - high back unit with wheel guards
- » SBA106R - strong angle iron unit complete with wheel guards
- » SBA107R - mesh back unit with wheel guards

INFORMATION



Units complete with puncture proof wheels "Will not let you down"



SBA103R

SBA104R



Folding Toe Plate stays in folded position by the use of a magnet

Capacity kg	Overall Size H x W x D mm	Fixed Toe Plate Size W x D mm	Folding Toe Plate Size W x D mm	Model	Price
300	1150 x 550 x 540	350 x 250	-	SBA101R	£164.85
300	1205 x 650 x 590	450 x 300	-	SBA102R	£182.70
300	1300 x 550 x 540	350 x 250	-	SBA103R	£164.85
300	1205 x 600 x 540/740	400 x 200	350 x 400	SBA104R	£200.60
300	1350 x 550 x 540	350 x 250	-	SBA105R	£182.70
300	1205 x 550 x 590	350 x 300	-	SBA106R	£182.70
300	1150 x 550 x 540	350 x 250	-	SBA107R	£173.80

Heavy Duty Sack Trucks with Puncture Proof & REACH compliant Wheels



NEW

INFORMATION

Units complete with puncture proof wheels
"Will not let you down"

FROM ONLY £164.85



SBA107R



SBA105R



REACH COMPLIANT WHEELS

REACH (Registration, Evaluation, Authorisation & Restriction of Chemicals) is a European regulation that addresses the production & use of chemical substances, & their potential impacts on both human health & the environment



SBA106R



Sack Trucks

Folding Toe Sack Trucks



- » Ideal for storing in a car boot or van
- » Mobile on 150mm rubber plain bearing wheels
- » GI151Y: straight back frame
- » GI162Y: Telescopic handle with 3 positional heights - 800, 930 & 1060mm

Description	Overall Size H x W mm	Toe Plate Size W x D mm	Weight kg	Model	Price
Straight Back Frame	1020 x 360	300 x 380	5	GI151Y	£73.55
Telescopic Back Frame	1060 x 360	300 x 380	5	GI162Y	£74.30

Aluminium Sack Truck



- » Concave cross members & knuckle guard hand grips
- » 260mm pneumatic wheels for rough terrain
- » Fixed solid toe plate & wheel guards
- » Fitted with skids to enable this unit to be placed horizontally for ease of loading & unloading
- » Toe Plate Size: 250W x 270Dmm

Overall Size H x W x D mm	Weight kg	Model	Price
1310 x 470 x 610	11	GI998P	£186.25

Step-A-Trucks



- » Versatile - neat & compact
- » Large toe plate & wide step treads
- » Load capacity: as sack truck - 60kg & as step unit - 150kg
- » Multi purpose, simple & easy to convert from step to sack truck
- » When in sack truck mode they are mobile on two 100mm wheels



No. of Treads	Overall Size - W x D x H mm			Platform Height mm	Sack Truck Toe Plate	Step Tread Size	Weight kg	Model	Price 1 Off	Price (each) 2+
	Folded	as Sack Truck	as Step Unit							
2	460 x 70 x 990	480 x 490 x 990	470 x 530 x 920	490	390 x 280 mm	375 x 210 mm	6.5	FMS82Y	£102.95	£95.15
3	470 x 90 x 1265	490 x 450 x 1265	470 x 735 x 1190	750		9	FMS83Y	£119.05	£108.55	

Steel Sack Trucks



**FROM ONLY
£76.70**

**LOWER
PRICES**

- » REACH compliant wheels
- » Wheel guards
- » Knuckle guard hand grips
- » Hardwearing finish

Wheels	Overall Size H x W x D mm	Toe Plate Size W x D mm	Weight kg	Model	Price
200mm Cushion	1135 x 480 x 445	350 x 200	11.5	GI521H	£76.70
250mm Pneumatic	1120 x 545 x 435	350 x 185	11	GI523P	£84.30

Budget Sack Trucks

- » Lightweight
- » 200mm rubber wheels
- » Hardwearing finish



**FROM ONLY
£62.15**

Overall Size H x W x D mm	Toe Plate Size W x D mm	Weight kg	Model	Price
1120 x 470 x 410	350 x 228	11	GI256H	£62.15
1000 x 470 x 410	350 x 180	10	GI258H	£62.15

'P' Handle Sack Trucks

- » 'P' handle allows the unit to be laid horizontally for ease of loading & unloading
- » Mobile on pneumatic wheels giving a smooth ride over uneven terrain
- » GI340Y: designed for moving electrical goods. Fitted with plastic tube protectors to protect your load from damage



**FROM ONLY
£65.95**

**LOWER
PRICES**

Description	Load Capacity	Overall Size H x W x D mm	Wheel Size mm	Toe Plate Size W x D mm	Weight kg	Model	Price
Economy	100kg	1310 x 550 x 460	250	350 x 210	9	GI708P	£65.95
White Goods	250kg	1315 x 550 x 495	250	510 x 190	14	GI340Y	£100.35
Heavy Duty	300kg	1260 x 570 x 460	300	350 x 230	15	GI300P	£123.30

Sack Trucks

ONLY
£64.25

Easy operation
on stairs

Compact Sack Truck

- » Aluminium frame with a folding steel toe plate
- » Easily folded to fit in your car/van boot
- » Easily carried & stored once folded
- » 2 x 150mm solid rubber wheels
- » Folding toe plate size: 360W x 250D mm

90kg evenly distributed

GI960Y
Folded

LOWER PRICES

Overall Size - Open H x W x D mm	Overall Size - Folded H x W x D mm	Weight kg	Model	Price
1090 x 412 x 406	715 x 412 x 190	7	GI960Y	£57.45

Centaur® Compact Stairclimber

- » Lightweight aluminium frame
- » Toe plate size: 387 x 270mm
- » Complete with load strap & folding box clip
- » Mounted on 58mm wheels on a '3 star' system
- » Max load: 30kg on stairs & 60kg as truck

LOWER PRICE

GI083Y shown
with the
GC066Z
Folding Box

GI083Y
Folded

GI083Y

Overall Size H x W x D mm	Folded Size H x W x D mm	Weight kg	Model	Price
1050 x 415 x 415	635 x 395 x 67	3.5	GI083Y	£64.25
46L Folding Box (525L x 375W x 280Hmm)			GC066Z	£29.75*

*price applicable when ordering with the GI083Y. Order charges will apply if ordered on their own.

'THE PRO' Folding Sack Truck

- » Quickly & easily folds for compact storage & transportation. The toe plate, wheels & handles fold into the sack truck with a simple move of the handles
- » Mobile on 2 x 200mm puncture-proof rubber wheels
- » Folding toe plate size: 310W x 310D mm

THIS TO THIS

270kg evenly distributed

Simply turn the handles which will lift the toe plate & fold the wheels

GI270H

Overall Size - Open H x W x D mm	Overall Size - Folded H x W x D mm	Weight kg	Model	Price
1150 x 480 x 520	1165 x 435 x 145	6	GI270H	£154.25

Centaur® Super Compact Trucks

- >> Unfold in seconds
- >> Lightweight, simple to use & easy to carry
- >> Three versions available:
 - >> GI025Y - the 'mini' model
 - >> GI033Y - the 'super' model
 - >> GI043Y - the 'heavy duty' model
- >> All units are of aluminium construction
- >> These units can be stored or transported in confined spaces making them ideal for deliveries
- >> GI043Y comes complete with knuckle guard hand grips



**CENTAUR®
TRUCKS**



**LOWER
PRICES**



**FROM ONLY
£43.25**

Padded handles & knuckle guard hand grips on the GI043Y which fold flat for compact storage



INFORMATION

Ideal for use in schools & offices etc



Description	Load Capacity kg	Overall Size H x W x D mm when folded	Overall Size H x W x D mm when open	Toe Plate W x D mm	Wheels mm	Weight kg	Model	Price 1 Off	Price (each) 2+	Price (each) Box of 4
Mini Compact	60	650 x 390 x 60	1000 x 400 x 420	390 x 240	2 x 120	3	GI025Y	£50.85	£48.10	£43.25
Super Compact	100	700 x 490 x 60	1000 x 490 x 450	490 x 270	2 x 180	4	GI033Y	£78.65	£72.50	-
Heavy Duty Compact	200	1010 x 595 x 97	1255 x 620 x 600	590 x 335	2 x 200	10	GI043Y	£174.95	-	-

Sack Trucks



Centaur® Aluminium Sack Trucks

- » Aluminium frame is lightweight & easily manoeuvrable
- » 250mm pneumatic, high quality, wheels for use on uneven or rough terrain
- » GI814P/GI824P: Toe Plate Size: 355W x 232D mm
- » GI816P/GI826P: Toe Plate Size: 457W x 232D mm
- » GI817P/GI827P: Toe Plate Size: 355W x 232D mm. Large Folding Toe Plate Size: 355W x 590D mm



Description	Overall Size H x W x D mm	Weight kg	Model	Price
Standard Toe Sack Truck				
Without Sliders	1320 x 510 x 470	10	GI814P	£188.85
With Sliders	1320 x 510 x 470	11	GI824P	£203.85
Solid Toe Sack Truck				
Without Sliders	1240 x 500 x 470	10	GI816P	£200.25
With Sliders	1240 x 500 x 470	11	GI826P	£215.25
Large Toe Sack Truck (Fixed & Folding Toe)				
Without Sliders	1320 x 480 x 830	11	GI817P	£201.35
With Sliders	1320 x 480 x 830	12	GI827P	£216.35

Aluminium Two Way Truck

- » Strong, robust & lightweight
- » 250mm pneumatic, high quality wheels
- » Use as a sack truck or platform truck
- » Toe plate size: 457W x 232D mm
- » 200kg capacity in sack truck mode



PRICE HELD



GI815P as Sack Truck

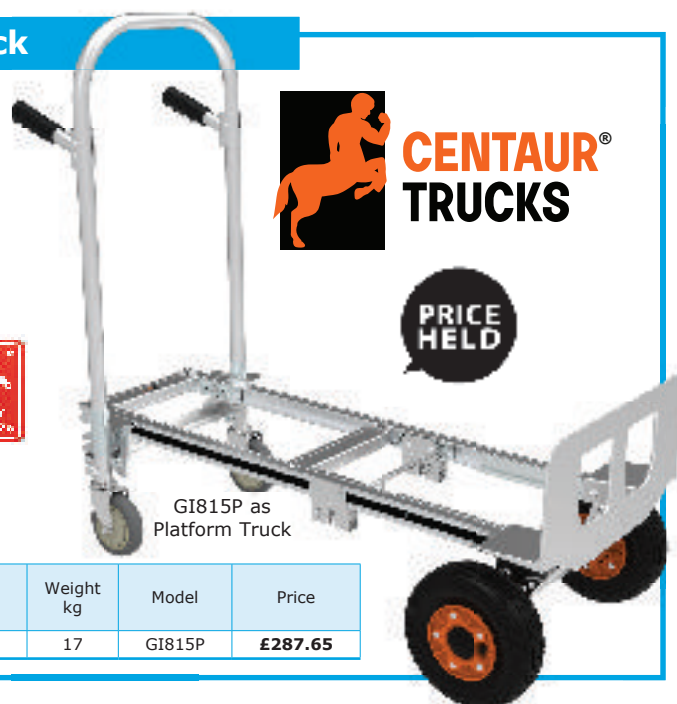

GI815P as Platform Truck

Overall Size As Platform Truck L x W x H mm	Overall Size As Sack Truck L x W x H mm	Weight kg	Model	Price
1187 x 506 x 1033	466 x 506 x 1322	17	GI815P	£287.65

Centaur® Aluminium Sack Trucks

- » Aluminium frame is lightweight & easily manoeuvrable
- » 250mm pneumatic, high quality, wheels for use on uneven or rough terrain
- » Flat frame gives extra stability when moving large or bulky loads
- » The robust construction, with heavy duty toe plates, gives strength & durability
- » Toe Plate Size: 355W x 232Dmm



Centaur® Aluminium Sack Trucks

Description	Overall Size H x W x D mm	Weight kg	Model	Price
High Back Sack Truck	1595 x 510 x 470	10.5	GI811P	£179.65
Pram Handle Sack Truck	1250 x 510 x 470	9	GI812P	£178.15
P Handle Sack Truck	1345 x 510 x 470	9.5	GI813P	£174.75

Centaur® Aluminium Sack Trucks with Sliders

Description	Overall Size H x W x D mm	Weight kg	Model	Price
High Back Sack Truck	1595 x 510 x 470	11.5	GI821P	£194.65
Pram Handle Sack Truck	1250 x 510 x 470	10	GI822P	£193.15
P Handle Sack Truck	1345 x 510 x 470	10.5	GI823P	£189.75

Aluminium Three Way Truck

- » Easily converts from a basic sack truck to a 4 wheel sack truck or platform truck
- » Incorporates 2 toe plates. A fixed toe plate (457W x 190Dmm) & a large folding toe plate (228W x 686Dmm)
- » Mobile on 250mm pneumatic wheels & 125mm polyurethane castors



INFORMATION

Converts quickly & easily into 3 positions

LOWER PRICE

Overall Size As Platform Truck L x W x H mm	Overall Size As Sack Truck L x W x H mm	Weight kg	Model	Price
1500 x 530 x 980	470 x 530 x 1325	18	GI935P	£373.20

GI935P Sack Truck

GI935P Platform Truck

GI935P 4 Wheel Sack Truck

Sack Trucks

Two Way Truck

- » Converts from a sack truck to a platform truck in seconds
- » Mobile on 250mm pneumatic wheels & 100mm swivel castors



GI358Y as Sack Truck



INFORMATION

Converts in seconds



GI358Y as Platform Truck

LOWER PRICE

Overall Size - L x W x H mm		Toe Plate Size D x W mm	Weight kg	Model	Price
Sack Truck Mode	Platform Truck Mode				
450 x 550 x 1240	980 x 550 x 890	180 x 350	12	GI358Y	£107.55

Two Way Cargo Truck

- » Converts from a sack truck to a platform truck in seconds
- » Mobile on 250mm pneumatic wheels & 100mm swivel castors
- » Load Capacity: 150kg in platform truck mode & 250kg in sack truck mode



GI352Y as Sack Truck



Close up of clasp holding the handle in position when the unit is in sack truck mode



INFORMATION

Converts in seconds



GI352Y as Platform Truck

LOWER PRICE

Overall Size - L x W x H mm		Toe Plate Size D x W mm	Weight kg	Model	Price
Sack Truck Mode	Platform Truck Mode				
585 x 390 x 1175	1175 x 390 x 930	335 x 310	14	GI352Y	£128.10

Three Position Truck with Bag Holder

- » Converts from a sack truck to a platform truck in seconds
- » Mobile on 200mm solid rubber wheels & 100mm swivel castors
- » Complete with a movable bag holder which incorporates an elastic strap to hold the bag in place (bag not supplied)



330

GI354Y as Sack Truck



Elastic strap holding the bag in place



GI354Y with bag holder down



LOWER PRICE



GI354Y as Platform Truck with bag holder up

Overall Size - L x W x H mm		Toe Plate Size D x W mm	Weight kg	Model	Price
Sack Truck Mode	Platform Truck Mode				
350 x 450 x 1180	630 x 450 x 795	130 x 350	8.5	GI354Y	£72.95

Medium Duty Three Way Truck

- >> A multi-purpose truck which easily & quickly converts from a basic sack truck to a 4 wheel sack truck or platform truck
- >> Fitted with 2 x 200mm rubber tyred wheels & 2 x 125mm rubber tyred castors
- >> Horizontal platform height: 260mm
- >> Toe plate size: 470 x 190mm

250kg evenly distributed

INFORMATION
Converts quickly & easily into 3 positions



GI135Y as Sack Truck



GI135Y as Platform Truck



GI135Y as 4 Wheel Sack Truck

LOWER PRICE



As Platform Truck L x W x H mm	As 4 Wheel Sack Truck L x W x H mm	As Basic Sack Truck W x H mm	Weight kg	Model	Price
1280 x 470 x 710	1205 x 470 x 840	470 x 1280	19	GI135Y	£130.85



Heavy Duty Three Way Truck

- >> A heavy duty truck which easily & quickly converts from a basic sack truck to a 4 wheel sack truck or platform truck
- >> High quality steel with a hardwearing powder coated anthracite grey finish
- >> Fitted with 2 x 200mm rubber tyred wheels & 2 x 125mm rubber tyred castors
- >> Toe plate size: 475 x 200mm
- >> 400kg load capacity (300kg as a 4 wheel truck)

3 YR GUARANTEE



SBA109R as Platform Truck



SBA109R as 4 Wheel Sack Truck



SBA109R as Sack Truck

up to 400kg evenly distributed

NEW

INFORMATION
Converts quickly & easily into 3 positions



As Platform Truck L x W x H mm	As 4 Wheel Sack Truck L x W x H mm	As Basic Sack Truck W x H mm	Weight kg	Model	Price
1245 x 490 x 835	1190 x 490 x 915	490 x 1245	27	SBA109R	£358.45

Sack Trucks

Wide Stairclimber



- » Mounted on 150mm wheels on a '3 star' system
- » Max load: 50kg on stairs 150kg as a sack truck
- » Fitted with knuckle guard hand grips, wheel guards & plastic guarded skids
- » Fixed & folding toe plates - folding toe plate size: 395 x 460mm
- » Complete with adjustable strap



INFORMATION

Complete with fixed & folding toe plates

Overall Size H x W x D mm	Toe Plate Size W x D mm	Weight kg	Model	Price
1160 x 605 x 795	410 x 200	22	GI360Y	£151.90

Heavy Duty 'BULKY' Sack Truck



- » 'Bulky' load sack truck is 1310H x 655W mm with a folding toe plate size: 600W x 405D mm
- » Large, robust puncture proof semi-pneumatic 250mm wheels for a smooth ride over uneven terrain
- » Ideal for rough & tough applications
- » Fixed (400kg capacity) & folding (350kg capacity) toe plates

INFORMATION

Bulky sack truck with a massive capacity - up to 400kg

Overall Size H x W x D mm	Toe Plate Size W x D mm	Weight kg	Model	Price
1310 x 655 x 710	655 x 190	20	GI400P	£177.40

Stairclimber with Skids



- » Mounted on 150mm wheels on a '3 star' system
- » Max load: 60kg on stairs 150kg as a sack truck
- » Fitted with knuckle guard hand grips, wheel guards & plastic guarded skids



LOWER PRICE



Overall Size H x W x D mm	Toe Plate Size W x D mm	Weight kg	Model	Price
1180 x 480 x 600	300 x 245	11	GI370Y	£115.00

Aluminium Stairclimber with Skids



- » Mounted on 150mm wheels on a '3 star' system
- » Max load: 60kg on stairs 150kg as a sack truck
- » Fitted with knuckle guard hand grips, wheel guards & plastic guarded skids



LOWER PRICE



Overall Size H x W x D mm	Toe Plate Size W x D mm	Weight kg	Model	Price
1180 x 500 x 550	300 x 210	8.5	GI380Y	£175.80

For safe use of stairclimbers please ensure the load does not overhang the leading edge of the toe plate

'ProPlaz®' Folding Box Trucks

- » Durable plastic construction
- » Opens & folds in seconds
- » Folds flat for easy carrying & storage

ProPlaz®
box truck

INFORMATION

Holds A4 files

FROM ONLY

£25.90



LOWER PRICES



PI041Y



GI040Y



GI041Y

INFORMATION

Holds fooscap lever arch & box files

ProPlaz®
box truck

INFORMATION

Strong canvas bag
Carry & store your tools



Folding Box Trucks fold to a depth of just 85mm



BI045Y

ProPlaz®
box truck



GI042Y with removable lid

Description	Load Capacity	Overall Size - Open H x W x D mm	Overall Size - Folded H x W x D mm	Internal Size H x W x D mm	Weight kg	Model	Price (each) 1+	Price (each) 3+
Blue/Yellow	25 kg	850 x 375 x 325	410 x 375 x 85	290 x 345 x 270	3	GI040Y	£31.35	£28.05
Blue/Yellow	35 kg	990 x 460 x 390	470 x 460 x 85	350 x 395 x 330	4	GI041Y	£38.50	£35.20
Black	35 kg	990 x 460 x 390	470 x 460 x 85	350 x 395 x 330	4	BI041Y	£35.65	£32.35
Black with Compartment Bag	35 kg				5	BI045Y	£43.95	£40.65
Pink	35 kg	990 x 460 x 390	470 x 460 x 85	350 x 395 x 330	4	PI041Y	£28.80	£25.90
Grey/Red with removable lid	35 kg	990 x 460 x 390	470 x 460 x 85	350 x 395 x 330	5	GI042Y	£42.55	£39.25

Platform & Shelf Trolleys

ProPlaz® Blue

'ProPlaz® Blue' Platform & Shelf Trolleys



PPU96Y
£277.80

PPU96Y



PPU95Y
£186.00

PPU95Y



PPU23Y
£187.55

PPU23Y



PPU24Y
£236.35

PPU24Y



Hinged Lid Top & 1/2 Drop Side



Mechanism on the 1/2 Drop Side



Description	Platform Size L x W x H mm	Handle Height mm	Size between Shelves Top / Bottom mm	Internal Size L x W x H mm	Load Capacity	Weight kg	Model	Price
Platform Trolley - Small	720 x 490 x 170	860	-	-	150kg	10	PPU81Y	£87.30
Platform Trolley - Large	900 x 600 x 220	890	-	-	300kg	15	PPU91Y	£126.35
Two Tier Trolley	900 x 600 x 730	930	465	-	300kg	22.5	PPU95Y	£186.00
Three Tier Trolley	900 x 600 x 730	930	208 / 208	-	300kg	30	PPU96Y	£277.80
Two Tier Trolley with Wire Surround	900 x 600 x 730	920	465	-	300kg	25	PPU25Y	£217.45
Mesh Truck with Open Top & 1/2 Drop Side	900 x 600 x 210	880	-	860 x 560 x 500	300kg	27	PPU23Y	£187.55
Mesh Truck with Hinged Lid Top & 1/2 Drop Side	900 x 600 x 210	895	-	860 x 560 x 500	300kg	29	PPU24Y	£236.35

'ProPlaz® Blue' Platform & Shelf Trolleys

- >> Constructed from re-inforced polypropylene platforms & shelves
- >> Ideal for many different environments - hygienic & easy to clean
- >> Mobile on 2 fixed & 2 swivel 125mm low noise castors (PPU81Y has 100mm castors)



ProPlaz®
Blue

FROM ONLY

£87.30



PPU81Y
Folded

LOWER PRICES



PPU91Y



INFORMATION



High quality polypropylene decks, platforms & shelves



Anti-slip discs on all platforms & shelves prevent your goods from slipping



Strong sub-structure on all units for greater load capacity



PPU25Y

£217.45

PPU25Y

Platform & Shelf Trolleys



'ProPlaz® Super Silent' Platform & Shelf Trolleys



PPS75Y



PPS45Y

FROM ONLY
£196.05

LOWER PRICES

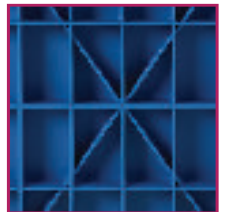

Strong sub-structure on all units for greater load capacity

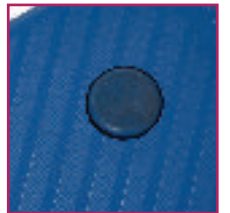

Anti-slip discs on all platforms & shelves prevent your goods from slipping



PPS71Y



INFORMATION 
High quality polypropylene decks, platforms & shelves

336
PPS71Y
Folded

Platform & Shelf Trolleys

Plastic Platform Trolley

- >> Constructed from injection moulded, lightweight & hygienic plastic
- >> Mobile on 2 fixed & 2 swivel 100mm rubber castors



SOME ASSEMBLY REQUIRED

3 day delivery

120kg evenly distributed

GI152Y
£79.95

Aluminium Platform Trolley

- >> Ergonomically designed folding handles
- >> Fits easily into a car boot/van
- >> Mobile on 2 fixed & 2 swivel 180mm castors



SOME ASSEMBLY REQUIRED

3 day delivery

300kg evenly distributed

GI066Y
£206.55

Platform Size L x W x H mm	Handle Height mm	Weight kg	Model	Price
710 x 460 x 140	825	8.5	GI152Y	£79.95

Folded Size L x W x H mm	Platform Size L x W mm	Handle Height mm	Weight kg	Model	Price
900 x 610 x 395	900 x 610	1040	19	GI066Y	£206.55

Plastic Platform Trolleys

- >> Constructed from injection moulded, lightweight & hygienic plastic
- >> Mobile on 2 fixed & 2 swivel 100mm rubber castors



120kg evenly distributed

GI153Y in Grey

COLOUR OPTIONS

- Red
- Blue
- Grey

specify when ordering

GI153Y in Red

GI153Y in Blue

SOME ASSEMBLY REQUIRED

LOWER PRICE

Platform Size L x W x H mm	Handle Height mm	Weight kg	Model	Price
600 x 385 x 150	820	6	GI153Y	£65.60

Plastic Platform Trolleys

- >> Constructed from injection moulded, lightweight & hygienic plastic
- >> The handle folds neatly into the recessed holes in the platform enabling the unit to be used as a dolly
- >> The platform has integral carry handles

PRICES HELD

3 day delivery



- >> GI920Y - 100kg load capacity. Mobile on 2 fixed & 2 swivel 75mm castors
- >> GI921Y - 150kg load capacity. Mobile on 2 fixed & 2 swivel 100mm castors
- >> Available whilst stocks last

NEXT DAY DELIVERY

GI921Y Folded

GI921Y being Carried

SOME ASSEMBLY REQUIRED

GI921Y

Platform Size L x W x H mm	Weight kg	Model	Price
600 x 385 x 130	6	GI920Y	£52.35
710 x 453 x 160	7	GI921Y	£70.20

Multi Position Foldaway Trolleys



LOWER PRICES

NEXT DAY DELIVERY
Call for details

3 day delivery

FROM ONLY
£85.85

GI001Y Folded

GI001Y Extended

GI111Y Folded



Quick Release Mechanism

GI111Y

- >> Aluminium construction with a telescopic handle & expanding/contracting base
- >> Fits easily into a car boot/van
- >> GI001Y incorporates a foam rubber handle for your comfort, plastic load protectors on the base of the rear uprights & corner buffers for added protection to your walls
- >> GI111Y incorporates fully moulded plastic ends
- >> Mobile on 100mm castors (2 fixed & 2 swivel)
- >> Platform height: 160mm



Description	Overall Size - Open L x W x H mm	Overall Size - Folded L x W x H mm	Weight kg	Model	Price
Multi Position Trolley	725 x 420 x 960	570 x 420 x 230	8.5	GI001Y	£85.85
Multi Position Trolley with Moulded Ends	760 x 440 x 930	570 x 440 x 240	8	GI111Y	£105.10

Platform & Shelf Trolleys

Deluxe Folding Trolleys

- » Yellow foam covered handle for your comfort
- » Flat pressed sheet steel base with PVC surface
- » GIK02Y - mobile on 100mm 2 fixed & 2 swivel polyurethane castors
- » GIK03Y - mobile on 125mm 2 fixed & 2 swivel polyurethane castors



GIK02Y
Folded



GIK03Y

Overall Size L x W x H mm	Weight kg	Model	Price
740 x 482 x 830	9.5	GIK02Y	£76.90
914 x 620 x 870	16.5	GIK03Y	£111.80

Wooden Deck Trolley

- » This trolley has a high quality wooden deck & chrome plated folding handle
- » Mobile on 2 fixed, & 2 swivel 100mm non-marking rubber castors
- » Subject to availability



GI110Y

Overall Size L x W x H mm	Weight kg	Model	Price
740 x 480 x 860	11	GI110Y	£59.45

'Foldaway' Platform Trolley

- » Unique wheels which fold underneath the platform when the handle is folded
- » Plastic platform with integral carry handles
- » Telescopic handle with 3 heights: 720/820/920mm
- » Mobile on 2 fixed & 2 swivel braked 100mm castors



Overall Size L x W x H mm	Folded Size L x W x H mm	Weight kg	Model	Price
680 x 410 x 920	680 x 410 x 80	7	GI392Y	£123.05

Folding Trolleys



INFORMATION

Flat pressed steel base with PVC surface

- >> Flat pressed sheet steel base with PVC surface
- >> GI102Y - mobile on 100mm 2 fixed & 2 swivel rubber castors
- >> GI103Y - mobile on 125mm 2 fixed & 2 swivel rubber castors

Overall Size L x W x H mm	Weight kg	Model	Price
725 x 472 x 820	9.5	GI102Y	£61.40
907 x 608 x 850	16.5	GI103Y	£96.10

Large Wheeled Folding Trolley

- >> Foldable handle makes this unit easy to store
- >> Heavy duty 200mm 2 fixed & 2 swivel pneumatic wheels - ideal for rough terrain



Overall Size L x W x H mm	Weight kg	Model	Price
907 x 608 x 925	22	GI009P	£232.25

Platform & Shelf Trolleys

Pro-Dek Heavy Duty Platform Trolleys with 'QuietCastors'

- » Heavy duty plastic trolley with corner buffers
- » Can be stacked 5 high for easy storage
- » Complete with mechanism protectors
- » Mobile on 2 fixed & 2 swivel braked non-marking rubber 'QuietCastors'



GI918Y
Folded



GI918Y Carried

FROM ONLY
£114.10



GI918Y Stacked 5 high



Braked 'QuietCastors'



GI918Y

Carry
Handles

LOWER PRICES

Overall Size L x W x H mm	Overall Size - Folded L x W x H mm	Capacity kg	Castor Size mm	Weight kg	Model	Price
740 x 468 x 930	740 x 468 x 274	200	100	8.5	GI918Y	£114.10
900 x 610 x 945	900 x 610 x 298	350	125	13	GI919Y	£159.75

Plastic Platform Trolley

- » 3 position handle:
 - » Upright - for pushing
 - » Angled - for towing
 - » Flat - for use as a dolly
- » Manufactured from rugged structural foam plastic
- » 2 fixed & 2 swivel non-marking 125mm rubber castors



Easy to
carry



HI914C folded
for use as a dolly

INFORMATION

3 position handle



HI914C

LOWER PRICE

Platform Size L x W x H mm	Handle Height mm	Weight kg	Model	Price
790 x 500 x 150	800	11	HI914C	£141.80

Heavy Duty Stacking Dolly

- >> Strong & durable with heavy duty hardwood deck
- >> Fitted with edge carpet to protect your goods during transport
- >> Easily stacked for ease of storage
- >> Mobile on 4 x 75mm rubber swivel castors



PD667Y

Carpeted Edges

INFORMATION

350kg capacity - ideal solution for moving heavy equipment



Stack of PD667Y

Overall Size L x W x H mm	Weight kg	Model	Price
705 x 705 x 130	7	PD667Y	£44.20

Heavy Duty Plastic Dolly

- >> Strong & durable
- >> Mobile on 4 x 75mm polypropylene swivel castors



ONLY

£112.80



PD350N



Overall Size L x W x H mm	Weight kg	Model	Price
610 x 405 x 125	6	PD350N	£112.80

Wooden Dolly

- >> Strong & durable MDF wood dolly with 4 anti-slip pads
- >> Mobile on 4 x 75mm polypropylene swivel castors

PD663Y
Carried



Anti-slip pads



PD663Y



Overall Size L x W x H mm	Weight kg	Model	Price
580 x 290 x 110	4	PD663Y	£30.45

Platform & Shelf Trolleys

Heavy Duty Container Dolly

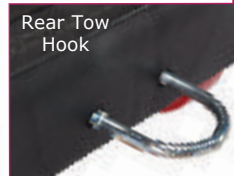

PD665Y Carry Handle

PD665Y

PRICE HELD

- » Ideal for carrying 600 x 400mm containers. The rim around the deck of the dolly helps to keep the containers/boxes on the unit
- » The unit incorporates a handy carry handle & tow hook
- » Mobile on 2 fixed & 2 swivel 75mm polypropylene castors (2 braked)

Overall Size L x W x H mm	Weight kg	Model	Price
670 x 460 x 145	5.5	PD665Y	£96.10



PD665Y

Carpeted Dollies

- » Strong & durable hardwood construction with carpeted ends
- » Subject to availability



FD900Y



LOWER PRICES



FD400Y

Overall Size L x W mm	Load Capacity	Weight kg	Model	Price 1 Off	Price (each) 2+
460 x 310	450 kg	5.5	FD400Y	£44.50	£40.10
450 x 750	380 kg	8	FD750Y	£46.55	£42.15
600 x 900	300 kg	10	FD900Y	£53.95	£49.55

'Mini' Plastic Platform Dolly

- » Constructed from injection moulded, lightweight & hygienic plastic
- » Mobile on 4 x 80mm plastic swivel castors

LOWER PRICES



GI154Y

Colour	Platform Size L x W x H mm	Wt kg	Model	Price (each) 1+	Price (each) 3+
Blue, Red & Grey	600 x 400 x 110	3.5	GI154Y	£55.35	£46.85

Furniture Dolly

- » Supplied in pairs
- » Fitted with ribbed green carpet
- » Mobile on 4 x 100mm swivel castors
- » Subject to availability

LOWER PRICES



200kg evenly distributed
per Dolly



FD201N

Overall Size L x W x H mm	Weight kg	Model	Pack Price (per Pair)	2+ Pack Price (per Pair)
600 x 300 x 130	5	FD201N	£89.30	£84.90

Platform & Shelf Trolleys

'Connect 'N' Roll' Dollies - Pair

- » Each pack consists of 2 dollies (1 black & 1 red)
- » Simply 'snap lock' the dollies together to create your required size
- » Mobile on 4 x 40mm polypropylene castors



6 x PD502Y

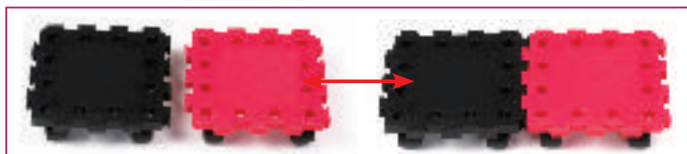

SNAP LOCK THE DOLLIES TOGETHER TO CREATE YOUR REQUIRED SIZE

Overall Size L x W x H mm	Weight kg	Model	Pack Price (per Pair)
260 x 260 x 65	2	PD502Y	£40.70

Interconnecting Dollies - Pair

- » Each pack consists of 2 dollies. For a greater saving purchase 5 packs (10 dollies)
- » Simply 'snap lock' the dollies together to create your required size
- » Mobile on 4 x 50mm polypropylene castors



Overall Size L x W x H mm	Weight kg	Model	Pack Price (per Pair)	5 Pack Price (per Pair)
485 x 380 x 85	5	PD638Y	£70.90	£61.00

Container Dolly

- » Stackable up to 2.3m high
- » Dollies are linkable on either side
- » Ideal for use with 600 x 400mm containers
- » Mobile on 4 x 100mm swivel castors

2 x PD669Y



Overall Size L x W x H mm	Weight kg	Model	Price
600 x 400 x 174	2.1	PD669Y	£66.20

Plastic Dollies

- » Strong, robust & versatile
- » Ideal for use with 600 x 400mm containers
- » Mobile on 4 x 100mm swivel castors



Description	Overall Size L x W x H mm	Weight kg	Model	Price
Dolly	600 x 400 x 170	4	PD064S	£65.00
Dolly with Handle	610 x 400 x 930	9	PDT63S	£122.75

Platform & Shelf Trolleys

Individual Skates



- » Industrial shifting skates are designed for moving heavy objects
- » They are ideal for moving factory machinery, power generators, large steel constructions etc
- » Loads can be raised using either a roller crowbar or a hydraulic jack
- » Skates are maintenance free with sealed bearings & are fitted with handles for ease of carrying & positioning
- » Skates are covered with an anti-slip rubber mat for stability & protection of loads



Capacity kg	No of Rollers	Rollers mm	Overall Size L x W x H mm	Weight kg	Model	Price
1000	4	100 x 35 Nylon	330 x 220 x 120	7	SKI100	£101.20
2000	8	100 x 35 Nylon	330 x 220 x 120	8	SKI200	£125.00
6000	6	85 x 90 Nylon	260 x 230 x 105	12	SKI600	£172.65

Individual Skates with Swivel Castors

- » Industrial shifting skates are designed for moving heavy objects, almost on the spot & can change direction quickly
- » Fitted with 4 swivel castors
- » Skates are maintenance free with sealed bearings & are fitted with handles for ease of carrying & positioning
- » Skates are covered with an anti-slip rubber mat for stability & protection of loads



Capacity kg	No of Rollers	Rollers mm	Overall Size L x W x H mm	Weight kg	Model	Price
1000	4	75 x 46 Nylon	430 x 340 x 120	13	SKSW100	£196.45

Heavy Duty Individual Skates with Swivel Castors

- » Skates with swivel castors are designed to travel in any direction
- » The 360° degree rotating castors (80 x 70mm Polyurethane) enables quick change of direction
- » Circular anti-slip mat on top of skates for stability & protection of loads
- » Supplied with a two-piece removable steering handle - easy handle storage



SKHD200



SKHD300



SKHD200

SKHD300

INFORMATION



Other skates available up to 200T - please call for details



Capacity kg	No of Rollers	Overall Size L x W x H mm	Weight kg	Model	Price
2000	3	410 x 500 x 110	25	SKHD200	£279.80
3000	4	410 x 470 x 110	29.6	SKHD300	£303.60

Corner Skate Set

- » Set of 4 low-level corner skates, designed to assist with the moving of large rectangular loads such as cupboards, office cabinets & storage system
- » The skates are placed under each corner of the load to be moved
- » Pressed steel frame
- » Mobile on 4 x 50mm non-marking, rubber, swivel castors

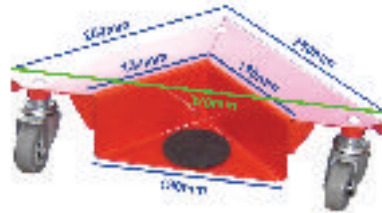

SKCR60

Capacity kg	Overall Size L x W x H mm	Weight kg	Model	Price
600	260 x 260 x 320	11	SKCR60	£154.80

Complete Skate Set

- » Industrial shifting skates are designed for moving heavy objects.
- » They are ideal for moving factory machinery, power generators, large steel constructions etc
- » Loads can be raised using either a roller crowbar or a hydraulic jack
- » Skates are maintenance free with sealed bearings
- » They are fitted with handles for ease of carrying and positioning
- » The tops of the skates are covered with an anti-slip rubber mat for stability and protection of loads
- » Includes steerable skate & drawbar, 2 x adjustable skates & connecting rods



SKSE60

SKSE120



SKSE360

Capacity kg	Rollers mm	Weight kg	Model	Price
6000	85 x 90 Nylon	31	SKSE60	£458.35
12,000	85 x 90 Nylon	80	SKSE120	£821.45
36,000	83 x 85 Steel	131	SKSE360	£1166.70



Caterpillar Skate Kits

- » Caterpillar style skate sets are ideal for transportation of very heavy items over good firm floors
- » Suitable for installation and movement of heavy loads
- » Steering handles provide precise control
- » Travel speed up to 5m/min
- » Minimum turning circle: 3mm
- » Each set consist of:
 - 4 caterpillar style (connected) roller skates
 - 2 turntables
 - 2 packing plates
 - 2 steering handles
 - 2 link-up bars & 1 draw bar
- » Each set is supplied in a steel box for easy storage & transportation



Capacity kg	Rollers mm	Height mm	Weight kg	Model	Price
60,000	30	140	92	SKCA600	£946.45

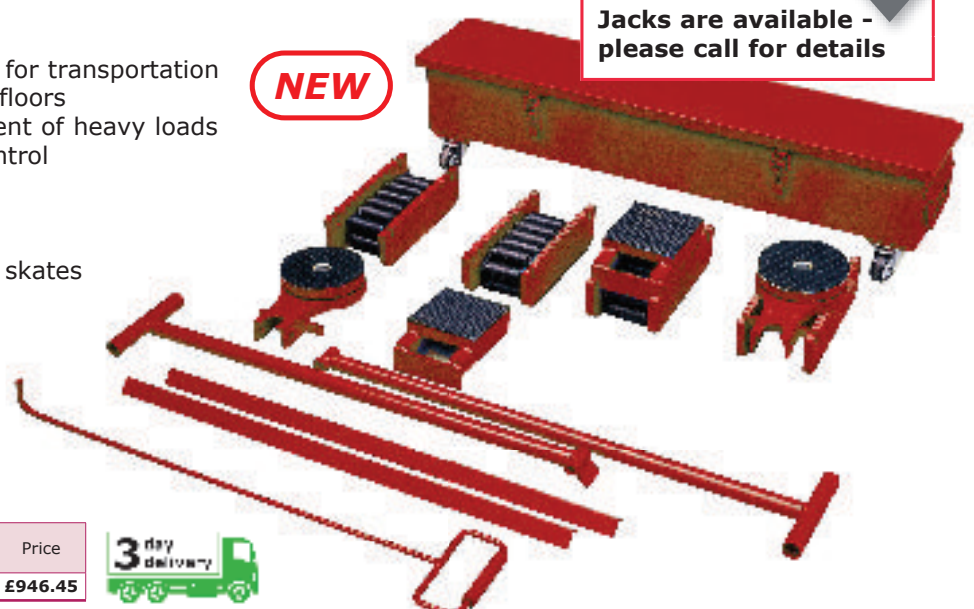

INFORMATION

Jacks are available - please call for details

Platform & Shelf Trolleys



'ProPlaz® Handy' Tool Trolley



- >> High quality hardwearing black plastic shelves with aluminium uprights
- >> Complete with optional shelf dividers to keep your tools tidy
- >> Ideal for use in warehouses & workshops
- >> Lightweight & easy to clean
- >> Mobile on 4 x 100mm swivel castors, 2 with brakes



Complete with optional shelf dividers to easily keep your tools & fixings tidy & organised



ProPlaz® Handy

Overall Size H x W x D mm	Weight kg	Model	Price
1310 x 550 x 460	8	HI663Y	£128.75



'ProPlaz® Super Silent' Shelf Trolleys

- >> Mobile on 4 swivel 125mm ultra smooth silent castors
- >> Constructed from re-inforced polypropylene shelves
- >> Ideal for hospitals, libraries, laboratories, offices, warehouses, workshops etc
- >> Lightweight, hygienic & easy to clean

LOWER PRICES

ProPlaz® Super Silent



Anti-slip discs on all platforms & shelves prevent your goods from slipping



Strong sub-structure on all units for greater load capacity

Super Silent castors - see page 337 for more information



Description	Platform Size L x W x H mm	Handle Height mm	Size between Shelves Top / Bottom mm	Load Capacity	Weight kg	Model	Price
Three Tier Trolley with Mesh Ends	900 x 600 x 1000	1200	300 / 300	300kg	30	PPS97Y	£274.80
Three Tier Trolley with Mesh Side & Ends	900 x 600 x 1000	1200	300 / 300	300kg	31	PPS98Y	£305.75

'ProPlaz® Fold' Folding Trolley

- >> A versatile & extremely useful folding trolley manufactured with an anodised aluminium frame & polypropylene shelves
- >> Ideal for use in offices, shops, schools etc
- >> Can be folded in one simple move - ideal in areas where space is limited
- >> Mobile on 4 x 75mm swivel polypropylene castors (2 braked)
- >> Clearance between shelves: 300mm
- >> Capacity of 25kg per shelf U.D.L.
- >> Shelf size: 560L x 370W mm

ProPlaz® Fold

Easy Fold Mechanism



CI583Y
Folded

CI583Y
Part Folded



Overall Size - Open L x W x H mm	Overall Size - Folded L x W x H mm	Weight kg	Model	Price
430 x 670 x 850	430 x 200 x 1060	8	CI583Y	£153.50

PRICE HELD

CI583Y
£153.50

75kg
evenly
distributed



CI583Y

Steel Folding Trolley

- >> Sturdy, easy to fold & neat to store
- >> Ideal for use in offices, warehouses, schools etc
- >> Can be folded in one simple move
- >> Mobile on 4 x 100mm swivel rubber tyred castors, 2 with brakes
- >> Size when folded: 580L x 100W x 1080H mm
- >> Clearance between shelves: 300mm
- >> Capacity of 25kg per shelf U.D.L. (30kg U.D.L. on the top shelf)



CI203Y
Folded

80kg
evenly
distributed



CI203Y
£186.50

LOWER PRICE



CI203Y

Overall Size L x W x H mm	Weight kg	Model	Price
580 x 450 x 890	14	CI203Y	£186.50

Platform & Shelf Trolleys

'ProPlaz®' Shelf Trolleys

ProPlaz®



HI291Y

HI292Y

INFORMATION

Lockable drawers & cupboards

Smooth running drawers on all units



HI393Y with the cupboard closed

HI393Y with the cupboard open

LOWER PRICES

Description	Overall Size L x W x H mm	Size between Shelves Top / Bottom mm	Load Capacity kg	Weight kg	Model	Price
2 Shelf Trolley	750 x 460 x 940	560	150	10	HI275Y	£119.40
	990 x 515 x 970			15	HI299Y	£185.15
3 Shelf Trolley	750 x 460 x 980	280 / 280	150	13	HI375Y	£136.20
	990 x 515 x 1010			21	HI399Y	£234.85
3 Shelf Trolley with high quality Plastic Sides	750 x 460 x 980	280 / 280	150	15	HI346Y	£221.30
	990 x 515 x 1010			25	HI351Y	£281.75
2 Shelf Trolley with a Lockable Steel Drawer	750 x 460 x 940	560	150	16	HI291Y	£233.85
2 Shelf Trolley with 2 x Steel Drawers				20	HI292Y	£303.90
3 Shelf Trolley with a Lockable Steel Drawer & Cupboard	750 x 460 x 980	280	150	24	HI393Y	£334.15

'Proplaz®' Shelf Trolleys

- >> High quality hardwearing black plastic shelves with grey anodised aluminium uprights
- >> Ideal for warehouses, garages, workshops, laboratories etc
- >> Lightweight & easy to clean
- >> Mobile on 4 x 100mm swivel castors (2 with brakes)
- >> HI291Y, HI292Y & HI393Y incorporate smooth running grey drawers & model HI393Y also has a black plastic cupboard

LOWER PRICES

ProPlaz®



Red Comfort Grip Handles

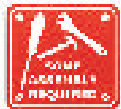

INFORMATION



All shelves have retention lips on 3 sides

HI375Y



HI275Y



HI351Y



HI346Y

Platform & Shelf Trolleys

Shelf Trolleys



HI424Y



HI524Y

LOWER PRICES

- >> Hygienic - easy to clean
- >> Clearance between shelves: 280mm
- >> Plastic shelves with strong aluminium uprights
- >> Model HI424Y has a 25mm lip on 3 sides & a 5mm rim on 1 side
- >> HI524Y has a full 25mm lip surround
- >> Mobile on 4 swivel non marking rubber castors



Description	Overall Size L x W x H mm	Wheel Size mm	Weight kg	Model	Price
3 Shelf Grey Trolley	850 x 420 x 910	75	8	HI424Y	£134.40
	1030 x 510 x 960	100	19	HI524Y	£191.30

Plastic Multi Purpose Trolleys



GI403L



GI699L



FREE!

ProPlaz
SUPER STRENGTH

- >> Easy to clean - will not rust, dent or chip
- >> Depth of storage trays: 63mm
- >> Mobile on 100mm non-marking rubber swivel castors, 2 with brake
- >> Manufactured from a non conductive polyethylene which will not pass an electrical current & is unaffected by battery acid, solvents & cleaning solutions

PRICES HELD

- >> Easy to clean - will not rust, dent or chip
- >> Mobile on 130mm non-marking rubber swivel castors, 2 with brake
- >> Integral cup holder & tool compartments in the handle

Description	Overall Size L x W x H mm	Size Between Shelves Top / Bottom mm	Weight kg	Model	Price
2 Storage Trays	895 x 457 x 870	571.5	10	GI402L	£221.40
3 Storage Trays	895 x 457 x 920	266 / 266	14	GI403L	£281.70

Description	Overall Size L x W x H mm	Size Between Shelves Top / Bottom mm	Weight kg	Model	Price
2 Storage Trays	1155 x 622 x 838	558	17	GI699L	£303.20

'ProPlaz® Plus' Trolleys with Deep Trays

- » High quality hardwearing black plastic trays with anodised aluminium uprights
- » Ideal for warehouses, garages, workshops, laboratories etc
- » Lightweight & easy to clean
- » Mobile on 4 x 100mm swivel castors (2 with brakes)
- » Tray depth of 100mm
- » HIT32Y - comes complete with buckets which attach to the top shelf. Bucket sizes are: 200H x 350W x 240Dmm & 470H x 350W x 240Dmm

ProPlaz® Plus



HIT32Y



HIT29Y



HIT31Y

LOWER PRICES

Description	Overall Size L x W x H mm	Size between Shelves Top / Bottom mm	Weight kg	Model	Price
2 Tray Trolley	870 x 490 x 990	553	10.5	HIT29Y	£155.05
3 Tray Trolley	870 x 490 x 1050	275 / 275	11.5	HIT31Y	£190.60
3 Tray Trolley (Top Flat Shelf & 2 Storage Trays)	1100 x 490 x 1030	275 / 275	13.5	HIT32Y	£221.60

Platform & Shelf Trolleys

Plastic Multi Purpose Trolleys

ProPlaz[®]

SUPER-STRENGTH



GI335L
£307.85

150kg
evenly
distributed

BESTSELLER



GI334L
£250.40



10
YR
GUARANTEE



175kg
evenly
distributed

**PRICES
HELD**



Description	Overall Size L x W x H mm	Size Between Shelves Top / Bottom mm	Weight kg	Model	Price
2 Shelf Trolley (2 flat shelves)	610 x 458 x 840	660	8	GI241L	£140.20
3 Shelf Trolley (3 flat shelves)	610 x 458 x 840	305 / 305	11	GI341L	£162.30
2 Shelf Trolley (2 flat shelves)	890 x 610 x 880	650	16	GI334L	£250.40
3 Shelf Trolley (3 flat shelves)	890 x 610 x 865	292 / 292	22	GI335L	£307.85
2 Storage Trays - Black	610 x 460 x 980	660	10.5	GI927L	£166.90
3 Storage Trays - Black	610 x 460 x 1000	305 / 305	14	GI937L	£207.40
2 Storage Trays - Grey	610 x 460 x 980	660	10.5	GI627L	£192.80
3 Storage Trays - Grey	610 x 460 x 1000	305 / 305	14	GI637L	£248.35
2 Storage Trays - Black	920 x 640 x 960	635	20	GI237L	£343.75
3 Storage Trays - Black	920 x 640 x 975	280 / 280	24	GI337L	£461.65

Plastic Multi Purpose Trolleys

- » Strong polyethylene moulded trolleys
- » Easy to clean - will not rust, dent or chip
- » Ideal for workshops, storerooms, warehouses, automotive, electronics, chemical & pharmaceutical industries
- » Manufactured from a non conductive polyethylene which will not pass an electrical current & is unaffected by battery acid, solvents & cleaning solutions
- » Models GI237L & GI337L have a higher load capacity as the shelves are re-inforced with a steel bar
- » Mobile on 4 x 100mm non-marking rubber swivel castors, 2 with brakes

Optional Buckets

- » Set of 2 buckets to suit "Super Strength" Trolleys with Storage Trays



Complete with removable, half open lids

Overall Size H x W x D mm	Weight kg	Model	Price
229 x 356 x 260	2	GI004L	£63.50

*price applicable when ordering with the Trolleys.
Order charges will apply if ordered on their own.



GI341L

£162.30



GI241L

GI341L

ProPlaz®
SUPER STRENGTH

PRICES HELD

10 YR GUARANTEE

150kg evenly distributed

3 day delivery

NEXT DAY DELIVERY AVAILABLE Full UK Delivery

INFORMATION



Unaffected by battery acid, solvents & cleaning solutions



GI937L



GI627L



GI927L



GI637L

FREE!



Platform & Shelf Trolleys

Shelf Trolleys

- >> Super strong polyethylene moulded trolleys - will not rust, dent or chip. These easy to manoeuvre units are ideal for use in many different environments
- >> Constructed from a non conductive material - resistant to most substances
- >> Mobile on 4 x 100mm rubber swivel castors, 2 with brakes



No of Shelves	Overall Size L x W x H mm	Clearance Between Shelves	Wt kg	Model	Price
3	610 x 458 x 840	305 mm	11	GI541L	£205.80
2	890 x 610 x 880	650 mm	16	GI534L	£307.85
4	610 x 458 x 915	222 mm	13	GI542L*	£145.00
4	813 x 610 x 915	203 mm	24	GI536L*	£222.00
5	610 x 458 x 915	159 mm	17	GI543L*	£170.00

*Subject to availability

Coloured Service Trolleys

- >> Super strong polyethylene moulded trolleys - will not rust, dent or chip
- >> Constructed from a non conductive material - resistant to most substances
- >> 4 x 100mm rubber swivel castors, 2 with brakes
- >> GI851L has a top flat shelf & a bottom storage tray. The GI853L has top, middle & bottom storage trays
- >> Subject to availability



Description & Colours	Capacity kg	No of Shelves	Overall Size L x W x H mm	Clearance Between Shelves	Weight kg	Model	Price
Beige Legs with Red, Blue, Green or Cream Shelves	90	3	610 x 457 x 1067	419mm	13	GI425W	£118.15
Black Legs with Red, Blue or Yellow Shelves	90	3	610 x 457 x 864	216/419mm	13	GI843W	£145.10
Black Legs with Red, Blue or Yellow Shelves	90	3	610 x 457 x 1067	419mm	14	GI825W	£145.10
Coloured Legs with Coloured Shelves in Red or Blue	150	2	610 x 458 x 980	660mm	11	GI851L	£136.50
Coloured Legs with Coloured Shelves in Red or Blue	150	3	610 x 458 x 980	305/305mm	13.5	GI853L	£168.20

Plastic Multi Purpose Trolleys

- >> Super strong black polyethylene moulded trolleys
- >> Easy to clean, versatile - will not rust, dent or chip
- >> Non-conductive material, resistant to most substances
- >> 4 x 100mm non marking rubber swivel castors, 2 with brakes



Overall Size L x W x H mm	Size Between Shelves Top / Bottom mm	Weight kg	Model	Price
3 Shelf Service Trolley with top flat shelf & middle and bottom storage trays				
610 x 460 x 970	300 / 300	13	GI644L	£199.95
3 Shelf Service Trolley with top & bottom storage trays and middle flat shelf				
610 x 460 x 970	300 / 300	13	GI645L	£214.30



COLOUR OPTIONS

- Red
- Blue
- Yellow
- Green
- Cream

specify when ordering

Plastic Service Trolleys

NEW



**FROM ONLY
£155.30**

255kg
evenly distributed

3 day delivery

SOME ASSEMBLY REQUIRED

HI936C

HI927C

- » Strong plastic construction with 70mm deep trays
- » Push/pull handle has integral storage facility
- » Mobile on 2 fixed & 2 swivel 125mm rubber castors

Description	Overall Size L x W x H mm	Weight kg	Model	Price
2 Tray Unit	876 x 419 x 825	14	HI926C	£155.30
3 Tray Unit		18	HI936C	£188.90
2 Tray Unit	1013 x 625 x 825	19	HI927C	£202.05
3 Tray Unit		26	HI937C	£251.80

Plastic Service Trolleys



**FROM ONLY
£181.55**

225kg
evenly distributed

3 day delivery

SOME ASSEMBLY REQUIRED

- » 70mm deep trays
- » Heavy duty construction
- » Push/pull handle has integral storage facility
- » Mobile on 2 fixed & 2 swivel 125mm rubber castors

HI935C



HI934C

LOWER PRICES



HI925C & HI935C Tool Handle

NEXT DAY
Call for details



HI924C & HI934C Tool Handle

Description	Overall Size L x W x H mm	Weight kg	Model	Price
2 Tray Unit	950 x 440 x 850	18	HI924C	£181.55
3 Tray Unit		22	HI934C	£233.50
2 Tray Unit	1100 x 650 x 850	23	HI925C	£239.75
3 Tray Unit		30	HI935C	£313.00

Platform & Shelf Trolleys

Shelf Trucks



PI303Y



PI304Y



PI307Y



- >> Budget range of trucks with veneer finish
- >> Manoeuvrable & strong
- >> 30kg load capacity on top shelf
- >> Mobile on 2 fixed, 2 swivel braked rubber castors

Description	Platform Size mm	Overall Size L x W x H mm	Load Capacity	Wheel Size mm	Weight kg	Model	Price
2 Shelf	1000 x 600	1050 x 605 x 890	250 kg	125	31.5	PI302Y	£261.85
3 Shelf	1000 x 600	1050 x 605 x 890	250 kg	125	36.5	PI303Y	£285.10
2 Shelf - Tubular End	940 x 695	1050 x 700 x 1050	250 kg	150	41	PI304Y	£325.15
2 Shelf - with 60mm Lip Surround	1000 x 600	1050 x 605 x 910	250 kg	125	36	PI307Y	£275.30

Shelf Trucks



- >> Budget range of trucks with veneer finish
- >> Manoeuvrable
- >> Strong
- >> Mobile on 2 fixed, 2 swivel braked rubber castors

Description	Platform Size mm	Overall Size L x W x H mm	Load Capacity	Wheel Size mm	Weight kg	Model	Price
2 Shelf - Push Handle	940 x 695	1100 x 700 x 940	500 kg	200	41.5	PI305Y	£320.75
3 Shelf - Push Handle	940 x 695	1100 x 700 x 965	500 kg	200	53	PI306Y	£358.45

Platform Truck - 500kg

- >> Heavy duty veneer supported by a steel frame
- >> Mobile on 2 fixed & 2 swivel braked 200mm castors
- >> 240mm platform height



PI200Y

£256.90



Heavy Duty
200mm castors



PI200Y



Platform Size mm	Handle Height mm	Weight kg	Model	Price
1000 x 700	810	28	PI200Y	£256.90

Platform Truck - 250kg

- >> Heavy duty veneer supported by a steel frame
- >> Mobile on 2 fixed & 2 swivel braked 100mm castors
- >> 140mm platform height



PI100Y

PI100Y

£139.85



PI100Y

Platform Size mm	Handle Height mm	Weight kg	Model	Price
990 x 490	900	12.5	PI100Y	£139.85



Platform & Shelf Trolleys

Platform Trucks with Sides & Ends

- » Super quality heavy duty veneer deck finish
- » Mobile on 2 fixed, 2 swivel braked, steel centred 200mm rubber castors
- » Sides, ends & deck are supported by a steel frame
- » Available with mesh or heavy duty veneer sides & ends
- » Large 500kg load capacity (U.D.L.) when using these Platform Trucks on a level/even surface

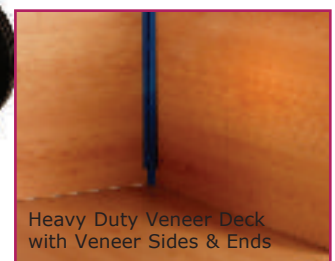
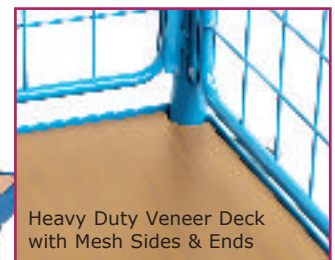

Description	Platform Height mm	Platform Size: 1000 x 700 mm				Platform Size: 1200 x 800 mm			
		Overall Size H x L mm	Weight	Model	Price	Overall Size H x L mm	Weight	Model	Price
Platform Trucks with Veneer Sides & Ends									
Single Veneer End	270	1050 x 1300	35 kg	PI811H	£293.20	1050 x 1500	38 kg	PI831H	£309.10
2 Veneer Ends			41 kg	PI812H	£315.30		44 kg	PI832H	£346.85
2 Veneer Sides			43 kg	PI816H	£344.50		46 kg	PI836H	£368.65
3 Veneer Sides			44 kg	PI813H	£357.40		49 kg	PI833H	£374.30
4 Veneer Sides			45 kg	PI814H	£372.50		50 kg	PI834H	£396.55
Platform Trucks with Mesh Sides & Ends									
Single Mesh End	270	1050 x 1300	35 kg	PI801H	£293.20	1050 x 1500	38 kg	PI821H	£309.10
2 Mesh Ends			41 kg	PI802H	£315.30		44 kg	PI822H	£346.85
2 Mesh Sides			43 kg	PI806H	£344.50		46 kg	PI826H	£368.65
3 Mesh Sides			44 kg	PI803H	£357.40		49 kg	PI823H	£374.30
4 Mesh Sides			45 kg	PI804H	£372.50		50 kg	PI824H	£396.55



Platform & Shelf Trolleys



Heavy Duty Platform Trucks

- » Manufactured from a strong steel frame, powder coated in anthracite grey & heavy duty timber decks with a durable painted finish
- » Mobile on 2 fixed & 2 swivel braked, 200mm rubber castors with blue centres
- » Large 600kg load capacity (U.D.L.) when using these trucks on a level/even surface

FROM ONLY
£368.60

NEW



PAPT410Y



PAPT406Y



Platform Size mm	Overall Size H x W x D mm	Model	Price
Double Bar End Platform Trucks			
1000 x 700	1055 x 700 x 1120	PAPT410Y	£368.60
1200 x 800	1055 x 800 x 1330	PAPT430Y	£395.50
Long Load Platform Trucks			
1000 x 700	1005 x 700 x 1000	PAPT406Y	£392.15
1200 x 800	1005 x 800 x 1200	PAPT426Y	£419.05

Platform Trucks

- » Protected wood edges
- » Strong & manoeuvrable
- » Mobile on 2 fixed & 2 swivel braked rubber castors
- » The deck & sides are of heavy duty veneer supported by a steel frame. PI205Y has a plywood base
- » Sides/ends are fixed in position
- » PI205Y is subject to availability



PI207Y



FROM ONLY
£257.30



PI205Y

LOWER PRICES

Description	Capacity kg	Platform Size mm	Handle Height mm	Platform Height mm	Wheel Size mm	Weight kg	Model	Price
4 Corner Uprights	500	1000 x 700	900	240	200	27.5	PI205Y	£257.30
2 Tubular Bar Sides			820		200	35.5	PI207Y	£286.65



Heavy Duty Platform Trucks with Single Ends

- » Manufactured from a strong steel frame, powder coated in anthracite grey & heavy duty timber decks with a durable painted finish
- » Mobile on 2 fixed & 2 swivel braked, 200mm rubber castors with blue centres
- » Large 600kg load capacity (U.D.L.) when using these trucks on a level/even surface

FROM ONLY
£340.05



PAPT400Y

PAPT401Y

PAPT411Y

Description	1000 x 700mm Platform Size			1200 x 800mm Platform Size		
	Size: H x W x D mm	Model	Price	Size: H x W x D mm	Model	Price
Single Bar End	1055 x 700 x 1060	PAPT400Y	£340.05	1055 x 800 x 1270	PAPT420Y	£364.40
Single Mesh End	1055 x 700 x 1060	PAPT401Y	£368.60	1055 x 800 x 1270	PAPT421Y	£396.35
Single Timber End	1055 x 700 x 1060	PAPT411Y	£351.80	1055 x 800 x 1270	PAPT431Y	£377.85

Platform & Shelf Trolleys



Heavy Duty Platform Trucks with Timber Sides & Ends

- » Manufactured from a strong steel frame, powder coated in anthracite grey & heavy duty timber decks with a durable painted finish
- » Mobile on 2 fixed & 2 swivel braked, 200mm rubber castors with blue centres
- » Large 600kg load capacity (U.D.L.) when using these trucks on a level/even surface



PAPT412Y

FROM ONLY
£392.15

NEW

600kg
evenly distributed

3 YR
GUARANTEE

3 day
delivery



PAPT413Y



PAPT414Y

Description	1000 x 700mm Platform Size			1200 x 800mm Platform Size		
	Size: H x W x D mm	Model	Price	Size: H x W x D mm	Model	Price
Double Timber End	1055 x 700 x 1060	PAPT412Y	£392.15	1055 x 800 x 1270	PAPT432Y	£422.40
3 Timber Sides	1055 x 700 x 1060	PAPT413Y	£416.50	1055 x 800 x 1270	PAPT433Y	£449.30
4 Timber Sides	1055 x 700 x 1060	PAPT414Y	£427.45	1055 x 800 x 1270	PAPT434Y	£462.70



Heavy Duty Platform Trucks with Zinc Plated Mesh Sides & Ends

- » Manufactured from a strong steel frame, powder coated in anthracite grey & heavy duty timber decks with a durable painted finish
- » Mobile on 2 fixed & 2 swivel braked, 200mm rubber castors with blue centres
- » Large 600kg load capacity (U.D.L.) when using these trucks on a level/even surface

FROM ONLY
£425.75

NEW

600kg
evenly distributed

3 YR
GUARANTEE

3 day
delivery



PAPT402Y



PAPT403Y



PAPT404Y

Description	1000 x 700mm Platform Size			1200 x 800mm Platform Size		
	Size: H x W x D mm	Model	Price	Size: H x W x D mm	Model	Price
Double Mesh End	1055 x 700 x 1060	PAPT402Y	£425.75	1055 x 800 x 1270	PAPT422Y	£459.35
3 Mesh Sides	1055 x 700 x 1060	PAPT403Y	£472.80	1055 x 800 x 1270	PAPT423Y	£509.80
4 Mesh Sides	1055 x 700 x 1060	PAPT404Y	£506.40	1055 x 800 x 1270	PAPT424Y	£546.75

Platform & Shelf Trolleys



Heavy Duty Powered Platform Trucks

- » Manufactured from a strong steel frame & steel back, powder coated in anthracite grey
- » Heavy duty timber deck, with a durable painted finish & timber or mesh sides & ends
- » Mobile on 2 swivel 200mm rubber castors & 2 fixed pneumatic 200mm drive wheels
- » Large 600kg load capacity (U.D.L.) when using these trucks on a level/even surface
- » 6 hour run time on a full charge (do not let the battery run flat) which will give a 2.5 to 6 mile range, depending on load
- » Neat & tidy cable management system to prevent any snags
- » Complete with a powered controller which has easy forward & reverse levers, adjustable speed toggle & an emergency stop button



PWPT413Y



PWPT403Y



PWPT404Y



PWPT414Y



Heavy Duty Powered Platform Trucks

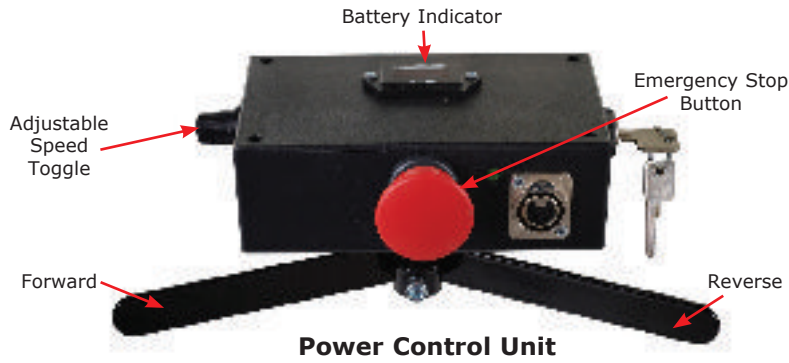

PWPT401Y



PWPT402Y



PWPT412Y

Description	1000 x 700mm Platform Size			1200 x 800mm Platform Size		
	Size: H x W x D mm	Model	Price	Size: H x W x D mm	Model	Price
Single Steel End	1055 x 700 x 1060	PWPT401Y	£3394.95	1055 x 800 x 1270	PWPT421Y	£3680.70
Single Steel End with Mesh Opposite End	1055 x 700 x 1060	PWPT402Y	£3452.10	1055 x 800 x 1270	PWPT422Y	£3743.70
Single Steel End with Timber Opposite End	1055 x 700 x 1060	PWPT412Y	£3435.30	1055 x 800 x 1270	PWPT432Y	£3725.20
Single Steel End with Mesh Opposite End & Mesh Side	1055 x 700 x 1060	PWPT403Y	£3532.80	1055 x 800 x 1270	PWPT423Y	£3830.25
Single Steel End with Timber Opposite End & Timber Side	1055 x 700 x 1060	PWPT413Y	£3493.30	1055 x 800 x 1270	PWPT433Y	£3788.25
Single Steel End with Mesh Opposite End & 2 x Mesh Sides	1055 x 700 x 1060	PWPT404Y	£3566.40	1055 x 800 x 1270	PWPT424Y	£3867.25
Single Steel End with Timber Opposite End & 2 x Timber Side	1055 x 700 x 1060	PWPT414Y	£3504.20	1055 x 800 x 1270	PWPT434Y	£3801.70

Platform & Shelf Trolleys

Tray Trolleys

- » Utility budget price trolleys
- » Easy to manoeuvre with a push/pull handle & 2 fixed, 2 swivel braked 125mm rubber castors
- » 85mm deep sides on the shelves



WI203Y



WI202Y

**FROM ONLY
£208.25**



No of Shelves	Overall Size L x W x H mm	Shelf Heights mm	Weight kg	Model	Price
2	1015 x 635 x 805	150, 720	25	WI202Y	£208.25
3	1015 x 635 x 805	150, 435, 720	32.5	WI203Y	£254.70

Distribution Trolleys

- » Trolleys with adjustable laminated shelves &/or wire baskets
- » Available in black or electro galvanised finish
- » Mobile on 4 swivel 100mm rubber tyred castors



PBT03Y



GBT02Y



PBT04Y

Description	Overall Size L x W x H mm	Basket Size L x W x H mm	Shelf Size L x W mm	Weight kg	Painted Black		Electro galvanised	
					Model	Price	Model	Price
Trolley with 1 Upper Shelf	660 x 385 x 1090	-	410 x 355	10	PBT01Y	£193.30	GBT01Y	£193.30
Trolley with 1 Upper Basket		415 x 355 x 220	-	8	PBT02Y	£193.30	GBT02Y	£193.30
Trolley with 2 Upper Shelves		-	410 x 355	12	PBT03Y	£223.55	GBT03Y	£223.55
Trolley with 2 Upper Baskets		415 x 355 x 220	-	9	PBT04Y	£223.55	GBT04Y	£223.55
Trolley with 1 Upper Shelf & 1 Upper Basket		415 x 355 x 220	410 x 355	13	PBT05Y	£223.55	GBT05Y	£250.45



Heavy Duty Shelf Trolleys

- » Manufactured from a strong steel frame & shelves/trays, powder coated in anthracite grey. Also available with heavy duty timber shelves/trays with a durable painted finish
- » Mobile on 2 fixed & 2 swivel braked, 200mm rubber castors with blue centres
- » Large 600kg load capacity (U.D.L.) when using these trucks on a level/even surface



PAST536Y



PAST505Y



PAST515Y



PAST526Y

Description	Shelf Heights mm	1000 x 700mm Platform Size			1200 x 800mm Platform Size		
		Size: H x W x D mm	Model	Price	Size: H x W x D mm	Model	Price
2 Timber Shelves	240 / 915	955 x 700 x 1110	PAST505Y	£481.65	955 x 800 x 1305	PAST525Y	£520.35
2 Steel Trays	240 / 915	955 x 700 x 1110	PAST515Y	£476.65	955 x 800 x 1305	PAST535Y	£515.30
3 Timber Shelves	240 / 580 / 915	955 x 700 x 1110	PAST506Y	£616.10	955 x 800 x 1305	PAST526Y	£671.60
3 Steel Trays	240 / 580 / 915	955 x 700 x 1110	PAST516Y	£602.70	955 x 800 x 1305	PAST536Y	£658.15

Platform & Shelf Trolleys

Heavy Duty Tray Trolleys

- » Chassis is of square tubular steel with round tubular steel handles
- » Three steel shelves with a 40mm lip
- » Mobile on 2 fixed, 2 swivel roller bearing cushion castors
- » Platform size: 900L x 500W mm



KT832H

Tray Heights mm	Total Height mm	Wheels mm	Weight kg	Model	Price
210 / 520 / 810	850	150	35	KT831Y	£630.90
265 / 570 / 860	900	200	38	KT831H	£639.95
215 / 665 / 1110	1150	150	38	KT832Y	£694.95
265 / 715 / 1160	1200	200	41	KT832H	£706.55

Tray Trolleys

- » Fully welded frame
- » Easy to wipe clean - suitable for kitchen/canteen use
- » Trays are open on one side for easy access
- » Mobile on 4 x 125mm cushion swivel castors
- » Tray size: 785 x 590mm
- » Height between shelves: 457mm



TT3363

No of Trays	Tray Height mm	Weight kg	Melamine Trays	
			Model	Price
2	240/736	23	TT3363	£647.15

2 Tier Shelf Trolley

- » This unit has a push/pull handle
- » Mobile on 2 fixed, 2 swivel 150mm rubber castors



GI230H



Overall Size L x W x H mm	Platform Size mm	Shelf Heights mm	Wt kg	Model	Price
1100 x 700 x 980	1000 x 700	320 / 960	55	GI230H	£381.80

Tray Trolleys

- » Fully welded frame
- » Tubular steel frames with easy to clean, removable trays
- » Handle height: 980mm



PT1223

No of Trays	Tray Height mm	Wheels	Weight kg	Tray Size: 755 x 450 mm	
				Plastic	
				Model	Price
2	165 830	127mm Cushion	24	PT1203	£570.55
		127mm Nylon	22	PT1204	£588.55
3	165 500 830	127mm Cushion	28	PT1223	£684.75
		127mm Nylon	26	PT1224	£702.85

Adjustable Height Trolleys

- >> Mobile on 4 x 100mm swivel castors, 2 braked
- >> Perfect for colour co-ordinating company depts etc
- >> Shelves are manufactured from 20 gauge steel with smooth rounded edges for extra strength, with the legs constructed from 14 gauge steel
- >> Easily adjustable top shelf height in 13 positions from 715 to 1055mm. Top shelf also comes complete with a ribbed rubber mat



3 x GI942W

Overall Size L x W mm	Weight kg	Model	Price
610 x 460	20	GI942W	£275.65

COLOUR OPTIONS

- Red
- Grey
- Blue

specify when ordering

Reversible Tray/Shelf Trolleys

- >> Reversible shelves enable use as either a smooth shelf or as a tray with surrounding lip
- >> The height of the centre shelf on the 3 shelf model is adjustable
- >> Mobile on 2 fixed, 2 swivel braked 100mm polyurethane red castors



TI357Y



TI246Y



Description	Overall Size L x W x H mm	Weight kg	Model	Price
2 Shelf	670 x 400 x 910	17	TI246Y	£207.05
	820 x 500 x 910	20	TI257Y	£236.60
3 Shelf	670 x 400 x 910	20	TI346Y	£233.80
	820 x 500 x 910	23.5	TI357Y	£289.90



Platform & Shelf Trolleys

'ProPlaz®' Clever Folding Trolley

FROM ONLY
£214.70

- » Load capacity: 25kg on top tray
45kg on bottom tray
- » Manufactured to the recognised European GS standard
- » Manufactured from injection moulded plastic & anodised aluminium
- » Folding boxes are stackable & are kept securely in place by male & female connectors
- » Folding box has a capacity of 46 litres
- » Folding boxes can be stacked up to 4 high
- » Folded size: 670H x 470W x 110D mm



2 x GC066Z

ProPlaz®
clever trolley

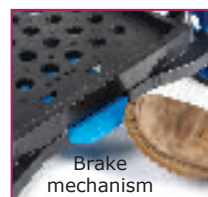

70kg
evenly distributed

PRICES HELD



Unclip the wheels from the base & clip into the frame of the unit. Push the blue button on the handle & lift up to open the unit. Then simply strap the box into the top tray using the Safety Straps & you're ready to go.... The unit even has a foot operated brake between the rear wheels.

Description	Overall Size L x W x H mm	Weight kg	Model	Price
Clever Trolley - c/w 1 folding box	890 x 550 x 1030	10	GC062Y	£214.70
Extra Folding Box	525 x 375 x 280	1.5	GC066Z	£29.75*

Clever Folding Trolley

- » Load capacity: 20kg on top tray & 40kg on bottom tray
- » Manufactured to the recognised European GS standard
- » Manufactured from injection moulded plastic & anodised aluminium
- » Folded size: 670H x 470W x 110D mm

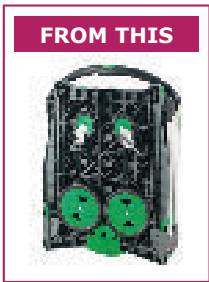

FROM ONLY
£233.75

COLOUR OPTIONS

- Red
- Green
- Black

specify when ordering

GC058Y
in Black

GC058Y
in Red

GC051Y
in Green &
GC055Z



60kg
evenly distributed



Description	Colour	Overall Size L x W x H mm	Weight kg	Model	Price
Clever Trolley - c/w 1 folding box	Green	890 x 550 x 1030	7	GC051Y	£233.75
Clever Trolley - c/w 1 folding box	Red or Black	890 x 550 x 1030	7	GC058Y	£238.10
Grey/Black Extra Folding Box for the GC051Y & GC058Y in Red - 46 litre capacity		525 x 375 x 280	1.5	GC055Z	£30.10*
Full Black Extra Folding Box for the GC058Y in Black - 46 litre capacity		525 x 375 x 280	1.5	GC056Z	£30.10*

Order Picking Trolleys with Clipboard Shelf

- >> Manufactured in angle steel with fixed painted steel trays
- >> Tray sizes: KTI13Y - 900 x 500mm & KTI14Y - 1000 x 700mm
- >> Shelf heights of 220 & 800mm
- >> Mobile on 2 fixed, 2 swivel braked 125mm rubber castors



FROM ONLY
£341.90



KTI13Y

Overall Size L x W x H mm	Weight kg	Model	Price
1330 x 500 x 1070	43	KTI13Y	£341.90
1430 x 700 x 1070	53	KTI14Y	£382.20



Heavy Duty Order Picking Trolleys

- >> Manufactured from a strong steel frame, powder coated in anthracite grey with heavy duty timber shelves with a durable painted finish
- >> Mobile on 2 fixed & 2 swivel braked, 125mm rubber castors
- >> Complete with clipboard shelf within the handle
- >> 300kg load capacity (U.D.L.) when using these trolleys on a level/even surface



PAOP202Y



PAOP202Y



FROM ONLY
£449.85

PAOP201Y



Description	Overall Size H x W x D mm	Shelf Heights mm	Shelf Size L x W mm	Model	Price
2 Shelf Order Picking Trolley - Cantilever	1170 x 605 x 1400	205 / 815	1010 x 605	PAOP201Y	£449.85
2 Shelf Order Picking Trolley	1170 x 515 x 1250	200 / 840	895 x 495	PAOP202Y	£449.85

Platform & Shelf Trolleys



Heavy Duty Container Trolleys complete with Containers

NEW

- >> Manufactured from a strong steel frame, powder coated in anthracite grey, complete with 2 x 600 x 400mm containers
- >> Lightweight making it easy to move around & transport goods efficiently
- >> Shelf heights: 505 & 1070mm
- >> Mobile on 4 x 100mm swivel castors



ONLY
£330.65



Overall Size H x W x D mm	Shelf Size L x W mm	Model	Price
1080 x 440 x 1000	600 x 400	PATT808Y	£330.65

Tray Trolleys



INFORMATION *i*
3 shelf/tray options available to suit your requirements



- >> Fully welded frame
- >> 3 options available:- MFC shelves, plastic removable trays or steel removable/reversible shelf/trays which are powder coated cream
- >> Mobile on 4 swivel 100mm non-marking castors

No of Trays	Tray Height mm	Overall Size: 1110L x 1030H x 500W mm						Tray Size 760 x 460 mm		
		MFC Shelves			Plastic Removable Trays			Steel Removable/Reversible Shelf/Trays		
		Weight kg	Model	Price	Weight kg	Model	Price	Weight kg	Model	Price
2	175 / 840	15	TT4312	£422.00	15	TT4412	£441.20	17	TT4512	£522.55
3	175 / 510 / 840	20	TT4313	£492.90	20	TT4413	£568.00	22	TT4513	£690.60



Order Picking Trolleys with Steps

- » Manufactured from a strong steel frame & shelves, powder coated in anthracite grey. Also available with heavy duty timber shelves with a durable painted finish
- » Spring loaded steps allow you to easily pick higher items
- » Mobile on 2 fixed & 2 swivel 125mm rubber castors
- » Large 300kg load capacity (U.D.L.) when using these trolleys on a level/even surface



PAOP206Y



PAOP203Y



PAOP204Y



PAOP205Y

Description	No of Steps	Overall Size H x W x D mm	Shelf Heights mm	Shelf Size L x W mm	Timber Shelves		Steel Shelves	
					Model	Price	Model	Price
2 Shelf	3	1380 x 600 x 1440	180 / 1000	800 x 500	PAOP203Y	£547.80	PAOP204Y	£556.00
3 Shelf	4	1570 x 600 x 1750	180 / 710 / 1240	1000 x 500	PAOP205Y	£751.90	PAOP206Y	£768.20

Platform & Shelf Trolleys

2 & 3 Tier General Purpose Trolleys

- » Strong & durable chrome wire trolley
- » Adjustable shelves
- » 4 x 75mm swivel castors, 2 braked



ET1824/2

2 & 3 Tier Basket Trolleys

- » Versatile & adjustable
- » 4 x 75mm swivel castors, 2 braked



EBT1836/2

Overall Size W x L x H mm	2 Tier		3 Tier	
	Model	Price	Model	Price
460 x 610 x 1060	ET1824/2	£123.64	ET1824/3	£144.55
460 x 915 x 1060	ET1836/2	£136.36	ET1836/3	£163.64

Overall Size W x L x H mm	2 Tier		3 Tier	
	Model	Price	Model	Price
460 x 610 x 1060	EBT1824/2	£136.36	EBT1824/3	£163.64
460 x 915 x 1060	EBT1836/2	£161.82	EBT1836/3	£201.82

Euro Box Carts

- » Fully adjustable
 - » Bolt Free assembly
 - » Robust chrome finish
 - » Mix & match different height boxes
 - » Designed to hold 600W x 400D mm & 300W x 400D mm euro boxes
- Boxes are not included in the below prices*



BC6220

Description	120mm High Box		220mm High Box		320mm High Box	
	Model	Price	Model	Price	Model	Price
2 Box - 1200H mm	-	-	-	-	BC2325	£143.64
3 Box - 1200H mm	-	-	BC3220	£158.18	-	-
4 Box - 1750H mm	-	-	-	-	BC4325	£172.73
6 Box - 1200H mm	BC6120	£201.82	-	-	-	-
6 Box - 1750H mm	-	-	BC6220	£201.82	-	-
8 Box - 1450H mm	BC8120	£230.91	-	-	-	-
10 Box - 1750H mm	BC10120	£260.00	-	-	-	-



MSC41836

*Perma Plus models have anti-bacterial additives which help fight the build up of germs & improve hygiene standards

Eclipse - Security Enclosures

- » Eclipse chrome wire shelving enclosed in a tough, durable chrome wire cage
 - » The unit incorporates 2 hinged padlocked* doors & 4 shelves (top, bottom & 2 adjustable intermediate) *padlock not included
- **units delivered fully assembled



Static Unit Complete

Finish	Size D x L x H mm	Model	Price
Standard Chrome	460 x 915 x 1625	ESC41836	£590.91
Standard Chrome	460 x 1220 x 1625	ESC41848	£675.45
Standard Chrome	610 x 1220 x 1625	ESC42448	£701.82
Perma Plus Nylon*	610 x 1220 x 1625	EPPSC42448	£746.36

Mobile Unit c/w 4 x 120mm Castors

Finish	Size D x L x H mm	Model	Price
Standard Chrome	460 x 915 x 1750	MSC41836	£661.82
Standard Chrome	460 x 1220 x 1750	MSC41848	£746.36
Standard Chrome	610 x 1220 x 1750	MSC42448	£772.73
Perma Plus Nylon*	610 x 1220 x 1750	MEPPSC42448	£817.27

Chrome Plated Wire Tray Trolley

- >> Hygienic - easy to clean
- >> Removable centre shelf for bulky loads
- >> Mobile on 2 large fixed 200mm wheels & 2 swivel braked 125mm castors



Removable Shelf

LOWER PRICE



SWI52Y



SWI52Y

120kg
evenly distributed



Overall Size L x W x H mm	Weight kg	Model	Price
860 x 660 x 990	17.5	SWI52Y	£239.75

Chrome Plated Wire Tray Trolley

- >> Hygienic - easy to clean
- >> Corner buffers for added protection
- >> Mobile on 125mm rubber wheels, 2 with brakes
- >> Both trays have deep 130mm sides to help contain contents



INFORMATION



Corner buffers for added protection of surfaces

120kg
evenly distributed



LOWER PRICE



SWI42Y

Overall Size L x W x H mm	Weight kg	Model	Price
950 x 510 x 1100	16.5	SWI42Y	£220.90

Platform & Shelf Trolleys

Stainless Steel Platform Truck

- » Manufactured from grade 304 stainless steel
- » Mobile on 2 fixed & 2 swivel low noise, REACH compliant, Super Silent superior 125mm castors



The Super Silent units are mobile on superior smooth running rubber, silent castors.

- ✓ Effortless manoeuvrability with minimal resistance
- ✓ Non-conductive, water proof & wear resistant
- ✓ REACH compliant, resistant to chemicals & extreme temperatures



Platform Size L x W mm	Handle Height mm	Weight kg	Model	Price
700 x 480	845	11	SI374Y	£349.00

Stainless Steel Tray Trolleys

- » Manufactured from grade 201 stainless steel
- » Useable tray size: 775L x 400Wmm with a 100mm tray depth
- » Mobile on 4 swivel braked non-marking 100mm castors



SI822Y
£246.40

SI822Y

No of Shelves	Overall Size L x W x H mm	Weight kg	Model	Price
2	837 x 443 x 895	14	SI822Y	£246.40

Stainless Steel Platform Trucks

- » Heavy duty type 304 stainless steel truck
- » Suitable for food processing plants, laundries etc
- » Mobile on 4 swivel (2 braked) 125mm rubber tyred castors



SST02Y

SST01Y



Folding Stainless Steel Trolleys

- » Stainless steel corrosion resistant platform & handle
- » Handle folds for ease of storage
- » Mobile on 4 swivel (2 braked) 100mm rubber tyred castors



SST515

No of Shelves	Overall Size L x W x H mm	Weight kg	Model	Price
1	880 x 575 x 905	11	SST01Y	£653.80
2	700 x 435 x 905	12	SST02Y	£608.45

Overall Size L x W x H mm	Folded Height mm	Weight kg	Model	Price
820 x 515 x 970	185	15	SST515	£359.70

Platform & Shelf Trolleys

Stainless Steel Shelf Trolleys

- » Manufactured from grade 304 stainless steel
- » Useable shelf size: 610L x 410Wmm with a 30mm lip depth
- » Mobile on 4 swivel 100mm non-marking castors

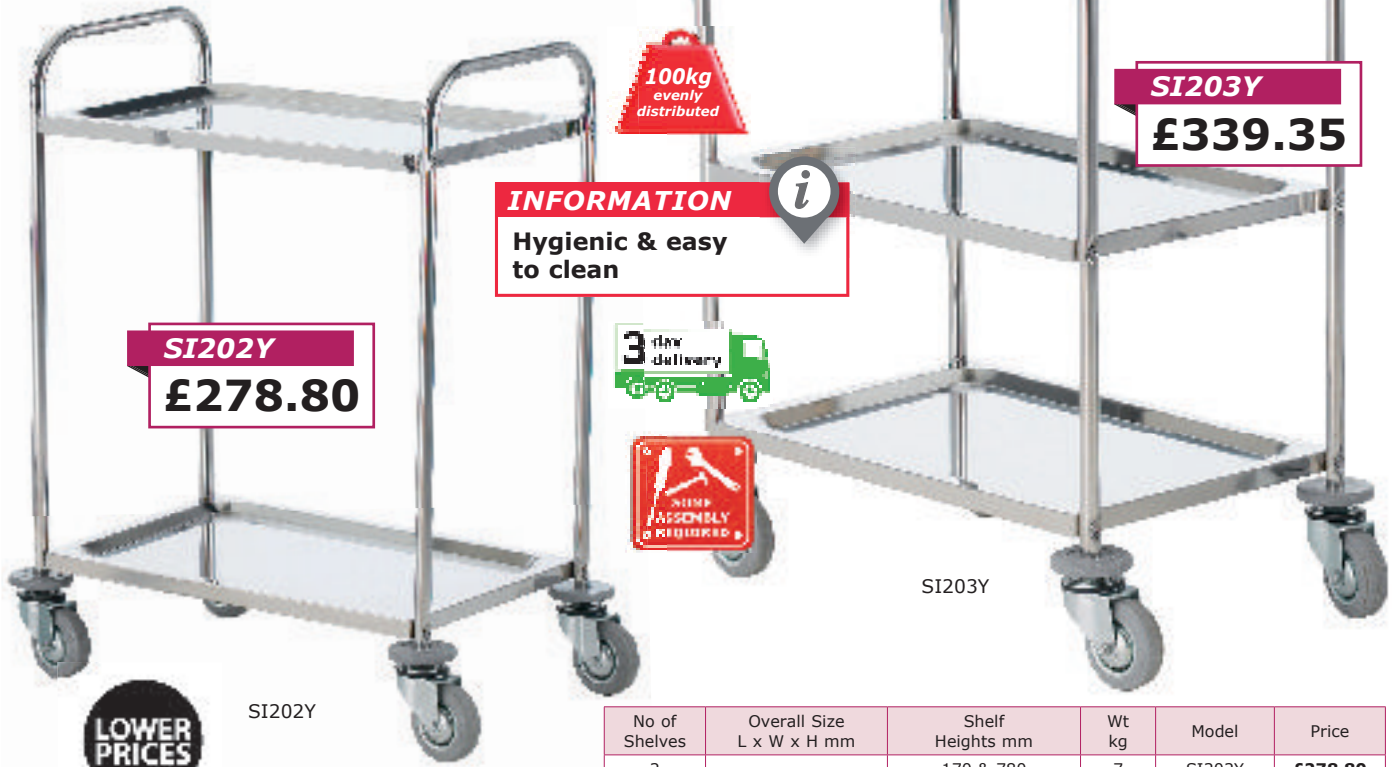

SI202Y
£278.80

SI203Y
£339.35

INFORMATION
Hygienic & easy to clean

100kg evenly distributed

3 day delivery

TEMP ASSEMBLY REQUIRED

LOWER PRICES

No of Shelves	Overall Size L x W x H mm	Shelf Heights mm	Wt kg	Model	Price
2	710 x 470	170 & 780	7	SI202Y	£278.80
3	x 900	170, 475 & 780	8.5	SI203Y	£339.35

Stainless Steel Shelf Trolleys

- » Manufactured from grade 201 stainless steel
- » Hygienic - easy to clean
- » Mobile on 4 non-marking 100mm braked swivel castors
- » Tray size: 775L x 400Wmm



FROM ONLY
£219.45

SI803Y

SI812Y

LOWER PRICES

3 day delivery

TEMP ASSEMBLY REQUIRED

100kg evenly distributed

No of Shelves	Overall Size L x W x H mm	Distance Between Shelves	Wt kg	Model	Price
3	850 x 445 x 895	260	14	SI803Y	£219.45
2 with rod surround		345	10	SI812Y	£231.90

Distribution Trucks & Roll Containers

Heavy Duty Shelf Trucks



FROM ONLY
£516.95



DT809Y with
2 x DTS08S

Base / Shelf Size mm	Overall Size L x W x H mm	Weight kg	Model	Price
960 x 660	1035 x 705 x 1750	52.5	DT809Y	£516.95
1160 x 760	1235 x 805 x 1750	57	DT810Y	£560.40
Optional Shelves (must be ordered with the Heavy Duty Shelf Trucks)				
Shelf to Suit DT809Y - 960 x 660		12	DTS08S	£46.95
Shelf to Suit DT810Y - 1160 x 760		13.5	DTS10S	£46.95

- » Ideal for use in factories, warehouses etc.
- » Standard unit comes with 1 x shelf but the unit can hold 2 further shelves (available as extras)
- » Load capacity per shelf: 30kg
- » Heavy duty veneer removable shelves
- » Mobile on 2 fixed & 2 swivel braked castors - 200 x 50mm rubber

Heavy Duty Distribution Trucks with Steel Shelves



INFORMATION



Available with or without doors



DT403Y



DT701Y & 3 x DTS07S

**FROM ONLY
£478.05**

- » Available with or without lockable doors
- » 2 fixed & 2 swivel braked 200mm rubber castors
- » DT403Y & DT401Y: comes with the base and the unit can hold an additional 2 shelves (available as extras) which can be placed at 690 & 1090mm heights
- » DT703Y & DT701Y: comes with the base and the unit can hold an additional 3 shelves (available as extras) which can be placed at 630, 1050 & 1440mm heights
- » Load capacity per shelf: 50kg



Description	Base / Shelf Size mm	Overall Size L x W x H mm	Weight kg	Model	Price
Heavy Duty Distribution Trucks - 1490mm high					
Without Doors	860 x 620	900 x 650 x 1490	54	DT403Y	£478.05
With Lockable Doors	860 x 620	900 x 650 x 1490	68	DT401Y	£513.25
Large Heavy Duty Distribution Trucks - 1790mm high					
Without Doors	1150 x 750	1270 x 750 x 1790	68	DT703Y	£531.15
With Lockable Doors	1150 x 750	1270 x 750 x 1790	87	DT701Y	£576.60
Optional Shelves (must be ordered with the Heavy Duty Distribution Truck)					
Optional Shelf to Suit the DT403Y or DT401Y - Shelf Size: 860W x 620Dmm				DTS04S	£65.95
Optional Shelf to Suit the DT703Y or DT701Y - Shelf Size: 1150W x 750Dmm				DTS07S	£65.95

Distribution Trucks & Roll Containers

Heavy Duty Distribution Trucks



DT603Y & 2 x DTS06S



DT603Y



DT601Y & 2 x DTS06S

Heavy Duty Distribution Trucks - 1490mm high



DT903Y & 3 x DTS09S



DT903Y



DT901Y

Large Heavy Duty Distribution Trucks - 1790mm high

Heavy Duty Distribution Trucks



INFORMATION



Available with or without doors & 1490 or 1790mm high

**FROM ONLY
£467.60**



DT601Y

DT901Y & 3 x DTS09S

- » Available with or without lockable doors
- » 2 fixed & 2 swivel braked 200mm rubber castors
- » DT603Y & DT601Y: comes with the base and the unit can hold an additional 2 shelves (available as extras) which can be placed at 690 & 1090mm heights
- » DT903Y & DT901Y: comes with the base and the unit can hold an additional 3 shelves (available as extras) which can be placed at 630, 1050 & 1440mm heights
- » Load capacity per shelf: 30kg



Description	Base / Shelf Size mm	Overall Size L x W x H mm	Weight kg	Model	Price
Heavy Duty Distribution Trucks - 1490mm high					
Without Doors	860 x 620	900 x 650 x 1490	54	DT603Y	£467.60
With Lockable Doors	860 x 620	900 x 650 x 1490	68	DT601Y	£502.75
Large Heavy Duty Distribution Trucks - 1790mm high					
Without Doors	1150 x 750	1270 x 750 x 1790	68	DT903Y	£519.80
With Lockable Doors	1150 x 750	1270 x 750 x 1790	87	DT901Y	£578.95
Optional Shelves (must be ordered with the Heavy Duty Distribution Truck)					
Optional Shelf to Suit the DT603Y or DT601Y - Shelf Size: 860 x 620				DTS06S	£46.95
Optional Shelf to Suit the DT903Y or DT901Y - Shelf Size: 1150 x 750				DTS09S	£46.95

Distribution Trucks & Roll Containers



Heavy Duty Distribution Trucks

NEW

- » Manufactured from a strong steel frame, powder coated in anthracite grey & heavy duty timber decks with a durable painted finish
- » Mobile on 2 fixed & 2 swivel braked, 200mm rubber castors with blue centres
- » Large 600kg load capacity (U.D.L.) when using these trolleys on a level/even surface. Heavy duty shelves, with steel frames, can hold up to 100kg each

600kg
evenly distributed



PADT302Y



PADT301Y



PADT303Y



PADT305Y



PADT304Y



PADT306Y



INFORMATION

Adjustable shelves in 100mm increments





Heavy Duty Distribution Trucks



FROM ONLY
£597.65

PADT312Y

Adjustable shelves in 100mm increments

Description	1000 x 700mm Platform Size			1200 x 800mm Platform Size		
	Size: H x W x D mm	Model	Price	Size: H x W x D mm	Model	Price
Distribution Trucks with 1100mm high sides from Base						
Distribution Truck with Sides & 2 Shelves	1340 x 1100 x 700	PADT301Y	£618.45	1340 x 1300 x 800	PADT307Y	£666.95
Distribution Truck with Sides & Back	1340 x 1100 x 700	PADT302Y	£597.65	1340 x 1300 x 800	PADT308Y	£639.20
Distribution Truck with Sides, Back & 2 Shelves	1340 x 1100 x 700	PADT303Y	£701.55	1340 x 1300 x 800	PADT309Y	£760.45
Distribution Trucks with 1500mm high sides from Base						
Distribution Truck with Sides & 3 Shelves	1740 x 1100 x 700	PADT304Y	£679.05	1740 x 1300 x 800	PADT310Y	£736.20
Distribution Truck with Sides & Back	1740 x 1100 x 700	PADT305Y	£627.10	1740 x 1300 x 800	PADT311Y	£672.10
Distribution Truck with Sides, Back & 3 Shelves	1740 x 1100 x 700	PADT306Y	£782.95	1740 x 1300 x 800	PADT312Y	£853.95

Distribution Trucks & Roll Containers



Heavy Duty Powered Distribution Trucks

- » Manufactured from a strong steel frame, powder coated in anthracite grey & heavy duty timber decks with a durable painted finish
- » Mobile on 2 swivel 200mm rubber castors & 2 fixed pneumatic drive wheels
- » Large 600kg load capacity (U.D.L.) when using these trolleys on a level/even surface
- » Heavy duty shelves, with steel frames, can hold up to 100kg each
- » 6 hour run time on a full charge (do not let the battery run flat) which will give a 2.5 to 6 mile range, depending on load
- » Neat & tidy cable management system to prevent any snags
- » Complete with a powered controller which has easy forward & reverse levers, adjustable speed toggle & an emergency stop button

NEW

600kg
evenly
distributed



PWDT302Y



PWDT301Y



PWDT309Y

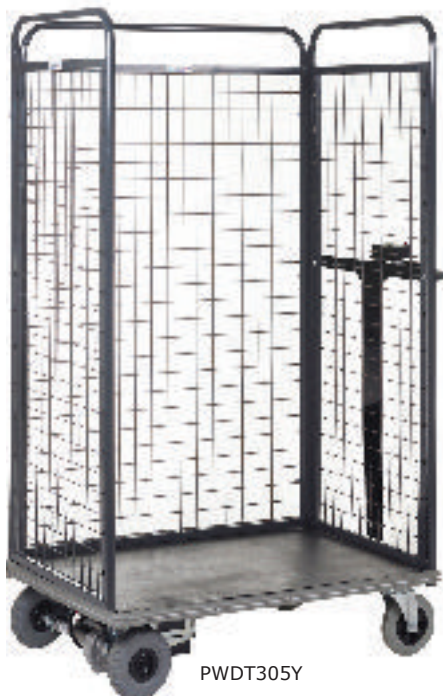

PWDT305Y



PWDT304Y



PWDT306Y



INFORMATION

Adjustable shelves in 100mm increments





Heavy Duty Powered Distribution Trucks



PWDT303Y

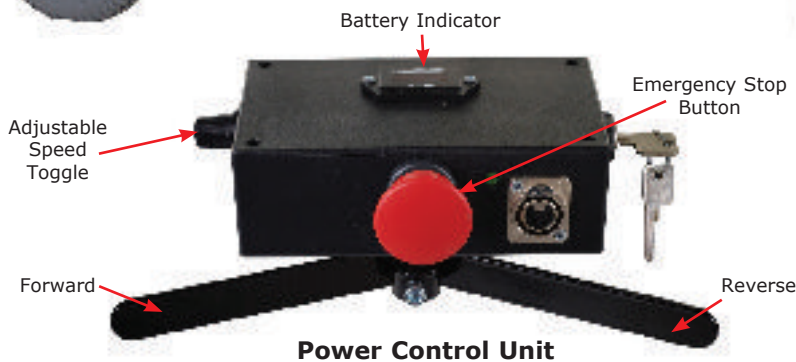

Power Control Unit



Description	1000 x 700mm Platform Size			1200 x 800mm Platform Size		
	Size: H x W x D mm	Model	Price	Size: H x W x D mm	Model	Price
Distribution Trolleys with 1100mm high sides						
Distribution Truck with Sides & 2 Shelves	1340 x 1100 x 700	PWDT301Y	£3563.05	1340 x 1300 x 800	PWDT307Y	£3873.95
Distribution Truck with Sides & Back	1340 x 1100 x 700	PWDT302Y	£3542.85	1340 x 1300 x 800	PWDT308Y	£3847.05
Distribution Truck with Sides, Back & 2 Shelves	1340 x 1100 x 700	PWDT303Y	£3643.70	1340 x 1300 x 800	PWDT309Y	£3964.70
Distribution Trolleys with 1500mm high sides						
Distribution Truck with Sides & 3 Shelves	1740 x 1100 x 700	PWDT304Y	£3621.85	1740 x 1300 x 800	PWDT310Y	£3941.20
Distribution Truck with Sides & Back	1740 x 1100 x 700	PWDT305Y	£3571.45	1740 x 1300 x 800	PWDT311Y	£3879.00
Distribution Truck with Sides, Back & 3 Shelves	1740 x 1100 x 700	PWDT306Y	£3722.70	1740 x 1300 x 800	PWDT312Y	£4055.45

Distribution Trucks & Roll Containers

Heavy Duty Storage Vault Cabinets



INFORMATION



Static units are available - see page 135

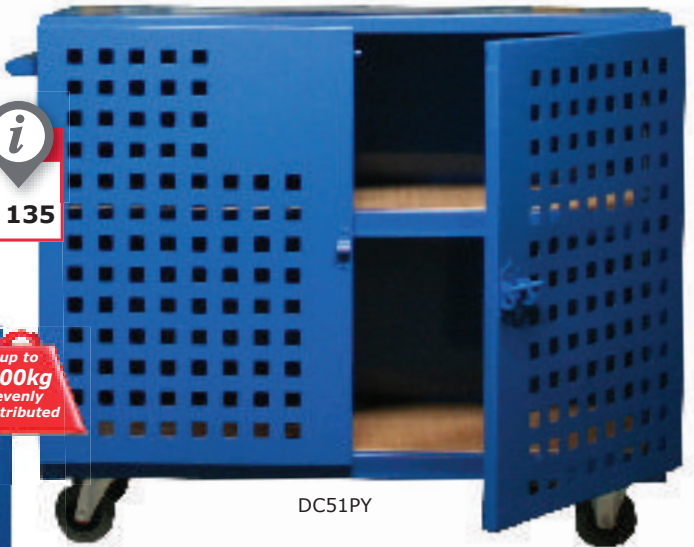

DC51PY



DC20PH

N.B - A Fork Lift will be needed to unload these units

- » Fully welded construction for heavy duty use (handles are bolt-on)
- » Exterior grade plywood shelves with steel surround for edge protection. Shelves are centrally positioned within the unit
- » Mobile on 2 fixed & 2 swivel braked 200mm castors (125mm on DC5's)
- » Complete with hasp & staple lock with padlock facility (padlock not included)
- » Extra shelves are available - call for details
- » 500kg load capacity (300kg on the DC5's)

Overall Size L x W x H mm	Storage Vault Cabinets			Storage Vault Cabinets with 1 Shelf		
	Weight kg	Model	Price	Weight kg	Model	Price
1090 x 730 x 1460	109	DC20PH	£1078.10	125	DC21PH	£1179.90
1090 x 830 x 1260	112	DC40PH	£1078.85	128	DC41PH	£1181.45
1290 x 730 x 1260	112	DC30PH	£1080.25	128	DC31PH	£1184.20
1290 x 830 x 1460	114	DC10PH	£1132.75	130	DC11PH	£1235.70
1310 x 535 x 1060	110	DC50PY	£1018.35	126	DC51PY	£1111.30

Heavy Duty Roll Container

- » 3 tubular sides & sheet steel base
- » Rigidity bar when the unit is open
- » Nestable units - ideal where space is limited
- » Mobile on 4 swivel, 2 braked, 150mm rubber castors



RI2003



Rigidity Bar

INFORMATION



Ideal where space is limited



RI2003
ready for nesting

Overall Size L x W x H mm	Weight kg	Model	Price
800 x 600 x 1690	42	RI2003	£355.00

Distribution Trucks & Roll Containers

Distribution Trucks

- » Mobile distribution trucks ideal for many environments
- » Complete with 2 adjustable steel or plywood shelves with a capacity of 100kg UDL per shelf
- » Mobile on 2 fixed & 2 swivel castors

COLOUR OPTIONS

- Green
- Light Grey
- Blue
- Red

specify when ordering



FROM ONLY
£710.85

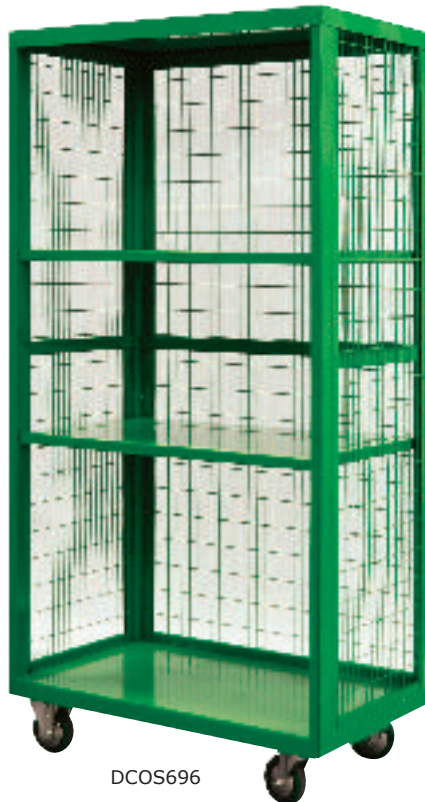

DCOS696



DCDS696

Extra Shelves

Overall Size L x W mm	Steel Shelf		Plywood Shelf	
	Model	Price each	Model	Price each
900 x 600	DCESS	£65.85	DCESPL	£79.00

Distribution Trucks - Open Front

Overall Size L x W x H mm	Steel Shelves		Plywood Shelves	
	Model	Price	Model	Price
900 x 600 x 1355	DCOS396	£710.85	DCOP396	£750.35
900 x 600 x 1655	DCOS696	£751.65	DCOP696	£788.50
900 x 600 x 1955	DCOS996	£784.60	DCOP996	£822.75

Distribution Trucks - With Doors

Overall Size L x W x H mm	Steel Shelves		Plywood Shelves	
	Model	Price	Model	Price
900 x 600 x 1355	DCDS396	£896.45	DCDP396	£933.30
900 x 600 x 1655	DCDS696	£945.15	DCDP696	£983.30
900 x 600 x 1955	DCDS996	£993.85	DCDP996	£1033.35

Hazardous Distribution Trucks

- » Mobile distribution trucks ideal for the safe & secure storage & transport of valuable & hazardous items between storage, production & work area environments
- » Complete with 2 adjustable steel or plywood shelves with a capacity of 100kg UDL per shelf
- » Mobile on 2 fixed & 2 swivel castors



FROM ONLY
£753.00



HDOS696



HDDS696

Extra Shelves

Overall Size L x W mm	Steel Shelf		Plywood Shelf	
	Model	Price each	Model	Price each
900 x 600	HDESST	£65.85	HDESPL	£79.00

Distribution Trucks - Open Front

Overall Size L x W x H mm	Steel Shelves		Plywood Shelves	
	Model	Price	Model	Price
900 x 600 x 1355	HDOS396	£753.00	HDOP396	£792.45
900 x 600 x 1655	HDOS696	£793.80	HDOP696	£830.65
900 x 600 x 1955	HDOS996	£826.70	HDOP996	£864.85

Distribution Trucks - With Doors

Overall Size L x W x H mm	Steel Shelves		Plywood Shelves	
	Model	Price	Model	Price
900 x 600 x 1355	HDDS396	£938.55	HDDP396	£975.40
900 x 600 x 1655	HDDS696	£987.25	HDDP696	£1025.45
900 x 600 x 1955	HDDS996	£1037.30	HDDP996	£1075.45

Distribution Trucks & Roll Containers

Heavy Duty Roll Containers

NEW



3 YR
GUARANTEE

500kg
evenly
distributed



TRC1105

INFORMATION

Heavy Duty Roll Containers which are suitable for a wide range of applications

- » Manufactured from high quality steel powder coated in blue
- » Available with or without removable shelves
- » Mobile on 2 fixed & 2 swivel 100mm castors
- » Load capacity per shelf: 75 kg
- » Supplied flat packed for easy assembly

Description	Overall Size L x W x H mm	Roll Containers without Shelves		Roll Containers with 2 Shelves	
		Model	Price	Model	Price
Heavy Duty Roll Container with 2 Ends	1100 x 700 x 1500	TRC1101	£875.15	TRC1104	£1314.50
Heavy Duty Roll Container with 2 Ends & 1 Side		TRC1102	£1031.50	TRC1105	£1470.85
Heavy Duty Roll Container with 2 Ends & 2 Sides		TRC1103	£1187.85	TRC1106	£1627.20
Heavy Duty Roll Container with 2 Ends	1730 x 725 x 1800	TRC1107	£1043.15	TRC1110	£1422.80
Heavy Duty Roll Container with 2 Ends & 1 Side		TRC1108	£1252.25	TRC1111	£1631.90
Heavy Duty Roll Container with 2 Ends & 2 Sides		TRC1109	£1461.35	TRC1112	£1841.00



DT1020Y



Shelves adjustable in 75mm increments



DT1010Y



Lock Mechanism

DT1020Y Lock

Heavy Duty Distribution Trucks

- » Manufactured from 50 x 50mm mesh panels with steel frame plywood shelves
- » Complete with 2 shelves which are adjustable in 75mm increments
- » Mobile on 4 cushion swivel 200mm castors
- » Load capacity per shelf: 75 kg
- » DT1020Y is fitted with a locking handle & supplied with keys

Description	Overall Size L x W x H mm	Shelf Size L x W mm	Weight kg	Model	Price
Mesh End Distribution Cage	1205 x 725 x 1770	1100 x 690	60	DT1010Y	£1028.15
Security Distribution Cage	1205 x 770 x 1770	1100 x 690	80	DT1020Y	£1271.95
Extra Plywood Shelf (must be ordered with the Heavy Duty Distribution Truck)		1100 x 690	6	DT7970ES	£109.45

N.B - A Fork Lift will be needed to unload these units

Distribution Trucks & Roll Containers



CMT1010

Compact Merchandising Trolley

- » This trolley has been designed specifically to accommodate four 600 x 400mm containers
- » The sides all have 50mm infill to stop any loose product falling out in use
- » A push/pull handle bar allows for easy manoeuvrability even when loaded
- » Complete with middle shelf
- » Mobile on 2 fixed & 2 swivel braked nylon castors

PRICE HELD

INFORMATION



Ideal for use with 600 x 400 containers



Overall Size L x W x H mm	Model	Price
1010 x 660 x 1000	CMT1010	£234.85

Multi Tier Trolley

- » This trolley has been designed specifically to accommodate eight 600 x 400mm containers
- » Trolley comes with a bag hanger, scanner basket, storage basket & rubber buffers
- » A push/pull handle allows for easy manoeuvrability even when loaded
- » Mobile on 4 swivel castors



MTT1170
(containers not included)

INFORMATION



Ideal for use with 600 x 400 containers



PRICES HELD

Large Merchandising Trolley

- » This trolley has been designed specifically to accommodate six 600 x 400mm containers
- » A push/pull handle allows for easy manoeuvrability even when loaded
- » Complete with two middle shelves
- » Mobile on 2 fixed & 2 swivel braked nylon castors



LMT1690

Overall Size L x W x H mm	Model	Price
1010 x 615 x 1170	MTT1170	£335.10

Overall Size L x W x H mm	Model	Price
1010 x 660 x 1690	LMT1690	£298.35

Security Trolleys

- » Wire shelf security enclosure complete with 2 height adjustable shelves - ideal for securely storing items but ensuring goods are easily viewed
- » Deep shelves for extra capacity & stability
- » Mobile on 4 swivel 100mm rubber castors, 2 braked
- » Complete with hasp & staple facility (padlock not included)
- » Load capacity per shelf: 80kg

350kg
evenly distributed

FROM ONLY
£653.70

INFORMATION



Deep shelves for extra capacity & stability



SW092Y

Description	Overall Size L x W x H mm	Weight kg	Model	Price
Small Unit	910 x 650 x 1750	61	SW091Y	£653.70
Large Unit	1220 x 650 x 1750	73	SW092Y	£689.10

Wire Mesh Trolley

- » Wire shelf trolley complete with 4 height adjustable shelves - ideal for storing items but ensuring goods are easily viewed
- » Mobile on 4 swivel 100mm rubber castors, 2 braked
- » Load capacity per shelf: 80kg

320kg
evenly distributed



INFORMATION



Complete with 4 high quality chrome wire basket shelves



SW491Y
£280.30

SW491Y

Overall Size L x W x H mm	Basket Size L x W x H mm	Weight kg	Model	Price
910 x 460 x 1750	910 x 460 x 135	22	SW491Y	£280.30

Distribution Trucks & Roll Containers

Plastic Base Nestable Roll Containers

- » Bright zinc electroplated finish with heavy duty plastic bases
- » PBR2725: on this model the front gate opens through 270°
- » Mobile on 2 fixed & 2 swivel 125mm nylon castors with roller bearings

LOWER PRICES

7 day delivery



PBR2723 - ready to be nested



PBR2723



PBR2725
(comes with 1 shelf)



3 x PBR2725
Nested

BASE COLOUR OPTIONS

- Red
- Purple
- Blue

specify when ordering

External Size L x W x H mm	Internal Height mm	3 Sided		Security (50 x 50mm Mesh)		Wire Shelf to Suit (factory fitted)	
		Model	Price	Model	Price	Model	Price
735 x 850 x 1690	1430	PBR2723	£244.80	PBR2725	£323.85	RC7383	£22.10

'A' Type Nestable Roll Containers

- » Bright zinc electroplated finish
- » RB1725: on this model the front gate opens through 270°
- » Mobile on 2 fixed & 2 swivel 125mm nylon castors with roller bearings
- » Re-inforced wire base

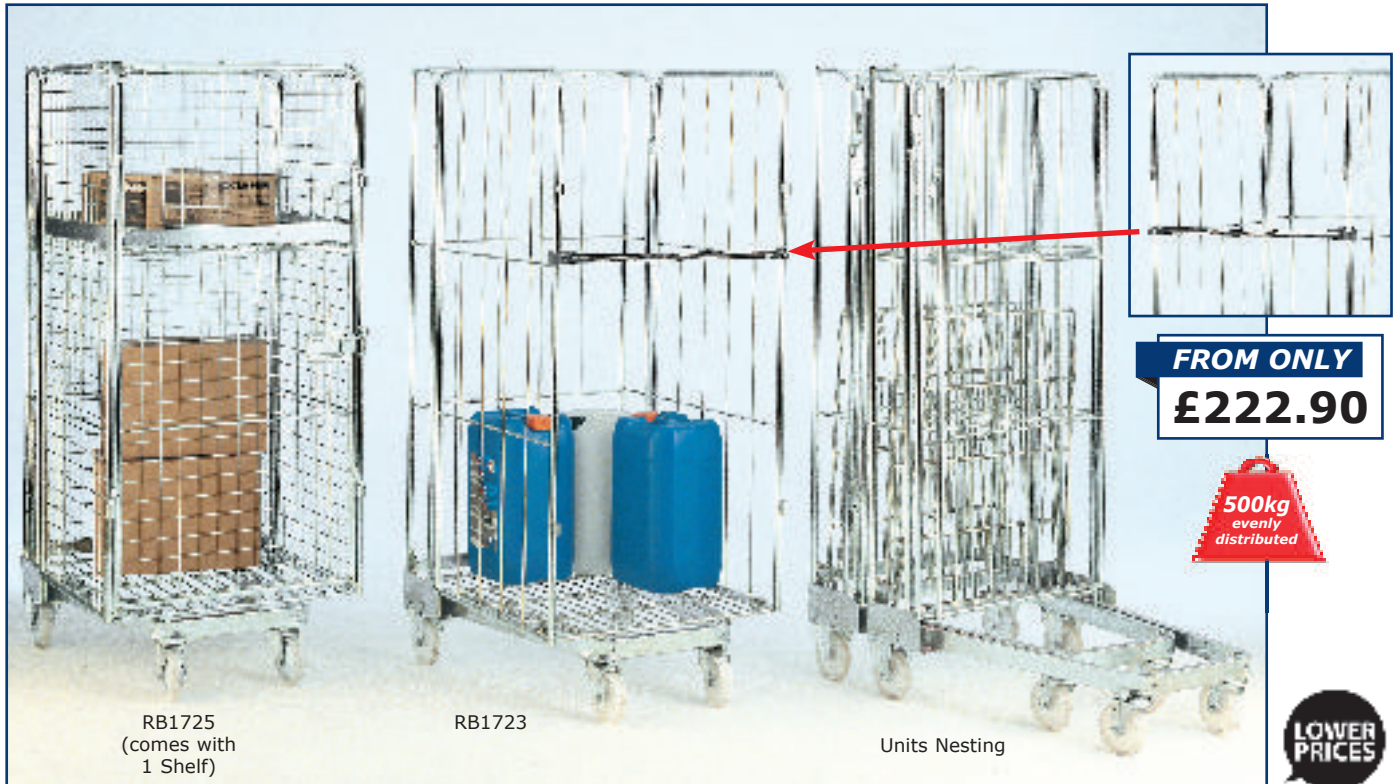

RB1725
(comes with 1 Shelf)

RB1723

Units Nesting

FROM ONLY
£222.90

500kg
evenly distributed

LOWER PRICES

External Size L x W x H mm	Internal Height mm	3 Sided		4 Sided		Security (50 x 50mm Mesh)		Shelf to Suit (factory fitted)	
		Model	Price	Model	Price	Model	Price	Model	Price
735 x 830 x 1720	1430	RB1723	£222.90	RB1724	£257.05	RB1725	£301.95	RC7383	£22.10

Demountable Roll Containers

- » Bright zinc electroplated finish with a re-inforced wire base
- » Hygienic - steam clean or pressure wash
- » Detachable rod infill sides for easy storage
- » Mobile on 2 fixed & 2 swivel 100mm nylon castors with roller bearings



RB1693



RB1694



RB1835 & RC7180



RB1692

INFORMATION 
 Many sizes & models available to suit your application

LOWER PRICES

500kg
evenly distributed

External Size L x W x H mm	Internal Height	2 Sided & Straps		3 Sided		4 Sided (½ Drop Side)		Security (50 x 50mm Mesh)	
		Model	Price	Model	Price	Model	Price	Model	Price
715 x 800 x 1520	1360mm	RB1522	£185.75	RB1523	£221.85	RB1524	£257.05	-	-
715 x 800 x 1690	1530mm	RB1692	£192.70	RB1693	£229.00	RB1694	£267.25	-	-
715 x 800 x 1815	1630mm	RB1812	£200.40	RB1813	£238.40	RB1814	£279.55	-	-
715 x 800 x 1830	1640mm	-	-	-	-	-	-	RB1835	£420.80
Shelf to Suit Above Roll Containers - 715 x 800mm (factory fitted)								RC7180	£22.10

Distribution Trucks & Roll Containers

Cash & Carry Nestable Trolleys

- » Platform size: 1130 x 620mm
- » 100 nestable trolleys can be stored in the space normally occupied by 27 conventional units (37m)
- » Both models with roller bearing wheels
- » Load capacity: GP1633 - 300kg & GP164H - 500kg



Nesting Stock Trolleys

- » Ergonomically designed handles for your comfort
- » Nestable trolleys with either mesh or solid base
- » Mobile on 4 swivel 125mm rubber tyred castors



Description	Overall Size L x W x H mm	Platform L x W mm	Weight kg	Model	Price
Mesh Base	1170 x 700 x 980	850 x 540/600	20	NST20Y	£342.90
Solid MDF Base	1170 x 700 x 980	850 x 540/600	22	NST30Y	£503.60

Stock Trolley

- » Folding top shelf to allow you to fit larger goods on the bottom shelf
- » Mobile on 4 swivel 125mm rubber castors
- » Load cap: top shelf 50kg & bottom shelf 150kg



3 x NST10Y Nested



NST10Y



Overall Size L x W x H mm	Shelf Heights mm	Weight kg	Model	Price
905 x 540 x 940	220 / 535	24	NST10Y	£216.50

Folding Top Shelf Stock Trolleys

- » Folding top shelf to allow you to fit larger goods on the bottom shelf
- » Available with mesh platform shelf/basket
- » Mobile on 4 swivel 125mm rubber castors
- » Capacity: top shelf 100kg & bottom shelf 200kg



NST40Y
Nested



NST40Y

FROM ONLY
£328.60



NST50Y



Description	Overall Size L x W x H mm	Weight kg	Model	Price
Folding Flat Top Shelf	870 x 530 x 1010	18	NST40Y	£328.60
Folding Basket Top Shelf	870 x 530 x 1010	21	NST50Y	£375.00

Distribution Trucks & Roll Containers

Narrow Aisle Cash & Carry Trolley



INFORMATION



Ideal for narrow passageways & tight spaces

- » Ideal for use where there is restricted turning space
- » Mobile on 4 x 125mm swivel rubber castors & 2 x 200mm centrally positioned fixed rubber wheels
- » 230mm platform height



GP160H

Overall Size L x W x H mm	Weight kg	Model	Price
1220 x 400 x 1209	28	GP160H	£602.60
1525 x 400 x 1209	39	GP162H	£624.25

Stock Trolley



GP700H



- » Fully welded frame, push/pull handles & steel base
- » Mobile on 2 fixed & 2 swivel 200mm cushion castors
- » Handle height: 1000mm
- » Durable powder coated finish

Platform Size L x W mm	Overall Size L x W x H mm	Weight kg	Model	Price
1000 x 700	1200 x 700 x 1245	30	GP700H	£642.40

Distribution Trucks & Roll Containers

Heavy Duty Dry Wall Trolley

- » Mobile on 2 fixed & 2 swivel 200mm heavy duty castors
- » Ideal for a vast range of boards from doors, fences, drywall to large sheet panels
- » The platform incorporates lips either side to help make it easier to put the board on the trolley

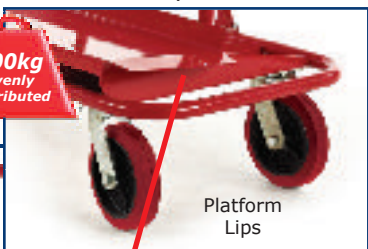

Platform Lips



DWT80Y

LOWER PRICE

Overall Size L x W x H mm	Weight kg	Model	Price
1219 x 584 x 1219	40	DWT80Y	£321.30

D.I.Y. Trolley

- » Fully welded construction
- » Heavy duty units suitable for large sheet or panels & heavy bagged / boxed materials
- » Tubular steel support frame helps prevent larger items sliding off





GS201H

Load Capacity	Overall Size L x W x H mm	Wheels mm	Weight kg	Model	Price
250 kg	1370 x 700 x 1010	125	38	GS201H*	£847.50

Heavy Duty Board Trolley

- » Mobile on 4 swivel rubber tyred castors
- » Ideal for a vast range of boards from doors, fences, drywall to large sheet panels
- » 300mm deep load space





GS202H



GS203H

Load Capacity	Overall Size L x W x H mm	Wheels mm	Weight kg	Model	Price
300 kg	1500 x 700 x 1205	125	25	GS202H*	£699.20
500 kg	1500 x 700 x 1290	200	28	GS203H*	£731.50

*N.B - A Fork Lift may be needed to unload these units

399

Distribution Trucks & Roll Containers

Wire Mesh Truck



GIS73M
£465.65

GIS73M



- » 40mm mesh with a half drop down front
- » Mobile on 2 fixed & 2 swivel braked 125mm castors
- » Internal size of 840L x 545W x 520Hmm

Overall Size L x W x H mm	Weight kg	Model	Price
1155 x 615 x 905	24	GIS73M	£465.65

Security Trolley - Mesh

- » Lockable lid for full security & half drop front
- » Mobile on 4 x 200mm rubber (2 fixed & 2 swivel braked)
- » 50 x 50mm mesh sides & half hinged lid which provides easy access & visibility of goods



GIS71M

350kg
evenly distributed



Key Locking Mechanism

Overall Size L x W x H mm	Weight kg	Model	Price
1100 x 700 x 1140	81	GIS71M	£542.95

Wire Mesh Trucks

- » Constructed from 50mm mesh with 18mm exterior grade plywood base
- » The lids are padlockable (*padlock not included*)
- » Mobile on 2 fixed & 2 swivel 125mm castors
- » When the lid is shut the drop down front will not open leaving a completely secure & enclosed unit



GL1243

FROM ONLY
£625.70

1000L x 610W x 970Hmm Units

Description	Weight kg	Model	Price
4 Mesh Sides	25	GL1243	£625.70
4 Mesh Sides with Lid	30	GL1253	£794.65
4 Mesh Sides with ½ Drop Side	28	GL1263	£729.35
4 Mesh Sides with ½ Drop Side & Lid	33	GL1273	£898.55

1300L x 730W x 970Hmm Units

Description	Weight kg	Model	Price
4 Mesh Sides	28	GL1543	£825.20
4 Mesh Sides with Lid	35	GL1553	£1005.75
4 Mesh Sides with ½ Drop Side	33	GL1563	£906.10
4 Mesh Sides with ½ Drop Side & Lid	40	GL1573	£1086.55

400

N.B - A Fork Lift will be needed to unload these units

Security Trolley

- » Lockable lid for full security
- » Half drop front for easy access
- » Mobile on 4 x 200mm rubber (2 fixed & 2 swivel braked)
- » An 'anti-close' mechanism on the lid which keeps the lid in position whilst in use
- » Strong timber deck at the bottom of the unit

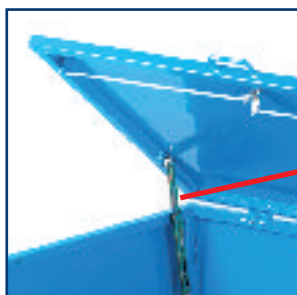

'anti-close' mechanism which stops the lid from closing whilst the unit is in use



GIS72S

Overall Size L x W x H mm	Weight kg	Model	Price
1100 x 700 x 1140	103	GIS72S	£612.35

Security Box Trolleys

- » Heavy duty - *bigger storage space*
- » Handle height: 1000mm
- » Units have a lockable lid for full security, & a half drop front to aid access to the contents
- » Padlock not supplied
- » Mobile on 2 fixed, 2 swivel 200mm rubber tyred castors



BT271M



BT272S



Description	Overall Size W x D x H mm	Useable Body Size W x D x H mm	Weight kg	Model	Price
Steel Box Truck	1320 x 770	1150 x 715	130	BT272S	£1546.75
Mesh Box Truck	x 1140	x 850	85	BT271M	£1327.40

N.B - A Fork Lift will be needed to unload these units

Turntable, General Purpose & Ackerman Trucks

General Purpose Trucks

- » General Purpose Trucks with either mesh or strong exterior grade plywood base
- » Mobile on REACH compliant, 340mm pneumatic steel centred wheels
- » Sides (2 x 275mm drop down) & ends interlock together



TI205R
£302.50



TI205R

INFORMATION



General purpose trucks which are ideal for use throughout industry

TI216R
£269.70

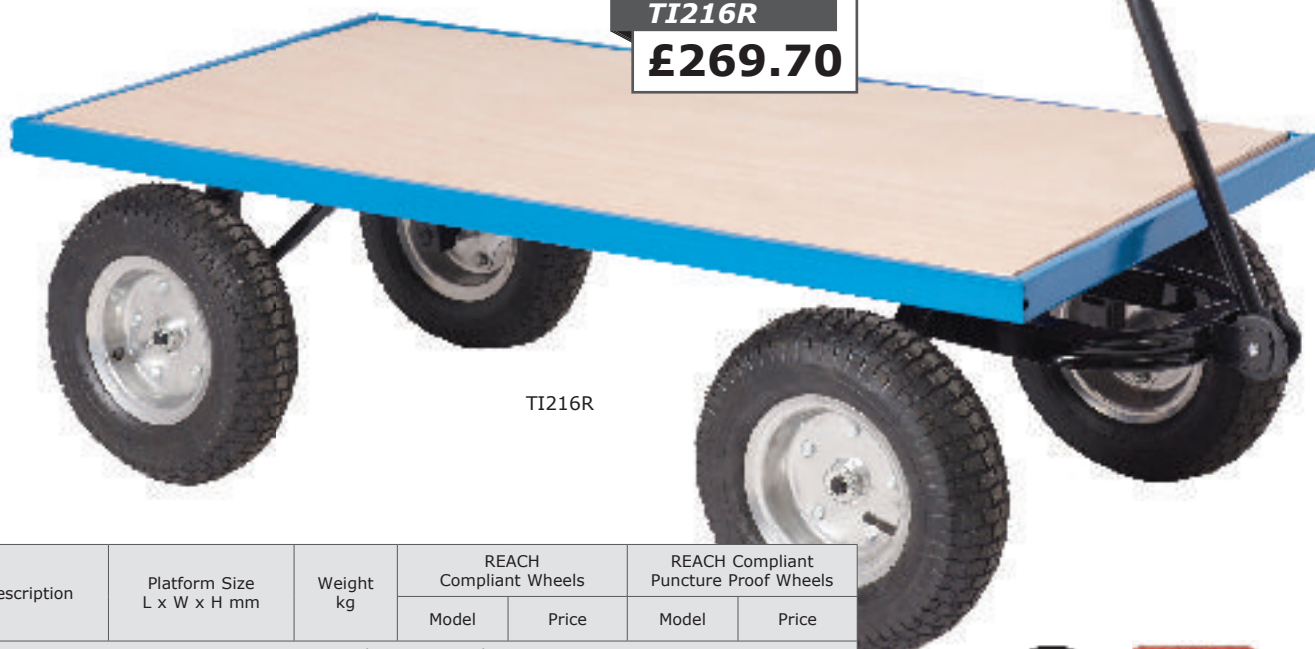

TI216R

Description	Platform Size L x W x H mm	Weight kg	REACH Compliant Wheels		REACH Compliant Puncture Proof Wheels	
			Model	Price	Model	Price
General Purpose Trucks						
Mesh Base	1200 x 600 x 360	26	TI212R	£248.30	TI222R	£368.40
Plywood Base		30	TI216R	£269.70	TI226R	£389.85
General Purpose Trucks with Mesh Sides & Ends						
Mesh Base	1200 x 600 x 360	32	TI201R	£281.05	TI231R	£401.15
Plywood Base		36	TI205R	£302.50	TI235R	£422.60



Turntable, General Purpose & Ackerman Trucks

General Purpose Trucks



PRICES HELD

TI212R
£248.30



TI212R



INFORMATION



Units available with puncture proof wheels "will not let you down"

INFORMATION



For heavy duty use with a massive **400kg** load capacity U.D.L.

REACH COMPLIANT WHEELS

REACH (Registration, Evaluation, Authorisation & Restriction of Chemicals) is a European regulation that addresses the production & use of chemical substances, & their potential impacts on both human health & the environment

TI201R
£281.05



TI201R



Turntable, General Purpose & Ackerman Trucks

2 Tonne Trucks

- » Heavy duty steel frame with exterior grade plywood deck & mobile on H.D. 300mm wheels
- » Heavy duty ball bearing turntable assembly for easy movement when fully loaded



Heavy duty ball bearing turntable assembly for easy movement when fully loaded

INFORMATION

Heavy duty 4.5mm thick ball race plate for strength & easy movement



TT2000Y



TT2000Y

N.B. A Fork Lift may be needed to unload these units

Platform Size L x W mm	Handle Height mm	Weight kg	Model	Price
1200 x 600	1080	90	TT1200Y	£1714.30
1500 x 800	1080	110	TT1500Y	£1850.75
2000 x 1000	1080	130	TT2000Y	£2023.65

Plywood Decked Balanced Trucks

- » Strong & robust plywood decked trucks
- » Fully welded rolled steel & tubular sections
- » Hinged plywood sides can be easily removed when required
- » Mobile on 2 x 250mm & 2 x 200mm rubber wheels



HB800J



HB850J

Overall Size L x W x H mm	Platform Size L x W x H mm	Weight kg	Model	Price
4 Wheel Truck				
1420 x 810 x 1000	1135 x 800 x 450	52	HB800J	£971.25
4 Wheel Truck with 300mm high sides				
1420 x 810 x 1000	1100 x 765 x 450	60	HB850J	£1095.30

Turntable, General Purpose & Ackerman Trucks

Utility Truck

- >> Heavy duty steel frame which will carry up to 450kg
- >> Mobile on 330mm REACH compliant pneumatic wheels
- >> Removable sides & ends interlock together



Mechanism for sides & ends



TI301R

ONLY

£285.60



TI301R with sides & ends removed



TI301R with one side removed

Platform Size L x W mm	Model	Price
1000 x 600	TI301R	£285.60

405

Turntable, General Purpose & Ackerman Trucks

Industrial General Purpose Trucks



- >> **Large 1500L x 750Wmm platform**
- >> Industrial General Purpose Trucks with either mesh or strong exterior grade plywood base
- >> Mobile on REACH compliant, 340mm pneumatic steel centred wheels
- >> Sides (2 x 275mm drop down) & ends interlock together



TI556R
£363.65

TI556R

INFORMATION



For heavy duty use with a massive **500kg** load capacity U.D.L.



TI545R
£423.70

TI545R



Description	Platform Size L x W x H mm	Weight kg	REACH Compliant Wheels		REACH Compliant Puncture Proof Wheels	
			Model	Price	Model	Price
General Purpose Trucks						
Mesh Base	1500 x 750 x 360	27	TI552R	£310.20	TI592R	£452.20
Plywood Base		33	TI556R	£363.65	TI596R	£505.60
General Purpose Trucks with Mesh Sides & Ends						
Mesh Base	1500 x 750 x 360	34.5	TI541R	£366.35	TI581R	£502.15
Plywood Base		40.5	TI545R	£423.70	TI585R	£565.65

**REACH
COMPLIANT
WHEELS**

REACH (Registration, Evaluation, Authorisation & Restriction of Chemicals) is a European regulation that addresses the production & use of chemical substances, & their potential impacts on both human health & the environment

Turntable, General Purpose & Ackerman Trucks



TI541R

FROM ONLY
£310.20

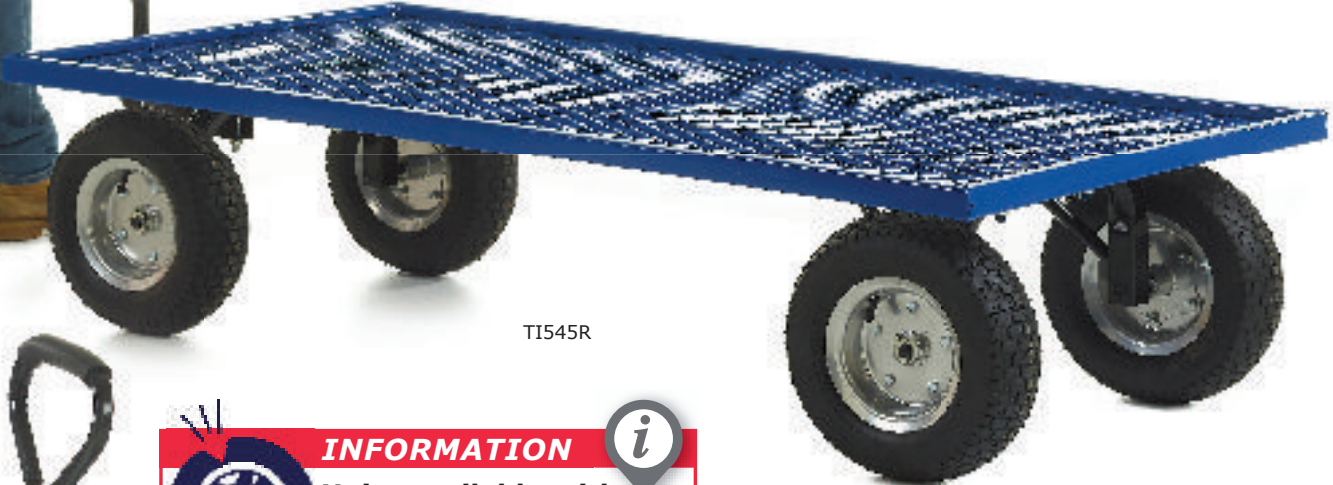

TI545R

INFORMATION

Units available with puncture proof wheels "will not let you down"

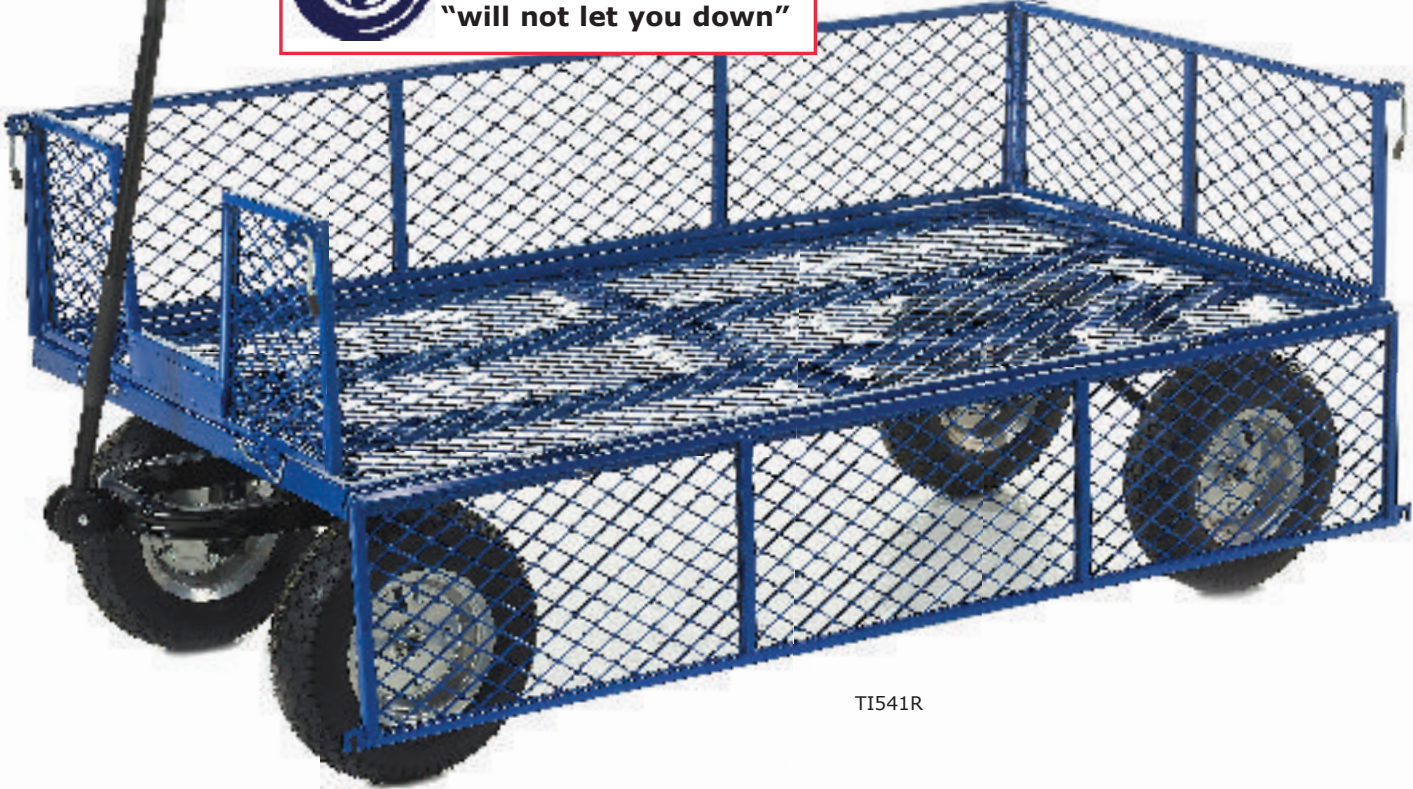

TI541R

Turntable, General Purpose & Ackerman Trucks

Tip-A-Trucks

- » Unique tipping action - the trucks easily tip when lifted to make it easier to dispense the contents
- » Large wheels give these units a smooth ride over rough & uneven terrain
- » The easy to clean polyethylene body is supported by a strong & durable steel frame

UNIQUE TIPPING ACTION



As the unit is tipped, the wheels slide to the middle of the unit, giving you a greater degree of stability when emptying

Locking mechanism keeps the easy clean Polyethylene body from tipping, controlled by an easy release mechanism



FROM ONLY
£196.90

TI208B



Load Capacity	Capacity Litres	Overall Size L x W x H mm	Wheel Size	Weight kg	Model	Price
200 kg	80	1150 x 500 x 470	250mm	17	TI207B	£196.90
400 kg	125	1180 x 580 x 630	300mm	25	TI208B	£271.25

'Hefty' Wheelbarrow

- » Heavy duty polypropylene plastic body with a strong galvanised steel frame & reinforced galvanised base plate
- » Mobile on a 400mm pneumatic wheel



WB714B



Capacity Litres	Overall Size L x W x H mm	Model	Price
110	1280 x 540 x 590	WB714B	£118.60

Galv. & Steel Pan Wheelbarrows

- » WB713B: features galvanised steel rust resistant body. Mobile on a 300mm pneumatic wheel for use over rough terrain
- » WB712B: features under pan support that gives far greater strength. Mobile on a 300mm pneumatic wheel for uneven terrain



WB713B

WB712B



Body Material	Capacity Litres	Overall Size L x W x H mm	Model	Price
Galvanised	90	1280 x 590 x 540	WB713B	£101.20
Steel	90	1280 x 590 x 540	WB712B	£96.70

H.D 200L Wheelbarrow

- » Strong galvanised steel frame & polypropylene body
- » Mobile on 2 x 400mm pneumatic wheels for use over rough terrain



WB200B

LOWER PRICE

WB200B
£267.05

INFORMATION

Large 200L heaped capacity



Capacity Litres	Overall Size L x W x H mm	Body Size L x W x H mm	Weight kg	Model	Price
200	1620 x 700 x 770	1080 x 700 x 420	20	WB200B	£267.05

408

Turntable, General Purpose & Ackerman Trucks

Prime Heavy Duty Turntable Trucks

- » 250mm dia rubber, steel centred heavy duty wheels
- » Handle height: 1070mm
- » 180mm fixed ends & hinged sides
- » TI802B & TI801B incorporate a heavy duty handle operated park brake - lift the handle up & it operates the stoppers on the wheels
- » TI812B, TI811B & TI802B - subject to availability

**FROM ONLY
£541.65**



PRICES HELD

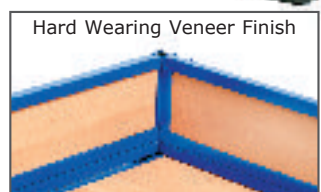

Description	Platform Size L x W x H mm	Weight kg	Standard Unit		Units with Brake	
			Model	Price	Model	Price
Flat Deck Unit	1250 x 700 x 335	65	TI812B	£541.65	TI802B	£577.40
4 Sided Unit		86	TI811B	£630.80	TI801B	£663.95



Four Wheel Ackerman Trucks

- » Available in 3 wheel options
- » Ackerman, dual axle trolley - enables tight turning circles without threatening the stability of the load
- » Detachable sides & ends are available as options
- » Large 1200 x 600 platform size

**FROM ONLY
£731.75**



**ACKERMAN
STEERING
LINKAGE**

INFORMATION
Ideal for the most demanding jobs

Description	Wheels	Platform Height mm	Load Capacity kg	Weight kg	Model	Price
Flat Deck Unit	250mm Pneumatic	310	250	38	AT901P	£731.75
	250mm Cushion		250	42	AT901J	£756.25
Detachable Sides & Ends		-	-	-	AT901S	£254.10*

*price applicable when ordering with the Ackerman Trucks. Order charges will apply if ordered on their own.

Turntable, General Purpose & Ackerman Trucks

Utility Turntable Trucks

- » Fully welded construction with exterior grade plywood deck with optional factory fitted fixed plywood sides & ends
- » Friction turntable mechanism with fixed rear axle

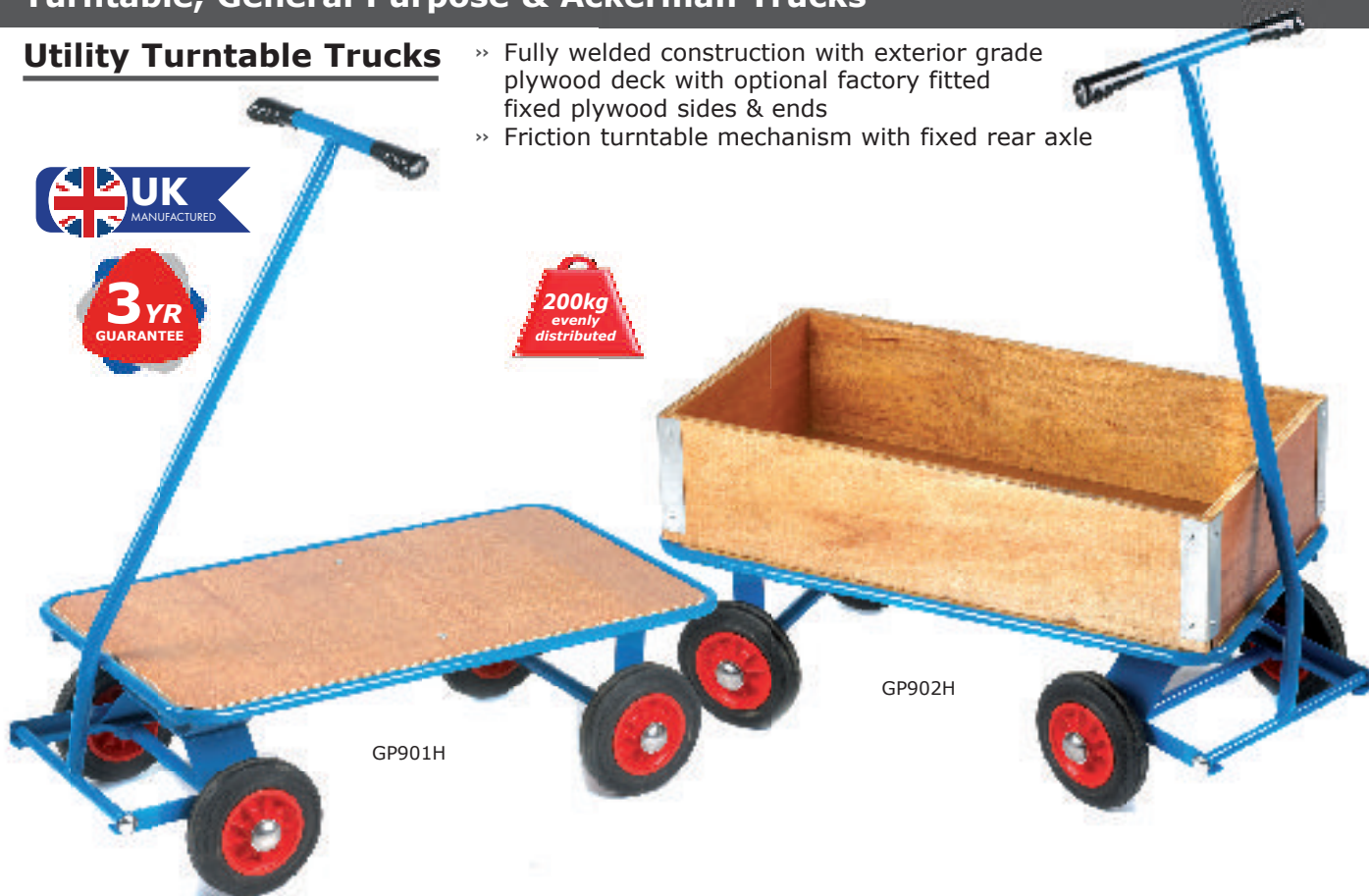

GP901H

GP902H

Utility Turntable Trucks - 200mm Rubber Wheels

Platform Size L x W x H mm	Truck without Sides & Ends			Truck with 200mm Sides & Ends		
	Wt. kg	Model	Price	Wt. kg	Model	Price
900 x 500 x 328	21	GP901H	£510.20	28	GP902H	£621.40
1200 x 600 x 328	28	GP903H	£571.95	37	GP904H	£724.25
1500 x 700 x 328	35	GP905H	£705.65	45	GP906H	£928.20

Utility Turntable Trucks - 260mm Pneumatic Wheels

Platform Size L x W x H mm	Truck without Sides & Ends			Truck with 200mm Sides & Ends		
	Wt. kg	Model	Price	Wt. kg	Model	Price
900 x 500 x 398	21	GP901P	£580.95	28	GP902P	£691.40
1200 x 600 x 398	28	GP903P	£644.10	37	GP904P	£796.65
1500 x 700 x 398	35	GP905P	£782.50	45	GP906P	£1004.05

Rough Terrain Trucks

- » Fitted with a ball bearing turntable plate & the handle is spring loaded to return to an upright position
- » Include a 35mm lip all round the deck



GP898P

GP998P

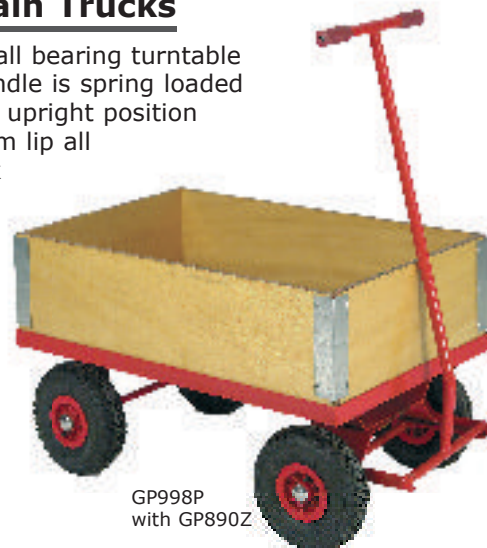

GP998P
with GP890Z

Wheels	Load Cap. kg	Weight kg	Model	Price
Sheet Steel Deck - 910L x 610W x 300Hmm Platform Size				
200mm Cushion	350	35	GP897H	£722.80
250mm Pneumatic	450	36	GP898P	£833.20
250mm Cushion	450	39	GP899J	£833.20
Expanded Steel Deck - 910L x 610W x 280Hmm Platform Size				
200mm Cushion	350	27	GP997H	£728.50
250mm Pneumatic	450	28	GP998P	£838.20
250mm Cushion	450	31	GP999J	£838.20
Box Body with 18mm Plywood Base for the above Trucks				
-	-	-	GP890Z	£235.20

Turntable, General Purpose & Ackerman Trucks

Hand Drawn Trucks

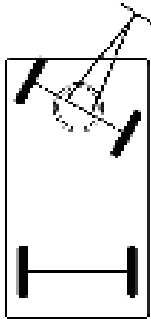

NT502B



NT482B



- » All sizes are fitted with a friction turntable plate assembly. Ball Bearing turntable plate assembly is available on all models - *call for details*
- » Both metal & plywood sided units have removable hinged sides & fixed ends

Friction Parking Brake

Description	Model	Price
Friction Parking Brake - Can be fitted to all new trucks. Operated by a foot pedal at the rear of the platform	ET709A	£361.70

Wire Mesh Superstructure

- » Suitable for trucks without sides & ends
- » Height: 910mm infilled with 50 x 50mm mesh & a half drop side gate
- » Demountable to enable wider application



NT482B & 2000x1000/WG

Platform Size mm	Box with Half Drop Side Suffix	Price
1220 x 760	/ WG	£825.65
1500 x 760	/ WG	£924.85
2000 x 1000	/ WG	£1112.85

Load Capacity	Platform Size mm	Platform Height mm	Wheels	Without Sides & Ends			With Plywood Sides & Ends 300mm Deep			With Sheet Steel Sides & Ends 200mm Deep		
				Weight kg	Model	Price	Weight kg	Model	Price	Weight kg	Model	Price
750 kg	1220 x 760	480	350mm Cushion Roller Bearing	60	NT480L	£991.85	84	NT490L	£1407.55	108	NT500L	£1425.60
		505	400mm Cushion Roller Bearing	70	NT480M	£1045.15	94	NT490M	£1460.60	118	NT500M	£1478.45
		505	400mm Pneumatic Roller Bearing	50	NT480B	£962.60	74	NT490B	£1378.35	98	NT500B	£1396.30
750 kg	1500 x 760	480	350mm Cushion Roller Bearing	65	NT481L	£1089.05	91	NT491L	£1550.50	117	NT501L	£1539.00
		505	400mm Cushion Roller Bearing	75	NT481M	£1139.40	101	NT491M	£1601.30	127	NT501M	£1589.80
		505	400mm Pneumatic Roller Bearing	55	NT481B	£1066.80	81	NT491B	£1528.10	107	NT501B	£1516.95
750 kg	2000 x 1000	480	350mm Cushion Roller Bearing	85	NT482L	£1273.05	119	NT492L	£1806.20	153	NT502L	£1781.10
		505	400mm Cushion Roller Bearing	95	NT482M	£1300.85	129	NT492M	£1833.80	163	NT502M	£1809.00
		505	400mm Pneumatic Roller Bearing	70	NT482B	£1239.55	104	NT492B	£1772.60	138	NT502B	£1747.45

N.B - A Fork Lift will be needed to unload these units

411

Turntable, General Purpose & Ackerman Trucks

Turntable & Ackerman Trucks



FROM ONLY
£1389.10

TP622C

INFORMATION



Suitable for use throughout industry

» Manufactured from fully welded tubular steel & angle section with an exterior grade plywood platform

- » **Turntable Trucks:** fitted with ball-bearing turntable assembly. Easily steered when loaded
- » **Ackerman Trucks:** steers from a central pivot, transmitted by adjustable track rods. No possibility of tipping whilst turning as the wheels are located underneath the corners at all times

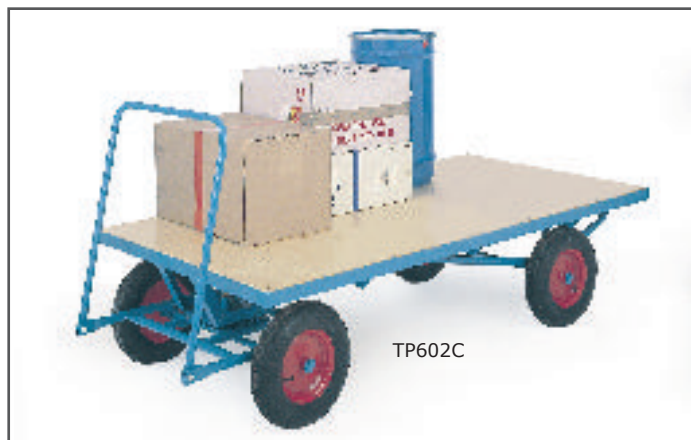

TP602C

Description	Model	Price
Friction Parking Brake - Can be fitted to all new trucks. Operated by a foot pedal at the rear of the platform	TP709A	£361.70

Wire Mesh Superstructure

- » Suitable for turntable or ackerman trucks without sides & ends
- » Height: 915mm infilled with 50 x 50mm mesh
- » Box construction with 1 lift out long side

Platform Size mm	Box Suffix	Price	Box with Half Drop Side Suffix	Price
1200 x 700	/ WM	£758.05	/ WG	£825.65
1500 x 800	/ WM	£894.05	/ WG	£924.85
2000 x 1000	/ WM	£1097.95	/ WG	£1112.85

Load Capacity	Platform Size mm	Platform Height mm	Wheels 4 x Roller Bearing	Without Sides & Ends			With Sides & Ends (300mm Deep)		
				Weight	Plywood Model	Price	Weight	Plywood Model	Price
Turntable Trucks									
1000 kg	1500 x 800	505	400mm Cushion	105 kg	TP601M	£1533.10	133 kg	TP621M	£2299.25
			400mm Pneumatic	77 kg	TP601C	£1389.10	105 kg	TP621C	£2140.55
	2000 x 1000		400mm Cushion	132 kg	TP602M	£1877.15	165 kg	TP622M	£2630.75
			400mm Pneumatic	105 kg	TP602C	£1720.35	138 kg	TP622C	£2473.00
Two Wheel Ackerman Trucks									
1000 kg	1500 x 800	505	400mm Pneumatic	79 kg	TP603C	£1721.25	109 kg	TP623C	£2381.60
			400mm Cushion	106 kg	TP603M	£1879.40	137 kg	TP623M	£2544.85
	2000 x 1000		400mm Pneumatic	99 kg	TP604C	£1982.25	133 kg	TP624C	£2746.50
			400mm Cushion	126 kg	TP604M	£2139.70	160 kg	TP624M	£2904.15

Turntable, General Purpose & Ackerman Trucks

Industrial Trailers

- » Platforms of exterior grade plywood construction
- » Ball bearing turntable design assuring easy turning even when fully laden
- » Safety Features Include:
 - » A 'stop' prevents the drawbar dropping below 230mm from the ground
 - » A 'lock' holds the drawbar vertically
 - » Heavy king pins & spring loaded retaining ball in the rear coupling pin ensure safe towing & eliminates self-releasing
- » Wire mesh superstructure, many more sizes & options are available - call for details



Description	Model	Price
Towing Hitch - When several trailers are to be used in a train. A rear towing hitch can be fitted to all new trucks	IT710A	£145.65

Description	Model	Price
Friction Parking Brake - Can be fitted to all new trucks. Operated by a foot pedal at the rear of the platform	IT709A	£368.70

FROM ONLY
£1909.85



Load Capacity	Platform Size mm	Platform Height mm	Wheels 4 x Roller Bearing	Without Sides & Ends			With Sides & Ends (300mm Deep)		
				Weight	Model	Price	Weight	Model	Price
1000 kg	2000 x 1000	505	400mm Pneumatic	110 kg	IT541C	£1909.85	143 kg	IT561C	£2774.75
			400mm Cushion	138 kg	IT541M	£2087.00	171 kg	IT561M	£2951.40

Heavy Duty Industrial Trailers

- » Towing eye diameter 50mm
- » Safety features include:
 - » A 'stop' prevents the drawbar dropping below 230mm
 - » A 'lock' holds the drawbar vertically
 - » Heavy king pins & spring loaded retaining ball in the rear coupling pin ensure safe towing & eliminates self-releasing

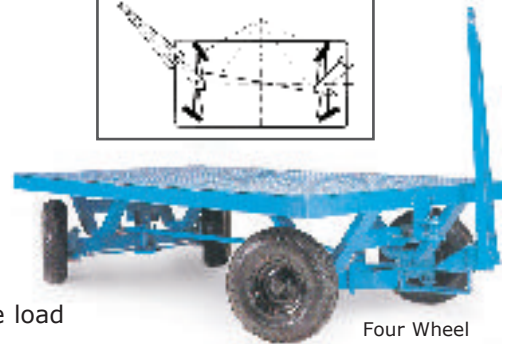
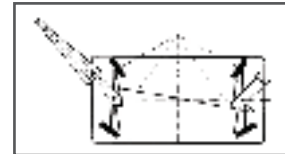

Four Wheel Steering Ackerman Trailer

ACKERMAN STEERING TRAILERS

- » Ackerman steering for tight turning circles without destabilising the load
- » Removable drawbar which can be used at either end of the trailers
- » Heavy duty steering turrets fitted with thrust bearing & phosphor bronze bushes



Load Capacity	Platform Size L x W mm	Platform Height mm	Wheels	Platform Type	Weight kg	Model	Price
Heavy Duty Industrial Trailers							
5000kg	2500 x 1250	420	300mm Cast Centred Polyurethane Tyres 32mm Taper Roller Bearing	Steel - Chequer Plate	350	HT875P	£9201.75
		470		Exterior Grade Plywood	350	HT895P	£9483.80
Four Wheel Steering Ackerman Trailers							
3000kg	2500 x 1250	580	450mm Solid Rubber Tyred 30mm Roller Bearings	Steel - Chequer Plate	350	HA573N	£6714.45
		630		Exterior Grade Plywood	350	HA583N	£7247.55

N.B - A Fork Lift will be needed to unload the units on this page

413

Turntable, General Purpose & Ackerman Trucks

Electric Tugs

- » Reduces strain & manual exertions for users
- » Great alternative to forklifts
- » Interchangeable battery packs are ideal to cover multiple working shifts (extra battery packs available)
- » Many hitch options available - please see below. Electric & specialist hitches also available - call for more details

FROM ONLY
£3685.95



INFORMATION



Demonstrations available - please call for details

INFORMATION



Suitable for many industries & applications



Electric Tug - Hitch Options



No	Description	Model	Price
1	Ball Top Hitch	MT01H	£197.05
2	Pin Hitch	MT02H	£197.05
3	Ball Top Hitch with Flat Plate	MT03H	£197.05
4	Pin Hitch with Flat Plate	MT04H	£197.05

Turntable, General Purpose & Ackerman Trucks

Premium Electric Tug



- » Compact design - can be used where other materials handling equipment can't be used because of their dimensions
- » Pedestrian tug doesn't require a licence - safe tillerhead controls
- » Equipped with a 5 speed switch
- » Interchangeable battery pack system so it is ideal to cover multiple working shifts (extra battery packs available)
- » Mobile on 340mm pneumatic driving wheels but many other wheel types are available - please call for details

Towing Capacity	Overall Size L x W x H mm	Wheelbase mm	Turning Circle mm	Driving Wheels	Model	Price
1500kg	592 x 535 x 1256	340	900	340mm Pneumatic	MT100312	£6408.90

Electric Tug - 1500kg

- » Allows easy pulling operations in low duty applications over short distances
- » Rear castors ensure higher stability when in use
- » Interchangeable battery pack system so it is ideal to cover multiple working shifts (extra battery packs available)
- » Mobile on 250mm solid foam filled wheels



Towing Capacity	Overall Size L x W x H mm	Wheelbase mm	Turning Circle mm	Model	Price
1500kg	590 x 700 x 1350	345	950	MT100215	£4441.00

Electric Tug - 1000kg

- » Allows easy pulling operations in low duty applications over short distances
- » Interchangeable battery pack system so it is ideal to cover multiple working shifts (extra battery packs available)
- » Rear castors ensure higher stability when in use
- » Adjustable tiller position for easy operation
- » Mobile on 250mm non-marking solid tyres



Towing Capacity	Overall Size L x W x H mm	Wheelbase mm	Turning Circle mm	Model	Price
1000kg	487 x 460 x 1250	325	950	MT100110	£3685.95

Container Trucks & Trolleys

'ProPlaz® Xtra' Mobile Tapered Trucks

ProPlaz® Xtra



**LOWER
PRICES**



COLOUR OPTIONS	
■	Red
■	Green
■	Blue
■	Yellow
■	Natural

specify when ordering



BLUE ONLY

- » Moulded in food grade polyethylene
- » Tolerant between -20°C to +47°C
- » Tapered for easy storage

Overall Size L x W x H mm		Capacity Litres	Wheels	Container		Lid to Suit	
Internal	External			Model	Price	Model	Price
420 x 420 x 415	480 x 480 x 515	72	4 x 75mm swivel castors	GC0072	£81.35	GC0087	£16.20*
415 x 415 x 670	480 x 480 x 770	118	4 x 75mm swivel castors	GC0118	£98.15	GC0086	£16.20*
550 x 455 x 580	625 x 540 x 680	135	4 x 75mm swivel castors	GC0135	£103.95	GC0088	£19.55*
765 x 420 x 650	850 x 495 x 785	200	4 x 75mm swivel castors	GC0200	£124.85	GC0089	£25.45*
880 x 550 x 570	1000 x 670 x 695	320	2 fixed & 2 swivel 100mm castors	GC0320	£170.70	GC0090	£38.15*
1245 x 615 x 640	1410 x 775 x 790	455		GC0455	£232.90	GC0091	£50.85*

*prices applicable when ordering with the Containers. Order charges will apply if ordered on their own

416

'ProPlaz® Xtra' Bottle Skips

**ProPlaz®
Xtra**

LOWER PRICES



INFORMATION 
Ideal for hotel bars



- COLOUR OPTIONS**
- Red
 - Green
 - Blue
 - Yellow
 - Natural
- specify when ordering*



- » Tolerant between -20°C to +47°C
- » Tapered for easy storage
- » Moulded in food grade polyethylene
- » Fully nestable when empty, moulded in anti-jam design & fully watertight
- » Mobile on 4 x 50mm swivel castors

Overall Size - L x W x H mm		Capacity		Weight kg	Model	Price
Internal	External	Litres	kg			
600 x 390 x 580	650 x 460 x 660	135	135	8	GC9414	£86.65
555 x 400 x 685	615 x 455 x 750	150	150	8	GC9424	£88.45
780 x 405 x 555	820 x 455 x 620	165	165	8	GC9434	£89.70
610 x 555 x 560	670 x 615 x 620	185	185	8	GC9444	£93.55
910 x 320 x 555	970 x 380 x 620	165	165	8	GC9454	£93.55

Container Trucks & Trolleys

100% Recycled Bottle Skips

- » Moulded from 100% recycled polyethylene
- » Tolerant between -20°C to +47°C
- » Tapered for easy storage
- » Not food grade material



INFORMATION 

Moulded from 100% recycled polyethylene



Overall Size - L x W x H mm		Capacity		Weight kg	Model	Price
Internal	External	Litres	kg			
600 x 390 x 580	650 x 460 x 660	135	135	8	GBK9414	£75.30
555 x 400 x 685	615 x 455 x 750	150	150	8	GBK9424	£77.05
780 x 405 x 555	820 x 455 x 620	165	165	8	GBK9434	£78.30
610 x 555 x 560	670 x 615 x 620	185	185	8	GBK9444	£82.85
910 x 320 x 555	970 x 380 x 620	165	165	8	GBK9454	£82.85



100% Recycled Mobile Tapered Trucks

- » Moulded from 100% recycled polyethylene
- » Tolerant between -20°C to +47°C
- » Tapered for easy storage
- » Not food grade



INFORMATION 

Moulded from 100% recycled polyethylene



Overall Size L x W x H mm		Capacity Litres	Wheels	Container		Lid to Suit	
Internal	External			Model	Price	Model	Price
420 x 420 x 415	480 x 480 x 515	72	4 x 75mm swivel castors	GBK072	£71.75	GBK087	£13.90*
415 x 415 x 670	480 x 480 x 770	118	4 x 75mm swivel castors	GBK118	£82.15	GBK086	£13.90*
550 x 455 x 580	625 x 540 x 680	135	4 x 75mm swivel castors	GBK135	£87.45	GBK088	£17.35*
765 x 420 x 650	850 x 495 x 785	200	4 x 75mm swivel castors	GBK200	£107.10	GBK089	£21.95*
880 x 550 x 570	1000 x 670 x 695	320	2 fixed & 2 swivel 100mm castors	GBK320	£146.60	GBK090	£32.35*
1245 x 615 x 640	1410 x 775 x 790	455		GBK455	£188.40	GBK091	£41.60*

*prices applicable when ordering with the Containers. Order charges will apply if ordered on their own.

Container Trucks



INFORMATION **Ideal for bulky items**

LOWER PRICES

Overall Size - L x W x H mm		Capacity Litres	Weight kg	Model	Price
External	Internal				
1170 x 720 x 800	900 x 630 x 590	250	32	PCI08Y	£348.30
1400 x 770 x 810	1130 x 680 x 600	350	39	PCI09Y	£399.45

- » Removable polypropylene containers
- » Push/pull handle & 2 fixed & 2 swivel 125mm rubber castors make the units manoeuvrable

Mobile Tapered Trucks with Handles

- » Moulded in food grade or 100% recycled polyethylene
- » Tolerant between -20°C to +47°C
- » Tapered for easy storage



LOWER PRICES



COLOUR OPTIONS
 ■ Red
 ■ Blue
 ■ Black
 specify when ordering



Overall Size L x W x H mm		Capacity Litres	Wheels	Coloured Container		Black Recycled Container	
Internal	External			Model	Price	Model	Price
765 x 420 x 650	1060 x 480 x 905	200	4 x 75mm swivel castors	GC180200H	£153.15	GBK18200H	£133.60
880 x 550 x 570	1200 x 690 x 810	320	2 fixed & 2 swivel 100mm castors	GC180320H	£199.00	GBK18320H	£173.15
1245 x 615 x 640	1570 x 780 x 900	455		GC180455H	£261.20	GBK18455H	£214.95

Container Trucks & Trolleys

Nesting Mobile Container with Lid



NC5509

£128.60



- » Easily cleaned
- » Smooth snag free
- » Stackable
- » Moulded from high density polyethylene
- » Stackable for compact storage the container comes complete with a close fitting lid
- » Tolerant between -40°C to +70°C
- » Mobile on 4 x 50 mm diameter nylon swivel castors

COLOUR OPTIONS

- Red
- Natural
- Blue
- Yellow

specify when ordering

Overall Size W x D x H mm	Capacity kg	Weight kg	Model	Price
610 x 510 x 540	50	7.5	NC5509	£128.60

Robust Rim Trucks

- » Strong & durable trucks moulded from 100% virgin (red, blue, yellow or green) or 100% recycled (black only) high density polyethylene
- » Robust rim with recessed gripping improves handling
- » Suitable for temperatures between - 20°C and + 47°C
- » Mobile on 2 fixed & 2 swivel 100mm rubber tyred castors. These are able to be fixed either in the corners or in a diamond pattern - please specify when ordering. The 100% virgin have 2 swivel braked castors
- » 600 litre capacity



COLOUR OPTIONS

- Red
- Blue
- Yellow
- Green
- Black

specify when ordering



Description	Overall Size L x W x H mm	Internal Depth mm	Model	Price
100% Virgin High Density Polyethylene Robust Rim Trucks - Red, Blue, Yellow or Green				
Container Only	1105 x 765 x 880	690	GC1105	£304.80
Container with removable Half Hinged Lid	1120 x 780 x 1000	690	GC1120	£423.55
100% Recycled High Density Polyethylene Robust Rim Trucks - Black				
Container Only	1105 x 765 x 880	690	GC1205	£279.40
Container with removable Half Hinged Lid	1120 x 780 x 1000	690	GC1220	£384.90

Tilt Trucks

- >> Easy tilt polypropylene trucks
- >> Push/pull handle & 2 fixed 230mm rubber wheels & 2 swivel 100mm polypropylene castors which make the units extremely manoeuvrable



450L
capacity

SOME
ASSEMBLY
IS REQUIRED

Description	Overall Size L x W x H mm	Capacity Litres/kg	Weight kg	Model	Price
Without Lid	1180 x 780 x 925	450/250	21	PCN92Y	£391.45
With Removable Lid	1180 x 780 x 955		23	PCN95Y	£468.15

LOWER PRICES **5 day delivery**

Container Trucks

- >> Manufactured from food grade polyethylene
- >> Tolerant between -20°C to +47°C
- >> Inert to a wide range of chemicals
- >> Other colours available for quantities - please call for details



Description	Capacity Litres	Overall Size L x W x H mm	Container Size L x W x H mm	Model	Price
Container & Truck with 200mm corner mounted Rubber wheels	370	1040 x 730 x 845	940 x 640 x 610	GC420H	£367.95
Container & Truck with 200mm corner mounted Rubber wheels	455	1340 x 750 x 860	1225 x 595 x 620	GC455H	£411.25
Container & Truck with 200mm corner mounted Rubber wheels	540	1090 x 800 x 940	920 x 610 x 700	GC540H	£442.40
Container Only	370	-	940 x 640 x 610	GC4200	£151.30
Container Only	455	-	1225 x 595 x 620	GC4500	£172.75
Container Only	540	-	920 x 610 x 700	GC4800	£194.15

Container Trucks & Trolleys

Ribbed Sided Trucks



GC325RST

COLOUR OPTIONS

Natural
 Black

specify when ordering



INFORMATION

Hygienic & easy to clean



GC455RLI

- » Manufactured from medium density polyethylene
- » 5mm thick, ribbed walls give the truck extra strength
- » Mobile on 2 fixed & 2 swivel 100mm nylon castors

Overall Size L x W x H mm		Capacity Litres	Containers		Lid to Suit	
Internal	External		Model	Price	Model	Price
740 x 610 x 600	860 x 710 x 740	225	GC225RST	£180.35	GC225RLI	£35.20
1070 x 630 x 585	1170 x 720 x 720	325	GC325RST	£187.95	GC325RLI	£36.90
1070 x 630 x 785	1170 x 720 x 920	450	GC455RST	£238.30	GC455RLI	£38.65

Interstacking Bins

LOWER PRICES



GC5424

2 x GC5422

GC5423

3 x GC5421
& 1 x PD001Y

- » Manufactured from food grade polyethylene
- » Tolerant between -20°C to +47°C
- » PD001Y is 440L x 400Wmm with an internal dia. of 380mm. Mobile on 4 x 75mm swivel castors



INFORMATION

Hygienic & easy to clean

COLOUR OPTIONS

Red
 Green
 Blue
 Yellow
 Natural

specify when ordering

Overall Size Dia. x H mm		Capacity		Weight kg	Container		Lid to Suit		Dolly to Suit	
Internal	External	Litres	kg		Model	Price	Model	Price	Model	Price
357 x 160	440 x 175	15	15	1.82	GC5421	£47.65	GC0400	£16.80*	PD001Y	£77.30
357 x 280	440 x 300	25	25	2.72	GC5422	£51.00				
357 x 390	440 x 405	40	40	2.27	GC5423	£57.75				
357 x 620	440 x 650	60	60	3.18	GC5424	£75.65				

*price applicable when ordering with the Containers. Order charges will apply if ordered on their own.



Heavy Duty Order Picking Trolleys

- » Manufactured from a strong steel frame, powder coated in anthracite grey with heavy duty timber shelves with a durable painted finish
- » Mobile on 2 fixed & 2 swivel braked, 125mm rubber castors
- » Complete with clipboard shelf within the handle
- » 300kg load capacity (U.D.L.) when using these trolleys on a level/even surface



Description	Overall Size H x W x D mm	Shelf Heights mm	Shelf Size L x W mm	Model	Price
2 Shelf Order Picking Trolley - Cantilever	1170 x 605 x 1400	205 / 815	1010 x 605	PAOP201Y	£449.85
2 Shelf Order Picking Trolley	1170 x 515 x 1250	200 / 840	895 x 495	PAOP202Y	£449.85



Heavy Duty Container Trolleys complete with Containers

- » Manufactured from a strong steel frame, powder coated in anthracite grey, complete with 2 x 600 x 400mm containers
- » Lightweight making it easy to move around & transport goods efficiently
- » Shelf heights: 505 & 1070mm
- » Mobile on 4 x 100mm swivel castors



ONLY
£330.65



Overall Size H x W x D mm	Shelf Size L x W mm	Model	Price
1080 x 440 x 1000	600 x 400	PATT808Y	£330.65

Container Trucks & Trolleys



Clever Folding Trolley

- >> Load capacity: 20kg on top tray & 40kg on bottom tray
- >> Manufactured to the recognised European GS standard
- >> Manufactured from injection moulded plastic & anodised aluminium
- >> Folded size: 670H x 470W x 110L mm



COLOUR OPTIONS

- Red
- Green
- Black

specify when ordering

Unclip the wheels from the base & clip into the frame of the unit. Push the button on the handle & lift up to open the unit. Then simply strap the box into the top tray using the Safety Straps & you're ready to go.... The unit even has a foot operated brake between the rear wheels.

Description	Colour	Overall Size L x W x H mm	Weight kg	Model	Price
Clever Trolley - c/w 1 folding box	Green	890 x 550 x 1030	7	GC051Y	£233.75
	Red or Black	890 x 550 x 1030	7	GC058Y	£238.05
Extra Folding Box for GC051Y & GC058Y in Red		525 x 375 x 280	1.5	GC055Z	£30.10*
Extra Folding Box for GC058Y in Black		525 x 375 x 280	1.5	GC056Z	£30.10*

'Foldaway' Platform Trolley

- >> Unique wheels which fold underneath the platform when the handle is folded
- >> Plastic platform with integral carry handles
- >> Telescopic handle with 3 heights: 720/820/920mm
- >> Mobile on 2 fixed & 2 swivel braked 100mm castors
- >> Folding box size open - 570L x 410W x 265H mm
- >> Folding box size folded - 570L x 410W x 75H mm

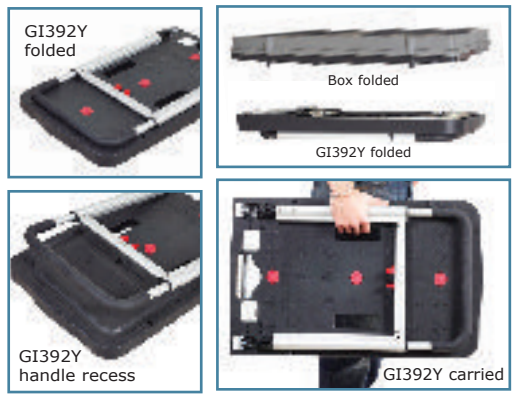

LOWER PRICES



Description	Overall Size - Open H x W x L mm	Overall Size - Folded H x W x L mm	Handle Heights mm	Weight kg	Model	Price
Platform Trolley	920 x 410 x 680 (trolley only)	80 x 410 x 680 (trolley only)	720 / 820 / 920 (trolley only)	7	GI392Y	£123.05
Platform Trolley with 1 x Removable Folding Box				9	GI393Y	£149.65
Platform Trolley with 2 x Removable Folding Boxes				11	GI394Y	£175.15

'ProPlaz®' Clever Folding Trolley

- » Load capacity: 25kg on top tray
45kg on bottom tray
- » Manufactured to the recognised European GS standard
- » Manufactured from injection moulded plastic & anodised aluminium
- » Folding boxes are stackable & are kept securely in place by male & female connectors
- » Folding box has a capacity of 46 litres
- » Folding boxes can be stacked up to 4 high
- » Folded size: 670H x 470W x 110D mm



FROM ONLY
£214.70

ProPlaz®

clever trolley



2 x GC066Z



Brake Mechanism

Box Fixing Mechanism



Folding Box Male & Female Connectors



PRICES HELD

GC062Y

FROM THIS

TO THIS

TO THIS

TO THIS

TO THIS

Unclip the wheels from the base & clip into the frame of the unit. Push the blue button on the handle & lift up to open the unit. Then simply strap the box into the top tray using the Safety Straps & you're ready to go.... The unit even has a foot operated brake between the rear wheels.

Description	Overall Size L x W x H mm	Weight kg	Model	Price
Clever Trolley - c/w 1 folding box	890 x 550 x 1030	10	GC062Y	£214.70
Extra Folding Box	525 x 375 x 280	1.5	GC066Z	£29.75*

*price applicable when ordering with the GC062Y. Order charges will apply if ordered on their own.

Container Trucks & Trolleys

Baker Trolleys

- » Made from corrosion resistant anodised aluminium
- » Containers & trays are extra
- » More sizes available - *call for details*



Overall Size W x D x H mm	Model	Price
500 x 600 x 1565	STT4	£355.84
500 x 600 x 1715	STT6	£376.68
553 x 762 x 1535	STT10/BAKER	£517.83

Preparation Trolleys

- » Made from corrosion resistant anodised aluminium
- » Containers & trays are extra
- » More sizes available - *call for details*

LOWER PRICES



Overall Size W x D x H mm	Model	Price
500 x 600 x 1275	STT8	£415.39
955 x 600 x 1275	STT16	£576.51
955 x 600 x 890	STT10/PREP	£525.48

Trolleys - suitable for Healthcare, Education & Pharmaceutical Environments



- » Made from corrosion resistant anodised aluminium
- » Complete with trays
- » More sizes available - *call for details*



Overall Size W x D x H mm	Model	Price
530 x 430 x 1105	SCT8	£385.72
1090 x 430 x 1850	SCT12	£587.25
515 x 490 x 550	SCT5	£337.97

Dispensing Box Trolley

- » Made from corrosion resistant anodised aluminium
- » Designed to hold 12 x 240mm cardboard boxes of fluid bags such as saline drips, rubber gloves etc

LOWER PRICE



Overall Size W x D x H mm	Model	Price
395 x 800 x 1687	DBT1687	£645.53

Lineside Trolley & Combi Trolley



- » Made from corrosion resistant anodised aluminium
- » Containers & trays are extra

Description	Overall Size W x D x H mm	Model	Price
Combi Trolley	500 x 870 x 1015	STT6C	£552.56
Lineside Trolley	460 x 600 x 880	CSTT4LS	£329.55

Open Bin Trolleys

- » Constructed from rigid PVC & supplied with plastic containers

NEW



Description	Overall Size W x D x H mm	Model	Price
Slimline - 4 Bins	406 x 555 x 1250	SL42B	£313.55
Slimline - 5 Bins	406 x 555 x 1565	SL52B	£413.60
Slimline - 6 Bins	406 x 555 x 1818	SL62B	£478.99
Double - 6 Bins	770 x 555 x 1130	BR62B	£478.99
Double - 10 Bins	770 x 555 x 1565	BR102B	£642.45
Double - 12 Bins	770 x 555 x 1818	BR122B	£752.37

Self Levelling Trolleys



INFORMATION 
 Bring picked goods to you, helping prevent back strain

GS9226



Spring Loaded mechanism moves up & down dependent on the load applied

Self Levelling Trolleys - Box

- » Constructed from galvanised steel sides & ends
- » Fully welded frame & plastic deck
- » Unloaded platform height: 800mm
- » Loaded platform height: 300mm
- » 26kg is needed to initiate the lowering process

Self Levelling Trolleys - Bag

- » Re-inforced heavy duty PVC bag
- » Fully welded frame & exterior grade plywood deck
- » Unloaded platform height: 650mm
- » Loaded platform height: 150mm
- » 26kg is needed to initiate the lowering process



GS9125

Version	Overall Size L x W x H mm	Wheels	Load Capacity	Wt kg	Model	Price
Box	935 x 730 x 932	125mm Cushion	100 kg	50	GS9226	£1554.55
Bag	935 x 730 x 932	125mm Cushion	100 kg	40	GS9125	£1518.25

N.B. A Fork Lift will be needed to unload these units

Wheels, Castors & Conveyors

Light Duty Roller Tracks - packs of 4



- >> Cylindrical plastic rollers
- >> Roller pitch: 28mm
- >> Can be supplied individually - please call for details

- >> Flanged plastic rollers
- >> Roller pitch: 42mm
- >> Can be supplied individually - please call for details

- >> Steel spindle cylindrical rollers
- >> Roller pitch: 28mm
- >> Can be supplied individually - please call for details

Length mm	Capacity per Linear Metre	Model	Price (pack of 4)
2000	140kg	RT20CR28X4	£56.40
3000	140kg	RT30CR28X4	£78.00

Length mm	Capacity per Linear Metre	Model	Price (pack of 4)
2000	90kg	RT20FR42X4	£75.20
3000	90kg	RT30FR42X4	£111.60

Length mm	Capacity per Linear Metre	Model	Price each (pack of 4)
2000	280kg	RT20SSR28X4	£68.40
3000	280kg	RT30SSR28X4	£93.80

Heavy Duty Roller Tracks



Length mm	Capacity per Linear Metre	Roller Pitch: 96mm		Roller Pitch: 72mm	
		Model	Price (each)	Model	Price (each)
2400	845kg	RT24FPR96	£121.55	RT24FPR72	£135.75
3600	845kg	RT36FPR96	£172.50	RT36FPR72	£197.30



Length mm	Capacity per Linear Metre	Roller Pitch: 96mm		Roller Pitch: 72mm		Roller Pitch: 48mm	
		Model	Price (each)	Model	Price (each)	Model	Price (each)
2400	1300kg	RT24CPR96	£125.85	RT24CPR72	£148.90	RT24CPR48	£190.00
3600	1300kg	RT36CPR96	£179.95	RT36CPR72	£216.95	RT36CPR48	£276.90

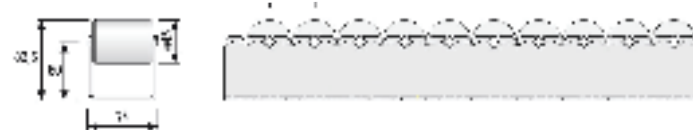

Length mm	Capacity per Linear Metre	Roller Pitch: 96mm		Roller Pitch: 72mm		Roller Pitch: 48mm	
		Model	Price (each)	Model	Price (each)	Model	Price (each)
2400	2600kg	RT24STR96	£233.65	RT24STR72	£287.75	RT24STR48	£400.80
3600	2600kg	RT36STR96	£336.40	RT36STR72	£424.80	RT36STR48	£593.20

Light Duty Top Plate Castors

- >> A competitively priced range of robust light duty castors
- >> Wheel sizes from 50mm to 200mm



Black Rubber Tyred Swivel

Grey Rubber Tyred Braked

White Polypropylene Swivel

Grey Rubber Tyred Fixed

Wheel Dia.	Wheel Type	Load Capacity	Overall Height	Bearing Type	Fixing Centres	Castor Code Swivel	Price	Castor Code Fixed	Price	Castor Code Braked	Price
50mm	White Polypropylene	40kg	73mm	Plain	35 x 35	50DRL4PP	£4.45	-	-	50DRL4PPSWB	£5.45
	Grey Rubber Tyred					50DRL4GRG	£4.45	-	-	50DRL4GRGSWB	£5.45
75mm	White Polypropylene	50kg	100mm		45 x 45	75DRL4PP	£5.55	-	-	75DRL4PPSWB	£6.00
	Grey Rubber Tyred					75DRL4GRG	£6.00	-	-	75DRL4GRGSWB	£7.25
100mm	White Polypropylene	185kg	128mm	Roller	80 x 60	100DR4PPB	£7.40	100DR8PPB	£5.80	100DR4PPBSWB	£11.45
	Grey Rubber Tyred	75kg				100DR4GRB	£8.75	100DR8GRB	£6.90	100DR4GRBSWB	£10.00
	Black Rubber Tyred	80kg				100DR4BSB	£7.95	100DR8BSB	£7.25	100DR4BSBSWB	£10.10
125mm	White Polypropylene	220kg	152mm	Roller		125DR4PPB	£9.90	125DR8PPB	£8.80	125DR4PPBSWB	£14.00
	Grey Rubber Tyred	100kg				125DR4GRB	£13.00	125DR8GRB	£11.00	125DR4GRBSWB	£17.60
	Black Rubber Tyred					125DR4BSB	£13.55	125DR8BSB	£11.00	125DR4BSBSWB	£19.10
160mm	White Polypropylene	250kg	195mm	Roller	105 x 80	160DR4PP	£17.80	160DR8PP	£16.85	160DR4PPSWB	£25.15
	Grey Rubber Tyred	160kg				160DR4GRB	£28.35	160DR8GRB	£24.40	160DR4GRBSWB	£34.60
	Black Rubber Tyred					160DR4BSB	£22.65	160DR8BSB	£18.05	160DR4BSBSWB	£27.65
200mm	White Polypropylene	250kg	237mm	Roller		200DR4PP	£22.95	200DR8PP	£21.40	200DR4PPSWB	£25.65
	Grey Rubber Tyred	205kg				200DR4GRB	£28.80	200DR8GRB	£26.25	200DR4GRBSWB	£34.10
	Black Rubber Tyred					200DR4BSB	£25.30	200DR8BSB	£22.50	200DR4BSBSWB	£32.65

Light Duty Bolt Hole Castors



White Polypropylene Bolt Hole - Swivel

White Polypropylene Bolt Hole - Swivel Braked

Grey Rubber Tyred Bolt Hole - Swivel

Grey Rubber Tyred Bolt Hole - Swivel Braked

Wheel Dia.	Wheel Type	Load Capacity	Overall Height	Bearing Type	Suits Bolts Dia.	Castor Code - Swivel	Price	Castor Code - Braked	Price
50mm	White Polypropylene	40kg	71mm	Plain	10mm	50DRLBH10PP	£4.60	50DRLBH10PPSWB	£5.60
	Grey Rubber Tyred					50DRLBH10GRG	£5.10	50DRLBH10GRGSWB	£6.10
75mm	White Polypropylene	50kg	95mm			75DRLBH10PP	£6.55	75DRLBH10PPSWB	£6.90
	Grey Rubber Tyred					75DRLBH10GRG	£6.55	75DRLBH10GRGSWB	£7.55
100mm	White Polypropylene	80kg	128mm		12mm	100DRLBH12PP	£8.15	100DRLBH12PPSWB	£10.25
	Grey Rubber Tyred					100DRLBH10GRG	£9.00	100DRLBH10GRGSWB	£9.75
125mm	White Polypropylene	100kg	150mm	125DRLBH12PP	£10.45	125DRLBH12PPSWB	£11.50		
	Grey Rubber Tyred			125DRLBH12GRG	£11.40	125DRLBH12GRGSWB	£14.00		

Expander Fittings

- >> This range of nylon fittings allow castors to be fitted to hollow tube equipment
- >> Add expander code & price to your choice of bolt hole castor

Tube Size (Internal mm)		Round Code	Square Code	Price
Min	Max			
19	21.5	R19	-	£2.65
21.5	24	R21	S21	£2.65
24	27	R24	S24	£2.65
27	30	R27	S27	£2.65
31	35	R31	-	£5.05
31	35	-	S31	£5.05
36	40	-	S36	£5.05

Round Expander

Square Expander



Low value orders may be subject to a handling charge - CALL FOR DETAILS

Wheels, Castors & Conveyors

Medium Duty Steel Castors

- » Wheel sizes from 50mm to 150mm
- » Load capacities from 27kg to 600kg
- » Traditional style castors with original UK bolt hole spacings

Footbrake

- » Brakes are available on 75 or 100mm swivel castors with RN or NY wheels
- The 75mm castors have a single ended brake & the 100mm castors have a double ended brake
- add suffix **BR** to swivel castor code
- Price Extra: 75mm = **£3.25**
- 100mm = **£4.75**



Wheel dia.	Swivel/Fixed	Overall Height	Bolt Hole Spacing	Bearing	Load Capacity Nylon	Load Capacity Poly Tyred Nylon	Load Capacity Rubber Tyred Nylon	Nylon	Price	Poly Tyred Nylon	Price	Rubber Tyred Nylon	Price
50	Swivel	64	54 x 25	Plain	54	-	27	P961NY	£3.30	-	-	P961RN	£6.55
	Fixed							P988NY	£2.80	-	-	P988RN	£5.65
63	Swivel	81	76 x 44	Plain	122		45	P261NY	£5.05	-	-	P261RN	£10.75
	Fixed							P288NY	£3.65	-	-	P288RN	£8.80
75	Swivel	95	80 x 60	Plain	170		90	P361NY	£6.05	-	-	P361RN	£7.45
	Fixed		83 x 35					P388NY	£4.35	-	-	P388RN	£6.20
100	Swivel	125	105 x 80	Plain	270	250	160	P461NY	£12.70	P461PN	£17.00	P461RN	£13.25
	Fixed		110 x 38					P488NY	£7.55	P488PN	£13.25	P488RN	£11.75
125	Swivel	153	116 x 64	Plain	365	300	180	P561NY	£21.05	P561PN	£22.20	P561RN	£20.75
	Fixed		116 x 64					P588NY	£11.90	P588PN	£17.80	P588RN	£13.25
150	Swivel	181	140 x 105	Plain	520	600	-	P661NY	£36.95	P661PN	£57.50	-	-
				Ball				P661NYBJ	£60.45	P661PNBJ	£72.55	P661RNBJ	£64.00
	Fixed		133 x 67	Plain	520	600	-	P688NY	£28.25	P688PN	£47.50	-	-
				Ball				P688NYBJ	£50.45	P688PNBJ	£62.55	P688RNBJ	£54.05

Expanding Fitting Castors

- » Robust institutional castors
- » Precision ball bearings & plastic thread guards to reduce noise & rolling resistance
- » 10mm single bolt hole fixing but can be used with any of the expanders listed



WR4721.5-24



PS75JPBHBR



PS75JPBH



Expanding Tubular Adaptors

To suit Tubing	Model	Price
Round		
19mm to 21.5mm	WR0719-21.5	£3.45
21.5mm to 24mm	WR0721.5-24	£3.45
24mm to 27mm	WR0724-27	£3.45
27mm to 30mm	WR0727-30	£3.45
31mm to 35mm	WR0731-35	£4.40
Square		
21.5mm to 24mm	WR4721.5-24	£3.45
24mm to 27mm	WR4724-27	£3.45
27mm to 30mm	WR4727-30	£3.45
32mm to 35mm	WR4732-35	£4.40
36mm to 40mm	WR4736-40	£4.40

Wheel Dia.	Wheel Type	Tread Width	Load Cap kg	Overall Height	Bearing Type	Swivel Model	Price	Swivel Braked Model	Price
75	Grey Rubber	30mm	75	100	Ball	PS75JPBH	£11.15	PS75JPBHBR	£14.05
100	Grey Rubber	32mm	100	134	Ball	PS100JPBH	£11.95	PS100JPBHBR	£14.85
125	Grey Rubber	32mm	100	159	Ball	PS125JPBH	£19.45	PS125JPBHBR	£22.40

Top Plate Medium Duty Castors

- >> Pressed steel double ball race swivel heads
- >> Wheel sizes from 100mm to 200mm
- >> Load capacity: ranges from 80kg to 350kg



Swivel with Brake

Swivel

Swivel

Wheel Dia.	Wheel Type	Tread Width	Load Cap kg	Overall Height	Plate Dims	Bolt Centres	Suits Bolt	Bearing Type	Swivel Model	Price	Fixed Model	Price	Braked Model	Price
100	Nylon	35	200	128	105x85	80x60	M8	Plain	100DR4NY	£17.95	100DR8NY	£14.05	100DR4NYSWB	£23.80
	Polyurethane	38	220	128	105x85	80x60	M8	Ball	100DR4PNBJ	£22.05	100DR8PNBJ	£18.30	100DR4PNBJSWB	£28.20
	Blue Rubber Tyred	34	180	128	105x85	80x60	M8	Roller	100DR4BNB	£20.15	100DR8BNB	£16.20	100DR4BNBSWB	£26.55
	Black Rubber Tyred	32	80	128	105x85	80x60	M8	Roller	100DR4PSB	£16.75	100DR8PSB	£12.45	100DR4PSBSWB	£22.90
125	Nylon	35	270	152	105x85	80x60	M8	Plain	125DR4NY	£18.30	125DR8NY	£14.55	125DR4NYSWB	£24.45
	Polyurethane	38	270	152	105x85	80x60	M8	Ball	125DR4PNBJ	£23.35	125DR8PNBJ	£19.55	125DR4PNBJSWB	£29.45
	Blue Rubber Tyred	36	250	152	105x85	80x60	M8	Roller	125DR4BNB	£20.90	125DR8BNB	£17.15	125DR4BNBSWB	£26.90
	Black Rubber Tyred	37	100	152	105x85	80x60	M8	Roller	125DR4PSB	£17.70	125DR8PSB	£14.10	125DR4PSBSWB	£24.10
150	Nylon	40	350	185	135x105	105x80	M10	Plain	150DR4NY	£31.10	150DR8NY	£27.05	150DR4NYSWB	£37.50
	Polyurethane	50	350	185	135x105	105x80	M10	Ball	150DR4PNBJ	£35.00	150DR8PNBJ	£31.10	150DR4PNBJSWB	£40.55
160	Blue Rubber Tyred	45	350	195	135x105	105x80	M10	Roller	160DR4BNB	£32.35	160DR8BNB	£28.35	160DR4BNBSWB	£38.10
	Black Rubber Tyred	40	175	195	135x105	105x80	M10	Roller	160DR4PSB	£24.90	160DR8PSB	£21.05	160DR4PSBSWB	£31.65
200	Nylon	50	350	237	135x105	105x80	M10	Plain	200DR4NY	£34.75	200DR8NY	£30.80	200DR4NYSWB	£40.50
	Polyurethane	50	350	237	135x105	105x80	M10	Ball	200DR4PNBJ	£40.85	200DR8PNBJ	£36.80	200DR4PNBJSWB	£47.25
	Blue Rubber Tyred	45	350	237	135x105	105x80	M10	Roller	200DR4BNB	£38.70	200DR8BNB	£34.80	200DR4BNBSWB	£44.50
	Black Rubber Tyred	50	205	237	135x105	105x80	M10	Roller	200DR4PSB	£26.30	200DR8PSB	£17.15	200DR4PSBSWB	£33.10

Bolt Hole Medium Duty Castors

- >> Pressed steel double ball race swivel heads
- >> Wheel sizes from 100mm to 200mm
- >> Load capacity: ranges from 80kg to 350kg



Swivel with Brake - Polyurethane

Swivel - Nylon

Swivel - Black Rubber Tyred

Wheel Dia.	Wheel Type	Tread Width	Load Cap kg	Overall Height	Suits Bolt	Bearing Type	Swivel Model	Price	Braked Model	Price
100	Nylon	35	200	128	M12	Plain	100DRBH12NY	£17.95	100DRBH12NYSWB	£23.80
	Polyurethane	38	220	128	M12	Ball	100DRBH12PNBJ	£22.05	100DRBH12PNBJSWB	£28.20
	Blue Rubber Tyred	34	180	128	M12	Roller	100DRBH12BNB	£20.15	100DRBH12BNBSWB	£26.55
	Black Rubber Tyred	32	80	128	M12	Roller	100DRBH12PSB	£16.75	100DRBH12PSBSWB	£22.90
125	Nylon	35	270	152	M12	Plain	125DRBH12NY	£18.30	125DRBH12NYSWB	£24.45
	Polyurethane	38	270	152	M12	Ball	125DRBH12PNBJ	£23.35	125DRBH12PNBJSWB	£29.45
	Blue Rubber Tyred	36	250	152	M12	Roller	125DRBH12BNB	£20.90	125DRBH12BNBSWB	£26.90
	Black Rubber Tyred	37	100	152	M12	Roller	125DRBH12PSB	£17.70	125DRBH12PSBSWB	£24.10
150	Nylon	40	350	185	M12	Plain	150DRBH12NY	£31.10	150DRBH12NYSWB	£37.50
	Polyurethane	50	350	185	M12	Ball	150DRBH12PNBJ	£35.00	150DRBH12PNBJSWB	£40.55
160	Blue Rubber Tyred	45	350	195	M12	Roller	160DRBH12BNB	£32.35	160DRBH12BNBSWB	£38.10
	Black Rubber Tyred	40	175	195	M12	Roller	160DRBH12PSB	£24.90	160DRBH12PSBSWB	£31.65
200	Nylon	50	350	237	M12	Plain	200DRBH12NY	£34.75	200DRBH12NYSWB	£40.50
	Polyurethane	50	350	237	M12	Ball	200DRBH12PNBJ	£40.85	200DRBH12PNBJSWB	£47.25
	Blue Rubber Tyred	45	350	237	M12	Roller	200DRBH12BNB	£38.70	200DRBH12BNBSWB	£44.50
	Black Rubber Tyred	50	205	237	M12	Roller	200DRBH12PSB	£26.30	200DRBH12PSBSWB	£33.10

Low value orders may be subject to a handling charge - CALL FOR DETAILS

Wheels, Castors & Conveyors

Heavy Duty Pressed Steel Castors

- >> Manufactured from heavy gauge zinc plated pressed steel
- >> Robust range of castors are all fitted with double ball races & hardened steel tracks in the swivel heads
- >> Suitable for power towing up to 6kph
- >> Wheel sizes from 125mm to 200mm
- >> Load capacities from 300kg to 800kg



150GDH4PTBJ



150GDH4NYBJ



160GDH4EABJSWB



150GDH8PTBJ

Wheel Dia.	Wheel Type	Tread Width	Load Cap kg	Overall Height	Plate Dims	Bolt Centres	Suits Bolt	Bearing Type	Swivel Model	Price	Fixed Model	Price	Braked Model	Price
125	Nylon	50	800	166	135x110	105x80	M12	Ball	125GDH4NYBJ	£44.15	125GDH8NYBJ	£36.80	125GDH4NYBJSWB	£53.90
	Rubber Tyred	50	300	166	135x105	105x80	M12	Ball	125GDH4EABJ	£44.50	125GDH8EABJ	£38.65	125GDH4EABJSWB	£56.15
	Polyurethane	50	550	166	135x105	105x80	M12	Ball	125GDH4PTBJ	£55.50	125GDH8PTBJ	£48.15	125GDH4PTBJSWB	£61.00
150	Nylon	45	700	194	135x105	105x80	M12	Ball	150GDH4NYBJ	£53.75	150GDH8NYBJ	£38.45	150GDH4NYBJSWB	£60.05
150	Polyurethane	50	800	194	135x105	105x80	M12	Ball	150GDH4PTBJ	£64.00	150GDH8PTBJ	£50.00	150GDH4PTBJSWB	£69.75
160	Rubber Tyred	50	350	199	135x105	105x80	M12	Ball	160GDH4EABJ	£59.30	160GDH8EABJ	£39.95	160GDH4EABJSWB	£65.25
	Nylon	50	800	239	135x105	105x80	M12	Ball	200GDH4NYBJ	£63.05	200GDH8NYBJ	£73.40	200GDH4NYBJSWB	£70.75
	Polyurethane	50	800	239	135x105	105x80	M12	Ball	200GDH4PTBJ	£74.95	200GDH8PTBJ	£85.00	200GDH4PTBJSWB	£83.45

Heavy Duty Fabricated Castors

Directional Lock

- >> 2 way directional lock
add suffix 'D' to swivel castor code
Price Extra: **£16.35**
available as a retro fit on
all the swivel castors



PSL100CIBJ



PFL100PTBJ



PSL100PTBJBR

Wheel Dia.	Wheel Type	Tread Width	Load Cap kg	Overall Height	Bearing Type	Swivel Model	Price	Fixed Model	Price	Swivel Braked Model	Price
100	Polyurethane	50mm	450	140	Ball	PSL100PTBJ	£57.70	PFL100PTBJ	£43.85	PSL100PTBJBR	£64.10
	Nylon	40mm	450		Ball	PSL100NYBJ	£36.50	PFL100NYBJ	£30.10	PSL100NYBJBR	£45.15
	Cast Iron	50mm	450		Ball	PSL100CIBJ	£37.85	PFL100CIBJ	£30.95	PSL100CIBJBR	£43.85
125	Polyurethane	50mm	500	165	Ball	PSL125PTBJ	£60.90	PFL125PTBJ	£46.80	PSL125PTBJBR	£67.30
	Nylon	45mm	500		Ball	PSL125NYBJ	£38.00	PFL125NYBJ	£30.15	PSL125NYBJBR	£46.25
	Cast Iron	40mm	500		Ball	PSL125CIBJ	£40.70	PFL125CIBJ	£29.20	PSL125CIBJBR	£44.95
150	Polyurethane	50mm	500	190	Ball	PSL150PTBJ	£65.45	PFL150PTBJ	£53.90	PSL150PTBJBR	£71.85
	Nylon	45mm	500		Ball	PSL150NYBJ	£45.50	PFL150NYBJ	£46.80	PSL150NYBJBR	£51.95
	Cast Iron	45mm	500		Ball	PSL150CIBJ	£42.65	PFL150CIBJ	£43.90	PSL150CIBJBR	£49.05
200	Polyurethane	50mm	500	241	Ball	PSL200PTBJ	£76.95	PFL200PTBJ	£68.90	PSL200PTBJBR	£83.40
	Nylon	50mm	500		Ball	PSL200NYBJ	£52.60	PFL200NYBJ	£44.55	PSL200NYBJBR	£59.05
	Cast Iron	45mm	500		Ball	PSL200CIBJ	£51.25	PFL200CIBJ	£42.65	PSL200CIBJBR	£57.65

Wheels

- >> Full range of industrial rubber tyred wheels in solid rubber & pneumatic
- >> Wide range of uses including sack trucks, wheel barrows, boat trailers, industrial trucks & trolleys



NSS SERIES



PW SERIES



BW SERIES Rubber



EPR SERIES



PBW SERIES



BW SERIES Pneumatic

Model	Wheel Dia.		Tyre Width	Hub Bore	Hub Length	Load Capacity	Wheel Centres	Bearing	Price	
	Inch	mm								
NSS Series - Black solid Rubber tyred wheels with Metal centres										
NSS8	8"	200	50mm	25.4mm	51mm	250kg	Metal	Plain	£25.85	
NSS8R								Roller	£29.65	
NSS10	10"	250				250kg		Plain	£47.05	
NSS10R								Roller	£48.60	
NSS12	12"	300	400kg	Plain	£48.70					
NSS12R				Roller	£52.40					
EPR Series - Black solid Rubber tyred wheels with Red Polypropylene centres										
EPR620	6.25"	160	40mm	20mm	51mm	150kg	Red Polypropylene	Plain	£8.10	
EPR61				25.4mm					£8.10	
EPR81	8"	200	50mm	200kg	£9.05					
EPR101	10"	250	60mm		275kg	£13.75				
PW Series - Black Pneumatic tyred wheels with Red Polypropylene centres										
PW250-425.4/764/51R	8.75"	220	65mm	25.4mm	76mm	100kg	Red Polypropylene	Plain	£25.95	
PWR250-425.4/764/51R					76mm				£25.95	
PW300-425.4/764/52R	10.5"	260	82mm		76mm	120kg			Plain	£29.00
PWR300-425.4/634/52R			85mm		63mm				Roller	£29.00
PWR400-425.4/634/52R	12"	300	100mm	150kg	£33.45					
PBW Series - Black solid Rubber tyred wheels with Red Polypropylene centres										
PBW28025.4/66RIBRED	11"	280	80mm	25.4mm	66mm	250kg	Red Polypropylene	Plain	£23.00	
PBW35525.4/66RIBBLK	14"	355	75mm			300kg			£35.35	
BW Series - Black solid Rubber tyred wheels with Metal centres										
BWR33025.4/63RIBRED	13"	330	70mm	25.4mm	63mm	300kg	Red Metal	Roller	£42.00	
BWB33025.4/83RIBRED					83mm			Ball Journal	£69.55	
BWG35525.4/66RIBRED	14"	355	75mm		66mm	400kg		Plain	£43.35	
BWR35525.4/63RIBRED					63mm			Roller	£48.60	
BWB35525.4/83RIBBLK	16"	400	90mm	83mm	500kg	Black Metal	Ball Journal	£70.10		
BWG40025.4/66RIBRED				66mm		Red Metal	Plain	£45.25		
BWR40025.4/63RIBRED	16"	400	90mm	63mm	500kg	Black Metal	Roller	£46.70		
BWB40025.4/83RIBBLK				83mm		Black Metal	Ball Journal	£77.15		
BW Series - Black Pneumatic tyred wheels with Metal Centres										
BWR250-425.4/634/51R	8.75"	220	65	25.4	63	100	Red Metal	Roller	£34.60	
BWG300-425.4/764/52R	10.5"	260	85	25.4	76	170		Plain	£34.50	
BWR300-425.4/634/52R	10.5"	260	85	25.4	63	170	Roller	£43.00		
BWR400-425.4/634/52B	12"	300	100	25.4	63	245	Black Metal	Roller	£44.10	
BWR400-825.4/634/01B	16"	400	100	25.4	63	305	Black Metal	Roller	£45.75	

Low value orders may be subject to a handling charge - CALL FOR DETAILS

Wheels, Castors & Conveyors

Telescopic Container/Trailer Conveyor – (for use over a level loading dock)

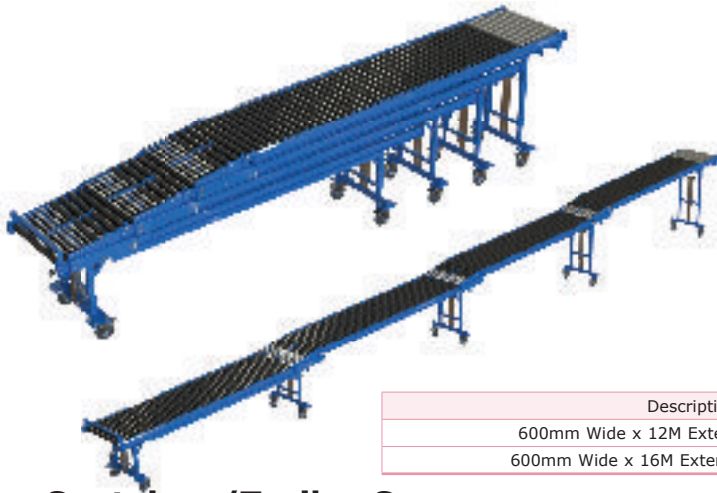

The Telescopic Expressway has been developed as a cost effective solution for efficient loading & unloading of shipping containers & trailers over a level loading dock. High impact, low inertia, 50mm diameter PVC rollers mounted in fully welded, powder coated steel channel frames. 50mm bright zinc plated mild steel rollers at load point & 20mm diameter bright zinc plated mild steel rollers at deck transfer sections. Each deck height adjustable by screw jacks. Alternative widths & lengths available on request.

Description	Model	Price
600mm Wide x 12M Extended (5M Closed)	TE4-600-3-12.0	£4977.00
600mm Wide x 16M Extended (5.5M Closed)	TE4-600-4-16.0	£6511.00

Container/Trailer Conveyor – (where no loading dock available)

The High Rise Telescopic conveyor has been developed as a safe, efficient & cost effective solution for quickly unloading shipping containers or trailers where no level loading dock is available. 600mm wide the conveyor will extend up to 10m inside the shipping container or trailer & will convey cartons under gravity to an offload point at ground level. The conveyor can be further extended by connecting an Expandaveyor, please see opposite page for specification. Suitable for container floor heights of 1,300-1,650mm (height options from 250-1,700mm available on request)



Description	Model	Price
High Rise Telescopic Conveyor	HRTE	£8999.00
6M Expandaveyor Extension	6MEE	£2080.00
7.5M Expandaveyor Extension	7MEE	£2533.00
9M Expandaveyor Extension	9MEE	£2986.00

Medium Duty Belt Conveyors



Motorised drum drive belt conveyor ideal for warehousing & light industrial use. Smooth faced anti-static PVC belt, supplied with variable speed controller with forward & reverse function. Rated at 30kg per running metre uniformly distributed load. Runs from a 230V (single phase) supply.

A complete range of belt conveyors, including inclined, mezzanine floor & vehicle loading conveyors available on request.

Belt Width	Length: 1.5M		Length: 2M		Length: 3M		Length: 4M		Length: 5M		Length: 7.5M		Length: 10M	
	Model	Price	Model	Price	Model	Price	Model	Price	Model	Price	Model	Price	Model	Price
300mm	BC130	£3451.00	BC2030	£3602.00	BC3030	£3905.00	BC4030	£4207.00	BC5030	£4630.00	BC7530	£5506.00	BC1030	£6262.00
450mm	BC145	£3547.00	BC2045	£3714.00	BC3045	£4049.00	BC4045	£4383.00	BC5045	£4964.00	BC7545	£5800.00	BC1045	£6636.00
600mm	BC160	£3763.00	BC2060	£3969.00	BC3060	£4381.00	BC4060	£4793.00	BC5060	£5466.00	BC7560	£6496.00	BC1060	£7526.00

Expanding Conveyors

- » Versatile mobile conveyor system which improves productivity & reduces manual handling - ideal for warehouse & industrial applications
- » Extends to suit changing applications & closes for efficient storage
- » Can be stretched around corners
- » High impact PVC Skatewheel & roller models available
- » Height adjustable from 650 to 1100mm
- » Supplied as standard with handles & 100mm swivel braked castors
- » Rated at 80kg per metre
- » Axle pitch when fully extended 125mm
- » All steelwork protected with a bright zinc plated finish
- » Options include end stops & hooks to connect multiple conveyors

Available on request

- » Bright zinc plated steel roller & skatewheel models
- » Height ranges of 450-700mm or 900-1200mm
- » Heavy duty models
- » Different lengths & widths
- » Roller end stops



Accessories

Accessories	Model	Price
Connecting Hooks	CH	£36.00
End Stop	ESP	£52.00

Skatewheel Model - use where conveyed items have a flat base & for tighter bends

Length Extended	Length Closed	400mm Width		600mm Width	
		Model	Price	Model	Price
2M	0.63M	EXP-PW400-2.0-L2	£492.00	EXP-PW600-2.0-L2	£632.00
3.5M	1.02M	EXP-PW400-3.5-L2	£762.00	EXP-PW600-3.5-L2	£983.00
5M	1.41M	EXP-PW400-5.0-L2	£1032.00	EXP-PW600-5.0-L2	£1335.00
6.5M	1.80M	EXP-PW400-6.5-L2	£1303.00	EXP-PW600-6.5-L2	£1687.00
8M	2.19M	EXP-PW400-8.0-L2	£1573.00	EXP-PW600-8.0-L2	£2039.00
9.5M	2.58M	EXP-PW400-9.5-L2	£1893.00	EXP-PW600-9.5-L2	£2440.00

Gravity Roller Conveyors

- » Improves productivity & reduces manual handling
- » Versatile modular design
- » Ideal for warehouse & industrial applications
- » Powder coated mild steel multipunched smoothline section frames
- » 50mm diameter rollers - 20kg capacity free running PVC or 80kg capacity heavy duty bright zinc plated rollers
- » Bright zinc plated steel stands, recommended 1500mm centres. Stands can be used to join lengths
- » Can be set at a decline or used horizontally
- » Other roller diameters, widths & pitches available & also gate sections, bends & ball transfer tables - *call for details*

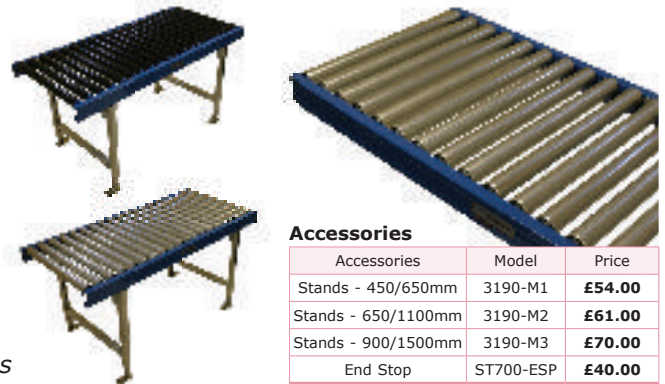

Accessories

Accessories	Model	Price
Stands - 450/650mm	3190-M1	£54.00
Stands - 650/1100mm	3190-M2	£61.00
Stands - 900/1500mm	3190-M3	£70.00
End Stop	ST700-ESP	£40.00

Description	75mm Roller Pitch (for items greater than 225mm long) - prefix below codes with ST700-				125mm Roller Pitch (for items greater than 375mm long) - prefix below codes with ST700-			
	1M Long	1.5M Long	2M Long	3M Long	1M Long	1.5M Long	2M Long	3M Long
300mm PVC Roller	PR50-300-75-1.0 £169.00	PR50-300-75-1.5 £229.00	PR50-300-75-2.0 £297.00	PR50-300-75-3.0 £409.00	PR50-300-125-1.0 £138.00	PR50-300-125-1.5 £184.00	PR50-300-125-2.0 £237.00	PR50-300-125-3.0 £318.00
450mm PVC Roller	PR50-450-75-1.0 £182.00	PR50-450-75-1.5 £249.00	PR50-450-75-2.0 £323.00	PR50-450-75-3.0 £449.00	PR50-450-125-1.0 £147.00	PR50-450-125-1.5 £196.00	PR50-450-125-2.0 £253.00	PR50-450-125-3.0 £343.00
600mm PVC Roller	PR50-600-75-1.0 £197.00	PR50-600-75-1.5 £272.00	PR50-600-75-2.0 £354.00	PR50-600-75-3.0 £495.00	PR50-600-125-1.0 £156.00	PR50-600-125-1.5 £210.00	PR50-600-125-2.0 £272.00	PR50-600-125-3.0 £372.00
300mm Zinc Plated Steel Roller	ZR50-300-75-1.0 £189.00	ZR50-300-75-1.5 £260.00	ZR50-300-75-2.0 £338.00	ZR50-300-75-3.0 £471.00	ZR50-300-125-1.0 £151.00	ZR50-300-125-1.5 £202.00	ZR50-300-125-2.0 £261.00	ZR50-300-125-3.0 £356.00
450mm Zinc Plated Steel Roller	ZR50-450-75-1.0 £204.00	ZR50-450-75-1.5 £282.00	ZR50-450-75-2.0 £368.00	ZR50-450-75-3.0 £516.00	ZR50-450-125-1.0 £160.00	ZR50-450-125-1.5 £216.00	ZR50-450-125-2.0 £280.00	ZR50-450-125-3.0 £384.00
600mm Zinc Plated Steel Roller	ZR50-600-75-1.0 £222.00	ZR50-600-75-1.5 £310.00	ZR50-600-75-2.0 £405.00	ZR50-600-75-3.0 £570.00	ZR50-600-125-1.0 £171.00	ZR50-600-125-1.5 £233.00	ZR50-600-125-2.0 £303.00	ZR50-600-125-3.0 £417.00
Side Guide per Side	75-1.0-SG £28.00	75-1.5-SG £37.00	75-2.0-SG £46.00	75-3.0-SG £56.00	125-1.0-SG £28.00	125-1.5-SG £37.00	125-2.0-SG £46.00	125-3.0-SG £56.00

Due to the size of these units additional carriage costs may be incurred - call for details

Kick, Handy & Low Level Steps

Plastic Step Stool

Handy carry hole

HE400Z

£31.95

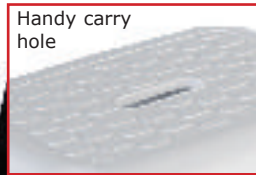

LOWER PRICE

130kg
evenly distributed

HE400Z



- » Manufactured from high quality plastic
- » Lightweight yet durable 2 step unit
- » Large anti-slip platform & feet

Overall Size L x W x H mm	Weight kg	Model	Price
470 x 510 x 400	1.8	HE400Z	£31.95

Steel Step-ups



150kg
evenly distributed



HJS02Z

HJS01Z

PRICES HELD

- » These nestable steps are constructed from tubular steel & come complete with grooved plastic feet
- » Platform size: 380W x 260D mm
- » Ribbed rubber mat platforms

No of Treads	Overall Size H x W x D mm	Weight kg	Model	Price	Price each +2 Off
1	255 x 440 x 385	2.2	HJS01Z	£46.25	£39.65
2	375 x 445 x 555	3.5	HJS02Z	£55.60	£49.00

Heavy Duty Industrial Steps

260kg
evenly distributed

HPE03Z

HPE04Z



COLOUR OPTIONS

- Red
- Blue
- Yellow
- Green

specify when ordering

LOWER PRICES



HPE01Z

HPE02Z



WHERE HIGHLIGHTED, RED, BLUE OR YELLOW ONLY

- » Manufactured from tough, medium density polyethylene & resistant to most chemicals
- » Ideal for wash down applications
- » Fitted with anti-slip strips on the treads

HPE05Z

No of Treads	Overall Size H x W x D mm	Weight kg	Model	Price
1	300 x 485 x 310	5	HPE01Z	£72.15
2	415 x 475 x 540	10	HPE02Z	£98.30
3	620 x 440 x 795	15	HPE03Z	£145.45
4	820 x 490 x 1080	20	HPE04Z	£238.40
4 with Handrail	1620 x 490 x 1080	22	HPE05Z	£391.70

Plastic Step-up

130kg
evenly distributed

- » This versatile nestable step is manufactured from injection moulded plastic complete with non-slip feet
- » Platform height: 240mm



HS501Z

£29.95



HS501Z

LOWER PRICE

INFORMATION

Easy to stack & store



Platform Size W x D mm	Overall Size W x D mm	Weight kg	Model	Price
425 x 280	480 x 330	1	HS501Z	£29.95

Kick Steps

- » **Manufactured & approved to the recognised European GS approval**
- » Manufactured from rugged plastic or quality steel. Both models have a thick rubber ring around the base for safety & durability
- » Mounted on 3 sprung loaded polypropylene castors which retract when weight is applied
- » Snap-lock for quick assembly



Steel Kick Step Model: GA009Z

STEEL COLOUR OPTIONS
GA009Z

- Red
- Green
- Blue
- Black
- Grey
- Yellow

specify when ordering

PLASTIC COLOUR OPTIONS
GA008Z

- Red
- Blue
- Black
- Grey

specify when ordering



FROM ONLY

£40.65



Plastic Kick Step Model: GA008Z



Description	Loaded Height mm	Unloaded Height mm	Base Dia. mm	Top Dia. mm	Weight kg	Model	Price (each) 1+	Price (each) 3+
Plastic	445	450	440	300	2	GA008Z	£43.95	£40.65
Steel	430	435	435	290	5	GA009Z	£46.70	£43.40

Aluminium & Glass Fibre Steps/Ladders

Climb-It® Platform Plus Steps



- » Certified to EN 14183 standard
- » Compact storage, ideal for storing in small gaps
- » Aluminium construction, with non-slip feet
- » Distance between the top platform & handrail is 595mm providing safety when in use
- » Large platform size: 350W x 320D mm

Climb-It®
Platform Plus

INFORMATION

Large platform of 350W x 320Dmm for superior user comfort & safety



No. of Treads	Height of top tread mm	Overall Size - Open H x W x D mm	Overall Size - Folded H x W x D mm	Weight kg	Model	Price
2	460	1075 x 555 x 476	1170 x 476 x 98	4	FS122Z	£82.15
3	690	1310 x 703 x 500	1420 x 500 x 98	6	FS123Z	£104.55
4	930	1515 x 935 x 540	1665 x 540 x 105	8	FS124Z	£123.80

Folding Steps with Soft Grip Handle

- » Tubular steel construction, fitted with non-slip treads, non-slip feet & soft grip foam handle, giving a comfortable backing when used as a seat
- » Tread size: 380W x 260Dmm



INFORMATION

Soft grip handle for your comfort

FROM ONLY
£52.40

LOWER PRICES



No. of Treads	Height of top tread mm	Overall Size - Open H x W x D mm	Overall Size - Folded H x W x D mm	Weight kg	Model	Price
2	480	900 x 475 x 490	990 x 475 x 75	4	GS402Z	£52.40
3	725	1180 x 460 x 670	1310 x 460 x 90	6	GS403Z	£64.35
4	980	1435 x 500 x 850	1580 x 500 x 90	8	GS404Z	£86.30

Aluminium & Glass Fibre Steps/Ladders

Climb-It® Slim Folding Steps

- » Certified to EN 14183 standard
- » Compact storage, ideal for storing in small gaps
- » Aluminium construction, with non-slip feet
- » Distance between the top platform & handrail is 600mm providing safety when in use
- » Large platform size: 330W x 260D mm



INFORMATION
Slim folding step for storing in small gaps

INFORMATION
Deep treads for increased safety & stability

PRICES HELD

Only 55mm when Folded

Climb-It®

certified to **EN 14183**



FS192Z

FS193Z



No. of Treads	Height of top tread mm	Overall Size - Open H x W x D mm	Overall Size - Folded H x W x D mm	Weight kg	Model	Price
2 with Handrail	450	1050 x 475 x 565	1160 x 475 x 55	4	FS192Z	£89.60
3 with Handrail	680	1280 x 475 x 745	1410 x 475 x 55	5.5	FS193Z	£108.80
4 with Handrail	910	1510 x 475 x 915	1660 x 475 x 55	7	FS194Z	£126.20

Folding Aluminium Handy Steps

certified to **EN 14183**

FS253Z

certified to **EN 131 professional**

FS369Z

150kg evenly distributed

FROM ONLY £55.00



FS253Z

FS369Z

- » Certified to EN 14183 (FS253Z) & EN 131 (FS369Z)
- » Strong & sturdy folding aluminium steps
- » Large (365W x 131D mm) durable platform for safe & comfortable standing
- » Featuring strengthening braces & support straps

No. of Treads	O/A Size - In Use H x W x D mm	O/A Size - Folded H x W x D mm	Wt kg	Model	Price	Price (each) 2+
2	443 x 416 x 439	490 x 416 x 164	2.5	FS253Z	£63.50	£56.90
3	649 x 441 x 596	720 x 441 x 164	3.5	FS369Z	£85.05	£78.45



Aluminium & Glass Fibre Steps/Ladders

Step-A-Trucks

- >> Versatile - neat & compact
- >> Large toe plate & wide step treads
- >> Load capacity: as sack truck - 60kg & as step unit - 150kg
- >> Multi purpose, simple & easy to convert from step to sack truck
- >> When in sack truck mode they are mobile on two 100mm wheels

SOFT GRIP
FOAM RUBBER
HANDLE

NON SLIP
PLASTIC
TREADS

FROM ONLY
£95.15



LOWER
PRICES



FMS83Y
as Sack
Truck



FMS83Y as
Step Unit



FMS82Y as
Step Unit

FOLD AWAY
WHEELS



Easy to
move into
position

No. of Treads	Overall Size - W x D x H mm			Platform Height mm	Sack Truck Toe Plate	Step Tread Size	Weight kg	Model	Price 1 Off	Price (each) 2+
	Folded	as Sack Truck	as Step Unit							
2	460 x 70 x 990	480 x 490 x 990	470 x 530 x 920	490	390 x 280 mm	375 x 210 mm	6.5	FMS82Y	£102.95	£95.15
3	470 x 90 x 1265	490 x 450 x 1265	470 x 735 x 1190	750						
							9	FMS83Y	£119.05	£108.55

Climb-It® Shelf Ladder

- >> Handrails & shafting hooks available as standard
- >> Manufactured from lightweight EN131 Certified aluminium profiles
- >> Deep 80mm serrated non-slip treads with ridge reinforcement & double riveting at each corner for maximum durability and comfort when working at height
- >> Large ribbed channel section stiles and reinforced bottom tread & horns for improved resistance to heavy usage
- >> Hard wearing, non-slip feet for maximum grip on all floor surfaces
- >> Rated to a maximum load & duty rating of 150kg

Climb-It®



No of Treads	Length mm	Max Working Height mm	Max Standing Height mm	Depth mm	Weight kg	Model	Price
5	1100	2200	600	600	4	SLA205	£225.65
6	1400	2500	900	700	4.5	SLA206	£233.85
7	1600	2700	1100	800	5.0	SLA207	£242.05
8	1900	2900	1300	900	5.5	SLA208	£250.25
9	2100	3100	1600	1000	6.0	SLA209	£258.45
10	2400	3400	1800	1100	6.5	SLA210	£297.75
11	2600	3600	2000	1200	7.0	SLA211	£305.95
12	2900	3800	2200	1300	7.5	SLA212	£314.15

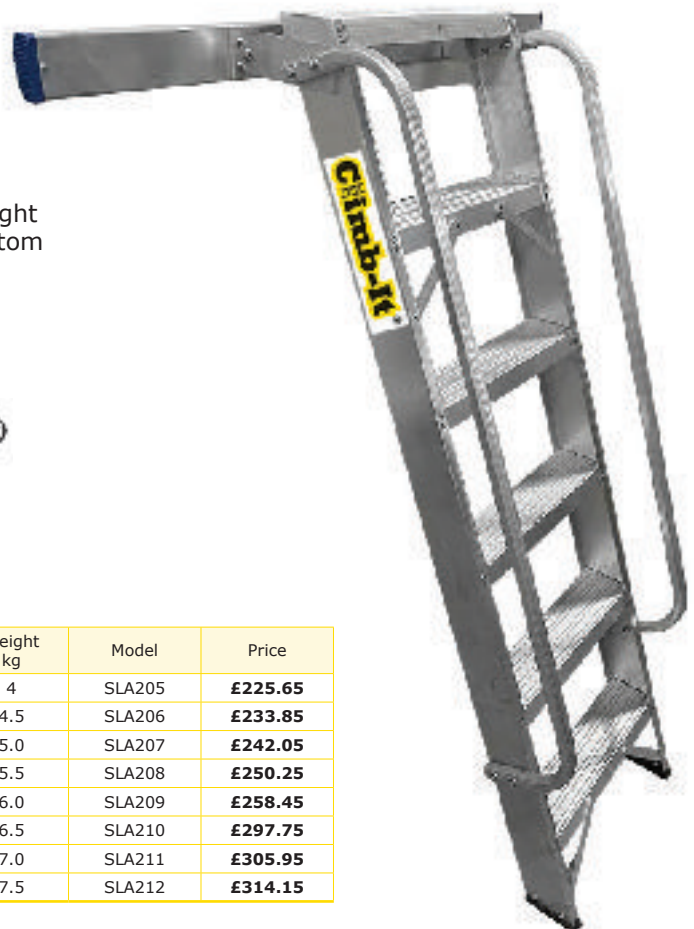

Aluminium & Glass Fibre Steps/Ladders

Climb-It® Easy Slope Aluminium Folding Leader Steps

- >> **Certified to EN 14183**
- >> Aluminium folding steps are ideal for use in offices, storerooms, warehouses etc.
- >> Large aluminium serrated treads (360W x 205Dmm) & high handrail offer increased safety during use
- >> Tilt & pull wheels for easy movement without lifting
- >> Easy slope incline
- >> Folded size: only 130mm deep

Climb-It®

AFGS4Z
£214.25



AFGS3Z
Folded

AFGS3Z
£188.95

certified to
EN
14183

LOWER PRICES



AFGS4Z

INFORMATION

Robust & sturdy

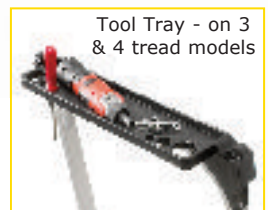

Tool Tray - on 3 & 4 tread models



AFGS2Z -
Tilt & Pull



AFGS2Z

AFGS2Z
Folded

AFGS2Z
£156.30



Description	Platform Height mm	Overall Size - In Use H x W x D mm	Overall Size - Folded H x W x D mm	Weight kg	Model	Price
2 Tread with Aluminium Treads	440	825 x 535 x 555	775 x 535 x 130	6.5	AFGS2Z	£156.30
3 Tread with Aluminium Treads	660	1260 x 550 x 840	1075 x 550 x 130	9	AFGS3Z	£188.95
4 Tread with Aluminium Treads	880	1480 x 570 x 1130	1380 x 570 x 130	11	AFGS4Z	£214.25

Aluminium & Glass Fibre Steps/Ladders

Double Decker



ALT-502113
Folded

ALT-502115



TOOL TRAY & BUCKET HOOK

FROM ONLY
£121.25



UNIQUE DOUBLE STEP & RUBBER PLATFORM STRIP FOR EXTRA COMFORT



ALT-502105

- » **Certified to EN 131 Professional**
- » Integral toolholder, bucket hook & screwtray
- » A quality professional aluminium stepladder. These units come complete with heavy-duty sturdy rubber anti-slip feet to make this a superior, professional, stepladder
- » The aluminium platform features a red safety strip - indicator for maximum recommended step height & protective edge to prevent cuts & grazes
- » Patented large double step underneath the platform for safe & comfortable standing

Double Decker

No. of Treads	Platform Height	O/A Size - In Use H x W x D mm	Folded Height mm	Wt kg	Model	Price
3	616mm	1244 x 470 x 723	1426	3.8	ALT-502103	£121.25
4	828mm	1461 x 496 x 869	1656	4.4	ALT-502104	£133.75
5	1041mm	1677 x 525 x 1016	1887	5	ALT-502105	£152.30
6	1253mm	1893 x 552 x 1163	2117	6.1	ALT-502106	£169.00
7	1465mm	2110 x 580 x 1309	2348	7.2	ALT-502107	£187.80
8	1677mm	2326 x 607 x 1456	2529	8.4	ALT-502108	£205.00

Double Decker with Handrails

No. of Treads	Platform Height	O/A Size - In Use H x W x D mm	Folded Height mm	Wt kg	Model	Price
3	616mm	1244 x 470 x 723	1426	4.8	ALT-502113	£166.95
4	828mm	1461 x 496 x 869	1656	5.4	ALT-502114	£179.45
5	1041mm	1677 x 525 x 1016	1887	6	ALT-502115	£198.00
6	1253mm	1893 x 552 x 1163	2117	7.1	ALT-502116	£214.75
7	1465mm	2110 x 580 x 1309	2348	8.2	ALT-502117	£233.55
8	1677mm	2326 x 607 x 1456	2529	9.4	ALT-502118	£250.75

Aluminium & Glass Fibre Steps/Ladders

Climb-It® Professional Aluminium Stepladders with Carry Handle



FROM ONLY
£91.65



Platform Size
250 x 280mm



CAH105

CAH103



- » **Certified to EN 131 Professional**
- » Light & practical aluminium frame with a glass fibre reinforced polypropylene platform
- » 100mm wide treads with non-slip surface to prevent slips
- » Multifunctional tool tray
- » Non-slip feet

No. of Treads	Platform Height mm	Open Size H x W x D mm	Folded Height mm	Weight kg	Model	Price
3	670	1268 x 436 x 759	1386	4.4	CAH103	£91.65
4	930	1531 x 466 x 944	1667	5.2	CAH104	£105.10
5	1190	1792 x 493 x 1135	1945	6.2	CAH105	£122.75
6	1450	2049 x 523 x 1314	2218	7	CAH106	£141.30
7	1710	2314 x 552 x 1499	2497	8	CAH107	£158.85



Aluminium & Glass Fibre Steps/Ladders



FROM ONLY
£83.20

ALR06Z

Aluminium Folding Steps

- >> **Certified to EN 131 Professional**
- >> Strong, lightweight & robust aluminium platform range
- >> Distance between the platform & top handrail is 600mm providing safety at high levels
- >> Tread depth: 80mm



Rubber feet provide slip resistance & floor protection



Fitted with high tensile straps

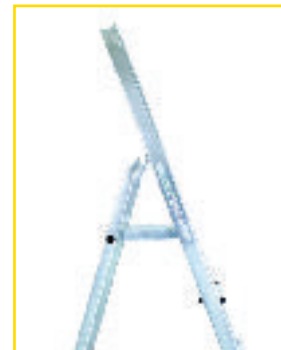

Slim design which is ideal for storage & transport

No. of Treads	Platform Height mm	Open Size H x W x D mm	Folded Height mm	Weight kg	Model	Price
3	610	1220 x 427 x 657	1250	3.2	ALR03Z	£83.20
4	830	1440 x 452 x 811	1490	3.8	ALR04Z	£98.50
5	1050	1660 x 476 x 967	1730	4.5	ALR05Z	£115.85
6	1270	1860 x 500 x 1127	1970	5.9	ALR06Z	£137.80
8	1705	2315 x 555 x 1437	2450	8.1	ALR08Z	£170.45



AFA04Z

AFA06Z

Professional Aluminium Folding Steps

- >> **Certified to EN 131 Professional**
- >> Large working platform - 275W x 400Dmm
- >> Deep non-slip aluminium treads
- >> These units have an extra large standing platform, twin handrails, handy work tray & high support rail
- >> Distance from platform to top hand rail: 750mm



High Support Rail



Tool Tray



Large Platform

No. of Treads	Platform Height mm	Overall Size - In Use H x W x D mm	Overall Height when folded	Weight kg	Model	Price
3	580	1330 x 445 x 805	1420 mm	5	AFA03Z	£170.25
4	800	1550 x 465 x 955	1660 mm	6	AFA04Z	£189.00
5	1020	1775 x 490 x 1110	1900 mm	6.5	AFA05Z	£207.35
6	1250	2000 x 515 x 1260	2140 mm	7.5	AFA06Z	£225.65
7	1470	2225 x 535 x 1415	2380 mm	9	AFA07Z	£253.15

Aluminium & Glass Fibre Steps/Ladders

Climb-It® Aluminium Library Steps

- » Robust fixed-frame designed for servicing machinery
- » Large 460 x 415mm chequer plate platform gives ample workspace & grip
- » Deep 80mm serrated non-slip treads with ridge reinforcement & double riveting at each corner for maximum durability
- » Large ribbed channel section stiles, box section back legs & reinforced bottom tread for improved resistance to heavy usage
- » Hard wearing, non-slip feet for maximum grip on all floor surfaces
- » Available as a double sided step unit - *call for details*

Climb-It®



INFORMATION



Straight backed for closer access



ALS03Z



ALS14Z

No. of Treads	Overall Size W x D mm	Platform Height mm	Units without Handrails			Units with Handrails		
			Weight	Model	Price	Weight	Model	Price
3	460 x 840	730	6.5 kg	ALS03Z	£268.10	9.5 kg	ALS13Z	£411.00
4	480 x 970	890	8 kg	ALS04Z	£311.00	11 kg	ALS14Z	£453.90
5	510 x 1090	1120	9 kg	ALS05Z	£332.40	12 kg	ALS15Z	£475.30

Climb-It® Aluminium Wide Steps

**FROM ONLY
£357.15**



Climb-It®



ALP04Z

- » **Certified to EN 131 Professional**
- » Wheels at the back of the unit make this range of steps easy to manoeuvre
- » The unit incorporates a safety chain at the front of the platform for increased safety
- » Platform size: 400D x 600W mm

No. of Treads	Platform Height mm	Open Height mm	Closed Height mm	Weight kg	Model	Price
2	380	1430	1580	6	ALP02Z	£357.15
3	615	1645	1790	8	ALP03Z	£394.05
4	830	1850	1970	9	ALP04Z	£424.45
5	1040	2040	2260	10	ALP05Z	£458.95
6	1270	2280	2500	11	ALP06Z	£498.25
7	1480	2470	2790	12	ALP07Z	£531.55
8	1690	2660	3080	13	ALP08Z	£575.00

Aluminium & Glass Fibre Steps/Ladders



Extension Ladders

- » **Certified to EN 131 Professional**
- » Stabiliser comes as standard on all ladders that extend beyond 3m
- » Large D shaped serrated rungs
- » Deep serrated rubber feet for maximum grip on all surfaces
- » Heavy duty galvanised steel locking catch standard on all extension ladders



No. of Rungs	Closed Height mm	Extended Height mm	Weight kg	Model	Price
Two Section Push Up Ladders					
2 x 8	2450	3850	10	ELL208	£214.30
2 x 10	2930	4900	12.5	ELL210	£235.75
2 x 12	3450	5970	17	ELL212	£289.55
2 x 14	4040	7140	18.5	ELL214	£330.50
2 x 15	4450	7810	22	ELL215	£375.25
2 x 17	4950	8880	24.5	ELL217	£401.95
Three Section Push Up Ladders					
3 x 8	2450	5230	18.5	ELL308	£305.75
3 x 10	2930	6920	23	ELL310	£365.25
3 x 12	3450	8480	27	ELL312	£438.60
3 x 14	4040	10,200	31	ELL314	£499.55

Combination Ladder

- » **Certified to EN 131 Professional**
- » Super-lightweight & sturdy aluminium design ensures easy handling
- » 3 modes of operation for ultimate flexibility
- » Stabiliser as standard to ensure maximum stability
- » Deep serrated rubber feet for maximum grip on all surfaces
- » Locking catch keeps the sections secure during use & storage
- » PCL306 & PCL309 are able to be used on stairs



FROM ONLY
£418.10



No. of Rungs	Closed Length mm	Extended Length mm	Weight kg	Model	Price
3 x 6	1860	4100	14.5	PCL306	£418.10
3 x 9	2690	6100	20.5	PCL309	£471.00
3 x 12	3540	8400	25	PCL312	£556.70



PCL312

Aluminium & Glass Fibre Steps/Ladders

Climb-It® Telescopic Ladder with Stabiliser

- >> **Certified to EN 131 standard**
- >> To open the unit lift from any step dependent on the height you are trying to achieve. The step can be adjusted all in one go or step by step to suit your requirements
- >> Folds quickly & easily for compact storage
- >> Controlled retraction to guard against trapped fingers
- >> One time release locking mechanism
- >> Manufactured in strong aluminium
- >> For safe use, do not stand on or above the red rung

Climb-It®

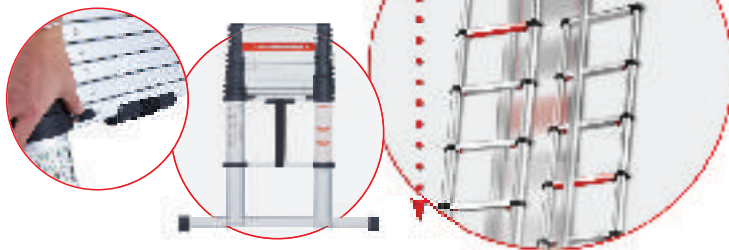

LOWER PRICE

Folds quickly & easily for compact storage. Simply push the buttons to close. The unit has a flange in the legs which restricts air flow and therefore gives controlled retraction to compact the unit smoothly from 3810mm extended height to 910mm closed height

No. of Rungs	Extended Height mm	Closed Height mm	Weight kg	Model	Price
13	3810	910	14.5	GXF21Z	£222.60



NEW spacers allow the unit to sit away from the wall at the top in line with new EN 131 regulations

5 Way Combination Ladder

- >> Combines a stepladder, extension ladder, stairwell ladder, work platform & stairwell platform
- >> Complete with large platform for increased safety
- >> Rigid construction with wide base stabilisers



CLW05Z Stepladder



CLW05Z Extended Ladder



CLW05Z Stairwell Ladder



CLW05Z Stairwell Platform



CLW05Z Work Platform

PRICE HELD

INFORMATION



Easily convert to 5 positions - ideal for many applications

No of Rungs	Base to Platform mm	Closed Height mm	Stepladder Height mm	Extended Length mm	Weight kg	Model	Price
2 x 5	850	1550	1490	2480	17	CLW05Z	£289.65

Aluminium & Glass Fibre Steps/Ladders

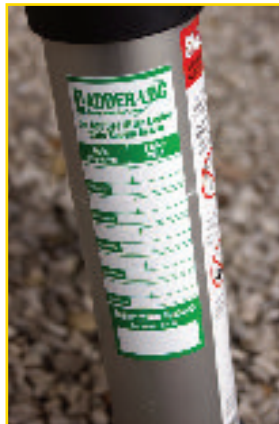

Ladder Log Inspection Systems

The Ladder Log Inspection System is a simple & straightforward process to ensure you are complying with the work at height regulations of 2005. Carry out a full inspection of your ladder every 3 to 6 months, file the paperwork & give the user a visual sign the equipment is safe to use.

The range consists of reversible tags slotted into holders or a self-adhesive plastic sticker. Both variations of this tag enable the user to record their asset reference alongside the date & time it was last inspected, as well as the name of the competent person who inspected the ladder.



Description	Model	Price (each) 0-49 off	Price (each) 50-250 off	Price (each) 251+ off
Reversible Tag	LLRT01	£2.75	£2.50	£2.38
Tag Holder	LLTH02	£3.25	£3.00	£2.75
Green Sticker	LLGS03	£3.00	£2.75	£2.38
Red Sticker	LLRS04	£3.00	£2.75	£2.38



Ladder Log Inspection Systems

The Ladder Log Business pack is perfect for getting started with ladder inspections if you haven't already got a system in place. It comes with tags and holders, or stickers if you prefer alongside an A4 register and all the paperwork required to make recording inspections as straightforward as possible. All business packs come with an A4 Inspection Folder & indelible marker pen.



Description	Model	Price (each)
Inspection Folder, 10 Tags, 5 Holders & 1 Pen	LLBPS05	£58.93
Inspection Folder, 30 Tags, 15 Holders & 1 Pen	LLBPM06	£73.75
Inspection Folder, 50 Tags, 25 Holders & 1 Pen	LLBPL07	£87.50
Inspection Folder, 10 Green & 2 Red Stickers & 1 Pen	LLBPS08	£56.25
Inspection Folder, 30 Green & 6 Red Stickers & 1 Pen	LLBPM09	£62.50
Inspection Folder, 50 Green & 10 Red Stickers & 1 Pen	LLBPM10	£68.75

Personalised Ladder Log Tags

Why not add your company logo and brand colours to your inspection tags? Modify your tags to suit your business requirements; colour code based on department, add extra information or change the tag material, they don't even have to be used just with ladders in mind.



Description	Price
Bespoke Tag with your logo & colours	Starting at £315.00 for 100

Aluminium & Glass Fibre Steps/Ladders

Roof Ladders

- » Heavy duty galvanised steel hooks with aluminium cross bars give best strength whilst remaining lightweight & easy to move around
- » Large diameter wheels allow easy positioning on roof
- » PVC covered bearers for improved grip & protection of roof tiles
- » Large heavy duty 33mm square rungs with 4-way crimp & swage for comfort and grip whilst working from the roof



INFORMATION
Large wheels allow for easy positioning on the roof

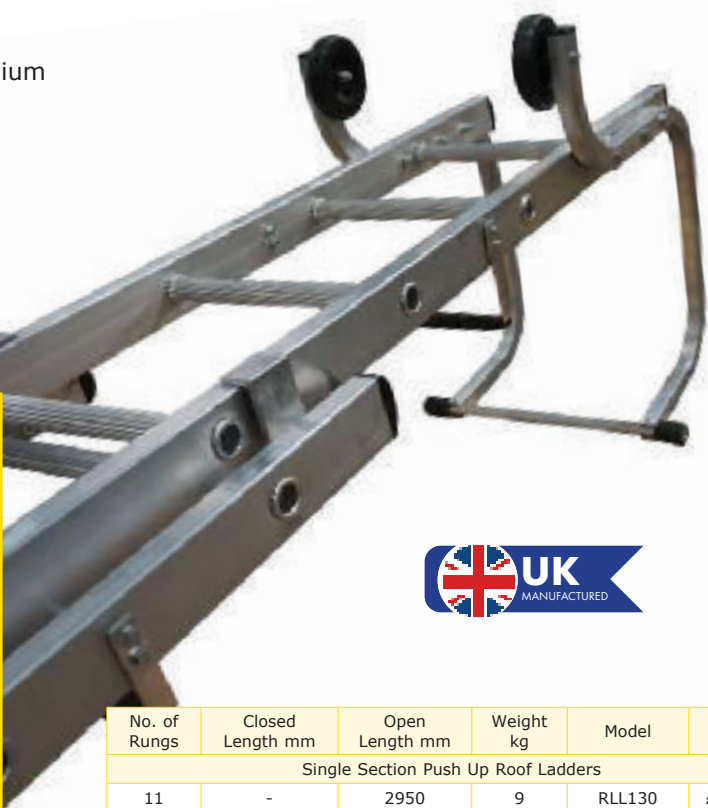

No. of Rungs	Closed Length mm	Open Length mm	Weight kg	Model	Price
Single Section Push Up Roof Ladders					
11	-	2950	9	RLL130	£257.15
15	-	3940	12	RLL140	£289.55
19	-	4940	14	RLL150	£332.40
21	-	5430	15	RLL155	£353.85
Two Section Push Up Roof Ladders					
11 + 9	2940	4670	14.5	RLL230	£388.60
13 + 11	3450	5670	16.5	RLL235	£439.55
15 + 13	3950	6670	18.5	RLL240	£449.55
17 + 15	4450	7670	20.5	RLL245	£492.40

Trade Ladder Stay

- » Fitted easily to most extension ladders
- » Holds the ladder 300mm from the wall
- » Working at height made easier
- » Avoids damage to guttering, tiles & window frames



Clearance	Weight kg	Model	Price
300mm	2	TLS30V	£65.25

Ladder Guard

- » The ideal deterrent to the unauthorised use of site ladders
- » Quickly locks in position on the ladder using padlock supplied
- » Made from 2.5mm aluminium sheet



Size L x W mm	Weight kg	Model	Price
1140 x 275	5.5	LG275	£178.95
1140 x 315	6	LG315	£183.55

Aluminium & Glass Fibre Steps/Ladders

Climb-It® Aluminium Swingback Stepladders



FROM ONLY
£100.00



ATS08Z

ATS06Z



INFORMATION



Ideal for maintenance applications

- » **Certified to EN 131 Professional**
- » Meets all strength requirements of BS2037 Class 1
- » Deep 80mm serrated non-slip treads with ridge reinforcement & double riveting for maximum durability & comfort
- » Large ribbed channel section stiles, box section back legs, steel hinge & reinforced horns for improved resistance to heavy usage
- » No tapes or flimsy arms to break
- » Hard wearing, non-slip feet for maximum grip on all floor surfaces
- » Integral tool tray for convenient storage



Complete with Integral Tool Tray

No. of Treads inc. Tray	Closed Height mm	Open Depth mm	Wt. kg	Without Handrails		With Handrails	
				Model	Price	Model	Price
4	1190	700	5	ATS04Z	£100.00	ATS14Z	£137.65
5	1440	1000	6	ATS05Z	£118.60	ATS15Z	£150.00
6	1680	1200	7	ATS06Z	£126.70	ATS16Z	£167.15
7	1930	1300	8	ATS07Z	£142.90	ATS17Z	£183.85

No. of Treads inc. Tray	Closed Height mm	Open Depth mm	Wt. kg	Without Handrails		With Handrails	
				Model	Price	Model	Price
8	2170	1500	9	ATS08Z	£152.90	ATS18Z	£190.50
10	2660	1900	11	ATS10Z	£183.85	ATS110Z	£224.80
12	3150	2200	13	ATS12Z	£214.30	ATS112Z	£254.80

Aluminium & Glass Fibre Steps/Ladders

Climb-It® Aluminium Stepladders

- >> **Certified to EN 131 Professional**
- >> Meets all strength requirements of BS2037 Class 1
- >> Deep 80mm serrated non-slip treads with ridge reinforcement & double riveting for maximum durability & comfort
- >> Large ribbed channel section stiles, box section back legs, steel hinge & reinforced horns for improved resistance to heavy usage
- >> No tapes or flimsy arms to break
- >> Hard wearing, non-slip feet for maximum grip on all floor surfaces
- >> Integral tool tray for convenient storage



**FROM ONLY
£140.00**



Handrails Available

APS05Z

APS07Z



Complete with Integral Tool Tray

INFORMATION



Ideal for many applications & industries

Climb-It®

No. of Treads	Platform Height mm	Closed Height mm	Wt. kg	Without Handrails		With Handrails		No. of Treads	Platform Height mm	Closed Height mm	Wt. kg	Without Handrails		With Handrails	
				Model	Price	Model	Price					Model	Price	Model	Price
3	600	1370	6.5	APS03Z	£140.00	APS13Z	£177.65	7	1600	2330	10	APS07Z	£191.95	APS17Z	£229.55
4	900	1600	7.3	APS04Z	£154.30	APS14Z	£185.75	8	1800	2580	11	APS08Z	£203.85	APS18Z	£244.80
5	1100	1840	8	APS05Z	£163.35	APS15Z	£203.85	10	2200	3070	13	APS10Z	£234.80	APS110Z	£275.25
6	1300	2090	9	APS06Z	£173.35	APS16Z	£214.30	12	2700	3450	15	APS12Z	£267.15	APS112Z	£316.20

Aluminium & Glass Fibre Steps/Ladders

Climb-It® Glass Fibre Swingback Stepladders

- >> **Certified to EN 131 Professional**
- >> Rubber feet & aluminium side arms help prevent slips & twists as there are no tapes or flimsy arms to break
- >> Lightweight & easy to carry
- >> Integral tool tray incorporates a bucket hook & 110mm & 180mm recesses for holding paint cans



Complete with Integral Tool Tray

INFORMATION
Insulated to 30,000 volts



GFS34Z



GFS35Z

GFS33Z

LOWER PRICES

No. of Treads	Open Size H x W x D mm	Folded Height mm	Weight kg	Model	Price
3	950 x 460 x 780	1060	5.5	GFS33Z	£90.00
4	1190 x 490 x 890	1300	6.5	GFS34Z	£109.80
5	1390 x 530 x 990	1560	7.5	GFS35Z	£128.80

No. of Treads	Open Size H x W x D mm	Folded Height mm	Weight kg	Model	Price
6	1550 x 560 x 1230	1830	8.5	GFS36Z	£146.60
7	1890 x 590 x 1340	2080	10	GFS37Z	£164.00
8	2130 x 625 x 1500	2290	11	GFS38Z	£183.85

Aluminium & Glass Fibre Steps/Ladders

Climb-It® Glass Fibre Platform Stepladders

- >> **Certified to EN 131 Professional**
- >> Rubber feet & aluminium side arms help prevent slips & twists as there are no tapes or flimsy arms to break
- >> Lightweight steps with high safety rail providing added safety when working at high levels
- >> Integral tool tray incorporates a bucket hook & 110mm & 180mm recesses for holding paint cans

Climb-It®



INFORMATION
 Insulated to 30,000 volts



GFP43Z



GFP46Z



Complete with Integral Tool Tray



No. of Treads	Platform Height mm	Open Size H x W x D mm	Folded Height mm	Wt kg	Model	Price	No. of Treads	Platform Height mm	Open Size H x W x D mm	Folded Height mm	Wt kg	Model	Price
3	725	1350 x 490 x 810	1490	8	GFP43Z	£135.55	6	1420	2054 x 585 x 1300	2260	11	GFP46Z	£192.35
4	950	1590 x 525 x 970	1740	9	GFP44Z	£153.70	7	1650	2280 x 620 x 1460	2490	12	GFP47Z	£210.55
5	1190	1930 x 555 x 1130	1980	10	GFP45Z	£172.90	8	1885	2530 x 650 x 1610	2740	14	GFP48Z	£228.75

Aluminium & Glass Fibre Steps/Ladders



GLF75Z

SAFETY CHAIN

Glass Fibre Wide Steps

- » Certified to EN 131 Professional
- » Manufactured from a glass fibre frame with aluminium treads
- » Wheels at the back of the unit make this range of steps easy to manoeuvre
- » The unit incorporates a safety chain at the front of the platform for increased safety
- » Platform size: 400W x 600D mm

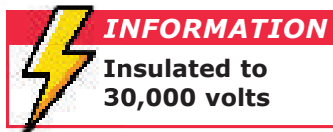

GLF72Z

No. of Treads	Open Height mm	Platform Height mm	Closed Height mm	Weight kg	Model	Price
2	1410	380	1570	8	GLF72Z	£388.60
3	1620	610	1780	9	GLF73Z	£428.10
4	1840	830	1980	11	GLF74Z	£469.05
5	2050	1050	2220	14	GLF75Z	£505.75
6	2260	1260	2490	16	GLF76Z	£552.40
7	2470	1480	2730	18	GLF77Z	£608.60
8	2700	1710	2960	20	GLF78Z	£661.45

V3 - Glass Fibre Ladder

- » Certified to EN 131 Professional & EN 50528
- » Locking mechanism to ensure increased safety
- » Roller wheels for ease of movement on a building/against a wall
- » Available for use as a stepladder, extension ladder or freestanding extension ladder



Wall Wheels



Stabiliser Bar



SV-V3-3x8

No. of Rungs	Closed Length mm	Extended Length mm	Overall Height in A position mm	Weight kg	Model	Price
3 x 8	2400	5470	2300	21	SV-V3-3x8	£821.90
3 x 10	3000	7450	2900	32	SV-V3-3x10	£1143.05

Aluminium & Glass Fibre Steps/Ladders

Climb-It® Glass Fibre Podium Steps

- » **Certified to EN 131 Professional**
- » Large platform: 406W x 475Dmm with kick boards
- » Podium steps with high safety rail, which is 950mm above the platform, provides added safety when working at high levels
- » Includes an integral tool tray
- » Wheels enable easy positioning (when folded)
- » Rubber feet & aluminium side arms help prevent slips & twists
- » Stabilisers on the GFP55Z, GFP56Z, GFP57Z & GFP58Z gives increased safety & stability when working at height



INFORMATION
Insulated to 30,000 volts

PRICES HELD



GFP54Z



GFP57Z

Stabilisers on the 5, 6, 7 & 8 tread units give increased safety & stability when working at height



Tool Tray



Large Platform with Kick Boards

Climb-It®

No. of Treads	Platform Height mm	Open Size H x W x D mm	Weight kg	Model	Price
2	520	1470 x 604 x 749	10	GFP52Z	£288.75
3	805	1755 x 644 x 935	15	GFP53Z	£334.60
4	1090	2040 x 684 x 1122	16.5	GFP54Z	£381.90
5	1375	2325 x 724 x 1308	17.5	GFP55Z	£454.30

No. of Treads	Platform Height mm	Open Size H x W x D mm	Weight kg	Model	Price
6	1660	2610 x 764 x 1495	18.5	GFP56Z	£489.20
7	1945	2895 x 804 x 1681	19.5	GFP57Z	£522.90
8	2230	3180 x 844 x 1868	20.5	GFP58Z	£579.15

Aluminium & Glass Fibre Steps/Ladders

Climb-It® Aluminium Warehouse Steps

- » Strong but lightweight aluminium & steel construction
- » Permanently fixed bracing for improved strength & durability
- » Handrails on both sides for stability whilst climbing
- » Deep 80mm serrated non-slip treads with ridge reinforcement & double riveting at each corner for maximum durability
- » Large ribbed channel section stiles, box section back legs & reinforced bottom tread for improved resistance to heavy usage
- » Hard wearing, non-slip feet for maximum grip on all floor surfaces
- » Wheels at the back of the unit make this range of steps easy to manoeuvre
- » 8 tread & above are sent folded for delivery - easy to erect



Climb-It®



ALW04Z

ALW08Z

No. of Treads	Platform Height mm	Size W x D mm	Weight kg	Model	Price
4	1000	510 x 1000	9	ALW04Z	£319.55
5	1200	530 x 1100	10	ALW05Z	£338.60
6	1500	550 x 1200	11	ALW06Z	£388.60

No. of Treads	Platform Height mm	Size W x D mm	Weight kg	Model	Price
8	2000	600 x 1400	16	ALW08Z	£476.20
10	2500	660 x 1700	20	ALW10Z	£581.00
12	3000	700 x 1900	24	ALW12Z	£621.00

Climb-It® Load Steps

- » Sliding mechanism allows platform to adapt to laden & unladen lorry bed heights
- » Single handrail with 2 locking settings
- » Wide 3mm thick 5 Bar chequer plate aluminium platform provides stability, strength & durability
- » Integral locking strap allows ladder to be secured to vehicle while in use
- » Supplied with easily installed bracket, padlock, & chain for secure storage on vehicle
- » Robust BS2037 Class 1 industrial design tested to 175kg maximum load.

NEW

Climb-It®



No of Rungs	Min Standing Height mm	Max Standing Height mm	Extended Length mm	Weight kg	Model	Price
3	720	950	1000	6.4	LOS203	£319.10
4	950	1180	1100	6.8	LOS204	£342.25
5	1180	1410	1360	7.2	LOS205	£350.90
6	1410	1640	1610	7.6	LOS206	£371.90
7	1640	1870	1860	8.0	LOS207	£407.95
8	1870	2100	2100	8.4	LOS208	£463.45

Climb-It® Large Platform Steps with Safety Gates



Enclosed Platform with Spring Gates



**FROM ONLY
£862.45**

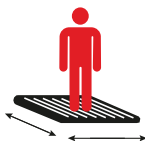

Large Platform
600 x 500mm



- » Certified to EN 131 Professional
- » Large, 600x500mm, anti slip plywood platform
- » Wide profile treads with a non-slip surface
- » Fully enclosed platform with spring gates
- » Fitted with braked swivel castors
- » CAW512 comes with adjustable stabilisers for increased stability



CAW508

No. of Treads	Platform Height mm	Open Size H x W x D mm	Weight kg	Model	Price
4	1000	2000 x 1030 x 1111	35	CAW504	£862.45
6	1500	2500 x 1030 x 1344	47	CAW506	£964.05
8	2000	3000 x 1030 x 1577	56.5	CAW508	£1155.70
10	2500	3500 x 1230 x 1810	62	CAW510	£1282.95
12	3000	4000 x 1387 x 2060	73.5	CAW512	£1620.15

Aluminium & Glass Fibre Steps/Ladders

Climb-It® Folding Telescopic Large Platform Step



Lifting barrier for user safety

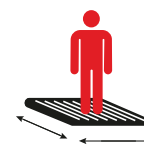

Large Platform
600 x 610mm

Climb-It®



Easy to use sliding stabilisers

- » Certified to EN 131 Professional
- » Telescopic legs allowing these steps to be used on stairs
- » Fitted with a lifting barrier to the front (entry) of the platform
- » Extendable locking stabilisers for safety when working at height
- » Non-slip aluminium platform with kick board
- » Wheels attached as standard, providing mobility without needing to lift
- » Foldable for easy storage

No. of Treads	Unextended Platform Height mm	Extended Platform Height mm	Open Size H x W x D mm	Folded Height mm	Weight kg	Model	Price
7 + 3	1760	2550	3552 x 917 x 2419	3086	41.8	CAT411	£1233.95

458

Aluminium & Glass Fibre Steps/Ladders

Climb-It® Large Platform Steps with Safety Gates

- » **Certified to EN 131 Professional**
- » Non-slip aluminium platform with a kick board
- » Fully enclosed platform with spring gates
- » 100mm wide treads with non-slip surface to prevent slips
- » Non-slip feet
- » Easily folded & mobile using wheels on rear of the step

FROM ONLY
£662.60



CAG307
Folded



CAG307

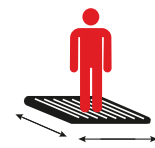

Large Platform
510 x 560mm



Enclosed Platform with Spring Gates



Climb-It®

Easy to use sliding stabilisers

No. of Treads	Platform Height mm	Open Size H x W x D mm	Weight kg	Model	Price
3	750	1726 x 680 x 1151	17	CAG303	£662.60
4	1000	1975 x 680 x 1332	20	CAG304	£683.00
5	1250	2224 x 680 x 1516	24	CAG305	£718.45
6	1500	2473 x 680 x 1697	27	CAG306	£773.85
7	1750	2724 x 680 x 1880	30.5	CAG307	£828.50

No. of Treads	Platform Height mm	Open Size H x W x D mm	Weight kg	Model	Price
8	2000	2974 x 680 x 2063	34	CAG308	£863.20
9	2250	3224 x 680 x 2245	37	CAG309	£868.25
10	2500	3474 x 680 x 2426	41	CAG310	£959.50
11	2750	3723 x 680 x 2608	44	CAG311	£1033.85
12	3000	3972 x 680 x 2792	47	CAG312	£1071.90

Aluminium & Glass Fibre Steps/Ladders

Climb-It® Weight Reactive Mobile Steps

Climb-It®

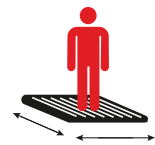

Large Platform
600 x 610mm



Enclosed
Platform with
Spring Gates



CAR604



CAR604



- » **Certified to EN 131 Professional**
- » Mobile on 4 x spring loaded castors. When body weight is applied the castors retract & the step becomes grounded on the large feet
- » Fully enclosed platform with spring gates
- » Turns in it's own circle
- » Wide platform with a non-slip surface & deep kick boards
- » Wide profile treads with a non-slip surface

No. of Treads	Platform Height mm	Open Size H x W x D mm	Weight kg	Model	Price
3	750	1850 x 770 x 1180	45.5	CAR603	£1013.60
4	1000	2100 x 790 x 1360	51	CAR604	£1200.20
5	1250	2350 x 810 x 1540	57	CAR605	£1302.00

460

Aluminium & Glass Fibre Steps/Ladders

Climb-It® Safety Steps with Safety Lock



Climb-It®



**Large Platform
600 x 610mm**



**Enclosed
Platform with
Spring Gates**



CAL706

CAL706



- » **Certified to EN 131 Professional**
- » Easy to use locking system which raises & lowers all 4 wheels. Simply push the handle down to engage the wheels & safety barrier thus making the step easily manoeuvrable
- » Fully enclosed platform with spring gates
- » Turns in it's own circle
- » Wide platform with a non-slip surface & deep kick boards
- » Wide profile treads with a non-slip surface

No. of Treads	Platform Height mm	Open Size H x W x D mm	Weight kg	Model	Price
3	750	1850 x 750 x 1180	45.5	CAL703	£1060.40
4	1000	2100 x 780 x 1360	51	CAL704	£1254.80
5	1250	2350 x 810 x 1540	57	CAL705	£1361.65
6	1500	2600 x 830 x 1720	62	CAL706	£1456.10
7	1750	2850 x 860 x 1900	67	CAL707	£1558.50

Aluminium & Glass Fibre Steps/Ladders

Climb-It® Cantilever Height Adjustable Platforms



Climb-It®

5 YR
GUARANTEE

certified to
EN 131
professional

Large Platform
600 x 760mm

CAM903



Enclosed Platform with Spring Gates

NEW



- » **Certified to EN 131 Professional**
- » Can be easily adjusted in height thanks to the pulley system
- » Reinforced with stabilisers, manufactured for heavy & difficult working conditions
- » Wide platform with a non-slip surface & kick board
- » Wide profile treads with a non-slip surface

No. of Treads	Platform Height mm	Base Size W x D mm	Weight kg	Model	Price
9	2480 to 3180	2100 x 1750	327	CAM903	P.O.A.
11	3050 to 4050	2330 x 1750	335	CAM904	P.O.A.
15	4000 to 6000	3750 x 2100	537	CAM905	P.O.A.

Aluminium & Glass Fibre Steps/Ladders

Climb-It® Extra Large Platform Safety Steps with Adjustable Stabilisers



Enclosed Platform with Spring Gates

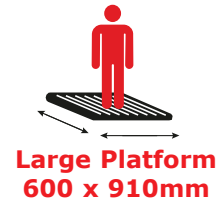

CAS807



CAS807

Climb-It®

- » **Certified to EN 131 Professional**
- » Designed for use in difficult working conditions, this range of steps have extendable & adjustable stabilisers
- » Wide platform with a non-slip surface & deep kick boards
- » Wide non-slip treads for extra comfort
- » Fully enclosed platform with spring gates
- » Mobile on 4 x swivel braked castors

No. of Treads	Platform Height mm	Open Size H x W x D mm	Weight kg	Model	Price
4	1000	2100 x 1180/2040 x 1540	76.5	CAS804	£1505.30
5	1250	2350 x 1180/2040 x 1720	80	CAS805	£1585.60
6	1500	2600 x 1180/2040 x 1900	85.5	CAS806	£1720.90
7	1750	2850 x 1180/2040 x 2080	90	CAS807	£1904.15
8	2000	3100 x 1180/2040 x 2260	94.5	CAS808	£2194.20
10	2500	3600 x 1180/2040 x 2620	102	CAS810	£2810.30
12	3000	4100 x 1180/2040 x 2980	106.5	CAS812	£3388.00

Mobile, Safety, Warehouse Steps & Platforms

Climb-It® Working Steps

Climb-It®

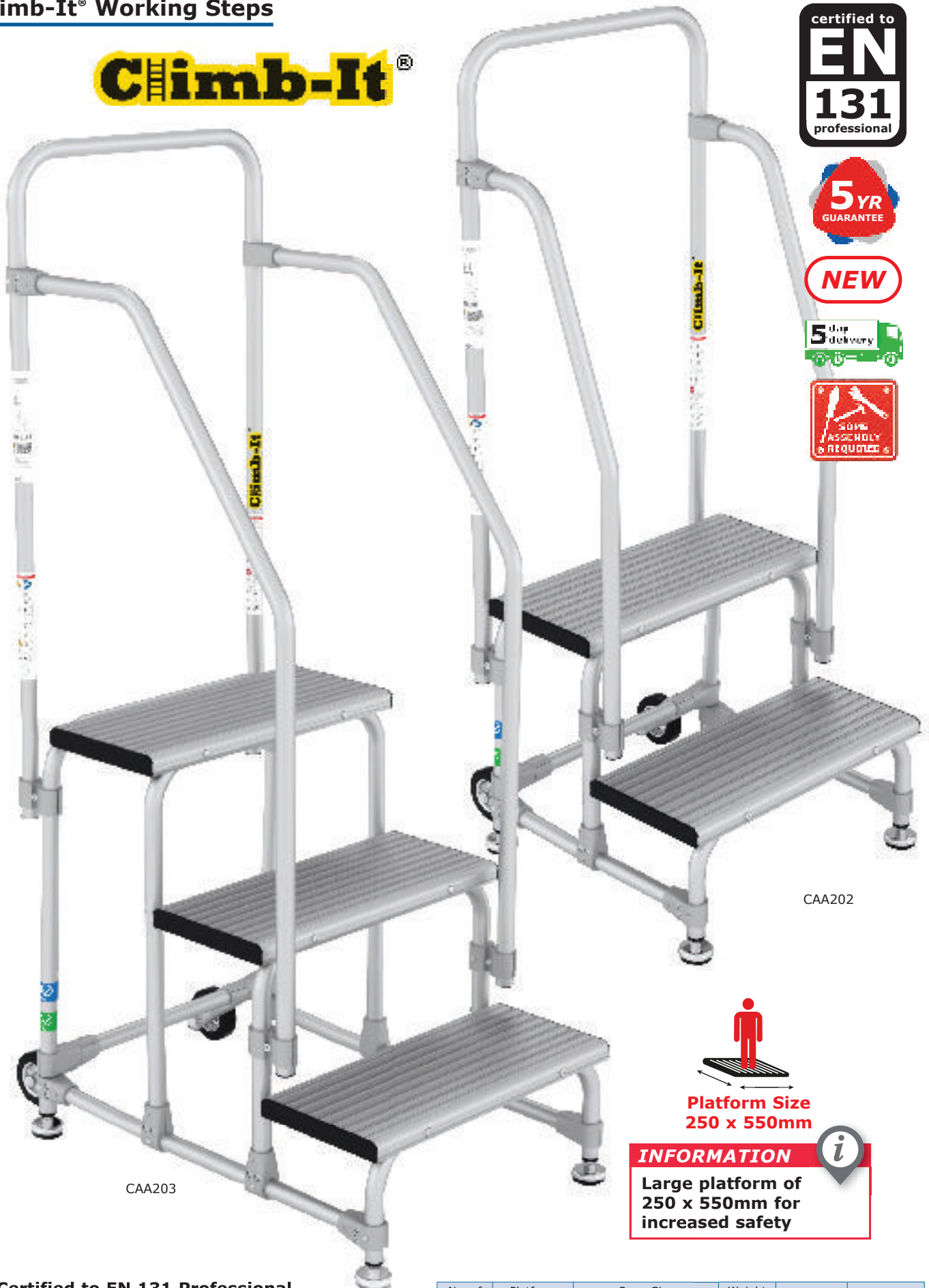

CAA202

CAA203

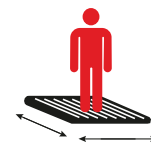

**Platform Size
250 x 550mm**

INFORMATION

**Large platform of
250 x 550mm for
increased safety**

- » **Certified to EN 131 Professional**
- » Large step with 250 x 550mm non-slip surface
- » Pull wheels for easy manoeuvrability & large feet for extra stability
- » Guardrail & handrail for increased safety

No. of Treads	Platform Height mm	Open Size H x W x D mm	Weight kg	Model	Price
2	500	1430 x 580 x 640	15.5	CAA202	£426.05
3	750	1680 x 580 x 933	20.5	CAA203	£576.65
4	1000	1930 x 580 x 1157	25.5	CAA204	£699.50



Domed Feet Handy Steps

- » Manufactured from durable blue painted strong tubular steel with 4 domed feet spring loaded castors
- » These steps easily glide across floors & engage or disengage depending on whether or not weight is applied
- » Anti-slip treads (380 x 180mm) ensure secure grip

FROM ONLY
£213.90



AAP20



AAP22

150kg
evenly
distributed

NEW

3 YR
GUARANTEE



AAP21

INFORMATION



These steps easily glide across floors & engage or disengage depending on whether or not weight is applied

Description	Platform Height mm	Overall Size H x W x D mm	Model	Price
2 Tread with No Handrail	510	630 x 540 x 540	AAP20	£213.90
2 Tread with Side Handrail	510	1185 x 540 x 540	AAP21	£223.70
2 Tread with Full Handrail	510	1185 x 540 x 540	AAP22	£237.45

Mobile, Safety, Warehouse Steps & Platforms



Domed Feet Steps

- › Manufactured from durable red painted strong tubular steel with 4 domed feet spring loaded castors
- › These steps easily glide across floors & engage or disengage depending on whether or not weight is applied
- › Anti-slip or punched steel treads (180D x 380Wmm) & platforms (400D x 380Wmm) ensure secure grip
- › Kick board to support the users safety

NEW

150kg evenly distributed

3 YR GUARANTEE



FROM ONLY
£249.30



AAD02PRD

AAD03SRD

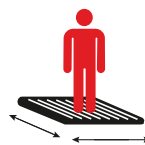

Platform Size
400 x 380mm



Anti-Slip Treads



Punched Steel Treads

INFORMATION



These steps easily glide across floors & engage or disengage depending on whether or not weight is applied

No of Treads	Platform Height mm	Overall Size H x W x D mm	Anti-Slip Treads		Punched Steel Treads	
			Model	Price	Model	Price
2	545	1085 x 550 x 690	AAD02SRD	£249.30	AAD02PRD	£249.30
3	770	1420 x 575 x 820	AAD03SRD	£278.20	AAD03PRD	£278.20
4	1030	1725 x 580 x 985	AAD04SRD	£351.15	AAD04PRD	£351.15
5	1290	2030 x 610 x 1150	AAD05SRD	£380.10	AAD05PRD	£380.10



Domed Feet Steps FROM STOCK

- » Manufactured from durable blue painted strong tubular steel with 4 domed feet spring loaded castors
- » These steps easily glide across floors & engage or disengage depending on whether or not weight is applied
- » Anti-slip or punched steel treads (180D x 380Wmm) & platforms (400D x 380Wmm) ensure secure grip
- » Kick board to support the users safety



NEW

**FROM ONLY
£249.30**



AAD04SBL

AAD03PBL

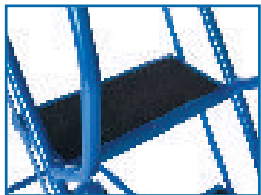

Anti-Slip Treads

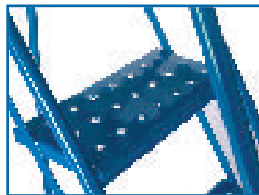

Punched Steel Treads



AAD05PBL

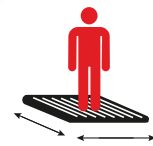

**Platform Size
400 x 380mm**

INFORMATION



These steps easily glide across floors & engage or disengage depending on whether or not weight is applied

No of Treads	Platform Height mm	Overall Size H x W x D mm	Anti-Slip Treads		Punched Steel Treads	
			Model	Price	Model	Price
2	545	1085 x 550 x 690	AAD02SBL	£249.30	AAD02PBL	£249.30
3	770	1420 x 575 x 820	AAD03SBL	£278.20	AAD03PBL	£278.20
4	1030	1725 x 580 x 985	AAD04SBL	£351.15	AAD04PBL	£351.15
5	1290	2030 x 610 x 1150	AAD05SBL	£380.10	AAD05PBL	£380.10

Mobile, Safety, Warehouse Steps & Platforms



Spring Loaded Steps

- » Manufactured from durable powder coated strong tubular steel with 4 x 50mm spring loaded castors
- » These steps easily glide across floors & engage or disengage depending on whether or not weight is applied
- » Punched steel treads (200D x 550Wmm) & platforms (400D x 550Wmm) ensure secure grip
- » Kick board to support the users safety
- » Box section base gives extra strength & stability

NEW

3YR
GUARANTEE

COLOUR OPTIONS
■ Blue
■ Grey

FROM ONLY
£482.95



AHSL03_BL



AHSL05_GY

150kg
evenly distributed

INFORMATION ⓘ
 These steps easily glide across floors & engage or disengage depending on whether or not weight is applied



Platform Size
400 x 550mm



Box Section Base

No of Treads	Platform Height mm	Overall Size H x W x D mm	Model Blue	Model Grey	Price
2	500	1440 x 600 x 640	AHSL02_BL	AHSL02_GY	£482.95
3	750	1690 x 600 x 910	AHSL03_BL	AHSL03_GY	£525.00
4	1000	1940 x 600 x 1110	AHSL04_BL	AHSL04_GY	£567.00
5	1250	2195 x 600 x 1380	AHSL05_BL	AHSL05_GY	£680.20



**Weight Reactive Steps
FROM STOCK**

- » Manufactured from durable blue painted strong tubular steel with 4 x 75mm spring loaded castors
- » These steps easily glide across floors & engage or disengage depending on whether or not weight is applied
- » Anti-slip treads (200D x 550Wmm) & platforms (400D x 550Wmm) ensure secure grip
- » Kick board to support the users safety

NEW

**3 YR
GUARANTEE**

**150kg
evenly
distributed**

**FROM ONLY
£350.85**



AAW83



AAW84



AAW85



**Platform Size
400 x 550mm**

No of Treads	Platform Height mm	Overall Size H x W x D mm	Model	Price
3	720	1575 x 600 x 735	AAW83	£350.85
4	930	1755 x 600 x 870	AAW84	£408.70
5	1160	2030 x 600 x 990	AAW85	£464.65

Mobile, Safety, Warehouse Steps & Platforms



Tilt & Pull Steps

- » Manufactured from durable blue painted strong tubular steel with 2 wheels at the front, enabling the unit to be pushed or pulled
- » Handrails on the AAT04 provide extra safety & support
- » Anti-slip treads (200D x 400Wmm) ensure secure grip

NEW

3YR
GUARANTEE

FROM ONLY
£178.20



150kg
evenly
distributed

No of Treads	Platform Height mm	Overall Size H x W x D mm	Model	Price
2	500	1050 x 480 x 610	AAT02	£178.20
3	745	1300 x 470 x 770	AAT03	£209.45
4	995	1690 x 560 x 990	AAT04	£246.25

INFORMATION

2 wheels at the front of the step enable the units to be pushed or pulled



Loading Steps FROM STOCK

- » Manufactured from strong tubular steel powder coated in blue or a galvanised finish
- » The open back is ideal for stepping on & off vehicles & loading bays
- » Anti-slip treads (145D x 550Wmm) & platform (400D x 550Wmm) ensure secure grip
- » Knuckle guard handles provide extra protection



**FROM ONLY
£400.55**



SLS02G

SLS03G



SLS04P

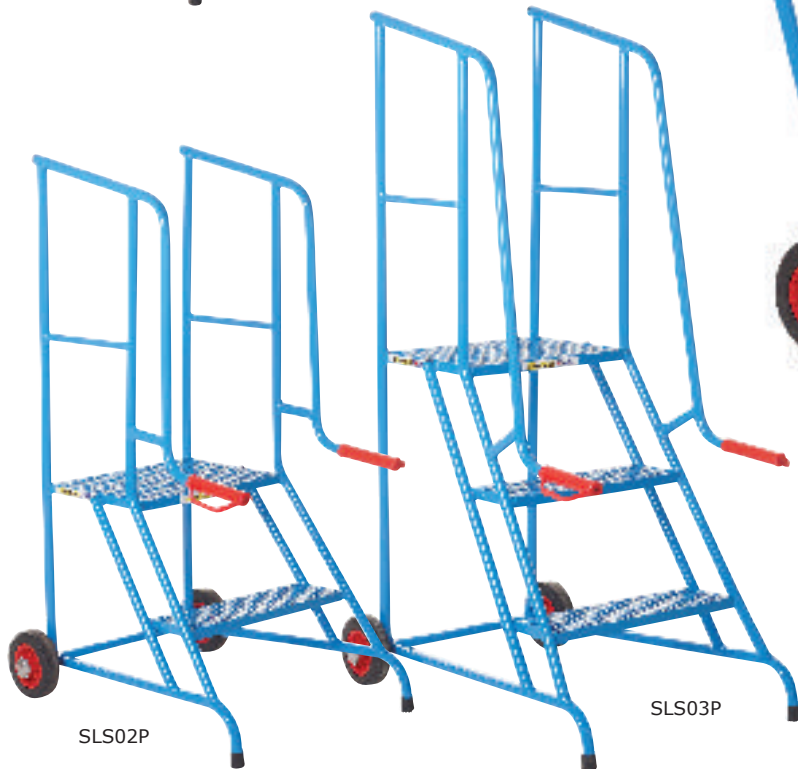

SLS02P

SLS03P



**Platform Size
400 x 550mm**

INFORMATION



The open back is ideal for stepping on & off vehicles & loading bays

No of Treads	Platform Height mm	Overall Size H x W x D mm	Powder Coated Blue		Galvanised	
			Model	Price	Model	Price
2	500	1200 x 610 x 685	SLS02P	£400.55	SLS02G	£523.40
3	750	1480 x 610 x 860	SLS03P	£447.85	SLS03G	£592.65
4	1000	1730 x 610 x 1020	SLS04P	£499.45	SLS04G	£664.85

Mobile, Safety, Warehouse Steps & Platforms



Wide Work Steps FROM STOCK

FROM ONLY
£196.60



- » Manufactured from powder coated anthracite grey, strong tubular steel with or without handrails
- » Chequer plate treads (250mm deep) & platform (300D x 550Wmm) ensure secure grip
- » Mobile on wheels for easy movement (except SWW02C)
- » The side handrail gives extra support when in use & is 700mm above the top platform

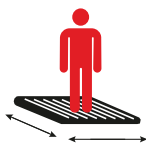

**Platform Size
300 x 550mm**

INFORMATION

Large width platforms & treads for extra support & safety



No of Treads	Platform Height mm	Overall Size H x W x D mm	No Handrails		1 Handrail		2 Handrails	
			Model	Price	Model	Price	Model	Price
2	400	400 x 770 x 700	SWW02C	£196.60	-	-	-	-
3	600	600 x 840 x 890	SWW03C	£382.70	SWW13C	£424.25	SWW23C	£465.80
4	800	800 x 870 x 1100	SWW04C	£485.15	SWW14C	£526.75	SWW24C	£568.30
5	1000	1000 x 880 x 1300	SWW05C	£571.90	SWW15C	£613.45	SWW25C	£655.05



Picking Steps

- » Manufactured from durable powder coated strong tubular steel
- » The 3 to 6 tread units are mobile on 75mm spring loaded castors that easily glide across floors & engage or disengage depending on whether or not weight is applied
- » The 7 & 8 tread models incorporate tilt & push handles which make these steps manoeuvrable
- » Punched steel treads (200D x 550Wmm) & platforms (400D x 550Wmm) ensure secure grip
- » Kick board to support the users safety
- » Box section base gives extra strength & stability

NEW

3 YR
GUARANTEE

150kg
evenly distributed

FROM ONLY
£528.25



AHPI07_BL

COLOUR OPTIONS

- Blue
- Grey

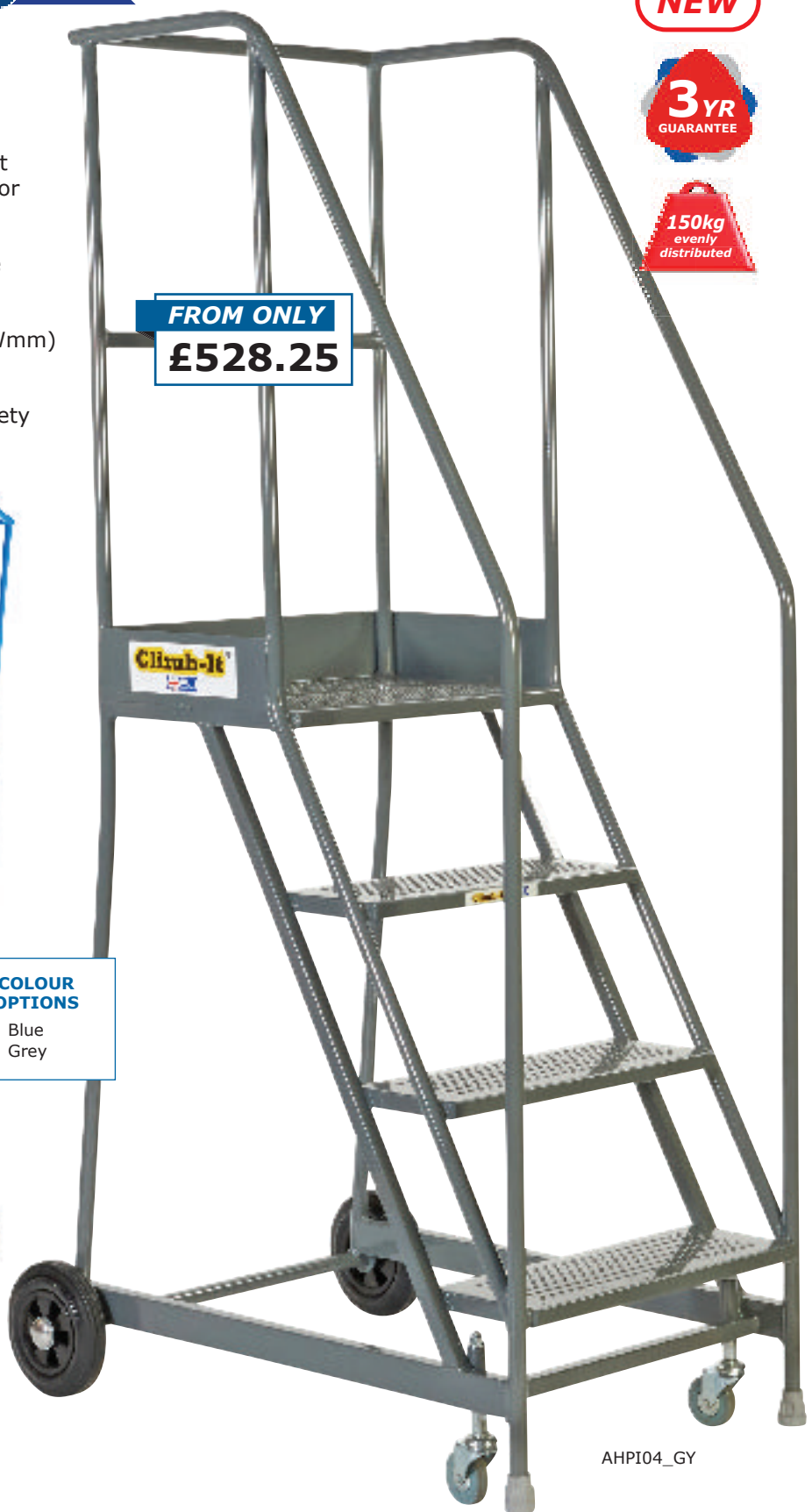

AHPI04_GY

Platform Size
400 x 550mm

Box Section Base

INFORMATION

Spring loaded steps (3 to 6 tread) or tilt & push handles (7 & 8 tread) make these units easily manoeuvrable

No of Treads	Platform Height mm	Overall Size H x W x D mm	Model Blue	Model Grey	Price
3	750	1705 x 745 x 840	AHPI03_BL	AHPI03_GY	£528.25
4	1000	1955 x 745 x 1080	AHPI04_BL	AHPI04_GY	£586.65
5	1250	2205 x 745 x 1187	AHPI05_BL	AHPI05_GY	£645.10
6	1500	2455 x 745 x 1478	AHPI06_BL	AHPI06_GY	£703.45
7	1750	2705 x 745 x 1652	AHPI07_BL	AHPI07_GY	£761.85
8	2000	2955 x 745 x 1822	AHPI08_BL	AHPI08_GY	£820.30

N.B - Unloading requirements may apply - please check when ordering

Mobile, Safety, Warehouse Steps & Platforms



Easy Climb Steps

- » Manufactured from durable powder coated strong tubular steel with a handlock mechanism which engages or disengages the front castors so the steps become mobile or static
 - » Punched steel treads (200D x 610Wmm) & platforms (600D x 610Wmm) ensure secure grip
 - » Kick board to support the users safety
 - » Box section base gives extra strength & stability
 - » Easy slope 50° angle enabling you to turn around & descend facing forwards



FROM ONLY
£681.30



AHEC05_GY

AHEC09_BL

NEW

3 YR
GUARANTEE

COLOUR
OPTIONS

- Blue
- Grey

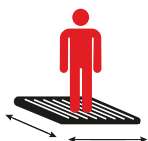

Platform Size
600 x 610mm



Box Section
Base



50° Easy
Slope



150kg
evenly
distributed

No of Treads	Platform Height mm	Overall Size H x W x D mm	Model Blue	Model Grey	Price
3	750	1705 x 800 x 1100	AHEC03_BL	AHEC03_GY	£681.30
4	1000	1955 x 800 x 1310	AHEC04_BL	AHEC04_GY	£730.80
5	1250	2205 x 800 x 1520	AHEC05_BL	AHEC05_GY	£780.25
6	1500	2455 x 800 x 1730	AHEC06_BL	AHEC06_GY	£829.70
7	1750	2705 x 800 x 1940	AHEC07_BL	AHEC07_GY	£879.20
8	2000	2955 x 900 x 2150	AHEC08_BL	AHEC08_GY	£928.70
9	2250	3205 x 950 x 2360	AHEC09_BL	AHEC09_GY	£978.15
10	2500	3455 x 1000 x 2570	AHEC10_BL	AHEC10_GY	£1027.60

INFORMATION



Easy slope 50° angle enables you to turn around & descend facing forwards



Warehouse Safety Steps

- » Manufactured from durable powder coated strong tubular steel with a handlock mechanism which engages or disengages the front castors so the steps become mobile or static
- » Punched steel treads (200D x 610Wmm) & platforms (600D x 610Wmm) ensure secure grip
- » Kick board to support the users safety
- » Box section base gives extra strength & stability

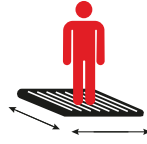

Large Platform
600 x 610mm



NEW



Box Section Base

COLOUR OPTIONS

- Blue
- Grey

FROM ONLY
£619.35



AHWS10_BL



AHWS05_GY

No of Treads	Platform Height mm	Overall Size H x W x D mm	Model Blue	Model Grey	Price
3	750	1705 x 800 x 1000	AHWS03_BL	AHWS03_GY	£619.35
4	1000	1955 x 800 x 1150	AHWS04_BL	AHWS04_GY	£674.40
5	1250	2205 x 800 x 1300	AHWS05_BL	AHWS05_GY	£729.35
6	1500	2455 x 800 x 1450	AHWS06_BL	AHWS06_GY	£784.30
7	1750	2705 x 800 x 1600	AHWS07_BL	AHWS07_GY	£839.25
8	2000	2955 x 900 x 1750	AHWS08_BL	AHWS08_GY	£950.10
9	2250	3205 x 950 x 1900	AHWS09_BL	AHWS09_GY	£1008.50
10	2500	3455 x 1000 x 2050	AHWS10_BL	AHWS10_GY	£1066.90
11	2750	3705 x 1050 x 2200	AHWS11_BL	AHWS11_GY	£1125.30
12	3000	3955 x 1100 x 2350	AHWS12_BL	AHWS12_GY	£1183.75
13	3250	4205 x 1100 x 2500	AHWS13_BL	AHWS13_GY	£1242.10
14	3500	4455 x 1100 x 2650	AHWS14_BL	AHWS14_GY	£1300.50
15	3750	4705 x 1100 x 2800	AHWS15_BL	AHWS15_GY	£1358.90

N.B - Unloading requirements may apply - please check when ordering

475

Mobile, Safety, Warehouse Steps & Platforms



Easy Slope Work Platforms



COLOUR OPTIONS

- Blue
- Grey

INFORMATION

Lift out handrails on 3 sides of the platform allow easy access to your work area

AHWPE1204_GY

- » Manufactured from durable powder coated strong tubular steel with a handlock mechanism which engages or disengages the front castors so the steps become mobile or static
- » Punched steel treads (730 x 195mm) & platforms (1200 or 1800mm) ensure secure grip
- » Easy slope 50° angle enabling you to turn around & descend facing forwards
- » Box section base gives extra strength & stability
- » Lift out handrails on 3 sides of the platform allow easy access to your work area
- » Load capacity of 300kg - can hold 2 people on the platform at one time



Box Section Base



50° Easy Slope

No of Treads	Platform Height mm	1200mm Platform Length				1800mm Platform Length			
		Size: H x W x D mm	Model - Blue	Model - Grey	Price	Size: H x W x D mm	Model - Blue	Model - Grey	Price
3	750	1705 x 920 x 1690	AHWPE1203_BL	AHWPE1203_GY	£1283.30	1705 x 920 x 2280	AHWPE1803_BL	AHWPE1803_GY	£1476.35
4	1000	1955 x 920 x 1900	AHWPE1204_BL	AHWPE1204_GY	£1348.85	1955 x 920 x 2490	AHWPE1804_BL	AHWPE1804_GY	£1541.90
5	1250	2205 x 920 x 2110	AHWPE1205_BL	AHWPE1205_GY	£1414.40	2205 x 920 x 2700	AHWPE1805_BL	AHWPE1805_GY	£1607.45
6	1500	2455 x 920 x 2320	AHWPE1206_BL	AHWPE1206_GY	£1479.90	2455 x 920 x 2910	AHWPE1806_BL	AHWPE1806_GY	£1673.00
7	1750	2705 x 920 x 2530	AHWPE1207_BL	AHWPE1207_GY	£1545.45	2705 x 920 x 3120	AHWPE1807_BL	AHWPE1807_GY	£1738.50
8	2000	2955 x 920 x 2740	AHWPE1208_BL	AHWPE1208_GY	£1611.05	2955 x 920 x 3330	AHWPE1808_BL	AHWPE1808_GY	£1804.10
9	2250	3205 x 920 x 2950	AHWPE1209_BL	AHWPE1209_GY	£1676.60	3205 x 920 x 3540	AHWPE1809_BL	AHWPE1809_GY	£1869.65
10	2500	3455 x 920 x 3160	AHWPE1210_BL	AHWPE1210_GY	£1742.10	3455 x 920 x 3750	AHWPE1810_BL	AHWPE1810_GY	£1935.20



Standard Slope Work Platforms

- » Manufactured from durable powder coated strong tubular steel with a handlock mechanism which engages or disengages the front castors so the steps become mobile or static
- » Punched steel treads (730 x 195mm) & platforms (1200 or 1800mm) ensure secure grip
- » Box section base gives extra strength & stability
- » Lift out handrails on 3 sides of the platform allow easy access to your work area
- » Load capacity of 300kg - can hold 2 people on the platform at one time



AHWPS1805_BL

COLOUR OPTIONS

- Blue
- Grey



Box Section Base

No of Treads	Platform Height mm	1200mm Platform Length				1800mm Platform Length			
		Size: H x W x D mm	Model - Blue	Model - Grey	Price	Size: H x W x D mm	Model - Blue	Model - Grey	Price
3	750	1705 x 920 x 1555	AHWPS1203_BL	AHWPS1203_GY	£1247.60	1705 x 920 x 2135	AHWPS1803_BL	AHWPS1803_GY	£1440.65
4	1000	1955 x 920 x 1715	AHWPS1204_BL	AHWPS1204_GY	£1313.15	1955 x 920 x 2285	AHWPS1804_BL	AHWPS1804_GY	£1506.20
5	1250	2205 x 920 x 1865	AHWPS1205_BL	AHWPS1205_GY	£1378.70	2205 x 920 x 2425	AHWPS1805_BL	AHWPS1805_GY	£1571.75
6	1500	2455 x 920 x 2015	AHWPS1206_BL	AHWPS1206_GY	£1444.20	2455 x 920 x 2585	AHWPS1806_BL	AHWPS1806_GY	£1637.30
7	1750	2705 x 920 x 2165	AHWPS1207_BL	AHWPS1207_GY	£1509.75	2705 x 920 x 2735	AHWPS1807_BL	AHWPS1807_GY	£1702.80
8	2000	2955 x 920 x 2315	AHWPS1208_BL	AHWPS1208_GY	£1575.30	2955 x 920 x 2885	AHWPS1808_BL	AHWPS1808_GY	£1768.35
9	2250	3205 x 950 x 2465	AHWPS1209_BL	AHWPS1209_GY	£1640.85	3205 x 950 x 3035	AHWPS1809_BL	AHWPS1809_GY	£1833.90
10	2500	3455 x 1000 x 2615	AHWPS1210_BL	AHWPS1210_GY	£1706.40	3455 x 1000 x 3185	AHWPS1810_BL	AHWPS1810_GY	£1899.50

N.B - Unloading requirements may apply - please check when ordering

Mobile, Safety, Warehouse Steps & Platforms

Climb-It



APJ04Z

INFORMATION
Insulated to 10,000 volts

Climb-It® Glass Fibre Leg Platform

- >> Certified to EN 14183
- >> Ideal for compact storage as the unit is lightweight & the legs fold neatly underneath the platform
- >> The large serrated platform gives an anti-slip work surface



Platform Size L x W x H mm	Folded Size L x W x H mm	Weight kg	Model	Price
600 x 600 x 470	700 x 600 x 210	8	APJ04Z	£133.45

Aluminium Platforms



ONLY
£95.00

APJ69Z

- >> Simple & safe to use with locking hinges for added safety
- >> Ideal for compact storage & transportation as the unit is lightweight & the legs fold neatly underneath the platform
- >> The serrated treads & platform help give an anti-slip work surface



Platform Size L x W x H mm	Folded Size L x W mm	Weight kg	Model	Price
690 x 300 x 500	790 x 390	4	APJ69Z	£95.00

Climb-It **UK**

Platform FROM STOCK

- >> Manufactured from strong tubular steel frame with a large 800 x 800mm platform
- >> Durable, anthracite grey, powder coated finish
- >> Non-slip chequer plate surface
- >> Adjustable feet accommodate uneven flooring by +/- 20mm
- >> Modular design allows the units to be bolted together to create a large working area

INFORMATION

Modular design allows the platforms to be bolted together to create a large working area



Large Platform 800 x 800mm



Non-slip chequer plate surface

2 x BWP25

Height adjustable feet



Platform Size L x W x H mm	Model	Price
800 x 800 x 250	BWP25	£534.50

Mobile, Safety, Warehouse Steps & Platforms

Climb-It® Folding Work Platforms

- » Aluminium folding work platform with a large, anti-slip, standing surface
- » Steel handrails either side of the platform for increased safety
- » Adjustable stabilisers allow the unit to be positioned close to a wall or working areas
- » Built-in inclined ladder
- » Easily folds for ease of movement. Will fit through doorways & narrow aisles
- » Complete with a built-in tool holder on the EP880Y
- » Mobile on 2 x 100mm nylon wheels
- » Platform suitable for 150kg

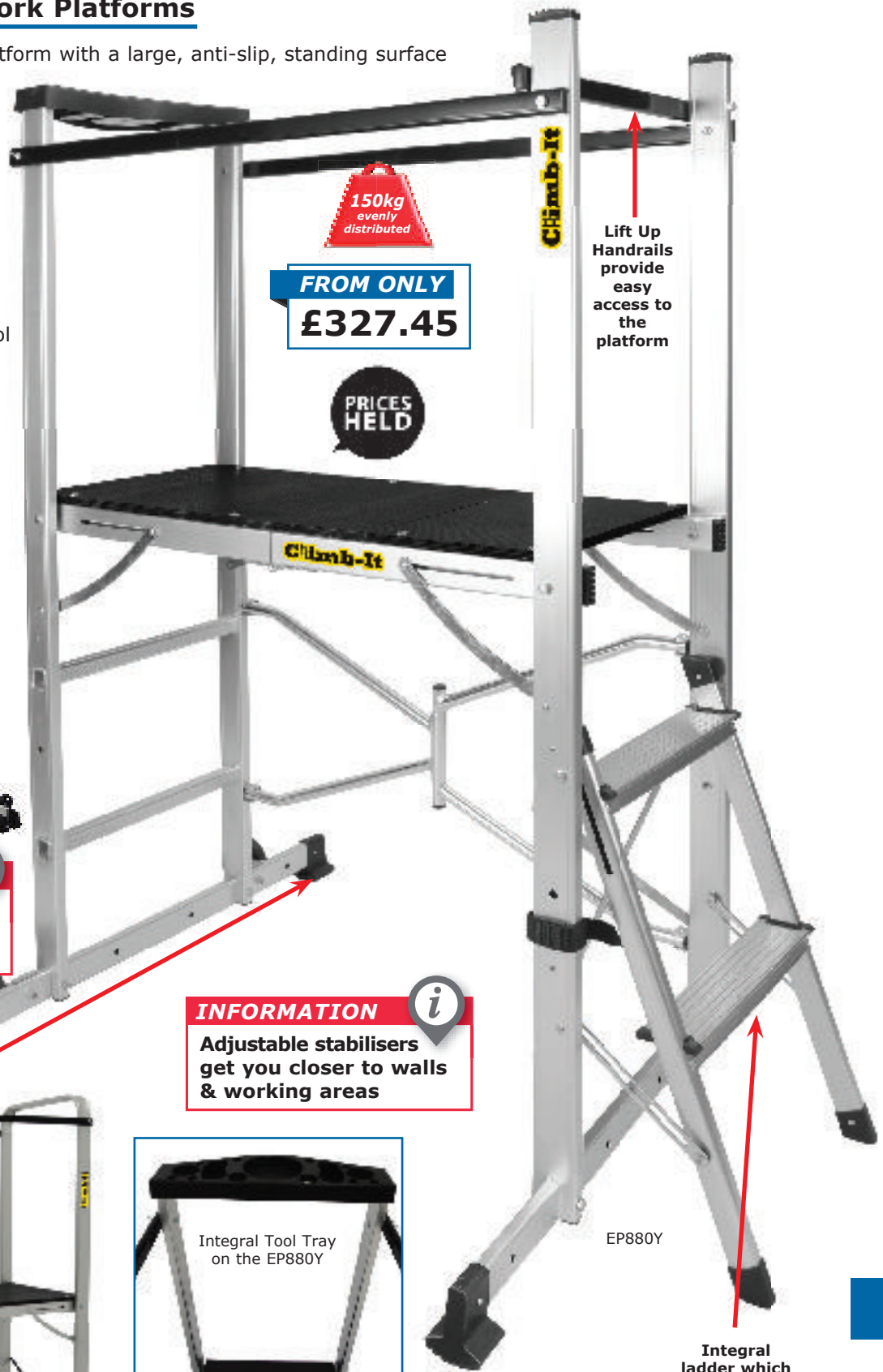

INFORMATION 
Folds to a compact size for easy storage & transportation

INFORMATION 
Adjustable stabilisers get you closer to walls & working areas



EP880Y

Integral ladder which easily folds in & out of the Work Platform



EP990Y



No of Treads	Platform Height mm	Platform Size W x D mm	Overall Size H x W x D mm	Overall Size Folded H x W x D mm	Weight kg	Model	Price
2	880	980 x 400	1550 x 930 x 1140	1550 x 930 x 180	14	EP880Y	£327.45
3	994	1205 x 545	1860 x 1077 x 1360	1860 x 1077 x 180	19	EP990Y	£374.15

Mobile, Safety, Warehouse Steps & Platforms



Climb-It® Deck

- » Integrated gate locking hook
- » Constructed from a heavy-duty aluminium frame with a Patent-pending "Super Knuckle" joint system
- » Adjustable legs offering three operational platform heights of 550mm, 630mm & 700mm
- » Three working heights of 2550, 2630 & 2700mm with guardrails that erect at correct height
- » Non-slip, high grip rubber feet & a Phenyl mesh coated Class 3 marine plywood deck
- » Compact, lightweight folded footprint of 1100mm x 660mm

Climb-It®



Length mm	Width mm	Working Height mm	Weight kg	Model	Price
1730	700	2550 to 2700	25	PD1166	£687.50

Podium Steps



FROM ONLY £819.20



INFORMATION
Certified to PAS 250

- » Certified to PAS 250
- » Only 2 removable parts: platform deck & access ladder
- » Saloon gates for easy access & exit from the platform
- » 1000mm all round guardrail system with non-slip platform

- » Mobile on 2 x swivel braked castors
- » Folds & unfolds in seconds
- » Fits through standard doorways
- » Platform size: 670 x 670mm

Open Height mm	Platform Height mm	Working Height mm	Overall Width mm	Weight kg	Model	Price
2010	752 & 975	2710 to 2960	670	37	PODX0752	£819.20
2260	975 & 1225	2910 to 3160	670	40	PODX0975	£869.65
2510	1225 & 1475	3225 to 3475	670	43	PODX1225	£951.95

Climb-It® Telescopic Work Platform

- » **Certified to EN 131 Professional**
- » Large 550 x 1550mm anti slip plywood platform
- » This unit is telescopic, enabling the height of the platform to be increased from 690 to 970mm
- » Strong aluminium treads with a non-slip surface
- » Easy to manoeuvre on 2 wheels

CAP903

£790.80



CAP903

Climb-It®



No. of Treads	Unextended Platform Height mm	Extended Platform Height mm	Open Size H x W x D mm	Weight kg	Model	Price
3 + 1	690	970	2070 x 1200 x 350	41.8	CAP903	£790.80

Mobile, Safety, Warehouse Steps & Platforms



Single Platforms FROM STOCK

- » Manufactured from strong tubular steel frame with large 800 x 800mm platforms
- » Durable, anthracite grey, powder coated finish
- » Non-slip chequer plate surface
- » Adjustable feet accommodate uneven flooring by +/- 20mm
- » Modular design - simply bolt the platforms together

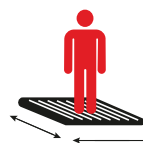

Large Platform
800 x 800mm

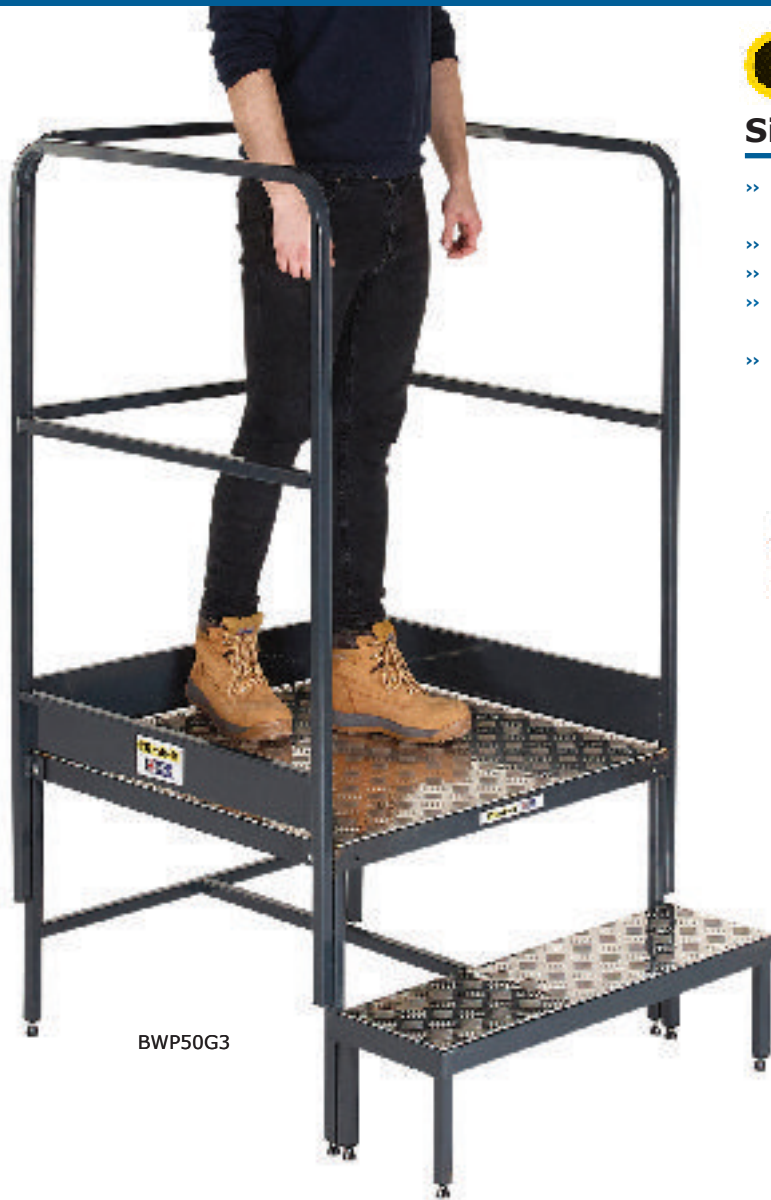

BWP50G3



BWP50G2

INFORMATION



Large platforms allow for easy user movement for a variety of tasks

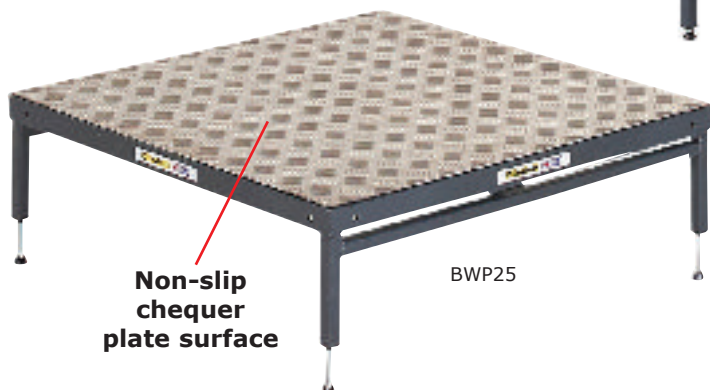

Non-slip chequer plate surface

BWP25

Platform Height mm	No of Treads	No of Handrails	Model	Price
250	-	-	BWP25	£534.50
500	1	2	BWP50G2	£1286.15
500	1	3	BWP50G3	£1509.25
750	2	2	BWP75G2	£1550.50
750	2	3	BWP75G3	£1773.65
1000	3	2	BWP100G2	£1726.75
1000	3	3	BWP100G3	£1949.90

Climb-It
Platforms

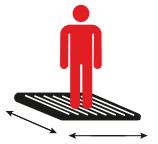

Large Platform
1600 x 800mm

FROM STOCK



INFORMATION

Non-slip chequer plate surface



BWP75X2G5



BWP50X2G3

Two Inline Platforms



- » Manufactured from strong tubular steel frame with 2 x large 800 x 800mm platforms
- » Durable, anthracite grey, powder coated finish
- » Non-slip chequer plate surface
- » Adjustable feet accommodate uneven flooring by +/- 20mm
- » Modular design - simply bolt the platforms together

Platform Height mm	No of Treads	No of Handrails	Model	Price
250	-	-	BWP25X2	£1003.00
500	1	3	BWP50X2G3	£2036.15
500	1	5	BWP50X2G5	£2482.40
750	2	3	BWP75X2G3	£2424.15
750	2	5	BWP75X2G5	£2870.40
1000	3	3	BWP100X2G3	£2634.15
1000	3	5	BWP100X2G5	£3080.40

Mobile, Safety, Warehouse Steps & Platforms



BWP75X3G4



BWP75X4G9

Three Inline Platforms

Platform Height mm	No of Treads	No of Handrails	Model	Price
250	-	-	BWP25X3	£1460.50
500	1	4	BWP50X3G4	£2874.15
500	1	7	BWP50X3G7	£3543.50
750	2	4	BWP75X3G4	£3209.75
750	2	7	BWP75X3G7	£3879.15
1000	3	4	BWP100X3G4	£3453.50
1000	3	7	BWP100X3G7	£4122.90

Four Inline Platforms

Platform Height mm	No of Treads	No of Handrails	Model	Price
250	-	-	BWP25X4	£2006.00
500	1	5	BWP50X4G5	£3624.15
500	1	9	BWP50X4G9	£4516.65
750	2	5	BWP75X4G5	£4083.40
750	2	9	BWP75X4G9	£4975.90
1000	3	5	BWP100X4G5	£4360.90
1000	3	9	BWP100X4G9	£5253.40



BWP75X3CRG5



Three Platforms (2x1) Corner

*Handrails cannot be fitted to both sides of an inside corner

Platform Height mm	No of Treads	No of Handrails	Model	Price
250	-	-	BWP25X3CR	£1460.50
500	1	5	BWP50X3CRG5	£3097.25
500	1	6	BWP50X3CRG6	£3320.40
750	2	5	BWP75X3CRG5	£3432.90
750	2	6	BWP75X3CRG6	£3656.00
1000	3	5	BWP100X3CRG5	£3676.65
1000	3	6	BWP100X3CRG6	£3899.75

Four Platforms (3x1) Corner

*Handrails cannot be fitted to both sides of an inside corner

Platform Height mm	No of Treads	No of Handrails	Model	Price
250	-	-	BWP25X4CR	£2006.00
500	1	6	BWP50X4CRG6	£3847.25
500	1	8	BWP50X4CRG8	£4293.50
750	2	6	BWP75X4CRG6	£4306.50
750	2	8	BWP75X4CRG8	£4752.75
1000	3	6	BWP100X4CRG6	£4584.00
1000	3	8	BWP100X4CRG8	£5030.25



BWP75X4SQG6

INFORMATION



Modular design allows the platforms to be placed alongside each other to create a large working area

Four Platforms (2x2) Square

Platform Height mm	No of Treads	No of Handrails	Model	Price
250	-	-	BWP25X4SQ	£2006.00
500	2 x 1	4	BWP50X4SQG4	£3626.00
500	2 x 1	6	BWP50X4SQG6	£4072.25
750	2 x 2	4	BWP75X4SQG4	£4314.00
750	2 x 2	6	BWP75X4SQG6	£4760.25
1000	2 x 3	4	BWP100X4SQG4	£4734.00
1000	2 x 3	6	BWP100X4SQG6	£5180.25

Climb-It 
Platforms FROM STOCK

3 YR
GUARANTEE

3 day
delivery

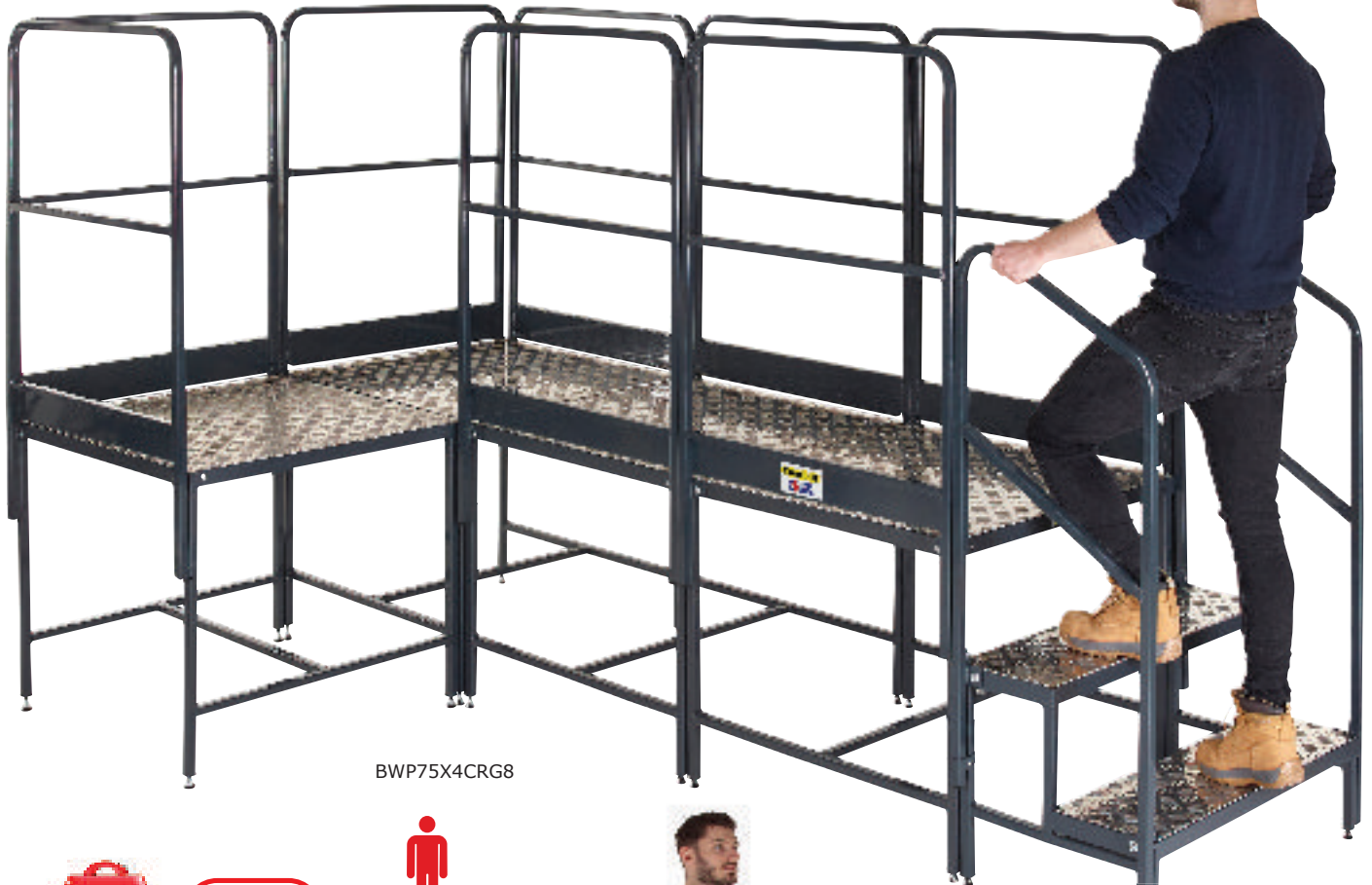

BWP75X4CRG8

150kg
per platform
evenly
distributed

NEW

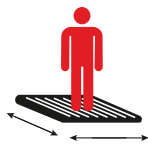

**Large Platform
Modules of
800 x 800mm**

INFORMATION

**Non-slip chequer
plate surface**

- » Manufactured from strong tubular steel frame with large 800 x 800mm platforms
- » Durable, anthracite grey, powder coated finish
- » Non-slip chequer plate surface
- » Adjustable feet accommodate uneven flooring
- » Modular design - simply bolt the platforms together



BWP75X3G7

INFORMATION

**Large platforms
allow for easy user
movement for a variety
of tasks**

INFORMATION

**NOT FOUND WHAT
YOU ARE LOOKING FOR?
Make up your own
system - please call
for details**

Mobile, Safety, Warehouse Steps & Platforms

Sky-High Tower

- >> Certified to BSEN1004:2004 & 3T compatible
- >> Quick release pull rings with stainless steel pin on bracings for quick & easy assembly - saving time on each job



INFORMATION

Meets all your requirements of the working at height regulations



Description	Base Unit - 1800mm Wide				Base Unit - 2500mm Wide			
	850mm Deep		1450mm Deep		850mm Deep		1450mm Deep	
	Model	Price	Model	Price	Model	Price	Model	Price
System to 2.2M Platform Height	TBL180822	£1971.45	TBL181422	£2514.30	TBL250822	£2228.60	TBL251422	£2961.95
System to 2.7M Platform Height	TBL180827	£2104.80	TBL181427	£2657.15	TBL250827	£2371.45	TBL251427	£3114.30
System to 3.2M Platform Height	TBL180832	£2542.90	TBL181432	£3104.80	TBL250832	£2914.30	TBL251432	£3657.15
System to 3.7M Platform Height	TBL180837	£2742.90	TBL181437	£3314.30	TBL250837	£3123.85	TBL251437	£3885.75
System to 4.2M Platform Height	TBL180842	£2800.00	TBL181442	£3381.00	TBL250842	£3181.00	TBL251442	£3942.90
System to 4.7M Platform Height	TBL180847	£3552.40	TBL181447	£4152.40	TBL250847	£3923.85	TBL251447	£4581.00
System to 5.2M Platform Height	TBL180852	£3609.55	TBL181452	£4219.05	TBL250852	£3981.00	TBL251452	£4638.10
System to 5.7M Platform Height	TBL180857	£3809.55	TBL181457	£4428.60	TBL250857	£4190.50	TBL251457	£4866.70
System to 6.2M Platform Height	TBL180862	£3866.70	TBL181462	£4495.25	TBL250862	£4247.65	TBL251462	£4923.85
System to 6.7M Platform Height	TBL180867	£4695.25	TBL181467	£5142.90	TBL250867	£5161.95	TBL251467	£5685.75
System to 7.2M Platform Height	TBL180872	£4742.90	TBL181472	£5504.80	TBL250872	£5219.05	TBL251472	£6047.65
System to 7.7M Platform Height	TBL180877	£4942.90	TBL181477	£5723.85	TBL250877	£5428.60	TBL251477	£6266.70
System to 8.2M Platform Height	TBL180882	£5000.00	TBL181482	£5781.00	TBL250882	£5485.75	TBL251482	£6333.35

Alpine Tower

- » Certified to BSEN1004:2004 & 3T compatible
- » Base size: 730D x 1800Wmm
- » Quick & easy to erect - saving time on each job
- » Fits easily into most small vans or estate cars
- » Narrow width - compact & easy storage
- » Quick release pull rings with stainless steel pin on bracings for easy assembly



AP0600Z



INFORMATION



Fits through doors & easily into car boots



AP6100Z

Description	Model	Price
System to 0.6M Platform Height	AP0600Z	£685.75
System to 1.6M Platform Height	AP1600Z	£1257.15
System to 2.1M Platform Height	AP2100Z	£1666.70
System to 3.1M Platform Height	AP3100Z	£2238.10
System to 3.6M Platform Height	AP3600Z	£2285.75
System to 4.6M Platform Height	AP4600Z	£2714.30
System to 5.1M Platform Height	AP5100Z	£2761.95
System to 6.1M Platform Height	AP6100Z	£3238.10

Mobile, Safety, Warehouse Steps & Platforms

Order Picking Machines & Access Platforms

- » High quality construction
- » Self-Propelled machines that can be driven at height
- » Electrically controlled picking platform with a capacity of up to 100kg
- » 12v 105Ah batteries with 110v-220v built in charger
- » Very tight turning radius
- » Can be used as picking platforms & for maintenance work
- » Single Joystick control along with an adjustable speed control allow for easy & precise manoeuvrability in the tightest of spaces



INFORMATION

On site demos available - please call for details

INFORMATION

Prices on application - call for your special prices



Picking/Working Height mm	Picking Tray Capacity kg	Base Size L x W mm	Weight kg	Model
Access Platforms - without Picking Tray				
4000	-	1000 x 715	265	Elevah 40 Move
5000	-	980 x 700	580	Elevah 5 Move
6000	-	1100 x 780	660	Elevah 6 Move
6500	-	1280 x 780	680	Elevah 65 Move
8000	-	1280 x 780	750	Elevah 80 Move
Access Platforms - with Picking Tray				
4000	100	1000 x 715	365	Elevah 40 MP
5000	100	1150 x 700	640	Elevah 5 MP
6000	100	1100 x 780	705	Elevah 6 MP
6500	100	1280 x 780	830	Elevah 65 MP
8000	100	1780 x 780	960	Elevah 80 MP

Mobile, Safety, Warehouse Steps & Platforms

Fork Lift Cages

- » Robust fully welded construction
- » Complies with Health & Safety guidance note PM28 - 4th Edition. Units are supplied with a user guide
- » Fits quickly & easily to the majority of fork lifts
- » Safety gate opens inwards, closing automatically through the use of a tension spring loaded retention latch
- » Non-slip floor plate with a high kick plate
- » Various safety features including:
 - » Internal grab rail
 - » Safety harness anchor point
 - » Drivers warning plate
 - » High visibility yellow finish

Economy Range

- » Front opening gate
- » Full height mesh rear guard

Standard Range

- » Front opening gate
- » Mesh back & half sides

Heavy Duty Range

- » Side opening gate
- » Large tool container



INFORMATION



Safe & stable access at high levels



FLC08Z

FORK POCKET FOR ECONOMY RANGE

Simply lift the bar on the side of the cage once the fork has been entered. The brace at the rear of the mechanism will then swing, fitting neatly behind the heel of the fork tines, securing the cage to the fork lift



FLC04Z



FLC03Z



FLC02Z



FLC01Z shown with FLC09Z

Load Capacity	Platform Size W x D mm	Overall Height mm	Wheels	Weight kg	Model	Price
Economy Range						
250 kg	1000 x 1000	1900	-	70	FLC08Z	£1481.55
Standard Range						
250 kg	990 x 990	1780	-	70	FLC01Z	£2013.15
		1830	4 Swivel 125mm Nylon	74	FLC11Y	£2081.40
Optional Tool Box - fitted with 2 hooks to hook onto the cage				3	FLC09Z	£169.40
Heavy Duty Range						
300 kg	1260 x 800	1985	-	120	FLC02Z	£2153.65
		2110	4 Swivel 125mm Nylon	120	FLC12Y	£2319.05
		1985	-	125	FLC03Z	£2301.15
		2110	4 Swivel 125mm Nylon	125	FLC13Y	£2434.55
		2100	-	132	FLC04Z	£2386.50
		2225	4 Swivel 125mm Nylon	132	FLC14Y	£2518.10

FORK POCKET FOR THE STANDARD & HEAVY DUTY

184W x 83Dmm with inside clearance of 545mm & overall clearance of 921mm

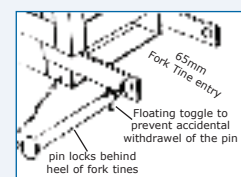

NOTE:

Fork pocket specifications can be altered to meet your requirements. Please specify when ordering

First Aid, Hygiene & Janitorial Equipment



HSE First Aid Kits



BS First Aid Kits

Description	HSE First Aid Kit		BS First Aid Kit	
	Model	Price	Model	Price
Small	10E	£8.95	S9	£14.95
Medium	20E	£12.95	M9	£22.95
Large	50E	£17.95	L9	£28.95

First Aid Kits

- » Either HSE or BS 8599-1:2019 compliant first aid kits to suit home & workplace needs
- » The kits provide you with components & contents which can assist in providing adequate first aid provision based upon each company's risk assessment
- » Durable & robust plastic cases, available in 3 sizes



Description	HSE Small	HSE Medium	HSE Large	BS Small	BS Medium	BS Large
Guidance Leaflet & Instructions	1	1	1	1	1	1
Medium Sterile Dressing - 120 x 120mm	6	9	12	2	4	6
Large Sterile Dressing - 180 x 180mm	2	3	4	2	3	4
Triangular Bandage - 900 x 900 x 1270mm	4	6	8	2	3	4
Safety Pins (pack of 6)	1	2	2			
Eye Pad Sterile Dressing	2	4	6	2	3	4
Washproof Plasters (pack of 20)	1	2	3	2	3	5
Microporous Tape - 250mm x 5M	-	-	-	1	2	3
Nitrile powder-free Disposable Gloves (pair)	1	2	3	6	9	12
Cleansing Wipes	6	10	20	20	30	40
Finger Dressing - 350 x 350mm	-	-	-	2	3	4
Revive Aid (Resuscitation Device)	-	-	-	1	1	2
Thermal Blanket	-	-	-	1	2	3
Burn Dressing - 100 x 100mm	-	-	-	1	2	2
Tuff-Kut Scissors	-	-	-	1	1	1
Conforming Bandage - 750mm x 4.5M	-	-	-	1	2	2

Burns Kit

- » This Burns Kit is effective for use at work or home & provides effective relief from a variety of burns including scalds & sunburn
- » An essential requirement within the workplace, particularly where the risk of getting burn related injuries is higher
- » Includes; 1 of 20 x 20cm & 2 of 10 x 10cm burns dressing, 2 of 10 x 10cm & 1 of 10 x 20cm low adherent dressing, 8 x burn gel sachets, 8 x 20ml eye wash pods, crepe bandage (10cm x 4.5M), 2 x conforming bandage (7.5cm x 4.5M), 2 pairs of gloves, 1 x microporous tape (2.5cm x 5M) & scissors



Model	Price
90816	£13.95



Vehicle First Aid Kit

- » This robust first aid kit is designed with the user in mind, containing essential equipment in case of emergency. This motorist kit is ideal for use in domestic vehicles as well as company cars.
- » Includes; pack of 6 safety pins, clinical waste bag (203 x 354mm), assorted washproof plasters (bag of 20), 10 x sterile saline wipes, thermal blanket (204 x 140cm), large flow wrapped dressing (18 x 18cm), 3 of medium flow wrapped dressing (12 x 12cm), triangular bandage (90 x 90 x 127cm), pair of gloves, revive aid resuscitation device, conforming bandage (7.5cm x 4.5M) & scissors



Model	Price
8084B	£8.95

Ice Pack & Hot/Cold Pack

- » Provides on-the-spot cold therapy for bruising, sprains and muscle injuries



Description	Pack Size	Size	Model	Price
Ice Pack	10	190 x 130	9987	£4.56
Reusable Cold & Hot Pack	10	260 x 135	30REUHC1	£17.06



Defibrillators

- >> Reliable, durable & easy to use
- >> Dustproof & waterproof resistance IP rate 56
- >> It can be easily operated by anyone in the medical field (e.g. ambulance, emergency room, etc.) & non-medical field too (e.g. public or private places)
- >> It allows to deliver one or more de-fibrillating shocks on adult or paediatric patients affected by ventricular fibrillation or ventricular tachycardia, by means of a thorax impedance-compensated, biphasic truncated exponential discharge (BTE).
- >> The semi automatic model analyses the patient's ECG & if a shockable rhythm is detected it automatically starts charging the reservoir capacitor. The AED vocal message will suggest the operator to press the shock button to deliver the de-fibrillating shock
- >> The fully automatic model will, if a shockable rhythm is detected, warn the user of the imminent shock delivery & after 5 seconds the de-fibrillating shock will be released automatically; the CPR phase will follow



Description	Model	Price
Semi automatic Defibrillator	SM1B1001	£1075.00
Fully automatic Defibrillator	SM1B1002	£1150.00

Eye Wash Solution

- >> Sterile, single use emergency eye wash solution for ocular, topical irrigation & wound cleansing. Ready to use, twist off top for ease of use

Description	Pack Size	Model	Price
20ml Eye Wash Pods	25	7912	£4.95
500ml Eye Wash Solution	10	2143	£14.95



Eye Wash Pod Station

- >> Designed to hold 20ml sterile eyewash pods. There is a mirror to provide assistance when irrigating the eye & the instructions for use provide a quick reference point for using the sterile eyewash. Easily wall mountable, it provides a fixed location for the provision of eye care within a workplace

Model	Price
81103	£5.95



Sharps Disposal Pack

- >> Our standard sharps pack provides the basic utensils for dealing with used needles, syringes & blades in a safe & efficient way
- >> Includes; instructions, 1 pair of gloves, 1 disinfectant wipe, 1 sharps disposal container (0.5L), 1 x biohazard bag & 1 x plastic tweezers



Size H x W x D mm	Model	Price
260 x 164 x 45	51060	£5.95

Lower value orders may incur carriage costs - please call for details

First Aid, Hygiene & Janitorial Equipment



CLD163U



CLD1634

Utility Cupboards

- » Made from high quality plastic
- » Anti-wear steel hinges that provide a snap closure
- » Hygienic - easy to clean
- » Compact cupboards - feature 1 shelf
- » Large cupboards - features 3 shelves
- » Utility cupboards - features 3 half shelves

**FROM ONLY
£101.35**



CLD163T

Doors	Overall Size H x W x D mm	Model	Price
Compact Cupboard - 1 Shelf			
Double	840 x 680 x 370	CLD084D	£101.35
Triple	840 x 1020 x 370	CLT084T	£151.30
Large Cupboard - 3 Shelves			
Double	1630 x 680 x 370	CLD1634	£171.25
Triple	1630 x 1020 x 370	CLD163T	£246.85
Utility Cupboard - 3 ½ Shelves			
Double	1630 x 680 x 370	CLD163U	£171.25

FACS189046



FACS079046



FACS094646



FACS099046

First Aid Cupboards

- » Strong construction provides all round robustness
- » 'No snag' handles with 2-point locking
- » Adjustable spill-retaining galvanised shelves for superior spill management. Integral liquid-tight sump encourages the correct handling of spills through the use of absorbents (except the Wall Cupboard)
 - » White powder coated finish with identification symbol signs/labels
 - » Powder coated with Germ Guard Active Technology anti-bacterial paint
 - » Wall cupboards are pre-drilled for mounting (fixings not supplied)
 - » Stands raise cupboards by 500mm & they incorporate an adjustable foot for uneven surfaces
 - » Reaction to Fire Classification EN 13501-1

FACS073530



FACW578525

Static Cupboards

Overall Size H x W x D mm	No of Shelves	Model	Price
700 x 350 x 300	1	FACS073530	£227.75
700 x 900 x 460	1	FACS079046	£318.55
900 x 460 x 460	1	FACS094646	£271.20
900 x 900 x 460	1	FACS099046	£347.50
1800 x 900 x 460	3	FACS189046	£525.10

Mobile Cupboards

Overall Size H x W x D mm	No of Shelves	Model	Price
840 x 900 x 460	1	FACM089046	£515.90
1040 x 900 x 460	1	FACM109046	£522.50

Wall Cupboards

Overall Size H x W x D mm	No of Shelves	Model	Price
570 x 850 x 255	1	FACW578525	£301.45

Extra Shelves

To Fit W x D mm	Model	Price
350 x 300	FACES3530	£31.60
460 x 460	FACES4646	£38.20
900 x 460	FACES9046	£50.00

Stands (height of 543mm)

To Fit W x D mm	Model	Price
350 x 300	FACST3530	£133.05
460 x 460	FACST4646	£138.30
900 x 460	FACST9046	£160.65

Janitorial Cleaning Trolley

- » Manufactured from durable plastic
- » Mobile on 2 x 200mm wheels at the back & 2 x 75mm swivel castors at the front
- » Complete with a removable, strong PVC sack
- » Shelf heights of 580 & 970mm



HI328Y Bag Lid

FROM ONLY
£112.60

LOWER PRICES



HI308Y

Description	Overall Size L x W x H mm	Weight kg	Model	Price
Janitorial Trolley	1140 x 500 x 972	9	HI308Y	£112.60
Janitorial Trolley with Bag Lid		10	HI328Y	£117.65

'ProPlaz®' Plus Shelf Trolleys

ProPlaz®
Plus

- » High quality hardwearing black plastic shelves with grey aluminium uprights
- » Ideal for healthcare environments
- » Lightweight & easy to clean
- » Mobile on 4 x 100mm swivel castors (2 with brakes)
- » Tray depth of 100mm
- » HIT32Y - comes complete with buckets which attach to the top shelf. Bucket sizes are: 200H x 350W x 240D mm & 470H x 350W x 240D mm



HIT32Y



LOWER PRICES



HIT31Y



HIT29Y

Description	Overall Size L x W x H mm	Size between Shelves Top / Bottom mm	Weight kg	Model	Price
2 Tray Trolley	870 x 490 x 990	553	10.5	HIT29Y	£155.05
3 Tray Trolley	870 x 490 x 1050	275 / 275	11.5	HIT31Y	£190.60
3 Shelf (Top Flat Shelf & 2 Storage Trays)	1100 x 490 x 1030	275 / 275	13.5	HIT32Y	£221.60

First Aid, Hygiene & Janitorial Equipment

Collector Trolley

- » Mobile on 4 x swivel castors - 2 with brakes
- » Complete with 3 x 30L plastic containers & 2 x 14L bins, all removable
- » 2 x 14L bins are suitable for light duty use (recommended maximum capacity of 5kg per bin)



GIC816



Overall Size L x W x H mm	Weight kg	Model	Price
776 x 455 x 925	15	GIC816	£179.25

Shelf Trolley

- » Clearance between shelves: 280mm
- » Complete with aluminium uprights
- » 25mm lip on 3 sides & a 5mm rim on 1 side
- » Mobile on 4 swivel 75mm 'quietcastors'



HI424Y

Overall Size L x W x H mm	Weight kg	Model	Price
850 x 420 x 910	8	HI424Y	£134.40

Deep Tray Trolleys

- » 70mm deep trays
- » Strong polyethylene moulded trolleys
- » Non-conductive & resistant to most substances
- » GI627L - clearance between shelves: 660mm
- » GI637L - clearance between shelves: 305mm
- » Mobile on 4 swivel 100mm castors, 2 with brakes



GI637L

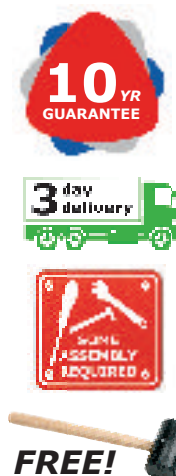

Description	Overall Size L x W x H mm	Weight kg	Model	Price
2 Tray Unit	610 x 460 x 980	10.5	GI627L	£192.80
3 Tray Unit	610 x 460 x 1000	14	GI637L	£248.35

Grey Shelf Trolley

- » Super strong polyethylene moulded trolleys
- » Will not rust, dent or chip - easy to clean
- » These easy to manoeuvre units are ideal for use in healthcare applications such as hospitals & surgeries
- » Mobile on 4 x 100mm swivel castors, 2 with brakes



GI541L

No of Shelves	Overall Size L x W x H mm	Clearance Between Shelves	Wt kg	Model	Price
3	610 x 458 x 840	305mm	11	GI541L	£205.80

PRICES HELD

PRICE HELD

ProPlaz
SUPER-STRENGTH

Folding Laundry Trolley

- » Strong plastic frame & removable PVC sack
- » Base frame to support the sack
- » Mobile on 4 x 75mm swivel rubber castors



Overall Size L x W x H mm	Weight kg	Model	Price
710 x 660 x 950	9	HI513Y	£130.05

Laundry Trolleys

- » Chrome plated steel tubular frame with a strong, removable canvas sack (base frame for support)
- » HI552Y canvas sack includes a drawstring - ideal for transportation
- » Mobile on 4 x 75mm swivel non-marking rubber castors
- » Model HI552Y folds for compact storage



Description	Overall Size L x W x H mm	Folded Size H x W x D mm	Weight kg	Model	Price
Rectangular Model	920 x 560 x 880	-	14	HI551Y	£169.05
Folding X Type Model	685 x 590 x 1030	1200 x 590 x 380	9	HI552Y	£140.65

First Aid, Hygiene & Janitorial Equipment

Wet & Dry Vacuum Cleaners



- >> Designed to pick up large quantities of wet or dry dirt
- >> All accessories/power cables are accommodated on the unit
- >> The ergonomically designed carrying handle makes the unit easy & convenient to transport & the tough, impact resistant plastic tub is designed to withstand the demands of professional cleaning tasks
- >> Includes; 2.5M suction hose with bend
 - 2 piece metal suction tube (500mm)
 - 1 piece paper filter bag
 - Crevice nozzle
 - 14285090 - wet & dry floor tool of 300mm
 - 14286220 - wet & dry floor tool of 400mm

Container Capacity L	Size L x W x H mm	Air Flow L/S	Vacuum (mbar / kPa)	Model	Price
27	420 x 420 x 525	72	249 / 24.9	14285090	£227.41
48	490 x 390 x 780	67	200 / 20	14286220	£294.11

Professional Wet & Dry Vacuum Cleaner

- > Tough, high capacity vacuum cleaner designed for demanding professional use. With 70 litre container capacity, tough construction & high manoeuvrability, this unit is equally suited to use in workshops, manufacturing & industrial tasks
- >> The machine's two independently-switched motors ensure high suction power when required & economy with reduced noise when only one motor is needed
- >> Includes; 4M suction hose with bend
 - 2 piece metal suction tube (500mm)
 - 1 piece paper filter bag
 - Crevice nozzle
 - Wet & dry floor tool of 400mm



Container Capacity L	Size L x W x H mm	Air Flow L/S	Vacuum (mbar / kPa)	Model	Price
70	720 x 510 x 975	2 x 74	254 / 25.4	16672770	£633.04

Spray Extraction Cleaner

- >> Deep cleans carpets & upholstery leaving only minimal residual moisture, reducing the risk of resoiling & enabling cleaned areas to be used again very quickly
- >> Includes; upholstery nozzle
- 2.5M spray suction hose with D handle



Tank L Fresh / Dirty	Size L x W x H mm	Model	Price
10 / 9	705 x 320 x 435	11001320	£730.35

Professional Spray Extraction Cleaner

- >> Leaves only 9% residual moisture so carpets & upholstery are left almost completely dry
- >> Designed to withstand the demands of professional cleaning tasks
- >> Includes; spray/suction gun, 4M spray suction hose with D handle & 350mm floor tool



Tank L Fresh / Dirty	Size L x W x H mm	Model	Price
30 / 15	590 x 470 x 783	11011230	£2086.08

Push Sweeper

- » Push sweeper which sweeps 7 x faster than a conventional broom
- » Reduces dust whilst in use & guarantees consistent, thorough results
- » Complete with adjustable side brush for cleaning right up to kerb edges
- » Ideal for cleaning paths, halls & warehouses quickly & efficiently
- » Folds flat for easy storage



INFORMATION



Clean right up to kerb edges with the adjustable side brush

NEW



Container Capacity L	Size L x W x H mm	Working Width mm	Model	Price
42	1300 x 810 x 1040	480	15171510	£459.20

Push Sweeper

- » Push sweeper which sweeps 7 x faster than a conventional broom
- » Complete with fine dust filters this unit massively reduces dust whilst in use & guarantees consistent, thorough results
- » Complete with adjustable side brush for cleaning right up to kerb edges
- » Ideal for cleaning paths, halls & warehouses quickly & efficiently
- » Folds flat for easy storage

INFORMATION



Complete with fine dust filters for a better cleaning outcome

NEW



Container Capacity L	Size L x W x H mm	Working Width mm	Model	Price
42	1300 x 765 x 1035	480	15171060	£651.63

Electric Sweeper

- » Electrically powered main roller brush & side brush to make pushing easier & increase productivity
- » Features an integrated extraction system for dust free applications
- » Both main and side brushes are adjustable to suit different surfaces
- » Ideal for cleaning paths, halls & warehouses quickly & efficiently
- » Battery & built-in charger included
- » Folds flat for easy storage



INFORMATION



Increase productivity with this electric sweeper

NEW



Container Capacity L	Size L x W x H mm	Working Width mm	Model	Price
42	1200 x 770 x 1050	480	15172130	£2016.11

First Aid, Hygiene & Janitorial Equipment

NEW



Steam Cleaners

- » Provides thorough, deep & hygienic cleaning without the use of detergents
- » With steam pressure of 4 bar & a 4 litre tank, these steam cleaners are highly effective & productive
- » Simple to use, heats up quickly & can be used continuously thanks to its two-tank system
- » These machines are equally suited to detail work around kitchen appliances & bathroom fittings as they are to cleaning floors & walls
- » Includes; steam suction hose with handle, 2 steam tubes, floor tool (1 with slats & 1 with bristles), hand tool, round brush, upholstery tool with brush, power nozzle & detail nozzle



Tank Capacity L	Size L x W x H mm	Voltage V	Steam Pressure (bar)	Model	Price
4	475 x 320 x 275	220/240	4	10922820	£943.55

Professional Steam Cleaner

- » Steam pressurised to 8 bar & a powerful wet & dry vacuum function ensures hygiene-critical environments like kitchens, bathrooms, restaurants, hospitals & care homes are kept hygienically clean with minimal operator effort
- » The pressurised steam easily cuts through grease, fat & dirt and the vacuum instantly dries the area being cleaned
- » The unique self-clean function ensures the machine itself is fully cleaned after each use & the detergent function is ideal for deep cleaning of large areas like floors, or where a shine or fragrance is preferred
- » The small footprint, high handle & large wheels make it easy to manoeuvre in tight spaces

NEW



Tank Capacity L	Size L x W x H mm	Voltage V	Steam Pressure (bar)	Model	Price
5	640 x 495 x 965	240/240	8	10920120	£4024.56

Scrubber Drier

- » This scrubber drier eliminates the hassle & safety risks associated with floor mopping in public areas
- » As easy to use as an upright vacuum cleaner, this unit thoroughly cleans & dries floors in a single pass & can also be used for deep cleaning
- » Its 4 litre clean & dirty water tanks are fully removable & easy to clean & refill, while the roller brush & squeegees can be removed & replaced without tools

INFORMATION



More hygienic & faster to clean than traditional mopping

NEW



Orbital Machine

- » With a working width of 430mm & a large range of applications, this orbital single-disc machine is designed for the area of cleaning buildings
- » The machine combines orbital & rotary motions into a constant vibration, thus increasing the cleaning efficiency to a maximum. In addition, the machine is equipped with spray nozzles especially for carpet cleaning, which distribute the required amount of cleaning solution on large areas & apart from excellent cleaning results also make short drying times possible

NEW

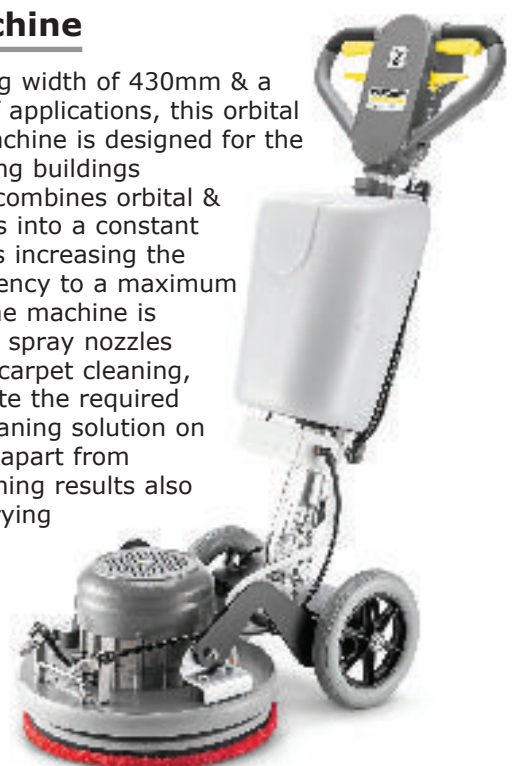

Tank L Fresh / Dirty	Size L x W x H mm	Working Width mm	Model	Price
4 / 4	390 x 335 x 1180	300	17832240	£1252.96

Tank L Fresh	Size L x W x H mm	Working Width mm	Model	Price
12	430 x 520 x 1070	430	12912530	£1209.23

First Aid, Hygiene & Janitorial Equipment

Pressure Washer

- >> Mobile & compact high pressure cleaner with reliable three-piston axial pump, automatic pressure relief, retractable pull handle & robust wheels
- >> Includes; standard trigger gun, 8M high pressure hose, spray lance (100mm) & pressure switch control



Flow Rate (L/H)	Max Pressure (bar)	Model	Price
400	120	15209770	£261.31

Pressure Washer

- >> Mobile high-pressure cleaner with automatic pressure relief & integrated hose reel. Very ergonomic thanks to retractable pull handle & robust wheels
- >> Includes; standard trigger gun, 8M high pressure hose, spray lance (600mm) & pressure switch control



Flow Rate (L/H)	Max Pressure (bar)	Model	Price
400	145	15209780	£303.95

HD Pressure Washer

- >> Compact, high performance pressure washer with unique stand-up or lay-flat operating position & large carry handle
- >> Includes; EASY!Force trigger gun, 10M high pressure hose, dirt blaster spray lance (840mm) & pressure switch control



Flow Rate (L/H)	Max Pressure (bar)	Model	Price
500	175	15209030	£684.43

Professional Pressure Washer

- >> Compact hot water high pressure cleaner with eco!efficiency mode & steam function
- >> State-of-the-art compact hot water pressure washer with unique eco!efficiency mode that reduces diesel consumption by 20% without compromising daily cleaning performance
- >> Incorporates unique machine protector system that prolongs component life & provides a 3-year burner coil warranty
- >> With central one-button operation, excellent mobility & superb cleaning performance this unit is easy to set-up, intuitive to operate & cheap to run
- >> Includes; EASY!Force trigger gun, 10M high pressure hose, spray lance (1050mm), power nozzle, SDS system, integrated fuel & detergent tank & pressure switch control



Flow Rate (L/H)	Max Pressure (bar)	Fuel Tank L	Size L x W x H mm	Model	Price
240 / 560	155	15	1060 x 650 x 920	11699040	£2732.24

Waste Management



15L Pedal Bins - Set of 3

- » **Conforms to EN 840**
- » Ideal for offices, warehouses, schools & factories etc
- » Manufactured from high quality polypropylene
- » Hygienic & easy to wipe clean
- » Large pedal for easy operation
- » Set of 3 Bins to be ordered in the same colours



COLOUR OPTIONS

- Yellow
 - Grey
- specify when ordering*

Capacity Litres	Overall Size (each) H x W x D mm	Weight kg (each)	Model	Price each Set of 3
15	340 x 260 x 270	1	LPB15Z	£47.35

Pedal Bins with Soft Closing Lid



COLOUR OPTIONS

- Yellow
 - Red
 - Charcoal
 - White
- specify when ordering*

- » Made from high quality polypropylene - hygienic & easy to clean
- » Hands free operation pedal bin featuring a soft closing lid giving you plenty of time to dispose of your rubbish
- » Large pedal ideal for safety shoes

Capacity Litres	Overall Size H x W x D mm	Model	Price each 1 to 4	Price each 5+
35	440 x 390 x 390	PB01SL	£94.90	£88.46
60	690 x 390 x 390	PB02SL	£124.48	£119.00
85	790 x 490 x 390	PB03SL	£145.05	£139.96

500



FROM ONLY
£24.05

LOWER PRICES

Pedal Bins

- » **Conforms to EN 840**
- » Ideal for offices, warehouses, schools & factories etc
- » Manufactured from high quality polypropylene
- » Hygienic & easy to wipe clean
- » Large pedal for easy operation



COLOUR OPTIONS

- Yellow
- Red/Orange
- Grey

specify when ordering

Capacity Litres	Overall Size H x W x D mm	Weight kg	Model	Price each 1+	Price each 3+	Price each 5+
30	455 x 370 x 380	2	LPB30Z	£30.45	£27.90	£24.05
50	560 x 380 x 410	2.5	LPB50Z	£40.10	£34.05	£30.20
80	670 x 410 x 470	3	LPB80Z	£49.70	£42.25	£38.35



FROM ONLY
£24.05

Pedal Bins with Coloured Lids

- » **Conforms to EN 840**
- » Ideal for where recycling & waste segregation is important
- » Ideal for offices, warehouses, schools & factories etc
- » Manufactured from high quality polypropylene
- » Hygienic & easy to wipe clean
- » Large pedal for easy operation

LOWER PRICES



LID COLOUR OPTIONS

- Yellow
- Red/Orange
- Green
- Blue

specify when ordering

Capacity Litres	Overall Size H x W x D mm	Weight kg	Model	Price each 1+	Price each 3+	Price each 5+
30	455 x 370 x 380	2	CPB30Z	£30.45	£27.90	£24.05
50	560 x 380 x 410	2.5	CPB50Z	£40.10	£34.05	£30.20
80	670 x 410 x 470	3	CPB80Z	£49.70	£42.25	£38.35



Waste Management

Pedal Bins

» Fitted with plastic liners



PBSS003Z



PB012Z



PBSS012Z



PB020Z

White Body Pedal Bins

Capacity Litres	Overall Size H x dia. mm	Model	Price each 1 to 4	Price each 5+
3	270 x 167	PB003Z	£23.09	£18.39
12	400 x 248	PB012Z	£41.48	£36.05
20	445 x 292	PB020Z	£49.57	£41.93
30	640 x 292	PB030Z	£64.29	£58.57

Stainless Steel Body Pedal Bins

Capacity Litres	Overall Size H x dia. mm	Model	Price each 1 to 4	Price each 5+
3	270 x 167	PBSS003Z	£23.09	£18.39
12	400 x 248	PBSS012Z	£41.48	£36.05
20	445 x 292	PBSS020Z	£49.57	£41.93
30	640 x 292	PBSS030Z	£64.29	£58.57

Premium Pedal Bin with Butterfly Lid



PB06SL

- » Manufactured from high quality, metal effect polypropylene - hygienic & easy to clean
- » Hands free operation pedal bin featuring a butterfly soft closing lid, large pedal & integrated bag holder

Capacity Litres	Overall Size H x W x D mm	Model	Price each 1 to 4	Price each 5+
50	670 x 290 x 440	PB08BL	£121.02	£113.86

Dome Top Bins

- » 40 litre steel pushbin complete with liner
- » Available in a choice of finishes from matt or mirror stainless steel, grey or black epoxy coated.



DTB02Z



DTB03Z

Overall Size H x Dia. mm	Colour	Model	Price each 1 to 4	Price each 5+
740 x 350	Black Painted	DTB02Z	£208.10	£197.39
	Stainless Steel Matt	DTB03Z	£200.48	£191.11

Pedal Bins

- » Ideal for offices, warehouses, schools & factories etc
- » Manufactured from polypropylene
- » Hygienic & easy to wipe clean
- » Lightweight but durable construction
- » Pedal operated
- » Fitted with two wheels to allow easy movement



GBI45Z

PRICES HELD



GBI68Z

INFORMATION

Hygienic & easy to wipe clean



FROM ONLY
£52.55



COLOUR OPTIONS

- Yellow
- Grey

specify when ordering



GBI45Z

Capacity Litres	Overall Size H x W x D mm	Weight kg	Model	Price (each) 1+	Price Box of 3
45	600 x 410 x 400	3	GBI45Z	£59.00	£157.65
68	670 x 500 x 410	4.5	GBI68Z	£75.75	£203.05

Refuse Sacks

- » High quality refuse sacks in varying capacities
- » Subject to availability



ENSA1290G

PRICES HELD



CHSA1090B



Description	Capacity	Colours	Liners per Box	Model	Price
5kg CHSA Refuse Sacks	90 Litre	Black	200	CHSA0590B	£22.39
10kg CHSA Refuse Sacks	90 Litre	Black	200	CHSA1090B	£29.72
10kg CHSA Refuse Sacks	90 Litre	Natural	200	CHSA1090N	£33.94
12kg ENSA Professional Refuse Sacks	90 Litre	Green	200	ENSA1290G	£40.43
Heavy Duty Refuse Sacks	140 Litre	Black	100	HDRS140B	£40.22

Waste Management

Sack Holder with Body

- » Enclosed solid body sack holder
- » Steel construction - pedal operated

SHB65Z
White



COLOUR OPTIONS

White
 Yellow

specify when ordering



Capacity Litres	Overall Size D x W x H mm	Model	Price each 1 to 4	Price each 5+
65	410 x 230 x 820	SHB65Z	£182.54	£171.38

Premium Pedal Bins

- » Manufactured from high quality polypropylene - hygienic & easy to clean
- » Hands free operation pedal bin featuring a soft closing lid, large pedal & integrated bag holder



PB064C



COLOUR OPTIONS

Carbon Effect
 Metal Effect

specify when ordering

Colour	Capacity Litres	Overall Size H x W x D mm	Model	Price each 1 to 4	Price each 5+
Carbon Effect	20	460 x 270 x 290	PB042C	£65.48	£59.79
Metal Effect	20	460 x 270 x 290	PB052M	£65.48	£59.79
Carbon Effect	40	680 x 350 x 300	PB064C	£85.34	£79.27
Metal Effect	40	680 x 350 x 300	PB074M	£85.34	£79.27

Sack Holder with Lid

- » Free standing steel sack holder which is pedal operated
- » Available with wheels & with a silent closing lid - please call for details



COLOUR OPTIONS

White
 Yellow

specify when ordering



SHL70Z

Capacity Litres	Overall Size D x W x H mm	Model	Price each 1 to 4	Price each 5+
70	360 x 430 x 850	SHL70Z	£108.52	£100.98

Sack Holder with Lid

- » Self assembly, free standing steel sack holder which is pedal operated



SASH70Z



Capacity Litres	Overall Size D x W x H mm	Model	Price each 1 to 4	Price each 5+
70	440 x 430 x 810	SASH70Z	£86.07	£77.50

Plastic Sackholders

- » All plastic construction for easy maintenance & cleaning - will not rust or dent
- » Manufactured from ABS, PVC & polyethylene
- » Silent closing lid
- » Mobile on 2 wheels for ease of movement



FROM ONLY
£96.11

LID COLOUR OPTIONS

- Yellow
- White
- Black
- Orange
- Green
- Blue
- Red

specify when ordering



PSH065

Capacity Litres	Overall Size H x W x D mm	Model	Price each 1 to 4	Price each 5+
45	590 x 440 x 455	PSH045	£103.27	£96.11
65	790 x 440 x 455	PSH065	£114.04	£106.86

Plastic Sackholders with Removable Bodies

- » Manufactured from fire resistant ABS (UL V0) lid & PVC (class 100 fire resistant) body & component parts
- » Tested to HTM0503 & conforms to NHS HTM WM0701 for colour coded waste management
- » Silent closing lid
- » Mobile on 2 wheels for ease of movement



LID COLOUR OPTIONS

- Yellow
- White
- Black

specify when ordering



FSH025

Capacity Litres	Overall Size H x W x D mm	Model	Price each 1 to 4	Price each 5+
25	645 x 225 x 340	FSH025	£133.29	£126.20
45	590 x 440 x 455	FSH045	£214.29	£206.73
65	790 x 440 x 455	FSH065	£218.05	£214.93

Waste Management

Recycling Bins with Lid Options

- » High quality plastic base with different lid options
- » Available with a choice of 4 lids for many applications



Push Flap Lid



Yellow Round Aperture Lid



Paper Slot Lid



Swing Lid



**FROM ONLY
£74.35**

PD060YRAZ

PD060PUSZ

Description	Capacity Litres	Overall Size H x W x D mm	Model	Price each 1 to 4	Price each 5+
Grey Bin with Grey Push Flap Lid	60	780 x 340 x 470	PD060PUSZ	£80.40	£74.35
Grey Bin with Grey Paper Slot Lid	60	780 x 340 x 470	PD060PAPZ	£80.40	£74.35
Grey Bin with Grey Swing Lid	60	780 x 340 x 470	PD060SWIZ	£80.40	£74.35
Grey Bin with Yellow Round Aperture Lid	60	780 x 340 x 470	PD060YRAZ	£80.40	£74.35
Grey Bin with Grey Push Flap Lid	80	950 x 340 x 470	PD080PUSZ	£100.49	£92.96
Grey Bin with Grey Paper Slot Lid	80	950 x 340 x 470	PD080PAPZ	£100.49	£92.96
Grey Bin with Grey Swing Lid	80	950 x 340 x 470	PD080SWIZ	£108.20	£100.15
Grey Bin with Yellow Round Aperture Lid	80	950 x 340 x 470	PD080YRAZ	£100.49	£92.96

Recycling Waste Bins with Lid Options

- » High quality plastic base with different lid options
- » Available with a choice of 4 lids for many applications



PB060GHAL



PB060YSAL



PB080GRAL

**FROM ONLY
£74.35**

60L Bins - 655H x 330W x 455Dmm

Description	Model	Price each 1 to 4	Price each 5+
Grey Bin with Green Round Aperture Lid	PB060GRAL	£80.40	£74.35
Grey Bin with Yellow Square Aperture Lid	PB060YSAL	£80.40	£74.35
Grey Bin with Blue Paper Slot Lid	PB060BPAP	£80.40	£74.35
Grey Bin with Grey Handle Lid	PB060GHAL	£80.40	£74.35

80L Bins - 840H x 330W x 455Dmm

Description	Model	Price each 1 to 4	Price each 5+
Grey Bin with Green Round Aperture Lid	PB080GRAL	£108.20	£100.15
Grey Bin with Yellow Square Aperture Lid	PB080YSAL	£108.20	£100.15
Grey Bin with Blue Paper Slot Lid	PB080BPAP	£108.20	£100.15
Grey Bin with Grey Handle Lid	PB080GHAL	£108.20	£100.15



INFORMATION



Supplied complete with recycling stickers

Recycling Bins - Set of 3

- » Supplied as a set of 3 complete with 5 stickers: General Waste (White), Paper (Blue), Plastic (Red), Food & Drinks Cans (Dk Grey) & Glass (Green) *Simply select the ones you want to use*
- » Ideal for offices, warehouses & factories etc
- » Hygienic wipe-clean plastic

LOWER PRICE



RCY63Z Set of 3



Capacity Litres each	Overall Size L x W x H mm each	Weight kg each	Model	Price (Set)
60	330 x 450 x 790	3	RCY63Z	£106.40

Waste Management

Recycling Bins with Coloured Lids



- LID COLOUR OPTIONS**
- ☐ Grey
 - ☐ Red
 - ☐ Blue
 - ☐ Green
 - ☐ Black
- specify when ordering*

FROM ONLY
£25.20

- >> Ideal for all your waste needs
- >> 7 colour/sticker options to choose from (please specify when ordering):
 - >> Blue - Paper
 - >> Green - Mixed Recycling
 - >> Grey - Cans
 - >> Red - Plastic Bottles
 - >> Yellow - Non Recyclables
 - >> Dark Green - Food Waste
 - >> Black - General Waste



Description	Overall Size H x W x D mm	Model	Price each 1 to 4	Price each 5+
20L Bin	520 x 265 x 235	RB020BI	£26.68	£25.20
2 x 20L Bin Recycling Station	530 x 480 x 265	RB0202S	£77.98	£72.20
50L Bin	730 x 330 x 330	RB050BI	£47.82	£45.98
2 x 50L Bin Recycling Station	730 x 545 x 360	RB0502S	£140.71	£135.93
70L Bin	730 x 390 x 390	RB070BI	£67.14	£64.29
2 x 70L Bin Recycling Station	730 x 605 x 420	RB0702S	£199.46	£192.39

Slim Bins

- >> Slim metal look plastic recycling bins are the perfect choice for the workplace & home
- >> Ideal for recycling & your normal waste
- >> Available with a choice of 6 stickers - please specify which sticker is required when ordering



FROM ONLY
£102.63



Description	Aperture Colour	Capacity Litres	Overall Size H x W x D mm	Model	Price each 1 to 4	Price each 5+
Slot Lid	Blue	55	610 x 290 x 490	SB155Z	£109.45	£102.63
Hole Lid	Green, Red or Yellow	55	610 x 290 x 490	SB255Z	£109.45	£102.63
Handle Top	Grey	55	610 x 290 x 490	SB355Z	£109.45	£102.63
Slot Lid	Blue	70	810 x 300 x 490	SB170Z	£127.38	£118.09
Hole Lid	Green, Red or Yellow	70	810 x 300 x 490	SB270Z	£127.38	£118.09
Handle Top	Grey	70	810 x 300 x 490	SB370Z	£127.38	£118.09

Push Spring Lid Bins

- » Ideal for recycling & your normal waste
- » Available in grey bases with coloured lids - please specify when ordering
- » Available with a choice of 12 stickers - please specify which sticker is required when ordering, along with the lid colour



LID COLOUR OPTIONS

- Yellow
- Red
- Green
- Blue
- Grey

specify when ordering

STICKERS - specify when ordering

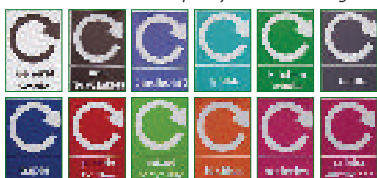

Capacity Litres	Overall Size H x W x D mm	Model	Price each 1 to 4	Price each 5+
12	350 x 265 x 247	PLB12Z	£18.18	£15.50
28	491 x 360 x 293	PLB28Z	£22.07	£19.48
45	600 x 393 x 335	PLB45Z	£30.64	£28.39



Steel Recycling Bins

- » Ideal for all your waste needs
- » 7 colour/sticker options to choose from (please specify when ordering):
 - » Blue - Paper
 - » Green - Mixed Recycling
 - » Grey - Cans
 - » Red - Plastic Bottles
 - » Yellow - Non Recyclables
 - » Dark Green - Food Waste
 - » Black - General Waste

FROM ONLY
£237.27



LID COLOUR OPTIONS

- Red
- Blue
- Green
- Black

specify when ordering

Capacity Litres	Overall Size H x W x D mm	Model	Price each 1 to 4	Price each 5+
60	785 x 395 x 260	SRB060Z	£255.66	£237.27
80	985 x 395 x 260	SRB080Z	£274.05	£256.13

Waste Management

Clear Recycling Bins

- >> All plastic construction
- >> Clear body allows for easy identification of waste helping to prevent cross contamination of waste
- >> 6 lid colour/sticker options to choose from - please specify when ordering:
 - >> Black Lid - Circular Aperture - General Waste Graphic
 - >> Blue Lid - Paper Slot Aperture - Paper Graphic
 - >> Green Lid - Circular Aperture - Food Waste Graphic
 - >> Grey Lid - Circular Aperture - Cans Graphic
 - >> Lime Green Lid - Circular Aperture - Mixed Recycling Graphic
 - >> Red Lid - Circular Aperture - Plastics Graphic



FROM ONLY
£171.38

INFORMATION 
Clear body for easy identification of waste

Capacity Litres each	Overall Size H x W x D mm each	Model	Price (each) 1 to 4	Price (each) 5+
60	640 x 395 x 265	CRB060	£188.69	£171.38
80	840 x 395 x 265	CRB080	£224.69	£212.24



Cardboard Recycling Bins - Set of 5

- >> A lightweight & highly portable solution to recyclable rubbish & waste. This Pack of 5 Cardboard Recycling Bins incorporates different colour lids to help you successfully separate mixed recycling, general waste, cans, paper & plastic bottles
- >> Complete with 5 clear plastic liners



FROM ONLY
£55.79

Capacity Litres each	Overall Size H x W x D mm each	Model	Price (each) 1 to 4	Price (each) 5+
60	750 x 288 x 380	CB030Z	£60.00	£55.79



Waste Bins

- » Hygienic wipe-clean plastic
- » Push flap opening with clear lettering & directional arrow
- » Ideal for use in kitchens, offices, shops, warehouses etc



FROM ONLY
£18.95



Capacity Litres	Overall Size L x W x H mm	Weight kg	Model	Price (each) 1+	Price (each) 2+
20	355 x 255 x 500	1.2	RCY29Z	£25.55	£18.95
50	420 x 300 x 670	2	RCY43Z	£37.30	£30.70
60	455 x 320 x 750	2.5	RCY57Z	£40.15	£33.55

60L Recycling Bins

- » Capacity: 60 litres
- » Charcoal base with a choice of coloured lids & pictograms
- » Swing lid is self-closing
- » Overall size: 680H x 400W x 330D mm



Description	Model	Price each 1 to 4	Price each 5+
Blue Lid (Paper Sticker)	RBB60P	£50.77	£44.32
Red Lid (Plastic Bottles Sticker)	RBR60P	£50.77	£44.32
Green Lid (Mixed Recyclables Sticker)	RBG60M	£50.77	£44.32
Silver Lid (Non-recyclables Sticker)	RBS60N	£50.77	£44.32

Waste Management

Waste & Storage Bins

- » Heavy duty, durable construction which will not rust, chip or peel
- » Reinforced rims for durability
- » Built in handles for easy lifting
- » Easy anti-jam nesting
- » Thermal resistance between -20°C to +60°C



COLOUR OPTIONS

- White
- Yellow
- Black
- Blue
- Green
- Grey
- Red

specify when ordering

INFORMATION 

H.D. construction which will not rust/chip



Knot free Bin Bag Cinches allow bags to be attached to handles without knots for faster line changes



RMB166



FROM ONLY
£55.08



Capacity Litres	Overall Size Dia. x H mm	Container			Lids (must be ordered with container)		
		Colour	Model	Price	Colour	Model	Price
37	397 x 435	Grey & White	RMB037	£55.08	Grey & White	RMBL01	£10.28
75	495 x 581	Blue, Green, Grey, White & Yellow	RMB075	£75.18	Blue, Grey & White	RMBL02	£12.29
121	559 x 692	Blue, Green, Grey, White, Yellow & Red	RMB121	£93.12	Blue, Grey, White, Yellow & Red	RMBL03	£17.89
166	610 x 800	Black, Grey, Red, Yellow & White	RMB166	£145.15	Black, Grey, Red & White	RMBL04	£32.09
208	673 x 838	Grey	RMB208	£183.39	Grey	RMBL05	£40.23

Recycling Bins

- » Ideal for recycling & your normal waste
- » Available with a choice of 6 stickers - please specify which sticker is required when ordering along with your lid colour



LID COLOUR OPTIONS	
	Yellow
	Red
	Green
	Blue
	Dark Grey
	Black
	Lime
	Brown
	Orange

specify when ordering

STICKERS
specify when ordering

FROM ONLY
£33.35

8 x RB250Z

Description	Capacity Litres	Overall Size H x W x D mm	Model	Price each 1 to 4	Price each 5+
Grey Base/Coloured Lid	30	415 x 410 x 320	RB230Z	£37.28	£33.35
Grey Base/Coloured Lid	50	620 x 410 x 320	RB250Z	£43.16	£38.84

Open Top Bins

- » High quality coloured grey plastic base with coloured lids
- » Foot plate assists with bag/waste removal



LID COLOUR OPTIONS	
	Yellow
	Red
	Green
	Blue
	Grey

specify when ordering

4 x OP050Z

Capacity Litres	Overall Size H x dia. mm	Model	Price each 1 to 4	Price each 5+
50	650 x 400	OP050Z	£36.32	£29.61

OP050Z

Waste Management



SHB035Z

Outdoor Hooded Top Litter Bin

- » Capacity: 100 litres
- » Hooded top prevents the ingress of rainwater
- » Removable body for easy emptying
- » Polyethylene body complete with galvanised liner



SHB034Z



SHB033Z



Stubber Plate

Description	Overall Size H x dia. mm	Model	Price
Black	990 x 550	SHB032Z	£250.45
Dark Green	990 x 550	SHB033Z	£250.45
Dark Blue	990 x 550	SHB034Z	£250.45
Black with Stubber Plate	990 x 550	SHB035Z	£259.60
Dark Green with Stubber Plate	990 x 550	SHB036Z	£259.60
Dark Blue with Stubber Plate	990 x 550	SHB037Z	£259.60
Ground Fixing plate & 4 Fixing Bolts	-	SHB038Z	£22.90
Ballast Pack	-	SHB039Z	£22.90

Outdoor Open Top Steel Bin



OOT40Z
Light Grey



OOT70Z
Light Grey

**COLOUR
OPTIONS**
 ■ Dark Grey
 ■ Light Grey
specify when ordering

**FROM ONLY
£314.52**



OOT70Z
Dark Grey



OOT40Z
Dark Grey

- » Heavy duty steel construction complete with polyester coated zintec liner
- » Ground fixing bolt options available - call for details
- » Fire resistant

Capacity Litres	Overall Size H x W x D mm	Model	Price each 1 to 4	Price each 5+
40	740 x 520 x 520	OOT40Z	£351.13	£314.52
70	740 x 565 x 565	OOT70Z	£386.07	£347.63

Wood Effect Bins

- » Manufactured from powder coated steel with plastic wood effect strips (Walnut) or Sapele hardwood
- » Openings each measuring 210 x 110mm
- » Complete with a galvanised liner



Wood Type	Capacity Litres	Overall Size H x W x D mm	Model	Price
Circle Wood Effect bin - 1 Opening				
Plastic Wood Effect	33	755 x 400 x 400	WEB42HE	£451.79
Sapele Hardwood			WEB46HE	£451.79
Square Wood Effect bin - 4 Openings				
Plastic Wood Effect	36	810 x 350 x 350	WEB36HE	£451.79
Sapele Hardwood			WEB40HE	£451.79

Circular Wood Effect Bins

- » Manufactured from powder coated steel with plastic wood effect strips (Walnut or Beech)
- » Complete with a galvanised liner



Wood Type	Capacity Litres	Overall Size H x W x D mm	Model	Price
Wood Effect - Beech	40	470 x 370 x 370	WEB50HE	£329.23
Wood Effect - Walnut			WEB55HE	£329.23
Wood Effect - Beech	65	665 x 370 x 370	WEB60HE	£347.54
Wood Effect - Walnut			WEB65HE	£347.54

Outdoor 2 Compartment Bin

- » Manufactured from powder coated steel
- » Supplied with Mixed Recycling & General Waste plaques
- » Complete with 2 x 39L liners which are covered by a lockable door



Capacity Litres	Overall Size H x W x D mm	Model	Price
2 x 39	1000 x 720 x 405	WEB80AJ	£634.55

Wood Effect Bin - Double

- » Manufactured from powder coated steel with plastic wood effect strips (Beech) or Sapele hardwood
- » Supplied with Mixed Recycling & General Waste plaques
- » Complete with 2 x 39L liners which are covered by a lockable door



Wood Type	Capacity Litres	Overall Size H x W x D mm	Model	Price
Plastic Wood Effect	2 x 39	1000 x 700 x 400	WEB78AJ	£634.55
Sapele Hardwood			WEB82AJ	£634.55

Waste Management

Outdoor Open Top Litter Bins

- » Capacity: 75 litres
- » Open top bin range which has a smooth easy to clean surface
- » Comes complete with zinc coated liner, lock & base
- » Optional moulded concrete ballast blocks for fixing to soft ground or floor fixings for fixing to solid ground are available - see table for details



COLOUR OPTIONS

- Blue
- Green
- Red
- Yellow

specify when ordering



SOC75Z



SOV75Z

**FROM ONLY
£216.10**

INFORMATION

Manufactured from high density plastic



SOC75Z

Description	Overall Size H x dia. mm	Model	Price
Coloured Bin	745 x 485	SOC75Z	£216.10
Victorian Bin		SOV75Z	£233.95
Fixing Plate & 4 Fixing Bolts	-	SOF75Z	£25.20
3 x Moulded Concrete Ballast Blocks	-	SCB75Z	£62.50

Outdoor Hooded Top Litter Bins

INFORMATION

Manufactured from high density plastic



SHB75Z



SHV75Z



SHB75Z



COLOUR OPTIONS

- Blue
- Green
- Red
- Yellow

specify when ordering



**FROM ONLY
£237.50**

- » Capacity: 75 litres
- » Hooded bin range which has a smooth easy to clean surface & prevents ingress of rainwater
- » Comes complete with liner, lock & base. The body is removable for easy cleaning
- » Optional moulded concrete ballast blocks for fixing to soft ground or floor fixings for fixing to solid ground are available - see table for details

Description	Overall Size H x dia. mm	Model	Price
Coloured Bin	1000 x 485	SHB75Z	£237.50
Victorian Bin		SHV75Z	£278.60
Fixing Plate & 4 Fixing Bolts	-	SHF75Z	£25.20
3 x Moulded Concrete Ballast Blocks	-	SHC75Z	£62.50

Open & Closed Top Litter Bins

- » Manufactured from strong polyethylene - ideal for indoor & outdoor use
- » Supplied with the widely recognised 'Tidy Man' logo or the 'Smiley Face' symbol



LBGO60SF

LBYO60SF

LBOR60SF

LBOB60SF

Colour	Open Top Litter Bins - 95 Litres				Closed Top Litter Bins - 145 Litres					
	Overall Size H x Dia. mm	Tidy Man Logo		Smiley Face Logo		Overall Size H x Dia. mm	Tidy Man Logo		Smiley Face Logo	
		Model	Price	Model	Price		Model	Price	Model	Price
Red	730 x 600	LBOR60TM	£108.95	LBOR60SF	£108.95	1040 x 600	LBCR60TM	£258.95	LBCR60SF	£260.75
Blue		LBOB60TM	£108.95	LBOB60SF	£108.95		LBCB60TM	£258.95	LBCB60SF	£260.75
Green		LBOG60TM	£108.95	LBOG60SF	£108.95		LBCG60TM	£258.95	LBCG60SF	£260.75
Yellow		LBOY60TM	£108.95	LBOY60SF	£108.95		LBCY60TM	£258.95	LBCY60SF	£260.75

Litter Bins

- » Manufactured from polyethylene
- » Supplied with the widely recognised 'Tidy Man' logo



LB906N

LB904N

LB914N

Description	Capacity Litres	Overall Size L x W x H mm	Model	Price
Open Top Square Bin	55	300 x 300 x 610	LB906N	£69.65
Closed Top Square Bin	114	432 x 432 x 990	LB904N	£165.20
Closed Top Square Bin with Push Flap	114	432 x 432 x 990	LB914N	£180.40

Waste Management

Wall Ashtrays

- » Steel construction with drop down door for ease of emptying
- » Fitted with lock & inner galvanized liner
- » Manufactured from epoxy powder coated steel or 304 matt stainless steel
- » Integral collection box



WMASS85

WMABL85

Colour	Overall Size H x W x D mm	Model	Price each 1 to 4	Price each 5+
Silver/Grey & Black	320 x 260 x 80	WMABL85	£67.51	£60.76
Stainless Steel		WMASS85	£131.56	£124.64

Tubular Steel Floor Mounted Ashtray

- » Fully galvanised steel, epoxy powder coated to protect against severe weather conditions
- » Stainless steel snuff plate
- » 3 litre capacity (will hold estimated 900+/- butts)
- » Fitted with lock & internal liner for ease of emptying
- » Weighted base for stability
- » Optional floor fixing bolts included



Overall Size H x W x D mm	Model	Price each 1 to 4	Price each 5+
1080 x 300 x 300	FSABL92	£151.66	£144.54

Battery Bins

- » Simple twist system secures lid
- » Large easy lift handles
- » Narrow opening restricts child access
- » Internal cushioned base



BAB015
Black

BAB010
Pink

Capacity Litres	Overall Size H x W x D mm	Model	Price each 1 to 4	Price each 5+
10	650 x 220 x 220	BAB010	£61.79	£55.71
15	900 x 220 x 220	BAB015	£78.04	£73.21

Clip Bins

- » Heavy duty plastic construction with clip on lids



Colour	Capacity Litres	Overall Size H x W x D mm	Model	Price each 1 to 4	Price each 5+
Black	85	700 x 560 x 560	CLB085ZBLK	£33.45	£30.89
Others	85	700 x 560 x 560	CLB085ZCOL	£42.27	£38.66
Black	110	720 x 590 x 590	CLB110ZBLK	£36.27	£32.12
Others	110	720 x 590 x 590	CLB110ZCOL	£56.55	£52.07

Wheeled Bin - 30 & 50 Litre

- » **Conforms to EN 840**
- » Manufactured from either 30% recycled polyethylene (Blue, Green, Dark Grey or Red/Orange) or 100% virgin polyethylene (Yellow)
- » Mobile on 35mm (LWB30Y) & 50mm castors (LWB50Y)
- » LWB30Y is not available in yellow

**FROM ONLY
£22.10**



COLOUR OPTIONS

- Blue
- Green
- Dark Grey
- Red/Orange
- Yellow (50L only)

specify when ordering

Colours	Capacity Litres	Overall Size L x W x H mm	Weight kg	Model	Price 1 Off	Price (each) 2+
Blue, Green, Dark Grey or Red/Orange	30	350 x 255 x 490	2	LWB30Y	£28.70	£22.10
Blue, Green, Dark Grey or Red/Orange	50	420 x 470 x 650	3	LWB50Y	£36.65	£30.05
Yellow				LWB50YYEL	£36.95	£30.35

50 Litre Bin with Feet » **Conforms to EN 840** » Manufactured from 30% recycled polyethylene



COLOUR OPTIONS

- Blue
- Green
- Dark Grey
- Red/Orange

specify when ordering

Capacity Litres	Overall Size L x W x H mm	Weight kg	Model	Price 1 Off	Price (each) 2+
50	420 x 470 x 650	3	LFB50Z	£38.50	£31.20

Waste Management



COLOUR OPTIONS

- Dark Grey
 - Green
- specify when ordering*

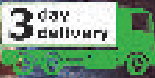

LPB70Y

Pedal Bin - 70 Litre

- » **Conforms to EN 840**
- » Manufactured from 30% recycled polyethylene
- » Mobile on 155mm wheels for easy movement

LOWER PRICES



Smooth pedal operation to open the lid

FROM ONLY

£46.25



2 x LPB70Y

Capacity Litres	Overall Size L x W x H mm	Weight kg	Model	Price 1 Off	Price (each) 2+
70	555 x 510 x 750	4.5	LPB70Y	£52.85	£46.25

Wheeled Bin - 80 Litre

- » **Conforms to EN 840**
- » Manufactured from either 30% recycled polyethylene (Blue, Green, Dark Grey or Red/Orange) or 100% virgin polyethylene (Yellow)
- » Mobile on 200mm wheels

LOWER PRICES

FROM ONLY

£51.05



COLOUR OPTIONS

- Blue
 - Green
 - Dark Grey
 - Red/Orange
 - Yellow
- specify when ordering*

Colours	Capacity Litres	Overall Size L x W x H mm	Weight kg	Model	Price 1 Off	Price (each) 2+
Blue, Green, Dark Grey or Red/Orange	80	470 x 540 x 780	6.5	LWB80Y	£57.65	£51.05
Yellow				LWB80YYEL	£64.10	£57.50

Wheeled Bin with Coloured Lids - 120 Litre

- » **Conforms to EN 840**
- » Easily manoeuvrable on 200mm wheels
- » Ideal for use in schools, colleges, hospitals, healthcare centres, offices, warehouses etc
- » Manufactured from 30% recycled polyethylene
- » Dark grey bodies with coloured lids: dark grey blue, red or light grey - please specify which colour lid you require



LID COLOUR OPTIONS

- Blue
 - Light Grey
 - Dark Grey
 - Red/Orange
- specify when ordering*

LOWER PRICES

Capacity Litres	Overall Size L x W x H mm	Weight kg	Model	Price 1 Off	Price (each) 2+
120	460 x 550 x 940	8.5	LW1120Y	£57.65	£51.05



520

Wheeled Bins

FROM ONLY

£51.05

3 day delivery

COLOUR OPTIONS

- Blue
 - Green
 - Dark Grey
 - Red/Orange
 - Yellow
- specify when ordering*



- » **Conforms to EN 840**
- » Manufactured from either 30% recycled Polyethylene (Blue, Green, Dark Grey or Red/Orange) or 100% virgin polyethylene (Yellow)
- » Easily manoeuvrable on 200mm wheels
- » *Model LWB360Y is available in blue, green & dark grey as standard. Other colours available upon request*

Capacity Litres	Overall Size L x W x H mm	Weight kg	Blue, Green, Dark Grey or Red/Orange			Yellow		
			Model	Price 1 Off	Price (each) 2+	Model	Price 1 Off	Price (each) 2+
80	470 x 540 x 780	6.5	LWB80Y	£57.65	£51.05	LWB80YYEL	£64.10	£57.50
120	460 x 550 x 940	7	LWB120Y	£57.65	£51.05	LWB120YYEL	£64.60	£58.00
240	590 x 750 x 1000	10	LWB240Y	£75.30	£67.60	LWB240YYEL	£84.75	£77.05
360	710 x 850 x 1120	22	LWB360Y	£169.00	£152.50	-	-	-

Waste Management

Pedal Wheeled Bins



FROM ONLY
£68.70

LID COLOUR OPTIONS

- Blue
- Green
- Dark Grey
- Red/Orange
- Yellow

specify when ordering

Capacity Litres	Overall Size L x W x H mm	Model	Price
120	460 x 550 x 940	LPB120Z	£68.70
240	590 x 750 x 1000	LPB240Z	£95.80

- » **Conforms to EN 840**
- » Manufactured from high quality polypropylene
- » Large, heavy duty, steel pedal for easy operation
- » Mobile on 200mm wheels

Wheeled Bin Accessories

- » **Conforms to EN 840**
- » Wheeled bins complete with bottle hole lid, letter slot lid, push flap lid or side pedal
- » Option 1 - available in blue, green, dark grey, red/orange with a dark grey lid
- » Option 2 - yellow with a dark grey lid
- » Mobile on 200mm wheels



FROM ONLY
£75.60

Option	120L Wheeled Bin 460L x 550W x 940H mm		240L Wheeled Bin 590L x 750W x 1000Hmm	
	Model	Price	Model	Price
1	LWB12BHY	£75.60	LWB24BHY	£97.40
2	LWB12BHYEL	£82.55	LWB24BHYEL	£106.85

Option	120L Wheeled Bin 460L x 550W x 940H mm		240L Wheeled Bin 590L x 750W x 1000Hmm	
	Model	Price	Model	Price
1	LWB12PFY	£75.60	LWB24PFY	£99.50
2	LWB12PFYEL	£82.55	LWB24PFYEL	£108.95

Option	120L Wheeled Bin 460L x 550W x 940H mm		240L Wheeled Bin 590L x 750W x 1000Hmm	
	Model	Price	Model	Price
1	LWB12LSY	£75.60	LWB24LSY	£97.40
2	LWB12LSYEL	£82.55	LWB24LSYEL	£106.85

Option	120L Wheeled Bin 460L x 550W x 940H mm		240L Wheeled Bin 590L x 750W x 1000Hmm	
	Model	Price	Model	Price
1	LWB12SPY	£74.35	LWB24SPY	£94.50
2	LWB12SPYEL	£81.30	LWB24SPYEL	£103.95

660 & 1100L Waste Bins



- » **Conforms to EN 840**
- » Easy to clean - lightweight yet robust construction
- » Easily manoeuvrable when full
- » Made from high density polyethylene
- » Compatible with most standard lifting mechanisms
- » For use where large amounts of waste are generated
- » Brakes are fitted to the two front wheels

COLOUR OPTIONS

- Dark Grey
- Green

specify when ordering



Capacity Litres	Overall Size H x W x D mm	Weight kg	Model	Price
660	1260 x 760 x 1230	45	LWB660Y	£388.15
1100	1360 x 1060 x 1370	51.5	LWB1100Y	£485.00

Wheeled Bins - Recycling Centre

- » **Conforms to EN 840**
- » Comes complete as a set of 4, 1 of each lid colour & set of 4 stickers

LOWER PRICE



LW4120Y

- » Easily manoeuvrable on 200mm wheels
- » Ideal for use in schools, colleges, hospitals, healthcare centres, offices, warehouses etc
- » Manufactured from 30% recycled polyethylene

Description	Capacity Litres each	Overall Size each L x W x H mm	Weight kg each	Model	Price 1 Set of 4
Set of 4	120	460 x 550 x 940	8.5	LW4120Y	£177.80

Waste Management



Quick Lift Wheeled Bin Lifter

- » Safe lifting capacity of 30kg (50kg with 2 people)
- » Lifts 120L and 240L wheeled bins
- » Empties containers over a max. wall height of 1600mm
- » Fast lift bin emptier assisted by gas struts providing easy emptying
- » No lever handle to operate simply lifts & the empty cycle is only 10 seconds
- » No finger traps, completely safe for any application
- » Easy and safe to operate
- » Ideal for schools, factories & retail outlets



Model	Price
ESMBT-0230-GL	£2682.70



Wheeled Bin Shelter

- » No fixing required - simply secure these units by using six 600 x 600mm paving slabs (not supplied)
- » Fabricated from robust heavy duty box section
- » Complemented by tri wall fluted plastic side panels & a galvanised sheet steel roof

N.B. A Fork Lift will be needed to unload these units

INFORMATION 

Keep your wheeled bin area neat & tidy



Overall Size L x W x H mm	Model	Price
1980 x 1250 x 2040	BWS204	£1474.05

Front Emptying Skip

- » Volume: 1000 litres
- » Chassis welded heavy gauge construction
- » Fitted with fork pockets & stackable 2 high
- » Load can be easily discharged without the operator leaving the vehicle



INFORMATION
Unit can be emptied from your vehicle



500kg evenly distributed



SK105Y
£2890.05

SK105Y

N.B. A Fork Lift will be needed to unload these units

Overall Size L x W x H mm	Internal Size L x W x H mm	Wheels	Weight kg	Model	Price
1600 x 1500 x 1260	1420 x 1320 x 1020	2 Fixed & 2 Swivel 152mm Nylon	130	SK105Y	£2890.05



Heavy Duty Craning Cage

- » Fully welded 50 x 50mm mesh sides & sheet steel base (SK501Z has a sheet steel side which can be used as a ramp)
- » Can accommodate euro pallets
- » Complete with craning eyes

N.B. A Fork Lift will be needed to unload these units



500kg evenly distributed



SK501Z

SK502Z

Overall Size L x W x H mm	Weight kg	Model	Price
Craning Cage with Loading Ramp			
1335 x 1335 x 1200	120	SK501Z	£1331.50
Craning Cage with Opening Front & 1/2 fold Security Roof			
1335 x 1335 x 1200	110	SK502Z	£1602.25

Bottom Emptying Skip

- » Stackable 4 high
- » Fork pocket centres: 670mm
- » This unit is stackable to give compact storage
- » Pushing down on the bar positioned at the back releases the mechanism & opens the bottom. The bar can be connected to a chain which would allow you to operate the mechanism from a Fork Lift (not supplied)
- » The base closes when the skip is lowered to the floor

N.B. A Fork Lift will be needed to unload these units



2 x SK209Z



SK209Z

Overall Size L x W x H mm	Volume Litres	Weight kg	Model	Price
1330 x 1110 x 1110	890	165	SK209Z	£2087.25
Optional Castors - 4 x 150mm swivel nylon			SK999Y	£197.05

Waste Management

Tilting Skip/Truck



**FROM ONLY
£1813.95**

INFORMATION

Ideal for swarf & waste materials



FORK GUIDE:

500 litre capacity - Side Entry
1000 litre capacity - Back Entry

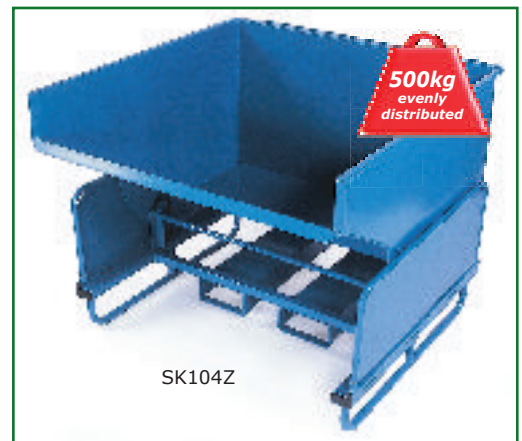

SK104Z

Body Size L x W x H mm	Overall Height mm	Wheels	Weight kg	Model	Price
Volume: 500 litres / 300kg Load Capacity					
1220 x 600 x 700	1080	-	85	SK103Z	£1813.95
	1115	2 Fixed & 2 Swivel 160mm Nylon		SK101Y	£1924.15
Volume: 1000 litres / 500kg Load Capacity					
1220 x 1200 x 700	1080	-	116	SK104Z	£2562.20
	1150	2 Fixed & 2 Swivel 200mm Nylon		SK102Y	£2684.20

Tilting Skips



- » Chassis from welded hollow sections fitted to a sheet steel base
- » Tubular steel handle aids the manoeuvring & safe tipping of the skip
- » Safety catch avoids accidental tipping of the body
- » Mobile on 2 swivel 150mm cushion castors & 2 fixed 200mm cushion wheels
- » SK202Y has an internal drain

N.B. A Fork Lift will be needed to unload these units

Description	Overall Size L x W x H mm	Volume Litres	Weight kg	Model	Price
Tilting Skip	1350 x	490	80	SK201Y	£1362.00
Swarf Skip	930 x 1105		82	SK202Y	£1465.00

Side Emptying Skip

- » Fully welded construction with 4 way entry fork pockets
- » This side emptying skip is capable of tipping its contents from either side. The balanced tipping action is engaged by a foot operated release mechanism & uses a dampening system for controlled emptying
- » Mobile on 2 fixed & 2 swivel 125mm nylon castors

N.B. A Fork Lift will be needed to unload these units



SK204Y

Overall Size L x W x H mm	Internal Size L x W x H mm	Volume Litres	Wt. kg	Model	Price
1335 x 800 x 1110	1000 x 750 x 600	300	78	SK204Y	£1750.35

Heavy Duty Tilting Skips

- » Robust construction with a strong chassis design & designed for use with a fork lift truck
- » Mesh top cage (580mm high) is available factory fitted

N.B. A Fork Lift will be needed to unload these units



SK305Y

FORK GUIDE:

250 to 500 litre capacity - 3 Way Entry
1000 to 1500 litre capacity - Back Entry



Mesh Cage



SK315Z



Volume Litres	Wheels	Load Capacity kg	Overall Size L x W x H mm	Weight kg	Skip Unit		Mesh Cage to Suit	
					Model	Price	Model	Price
250	2 Fixed & 2 Swivel 125mm High-Density Nylon	750	1400 x 820 x 890	110	SK302Y	£1856.05	SK001Z	£472.55
500		1000	1670 x 1010 x 1030	133	SK305Y	£2130.35	SK002Z	£503.40
1000	-	1250	2030 x 1270 x 1030	213	SK310Z	£2637.20	SK003Z	£563.45
1200	-	1250	2120 x 1270 x 1140	219	SK312Z	£2837.10	SK004Z	£581.95
1500	-	1500	2328 x 1435 x 1140	250	SK315Z	£3203.90	SK005Z	£658.65

Mini Skips

- » Fits neatly underneath a workbench
- » Specifically designed for production areas where space is limited
- » Mesh top cage (200mm high) is available factory fitted
- » Mobile on 3 x 100mm nylon castors 2 fixed & 1 swivel

N.B. A Fork Lift will be needed to unload these units



SK415Y & SK007Z

Volume Litres	Overall Size L x W x H mm	Weight kg	Skip Unit		Mesh Cage to Suit	
			Model	Price	Model	Price
100	850 x 450 x 480	47	SK410Y	£1041.85	SK006Z	£295.90
150	850 x 600 x 480	52	SK415Y	£1160.10	SK007Z	£300.50
190	850 x 750 x 480	59	SK419Y	£1239.55	SK008Z	£304.70

Heavy Duty Industrial Waste Truck

- » Fitted as standard with a DEFLECTOR panel at the base to allow gradual safe & controlled emptying
- » This truck is fitted with 6 x 100mm nylon swivel castors for mobility whilst also being fork liftable under the handles
- » It features a hinged drop away base for easy emptying & can be supplied with a rodent-proof lid.

N.B. A Fork Lift will be needed to unload these units



SK206Y



SK206Y

Overall Height mm	Overall Width mm	Internal Bin Height x Width mm	Volume Litres	Weight kg	Model	Price
1460	1150	1210 x 720	800	100	SK206Y	£1856.05
Lid for above				17	SK206Z	£338.25

Winter Management

Snow Plough

- >> The blade is manufactured from polypropylene with a durable metal edge & the steel frame incorporates a foam handle
- >> Mobile on 2 x 160mm ribbed wheels which are ideal for rough terrain use
- >> The handle is extendable from 1300mm to 1400mm



INFORMATION

Clear car parks, walkways & pavements in minutes



SCA05Y

Blade Size W x H mm	Handle Height mm	Weight kg	Model	Price
660 x 320	1300 to 1400	4	SCA05Y	£69.10

Salt & Grit Bin

- >> Capacity: 30 litres
- >> Comes complete with 10kg of rock salt & a moulded scoop
- >> Fitted with 1 x hasp & staple (padlock not included)



GCB030



INFORMATION

Complete with 10kg of rock salt & moulded scoop



GCB030



Overall Size W x D x H mm	Internal Size W x D x H mm	Bin Weight	Model	Price
475 x 383 x 305	460 x 370 x 230	5 kg	GCB030	£73.20

Salt & Grit Bins



GCB060

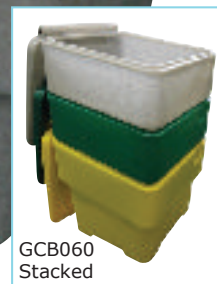

GCB060 Stacked

60L COLOUR OPTIONS

- Yellow
- Green
- Grey

specify when ordering

115L COLOUR OPTIONS

- Yellow



- >> Manufactured from tough, medium duty UV stabilised polyethylene
- >> Hinged lid protects grit/salt from the elements
- >> Hasp & staple, wording & other colours are available upon request

Capacity Litres	Overall Size W x D x H mm	Bin Weight kg	Grit Bins	
			Model	Price
60	500 x 470 x 475	5	GCB060	£80.80
115	800 x 474 x 605	8	GCB115	£122.10

Salt Spreader

- » The large, easy to clean, polyethylene hopper bucket is supported by a strong steel frame mounted on large 310mm pneumatic wheels to give this unit a smooth ride over rough terrain
- » Can hold 25kg of salt
- » Complete with weather shield cover
- » Spread distance is 2.5M to 3M

INFORMATION

A large hopper means less downtime!



SQT01Y

SQT01Y
£280.60



SQT01Y

Capacity Litres	Overall Size L x W x H mm	Weight kg	Model	Price
43	1170 x 690 x 925	13	SQT01Y	£280.60



Please check the suitability of the salt prior to use with the spreaders, ensuring the grain size is suitable. The Salt should also be compliant to BS3247 & must be dry & free flowing.

Salt (Seed) Spreader

- » Manufactured from heavy duty plastic with a steel handle
- » 8 point adjustment system to increase & decrease the rate at which salt or seed is dispensed
- » Mobile on 2 x 200mm plastic wheels

SCA06Y
£68.50



Dispenser Open



Dispenser Closed



SCA06Y

Capacity Litres	Body Width mm	Handle Height mm	Weight kg	Model	Price
20	660	1250	3	SCA06Y	£68.50

Snow Clearer

- » The blades & the main body of this unit are manufactured from heavy duty plastic
- » Ideal for clearing car parks, walkways, pavements etc
- » Available whilst stocks last

SCA03Z
£59.00



SCA03Z

Snow Spout Direction	Working Width mm	Handle Height mm	Weight kg	Model	Price
Right	570	1230	4	SCA03Z	£59.00

Winter Management

Victorian Salt & Grit Bin

- » Manufactured from tough, medium duty, non-corrosive, polyethylene
- » Hinged lid protects grit/salt from the elements
- » Fork lift truck grooves enable easy handling
- » Hasp & staple & hopper feeds available - call for details



GBV200



GBV400

GBV200

**FROM ONLY
£242.90**



Capacity Litres	Overall Size W x D x H mm	Model	Price
200	850 x 505 x 725	GBV200	£242.90
400	1050 x 650 x 900	GBV400	£316.10

Storage Bins

- » These storage bins are rotationally moulded in medium density polyethylene
- » Robust and lightweight they can be used outside as well as indoors
- » Supplied with a hasp & staple (padlock not included)

COLOUR OPTIONS

- Blue
- Green
- Red
- Yellow

specify when ordering



**FROM ONLY
£292.90**

Hasp & Staple mechanism



**FROM ONLY
£241.10**

LOWER PRICES

Overall Size W x D x H mm	Capacity Litres	Capacity kg	Weight kg	Model	Price
850 x 505 x 725	200	150	12	SSB702L	£292.90
1050 x 650 x 900	400	300	19	SSB704L	£387.50

Overall Size W x D x H mm	Capacity Litres	Capacity kg	Weight kg	Model	Price
850 x 505 x 725	200	150	12	SGB200	£241.10
1050 x 650 x 900	400	300	19	SGB400	£317.90

Stackable Grit Bins

- » Manufactured from tough, medium density polyethylene
- » Hinged lids protect the grit/salt from the elements
- » Lockable by the use of a padlock (*not included*)
- » Ideal for use on highways or private premises
- » Can be handled with either slings or a fork lift truck

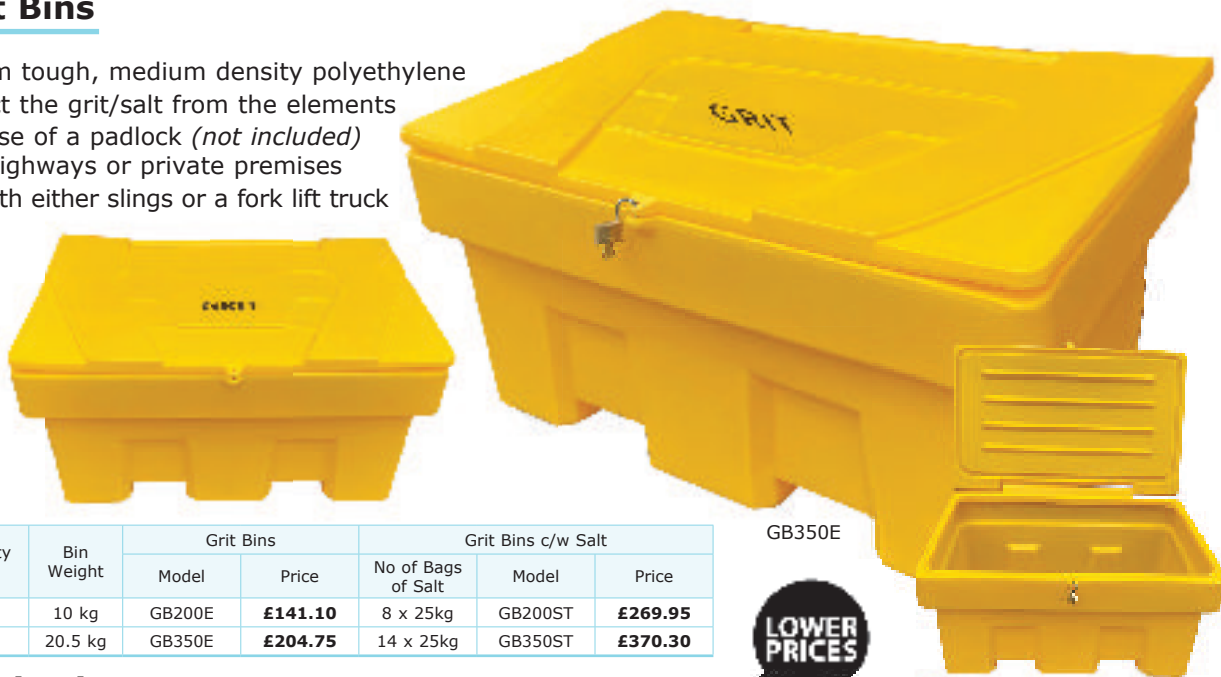

External Size L x W x H mm	Capacity Litres	Bin Weight	Grit Bins		Grit Bins c/w Salt		
			Model	Price	No of Bags of Salt	Model	Price
1020 x 520 x 720	200	10 kg	GB200E	£141.10	8 x 25kg	GB200ST	£269.95
1200 x 725 x 750	350	20.5 kg	GB350E	£204.75	14 x 25kg	GB350ST	£370.30

GB350E

LOWER PRICES

Heavy Duty Grit Bins

- » Manufactured from tough, medium density polyethylene
- » Hinged Lids - protects the grit/salt from the elements
- » GCB200: fitted with 1 x hasp & staple (*padlock not included*)
- » GCB400: fitted with 2 x hasp & staple (*padlock not included*)

200L
evenly
distributed



GCB400



COLOUR OPTIONS

- Red
- Blue
- Yellow
- Green

specify when ordering

GCB200

LOWER PRICES

External Size L x W x H mm	Capacity Litres	Bin Weight	Grit Bins		Grit Bins c/w Salt		
			Model	Price	No of Bags of Salt	Model	Price
720 x 750 x 710	200	14 kg	GCB200	£176.80	8 x 25kg	GCB200ST	£301.60
1260 x 750 x 710	400	22 kg	GCB400	£247.60	16 x 25kg	GCB400ST	£432.60

Rock Salt

- » Highest purity salt for de-icing snow & ice
- » Ideal for quick de-icing of car parks, pathways & steps
- » Works quickly to leave areas free from ice with virtually no residue
- » Also guards against re-freezing
- » Supplied in 25kg Bags
- » Ideal for use with all grit bins & the salt spreaders shown on page 529



Description	Model	Price
10 bags of Rock Salt	WRS10P	£229.65
40 bags of Rock Salt	WRS42P	£403.40

Office Desks, Seating & Canteen Furniture

Core Twin Upright Rectangular Desk with 2 Drawer Pedestal



CB2D1280
in Canadian Oak

- » Bundle includes either a Twin Upright 1200, 1400 or 1600 rectangular desk & 2 drawer mobile pedestal
- » Component guarantee: 5 years
- » Top thickness: 25mm

WORKTOP COLOUR OPTIONS
please specify when ordering



FRAME COLOUR OPTIONS
please specify when ordering



Overall Size W x D x H mm	Model	Price
1200 x 800 x 730	CB2D1280	£249.95
1400 x 800 x 730	CB2D1480	£253.25
1600 x 800 x 730	CB2D1680	£264.95

Core Twin Upright Rectangular Desk with 3 Drawer Pedestal



CB3D1280
in Alaskan Grey Oak

- » Bundle includes either a Twin Upright 1200, 1400 or 1600 rectangular desk & 3 drawer mobile pedestal
- » Component guarantee: 5 years
- » Top thickness: 25mm

WORKTOP COLOUR OPTIONS
please specify when ordering



FRAME COLOUR OPTIONS
please specify when ordering



Overall Size W x D x H mm	Model	Price
1200 x 800 x 730	CB3D1280	£249.95
1400 x 800 x 730	CB3D1480	£253.25
1600 x 800 x 730	CB3D1680	£264.95

Core Twin Upright Radial Desk with 3 Drawer Pedestal



CB1D16LH
in Norwegian Beech

- » Bundle includes a Twin Upright radial desk (either left or right hand) & 3 drawer pedestal
- » Component guarantee: 5 years
- » Top thickness: 25mm

WORKTOP COLOUR OPTIONS
please specify when ordering



FRAME COLOUR OPTIONS
please specify when ordering



Overall Size W x D x H mm	Radial Left Hand		Radial Right Hand	
	Model	Price	Model	Price
1600 x 800/1200 x 730	CB1D16LH	£308.25	CB1D16RH	£308.25

Office Desks, Seating & Canteen Furniture

Core Twin Upright Rectangular Desk

- >> Component guarantee: 5 years
- >> Top thickness: 25mm

WORKTOP COLOUR OPTIONS				FRAME COLOUR OPTIONS	
please specify when ordering				please specify when ordering	
Norwegian Beech	Canadian Oak	Alaskan Grey Oak	Artic White	Silver	White

NEW



Overall Size W x D x H mm	Model	Price
1200 x 600 x 730	CRED1260	£138.25
1200 x 800 x 730	CRED1280	£143.25
1400 x 600 x 730	CRED1460	£141.60
1400 x 800 x 730	CRED1480	£153.25
1600 x 600 x 730	CRED1660	£148.25
1600 x 800 x 730	CRED1680	£154.95



CRED1460
in Norwegian Beech

Core Twin Upright Radial Desk

- >> Component guarantee: 5 years
- >> Top thickness: 25mm

WORKTOP COLOUR OPTIONS			
please specify when ordering			
Norwegian Beech	Canadian Oak	Alaskan Grey Oak	Artic White

FRAME COLOUR OPTIONS	
please specify when ordering	
Silver	White

Overall Size W x D x H mm	Radial Left Hand		Radial Right Hand	
	Model	Price	Model	Price
1600 x 800/1200 x 730	CRAD16LH	£181.60	CRAD16RH	£181.60

NEW

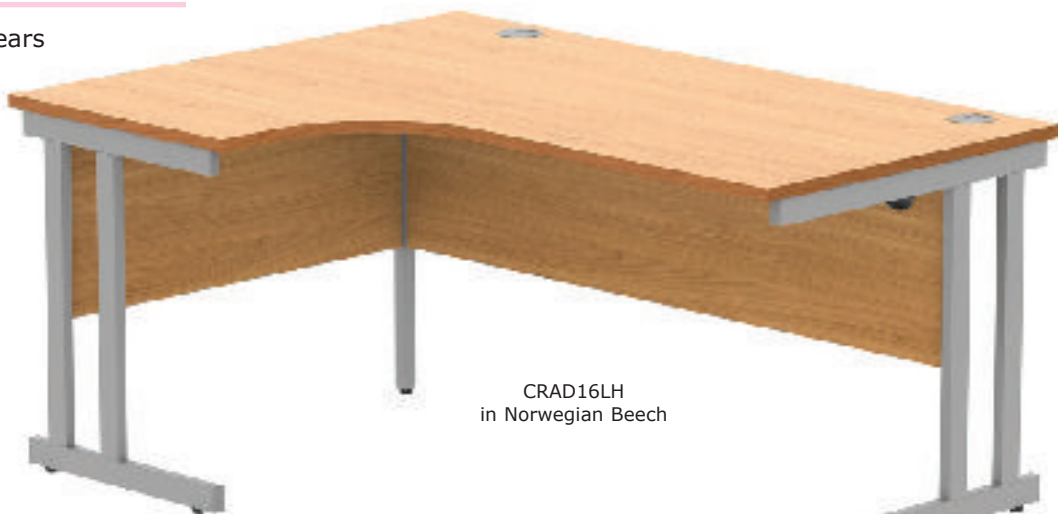

CRAD16LH
in Norwegian Beech

Core Multi-purpose Tables

- >> Component guarantee: 5 years
- >> Top thickness: 25mm

WORKTOP COLOUR OPTIONS			
please specify when ordering			
Norwegian Beech	Canadian Oak	Alaskan Grey Oak	Artic White

FRAME COLOUR OPTION	
please specify when ordering	
Silver	

Overall Size W x D x H mm	Model	Price
1200 x 600 x 730	CMPT1260	£93.25
1200 x 800 x 730	CMPT1280	£96.60
1600 x 600 x 730	CMPT1660	£104.95
1600 x 800 x 730	CMPT1680	£108.25

NEW



CMPT1260
in Alaskan Grey Oak

A delivery consignment charge will apply for these products - please call for details

Office Desks, Seating & Canteen Furniture

Core High Desk Pedestals



» Lockable top drawer

7 day delivery

NEW

COLOUR OPTIONS
please specify when ordering

Norwegian Beech Canadian Oak Alaskan Grey Oak Artic White

CDHP4060
in Norwegian Beech

Overall Size W x D x H mm	Model	Price
400 x 600 x 730	CDHP4060	£138.25
400 x 800 x 730	CDHP4080	£159.95

Core Mobile Under Desk Pedestals



» Lockable top drawer

7 day delivery

NEW

COLOUR OPTIONS
please specify when ordering

Norwegian Beech Canadian Oak Alaskan Grey Oak Artic White

CMUDP0240
in Canadian Oak

Description	Overall Size W x D x H mm	Model	Price
2 Drawer	400 x 500 x 590	CMUDP0240	£116.60
3 Drawer	400 x 500 x 590	CMUDP0340	£116.60

Filing Cupboards

- » A4 & foolscap suspension filing
- » 100% drawer extension with anti-tilt
- » Lockable drawers with 40kg capacity per drawer
- » 7 year guarantee



NEW **7 day delivery**

TFC13 TFC10 TFC07

INFORMATION

100% drawer extension with anti-tilt

COLOUR OPTIONS
please specify when ordering



Description	Overall Size W x D x H mm	Model	Price
2 Drawers	465 x 620 x 700	TFC07	£164.95
3 Drawers	465 x 620 x 1000	TFC10	£191.60
4 Drawers	465 x 620 x 1300	TFC13	£216.60

Straight Desk Screens



NEW **7 day delivery**

COLOUR OPTIONS
please specify when ordering

Royal Blue Black

Overall Size W x D x H mm	Model	Price
1200 x 25 x 400	DS1200	£49.95
1400 x 25 x 400	DS1400	£54.95
1600 x 25 x 400	DS1600	£58.25
1800 x 25 x 400	DS1800	£61.60

Standing Screens



COLOUR OPTIONS
please specify when ordering

Royal Blue Black

7 day delivery

NEW

SS1216 SS1216

Overall Size W x H mm	Model	Price
1400 x 1200	SS1412	£93.25
1600 x 1200	SS1612	£99.95
1200 x 1600	SS1216	£109.95
1600 x 1600	SS1616	£124.95

Overall Size W x H mm	Model	Price
1200 x 1800	SS1218	£121.60
1400 x 1800	SS1418	£128.25
1600 x 1800	SS1618	£136.60

Office Desks, Seating & Canteen Furniture

Core Bookcases

- >> Floating shelves included
- >> Component guarantee: 5 years

COLOUR OPTIONS
please specify when ordering

			
Norwegian Beech	Canadian Oak	Alaskan Grey Oak	Artic White

NEW



Description	Overall Size W x D x H mm	Model	Price
1 Shelf	800 x 400 x 730	CBC8407	£116.60
1 Shelf	800 x 400 x 816	CBC8408	£126.60
2 Shelves	800 x 400 x 1204	CBC8412	£153.25
3 Shelves	800 x 400 x 1592	CBC8415	£174.95
4 Shelves	800 x 400 x 1980	CBC8418	£224.95

Core Cupboards

- >> Floating shelves included
- >> Component guarantee: 5 years

COLOUR OPTIONS
please specify when ordering

			
Norwegian Beech	Canadian Oak	Alaskan Grey Oak	Artic White

NEW





Description	Overall Size W x D x H mm	Model	Price
1 Shelf	800 x 400 x 730	CCU8407	£151.60
1 Shelf	800 x 400 x 816	CCU8408	£159.95
2 Shelves	800 x 400 x 1204	CCU8412	£181.60
3 Shelves	800 x 400 x 1592	CCU8415	£224.95
4 Shelves	800 x 400 x 1980	CCU8418	£281.60

Tambours

- >> A4 & fooscap suspension filing
- >> 100% drawer extension with anti-tilt
- >> Lockable doors with 40kg capacity shelves
- >> 7 year guarantee

COLOUR OPTIONS
please specify when ordering

	
Grey	White

NEW



Description	Overall Size W x D x H mm	Model	Price
2 Shelves	1000 x 450 x 1050	TAM105	£358.25
4 Shelves	1000 x 450 x 1950	TAM195	£458.25
Roll Out Tambour Filing Frame		TAMROF	£116.60
Dual purpose Tambour Shelf		TAMTAS	£19.95

A delivery consignment charge will apply for these products - please call for details

535

Office Desks, Seating & Canteen Furniture

Ergo Blaster PU Operator & Deluxe Draughting Chairs



- >> Wipe clean operator chair/draughting chairs
- >> Backrest with height adjustment & hinged tilt
- >> Tamper proof seat fixings
- >> Generous seat size: 460W x 460Dmm
- >> Medium back size: 400W x 330Hmm
- >> Gas lift seat height adjustment
- >> 1100-PU: mobile on castors for easy movement
- >> 1100-PU-1164: nylon base with glides & adj. footing

Colour	Seat Height mm	Model	Price
Ergo Blaster PU Operator Chair			
White	470 to 590	1100-PUWH	£87.50
Black		1100-PUBK	£87.50
Ergo Blaster PU Deluxe Draughting Chair			
White	600 to 860	1100-PU-1164WH	£151.20
Black		1100-PU-1164BK	£151.20

Polly Operator & Deluxe Draughting Stools



- >> Easy clean, soft polyurethane stool/draughting chairs
- >> Seat size: 320W x 320Dmm
- >> Gas lift seat height adjustment
- >> 1850: mobile on castors for easy movement
- >> 1850-1164: nylon base with glides & adj. footing

Description	Seat Height mm	Model	Price
Polly Operator Stool	430 to 560	1850	£98.75
Polly Deluxe Draughting Stool	590 to 830	1850-1164	£162.55

Labour Deluxe Draughting Chair



- >> Polyurethane draughting chair
- >> Floating or fixed permanent contact backrest
- >> Generous seat size: 460W x 430Dmm
- >> Medium back size: 410W x 310Hmm
- >> Gas lift seat height adjustment
- >> Nylon base with glides & adjustable footing

Seat Height mm	Model	Price
590 to 830	9999-1164	£207.30

Perch Stool



COLOUR OPTIONS
 White
 Black
 specify when ordering

- >> Industrial perch stool with polyurethane seat
- >> Seat size: 440W x 340Dmm
- >> 8 position seat height adjustment from 600 to 800mm
- >> Contoured cushioned saddle seats

Description	Model	Price
Perch Stool	6926	£186.70

Ergo Twin & Deluxe PU



- >> Wipe clean twin lever chair/draughting chair
- >> Tamper proof seat fixings
- >> Twin & Deluxe seat size: 460W x 440D
- >> Gas lift seat height adjustment
- >> 2900PU: accepts optional armrests
- >> 2900PU/1164: durable nylon base with glides for stability

Seat Height mm	Model	Price
Ergo Twin PU		
440 to 580	2900PU	£104.95
Ergo Twin PU Deluxe Draughting		
570 to 850	2900PU/1164	£168.70

Office Desks, Seating & Canteen Furniture

Ergo Blaster



1100

COLOUR OPTIONS
■ Blue
■ Black
specify when ordering

- » Backrest with height adjustment & hinged tilt
- » Tamper proof seat fixings
- » Seat size: 460W x 460Dmm
- » Back size: 400W x 330Hmm
- » Gas lift seat height adjustment from 470 to 590mm

Description	Model	Price
Ergo Blaster	1100	£82.30

Ergo Twin



2900 & 0280

COLOUR OPTIONS
■ Blue
■ Black
specify when ordering

- » Twin lever, high back, chair
- » Floating or fixed permanent contact backrest & pronounced lumbar support
- » Seat size: 460W x 440Dmm
- » Back size: 430W x 500Hmm
- » Gas lift seat height adjustment from 440 to 580mm

Description	Model	Price
Ergo Twin	2900	£98.75
Step Armrests	0280	£41.15

Ergo Trio



2901 & 0280

COLOUR OPTIONS
■ Blue
■ Black
specify when ordering

- » Ergonomic high back chair
- » 3 lever, asynchronous mechanism
- » Independent tilt to seat & backrest
- » Seat size: 460W x 440Dmm
- » Back size: 430W x 500Hmm
- » Gas lift seat height adjustment from 460 to 590mm

Description	Model	Price
Ergo Trio	2901	£102.90
Step Armrests	0280	£41.15

Ergo Comfort 24 Hour



9500 & 0270

COLOUR OPTIONS
■ Blue
■ Black
specify when ordering

- » Ergonomic high back, 24 hour, executive chairs
- » Certified for 24 hour use - BS5459-2:2000
- » Posture curve backrest & forward ergo tilt seat
- » 4 lever asynchronous mechanism
- » Seat size: 500W x 470Dmm
- » Gas lift seat height adjustment from 520 to 640mm

Description	Model	Price
Ergo Comfort	9500	£163.05
Ergo Comfort Air - Pump up Lumbar Support	9500AIR	£178.50
Ergo Comfort PU - Wipe Clean	9500PU	£172.80
Ergo Comfort Mesh - Mesh Backrest	9500MESH	£178.50
Comfort Adjustable Armrests	0270	£41.15



9500AIR

9500PU & 0270

9500MESH

Ergo Plus HR Premier Chair

- » Certified for 24 hour use - BS5459-2:2000
- » Stylish headrest for added comfort
- » 2:1 back & seat synchron (5 position)
- » 4 position seat slide
- » Lumbar adjustment on backrest
- » Ratchet back height adjustment
- » Aluminium base

COLOUR OPTIONS
■ Blue
■ Black
specify when ordering



9700/R530 & 0270

Description	Model	Price
Ergo Plus HR Premier Chair	9700/R530	£310.15
Comfort Adjustable Armrests	0270	£41.15

Office Desks, Seating & Canteen Furniture

Leader Executive



- » Bonded leather faced executive armchair with sturdy nylon base
- » Durable nylon armrests
- » Seat size: 490W x 470Dmm
- » Back size: 480W x 680Hmm
- » Gas lift seat height adjustment from 500 to 600mm

Description	Model	Price
Leader Executive	6987	£114.20

Star Mesh



- » Stylish mesh back & fabric seat
- » Reclining function with tilt tension
- » Seat size: 470W x 480Dmm
- » Back size: 450W x 440Hmm
- » Gas lift seat height adjustment from 440 to 520mm

Description	Model	Price
Black Mesh Back	6910BK	£92.10
White Mesh Back	6910WH	£92.10
Blue Mesh Back	6910BL	£92.10

Harmony Mesh



- » Luxury mesh executive chair
- » Fully synchronising mechanism with weight tension control
- » Fold back armrests & adj. headrest
- » Seat size: 490W x 500Dmm
- » Back size: 490W x 560Hmm
- » Gas lift seat height adjustment from 450 to 560mm

Description	Model	Price
Harmony	6956	£228.90

Milan Executive



- » Leather look armchair with durable nylon armrests & chrome base
- » Reclining function with tilt tension
- » Seat size: 490W x 500Dmm
- » Back size: 490W x 550Hmm
- » Gas lift seat height adjustment from 470 to 570mm

Description	Model	Price
Milan Executive	6914	£138.35

Goliath Duo Heavy Duty



- » Stylish contrasting piping detail
- » Rated to 27 stone (170kg)
- » Suitable for 24 hour use
- » Seat size: 510W x 600Dmm
- » Back size: 590W x 700Hmm
- » Gas lift seat height adjustment from 460 to 560mm

Description	Model	Price
Goliath - Grey Fabric	6989	£364.15
Goliath - Blue Fabric	6991	£364.15
Goliath - Brown Fabric	6992	£364.15
Goliath - Leather	6925	£364.15

Hercules



- » Extreme heavy duty, 35 stone, chair
- » Durable mesh back, depth adjustable lumbar support & soft touch fold up armrests
- » Ultra deep cushioned fabric seat
- » Reclining function with tilt tension
- » Seat size: 600W x 590Dmm
- » Back size: 580W x 630Hmm
- » Gas lift seat height adjustment from 500 to 600mm

Description	Model	Price
Hercules	6973	£349.75

Office Desks, Seating & Canteen Furniture

Skandi



6980



6981



6982



- >> Contemporary reception armchairs & sofas
- >> Durable grey fabric & stylish 'pared back' design
- >> Classic button back & smart wooden legs

Description	Size H x W x D mm	Seat Size W x D mm	Model	Price
Skandi Armchair	800 x 830 x 640	480 x 500	6980	£370.30
Skandi 2 Seater Sofa	800 x 1350 x 640	1020 x 500	6981	£565.75
Skandi 3 Seater Sofa	800 x 1770 x 640	1420 x 500	6982	£694.30

Conference Chair PU



SEAT COLOUR OPTIONS

- Black
- Blue

specify when ordering

- >> Minimum order quantity of 4
- >> Utility seating in a wipe clean finish for varied use, (reception, conferences etc)
- >> Padded seat and backrest
- >> Stacks for easy space saving storage

Size H x W x D mm	Minimum Order Qty	Model	Price
470 x 470 x 440	4	1500PU	£51.95

4 Legged Reception Chair

- >> Contemporary reception chair with soft brushed fabric
- >> Modern oak legs
- >> Same colour when purchasing packs of 2
- >> Seat Size: 470H x 440D
- >> Back size: 400W



FABRIC COLOUR OPTIONS

- Graphite
- Plum
- Teal
- Yellow

specify when ordering



Description	Overall Width mm	Model	Price 1 off	Price pack of 2
4 Legged Chair	590	6929	£130.65	£222.20

Loft Bistro Set

- >> Bistro set comprising of a white table & four wenge coloured chairs
- >> Stylish modern design
- >> Ideal for canteen & breakout areas
- >> Exposed ply accent on chairs
- >> Wipe clean table
- >> Chrome frame on table & chairs



Description	Table Size H x dia. mm	Seat Height mm	Seat Width mm	Model	Price
Table Only	760 x 900	-	-	6455WH	£114.70
Table & 4 Chairs	760 x 900	470	380	6907	£424.30

Office Desks, Seating & Canteen Furniture

Beam Benches

- » Heavy duty polypropylene chairs mounted on a strong & durable steel frame
- » Seat height: 450mm



BBT04Z



BBT03Z

INFORMATION



Ideal for waiting rooms, educational environments, retail & hospitals

Description	Overall Size L x D x H mm	Weight kg	Model	Price
3 Seater	1670 x 550 x 790	15	BBT03Z	£199.95
4 Seater	2235 x 550 x 790	19	BBT04Z	£233.70

Beam Benches with Steel Seats

- » Heavy duty steel chairs mounted on a strong & durable steel frame

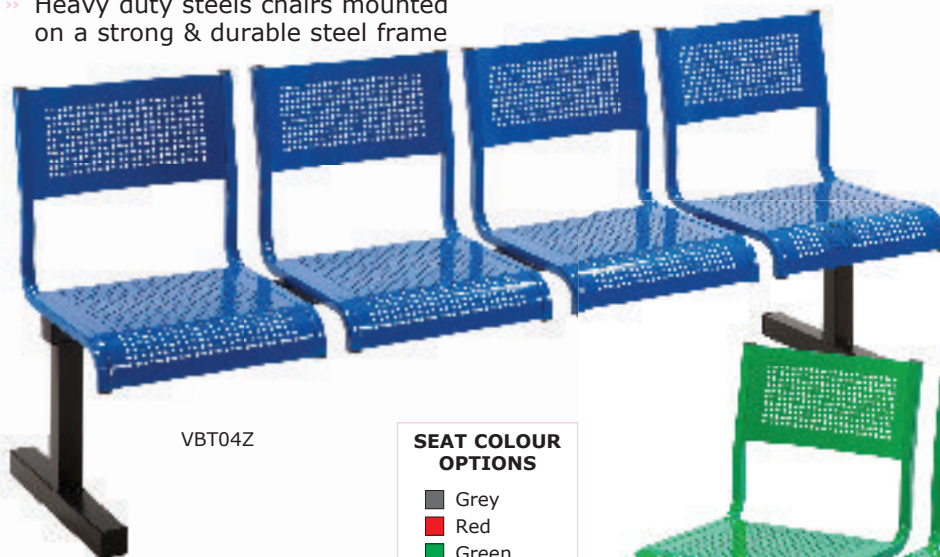

VBT04Z

SEAT COLOUR OPTIONS

- Grey
- Red
- Green
- Blue
- Black

specify when ordering



VBT03Z

Description	Overall Size L x W x H mm	Model	Price
2 Seater	930 x 510 x 750	VBT02Z	£411.80
3 Seater	1405 x 510 x 750	VBT03Z	£563.05
4 Seater	1878 x 510 x 750	VBT04Z	£716.85
5 Seater	2380 x 510 x 750	VBT05Z	£880.70

Office Desks, Seating & Canteen Furniture

Canteen Tables

- » Ideal for use in eating areas in offices, halls, factories, warehouses & retail premises
- » Seats are manufactured from moulded polypropylene mounted on a strong steel frame
- » Table top is manufactured from chipboard with a melamine coating
- » Full length table for your comfort

CBT42Z

£316.55

PRICES HELD

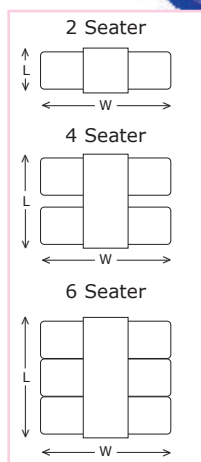

CBT42Z

INFORMATION

Supplied knock down for easy access into your premises



THE HEAVY DUTY POLYPROPYLENE SEATS & HARDWEARING MELAMINE WORKTOP ARE MOUNTED ON A STRONG & DURABLE STEEL FRAME

Description	No. of Seats	Overall Size L x W x H mm	Table Size L x W mm	Weight kg	Model	Price
Peninsula Units - Access 1 Way						
	2	600 x 1730 x 810	600 x 600	26	CBT21Z	£208.40
	4	1250 x 1730 x 810	1250 x 600	38	CBT41Z	£327.55
	6	1745 x 1730 x 810	1745 x 600	55	CBT61Z	£443.15
Island Units - Access 2 Ways						
	4	1250 x 1730 x 810	1250 x 600	38	CBT42Z	£316.55
	6	1745 x 1730 x 810	1745 x 600	55	CBT62Z	£443.15

Office Desks, Seating & Canteen Furniture



BLUE ONLY

*Maximum quantity of 5

Canteen Tables

- » Fully welded construction for durability
- » Ideal for use in eating areas in offices, halls, factories, warehouses & retail premises
- » Blue seats manufactured from moulded polypropylene mounted on a steel frame
- » Laminate, light grey table tops with PVC edging

FROM ONLY
£268.70



QCT42Z

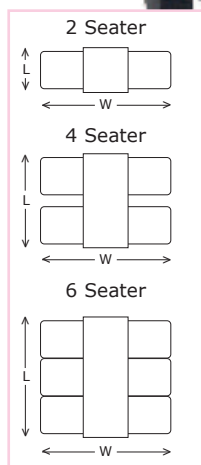

SEAT COLOUR OPTIONS

- Black
- Red
- Blue

specify when ordering

No. of Seats	Overall Size L x W x H mm	Table Size L x W mm	Model	Price
1 Way Entry (Wall Units)				
2	530 x 1690 x 725	530 x 600	QCT21Z	£268.70
4	1070 x 1690 x 725	1070 x 600	QCT41Z	£402.75
6	1580 x 1690 x 725	1580 x 600	QCT61Z	£566.15
2 Way Entry				
4	1070 x 1690 x 725	1070 x 600	QCT42Z	£402.75
6	1580 x 1690 x 725	1580 x 600	QCT62Z	£566.15

Canteen Tables with Steel Seats

- » Fully welded robust canteen unit with seats made from 1.2mm mild steel
- » MFC table tops come in a light grey, with PVC edging for extra strength & protection
- » Frames are powder coated with light grey Germ Guard Active Technology Paint
- » Seats available in green, red, blue or dark grey - please specify when ordering (any other RAL colour available to suit your corporate colours - call for details)
- » Table height of 710mm
- » Seat height of 425mm



QST841Z

QST821Z

QST861Z

SEAT COLOUR OPTIONS

- Grey
- Red
- Green
- Blue

specify when ordering

Description	Overall Size H x W x L mm	Table Size W x L mm	Model	Price
2 Seater				
Single Entry	790 x 1755 x 570	600 x 535	QST821Z	£620.85
4 Seater				
Single Entry	790 x 1755 x 1100	600 x 1070	QST841Z	£886.85
Double Entry	790 x 1755 x 1100	600 x 1070	QST842Z	£886.85
6 Seater				
Single Entry	790 x 1755 x 1600	600 x 1580	QST861Z	£1132.00
Double Entry	790 x 1755 x 1600	600 x 1580	QST862Z	£1132.00



Wooden Seat Canteen Tables

- » Fully welded construction for durability with 25mm thick table top
- » Ideal for use in eating areas in offices, halls, factories, warehouses & retail premises
- » Seats are manufactured from beech veneer & mounted on a strong steel frame



WORKTOP COLOUR OPTIONS

- White
- Grey
- Beech

specify when ordering

FRAME COLOUR OPTIONS

- Silver
- Black

specify when ordering

FROM ONLY
£377.35

No. of Seats	Overall Size L x W x H mm	Table Size L x W mm	Single Entry		Double Entry	
			Model	Price	Model	Price
2	535 x 1600 x 750	600 x 600	VTD21Z	£377.35	-	-
4	1070 x 1600 x 750	1000 x 600	VTD41Z	£579.85	VTD42Z	£579.85
6	1600 x 1600 x 750	1600 x 600	VTD61Z	£826.10	VTD62Z	£826.10

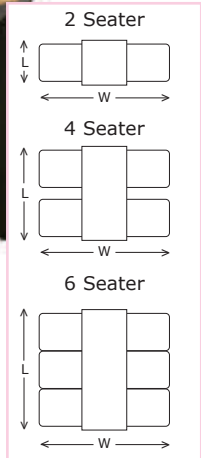

Canteen Tables with Upholstered Seats

- » Fully welded construction for durability with 25mm thick table top
- » Ideal for use in eating areas in offices, halls, factories, warehouses & retail premises
- » Seats are manufactured from coloured vinyl & mounted on a strong steel frame



SEAT COLOUR OPTIONS

- Blue
- Red
- Grey
- Purple
- Green

specify when ordering

WORKTOP COLOUR OPTIONS

- White
- Grey
- Beech

specify when ordering

FRAME COLOUR OPTIONS

- Silver
- Black

specify when ordering

FROM ONLY
£469.75

No. of Seats	Overall Size L x W x H mm	Table Size L x W mm	Single Entry		Double Entry	
			Model	Price	Model	Price
2	535 x 1600 x 750	600 x 600	VTE21Z	£469.75	-	-
4	1070 x 1600 x 750	1000 x 600	VTE41Z	£768.95	VTE42Z	£768.95
6	1600 x 1600 x 750	1600 x 600	VTE61Z	£1105.05	VTE62Z	£1105.05

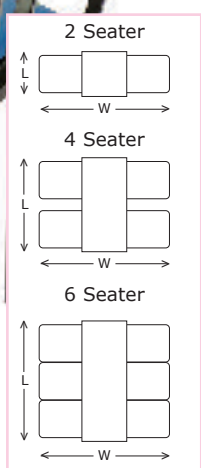

Mailroom, Packaging & Retail Equipment

Mail Distribution Trolleys

- » Non marking buffering helps prevent damaging doorways & furniture
- » These tubular steel trolleys can be used both indoors & outdoors
- » Models MTE01S & MTE02L have high cap. removable baskets, with a pannier basket available for both models
- » On the larger model, MTE02L, the upper basket can tilt back giving easy access to the lower basket
- » Platform trolley model MTE03C has side & end panels to help maximise the storage capabilities of this large trolley
- » Side panels are easy to remove to aid loading & unloading
- » Large basket model MTE04D has 2 large capacity removable baskets designed to accommodate concertina files
- » Diamond formation wheels on models MTE03C & MTE04D give easy manoeuvrability



**FROM ONLY
£507.75**

MTE02L shown with MTEB1Z, concertina files & support bars, call for details



MTE01S shown with concertina files & support bars, call for details



MTE03C



MTE04D

Description	Overall Size W x D x H mm	Basket Size W x D x H mm	Wheels	Max Load	Weight kg	Model	Price
Mail Trolley	610 x 915 x 1000	460 x 485 x 255	2 x 125 mm Swivel Castors, 2 x 200 mm Fixed Wheels	Lower Basket - 50 kg Upper Basket - 20 kg	25	MTE01S	£507.75
Mail Trolley	610 x 1030 x 1000	460 x 635 x 255		Lower Basket - 60 kg Upper Basket - 30 kg	30	MTE02L	£599.85
Optional Pannier Basket to suit above models	-	460 x 130 x 350	-	10 kg	-	MTEB1Z	£71.45*
Platform Trolley with side/end panels	610 x 1200 x 1070	-	4 x 200 mm Castors, 2 fixed, 2 swivel	300 kg	66	MTE03C	£974.45
Platform Trolley with large baskets	610 x 1200 x 1070	425 x 960 x 425		Lower Basket - 60 kg Upper Basket - 20 kg	68	MTE04D	£950.55

Mailroom, Packaging & Retail Equipment



FROM ONLY
£268.75



Mailroom Trolleys

- » Manufactured from strong tubular steel
- » Supplied complete with baskets
- » Mobile on fixed 200mm wheels & swivel wheels at the front for manoeuvrability

Overall Size W x D x H mm	Basket Size W x D x H mm	Model	Price
Mailroom Trolley with 2 x Baskets			
555 x 735 x 940	470 x 370 x 270	MRT01Y	£268.75
Large Mailroom Trolley with 2 x Baskets & Panier Basket			
510 x 710 x 910	630 x 450 x 270	MRT02Y	£369.75



NEW

Premium Mailroom Trolley

- » Manufactured from strong tubular steel
- » Supplied complete with extra large baskets
- » Mobile on fixed 200mm wheels & swivel wheels at the front for manoeuvrability

FROM ONLY
£547.85



Overall Size W x D x H mm	Basket Size W x D x H mm	Model	Price
540 x 1180 x 980	780 x 480 x 220	MRT03Y	£547.85

Mailroom, Packaging & Retail Equipment

Compact Self Levelling Trolleys - Open & Secure Versions

FROM ONLY
£918.70

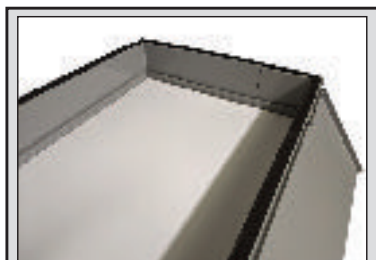

Platform shown at full height

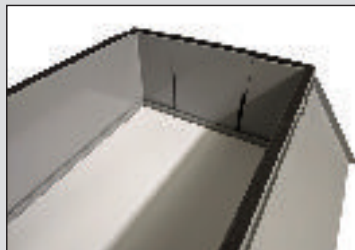

Platform shown under load



GS9338

- » Robust & compact construction gives greater storage space
- » Fully welded construction with powder coated sheet panels, neoprene foam edges & plastic deck
- » Designed to fit through standard doorways
- » GS9337: open version
- » GS9338: secure version with padlock hole (padlock not supplied)
- » The standard trolley internal platform has a 30mm lip & the unladen platform is set 120mm down. The platform moves down 350mm with 40kg & the springs are factory set to the required load
- » Mobile on 2 fixed & 2 swivel 125mm castors

N.B. A Fork Lift will be needed to unload these units

Overall Size L x W x H mm	Load Capacity	Weight kg	Model	Price
Self Levelling Trolley				
900 x 505 x 900	60 kg	43	GS9337	£918.70
Secure Self Levelling Trolley with Lid				
905 x 510 x 925	60 kg	50	GS9338	£985.85



Self Levelling Trolleys

- » GS9125: reinforced heavy duty PVC bag with a plywood deck
- » GS9226: constructed from galvanised steel sides & ends with a plastic deck
- » Unloaded height:
bag - 650mm &
box - 800mm

N.B. A Fork Lift will be needed to unload these units



GS9125

Overall Size L x W x H mm	Wheels	Load Capacity	Weight kg	Model	Price
Self Levelling Trolley - Bag					
935 x 730 x 932	125mm Cushion	100 kg	40	GS9125	£1518.25
Self Levelling Trolley - Box					
935 x 730 x 932	125mm Cushion	100 kg	50	GS9226	£1554.55



GS9226

Mailroom, Packaging & Retail Equipment

Mailroom Sack Holders

- » Manufactured from strong tubular steel
- » Notches on the top of the frames hold postal bags into place (bags not included)
- » Mobile on 4 x 75mm swivel castors

FROM ONLY
£218.90

NEW



MRS02Y



MRS01Y

Description	Overall Size W x D x H mm	Model	Price
Single Sack Holder	432 x 406 x 1118	MRS01Y	£218.90
Double Sack Holder	788 x 406 x 1118	MRS02Y	£268.75

Mailroom Sorting Systems

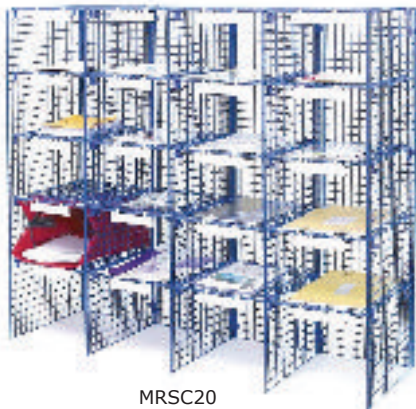

MRSC20

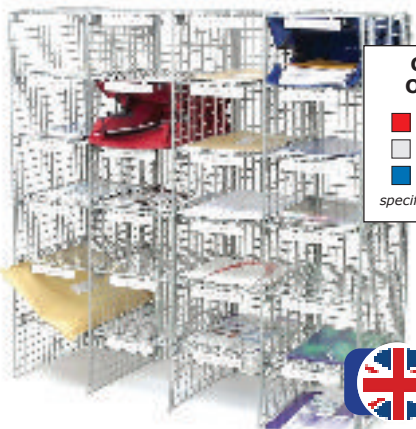

MRSC24

COLOUR OPTIONS

- Red
- Grey
- Blue

specify when ordering



MRSC18



NEW

- » Plastic coated wire mesh frames provide a clear view of the contents so letters, message slips or small envelopes cannot get overlooked or mislaid
- » Swing labels are available as optional extras

No of Compartments	Overall Size W x D x H mm	Compartment Size W x D x H mm	Model	Price
6	1067 x 381 x 554	356 x 380 x 197	MRSC06	£111.75
12	1067 x 381 x 725	356 x 380 x 197	MRSC12	£236.45
18	1067 x 381 x 1067	343 x 380 x 171	MRSC18	£310.45
20	1219 x 381 x 1067	292 x 380 x 197	MRSC20	£328.25
24	1067 x 381 x 1067	245 x 380 x 171	MRSC24	£346.05

Mailroom, Packaging & Retail Equipment

Multi-Purpose Cupboards



- » Each cupboard is fitted with a 3-point lock for extra security
- » The 1850mm high multi-purpose cupboard is fitted with 4 adjustable shelves
- » The 900mm high cupboard includes 1 shelf
- » Each cupboard shelf has a UDL of 40kg
- » Adjustable powder-coated shelves



Overall Size W x D x H mm	No of Shelves	Model	Price
900 x 400 x 900	1	MPC909040LG	£209.32
900 x 400 x 1850	4	MPC189040LG	£262.05

Post Lockers

- » Ideal for use in offices, flats, schools, colleges, hospitals etc
- » Use for central mail & internal post systems
- » Fitted with standard mastered cam locks with 2,000 differs
- » Each box has its own posting slot
- » Pre-drilled for nesting
- » Powder coated with Germ Guard Active Technology paint
- » Light grey carcass with blue doors



LX1023258

LX132325N



LX1630386

LX8730383

Overall Size W x D x H mm	No of Boxes	Model	Price
15mm Post Slots			
230 x 255 x 1075	8	LX1023258	£342.96
230 x 255 x 1325	10	LX132325N	£371.42
25mm Post Slots			
300 x 380 x 1230	7	LX1230387	£357.19
300 x 380 x 1725	10	LX173038N	£419.81
40mm Post Slots			
300 x 380 x 870	3	LX8730383	£278.92
300 x 380 x 1665	6	LX1630386	£357.19

548

Mailroom, Packaging & Retail Equipment

Clearview Sort Units

- » Configurable sorting shelves in a strong MFC cabinet with a smart, modern looking titanium finish
- » Made from sturdy transparent acrylic, clearview shelving provides one of the most efficient ways to sort mail & store documents. As you can see straight through each shelf no important letters or documents need be overlooked
- » The clear shelves are easily adjustable within the vertical columns, enabling you to configure the size & layout of the units to your needs
- » Each unit holds a maximum capacity of 36 shelves, to create 40 separate compartments - each 335D x 277W & 100H mm - or you can opt for fewer compartments with a larger capacity



GSC151047



GSC121975



GSC151975

Description	Shelves Included	Shelf Width mm	Size L x W x H mm	Model	Price
Clearview Sorting Unit	16 (Max 36)	277	1200 x 1048 x 360	GSC121036	£1235.05
Clearview Sorting Unit & Open Bench with Bottom Shelf	16 (Max 36)	277	1200 x 1948 x 750	GSC121975	£1998.10
Clearview Sorting Unit with Tambour Doors	16 (Max 36)	277	1500 x 1048 x 470	GSC151047	£2063.65
Clearview Sorting Unit with Tambour Doors & Cupboard with Sliding Doors	16 (Max 36)	277	1500 x 1948 x 750	GSC151975	£3186.30
Extra Shelves - pack of 5	-	277	-	GSCES	£125.15

Mailroom, Packaging & Retail Equipment

Economy Packing Bench



**FROM ONLY
£816.55**

- » Complete with 2 reel holders
- » Upper storage shelf - 200mm deep
- » Worktop height: 915mm
- » 25mm thick MDF worktop & lower shelf
- » For ease of transport, the unit is supplied in two components
- » The upper back frame is supplied separately for bolting into position

INFORMATION

Stay organised with this quality packing bench



MB156M

N.B - A Fork Lift will be needed to unload these units

Overall L x W mm	Overall Height mm	Lower Shelf Depth mm	Weight kg	Model	Price
1525 x 610	1525	350	70	MB156M	£816.55
1830 x 760	1525	350	85	MB187M	£863.60

Chrome Plated Wire Tray Trolley

- » Hygienic - easy to clean
- » Removable centre shelf for bulky loads
- » Mobile on 2 large fixed 200mm wheels & 2 swivel braked 125mm castors



Removable Shelf

LOWER PRICE



SWI52Y



SWI52Y



Overall Size L x W x H mm	Weight kg	Model	Price
860 x 660 x 990	17.5	SWI52Y	£239.75

Mailroom, Packaging & Retail Equipment

Workbench TPB

- » Stepless height-adjustable workbench (650–900mm) and above workbench add-on (1080–1550mm)
- » Adapts and grows according to needs; 50+ accessories
- » The TPB standard package includes: 2 roll holders, an upper shelf, divider hoops, a perforated panel, and auxiliary shelf



TPB918

Worktop Size D x W mm	Model	Price
900 x 1500	TPB915	£1226.35
900 x 1800	TPB918	£1258.76



Workbench With Full Accessories
Please call for more details



Quick Edge Workstation

- » The quickest height adjustment on the market - no electricity needed
- » Extremely wide height adjustment range 570–1300mm
- » Patent pending solution: Adjust the optimal height effortlessly for every task/ produced item
- » Grounding Set needed to make EPA safe (ESD) - Please call for more details



TQEW712-41

Worktop Size D x W mm	Model	Price
700 x 1200	TQEW712-41	£2640.65



Workstation With Full Accessories
Please call for more details



Requires Grounding set to make EPA Safe (ESD)

Mailroom, Packaging & Retail Equipment

Hacona C-Type Impulse Heat Sealers

- » Fully adjustable sealing time for different films, integrated safety cutter knife, LED red/yellow light display for sealing indication & simply require a 230 V domestic power supply making them ready to go straight from the box



HG005-175



Description	Model	Price
200mm long seal by 2.5mm wide	HG005-175	£195.00
300mm long seal by 2.5mm wide	HG005-176	£235.00
400mm long seal by 2.5mm wide	HG005-177	£289.00
600mm long seal by 2.5mm wide	HG005-178	£370.00
800mm long seal by 2.5 mm wide	HG005-179	£470.00

Hacona S-Type Heat Sealing Machines

- » Industrial heat sealing machines with integral cutter, timed sealing & cooling for stronger heat seals on your polythene bags etc

Description	Model	Price
320mm wide with 5mm sealing width	HG001-270	£890.00
420mm wide with 5mm sealing width	HG001-272	£1030.00
600mm wide with 5mm sealing width	HG001-273	£1400.00
820mm wide with 5mm sealing width	HG001-274	£2040.00
1020mm wide with 5mm sealing width	HG001-275	£2330.00

Hacona C-Type Work Table & Roll Holder

- » The dual film holder makes it easier to dispense your film whilst the work table surface allows you to position your package at the same height as the sealing blade, creating a complete sealing system for your products



HG004-877



Description	Model	Price
For use with the HG005-175 Impulse Heat Sealer	HG004-876	£125.00
For use with the HG005-176 Impulse Heat Sealer	HG004-877	£145.00
For use with the HG005-177 Impulse Heat Sealer	HG004-878	£170.00
For use with the HG005-178 Impulse Heat Sealer	HG004-879	£205.00
For use with the HG005-179 Impulse Heat Sealer	HG004-880	£225.00

Shrink-it Propane Gas Shrink System

- » Ideal way to start heat wrapping your pallets with heavy duty polythene heat shrink films
- » Includes; 8m hose, Propane gas regulator & oil bottle (SHRINK-SK-CSA also comes with a hard carry case, safety specs & heat proof gloves)
- » 32 kw heat output



SHRINK-SK-CS

Model	Price
SHRINK-SK-CS	£465.00
SHRINK-SK-CSA	£550.00

SHRINK-SK-CSA



Hacona S-Type Heat Sealing Accessories



Work Table

Workstand & Foot Pedal



Description	Model	Price
Workstand & Foot Pedal for the HG001-270	HG-001-287	£380.00
Work Table for the HG001-270	HG-001-292	£190.00
Workstand & Foot Pedal for the HG001-272	HG-001-288	£395.00
Work Table for the HG001-272	HG-001-293	£229.00
Workstand & Foot Pedal for the HG001-273	HG-001-289	£440.00
Work Table for the HG001-273	HG-001-294	£250.00
Workstand & Foot Pedal for the HG001-274	HG-001-290	£525.00
Work Table for the HG001-274	HG-001-296	£270.00
Workstand & Foot Pedal for the HG001-275	HG-001-291	£540.00
Work Table for the HG001-275	HG-001-297	£285.00

Mailroom, Packaging & Retail Equipment

Cushion Pack Cardboard Box Shredding Machine

- » An ideal starter machine when you want to start producing your own packaging void fill from waste cardboard. This simple to use machine will turn your waste cardboard into not only a useful packaging void fill material but an environmentally friendly one too!
- » Run time: 2 hours
- » Voltage: 240 0.75 kw
- » Current Amps: 13
- » Noise level: 55 db/(A)
- » Emergency stop
- » Made in Germany



INFORMATION



Environmentally friendly way of producing your own void fill



GCP 316 S2i

Cutting Width	Cubic/M per hour	Max Board Thickness	Production Throughput	Model	Price
320mm	1-2	12mm	10M/min	GCP 316 S2i	£2500.00

Cushion Pack Cardboard Box Shredding Machine with Dust Extraction Facility

- » Ideal machine for more demanding applications. This simple to use machine will turn your waste cardboard into not only a useful packaging void fill material but an environmentally friendly one too!
- » Emergency stop
- » Dust extraction machine helps to keep the machine clean as well as reducing dust from the void fill material
- » Made in Germany



SFP-100 W796



GCP 422 S2i



Cutting Width	Cubic/M per hour	Max Board Thickness	Production Throughput	Run Time	Voltage kw	Current Amps	Noise Level	Model	Price
420mm	4-6	18mm	10M/min	2-3	240 1.5kw	13	60	GCP 422 S2i	£5150.00
Dust Extractor Unit								SFP-100 W796	£550.00

Mailroom, Packaging & Retail Equipment



SIAT Semi-Automatic Case Sealing Machine Bottom Belt Driven

- » A very reliable semi-automatic bottom belt driven case & box taping machine specifically for medium sized boxes of the same size with a minimum weight of 3kg. Ideal case sealing machine for a variety of industries like food & beverage, pharmaceutical, clothing & electronics
- » Seals top & bottom flaps of cardboard boxes/cartons
- » Bottom belt driven - left side operation
- » Standard 240v power supply
- » Tape head & width: 50mm (75mm available)
- » Central emergency stop to work safely on both sides of the machine
- » Lockable electric isolation switch for added protection
- » Made in Italy

NEW



Box Weight Min to Max	Min Box Size L x W x H mm	Max Box Size W x H mm	Production Capacity	Model	Price
3 to 30kg	150 x 140 x 100	500 x 500	1200 per hour	SK10	£3100.00



SIAT Semi-Automatic Random Case Sealing Machine, Top & Bottom Belt Driven

- » Semi-Automatic Random case taping machine, the height & the width of the box is detected as it is fed into the machine, the machine then automatically adjusts to the required size. It is top & bottom belt driven so the tape is then applied to either the top of the case, or to the top & bottom as required. Ideal for e-commerce & logistics operation
- » Seals upper & lower flaps of cardboard boxes/cartons
- » Top and bottom belts are driven
- » Motorization 2 x 130 Watt
- » Tape head & width: 50mm (75mm available)
- » Requires air supply
- » Made in Italy

NEW



Box Weight Min to Max	Min Box Size L x W x H mm	Max Box Size W x H mm	Production Capacity	Model	Price
0.5 to 32kg	150 x 140 x 100	500 x 500	900 per hour	SR20	£7500.00

SIAT One Wrap Semi-Auto Pallet Stretch Wrapping Machine

- » Simple to operate with a user friendly control panel - once programmed it is simply a case of pressing "start" to initiate the wrap cycle. This SIAT stretch wrapper improves pallet stability, reduce stretch film consumption & eliminate the need to hand wrap pallets
- » Manual & 4 automatic modes, 9 + 1 individual programs & lockable control panel
- » 6 - 12 rpm (adjustable)
- » 72,0 dB(A)
- » Smooth start / stop
- » Film width: 500 mm / ext. Φ 300 mm / core Φ 76mm (fix) / weight 20 kg / thickness up to 35 micron
- » Independent setting of rotation & carriage speeds
- » Top-sheet function
- » No. of top & bottom windings (independently settable)
- » Automatic height detection
- » Top edge overlap (settable from control-panel)
- » Adjustable bottom overlap
- » Pausable wrapping cycle
- » Made in Italy

NEW



Model	Price
L-16-M	£5900.00

554

Ultra Accurate Counting/Weigh Scale

- » Stainless steel top plate 230mm x 300mm
- » Backlit LCD display for easy reading at all angles
- » Internal rechargeable battery, up to 50 hours life - mains charger supplied
- » Robust construction
- » Optional Traceable ISO 9000 calibration certificate available at time of order



PRICES HELD

INFORMATION

Ultra accurate counting scale

Models Available

- » GASC-15: 0.2g increments & counts pieces down to 0.05g
- » GASC-30: 0.5g increments & counts pieces down to 0.1g

Description	Model	Price
15kg capacity	GASC-15	£395.00
30kg capacity	GASC-30	£395.00
Optional ISO 9000 Calibration Certificate	GSC9000	£35.00

Ultra Accurate Bench/Floor Scale

- » Large heavy duty base. 350mm x 450mm with stainless steel loading plate
- » 150kg with 0.05kg increments
- » Robust construction
- » Large Backlit 24mm High for easy reading
- » Internal rechargeable battery, up to 50 hours life - mains charger supplied
- » Optional Traceable ISO 9000 calibration certificate available at time of order



PRICES HELD

INFORMATION

Ultra accurate to 0.05kg increments

Description	Model	Price
150kg x 0.05kg	GAFWC-150	£475.00
Optional ISO 9000 Calibration Certificate	GAFWC9000	£35.00



Mailroom, Packaging & Retail Equipment

Dump Baskets

» White plastic coated



D2400



D1600

- » D2100: round dump bin
- » D1600 & D2400: square collapsible basket with adjustable base



D2100

INFORMATION

Ideal for catering for the impulse buyer

LOWER PRICES

Stacking Display Baskets

» A fantastic value & versatile stacking basket with a smooth epoxy coated finish with collapsible design

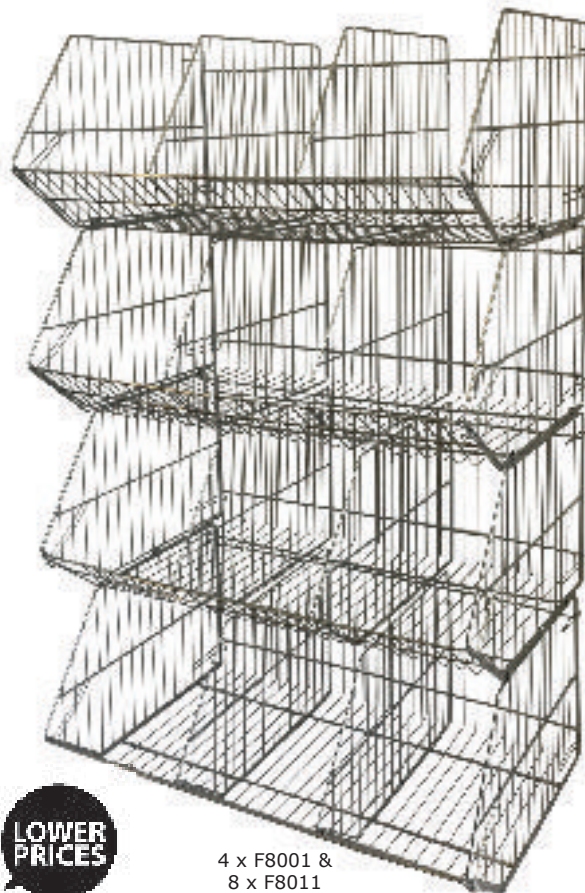

4 x F8001 & 8 x F8011

LOWER PRICES

Overall Size W x D x H mm	Model	Price
400 x 400 x 726	D1600	£29.55
600 x 600 x 726	D2400	£39.78
533 x 533 x 720	D2100	£25.31

Description	Overall Size W x D x H mm	Model	Price
Single Stacking Basket - Silver	900 x 500 x 345	F8001	£34.06
Divider - Silver	-	F8011	£5.62
Single Stacking Basket - White	900 x 500 x 345	F8002	£34.06
Divider - White	-	F8012	£5.62

Oceanis Shopping Baskets

» Range of shopping baskets made from recycled ocean plastics such as discarded fishing ropes

INFORMATION

Made from recycled ocean plastics



B07/OCEANIS



B34/OCEANIS



B52/OCEANIS



B65/OCEANIS

Description	Overall Size W x D x H mm	Model	Price
22L Plastic Shopping Basket with 2 Handles	314 x 415 x 220	B07/OCEANIS	£5.27
34L Plastic Shopping Basket	465 x 353 x 404	B34/OCEANIS	£22.49
52L Plastic Shopping Basket	390 x 390 x 529	B52/OCEANIS	£25.74
65L Plastic Shopping Basket	390 x 540 x 875	B65/OCEANIS	£30.10

Display Baskets



COLOUR OPTIONS

- Green
- Blue
- Red

specify when ordering. other colours available

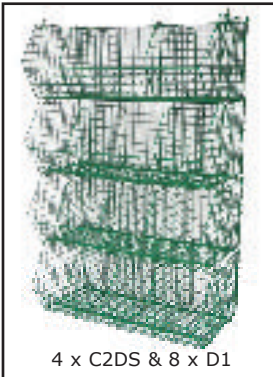
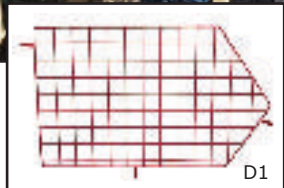

- » Ideal for order picking & fulfilment operations
- » For warehouse/bulk storage
- » The simplest & most effective way to display stock
- » Tough & durable, constructed from welded steel wire with plastic coating to prevent corrosion
- » Designed by engineers & built to withstand the rigours of harsh environments
- » Safe & stable, the interlocking design of these baskets ensures safe stacking
- » Plastic coating which protects the goods from damage
- » Open front containers which allow easy access to even bulky goods
- » Finish: durable plastic coating
- » Dividers available

External Size W x D x H mm	Mesh Size mm	Capacity Litres	Capacity kg	Model	Price	Model Divider	Price
660 x 460 x 350	24 x 46	65	0.088	MT8	£30.85	D1	£4.45
980 x 460 x 350		88	0.140	C12	£34.96		
980 x 680 x 480	46 x 46	300	0.300	C2DS	£49.64	D2	£6.25
1220 x 680 x 480		360	0.400	C4	£58.04		

Description	Overall Size W x D x H mm	Model	Price
Wheels to suit - MT8		F9901	£77.84
Wheels to suit - C12		F9903	£77.84
Wheels to suit - C2DS & C4		F9902	£77.84
Hook On Price Tag	120 x 40	PPB	£0.87
Hook On Price Tag	165 x 80	PPA	£0.98
EPOS Strip	980 x 60	EPOS	£2.83

Lower Value Orders May Incur a Handling Charge

Index

A

Absorbents	294
Access Equipment	436 to 489
Access Gates	211
Access Machines	488
Access Platforms	478 to 485
Ackerman Trucks	409 to 413
Adjustable Shelving	50
Aisle Labelling	168 to 178
Aluminium Steps	438 to 451 & 456 to 464
Aluminium Trucks & Trolleys	327 to 332, 339, 341 & 362
Anti-collapse System	8
Anti-static Workbenches	244 & 245
Archive Shelving	25
Ashtrays	518
Attached Lid Containers	120 & 121

B

Balanced Trucks	411
Bar Pallets	62
Bar Racks	62 to 67
Bar Trucks	416 & 417
Barriers	11, 37 & 186 to 215
Baskets	556 & 557
Beam Benches	540
Belt Barriers	187 to 192
Benches	224 to 259, 550 & 551
Bench Scales	555
Bicycle Racks & Shelters	218 to 221
Bin Lifter	524
Bin Racks & Trolleys	106 to 112
Bins - Litter	500 to 523
Board Trolleys	397 to 399
Boot Wash	319
Bottle Skips	416 to 418
Box Pallets	62, 122, 123
Buffers	155 & 318
Bulk Handling Trucks	398 & 399

C

Cable Ramps & Protectors	157 & 212
Canteen Furniture	540 to 543
Cantilever Racking	66 & 67
Cantilever Workbenches	230, 231 & 245
Carry Case - Storage	106
Cash & Carry Trolleys	396 to 399
Castors & Wheels	428 to 433
Chain Posts & Barriers	192
Chairs	247 & 536 to 539
Charging Laptop Lockers	77 & 84
Chemstores	281
Cherry Pickers	488
Chrome Wire Shelving	61

Clever Trolley	372 & 424
Cloakroom Equipment	90 to 93
Clothing	148
Coat Racks & Stands	90 to 93
Combination Ladders	445 to 447
Compartment Cases	102 to 109
Computer Cabinets	84
Cones	214
Connecting Dollies	344 & 345
Container Trucks & Trolleys	416 to 427
Container Walls	116
Containers	114 to 123
Convertible Trolleys	328 to 331
Conveyors	434 & 435
CoSHH Cupboards	128 & 131
Crowd Barriers	207, 214 & 215
Cube Lockers	68
Cupboards	85 to 89, 126 to 132 & 492
Cycle Racks & Shelters	218 to 221
Cylinder Storage & Cages	138 to 147 & 290
Cylinder Trolleys	288 & 289

D

Delta Plus Shelving	26 & 27
Defibrillators	491
Desks & Pedestals	532 to 535
Display Baskets	556 & 557
Display Racks & Stands	179 to 185
Distribution Pallets	123
Distribution Trucks	380 to 393
Dividers & Screens	534
Docking Equipment	154, 155 & 471
Dock Lights	154
Document Pockets	173 to 176
Dollies	343 to 345
Drawer Cabinets	248 to 257
Drip/Spill Trays	274 to 276
Drum Dollies	268
Drum Handling	268 to 273
Drum Lifting	273
Drum Storage	274 to 287
Dry Wall Trolleys	398 & 399
Dump Baskets	556 & 557

E

Easy Slope Steps	474 & 476
Eclipse Shelving	61
Electric Trucks & Trolleys	366, 367, 386, 387, 414 & 415
Euro Containers	117 & 119
Expanding Conveyors	435
Extension Ladders	446
Eye Wash	491
Fibreglass Steps	452 to 455

F

Fire Extinguishers	149
First Aid Cupboards	492
First Aid Kits	490 & 491
Flammable Storage	126 to 147, 292 & 293
Floor Marking	163 to 165
Floor Matting	157 to 163
Floor Paint	165
Folding Box Trucks	333
Folding Steps	436 to 459
Fork Attachments	318 & 319
Fork Extensions	319
Fork Lift Cages	489

G

Galvanised Shelving	32 & 33
Galvanised Steps	471
Garment Shelving	24
Gas Cylinder Storage & Cages	141 to 147 & 290
Glass Fibre Steps	452 to 455
Glass Whiteboards	183
Grit Bins	528 to 531
Grit Spreaders	529

H

Hand Drawn Trucks	402 to 413
Handling Cans	292 & 293
Handy Steps & Stools	436 & 437
Hazardous Storage	126 to 147
Healthcare Trolleys	493 to 495
Hi-Vis Clothing	148
High Lift Pallet Trucks	307
Hygienic Shelving	60 & 61

I

IBC Storage	281, 282, 286 & 287
Ice Packs	490
Identification Labels	168 to 178
Impact Protection	193 to 203
Inclined Shelving	56 & 58
Industrial Trailers	413

J

Janitorial Trolleys	493 to 495
Jibs	318

K

Kanban Shelving	56
Key Cabinets	152
Key Storage	150 & 152
Kick Steps	437 & 438
Kwikrack Shelving	14 & 15

L

Labelling	166 to 178
Ladder Accessories	448 & 449
Ladders	446, 447 & 454 to 456
Laddertags	448
Laundry Trolleys	495
Lift Tables	308 & 309
Lifters & Stackers	308 to 316
Lights	154
Literature Storage	179 to 185
Litter Bins	500 to 523
Load Buffers	155 & 318
Load Movers	310 to 317 & 343 to 347
Loading Steps	471
Location Markers	166 to 176
Lockers	68 to 80
Cube	68
Express	69
Garment	74
Laptop	79
Personal Effect	68 & 75
Plastic	78
Z Door	68
Louvered Panel Kits	97 & 106

M

Machine Guards	193 to 203
Mailroom Equipment	544 to 551
Matting	157 to 163
Merchandising Trolleys	392
Mesh Cages/Mini/Maxi Boxes	146
Mesh Pallets	124 & 125
Mirrors	153 & 217
Mobile Bar Rack	64 & 65
Mobile Shelving	58
Mobile Steps	436 & 456 to 477

N

Noticeboards	180 to 185
--------------	------------

O

Office Chairs	536 to 539
Office Furniture	532 to 539
Office Partitioning	7
Office Planners	184 & 185
Office Seating	536 to 539
Order Picking Trolleys	373 & 374
Outdoor Litter Bins	515 to 518

P

PPE Equipment	148
Packaging Equipment	552 to 555
Packing Benches	550 & 551
Padlocks	150

Pallet Boxes	62, 122, 123
Pallet Loading	317
Pallet Racking	36 to 39
Pallet Stacking Systems	62
Pallet Trucks	296 to 307
High Lift	307
Long Fork	299
Powered	303 to 313
Printers	298
Weigh Scale	300 to 301
Pallets - Plastic	122 & 123
Pallets	124 & 125
Pallet Retention	124
Parking Posts	207 to 209
Pedal Bins	500 to 503
Plastic Cupboards	89 & 492
Plastic Lockers	78
Plastic Shelving	59
Plastic Steps	437
Plastic Trolleys	334 to 345
Platform Steps	455 to 485
Platform Trucks & Trolleys	334 to 341
Platforms	478 to 485
Podium Steps	455 & 480
Polyethylene Trucks	416 to 422
Post Room Equipment	544 to 555
Powered Distribution Trolleys	386 & 387
Powered Pallet Trucks	303 to 305
Powered Platform Trucks	366 & 367
Powered Stackers	318 to 321
Pressure Washers	499
PVC Strip Curtains	156

R

Rack Guards	193 to 203
Racksack	172 & 173
Ramps	213
Reception Furniture	545
Recycling Bins	500 to 512
Refuse Sacks & Holders	505
Rivet Racking	16 to 25, 54 & 55
Rivet Workbenches	224 to 226
Rock Salt	531
Roll Containers	394 & 396
Roller Tracks	428
Roof Ladders	449
Rope Barriers	186

S

Sack Holders & Refuse Sacks	503 to 505
Sack Trucks	320 to 333
2 & 3 Way	328 to 331
Aluminium	327 to 329
Compact	327
Stairclimbers	332
White Goods	325
Safes	151
Safety Matting	158 to 165
Safety Signs	166 to 178

Salt & Grit Bins	528 to 531
Salt Spreaders	529
Scaffold Towers	479
Scales - Weight	555
Scissor Lift Tables	309
Screens & Dividers	534
Seating	536 to 539
Security Cages	140 to 147
Security Cupboards	88
Security Trolleys	399 & 400
Self Levelling Trucks	427 & 546
Service Trolleys	354 to 357
Sheet & Bar Racks	62 to 67
Shelf/Tray Trolleys	348 to 379
Shelving	14 to 32 & 49 to 61
Archive	25
Delta Plus	26 & 27
Expo	28 & 29
Expo 4D	30 & 31
Galvanised	32 & 33
Kwikrack	14 & 15
Longspan	34 & 35
Midispan	33
Rivet	16 to 25, 52 & 53
Shrink Wrap Systems	552 to 554
Shoe Racks	90 to 93
Shopping Baskets	556
Signs & Identification	166 to 178
Skates	346 & 347
Skip Trucks	525 to 527
Small Parts Storage	94 to 125
Smoking Shelters	221 to 223
Snow Shovels & Ploughs	528 & 529
Speed Ramps	210 & 213
Spill Control	281 to 295
Spill Kits	295
Stackable Pallets	125
Stackers & Lifters	310 to 317
Stainless Steel	
Cloakroom Equipment	92
Cupboards	88
Lockers	80
Platform Trucks	378
Shelf Trolleys	378 & 379
Work Benches	248 & 249
Stairclimbers	332
Stair Treads	158
Steam Cleaners	498
Steel Bins & Racks	110 & 111
Steps	436 to 477
Aluminium	438 to 451 & 456 to 464
Combination	445 to 447
Folding	436 to 459
Glass Fibre	452 to 455
Handy Steps	436 & 439
Kick/Stools	436 & 437
Mobile Steps	436 & 456 to 477
Stock Trolleys	396 & 397

S continued

Storage & Bar Racks	62 to 67
Storage Cupboards	126 to 131
Storage Racks - Literature	182 to 185
Storage Vaults	130 & 280
Stores	136 & 137
Straddle Stackers	312 & 313
Strapping Systems	552 to 554
Stretch Film Systems	552
Strip Curtains	156
Sump Storage	277 to 287
Sweepers	319 & 497
System Flow Trolleys	263

T

T-Cards	184
Tables	540 to 543
Telescopic Ladders	447
Three Way Trucks	330 & 331
Tilt & Pull Steps	470
Tilt Trucks	327 & 524
Tip-A-Trucks	419 & 421
Tool Storage	264 to 267

Tool Trolleys	260 to 263
Tote Bins & Racks	110 & 111
Towers	486 & 487
Tow Trucks	414 & 415
Traffic Cones	214
Traffic Management	186 to 217
Traffic Mirrors	153 & 217
Trailers	413
Tray Trolleys	348 to 379
Treads	158
Tugs	414 & 415
Turntable Trucks	402 to 412
Two Way Trucks	330

V

Vacuum Cleaners	496
Vaults	133 & 280
Vision Barriers	196

W

Wall Mounted Barriers	188 & 192
Wall Planners	185
Warehouse Identification	166 to 178

Warehouse Trucks	394 & 399
Waste Converters	552 to 554
Waste Management	500 to 527
Weigh Scales	555
Wheelbarrows	408
Wheeled Bin Shelters	524
Wheeled Bins	519 to 523
Wheels & Castors	429 to 433
Wheel Chocks	154
Wheel Stops	213
Whiteboards	180 to 183
Winter Management Products	528 to 531
Wire Baskets	556 & 557
Wire Mesh Lockers	81 to 83
Wire Shelving	61
Workbenches	224 to 269 & 550
Workshop Chairs	247
Workwear	148
Work Lights	154

CONDITIONS OF SALE:

1. ACCEPTANCE

Acceptance of any order by the purchaser for the supply of goods will be subject to these conditions of sale.

2. PRICES

PRICES QUOTED ARE NORMALLY EX-WORKS EXCLUSIVE OF VAT & CARRIAGE

Whilst we shall endeavour to maintain the prices shown, this we cannot guarantee & we reserve the right to charge the price ruling at date of despatch. In the event of a price alteration after an order has been placed & prior to despatch notification of such alteration will be made before despatch of goods.

**Low value orders may be subject to an administration charge.
Prices will be subject to any customs tariffs following Brexit**

3. SPECIFICATIONS

Due to continual improvements in the design & manufacturing methods strict accuracy of specifications & illustrations cannot be guaranteed. So that any product improvements can reach the purchaser as soon as possible the Company reserves the right to change design of specification without formal notice. Stated load capacities are for evenly distributed loads only & must not be exceeded.

4. GUARANTEE*

Where the goods have been supplied by the seller & are found to be defective, the seller shall repair, or at their discretion, replace defective goods free of charge within one year (unless otherwise stated) from the date of delivery, subject to the following conditions:

- 4.1 The buyer notifying the seller in writing immediately upon the defect becoming apparent.
- 4.2 The defect being due to faulty design, materials or workmanship of the seller.
- 4.3 Any goods to be repaired or replaced shall be returned to the seller at the buyer's expense, if so requested by the seller.
- 4.4 Where the goods have been manufactured & supplied to the seller by a third-party, any guarantee granted to the seller in respect of the goods shall be passed on to the buyer.
- 4.5 The seller shall be entitled at their absolute discretion to refund the price of the defective goods in the event that such price has already been paid.
- 4.6 Guarantee excludes product finish & paint, locks, feet, wheels & castors.
- 4.7 The remedies contained in this clause are without prejudice to the other terms & conditions herein.

5. DELIVERY

Delivery dates are estimates only & the company shall not be liable for any loss or damages resulting from any delay in delivery. In addition we shall not be liable for any matter which results from any act of God, war or riot, extreme weather, strikes or any other events which are beyond our control. The company reserves the right to deliver goods by installments, each installment being treated as a separate contract. Goods will be delivered at the point most convenient to our carrier, usually the goods inwards department or reception on the ground floor. Further transfer or installation within the purchasers premises, particularly for large or heavy items, must be arranged prior to delivery & will be charged extra.

We can also not take responsibility for deliveries that require pallet trucks or fork lifts to offload from the courier or move the goods within your premises. All goods must be examined upon receipt & any damage or discrepancy recorded with the carrier.

6. CLAIMS

All goods must be examined upon receipt & any damage or discrepancy recorded with the carrier. The company must be notified in writing of any damage or incomplete delivery within 3 days of delivery. **No claims for shortage or damage will be entertained after a clear receipt has been given to the carriers.** The company will not be liable if this procedure is not followed or if the goods have been moved by a third party to a further address.

Total non delivery due to loss in transit must be notified within 7 days of invoice. Goods are not sold for any particular purpose, the end user should be responsible for the suitability of the product for use. The company shall not be liable for any indirect or consequential loss arising out of or in connection with the sale of goods. Any claim is limited to the value of the goods purchased.

7. RETURN OF GOODS

Standard goods will only be accepted for return after prior agreement with us & within 14 days of receipt. A handling charge may be imposed which will vary dependent on the condition of the goods when returned. Carriage charges for the outward journey plus the return of standard goods are payable by the purchaser. Bespoke goods manufactured specially for a customer **will not** be eligible for return.

8. RESERVATION OF TITLE

Goods supplied will remain the property of 'the company' until full payment is received. In the event of sale of these goods to a third party "the company" reserves title to the proceeds of sale. Responsibility for maintenance & insurance passes to the purchaser on delivery.



Design
Supply
Installation
by
Storage Design Limited

KEY TO SYMBOLS



Denotes the maximum UDL that can be applied to a particular product



Denotes where a product requires **some assembly**



Look for the EN-14183 & EN-131 symbols for Steps with accreditation



Look for the **UK Manufactured** symbol highlighting our quality UK manufactured products.



We will endeavour to deliver products showing these symbols within the shown working days (subject to quantity).

Orders must be received by 11am



The possibilities are endless.

The paper in this catalogue has been produced using wood/pulp supplied from sustainable sources



Look for this symbol which highlights quality products which are on sale for low, low prices



STORAGE DESIGN LIMITED

Primrose Hill, Cowbridge, South Wales, CF71 7DU

Email info@storage-design.ltd.uk

Tel 01446 772614

Rhino Tuff



elite lockers



Apollo



ProPlaz



Climb-It



UK MANUFACTURED



GRENADIER CAGES



CENTAUR TRUCKS



OBEX Barriers



G-TRUCK



VULCAN

