

effepack.[®]

effective packaging systems



SAVE TIME AND INCREASE
YOUR EMPLOYEES'
PRODUCTIVITY!

FACILITATE PACKAGING AND
ORDER PICKING

www.effepack.com



Briefly about effepack

We are a **manufacturer** specializing in **solutions that accelerate packaging and transport processes** in your warehouse. Our flagship proprietary products include **packing tables, turntables/wrapping machines, warehouse tables, and specialized trolleys**. Everything we create is based on our many years of specialized experience in this field.

We have always been fascinated by the possibility of creating **products that are better than others** – products that have a **positive impact on their surroundings**. They assist in work, help businesses grow, and solve problems. These values guide us in every project we undertake. As a result, we always offer only what meets these standards.

Our efforts are highly appreciated by our clients. **Proof? You can see it in the References.**

Guido Kneier

Administration, PEP



It is also worth highlighting the professionalism and reliability of the effepack consultants. Communication with the company's representatives was always prompt and to the point. All our questions and concerns were addressed in a competent manner.

We are very satisfied with our choice of effepack as our warehouse equipment supplier.



Laura Flügel

SMT Germany GmbH



We found the right table at effepack. The dedicated shelves helped organize the area around the work surface, and the aluminum top increased the durability of the workspace. The electric height adjustment is an ideal solution that is easy to operate and requires no physical effort.

The after-sales service is efficient, and the consultants are eager to provide additional information.

We highly recommend working with effepack.



The table we received meets our expectations. The packing process is now more efficient and much faster. The shelves are conveniently positioned, so we don't waste time organizing tools, as everything is ergonomically arranged.

The store's customer service is professional and assists at every stage of the order. Everything is clear and straightforward, with any concerns addressed immediately.

We recommend effepack as a reliable and trustworthy partner.



As part of the investment in our new logistics center, we have chosen professional packaging systems from effepack. When selecting the packaging systems, we were impressed by the wide range of options, modular design, and variety offered by effepack's products. The efficient packaging processes ensure increased productivity and faster flow of goods. Special mention should be given to the positive order processing, reliability, and personalized after-sales service provided by competent staff. Therefore, we highly recommend effepack products.



Florian Pielsch

Logistik Manager



All of our requirements were met by the packing tables we ordered from effepack. Work has significantly sped up, employees are less fatigued, and their workspace is neat and organized.

Another big advantage is the fully professional customer service. The consultants are knowledgeable and can quickly provide answers to any questions we have.



Niklas Becker

ACV Electronic GmbH



The analysis of the online store's offer led to the creation of a packing station that we were able to fully customize to our needs. Since the table was installed in our warehouse, our employees have been able to perform their tasks faster and more efficiently. Ergonomics have also improved, making the packing process much more enjoyable.

In summary, we are pleased to give effepack's representative positive feedback and look forward to future projects together.



Packing table for parcels

Modular, professional, customized

The professional, modular effepack packing table can be **perfectly configured** to **suit your needs, packing methods, or the types of packing materials used**, thanks to the **wide range of available accessories**.

Packing is easy!

- » **Indestructible steel structure.**
- » The only table with a **revolutionary aluminum tabletop**.
- » The highest level of customization thanks to **modularity**.



It will increase your employees' productivity by up to 100%.



Reduce packaging material usage by up to 20%.



Save up to 100% of your packing time.



Improve workcomfort and ergonomics by up to 100%.

You can find **effepack packing tables** in the **most efficient warehouses** of small and large companies.



Discover the **most advanced PACKING TABLE!**

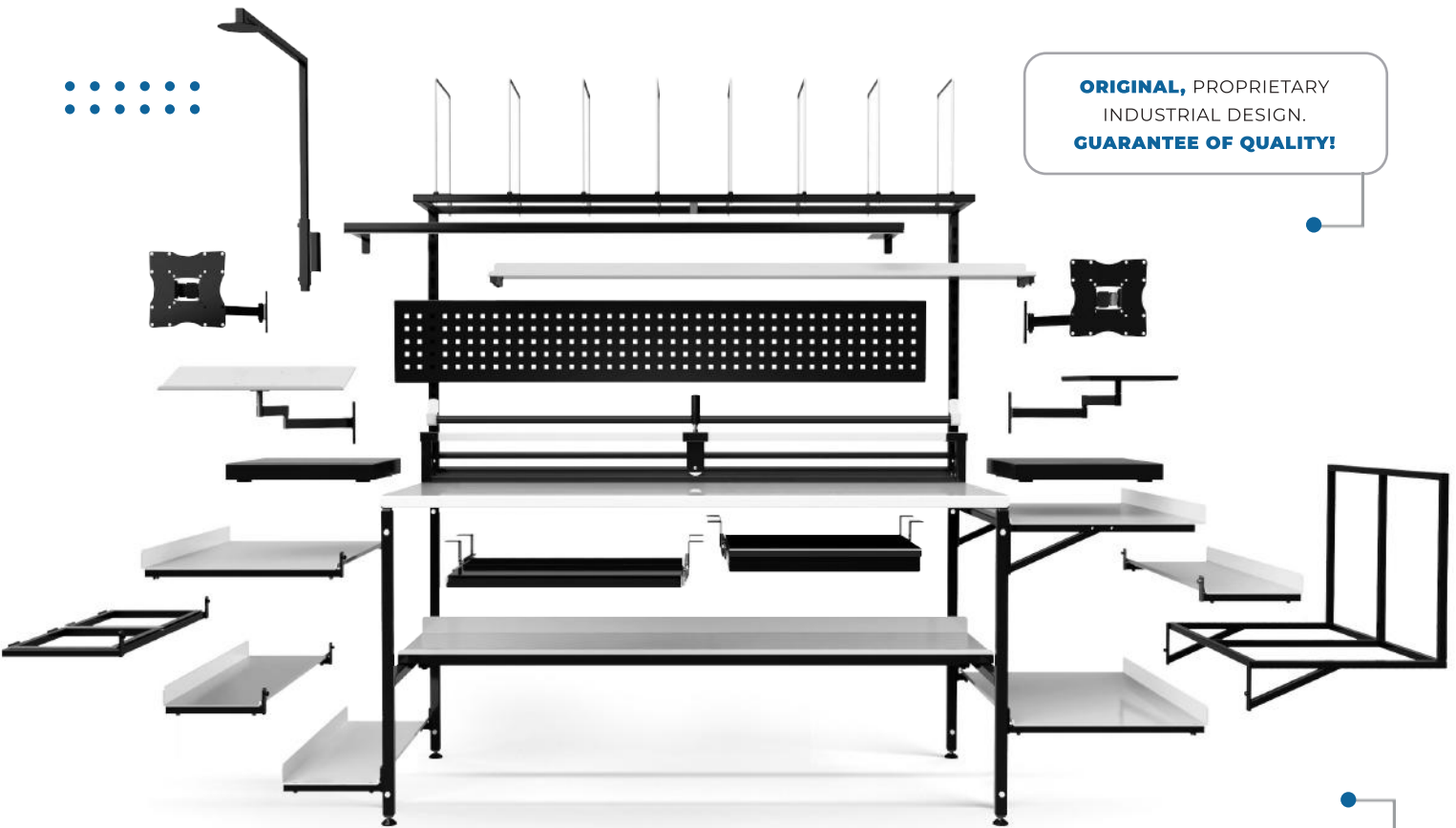

ORIGINAL, PROPRIETARY INDUSTRIAL DESIGN.
GUARANTEE OF QUALITY!

INDESTRUCTIBLE
ALUMINUM TABLETOP,
GUARANTEE OF RELIABILITY.

STABLE STEEL CONSTRUCTION,
PERFECT EVEN FOR EXTREME CHALLENGES!

TAILORED TO YOUR NEEDS!
CONFIGURE THE PERFECT SOLUTION FOR YOU.

Configure the table **perfectly** to meet the needs of your warehouse!



Warehouse table

For order picking, returns, inventory

We know that every process is unique, which is why we have created a table that you can **customize to your needs**. This is the only **specialized tool** of its kind that will take your warehouse to an **entirely new level of efficiency**.

- WORK **2x FASTER**
- WORK **2x MORE PRECISELY**
- WORK **2x BETTER**

7-year
warranty

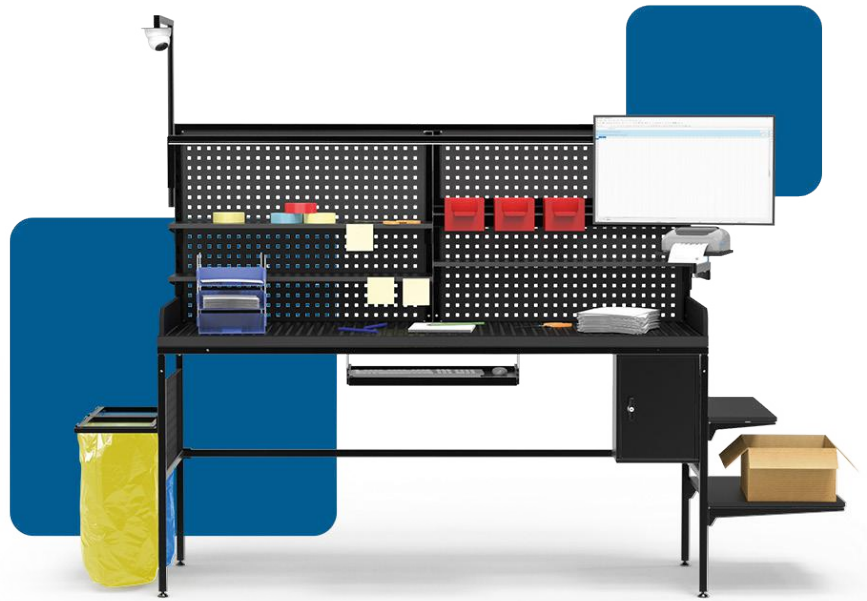

Discover the most advanced **warehouse table** revolutionizing processes such as **returns, order picking, and inventory**. Configure your workstation **perfectly to suit your needs**, the products you work with, and the available space. Thanks to its modularity, you will be able to work **faster, better, and more precisely!**



40+
accessories to choose from



90 000+
configuration combinations



7-year
warranty





One warehouse table - thousands of possibilities!



Increase work efficiency

A perfectly tailored workstation is the key to increasing efficiency.

An increase in efficiency by up to 100%!



Reduce the number of mistakes

Perfect organization of everything necessary ensures a certain increase in effectiveness.

Improvement by up to 50%.



Take care of the products

Choose solutions that ensure the safety of your products.

Up to 100% safety.



Improve work ergonomics

Ensure quality, hygiene, and work safety, and focus on health-promoting solutions.

100% certainty of increased satisfaction!

40+ accessories to choose from

That's truly an **enormous amount**, but it's precisely what makes our warehouse table so unique! We've taken care of every little detail so you can **simplify your team's work to the maximum** and shift its burden to an excellent tool.



Every centimeter utilized

The table is divided into **several zones**, each designed **for mounting different, dedicated accessories**. You have the right and left sides of the table, the front panel (also divided into two parts), and the area directly beneath the tabletop at your disposal.

Discover a truly sturdy table

You'll recognize the quality of this product just by its weight! We use only **thick-walled steel**, mostly welded together. We've minimized bolted connections, thereby achieving **excellent stability**.

You will love this ergonomics

Our warehouse table has been designed to take ergonomics to a whole new level! Each accessory can be **mounted at a height selected by you** to suit factors such as the operator's height.



90 000+ combinations

Modularity is the key word if we want to create a tool that will truly improve warehouse processes such as order picking, returns handling, or inventory management. **Configure the table** exactly as you need it!

Ready for any task

We offer a **variety of materials** for the table top. Choose one based on your needs. Indestructible? Gentle on products? Resistant to liquids? No problem!



Gastronomy table

For working with food

Working with food and food products is a demanding and specific process, which is why we have designed a tool to make it **easier** and **faster**. This is the only product that is so **specialized** and **dedicated!**

The effepack gastronomy table is the **key to revolutionizing your packaging, repackaging, and order-picking processes**. Discover how we can help you streamline every step.



A new dimension in working with food and food products!



Increase work efficiency

A perfectly tailored workstation is the key to increasing efficiency.



Reduce the number of mistakes

Perfect organization of all essentials is a surefire way to increase effectiveness.



For food

Dedicated to working with food and food products.



Improve work ergonomics

Ensure quality, hygiene, and work safety, and focus on health-promoting solutions.



MODULAR DESIGN

7-YEAR WARRANTY

STAINLESS STEEL

40+ ACCESSORIES TO CHOOSE FROM

90 000+ CONFIGURATION COMBINATIONS



Table for large packages

Designed for special tasks

Packing large or long shipments is a very difficult and time-consuming process that often requires more than one person. To address this problem, we created the special **effepack table for large packages**. We increased its depth to 100 cm and designed dedicated holders for securing packing materials. This makes the work **much simpler, faster, and more convenient**.



It will increase your employees' productivity by up to 100%.



Reduce packaging material usage by up to 20%.



Save up to 100% of your packing time.



Improve work comfort and ergonomics by up to 100%.

Configure

it to suit your needs!

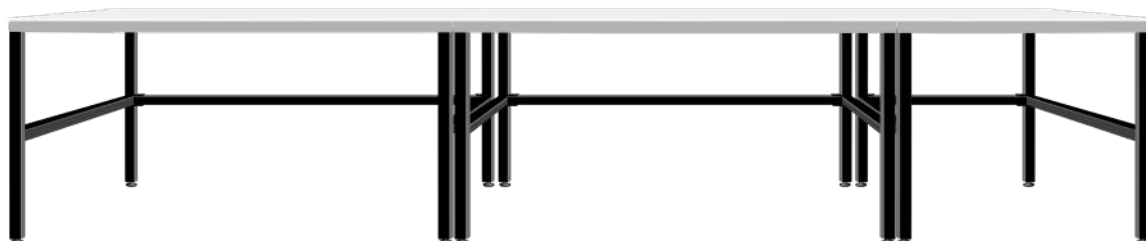

Watch the video on
 YouTube



Scan and **configure** the table for large packages

Turntables for package packing

Choose the right wrapping machine for packages

Save time needed for packing boxes and parcels, improve the comfort and efficiency of your employees, and reduce the consumption of packing materials. Introduce proven devices for manual, semi-automatic, or automatic packing into your company, and effectively secure shipments of any size - from small and medium to really large packages.



WORK
FASTER



WORK MORE
EFFICIENTLY



WORK MORE
ECONOMICALLY



Watch the video on



Semi-automatic wrapping machines



Standard wrapping machines



Scan,
choose a wrapping
machine
for packages, and
configure
it according to your
warehouse's needs.





Standard wrapping machine



TECHNICAL DATA	STANDARD WRAPPING MACHINE	REINFORCED STANDARD WRAPPING MACHINE	STANDARD WRAPPING MACHINE WITH ACTUATOR	REINFORCED STANDARD WRAPPING MACHINE WITH A ACTUATOR
Maximum load	75 kg	120 kg	75 kg	120 kg
Maximum width of the package	100 cm	100 cm	100 cm	100 cm
Maximum package height (maximum height to which the stretch film can be lifted)	130 cm	130 cm	90 cm	90 cm
Height adjustment of the tabletop (in increments of 5 cm)	70 cm - 85 cm	70 cm - 85 cm	70 cm - 85 cm	70 cm - 85 cm
Method of rotating the tabletop	manual	manual	manual	manual
Construction and table top material	steel	steel	steel	steel
Applied bearings	yes, 2 pcs.	yes, 2 pcs.	yes, 2 pcs.	yes, 2 pcs.
Supporting wheels used for the tabletop	-	yes, 4 pcs.	-	yes, 4 pcs.
Adjustment of the stretch film suspension height		yes, smooth		yes, smooth, using an actuator
Power Supply		-		230 V
Carton movement lock			yes	
Stretch film tension adjustment			yes, smooth	
Tabletop covered with an anti-slip mat			yes	
Warranty			3 years	

Low-profile wrapping machine



TECHNICAL DATA	LOW-PROFILE WRAPPING MACHINE	REINFORCED LOW-PROFILE WRAPPING MACHINE	LOW-PROFILE WRAPPING MACHINE WITH ACTUATOR	REINFORCED LOW-PROFILE WRAPPING MACHINE WITH AN ACTUATOR
Maximum load	75 kg	120 kg	75 kg	120 kg
Maximum width of the package	100 cm	100 cm	100 cm	100 cm
Maximum package height (maximum height to which the stretch film can be lifted)	100 cm	100 cm	90 cm	90 cm
Wysokość blatu	20 cm	20 cm	20 cm	20 cm
Method of rotating the tabletop	manual	manual	manual	manual
Construction and table top material	steel	steel	steel	steel
Applied bearings	yes, 2 pcs.	yes, 2 pcs.	yes, 2 pcs.	yes, 2 pcs.
Supporting wheels used for the tabletop	-	yes, 4 pcs.	-	yes, 4 pcs.
Adjustment of the stretch film suspension height		yes, smooth		yes, smooth, using an actuator
Power Supply		-		230 V
Carton movement lock			yes	
Stretch film tension adjustment			yes, smooth	
Tabletop covered with an anti-slip mat			yes	
Warranty			3 years	

Rotating platform



TECHNICAL DATA	ROTATING PLATFORM	REINFORCED ROTATING PLATFORM
Maximum load	75 kg	120 kg
Method of rotating the tabletop	manual	manual
Construction and table top material	steel	steel
Applied bearings	yes, 2 pcs.	yes, 2 pcs.
Supporting wheels used for the tabletop	-	yes, 4 pcs.
Carton movement lock	yes	yes
Tabletop covered with an anti-slip mat	yes	yes
Warranty	3 years	3 years

Computer / Workstation

Choose your version

Fully **customizable**, designed based on **proprietary, industrial design**, modular computer/workstations can be used in your warehouse, office, or showroom. They are perfect for special tasks such as a **printing station, standing workstation, or inspection station**. Thanks to their modularity and a wide range of accessories, you can tailor them **perfectly to your needs!**



-  **multifunctional**
-  **for the office**
-  **for the warehouse**
-  **for the showroom**



single-sided tall

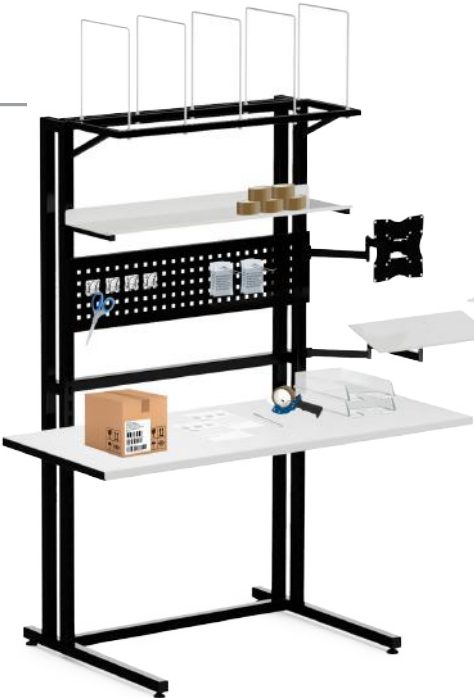

Double-sided tall



Perfect for both standing and sitting work



Configurable



3 basic versions

Specialized warehouse chairs

A combination of comfort, quality, and convenience

Specialized **chairs and stools** that are ideal for any warehouse. The seats and backrests are **made from soft, anti-slip polyurethane**, which, in addition to its **remarkable durability**, is very easy to keep clean.

Mechanisms equipped with backrest angle adjustment (for chairs) allow for perfect position customization. Meanwhile, footrests are made of chrome-plated steel to enhance their durability.

All of this ensures that these chairs and stools will perform well even in more demanding conditions.



Warehouse chair

SC-01



Height:
480 mm - 680 mm;



Seat and backrest material:
Polyurethane;



Swivel:
Yes;



Tilt adjustment:
Yes;

Watch the video on



YouTube



Warehouse chair

SC-02



Height:
480 mm - 680 mm;



Seat and backrest material:
Polyurethane;



Swivel:
Yes;



Tilt adjustment:
Yes;



Warehouse stool

SS-01



Height:
480 mm - 680 mm;



Seat material:
Polyurethane;



Swivel:
Yes;



Warehouse stool

SS-02



Height:
480 mm - 680 mm;



Seat material:
Polyurethane;



Swivel:
Yes;

Warehouse trolleys / order-picking trolleys

For transporting bins, Euro containers

Discover our **uniquely designed** effepack warehouse / order-picking trolley, created by **our experienced team** of specialists. Ideal for **transporting Euro containers, crates, and bins**, it's indispensable in any warehouse. It will revolutionize your picking process and elevate workplace ergonomics to a whole new level. **Available in two versions: with or without a built-in scale.**



Choose the perfect warehouse trolley

for your needs

Two versions of the trolley:

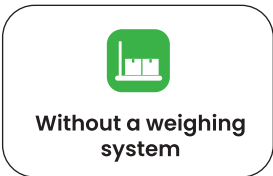
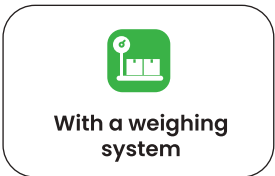

Two trolley sizes:

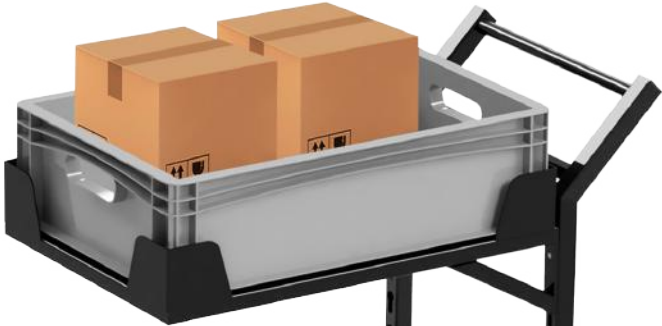
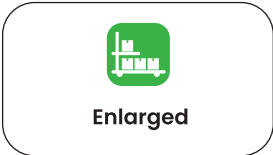
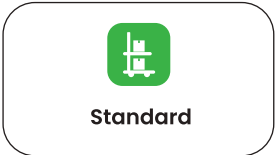

Shelf warehouse trolleys

Universal, versatile, multifunctional

Improve the **efficiency** and **safety** of transport processes in your warehouse. Introduce **reliable, customized trolleys** that will **facilitate** daily operations, including **speeding up** tasks related to receiving, transferring, and picking inventory. **Minimize the risk of downtime or damage.**

Explore the full range of solutions that can be easily tailored to the nature and needs of your business.

 ACCELERATE
TRANSPORT

 INCREASE
EFFICIENCY

 WORK MORE
COMFORTABLY



two-shelf



high three-shelf



three-shelf



with an adjustable basket

Warehouse accessories

Accessories that can make a big difference

Equip your warehouse with everything necessary to ensure work **is safe, runs smoothly, and proceeds without any additional issues.** Choose **reliable accessories** that enhance the **ergonomics** and **efficiency** of various warehouse and logistics processes!



Roller conveyor



Mobile waste sack holder

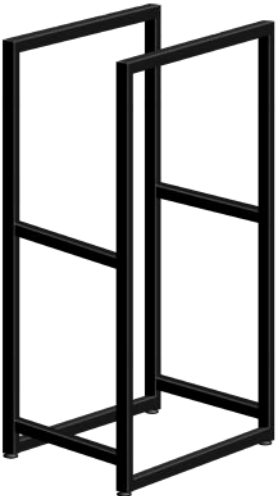

Rack for stretch film



Wall holder for film





We are here for you

effepack conquers the warehouses!

Since 2014, we have been working on our recognition and trust. You will find our products in every corner of the country, both in small, family-run companies and huge, international corporations. According to our customers, **we are number 1** and the first contact when the packaging process needs improvement.

REDUCE PACKAGING
MATERIAL USAGE

INTRODUCE SUPER
ERGONOMICS AT WORK

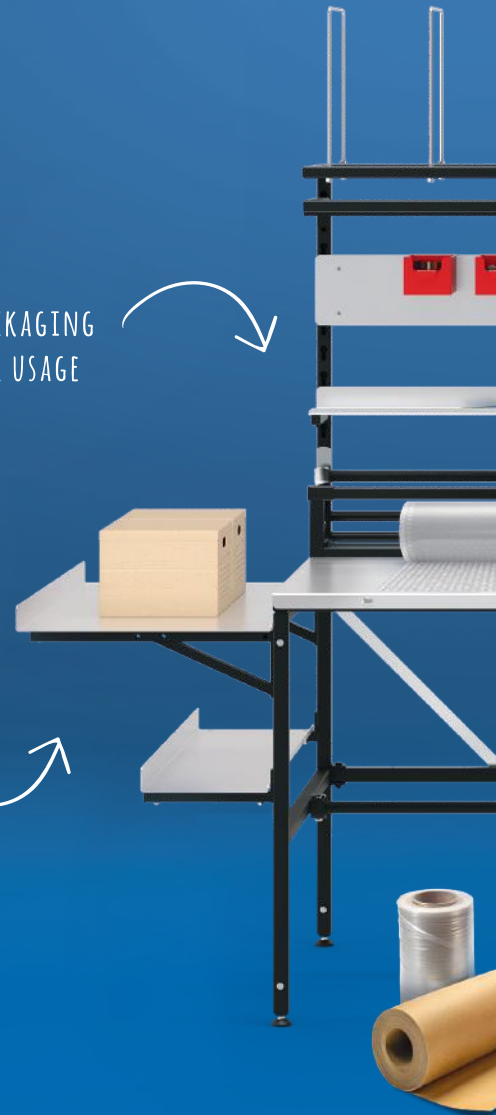

Contact us:



info@effepack.com



www.effepack.com



Visit us on:

