



PRODUCT QUICK GUIDE
**CCTV CHANNEL
PRODUCTS**

January-June 2023

HIKVISION[®]

CONTENTS

001

Turbo HD Cameras

- 002** Turbo HD Cameras with ColorVu
- 015** Smart Hybrid Light Series
- 018** IoT Series
- 021** Pro Series
- 031** Value Series
- 048** Eco Series

051

Turbo HD PTZ Cameras

- 052** AE7
- 053** AE5
- 054** AE4

055

DVRs

- 056** eDVR Series with eSSD
- 058** Ultra Series with AcuSense
- 061** Pro Series with AcuSense
- 068** Value Series
- 073** Special Series

075

Encoders

- 076** DVS

079

Network Cameras

- 080** Pro Series (EasyIP)
- 114** Value Series
- 140** Solar-powered Series

142

Network PT Cameras

- 143** Network PT Cameras

149

Network PTZ Cameras

- 150** Pro Series

156

Panoramic Cameras

- 157** Fisheye Series

158

NVRs

- 159** Pro Series with AcuSense
- 165** Pro Series (EasyIP)
- 173** Value Series

176

KITs

- 178** Wi-Fi Kits
- 179** PoE Kits

181

**Thermal
Cameras**

182 HeatPro Series

187

Monitors

188 Pro Series

191 Value Series

194

Switches

196 Ultra Series

197 Pro Series

209 Value Series

213

Cables

214 Coaxial Cables

215 Network Cables

217

**Control &
Transmission**

218 Keyboard

220 Wireless Bridge

222

Software

223 Hik-Partner Pro

226

Accessories

227 Brackets and Housings

271 Power Adapter

273 Camera Tester

274 Pickup

275

DORI Distance

SMART HYBRID LIGHT

Security cameras featuring our Smart Hybrid Light allow users to flexibly switch among three supplemental lighting modes, suiting virtually any need or application.

1. IR Mode

The IR light is always on, and video imaging remains black and white (at night).

2. White Light Mode

White light is always on, and the camera captures color imaging 24/7.

3. Smart Mode

In this mode, the camera maintains infrared illumination until an event triggers color imaging to capture critical details.



When there is no vehicle or person, the camera uses only the IR light.



When a vehicle or person appears, the white light is automatically triggered, resulting in vivid color imaging with clear details.



When the vehicle or person leaves, the camera switches back to the IR light.



IR  White light

Smart Hybrid Light

ColorVu
Technology

SMART HYBRID LIGHT CAMERAS WITH COLORVU

Smart Hybrid Light Cameras with ColorVu are designed to upgrade night vision experience in virtually any setting with always sharply-focused imaging and versatile lighting options. Powerful technologies including ColorVu, Super Confocal, Smart Hybrid Light, and other functionalities energize our cameras with amazing reliability and advanced capabilities.

Powerful new features include

Stunning low-light imaging: F1.0 Super Aperture and advanced sensor ensure excellent color imaging in ultra-low light.

Smart hybrid light: Three lighting modes offer color, black & white or motion-triggered color imaging to suit virtually any need in any setting.

Super confocal technology: Guarantees equally sharp night vision in IR or visible light, leading the industry by achieving delicate & complex confocal effect with an F1.0 large-aperture lens.

HIKVISION ACUSENSE TECHNOLOGY

Easy and affordable Artificial Intelligence has come to the mass market and a diverse set of users.

Hikvision's AcuSense technology embeds deep-learning algorithms into various security cameras and video recorders to automatically detect humans and vehicles through real-time video analytics and push instant notifications to users' mobile devices.

By minimizing false alarms triggered by animals, falling leaves, heavy rain, and other moving objects, and by sorting video footage into "Person Files" and "Vehicle Files" for easier search, AcuSense enables businesses and homeowners to focus security resources on real threats. Camera models with the Live Guard function also feature visual and auditory warnings to ward off trespassers the moment they are detected.

Sophisticated, highly effective, and affordable, the AcuSense solution provides SMB owners and operators an intelligent and easy-to-use protection system for their property and assets, while helping resellers build a uniquely competitive go-to-market proposition.

AcuSense
Technology

Making

a Breeze





24 Hours × 7 Colorful Imaging

View in color,
Even in darkness

HIKVISION COLORVU TECHNOLOGY

Darkness provides cover for theft, trespassing, and other crimes. When incidents occur at night, dim, low-quality images from conventional cameras miss or lose critical details. Cameras with infrared LEDs are able to provide extra light for clearer image, but in black-and-white.

But now, imagine capturing vivid, colorful details – such as the color of people’s clothing or of a car – even in total darkness. Hikvision ColorVu Technology makes this possible.

Hikvision ColorVu Technology enables front-end products to capture details in low light with three advantages: advanced hardware, superior ISP algorithm, and reliable quality control. ColorVu technology employs two specific breakthroughs in hardware technology: advanced lenses and powerful sensors. These lenses reach up to F1.0, allowing more light to enter and thereby increasing image brightness. Next, high-sensitivity sensors vastly improve the utilization of that light. The frontier ISP algorithm realizes precise color rendition to produce accurate colorful images. Moreover, active alignment technology guarantees the focusing performance of lenses in the mass production of ultra-high definition ColorVu products, resulting in superlative quality control.

Extreme light conditions are also taken into consideration in the design process. Some cameras are equipped with warm, natural-looking supplemental lighting. This way, when there is no light source whatsoever – even starlight or street lights – they can guarantee colorful imaging. For most scenes, the environmental light is bright enough for ColorVu cameras to render vivid color without supplemental lighting.



HeatPro



Hikvision HeatPro Series Thermal Cameras Professional Protection Made Simple



HIKVISION THERMAL VCA2.0

Detecting differences in heat radiation among objects, thermal cameras make invisible, infrared light “visible” in the form of heat-zone images. Image reproduction by thermal cameras is not affected by lighting or weather conditions, so they operate in virtually any environment at any time.

Using Hikvision’s Thermal VCA2.0 – an intelligent video content analysis technology based on deep-learning algorithms – our thermal cameras are becoming even more powerful. Alarm accuracy is further improved through target detection and classification into human, vehicle, and other categories. With their simple, three-step configuration, users can easily set up VCA rules to detect actions such as line crossing, intrusion, and region entry and exit.

VCA2.0 operates on Hikvision’s HeatPro Series Thermal Cameras to provide professional perimeter protection and precise temperature measurement. It’s designed for a variety of application scenarios including apartments, construction sites, warehouses, industrial parks, stores, and more.

4K

With the development of 4K technology quickly coming into focus, opportunities to use this technology in security will continue to grow. As a leading video security equipment manufacturer, Hikvision has paid close attention to the rise in high-resolution imaging, and launched a total 4K system to harness this technology in the global security industry.

Without complementary 4K components, such as monitors and DVRs / NVRs, 4K cameras cannot be used to their full potential, and therefore have little practical use in video security. By building a total system – complete with cameras, DVRs, NVRs, and more – Hikvision provides systems that are more helpful and more useful to customers. The Hikvision 4K system, which comes equipped with a variety of smart functions, satisfies the security industry's need for ultra-high resolution and smart video monitoring.

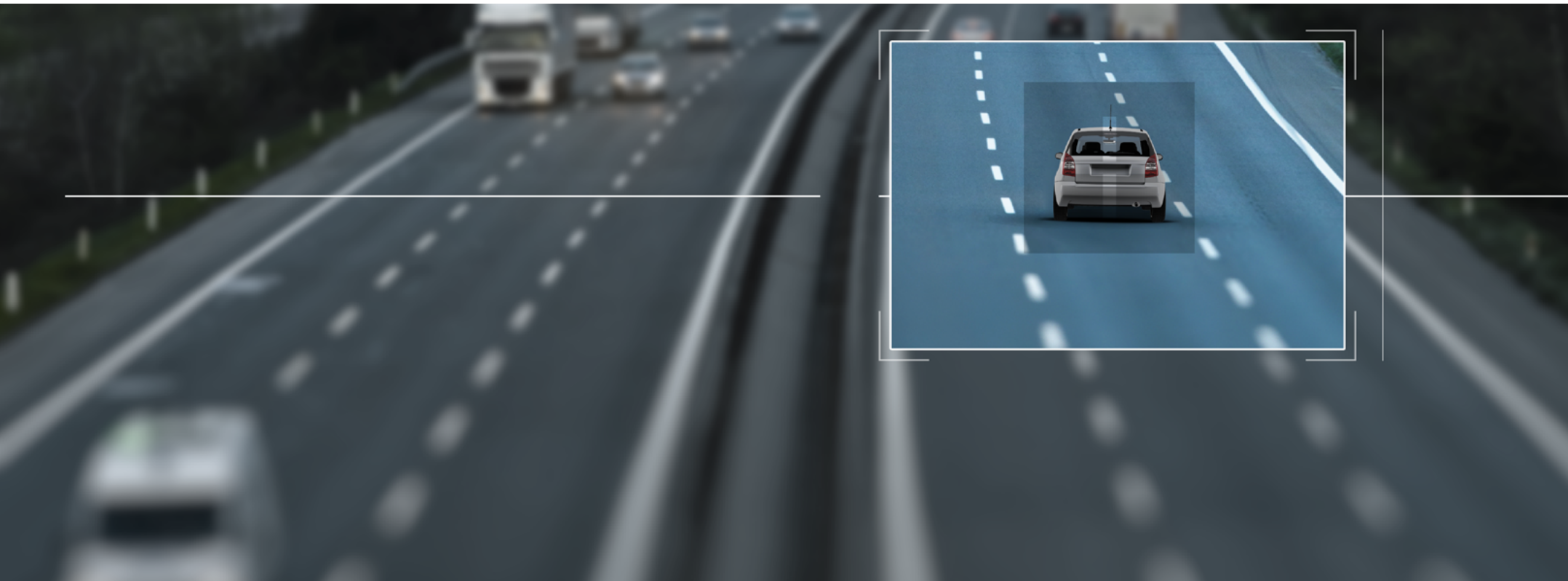



16:9 video output on a wide screen



4:3 video output on a wide screen

3K

3K is a new resolution option for Turbo HD cameras, meaning 5 MP with an aspect ratio of 16:9. As we know, the aspect ratio of conventional 5 MP cameras is 4:3, while the monitors in the market usually have an aspect ratio of 16:9, causing distortion of output video. With the 3K resolution, there is no distortion during video preview or playback, enabling better visual experience than with conventional 5 MP cameras.

Hikvision provides a complete set of 3K system, including cameras and DVRs, and the whole system comes equipped with a variety of advanced technologies, such as ColorVu, Live Guard, and dual supplemental lights, giving you smart and high-quality video monitoring.

H.265+ TECHNOLOGY

The H.265+ smart codec algorithm is an intelligent proprietary algorithm developed by Hikvision. It can vastly decrease the bitrate of video – while retaining the quality – of the standard H.265 codec. H.265+ does this via three core technologies: predictive encoding, noise suppression and bitrate control. This smart codec drastically reduces bandwidth and data storage while rendering amazing video quality.

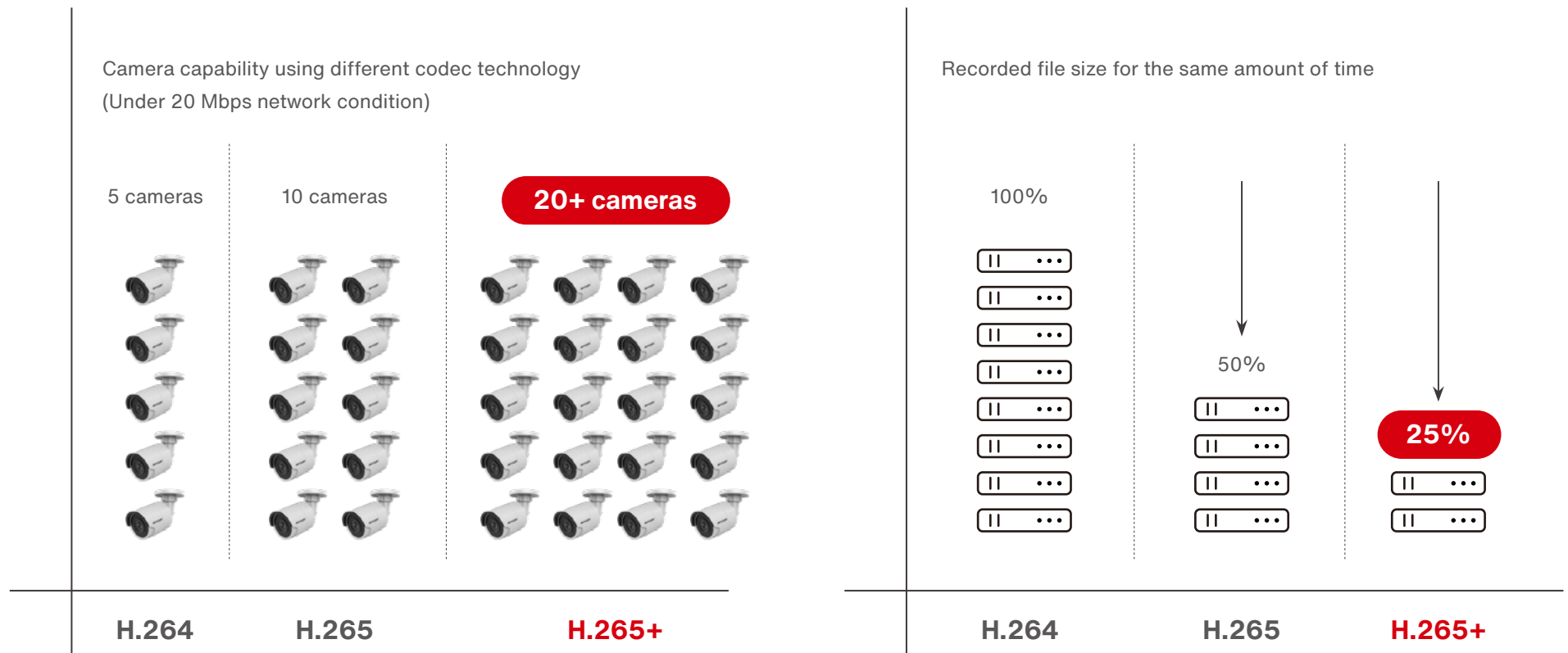

Note: this test result is for reference only.

Reset Password via Hik-Connect

To help users with easier password retrieval without needing to consult aftersales, Hikvision offers the new password reset function which is easy and safe. With this function, users can reset password for DVR or NVR via Hik-Connect in only about 1 minute.

3 steps, within 1 minute

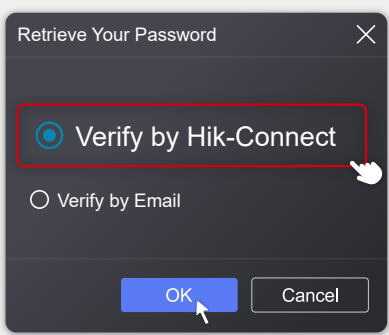

Select "Verify by Hik-Connect" on the device.

01

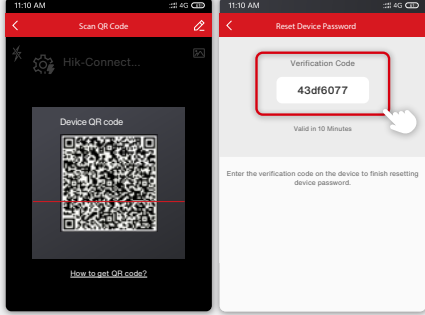

Scan QR code via the Hik-Connect App to get a verification code.

02

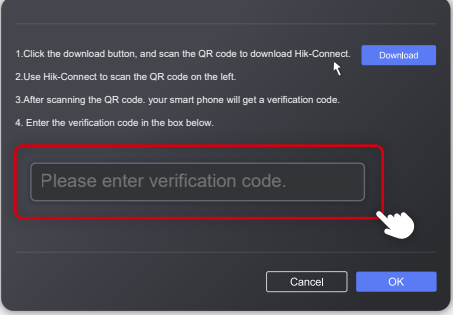

Key in the verification code to reset password.

03

Double assurance for better security



Registered account

This function is available for registered Hik-Connect account, not with visitor mode.



Authority control

The Hik-Connect account need to be linked with the device. Other unlinked accounts don't have the permission to reset password.

Tips

It is highly suggested that you link your device to the Hik-Connect account upon device activation as password reset can only be performed with a linked account.

Brand-new User Interface – "E-UI"

What is E-UI?

The E-UI is an easy and efficient user interface for Hikvision NVRs.

"Easy" means that users can easily find what they are looking for;

"Efficient" means that users can finish their settings quickly and effectively.

What are the features of E-UI?

Efficient to connect: Customers need to complete just a few initial settings on the NVR to begin. The NVR will then automatically activate and add inactive cameras within the same network segment.

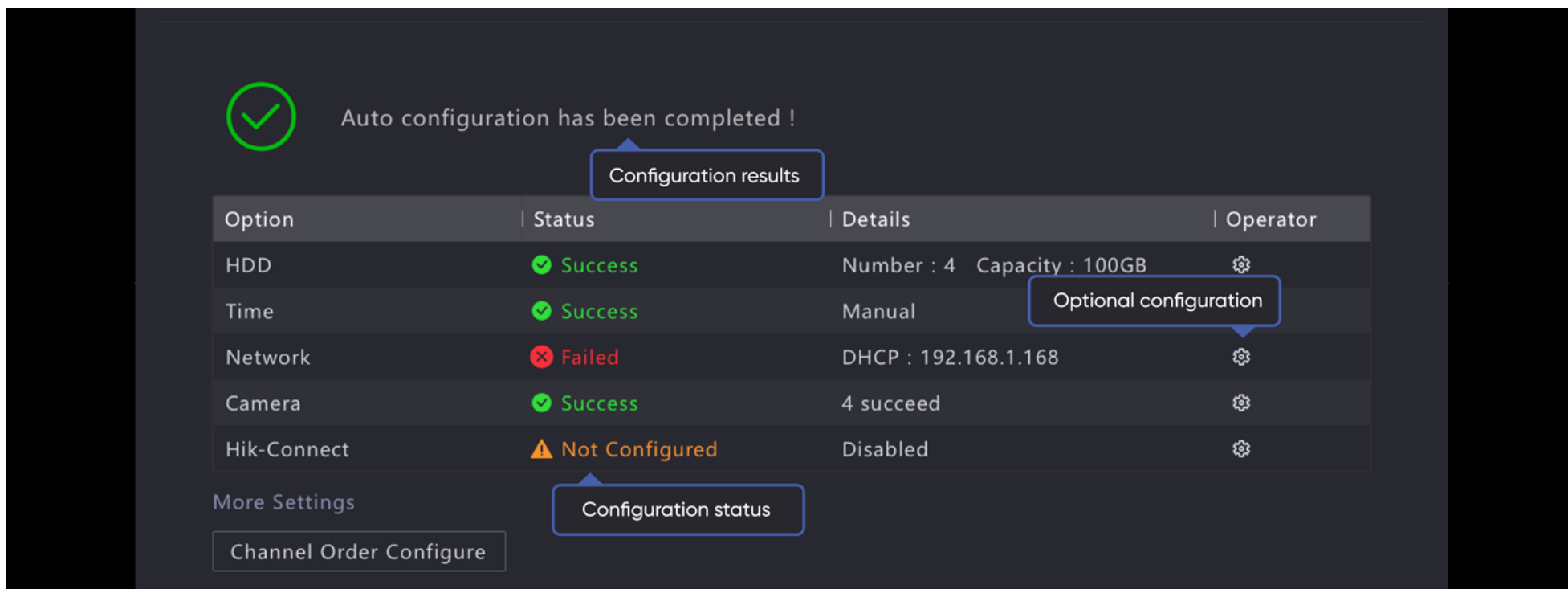

Auto configuration has been completed !

Configuration results

Option	Status	Details	Operator
HDD	✔ Success	Number : 4 Capacity : 100GB	⚙
Time	✔ Success	Manual	⚙
Network	✘ Failed	DHCP : 192.168.1.168	⚙
Camera	✔ Success	4 succeed	⚙
Hik-Connect	⚠ Not Configured	Disabled	⚙

Optional configuration

Configuration status

More Settings

Channel Order Configure

*This function only works with non-PoE series NVRs.

Easy to configure:

There are 4 buttons on the top menu for quick access. The E-UI offers two configuration mode options to cater to a variety of user habits.

Modular design for quick access



Live view



Playback



Search



Configuration

Flexible switch
between
two modes
for easy
configuration

Presents all the configurations, suitable for professional project users

Expert Mode

Easy Mode

Presents frequently used configurations, suitable for most clients

Turbo HD History

The Turbo HD line transforms analog CCTV video into high quality, high definition monitoring. Each iteration of the Turbo HD product portfolio advances the technology to the next amazing level. Further more, Turbo HD helps users achieve real-time response.

In 2022, Hikvision uncovers its brand-new Turbo HD GT – the latest Turbo iteration – taking the series to broader, faster, stronger levels, and offering more innovations and technological achievements to our customers. The new Turbo HD GT lineup has arrived with three big players: PT Cameras, Smart Hybrid Light Cameras, and eDVRs.

**Turbo HD
2013**

1.0

- HD 1080p
- H.264

**Turbo HD
2016**

3.0

- 5 MP
- H.264+
- TVI/CVBS/IPC standards and more
- PoC 1.0

**Turbo HD
2017**

4.0

- 4K
- H.265 & H.265+
- Ultra-low-light technology
- PoC 2.0

**Turbo HD
2018**

5.0

AcuSense
ColorVu

**Turbo HD
2019**

X

- Built-in siren and flashing light
- Active prevention
- Integrated response
- Real-time alerts

**Turbo HD
2022**

GT

- Smart Hybrid Light Technology
- Pan and tilt functionalities
- Scene-adaptive bitrate control
- ColorVu technology
- AcuSense Technology



Energy-efficient DVR for the future



Hikvision eDVR with eSSD

To reduce your cost of living and minimize environmental pollution, you need to make efficient energy choices. Here comes Hikvision's all-new eDVR Series – a huge leap forward in essential power efficiency.

Thanks to Hikvision's embedded solid state drive technology, this energy-efficient eDVR Series lasts longer, is more durable and offers comparable or higher quality than traditional DVRs, making nearly every experience better. Powered by Motion Detection 2.0 or AcuSense, the eDVR series also provides a new level of convenience and simplicity for users to search video footage. Get the confidence that comes with energy-efficient, cost-saving and reliable data storage.



eco-friendly

Ultra-low power consumption



eSSD technology

Embedded SSD, no extra efforts on hard drive installation



enduring storage

Longer service life with less maintenance



easy to set up and use

Compact, space-saving design fits anywhere



efficient video analytics

Detect real threats accurately

H.265 Pro+

The H.265 Pro video compression optimizes H.265 through advanced algorithms. H.265 Pro can intelligently adjust video bitrates according to given scenarios, significantly compressing the video file while maintaining high image quality.

Furthermore, when combining H.265 Pro with Hikvision's unique "H.265+", the newly generated "H.265 Pro+" works even better. Compared with H.265, H.265 Pro reduces video file size by 50% on average while H.265 Pro+ reduces video file size by up to 75% – and at times even more.

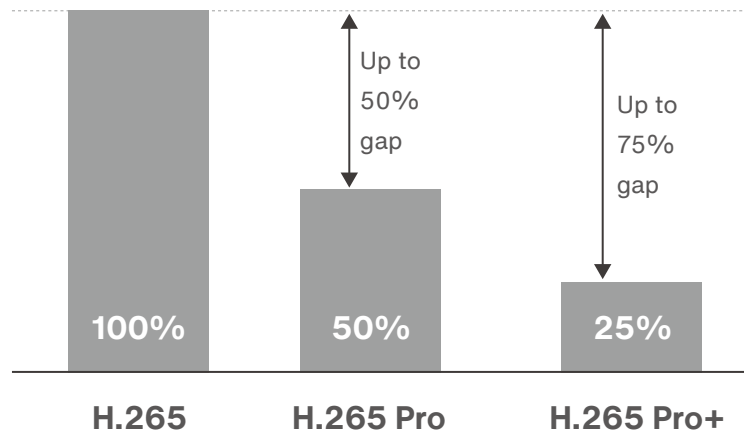

Storage time is four times longer under the same storage capability

AoC (Audio over Coax) Solution

Coaxial audio makes transmission of both HD video and sound possible over a coaxial cable, which means audio accessories like pick-ups and audio adaptors – especially audio cabling – can be removed. Enjoy a compact and efficient video & audio system with Hikvision's audio over coax solution.

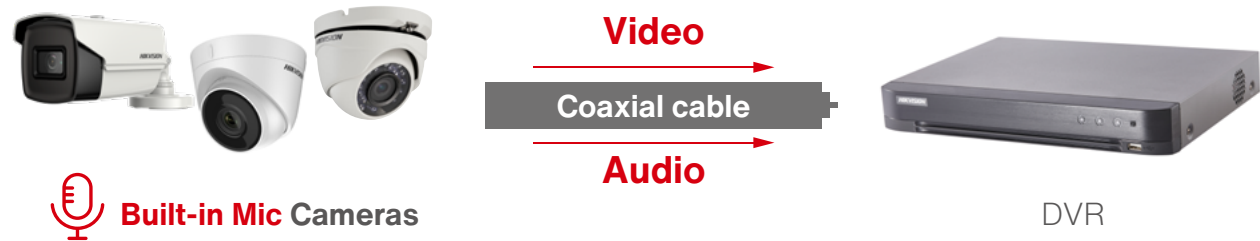

4-in-1 & 5-in-1

4-in-1 means the camera is able to deliver HD-TVI, AHD, CVI and CVBS signals. Users can choose suitable signal accordingly.

5-in-1 means the DVR is not only able to access HD-TVI, AHD, CVI and CVBS signals, but also able to access IP cameras.

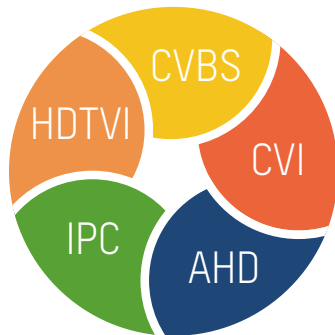

PoC 2.0

PoC 2.0 (Power Over Coax)

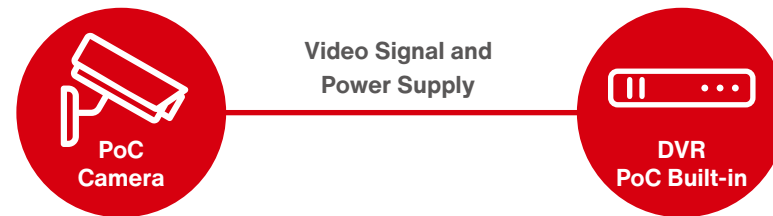

- > Transmits both HD video and power over the same coax cable
- > Unique built-in design
- > Patented Hikvision technology

Turbo HD Cameras

- 002** Turbo HD Cameras with ColorVu
- 015** Smart Hybrid Light Series
- 018** IoT Series
- 021** Pro Series
- 031** Value Series
- 048** Eco Series



Turbo HD Cameras With ColorVu







Hikvision Turbo HD cameras with ColorVu technology render colorful imaging, 24/7. These cameras can provide colorful video in ultra-low-light scenarios even without any supplemental lighting. In zero-light environments, automatic supplemental lighting from the camera itself will enhance imaging.







ColorVu technology has now been paired with Smart Hybrid Light technology to offer greater flexibility in virtually any scenario. With Smart Hybrid Light Cameras featuring ColorVu, users can enjoy the benefits of clear and colorful images without the need for supplemental lighting in most environments, regardless of the type of light used. Only in very low light conditions is it necessary to activate the supplemental lighting.







Highlights of cameras with ColorVu include:







- > Ultra HD video
- > 24/7 colorful imaging
- > Ultra-low-light night vision
- > Smart hybrid light technology
- > Super confocal technology
- > 130 dB True WDR
- > 4-in-1 video output
- > Audio over coaxial
- > New camera appearance and package design (Moonlit silver / Starry gold / Polar glow)















Model	DS-2CE10DF0T-PF	DS-2CE10DF0T-F	DS-2CE10DF0T-FS	DS-2CE10DF0T-LFS	DS-2CE10DF0T-LPFS	DS-2CE10DF0T-PFS
Image	 ColorVu	 ColorVu	 ColorVu	 ColorVu Technology	 ColorVu Technology	 ColorVu
Description	2 MP Full Time Color Bullet Camera	2 MP Full Time Color Bullet Camera	2MP ColorVu Audio Fixed Mini Bullet Camera	2 MP ColorVu Smart Hybrid Light Fixed Mini Bullet Camera	2 MP ColorVu Smart Hybrid Light Fixed Mini Bullet Camera	2MP ColorVu Audio Fixed Mini Bullet Camera
Lens	2.8 mm, 3.6mmfixed lens	2.8 mm, 3.6mmfixed lens	2.8 mm, 3.6 mm fixed focal lens	2.8 mm, 3.6 mm fixed focal lens	2.8 mm, 3.6 mm fixed focal lens	2.8 mm, 3.6 mm fixed focal lens
Min. Illumination	0.001 Lux @ (F1.0, AGC ON), 0 Lux with white light	0.001 Lux @ (F1.0, AGC ON), 0 Lux with white light	0.001 Lux @ (F1.0, AGC ON), 0 Lux with white light	0.001 Lux @ (F1.0, AGC ON), 0 Lux with white light	0.001 Lux @ (F1.0, AGC ON), 0 Lux with white light	0.001 Lux @ (F1.0, AGC ON), 0 Lux with white light
FOV	2.8 mm, horizontal FOV: 98°, vertical FOV: 51°, diagonal FOV: 115° 3.6 mm, horizontal FOV: 76°, vertical FOV: 41°, diagonal FOV: 90°	2.8 mm, horizontal FOV: 98°, vertical FOV: 51°, diagonal FOV: 115° 3.6 mm, horizontal FOV: 76°, vertical FOV: 41°, diagonal FOV: 90°	2.8 mm, horizontal FOV: 105°, vertical FOV: 55°, diagonal FOV: 125° 3.6 mm, horizontal FOV: 84°, vertical FOV: 45°, diagonal FOV: 99°	2.8 mm, horizontal FOV: 105°, vertical FOV: 56°, diagonal FOV: 126° 3.6 mm, horizontal FOV: 84°, vertical FOV: 46°, diagonal FOV: 98°	2.8 mm, horizontal FOV: 105°, vertical FOV: 56°, diagonal FOV: 126° 3.6 mm, horizontal FOV: 84°, vertical FOV: 46°, diagonal FOV: 98°	2.8 mm, horizontal FOV: 105°, vertical FOV: 55°, diagonal FOV: 125° 3.6 mm, horizontal FOV: 84°, vertical FOV: 45°, diagonal FOV: 99°
Angle Adjustment	Pan: 0° to 360°, Tilt: 0° to 90°, Rotate: 0° to 360°	Pan: 0° to 360°, Tilt: 0° to 90°, Rotate: 0° to 360°	Pan: 0° to 360°, Tilt: 0° to 90°, Rotate: 0° to 360°	Pan: 0° to 360°,Tilt: 0° to 90°, Rotate: 0° to 360°	Pan: 0° to 360°,Tilt: 0° to 90°, Rotate: 0° to 360°	Pan: 0° to 360°, Tilt: 0° to 90°, Rotate: 0° to 360°
Day & Night	Color	Color	Color	Color	Color	Color
WDR	DWDR	DWDR	DWDR	DWDR	DWDR	DWDR
Max. Light Range	Up to 20 m	Up to 20 m	Up to 20 m	IR: Up to 20 m,White Light: Up to 20 m	IR: Up to 20 m,White Light: Up to 20 m	Up to 20 m
HD Video Output	Switchable TVI / AHD / CVI / CVBS	Switchable TVI / AHD / CVI / CVBS	Switchable TVI / AHD / CVI / CVBS	Switchable TVI/AHD/CVI/CVBS	Switchable TVI/AHD/CVI/CVBS	Switchable TVI / AHD / CVI / CVBS
CVBS Output	-	-	-	-	-	-
White Balance	Auto/Manual	Auto/Manual	Auto, Manual	Auto, Manual	Auto, Manual	Auto, Manual
BLC	WDR/BLC/OFF	WDR/BLC/OFF	DWDR, BLC, HLC, Global	DWDR, BLC, HLC, Global	DWDR, BLC, HLC, Global	DWDR, BLC, HLC, Global
3D DNR	3D DNR	3D DNR	3D DNR/2D DNR	3D DNR/2D DNR	3D DNR/2D DNR	3D DNR/2D DNR
Functions	Brightness, Sharpness, Mirror, Smart Light, Anti-Banding	Brightness, Sharpness, Mirror, Smart Light, Anti-Banding	Brightness, Sharpness, Anti-banding, AGC	Brightness, Sharpness, Anti-banding, AGC	Brightness, Sharpness, Anti-banding, AGC	Brightness, Sharpness, Anti-banding, AGC
Protection Level	IP67	IP67	IP67	IP67	IP67	IP67
Alarm I/O	-	-	-	-	-	-
Power	12 VDC ±25%	12 VDC ±25%	12 VDC ± 25%, max. 2 W	12 VDC ± 25%, max. 2.9 W	12 VDC ± 25%, max. 2.9 W	12 VDC ± 25%, max. 2 W







Model	DS-2CE12DF0T-F	DS-2CE12DF0T-FS	DS-2CE12DF0T-LFS	DS-2CE70DF0T-MFS	DS-2CE70DF0T-PFS	DS-2CE70DF0T-LMFS
Image	 HOT ColorVu	 NEW HOT ColorVu	 NEW HOT ColorVu Technology	 NEW HOT ColorVu	 NEW HOT ColorVu	 NEW HOT ColorVu Technology
Description	2 MP Full Time Color Bullet Camera	2MP ColorVu Audio Fixed Bullet Camera	2 MP ColorVu Smart Hybrid Light Fixed Bullet Camera	2MP ColorVu Audio Fixed Turret Camera	2MP ColorVu Audio Indoor Fixed Turret Camera	2 MP ColorVu Smart Hybrid Light Fixed Turret Camera
Lens	2.8 mm, 3.6mm fixed lens	2.8 mm, 3.6 mm fixed focal lens	2.8 mm, 3.7 mm fixed focal lens	2.8 mm, 3.6 mm fixed focal lens	2.8 mm, 3.6 mm fixed focal lens	2.8 mm, 3.6 mm fixed focal lens
Min. Illumination	0.001 Lux @ (F1.0, AGC ON), 0 Lux with white light	0.001 Lux @ (F1.0, AGC ON), 0 Lux with white light	0.001 Lux @ (F1.0, AGC ON), 1 Lux with white light	0.001 Lux @ (F1.0, AGC ON), 0 Lux with white light	0.001 Lux @ (F1.0, AGC ON), 0 Lux with white light	0.001 Lux @ (F1.0, AGC ON), 0 Lux with white light
FOV	2.8 mm, horizontal FOV: 98°, vertical FOV: 51°, diagonal FOV: 115° 3.6 mm, horizontal FOV: 76°, vertical FOV: 41°, diagonal FOV: 90° 6 mm, horizontal FOV: 50°, vertical FOV: 27°, diagonal FOV: 58°	2.8 mm, horizontal FOV: 105°, vertical FOV: 55°, diagonal FOV: 125° 3.6 mm, horizontal FOV: 84°, vertical FOV: 45°, diagonal FOV: 99°	2.8 mm, horizontal FOV: 105°, vertical FOV: 56°, diagonal FOV: 126° 3.6 mm, horizontal FOV: 84°, vertical FOV: 46°, diagonal FOV: 98°	2.8 mm, horizontal FOV: 105°, vertical FOV: 55°, diagonal FOV: 125° 3.6 mm, horizontal FOV: 84°, vertical FOV: 45°, diagonal FOV: 99°	2.8 mm, horizontal FOV: 105°, vertical FOV: 55°, diagonal FOV: 125° 3.6 mm, horizontal FOV: 84°, vertical FOV: 45°, diagonal FOV: 99°	2.8 mm, horizontal FOV: 105°, vertical FOV: 56°, diagonal FOV: 126° 3.6 mm, horizontal FOV: 84°, vertical FOV: 46°, diagonal FOV: 98°
Angle Adjustment	Pan: 0° to 360°, Tilt: 0° to 180°, Rotate: 0° to 360°	Pan: 0° to 360°, Tilt: 0° to 90°, Rotate: 0° to 360°	Pan: 0° to 360°, Tilt: 0° to 180°, Rotate: 0° to 360°	Pan: 0° to 360°, Tilt: 0° to 75°, Rotate: 0° to 360°	Pan: 0° to 360°, Tilt: 0° to 75°, Rotate: 0° to 360°	Pan: 0° to 360°, Tilt: 0° to 75°, Rotate: 0° to 360°
Day & Night	Color	Color	Color	Color	Color	Color
WDR	DWDR	DWDR	DWDR	DWDR	DWDR	DWDR
Max. Light Range	Up to 40 m	Up to 40 m	IR: Up to 40 m, White Light: Up to 40 m	Up to 20 m	Up to 20 m	IR: Up to 20 m, White Light: Up to 20 m
HD Video Output	Switchable TVI / AHD / CVI / CVBS	Switchable TVI / AHD / CVI / CVBS	Switchable TVI / AHD / CVI / CVBS	Switchable TVI / AHD / CVI / CVBS	Switchable TVI / AHD / CVI / CVBS	Switchable TVI / AHD / CVI / CVBS
CVBS Output	-	-	-	-	-	-
White Balance	Auto/Manual	Auto, Manual	Auto, Manual	Auto, Manual	Auto, Manual	Auto, Manual
BLC	WDR/BLC/OFF	DWDR, BLC, HLC, Global	DWDR, BLC, HLC, Global	DWDR, BLC, HLC, Global	DWDR, BLC, HLC, Global	DWDR, BLC, HLC, Global
3D DNR	3D DNR	3D DNR/2D DNR	3D DNR/3D DNR	3D DNR/2D DNR	3D DNR/2D DNR	3D DNR/2D DNR
Functions	Brightness, Sharpness, Mirror, Smart Light, Anti-Banding	Brightness, Sharpness, Anti-banding, AGC	Brightness, Sharpness, Anti-banding, AGC	Brightness, Sharpness, Anti-banding, AGC	Brightness, Sharpness, Anti-banding, AGC	Brightness, Sharpness, Anti-banding, AGC
Protection Level	IP67	IP67	IP67	IP67	-	IP67
Alarm I/O	-	-	-	-	-	-
Power	12 VDC ±25%	12 VDC ± 25%, max. 3.2 W	12 VDC ± 25%, max. 4.2 W	12 VDC ± 25%, max. 2 W	12 VDC ± 25%, max. 2 W	12 VDC ± 25%, max. 2.9 W

Model	DS-2CE70DF0T-LPFS	DS-2CE70DF0T-PF	DS-2CE70DF0T-MF	DS-2CE72DF0T-F	DS-2CE72DF0T-FS	DS-2CE72DF0T-LFS
Image						
Description	2 MP ColorVu Smart Hybrid Light Indoor Fixed Turret Camera	2 MP Full Time Color Turret Camera	2 MP Full Time Color Turret Camera	2 MP Full Time Color Turret Camera	2 MP ColorVu Audio Fixed Turret Camera	2 MP ColorVu Smart Hybrid Light Fixed Turret Camera
Lens	2.8 mm, 3.6 mm fixed focal lens	2.8 mm, 3.6mmfixed lens	2.8 mm, 3.6mmfixed lens	2.8 mm, 3.6mmfixed lens	2.8 mm, 3.6 mm fixed focal lens	2.8 mm, 3.6 mm fixed focal lens
Min. Illumination	0.001 Lux @ (F1.0, AGC ON), 0 Lux with white light	0.001 Lux @ (F1.0, AGC ON), 0 Lux with white light	0.001 Lux @ (F1.0, AGC ON), 0 Lux with white light	0.001 Lux @ (F1.0, AGC ON), 0 Lux with white light	0.001 Lux @ (F1.0, AGC ON), 0 Lux with white light	0.001 Lux @ (F1.0, AGC ON), 0 Lux with white light
FOV	2.8 mm, horizontal FOV: 105°, vertical FOV: 56°, diagonal FOV: 126° 3.6 mm, horizontal FOV: 84°, vertical FOV: 46°, diagonal FOV: 98°	2.8 mm, horizontal FOV: 98°, vertical FOV: 51°, diagonal FOV: 115° 3.6 mm, horizontal FOV: 76°, vertical FOV: 41°, diagonal FOV: 90°	2.8 mm, horizontal FOV: 98°, vertical FOV: 51°, diagonal FOV: 115° 3.6 mm, horizontal FOV: 76°, vertical FOV: 41°, diagonal FOV: 90°	2.8 mm, horizontal FOV: 98°, vertical FOV: 51°, diagonal FOV: 115° 3.6 mm, horizontal FOV: 76°, vertical FOV: 41°, diagonal FOV: 90°	2.8 mm, horizontal FOV: 105°, vertical FOV: 55°, diagonal FOV: 125° 3.6 mm, horizontal FOV: 84°, vertical FOV: 45°, diagonal FOV: 99°	2.8 mm, horizontal FOV: 105°, vertical FOV: 56°, diagonal FOV: 126° 3.6 mm, horizontal FOV: 84°, vertical FOV: 46°, diagonal FOV: 98°
Angle Adjustment	Pan: 0° to 360°,Tilt: 0° to 75°, Rotate: 0° to 360°	Pan: 0° to 360°, Tilt: 0° to 75°, Rotate: 0° to 360°	Pan: 0° to 360°, Tilt: 0° to 75°, Rotate: 0° to 360°	Pan: 0° to 360°, Tilt: 0° to 75°, Rotate: 0° to 360°	Pan: 0° to 360°, Tilt: 0° to 75°, Rotate: 0° to 360°	Pan: 0° to 360°,Tilt: 0° to 75°, Rotate: 0° to 360°
Day & Night	Color	Color	Color	Color	Color	Color
WDR	DWDR	DWDR	DWDR	DWDR	DWDR	DWDR
Max. Light Range	IR: Up to 20 m, White Light: Up to 20 m	Up to 20 m	Up to 20 m	Up to 40 m	Up to 40 m	IR: Up to 40 m, White Light: Up to 40 m
HD Video Output	Switchable TVI / AHD / CVI / CVBS	Switchable TVI / AHD / CVI / CVBS	Switchable TVI / AHD / CVI / CVBS	Switchable TVI / AHD / CVI / CVBS	Switchable TVI / AHD / CVI / CVBS	Switchable TVI / AHD / CVI / CVBS
CVBS Output	-	-	-	-	-	-
White Balance	Auto, Manual	Auto/Manual	Auto/Manual	Auto/Manual	Auto, Manual	Auto, Manual
BLC	DWDR, BLC, HLC, Global	WDR/BLC/OFF	WDR/BLC/OFF	WDR/BLC/OFF	DWDR, BLC, HLC, Global	DWDR, BLC, HLC, Global
3D DNR	3D DNR/2D DNR	3D DNR	3D DNR	3D DNR	3D DNR/2D DNR	3D DNR/2D DNR
Functions	Brightness, Sharpness, Anti-banding, AGC	Brightness, Sharpness, Mirror, Smart Light, Anti-Banding	Brightness, Sharpness, Mirror, Smart Light, Anti-Banding	Brightness, Sharpness, Mirror, Smart Light, Anti-Banding	Brightness, Sharpness, Anti-banding, AGC	Brightness, Sharpness, Anti-banding, AGC
Protection Level	-	-	IP67	IP67	IP67	IP67
Alarm I/O	-	-	-	-	-	-
Power	12 VDC ± 25%, max. 2.9 W	12 VDC ±25%	12 VDC ±25%	12 VDC ±25%	12 VDC ± 25%, max. 3.2 W	12 VDC ± 25%, max. 4.2 W



Model	DS-2CE10DF3T-PF	DS-2CE10DF3T-F	DS-2CE12DF3T-F	DS-2CE70DF3T-PF	DS-2CE70DF3T-MF	DS-2CE72DF3T-F
Image	 HOT ColorVu	 HOT ColorVu	 HOT ColorVu	 HOT ColorVu	 HOT ColorVu	 HOT ColorVu
Description	2 MP Full Time Color Bullet Camera	2 MP Full Time Color Bullet Camera	2 MP Full Time Color Bullet Camera	2 MP Full Time Color Turret Camera	2 MP Full Time Color Turret Camera	2 MP Full Time Color Turret Camera
Lens	2.8 mm, 3.6mmfixed lens	2.8 mm, 3.6mmfixed lens	2.8 mm, 3.6mm fixed lens	2.8 mm, 3.6mmfixed lens	2.8 mm, 3.6mmfixed lens	2.8 mm, 3.6mmfixed lens
Min. Illumination	0.0005 Lux @ (F1.0, AGC ON), 0 Lux with white light	0.0005 Lux @ (F1.0, AGC ON), 0 Lux with white light	0.0005 Lux @ (F1.0, AGC ON), 0 Lux with white light	0.0005 Lux @ (F1.0, AGC ON), 0 Lux with white light	0.0005 Lux @ (F1.0, AGC ON), 0 Lux with white light	0.0005 Lux @ (F1.0, AGC ON), 0 Lux with white light
FOV	2.8 mm, horizontal FOV: 106°, vertical FOV: 56°, diagonal FOV: 129° 3.6 mm, horizontal FOV: 83°, vertical FOV: 44°, diagonal FOV: 100°	2.8 mm, horizontal FOV: 106°, vertical FOV: 56°, diagonal FOV: 129° 3.6 mm, horizontal FOV: 83°, vertical FOV: 44°, diagonal FOV: 100°	2.8 mm, horizontal FOV: 106°, vertical FOV: 56°, diagonal FOV: 129° 3.6 mm, horizontal FOV: 83°, vertical FOV: 44°, diagonal FOV: 100° 6 mm, horizontal FOV: 54°, vertical FOV: 30°, diagonal FOV: 64°	2.8 mm, horizontal FOV: 106°, vertical FOV: 56°, diagonal FOV: 129° 3.6 mm, horizontal FOV: 83°, vertical FOV: 44°, diagonal FOV: 100°	2.8 mm, horizontal FOV: 106°, vertical FOV: 56°, diagonal FOV: 129° 3.6 mm, horizontal FOV: 83°, vertical FOV: 44°, diagonal FOV: 100°	2.8 mm, horizontal FOV: 106°, vertical FOV: 56°, diagonal FOV: 129° 3.6 mm, horizontal FOV: 83°, vertical FOV: 44°, diagonal FOV: 100°
Angle Adjustment	Pan: 0° to 360°, Tilt: 0° to 90°, Rotate: 0° to 360°	Pan: 0° to 360°, Tilt: 0° to 90°, Rotate: 0° to 360°	Pan: 0° to 360°, Tilt: 0° to 180°, Rotate: 0° to 360°	Pan: 0° to 360°, Tilt: 0° to 75°, Rotate: 0° to 360°	Pan: 0° to 360°, Tilt: 0° to 75°, Rotate: 0° to 360°	Pan: 0° to 360°, Tilt: 0° to 75°, Rotate: 0° to 360°
Day & Night	Color	Color	Color	Color	Color	Color
WDR	≥ 130 dB	≥ 130 dB	≥ 130 dB	≥ 130 dB	≥ 130 dB	≥ 130 dB
Max. Light Range	Up to 20 m	Up to 20 m	Up to 40 m	Up to 20 m	Up to 20 m	Up to 40 m
HD Video Output	Switchable TVI / AHD / CVI / CVBS	Switchable TVI / AHD / CVI / CVBS	Switchable TVI / AHD / CVI / CVBS	Switchable TVI / AHD / CVI / CVBS	Switchable TVI / AHD / CVI / CVBS	Switchable TVI / AHD / CVI / CVBS
CVBS Output	-	-	-	-	-	-
White Balance	Auto/Manual	Auto/Manual	Auto/Manual	Auto/Manual	Auto/Manual	Auto/Manual
BLC	WDR/BLC/HLS/OFF	WDR/BLC/HLS/OFF	WDR/BLC/HLS/OFF	WDR/BLC/HLS/OFF	WDR/BLC/HLS/OFF	WDR/BLC/HLS/OFF
3D DNR	3D DNR	3D DNR	3D DNR	3D DNR	3D DNR	3D DNR
Functions	Brightness, Sharpness, Mirror, Smart Light, Anti-Banding, Contrast, Defective Pixel Correction	Brightness, Sharpness, Mirror, Smart Light, Anti-Banding, Contrast, Defective Pixel Correction	Brightness, Sharpness, Mirror, Smart Light, Anti-Banding, Contrast, Defective Pixel Correction	Brightness, Sharpness, Mirror, Smart Light, Anti-Banding, Contrast, Defective Pixel Correction	Brightness, Sharpness, Mirror, Smart Light, Anti-Banding, Contrast, Defective Pixel Correction	Brightness, Sharpness, Mirror, Smart Light, Anti-Banding, Contrast, Defective Pixel Correction
Protection Level	IP67	IP67	IP67	-	IP67	IP67
Alarm I/O	-	-	-	-	-	-
Power	12 VDC ±25%	12 VDC ±25%	12 VDC ±25%	12 VDC ±25%	12 VDC ±25%	12 VDC ±25%

Model	DS-2CE10DF8T-PF	DS-2CE10DF8T-F	DS-2CE12DF8T-F	DS-2CE70DF8T-PF	DS-2CE70DF8T-MF	DS-2CE72DF8T-F
Image	 ColorVu	 ColorVu	 ColorVu	 ColorVu	 ColorVu	 ColorVu
Description	2 MP Full Time Color Bullet Camera	2 MP Full Time Color Bullet Camera	2 MP Full Time Color Bullet Camera	2 MP Full Time Color Turret Camera	2 MP Full Time Color Turret Camera	2 MP Full Time Color Turret Camera
Lens	2.8 mm, 3.6mmfixed lens	2.8 mm, 3.6mmfixed lens	2.8 mm, 3.6mm fixed lens	2.8 mm, 3.6mmfixed lens	2.8 mm, 3.6mmfixed lens	2.8 mm, 3.6mmfixed lens
Min. Illumination	0.0003 Lux @ (F1.0, AGC ON), 0 Lux with white light	0.0003 Lux @ (F1.0, AGC ON), 0 Lux with white light	0.0003 Lux @ (F1.0, AGC ON), 0 Lux with white light	0.0003 Lux @ (F1.0, AGC ON), 0 Lux with white light	0.0003 Lux @ (F1.0, AGC ON), 0 Lux with white light	0.0003 Lux @ (F1.0, AGC ON), 0 Lux with white light
FOV	2.8 mm, horizontal FOV: 106°, vertical FOV: 56°, diagonal FOV: 129° 3.6 mm, horizontal FOV: 83°, vertical FOV: 44°, diagonal FOV: 100°	2.8 mm, horizontal FOV: 106°, vertical FOV: 56°, diagonal FOV: 129° 3.6 mm, horizontal FOV: 83°, vertical FOV: 44°, diagonal FOV: 100°	2.8 mm, horizontal FOV: 106°, vertical FOV: 56°, diagonal FOV: 129° 3.6 mm, horizontal FOV: 83°, vertical FOV: 44°, diagonal FOV: 100° 6 mm, horizontal FOV: 54°, vertical FOV: 30°, diagonal FOV: 64°	2.8 mm, horizontal FOV: 106°, vertical FOV: 56°, diagonal FOV: 129° 3.6 mm, horizontal FOV: 83°, vertical FOV: 44°, diagonal FOV: 100°	2.8 mm, horizontal FOV: 106°, vertical FOV: 56°, diagonal FOV: 129° 3.6 mm, horizontal FOV: 83°, vertical FOV: 44°, diagonal FOV: 100°	2.8 mm, horizontal FOV: 106°, vertical FOV: 56°, diagonal FOV: 129° 3.6 mm, horizontal FOV: 83°, vertical FOV: 44°, diagonal FOV: 100°
Angle Adjustment	Pan: 0° to 360°, Tilt: 0° to 90°, Rotate: 0° to 360°	Pan: 0° to 360°, Tilt: 0° to 90°, Rotate: 0° to 360°	Pan: 0° to 360°, Tilt: 0° to 180°, Rotate: 0° to 360°	Pan: 0° to 360°, Tilt: 0° to 75°, Rotate: 0° to 360°	Pan: 0° to 360°, Tilt: 0° to 75°, Rotate: 0° to 360°	Pan: 0° to 360°, Tilt: 0° to 75°, Rotate: 0° to 360°
Day & Night	Color	Color	Color	Color	Color	Color
WDR	≥ 130 dB	≥ 130 dB	≥ 130 dB	≥ 130 dB	≥ 130 dB	≥ 130 dB
Max. Light Range	Up to 20 m	Up to 20 m	Up to 40 m	Up to 20 m	Up to 20 m	Up to 40 m
HD Video Output	Switchable TVI / AHD / CVI / CVBS	Switchable TVI / AHD / CVI / CVBS	Switchable TVI / AHD / CVI / CVBS	Switchable TVI / AHD / CVI / CVBS	Switchable TVI / AHD / CVI / CVBS	Switchable TVI / AHD / CVI / CVBS
CVBS Output	-	-	-	-	-	-
White Balance	Auto/Manual	Auto/Manual	Auto/Manual	Auto/Manual	Auto/Manual	Auto/Manual
BLC	WDR/BLC/HLS/OFF	WDR/BLC/HLS/OFF	WDR/BLC/HLS/OFF	WDR/BLC/HLS/OFF	WDR/BLC/HLS/OFF	WDR/BLC/HLS/OFF
3D DNR	3D DNR	3D DNR	3D DNR	3D DNR	3D DNR	3D DNR
Functions	Brightness, Sharpness, Mirror, Smart Light, Anti-Banding, Contrast	Brightness, Sharpness, Mirror, Smart Light, Anti-Banding, Contrast	Brightness, Sharpness, Mirror, Smart Light, Anti-Banding, Contrast	Brightness, Sharpness, Mirror, Smart Light, Anti-Banding, Contrast	Brightness, Sharpness, Mirror, Smart Light, Anti-Banding, Contrast	Brightness, Sharpness, Mirror, Smart Light, Anti-Banding, Contrast
Protection Level	IP68	IP68	IP68	-	IP68	IP68
Alarm I/O	-	-	-	-	-	-
Power	12 VDC ±25%	12 VDC ±25%	12 VDC ±25%	12 VDC ±25%	12 VDC ±25%	12 VDC ±25%







Model	DS-2CE10DF3T-PFS	DS-2CE10DF3T-FS	DS-2CE12DF3T-FS	DS-2CE70DF3T-PFS	DS-2CE70DF3T-MFS	DS-2CE72DF3T-FS
Image	 ColorVu	 ColorVu	 ColorVu	 ColorVu	 ColorVu	 ColorVu
Description	2 MP Full Time Color Bullet Camera	2 MP Full Time Color Bullet Camera	2 MP Full Time Color Bullet Camera	2 MP Full Time Color Turret Camera	2 MP Full Time Color Turret Camera	2 MP Full Time Color Turret Camera
Lens	2.8 mm, 3.6 mm fixed focal lens	2.8 mm, 3.6 mm fixed focal lens	2.8 mm, 3.6 mm fixed focal lens	2.8 mm, 3.6 mm fixed focal lens	2.8 mm, 3.6 mm fixed focal lens	2.8 mm, 3.6 mm fixed focal lens
Min. Illumination	0.0005 Lux @ (F1.0, AGC ON), 0 Lux with white light	0.0005 Lux @ (F1.0, AGC ON), 0 Lux with white light	0.0005 Lux @ (F1.0, AGC ON), 0 Lux with white light	0.0005 Lux @ (F1.0, AGC ON), 0 Lux with white light	0.0005 Lux @ (F1.0, AGC ON), 0 Lux with white light	0.0005 Lux @ (F1.0, AGC ON), 0 Lux with white light
FOV	2.8 mm, horizontal FOV: 98°, vertical FOV: 52°, diagonal FOV: 116° 3.6 mm, horizontal FOV: 77°, vertical FOV: 42°, diagonal FOV: 91°	2.8 mm, horizontal FOV: 98°, vertical FOV: 52°, diagonal FOV: 116° 3.6 mm, horizontal FOV: 77°, vertical FOV: 42°, diagonal FOV: 91°	2.8 mm, horizontal FOV: 98°, vertical FOV: 52°, diagonal FOV: 116° 3.6 mm, horizontal FOV: 77°, vertical FOV: 42°, diagonal FOV: 91° 6 mm, horizontal FOV: 51°, vertical FOV: 28°, diagonal FOV: 59°	2.8 mm, horizontal FOV: 98°, vertical FOV: 52°, diagonal FOV: 116° 3.6 mm, horizontal FOV: 77°, vertical FOV: 42°, diagonal FOV: 91°	2.8 mm, horizontal FOV: 98°, vertical FOV: 52°, diagonal FOV: 116° 3.6 mm, horizontal FOV: 77°, vertical FOV: 42°, diagonal FOV: 91°	2.8 mm, horizontal FOV: 98°, vertical FOV: 52°, diagonal FOV: 116° 3.6 mm, horizontal FOV: 77°, vertical FOV: 42°, diagonal FOV: 91°
Angle Adjustment	Pan: 0° to 360°, Tilt: 0° to 90°, Rotation: 0° to 360°	Pan: 0° to 360°, Tilt: 0° to 90°, Rotation: 0° to 360°	Pan: 0° to 360°, Tilt: 0° to 180°, Rotation: 0° to 360°	Pan: 0° to 360°, Tilt: 0° to 75°, Rotation: 0° to 360°	Pan: 0° to 360°, Tilt: 0° to 75°, Rotation: 0° to 360°	Pan: 0° to 360°, Tilt: 0° to 75°, Rotation: 0° to 360°
Day & Night	Color	Color	Color	Color	Color	Color
WDR	≥ 130 dB	≥ 130 dB	≥ 130 dB	≥ 130 dB	≥ 130 dB	≥ 130 dB
Max. Light Range	Up to 20 m	Up to 20 m	Up to 40 m	Up to 20 m	Up to 20 m	Up to 40 m
HD Video Output	Switchable TVI / AHD / CVI / CVBS	Switchable TVI / AHD / CVI / CVBS	Switchable TVI / AHD / CVI / CVBS	Switchable TVI / AHD / CVI / CVBS	Switchable TVI / AHD / CVI / CVBS	Switchable TVI / AHD / CVI / CVBS
CVBS Output	-	-	-	-	-	-
White Balance	Auto/Manual	Auto/Manual	Auto/Manual	Auto/Manual	Auto/Manual	Auto/Manual
BLC	WDR;BLC;HLC;Global;HLS	WDR;BLC;HLC;Global;HLS	WDR;BLC;HLC;Global;HLS	WDR;BLC;HLC;Global;HLS	WDR;BLC;HLC;Global;HLS	WDR;BLC;HLC;Global;HLS
3D DNR	3D DNR	3D DNR	3D DNR	3D DNR	3D DNR	3D DNR
Functions	Brightness, Contrast, Mirror, Defective Pixel Correction, Sharpness, Anti-Banding, Smart Light	Brightness, Contrast, Mirror, Defective Pixel Correction, Sharpness, Anti-Banding, Smart Light	Brightness, Contrast, Mirror, Defective Pixel Correction, Sharpness, Anti-Banding, Smart Light	Brightness, Contrast, Mirror, Defective Pixel Correction, Sharpness, Anti-Banding, Smart Light	Brightness, Contrast, Mirror, Defective Pixel Correction, Sharpness, Anti-Banding, Smart Light	Brightness, Contrast, Mirror, Defective Pixel Correction, Sharpness, Anti-Banding, Smart Light
Protection Level	IP67	IP67	IP67	-	IP67	IP67
Alarm I/O	-	-	-	-	-	-
Power	12 VDC ± 25%	12 VDC ± 25%	12 VDC ± 25%	12 VDC ± 25%	12 VDC ± 25%	12 VDC ± 25%







Model	DS-2CE10DF8T-PFSLN	DS-2CE10DF8T-FSLN	DS-2CE12DF8T-FSLN	DS-2CE70DF8T-PFSLN	DS-2CE70DF8T-MFSLN	DS-2CE72DF8T-FSLN
Image	 ColorVu	 ColorVu	 ColorVu	 ColorVu	 ColorVu	 ColorVu
Description	2 MP Full Time Color Bullet Camera	2 MP Full Time Color Bullet Camera	2 MP Full Time Color Bullet Camera	2 MP Full Time Color Turret Camera	2 MP Full Time Color Turret Camera	2 MP Full Time Color Turret Camera
Lens	2.8 mm, 3.6 mm fixed focal lens	2.8 mm, 3.6 mm fixed focal lens	2.8 mm, 3.6 mm fixed focal lens	2.8 mm, 3.6 mm fixed focal lens	2.8 mm, 3.6 mm fixed focal lens	2.8 mm, 3.6 mm fixed focal lens
Min. Illumination	0.0003 Lux @ (F1.0, AGC ON), 0 Lux with white light	0.0003 Lux @ (F1.0, AGC ON), 0 Lux with white light	0.0003 Lux @ (F1.0, AGC ON), 0 Lux with white light	0.0003 Lux @ (F1.0, AGC ON), 0 Lux with white light	0.0003 Lux @ (F1.0, AGC ON), 0 Lux with white light	0.0003 Lux @ (F1.0, AGC ON), 0 Lux with white light
FOV	2.8 mm, horizontal FOV: 106°, vertical FOV: 56°, diagonal FOV: 129° 3.6 mm, horizontal FOV: 83°, vertical FOV: 44°, diagonal FOV: 100°	2.8 mm, horizontal FOV: 106°, vertical FOV: 56°, diagonal FOV: 129° 3.6 mm, horizontal FOV: 83°, vertical FOV: 44°, diagonal FOV: 100°	2.8 mm, horizontal FOV: 106°, vertical FOV: 56°, diagonal FOV: 129° 3.6 mm, horizontal FOV: 83°, vertical FOV: 44°, diagonal FOV: 100° 6 mm, horizontal FOV: 54°, vertical FOV: 30°, diagonal FOV: 64°	2.8 mm, horizontal FOV: 106°, vertical FOV: 56°, diagonal FOV: 129° 3.6 mm, horizontal FOV: 83°, vertical FOV: 44°, diagonal FOV: 100°	2.8 mm, horizontal FOV: 106°, vertical FOV: 56°, diagonal FOV: 129° 3.6 mm, horizontal FOV: 83°, vertical FOV: 44°, diagonal FOV: 100°	2.8 mm, horizontal FOV: 106°, vertical FOV: 56°, diagonal FOV: 129° 3.6 mm, horizontal FOV: 83°, vertical FOV: 44°, diagonal FOV: 100°
Angle Adjustment	Pan: 0° to 360°, Tilt: 0° to 90°, Rotation: 0° to 360°	Pan: 0° to 360°, Tilt: 0° to 90°, Rotation: 0° to 360°	Pan: 0° to 360°, Tilt: 0° to 180°, Rotation: 0° to 360°	Pan: 0° to 360°, Tilt: 0° to 75°, Rotation: 0° to 360°	Pan: 0° to 360°, Tilt: 0° to 75°, Rotation: 0° to 360°	Pan: 0° to 360°, Tilt: 0° to 75°, Rotation: 0° to 360°
Day & Night	Color	Color	Color	Color	Color	Color
WDR	≥ 130 dB	≥ 130 dB	≥ 130 dB	≥ 130 dB	≥ 130 dB	≥ 130 dB
Max. Light Range	Up to 20 m	Up to 20 m	Up to 40 m	Up to 20 m	Up to 20 m	Up to 40 m
HD Video Output	Switchable TVI / AHD / CVI / CVBS	Switchable TVI / AHD / CVI / CVBS	Switchable TVI / AHD / CVI / CVBS	Switchable TVI / AHD / CVI / CVBS	Switchable TVI / AHD / CVI / CVBS	Switchable TVI / AHD / CVI / CVBS
CVBS Output	-	-	-	-	-	-
White Balance	Auto/Manual	Auto/Manual	Auto/Manual	Auto/Manual	Auto/Manual	Auto/Manual
BLC	WDR;BLC;HLC;Global;HLS	WDR;BLC;HLC;Global;HLS	WDR;BLC;HLC;Global;HLS	WDR;BLC;HLC;Global;HLS	WDR;BLC;HLC;Global;HLS	WDR;BLC;HLC;Global;HLS
3D DNR	3D DNR	3D DNR	3D DNR	3D DNR	3D DNR	3D DNR
Functions	Brightness, Contrast, Mirror, Defective Pixel Correction, Sharpness, Anti-Banding, Smart Light	Brightness, Contrast, Mirror, Defective Pixel Correction, Sharpness, Anti-Banding, Smart Light	Brightness, Contrast, Mirror, Defective Pixel Correction, Sharpness, Anti-Banding, Smart Light	Brightness, Contrast, Mirror, Defective Pixel Correction, Sharpness, Anti-Banding, Smart Light	Brightness, Contrast, Mirror, Defective Pixel Correction, Sharpness, Anti-Banding, Smart Light	Brightness, Contrast, Mirror, Defective Pixel Correction, Sharpness, Anti-Banding, Smart Light
Protection Level	IP67	IP67	IP67	-	IP67	IP67
Alarm I/O	-	-	-	-	-	-
Power	12 VDC ± 25%	12 VDC ± 25%	12 VDC ± 25%	12 VDC ± 25%	12 VDC ± 25%	12 VDC ± 25%







5 MP









Model	DS-2CE19DF8T-AZE	DS-2CE79DF8T-AZE	DS-2CE59DF8T-AVPZE
Image	 ColorVu	 ColorVu	 ColorVu
Description	2 MP Full Time Color Bullet Camera	2 MP Full Time Color Turret Camera	2 MP Full Time Color Turret Camera
Lens	2.8 mm to 12 mm motorized, auto focus	2.8 mm to 12 mm motorized, auto focus	2.8 mm to 12 mm motorized, auto focus
Min. Illumination	0.0003 Lux @ (F1.0, AGC ON), 0 Lux with white Light	0.0003 Lux @ (F1.0, AGC ON), 0 Lux with white Light	0.0003 Lux @ (F1.0, AGC ON), 0 Lux with white Light
FOV	horizontal FOV: 92.3° to 34.2°, vertical FOV: 48.4° to 19°, diagonal FOV: 112.2° to 39.2°	horizontal FOV: 92.3° to 34.2°, vertical FOV: 48.4° to 19°, diagonal FOV: 112.2° to 39.2°	horizontal FOV: 92.3° to 34.2°, vertical FOV: 48.4° to 19°, diagonal FOV: 112.2° to 39.2°
Angle Adjustment	Pan:0° to 360°, Tilt: 0° to 90°, Rotation: 0° to 360°	Pan:0° to 360°, Tilt: 0° to 75°, Rotation: 0° to 360°	Pan:0° to 355°, Tilt: 0° to 75°, Rotation: 0° to 355°
Day & Night	Color	Color	Color
WDR	≥ 130 dB	≥ 130 dB	≥ 130 dB
Max. Light Range	Up to 40 m	Up to 40 m	Up to 40 m
HD Video Output	1 HD analog output	1 HD analog output	1 HD analog output
CVBS Output	-	-	-
White Balance	Auto/Manual	Auto/Manual	Auto/Manual
BLC	WDR, BLC, HLC, Global, HLS	WDR, BLC, HLC, Global, HLS	WDR, BLC, HLC, Global, HLS
3D DNR	3D DNR	3D DNR	3D DNR
Functions	Brightness, Contrast, Mirror, Defective Pixel Correction, Sharpness, Anti-Banding, Smart Light	Brightness, Contrast, Mirror, Defective Pixel Correction, Sharpness, Anti-Banding, Smart Light	Brightness, Contrast, Mirror, Defective Pixel Correction, Sharpness, Anti-Banding, Smart Light
Protection Level	IP68	IP68	IK10 ; IP68
Alarm I/O	-	-	-
Power	12 VDC/24 VAC±20%/PoC.at	12 VDC/24 VAC±20%/PoC.at	12 VDC/24 VAC±20%/PoC.at

Model	DS-2CE10HFT-F28 (2.8mm)
Image	 ColorVu
Description	5 MP Full Time Color Bullet Camera
Lens	2.8 mm fixed lens
Min. Illumination	0.0005 Lux @ (F1.0, AGC ON), 0 Lux with White Light
FOV	2.8 mm, horizontal FOV: 99.7°, verticalFOV: 72°, diagonal FOV: 139.8°
Angle Adjustment	Pan: 0 to 360°, Tilt: 0 to 90°, Zoom 0 to 360°
Day & Night	Color
WDR	≥ 130 dB
Max. Light Range	Up to 20 m
HD Video Output	Switchable TVI / AHD / CVI / CVBS
CVBS Output	-
White Balance	Auto/Manual
BLC	-
3D DNR	3D DNR
Functions	Brightness, Sharpness, Mirror, Smart Light
Protection Level	IP67
Alarm I/O	-
Power	12 VDC ±25%

Model	DS-2CE72HFT-F28 (2.8mm)	DS-2CE12HFT-F28 (2.8mm)	DS-2CE12HFT-F	DS-2CE10HFT-E	DS-2CE72HFT-E	DS-2CE12HFT-E
Image	 ColorVu	 ColorVu	 ColorVu	 ColorVu	 ColorVu	 ColorVu
Description	5 MP Full Time Color Turret Camera	5 MP Full Time Color Bullet Camera	5 MP Full Time Color Bullet Camera	5 MP Full Time Color Bullet Camera	5 MP Full Time Color Turret Camera	5 MP Full Time Color Bullet Camera
Lens	2.8 mm fixed lens	2.8 mm fixed lens	3.6 mm fixed lens	2.8 mm, 3.6 mm fixed focal lens	2.8 mm, 3.6 mm fixed focal lens	2.8 mm, 3.6 mm fixed focal lens
Min. Illumination	0.0005 Lux @ (F1.0, AGC ON), 0 Lux with White Light	0.0005 Lux @ (F1.0, AGC ON), 0 Lux with White Light	0.0005 Lux @ (F1.0, AGC ON), 0 Lux with White Light	0.0005 Lux @ (F1.0, AGC ON), 0 Lux with White Light	0.0005 Lux @ (F1.0, AGC ON), 0 Lux with White Light	0.0005 Lux @ (F1.0, AGC ON), 0 Lux with White Light
FOV	2.8 mm, horizontal FOV: 99.7°, verticalFOV: 72°, diagonal FOV: 139.8°	2.8 mm, horizontal FOV: 99.7°, verticalFOV: 72°, diagonal FOV: 139.8°	80.1° (3.6 mm), 49.3° (6 mm)	2.8 mm, horizontal FOV: 99.7°, vertical FOV: 72°, diagonal FOV: 139.8° 3.6 mm, horizontal FOV: 80.1°, vertical FOV: 58.6°, diagonal FOV: 106.2°	2.8 mm, horizontal FOV: 99.7°, vertical FOV: 72°, diagonal FOV: 139.8° 3.6 mm, horizontal FOV: 80.1°, vertical FOV: 58.6°, diagonal FOV: 106.2°	2.8 mm, horizontal FOV: 99.7°, vertical FOV: 72°, diagonal FOV: 139.8° 3.6 mm, horizontal FOV: 80.1°, vertical FOV: 58.6°, diagonal FOV: 106.2°
Angle Adjustment	Pan: 0 to 360°, Tilt: 0 to 75°, Zoom 0 to 360°	Pan: 0 to 360°, Tilt: 0 to 90°, Zoom 0 to 360°	Pan: 0 to 360°, Tilt: 0 to 90°, Zoom 0 to 360°	Pan: 0° to 360°, Tilt: 0° to 90°, Rotation: 0° to 360°	Pan: 0° to 360°, Tilt: 0° to 75°, Rotation: 0° to 360°	Pan: 0° to 360°, Tilt: 0° to 90°, Rotation: 0° to 360°
Day & Night	Color	Color	Color	Color	Color	Color
WDR	≥ 130 dB	≥ 130 dB	≥ 130 dB	≥ 130 dB	≥ 130 dB	≥ 130 dB
Max. Light Range	Up to 20 m	Up to 40 m	Up to 40 m	Up to 20 m	Up to 40 m	Up to 40 m
HD Video Output	Switchable TVI / AHD / CVI / CVBS	Switchable TVI / AHD / CVI / CVBS	Switchable TVI / AHD / CVI / CVBS	1 HD analog output	1 HD analog output	1 HD analog output
CVBS Output	-	-	-	-	-	-
White Balance	Auto/Manual	Auto/Manual	Auto/Manual	Auto/Manual	Auto/Manual	Auto/Manual
BLC	-	-	-	BLC	BLC	BLC
3D DNR	3D DNR	3D DNR	3D DNR	3D DNR	3D DNR	3D DNR
Functions	Brightness, Sharpness, Mirror, Smart Light	Brightness, Sharpness, Mirror, Smart Light	Brightness, Sharpness, Mirror, Smart Light	Brightness, Mirror, Sharpness, Anti-Banding, Smart Light	Brightness, Mirror, Sharpness, Anti-Banding, Smart Light	Brightness, Mirror, Sharpness, Anti-Banding, Smart Light
Protection Level	IP67	IP67	IP67	IP67	IP67	IP67
Alarm I/O	-	-	-	-	-	-
Power	12 VDC ±25%	12 VDC ±25%	12 VDC ±25%	12 VDC ±25%/PoC.af	12 VDC ±25%/PoC.af	12 VDC ±25%/PoC.af

Model	DS-2CE10KF0T-PFS	DS-2CE10KF0T-FS	DS-2CE12KF0T-FS	DS-2CE70KF0T-PFS	DS-2CE70KF0T-MFS	DS-2CE72KF0T-FS
Image	 ColorVu	 ColorVu	 ColorVu	 ColorVu	 ColorVu	 ColorVu
Description	3K ColorVu Audio Fixed Mini Bullet Camera	3K ColorVu Audio Fixed Bullet Camera	3K ColorVu Audio Fixed Bullet Camera	3K ColorVu Indoor Audio Fixed Turret Camera	3K ColorVu Audio Fixed Turret Camera	3K ColorVu Audio Fixed Turret Camera
Lens	2.8 mm and 3.6 mm fixed focal lens	2.8 mm, 3.6 mm, 6 mm fixed focal lens	2.8 mm, 3.6 mm, 6 mm fixed focal lens	2.8 mm and 3.6 mm fixed focal lens	2.8 mm, 3.6 mm fixed focal lens	2.8 mm and 3.6 mm fixed focal lens
Min. Illumination	0.001 Lux @ (F1.0, AGC ON), 0 Lux with white light	0.001 Lux @ (F1.0, AGC ON), 0 Lux with white light	0.001 Lux @ (F1.0, AGC ON), 0 Lux with white light	0.001 Lux @ (F1.0, AGC ON), 0 Lux with white light	0.001 Lux @ (F1.0, AGC ON), 0 Lux with white light	0.001 Lux @ (F1.0, AGC ON), 0 Lux with white light
FOV	2.8 mm, horizontal FOV: 102°, vertical FOV: 56°, diagonal FOV: 122° 3.6 mm, horizontal FOV: 80°, vertical FOV: 45°, diagonal FOV: 96°	2.8 mm, horizontal FOV: 102°, vertical FOV: 56°, diagonal FOV: 122° 3.6 mm, horizontal FOV: 80°, vertical FOV: 45°, diagonal FOV: 96° 6 mm, horizontal FOV: 56°, vertical FOV: 30°, diagonal FOV: 61°	2.8 mm, horizontal FOV: 102°, vertical FOV: 56°, diagonal FOV: 122° 3.6 mm, horizontal FOV: 80°, vertical FOV: 45°, diagonal FOV: 96° 6 mm, horizontal FOV: 56°, vertical FOV: 30°, diagonal FOV: 61°	2.8 mm, horizontal FOV: 102°, vertical FOV: 56°, diagonal FOV: 122° 3.6 mm, horizontal FOV: 80°, vertical FOV: 45°, diagonal FOV: 96°	2.8 mm, horizontal FOV: 102°, vertical FOV: 56°, diagonal FOV: 122° 3.6 mm, horizontal FOV: 80°, vertical FOV: 45°, diagonal FOV: 96°	2.8 mm, horizontal FOV: 102°, vertical FOV: 56°, diagonal FOV: 122° 3.6 mm, horizontal FOV: 80°, vertical FOV: 45°, diagonal FOV: 96°
Angle Adjustment	Pan: 0° to 360°, Tilt: 0° to 90°, Rotation: 0° to 360°	Pan: 0° to 360°, Tilt: 0° to 180°, Rotation: 0° to 360°	Pan: 0° to 360°, Tilt: 0° to 180°, Rotation: 0° to 360°	Pan: 0° to 360°, Tilt: 0° to 75°, Rotation: 0° to 360°	Pan: 0° to 360°, Tilt: 0° to 75°, Rotation: 0° to 360°	Pan: 0° to 360°, Tilt: 0° to 75°, Rotation: 0° to 360°
Day & Night	Color	Color	Color	Color	Color	Color
WDR	DWDR	DWDR	DWDR	DWDR	DWDR	DWDR
Max. Light Range	Up to 20 m	Up to 40 m	Up to 40 m	Up to 20 m	Up to 20 m	Up to 40 m
HD Video Output	Switchable TVI/AHD/CVI/CVBS	Switchable TVI/AHD/CVI/CVBS	Switchable TVI/AHD/CVI/CVBS	Switchable TVI/AHD/CVI/CVBS	Switchable TVI/AHD/CVI/CVBS	Switchable TVI/AHD/CVI/CVBS
CVBS Output	-	-	-	-	-	-
White Balance	Auto/Outdoor/Global/Manual	Auto/Outdoor/Global/Manual	Auto/Outdoor/Global/Manual	Auto/Outdoor/Global/Manual	Auto/Outdoor/Global/Manual	Auto/Outdoor/Global/Manual
BLC	BLC	BLC	BLC	BLC	BLC	BLC
3D DNR	3D DNR/2D DNR	3D DNR/2D DNR	3D DNR/2D DNR	3D DNR/2D DNR	3D DNR/2D DNR	3D DNR/2D DNR
Functions	Defective Pixel Correction; Sharpness; Mirror; Contrast; Brightness; Anti-Banding; Smart Light	Defective Pixel Correction; Sharpness; Mirror; Contrast; Brightness; Anti-Banding; Smart Light	Defective Pixel Correction; Sharpness; Mirror; Contrast; Brightness; Anti-Banding; Smart Light	Defective Pixel Correction; Sharpness; Mirror; Contrast; Brightness; Anti-Banding; Smart Light	Defective Pixel Correction; Sharpness; Mirror; Contrast; Brightness; Anti-Banding; Smart Light	Defective Pixel Correction; Sharpness; Mirror; Contrast; Brightness; Anti-Banding; Smart Light
Protection Level	IP67	IP67	IP67	-	IP67	IP67
Alarm I/O	-	-	-	-	-	-
Power	12 VDC ± 25%	12 VDC ± 25%	12 VDC ± 25%	12 VDC ± 25%	12 VDC ± 25%	12 VDC ± 25%

Model	DS-2CE10KF3T	DS-2CE12KF3T	DS-2CE72KF3T	DS-2CE10KF3T-E	DS-2CE12KF3T-E	DS-2CE72KF3T-E
Image	 ColorVu	 ColorVu	 ColorVu	 ColorVu	 ColorVu	 ColorVu
Description	3K ColorVu Fixed Mini Bullet Camera	3K ColorVu Fixed Bullet Camera	3K ColorVu Fixed Turret Camera	3K ColorVu PoC Fixed Mini Bullet Camera	3K ColorVu PoC Fixed Mini Bullet Camera	3K ColorVu PoC Fixed Turret Camera
Lens	2.8 mm and 3.6 mm fixed focal lens	2.8 mm and 3.6 mm fixed focal lens	2.8 mm, 3.6 mm fixed focal lens	2.8 mm, 3.6 mm fixed focal lens	2.8 mm, 3.6 mm fixed focal lens	2.8 mm and 3.6 mm fixed focal lens
Min. Illumination	0.0003 Lux @ (F1.0, AGC ON), 0 Lux with white light	0.0003 Lux @ (F1.0, AGC ON), 0 Lux with white light	0.0003 Lux @ (F1.0, AGC ON), 0 Lux with white light	0.0003 Lux @ (F1.0, AGC ON), 0 Lux with white light	0.0003 Lux @ (F1.0, AGC ON), 0 Lux with white light	0.0003 Lux @ (F1.0, AGC ON), 0 Lux with white light
FOV	2.8 mm, horizontal FOV: 112°, vertical FOV: 60°, diagonal FOV: 133° 3.6 mm, horizontal FOV: 95°, vertical FOV: 50°, diagonal FOV: 115°	2.8 mm, horizontal FOV: 112°, vertical FOV: 60°, diagonal FOV: 133° 3.6 mm, horizontal FOV: 95°, vertical FOV: 50°, diagonal FOV: 115°	2.8 mm, horizontal FOV: 112°, vertical FOV: 60°, diagonal FOV: 133° 3.6 mm, horizontal FOV: 95°, vertical FOV: 50°, diagonal FOV: 115°	2.8 mm, horizontal FOV: 112°, vertical FOV: 60°, diagonal FOV: 133° 3.6 mm, horizontal FOV: 95°, vertical FOV: 50°, diagonal FOV: 115°	2.8 mm, horizontal FOV: 112°, vertical FOV: 60°, diagonal FOV: 133° 3.6 mm, horizontal FOV: 95°, vertical FOV: 50°, diagonal FOV: 115°	2.8 mm, horizontal FOV: 112°, vertical FOV: 60°, diagonal FOV: 133° 3.6 mm, horizontal FOV: 95°, vertical FOV: 50°, diagonal FOV: 115°
Angle Adjustment	Pan: 0° to 360°, Tilt: 0° to 90°, Rotation: 0° to 360°	Pan: 0° to 360°, Tilt: 0° to 180°, Rotation: 0° to 360°	Pan: 0° to 360°, Tilt: 0° to 75°, Rotation: 0° to 360°	Pan: 0° to 360°, Tilt: 0° to 90°, Rotation: 0° to 360°	Pan: 0° to 360°, Tilt: 0° to 90°, Rotation: 0° to 360°	Pan: 0° to 360°, Tilt: 0° to 75°, Rotation: 0° to 360°
Day & Night	Color	Color	Color	Color	Color	Color
WDR	≥ 130 dB	≥ 130 dB	≥ 130 dB	≥ 130 dB	≥ 130 dB	≥ 130 dB
Max. Light Range	Up to 20 m	Up to 40 m	Up to 40 m	Up to 20 m	Up to 20 m	Up to 40 m
HD Video Output	1 HD analog output	1 HD analog output	1 HD analog output	1 HD analog output	1 HD analog output	1 HD analog output
CVBS Output	-	-	-	-	-	-
White Balance	Auto/Outdoor/Global/Manual	Auto/Outdoor/Global/Manual	Auto/Outdoor/Global/Manual	Auto/Outdoor/Global/Manual	Auto/Outdoor/Global/Manual	Auto/Outdoor/Global/Manual
BLC	BLC	BLC	BLC	BLC	BLC	BLC
3D DNR	3D DNR/2D DNR	3D DNR/2D DNR	3D DNR/2D DNR	3D DNR/2D DNR	3D DNR/2D DNR	3D DNR/2D DNR
Functions	Brightness, Contrast, Mirror, Smart Light, Anti-Banding	Brightness, Contrast, Mirror, Smart Light, Anti-Banding	Brightness, Contrast, Mirror, Smart Light, Anti-Banding	Brightness, Contrast, Mirror, Smart Light, Anti-Banding	Brightness, Contrast, Mirror, Smart Light, Anti-Banding	Brightness, Contrast, Mirror, Smart Light, Anti-Banding
Protection Level	IP67	IP67	IP67	IP67	IP67	IP67
Alarm I/O	-	-	-	-	-	-
Power	12 VDC ± 25%	12 VDC ± 25%	12 VDC ± 25%	12 VDC ± 25%/PoC.at	12 VDC ± 25%/PoC.at	12 VDC ± 25%/PoC.at

Model	DS-2CE10UF3T-E	DS-2CE12UF3T-E	DS-2CE72UF3T-E
Image	  	  	  
Description	4K ColorVu PoC Fixed Mini Bullet Camera	4K ColorVu PoC Fixed Bullet Camera	4K ColorVu PoC Fixed Turret Camera
Lens	2.8 mm, 3.6 mm fixed focal lens	2.8 mm, 3.6 mm, 6mm fixed focal lens	2.8 mm, 3.6 mm fixed focal lens
Min. Illumination	0.0005 Lux@(F1.0, AGC ON), 0 Lux with white light	0.0005 Lux@(F1.0, AGC ON), 0 Lux with white light	0.0005 Lux@(F1.0, AGC ON), 0 Lux with white light
FOV	2.8 mm, horizontal FOV: 110°, vertical FOV: 59°, diagonal FOV: 131° 3.6 mm, horizontal FOV: 93°, vertical FOV: 48°, diagonal FOV: 113°	2.8 mm, horizontal FOV: 110°, vertical FOV: 59°, diagonal FOV: 131° 3.6 mm, horizontal FOV: 93°, vertical FOV: 48°, diagonal FOV: 113° 6 mm, horizontal FOV: 57°, vertical FOV: 30°, diagonal FOV: 67°	2.8 mm, horizontal FOV: 110°, vertical FOV: 59°, diagonal FOV: 131° 3.6 mm, horizontal FOV: 93°, vertical FOV: 48°, diagonal FOV: 113°
Angle Adjustment	Pan: 0° to 360°, Tilt: 0° to 90°, Rotation: 0° to 360°	Pan: 0° to 360°, Tilt: 0° to 180°, Rotation: 0° to 360°	Pan: 0° to 360°, Tilt: 0° to 180°, Rotation: 0° to 360°
Day & Night	Color	Color	Color
WDR	≥ 130 dB	≥ 130 dB	≥ 130 dB
Max. Light Range	Up to 20 m	Up to 40 m	Up to 40 m
HD Video Output	1 HD analog output	1 HD analog output	1 HD analog output
CVBS Output	-	-	-
White Balance	Auto/Outdoor/Global/Manual	Auto/Outdoor/Global/Manual	Auto/Outdoor/Global/Manual
BLC	BLC	BLC	BLC
3D DNR	3D DNR/2D DNR	3D DNR/2D DNR	3D DNR/2D DNR
Functions	Sharpness; Mirror; Brightness; Anti-Banding; Smart Light; Contrast	Sharpness; Mirror; Brightness; Anti-Banding; Smart Light; Contrast	Sharpness; Mirror; Brightness; Anti-Banding; Smart Light; Contrast
Protection Level	IP67	IP67	IP67
Alarm I/O	-	-	-
Power	12 VDC±25%/PoC.at	12 VDC±25%/PoC.at	12 VDC±25%/PoC.at













Turbo HD Cameras







Smart Hybrid Light Series

Conventional IR cameras only render black and white images at night, resulting in massive, critical color-related information loss. To resolve this issue, our Smart Hybrid Light Cameras feature smart supplemental lighting with optional IR and visible light. When a person or vehicle target is detected, the visible white light turns on to not only deter intruders but also record colorful imaging with key information. When no person or vehicle appears in the monitoring area, the white light turns off and the IR turns on, which intelligently reduces light pollution in the area.

- > IR and white supplemental lights
- > Audio over coaxial
- > Smart supplemental lighting
- > 4-in-1 video output
- > Easy and quick installation



Model	DS-2CE16D0T-LPFS	DS-2CE16D0T-LFS	DS-2CE17D0T-LFS	DS-2CE76D0T-LPFS	DS-2CE76D0T-LMFS	DS-2CE76D0T-LFS
Image	 	 	 	 	 	 
Description	2 MP Smart Hybrid Light Audio Fixed Mini Bullet Camera	2 MP Smart Hybrid Light Audio Fixed Mini Bullet Camera	2 MP Smart Hybrid Light Audio Fixed Bullet Camera	2MP Smart Hybrid Light Audio Indoor Fixed Turret Camera	2 MP Smart Hybrid Light Audio Fixed Turret Camera	2MP Smart Hybrid Light Audio Fixed Turret Camera
Lens	2.8 mm, 3.6 mm fixed focal lens	2.8 mm, 3.6 mm fixed focal lens	2.8 mm, 3.6 mm and 6 mm fixed focal lens	2.8 mm, 3.6 mm fixed focal lens	2.8 mm, 3.6 mm fixed focal lens	2.8 mm, 3.6 mm fixed focal lens
Min. Illumination	0.01 Lux @ (F1.2, AGC ON), 0 Lux with IR	0.01 Lux @ (F1.2, AGC ON), 0 Lux with IR	0.01 Lux @ (F1.2, AGC ON), 0 Lux with IR	0.01 Lux @ (F1.2, AGC ON), 0 Lux with IR	0.01 Lux @ (F1.2, AGC ON), 0 Lux with IR	0.01 Lux @ (F1.2, AGC ON), 0 Lux with IR
FOV	2.8 mm, horizontal FOV: 101°, vertical FOV: 56°, diagonal FOV: 118° 3.6 mm, horizontal FOV: 78°, vertical FOV: 42°, diagonal FOV: 92°	2.8 mm, horizontal FOV: 101°, vertical FOV: 56°, diagonal FOV: 118° 3.6 mm, horizontal FOV: 78°, vertical FOV: 42°, diagonal FOV: 92°	2.8 mm, horizontal FOV: 101°, vertical FOV: 56°, diagonal FOV: 118° 3.6 mm, horizontal FOV: 78°, vertical FOV: 42°, diagonal FOV: 92° 6 mm, horizontal FOV: 49.2°, vertical FOV: 28.3°, diagonal FOV: 56.1°	2.8 mm, horizontal FOV: 101°, vertical FOV: 56°, diagonal FOV: 118° 3.6 mm, horizontal FOV: 78°, vertical FOV: 42°, diagonal FOV: 92°	2.8 mm, horizontal FOV: 101°, vertical FOV: 56°, diagonal FOV: 118° 3.6 mm, horizontal FOV: 78°, vertical FOV: 42°, diagonal FOV: 92°	2.8 mm, horizontal FOV: 101°, vertical FOV: 56°, diagonal FOV: 118° 3.6 mm, horizontal FOV: 78°, vertical FOV: 42°, diagonal FOV: 92°
Angle Adjustment	Pan: 0 to 360°, Tilt: 0 to 180°, Rotation: 0 to 360°	Pan: 0 to 360°, Tilt: 0 to 180°, Rotation: 0 to 360°	Pan: 0 to 360°, Tilt: 0 to 180°, Rotation: 0 to 360°	Pan: 0 to 360°, Tilt: 0 to 75°, Rotation: 0 to 360°	Pan: 0 to 360°, Tilt: 0 to 75°, Rotation: 0 to 360°	Pan: 0 to 360°, Tilt: 0 to 75°, Rotation: 0 to 360°
Day & Night	ICR	ICR	ICR	ICR	ICR	ICR
WDR	Digital WDR	Digital WDR	Digital WDR	Digital WDR	Digital WDR	Digital WDR
Max. Light Range (meters)	IR : Up to 25 m White Light : Up to 20 m	IR : Up to 30 m White Light : Up to 20 m	IR : Up to 40 m White Light : Up to 40 m	IR : Up to 20 m White Light : Up to 20 m	IR : Up to 30 m White Light : Up to 20 m	IR : Up to 40 m White Light : Up to 20 m
HD Video Output	Switchable TVI/AHD/CVI/CVBS	Switchable TVI/AHD/CVI/CVBS	Switchable TVI/AHD/CVI/CVBS	Switchable TVI/AHD/CVI/CVBS	Switchable TVI/AHD/CVI/CVBS	Switchable TVI/AHD/CVI/CVBS
CVBS Output	-	-	-	-	-	-
D/N Mode	IR/White Light	IR/White Light	IR/White Light	IR/White Light	IR/White Light	IR/White Light
White Balance	Auto/Manual	Auto/Manual	Auto/Manual	Auto/Manual	Auto/Manual	Auto/Manual
BLC	-	-	-	-	-	-
DNR	-	-	-	-	-	-
Functions	Brightness, Sharpness, Smart IR	Brightness, Sharpness, Smart IR	Brightness, Sharpness, Smart IR	Brightness, Sharpness, Smart IR	Brightness, Sharpness, Smart IR	Brightness, Sharpness, Smart IR
Protection Level	IP67	IP67	IP67	-	IP67	IP67
Alarm I/O	-	-	-	-	-	-
Power	12 VDC ± 25%	12 VDC ± 25%	12 VDC ± 25%	12 VDC ± 25%	12 VDC ± 25%	12 VDC ± 25%

Model	DS-2CE16K0T-LPFS	DS-2CE16K0T-LFS	DS-2CE17K0T-LFS	DS-2CE76K0T-LPFS	DS-2CE76K0T-LMFS	DS-2CE78K0T-LFS
Image						
Description	3K Smart Hybrid Light Audio Fixed Mini Bullet Camera	3K Smart Hybrid Light Audio Fixed Mini Bullet Camera	3K Smart Hybrid Light Audio Fixed Bullet Camera	3K Smart Hybrid Light Audio Indoor Fixed Turret Camera	3K Smart Hybrid Light Audio Fixed Turret Camera	3K Smart Hybrid Light Audio Fixed Turret Camera
Lens	2.8 mm and 3.6 mm fixed focal lens	2.8 mm and 3.6 mm fixed focal lens	2.8 mm, 3.6 mm and 6 mm fixed focal lens	2.8 mm and 3.6 mm fixed focal lens	2.8 mm and 3.6 mm fixed focal lens	2.8 mm and 3.6 mm fixed focal lens
Min. Illumination	0.01 Lux @ (F1.2, AGC ON), 0 Lux with IR	0.01 Lux @ (F1.2, AGC ON), 0 Lux with IR	0.01 Lux @ (F1.2, AGC ON), 0 Lux with IR	0.01 Lux @ (F1.2, AGC ON), 0 Lux with IR	0.01 Lux @ (F1.2, AGC ON), 0 Lux with IR	0.01 Lux @ (F1.2, AGC ON), 0 Lux with IR
FOV	2.8 mm, horizontal FOV: 107°, vertical FOV: 64°, diagonal FOV: 129° 3.6 mm, horizontal FOV: 83°, vertical FOV: 48°, diagonal FOV: 102°	2.8 mm, horizontal FOV: 107°, vertical FOV: 64°, diagonal FOV: 129° 3.6 mm, horizontal FOV: 83°, vertical FOV: 48°, diagonal FOV: 102°	2.8 mm, horizontal FOV: 107°, vertical FOV: 64°, diagonal FOV: 129° 3.6 mm, horizontal FOV: 83°, vertical FOV: 48°, diagonal FOV: 102° 6 mm, horizontal FOV: 53°, vertical FOV: 31°, diagonal FOV: 63°	2.8 mm, horizontal FOV: 107°, vertical FOV: 64°, diagonal FOV: 129° 3.6 mm, horizontal FOV: 83°, vertical FOV: 48°, diagonal FOV: 102°	2.8 mm, horizontal FOV: 107°, vertical FOV: 64°, diagonal FOV: 129° 3.6 mm, horizontal FOV: 83°, vertical FOV: 48°, diagonal FOV: 102°	2.8 mm, horizontal FOV: 107°, vertical FOV: 64°, diagonal FOV: 129° 3.6 mm, horizontal FOV: 83°, vertical FOV: 48°, diagonal FOV: 102°
Angle Adjustment	Pan: 0 to 360°, Tilt: 0 to 180°, Rotation: 0 to 360°	Pan: 0 to 360°, Tilt: 0 to 180°, Rotation: 0 to 360°	Pan: 0 to 360°, Tilt: 0 to 180°, Rotation: 0 to 360°	Pan: 0 to 360°, Tilt: 0 to 75°, Rotation: 0 to 360°	Pan: 0 to 360°, Tilt: 0 to 75°, Rotation: 0 to 360°	-
Day & Night	ICR	ICR	ICR	ICR	ICR	ICR
WDR	Digital WDR	Digital WDR	Digital WDR	Digital WDR	Digital WDR	Digital WDR
Max. Light Range (meters)	IR : Up to 25 m White Light : Up to 20 m	IR : Up to 30 m White Light : Up to 20 m	IR : Up to 40 m White Light : Up to 40 m	IR : Up to 20 m White Light : Up to 20 m	IR : Up to 30 m White Light : Up to 20 m	IR : Up to 40 m White Light : Up to 20 m
HD Video Output	Switchable TVI/AHD/CVI/CVBS	Switchable TVI/AHD/CVI/CVBS	Switchable TVI/AHD/CVI/CVBS	Switchable TVI/AHD/CVI/CVBS	Switchable TVI/AHD/CVI/CVBS	Switchable TVI/AHD/CVI/CVBS
CVBS Output	-	-	-	-	-	-
D/N Mode	IR/White Light	IR/White Light	IR/White Light	IR/White Light	IR/White Light	IR/White Light
White Balance	Auto/Manual	Auto/Manual	Auto/Manual	Auto/Manual	Auto/Manual	Auto/Manual
BLC	-	-	-	-	-	-
DNR	-	-	-	-	-	-
Functions	Brightness, Sharpness, Smart IR	Brightness, Sharpness, Smart IR	Brightness, Sharpness, Smart IR	Brightness, Sharpness, Smart IR	Brightness, Sharpness, Smart IR	Brightness, Sharpness, Smart IR
Protection Level	IP67	IP67	IP67	-	IP67	IP67
Alarm I/O	-	-	-	-	-	-
Power	12 VDC ± 25%	12 VDC ± 25%	12 VDC ± 25%	12 VDC ± 25%	12 VDC ± 25%	12 VDC ± 25%





Turbo HD Cameras







IoT Series

IoT Series Cameras provide visual and auditory warnings on-site with real-time notifications, ensuring proactive protection day and night. Equipped with ColorVu technology, the camera renders 24/7 colorful imaging with rich details. Combining with intelligent DVRs, these together create a system that can reduce false alarms to improve alarm accuracy and overall security.

- > Ultra HD video
- > PIR detection
- > Hikvision ColorVu technology
- > Visual alarm and sound alarm
- > Audio customization
- > Audio over coaxial
- > Ultra-low-light night vision



Model	DS-2CE12DF3T-PIRX0S	DS-2CE72DF3T-PIRX0S	DS-2CE11H0T-PIRLO	DS-2CE11H0T-PIRLP0	DS-2CE12H0T-PIRLO
Image	 PIR detection & strobe light alarm & audible alarm	 PIR detection & strobe light alarm & audible alarm	 PIR Detection & Light Alarm	 PIR Detection & Light Alarm	 PIR Detection & Light Alarm
Description	2 MP PIR Bullet Camera	2 MP PIR Turret Camera	5 MP PIR Bullet Camera	5 MP PIR Bullet Camera	5 MP PIR Bullet Camera
Lens	2.8 mm, 3.6 mm fixed focal lens	2.8 mm, 3.6 mm fixed focal lens	2.8 mm, 3.6 mm fixed lens	2.8 mm, 3.6 mm fixed lens	2.8 mm, 3.6 mm fixed lens
Min. Illumination	0.0005 Lux @ (F1.0, AGC ON), 0 Lux with white light	0.0005 Lux @ (F1.0, AGC ON), 0 Lux with white light	0.01 Lux @ (F1.2, AGC ON), 0 Lux with IR	0.01 Lux @ (F1.2, AGC ON), 0 Lux with IR	0.01 Lux @ (F1.2, AGC ON), 0 Lux with IR
FOV	2.8 mm, horizontal FOV: 98°, vertical FOV: 52°, diagonal FOV: 116° 3.6 mm, horizontal FOV: 77°, vertical FOV: 42°, diagonal FOV: 91°	2.8 mm, horizontal FOV: 98°, vertical FOV: 52°, diagonal FOV: 116° 3.6 mm, horizontal FOV: 77°, vertical FOV: 42°, diagonal FOV: 91°	85.5° (2.8 mm), 80.1° (3.6 mm)	85.5° (2.8 mm), 80.1° (3.6 mm)	85.5° (2.8 mm), 80.1° (3.6 mm)
Angle Adjustment	Pan: 0° to 360°, Tilt: 0° to 180°, Rotation: 0° to 360°	Pan: 0° to 360°, Tilt: 0° to 75°, Rotation: 0° to 360°	Pan: 0° to 360°, Tilt: 0° to 180°, Rotate: 0° to 360°	Pan: 0° to 360°, Tilt: 0° to 180°, Rotate: 0° to 360°	Pan: 0° to 360°, Tilt: 0° to 180°, Rotate: 0° to 360°
Day & Night	Color	Color	IR cut filter	IR cut filter	IR cut filter
WDR	≥130 dB	≥130 dB	DWDR	DWDR	DWDR
Max. Light Range (meters)	Up to 40 m	Up to 20 m	Up to 20 m	Up to 20 m	Up to 20 m
HD Video Output	1 HD analog output	1 HD analog output	1 HD Analog Output	1 HD Analog Output	1 HD Analog Output
CVBS Output	-	-	-	-	-
D/N Mode	Color	Color	Auto/Color/BW (Black and White)	Auto/Color/BW (Black and White)	Auto/Color/BW (Black and White)
White Balance	Auto/Manual	Auto/Manual	Auto/Manual	Auto/Manual	Auto/Manual
BLC	WDR, BLC, HLC, Global, HLS	WDR, BLC, HLC, Global, HLS	DWDR/BLC/HLC/Global	DWDR/BLC/HLC/Global	DWDR/BLC/HLC/Global
DNR	3D DNR/2D DNR	3D DNR/2D DNR	2D	2D	2D
Functions	Brightness, Contrast, Mirror, Defective Pixel Correction, Sharpness, Anti-Banding, Smart Light	Brightness, Contrast, Mirror, Defective Pixel Correction, Sharpness, Anti-Banding, Smart Light	Brightness, Sharpness, Mirror, Smart IR	Brightness, Sharpness, Mirror, Smart IR	Brightness, Sharpness, Mirror, Smart IR
Protection Level	IP67	IP67	IP67	IP67	IP67
Alarm I/O	1 line out	1 line out	1 alarm out	1 alarm out	1 alarm out
Power	12 VDC ± 25%	12 VDC ± 25%	12 VDC ± 25%	12 VDC ± 25%	12 VDC ± 25%

Model	DS-2CE71HOT-PIRLO	DS-2CE71HOT-PIRLPO	DS-2CE12KF3T-PIRX0	DS-2CE72KF3T-PIRX0	DS-2CE12UF3T-PIRX0	DS-2CE72UF3T-PIRX0
Image	 PIR Detection & Light Alarm	 PIR Detection & Light Alarm	 PIR detection & strobe light alarm & audible alarm	 PIR detection & strobe light alarm & audible alarm	 PIR detection & strobe light alarm & audible alarm	 PIR detection & strobe light alarm & audible alarm
Description	5 MP PIR Turret Camera	5 MP PIR Turret Camera	3K PIR Bullet Camera	3K PIR Turret Camera	4K PIR Bullet Camera	4K PIR Turret Camera
Lens	2.8 mm, 3.6 mm fixed lens	2.8 mm, 3.6 mm fixed lens	2.8 mm, 3.6 mm fixed focal lens	2.8 mm, 3.6 mm fixed focal lens	2.8 mm, 3.6 mm fixed focal lens	2.8 mm, 3.6 mm fixed focal lens
Min. Illumination	0.01 Lux @ (F1.2, AGC ON), 0 Lux with IR	0.01 Lux @ (F1.2, AGC ON), 0 Lux with IR	0.0003 Lux @ (F1.0, AGC ON), 0 Lux with white Light	0.0003Lux @ (F1.0, AGC ON), 0 Lux with white light	0.0005 Lux @ (F1.0, AGC ON), 0 Lux with white light	0.0005 Lux @ (F1.0, AGC ON), 0 Lux with white Light
FOV	85.5° [2.8 mm], 80.1° [3.6 mm]	85.5° [2.8 mm], 80.1° [3.6 mm]	2.8 mm, horizontal FOV: 109°, vertical FOV: 58°, diagonal FOV: 129° 3.6 mm, horizontal FOV: 92°, vertical FOV: 45°, diagonal FOV: 111°	2.8 mm, horizontal FOV: 109°, vertical FOV: 58°, diagonal FOV: 129° 3.6 mm, horizontal FOV: 92°, vertical FOV: 45°, diagonal FOV: 111°	2.8 mm, horizontal FOV: 108°, vertical FOV: 57°, diagonal FOV: 127° 3.6 mm, horizontal FOV: 91°, vertical FOV: 45°, diagonal FOV: 110°	2.8 mm, horizontal FOV: 108°, vertical FOV: 57°, diagonal FOV: 127° 3.6 mm, horizontal FOV: 91°, vertical FOV: 45°, diagonal FOV: 110°
Angle Adjustment	Pan: 0° to 360°, Tilt: 0° to 75°, Rotate: 0° to 360°	Pan: 0° to 360°, Tilt: 0° to 75°, Rotate: 0° to 360°	Pan: 0° to 360°, Tilt: 0° to 180°, Rotation: 0° to 360°	Pan: 0° to 360°, Tilt: 0° to 75°, Rotation: 0° to 360°	Pan: 0° to 360°, Tilt: 0° to 180°, Rotation: 0° to 360°	Pan: 0° to 360°, Tilt: 0° to 75°, Rotation: 0° to 360°
Day & Night	IR cut filter	IR cut filter	Color	Color	Color	Color
WDR	DWDR	DWDR	≥ 130 dB	≥ 130 dB	≥ 130 dB	≥ 130 dB
Max. Light Range (meters)	Up to 20 m	Up to 20 m	Up to 40 m	Up to 20m	Up to 40 m	Up to 20m
HD Video Output	1 HD Analog Output	1 HD Analog Output	1 HD analog output	1 HD analog output	1 HD analog output	1 HD analog output
CVBS Output	-	-	-	-	-	-
D/N Mode	Auto/Color/BW (Black and White)	Auto/Color/BW (Black and White)	Color	Color	Color	Color
White Balance	Auto/Manual	Auto/Manual	Auto/Manual	Auto/Manual	Auto/Manual	Auto/Manual
BLC	DWDR/BLC/HLC/Global	DWDR/BLC/HLC/Global	WDR;BLC;HLC;Global;HLS	WDR;BLC;HLC;Global;HLS	WDR;BLC;HLC;Global;HLS	WDR;BLC;HLC;Global;HLS
DNR	2D	2D	3D DNR/2D DNR	3D DNR/2D DNR	3D DNR/2D DNR	3D DNR/2D DNR
Functions	Brightness, Sharpness, Mirror, Smart IR	Brightness, Sharpness, Mirror, Smart IR	AGC; Brightness; Contrast; Mirror; Defective Pixel Correction; Sharpness; Anti-Banding; Smart Light	AGC; Brightness; Contrast; Mirror; Defective Pixel Correction; Sharpness; Anti-Banding; Smart Light	AGC; Brightness; Contrast; Mirror; Defective Pixel Correction; Sharpness; Anti-Banding; Smart Light	AGC; Brightness; Contrast; Mirror; Defective Pixel Correction; Sharpness; Anti-Banding; Smart Light
Protection Level	IP67	IP67	IP67		IP67	IP67
Alarm I/O	1 alarm out	1 alarm out	1 line out Flashing Light Alarm (White)	1 line out flashing light alarm (white)	1 line out flashing light alarm (white)	1 line out flashing light alarm (white)
Power	12 VDC ± 25%	12 VDC ± 25%	12 VDC ± 25%, max. 7.9 W	12 VDC ± 25%, max. 7.7 W	12 VDC ± 25%, max 6.7W	12 VDC ± 25%, max. 6.4 W







Turbo HD Cameras







Pro Series





Pro Series Cameras provide high quality imaging with advanced technologies including ultra-high-definition resolutions, ultra-low-light performance, and 130 dB True WDR. And depending on the power of the base, these cameras can give clearer details even in extremely wide, ultra-low light, and strongly back-lit places.







- › Ultra HD
- › Ultra-low-light night vision
- › 130 dB True WDR
- › PoC for easy installation
- › 4-in-1 video output
- › EXIR 2.0















Model	DS-2CE16D8T-ITPF	DS-2CE16D8T-ITF	DS-2CE16D8T-IT1F	DS-2CE16D8T-IT3F	DS-2CE16D8T-IT5F	DS-2CE56D8T-VPITF	DS-2CE56D8T-ITMF
Image	 Ultra-Low Light	 Ultra-Low Light	 Ultra-Low Light	 Ultra-Low Light	 Ultra-Low Light	 Ultra-Low Light	 Ultra-Low Light
Description	2 MP Ultra-Low Light EXIR Bullet Camera	2 MP Ultra-Low Light Bullet Camera	2 MP Ultra-Low Light EXIR Bullet Camera	2 MP Ultra-Low Light Bullet Camera	2 MP Ultra-Low Light EXIR Bullet Camera	2 MP Ultra-Low Light Dome Camera	2 MP Ultra-Low Light Turret Camera
Lens	2.8 mm, 3.6 mm fixed focal lens	2.8 mm, 3.6 mm, 8 mm fixed focal lens	2.8 mm, 3.6 mm, 6 mm, 8 mm fixed focal lens	2.8 mm, 3.6 mm, 6 mm, 8 mm, 12 mm fixed focal lens	3.6 mm, 6 mm, 8 mm, 12 mm fixed focal lens	2.8 mm, 3.6 mm fixed focal lens	2.8 mm, 3.6 mm fixed focal lens
Min. Illumination	Color: 0.003 Lux @ (F1.2, AGC ON), 0 Lux with IR	Color: 0.003 Lux @ (F1.2, AGC ON), 0 Lux with IR	Color: 0.003 Lux @ (F1.2, AGC ON), 0 Lux with IR	Color: 0.003 Lux @ (F1.2, AGC ON), 0 Lux with IR	Color: 0.003 Lux @ (F1.2, AGC ON), 0 Lux with IR	Color: 0.003 Lux @ (F1.2, AGC ON), 0 Lux with IR	Color: 0.003 Lux @ (F1.2, AGC ON), 0 Lux with IR
FOV	Horizontal Field of View 103.5° (2.8 mm), 82.6° (3.6 mm), 54.4° (6 mm)	Horizontal Field of View 103.5° (2.8 mm), 82.6° (3.6 mm), 54.4° (6 mm), 38° (8 mm)	Horizontal Field of View 103.5° (2.8 mm), 82.6° (3.6 mm), 54.4° (6 mm), 38° (8 mm)	103.5° (2.8 mm), 82.6° (3.6 mm), 54.4° (6 mm), 38° (8 mm), 24.4° (12 mm)	Horizontal Field of View 82.6° (3.6 mm), 54.4° (6 mm), 38° (8 mm), 24.4° (12 mm)	Horizontal Field of View 103.5° (2.8 mm), 82.6° (3.6 mm), 54.4° (6 mm)	Horizontal Field of View 103.5° (2.8 mm), 82.6° (3.6 mm), 54.4° (6 mm)
Angle Adjustment	Pan: 0° to 360°, Tilt: 0° to 90°, Rotate: 0° to 360°	Pan: 0° to 360°, Tilt: 0° to 180°, Rotate: 0° to 360°	Pan: 0° to 360°, Tilt: 0° to 180°, Rotate: 0° to 360°	Pan: 0° to 360°, Tilt: 0° to 180°, Rotate: 0° to 360°	Pan: 0° to 360°, Tilt: 0° to 180°, Rotate: 0° to 360°	Pan: 0° to 360°, Tilt: 0° to 75°, Rotate: 0° to 360°	Pan: 0° to 360°, Tilt: 0° to 75°, Rotate: 0° to 360°
Day & Night	IR Cut Filter	IR Cut Filter	IR Cut Filter	IR Cut Filter	IR Cut Filter	IR Cut Filter	IR Cut Filter
WDR	≥ 130 dB	≥ 130 dB	≥ 130 dB	≥ 130 dB	≥ 130 dB	≥ 130 dB	≥ 130 dB
Max. IR Range	Up to 30 m	Up to 30 m	Up to 30 m	Up to 60 m	Up to 80 m	Up to 30 m	Up to 30 m
HD Video Output	Switchable TVI / AHD / CVI / CVBS	Switchable TVI / AHD / CVI / CVBS	Switchable TVI / AHD / CVI / CVBS	Switchable TVI / AHD / CVI / CVBS	Switchable TVI / AHD / CVI / CVBS	Switchable TVI / AHD / CVI / CVBS	Switchable TVI / AHD / CVI / CVBS
CVBS Output	-	-	-	-	-	-	-
D/N Mode	Auto/Color/BW (Black and White)	Auto/Color/BW (Black and White)	Auto/Color/BW (Black and White)	Auto/Color/BW (Black and White)	Auto/Color/BW (Black and White)	Auto/Color/BW (Black and White)	Auto/Color/BW (Black and White)
White Balance	ATW/MANUAL	ATW/MANUAL	ATW/MANUAL	ATW/MANUAL	ATW/MANUAL	ATW/MANUAL	ATW/MANUAL
BLC	WDR/BLC/HLC/OFF	WDR/BLC/HLC/OFF	WDR/BLC/HLC/OFF	WDR/BLC/HLC/OFF	WDR/BLC/HLC/OFF	WDR/BLC/HLC/OFF	WDR/BLC/HLC/OFF
3D DNR	3D DNR	3D DNR	3D DNR	3D DNR	3D DNR	3D DNR	3D DNR
Functions	Brightness, Sharpness, Mirror, Smart IR	Brightness, Sharpness, Mirror, Smart IR	Brightness, Sharpness, Mirror, Smart IR	Brightness, Sharpness, Mirror, Smart IR	Brightness, Sharpness, Mirror, Smart IR	Brightness, Sharpness, Mirror, Smart IR	Brightness, Sharpness, Mirror, Smart IR
Protection Level	IP67	IP67	IP67	IP67	IP67	IP67,IK10	IP67
Alarm I/O	-	-	-	-	-	-	-
Power	12 VDC ±25%	12 VDC ±25%	12 VDC ±25%	12 VDC ±25%	12 VDC ±25%	12 VDC ±25%	12 VDC ±25%





Model	DS-2CE56D8T-IT1F	DS-2CE56D8T-IT3F	DS-2CE16D8T-IT3ZF	DS-2CE16D8T-AIT3ZF	DS-2CE56D8T-IT3ZF	DS-2CE56D8T-ITZF	DS-2CE56D8T-AITZF
Image	 Ultra-Low Light	 Ultra-Low Light	 Ultra-Low Light	 Ultra-Low Light	 Ultra-Low Light	 Ultra-Low Light	 Ultra-Low Light
Description	2 MP Ultra-Low Light EXIR Turret Camera	2 MP Ultra-Low Light EXIR Turret Camera	2 MP Ultra-Low Light VF Bullet Camera	2 MP Ultra-Low Light VF Bullet Camera	2 MP Ultra-Low Light VF Turret Camera	2 MP Ultra-Low Light ZF EXIR Dome Camera	2 MP Ultra-Low Light ZF EXIR Dome Camera
Lens	Lens 2.8 mm, 3.6 mm, fixed focal lens	2.8 mm, 3.6 mm, 8 mm, 12 mm fixed focal lens	2.8 mm to 12 mm motorized auto focus lens	2.8 mm to 12 mm motorized auto focus lens	2.8 mm to 12 mm motorized auto focus lens	2.8 mm to 12 mm motorized auto focus lens	2.8 mm to 12 mm motorized auto focus lens
Min. Illumination	Color: 0.003 Lux @ (F1.2, AGC ON), 0 Lux with IR	Color: 0.003 Lux @ (F1.2, AGC ON), 0 Lux with IR	Color: 0.003 Lux @ (F1.2, AGC ON), 0 Lux with IR	Color: 0.003 Lux @ (F1.2, AGC ON), 0 Lux with IR	Min. illumination Color: 0.003 Lux @ (F1.2, AGC ON), 0 Lux with IR	Color: 0.003 Lux @ (F1.2, AGC ON), 0 Lux with IR	Color: 0.003 Lux @ (F1.2, AGC ON), 0 Lux with IR
FOV	Horizontal Field of View 103.5° (2.8 mm), 82.6° (3.6 mm), 54.4° (6 mm)	Horizontal Field of View 103.5° (2.8 mm), 82.6° (3.6 mm), 54.4° (6 mm), 38° (8 mm), 24.4° (12 mm)	103.5° (2.8 mm), 82.6° (3.6 mm), 54.4° (6 mm), 38° (8 mm), 24.4° (12 mm)	Horizontal Field of View 32.1° to 103°	Horizontal Field of View 32.1° to 103°	Horizontal Field of View 32.1° to 103°	Horizontal Field of View 32.1° to 103°
Angle Adjustment	Pan: 0° to 360°, Tilt: 0° to 75°, Rotate: 0° to 360°	Angle Adjustment Pan: 0° to 360°, Tilt: 0° to 75°, Rotate: 0° to 360°	Pan: 0° to 360°, Tilt: 0° to 90°, Rotate: 0° to 360°	Angle Adjustment Pan: 0° to 360°, Tilt: 0° to 90°, Rotate: 0° to 360°	Angle Adjustment Pan: 0° to 360°, Tilt: 0° to 75°, Rotate: 0° to 360°	Pan: 0° to 340°, Tilt: 0° to 75°, Rotate: 0° to 355°	Pan: 0° to 340°, Tilt: 0° to 75°, Rotate: 0° to 355°
Day & Night	IR Cut Filter	IR Cut Filter	IR Cut Filter	IR Cut Filter	IR Cut Filter	IR Cut Filter	IR Cut Filter
WDR	≥ 130 dB	≥ 130 dB	≥ 130 dB	≥ 130 dB	≥ 130 dB	≥ 130 dB	≥ 130 dB
Max. IR Range	Up to 30 m	Up to 60 m	Up to 60 m	Up to 60 m	Up to 60 m	Up to 60 m	Up to 60 m
HD Video Output	Switchable TVI / AHD / CVI / CVBS	Switchable TVI / AHD / CVI / CVBS	Switchable TVI / AHD / CVI / CVBS	Switchable TVI / AHD / CVI / CVBS	Switchable TVI / AHD / CVI / CVBS	Switchable TVI / AHD / CVI / CVBS	Switchable TVI / AHD / CVI / CVBS
CVBS Output	-	-	-	-	-	-	-
D/N Mode	Auto/Color/BW (Black and White)	Auto/Color/BW (Black and White)	Auto/Color/BW (Black and White)	Auto/Color/BW (Black and White)	Auto/Color/BW (Black and White)	Auto/Color/BW (Black and White)	Auto/Color/BW (Black and White)
White Balance	ATW/MANUAL	ATW/MANUAL	ATW/MANUAL	ATW/MANUAL	ATW/MANUAL	ATW/MANUAL	ATW/MANUAL
BLC	WDR/BLC/HLC/OFF	WDR/BLC/HLC/OFF	WDR/BLC/HLC/OFF	WDR/BLC/HLC/OFF	WDR/BLC/HLC/OFF	WDR/BLC/HLC/OFF	WDR/BLC/HLC/OFF
3D DNR	3D DNR	3D DNR	3D DNR	3D DNR	3D DNR	3D DNR	3D DNR
Functions	Brightness, Sharpness, Mirror, Smart IR	Brightness, Sharpness, Mirror, Smart IR	Brightness, Sharpness, Mirror, Smart IR	Brightness, Sharpness, Mirror, Smart IR	Brightness, Sharpness, Mirror, Smart IR	Brightness, Sharpness, Mirror, Smart IR	Brightness, Sharpness, Mirror, Smart IR
Protection Level	IP67	IP67	IP67	IP67	IP67	-	-
Alarm I/O	-	-	-	-	-	-	-
Power	12 VDC ±25%	12 VDC ±25%	12 VDC ±25%	9.6 VDC to 14.4 VDC; 19.2 VAC to 28.8 VAC	9 VDC to 15 VDC	9 VDC to 15 VDC	9.6 VDC to 14.4 VDC; 19.2 VAC to 28.8 VAC

Model	DS-2CE56D8T-VPIT3ZF	DS-2CE56D8T-AVPIT3ZF	DS-2CE5AD8T-VPIT3ZF	DS-2CE5AD8T-AVPIT3ZF	DS-2CC12D8T-AMM	DS-2CE16D8T-ITE
Image	 Ultra-Low Light	 Ultra-Low Light	 Ultra-Low Light	 Ultra-Low Light	 Ultra-Low Light	 Ultra-Low Light & PoC
Description	2 MP Ultra-Low Light VF Dome Camera	2 MP Ultra-Low Light VF Dome Camera	2 MP Ultra-Low Light VF Dome Camera	2 MP Ultra-Low Light VF Dome Camera	2 MP Ultra-Low Light Box Camera	2 MP Ultra-Low Light PoC EXIR Bullet Camera
Lens	2.8 mm to 12 mm motorized auto focus lens	2.8 mm to 12 mm motorized auto focus lens	2.8 mm to 12 mm motorized auto focus lens	2.8 mm to 12 mm motorized auto focus lens	C/CS	2.8 mm, 3.6 mm fixed focal lens
Min. Illumination	Color: 0.003 Lux @ (F1.2, AGC ON), 0 Lux with IR	Color: 0.003 Lux @ (F1.2, AGC ON), 0 Lux with IR	Color: 0.003 Lux @ (F1.2, AGC ON), 0 Lux with IR	Color: 0.003 Lux @ (F1.2, AGC ON), 0 Lux with IR	Color: 0.005 Lux @ (F1.2, AGC ON), 0 Lux with IR	Color: 0.003 Lux @ (F1.2, AGC ON), 0 Lux with IR
FOV	Horizontal Field of View 32.1° to 103°	Horizontal Field of View 32.1° to 103°	Horizontal Field of View 32.1° to 103°	32.1° to 103°	-	Horizontal Field of View 103.5° (2.8 mm), 82.6° (3.6 mm), 54.4° (6 mm)
Angle Adjustment	Pan: 0° to 340°, Tilt: 0° to 75°, Rotate: 0° to 355°	Pan: 0° to 340°, Tilt: 0° to 75°, Rotate: 0° to 355°	Pan: 0° to 340°, Tilt: 0° to 75°, Rotate: 0° to 355°	Pan: 0° to 340°, Tilt: 0° to 75°, Rotate: 0° to 355°	-	Pan: 0° to 360°, Tilt: 0° to 180°, Rotate: 0° to 360°
Day & Night	IR Cut Filter	IR Cut Filter	IR Cut Filter	IR Cut Filter	-	IR Cut Filter
WDR	≥ 130 dB	≥ 130 dB	≥ 130 dB	≥ 130 dB	≥ 130 dB	≥ 130 dB
Max. IR Range	Up to 60 m	Up to 60 m	Up to 60 m	Up to 60 m	-	Up to 30 m
HD Video Output	Switchable TVI / AHD / CVI / CVBS	Switchable TVI / AHD / CVI / CVBS	Switchable TVI / AHD / CVI / CVBS	Switchable TVI / AHD / CVI / CVBS	1 HD analog output	1 HD analog output
CVBS Output	-	-	-	-	-	-
D/N Mode	Auto/Color/BW (Black and White)	Auto/Color/BW (Black and White)	Auto/Color/BW (Black and White)	Auto/Color/BW (Black and White)	Auto/Color/BW (Black and White)	Auto/Color/BW (Black and White)
White Balance	ATW/MANUAL	ATW/MANUAL	ATW/MANUAL	ATW/MANUAL	ATW/MANUAL	ATW/MANUAL
BLC	WDR/BLC/HLC/OFF	WDR/BLC/HLC/OFF	WDR/BLC/HLC/OFF	WDR/BLC/HLC/OFF	WDR/BLC/HLC/OFF	WDR/BLC/HLC/OFF
3D DNR	3D DNR	3D DNR	3D DNR	3D DNR	3D DNR	3D DNR
Functions	Brightness, Sharpness, Mirror, Smart IR	Brightness, Sharpness, Mirror, Smart IR	Brightness, Sharpness, Mirror, Smart IR	Brightness, Sharpness, Mirror, Smart IR	Brightness, sharpness, mirror	Brightness, Sharpness, Mirror, Smart IR
Protection Level	IP67,IK10	IP67,IK10	IP67,IK10	IP67,IK10	-	IP67
Alarm I/O	-	-	-	-	-	-
Power	12 VDC ±25%	9.6 VDC to 14.4 VDC; 19.2 VAC to 28.8 VAC	9 VDC to 15 VDC	9.6 VDC to 14.4 VDC; 19.2 VAC to 28.8 VAC	12 VDC ±25% 24 VAC ±25%	12 VDC ±25%/PoC.af



Model	DS-2CE16D8T-IT1E	DS-2CE16D8T-IT3E	DS-2CE16D8T-IT5E	DS-2CE56D8T-VP1TE	DS-2CE56D8T-ITME	DS-2CE56D8T-IT1E
Image	 Ultra-Low Light & PoC	 Ultra-Low Light & PoC	 Ultra-Low Light & PoC	 Ultra-Low Light & PoC	 Ultra-Low Light & PoC	 Ultra-Low Light & PoC
Description	2 MP Ultra-Low Light PoC Bullet Camera	2 MP Ultra-Low Light PoC EXIR Bullet Camera	2 MP Ultra-Low Light PoC EXIR Bullet Camera	2 MP Ultra-Low Light PoC Dome Camera	2 MP Ultra-Low Light PoC Turret Camera	2 MP Ultra Low-Light PoC EXIR Turret Camera
Lens	2.8 mm, 3.6 mm, 6 mm, 8 mm fixed focal lens	2.8 mm, 3.6 mm, 6 mm, 8 mm, 12 mm fixed focal lens	3.6 mm, 6 mm, 8 mm, 12 mm fixed focal lens	2.8 mm, 3.6 mm fixed focal lens	2.8 mm, 3.6 mm fixed focal lens	2.8 mm, 3.6 mm fixed focal lens
Min. Illumination	Color: 0.003 Lux @ (F1.2, AGC ON), 0 Lux with IR	Color: 0.003 Lux @ (F1.2, AGC ON), 0 Lux with IR	Color: 0.003 Lux @ (F1.2, AGC ON), 0 Lux with IR	Color: 0.003 Lux @ (F1.2, AGC ON), 0 Lux with IR	Color: 0.003 Lux @ (F1.2, AGC ON), 0 Lux with IR	Color: 0.003 Lux @ (F1.2, AGC ON), 0 Lux with IR
FOV	Horizontal Field of View 103.5° (2.8 mm), 82.6° (3.6 mm), 54.4° (6 mm), 38° (8 mm)	103.5° (2.8 mm), 82.6° (3.6 mm), 54.4° (6 mm), 38° (8 mm), 24.4° (12 mm)	Horizontal Field of View 82.6° (3.6 mm), 54.4° (6 mm), 38° (8 mm), 24.4° (12 mm)	Horizontal Field of View 103.5° (2.8 mm), 82.6° (3.6 mm), 54.4° (6 mm)	Horizontal Field of View 103.5° (2.8 mm), 82.6° (3.6 mm), 54.4° (6 mm)	Horizontal Field of View 103.5° (2.8 mm), 82.6° (3.6 mm), 54.4° (6 mm)
Angle Adjustment	Pan: 0° to 360°, Tilt: 0° to 180°, Rotate: 0° to 360°	Pan: 0° to 360°, Tilt: 0° to 180°, Rotate: 0° to 360°	Pan: 0° to 360°, Tilt: 0° to 180°, Rotate: 0° to 360°	Pan: 0° to 355°, Tilt: 0° to 75°, Rotate: 0° to 355°	Pan: 0° to 360°, Tilt: 0° to 75°, Rotate: 0° to 360°	Angle Adjustment Pan: 0° to 360°, Tilt: 0° to 75°, Rotate: 0° to 360°
Day & Night	IR Cut Filter	IR Cut Filter	IR Cut Filter	IR Cut Filter	IR Cut Filter	IR Cut Filter
WDR	≥ 130 dB	≥ 130 dB	≥ 130 dB	≥ 130 dB	≥ 130 dB	≥ 130 dB
Max. IR Range	Up to 30 m	Up to 60 m	Up to 80 m	Up to 30 m	Up to 30 m	Up to 30 m
HD Video Output	1 HD analog output	1 HD analog output	1 HD analog output	1 HD analog output	1 HD analog output	1 HD analog output
CVBS Output	-	-	-	-	-	-
D/N Mode	Auto/Color/BW (Black and White)	Auto/Color/BW (Black and White)	Auto/Color/BW (Black and White)	Auto/Color/BW (Black and White)	Auto/Color/BW (Black and White)	Auto/Color/BW (Black and White)
White Balance	ATW/MANUAL	ATW/MANUAL	ATW/MANUAL	ATW/MANUAL	ATW/MANUAL	ATW/MANUAL
BLC	WDR/BLC/HLC/OFF	WDR/BLC/HLC/OFF	WDR/BLC/HLC/OFF	WDR/BLC/HLC/OFF	WDR/BLC/HLC/OFF	WDR/BLC/HLC/OFF
3D DNR	3D DNR	3D DNR	3D DNR	3D DNR	3D DNR	3D DNR
Functions	Brightness, Sharpness, Mirror, Smart IR	Brightness, Sharpness, Mirror, Smart IR	Brightness, Sharpness, Mirror, Smart IR	Brightness, Sharpness, Mirror, Smart IR	Brightness, Sharpness, Mirror, Smart IR	Brightness, Sharpness, Mirror, Smart IR
Protection Level	IP67	IP67	IP67	IP67, IK10	IP67	IP67
Alarm I/O	-	-	-	-	-	-
Power	12 VDC ±25%/PoC.af	12 VDC ±25%/PoC.af	12 VDC ±25%/PoC.at	12 VDC ;25%/PoC.af	12 VDC ±25%/PoC.af	12 VDC ±25%/PoC.af







Model	DS-2CE56D8T-IT3E	DS-2CE16D8T-IT3ZE	DS-2CE56D8T-IT3ZE	DS-2CE56D8T-ITZE	DS-2CE56D8T-VPIT3ZE	DS-2CE5AD8T-VPIT3ZE
Image	 Ultra-Low Light & PoC	 Ultra-Low Light & PoC	 Ultra-Low Light & PoC	 Ultra-Low Light & PoC	 Ultra-Low Light & PoC	 Ultra-Low Light & PoC
Description	2 MP Ultra-Low Light PoC Turret Camera	2 MP Ultra-Low Light VF PoC Bullet Camera	2 MP Ultra-Low Light VF PoC Turret Camera	2 MP Ultra-Low Light VF PoC EXIR Dome Camera	2 MP Ultra-Low Light VF PoC Dome Camera	2 MP Ultra-Low Light VF PoC Dome Camera
Lens	2.8 mm, 3.6 mm, 8 mm, 12 mm fixed focal lens	2.7 mm to 13.5 mm motorized auto focus lens	2.7 mm to 13.5 mm motorized auto focus lens	2.7 mm to 13.5 mm motorized auto focus lens	2.7 mm to 13.5 mm motorized auto focus lens	2.7 mm to 13.5 mm motorized auto focus lens
Min. Illumination	Color: 0.003 Lux @ (F1.2, AGC ON), 0 Lux with IR	Color: 0.003 Lux @ (F1.2, AGC ON), 0 Lux with IR	Color: 0.003 Lux @ (F1.2, AGC ON), 0 Lux with IR	Color: 0.003 Lux @ (F1.2, AGC ON), 0 Lux with IR	Color: 0.003 Lux @ (F1.2, AGC ON), 0 Lux with IR	Color: 0.003 Lux @ (F1.2, AGC ON), 0 Lux with IR
FOV	Horizontal Field of View 103.5° (2.8 mm), 82.6° (3.6 mm), 54.4° (6 mm), 38° (8 mm), 24.4° (12 mm)	Horizontal Field of View 32.1° to 103°	Horizontal Field of View 32.1° to 103°	Horizontal Field of View 32.1° to 103°	Horizontal Field of View 32.1° to 103°	32.1° to 103°
Angle Adjustment	Angle Adjustment Pan: 0° to 360°, Tilt: 0° to 75°, Rotate: 0° to 360°	Angle Adjustment Pan: 0° to 360°, Tilt: 0° to 90°, Rotate: 0° to 360°	Pan: 0° to 360°, Tilt: 0° to 75°, Rotate: 0° to 360°	Pan: 0° to 340°, Tilt: 0° to 75°, Rotate: 0° to 355°	Pan: 0° to 340°, Tilt: 0° to 75°, Rotate: 0° to 355°	Pan: 0° to 340°, Tilt: 0° to 75°, Rotate: 0° to 355°
Day & Night	IR Cut Filter	IR Cut Filter	IR Cut Filter	IR Cut Filter	IR Cut Filter	IR Cut Filter
WDR	≥ 130 dB	≥ 130 dB	≥ 130 dB	≥ 130 dB	≥ 130 dB	≥ 130 dB
Max. IR Range	Up to 60 m	Up to 60 m	Up to 60 m	Up to 30 m	Up to 60 m	Up to 60 m
HD Video Output	1 HD analog output	1 HD analog output	1 HD analog output	1 HD analog output	1 HD analog output	1 HD analog output
CVBS Output	-	-	-	-	-	-
D/N Mode	Auto/Color/BW (Black and White)	Auto/Color/BW (Black and White)	Auto/Color/BW (Black and White)	Auto/Color/BW (Black and White)	Auto/Color/BW (Black and White)	Auto/Color/BW (Black and White)
White Balance	ATW/MANUAL	ATW/MANUAL	ATW/MANUAL	ATW/MANUAL	ATW/MANUAL	ATW/MANUAL
BLC	WDR/BLC/HLC/OFF	WDR/BLC/HLC/OFF	WDR/BLC/HLC/OFF	WDR/BLC/HLC/OFF	WDR/BLC/HLC/OFF	WDR/BLC/HLC/OFF
3D DNR	3D DNR	3D DNR	3D DNR	3D DNR	3D DNR	3D DNR
Functions	Brightness, Sharpness, Mirror, Smart IR	Brightness, Sharpness, Mirror, Smart IR	Brightness, Sharpness, Mirror, Smart IR	Brightness, Sharpness, Mirror, Smart IR	Brightness, Sharpness, Mirror, Smart IR	Brightness, Sharpness, Mirror, Smart IR
Protection Level	IP67	IP67	IP67	IP50	IP67, IK10	IP67, IK10
Alarm I/O	-	-	-	-	-	-
Power	12 VDC ±25%/PoC.af	12 VDC ±25%/PoC.at	12 VDC ±25%/PoC.at	12 VDC ±25%/PoC.at	12 VDC ±25%/PoC.af	9 VDC to 15 VDC/PoC.af

Model	DS-2CE16H8T-ITF	DS-2CE16H8T-IT1F	DS-2CE16H8T-IT3F	DS-2CE16H8T-IT5F	DS-2CE57H8T-VP1TF	DS-2CE76H8T-ITMF
Image	 Ultra-Low Light	 Ultra-Low Light	 Ultra-Low Light	 Ultra-Low Light	 Ultra-Low Light	 Ultra-Low Light
Description	5 MP Ultra-Low Light Bullet Camera	5 MP Ultra-Low Light Bullet Camera	5 MP Ultra-Low Light Bullet Camera	5 MP Ultra-Low Light Bullet Camera	5 MP Ultra-Low Light Dome Camera	5 MP Ultra-Low Light Turret Camera
Lens	2.8 mm, 3.6 mm fixed focal lens	2.8 mm, 3.6 mm, 6 mm fixed focal lens	2.8 mm, 3.6 mm, 6 mm fixed focal lens	3.6 mm, 6 mm fixed focal lens	2.8 mm, 3.6 mm fixed focal lens	2.8 mm, 3.6 mm fixed focal lens
Min. Illumination	Color: 0.003 Lux @ (F1.2, AGC ON), 0 Lux with IR	Color: 0.003 Lux @ (F1.2, AGC ON), 0 Lux with IR	Color: 0.003 Lux @ (F1.2, AGC ON), 0 Lux with IR	Color: 0.003 Lux @ (F1.2, AGC ON), 0 Lux with IR	Color: 0.003 Lux @ (F1.2, AGC ON), 0 Lux with IR	Color: 0.003 Lux @ (F1.2, AGC ON), 0 Lux with IR
FOV	98° (2.8 mm), 78° (3.6 mm), 48° (6 mm)	98° (2.8 mm), 78° (3.6 mm), 48° (6 mm)	98° (2.8 mm), 78° (3.6 mm), 48° (6 mm), 37° (8 mm), 23° (12 mm)	78° (3.6 mm), 48° (6 mm), 37° (8 mm), 23° (12 mm)	98° (2.8 mm), 78° (3.6 mm), 48° (6 mm)	98° (2.8 mm), 78° (3.6 mm), 48° (6 mm)
Angle Adjustment	Pan: 0° to 360°; Tilt: 0° to 180°; Rotate: 0° to 360°	Pan: 0° to 360°; Tilt: 0° to 180°; Rotate: 0° to 360°	Pan: 0° to 360°; Tilt: 0° to 180°; Rotate: 0° to 360°	Pan: 0° to 360°; Tilt: 0° to 180°; Rotate: 0° to 360°	Pan: 0° to 355°; Tilt: 0° to 75°; Rotate: 0° to 355°	Pan: 0° to 360°; Tilt: 0° to 75°; Rotate: 0° to 360°
Day & Night	IR Cut Filter	IR Cut Filter	IR Cut Filter	IR Cut Filter	IR Cut Filter	IR Cut Filter
WDR	≥ 130 dB	≥ 130 dB	≥ 130 dB	≥ 130 dB	≥ 130 dB	≥ 130 dB
Max. IR Range	Up to 30 m	Up to 30 m	Up to 60 m	Up to 80 m	Up to 30 m	Up to 30 m
HD Video Output	Switchable TVI / AHD / CVI / CVBS	Switchable TVI / AHD / CVI / CVBS	Switchable TVI / AHD / CVI / CVBS	Switchable TVI / AHD / CVI / CVBS	Switchable TVI / AHD / CVI / CVBS	Switchable TVI / AHD / CVI / CVBS
CVBS Output	-	-	-	-	-	-
D/N Mode	Auto/Color/BW (Black and White)	Auto/Color/BW (Black and White)	Auto/Color/BW (Black and White)	Auto/Color/BW (Black and White)	Auto/Color/BW (Black and White)	Auto/Color/BW (Black and White)
White Balance	ATW/MWB	ATW/MWB	ATW/MWB	ATW/MWB	ATW/MWB	ATW/MWB
BLC	WDR/BLC/OFF	WDR/BLC/OFF	WDR/BLC/OFF	WDR/BLC/OFF	WDR/BLC/OFF	WDR/BLC/OFF
DNR	3D DNR	3D DNR	3D DNR	3D DNR	3D DNR	3D DNR
Functions	Brightness, Sharpness, 3D DNR, Mirror, Smart IR	Brightness, Sharpness, 3D DNR, Mirror, Smart IR	Brightness, Sharpness, 3D DNR, Mirror, Smart IR	Brightness, Sharpness, 3D DNR, Mirror, Smart IR	Brightness, Sharpness, 3D DNR, Mirror, Smart IR	Brightness, Sharpness, 3D DNR, Mirror, Smart IR
Protection Level	IP67	IP67	IP67	IP67	IP67, IK10	IP67
Alarm I/O	-	-	-	-	-	-
Power	12 VDC ±25%	12 VDC ±25%	12 VDC ±25%	12 VDC ±25%	12 VDC ±25%	12 VDC ±25%

Model	DS-2CE78H8T-IT1F	DS-2CE78H8T-IT3F	DS-2CE19H8T-AIT3ZF	DS-2CE79H8T-AIT3ZF	DS-2CE56H8T-AITZF
Image	 Ultra-Low Light	 Ultra-Low Light	 Ultra-Low Light	 Ultra-Low Light	 Ultra-Low Light
Description	5 MP Ultra-Low Light EXIR Turret Camera	5 MP Ultra-Low Light Turret Camera	5 MP Ultra-Low Light VF Bullet Camera	5 MP Ultra-Low Light VF Turret Camera	5 MP Ultra-Low Light VF Dome Camera
Lens	2.8 mm, 3.6 mm fixed focal lens	3.6 mm, 6 mm fixed focal lens	2.7 mm to 13.5 mm motorized auto focus lens	2.7 mm to 13.5 mm motorized auto focus lens	2.7 mm to 13.5 mm motorized auto focus lens
Min. Illumination	Color: 0.003 Lux @ (F1.2, AGC ON), 0 Lux with IR	Color: 0.003 Lux @ (F1.2, AGC ON), 0 Lux with IR	Color: 0.003 Lux @ (F1.2, AGC ON), 0 Lux with IR	Color: 0.003 Lux @ (F1.2, AGC ON), 0 Lux with IR	Color: 0.003 Lux @ (F1.2, AGC ON), 0 Lux with IR
FOV	98° (2.8 mm), 78° (3.6 mm), 48° (6 mm)	98° (2.8 mm), 78° (3.6 mm), 48° (6 mm), 37° (8 mm), 23° (12 mm)	92.3° to 29.3°	92.3° to 29.3°	92.3° to 29.3°
Angle Adjustment	Pan: 0° to 360°; Tilt: 0° to 75°; Rotate: 0° to 360°	Pan: 0° to 360°; Tilt: 0° to 75°; Rotate: 0° to 360°	Pan: 0° to 360°; Tilt: 0° to 90°; Rotate: 0° to 360°	Pan: 0° to 360°; Tilt: 0° to 75°; Rotate: 0° to 360°	Pan: 0° to 355°; Tilt: 0° to 75°; Rotate: 0° to 355°
Day & Night	IR Cut Filter	IR Cut Filter	IR Cut Filter	IR Cut Filter	IR Cut Filter
WDR	≥130 dB	≥130 dB	≥130 dB	≥130 dB	≥130 dB
Max. IR Range	Up to 30 m	Up to 60 m	Up to 80 m	Up to 60 m	Up to 60 m
HD Video Output	Switchable TVI / AHD / CVI / CVBS	Switchable TVI / AHD / CVI / CVBS	Switchable TVI / AHD / CVI / CVBS	Switchable TVI / AHD / CVI / CVBS	Switchable TVI / AHD / CVI / CVBS
CVBS Output	-	-	-	-	-
D/N Mode	Auto/Color/BW (Black and White)	Auto/Color/BW (Black and White)	Auto/Color/BW (Black and White)	Auto/Color/BW (Black and White)	Auto/Color/BW (Black and White)
White Balance	ATW/MWB	ATW/MWB	ATW/MWB	ATW/MWB	ATW/MWB
BLC	WDR/BLC/OFF	WDR/BLC/OFF	WDR/BLC/OFF	WDR/BLC/OFF	WDR/BLC/OFF
DNR	3D DNR	3D DNR	3D DNR	3D DNR	3D DNR
Functions	Brightness, Sharpness, 3D DNR, Mirror, Smart IR	Brightness, Sharpness, 3D DNR, Mirror, Smart IR	Brightness, Sharpness, 3D DNR, Mirror, Smart IR	Brightness, Sharpness, 3D DNR, Mirror, Smart IR	Brightness, Sharpness, 3D DNR, Mirror, Smart IR
Protection Level	IP67	IP67	IP67	IP67	IP67
Alarm I/O	-	-	-	-	-
Power	12 VDC ±25%	12 VDC ±25%	9.6 VDC to 14.4 VDC; 19.2 VAC to 28.8 VAC	12 VDC ± 20%, 24 VAC ± 20%	9.6 VDC to 14.4 VDC; 19.2 VAC to 28.8 VAC

Model	DS-2CE59H8T-AVPIT3ZF	DS-2CE5AH8T-AVPIT3ZF
Image	 Ultra-Low Light	 Ultra-Low Light
Description	5 MP Ultra-Low Light VF Dome Camera	5 MP Ultra-Low Light VF Dome Camera
Lens	2.7 mm to 13.5 mm motorized auto focus lens	2.7 mm to 13.5 mm motorized auto focus lens
Min. Illumination	Color: 0.003 Lux @ (F1.2, AGC ON), 0 Lux with IR	Color: 0.003 Lux @ (F1.2, AGC ON), 0 Lux with IR
FOV	92.3° to 29.3°	92.3° to 29.3°
Angle Adjustment	Pan: 0° to 355°; Tilt: 0° to 75°; Rotate: 0° to 355°	Pan: 0° to 355°; Tilt: 0° to 75°; Rotate: 0° to 355°
Day & Night	IR Cut Filter	IR Cut Filter
WDR	≥130 dB	≥130 dB
Max. IR Range	Up to 60 m	Up to 60 m
HD Video Output	Switchable TVI / AHD / CVI / CVBS	Switchable TVI / AHD / CVI / CVBS
CVBS Output	-	-
D/N Mode	Auto/Color/BW (Black and White)	Auto/Color/BW (Black and White)
White Balance	ATW/MWB	ATW/MWB
BLC	WDR/BLC/OFF	WDR/BLC/OFF
DNR	3D DNR	3D DNR
Functions	Brightness, Sharpness, 3D DNR, Mirror, Smart IR	Brightness, Sharpness, 3D DNR, Mirror, Smart IR
Protection Level	IP67, IK10	IP67, IK10
Alarm I/O	-	-
Power	9.6 VDC to 14.4 VDC; 19.2 VAC to 28.8 VAC	9.6 VDC to 14.4 VDC; 19.2 VAC to 28.8 VAC

Model	DS-2CE16U7T-ITF	DS-2CE16U7T-IT3F	DS-2CE57U7T-VPITF
Image	 Ultra-Low Light	 Ultra-Low Light	 Ultra-Low Light
Description	8 MP Ultra-Low Light Bullet Camera	8 MP Ultra-Low Light Bullet Camera	8 MP Ultra-Low Light Dome Camera
Lens	2.8 mm, 3.6 mm fixed focal lens	2.8 mm, 3.6 mm, 6 mm, 8 mm, 12 mm fixed focal lens	2.8 mm, 3.6 mm fixed focal lens
Min. Illumination	Color: 0.003 Lux @ (F1.2, AGC ON), 0 Lux with IR	Color: 0.003 Lux @ (F1.2, AGC ON), 0 Lux with IR	Color: 0.003 Lux @ (F1.2, AGC ON), 0 Lux with IR
FOV	102.2° [2.8 mm], 79° [3.6 mm], 50.8° [6 mm]	102.2° [2.8 mm], 79° [3.6 mm], 50.8° [6 mm], 37.73° [8 mm], 23.96° [12 mm]	102.2° [2.8 mm], 79° [3.6 mm], 50.8° [6 mm]
Angle Adjustment	Pan: 0° to 360°; Tilt: 0° to 180°; Rotate: 0° to 360°	Pan: 0° to 360°; Tilt: 0° to 180°; Rotate: 0° to 360°	Pan: 0° to 355°; Tilt: 0° to 75°; Rotate: 0° to 355°
Day & Night	IR Cut Filter	IR Cut Filter	IR Cut Filter
WDR	≥ 130 dB	≥ 130 dB	≥ 130 dB
Max. IR Range	Up to 30 m	Up to 60 m	Up to 30 m
HD Video Output	Switchable TVI / AHD / CVI / CVBS	Switchable TVI / AHD / CVI / CVBS	Switchable TVI / AHD / CVI / CVBS
CVBS Output	-	-	-
D/N Mode	Auto/Color/BW (Black and White)	Auto/Color/BW (Black and White)	Auto/Color/BW (Black and White)
White Balance	ATW/MWB	ATW/MWB	ATW/MWB
BLC	WDR/BLC/HLC/OFF	WDR/BLC/HLC/OFF	WDR/BLC/HLC/OFF
3D DNR	3D DNR	3D DNR	3D DNR
Functions	Brightness, Sharpness, 3D DNR, Mirror, Smart IR	Brightness, Sharpness, 3D DNR, Mirror, Smart IR	Brightness, Sharpness, 3D DNR, Mirror, Smart IR
Protection Level	IP67	IP67	IP67, IK10
Alarm I/O	-	-	-
Power	12 VDC ±25%	12 VDC ±25%	12 VDC ±25%

Model	DS-2CE76U7T-ITMF	DS-2CE78U7T-IT3F	DS-2CE19U7T-AIT3ZF	DS-2CE79U7T-AIT3ZF	DS-2CE59U7T-AVPIT3ZF	DS-2CE5AU7T-AVPIT3ZF
Image	 Ultra-Low Light	 Ultra-Low Light	 Ultra-Low Light	 Ultra-Low Light	 Ultra-Low Light	 Ultra-Low Light
Description	8 MP Ultra-Low Light Turret Camera	8 MP Ultra-Low Light Turret Camera	8 MP Ultra-Low Light Bullet Camera	8 MP Ultra-Low Light Turret Camera	8 MP Ultra-Low Light Dome Camera	8 MP Ultra-Low Light Dome Camera
Lens	2.8 mm, 3.6 mm fixed focal lens	2.8 mm, 3.6 mm, 8 mm, 12 mm fixed focal lens	2.7 mm to 13.5 mm motorized auto focus lens	2.7 mm to 13.5 mm motorized auto focus lens	2.7 mm to 13.5 mm motorized auto focus lens	2.7 mm to 13.5 mm motorized auto focus lens
Min. Illumination	Color: 0.003 Lux @ (F1.2, AGC ON), 0 Lux with IR	Color: 0.003 Lux @ (F1.2, AGC ON), 0 Lux with IR	Color: 0.003 Lux @ (F1.2, AGC ON), 0 Lux with IR	Color: 0.003 Lux @ (F1.2, AGC ON), 0 Lux with IR	Color: 0.003 Lux @ (F1.2, AGC ON), 0 Lux with IR	Color: 0.003 Lux @ (F1.2, AGC ON), 0 Lux with IR
FOV	102.2° (2.8 mm), 79° (3.6 mm), 50.8° (6 mm)	102.2° (2.8 mm), 79° (3.6 mm), 50.8° (6 mm), 37.73° (8 mm), 23.96° (12 mm)	108.1° to 45.6°	108.1° to 45.6°	108.1° to 45.6°	108.1° to 45.6°
Angle Adjustment	Pan: 0° to 360°; Tilt: 0° to 75°; Rotate: 0° to 360°	Pan: 0° to 360°; Tilt: 0° to 75°; Rotate: 0° to 360°	Pan: 0° to 360°; Tilt: 0° to 90°; Rotate: 0° to 360°	Pan: 0° to 355°; Tilt: 0° to 75°; Rotate: 0° to 355°	Pan: 0° to 355°; Tilt: 0° to 75°; Rotate: 0° to 355°	Pan: 0° to 355°; Tilt: 0° to 75°; Rotate: 0° to 355°
Day & Night	IR Cut Filter	IR Cut Filter	IR Cut Filter	IR Cut Filter	IR Cut Filter	IR Cut Filter
WDR	≥ 130 dB	≥ 130 dB	≥ 130 dB	≥ 130 dB	≥ 130 dB	≥ 130 dB
Max. IR Range	Up to 30 m	Up to 60 m	Up to 80 m	Up to 60 m	Up to 60 m	Up to 60 m
HD Video Output	Switchable TVI / AHD / CVI / CVBS	Switchable TVI / AHD / CVI / CVBS	Switchable TVI / AHD / CVI / CVBS	Switchable TVI / AHD / CVI / CVBS	Switchable TVI / AHD / CVI / CVBS	Switchable TVI / AHD / CVI / CVBS
CVBS Output	-	-	-	-	-	-
D/N Mode	Auto/Color/BW (Black and White)	Auto/Color/BW (Black and White)	Auto/Color/BW (Black and White)	Auto/Color/BW (Black and White)	Auto/Color/BW (Black and White)	Auto/Color/BW (Black and White)
White Balance	ATW/MWB	ATW/MWB	ATW/MWB	ATW/MWB	ATW/MWB	ATW/MWB
BLC	WDR/BLC/HLC/OFF	WDR/BLC/HLC/OFF	WDR/BLC/HLC/OFF	WDR/BLC/HLC/OFF	WDR/BLC/HLC/OFF	WDR/BLC/HLC/OFF
3D DNR	3D DNR	3D DNR	3D DNR	3D DNR	3D DNR	3D DNR
Functions	Brightness, Sharpness, 3D DNR, Mirror, Smart IR	Brightness, Sharpness, 3D DNR, Mirror, Smart IR	Brightness, Sharpness, 3D DNR, Mirror, Smart IR	Brightness, Sharpness, 3D DNR, Mirror, Smart IR	Brightness, Sharpness, 3D DNR, Mirror, Smart IR	Brightness, Sharpness, 3D DNR, Mirror, Smart IR
Protection Level	IP67	IP67	IP67	IP67,IK10	IP67,IK10	IP67,IK10
Alarm I/O	-	-	-	-	-	-
Power	12 VDC ±25%	12 VDC ±25%	9.6 VDC to 14.4 VDC; 19.2 VAC to 28.8 VAC	12 VDC ± 20%, 24 VAC ± 20%	9.6 VDC to 14.4 VDC; 19.2 VAC to 28.8 VAC	9.6 VDC to 14.4 VDC; 19.2 VAC to 28.8 VAC

Turbo HD Cameras

Value Series

Value Series Cameras offer cost-effective, high quality video security solution. Users will enjoy high definition video, plug and play through coaxial cable, high quality components, and great durability.

> Ultra HD







> PoC easy installation







> Audio over coaxial







> 4-in-1 video output







> EXIR 2.0

















Model	DS-2CE16D0T-IRPE	DS-2CE16D0T-IRE	DS-2CE16D0T-IT1E	DS-2CE16D0T-IT3E	DS-2CE16D0T-IT5E	DS-2CE56D0T-IT1E	DS-2CE56D0T-IT3E
Image	 PoC	 PoC	 PoC	 PoC	 PoC	 PoC	 PoC
Description	HD 1080p PoC IR Bullet Camera	HD 1080p PoC IR Bullet Camera	HD 1080p PoC EXIR Bullet Camera	HD 1080p PoC EXIR Bullet Camera	HD 1080p PoC EXIR Bullet Camera	HD 1080p PoC EXIR Turret Camera	HD 1080p PoC EXIR Turret Camera
Lens	2.8 mm, 3.6 mm fixed focal lens	2.8 mm, 3.6 mm fixed focal lens	2.8 mm, 3.6 mm, 6 mm fixed focal lens	2.8 mm, 3.6 mm, 6 mm, 8 mm, 12 mm, 16 mm fixed focal lens	3.6 mm, 6 mm, 8 mm, 12 mm, 16 mm fixed focal lens	2.8 mm, 3.6 mm optional	2.8 mm, 3.6 mm, 8 mm, 12 mm, 16 mm fixed focal lens
Min. Illumination	0.01 Lux@(F1.2, AGC ON), 0 Lux with IR	0.01 Lux@(F1.2, AGC ON), 0 Lux with IR	0.01 Lux@(F1.2, AGC ON), 0 Lux with IR	0.01 Lux @ (F1.2,AGC ON), 0 Lux with IR	0.01 Lux@(F1.2, AGC ON), 0 Lux with IR	0.01 Lux@(F1.2,AGC ON), 0 Lux with IR	0.01 Lux@(F1.2, AGC ON), 0 Lux with IR
FOV	103.55° (2.8 mm), 82.63° (3.6 mm), 54.38° (6 mm)	103.55° (2.8 mm), 82.63° (3.6 mm), 54.38° (6 mm)	103.55° (2.8 mm), 82.63° (3.6 mm), 54.38° (6 mm)	103.55° (2.8 mm), 82.63° (3.6 mm), 54.38° (6 mm), 37.96° (8 mm), 24.36° (12 mm), 18.92°	82.63° (3.6 mm), 54.38° (6 mm), 37.96° (8 mm), 24.36° (12 mm), 18.92° (16 mm)	Field of view: 103° (2.8 mm), 82.2° (3.6 mm), 54° (6 mm)	103.55° (2.8 mm), 82.63° (3.6 mm), 54.38° (6 mm), 37.96° (8 mm), 24.36° (12 mm), 18.92° (16 mm)
Angle Adjustment	Pan: 0° to 360°, Tilt:0° to 180°, Rotate: 0° to 360°	Pan: 0° to 360°, Tilt:0° to 180°, Rotate: 0° to 360°	Pan: 0° to 360°, Tilt:0° to 180°, Rotate: 0° to 360°	(16 mm)Pan: 0° to 360°, Tilt:0° to 180°, Rotate: 0° to 360°	Pan: 0° to 360°, Tilt:0° to 180°, Rotate: 0° to 360°	Pan: 0° to 360°, Tilt: 0° to 75°, Rotation: 0° to 360°	Pan: 0° to 360°, Tilt: 0° to 75°, Rotation: 0° to 360°
Day & Night	ICR	ICR	ICR	ICR	ICR	ICR	IR cut filter
WDR	DWDR	DWDR	DWDR	DWDR	DWDR	DWDR	DWDR
Max. IR Range (meters)	Up to 20 m	Up to 20 m	Up to 20 m	Up to 40 m	Up to 80 m	Up to 20 m	Up to 40 m
HD Video Output	1 HD analog output	1 HD analog output	1 HD analog output	1 HD analog output	1 HD analog output	1 analog HD output	1 analog HD output
CVBS Output	-	-	-	-	-	-	-
D/N Mode	Auto	Auto	Auto	Auto	Auto	Auto	Auto
White Balance	ATW	ATW	ATW	ATW	ATW	ATW	ATW
BLC	-	-	-	-	-	-	-
DNR	2D	2D	2D	2D	2D	2D	2D
Functions	-	-	-	-	-	-	-
Protection Level	IP66	IP66	IP66	IP66	IP66	IP66	IP66
Alarm I/O	-	-	-	-	-	-	-
Power	12 VDC ±25%, PoC.af	12 VDC ±25%, PoC.af	12 VDC ±25%, PoC.af	12 VDC ±25%, PoC.af	12 VDC ±15%/PoC.at	12 VDC ±25%, PoC.af	12 VDC ±25%, PoC.af







Model	DS-2CE16D0T-VFIR3E	DS-2CE56D0T-VFIR3E	DS-2CE56D0T-VFIRE	DS-2CE56D0T-VPIR3E	DS-2CE70D0T-ITMF	DS-2CE16D0T-VFIR3F	DS-2CE56D0T-VFIR3F
Image	 PoC	 PoC	 PoC	 PoC			
Description	2 MP Vari-focal PoC Bullet Camera	2 MP Vari-focal PoC Turret Camera	2 MP Vari-focal PoC Dome Camera	2 MP Vandal Proof PoC Dome Camera	2 MP Camera	HD 1080p IR Bullet Camera	HD 1080p IR Turret Camera
Lens	2.8 mm to 12 mm	2.8 mm to 12 mm	2.8 mm to 12 mm	2.8 mm to 12 mm	2.8 mm, 3.6 mm, 6 mm fixed len	2.8 - 12 mm @ F1.4	2.8 - 12 mm @ F1.4
Min. Illumination	0.01 Lux@(F1.2, AGC ON), 0 Lux with IR	0.01 Lux@(F1.2,AGC ON), 0 Lux with IR	0.01 Lux@(F1.2,AGC ON), 0 Lux with IR	0.01 Lux@(F1.2,AGC ON), 0 Lux with IR	0.01 Lux @ (F1.2, AGC ON), 0 Lux with IR	0.01 Lux@(F1.2,AGC ON), 0 Lux with IR	0.01 Lux@(F1.2,AGC ON), 0 Lux with IR
FOV	105.2° to 32.8°	Horizontal Field of View 105.2° to 32.8°	Horizontal Field of View 105.2° to 32.8°	Horizontal Field of View 105.2° to 32.8°	106° (2.8 mm), 80° (3.6 mm), 51° (6 mm)	Angle of view: 102.25° - 32°	Angle of view: 102.25° - 32°
Angle Adjustment	Pan: 0° to 360°, Tilt: 0° to 90°, Rotation: 0° to 360°	Pan: 0° to 360°, Tilt: 0° to 75°, Rotation: 0° to 360°	Pan: 0° to 340°, Tilt: 0° to 75°, Rotation: 0° to 355°	Pan: 0° to 355°, Tilt: 0° to 75°, Rotation: 0° to 355°	Pan: 0° to 360°, Tilt: 0° to 80°, Rotation: 0° to 360°	Pan: 0° to 360°, Tilt: 0° to 90°, Rotation: 0° to 360°	Pan: 0° to 360°, Tilt: 0° to 75°, Rotation: 0° to 360°
Day & Night	ICR	IR cut filter	IR cut filter	IR cut filter	ICR	ICR	ICR
WDR	DWDR	DWDR	DWDR	DWDR	DWDR	DWDR	DWDR
Max. IR Range (meters)	Up to 40 m	Up to 40 m	Up to 30 m	Up to 40 m	Up to 20 m	Up to 40 m	Up to 40 m
HD Video Output	1 analog HD output	1 analog HD output	1 analog HD output	1 analog HD output	Switchable TVI / AHD / CVI / CVBS	Switchable TVI / AHD / CVI / CVBS	Switchable TVI / AHD / CVI / CVBS
CVBS Output	-	-	-	-	-	-	-
D/N Mode	Auto	Auto	Auto	Auto	Auto/Color/BW (Black and White)	Auto	Auto
White Balance	ATW	ATW	ATW	ATW	Auto	ATW	ATW
BLC	-	-	-	-	DWDR/BLC/HLC/Global	-	-
DNR	2D	2D	2D	2D	2D	2D	2D
Functions	-	-	-	-	Brightness, Sharpness, Mirror, Smart IR	-	-
Protection Level	IP66	IP66	-	IP66	IP67	IP66	IP66
Alarm I/O	-	-	-	-	-	-	-
Power	12 VDC ±15%/PoC.at	12 VDC ±15%/PoC.at	12 VDC ±15%/PoC.af	12 VDC ±15%/PoC.af	12 VDC ± 25%	12 VDC ± 15%	12 VDC ± 15%







Model	DS-2CE56D0T-VFIRF	DS-2CE56D0T-VP1R3F	DS-2CE5A00T-VP1T3F	DS-2CE16D3T-I3PF	DS-2CE16D3T-I3F	DS-2CE16D3T-ITPF	DS-2CE16D3T-ITF
Image				 Ultra-Low Light	 Ultra-Low Light	 Ultra-Low Light	 Ultra-Low Light
Description	HD 1080p IR Dome Camera	HD 1080p Vandal Proof IR Dome Camera	2 MP Vandal Proof VF Dome Camera	2 MP Ultra-Low-Light Bullet Camera	2 MP Ultra-Low-Light Bullet Camera	2 MP Ultra-Low-Light Bullet Camera	2 MP Ultra-Low-Light Bullet Camera
Lens	2.8 - 12 mm @ F1.4	2.8 - 12 mm @ F1.4	2.8 mm to 12 mm vari-focal lens	2.8 mm, 3.6 mm fixed focal lens	2.8 mm, 3.6 mm fixed focal lens	2.8 mm, 3.6 mm fixed focal lens	2.8 mm, 3.6 mm fixed focal lens
Min. Illumination	0.01 Lux@(F1.2,AGC ON), 0 Lux with IR	0.01 Lux@(F1.2,AGC ON), 0 Lux with IR	Color: 0.01 Lux@(F1.2, AGC ON), 0 Lux with IR	Color: 0.005Lux @ (F1.2, AGC ON), 0 Lux with IR	Color: 0.005Lux @ (F1.2, AGC ON), 0 Lux with IR	Color: 0.005Lux @ (F1.2, AGC ON), 0 Lux with IR	Color: 0.005Lux @ (F1.2, AGC ON), 0 Lux with IR
FOV	Angle of view: 102.25° to 32°	Angle of view: 102.25° to 32°	Angle of view: 102.25° to 32°	106° (2.8 mm), 82° (3.6 mm), 51° (6 mm)	106° (2.8 mm), 82° (3.6 mm), 51° (6 mm)	106° (2.8 mm), 82° (3.6 mm), 51° (6 mm)	106° (2.8 mm), 82° (3.6 mm), 51° (6 mm)
Angle Adjustment	Pan: 0° to 340°, Tilt: 0° to 75°, Rotation: 0° to 355°	Pan: 0° to 355°, Tilt: 0° to 75°, Rotation: 0° to 355°	Pan: 0° to 355°, Tilt: 0° to 70°, Rotation: 0° to 355°	Pan: 0° to 360°; Tilt: 0° to 180°; Rotate: 0° to 360°	Pan: 0° to 360°; Tilt: 0° to 180°; Rotate: 0° to 360°	Pan: 0° to 360°; Tilt: 0° to 180°; Rotate: 0° to 360°	Pan: 0° to 360°; Tilt: 0° to 180°; Rotate: 0° to 360°
Day & Night	ICR	ICR	IR cut filter	IR cut filter	IR cut filter	IR cut filter	IR cut filter
WDR	DWDR	DWDR	DWDR	≥ 120 dB	≥ 120 dB	≥ 120 dB	≥ 120 dB
Max. IR Range (meters)	Up to 30 m	Up to 40 m	Up to 40 m	Up to 20 m	Up to 30 m	Up to 30 m	Up to 30 m
HD Video Output	Switchable TVI / AHD / CVI / CVBS	Switchable TVI / AHD / CVI / CVBS	Switchable TVI / AHD / CVI / CVBS	Switchable TVI / AHD / CVI / CVBS	Switchable TVI / AHD / CVI / CVBS	Switchable TVI / AHD / CVI / CVBS	Switchable TVI / AHD / CVI / CVBS
CVBS Output	-	-	-	-	-	-	-
D/N Mode	Auto	Auto	Auto	Auto/Color/BW (Black and White)	Auto/Color/BW (Black and White)	Auto/Color/BW (Black and White)	Auto/Color/BW (Black and White)
White Balance	ATW	ATW	ATW	ATW/MWB	ATW/MWB	ATW/MWB	ATW/MWB
BLC	-	-	-	WDR/BLC/GLOBAL	WDR/BLC/GLOBAL	WDR/BLC/GLOBAL	WDR/BLC/GLOBAL
DNR	2D	2D	2D	3D DNR	3D DNR	3D DNR	3D DNR
Functions	-	-	-	Brightness, Sharpness, 3D DNR, Mirror, Smart IR	Brightness, Sharpness, 3D DNR, Mirror, Smart IR	Brightness, Sharpness, 3D DNR, Mirror, Smart IR	Brightness, Sharpness, 3D DNR, Mirror, Smart IR
Protection Level	IP66	IP66,IK10	IP67,IK10	IP67	IP67	IP67	IP67
Alarm I/O	-	-	-	-	-	-	-
Power	12 VDC±15%	12 VDC±15%	12 VDC ±25%	12 VDC ±25%	12 VDC ±25%	12 VDC ±25%	12 VDC ±25%







Model	DS-2CE16D3T-IT3F	DS-2CE57D3T-VPITF	DS-2CE76D3T-ITMF	DS-2CE78D3T-IT3F	DS-2CE19D3T-IT3ZF	DS-2CE19D3T-AIT3ZF	DS-2CE79D3T-IT3ZF
Image	 Ultra-Low Light	 Ultra-Low Light	 Ultra-Low Light	 Ultra-Low Light	 Ultra-Low Light	 Ultra-Low Light	 Ultra-Low Light
Description	2 MP Ultra-Low-Light Bullet Camera	2 MP Ultra-Low-Light Dome Camera	2 MP Ultra-Low-Light Turret Camera	2 MP Ultra-Low-Light Turret Camera	2 MP Ultra-Low-Light Bullet Camera	2 MP Ultra-Low-Light Bullet Camera	2 MP Ultra-Low-Light Dome Camera
Lens	2.8 mm, 3.6 mm, 6 mm, 8 mm, 12 mm fixed focal lens	2.8 mm, 3.6 mm fixed focal lens	2.8 mm, 3.6 mm fixed focal lens	2.8 mm, 3.6 mm, 8 mm, 12 mm fixed focal lens	2.7 mm to 13.5 mm motorized auto focus lens	2.7 mm to 13.5 mm motorized auto focus lens	2.7 mm to 13.5 mm motorized auto focus lens
Min. Illumination	Color: 0.005Lux @ (F1.2, AGC ON), 0 Lux with IR	Color: 0.005Lux @ (F1.2, AGC ON), 0 Lux with IR	Color: 0.005Lux @ (F1.2, AGC ON), 0 Lux with IR	Color: 0.005Lux @ (F1.2, AGC ON), 0 Lux with IR	Color: 0.005Lux @ (F1.2, AGC ON), 0 Lux with IR	Color: 0.005Lux @ (F1.2, AGC ON), 0 Lux with IR	Color: 0.005Lux @ (F1.2, AGC ON), 0 Lux with IR
FOV	106° (2.8 mm), 82° (3.6 mm), 51° (6 mm), 39° (8 mm), 24° (12 mm)	106° (2.8 mm), 82° (3.6 mm), 51° (6 mm)	106° (2.8 mm), 82° (3.6 mm), 51° (6 mm)	106° (2.8 mm), 82° (3.6 mm), 51° (6 mm), 39° (8 mm), 24° (12 mm)	102° - 31°	102° - 31°	102° - 31°
Angle Adjustment	Pan: 0° to 360°; Tilt: 0° to 180°; Rotate: 0° to 360°	Pan: 0° to 355°; Tilt: 0° to 75°; Rotate: 0° to 355°	Pan: 0° to 360°; Tilt: 0° to 75°; Rotate: 0° to 360°	Pan: 0° to 360°; Tilt: 0° to 75°; Rotate: 0° to 360°	Pan: 0° to 360°; Tilt: 0° to 90°; Rotate: 0° to 360°	Pan: 0° to 360°; Tilt: 0° to 90°; Rotate: 0° to 360°	Pan: 0° to 360°; Tilt: 0° to 75°; Rotate: 0° to 360°
Day & Night	IR cut filter	IR cut filter	IR cut filter	IR cut filter	IR cut filter	IR cut filter	IR cut filter
WDR	≥ 120 dB	≥ 120 dB	≥ 120 dB	≥ 120 dB	≥ 120 dB	≥ 120 dB	≥ 120 dB
Max. IR Range (meters)	Up to 50 m	Up to 30 m	Up to 30 m	Up to 50 m	Up to 70 m	Up to 70 m	Up to 70 m
HD Video Output	Switchable TVI / AHD / CVI / CVBS	Switchable TVI / AHD / CVI / CVBS	Switchable TVI / AHD / CVI / CVBS	Switchable TVI / AHD / CVI / CVBS	Switchable TVI / AHD / CVI / CVBS	Switchable TVI / AHD / CVI / CVBS	Switchable TVI / AHD / CVI / CVBS
CVBS Output	-	-	-	-	-	-	-
D/N Mode	Auto/Color/BW (Black and White)	Auto/Color/BW (Black and White)	Auto/Color/BW (Black and White)	Auto/Color/BW (Black and White)	Auto/Color/BW (Black and White)	Auto/Color/BW (Black and White)	Auto/Color/BW (Black and White)
White Balance	ATW/MWB	ATW/MWB	ATW/MWB	ATW/MWB	ATW/MWB	ATW/MWB	ATW/MWB
BLC	WDR/BLC/GLOBAL	WDR/BLC/GLOBAL	WDR/BLC/GLOBAL	WDR/BLC/GLOBAL	WDR/BLC/GLOBAL	WDR/BLC/GLOBAL	WDR/BLC/GLOBAL
DNR	3D DNR	3D DNR	3D DNR	3D DNR	3D DNR	3D DNR	3D DNR
Functions	Brightness, Sharpness, 3D DNR, Mirror, Smart IR	Brightness, Sharpness, 3D DNR, Mirror, Smart IR	Brightness, Sharpness, 3D DNR, Mirror, Smart IR	Brightness, Sharpness, 3D DNR, Mirror, Smart IR	Brightness, Sharpness, 3D DNR, Mirror, Smart IR	Brightness, Sharpness, 3D DNR, Mirror, Smart IR	Brightness, Sharpness, 3D DNR, Mirror, Smart IR
Protection Level	IP67	IP67, IK10	IP67	IP67	IP67	IP67	IP67
Alarm I/O	-	-	-	-	-	-	-
Power	12 VDC ±25%	12 VDC ±25%	12 VDC ±25%	12 VDC ±25%	12 VDC ±25%	24 VAC ±15%, 12 VDC ±20%	12 VDC ±25%







Model	DS-2CE5AD3T-VPIT3ZF	DS-2CE5AD3T-AVPIT3ZF	DS-2CE16D0T-IRP(C)	DS-2CE16D0T-IR(C)	DS-2CE17D0T-IT1 (C)	DS-2CE17D0T-IT3(C)	DS-2CE17D0T-IT5(C)
Image	 Ultra-Low Light	 Ultra-Low Light					
Description	2 MP Ultra-Low-Light Dome Camera	2 MP Ultra-Low-Light Dome Camera	2 MP CMOS	2 MP CMOS	2 MP CMOS	2 MP CMOS	2 MP CMOS
Lens	2.7 mm to 13.5 mm motorized auto focus lens	2.7 mm to 13.5 mm motorized auto focus lens	2.8 mm, 3.6 mm fixed lens	2.8 mm, 3.6 mm fixed lens	2.8 mm, 3.6 mm, 6 mm fixed lens	2.8 mm, 3.6 mm, 6 mm, 8 mm, 12 mm fixed lens	3.6 mm, 6 mm, 8 mm, 12 mm fixed lens
Min. Illumination	Color: 0.005Lux @ (F1.2, AGC ON), 0 Lux with IR	Color: 0.005Lux @ (F1.2, AGC ON), 0 Lux with IR	0.01 Lux@(F1.2, AGC ON), 0 Lux with IR	0.01 Lux@(F1.2, AGC ON), 0 Lux with IR	0.01 Lux @ (F1.2, AGC ON), 0 Lux with IR	0.01 Lux @ (F1.2, AGC ON), 0 Lux with IR	0.01 Lux @ (F1.2, AGC ON), 0 Lux with IR
FOV	102° - 31°	102° - 31°	2.8 mm, horizontal FOV: 106.4°, vertical FOV: 57.9°, diagonal FOV: 124.6° 3.6 mm, horizontal FOV: 79.6°, vertical FOV: 43.5°, diagonal FOV: 93.7° 6 mm, horizontal FOV: 51.9°, vertical FOV: 30°, diagonal FOV: 58.8°	2.8 mm, horizontal FOV: 106.4°, vertical FOV: 57.9°, diagonal FOV: 124.6° 3.6 mm, horizontal FOV: 79.6°, vertical FOV: 43.5°, diagonal FOV: 93.7° 6 mm, horizontal FOV: 51.9°, vertical FOV: 30°, diagonal FOV: 58.8°	2.8 mm, horizontal FOV: 106.4°, vertical FOV: 57.9°, diagonal FOV: 124.6° 3.6 mm, horizontal FOV: 79.6°, vertical FOV: 43.5°, diagonal FOV: 93.7° 6 mm, horizontal FOV: 51.9°, vertical FOV: 30°, diagonal FOV: 58.8°	2.8 mm, horizontal FOV: 106.4°, vertical FOV: 57.9°, diagonal FOV: 124.6° 3.6 mm, horizontal FOV: 79.6°, vertical FOV: 43.5°, diagonal FOV: 93.7° 6 mm, horizontal FOV: 51.9°, vertical FOV: 30°, diagonal FOV: 58.8° 8 mm, horizontal FOV: 39.9°, vertical FOV: 21.9°, diagonal FOV: 46.5° 12 mm, horizontal FOV: 24.6°, vertical FOV: 13.9°, diagonal FOV: 28.1°	3.6 mm, horizontal FOV: 79.6°, vertical FOV: 43.5°, diagonal FOV: 93.7° 6 mm, horizontal FOV: 51.9°, vertical FOV: 30°, diagonal FOV: 58.8° 8 mm, horizontal FOV: 39.9°, vertical FOV: 21.9°, diagonal FOV: 46.5° 12 mm, horizontal FOV: 24.6°, vertical FOV: 13.9°, diagonal FOV: 28.1°
Angle Adjustment	Pan: 0° to 355°; Tilt: 0° to 75°; Rotate: 0° to 355°	Pan: 0° to 355°; Tilt: 0° to 75°; Rotate: 0° to 355°	Pan: 0° to 360°; Tilt: 0° to 90°; Rotate: 0° to 360°	Pan: 0° to 360°; Tilt: 0° to 90°; Rotate: 0° to 360°	Pan: 0° to 360°; Tilt: 0° to 90°; Rotate: 0° to 360°	Pan: 0 to 360°, Tilt: 0 to 180°, Rotation: 0 to 360°	Pan: 0° to 360°; Tilt: 0° to 90°; Rotate: 0° to 360°
Day & Night	IR cut filter	IR cut filter	IR cut filter	IR cut filter	IR cut filter	IR cut filter	IR cut filter
WDR	≥ 120 dB	≥ 120 dB	DWDR	DWDR	DWDR	DWDR	DWDR
Max. IR Range (meters)	Up to 70 m	Up to 70 m	Up to 20 m	Up to 25 m	Up to 30 m	Up to 40 m	Up to 80 m
HD Video Output	Switchable TVI / AHD / CVI / CVBS	Switchable TVI / AHD / CVI / CVBS	1 HD analog output	1 HD analog output	1 HD analog output	1 HD analog output	1 HD analog output
CVBS Output	-	-	-	-	-	-	-
D/N Mode	Auto/Color/BW (Black and White)	Auto/Color/BW (Black and White)	Auto/Color/BW (Black and White)	Auto/Color/BW (Black and White)	Auto/Color/BW (Black and White)	Auto/Color/BW (Black and White)	Auto/Color/BW (Black and White)
White Balance	ATW/MWB	ATW/MWB	Auto/Manual	Auto/Manual	Auto/Manual	Auto/Manual	Auto/Manual
BLC	WDR/BLC/GLOBAL	WDR/BLC/GLOBAL	-	-	DWDR/BLC/HLC/Global	DWDR/BLC/HLC/Global	DWDR/BLC/HLC/Global
DNR	3D DNR	3D DNR	2D DNR	2D DNR	2D DNR	2D DNR	2D DNR
Functions	Brightness, Sharpness, 3D DNR, Mirror, Smart IR	Brightness, Sharpness, 3D DNR, Mirror, Smart IR	Brightness, Sharpness, Smart IR	Brightness, Sharpness, Smart IR	Brightness, Sharpness, Smart IR	Brightness, Sharpness, Smart IR	Brightness, Sharpness, Smart IR
Protection Level	IP67,IK10	IP67,IK10	IP67	IP67	IP67	IP67	IP67
Alarm I/O	-	-	-	-	-	-	-
Power	12 VDC ±25%	24 VAC ±15%, 12 VDC ±20%	12 VDC ±25%	12 VDC ±25%	12 VDC ±25%	12 VDC ±25%	12 VDC ±25%







Model	DS-2CE56D0T-IRMM(C)	DS-2CE56D0T-IRP(C)	DS-2CE56D0T-IR(C)	DS-2CE56D0T-IRM(C)	DS-2CE56D0T-IT1(C)	DS-2CE56D0T-IT3(C)	DS-2CE16D0T-ITPF(C)
Image							
Description	2 MP CMOS	2 MP CMOS	2 MP CMOS	2 MP CMOS	2 MP CMOS	2 MP CMOS	2 MP CMOS
Lens	2.8 mm, 3.6 mm fixed lens	2.8 mm, 3.6 mm fixed lens	2.8 mm, 3.6 mm fixed lens	2.8 mm, 3.6 mm fixed lens	2.8 mm, 3.6 mm fixed lens	2.8 mm, 3.6 mm, 8 mm, 12 mm fixed lens	2.8 mm, 3.6 mm fixed lens
Min. Illumination	0.01 Lux@(F1.2, AGC ON), 0 Lux with IR	0.01 Lux@(F1.2, AGC ON), 0 Lux with IR	0.01 Lux@(F1.2, AGC ON), 0 Lux with IR	0.01 Lux@(F1.2, AGC ON), 0 Lux with IR	0.01 Lux@(F1.2, AGC ON), 0 Lux with IR	0.01 Lux@(F1.2, AGC ON), 0 Lux with IR	0.01 Lux@(F1.2, AGC ON), 0 Lux with IR
FOV	2.8 mm, horizontal FOV: 106.4°, vertical FOV: 57.9°, diagonal FOV: 124.6° 3.6 mm, horizontal FOV: 79.6°, vertical FOV: 43.5°, diagonal FOV: 93.7° 6 mm, horizontal FOV: 51.9°, vertical FOV: 30°, diagonal FOV: 58.8°	2.8 mm, horizontal FOV: 106.4°, vertical FOV: 57.9°, diagonal FOV: 124.6° 3.6 mm, horizontal FOV: 79.6°, vertical FOV: 43.5°, diagonal FOV: 93.7° 6 mm, horizontal FOV: 51.9°, vertical FOV: 30°, diagonal FOV: 58.8°	2.8 mm, horizontal FOV: 106.4°, vertical FOV: 57.9°, diagonal FOV: 124.6° 3.6 mm, horizontal FOV: 79.6°, vertical FOV: 43.5°, diagonal FOV: 93.7° 6 mm, horizontal FOV: 51.9°, vertical FOV: 30°, diagonal FOV: 58.8°	2.8 mm, horizontal FOV: 106.4°, vertical FOV: 57.9°, diagonal FOV: 124.6° 3.6 mm, horizontal FOV: 79.6°, vertical FOV: 43.5°, diagonal FOV: 93.7° 6 mm, horizontal FOV: 51.9°, vertical FOV: 30°, diagonal FOV: 58.8°	2.8 mm, horizontal FOV: 106.4°, vertical FOV: 57.9°, diagonal FOV: 124.6° 3.6 mm, horizontal FOV: 79.6°, vertical FOV: 43.5°, diagonal FOV: 93.7° 6 mm, horizontal FOV: 51.9°, vertical FOV: 30°, diagonal FOV: 58.8°	2.8 mm, horizontal FOV: 106.4°, vertical FOV: 57.9°, diagonal FOV: 124.6° 3.6 mm, horizontal FOV: 79.6°, vertical FOV: 43.5°, diagonal FOV: 93.7° 6 mm, horizontal FOV: 51.9°, vertical FOV: 30°, diagonal FOV: 58.8° 8 mm, horizontal FOV: 39.9°, vertical FOV: 21.9°, diagonal FOV: 46.5° 12 mm, horizontal FOV: 24.6°, vertical FOV: 13.9°, diagonal FOV: 28.1°	2.8 mm, horizontal FOV: 106.4°, vertical FOV: 57.9°, diagonal FOV: 124.6° 3.6 mm, horizontal FOV: 79.6°, vertical FOV: 43.5°, diagonal FOV: 93.7° 6 mm, horizontal FOV: 51.9°, vertical FOV: 30°, diagonal FOV: 58.8°
Angle Adjustment	Pan: 0 to 360°, Tilt: 0 to 180°, Rotation: 0 to 360°	Pan: 0° to 360°; Tilt: 0° to 75°; Rotate: 0° to 360°	Pan: 0° to 360°; Tilt: 0° to 75°; Rotate: 0° to 360°	Pan: 0° to 360°; Tilt: 0° to 75°; Rotate: 0° to 360°	Pan: 0° to 360°; Tilt: 0° to 75°; Rotate: 0° to 360°	Pan: 0° to 360°; Tilt: 0° to 75°; Rotate: 0° to 360°	Pan: 0° to 360°; Tilt: 0° to 90°; Rotate: 0° to 360°
Day & Night	IR cut filter	IR cut filter	IR cut filter	IR cut filter	IR cut filter	IR cut filter	IR cut filter
WDR	DWDR	DWDR	DWDR	DWDR	DWDR	DWDR	DWDR
Max. IR Range (meters)	Up to 20 m	Up to 20 m	Up to 25 m	Up to 25 m	Up to 30 m	Up to 40 m	Up to 25 m
HD Video Output	1 HD analog output	1 HD analog output	1 HD analog output	1 HD analog output	1 HD analog output	1 HD analog output	1 HD analog output
CVBS Output	-	-	-	-	-	-	-
D/N Mode	Auto/Color/BW (Black and White)	Auto/Color/BW (Black and White)	Auto/Color/BW (Black and White)	Auto/Color/BW (Black and White)	Auto/Color/BW (Black and White)	Auto/Color/BW (Black and White)	Auto/Color/BW (Black and White)
White Balance	Auto/Manual	Auto/Manual	Auto/Manual	Auto/Manual	Auto/Manual	Auto/Manual	Auto/Manual
BLC	-	-	-	-	-	-	-
DNR	2D DNR	2D DNR	2D DNR	2D DNR	2D DNR	2D DNR	2D DNR
Functions	Brightness, Sharpness, Smart IR	Brightness, Sharpness, Smart IR	Brightness, Sharpness, Smart IR	Brightness, Sharpness, Smart IR	Brightness, Sharpness, Smart IR	Brightness, Sharpness, Smart IR	Brightness, Sharpness, Smart IR
Protection Level	-	-	IP67	IP67	IP67	IP67	IP67
Alarm I/O	-	-	-	-	-	-	-
Power	12 VDC ±25%	12 VDC ±25%	12 VDC ±25%	12 VDC ±25%	12 VDC ±25%	12 VDC ±25%	12 VDC ±25%







Model	DS-2CE16D0T-ITF(C)	DS-2CE17D0T-IT1F	DS-2CE17D0T-IT3F	DS-2CE17D0T-ITSF	DS-2CE56D0T-IRPF(C)	DS-2CE56D0T-IRF(C)
Image						
Description	2 MP CMOS			2 MP CMOS	2 MP CMOS	2 MP CMOS
Lens	2.8 mm, 3.6 mm fixed lens	2.8 mm, 3.6 mm, 6 mm fixed lens	2.8 mm, 3.6 mm, 6 mm, 8 mm, 12 mm fixed lens	3.6 mm, 6 mm, 8 mm, 12 mm fixed lens	2.8 mm, 3.6 mm fixed lens	2.8 mm, 3.6 mm fixed lens
Min. Illumination	0.01 Lux@(F1.2, AGC ON), 0 Lux with IR	0.01 Lux@(F1.2, AGC ON), 0 Lux with IR	0.01 Lux@(F1.2, AGC ON), 0 Lux with IR	0.01 Lux@(F1.2, AGC ON), 0 Lux with IR	0.01 Lux@(F1.2, AGC ON), 0 Lux with IR	0.01 Lux@(F1.2, AGC ON), 0 Lux with IR
FOV	2.8 mm, horizontal FOV: 106.4°, vertical FOV: 57.9°, diagonal FOV: 124.6° 3.6 mm, horizontal FOV: 79.6°, vertical FOV: 43.5°, diagonal FOV: 93.7° 6 mm, horizontal FOV: 51.9°, vertical FOV: 30°, diagonal FOV: 58.8°	2.8 mm, horizontal FOV: 106.4°, vertical FOV: 57.9°, diagonal FOV: 124.6° 3.6 mm, horizontal FOV: 79.6°, vertical FOV: 43.5°, diagonal FOV: 93.7° 6 mm, horizontal FOV: 51.9°, vertical FOV: 30°, diagonal FOV: 58.8°	2.8 mm, horizontal FOV: 106.4°, vertical FOV: 57.9°, diagonal FOV: 124.6° 3.6 mm, horizontal FOV: 79.6°, vertical FOV: 43.5°, diagonal FOV: 93.7° 6 mm, horizontal FOV: 51.9°, vertical FOV: 30°, diagonal FOV: 58.8° 8 mm, horizontal FOV: 39.9°, vertical FOV: 21.9°, diagonal FOV: 46.5° 12 mm, horizontal FOV: 24.6°, vertical FOV: 13.9°, diagonal FOV: 28.1°	3.6 mm, horizontal FOV: 79.6°, vertical FOV: 43.5°, diagonal FOV: 93.7° 6 mm, horizontal FOV: 51.9°, vertical FOV: 30°, diagonal FOV: 58.8° 8 mm, horizontal FOV: 39.9°, vertical FOV: 21.9°, diagonal FOV: 46.5° 12 mm, horizontal FOV: 24.6°, vertical FOV: 13.9°, diagonal FOV: 28.1°	2.8 mm, horizontal FOV: 106.4°, vertical FOV: 57.9°, diagonal FOV: 124.6° 3.6 mm, horizontal FOV: 79.6°, vertical FOV: 43.5°, diagonal FOV: 93.7° 6 mm, horizontal FOV: 51.9°, vertical FOV: 30°, diagonal FOV: 58.8°	2.8 mm, horizontal FOV: 106.4°, vertical FOV: 57.9°, diagonal FOV: 124.6° 3.6 mm, horizontal FOV: 79.6°, vertical FOV: 43.5°, diagonal FOV: 93.7° 6 mm, horizontal FOV: 51.9°, vertical FOV: 30°, diagonal FOV: 58.8°
Angle Adjustment	Pan: 0° to 360°; Tilt: 0° to 90°; Rotate: 0° to 360°	Pan: 0 to 360°, Tilt: 0 to 180°, Rotation: 0 to 360°	Pan: 0 to 360°, Tilt: 0 to 180°, Rotation: 0 to 360°	Pan: 0 to 360°, Tilt: 0 to 180°, Rotation: 0 to 360°	Pan: 0° to 360°; Tilt: 0° to 75°; Rotate: 0° to 360°	Pan: 0° to 360°; Tilt: 0° to 75°; Rotate: 0° to 360°
Day & Night	IR cut filter	IR cut filter	IR cut filter	IR cut filter	IR cut filter	IR cut filter
WDR	DWDR	DWDR	DWDR	DWDR	DWDR	DWDR
Max. IR Range (meters)	Up to 25 m	Up to 30 m	Up to 40 m	Up to 80 m	Up to 20 m	Up to 25 m
HD Video Output	Switchable TVI / AHD / CVI / CVBS	Switchable TVI / AHD / CVI / CVBS	Switchable TVI / AHD / CVI / CVBS	Switchable TVI / AHD / CVI / CVBS	Switchable TVI / AHD / CVI / CVBS	Switchable TVI / AHD / CVI / CVBS
CVBS Output	-	-	-	-	-	-
D/N Mode	Auto/Color/BW (Black and White)	Auto/Color/BW (Black and White)	Auto/Color/BW (Black and White)	Auto/Color/BW (Black and White)	Auto/Color/BW (Black and White)	Auto/Color/BW (Black and White)
White Balance	Auto/Manual	Auto/Manual	Auto/Manual	Auto/Manual	Auto/Manual	Auto/Manual
BLC	-	DWDR/BLC/HLC/Global	DWDR/BLC/HLC/Global	DWDR/BLC/HLC/Global	-	-
DNR	2D DNR	2D DNR	2D DNR	2D DNR	2D DNR	2D DNR
Functions	Brightness, Sharpness, Smart IR	Brightness, Sharpness, Smart IR	Brightness, Sharpness, Smart IR	Brightness, Sharpness, Smart IR	Brightness, Sharpness, Smart IR	Brightness, Sharpness, Smart IR
Protection Level	IP67	IP67	IP67	IP67	-	IP67
Alarm I/O	-	-	-	-	-	-
Power	12 VDC ±25%	12 VDC ±25%	12 VDC ±25%	12 VDC ±25%	12 VDC ±25%	12 VDC ±25%







Model	DS-2CE56D0T-IRMF(C)	DS-2CE76D0T-ITPF(C)	DS-2CE76D0T-ITMF(C)	DS-2CE56D0T-IRMMF(C)	DS-2CE56D0T-IT1F(C)	DS-2CE56D0T-IT3F(C)	
Image							
Description	2 MP CMOS	2 MP CMOS	2 MP CMOS	2 MP CMOS	2 MP CMOS	2 MP CMOS	
Lens	2.8 mm, 3.6 mm fixed lens	2.8 mm, 3.6 mm fixed lens	2.8 mm, 3.6 mm fixed lens	2.8 mm, 3.6 mm fixed lens	2.8 mm, 3.6 mm fixed lens	2.8 mm, 3.6 mm, 8 mm, 12 mm fixed lens	
Min. Illumination	0.01 Lux@(F1.2, AGC ON), 0 Lux with IR	0.01 Lux@(F1.2, AGC ON), 0 Lux with IR	0.01 Lux@(F1.2, AGC ON), 0 Lux with IR	0.01 Lux@(F1.2, AGC ON), 0 Lux with IR	0.01 Lux@(F1.2, AGC ON), 0 Lux with IR	0.01 Lux@(F1.2, AGC ON), 0 Lux with IR	
FOV	2.8 mm, horizontal FOV: 106.4°, vertical FOV: 57.9°, diagonal FOV: 124.6° 3.6 mm, horizontal FOV: 79.6°, vertical FOV: 43.5°, diagonal FOV: 93.7° 6 mm, horizontal FOV: 51.9°, vertical FOV: 30°, diagonal FOV: 58.8°	2.8 mm, horizontal FOV: 106.4°, vertical FOV: 57.9°, diagonal FOV: 124.6° 3.6 mm, horizontal FOV: 79.6°, vertical FOV: 43.5°, diagonal FOV: 93.7° 6 mm, horizontal FOV: 51.9°, vertical FOV: 30°, diagonal FOV: 58.8°	2.8 mm, horizontal FOV: 106.4°, vertical FOV: 57.9°, diagonal FOV: 124.6° 3.6 mm, horizontal FOV: 79.6°, vertical FOV: 43.5°, diagonal FOV: 93.7° 6 mm, horizontal FOV: 51.9°, vertical FOV: 30°, diagonal FOV: 58.8°	2.8 mm, horizontal FOV: 106.4°, vertical FOV: 57.9°, diagonal FOV: 124.6° 3.6 mm, horizontal FOV: 79.6°, vertical FOV: 43.5°, diagonal FOV: 93.7° 6 mm, horizontal FOV: 51.9°, vertical FOV: 30°, diagonal FOV: 58.8°	2.8 mm, horizontal FOV: 106.4°, vertical FOV: 57.9°, diagonal FOV: 124.6° 3.6 mm, horizontal FOV: 79.6°, vertical FOV: 43.5°, diagonal FOV: 93.7° 6 mm, horizontal FOV: 51.9°, vertical FOV: 30°, diagonal FOV: 58.8°	2.8 mm, horizontal FOV: 106.4°, vertical FOV: 57.9°, diagonal FOV: 124.6° 3.6 mm, horizontal FOV: 79.6°, vertical FOV: 43.5°, diagonal FOV: 93.7° 6 mm, horizontal FOV: 51.9°, vertical FOV: 30°, diagonal FOV: 58.8°	2.8 mm, horizontal FOV: 106.4°, vertical FOV: 57.9°, diagonal FOV: 124.6° 3.6 mm, horizontal FOV: 79.6°, vertical FOV: 43.5°, diagonal FOV: 93.7° 6 mm, horizontal FOV: 51.9°, vertical FOV: 30°, diagonal FOV: 58.8° 8 mm, horizontal FOV: 39.9°, vertical FOV: 21.9°, diagonal FOV: 46.5° 12 mm, horizontal FOV: 24.6°, vertical FOV: 13.9°, diagonal FOV: 28.1°
Angle Adjustment	Pan: 0° to 360°; Tilt: 0° to 75°; Rotate: 0° to 360°	Pan: 0° to 360°; Tilt: 0° to 75°; Rotate: 0° to 360°	Pan: 0° to 360°; Tilt: 0° to 75°; Rotate: 0° to 360°	Pan: 0° to 360°; Tilt: 0° to 70°; Rotate: 0° to 360°	Pan: 0° to 360°; Tilt: 0° to 75°; Rotate: 0° to 360°	Pan: 0° to 360°; Tilt: 0° to 75°; Rotate: 0° to 360°	
Day & Night	IR cut filter	IR cut filter	IR cut filter	IR cut filter	IR cut filter	IR cut filter	
WDR	DWDR	DWDR	DWDR	DWDR	DWDR	DWDR	
Max. IR Range (meters)	Up to 25 m	Up to 20 m	Up to 30 m	Up to 20 m	Up to 30 m	Up to 40 m	
HD Video Output	Switchable TVI / AHD / CVI / CVBS	Switchable TVI / AHD / CVI / CVBS	Switchable TVI / AHD / CVI / CVBS	Switchable TVI / AHD / CVI / CVBS	Switchable TVI / AHD / CVI / CVBS	Switchable TVI / AHD / CVI / CVBS	
CVBS Output	-	-	-	-	-	-	
D/N Mode	Auto/Color/BW (Black and White)	Auto/Color/BW (Black and White)	Auto/Color/BW (Black and White)	Auto/Color/BW (Black and White)	Auto/Color/BW (Black and White)	Auto/Color/BW (Black and White)	
White Balance	Auto/Manual	Auto/Manual	Auto/Manual	Auto/Manual	Auto/Manual	Auto/Manual	
BLC	-	-	-	-	-	-	
DNR	2D DNR	2D DNR	2D DNR	2D DNR	2D DNR	2D DNR	
Functions	Brightness, Sharpness, Smart IR	Brightness, Sharpness, Smart IR	Brightness, Sharpness, Smart IR	Brightness, Sharpness, Smart IR	Brightness, Sharpness, Smart IR	Brightness, Sharpness, Smart IR	
Protection Level	IP67	-	IP67	-	IP67	IP67	
Alarm I/O	-	-	-	-	-	-	
Power	12 VDC ±25%	12 VDC ±25%	12 VDC ±25%	12 VDC ±25%	12 VDC ±25%	12 VDC ±25%	







Model	DS-2CE16D0T-ITPFS	DS-2CE16D0T-ITFS	DS-2CE76D0T-ITPFS	DS-2CE76D0T-ITMFS	DS-2CE78D0T-IT3FS	DS-2CE17D0T-IT3FS	
Image	 HOT Built-in Mic	 HOT Built-in Mic	 HOT Built-in Mic	 HOT Built-in Mic	 HOT Built-in Mic	 NEW Built-in Mic	
Description	2 MP CMOS	2 MP CMOS	2 MP CMOS	2 MP CMOS	2 MP CMOS	2 MP CMOS	
Lens	2.8 mm, 3.6 mm	2.8 mm, 3.6 mm	2.8 mm, 3.6 mm	2.8 mm, 3.6 mm	2.8 mm, 3.6 mm	2.8 mm, 3.6 mm, 6 mm fixed focal lens	
Min. Illumination	0.01 Lux@(F1.2, AGC ON), 0 Lux with IR	0.01 Lux@(F1.2, AGC ON), 0 Lux with IR	0.01 Lux@(F1.2, AGC ON), 0 Lux with IR	0.01 Lux@(F1.2, AGC ON), 0 Lux with IR	0.01 Lux@(F1.2, AGC ON), 0 Lux with IR	0.01 Lux @ (F1.2, AGC ON), 0 Lux with IR	
FOV	2.8 mm, horizontal FOV: 106.4°, vertical FOV: 57.9°, diagonal FOV: 124.6° 3.6 mm, horizontal FOV: 79.6°, vertical FOV: 43.5°, diagonal FOV: 93.7° 6 mm, horizontal FOV: 51.9°, vertical FOV: 30°, diagonal FOV: 58.8°	2.8 mm, horizontal FOV: 106.4°, vertical FOV: 57.9°, diagonal FOV: 124.6° 3.6 mm, horizontal FOV: 79.6°, vertical FOV: 43.5°, diagonal FOV: 93.7° 6 mm, horizontal FOV: 51.9°, vertical FOV: 30°, diagonal FOV: 58.8°	2.8 mm, horizontal FOV: 106.4°, vertical FOV: 57.9°, diagonal FOV: 124.6° 3.6 mm, horizontal FOV: 79.6°, vertical FOV: 43.5°, diagonal FOV: 93.7° 6 mm, horizontal FOV: 51.9°, vertical FOV: 30°, diagonal FOV: 58.8°	2.8 mm, horizontal FOV: 106.4°, vertical FOV: 57.9°, diagonal FOV: 124.6° 3.6 mm, horizontal FOV: 79.6°, vertical FOV: 43.5°, diagonal FOV: 93.7° 6 mm, horizontal FOV: 51.9°, vertical FOV: 30°, diagonal FOV: 58.8°	2.8 mm, horizontal FOV: 106.4°, vertical FOV: 57.9°, diagonal FOV: 124.6° 3.6 mm, horizontal FOV: 79.6°, vertical FOV: 43.5°, diagonal FOV: 93.7° 6 mm, horizontal FOV: 51.9°, vertical FOV: 30°, diagonal FOV: 58.8°	2.8 mm, horizontal FOV: 106.4°, vertical FOV: 57.9°, diagonal FOV: 124.6° 3.6 mm, horizontal FOV: 79.6°, vertical FOV: 43.5°, diagonal FOV: 93.7° 6 mm, horizontal FOV: 51.9°, vertical FOV: 30°, diagonal FOV: 58.8°	2.8 mm, horizontal FOV: 106.4°, vertical FOV: 57.9°, diagonal FOV: 124.6° 3.6 mm, horizontal FOV: 79.6°, vertical FOV: 43.5°, diagonal FOV: 93.7° 6 mm, horizontal FOV: 51.9°, vertical FOV: 30°, diagonal FOV: 58.8°
Angle Adjustment	Pan: 0° to 360°; Tilt: 0° to 180°; Rotate: 0° to 360°	Pan: 0° to 360°; Tilt: 0° to 180°; Rotate: 0° to 360°	Pan: 0° to 360°; Tilt: 0° to 180°; Rotate: 0° to 360°	Pan: 0° to 360°; Tilt: 0° to 75°; Rotate: 0° to 360°	Pan: 0° to 360°; Tilt: 0° to 75°; Rotate: 0° to 360°	Pan: 0° to 360°; Tilt: 0° to 180°, Rotation: 0° to 360°	
Day & Night	IR cut filter	IR cut filter	IR cut filter	IR cut filter	IR cut filter	IR Cut Filter	
WDR	DWDR	DWDR	DWDR	DWDR	DWDR	DWDR	
Max. IR Range (meters)	Up to 25 m	Up to 30 m	Up to 20 m	Up to 30 m	Up to 40 m	Up to 40 m	
HD Video Output	Switchable TVI / AHD / CVI / CVBS	Switchable TVI / AHD / CVI / CVBS	Switchable TVI / AHD / CVI / CVBS	Switchable TVI / AHD / CVI / CVBS	Switchable TVI / AHD / CVI / CVBS	Switchable TVI / AHD / CVI / CVBS	
CVBS Output	-	-	-	-	-	-	
D/N Mode	Auto/Color/BW (Black and White)	Auto/Color/BW (Black and White)	Auto/Color/BW (Black and White)	Auto/Color/BW (Black and White)	Auto/Color/BW (Black and White)	Auto/Color/BW (Black and White)	
White Balance	Auto/Manual	Auto/Manual	Auto/Manual	Auto/Manual	Auto/Manual	Auto/Manual	
BLC	-	-	-	-	-	BLC;HLC;Global;DWDR	
DNR	2D DNR	2D DNR	2D DNR	2D DNR	2D DNR	2D DNR	
Functions	Brightness, Sharpness, Mirror, Smart IR	Brightness, Sharpness, Mirror, Smart IR	Brightness, Sharpness, Mirror, Smart IR	Brightness, Sharpness, Mirror, Smart IR	Brightness, Sharpness, Mirror, Smart IR	Sharpness;Brightness; Smart IR	
Protection Level	IP67	IP67	-	IP67	IP67	IP67	
Alarm I/O	-	-	-	-	-	-	
Power	12 VDC ±25%	12 VDC ±25%	12 VDC ±25%	12 VDC ±25%	12 VDC ±25%	12 VDC ± 25%	







Model	DS-2CE16H0T-ITPF(C)	DS-2CE16H0T-ITF(C)	DS-2CE17H0T-IT1F(C)	DS-2CE17H0T-IT3F(C)	DS-2CE17H0T-IT5F(C)	DS-2CE76H0T-ITMF(C)	DS-2CE76H0T-ITPF(C)
Image							
Descriptio	5 MP high performance COMS	5MP high performance COMS	5 MP CMOS	5 MP CMOS	5 MP CMOS	-	-
Lens	2.4 mm, 2.8 mm, 3.6 mm fixed lens	2.4 mm, 2.8 mm, 3.6 mm fixed lens	2.4 mm, 2.8 mm, 3.6 mm, 6 mm fixed lens	2.8 mm, 3.6 mm, 6 mm, 8 mm, 12 mm fixed lens	3.6 mm, 6 mm, 8 mm, 12 mm fixed lens	2.4 mm, 2.8 mm, 6 mm fixed lens	2.4 mm, 2.8 mm, 3.6 mm fixed lens
Min. Illumination	Color: 0.01 Lux @ (F1.2, AGC ON), 0 Lux with IR	Color: 0.01 Lux @ (F1.2, AGC ON), 0 Lux with IR	0.01 Lux @ (F1.2, AGC ON), 0 Lux with IR	0.01 Lux @ (F1.2, AGC ON), 0 Lux with IR	0.01 Lux @ (F1.2, AGC ON), 0 Lux with IR	0.01 Lux @ (F1.2, AGC ON), 0 Lux with IR	0.01 Lux @ (F1.2, AGC ON), 0 Lux with IR
FOV	2.4 mm, horizontal FOV: 110°, vertical FOV: 81°, diagonal FOV:137° 2.8 mm, horizontal FOV: 85°, vertical FOV: 63°, diagonal FOV:110° 3.6 mm, horizontal FOV: 80°, vertical FOV: 63°, diagonal FOV:105° 6 mm, horizontal FOV: 57°, vertical FOV: 43°, diagonal FOV:72°	2.4 mm, horizontal FOV: 110°, vertical FOV: 81°, diagonal FOV:137° 2.8 mm, horizontal FOV: 85°, vertical FOV: 63°, diagonal FOV:110° 3.6 mm, horizontal FOV: 80°, vertical FOV: 63°, diagonal FOV:105° 6 mm, horizontal FOV: 57°, vertical FOV: 43°, diagonal FOV:72°	2.4 mm, horizontal FOV: 110°, vertical FOV: 81°, diagonal FOV:137° 2.8 mm, horizontal FOV: 85°, vertical FOV: 63°, diagonal FOV:110° 3.6 mm, horizontal FOV: 80°, vertical FOV: 63°, diagonal FOV:105° 6 mm, horizontal FOV: 57°, vertical FOV: 43°, diagonal FOV:72°	2.8 mm, horizontal FOV: 85°, vertical FOV: 63°, diagonal FOV:110° 3.6 mm, horizontal FOV: 80°, vertical FOV: 63°, diagonal FOV:105° 6 mm, horizontal FOV: 57°, vertical FOV: 43°, diagonal FOV:72° 8 mm, horizontal FOV: 41°, vertical FOV: 31°, diagonal FOV:52° 12 mm, horizontal FOV: 26°, vertical FOV: 19°, diagonal FOV:32°	3.6 mm, horizontal FOV: 80°, vertical FOV: 63°, diagonal FOV:105° 6 mm, horizontal FOV: 57°, vertical FOV: 43°, diagonal FOV:72° 8 mm, horizontal FOV: 41°, vertical FOV: 31°, diagonal FOV:52° 12 mm, horizontal FOV: 26°, vertical FOV: 19°, diagonal FOV:32°	2.4 mm, horizontal FOV: 110°, vertical FOV: 81°, diagonal FOV:137° 2.8 mm, horizontal FOV: 85°, vertical FOV: 63°, diagonal FOV:110° 3.6 mm, horizontal FOV: 80°, vertical FOV: 63°, diagonal FOV:105° 6 mm, horizontal FOV: 57°, vertical FOV: 43°, diagonal FOV:72°	2.4 mm, horizontal FOV: 110°, vertical FOV: 81°, diagonal FOV:137° 2.8 mm, horizontal FOV: 85°, vertical FOV: 63°, diagonal FOV:110° 3.6 mm, horizontal FOV: 80°, vertical FOV: 63°, diagonal FOV:105° 6 mm, horizontal FOV: 57°, vertical FOV: 43°, diagonal FOV:72°
Angle Adjustment	Pan: 0° to 360°; Tilt: 0° to 90°; Rotate: 0° to 360°	Pan: 0° to 360°; Tilt: 0° to 90°; Rotate: 0° to 360°	Pan: 0 to 360°, Tilt: 0 to 180°, Rotation 0 to 360°	Pan: 0 to 360°, Tilt: 0 to 180°, Rotation 0 to 360°	Pan: 0 to 360°, Tilt: 0 to 180°, Rotation 0 to 360°	Pan: 0 to 360°, Tilt: 0 to 75°, Rotation 0 to 360°	Pan: 0 to 360°, Tilt: 0 to 75°, Rotation 0 to 360°
Day & Night	IR cut filter	IR cut filter	ICR	ICR	ICR	ICR	ICR
WDR	DWDR	DWDR	DWDR/BLC/HLC/Global	DWDR/BLC/HLC/Global	DWDR/BLC/HLC/Global	DWDR/BLC/HLC/Global	DWDR/BLC/HLC/Global
Max. IR Range	Up to 25 m	Up to 30 m	Up to 30 m	Up to 40 m	Up to 80 m	Up to 30 m	Up to 20 m
HD Video Output	Switchable TVI / AHD / CVI / CVBS	Switchable TVI / AHD / CVI / CVBS	Switchable TVI/AHD/CVI/CVBS	Switchable TVI/AHD/CVI/CVBS	Switchable TVI/AHD/CVI/CVBS	Switchable TVI/AHD/CVI/CVBS	Switchable TVI/AHD/CVI/CVBS
CVBS Output	-	-	-	-	-	-	-
D/N Mode	Auto/Color/BW (Black and White)	Auto/Color/BW (Black and White)	Auto/Color/BW (Black and White)	Auto/Color/BW (Black and White)	Auto/Color/BW (Black and White)	Auto/Color/BW (Black and White)	Auto/Color/BW (Black and White)
White Balance	ATW/MWB	ATW/MWB	Auto/Manual	Auto/Manual	Auto/Manual	Auto/Manual	Auto/Manual
BLC	Support	Support	DWDR/BLC/HLC/Global	DWDR/BLC/HLC/Global	DWDR/BLC/HLC/Global	DWDR/BLC/HLC/Global	DWDR/BLC/HLC/Global
DNR	2D DNR	2D DNR	2D DNR	2D DNR	2D DNR	2D DNR	2D DNR
Functions	Brightness, Sharpness, DNR, Mirror, Smart IR	Brightness, Sharpness, DNR, Mirror, Smart IR	Brightness, Sharpness, Mirror, Smart IR	Brightness, Sharpness, Mirror, Smart IR	Brightness, Sharpness, Mirror, Smart IR	Brightness, Sharpness, Mirror, Smart IR	Brightness, Sharpness, Mirror, Smart IR
Protection Level	IP67	IP67	IP67	IP67	IP67	IP67	IP67
Alarm I/O	-	-	-	-	-	-	-
Power	12 VDC ±25%	12 VDC ±25%	12 VDC ± 25%	12 VDC ± 25%	12 VDC ± 25%	12 VDC ± 25%	12 VDC ± 25%







Model	DS-2CE56H0T-IRMMF(C)	DS-2CE57H0T-VPITF (C)	DS-2CE78H0T-IT1F (C)	DS-2CE78H0T-IT3F (C)	DS-2CE16H0T-ITPFS	DS-2CE16H0T-ITFS
Image					 Hot Built-in Mic	 Hot Built-in Mic
Descriptio	5 MP high performance COMS	-	-	5 MP CMOS	5 MP CMOS	5 MP CMOS
Lens	2.8 mm, 3.6 mm fixed lens	2.8 mm, 3.6 mm fixed lens	2.4 mm, 2.8 mm, 3.6 mm fixed lens	2.8 mm, 3.6 mm fixed lens	2.8 mm, 3.6 mm fixed lens	2.8 mm, 3.6 mm fixed lens
Min. Illumination	Color: 0.01 Lux @ (F1.2, AGC ON), 0 Lux with IR	0.01 Lux @ (F1.2, AGC ON), 0 Lux with IR	0.01 Lux @ (F1.2, AGC ON), 0 Lux with IR	0.01 Lux@(F1.2, AGC ON), 0 Lux with IR	0.01 Lux@(F1.2, AGC ON), 0 Lux with IR	0.01 Lux@(F1.2, AGC ON), 0 Lux with IR
FOV	85.5° (2.8 mm), 80.1° (3.6 mm), 57.1° (6 mm)	2.8 mm, horizontal FOV: 85°, vertical FOV: 63°, diagonal FOV:110° 3.6 mm, horizontal FOV: 80°, vertical FOV: 63°, diagonal FOV:105° 6 mm, horizontal FOV: 57°, vertical FOV: 43°, diagonal FOV:72°	2.4 mm, horizontal FOV: 110°, vertical FOV: 81°, diagonal FOV:137° 2.8 mm, horizontal FOV: 85°, vertical FOV: 63°, diagonal FOV:110° 3.6 mm, horizontal FOV: 80°, vertical FOV: 63°, diagonal FOV:105° 6 mm, horizontal FOV: 57°, vertical FOV: 43°, diagonal FOV:72°	2.8 mm, horizontal FOV: 85.5°, vertical FOV: 63.7°, diagonal FOV: 110.7° 3.6 mm, horizontal FOV: 80.1°, vertical FOV: 63.7°, diagonal FOV: 105.9° 6 mm, horizontal FOV: 57.1°, vertical FOV: 43.1°, diagonal FOV: 72.5°	2.8 mm, horizontal FOV: 85.5°, vertical FOV: 63.7°, diagonal FOV: 110.7° 3.6 mm, horizontal FOV: 80.1°, vertical FOV: 63.7°, diagonal FOV: 105.9° 6 mm, horizontal FOV: 57.1°, vertical FOV: 43.1°, diagonal FOV: 72.5°	2.8 mm, horizontal FOV: 85.5°, vertical FOV: 63.7°, diagonal FOV: 110.7° 3.6 mm, horizontal FOV: 80.1°, vertical FOV: 63.7°, diagonal FOV: 105.9° 6 mm, horizontal FOV: 57.1°, vertical FOV: 43.1°, diagonal FOV: 72.5°
Angle Adjustment	Pan: 0° to 350°; Tilt: 0° to 70°; Rotate: 0° to 350°	Pan: 0 to 360°, Tilt: 0 to 75°, Rotation 0 to 360°	Pan: 0 to 360°, Tilt: 0 to 75°, Rotation 0 to 360°	Pan: 0 to 360°, Tilt: 0 to 75°, Zoom 0 to 360°	Pan: 0 to 355°, Tilt: 0 to 75°, Zoom 0 to 355°	Pan: 0 to 355°, Tilt: 0 to 75°, Zoom 0 to 355°
Day & Night	ICR	ICR	ICR	ICR	ICR	ICR
WDR	Support	DWDR/BLC/HLC/Global	DWDR/BLC/HLC/Global	Digital WDR	Digital WDR	Digital WDR
Max. IR Range	Up to 20 m	Up to 20 m	-	Up to 40 m	Up to 25 m	Up to 30 m
HD Video Output	Switchable TVI/AHD/CVI/CVBS	Switchable TVI/AHD/CVI/CVBS	Switchable TVI/AHD/CVI/CVBS	Switchable TVI/AHD/CVI/CVBS	Switchable TVI/AHD/CVI/CVBS	Switchable TVI/AHD/CVI/CVBS
CVBS Output	-	-	-	-	-	-
D/N Mode	Auto/Color/BW (Black and White)	Auto/Color/BW (Black and White)	Auto/Color/BW (Black and White)	Auto/Color/BW (Black and White)	Auto/Color/BW (Black and White)	Auto/Color/BW (Black and White)
White Balance	ATW/MWB	Auto/Manual	Auto/Manual	Auto/Manual	Auto/Manual	Auto/Manual
BLC	Support	DWDR/BLC/HLC/Global	DWDR/BLC/HLC/Global	-	-	-
DNR	2D DNR	2D DNR	2D DNR	2D DNR	2D DNR	2D DNR
Functions	Brightness, Sharpness, DNR , Mirror, Smart IR	Brightness, Sharpness, Mirror, Smart IR	Brightness, Sharpness, Mirror, Smart IR	Brightness, Sharpness, Mirror, Smart IR	Brightness, Sharpness, Mirror, Smart IR	Brightness, Sharpness, Mirror, Smart IR
Protection Level	-	IP67	IP67	IP67	IP67	IP67
Alarm I/O	-	-	-	-	-	-
Power	12 VDC ± 25%	12 VDC ± 25%	12 VDC ± 25%	12 VDC ± 25%	12 VDC ± 25%	12 VDC ± 25%

Model	DS-2CE76H0T-ITPFS	DS-2CE76H0T-ITMFS	DS-2CE78H0T-IT3FS	DS-2CE17H0T-IT3FS	DS-2CE19H0T-AIT3ZF(C)	DS-2CE5AH0T-AVPT3ZF(C)	DS-2CE79H0T-IT3ZF(C)
Image	 HOT Built-in Mic	 HOT Built-in Mic	 HOT Built-in Mic	 NEW Built-in Mic			
Descriptio	5 MP CMOS	5 MP CMOS	5 MP CMOS	5 MP CMOS	5 MP CMOS	5 MP CMOS	5 MP CMOS
Lens	2.8 mm, 3.6 mm fixed lens	2.8 mm, 3.6 mm fixed lens	2.8 mm, 3.6 mm fixed lens	2.8 mm, 3.6 mm, 6 mm fixed focal lens	2.7 mm to 13.5 mm motorized varifocal lens	2.7 mm to 13.5 mm motorized varifocal lens	2.7 mm to 13.5 mm motorized varifocal lens
Min. Illumination	0.01 Lux@(F1.2, AGC ON), 0 Lux with IR	0.01 Lux@(F1.2, AGC ON), 0 Lux with IR	0.01 Lux@(F1.2, AGC ON), 0 Lux with IR	0.01 Lux @ (F1.2, AGC ON), 0 Lux with IR	0.01 Lux @ (F1.2, AGC ON), 0 Lux with IR	0.01 Lux @ (F1.2, AGC ON), 0 Lux with IR	0.01 Lux @ (F1.2, AGC ON), 0 Lux with IR
FOV	2.8 mm, horizontal FOV: 85.5°, vertical FOV: 63.7°, diagonal FOV: 110.7° 3.6 mm, horizontal FOV: 80.1°, vertical FOV: 63.7°, diagonal FOV: 105.9° 6 mm, horizontal FOV: 57.1°, vertical FOV: 43.1°, diagonal FOV: 72.5°	2.8 mm, horizontal FOV: 85.5°, vertical FOV: 63.7°, diagonal FOV: 110.7° 3.6 mm, horizontal FOV: 80.1°, vertical FOV: 63.7°, diagonal FOV: 105.9° 6 mm, horizontal FOV: 57.1°, vertical FOV: 43.1°, diagonal FOV: 72.5°	2.8 mm, horizontal FOV: 85.5°, vertical FOV: 63.7°, diagonal FOV: 110.7° 3.6 mm, horizontal FOV: 80.1°, vertical FOV: 63.7°, diagonal FOV: 105.9° 6 mm, horizontal FOV: 57.1°, vertical FOV: 43.1°, diagonal FOV: 72.5°	2.8 mm, horizontal FOV: 85°, vertical FOV: 63°, diagonal FOV: 110° 3.6 mm, horizontal FOV: 80°, vertical FOV: 63°, diagonal FOV: 105° 6 mm, horizontal FOV: 57°, vertical FOV: 43°, diagonal FOV: 72°	horizontal FOV: 95° to 26°, vertical FOV: 72° to 20°, diagonal FOV: 126° to 33°	horizontal FOV: 95° to 26°, vertical FOV: 72° to 20°, diagonal FOV: 126° to 33°	horizontal FOV: 95° to 26°, vertical FOV: 72° to 20°, diagonal FOV: 126° to 33°
Angle Adjustment	Pan: 0 to 360°, Tilt: 0 to 75°, Zoom 0 to 360°	Pan: 0 to 360°, Tilt: 0 to 75°, Zoom 0 to 360°	Pan: 0 to 360°, Tilt: 0 to 75°, Zoom 0 to 360°	Pan: 0° to 360°, Tilt: 0° to 180°, Rotation: 0° to 360°	Pan: 0° to 360°, Tilt: 0° to 90°, Rotation: 0° to 360°	Pan: 0° to 355°, Tilt: 0° to 75°, Rotation: 0° to 355°	Pan: 0° to 360°, Tilt: 0° to 75°, Rotation: 0° to 360°
Day & Night	ICR	ICR	ICR	IR Cut Filter	IR Cut Filter	IR Cut Filter	IR Cut Filter
WDR	Digital WDR	Digital WDR	Digital WDR	Digital WDR	Digital WDR	Digital WDR	Digital WDR
Max. IR Range	Up to 20 m	Up to 30 m	Up to 40 m	Up to 40 m	Up to 40 m	Up to 40 m	Up to 40 m
HD Video Output	Switchable TVI/AHD/CVI/CVBS	Switchable TVI/AHD/CVI/CVBS	Switchable TVI/AHD/CVI/CVBS	Switchable TVI/AHD/CVI/CVBS	Switchable TVI/AHD/CVI/CVBS	Switchable TVI/AHD/CVI/CVBS	Switchable TVI/AHD/CVI/CVBS
CVBS Output	-	-	-	-	-	-	-
D/N Mode	Auto/Color/BW (Black and White)	Auto/Color/BW (Black and White)	Auto/Color/BW (Black and White)	Auto/Color/BW (Black and White)	Auto/Color/BW (Black and White)	Auto/Color/BW (Black and White)	Auto/Color/BW (Black and White)
White Balance	Auto/Manual	Auto/Manual	Auto/Manual	Auto/Manual	Auto/Manual	Auto/Manual	Auto/Manual
BLC	-	-	-	DWDR, BLC, HLC, Global	DWDR, BLC, HLC, Global	DWDR, BLC, HLC, Global	DWDR, BLC, HLC, Global
DNR	2D DNR	2D DNR	2D DNR	2D DNR	2D DNR	2D DNR	2D DNR
Functions	Brightness, Sharpness, Mirror, Smart IR	Brightness, Sharpness, Mirror, Smart IR	Brightness, Sharpness, Mirror, Smart IR	Brightness, Mirror, Smart IR, Sharpness	Brightness, Smart IR, Sharpness	Brightness, Smart IR, Sharpness	Brightness, Smart IR, Sharpness
Protection Level	-	IP67	IP67	IP67	IP67	IP67, IK10	IP67
Alarm I/O	-	-	-	-	-	-	-
Power	12 VDC ± 25%	12 VDC ± 25%	12 VDC ± 25%	12 VDC ± 25%	12 VDC±15%, 24 VAC±15%	12 VDC±15%, 24 VAC±15%	12 VDC±15%

Model	DS-2CE19H0T-IT3ZE(C)	DS-2CE5AH0T-VPIT3ZE(C)	DS-2CE79H0T-IT3ZE(C)	DS-2CE16H0T-ITE(C)	DS-2CE17H0T-IT3E(C)	DS-2CE57H0T-VPITE(C)	DS-2CE78H0T-IT3E(C)
Image							
Descriptio	5 MP CMOS	5 MP CMOS	5 MP CMOS	5 MP CMOS	5 MP CMOS	5 MP CMOS	5 MP CMOS
Lens	2.7 mm to 13.5 mm motorized varifocal lens	2.7 mm to 13.5 mm motorized varifocal lens	2.7 mm to 13.5 mm motorized varifocal lens	2.8 mm and 3.6 mm fixed focal lens	2.8 mm, 3.6 mm and 6 mm fixed focal lens	2.8 mm and 3.6 mm fixed focal lens	2.8 mm and 3.6 mm fixed focal lens
Min. Illumination	0.01 Lux @ (F1.2, AGC ON), 0 Lux with IR	0.01 Lux @ (F1.2, AGC ON), 0 Lux with IR	0.01 Lux @ (F1.2, AGC ON), 0 Lux with IR	0.01 Lux @ (F2.0, AGC ON), 0 Lux with IR	2.8 mm, 3.6 mm and 6 mm: 0.01 Lux @ (F2.0, AGC ON), 0 Lux with IR	0.01 Lux @ (F2.0, AGC ON), 0 Lux with IR	0.01 Lux @ (F2.0, AGC ON), 0 Lux with IR
FOV	horizontal FOV: 95° to 26°, vertical FOV: 72° to 20°, diagonal FOV: 126° to 33°	horizontal FOV: 95° to 26°, vertical FOV: 72° to 20°, diagonal FOV: 126° to 33°	horizontal FOV: 95° to 26°, vertical FOV: 72° to 20°, diagonal FOV: 126° to 33°	2.8 mm, horizontal FOV: 85°, vertical FOV: 63°, diagonal FOV: 110° 3.6 mm, horizontal FOV: 80°, vertical FOV: 63°, diagonal FOV: 105°	2.8 mm, horizontal FOV: 85°, vertical FOV: 63°, diagonal FOV: 110° 3.6 mm, horizontal FOV: 80°, vertical FOV: 63°, diagonal FOV: 105° 6 mm, horizontal FOV: 57°, vertical FOV: 43°, diagonal FOV: 72°	2.8 mm, horizontal FOV: 85°, vertical FOV: 63°, diagonal FOV: 110° 3.6 mm, horizontal FOV: 80°, vertical FOV: 63°, diagonal FOV: 105°	2.8 mm, horizontal FOV: 85°, vertical FOV: 63°, diagonal FOV: 110° 3.6 mm, horizontal FOV: 80°, vertical FOV: 63°, diagonal FOV: 105°
Angle Adjustment	Pan: 0° to 360°, Tilt: 0° to 90°, Rotation: 0° to 360°	Pan: 0° to 355°, Tilt: 0° to 75°, Rotation: 0° to 355°	Pan: 0° to 360°, Tilt: 0° to 75°, Rotation: 0° to 360°	Pan: 0 to 360°, Tilt: 0 to 90°, Rotation 0 to 360°	Pan: 0 to 360°, Tilt: 0 to 180°, Rotation 0 to 360°	Pan: 0 to 355°, Tilt: 0 to 75°, Rotation 0 to 355°	Pan: 0 to 360°, Tilt: 0 to 75°, Rotation 0 to 360°
Day & Night	IR Cut Filter	IR Cut Filter	IR Cut Filter	ICR	ICR	ICR	ICR
WDR	Digital WDR	Digital WDR	Digital WDR	Digital WDR	Digital WDR	Digital WDR	Digital WDR
Max. IR Range	Up to 40 m	Up to 40 m	Up to 40 m	Up to 30 m	Up to 40 m	Up to 20 m	Up to 40 m
HD Video Output	1 HD analog output	1 HD analog output	1 HD analog output	1 HD analog output	1 HD analog output	1 HD analog output	1 HD analog output
CVBS Output	-	-	-	-	-	-	-
D/N Mode	Auto/Color/BW (Black and White)	Auto/Color/BW (Black and White)	Auto/Color/BW (Black and White)	Auto/Color/BW (Black and White)	Auto/Color/BW (Black and White)	Auto/Color/BW (Black and White)	Auto/Color/BW (Black and White)
White Balance	Auto/Manual	Auto/Manual	Auto/Manual	Auto/Manual	Auto/Manual	Auto/Manual	Auto/Manual
BLC	DWDR, BLC, HLC, Global	DWDR, BLC, HLC, Global	DWDR, BLC, HLC, Global	DWDR, BLC, HLC, Global	DWDR, BLC, HLC, Global	DWDR, BLC, HLC, Global	DWDR, BLC, HLC, Global
DNR	2D DNR	2D DNR	2D DNR	2D DNR	2D DNR	2D DNR	2D DNR
Functions	Brightness, Smart IR, Sharpness	Brightness, Smart IR, Sharpness	Brightness, Smart IR, Sharpness	Brightness, Sharpness, Smart IR	Brightness, Sharpness, Smart IR	Brightness, Sharpness, Smart IR	Brightness, Sharpness, Smart IR
Protection Level	IP67	IP67, IK10	IP67	IP67	IP67	IP67, IK10	IP67
Alarm I/O	-	-	-	-	-	-	-
Power	12 VDC±15%/PoC.at	12 VDC±15%/PoC.at	12 VDC±15%/PoC.at	12 VDC ±25%/PoC.af	12 VDC ±25%/PoC.af	12 VDC ±25%/PoC.af	12 VDC ±25%/PoC.af

Model	DS-2CE16U1T-ITF	DS-2CE16U1T-ITPF	DS-2CE16U1T-IT1F	DS-2CE16U1T-IT3F	DS-2CE16U1T-IT5F	DS-2CE57U1T-VPITF
Image						
Description	8 MP Bullet Camera	8 MP Bullet Camera	8 MP Bullet Camera	8 MP Bullet Camera	8 MP Bullet Camera	8 MP Bullet Camera
Lens	2.8 mm, 3.6 mm fixed focal lens	2.8 mm, 3.6 mm fixed focal lens	2.8 mm, 3.6 mm, 6 mm fixed focal lens	2.8 mm, 3.6 mm, 6 mm fixed focal lens	3.6 mm, 6 mm fixed focal lens	2.8 mm, 3.6 mm fixed focal lens
Min. Illumination	Color: 0.01 Lux @ (F1.2, AGC ON), 0 Lux with IR	Color: 0.01 Lux @ (F1.2, AGC ON), 0 Lux with IR	Color: 0.01 Lux @ (F1.2, AGC ON), 0 Lux with IR	Color: 0.01 Lux @ (F1.2, AGC ON), 0 Lux with IR	Color: 0.01 Lux @ (F1.2, AGC ON), 0 Lux with IR	Color: 0.01 Lux @ (F1.2, AGC ON), 0 Lux with IR
FOV	102.2° (2.8 mm), 79° (3.6 mm), 50.8° (6 mm)	102.2° (2.8 mm), 79° (3.6 mm), 50.8° (6 mm)	102.2° (2.8 mm), 79° (3.6 mm), 50.8° (6 mm)	102.2° (2.8 mm), 79° (3.6 mm), 50.8° (6 mm), 37.73° (8 mm), 23.96° (12 mm)	79° (3.6 mm), 50.8° (6 mm), 37.73° (8 mm), 23.96° (12 mm)	102.2° (2.8 mm), 79° (3.6 mm), 50.8° (6 mm)
Angle Adjustment	Pan: 0° to 360°; Tilt: 0° to 180°; Rotate: 0° to 360°	Pan: 0° to 360°; Tilt: 0° to 180°; Rotate: 0° to 360°	Pan: 0° to 360°; Tilt: 0° to 180°; Rotate: 0° to 360°	Pan: 0° to 360°; Tilt: 0° to 180°; Rotate: 0° to 360°	Pan: 0° to 360°; Tilt: 0° to 180°; Rotate: 0° to 360°	Pan: 0° to 355°; Tilt: 0° to 75°; Rotate: 0° to 355°
Day & Night	IR cut filter	IR cut filter	IR cut filter	IR cut filter	IR cut filter	IR cut filter
WDR	DWDR	DWDR	DWDR	DWDR	DWDR	DWDR
Max. IR Range (meters)	Up to 30 m	Up to 30 m	Up to 30 m	Up to 60 m	Up to 80 m	Up to 30 m
HD Video Output	Switchable TVI / AHD / CVI / CVBS	Switchable TVI / AHD / CVI / CVBS	Switchable TVI / AHD / CVI / CVBS	Switchable TVI / AHD / CVI / CVBS	Switchable TVI / AHD / CVI / CVBS	Switchable TVI / AHD / CVI / CVBS
CVBS Output	-	-	-	-	-	-
D/N Mode	Auto/Color/BW (Black and White)	Auto/Color/BW (Black and White)	Auto/Color/BW (Black and White)	Auto/Color/BW (Black and White)	Auto/Color/BW (Black and White)	Auto/Color/BW (Black and White)
White Balance	ATW/MWB	ATW/MWB	ATW/MWB	ATW/MWB	ATW/MWB	ATW/MWB
BLC	WDR/BLC/OFF	WDR/BLC/OFF	WDR/BLC/OFF	WDR/BLC/OFF	WDR/BLC/OFF	WDR/BLC/OFF
DNR	2D	2D	2D	2D	2D	2D
Functions	Brightness, Sharpness, DNR, Mirror, Smart IR	Brightness, Sharpness, DNR, Mirror, Smart IR	Brightness, Sharpness, DNR, Mirror, Smart IR	Brightness, Sharpness, DNR, Mirror, Smart IR	Brightness, Sharpness, DNR, Mirror, Smart IR	Brightness, Sharpness, DNR, Mirror, Smart IR
Protection Level	IP67	IP67	IP67	IP67	IP67	IP67, IK10
Alarm I/O	-	-	-	-	-	-
Power	12 VDC ±25%	12 VDC ±25%	12 VDC ±25%	12 VDC ±25%	12 VDC ±25%	12 VDC ±25%

Model	DS-2CE76U1T-ITPF	DS-2CE76U1T-ITMF	DS-2CE78U1T-IT1F	DS-2CE78U1T-IT3F	DS-2CE19U1T-IT3ZF	DS-2CE19U1T-AIT3ZF	DS-2CE79U1T-IT3ZF
Image							
Description	8 MP Bullet Camera	8 MP Bullet Camera	8 MP Bullet Camera	8 MP Bullet Camera	8 MP Bullet Camera	8 MP Bullet Camera	8 MP Bullet Camera
Lens	2.8 mm, 3.6 mm fixed focal lens	2.8 mm, 3.6 mm fixed focal lens	2.8 mm, 3.6 mm fixed focal lens	3.6 mm, 6 mm fixed focal lens	2.7 mm to 13.5 mm motorized auto focus lens	2.7 mm to 13.5 mm motorized auto focus lens	2.7 mm to 13.5 mm motorized auto focus lens
Min. Illumination	Color: 0.01 Lux @ (F1.2, AGC ON), 0 Lux with IR	Color: 0.01 Lux @ (F1.2, AGC ON), 0 Lux with IR	Color: 0.01 Lux @ (F1.2, AGC ON), 0 Lux with IR	Color: 0.01 Lux @ (F1.2, AGC ON), 0 Lux with IR	Color: 0.01 Lux @ (F1.2, AGC ON), 0 Lux with IR	Color: 0.01 Lux @ (F1.2, AGC ON), 0 Lux with IR	Color: 0.01 Lux @ (F1.2, AGC ON), 0 Lux with IR
FOV	102.2° (2.8 mm), 79° (3.6 mm), 50.8° (6 mm)	102.2° (2.8 mm), 79° (3.6 mm), 50.8° (6 mm)	102.2° (2.8 mm), 79° (3.6 mm), 50.8° (6 mm)	102.2° (2.8 mm), 79° (3.6 mm), 50.8° (6 mm), 37.73° (8 mm), 23.96° (12 mm)	108.1° to 45.6°	108.1° to 45.6°	108.1° to 45.6°
Angle Adjustment	Pan: 0° to 360°; Tilt: 0° to 75°; Rotate: 0° to 360°	Pan: 0° to 360°; Tilt: 0° to 75°; Rotate: 0° to 360°	Pan: 0° to 360°; Tilt: 0° to 75°; Rotate: 0° to 360°	Pan: 0° to 360°; Tilt: 0° to 75°; Rotate: 0° to 360°	Pan: 0° to 360°; Tilt: 0° to 90°; Rotate: 0° to 360°	Pan: 0° to 360°; Tilt: 0° to 90°; Rotate: 0° to 360°	Pan: 0° to 360°; Tilt: 0° to 75°; Rotate: 0° to 360°
Day & Night	IR cut filter	IR cut filter	IR cut filter	IR cut filter	IR cut filter	IR cut filter	IR cut filter
WDR	DWDR	DWDR	DWDR	DWDR	DWDR	DWDR	DWDR
Max. IR Range (meters)	Up to 30 m	Up to 30 m	Up to 30 m	Up to 60 m	Up to 60 m	Up to 60 m	Up to 60 m
HD Video Output	Switchable TVI / AHD / CVI / CVBS	Switchable TVI / AHD / CVI / CVBS	Switchable TVI / AHD / CVI / CVBS	Switchable TVI / AHD / CVI / CVBS	Switchable TVI / AHD / CVI / CVBS	Switchable TVI / AHD / CVI / CVBS	Switchable TVI / AHD / CVI / CVBS
CVBS Output	-	-	-	-	-	-	-
D/N Mode	Auto/Color/BW (Black and White)	Auto/Color/BW (Black and White)	Auto/Color/BW (Black and White)	Auto/Color/BW (Black and White)	Auto/Color/BW (Black and White)	Auto/Color/BW (Black and White)	Auto/Color/BW (Black and White)
White Balance	ATW/MWB	ATW/MWB	ATW/MWB	ATW/MWB	ATW/MWB	ATW/MWB	ATW/MWB
BLC	WDR/BLC/OFF	WDR/BLC/OFF	WDR/BLC/OFF	WDR/BLC/OFF	WDR/BLC/OFF	WDR/BLC/OFF	WDR/BLC/OFF
DNR	2D	2D	2D	2D	2D	2D	2D
Functions	Brightness, Sharpness, DNR, Mirror, Smart IR	Brightness, Sharpness, DNR, Mirror, Smart IR	Brightness, Sharpness, DNR, Mirror, Smart IR	Brightness, Sharpness, DNR, Mirror, Smart IR	Brightness, Sharpness, DNR, Mirror, Smart IR	Brightness, Sharpness, DNR, Mirror, Smart IR	Brightness, Sharpness, DNR, Mirror, Smart IR
Protection Level	-	IP67	IP67	IP67	IP67	IP67	IP67
Alarm I/O	-	-	-	-	-	-	-
Power	12 VDC ±25%	12 VDC ±25%	12 VDC ±25%	12 VDC ±25%	12 VDC ±25%	9.6 VDC to 14.4 VDC; 19.2 VAC to 28.8 VAC	9 VDC to 15 VDC

Model	DS-2CE56U1T-ITZF	DS-2CE56U1T-AITZF	DS-2CE59U1T-VPIT3ZF	DS-2CE59U1T-AVPIT3ZF	DS-2CE5AU1T-VPIT3ZF	DS-2CE5AU1T-AVPIT3ZF
Image						
Description	8 MP Bullet Camera	8 MP Bullet Camera	8 MP Bullet Camera	8 MP Bullet Camera	8 MP Bullet Camera	8 MP Bullet Camera
Lens	2.7 mm to 13.5 mm motorized auto focus lens	2.7 mm to 13.5 mm motorized auto focus lens	2.7 mm to 13.5 mm motorized auto focus lens	2.7 mm to 13.5 mm motorized auto focus lens	2.7 mm to 13.5 mm motorized auto focus lens	2.7 mm to 13.5 mm motorized auto focus lens
Min. Illumination	Color: 0.01 Lux @ (F1.2, AGC ON), 0 Lux with IR	Color: 0.01 Lux @ (F1.2, AGC ON), 0 Lux with IR	Color: 0.01 Lux @ (F1.2, AGC ON), 0 Lux with IR	Color: 0.01 Lux @ (F1.2, AGC ON), 0 Lux with IR	Color: 0.01 Lux @ (F1.2, AGC ON), 0 Lux with IR	Color: 0.01 Lux @ (F1.2, AGC ON), 0 Lux with IR
FOV	108.1° to 45.6°	108.1° to 45.6°	108.1° to 45.6°	108.1° to 45.6°	108.1° to 45.6°	108.1° to 45.6°
Angle Adjustment	Pan: 0° to 355°; Tilt: 0° to 75°; Rotate: 0° to 355°	Pan: 0° to 355°; Tilt: 0° to 75°; Rotate: 0° to 355°	Pan: 0° to 355°; Tilt: 0° to 75°; Rotate: 0° to 355°	Pan: 0° to 355°; Tilt: 0° to 75°; Rotate: 0° to 355°	Pan: 0° to 355°; Tilt: 0° to 75°; Rotate: 0° to 355°	Pan: 0° to 355°; Tilt: 0° to 75°; Rotate: 0° to 355°
Day & Night	IR cut filter	IR cut filter	IR cut filter	IR cut filter	IR cut filter	IR cut filter
WDR	DWDR	DWDR	DWDR	DWDR	DWDR	DWDR
Max. IR Range (meters)	Up to 60 m	Up to 60 m	Up to 60 m	Up to 60 m	Up to 60 m	Up to 60 m
HD Video Output	Switchable TVI / AHD / CVI / CVBS	Switchable TVI / AHD / CVI / CVBS	Switchable TVI / AHD / CVI / CVBS	Switchable TVI / AHD / CVI / CVBS	Switchable TVI / AHD / CVI / CVBS	Switchable TVI / AHD / CVI / CVBS
CVBS Output	-	-	-	-	-	-
D/N Mode	Auto/Color/BW (Black and White)	Auto/Color/BW (Black and White)	Auto/Color/BW (Black and White)	Auto/Color/BW (Black and White)	Auto/Color/BW (Black and White)	Auto/Color/BW (Black and White)
White Balance	ATW/MWB	ATW/MWB	ATW/MWB	ATW/MWB	ATW/MWB	ATW/MWB
BLC	WDR/BLC/OFF	WDR/BLC/OFF	WDR/BLC/OFF	WDR/BLC/OFF	WDR/BLC/OFF	WDR/BLC/OFF
DNR	2D	2D	2D	2D	2D	2D
Functions	Brightness, Sharpness, DNR, Mirror, Smart IR	Brightness, Sharpness, DNR, Mirror, Smart IR	Brightness, Sharpness, DNR, Mirror, Smart IR	Brightness, Sharpness, DNR, Mirror, Smart IR	Brightness, Sharpness, DNR, Mirror, Smart IR	Brightness, Sharpness, DNR, Mirror, Smart IR
Protection Level	IP67	IP67	IP67, IK10	IP67, IK10	IP67, IK10	IP67, IK10
Alarm I/O	-	-	-	-	-	-
Power	9 VDC to 15 VDC	9.6 VDC to 14.4 VDC; 19.2 VAC to 28.8 VAC	9 VDC to 15 VDC	9.6 VDC to 14.4 VDC; 19.2 VAC to 28.8 VAC	9 VDC to 15 VDC	9.6 VDC to 14.4 VDC; 19.2 VAC to 28.8 VAC

Turbo HD Cameras

Eco Series

Eco Smart Hybrid Light cameras make use of intelligent DVRs to provide colorful imaging when the system detects persons and vehicles at night, providing even more critical color-related information to help ensure security.







> 1080p







> Smart Hybrid Light technology

> 4-in-1 video output

> Easy and quick installation



Model	DS-2CE16D0T-EXIF	DS-2CE16D0T-EXIPF	DS-2CE16D0T-EXLF	DS-2CE16D0T-EXLPF	DS-2CE16D0T-IPF	DS-2CE17D0T-EXLF
Image	 NEW HOT	 NEW HOT	 NEW HOT Smart Hybrid Light	 NEW HOT Smart Hybrid Light	 NEW HOT	 NEW HOT Smart Hybrid Light
Description	2 MP Fixed Mini Bullet Camera	2MP Outdoor EXIR Fixed Mini Bullet Camera	2MP Smart Hybrid Light Fixed Mini Bullet Camera	2 MP Smart Hybrid Light Fixed Mini Bullet Camera	2 MP Bullet Camera	2 MP Smart Hybrid Light Fixed Mini Bullet Camera
Lens	2.8 mm, 3.6 mm Fixed Lens	2.8 mm, 3.6 mm Fixed Lens	Fixed focal lens, 2.8 and 3.6 mm optional	Fixed focal lens, 2.8 and 3.6 mm optional	2.8 mm, 3.6 mm Fixed Lens	Fixed focal lens, 2.8 and 3.6 mm optional
Illumination	Min. Illumination: 0.02 Lux @ (F1.2, AGC ON), 0 Lux with IR	Min. Illumination: 0.02 Lux @ (F1.2, AGC ON), 0 Lux with IR	Min. Illumination: 0.02 Lux @ (F1.2, AGC ON), 0 Lux with IR	"White Light,IR IR: Up to 20 m White Light: Up to 20 m"	Min. Illumination: 0.02 Lux @ (F1.2, AGC ON), 0 Lux with IR	"White Light,IR IR : Up to 40 m White Light : Up to 40 m"
FOV	2.8 mm, horizontal FOV: 96.5°, vertical FOV: 48.9°, diagonal FOV: 120.5° 3.6 mm, horizontal FOV: 76.9°, vertical FOV: 40.6°, diagonal FOV: 92.0°	2.8 mm, horizontal FOV: 97°, vertical FOV: 54°, diagonal FOV: 113° 3.6 mm, horizontal FOV: 77°, vertical FOV: 43°, diagonal FOV: 90°	2.8 mm, horizontal FOV: 97°, vertical FOV: 54°, diagonal FOV: 113° 3.6 mm, horizontal FOV: 77°, vertical FOV: 43°, diagonal FOV: 90°	2.8 mm, horizontal FOV: 97°, vertical FOV: 54°, diagonal FOV: 113° 3.6 mm, horizontal FOV: 77°, vertical FOV: 43°, diagonal FOV: 90°	2.8 mm, horizontal FOV: 96.9°, vertical FOV: 52.8°, diagonal FOV: 115.6° 3.6 mm, horizontal FOV: 76.9°, vertical FOV: 40.6°, diagonal FOV: 92.0°	2.8 mm, horizontal FOV: 97°, vertical FOV: 54°, diagonal FOV: 113° 3.6 mm, horizontal FOV: 77°, vertical FOV: 43°, diagonal FOV: 90°
Angle Adjustment	Pan: 0° to 360°, Tilt: 0° to 90°, Rotation: 0° to 360°	Pan: 0 to 360°, Tilt: 0 to 90°, Rotate: 0 to 360°	Pan: 0 to 360°, Tilt: 0 to 90°, Rotate: 0 to 360°	Pan: 0 to 360°, Tilt: 0 to 90°, Rotate: 0 to 360°	Pan: 0° to 360°, Tilt: 0° to 180°, Rotation: 0° to 360°	Pan: 0 to 360°, Tilt: 0 to 75°, Rotate: 0 to 360°
Day & Night	IR Cut Filter	IR Cut Filter	IR Cut Filter	ICR	IR Cut Filter	ICR
WDR	Digital WDR	Digital WDR	Digital WDR	Digital WDR	Digital WDR	Digital WDR
Max. Light Range (meters)	Up to 20 m	Up to 20 m	IR : Up to 20 m White Light : Up to 20 m	IR : Up to 20 m White Light : Up to 20 m	Up to 20 m	IR : Up to 40 m White Light : Up to 40 m
HD Video Output	Switchable TVI/AHD/CVI/CVBS	Switchable TVI/AHD/CVI/CVBS	Switchable TVI/AHD/CVI/CVBS	Switchable TVI/AHD/CVI/CVBS	Switchable TVI/AHD/CVI/CVBS	Switchable TVI/AHD/CVI/CVBS
CVBS Output	-	-	-	-	-	-
D/N Mode	Auto/Color/BW (Black and White)	-	-	-	Auto/Color/BW (Black and White)	-
White Balance	Auto	Auto	Auto/Manual	Auto/Manual	Auto	Auto/Manual
BLC	BLC;Global;DWDR	BLC;Global;DWDR	BLC;Global;DWDR;HLC	BLC;Global;DWDR;HLC	BLC;Global;DWDR	BLC;Global;DWDR;HLC
DNR	2D DNR	2D DNR	2D DNR	2D DNR	2D DNR	2D DNR
Functions	Sharpness;Smart IR;Mirror;Brightness	Sharpness;Smart IR;Mirror;Brightness	Sharpness;Smart IR;Mirror;Brightness	Sharpness;Smart IR;Mirror;Brightness	Brightness;Mirror;Smart IR;Sharpness	-
Protection Level	IP67	IP67	IP67	IP67	IP67	IP67
Alarm I/O	-	-	-	-	-	-
Power	12 VDC ±25%	12 VDC ±25%	12 VDC ±25%	12 VDC ±25%	12 VDC ±25%	12 VDC ±25%

Model	DS-2CE56D0T-IF	DS-2CE56D0T-IPF	DS-2CE76D0T-EXIMF	DS-2CE76D0T-EXIPF	DS-2CE76D0T-EXLMF	DS-2CE76D0T-EXLPF
Image	 NEW HOT	 NEW HOT	 NEW HOT	 NEW HOT	 NEW HOT Smart Hybrid Light	 NEW HOT Smart Hybrid Light
Description	2 MP IR Turret Camera	2 MP Indoor IR Turret Camera	2 MP Outdoor EXIR Fixed Turret Camera	2 MP Indoor Fixed Turret Camera	2MP Smart Hybrid Light Fixed Turret Camera	2MP Smart Hybrid Light Indoor Fixed Turret Camera
Lens	2.8 mm, 3.6 mm fixed lens	2.8 mm, 3.6 mm fixed lens	2.8 mm, 3.6 mm fixed lens	2.8 mm, 3.6 mm fixed lens	Fixed focal lens, 2.8 and 3.6 mm optional	Fixed focal lens, 2.8 and 3.6 mm optional
Illumination	Min. Illumination: 0.02 Lux @ (F1.2, AGC ON), 0 Lux with IR	Min. Illumination: 0.02 Lux @ (F1.2, AGC ON), 0 Lux with IR	Min. Illumination: 0.02 Lux @ (F1.2, AGC ON), 0 Lux with IR	Min. Illumination: 0.02 Lux @ (F1.2, AGC ON), 0 Lux with IR	Min. Illumination: 0.02 Lux @ (F1.2, AGC ON), 0 Lux with IR	Min. Illumination: 0.02 Lux @ (F1.2, AGC ON), 0 Lux with IR
FOV	Horizontal Field of View 103°(2.8 mm), 82.2°(3.6 mm)	2.8 mm, horizontal FOV: 96.9°, vertical FOV: 52.8°, diagonal FOV: 115.6° 3.6 mm, horizontal FOV: 76.9°, vertical FOV: 40.6°, diagonal FOV: 92.0°	2.8 mm, horizontal FOV: 96.5°, vertical FOV: 48.9°, diagonal FOV: 120.5° 3.6 mm, horizontal FOV: 76.9°, vertical FOV: 40.6°, diagonal FOV: 92.0°	2.8 mm, horizontal FOV: 96.5°, vertical FOV: 48.9°, diagonal FOV: 120.5° 3.6 mm, horizontal FOV: 76.9°, vertical FOV: 40.6°, diagonal FOV: 92.0°	2.8 mm, horizontal FOV: 97°, vertical FOV: 54°, diagonal FOV: 113° 3.6 mm, horizontal FOV: 77°, vertical FOV: 43°, diagonal FOV: 90°	2.8 mm, horizontal FOV: 97°, vertical FOV: 54°, diagonal FOV: 113° 3.6 mm, horizontal FOV: 77°, vertical FOV: 43°, diagonal FOV: 90°
Angle Adjustment	Pan: 0° to 360°, Tilt: 0° to 75°, Rotation: 0° to 360°	Pan: 0° to 360°, Tilt: 0° to 75°, Rotation: 0° to 360°	Pan: 0° to 360°, Tilt: 0° to 75°, Rotation: 0° to 360°	Pan: 0° to 360°, Tilt: 0° to 75°, Rotation: 0° to 360°	Pan: 0 to 360°, Tilt: 0 to 75°, Rotate: 0 to 360°	Pan: 0 to 360°, Tilt: 0 to 75°, Rotate: 0 to 360°
Day & Night	IR cut filter	IR cut filter	IR cut filter	IR Cut Filter	ICR	ICR
WDR	Digital WDR	Digital WDR	Digital WDR	Digital WDR	Digital WDR	Digital WDR
Max. Light Range (meters)	Up to 20 m	Up to 20 m	Up to 20 m	Up to 20 m	IR : Up to 20 m White Light : Up to 20 m	IR : Up to 20 m White Light : Up to 20 m
HD Video Output	Switchable TVI/AHD/CVI/CVBS	Switchable TVI/AHD/CVI/CVBS	Switchable TVI/AHD/CVI/CVBS	Switchable TVI/AHD/CVI/CVBS	Switchable TVI/AHD/CVI/CVBS	Switchable TVI/AHD/CVI/CVBS
CVBS Output	-	-	-	-	-	-
D/N Mode	Smart/color/BW(Black and White)	Auto/Color/BW (Black and White)	Auto/Color/BW (Black and White)	Auto/Color/BW (Black and White)	-	-
White Balance	Auto	Auto	Auto	Auto	Auto/Manual	Auto/Manual
BLC	BLC;Global;DWDR	BLC;Global;DWDR	BLC;Global;DWDR	BLC;Global;DWDR	DWDR/BLC/HLC/Global	DWDR/BLC/HLC/Global
DNR	2D DNR	2D DNR	2D DNR	2D DNR	-	-
Functions	Sharpness;Smart IR;Mirror;Brightness	Brightness;Mirror;Smart IR;Sharpness	Brightness;Mirror;Smart IR;Sharpness	Sharpness;Smart IR;Mirror;Brightness	Brightness, Sharpness, Smart IR	Brightness, Sharpness, Smart IR
Protection Level	IP66	IP67	IP67	-	IP67	-
Alarm I/O	-	-	-	-	-	-
Power	12 VDC ±25%	12 VDC ±25%	12 VDC ±25%	12 VDC ±25%	12 VDC ± 25%, Max. 3.2 W	12 VDC ± 25%, Max. 3.2 W

Turbo HD PTZ Cameras

052 AE7

053 AE5

054 AE4



Turbo HD PTZ Cameras







More Options, Better Compatibility







Turbo HD PTZ Cameras capture high quality images even in poorly lit environments. With the embedded CMOS chip, WDR and real-time 1920 x 1080 resolution becomes possible. The speed domes feature wide compatibility thanks to the 4-in-1 video output.

- > Up to 1920 x 1080 resolution
- > 120 dB WDR
- > 4-in-1 video output: 1 BNC, 4 switchable video outputs for TVI / AHD / CVI / CVBS
- > More options for zoom ratio – 32x / 25x / 15x
- > Minimum illumination
 - Color: 0.005 lux @ F1.6
 - AGC on B/W: 0.001 lux @ F1.6
 - AGC on IR: 0 lux



Model	DS-2AE7225TI-A	DS-2AE7232TI-A
Image		
Description	1/2.8" HD progressive scan CMOS 1920 x 1080 resolution 25x optical zoom, 16x digital zoom 120 dB true WDR (Wide Dynamic Range) Up to 150 m IR distance 3D intelligent positioning Switchable TVI/AHD/CVI/CVBS video outputs	1/2.8" HD progressive scan CMOS 1920 x 1080 resolution 32x optical zoom, 16x digital zoom 120 dB true WDR (Wide Dynamic Range) Up to 150 m IR distance 3D intelligent positioning Switchable TVI/AHD/CVI/CVBS video outputs
Lens	4.8 mm to 120 mm, 25x Optical	4.8 mm to 153 mm, 32x Optical
Min. Illumination	Color: 0.005 Lux @(F1.6, AGC ON)	Color: 0.005 Lux @(F1.2, AGC ON)
Angle Adjustment	57.6° to 2.5° (wide-tele)	54.2° to 1.97° (wide-tele)
Day & Night	ICR	ICR
WDR	≥ 120 dB	≥ 120 dB
Max. IR Range	Up to 150 m	Up to 150 m
HD Video Output	Switchable TVI/AHD/CVI/CVBS video output, (NTSC or PAL composite, BNC)	Switchable TVI/AHD/CVI/CVBS video output, (NTSC or PAL composite, BNC)
White Balance	AUTO/MANUAL/HAUTO/ATW/INDOOR/OUTDOOR	AUTO/MANUAL/HAUTO/ATW/INDOOR/OUTDOOR
BLC	Support	Support
3D DNR	Support	Support
UTC Functions	UTC protocol (or HIKVISION-C protocol in previous DVR)	UTC protocol (or HIKVISION-C protocol in previous DVR)
Protection Level	IP66 standard (outdoor dome) TVS 4,000 V lightning protection, surge protection and voltage transient protection IK10 (excluding glass window)	IP66 standard (outdoor dome) TVS 4,000 V lightning protection, surge protection and voltage transient protection IK10 (excluding glass window)
Alarm I/O	-	-
Power	24 VAC Max.: 40 W (Max. 14 W for IR)	24 VAC Max.: 40 W (Max. 14 W for IR)

Model	DS-2AE5225T-A	DS-2AE5232T-A	DS-2AE5225T-A3	DS-2AE5232T-A3	DS-2AE5225TI-A	DS-2AE5232TI-A
Image						
Description	1/2.8" HD progressive scan CMOS 1920 × 1080 resolution 25× optical zoom, 16× digital zoom 120 dB true WDR (Wide Dynamic Range) 3D intelligent positioning Switchable TVI/AHD/CVI/CVBS video outputs	1/2.8" HD progressive scan CMOS 1920 × 1080 resolution 32× optical zoom, 16× digital zoom 120 dB true WDR (Wide Dynamic Range) 3D intelligent positioning Switchable TVI/AHD/CVI/CVBS video outputs	1/2.8" HD progressive scan CMOS 1920 × 1080 resolution 25× optical zoom, 16× digital zoom 120 dB true WDR (Wide Dynamic Range) 3D intelligent positioning Switchable TVI/AHD/CVI/CVBS video outputs	1/2.8" HD progressive scan CMOS 1920 × 1080 resolution 32× optical zoom, 16× digital zoom 120 dB true WDR (Wide Dynamic Range) 3D intelligent positioning Switchable TVI/AHD/CVI/CVBS video outputs	1/2.8" HD progressive scan CMOS 1920 × 1080 resolution 25× optical zoom, 16× digital zoom 120 dB true WDR (Wide Dynamic Range) Up to 150 m IR distance 3D intelligent positioning Switchable TVI/AHD/CVI/CVBS video outputs	1/2.8" HD progressive scan CMOS 1920 × 1080 resolution 32× optical zoom, 16× digital zoom 120 dB true WDR (Wide Dynamic Range) Up to 150 m IR distance 3D intelligent positioning Switchable TVI/AHD/CVI/CVBS video outputs
Lens	4.8 mm to 120 mm, 25× Optical	4.8 mm to 153 mm, 32× Optical	4.8 mm to 120 mm, 25× Optical	4.8 mm to 153 mm, 32× Optical	4.8 mm to 120 mm, 25× Optical	4.8 mm to 153 mm, 32× Optical
Min. Illumination	Color: 0.005 Lux @(F1.6, AGC ON)	Color: 0.005 Lux @(F1.2, AGC ON)	Color: 0.005 Lux @(F1.6, AGC ON)	Color: 0.005 Lux @(F1.2, AGC ON)	Color: 0.005 Lux @(F1.6, AGC ON)	Color: 0.005 Lux @(F1.2, AGC ON)
Angle Adjustment	57.6° to 2.5° (wide-tele)	55.6° to 2.04° (wide-tele)	57.6° to 2.5° (wide-tele)	55.6° to 2.04° (wide-tele)	57.6° to 2.5° (wide to tele)	55.6° to 2.04° (wide to tele)
Day & Night	ICR	ICR	ICR	ICR	ICR	ICR
WDR	≥ 120 dB	≥ 120 dB	≥ 120 dB	≥ 120 dB	≥ 120 dB	≥ 120 dB
Max. IR Range	-	-	-	-	Up to 150 m	Up to 150 m
HD Video Output	Switchable TVI/AHD/CVI/CVBS video output, (NTSC or PAL composite, BNC)	Switchable TVI/AHD/CVI/CVBS video output, (NTSC or PAL composite, BNC)	Switchable TVI/AHD/CVI/CVBS video output, (NTSC or PAL composite, BNC)	Switchable TVI/AHD/CVI/CVBS video output, (NTSC or PAL composite, BNC)	Switchable TVI/AHD/CVI/CVBS video output, (NTSC or PAL composite, BNC)	Switchable TVI/AHD/CVI/CVBS video output, (NTSC or PAL composite, BNC)
White Balance	AUTO/MANUAL/HAUTO/ATW/INDOOR/OUTDOOR	AUTO/MANUAL/HAUTO/ATW/INDOOR/OUTDOOR	AUTO/MANUAL/HAUTO/ATW/INDOOR/OUTDOOR	AUTO/MANUAL/HAUTO/ATW/INDOOR/OUTDOOR	AUTO/MANUAL/HAUTO/ATW/INDOOR/OUTDOOR	AUTO/MANUAL/HAUTO/ATW/INDOOR/OUTDOOR
BLC	Support	Support	Support	Support	Support	Support
3D DNR	Support	Support	Support	Support	Support	Support
UTC Functions	UTC protocol (or HIKVISION-C protocol in previous DVR)	UTC protocol (or HIKVISION-C protocol in previous DVR)	UTC protocol (or HIKVISION-C protocol in previous DVR)	UTC protocol (or HIKVISION-C protocol in previous DVR)	UTC protocol (or HIKVISION-C protocol in previous DVR)	UTC protocol (or HIKVISION-C protocol in previous DVR)
Protection Level	IP66 standard (outdoor dome) TVS 4,000 V lightning protection, surge protection and voltage transient protection, IK10	IP66 standard (outdoor dome) TVS 4,000 V lightning protection, surge protection and voltage transient protection, IK10	TVS 4,000 V lightning protection, surge protection and voltage transient protection	TVS 4,000 V lightning protection, surge protection and voltage transient protection	IP66 standard (outdoor dome) TVS 4,000 V lightning protection, surge protection and voltage transient protection	IP66 standard (outdoor dome) TVS 4,000 V lightning protection, surge protection and voltage transient protection
Alarm I/O	2/1	2/1	2/1	2/1	2/1	2/1
Power	24 VAC Max.: 24 W	24 VAC Max.: 24 W	24 VAC Max.: 18 W	24 VAC Max.: 18 W	24 VAC Max.: 30 W (Max. 10 W for IR)	24 VAC Max.: 30 W (Max. 10 W for IR)

Model	DS-2AE4215T-D	DS-2AE4225T-D	DS-2AE4215T-D3	DS-2AE4225T-D3	DS-2AE4215TI-D	DS-2AE4225TI-D
Image						
Description	1/2.8" HD progressive scan CMOS 1920 × 1080 15 × optical zoom, 16× digital zoom 120 dB true WDR (Wide Dynamic Range) 3D intelligent positioning Switchable TVI/AHD/CVI/CVBS video outputs	1/2.8" HD progressive scan CMOS 1920 × 1080 resolution 25× optical zoom, 16× digital zoom 120 dB true WDR (Wide Dynamic Range) 3D intelligent positioning Switchable TVI/AHD/CVI/CVBS video outputs	1/2.8" HD progressive scan CMOS 1920 × 1080 15 × optical zoom, 16× digital zoom 120 dB true WDR (Wide Dynamic Range) 3D intelligent positioning Switchable TVI/AHD/CVI/CVBS video outputs	1/2.8" HD progressive scan CMOS 1920 × 1080 resolution 25 × optical zoom, 16× digital zoom 120 dB true WDR (Wide Dynamic Range) 3D intelligent positioning Switchable TVI/AHD/CVI/CVBS video outputs	1/2.8" HD progressive scan CMOS 1920 × 1080 resolution 15× optical zoom, 16× digital zoom 120 dB True WDR (Wide Dynamic Range) Up to 100 m IR distance 3D intelligent positioning Switchable Turbo HD and CVBS outputs	1/2.8" HD progressive scan CMOS 1920 × 1080 resolution 25× optical zoom, 120 dB true WDR (Wide Dynamic Range) Up to 100 m IR distance 3D intelligent positioning Switchable TVI/AHD/CVI/CVBS video outputs
Lens	5 mm to 75 mm, 15× Optical	4.8 mm to 120 mm, 25× Optical	5 mm to 75 mm, 15× Optical	4.8 mm to 120 mm, 25× Optical	5 mm to 75 mm, 15× Optical	4.8 mm to 120 mm, 25× Optical
Min. Illumination	Color: 0.005 Lux @(F1.6, AGC ON)	Color: 0.005 Lux @(F1.6, AGC ON)	Color: 0.005 Lux @(F1.6, AGC ON)	Color: 0.005 Lux @(F1.6, AGC ON)	Color: 0.005 Lux @(F1.6, AGC ON)	Color: 0.005 Lux @(F1.6, AGC ON)
Angle Adjustment	53.8° to 4.0° (wide-tele)	57.6° to 2.5° (wide-tele)	53.8° to 4.0° (wide-tele)	57.6° to 2.5° (wide-tele)	53.8° to 4.0° (wide-tele)	57.6° to 2.5° (wide-tele)
Day & Night	ICR	ICR	ICR	ICR	ICR	ICR
WDR	≥ 120 dB	≥ 120 dB	≥ 120 dB	≥ 120 dB	≥ 120 dB	≥ 120 dB
Max. IR Range	-	-	-	-	Up to 100 m	Up to 100 m
HD Video Output	Switchable TVI/AHD/CVI/CVBS video output, (NTSC or PAL composite, BNC)	Switchable TVI/AHD/CVI/CVBS video output, (NTSC or PAL composite, BNC)	Switchable TVI/AHD/CVI/CVBS video output, (NTSC or PAL composite, BNC)	Switchable TVI/AHD/CVI/CVBS video output, (NTSC or PAL composite, BNC)	Switchable TVI/AHD/CVI/CVBS video output, (NTSC or PAL composite, BNC)	Switchable TVI/AHD/CVI/CVBS video output, (NTSC or PAL composite, BNC)
White Balance	AUTO/MANUAL/HAUTO/ATW/INDOOR/OUTDOOR	AUTO/MANUAL/HAUTO/ATW/INDOOR/OUTDOOR	AUTO/MANUAL/HAUTO/ATW/INDOOR/OUTDOOR	AUTO/MANUAL/HAUTO/ATW/INDOOR/OUTDOOR	AUTO/MANUAL/HAUTO/ATW/INDOOR/OUTDOOR	AUTO/MANUAL/HAUTO/ATW/INDOOR/OUTDOOR
BLC	Support	Support	Support	Support	Support	Support
3D DNR	Support	Support	Support	Support	Support	Support
UTC Functions	UTC protocol (or HIKVISION-C protocol in previous DVR)	UTC protocol (or HIKVISION-C protocol in previous DVR)	UTC protocol (or HIKVISION-C protocol in previous DVR)	UTC protocol (or HIKVISION-C protocol in previous DVR)	UTC protocol (or HIKVISION-C protocol in previous DVR)	UTC protocol (or HIKVISION-C protocol in previous DVR)
Protection Level	IP66 standard (outdoor dome) TVS 4,000 V lightning protection, surge protection and voltage transient protection	IP66 standard (outdoor dome) TVS 4,000 V lightning protection, surge protection and voltage transient protection	TVS 4,000 V lightning protection, surge protection and voltage transient protection	TVS 4,000 V lightning protection, surge protection and voltage transient protection	IP66 standard (outdoor dome) TVS 4,000 V lightning protection, surge protection and voltage transient protection	IP66 standard (outdoor dome) TVS 4,000 V lightning protection, surge protection and voltage transient protection
Alarm I/O	2/1	2/1	2/1	2/1	-	-
Power	12 VDC Max.: 16 W	12 VDC Max.: 16 W	12 VDC Max.: 12 W	12 VDC Max.: 12 W	12 VDC Max.: 20 W (Max. 7 W for IR)	12 VDC Max.: 20 W (Max. 7 W for IR)

Turbo HD DVRs

056 eDVR Series with eSSD technology

058 Ultra Series with AcuSense

061 Pro Series with AcuSense

068 Value Series

073 Special Series







Turbo HD DVRs

eDVR Series with eSSD technology

With its embedded solid state drive (SSD), the Hikvision eDVR is stable and sturdy, immune to physical shocks or impacts, keeping your data safe. End-customers benefit from an easy and flexible installation process, low energy consumption, minimal maintenance requirements, and high performance video capture, storage, and processing.

- > Powered by eSSD technology
- > Low power consumption
- > Scene-adaptive bitrate control video compression
- > Deep learning-based person and vehicle target classification (Motion Detection 2.0 / AcuSense)
- > HDTVI/AHD/CVI/CVBS/ IP video inputs



Model	DS-E04HGHI-B	DS-E08HGHI-B	DS-E16HGHI-B	DS-E04HGHI-D	DS-E08HGHI-D
Image	 NEW	 NEW	 NEW	 NEW	 NEW
Video Compression	H.265 Pro/H.265	H.265 Pro/H.265	H.265 Pro/H.265	H.265 Pro/H.265	H.265 Pro/H.265
Analog Video-Audio Input	4-ch	8-ch	16-ch	4-ch	8-ch
IP Video Input	1-ch Up to 1080p resolution Support H.265+/H.265 IP cameras	2-ch Up to 5 MP resolution, Support H.265+/H.265 IP cameras	2-ch Up to 5 MP resolution, Support H.265+/H.265 IP cameras	1-ch Up to 1080p resolution Support H.265+/H.265 IP cameras	2-ch Up to 5 MP resolution Support H.265+/H.265 IP cameras
Audio Input	4-ch via coaxial cable	8-ch via coaxial cable	16-ch via coaxial cable	4-ch via coaxial cable	8-ch via coaxial cable
HDMI / VGA Output	1-ch, 1920 × 1080/60Hz, 1280 × 1024/60Hz, 1280 × 720/60Hz	1-ch, 1920 × 1080/60 Hz, 1280 × 1024/60 Hz, 1280 × 720/60 Hz	1-ch, 1920 × 1080/60 Hz, 1280 × 1024/60 Hz, 1280 × 720/60 Hz	1-ch, 1920 × 1080/60 Hz, 1280 × 1024/60 Hz, 1280 × 720/60 Hz	1-ch, 1920 × 1080/60 Hz, 1280 × 1024/60 Hz, 1280 × 720/60 Hz
Audio Output	1-ch via HDMI	1-ch via HDMI	1-ch via HDMI	1-ch via HDMI	
Encoding Capability	Main stream: 1080p Lite/720p/WD1/4CIF/CIF@25 fps (P)/30 fps (N) Note: 1080p Lite/720p is 15 fps by default Sub-stream: 4CIF@15 fps; CIF/QVGA@25 fps (P)/30 fps (N)	Main stream: 1080p Lite/720p/WD1/4CIF/CIF@25 fps (P)/30 fps (N) Note: 1080p Lite/720p is 15 fps by default Sub-stream: CIF/QVGA@25 fps (P)/30 fps (N)	Main stream: 1080p Lite/720p/WD1/4CIF@25 fps (P)/30 fps (N) Note: 1080p Lite/720p is 15 fps by default Sub-stream: CIF/QVGA@25 fps (P)/31 fps (N)	Main stream: 1080p Lite/720p/720p Lite/WD1/4CIF@25 fps (P)/30 fps (N) Note: 1080p Lite/720p is 15 fps by default Sub-stream: 4CIF@15 fps; CIF/QVGA@25 fps (P)/30 fps (N)	Main stream: 1080p Lite/720p/720p Lite/WD1/4CIF@15 fps (N) Note: 1080p Lite/720p is 15 fps by default Sub-stream: CIF/QVGA@15 fps
Capacity	Built-in 330 GB eSSD (300 GB available) Note: The device can store about 2 weeks videos for 4-ch analog cameras (default parameters), this estimation is for reference only.	Built-in 512 GB eSSD (480 GB available) Note: The device can store about 2 weeks videos for 8-ch analog cameras (default parameters), this estimation is for reference only.	Built-in 1024 GB eSSD (960 GB available) Note: The device can store about 2 weeks videos for 16-ch analog cameras (default parameters), this estimation is for reference only.	Built-in 512 GB eSSD (480 GB available) Note: The device can store about 4 weeks videos for 4-ch analog cameras (default parameters), this estimation is for reference only	Built-in 1024 GB eSSD (960 GB available) Note: The device can store about 4 weeks videos for 8-ch analog cameras (default parameters), this estimation is for reference only
Network Interface	1, RJ45 10/100 Mbps self-adaptive Ethernet interface	1, RJ45 10/100 Mbps self-adaptive Ethernet interface	1, RJ45 10/100 Mbps self-adaptive Ethernet interface	1, RJ45 10/100 Mbps self-adaptive Ethernet interface	1, RJ45 10/100 Mbps self-adaptive Ethernet interface
Serial Interface	-	-	-	-	-
USB Port	2 × USB 2.0	2 × USB 2.0	2 × USB 2.0	2 × USB 2.0	2 × USB 2.0
Smart Function	1. Human body & vehicle recognition 2. Motion Detection 2.0: human & vehicle classification for all analog channels	1. Human body & vehicle recognition 2. Motion Detection 2.0: human & vehicle classification for all analog channels	Motion Detection 2.0: human & vehicle classification for all analog channels	Motion Detection 2.0: human & vehicle classification for all analog channels	Motion Detection 2.0: human & vehicle classification for all analog channels
Alarm I/O	-	-	-	-	-
Power	12 VDC	12 VDC	12 VDC	12 VDC	12 VDC
Chassis	Metal mini 1U	Metal mini 1U	Metal mini 1U	Metal mini 1U	Metal mini 1U

HD 1080p

Model	DS-E04HGHI-E
Image	 NEW
Video Compression	H.265 Pro/H.265
Analog Video-Audio Input	4-ch
IP Video Input	1-ch Up to 1080p resolution Support H.265+/H.265 IP cameras
Audio Input	4-ch via coaxial cable
HDMI / VGA Output	1-ch, 1920 × 1080/60 Hz, 1280 × 1024/60 Hz, 1280 × 720/60 Hz
Audio Output	1-ch via HDMI
Encoding Capability	Main stream: 1080p Lite/720p/720p Lite/WD1/4CIF@25 fps (PI/30 fps (N)) Note: 1080p Lite/720p is 15 fps by default Sub-stream: 4CIF@15 fps; CIF/QVGA@25 fps (PI/30 fps (N))
Capacity	Built-in 1024 GB eSSD (960 GB available) Note: The device can store about 8 weeks videos for 4-ch analog cameras (default parameters), this estimation is for reference only.
Network Interface	1, RJ45 10/100 Mbps self-adaptive Ethernet interface
Serial Interface	-
USB Port	2 × USB 2.0
Smart Function	Motion Detection 2.0: human & vehicle classification for all analog channels
Alarm I/O	-
Power	12 VDC
Chassis	Metal mini 1U

Model	IDS-E04HQHI-B	IDS-E08HQHI-B	IDS-E04HQHI-D
Image	 NEW	 NEW	 NEW
Video Compression	H.265 Pro/H.265	H.265 Pro/H.265	H.265 Pro/H.265
Analog Video-Audio Input	4-ch	8-ch	4-ch
IP Video Input	1-ch Up to 6 MP Support H.265+/H.265 IP cameras	2-ch Up to 6 MP resolution Support H.265+/H.265 IP cameras	1-ch Up to 6 MP resolution Support H.265+/H.265 IP cameras
Audio Input	4-ch via coaxial cable	8-ch via coaxial cable	4-ch via coaxial cable
HDMI / VGA Output	1-ch, 1920 × 1080/60 Hz, 1280 × 1024/60 Hz, 1280 × 720/60 Hz	1-ch, 1920 × 1080/60 Hz, 1280 × 1024/60 Hz, 1280 × 720/60 Hz	1-ch, 1920 × 1080/60 Hz, 1280 × 1024/60 Hz, 1280 × 720/60 Hz
Audio Output	1-ch via HDMI	1-ch via HDMI	1-ch via HDMI
Encoding Capability	Main stream: When 1080p Lite mode not enabled: For 3K stream access: 3K Lite@12 fps; 4 MP Lite/1080p@15 fps; 720p/WD1/4CIF/VGA/CIF@20 fps For 5 MP stream access: 5 MP Lite@12fps; 4 MP Lite/1080p@15 fps; 720p/WD1/4CIF/VGA/CIF@20 fps For 4 MP stream access: 4 MP Lite/1080p@15 fps; 720p/WD1/4CIF/VGA/CIF@25 fps (PI/30 fps (N)) For 1080p stream access: 1080p/720p@15 fps; VGA/WD1/4CIF/CIF@25 fps (PI/30 fps (N)) For 720p stream access: 720p/VGA/WD1/4CIF/CIF@25 fps (PI/30 fps (N)) When 1080p Lite mode enabled: 3K Lite/5 MP Lite@12fps; 4 MP Lite@15 fps; 1080p Lite/720p Lite/VGA/WD1/4CIF/CIF@25 fps (PI/30 fps (N)) Sub-stream: WD1/4CIF@12 fps; CIF@25 fps (PI/30 fps (N)) note: for 3K Lite and 5MP Lite stream, only channel 1 support	Main stream: When 1080p lite mode not enabled: For 5 MP stream access: 5MP Lite@12fps; 4 MP lite/1080p@15fps; 720p/WD1/4CIF/VGA/CIF@20fps For 1080p stream access: 1080p/720p@15 fps; WD1/4CIF@25 fps (PI/30 fps (N)) For 720p stream access: 720p/WD1/4CIF@25 fps (PI/30 fps (N)) When 1080p Lite mode enabled: 5MP/3K lite@12fps; 4 MP lite/@15 fps; 1080p lite/720p/WD1/4CIF@25 fps (PI/30 fps (N))	Main stream: When 1080p Lite mode not enabled: For 3K stream access: 3K Lite@12 fps; 4 MP Lite/1080p@15 fps; 720p/WD1/4CIF/VGA/CIF@20 fps For 5 MP stream access: 5 MP Lite@12fps; 4 MP Lite/1080p@15 fps; 720p/WD1/4CIF/VGA/CIF@20 fps For 4 MP stream access: 4 MP Lite/1080p@15 fps; 720p/WD1/4CIF/VGA/CIF@25 fps (PI/30 fps (N)) For 1080p stream access: 1080p/720p@15 fps; VGA/WD1/4CIF/CIF@25 fps (PI/30 fps (N)) For 720p stream access: 720p/VGA/WD1/4CIF/CIF@25 fps (PI/30 fps (N)) When 1080p Lite mode enabled: 3K Lite/5 MP Lite@12fps; 4 MP Lite@15 fps; 1080p Lite/720p Lite/VGA/WD1/4CIF/CIF@25 fps (PI/30 fps (N)) Sub-stream: WD1/4CIF@12 fps; CIF@25 fps (PI/30 fps (N)) note: for 3K Lite and 5MP Lite stream, only channel 1 support
Capacity	Built-in 512 GB eSSD (480 GB available) Note: The device can store about 2 weeks videos for 4-ch analog cameras (default parameters), this estimation is for reference only	Built-in 1024 GB eSSD (960 GB available) Note: The device can store about 2 weeks videos for 8-ch analog cameras (default parameters), this estimation is for reference only.	Built-in 1024 GB eSSD (960 GB available) Note: The device can store about 4 weeks videos for 4-ch analog cameras (default parameters), this estimation is for reference only
Network Interface	1, RJ45 10/100 Mbps self-adaptive Ethernet interface	1, RJ45 10/100 Mbps self-adaptive Ethernet interface	1, RJ45 10/100 Mbps self-adaptive Ethernet interface
Serial Interface	-	-	-
USB Port	2 × USB 2.0	2 × USB 2.0	2 × USB 2.0
Smart Function	AcuSense: Motion Detection 2.0/ Perimeter protection	AcuSense: Motion Detection 2.0/ Perimeter protection	AcuSense: Motion Detection 2.0/ Perimeter protection
Alarm I/O	-	-	-
Power	12 VDC	12 VDC	12 VDC
Chassis	Metal mini 1U	Metal mini 1U	Metal mini 1U

HD 5MP

Model	IDS-E04HUHI-B
Image	 NEW
Video Compression	H.265 Pro/H.265
Analog Video-Audio Input	4-ch
IP Video Input	2-ch Up to 8 MP resolution Support H.265 IP cameras
Audio Input	4-ch via coaxial cable
HDMI / VGA Output	1-ch, 1920 × 1080/60 Hz, 1280 × 1024/60 Hz, 1280 × 720/60 Hz
Audio Output	1-ch via HDMI
Encoding Capability	Main stream: 8 MP@8 fps/3K@12 fps/5 MP@12 fps/4 MP@15 fps/3 MP@18 fps 1080p/720p/WD1/4CIF@25 fps (PI/30 fps (N)) *: 8 MP@8 fps is only available for channel 1. Sub-stream: WD1/4CIF/CIF@25 fps (PI/30 fps (N))
Capacity	Built-in 1024 GB eSSD (960 GB available) Note: The device can store about 2 weeks videos for 4-ch analog cameras (default parameters), this estimation is for reference only
Network Interface	1, RJ45 10/100 Mbps self-adaptive Ethernet interface
Serial Interface	-
USB Port	2 × USB 2.0
Smart Function	AcuSense: Motion Detection 2.0/ Perimeter protection
Alarm I/O	-
Power	12 VDC
Chassis	Metal mini 1U



Turbo HD DVRs



Ultra Series with AcuSense

With excellent performance, the Ultra Series DVRs can accommodate up to 32 channels of analog cameras. Ultra Series DVRs have strong hybrid access capability. The 8 SATA interfaces are useful for users who require larger storage space.

- > Motion Detection 2.0 with human & vehicle classification for all analog channels
- > Human & vehicle classification based on VCA results
- > Search human and vehicle targets quickly
- > Ultra HD, compatible with cameras of up to 4K resolution
- > H.265 Pro+ / H.265 Pro / H.265
- > Adaptive signal input (five types: HDTVI / AHD / CVI / CVBS / IP)
- > Enhanced network camera access capability



Model	IDS-8116HQHI-M8/S	IDS-9032HQHI-M8/S	IDS-7316HQHI-M4/S	IDS-7332HQHI-M4/S
Image	 AcuSense	 AcuSense	 AcuSense	 AcuSense
Video Compression	H.265Pro+/H.265Pro/H.265/H.264+/H.264	H.265Pro+/H.265Pro/H.265/H.264+/H.264	H.265 Pro+ / H.265 Pro / H.265 / H.264+ / H.264	H.265 Pro+ / H.265 Pro / H.265 / H.264+ / H.264
Analog Video-Audio Input	16-ch	32-ch	16-ch	32-ch
IP Video Input	8-ch (Up to 24-ch), Up to 6 MP	16-ch (Up to 48-ch), Up to 6 MP	8-ch (Up to 24-ch), Up to 6 MP resolution	16-ch (Up to 48-ch), Up to 6 MP resolution
Audio Input	16-ch, RCA (2.0 Vp-p, 1 KΩ)	16-ch, RCA (2.0 Vp-p, 1 KΩ)	4-ch, RCA (2.0 Vp-p, 1 KΩ)	4-ch, RCA (2.0 Vp-p, 1 KΩ)
HDMI / VGA Output	VGA: 1-ch, 1920 × 1080/60Hz, 1280 × 1024/60Hz, 1280 × 720/60Hz, 1024 × 768/60Hz HDMI: 1-ch, 4K (3840 × 2160)/30Hz, 2K (2560 × 1440)/60Hz, 1920 × 1080/60Hz, 1280 × 1024/60Hz, 1280 × 720/60Hz, 1024 × 768/60Hz	1-ch, 1920 × 1080/60Hz, 1280 × 1024/60Hz, 1280 × 720/60Hz, 1024 × 768/60Hz	VGA: 1-ch, 1920 × 1080/60Hz, 1280 × 1024/60Hz, 1280 × 720/60Hz, 1024 × 768/60Hz HDMI: 1-ch, 4K (3840 × 2160)/30Hz, 2K (2560 × 1440)/60Hz, 1920 × 1080/60Hz, 1280 × 1024/60Hz, 1280 × 720/60Hz, 1024 × 768/60Hz	1-ch, 1920 × 1080/60Hz, 1280 × 1024/60Hz, 1280 × 720/60Hz, 1024 × 768/60Hz
HDMI2 Output	-	1-ch, 4K (3840 × 2160)/30Hz, 2K (2560 × 1440)/60Hz, 1920 × 1080/60Hz, 1280 × 1024/60Hz, 1280 × 720/60Hz, 1024 × 768/60Hz	-	1-ch, 4K (3840 × 2160)/30Hz, 2K (2560 × 1440)/60Hz, 1920 × 1080/60Hz, 1280 × 1024/60Hz, 1280 × 720/60Hz, 1024 × 768/60Hz
CVBS Output	1-ch, BNC (1.0 Vp-p, 75 Ω), resolution: PAL: 704 × 576, NTSC: 704 × 480	1-ch, BNC (1.0 Vp-p, 75 Ω), resolution: PAL: 704 × 576, NTSC: 704 × 480	1-ch, BNC (1.0 Vp-p, 75 Ω), resolution: PAL: 704 × 576, NTSC: 704 × 480	1-ch, BNC (1.0 Vp-p, 75 Ω), resolution: PAL: 704 × 576, NTSC: 704 × 480
Audio Output	2-ch, RCA (Linear, 1 KΩ)	2-ch, RCA (Linear, 1 KΩ)	2-ch, RCA (Linear, 1KΩ)	1-ch, RCA (Linear, 1 KΩ)
Encoding Capability	Main stream: When 1080p Lite mode not enabled: For 4 MP stream access: 4 MP lite@15fps; 1080p lite/720p/WD1/4CIF/VGA/CIF@25fps (P)/30fps (N) For 3 MP stream access: 3 MP/1080p/720p/WD1/4CIF/VGA/CIF@15fps For 1080p stream access: 1080p/720p@15fps; 720p/WD1/4CIF/VGA/CIF@25fps (P)/30fps (N) For 720p stream access: 720p/WD1/4CIF/VGA/CIF@25fps (P)/30fps (N) When 1080p Lite mode enabled: For 4 MP stream access: 4 MP lite@15fps; 1080p lite/720p lite/WD1/4CIF/VGA/CIF@25fps (P)/30fps (N) For 3 MP stream access: 3 MP/1080p lite/720p lite/WD1/4CIF/VGA/CIF@15fps For 1080p stream access: 1080p lite/720p lite/WD1/4CIF/VGA/CIF@25fps (P)/30fps (N) For 720p stream access: 720p/WD1/4CIF/VGA/CIF@25fps (P)/30fps (N) Sub-stream: WD1/4CIF@12fps; CIF@25fps (P)/30fps (N)	Main stream: When 1080p Lite mode not enabled: For 4 MP stream access: 4 MP lite@15fps; 1080p lite/720p/WD1/4CIF/VGA/CIF@25fps (P)/30fps (N) For 3 MP stream access: 3 MP/1080p/720p/WD1/4CIF/VGA/CIF@15fps For 1080p stream access: 1080p/720p@15fps; 720p/WD1/4CIF/VGA/CIF@25fps (P)/30fps (N) For 720p stream access: 720p/WD1/4CIF/VGA/CIF@25fps (P)/30fps (N) When 1080p Lite mode enabled: For 4 MP stream access: 4 MP lite@15fps; 1080p lite/720p lite/WD1/4CIF/VGA/CIF@25fps (P)/30fps (N) For 3 MP stream access: 3 MP/1080p lite/720p lite/WD1/4CIF/VGA/CIF@15fps For 1080p stream access: 1080p lite/720p lite/WD1/4CIF/VGA/CIF@25fps (P)/30fps (N) For 720p stream access: 720p/WD1/4CIF/VGA/CIF@25fps (P)/30fps (N) Sub-stream: WD1/4CIF@12fps; CIF@25fps (P)/30fps (N)	Main stream: When 1080p Lite mode not enabled: For 4 MP stream access: 4 MP lite@15fps; 1080p lite/720p/WD1/4CIF/VGA/CIF@25fps (P)/30fps (N) For 3 MP stream access: 3 MP/1080p/720p/VGA/WD1/4CIF/CIF@15fps For 1080p stream access: 1080p@15fps; 720p/VGA/WD1/4CIF/CIF@25fps (P)/30fps (N) When 1080p Lite mode enabled: 4 MP lite/3 MP@15fps; 1080p lite/720p lite/VGA/WD1/4CIF/CIF@25fps (P)/30fps (N) Sub-stream: WD1/4CIF@12fps; CIF@25fps (P)/30fps (N)	Main stream: When 1080p Lite mode not enabled: For 4 MP stream access: 4 MP lite@15fps; 1080p lite/720p/WD1/4CIF/VGA/CIF@25fps (P)/30fps (N) For 3 MP stream access: 3 MP/1080p/720p/WD1/4CIF/VGA/CIF@15fps For 1080p stream access: 1080p/720p@15fps; 720p/WD1/4CIF/VGA/CIF@25fps (P)/30fps (N) For 720p stream access: 720p/WD1/4CIF/VGA/CIF@25fps (P)/30fps (N) When 1080p Lite mode enabled: For 4 MP stream access: 4 MP lite@15fps; 1080p lite/720p lite/WD1/4CIF/VGA/CIF@25fps (P)/30fps (N) For 3 MP stream access: 3 MP/1080p lite/720p lite/WD1/4CIF/VGA/CIF@15fps For 1080p stream access: 1080p lite/720p lite/WD1/4CIF/VGA/CIF@25fps (P)/30fps (N) For 720p stream access: 720p/WD1/4CIF/VGA/CIF@25fps (P)/30fps (N) Sub-stream: WD1/4CIF@12fps; CIF@25fps (P)/30fps (N)
SATA Capacity	8 SATA interfaces Up to 10 TB capacity for each disk	8 SATA interfaces Up to 10 TB capacity for each disk	4 SATA interface Up to 10 TB capacity for each disk	4 SATA interface Up to 10 TB capacity for each disk
Array Type	-	-	-	-
Network Interface	2, RJ45 10M/100M/1000M self-adaptive Ethernet interface	2, RJ45 10M/100M/1000M self-adaptive Ethernet interface	1, RJ45 10M/100M/1000M self-adaptive Ethernet interface	1, RJ45 10M/100M/1000M self-adaptive Ethernet interface
Serial Interface	RS-232, RS-485 (full-duplex), Keyboard	RS-232, RS-485 (full-duplex), Keyboard	RS-232, RS-485 (full-duplex), Keyboard	RS-232, RS-485 (full-duplex), Keyboard
USB Port	2 × USB 2.0, 1 × USB 3.0	2 × USB 2.0, 1 × USB 3.0	1 × USB 2.0, 1 × USB 3.0	1 × USB 2.0, 1 × USB 3.0
Alarm I/O	16/4	16/8	16/4	16/4
Power	100 to 240 VAC	100 to 240 VAC	100 to 240 VAC	100 to 240 VAC
Chassis	2U	2U	1.5U	1.5U

Model	IDS-9016HUHI-M8/S	IDS-9032HUHI-M8/S	IDS-7316HUHI-M4/S	IDS-7332HUHI-M4/S
Image	 AcuSense NEW	 AcuSense NEW	 AcuSense NEW	 AcuSense NEW
Video Compression	H.265 Pro+/H.265 Pro/H.265/H.264+/H.264	H.265 Pro+/H.265 Pro/H.265/H.264+/H.264	H.265 Pro+/H.265 Pro/H.265/H.264+/H.264	H.265+ / H.265 / H.264+ / H.264
Analog Video-Audio Input	16-ch	32-ch	16-ch	32-ch
IP Video Input	18-ch (Up to 34-ch), Up to 12MP	32-ch (Up to 64-ch), Up to 12MP	16-ch (Up to 32-ch), Up to 8 MP resolution	16-ch (Up to 48-ch), Up to 8 MP resolution
Audio Input	16-ch, RCA (2.0 Vp-p, 1 KΩ)	16-ch, RCA (2.0 Vp-p, 1 KΩ)	4-ch, RCA (2.0 Vp-p, 1 KΩ)	4-ch, RCA (2.0 Vp-p, 1 KΩ)
HDMI / VGA Output	1-ch, 1920 × 1080/60Hz, 1280 × 1024/60Hz, 1280 × 720/60Hz, 1024 × 768/60Hz	1-ch, 1920 × 1080/60Hz, 1280 × 1024/60Hz, 1280 × 720/60Hz, 1024 × 768/60Hz	1-ch, 1920 × 1080/60Hz, 1280 × 1024/60Hz, 1280 × 720/60Hz, 1024 × 768/60Hz	1-ch, 1920 × 1080/60Hz, 1280 × 1024/60Hz, 1280 × 720/60Hz, 1024 × 768/60Hz
HDMI2 Output	1-ch, 4K (3840 × 2160)/30Hz, 2K (2560 × 1440)/60Hz, 1920 × 1080/60Hz, 1280 × 1024/60Hz, 1280 × 720/60Hz, 1024 × 768/60Hz	1-ch, 4K (3840 × 2160)/30Hz, 2K (2560 × 1440)/60Hz, 1920 × 1080/60Hz, 1280 × 1024/60Hz, 1280 × 720/60Hz, 1024 × 768/60Hz	1-ch, 4K (3840 × 2160)/30Hz, 2K (2560 × 1440)/60Hz, 1920 × 1080/60Hz, 1280 × 1024/60Hz, 1280 × 720/60Hz, 1024 × 768/60Hz	1-ch, 4K (3840 × 2160)/30Hz, 2K (2560 × 1440)/60Hz, 1920 × 1080/60Hz, 1280 × 1024/60Hz, 1280 × 720/60Hz, 1024 × 768/60Hz
CVBS Output	1-ch, BNC (1.0 Vp-p, 75 Ω), resolution: PAL: 704 × 576, NTSC: 704 × 480	1-ch, BNC (1.0 Vp-p, 75 Ω), resolution: PAL: 704 × 576, NTSC: 704 × 480	1-ch, BNC (1.0 Vp-p, 75 Ω), resolution: PAL: 704 × 576, NTSC: 704 × 480	1-ch, BNC (1.0 Vp-p, 75 Ω), resolution: PAL: 704 × 576, NTSC: 704 × 480
Audio Output	2-ch, RCA (Linear, 1KΩ)	2-ch, RCA (Linear, 1KΩ)	2-ch, RCA (Linear, 1KΩ)	1-ch, RCA (Linear, 1KΩ)
Encoding Capability	Main stream: 8 MP@8fps; 5 MP@12fps; 4 MP@15fps; 3 MP@18fps; 1080p/720p/WD1/4CIF/VGA/CIF@25fps (P)/30fps (N) Sub-stream: WD1/4CIF/CIF@25fps (P)/30fps (N)	Main stream: 8MP@8fps; 5 MP@12fps; 4 MP@15fps; 3 MP@18fps; 1080p/720p/WD1/4CIF/VGA/CIF@25fps (P)/30fps (N) Sub-stream: WD1/4CIF/CIF@25fps (P)/30fps (N)	Main stream: 8 MP@8fps/5 MP@12fps; 4 MP@15fps; 3 MP@18fps; 1080p/720p/WD1/4CIF/VGA/CIF@25fps (P)/30fps (N) Sub-stream: WD1/4CIF/CIF@25fps (P)/30fps (N)	Main stream: 8MP@8fps; 5 MP@12fps; 4 MP@15fps; 3 MP@18fps; 1080p/720p/WD1/4CIF/VGA/CIF@25fps (P)/30fps (N) Sub-stream: WD1/4CIF/CIF@25fps (P)/30fps (N)
SATA Capacity	8 SATA interfaces Up to 10 TB capacity for each disk	8 SATA interfaces Up to 10 TB capacity for each disk	4 SATA interface Up to 10 TB capacity for each disk	4 SATA interface Up to 10 TB capacity for each disk
Array Type	RAID 0, RAID 1, RAID 5, RAID 6, RAID 10	RAID 0, RAID 1, RAID 5, RAID 6, RAID 10	RAID 0, RAID 1, RAID 5, RAID 6, RAID 10	RAID 0, RAID 1, RAID 5, RAID 6, RAID 10
Network Interface	2, RJ45 10M/100M/1000M self-adaptive Ethernet interface	2, RJ45 10M/100M/1000M self-adaptive Ethernet interface	2, RJ45 10M/100M/1000M self-adaptive Ethernet interface	2, RJ45 10M/100M/1000M self-adaptive Ethernet interface
Serial Interface	RS-232, RS-485 (full-duplex), Keyboard	RS-232, RS-485 (full-duplex), Keyboard	RS-232, RS-485 (full-duplex), Keyboard	RS-232, RS-485 (full-duplex), Keyboard
USB Port	2 × USB 2.0, 1 × USB 3.0	2 × USB 2.0, 1 × USB 3.0	2 × USB 2.0, 1 × USB 3.0	2 × USB 2.0, 1 × USB 3.0
Alarm I/O	16/8	16/8	16/4	16/4
Power	100 to 240 VAC	100 to 240 VAC	100 to 240 VAC	100 to 240 VAC
Chassis	2U	2U	1.5U	1.5U





Turbo HD DVRs





Pro Series with AcuSense

Pro Series DVRs support HD videos, H.265 / H.265 Pro+ encoding technology, 4K resolution output, power over coax (PoC), various VCA rules, and more.

- › Motion Detection 2.0 with human & vehicle classification for all analog channels
- › H.265 Pro+ / H.265 Pro / H.265
- › Adaptive signal input (five types: HDTVI / AHD / CVI / CVBS / IP)
- › Human & vehicle classification based on VCA results
- › Enhanced network camera access capability
- › Facial comparison (/FA models)
- › Audio over coaxial
- › Search human and vehicle targets quickly
- › PoC for easy installation
- › Ultra HD, compatible with cameras of up to 4K resolution











Model	IDS-7204HQHI-M1/S	IDS-7208HQHI-M1/S	IDS-7208HQHI-M2/S	IDS-7216HQHI-M1/S	IDS-7216HQHI-M2/S
Image	 AcuSense	 AcuSense	 AcuSense	 AcuSense	 AcuSense
Video Compression	H.265 Pro+ / H.265 Pro / H.265 / H.264+ / H.264	H.265 Pro+ / H.265 Pro / H.265 / H.264+ / H.264	H.265 Pro+ / H.265 Pro / H.265 / H.264+ / H.264	H.265 Pro+ / H.265 Pro / H.265 / H.264+ / H.264	H.265 Pro+ / H.265 Pro / H.265 / H.264+ / H.264
Analog Video Input	4-ch	8-ch	8-ch	16-ch	8-ch
IP Video Input	1-ch (up to 5-ch) IP enhanced mode on: 2-ch (up to 6-ch), each up to 4 Mbps	2-ch (up to 10-ch) IP enhanced mode on: 4-ch (up to 12-ch), each up to 4 Mbps	2-ch (up to 10-ch) IP enhanced mode on: 4-ch (up to 12-ch), each up to 4 Mbps	2-ch (up to 18-ch) IP enhanced mode on: 8-ch (up to 24-ch), each up to 4 Mbps	2-ch (up to 18-ch) IP enhanced mode on: 8-ch (up to 24-ch), each up to 4 Mbps
Audio Input	1-ch, RCA (2.0 Vp-p, 1 KΩ) 4-ch via coaxial cable	1-ch, RCA (2.0 Vp-p, 1 KΩ) 8-ch via coaxial cable	1-ch, RCA (2.0 Vp-p, 1 KΩ) 8-ch via coaxial cable	1-ch, RCA (2.0 Vp-p, 1 KΩ) 16-ch via coaxial cable	1-ch, RCA (2.0 Vp-p, 1 KΩ) 16-ch via coaxial cable
HDMI / VGA Output	1-ch, 1920 × 1080/60Hz, 1280 × 1024/60Hz, 1280 × 720/60Hz,	1-ch, 1920 × 1080/60Hz, 1280 × 1024/60Hz, 1280 × 720/60Hz,	1-ch, 1920 × 1080/60Hz, 1280 × 1024/60Hz, 1280 × 720/60Hz,	1-ch, 1920 × 1080/60Hz, 1280 × 1024/60Hz, 1280 × 720/60Hz,	1-ch, 1920 × 1080/60Hz, 1280 × 1024/60Hz, 1280 × 720/60Hz,
HDMI2 Output	-	-	-	-	-
CVBS Output	1-ch, BNC (1.0 Vp-p, 75 Ω), resolution: PAL: 704 × 576, NTSC: 704 × 480	1-ch, BNC (1.0 Vp-p, 75 Ω), resolution: PAL: 704 × 576, NTSC: 704 × 480	1-ch, BNC (1.0 Vp-p, 75 Ω), resolution: PAL: 704 × 576, NTSC: 704 × 480	1-ch, BNC (1.0 Vp-p, 75 Ω), resolution: PAL: 704 × 576, NTSC: 704 × 480	1-ch, BNC (1.0 Vp-p, 75 Ω), resolution: PAL: 704 × 576, NTSC: 704 × 480
Audio Output	1-ch, RCA (Linear, 1KΩ)	1-ch, RCA (Linear, 1KΩ)	1-ch, RCA (Linear, 1KΩ)	1-ch, RCA (Linear, 1KΩ)	1-ch, RCA (Linear, 1KΩ)
Encoding Capability	Main stream: When 1080p Lite mode not enabled: For 5 MP stream access: 5 MP lite@12fps;4 MP lite/1080p@15fps;720p/WD1/4CIF/VGA/CIF@25fps (PI)/30fps (N) For 4 MP stream access: 4 MP lite/1080p@15fps;720p/WD1/4CIF/VGA/CIF@25fps (PI)/30fps (N) For 3K stream access: 3K lite@12fps;4 MP lite/1080p@15fps;720p/WD1/4CIF/VGA/CIF@25fps (PI)/30fps (N) For 1080p stream access: 1080p/720p@15fps; VGA/WD1/4CIF/CIF@25fps (PI)/30fps (N) For 720p stream access: 720p/VGA/WD1/4CIF/CIF@25fps (PI)/30fps (N) When 1080p Lite mode enabled: 5 MP lite/3K lite@15fps;4 MP lite@15fps;1080p lite/720p lite/VGA/WD1/4CIF/CIF@25fps (PI)/30fps (N) Sub-stream: WD1/4CIF@12fps; CIF@25fps (PI)/30fps (N)	Main stream: When 1080p Lite mode not enabled: For 5 MP stream access: 5 MP lite@12fps;4 MP lite/1080p@15fps;720p/WD1/4CIF/VGA/CIF@25fps (PI)/30fps (N) For 4 MP stream access: 4 MP lite/1080p@15fps;720p/WD1/4CIF/VGA/CIF@25fps (PI)/30fps (N) For 3K stream access: 3K lite@12fps;4 MP lite/1080p@15fps;720p/WD1/4CIF/VGA/CIF@25fps (PI)/30fps (N) For 1080p stream access: 1080p/720p@15fps; VGA/WD1/4CIF/CIF@25fps (PI)/30fps (N) For 720p stream access: 720p/VGA/WD1/4CIF/CIF@25fps (PI)/30fps (N) When 1080p Lite mode enabled: 5 MP lite/3K lite@15fps;4 MP lite@15fps;1080p lite/720p lite/VGA/WD1/4CIF/CIF@25fps (PI)/30fps (N) Sub-stream: WD1/4CIF@12fps; CIF@25fps (PI)/30fps (N)	Main stream: When 1080p Lite mode not enabled: For 5 MP stream access: 5 MP lite@12fps;4 MP lite/1080p@15fps;720p/WD1/4CIF/VGA/CIF@25fps (PI)/30fps (N) For 4 MP stream access: 4 MP lite/1080p@15fps;720p/WD1/4CIF/VGA/CIF@25fps (PI)/30fps (N) For 3K stream access: 3K lite@12fps;4 MP lite/1080p@15fps;720p/WD1/4CIF/VGA/CIF@25fps (PI)/30fps (N) For 1080p stream access: 1080p/720p@15fps; VGA/WD1/4CIF/CIF@25fps (PI)/30fps (N) For 720p stream access: 720p/VGA/WD1/4CIF/CIF@25fps (PI)/30fps (N) When 1080p Lite mode enabled: 5 MP lite/3K lite@15fps;4 MP lite@15fps;1080p lite/720p lite/VGA/WD1/4CIF/CIF@25fps (PI)/30fps (N) Sub-stream: WD1/4CIF@12fps; CIF@25fps (PI)/30fps (N)	Main stream: When 1080p Lite mode not enabled: For 5 MP stream access: 5 MP lite@12fps;4 MP lite/1080p@15fps;720p/WD1/4CIF/VGA/CIF@25fps (PI)/30fps (N) For 4 MP stream access: 4 MP lite/1080p@15fps;720p/WD1/4CIF/VGA/CIF@25fps (PI)/30fps (N) For 3K stream access: 3K lite@12fps;4 MP lite/1080p@15fps;720p/WD1/4CIF/VGA/CIF@25fps (PI)/30fps (N) For 1080p stream access: 1080p/720p@15fps; VGA/WD1/4CIF/CIF@25fps (PI)/30fps (N) For 720p stream access: 720p/VGA/WD1/4CIF/CIF@25fps (PI)/30fps (N) When 1080p Lite mode enabled: 5 MP lite/3K lite@15fps;4 MP lite@15fps;1080p lite/720p lite/VGA/WD1/4CIF/CIF@25fps (PI)/30fps (N) Sub-stream: WD1/4CIF@12fps; CIF@25fps (PI)/30fps (N)	Main stream: When 1080p Lite mode not enabled: For 5 MP stream access: 5 MP lite@12fps;4 MP lite/1080p@15fps;720p/WD1/4CIF/VGA/CIF@25fps (PI)/30fps (N) For 4 MP stream access: 4 MP lite/1080p@15fps;720p/WD1/4CIF/VGA/CIF@25fps (PI)/30fps (N) For 3K stream access: 3K lite@12fps;4 MP lite/1080p@15fps;720p/WD1/4CIF/VGA/CIF@25fps (PI)/30fps (N) For 1080p stream access: 1080p/720p@15fps; VGA/WD1/4CIF/CIF@25fps (PI)/30fps (N) For 720p stream access: 720p/VGA/WD1/4CIF/CIF@25fps (PI)/30fps (N) When 1080p Lite mode enabled: 5 MP lite/3K lite@15fps;4 MP lite@15fps;1080p lite/720p lite/VGA/WD1/4CIF/CIF@25fps (PI)/30fps (N) Sub-stream: WD1/4CIF@12fps; CIF@25fps (PI)/30fps (N)
SATA Capacity	1 SATA interface, up to 10 TB capacity for each disk	1 SATA interface, up to 10 TB capacity for each disk	2 SATA interfaces, up to 10 TB capacity for each disk	1 SATA interface, up to 10 TB capacity for each disk	2 SATA interfaces, up to 10 TB capacity for each disk
Network Interface	1, RJ45 10M/100M self-adaptive Ethernet interface	1, RJ45 10M/100M self-adaptive Ethernet interface	1, RJ45 10M/100M self-adaptive Ethernet interface	1, RJ45 10M/100M/1000M self-adaptive Ethernet interface	1, RJ45 10M/100M/1000M self-adaptive Ethernet interface
Serial Interface	RS-485 (half-duplex)	RS-485 (half-duplex)	RS-485 (half-duplex)	RS-485 (half-duplex)	RS-485 (half-duplex)
USB Port	2 × USB 2.0	2 × USB 2.0	2 × USB 2.0	1 × USB 2.0 1 × USB 3.0	1 × USB 2.0 1 × USB 3.0
Smart Function	1. Human body & vehicle recognition 2. Motion Detection 2.0: all channels 3. VCA: Line crossing, Intrusion detection, up to 2-ch	1. Human body & vehicle recognition 2. Motion Detection 2.0: all channels 3. VCA: Line crossing, Intrusion detection, up to 4-ch	1. Human body & vehicle recognition 2. Motion Detection 2.0: all channels 3. VCA: Line crossing, Intrusion detection, up to 4-ch	1. Human body & vehicle recognition 2. Motion Detection 2.0: all channels 3. VCA: Line crossing, Intrusion detection, up to 4-ch	1. Human body & vehicle recognition 2. Motion Detection 2.0: all channels 3. VCA: Line crossing, Intrusion detection, up to 4-ch
Alarm I/O	-	-	-	-	-
Power	12 VDC	12 VDC	12 VDC	12 VDC	12 VDC
Chassis	1U (315mm)	1U (315mm)	1U (380mm)	1U (315mm)	1U (380mm)



Model	IDS-7232HQHI-M2/S	IDS-7204HQHI-M1/FA	IDS-7208HQHI-M1/FA	IDS-7208HQHI-M2/FA	IDS-7216HQHI-M1/FA
Image	 AcuSense	 AcuSense	 AcuSense	 AcuSense	 AcuSense
Video Compression	H.265 Pro+/H.265 Pro/H.265/H.264+/H.264	H.265 Pro+ / H.265 Pro / H.265 / H.264+ / H.264	H.265 Pro+ / H.265 Pro / H.265 / H.264+ / H.264	H.265 Pro+ / H.265 Pro / H.265 / H.264+ / H.264	H.265 Pro+ / H.265 Pro / H.265 / H.264+ / H.264
Analog Video Input	32-ch	4-ch	8-ch	8-ch	16-ch
IP Video Input	2-ch (up to 34-ch) Enhanced IP mode on: 8-ch (up to 40-ch), each up to 4 Mbps, Up to 6 MP resolution	1-ch (up to 5-ch) IP enhanced mode on: 2-ch (up to 6-ch), each up to 4 Mbps	2-ch (up to 10-ch) IP enhanced mode on: 4-ch (up to 12-ch), each up to 4 Mbps	2-ch (up to 10-ch) IP enhanced mode on: 4-ch (up to 12-ch), each up to 4 Mbps	2-ch (up to 18-ch) IP enhanced mode on: 8-ch (up to 24-ch), each up to 4 Mbps
Audio Input	1-ch, RCA (2.0 Vp-p, 1 KΩ), 32-ch via coaxial cable	1-ch, RCA (2.0 Vp-p, 1 KΩ) 4-ch via coaxial cable	1-ch, RCA (2.0 Vp-p, 1 KΩ) 8-ch via coaxial cable	1-ch, RCA (2.0 Vp-p, 1 KΩ) 8-ch via coaxial cable	1-ch, RCA (2.0 Vp-p, 1 KΩ) 16-ch via coaxial cable
HDMI / VGA Output	HDMI:1-ch, 4K (3840 × 2160)/30Hz, 2K (2560 × 1440)/60Hz, 1920 × 1080/60Hz, 1280 × 1024/60Hz, 1280 × 720/60Hz, 1024 × 768/60Hz VGA: 1-ch, 1920 × 1080/60 Hz, 1280 × 1024/60 Hz, 1280 × 720/60 Hz, 1024 × 768/60 Hz HDMI/VGA simultaneous output	1-ch, 1920 × 1080/60Hz, 1280 × 1024/60Hz, 1280 × 720/60Hz,	1-ch, 1920 × 1080/60Hz, 1280 × 1024/60Hz, 1280 × 720/60Hz,	1-ch, 1920 × 1080/60Hz, 1280 × 1024/60Hz, 1280 × 720/60Hz,	1-ch, 1920 × 1080/60Hz, 1280 × 1024/60Hz, 1280 × 720/60Hz,
HDMI2 Output	-	-	-	-	-
CVBS Output	1-ch, BNC (1.0 Vp-p, 75 Ω), resolution: PAL: 704 × 576, NTSC: 704 × 480	1-ch, BNC (1.0 Vp-p, 75 Ω), resolution: PAL: 704 × 576, NTSC: 704 × 480	1-ch, BNC (1.0 Vp-p, 75 Ω), resolution: PAL: 704 × 576, NTSC: 704 × 480	1-ch, BNC (1.0 Vp-p, 75 Ω), resolution: PAL: 704 × 576, NTSC: 704 × 480	1-ch, BNC (1.0 Vp-p, 75 Ω), resolution: PAL: 704 × 576, NTSC: 704 × 480
Audio Output	1-ch, RCA (Linear, 1 KΩ)	1-ch, RCA (Linear, 1KΩ)	1-ch, RCA (Linear, 1KΩ)	1-ch, RCA (Linear, 1KΩ)	1-ch, RCA (Linear, 1KΩ)
Encoding Capability	Main stream: When 1080p Lite mode not enabled: For 5 MP stream access: 5 MP lite@12fps;4 MP lite/1080p@15fps;720p/WD1/4CIF/VGA/CIF@25fps (P)/30fps (N) For 3K stream access: 3K lite@12fps;4 MP lite/1080p@15fps;720p/WD1/4CIF/VGA/CIF@25fps (P)/30fps (N) For 4 MP stream access: 4 MP lite/1080p@15fps;720p/WD1/4CIF/VGA/CIF@25fps (P)/30fps (N) For 1080p stream access: 1080p/720p@15fps; VGA/WD1/4CIF/CIF@25fps (P)/30fps (N) For 720p stream access: 720p/VGA/WD1/4CIF/CIF@25fps (P)/30fps (N) When 1080p Lite mode enabled: 5 MP lite/3K lite@15fps;4 MP lite@15fps;1080p lite/720p lite/VGA/WD1/4CIF/CIF@25fps (P)/30fps (N) Sub-stream: WD1/4CIF@12fps; CIF@25fps (P)/30fps (N)	Main stream: When 1080p Lite mode not enabled: For 5 MP stream access: 5 MP lite@12fps;4 MP lite/1080p@15fps;720p/WD1/4CIF/VGA/CIF@25fps (P)/30fps (N) For 3K stream access: 3K lite@12fps;4 MP lite/1080p@15fps;720p/WD1/4CIF/VGA/CIF@25fps (P)/30fps (N) For 4 MP stream access: 4 MP lite/1080p@15fps;720p/WD1/4CIF/VGA/CIF@25fps (P)/30fps (N) For 1080p stream access: 1080p/720p@15fps; VGA/WD1/4CIF/CIF@25fps (P)/30fps (N) For 720p stream access: 720p/VGA/WD1/4CIF/CIF@25fps (P)/30fps (N) When 1080p Lite mode enabled: 5 MP lite/3K lite@15fps;4 MP lite@15fps;1080p lite/720p lite/VGA/WD1/4CIF/CIF@25fps (P)/30fps (N) Sub-stream: WD1/4CIF@12fps; CIF@25fps (P)/30fps (N)	Main stream: When 1080p Lite mode not enabled: For 5 MP stream access: 5 MP lite@12fps;4 MP lite/1080p@15fps;720p/WD1/4CIF/VGA/CIF@25fps (P)/30fps (N) For 3K stream access: 3K lite@12fps;4 MP lite/1080p@15fps;720p/WD1/4CIF/VGA/CIF@25fps (P)/30fps (N) For 4 MP stream access: 4 MP lite/1080p@15fps;720p/WD1/4CIF/VGA/CIF@25fps (P)/30fps (N) For 1080p stream access: 1080p/720p@15fps; VGA/WD1/4CIF/CIF@25fps (P)/30fps (N) For 720p stream access: 720p/VGA/WD1/4CIF/CIF@25fps (P)/30fps (N) When 1080p Lite mode enabled: 5 MP lite/3K lite@15fps;4 MP lite@15fps;1080p lite/720p lite/VGA/WD1/4CIF/CIF@25fps (P)/30fps (N) Sub-stream: WD1/4CIF@12fps; CIF@25fps (P)/30fps (N)	Main stream: When 1080p Lite mode not enabled: For 5 MP stream access: 5 MP lite@12fps;4 MP lite/1080p@15fps;720p/WD1/4CIF/VGA/CIF@25fps (P)/30fps (N) For 3K stream access: 3K lite@12fps;4 MP lite/1080p@15fps;720p/WD1/4CIF/VGA/CIF@25fps (P)/30fps (N) For 4 MP stream access: 4 MP lite/1080p@15fps;720p/WD1/4CIF/VGA/CIF@25fps (P)/30fps (N) For 1080p stream access: 1080p/720p@15fps; VGA/WD1/4CIF/CIF@25fps (P)/30fps (N) For 720p stream access: 720p/VGA/WD1/4CIF/CIF@25fps (P)/30fps (N) When 1080p Lite mode enabled: 5 MP lite/3K lite@15fps;4 MP lite@15fps;1080p lite/720p lite/VGA/WD1/4CIF/CIF@25fps (P)/30fps (N) Sub-stream: WD1/4CIF@12fps; CIF@25fps (P)/30fps (N)	Main stream: When 1080p Lite mode not enabled: For 5 MP stream access: 5 MP lite@12fps;4 MP lite/1080p@15fps;720p/WD1/4CIF/VGA/CIF@25fps (P)/30fps (N) For 3K stream access: 3K lite@12fps;4 MP lite/1080p@15fps;720p/WD1/4CIF/VGA/CIF@25fps (P)/30fps (N) For 4 MP stream access: 4 MP lite/1080p@15fps;720p/WD1/4CIF/VGA/CIF@25fps (P)/30fps (N) For 1080p stream access: 1080p/720p@15fps; VGA/WD1/4CIF/CIF@25fps (P)/30fps (N) For 720p stream access: 720p/VGA/WD1/4CIF/CIF@25fps (P)/30fps (N) When 1080p Lite mode enabled: 5 MP lite/3K lite@15fps;4 MP lite@15fps;1080p lite/720p lite/VGA/WD1/4CIF/CIF@25fps (P)/30fps (N) Sub-stream: WD1/4CIF@12fps; CIF@25fps (P)/30fps (N)
SATA Capacity	2 SATA interfaces, Up to 10 TB capacity for each disk	1 SATA interface, up to 10 TB capacity for each disk	1 SATA interface, up to 10 TB capacity for each disk	2 SATA interfaces, up to 10 TB capacity for each disk	1 SATA interface, up to 10 TB capacity for each disk
Network Interface	1, RJ45 10/100/1000 Mbps self-adaptive Ethernet interface	1, RJ45 10M/100M self-adaptive Ethernet interface	1, RJ45 10M/100M self-adaptive Ethernet interface	1, RJ45 10M/100M self-adaptive Ethernet interface	1, RJ45 10M/100M/1000M self-adaptive Ethernet interface
Serial Interface	RS-485 (half-duplex)	RS-485 (half-duplex)	RS-485 (half-duplex)	RS-485 (half-duplex)	RS-485 (half-duplex)
USB Port	Front panel: 1 × USB 2.0 Rear panel: 1 × USB 3.0	2 × USB 2.0	2 × USB 2.0	2 × USB 2.0	1 × USB 2.0 1 × USB 3.0
Smart Function	1. Human body & vehicle recognition 2. Motion Detection 2.0: all channels 3. VCA: Line crossing, Intrusion detection, up to 4-ch	1. 1-ch face picture comparison and face picture search 2. Human body & vehicle recognition 3. Motion Detection 2.0: all channels 4. VCA: Line crossing, Intrusion detection, up to 2-ch	1. 1-ch face picture comparison and face picture search 2. Human body & vehicle recognition 3. Motion Detection 2.0: all channels 4. VCA: Line crossing, Intrusion detection, up to 2-ch	1. 1-ch face picture comparison and face picture search 2. Human body & vehicle recognition 3. Motion Detection 2.0: all channels 4. VCA: Line crossing, Intrusion detection, up to 2-ch	1. 1-ch face picture comparison and face picture search 2. Human body & vehicle recognition 3. Motion Detection 2.0: all channels 4. VCA: Line crossing, Intrusion detection, up to 2-ch
Alarm I/O	-	-	-	-	-
Power	12 VDC	12 VDC	12 VDC	12 VDC	12 VDC
Chassis	1U (380mm)	1U (315mm)	1U (315mm)	1U (380mm)	1U (315mm)

Model	IDS-7216HQHI-M2/FA
Image	 AcuSense
Video Compression	H.265 Pro+ / H.265 Pro / H.265 / H.264+ / H.264
Analog Video Input	16-ch
IP Video Input	2-ch (up to 18-ch) IP enhanced mode on: 8-ch (up to 24-ch), each up to 4 Mbps
Audio Input	1-ch, RCA (2.0 Vp-p, 1 KΩ) 16-ch via coaxial cable
HDMI / VGA Output	1-ch, 1920 × 1080/60Hz, 1280 × 1024/60Hz, 1280 × 720/60Hz,
HDMI2 Output	-
CVBS Output	1-ch, BNC (1.0 Vp-p, 75 Ω), resolution: PAL: 704 × 576, NTSC: 704 × 480
Audio Output	1-ch, RCA (Linear, 1KΩ)
Encoding Capability	Main stream: When 1080p Lite mode not enabled: For 5 MP stream access: 5 MP lite@12fps;4 MP lite/1080p@15fps;720p/WD1/4CIF/VGA/ CIF@25fps (P)/30fps (N) For 3K stream access: 3K lite@12fps;4 MP lite/1080p@15fps;720p/ WD1/4CIF/VGA/CIF@25fps (P)/30fps (N) For 4 MP stream access: 4 MP lite/1080p@15fps;720p/WD1/4CIF/ VGA/CIF@25fps (P)/30fps (N) For 1080p stream access: 1080p/720p@15fps; VGA/WD1/4CIF/ CIF@25fps (P)/30fps (N) For 720p stream access: 720p/VGA/WD1/4CIF/CIF@25fps (P)/30fps (N) When 1080p Lite mode enabled: 5 MP lite/3K lite@15fps;4 MP lite@15fps;1080p lite/720p lite/VGA/ WD1/4CIF/CIF@25fps (P)/30fps (N) Sub-stream: WD1/4CIF@12fps; CIF@25fps (P)/30fps (N)
SATA Capacity	2 SATA interfaces, up to 10 TB capacity for each disk
Network Interface	1, RJ45 10M/100M/1000M self-adaptive Ethernet interface
Serial Interface	RS-485 (half-duplex)
USB Port	1 × USB 2.0 1 × USB 3.0
Smart Function	1. 1-ch face picture comparison and face picture search 2. Human body & vehicle recognition 3. Motion Detection 2.0: all channels 4. VCA: Line crossing, Intrusion detection, up to 2-ch
Alarm I/O	-
Power	12 VDC
Chassis	1U (380mm)

Model	IDS-7204HUHI-M1/S	IDS-7204HUHI-M2/S	IDS-7208HUHI-M1/S	IDS-7208HUHI-M2/S
Image	 AcuSense	 AcuSense	 AcuSense	 AcuSense
Video Compression	H.265 Pro+ / H.265 Pro / H.265 / H.264+ / H.264	H.265 Pro+ / H.265 Pro / H.265 / H.264+ / H.264	H.265 Pro+ / H.265 Pro / H.265 / H.264+ / H.264	H.265 Pro+ / H.265 Pro / H.265 / H.264+ / H.264
Analog Video Input	4-ch	4-ch	4-ch	4-ch
IP Video Input	2-ch (up to 6-ch) IP enhanced mode on: 4-ch (up to 8-ch), each up to 4 Mbps	2-ch (up to 6-ch) IP enhanced mode on: 4-ch (up to 8-ch), each up to 4 Mbps	4-ch (up to 12-ch) IP enhanced mode on: 8-ch (up to 16-ch), each up to 4 Mbps	4-ch (up to 12-ch) IP enhanced mode on: 8-ch (up to 16-ch), each up to 4 Mbps
Audio Input	1-ch, RCA (2.0 Vp-p, 1 KΩ)	1-ch, RCA (2.0 Vp-p, 1 KΩ)	1-ch, RCA (2.0 Vp-p, 1 KΩ)	1-ch, RCA (2.0 Vp-p, 1 KΩ)
HDMI / VGA Output	1-ch, 2K (2560 × 1440)/60Hz, 1920 × 1080/60Hz, 1280 × 1024/60Hz, 1280 × 720/60Hz, 1024 × 768/60Hz HDMI/VGA simultaneous output	1-ch, 2K (2560 × 1440)/60Hz, 1920 × 1080/60Hz, 1280 × 1024/60Hz, 1280 × 720/60Hz, 1024 × 768/60Hz HDMI/VGA simultaneous output	1-ch, 4K (3840 × 2160)/30Hz, 2K (2560 × 1440)/60Hz, 1920 × 1080/60Hz, 1280 × 1024/60Hz, 1280 × 720/60Hz, 1024 × 768/60Hz HDMI/VGA simultaneous output	1-ch, 4K (3840 × 2160)/30Hz, 2K (2560 × 1440)/60Hz, 1920 × 1080/60Hz, 1280 × 1024/60Hz, 1280 × 720/60Hz, 1024 × 768/60Hz HDMI/VGA simultaneous output
HDMI2 Output	-	-	-	-
CVBS Output	1-ch, BNC (1.0 Vp-p, 75 Ω), resolution: PAL: 704 × 576, NTSC: 704 × 480	1-ch, BNC (1.0 Vp-p, 75 Ω), resolution: PAL: 704 × 576, NTSC: 704 × 480	1-ch, BNC (1.0 Vp-p, 75 Ω), resolution: PAL: 704 × 576, NTSC: 704 × 480	1-ch, BNC (1.0 Vp-p, 75 Ω), resolution: PAL: 704 × 576, NTSC: 704 × 480
Audio Output	1-ch, RCA (Linear, 1 KΩ)	1-ch, RCA (Linear, 1 KΩ)	1-ch, RCA (Linear, 1 KΩ)	1-ch, RCA (Linear, 1 KΩ)
Encoding Capability	Main stream: 8 MP@8 fps/5 MP@12 fps/3K@12 fps/4 MP@15 fps/8 MP Lite@15 fps/3 MP@18 fps 1080p/720p/WD1/4CIF/VGA/CIF@25 fps (P)/30 fps (N) *: 8 MP@8 fps is only available for channel 1 Sub-stream: WD1/4CIF/CIF@25 fps (P)/30 fps (N)	Main stream: 8 MP@8 fps/5 MP@12 fps/3K@12 fps/4 MP@15 fps/8 MP Lite@15 fps/3 MP@18 fps 1080p/720p/WD1/4CIF/VGA/CIF@25 fps (P)/30 fps (N) *: 8 MP@8 fps is only available for channel 1 Sub-stream: WD1/4CIF/CIF@25 fps (P)/30 fps (N)	Main stream: 8 MP@8 fps/5 MP@12 fps/3K@12 fps/ 4 MP@15 fps/3 MP@18 fps 1080p/720p/WD1/4CIF/VGA/CIF@25 fps (P)/30 fps (N) Sub-stream: WD1/4CIF/CIF@25 fps (P)/30 fps (N)	Main stream: 8 MP@8 fps/5 MP@12 fps/3K@12 fps/ 4 MP@15 fps/3 MP@18 fps 1080p/720p/WD1/4CIF/VGA/CIF@25 fps (P)/30 fps (N) Sub-stream: WD1/4CIF/CIF@25 fps (P)/30 fps (N)
SATA Capacity	1 SATA interface Up to 10 TB capacity for each disk	2 SATA interface Up to 10 TB capacity for each disk	1 SATA interface Up to 10 TB capacity for each disk	2 SATA interface Up to 10 TB capacity for each disk
Network Interface	1, RJ45 10M/100M self-adaptive Ethernet interface	1, RJ45 10M/100M self-adaptive Ethernet interface	1, RJ45 10M/100M/1000M self-adaptive Ethernet interface	1, RJ45 10M/100M/1000M self-adaptive Ethernet interface
Serial Interface	RS-485 (half-duplex)	RS-485 (half-duplex)	RS-485 (half-duplex)	RS-485 (half-duplex)
USB Port	2 × USB 2.0	2 × USB 2.0	1 × USB 2.0 1 × USB 3.0	1 × USB 2.0 1 × USB 3.0
Smart Function	1. Human body & vehicle recognition 2. Motion Detection 2.0: all channels 3. VCA: Line crossing, Intrusion detection, up to 4-ch*	1. Human body & vehicle recognition 2. Motion Detection 2.0: all channels 3. VCA: Line crossing, Intrusion detection, up to 4-ch	1. Human body & vehicle recognition 2. Motion Detection 2.0: all channels 3. VCA: Line crossing, Intrusion detection, up to 4-ch	1. Human body & vehicle recognition 2. Motion Detection 2.0: all channels 3. VCA: Line crossing, Intrusion detection, up to 4-ch
Alarm I/O	-	-	-	-
Power	12 VDC	12 VDC	12 VDC	12 VDC
Chassis	1U (315mm)	1U (380mm)	1U (315mm)	1U (380mm)

Model	IDS-7216HUHI-M2/S	IDS-7204HUHI-M1/FA	IDS-7204HUHI-M2/FA	IDS-7208HUHI-M1/FA	IDS-7208HUHI-M2/FA
Image	 AcuSense	 AcuSense	 AcuSense	 AcuSense	 AcuSense
Video Compression	H.265 Pro+/H.265 Pro/H.265/H.264+/H.264	H.265 Pro+ / H.265 Pro / H.265 / H.264+ / H.264	H.265 Pro+ / H.265 Pro / H.265 / H.264+ / H.264	H.265 Pro+ / H.265 Pro / H.265 / H.264+ / H.264	H.265 Pro+ / H.265 Pro / H.265 / H.264+ / H.264
Analog Video Input	16-ch	4-ch	4-ch	4-ch	4-ch
IP Video Input	8-ch (up to 24-ch) Enhanced IP mode on: 16-ch (up to 32-ch), each up to 4 Mbps	2-ch (up to 6-ch) IP enhanced mode on: 4-ch (up to 8-ch), each up to 4 Mbps	2-ch (up to 6-ch) IP enhanced mode on: 4-ch (up to 8-ch), each up to 4 Mbps	4-ch (up to 12-ch) IP enhanced mode on: 8-ch (up to 16-ch), each up to 4 Mbps	4-ch (up to 12-ch) IP enhanced mode on: 8-ch (up to 16-ch), each up to 4 Mbps
Audio Input	1-ch (up to 16-ch is optional, RCA [2.0 Vpp, 1 KΩ] 16-ch via coaxial cable	1-ch, RCA [2.0 Vp-p, 1 KΩ] 16-ch via coaxial cable	1-ch, RCA [2.0 Vp-p, 1 KΩ] 16-ch via coaxial cable	1-ch, RCA [2.0 Vp-p, 1 KΩ] 16-ch via coaxial cable	1-ch, RCA [2.0 Vp-p, 1 KΩ] 16-ch via coaxial cable
HDMI / VGA Output	HDMI:1-ch, 4K (3840 × 2160)/30Hz, 2K (2560 × 1440)/60Hz, 1920 × 1080/60Hz, 1280 × 1024/60Hz, 1280 × 720/60Hz, 1024 × 768/60Hz VGA: 1-ch, 1920 × 1080/60Hz, 1280 × 1024/60Hz, 1280 × 720/60Hz, 1024 × 768/60Hz HDMI/VGA simultaneous output	1-ch, 2K (2560 × 1440)/60Hz, 1920 × 1080/60Hz, 1280 × 1024/60Hz, 1280 × 720/60Hz, 1024 × 768/60Hz HDMI/VGA simultaneous output	1-ch, 2K (2560 × 1440)/60Hz, 1920 × 1080/60Hz, 1280 × 1024/60Hz, 1280 × 720/60Hz, 1024 × 768/60Hz HDMI/VGA simultaneous output	1-ch, 4K (3840 × 2160)/30Hz, 2K (2560 × 1440)/60Hz, 1920 × 1080/60Hz, 1920 × 1080/60Hz, 1280 × 1024/60Hz, 1280 × 720/60Hz, 1024 × 768/60Hz HDMI/VGA simultaneous output	1-ch, 4K (3840 × 2160)/30Hz, 2K (2560 × 1440)/60Hz, 1920 × 1080/60Hz, 1920 × 1080/60Hz, 1280 × 1024/60Hz, 1280 × 720/60Hz, 1024 × 768/60Hz HDMI/VGA simultaneous output
HDMI2 Output	-	-	-	-	-
CVBS Output	1-ch, BNC [1.0 Vp-p, 75 Ω], resolution: PAL: 704 × 576, NTSC: 704 × 480	1-ch, BNC [1.0 Vp-p, 75 Ω], resolution: PAL: 704 × 576, NTSC: 704 × 480	1-ch, BNC [1.0 Vp-p, 75 Ω], resolution: PAL: 704 × 576, NTSC: 704 × 480	1-ch, BNC [1.0 Vp-p, 75 Ω], resolution: PAL: 704 × 576, NTSC: 704 × 480	1-ch, BNC [1.0 Vp-p, 75 Ω], resolution: PAL: 704 × 576, NTSC: 704 × 480
Audio Output	1-ch, RCA [Linear, 1 KΩ]	1-ch, RCA [Linear, 1 KΩ]	1-ch, RCA [Linear, 1 KΩ]	1-ch, RCA [Linear, 1 KΩ]	1-ch, RCA [Linear, 1 KΩ]
Encoding Capability	Main stream: 8 MP@8 fps/5 MP@12 fps/3K@12 fps/ 4 MP@15 fps/3 MP@18 fps 1080p/720p/WD1/4CIF/VGA/CIF@25 fps (P)/30 fps (N) Sub-stream: WD1/4CIF/CIF@25 fps (P)/30 fps (N)	Main stream: 8 MP@8 fps/5 MP@12 fps/3K@12 fps/4 MP@15 fps/8 MP Lite@15 fps/3 MP@18 fps 1080p/720p/WD1/4CIF/VGA/CIF@25 fps (P)/30 fps (N) *: 8 MP@8 fps is only available for channel 1 Sub-stream: WD1/4CIF/CIF@25 fps (P)/30 fps (N)	Main stream: 8 MP@8 fps/5 MP@12 fps/3K@12 fps/4 MP@15 fps/8 MP Lite@15 fps/3 MP@18 fps 1080p/720p/WD1/4CIF/VGA/CIF@25 fps (P)/30 fps (N) *: 8 MP@8 fps is only available for channel 1 Sub-stream: WD1/4CIF/CIF@25 fps (P)/30 fps (N)	Main stream: 8 MP@8 fps/5 MP@12 fps/3K@12 fps/ 4 MP@15 fps/3 MP@18 fps 1080p/720p/WD1/4CIF/VGA/CIF@25 fps (P)/30 fps (N) Sub-stream: WD1/4CIF/CIF@25 fps (P)/30 fps (N)	Main stream: 8 MP@8 fps/5 MP@12 fps/3K@12 fps/ 4 MP@15 fps/3 MP@18 fps 1080p/720p/WD1/4CIF/VGA/CIF@25 fps (P)/30 fps (N) Sub-stream: WD1/4CIF/CIF@25 fps (P)/30 fps (N)
SATA Capacity	2 SATA interfaces Up to 10 TB capacity for each disk	1 SATA interface Up to 10 TB capacity for each disk	2 SATA interface Up to 10 TB capacity for each disk	1 SATA interface Up to 10 TB capacity for each disk	2 SATA interface Up to 10 TB capacity for each disk
Network Interface	1, RJ45 10/100/1000 Mbps self-adaptive Ethernet interface	1, RJ45 10M/100M self-adaptive Ethernet interface	1, RJ45 10M/100M self-adaptive Ethernet interface	1, RJ45 10M/100M/1000M self-adaptive Ethernet interface	1, RJ45 10M/100M/1000M self-adaptive Ethernet interface
Serial Interface	RS-485 (half-duplex)	RS-485 (half-duplex)	RS-485 (half-duplex)	RS-485 (half-duplex)	RS-485 (half-duplex)
USB Port	1 × USB 2.0 1 × USB 3.0	2 × USB 2.0	2 × USB 2.0	1 × USB 2.0 1 × USB 3.0	1 × USB 2.0 1 × USB 3.0
Smart Function	1. Human body & vehicle recognition 2. Motion Detection 2.0: all channels 3. VCA: Line crossing, Intrusion detection, up to 4-ch	1.1-ch face picture comparasion and face picture search 2. Human body & vehicle recognition 3. Motion Detection 2.0: all channels 4. VCA: Line crossing, Intrusion detection, up to 4-ch	1.1-ch face picture comparasion and face picture search 2. Human body & vehicle recognition 3. Motion Detection 2.0: all channels 4. VCA: Line crossing, Intrusion detection, up to 4-ch	1.1-ch face picture comparasion and face picture search 2. Human body & vehicle recognition 3. Motion Detection 2.0: all channels 4. VCA: Line crossing, Intrusion detection, up to 4-ch	1.1-ch face picture comparasion and face picture search 2. Human body & vehicle recognition 3. Motion Detection 2.0: all channels 4. VCA: Line crossing, Intrusion detection, up to 4-ch
Alarm I/O	-	-	-	-	-
Power	12 VDC	12 VDC	12 VDC	12 VDC	12 VDC
Chassis	1U (380mm)	1U (315mm)	1U (380mm)	1U (380mm)	1U (380mm)

Model	IDS-7204HTHI-M1/S	IDS-7204HTHI-M2/S	IDS-7208HTHI-M2/S
Image	 AcuSense	 AcuSense	 AcuSense
Video Compression	H.265 Pro+ / H.265 Pro / H.265 / H.264+ / H.264	H.265 Pro+ / H.265 Pro / H.265 / H.264+ / H.264	H.265 Pro+ / H.265 Pro / H.265 / H.264+ / H.264
Analog Video Input	4-ch, Coaxial video-audio	4-ch, Coaxial video-audio	8-ch, Coaxial video-audio
IP Video Input	4-ch (Up to 8-ch), Up to 8 MP resolution	4-ch (Up to 8-ch), Up to 8 MP resolution	8-ch (Up to 16-ch), Up to 8 MP resolution
Audio Input	4-ch, RCA (2.0 Vp-p, 1 KΩ)	4-ch, RCA (2.0 Vp-p, 1 KΩ)	4-ch, RCA (2.0 Vp-p, 1 KΩ)
HDMI / VGA Output	VGA: 1-ch, 1920 × 1080/60Hz, 1280 × 1024/60Hz, 1280 × 720/60Hz, 1024 × 768/60Hz HDMI: 1-ch, 4K (3840 × 2160)/30Hz, 2K (2560 × 1440)/60Hz, 1920 × 1080/60Hz, 1280 × 1024/60Hz, 1280 × 720/60Hz, 1024 × 768/60Hz	VGA: 1-ch, 1920 × 1080/60Hz, 1280 × 1024/60Hz, 1280 × 720/60Hz, 1024 × 768/60Hz HDMI: 1-ch, 4K (3840 × 2160)/30Hz, 2K (2560 × 1440)/60Hz, 1920 × 1080/60Hz, 1280 × 1024/60Hz, 1280 × 720/60Hz, 1024 × 768/60Hz	VGA: 1-ch, 1920 × 1080/60Hz, 1280 × 1024/60Hz, 1280 × 720/60Hz, 1024 × 768/60Hz HDMI: 1-ch, 4K (3840 × 2160)/30Hz, 2K (2560 × 1440)/60Hz, 1920 × 1080/60Hz, 1280 × 1024/60Hz, 1280 × 720/60Hz, 1024 × 768/60Hz
HDMI2 Output	-	-	-
CVBS Output	1-ch, BNC (1.0 Vp-p, 75 Ω), resolution: PAL: 704 × 576, NTSC: 704 × 480	1-ch, BNC (1.0 Vp-p, 75 Ω), resolution: PAL: 704 × 576, NTSC: 704 × 480	1-ch, BNC (1.0 Vp-p, 75 Ω), resolution: PAL: 704 × 576, NTSC: 704 × 480
Audio Output	1-ch, RCA (Linear, 1 KΩ)	1-ch, RCA (Linear, 1 KΩ)	1-ch, RCA (Linear, 1 KΩ)
Encoding Capability	Main stream: 8 MP@15fps, 5 MP@20fps, 3 MP@18fps 4 MP/1080p/720p/WD1/4CIF/VGA/CIF@25fps (P)/30fps (N) Sub-stream: WD1/4CIF/CIF@25fps (P)/30fps (N)	Main stream: 8 MP@15fps, 5 MP@20fps, 3 MP@18fps 4 MP/1080p/720p/WD1/4CIF/VGA/CIF@25fps (P)/30fps (N) Sub-stream: WD1/4CIF/CIF@25fps (P)/30fps (N)	Main stream: 8 MP@15fps, 5 MP@20fps, 3 MP@18fps 4 MP/1080p/720p/WD1/4CIF/VGA/CIF@25fps (P)/30fps (N) Sub-stream: WD1/4CIF/CIF@25fps (P)/30fps (N)
SATA Capacity	1 SATA interfaces Up to 10 TB capacity for each disk	2SATA interfaces Up to 10 TB capacity for each disk	2 SATA interfaces Up to 10 TB capacity for each disk
Array Type	-	-	-
Network Interface	1, RJ45 10M/100M/1000M self-adaptive Ethernet interface	1, RJ45 10M/100M/1000M self-adaptive Ethernet interface	1, RJ45 10M/100M/1000M self-adaptive Ethernet interface
Serial Interface	RS-485 (half-duplex)	RS-485 (half-duplex)	RS-485 (half-duplex)
USB Port	1 × USB 2.0 1 × USB 3.0	1 × USB 2.0 1 × USB 3.0	1 × USB 2.0 1 × USB 3.0
Smart Function	1. Human body & vehicle recognition 2. Motion Detection 2.0: all channels 3. VCA: Line crossing, Intrusion detection, up to 4-ch	1. Human body & vehicle recognition 2. Motion Detection 2.0: all channels 3. VCA: Line crossing, Intrusion detection, up to 4-ch	1. Human body & vehicle recognition 2. Motion Detection 2.0: all channels 3. VCA: Line crossing, Intrusion detection, up to 8-ch
Alarm I/O	OPTIONAL	OPTIONAL	OPTIONAL
Power	12 VDC	12 VDC	12 VDC
Chassis	1U (315mm)	1U (380mm)	1U (380mm)

Model	IDS-7204HUHI-M1/P	IDS-7208HUHI-M2/P	IDS-7216HUHI-M2/P
Image	 <p>PoC AcuSense</p>	 <p>PoC AcuSense</p>	 <p>PoC AcuSense</p>
Video Compression	H.265 Pro+/H.265 Pro/H.265/H.264+/H.264	H.265 Pro+/H.265 Pro/H.265/H.264+/H.264	H.265 Pro+/H.265 Pro/H.265/H.264+/H.264
Analog Video Input	4-ch	8-ch	16-ch
IP Video Input	4-ch (Up to 8-ch), Up to 8 MP resolution	8-ch (Up to 16-ch), Up to 8 MP resolution	16-ch (Up to 32-ch), Up to 8 MP resolution
Audio Input	4-ch, RCA (2.0 Vp-p, 1 KΩ)	4-ch, RCA (2.0 Vp-p, 1 KΩ)	4-ch, RCA (2.0 Vp-p, 1 KΩ)
HDMI / VGA Output	1-ch, 1920 × 1080/60Hz, 1280 × 1024/60Hz, 1280 × 720/60Hz, 1024 × 768/60Hz	VGA: 1-ch, 1920 × 1080/60Hz, 1280 × 1024/60Hz, 1280 × 720/60Hz, 1024 × 768/60Hz HDMI: 1-ch, 4K (3840 × 2160)/30Hz, 2K (2560 × 1440)/60Hz, 1920 × 1080/60Hz, 1280 × 1024/60Hz, 1280 × 720/60Hz, 1024 × 768/60Hz	VGA: 1-ch, 1920 × 1080/60Hz, 1280 × 1024/60Hz, 1280 × 720/60Hz, 1024 × 768/60Hz HDMI: 1-ch, 4K (3840 × 2160)/30Hz, 2K (2560 × 1440)/60Hz, 1920 × 1080/60Hz, 1280 × 1024/60Hz, 1280 × 720/60Hz, 1024 × 768/60Hz
HDMI2 Output	-	-	-
CVBS Output	1-ch, BNC (1.0 Vp-p, 75 Ω), resolution: PAL: 704 × 576, NTSC: 704 × 480	1-ch, BNC (1.0 Vp-p, 75 Ω), resolution: PAL: 704 × 576, NTSC: 704 × 480	1-ch, BNC (1.0 Vp-p, 75 Ω), resolution: PAL: 704 × 576, NTSC: 704 × 480
Audio Output	1-ch, RCA (Linear, 1KΩ)	1-ch, RCA (Linear, 1KΩ)	1-ch, RCA (Linear, 1KΩ)
Encoding Capability	Main stream: 5 MP@12fps/4 MP@15fps/3 MP@18fps 1080p/720p/WD1/4CIF/VGA/CIF@25fps (P)/30fps (N) Sub-stream: WD1/4CIF/CIF@25fps (P)/30fps (N)	Main stream: 8 MP@8fps/5 MP@12fps/4 MP@15fps/3 MP@18fps 1080p/720p/WD1/4CIF/VGA/CIF@25fps (P)/30fps (N) Sub-stream: WD1/4CIF/CIF@25fps (P)/30fps (N)	Main stream: 8 MP@8fps/5 MP@12fps/4 MP@15fps/3 MP@18fps 1080p/720p/WD1/4CIF/VGA/CIF@25fps (P)/30fps (N) Sub-stream: WD1/4CIF/CIF@25fps (P)/30fps (N)
SATA Capacity	1 SATA interface Up to 10 TB capacity for each disk	2 SATA interface Up to 10 TB capacity for each disk	2 SATA interface Up to 10 TB capacity for each disk
Array Type	-	-	-
Network Interface	1, RJ45 10M/100M self-adaptive Ethernet interface	1, RJ45 10M/100M/1000M self-adaptive Ethernet interface	1, RJ45 10M/100M/1000M self-adaptive Ethernet interface
Serial Interface	RS-485 (half-duplex)	RS-485 (half-duplex)	RS-485 (half-duplex)
USB Port	2 × USB 2.0	1 × USB 2.0 1 × USB 3.0	1 × USB 2.0 1 × USB 3.0
Smart Function	1. Human body & vehicle recognition 2. Motion Detection 2.0: all channels 3. VCA: Line crossing, Intrusion detection, up to 4-ch	1. Human body & vehicle recognition 2. Motion Detection 2.0: all channels 3. VCA: Line crossing, Intrusion detection, up to 4-ch	1. Human body & vehicle recognition 2. Motion Detection 2.0: all channels 3. VCA: Line crossing, Intrusion detection, up to 4-ch
Alarm I/O	4/1	8/4	4/1
Power	48 VDC	48 VDC	100 to 240 VAC
Chassis	1U (315mm)	1U (380mm)	1U (380mm)







Turbo HD DVRs

Value Series

Value Series DVRs include DVRs with AcuSense and DVRs with Motion Detection 2.0, offering cost-effective high-quality video security. Value Series DVRs deliver high-quality video monitoring with H.265 Pro+ and H.265 Pro compression technologies, up to 5 MP ultra HD encoding ability and great durability.





- > Motion Detection 2.0 with person and vehicle classification for all analog channels
- > Person and vehicle classification based on VCA results (Value Series with AcuSense)
- > Search person and vehicle targets quickly
- > Ultra HD, compatible with cameras of up to 5 MP resolution
- > H.265 Pro+ / H.265 Pro / H.265
- > Adaptive signal input (five types: HDTV / AHD / CVI / CVBS / IP)
- > Enhanced network camera access capability







Model	DS-7104HGHI-K1	DS-7104HGHI-M1	DS-7108HGHI-K1	DS-71048HGHI-M1	DS-7116HGHI-K1	DS-7116HGHI-M1
Image	 HOT	 HOT	 HOT	 HOT	 HOT	 HOT
Video Compression	H.265 Pro+/H.265 Pro/H.265/H.264+/H.264	H.265 Pro+/H.265 Pro/H.265/H.264+/H.264	H.265 Pro+/H.265 Pro/H.265/H.264+/H.264	H.265 Pro+/H.265 Pro/H.265/H.264+/H.264	H.265 Pro+/H.265 Pro/H.265/H.264+/H.264	H.265 Pro+/H.265 Pro/H.265/H.264+/H.264
Analog Video-Audio Input	4-ch	4-ch	8-ch	8-ch	16-ch	16-ch
IP Video Input	1-ch (up to 5-ch), Up to 1080p	1-ch (up to 5-ch), Up to 1080p	2-ch (up to 10ch), Up to 5 MP	2-ch (up to 10ch), Up to 5 MP	2-ch (up to 18-ch), Up to 5 MP	2-ch (up to 18-ch), Up to 5 MP
Audio Input	1-ch, RCA (2.0 Vp-p, 1 KΩ) 4-ch via coaxial cable	1-ch, RCA (2.0 Vp-p, 1 KΩ) 4-ch via coaxial cable	1-ch, RCA (2.0 Vp-p, 1 KΩ) 8-ch via coaxial cable	1-ch, RCA (2.0 Vp-p, 1 KΩ) 8-ch via coaxial cable	1-ch, RCA (2.0 Vp-p, 1 KΩ) 16-ch via coaxial cable	1-ch, RCA (2.0 Vp-p, 1 KΩ) 16-ch via coaxial cable
HDMI / VGA Output	1-ch, 1920 × 1080/60Hz, 1280 × 1024/60Hz, 1280 × 720/60Hz, 1024 × 768/60Hz	1-ch, 1920 × 1080/60Hz, 1280 × 1024/60Hz, 1280 × 720/60Hz, 1024 × 768/60Hz	1-ch, 1920 × 1080/60Hz, 1280 × 1024/60Hz, 1280 × 720/60Hz, 1024 × 768/60Hz	1-ch, 1920 × 1080/60Hz, 1280 × 1024/60Hz, 1280 × 720/60Hz, 1024 × 768/60Hz	1-ch, 1920 × 1080/60Hz, 1280 × 1024/60Hz, 1280 × 720/60Hz, 1024 × 768/60Hz HDMI/VGA simultaneous output	1-ch, 1920 × 1080/60Hz, 1280 × 1024/60Hz, 1280 × 720/60Hz, 1024 × 768/60Hz HDMI/VGA simultaneous output
Audio Output	1-ch, RCA (Linear, 1KΩ)	1-ch, RCA (Linear, 1KΩ)	1-ch, RCA (Linear, 1KΩ)	1-ch, RCA (Linear, 1KΩ)	1-ch, RCA (Linear, 1 KΩ)	1-ch, RCA (Linear, 1 KΩ)
Encoding Capability	Main stream: When 1080p Lite mode not enabled: For 720p stream access: 720p/ WD1/4CIF/VGA/CIF@25fps (P)/30fps (N) When 1080p Lite mode enabled: 1080p lite/720p/WD1/4CIF/VGA/ CIF@25fps (P)/30fps (N) Sub-stream: 2CIF@6fps; CIF/QVGA/QCIF@ 25fps (P)/30fps (N)	Main stream: When 1080p Lite mode not enabled: For 720p stream access: 720p/ WD1/4CIF/VGA/CIF@25fps (P)/30fps (N) When 1080p Lite mode enabled: 1080p lite/720p/WD1/4CIF/VGA/ CIF@25fps (P)/30fps (N) Sub-stream: 2CIF@6fps; CIF/QVGA/QCIF@ 25fps (P)/30fps (N)	Main stream: When 1080p lite mode enabled: 1080p lite/HD 720p lite/WD1/4CIF/ VGA@12fps; CIF@25fps (P)/30fps (N) When 1080p lite mode not enabled: For 720p stream access: 720p/WD1/4CIF/VGA@12fps; CIF@25fps (P)/30fps (N) For SD stream access: WD1/4CIF/VGA/CIF@25fps (P)/30fps (N) Sub-stream: CIF/QVGA/QCIF@25fps (P)/30fps (N)	Main stream: When 1080p lite mode enabled: 1080p lite/HD 720p lite/WD1/4CIF/ VGA@12fps; CIF@25fps (P)/30fps (N) When 1080p lite mode not enabled: For 720p stream access: 720p/WD1/4CIF/VGA@12fps; CIF@25fps (P)/30fps (N) For SD stream access: WD1/4CIF/VGA/CIF@25fps (P)/30fps (N) Sub-stream: CIF/QVGA/QCIF@25fps (P)/30fps (N)	Main stream: For 1080p stream access: 1080p lite/720p lite/WD1/4CIF/ VGA@15 fps; CIF@25 fps (P)/30 fps (N) For 720p stream access: 720p/ WD1/4CIF/VGA@15 fps; CIF@ 25fps (P)/30 fps (N) For standard definition stream access: WD1/4CIF/VGA/CIF@25 fps (P)/30 fps (N) Sub-stream: For 1080p and 720p stream access: CIF/QVGA@15 fps For standard definition stream access: CIF/QVGA@25 fps (P)/30 fps (N)	Main stream: For 1080p stream access: 1080p lite/720p lite/WD1/4CIF/ VGA@15 fps; CIF@25 fps (P)/30 fps (N) For 720p stream access: 720p/ WD1/4CIF/VGA@15 fps; CIF@ 25fps (P)/30 fps (N) For standard definition stream access: WD1/4CIF/VGA/CIF@25 fps (P)/30 fps (N) Sub-stream: For 1080p and 720p stream access: CIF/QVGA@15 fps For standard definition stream access: CIF/QVGA@25 fps (P)/30 fps (N)
SATA Capacity	1 SATA interface Up to 6TB capacity for each disk	1 SATA interface Up to 6TB capacity for each disk	1 SATA interface Up to 6TB capacity for each disk	1 SATA interface Up to 6TB capacity for each disk	1 SATA interface Up to 10TB capacity for each disk	1 SATA interface Up to 10TB capacity for each disk
Network Interface	1, RJ45 10M/100M self-adaptive Ethernet interface	1, RJ45 10M/100M self-adaptive Ethernet interface	1, RJ45 10M/100M self-adaptive Ethernet interface	1, RJ45 10M/100M self-adaptive Ethernet interface	1, RJ45 10M/100M self-adaptive Ethernet interface	1, RJ45 10M/100M self-adaptive Ethernet interface
Serial Interface	-	-	-	-	-	-
USB Port	2 × USB 2.0	2 × USB 2.0	2 × USB 2.0	2 × USB 2.0	2 × USB 2.0	2 × USB 2.0
Smart Function	1. Human body & vehicle recognition 2. Motion Detection 2.0: all channels	1. Human body & vehicle recognition 2. Motion Detection 2.0: all channels	1. Human body & vehicle recognition 2. Motion Detection 2.0: all channels	1. Human body & vehicle recognition 2. Motion Detection 2.0: all channels	1. Human body & vehicle recognition 2. Motion Detection 2.0: all channels	1. Human body & vehicle recognition 2. Motion Detection 2.0 : all channels
Alarm I/O	-	-	-	-	-	-
Power	12 VDC	12 VDC	12 VDC	12 VDC	12 VDC	12 VDC
Chassis	Mini 1U (200mm)	Mini 1U (200mm)	Mini 1U (200mm)	Mini 1U (200mm)	Mini 1U (285mm)	Mini 1U (285mm)

Model	DS-7204HGHI-K1	DS-7204HGHI-M1	DS-7208HGHI-K1	DS-7208HGHI-M1	DS-7216HGHI-K1	DS-7216HGHI-M1
Image						
Video Compression	H.265 Pro+ / H.265 Pro / H.265 / H.264+ / H.264	H.265 Pro+ / H.265 Pro / H.265 / H.264+ / H.264	H.265 Pro+ / H.265 Pro / H.265 / H.264+ / H.264	H.265 Pro+ / H.265 Pro / H.265 / H.264+ / H.264	H.265 Pro+ / H.265 Pro / H.265 / H.264+ / H.264	H.265 Pro+ / H.265 Pro / H.265 / H.264+ / H.264
Analog Video-Audio Input	4-ch	4-ch	8-ch	8-ch	16-ch	16-ch
IP Video Input	1-ch(Up to 5-ch),Up to 1080p	1-ch(Up to 5-ch),Up to 1080p	2-ch(Up to 10-ch),Up to 5 MP	2-ch(Up to 10-ch),Up to 5 MP	2-ch (up to 18-ch),Up to 5 MP	2-ch (up to 18-ch),Up to 5 MP
Audio Input	1-ch, RCA (2.0 Vp-p, 1 KΩ) 4-ch via coaxial cable	1-ch, RCA (2.0 Vp-p, 1 KΩ) 4-ch via coaxial cable	1-ch, RCA (2.0 Vp-p, 1 KΩ) 8-ch via coaxial cable	1-ch, RCA (2.0 Vp-p, 1 KΩ) 8-ch via coaxial cable	1-ch, RCA (2.0 Vp-p, 1 KΩ) 16-ch via coaxial cable	1-ch, RCA (2.0 Vp-p, 1 KΩ) 16-ch via coaxial cable
HDMI / VGA Output	1-ch, 1920 × 1080/60Hz, 1280 × 1024/60Hz, 1280 × 720/60Hz, 1024 × 768/60Hz	1-ch, 1920 × 1080/60Hz, 1280 × 1024/60Hz, 1280 × 720/60Hz, 1024 × 768/60Hz	1-ch, 1920 × 1080/60Hz, 1280 × 1024/60Hz, 1280 × 720/60Hz, 1024 × 768/60Hz	1-ch, 1920 × 1080/60Hz, 1280 × 1024/60Hz, 1280 × 720/60Hz, 1024 × 768/60Hz	1-ch, 1920 × 1080/60 Hz, 1280 × 1024/60 Hz, 1280 × 720/60 Hz, 1024 × 768/60 Hz	1-ch, 1920 × 1080/60 Hz, 1280 × 1024/60 Hz, 1280 × 720/60 Hz, 1024 × 768/60 Hz
Audio Output	1-ch, RCA (Linear, 1KΩ)	1-ch, RCA (Linear, 1KΩ)	1-ch, RCA (Linear, 1KΩ)	1-ch, RCA (Linear, 1KΩ)	1-ch, RCA (Linear, 1 KΩ)	1-ch, RCA (Linear, 1 KΩ)
Encoding Capability	Main stream: When 1080p lite mode enabled: 1080p lite/HD 720p lite/WD1/4CIF/ VGA@12fps; CIF@25fps (PI)/30fps (N) When 1080p lite mode not enabled: For 720p stream access: 720p/WD1/4CIF/VGA@12fps; CIF@25fps (PI)/30fps (N) Sub-stream: CIF/QVGA/QCIF@25fps (PI)/30fps (N) For SD stream access: WD1/4CIF/VGA/CIF@25fps (PI)/30fps (N)	Main stream: When 1080p lite mode enabled: 1080p lite/HD 720p lite/WD1/4CIF/ VGA@12fps; CIF@25fps (PI)/30fps (N) When 1080p lite mode not enabled: For 720p stream access: 720p/WD1/4CIF/VGA@12fps; CIF@25fps (PI)/30fps (N) Sub-stream: CIF/QVGA/QCIF@25fps (PI)/30fps (N) For SD stream access: WD1/4CIF/VGA/CIF@25fps (PI)/30fps (N)	Main stream: When 1080p lite mode enabled: 1080p lite/HD 720p lite/WD1/4CIF/ VGA@12fps; CIF@25fps (PI)/30fps (N) When 1080p lite mode not enabled: For 720p stream access: 720p/WD1/4CIF/VGA@12fps; CIF@25fps (PI)/30fps (N) Sub-stream: CIF/QVGA/QCIF@25fps (PI)/30fps (N) For SD stream access: WD1/4CIF/VGA/CIF@25fps (PI)/30fps (N)	Main stream: When 1080p lite mode enabled: 1080p lite/HD 720p lite/WD1/4CIF/ VGA@12fps; CIF@25fps (PI)/30fps (N) When 1080p lite mode not enabled: For 720p stream access: 720p/WD1/4CIF/VGA@12fps; CIF@25fps (PI)/30fps (N) Sub-stream: CIF/QVGA/QCIF@25fps (PI)/30fps (N) For SD stream access: WD1/4CIF/VGA/CIF@25fps (PI)/30fps (N)	Main stream: For 1080p stream access: 1080p lite/720p lite/WD1/4CIF/ VGA@15fps; CIF@25fps (PI)/30fps (N) For 720p stream access: 720p/ WD1/4CIF/VGA@15fps; CIF@25fps (PI)/30fps (N) For standard definition stream access: WD1/4CIF/VGA@15fps/ CIF@25fps (PI)/30fps (N) Sub-stream: For 1080p and 720p stream access: CIF/QVGA@15fps For standard definition stream access: CIF/QVGA@25fps (PI)/30fps (N)	Main stream: For 1080p stream access: 1080p lite/720p lite/WD1/4CIF/ VGA@15fps; CIF@25fps (PI)/30fps (N) For 720p stream access: 720p/ WD1/4CIF/VGA@15fps; CIF@25fps (PI)/30fps (N) For standard definition stream access: WD1/4CIF/VGA@15fps/ CIF@25fps (PI)/30fps (N) Sub-stream: For 1080p and 720p stream access: CIF/QVGA@15fps For standard definition stream access: CIF/QVGA@25fps (PI)/30fps (N)
SATA Capacity	1 SATA interface Up to 6TB capacity for each disk	1 SATA interface Up to 6TB capacity for each disk	1 SATA interface Up to 6TB capacity for each disk	1 SATA interface Up to 6TB capacity for each disk	1 SATA interface Up to 10 TB capacity for each disk	1 SATA interface Up to 10 TB capacity for each disk
Network Interface	1, RJ45 10M/100M self-adaptive Ethernet interface	1, RJ45 10M/100M self-adaptive Ethernet interface	1, RJ45 10M/100M self-adaptive Ethernet interface	1, RJ45 10M/100M self-adaptive Ethernet interface	1, RJ45 10M/100M self-adaptive Ethernet interface	1, RJ45 10M/100M self-adaptive Ethernet interface
Serial Interface	-	-	-	-	-	-
USB Port	2 × USB 2.0	2 × USB 2.0	2 × USB 2.0	2 × USB 2.0	2 × USB 2.0	2 × USB 2.0
Smart Function	1. Human body & vehicle recognition 2. Motion Detection 2.0: all channels	1. Human body & vehicle recognition 2. Motion Detection 2.0: all channels	1. Human body & vehicle recognition 2. Motion Detection 2.0: all channels	1. Human body & vehicle recognition 2. Motion Detection 2.0: all channels	1. Human body & vehicle recognition 2. Motion Detection 2.0: all channels	1. Human body & vehicle recognition 2. Motion Detection 2.0: all channels
Alarm I/O	-	-	-	-	-	-
Power	12 VDC	12 VDC	12 VDC	12 VDC	12 VDC	12 VDC
Chassis	1U (260mm)	1U (260mm)	1U (260mm)	1U (260mm)	1U(260mm)	1U(260mm)

Model	DS-7232HGHI-M2
Image	
Video Compression	H.265 Pro+/H.265 Pro/H.265/H.264PRO+/H.264PRO/H.264
Analog Video-Audio Input	32-ch
IP Video Input	2-ch (up to 18-ch), Up to 5 MP
Audio Input	1-ch, RCA (2.0 Vp-p, 1 KΩ) 16-ch via coaxial cable
HDMI / VGA Output	VGA: 1-ch, 1920 × 1080/60 Hz, 1280 × 1024/60 Hz, 1280 × 720/60 Hz, 1024 × 768/60 Hz HDMI: 1920 × 1080/60Hz, 1280 × 1024/60Hz, 1280 × 720/60Hz, 1024 × 768/60Hz
Audio Output	1-ch, RCA (Linear, 1 KΩ)
Encoding Capability	Main stream: 1080p Lite @15fps/HD 720p@15fps/ WD1/4CIF/VGA/CIF@25 fps (PI)/30 fps (N) Sub-stream: 4CIF/CIF/OVGA@25 fps (PI)/30 fps (N)
SATA Capacity	2 SATA interface Up to 10 TB capacity for each disk
Network Interface	1, RJ45 10M/100M self-adaptive Ethernet interface
Serial Interface	-
USB Port	1 × USB 2.0 1 × USB 3.0
Smart Function	1. Human body & vehicle recognition 2. Motion Detection 2.0: all channels
Alarm I/O	-
Power	12 VDC
Chassis	1U(380mm)

Model	IDS-7104HQHI-M1/S	IDS-7204HQHI-M1/E	IDS-7108HQHI-M1/S	IDS-7208HQHI-M1/E
Image	 AcuSense	 AcuSense	 AcuSense	 AcuSense
Video Compression	H.265 Pro+ / H.265 Pro / H.265 / H.264+ / H.264	H.265 Pro+ / H.265 Pro / H.265 / H.264+ / H.264	H.265 Pro+ / H.265 Pro / H.265 / H.264+ / H.264	H.265 Pro+ / H.265 Pro / H.265 / H.264+ / H.264
Analog Video-Audio Input	4-ch, Coaxial video-audio	4-ch, Coaxial video-audio	8-ch, Coaxial video-audio	8-ch, Coaxial video-audio
IP Video Input	2-ch (Up to 6-ch), Up to 6 MP resolution	2-ch (Up to 6-ch), Up to 6 MP resolution	4-ch (Up to 12-ch), Up to 6 MP resolution	4-ch (Up to 12-ch), Up to 6 MP resolution
Audio Input	1-ch, RCA (2.0 Vp-p, 1 KΩ)	1-ch, RCA (2.0 Vp-p, 1 KΩ)	1-ch, RCA (2.0 Vp-p, 1 KΩ)	1-ch, RCA (2.0 Vp-p, 1 KΩ)
HDMI / VGA Output	1-ch, 1920 × 1080/60Hz, 1280 × 1024/60Hz, 1280 × 720/60Hz, 1024 × 768/60Hz	1-ch, 1920 × 1080/60Hz, 1280 × 1024/60Hz, 1280 × 720/60Hz, 1024 × 768/60Hz	1-ch, 1920 × 1080/60Hz, 1280 × 1024/60Hz, 1280 × 720/60Hz, 1024 × 768/60Hz	1-ch, 1920 × 1080/60Hz, 1280 × 1024/60Hz, 1280 × 720/60Hz, 1024 × 768/60Hz
Audio Output	1-ch, RCA (Linear, 1KΩ)	1-ch, RCA (Linear, 1KΩ)	1-ch, RCA (Linear, 1KΩ)	1-ch, RCA (Linear, 1KΩ)
Encoding Capability	Main stream: When 1080p Lite mode not enabled: For 5 MP stream access: 5 MP lite@12fps;4 MP lite/1080p@15fps;720p/WD1/4CIF/VGA/CIF@25fps (PI)/30fps (N) For 3K stream access: 3K lite@12fps;4 MP lite/1080p@15fps;720p/WD1/4CIF/VGA/CIF@25fps (PI)/30fps (N) For 4 MP stream access: 4 MP lite/1080p@15fps;720p/WD1/4CIF/VGA/CIF@25fps (PI)/30fps (N) For 1080p stream access: 1080p/720p@15fps;VGA/WD1/4CIF/CIF@25fps (PI)/30fps (N) For 720p stream access: 720p/VGA/WD1/4CIF/CIF@25fps (PI)/30fps (N) When 1080p Lite mode enabled: 5 MP lite/3K lite@15fps;4 MP lite@15fps;1080p lite/720p lite/VGA/WD1/4CIF/CIF@25fps (PI)/30fps (N) Sub-stream: WD1/4CIF@12fps; CIF@25fps (PI)/30fps (N)	Main stream: When 1080p Lite mode not enabled: For 5 MP stream access: 5 MP lite@12fps;4 MP lite/1080p@15fps;720p/WD1/4CIF/VGA/CIF@25fps (PI)/30fps (N) For 3K stream access: 3K lite@12fps;4 MP lite/1080p@15fps;720p/WD1/4CIF/VGA/CIF@25fps (PI)/30fps (N) For 4 MP stream access: 4 MP lite/1080p@15fps;720p/WD1/4CIF/VGA/CIF@25fps (PI)/30fps (N) For 1080p stream access: 1080p/720p@15fps;VGA/WD1/4CIF/CIF@25fps (PI)/30fps (N) For 720p stream access: 720p/VGA/WD1/4CIF/CIF@25fps (PI)/30fps (N) When 1080p Lite mode enabled: 5 MP lite/3K lite@15fps;4 MP lite@15fps;1080p lite/720p lite/VGA/WD1/4CIF/CIF@25fps (PI)/30fps (N) Sub-stream: WD1/4CIF@12fps; CIF@25fps (PI)/30fps (N)	Main stream: When 1080p Lite mode not enabled: For 5 MP stream access: 5 MP lite@12fps;4 MP lite/1080p@15fps;720p/WD1/4CIF/VGA/CIF@25fps (PI)/30fps (N) For 3K stream access: 3K lite@12fps;4 MP lite/1080p@15fps;720p/WD1/4CIF/VGA/CIF@25fps (PI)/30fps (N) For 4 MP stream access: 4 MP lite/1080p@15fps;720p/WD1/4CIF/VGA/CIF@25fps (PI)/30fps (N) For 1080p stream access: 1080p/720p@15fps;VGA/WD1/4CIF/CIF@25fps (PI)/30fps (N) For 720p stream access: 720p/VGA/WD1/4CIF/CIF@25fps (PI)/30fps (N) When 1080p Lite mode enabled: 5 MP lite/3K lite@15fps;4 MP lite@15fps;1080p lite/720p lite/VGA/WD1/4CIF/CIF@25fps (PI)/30fps (N) Sub-stream: WD1/4CIF@12fps; CIF@25fps (PI)/30fps (N)	Main stream: When 1080p Lite mode not enabled: For 5 MP stream access: 5 MP lite@12fps;4 MP lite/1080p@15fps;720p/WD1/4CIF/VGA/CIF@25fps (PI)/30fps (N) For 3K stream access: 3K lite@12fps;4 MP lite/1080p@15fps;720p/WD1/4CIF/VGA/CIF@25fps (PI)/30fps (N) For 4 MP stream access: 4 MP lite/1080p@15fps;720p/WD1/4CIF/VGA/CIF@25fps (PI)/30fps (N) For 1080p stream access: 1080p/720p@15fps;VGA/WD1/4CIF/CIF@25fps (PI)/30fps (N) For 720p stream access: 720p/VGA/WD1/4CIF/CIF@25fps (PI)/30fps (N) When 1080p Lite mode enabled: 5 MP lite/3K lite@15fps;4 MP lite@15fps;1080p lite/720p lite/VGA/WD1/4CIF/CIF@25fps (PI)/30fps (N) Sub-stream: WD1/4CIF@12fps; CIF@25fps (PI)/30fps (N)
SATA Capacity	1 SATA interface Up to 10 TB capacity for each disk	1 SATA interface Up to 10 TB capacity for each disk	1 SATA interface Up to 10 TB capacity for each disk	1 SATA interface Up to 10 TB capacity for each disk
Network Interface	1, RJ45 10M/100M self-adaptive Ethernet interface	1, RJ45 10M/100M self-adaptive Ethernet interface	1, RJ45 10M/100M self-adaptive Ethernet interface	1, RJ45 10M/100M self-adaptive Ethernet interface
Serial Interface	-	-	-	-
USB Port	2 × USB 2.0	2 × USB 2.0	2 × USB 2.0	2 × USB 2.0
Smart Function	1. Human body & vehicle recognition 2. Motion Detection 2.0: all channels 3. VCA: Line crossing, Intrusion detection, up to 2-ch	1. Human body & vehicle recognition 2. Motion Detection 2.0: all channels 3. VCA: Line crossing, Intrusion detection, up to 2-ch	1. Human body & vehicle recognition 2. Motion Detection 2.0: all channels 3. VCA: Line crossing, Intrusion detection, up to 2-ch	1. Human body & vehicle recognition 2. Motion Detection 2.0: all channels 3. VCA: Line crossing, Intrusion detection, up to 2-ch
Alarm I/O	-	-	-	-
Power	12 VDC	12 VDC	12 VDC	12 VDC
Chassis	Mini 1U (200mm)	Mini 1U (200mm)	Mini 1U (200mm)	Mini 1U (200mm)

Model	IDS-7116HQHI-M1/S	IDS-7216HQHI-M1/E
Image	 AcuSense	 AcuSense
Video Compression	H.265 Pro+ / H.265 Pro / H.265 / H.264+ / H.264	H.265 Pro+ / H.265 Pro / H.265 / H.264+ / H.264
Analog Video-Audio Input	16-ch, Coaxial video-audio	16-ch, Coaxial video-audio
IP Video Input	8-ch (Up to 24-ch), Up to 6 MP resolution	8-ch (Up to 24-ch), Up to 6 MP resolution
Audio Input	1-ch, RCA (2.0 Vp-p, 1 KΩ)	1-ch, RCA (2.0 Vp-p, 1 KΩ)
HDMI / VGA Output	VGA: 1-ch, 1920 × 1080/60Hz, 1280 × 1024/60Hz, 1280 × 720/60Hz, 1024 × 768/60Hz HDMI: 1-ch, 4K (3840 × 2160)/30Hz, 2K (2560 × 1440)/60Hz, 1920 × 1080/60Hz, 1280 × 1024/60Hz, 1280 × 720/60Hz, 1024 × 768/60Hz	VGA: 1-ch, 1920 × 1080/60Hz, 1280 × 1024/60Hz, 1280 × 720/60Hz, 1024 × 768/60Hz HDMI: 1-ch, 4K (3840 × 2160)/30Hz, 2K (2560 × 1440)/60Hz, 1920 × 1080/60Hz, 1280 × 1024/60Hz, 1280 × 720/60Hz, 1024 × 768/60Hz
Audio Output	1-ch, RCA (Linear, 1KΩ)	1-ch, RCA (Linear, 1KΩ)
Encoding Capability	Main stream: When 1080p Lite mode not enabled: For 5 MP stream access: 5 MP lite@12fps;4 MP lite/1080p@15fps;720p/WD1/4CIF/VGA/CIF@25fps (PI)/30fps (N) For 3K stream access: 3K lite@12fps;4 MP lite/1080p@15fps;720p/WD1/4CIF/VGA/CIF@25fps (PI)/30fps (N) For 4 MP stream access: 4 MP lite/1080p@15fps;720p/WD1/4CIF/VGA/CIF@25fps (PI)/30fps (N) For 1080p stream access: 1080p/720p@15fps;VGA/WD1/4CIF/CIF@25fps (PI)/30fps (N) For 720p stream access: 720p/VGA/WD1/4CIF/CIF@25fps (PI)/30fps (N) When 1080p Lite mode enabled: 5 MP lite/3K lite@15fps;4 MP lite@15fps;1080p lite/720p lite/VGA/WD1/4CIF/CIF@25fps (PI)/30fps (N) Sub-stream: WD1/4CIF@12fps; CIF@25fps (PI)/30fps (N)	Main stream: When 1080p Lite mode not enabled: For 5 MP stream access: 5 MP lite@12fps;4 MP lite/1080p@15fps;720p/WD1/4CIF/VGA/CIF@25fps (PI)/30fps (N) For 3K stream access: 3K lite@12fps;4 MP lite/1080p@15fps;720p/WD1/4CIF/VGA/CIF@25fps (PI)/30fps (N) For 4 MP stream access: 4 MP lite/1080p@15fps;720p/WD1/4CIF/VGA/CIF@25fps (PI)/30fps (N) For 1080p stream access: 1080p/720p@15fps;VGA/WD1/4CIF/CIF@25fps (PI)/30fps (N) For 720p stream access: 720p/VGA/WD1/4CIF/CIF@25fps (PI)/30fps (N) When 1080p Lite mode enabled: 5 MP lite/3K lite@15fps;4 MP lite@15fps;1080p lite/720p lite/VGA/WD1/4CIF/CIF@25fps (PI)/30fps (N) Sub-stream: WD1/4CIF@12fps; CIF@25fps (PI)/30fps (N)
SATA Capacity	1 SATA interface Up to 10 TB capacity for each disk	1 SATA interface Up to 10 TB capacity for each disk
Network Interface	1, RJ45 10M/100M/1000M self-adaptive Ethernet interface	1, RJ45 10M/100M/1000M self-adaptive Ethernet interface
Serial Interface	-	-
USB Port	2 × USB 2.0	2 × USB 2.0
Smart Function	1. Human body & vehicle recognition 2. Motion Detection 2.0: all channels 3. VCA: Line crossing, Intrusion detection, up to 2-ch	1. Human body & vehicle recognition 2. Motion Detection 2.0: all channels 3. VCA: Line crossing, Intrusion detection, up to 2-ch
Alarm I/O	-	-
Power	12 VDC	12 VDC
Chassis	Mini 1U (285mm)	Mini 1U (285mm)

Model	IDS-7104HUHI-M1/S	IDS-7204HUHI-M1/E	IDS-7108HUHI-M1/S	IDS-7208HUHI-M1/E
Image	 AcuSense	 AcuSense	 AcuSense	 AcuSense
Video Compression	H.265 Pro+ / H.265 Pro / H.265 / H.264+ / H.264	H.265 Pro+ / H.265 Pro / H.265 / H.264+ / H.264	H.265 Pro+ / H.265 Pro / H.265 / H.264+ / H.264	H.265 Pro+ / H.265 Pro / H.265 / H.264+ / H.264
Analog Video-Audio Input	4-ch, Coaxial video-audio	4-ch, Coaxial video-audio	8-ch, Coaxial video-audio	8-ch, Coaxial video-audio
IP Video Input	4-ch (Up to 8-ch), Up to 8 MP resolution	4-ch (Up to 8-ch), Up to 8 MP resolution	8-ch (Up to 16-ch), Up to 8 MP resolution	8-ch (Up to 16-ch), Up to 8 MP resolution
Audio Input	1-ch, RCA (2.0 Vp-p, 1 KΩ)	1-ch, RCA (2.0 Vp-p, 1 KΩ)	1-ch, RCA (2.0 Vp-p, 1 KΩ)	1-ch, RCA (2.0 Vp-p, 1 KΩ)
HDMI / VGA Output	1920 × 1080/60Hz, 1280 × 1024/60Hz, 1280 × 720/60Hz, 1024 × 768/60Hz	1920 × 1080/60Hz, 1280 × 1024/60Hz, 1280 × 720/60Hz, 1024 × 768/60Hz	VGA: 1920 × 1080/60Hz, 1280 × 1024/60Hz, 1280 × 720/60Hz, 1024 × 768/60Hz HDMI: 4K (3840 × 2160)/30Hz, 2K (2560 × 1440)/60Hz, 1920 × 1080/60Hz, 1280 × 1024/60Hz, 1280 × 720/60Hz, 1024 × 768/60Hz	VGA: 1920 × 1080/60Hz, 1280 × 1024/60Hz, 1280 × 720/60Hz, 1024 × 768/60Hz HDMI: 4K (3840 × 2160)/30Hz, 2K (2560 × 1440)/60Hz, 1920 × 1080/60Hz, 1280 × 1024/60Hz, 1280 × 720/60Hz, 1024 × 768/60Hz
Audio Output	1-ch, RCA (Linear, 1KΩ)	1-ch, RCA (Linear, 1KΩ)	1-ch, RCA (Linear, 1KΩ)	1-ch, RCA (Linear, 1KΩ)
Encoding Capability	Main stream: When 8 MP Lite mode is not enabled: 8 MP@8 fps/5MP@12 fps/4 MP@15 fps/3 MP@18 fps 1080p/720p/WD1/4CIF/VGA/CIF@25 fps (PI)/30 fps (N) *: 8 MP@8 fps is only available for channel 1 of DS-7104HUHI-K1. When 8 MP Lite mode enabled: 8 MP Lite/3MP/1080P/720P/WD1/4CIF/VGA/CIF@15 fps *: 8 MP Lite is only available for DS-7104HUHI-K1. Sub-stream: WD1/4CIF/CIF@25fps (PI)/30fps (N)	Main stream: When 8 MP Lite mode is not enabled: 8 MP@8 fps/5MP@12 fps/4 MP@15 fps/3 MP@18 fps 1080p/720p/WD1/4CIF/VGA/CIF@25 fps (PI)/30 fps (N) *: 8 MP@8 fps is only available for channel 1 of DS-7104HUHI-K1. When 8 MP Lite mode enabled: 8 MP Lite/3MP/1080P/720P/WD1/4CIF/VGA/CIF@15 fps *: 8 MP Lite is only available for DS-7104HUHI-K1. Sub-stream: WD1/4CIF/CIF@25fps (PI)/30fps (N)	Main stream: When 8 MP Lite mode is not enabled: 8 MP@8 fps/5MP@12 fps/4 MP@15 fps/3 MP@18 fps 1080p/720p/WD1/4CIF/VGA/CIF@25 fps (PI)/30 fps (N) *: 8 MP@8 fps is only available for channel 1 of DS-7104HUHI-K1. When 8 MP Lite mode enabled: 8 MP Lite/3MP/1080P/720P/WD1/4CIF/VGA/CIF@15 fps *: 8 MP Lite is only available for DS-7104HUHI-K1. Sub-stream: WD1/4CIF/CIF@25fps (PI)/30fps (N)	Main stream: When 8 MP Lite mode is not enabled: 8 MP@8 fps/5MP@12 fps/4 MP@15 fps/3 MP@18 fps 1080p/720p/WD1/4CIF/VGA/CIF@25 fps (PI)/30 fps (N) *: 8 MP@8 fps is only available for channel 1 of DS-7104HUHI-K1. When 8 MP Lite mode enabled: 8 MP Lite/3MP/1080P/720P/WD1/4CIF/VGA/CIF@15 fps *: 8 MP Lite is only available for DS-7104HUHI-K1. Sub-stream: WD1/4CIF/CIF@25fps (PI)/30fps (N)
SATA Capacity	1 SATA interface Up to 6TB capacity for each disk	1 SATA interface Up to 6TB capacity for each disk	1 SATA interface Up to 6TB capacity for each disk	1 SATA interface Up to 6TB capacity for each disk
Network Interface	1, RJ45 10M/100M self-adaptive Ethernet interface	1, RJ45 10M/100M self-adaptive Ethernet interface	1, RJ45 10M/100M/1000M self-adaptive Ethernet interface	1, RJ45 10M/100M/1000M self-adaptive Ethernet interface
Serial Interface	-	-	-	-
USB Port	2 × USB 2.0	2 × USB 2.0	2 × USB 2.0	2 × USB 2.0
Smart Function	1. Human body & vehicle recognition 2. Motion Detection 2.0: all channels 3. VCA: Line crossing, Intrusion detection, up to 4-ch	1. Human body & vehicle recognition 2. Motion Detection 2.0: all channels 3. VCA: Line crossing, Intrusion detection, up to 4-ch	1. Human body & vehicle recognition 2. Motion Detection 2.0: all channels 3. VCA: Line crossing, Intrusion detection, up to 4-ch	1. Human body & vehicle recognition 2. Motion Detection 2.0: all channels 3. VCA: Line crossing, Intrusion detection, up to 4-ch
Alarm I/O	-	-	-	-
Power	12 VDC	12 VDC	12 VDC	12 VDC
Chassis	Mini 1U (200mm)	Mini 1U (200mm)	Mini 1U (200mm)	Mini 1U (200mm)

Turbo HD DVRs

Special Series

Hikvision's banking-specific solution for ATM systems features devices that come equipped with smart analysis functions. These functions include multi-channel analyses based on preset rules to respond to specific behaviors in the immediate vicinity around ATM machines.

- > 1-ch human face mode and 1-ch panel mode for analog channels (IDS-7200AHQHI-M1)
- > Supports overlapping multiple ATM card numbers and multiple protocols (IDS-7200AHQHI-M1)
- > Supports triggering recording upon inserting an ATM card (IDS-7200AHQHI-M1)
- > Playback by inputting ATM card number, transaction amount, or transaction type (IDS-7200AHQHI-M1)
- > H.265 Pro+ / H.265 Pro / H.265
- > Deep learning algorithm
- > Multiple VCA events
- > Multi-channel smart analysis



ATM Seires

Model	IDS-7204AHQHI-M1
Image	
Video Compression	H.265 Pro+ / H.265 Pro / H.265 / H.264+ / H.264
Analog Video Input	4-ch
IP Video Input	Defaulted 0-ch; Up to 6-ch, 6 MP resolution
Audio Input	1-ch, RCA (2.0 Vp-p, 1 KΩ)
HDMI / VGA Output	1-ch, 1920 × 1080/60Hz, 1280 × 1024/60Hz, 1280 × 720/60Hz, 1024 × 768/60Hz, HDMI/VGA simultaneous output
CVBS Output	BNC (1.0 Vp-p, 75 Ω), resolution: PAL: 704 × 576, NTSC: 704 × 480
Audio Output	1-ch, RCA (Linear, 1 KΩ)
Encoding Capability	Main stream: When 1080p lite mode not enabled: For 4 MP stream access: 4 MP lite@15 fps; 1080p lite/720p/WD1/4CIF/VGA/CIF@25 fps (P)/30 fps (N) For 1080p stream access: 1080p/720p@15 fps; VGA/WD1/4CIF/CIF@25 fps (P)/30 fps (N) For 720p stream access: 720p/VGA/WD1/4CIF/CIF@25 fps (P)/30 fps (N) When 1080p Lite mode enabled: 4 MP lite@15 fps; 1080p lite/720p lite/VGA/WD1/4CIF/CIF@25 fps (P)/30 fps (N) Sub-stream: WD1/4CIF@12 fps; CIF@25 fps (P)/30 fps (N)
SATA Capacity	1 SATA interface Up to 8 TB capacity for each disk
Network Interface	1, RJ45 10/100 Mbps self-adaptive Ethernet interface
Serial Interface	RS-232, RS-485 (full-duplex)
USB Port	2 × USB 2.0
Smart Function	1. 1-ch human face mode and 1-ch panel mode for analog channel 2. Support overlapping the multiple ATM cards' number and multiple protocols 3. Support triggering recording once inserting the ATM card 4. Enabling/disabling the function of transaction information overlapping during playback and live view 5. Playback by inputting ATM card number, transaction amount or transaction type 6. Playback by smart ATM alarm
Alarm I/O	N/A
Power	12 VDC, 1.5 A
Chassis	315 × 242 × 45 mm

Accessory

PoC

Model	DS-1TP04I/AT	DS-1TP08I/AT
Image		
Video Compression	4-ch BNC interface for PoC camera	8-ch BNC interface for PoC camera
Analog Video Input	PoC AF camera power supply distance: 200 m 75-3; 300 m 75-5 PoC AT camera power supply distance: 100 m 75-3; 200 m 75-5 Maximum power: 10 W Only Hikvision PoC cameras are supported	PoC AF camera power supply distance: 200 m 75-3; 300 m 75-5 PoC AT camera power supply distance: 100 m 75-3; 200 m 75-5 Maximum power: 10 W Only Hikvision PoC cameras are supported
IP Video Input	4-ch BNC interface for DVR	8-ch BNC interface for DVR
Audio Input	4-ch	8-ch
HDMI / VGA Output	-	-
CVBS Output	8MP	8MP
Audio Output	-	-
Encoding Capability	1U	1U
SATA Capacity	Metal	Metal
Network Interface	48 VDC	48 VDC
Serial Interface	≤ 6 W (not connected to PoC camera)	≤ 10 W (not connected to PoC camera)
USB Port	-10 °C to +55 °C (14 °F to 131 °F)	-10 °C to +55 °C (14 °F to 131 °F)
Smart Function	10% to 90%	10% to 90%
Alarm I/O	1 U	1 U
Power	315 × 242 × 45 mm (12.4 × 9.53 × 1.8 inch)	315 × 242 × 45 mm (12.4 × 9.53 × 1.8 inch)
Chassis	≤ 2.3 kg (5.1 lb)	≤ 2.4 kg (5.3 lb)

Encoders

076 DVS







Encoders

Hikvision Encoder Servers allow the analog signal to be digitized and then stored on a hard drive or transmitted via network, capable of encoding at up to 4K resolution.

- > H.265+ / H.265
- > Ultra HD
- > Various network protocols



Model	DS-6701HUHI	DS-6704HUHI	IDS-6704HUHI-M	IDS-6708HUHI-M	IDS-6716HUHI-M
Image					
Video Compression	H.265+ / H.265 / H.264+ / H.264	H.265+ / H.265 / H.264+ / H.264	H.265+ / H.265 / H.264+ / H.264	H.265+ / H.265 / H.264+ / H.264	H.265+ / H.265 / H.264+ / H.264
Analog Video Input	1-ch	4-ch	4-ch	8-ch	16-ch
Supported Analog Camera Types	HDTVI: 5 MP, 4 MP, 3MP, 1080p30, 1080p25, 720p60, 720p50, 720p30, 720p25 AHD: 1080p30, 1080p25, 720p30, 720p25 HDCVI: 1080p30, 1080p25, 720p30, 720p25 CVBS: PAL/NTSC	HDTVI: 5 MP, 4 MP, 3MP, 1080p30, 1080p25, 720p60, 720p50, 720p30, 720p25 AHD: 1080p30, 1080p25, 720p30, 720p25 HDCVI: 1080p30, 1080p25, 720p30, 720p25 CVBS: PAL/NTSC	HDTVI: 5 MP, 4 MP, 3MP, 1080p30, 1080p25, 720p60, 720p50, 720p30, 720p25 AHD: 5 MP, 4 MP, 1080p30, 1080p25, 720p30, 720p25 HDCVI: 4 MP, 1080p30, 1080p25, 720p30, 720p25 CVBS: PAL/NTSC	HDTVI: 8 MP, 5 MP, 4 MP, 3 MP, 1080p30, 1080p25, 720p60, 720p50, 720p30, 720p25 AHD: 5 MP, 4 MP, 1080p30, 1080p25, 720p30, 720p25 HDCVI: 4 MP, 1080p30, 1080p25, 720p30, 720p25 CVBS: PAL/NTSC	HDTVI: 8 MP, 5 MP, 4 MP, 3 MP, 1080p30, 1080p25, 720p60, 720p50, 720p30, 720p25 AHD: 5 MP, 4 MP, 1080p30, 1080p25, 720p30, 720p25 HDCVI: 4 MP, 1080p30, 1080p25, 720p30, 720p25 CVBS: PAL/NTSC
Audio Output	1-ch, RCA (Linear, 1 KΩ)	1-ch, RCA (Linear, 1 KΩ)	1-ch, RCA (Linear, 1 KΩ)	1-ch, RCA (Linear, 1 KΩ)	1-ch, RCA (Linear, 1 KΩ)
Audio Input	1-ch, 3.5mm interface (2.0 Vp-p, 1 kΩ) (LINE IN)	4-ch, RCA (2.0 Vp-p, 1 KΩ)	4-ch, RCA (2.0 Vp-p, 1 KΩ)	4-ch, RCA (2.0 Vp-p, 1 KΩ)	4-ch, RCA (2.0 Vp-p, 1 KΩ)
Encoding Capability	Main stream: 5 MP@12fps/4 MP@15fps/3 MP@18fps 1080p/720p/WD1/4CIF/VGA/CIF@25fps (P)/30fps (N) Sub-stream: WD1/4CIF/CIF@25fps (P)/30fps (N)	Main stream: 5 MP@12fps/4 MP@15fps/3 MP@18fps 1080p/720p/WD1/4CIF/VGA/CIF@25fps (P)/30fps (N) Sub-stream: WD1/4CIF/CIF@25fps (P)/30fps (N)	Main stream: 5 MP@12fps/4 MP@15fps/3 MP@18fps 1080p/720p/WD1/4CIF/VGA/CIF@25fps (P)/30fps (N) Sub-stream: WD1/4CIF/CIF@25fps (P)/30fps (N)	Main stream: 8 MP@8fps/5 MP@12fps/4 MP@15fps/3 MP@18fps 1080p/720p/WD1/4CIF/VGA/CIF@25fps (P)/30fps (N) Sub-stream: WD1/4CIF/CIF@25fps (P)/30fps (N)	Main stream: 8 MP@8fps/5 MP@12fps/4 MP@15fps/3 MP@18fps 1080p/720p/WD1/4CIF/VGA/CIF@25fps (P)/30fps (N) Sub-stream: WD1/4CIF/CIF@25fps (P)/30fps (N)
Storage	1 Micro SD card slot, supports Micro SD card 8G Up to 128 GB	1 Micro SD card slot, supports Micro SD card 8G Up to 128 GB	1 SATA interface Up to 8 TB capacity for each disk	1SATA interface Up to 8 TB capacity for each disk	2 SATA interface Up to 8 TB capacity for each disk
Network Interface	1, RJ45 10M/100M self-adaptive Ethernet interface	1, RJ45 10M/100M self-adaptive Ethernet interface	1, RJ45 10M/100M self-adaptive Ethernet interface	1, RJ45 10M/100M/1000M self-adaptive Ethernet interface	1, RJ45 10M/100M/1000M self-adaptive Ethernet interface
Serial Interface	RS-485 (half-duplex); RS-232	RS-485 (half-duplex); RS-232	RS-485 (half-duplex); RS-232	RS-485 (half-duplex); RS-232	RS-485 (half-duplex); RS-232
Alarm I/O	1/1	4/2	4/1	8/4	16/4
Power	12 VDC	12 VDC	12 VDC	12 VDC	12 VDC
Chassis	162.5 × 114 × 47.5 mm (6.4 × 4.5 × 1.9 inch)	162.5 × 114 × 47.5 mm (6.4 × 4.5 × 1.9 inch)	315 × 242 × 45 mm (12.4 × 9.5 × 1.8 inch)	315 × 242 × 45 mm (12.4 × 9.5 × 1.8 inch)	380 × 320 × 48 mm (15.0 × 12.6 × 1.9 inch)

Pro (EasyIP) Series Hierarchy

To meet the demands for various applications, Hikvision provides four levels of Pro (EasyIP) series cameras.

The entry level EasyIP 1.0+ provides budget-friendly, high quality 2 MP cameras with basic functions.

The second level – EasyIP 2.0+ with AcuSense – provides deep learning-based technology for more efficient security management, making SMB solutions easier to use. This series provides 2, 4, 6, and 8 MP resolution options and various camera forms. Supporting Hikvision AcuSense technology, the EasyIP 2.0+ camera models give SMB users easy, budget-friendly access to AI technology.

The EasyIP 4.0 series come equipped with Hikvision AcuSense technology in both front- and back-end products. Camera models in the EasyIP 4.0 with AcuSense level get a boost from Powered-by-DarkFighter technology, providing better low-light images over their EasyIP 2.0+ with AcuSense cousins.

Moreover, camera models in the EasyIP 4.0 with ColorVu level render 24/7 color imaging even in ultra low-light environments. They now also offer Smart Hybrid Light Cameras with ColorVu, providing flexible lighting options with upgraded night vision.

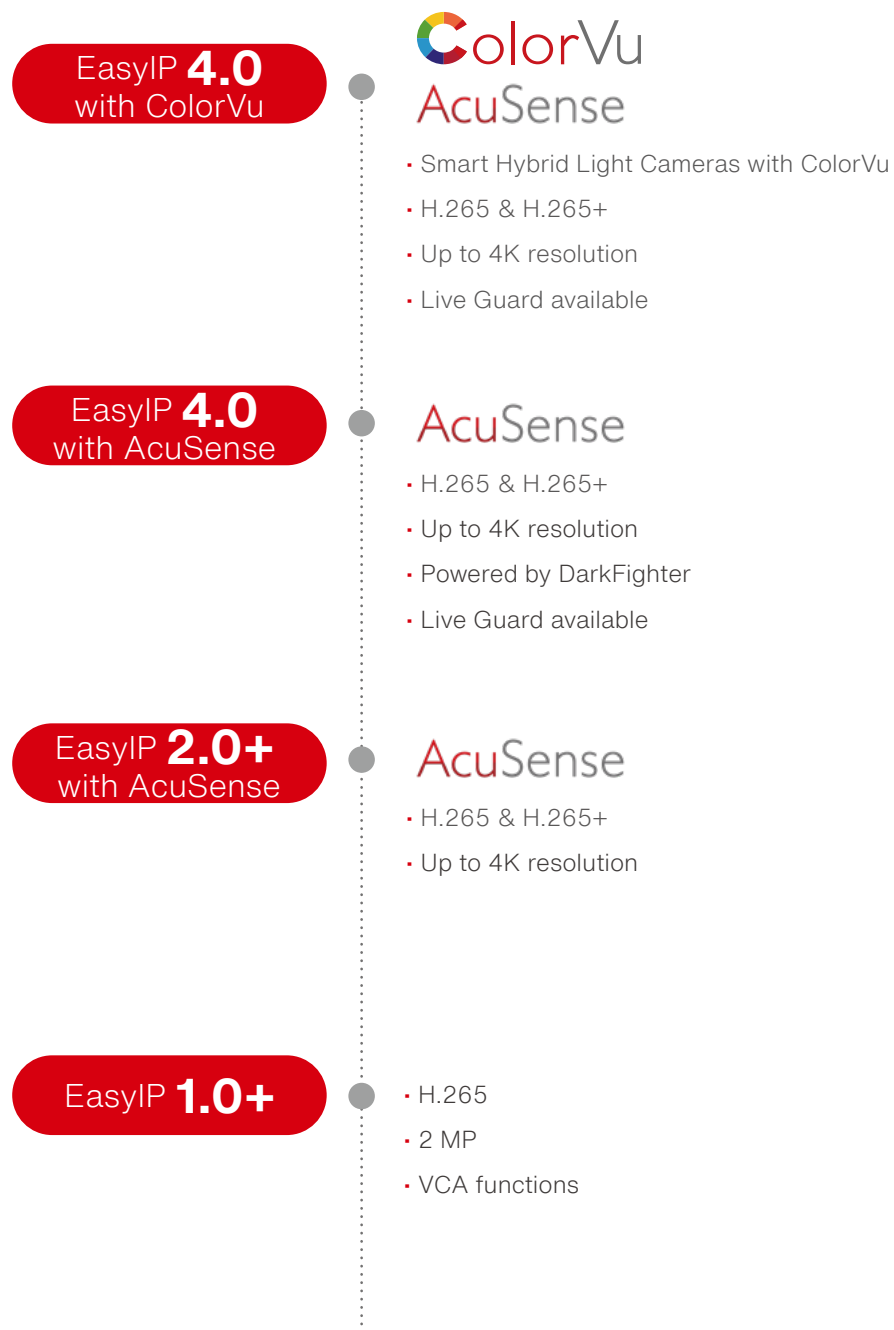

Powered by DarkFighter

The excellent low-light imaging is supported on cameras of up-to-4K ultra HD resolution.

The combination of bright night imagery and high definition guarantees round-the-clock recording of video evidence.

Better color imaging in low-light environments

2 MP



Captured with a conventional 2 MP camera



Captured with a Powered by DarkFighter 2 MP camera

4 MP



Captured with a conventional 4 MP camera



Captured with a Powered by DarkFighter 4 MP camera

8 MP (4K)



Captured with a conventional 8 MP camera



Captured with a Powered by DarkFighter 8 MP camera

Other Features

Video Content Analytics is no longer reserved only for enterprise level security systems. The EasyIP solution brings VCAs into reach for SMB security. Designed for state-of-the-art performance with easy installation, our solution comes armed with reliable components and robust protections. With automatic network backup features and simple Internet connection services, a vigorous security system goes into operation quickly—and stays that way.

- VCAs
- Designed for easy installation
- 180° seamless image stitching
- EchoLight technology
- EXIR 2.0
- Triple-stream
- IP67, IP66, & IK10 protection
- ANR (Automatic Network Replenishment)
- Dual system backup (NVR)
- IP address automatic allocation
- Free Hik-Connect cloud service

Network Cameras

080 Pro Series (EasyIP)

114 Value Series

140 Solar-powered Series



Network Cameras













Pro Series (EasyIP)

Simply Powerful, the Easier Journey to Better Security













With a perfect balance of performance and value, Hikvision Pro Series network cameras aim to provide just the right components, including artificial intelligence features that are affordable and easy to use.

- > Smart Hybrid Light Cameras with ColorVu
- > Hikvision ColorVu technology: 24/7 colorful imaging
- > Hikvision AcuSense technology: focus on person and vehicle targets based on deep learning algorithms
- > Live Guard
- > H.265+ / H.265 codec
- > Up to 4K ultra-HD
- > Powered by DarkFighter
- > Efficient VCA functions
- > Easy to install, set up, and manage











Model	DS-2CD204762H-LI(U)	DS-2CD206762H-LI(U)	DS-2CD208762H-LI(U)	DS-2CD214762H-LI(U)	DS-2CD216762H-LI(U)	DS-2CD218762H-LI(U)
Image	 	 	 	 	 	 
Image Sensor	1/1.8" Progressive Scan CMOS	1/1.8" Progressive Scan CMOS	1/1.8" Progressive Scan CMOS	1/1.8" Progressive Scan CMOS	1/1.8" Progressive Scan CMOS	1/1.8" Progressive Scan CMOS
Resolution	2688 × 1520	3200 × 1800	3840 × 2160	2688 × 1520	3200 × 1800	3840 × 2160
Video Compression	H.265/H.265+/H.264+/H.264 / MJPEG	H.265/H.265+/H.264+/H.264 / MJPEG	H.265/H.265+/H.264+/H.264 / MJPEG	H.265/H.265+/H.264+/H.264 / MJPEG	H.265/H.265+/H.264+/H.264 / MJPEG	H.265/H.265+/H.264+/H.264 / MJPEG
Min. Illumination	0.0005 Lux @ (F1.0, AGC ON), 0 Lux with light	0.0005 Lux @ (F1.0, AGC ON), 0 Lux with light	0.0005 Lux @ (F1.0, AGC ON), 0 Lux with light	0.0005 Lux @ (F1.0, AGC ON), 0 Lux with light	0.0005 Lux @ (F1.0, AGC ON), 0 Lux with light	0.0005 Lux @ (F1.0, AGC ON), 0 Lux with light
WDR	130dB	130dB	130dB	130dB	130dB	130dB
Lens	Fixed focal lens, 2.8 and 4 mm optional	Fixed focal lens, 2.8 and 4 mm optional	Fixed focal lens, 2.8 and 4 mm optional	Fixed focal lens, 2.8 and 4 mm optional	Fixed focal lens, 2.8 and 4 mm optional	Fixed focal lens, 2.8 and 4 mm optional
FOV	2.8 mm, horizontal FOV 104.0°, vertical FOV 54.4°, diagonal FOV 126.7° 4 mm, horizontal FOV 89.2°, vertical FOV 45.5°, diagonal FOV 108.2°	2.8 mm, horizontal FOV 105.1°, vertical FOV 54.8°, diagonal FOV 128.2° 4 mm, horizontal FOV 90.0°, vertical FOV 45.8°, diagonal FOV 109.4°	2.8 mm, horizontal FOV 105.1°, vertical FOV 54.8°, diagonal FOV 128.2° 4 mm, horizontal FOV 90.0°, vertical FOV 45.8°, diagonal FOV 109.4°	2.8 mm, horizontal FOV 104.0°, vertical FOV 54.4°, diagonal FOV 126.7° 4 mm, horizontal FOV 89.2°, vertical FOV 45.5°, diagonal FOV 108.2°	2.8 mm, horizontal FOV 105.1°, vertical FOV 54.8°, diagonal FOV 128.2° 4 mm, horizontal FOV 90.0°, vertical FOV 45.8°, diagonal FOV 109.4°	2.8 mm, horizontal FOV 105.1°, vertical FOV 54.8°, diagonal FOV 128.2° 4 mm, horizontal FOV 90.0°, vertical FOV 45.8°, diagonal FOV 109.4°
Max. Light Range	40m	40m	40m	40m	40m	40m
VCA	Line crossing detection, intrusion detection, region entrance detection, region exiting detection (support alarm triggered by specified target types (human and vehicle)), scene change detection	Line crossing detection, intrusion detection, region entrance detection, region exiting detection (support alarm triggered by specified target types (human and vehicle)), scene change detection	Line crossing detection, intrusion detection, region entrance detection, region exiting detection (support alarm triggered by specified target types (human and vehicle)), scene change detection	Line crossing detection, intrusion detection, region entrance detection, region exiting detection (support alarm triggered by specified target types (human and vehicle)), scene change detection	Line crossing detection, intrusion detection, region entrance detection, region exiting detection (support alarm triggered by specified target types (human and vehicle)), scene change detection	Line crossing detection, intrusion detection, region entrance detection, region exiting detection (support alarm triggered by specified target types (human and vehicle)), scene change detection
Frame Rate	50 Hz: 25 fps (2688 × 1520, 1920 × 1080, 1280 × 720) 60 Hz: 30 fps (2688 × 1520, 1920 × 1080, 1280 × 720)*	50 Hz: 25 fps (3200 × 1800, 2688 × 1520, 1920 × 1080, 1280 × 720) 60 Hz: 24 fps (3200 × 1800) 30 fps (2688 × 1520, 1920 × 1080, 1280 × 720)	50 Hz: 25 fps (3840 × 2160, 3200 × 1800, 2688 × 1520, 1920 × 1080, 1280 × 720) 60 Hz: 24 fps (3840 × 2160) 30 fps (3200 × 1800, 2688 × 1520, 1920 × 1080, 1280 × 720)	50 Hz: 25 fps (2688 × 1520, 1920 × 1080, 1280 × 720) 60 Hz: 30 fps (2688 × 1520, 1920 × 1080, 1280 × 720)	50 Hz: 25 fps (3200 × 1800, 2688 × 1520, 1920 × 1080, 1280 × 720) 60 Hz: 24 fps (3200 × 1800) 30 fps (2688 × 1520, 1920 × 1080, 1280 × 720)	50 Hz: 25 fps (3840 × 2160, 3200 × 1800, 2688 × 1520, 1920 × 1080, 1280 × 720) 60 Hz: 24 fps (3840 × 2160) 30 fps (3200 × 1800, 2688 × 1520, 1920 × 1080, 1280 × 720)
Streams	3	3	3	3	3	3
Protection Level	IP67	IP67	IP67	IP67	IP67	IP67
Angle Adjustment	Pan: 0° to 360°, tilt: 0° to 90°, rotate: 0° to 360°	Pan: 0° to 360°, tilt: 0° to 90°, rotate: 0° to 360°	Pan: 0° to 360°, tilt: 0° to 90°, rotate: 0° to 360°	Pan: 0° to 360°, tilt: 0° to 90°, rotate: 0° to 360°	Pan: 0° to 360°, tilt: 0° to 90°, rotate: 0° to 360°	Pan: 0° to 360°, tilt: 0° to 90°, rotate: 0° to 360°
Operating Temperature	-30 °C to 60 °C (-22 °F to 140 °F)	-30 °C to 60 °C (-22 °F to 140 °F)	-30 °C to 60 °C (-22 °F to 140 °F)	-30 °C to 60 °C (-22 °F to 140 °F)	-30 °C to 60 °C (-22 °F to 140 °F)	-30 °C to 60 °C (-22 °F to 140 °F)
Humidity	95% or less (non-condensing)	95% or less (non-condensing)	95% or less (non-condensing)	95% or less (non-condensing)	95% or less (non-condensing)	95% or less (non-condensing)
Local Storage	512 GB	512 GB	512 GB	512 GB	512 GB	512 GB
Indoor/Outdoor	Outdoor	Outdoor	Outdoor	Outdoor	Outdoor	Outdoor
Audio I/O	-U: Built-in microphone	-U: Built-in microphone	-U: Built-in microphone	-U: Built-in microphone	-U: Built-in microphone	-U: Built-in microphone
Alarm I/O	-	-	-	-	-	-
Power	12 VDC ± 25%, PoE (802.3af, class 3)	12 VDC ± 25%, PoE (802.3af, class 3)	12 VDC ± 25%, PoE (802.3af, class 3)	12 VDC ± 25%, PoE (802.3af, class 3)	12 VDC ± 25%, PoE (802.3af, class 3)	12 VDC ± 25%, PoE (802.3af, class 3)



Model	DS-2CD234762H-LI(U)	DS-2CD236762H-LI(U)	DS-2CD238762H-LI(U)	DS-2CD2T4762H-LI(U)	DS-2CD2T6762H-LI(U)	DS-2CD2T8762H-LI(U)
Image	 <NEW	 <NEW	 <NEW	 <NEW	 <NEW	 <NEW
Image Sensor	1/1.8" Progressive Scan CMOS	1/1.8" Progressive Scan CMOS	1/1.8" Progressive Scan CMOS	1/1.8" Progressive Scan CMOS	1/1.8" Progressive Scan CMOS	1/1.8" Progressive Scan CMOS
Resolution	2688 × 1520	3200 × 1800	3840 × 2160	2688 × 1520	3200 × 1800	3840 × 2160
Video Compression	H.265/H.265+/H.264+/H.264 / MJPEG	H.265/H.265+/H.264+/H.264 / MJPEG	H.265/H.265+/H.264+/H.264 / MJPEG	H.265/H.265+/H.264+/H.264 / MJPEG	H.265/H.265+/H.264+/H.264 / MJPEG	H.265/H.265+/H.264+/H.264 / MJPEG
Min. Illumination	0.0005 Lux @ (F1.0, AGC ON), 0 Lux with light	0.0005 Lux @ (F1.0, AGC ON), 0 Lux with light	0.0005 Lux @ (F1.0, AGC ON), 0 Lux with light	0.0005 Lux @ (F1.0, AGC ON), 0 Lux with light	0.0005 Lux @ (F1.0, AGC ON), 0 Lux with light	0.0005 Lux @ (F1.0, AGC ON), 0 Lux with light
WDR	130dB	130dB	130dB	130dB	130dB	130dB
Lens	Fixed focal lens, 2.8 and 4 mm optional	Fixed focal lens, 2.8 and 4 mm optional	Fixed focal lens, 2.8 and 4 mm optional	Fixed focal lens, 2.8 and 4 mm optional	Fixed focal lens, 2.8 and 4 mm optional	Fixed focal lens, 2.8 and 4 mm optional
FOV	2.8 mm, horizontal FOV 111.1°, vertical FOV 57.6°, diagonal FOV 138.5° 4 mm, horizontal FOV 95.2°, vertical FOV 48.3°, diagonal FOV 117.4°	2.8 mm, horizontal FOV 108.8°, vertical FOV 56.4°, diagonal FOV 134.3° 4 mm, horizontal FOV 93.3°, vertical FOV 47.2°, diagonal FOV 114.2°	2.8 mm, horizontal FOV 108.8°, vertical FOV 56.4°, diagonal FOV 134.3° 4 mm, horizontal FOV 93.3°, vertical FOV 47.2°, diagonal FOV 114.2°	2.8 mm, horizontal FOV 104.0°, vertical FOV 54.4°, diagonal FOV 126.7° 4 mm, horizontal FOV 89.2°, vertical FOV 45.5°, diagonal FOV 108.2°	2.8 mm, horizontal FOV 105.1°, vertical FOV 54.8°, diagonal FOV 128.2° 4 mm, horizontal FOV 90.0°, vertical FOV 45.8°, diagonal FOV 109.4°	2.8 mm, horizontal FOV 105.1°, vertical FOV 54.8°, diagonal FOV 128.2° 4 mm, horizontal FOV 90.0°, vertical FOV 45.8°, diagonal FOV 109.4°
Max. Light Range	40m	40m	40m	60m	60m	60m
VCA	Line crossing detection, intrusion detection, region entrance detection, region exiting detection (support alarm triggered by specified target types (human and vehicle)), scene change detection	Line crossing detection, intrusion detection, region entrance detection, region exiting detection (support alarm triggered by specified target types (human and vehicle)), scene change detection	Line crossing detection, intrusion detection, region entrance detection, region exiting detection (support alarm triggered by specified target types (human and vehicle)), scene change detection	Line crossing detection, intrusion detection, region entrance detection, region exiting detection (support alarm triggered by specified target types (human and vehicle)), scene change detection	Line crossing detection, intrusion detection, region entrance detection, region exiting detection (support alarm triggered by specified target types (human and vehicle)), scene change detection	Line crossing detection, intrusion detection, region entrance detection, region exiting detection (support alarm triggered by specified target types (human and vehicle)), scene change detection
Frame Rate	50 Hz: 25 fps (2688 × 1520, 1920 × 1080, 1280 × 720) 60 Hz: 30 fps (2688 × 1520, 1920 × 1080, 1280 × 720)	50 Hz: 25 fps (3200 × 1800, 2688 × 1520, 1920 × 1080, 1280 × 720) 60 Hz: 24 fps (3200 × 1800) 30 fps (2688 × 1520, 1920 × 1080, 1280 × 720)	50 Hz: 25 fps (3840 × 2160, 3200 × 1800, 2688 × 1520, 1920 × 1080, 1280 × 720) 60 Hz: 24 fps (3840 × 2160) 30 fps (3200 × 1800, 2688 × 1520, 1920 × 1080, 1280 × 720)	50 Hz: 25 fps (2688 × 1520, 1920 × 1080, 1280 × 720) 60 Hz: 30 fps (2688 × 1520, 1920 × 1080, 1280 × 720)	50 Hz: 25 fps (3200 × 1800, 2688 × 1520, 1920 × 1080, 1280 × 720) 60 Hz: 24 fps (3200 × 1800) 30 fps (2688 × 1520, 1920 × 1080, 1280 × 720)	50 Hz: 25 fps (3840 × 2160, 3200 × 1800, 2688 × 1520, 1920 × 1080, 1280 × 720) 60 Hz: 24 fps (3840 × 2160) 30 fps (3200 × 1800, 2688 × 1520, 1920 × 1080, 1280 × 720)
Streams	3	3	3	3	3	3
Protection Level	IP67	IP67	IP67	IP67	IP67	IP67
Angle Adjustment	Pan: 0° to 360°, tilt: 0° to 75°, rotate: 0° to 360°	Pan: 0° to 360°, tilt: 0° to 75°, rotate: 0° to 360°	Pan: 0° to 360°, tilt: 0° to 75°, rotate: 0° to 360°	Pan: 0° to 360°, tilt: 0° to 90°, rotate: 0° to 360°	Pan: 0° to 360°, tilt: 0° to 90°, rotate: 0° to 360°	Pan: 0° to 360°, tilt: 0° to 90°, rotate: 0° to 360°
Operating Temperature	-30 °C to 60 °C (-22 °F to 140 °F)	-30 °C to 60 °C (-22 °F to 140 °F)	-30 °C to 60 °C (-22 °F to 140 °F)	-30 °C to 60 °C (-22 °F to 140 °F)	-30 °C to 60 °C (-22 °F to 140 °F)	-30 °C to 60 °C (-22 °F to 140 °F)
Humidity	95% or less (non-condensing)	95% or less (non-condensing)	95% or less (non-condensing)	95% or less (non-condensing)	95% or less (non-condensing)	95% or less (non-condensing)
Local Storage	512 GB	512 GB	512 GB	512 GB	512 GB	512 GB
Indoor/Outdoor	Outdoor	Outdoor	Outdoor	Outdoor	Outdoor	Outdoor
Audio I/O	-U: Built-in microphone	-U: Built-in microphone	-U: Built-in microphone	-U: Built-in microphone	-U: Built-in microphone	-U: Built-in microphone
Alarm I/O	-	-	-	-	-	-
Power	12 VDC ± 25%, PoE (802.3af, class 3)	12 VDC ± 25%, PoE (802.3af, class 3)	12 VDC ± 25%, PoE (802.3af, class 3)	12 VDC ± 25%, PoE (802.3af, class 3)	12 VDC ± 25%, PoE (802.3af, class 3)	12 VDC ± 25%, PoE (802.3af, class 3)





Model	DS-2CD204762H-LIU/SL	DS-2CD206762H-LIU/SL	DS-2CD208762H-LIU/SL	DS-2CD234762H-LIU/SL	DS-2CD236762H-LIU/SL	DS-2CD238762H-LIU/SL
Image	 	 	 	 	 	 
Image Sensor	1/1.8" Progressive Scan CMOS	1/1.8" Progressive Scan CMOS	1/1.8" Progressive Scan CMOS	1/1.8" Progressive Scan CMOS	1/1.8" Progressive Scan CMOS	1/1.8" Progressive Scan CMOS
Resolution	2688 × 1520	3200 × 1800	3840 × 2160	2688 × 1520	3200 × 1800	3840 × 2160
Video Compression	H.265/H.265+/H.264+/H.264 / MJPEG	H.265/H.265+/H.264+/H.264 / MJPEG	H.265/H.265+/H.264+/H.264 / MJPEG	H.265/H.265+/H.264+/H.264 / MJPEG	H.265/H.265+/H.264+/H.264 / MJPEG	H.265/H.265+/H.264+/H.264 / MJPEG
Min. Illumination	0.0005 Lux @ (F1.0, AGC ON), 0 Lux with light	0.0005 Lux @ (F1.0, AGC ON), 0 Lux with light	0.0005 Lux @ (F1.0, AGC ON), 0 Lux with light	0.0005 Lux @ (F1.0, AGC ON), 0 Lux with light	0.0005 Lux @ (F1.0, AGC ON), 0 Lux with light	0.0005 Lux @ (F1.0, AGC ON), 0 Lux with light
WDR	130dB	130dB	130dB	130dB	130dB	130dB
Lens	Fixed focal lens, 2.8 and 4 mm optional	Fixed focal lens, 2.8 and 4 mm optional	Fixed focal lens, 2.8 and 4 mm optional	Fixed focal lens, 2.8 and 4 mm optional	Fixed focal lens, 2.8 and 4 mm optional	Fixed focal lens, 2.8 and 4 mm optional
FOV	2.8 mm, horizontal FOV 104.0°, vertical FOV 54.4°, diagonal FOV 126.7° 4 mm, horizontal FOV 89.2°, vertical FOV 45.5°, diagonal FOV 108.2°	2.8 mm, horizontal FOV 105.1°, vertical FOV 54.8°, diagonal FOV 128.2° 4 mm, horizontal FOV 90.0°, vertical FOV 45.8°, diagonal FOV 109.4°	2.8 mm, horizontal FOV 105.1°, vertical FOV 54.8°, diagonal FOV 128.2° 4 mm, horizontal FOV 90.0°, vertical FOV 45.8°, diagonal FOV 109.4°	2.8 mm, horizontal FOV 111.1°, vertical FOV 57.6°, diagonal FOV 138.5° 4 mm, horizontal FOV 95.2°, vertical FOV 48.3°, diagonal FOV 117.4°	2.8 mm, horizontal FOV 108.8°, vertical FOV 56.4°, diagonal FOV 134.3° 4 mm, horizontal FOV 93.3°, vertical FOV 47.2°, diagonal FOV 114.2°	2.8 mm, horizontal FOV 108.8°, vertical FOV 56.4°, diagonal FOV 134.3° 4 mm, horizontal FOV 93.3°, vertical FOV 47.2°, diagonal FOV 114.2°
Max. Light Range	40m	40m	40m	40m	40m	40m
VCA	Line crossing detection, intrusion detection, region entrance detection, region exiting detection (support alarm triggered by specified target types (human and vehicle)), scene change detection	Line crossing detection, intrusion detection, region entrance detection, region exiting detection (support alarm triggered by specified target types (human and vehicle)), scene change detection	Line crossing detection, intrusion detection, region entrance detection, region exiting detection (support alarm triggered by specified target types (human and vehicle)), scene change detection	Line crossing detection, intrusion detection, region entrance detection, region exiting detection (support alarm triggered by specified target types (human and vehicle)), scene change detection	Line crossing detection, intrusion detection, region entrance detection, region exiting detection (support alarm triggered by specified target types (human and vehicle)), scene change detection	Line crossing detection, intrusion detection, region entrance detection, region exiting detection (support alarm triggered by specified target types (human and vehicle)), scene change detection
Frame Rate	50 Hz: 25 fps (2688 × 1520, 1920 × 1080, 1280 × 720) 60 Hz: 30 fps (2688 × 1520, 1920 × 1080, 1280 × 720)	50 Hz: 25 fps (3200 × 1800, 2688 × 1520, 1920 × 1080, 1280 × 720) 60 Hz: 24 fps (3200 × 1800) 30 fps (2688 × 1520, 1920 × 1080, 1280 × 720)	50 Hz: 25 fps (3840 × 2160, 3200 × 1800, 2688 × 1520, 1920 × 1080, 1280 × 720) 60 Hz: 24 fps (3840 × 2160) 30 fps (3200 × 1800, 2688 × 1520, 1920 × 1080, 1280 × 720)	50 Hz: 25 fps (2688 × 1520, 1920 × 1080, 1280 × 720) 60 Hz: 30 fps (2688 × 1520, 1920 × 1080, 1280 × 720)	50 Hz: 25 fps (3200 × 1800, 2688 × 1520, 1920 × 1080, 1280 × 720) 60 Hz: 24 fps (3200 × 1800) 30 fps (2688 × 1520, 1920 × 1080, 1280 × 720)	50 Hz: 25 fps (3840 × 2160, 3200 × 1800, 2688 × 1520, 1920 × 1080, 1280 × 720) 60 Hz: 24 fps (3840 × 2160) 30 fps (3200 × 1800, 2688 × 1520, 1920 × 1080, 1280 × 720)
Streams	3	3	3	3	3	3
Protection Level	IP67	IP67	IP67	IP67	IP67	IP67
Angle Adjustment	Pan: 0° to 360°, tilt: 0° to 90°, rotate: 0° to 360°	Pan: 0° to 360°, tilt: 0° to 90°, rotate: 0° to 360°	Pan: 0° to 360°, tilt: 0° to 90°, rotate: 0° to 360°	Pan: 0° to 360°, tilt: 0° to 75°, rotate: 0° to 360°	Pan: 0° to 360°, tilt: 0° to 75°, rotate: 0° to 360°	Pan: 0° to 360°, tilt: 0° to 75°, rotate: 0° to 360°
Operating Temperature	-30 °C to 60 °C (-22 °F to 140 °F)	-30 °C to 60 °C (-22 °F to 140 °F)	-30 °C to 60 °C (-22 °F to 140 °F)	-30 °C to 60 °C (-22 °F to 140 °F)	-30 °C to 60 °C (-22 °F to 140 °F)	-30 °C to 60 °C (-22 °F to 140 °F)
Humidity	95% or less (non-condensing)	95% or less (non-condensing)	95% or less (non-condensing)	95% or less (non-condensing)	95% or less (non-condensing)	95% or less (non-condensing)
Local Storage	512 GB	512 GB	512 GB	512 GB	512 GB	512 GB
Indoor/Outdoor	Outdoor	Outdoor	Outdoor	Outdoor	Outdoor	Outdoor
Audio I/O	1 In, 1 Out Built-in microphone Built-in speaker	1 In, 1 Out Built-in microphone Built-in speaker	1 In, 1 Out Built-in microphone Built-in speaker	1 In, 1 Out Built-in microphone Built-in speaker	1 In, 1 Out Built-in microphone Built-in speaker	1 In, 1 Out Built-in microphone Built-in speaker
Alarm I/O	1 In, 1 Out	1 In, 1 Out	1 In, 1 Out	1 In, 1 Out	1 In, 1 Out	1 In, 1 Out
Power	12 VDC ± 25%, PoE (802.3af, class 3)	12 VDC ± 25%, PoE (802.3af, class 3)	12 VDC ± 25%, PoE (802.3af, class 3)	12 VDC ± 25%, PoE (802.3af, class 3)	12 VDC ± 25%, PoE (802.3af, class 3)	12 VDC ± 25%, PoE (802.3af, class 3)







Model	DS-2CD2T4762H-LIU/SL	DS-2CD2T6762H-LIU/SL	DS-2CD2T8762H-LIU/SL	DS-2CD202762-L(U)	DS-2CD204762-L(U)	DS-2CD204762-LU/SL
Image	 ColorVu AcuSense NEW	 ColorVu AcuSense NEW	 ColorVu AcuSense NEW	 ColorVu AcuSense	 ColorVu AcuSense	 ColorVu AcuSense HOT
Image Sensor	1/1.8" Progressive Scan CMOS	1/1.8" Progressive Scan CMOS	1/1.8" Progressive Scan CMOS	1/2.8" Progressive Scan CMOS	1/1.8" Progressive Scan CMOS	1/1.8" Progressive Scan CMOS
Resolution	2688 × 1520	3200 × 1800	3840 × 2160	1920 × 1080	2688 × 1520	2688 × 1520
Video Compression	H.265/H.265+/H.264+/H.264 / MJPEG	H.265/H.265+/H.264+/H.264 / MJPEG	H.265/H.265+/H.264+/H.264 / MJPEG	H.265/H.265+/H.264+/H.264 / MJPEG	H.265/H.265+/H.264+/H.264 / MJPEG	H.265/H.265+/H.264+/H.264 / MJPEG
Min. Illumination	0.0005 Lux @ (F1.0, AGC ON), 0 Lux with light	0.0005 Lux @ (F1.0, AGC ON), 0 Lux with light	0.0005 Lux @ (F1.0, AGC ON), 0 Lux with light	0.0005 Lux @ (F1.0, AGC ON), 0 Lux with Light	0.0005 Lux @ (F1.0, AGC ON), 0 Lux with Light	0.0005 Lux @ (F1.0, AGC ON), 0 Lux with Light
WDR	130dB	130dB	130dB	120dB	130dB	130dB
Lens	Fixed focal lens, 2.8 and 4 mm optional	Fixed focal lens, 2.8 and 4 mm optional	Fixed focal lens, 2.8 and 4 mm optional	2.8mm, 4 mm, 6 mm	2.8mm, 4 mm, 6 mm	2.8mm, 4 mm, 6 mm
FOV	2.8 mm, horizontal FOV 104.0°, vertical FOV 54.4°, diagonal FOV 126.7° 4 mm, horizontal FOV 89.2°, vertical FOV 45.5°, diagonal FOV 108.2°	2.8 mm, horizontal FOV 105.1°, vertical FOV 54.8°, diagonal FOV 128.2° 4 mm, horizontal FOV 90.0°, vertical FOV 45.8°, diagonal FOV 109.4°	2.8 mm, horizontal FOV 105.1°, vertical FOV 54.8°, diagonal FOV 128.2° 4 mm, horizontal FOV 90.0°, vertical FOV 45.8°, diagonal FOV 109.4°	2.8 mm, horizontal FOV 107°, vertical FOV 56°, diagonal FOV 127° 4 mm, horizontal FOV 84°, vertical FOV 45°, diagonal FOV 99° 6 mm, horizontal FOV 55°, vertical FOV 30°, diagonal FOV 63°	2.8 mm, horizontal FOV 112°, vertical FOV 61°, diagonal FOV 134° 4 mm, horizontal FOV 95°, vertical FOV 51°, diagonal FOV 115° 6 mm, horizontal FOV 58°, vertical FOV 31°, diagonal FOV 69°	2.8 mm, horizontal FOV 112°, vertical FOV 61°, diagonal FOV 134° 4 mm, horizontal FOV 95°, vertical FOV 51°, diagonal FOV 115° 6 mm, horizontal FOV 58°, vertical FOV 31°, diagonal FOV 69°
Max. Light Range	60m	60m	60m	40 m	40 m	40m
VCA	Line crossing detection, intrusion detection, region entrance detection, region exiting detection (support alarm triggered by specified target types (human and vehicle)), scene change detection	Line crossing detection, intrusion detection, region entrance detection, region exiting detection (support alarm triggered by specified target types (human and vehicle)), scene change detection	Line crossing detection, intrusion detection, region entrance detection, region exiting detection (support alarm triggered by specified target types (human and vehicle)), scene change detection	Line crossing detection, intrusion detection, region entrance detection, region exiting detection	Line crossing detection, intrusion detection, region entrance detection, region exiting detection	Line crossing detection, intrusion detection, region entrance detection, region exiting detection
Frame Rate	50 Hz: 25 fps (2688 × 1520, 1920 × 1080, 1280 × 720) 60 Hz: 30 fps (2688 × 1520, 1920 × 1080, 1280 × 720)	50 Hz: 25 fps (3200 × 1800, 2688 × 1520, 1920 × 1080, 1280 × 720) 60 Hz: 24 fps (3200 × 1800) 30 fps (2688 × 1520, 1920 × 1080, 1280 × 720)	50 Hz: 25 fps (3840 × 2160, 3200 × 1800, 2688 × 1520, 1920 × 1080, 1280 × 720) 60 Hz: 24 fps (3840 × 2160) 30 fps (3200 × 1800, 2688 × 1520, 1920 × 1080, 1280 × 720)	50Hz: 25fps (1920 × 1080, 1280 × 720) 60Hz: 30fps (1920 × 1080, 1280 × 720)	50Hz: 25fps (2688 × 1520, 1920 × 1080, 1280 × 720) 60Hz: 30fps (2688 × 1520, 1920 × 1080, 1280 × 720)	50Hz: 25fps (2688 × 1520, 1920 × 1080, 1280 × 720) 60Hz: 30fps (2688 × 1520, 1920 × 1080, 1280 × 720)
Streams	3	3	3	3	3	3
Protection Level	IP67	IP67	IP67	IP67	IP67	IP67
Angle Adjustment	Pan: 0° to 360°, tilt: 0° to 90°, rotate: 0° to 360°	Pan: 0° to 360°, tilt: 0° to 90°, rotate: 0° to 360°	Pan: 0° to 360°, tilt: 0° to 90°, rotate: 0° to 360°	Pan: 0° to 360°, tilt: 0° to 90°, rotate: 0° to 360°	Pan: 0° to 360°, tilt: 0° to 90°, rotate: 0° to 360°	Pan: 0° to 360°, tilt: 0° to 90°, rotate: 0° to 360°
Operating Temperature	-30 °C to 60 °C (-22 °F to 140 °F)	-30 °C to 60 °C (-22 °F to 140 °F)	-30 °C to 60 °C (-22 °F to 140 °F)	-30 °C to +60 °C (-22 °F to +140 °F)	-30 °C to +60 °C (-22 °F to +140 °F)	-30 °C to +60 °C (-22 °F to +140 °F)
Humidity	95% or less (non-condensing)	95% or less (non-condensing)	95% or less (non-condensing)	95% or less (non-condensing)	95% or less (non-condensing)	95% or less (non-condensing)
Local Storage	512 GB	512 GB	512 GB	256 GB	256 GB	256 GB
Indoor/Outdoor	Outdoor	Outdoor	Outdoor	Outdoor	Outdoor	Outdoor
Audio I/O	1 In, 1 Out Built-in microphone Built-in speaker	1 In, 1 Out Built-in microphone Built-in speaker	1 In, 1 Out Built-in microphone Built-in speaker	-U: Built-in microphone	-U: Built-in microphone	1 built-in microphone 1 built-in speaker
Alarm I/O	1 In, 1 Out	1 In, 1 Out	1 In, 1 Out	-	-	-
Power	12 VDC ± 25%, PoE (802.3af, class 3)	12 VDC ± 25%, PoE (802.3af, class 3)	12 VDC ± 25%, PoE (802.3af, class 3)	12 VDC ± 25%, PoE (802.3af, class 3)	12 VDC ± 25%, PoE (802.3af, class 3)	12 VDC ± 25%, PoE (802.3af, class 3)

Model	DS-2CD206762-L(U)	DS-2CD208762-L(U)	DS-2CD212762(-SU)	DS-2CD214762-L(SU)	DS-2CD218762-L(SU)	DS-2CD232762-L(U)
Image	 ColorVu AcuSense NEW	 ColorVu AcuSense HOT	 ColorVu AcuSense	 ColorVu AcuSense HOT	 ColorVu AcuSense NEW	 ColorVu AcuSense
Image Sensor	1/1.8" Progressive Scan CMOS	1/1.2" Progressive Scan CMOS	1/2.8" Progressive Scan CMOS	1/1.8" Progressive Scan CMOS	1/1.8" Progressive Scan CMOS	1/2.8" Progressive Scan CMOS
Resolution	3200 x 1800	3840 x 2160	1920 x 1080	2688 x 1520	3840 x 2160	1920 x 1080
Video Compression	H.265/H.265+/H.264+/H.264 / MJPEG	H.265/H.265+/H.264+/H.264 / MJPEG	H.265/H.265+/H.264+/H.264 / MJPEG	H.265/H.265+/H.264+/H.264 / MJPEG	H.265/H.265+/H.264+/H.264 / MJPEG	H.265/H.265+/H.264+/H.264 / MJPEG
Min. Illumination	0.0008 Lux @ (F1.0, AGC ON), 0 Lux with light	0.0005 Lux @ (F1.0, AGC ON), 0 Lux with Light	0.0005 Lux @ (F1.0, AGC ON)	0.0005 Lux @ (F1.0, AGC ON), 0 Lux with Light	0.0008 Lux @ (F1.0, AGC ON), 0 Lux with light	0.0005 Lux @ (F1.0, AGC ON), 0 Lux with Light
WDR	130dB	130dB	120dB	130dB	130dB	120dB
Lens	2.8mm, 4 mm, 6 mm	2.8mm, 4 mm, 6 mm	2.8mm, 4 mm	2.8mm, 4 mm	2.8mm, 4 mm	2.8mm, 4 mm
FOV	2.8mm, Horizontal FOV: 109°, Vertical FOV: 59°, Diagonal FOV: 130° 4 mm, Horizontal FOV: 93°, Vertical FOV: 49°, Diagonal FOV: 111° 6 mm, Horizontal FOV: 57°, Vertical FOV: 30°, Diagonal FOV: 67°	2.8 mm, horizontal FOV102°, vertical FOV 52°, diagonal FOV 124° 4 mm, horizontal FOV 88°, vertical FOV 49°, diagonal FOV 102° 6 mm, horizontal FOV 54°, vertical FOV 30°, diagonal FOV 62°	2.8 mm, horizontal FOV 107°, vertical FOV 56°, diagonal FOV 127° 4 mm, horizontal FOV 84°, vertical FOV 45°, diagonal FOV 99°	2.8 mm, horizontal FOV 112°, vertical FOV 61°, diagonal FOV 134° 4 mm, horizontal FOV 95°, vertical FOV 51°, diagonal FOV 115°	2.8 mm, horizontal FOV102°, vertical FOV 52°, diagonal FOV 124° 4 mm, horizontal FOV 88°, vertical FOV 49°, diagonal FOV 102°	2.8 mm, horizontal FOV 107°, vertical FOV 56°, diagonal FOV 127° 4 mm, horizontal FOV 84°, vertical FOV 45°, diagonal FOV 99°
Max. Light Range	40m	40 m	-	30 m	30 m	30 m
VCA	Line crossing detection, intrusion detection, region entrance detection, region exiting detection	Line crossing detection, intrusion detection, region entrance detection, region exiting detection	Line crossing detection, intrusion detection, region entrance detection, region exiting detection	Line crossing detection, intrusion detection, region entrance detection, region exiting detection	Line crossing detection, intrusion detection, region entrance detection, region exiting detection	Line crossing detection, intrusion detection, region entrance detection, region exiting detection
Frame Rate	50 Hz: 25 fps (3200 × 1800, 2688 × 1520, 1920 × 1080, 1280 × 720) 60 Hz: 24 fps (3200 × 1800) 30 fps (2688 × 1520, 1920 × 1080, 1280 × 720)	50Hz: 25fps (3840 × 2160, 3200 × 1800, 2688 × 1520, 1920 × 1080, 1280 × 720) 60Hz: 24fps (3840 × 2160) 30fps (3200 × 1800, 2688 × 1520, 1920 × 1080, 1280 × 720)	50Hz: 25fps (1920 × 1080, 1280 × 720) 60Hz: 30fps (1920 × 1080, 1280 × 720)	50 Hz: 25 fps (2688 × 1520, 1280 × 720) 60 Hz: 30 fps (2688 × 1520, 1920 × 1080, 1280 × 720)	50Hz: 25fps (3840 × 2160, 3200 × 1800, 2688 × 1520, 1920 × 1080, 1280 × 720) 60Hz: 24fps (3840 × 2160) 30fps (3200 × 1800, 2688 × 1520, 1920 × 1080, 1280 × 720)	50Hz: 25fps (1920 × 1080, 1280 × 720) 60Hz: 30fps (1920 × 1080, 1280 × 720)
Streams	3	3	3	3	3	3
Protection Level	IP67	IP67	IP67, IK10	IP67, IK10	IP67, IK10	IP67
Angle Adjustment	Pan: 0° to 360°, tilt: 0° to 90°, rotate: 0° to 360°	Pan: 0° to 360°, tilt: 0° to 90°, rotate: 0° to 360°	Pan: 0° to 355°, tilt: 0° to 75°, rotate: 0° to 355°	Pan: 0° to 355°, tilt: 0° to 75°, rotate: 0° to 355°	Pan: 0° to 355°, tilt: 0° to 75°, rotate: 0° to 355°	Pan: 0° to 360°, tilt: 0° to 75°, rotate: 0° to 360°
Operating Temperature	-30 °C to +60 °C (-22 °F to +140 °F)	-30 °C to +60 °C (-22 °F to +140 °F)	-30 °C to +60 °C (-22 °F to +140 °F)	-30 °C to +60 °C (-22 °F to +140 °F)	-30 °C to +60 °C (-22 °F to +140 °F)	-30 °C to +60 °C (-22 °F to +140 °F)
Humidity	95% or less (non-condensing)	95% or less (non-condensing)	95% or less (non-condensing)	95% or less (non-condensing)	95% or less (non-condensing)	95% or less (non-condensing)
Local Storage	256 GB	256 GB	256 GB	256 GB	256 GB	256 GB
Indoor/Outdoor	Outdoor	Outdoor	Outdoor	Outdoor	Outdoor	Outdoor
Audio I/O	-U: Built-in microphone	-U: Built-in microphone	1 In, 1 Out(-SU) Built-in microphone(-SU)	1 In, 1 Out(-SU) Built-in microphone(-SU)	1 In, 1 Out(-SU) Built-in microphone(-SU)	-U: Built-in microphone
Alarm I/O	-	-	1 In, 1 Out (-SU)	1 In, 1 Out (-SU)	1 In, 1 Out (-SU)	-
Power	12 VDC ± 25%, PoE (802.3af, class 3)	12 VDC ± 25%, PoE (802.3af, class 3)	12 VDC ± 25%, PoE (802.3af, class 3)	12 VDC ± 25%, PoE (802.3af, class 3)	12 VDC ± 25%, PoE (802.3af, class 3)	12 VDC ± 25%, PoE (802.3af, class 3)







Model	DS-2CD234762-L(U)	DS-2CD234762-LSU/SL	DS-2CD236762-L(U)	DS-2CD238762-L(U)	DS-2CD238762-LSU/SL	DS-2CD234762P-LSU/SL
Image	 -HOT ColorVu AcuSense	 -HOT ColorVu AcuSense	 -NEW ColorVu AcuSense	 -HOT ColorVu AcuSense	 -HOT ColorVu AcuSense	 -HOT ColorVu AcuSense
Image Sensor	1/1.8" Progressive Scan CMOS	1/1.8" Progressive Scan CMOS	1/1.8" Progressive Scan CMOS	1/1.2" Progressive Scan CMOS	1/1.2" Progressive Scan CMOS	2 × 1/2.5" Progressive Scan CMOS
Resolution	2688 × 1520	2688 × 1520	3200 × 1800	3840 × 2160	3840 × 2160	3040 × 1368
Video Compression	H.265/H.265+/H.264+/H.264 / MJPEG	H.265/H.265+/H.264+/H.264 / MJPEG	H.265/H.265+/H.264+/H.264 / MJPEG	H.265/H.265+/H.264+/H.264 / MJPEG	H.265/H.265+/H.264+/H.264 / MJPEG	H.265/H.265+/H.264+/H.264 / MJPEG
Min. Illumination	0.0005 Lux @ (F1.0, AGC ON), 0 Lux with Light	0.0005 Lux @ (F1.0, AGC ON), 0 Lux with Light	0.0008 Lux @ (F1.0, AGC ON), 0 Lux with Light	0.0005 Lux @ (F1.0, AGC ON), 0 Lux with Light	0.0005 Lux @ (F1.0, AGC ON), 0 Lux with Light	0.0005 Lux @ (F1.0, AGC ON), 0 Lux with Light
WDR	130dB	130dB	130dB	130dB	130dB	130dB
Lens	2.8mm, 4 mm	2.8mm, 4 mm	2.8mm, 4 mm	2.8mm, 4 mm	2.8mm, 4 mm	Fixed focal lens, Dual lens: 2.8 mm
FOV	2.8 mm, horizontal FOV 112°, vertical FOV 61°, diagonal FOV 134° 4 mm, horizontal FOV 95°, vertical FOV 51°, diagonal FOV 115°	2.8 mm, horizontal FOV 112°, vertical FOV 61°, diagonal FOV 134° 4 mm, horizontal FOV 95°, vertical FOV 51°, diagonal FOV 115°	2.8mm, Horizontal FOV: 109°, Vertical FOV: 59°, Diagonal FOV: 130° 4 mm, Horizontal FOV: 93°, Vertical FOV: 49°, Diagonal FOV: 111°	2.8 mm, horizontal FOV102°, vertical FOV 52°, diagonal FOV 124° 4 mm, horizontal FOV 88°, vertical FOV 49°, diagonal FOV 102°	2.8 mm, horizontal FOV102°, vertical FOV 52°, diagonal FOV 124° 4 mm, horizontal FOV 88°, vertical FOV 49°, diagonal FOV 102°	Horizontal FOV: 180° Vertical FOV: 82°
Max. Light Range	30 m	30 m	30 m	30 m	30 m	30m
VCA	Line crossing detection, intrusion detection, region entrance detection, region exiting detection	Line crossing detection, intrusion detection, region entrance detection, region exiting detection	Line crossing detection, intrusion detection, region entrance detection, region exiting detection	Line crossing detection, intrusion detection, region entrance detection, region exiting detection	Line crossing detection, intrusion detection, region entrance detection, region exiting detection	Line crossing detection, intrusion detection, region entrance detection, region exiting detection
Frame Rate	50Hz: 25fps (2688 × 1520, 1920 × 1080, 1280 × 720) 60Hz: 30fps (2688 × 1520, 1920 × 1080, 1280 × 720)	50Hz: 25fps (2688 × 1520, 1920 × 1080, 1280 × 720) 60Hz: 30fps (2688 × 1520, 1920 × 1080, 1280 × 720)	50 Hz: 25 fps (3200 × 1800, 2688 × 1520, 1920 × 1080, 1280 × 720) 60 Hz: 24 fps (3200 × 1800) 30 fps (2688 × 1520, 1920 × 1080, 1280 × 720)	50Hz: 25fps (3840 × 2160, 3200 × 1800, 2688 × 1520, 1920 × 1080, 1280 × 720) 60Hz: 24fps (3840 × 2160) 30fps (3200 × 1800, 2688 × 1520, 1920 × 1080, 1280 × 720)	50Hz: 25fps (3840 × 2160, 3200 × 1800, 2688 × 1520, 1920 × 1080, 1280 × 720) 60Hz: 24fps (3840 × 2160) 30fps (3200 × 1800, 2688 × 1520, 1920 × 1080, 1280 × 720)	50Hz: 25fps (3040 × 1368) 60Hz: 24fps (3040 × 1368)
Streams	3	3	3	3	3	2
Protection Level	IP67	IP67	IP67	IP67	IP67	IP67
Angle Adjustment	Pan: 0° to 360°, tilt: 0° to 75°, rotate: 0° to 360°	Pan: 0° to 360°, tilt: 0° to 75°, rotate: 0° to 360°	Pan: 0° to 360°, tilt: 0° to 75°, rotate: 0° to 360°	Pan: 0° to 360°, tilt: 0° to 90°, rotate: 0° to 360°	Pan: 0° to 360°, tilt: 0° to 90°, rotate: 0° to 360°	Pan: -30° to 30°, tilt: -75° to 75°
Operating Temperature	-30 °C to +60 °C (-22 °F to +140 °F)	-30 °C to +60 °C (-22 °F to +140 °F)	-30 °C to +60 °C (-22 °F to +140 °F)	-30 °C to +60 °C (-22 °F to +140 °F)	-30 °C to +60 °C (-22 °F to +140 °F)	-30 °C to +60 °C (-22 °F to +140 °F)
Humidity	95% or less (non-condensing)	95% or less (non-condensing)	95% or less (non-condensing)	95% or less (non-condensing)	95% or less (non-condensing)	95% or less (non-condensing)
Local Storage	256 GB	256 GB	256 GB	256 GB	256 GB	256 GB
Indoor/Outdoor	Outdoor	Outdoor	Outdoor	Outdoor	Outdoor	Outdoor
Audio I/O	-U: Built-in microphone	1 In, 1 Out Built-in microphone Built-in speaker	-U: Built-in microphone	-U: Built-in microphone	1 In, 1 Out Built-in microphone Built-in speaker	1 In, 1 Out Built-in microphone Built-in speaker
Alarm I/O	-	1 In, 1 Out	-	-	1 In, 1 Out	1 In, 1 Out
Power	12 VDC ± 25%, PoE (802.3af, class 3)	12 VDC ± 25%, PoE (802.3af, class 3)	12 VDC ± 25%, PoE (802.3af, class 3)	12 VDC ± 25%, PoE (802.3af, class 3)	12 VDC ± 25%, PoE (802.3af, class 3)	12 VDC ± 25%, PoE (802.3af, class 3)





Model	DS-2CD236762P-LSU/SL	DS-2CD238762P-LSU/SL	DS-2CD252762-LSU	DS-2CD254762-LSU	DS-2CD264762T-LZS
Image	 <HOT ColorVu AcuSense	 <HOT ColorVu AcuSense	 ColorVu AcuSense	 ColorVu AcuSense	 <HOT ColorVu AcuSense
Image Sensor	2 × 1/2.5" Progressive Scan CMOS	2 × 1/1.8" Progressive Scan CMOS	1/2.8" Progressive Scan CMOS	1/1.8" Progressive Scan CMOS	1/1.8" Progressive Scan CMOS
Resolution	3632 × 1632	5120 × 1440	1920 × 1080	2688 × 1520	2688 × 1520
Video Compression	H.265/H.265+/H.264+/H.264 / MJPEG	H.265/H.265+/H.264+/H.264 / MJPEG	H.265/H.265+/H.264+/H.264 / MJPEG	H.265/H.265+/H.264+/H.264 / MJPEG	H.265/H.265+/H.264+/H.264 / MJPEG
Min. Illumination	0.0005 Lux @ (F1.0, AGC ON), 0 Lux with Light	0.0005 Lux @ (F1.0, AGC ON), 0 Lux with Light	0.0005 Lux @ (F1.0, AGC ON), 0 Lux with Light	0.0005 Lux @ (F1.0, AGC ON), 0 Lux with Light	0.0005 Lux @ (F1.0, AGC ON), 0 Lux with Light
WDR	130dB	130dB	120dB	130dB	130dB
Lens	Fixed focal lens, Dual lens: 2.8 mm	Fixed focal lens, Dual lens: 4 mm	2.8mm, 4 mm	2.8mm, 4 mm	2.8 to 12 mm
FOV	Horizontal FOV: 180° Vertical FOV: 82°	Horizontal FOV: 180° Vertical FOV: 44°	2.8 mm, horizontal FOV 107°, vertical FOV 56°, diagonal FOV 127° 4 mm, horizontal FOV 84°, vertical FOV 45°, diagonal FOV 99°	2.8 mm, horizontal FOV 112°, vertical FOV 61°, diagonal FOV 134° 4 mm, horizontal FOV 95°, vertical FOV 51°, diagonal FOV 115°	horizontal FOV 105.4° to 56.4°, vertical FOV 53.9° to 31.6°, diagonal FOV 131.8° to 65.1°
Max. Light Range	30m	30m	30 m	30 m	60 m
VCA	Line crossing detection, intrusion detection, region entrance detection, region exiting detection	Line crossing detection, intrusion detection, region entrance detection, region exiting detection	Line crossing detection, intrusion detection, region entrance detection, region exiting detection	Line crossing detection, intrusion detection, region entrance detection, region exiting detection	Line crossing detection, intrusion detection, region entrance detection, region exiting detection
Frame Rate	50Hz: 20fps (3632 × 1632) 60Hz: 20fps (3632 × 1632)	When WDR is On: 50 Hz: 12.5 fps (5120 × 1440) 60 Hz: 15 fps (5120 × 1440) When WDR is Off: 50 Hz: 20 fps (5120 × 1440) 60 Hz: 20 fps (5120 × 1440)	50Hz: 25fps (1920 × 1080, 1280 × 720) 60Hz: 30fps (1920 × 1080, 1280 × 720)	50Hz: 25fps (2688 × 1520, 1920 × 1080, 1280 × 720) 60Hz: 30fps (2688 × 1520, 1920 × 1080, 1280 × 720)	50Hz: 25fps (2688 × 1520, 1920 × 1080, 1280 × 720) 60Hz: 30fps (2688 × 1520, 1920 × 1080, 1280 × 720)
Streams	2	2	3	3	3
Protection Level	IP67	IP67	IP67,IK08	IP67,IK08	IP67, IK10
Angle Adjustment	Pan: -30° to 30°, tilt: -75° to 75°	Pan: -30° to 30°, tilt: -75° to 75°	Pan: 0° to 360°, tilt: 0° to 75°, rotate: 0° to 360°	Pan: 0° to 360°, tilt: 0° to 75°, rotate: 0° to 360°	Pan: 0° to 355°, tilt: 0° to 90°, rotate: 0° to 360°
Operating Temperature	-30 °C to +60 °C (-22 °F to +140 °F)	-30 °C to +60 °C (-22 °F to +140 °F)	-30 °C to +60 °C (-22 °F to +140 °F)	-30 °C to +60 °C (-22 °F to +140 °F)	-30 °C to +60 °C (-22 °F to +140 °F)
Humidity	95% or less (non-condensing)	95% or less (non-condensing)	95% or less (non-condensing)	95% or less (non-condensing)	95% or less (non-condensing)
Local Storage	256 GB	256 GB	256 GB	256 GB	256 GB
Indoor/Outdoor	Outdoor	Outdoor	Outdoor	Outdoor	Outdoor
Audio I/O	1 In, 1 Out Built-in microphone Built-in speaker	1 In, 1 Out Built-in microphone Built-in speaker	1 In, 1 Out Built-in microphone	1 In, 1 Out Built-in microphone	1 In, 1 Out
Alarm I/O	1 In, 1 Out	1 In, 1 Out	1 In, 1 Out	1 In, 1 Out	1 In, 1 Out
Power	12 VDC ± 25%, PoE (802.3af, class 3)	12 VDC ± 25%, PoE (802.3af, class 3)	12 VDC ± 25%, PoE (802.3af, class 3)	12 VDC ± 25%, PoE (802.3af, class 3)	12 VDC ± 25%, PoE (802.3af, class 3)





Model	DS-2CD266762T-LZS	DS-2CD268762T-LZS	DS-2CD274762T-LZS	DS-2CD276762T-LZS	DS-2CD278762T-LZS
Image	 NEW ColorVu AcuSense	 NEW ColorVu AcuSense	 HOT ColorVu AcuSense	 NEW ColorVu AcuSense	 NEW ColorVu AcuSense
Image Sensor	1.8" Progressive Scan CMOS	1.8" Progressive Scan CMOS	1/1.8" Progressive Scan CMOS	1.8" Progressive Scan CMOS	1.8" Progressive Scan CMOS
Resolution	3200 × 1800	3840 × 2160	2688 × 1520	3200 × 1800	3840 × 2160
Video Compression	H.265/H.265+/H.264+/H.264 / MJPEG	H.265/H.265+/H.264+/H.264 / MJPEG	H.265/H.265+/H.264+/H.264 / MJPEG	H.265/H.265+/H.264+/H.264 / MJPEG	H.265/H.265+/H.264+/H.264 / MJPEG
Min. Illumination	0.0008 Lux @ (F1.0, AGC ON), 0 Lux with light	0.0008 Lux @ (F1.0, AGC ON), 0 Lux with light	0.0005 Lux @ (F1.0, AGC ON), 0 Lux with Light	0.0008 Lux @ (F1.0, AGC ON), 0 Lux with light	0.0008 Lux @ (F1.0, AGC ON), 0 Lux with light
WDR	130dB	130dB	130dB	130dB	130dB
Lens	2.8 to 12 mm	2.8 to 12 mm	2.8 to 12 mm	2.8 to 12 mm	2.8 to 12 mm
FOV	horizontal FOV 103.3° to 40°, vertical FOV 52.7° to 22.3°, diagonal FOV 127.9° to 46.1°	horizontal FOV 103.3° to 40°, vertical FOV 52.7° to 22.3°, diagonal FOV 127.9° to 46.1°	horizontal FOV 105.4° to 56.4°, vertical FOV 53.9° to 31.6°, diagonal FOV 131.8° to 65.1°	horizontal FOV 103.3° to 40°, vertical FOV 52.7° to 22.3°, diagonal FOV 127.9° to 46.1°	horizontal FOV 103.3° to 40°, vertical FOV 52.7° to 22.3°, diagonal FOV 127.9° to 46.1°
Max. Light Range	60 m	60 m	40 m	40 m	40 m
VCA	Line crossing detection, intrusion detection, region entrance detection, region exiting detection	Line crossing detection, intrusion detection, region entrance detection, region exiting detection	Line crossing detection, intrusion detection, region entrance detection, region exiting detection	Line crossing detection, intrusion detection, region entrance detection, region exiting detection	Line crossing detection, intrusion detection, region entrance detection, region exiting detection
Frame Rate	50 Hz: 25 fps (3200 × 1800, 2688 × 1520, 1920 × 1080, 1280 × 720) 60 Hz: 24 fps (3200 × 1800) 30 fps (2688 × 1520, 1920 × 1080, 1280 × 720)	50 Hz: 25 fps (3840 × 2160, 3200 × 1800, 2688 × 1520, 1920 × 1080, 1280 × 720) 60 Hz: 24 fps (3840 × 2160) 30 fps (3200 × 1800, 2688 × 1520, 1920 × 1080, 1280 × 720)	50Hz: 25fps (2688 × 1520, 1920 × 1080, 1280 × 720) 60Hz: 30fps (2688 × 1520, 1920 × 1080, 1280 × 720)	50 Hz: 25 fps (3200 × 1800, 2688 × 1520, 1920 × 1080, 1280 × 720) 60 Hz: 24 fps (3200 × 1800) 30 fps (2688 × 1520, 1920 × 1080, 1280 × 720)	50 Hz: 25 fps (3840 × 2160, 3200 × 1800, 2688 × 1520, 1920 × 1080, 1280 × 720) 60 Hz: 24 fps (3840 × 2160) 30 fps (3200 × 1800, 2688 × 1520, 1920 × 1080, 1280 × 720)
Streams	3	3	3	3	3
Protection Level	IP67, IK10	IP67, IK10	IP67, IK10	IP67, IK10	IP67, IK10
Angle Adjustment	Pan: 0° to 355°, tilt: 0° to 90°, rotate: 0° to 360°	Pan: 0° to 355°, tilt: 0° to 90°, rotate: 0° to 360°	Pan: 0° to 355°, tilt: 0° to 75°, rotate: 0° to 355°	Pan: 0° to 355°, tilt: 0° to 75°, rotate: 0° to 355°	Pan: 0° to 355°, tilt: 0° to 75°, rotate: 0° to 355°
Operating Temperature	-30 °C to +60 °C (-22 °F to +140 °F)	-30 °C to +60 °C (-22 °F to +140 °F)	-30 °C to +60 °C (-22 °F to +140 °F)	-30 °C to +60 °C (-22 °F to +140 °F)	-30 °C to +60 °C (-22 °F to +140 °F)
Humidity	95% or less (non-condensing)	95% or less (non-condensing)	95% or less (non-condensing)	95% or less (non-condensing)	95% or less (non-condensing)
Local Storage	256 GB	256 GB	256 GB	256 GB	256 GB
Indoor/Outdoor	Outdoor	Outdoor	Outdoor	Outdoor	Outdoor
Audio I/O	1 In, 1 Out	1 In, 1 Out	1 In, 1 Out	1 In, 1 Out	1 In, 1 Out
Alarm I/O	1 In, 1 Out	1 In, 1 Out	1 In, 1 Out	1 In, 1 Out	1 In, 1 Out
Power	12 VDC ± 25%, PoE (802.3af, class 3)	12 VDC ± 25%, PoE (802.3af, class 3)	12 VDC ± 25%, PoE (802.3af, class 3)	12 VDC ± 25%, PoE (802.3af, class 3)	12 VDC ± 25%, PoE (802.3af, class 3)





Model	DS-2CD2T2762-L	DS-2CD2T4762-L	DS-2CD2T4762-LSU/SL	DS-2CD2T6762-L	DS-2CD2T8762-L	DS-2CD2T8762-LSU/SL
Image	 ColorVu AcuSense	 ColorVu AcuSense	 ColorVu AcuSense	 ColorVu AcuSense	 ColorVu AcuSense	 ColorVu AcuSense
Image Sensor	1/2.8" Progressive Scan CMOS	1/1.8" Progressive Scan CMOS	1/1.8" Progressive Scan CMOS	1/1.8" Progressive Scan CMOS	1/1.2" Progressive Scan CMOS	1/1.2" Progressive Scan CMOS
Resolution	1920 × 1080	2688 × 1520	2688 × 1520	3200 × 1800	3840 × 2160	3840 × 2160
Video Compression	H.265/H.265+/H.264+/H.264 / MJPEG	H.265/H.265+/H.264+/H.264 / MJPEG	H.265/H.265+/H.264+/H.264 / MJPEG	H.265/H.265+/H.264+/H.264 / MJPEG	H.265/H.265+/H.264+/H.264 / MJPEG	H.265/H.265+/H.264+/H.264 / MJPEG
Min. Illumination	0.0005 Lux @ (F1.0, AGC ON), 0 Lux with Light	0.0005 Lux @ (F1.0, AGC ON), 0 Lux with Light	0.0005 Lux @ (F1.0, AGC ON), 0 Lux with Light	0.0008 Lux @ (F1.0, AGC ON), 0 Lux with light	0.0005 Lux @ (F1.0, AGC ON), 0 Lux with Light	0.0005 Lux @ (F1.0, AGC ON), 0 Lux with Light
WDR	120dB	130dB	130dB	130dB	130dB	130dB
Lens	2.8mm, 4 mm, 6 mm	2.8mm, 4 mm, 6 mm	2.8mm, 4 mm, 6 mm	2.8mm, 4 mm, 6 mm	2.8mm, 4 mm, 6 mm	2.8mm, 4 mm, 6 mm
FOV	2.8 mm, horizontal FOV: 112°, vertical FOV: 57°, diagonal FOV: 138° 4 mm, horizontal FOV: 89°, vertical FOV: 46°, diagonal FOV: 106° 6 mm, horizontal FOV: 56°, vertical FOV: 30°, diagonal FOV: 66°	2.8 mm, horizontal FOV 112°, vertical FOV 61°, diagonal FOV 134° 4 mm, horizontal FOV 95°, vertical FOV 51°, diagonal FOV 115° 6 mm, horizontal FOV 58°, vertical FOV 31°, diagonal FOV 69°	2.8 mm, horizontal FOV 112°, vertical FOV 61°, diagonal FOV 134° 4 mm, horizontal FOV 95°, vertical FOV 51°, diagonal FOV 115° 6 mm, horizontal FOV 58°, vertical FOV 31°, diagonal FOV 69°	2.8mm, Horizontal FOV: 109°, Vertical FOV: 59°, Diagonal FOV: 130° 4 mm, Horizontal FOV: 93°, Vertical FOV: 49°, Diagonal FOV: 111° 6 mm, Horizontal FOV: 57°, Vertical FOV: 30°, Diagonal FOV: 67°	2.8 mm, horizontal FOV102°, vertical FOV 52°, diagonal FOV 124° 4 mm, horizontal FOV 88°, vertical FOV 49°, diagonal FOV 102° 6 mm, horizontal FOV 54°, vertical FOV 30°, diagonal FOV 62°	2.8 mm, horizontal FOV102°, vertical FOV 52°, diagonal FOV 124° 4 mm, horizontal FOV 88°, vertical FOV 49°, diagonal FOV 102° 6 mm, horizontal FOV 54°, vertical FOV 30°, diagonal FOV 62°
Max. Light Range	60 m	60 m	60 m	60m	60 m	60 m
VCA	Line crossing detection, intrusion detection, region entrance detection, region exiting detection	Line crossing detection, intrusion detection, region entrance detection, region exiting detection	Line crossing detection, intrusion detection, region entrance detection, region exiting detection	Line crossing detection, intrusion detection, region entrance detection, region exiting detection	Line crossing detection, intrusion detection, region entrance detection, region exiting detection	Line crossing detection, intrusion detection, region entrance detection, region exiting detection
Frame Rate	50Hz: 25fps (1920 × 1080, 1280 × 960, 1280 × 720) 60Hz: 30fps (1920 × 1080, 1280 × 960, 1280 × 720)	50Hz: 25fps (2688 × 1520, 1920 × 1080, 1280 × 720) 60Hz: 30fps (2688 × 1520, 1920 × 1080, 1280 × 720)	50Hz: 25fps (2688 × 1520, 1920 × 1080, 1280 × 720) 60Hz: 30fps (2688 × 1520, 1920 × 1080, 1280 × 720)	50 Hz: 25 fps (3200 × 1800, 2688 × 1520, 1920 × 1080, 1280 × 720) 60 Hz: 24 fps (3200 × 1800) 30 fps (2688 × 1520, 1920 × 1080, 1280 × 720)	50Hz: 25fps (3840 × 2160, 3200 × 1800, 2688 × 1520, 1920 × 1080, 1280 × 720) 60Hz: 24fps (3840 × 2160) 30fps (3200 × 1800, 2688 × 1520, 1920 × 1080, 1280 × 720)	50Hz: 25fps (3840 × 2160, 3200 × 1800, 2688 × 1520, 1920 × 1080, 1280 × 720) 60Hz: 24fps (3840 × 2160) 30fps (3200 × 1800, 2688 × 1520, 1920 × 1080, 1280 × 720)
Streams	3	3	3	3	3	3
Protection Level	IP67	IP67	IP67	IP67	IP67	IP67
Angle Adjustment	Pan: 0° to 360°, tilt: 0° to 90°, rotate: 0° to 360°	Pan: 0° to 360°, tilt: 0° to 90°, rotate: 0° to 360°	Pan: 0° to 360°, tilt: 0° to 90°, rotate: 0° to 360°	Pan: 0° to 360°, tilt: 0° to 90°, rotate: 0° to 360°	Pan: 0° to 360°, tilt: 0° to 90°, rotate: 0° to 360°	Pan: 0° to 360°, tilt: 0° to 90°, rotate: 0° to 360°
Operating Temperature	-30 °C to +60 °C [-22 °F to +140 °F]	-30 °C to +60 °C [-22 °F to +140 °F]	-30 °C to +60 °C [-22 °F to +140 °F]	-30 °C to +60 °C [-22 °F to +140 °F]	-30 °C to +60 °C [-22 °F to +140 °F]	-30 °C to +60 °C [-22 °F to +140 °F]
Humidity	95% or less (non-condensing)	95% or less (non-condensing)	95% or less (non-condensing)	95% or less (non-condensing)	95% or less (non-condensing)	95% or less (non-condensing)
Local Storage	256 GB	256 GB	256 GB	256 GB	256 GB	256 GB
Indoor/Outdoor	Outdoor	Outdoor	Outdoor	Outdoor	Outdoor	Outdoor
Audio I/O	-	-	1 In, 1 Out Built-in microphone Built-in speaker	-	-	1 In, 1 Out Built-in microphone Built-in speaker
Alarm I/O	-	-	1 In, 1 Out	-	-	1 In, 1 Out
Power	12 VDC ± 25%, PoE (802.3af, class 3)	12 VDC ± 25%, PoE (802.3af, class 3)	12 VDC ± 25%, PoE (802.3af, class 3)	12 VDC ± 25%, PoE (802.3af, class 3)	12 VDC ± 25%, PoE (802.3af, class 3)	12 VDC ± 25%, PoE (802.3af, class 3)







Model	DS-2CD2T4762P-LSU/SL	DS-2CD2T6762P-LSU/SL	DS-2CD2T8762P-LSU/SL	DS-2CD264762HT-LIZS	DS-2CD266762HT-LIZS	DS-2CD268762HT-LIZS
Image	 HOT ColorVu AcuSense	 HOT ColorVu AcuSense	 HOT ColorVu AcuSense	 NEW ColorVu AcuSense	 NEW ColorVu AcuSense	 NEW ColorVu AcuSense
Image Sensor	2 × 1/2.5" Progressive Scan CMOS	2 × 1/2.5" Progressive Scan CMOS	2 × 1/1.8" Progressive Scan CMOS	1/1.8" Progressive Scan CMOS	1/1.8" Progressive Scan CMOS	1/1.8" Progressive Scan CMOS
Resolution	3040 × 1368	3632 × 1632	5120 × 1440	2688 × 1520	3200 × 1800	3840 × 2160
Video Compression	H.265/H.265+/H.264+/H.264 / MJPEG	H.265/H.265+/H.264+/H.264 / MJPEG	H.265/H.265+/H.264+/H.264 / MJPEG	H.265/H.265+/H.264+/H.264 / MJPEG	H.265/H.265+/H.264+/H.264 / MJPEG	H.265/H.265+/H.264+/H.264 / MJPEG
Min. Illumination	0.0005 Lux @ (F1.0, AGC ON), 0 Lux with Light	0.0005 Lux @ (F1.0, AGC ON), 0 Lux with Light	0.0005 Lux @ (F1.0, AGC ON), 0 Lux with Light	Color: 0.001 Lux @ (F1.2, AGC ON), 0 Lux with light	Color: 0.0028 Lux @ (F1.2, AGC ON), 0 Lux with light	0.0028 Lux @ (F1.2, AGC ON), 0 Lux with light
WDR	130dB	130dB	130dB	130dB	130dB	130dB
Lens	Fixed focal lens, Dual lens: 2.8 mm	Fixed focal lens, Dual lens: 2.8 mm	Fixed focal lens, Dual lens: 4 mm	Varifocal lens, motorized lens, 2.8 to 12 mm	Varifocal lens, motorized lens, 2.8 to 12 mm	Varifocal lens, motorized lens, 2.8 to 12 mm
FOV	Horizontal FOV: 180° Vertical FOV: 82°	Horizontal FOV: 180° Vertical FOV: 82°	Horizontal FOV: 180° Vertical FOV: 44°	horizontal FOV 114.6° to 41.8°, vertical FOV 59.3° to 23.6°, diagonal FOV 141.3° to 48.1°	horizontal FOV 112.3° to 41.2°, vertical FOV 58.1° to 23.1°, diagonal FOV 137.4° to 47.3°	horizontal FOV 112.3° to 41.2°, vertical FOV 58.1° to 23.1°, diagonal FOV 137.4° to 47.3°
Max. Light Range	40m	40m	40m	60m	60m	60m
VCA	Line crossing detection, intrusion detection, region entrance detection, region exiting detection	Line crossing detection, intrusion detection, region entrance detection, region exiting detection	Line crossing detection, intrusion detection, region entrance detection, region exiting detection	Line crossing detection, intrusion detection, region entrance detection, region exiting detection (support alarm triggered by specified target types (human and vehicle)), scene change detection	Line crossing detection, intrusion detection, region entrance detection, region exiting detection (support alarm triggered by specified target types (human and vehicle)), scene change detection	Line crossing detection, intrusion detection, region entrance detection, region exiting detection (support alarm triggered by specified target types (human and vehicle)), scene change detection
Frame Rate	50Hz: 25fps (3040 × 1368) 60Hz: 24fps (3040 × 1368)	50Hz: 20fps (3632 × 1632) 60Hz: 20fps (3632 × 1632)	When WDR is On: 50 Hz: 12.5 fps (5120 × 1440) 60 Hz: 15 fps (5120 × 1440) When WDR is Off: 50 Hz: 20 fps (5120 × 1440) 60 Hz: 20 fps (5120 × 1440)	50 Hz: 25 fps (2688 × 1520, 1920 × 1080, 1280 × 720) 60 Hz: 30 fps (2688 × 1520, 1920 × 1080, 1280 × 720)	50 Hz: 25 fps (3200 × 1800, 2688 × 1520, 1920 × 1080, 1280 × 720) 60 Hz: 24 fps (3200 × 1800), 30 fps (2688 × 1520, 1920 × 1080, 1280 × 720)	50 Hz: 25 fps (3840 × 2160, 3200 × 1800, 2688 × 1520, 1920 × 1080, 1280 × 720) 60 Hz: 24 fps (3840 × 2160), 30 fps (3200 × 1800, 2688 × 1520, 1920 × 1080, 1280 × 720)
Streams	2	2	2	3	3	3
Protection Level	IP67	IP67	IP67	IP67	IP67	IP67
Angle Adjustment	Pan: -30° to 30°, tilt: -75° to 75°	Pan: -30° to 30°, tilt: -75° to 75°	Pan: 0° to 355°, tilt: 0° to 90°, rotate: 0° to 360°	Pan: 0° to 355°, tilt: 0° to 90°, rotate: 0° to 360°	Pan: 0° to 355°, tilt: 0° to 90°, rotate: 0° to 360°	Pan: 0° to 355°, tilt: 0° to 90°, rotate: 0° to 360°
Operating Temperature	-30 °C to +60 °C (-22 °F to +140 °F)	-30 °C to +60 °C (-22 °F to +140 °F)	-30 °C to +60 °C (-22 °F to +140 °F)	-30 °C to 60 °C (-22 °F to 140 °F)	-30 °C to 60 °C (-22 °F to 140 °F)	-30 °C to 60 °C (-22 °F to 140 °F)
Humidity	95% or less (non-condensing)	95% or less (non-condensing)	95% or less (non-condensing)	95% or less (non-condensing)	95% or less (non-condensing)	95% or less (non-condensing)
Local Storage	256 GB	256 GB	256 GB	512 GB	512 GB	512 GB
Indoor/Outdoor	Outdoor	Outdoor	Outdoor	Outdoor	Outdoor	Outdoor
Audio I/O	1 In, 1 Out Built-in microphone Built-in speaker	1 In, 1 Out Built-in microphone Built-in speaker	1 In, 1 Out Built-in microphone Built-in speaker	1 In, 1 Out	1 In, 1 Out	1 In, 1 Out
Alarm I/O	1 In, 1 Out	1 In, 1 Out	1 In, 1 Out	1 In, 1 Out	1 In, 1 Out	1 In, 1 Out
Power	12 VDC ± 25%, PoE (802.3af, class 3)	12 VDC ± 25%, PoE (802.3af, class 3)	12 VDC ± 25%, PoE (802.3af, class 3)	12 VDC ± 25%, PoE (802.3af, class 4)	12 VDC ± 25%, PoE (802.3af, class 4)	12 VDC ± 25%, PoE (802.3af, class 4)







Model	DS-2CD274762HT-LIZS	DS-2CD276762HT-LIZS	DS-2CD278762HT-LIZS	DS-2CD264762HT-LIZSU/SL	DS-2CD266762HT-LIZSU/SL	DS-2CD268762HT-LIZSU/SL
Image	 NEW ColorVu AcuSense	 NEW ColorVu AcuSense	 NEW ColorVu AcuSense	 NEW ColorVu AcuSense	 NEW ColorVu AcuSense	 NEW ColorVu AcuSense
Image Sensor	1/1.8" Progressive Scan CMOS	1/1.8" Progressive Scan CMOS	1/1.8" Progressive Scan CMOS	1/1.8" Progressive Scan CMOS	1/1.8" Progressive Scan CMOS	1/1.8" Progressive Scan CMOS
Resolution	2688 × 1520	3200 × 1800	3840 × 2160	2688 × 1520	3200 × 1800	3840 × 2160
Video Compression	H.265/H.265+/H.264+/H.264 / MJPEG	H.265/H.265+/H.264+/H.264 / MJPEG	H.265/H.265+/H.264+/H.264 / MJPEG	H.265/H.265+/H.264+/H.264 / MJPEG	H.265/H.265+/H.264+/H.264 / MJPEG	H.265/H.265+/H.264+/H.264 / MJPEG
Min. Illumination	Color: 0.001 Lux @ (F1.2, AGC ON), 0 Lux with light	Color: 0.0028 Lux @ (F1.2, AGC ON), 0 Lux with light	0.0028 Lux @ (F1.2, AGC ON), 0 Lux with light	Color: 0.001 Lux @ (F1.2, AGC ON), 0 Lux with light	Color: 0.0028 Lux @ (F1.2, AGC ON), 0 Lux with light	0.0028 Lux @ (F1.2, AGC ON), 0 Lux with light
WDR	130dB	130dB	130dB	130dB	130dB	130dB
Lens	Varifocal lens, motorized lens, 2.8 to 12 mm	Varifocal lens, motorized lens, 2.8 to 12 mm	Varifocal lens, motorized lens, 2.8 to 12 mm	Varifocal lens, motorized lens, 2.8 to 12 mm	Varifocal lens, motorized lens, 2.8 to 12 mm	Varifocal lens, motorized lens, 2.8 to 12 mm
FOV	horizontal FOV 114.6° to 41.8°, vertical FOV 59.3° to 23.6°, diagonal FOV 141.3° to 48.1°	horizontal FOV 112.3° to 41.2°, vertical FOV 58.1° to 23.1°, diagonal FOV 137.4° to 47.3°	horizontal FOV 112.3° to 41.2°, vertical FOV 58.1° to 23.1°, diagonal FOV 137.4° to 47.3°	horizontal FOV 114.6° to 41.8°, vertical FOV 59.3° to 23.6°, diagonal FOV 141.3° to 48.1°	horizontal FOV 112.3° to 41.2°, vertical FOV 58.1° to 23.1°, diagonal FOV 137.4° to 47.3°	horizontal FOV 112.3° to 41.2°, vertical FOV 58.1° to 23.1°, diagonal FOV 137.4° to 47.3°
Max. Light Range	40m	40m	40m	60m	60m	60m
VCA	Line crossing detection, intrusion detection, region entrance detection, region exiting detection (support alarm triggered by specified target types (human and vehicle)), scene change detection	Line crossing detection, intrusion detection, region entrance detection, region exiting detection (support alarm triggered by specified target types (human and vehicle)), scene change detection	Line crossing detection, intrusion detection, region entrance detection, region exiting detection (support alarm triggered by specified target types (human and vehicle)), scene change detection	Line crossing detection, intrusion detection, region entrance detection, region exiting detection (support alarm triggered by specified target types (human and vehicle)), scene change detection	Line crossing detection, intrusion detection, region entrance detection, region exiting detection (support alarm triggered by specified target types (human and vehicle)), scene change detection	Line crossing detection, intrusion detection, region entrance detection, region exiting detection (support alarm triggered by specified target types (human and vehicle)), scene change detection
Frame Rate	50 Hz: 25 fps (2688 × 1520, 1920 × 1080, 1280 × 720) 60 Hz: 30 fps (2688 × 1520, 1920 × 1080, 1280 × 720)	50 Hz: 25 fps (3200 × 1800, 2688 × 1520, 1920 × 1080, 1280 × 720) 60 Hz: 24 fps (3200 × 1800), 30 fps (2688 × 1520, 1920 × 1080, 1280 × 720)	50 Hz: 25 fps (3840 × 2160, 3200 × 1800, 2688 × 1520, 1920 × 1080, 1280 × 720) 60 Hz: 24 fps (3840 × 2160), 30 fps (3200 × 1800, 2688 × 1520, 1920 × 1080, 1280 × 720)	50 Hz: 25 fps (2688 × 1520, 1920 × 1080, 1280 × 720) 60 Hz: 30 fps (2688 × 1520, 1920 × 1080, 1280 × 720)	50 Hz: 25 fps (3200 × 1800, 2688 × 1520, 1920 × 1080, 1280 × 720) 60 Hz: 24 fps (3200 × 1800), 30 fps (2688 × 1520, 1920 × 1080, 1280 × 720)	50 Hz: 25 fps (3840 × 2160, 3200 × 1800, 2688 × 1520, 1920 × 1080, 1280 × 720) 60 Hz: 24 fps (3840 × 2160), 30 fps (3200 × 1800, 2688 × 1520, 1920 × 1080, 1280 × 720)
Streams	3	3	3	3	3	3
Protection Level	IP67	IP67	IP67	IP67	IP67	IP67
Angle Adjustment	Pan: 0° to 355°, tilt: 0° to 75°, rotate: 0° to 355°	Pan: 0° to 355°, tilt: 0° to 75°, rotate: 0° to 355°	Pan: 0° to 355°, tilt: 0° to 75°, rotate: 0° to 355°	Pan: 0° to 355°, tilt: 0° to 90°, rotate: 0° to 360°	Pan: 0° to 355°, tilt: 0° to 90°, rotate: 0° to 360°	Pan: 0° to 355°, tilt: 0° to 90°, rotate: 0° to 360°
Operating Temperature	-30 °C to 60 °C (-22 °F to 140 °F)	-30 °C to 60 °C (-22 °F to 140 °F)	-30 °C to 60 °C (-22 °F to 140 °F)	-30 °C to 60 °C (-22 °F to 140 °F)	-30 °C to 60 °C (-22 °F to 140 °F)	-30 °C to 60 °C (-22 °F to 140 °F)
Humidity	95% or less (non-condensing)	95% or less (non-condensing)	95% or less (non-condensing)	95% or less (non-condensing)	95% or less (non-condensing)	95% or less (non-condensing)
Local Storage	512 GB	512 GB	512 GB	512 GB	512 GB	512 GB
Indoor/Outdoor	Outdoor	Outdoor	Outdoor	Outdoor	Outdoor	Outdoor
Audio I/O	1 In, 1 Out	1 In, 1 Out	1 In, 1 Out	1 In, 1 Out Built-in microphone Built-in speaker	1 In, 1 Out Built-in microphone Built-in speaker	1 In, 1 Out Built-in microphone Built-in speaker
Alarm I/O	1 In, 1 Out	1 In, 1 Out	1 In, 1 Out	1 In, 1 Out	1 In, 1 Out	1 In, 1 Out
Power	12 VDC ± 25%, PoE (802.3af, class 3)	12 VDC ± 25%, PoE (802.3af, class 3)	12 VDC ± 25%, PoE (802.3af, class 3)	12 VDC ± 25%, PoE (802.3af, class 4)	12 VDC ± 25%, PoE (802.3af, class 4)	12 VDC ± 25%, PoE (802.3af, class 4)

Model	DS-2CD2046G2H-I(U)	DS-2CD2086G2H-I(U)	DS-2CD2146G2H-I(U)	DS-2CD2186G2H-I(U)
Image	 NEW AcuSense Powered by DarkFighter+	 NEW AcuSense Powered by DarkFighter+	 NEW AcuSense Powered by DarkFighter+	 NEW AcuSense Powered by DarkFighter+
Image Sensor	1/3" Progressive Scan CMOS	1/1.8" Progressive Scan CMOS	1/3" Progressive Scan CMOS	1/1.8" Progressive Scan CMOS
Resolution	2688 × 1520	3840 × 2160	2688 × 1520	3840 × 2160
Video Compression	H.265/H.265+/H.264+/H.264 / MJPEG	H.265/H.265+/H.264+/H.264 / MJPEG	H.265/H.265+/H.264+/H.264 / MJPEG	H.265/H.265+/H.264+/H.264 / MJPEG
Min. Illumination	0.001 Lux @ (F1.0, AGC ON), 0 Lux with IR	0.0005 Lux @ (F1.0, AGC ON), 0 Lux with IR	0.001 Lux @ (F1.0, AGC ON), 0 Lux with IR	0.0008 Lux @ (F1.0, AGC ON), 0 Lux with IR
WDR	120 dB	130 dB	130dB	130dB
Lens	Fixed focal lens, 2.8 and 4 mm optional	Fixed focal lens, 2.8 and 4 mm optional	Fixed focal lens, 2.8 and 4 mm optional	Fixed focal lens, 2.8 and 4 mm optional
FOV	2.8 mm, horizontal FOV 100.2°, vertical FOV 54.7°, diagonal FOV 119.7° 4 mm, horizontal FOV 81.1°, vertical FOV 44.7°, diagonal FOV 94.6°	2.8 mm, horizontal FOV 105.1°, vertical FOV 54.8°, diagonal FOV 128.2° 4 mm, horizontal FOV 90.0°, vertical FOV 45.8°, diagonal FOV 109.4°	2.8 mm, horizontal FOV 100.2°, vertical FOV 54.7°, diagonal FOV 119.7° 4 mm, horizontal FOV 81.1°, vertical FOV 44.7°, diagonal FOV 94.6°	2.8 mm, horizontal FOV 109°, vertical FOV 59°, diagonal FOV 130° 4 mm, horizontal FOV 93°, vertical FOV 49°, diagonal FOV 111°
Max. Light Range	40m	40m	40m	30m
VCA	Line crossing detection, intrusion detection, region entrance detection, region exiting detection (support alarm triggered by specified target types (human and vehicle)), scene change detection	Line crossing detection, intrusion detection, region entrance detection, region exiting detection (support alarm triggered by specified target types (human and vehicle)), scene change detection	Line crossing detection, intrusion detection, region entrance detection, region exiting detection (support alarm triggered by specified target types (human and vehicle)), scene change detection	Line crossing detection, intrusion detection, region entrance detection, region exiting detection (support alarm triggered by specified target types (human and vehicle)), scene change detection
Frame Rate	50 Hz: 25 fps (2688 × 1520, 1920 × 1080, 1280 × 720) 60 Hz: 30 fps (2688 × 1520, 1920 × 1080, 1280 × 720)	50 Hz: 25 fps (3840 × 2160, 3200 × 1800, 2688 × 1520, 1920 × 1080, 1280 × 720) 60 Hz: 24 fps (3840 × 2160), 30 fps (3200 × 1800, 2688 × 1520, 1920 × 1080, 1280 × 720)	50 Hz: 25 fps (2688 × 1520, 1920 × 1080, 1280 × 720) 60 Hz: 30 fps (2688 × 1520, 1920 × 1080, 1280 × 720)	50 Hz: 25 fps (3840 × 2160, 3200 × 1800, 2688 × 1520, 1920 × 1080, 1280 × 720) 60 Hz: 24 fps (3840 × 2160), 30 fps (3200 × 1800, 2688 × 1520, 1920 × 1080, 1280 × 720)
Streams	3	3	3	3
Protection Level	IP67	IP67	IP67	IP67
Angle Adjustment	Pan: 0° to 360°, tilt: 0° to 90°, rotate: 0° to 360°	Pan: 0° to 360°, tilt: 0° to 90°, rotate: 0° to 360°	Pan: 0° to 355°, tilt: 0° to 75°, rotate: 0° to 355°	Pan: 0° to 355°, tilt: 0° to 75°, rotate: 0° to 355°
Operating Temperature	-30 °C to 60 °C (-22 °F to 140 °F)	-30 °C to 60 °C (-22 °F to 140 °F)	-30 °C to 60 °C (-22 °F to 140 °F)	-30 °C to 60 °C (-22 °F to 140 °F)
Humidity	95% or less (non-condensing)	95% or less (non-condensing)	95% or less (non-condensing)	95% or less (non-condensing)
Local Storage	512 GB	512 GB	512 GB	512 GB
Indoor/Outdoor	Outdoor	Outdoor	Outdoor	Outdoor
Audio I/O	-U: Built-in microphone	-U: Built-in microphone	-U: Built-in microphone	-U: Built-in microphone
Alarm I/O	-	-	-	-
Power	12 VDC ± 25%, PoE (802.3af, class 3)	12 VDC ± 25%, PoE (802.3af, class 3)	12 VDC ± 25%, PoE (802.3af, class 3)	12 VDC ± 25%, PoE (802.3af, class 3)

Model	DS-2CD2346G2H-I(U)	DS-2CD2386G2H-I(U)	DS-2CD2T46G2H-I(U)	DS-2CD2T86G2H-I(U)
Image	 NEW AcuSense Powered by DarkFighter +	 NEW AcuSense Powered by DarkFighter +	 NEW AcuSense Powered by DarkFighter +	 NEW AcuSense Powered by DarkFighter +
Image Sensor	1/3" Progressive Scan CMOS	1/1.8" Progressive Scan CMOS	1/3" Progressive Scan CMOS	1/1.8" Progressive Scan CMOS
Resolution	2688 × 1520	3840 × 2160	2688 × 1520	3840 × 2160
Video Compression	H.265/H.265+/H.264+/H.264 / MJPEG	H.265/H.265+/H.264+/H.264 / MJPEG	H.265/H.265+/H.264+/H.264 / MJPEG	H.265/H.265+/H.264+/H.264 / MJPEG
Min. Illumination	0.001 Lux @ (F1.0, AGC ON), 0 Lux with IR	0.0005 Lux @ (F1.0, AGC ON), 0 Lux with IR	0.001 Lux @ (F1.0, AGC ON), 0 Lux with IR	0.0005 Lux @ (F1.0, AGC ON), 0 Lux with IR
WDR	120 dB	130dB	120 dB	130dB
Lens	Fixed focal lens, 2.8 and 4 mm optional	Fixed focal lens, 2.8 and 4 mm optional	Fixed focal lens, 2.8 and 4 mm optional	Fixed focal lens, 2.8 and 4 mm optional
FOV	2.8 mm, horizontal FOV 100.2°, vertical FOV 54.7°, diagonal FOV 119.7° 4 mm, horizontal FOV 81.1°, vertical FOV 44.7°, diagonal FOV 94.6°	2.8 mm, horizontal FOV 108.8°, vertical FOV 56.4°, diagonal FOV 134.3° 4 mm, horizontal FOV 93.3°, vertical FOV 47.2°, diagonal FOV 114.2°	2.8 mm, horizontal FOV 100.2°, vertical FOV 54.7°, diagonal FOV 119.7° 4 mm, horizontal FOV 81.1°, vertical FOV 44.7°, diagonal FOV 94.6°	2.8 mm, horizontal FOV 105.1°, vertical FOV 54.8°, diagonal FOV 128.2° 4 mm, horizontal FOV 90.0°, vertical FOV 45.8°, diagonal FOV 109.4°
Max. Light Range	40m	40m	60m	60m
VCA	Line crossing detection, intrusion detection, region entrance detection, region exiting detection (support alarm triggered by specified target types (human and vehicle)), scene change detection	Line crossing detection, intrusion detection, region entrance detection, region exiting detection (support alarm triggered by specified target types (human and vehicle)), scene change detection	Line crossing detection, intrusion detection, region entrance detection, region exiting detection (support alarm triggered by specified target types (human and vehicle)), scene change detection	Line crossing detection, intrusion detection, region entrance detection, region exiting detection (support alarm triggered by specified target types (human and vehicle)), scene change detection
Frame Rate	50 Hz: 25 fps (2688 × 1520, 1920 × 1080, 1280 × 720) 60 Hz: 30 fps (2688 × 1520, 1920 × 1080, 1280 × 720)	50 Hz: 25 fps (3840 × 2160, 3200 × 1800, 2688 × 1520, 1920 × 1080, 1280 × 720) 60 Hz: 24 fps (3840 × 2160), 30 fps (3200 × 1800, 2688 × 1520, 1920 × 1080, 1280 × 720)	50 Hz: 25 fps (2688 × 1520, 1920 × 1080, 1280 × 720) 60 Hz: 30 fps (2688 × 1520, 1920 × 1080, 1280 × 720)	50 Hz: 25 fps (3840 × 2160, 3200 × 1800, 2688 × 1520, 1920 × 1080, 1280 × 720) 60 Hz: 24 fps (3840 × 2160), 30 fps (3200 × 1800, 2688 × 1520, 1920 × 1080, 1280 × 720)
Streams	3	3	3	3
Protection Level	IP67	IP67	IP67	IP67
Angle Adjustment	Pan: 0° to 360°, tilt: 0° to 75°, rotate: 0° to 360°	Pan: 0° to 360°, tilt: 0° to 75°, rotate: 0° to 360°	Pan: 0° to 360°, tilt: 0° to 90°, rotate: 0° to 360°	Pan: 0° to 360°, tilt: 0° to 90°, rotate: 0° to 360°
Operating Temperature	-30 °C to 60 °C (-22 °F to 140 °F)	-30 °C to 60 °C (-22 °F to 140 °F)	-30 °C to 60 °C (-22 °F to 140 °F)	-30 °C to 60 °C (-22 °F to 140 °F)
Humidity	95% or less (non-condensing)	95% or less (non-condensing)	95% or less (non-condensing)	95% or less (non-condensing)
Local Storage	512 GB	512 GB	512 GB	512 GB
Indoor/Outdoor	Outdoor	Outdoor	Outdoor	Outdoor
Audio I/O	-U: Built-in microphone	-U: Built-in microphone	-U: Built-in microphone	-U: Built-in microphone
Alarm I/O	-	-	-	-
Power	12 VDC ± 25%, PoE (802.3af, class 3)	12 VDC ± 25%, PoE (802.3af, class 3)	12 VDC ± 25%, PoE (802.3af, class 3)	12 VDC ± 25%, PoE (802.3af, class 3)







Model	DS-2CD2026G2-I(U)	DS-2CD2026G2-IU/SL	DS-2CD2046G2-I(U)	DS-2CD2046G2-IU/SL	DS-2CD2066G2-I(U)
Image	 AcuSense Powered by DarkFighter	 AcuSense Powered by DarkFighter	 AcuSense Powered by DarkFighter	 AcuSense Powered by DarkFighter	 AcuSense Powered by DarkFighter
Image Sensor	1/2.8" Progressive Scan CMOS	1/2.8" Progressive Scan CMOS	1/3" Progressive Scan CMOS	1/3" Progressive Scan CMOS	1/2.4" Progressive Scan CMOS
Resolution	1920 × 1080	1920 × 1080	2688 × 1520	2688 × 1520	3200 × 1800
Video Compression	H.265/H.265+/H.264+/H.264 / MJPEG	H.265/H.265+/H.264+/H.264 / MJPEG	H.265/H.265+/H.264+/H.264 / MJPEG	H.265/H.265+/H.264+/H.264 / MJPEG	H.265/H.265+/H.264+/H.264 / MJPEG
Min. Illumination	0.002 Lux @ (F1.4, AGC ON)	0.002 Lux @ (F1.4, AGC ON)	0.003 Lux @ (F1.4, AGC ON)	0.003 Lux @ (F1.4, AGC ON)	0.003 Lux @ (F1.6, AGC ON)
WDR	120dB	120dB	120dB	120dB	120dB
Lens	2.8mm, 4 mm, 6 mm	2.8mm, 4 mm, 6 mm	2.8mm, 4 mm, 6 mm	2.8mm, 4 mm, 6 mm	2.8mm, 4 mm, 6 mm
FOV	2.8 mm, horizontal FOV 107°, vertical FOV 57°, diagonal FOV 129° 4 mm, horizontal FOV 86°, vertical FOV 47°, diagonal FOV 102° 6 mm, horizontal FOV 55°, vertical FOV 29°, diagonal FOV 65°	2.8 mm, horizontal FOV: 107°, vertical FOV: 57°, diagonal FOV: 129° 4 mm, horizontal FOV: 86°, vertical FOV: 47°, diagonal FOV: 102° 6 mm, horizontal FOV: 55°, vertical FOV: 29°, diagonal FOV: 65°	2.8 mm, horizontal FOV 103°, vertical FOV 55°, diagonal FOV 123° 4 mm, horizontal FOV 83°, vertical FOV 45°, diagonal FOV 98° 6 mm, horizontal FOV 53°, vertical FOV 28°, diagonal FOV 62°	2.8 mm, horizontal FOV 103°, vertical FOV 55°, diagonal FOV 123° 4 mm, horizontal FOV 83°, vertical FOV 45°, diagonal FOV 98° 6 mm, horizontal FOV 53°, vertical FOV 28°, diagonal FOV 62°	2.8 mm, horizontal FOV 105.1°, vertical FOV 53.4°, diagonal FOV 128.6° 4 mm, horizontal FOV 83.9°, vertical FOV 44.5°, diagonal FOV 100.8° 6 mm, horizontal FOV 47.5°, vertical FOV 26°, diagonal FOV 54.5°
Max. IR Range	40 m	40 m	40 m	40 m	40 m
VCA	Line crossing detection, intrusion detection, region entrance detection, region exiting detection	Line crossing detection, intrusion detection, region entrance detection, region exiting detection	Line crossing detection, intrusion detection, region entrance detection, region exiting detection	Line crossing detection, intrusion detection, region entrance detection, region exiting detection	Line crossing detection, intrusion detection, region entrance detection, region exiting detection
Frame Rate	50Hz: 25fps (1920 × 1080, 1280 × 720) 60Hz: 30fps (1920 × 1080, 1280 × 720)	50Hz: 25fps (1920 × 1080, 1280 × 720) 60Hz: 30fps (1920 × 1080, 1280 × 720)	50Hz: 25fps (2688 × 1520, 1920 × 1080, 1280 × 720) 60Hz: 30fps (2688 × 1520, 1920 × 1080, 1280 × 720)	50Hz: 25fps (2688 × 1520, 1920 × 1080, 1280 × 720) 60Hz: 30fps (2688 × 1520, 1920 × 1080, 1280 × 720)	50 Hz: 25 fps (3200 × 1800, 2688 × 1520, 1920 × 1080, 1280 × 720) 60 Hz: 30 fps (3200 × 1800, 2688 × 1520, 1920 × 1080, 1280 × 720)
Streams	3	3	3	3	3
Protection Level	IP67	IP67	IP67	IP67	IP67
Angle Adjustment	Pan: 0° to 360°, tilt: 0° to 90°, rotate: 0° to 360°	Pan: 0° to 360°, tilt: 0° to 90°, rotate: 0° to 360°	Pan: 0° to 360°, tilt: 0° to 90°, rotate: 0° to 360°	Pan: 0° to 360°, tilt: 0° to 90°, rotate: 0° to 360°	Pan: 0° to 360°, tilt: 0° to 90°, rotate: 0° to 360°
Operating Temperature	-30 °C to +60 °C [-22 °F to +140 °F]	-30 °C to +60 °C [-22 °F to +140 °F]	-30 °C to +60 °C [-22 °F to +140 °F]	-30 °C to +60 °C [-22 °F to +140 °F]	-30 °C to +60 °C [-22 °F to +140 °F]
Humidity	95% or less (non-condensing)	95% or less (non-condensing)	95% or less (non-condensing)	95% or less (non-condensing)	95% or less (non-condensing)
Local Storage	256 GB	256 GB	256 GB	256 GB	256 GB
Indoor/Outdoor	Outdoor	Outdoor	Outdoor	Outdoor	Outdoor
Audio I/O	Built-in microphone(-IU)	1 built-in microphone 1 built-in speaker	Built-in microphone(-IU)	1 built-in microphone 1 built-in speaker	Built-in microphone(-IU)
Alarm I/O	-	-	-	-	-
Power	12 VDC ± 25%, PoE (802.3af, class 3)	12 VDC ± 25%, PoE (802.3af, class 3)	12 VDC ± 25%, PoE (802.3af, class 3)	12 VDC ± 25%, PoE (802.3af, class 3)	12 VDC ± 25%, PoE (802.3af, class 3)







Model	DS-2CD2066G2-IU/SL	DS-2CD2086G2-I(U)	DS-2CD2086G2-IU/SL	DS-2CD2126G2-I(SU)	DS-2CD2146G2-I(SU)	DS-2CD2166G2-I(SU)	
Image	 AcuSense Powered by DarkFighter	 HOT AcuSense Powered by DarkFighter	 AcuSense Powered by DarkFighter	 AcuSense Powered by DarkFighter	 HOT AcuSense Powered by DarkFighter	 HOT AcuSense Powered by DarkFighter	
Image Sensor	1/2.4" Progressive Scan CMOS	1/1.8" Progressive Scan CMOS	1/1.8" Progressive Scan CMOS	1/2.8" Progressive Scan CMOS	1/3" Progressive Scan CMOS	1/2.4" Progressive Scan CMOS	
Resolution	3200 × 1800	3840 × 2160	3840 × 2160	1920 × 1080	2688 × 1520	3200 × 1800	
Video Compression	H.265/H.265+/H.264+/H.264 / MJPEG	H.265/H.265+/H.264+/H.264 / MJPEG	H.265/H.265+/H.264+/H.264 / MJPEG	H.265/H.265+/H.264+/H.264 / MJPEG	H.265/H.265+/H.264+/H.264 / MJPEG	H.265/H.265+/H.264+/H.264 / MJPEG	
Min. Illumination	0.003 Lux @ (F1.6, AGC ON)	0.003 Lux @ (F1.6, AGC ON)	0.003 Lux @ (F1.6, AGC ON)	0.002 Lux @ (F1.4, AGC ON)	0.003 Lux @ (F1.4, AGC ON)	0.003 Lux @ (F1.6, AGC ON)	
WDR	120dB	120dB	120dB	120dB	120dB	120dB	
Lens	2.8mm, 4 mm, 6 mm	2.8mm, 4 mm, 6 mm	2.8mm, 4 mm, 6 mm	2.8mm, 4 mm	2.8mm, 4 mm	2.8mm, 4 mm	
FOV	2.8 mm, horizontal FOV 105.1°, vertical FOV 53.4°, diagonal FOV 128.6° 4 mm, horizontal FOV 83.9°, vertical FOV 44.5°, diagonal FOV 100.8° 6 mm, horizontal FOV 47.5°, vertical FOV 26°, diagonal FOV 54.5°	2.8 mm, horizontal FOV 111°, vertical FOV 59°, diagonal FOV 131° 4 mm, horizontal FOV 87°, vertical FOV 47°, diagonal FOV 102° 6 mm, horizontal FOV 51°, vertical FOV 28°, diagonal FOV 60°	2.8 mm, horizontal FOV 111°, vertical FOV 59°, diagonal FOV 131° 4 mm, horizontal FOV 87°, vertical FOV 47°, diagonal FOV 102° 6 mm, horizontal FOV 51°, vertical FOV 28°, diagonal FOV 60°	2.8 mm, horizontal FOV 107°, vertical FOV 57°, diagonal FOV 129° 4 mm, horizontal FOV 86°, vertical FOV 47°, diagonal FOV 102°	2.8 mm, horizontal FOV 103°, vertical FOV 55°, diagonal FOV 123° 4 mm, horizontal FOV 83°, vertical FOV 45°, diagonal FOV 98°	2.8 mm, horizontal FOV 105.1°, vertical FOV 53.4°, diagonal FOV 128.6° 4 mm, horizontal FOV 83.9°, vertical FOV 44.5°, diagonal FOV 100.8°	2.8 mm, horizontal FOV 105.1°, vertical FOV 53.4°, diagonal FOV 128.6° 4 mm, horizontal FOV 83.9°, vertical FOV 44.5°, diagonal FOV 100.8°
Max. IR Range	40 m	40 m	40 m	30 m	30 m	30 m	
VCA	Line crossing detection, intrusion detection, region entrance detection, region exiting detection	Line crossing detection, intrusion detection, region entrance detection, region exiting detection	Line crossing detection, intrusion detection, region entrance detection, region exiting detection	Line crossing detection, intrusion detection, region entrance detection, region exiting detection	Line crossing detection, intrusion detection, region entrance detection, region exiting detection	Line crossing detection, intrusion detection, region entrance detection, region exiting detection	
Frame Rate	50 Hz: 25 fps (3200 × 1800, 2688 × 1520, 1920 × 1080, 1280 × 720) 60 Hz: 30 fps (3200 × 1800, 2688 × 1520, 1920 × 1080, 1280 × 720)	50Hz: 25fps (3840 × 2160, 3200 × 1800, 2688 × 1520, 1920 × 1080, 1280 × 720) 60Hz: 24fps (3840 × 2160) 30fps (3200 × 1800, 2688 × 1520, 1920 × 1080, 1280 × 720)	50Hz: 25fps (3840 × 2160, 3200 × 1800, 2688 × 1520, 1920 × 1080, 1280 × 720) 60Hz: 24fps (3840 × 2160) 30fps (3200 × 1800, 2688 × 1520, 1920 × 1080, 1280 × 720)	50Hz: 25fps (1920 × 1080, 1280 × 720) 60Hz: 30fps (1920 × 1080, 1280 × 720)	50Hz: 25fps (2688 × 1520, 1920 × 1080, 1280 × 720) 60Hz: 30fps (2688 × 1520, 1920 × 1080, 1280 × 720)	50 Hz: 25 fps (3200 × 1800, 2688 × 1520, 1920 × 1080, 1280 × 720) 60 Hz: 30 fps (3200 × 1800, 2688 × 1520, 1920 × 1080, 1280 × 720)	50 Hz: 25 fps (3200 × 1800, 2688 × 1520, 1920 × 1080, 1280 × 720) 60 Hz: 30 fps (3200 × 1800, 2688 × 1520, 1920 × 1080, 1280 × 720)
Streams	3	3	3	3	3	3	
Protection Level	IP67	IP67	IP67	IP67, IK10	IP67, IK10	IP67, IK10	
Angle Adjustment	Pan: 0° to 360°, tilt: 0° to 90°, rotate: 0° to 360°	Pan: 0° to 360°, tilt: 0° to 90°, rotate: 0° to 360°	Pan: 0° to 360°, tilt: 0° to 90°, rotate: 0° to 360°	Pan: 0° to 355°, tilt: 0° to 75°, rotate: 0° to 355°	Pan: 0° to 355°, tilt: 0° to 75°, rotate: 0° to 355°	Pan: 0° to 355°, tilt: 0° to 75°, rotate: 0° to 355°	
Operating Temperature	-30 °C to +60 °C [-22 °F to +140 °F]	-30 °C to +60 °C [-22 °F to +140 °F]	-30 °C to +60 °C [-22 °F to +140 °F]	-30 °C to +60 °C [-22 °F to +140 °F]	-30 °C to +60 °C [-22 °F to +140 °F]	-30 °C to +60 °C [-22 °F to +140 °F]	
Humidity	95% or less (non-condensing)	95% or less (non-condensing)	95% or less (non-condensing)	95% or less (non-condensing)	95% or less (non-condensing)	95% or less (non-condensing)	
Local Storage	256 GB	256 GB	256 GB	256 GB	256 GB	256 GB	
Indoor/Outdoor	Outdoor	Outdoor	Outdoor	Outdoor	Outdoor	Outdoor	
Audio I/O	1 built-in microphone 1 built-in speaker	Built-in microphone(-IU)	1 built-in microphone 1 built-in speaker	1 In, 1 Out(-ISU) Built-in microphone(-ISU)	1 In, 1 Out(-ISU) Built-in microphone(-ISU)	1 In, 1 Out(-ISU) Built-in microphone(-ISU)	
Alarm I/O	-	-	-	1 In, 1 Out (-ISU)	1 In, 1 Out (-ISU)	1 In, 1 Out (-ISU)	
Power	12 VDC ± 25%, PoE (802.3af, class 3)	12 VDC ± 25%, PoE (802.3af, class 3)	12 VDC ± 25%, PoE (802.3af, class 3)	12 VDC ± 25%, PoE (802.3af, class 3)	12 VDC ± 25%, PoE (802.3af, class 3)	12 VDC ± 25%, PoE (802.3af, class 3)	





Model	DS-2CD2186G2-I(SU)	DS-2CD2326G2-I(U)	DS-2CD2326G2-ISU/SL	DS-2CD2346G2-I(U)	DS-2CD2346G2-ISU/SL	DS-2CD2346G2P-ISU/SL
Image	 AcuSense Powered by DarkFighter +	 AcuSense Powered by DarkFighter +	 AcuSense Powered by DarkFighter +	 AcuSense Powered by DarkFighter +	 AcuSense Powered by DarkFighter +	 AcuSense Powered by DarkFighter +
Image Sensor	1/1.8" Progressive Scan CMOS	1/2.8" Progressive Scan CMOS	1/2.8" Progressive Scan CMOS	1/3" Progressive Scan CMOS	1/3" Progressive Scan CMOS	2 x 1/2.5" Progressive Scan CMOS
Resolution	3840 × 2160	1920 × 1080	1920 × 1080	2688 × 1520	2688 × 1520	3040 × 1368
Video Compression	H.265/H.265+/H.264+/H.264 / MJPEG	H.265/H.265+/H.264+/H.264 / MJPEG	H.265/H.265+/H.264+/H.264 / MJPEG	H.265/H.265+/H.264+/H.264 / MJPEG	H.265/H.265+/H.264+/H.264 / MJPEG	H.265/H.265+/H.264+/H.264 / MJPEG
Min. Illumination	0.003 Lux @ (F1.6, AGC ON)	0.002 Lux @ (F1.4, AGC ON)	0.002 Lux @ (F1.4, AGC ON)	0.003 Lux @ (F1.4, AGC ON)	0.003 Lux @ (F1.4, AGC ON)	0.003 Lux @ (F1.6, AGC ON),
WDR	120dB	120dB	120dB	120dB	120dB	120dB
Lens	2.8mm, 4 mm	2.8mm, 4 mm	2.8mm, 4 mm	2.8mm, 4 mm	2.8mm, 4 mm	Fixed focal lens, Dual lens: 2.8 mm
FOV	2.8 mm, horizontal FOV 111°, vertical FOV 59°, diagonal FOV 131° 4 mm, horizontal FOV 87°, vertical FOV 47°, diagonal FOV 102°	2.8 mm, horizontal FOV 107°, vertical FOV 57°, diagonal FOV 129° 4 mm, horizontal FOV 86°, vertical FOV 47°, diagonal FOV 102°	2.8 mm, horizontal FOV 107°, vertical FOV 57°, diagonal FOV 129° 4 mm, horizontal FOV 86°, vertical FOV 47°, diagonal FOV 102°	2.8 mm, horizontal FOV 103°, vertical FOV 55°, diagonal FOV 123° 4 mm, horizontal FOV 83°, vertical FOV 45°, diagonal FOV 98°	2.8 mm, horizontal FOV 103°, vertical FOV 55°, diagonal FOV 123° 4 mm, horizontal FOV 83°, vertical FOV 45°, diagonal FOV 98°	Horizontal FOV: 180° Vertical FOV: 84°
Max. IR Range	30 m	30 m	30 m	30 m	30 m	30m
VCA	Line crossing detection, intrusion detection, region entrance detection, region exiting detection	Line crossing detection, intrusion detection, region entrance detection, region exiting detection	Line crossing detection, intrusion detection, region entrance detection, region exiting detection	Line crossing detection, intrusion detection, region entrance detection, region exiting detection	Line crossing detection, intrusion detection, region entrance detection, region exiting detection	Line crossing detection, intrusion detection, region entrance detection, region exiting detection
Frame Rate	50Hz: 25fps (3840 × 2160, 3200 × 1800, 2688 × 1520, 1920 × 1080, 1280 × 720) 60Hz: 24fps (3840 × 2160) 30fps (3200 × 1800, 2688 × 1520, 1920 × 1080, 1280 × 720)	50Hz: 25fps (1920 × 1080, 1280 × 720) 60Hz: 30fps (1920 × 1080, 1280 × 720)	50Hz: 25fps (1920 × 1080, 1280 × 720) 60Hz: 30fps (1920 × 1080, 1280 × 720)	50Hz: 25fps (2688 × 1520, 1920 × 1080, 1280 × 720) 60Hz: 30fps (2688 × 1520, 1920 × 1080, 1280 × 720)	50Hz: 25fps (2688 × 1520, 1920 × 1080, 1280 × 720) 60Hz: 30fps (2688 × 1520, 1920 × 1080, 1280 × 720)	50Hz: 25fps (3040 × 1368) 60Hz: 24fps (3040 × 1368)
Streams	3	3	3	3	3	2
Protection Level	IP67, IK10	IP67	IP67	IP67	IP67	IP67
Angle Adjustment	Pan: 0° to 355°, tilt: 0° to 75°, rotate: 0° to 355°	Pan: 0° to 360°, tilt: 0° to 75°, rotate: 0° to 360°	Pan: 0° to 360°, tilt: 0° to 75°, rotate: 0° to 360°	Pan: 0° to 360°, tilt: 0° to 75°, rotate: 0° to 360°	Pan: 0° to 360°, tilt: 0° to 75°, rotate: 0° to 360°	Pan: -30° to 30°, tilt: -75° to 75°
Operating Temperature	-30 °C to +60 °C [-22 °F to +140 °F]	-30 °C to +60 °C [-22 °F to +140 °F]	-30 °C to +60 °C [-22 °F to +140 °F]	-30 °C to +60 °C [-22 °F to +140 °F]	-30 °C to +60 °C [-22 °F to +140 °F]	-30 °C to +60 °C [-22 °F to +140 °F]
Humidity	95% or less (non-condensing)	95% or less (non-condensing)	95% or less (non-condensing)	95% or less (non-condensing)	95% or less (non-condensing)	95% or less (non-condensing)
Local Storage	256 GB	256 GB	256 GB	256 GB	256 GB	256 GB
Indoor/Outdoor	Outdoor	Outdoor	Outdoor	Outdoor	Outdoor	Outdoor
Audio I/O	1 In, 1 Out(-ISU) Built-in microphone(-ISU)	Built-in microphone(-IU)	1 In, 1 Out Built-in microphone Built-in speaker	Built-in microphone(-IU)	1 In, 1 Out Built-in microphone Built-in speaker	1 In, 1 Out Built-in microphone Built-in speaker
Alarm I/O	1 In, 1 Out (-ISU)	-	1 In, 1 Out	-	1 In, 1 Out	1 In, 1 Out
Power	12 VDC ± 25%, PoE (802.3af, class 3)	12 VDC ± 25%, PoE (802.3af, class 3)	12 VDC ± 25%, PoE (802.3af, class 3)	12 VDC ± 25%, PoE (802.3af, class 3)	12 VDC ± 25%, PoE (802.3af, class 3)	12 VDC ± 25%, PoE (802.3af, class 3)







Model	DS-2CD2366G2-I(U)	DS-2CD2366G2-ISU/SL	DS-2CD2366G2P-ISU/SL	DS-2CD2366G2-I(U)	DS-2CD2366G2-ISU/SL	DS-2CD2426G2-I
Image	 AcuSense Powered by DarkFighter	 AcuSense Powered by DarkFighter	 AcuSense Powered by DarkFighter	 AcuSense Powered by DarkFighter	 AcuSense Powered by DarkFighter	 AcuSense Powered by DarkFighter
Image Sensor	1/2.4" Progressive Scan CMOS	1/2.4" Progressive Scan CMOS	2 × 1/2.5" Progressive Scan CMOS	1/1.8" Progressive Scan CMOS	1/1.8" Progressive Scan CMOS	1/2.8" Progressive Scan CMOS
Resolution	3200 × 1800	3200 × 1800	3632 × 1632	3840 × 2160	3840 × 2160	1920 × 1080
Video Compression	H.265/H.265+/H.264+/H.264 / MJPEG	H.265/H.265+/H.264+/H.264 / MJPEG	H.265/H.265+/H.264+/H.264 / MJPEG	H.265/H.265+/H.264+/H.264 / MJPEG	H.265/H.265+/H.264+/H.264 / MJPEG	H.265/H.265+/H.264+/H.264 / MJPEG
Min. Illumination	0.003 Lux @ (F1.6, AGC ON)	0.003 Lux @ (F1.6, AGC ON)	0.003 Lux @ (F1.6, AGC ON)	0.003 Lux @ (F1.6, AGC ON)	0.003 Lux @ (F1.6, AGC ON)	0.002 Lux @ (F1.4, AGC ON)
WDR	120dB	120dB	120dB	120dB	120dB	120dB
Lens	2.8mm, 4 mm	2.8mm, 4 mm	Fixed focal lens, Dual lens: 2.8 mm	2.8mm, 4 mm	2.8mm, 4 mm	2.8mm, 4 mm
FOV	2.8 mm, horizontal FOV 105.1°, vertical FOV 53.4°, diagonal FOV 128.6° 4 mm, horizontal FOV 83.9°, vertical FOV 44.5°, diagonal FOV 100.8°	2.8 mm, horizontal FOV 105.1°, vertical FOV 53.4°, diagonal FOV 128.6° 4 mm, horizontal FOV 83.9°, vertical FOV 44.5°, diagonal FOV 100.8°	Horizontal FOV: 180° Vertical FOV: 84°	2.8 mm, horizontal FOV 111°, vertical FOV 59°, diagonal FOV 131° 4 mm, horizontal FOV 87°, vertical FOV 47°, diagonal FOV 102°	2.8 mm, horizontal FOV 111°, vertical FOV 59°, diagonal FOV 131° 4 mm, horizontal FOV 87°, vertical FOV 47°, diagonal FOV 102°	2.8 mm, horizontal FOV 107°, vertical FOV 57°, diagonal FOV 129° 4 mm, horizontal FOV 86°, vertical FOV 47°, diagonal FOV 102°
Max. IR Range	30 m	30 m	30m	30 m	30 m	10 m
VCA	Line crossing detection, intrusion detection, region entrance detection, region exiting detection	Line crossing detection, intrusion detection, region entrance detection, region exiting detection	Line crossing detection, intrusion detection, region entrance detection, region exiting detection	Line crossing detection, intrusion detection, region entrance detection, region exiting detection	Line crossing detection, intrusion detection, region entrance detection, region exiting detection	Line crossing detection, intrusion detection, region entrance detection, region exiting detection
Frame Rate	50 Hz: 25 fps (3200 × 1800, 2688 × 1520, 1920 × 1080, 1280 × 720) 60 Hz: 30 fps (3200 × 1800, 2688 × 1520, 1920 × 1080, 1280 × 720)	50 Hz: 25 fps (3200 × 1800, 2688 × 1520, 1920 × 1080, 1280 × 720) 60 Hz: 30 fps (3200 × 1800, 2688 × 1520, 1920 × 1080, 1280 × 720)	50Hz: 20fps (3632 x 1632) 60Hz: 20fps (3632 x 1632)	50Hz: 25fps (3840 × 2160, 3200 × 1800, 2688 × 1520, 1920 × 1080, 1280 × 720) 60Hz: 24fps (3840 × 2160) 30fps (3200 × 1800, 2688 × 1520, 1920 × 1080, 1280 × 720)	50Hz: 25fps (3840 × 2160, 3200 × 1800, 2688 × 1520, 1920 × 1080, 1280 × 720) 60Hz: 24fps (3840 × 2160) 30fps (3200 × 1800, 2688 × 1520, 1920 × 1080, 1280 × 720)	50Hz: 25fps (1920 × 1080, 1280 × 720) 60Hz: 30fps (1920 × 1080, 1280 × 720)
Streams	3	3	2	3	3	3
Protection Level	IP67	IP67	IP67	IP67	IP67	-
Angle Adjustment	Pan: 0° to 360°, tilt: 0° to 75°, rotate: 0° to 360°	Pan: 0° to 360°, tilt: 0° to 75°, rotate: 0° to 360°	Pan: -30° to 30°, tilt: -75° to 75°	Pan: 0° to 360°, tilt: 0° to 75°, rotate: 0° to 360°	Pan: 0° to 360°, tilt: 0° to 75°, rotate: 0° to 360°	Pan: 0° to 360°, tilt: 0° to 90°, rotate: 0° to 360°
Operating Temperature	-30 °C to +60 °C (-22 °F to +140 °F)	-30 °C to +60 °C (-22 °F to +140 °F)	-30 °C to +60 °C (-22 °F to +140 °F)	-30 °C to +60 °C (-22 °F to +140 °F)	-30 °C to +60 °C (-22 °F to +140 °F)	-10 °C to +40 °C (14 °F to +104 °F)
Humidity	95% or less (non-condensing)	95% or less (non-condensing)	95% or less (non-condensing)	95% or less (non-condensing)	95% or less (non-condensing)	95% or less (non-condensing)
Local Storage	256 GB	256 GB	256 GB	256 GB	256 GB	256 GB
Indoor/Outdoor	Outdoor	Outdoor	Outdoor	Outdoor	Outdoor	Indoor
Audio I/O	Built-in microphone(-IU)	1 In, 1 Out Built-in microphone Built-in speaker	1 In, 1 Out Built-in microphone Built-in speaker	Built-in microphone(-IU)	1 In, 1 Out Built-in microphone Built-in speaker	1 built-in mic, 1 built-in speaker
Alarm I/O	-	1 In, 1 Out	1 In, 1 Out	-	1 In, 1 Out	-
Power	12 VDC ± 25%, PoE (802.3af, class 3)	12 VDC ± 25%, PoE (802.3af, class 3)	12 VDC ± 25%, PoE (802.3af, class 3)	12 VDC ± 25%, PoE (802.3af, class 3)	12 VDC ± 25%, PoE (802.3af, class 3)	12 VDC ± 25%, PoE (802.3af, class 3)







Model	DS-2CD244662-I	DS-2CD246662-I	DS-2CD252662-I(S)	DS-2CD254662-I(W)(S)	DS-2CD256662-I(S)	DS-2CD258662-I(S)
Image						
Image Sensor	1/3" Progressive Scan CMOS	1/2.4" Progressive Scan CMOS	1/2.8" Progressive Scan CMOS	1/3" Progressive Scan CMOS	1/2.4" Progressive Scan CMOS	1/1.8" Progressive Scan CMOS
Resolution	2688 × 1520	3200 × 1800	1920 × 1080	2688 × 1520	3200 × 1800	3840 × 2160
Video Compression	H.265/H.265+/H.264+/H.264 / MJPEG	H.265/H.265+ / MJPEG	H.265/H.265+/H.264+/H.264 / MJPEG	H.265/H.265+/H.264+/H.264 / MJPEG	H.265/H.265+/H.264+/H.264 / MJPEG	H.265/H.265+/H.264+/H.264 / MJPEG
Min. Illumination	2 mm: 0.008 Lux @ (F2.25, AGC ON) 2.8 mm and 4 mm: 0.003 Lux @ (F1.4, AGC ON)	0.003 Lux @ (F1.6, AGC ON)	0.002 Lux @ (F1.4, AGC ON)	0.003 Lux @ (F1.4, AGC ON)	0.003 Lux @ (F1.6, AGC ON)	0.003 Lux @ (F1.6, AGC ON)
WDR	120dB	120dB	120dB	120dB	120dB	120dB
Lens	2.0mm, 2.8mm, 4 mm	2.8mm, 4 mm	2.8mm, 4 mm	2.8mm, 4 mm	2.8mm, 4 mm	2.8mm, 4 mm
FOV	2 mm, horizontal FOV 128.4°, vertical FOV 75.4°, diagonal FOV 147.1° 2.8 mm, horizontal FOV 102.7°, vertical FOV 55.2°, diagonal FOV 122.5° 4 mm, horizontal FOV 82.8°, vertical FOV 45.3°, diagonal FOV 97.7°	2.8 mm, horizontal FOV 105.1°, vertical FOV 53.4°, diagonal FOV 128.6° 4 mm, horizontal FOV 83.9°, vertical FOV 44.5°, diagonal FOV 100.8°	2.8 mm, horizontal FOV 107°, vertical FOV 57°, diagonal FOV 129° 4 mm, horizontal FOV 86°, vertical FOV 47°, diagonal FOV 102°	2.8 mm, horizontal FOV 103°, vertical FOV 55°, diagonal FOV 123° 4 mm, horizontal FOV 83°, vertical FOV 45°, diagonal FOV 98°	2.8 mm, horizontal FOV 105.1°, vertical FOV 53.4°, diagonal FOV 128.6° 4 mm, horizontal FOV 83.9°, vertical FOV 44.5°, diagonal FOV 100.8°	2.8 mm, horizontal FOV 111°, vertical FOV 59°, diagonal FOV 131° 4 mm, horizontal FOV 87°, vertical FOV 47°, diagonal FOV 102°
Max. IR Range	10 m	10 m	30 m	30 m	30 m	30 m
VCA	Line crossing detection, intrusion detection, region entrance detection, region exiting detection	Line crossing detection, intrusion detection, region entrance detection, region exiting detection	Line crossing detection, intrusion detection, region entrance detection, region exiting detection	Line crossing detection, intrusion detection, region entrance detection, region exiting detection	Line crossing detection, intrusion detection, region entrance detection, region exiting detection	Line crossing detection, intrusion detection, region entrance detection, region exiting detection
Frame Rate	50Hz: 25fps (2688 × 1520, 1920 × 1080, 1280 × 720) 60Hz: 30fps (2688 × 1520, 1920 × 1080, 1280 × 720)	50 Hz: 12.5 fps (3200 × 1800) 25 fps (2688 × 1520, 1920 × 1080, 1280 × 720) 60 Hz: 15 fps (3200 × 1800) 30 fps (2688 × 1520, 1920 × 1080, 1280 × 720)	50Hz: 25 fps (1920 × 1080, 1280 × 720) 60Hz: 30 fps (1920 × 1080, 1280 × 720)	50Hz: 25fps (2688 × 1520, 1920 × 1080, 1280 × 720) 60Hz: 30fps (2688 × 1520, 1920 × 1080, 1280 × 720)	50 Hz: 25 fps (3200 × 1800, 2688 × 1520, 1920 × 1080, 1280 × 720) 60 Hz: 30 fps (3200 × 1800, 2688 × 1520, 1920 × 1080, 1280 × 720)	50Hz: 25fps (3840 × 2160, 3200 × 1800, 2688 × 1520, 1920 × 1080, 1280 × 720) 60Hz: 24fps (3840 × 2160) 30fps (3200 × 1800, 2688 × 1520, 1920 × 1080, 1280 × 720)
Streams	3	3	3	3	3	3
Protection Level	-	-	IP67, IK08	IP67, IK08	IP67, IK08	IP67, IK08
Angle Adjustment	Pan: 0° to 360°, tilt: 0° to 90°, rotate: 0° to 360°	Pan: 0° to 360°, tilt: 0° to 90°, rotate: 0° to 360°	Pan: -30° to 30°, tilt: 0° to 75°, rotate: 0° to 360°	Pan: -30° to 30°, tilt: 0° to 75°, rotate: 0° to 360°	Pan: -30° to 30°, tilt: 0° to 75°, rotate: 0° to 360°	Pan: -30° to 30°, tilt: 0° to 75°, rotate: 0° to 360°
Operating Temperature	-10 °C to +40 °C (14 °F to +104 °F)	-10 °C to +40 °C (14 °F to +104 °F)	-30 °C to +60 °C (-22 °F to +140 °F)	-30 °C to +60 °C (-22 °F to +140 °F)	-30 °C to +60 °C (-22 °F to +140 °F)	-30 °C to +60 °C (-22 °F to +140 °F)
Humidity	95% or less (non-condensing)	95% or less (non-condensing)	95% or less (non-condensing)	95% or less (non-condensing)	95% or less (non-condensing)	95% or less (non-condensing)
Local Storage	256 GB	256 GB	256 GB	256 GB	256 GB	256 GB
Indoor/Outdoor	Indoor	Indoor	Outdoor	Outdoor	Outdoor	Outdoor
Audio I/O	1 built-in mic, 1 built-in speaker	1 built-in mic, 1 built-in speaker	1 In, 1 Out (-IS) Built-in microphone	1 In, 1 Out (-IS) Built-in microphone	1 In, 1 Out (-IS) Built-in microphone	1 In, 1 Out (-IS) Built-in microphone
Alarm I/O	-	-	1 In, 1 Out (-IS)	1 In, 1 Out (-IS)	1 In, 1 Out (-IS)	1 In, 1 Out (-IS)
Power	12 VDC ± 25%, PoE (802.3af, class 3)	12 VDC ± 25%, PoE (802.3af, class 3)	12 VDC ± 25%, PoE (802.3af, class 3)	12 VDC ± 25%, PoE (802.3af, class 3)	12 VDC ± 25%, PoE (802.3af, class 3)	12 VDC ± 25%, PoE (802.3af, class 3)



Model	DS-2CD2626G2-IZS	DS-2CD2626G2-IZSU/SL	DS-2CD2646G2-IZS	DS-2CD2646G2-IZSU/SL	DS-2CD2646G2-IZSY	DS-2CD2666G2-IZS
Image	 AcuSense Powered by DarkFighter	 AcuSense Powered by DarkFighter	 AcuSense Powered by DarkFighter	 AcuSense Powered by DarkFighter	 AcuSense Powered by DarkFighter	 AcuSense Powered by DarkFighter
Image Sensor	1/2.8" Progressive Scan CMOS	1/2.8" Progressive Scan CMOS	1/3" Progressive Scan CMOS	1/3" Progressive Scan CMOS	1/3" Progressive Scan CMOS	1/2.4" Progressive Scan CMOS
Resolution	1920 × 1080	1920 × 1080	2688 × 1520	2688 × 1520	2688 × 1520	3200 × 1800
Video Compression	H.265/H.265+/H.264+/H.264 / MJPEG	H.265/H.265+/H.264+/H.264 / MJPEG	H.265/H.265+/H.264+/H.264 / MJPEG	H.265/H.265+/H.264+/H.264 / MJPEG	H.265/H.265+/H.264+/H.264 / MJPEG	H.265/H.265+/H.264+/H.264 / MJPEG
Min. Illumination	0.002 Lux @ (F1.4, AGC ON)	0.002 Lux @ (F1.4, AGC ON)	0.003 Lux @ (F1.4, AGC ON)	0.003 Lux @ (F1.4, AGC ON)	0.003 Lux @ (F1.4, AGC ON)	0.003 Lux @ (F1.4, AGC ON)
WDR	120dB	120dB	120dB	120dB	120dB	120dB
Lens	2.8 to 12 mm	2.8 to 12 mm	2.8 to 12 mm	2.8 to 12 mm	2.8 to 12 mm	2.8 to 12 mm
FOV	2.8 to 12 mm, horizontal FOV 113° to 31°, vertical FOV 58° to 18°, diagonal FOV 138° to 36°	2.8 to 12 mm, horizontal FOV 113° to 31°, vertical FOV 58° to 18°, diagonal FOV 138° to 36°	2.8 to 12 mm, horizontal FOV 108° to 30°, vertical FOV 56° to 17°, diagonal FOV 131° to 35°	2.8 to 12 mm, horizontal FOV 108° to 30°, vertical FOV 56° to 17°, diagonal FOV 131° to 35°	2.8 to 12 mm, horizontal FOV 108° to 30°, vertical FOV 56° to 17°, diagonal FOV 131° to 35°	2.8 to 12 mm, horizontal FOV 116.5° to 34.9°, vertical FOV 60° to 19.6°, diagonal FOV 141.9° to 41°
Max. IR Range	60 m	60 m	60 m	60 m	60 m	60 m
VCA	Line crossing detection, intrusion detection, region entrance detection, region exiting detection	Line crossing detection, intrusion detection, region entrance detection, region exiting detection	Line crossing detection, intrusion detection, region entrance detection, region exiting detection	Line crossing detection, intrusion detection, region entrance detection, region exiting detection	Line crossing detection, intrusion detection, region entrance detection, region exiting detection	Line crossing detection, intrusion detection, region entrance detection, region exiting detection
Frame Rate	50Hz: 25fps (1920 × 1080, 1280 × 720) 60Hz: 30fps (1920 × 1080, 1280 × 720)	50Hz: 25fps (1920 × 1080, 1280 × 720) 60Hz: 30fps (1920 × 1080, 1280 × 720)	50Hz: 25fps (2688 × 1520, 1920 × 1080, 1280 × 720) 60Hz: 30fps (2688 × 1520, 1920 × 1080, 1280 × 720)	50Hz: 25fps (2688 × 1520, 1920 × 1080, 1280 × 720) 60Hz: 30fps (2688 × 1520, 1920 × 1080, 1280 × 720)	50Hz: 25fps (2688 × 1520, 1920 × 1080, 1280 × 720) 60Hz: 30fps (2688 × 1520, 1920 × 1080, 1280 × 720)	50 Hz: 25 fps (3200 × 1800, 2688 × 1520, 1920 × 1080, 1280 × 720) 60 Hz: 30 fps (3200 × 1800, 2688 × 1520, 1920 × 1080, 1280 × 720)
Streams	3	3	3	3	3	3
Protection Level	IP66, IK10	IP66, IK10	IP66, IK10	IP66, IK10	IP67, IK10, NEMA4X	IP66, IK10
Angle Adjustment	Pan: 0° to 355°, tilt: 0° to 90°, rotate: 0° to 360°	Pan: 0° to 355°, tilt: 0° to 90°, rotate: 0° to 360°	Pan: 0° to 355°, tilt: 0° to 90°, rotate: 0° to 360°	Pan: 0° to 355°, tilt: 0° to 90°, rotate: 0° to 360°	Pan: 0° to 355°, tilt: 0° to 90°, rotate: 0° to 360°	Pan: 0° to 355°, tilt: 0° to 90°, rotate: 0° to 360°
Operating Temperature	-30 °C to +60 °C (-22 °F to +140 °F)	-30 °C to +60 °C (-22 °F to +140 °F)	-30 °C to +60 °C (-22 °F to +140 °F)	-30 °C to +60 °C (-22 °F to +140 °F)	-30 °C to +60 °C (-22 °F to +140 °F)	-30 °C to +60 °C (-22 °F to +140 °F)
Humidity	95% or less (non-condensing)	95% or less (non-condensing)	95% or less (non-condensing)	95% or less (non-condensing)	95% or less (non-condensing)	95% or less (non-condensing)
Local Storage	256 GB	256 GB	256 GB	256 GB	256 GB	256 GB
Indoor/Outdoor	Outdoor	Outdoor	Outdoor	Outdoor	Outdoor	Outdoor
Audio I/O	1 In, 1 Out	1 In, 1 Out Built-in microphone Built-in speaker	1 In, 1 Out	1 In, 1 Out Built-in microphone Built-in speaker	1 In, 1 Out	1 In, 1 Out
Alarm I/O	1 In, 1 Out	1 In, 1 Out	1 In, 1 Out	1 In, 1 Out	1 In, 1 Out	1 In, 1 Out
Power	12 VDC ± 25%, PoE (802.3at, class4)	12 VDC ± 25%, PoE (802.3at, class4)	12 VDC ± 25%, PoE (802.3at, class4)	12 VDC ± 25%, PoE (802.3at, class4)	12 VDC ± 25%, PoE (802.3at, class4)	12 VDC ± 25%, PoE (802.3at, class4)







Model	DS-2CD2666G2-IZSU/SL	DS-2CD2686G2-IZS	DS-2CD2686G2-IZSU/SL	DS-2CD2686G2T-IZSY	DS-2CD2726G2-IZS	DS-2CD2746G2-IZS
Image	 AcuSense Powered by DarkFighter	 AcuSense Powered by DarkFighter	 AcuSense Powered by DarkFighter	 AcuSense Powered by DarkFighter	 AcuSense Powered by DarkFighter	 AcuSense Powered by DarkFighter
Image Sensor	1/2.4" Progressive Scan CMOS	1/1.8" Progressive Scan CMOS	1/1.8" Progressive Scan CMOS	1/1.8" Progressive Scan CMOS	1/2.8" Progressive Scan CMOS	1/3" Progressive Scan CMOS
Resolution	3200 × 1800	3840 × 2160	3840 × 2160	3840 × 2160	1920 × 1080	2688 × 1520
Video Compression	H.265/H.265+/H.264+/H.264 / MJPEG	H.265/H.265+/H.264+/H.264 / MJPEG	H.265/H.265+/H.264+/H.264 / MJPEG	H.265/H.265+/H.264+/H.264 / MJPEG	H.265/H.265+/H.264+/H.264 / MJPEG	H.265/H.265+/H.264+/H.264 / MJPEG
Min. Illumination	0.003 Lux @ (F1.4, AGC ON)	0.003 Lux @ (F1.4, AGC ON)	0.003 Lux @ (F1.4, AGC ON)	0.003 Lux @ (F1.4, AGC ON)	0.002 Lux @ (F1.4, AGC ON)	0.003 Lux @ (F1.4, AGC ON)
WDR	120dB	120dB	120dB	120dB	120dB	120dB
Lens	2.8 to 12 mm	2.8 to 12 mm	2.8 to 12 mm	2.8 to 12 mm	2.8 to 12 mm	2.8 to 12 mm
FOV	2.8 to 12 mm, horizontal FOV 116.5° to 34.9°, vertical FOV 60° to 19.6°, diagonal FOV 141.9° to 41°	2.8 to 12mm, horizontal FOV 108.1° to 45.5°, vertical FOV 58.4° to 25.7°, diagonal FOV 127.3° to 52.1°	2.8 to 12mm, horizontal FOV 108.1° to 45.5°, vertical FOV 58.4° to 25.7°, diagonal FOV 127.3° to 52.1°	2.8 to 12mm, horizontal FOV 108.1° to 45.5°, vertical FOV 58.4° to 25.7°, diagonal FOV 127.3° to 52.1°	2.8 to 12 mm, horizontal FOV 113° to 31°, vertical FOV 58° to 18°, diagonal FOV 138° to 36°	2.8 to 12 mm, horizontal FOV 108° to 30°, vertical FOV 56° to 17°, diagonal FOV 131° to 35°
Max. IR Range	60 m	60 m	60 m	60 m	40 m	40 m
VCA	Line crossing detection, intrusion detection, region entrance detection, region exiting detection	Line crossing detection, intrusion detection, region entrance detection, region exiting detection	Line crossing detection, intrusion detection, region entrance detection, region exiting detection	Line crossing detection, intrusion detection, region entrance detection, region exiting detection	Line crossing detection, intrusion detection, region entrance detection, region exiting detection	Line crossing detection, intrusion detection, region entrance detection, region exiting detection
Frame Rate	50 Hz: 25 fps (3200 × 1800, 2688 × 1520, 1920 × 1080, 1280 × 720) 60 Hz: 30 fps (3200 × 1800, 2688 × 1520, 1920 × 1080, 1280 × 720)	50Hz: 25fps (3840 × 2160, 3200 × 1800, 2688 × 1520, 1920 × 1080, 1280 × 720) 60Hz: 24fps (3840 × 2160) 30fps (3200 × 1800, 2688 × 1520, 1920 × 1080, 1280 × 720)	50Hz: 25fps (3840 × 2160, 3200 × 1800, 2688 × 1520, 1920 × 1080, 1280 × 720) 60Hz: 24fps (3840 × 2160) 30fps (3200 × 1800, 2688 × 1520, 1920 × 1080, 1280 × 720)	50Hz: 25fps (3840 × 2160, 3200 × 1800, 2688 × 1520, 1920 × 1080, 1280 × 720) 60Hz: 24fps (3840 × 2160) 30fps (3200 × 1800, 2688 × 1520, 1920 × 1080, 1280 × 720)	50Hz: 25fps (1920 × 1080, 1280 × 720) 60Hz: 30fps (1920 × 1080, 1280 × 720)	50Hz: 25fps (2688 × 1520, 1920 × 1080, 1280 × 720) 60Hz: 30fps (2688 × 1520, 1920 × 1080, 1280 × 720)
Streams	3	3	3	3	3	3
Protection Level	IP66, IK10	IP66, IK10	IP66, IK10	IP67, IK10, NEMA4X	IP66, IK10	IP66, IK10
Angle Adjustment	Pan: 0° to 355°, tilt: 0° to 90°, rotate: 0° to 360°	Pan: 0° to 355°, tilt: 0° to 90°, rotate: 0° to 360°	Pan: 0° to 355°, tilt: 0° to 90°, rotate: 0° to 360°	Pan: 0° to 355°, tilt: 0° to 90°, rotate: 0° to 360°	Pan: 0° to 355°, tilt: 0° to 75°, rotate: 0° to 355°	Pan: 0° to 355°, tilt: 0° to 75°, rotate: 0° to 355°
Operating Temperature	-30 °C to +60 °C (-22 °F to +140 °F)	-30 °C to +60 °C (-22 °F to +140 °F)	-30 °C to +60 °C (-22 °F to +140 °F)	-30 °C to +60 °C (-22 °F to +140 °F)	-30 °C to +60 °C (-22 °F to +140 °F)	-30 °C to +60 °C (-22 °F to +140 °F)
Humidity	95% or less (non-condensing)	95% or less (non-condensing)	95% or less (non-condensing)	95% or less (non-condensing)	95% or less (non-condensing)	95% or less (non-condensing)
Local Storage	256 GB	256 GB	256 GB	256 GB	256 GB	256 GB
Indoor/Outdoor	Outdoor	Outdoor	Outdoor	Outdoor	Outdoor	Outdoor
Audio I/O	1 In, 1 Out Built-in microphone Built-in speaker	1 In, 1 Out	1 In, 1 Out Built-in microphone Built-in speaker	1 In, 1 Out	1 In, 1 Out	1 In, 1 Out
Alarm I/O	1 In, 1 Out	1 In, 1 Out	1 In, 1 Out	1 In, 1 Out	1 In, 1 Out	1 In, 1 Out
Power	12 VDC ± 25%, PoE (802.3at, class4)	12 VDC ± 25%, PoE (802.3at, class4)	12 VDC ± 25%, PoE (802.3at, class4)	12 VDC ± 25%, PoE (802.3at, class4)	12 VDC ± 25%, PoE (802.3af, class 3)	12 VDC ± 25%, PoE (802.3af, class 3)







Model	DS-2CD2766G2-IZS	DS-2CD2786G2-IZS	DS-2CD2H26G2-IZS	DS-2CD2H46G2-IZS	DS-2CD2H66G2-IZS	DS-2CD2H86G2-IZS
Image						
Image Sensor	1/2.4" Progressive Scan CMOS	1/1.8" Progressive Scan CMOS	1/2.8" Progressive Scan CMOS	1/3" Progressive Scan CMOS	1/2.4" Progressive Scan CMOS	1/1.8" Progressive Scan CMOS
Resolution	3200 × 1800	3840 × 2160	1920 × 1080	2688 × 1520	3200 × 1800	3840 × 2160
Video Compression	H.265/H.265+/H.264+/H.264 / MJPEG	H.265/H.265+/H.264+/H.264 / MJPEG	H.265/H.265+/H.264+/H.264 / MJPEG	H.265/H.265+/H.264+/H.264 / MJPEG	H.265/H.265+/H.264+/H.264 / MJPEG	H.265/H.265+/H.264+/H.264 / MJPEG
Min. Illumination	0.003 Lux @ (F1.4, AGC ON)	0.003 Lux @ (F1.4, AGC ON)	0.002 Lux @ (F1.4, AGC ON)	0.003 Lux @ (F1.4, AGC ON)	0.003 Lux @ (F1.4, AGC ON)	0.003 Lux @ (F1.4, AGC ON)
WDR	120dB	120dB	120dB	120dB	120dB	120dB
Lens	2.8 to 12 mm	2.8 to 12 mm	2.8 to 12 mm	2.8 to 12 mm	2.8 to 12 mm	2.8 to 12 mm
FOV	2.8 to 12 mm, horizontal FOV 116.5° to 34.9°, vertical FOV 60° to 19.6°, diagonal FOV 141.9° to 41°	2.8 to 12 mm, horizontal FOV 108.1° to 45.5°, vertical FOV 58.4° to 25.7°, diagonal FOV 127.3° to 52.1°	2.8 to 12 mm, horizontal FOV 113° to 33.9°, vertical FOV 58° to 18.9°, diagonal FOV 138° to 39°	2.8 to 12 mm, horizontal FOV 108° to 32.8°, vertical FOV 56° to 18.5°, diagonal FOV 131° to 37.8°	2.8 to 12 mm, horizontal FOV 116.5° to 34.9°, vertical FOV 60° to 19.6°, diagonal FOV 141.9° to 41°	2.8 to 12 mm, horizontal FOV 108° to 45.8°, vertical FOV 58.4° to 25.7°, diagonal FOV 127.3° to 52.1°
Max. IR Range	40m	40 m	40m	40m	40m	40m
VCA	Line crossing detection, intrusion detection, region entrance detection, region exiting detection	Line crossing detection, intrusion detection, region entrance detection, region exiting detection	Line crossing detection, intrusion detection, region entrance detection, region exiting detection	Line crossing detection, intrusion detection, region entrance detection, region exiting detection	Line crossing detection, intrusion detection, region entrance detection, region exiting detection	Line crossing detection, intrusion detection, region entrance detection, region exiting detection
Frame Rate	50 Hz: 25 fps (3200 × 1800, 2688 × 1520, 1920 × 1080, 1280 × 720) 60 Hz: 30 fps (3200 × 1800, 2688 × 1520, 1920 × 1080, 1280 × 720)	50Hz: 25fps (3840 × 2160, 3200 × 1800, 2688 × 1520, 1920 × 1080, 1280 × 720) 60Hz: 24fps (3840 × 2160) 30fps (3200 × 1800, 2688 × 1520, 1920 × 1080, 1280 × 720)	50Hz: 25fps (1920 × 1080, 1280 × 720) 60Hz: 30fps (1920 × 1080, 1280 × 720)	50Hz: 25fps (2688 × 1520, 1920 × 1080, 1280 × 720) 60Hz: 30fps (2688 × 1520, 1920 × 1080, 1280 × 720)	50 Hz: 25 fps (3200 × 1800, 2688 × 1520, 1920 × 1080, 1280 × 720) 60 Hz: 30 fps (3200 × 1800, 2688 × 1520, 1920 × 1080, 1280 × 720)	50Hz: 25fps (3840 × 2160, 3200 × 1800, 2688 × 1520, 1920 × 1080, 1280 × 720) 60Hz: 24fps (3840 × 2160) 30fps (3200 × 1800, 2688 × 1520, 1920 × 1080, 1280 × 720)
Streams	3	3	3	3	3	3
Protection Level	IP66, IK10	IP66, IK10	IP66, IK10	IP66, IK10	IP66, IK10	IP66, IK10
Angle Adjustment	Pan: 0° to 355°, tilt: 0° to 75°, rotate: 0° to 355°	Pan: 0° to 355°, tilt: 0° to 75°, rotate: 0° to 355°	Pan: 0° to 355°, tilt: 0° to 75°, rotate: 0° to 360°	Pan: 0° to 355°, tilt: 0° to 75°, rotate: 0° to 360°	Pan: 0° to 355°, tilt: 0° to 75°, rotate: 0° to 360°	Pan: 0° to 355°, tilt: 0° to 75°, rotate: 0° to 360°
Operating Temperature	-30 °C to +60 °C (-22 °F to +140 °F)	-30 °C to +60 °C (-22 °F to +140 °F)	-30 °C to +60 °C (-22 °F to +140 °F)	-30 °C to +60 °C (-22 °F to +140 °F)	-30 °C to +60 °C (-22 °F to +140 °F)	-30 °C to +60 °C (-22 °F to +140 °F)
Humidity	95% or less (non-condensing)	95% or less (non-condensing)	95% or less (non-condensing)	95% or less (non-condensing)	95% or less (non-condensing)	95% or less (non-condensing)
Local Storage	256 GB	256 GB	256 GB	256 GB	256 GB	256 GB
Indoor/Outdoor	Outdoor	Outdoor	Outdoor	Outdoor	Outdoor	Outdoor
Audio I/O	1 In, 1 Out	1 In, 1 Out	1 In, 1 Out	1 In, 1 Out	1 In, 1 Out	1 In, 1 Out
Alarm I/O	1 In, 1 Out	1 In, 1 Out	1 In, 1 Out	1 In, 1 Out	1 In, 1 Out	1 In, 1 Out
Power	12 VDC ± 25%, PoE (802.3af, class 3)	12 VDC ± 25%, PoE (802.3af, class 3)	12 VDC ± 25%, PoE (802.3af, class 3)	12 VDC ± 25%, PoE (802.3af, class 3)	12 VDC ± 25%, PoE (802.3af, class 3)	12 VDC ± 25%, PoE (802.3af, class 3)







Model	DS-2CD2T26G2-2I/4I	DS-2CD2T26G2-ISU/SL	DS-2CD2T46G2-2I/4I	DS-2CD2T46G2-ISU/SL	DS-2CD2T46G2P-ISU/SL	DS-2CD2T46G2-4IY
Image	 AcuSense Powered by DarkFighter+	 AcuSense Powered by DarkFighter+	 AcuSense Powered by DarkFighter+	 AcuSense Powered by DarkFighter+	 AcuSense Powered by DarkFighter+	 AcuSense Powered by DarkFighter+
Image Sensor	1/2.8" Progressive Scan CMOS	1/2.8" Progressive Scan CMOS	1/3" Progressive Scan CMOS	1/3" Progressive Scan CMOS	1/2.5" Progressive Scan CMOS	2 x 1/2.5" Progressive Scan CMOS
Resolution	1920 × 1080	1920 × 1080	2688 × 1520	2688 × 1520	3040 × 1368	2688 × 1520
Video Compression	H.265/H.265+/H.264+/H.264 / MJPEG	H.265/H.265+/H.264+/H.264 / MJPEG	H.265/H.265+/H.264+/H.264 / MJPEG	H.265/H.265+/H.264+/H.264 / MJPEG	H.265/H.265+/H.264+/H.264 / MJPEG	H.265/H.265+/H.264+/H.264 / MJPEG
Min. Illumination	0.002 Lux @ (F1.4, AGC ON)	0.002 Lux @ (F1.4, AGC ON)	0.003 Lux @ (F1.4, AGC ON)	0.003 Lux @ (F1.4, AGC ON)	0.003 Lux @ (F1.0, AGC ON)	0.003 Lux @ (F1.4, AGC ON)
WDR	120dB	120dB	120dB	120dB	120dB	120dB
Lens	2.8mm, 4 mm, 6 mm	2.8mm, 4 mm, 6 mm	2.8mm, 4 mm, 6 mm	2.8mm, 4 mm, 6 mm	Fixed focal lens, Dual lens: 2.8 mm	2.8mm, 4 mm, 6 mm
FOV	2.8 mm, horizontal FOV 107°, vertical FOV 57°, diagonal FOV 129° 4 mm, horizontal FOV 86°, vertical FOV 47°, diagonal FOV 102° 6 mm, horizontal FOV 55°, vertical FOV 29°, diagonal FOV 65°	2.8 mm, horizontal FOV 107°, vertical FOV 57°, diagonal FOV 129° 4 mm, horizontal FOV 86°, vertical FOV 47°, diagonal FOV 102° 6 mm, horizontal FOV 55°, vertical FOV 29°, diagonal FOV 65°	2.8 mm, horizontal FOV 103°, vertical FOV 55°, diagonal FOV 123° 4 mm, horizontal FOV 83°, vertical FOV 45°, diagonal FOV 98° 6 mm, horizontal FOV 53°, vertical FOV 28°, diagonal FOV 62°	2.8 mm, horizontal FOV 103°, vertical FOV 55°, diagonal FOV 123° 4 mm, horizontal FOV 83°, vertical FOV 45°, diagonal FOV 98° 6 mm, horizontal FOV 53°, vertical FOV 28°, diagonal FOV 62°	Horizontal FOV: 180° Vertical FOV: 84°	2.8 mm, horizontal FOV 103°, vertical FOV 55°, diagonal FOV 123° 4 mm, horizontal FOV 83°, vertical FOV 45°, diagonal FOV 98° 6 mm, horizontal FOV 53°, vertical FOV 28°, diagonal FOV 62°
Max. IR Range	-2l: 60 m -4l: 80 m	60 m	-2l: 60 m -4l: 80 m	60 m	40m	80 m
VCA	Line crossing detection, intrusion detection, region entrance detection, region exiting detection	Line crossing detection, intrusion detection, region entrance detection, region exiting detection	Line crossing detection, intrusion detection, region entrance detection, region exiting detection	Line crossing detection, intrusion detection, region entrance detection, region exiting detection	Line crossing detection, intrusion detection, region entrance detection, region exiting detection	Line crossing detection, intrusion detection, region entrance detection, region exiting detection
Frame Rate	50Hz: 25fps (1920 × 1080, 1280 × 720) 60Hz: 30fps (1920 × 1080, 1280 × 720)	50Hz: 25fps (1920 × 1080, 1280 × 720) 60Hz: 30fps (1920 × 1080, 1280 × 720)	50Hz: 25fps (2688 × 1520, 1920 × 1080, 1280 × 720) 60Hz: 30fps (2688 × 1520, 1920 × 1080, 1280 × 720)	50Hz: 25fps (2688 × 1520, 1920 × 1080, 1280 × 720) 60Hz: 30fps (2688 × 1520, 1920 × 1080, 1280 × 720)	50Hz: 25fps (3040 × 1368) 60Hz: 24fps (3040 × 1368)	50Hz: 25fps (2688 × 1520, 1920 × 1080, 1280 × 720) 60Hz: 30fps (2688 × 1520, 1920 × 1080, 1280 × 720)
Streams	3	3	3	3	2	3
Protection Level	IP67	IP67	IP67	IP67	IP67	IP67, NEMA4X
Angle Adjustment	Pan: 0° to 355°, tilt: 0° to 90°, rotate: 0° to 360°	Pan: 0° to 355°, tilt: 0° to 90°, rotate: 0° to 360°	Pan: 0° to 355°, tilt: 0° to 90°, rotate: 0° to 360°	Pan: 0° to 355°, tilt: 0° to 90°, rotate: 0° to 360°	Pan: -30° to 30°, tilt: -75° to 75°	Pan: 0° to 355°, tilt: 0° to 90°, rotate: 0° to 360°
Operating Temperature	-30 °C to +60 °C (-22 °F to +140 °F)	-30 °C to +60 °C (-22 °F to +140 °F)	-30 °C to +60 °C (-22 °F to +140 °F)	-30 °C to +60 °C (-22 °F to +140 °F)	-30 °C to +60 °C (-22 °F to +140 °F)	-30 °C to +60 °C (-22 °F to +140 °F)
Humidity	95% or less (non-condensing)	95% or less (non-condensing)	95% or less (non-condensing)	95% or less (non-condensing)	95% or less (non-condensing)	95% or less (non-condensing)
Local Storage	256 GB	256 GB	256 GB	256 GB	256 GB	256 GB
Indoor/Outdoor	Outdoor	Outdoor	Outdoor	Outdoor	Outdoor	Outdoor
Audio I/O	-	1 In, 1 Out Built-in microphone Built-in speaker	-	1 In, 1 Out Built-in microphone Built-in speaker	1 In, 1 Out Built-in microphone Built-in speaker	-
Alarm I/O	-	1 In, 1 Out	-	1 In, 1 Out	1 In, 1 Out	-
Power	12 VDC ± 25%, PoE (802.3af, class 3)	12 VDC ± 25%, PoE (802.3af, class 3)	12 VDC ± 25%, PoE (802.3af, class 3)	12 VDC ± 25%, PoE (802.3af, class 3)	12 VDC ± 25%, PoE (802.3af, class 3)	12 VDC ± 25%, PoE (802.3af, class 3)

Model	DS-2CD2T6662-2I/4I	DS-2CD2T6662-ISU/SL	DS-2CD2T6662P-ISU/SL	DS-2CD2T8662-2I/4I	DS-2CD2T8662-ISU/SL	DS-2CD2T8662-4IY	
Image	 AcuSense Powered by DarkFighter	 AcuSense Powered by DarkFighter	 AcuSense Powered by DarkFighter	 AcuSense Powered by DarkFighter	 AcuSense Powered by DarkFighter	 AcuSense Powered by DarkFighter	
Image Sensor	1/2.4" Progressive Scan CMOS	1/2.4" Progressive Scan CMOS	2 × 1/2.5" Progressive Scan CMOS	1/1.8" Progressive Scan CMOS	1/1.8" Progressive Scan CMOS	1/1.8" Progressive Scan CMOS	
Resolution	3200 × 1800	3200 × 1800	3632 × 1632	3840 × 2160	3840 × 2160	3840 × 2160	
Video Compression	H.265/H.265+/H.264+/H.264 / MJPEG	H.265/H.265+/H.264+/H.264 / MJPEG	H.265/H.265+/H.264+/H.264 / MJPEG	H.265/H.265+/H.264+/H.264 / MJPEG	H.265/H.265+/H.264+/H.264 / MJPEG	H.265/H.265+/H.264+/H.264 / MJPEG	
Min. Illumination	0.003 Lux @ (F1.6, AGC ON)	0.003 Lux @ (F1.6, AGC ON)	0.003 Lux @ (F1.0, AGC ON)	0.003 Lux @ (F1.6, AGC ON)	0.003 Lux @ (F1.6, AGC ON)	0.003 Lux @ (F1.6, AGC ON)	
WDR	120dB	120dB	120dB	120dB	120dB	120dB	
Lens	2.8mm, 4 mm, 6 mm	2.8mm, 4 mm, 6 mm	Fixed focal lens, Dual lens: 2.8 mm	2.8mm, 4 mm, 6 mm	2.8mm, 4 mm, 6 mm	2.8mm, 4 mm, 6 mm	
FOV	2.8 mm, horizontal FOV 105.1°, vertical FOV 53.4°, diagonal FOV 128.6° 4 mm, horizontal FOV 83.9°, vertical FOV 44.5°, diagonal FOV 100.8° 6 mm, horizontal FOV 47.5°, vertical FOV 26°, diagonal FOV 54.5°	2.8 mm, horizontal FOV 105.1°, vertical FOV 53.4°, diagonal FOV 128.6° 4 mm, horizontal FOV 83.9°, vertical FOV 44.5°, diagonal FOV 100.8° 6 mm, horizontal FOV 47.5°, vertical FOV 26°, diagonal FOV 54.5°	Horizontal FOV: 180° Vertical FOV: 84°	2.8 mm, horizontal FOV 111°, vertical FOV 59°, diagonal FOV 131° 4 mm, horizontal FOV 87°, vertical FOV 47°, diagonal FOV 102° 6 mm, horizontal FOV 51°, vertical FOV 28°, diagonal FOV 60°	2.8 mm, horizontal FOV 111°, vertical FOV 59°, diagonal FOV 131° 4 mm, horizontal FOV 87°, vertical FOV 47°, diagonal FOV 102° 6 mm, horizontal FOV 51°, vertical FOV 28°, diagonal FOV 60°	2.8 mm, horizontal FOV 111°, vertical FOV 59°, diagonal FOV 131° 4 mm, horizontal FOV 87°, vertical FOV 47°, diagonal FOV 102° 6 mm, horizontal FOV 51°, vertical FOV 28°, diagonal FOV 60°	2.8 mm, horizontal FOV 111°, vertical FOV 59°, diagonal FOV 131° 4 mm, horizontal FOV 87°, vertical FOV 47°, diagonal FOV 102° 6 mm, horizontal FOV 51°, vertical FOV 28°, diagonal FOV 60°
Max. IR Range	-2l: 60 m -4l: 80 m	60 m	40m	-2l: 60 m -4l: 80 m	60 m	80 m	
VCA	Line crossing detection, intrusion detection, region entrance detection, region exiting detection	Line crossing detection, intrusion detection, region entrance detection, region exiting detection	Line crossing detection, intrusion detection, region entrance detection, region exiting detection	Line crossing detection, intrusion detection, region entrance detection, region exiting detection	Line crossing detection, intrusion detection, region entrance detection, region exiting detection	Line crossing detection, intrusion detection, region entrance detection, region exiting detection	
Frame Rate	50 Hz: 25 fps (3200 × 1800, 2688 × 1520, 1920 × 1080, 1280 × 720) 60 Hz: 30 fps (3200 × 1800, 2688 × 1520, 1920 × 1080, 1280 × 720)	50 Hz: 25 fps (3200 × 1800, 2688 × 1520, 1920 × 1080, 1280 × 720) 60 Hz: 30 fps (3200 × 1800, 2688 × 1520, 1920 × 1080, 1280 × 720)	50Hz: 20fps (3632 × 1632) 60Hz: 20fps (3632 × 1632)	50Hz: 25fps (3840 × 2160, 3200 × 1800, 2688 × 1520, 1920 × 1080, 1280 × 720) 60Hz: 24fps (3840 × 2160) 30fps (3200 × 1800, 2688 × 1520, 1920 × 1080, 1280 × 720)	50Hz: 25fps (3840 × 2160, 3200 × 1800, 2688 × 1520, 1920 × 1080, 1280 × 720) 60Hz: 24fps (3840 × 2160) 30fps (3200 × 1800, 2688 × 1520, 1920 × 1080, 1280 × 720)	50Hz: 25fps (3840 × 2160, 3200 × 1800, 2688 × 1520, 1920 × 1080, 1280 × 720) 60Hz: 24fps (3840 × 2160) 30fps (3200 × 1800, 2688 × 1520, 1920 × 1080, 1280 × 720)	50Hz: 25fps (3840 × 2160, 3200 × 1800, 2688 × 1520, 1920 × 1080, 1280 × 720) 60Hz: 24fps (3840 × 2160) 30fps (3200 × 1800, 2688 × 1520, 1920 × 1080, 1280 × 720)
Streams	3	3	2	3	3	3	
Protection Level	IP67	IP67	IP67	IP67	IP67	IP67, NEMA4X	
Angle Adjustment	Pan: 0° to 355°, tilt: 0° to 90°, rotate: 0° to 360°	Pan: 0° to 355°, tilt: 0° to 90°, rotate: 0° to 360°	Pan: -30° to 30°, tilt: -75° to 75°	Pan: 0° to 355°, tilt: 0° to 90°, rotate: 0° to 360°	Pan: 0° to 355°, tilt: 0° to 90°, rotate: 0° to 360°	Pan: 0° to 355°, tilt: 0° to 90°, rotate: 0° to 360°	
Operating Temperature	-30 °C to +60 °C (-22 °F to +140 °F)	-30 °C to +60 °C (-22 °F to +140 °F)	-30 °C to +60 °C (-22 °F to +140 °F)	-30 °C to +60 °C (-22 °F to +140 °F)	-30 °C to +60 °C (-22 °F to +140 °F)	-30 °C to +60 °C (-22 °F to +140 °F)	
Humidity	95% or less (non-condensing)	95% or less (non-condensing)	95% or less (non-condensing)	95% or less (non-condensing)	95% or less (non-condensing)	95% or less (non-condensing)	
Local Storage	256 GB	256 GB	256 GB	256 GB	256 GB	256 GB	
Indoor/Outdoor	Outdoor	Outdoor	Outdoor	Outdoor	Outdoor	Outdoor	
Audio I/O	-	1 In, 1 Out Built-in microphone Built-in speaker	1 In, 1 Out Built-in microphone Built-in speaker	-	1 In, 1 Out Built-in microphone Built-in speaker	-	
Alarm I/O	-	1 In, 1 Out	1 In, 1 Out	-	1 In, 1 Out	-	
Power	12 VDC ± 25%, PoE (802.3af, class 3)	12 VDC ± 25%, PoE (802.3af, class 3)	12 VDC ± 25%, PoE (802.3af, class 3)	12 VDC ± 25%, PoE (802.3af, class 3)	12 VDC ± 25%, PoE (802.3af, class 3)	12 VDC ± 25%, PoE (802.3af, class 3)	







Model	DS-2CD234560P-I	DS-2CD2T4560P-I
Image		
Image Sensor	1/2.7" Progressive Scan CMOS	1/2.7" Progressive Scan CMOS
Resolution	2688 × 1520	2688 × 1520
Video Compression	H.265/H.265+/H.264+/H.264 / MJPEG	H.265/H.265+/H.264+/H.264 / MJPEG
Min. Illumination	0.028 Lux @ (F2.0, AGC ON)	0.028 Lux @ (F2.0, AGC ON)
WDR	120dB	120dB
Lens	1.68 mm	1.68 mm
FOV	horizontal FOV: 180°, vertical FOV: 101°, diagonal FOV: 180°	horizontal FOV: 180°, vertical FOV: 101°, diagonal FOV: 180°
Max. IR Range	10 m	10 m
VCA	Line crossing detection, intrusion detection, unattended baggage detection, object removal detection, face detection, scene change detection	Line crossing detection, intrusion detection, unattended baggage detection, object removal detection, face detection, scene change detection
Frame Rate	50Hz: 25fps (2688 × 1520, 2304 × 1296, 1920 × 1080, 1280 × 720) 60Hz: 24fps (2688 × 1520), 30fps (2304 × 1296, 1920 × 1080, 1280 × 720)	50Hz: 25fps (2688 × 1520, 2304 × 1296, 1920 × 1080, 1280 × 720) 60Hz: 24fps (2688 × 1520), 30fps (2304 × 1296, 1920 × 1080, 1280 × 720)
Streams	3	3
Protection Level	-	IP67
Angle Adjustment	Pan: 0° to 360°, tilt: 0° to 75°, rotate: 0° to 360°	Pan: 0° to 360°, tilt: 0° to 75°, rotate: 0° to 360°
Operating Temperature	-30 °C to +60 °C [-22 °F to +140 °F]	-30 °C to +60 °C [-22 °F to +140 °F]
Humidity	95% or less (non-condensing)	95% or less (non-condensing)
Local Storage	128 GB	128 GB
Indoor/Outdoor	Indoor	Outdoor
Audio I/O	-	-
Alarm I/O	-	-
Power	12 VDC ± 25%, PoE (802.3af, class 3)	12 VDC ± 25%, PoE (802.3af, class 3)







Model	DS-2CD202362-I(U)	DS-2CD204362-I(U)	DS-2CD206362-I(U)	DS-2CD208362-I(U)	DS-2CD212362-I(S)	DS-2CD212362-IU
Image	 AcuSense	 AcuSense	 AcuSense	 AcuSense	 AcuSense	 AcuSense
Image Sensor	1/2.8" Progressive Scan CMOS	1/3" Progressive Scan CMOS	1/2.8" Progressive Scan CMOS	1/2.8" Progressive Scan CMOS	1/2.8" Progressive Scan CMOS	1/2.8" Progressive Scan CMOS
Resolution	1920 × 1080	2688 × 1520	3200 × 1800	3840 × 2160	1920 × 1080	1920 × 1080
Video Compression	H.265/H.265+/H.264+/H.264 / MJPEG	H.265/H.265+/H.264+/H.264 / MJPEG	H.265/H.265+/H.264+/H.264 / MJPEG	H.265/H.265+/H.264+/H.264 / MJPEG	H.265/H.265+/H.264+/H.264 / MJPEG	H.265/H.265+/H.264+/H.264 / MJPEG
Min. Illumination	0.005 Lux @ (F1.6, AGC ON)	0.005 Lux @ (F1.6, AGC ON)	0.005 Lux @ (F1.6, AGC ON)	0.005 Lux @ (F1.6, AGC ON)	0.005 Lux @ (F1.6, AGC ON)	0.005 Lux @ (F1.6, AGC ON)
WDR	120dB	120dB	120dB	120dB	120dB	120dB
Lens	2.8mm, 4 mm, 6 mm	2.8mm, 4 mm, 6 mm	2.8mm, 4 mm, 6 mm	2.8mm, 4 mm, 6 mm	2.8mm, 4 mm	2.8mm, 4 mm
FOV	2.8 mm, horizontal FOV 107°, vertical FOV 57°, diagonal FOV 127° 4 mm, horizontal FOV 87°, vertical FOV 46°, diagonal FOV 104° 6 mm, horizontal FOV 54°, vertical FOV 29°, diagonal FOV 63°	2.8 mm, horizontal FOV 103°, vertical FOV 55°, diagonal FOV 122° 4 mm, horizontal FOV 84°, vertical FOV 45°, diagonal FOV 100° 6 mm, horizontal FOV 52°, vertical FOV 28°, diagonal FOV 61°	2.8 mm, horizontal FOV 107.1°, vertical FOV 57°, diagonal FOV 127.6° 4 mm, horizontal FOV 87.2°, vertical FOV 46.2°, diagonal FOV 104.8° 6 mm, horizontal FOV 53.9°, vertical FOV 28.8°, diagonal FOV 62.8°	2.8 mm, horizontal FOV 107.1°, vertical FOV 57°, diagonal FOV 127.6° 4 mm, horizontal FOV 87.2°, vertical FOV 46.2°, diagonal FOV 104.8° 6 mm, horizontal FOV 53.9°, vertical FOV 28.8°, diagonal FOV 62.8°	2.8 mm, horizontal FOV 107°, vertical FOV 57°, diagonal FOV 127° 4 mm, horizontal FOV 87°, vertical FOV 46°, diagonal FOV 104°	2.8 mm, horizontal FOV 107°, vertical FOV 57°, diagonal FOV 127° 4 mm, horizontal FOV 87°, vertical FOV 46°, diagonal FOV 104°
Max. IR Range	40 m	40 m	40 m	40 m	30 m	30 m
VCA	Line crossing detection, intrusion detection	Line crossing detection, intrusion detection	Line crossing detection, intrusion detection	Line crossing detection, intrusion detection	Line crossing detection, intrusion detection	Line crossing detection, intrusion detection
Frame Rate	50Hz: 25fps (1920 × 1080, 1280 × 720) 60Hz: 30fps (1920 × 1080, 1280 × 720)	50Hz: 25fps (2688 × 1520, 1920 × 1080, 1280 × 720) 60Hz: 30fps (2688 × 1520, 1920 × 1080, 1280 × 720)	50Hz: 20fps (3200 × 1800), 25fps (2688 × 1520, 1920 × 1080, 1280 × 720) 60Hz: 20fps (3200 × 1800), 30fps (2688 × 1520, 1920 × 1080, 1280 × 720)	50Hz: 20fps (3840 × 2160), 25fps (3200 × 1800, 2688 × 1520, 1920 × 1080, 1280 × 720) 60Hz: 20fps (3840 × 2160), 30fps (3200 × 1800, 2688 × 1520, 1920 × 1080, 1280 × 720)	50Hz: 25fps (1920 × 1080, 1280 × 720) 60Hz: 30fps (1920 × 1080, 1280 × 720)	50Hz: 25fps (1920 × 1080, 1280 × 720) 60Hz: 30fps (1920 × 1080, 1280 × 720)
Streams	3	3	3	3	3	3
Protection Level	IP67	IP67	IP67	IP67	IP67, IK10	IP67, IK10
Angle Adjustment	Pan: 0° to 360°, tilt: 0° to 90°, rotate: 0° to 360°	Pan: 0° to 360°, tilt: 0° to 90°, rotate: 0° to 360°	Pan: 0° to 360°, tilt: 0° to 90°, rotate: 0° to 360°	Pan: 0° to 360°, tilt: 0° to 90°, rotate: 0° to 360°	Pan: 0° to 355°, tilt: 0° to 75°, rotate: 0° to 355°	Pan: 0° to 355°, tilt: 0° to 75°, rotate: 0° to 355°
Operating Temperature	-30 °C to +60 °C (-22 °F to +140 °F)	-30 °C to +60 °C (-22 °F to +140 °F)	-30 °C to +60 °C (-22 °F to +140 °F)	-30 °C to +60 °C (-22 °F to +140 °F)	-30 °C to +60 °C (-22 °F to +140 °F)	-30 °C to +60 °C (-22 °F to +140 °F)
Humidity	95% or less (non-condensing)	95% or less (non-condensing)	95% or less (non-condensing)	95% or less (non-condensing)	95% or less (non-condensing)	95% or less (non-condensing)
Local Storage	256 GB	256 GB	256 GB	256 GB	256 GB	256 GB
Indoor/Outdoor	Outdoor	Outdoor	Outdoor	Outdoor	Outdoor	Outdoor
Audio I/O	Built-in microphone(-IU)	Built-in microphone(-IU)	Built-in microphone(-IU)	Built-in microphone(-IU)	1 In, 1 Out(-S)	1 built-in microphone
Alarm I/O	-	-	-	-	1 In, 1 Out(-S)	-
Power	12 VDC ± 25%, PoE (802.3af, class 3)	12 VDC ± 25%, PoE (802.3af, class 3)	12 VDC ± 25%, PoE (802.3af, class 3)	12 VDC ± 25%, PoE (802.3af, class 3)	12 VDC ± 25%, PoE (802.3af, class 3)	12 VDC ± 25%, PoE (802.3af, class 3)

Model	DS-2CD2143G2-I(S)	DS-2CD2143G2-IU	DS-2CD2163G2-I(S)	DS-2CD2163G2-IU	DS-2CD2183G2-I(S)	DS-2CD2183G2-IU
Image						
Image Sensor	1/3" Progressive Scan CMOS	1/3" Progressive Scan CMOS	1/2.8" Progressive Scan CMOS	1/2.8" Progressive Scan CMOS	1/2.8" Progressive Scan CMOS	1/2.8" Progressive Scan CMOS
Resolution	2688 × 1520	2688 × 1520	3200 × 1800	3200 × 1800	3840 × 2160	3840 × 2160
Video Compression	H.265/H.265+/H.264+/H.264 / MJPEG	H.265/H.265+/H.264+/H.264 / MJPEG	H.265/H.265+/H.264+/H.264 / MJPEG	H.265/H.265+/H.264+/H.264 / MJPEG	H.265/H.265+/H.264+/H.264 / MJPEG	H.265/H.265+/H.264+/H.264 / MJPEG
Min. Illumination	0.005 Lux @ (F1.6, AGC ON)	0.005 Lux @ (F1.6, AGC ON)	0.005 Lux @ (F1.6, AGC ON)	0.005 Lux @ (F1.6, AGC ON)	0.005 Lux @ (F1.6, AGC ON)	0.005 Lux @ (F1.6, AGC ON)
WDR	120dB	120dB	120dB	120dB	120dB	120dB
Lens	2.8mm, 4 mm	2.8mm, 4 mm	2.8mm, 4 mm	2.8mm, 4 mm	2.8mm, 4 mm	2.8mm, 4 mm
FOV	2.8 mm, horizontal FOV 103°, vertical FOV 55°, diagonal FOV 122° 4 mm, horizontal FOV 84°, vertical FOV 45°, diagonal FOV 100°	2.8 mm, horizontal FOV 103°, vertical FOV 55°, diagonal FOV 122° 4 mm, horizontal FOV 84°, vertical FOV 45°, diagonal FOV 100°	2.8 mm, horizontal FOV 107.1°, vertical FOV 57°, diagonal FOV 127.6° 4 mm, horizontal FOV 87.2°, vertical FOV 46.2°, diagonal FOV 104.8°	2.8 mm, horizontal FOV 107.1°, vertical FOV 57°, diagonal FOV 127.6° 4 mm, horizontal FOV 87.2°, vertical FOV 46.2°, diagonal FOV 104.8°	2.8 mm, horizontal FOV 107.1°, vertical FOV 57°, diagonal FOV 127.6° 4 mm, horizontal FOV 87.2°, vertical FOV 46.2°, diagonal FOV 104.8°	2.8 mm, horizontal FOV 107.1°, vertical FOV 57°, diagonal FOV 127.6° 4 mm, horizontal FOV 87.2°, vertical FOV 46.2°, diagonal FOV 104.8°
Max. IR Range	30 m	30 m	30 m	30 m	30 m	30 m
VCA	Line crossing detection, intrusion detection	Line crossing detection, intrusion detection	Line crossing detection, intrusion detection	Line crossing detection, intrusion detection	Line crossing detection, intrusion detection	Line crossing detection, intrusion detection
Frame Rate	50Hz: 25fps (2688 × 1520, 1920 × 1080, 1280 × 720) 60Hz: 30fps (2688 × 1520, 1920 × 1080, 1280 × 720)	50Hz: 25fps (2688 × 1520, 1920 × 1080, 1280 × 720) 60Hz: 30fps (2688 × 1520, 1920 × 1080, 1280 × 720)	50Hz: 20fps (3200 × 1800), 25fps (2688 × 1520, 1920 × 1080, 1280 × 720) 60Hz: 20fps (3200 × 1800), 30fps (2688 × 1520, 1920 × 1080, 1280 × 720)	50Hz: 20fps (3200 × 1800), 25fps (2688 × 1520, 1920 × 1080, 1280 × 720) 60Hz: 20fps (3200 × 1800), 30fps (2688 × 1520, 1920 × 1080, 1280 × 720)	50Hz: 20fps (3840 × 2160), 25fps (3200 × 1800, 2688 × 1520, 1920 × 1080, 1280 × 720) 60Hz: 20fps (3840 × 2160), 30fps (3200 × 1800, 2688 × 1520, 1920 × 1080, 1280 × 720)	50Hz: 20fps (3840 × 2160), 25fps (3200 × 1800, 2688 × 1520, 1920 × 1080, 1280 × 720) 60Hz: 20fps (3840 × 2160), 30fps (3200 × 1800, 2688 × 1520, 1920 × 1080, 1280 × 720)
Streams	3	3	3	3	3	3
Protection Level	IP67, IK10	IP67, IK10	IP67, IK10	IP67, IK10	IP67, IK10	IP67, IK10
Angle Adjustment	Pan: 0° to 355°, tilt: 0° to 75°, rotate: 0° to 355°	Pan: 0° to 355°, tilt: 0° to 75°, rotate: 0° to 355°	Pan: 0° to 355°, tilt: 0° to 75°, rotate: 0° to 355°	Pan: 0° to 355°, tilt: 0° to 75°, rotate: 0° to 355°	Pan: 0° to 355°, tilt: 0° to 75°, rotate: 0° to 355°	Pan: 0° to 355°, tilt: 0° to 75°, rotate: 0° to 355°
Operating Temperature	-30 °C to +60 °C [-22 °F to +140 °F]	-30 °C to +60 °C [-22 °F to +140 °F]	-30 °C to +60 °C [-22 °F to +140 °F]	-30 °C to +60 °C [-22 °F to +140 °F]	-30 °C to +60 °C [-22 °F to +140 °F]	-30 °C to +60 °C [-22 °F to +140 °F]
Humidity	95% or less (non-condensing)	95% or less (non-condensing)	95% or less (non-condensing)	95% or less (non-condensing)	95% or less (non-condensing)	95% or less (non-condensing)
Local Storage	256 GB	256 GB	256 GB	256 GB	256 GB	256 GB
Indoor/Outdoor	Outdoor	Outdoor	Outdoor	Outdoor	Outdoor	Outdoor
Audio I/O	1 In, 1 Out(-S)	1 built-in microphone	1 In, 1 Out(-S)	1 built-in microphone	1 In, 1 Out(-S)	1 built-in microphone
Alarm I/O	1 In, 1 Out(-S)	-	1 In, 1 Out(-S)	-	1 In, 1 Out(-S)	-
Power	12 VDC ± 25%, PoE (802.3af, class 3)	12 VDC ± 25%, PoE (802.3af, class 3)	12 VDC ± 25%, PoE (802.3af, class 3)	12 VDC ± 25%, PoE (802.3af, class 3)	12 VDC ± 25%, PoE (802.3af, class 3)	12 VDC ± 25%, PoE (802.3af, class 3)



Model	DS-2CD232362-I(U)	DS-2CD234362-I(U)	DS-2CD236362-I(U)	DS-2CD238362-I(U)	DS-2CD242362-I	DS-2CD244362-I
Image	 AcuSense	 AcuSense	 AcuSense	 AcuSense	 AcuSense	 AcuSense
Image Sensor	1/2.8" Progressive Scan CMOS	1/3" Progressive Scan CMOS	1/2.8" Progressive Scan CMOS	1/2.8" Progressive Scan CMOS	1/2.8" Progressive Scan CMOS	1/3" Progressive Scan CMOS
Resolution	1920 × 1080	2688 × 1520	3200 × 1800	3840 × 2160	1920 × 1080	2688 × 1520
Video Compression	H.265/H.265+/H.264+/H.264 / MJPEG	H.265/H.265+/H.264+/H.264 / MJPEG	H.265/H.265+/H.264+/H.264 / MJPEG	H.265/H.265+/H.264+/H.264 / MJPEG	H.265/H.265+/H.264+/H.264 / MJPEG	H.265/H.265+/H.264+/H.264 / MJPEG
Min. Illumination	0.005 Lux @ (F1.6, AGC ON)	0.005 Lux @ (F1.6, AGC ON)	0.005 Lux @ (F1.6, AGC ON)	0.005 Lux @ (F1.6, AGC ON)	0.005 Lux @ (F1.6, AGC ON)	0.005 Lux @ (F1.6, AGC ON) 0.008 Lux @ (F2.25, AGC ON)
WDR	120dB	120dB	120dB	120dB	120dB	120dB
Lens	2.8mm, 4 mm	2.8mm, 4 mm	2.8mm, 4 mm	2.8mm, 4 mm	2.8mm, 4 mm	2.0mm, 2.8mm, 4 mm
FOV	2.8 mm, horizontal FOV 107°, vertical FOV 57°, diagonal FOV 127° 4 mm, horizontal FOV 87°, vertical FOV 46°, diagonal FOV 104°	2.8 mm, horizontal FOV 103°, vertical FOV 55°, diagonal FOV 122° 4 mm, horizontal FOV 84°, vertical FOV 45°, diagonal FOV 100°	2.8 mm, horizontal FOV 107.1°, vertical FOV 57°, diagonal FOV 127.6° 4 mm, horizontal FOV 87.2°, vertical FOV 46.2°, diagonal FOV 104.8°	2.8 mm, horizontal FOV 107.1°, vertical FOV 57°, diagonal FOV 127.6° 4 mm, horizontal FOV 87.2°, vertical FOV 46.2°, diagonal FOV 104.8°	2.8 mm, horizontal FOV 108.8°, vertical FOV 57.7°, diagonal FOV 129.4° 4 mm, horizontal FOV 87.6°, vertical FOV 44.4°, diagonal FOV 104.9°	2 mm, horizontal FOV 128.4°, vertical FOV 75.4°, diagonal FOV 147.1° 2.8 mm, horizontal FOV 104.3°, vertical FOV 55.9°, diagonal FOV 123.8° 4 mm, horizontal FOV 83.7°, vertical FOV 43°, diagonal FOV 100.3°
Max. IR Range	30 m	30 m	30 m	30 m	10 m	10 m
VCA	Line crossing detection, intrusion detection	Line crossing detection, intrusion detection	Line crossing detection, intrusion detection	Line crossing detection, intrusion detection	Line crossing detection, intrusion detection	Line crossing detection, intrusion detection
Frame Rate	50Hz: 25fps (1920 × 1080, 1280 × 720) 60Hz: 30fps (1920 × 1080, 1280 × 720)	50Hz: 25fps (2688 × 1520, 1920 × 1080, 1280 × 720) 60Hz: 30fps (2688 × 1520, 1920 × 1080, 1280 × 720)	50Hz: 20fps (3200 × 1800), 25fps (2688 × 1520, 1920 × 1080, 1280 × 720) 60Hz: 20fps (3200 × 1800), 30fps (2688 × 1520, 1920 × 1080, 1280 × 720)	50Hz: 20fps (3840 × 2160), 25fps (3200 × 1800, 2688 × 1520, 1920 × 1080, 1280 × 720) 60Hz: 20fps (3840 × 2160), 30fps (3200 × 1800, 2688 × 1520, 1920 × 1080, 1280 × 720)	50Hz: 25fps (1920 × 1080, 1280 × 720) 60Hz: 30fps (1920 × 1080, 1280 × 720)	50Hz: 25fps (2688 × 1520, 1920 × 1080, 1280 × 720) 60Hz: 30fps (2688 × 1520, 1920 × 1080, 1280 × 720)
Streams	3	3	3	3	3	3
Protection Level	IP67	IP67	IP67	IP67	-	-
Angle Adjustment	Pan: 0° to 360°, tilt: 0° to 75°, rotate: 0° to 360°	Pan: 0° to 360°, tilt: 0° to 75°, rotate: 0° to 360°	Pan: 0° to 360°, tilt: 0° to 75°, rotate: 0° to 360°	Pan: 0° to 360°, tilt: 0° to 75°, rotate: 0° to 360°	Pan: 0° to 360°, tilt: 0° to 90°, rotate: 0° to 360°	Pan: 0° to 360°, tilt: 0° to 90°, rotate: 0° to 360°
Operating Temperature	-30 °C to +60 °C (-22 °F to +140 °F)	-30 °C to +60 °C (-22 °F to +140 °F)	-30 °C to +60 °C (-22 °F to +140 °F)	-30 °C to +60 °C (-22 °F to +140 °F)	-10 °C to +40 °C (14 °F to +104 °F)	-10 °C to +40 °C (14 °F to +104 °F)
Humidity	95% or less (non-condensing)	95% or less (non-condensing)	95% or less (non-condensing)	95% or less (non-condensing)	95% or less (non-condensing)	95% or less (non-condensing)
Local Storage	256 GB	256 GB	256 GB	256 GB	256 GB	256 GB
Indoor/Outdoor	Outdoor	Outdoor	Outdoor	Outdoor	Indoor	Indoor
Audio I/O	Built-in microphone(-IU)	Built-in microphone(-IU)	Built-in microphone(-IU)	Built-in microphone(-IU)	1 built-in mic, 1 built-in speaker	1 built-in mic, 1 built-in speaker
Alarm I/O	-	-	-	-	-	-
Power	12 VDC ± 25%, PoE (802.3af, class 3)	12 VDC ± 25%, PoE (802.3af, class 3)	12 VDC ± 25%, PoE (802.3af, class 3)	12 VDC ± 25%, PoE (802.3af, class 3)	12 VDC ± 25%, PoE (802.3af, class 3)	12 VDC ± 25%, PoE (802.3af, class 3)

Model	DS-2CD246362-I	DS-2CD248362-I	DS-2CD252362-I(S)	DS-2CD254362-I(W)(S)	DS-2CD256362-I(S)	DS-2CD258362-I(S)
Image	 AcuSense	 AcuSense	 AcuSense	 AcuSense	 AcuSense	 AcuSense
Image Sensor	1/2.8" Progressive Scan CMOS	1/2.8" Progressive Scan CMOS	1/2.8" Progressive Scan CMOS	1/3" Progressive Scan CMOS	1/2.8" Progressive Scan CMOS	1/2.8" Progressive Scan CMOS
Resolution	3200 × 1800	3840 × 2160	1920 × 1080	2688 × 1520	3200 × 1800	3840 × 2160
Video Compression	H.265/H.265+/MJPEG	H.265/H.265+/ MJPEG	H.265/H.265+/H.264+/H.264 / MJPEG	H.265/H.265+/H.264+/H.264 / MJPEG	H.265/H.265+/H.264+/H.264 / MJPEG	H.265/H.265+/H.264+/H.264 / MJPEG
Min. Illumination	0.005 Lux @ (F1.6, AGC ON)	0.005 Lux @ (F1.6, AGC ON)	0.005 Lux @ (F1.6, AGC ON)	0.005 Lux @ (F1.6, AGC ON)	0.005 Lux @ (F1.6, AGC ON)	0.005 Lux @ (F1.6, AGC ON)
WDR	120dB	120dB	120dB	120dB	120dB	120dB
Lens	2.8mm, 4 mm	2.8mm, 4 mm	2.8mm, 4 mm	2.8mm, 4 mm	2.8mm, 4 mm	2.8mm, 4 mm
FOV	2.8 mm, horizontal FOV 107.8°, vertical FOV 57.9°, diagonal FOV 126.7° 4 mm, horizontal FOV 82.8°, vertical FOV 45.1°, diagonal FOV 98°	2.8 mm, horizontal FOV 107.8°, vertical FOV 57.9°, diagonal FOV 126.7° 4 mm, horizontal FOV 82.8°, vertical FOV 45.1°, diagonal FOV 98°	2.8 mm, horizontal FOV 107°, vertical FOV 57°, diagonal FOV 127° 4 mm, horizontal FOV 87°, vertical FOV 46°, diagonal FOV 104°	2.8 mm, horizontal FOV 103°, vertical FOV 55°, diagonal FOV 122° 4 mm, horizontal FOV 84°, vertical FOV 45°, diagonal FOV 100°	2.8 mm, horizontal FOV 107.1°, vertical FOV 57°, diagonal FOV 127.6° 4 mm, horizontal FOV 87.2°, vertical FOV 46.2°, diagonal FOV 104.8°	2.8 mm, horizontal FOV 107.1°, vertical FOV 57°, diagonal FOV 127.6° 4 mm, horizontal FOV 87.2°, vertical FOV 46.2°, diagonal FOV 104.8°
Max. IR Range	10 m	10 m	30 m	30 m	30 m	30 m
VCA	Line crossing detection, intrusion detection	Line crossing detection, intrusion detection	Line crossing detection, intrusion detection	Line crossing detection, intrusion detection	Line crossing detection, intrusion detection	Line crossing detection, intrusion detection
Frame Rate	50 Hz: 12.5 fps (3200 × 1800) 25 fps (2688 × 1520, 1920 × 1080, 1280 × 720) 60 Hz: 15 fps (3200 × 1800) 30 fps (2688 × 1520, 1920 × 1080, 1280 × 720)	50 Hz: 12.5 fps (3200 × 1800) 25 fps (2688 × 1520, 1920 × 1080, 1280 × 720) 60 Hz: 15 fps (3200 × 1800) 30 fps (2688 × 1520, 1920 × 1080, 1280 × 720)	50Hz: 25fps (1920 × 1080, 1280 × 720) 60Hz: 30fps (1920 × 1080, 1280 × 720)	50Hz: 25fps (2688 × 1520, 1920 × 1080, 1280 × 720) 60Hz: 30fps (2688 × 1520, 1920 × 1080, 1280 × 720)	50Hz: 20fps (3200 × 1800), 25fps (2688 × 1520, 1920 × 1080, 1280 × 720) 60Hz: 20fps (3200 × 1800), 30fps (2688 × 1520, 1920 × 1080, 1280 × 720)	50Hz: 20fps (3840 × 2160), 25fps (3200 × 1800, 2688 × 1520, 1920 × 1080, 1280 × 720) 60Hz: 20fps (3840 × 2160), 30fps (3200 × 1800, 2688 × 1520, 1920 × 1080, 1280 × 720)
Streams	3	3	3	3	3	3
Protection Level	-	-	IP67, IK08	IP67, IK08	IP67, IK08	IP67, IK08
Angle Adjustment	Pan: 0° to 360°, tilt: 0° to 90°, rotate: 0° to 360°	Pan: 0° to 360°, tilt: 0° to 90°, rotate: 0° to 360°	Pan: -30° to 30°, tilt: 0° to 75°, rotate: 0° to 360°	Pan: -30° to 30°, tilt: 0° to 75°, rotate: 0° to 360°	Pan: -30° to 30°, tilt: 0° to 75°, rotate: 0° to 360°	Pan: -30° to 30°, tilt: 0° to 75°, rotate: 0° to 360°
Operating Temperature	-10 °C to +40 °C (14 °F to +104 °F)	-10 °C to +40 °C (14 °F to +104 °F)	-30 °C to +60 °C (-22 °F to +140 °F)	-30 °C to +60 °C (-22 °F to +140 °F)	-30 °C to +60 °C (-22 °F to +140 °F)	-30 °C to +60 °C (-22 °F to +140 °F)
Humidity	95% or less (non-condensing)	95% or less (non-condensing)	95% or less (non-condensing)	95% or less (non-condensing)	95% or less (non-condensing)	95% or less (non-condensing)
Local Storage	256 GB	256 GB	256 GB	256 GB	256 GB	256 GB
Indoor/Outdoor	Indoor	Indoor	Outdoor	Outdoor	Outdoor	Outdoor
Audio I/O	1 built-in mic, 1 built-in speaker	1 built-in mic, 1 built-in speaker	1 In, 1 Out(-S) Built-in microphone	1 In, 1 Out(-S) Built-in microphone	1 In, 1 Out(-S) Built-in microphone	1 In, 1 Out(-S) Built-in microphone
Alarm I/O	-	-	1 In, 1 Out(-S)	1 In, 1 Out(-S)	1 In, 1 Out(-S)	1 In, 1 Out(-S)
Power	12 VDC ± 25%, PoE (802.3af, class 3)	12 VDC ± 25%, PoE (802.3af, class 3)	12 VDC ± 25%, PoE (802.3af, class 3)	12 VDC ± 25%, PoE (802.3af, class 3)	12 VDC ± 25%, PoE (802.3af, class 3)	12 VDC ± 25%, PoE (802.3af, class 3)

Model	DS-2CD262362-IZS	DS-2CD264362-IZS	DS-2CD266362-IZS	DS-2CD268362-IZS	DS-2CD272362-IZS	DS-2CD274362-IZS
Image	 AcuSense	 AcuSense	 AcuSense	 AcuSense	 AcuSense	 AcuSense
Image Sensor	1/2.8" Progressive Scan CMOS	1/3" Progressive Scan CMOS	1/2.8" Progressive Scan CMOS	1/2.8" Progressive Scan CMOS	1/2.8" Progressive Scan CMOS	1/3" Progressive Scan CMOS
Resolution	1920 × 1080	2688 × 1520	3200 × 1800	3840 × 2160	1920 × 1080	2688 × 1520
Video Compression	H.265/H.265+/H.264+/H.264 / MJPEG	H.265/H.265+/H.264+/H.264 / MJPEG	H.265/H.265+/H.264+/H.264 / MJPEG	H.265/H.265+/H.264+/H.264 / MJPEG	H.265/H.265+/H.264+/H.264 / MJPEG	H.265/H.265+/H.264+/H.264 / MJPEG
Min. Illumination	0.005 Lux @ (F1.6, AGC ON)	0.005 Lux @ (F1.6, AGC ON)	0.005 Lux @ (F1.6, AGC ON)	0.005 Lux @ (F1.6, AGC ON)	0.005 Lux @ (F1.6, AGC ON)	0.005 Lux @ (F1.6, AGC ON)
WDR	120dB	120dB	120dB	120dB	120dB	120dB
Lens	2.8 to 12 mm	2.8 to 12 mm	2.8 to 12 mm	2.8 to 12 mm	2.8 to 12 mm	2.8 to 12 mm
FOV	horizontal FOV 106.6° to 31.7°, vertical FOV 54.7° to 17.7°, diagonal FOV 130.3° to 36.4°	horizontal FOV 95.8° to 29.2°, vertical FOV 50.6° to 16.4°, diagonal FOV 114.6° to 33.4°	horizontal FOV 105.9° to 31.6°, vertical FOV 55° to 17.8°, diagonal FOV 129.1° to 36.2°	horizontal FOV 108° to 30.3°, vertical FOV 56.3° to 17.1°, diagonal FOV 130.8° to 34.8°	horizontal FOV 106.6° to 31.7°, vertical FOV 54.7° to 17.7°, diagonal FOV 130.3° to 36.4°	horizontal FOV 95.8° to 29.2°, vertical FOV 50.6° to 16.4°, diagonal FOV 114.6° to 33.4°
Max. IR Range	60 m	60 m	60 m	60 m	40 m	40 m
VCA	Line crossing detection, intrusion detection	Line crossing detection, intrusion detection	Line crossing detection, intrusion detection	Line crossing detection, intrusion detection	Line crossing detection, intrusion detection	Line crossing detection, intrusion detection
Frame Rate	50Hz: 25fps (1920 × 1080, 1280 × 720) 60Hz: 30fps (1920 × 1080, 1280 × 720)	50Hz: 25fps (2688 × 1520, 1920 × 1080, 1280 × 720) 60Hz: 30fps (2688 × 1520, 1920 × 1080, 1280 × 720)	50Hz: 20fps (3200 × 1800), 25fps (2688 × 1520, 1920 × 1080, 1280 × 720) 60Hz: 20fps (3200 × 1800), 30fps (2688 × 1520, 1920 × 1080, 1280 × 720)	50Hz: 20fps (3840 × 2160), 25fps (3200 × 1800, 2688 × 1520, 1920 × 1080, 1280 × 720) 60Hz: 20fps (3840 × 2160), 30fps (3200 × 1800, 2688 × 1520, 1920 × 1080, 1280 × 720)	50Hz: 25fps (1920 × 1080, 1280 × 720) 60Hz: 30fps (1920 × 1080, 1280 × 720)	50Hz: 25fps (2688 × 1520, 1920 × 1080, 1280 × 720) 60Hz: 30fps (2688 × 1520, 1920 × 1080, 1280 × 720)
Streams	3	3	3	3	3	3
Protection Level	IP67, IK10	IP67, IK10	IP67, IK10	IP67, IK10	IP67, IK10	IP67, IK10
Angle Adjustment	Pan: 0° to 360°, tilt: 0° to 90°, rotate: 0° to 360°	Pan: 0° to 360°, tilt: 0° to 90°, rotate: 0° to 360°	Pan: 0° to 360°, tilt: 0° to 90°, rotate: 0° to 360°	Pan: 0° to 360°, tilt: 0° to 90°, rotate: 0° to 360°	Pan: 0° to 355°, tilt: 0° to 75°, rotate: 0° to 355°	Pan: 0° to 355°, tilt: 0° to 75°, rotate: 0° to 355°
Operating Temperature	-30 °C to +60 °C (-22 °F to +140 °F)	-30 °C to +60 °C (-22 °F to +140 °F)	-30 °C to +60 °C (-22 °F to +140 °F)	-30 °C to +60 °C (-22 °F to +140 °F)	-30 °C to +60 °C (-22 °F to +140 °F)	-30 °C to +60 °C (-22 °F to +140 °F)
Humidity	95% or less (non-condensing)	95% or less (non-condensing)	95% or less (non-condensing)	95% or less (non-condensing)	95% or less (non-condensing)	95% or less (non-condensing)
Local Storage	256 GB	256 GB	256 GB	256 GB	256 GB	256 GB
Indoor/Outdoor	Outdoor	Outdoor	Outdoor	Outdoor	Outdoor	Outdoor
Audio I/O	1 In, 1 Out	1 In, 1 Out	1 In, 1 Out	1 In, 1 Out	1 In, 1 Out	1 In, 1 Out
Alarm I/O	1 In, 1 Out	1 In, 1 Out	1 In, 1 Out	1 In, 1 Out	1 In, 1 Out	1 In, 1 Out
Power	12 VDC ± 25%, PoE (802.3at, class 4)	12 VDC ± 25%, PoE (802.3at, class 4)	12 VDC ± 25%, PoE (802.3at, class 4)	12 VDC ± 25%, PoE (802.3at, class 4)	12 VDC ± 25%, PoE (802.3af, class 3)	12 VDC ± 25%, PoE (802.3af, class 3)

Model	DS-2CD276362-IZS	DS-2CD278362-IZS	DS-2CD2E2362-U	DS-2CD2E4362-U	DS-2CD2H2362-IZS	DS-2CD2H4362-IZS
Image	 AcuSense	 AcuSense	 AcuSense	 AcuSense	 AcuSense	 AcuSense
Image Sensor	1/2.8" Progressive Scan CMOS	1/2.8" Progressive Scan CMOS	1/2.8" Progressive Scan CMOS	1/3" Progressive Scan CMOS	1/2.8" Progressive Scan CMOS	1/3" Progressive Scan CMOS
Resolution	3200 × 1800	3840 × 2160	1920 × 1080	2688 × 1520	1920 × 1080	2688 × 1520
Video Compression	H.265/H.265+/H.264+/H.264 / MJPEG	H.265/H.265+/H.264+/H.264 / MJPEG	H.265/H.265+/H.264+/H.264 / MJPEG	H.265/H.265+/H.264+/H.264 / MJPEG	H.265/H.265+/H.264+/H.264 / MJPEG	H.265/H.265+/H.264+/H.264 / MJPEG
Min. Illumination	0.005 Lux @ (F1.6, AGC ON)	0.005 Lux @ (F1.6, AGC ON)	0.005 Lux @ (F1.6, AGC ON)	0.005 Lux @ (F1.6, AGC ON)	0.005 Lux @ (F1.6, AGC ON)	0.005 Lux @ (F1.6, AGC ON)
WDR	120dB	120dB	120dB	120dB	120dB	120dB
Lens	2.8 to 12 mm	2.8 to 12 mm	2.8mm, 4 mm	2.8mm, 4 mm	2.8 to 12 mm	2.8 to 12 mm
FOV	horizontal FOV 105.9° to 31.6°, vertical FOV 55° to 17.8°, diagonal FOV 129.1° to 36.2°	horizontal FOV 108° to 30.3°, vertical FOV 56.3° to 17.1°, diagonal FOV 130.8° to 34.8°	2.8 mm, horizontal FOV 107°, vertical FOV 57°, diagonal FOV 128° 4 mm, horizontal FOV 88°, vertical FOV 44°, diagonal FOV 105°	2.8 mm, horizontal FOV 103°, vertical FOV 55°, diagonal FOV 122° 4 mm, horizontal FOV 84°, vertical FOV 43°, diagonal FOV 100°	horizontal FOV 106.6° to 31.7°, vertical FOV 54.7° to 17.7°, diagonal FOV 130.3° to 36.4°	horizontal FOV 95.8° to 29.2°, vertical FOV 50.6° to 16.4°, diagonal FOV 114.6° to 33.4°
Max. IR Range	40 m	40 m	-	-	40 m	40 m
VCA	Line crossing detection, intrusion detection	Line crossing detection, intrusion detection	Line crossing detection, intrusion detection	Line crossing detection, intrusion detection	Line crossing detection, intrusion detection	Line crossing detection, intrusion detection
Frame Rate	50Hz: 20fps (3200 × 1800), 25fps (2688 × 1520, 1920 × 1080, 1280 × 720) 60Hz: 20fps (3200 × 1800), 30fps (2688 × 1520, 1920 × 1080, 1280 × 720)	50Hz: 20fps (3840 × 2160), 25fps (3200 × 1800, 2688 × 1520, 1920 × 1080, 1280 × 720) 60Hz: 20fps (3840 × 2160), 30fps (3200 × 1800, 2688 × 1520, 1920 × 1080, 1280 × 720)	50Hz: 25fps (1920 × 1080, 1280 × 720) 60Hz: 30fps (1920 × 1080, 1280 × 720)	50Hz: 25fps (2688 × 1520, 1920 × 1080, 1280 × 720) 60Hz: 30fps (2688 × 1520, 1920 × 1080, 1280 × 720)	50Hz: 25fps (1920 × 1080, 1280 × 720) 60Hz: 30fps (1920 × 1080, 1280 × 720)	50Hz: 25fps (2688 × 1520, 1920 × 1080, 1280 × 720) 60Hz: 30fps (2688 × 1520, 1920 × 1080, 1280 × 720)
Streams	3	3	3	3	3	3
Protection Level	IP67, IK10	IP67, IK10	-	-	IP67, IK10	IP67, IK10
Angle Adjustment	Pan: 0° to 355°, tilt: 0° to 75°, rotate: 0° to 355°	Pan: 0° to 355°, tilt: 0° to 75°, rotate: 0° to 355°	Tilt: 0° to 75°	Tilt: 0° to 75°	Pan: 0° to 360°, tilt: 0° to 75°, rotate: 0° to 360°	Pan: 0° to 360°, tilt: 0° to 75°, rotate: 0° to 360°
Operating Temperature	-30 °C to +60 °C [-22 °F to +140 °F]	-30 °C to +60 °C [-22 °F to +140 °F]	-10 °C to +40 °C [14 °F to +104 °F]	-10 °C to +40 °C [14 °F to +104 °F]	-30 °C to +60 °C [-22 °F to +140 °F]	-30 °C to +60 °C [-22 °F to +140 °F]
Humidity	95% or less (non-condensing)	95% or less (non-condensing)	95% or less (non-condensing)	95% or less (non-condensing)	95% or less (non-condensing)	95% or less (non-condensing)
Local Storage	256 GB	256 GB	256 GB	256 GB	256 GB	256 GB
Indoor/Outdoor	Outdoor	Outdoor	Indoor	Indoor	Outdoor	Outdoor
Audio I/O	1 In, 1 Out	1 In, 1 Out	Built-in microphone	Built-in microphone	1 In, 1 Out	1 In, 1 Out
Alarm I/O	1 In, 1 Out	1 In, 1 Out	-	-	1 In, 1 Out	1 In, 1 Out
Power	12 VDC ± 25%, PoE (802.3af, class 3)	12 VDC ± 25%, PoE (802.3af, class 3)	12 VDC ± 25%, PoE (802.3af, class 3)	12 VDC ± 25%, PoE (802.3af, class 3)	12 VDC ± 25%, PoE (802.3af, class 3)	12 VDC ± 25%, PoE (802.3af, class 3)

HOT

Model	DS-2CD2H6362-IZS	DS-2CD2H8362-IZS	DS-2CD2T2362-2I/4I	DS-2CD2T4362-2I/4I	DS-2CD2T6362-2I/4I	DS-2CD2T8362-2I/4I
Image	 AcuSense	 AcuSense	 AcuSense	 AcuSense	 AcuSense	 AcuSense
Image Sensor	1/2.8" Progressive Scan CMOS	1/2.8" Progressive Scan CMOS	1/2.8" Progressive Scan CMOS	1/3" Progressive Scan CMOS	1/2.8" Progressive Scan CMOS	1/2.8" Progressive Scan CMOS
Resolution	3200 × 1800	3840 × 2160	1920 × 1080	2688 × 1520	3200 × 1800	3840 × 2160
Video Compression	H.265/H.265+/H.264+/H.264 / MJPEG	H.265/H.265+/H.264+/H.264 / MJPEG	H.265/H.265+/H.264+/H.264 / MJPEG	H.265/H.265+/H.264+/H.264 / MJPEG	H.265/H.265+/H.264+/H.264 / MJPEG	H.265/H.265+/H.264+/H.264 / MJPEG
Min. Illumination	0.005 Lux @ (F1.6, AGC ON)	0.005 Lux @ (F1.6, AGC ON)	0.005 Lux @ (F1.6, AGC ON)	0.005 Lux @ (F1.6, AGC ON)	0.005 Lux @ (F1.6, AGC ON)	0.005 Lux @ (F1.6, AGC ON)
WDR	120dB	120dB	120dB	120dB	120dB	120dB
Lens	2.8 to 12 mm	2.8 to 12 mm	2.8mm, 4 mm, 6 mm	2.8mm, 4 mm, 6 mm	2.8mm, 4 mm, 6 mm	2.8mm, 4 mm, 6 mm
FOV	horizontal FOV 105.9° to 31.6°, vertical FOV 55° to 17.8°, diagonal FOV 129.1° to 36.2°	horizontal FOV 108° to 30.3°, vertical FOV 56.3° to 17.1°, diagonal FOV 130.8° to 34.8°	2.8 mm, horizontal FOV 107°, vertical FOV 57°, diagonal FOV 127° 4 mm, horizontal FOV 87°, vertical FOV 46°, diagonal FOV 104° 6 mm, horizontal FOV 54°, vertical FOV 29°, diagonal FOV 63°	2.8 mm, horizontal FOV 103°, vertical FOV 55°, diagonal FOV 122° 4 mm, horizontal FOV 84°, vertical FOV 45°, diagonal FOV 100° 6 mm, horizontal FOV 52°, vertical FOV 28°, diagonal FOV 61°	2.8 mm, horizontal FOV 107.1°, vertical FOV 57°, diagonal FOV 127.6° 4 mm, horizontal FOV 87.2°, vertical FOV 46.2°, diagonal FOV 104.8° 6 mm, horizontal FOV 53.9°, vertical FOV 28.8°, diagonal FOV 62.8°	2.8 mm, horizontal FOV 107.1°, vertical FOV 57°, diagonal FOV 127.6° 4 mm, horizontal FOV 87.2°, vertical FOV 46.2°, diagonal FOV 104.8° 6 mm, horizontal FOV 53.9°, vertical FOV 28.8°, diagonal FOV 62.8°
Max. IR Range	40 m	40 m	-2l: 60 m -4l: 80 m	-2l: 60 m -4l: 80 m	-2l: 60 m -4l: 80 m	-2l: 60 m -4l: 80 m
VCA	Line crossing detection, intrusion detection	Line crossing detection, intrusion detection	Line crossing detection, intrusion detection	Line crossing detection, intrusion detection	Line crossing detection, intrusion detection	Line crossing detection, intrusion detection
Frame Rate	50Hz: 20fps (3200 × 1800) , 25fps (2688 × 1520, 1920 × 1080, 1280 × 720) 60Hz: 20fps (3200 × 1800) , 30fps (2688 × 1520, 1920 × 1080, 1280 × 720)	50Hz: 20fps (3840 × 2160) , 25fps (3200 × 1800, 2688 × 1520, 1920 × 1080, 1280 × 720) 60Hz: 20fps (3840 × 2160) , 30fps (3200 × 1800, 2688 × 1520, 1920 × 1080, 1280 × 720)	50Hz: 25fps (1920 × 1080, 1280 × 720) 60Hz: 30fps (1920 × 1080, 1280 × 720)	50Hz: 25fps (2688 × 1520, 1920 × 1080, 1280 × 720) 60Hz: 30fps (2688 × 1520, 1920 × 1080, 1280 × 720)	50Hz: 20fps (3200 × 1800) , 25fps (2688 × 1520, 1920 × 1080, 1280 × 720) 60Hz: 20fps (3200 × 1800) , 30fps (2688 × 1520, 1920 × 1080, 1280 × 720)	50Hz: 20fps (3840 × 2160) , 25fps (3200 × 1800, 2688 × 1520, 1920 × 1080, 1280 × 720) 60Hz: 20fps (3840 × 2160) , 30fps (3200 × 1800, 2688 × 1520, 1920 × 1080, 1280 × 720)
Streams	3	3	3	3	3	3
Protection Level	IP67, IK10	IP67, IK10	IP67	IP67	IP67	IP67
Angle Adjustment	Pan: 0° to 360°, tilt: 0° to 75°, rotate: 0° to 360°	Pan: 0° to 360°, tilt: 0° to 75°, rotate: 0° to 360°	Pan: 0° to 360°, tilt: 0° to 90°, rotate: 0° to 360°	Pan: 0° to 360°, tilt: 0° to 90°, rotate: 0° to 360°	Pan: 0° to 360°, tilt: 0° to 90°, rotate: 0° to 360°	Pan: 0° to 360°, tilt: 0° to 90°, rotate: 0° to 360°
Operating Temperature	-30 °C to +60 °C (-22 °F to +140 °F)	-30 °C to +60 °C (-22 °F to +140 °F)	-30 °C to +60 °C (-22 °F to +140 °F)	-30 °C to +60 °C (-22 °F to +140 °F)	-30 °C to +60 °C (-22 °F to +140 °F)	-30 °C to +60 °C (-22 °F to +140 °F)
Humidity	95% or less (non-condensing)	95% or less (non-condensing)	95% or less (non-condensing)	95% or less (non-condensing)	95% or less (non-condensing)	95% or less (non-condensing)
Local Storage	256 GB	256 GB	256 GB	256 GB	256 GB	256 GB
Indoor/Outdoor	Outdoor	Outdoor	Outdoor	Outdoor	Outdoor	Outdoor
Audio I/O	1 In, 1 Out	1 In, 1 Out	-	-	-	-
Alarm I/O	1 In, 1 Out	1 In, 1 Out	-	-	-	-
Power	12 VDC ± 25%, PoE (802.3af, class 3)	12 VDC ± 25%, PoE (802.3af, class 3)	12 VDC ± 25%, PoE (802.3af, class 3)	12 VDC ± 25%, PoE (802.3af, class 3)	12 VDC ± 25%, PoE (802.3af, class 3)	12 VDC ± 25%, PoE (802.3af, class 3)

EasyIP 2.0 Plus Series

Model	DS-2CD2423G0-IW	DS-2CD2443G0-IW
Image		
Image Sensor	1/2.7" Progressive Scan CMOS	1/3" Progressive Scan CMOS
Resolution	1920 × 1080	2688 × 1520
Video Compression	H.265/H.264/MJPEG/H.264+/H.265+	H.265/H.264/MJPEG/H.264+/H.265+
Min. Illumination	Color:0.028 lux @(F2.0, AGC ON)	Color:0.018 lux @(F1.6, AGC ON)
WDR	120dB	120dB
Lens	2.8mm, 4 mm	2.8mm, 4 mm
FOV	2.8 mm: horizontal FOV: 114°, vertical FOV: 62°, diagonal FOV: 135° 4 mm: horizontal FOV: 86°, vertical FOV: 46°, diagonal FOV: 102°	2.8 mm: horizontal FOV: 98°, vertical FOV: 55°, diagonal FOV: 114° 4 mm: horizontal FOV: 78°, vertical FOV: 42°, diagonal FOV: 93°
Max. IR Range	10 m	10 m
VCA	Line crossing detection, intrusion detection, face detection	Line crossing detection, intrusion detection, face detection
Frame Rate	50Hz: 25fps (1920 × 1080, 1280 × 960, 1280 × 720) 60Hz: 30fps (1920 × 1080, 1280 × 960, 1280 × 720)	50Hz: 25fps (2688 × 1520, 2560 × 1440, 2304 × 1296, 1920 × 1080) 60Hz: 30fps (2688 × 1520, 2560 × 1440, 2304 × 1296, 1920 × 1080)
Streams	3	3
Protection Level	-	-
Angle Adjustment	Pan: 0° to 360°, tilt: 0° to 90°, rotate: 0° to 360°	Pan: 0° to 360°, tilt: 0° to 90°, rotate: 0° to 360°
Operating Temperature	-10 °C to +40 °C (14 °F to +104 °F)	-10 °C to +40 °C (14 °F to +104 °F)
Humidity	95% or less (non-condensing)	95% or less (non-condensing)
Local Storage	128GB	128GB
Indoor/Outdoor	Indoor	Indoor
Audio I/O	1 built-in mic, 1 built-in speaker	1 built-in mic, 1 built-in speaker
Alarm I/O	-	-
Power	12 VDC ± 25%, PoE (802.3af, class 3)	12 VDC ± 25%, PoE (802.3af, class 3)

EasyIP 1.0 Plus Series

Model	DS-2CD2021G1-I	DS-2CD2121G0-I(S)
Image		
Image Sensor	1/2.8" Progressive Scan CMOS	1/2.8" Progressive Scan CMOS
Resolution	1920 × 1080	1920 × 1080
Video Compression	H.265/H.264/MJPEG/H.264+/H.265+	H.265/H.264/MJPEG/H.264+/H.265+
Min. Illumination	Color:0.028 Lux @(F1.6, AGC ON)	Color:0.028Lux @(F1.6, AGC ON)
WDR	120dB	120dB
Lens	2.8mm, 4mm, 6mm	2.8mm, 4mm, 6mm
FOV	2.8 mm: horizontal FOV: 114°, vertical FOV: 62°, diagonal FOV: 136° 4 mm: horizontal field of view: 86°, vertical FOV: 46°, diagonal FOV: 102° 6 mm: horizontal field of view: 54.5°, vertical FOV: 31.3°, diagonal FOV: 62.3°	2.8 mm: horizontal FOV: 115°, vertical FOV: 62°, diagonal FOV: 136° 4 mm: horizontal FOV: 86°, vertical FOV: 47°, diagonal FOV: 103° 6 mm: horizontal FOV: 55°, vertical FOV: 31°, diagonal FOV: 62°
Max. IR Range	30 m	30 m
VCA	Line crossing detection, intrusion detection	Line crossing detection, intrusion detection
Frame Rate	50Hz: 25fps (1920 × 1080, 1280 × 960, 1280 × 720) 60Hz: 30fps (1920 × 1080, 1280 × 960, 1280 × 720)	50Hz: 25fps (1920 × 1080, 1280 × 960, 1280 × 720) 60Hz: 30fps (1920 × 1080, 1280 × 960, 1280 × 720)
Streams	2	2
Protection Level	IP67	IP67 and IK10
Angle Adjustment	Pan: 0° to 360°, tilt: 0° to 90°, rotate: 0° to 360°	Pan: 0° to 355°, tilt: 0° to 70°, rotate: 0° to 355°
Operating Temperature	-30 °C to +60 °C (-22 °F to +140 °F)	-30 °C to +60 °C (-22 °F to +140 °F)
Humidity	95% or less (non-condensing)	95% or less (non-condensing)
Local Storage	128GB	128GB
Indoor/Outdoor	Outdoor	Outdoor
Audio I/O	-	1 in ,1 out (-S model)
Alarm I/O	-	1 in ,1 out (-S model)
Power	12 VDC ± 25%, PoE: 802.3af, class 3	12 VDC ± 25%, PoE (802.3af, class 3)

Model	DS-2CD232160-I/NF	DS-2CD262160-IZ(S)	DS-2CD272160-IZ(S)	DS-2CD282160	DS-2CD242160-I	DS-2CD244160-I
Image						 NEW
Image Sensor	1/2.8" Progressive Scan CMOS	1/2.8" Progressive Scan CMOS	1/2.8" Progressive Scan CMOS	1/2.7" Progressive Scan CMOS	1/2.8" Progressive Scan CMOS	1/3" Progressive Scan CMOS
Resolution	1920 × 1080	1920 × 1080	1920 × 1080	1920 × 1080	1920 × 1080	2560 × 1440
Video Compression	H.265/H.264/MJPEG/H.264+/H.265+	H.265/H.264/MJPEG/H.264+/H.265+	H.265/H.264/MJPEG/H.264+/H.265+	H.265/H.265+/H.264+/H.264 / MJPEG	H.265/H.265+/H.264+/H.264 / MJPEG	H.265/H.265+/H.264+/H.264 / MJPEG
Min. Illumination	Color:0.028Lux @(F1.6, AGC ON)	Color:0.028Lux @(F1.6, AGC ON)	Color:0.028Lux @(F1.6, AGC ON)	0.005 Lux @(F1.6, AGC ON)	0.028 Lux @ (F1.6, AGC ON)	0.028 Lux @ (F1.6, AGC ON)
WDR	120dB	120dB	120dB	120dB	DWDR	120dB
Lens	2.8mm, 4mm, 6mm	2.8 to 12 mm	2.8 to 12 mm	-	2 mm, 2.8 mm, 4 mm	2 mm, 2.8 mm, 4 mm
FOV	2.8 mm: horizontal FOV: 103°, vertical FOV: 62°, diagonal FOV: 118° 4 mm: horizontal FOV: 90°, vertical FOV: 48°, diagonal FOV: 109° 6 mm: horizontal FOV: 55°, vertical FOV: 31°, diagonal FOV: 62°	Horizontal FOV: 99.6° to 35°, vertical FOV: 53.5° to 20°, diagonal FOV: 118.6° to 40.2°	Horizontal FOV: 99.6° to 35°, vertical FOV: 53.5° to 20°, diagonal FOV: 118.6° to 40.2°	-	2 mm: horizontal FOV: 132°, vertical FOV: 77°, diagonal FOV: 153° 2.8 mm: horizontal FOV: 107°, vertical FOV: 57°, diagonal FOV: 126° 4 mm: horizontal FOV: 85°, vertical FOV: 45°, diagonal FOV: 101°	2 mm: horizontal FOV: 122.6°, vertical FOV: 71.7°, diagonal FOV: 139.9° 2.8 mm: horizontal FOV: 98.6°, vertical FOV: 52.8°, diagonal FOV: 116.2° 4 mm: horizontal FOV: 78°, vertical FOV: 42.7°, diagonal FOV: 90.7°
Max. IR Range	30 m	30 m	30 m	-	10 m	10m
VCA	Line crossing detection, intrusion detection	Line crossing detection, intrusion detection	Line crossing detection, intrusion detection	Line crossing detection, intrusion detection	-	-
Frame Rate	50Hz: 25fps (1920 × 1080, 1280 × 960, 1280 × 720) 60Hz: 30fps (1920 × 1080, 1280 × 960, 1280 × 720)	50Hz: 25fps (1920 × 1080, 1280 × 960, 1280 × 720) 60Hz: 30fps (1920 × 1080, 1280 × 960, 1280 × 720)	50Hz: 25fps (1920 × 1080, 1280 × 960, 1280 × 720) 60Hz: 30fps (1920 × 1080, 1280 × 960, 1280 × 720)	50Hz: 25fps (1920 × 1080, 1280 × 960, 1280 × 720) 60Hz: 30fps (1920 × 1080, 1280 × 960, 1280 × 720)	50Hz: 25fps (1920 × 1080, 1280 × 720) 60Hz: 30fps (1920 × 1080, 1280 × 720)	50Hz: 15fps (2560 × 1440) 25fps (1920 × 1080, 1280 × 720) 60Hz: 15fps (2560 × 1440) 30fps (1920 × 1080, 1280 × 720)
Streams	2	2	2	2	2	2
Protection Level	IP67	IP67	IP67,IK10	-	-	-
Angle Adjustment	Pan: 0° to 360°, tilt: 0° to 75°, rotate: 0° to 360°	Pan: 0° to 360°, tilt: 0° to 100°, rotation: 0° to 360°	Pan: 0° to 355°, tilt: 0° to 75°, rotation: 0° to 355°	-	Pan: 0° to 360°, Tilt: 0° to 90°, Rotate: 0° to 360°	Pan: 0° to 360°, Tilt: 0° to 90°, Rotate: 0° to 360°
Operating Temperature	-30 °C to +60 °C [-22 °F to +140 °F]	-30 °C to +60 °C [22 °F to +140 °F]	-30 °C to +60 °C [22 °F to +140 °F]	-10 °C to +50 °C [14 °F to +122 °F]	-10 °C to 40°C [14 °F to 104 °F]	-10 °C to 40°C [14 °F to 104 °F]
Humidity	95% or less (non-condensing)	95% or less (non-condensing)	95% or less (non-condensing)	95% or less (non-condensing)	95% or less (non-condensing)	95% or less (non-condensing)
Local Storage	-	128GB	128GB	128GB	256GB	256GB
Indoor/Outdoor	Outdoor	Outdoor	Outdoor	indoor	indoor	indoor
Audio I/O	-	1 In, 1 Out	1 In, 1 Out	1 In, 1 Out	1 built-in mic, 1 built-in speaker	1 In, 1 Out
Alarm I/O	-	2 In, 2 Out	2 In, 2 Out	1 In, 1 Out	-	-
Power	12 VDC ± 25%, PoE (802.3af, class 3)	12 VDC ± 25%, PoE (802.3af, class 3)	12 VDC ± 25%, PoE (802.3af, class 3)	12VDC/24VAC/PoE(802.3af)	12 VDC ± 25%, PoE (802.3af, class 3)	12 VDC ± 25%, PoE (802.3af, class 3)

Network Cameras

Value Series

Cut Down on Costs, Not Performance

1-Series:







- > High quality imaging with up to 8 MP resolution
- > Easy to install, set up, and manage
- > Multiple functions such as built-in mic, ColorVu technology, and more meet a variety of needs
- > Person and vehicle detection based on deep-learning technology (Motion Detection 2.0)
*Vehicle detection will be available with future firmware upgrades
- > Smart Hybrid Light technology: White light on when a person is detected, IR on otherwise













- > Remote control via Hik-Connect app enables flexible viewing angles anytime, from anywhere







Wi-Fi Series:





- > Easy to install
- > 2 antennas provide stable and high quality images
- > ColorVu models support 24/7 colorful images, with person and vehicle classification
- > AcuSense models also support person and vehicle classification



















Model	DS-2CD102762-L	DS-2CD102762-LUF	DS-2CD104762-L	DS-2CD104762-LUF	DS-2CD106762-L	DS-2CD106762-LUF
Image	 ColorVu	 ColorVu	 ColorVu	 ColorVu	 ColorVu	 ColorVu
Image Sensor	1/2.8" Progressive Scan CMOS	1/2.8" Progressive Scan CMOS	1/3" Progressive Scan CMOS	1/3" Progressive Scan CMOS	1/2.5" Progressive Scan CMOS	1/2.5" Progressive Scan CMOS
Resolution	1920 × 1080	1920 × 1080	2560 × 1440	2560 × 1440	3200*1800	3200*1800
Video Compression	H.265/H.264/MJPEG/H.265+/H.264+	H.265/H.264/MJPEG/H.265+/H.264+	H.265/H.264/MJPEG/H.265+/H.264+	H.265/H.264/MJPEG/H.265+/H.264+	H.265/H.264/MJPEG/H.265+/H.264+	H.265/H.264/MJPEG/H.265+/H.264+
Min. Illumination	Color: 0.001Lux @ (F1.0, AGC ON)	Color: 0.001Lux @ (F1.0, AGC ON)	Color: 0.001Lux @ (F1.0, AGC ON)	Color: 0.001Lux @ (F1.0, AGC ON)	Color: 0.001Lux @ (F2.0, AGC ON)	Color: 0.001Lux @ (F2.0, AGC ON)
WDR	DWDR	DWDR	120 dB	120 dB	120 dB	120 dB
Lens	2.8 mm, 4 mm	2.8 mm, 4 mm	2.8 mm, 4 mm	2.8 mm, 4 mm	2.8 mm, 4 mm	2.8 mm, 4 mm
FOV	2.8mm, horizontal FOV 107°, vertical FOV 56°, diagonal FOV 127° 4mm, horizontal FOV 84°, vertical FOV 45°, diagonal FOV 99°	2.8mm, horizontal FOV 107°, vertical FOV 56°, diagonal FOV 127° 4mm, horizontal FOV 84°, vertical FOV 45°, diagonal FOV 99°	2.8 mm, horizontal FOV 96.5°, vertical FOV 50.8°, diagonal FOV 113.9° 4 mm, horizontal FOV 75.8°, vertical FOV 40.8°, diagonal FOV 89.1°	2.8 mm, horizontal FOV 96.5°, vertical FOV 50.8°, diagonal FOV 113.9° 4 mm, horizontal FOV 75.8°, vertical FOV 40.8°, diagonal FOV 89.1°	2.8 mm, horizontal FOV 96°, vertical FOV 54°, diagonal FOV 112° 4 mm, horizontal FOV 68°, vertical FOV 38°, diagonal FOV 79°	2.8 mm, horizontal FOV 96°, vertical FOV 54°, diagonal FOV 112° 4 mm, horizontal FOV 68°, vertical FOV 38°, diagonal FOV 79°
Optical Zoom	-	-	-	-	-	-
Max. Light Range	30 m	30 m	30 m	30 m	30 m	30 m
VCA	Motion Detection 2.0	Motion Detection 2.0	Motion Detection 2.0	Motion Detection 2.0	Motion Detection2.0	Motion Detection2.0
Frame Rate	50 Hz: 25fps (1920 × 1080, 1280 × 960, 1280 × 720) 60 Hz: 30fps (1920 × 1080, 1280 × 960, 1280 × 720)	50Hz: 25fps (1920 × 1080, 1280 × 960, 1280 × 720) 60Hz: 30fps (1920 × 1080, 1280 × 960, 1280 × 720)	50 Hz: 20 fps (2560 × 1440), 25 fps (1920 × 1080, 1280 × 720) 60 Hz: 20 fps (2560 × 1440), 30 fps (1920 × 1080, 1280 × 720)	50 Hz: 20 fps (2560 × 1440), 25 fps (1920 × 1080, 1280 × 720) 60 Hz: 20 fps (2560 × 1440), 30 fps (1920 × 1080, 1280 × 720)	50 Hz: 20 fps (3200*1800, 2560 × 1440, 1920 × 1080, 1280 × 720) 60 Hz: 25 fps (3200*1800, 2560 × 1440, 1920 × 1080, 1280 × 720)	50 Hz: 20 fps (3200*1800, 2560 × 1440, 1920 × 1080, 1280 × 720) 60 Hz: 25 fps (3200*1800, 2560 × 1440, 1920 × 1080, 1280 × 720)
Streams	2	2	2	2	2	2
Protection Level	IP67	IP67	IP67	IP67	IP67	IP67
Angle Adjustment	Pan: 0° to 360°, tilt: 0° to 90°, rotate: 0° to 360°	Pan: 0° to 360°, tilt: 0° to 90°, rotate: 0° to 360°	Pan: 0° to 360°, tilt: 0° to 90°, rotate: 0° to 360°	Pan: 0° to 360°, tilt: 0° to 90°, rotate: 0° to 360°	Pan: 0° to 360°, tilt: 0° to 90°, rotate: 0° to 360°	Pan: 0° to 360°, tilt: 0° to 90°, rotate: 0° to 360°
Operating Temperature	-30 °C to 60 °C (-22 °F to 140 °F)	-30 °C to 60 °C (-22 °F to 140 °F)	-30 °C to 60 °C (-22 °F to 140 °F)	-30 °C to 60 °C (-22 °F to 140 °F)	-30 °C to 60 °C (-22 °F to 140 °F)	-30 °C to 60 °C (-22 °F to 140 °F)
Humidity	95% or less (non-condensing)	95% or less (non-condensing)	95% or less (non-condensing)	95% or less (non-condensing)	95% or less (non-condensing)	95% or less (non-condensing)
Local Storage	-	-	-	-	-	-
Indoor/Outdoor	Outdoor	Outdoor	Outdoor	Outdoor	Outdoor	Outdoor
Audio I/O	-	1 Build-in Microphone	-	1 Build-in Microphone	-	1 Build-in Microphone
Power	12 VDC ± 25% PoE: 802.3af, class 3	12 VDC ± 25% PoE: 802.3af, class 3	12 VDC ± 25% PoE: 802.3af, class 3	12 VDC ± 25% PoE: 802.3af, class 3	12 VDC ± 25% PoE: 802.3af, class 3	12 VDC ± 25% PoE: 802.3af, class 3
Interface	1 RJ45 10M/100M Ethernet port	1 RJ45 10M/100M Ethernet port support microSD	1 RJ45 10M/100M Ethernet port	1 RJ45 10M/100M Ethernet port support microSD	1 RJ45 10M/100M Ethernet port	1 RJ45 10M/100M Ethernet port support microSD







Model	DS-2CD112762-L	DS-2CD112762-LUF	DS-2CD114762-L	DS-2CD114762-LUF	DS-2CD116762-L	DS-2CD116762-LUF
Image						
						
Image Sensor	1/2.8" Progressive Scan CMOS	1/2.8" Progressive Scan CMOS	1/3" Progressive Scan CMOS	1/3" Progressive Scan CMOS	1/2.5" Progressive Scan CMOS	1/2.5" Progressive Scan CMOS
Resolution	1920 × 1080	1920 × 1080	2560 × 1440	2560 × 1440	3200*1800	3200*1800
Video Compression	H.265/H.264/MJPEG/H.265+/H.264+	H.265/H.264/MJPEG/H.265+/H.264+	H.265/H.264/MJPEG/H.265+/H.264+	H.265/H.264/MJPEG/H.265+/H.264+	H.265/H.264/MJPEG/H.265+/H.264+	H.265/H.264/MJPEG/H.265+/H.264+
Min. Illumination	Color: 0.001Lux @ (F1.0, AGC ON)	Color: 0.001Lux @ (F1.0, AGC ON)	Color: 0.001Lux @ (F1.0, AGC ON)	Color: 0.001Lux @ (F1.0, AGC ON)	Color: 0.001Lux @ (F2.0, AGC ON)	Color: 0.001Lux @ (F2.0, AGC ON)
WDR	DWDR	DWDR	120 dB	120 dB	120 dB	120 dB
Lens	2.8 mm, 4 mm	2.8 mm, 4 mm	2.8 mm, 4 mm	2.8 mm, 4 mm	2.8 mm, 4 mm	2.8 mm, 4 mm
FOV	2.8 mm, horizontal FOV 105.2°, vertical FOV 56.5°, diagonal FOV 125.1° 4 mm, horizontal FOV 83.6°, vertical FOV 46.2°, diagonal FOV 97.5°	2.8 mm, horizontal FOV 105.2°, vertical FOV 56.5°, diagonal FOV 125.1° 4 mm, horizontal FOV 83.6°, vertical FOV 46.2°, diagonal FOV 97.5°	2.8 mm, horizontal FOV 105°, vertical FOV 58°, diagonal FOV 123° 4 mm, horizontal FOV 81°, vertical FOV 43°, diagonal FOV 97°	2.8 mm, horizontal FOV 105°, vertical FOV 58°, diagonal FOV 123° 4 mm, horizontal FOV 81°, vertical FOV 43°, diagonal FOV 97°	2.8 mm, horizontal FOV 96°, vertical FOV 54°, diagonal FOV 112° 4 mm, horizontal FOV 68°, vertical FOV 38°, diagonal FOV 79°	2.8 mm, horizontal FOV 96°, vertical FOV 54°, diagonal FOV 112° 4 mm, horizontal FOV 68°, vertical FOV 38°, diagonal FOV 79°
Optical Zoom	-	-	-	-	-	-
Max. Light Range	30 m	30 m	30 m	30 m	30 m	30 m
VCA	Motion Detection 2.0	Motion Detection 2.0	Motion Detection 2.0	Motion Detection 2.0	Motion Detection2.0	Motion Detection2.0
Frame Rate	50 Hz: 25 fps (1920 × 1080, 1280 × 720) 60 Hz: 30 fps (1920 × 1080, 1280 × 720)	50 Hz: 25 fps (1920 × 1080, 1280 × 720) 60 Hz: 30 fps (1920 × 1080, 1280 × 720)	50 Hz: 20 fps (2560 × 1440), 25 fps (1920 × 1080, 1280 × 720) 60 Hz: 20 fps (2560 × 1440), 30 fps (1920 × 1080, 1280 × 720)	50 Hz: 20 fps (2560 × 1440), 25 fps (1920 × 1080, 1280 × 720) 60 Hz: 20 fps (2560 × 1440), 30 fps (1920 × 1080, 1280 × 720)	50 Hz: 20 fps (3200*1800, 2560 × 1440, 1920 × 1080, 1280 × 720) 60 Hz: 25 fps (3200*1800, 2560 × 1440, 1920 × 1080, 1280 × 720)	50 Hz: 20 fps (3200*1800, 2560 × 1440, 1920 × 1080, 1280 × 720) 60 Hz: 25 fps (3200*1800, 2560 × 1440, 1920 × 1080, 1280 × 720)
Streams	2	2	2	2	2	2
Protection Level	IP67, IK10	IP67, IK10	IP67, IK10	IP67, IK10	IP67, IK10	IP67, IK10
Angle Adjustment	Pan: 0° to 355°, tilt: 0° to 75°	Pan: 0° to 355°, tilt: 0° to 75°	Pan: 0° to 360°, tilt: 0° to 180°, rotation: 0° to 360°	Pan: 0° to 360°, tilt: 0° to 180°, rotation: 0° to 360°	Pan: 0° to 360°, tilt: 0° to 180°, rotation: 0° to 360°	Pan: 0° to 360°, tilt: 0° to 180°, rotation: 0° to 360°
Operating Temperature	-30 °C to 60 °C (-22 °F to 140 °F)	-30 °C to 60 °C (-22 °F to 140 °F)	-30 °C to 60 °C (-22 °F to 140 °F)	-30 °C to 60 °C (-22 °F to 140 °F)	-30 °C to 60 °C (-22 °F to 140 °F)	-30 °C to 60 °C (-22 °F to 140 °F)
Humidity	95% or less (non-condensing)	95% or less (non-condensing)	95% or less (non-condensing)	95% or less (non-condensing)	95% or less (non-condensing)	95% or less (non-condensing)
Local Storage	-	-	-	-	-	-
Indoor/Outdoor	Outdoor	Outdoor	Outdoor	Outdoor	Outdoor	Outdoor
Audio I/O	-	1 Build-in Microphone	-	1 Build-in Microphone	-	1 Build-in Microphone
Power	12 VDC ± 25% PoE: 802.3af, class 3	12 VDC ± 25% PoE: 802.3af, class 3	12 VDC ± 25% PoE: 802.3af, class 3	12 VDC ± 25% PoE: 802.3af, class 3	12 VDC ± 25% PoE: 802.3af, class 3	12 VDC ± 25% PoE: 802.3af, class 3
Interface	1 RJ45 10M/100M Ethernet port	1 RJ45 10M/100M Ethernet port support microSD	1 RJ45 10M/100M Ethernet port	1 RJ45 10M/100M Ethernet port support microSD	1 RJ45 10M/100M Ethernet port	1 RJ45 10M/100M Ethernet port support microSD







Model	DS-2CD132762-L	DS-2CD132762-LUF	DS-2CD134762-L	DS-2CD134762-LUF	DS-2CD136762-L	DS-2CD136762-LUF
Image						
Image Sensor	1/2.8" Progressive Scan CMOS	1/2.8" Progressive Scan CMOS	1/3" Progressive Scan CMOS	1/3" Progressive Scan CMOS	1/2.5" Progressive Scan CMOS	1/2.5" Progressive Scan CMOS
Resolution	1920 × 1080	1920 × 1080	2560 × 1440	2560 × 1440	3200 × 1800	3200 × 1800
Video Compression	H.265/H.264/MJPEG/H.265+/H.264+	H.265/H.264/MJPEG/H.265+/H.264+	H.265/H.264/MJPEG/H.265+/H.264+	H.265/H.264/MJPEG/H.265+/H.264+	H.265/H.264/MJPEG/H.265+/H.264+	H.265/H.264/MJPEG/H.265+/H.264+
Min. Illumination	Color: 0.001Lux @ (F1.0, AGC ON)	Color: 0.001Lux @ (F1.0, AGC ON)	Color: 0.001Lux @ (F1.0, AGC ON)	Color: 0.001Lux @ (F1.0, AGC ON)	Color: 0.001Lux @ (F2.0, AGC ON)	Color: 0.001Lux @ (F2.0, AGC ON)
WDR	DWDR	DWDR	120 dB	120 dB	120 dB	120 dB
Lens	2.8 mm, 4 mm	2.8 mm, 4 mm	2.8 mm, 4 mm	2.8 mm, 4 mm	2.8 mm, 4 mm	2.8 mm, 4 mm
FOV	2.8 mm, horizontal FOV 107°, vertical FOV 56°, diagonal FOV 127° 4 mm, horizontal FOV 84°, vertical FOV 45°, diagonal FOV 99°	2.8 mm, horizontal FOV 107°, vertical FOV 56°, diagonal FOV 127° 4 mm, horizontal FOV 84°, vertical FOV 45°, diagonal FOV 99°	2.8 mm, horizontal FOV 96.5°, vertical FOV 50.8°, diagonal FOV 113.9° 4 mm, horizontal FOV 75.8°, vertical FOV 40.8°, diagonal FOV 89.1°	2.8 mm, horizontal FOV 96.5°, vertical FOV 50.8°, diagonal FOV 113.9° 4 mm, horizontal FOV 75.8°, vertical FOV 40.8°, diagonal FOV 89.1°	2.8 mm, horizontal FOV 96°, vertical FOV 54°, diagonal FOV 112° 4 mm, horizontal FOV 68°, vertical FOV 38°, diagonal FOV 79°	2.8 mm, horizontal FOV 96°, vertical FOV 54°, diagonal FOV 112° 4 mm, horizontal FOV 68°, vertical FOV 38°, diagonal FOV 79°
Optical Zoom	-	-	-	-	-	-
Max. Light Range	30 m	30 m	30 m	30 m	30 m	30 m
VCA	Motion Detection 2.0	Motion Detection 2.0	Motion Detection 2.0	Motion Detection 2.0	Motion Detection 2.0	Motion Detection 2.0
Frame Rate	50Hz: 25fps (1920 × 1080, 1280 × 960, 1280 × 720) 60Hz: 30fps (1920 × 1080, 1280 × 960, 1280 × 720)	50Hz: 25fps (1920 × 1080, 1280 × 960, 1280 × 720) 60Hz: 30fps (1920 × 1080, 1280 × 960, 1280 × 720)	50 Hz: 20 fps (2560 × 1440), 25 fps (1920 × 1080, 1280 × 720) 60 Hz: 20 fps (2560 × 1440), 30 fps (1920 × 1080, 1280 × 720)	50 Hz: 20 fps (2560 × 1440), 25 fps (1920 × 1080, 1280 × 720) 60 Hz: 20 fps (2560 × 1440), 30 fps (1920 × 1080, 1280 × 720)	50 Hz: 20 fps (3200 × 1800, 2560 × 1440, 1920 × 1080, 1280 × 720) 60 Hz: 25 fps (3200 × 1800, 2560 × 1440, 1920 × 1080, 1280 × 720)	50 Hz: 20 fps (3200 × 1800, 2560 × 1440, 1920 × 1080, 1280 × 720) 60 Hz: 25 fps (3200 × 1800, 2560 × 1440, 1920 × 1080, 1280 × 720)
Streams	2	2	2	2	2	2
Protection Level	IP67	IP67	IP67	IP67	IP67	IP67
Angle Adjustment	Pan: 0° to 360°, tilt: 0° to 75°, rotate: 0° to 360°	Pan: 0° to 360°, tilt: 0° to 75°, rotate: 0° to 360°	Pan: 0° to 360°, tilt: 0° to 75°, rotate: 0° to 360°	Pan: 0° to 360°, tilt: 0° to 75°, rotate: 0° to 360°	Pan: 0° to 360°, tilt: 0° to 75°, rotate: 0° to 360°	Pan: 0° to 360°, tilt: 0° to 75°, rotate: 0° to 360°
Operating Temperature	-30 °C to 60 °C (-22 °F to 140 °F)	-30 °C to 60 °C (-22 °F to 140 °F)	-30 °C to 60 °C (-22 °F to 140 °F)	-30 °C to 60 °C (-22 °F to 140 °F)	-30 °C to 60 °C (-22 °F to 140 °F)	-30 °C to 60 °C (-22 °F to 140 °F)
Humidity	95% or less (non-condensing)	95% or less (non-condensing)	95% or less (non-condensing)	95% or less (non-condensing)	95% or less (non-condensing)	95% or less (non-condensing)
Local Storage	-	-	-	-	-	-
Indoor/Outdoor	Outdoor	Outdoor	Outdoor	Outdoor	Outdoor	Outdoor
Audio I/O	-	1 Build-in Microphone	-	1 Build-in Microphone	-	1 Build-in Microphone
Power	12 VDC ± 25% PoE: 802.3af, class 3	12 VDC ± 25% PoE: 802.3af, class 3	12 VDC ± 25% PoE: 802.3af, class 3	12 VDC ± 25% PoE: 802.3af, class 3	12 VDC ± 25% PoE: 802.3af, class 3	12 VDC ± 25% PoE: 802.3af, class 3
Interface	1 RJ45 10M/100M Ethernet port	1 RJ45 10M/100M Ethernet port support microSD	1 RJ45 10M/100M Ethernet port	1 RJ45 10M/100M Ethernet port support microSD	1 RJ45 10M/100M Ethernet port	1 RJ45 10M/100M Ethernet port support microSD







Model	DS-2CD1T2762-L	DS-2CD1T2762-LUF	DS-2CD1T4762-L	DS-2CD1T4762-LUF
Image	 ColorVu	 ColorVu	 ColorVu	 ColorVu
Image Sensor	1/2.8" Progressive Scan CMOS	1/2.8" Progressive Scan CMOS	1/3" Progressive Scan CMOS	1/3" Progressive Scan CMOS
Resolution	1920 × 1080	1920 × 1080	2560 × 1440	2560 × 1440
Video Compression	H.265/H.264/MJPEG/H.265+/H.264+	H.265/H.264/MJPEG/H.265+/H.264+	H.265/H.264/MJPEG/H.265+/H.264+	H.265/H.264/MJPEG/H.265+/H.264+
Min. Illumination	Color: 0.001Lux @ (F1.0, AGC ON)	Color: 0.001Lux @ (F1.0, AGC ON)	Color: 0.001Lux @ (F1.0, AGC ON)	Color: 0.001Lux @ (F1.0, AGC ON)
WDR	DWDR	DWDR	120 dB	120 dB
Lens	4 mm, 6mm	4 mm, 6mm	4 mm, 6mm	4 mm, 6mm
FOV	4 mm, horizontal FOV 83.6°, vertical FOV 44.6°, diagonal FOV 99.1° 6 mm, horizontal FOV 54.6°, vertical FOV 29.9°, diagonal FOV 63.3°	4 mm, horizontal FOV 83.6°, vertical FOV 44.6°, diagonal FOV 99.1° 6 mm, horizontal FOV 54.6°, vertical FOV 29.9°, diagonal FOV 63.3°	4 mm, horizontal FOV 75.8°, vertical FOV 40.8°, diagonal FOV 89.1° 6 mm, horizontal FOV 49.9°, vertical FOV 27.4°, diagonal FOV 57.8°	4 mm, horizontal FOV 75.8°, vertical FOV 40.8°, diagonal FOV 89.1° 6 mm, horizontal FOV 49.9°, vertical FOV 27.4°, diagonal FOV 57.8°
Optical Zoom	-	-	-	-
Max. Light Range	50m	50m	50m	50m
VCA	Motion Detection 2.0	Motion Detection 2.0	Motion Detection 2.0	Motion Detection 2.0
Frame Rate	50 Hz: 25 fps (1920 × 1080, 1280 × 720) 60 Hz: 30 fps (1920 × 1080, 1280 × 720)	50 Hz: 25 fps (1920 × 1080, 1280 × 720) 60 Hz: 30 fps (1920 × 1080, 1280 × 720)	50 Hz: 20 fps (2560 × 1440), 25 fps (1920 × 1080, 1280 × 720) 60 Hz: 20 fps (2560 × 1440), 30 fps (1920 × 1080, 1280 × 720)	50 Hz: 20 fps (2560 × 1440), 25 fps (1920 × 1080, 1280 × 720) 60 Hz: 20 fps (2560 × 1440), 30 fps (1920 × 1080, 1280 × 720)
Streams	2	2	2	2
Protection Level	IP67	IP67	IP67	IP67
Angle Adjustment	Pan: 0° to 360°, tilt: 0° to 180°, rotation: 0° to 360°	Pan: 0° to 360°, tilt: 0° to 180°, rotation: 0° to 360°	Pan: 0° to 360°, tilt: 0° to 180°, rotation: 0° to 360°	Pan: 0° to 360°, tilt: 0° to 180°, rotation: 0° to 360°
Operating Temperature	-30 °C to 60 °C (-22 °F to 140 °F)	-30 °C to 60 °C (-22 °F to 140 °F)	-30 °C to 60 °C (-22 °F to 140 °F)	-30 °C to 60 °C (-22 °F to 140 °F)
Humidity	95% or less (non-condensing)	95% or less (non-condensing)	95% or less (non-condensing)	95% or less (non-condensing)
Local Storage	-	-	-	-
Indoor/Outdoor	Outdoor	Outdoor	Outdoor	Outdoor
Audio I/O	-	1 Build-in Microphone	-	1 Build-in Microphone
Power	12 VDC ± 25% PoE: 802.3af, class 3	12 VDC ± 25% PoE: 802.3af, class 3	12 VDC ± 25% PoE: 802.3af, class 3	12 VDC ± 25% PoE: 802.3af, class 3
Interface	1 RJ45 10M/100M Ethernet port	1 RJ45 10M/100M Ethernet port support microSD	1 RJ45 10M/100M Ethernet port	1 RJ45 10M/100M Ethernet port support microSD













Model	DS-2CD1T6762-L	DS-2CD1T6762-LUF	DS-2CD102362-LIU	DS-2CD102362-LIUF
Image	 ColorVu	 ColorVu	 Smart Hybrid Light	 Smart Hybrid Light
Image Sensor	1/2.5" Progressive Scan CMOS	1/2.5" Progressive Scan CMOS	1/2.9" Progressive Scan CMOS	1/2.9" Progressive Scan CMOS
Resolution	3200*1800	3200*1800	1920 × 1080	1920 × 1080
Video Compression	H.265/H.264/MJPEG/H.265+/H.264+	H.265/H.264/MJPEG/H.265+/H.264+	H.265/H.264/MJPEG/H.265+/H.264+	H.265/H.264/MJPEG/H.265+/H.264+
Min. Illumination	Color: 0.001Lux @ (F2.0, AGC ON)	Color: 0.001Lux @ (F2.0, AGC ON)	Color: 0.01Lux @ (F2.0, AGC ON)	Color: 0.01Lux @ (F2.0, AGC ON)
WDR	120 dB	120 dB	DWDR	DWDR
Lens	4 mm, 6mm	4 mm, 6mm	2.8mm, 4mm	2.8mm, 4mm
FOV	2.8 mm, horizontal FOV 96°, vertical FOV 54°, diagonal FOV 112° 4 mm, horizontal FOV 68°, vertical FOV 38°, diagonal FOV 79°	2.8 mm, horizontal FOV 96°, vertical FOV 54°, diagonal FOV 112° 4 mm, horizontal FOV 68°, vertical FOV 38°, diagonal FOV 79°	2.8 mm, horizontal FOV 105°, vertical FOV 58°, diagonal FOV 123° 4 mm, horizontal FOV 81°, vertical FOV 43°, diagonal FOV 97°	2.8 mm, horizontal FOV 105°, vertical FOV 58°, diagonal FOV 123° 4 mm, horizontal FOV 81°, vertical FOV 43°, diagonal FOV 97°
Optical Zoom	-	-	-	-
Max. Light Range	50m	50m	IR: 30 m White Light:20m	IR: 30 m White Light:20m
VCA	Motion Detection2.0	Motion Detection2.0	Motion Detection2.0	Motion Detection2.0
Frame Rate	50 Hz: 20 fps (3200*1800, 2560 × 1440, 1920 × 1080, 1280 × 720) 60 Hz: 25 fps (3200*1800, 2560 × 1440, 1920 × 1080, 1280 × 720)	50 Hz: 20 fps (3200*1800, 2560 × 1440, 1920 × 1080, 1280 × 720) 60 Hz: 25 fps (3200*1800, 2560 × 1440, 1920 × 1080, 1280 × 720)	50Hz: 25fps (1920 × 1080, 1280 × 960, 1280 × 720) 60Hz: 30fps (1920 × 1080, 1280 × 960, 1280 × 720)	50Hz: 25fps (1920 × 1080, 1280 × 960, 1280 × 720) 60Hz: 30fps (1920 × 1080, 1280 × 960, 1280 × 720)
Streams	2	2	2	2
Protection Level	IP67	IP67	IP67	IP67
Angle Adjustment	Pan: 0° to 360°, tilt: 0° to 180°, rotation: 0° to 360°	Pan: 0° to 360°, tilt: 0° to 180°, rotation: 0° to 360°	Pan: 0° to 360°, tilt: 0° to 180°, rotation: 0° to 360°	Pan: 0° to 360°, tilt: 0° to 180°, rotation: 0° to 360°
Operating Temperature	-30 °C to 60 °C [-22 °F to 140 °F]	-30 °C to 60 °C [-22 °F to 140 °F]	-30 °C to 60 °C [-22 °F to 140 °F]	-30 °C to 60 °C [-22 °F to 140 °F]
Humidity	95% or less (non-condensing)	95% or less (non-condensing)	95% or less (non-condensing)	95% or less (non-condensing)
Local Storage	-	-	-	-
Indoor/Outdoor	Outdoor	Outdoor	Outdoor	Outdoor
Audio I/O	-	1 Build-in Microphone	1 Build-in Microphone	1 Build-in Microphone
Power	12 VDC ± 25% PoE: 802.3af, class 3	12 VDC ± 25% PoE: 802.3af, class 3	12 VDC ± 25% PoE: 802.3af, class 3	12 VDC ± 25% PoE: 802.3af, class 3
Interface	1 RJ45 10M/100M Ethernet port	1 RJ45 10M/100M Ethernet port support microSD	1 RJ45 10M/100M Ethernet port	1 RJ45 10M/100M Ethernet port support microSD







Model	DS-2CD104362-LIU	DS-2CD104362-LIUF	DS-2CD106362-LIU	DS-2CD106362-LIUF	DS-2CD108362-LIU	DS-2CD108362-LIUF
Image	 	 	 	 	 	 
Image Sensor	1/2.9" Progressive Scan CMOS	1/2.9" Progressive Scan CMOS	1/2.5" Progressive Scan CMOS	1/2.5" Progressive Scan CMOS	1/2.7" Progressive Scan CMOS	1/2.7" Progressive Scan CMOS
Resolution	2560 × 1440	2560 × 1440	3200*1800	3200*1800	3840 × 2160	3840 × 2160
Video Compression	H.265/H.264/MJPEG/H.265+/H.264+	H.265/H.264/MJPEG/H.265+/H.264+	H.265/H.264/MJPEG/H.265+/H.264+	H.265/H.264/MJPEG/H.265+/H.264+	H.265/H.264/MJPEG/H.265+/H.264+	H.265/H.264/MJPEG/H.265+/H.264+
Min. Illumination	Color: 0.01Lux @ (F2.0, AGC ON)	Color: 0.01Lux @ (F2.0, AGC ON)	Color: 0.005 Lux @ (F1.6, AGC ON),B/W: 0 Lux with IR	Color: 0.005 Lux @ (F1.6, AGC ON),B/W: 0 Lux with IR	Color: 0.01Lux @ (F2.0, AGC ON)	Color: 0.01Lux @ (F2.0, AGC ON)
WDR	120 dB	120 dB	120 dB	120 dB	120 dB	120 dB
Lens	2.8mm, 4mm	2.8mm, 4mm	2.8mm, 4mm	2.8mm, 4mm	2.8mm, 4mm	2.8mm, 4mm
FOV	2.8 mm, horizontal FOV 105°, vertical FOV 58°, diagonal FOV 123° 4 mm, horizontal FOV 81°, vertical FOV 43°, diagonal FOV 97°	2.8 mm, horizontal FOV 105°, vertical FOV 58°, diagonal FOV 123° 4 mm, horizontal FOV 81°, vertical FOV 43°, diagonal FOV 97°	2.8 mm, horizontal FOV 105°, vertical FOV 55°, diagonal FOV 127° 4 mm, horizontal FOV 78°, vertical FOV 38°, diagonal FOV 96°	2.8 mm, horizontal FOV 105°, vertical FOV 55°, diagonal FOV 127° 4 mm, horizontal FOV 78°, vertical FOV 38°, diagonal FOV 96°	2.8 mm, horizontal FOV 113°, vertical FOV 62°, diagonal FOV 134° 4 mm, horizontal FOV 90°, vertical FOV 49°, diagonal FOV 108°	2.8 mm, horizontal FOV 113°, vertical FOV 62°, diagonal FOV 134° 4 mm, horizontal FOV 90°, vertical FOV 49°, diagonal FOV 108°
Optical Zoom	-	-	-	-	-	-
Max. Light Range	IR: 30 m White Light:20m	IR: 30 m White Light:20m	IR: 30 m White Light:20m	IR: 30 m White Light:20m	IR: 30 m White Light:20m	IR: 30 m White Light:20m
VCA	Motion Detection2.0	Motion Detection2.0	Motion Detection2.0	Motion Detection2.0	Motion Detection2.0	Motion Detection2.0
Frame Rate	50Hz: 20fps (2560 × 1440), 25fps (2304 × 1296, 1920 × 1080, 1280 × 720) 60Hz: 20fps (2560 × 1440), 30fps (2304 × 1296, 1920 × 1080, 1280 × 720)	50Hz: 20fps (2560 × 1440), 25fps (2304 × 1296, 1920 × 1080, 1280 × 720) 60Hz: 20fps (2560 × 1440), 30fps (2304 × 1296, 1920 × 1080, 1280 × 720)	50 Hz: 20 fps (3200*1800, 2560 × 1440, 1920 × 1080, 1280 × 720) 60 Hz: 25 fps (3200*1800, 2560 × 1440, 1920 × 1080, 1280 × 720)	50 Hz: 20 fps (3200*1800, 2560 × 1440, 1920 × 1080, 1280 × 720) 60 Hz: 25 fps (3200*1800, 2560 × 1440, 1920 × 1080, 1280 × 720)	50 Hz: 15 fps (3840 × 2160, 3200*1800, 2560 × 1440, 1920 × 1080, 1280 × 720) 60 Hz: 20 fps (3840 × 2160, 3200*1800, 2560 × 1440, 1920 × 1080, 1280 × 720)	50 Hz: 15 fps (3840 × 2160, 3200*1800, 2560 × 1440, 1920 × 1080, 1280 × 720) 60 Hz: 20 fps (3840 × 2160, 3200*1800, 2560 × 1440, 1920 × 1080, 1280 × 720)
Streams	2	2	2	2	2	2
Protection Level	IP67	IP67	IP67	IP67	IP67	IP67
Angle Adjustment	Pan: 0° to 360°, tilt: 0° to 180°, rotation: 0° to 360°	Pan: 0° to 360°, tilt: 0° to 180°, rotation: 0° to 360°	Pan: 0° to 360°, tilt: 0° to 180°, rotation: 0° to 360°	Pan: 0° to 360°, tilt: 0° to 180°, rotation: 0° to 360°	Pan: 0° to 360°, tilt: 0° to 180°, rotation: 0° to 360°	Pan: 0° to 360°, tilt: 0° to 180°, rotation: 0° to 360°
Operating Temperature	-30 °C to 60 °C (-22 °F to 140 °F)	-30 °C to 60 °C (-22 °F to 140 °F)	-30 °C to 60 °C (-22 °F to 140 °F)	-30 °C to 60 °C (-22 °F to 140 °F)	-30 °C to 60 °C (-22 °F to 140 °F)	-30 °C to 60 °C (-22 °F to 140 °F)
Humidity	95% or less (non-condensing)	95% or less (non-condensing)	95% or less (non-condensing)	95% or less (non-condensing)	95% or less (non-condensing)	95% or less (non-condensing)
Local Storage			-	256GB	-	256GB
Indoor/Outdoor	Outdoor	Outdoor	Outdoor	Outdoor	Outdoor	Outdoor
Audio I/O	1 Build-in Microphone	1 Build-in Microphone	1 Build-in Microphone	1 Build-in Microphone	1 Build-in Microphone	1 Build-in Microphone
Power	12 VDC ± 25% PoE: 802.3af, class 3	12 VDC ± 25% PoE: 802.3af, class 3	12 VDC ± 25% PoE: 802.3af, class 3	12 VDC ± 25% PoE: 802.3af, class 3	12 VDC ± 25% PoE: 802.3af, class 3	12 VDC ± 25% PoE: 802.3af, class 3
Interface	1 RJ45 10M/100M Ethernet port	1 RJ45 10M/100M Ethernet port support microSD	1 RJ45 10M/100M Ethernet port	1 RJ45 10M/100M Ethernet port support microSD	1 RJ45 10M/100M Ethernet port	1 RJ45 10M/100M Ethernet port support microSD







Model	DS-2CD1123G2-LIU	DS-2CD1123G2-LIUF	DS-2CD1143G2-LIU	DS-2CD1143G2-LIUF	DS-2CD1163G2-LIU	DS-2CD1163G2-LIUF
Image						
Image Sensor	1/2.9" Progressive Scan CMOS	1/2.9" Progressive Scan CMOS	1/2.9" Progressive Scan CMOS	1/2.9" Progressive Scan CMOS	1/2.5" Progressive Scan CMOS	1/2.5" Progressive Scan CMOS
Resolution	1920 × 1080	1920 × 1080	2560 × 1440	2560 × 1440	3200 × 1800	3200 × 1800
Video Compression	H.265/H.264/MJPEG/H.265+/H.264+	H.265/H.264/MJPEG/H.265+/H.264+	H.265/H.264/MJPEG/H.265+/H.264+	H.265/H.264/MJPEG/H.265+/H.264+	H.265/H.264/MJPEG/H.265+/H.264+	H.265/H.264/MJPEG/H.265+/H.264+
Min. Illumination	Color: 0.01Lux @ (F2.0, AGC ON)	Color: 0.01Lux @ (F2.0, AGC ON)	Color: 0.01Lux @ (F2.0, AGC ON)	Color: 0.01Lux @ (F2.0, AGC ON)	Color: 0.005 Lux @ (F1.6, AGC ON), B/W: 0 Lux with IR	Color: 0.005 Lux @ (F1.6, AGC ON), B/W: 0 Lux with IR
WDR	DWDR	DWDR	120 dB	120 dB	120 dB	120 dB
Lens	2.8mm, 4mm	2.8mm, 4mm	2.8mm, 4mm	2.8mm, 4mm	2.8mm, 4mm	2.8mm, 4mm
FOV	2.8 mm, horizontal FOV 105°, vertical FOV 58°, diagonal FOV 123° 4 mm, horizontal FOV 81°, vertical FOV 43°, diagonal FOV 97°	2.8 mm, horizontal FOV 105°, vertical FOV 58°, diagonal FOV 123° 4 mm, horizontal FOV 81°, vertical FOV 43°, diagonal FOV 97°	2.8 mm, horizontal FOV 105°, vertical FOV 58°, diagonal FOV 123° 4 mm, horizontal FOV 81°, vertical FOV 43°, diagonal FOV 97°	2.8 mm, horizontal FOV 105°, vertical FOV 58°, diagonal FOV 123° 4 mm, horizontal FOV 81°, vertical FOV 43°, diagonal FOV 97°	2.8 mm, horizontal FOV 105°, vertical FOV 55°, diagonal FOV 127° 4 mm, horizontal FOV 78°, vertical FOV 38°, diagonal FOV 96°	2.8 mm, horizontal FOV 105°, vertical FOV 55°, diagonal FOV 127° 4 mm, horizontal FOV 78°, vertical FOV 38°, diagonal FOV 96°
Optical Zoom	-	-	-	-	-	-
Max. Light Range	IR: 30 m White Light: 20m	IR: 30 m White Light: 20m	IR: 30 m White Light: 20m	IR: 30 m White Light: 20m	IR: 30 m White Light: 20m	IR: 30 m White Light: 20m
VCA	Motion Detection 2.0	Motion Detection 2.0	Motion Detection 2.0	Motion Detection 2.0	Motion Detection 2.0	Motion Detection 2.0
Frame Rate	50Hz: 25fps (1920 × 1080, 1280 × 960, 1280 × 720) 60Hz: 30fps (1920 × 1080, 1280 × 960, 1280 × 720)	50Hz: 25fps (1920 × 1080, 1280 × 960, 1280 × 720) 60Hz: 30fps (1920 × 1080, 1280 × 960, 1280 × 720)	50Hz: 20fps (2560 × 1440), 25fps (2304 × 1296, 1920 × 1080, 1280 × 720) 60Hz: 20fps (2560 × 1440), 30fps (2304 × 1296, 1920 × 1080, 1280 × 720)	50Hz: 20fps (2560 × 1440), 25fps (2304 × 1296, 1920 × 1080, 1280 × 720) 60Hz: 20fps (2560 × 1440), 30fps (2304 × 1296, 1920 × 1080, 1280 × 720)	50 Hz: 20 fps (3200 × 1800, 2560 × 1440, 1920 × 1080, 1280 × 720) 60 Hz: 25 fps (3200 × 1800, 2560 × 1440, 1920 × 1080, 1280 × 720)	50 Hz: 20 fps (3200 × 1800, 2560 × 1440, 1920 × 1080, 1280 × 720) 60 Hz: 25 fps (3200 × 1800, 2560 × 1440, 1920 × 1080, 1280 × 720)
Streams	2	2	2	2	2	2
Protection Level	IP67	IP67	IP67	IP67	IP67	IP67
Angle Adjustment	Pan: 0° to 360°, tilt: 0° to 180°, rotation: 0° to 360°	Pan: 0° to 360°, tilt: 0° to 180°, rotation: 0° to 360°	Pan: 0° to 360°, tilt: 0° to 180°, rotation: 0° to 360°	Pan: 0° to 360°, tilt: 0° to 180°, rotation: 0° to 360°	Pan: 0° to 360°, tilt: 0° to 180°, rotation: 0° to 360°	Pan: 0° to 360°, tilt: 0° to 180°, rotation: 0° to 360°
Operating Temperature	-30 °C to 60 °C (-22 °F to 140 °F)	-30 °C to 60 °C (-22 °F to 140 °F)	-30 °C to 60 °C (-22 °F to 140 °F)	-30 °C to 60 °C (-22 °F to 140 °F)	-30 °C to 60 °C (-22 °F to 140 °F)	-30 °C to 60 °C (-22 °F to 140 °F)
Humidity	95% or less (non-condensing)	95% or less (non-condensing)	95% or less (non-condensing)	95% or less (non-condensing)	95% or less (non-condensing)	95% or less (non-condensing)
Local Storage					-	256GB
Indoor/Outdoor	Outdoor	Outdoor	Outdoor	Outdoor	Outdoor	Outdoor
Audio I/O	1 Build-in Microphone	1 Build-in Microphone	1 Build-in Microphone	1 Build-in Microphone	1 Build-in Microphone	1 Build-in Microphone
Power	12 VDC ± 25% PoE: 802.3af, class 3	12 VDC ± 25% PoE: 802.3af, class 3	12 VDC ± 25% PoE: 802.3af, class 3	12 VDC ± 25% PoE: 802.3af, class 3	12 VDC ± 25% PoE: 802.3af, class 3	12 VDC ± 25% PoE: 802.3af, class 3
Interface	1 RJ45 10M/100M Ethernet port	1 RJ45 10M/100M Ethernet port support microSD	1 RJ45 10M/100M Ethernet port	1 RJ45 10M/100M Ethernet port support microSD	1 RJ45 10M/100M Ethernet port	1 RJ45 10M/100M Ethernet port support microSD

Model	DS-2CD118362-LIU	DS-2CD118362-LIUF	DS-2CD132362-LIU	DS-2CD132362-LIUF	DS-2CD134362-LIU	DS-2CD134362-LIUF
Image						
Image Sensor	1/2.7" Progressive Scan CMOS	1/2.7" Progressive Scan CMOS	1/2.9" Progressive Scan CMOS	1/2.9" Progressive Scan CMOS	1/2.9" Progressive Scan CMOS	1/2.9" Progressive Scan CMOS
Resolution	3840 × 2160	3840 × 2160	1920 × 1080	1920 × 1080	2560 × 1440	2560 × 1440
Video Compression	H.265/H.264/MJPEG/H.265+/H.264+	H.265/H.264/MJPEG/H.265+/H.264+	H.265/H.264/MJPEG/H.265+/H.264+	H.265/H.264/MJPEG/H.265+/H.264+	H.265/H.264/MJPEG/H.265+/H.264+	H.265/H.264/MJPEG/H.265+/H.264+
Min. Illumination	Color: 0.01Lux @ (F2.0, AGC ON)	Color: 0.01Lux @ (F2.0, AGC ON)	Color: 0.01Lux @ (F2.0, AGC ON)	Color: 0.01Lux @ (F2.0, AGC ON)	Color: 0.01Lux @ (F2.0, AGC ON)	Color: 0.01Lux @ (F2.0, AGC ON)
WDR	120 dB	120 dB	DWDR	DWDR	120 dB	120 dB
Lens	2.8mm, 4mm	2.8mm, 4mm	2.8mm, 4mm	2.8mm, 4mm	2.8mm, 4mm	2.8mm, 4mm
FOV	2.8 mm, horizontal FOV 113°, vertical FOV 62°, diagonal FOV 134° 4 mm, horizontal FOV 90°, vertical FOV 49°, diagonal FOV 108°	2.8 mm, horizontal FOV 113°, vertical FOV 62°, diagonal FOV 134° 4 mm, horizontal FOV 90°, vertical FOV 49°, diagonal FOV 108°	2.8 mm, horizontal FOV 105°, vertical FOV 58°, diagonal FOV 123° 4 mm, horizontal FOV 81°, vertical FOV 43°, diagonal FOV 97°	2.8 mm, horizontal FOV 105°, vertical FOV 58°, diagonal FOV 123° 4 mm, horizontal FOV 81°, vertical FOV 43°, diagonal FOV 97°	2.8 mm, horizontal FOV 105°, vertical FOV 58°, diagonal FOV 123° 4 mm, horizontal FOV 81°, vertical FOV 43°, diagonal FOV 97°	2.8 mm, horizontal FOV 105°, vertical FOV 58°, diagonal FOV 123° 4 mm, horizontal FOV 81°, vertical FOV 43°, diagonal FOV 97°
Optical Zoom	-	-	-	-	-	-
Max. Light Range	IR: 30 m White Light:20m	IR: 30 m White Light:20m	IR: 30 m White Light:20m	IR: 30 m White Light:20m	IR: 30 m White Light:20m	IR: 30 m White Light:20m
VCA	Motion Detection2.0	Motion Detection2.0	Motion Detection2.0	Motion Detection2.0	Motion Detection2.0	Motion Detection2.0
Frame Rate	50 Hz: 15 fps (3840 × 2160, 3200 × 1800, 2560 × 1440, 1920 × 1080, 1280 × 720) 60 Hz: 20 fps (3840 × 2160, 3200 × 1800, 2560 × 1440, 1920 × 1080, 1280 × 720)	50 Hz: 15 fps (3840 × 2160, 3200 × 1800, 2560 × 1440, 1920 × 1080, 1280 × 720) 60 Hz: 20 fps (3840 × 2160, 3200 × 1800, 2560 × 1440, 1920 × 1080, 1280 × 720)	50Hz: 25fps (1920 × 1080, 1280 × 960, 1280 × 720) 60Hz: 30fps (1920 × 1080, 1280 × 960, 1280 × 720)	50Hz: 25fps (1920 × 1080, 1280 × 960, 1280 × 720) 60Hz: 30fps (1920 × 1080, 1280 × 960, 1280 × 720)	50Hz: 20fps (2560 × 1440), 25fps (2304 × 1296, 1920 × 1080, 1280 × 720) 60Hz: 20fps (2560 × 1440), 30fps (2304 × 1296, 1920 × 1080, 1280 × 720)	50Hz: 20fps (2560 × 1440), 25fps (2304 × 1296, 1920 × 1080, 1280 × 720) 60Hz: 20fps (2560 × 1440), 30fps (2304 × 1296, 1920 × 1080, 1280 × 720)
Streams	2	2	2	2	2	2
Protection Level	IP67	IP67	IP67	IP67	IP67	IP67
Angle Adjustment	Pan: 0° to 360°, tilt: 0° to 180°, rotation: 0° to 360°	Pan: 0° to 360°, tilt: 0° to 180°, rotation: 0° to 360°	Pan: 0° to 360°, tilt: 0° to 180°, rotation: 0° to 360°	Pan: 0° to 360°, tilt: 0° to 180°, rotation: 0° to 360°	Pan: 0° to 360°, tilt: 0° to 180°, rotation: 0° to 360°	Pan: 0° to 360°, tilt: 0° to 180°, rotation: 0° to 360°
Operating Temperature	-30 °C to 60 °C (-22 °F to 140 °F)	-30 °C to 60 °C (-22 °F to 140 °F)	-30 °C to 60 °C (-22 °F to 140 °F)	-30 °C to 60 °C (-22 °F to 140 °F)	-30 °C to 60 °C (-22 °F to 140 °F)	-30 °C to 60 °C (-22 °F to 140 °F)
Humidity	95% or less (non-condensing)	95% or less (non-condensing)	95% or less (non-condensing)	95% or less (non-condensing)	95% or less (non-condensing)	95% or less (non-condensing)
Local Storage	-	256GB				
Indoor/Outdoor	Outdoor	Outdoor	Outdoor	Outdoor	Outdoor	Outdoor
Audio I/O	1 Build-in Microphone	1 Build-in Microphone	1 Build-in Microphone	1 Build-in Microphone	1 Build-in Microphone	1 Build-in Microphone
Power	12 VDC ± 25% PoE: 802.3af, class 3	12 VDC ± 25% PoE: 802.3af, class 3	12 VDC ± 25% PoE: 802.3af, class 3	12 VDC ± 25% PoE: 802.3af, class 3	12 VDC ± 25% PoE: 802.3af, class 3	12 VDC ± 25% PoE: 802.3af, class 3
Interface	1 RJ45 10M/100M Ethernet port	1 RJ45 10M/100M Ethernet port support microSD	1 RJ45 10M/100M Ethernet port	1 RJ45 10M/100M Ethernet port support microSD	1 RJ45 10M/100M Ethernet port	1 RJ45 10M/100M Ethernet port support microSD











Model	DS-2CD136362-LIU	DS-2CD136362-LIUF	DS-2CD138362-LIU	DS-2CD138362-LIUF	DS-2CD1T2362-LIU	DS-2CD1T2362-LIUF
Image						
Image Sensor	1/2.5" Progressive Scan CMOS	1/2.5" Progressive Scan CMOS	1/2.7" Progressive Scan CMOS	1/2.7" Progressive Scan CMOS	1/2.9" Progressive Scan CMOS	1/2.9" Progressive Scan CMOS
Resolution	3200*1800	3200*1800	3840 × 2160	3840 × 2160	1920 × 1080	1920 × 1080
Video Compression	H.265/H.264/MJPEG/H.265+/H.264+	H.265/H.264/MJPEG/H.265+/H.264+	H.265/H.264/MJPEG/H.265+/H.264+	H.265/H.264/MJPEG/H.265+/H.264+	H.265/H.264/MJPEG/H.265+/H.264+	H.265/H.264/MJPEG/H.265+/H.264+
Min. Illumination	Color: 0.005 Lux @ (F1.6, AGC ON), B/W: 0 Lux with IR	Color: 0.005 Lux @ (F1.6, AGC ON), B/W: 0 Lux with IR	Color: 0.01Lux @ (F2.0, AGC ON)	Color: 0.01Lux @ (F2.0, AGC ON)	Color: 0.01Lux @ (F2.0, AGC ON)	Color: 0.01Lux @ (F2.0, AGC ON)
WDR	120 dB	120 dB	120 dB	120 dB	DWDR	DWDR
Lens	2.8mm, 4mm	2.8mm, 4mm	2.8mm, 4mm	2.8mm, 4mm	4 mm, 6mm	4 mm, 6mm
FOV	2.8 mm, horizontal FOV 105°, vertical FOV 55°, diagonal FOV 127° 4 mm, horizontal FOV 78°, vertical FOV 38°, diagonal FOV 96°	2.8 mm, horizontal FOV 105°, vertical FOV 55°, diagonal FOV 127° 4 mm, horizontal FOV 78°, vertical FOV 38°, diagonal FOV 96°	2.8 mm, horizontal FOV 113°, vertical FOV 62°, diagonal FOV 134° 4 mm, horizontal FOV 90°, vertical FOV 49°, diagonal FOV 108°	2.8 mm, horizontal FOV 113°, vertical FOV 62°, diagonal FOV 134° 4 mm, horizontal FOV 90°, vertical FOV 49°, diagonal FOV 108°	4 mm, horizontal FOV 81.3°, vertical FOV 43.9°, diagonal FOV 97.1° 6 mm, horizontal FOV 51.8°, vertical FOV 27.9°, diagonal FOV 60.5°	4 mm, horizontal FOV 81.3°, vertical FOV 43.9°, diagonal FOV 97.1° 6 mm, horizontal FOV 51.8°, vertical FOV 27.9°, diagonal FOV 60.5°
Optical Zoom	-	-	-	-	-	-
Max. Light Range	IR: 30 m White Light:20m	IR: 30 m White Light:20m	IR: 30 m White Light:20m	IR: 30 m White Light:20m	IR: 50 m White Light:40m	IR: 50 m White Light:40m
VCA	Motion Detection2.0	Motion Detection2.0	Motion Detection2.0	Motion Detection2.0	Motion Detection2.0	Motion Detection2.0
Frame Rate	50 Hz: 20 fps (3200*1800, 2560 × 1440, 1920 × 1080, 1280 × 720) 60 Hz: 25 fps (3200*1800, 2560 × 1440, 1920 × 1080, 1280 × 720)	50 Hz: 20 fps (3200*1800, 2560 × 1440, 1920 × 1080, 1280 × 720) 60 Hz: 25 fps (3200*1800, 2560 × 1440, 1920 × 1080, 1280 × 720)	50 Hz: 15 fps (3840 × 2160, 3200*1800, 2560 × 1440, 1920 × 1080, 1280 × 720) 60 Hz: 20 fps (3840 × 2160, 3200*1800, 2560 × 1440, 1920 × 1080, 1280 × 720)	50 Hz: 15 fps (3840 × 2160, 3200*1800, 2560 × 1440, 1920 × 1080, 1280 × 720) 60 Hz: 20 fps (3840 × 2160, 3200*1800, 2560 × 1440, 1920 × 1080, 1280 × 720)	50Hz: 25fps (1920 × 1080, 1280 × 960, 1280 × 720) 60Hz: 30fps (1920 × 1080, 1280 × 960, 1280 × 720)	50Hz: 25fps (1920 × 1080, 1280 × 960, 1280 × 720) 60Hz: 30fps (1920 × 1080, 1280 × 960, 1280 × 720)
Streams	2	2	2	2	2	2
Protection Level	IP67	IP67	IP67	IP67	IP67	IP67
Angle Adjustment	Pan: 0° to 360°, tilt: 0° to 180°, rotation: 0° to 360°	Pan: 0° to 360°, tilt: 0° to 180°, rotation: 0° to 360°	Pan: 0° to 360°, tilt: 0° to 180°, rotation: 0° to 360°	Pan: 0° to 360°, tilt: 0° to 180°, rotation: 0° to 360°	Pan: 0° to 360°, tilt: 0° to 180°, rotation: 0° to 360°	Pan: 0° to 360°, tilt: 0° to 180°, rotation: 0° to 360°
Operating Temperature	-30 °C to 60 °C (-22 °F to 140 °F)	-30 °C to 60 °C (-22 °F to 140 °F)	-30 °C to 60 °C (-22 °F to 140 °F)	-30 °C to 60 °C (-22 °F to 140 °F)	-30 °C to 60 °C (-22 °F to 140 °F)	-30 °C to 60 °C (-22 °F to 140 °F)
Humidity	95% or less (non-condensing)	95% or less (non-condensing)	95% or less (non-condensing)	95% or less (non-condensing)	95% or less (non-condensing)	95% or less (non-condensing)
Local Storage	-	256GB	-	256GB		
Indoor/Outdoor	Outdoor	Outdoor	Outdoor	Outdoor	Outdoor	Outdoor
Audio I/O	1 Build-in Microphone	1 Build-in Microphone	1 Build-in Microphone	1 Build-in Microphone	1 Build-in Microphone	1 Build-in Microphone
Power	12 VDC ± 25% PoE: 802.3af, class 3	12 VDC ± 25% PoE: 802.3af, class 3	12 VDC ± 25% PoE: 802.3af, class 3	12 VDC ± 25% PoE: 802.3af, class 3	12 VDC ± 25% PoE: 802.3af, class 3	12 VDC ± 25% PoE: 802.3af, class 3
Interface	1 RJ45 10M/100M Ethernet port	1 RJ45 10M/100M Ethernet port support microSD	1 RJ45 10M/100M Ethernet port	1 RJ45 10M/100M Ethernet port support microSD	1 RJ45 10M/100M Ethernet port	1 RJ45 10M/100M Ethernet port support microSD

Model	DS-2CD1T4362-LIU	DS-2CD1T4362-LIUF	DS-2CD1T6362-LIU	DS-2CD1T6362-LIUF	DS-2CD1T8362-LIU	DS-2CD1T8362-LIUF
Image	 	 	 	 	 	 
Image Sensor	1/2.9" Progressive Scan CMOS	1/2.9" Progressive Scan CMOS	1/2.5" Progressive Scan CMOS	1/2.5" Progressive Scan CMOS	1/2.7" Progressive Scan CMOS	1/2.7" Progressive Scan CMOS
Resolution	2560 × 1440	2560 × 1440	3200*1800	3200*1800	3840 × 2160	3840 × 2160
Video Compression	H.265/H.264/MJPEG/H.265+/H.264+	H.265/H.264/MJPEG/H.265+/H.264+	H.265/H.264/MJPEG/H.265+/H.264+	H.265/H.264/MJPEG/H.265+/H.264+	H.265/H.264/MJPEG/H.265+/H.264+	H.265/H.264/MJPEG/H.265+/H.264+
Min. Illumination	Color: 0.01Lux @ (F2.0, AGC ON)	Color: 0.01Lux @ (F2.0, AGC ON)	Color: 0.005 Lux @ (F1.6, AGC ON),B/W: 0 Lux with IR	Color: 0.005 Lux @ (F1.6, AGC ON),B/W: 0 Lux with IR	Color: 0.01Lux @ (F2.0, AGC ON)	Color: 0.01Lux @ (F2.0, AGC ON)
WDR	120 dB	120 dB	120 dB	120 dB	120 dB	120 dB
Lens	4 mm, 6mm	4 mm, 6mm	4 mm, 6mm	4 mm, 6mm	4 mm, 6mm	4 mm, 6mm
FOV	4 mm, horizontal FOV 81.3°, vertical FOV 43.9°, diagonal FOV 97.1° 6 mm, horizontal FOV 51.8°, vertical FOV 27.9°, diagonal FOV 60.5°	4 mm, horizontal FOV 81.3°, vertical FOV 43.9°, diagonal FOV 97.1° 6 mm, horizontal FOV 51.8°, vertical FOV 27.9°, diagonal FOV 60.5°	4 mm, horizontal FOV 90°, vertical FOV 49°, diagonal FOV 108° 6 mm, horizontal FOV 56°, vertical FOV 30°, diagonal FOV 65°	4 mm, horizontal FOV 90°, vertical FOV 49°, diagonal FOV 108° 6 mm, horizontal FOV 56°, vertical FOV 30°, diagonal FOV 65°	4 mm, horizontal FOV 90°, vertical FOV 49°, diagonal FOV 108° 6 mm, horizontal FOV 56°, vertical FOV 30°, diagonal FOV 65°	4 mm, horizontal FOV 90°, vertical FOV 49°, diagonal FOV 108° 6 mm, horizontal FOV 56°, vertical FOV 30°, diagonal FOV 65°
Optical Zoom	-	-	-	-	-	-
Max. Light Range	IR: 50 m White Light: 40 m	IR: 50 m White Light: 40 m	IR: 50 m White Light: 40 m	IR: 50 m White Light: 40 m	IR: 50 m White Light: 40 m	IR: 50 m White Light: 40 m
VCA	Motion Detection 2.0	Motion Detection 2.0	Motion Detection 2.0	Motion Detection 2.0	Motion Detection 2.0	Motion Detection 2.0
Frame Rate	50Hz: 20fps (2560 × 1440), 25fps (2304 × 1296, 1920 × 1080, 1280 × 720) 60Hz: 20fps (2560 × 1440), 30fps (2304 × 1296, 1920 × 1080, 1280 × 720)	50Hz: 20fps (2560 × 1440), 25fps (2304 × 1296, 1920 × 1080, 1280 × 720) 60Hz: 20fps (2560 × 1440), 30fps (2304 × 1296, 1920 × 1080, 1280 × 720)	50 Hz: 20 fps (3200*1800, 2560 × 1440, 1920 × 1080, 1280 × 720) 60 Hz: 25 fps (3200*1800, 2560 × 1440, 1920 × 1080, 1280 × 720)	50 Hz: 20 fps (3200*1800, 2560 × 1440, 1920 × 1080, 1280 × 720) 60 Hz: 25 fps (3200*1800, 2560 × 1440, 1920 × 1080, 1280 × 720)	50 Hz: 15 fps (3840 × 2160, 3200*1800, 2560 × 1440, 1920 × 1080, 1280 × 720) 60 Hz: 20 fps (3840 × 2160, 3200*1800, 2560 × 1440, 1920 × 1080, 1280 × 720)	50 Hz: 15 fps (3840 × 2160, 3200*1800, 2560 × 1440, 1920 × 1080, 1280 × 720) 60 Hz: 20 fps (3840 × 2160, 3200*1800, 2560 × 1440, 1920 × 1080, 1280 × 720)
Streams	2	2	2	2	2	2
Protection Level	IP67	IP67	IP67	IP67	IP67	IP67
Angle Adjustment	Pan: 0° to 360°, tilt: 0° to 180°, rotation: 0° to 360°	Pan: 0° to 360°, tilt: 0° to 180°, rotation: 0° to 360°	Pan: 0° to 360°, tilt: 0° to 180°, rotation: 0° to 360°	Pan: 0° to 360°, tilt: 0° to 180°, rotation: 0° to 360°	Pan: 0° to 360°, tilt: 0° to 180°, rotation: 0° to 360°	Pan: 0° to 360°, tilt: 0° to 180°, rotation: 0° to 360°
Operating Temperature	-30 °C to 60 °C (-22 °F to 140 °F)	-30 °C to 60 °C (-22 °F to 140 °F)	-30 °C to 60 °C (-22 °F to 140 °F)	-30 °C to 60 °C (-22 °F to 140 °F)	-30 °C to 60 °C (-22 °F to 140 °F)	-30 °C to 60 °C (-22 °F to 140 °F)
Humidity	95% or less (non-condensing)	95% or less (non-condensing)	95% or less (non-condensing)	95% or less (non-condensing)	95% or less (non-condensing)	95% or less (non-condensing)
Local Storage			-	256GB	-	256GB
Indoor/Outdoor	Outdoor	Outdoor	Outdoor	Outdoor	Outdoor	Outdoor
Audio I/O	1 Build-in Microphone	1 Build-in Microphone	1 Build-in Microphone	1 Build-in Microphone	1 Build-in Microphone	1 Build-in Microphone
Power	12 VDC ± 25% PoE: 802.3af, class 3	12 VDC ± 25% PoE: 802.3af, class 3	12 VDC ± 25% PoE: 802.3af, class 3	12 VDC ± 25% PoE: 802.3af, class 3	12 VDC ± 25% PoE: 802.3af, class 3	12 VDC ± 25% PoE: 802.3af, class 3
Interface	1 RJ45 10M/100M Ethernet port	1 RJ45 10M/100M Ethernet port support microSD	1 RJ45 10M/100M Ethernet port	1 RJ45 10M/100M Ethernet port support microSD	1 RJ45 10M/100M Ethernet port	1 RJ45 10M/100M Ethernet port support microSD

Model	DS-2CD102362-I	DS-2CD102362-IUF	DS-2CD112362-I	DS-2CD112362-IUF	DS-2CD132362-I	DS-2CD132362-IUF
Image						
Image Sensor	1/2.9" Progressive Scan CMOS	1/2.9" Progressive Scan CMOS	1/2.9" Progressive Scan CMOS	1/2.9" Progressive Scan CMOS	1/2.9" Progressive Scan CMOS	1/2.9" Progressive Scan CMOS
Resolution	1920 × 1080	1920 × 1080	1920 × 1080	1920 × 1080	1920 × 1080	1920 × 1080
Video Compression	H.265/H.264/MJPEG/H.265+/H.264+	H.265/H.264/MJPEG/H.265+/H.264+	H.265/H.264/MJPEG/H.265+/H.264+	H.265/H.264/MJPEG/H.265+/H.264+	H.265/H.264/MJPEG/H.265+/H.264+	H.265/H.264/MJPEG/H.265+/H.264+
Min. Illumination	Color: 0.01Lux @ (F2.0, AGC ON)	Color: 0.01Lux @ (F2.0, AGC ON)	Color: 0.01Lux @ (F2.0, AGC ON)	Color: 0.01Lux @ (F2.0, AGC ON)	Color: 0.01Lux @ (F2.0, AGC ON)	Color: 0.01Lux @ (F2.0, AGC ON)
WDR	DWDR	DWDR	DWDR	DWDR	DWDR	DWDR
Lens	2.8 mm, 4 mm	2.8 mm, 4 mm	2.8 mm, 4 mm	2.8 mm, 4 mm	2.8 mm, 4 mm	2.8 mm, 4 mm
FOV	2.8 mm, horizontal FOV 105°, vertical FOV 58°, diagonal FOV 123° 4 mm, horizontal FOV 81°, vertical FOV 43°, diagonal FOV 97°	2.8 mm, horizontal FOV 105°, vertical FOV 58°, diagonal FOV 123° 4 mm, horizontal FOV 81°, vertical FOV 43°, diagonal FOV 97°	2.8 mm, horizontal FOV 105°, vertical FOV 58°, diagonal FOV 123° 4 mm, horizontal FOV 81°, vertical FOV 43°, diagonal FOV 97°	2.8 mm, horizontal FOV 105°, vertical FOV 58°, diagonal FOV 123° 4 mm, horizontal FOV 81°, vertical FOV 43°, diagonal FOV 97°	2.8 mm, horizontal FOV 105°, vertical FOV 58°, diagonal FOV 123° 4 mm, horizontal FOV 81°, vertical FOV 43°, diagonal FOV 97°	2.8 mm, horizontal FOV 105°, vertical FOV 58°, diagonal FOV 123° 4 mm, horizontal FOV 81°, vertical FOV 43°, diagonal FOV 97°
Optical Zoom	-	-	-	-	-	-
Max. IR Range	30 m	30 m	30 m	30 m	30 m	30 m
VCA	Motion Detection 2.0	Motion Detection 2.0	Motion Detection 2.0	Motion Detection 2.0	Motion Detection 2.0	Motion Detection 2.0
Frame Rate	50Hz: 25fps (1920 × 1080, 1280 × 960, 1280 × 720) 60Hz: 30fps (1920 × 1080, 1280 × 960, 1280 × 720)	50Hz: 25fps (1920 × 1080, 1280 × 960, 1280 × 720) 60Hz: 30fps (1920 × 1080, 1280 × 960, 1280 × 720)	50Hz: 25fps (1920 × 1080, 1280 × 960, 1280 × 720) 60Hz: 30fps (1920 × 1080, 1280 × 960, 1280 × 720)	50Hz: 25fps (1920 × 1080, 1280 × 960, 1280 × 720) 60Hz: 30fps (1920 × 1080, 1280 × 960, 1280 × 720)	50Hz: 25fps (1920 × 1080, 1280 × 960, 1280 × 720) 60Hz: 30fps (1920 × 1080, 1280 × 960, 1280 × 720)	50Hz: 25fps (1920 × 1080, 1280 × 960, 1280 × 720) 60Hz: 30fps (1920 × 1080, 1280 × 960, 1280 × 720)
Streams	2	2	2	2	2	2
Protection Level	IP67	IP67	IP67, IK10	IP67, IK10	IP67	IP67
Angle Adjustment	Pan: 0° to 360°, tilt: 0° to 180°, rotation: 0° to 360°	Pan: 0° to 360°, tilt: 0° to 180°, rotation: 0° to 360°	Pan: 0° to 360°, tilt: 0° to 180°, rotation: 0° to 360°	Pan: 0° to 360°, tilt: 0° to 180°, rotation: 0° to 360°	Pan: 0° to 360°, tilt: 0° to 180°, rotation: 0° to 360°	Pan: 0° to 360°, tilt: 0° to 180°, rotation: 0° to 360°
Operating Temperature	-30 °C to 60 °C (-22 °F to 140 °F)	-30 °C to 60 °C (-22 °F to 140 °F)	-30 °C to 60 °C (-22 °F to 140 °F)	-30 °C to 60 °C (-22 °F to 140 °F)	-30 °C to 60 °C (-22 °F to 140 °F)	-30 °C to 60 °C (-22 °F to 140 °F)
Humidity		95% or less (non-condensing)	95% or less (non-condensing)	95% or less (non-condensing)	95% or less (non-condensing)	95% or less (non-condensing)
Local Storage	-	-	-	-	-	-
Indoor/Outdoor	Outdoor	Outdoor	Outdoor	Outdoor	Outdoor	Outdoor
Audio I/O	-	1 Build-in Microphone	-	1 Build-in Microphone	-	1 Build-in Microphone
Power	12 VDC ± 25% PoE: 802.3af, class 3	12 VDC ± 25% PoE: 802.3af, class 3	12 VDC ± 25% PoE: 802.3af, class 3	12 VDC ± 25% PoE: 802.3af, class 3	12 VDC ± 25% PoE: 802.3af, class 3	12 VDC ± 25% PoE: 802.3af, class 3
Interface	1 RJ45 10M/100M Ethernet port	1 RJ45 10M/100M Ethernet port support microSD	1 RJ45 10M/100M Ethernet port	1 RJ45 10M/100M Ethernet port support microSD	1 RJ45 10M/100M Ethernet port	1 RJ45 10M/100M Ethernet port support microSD





Model	DS-2CD1T2362-I	DS-2CD1T2362-IUF	DS-2CD104362-I	DS-2CD104362-IUF	DS-2CD114362-I	DS-2CD114362-IUF
Image						
Image Sensor	1/2.9" Progressive Scan CMOS	1/2.9" Progressive Scan CMOS	1/3" Progressive Scan CMOS	1/3" Progressive Scan CMOS	1/3" Progressive Scan CMOS	1/3" Progressive Scan CMOS
Resolution	1920 × 1080	1920 × 1080	2560 × 1440	2560 × 1440	2560 × 1440	2560 × 1440
Video Compression	H.265/H.264/MJPEG/H.265+/H.264+	H.265/H.264/MJPEG/H.265+/H.264+	H.265/H.264/MJPEG/H.265+/H.264+	H.265/H.264/MJPEG/H.265+/H.264+	H.265/H.264/MJPEG/H.265+/H.264+	H.265/H.264/MJPEG/H.265+/H.264+
Min. Illumination	Color: 0.01Lux @ (F2.0, AGC ON)	Color: 0.01Lux @ (F2.0, AGC ON)	Color: 0.01Lux @ (F2.0, AGC ON)	Color: 0.01Lux @ (F2.0, AGC ON)	Color: 0.01Lux @ (F2.0, AGC ON)	Color: 0.01Lux @ (F2.0, AGC ON)
WDR	DWDR	DWDR	120 dB	120 dB	120 dB	120 dB
Lens	4 mm, 6mm	4 mm, 6mm	2.8 mm, 4 mm	2.8 mm, 4 mm	2.8 mm, 4 mm	2.8 mm, 4 mm
FOV	4 mm, horizontal FOV 81.3°, vertical FOV 43.7°, diagonal FOV 96.9° 6 mm, horizontal FOV 50.9°, vertical FOV 29.3°, diagonal FOV 58.1°	4 mm, horizontal FOV 81.3°, vertical FOV 43.7°, diagonal FOV 96.9° 6 mm, horizontal FOV 50.9°, vertical FOV 29.3°, diagonal FOV 58.1°	2.8 mm, horizontal FOV 105°, vertical FOV 58°, diagonal FOV 123° 4 mm, horizontal FOV 81°, vertical FOV 43°, diagonal FOV 97°	2.8 mm, horizontal FOV 105°, vertical FOV 58°, diagonal FOV 123° 4 mm, horizontal FOV 81°, vertical FOV 43°, diagonal FOV 97°	2.8 mm, horizontal FOV 105°, vertical FOV 58°, diagonal FOV 123° 4 mm, horizontal FOV 81°, vertical FOV 43°, diagonal FOV 97°	2.8 mm, horizontal FOV 105°, vertical FOV 58°, diagonal FOV 123° 4 mm, horizontal FOV 81°, vertical FOV 43°, diagonal FOV 97°
Optical Zoom	-	-	-	-	-	-
Max. IR Range	50m	50m	30 m	30 m	30 m	30 m
VCA	Motion Detection 2.0	Motion Detection 2.0	Motion Detection 2.0	Motion Detection 2.0	Motion Detection 2.0	Motion Detection 2.0
Frame Rate	50Hz: 25fps (1920 × 1080, 1280 × 960, 1280 × 720) 60Hz: 30fps (1920 × 1080, 1280 × 960, 1280 × 720)	50Hz: 25fps (1920 × 1080, 1280 × 960, 1280 × 720) 60Hz: 30fps (1920 × 1080, 1280 × 960, 1280 × 720)	50Hz: 20fps (2560 × 1440) 25fps (2304 × 1296, 1920 × 1080, 1280 × 720) 60Hz: 20fps (2560 × 1440) 30fps (2304 × 1296, 1920 × 1080, 1280 × 720)	50Hz: 20fps (2560 × 1440) 25fps (2304 × 1296, 1920 × 1080, 1280 × 720) 60Hz: 20fps (2560 × 1440) 30fps (2304 × 1296, 1920 × 1080, 1280 × 720)	50Hz: 20fps (2560 × 1440) 25fps (2304 × 1296, 1920 × 1080, 1280 × 720) 60Hz: 20fps (2560 × 1440) 30fps (2304 × 1296, 1920 × 1080, 1280 × 720)	50Hz: 20fps (2560 × 1440) 25fps (2304 × 1296, 1920 × 1080, 1280 × 720) 60Hz: 20fps (2560 × 1440) 30fps (2304 × 1296, 1920 × 1080, 1280 × 720)
Streams	2	2	2	2	2	2
Protection Level	IP67	IP67	IP67	IP67	IP67, IK10	IP67, IK10
Angle Adjustment	Pan: 0° to 360°, tilt: 0° to 180°, rotation: 0° to 360°	Pan: 0° to 360°, tilt: 0° to 180°, rotation: 0° to 360°	Pan: 0° to 360°, tilt: 0° to 180°, rotation: 0° to 360°	Pan: 0° to 360°, tilt: 0° to 180°, rotation: 0° to 360°	Pan: 0° to 360°, tilt: 0° to 180°, rotation: 0° to 360°	Pan: 0° to 360°, tilt: 0° to 180°, rotation: 0° to 360°
Operating Temperature	-30 °C to 60 °C (-22 °F to 140 °F)	-30 °C to 60 °C (-22 °F to 140 °F)	-30 °C to 60 °C (-22 °F to 140 °F)	-30 °C to 60 °C (-22 °F to 140 °F)	-30 °C to 60 °C (-22 °F to 140 °F)	-30 °C to 60 °C (-22 °F to 140 °F)
Humidity	95% or less (non-condensing)	95% or less (non-condensing)	95% or less (non-condensing)	95% or less (non-condensing)	95% or less (non-condensing)	95% or less (non-condensing)
Local Storage	-	-	-	-	-	-
Indoor/Outdoor	Outdoor	Outdoor	Outdoor	Outdoor	Outdoor	Outdoor
Audio I/O	-	1 Build-in Microphone	-	1 Build-in Microphone	-	1 Build-in Microphone
Power	12 VDC ± 25% PoE: 802.3af, class 3	12 VDC ± 25% PoE: 802.3af, class 3	12 VDC ± 25% PoE: 802.3af, class 3	12 VDC ± 25% PoE: 802.3af, class 3	12 VDC ± 25% PoE: 802.3af, class 3	12 VDC ± 25% PoE: 802.3af, class 3
Interface	1 RJ45 10M/100M Ethernet port	1 RJ45 10M/100M Ethernet port support microSD*	1 RJ45 10M/100M Ethernet port	1 RJ45 10M/100M Ethernet port support microSD*	1 RJ45 10M/100M Ethernet port	1 RJ45 10M/100M Ethernet port support microSD





Model	DS-2CD134362-I	DS-2CD134362-IUF	DS-2CD1T4362-I	DS-2CD1T4362-IUF	DS-2CD162362-IZ	DS-2CD162362-IZS
Image						
Image Sensor	1/3" Progressive Scan CMOS	1/3" Progressive Scan CMOS	1/3" Progressive Scan CMOS	1/3" Progressive Scan CMOS	1/2.9" Progressive Scan CMOS	1/2.9" Progressive Scan CMOS
Resolution	2560 × 1440	2560 × 1440	2560 × 1440	2560 × 1440	1920 × 1080	1920 × 1080
Video Compression	H.265/H.264/MJPEG/H.265+/H.264+	H.265/H.264/MJPEG/H.265+/H.264+	H.265/H.264/MJPEG/H.265+/H.264+	H.265/H.264/MJPEG/H.265+/H.264+	H.265/H.264/MJPEG/H.265+/H.264+	H.265/H.264/MJPEG/H.265+/H.264+
Min. Illumination	Color: 0.01Lux @(F2.0, AGC ON)	Color: 0.01Lux @(F2.0, AGC ON)	Color: 0.01Lux @(F2.0, AGC ON)	Color: 0.01Lux @(F2.0, AGC ON)	Color: 0.007 Lux @(F1.6, AGC ON)	Color: 0.007 Lux @(F1.6, AGC ON)
WDR	120 dB	120 dB	120 dB	120 dB	DWDR	DWDR
Lens	2.8 mm, 4 mm	2.8 mm, 4 mm	4 mm, 6mm	4 mm, 6mm	2.8-12mm	2.8-12mm
FOV	2.8 mm, horizontal FOV 105°, vertical FOV 58°, diagonal FOV 123° 4 mm, horizontal FOV 81°, vertical FOV 43°, diagonal FOV 97°	2.8 mm, horizontal FOV 105°, vertical FOV 58°, diagonal FOV 123° 4 mm, horizontal FOV 81°, vertical FOV 43°, diagonal FOV 97°	4 mm, horizontal FOV 81.3°, vertical FOV 43.9°, diagonal FOV 97.1° 6 mm, horizontal FOV 51.8°, vertical FOV 27.9°, diagonal FOV 60.5°	4 mm, horizontal FOV 81.3°, vertical FOV 43.9°, diagonal FOV 97.1° 6 mm, horizontal FOV 51.8°, vertical FOV 27.9°, diagonal FOV 60.5°	2.8 to 12 mm: horizontal FOV 96° to 36°, vertical FOV 51° to 20°, diagonal FOV 113° to 42°	2.8 to 12 mm: horizontal FOV 96° to 36°, vertical FOV 51° to 20°, diagonal FOV 113° to 42°
Optical Zoom	-	-	-	-	4x	4x
Max. IR Range	30 m	30 m	50m	50m	50m	50m
VCA	Motion Detection 2.0	Motion Detection 2.0	Motion Detection 2.0	Motion Detection 2.0	Motion Detection 2.0	Motion Detection 2.0
Frame Rate	50Hz: 20fps (2560 × 1440) 25fps (2304 × 1296, 1920 × 1080, 1280 × 720) 60Hz: 20fps (2560 × 1440) 30fps (2304 × 1296, 1920 × 1080, 1280 × 720)	50Hz: 20fps (2560 × 1440) 25fps (2304 × 1296, 1920 × 1080, 1280 × 720) 60Hz: 20fps (2560 × 1440) 30fps (2304 × 1296, 1920 × 1080, 1280 × 720)	50Hz: 20fps (2560 × 1440) 25fps (2304 × 1296, 1920 × 1080, 1280 × 720) 60Hz: 20fps (2560 × 1440) 30fps (2304 × 1296, 1920 × 1080, 1280 × 720)	50Hz: 20fps (2560 × 1440) 25fps (2304 × 1296, 1920 × 1080, 1280 × 720) 60Hz: 20fps (2560 × 1440) 30fps (2304 × 1296, 1920 × 1080, 1280 × 720)	50 Hz: 25 fps (1920 × 1080, 1280 × 720) 60 Hz: 30 fps (1920 × 1080, 1280 × 720)	50 Hz: 25 fps (1920 × 1080, 1280 × 720) 60 Hz: 30 fps (1920 × 1080, 1280 × 720)
Streams	2	2	2	2	2	2
Protection Level	IP67	IP67	IP67	IP67	IP67	IP67
Angle Adjustment	Pan: 0° to 360°, tilt: 0° to 180°, rotation: 0° to 360°	Pan: 0° to 360°, tilt: 0° to 180°, rotation: 0° to 360°	Pan: 0° to 360°, tilt: 0° to 180°, rotation: 0° to 360°	Pan: 0° to 360°, tilt: 0° to 180°, rotation: 0° to 360°	Pan: 0° to 360°, tilt: 0° to 90°, rotation: 0° to 360°	Pan: 0° to 360°, tilt: 0° to 90°, rotation: 0° to 360°
Operating Temperature	-30 °C to 60 °C (-22 °F to 140 °F)	-30 °C to 60 °C (-22 °F to 140 °F)	-30 °C to 60 °C (-22 °F to 140 °F)	-30 °C to 60 °C (-22 °F to 140 °F)	-30 °C to 60 °C (-22 °F to 140 °F)	-30 °C to 60 °C (-22 °F to 140 °F)
Humidity	95% or less (non-condensing)	95% or less (non-condensing)	95% or less (non-condensing)	95% or less (non-condensing)	95% or less (non-condensing)	95% or less (non-condensing)
Local Storage	-	-	-	-	-	-
Indoor/Outdoor	Outdoor	Outdoor	Outdoor	Outdoor	Outdoor	Outdoor
Audio I/O	-	1 Build-in Microphone	-	1 Build-in Microphone	-	1 Line in and Line out
Power	12 VDC ± 25% PoE: 802.3af, class 3	12 VDC ± 25% PoE: 802.3af, class 3	12 VDC ± 25% PoE: 802.3af, class 3	12 VDC ± 25% PoE: 802.3af, class 3	12 VDC ± 25% PoE: 802.3af, class 3	12 VDC ± 25% PoE: 802.3af, class 3
Interface	1 RJ45 10M/100M Ethernet port	1 RJ45 10M/100M Ethernet port support microSD	1 RJ45 10M/100M Ethernet port	1 RJ45 10M/100M Ethernet port support microSD	1 RJ45 10M/100M Ethernet port support microSD	1 RJ45 10M/100M Ethernet port support microSD

Model	DS-2CD166362-LIZU	DS-2CD166362-LIZSU	DS-2CD176362-LIZU	DS-2CD176362-LIZSU	DS-2CD172362-IZ	DS-2CD172362-IZS
Image	 	 	 	 		
Image Sensor	1/2.5" Progressive Scan CMOS	1/2.5" Progressive Scan CMOS	1/2.5" Progressive Scan CMOS	1/2.5" Progressive Scan CMOS	1/2.9" Progressive Scan CMOS	1/2.9" Progressive Scan CMOS
Resolution	3200*1800	3200*1800	3200*1800	3200*1800	1920 × 1080	1920 × 1080
Video Compression	H.265/H.264/MJPEG/H.265+/H.264+	H.265/H.264/MJPEG/H.265+/H.264+	H.265/H.264/MJPEG/H.265+/H.264+	H.265/H.264/MJPEG/H.265+/H.264+	H.265/H.264/MJPEG/H.265+/H.264+	H.265/H.264/MJPEG/H.265+/H.264+
Min. Illumination	Color: 0.007 Lux @(F1.6, AGC ON)	Color: 0.007 Lux @(F1.6, AGC ON)	Color: 0.005 Lux @(F1.6, AGC ON)	Color: 0.005 Lux @(F1.6, AGC ON)	Color: 0.007 Lux @(F1.6, AGC ON)	Color: 0.005 Lux @(F1.6, AGC ON)
WDR	120 dB	120 dB	120 dB	120 dB	DWDR	DWDR
Lens	2.8-12mm	2.8-12mm	2.8-12mm	2.8-12mm	2.8-12mm	2.8-12mm
FOV	2.8 to 12 mm: horizontal FOV 106° to 35.5°, vertical FOV 55.9° to 60°, diagonal FOV 127.4° to 40.8°	2.8 to 12 mm: horizontal FOV 106° to 35.5°, vertical FOV 55.9° to 60°, diagonal FOV 127.4° to 40.8°	2.8 to 12 mm: horizontal FOV 106° to 35.5°, vertical FOV 55.9° to 60°, diagonal FOV 127.4° to 40.8°	2.8 to 12 mm: horizontal FOV 106° to 35.5°, vertical FOV 55.9° to 60°, diagonal FOV 127.4° to 40.8°	2.8 to 12 mm: horizontal FOV 96° to 36°, vertical FOV 51° to 20°, diagonal FOV 113° to 42°	2.8 to 12 mm: horizontal FOV 96° to 36°, vertical FOV 51° to 20°, diagonal FOV 113° to 42°
Optical Zoom	4x	4x	4x	4x	4x	4x
Max. IR Range	IR:30 m; White Light:20m	IR:30 m; White Light:20m	IR:30 m; White Light:20m	IR:30 m; White Light:20m	30 m	30 m
VCA	Motion Detection2.0	Motion Detection2.0	Motion Detection2.0	Motion Detection2.0	Motion Detection 2.0	Motion Detection 2.0
Frame Rate	50 Hz: 20 fps (3200 × 1800, 1920 × 1080, 1280 × 720), 60 Hz: 25 fps (3200 × 1800, 1920 × 1080, 1280 × 720)	50 Hz: 20 fps (3200 × 1800, 1920 × 1080, 1280 × 720), 60 Hz: 25 fps (3200 × 1800, 1920 × 1080, 1280 × 720)	50 Hz: 20 fps (3200 × 1800, 1920 × 1080, 1280 × 720), 60 Hz: 25 fps (3200 × 1800, 1920 × 1080, 1280 × 720)	50 Hz: 20 fps (3200 × 1800, 1920 × 1080, 1280 × 720), 60 Hz: 25 fps (3200 × 1800, 1920 × 1080, 1280 × 720)	50 Hz: 25 fps (1920 × 1080, 1280 × 720), 60 Hz: 30 fps (1920 × 1080, 1280 × 720)	50 Hz: 25 fps (1920 × 1080, 1280 × 720), 60 Hz: 30 fps (1920 × 1080, 1280 × 720)
Streams	2	2	2	2	2	2
Protection Level	IP67	IP67	IP67, IK10	IP67, IK10	IP67, IK10	IP67, IK10
Angle Adjustment	Pan: 0° to 360°, tilt: 0° to 90°, rotation: 0° to 360°	Pan: 0° to 360°, tilt: 0° to 90°, rotation: 0° to 360°	Pan: 0° to 355°, tilt: 0° to 70°, rotation: 0° to 355°	Pan: 0° to 355°, tilt: 0° to 70°, rotation: 0° to 355°	Pan: 0° to 355°, tilt: 0° to 70°, rotation: 0° to 355°	Pan: 0° to 355°, tilt: 0° to 70°, rotation: 0° to 355°
Operating Temperature	-30 °C to 60 °C (-22 °F to 140 °F)	-30 °C to 60 °C (-22 °F to 140 °F)	-30 °C to 60 °C (-22 °F to 140 °F)	-30 °C to 60 °C (-22 °F to 140 °F)	-30 °C to 60 °C (-22 °F to 140 °F)	-30 °C to 60 °C (-22 °F to 140 °F)
Humidity	95% or less (non-condensing)	95% or less (non-condensing)	95% or less (non-condensing)	95% or less (non-condensing)	95% or less (non-condensing)	95% or less (non-condensing)
Local Storage	-	-	-	-	-	-
Indoor/Outdoor	Outdoor	Outdoor	Outdoor	Outdoor	Outdoor	Outdoor
Audio I/O	-	1 Line in and Line out	-	1 Line in and Line out	-	1 Line in and Line out
Power	12 VDC ± 25% PoE: 802.3af, class 3	12 VDC ± 25% PoE: 802.3af, class 3	12 VDC ± 25% PoE: 802.3af, class 3	12 VDC ± 25% PoE: 802.3af, class 3	12 VDC ± 25% PoE: 802.3af, class 3	12 VDC ± 25% PoE: 802.3af, class 3
Interface	1 RJ45 10M/100M Ethernet port support microSD	1 RJ45 10M/100M Ethernet port support microSD	1 RJ45 10M/100M Ethernet port support microSD	1 RJ45 10M/100M Ethernet port support microSD	1 RJ45 10M/100M Ethernet port support microSD	1 RJ45 10M/100M Ethernet port support microSD





Model	DS-2CD1H2362-IZ	DS-2CD1H2362-IZS	DS-2CD164362-IZ	DS-2CD164362-IZS	DS-2CD174362-IZ
Image					
Image Sensor	1/2.9" Progressive Scan CMOS	1/2.9" Progressive Scan CMOS	1/3" Progressive Scan CMOS	1/3" Progressive Scan CMOS	1/3" Progressive Scan CMOS
Resolution	1920 × 1080	1920 × 1080	2560 × 1440	2560 × 1440	2560 × 1440
Video Compression	H.265/H.264/MJPEG/H.265+/H.264+	H.265/H.264/MJPEG/H.265+/H.264+	H.265/H.264/MJPEG/H.265+/H.264+	H.265/H.264/MJPEG/H.265+/H.264+	H.265/H.264/MJPEG/H.265+/H.264+
Min. Illumination	Color: 0.007 Lux @(F1.6, AGC ON)	Color: 0.007 Lux @(F1.6, AGC ON)	Color: 0.007 Lux @(F1.6, AGC ON)	Color: 0.007Lux @(F1.6, AGC ON)	Color: 0.007 Lux @(F1.6, AGC ON)
WDR	DWDR	DWDR	120 dB	120 dB	120 dB
Lens	2.8-12mm	2.8-12mm	2.8-12mm	2.8-12mm	2.8-12mm
FOV	2.8 to 12 mm: horizontal FOV 112° to 33°, vertical FOV 58° to 19°, diagonal FOV 134° to 39°	2.8 to 12 mm: horizontal FOV 112° to 33°, vertical FOV 58° to 19°, diagonal FOV 134° to 39°	2.8 to 12 mm: horizontal FOV 102° to 31°, vertical FOV 55° to 18°, diagonal FOV 122° to 36°	2.8 to 12 mm: horizontal FOV 102° to 31°, vertical FOV 55° to 18°, diagonal FOV 122° to 36°	2.8 to 12 mm: horizontal FOV 102° to 31°, vertical FOV 54° to 17°, diagonal FOV 123° to 35°
Optical Zoom	4x	4x	4x	4x	4x
Max. IR Range	30 m	30 m	50m	50m	30 m
VCA	Motion Detection 2.0	Motion Detection 2.0	Motion Detection 2.0	Motion Detection 2.0	Motion Detection 2.0
Frame Rate	50 Hz: 25 fps (1920 × 1080, 1280 × 720), 60 Hz: 30 fps (1920 × 1080, 1280 × 720)	50 Hz: 25 fps (1920 × 1080, 1280 × 720), 60 Hz: 30 fps (1920 × 1080, 1280 × 720)	50Hz: 20fps (2560 × 1440) 25fps (2304 × 1296, 1920 × 1080, 1280 × 720) 60Hz: 20fps (2560 × 1440) 30fps (2304 × 1296, 1920 × 1080, 1280 × 720)	50Hz: 20fps (2560 × 1440) 25fps (2304 × 1296, 1920 × 1080, 1280 × 720) 60Hz: 20fps (2560 × 1440) 30fps (2304 × 1296, 1920 × 1080, 1280 × 720)	50 Hz: 20 fps (2560 × 1440) 25 fps (2304 × 1296, 1920 × 1080, 1280 × 720) 60 Hz: 20 fps (2560 × 1440) 30 fps (2304 × 1296, 1920 × 1080, 1280 × 720)
Streams	2	2	2	2	2
Protection Level	IP67	IP67	IP67	IP67	IP67, IK10
Angle Adjustment	Pan: 0° to 360°, tilt: 0° to 75°, rotation: 0° to 360°	Pan: 0° to 360°, tilt: 0° to 75°, rotation: 0° to 360°	Pan: 0° to 360°, tilt: 0° to 180°, rotation: 0° to 360°	Pan: 0° to 360°, tilt: 0° to 180°, rotation: 0° to 360°	Pan: 0° to 355°, tilt: 0° to 70°, rotation: 0° to 355°
Operating Temperature	-30 °C to 60 °C (-22 °F to 140 °F)	-30 °C to 60 °C (-22 °F to 140 °F)	-30 °C to 60 °C (-22 °F to 140 °F)	-30 °C to 60 °C (-22 °F to 140 °F)	-30 °C to 60 °C (-22 °F to 140 °F)
Humidity	95% or less (non-condensing)	95% or less (non-condensing)	95% or less (non-condensing)	95% or less (non-condensing)	95% or less (non-condensing)
Local Storage	-	-	-	-	-
Indoor/Outdoor	Outdoor	Outdoor	Outdoor	Outdoor	Outdoor
Audio I/O	-	1 Line in and Line out	-	1 Line in and Line out	-
Power	12 VDC ± 25% PoE: 802.3af, class 3	12 VDC ± 25% PoE: 802.3af, class 3	12 VDC ± 25% PoE: 802.3af, class 3	12 VDC ± 25% PoE: 802.3af, class 3	12 VDC ± 25% PoE: 802.3af, class 3
Interface	1 RJ45 10M/100M Ethernet port support microSD	1 RJ45 10M/100M Ethernet port support microSD alarm: 1 input and 1 output	1 RJ45 10M/100M Ethernet port support microSD	1 RJ45 10M/100M Ethernet port support microSD alarm: 1 input and 1 output	1 RJ45 10M/100M Ethernet port support microSD





Model	DS-2CD174362-IZS	DS-2CD1H4362-IZ	DS-2CD1H4362-IZS	DS-2CD1021-I	DS-2CD102360E-I
Image					
Image Sensor	1/3" Progressive Scan CMOS	1/3" Progressive Scan CMOS	1/3" Progressive Scan CMOS	1/2.8" Progressive Scan CMOS	1/2.8" Progressive Scan CMOS
Resolution	2560 × 1440	2560 × 1440	2560 × 1440	1920 × 1080	1920 × 1080
Video Compression	H.265/H.264/MJPEG/H.265+/H.264+	H.265/H.264/MJPEG/H.265+/H.264+	H.265/H.264/MJPEG/H.265+/H.264+	H.264/MJPEG/H.264+	H.265/H.264/MJPEG/H.265+/H.264+
Min. Illumination	Color: 0.007 Lux @(F1.6, AGC ON)	Color: 0.007 Lux @(F1.6, AGC ON)	Color: 0.007 Lux @(F1.6, AGC ON)	Color: 0.028Lux @(F2.0, AGC ON)	Color: 0.028Lux @(F2.0, AGC ON)
WDR	120 dB	120 dB	120 dB	DWDR	DWDR
Lens	2.8-12mm	2.8-12mm	2.8-12mm	2.8 mm, 4 mm	2.8 mm, 4 mm
FOV	2.8 to 12 mm: horizontal FOV 102° to 31°, vertical FOV 54° to 17°, diagonal FOV 123° to 35°	2.8 to 12 mm: horizontal FOV 102° to 31°, vertical FOV 54° to 17°, diagonal FOV 123° to 35°	2.8 to 12 mm: horizontal FOV 102° to 31°, vertical FOV 54° to 17°, diagonal FOV 123° to 35°	2.8 mm, horizontal FOV 114°, vertical FOV 62°, diagonal FOV: 135° 4 mm, horizontal FOV 87°, vertical FOV 48°, diagonal FOV: 102°	2.8 mm, horizontal FOV 114°, vertical FOV 62°, diagonal FOV 135° 4 mm, horizontal FOV 86°, vertical FOV 46°, diagonal FOV 102°
Optical Zoom	4x	4x	4x	-	-
Max. IR Range	30 m	30 m	30 m	30 m	30 m
VCA	Motion Detection 2.0	Motion Detection 2.0	Motion Detection 2.0	Motion Detection	Motion Detection
Frame Rate	50 Hz: 20 fps (2560 × 1440) 25 fps (2304 × 1296, 1920 × 1080, 1280 × 720) 60 Hz: 20 fps (2560 × 1440) 30 fps (2304 × 1296, 1920 × 1080, 1280 × 720)	50 Hz: 20 fps (2560 × 1440) 25 fps (2304 × 1296, 1920 × 1080, 1280 × 720) 60 Hz: 20 fps (2560 × 1440) 30 fps (2304 × 1296, 1920 × 1080, 1280 × 720)	50 Hz: 20 fps (2560 × 1440) 25 fps (2304 × 1296, 1920 × 1080, 1280 × 720) 60 Hz: 20 fps (2560 × 1440) 30 fps (2304 × 1296, 1920 × 1080, 1280 × 720)	50Hz: 25fps (1920 × 1080, 1280 × 960, 1280 × 720) 60Hz: 30fps (1920 × 1080, 1280 × 960, 1280 × 720)	50Hz: 25fps (1920 × 1080, 1280 × 960, 1280 × 720) 60Hz: 30fps (1920 × 1080, 1280 × 960, 1280 × 720)
Streams	2	2	2	2	2
Protection Level	IP67, IK10	IP67	IP67	IP67	IP67
Angle Adjustment	Pan: 0° to 355°, tilt: 0° to 70°, rotation: 0° to 355°	Pan: 0° to 355°, tilt: 0° to 70°, rotation: 0° to 355°	Pan: 0° to 355°, tilt: 0° to 70°, rotation: 0° to 355°	Pan: 0° to 360°, tilt: 0° to 180°, rotation: 0° to 360°	Pan: 0° to 360°, tilt: 0° to 180°, rotation: 0° to 360°
Operating Temperature	-30 °C to 60 °C (-22 °F to 140 °F)	-30 °C to 60 °C (-22 °F to 140 °F)	-30 °C to 60 °C (-22 °F to 140 °F)	-30 °C to 60 °C (-22 °F to 140 °F)	-30 °C to 60 °C (-22 °F to 140 °F)
Humidity	95% or less (non-condensing)	95% or less (non-condensing)	95% or less (non-condensing)	95% or less (non-condensing)	95% or less (non-condensing)
Local Storage	-	-	-	-	-
Indoor/Outdoor	Outdoor	Outdoor	Outdoor	Outdoor	Outdoor
Audio I/O	1 Line in and Line out	-	1 Line in and Line out	-	-
Power	12 VDC ± 25% PoE: 802.3af, class 3	12 VDC ± 25% PoE: 802.3af, class 3	12 VDC ± 25% PoE: 802.3af, class 3	12 VDC ± 25% PoE: 802.3af, class 3	12 VDC ± 25% PoE: 802.3af, class 3
Interface	1 RJ45 10M/100M Ethernet port support microSD alarm: 1 input and 1 output	1 RJ45 10M/100M Ethernet port support microSD	1 RJ45 10M/100M Ethernet port support microSD alarm: 1 input and 1 output	1 RJ45 10M/100M Ethernet port	1 RJ45 10M/100M Ethernet port





Model	DS-2CD102360-IUF	DS-2CD104360-I	DS-2CD104360-IUF	DS-2CD105360-I	DS-2CD105360-IUF
Image		 HOT			
Image Sensor	1/2.8" Progressive Scan CMOS	1/3" Progressive Scan CMOS	1/3" Progressive Scan CMOS	1/2.7" Progressive Scan CMOS	1/2.7" Progressive Scan CMOS
Resolution	1920 × 1080	2560 × 1440	2560 × 1440	2560 × 1920	2560 × 1920
Video Compression	H.265/H.264/MJPEG/H.265+/H.264+	H.265/H.264/MJPEG/H.265+/H.264+	H.265/H.264/MJPEG/H.265+/H.264+	H.265/H.264/MJPEG/H.265+/H.264+	H.265/H.264/MJPEG/H.265+/H.264+
Min. Illumination	Color: 0.028Lux @ (F2.0, AGC ON)	Color: 0.028 Lux @ (F2.0, AGC ON)	Color: 0.028 Lux @ (F2.0, AGC ON)	Color: 0.028 Lux @ (F2.0; AGC ON)	Color: 0.028 Lux @ (F2.0; AGC ON)
WDR	DWDR	120dB	120dB	120dB	120dB
Lens	2.8 mm, 4 mm	2.8 mm, 4 mm	2.8 mm, 4 mm	2.8 mm, 4 mm	2.8 mm, 4 mm
FOV	2.8 mm, horizontal FOV 114°, vertical FOV 62°, diagonal FOV 135° 4 mm, horizontal FOV 86°, vertical FOV 46°, diagonal FOV 102°	2.8 mm, horizontal FOV 100°, vertical FOV 55°, diagonal FOV 117° 4 mm, horizontal FOV 77°, vertical FOV 42°, diagonal FOV 88°	2.8 mm, horizontal FOV 100°, vertical FOV 55°, diagonal FOV 117° 4 mm, horizontal FOV 77°, vertical FOV 42°, diagonal FOV 88°	2.8 mm, horizontal FOV: 100°, vertical FOV: 74°, diagonal FOV: 130° 4 mm, horizontal field of view: 75°, vertical FOV: 55°, diagonal FOV: 98°	2.8 mm, horizontal FOV: 100°, vertical FOV: 74°, diagonal FOV: 130° 4 mm, horizontal field of view: 75°, vertical FOV: 55°, diagonal FOV: 98°
Optical Zoom	-	-	-	-	-
Max. IR Range	30 m	30 m	30 m	30 m	30 m
VCA	Motion Detection	Motion Detection	Motion Detection	Motion Detection	Motion Detection
Frame Rate	50Hz: 25fps (1920 × 1080, 1280 × 960, 1280 × 720) 60Hz: 30fps (1920 × 1080, 1280 × 960, 1280 × 720)	50Hz: 20fps (2560 × 1440), 25fps (2304 × 1296, 1920 × 1280, 1280 × 720) 60Hz: 20fps (2560 × 1440), 30fps (2304 × 1296, 1920 × 1280, 1280 × 720)	50Hz: 20fps (2560 × 1440), 25fps (2304 × 1296, 1920 × 1280, 1280 × 720) 60Hz: 20fps (2560 × 1440), 30fps (2304 × 1296, 1920 × 1280, 1280 × 720)	50Hz: 12.5fps (2560 × 1920), 20fps (2560 × 1440), 25fps (2304 × 1296, 1920 × 1080, 1280 × 720) 60Hz: 15fps (2560 × 1920), 20fps (2560 × 1440), 30fps (2304 × 1296, 1920 × 1080, 1280 × 720)	50Hz: 12.5fps (2560 × 1920), 20fps (2560 × 1440), 25fps (2304 × 1296, 1920 × 1080, 1280 × 720) 60Hz: 15fps (2560 × 1920), 20fps (2560 × 1440), 30fps (2304 × 1296, 1920 × 1080, 1280 × 720)
Streams	2	2	2	2	2
Protection Level	IP66	IP67	IP67	IP67	IP67
Angle Adjustment	Pan: 0° to 360°, tilt: 0° to 180°, rotation: 0° to 360°	Pan: 0° to 360°, tilt: 0° to 180°, rotation: 0° to 360°	Pan: 0° to 360°, tilt: 0° to 180°, rotation: 0° to 360°	Pan: 0° to 360°, tilt: 0° to 180°, rotate: 0° to 360°	Pan: 0° to 360°, tilt: 0° to 180°, rotate: 0° to 360°
Operating Temperature	-30 °C to 60 °C (-22 °F to 140 °F)	-30 °C to 60 °C (-22 °F to 122 °F)	-30 °C to 60 °C (-22 °F to 122 °F)	-30 °C to 60 °C (-22 °F to 140 °F)	-30 °C to 60 °C (-22 °F to 140 °F)
Humidity	95% or less (non-condensing)	95% or less (non-condensing)	95% or less (non-condensing)	95% or less (non-condensing)	95% or less (non-condensing)
Local Storage	256GB	-	256GB	-	256GB
Indoor/Outdoor	Outdoor	Outdoor	Outdoor	Outdoor	Outdoor
Audio I/O	1 Build-in Microphone	-	-	-	-
Power	12 VDC ± 25% PoE: 802.3af, class 3	12 VDC ± 25% PoE: 802.3af, class 3	12 VDC ± 25% PoE: 802.3af, class 3	12 VDC ± 25% PoE: 802.3af, class 3	12 VDC ± 25% PoE: 802.3af, class 3
Interface	1 RJ45 10M/100M Ethernet port	1 RJ45 10M/100M Ethernet port	1 RJ45 10M/100M Ethernet port	1 RJ45 10M/100M Ethernet port	1 RJ45 10M/100M Ethernet port





Model	DS-2CD108360-I	DS-2CD108360-IUF	DS-2CD1121-I	DS-2CD112360E-I	DS-2CD114360-I HOT
Image					
Image Sensor	1/2.5" Progressive Scan CMOS	1/2.5" Progressive Scan CMOS	1/2.8" Progressive Scan CMOS	1/2.8" Progressive Scan CMOS	1/3" Progressive Scan CMOS
Resolution	3840 × 2160	3840 × 2160	1920 × 1080	1920 × 1080	2560 × 1440
Video Compression	H.265/H.265+/MJPEG	H.265/H.265+/MJPEG	H.264/MJPEG/H.264+	H.265/H.264/MJPEG/H.265+/H.264+	H.265/H.264/MJPEG/H.265+/H.264+
Min. Illumination	0.01 Lux @ (F2.0, AGC ON)	0.01 Lux @ (F2.0, AGC ON)	Color: 0.028 Lux @ (F2.0, AGC ON)	Color: 0.028Lux @ (F2.0, AGC ON)	Color: 0.028 Lux @ (F2.0, AGC ON)
WDR	120dB	120dB	DWDR	DWDR	120dB
Lens	2.8 mm, 4 mm	2.8 mm, 4 mm	2.8 mm, 4 mm	2.8 mm, 4 mm	2.8 mm, 4 mm
FOV	2.8 mm, horizontal FOV 102°, vertical FOV 53°, diagonal FOV 123° 4 mm, horizontal FOV 83°, vertical FOV 44°, diagonal FOV 98°	2.8 mm, horizontal FOV 102°, vertical FOV 53°, diagonal FOV 123° 4 mm, horizontal FOV 83°, vertical FOV 44°, diagonal FOV 98°	2.8 mm @F2.0, horizontal FOV 114°, vertical FOV 62°, diagonal FOV: 135° 4 mm @F2.0, horizontal FOV 87°, vertical FOV 48°, diagonal FOV: 102°	2.8 mm, horizontal FOV 114°, vertical FOV 62°, diagonal FOV 135° 4 mm, horizontal FOV 86°, vertical FOV 46°, diagonal FOV 102°	2.8 mm, horizontal FOV 100°, vertical FOV 55°, diagonal FOV 117° 4 mm, horizontal FOV 77°, vertical FOV 42°, diagonal FOV 88°
Optical Zoom	-	-	-	-	-
Max. IR Range	30 m	30 m	30 m	30 m	30 m
VCA	Motion Detection, Face Detectin, Line Crossing Detection, Intrusion Detection	Motion Detection, Face Detectin, Line Crossing Detection, Intrusion Detection	Motion Detection	Motion Detection	Motion Detection
Frame Rate	50Hz: 12.5 fps (3840 × 2160, 2560 × 1440, 1920 × 1080, 1280 × 720) 60Hz: 15 fps (3840 × 2160, 2560 × 1440, 1920 × 1080, 1280 × 720)	50Hz: 12.5 fps (3840 × 2160, 2560 × 1440, 1920 × 1080, 1280 × 720) 60Hz: 15 fps (3840 × 2160, 2560 × 1440, 1920 × 1080, 1280 × 720)	50Hz: 25fps (1920 × 1080, 1280 × 960, 1280 × 720) 60Hz: 30fps (1920 × 1080, 1280 × 960, 1280 × 720)	50Hz: 25fps (1920 × 1080, 1280 × 960, 1280 × 720) 60Hz: 30fps (1920 × 1080, 1280 × 960, 1280 × 720)	50Hz: 20fps (2560 × 1440), 25fps (2304 × 1296, 1920 × 1280, 1280 × 720) 60Hz: 20fps (2560 × 1440), 30fps (2304 × 1296, 1920 × 1280, 1280 × 720)
Streams	2	2	2	2	2
Protection Level	IP67	IP67	IP67,IK10	IP67,IK10	IP67,IK10
Angle Adjustment	Pan: 0° to 360°, tilt: 0° to 90°, rotate: 0° to 360°	Pan: 0° to 360°, tilt: 0° to 90°, rotate: 0° to 360°	Pan: 0° to 355°, tilt: 0° to 75°	Pan: 0° to 355°, tilt: 0° to 75°	Pan: 0° to 355°, tilt: 0° to 75°
Operating Temperature	-30 °C to 60 °C (-22 °F to 140 °F)	-30 °C to 60 °C (-22 °F to 140 °F)	-30 °C to 60 °C (-22 °F to 140 °F)	-30 °C to 60 °C (-22 °F to 140 °F)	-30 °C to 60 °C (-22 °F to 122 °F)
Humidity	95% or less (non-condensing)	95% or less (non-condensing)	95% or less (non-condensing)	95% or less (non-condensing)	95% or less (non-condensing)
Local Storage	-	256GB	-	-	-
Indoor/Outdoor	Outdoor	Outdoor	Outdoor	Outdoor	Outdoor
Audio I/O	-	1 Build-in Microphone	-	-	-
Power	12 VDC ± 25% PoE: 802.3af, class 3	12 VDC ± 25% PoE: 802.3af, class 3	12 VDC ± 25% PoE: 802.3af, class 3	12 VDC ± 25% PoE: 802.3af, class 3	12 VDC ± 25% PoE: 802.3af, class 3
Interface	1 RJ45 10M/100M Ethernet port	1 RJ45 10M/100M Ethernet port	1 RJ45 10M/100M Ethernet port	1 RJ45 10M/100M Ethernet port	1 RJ45 10M/100M Ethernet port







Model	DS-2CD114360-IUF	DS-2CD115360-I	DS-2CD115360-IUF	DS-2CD118360-I	DS-2CD118360-IUF
Image					
Image Sensor	1/3" Progressive Scan CMOS	1/2.7" Progressive Scan CMOS	1/2.7" Progressive Scan CMOS	1/2.5" Progressive Scan CMOS	1/2.5" Progressive Scan CMOS
Resolution	2560 × 1440	2560 × 1920	2560 × 1920	3840 × 2160	3840 × 2160
Video Compression	H.265/H.264/MJPEG/H.265+/H.264+	H.265/H.264/MJPEG/H.265+/H.264+	H.265/H.264/MJPEG/H.265+/H.264+	H.265/H.265+/MJPEG	H.265/H.265+/MJPEG
Min. Illumination	Color: 0.028 Lux @ (F2.0, AGC ON)	Color: 0.028 Lux @ (F2.0; AGC ON)	Color: 0.028 Lux @ (F2.0; AGC ON)	0.01 Lux @ (F2.0, AGC ON)	0.01 Lux @ (F2.0, AGC ON)
WDR	120dB	120dB	120dB	120dB	120dB
Lens	2.8 mm, 4 mm	2.8 mm, 4 mm	2.8 mm, 4 mm	2.8 mm, 4 mm	2.8 mm, 4 mm
FOV	2.8 mm, horizontal FOV 100°, vertical FOV 55°, diagonal FOV 117° 4 mm, horizontal FOV 77°, vertical FOV 42°, diagonal FOV 88°	2.8 mm, horizontal FOV: 100°, vertical FOV: 74°, diagonal FOV: 130° 4 mm, horizontal FOV: 75°, vertical FOV: 55°, diagonal FOV: 98°	2.8 mm, horizontal FOV: 100°, vertical FOV: 74°, diagonal FOV: 130° 4 mm, horizontal FOV: 75°, vertical FOV: 55°, diagonal FOV: 98°	2.8 mm, horizontal FOV 102°, vertical FOV 53°, diagonal FOV 123° 4 mm, horizontal FOV 83°, vertical FOV 44°, diagonal FOV 98°	2.8 mm, horizontal FOV 102°, vertical FOV 53°, diagonal FOV 123° 4 mm, horizontal FOV 83°, vertical FOV 44°, diagonal FOV 98°
Optical Zoom	-	-	-	-	-
Max. IR Range	30 m	30 m	30 m	30 m	30 m
VCA	Motion Detection	Motion Detection	Motion Detection	Motion Detection, Face Detectin, Line Crossing Detection, Intrusion Detection	Motion Detection, Face Detectin, Line Crossing Detection, Intrusion Detection
Frame Rate	50Hz: 20fps (2560 × 1440), 25fps (2304 × 1296, 1920 × 1280, 1280 × 720) 60Hz: 20fps (2560 × 1440), 30fps (2304 × 1296, 1920 × 1280, 1280 × 720)	50Hz:12.5fps (2560 × 1920), 20fps (2560 × 1440), 25fps (2304 × 1296, 1920 × 1080, 1280 × 720) 60Hz: 15fps (2560 × 1920), 20fps (2560 × 1440), 30fps (2304 × 1296, 1920 × 1080, 1280 × 720)	50Hz:12.5fps (2560 × 1920), 20fps (2560 × 1440), 25fps (2304 × 1296, 1920 × 1080, 1280 × 720) 60Hz: 15fps (2560 × 1920), 20fps (2560 × 1440), 30fps (2304 × 1296, 1920 × 1080, 1280 × 720)	50Hz: 12.5 fps (3840 × 2160, 2560 × 1440, 1920 × 1080, 1280 × 720) 60Hz: 15 fps (3840 × 2160, 2560 × 1440, 1920 × 1080, 1280 × 720)	50Hz: 12.5 fps (3840 × 2160, 2560 × 1440, 1920 × 1080, 1280 × 720) 60Hz: 15 fps (3840 × 2160, 2560 × 1440, 1920 × 1080, 1280 × 720)
Streams	2	2	2	2	2
Protection Level	IP67,IK10	IP67,IK10	IP67,IK10	IP67, IK10	IP67, IK10
Angle Adjustment	Pan: 0° to 355°, tilt: 0° to 75°	Pan: 0° to 355°, tilt: 0° to 75°	Pan: 0° to 355°, tilt: 0° to 75°	Pan: 0° to 355°, tilt: 0° to 60°	Pan: 0° to 355°, tilt: 0° to 60°
Operating Temperature	-30 °C to 60 °C (-22 °F to 122 °F)	-30 °C to 60 °C (-22 °F to 140 °F)	-30 °C to 60 °C (-22 °F to 140 °F)	-30 °C to 60 °C (-22 °F to 140 °F)	-30 °C to 60 °C (-22 °F to 140 °F)
Humidity	95% or less (non-condensing)	95% or less (non-condensing)	95% or less (non-condensing)	95% or less (non-condensing)	95% or less (non-condensing)
Local Storage	256GB	-	256GB	-	256GB
Indoor/Outdoor	Outdoor	Outdoor	Outdoor	Outdoor	Outdoor
Audio I/O	-	-	-	-	1 Build-in Microphone
Power	12 VDC ± 25% PoE: 802.3af, class 3	12 VDC ± 25% PoE: 802.3af, class 3	12 VDC ± 25% PoE: 802.3af, class 3	12 VDC ± 25% PoE: 802.3af, class 3	12 VDC ± 25% PoE: 802.3af, class 3
Interface	1 RJ45 10M/100M Ethernet port	1 RJ45 10M/100M Ethernet port	1 RJ45 10M/100M Ethernet port	1 RJ45 10M/100M Ethernet port	1 RJ45 10M/100M Ethernet port







Model	DS-2CD1321-I	DS-2CD132360E-I	DS-2CD132360-IUF	DS-2CD134360-I	DS-2CD134360-IUF
Image				 HOT	
Image Sensor	1/2.8" Progressive Scan CMOS	1/2.8" Progressive Scan CMOS	1/2.8" Progressive Scan CMOS	1/3" Progressive Scan CMOS	1/3" Progressive Scan CMOS
Resolution	1920 × 1080	1920 × 1080	1920 × 1080	2560 × 1440	2560 × 1440
Video Compression	H.264/MJPEG/H.264+	H.265/H.264/MJPEG/H.265+/H.264+	H.265/H.264/MJPEG/H.265+/H.264+	H.265/H.264/MJPEG/H.265+/H.264+	H.265/H.264/MJPEG
Min. Illumination	Color: 0.028 Lux @(F2.0, AGC ON)	Color: 0.028Lux @(F2.0, AGC ON)	Color: 0.028Lux @(F2.0, AGC ON)	Color: 0.028 Lux @(F2.0, AGC ON)	Color: 0.01 Lux @(F1.2, AGC ON), 0.028 Lux @(F2.0, AGC ON)
WDR	DWDR	DWDR	DWDR	120dB	120dB
Lens	2.8 mm, 4 mm	2.8 mm, 4 mm	2.8 mm, 4 mm	2.8 mm, 4 mm	2.8 mm, 4 mm
FOV	2.8 mm @F2.0, horizontal FOV 114°, vertical FOV 62°, diagonal FOV: 135° 4 mm @F2.0, horizontal FOV 87°, vertical FOV 48°, diagonal FOV: 102°	2.8 mm, horizontal FOV 114°, vertical FOV 62°, diagonal FOV 135° 4 mm, horizontal FOV 86°, vertical FOV 46°, diagonal FOV 102°	2.8 mm, horizontal FOV 114°, vertical FOV 62°, diagonal FOV 135° 4 mm, horizontal FOV 86°, vertical FOV 46°, diagonal FOV 102°	2.8 mm, horizontal FOV 100°, vertical FOV 55°, diagonal FOV 117° 4 mm, horizontal FOV 77°, vertical FOV 42°, diagonal FOV 88°	2.8 mm, horizontal FOV 98°, vertical FOV 53°, diagonal FOV 115° 4 mm, horizontal FOV 77°, vertical FOV 42°, diagonal FOV 91°
Optical Zoom	-	-	-	-	-
Max. IR Range	30 m	30 m	30 m	30 m	30 m
VCA	Motion Detection	Motion Detection	Motion Detection	Motion Detection	Motion Detection
Frame Rate	50Hz: 25fps (1920 × 1080, 1280 × 960, 1280 × 720) 60Hz: 30fps (1920 × 1080, 1280 × 960, 1280 × 720)	50Hz: 25fps (1920 × 1080, 1280 × 960, 1280 × 720) 60Hz: 30fps (1920 × 1080, 1280 × 960, 1280 × 720)	50Hz: 25fps (1920 × 1080, 1280 × 960, 1280 × 720) 60Hz: 30fps (1920 × 1080, 1280 × 960, 1280 × 720)	50Hz: 20fps (2560 × 1440), 25fps (2304 × 1296, 1920 × 1280, 1280 × 720) 60Hz: 20fps (2560 × 1440), 30fps (2304 × 1296, 1920 × 1280, 1280 × 720)	50Hz: 20 fps (2560 × 1440), 25 fps (2304 × 1296, 1920 × 1080, 1280 × 720) 60Hz: 20 fps (2560 × 1440), 30 fps (2304 × 1296, 1920 × 1080, 1280 × 720)
Streams	2	2	2	2	2
Protection Level	IP67	IP67	IP66	IP67	IP67
Angle Adjustment	Pan: 0° to 360°, tilt: 0° to 75°, rotation: 0° to 360°	Pan: 0° to 360°, tilt: 0° to 75°, rotation: 0° to 360°	Pan: 0° to 360°, tilt: 0° to 75°, rotation: 0° to 360°	Pan: 0° to 360°, tilt: 0° to 75°, rotation: 0° to 360°	Pan: 0° to 360°, tilt: 0° to 75°, rotation: 0° to 360°
Operating Temperature	-30 °C to 60 °C [-22 °F to 140 °F]	-30 °C to 60 °C [-22 °F to 140 °F]	-30 °C to 60 °C [-22 °F to 140 °F]	-30 °C to 60 °C [-22 °F to 122 °F]	-30 °C to 60 °C [-22 °F to 122 °F]
Humidity	95% or less (non-condensing)	95% or less (non-condensing)	95% or less (non-condensing)	95% or less (non-condensing)	95% or less (non-condensing)
Local Storage	-	-	256GB	-	256GB
Indoor/Outdoor	Outdoor	Outdoor	Outdoor	Outdoor	Outdoor
Audio I/O	-	-	1 Build-in Microphone	-	1 Build-in Microphone
Power	12 VDC ± 25% PoE: 802.3af, class 3	12 VDC ± 25% PoE: 802.3af, class 3	12 VDC ± 25% PoE: 802.3af, class 3	12 VDC ± 25% PoE: 802.3af, class 3	12 VDC ± 25% PoE: 802.3af, class 3
Interface	1 RJ45 10M/100M Ethernet port	1 RJ45 10M/100M Ethernet port	1 RJ45 10M/100M Ethernet port	1 RJ45 10M/100M Ethernet port	1 RJ45 10M/100M Ethernet port

Model	DS-2CD135360-I	DS-2CD135360-IUF	DS-2CD138360-I	DS-2CD138360-IUF	DS-2CD1T2360-I	DS-2CD1T2360-IUF
Image						
Image Sensor	1/2.7" Progressive Scan CMOS	1/2.7" Progressive Scan CMOS	1/2.5" Progressive Scan CMOS	1/2.5" Progressive Scan CMOS	1/2.8" Progressive Scan CMOS	1/2.7" Progressive Scan CMOS
Resolution	2560 × 1920	2560 × 1920	3840 × 2160	3840 × 2160	1920 × 1080	1920 × 1080
Video Compression	H.265/H.264/MJPEG/H.265+/H.264+	H.265/H.264/MJPEG/H.265+/H.264+	H.265/H.265+/MJPEG	H.265/H.265+/MJPEG	H.265/H.264/MJPEG/H.265+/H.264+	H.265+/H.264+/H.265/H.264 Sub-stream: H.265/H.264/MJPEG
Min. Illumination	Color: 0.028 Lux @(F2.0; AGC ON)	Color: 0.028 Lux @(F2.0; AGC ON)	0.01 Lux @(F2.0, AGC ON)	0.01 Lux @(F2.0, AGC ON)	Color: 0.028 Lux @(F2.0; AGC ON)	Color: 0.01 Lux @(F2.0, AGC ON), B/W: 0 Lux with IR
WDR	120dB	120dB	120dB	120dB	DWDR	DWDR
Lens	2.8 mm, 4 mm	2.8 mm, 4 mm	2.8 mm, 4 mm	2.8 mm, 4 mm	4mm, 6mm	4mm,6mm
FOV	2.8 mm, horizontal FOV: 100°, vertical FOV: 74°, diagonal FOV: 130° 4 mm, horizontal FOV: 75°, vertical FOV: 55°, diagonal FOV: 98°	2.8 mm, horizontal FOV: 100°, vertical FOV: 74°, diagonal FOV: 130° 4 mm, horizontal FOV: 75°, vertical FOV: 55°, diagonal FOV: 98°	2.8 mm, horizontal FOV 102°, vertical FOV 53°, diagonal FOV 123° 4 mm, horizontal FOV 83°, vertical FOV 44°, diagonal FOV 98°	2.8 mm, horizontal FOV 102°, vertical FOV 53°, diagonal FOV 123° 4 mm, horizontal FOV 83°, vertical FOV 44°, diagonal FOV 98°	4 mm, horizontal FOV 86°, vertical FOV 47°, diagonal FOV 103° 6mm, horizontal FOV 54°, vertical FOV 31°, diagonal FOV 63°	4 mm, horizontal FOV 90.2°, vertical FOV 48.6°, diagonal FOV 107.6° 6 mm, horizontal FOV 54.6°, vertical FOV 30.7°, diagonal FOV 62.7°
Optical Zoom	-	-	-	-	-	-
Max. IR Range	30 m	30 m	30 m	30 m	50 m	50 m
VCA	Motion Detection	Motion Detection	Motion Detection, Face Detectin, Line Crossing Detection, Intrusion Detection	Motion Detection, Face Detectin, Line Crossing Detection, Intrusion Detection	Motion Detection	Motion detection,
Frame Rate	50Hz:12.5fps (2560 × 1920), 20fps (2560 × 1440), 25fps (2304 × 1296, 1920 × 1080, 1280 × 720) 60Hz: 15fps (2560 × 1920), 20fps (2560 × 1440), 30fps (2304 × 1296, 1920 × 1080, 1280 × 720)	50Hz:12.5fps (2560 × 1920), 20fps (2560 × 1440), 25fps (2304 × 1296, 1920 × 1080, 1280 × 720) 60Hz: 15fps (2560 × 1920), 20fps (2560 × 1440), 30fps (2304 × 1296, 1920 × 1080, 1280 × 720)	50Hz: 12.5 fps (3840 × 2160, 2560 × 1440, 1920 × 1080, 1280 × 720) 60Hz: 15 fps (3840 × 2160, 2560 × 1440, 1920 × 1080, 1280 × 720)	50Hz: 12.5 fps (3840 × 2160, 2560 × 1440, 1920 × 1080, 1280 × 720) 60Hz: 15 fps (3840 × 2160, 2560 × 1440, 1920 × 1080, 1280 × 720)	50Hz: 25fps (1920 × 1080, 1280 × 960, 1280 × 720) 60Hz: 30fps (1920 × 1080, 1280 × 960, 1280 × 720)	50 Hz: 25 fps (1920 × 1080, 1280 × 720) 60 Hz: 30 fps (1920 × 1080, 1280 × 720)
Streams	2	2	2	2	2	2
Protection Level	IP67	IP67	IP67	IP67	IP67	IP67
Angle Adjustment	Pan: 0° to 360°, tilt: 0° to 75°, rotate: 0° to 360°	Pan: 0° to 360°, tilt: 0° to 75°, rotate: 0° to 360°	Pan: 0° to 360°, tilt: 0° to 75°, rotate: 0° to 360°	Pan: 0° to 360°, tilt: 0° to 75°, rotate: 0° to 360°	Pan: 0° to 360°, tilt: 0° to 180°, rotate: 0° to 360°	Pan: 0° to 360°, tilt: 0° to 180°, rotate: 0° to 360°
Operating Temperature	-30 °C to 60 °C (-22 °F to 140 °F)	-30 °C to 60 °C (-22 °F to 140 °F)	-30 °C to 60 °C (-22 °F to 140 °F)	-30 °C to 60 °C (-22 °F to 140 °F)	-30 °C to 60 °C (-22 °F to 140 °F)	-30 °C to 60 °C (-22 °F to 140 °F)
Humidity	95% or less (non-condensing)	95% or less (non-condensing)	95% or less (non-condensing)	95% or less (non-condensing)	95% or less (non-condensing)	95% or less (non-condensing)
Local Storage	-	256GB	-	256GB	-	256 GB
Indoor/Outdoor	Outdoor	Outdoor	Outdoor	Outdoor	Outdoor	Outdoor
Audio I/O	-	-	-	1 Build-in Microphone	-	1 Build-in Microphone
Power	12 VDC ± 25% PoE: 802.3af, class 3	12 VDC ± 25% PoE: 802.3af, class 3	12 VDC ± 25% PoE: 802.3af, class 3	12 VDC ± 25% PoE: 802.3af, class 3	12 VDC ± 25% PoE: 802.3af, class 3	12 VDC ± 25%, 0.4 A, max. 5 W, Ø 5.5 mm coaxial power plug PoE: 802.3af, Class 3, 36 V to 57 V, 0.2 A to 0.15 A, max. 6.5 W
Interface	1 RJ45 10M/100M Ethernet port	1 RJ45 10M/100M Ethernet port	1 RJ45 10M/100M Ethernet port	1 RJ45 10M/100M Ethernet port	1 RJ45 10M/100M Ethernet port	1 RJ45 10 M/100 M Ethernet port

Model	DS-2CD1T4360-I	DS-2CD1T4360-IUF	DS-2CD1T8360-I	DS-2CD1T8360-IUF	DS-2CD162360-IZ
Image	 HOT				
Image Sensor	1/3" Progressive Scan CMOS	1/3" Progressive Scan CMOS	1/2.8" Progressive Scan CMOS	1/2.8" Progressive Scan CMOS	1/2.8" Progressive Scan CMOS
Resolution	2560 × 1440	2560 × 1440	3840 × 2160	3840 × 2160	1920 × 1080
Video Compression	H.265/H.264/MJPEG/H.265+/H.264+	H.265+/H.264+/H.265/H.264 Sub-stream: H.265/H.264/MJPEG	H.265+/H.264+/H.265/H.264 Sub-stream: H.265/H.264/MJPEG	H.265+/H.264+/H.265/H.264 Sub-stream: H.265/H.264/MJPEG	H.265/H.264/MJPEG/H.265+/H.264+
Min. Illumination	Color: 0.028 Lux @(F2.0; AGC ON)	Color: 0.01 Lux @ (F2.0, AGC ON), B/W: 0 Lux with IR	4 mm: Color: 0.01 Lux @ (F2.0, AGC ON), B/W: 0 Lux with IR 6 mm: Color: 0.01 Lux @ (F1.6, AGC ON), B/W: 0 Lux with IR	4 mm: Color: 0.01 Lux @ (F2.0, AGC ON), B/W: 0 Lux with IR 6 mm: Color: 0.01 Lux @ (F1.6, AGC ON), B/W: 0 Lux with IR	Color: 0.018 Lux @ (F1.6, AGC ON)
WDR	120dB	120 dB	120 dB	120 dB	DWDR
Lens	4mm, 6mm	4mm,6mm	4mm,6mm	4mm,6mm	2.8 to 12 mm
FOV	4 mm, horizontal FOV 75°, vertical FOV 41°, diagonal FOV 88° 6 mm, horizontal FOV 49°, vertical FOV 26°, diagonal FOV 57°	4 mm, horizontal FOV 83.2°, vertical FOV 45.5°, diagonal FOV 98.3° 6 mm, horizontal FOV 50.9°, vertical FOV 28.8°, diagonal FOV 58.5°	4 mm, horizontal FOV 86°, vertical FOV 46°, diagonal FOV 102° 6 mm, horizontal FOV 53°, vertical FOV 29°, diagonal FOV 62°	4 mm, horizontal FOV 86°, vertical FOV 46°, diagonal FOV 102° 6 mm, horizontal FOV 53°, vertical FOV 29°, diagonal FOV 62°	Horizontal field of view: 98° to 34° Vertical field of view: 51° to 19° Diagonal field of view: 115° to 40°
Optical Zoom	-	-	-	-	4x
Max. IR Range	50 m	50m	50m	50m	30 m
VCA	Motion Detection	Motion detection,	Motion detection,	Motion detection,	Motion Detection
Frame Rate	50Hz: 20fps (2560 × 1440), 25fps (2304 × 1296, 1920 × 1080, 1280 × 720) 60Hz: 20fps (2560 × 1440), 30fps (2304 × 1296, 1920 × 1080, 1280 × 720)	50 Hz: 20 fps (2560 × 1440), 25 fps (1920 × 1080, 1280 × 720) 60 Hz: 20 fps (2560 × 1440), 30 fps (1920 × 1080, 1280 × 720)	50 Hz: 12.5 fps (3840 × 2160), 20 fps (2592 × 1944), 25 fps (2688 × 1520, 1920 × 1080, 1280 × 720) 60 Hz: 15 fps (3840 × 2160), 20 fps (2592 × 1944), 30 fps (2688 × 1520, 1920 × 1080, 1280 × 720)	50 Hz: 12.5 fps (3840 × 2160), 20 fps (2592 × 1944), 25 fps (2688 × 1520, 1920 × 1080, 1280 × 720) 60 Hz: 15 fps (3840 × 2160), 20 fps (2592 × 1944), 30 fps (2688 × 1520, 1920 × 1080, 1280 × 720)	50Hz: 25fps (1920 × 1080, 1280 × 960, 1280 × 720) 60Hz: 30fps (1920 × 1080, 1280 × 960, 1280 × 720)
Streams	2	2	2	2	2
Protection Level	IP67	IP67	IP67	IP67	IP67
Angle Adjustment	Pan: 0° to 360°, tilt: 0° to 180°, rotate: 0° to 360°	Pan: 0° to 360°, tilt: 0° to 180°, rotate: 0° to 360°	Pan: 0° to 360°, tilt: 0° to 180°, rotate: 0° to 360°	Pan: 0° to 360°, tilt: 0° to 180°, rotate: 0° to 360°	Pan: 0° to 355°, tilt: 0° to 90°, rotation: 0° to 355°
Operating Temperature	-30 °C to 60 °C (-22 °F to 140 °F)	-30 °C to 60 °C (-22 °F to 140 °F)	-30 °C to 60 °C (-22 °F to 140 °F)	-30 °C to 60 °C (-22 °F to 140 °F)	-30 °C to 60 °C (-22 °F to 140 °F)
Humidity	95% or less (non-condensing)	95% or less (non-condensing)	95% or less (non-condensing)	95% or less (non-condensing)	95% or less (non-condensing)
Local Storage	-	256 GB	256 GB	256 GB	128GB
Indoor/Outdoor	Outdoor	Outdoor	Outdoor	Outdoor	Outdoor
Audio I/O	-	-	-	1 Build-in Microphone	-
Power	12 VDC ± 25% PoE: 802.3af, class 3	12 VDC ± 25%, 0.4 A, max. 5 W, Ø5.5 mm coaxial power plug PoE: 802.3af, Class 3, 36 V to 57 V, 0.2 A to 0.15 A, max. 6.5 W	12 VDC ± 25%, 0.5 A, max. 6 W, Ø5.5 mm coaxial power plug PoE: 802.3af, Class 3, 36 V to 57 V, 0.2 A to 0.15 A, max. 7.5 W	12 VDC ± 25%, 0.5 A, max. 6 W, Ø5.5 mm coaxial power plug PoE: 802.3af, Class 3, 36 V to 57 V, 0.2 A to 0.15 A, max. 7.5 W	12 VDC ± 25% PoE: 802.3af, class 3
Interface	1 RJ45 10M/100M Ethernet port	1 RJ45 10 M/100 M Ethernet port	1 RJ45 10 M/100 M Ethernet port	1 RJ45 10 M/100 M Ethernet port	1 RJ45 10M/100M Ethernet port

Model	DS-2CD164360-IZ	DS-2CD165360-IZ	DS-2CD172360-IZ	DS-2CD174360-IZ	DS-2CD175360-IZ
Image	 HOT			 HOT	
Image Sensor	1/3" Progressive Scan CMOS	1/2.7" Progressive Scan CMOS	1/2.8" Progressive Scan CMOS	1/3" Progressive Scan CMOS	1/2.7" Progressive Scan CMOS
Resolution	2560 × 1440	2560 × 1920	1920 × 1080	2560 × 1440	2560 × 1920
Video Compression	H.265/H.264/MJPEG/H.265+/H.264+	H.265/H.264/MJPEG/H.265+/H.264+	H.265/H.264/MJPEG/H.265+/H.264+	H.265/H.264/MJPEG/H.265+/H.264+	H.265/H.264/MJPEG/H.265+/H.264+
Min. Illumination	Color: 0.018 Lux @ (F1.6, AGC ON)	Color: 0.02 Lux @ (F1.6, AGC ON)	Color: 0.018 Lux @ (F1.6, AGC ON)	Color: 0.018 Lux @ (F1.6, AGC ON)	Color: 0.02 Lux @ (F1.6, AGC ON)
WDR	120dB	120dB	DWDR	120dB	120dB
Lens	2.8 to 12 mm	2.8 to 12 mm	2.8 to 12 mm	2.8 to 12 mm	2.8 to 12 mm
FOV	Horizontal field of view: 98° to 28° Vertical field of view: 51° to 16° Diagonal field of view: 115° to 32°	Horizontal FOV: 98° to 28°, vertical FOV: 71° to 21°, diagonal FOV: 130° to 35°	Horizontal field of view: 98° to 34° Vertical field of view: 51° to 19° Diagonal field of view: 116° to 40	Horizontal field of view: 98° to 28° Vertical field of view: 51° to 16° Diagonal field of view: 115° to 32°	Horizontal FOV: 98° to 28°, vertical FOV: 71° to 21°, diagonal FOV: 130° to 35°
Optical Zoom	4x	4x	4x	4x	4x
Max. IR Range	30 m	30 m	30 m	30 m	30 m
VCA	Motion Detection	Motion Detection	Motion Detection	Motion Detection	Motion Detection
Frame Rate	50Hz: 20fps (2560 × 1440), 25fps (2304 × 1296, 1920 × 1280, 1280 × 720) 60Hz: 20fps (2560 × 1440), 30fps (2304 × 1296, 1920 × 1280, 1280 × 720)	50Hz: 12.5fps (2560 × 1920), 20fps (2560 × 1440), 25fps (2304 × 1296, 1920 × 1080, 1280 × 720) 60Hz: 15fps (2560 × 1920), 20fps (2560 × 1440), 30fps (2304 × 1296, 1920 × 1080, 1280 × 720)	50Hz: 25fps (1920 × 1080, 1280 × 960, 1280 × 720) 60Hz: 30fps (1920 × 1080, 1280 × 960, 1280 × 720)	50Hz: 20fps (2560 × 1440), 25fps (2304 × 1296, 1920 × 1280, 1280 × 720) 60Hz: 20fps (2560 × 1440), 30fps (2304 × 1296, 1920 × 1280, 1280 × 720)	50Hz: 12.5fps (2560 × 1920), 20fps (2560 × 1440), 25fps (2304 × 1296, 1920 × 1080, 1280 × 720) 60Hz: 15fps (2560 × 1920), 20fps (2560 × 1440), 30fps (2304 × 1296, 1920 × 1080, 1280 × 720)
Streams	2	2	2	2	2
Protection Level	IP67	IP67	IP67, IK10	IP67, IK10	IP67, IK10
Angle Adjustment	Pan: 0° to 360°, tilt: 0° to 90°, rotation: 0° to 360°	Pan: 0° to 360°, tilt: 0° to 100°, rotate: 0° to 360°	Pan: 0° to 355°, tilt: 0° to 70°, rotation: 0° to 360°	Pan: 0° to 355°, tilt: 0° to 70°, rotation: 0° to 360°	Pan: 0° to 355°, tilt: 0° to 70°, rotate: 0° to 355°
Operating Temperature	-30 °C to 60 °C (-22 °F to 140 °F)	-30 °C to 60 °C (-22 °F to 140 °F)	-30 °C to 60 °C (-22 °F to 122 °F)	-30 °C to 60 °C (-22 °F to 140 °F)	-30 °C to 60 °C (-22 °F to 140 °F)
Humidity	95% or less (non-condensing)	95% or less (non-condensing)	95% or less (non-condensing)	95% or less (non-condensing)	95% or less (non-condensing)
Local Storage	128GB	128GB	128GB	128GB	128GB
Indoor/Outdoor	Outdoor	Outdoor	Outdoor	Outdoor	Outdoor
Audio I/O	-	-	-	-	-
Power	12 VDC ± 25% PoE: 802.3af, class 3	12 VDC ± 25% PoE: 802.3af, class 3	12 VDC ± 25% PoE: 802.3af, class 3	12 VDC ± 25% PoE: 802.3af, class 3	12 VDC ± 25% PoE: 802.3af, class 3
Interface	1 RJ45 10M/100M Ethernet port	1 RJ45 10M/100M Ethernet port	1 RJ45 10M/100M Ethernet port	1 RJ45 10M/100M Ethernet port	1 RJ45 10M/100M Ethernet port

Model	DS-2CD1H2360-IZ	DS-2CD1H4360-IZ	DS-2CD1H5360-IZ	DS-2CD102160-I	DS-2CD112160-I	DS-2CD132160-I
Image		 HOT			 NEW	
Image Sensor	1/2.7" Progressive Scan CMOS	1/3" Progressive Scan CMOS	1/2.7" Progressive Scan CMOS	1/2.9" Progressive Scan CMOS	1/2.9" Progressive Scan CMOS	1/2.9" Progressive Scan CMOS
Resolution	1920 × 1080	2560 × 1440	2560 × 1920	1920 × 1080	1920 × 1080	1920 × 1080
Video Compression	H.265/H.264/MJPEG/H.265+/H.264+	H.265/H.264/MJPEG/H.265+/H.264+	H.265/H.264/MJPEG/H.265+/H.264+	H.265/H.264/MJPEG/H.265+/H.264+	H.265/H.264/MJPEG/H.265+/H.264+	H.265/H.264/MJPEG/H.265+/H.264+
Min. Illumination	Color: 0.02 Lux @ (F1.6, AGC ON)	Color: 0.02 Lux @ (F1.6, AGC ON)	Color: 0.02 Lux @ (F1.6, AGC ON)	Color: 0.01 Lux @ (F2.2, AGC ON), B/W: 0 Lux with IR	Color: 0.01 Lux @ (F2.2, AGC ON), B/W: 0 Lux with IR	Color: 0.01 Lux @ (F2.2, AGC ON), B/W: 0 Lux with IR
WDR	DWDR	120dB	120dB	DWDR	DWDR	DWDR
Lens	2.8 to 12 mm	2.8 to 12 mm	2.8 to 12 mm	2.8mm, 4mm	2.8mm, 4mm	2.8mm, 4mm
FOV	Horizontal FOV 108.5° to 33.2°, vertical FOV 57.5° to 18.8°, diagonal FOV 130° to 38°	Horizontal FOV 92.8° to 29°, vertical FOV 50.2° to 16.4°, diagonal FOV 109° to 32.3°	Horizontal FOV: 98° to 28°, vertical FOV: 71° to 21°, diagonal FOV: 130° to 35°	2.8 mm, horizontal FOV 94°, vertical FOV 51°, diagonal FOV 112° 4 mm, horizontal FOV 80°, vertical FOV 44°, diagonal FOV 94°	2.8 mm, horizontal FOV 94°, vertical FOV 51°, diagonal FOV 112° 4 mm, horizontal FOV 80°, vertical FOV 44°, diagonal FOV 94°	2.8 mm, horizontal FOV 94°, vertical FOV 51°, diagonal FOV 112° 4 mm, horizontal FOV 80°, vertical FOV 44°, diagonal FOV 94°
Optical Zoom	4x	4x	4x	-	-	-
Max. IR Range	30 m	30 m	30 m	30 m	30 m	30 m
VCA	Motion Detection	Motion Detection	Motion Detection	Motion Detection	Motion Detection	Motion Detection
Frame Rate	50Hz: 25fps (1920 × 1080, 1280 × 960, 1280 × 720) 60Hz: 30fps (1920 × 1080, 1280 × 960, 1280 × 720)	50Hz: 20fps (2560 × 1440), 25fps (2304 × 1296, 1920 × 1280, 1280 × 720) 60Hz: 20fps (2560 × 1440), 30fps (2304 × 1296, 1920 × 1280, 1280 × 720)	50Hz: 12.5fps (2560 × 1920), 20fps (2560 × 1440), 25fps (2304 × 1296, 1920 × 1080, 1280 × 720) 60Hz: 15fps (2560 × 1920), 20fps (2560 × 1440), 30fps (2304 × 1296, 1920 × 1080, 1280 × 720)	50 Hz: 25 fps (1920 × 1080, 1280 × 720) 60 Hz: 30 fps (1920 × 1080, 1280 × 720)	50 Hz: 25 fps (1920 × 1080, 1280 × 720) 60 Hz: 30 fps (1920 × 1080, 1280 × 720)	50 Hz: 25 fps (1920 × 1080, 1280 × 720) 60 Hz: 30 fps (1920 × 1080, 1280 × 720)
Streams	2	2	2	2	2	2
Protection Level	IP67	IP67	IP67	IP67	IP66	IP67
Angle Adjustment	Pan: 0° to 360°, tilt: 0° to 75°, rotate: 0° to 360°	Pan: 0° to 360°, tilt: 0° to 75°, rotate: 0° to 360°	Pan: 0° to 360°, tilt: 0° to 75°, rotate: 0° to 360°	Pan: 0° to 360°, tilt: 0° to 90°, rotate: 0° to 360°	Pan: 0° to 360°, tilt: 0° to 90°, rotate: 0° to 360°	Pan: 0° to 360°, tilt: 0° to 75°, rotate: 0° to 360°
Operating Temperature	-30 °C to 60 °C (-22 °F to 140 °F)	-30 °C to 60 °C (-22 °F to 140 °F)	-30 °C to 60 °C (-22 °F to 140 °F)	-30 °C to 60 °C (-22 °F to 140 °F)	-30 °C to 60 °C (-22 °F to 140 °F)	-30 °C to 60 °C (-22 °F to 140 °F)
Humidity	95% or less (non-condensing)	95% or less (non-condensing)	95% or less (non-condensing)	95% or less (non-condensing)	95% or less (non-condensing)	95% or less (non-condensing)
Local Storage	128GB	128GB	128GB	-	-	-
Indoor/Outdoor	Outdoor	Outdoor	Outdoor	Outdoor	Indoor	Outdoor
Audio I/O	-	-	-	-	-	-
Power	12 VDC ± 25% PoE: 802.3af, class 3	12 VDC ± 25% PoE: 802.3af, class 3	12 VDC ± 25% PoE: 802.3af, class 3	12 VDC ± 25% PoE: 802.3af, Class 3	12 VDC ± 25% PoE: 802.3af, Class 3	12 VDC ± 25% PoE: 802.3af, Class 3
Interface	1 RJ45 10M/100M Ethernet port	1 RJ45 10M/100M Ethernet port	1 RJ45 10M/100M Ethernet port	1 RJ45 10M/100M Ethernet port	1 RJ45 10M/100M Ethernet port	1 RJ45 10M/100M Ethernet port

Model	DS-2CV2021FD-IW	DS-2CV2021FD-IW	DS-2CV202162-IDW	DS-2CV204162-IDW	DS-2CV212162-IDW	DS-2CV214162-IDW
Image						
Image Sensor	1/2.8" Progressive Scan CMOS	1/2.8" Progressive Scan CMOS	1/2.7" Progressive Scan CMOS	1/2.7" Progressive Scan CMOS	1/2.7" Progressive Scan CMOS	1/2.7" Progressive Scan CMOS
Resolution	1920 × 1080	1920 × 1080	1920 × 1080	2560 × 1440	1920 × 1080	2560 × 1440
Video Compression	H.265+/H.265/H.264+/H.264/MJPEG	H.265+/H.265/H.264+/H.264/MJPEG	H.265+/H.265/H.264+/H.264/MJPEG	H.265+/H.265/H.264+/H.264/MJPEG	H.265+/H.265/H.264+/H.264/MJPEG	H.265+/H.265/H.264+/H.264/MJPEG
Min. Illumination	Color: 0.028 Lux @ (F2.0, AGC ON), 0 Lux with IR	Color: 0.028 Lux @ (F2.0, AGC ON), 0 Lux with IR	Color: 0.018 Lux @ (F1.6, AGC ON), 0 Lux with IR	Color: 0.009 Lux @ (F1.6, AGC ON), 0 Lux with IR	Color: 0.018 Lux @ (F1.6, AGC ON), 0 Lux with IR	Color: 0.009 Lux @ (F1.6, AGC ON), 0 Lux with IR
WDR	DWDR	DWDR	DWDR	120dB WDR	120dB WDR	120dB WDR
Lens	2.0/2.8 mm	2.0/2.8 mm	2.8/4 mm	2.8/4 mm	2.8/4 mm	2.8/4 mm
FOV	2.0 mm, Horizontal FOV: 130°, Vertical FOV: 76°, Diagonal FOV: 147° 2.8 mm, Horizontal FOV: 112°, Vertical FOV: 60°, Diagonal FOV: 132°	2.0 mm, Horizontal FOV: 130°, Vertical FOV: 76°, Diagonal FOV: 147° 2.8 mm, Horizontal FOV: 112°, Vertical FOV: 60°, Diagonal FOV: 132°	2.8 mm, horizontal FOV: 112°, vertical FOV: 59°, diagonal FOV: 134°; 4 mm, horizontal FOV: 91°, vertical FOV: 48°, diagonal FOV: 109°	2.8 mm: horizontal FOV: 97°, vertical FOV: 52°, diagonal FOV: 114°; 4 mm: horizontal FOV: 79°, vertical FOV 42°, diagonal FOV 93°	2.8 mm, horizontal FOV: 107°, vertical FOV: 57°, diagonal FOV: 127°; 4 mm, horizontal FOV: 87°, vertical FOV: 46°, diagonal FOV: 104°	2.8 mm, horizontal FOV: 97°, vertical FOV: 52°, diagonal FOV: 114°; 4 mm, horizontal FOV: 79°, vertical FOV: 42°, diagonal FOV: 93°
Optical Zoom	-	-	-	-	-	-
Max. IR Range	10 m	10 m	30 m	30 m	30 m	30 m
VCA	Motion Detection	Motion Detection	Motion Detection	Motion Detection	Motion Detection	Motion Detection
Frame Rate	50Hz: 25fps (1920 × 1080, 1280 × 720) 60Hz: 30fps (1920 × 1080, 1280 × 720)	50Hz: 25fps (1920 × 1080, 1280 × 720) 60Hz: 30fps (1920 × 1080, 1280 × 720)	50Hz:25fps (1920 × 1080,1280×720) 60Hz:30fps 1920 × 1080,1280 × 720	50Hz: 25fps (2560 × 1440, 1920 × 1080, 1280 × 720) 60Hz: 30fps (2560 × 1440, 1920 × 1080, 1280 × 720)	50Hz:25fps (1920 × 1080, 1280 × 720); 60Hz:30fps (1920 × 1080, 1280 × 720)	50Hz: 25fps (2560 × 1440, 1920 × 1080, 1280 × 720) 60Hz: 30fps (2560 × 1440, 1920 × 1080, 1280 × 720)
Streams	2	2	2	2	2	2
Protection Level	-	-	IP 66	IP 66	IP 66	IP 66
Angle Adjustment	Pan: 0° to 355°; Tilt: -10° to 85°	-	Pan: 0° to 360°, tilt: 0° to 90°, rotate: 0° to 360°	Pan: 0° to 360°, tilt: 0° to 90°, rotate: 0° to 360°	Pan: 0° to 355°, tilt: 0° to 75°	Pan: 0° to 355°, tilt: 0° to 75°
Operating Temperature	-10 °C to 40°C (14 °F to 104 °F)	-10 °C to 40°C (14 °F to 104 °F)	-30 °C to +60 °C (-22 °F to +140 °F)	-30 °C to +60 °C (-22 °F to +140 °F)	-30 °C to +60 °C (-22 °F to +140 °F)	-30 °C to +60 °C (-22 °F to +140 °F)
Humidity	Humidity 95% or less (non-condensing)	Humidity 95% or less (non-condensing)	Humidity 95% or less (non-condensing)	Humidity 95% or less (non-condensing)	Humidity 95% or less (non-condensing)	Humidity 95% or less (non-condensing)
Local Storage	Built-in microSD/SDHC/SDXC slot, up to 256 GB	Built-in microSD/SDHC/SDXC slot, up to 256 GB	Built-in microSD/SDHC/SDXC slot, up to 256 GB	Built-in microSD/SDHC/SDXC slot, up to 256 GB	Built-in microSD/SDHC/SDXC slot, up to 256 GB	Built-in microSD/SDHC/SDXC slot, up to 256 GB
Indoor/Outdoor	Indoor	Indoor	Indoor/Outdoor	Indoor/Outdoor	Indoor/Outdoor	Indoor/Outdoor
Audio I/O	1 build-in microphone, 1 build-in speaker	1 build-in microphone, 1 build-in speaker	1 build-in microphone, 1 build-in speaker	1 build-in microphone, 1 build-in speaker	1 build-in microphone, 1 build-in speaker	1 build-in microphone, 1 build-in speaker
Alarm I/O	-	-	-	-	-	-
Power	5 VDC ± 10 %	5 VDC ± 10 %	12 VDC ± 25%	12 VDC ± 25%	12 VDC ± 25%	12 VDC ± 25%
Interface	1 RJ45 10M/100M self-adaptive Ethernet port	-	1 RJ45 10M/100M self-adaptive Ethernet port	1 RJ45 10M/100M self-adaptive Ethernet port	1 RJ45 10M/100M self-adaptive Ethernet port	1 RJ45 10M/100M self-adaptive Ethernet port



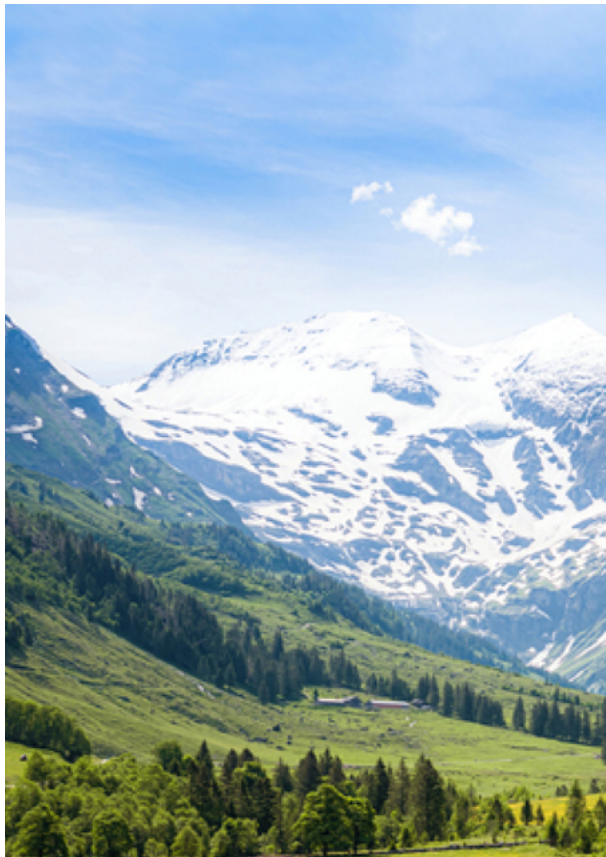

Network Cameras

Solar-powered Series

- > Ultra-low power consumption, ultra-long battery life
- > Lightweight design, one-person installation
- > Dual detectors – PIR + Radar – combine to reduce false alarms (optional)
- > 24 / 7 color imaging (optional)



Model	DS-2XS2T4761-LDH/46/C18S40	DS-2XS2T4761-LD/46/C18S40
Image	 	 
Image Sensor	1/3" Progressive Scan CMOS	1/3" Progressive Scan CMOS
Max. Resolution	2560x1440	2560x1440
Min. Illumination	Color: 0.001Lux @ (F1.0, AGC ON), B/W: 0 Lux with white light	Color: 0.001 Lux @ (F1.0, AGC ON), B/W: 0 Lux with white light
Angle Adjustment	Solar Cover: Pan: 0° to 358°, tilt: -40° to 40° Camera: Pan: 0° to 360°, tilt: -60° to 0°	Solar Cover: Pan: 0° to 358°, tilt: -40° to 40° Camera: Pan: 0° to 360°, tilt: -60° to 0°
Lens Type	Fixed focal lens, 2.8, 4, 6mm optional	Fixed focal lens, 2.8, 4, 6mm optional
Aperture	F1.0	F1.0
Focal Length & FOV	4 mm, horizontal FOV 80.2°, vertical FOV 43.2°, diagonal FOV 94.9° 6 mm, horizontal FOV 52.6°, vertical FOV 29°, diagonal FOV 61°	4 mm, horizontal FOV 80.2°, vertical FOV 43.2°, diagonal FOV 94.9° 6 mm, horizontal FOV 52.6°, vertical FOV 29°, diagonal FOV 61°
Supplement Light Range	Performance mode: up to 30 m Proactive mode: up to 10 m	Performance mode: up to 30 m Proactive mode: up to 10 m
Frame Rate	50 Hz: 12.5 fps (2560x1440, 1920 × 1080, 1280 × 720) 60 Hz: 15 fps (2560x1440,, 1920 × 1080, 1280 × 720)	50 Hz: 12.5 fps (2560x1440, 1920 × 1080, 1280 × 720) 60 Hz: 15 fps (2560x1440,, 1920 × 1080, 1280 × 720)
Frequency	LTE-TDD: Band 38/40/41; LTE-FDD: Band 1/3/5/7/8/20/28; WCDMA: Band 1/5/8; GSM: band 3/5/8	LTE-TDD: Band 38/40/41; LTE-FDD: Band 1/3/5/7/8/20/28; WCDMA: Band 1/5/8; GSM: band 3/5/8
Wide Dynamic Range (WDR)	120 dB	120 dB
PIR Range	Up to 15 m	Up to 15 m
On-Board Storage	Built-in memory card slot, support microSD/SDHC/SDXC card, up to 256 GB Built-in 64 GB eMMC storage (50 GB available for recording)	Built-in memory card slot, support microSD/SDHC/SDXC card, up to 256 GB Built-in 64 GB eMMC storage (50 GB available for recording)
Audio	1 built-in mic, 1 built-in speaker	1 built-in mic, 1 built-in speaker
Power	Power Consumption and Current: Typical power scenarios: 1.85 W (4G working) Standby scenarios: 40 mW Max. power consumption: 6 W Power Supply: 12 VDC ± 25% *For debugging only 40 W Solar panels Power supply interface: Ø5.5 mm coaxial power plug	Power Consumption and Current: Typical power scenarios: 1.85 W (4G working) Standby scenarios: 40 mW Max. power consumption: 6 W Power Supply: 12 VDC ± 25% *For debugging only 40 W Solar panels Power supply interface: Ø5.5 mm coaxial power plug
Startup and Operating Conditions	-20 °C to 50 °C (-4 °F to 122 °F), Humidity 95% or less (non-condensing)	0 °C to 60 °C (32 °F to 140 °F), Humidity 95% or less (non-condensing)
Battery Type	Ternary lithium	Ternary lithium
Capacity	18Ah	18Ah
Battery Voltage	9.0V to 12.6	9.0V to 12.6
Battery Life	More than 500 cycles	More than 500 cycles
Protection	IP67 (IEC 60529-2013)	IP67 (IEC 60529-2013)

Model	DS-2XS3Q4761-LDH/46/C18S40	DS-2XS2T4161-ID/46/C05S07
Image	  	 
Image Sensor	1/3" Progressive Scan CMOS	1/3" Progressive Scan CMOS
Max. Resolution	2560x1440	2560x1440
Min. Illumination	Color: 0.0005 Lux @ (F1.0, AGC ON), 0 Lux with light	B/W: 0.01 Lux @ (F1.6, AGC ON), B/W: 0 Lux with IR
Angle Adjustment	Solar panel: pan: 0° to 358°, tilt: -40° to 0° Camera: pan: 0° to 340°, tilt: -5° to 105°	Solar panel: tilt: -45° to 45°, rotate: -30° to 30° -
Lens Type	Fixed focal lens, 4 and 6 mm optional	Fixed focal lens, 4 and 6 mm optional
Aperture	F1.0	4mm: F1.28, 6mm: F1.6
Focal Length & FOV	4 mm, Horizontal FOV: 75°, Vertical FOV: 40°, Diagonal FOV: 89° 6 mm, Horizontal FOV: 49°, Vertical FOV: 27°, Diagonal FOV: 57°	4 mm, Horizontal FOV: 79°, Vertical FOV: 43°, Diagonal FOV: 93° 6 mm, Horizontal FOV: 49°, Vertical FOV: 26°, Diagonal FOV: 57°
Supplement Light Range	Performance mode: up to 30 m Proactive mode: up to 10 m	Performance mode: up to 30 m, proactive mode: up to 10 m
Frame Rate	50 Hz: 12.5 fps (2688 × 1520, 1920 × 1080, 1280 × 720) 60 Hz: 15 fps (2688 × 1520, 1920 × 1080, 1280 × 720)	50 Hz: 12.5 fps (2560 × 1440, 1920 × 1080, 1280 × 720) 60 Hz: 15 fps (2560 × 1440, 1920 × 1080, 1280 × 720)
Frequency	EU: LTE-TDD: B38/B40/B41 LTE-FDD: B1/B3/B5/B7/B8/B20/B28 WCDMA: B1/B5/B8 GSM: B3/B5/B8 LA: LTE-TDD: B38/B40 LTE-FDD: B1/B2/B3/B4/B5/B7/B8/B12/B17/B28/B66 WCDMA: B1/B2/B3/B4/B5/B8 GSM: B2/B3/B5/B8 US: LTE-FDD: B2/B4/B5/B12/B13/B17/B66/B71 WCDMA: B2/B4/B5	EU: LTE-TDD: B38/B40/B41 LTE-FDD: B1/B3/B5/B7/B8/B20/B28 WCDMA: B1/B5/B8 GSM: B3/B5/B8 LA: LTE-TDD: B38/B40 LTE-FDD: B1/B2/B3/B4/B5/B7/B8/B12/B17/B28/B66 WCDMA: B1/B2/B3/B4/B5/B8 GSM: B2/B3/B5/B8
Wide Dynamic Range (WDR)	120 dB	Digital WDR
PIR Range	-	Up to 12 m
On-Board Storage	Built-in eMMC storage, up to 64 GB, Built-in memory card slot, support microSD/microSDHC/microSDXC card, up to 256 GB, For eMMC storage, 50 GB is available for recording.	Built-in eMMC storage, up to 8 GB, Built-in memory card slot, support microSD/microSDHC/microSDXC card, up to 256 GB, For eMMC storage, 5 GB is available for recording
Audio	1 built-in mic, 1 built-in speaker	1 built-in mic, 1 built-in speaker
Power	Power Consumption and Current: Typical power scenarios: 1.85 W (4G working) Standby scenarios: 40 mW Max. power consumption: 6 W Power Supply: 12 VDC ± 25% *For debugging only 40 W (deviation: ± 2 W) Solar panels Power Interface: Power supply interface: Ø5.5 mm coaxial power plug Extended solar panel: four-core aviation connector	Power Consumption and Current: Typical power scenarios: 1.85 W (4G working) Standby scenarios: 70 mW Max. power consumption: 7 W Power Supply: 12 VDC *For debugging only 6.5 W (deviation: ± 1 W) Solar panels Power Interface: Power supply interface: Ø 5.5 mm coaxial power plug Extended solar panel: Ø 5.5 mm coaxial power plug
Startup and Operating Conditions	-20 °C to 50 °C (-4 °F to 122 °F). Humidity 95% or less (non-condensing)	0 °C to 50 °C (32 °F to 122 °F). Humidity 95% or less (non-condensing)
Battery Type	Ternary Lithium	Ternary Lithium
Capacity	8.4 Ah × 2 packs	51.46 Wh
Battery Voltage	9.0V to 12.6	8.1 V to 12.6 V
Battery Life	More than 500 cycles	More than 800 cycles
Protection	IP65: IEC60529-2013	IP67: IEC 60529-2013

Network PT Cameras

143 Network PT Cameras













Network PT Cameras





This series features compact designs and high quality imaging to realize cost-efficiency and good user experience.

- › Network PT Cameras are specifically designed for indoor or outdoor use, with various options of resolutions (from 2 MP to 4 MP), sizes (from 1 inch to 3 inch), and zoom ratios (up to 4x).
- › Motorized panning and tilting makes installation easier and more efficient.
- › With Hikvision's unique ColorVu technology, the color information can be captured and reproduced even in darkness.
- › IR or white supplemental light available, suited for environments with varied requirements.
- › Two-way audio is a versatile feature for indoor use, with real-time communication enabled by built-in microphones and speakers.
- › Remote control via Hik-Connect app enables flexible viewing angles anytime, from anywhere.
- › AcuSense technology for DE3 models







Model	DS-2DE3A404IWG-E	DS-2DE3A404IWG-E/W	DS-2DE3A400BW-DE/W(F1)(T5)	DS-2DE3A400BW-DE(F1)(T5)
Image	 NEW	 NEW Wireless (Wi-Fi)	 HOT NEW ColorVu	 ColorVu
Image Sensor	1/2.8" Progressive Scan CMOS	1/2.8" progressive scan CMOS	1/1.8" progressive scan CMOS	1/1.8" progressive scan CMOS
Resolution	2560 × 1440	2560 × 1440	2560 × 1440	2560 × 1440
Video Compression	H.265+/H.265/H.264+/H.264/MJPEG	H.265+/H.265/H.264+/H.264/MJPEG	H.265+/H.265/H.264+/H.264/MJPEG	H.265+/H.265/H.264+/H.264/MJPEG
Lens	2.8 to 12 mm 4 × optical zoom	2.8 to 12 mm 4 × optical zoom	4 mm	4 mm
Angle of View	Horizontal field of view: 96.7° to 31.6° (wide-tele) Vertical field of view: 51.1° to 17.7° (wide-tele) Diagonal field of view: 115.1° to 36.3° (wide-tele)	Horizontal field of view: 96.7° to 31.6° (wide-tele) Vertical field of view: 51.1° to 17.7° (wide-tele) Diagonal field of view: 115.1° to 36.3° (wide-tele)	Horizontal field of view: 88.7° Vertical field of view: 46.5° Diagonal field of view: 105.0°	Horizontal field of view: 88.7° Vertical field of view: 46.5° Diagonal field of view: 105.0°
Min. Illumination	Color: 0.005 Lux @ (F1.5, AGC ON)	Color: 0.005 Lux @ (F1.5, AGC ON)	Color: 0.0005 Lux @ (F1.0, AGC ON); 0 Lux with white light	Color: 0.0005 Lux @ (F1.0, AGC ON); 0 Lux with white light
WDR	120dB	120dB	120dB	120dB
Max. IR Range	50 m	50 m	30m white light	30m white light
VCA	Face detection, line crossing detection, intrusion detection, region entrance detection, region exiting detection, unattended baggage detection, object removal detection, audio exception detection	Face detection, line crossing detection, intrusion detection, region entrance detection, region exiting detection, unattended baggage detection, object removal detection, audio exception detection	Face capture, Intrusion detection, line crossing detection, region entrance detection, region exiting detection, unattended baggage detection, object removal detection, audio exception detection	Face capture, Intrusion detection, line crossing detection, region entrance detection, region exiting detection, unattended baggage detection, object removal detection, audio exception detection
Frame Rate	50 Hz: 25 fps (2560 × 1440, 1920 × 1080, 1280 × 960, 1280 × 720) 60 Hz: 30 fps (2560 × 1440, 1920 × 1080, 1280 × 960, 1280 × 720)	50 Hz: 25 fps (2560 × 1440, 1920 × 1080, 1280 × 960, 1280 × 720) 60 Hz: 30 fps (2560 × 1440, 1920 × 1080, 1280 × 960, 1280 × 720)	50 Hz: 25 fps (2560 × 1440, 1920 × 1080, 1280 × 960, 1280 × 720); 60 Hz: 30 fps (2560 × 1440, 1920 × 1080, 1280 × 960, 1280 × 720)	50 Hz: 25 fps (2560 × 1440, 1920 × 1080, 1280 × 960, 1280 × 720); 60 Hz: 30 fps (2560 × 1440, 1920 × 1080, 1280 × 960, 1280 × 720)
Streams	3	3	3	3
Protection Level	IP66 (IEC 60529-2013), TVS 6000V lightning protection, surge protection and voltage transient protection	IP66 (IEC 60529-2013), TVS 6000V lightning protection, surge protection and voltage transient protection	IP66; 6000 V Lightning Protection, Surge Protection and Voltage Transient Protection	IP66; 6000 V Lightning Protection, Surge Protection and Voltage Transient Protection
Pan Range	0° to 350°	0° to 350°	0° to 350°	0° to 350°
Tilt Range	0° to 90°	0° to 90°	0° to 90°	0° to 90°
Pan Speed	Configurable, from 0.1°/s to 60°/s. Preset speed: 60°/s	Configurable, from 0.1°/s to 60°/s. Preset speed: 60°/s	0.1°/s to 60°/s	0.1°/s to 60°/s
Tilt Speed	Configurable, from 0.1°/s to 50°/s. Preset speed: 60°/s	Configurable, from 0.1°/s to 50°/s. Preset speed: 60°/s	0.1°/s to 50°/s	0.1°/s to 50°/s
Operating Temperature	30 °C to 65 °C (-22 °F to 149 °F)	-30 °C to 65 °C (-22 °F to 149 °F)	-30°C to 65°C (-22°F to 149°F)	-30°C to 65°C (-22°F to 149°F)
Humidity	Humidity 90% or less (non-condensing)	Humidity 90% or less (non-condensing)	≤ 90%	≤ 90%
Local Storage	Built-in memory card slot, support microSD/microSDHC/microSDXC card, up to 256 GB	Built-in memory card slot, support microSD/microSDHC/microSDXC card, up to 256 GB	Built-in memory card slot, support Micro SD/SDHC/SDXC, up to 512 GB	Built-in memory card slot, support Micro SD/SDHC/SDXC, up to 512 GB
Audio I/O	1/1	1/1	1/1	1/1
Alarm I/O	1/1	1/1	1/1	1/1
Power	12 VDC, 3.33 A & PoE (802.3at), 42.5 to 57 VDC, 0.6 A Max. 14 W (including max. 2.4 W for IR, 1.2 W for white light flashing)	12 VDC, 3.33 A & PoE (802.3at), 42.5 to 57 VDC, 0.6 A Max. 16 W (including max. 2.4 W for IR, 1.2 W for white light flashing)	12 VDC, 3.33 A & PoE (802.3at), 42.5 to 57 VDC, 0.6 A Max. 16 W (including max. 4 W for white light)	12 VDC, 3.33 A & PoE (802.3at), 42.5 to 57 VDC, 0.6 A Max. 14 W (including max. 4 W for white light)

Model	DS-2DE2A204IW-DE3(S6)(C)	DS-2DE2A404IW-DE3(S6)(C)	DS-2DE2A404IW-DE3(W/S6)(C)	DS-2DE2C200MW-DE(F0)(S7)	DS-2DE2C200MW-DE(F1)(S7)	DS-2DE2C400MW-DE(F0)(S7)
Image						
Image Sensor	1/2.8" Progressive Scan CMOS	1/2.8" Progressive Scan CMOS	1/2.8" Progressive Scan CMOS	1/2.7" Progressive Scan CMOS	1/2.7" Progressive Scan CMOS	1/3" Progressive Scan CMOS
Resolution	1920 × 1080	2560 × 1440	2560 × 1440	1920 × 1080	1920 × 1080	2560 × 1440
Video Compression	Main Stream: H.265+/H.265/H.264+/H.264	Main Stream: H.265+/H.265/H.264+/H.264	Main Stream: H.265+/H.265/H.264+/H.264	Main Stream: H.265+/H.265/H.264+/H.264	Main Stream: H.265+/H.265/H.264+/H.264	Main Stream: H.265+/H.265/H.264+/H.264
Lens	2.8 to 12 mm, 4× optical	2.8 to 12 mm, 4× optical	2.8 to 12 mm, 4× optical	2.8 mm	4 mm	2.8 mm
Angle of View	Horizontal field of view: 100.5° to 32.6° (Wide-Tele) Vertical field of view: 52.8° to 18.3° (Wide-Tele) Diagonal field of view: 120.2° to 37.5° (Wide-Tele)	Horizontal field of view: 96.7° to 31.6° (Wide-Tele) Vertical field of view: 51.1° to 17.7° (Wide-Tele) Diagonal field of view: 115.1° to 36.3° (Wide-Tele)	Horizontal field of view: 96.7° to 31.6° (Wide-Tele) Vertical field of view: 51.1° to 17.7° (Wide-Tele) Diagonal field of view: 115.1° to 36.3° (Wide-Tele)	horizontal FOV 111.4°, vertical FOV 59.1°, diagonal FOV 133.6°	horizontal FOV 91.5°, vertical FOV 46.1°, diagonal FOV 109.8°	horizontal FOV 97°, vertical FOV 52.3°, diagonal FOV 114.3°
Min. Illumination	Color: 0.005 Lux @(F1.6, AGC ON)	Color: 0.005 Lux @(F1.5, AGC ON)	Color: 0.005 Lux @(F1.6, AGC ON)	Color: 0.01 Lux @(F1.2, AGC ON), B/W: 0 Lux with IR	Color: 0.01 Lux @(F1.2, AGC ON), B/W: 0 Lux with IR	Color: 0.005 Lux @(F1.2, AGC ON), B/W: 0 Lux with IR
WDR	120dB	120dB	120dB	120dB	120dB	120dB
Max. IR Range (meters)	20 m	20 m	20 m	30m	30m	30m
VCA	Face detection, intrusion detection, line crossing detection, region entrance detection, region exiting detection, object removal detection, unattended baggage detection, audio exception detection	Face detection, intrusion detection, line crossing detection, region entrance detection, region exiting detection, object removal detection, unattended baggage detection, audio exception detection	Face detection, intrusion detection, line crossing detection, region entrance detection, region exiting detection, object removal detection, unattended baggage detection, audio exception detection	Motion detection, upload to FTP, notify surveillance center, send email, upload to memory card	Motion detection, upload to FTP, notify surveillance center, send email, upload to memory card	Motion detection, upload to FTP, notify surveillance center, send email, upload to memory card
Frame Rate	50Hz: 25fps (1920 × 1080, 1280 × 960, 1280 × 720) 60Hz: 30fps (1920 × 1080, 1280 × 960, 1280 × 720)	50Hz: 25fps (2560 × 1440, 2048 × 1536, 1920 × 1080, 1280 × 960, 1280 × 720) 60Hz: 24fps (2560 × 1440), 30fps(2048 × 1536, 1920 × 1080, 1280 × 960, 1280 × 720)	50Hz: 25fps (2560 × 1440, 2048 × 1536, 1920 × 1080, 1280 × 960, 1280 × 720) 60Hz: 24fps (2560 × 1440), 30fps(2048 × 1536, 1920 × 1080, 1280 × 960, 1280 × 720)	50 Hz: 25 fps (1920 × 1080, 1280 × 720)	50 Hz: 25 fps (1920 × 1080, 1280 × 720)	50 Hz: 25 fps (2560 × 1440, 1920 × 1080, 1280 × 720)
Streams	3	3	3	2	2	2
Protection Level	IP66 standard, IK 10, surge protection, ±2kV Line to Gnd, ±1kV Line to Line, IEC61000-4-5	IP66 standard, IK 10, surge protection, ±2kV Line to Gnd, ±1kV Line to Line, IEC61000-4-5	IP66 standard, IK 10, surge protection, ±2kV Line to Gnd, ±1kV Line to Line, IEC61000-4-5	IP66 (IEC 60529-2013)	IP66 (IEC 60529-2013)	IP66 (IEC 60529-2013)
Pan Range	0° to 355°	0° to 355°	0° to 355°	0° to 340°	0° to 340°	0° to 340°
Tilt Range	0° to 90°	0° to 90°	0° to 90°	-5° to 105°	-5° to 105°	-5° to 105°
Pan Speed	Configurable, from 0.1°/s to 100°/s, Preset speed: 100°/s	Configurable, from 0.1°/s to 100°/s, Preset speed: 100°/s	Configurable, from 0.1°/s to 100°/s, Preset speed: 100°/s	configurable from 4° to 21°/s	configurable from 4° to 21°/s	configurable from 4° to 21°/s
Tilt Speed	Configurable, from 0.1°/s to 100°/s Preset Speed: 100°/s	Configurable, from 0.1°/s to 100°/s Preset Speed: 100°/s	Configurable, from 0.1°/s to 100°/s Preset Speed: 100°/s	configurable from 4° to 19°/s	configurable from 4° to 19°/s	configurable from 4° to 19°/s
Operating Temperature	-20°C to 60°C (-4°F to 140°F)	-20°C to 60°C (-4°F to 140°F)	-20°C to 60°C (-4°F to 140°F)	With supplement light on: -30°C to 40°C With supplement light off: -30°C to 50°C	With supplement light on: -30°C to 40°C With supplement light off: -30°C to 50°C	With supplement light on: -30°C to 40°C With supplement light off: -30°C to 50°C
Humidity	90% or less	90% or less	90% or less	95% or less	95% or less	95% or less
Local Storage	Built-in memory card slot, support Micro SD/SDHC/SDXC, up to 256 GB; NAS (NPS, SMB/ CIFS), ANR	Built-in memory card slot, support Micro SD/SDHC/SDXC, up to 256 GB; NAS (NPS, SMB/ CIFS), ANR	Built-in memory card slot, support Micro SD/SDHC/SDXC, up to 256 GB; NAS (NPS, SMB/ CIFS), ANR	Built-in memory card slot, support microSD/SDHC/SDXC card, up to 256 GB	Built-in memory card slot, support microSD/SDHC/SDXC card, up to 256 GB	Built-in memory card slot, support microSD/SDHC/SDXC card, up to 256 GB
Audio I/O	1/1	1/1	1/1	1/1	1/1	1/1
Alarm I/O	-	-	-	-	-	-
Power	12 VDC & PoE (802.3af) Max.: 11.2 W (Max. 4.2 W for IR)	12 VDC, Max. 9.2 W; PoE (802.3af)	12 VDC & PoE (802.3af) Max.: 12.2 W (Max. 4.2 W for IR)	12 VDC ± 25%, 0.75 A, max. 9 W PoE: 0.2 A to 0.3 A, max. 10.8 W	12 VDC ± 25%, 0.75 A, max. 9 W PoE: 0.2 A to 0.3 A, max. 10.8 W	12 VDC ± 25%, 0.75 A, max. 9 W PoE: 0.2 A to 0.3 A, max. 10.8 W

Model	DS-2DE2C400MW-DE(F1)(S7)	DS-2DE2C200SC6-E(F0)	DS-2DE2C200SC6-E(F1)	DS-2DE2C400SC6-E(F0)	DS-2DE2C400SC6-E(F1)
Image					
Image Sensor	1/3" Progressive Scan CMOS	1/2.7" Progressive Scan CMOS	1/2.7" Progressive Scan CMOS	1/1.8" Progressive Scan CMOS	1/1.8" Progressive Scan CMOS
Resolution	2560 × 1440	1920 × 1080	1920 × 1080	2560 × 1440	2560 × 1440
Video Compression	Main Stream: H.265+/H.265/H.264+/H.264	Main Stream: H.265+/H.265/H.264+/H.264	Main Stream: H.265+/H.265/H.264+/H.264	Main Stream: H.265+/H.265/H.264+/H.264	Main Stream: H.265+/H.265/H.264+/H.264
Lens	4mm	2.8 mm	4 mm	2.8 mm	4mm
Angle of View	horizontal FOV 79°, vertical FOV 42.4°, diagonal FOV 93.3°	horizontal FOV 106.1°, vertical FOV 55.8°, diagonal FOV 126.5°	horizontal FOV 83.6°, vertical FOV 44.6°, diagonal FOV 99.1°	horizontal FOV 105.7°, vertical FOV 57.3°, diagonal FOV 124.9°	horizontal FOV 88.7°, vertical FOV 44.7°, diagonal FOV 107.5°
Min. Illumination	Color: 0.005 Lux @(F1.2, AGC ON), B/W: 0 Lux with IR	Color: 0.001 Lux @(F1.0, AGC ON), 0 Lux with Light	Color: 0.001 Lux @(F1.0, AGC ON), 0 Lux with Light	Color: 0.001 Lux @(F1.0, AGC ON), 0 Lux with Light	Color: 0.001 Lux @(F1.0, AGC ON), 0 Lux with Light
WDR	120dB	120dB	120dB	120dB	120dB
Max. Light Range	30m	30m	30m	30m	30m
VCA	Motion detection, upload to FTP, notify surveillance center, send email, upload to memory card	Motion detection, upload to FTP, notify surveillance center, send email, upload to memory card	Motion detection, upload to FTP, notify surveillance center, send email, upload to memory card	Motion detection, upload to FTP, notify surveillance center, send email, upload to memory card	Motion detection, upload to FTP, notify surveillance center, send email, upload to memory card
Frame Rate	50 Hz: 25 fps (2560 × 1440, 1920 × 1080, 1280 × 720)	50 Hz: 25 fps (1920 × 1080, 1280 × 720) 60 Hz: 30 fps (1920 × 1080, 1280 × 720)	50 Hz: 25 fps (1920 × 1080, 1280 × 720) 60 Hz: 30 fps (1920 × 1080, 1280 × 720)	50 Hz: 25 fps (2560 × 1440, 1920 × 1080, 1280 × 720) 60 Hz: 30 fps (2560 × 1440, 1920 × 1080, 1280 × 720)	50 Hz: 25 fps (2560 × 1440, 1920 × 1080, 1280 × 720) 60 Hz: 30 fps (2560 × 1440, 1920 × 1080, 1280 × 720)
Streams	2	2	2	2	2
Protection Level	IP66 (IEC 60529-2013)	IP66 (IEC 60529-2013)	IP66 (IEC 60529-2013)	IP66 (IEC 60529-2013)	IP66 (IEC 60529-2013)
Pan Range	0° to 340°	0° to 340°	0° to 340°	0° to 340°	0° to 340°
Tilt Range	-5° to 105°	-5° to 105°	-5° to 105°	-5° to 105°	-5° to 105°
Pan Speed	configurable from 4° to 21°/s	configurable from 4° to 21°/s	configurable from 4° to 21°/s	configurable from 4° to 21°/s	configurable from 4° to 21°/s
Tilt Speed	configurable from 4° to 19°/s	configurable from 4° to 19°/s	configurable from 4° to 19°/s	configurable from 4° to 19°/s	configurable from 4° to 19°/s
Operating Temperature	With supplement light on: -30°C to 40°C With supplement light off: -30°C to 50°C	With supplement light on: -30°C to 40°C With supplement light off: -30°C to 50°C	With supplement light on: -30°C to 40°C With supplement light off: -30°C to 50°C	With supplement light on: -30°C to 40°C With supplement light off: -30°C to 50°C	With supplement light on: -30°C to 40°C With supplement light off: -30°C to 50°C
Humidity	95% or less	95% or less	95% or less	95% or less	95% or less
Local Storage	Built-in memory card slot, support microSD/ SDHC/SDXC card, up to 256 GB	Built-in memory card slot, support microSD/ SDHC/SDXC card, up to 256 GB	Built-in memory card slot, support microSD/ SDHC/SDXC card, up to 256 GB	Built-in memory card slot, support microSD/ SDHC/SDXC card, up to 256 GB	Built-in memory card slot, support microSD/ SDHC/SDXC card, up to 256 GB
Audio I/O	1/1	1/1	1/1	1/1	1/1
Alarm I/O	-	-	-	-	-
Power	12 VDC ± 25%, 0.75 A, max. 9 W PoE: 0.2 A to 0.3 A, max. 10.8 W	12 VDC ± 25%, 0.75 A, max. 9 W PoE: 802.3af, 36 V to 57 V, 0.2 A to 0.3 A, max. 10 W	12 VDC ± 25%, 0.75 A, max. 9 W PoE: 802.3af, 36 V to 57 V, 0.2 A to 0.3 A, max. 10 W	12 VDC ± 25%, 0.75 A, max. 9 W PoE: 802.3af, 36 V to 57 V, 0.2 A to 0.3 A, max. 10 W	12 VDC ± 25%, 0.75 A, max. 9 W PoE: 802.3af, 36 V to 57 V, 0.2 A to 0.3 A, max. 10 W

Model	DS-2CD1P2362-I	DS-2CD1P2362-IUF	DS-2CD1P4362-I	DS-2CD1P4362-IUF	DS-2CD1A2360-IZU	DS-2CD1A4360-IZU
Image						
Image Sensor	1/2.8" Progressive Scan CMOS	1/2.8" Progressive Scan CMOS	1/3" Progressive Scan CMOS	1/3" Progressive Scan CMOS	1/2.7" Progressive Scan CMOS	1/3" Progressive Scan CMOS
Resolution	1920 × 1080	1920 × 1080	2560 × 1440	2560 × 1440	1920 × 1080	2560 × 1440
Video Compression	H.265/H.264/MJPEG/H.265+/H.264+	H.265/H.264/MJPEG/H.265+/H.264+	H.265/H.264/MJPEG/H.265+/H.264+	H.265/H.264/MJPEG/H.265+/H.264+	H.265/H.264/MJPEG/H.265+/H.264+	H.265/H.264/MJPEG/H.265+/H.264+
Min. Illumination	Color: 0.01Lux @ (F2.0, AGC ON)	Color: 0.01Lux @ (F2.0, AGC ON)	Color: 0.01Lux @ (F2.0, AGC ON)	Color: 0.01Lux @ (F2.0, AGC ON)	Color: 0.007 Lux @ (F1.6, AGC ON), 0 Lux with light	Color: 0.007 Lux @ (F1.6, AGC ON), 0 Lux with light
WDR	120 dB	120 dB	120 dB	120 dB	120 dB	120 dB
Lens	2.8 mm, 4 mm	2.8 mm, 4 mm	2.8 mm, 4 mm	2.8 mm, 4 mm	2.8 to 12 mm	2.8 to 12 mm
FOV	2.8 mm, horizontal FOV 109°, vertical FOV 60°, diagonal FOV 129° 4 mm, horizontal FOV 86°, vertical FOV 47°, diagonal FOV 103°	2.8 mm, horizontal FOV 109°, vertical FOV 60°, diagonal FOV 129° 4 mm, horizontal FOV 86°, vertical FOV 47°, diagonal FOV 103°	2.8 mm, horizontal FOV 99°, vertical FOV 55°, diagonal FOV 116° 4 mm, horizontal FOV 79°, vertical FOV 43°, diagonal FOV 92°	2.8 mm, horizontal FOV 99°, vertical FOV 55°, diagonal FOV 116° 4 mm, horizontal FOV 79°, vertical FOV 43°, diagonal FOV 92°	horizontal FOV 106.9° to 32.3°, vertical FOV 56.4° to 18.2°, diagonal FOV 127.9° to 37°	horizontal FOV 106.9° to 32.3°, vertical FOV 56.4° to 18.2°, diagonal FOV 127.9° to 37°
Optical Zoom	-	-	-	-	4x	4x
Max. IR Range	30 m	30 m	30 m	30 m	50 m	50 m
VCA	Motion Detection 2.0	Motion Detection 2.0	Motion Detection 2.0	Motion Detection 2.0	Motion Detection	Motion Detection
Frame Rate	50Hz: 25fps (1920 × 1080, 1280 × 960, 1280 × 720) 60Hz: 30fps (1920 × 1080, 1280 × 960, 1280 × 720)	50Hz: 25fps (1920 × 1080, 1280 × 960, 1280 × 720) 60Hz: 30fps (1920 × 1080, 1280 × 960, 1280 × 720)	50Hz: 20fps (2560 × 1440) 25fps (2304 × 1296, 1920 × 1080, 1280 × 720) 60Hz: 20fps (2560 × 1440) 30fps (2304 × 1296, 1920 × 1080, 1280 × 720)	50Hz: 25fps (1920 × 1080, 1280 × 960, 1280 × 720) 60Hz: 30fps (1920 × 1080, 1280 × 960, 1280 × 720)	50 Hz: 25 fps (1920 × 1080, 1280 × 720) 60 Hz: 30 fps (1920 × 1080, 1280 × 720)	50 Hz: 20 fps (2560 × 1440), 25 fps (1920 × 1080, 1280 × 720) 60 Hz: 20 fps (2560 × 1440), 30 fps (1920 × 1080, 1280 × 720)
Streams	2	2	2	2	2	2
Protection Level	IP66	IP66	IP66	IP66	IP66	IP66
Angle Adjustment	Pan: -100° to 100°, tilt: -20° to 45°	Pan: -100° to 100°, tilt: -20° to 45°	Pan: -100° to 100°, tilt: -20° to 45°	Pan: -100° to 100°, tilt: -20° to 45°	Pan: -100° to 100°, tilt: -20° to 45°	Pan: -100° to 100°, tilt: -20° to 45°
Operating Temperature	-30 °C to 60 °C (-22 °F to 140 °F)	-30 °C to 60 °C (-22 °F to 140 °F)	-30 °C to 60 °C (-22 °F to 140 °F)	-30 °C to 60 °C (-22 °F to 140 °F)	-30 °C to 60 °C (-22 °F to 140 °F)	-30 °C to 60 °C (-22 °F to 140 °F)
Humidity	95% or less (non-condensing)	95% or less (non-condensing)	95% or less (non-condensing)	95% or less (non-condensing)	95% or less (non-condensing)	95% or less (non-condensing)
Local Storage	support microSD	support microSD	support microSD	support microSD	256 GB	256 GB
Indoor/Outdoor	Outdoor	Outdoor	Outdoor	Outdoor	Outdoor	Outdoor
Audio I/O	-	1 Build-in Microphone	-	1 Build-in Microphone	1 Build-in Microphone	1 Build-in Microphone
Power	12 VDC ± 25% PoE: 802.3af, class 3	12 VDC ± 25% PoE: 802.3af, class 3	12 VDC ± 25% PoE: 802.3af, class 3	12 VDC ± 25% PoE: 802.3af, class 3	12 VDC ± 25% PoE: 802.3af, class 3	12 VDC ± 25% PoE: 802.3af, class 3
Interface	1 RJ45 10M/100M Ethernet port	1 RJ45 10M/100M Ethernet port support microSD	1 RJ45 10M/100M Ethernet port	1 RJ45 10M/100M Ethernet port support microSD	1 RJ45 10M/100M Ethernet port support microSD	1 RJ45 10M/100M Ethernet port support microSD

Model	DS-2CD1P2762-L	DS-2CD1P2762-LUF	DS-2CD1P4762-L	DS-2CD1P4762-LUF
Image	 ColorVu	 ColorVu	 ColorVu	 ColorVu
Image Sensor	1/2.5" Progressive Scan CMOS	1/2.5" Progressive Scan CMOS	1/3" Progressive Scan CMOS	1/3" Progressive Scan CMOS
Resolution	1920 × 1080	1920 × 1080	2560 × 1440	2560 × 1440
Video Compression	H.265/H.264/MJPEG/H.265+/H.264+	H.265/H.264/MJPEG/H.265+/H.264+	H.265/H.264/MJPEG/H.265+/H.264+	H.265/H.264/MJPEG/H.265+/H.264+
Min. Illumination	Color: 0.001Lux @ (F1.0, AGC ON)	Color: 0.001Lux @ (F1.0, AGC ON)	Color: 0.001Lux @ (F1.0, AGC ON)	Color: 0.001Lux @ (F1.0, AGC ON)
WDR	WDR	WDR	WDR	WDR
Lens	2.8 mm, 4 mm	2.8 mm, 4 mm	2.8 mm, 4 mm	2.8 mm, 4 mm
FOV	2.8 mm, horizontal FOV 106°, vertical FOV 57°, diagonal FOV 126° 4 mm, horizontal FOV 83°, vertical FOV 44°, diagonal FOV 99°	2.8 mm, horizontal FOV 106°, vertical FOV 57°, diagonal FOV 126° 4 mm, horizontal FOV 83°, vertical FOV 44°, diagonal FOV 99°	2.8 mm, horizontal FOV 96°, vertical FOV 52°, diagonal FOV 113° 4 mm, horizontal FOV 76°, vertical FOV 41°, diagonal FOV 89°	2.8 mm, horizontal FOV 96°, vertical FOV 52°, diagonal FOV 113° 4 mm, horizontal FOV 76°, vertical FOV 41°, diagonal FOV 89°
Optical Zoom	-	-	-	-
Max. Light Range	30m	30m	30m	30m
VCA	Motion Detection 2.0	Motion Detection 2.0	Motion Detection 2.0	Motion Detection 2.0
Frame Rate	50Hz: 25fps (1920 × 1080, 1280 × 960, 1280 × 720) 60Hz: 30fps (1920 × 1080, 1280 × 960, 1280 × 720)	50Hz: 25fps (1920 × 1080, 1280 × 960, 1280 × 720) 60Hz: 30fps (1920 × 1080, 1280 × 960, 1280 × 720)	50Hz: 20fps (2560 × 1440) 25fps (2304 × 1296, 1920 × 1080, 1280 × 720) 60Hz: 20fps (2560 × 1440) 30fps (2304 × 1296, 1920 × 1080, 1280 × 720)	50Hz: 20fps (2560 × 1440) 25fps (2304 × 1296, 1920 × 1080, 1280 × 720) 60Hz: 20fps (2560 × 1440) 30fps (2304 × 1296, 1920 × 1080, 1280 × 720)
Streams	2	2	2	2
Protection Level	IP66	IP66	IP66	IP66
Angle Adjustment	Pan: -100° to 100°, tilt: -20° to 45°	Pan: -100° to 100°, tilt: -20° to 45°	Pan: -100° to 100°, tilt: -20° to 45°	Pan: -100° to 100°, tilt: -20° to 45°
Operating Temperature	-30 °C to 60 °C (-22 °F to 140 °F)	-30 °C to 60 °C (-22 °F to 140 °F)	-30 °C to 60 °C (-22 °F to 140 °F)	-30 °C to 60 °C (-22 °F to 140 °F)
Humidity	95% or less (non-condensing)	95% or less (non-condensing)	95% or less (non-condensing)	95% or less (non-condensing)
Local Storage	support microSD	support microSD	support microSD	support microSD
Indoor/Outdoor	Outdoor	Outdoor	Outdoor	Outdoor
Audio I/O	-	1 Build-in Microphone	-	1 Build-in Microphone
Power	12 VDC ± 25% PoE: 802.3af, class 3	12 VDC ± 25% PoE: 802.3af, class 3	12 VDC ± 25% PoE: 802.3af, class 3	12 VDC ± 25% PoE: 802.3af, class 3
Interface	1 RJ45 10M/100M Ethernet port	1 RJ45 10M/100M Ethernet port support microSD	1 RJ45 10M/100M Ethernet port	1 RJ45 10M/100M Ethernet port support microSD

Network PTZ Cameras

150 Pro Series



Network PTZ Cameras





Pro Series



Hikvision's Pro Series gives users a taste of professional-level PTZ cameras and high performance. Almost all of the Pro Series PTZ Cameras are equipped with "powered-by-DarkFighter" technology, even ColorVu technology, making low-light monitoring an easy task. With abundant options for various camera sizes and amazing zoom capability, Pro Series cameras provide the ideal solution for hundreds of scenarios.





- Pro Series products are abundant, with various options of resolutions (from 2 to 8 MP), sizes (from 4- to 7-inch), and zoom ratios (from 15x to 32x).
- PTZ cameras with ColorVu technology provide crystal-clear detail and color on objects within 100 meters.
- PTZ cameras with Powered-by-DarkFighter technology render clear imaging even in low-light conditions.
- Powered by deep-learning algorithms, PTZs with AcuSense technology can classify targets into human / vehicle / other categories, and can respond in real time to multiple targets.
- Some Pro Series products also support strobe light and audio alarm functions, providing great value for perimeter protection.
- Pro Series equipment is designed for applications in factories, schools, parks, streets, and other outdoor or indoor environments.
- The TandemVu technology features Hikvision's next-generation camera design, integrating multiple lenses in one unit to provide big picture and small details in tandem.
- Support 4G network transmission, including LTE FDD/LTE TDD/WCDMA/HSPA+/GSM/GPRS/EDGE (only available for /4G models)





Model	DS-2DE5425IW-AE(T5)	DS-2DE5225W-AE(T5)	DS-2DE5232W-AE(T5)	DS-2DE5225W-AE3	DS-2DE5232W-AE3
Image					
Image Sensor	1/2.8" Progressive Scan CMOS	1/2.8" Progressive Scan CMOS	1/2.8" Progressive Scan CMOS	1/2.8" Progressive Scan CMOS	1/2.8" Progressive Scan CMOS*
Resolution	2560 × 1440	1920×1080	1920×1080	1920 × 1080	1921 × 1080
Video Compression	Main Stream: H.265+/H.265/H.264+/H.264	Main Stream: H.265+/H.265/H.264+/H.264	Main Stream: H.265+/H.265/H.264+/H.264	Main Stream: H.265+/H.265/H.264+/H.264	Main Stream: H.265+/H.265/H.264+/H.265
Lens	4.8 mm to 120 mm, 25x optical zoom	4.8 mm to 120 mm, 25x optical	4.8 mm to 153.6 mm, 32x optical	4.8 mm to 120 mm 25x optional, 16x digital	4.8 mm to 153.6 mm 32x optional, 16x digital
Angle of View	Horizontal field of view: 55° to 2.4° (Wide-Tele) Vertical field of view: 33° to 1.4° (Wide-Tele) Diagonal field of view: 61.5° to 2.8° (Wide-Tele)	Horizontal field of view: 57.6° to 2.5° (Wide-Tele) Vertical field of view: 34.4° to 1.4° (Wide-Tele) Diagonal field of view: 64.5° to 2.9° (Wide-Tele)	Horizontal field of view: 55.6° to 2.04° (Wide-Tele) Vertical field of view: 32.4° to 1.14° (Wide-Tele) Diagonal field of view: 63° to 2.34° (Wide-Tele)	Horizontal field of view: 57.6° to 2.5° (wide-tele), Vertical field of view: 34.4° to 1.4° (wide-tele), Diagonal field of view: 64.5° to 2.9° (wide-tele)	Horizontal field of view: 50.8° to 2.6° (wide-tele), Vertical field of view: 29.4° to 1.5° (wide-tele), Diagonal field of view: 57.4° to 3° (wide-tele)
Min. Illumination	Color: 0.005 Lux @(F1.6, AGC ON)	Color: 0.005 Lux @(F1.6, AGC ON)	Color: 0.005 Lux @(F1.6, AGC ON)	Color: 0.005 Lux @ (F1.6, AGC ON); B/W: 0.001 Lux @ (F1.6, AGC ON)	Color: 0.005 Lux @ (F1.6, AGC ON); B/W: 0.001 Lux @ (F1.6, AGC ON)
WDR	120dB	120dB	120dB	120dB	120dB
Max. IR Range	150 m	-	-	-	-
VCA	Intrusion Detection, Line Crossing Detection, Region Entrance Detection, Region Exiting Detection, Object Removal Detection, Unattended Baggage Detection, Audio Exception Detection	Face Capture, Intrusion Detection, Line Crossing Detection, Region Entrance Detection, Region Exiting Detection, Object Removal Detection, Unattended Baggage Detection	Face Capture, Intrusion Detection, Line Crossing Detection, Region Entrance Detection, Region Exiting Detection, Object Removal Detection, Unattended Baggage Detection	Face Capture, line crossing detection, intrusion detection, region entrance detection, region exiting detection, unattended baggage detection, object removal detection, audio exception detection	Face Capture, line crossing detection, intrusion detection, region entrance detection, region exiting detection, unattended baggage detection, object removal detection, audio exception detection
Frame Rate	50Hz: 25fps (2560 × 1440, 2048 × 1536, 1920 × 1080, 1280 × 960, 1280 × 720) 60Hz: 30fps (2560 × 1440, 2048 × 1536, 1920 × 1080, 1280 × 960, 1280 × 720)	50Hz: 25fps (1920 × 1080, 1280 × 960, 1280 × 720) 50fps (1920 × 1080, 1280 × 960, 1280 × 720) 60Hz: 30fps (1920 × 1080, 1280 × 960, 1280 × 720) 60fps (1920 × 1080, 1280 × 960, 1280 × 720)	50Hz: 25fps (1920 × 1080, 1280 × 960, 1280 × 720) 50fps (1920 × 1080, 1280 × 960, 1280 × 720) 60Hz: 30fps (1920 × 1080, 1280 × 960, 1280 × 720) 60fps (1920 × 1080, 1280 × 960, 1280 × 720)	50 Hz: 25 fps (1920 × 1080, 1280 × 960, 1280 × 720) 60 Hz: 30 fps (1920 × 1080, 1280 × 960, 1280 × 720)	50 Hz: 25 fps (1920 × 1080, 1280 × 960, 1280 × 720) 60 Hz: 30 fps (1920 × 1080, 1280 × 960, 1280 × 720)
Streams	3	3	3	3	3
Protection Level	IP66 Standard, 4000V Lightning Protection, Surge Protection and Voltage Transient Protection	IP66 Standard, IK10, 4000V Lightning Protection, Surge Protection and Voltage Transient Protection	IP66 Standard, IK10, 4000V Lightning Protection, Surge Protection and Voltage Transient Protection	IP66 Standard, IK10 (IEC 62262:2002), TVS 6000V lightning protection, surge protection and voltage transient protection	IP66 Standard, IK10 (IEC 62262:2002), TVS 6000V lightning protection, surge protection and voltage transient protection
Pan Range	360° endless	360° endless	360° endless	360° endless	360° endless
Tilt Range	From -15° to 90° (auto-flip)	From -5° to 90° (Auto-flip)	From -5° to 90° (Auto-flip)	From -5° to 90° (auto flip)	From -5° to 90° (auto flip)
Pan Speed	Configurable, from 0.1°/s to 120°/s	Configurable, from 0.1°/s to 250°/s	Configurable, from 0.1°/s to 250°/s	Configurable from 0.1° to 250°/s; preset speed: 300°/s	Configurable from 0.1° to 250°/s; preset speed: 300°/s
Tilt Speed	Configurable, from 0.1°/s to 80°/s	Configurable, from 0.1°/s to 150°/s	Configurable, from 0.1°/s to 150°/s	Configurable from 0.1° to 150°/s, preset speed 200°/s	Configurable from 0.1° to 150°/s, preset speed 200°/s
Operating Temperature	-30°C to 65°C (-22°F to 149°F)	-30°C to 65°C (-22°F to 149°F)	-30°C to 65°C (-22°F to 149°F)	-10°C to 50°C (14°F to 122°F)	-10°C to 50°C (14°F to 122°F)
Humidity	≤ 90%	≤ 90%	≤ 90%	≤ 90%	≤ 90%
Local Storage	Built-in memory card slot, support Micro SD/SDHC/SDXC, up to 256 GB; NAS (NFS, SMB/CIFS), ANR	Built-in memory card slot, support Micro SD/SDHC/SDXC, up to 256 GB; NAS (NFS, SMB/CIFS), ANR	Built-in memory card slot, support Micro SD/SDHC/SDXC, up to 256 GB; NAS (NFS, SMB/CIFS), ANR	Built-in memory card slot, support Micro SD/SDHC/SDXC, up to 256 GB; NAS (NFS, SMB/CIFS), ANR	Built-in memory card slot, support Micro SD/SDHC/SDXC, up to 256 GB; NAS (NFS, SMB/CIFS), ANR
Audio I/O	1/1	1/1	1/1	1/1	1/1
Alarm I/O	2/1	2/1	2/1	2/2	2/2
Power	24 VAC & Hi-PoE Max.: 30 W (Max. 10 W for IR)	24 VAC & PoE (802.3at) Max.: 22 W	24 VAC & PoE (802.3at) Max.: 22 W	24 VAC, Max. 20 W; PoE (802.3at)	24 VAC, Max. 20 W; PoE (802.3at)

Model	DS-2SE4C215MW6-E(12F0)	DS-2SE4C225MW6-E(12F0)	DS-2SE4C415MW6-E(14F0)	DS-2SE4C425MW6-E(14F0)
Image				
Image Sensor	[Bullet channel] 1/2.8" Progressive Scan CMOS, [PTZ channel] 1/2.8" Progressive Scan CMOS	[Bullet channel] 1/2.8" Progressive Scan CMOS, [PTZ channel] 1/2.8" Progressive Scan CMOS	[Bullet channel]: 1/3" Progressive Scan CMOS; [PTZ channel]: 1/2.8" progressive scan CMOS	[Bullet channel]: 1/3" Progressive Scan CMOS; [PTZ channel]: 1/2.8" progressive scan CMOS
Resolution	1920 × 1080	1920 × 1080	2560 × 1440	2560 × 1440
Video Compression	Main Stream: H.265+ / H.265 / H.264+ / H.264	Main Stream: H.265+ / H.265 / H.264+ / H.264	Main Stream: H.265+ / H.265 / H.264+ / H.264	Main Stream: H.265+ / H.265 / H.264+ / H.264
Lens	[Bullet channel]: 2.8 mm; [PTZ channel]: 5 to 75 mm	[Bullet channel]: 2.8 mm; [PTZ channel]: 4.8 to 120 mm	[Bullet channel]: 2.8 mm; [PTZ channel]: 4.8 to 72 mm	[Bullet channel]: 2.8 mm; [PTZ channel]: 4.8 to 120 mm
Angle of View	[Bullet channel]: Horizontal field of view: 106.1°, Vertical field of view: 56.8°, Diagonal field of view: 126.5°; [PTZ channel]: Horizontal field of view: 54.8° to 4° (wide-tele), Vertical field of view: 31.4° to 2.3° (wide-tele), Diagonal field of view: 62.2° to 4.6° (wide-tele)	[Bullet channel]: Horizontal field of view: 106.1°, Vertical field of view: 56.8°, Diagonal field of view: 126.5°; [PTZ channel]: Horizontal field of view: 54.8° to 2.8° (wide-tele), Vertical field of view: 31.4° to 1.5° (wide-tele), Diagonal field of view: 62.2° to 3.2° (wide-tele)	[Bullet channel]: Horizontal field of view: 96.1°, Vertical field of view: 52.1°, Diagonal field of view: 113.3°; [PTZ channel]: Horizontal field of view: 55° to 4° (wide-tele), Vertical field of view: 33° to 2.2° (wide-tele), Diagonal field of view: 61.5° to 4.6° (wide-tele)	[Bullet channel]: Horizontal field of view: 96.1°, Vertical field of view: 52.1°, Diagonal field of view: 113.3°; [PTZ channel]: Horizontal field of view: 55° to 2.4° (wide-tele), Vertical field of view: 33° to 1.4° (wide-tele), Diagonal field of view: 61.5° to 2.8° (wide-tele)
Min. Illumination	[Bullet channel]: 0.0005 Lux @ (F1.0, AGC ON), 0 Lux with light; [PTZ channel]: Color: 0.005 Lux @ (F1.6, AGC ON), B/W: 0.001 Lux @ (F1.6, AGC ON), 0 Lux with IR	[Bullet channel]: 0.0005 Lux @ (F1.0, AGC ON), 0 Lux with light; [PTZ channel]: Color: 0.005 Lux @ (F1.6, AGC ON), B/W: 0.001 Lux @ (F1.6, AGC ON), 0 Lux with IR	[Bullet channel]: 0.0005 Lux @ (F1.0, AGC ON), 0 Lux with light; [PTZ channel]: Color: 0.005 Lux @ (F1.6, AGC ON), B/W: 0.001 Lux @ (F1.6, AGC ON), 0 Lux with IR	[Bullet channel]: 0.0005 Lux @ (F1.0, AGC ON), 0 Lux with light; [PTZ channel]: Color: 0.005 Lux @ (F1.6, AGC ON), B/W: 0.001 Lux @ (F1.6, AGC ON), 0 Lux with IR
WDR	120 dB	120 dB	120 dB	120 dB
Max. Supplement Light Range	[PTZ channel]: up to 100 m; [Bullet channel]: up to 30 m	[PTZ channel]: up to 100 m; [Bullet channel]: up to 30 m	[PTZ channel]: up to 100 m; [Bullet channel]: up to 30 m	[PTZ channel]: up to 100 m; [Bullet channel]: up to 30 m
VCA	Motion detection, video tampering alarm, exception, alarm input and output audio exception detection, region exiting detection, region entrance detection, intrusion detection, Line crossing detection	Motion detection, video tampering alarm, exception, alarm input and output audio exception detection, region exiting detection, region entrance detection, intrusion detection, Line crossing detection	Motion detection, video tampering alarm, exception, alarm input and output audio exception detection, region exiting detection, region entrance detection, intrusion detection, Line crossing detection	Motion detection, video tampering alarm, exception, alarm input and output audio exception detection, region exiting detection, region entrance detection, intrusion detection, Line crossing detection
Frame Rate	[Bullet channel]: 50 Hz: 25 fps (1920 × 1080, 1280 × 960, 1280 × 720) 60 Hz: 30 fps (1920 × 1080, 1280 × 960, 1280 × 720) [PTZ channel]: 50 Hz: 25 fps (1920 × 1080, 1280 × 960, 1280 × 720) 60 Hz: 30 fps (1920 × 1080, 1280 × 960, 1280 × 720)	[Bullet channel]: 50 Hz: 25 fps (1920 × 1080, 1280 × 960, 1280 × 720) 60 Hz: 30 fps (1920 × 1080, 1280 × 960, 1280 × 720) [PTZ channel]: 50 Hz: 25 fps (1920 × 1080, 1280 × 960, 1280 × 720) 60 Hz: 30 fps (1920 × 1080, 1280 × 960, 1280 × 720)	[Bullet channel]: 50 Hz: 25 fps (2560 × 1440, 1920 × 1080, 1280 × 960, 1280 × 720) 60 Hz: 30 fps (2560 × 1440, 1920 × 1080, 1280 × 960, 1280 × 720) [PTZ channel]: 50 Hz: 25 fps (2560 × 1440, 1920 × 1080, 1280 × 960, 1280 × 720) 60 Hz: 30 fps (2560 × 1440, 1920 × 1080, 1280 × 960, 1280 × 720)	[Bullet channel]: 50 Hz: 25 fps (2560 × 1440, 1920 × 1080, 1280 × 960, 1280 × 720) 60 Hz: 30 fps (2560 × 1440, 1920 × 1080, 1280 × 960, 1280 × 720) [PTZ channel]: 50 Hz: 25 fps (2560 × 1440, 1920 × 1080, 1280 × 960, 1280 × 720) 60 Hz: 30 fps (2560 × 1440, 1920 × 1080, 1280 × 960, 1280 × 720)
Streams	3	3	3	3
Protection Level	IP66 (IEC 60529-2013), TVS 6000 V lightning protection, surge protection and voltage transient protection	IP66 Standard, 6000 V Lightning Protection, Surge Protection and Voltage Transient Protection	IP66 Standard, 6000 V Lightning Protection, Surge Protection and Voltage Transient Protection	IP66 Standard, 6000 V Lightning Protection, Surge Protection and Voltage Transient Protection
Pan Range	360° endless	360° endless	360° endless	360° endless
Tilt Range	-15° to 90° (auto flip)	-15° to 90° (auto flip)	-15° to 90° (auto flip)	-15° to 90° (auto flip)
Pan Speed	Pan speed: configurable from 0.1° to 80°/s, preset speed: 80°/s	pan speed: configurable from 0.1° to 80°/s; preset speed: 80°/s	pan speed: configurable from 0.1° to 80°/s; preset speed: 80°/s	pan speed: configurable from 0.1° to 80°/s; preset speed: 80°/s
Tilt Speed	Tilt speed: configurable from 0.1° to 80°/s, preset speed 80°/s	Tilt speed: configurable from 0.1° to 80°/s, preset speed 80°/s	Tilt speed: configurable from 0.1° to 80°/s, preset speed 80°/s	Tilt speed: configurable from 0.1° to 80°/s, preset speed 80°/s
Operating Temperature Humidity	-30°C to 65°C (-22°F to 149°F), ≤ 90%	-30°C to 65°C (-22°F to 149°F), ≤ 90%	-30°C to 65°C (-22°F to 149°F), ≤ 90%	-30°C to 65°C (-22°F to 149°F), ≤ 90%
Local Storage	Built-in memory card slot, support Micro SD/Micro SDHC/Micro SDXC, up to 256 GB	Built-in memory card slot, support Micro SD/Micro SDHC/Micro SDXC, up to 256 GB	Built-in memory card slot, support Micro SD/Micro SDHC/Micro SDXC, up to 256 GB	Built-in memory card slot, support Micro SD/Micro SDHC/Micro SDXC, up to 256 GB
Audio I/O	1/1	1/1	1/1	1/1
Alarm I/O	1/1	1/1	1/1	1/1
Power	DC12V, PoE+ Max. 24 W, including max. 2.6 W for heater and max. 11 W for supplement light	DC12V, PoE+ Max. 24 W, including max. 2.6 W for heater and max. 11 W for supplement light	DC12V, PoE+ Max. 24 W, including max. 2.6 W for heater and max. 11 W for supplement light	DC12V, PoE+ Max. 24 W, including max. 2.6 W for heater and max. 11 W for supplement light

Model	DS-2SE4C215MWG-E/26(F0)	DS-2SE4C225MWG-E/26(F0)	DS-2SE4C415MWG-E/26(F0)	DS-2SE4C425MWG-E/26(F0)
Image	 	 	 	 
Image Sensor	[Bullet channel] 1/2.5" Progressive Scan CMOS, [PTZ channel] 1/2.8" Progressive Scan CMOS	[Bullet channel] 1/2.5" Progressive Scan CMOS, [PTZ channel] 1/2.8" Progressive Scan CMOS	[Bullet channel]: 1/2.5" Progressive Scan CMOS; [PTZ channel]: 1/2.8" progressive scan CMOS	[Bullet channel]: 1/2.5" Progressive Scan CMOS; [PTZ channel]: 1/2.8" progressive scan CMOS
Resolution	[Bullet channel] 3632 × 1632, [PTZ channel] 1920 × 1080	[Bullet channel] 3632 × 1632, [PTZ channel] 1920 × 1080	[Bullet channel] 3632 × 1632, [PTZ channel] 2560 × 1440	[Bullet channel] 3632 × 1632, [PTZ channel] 2560 × 1440
Video Compression	H.265/H265+, H.264/H264+, MJPEG	H.265/H265+, H.264/H264+, MJPEG	H.265/H265+, H.264/H264+, MJPEG	H.265/H265+, H.264/H264+, MJPEG
Lens	[Bullet channel]: 2.8 mm; [PTZ channel]: 5 to 75 mm, 15 × optical	[Bullet channel]: 2.8 mm; [PTZ channel]: 4.8 to 120 mm, 25 × optical	[Bullet channel]: 2.8 mm; [PTZ channel]: 4.8 to 72 mm, 15 × optical	[Bullet channel]: 2.8 mm; [PTZ channel]: 4.8 to 120 mm, 25 × optical
Angle of View	[Bullet channel]: Horizontal field of view: 180±10°, Vertical field of view: 80±5°; [PTZ channel]: Horizontal field of view: 54.8° to 4° (wide-tele), Vertical field of view: 31.4° to 2.3° (wide-tele), Diagonal field of view: 62.2° to 4.6° (wide-tele)	[Bullet channel]: Horizontal field of view: 180±10°, Vertical field of view: 80±5°; [PTZ channel]: Horizontal field of view: 54.8° to 2.8° (wide-tele), Vertical field of view: 31.4° to 1.5° (wide-tele), Diagonal field of view: 62.2° to 3.2° (wide-tele)	[Bullet channel]: Horizontal field of view: 180±10°, Vertical field of view: 80±5°; [PTZ channel]: Horizontal field of view: 55° to 4° (wide-tele), Vertical field of view: 33° to 2.2° (wide-tele), Diagonal field of view: 61.5° to 4.6° (wide-tele)	[Bullet channel]: Horizontal field of view: 180±10°, Vertical field of view: 80±5°; [PTZ channel]: Horizontal field of view: 55° to 2.4° (wide-tele), Vertical field of view: 33° to 1.4° (wide-tele), Diagonal field of view: 61.5° to 2.8° (wide-tele)
Min. Illumination	[Bullet channel]: 0.0005 Lux @ (F1.0, AGC ON), 0 Lux with light; [PTZ channel]: Color: 0.005 Lux @ (F1.6, AGC ON)	[Bullet channel]: 0.0005 Lux @ (F1.0, AGC ON), 0 Lux with light; [PTZ channel]: Color: 0.005 Lux @ (F1.6, AGC ON)	[Bullet channel]: 0.0005 Lux @ (F1.0, AGC ON), 0 Lux with light; [PTZ channel]: Color: 0.005 Lux @ (F1.6, AGC ON)	[Bullet channel]: 0.0005 Lux @ (F1.0, AGC ON), 0 Lux with light; [PTZ channel]: Color: 0.005 Lux @ (F1.6, AGC ON)
WDR	120 dB	120 dB	120 dB	120 dB
Max. Supplement Light Range	[PTZ channel]: up to 100 m; [Bullet channel]: up to 30 m	[PTZ channel]: up to 100 m; [Bullet channel]: up to 30 m	[PTZ channel]: up to 100 m; [Bullet channel]: up to 30 m	[PTZ channel]: up to 100 m; [Bullet channel]: up to 30 m
VCA	Motion detection, video tampering alarm, exception, alarm input and output, audio exception detection, region exiting detection, region entrance detection, intrusion detection, Line crossing detection, Face Capture	Motion detection, video tampering alarm, exception, alarm input and output, audio exception detection, region exiting detection, region entrance detection, intrusion detection, Line crossing detection, Face Capture	Motion detection, video tampering alarm, exception, alarm input and output, audio exception detection, region exiting detection, region entrance detection, intrusion detection, Line crossing detection, Face Capture	Motion detection, video tampering alarm, exception, alarm input and output, audio exception detection, region exiting detection, region entrance detection, intrusion detection, Line crossing detection, Face Capture
Frame Rate	[Bullet channel] 50 Hz: 25 fps (3632 × 1632, 3680 × 1656), 60 Hz: 30 fps (3632 × 1632, 3680 × 1656), [PTZ channel] 50 Hz: 25 fps (1920 × 1080, 1280 × 960, 1280 × 720), 60 Hz: 30 fps (1920 × 1080, 1280 × 960, 1280 × 720)	[Bullet channel] 50 Hz: 25 fps (3632 × 1632, 3680 × 1656), 60 Hz: 30 fps (3632 × 1632, 3680 × 1656), [PTZ channel] 50 Hz: 25 fps (1920 × 1080, 1280 × 960, 1280 × 720), 60 Hz: 30 fps (1920 × 1080, 1280 × 960, 1280 × 721)	[Bullet channel] 50 Hz: 25 fps (3632 × 1632, 3680 × 1656), 60 Hz: 30 fps (3632 × 1632, 3680 × 1656), [PTZ channel] 50 Hz: 25 fps (2560 × 1440, 1920 × 1080, 1280 × 960, 1280 × 720), 60 Hz: 30 fps (2560 × 1440, 1920 × 1080, 1280 × 960, 1280 × 720)	[Bullet channel] 50 Hz: 25 fps (3632 × 1632, 3680 × 1656), 60 Hz: 30 fps (3632 × 1632, 3680 × 1656), [PTZ channel] 50 Hz: 25 fps (2560 × 1440, 1920 × 1080, 1280 × 960, 1280 × 720), 60 Hz: 30 fps (2560 × 1440, 1920 × 1080, 1280 × 960, 1280 × 720)
Streams	3	3	3	3
Protection Level	IP66 (IEC 60529-2013), TVS 6000 V lightning protection, surge protection and voltage transient protection	IP66 (IEC 60529-2013), TVS 6000 V lightning protection, surge protection and voltage transient protection	IP66 (IEC 60529-2013), TVS 6000 V lightning protection, surge protection and voltage transient protection	IP66 (IEC 60529-2013), TVS 6000 V lightning protection, surge protection and voltage transient protection
Pan Range	360° endless	360° endless	360° endless	360° endless
Tilt Range	-15° to 90° (auto flip)	-15° to 90° (auto flip)	-15° to 90° (auto flip)	-15° to 90° (auto flip)
Pan Speed	Pan speed: configurable from 0.1° to 80°/s, preset speed: 80°/s	Pan speed: configurable from 0.1° to 80°/s, preset speed: 80°/s	Pan speed: configurable from 0.1° to 80°/s, preset speed: 80°/s	Pan speed: configurable from 0.1° to 80°/s, preset speed: 80°/s
Tilt Speed	Tilt speed: configurable from 0.1° to 80°/s, preset speed 80°/s	Tilt speed: configurable from 0.1° to 80°/s, preset speed 80°/s	Tilt speed: configurable from 0.1° to 80°/s, preset speed 80°/s	Tilt speed: configurable from 0.1° to 80°/s, preset speed 80°/s
Operating Temperature	-30°C to 65°C (-22°F to 149°F)	-30°C to 65°C (-22°F to 149°F)	-30°C to 65°C (-22°F to 149°F)	-30°C to 65°C (-22°F to 149°F)
Humidity	≤ 90%	≤ 90%	≤ 90%	≤ 90%
Local Storage	Built-in memory card slot, support Micro SD/Micro SDHC/Micro SDXC, up to 256 GB	Built-in memory card slot, support Micro SD/Micro SDHC/Micro SDXC, up to 256 GB	Built-in memory card slot, support Micro SD/Micro SDHC/Micro SDXC, up to 256 GB	Built-in memory card slot, support Micro SD/Micro SDHC/Micro SDXC, up to 256 GB
Audio I/O	1/1	1/1	1/1	1/1
Alarm I/O	1/1	1/1	1/1	1/1
Power	DC12V, PoE+ Max. 24 W, including max. 2.6 W for heater and max. 11 W for supplement light	DC12V, PoE+ Max. 24 W, including max. 2.6 W for heater and max. 11 W for supplement light	DC12V, PoE+ Max. 24 W, including max. 2.6 W for heater and max. 11 W for supplement light	DC12V, PoE+ Max. 24 W, including max. 2.6 W for heater and max. 11 W for supplement light

Model	DS-2DE4215IW-DE(TS)	DS-2DE4225IW-DE(TS)	DS-2DE4415IW-DE(TS)	DS-2DE4425IW-DE(TS)
Image			 HOT	 HOT
Image Sensor	1/2.8" Progressive Scan CMOS	1/2.8" Progressive Scan CMOS	1/2.8" Progressive Scan CMOS	1/2.8" Progressive Scan CMOS
Resolution	1920×1080	1920×1080	2560 × 1440	2560 × 1440
Video Compression	Main Stream: H.265+ /H.265/H.264+ /H.264	Main Stream: H.265+ /H.265/H.264+ /H.264	Main Stream: H.265+ /H.265/H.264+ /H.264	Main Stream: H.265+ /H.265/H.264+ /H.264
Lens	5 mm to 75 mm, 15× optical zoom	4.8 mm to 120 mm, 25× optical zoom	5 mm to 75 mm, 15× optical zoom	4.8 mm to 120 mm, 25× optical zoom
Angle of View	Horizontal field of view: 57.6° to 4° (Wide-Tele) Vertical field of view: 34.4° to 2.2° (Wide-Tele) Diagonal field of view: 64.5° to 4.6° (Wide-Tele)	Horizontal field of view: 57.6° to 2.5° (Wide-Tele) Vertical field of view: 34.4° to 1.4° (Wide-Tele) Diagonal field of view: 64.5° to 2.9° (Wide-Tele)	Horizontal field of view: 55° to 4° (Wide-Tele) Vertical field of view: 33° to 2.2° (Wide-Tele) Diagonal field of view: 61.5° to 4.6° (Wide-Tele)	Horizontal field of view: 55° to 2.4° (Wide-Tele) Vertical field of view: 33° to 1.4° (Wide-Tele) Diagonal field of view: 61.5° to 2.8° (Wide-Tele)
Min. Illumination	Color: 0.005 Lux @(F1.6, AGC ON)	Color: 0.005 Lux @(F1.6, AGC ON)	Color: 0.005 Lux @(F1.6, AGC ON)	Color: 0.005 Lux @(F1.6, AGC ON)
WDR	120dB	120dB	120dB	120dB
Max. IR Range	100 m	100 m	100 m	100 m
VCA	Face Capture, Intrusion Detection, Line Crossing Detection, Region Entrance Detection, Region Exiting Detection, Object Removal Detection, Unattended Baggage Detection	Face Capture, Intrusion Detection, Line Crossing Detection, Region Entrance Detection, Region Exiting Detection, Object Removal Detection, Unattended Baggage Detection	Face Capture, Intrusion Detection, Line Crossing Detection, Region Entrance Detection, Region Exiting Detection, Object Removal Detection, Unattended Baggage Detection	Face Capture, Intrusion Detection, Line Crossing Detection, Region Entrance Detection, Region Exiting Detection, Object Removal Detection, Unattended Baggage Detection
Frame Rate	50Hz: 25fps (1920 × 1080, 1280 × 960, 1280 × 720) 60Hz: 30fps (1920 × 1080, 1280 × 960, 1280 × 720)	50Hz: 25fps (1920 × 1080, 1280 × 960, 1280 × 720) 60Hz: 30fps (1920 × 1080, 1280 × 960, 1280 × 720)	50Hz: 25fps (2560 × 1440, 2048 × 1536, 1920 × 1080, 1280 × 960, 1280 × 720) 60Hz: 30fps (2560 × 1440, 2048 × 1536, 1920 × 1080, 1280 × 960, 1280 × 720)	50Hz: 25fps (2560 × 1440, 2048 × 1536, 1920 × 1080, 1280 × 960, 1280 × 720) 60Hz: 30fps (2560 × 1440, 2048 × 1536, 1920 × 1080, 1280 × 960, 1280 × 720)
Streams	3	3	3	3
Protection Level	IP66 Standard, 4000V Lightning Protection, Surge Protection and Voltage Transient Protection	IP66 Standard, 4000V Lightning Protection, Surge Protection and Voltage Transient Protection	IP66 Standard, 4000V Lightning Protection, Surge Protection and Voltage Transient Protection	IP66 Standard, 4000V Lightning Protection, Surge Protection and Voltage Transient Protection
Pan Range	360° endless	360° endless	360° endless	360° endless
Tilt Range	From -15° to 90° (Auto-flip)	From -15° to 90° (Auto-flip)	From -15° to 90° (Auto-flip)	From -15° to 90° (Auto-flip)
Pan Speed	Configurable, from 0.1°/s to 80°/s, Preset speed: 80°/s	Configurable, from 0.1°/s to 80°/s, Preset speed: 80°/s	Configurable, from 0.1°/s to 80°/s, Preset speed: 80°/s	Configurable, from 0.1°/s to 80°/s, Preset speed: 80°/s
Tilt Speed	Configurable, from 0.1°/s to 80°/s Preset Speed: 80°/s	Configurable, from 0.1°/s to 80°/s Preset Speed: 80°/s	Configurable, from 0.1°/s to 80°/s Preset Speed: 80°/s	Configurable, from 0.1°/s to 80°/s Preset Speed: 80°/s
Operating Temperature	-30°C to 65°C (-22°F to 149°F)	-30°C to 65°C (-22°F to 149°F)	-30°C to 65°C (-22°F to 149°F)	-30°C to 65°C (-22°F to 149°F)
Humidity	≤ 90%	≤ 90%	≤ 90%	≤ 90%
Local Storage	Built-in memory card slot, support Micro SD/SDHC/SDXC, up to 256 GB; NAS (NFS, SMB/ CIFS), ANR	Built-in memory card slot, support Micro SD/SDHC/SDXC, up to 256 GB; NAS (NFS, SMB/ CIFS), ANR	Built-in memory card slot, support Micro SD/SDHC/SDXC, up to 256 GB; NAS (NFS, SMB/ CIFS), ANR	Built-in memory card slot, support Micro SD/SDHC/SDXC, up to 256 GB; NAS (NFS, SMB/ CIFS), ANR
Audio I/O	-	1/1	-	1/1
Alarm I/O	-	-	-	-
Power	12 VDC & PoE (802.3at) Max.: 18 W (Max. 7 W for IR)	12 VDC & PoE (802.3at) Max.: 18 W (Max. 7 W for IR)	12 VDC & PoE (802.3at) Max.: 18 W (Max. 7 W for IR)	12 VDC & PoE (802.3at) Max.: 18 W (Max. 7 W for IR)

Model	DS-2DE4A225IW6-E	DS-2DE4A425IW6-E	DS-2DE4225W6-E3
Image	 -NEW	 -NEW	
Image Sensor	1/2.8" Progressive Scan CMOS	1/2.8" Progressive Scan CMOS	1/2.8" progressive scan CMOS
Resolution	1920 × 1080	2560 × 1440	1920 × 1080
Video Compression	Main Stream: H.265+/H.265/H.264+/H.264	Main Stream: H.265+/H.265/H.264+/H.264	Main Stream: H.265+/H.265/H.264+/H.264
Lens	4.8 to 120 mm, 25 × optical zoom	4.8 to 120 mm, 25 × optical zoom	4.8 mm to 120 mm, 25× optical zoom
Angle of View	Horizontal FOV 54.9° to 2.7°, vertical FOV 31.5° to 1.5°, diagonal FOV 62.3° to 3.1°	Horizontal FOV 53.3° to 2.6°, vertical FOV 30.6° to 1.5°, diagonal FOV 60.5° to 3°	Horizontal field of view: 57.6° to 2.5° (Wide-Tele), Vertical field of view: 34.4° to 1.4° (Wide-Tele),
Min. Illumination	Color: 0.005 Lux @ (F1.6, AGC ON)	Color: 0.005 Lux @ (F1.6, AGC ON)	Color: 0.005 Lux @ (F1.6, AGC ON)
WDR	120dB	120dB	120dB
Max. IR Range	up to 50 m	up to 50 m	
VCA	<p>Manual tracking, auto-tracking, line crossing detection, intrusion detection, region entrance detection, region exiting detection, unattended baggage detection, object removal detection, audio exception detection, Detects up to 5 faces simultaneously,</p> <p>Supports detecting, tracking, capturing, grading, selecting of face in motion, and outputs the best face picture</p>	<p>Manual tracking, auto-tracking, line crossing detection, intrusion detection, region entrance detection, region exiting detection, unattended baggage detection, object removal detection, audio exception detection, Detects up to 5 faces simultaneously,</p> <p>Supports detecting, tracking, capturing, grading, selecting of face in motion, and outputs the best face picture</p>	<p>Intrusion Detection, Line Crossing Detection, Region Entrance Detection, Region Exiting Detection, Object Removal Detection, Unattended Baggage Detection, Audio Exception Detection"</p>
Frame Rate	50 Hz: 50 fps (1920 × 1080, 1280 × 960, 1280 × 720); 60 Hz: 60 fps (1920 × 1080, 1280 × 960, 1280 × 720)	50 Hz: 25 fps (2560 × 1440, 1920 × 1080, 1280 × 960, 1280 × 720) 60 Hz: 30 fps (2560 × 1440, 1920 × 1080, 1280 × 960, 1280 × 720)	50Hz: 25fps (1920 × 1080, 1280 × 960, 1280 × 720) 50fps (1280 × 960, 1280 × 720); 60Hz: 30fps (1920 × 1080, 1280 × 960, 1280 × 720) 60fps (1280 × 960, 1280 × 720)
Streams	3	3	3
Protection Level	IP66 (IEC 60529-2013), TVS 6000V lightning protection, surge protection and voltage transient protection	IP66 (IEC 60529-2013), TVS 6000V lightning protection, surge protection and voltage transient protection	4000V Lightning Protection, Surge Protection and Voltage Transient Protection
Pan Range	360° endless	360° endless	360° endless
Tilt Range	-5° to 90°	-5° to 90°	From 0° to 90° (auto-flip)
Pan Speed	Configurable from 0.1° to 300°/s; preset speed: 350°/s	Configurable from 0.1° to 300°/s; preset speed: 350°/s	Configurable, from 0.1°/s to 160°/s Preset speed: 160°/s
Tilt Speed	Configurable from 0.1° to 160°/s, preset speed 200°/s	Configurable from 0.1° to 160°/s, preset speed 200°/s	Configurable, from 0.1°/s to 120°/s Preset Speed: 120°/s
Operating Temperature	-30 °C to 65 °C [-22 °F to 149 °F]	-30 °C to 65 °C [-22 °F to 149 °F]	-10°C to 50°C [-14°F to 122°F]
Humidity	≤ 90%	≤ 90%	≤ 90%
Local Storage	Built-in memory card slot, support Micro SD/SDHC/SDXC, up to 256 GB; NAS (NFS, SMB/ CIFS), ANR	Built-in memory card slot, support Micro SD/SDHC/SDXC, up to 256 GB; NAS (NFS, SMB/ CIFS), ANR	Built-in memory card slot, support Micro SD/SDHC/SDXC, up to 256 GB; NAS (NFS, SMB/ CIFS), ANR
Audio I/O	1/1	1/1	1/1
Alarm I/O	2/2	2/2	1/1
Power	12 VDC, Max. 24 W; PoE (802.3at)	12 VDC, Max. 24 W; PoE (802.3at)	12 VDC, 2.0 A and PoE (802.3at), 42.5 to 57 VDC, 0.6 A, Class4 Max.18 W

Panoramic Cameras

157 Fisheye Series



Network Panoramic Cameras



Fisheye Series

Single Sensor Panorama Camera

Hikvision's Fisheye Cameras offer a complete, high-resolution, 360-degree, 0-blind spots, panoramic view. They secure offices, warehouses, shops, hotel lobbies, and more with HD video monitoring without any blind areas. The resulting image is automatically dewarped for intuitive and easy use.

- > 360° / 180° overview
- > H.265+ codec
- > Multiple dewarping modes



Model	DS-2CD2935FWD-I(S)	DS-2CD2955FWD-I(S)
Image		
Image Sensor	1/2.8" Progressive Scan CMOS	1/2.5" Progressive Scan CMOS
Resolution	2048 × 1536	2560 × 1920
Video Compression	H.265/H.264/MJPEG/H.264+/H.265+	H.265/H.264/MJPEG/H.264+/H.265+
Min. Illumination	Color: 0.017Lux @ (F2.2, AGC ON), 0 Lux with IR on	Color: 0.034Lux @ (F2.2, AGC ON), 0 Lux with IR on
WDR	120dB	120dB
Lens	1.16 mm	1.05 mm
FOV	horizontal field of view: 180°, vertical field of view: 180°	horizontal field of view: 180°, vertical field of view: 180°
Max. IR Range	8 m	8 m
VCA	Line crossing detection, intrusion detection	Line crossing detection, intrusion detection
Frame Rate	50Hz:25fps (2048 × 1536, 1600 × 1200, 1280 × 960) 60Hz:30fps (2048 × 1536, 1600 × 1200, 1280 × 960)	50Hz: 25fps (2560 × 1920, 2048 × 1536, 1280 × 960) 60Hz: 30fps (2560 × 1920, 2048 × 1536, 1280 × 960)
Streams	2	2
Protection Level	-	-
Operating Temperature	-10 °C to +50 °C (-14 °F to +122 °F)	-10 °C to +50 °C (-14 °F to +122 °F)
Humidity	95% or less	95% or less
Local Storage	128 GB	128 GB
Indoor/Outdoor	Indoor	Indoor
Audio I/O	-S: 1 in, 1 out	-S: 1 in, 1 out
Alarm I/O	-S: 1 in, 1 out	-S: 1 in, 1 out
Power	12 VDC, 0.4 A, max.5 W PoE (802.3af, 36 V to 57 V), 0.2 A to 0.1 A, max.6.5 W	12 VDC, 0.5 A, max. 6 W PoE (802.3af, 36 V to 57 V), 0.2 A to 0.1 A, max. 7.5 W

NVRs

159 Pro Series with AcuSense

165 Pro Series NVRs

173 Value Series NVRs







Network Video Recorders





Pro Series with AcuSense

Based on deep learning technology, Hikvision Pro Series NVRs with AcuSense are able to analyze and classify human and vehicle targets from video streams, as well as to enable efficient video searching by target type.





- › Up to 4-ch human & vehicle classification on VCA results for I Series NVRs with AcuSense
- › Up to 2-ch human & vehicle classification on VCA results for K Series NVRs with AcuSense
- › Full-channel human & vehicle classification on motion detection results
- › One facial-recognition channel on video streams
- › Quick target search of video footage with humans and vehicles
- › Up to 16-ch @ 1080p decoding for I Series NVRs with AcuSense, up to 12-ch @ 1080p decoding for K Series NVRs with AcuSense









Model	DS-7732NXI-I4/16P/S	DS-7732NXI-I4/S	DS-7716NXI-I4/16P/S	DS-7716NXI-I4/S
Image				
Channel No.	32-ch	32-ch	16-ch	16-ch
Decoding Format	H.265/H.265+/H.264/H.264+/MPEG4	H.265/H.265+/H.264/H.264+/MPEG4	H.265/H.265+/H.264/H.264+/MPEG4	H.265/H.265+/H.264/H.264+/MPEG4
Incoming/Outgoing Bandwidth	256/256Mbps	256/256Mbps	256/256Mbps	256/256Mbps
Decoding Capacity	16-ch @1080p	16-ch @1080p	16-ch @1080p	16-ch @1080p
Recording Resolution	12 MP/8 MP/6 MP/5 MP/4 MP/3 MP/1080p/ UXGA/720p/VGA/4CIF/ DCIF/2CIF/CIF/QCIF	12 MP/8 MP/6 MP/5 MP/4 MP/3 MP/1080p/ UXGA/720p/VGA/4CIF/ DCIF/2CIF/CIF/QCIF	12 MP/8 MP/6 MP/5 MP/4 MP/3 MP/1080p/ UXGA/720p/VGA/4CIF/ DCIF/2CIF/CIF/QCIF	12 MP/8 MP/6 MP/5 MP/4 MP/3 MP/1080p/ UXGA/720p/VGA/4CIF/ DCIF/2CIF/CIF/QCIF
Display	2 HDMI/1 VGA/1CVBS	2 HDMI/1 VGA/1CVBS	2 HDMI/1 VGA/1CVBS	2 HDMI/1 VGA/1CVBS
Storage Capacity	4 SATA interfaces Up to 8 TB capacity for each HDD	4 SATA interfaces Up to 8 TB capacity for each HDD	4 SATA interfaces Up to 8 TB capacity for each HDD	4 SATA interfaces Up to 8 TB capacity for each HDD
eSATA/Mini SAS	1 eSATA interface(Optional)	1 eSATA interface(Optional)	1 eSATA interface(Optional)	1 eSATA interface(Optional)
Video Output	HDMI1: 4K (3840 × 2160)/60Hz, 4K (3840 × 2160)/30Hz, 2K (2560 × 1440)/60Hz, 1920 × 1080/60Hz, 1600 × 1200/60Hz, 1280 × 1024/60Hz, 1280 × 720/60Hz, 1024 × 768/60Hz, HDMI1/VGA simultaneous output; HDMI2: 1920 × 1080/60Hz, 1280 × 1024/60Hz, 1280 × 720/60Hz, 1024 × 768/60Hz, HDMI2/VGA independent output; VGA: 1920 × 1080/60Hz, 1280 × 1024/60Hz, 1280 × 720/60Hz, 1024 × 768/60Hz, HDMI1/VGA simultaneous output	HDMI1: 4K (3840 × 2160)/60Hz, 4K (3840 × 2160)/30Hz, 2K (2560 × 1440)/60Hz, 1920 × 1080/60Hz, 1600 × 1200/60Hz, 1280 × 1024/60Hz, 1280 × 720/60Hz, 1024 × 768/60Hz, HDMI1/VGA simultaneous output; HDMI2: 1920 × 1080/60Hz, 1280 × 1024/60Hz, 1280 × 720/60Hz, 1024 × 768/60Hz, HDMI2/VGA independent output; VGA: 1920 × 1080/60Hz, 1280 × 1024/60Hz, 1280 × 720/60Hz, 1024 × 768/60Hz, HDMI1/VGA simultaneous output	HDMI1: 4K (3840 × 2160)/60Hz, 4K (3840 × 2160)/30Hz, 2K (2560 × 1440)/60Hz, 1920 × 1080/60Hz, 1600 × 1200/60Hz, 1280 × 1024/60Hz, 1280 × 720/60Hz, 1024 × 768/60Hz, HDMI1/VGA simultaneous output; HDMI2: 1920 × 1080/60Hz, 1280 × 1024/60Hz, 1280 × 720/60Hz, 1024 × 768/60Hz, HDMI2/VGA independent output; VGA: 1920 × 1080/60Hz, 1280 × 1024/60Hz, 1280 × 720/60Hz, 1024 × 768/60Hz, HDMI1/VGA simultaneous output	HDMI1: 4K (3840 × 2160)/60Hz, 4K (3840 × 2160)/30Hz, 2K (2560 × 1440)/60Hz, 1920 × 1080/60Hz, 1600 × 1200/60Hz, 1280 × 1024/60Hz, 1280 × 720/60Hz, 1024 × 768/60Hz, HDMI1/VGA simultaneous output; HDMI2: 1920 × 1080/60Hz, 1280 × 1024/60Hz, 1280 × 720/60Hz, 1024 × 768/60Hz, HDMI2/VGA independent output; VGA: 1920 × 1080/60Hz, 1280 × 1024/60Hz, 1280 × 720/60Hz, 1024 × 768/60Hz, HDMI1/VGA simultaneous output
Audio Output	1-ch, RCA (Linear, 1 KΩ)	1-ch, RCA (Linear, 1 KΩ)	1-ch, RCA (Linear, 1 KΩ)	1-ch, RCA (Linear, 1 KΩ)
Alarm I/O	16/4	16/4	16/4	16/4
Network Interface	1 RJ-45 10/100/1000 Mbps self-adaptive Ethernet interfaces	2 RJ-45 10/100/1000 Mbps self-adaptive Ethernet interfaces	1 RJ-45 10/100/1000 Mbps self-adaptive Ethernet interfaces	2 RJ-45 10/100/1000 Mbps self-adaptive Ethernet interfaces
PoE Port	16P	-	16P	-
USB Port	Front panel: 2 × USB 2.0; Rear panel: 1 × USB 3.0	Front panel: 2 × USB 2.0; Rear panel: 1 × USB 3.0	Front panel: 2 × USB 2.0; Rear panel: 1 × USB 3.0	Front panel: 2 × USB 2.0; Rear panel: 1 × USB 3.0
Smart Function	Human/vehicle classification on all-channel motion detection results and on 4-channel VCA results by 2 MP network cameras; 1-channel face capture capacity; 1-channel face comparison capacity	Human/vehicle classification on all-channel motion detection results and on 4-channel VCA results by 2 MP network cameras; 1-channel face capture capacity; 1-channel face comparison capacity	Human/vehicle classification on all-channel motion detection results and on 4-channel VCA results by 2 MP network cameras; 1-channel face capture capacity; 1-channel face comparison capacity	Human/vehicle classification on all-channel motion detection results and on 4-channel VCA results by 2 MP network cameras; 1-channel face capture capacity; 1-channel face comparison capacity
Power Consumption (without HDD)	≤ 15 W	≤ 15 W	≤ 15 W	≤ 15 W

Model	DS-7616NXI-I2/16P/S	DS-7616NXI-I2/S	DS-7608NXI-I2/8P/S	DS-7608NXI-I2/S
Image				
Channel No.	16-ch	16-ch	8-ch	8-ch
Decoding Format	H.265/H.265+/H.264/H.264+/MPEG4	H.265/H.265+/H.264/H.264+/MPEG4	H.265/H.265+/H.264/H.264+/MPEG4	H.265/H.265+/H.264/H.264+/MPEG4
Incoming/Outgoing Bandwidth	160/256Mbps	160/256Mbps	80/256Mbps	80/256Mbps
Decoding Capacity	16-ch @1080p	16-ch @1080p	16-ch @1080p	16-ch @1080p
Recording Resolution	12 MP/8 MP/6 MP/5 MP/4 MP/3 MP/1080p/ UXGA/720p/VGA/4CIF/ DCIF/2CIF/CIF/QCIF	12 MP/8 MP/6 MP/5 MP/4 MP/3 MP/1080p/ UXGA/720p/VGA/4CIF/ DCIF/2CIF/CIF/QCIF	12 MP/8 MP/6 MP/5 MP/4 MP/3 MP/1080p/ UXGA/720p/VGA/4CIF/ DCIF/2CIF/CIF/QCIF	12 MP/8 MP/6 MP/5 MP/4 MP/3 MP/1080p/ UXGA/720p/VGA/4CIF/ DCIF/2CIF/CIF/QCIF
Display	1 HDMI/1 VGA/1CVBS	1 HDMI/1 VGA/1CVBS	1 HDMI/1 VGA/1CVBS	1 HDMI/1 VGA/1CVBS
Storage Capacity	2 SATA interfaces Up to 8 TB capacity for each HDD	2 SATA interfaces Up to 8 TB capacity for each HDD	2 SATA interfaces Up to 8 TB capacity for each HDD	2 SATA interfaces Up to 8 TB capacity for each HDD
eSATA/Mini SAS	-	-	-	-
Video Output	VGA: 1920×1080/60Hz, 1280×1024/60Hz, 1280×720/60Hz, 1024×768/60Hz HDMI: 4K (3840×2160)/60Hz, 4K (3840×2160)/30Hz, 2K (2560×1440)/60Hz, 1920×1080/60Hz, 1600×1200/60Hz, 1280×1024/60Hz,	VGA: 1920×1080/60Hz, 1280×1024/60Hz, 1280×720/60Hz, 1024×768/60Hz HDMI: 4K (3840×2160)/60Hz, 4K (3840×2160)/30Hz, 2K (2560×1440)/60Hz, 1920×1080/60Hz, 1600×1200/60Hz, 1280×1024/60Hz,	VGA: 1920×1080/60Hz, 1280×1024/60Hz, 1280×720/60Hz, 1024×768/60Hz HDMI: 4K (3840×2160)/60Hz, 4K (3840×2160)/30Hz, 2K (2560×1440)/60Hz, 1920×1080/60Hz, 1600×1200/60Hz, 1280×1024/60Hz,	VGA: 1920×1080/60Hz, 1280×1024/60Hz, 1280×720/60Hz, 1024×768/60Hz HDMI: 4K (3840×2160)/60Hz, 4K (3840×2160)/30Hz, 2K (2560×1440)/60Hz, 1920×1080/60Hz, 1600×1200/60Hz, 1280×1024/60Hz,
Audio Output	1-ch, RCA (Linear, 1 KΩ)	1-ch, RCA (Linear, 1 KΩ)	1-ch, RCA (Linear, 1 KΩ)	1-ch, RCA (Linear, 1 KΩ)
Alarm I/O	4/1	4/1	4/1	4/1
Network Interface	1 RJ-45 10/100/1000 Mbps self-adaptive Ethernet interfaces	1 RJ-45 10/100/1000 Mbps self-adaptive Ethernet interfaces	1 RJ-45 10/100/1000 Mbps self-adaptive Ethernet interfaces	1 RJ-45 10/100/1000 Mbps self-adaptive Ethernet interfaces
PoE Port	16P	-	8P	-
USB Port	Front panel: 1 × USB 2.0; Rear panel: 1 × USB 3.0	Front panel: 1 × USB 2.0; Rear panel: 1 × USB 3.0	Front panel: 1 × USB 2.0; Rear panel: 1 × USB 3.0	Front panel: 1 × USB 2.0; Rear panel: 1 × USB 3.0
Smart Function	Human/vehicle classification on all-channel motion detection results and on 4-channel VCA results by 2 MP network cameras; 1-channel face capture capacity; 1-channel face comparison capacity	Human/vehicle classification on all-channel motion detection results and on 4-channel VCA results by 2 MP network cameras; 1-channel face capture capacity; 1-channel face comparison capacity	Human/vehicle classification on all-channel motion detection results and on 4-channel VCA results by 2 MP network cameras; 1-channel face capture capacity; 1-channel face comparison capacity	Human/vehicle classification on all-channel motion detection results and on 4-channel VCA results by 2 MP network cameras; 1-channel face capture capacity; 1-channel face comparison capacity
Power Consumption (without HDD)	≤ 15 W	≤ 15 W	≤ 15 W	≤ 15 W

K Series with AcuSense

Model	DS-7732NXI-K4	DS-7732NXI-K4/16P	DS-7716NXI-K4	DS-7716NXI-K4/16P	DS-7632NXI-K2
Image	 NEW	 NEW	 NEW	 NEW	 NEW
Channel No.	32-ch	32-ch	16-ch	16-ch	32-ch
Decoding Format	H.265/H.265+/H.264/H.264+	H.265/H.265+/H.264/H.264+	H.265/H.265+/H.264/H.264+	H.265/H.265+/H.264/H.264+	H.265/H.265+/H.264/H.264+
Incoming/Outgoing Bandwidth	256Mbps/ 160Mbps	256Mbps/ 160Mbps	160Mbps/ 160Mbps	160Mbps/ 160Mbps	256Mbps/ 160Mbps
Decoding Capacity	AI on: 1-ch@12 MP (30 fps)/2-ch@8 MP (30 fps)/4-ch@4 MP (30 fps)/8-ch@1080p (30 fps) AI off: 2-ch@12 MP (30 fps)/3-ch@8 MP (30 fps)/6-ch@4 MP (30 fps)/12-ch@1080p (30 fps)	AI on: 1-ch@12 MP (30 fps)/2-ch@8 MP (30 fps)/4-ch@4 MP (30 fps)/8-ch@1080p (30 fps) AI off: 2-ch@12 MP (30 fps)/3-ch@8 MP (30 fps)/6-ch@4 MP (30 fps)/12-ch@1080p (30 fps)	AI on: 1-ch@12 MP (30 fps)/2-ch@8 MP (30 fps)/4-ch@4 MP (30 fps)/8-ch@1080p (30 fps) AI off: 2-ch@12 MP (30 fps)/3-ch@8 MP (30 fps)/6-ch@4 MP (30 fps)/12-ch@1080p (30 fps)	AI on: 1-ch@12 MP (30 fps)/2-ch@8 MP (30 fps)/4-ch@4 MP (30 fps)/8-ch@1080p (30 fps) AI off: 2-ch@12 MP (30 fps)/3-ch@8 MP (30 fps)/6-ch@4 MP (30 fps)/12-ch@1080p (30 fps)	AI on: 1-ch@12 MP (30 fps)/2-ch@8 MP (30 fps)/4-ch@4 MP (30 fps)/8-ch@1080p (30 fps) AI off: 2-ch@12 MP (30 fps)/3-ch@8 MP (30 fps)/6-ch@4 MP (30 fps)/12-ch@1080p (30 fps)
Recording Resolution	12MP/8MP/6MP/5MP/4MP/3MP/108p/UXGA/720p/VGA/4CIF/DCIF/2CIF/CIF/QCIF	12MP/8MP/6MP/5MP/4MP/3MP/108p/UXGA/720p/VGA/4CIF/DCIF/2CIF/CIF/QCIF	12MP/8MP/6MP/5MP/4MP/3MP/108p/UXGA/720p/VGA/4CIF/DCIF/2CIF/CIF/QCIF	12MP/8MP/6MP/5MP/4MP/3MP/108p/UXGA/720p/VGA/4CIF/DCIF/2CIF/CIF/QCIF	12MP/8MP/6MP/5MP/4MP/3MP/108p/UXGA/720p/VGA/4CIF/DCIF/2CIF/CIF/QCIF
Display	1 HDMI/1 VGA	1 HDMI/1 VGA	1 HDMI/1 VGA	1 HDMI/1 VGA	1 HDMI/1 VGA
Storage Capacity	4 SATA interfaces Up to 10TB capacity for each HDD	4 SATA interfaces Up to 10TB capacity for each HDD	4 SATA interfaces Up to 10TB capacity for each HDD	4 SATA interfaces Up to 10TB capacity for each HDD	2 SATA interfaces Up to 10TB capacity for each HDD*
eSATA/Mini SAS	optional:1 eSATA	optional:1 eSATA	optional:1 eSATA	optional:1 eSATA	-
Video Output	HDMI:4K (3840 × 2160)/30Hz, 2K (2560 × 1440)/60Hz, 1920 × 1080/60Hz, 1600 × 1200/60Hz, 1280 × 1024/60Hz, 1280 × 720/60Hz VGA:1920 × 1080/60Hz, 1280 × 1024/60Hz, 1280 × 720/60Hz, 1024 × 768/60Hz	HDMI:4K (3840 × 2160)/30Hz, 2K (2560 × 1440)/60Hz, 1920 × 1080/60Hz, 1600 × 1200/60Hz, 1280 × 1024/60Hz, 1280 × 720/60Hz VGA:1920 × 1080/60Hz, 1280 × 1024/60Hz, 1280 × 720/60Hz, 1024 × 768/60Hz	HDMI:4K (3840 × 2160)/30Hz, 2K (2560 × 1440)/60Hz, 1920 × 1080/60Hz, 1600 × 1200/60Hz, 1280 × 1024/60Hz, 1280 × 720/60Hz VGA:1920 × 1080/60Hz, 1280 × 1024/60Hz, 1280 × 720/60Hz, 1024 × 768/60Hz	HDMI:4K (3840 × 2160)/30Hz, 2K (2560 × 1440)/60Hz, 1920 × 1080/60Hz, 1600 × 1200/60Hz, 1280 × 1024/60Hz, 1280 × 720/60Hz VGA:1920 × 1080/60Hz, 1280 × 1024/60Hz, 1280 × 720/60Hz, 1024 × 768/60Hz	HDMI:4K (3840 × 2160)/30Hz, 2K (2560 × 1440)/60Hz, 1920 × 1080/60Hz, 1600 × 1200/60Hz, 1280 × 1024/60Hz, 1280 × 720/60Hz VGA:1920 × 1080/60Hz, 1280 × 1024/60Hz, 1280 × 720/60Hz, 1024 × 768/60Hz
Audio Output	1-ch, RCA (Linear, 1 KΩ)	1-ch, RCA (Linear, 1 KΩ)	1-ch, RCA (Linear, 1 KΩ)	1-ch, RCA (Linear, 1 KΩ)	1-ch, RCA (Linear, 1 KΩ)
Alarm I/O	16/4(optional:16/9)	16/4(optional:16/9)	16/4(optional:16/9)	16/4(optional:16/9)	4/1
Network Interface	2, RJ-45 10/100/1000 Mbps self adaptive Ethernet interface	1, RJ-45 10/100/1000 Mbps self adaptive Ethernet interface	2, RJ-45 10/100/1000 Mbps self adaptive Ethernet interface	1, RJ-45 10/100/1000 Mbps self adaptive Ethernet interface	1, RJ-45 10/100/1000 Mbps self adaptive Ethernet interfaces
PoE Port	-	16P	-	16P	-
USB Port	Front panel: 2 × USB 2.0; Rear panel: 1 × USB 3.0	Front panel: 2 × USB 2.0; Rear panel: 1 × USB 3.0	Front panel: 2 × USB 2.0; Rear panel: 1 × USB 3.0	Front panel: 2 × USB 2.0; Rear panel: 1 × USB 3.0	Front panel: 1 × USB 2.0; Rear panel: 1 × USB 2.0
Smart Function	choose one of three options: 1-ch human face capture or 4-ch face picture comparison alarm; 2-ch video analysis for human and vehicle recognition to reduce false alarm; All-channel Motion Detection 2.0;	choose one of three options: 1-ch human face capture or 4-ch face picture comparison alarm; 2-ch video analysis for human and vehicle recognition to reduce false alarm; All-channel Motion Detection 2.0;	choose one of three options: 1-ch human face capture or 4-ch face picture comparison alarm; 2-ch video analysis for human and vehicle recognition to reduce false alarm; All-channel Motion Detection 2.0;	choose one of three options: 1-ch human face capture or 4-ch face picture comparison alarm; 2-ch video analysis for human and vehicle recognition to reduce false alarm; All-channel Motion Detection 2.0;	choose one of three options: 1-ch human face capture or 4-ch face picture comparison alarm; 2-ch video analysis for human and vehicle recognition to reduce false alarm; All-channel Motion Detection 2.0;
Power Consumption (without HDD)	≤20 W	≤20 W(without enabling PoE)	≤20 W	≤20 W(without enabling PoE)	≤ 15 W

Model	DS-7632NXI-K2/16P	DS-7616NXI-K2	DS-7616NXI-K2/16P	DS-7608NXI-K2	DS-7608NXI-K2/8P
Image	 NEW	 NEW	 NEW	 NEW	 NEW
Channel No.	32-ch	16-ch	16-ch	8-ch	8-ch
Decoding Format	H.265/H.265+/H.264/H.264+	H.265/H.265+/H.264/H.264+	H.265/H.265+/H.264/H.264+	H.265/H.265+/H.264/H.264+	H.265/H.265+/H.264/H.264+
Incoming/Outgoing Bandwidth	256Mbps/ 160Mbps	160 Mbps/160 Mbps	160 Mbps/160 Mbps	80 Mbps/160 Mbps	80 Mbps/160 Mbps
Decoding Capacity	AI on: 1-ch@12 MP (30 fps)/2-ch@8 MP (30 fps)/4-ch@4 MP (30 fps)/8-ch@1080p (30 fps) AI off: 2-ch@12 MP (30 fps)/3-ch@8 MP (30 fps)/6-ch@4 MP (30 fps)/12-ch@1080p (30 fps)	AI on: 1-ch@12 MP (30 fps)/2-ch@8 MP (30 fps)/4-ch@4 MP (30 fps)/8-ch@1080p (30 fps) AI off: 2-ch@12 MP (30 fps)/3-ch@8 MP (30 fps)/6-ch@4 MP (30 fps)/12-ch@1080p (30 fps)	AI on: 1-ch@12 MP (30 fps)/2-ch@8 MP (30 fps)/4-ch@4 MP (30 fps)/8-ch@1080p (30 fps) AI off: 2-ch@12 MP (30 fps)/3-ch@8 MP (30 fps)/6-ch@4 MP (30 fps)/12-ch@1080p (30 fps)	AI on: 1-ch@12 MP (30 fps)/2-ch@8 MP (30 fps)/4-ch@4 MP (30 fps)/8-ch@1080p (30 fps) AI off: 2-ch@12 MP (30 fps)/3-ch@8 MP (30 fps)/6-ch@4 MP (30 fps)/12-ch@1080p (30 fps)	AI on: 1-ch@12 MP (30 fps)/2-ch@8 MP (30 fps)/4-ch@4 MP (30 fps)/8-ch@1080p (30 fps) AI off: 2-ch@12 MP (30 fps)/3-ch@8 MP (30 fps)/6-ch@4 MP (30 fps)/12-ch@1080p (30 fps)
Recording Resolution	12MP/8MP/6MP/5MP/4MP/3MP/108p/UXGA/720p/VGA/4CIF/DCIF/2CIF/CIF/QCIF	12MP/8MP/6MP/5MP/4MP/3MP/108p/UXGA/720p/VGA/4CIF/DCIF/2CIF/CIF/QCIF	12MP/8MP/6MP/5MP/4MP/3MP/108p/UXGA/720p/VGA/4CIF/DCIF/2CIF/CIF/QCIF	12MP/8MP/6MP/5MP/4MP/3MP/108p/UXGA/720p/VGA/4CIF/DCIF/2CIF/CIF/QCIF	12MP/8MP/6MP/5MP/4MP/3MP/108p/UXGA/720p/VGA/4CIF/DCIF/2CIF/CIF/QCIF
Display	1 HDMI/1 VGA	1 HDMI/1 VGA	1 HDMI/1 VGA	1 HDMI/1 VGA	1 HDMI/1 VGA
Storage Capacity	2 SATA interfaces Up to 10TB capacity for each HDD	2 SATA interfaces Up to 10TB capacity for each HDD	2 SATA interfaces Up to 10TB capacity for each HDD	2 SATA interfaces Up to 10TB capacity for each HDD	2 SATA interfaces Up to 10TB capacity for each HDD
eSATA/Mini SAS	-	-	-	-	-
Video Output	HDMI:4K (3840 × 2160)/30Hz, 2K (2560 × 1440)/60Hz, 1920 × 1080/60Hz, 1600 × 1200/60Hz, 1280 × 1024/60Hz, 1280 × 720/60Hz VGA:1920 × 1080/60Hz, 1280 × 1024/60Hz, 1280 × 720/60Hz, 1024 × 768/60Hz	HDMI:4K (3840 × 2160)/30Hz, 2K (2560 × 1440)/60Hz, 1920 × 1080/60Hz, 1600 × 1200/60Hz, 1280 × 1024/60Hz, 1280 × 720/60Hz VGA:1920 × 1080/60Hz, 1280 × 1024/60Hz, 1280 × 720/60Hz, 1024 × 768/60Hz	HDMI:4K (3840 × 2160)/30Hz, 2K (2560 × 1440)/60Hz, 1920 × 1080/60Hz, 1600 × 1200/60Hz, 1280 × 1024/60Hz, 1280 × 720/60Hz VGA:1920 × 1080/60Hz, 1280 × 1024/60Hz, 1280 × 720/60Hz, 1024 × 768/60Hz	HDMI:4K (3840 × 2160)/30Hz, 2K (2560 × 1440)/60Hz, 1920 × 1080/60Hz, 1600 × 1200/60Hz, 1280 × 1024/60Hz, 1280 × 720/60Hz VGA:1920 × 1080/60Hz, 1280 × 1024/60Hz, 1280 × 720/60Hz, 1024 × 768/60Hz	HDMI:4K (3840 × 2160)/30Hz, 2K (2560 × 1440)/60Hz, 1920 × 1080/60Hz, 1600 × 1200/60Hz, 1280 × 1024/60Hz, 1280 × 720/60Hz VGA:1920 × 1080/60Hz, 1280 × 1024/60Hz, 1280 × 720/60Hz, 1024 × 768/60Hz
Audio Output	1-ch, RCA (Linear, 1 KΩ)	1-ch, RCA (Linear, 1 KΩ)	1-ch, RCA (Linear, 1 KΩ)	1-ch, RCA (Linear, 1 KΩ)	1-ch, RCA (Linear, 1 KΩ)
Alarm I/O	4/1	4/1	4/1	4/1	4/1
Network Interface	1 RJ-45 10/100/1000 Mbps self adaptive Ethernet interfaces	1 RJ-45 10/100/1000 Mbps self adaptive Ethernet interfaces	1 RJ-45 10/100/1000 Mbps self adaptive Ethernet interfaces	1 RJ-45 10/100/1000 Mbps self adaptive Ethernet interfaces	1 RJ-45 10/100/1000 Mbps self adaptive Ethernet interfaces
PoE Port	16P	-	16P	-	8P
USB Port	Front panel: 1 × USB 2.0; Rear panel: 1 × USB 2.0	Front panel: 1 × USB 2.0; Rear panel: 1 × USB 2.0	Front panel: 1 × USB 2.0; Rear panel: 1 × USB 2.0	Front panel: 1 × USB 2.0; Rear panel: 1 × USB 2.0	Front panel: 1 × USB 2.0; Rear panel: 1 × USB 2.0
Smart Function	choose one of three options: 1-ch human face capture or 4-ch face picture comparison alarm; 2-ch video analysis for human and vehicle recognition to reduce false alarm; All-channel Motion Detection 2.0;	choose one of three options: 1-ch human face capture or 4-ch face picture comparison alarm; 2-ch video analysis for human and vehicle recognition to reduce false alarm; All-channel Motion Detection 2.0;	choose one of three options: 1-ch human face capture or 4-ch face picture comparison alarm; 2-ch video analysis for human and vehicle recognition to reduce false alarm; All-channel Motion Detection 2.0;	choose one of three options: 1-ch human face capture or 4-ch face picture comparison alarm; 2-ch video analysis for human and vehicle recognition to reduce false alarm; All-channel Motion Detection 2.0;	choose one of three options: 1-ch human face capture or 4-ch face picture comparison alarm; 2-ch video analysis for human and vehicle recognition to reduce false alarm; All-channel Motion Detection 2.0;
Power Consumption (without HDD)	≤15 W (without enabling PoE)	≤ 15 W	≤15 W (without enabling PoE)	≤ 15 W	≤15 W (without enabling PoE)

Model	DS-7616NXI-K1(B)	DS-7608NXI-K1(B)	DS-7608NXI-K1/8P(B)	DS-7604NXI-K1(B)	DS-7604NXI-K1/4P(B)
Image	 NEW	 NEW	 NEW	 NEW	 NEW
Channel No.	16-ch	8-ch	8-ch	4-ch	4-ch
Decoding Format	H.265/H.265+/H.264/H.264+	H.265/H.265+/H.264/H.264+	H.265/H.265+/H.264/H.264+	H.265/H.265+/H.264/H.264+	H.265/H.265+/H.264/H.264+
Incoming/Outgoing Bandwidth	160Mbps/ 80Mbps	80Mbps/ 80Mbps	80Mbps/ 80Mbps	40Mbps/ 80Mbps	40Mbps/ 80Mbps
Decoding Capacity	AI on: 1-ch@12 MP (30 fps)/1-ch@8 MP (30 fps)/3-ch@4 MP (30 fps)/6-ch@1080p (30 fps) AI off: 1-ch@12 MP (30 fps)/2-ch@8 MP (30 fps)/4-ch@4 MP (30 fps)/8-ch@1080p (30 fps)	AI on: 1-ch@12 MP (30 fps)/1-ch@8 MP (30 fps)/3-ch@4 MP (30 fps)/6-ch@1080p (30 fps) AI off: 1-ch@12 MP (30 fps)/2-ch@8 MP (30 fps)/4-ch@4 MP (30 fps)/8-ch@1080p (30 fps)	AI on: 1-ch@12 MP (30 fps)/1-ch@8 MP (30 fps)/3-ch@4 MP (30 fps)/6-ch@1080p (30 fps) AI off: 1-ch@12 MP (30 fps)/2-ch@8 MP (30 fps)/4-ch@4 MP (30 fps)/8-ch@1080p (30 fps)	AI on: 1-ch@12 MP (30 fps)/1-ch@8 MP (30 fps)/3-ch@4 MP (30 fps)/6-ch@1080p (30 fps) AI off: 1-ch@12 MP (30 fps)/2-ch@8 MP (30 fps)/4-ch@4 MP (30 fps)/8-ch@1080p (30 fps)	AI on: 1-ch@12 MP (30 fps)/1-ch@8 MP (30 fps)/3-ch@4 MP (30 fps)/6-ch@1080p (30 fps) AI off: 1-ch@12 MP (30 fps)/2-ch@8 MP (30 fps)/4-ch@4 MP (30 fps)/8-ch@1080p (30 fps)
Recording Resolution	12MP/8MP/6MP/5MP/4MP/3MP/108p/UXGA/720p/VGA/4CIF/DCIF/2CIF/CIF/QCIF	12MP/8MP/6MP/5MP/4MP/3MP/108p/UXGA/720p/VGA/4CIF/DCIF/2CIF/CIF/QCIF	12MP/8MP/6MP/5MP/4MP/3MP/108p/UXGA/720p/VGA/4CIF/DCIF/2CIF/CIF/QCIF	12MP/8MP/6MP/5MP/4MP/3MP/108p/UXGA/720p/VGA/4CIF/DCIF/2CIF/CIF/QCIF	12MP/8MP/6MP/5MP/4MP/3MP/108p/UXGA/720p/VGA/4CIF/DCIF/2CIF/CIF/QCIF
Display	1 HDMI/1 VGA	1 HDMI/1 VGA	1 HDMI/1 VGA	1 HDMI/1 VGA	1 HDMI/1 VGA
Storage Capacity	1 SATA interfaces Up to 10TB capacity for each HDD*	1 SATA interfaces Up to 10TB capacity for each HDD*	*1 SATA interfaces Up to 10TB capacity for each HDD*	1 SATA interfaces Up to 10TB capacity for each HDD	1 SATA interfaces Up to 10TB capacity for each HDD
eSATA/Mini SAS	-	-	-	-	-
Video Output	HDMI:4K (3840 × 2160)/30Hz, 2K (2560 × 1440)/60Hz, 1920 × 1080/60Hz, 1600 × 1200/60Hz, 1280 × 1024/60Hz, 1280 × 720/60Hz VGA:1920 × 1080/60Hz, 1280 × 1024/60Hz, 1280 × 720/60Hz, 1024 × 768/60Hz	HDMI:4K (3840 × 2160)/30Hz, 2K (2560 × 1440)/60Hz, 1920 × 1080/60Hz, 1600 × 1200/60Hz, 1280 × 1024/60Hz, 1280 × 720/60Hz VGA:1920 × 1080/60Hz, 1280 × 1024/60Hz, 1280 × 720/60Hz, 1024 × 768/60Hz	HDMI:4K (3840 × 2160)/30Hz, 2K (2560 × 1440)/60Hz, 1920 × 1080/60Hz, 1600 × 1200/60Hz, 1280 × 1024/60Hz, 1280 × 720/60Hz VGA:1920 × 1080/60Hz, 1280 × 1024/60Hz, 1280 × 720/60Hz, 1024 × 768/60Hz	HDMI:4K (3840 × 2160)/30Hz, 2K (2560 × 1440)/60Hz, 1920 × 1080/60Hz, 1600 × 1200/60Hz, 1280 × 1024/60Hz, 1280 × 720/60Hz VGA:1920 × 1080/60Hz, 1280 × 1024/60Hz, 1280 × 720/60Hz, 1024 × 768/60Hz	HDMI:4K (3840 × 2160)/30Hz, 2K (2560 × 1440)/60Hz, 1920 × 1080/60Hz, 1600 × 1200/60Hz, 1280 × 1024/60Hz, 1280 × 720/60Hz VGA:1920 × 1080/60Hz, 1280 × 1024/60Hz, 1280 × 720/60Hz, 1024 × 768/60Hz
Audio Output	1-ch, RCA (Linear, 1 KΩ)	1-ch, RCA (Linear, 1 KΩ)	1-ch, RCA (Linear, 1 KΩ)	1-ch, RCA (Linear, 1 KΩ)	1-ch, RCA (Linear, 1 KΩ)
Alarm I/O	optional:4/1	optional:4/1	optional:4/1	optional:4/1	optional:4/1
Network Interface	1 RJ-45 10/100/1000 Mbps self adaptive Ethernet interfaces	1 RJ-45 10/100/1000 Mbps self adaptive Ethernet interfaces	1 RJ-45 10/100 Mbps self adaptive Ethernet interfaces	1 RJ-45 10/100 Mbps self adaptive Ethernet interfaces	1 RJ-45 10/100 Mbps self adaptive Ethernet interfaces
PoE Port	-	-	8P	-	4P
USB Port	Front panel: 1 × USB 2.0; Rear panel: 1 × USB 2.0	Front panel: 1 × USB 2.0; Rear panel: 1 × USB 2.0	Front panel: 1 × USB 2.0; Rear panel: 1 × USB 2.0	Front panel: 1 × USB 2.0; Rear panel: 1 × USB 2.0	Front panel: 1 × USB 2.0; Rear panel: 1 × USB 2.0
Smart Function	choose one of three options: 1-ch human face capture 1-ch video analysis for human and vehicle recognition to reduce false alarm; 4-ch Motion Detection 2.0 by NVR;	choose one of three options: 1-ch human face capture 1-ch video analysis for human and vehicle recognition to reduce false alarm; 4-ch Motion Detection 2.0 by NVR;	choose one of three options: 1-ch human face capture 1-ch video analysis for human and vehicle recognition to reduce false alarm; 4-ch Motion Detection 2.0 by NVR;	choose one of three options: 1-ch human face capture 1-ch video analysis for human and vehicle recognition to reduce false alarm; 4-ch Motion Detection 2.0 by NVR;	choose one of three options: 1-ch human face capture 1-ch video analysis for human and vehicle recognition to reduce false alarm; 4-ch Motion Detection 2.0 by NVR;
Power Consumption (without HDD)	≤10 W	≤10 W	≤10 W (without enabling PoE)	≤10 W	≤10 W (without enabling PoE)

Network Video Recorders

Pro Series NVRs



Hikvision Pro Series NVRs feature optimized H.265+ and H.264+ compression codecs, enabling highly effective bandwidth and storage management. With plug-and-play functionality, accessing IP cameras and other smart functions has never been easier. The Pro Series is the ideal solution for small to medium size businesses.

- Quick target search
- Up to 16-ch @ 1080p decoding for I-Series, 8-ch @ 1080p decoding for K-Series and 6-ch @ 1080p decoding for Q-Series
- GUI 4.0 and E-UI, intuitive and easy-to-use interface
- Supports automatic addition of inactive cameras
- *Long-distance (100 to 250 meters) network transmission for I-Series and K-Series NVRs
- ISUP protocol accessible



*The 250-meter distance is a test result in an ideal situation. The actual application results may vary as network conditions and camera and transmission models change.

















Model	DS-7732NI-I4/24P	DS-7732NI-I4/16P(B)	DS-7732NI-I4(B)	DS-7716NI-I4/16P(B)	DS-7716NI-I4(B)
Image					
Channel No.	32-ch	32-ch	32-ch	16-ch	16-ch
Decoding Format	H.265+/H.265/H.264+/H.264/MPEG4	H.265/H.265+/H.264/H.264+/MPEG4	H.265/H.265+/H.264/H.264+/MPEG4	H.265/H.265+/H.264/H.264+/MPEG4	H.265/H.265+/H.264/H.264+/MPEG4
Incoming/Outgoing Bandwidth	320Mbps/ 256Mbps	256Mbps/ 256Mbps	256Mbps/ 256Mbps	160Mbps/ 256Mbps	160Mbps/ 256Mbps
Decoding Capacity	2-ch @ 12 MP (20fps) / 4-ch @ 8 MP (30fps) / 8-ch @ 4MP (30fps) / 16-ch @ 1080p (30fps)	2-ch @ 12 MP (20fps) / 4-ch @ 8 MP (25fps) / 8-ch @ 4MP (30fps) / 16-ch @ 1080p (30fps)	2-ch @ 12 MP (20fps) / 4-ch @ 8 MP (25fps) / 8-ch @ 4MP (30fps) / 16-ch @ 1080p (30fps)	2-ch @ 12 MP (20fps) / 4-ch @ 8 MP (25fps) / 8-ch @ 4MP (30fps) / 16-ch @ 1080p (30fps)	2-ch @ 12 MP (20fps) / 4-ch @ 8 MP (25fps) / 8-ch @ 4MP (30fps) / 16-ch @ 1080p (30fps)
Recording Resolution	12 MP/8 MP/6 MP/5 MP/4 MP/3 MP/1080p/UXGA/720p/VGA /4CIF / DCIF/2CIF/CIF/QCIF	12 MP/8 MP/6 MP/5 MP/4 MP/3 MP/1080p/UXGA/720p/VGA /4CIF / DCIF / 2CIF/CIF/QCIF	12 MP/8 MP/6 MP/5 MP/4 MP/3 MP/1080p/UXGA/720p/VGA /4CIF / DCIF / 2CIF/CIF/QCIF	12 MP/8 MP/6 MP/5 MP/4 MP/3 MP/1080p/UXGA/720p/VGA /4CIF / DCIF / 2CIF/CIF/QCIF	12 MP/8 MP/6 MP/5 MP/4 MP/3 MP/1080p/UXGA/720p/VGA /4CIF / DCIF / 2CIF/CIF/QCIF
Display	2HDMI/1 VGA/1CVBS	2HDMI/1 VGA/1CVBS	2HDMI/1 VGA/1CVBS	2HDMI/1 VGA/1CVBS	2HDMI/1 VGA/1CVBS
Storage Capacity	4 SATA interfaces Up to 8TB capacity for each HDD	4 SATA interfaces Up to 8TB capacity for each HDD	4 SATA interfaces Up to 8TB capacity for each HDD	4 SATA interfaces Up to 8TB capacity for each HDD	4 SATA interfaces Up to 8TB capacity for each HDD
eSATA/Mini SAS	1 eSATA interface	1 eSATA interface	1 eSATA interface	1 eSATA interface	1 eSATA interface
Video Output	HDMI1: 4K (3840 × 2160)/60Hz, 4K (3840 × 2160)/30Hz, 2K (2560 × 1440)/60Hz, 1920 × 1080p/60Hz, 1600 × 1200/60Hz, 1280 × 1024/60Hz, 1280 × 720/60Hz, 1024×768/60Hz VGA: 2K (2560 × 1440)/60Hz, 1920 × 1080p/60Hz, 1600 × 1200/60Hz, 1280 × 1024/60Hz, 1280 × 720/60Hz, 1024×768/60Hz HDMI2:1920 × 1080p/60Hz, 1280 × 1024/60Hz, 1280 × 720/60Hz, 1024 × 768/60Hz	HDMI1: 4K (3840 × 2160)/60Hz, 4K (3840 × 2160)/30Hz, 2K (2560 × 1440)/60Hz, 1920 × 1080p/60Hz, 1600 × 1200/60Hz, 1280 × 1024/60Hz, 1280 × 720/60Hz, 1024×768/60Hz VGA: 2K (2560 × 1440)/60Hz, 1920 × 1080p/60Hz, 1600 × 1200/60Hz, 1280 × 1024/60Hz, 1280 × 720/60Hz, 1024×768/60Hz HDMI2:1920 × 1080p/60Hz, 1280 × 1024/60Hz, 1280 × 720/60Hz, 1024 × 768/60Hz	HDMI1: 4K (3840 × 2160)/60Hz, 4K (3840 × 2160)/30Hz, 2K (2560 × 1440)/60Hz, 1920 × 1080p/60Hz, 1600 × 1200/60Hz, 1280 × 1024/60Hz, 1280 × 720/60Hz, 1024×768/60Hz VGA: 2K (2560 × 1440)/60Hz, 1920 × 1080p/60Hz, 1600 × 1200/60Hz, 1280 × 1024/60Hz, 1280 × 720/60Hz, 1024×768/60Hz HDMI1/VGA Simultaneous Output HDMI2:1920 × 1080p/60Hz, 1280 × 1024/60Hz, 1280 × 720/60Hz, 1024 × 768/60Hz	HDMI1: 4K (3840 × 2160)/60Hz, 4K (3840 × 2160)/30Hz, 2K (2560 × 1440)/60Hz, 1920 × 1080p/60Hz, 1600 × 1200/60Hz, 1280 × 1024/60Hz, 1280 × 720/60Hz, 1024×768/60Hz VGA: 2K (2560 × 1440)/60Hz, 1920 × 1080p/60Hz, 1600 × 1200/60Hz, 1280 × 1024/60Hz, 1280 × 720/60Hz, 1024×768/60Hz HDMI2:1920 × 1080p/60Hz, 1280 × 1024/60Hz, 1280 × 720/60Hz, 1024 × 768/60Hz	HDMI1: 4K (3840 × 2160)/60Hz, 4K (3840 × 2160)/30Hz, 2K (2560 × 1440)/60Hz, 1920 × 1080p/60Hz, 1600 × 1200/60Hz, 1280 × 1024/60Hz, 1280 × 720/60Hz, 1024×768/60Hz VGA: 2K (2560 × 1440)/60Hz, 1920 × 1080p/60Hz, 1600 × 1200/60Hz, 1280 × 1024/60Hz, 1280 × 720/60Hz, 1024×768/60Hz HDMI1/VGA Simultaneous Output HDMI2:1920 × 1080p/60Hz, 1280 × 1024/60Hz, 1280 × 720/60Hz, 1024 × 768/60Hz
Audio Output	1-ch, RCA (Linear, 1 KΩ)	1-ch, RCA (Linear, 1 KΩ)	1-ch, RCA (Linear, 1 KΩ)	1-ch, RCA (Linear, 1 KΩ)	1-ch, RCA (Linear, 1 KΩ)
Alarm I/O	16/4(optional:16/8)	16/4(optional:16/8)	16/4(optional:16/8)	16/4(optional:16/8)	16/4(optional:16/8)
Network Interface	1 RJ-45 10/100/1000 Mbps self adaptive Ethernet interface	1 RJ-45 10/100/1000 Mbps self adaptive Ethernet interface	2 RJ-45 10/100/1000 Mbps self adaptive Ethernet interface	1 RJ-45 10/100/1000 Mbps self adaptive Ethernet interface	2 RJ-45 10/100/1000 Mbps self adaptive Ethernet interface
PoE Port	24P	16P	-	16P	-
USB Port	Front panel: 2 × USB 2.0; Rear panel: 1 × USB 3.0	Front panel: 2 × USB 2.0; Rear panel: 1 × USB 3.0	Front panel: 2 × USB 2.0; Rear panel: 1 × USB 3.0	Front panel: 2 × USB 2.0; Rear panel: 1 × USB 3.0	Front panel: 2 × USB 2.0; Rear panel: 1 × USB 3.0
Smart Function	Supports multiple VCA(Video Content Analytics) events for IP cameras	Supports multiple VCA(Video Content Analytics) events for IP cameras	Supports multiple VCA(Video Content Analytics) events for IP cameras	Supports multiple VCA(Video Content Analytics) events for IP cameras	Supports multiple VCA(Video Content Analytics) events for IP cameras
Power Consumption (without HDD)	≤20 W (without enabling PoE)	≤20 W (without enabling PoE)	≤20 W (without enabling PoE)	≤20 W (without enabling PoE)	≤20 W





Model	DS-7616NI-I2/16P	DS-7616NI-I2	DS-7608NI-I2/8P	DS-7608NI-I2	DS-7732NI-K4/16P
Image					
Channel No.	16-ch	16-ch	8-ch	8-ch	32-ch
Decoding Format	H.265/H.265+/H.264/H.264+/MPEG4	H.265/H.265+/H.264/H.264+/MPEG4	H.265/H.265+/H.264/H.264+/MPEG4	H.265/H.265+/H.264/H.264+/MPEG4	H.265/H.265+/H.264+/H.264/MPEG4
Incoming/Outgoing Bandwidth	160 Mbps/256 Mbps	160 Mbps/256 Mbps	80 Mbps/256 Mbps	80 Mbps/256 Mbps	256Mbps/ 160Mbps
Decoding Capacity	2-ch @ 12 MP (20fps) / 4-ch @ 8 MP (25fps) / 8-ch @ 4MP (30fps) / 16-ch @ 1080p (30fps)	2-ch @ 12 MP (20fps) / 4-ch @ 8 MP (25fps) / 8-ch @ 4MP (30fps) / 16-ch @ 1080p (30fps)	2-ch @ 12 MP (20fps) / 4-ch @ 8 MP (25fps) / 8-ch @ 4MP (30fps) / 16-ch @ 1080p (30fps)	2-ch @ 12 MP (20fps) / 4-ch @ 8 MP (25fps) / 8-ch @ 4MP (30fps) / 16-ch @ 1080p (30fps)	2-ch @ 8 MP (25fps) / 4-ch @ 4MP (30fps) / 8-ch @ 1080p (30fps)
Recording Resolution	12 MP/8 MP/6 MP/5 MP/4 MP/3MP/1080p/UXGA/720p / VGA/4CIF /DCIF/2CIF/CIF/QCIF	12 MP/8 MP/6 MP/5 MP/4 MP/3MP/1080p/UXGA/720p / VGA/4CIF /DCIF/2CIF/CIF/QCIF	12 MP/8 MP/6 MP/5 MP/4 MP/3MP/1080p/UXGA/720p / VGA/4CIF /DCIF/2CIF/CIF/QCIF	12 MP/8 MP/6 MP/5 MP/4 MP/3MP/1080p/UXGA/720p / VGA/4CIF /DCIF/2CIF/CIF/QCIF	8 MP/6 MP/5 MP/4 MP/3 MP/1080p/UXGA/720p/VGA/4CIF/DCIF /2CIF/CIF/QCIF
Display	1 HDMI/1 VGA/(CVBS optional)	1 HDMI/1 VGA/(CVBS optional)	1 HDMI/1 VGA/(CVBS optional)	1 HDMI/1 VGA/(CVBS optional)	1 HDMI/1 VGA
Storage Capacity	2 SATA interfaces Up to 8TB capacity for each HDD	2 SATA interfaces Up to 8TB capacity for each HDD	2 SATA interfaces Up to 8TB capacity for each HDD	2 SATA interfaces Up to 8TB capacity for each HDD	4 SATA interfaces Up to 6TB capacity for each HDD
eSATA/Mini SAS	-	-	-	-	-
Video Output	HDMI:4K (3840 × 2160)/60Hz, 4K (3840 × 2160)/30Hz, 2K (2560 × 1440)/60Hz, 1920 × 1080p/60Hz, 1600 × 1200/60Hz, 1280 × 1024/60Hz, 1280 × 720/60Hz, 1024 × 768/60Hz VGA:1920 × 1080p/60Hz, 1280 × 1024/60Hz, 1280 × 720/60Hz, 1024 × 768/60Hz	HDMI:4K (3840 × 2160)/60Hz, 4K (3840 × 2160)/30Hz, 1920 × 1080p/60Hz, 1600 × 1200/60Hz, 1280 × 1024/60Hz, 1280 × 720/60Hz, 1024 × 768/60Hz VGA:1920 × 1080p/60Hz, 1280 × 1024/60Hz, 1280 × 720/60Hz, 1024 × 768/60Hz	HDMI:4K (3840 × 2160)/60Hz, 4K (3840 × 2160)/30Hz, 2K (2560 × 1440)/60Hz, 1920 × 1080p/60Hz, 1600 × 1200/60Hz, 1280 × 1024/60Hz, 1280 × 720/60Hz, 1024 × 768/60Hz VGA:1920 × 1080p/60Hz, 1280 × 1024/60Hz, 1280 × 720/60Hz, 1024 × 768/60Hz	HDMI:4K (3840 × 2160)/60Hz, 4K (3840 × 2160)/30Hz, 1920 × 1080p/60Hz, 1600 × 1200/60Hz, 1280 × 1024/60Hz, 1280 × 720/60Hz, 1024 × 768/60Hz VGA:1920 × 1080p/60Hz, 1280 × 1024/60Hz, 1280 × 720/60Hz, 1024 × 768/60Hz	HDMI:4K (3840 × 2160)/30Hz, 2K (2560 × 1440)/60Hz, 1920 × 1080/60Hz, 1600 × 1200/60Hz, 1280 × 1024/60Hz, 1280 × 720/60Hz, 1024 × 768/60Hz VGA:1920 × 1080/60Hz, 1280 × 1024/60Hz, 1280 × 720/60Hz, 1024 × 768/60Hz
Audio Output	1-ch, RCA (Linear, 1 KΩ)	1-ch, RCA (Linear, 1 KΩ)	1-ch, RCA (Linear, 1 KΩ)	1-ch, RCA (Linear, 1 KΩ)	1-ch, RCA (Linear, 1 KΩ)
Alarm I/O	4/1	4/1	4/1	4/1	16/4
Network Interface	1 RJ-45 10/100/1000 Mbps self adaptive Ethernet interface	1 RJ-45 10/100/1000 Mbps self adaptive Ethernet interface	1 RJ-45 10/100/1000 Mbps self adaptive Ethernet interface	1 RJ-45 10/100/1000 Mbps self adaptive Ethernet interface	1 RJ-45 10/100/1000 Mbps self adaptive Ethernet interfaces
PoE Port	16P	-	8P	-	16P
USB Port	Front panel: 1 × USB 2.0; Rear panel: 1 × USB 3.0	Front panel: 1 × USB 2.0; Rear panel: 1 × USB 3.0	Front panel: 1 × USB 2.0; Rear panel: 1 × USB 3.0	Front panel: 1 × USB 2.0; Rear panel: 1 × USB 3.0	Front panel: 2 × USB 2.0; Rear panel: 1 × USB 3.0
Smart Function	Supports multiple VCA(Video Content Analytics) events for IP cameras	Supports multiple VCA(Video Content Analytics) events for IP cameras	Supports multiple VCA(Video Content Analytics) events for IP cameras	Supports multiple VCA(Video Content Analytics) events for IP cameras	Supports multiple VCA(Video Content Analytics) events for IP cameras
Power Consumption (without HDD)	≤15 W (without enabling PoE)	≤15 W (without enabling PoE)	≤15 W (without enabling PoE)	≤15 W (without enabling PoE)	≤20 W(without enabling PoE)



Turbo HD Cameras
 Turbo HD PTZ Cameras
 DVIs-recorders
 Network Cameras
 Network PTZ Cameras
 Network PTZ Cameras
 Panoramic Cameras
NVFS
 KITS
 Thermal Cameras
 Monitors
 Switches
 Cables
 Control & Transmission
 Software
 Accessories
 DORI
 Distance

Model	DS-7732NI-K4	DS-7716NI-K4/16P	DS-7716NI-K4	DS-7616NI-K2/16P	DS-7616NI-K2	DS-7608NI-K2/8P	
Image							
Channel No.	32-ch	16-ch	16-ch	16-ch	16-ch	8-ch	
Decoding Format	H.265/H.265+/H.264+/H.264/MPEG4	H.265/H.265+/H.264+/H.264/MPEG4	H.265/H.265+/H.264+/H.264/MPEG4	H.265/H.265+/H.264+/H.264+/MPEG4	H.265/H.265+/H.264/H.264+/MPEG4	H.265/H.265+/H.264/H.264+/MPEG4	
Incoming/Outgoing Bandwidth	256Mbps/ 160Mbps	160Mbps/ 160Mbps	160Mbps/ 160Mbps	160Mbps/ 160Mbps	160Mbps/ 160Mbps	80Mbps/ 160Mbps	
Decoding Capacity	2-ch @ 8 MP (25fps) / 4-ch @ 4MP (30fps) / 8-ch @ 1080p (30fps)	2-ch @ 8 MP (25fps) / 4-ch @ 4MP (30fps) / 8-ch @ 1080p (30fps)	2-ch @ 8 MP (25fps) / 4-ch @ 4MP (30fps) / 8-ch @ 1080p (30fps)	2-ch @ 8 MP (25fps) / 4-ch @ 4MP (30fps) / 8-ch @ 1080p (30fps)	2-ch @ 8 MP (25fps) / 4-ch @ 4MP (30fps) / 8-ch @ 1080p (30fps)	2-ch @ 8 MP (25fps) / 4-ch @ 4MP (30fps) / 8-ch @ 1080p (30fps)	
Recording Resolution	8 MP/6 MP/5 MP/4 MP/3 MP/1080p/UXGA/720p/VGA/4CIF/DCIF/2CIF/CIF/QCIF	8 MP/6 MP/5 MP/4 MP/3 MP/1080p/UXGA/720p/VGA/4CIF/DCIF/2CIF/CIF/QCIF	8 MP/6 MP/5 MP/4 MP/3 MP/1080p/UXGA/720p/VGA/4CIF/DCIF/2CIF/CIF/QCIF	8MP/6MP/5MP/4MP/3MP/1080p/UXGA/720p/VGA/4CIF/DCIF/2CIF/CIF/QCIF	8MP/6MP/5MP/4MP/3MP/1080p/UXGA/720p/VGA/4CIF/DCIF/2CIF/CIF/QCIF	8MP/6MP/5MP/4MP/3MP/1080p/UXGA/720p/VGA/4CIF/DCIF/2CIF/CIF/QCIF	
Display	1 HDMI/1 VGA	1 HDMI/1 VGA	1 HDMI/1 VGA	1 HDMI/1 VGA	1 HDMI/1 VGA	1 HDMI/1 VGA	
Storage Capacity	4 SATA interfaces Up to 6TB capacity for each HDD	4 SATA interfaces Up to 6TB capacity for each HDD	4 SATA interfaces Up to 6TB capacity for each HDD	2 SATA interfaces Up to 6TB capacity for each HDD	2 SATA interfaces Up to 6TB capacity for each HDD	2 SATA interfaces Up to 6TB capacity for each HDD	
eSATA/Mini SAS	-	-	-	-	-	-	
Video Output	HDMI:4K (3840 × 2160)/30Hz, 2K (2560 × 1440)/60Hz, 1920 × 1080/60Hz, 1600 × 1200/60Hz, 1280 × 1024/60Hz, 1280 × 720/60Hz, 1024 × 768/60Hz VGA:1920 × 1080/60Hz, 1280 × 1024/60Hz, 1280 × 720/60Hz, 1024 × 768/60Hz	HDMI:4K (3840 × 2160)/30Hz, 2K (2560 × 1440)/60Hz, 1920 × 1080/60Hz, 1600 × 1200/60Hz, 1280 × 1024/60Hz, 1280 × 720/60Hz, 1024 × 768/60Hz VGA:1920 × 1080/60Hz, 1280 × 1024/60Hz, 1280 × 720/60Hz, 1024 × 768/60Hz	HDMI:4K (3840 × 2160)/30Hz, 2K (2560 × 1440)/60Hz, 1920 × 1080/60Hz, 1600 × 1200/60Hz, 1280 × 1024/60Hz, 1280 × 720/60Hz, 1024 × 768/60Hz VGA:1920 × 1080/60Hz, 1280 × 1024/60Hz, 1280 × 720/60Hz, 1024 × 768/60Hz	HDMI:4K (3840 × 2160)/30Hz, 2K (2560 × 1440)/60Hz, 1920 × 1080/60Hz, 1600 × 1200/60Hz, 1280 × 1024/60Hz, 1280 × 720/60Hz, 1024 × 768/60Hz VGA:1920 × 1080/60Hz, 1280 × 1024/60Hz, 1280 × 720/60Hz, 1024 × 768/60Hz	HDMI:4K (3840 × 2160)/30Hz, 2K (2560 × 1440)/60Hz, 1920 × 1080/60Hz, 1600 × 1200/60Hz, 1280 × 1024/60Hz, 1280 × 720/60Hz, 1024 × 768/60Hz VGA:1920 × 1080/60Hz, 1280 × 1024/60Hz, 1280 × 720/60Hz, 1024 × 768/60Hz	HDMI:4K (3840 × 2160)/30Hz, 2K (2560 × 1440)/60Hz, 1920 × 1080/60Hz, 1600 × 1200/60Hz, 1280 × 1024/60Hz, 1280 × 720/60Hz, 1024 × 768/60Hz VGA:1920 × 1080/60Hz, 1280 × 1024/60Hz, 1280 × 720/60Hz, 1024 × 768/60Hz	HDMI:4K (3840 × 2160)/30Hz, 2K (2560 × 1440)/60Hz, 1920 × 1080/60Hz, 1600 × 1200/60Hz, 1280 × 1024/60Hz, 1280 × 720/60Hz, 1024 × 768/60Hz VGA:1920 × 1080/60Hz, 1280 × 1024/60Hz, 1280 × 720/60Hz, 1024 × 768/60Hz
Audio Output	1-ch, RCA (Linear, 1 KΩ)	1-ch, RCA (Linear, 1 KΩ)	1-ch, RCA (Linear, 1 KΩ)	1-ch, RCA (Linear, 1 KΩ)	1-ch, RCA (Linear, 1 KΩ)	1-ch, RCA (Linear, 1 KΩ)	
Alarm I/O	16/4	16/4	16/4	4/1	4/1	4/1	
Network Interface	2 RJ-45 10/100/1000 Mbps self adaptive Ethernet interfaces	1 RJ-45 10/100/1000 Mbps self adaptive Ethernet interfaces	2 RJ-45 10/100/1000 Mbps self adaptive Ethernet interfaces	1, RJ-45 10/100/1000 Mbps self adaptive Ethernet interface	1, RJ-45 10/100/1000 Mbps self adaptive Ethernet interface	1, RJ-45 10/100/1000 Mbps self adaptive Ethernet interface	
PoE Port	-	16P	-	16P	-	8P	
USB Port	Front panel: 2 × USB 2.0; Rear panel: 1 × USB 3.0	Front panel: 2 × USB 2.0; Rear panel: 1 × USB 3.0	Front panel: 2 × USB 2.0; Rear panel: 1 × USB 3.0	Front panel: 1 × USB 2.0; Rear panel: 1 × USB 3.0	Front panel: 1 × USB 2.0; Rear panel: 1 × USB 3.0	Front panel: 1 × USB 2.0; Rear panel: 1 × USB 3.0	
Smart Function	Supports multiple VCA(Video Content Analytics) events for IP cameras	Supports multiple VCA(Video Content Analytics) events for IP cameras	Supports multiple VCA(Video Content Analytics) events for IP cameras	Supports multiple VCA(Video Content Analytics) events for IP cameras	Supports multiple VCA(Video Content Analytics) events for IP cameras	Supports multiple VCA(Video Content Analytics) events for IP cameras	
Power Consumption (without HDD)	≤20 W (without enabling PoE)	≤20 W (without enabling PoE)	≤20 W (without enabling PoE)	≤15 W (without enabling PoE)	≤15 W	≤15 W (without enabling PoE)	

Model	DS-7608NI-K2	DS-7616NI-K1(D)	DS-7608NI-K1/8P(D)	DS-7608NI-K1(D)	DS-7604NI-K1/4P(D)
Image					
Channel No.	8-ch	16-ch	8-ch	8-ch	4-ch
Decoding Format	H.265/H.265+/H.264/H.264+/MPEG4	H.265/H.265+/H.264/H.264+	H.265/H.265+/H.264/H.264+	H.265/H.265+/H.264/H.264+	H.265/H.265+/H.264/H.264+
Incoming/Outgoing Bandwidth	80Mbps/ 160Mbps	160Mbps/ 80Mbps	80Mbps/ 80Mbps	80Mbps/ 80Mbps	40Mbps/ 80Mbps
Decoding Capacity	2-ch @ 8 MP (25fps) / 4-ch @ 4MP (30fps) / 8-ch @ 1080p (30fps)	1-ch@8 MP (30 fps)/3-ch@4 MP (30 fps)/6-ch@1080p (30 fps) *: The length or width of camera resolution (each track) cannot exceed 4096 pixels.	1-ch@8 MP (30 fps)/3-ch@4 MP (30 fps)/6-ch@1080p (30 fps) *: The length or width of camera resolution (each track) cannot exceed 4096 pixels.	1-ch@8 MP (30 fps)/3-ch@4 MP (30 fps)/6-ch@1080p (30 fps) *: The length or width of camera resolution (each track) cannot exceed 4096 pixels.	1-ch@8 MP (30 fps)/3-ch@4 MP (30 fps)/6-ch@1080p (30 fps) *: The length or width of camera resolution (each track) cannot exceed 4096 pixels.
Recording Resolution	8MP/6MP/5MP/4MP/3MP/1080p/UXGA/720p/VGA/4CIF/DCIF/2CIF/CIF/QCIF	8 MP/6 MP/5 MP/4 MP/3 MP/1080p/UXGA/720p/VGA/4CIF/DCIF/2CIF/CIF/QCIF	8 MP/6 MP/5 MP/4 MP/3 MP/1080p/UXGA/720p/VGA/4CIF/DCIF/2CIF/CIF/QCIF	8 MP/6 MP/5 MP/4 MP/3 MP/1080p/UXGA/720p/VGA/4CIF/DCIF/2CIF/CIF/QCIF	8 MP/6 MP/5 MP/4 MP/3 MP/1080p/UXGA/720p/VGA/4CIF/DCIF/2CIF/CIF/QCIF
Display	1 HDMI/1 VGA	1 HDMI/1 VGA	1 HDMI/1 VGA	1 HDMI/1 VGA	1 HDMI/1 VGA
Storage Capacity	2 SATA interfaces Up to 6TB capacity for each HDD	1 SATA interface Up to 8TB capacity for each HDD	1 SATA interface Up to 8TB capacity for each HDD	1 SATA interface Up to 8TB capacity for each HDD	1 SATA interface Up to 8TB capacity for each HDD
eSATA/Mini SAS	-	-	-	-	-
Video Output	HDMI:4K (3840 × 2160)/30Hz, 2K (2560 × 1440)/60Hz, 1920 × 1080/60Hz, 1600 × 1200/60Hz, 1280 × 1024/60Hz, 1280 × 720/60Hz, 1024 × 768/60Hz VGA:1920 × 1080/60Hz, 1280 × 1024/60Hz, 1280 × 720/60Hz, 1024 × 768/60Hz	HDMI: 1-ch, 4K (4096 × 2160)/30 Hz, 4K (3840 × 2160)/30 Hz, 2K (2560 × 1440)/60 Hz, 1920 × 1080/60 Hz, 1600 × 1200/60 Hz, 1280 × 1024/60 Hz, 1280 × 720/60 Hz VGA:1-ch, 1920 × 1080/60 Hz, 1280 × 1024/60 Hz, 1280 × 720/60 Hz HDMI/VGA simultaneous output	HDMI: 1-ch, 4K (4096 × 2160)/30 Hz, 4K (3840 × 2160)/30 Hz, 2K (2560 × 1440)/60 Hz, 1920 × 1080/60 Hz, 1600 × 1200/60 Hz, 1280 × 1024/60 Hz, 1280 × 720/60 Hz VGA:1-ch, 1920 × 1080/60 Hz, 1280 × 1024/60 Hz, 1280 × 720/60 Hz HDMI/VGA simultaneous output	HDMI: 1-ch, 4K (4096 × 2160)/30 Hz, 4K (3840 × 2160)/30 Hz, 2K (2560 × 1440)/60 Hz, 1920 × 1080/60 Hz, 1600 × 1200/60 Hz, 1280 × 1024/60 Hz, 1280 × 720/60 Hz VGA:1-ch, 1920 × 1080/60 Hz, 1280 × 1024/60 Hz, 1280 × 720/60 Hz HDMI/VGA simultaneous output	HDMI: 1-ch, 4K (4096 × 2160)/30 Hz, 4K (3840 × 2160)/30 Hz, 2K (2560 × 1440)/60 Hz, 1920 × 1080/60 Hz, 1600 × 1200/60 Hz, 1280 × 1024/60 Hz, 1280 × 720/60 Hz VGA:1-ch, 1920 × 1080/60 Hz, 1280 × 1024/60 Hz, 1280 × 720/60 Hz HDMI/VGA simultaneous output
Audio Output	1-ch, RCA (Linear, 1 KΩ)	1-ch, RCA (Linear, 1 KΩ)	1-ch, RCA (Linear, 1 KΩ)	1-ch, RCA (Linear, 1 KΩ)	1-ch, RCA (Linear, 1 KΩ)
Alarm I/O	4/1	N/A (4/1 is optional)	N/A (4/1 is optional)	N/A (4/1 is optional)	N/A (4/1 is optional)
Network Interface	1, RJ-45 10/100/1000 Mbps self adaptive Ethernet interface	1, RJ-45 10/100/1000 Mbps self adaptive Ethernet interface	1, RJ-45 10/100 Mbps self adaptive Ethernet interface	1, RJ-45 10/100 Mbps self adaptive Ethernet interface	1, RJ-45 10/100 Mbps self adaptive Ethernet interface
PoE Port	-	-	8P	-	4P
USB Port	Front panel: 1 × USB 2.0; Rear panel: 1 × USB 3.0	Front panel: 1 × USB 2.0; Rear panel: 1 × USB 2.0	Front panel: 1 × USB 2.0; Rear panel: 1 × USB 2.0	Front panel: 1 × USB 2.0; Rear panel: 1 × USB 2.0	Front panel: 1 × USB 2.0; Rear panel: 1 × USB 2.0
Smart Function	Supports multiple VCA(Video Content Analytics) events for IP cameras	Intrusion, Line crossing, Unattended Baggage, Object removal, Region exiting/entrance, People gathering, Fast moving, Parking, Loitering	Intrusion, Line crossing, Unattended Baggage, Object removal, Region exiting/entrance, People gathering, Fast moving, Parking, Loitering	Intrusion, Line crossing, Unattended Baggage, Object removal, Region exiting/entrance, People gathering, Fast moving, Parking, Loitering	Intrusion, Line crossing, Unattended Baggage, Object removal, Region exiting/entrance, People gathering, Fast moving, Parking, Loitering
Power Consumption (without HDD)	≤15 W	≤ 10W	≤ 10W(without enabling PoE)	≤ 10W	≤ 10W(without enabling PoE)

Model	DS-7604NI-K1(D)	DS-7616NI-Q2/16P(D)	DS-7616NI-Q2(D)	DS-7608NI-Q2/8P(D)	DS-7608NI-Q2(D)
					
Image					
Channel No.	4-ch	16-ch	16-ch	8-ch	8-ch
Decoding Format	H.265/H.265+/H.264/H.264+	H.265/H.265+/H.264/H.264+	H.265/H.265+/H.264/H.264+	H.265/H.265+/H.264/H.264+	H.265/H.265+/H.264/H.264+
Incoming/Outgoing Bandwidth	40Mbps/ 80Mbps	160Mbps/ 80Mbps	160Mbps/ 80Mbps	80Mbps/80Mbps	80Mbps/80Mbps
Decoding Capacity	1-ch@8 MP (30 fps)/3-ch@4 MP (30 fps)/6-ch@1080p (30 fps) *: The length or width of camera resolution (each track) cannot exceed 4096 pixels.	1-ch@8 MP (30 fps)/3-ch@4 MP (30 fps)/6-ch@1080p (30 fps) *: The length or width of camera resolution (each track) cannot exceed 4096 pixels.	1-ch@8 MP (30 fps)/3-ch@4 MP (30 fps)/6-ch@1080p (30 fps) *: The length or width of camera resolution (each track) cannot exceed 4096 pixels.	1-ch@8 MP (30 fps)/3-ch@4 MP (30 fps)/6-ch@1080p (30 fps) *: The length or width of camera resolution (each track) cannot exceed 4096 pixels.	1-ch@8 MP (30 fps)/3-ch@4 MP (30 fps)/6-ch@1080p (30 fps) *: The length or width of camera resolution (each track) cannot exceed 4096 pixels.
Recording Resolution	8 MP/6 MP/5 MP/4 MP/3 MP/1080p/UXGA /720p/VGA/4CIF/DCIF/ 2CIF/ CIF/QCIF	8 MP/6 MP/5 MP/4 MP/3 MP/1080p/UXGA /720p/VGA/4CIF/DCIF/ 2CIF/ CIF/QCIF	8 MP/6 MP/5 MP/4 MP/3 MP/1080p/UXGA /720p/VGA/4CIF/DCIF/ 2CIF/ CIF/QCIF	8 MP/6 MP/5 MP/4 MP/3 MP/1080p/UXGA /720p/VGA/4CIF/DCIF/ 2CIF/ CIF/QCIF	8 MP/6 MP/5 MP/4 MP/3 MP/1080p/UXGA /720p/VGA/4CIF/DCIF/ 2CIF/ CIF/QCIF
Display	1 HDMI/1 VGA	1 HDMI/1 VGA	1 HDMI/1 VGA	1 HDMI/1 VGA	1 HDMI/1 VGA
Storage Capacity	1 SATA interface Up to 8TB capacity for each HDD	2 SATA interfaces Up to 8TB capacity for each disk	2 SATA interfaces Up to 8TB capacity for each disk	2 SATA interfaces Up to 8TB capacity for each disk	2 SATA interfaces Up to 8TB capacity for each disk
eSATA/Mini SAS	-	-	-	-	-
Video Output	HDMI: 1-ch, 4K (4096 x 2160)/30 Hz, 4K (3840 x 2160)/30 Hz, 2K (2560 x 1440)/60 Hz, 1920 x 1080/60 Hz, 1600 x 1200/60 Hz, 1280 x 1024/60 Hz, 1280 x 720/60 Hz VGA: 1-ch, 1920 x 1080/60 Hz, 1280 x 1024/60 Hz, 1280 x 720/60 Hz HDMI/VGA simultaneous output	HDMI: 1-ch, 4K (4096 x 2160)/30 Hz, 4K (3840 x 2160)/30 Hz, 2K (2560 x 1440)/60 Hz, 1920 x 1080/60 Hz, 1600 x 1200/60 Hz, 1280 x 1024/60 Hz, 1280 x 720/60 Hz VGA: 1-ch, 1920 x 1080/60 Hz, 1280 x 1024/60 Hz, 1280 x 720/60 Hz HDMI/VGA simultaneous output	HDMI: 1-ch, 4K (4096 x 2160)/30 Hz, 4K (3840 x 2160)/30 Hz, 2K (2560 x 1440)/60 Hz, 1920 x 1080/60 Hz, 1600 x 1200/60 Hz, 1280 x 1024/60 Hz, 1280 x 720/60 Hz VGA: 1-ch, 1920 x 1080/60 Hz, 1280 x 1024/60 Hz, 1280 x 720/60 Hz HDMI/VGA simultaneous output	HDMI: 1-ch, 4K (4096 x 2160)/30 Hz, 4K (3840 x 2160)/30 Hz, 2K (2560 x 1440)/60 Hz, 1920 x 1080/60 Hz, 1600 x 1200/60 Hz, 1280 x 1024/60 Hz, 1280 x 720/60 Hz VGA: 1-ch, 1920 x 1080/60 Hz, 1280 x 1024/60 Hz, 1280 x 720/60 Hz HDMI/VGA simultaneous output	HDMI: 1-ch, 4K (4096 x 2160)/30 Hz, 4K (3840 x 2160)/30 Hz, 2K (2560 x 1440)/60 Hz, 1920 x 1080/60 Hz, 1600 x 1200/60 Hz, 1280 x 1024/60 Hz, 1280 x 720/60 Hz VGA: 1-ch, 1920 x 1080/60 Hz, 1280 x 1024/60 Hz, 1280 x 720/60 Hz HDMI/VGA simultaneous output
Audio Output	1-ch, RCA (Linear, 1 KΩ)	1-ch, RCA (Linear, 1 KΩ)	1-ch, RCA (Linear, 1 KΩ)	1-ch, RCA (Linear, 1 KΩ)	1-ch, RCA (Linear, 1 KΩ)
Alarm I/O	N/A (4/1 is optional)	-	-	-	-
Network Interface	1, RJ-45 10/100 Mbps self adaptive Ethernet interface	1, RJ-45 10/100/1000 Mbps self adaptive Ethernet interface	1, RJ-45 10/100/1000 Mbps self adaptive Ethernet interface	1, RJ-45 10/100 Mbps self adaptive Ethernet interface	1, RJ-45 10/100 Mbps self adaptive Ethernet interface
PoE Port	-	16P	-	8P	-
USB Port	Front panel: 1 x USB 2.0; Rear panel: 1 x USB 2.0	Front panel: 1 x USB 2.0; Rear panel: 1 x USB 2.0	Front panel: 1 x USB 2.0; Rear panel: 1 x USB 2.0	Front panel: 1 x USB 2.0; Rear panel: 1 x USB 2.0	Front panel: 1 x USB 2.0; Rear panel: 1 x USB 2.0
Smart Function	Intrusion, Line crossing, Unattended Baggage, Object removal, Region exiting/entrance, People gathering, Fast moving, Parking, Loitering	4-ch Motion Detection 2.0 Support multiple VCA (Video Content Analytics) events Configurable special camera smart functions, such as VCA detection (motion, line crossing, intrusion, etc.)	4-ch Motion Detection 2.0 Support multiple VCA (Video Content Analytics) events Configurable special camera smart functions, such as VCA detection (motion2.0, line crossing, intrusion, etc.)	4-ch Motion Detection 2.0 Support multiple VCA (Video Content Analytics) events Configurable special camera smart functions, such as VCA detection (motion2.0, line crossing, intrusion, etc.)	4-ch Motion Detection 2.0 Support multiple VCA (Video Content Analytics) events Configurable special camera smart functions, such as VCA detection (motion2.0, line crossing, intrusion, etc.)
Power Consumption (without HDD)	≤ 10W	≤15 W(without enabling PoE)	≤15 W	≤15 W(without enabling PoE)	≤15 W

Model	DS-7616NI-Q1(D)	DS-7608NI-Q1/8P(D)	DS-7608NI-Q1(D)	DS-7604NI-Q1/4P(D)	DS-7604NI-Q1(D)
	NEW	NEW	NEW	NEW	NEW
Image					
Channel No.	16-ch	8-ch	8-ch	4-ch	4-ch
Decoding Format	H.265/H.265+/H.264/H.264+	H.265/H.265+/H.264/H.264+	H.265/H.265+/H.264/H.264+	H.265/H.265+/H.264/H.264+	H.265/H.265+/H.264/H.264+
Incoming/Outgoing Bandwidth	160Mbps/ 80Mbps	80Mbps/80Mbps	80Mbps/80Mbps	40Mbps/ 80Mbps	40Mbps/ 80Mbps
Decoding Capacity	1-ch@8 MP (30 fps)/3-ch@4 MP (30 fps)/6-ch@1080p (30 fps) *: The length or width of camera resolution (each track) cannot exceed 4096 pixels.	1-ch@8 MP (30 fps)/3-ch@4 MP (30 fps)/6-ch@1080p (30 fps) *: The length or width of camera resolution (each track) cannot exceed 4096 pixels.	1-ch@8 MP (30 fps)/3-ch@4 MP (30 fps)/6-ch@1080p (30 fps) *: The length or width of camera resolution (each track) cannot exceed 4096 pixels.	1-ch@8 MP (30 fps)/3-ch@4 MP (30 fps)/6-ch@1080p (30 fps) *: The length or width of camera resolution (each track) cannot exceed 4096 pixels.	1-ch@8 MP (30 fps)/3-ch@4 MP (30 fps)/6-ch@1080p (30 fps) *: The length or width of camera resolution (each track) cannot exceed 4096 pixels.
Recording Resolution	8 MP/6 MP/5 MP/4 MP/3 MP/1080p/UXGA /720p/VGA/4CIF/DCIF/ 2CIF/ CIF/QCIF	8 MP/6 MP/5 MP/4 MP/3 MP/1080p/UXGA /720p/VGA/4CIF/DCIF/ 2CIF/ CIF/QCIF	8 MP/6 MP/5 MP/4 MP/3 MP/1080p/UXGA /720p/VGA/4CIF/DCIF/ 2CIF/ CIF/QCIF	8 MP/6 MP/5 MP/4 MP/3 MP/1080p/UXGA /720p/VGA/4CIF/DCIF/ 2CIF/ CIF/QCIF	8 MP/6 MP/5 MP/4 MP/3 MP/1080p/UXGA /720p/VGA/4CIF/DCIF/ 2CIF/ CIF/QCIF
Display	1 HDMI/1 VGA	1 HDMI/1 VGA	1 HDMI/1 VGA	1 HDMI/1 VGA	1 HDMI/1 VGA
Storage Capacity	1 SATA interfaces Up to 8TB capacity for each disk	1 SATA interfaces Up to 8TB capacity for each disk	1 SATA interfaces Up to 8TB capacity for each disk	1 SATA interfaces Up to 8TB capacity for each disk	1 SATA interfaces Up to 8TB capacity for each disk
eSATA/Mini SAS	-	-	-	-	-
Video Output	HDMI:1-ch, 4K (4096 x 2160)/30 Hz, 4K (3840 x 2160)/30 Hz, 2K (2560 x 1440)/60 Hz, 1920 x 1080/60 Hz, 1600 x 1200/60 Hz, 1280 x 1024/60 Hz, 1280 x 720/60 Hz VGA:1-ch, 1920 x 1080/60 Hz, 1280 x 1024/60 Hz, 1280 x 720/60 Hz HDMI/VGA simultaneous output	HDMI:1-ch, 4K (4096 x 2160)/30 Hz, 4K (3840 x 2160)/30 Hz, 2K (2560 x 1440)/60 Hz, 1920 x 1080/60 Hz, 1600 x 1200/60 Hz, 1280 x 1024/60 Hz, 1280 x 720/60 Hz VGA:1-ch, 1920 x 1080/60 Hz, 1280 x 1024/60 Hz, 1280 x 720/60 Hz HDMI/VGA simultaneous output	HDMI:1-ch, 4K (4096 x 2160)/30 Hz, 4K (3840 x 2160)/30 Hz, 2K (2560 x 1440)/60 Hz, 1920 x 1080/60 Hz, 1600 x 1200/60 Hz, 1280 x 1024/60 Hz, 1280 x 720/60 Hz VGA:1-ch, 1920 x 1080/60 Hz, 1280 x 1024/60 Hz, 1280 x 720/60 Hz HDMI/VGA simultaneous output	HDMI:1-ch, 4K (4096 x 2160)/30 Hz, 4K (3840 x 2160)/30 Hz, 2K (2560 x 1440)/60 Hz, 1920 x 1080/60 Hz, 1600 x 1200/60 Hz, 1280 x 1024/60 Hz, 1280 x 720/60 Hz VGA:1-ch, 1920 x 1080/60 Hz, 1280 x 1024/60 Hz, 1280 x 720/60 Hz HDMI/VGA simultaneous output	HDMI:1-ch, 4K (4096 x 2160)/30 Hz, 4K (3840 x 2160)/30 Hz, 2K (2560 x 1440)/60 Hz, 1920 x 1080/60 Hz, 1600 x 1200/60 Hz, 1280 x 1024/60 Hz, 1280 x 720/60 Hz VGA:1-ch, 1920 x 1080/60 Hz, 1280 x 1024/60 Hz, 1280 x 720/60 Hz HDMI/VGA simultaneous output
Audio Output	1-ch, RCA (Linear, 1 KΩ)	1-ch, RCA (Linear, 1 KΩ)	1-ch, RCA (Linear, 1 KΩ)	1-ch, RCA (Linear, 1 KΩ)	1-ch, RCA (Linear, 1 KΩ)
Alarm I/O	-	-	-	-	-
Network Interface	1, RJ-45 10/100/1000 Mbps self adaptive Ethernet interface	1, RJ-45 10/100 Mbps self adaptive Ethernet interface	1, RJ-45 10/100 Mbps self adaptive Ethernet interface	1, RJ-45 10/100 Mbps self adaptive Ethernet interface	1, RJ-45 10/100 Mbps self adaptive Ethernet interface
PoE Port	-	8P	-	4P	-
USB Port	Front panel: 1 × USB 2.0; Rear panel: 1 × USB 2.0	Front panel: 1 × USB 2.0; Rear panel: 1 × USB 2.0	Front panel: 1 × USB 2.0; Rear panel: 1 × USB 2.0	Front panel: 1 × USB 2.0; Rear panel: 1 × USB 2.0	Front panel: 1 × USB 2.0; Rear panel: 1 × USB 2.0
Smart Function	4-ch Motion Detection 2.0 Support multiple VCA (Video Content Analytics) events Configurable special camera smart functions, such as VCA detection (motion2.0, line crossing, intrusion, etc.)	4-ch Motion Detection 2.0 Support multiple VCA (Video Content Analytics) events Configurable special camera smart functions, such as VCA detection (motion2.0, line crossing, intrusion, etc.)	4-ch Motion Detection 2.0 Support multiple VCA (Video Content Analytics) events Configurable special camera smart functions, such as VCA detection (motion2.0, line crossing, intrusion, etc.)	1-ch Motion Detection 2.0 Support multiple VCA (Video Content Analytics) events Configurable special camera smart functions, such as VCA detection (motion2.0, line crossing, intrusion, etc.)	1-ch Motion Detection 2.0 Support multiple VCA (Video Content Analytics) events Configurable special camera smart functions, such as VCA detection (motion2.0, line crossing, intrusion, etc.)
Power Consumption (without HDD)	≤10 W	≤10 W(without enabling PoE)	≤10 W	≤10 W(without enabling PoE)	≤10 W

Model	DS-7716NI-Q4/16P(C)	DS-7716NI-Q4(C)
Image		
Channel No.	16-ch	16-ch
Decoding Format	H.265/H.265+/H.264/H.264+	H.265/H.265+/H.264/H.264+
Incoming/Outgoing Bandwidth	160Mbps/ 80Mbps	160Mbps/ 80Mbps
Decoding Capacity	1-ch@8 MP (30 fps)/6-ch@1080p (30 fps) *: The length or width of camera resolution (each track) cannot exceed 4096 pixels.	1-ch@8 MP (30 fps)/6-ch@1080p (30 fps) *: The length or width of camera resolution (each track) cannot exceed 4096 pixels.
Recording Resolution	8 MP/6 MP/5 MP/4 MP/3 MP/1080p/ UXGA /720p/VGA/4CIF/DCIF/ 2CIF/ CIF/QCIF	8 MP/6 MP/5 MP/4 MP/3 MP/1080p/ UXGA /720p/VGA/4CIF/DCIF/ 2CIF/ CIF/QCIF
Display	1 HDMI/1 VGA	1 HDMI/1 VGA
Storage Capacity	4 SATA interface Up to 8 TB capacity for each disk	4 SATA interface Up to 8 TB capacity for each disk
eSATA/Mini SAS	-	-
Video Output	HDMI: 1-ch, 4K (4096 x 2160)/30 Hz, 4K (3840 x 2160)/30 Hz, 2K (2560 x 1440)/60 Hz, 1920 x 1080/60 Hz, 1600 x 1200/60 Hz, 1280 x 1024/60 Hz, 1280 x 720/60 Hz VGA: 1-ch, 1920 x 1080/60 Hz, 1280 x 1024/60 Hz, 1280 x 720/60 Hz HDMI/VGA simultaneous output	HDMI: 1-ch, 4K (4096 x 2160)/30 Hz, 4K (3840 x 2160)/30 Hz, 2K (2560 x 1440)/60 Hz, 1920 x 1080/60 Hz, 1600 x 1200/60 Hz, 1280 x 1024/60 Hz, 1280 x 720/60 Hz VGA: 1-ch, 1920 x 1080/60 Hz, 1280 x 1024/60 Hz, 1280 x 720/60 Hz HDMI/VGA simultaneous output
Audio Output	1-ch, RCA (Linear, 1 KΩ)	1-ch, RCA (Linear, 1 KΩ)
Alarm I/O	16/4 (16/8 optional)	16/4
Network Interface	1 RJ-45 10/100/1000 Mbps self adaptive Ethernet interfaces	2, RJ-45 10/100/1000 Mbps self-adaptive Ethernet interface
PoE Port	16P	-
USB Port	Front panel: 1 x USB 2.0 x USB 2.0; Rear panel: 1 x USB 2.0	Front panel: 2 x USB 2.0; Rear panel: 1 x USB 2.0
Smart Function	Supports multiple VCA(Video Content Analytics) events for IP cameras	Supports multiple VCA(Video Content Analytics) events for IP cameras
Power Consumption (without HDD)	≤ 15 W(without enabling PoE)	≤ 15 W







Network Video Recorders

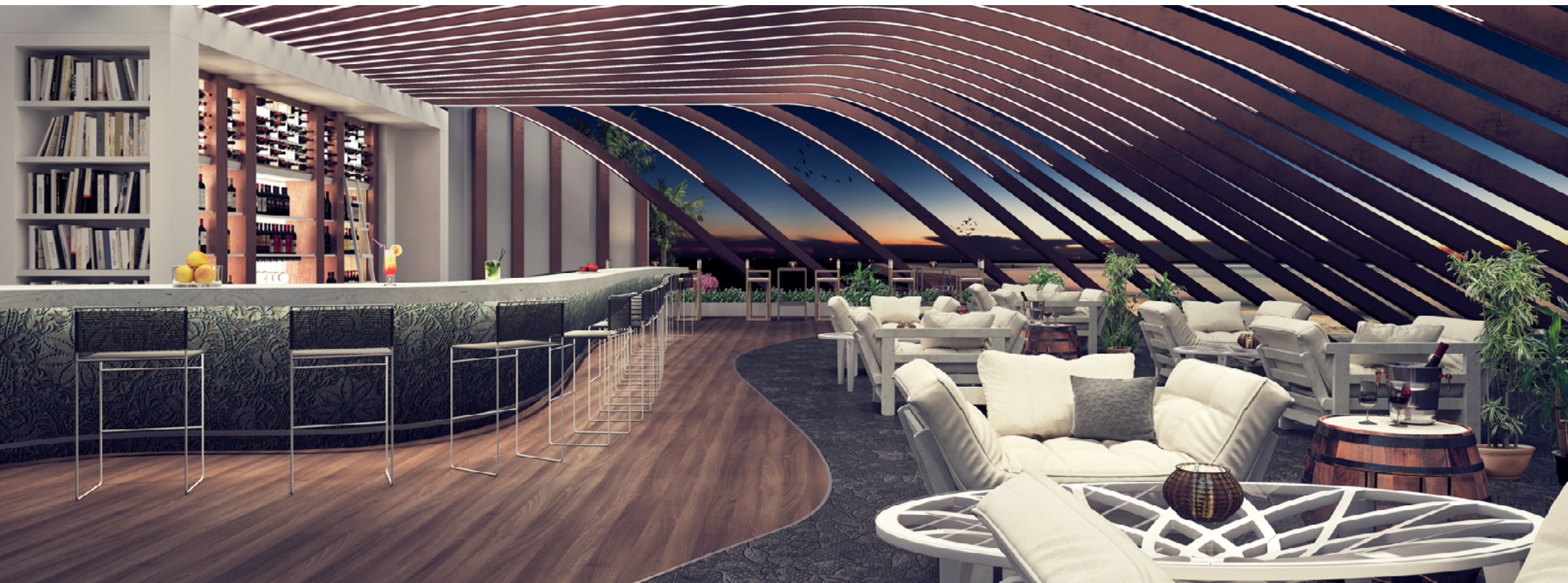

Value Series NVRs

Hikvision Value Series NVRs provide a highly cost-effective choice of video recording, live view, and playback. In particular, the Wi-Fi solutions of the Value Series NVRs make them easy to install and easy to manage.

- > Cost-effective
- > H.265+ / H.265, H.264+ / H.264 self-adapting decoding
- > Up to 4-ch @ 1080p decoding for 71 Series
- > Plug and Play for PoE models
- > Wi-Fi Series NVRs offer two MIMO antennas designed for excellent Wi-Fi performance
- > E-UI, an intuitive and easy-to-use interface



Model	DS-7108NI-Q1/8P/M	DS-7108NI-Q1/M	DS-7104NI-Q1/4P/M	DS-7104NI-Q1/M	DS-7108NI-Q1/8P	DS-7108NI-Q1	DS-7104NI-Q1/4P	DS-7104NI-Q1
Image								
Channel No.	8-ch	8-ch	4-ch	4-ch	8-ch	8-ch	4-ch	4-ch
Decoding Format	H.265+/H.265/ H.264+/H.264	H.265+/H.265/ H.264+/H.264	H.265+/H.265/ H.264+/H.264	H.265+/H.265/ H.264+/H.264	H.265+/H.265/ H.264+/H.264	H.265+/H.265/ H.264+/H.264	H.265+/H.265/ H.264+/H.264	H.265+/H.265/ H.264+/H.264
Incoming/Outgoing Bandwidth	60 Mbps/ 60 Mbps	60 Mbps/ 60 Mbps	40 Mbps/ 60 Mbps	40 Mbps/ 60 Mbps	60 Mbps/ 60 Mbps	60 Mbps/ 60 Mbps	40 Mbps/ 60 Mbps	40 Mbps/ 60 Mbps
Decoding Capacity	4-ch@1080p (25 fps), 2-ch@4 MP (25 fps)	4-ch@1080p (25 fps), 2-ch@4 MP (25 fps)	4-ch@1080p (25 fps), 2-ch@4 MP (25 fps)	4-ch@1080p (25 fps), 2-ch@4 MP (25 fps)	4-ch@1080p (25 fps), 2-ch@4 MP (25 fps)	4-ch@1080p (25 fps), 2-ch@4 MP (25 fps)	4-ch@1080p (25 fps), 2-ch@4 MP (25 fps)	4-ch@1080p (25 fps), 2-ch@4 MP (25 fps)
Recording Resolution	6 MP/4 MP/3 MP/1080p/UXGA /720p/VGA/4CIF/DCIF/ 2CIF/CIF/QCIF	6 MP/4 MP/3 MP/1080p/UXGA /720p/VGA/4CIF/DCIF/ 2CIF/CIF/QCIF	6 MP/4 MP/3 MP/1080p/UXGA /720p/VGA/4CIF/DCIF/ 2CIF/CIF/QCIF	6 MP/4 MP/3 MP/1080p/UXGA /720p/VGA/4CIF/DCIF/ 2CIF/CIF/QCIF	6 MP/4 MP/3 MP/1080p/UXGA /720p/VGA/4CIF/DCIF/ 2CIF/CIF/QCIF	6 MP/4 MP/3 MP/1080p/UXGA /720p/VGA/4CIF/DCIF/ 2CIF/CIF/QCIF	6 MP/4 MP/3 MP/1080p/UXGA /720p/VGA/4CIF/DCIF/ 2CIF/CIF/QCIF	6 MP/4 MP/3 MP/1080p/UXGA /720p/VGA/4CIF/DCIF/ 2CIF/CIF/QCIF
Display	1 HDMI/1 VGA	1 HDMI/1 VGA	1 HDMI/1 VGA	1 HDMI/1 VGA	1 HDMI/1 VGA	1 HDMI/1 VGA	1 HDMI/1 VGA	1 HDMI/1 VGA
Storage Capacity	1 SATA interface Up to 6TB capacity for each HDD	1 SATA interface Up to 6TB capacity for each HDD	1 SATA interface Up to 6TB capacity for each HDD	1 SATA interface Up to 6TB capacity for each HDD	1 SATA interface Up to 6TB capacity for each HDD	1 SATA interface Up to 6TB capacity for each HDD	1 SATA interface Up to 6TB capacity for each HDD	1 SATA interface Up to 6TB capacity for each HDD
eSATA/Mini SAS	-	-	-	-	-	-	-	-
Video Output	HDMI:1-ch, 1920 × 1080p/60Hz, 1280 × 1024/60Hz, 1280 × 720/60Hz, 1024 × 768/60Hz VGA:1-ch, 1920 × 1080p/60Hz, 1280 × 1024/60Hz, 1280 × 720/60Hz, 1024 × 768/60Hz, HDMI/VGA simultaneous output	HDMI:1-ch, 1920 × 1080p/60Hz, 1280 × 1024/60Hz, 1280 × 720/60Hz, 1024 × 768/60Hz VGA:1-ch, 1920 × 1080p/60Hz, 1280 × 1024/60Hz, 1280 × 720/60Hz, 1024 × 768/60Hz, HDMI/VGA simultaneous output	HDMI:1-ch, 1920 × 1080p/60Hz, 1280 × 1024/60Hz, 1280 × 720/60Hz, 1024 × 768/60Hz VGA:1-ch, 1920 × 1080p/60Hz, 1280 × 1024/60Hz, 1280 × 720/60Hz, 1024 × 768/60Hz, HDMI/VGA simultaneous output	HDMI:1-ch, 1920 × 1080p/60Hz, 1280 × 1024/60Hz, 1280 × 720/60Hz, 1024 × 768/60Hz VGA:1-ch, 1920 × 1080p/60Hz, 1280 × 1024/60Hz, 1280 × 720/60Hz, 1024 × 768/60Hz, HDMI/VGA simultaneous output	HDMI:1-ch, 1920 × 1080p/60Hz, 1280 × 1024/60Hz, 1280 × 720/60Hz, 1024 × 768/60Hz VGA:1-ch, 1920 × 1080p/60Hz, 1280 × 1024/60Hz, 1280 × 720/60Hz, 1024 × 768/60Hz, HDMI/VGA simultaneous output	HDMI:1-ch, 1920 × 1080p/60Hz, 1280 × 1024/60Hz, 1280 × 720/60Hz, 1024 × 768/60Hz VGA:1-ch, 1920 × 1080p/60Hz, 1280 × 1024/60Hz, 1280 × 720/60Hz, 1024 × 768/60Hz, HDMI/VGA simultaneous output	HDMI:1-ch, 1920 × 1080p/60Hz, 1280 × 1024/60Hz, 1280 × 720/60Hz, 1024 × 768/60Hz VGA:1-ch, 1920 × 1080p/60Hz, 1280 × 1024/60Hz, 1280 × 720/60Hz, 1024 × 768/60Hz, HDMI/VGA simultaneous output	HDMI:1-ch, 1920 × 1080p/60Hz, 1280 × 1024/60Hz, 1280 × 720/60Hz, 1024 × 768/60Hz VGA:1-ch, 1920 × 1080p/60Hz, 1280 × 1024/60Hz, 1280 × 720/60Hz, 1024 × 768/60Hz, HDMI/VGA simultaneous output
Audio Output	-	-	-	-	-	-	-	-
Alarm I/O	-	-	-	-	-	-	-	-
Network Interface	1, RJ-45 10/100Mbps self-adaptive Ethernet interface	1, RJ-45 10/100Mbps self-adaptive Ethernet interface	1, RJ-45 10/100Mbps self-adaptive Ethernet interface	1, RJ-45 10/100Mbps self-adaptive Ethernet interface	1, RJ-45 10/100Mbps self-adaptive Ethernet interface	1, RJ-45 10/100Mbps self-adaptive Ethernet interface	1, RJ-45 10/100Mbps self-adaptive Ethernet interface	1, RJ-45 10/100Mbps self-adaptive Ethernet interface
PoE Port	8P	-	4P	-	8P	-	4P	-
USB Port	2 × USB 2.0	2 × USB 2.0	2 × USB 2.0	2 × USB 2.0	2 × USB 2.0	2 × USB 2.0	2 × USB 2.0	2 × USB 2.0
Smart Function	line crossing and intrusion detection	line crossing and intrusion detection	line crossing and intrusion detection	line crossing and intrusion detection	line crossing and intrusion detection	line crossing and intrusion detection	line crossing and intrusion detection	line crossing and intrusion detection
Power Consumption (without HDD)	≤ 10W(without enabling PoE)	≤ 10W	≤ 10W(without enabling PoE)	≤ 10W	≤ 10W(without enabling PoE)	≤ 10W	≤ 10W(without enabling PoE)	≤ 10W

Model	DS-7108NI-K1/W/MIC	DS-7104NI-K1/W/M(C)
Image		
Channel No.	8-ch	4-ch
Decoding Format	H.264, H.265, H.264+, and H.265+	H.264, H.265, H.264+, and H.265+
Incoming/Outgoing Bandwidth	50/40 Mbps	50/40 Mbps
Decoding Capacity	4-ch@1080p (25 fps), 4-ch@4 MP (12 fps)	4-ch@1080p (25 fps), 4-ch@4 MP (12 fps)
Recording Resolution	4 MP/3 MP/1080p/UXGA /720p/VGA/4CIF/DCIF/ 2CIF/CIF/QCIF	4 MP/3 MP/1080p/UXGA /720p/VGA/4CIF/DCIF/ 2CIF/CIF/QCIF
Display	1 HDMI/1 VGA	1 HDMI/1 VGA
Video Output	HDMI:1-ch, 1920 × 1080p/60Hz, 1280 × 1024/60Hz, 1280 × 720/60Hz, 1024 × 768/60Hz VGA:1-ch, 1920 × 1080p/60Hz, 1280 × 1024/60Hz, 1280 × 720/60Hz, 1024 × 768/60Hz, HDMI/VGA simultaneous output	HDMI:1-ch, 1920 × 1080p/60Hz, 1280 × 1024/60Hz, 1280 × 720/60Hz, 1024 × 768/60Hz VGA:1-ch, 1920 × 1080p/60Hz, 1280 × 1024/60Hz, 1280 × 720/60Hz, 1024 × 768/60Hz, HDMI/VGA simultaneous output
Storage Capacity	Up to 6 TB capacity for each disk	Up to 6 TB capacity for each disk
Frequency band	2.4 GHz	2.4 GHz
Antenna structure	2 × 2MIMO	2 × 2MIMO
Transmission speed	144 Mbps	144 Mbps
Transmission standard	IEEE 802.11b/g/n	IEEE 802.11b/g/n
Audio Output	1-ch, RCA (linear, 1 KΩ)	1-ch, RCA (linear, 1 KΩ)
Alarm I/O	-	-
Network Interface	1, RJ45 10/100M Ethernet interface	1, RJ45 10/100M Ethernet interface
PoE Port	-	-
USB Port	Rear panel: 2 × USB 2.0	Rear panel: 2 × USB 2.0
Smart Function	Supports line crossing and intrusion VCA (Video Content Analytics) events for IP cameras	Supports line crossing and intrusion VCA (Video Content Analytics) events for IP cameras
Power Consumption (without HDD)	≤ 10 W	≤ 10 W

Kits

178 Wi-Fi Kits

179 PoE Kits



Kits



Wi-Fi Kits:

- A kit includes four Wi-Fi cameras, one Wi-Fi NVR, and all accessories to minimize time and costs
- Auto-connect function for quick connection
- Stable Wi-Fi signal provides up to 120 meters of Wi-Fi coverage (in open places)



PoE Kits:

- A kit includes four PoE cameras, one PoE NVR, and all accessories to save time and cost
- PoE function to save wiring installation time
- Plug and play function for quick configuration



Model	NK842W0H-1T(E)	NK844W0H-1T(E)	NK844W1H-1T(E)
Image			
Camera Case Type	Bullet	Bullet	Dome
Min. Illumination	Color: 0.005 Lux @ (F1.6, AGC ON), B/W: 0 Lux with IR	Color: 0.005 Lux @ (F1.6, AGC ON), B/W: 0 Lux with IR	Color: 0.005 Lux @ (F1.6, AGC ON), B/W: 0 Lux with IR
Protection Level	IP66	IP66	IP66
Material	Base: Metal, front cover: Metal, back cover: Plastic	Base: Metal, front cover: Metal, back cover: Plastic	Base: Metal, front cover: Polycarbonate, back cover: Polycarbonate
Focal Length	2.8 mm	2.8 mm	2.8 mm
IR Range	Up to 30 m	Up to 30 m	Up to 30 m
Video Compression	Main stream: H.265/H.264, Sub-stream: H.265/H.264	Main stream: H.265/H.264, Sub-stream: H.265/H.264	Main stream: H.265/H.264, Sub-stream: H.265/H.264
Max. Resolution	1920 × 1080	2560 × 1440	2560 × 1440
On-board Storage	-	-	-
Audio I/O	1 Built-in mic, mono sound	1 Built-in mic, mono sound	1 Built-in mic, mono sound
Power Supply	12 VDC ± 25%, 0.5 A, Ø 5.5 mm coaxial plug power	12 VDC ± 25%, 0.5 A, Ø 5.5 mm coaxial plug power	12 VDC ± 25%, 0.5 A, Ø 5.5 mm coaxial plug power
IP Video Input	8-ch	8-ch	8-ch
Incoming/Outgoing Bandwidth	50 Mbps/40 Mbps	50 Mbps/40 Mbps	50 Mbps/40 Mbps
HDMI/VGA Output	1-ch HDMI 1024×768/60Hz, 1280×720/60Hz, 1280×1024/60Hz, 1920×1080p/60Hz 1-ch VGA 1024×768/60Hz, 1280×720/60Hz, 1280×1024/60Hz, 1920×1080p/60Hz	1-ch HDMI 1024×768/60Hz, 1280×720/60Hz, 1280×1024/60Hz, 1920×1080p/60Hz 1-ch VGA 1024×768/60Hz, 1280×720/60Hz, 1280×1024/60Hz, 1920×1080p/60Hz	1-ch HDMI 1024×768/60Hz, 1280×720/60Hz, 1280×1024/60Hz, 1920×1080p/60Hz 1-ch VGA 1024×768/60Hz, 1280×720/60Hz, 1280×1024/60Hz, 1920×1080p/60Hz
Video Resolution	6MP/5MP/4MP/3MP/1080p/UXGA/720p/VGA/4CIF/DCIF/2CIF/CIF/QCIF	6MP/5MP/4MP/3MP/1080p/UXGA/720p/VGA/4CIF/DCIF/2CIF/CIF/QCIF	6MP/5MP/4MP/3MP/1080p/UXGA/720p/VGA/4CIF/DCIF/2CIF/CIF/QCIF
Capability	4-ch@4 MP [12 fps],4-ch@1080p [25 fps]	4-ch@4 MP [12 fps],4-ch@1080p [25 fps]	4-ch@4 MP [12 fps],4-ch@1080p [25 fps]
PoE Interfaces Power	-	-	-
SATA	1	1	1
Power Supply	12 VDC	12 VDC	12 VDC
Dimension (W × D × H)	260 mm × 246 mm × 48 mm [10.2" × 9.7" × 1.9"]	260 mm × 246 mm × 48 mm [10.2" × 9.7" × 1.9"]	260 mm × 246 mm × 48 mm [10.2" × 9.7" × 1.9"]
Accessories	Power cable: 4 × IPC power cables, 1 × NVR power cable Ethernet cable: RJ45, Cat5e UTP, 1 m. Connects NVR and Switch HDMI cable: 1 × HDMI cable, 2 m, black	Power cable: 4 × IPC power cables, 1 × NVR power cable Ethernet cable: RJ45, Cat5e UTP, 1 m. Connects NVR and Switch HDMI cable: 1 × HDMI cable, 2 m, black	Power cable: 4 × IPC power cables, 1 × NVR power cable Ethernet cable: RJ45, Cat5e UTP, 1 m. Connects NVR and Switch HDMI cable: 1 × HDMI cable, 2 m, black
Hard Drive	-1T:Pre-installed 1 TB HDD	-1T:Pre-installed 1 TB HDD	-1T:Pre-installed 1 TB HDD

Model	NK42E0H-1T(WD)	NK42E0H	NK42E1H-1T(WD)	NK42E1H
Image				
Camera Case Type	Bullet	Bullet	Dome	Dome
Min. Illumination	Color:0.028 Lux @(F2.0; AGC ON)	Color:0.028 Lux @(F2.0; AGC ON)	Color:0.028 Lux @(F2.0; AGC ON)	Color:0.028 Lux @(F2.0; AGC ON)
Protection Level	IP67	IP67	IP67, IK10	IP67, IK10
Material	Front cover: metal, back cover & bracket: plastic	Front cover: metal, back cover & bracket: plastic	Front cover: plastic, back cover & bracket: metal	Front cover: plastic, back cover & bracket: metal
Focal Length	2.8 mm	2.8 mm	2.8 mm	2.8 mm
IR Range	Up to 30 m	Up to 30 m	Up to 30 m	Up to 30 m
Video Compression	Main stream: H.265+/H.264+/H.265/H.264 Sub-stream: H.265/H.264	Main stream: H.265+/H.264+/H.265/H.264 Sub-stream: H.265/H.264	Main stream: H.265+/H.264+/H.265/H.264 Sub-stream: H.265/H.264	Main stream: H.265+/H.264+/H.265/H.264 Sub-stream: H.265/H.264
Max. Resolution	1920 × 1080	1920 × 1080	1920 × 1080	1920 × 1080
On-board Storage	No	No	No	No
Audio I/O	No	No	No	No
Power Supply	12 VDC ± 25%, Ø 5.5 mm coaxial plug power, or PoE (802.3af, class 3)	12 VDC ± 25%, Ø 5.5 mm coaxial plug power, or PoE (802.3af, class 3)	12 VDC ± 25%, Ø 5.5 mm coaxial plug power, or PoE (802.3af, class 3)	12 VDC ± 25%, Ø 5.5 mm coaxial plug power, or PoE (802.3af, class 3)
IP Video Input	4-ch	4-ch	4-ch	4-ch
Incoming/Outgoing Bandwidth	40 Mbps/60 Mbps	40 Mbps/60 Mbps	40 Mbps/60 Mbps	40 Mbps/60 Mbps
HDMI/VGA Output	1920 × 1080/60Hz, 1280 × 1024/60Hz, 1280 × 720/60Hz, 1024 × 768/60Hz	1920 × 1080/60Hz, 1280 × 1024/60Hz, 1280 × 720/60Hz, 1024 × 768/60Hz	1920 × 1080/60Hz, 1280 × 1024/60Hz, 1280 × 720/60Hz, 1024 × 768/60Hz	1920 × 1080/60Hz, 1280 × 1024/60Hz, 1280 × 720/60Hz, 1024 × 768/60Hz
Video Resolution	6 MP/4 MP/3 MP/1080p/UXGA /720p/VGA/4CIF/DCIF/ 2CIF/ CIF/QCIF	6 MP/4 MP/3 MP/1080p/UXGA /720p/VGA/4CIF/DCIF/ 2CIF/ CIF/QCIF	6 MP/4 MP/3 MP/1080p/UXGA /720p/VGA/4CIF/DCIF/ 2CIF/ CIF/QCIF	6 MP/4 MP/3 MP/1080p/UXGA /720p/VGA/4CIF/DCIF/ 2CIF/ CIF/QCIF
Capability	4ch@1080p / 1-ch@6MP	4ch@1080p / 1-ch@6MP	4ch@1080p / 1-ch@6MP	4ch@1080p / 1-ch@6MP
PoE Interfaces Power	≤ 36 W	≤ 36 W	≤ 36 W	≤ 36 W
SATA	1 SATA interface	1 SATA interface	1 SATA interface	1 SATA interface
Power Supply	48 VDC	48 VDC	48 VDC	48 VDC
Dimension (W × D × H)	265 × 225 × 48 mm (10.4" × 8.9" × 1.9")	265 × 225 × 48 mm (10.4" × 8.9" × 1.9")	265 × 225 × 48 mm (10.4" × 8.9" × 1.9")	265 × 225 × 48 mm (10.4" × 8.9" × 1.9")
Accessories	Power: 5 power cables Network cable: 4 × 18.3 m (60 ft) video and power cable	Power: 5 power cables Network cable: 4 × 18.3 m (60 ft) video and power cable	Power: 5 power cables Network cable: 4 × 18.3 m (60 ft) video and power cable	Power: 5 power cables Network cable: 4 × 18.3 m (60 ft) video and power cable
Hard Drive	-1T:Pre-installed 1 TB HDD	-	-1T:Pre-installed 1 TB HDD	-

Model	NK42E2H-1T(WD)	NK42E2H	NK42E3H-1T(WD)	NK42E3H
Image				
Camera Case Type	Turret	Turret	Bullet & Dome	Bullet & Dome
Min. Illumination	Color:0.028 Lux @(F2.0; AGC ON)	Color:0.028 Lux @(F2.0; AGC ON)	Color:0.028 Lux @(F2.0; AGC ON)	Color:0.028 Lux @(F2.0; AGC ON)
Protection Level	IP67	IP67	Bullet: IP67 Dome: IP67, IK10	Bullet: IP67 Dome: IP67, IK10
Material	Camera body: metal, bottom base : plastic	Camera body: metal, bottom base : plastic	Bullet: Front cover: metal, back cover & bracket: plastic Dome: Front cover: plastic, back cover & bracket: metal	Bullet: Front cover: metal, back cover & bracket: plastic Dome: Front cover: plastic, back cover & bracket: metal
Focal Length	2.8 mm	2.8 mm	2.8 mm	2.8 mm
IR Range	Up to 30 m	Up to 30 m	Up to 30 m	Up to 30 m
Video Compression	Main stream: H.265+/H.264+/H.265/H.264 Sub-stream: H.265/H.264	Main stream: H.265+/H.264+/H.265/H.264 Sub-stream: H.265/H.264	Main stream: H.265+/H.264+/H.265/H.264 Sub-stream: H.265/H.264	Main stream: H.265+/H.264+/H.265/H.264 Sub-stream: H.265/H.264
Max. Resolution	1920 × 1080	1920 × 1080	1920 × 1080	1920 × 1080
On-board Storage	No	No	No	No
Audio I/O	No	No	No	No
Power Supply	12 VDC ± 25%, Ø 5.5 mm coaxial plug power, or PoE (802.3af, class 3)	12 VDC ± 25%, Ø 5.5 mm coaxial plug power, or PoE (802.3af, class 3)	12 VDC ± 25%, Ø 5.5 mm coaxial plug power, or PoE (802.3af, class 3)	12 VDC ± 25%, Ø 5.5 mm coaxial plug power, or PoE (802.3af, class 3)
IP Video Input	4-ch	4-ch	4-ch	4-ch
Incoming/Outgoing Bandwidth	40 Mbps/60 Mbps	40 Mbps/60 Mbps	40 Mbps/60 Mbps	40 Mbps/60 Mbps
HDMI/VGA Output	1920 × 1080/60Hz, 1280 × 1024/60Hz, 1280 × 720/60Hz, 1024 × 768/60Hz	1920 × 1080/60Hz, 1280 × 1024/60Hz, 1280 × 720/60Hz, 1024 × 768/60Hz	1920 × 1080/60Hz, 1280 × 1024/60Hz, 1280 × 720/60Hz, 1024 × 768/60Hz	1920 × 1080/60Hz, 1280 × 1024/60Hz, 1280 × 720/60Hz, 1024 × 768/60Hz
Video Resolution	6 MP/4 MP/3 MP/1080p/UXGA /720p/VGA/4CIF/DCIF/ 2CIF/ CIF/QCIF	6 MP/4 MP/3 MP/1080p/UXGA /720p/VGA/4CIF/DCIF/ 2CIF/ CIF/QCIF	6 MP/4 MP/3 MP/1080p/UXGA /720p/VGA/4CIF/DCIF/ 2CIF/ CIF/QCIF	6 MP/4 MP/3 MP/1080p/UXGA /720p/VGA/4CIF/DCIF/ 2CIF/ CIF/QCIF
Capability	4ch@1080p / 1-ch@6MP	4ch@1080p / 1-ch@6MP	4ch@1080p / 1-ch@6MP	4ch@1080p / 1-ch@6MP
PoE Interfaces Power	≤ 36 W	≤ 36 W	≤ 36 W	≤ 36 W
SATA	1 SATA interface	1 SATA interface	1 SATA interface	1 SATA interface
Power Supply	48 VDC	48 VDC	48 VDC	48 VDC
Dimension (W × D × H)	265 × 225 × 48 mm (10.4" × 8.9" × 1.9")	265 × 225 × 48 mm (10.4" × 8.9" × 1.9")	265 × 225 × 48 mm (10.4" × 8.9" × 1.9")	265 × 225 × 48 mm (10.4" × 8.9" × 1.9")
Accessories	Power: 5 power cables Network cable: 4 × 18.3 m (60 ft) video and power cable	Power: 5 power cables Network cable: 4 × 18.3 m (60 ft) video and power cable	Power: 5 power cables Network cable: 4 × 18.3 m (60 ft) video and power cable	Power: 5 power cables Network cable: 4 × 18.3 m (60 ft) video and power cable
Hard Drive	-1T:Pre-installed 1 TB HDD	-	-1T:Pre-installed 1 TB HDD	-

Thermal Cameras

182 HeatPro Series



Thermal Cameras

HeatPro Series

Professional Protection Made Simple

Hikvision HeatPro Series Cameras feature deep-learning thermal video analytics for all-weather perimeter protection, object temperature measurement and fire detection with real-time alarms. They are affordable and easy to configure, making the cameras ideal for SMB applications in residential, retail, parking, museums, data centers, and other verticals. Working in a different manner, the newly released presence detectors add another option to the product lineup.

- > All-weather deterrence and alerts
- > Simple, three-step deployment for perimeter protection
- > Thermal video analytics with deep-learning human & vehicle classification, reducing maintenance overhead
- > Temperature exception alarms for fire prevention
- > Visual and auditory alarms

HeatPro



Hikvision HeatPro Series Thermal Cameras Professional Protection Made Simple

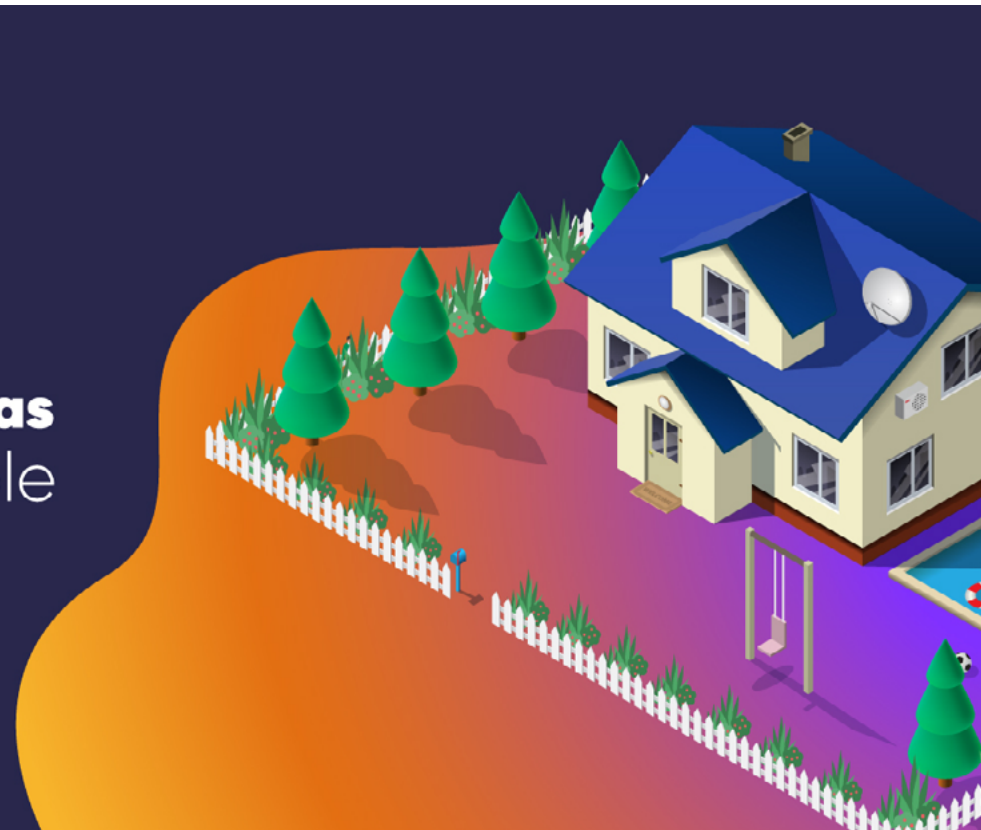

Thermal Cameras



Presence Detectors

Compared with conventional thermal cameras, presence detectors feature a more compact and discreet design. At the same time, thermal imaging protects user privacy by not capturing detailed features that allow personal identification. Furthermore, the ultra-low power consumption makes the detectors even more adaptable to a variety of installation conditions. These presence detectors are used widely in nursing homes, banks, apartments, and many other scenarios.



- › Support fall detection with built-in radar
- › Privacy protection using thermal imaging
- › Out-of-room, out-of-bed, leave-without-return and overstay detection
- › Compact and friendly design, suitable for indoor use
- › Audio anomaly detection







Single Lens

Model	HM-TD1017/QW	HM-TD1018-1/QR NEW
Image	 Thermal Presence Detector	 Thermal Radar Presence Detector
Sensor (Thermal)	Vanadium Oxide Uncooled Focal Plane Arrays	Vanadium Oxide Uncooled Focal Plane Arrays
NETD	< 50 mK (25°C, F1.1)	< 50 mK (25°C, F1.1)
Pixel Pitch (Thermal)	17 μm	12 μm
Resolution (Thermal)	160 × 120	160 × 120
Sensor (Optical)	-	-
Max. Resolution (Optical)	-	-
Min. Illumination (Optical)	-	-
Lens	Thermal:1 or 2mm	Thermal:1.3mm
Field of View (Thermal)	1mm: HS111:100° (H) × 82° (V) HS111(B):110° (H) × 89° (V) 2mm: HS121:90.0° (H) × 65.3° (V)	90.0° (H) × 65.2° (V)
Video Compression	H.265/H.264	H.265/H.264/MJPEG
Frame Rate	25 fps	25 fps
Ingress Protection	-	IP40
Pan/Tilt	-	-
Audio Input	-	Built-In Mic
Audio Output	-	Built-In Speaker
Alarm Input	-	-
Alarm Output	1, alarm output (alarm response actions configurable)	1, alarm output (alarm response actions configurable)
Power	5 to 16 VDC, type-C	DC 12 V (± 20%): 0.5 A, max. 5 W PoE (802.3af): 36 V to 57 V, 0.17 A to 0.11 A, max. 6 W
Environmental Requirement	Temperature: -10°C to 50°C (14°F to 122°F) Humidity: 95% or less	Temperature: -20°C to 50°C (-4°F to 122°F) Humidity: 95% or less
VCA	People number exception, presence detection and health tracking	Fall Detection, Out of Room Detection, Out of Bed Detection, Exit without Return and People Overstay Detection
Fire Detection	-	-
Temperature Mesuring Range	-10°C to 200°C (14°F to 392°F)	-
Temperature Accuracy	± 8°C (± 14.4°F)	-

Thermography

Model	DS-2TD1228T/QA HOT	DS-2TD2628T/QA HOT
Image	 Audible Alarm and Strobe Light	 Audible Alarm and Strobe Light
Sensor (Thermal)	Vanadium Oxide Uncooled Focal Plane Arrays	Vanadium Oxide Uncooled Focal Plane Arrays
NETD	< 40 mK (@ 25°C, F# = 1.0)	< 40 mK (@25° C, F# = 1.0)
Pixel Pitch (Thermal)	12 μm	12 μm
Resolution (Thermal)	256 × 192	256 × 192
Sensor (Optical)	1/2.7" Progressive Scan CMOS	1/2.7" Progressive Scan CMOS
Max. Resolution (Optical)	2688 × 1520	2688 × 1520
Min. Illumination (Optical)	20A: Color: 0.0176Lux @ (F2.25, AGC ON), 0 Lux with IR 30A: Color: 0.0089Lux @ (F1.6, AGC ON), 0 Lux with IR	Color: 0.0089Lux @ (F1.6, AGC ON), 0 Lux with IR
Lens	Thermal: 2 or 3mm Optical: 2 or 4mm	Thermal: 3 or 7mm Optical: 4 or 6 mm
Field of View (Thermal)	2mm:90.0° × 65.4° (H × V) 3mm:50.0° × 37.3° (H × V)	3mm:50.0° × 37.3° (H × V) 7mm:24.9° × 18.7° (H × V)
Video Compression	H.265/H.264/MJPEG	H.265/H.264/MJPEG
Frame Rate	25 fps	25 fps
Ingress Protection	IP66	IP67
Pan/Tilt	-	-
Audio Input	1, 3.5 mm Mic in/Line in interface Line input: 2 to 2.4 V (p-p), output impedance: 1 KΩ ± 10%	1, 3.5 mm Mic in/Line in interface Line input: 2 to 2.4 V (p-p), output impedance: 1 KΩ ± 10%
Audio Output	Linear level, impedance: 600 Ω	Linear level, impedance: 600 Ω
Alarm Input	1, alarm input (0 to 5 VDC)	2, alarm input (0 to 5 VDC)
Alarm Output	1, alarm output (alarm response actions configurable)	2, alarm output (alarm response actions configurable)
Power	12 VDC ± 25% PoE (802.3af)	24 VAC ± 25%, 12 VDC ± 25%, two-core terminal block PoE (802.3af)
Environmental Requirement	Temperature: -40°C to 65°C (-40°F to 149°F) Humidity: 95% or less	Temperature: -40°C to 65°C (-40°F to 149°F) Humidity: 95% or less
VCA	line crossing, intrusion, region entrance, and region exiting	line crossing, intrusion, region entrance, and region exiting
Fire Detection	Dynamic fire detection, up to 10 fire points detectable.	Dynamic fire detection, up to 10 fire points detectable.
Temperature Mesuring Range	-20°C to 550°C (-4°F to 1022°F)	-20°C to 550°C (-4°F to 1022°F)
Temperature Accuracy	Max. (± 2°C, ± 2%)	Max. (± 2°C, ± 2%)

Model	DS-2TD1217/QA	DS-2TD1228/QA	DS-2TD2617/QA	DS-2TD2628/QA	DS-2TD2608-1QA/2QA
Image	 Audible Alarm and Strobe Light	 HOT Audible Alarm and Strobe Light	 Audible Alarm and Strobe Light	 HOT Audible Alarm and Strobe Light	 NEW Audible Alarm and Strobe Light
Sensor (Thermal)	Vanadium Oxide Uncooled Focal Plane Arrays	Vanadium Oxide Uncooled Focal Plane Arrays	Vanadium Oxide Uncooled Focal Plane Arrays	Vanadium Oxide Uncooled Focal Plane Arrays	Vanadium Oxide Uncooled Focal Plane Arrays
NETD	< 40 mK (@25 °C, F# = 1.1)	< 40 mK (@25 °C, F# = 1.1)	< 40 mK (@25 °C, F# = 1.1)	< 40 mK (@25 °C, F# = 1.0)	< 55 mK (@25 °C, F# = 1.0)
Pixel Pitch (Thermal)	17 μm	12 μm	17 μm	12 μm	12 μm
Resolution (Thermal)	160 × 120	256 × 192	160 × 120	256 × 192	96 × 72
Sensor (Optical)	1/2.7" Progressive Scan CMOS	1/2.7" Progressive Scan CMOS	1/2.7" Progressive Scan CMOS	1/2.7" Progressive Scan CMOS	1/1.8" Progressive Scan CMOS
Max. Resolution (Optical)	2688 × 1520	2688 × 1520	2688 × 1520	2688 × 1520	2688 × 1520
Min. Illumination (Optical)	Color: 0.0176 Lux @ (F2.25, AGC ON), B/W: 0.0035 Lux @ (F2.25, AGC ON)	Color: 0.0176 Lux @ (F2.25, AGC ON), B/W: 0.0035 Lux @ (F2.25, AGC ON)	Color: 0.0176 Lux @ (F2.25, AGC ON), B/W: 0.0035 Lux @ (F2.25, AGC ON)	Color: 0.0176 Lux @ (F2.25, AGC ON), B/W: 0.0035 Lux @ (F2.25, AGC ON)	0.0005 Lux @ (F1.0, AGC ON), 0 Lux with Light
Lens	Thermal: 2, 3 or 6 mm Optical: 2, 4 or 6 mm	Thermal: 2, 3 or 7 mm Optical: 2, 4 or 6 mm	Thermal: 3, 6 or 10 mm Optical: 4 or 8 mm	Thermal: 3, 7 or 10 mm Optical: 4, 6 or 8 mm	Thermal: 1 or 2 mm Optical: 4 or 6 mm
Field of View (Thermal)	2 mm: 90° × 66.4° 3 mm: 50° × 37.2° 6 mm: 25.0° × 18.7°	2 mm: 90.0° × 65.4° 3 mm: 50.0° × 37.3° 7 mm: 24.9° × 18.7°	3 mm: 50° × 37.2° 6 mm: 25.0° × 18.7° 10 mm: 15.96° × 12°	3 mm: 50.0° × 37.3° 7 mm: 24.9° × 18.7° 10 mm: 18.0° × 13.5°	1 mm: 50.0° × 37.5° 2 mm: 25.0° × 18.75°
Video Compression	H.265/H.264/MJPEG	H.265/H.264/MJPEG	H.265/H.264/MJPEG	H.265/H.264/MJPEG	H.265/H.264/MJPEG
Frame Rate	25 fps	25 fps	25 fps	25 fps	25 fps
Ingress Protection	IP66	IP66	IP67	IP67	IP67
Pan/Tilt	-	-	-	-	-
Audio Input	1-ch 3.5 mm Mic in/Line in interface. Line input: 2 - 2.4 V [p-p], output impedance: 1 KΩ ± 10%	1-ch 3.5 mm Mic in/Line in interface. Line input: 2 - 2.4 V [p-p], output impedance: 1 KΩ ± 10%	1-ch 3.5 mm Mic in/Line in interface. Line input: 2 - 2.4 V [p-p], output impedance: 1 KΩ ± 10%	1-ch 3.5 mm Mic in/Line in interface. Line input: 2 - 2.4 V [p-p], output impedance: 1 KΩ ± 10%	-
Audio Output	Linear level; impedance: 600 Ω	Linear level; impedance: 600 Ω	Linear level; impedance: 600 Ω	Linear level; impedance: 600 Ω	-
Alarm Input	1-ch inputs (0-5 VDC)	1-ch inputs (0-5 VDC)	2-ch inputs (0-5 VDC)	2-ch inputs (0-5 VDC)	2-ch inputs (0-5 VDC)
Alarm Output	1-ch relay outputs, alarm response actions configurable	1-ch relay outputs, alarm response actions configurable	2-ch relay outputs, alarm response actions configurable	2-ch relay outputs, alarm response actions configurable	2, alarm output (alarm response actions configurable)
Power	12 VDC ± 25% PoE (802.3af)	12 VDC ± 25% PoE (802.3af)	12 VDC ± 25% PoE (802.3af)	24 VAC ± 25%, 12 VDC ± 25%, two-core terminal block PoE (802.3af, class 3)	12 VDC ± 25%, ϕ 5.5 mm coaxial power plug PoE (802.3af, class 3)
Environmental Requirement	From -40 °C to 65 °C (-40 °F to 149 °F); Humidity: 95% or less	From -40 °C to 65 °C (-40 °F to 149 °F); Humidity: 95% or less	From -40 °C to 65 °C (-40 °F to 149 °F); Humidity: 95% or less	From -40 °C to 65 °C (-40 °F to 149 °F); Humidity: 95% or less	From -40 °C to 65 °C (-40 °F to 149 °F); Humidity: 95% or less
VCA	Line Crossing, Intrusion, Region Entrance, Region Exiting	Line Crossing, Intrusion, Region Entrance, Region Exiting	Line Crossing, Intrusion, Region Entrance, Region Exiting	Line Crossing, Intrusion, Region Entrance, Region Exiting	Line Crossing, Intrusion, Region Entrance, Region Exiting
Temperature Measuring Range	-20 °C to +150 °C (-4 °F to +302 °F)	-20 °C to +150 °C (-4 °F to +302 °F)	-20 °C to +150 °C (-4 °F to +302 °F)	-20 °C to +150 °C (-4 °F to +302 °F)	-
Temperature Accuracy	± 8 °C (± 14.4 °F)	± 8 °C (± 14.4 °F)	± 8 °C (± 14.4 °F)	± 8 °C (± 14.4 °F)	-

Thermal Cameras

Thermography Cube Cameras

The Thermography Cube Camera is equipped with a 160 x 120 resolution thermal detector, designed for quickly and accurately locating areas with abnormal temperatures. The camera is small in size and easy for installation, with applications in fire prevention of electrical systems, industrial automation, and more.

- > Temperature measurement range: -20°C to 550°C
- > Temperature measurement accuracy: Up to ±2°C, ±2%
- > Audible alarm out

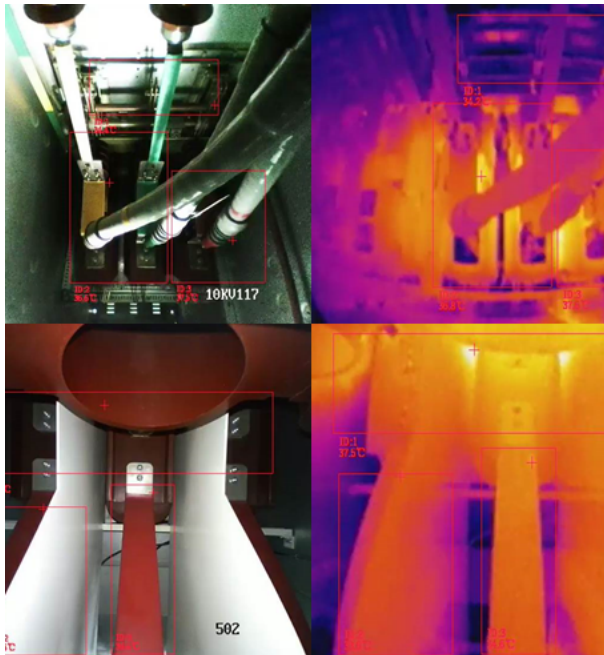

Model	DS-2TD3017T-2V/3V
Image	
Thermal Camera Sensor	Vanadium Oxide Uncooled Focal Plane Arrays
NETD	< 40 mk[(@25 °C,F# = 1.1)]
Pixel Pitch (Thermal)	17 μm
Max. Resolution (Thermal)	160 × 120
Thermal Lens	2 or 3 mm
Optical Camera Sensor	1600 × 1200
Max. Resolution (Optical)	Color: 0.04 Lux @ (2.4 AGC ON)
Min. Illumination	Thermal: 1.8 or 3.1 mm Optical: 1.29 mm
Field of View (Thermal)	2mm: 90° x 66.4° 3mm: 50° x 37.2°
Video Compression	H.265/H.264/MJPEG
Frame Rate	25 fps
Ingress Protection	IP67
Pan/Tilt	-
Audio Input	-
Audio Output	-
Alarm Input	1-ch inputs (0-5 VDC)
Alarm Output	1-ch relay outputs, alarm response actions configurable
Power	10-30 VDC, Max. 5W PoE (802.3af)
Environmental Requirement	From -20 ° C to 50 ° C (-40 ° F to 149 ° F); Humidity: 90% or less
VCA	-
Fire Detection	-
Temperature Mesuring Range	-20° C to 550° C [-4 °F to +1022°F]
Temperature Accuracy	Max (± 2 °C, ± 2%)

Monitors

188 Pro Series

191 Value Series



Monitors





Pro Series



Visual and Audio Clarity

Pro Series monitors deliver 24/7 operation with FHD or UHD images.

- > Full HD 1080p/UHD 4K resolution
- > Wide viewing angle – 178°(H) / 178°(V)
- > 3D comb filter, 3D de-interlace, 3D noise reduction
- > Longer life span for critical performance and minimum TCO
- > Perfect integration and compatibility with DVRs and NVRs
- > Supports multiple inputs: HDMI, DVI, VGA, BNC, USB, audio in, RS232, RJ45, IR
- > Standard VESA bracket
- > On Duty 24/7 for Mission Critical Applications



Model	DS-D5027UC	DS-D5043UC	DS-D5050UC-C	DS-D5055UC-C	DS-D5065UC-C	
Image						
Display	Max Resolution	3840*2160	3840*2160	3840*2160	3840*2160	
	Backlight	LED-Backlit TFT LCD	D-LED Backlight	LED	LED	
	Active Display Area	27"	42.5"	50"	55"	65"
	Brightness	350cd/m ²	400 cd/m ²	300 cd/m ²	350 cd/m ²	350 cd/m ²
	Aspect Ratio	16:9	16:9	16:9	16:9	16:9
	Contrast Ratio	1000:1	1200:1	5000:1	1200:1	1200:1
	Response Time	14ms	8ms	8 ms	8 ms	8 ms
	Color	1.07billion	1.07billion	1.07billion	1.07billion	1.07billion
	Viewing Angle	Horizontal 178°, Vertical 178°	Horizontal 178°, Vertical 178°	Horizontal 178°, Vertical 178°	Horizontal 178°, Vertical 178°	Horizontal 178°, Vertical 178°
Interface	Input	HDMI input 1 DP input 1	RS232 1 HDMI 2.0 2 VGA 1 LAN 1 Audio in 1 USB3.0*1 /USB2.0*1 2	HDMI 1.4 × 1, HDMI2.0 × 1, VGA × 1, Audio in × 1	HDMI 1.4 × 1, HDMI2.0 × 1, VGA × 1, Audio in × 1	HDMI 1.4 × 1, HDMI2.0 × 1, VGA × 1, Audio in × 1
	Output	Audio input 1	Audio out 1	Audio out 1	Audio out 1	Audio out 1
	Speaker	2 × 2W	8W × 2	11W × 2	11W × 2	11W × 2
General	Input Voltages	100-240 VAC,50/60 Hz	AC 100-240V, 50/60 Hz	100-240 VAC, 50/60Hz	100-240 VAC, 50/60Hz	100-240 VAC, 50/60Hz
	Power Consumption	≤56W	≤120W	≤ 135 W	≤ 165 W	≤ 220 W
	Dimensions	614.19mm × 400.4mm × 249.6mm	968.2mm × 559.4mm × 60.9 mm	1116.32 mm × 648 mm × 87.2 mm	1230.08 mm × 713.39 mm × 86.35 mm	1449.56 mm × 838.38 mm × 79.6 mm
	Weight	Gross Weight 6.55 Kg Net Weight 5.07 kg	Gross Weight 11.7kg Net Weight 8.6kg	Gross Weight 13.5 kg Net Weight 10.41 kg	Gross Weight 15.85 kg Net Weight 11.42 kg	Gross Weight 24.4 kg Net Weight 18.6 kg
	VESA Mounting	100mm × 100mm	200mm × 200mm/400mm × 400mm	200 mm × 200 mm	200 mm × 200 mm	200 mm × 200 mm
	Operating Temperature	0-40 °C (0 to 104 ° F)	0°C-40°C(0 to 104 ° F)	0°C to 40 °C (32 °F to 104 ° F)	0°C to 40 °C (32 °F to 104 ° F)	0°C to 40 °C (32 °F to 104 ° F)
	Working Time	7*24h	7*24h	7 × 24 h	7 × 24 h	7 × 24 h
	Wall mounted Bracket (Optional)	DS-DM1940W	DS-DM4255W	DS-DM4255W	DS-DM4255W	DS-DM4255W
	Stand Bracket (Optional)	Included by default	DS-DM4304B	Included by default	Included by default	Included by default

Model		DS-D5032FC-A	DS-D5022FC-C	DS-D5024FC-C
Image				
Display	Max Resolution	1920×1080	1920×1080	1920×1080
	Backlight	LED-Backlit TFT LCD	E-LED	E-LED
	Active Display Area	31.5"	21.5"	23.8"
	Brightness	300cd/m ²	250 cd/m ²	250 cd/m ²
	Aspect Ratio	16:9	16:09	16:09
	Contrast Ratio	1000:1	3000 : 1	4000 : 1
	Response Time	8ms	6.5 ms	6.5 ms
	Color	16.7M	16.7M	16.7M
	Viewing Angle	Horizontal 178°, Vertical 178°	Horizontal 178°, Vertical 178°	Horizontal 178°, Vertical 178°
Interface	Input	DVIx1,HDMIx1, VGA×1, BNCx1, AUDIO (3.5mm mini-jack)×1	HDMI × 1, VGA × 1, Audio In × 1, USB 2.0 × 1, BNC × 1	HDMI × 1, VGA × 1, Audio In × 1, USB 2.0 × 1, BNC × 1
	Output	BNC×1,PC AUDIO×1	-	-
	Speaker	2 W x 2, 6Ω	2*2W	2*2W
General	Input Voltages	100 - 240 V AC, 50/60 Hz	100-240 VAC, 50/60 Hz	100-240 VAC, 50/60 Hz
	Power Consumption	≤ 45 W	< 22W(on) <0.5W(Standby)	< 22W(on) <0.5W(Standby)
	Dimensions	729mm x433mm x50mm	492.356 (W) mm × 289.680 (H) mm × 43.88 (D) mm	539.1 (W) mm × 328.325 (H) mm × 43.78 (D) mm
	Weight	9.25 Kg(Gross weight) , 5.75 Kg(Net weight)	4.0 ± 0.5 Kg(Gross weight) , 2.6 ± 0.5 Kg(Net weight)	5.0 ± 0.5 Kg(Gross weight) , 3.6 ± 0.5 Kg(Net weight)
	VESA Mounting	100 mm × 100 mm	75 mm × 75 mm	75 mm × 75 mm
	Operating Temperature	0°C - 40°C	0°C to 40°C	0°Cto 40°C
	Working Time	7 × 24h	7 × 16 H	7 × 18 H
	Wall mounted Bracket (Optional)	DS-DM1940W	DS-DM1940W	DS-DM1940W
	Stand Bracket	Included by default	Included by default	Included by default

Monitors

Value Series

Accessible and Affordable

Value Series monitors deliver 24/7 operation at an affordable price

- > Wide viewing angle
- > Multiple inputs: HDMI / VGA
- > 3D comb filter, 3D de-interlace, 3D noise reduction
- > Longer life span for critical performance and minimum TCO
- > Perfect integration and compatibility with DVRs and NVRs
- > Standard VESA bracket
- > On duty 24/7 for mission-critical applications





QE Series

Model	DS-D5019QE-B	DS-D5032QE	DS-D5043QE	
Image	 HOT			
Display	Max Resolution	1366×768	1920×1080	1920 × 1080
	Backlight	LED-Backlit TFT LCD	LED-Backlit TFT LCD	LED-Backlit TFT LCD
	Active Display Area	18.5"	31.5"	42.5"
	Brightness	200cd/m2 (Typical)	300cd/m2 (Typical)	360 cd/m2(Typical)
	Aspect Ratio	16:9	16:9	16:9
	Contrast Ratio	600:1	1400:1	1200:1
	Response Time	5ms	8ms	8ms
	Color	16.7M	16.7M	16.7M
	Viewing Angle	Horizontal 90°, Vertical 65°	Horizontal 178°, Vertical 178°	Horizontal 178°, Vertical 178°
Interface	Input	HDMIx1, VGA×1	HDMIx1,VGA×1,Audio×1, RJ45(RS232)×1	HDMI x1,VGAx 1,Audio In x1
	Output	-	-	-
	Speaker	-	5W*2	5W*2
General	Input Voltages	AC100 - 240V, 50/60Hz	AC100 - 240V, 50/60Hz	100 to 240 V AC, 50/60Hz
	Power Consumption	≤ 25W	< 55W(on) < 0.5W(Standby)	≤75W 0.5W(Standby)
	Dimensions	446mm × 275mm × 45mm	727mm × 424mm × 64mm	968.18mm × 562.99mm × 76.8mm
	Weight	3.5Kg(Grossweight), 2.8Kg(Net weight)	6.763Kg(Grossweight), 5.09Kg(Net weight)	11.1Kg(Grossweight), 8.2Kg(Net weight)
	VESA Mounting	75mm x 75mm	100mm × 100mm	200mm × 200mm
	Operating Temperature	0°C - 40 °C	0°C - 40 °C	5°C - 40°C
	Working Time	7 × 24h	7 × 24h	7 × 24h
	Wall mounted Bracket (Optional)	DS-DM1940W	DS-DM1940W	DS-DM4255W
	Stand Bracket	Included by default	Included by default	Included by default

FN Series

Model	DS-D5027FN	DS-D5022FN-C	
Image			
Display	Max Resolution	1920 × 1080@60Hz	1920 × 1080@60Hz
	Backlight	TFT-LED Backlight	E-LED
	Active Display Area	598 × 336 mm	478.656 (H) mm × 260.28 (V) mm
	Brightness	300 cd/m ²	250 cd/m ²
	Aspect Ratio	16:9	16:9
	Contrast Ratio	1000: 1	1000:1
	Response Time	6.5ms	6.5ms
	Color	16.7M	16.7M
	Viewing Angle	Horizontal 178°, vertical 178°	Horizontal 178°, vertical 178°
Interface	Input	VGA input 1 HDMI input 1	HDMI 1.4 × 1, VGA × 1, Audio In × 1
	Output	-	-
	Speaker	-	-
General	Input Voltages	100 to 240 VAC, 50/60Hz	100-240 VAC, 50/60 Hz
	Power Consumption	≤ 40W	≤ 22 W
	Dimensions	614×454×226mm	492.356 (W) mm × 289.680 (H) mm × 43.88 (D) mm
	Weight	5.62 kg (Grossweight), 4.06 kg (Net weight)	4.0 ± 0.5 kg (Grossweight), 2.6 ± 0.5 kg (Net weight)
	VESA Mounting	100 × 100 mm	75 mm × 75 mm
	Operating Temperature	0 to 40 °C (32 to 104 ° F)	0°C to 40 °C
	Working Time	7*24h	7 × 16 H
	Wall mounted Bracket (Optional)	DS-DM1940W	-
	Stand Bracket	Included by default	Included by default

Model		DS-D5024FN	DS-D5024FN01	DS-D5027FN01
Image				
Display	Max Resolution	1920 ×1080@60Hz	1920 ×1080@60Hz	1920 ×1080@60Hz
	Backlight	TFT-LED Backlight	LED	LED
	Active Display Area	527 × 296 mm	527.04 mm × 296.46 mm	597.888 mm × 336.312 mm
	Brightness	250 cd/m ²	300 cd/m ²	300 cd/m ²
	Aspect Ratio	16:9	16:9	16:9
	Contrast Ratio	4000: 1	1000:1	1000:1
	Response Time	14ms	5 ms	5 ms
	Color	16.7M	72% NTSC	72% NTSC
	Viewing Angle	Horizontal 178°, vertical 178°	Horizontal 178°, vertical 178°	Horizontal 178°, vertical 178°
Interface	Input	VGA input 1 HDMI input 1	VGA input 1 HDMI input 1	VGA input 1 HDMI input 1
	Output	-	-	-
	Speaker	-	-	-
General	Input Voltages	100 to 240 VAC, 50/60Hz	100 to 240 VAC, 50/60 Hz	100 to 240 VAC, 50/60 Hz
	Power Consumption	≤ 30 W	≤ 30 W	≤ 30 W
	Dimensions	540 (W) mm × 324 (H) mm × 46 (D) mm	540 (W) mm × 324 (H) mm × 46 (D) mm	614 (W) mm × 367 (H) mm × 46 (D) mm
	Weight	4.44 kg (Gross weight) , 3.43 kg (Net weight)	4.44 kg (Gross weight) , 3.43 kg (Net weight)	5.624 kg (Gross weight) , 4.056 kg (Net weight)
	VESA Mounting	100 ×100 mm	100 mm × 100mm	100 mm × 100mm
	Operating Temperature	0 to 40 ° C (32 to 104 ° F)	0 ° C to 40 ° C (32 ° F to 104 ° F)	0 ° C to 40 ° C (32 ° F to 104 ° F)
	Working Time	7*24h	7*24h	7*24h
	Wall mounted Bracket (Optional)	DS-DM1940W	DS-DM1940W	DS-DM1940W
	Stand Bracket	Included by default	Included by default	Included by default

Switches

196 Ultra Series

197 Pro Series

209 Value Series

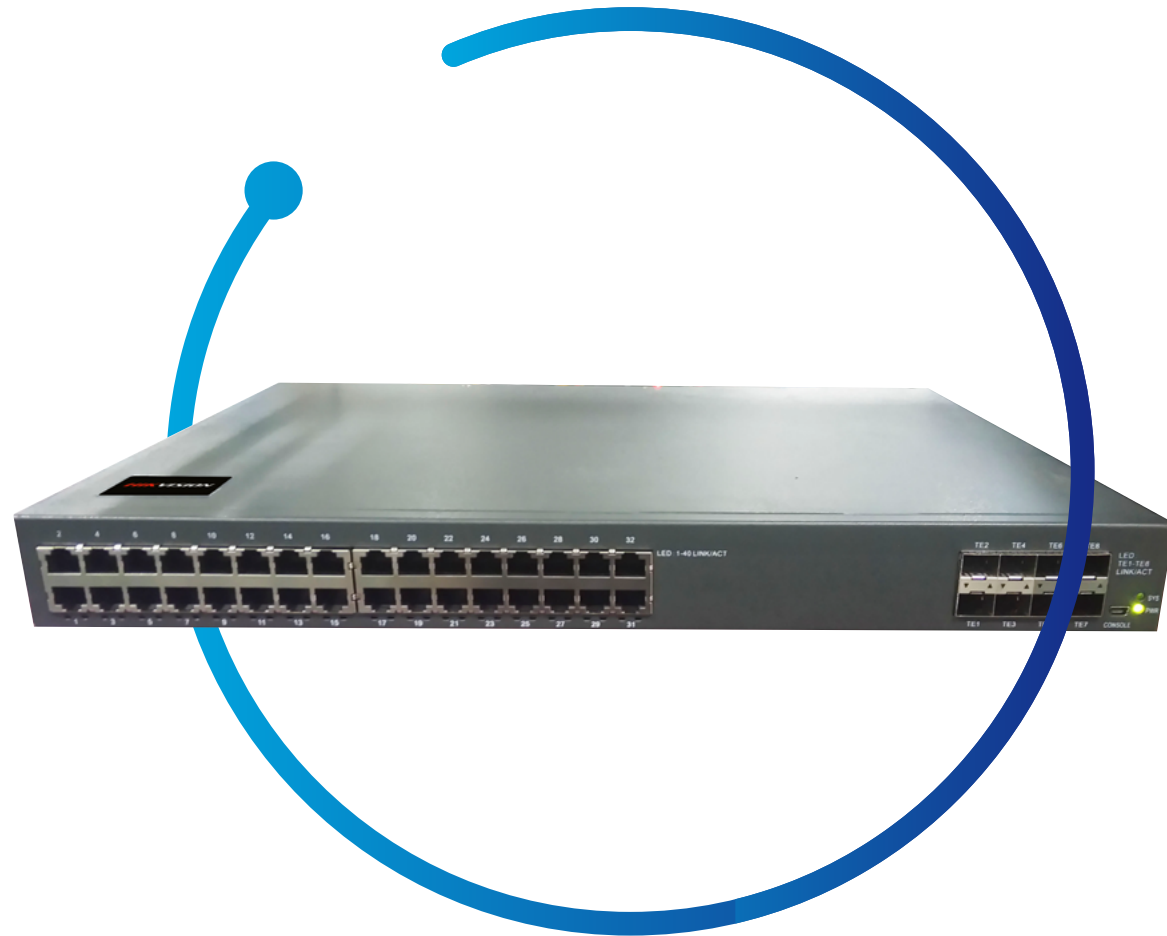

Switches

Hikvision Network Switches

Featuring smart operation, reliable functions and elevated security, Hikvision Network Switches meet your increasing network demands for video security from core to edge, making your network more stable and reliable. When integrated with Hikvision software, our network switches help centralize and visualize the management of nearly all Hikvision IP devices, providing comprehensive operation and maintenance capabilities based on a safe, stable network.



Smart and simple operation

- > Visualized topology management
- > Network health monitoring
- > Real-time alarm notifications
- > Easy video control and preview



Solid and reliable performance

- > 6 KV surge protection
- > PoE watchdog function
- > Long-distance transmission
- > Hi-PoE supply



Secure network at all times

- > Physical authentication
- > One-click port isolation

Switches



Ultra Series

Switch On for Powerful Transmission

- > IP route and full wire-speed L3 data package forwarding
- > IEEE802.1x, IP + MAC + port binding
- > Link aggregation
- > MPLS VPN P/PE, MPLS TE, and MPLS OAM
- > IRF
- > Multicast and QoS



L3 Series

Model		DS-3E3730	DS-3E3754TF
Image		 HOT	 HOT
Interface	Ethernet Port	24 Gigabit electrical ports and 6 10 Gigabit SFP+ optical port	24 Gigabit electrical ports, 24 Gigabit SFP optical ports and 6 10 Gigabit SFP + optical ports
	Uplink Port	6 10 Gigabit SFP+ optical port	6 10 Gigabit SFP + optical ports
Performance	Packet Forwarding Rate	222 Mpps	252 Mpps
	Switching Capacity	598 Gbps	598 Gbps
	MAC Address Table	32 K	32 K
Managed Features	Quality of Service	Support Diff-Serv QoS Support 802.1p/DSCP priority mapping Support Queue scheduling including SP, WRR, WFQ, SP+WRR, SP+WFQ Support Priority marking and remarking Support Traffic shaping Support Congestion avoidance, Tail-Drop and WRED Support 802.1p, TOS, DSCP, and EXP priority mapping Support Port/Flow- based Rate Limiting	Support Diff-Serv QoS Support 802.1p/DSCP priority mapping Support Queue scheduling including SP, WRR, WFQ, SP+WRR, SP+WFQ Support Priority marking and remarking Support Traffic shaping Support Congestion avoidance, Tail-Drop and WRED Support 802.1p, TOS, DSCP, and EXP priority mapping Support Port/Flow- based Rate Limiting
	STP	Support STP/RSTP/MSTP	Support STP/RSTP/MSTP
	Multicast	Support IGMP v1/v2/v3 Snooping Support IGMP V1/V2/V3 Support MLD Snooping v1/v2 Support MLD v1/v2	Support IGMP v1/v2/v3 Snooping Support IGMP V1/V2/V3 Support MLD Snooping v1/v2 Support MLD v1/v2
	VLAN	Support IEEE 802.1Q (VLAN), 4096 VLAN IDs Support GVRP Support QinQ Support VLAN based on MAC/ protocol /IP subnet / policy / port Support Private VLAN Support 1:1 and N:1 VLAN Mapping functions	Support IEEE 802.1Q (VLAN), 4096 VLAN IDs Support GVRP Support QinQ Support VLAN based on MAC/ protocol /IP subnet / policy / port Support Private VLAN Support 1:1 and N:1 VLAN Mapping functions
	Security	Support AAA,TACACS+ Radius Authentication Support 802.1X authentication, MAC authentication, MAC bypass authentication Support to prevent DOS, ARP attack function, ICMP anti attack Support binding of IP, MAC, port and VLAN Support MAC authentication Support MAC address filtering Support Broadcast/Multicast/Unknown-unicast Storm Control	Support AAA,TACACS+ Radius Authentication Support 802.1X authentication, MAC authentication, MAC bypass authentication Support to prevent DOS, ARP attack function, ICMP anti attack Support binding of IP, MAC, port and VLAN Support MAC authentication Support MAC address filtering Support Broadcast/Multicast/Unknown-unicast Storm Control
	Management and Maintenance	Support Console, Telnet, SSH Support web, http,https Support FTP, TFTP, Xmodem, SFTP Support SNMP V1/V2c/V3 Support RMON Support NTP	Support Console, Telnet, SSH Support web, http,https Support FTP, TFTP, Xmodem, SFTP Support SNMP V1/V2c/V3 Support RMON Support NTP
General	Power Supply	AC: 100V-240V, 50/60Hz Hot plug dual power supply optional	AC: 100V-240V, 50/60Hz Hot plug dual power supply optional
	Power Consumption	75 W	75 W
	Dimension	440 mm × 44 mm × 280 mm	440 mm × 44 mm × 350 mm

Switches

Pro Series

Switch More

Aggregate access switches and provide powerful management functions.





- > Layer 2, 100 M / 1,000 M network switch
- > Unmanaged or managed functions
- > 802.3af / at / bt PoE standard (on select models) and high PoE power budget
- > 8/4-core adaptable power supply to drastically reduce power loss (on select models)
- > Data from key cameras will be transmitted with priority to VIP ports (on select models)
- > Extend mode increases transmission distances to 300 m (on select models)
- > 6 KV surge protection ensures normal and reliable operation even in harsh conditions (on select models)
- > “Watchdog” function enables automatic camera detection, reducing manual inspection and restart and contributing to a self-healing network (on select models)
- > Smart managed switches can recognize IP devices and generate system topology for network information visualization





Unmanaged 1000M Series

Model		DS-3E0524TF	DS-3E0505-E	DS-3E0508-E(B)	DS-3E0516-E(B)	DS-3E0524-E(B)
Image						
Interface	Ethernet Port	12 x Gigabit Ethernet electrical ports , 12 x Gigabit SFP fiber optical port	5 x 1000M Ethernet port	8 x 1000M Ethernet port	16 x 1000M Ethernet port	24 x 1000M Ethernet port
	Uplink Port	-	-	-	-	-
	Lightning Protection	-	-	-	-	-
Performance	Packet Forwarding Rate	35.7 Mpps	7.44 Mpps	11.904 Mpps	23.808 Mpps	35.712 Mpps
	Switching Capacity	48 Gbps	10 Gbps	16 Gbps	32 Gbps	48 Gbps
	MAC Address Table	16 K	2 K	4 K	8 K	8 K
	Power Supply	220 VAC	5 VDC , 1 A	5 VDC , 1 A	220 VAC , 50/60 Hz , Max. 0.3 A	220 VAC , 50/60 Hz , Max. 0.7 A
General	Power Consumption	30 W	-	-	-	-
	Dimension	440 mm×44.5 mm×186.5 mm	103 mm × 25.6 mm × 61.1 mm	145 mm × 25.6 mm × 68.4 mm	257 mm × 44.5 mm ×175.8 mm	335 mm × 44.5 mm ×175.8 mm

Model	DS-3E0505P-E	DS-3E0510P-E	DS-3E0518P-E	DS-3E0526P-E	
Image					
Interface	Ethernet Port	4 × Gigabit PoE ports, and 1 × Gigabit RJ45 port	8 × Gigabit PoE ports, 1 × Gigabit RJ45 port	16 × Gigabit PoE ports, 1 × Gigabit RJ45 port	24 × Gigabit PoE ports, 1 × Gigabit RJ45 port
	Uplink Port	1 × Gigabit RJ45 port	1 × Gigabit RJ45 port and 1 × Gigabit SFP fiber optical port	1 × Gigabit RJ45 port and 1 × Gigabit SFP fiber optical port	1 × Gigabit RJ45 port and 1 × Gigabit SFP fiber optical port
	High Priority Port (default)	-	-	-	-
	PoE Standards	IEEE 802.3af, IEEE 802.3at	IEEE 802.3af, IEEE 802.3at	IEEE 802.3af, IEEE 802.3at	IEEE 802.3af, IEEE 802.3at
	PoE Ports	Ports 1 to 4	Ports 1 to 8	Ports 1 to 16	Ports 1 to 24
	PoE Budget	60 W	110 W	230 W	370 W
	PoE Extend Mode	-	-	-	-
	Surge Protection	6 KV	6 KV	6 KV	6 KV
	Hi-PoE	-	-	-	-
Dialing function	Long range	-	-	-	-
	Port isolation	-	-	-	-
	PoE watchdog	-	-	-	-
Performance	Packet Forwarding Rate	7.44 Mpps	14.88 Mpps	26.784 Mpps	38.688 Mpps
	Switching Capacity	10 Gbps	20 Gbps	36 Gbps	52 Gbps
	MAC Address Table	2 K	4 K	8 K	8 K
General	Power Supply	48 VDC, 1.35 A	48 VDC, 2.5 A	100 to 240 VAC, 50/60 Hz, Max. 4 A	100 to 240 VAC, 50/60 Hz, Max. 6.5 A
	Power Consumption	65 W	120W	250 W	400 W
	Dimension	105 mm × 27.6 mm × 83.1 mm	217.6 mm × 27.8 mm × 108.55 mm	440 mm × 44 mm × 220.8 mm	440 mm × 44 mm × 220.8 mm



Model		DS-3E0505HP-E	DS-3E0510HP-E	DS-3E0520HP-E	DS-3E0528HP-E	DS-3E0508P-0 NEW
Image						
Interface	Ethernet Port	3 × gigabit PoE ports, 1 × gigabit Hi-PoE port	6 × gigabit PoE ports, 2 × gigabit Hi-PoE ports	12 × gigabit PoE ports, 4 × gigabit Hi-PoE ports,	20 × gigabit PoE ports, 4 × gigabit Hi-PoE ports	4 × 1 Gigabit PoE port, 4 × 1 Gigabit RJ45 port
	Uplink Port	1 × gigabit RJ45 port	1 × gigabit RJ45 port, and 1 × gigabit fiber optical port	2 × gigabit RJ45 ports, and 2 × gigabit fiber optical ports	2 × gigabit RJ45 ports, and 2 × gigabit fiber optical ports	-
	High Priority Port (default)	-	-	-	-	-
	PoE Standards	Port 1: IEEE 802.3af, IEEE 802.3at, IEEE 802.3bt Ports 2 to 4: IEEE 802.3af, IEEE 802.3at	Ports 1 and 2: IEEE 802.3af, IEEE 802.3at, IEEE 802.3bt Ports 3 to 8: IEEE 802.3af, IEEE 802.3at	Ports 1 to 4: IEEE 802.3af, IEEE 802.3at, IEEE 802.3bt Ports 5 to 16: IEEE 802.3af, IEEE 802.3at	Ports 1 to 4: IEEE 802.3af, IEEE 802.3at, IEEE 802.3bt Ports 5 to 24: IEEE 802.3af, IEEE 802.3at	IEEE 802.3af, IEEE 802.3at
	PoE Ports	Ports 1 to 4	Ports 1 to 8	Ports 1 to 16	Ports 1 to 24	Ports 1 to 4
	PoE Budget	60 W	110 W	225 W	370 W	60W
	PoE Extend Mode	Ports 3 and 4 support	Ports 7 and 8 support	Ports 13 to 16 support	Ports 21 to 24 support	-
	Surge Protection	6 KV	6 KV	6 KV	6 KV	6 KV
	Hi-PoE	IEEE 802.3bt 60W	IEEE 802.3bt 90W	IEEE 802.3bt 90W	IEEE 802.3bt 90W	-
Dialing function	Long range	Ports 3 and 4: up to 300 m; and the speed rate of the port is 10 Mbps.	Ports 7 and 8: up to 300 m; and the speed rate of the port is 10 Mbps.	Ports 13 to 16: up to 300 m; and the speed rate of the port is 10 Mbps	Ports 21 to 24: up to 300 m; and the speed rate of the port is 10 Mbps	-
	Port isolation	Ports 1 to 4: port isolation mode to improve network security.	Ports 1 to 8: port isolation mode to improve network security.	Ports 1 to 16: port isolation mode to improve network security.	Ports 1 to 24: port isolation mode to improve network security.	-
	PoE watchdog	Ports 1 to 4: auto detect and restart the cameras that do not respond.	Ports 1 to 8: auto detect and restart the cameras that do not respond.	Ports 1 to 16: auto detect and restart the cameras that do not respond.	Ports 1 to 24: auto detect and restart the cameras that do not respond.	-
Performance	Packet Forwarding Rate	7.44 Mpps	14.88 Mpps	29.76 Mpps	41.664 Mpps	11.904 Mpps
	Switching Capacity	10 Gbps	20 Gbps	40 Gbps	56 Gbps	16 Gbps
	MAC Address Table	2 K	4 K	8 K	8 K	4 K
General	Power Supply	48 VDC, 1.35 A	54 VDC, 2.22 A	100 to 240 VAC, 50/60Hz, Max. 4 A	100 to 240 VAC, 50/60Hz, Max. 6.5 A	48 VDC, 1.35 A
	Power Consumption	65 W	120 W	250 W	400 W	65W
	Dimension	121 mm × 88.1 mm × 27.6 mm	217.6 mm × 108.55 mm × 27.8 mm	440 mm × 220.8 mm × 44 mm	440 mm × 220.8 mm × 44 mm	170.0 mm × 27.6 mm × 93.1 mm



Model		DS-3E2510P(B)	DS-3E2528P(B)	DS-3E2528(B)
Image				
Interface	Ethernet Port	8 Gigabit Poe electrical ports	24 Gigabit Poe electrical ports	24 Gigabit electrical ports
	Uplink Port	2 Gigabit SFP optical ports	4 Gigabit combo ports	4 Gigabit SFP optical ports
	High Priority Port (default)	-	-	-
	POE Standards	IEEE 802.3af, IEEE802.3at	IEEE 802.3af, IEEE802.3at	-
	PoE Ports	Ports 1 to 8	Ports 1 to 24	-
	PoE Budget	130 W	370 W	-
	PoE Extend Mode	-	-	-
Performance	Lightning Protection	4KV	4KV	4KV
	Packet Forwarding Rate	28 Mpps	51 Mpps	51 Mpps
	Switching Capacity	336 Gbps	336 Gbps	336 Gbps
	MAC Address Table	8 K	8 K	8 K
Managed Features	Quality of Service	Support Diff-Serv QoS Support 802.1p/DSCP priority mapping Support Queue scheduling including SP, WRR, WFQ, SP+WRR, SP+WFQ Support Priority marking and remarking Support Traffic shaping Support Congestion avoidance, Tail-Drop and WRED Support 802.1p, TOS, DSCP, and EXP priority mapping Support Port/Flow- based Rate Limiting	Support Diff-Serv QoS Support 802.1p/DSCP priority mapping Support Queue scheduling including SP, WRR, WFQ, SP+WRR, SP+WFQ Support Priority marking and remarking Support Traffic shaping Support Congestion avoidance, Tail-Drop and WRED Support 802.1p, TOS, DSCP, and EXP priority mapping Support Port/Flow- based Rate Limiting	Support Diff-Serv QoS Support 802.1p/DSCP priority mapping Support Queue scheduling including SP, WRR, WFQ, SP+WRR, SP+WFQ Support Priority marking and remarking Support Traffic shaping Support Congestion avoidance, Tail-Drop and WRED Support 802.1p, TOS, DSCP, and EXP priority mapping Support Port/Flow- based Rate Limiting
	L2 and L2+ Features	Support STP/RSTP/MSTP Support EAPS/MEAPS Support MRD-Ring Support ERPS Support VRRP Support BFD for OSPF Support BFD for OSPF	Support STP/RSTP/MSTP Support EAPS/MEAPS Support MRD-Ring Support ERPS Support VRRP Support BFD for OSPF Support BFD for OSPF	Support STP/RSTP/MSTP Support EAPS/MEAPS Support MRD-Ring Support ERPS Support VRRP Support BFD for OSPF Support BFD for OSPF
	VLAN	Support IEEE 802.1Q (VLAN), 4096 VLAN IDs Support GVRP Support QinQ Support VLAN based on MAC/ protocol /IP subnet / policy / port Support Private VLAN Support 1:1 and N:1 VLAN Mapping functions	Support IEEE 802.1Q (VLAN), 4096 VLAN IDs Support GVRP Support QinQ Support VLAN based on MAC/ protocol /IP subnet / policy / port Support Private VLAN Support 1:1 and N:1 VLAN Mapping functions	Support IEEE 802.1Q (VLAN), 4096 VLAN IDs Support GVRP Support QinQ Support VLAN based on MAC/ protocol /IP subnet / policy / port Support Private VLAN Support 1:1 and N:1 VLAN Mapping functions
General	Security	Support AAA,TACACS+ Radius Authentication Support 802.1X authentication, MAC authentication, MAC bypass authentication Support to prevent DOS, ARP attack function, ICMP anti attack Support binding of IP, MAC, port and VLAN Support MAC authentication Support MAC address filtering Support Broadcast/Multicast/Unknown-unicast Storm Control	Support AAA,TACACS+ Radius Authentication Support 802.1X authentication, MAC authentication, MAC bypass authentication Support to prevent DOS, ARP attack function, ICMP anti attack Support binding of IP, MAC, port and VLAN Support MAC authentication Support MAC address filtering Support Broadcast/Multicast/Unknown-unicast Storm Control	Support AAA,TACACS+ Radius Authentication Support 802.1X authentication, MAC authentication, MAC bypass authentication Support to prevent DOS, ARP attack function, ICMP anti attack Support binding of IP, MAC, port and VLAN Support MAC authentication Support MAC address filtering Support Broadcast/Multicast/Unknown-unicast Storm Control
	Management and Maintenance	Support Console, Telnet, SSH Support web, http,https Support FTP, TFTP, Xmodem, SFTP Support SNMP V1/V2c/V3 Support RMON Support NTP	Support Console, Telnet, SSH Support web, http,https Support FTP, TFTP, Xmodem, SFTP Support SNMP V1/V2c/V3 Support RMON Support NTP	Support Console, Telnet, SSH Support web, http,https Support FTP, TFTP, Xmodem, SFTP Support SNMP V1/V2c/V3 Support RMON Support NTP
General	Power Supply	AC: 100V-240V, 50/60Hz	AC: 100V-240V, 50/60Hz	AC: 100V-240V, 50/60Hz
	Power Consumption	140 W	387 W	20 W
	Dimension	280 mm × 44 mm × 180 mm	440 mm × 44 mm × 210 mm	440 mm × 44 mm × 210 mm





Unmanaged POE Series

Model		DS-3E0106HP-E	DS-3E0310HP-E	DS-3E0109P-E(C)
Image				
Interface	Ethernet Port	1 × 10/100 Mbps Hi-PoE port, 3 × 10/100 Mbps PoE ports, and 2 × 10/100 Mbps RJ45 ports	1 × 10/100 Mbps Hi-PoE port, 7 × 10/100 Mbps PoE ports, and 2 × 10/100/1000 Mbps RJ45 ports	8 × 100 Mbps PoE ports, 1 × 100 Mbps Ethernet port
	Uplink Port	2 × 10/100 Mbps RJ45 uplink ports	2 × 10/100/1000 Mbps RJ45 uplink ports	1 × 100 Mbps RJ45 uplink ports
	High Priority Port (default)	Ports 1 to 2	-	Ports 1 to 2
	PoE Standards	Port 1: IEEE 802.3af, IEEE 802.3at, IEEE 802.3bt Ports 2 to 4: IEEE 802.3af, IEEE 802.3at	Port 1: IEEE 802.3af, IEEE 802.3at, IEEE 802.3bt Ports 2 to 8: IEEE 802.3af, IEEE 802.3at	IEEE 802.3af, IEEE 802.3at
	PoE Ports	Port 1 to 4	Port 1 to 8	Port 1 to 8
	PoE Budget	60 W	110 W	115 W
	Hi-PoE	IEEE 802.3bt 60W	IEEE 802.3bt 60W	-
	PoE Extend Mode	Max. 250 m	Max. 250 m	Max. 250 m
	Surge Protection	6 KV	6 KV	6 KV
Dialing function	Long range	Support up to 250 m transmission	Support up to 250 m transmission	Support up to 250 m transmission
	Port isolation	-	-	-
	PoE watchdog	-	-	-
Performance	Packet Forwarding Rate	0.893 Mpps	4.166 Mpps	1.339 Mpps
	Switching Capacity	1.2 Gbps	5.6 Gbps	1.8 Gbps
	MAC Address Table	2 K	16 K	2 K
General	Power Supply	48 VDC, 1.35 A	48 VDC, 2.5 A	48 VDC, 2.5 A
	Power Consumption	65 W	120 W	120 W
	Dimension	145 mm × 25.6 mm × 68.45 mm	217.6 mm × 27.8 mm × 103.35 mm	170 mm × 27.6 mm × 93.1 mm

Model		DS-3E0105P-E(B)	DS-3E0318P-E(C)	DS-3E0326P-E(C)
Image				
Interface	Ethernet Port	4 × 10/100 Mbps PoE ports, and 1 × 10/100 Mbps RJ45 port	16 × 10/100 Mbps PoE ports, 2 × Gigabit combs	24 × 10/100 Mbps PoE ports, 2 × Gigabit combs
	Uplink Port	1 × 10/100 Mbps RJ45 port	2 × Gigabit combs	2 × Gigabit combs
	High Priority Port (default)	Ports 1 to 2	Ports 1 to 8	Ports 1 to 8
	PoE Standards	IEEE 802.3af, IEEE 802.3at	IEEE 802.3af, IEEE 802.3at	IEEE 802.3af, IEEE 802.3at
	PoE Ports	Ports 1 to 4	Ports 1 to 16	Ports 1 to 24
	PoE Budget	60 W	225 W	370 W
	Hi-PoE	-	-	-
	PoE Extend Mode	Max. 300 m	Max. 300 m	Max. 300 m
	Surge Protection	6 KV	6 KV	6 KV
Dialing function	Long range	Support up to 300 m transmission	Support up to 300 m transmission	Support up to 300 m transmission
	Port isolation	-	-	-
	PoE watchdog	-	-	-
Performance	Packet Forwarding Rate	0.744 Mpps	5.3568 Mpps	6.5472 Mpps
	Switching Capacity	1 Gbps	7.2 Gbps	8.8 Gbps
	MAC Address Table	1 K	16 K	16 K
General	Power Supply	48 VDC, 1.35 A	100 to 240 VAC, 50/60 Hz, Max. 4 A	100 to 240 VAC, 50/60 Hz, Max 6.5 A
	Power Consumption	35 W	250 W	400 W
	Dimension	105 mm × 27.6 mm × 83.1 mm	440 mm × 220.8 mm × 44 mm	440 mm × 220.8 mm × 44 mm

Model		DS-3T0306HP-E/HS	DS-3T0310HP-E/HS	DS-3T0506HP-E/HS
Image				
Standards		Port 1: IEEE 802.3af, IEEE 802.3at, IEEE 802.3bt Ports 2 to 4: IEEE 802.3af, IEEE 802.3at	Ports 1 and 2: IEEE 802.3af, IEEE 802.3at, IEEE 802.3bt Ports 3 to 8: IEEE 802.3af, IEEE 802.3at	Port 1: IEEE 802.3af, IEEE 802.3at, IEEE 802.3bt Ports 2 to 4: IEEE 802.3af, IEEE 802.3at
Interface	Ethernet Port	3 × 100M PoE ports, 1 × Hi-PoE port	6 × 100M PoE ports, 2 × Hi-PoE port	3 × gigabit PoE ports, 1 × gigabit Hi-PoE port
	Uplink Port	1 × gigabit RJ45 port and 1 × gigabit SFP Fiber Optical Port	1 × gigabit RJ45 port and 1 × gigabit SFP fiber optical port	2 × gigabit SFP fiber optical ports
	High Priority Port (default)	-	-	-
	PoE Budget	60 W	110 W	60 W
	PoE Extend Mode	Max. 300 m	Max. 300 m	Max. 300 m
	PoE Ports	Ports 1 to 4	Ports 1 to 8	Ports 1 to 4
	Hi-PoE	IEEE 802.3bt 60W	IEEE 802.3bt 90W	IEEE 802.3bt 60W
	Surge Protection	6KV	6KV	6KV
Dialing function	Long range	Ports 3 and 4: up to 300 m	Ports 7 and 8: up to 300 m	Ports 3 and 4: up to 300 m
	Port isolation	Ports 1 to 4: port isolation mode to improve network security	Ports 1 to 8: port isolation mode to improve network security	Ports 1 to 4: port isolation mode to improve network security
	PoE watchdog	Ports 1 to 4: auto detect and restart the cameras that do not respond	Ports 1 to 8: auto detect and restart the cameras that do not respond	Ports 1 to 4: auto detect and restart the cameras that do not respond
Performance	Packet Forwarding Rate	3.5712 Mpps	4.1664 Mpps	8.928 Mpps
	Switching Capacity/Backplane	4.8 Gbps	5.6 Gbps	22 Gbps
	MAC Address Table	2 K	2 K	4 K
Managed Features	Quality of Service	-	-	-
	L2 and L2+ Features	-	-	-
	VLAN	-	-	-
	Security	-	-	-
	Management and Maintenance	-	-	-
General	Power Supply	48 to 57 VDC, 1.35 A Max	48 to 57 VDC, 2.5 A Max	48 to 57 VDC, 1.35 A Max
	Power Requirements (max.)	65 W	120 W	65 W
	Dimension	158 mm × 101.2 mm × 31.6 mm	197 mm × 114.2 mm × 42.2 mm	158 mm × 101.2 mm × 31.6 mm
	Environment	Operating temperature / humidity: -30 °C to 65 °C (-22 °F to 149 °F), 5%-95% non-condensing Storage temperature / humidity: -40 °C to 85 °C (-40 °F to 185 °F), 5%-95% non-condensing	Operating temperature / humidity: -30 °C to 65 °C (-22 °F to 149 °F), 5%-95% non-condensing Storage temperature / humidity: -40 °C to 85 °C (-40 °F to 185 °F), 5%-95% non-condensing	Operating temperature / humidity: -30 °C to 65 °C (-22 °F to 149 °F), 5%-95% non-condensing Storage temperature / humidity: -40 °C to 85 °C (-40 °F to 185 °F), 5%-95% non-condensing
	Protection Grade	-	-	-
	EMI	FCC 47 CFR Part 15 Class A EN55022 Class A	FCC 47 CFR Part 15 Class A EN55022 Class A	FCC 47 CFR Part 15 Class A EN55022 Class A
	EMS	IEC (EN) I61000-4-2, Class 4 IEC (EN) I61000-4-4, Class 2 IEC (EN) I61000-4-5, Class 2 IEC (EN) I61000-4-11, Class 4	IEC (EN) I61000-4-2, Class 4 IEC (EN) I61000-4-4, Class 2 IEC (EN) I61000-4-5, Class 2 IEC (EN) I61000-4-11, Class 4	IEC (EN) I61000-4-2, Class 4 IEC (EN) I61000-4-4, Class 2 IEC (EN) I61000-4-5, Class 2 IEC (EN) I61000-4-11, Class 4

Model		DS-3T0510HP-E/HS	DS-3T3512P
Image			
Standards		Ports 1 and 2: IEEE 802.3af, IEEE 802.3at, IEEE 802.3bt; Ports 3 to 8: IEEE 802.3af, IEEE 802.3at	IEEE 802.3af, IEEE 802.3at
Interface	Ethernet Port	6 × gigabit PoE RJ45 ports, 2 × gigabit Hi-PoE RJ45 ports	8 × Gigabit RJ45 ports, 4× gigabit fiber optical port, and 1 × Management Serial CLI Port
	Uplink Port	2 × gigabit SFP fiber optical ports	4× gigabit fiber optical port
	High Priority Port (default)	-	-
	PoE Budget	110 W	240w
	PoE Extend Mode	Max. 300 m	-
	PoE Ports	Ports 1 to 8	Port 1 to 8
	Hi-PoE	IEEE 802.3bt 90W	-
	Surge Protection	6KV	6KV
Dialing function	Long range	Ports 7 and 8: up to 300 m	-
	Port isolation	Ports 1 to 8: port isolation mode to improve network security	-
Performance	PoE watchdog	Ports 1 to 8: auto detect and restart the cameras that do not respond	-
	Packet Forwarding Rate	14.88 Mpps	18 Mpps
	Switching Capacity/Backplane	20 Gbps	52 Gbps
	MAC Address Table	4 K	8 K
Managed Features	Quality of Service	-	Support Diff-Serv QoS; Support 802.1p/DSCP priority mapping Support Queue scheduling including SP, WRR, WFQ, SP+WRR, SP+WFQ Support Priority marking and remarking; Support Traffic shaping Support Congestion avoidance, Tail-Drop and WRED Support 802.1p, TOS, DSCP, and EXP priority mapping Support Port/Flow- based Rate Limiting
	L2 and L2+ Features	-	-
	VLAN	-	Support IEEE 802.1Q (VLAN), Up to 256 VLAN groups, 4096 VLAN IDs Support GVRP; Support QinQ Support VLAN based on MAC/ protocol /IP subnet / policy / port Support Private VLAN; Support 1:1 and N:1 VLAN Mapping functions
	Security	-	Support AAA,TACACS+ Radius Authentication Support 802.1X authentication, MAC authentication, MAC bypass authentication Support to prevent DOS, ARP attack function, ICMP anti attack Support binding of IP, MAC, port and VLAN Support MAC authentication Support MAC address filtering Support Broadcast/Multicast/Unknown-unicast Storm Control
	Management and Maintenance	-	Support CLI, Telnet, Console, mini usb console, SSH Support web, http,https Support FTP, TFTP, Xmodem, SFTP Support SNMP V1/V2c/V3 Support RMON Support NTP
	Power Supply	48 to 57 VDC, 2.5 A Max	48-57VDC, Redundant dual inputs (Power supply unit is not included)
	Power Requirements (max.)	120 W	250 W
General	Dimension	197 mm × 114.2 mm × 42.2 mm	140 mm × 52 mm × 110 mm
	Environment	Operating temperature / humidity: -30 °C to 65 °C (-22 °F to 149 °F), 5%-95% non-condensing Storage temperature / humidity: -40 °C to 85 °C (-40 °F to 185 °F), 5%-95% non-condensing	Operating temperature / humidity:-40°C to 75°C (-40°F to 167°F), 5%-95% non-condensing Storage temperature / humidity: -40 °C to 85 °C (-40 °F to 185 °F), 5%-95% non-condensing
	Protection Grade	-	-
	EMI	FCC 47 CFR Part 15 Class A EN55022 Class A	FCC (ANSI C63.4, 47 CFR PART 15B); CE-EMC/RCM (EN 55032: 2015+A11:2020, EN IEC 61000-3-2: 2019, EN 61000-3-3: 2013+A1:2019, EN 50130-4:2011+A1:2014, EN 55035:2017+A11:2020); IC (ICES-003: Issue 28)
	EMS	IEC (EN)61000-4-2, Class 4 IEC (EN)61000-4-4, Class 2 IEC (EN)61000-4-5, Class 2 IEC (EN)61000-4-11, Class 4	IEC (EN)61000-4-2, Class 4 IEC (EN)61000-4-4, Class 2 IEC (EN)61000-4-5, Class 2 IEC (EN)61000-4-11, Class 4 IEC (EN)61000-4-12, Class 4

Model		DS-3T1306P-SI/HS	DS-3T1310P-SI/HS	DS-3T0506P	DS-3T0510P
Image		 NEW	 NEW		
Standards		IEEE 802.3af, IEEE 802.3at	IEEE 802.3af, IEEE 802.3at	IEEE 802.3af, IEEE 802.3at	IEEE 802.3af, IEEE 802.3at
Interface	Ethernet Port	4 × 10/100 Mbps PoE port,	8 × 10/100 Mbps PoE port	4 Gigabit Poe electrical ports	8 Gigabit Poe electrical ports
	Uplink Port	1 × 1 Gigabit RJ45 port, 1 × 1 Gigabit fiber optical port	1 × 1 Gigabit fiber optical port, 1 × 1 Gigabit RJ45 port	2 Gigabit SFP optical ports	2 Gigabit SFP optical ports
	High Priority Port (default)	-	-	-	-
	PoE Budget	60 W	110 W	120 W	240 W
	PoE Extend Mode	Max. 300 m	Max. 300 m	-	-
	PoE Ports	Ports 1 to 4	Ports 1 to 8	Ports 3 to 6	Ports 3 to 10
	Hi-PoE	-	-	-	-
	Surge Protection	6KV	6KV	6KV	6KV
Dialing function	Long range	Ports 1 to 4: up to 300 m	Ports 1 to 8: up to 300 m	-	-
	Port isolation	Ports 1 to 4: port isolation mode to improve network security	Ports 1 to 8: port isolation mode to improve network security	-	-
	PoE watchdog	Ports 1 to 4 auto detect and restart the cameras that do not respond.	Ports 1 to 8 auto detect and restart the cameras that do not respond	-	-
Performance	Packet Forwarding Rate	3.86 Mpps	4.16 Mpps	-	-
	Switching Capacity/Backplane	2.4 Gbps	5.6 Gbps	20 Gbps	20 Gbps
	MAC Address Table	2 K	16 K	4 K	4 K
Managed Features	Quality of Service	WRR and SP scheduling and port priority	WRR and SP scheduling and port priority	-	-
	L2 and L2+ Features	PoE watchdog, STP/RSTP, VLAN, SNMP, QoS, ERPS, etc.	PoE watchdog, STP/RSTP, VLAN, SNMP, QoS, ERPS, etc.	-	-
	VLAN	4094 VLANs	4094 VLANs	-	-
	Security	-	-	-	-
	Management and Maintenance	Support remote upgrade, default parameter restoration, logs viewing, basic network parameter configuration, import and export configuration, and time synchronization.	Support remote upgrade, default parameter restoration, logs viewing, basic network parameter configuration, import and export configuration, and time synchronization.	-	-
General	Power Supply	Power adapter: 48 VDC (working temperature: 0°C to 45°C); Grounding terminal: 48-57 VDC (working temperature: -30°C to 65°C)	Power adapter: 48 VDC (working temperature: 0°C to 45°C); Grounding terminal: 48-57 VDC (working temperature: -30°C to 65°C)	DC: 48V-57V	DC: 48V-57V
	Power Requirements (max.)	65 W	120 W	120 W	250 W
	Dimension	158.00 mm × 101.20 mm × 31.60 mm	197.00 mm × 114.20 mm × 42.20 mm	52 mm × 140 mm × 110 mm	52 mm × 140 mm × 110 mm
	Environment	Operating temperature / humidity: -30 °C to 65 °C (-22 °F to 149 °F), 5%-95% non-condensing Storage temperature / humidity: -40 °C to 85 °C (-40 °F to 185 °F), 5%-95% non-condensing	Operating temperature / humidity: -30 °C to 65 °C (-22 °F to 149 °F), 5%-95% non-condensing Storage temperature / humidity: -40 °C to 85 °C (-40 °F to 185 °F), 5%-95% non-condensing	Operating temperature / humidity: -40°C to 75°C (-40°F to 167°F), 5%-95% non-condensing Storage temperature / humidity: -40 °C to 85 °C (-40 °F to 185 °F), 5%-95% non-condensing	Operating temperature / humidity: -40°C to 75°C (-40°F to 167°F), 5%-95% non-condensing Storage temperature / humidity: -40 °C to 85 °C (-40 °F to 185 °F), 5%-95% non-condensing
	Protection Grade	IP40	IP40	-	-
	EMI	FCC [47 CFR Part 15, Subpart B]; CE-EMC [EN 55032: 2015, EN IEC 61000-3-2: 2019, EN 61000-3-3: 2013+A1: 2019, EN 50130-4: 2011 +A1: 2014, EN 55035: 2017]; IC [ICES-003: Issue 6]; RCM [AS/NZS CISPR 32: 2015]	FCC [47 CFR Part 15, Subpart B]; CE-EMC [EN 55032: 2015, EN IEC 61000-3-2: 2019, EN 61000-3-3: 2013+A1: 2019, EN 50130-4: 2011 +A1: 2014, EN 55035: 2017]; IC [ICES-003: Issue 6]; RCM [AS/NZS CISPR 32: 2015]	FCC [47 CFR Part 15, Subpart B]; CE-EMC [EN 55032: 2015, EN 61000-3-2: 2014, EN 61000-3-3: 2013, EN 55024: 2010 +A1: 2015]; RCM [AS/NZS CISPR 32: 2015]; IC [ICES-003: Issue 6, 2016]	FCC [47 CFR Part 15, Subpart B]; CE-EMC [EN 55032: 2015, EN 61000-3-2: 2014, EN 61000-3-3: 2013, EN 55024: 2010 +A1: 2015]; RCM [AS/NZS CISPR 32: 2015]; IC [ICES-003: Issue 6, 2016]
	EMS	IEC [EN I61000-4-2, Class 4 IEC [EN I61000-4-4, Class 2 IEC [EN I61000-4-5, Class 2 IEC [EN I61000-4-11, Class 4	IEC [EN I61000-4-2, Class 4 IEC [EN I61000-4-4, Class 2 IEC [EN I61000-4-5, Class 2 IEC [EN I61000-4-11, Class 4	IEC [EN I61000-4-2, Class 4 IEC [EN I61000-4-4, Class 2 IEC [EN I61000-4-5, Class 2 IEC [EN I61000-4-11, Class 4	IEC [EN I61000-4-2, Class 4 IEC [EN I61000-4-4, Class 2 IEC [EN I61000-4-5, Class 2 IEC [EN I61000-4-11, Class 4

Smart Managed Series

Model	DS-3E1105P-EI	DS-3E1309P-EI	DS-3E1318P-EI	DS-3E1326P-EI	DS-3E1310P-SI	DS-3E1318P-SI	DS-3E1326P-SI	
Image								
		-HOT	-HOT	-HOT	-HOT	-HOT	-HOT	
Interface	Ethernet Port	4 × 100Mbps PoE RJ45 ports	8 × 100Mbps PoE RJ45 ports	16 × 100Mbps PoE RJ45 ports	24 × 100Mbps PoE RJ45 ports	8 × 100 Mbps PoE RJ45 port	16 × 100 Mbps PoE RJ45 port	24 × 100 Mbps PoE RJ45 port
	Uplink Port	1 × 100Mbps network RJ45 port	1 × gigabit network RJ45 port	2 × gigabit combos	2 × gigabit combos	2 × gigabit combo	2 × gigabit combo	2 × gigabit combo
	High Priority Port (default)	-	-	Ports 1 to 8	Ports 1 to 8	-	Ports 1 to 8	Ports 1 to 8
	PoE Standards	IEEE 802.3af, IEEE 802.3at	IEEE 802.3af, IEEE 802.3at	IEEE 802.3af, IEEE 802.3at	IEEE 802.3af, IEEE 802.3at	IEEE 802.3af, IEEE 802.3at	IEEE 802.3af, IEEE 802.3at	IEEE 802.3af, IEEE 802.3at
	PoE Ports	Ports 1 to 4	Ports 1 to 8	Ports 1 to 16	Ports 1 to 24	Ports 1 to 8	Ports 1 to 16	Ports 1 to 24
	PoE Budget	60 W	110 W	230 W	370 W	125 W	230 W	370 W
	Hi-PoE	-	-	-	-	-	-	-
	PoE Extend Mode	Max. 250 m	Max. 250 m	Max. 250 m	Max. 250 m	Max. 300 m	Max. 300 m	Max. 300 m
	Surge Protection	6KV	6KV	6KV	6KV	6KV	6KV	6KV
Dialing function	Long range	Ports 1 to 4: up to 250 m transmission	Ports 1 to 8: up to 250 m transmission	Ports 1 to 16: up to 250 m transmission	Ports 1 to 24: up to 250 m transmission	Ports 1 to 8: up to 300 m transmission	Ports 1 to 16: up to 300 m transmission	Ports 1 to 24: up to 300 m transmission
	Port isolation	-	-	-	-	Ports in isolation group cannot communicate with each other	Ports in isolation group cannot communicate with each other	Ports in isolation group cannot communicate with each other
	PoE watchdog	-	-	-	-	Ports 1 to 8 auto detect and restart the cameras that do not respond.	Ports 1 to 16 auto detect and restart the cameras that do not respond.	Ports 1 to 24 auto detect and restart the cameras that do not respond
Performance	Packet Forwarding Rate	0.744 Mpps	2.6784 Mpps	5.3568 Mpps	6.5472 Mpps	4.1664 Mpps	5.3568 Mpps	6.5472 Mpps
	Switching Capacity	1 Gbps	3.6 Gbps	7.2 Gbps	8.8 Gbps	5.6 Gbps	7.2 Gbps	8.8 Gbps
	MAC Address Table	2 K	16 K	4 K	4 K	16 K	16 K	16 K
General	Power Supply	48 VDC, 1.35 A	48 VDC, 2.5 A	100-240 VAC, 50/60Hz, Max. 2.5 A	100-240 VAC, 50/60Hz, Max. 6.5 A	100 VAC-240 VAC, 50/60 Hz, Max. 1.5 A	100 VAC-240 VAC, 50/60 Hz, Max. 2.5 A	100 VAC-240 VAC, 50/60 Hz, Max. 6.5 A
	Power Consumption	65 W	120 W	250 W	400 W	5 W	5 W	5 W
	Dimension	105 mm × 27.6 mm × 83.1 mm	170 mm × 27.6 mm × 93.1 mm	440 mm × 44 mm × 220.8 mm	440 mm × 44 mm × 221 mm	266 mm × 44.5 mm × 220.8 mm	440 mm × 44 mm × 220.8 mm	440 mm × 44 mm × 221 mm

Turbo HD Cameras
PTZ Cameras
Turbo HD Cameras
DVRs/Recorders
Network Cameras
Network PTZ Cameras
Network PTZ Cameras
Panoramic Cameras
NVRs
KITS
Thermal Cameras
Monitors
Switches
Cables
Transmission
Control & Software
Accessories
DOIR
Distance

Model	DS-3E1510P-SI	DS-3E1518P-SI	DS-3E1526P-SI	DS-3E1106HP-EI	DS-3E1508-EI	DS-3E1516-EI	DS-3E1524-EI
Image							
Interface	Ethernet Port	8 × gigabit PoE ports	16 × gigabit PoE ports	24 × gigabit PoE ports	4 × 100Mbps PoE RJ45 ports	8 × 1 Gbps RJ45 port	24 × 1 Gbps RJ45 port
	Uplink Port	2 × gigabit fiber optical ports	2 × gigabit fiber optical ports	2 × gigabit fiber optical ports	2 × 100Mbps network RJ45 port	-	-
	High Priority Port (default)	-	-	-	Ports 1 to 8	-	-
	PoE Standards	IEEE 802.3af, IEEE 802.3at	IEEE 802.3af, IEEE 802.3at	IEEE 802.3af, IEEE 802.3at	IEEE 802.3af, IEEE 802.3at, IEEE 802.3bt	-	-
	PoE Ports	Ports 1 to 8	Ports 1 to 16	Ports 1 to 24	Ports 1 to 4	-	-
	PoE Budget	110W	225W	370W	60 W	-	-
	Hi-PoE	-	-	-	60 W	-	-
	PoE Extend Mode	Max. 300 m	Max. 300 m	Max. 300 m	Max. 300 m	-	-
	Surge Protection	6KV	6KV	6KV	6KV	6KV	6KV
Dialing function	Long range	Ports 1 to 8: up to 300 m transmission	Ports 1 to 16: up to 300 m transmission	Ports 1 to 24: up to 300 m transmission	Ports 1 to 4: up to 300 m transmission	-	-
	Port isolation	Ports in isolation group cannot communicate with each other	Ports in isolation group cannot communicate with each other	Ports in isolation group cannot communicate with each other	-	-	-
	PoE watchdog	Ports 1 to 8 auto detect and restart the cameras that do not respond	Ports 1 to 16 auto detect and restart the cameras that do not respond	Ports 1 to 24 auto detect and restart the cameras that do not respond	-	-	-
Performance	Packet Forwarding Rate	14.88 Mpps	26.784 Mpps	36.688 Mpps	0.8928 Mpps	11.904 Mpps	35.712 Mpps
	Switching Capacity	20 Gbps	36 Gbps	52 Gbps	1.2 Gbps	16 Gbps	48 Gbps
	MAC Address Table	8 K	8 K	8 K	2 K	4 K	16 K
General	Power Supply	48 VDC, 2.5 A	100 to 240 VAC, 50/60 Hz, Max. 4 A	100 to 240 VAC, 50/60 Hz, Max. 6.5 A	48 VDC, 1.35 A	5 VDC, 1 A	220 VAC, 50/60 Hz, Max. 0.3 A
	Power Consumption	7 W	25 W	30 W	65 W	5 W	12 W
	Dimension	217.6 mm × 108.55 mm × 27.8 mm	440 mm × 220.8 mm × 44 mm	440 mm × 221 mm × 44 mm	145 mm × 25.6 mm × 68.45 mm	170.00 mm × 27.60 mm × 93.10 mm	257.00 mm × 44.50 mm × 175.80 mm

Switches

Value Series

Switch On and Stay On

Provide stable power supply and data transmission for cameras.





- > Layer 2, 100 M / 1,000 M network switch
- > Plug and play
- > 802.3 af / at PoE standard (on select models)
- > 8/4-core adaptable power supply drastically reduces power loss (on select models)
- > Extend mode increases transmission distances to 300 m (on select models)
- > Intelligent power sequencing prevents random power loss for cameras and prolongs service life of switches (on select models)
- > Increased bandwidth enables stable transmission of larger amount of data







Economic Unmanaged POE Series

Model	DS-3E0105P-E/M(B)	DS-3E0106P-E/M	DS-3E0109P-E/M(B)	DS-3E0310P-E/M	DS-3E0318P-E/M(B)	DS-3E0326P-E/M(B)	
Image							
Interface	Ethernet Port	4 x 100M PoE ports, 1 x 100M Ethernet port.	4 x 10/100Mbps PoE ports	8 x 100 Mbps PoE ports, 1 x 100 Mbps Ethernet port	8 x 10/100Mbps PoE ports	16 x 100 Mbps PoE ports, 1 x 1000 Mbps RJ45 port	24 x 100 Mbps PoE ports, 1 x 1000 Mbps RJ45 port
	Uplink Port	1 x 100M RJ45 uplink port	2 x 10/100Mbps RJ45 ports	1 x 100M RJ45 uplink port	2 x Gigabit RJ45 ports	1 x 1000M RJ45 uplink port and 1 x 1000 Mbps SFP fiber optical port	1 x 1000M RJ45 uplink port and 1 x 1000 Mbps SFP fiber optical port
	High Priority Port (default)	Port 1 to 2	Port 1 to 2	Port 1 to 2	-	Port 1 to 8	Port 1 to 8
	PoE Standards	IEEE 802.3af, IEEE 802.3at	IEEE 802.3af, IEEE 802.3at	IEEE 802.3af, IEEE 802.3at	IEEE 802.3af, IEEE 802.3at	IEEE 802.3af, IEEE 802.3at	IEEE 802.3af, IEEE 802.3at
	PoE Ports	Ports 1 to 4	Ports 1 to 4	Ports 1 to 8	Ports 1 to 8	Ports 1 to 16	Ports 1 to 24
	PoE Budget	35 W	35W	60 W	60 W	130 W	230 W
	Hi-PoE	-	-	-	-	-	-
	PoE Extend Mode	Max. 300 m	Max. 300 m	Max. 300 m	Max. 300 m	Max. 300 m	Max. 300 m
	Lightning Protection	6 KV	6KV	6 KV	6KV	6 KV	6 KV
Dialing function	Long range	Ports 1 and 4: up to 250 m	Ports 1 and 4: up to 300 m	Ports 1 and 8: up to 250 m	Ports 1 and 8: up to 300 m	Ports 9 and 16: up to 250 m	Ports 17 and 24: up to 250 m
	Port isolation	-	-	-	-	-	-
	PoE watchdog	-	-	-	-	-	-
Performance	Packet Forwarding Rate	0.744 Mpps	0.8928 Mpps	1.339 Mpps	4.1664 Mpps	5.356 Mpps	6.547 Mpps
	Switching Capacity	1 Gbps	1.6 Gbps	1.8 Gbps	5.6 Gbps	7.2 Gbps	8.8 Gbps
	MAC Address Table	1 K	4K	2 K	16 K	4 K	4 K
General	Power Supply	48 VDC, Max. 0.8 A	48V 0.8A	48 VDC, Max. 1.35 A	48 VDC, 1.35 A	100 to 240 VAC, 50/60 Hz, Max. 2.5 A	100 to 240 VAC, 50/60 Hz, Max. 4 A
	Power Consumption	38 W	38W	65 W	65W	150 W	250 W
	Dimension	105 mm x 27.6 mm x 83.1 mm	145 mm x 68.45 mm x 25.6 mm	170 mm x 27.6 mm x 93.1 mm	217.6 mm x 103.35 mm x 27.8 mm	266 mm x 44.5 mm x 220.8 mm	335 mm x 44.5 mm x 226 mm





Economic Smart ManagedPOE Serie

Model	DS-3E1105P-EI/M	DS-3E1309P-EI/M	DS-3E1318P-EI/M	DS-3E1326P-EI/M
Image	 NEW	 NEW	 NEW	 NEW
Interface	Ethernet Port	4 × 10/100 Mbps PoE port	8 × 10/100 Mbps PoE port	16 × 10/100 Mbps PoE port
	Uplink Port	1 × 100M RJ45 uplink port	1 × Gigabit RJ45 uplink port	1 × Gigabit combo, 1 × Gigabit RJ45 port
	High Priority Port (default)	Port 1 to 2	-	Port 1 to 8
	PoE Standards	IEEE 802.3af, IEEE 802.3at	IEEE 802.3af, IEEE 802.3at	IEEE 802.3af, IEEE 802.3at
	PoE Ports	Ports 1 to 4	Ports 1 to 8	Ports 1 to 16
	PoE Budget	45 W	60 W	130 W
	Hi-PoE	-	-	-
	PoE Extend Mode	Max. 300 m	Max. 300 m	Max. 300 m
	Lightning Protection	6 KV	6 KV	6 KV
Dialing function	Long range	Ports 1 and 4: up to 300 m	Ports 1 and 8: up to 300 m	Ports 1 and 16: up to 300 m
	Port isolation	-	-	-
	PoE watchdog	-	-	-
Performance	Packet Forwarding Rate	0.744 Mpps	2.6784 Mpps	5.36 Mpps
	Switching Capacity	1 Gbps	3.6 Gbps	7.2 Gbps
	MAC Address Table	2 K	8 K	16 K
General	Power Supply	48 VDC, Max. 1.04 A	48 VDC, Max. 1.35 A	100 to 240 VAC, 50/60 Hz, Max. 2.5 A
	Power Consumption	50 W	65 W	150 W
	Dimension	105 mm × 27.6 mm × 83.1 mm	170 mm × 27.6 mm × 93.1 mm	335 mm × 44.5 mm × 266 mm

Unmanaged 1000M PoE Series

Model	DS-3E0505P-E	DS-3E0510P-E	DS-3E0518P-E	DS-3E0526P-E	
Image					
Interface	Ethernet Port	4 × Gigabit PoE ports, and 1 × Gigabit RJ45 port	8 × Gigabit PoE ports, 1 × Gigabit RJ45 port	16 × Gigabit PoE ports, 1 × Gigabit RJ45 port	24 × Gigabit PoE ports, 1 × Gigabit RJ45 port
	Uplink Port	1 × Gigabit RJ45 port	1 × Gigabit RJ45 port and 1 × Gigabit SFP fiber optical port	1 × Gigabit RJ45 port and 1 × Gigabit SFP fiber optical port	1 × Gigabit RJ45 port and 1 × Gigabit SFP fiber optical port
	High Priority Port (default)	-	-	-	-
	PoE Standards	IEEE 802.3af, IEEE 802.3at	IEEE 802.3af, IEEE 802.3at	IEEE 802.3af, IEEE 802.3at	IEEE 802.3af, IEEE 802.3at
	PoE Ports	Ports 1 to 4	Ports 1 to 8	Ports 1 to 16	Ports 1 to 24
	PoE Budget	60 W	110 W	230 W	370 W
	Hi-PoE	-	-	-	-
	PoE Extend Mode	6 KV	6 KV	6 KV	6 KV
	Lightning Protection	-	-	-	-
	Dialing function	Long range	-	-	-
Port isolation		-	-	-	
PoE watchdog		-	-	-	
Performance	Packet Forwarding Rate	7.44 Mpps	14.88 Mpps	26.784 Mpps	38.688 Mpps
	Switching Capacity	10 Gbps	20 Gbps	36 Gbps	52 Gbps
	MAC Address Table	2 K	4 K	8 K	8 K
General	Power Supply	48 VDC, 1.35 A	48 VDC, 2.5 A	100 to 240 VAC, 50/60 Hz, Max. 4 A	100 to 240 VAC, 50/60 Hz, Max. 6.5 A
	Power Consumption	65 W	120W	250 W	400 W
	Dimension	105 mm × 27.6 mm × 83.1 mm	217.6 mm × 27.8 mm × 108.55 mm	440 mm × 44 mm × 220.8 mm	440 mm × 44 mm × 220.8 mm

Unmanaged Desktop Series

Model	DS-3E0505D-E	DS-3E0508D-E	DS-3E0105D-E	DS-3E0108D-E	
Image			 NEW	 NEW	
Interface	Ethernet Port	5 × 10/100/1000 Mbps RJ45 ports	5 × 10/100 Mbps RJ45 ports	8 × 10/100 Mbps RJ45 ports	
	Uplink Port	-	-	-	
	Lightning Protection	-	-	-	
Performance	Packet Forwarding Rate	7.44 Mpps	11.904 Mpps	0.744 Mpps	1.1904 Mpps
	Switching Capacity	10 Gbps	16 Gbps	1 Gbps	1.6 Gbps
	MAC Address Table	2 K	4 K	1 K	1 K
General	Power Supply	5 VDC, 0.6 A	9 VDC, 0.6 A	5 V DC, 0.6 A	5 V DC, 0.6 A
	Power Consumption	-	-	-	-
	Dimension	92.8 mm × 65.8 mm × 22.8 mm	142 mm × 90 mm × 23 mm	82 mm × 52mm × 22.4 mm	124 × 59 × 23.2 mm

Cables

214 Coaxial Cables

215 Network Cables



Cables

Coaxial Cables

- > Excellent transmission performance for analog signal
- > Oxygen-free copper conductor
- > High braiding density with aluminum foil
- > VW-1 Rating(Part of UL) flame resistance
- > High anti-interference ability
- > Full diameter and full length

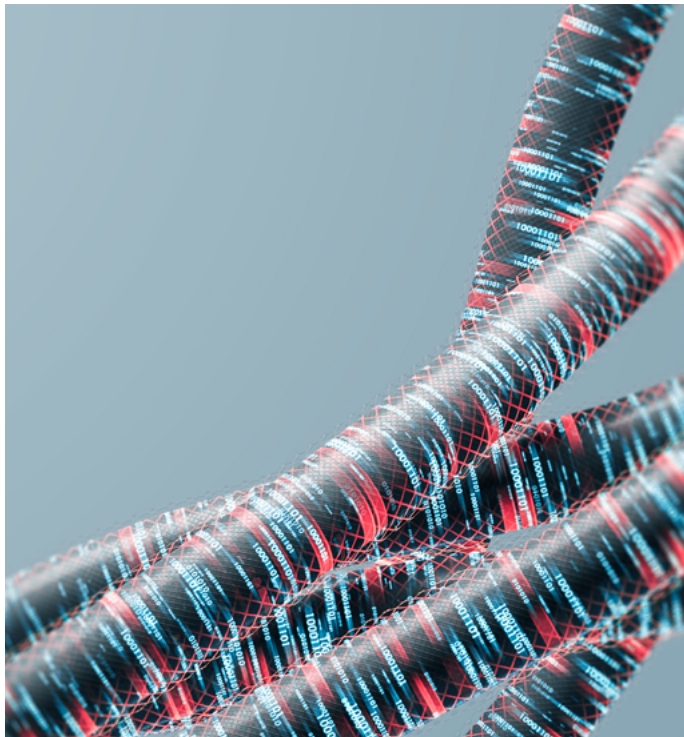

Model		DS-1LC1SCA2C-200B	DS-1LC1SCA-200B
Image			
Conductor	Material	Solid Copper	Solid Copper
	Wire Gauge	20AWG	20AWG
	Diameter	0.81 ± 0.01 mm	0.81 ± 0.01 mm
Insulation	Material	FPE	FPE
	Diameter	3.66 ± 0.05 mm	3.66 ± 0.05 mm
Tape	Material	Shielding Aluminum Foil, 15 mm width	Shielding Aluminum Foil, 15 mm width
	Thickness	0.04 mm	0.04 mm
Braid	Material	CCA(Copper-clad Aluminum)	CCA(Copper-clad Aluminum)
	Braiding Standard	8 × 16 × 0.12 mm	8 × 16 × 0.12 mm
	Braiding Density	95±1%	95±1%
Jacket	Material	PVC	PVC
	Average Thickness	≥ 0.65 mm	≥ 0.65 mm
	Diameter	6.10 ± 0.2 mm	6.10 ± 0.2 mm
Impedance		75 ohms	75 ohms
General			
Length		200 m	200 m
Color		Black	Black
Operating Temperature		-40 to 80°C	-40 to 80°C
Storage Temperature		-20 to 70°C	-20 to 70°C
Power Cable			
Conductor	Material	Solid copper	-
	Quantity	2	-
	Diameter	7 × 0.385 ± 0.01 mm	-
Insulation	Material	PE (Flame Retardant)	-
	Diameter	1.8 ± 0.1 mm	-
Jacket	Material	PVC	-
	Average Thickness	≥ 0.3 mm	-





Cables

Network Cables

- > 99.95% Cu purity ensures higher conductivity with lower signal transmission attenuation
- > 0.565 mm wire diameter provides more stable transmission with reduced resistance
- > Flame-retardant sheathing resists fire, stretching, and aging
- > Precise twisting technology improves transmission fluidity



Model	DS-1LN5E-S	DS-1LN6-UU	
Image			
Test Standard	ISO/IEC11801,TIA-568-C.2, YD/T1019	ISO/IEC11801,TIA-568-C.2, YD/T1019	
Conductor	Material	Solid-Bare Copper	SOLID-Bare Copper
	Nom.O.D.	0.500 ± 0.005 mm	0.565 ± 0.005 mm
Insulation	Material	HDPE	HDPE
	Diameter	0.88 ± 0.03 mm	1.02 ± 0.03 mm
Sheath	Thickness	0.50 ± 0.05 mm	0.55 ± 0.05 mm
	External O.D.	5.0 ± 0.4 mm	6.2 ± 0.4 mm
	Surface	Clean,Frap,Satiation	Clean,Frap,Satiation
	Material	PVC,CM	PVC,CM
Core Color	Color	Multiple	Multiple
		1 White- Blue /Blue 2 White-Orange /Orange 3 White- Green /Green 4 White- Brown /Brown	1 White- Blue /Blue 2 White-Orange /Orange 3 White- Green /Green 4 White- Brown /Brown
Packing	Wooden Tray & Carton	Wooden Tray & Carton	
Carton Dimension	Per request	Per request	
Packing Length	{305 ± 1.5} m	{305 ± 1.5} m	
Rip-cord	Yes	Yes	
Sheath Physical Properties		Before Aging Tensile Strength (Mpa) ≥13.5 Elongation(%) ≥150	Before Aging Tensile Strength (Mpa) ≥13.5 Elongation(%) ≥150
		Aging Period(°C×hrs) 100°C×24h×10d	Aging Period(°C×hrs) 100°C×24h×10d
		After Aging Tensile Strength(Mpa) ≥12.5 Elongation(%) ≥125	After Aging Tensile Strength(Mpa) ≥12.5 Elongation(%) ≥125
		Cold bend(-20±2°C×4h) 8×Cable O.D.,No visible cracks	Cold bend(-20±2°C×4h) 8×Cable O.D.,No visible cracks
Electrical Characteristics		1.0-100.0 MHz Impedance(Ω) 100±15	1.0-250.0MHz Impedance (Ω) 100±15
		1.0-100.0 MHz Delay Shew (ns/100m) ≤45	1.0-250.0 MHz Delay Skew (ns/100m) ≤45
		DC Resistance(Ω/100m) max 9.5	DC Resistance (Ω/100m) max 9.38
		DC Conductor Resistance Unbalance(%) max 5.0	DC Conductor Resistance Unbalance (%) max 5.0
Ambient temperature	-20°C to 75°C	20°C to 75°C	

Model	DS-1LN5E-E/E	DS-1LN6-UE-W	DS-1LN5E0-UU/E	DS-1LN5EU-SCO	DS-1LN6U-SCO	
Image						
Test Standard	ISO/IEC11801, TIA-568-C.2, YD/T1019	ISO/IEC11801, TIA-568-C.2, YD/T1019	ANSI/TIA-568-C.2	ISO/IEC11801, ANSI/TIA-568-C.2, RoHS 2.0	ISO/IEC11801, ANSI/TIA-568-C.2, RoHS 2.0	
Conductor	Material	SOLID-Bare Copper	SOLID-Bare Copper	Solid-Bare Copper	Solid-Bare Copper	
	Nom.O.D.	0.450 ± 0.005 mm	0.530 ± 0.005 mm	0.500 ± 0.01 mm	0.500 ± 0.005 mm	0.55 ± 0.005 mm
Insulation	Material	HDPE	HDPE	HDPE	HDPE	HDPE
	Diameter	0.82 ± 0.03 mm	0.95 ± 0.03 mm	0.88±0.03mm	0.88 ± 0.04 mm	0.98 ± 0.05 mm
Sheath	Thickness	0.50 ± 0.05 mm	0.55 ± 0.05 mm	0.55±0.03 mm	0.50 ± 0.05 mm	0.50 ± 0.10 mm
	External O.D.	4.7 ± 0.4 mm	5.8 ± 0.4 mm	5.0±0.3 mm	5.00 ± 0.4 mm	6.00 ± 0.30 mm
	Surface	Clean,Frap,Satiation	Clean,Frap,Satiation	Clean,Frap,Satiation	Clean,Frap,Satiation	Clean,Frap,Satiation
	Material	PVC,CM	PVC,CM	PE	PVC	PVC
	Color	Grey ZLC1003	White	Black	Gray	Orange
Core Color	1 White- Blue /Blue 2 White-Orange /Orange 3 White- Green /Green 4 White- Brown /Brown	1 White- Blue /Blue 2 White-Orange /Orange 3 White- Green /Green 4 White- Brown /Brown	1 White- Blue /Blue 2 White-Orange /Orange 3 White- Green /Green 4 White- Brown /Brown	1 White- Blue /Blue 2 White-Orange /Orange 3 White- Green /Green 4 White- Brown /Brown	1 White- Blue /Blue 2 White-Orange /Orange 3 White- Green /Green 4 White- Brown /Brown	
Packing	Wooden Tray & Carton	Wooden Tray & Carton	Wooden Tray & Carton	Wooden Tray & Carton	Wooden Tray & Carton	
Carton Dimension	Per request	Per request	Per request	Per request	Per request	
Packing Length	(305 ± 1.5) m	(305 ± 1.5) m	(305±0.5)m	(305 ± 1.5) m	(305 ± 1.5) m	
Rip-cord	Yes	Yes	Yes	Yes	Yes	
Sheath Physical Properties	Before Aging Tensile Strength (Mpa) ≥13.5 Elongation(%) ≥150	Before Aging Tensile Strength (Mpa) ≥13.5 Elongation(%) ≥150	Before Aging Tensile Strength (Mpa) ≥ 10 Elongation(%) ≥300	Before aging Tensile strength (Mpa)≥ 13.5 Elongation (%)≥ 150	Before aging Tensile strength (Mpa)≥ 13.5 Elongation (%)≥ 150	
	Aging Period(°C×hrs) 100°C×24h×10d	Aging Period(°C×hrs) 100°C×24h×10d	Aging Period(°C×hrs) 100°C×24h×10d	Aging Period(°C×hrs) 100°C×24h×10d	Aging Period(°C×hrs) 100°C×24h×10d	
	After Aging Tensile Strength(Mpa) ≥12.5 Elongation(%) ≥125	After Aging Tensile Strength(Mpa) ≥12.5 Elongation(%) ≥125	After Aging Tensile Strength(Mpa) ≥12.5 Elongation(%) ≥125	After aging Tensile Strength(Mpa) ≥12.5 Elongation(%) ≥125	After aging Tensile Strength(Mpa) ≥12.5 Elongation(%) ≥125	
	Cold bend(-20±2°C×4h) 8×Cable O.D., No visible cracks	Cold bend(-20±2°C×4h) 8×Cable O.D., No visible cracks	Cold bend(-20±2°C×4h) 8×Cable O.D., No visible cracks	Cold bend(-20±2°C×4h) 8×Cable O.D., No visible cracks	Cold bend(-20±2°C×4h) 8×Cable O.D., No visible cracks	
Electrical Characteristics	1.0-100.0 MHz Impedance(Ω) 100±15	1.0-250.0 MHz Impedance (Ω) 100±15	1.0-100.0 MHz Impedance(Ω) 100±15	1.0-250.0 MHz Impedance ((Ω) 100±15	1.0-250.0 MHz Impedance ((Ω) 100±15	
	1.0-100.0 MHz Delay Shew (ns/100m) ≤45	1.0-250.0 MHz Delay Skew (ns/100m) ≤45	1.0-100.0MHz Delay Skew (ns/100m) 552	1.0-100.0 MHz Delay Shew (ns/100m) ≤45	1.0-100.0 MHz Delay Shew (ns/100m) ≤45	
	DC Resistance(Ω/100m) max 14.8	DC Resistance (Ω/100m) max 9.38	DC Resistance(Ω/100m) max 9.5	DC Resistance(Ω/100m) max 9.5	DC Resistance(Ω/100m) max 9.38	
	DC Conductor Resistance Unbalance(%) max 5.0	DC Conductor Resistance Unbalance (%) max 5.0	DC Conductor Resistance Unbalance (%) max 2.0	DC Conductor Resistance Unbalance(%) max 5.0	DC Conductor Resistance Unbalance(%) max 5.0	
Ambient temperature	-20°C to 70°C	-20°C to 75°C	-20°C to 60°C	-20°C to 75°C	-20°C to 75°C	

Control & Transmission

218 Keyboards

220 Wireless Bridges







Control & Transmission

Keyboards

Control at Your Fingertips

- › Connection via network, RS485, or USB port
- › PTZ control via joystick
- › Access to Hikvision products, including DVRs, NVRs, IP cameras, Decoders, etc.



Model		DS-1006KI	DS-1005KI	DS-1200KI	DS-1100KI(B)	DS-1600KI(B)
Image						
System	Operating System	-	-	-	-	Android
	Compatible System	-	Window XP/7/8/8.1	-	-	-
	LCD screen	128 x 64 pixel screen	-	128 x 64 pixel screen	7" TFT LCD monitor with touch panel, Resolution: 1024 x 600	1280x800
	Joystick	4-axis joystick	3-axis control, rotating zoom	4-axis joystick	4-axis joystick	4-axis joystick
	Control Mode	RS-232, RS-422, RS-485	-	Network, RS-232, RS-422, RS-485	IP-based	IP-based
	Local Decoding	-	-	-	-	Local live view at 1080P/720P/HD1/BCIF/ CIF/QCIF resolution, and up to 16-division window display
Interfaces	Audio Input	-	-	-	1-ch, 3.5 mm connector (2.0 Vp-p, 1 kΩ)	1-ch, 3.5 mm connector (2.0Vp-p, >1kΩ)
	Audio Output	-	-	-	1-ch, 3.5 mm connector (Linear, 560 Ω)	1-ch, 3.5 mm connector (2.0 Vp-p, 600 Ω)
	Network Interface	-	-	1; 10 M/100 Mbps self-adaptive Ethernet interface	1 10M/100M/1000M Ethernet interface	10M/100M/1000M Adaptive Ethernet port
	Wi-Fi	-	-	-	-	Supported
	Serial Interface	1 RS-232, 1 RS-422, 1 RS-485	-	1 RS-232, 1 RS-422, 1 RS-485	1 RS-232 interface, 1 RS-485 interface	-
	Video Interface	-	-	-	-	HDMI, DVI
	USB Interface	1 x USB 2.0	1 x USB 2.0, DirectX	1 x USB 2.0	1 x USB2.0 (for data storage and device upgrade)	2 x USB 2.0
General	Power Supply	12 VDC	5 VDC via USB	12 VDC	12 VDC	12 VDC /POE
	Power Consumption	≤ 4.5 W	≤ 5W	≤ 4.5 W	≤ 15W	≤15W
	Working Temperature	-10 to +55° C (14 to 131° F)	-10°C - 55°C (14°F - 131°F)	-10 to +55° C (14 to 131° F)	-10°C - 55°C (14°F - 131°F)	-10°C -+55°C
	Working Humidity	10% to 90%	10%-90% (Non-condensing)	10% to 90%	10% - 90%	10%-90%
	Dimension (W x D x H)	435 x 193 x 110 mm	167x177.5x116mm	435 x 193 x 110 mm	435 x 193 x 110 mm	404 x 180 x 163 mm
	Weight	≤ 1 kg (2.2 lb)	-	≤ 1 kg (2.2 lb)	2 kg (4.4 lb)	1.7 kg

Control & Transmission





Wireless Bridges

Slick and Stylish Communications

Wireless Bridges create cordless communication between two or more networks.

- > High performance 802.11n 2x2 MIMO chip
- > TDMA, intelligent rate control, Auto ACK Time-out adjust
- > Unique RF and antenna design
- > Web-based operation selection makes installation and setup much easier



Model		DS-3WF0AC-2NT	DS-3WF01C-2N	DS-3WF02C-5N/0	DS-3WF03C	DS-3WF02C-5AC/0
Image						
Wireless	Standard	IEEE 802.11 b/g/n	IEEE802.11 b/g/n(2T2R 300Mbps)	IEEE802.11 a/n	IEEE802.11 a/n (2T2R 300 Mbps)	IEEE 802.11/a/n/ac
	Operation Frequency	2412-2472 MHz	2412 to 2472 MHz	5180-5825 MHz	5165 to 5825 MHz	5180-5825 MHz
	Modulation Mode	-	-	-	802.11 a/n: OFDM	OFDM
	Antenna	Internal, Gain 8 dBi, Horizontal: 60° Vertical: 30°	Internal, 6dBi, H: 65° V: 60°	Gain: 10 dBi, H: 60°, V: 16°	Internal, Gain 15dBi, H:40° V:15°	Gain:9 dBi Beamwidth [3dB] [35°± 5°]
	Max Output Power	20 dBm	27dBm	24 dBm	27dBm	22 dBm
	Receive Sensitivity	-92±1.5 dBm@1 Mbps, -72±1.5 dBm@MCS7	-72dBm@65Mbps, -97dBm@1Mbps	-85 dBm@MCS0, -67 dBm@MCS7	-74dBm@65Mbps, -96dBm@6Mbps	-58 ± 2 dBm@AC80 -MCS9; -84 ± 2 dBm@AC80 -MCS0
	Max Transmission Rate	300 Mbps	11n: 300Mbps(HT40)/130Mbps(HT20) 11g: 54Mbps	300 Mbps	11n: 300Mbps(HT40)/130Mbps(HT20) 11a: 54Mbps	≤ 867 Mbps
Hardware	Power Supply	12 V/1 A passive PoE or 12 V/1 A DC	48V/0.25A PoE or 12 VDC	24 V/0.5 A Passive PoE	24V/0.5A PoE	12 VDC/1 A Passive PoE; 12 VDC, 1 A
	Interface	10/100 M Base-TX × 1	3×10/100M Base-TX (Cat. 5/5E, RJ45) ports	10/100 Mbps Base-TX × 2	PoE×1+LAN×1	RJ45*2
	Operation Temperature	-30°C - 55°C (-22°F -131°F)	-30°C to +65°C(-22° F to +149° F)	-30°C -75°C (-22°F -167°F)	-30°C to +75°C (-22° F to +167° F)	-30°C to 70°C (-22°F to 158°F)
	Storage Temperature	-30°C - 55°C (-22°F -131°F)	-40°C to +85°C(-40° F to +185° F)	-40°C -85°C (-40°F -185°F)	-40°C to +85°C (-40° F to +185° F)	-40°C to 85°C (-40°F to 185°F)
	Operation Humidity	10% - 90% RH (non-condensing)	5% to 95%RH non-condensing	5%-95%RH non-condensing	5% to 95%RH non-condensing	5% to 95% (no condensation)
	Dimensions	193.5 mm × 80 mm × 67.5 mm	150 mm × 150 mm × 31.6 mm (5.9 × 5.9 × 1.24 inch)	200 mm × 98.8 mm × 45.5 mm (7.9 × 3.9 × 1.8 in)	270 mm × 40 mm × 88 mm (10.6 × 1.57 × 3.46 inch)	92 mm × 187 mm × 58 mm (3.62" × 7.36" × 2.28")
	Encryption	WPA-PSK/WPA2-PSK	WPA-PSK/WPA2-PSK	WPA-PSK/WPA2-PSK	802.1x/WPA-PSK/WPA2-PSK	WPA2-PSK
	Network Mode	-	Router/Bridge	-	Router/Bridge	Point-to-Point, Point-to-Multipoints (less than 4 points recommended)
	Operation Mode	-	-	-	Access Point, Station, WDS Access Point, WDS Station	Access Point, Station
	Security	IP/MAC filter, SSID hidden	IP/MAC filter, SSID hidden, Interface Isolation	IP/MAC filter, SSID hidden	IP/MAC filter, SSID hidden	WPA2-PSK, Wireless network name hidden
	Network Protocol	TCP/UDP/ARP/ICMP/HTTP/NTP	TCP/UDP/ARP/ICMP/DHCP/HTTP/NTP	TCP/UDP/ARP/ICMP/HTTP/NTP	TCP/UDP/ARP/ICMP/DHCP/HTTP/NTP	NTP (network time synchronization), SADP (auto search for IP address), HTTPS (web management), SSH (debugging)
	TDMA	-	Support (Extend private communication protocol)	-	Support (Avoid 802.11 hiddennode problems, and improve point-to-multi-point performance)	support
	Auto ACK Timing Adjust	-	Support	-	Support	Support
	Management and Logs	NTP, Syslog, SNMP	NTP, Syslog, Telnet, AC	NTP, Syslog, SNMP	NTP, Syslog, Telnet, AC	Syslog, control center information
	Web Based Configuration	Support	Support	Support	Support	Support
Firmware Update	Support update firmware by Web page	Support update firmware by Web page	Support update firmware by Web page	Support update firmware by Web page	Web, ivMS-4200	
Bandwidth	20 M/40 MHz	20M/40MHz	20 M/40 MHz	5M/10M/20M/40MHz	20/40/80 MHz	

Software

223 Hik-Partner Pro



Hik-Partner Pro

Security Business Assistant.
At Your Fingertips.



Product Info and Promotions



Marketing Trends and Handouts



Customizable Quote & Site Map



Remote Device Config and Maintenance



Value-added Services



Rewards Redemption



Hik-Partner Pro
Scan and download
the app



Visit Hik-Partner Pro website
portal via below URL :
www.hik-partner.com

Hik-Partner Pro

As a one-stop security service platform, Hik-Partner Pro gives Hikvision's partners easy access to all Hikvision product information, promotions and marketing handouts. It also provides partners with efficient device management and extended, value-added services with round-the-clock convenience.

- Stay up-to-date with Hikvision's product information and promotions. Gain first-hand insights on marketing trends and handouts.
- A complete, seamless workflow from selecting the products you need, completing the customizable quotation sheet to sending quotes to customers. This optimized process increases work efficiency and saves manpower and time costs.
- Install devices and manage customers efficiently through easy access to useful installation guides and visualized customer sites on clear site maps.
- Get real-time notifications on site issues, and even resolve them remotely to reduce costly daily and weekly on-site visits.
- Enjoy remote device maintenance and management through proactive system health monitoring, remote batch configuration tools, online support when needed, and timely updates of the RMA process.
- Expand your business awareness and influence with co-branding features like displaying your brand logo and info.
- Create recurring revenue with cloud storage and cloud-based VMS.
- Redeem rewards and services with points.



Key Features	
Site Management	Adding new site or existing site.
	Assigning multiple site managers to manage one site.
	Inviting end user as Site Owner by email or short message to hand over the site.
	Applying for site authorization from site owner for maintaining or managing the Site.
	Sharing sites with the maintenance service partners to allow them to cooperate with you in providing device management/maintenance services for your customers.
	Discarding site authorization unilaterally.
	Disabling Hik-Connect service for the device(s) if Allow Me to Disable Hik-Connect Service is enabled when inviting Site Owner.
Device Management	Adding device(s) by SADP, Hik-Connect (P2P) service, IP address or domain name, or pre-defined template.
	Using a Hik-ProConnect Box as a proxy device for accessing devices that cannot be added by Hik-Connect (P2P).
	Upgrading one or more devices remotely.
	Configuring DDNS for the encoding devices with invalid or old firmware versions added by Hik-Connect (P2P), to make sure they can be managed by Hik-Partner Pro properly.
	Batch upgrading encoding devices (on the same LAN with Hik-Partner Pro).
	Batch configuring devices (on the same LAN with Hik-Partner Pro). The batch configuration processes include: Activating devices and assigning IP addresses for them. Linking channels to NVR/DVR. Saving the configurations of a device as a template to the cloud and applying the template to other devices on the same LAN.
	Unbinding detected online device from its current account before adding it to your account.
	Moving a device from one site to another site with the same site owner.
	Resetting password for an authorized device (except AX PRO devices) in an onsite or offsite method.
	Synchronizing the devices from Hik-Connect account to Hik-Partner Pro, including the devices added in the Hik-Connect account and the ones shared from others.
	Authorizing Hik-Partner Pro to get the account information of Hik-Connect to log in.
	Device live view, playback, and video download.
	Entering the remote configuration page of the device and setting the device's parameters.
	Enabling remote log collection for troubleshooting.
	Configuring device regular rebooting for certain models of network cameras.
	*Configuring people counting parameters via Hik-Partner Pro Portal and viewing people counting data on Hik-Connect Mobile Client.
	*Configuring temperature screening parameters via Hik-Partner Pro Portal and viewing temperature screening data on Hik-Connect Mobile Client.
Remotely managing and maintaining AX PRO devices / AX HYBRID PRO devices: Remote configuration and remote maintenance for AX PRO / AX HYBRID PRO. *Creating parameter templates for AX PRO. *Batch configuring AX PRO remotely by template. *Batch arming/disarming AX PRO / AX HYBRID PRO. *Batch upgrading AX PRO / AX HYBRID PRO.	

Key Features		
Cross Device Linkage	Configuring linkage rule for the devices in a site.	
	Providing six pre-defined templates designed for typical applications.	
	Two linkage modes, including LAN and Cloud P2P.	
Health Monitoring	Viewing device list of each site and status information.	
	Automatically inspecting and manually inspecting the health status of the devices.	
	Automatically sending health monitoring reports.	
	Viewing status of encoding devices, security control panel, access control device, video intercom device, doorbell, Hik-ProConnect box, and network switch.	
*Notification Center	Supporting viewing network topology for the switch(es) and connected devices, including network links between devices, and link exceptions and abnormal devices.	
	Receiving and handling business notifications, including device management invitations and site sharing notifications.	
	Receiving exception notifications.	
Exceptions	Receiving platform notifications, including what's new and deals & offers.	
	Configuring exception rules to monitor the status of managed resources in real-time.	
	Receiving resource exception notifications.	
	Viewing exception records of the resources and exporting the exception records.	
*Enabling Cloud Storage Service	Handling exception notifications.	
	Purchasing the cloud attendance service online in the Service Market directly or by the service key (purchased from the local distributor offline).	
	Adding and activating new cloud attendance system for a site.	
	Enabling or disabling cloud attendance systems for end-users.	
	Deleting cloud attendance systems on a site that has not been authorized by the end-user.	
*Cloud Attendance	Person Management	Managing credentials, including facial information and cards.
		Adding, modifying, deleting and searching persons.
		Support sub administrators.
		Support Person group.
		Support upload face photos via mobile phone.
	Access control	Unlimited personnel management.
		Access control device management.
		Access group configuration.
		Access control schedule configuration.
	Time and attendance	Remote door opening permission issuance.
		Time table configuration.
		Shift schedule configuration.
		Assign shift schedule to person.
	Employee self-service (APP)	View and report attendance records.
		Sending attendance reports regularly.
Personnel self-help take pictures and input faces through mobile phones.		
Support to view himself/herself attendance results.		
	Support remote opening door and live view the camera.	
	Check-in by GPS positioning of mobile phone.	

Key Features	
Security	Supporting channel encryption: HTTPS and TLS/SSL used to ensure the security of the transmission process.
	Supporting signal encryption: AES 128 and RSA used to ensure the security of data content.
	Protection against account attacks.
	Supporting verification code encryption to ensure the security of streaming during remote live view and downloading.
	Supporting Cloud P2P to establish secure link without port mapping and avoid exposing ports to the public network.
	Unique serial number bound by one account to prevent the device from being added by an attacker.
*Reward Point System	Earning reward points redeemable for lots of gifts after completing specific tasks.
	Redeeming reward points for lots of gifts (e.g., certain value-added services) in the reward point market.
Open-Source Capabilities	Providing open-source capabilities for technological partners in different industries, such as vendors of Alarm Receiving Center (ARC) software, VSaaS software, smart home software, and attendance management software. Hik-Partner Pro Open API includes the following capabilities:
	Adding, editing, and deleting devices.
	Live view, playback, two-way audio, PTZ, etc.
	Alarm and event subscription.
	Uploading card-swiping records.
	Applying persons with access permissions to access control devices.
Others	Offering co-branding function to display company logo on the Hik-Connect Mobile Client for brand promotion.
	Account authentication: entering authentication code, or submitting online application. (Different countries or regions may vary.)
	Searching operation logs in the recent 90 days.
	* Supporting purchasing health monitoring package and setting the devices that can access the service.
	Using the AI Help Center to ask questions and get answers online.
	Submitting cases to seek for help by clicking "support" to contact Hikvision engineers.

Note: The features marked with * may be not released in certain countries or regions. Please refer to the actual interfaces

Specifications	
The following table shows the maximum performance of the Hik-Partner Pro Portal.	
Supported Languages	English, Arabic, Brazilian Portuguese, Bulgarian, Croatian, Czech, Danish, Dutch, Estonian, Farsi, Finnish, French, German, Greek, Hebrew, Hungarian, Indonesian, Italian, Japanese, Kazakh, Korean, Latvian, Lithuanian, Norwegian, Polish, Portuguese, Romanian, Russian, Serbian, Slovakian, Slovenian, Spanish, Swedish, Thai, Traditional Chinese, Turkish, Ukrainian, Uzbek, and Vietnamese
Number of Employees	Unlimited
Number of Sites	Unlimited
Number of Devices	Unlimited
Number of Templates for Remote Configuration of Security Control Panel	5
Transcoding by Hik-ProConnect Box	Resolution: 1920*1080 Frame rate: 10 fps (1 to 5 channels)/8 fps (6 channels)/7 fps (7 channels)/6 fps (8 channels) Bit rate: 800 kbps
Decoding by Hik-ProConnect Box	8*1080P
Notification Retention Period	Up to 7 days
Log Retention Period	Up to 90 days

Accessories

227 Brackets and Housings

271 Power Adapters

273 Camera Testers







274 Pickups





























Accessories







Brackets and Housings





















Appearance	Model	Recommended brackets for Hikvision analog camera					
		Relevant brackets and housings					
		Indoor			Indoor housing		Outdoor housing
	DS-2CC12D8T-AMM						
		DS-1299ZJ	DS-1280ZJ-XS	DS-1292ZJ	DS-1332HZ	DS-1330HZ	DS-1331HZ Series
		Pendant mount	Junction box	Wall mount	Indoor housing	Indoor housing	Outdoor housing
		Hik white Aluminum Alloy 77×77×198mm 165g	Hik white Aluminum Alloy ∅100 x 43.2 x 129mm 320g (Match up with DS-1299ZJ)	Hik white Aluminum alloy 70×97.1×217.9mm 201g	Hik white Aluminum alloy 288×149×100mm 800g	Hik white Complex fiber 290×142×92mm 640g	Hik white Aluminum alloy















Recommended brackets for Hikvision analog camera			
Relevant brackets and housings--- Indoor/Outdoor			
			
DS-1275ZJ-SUS	DS-1280ZJ-S	DS-1260ZJ	DS-1276ZJ-SUS
Hik white Stainless steel 127×46×250mm Diameter of clamp: ∅67-127mm 1480g	Hik white Aluminum alloy ∅137 x 53.4x 164.8mm 527g	Hik White Aluminum alloy ∅88.5 mm 251g	Hik white Stainless steel 126×105×250mm 2280g











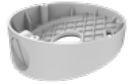

Appearance	Model	Appearance	Model	Appearance	Model	Appearance	Model	Recommended brackets for Hikvision analog camera Relevant brackets and housings--- Indoor/Outdoor
	DS-2CE16C0T-IR(F) DS-2CE16C2T-IR DS-2CE16D0T-IR(F)/(E) DS-2CE16D0T-I3F DS-2CE16D3T-I3F DS-2CE16D0T-I2FD DS-2CE16D0T-I2FB		DS-2CE16D0T-IT(F)(P)S		DS-2CE10HFT-F		DS-2CE16D0T-ITF DS-2CE16H0T-ITF(C) DS-2CE16D0T-EXIF	
	DS-2CE16C0T-IRP(F) DS-2CE16C2T-IRP DS-2CE16D0T-IRP(F)/(E) DS-2CE16D0T-IRP(F)(C) DS-2CE16D0T-IRP(F)(C) DS-2CE16D3T-I3PF DS-2CE16D0T-I2PFD DS-2CE16D0T-I2PFB		DS-2CE16D8T-IT(P)(F)/(E) DS-2CE16HST-IT(P)(E) DS-2CE16H0T-IT(P)F		DS-2CE12D8T-PIRL(O) DS-2CE12H0T-PIRL(O) DS-2CE18U8T-IT3 DS-2CE12D0T-PIRL(O)		DS-2CE16H0T-IT1/3/5F(C)	DS-1280ZJ-XS
					DS-2CE12DFT-F		DS-2CE16D0T-IT1(F)/IT3(F)/IT5(F)(C)	
	DS-2CC12D9T-IT3E/IT5E DS-2CE16C0T-IT1(F)/IT3(F)/IT5(F) DS-2CE16D0T-IT1(F)(E)/IT3(F)(E)/IT5(F)(E) DS-2CE16D8T-IT1(F)(E)/IT3(F)(E)/IT5(F)(E) DS-2CE16HST-IT1(E)/IT3(E)/IT5(E) DS-2CE16H0T-IT1/3/5F(E)		DS-2CE11D8T-PIRL(P)(O) DS-2CE11H0T-PIRL(P)(O) DS-2CE11D0T-PIRL(P)(O)		DS-2CE12HFT-F		DS-2CE17H0T-IT1/3/5F	
					DS-2CE16D0T-ITPF DS-2CE16H0T-ITPF(C) DS-2CE16D0T-EXIPF	 	DS-2CE17D0T-IT1/3/5F DS-2CE17D0T-IT1/3/5 DS-2CE12DFT-PIRXOF DS-2CE12D0T-PIRXOF	Junction Box









Recommended brackets for Hikvision analog camera						
Relevant brackets and housings--- Indoor/Outdoor						
						
DS-1293ZJ	DS-1275ZJ-SUS	DS-1269ZJ	DS-1233ZJ	DS-1232ZJ	DS-1232ZJ-T	DS-1276ZJ-SUS
Wall mount	Vertical pole mount	Pendant mount	Column mount	Cardan joint	Cardan joint	Corner mount
Hik white Aluminum alloy 88×116.6×297.3mm 473g	Hik white Stainless Steel 127×46×250mm Diameter of clamp: Ø67-127mm 1480g Match up with wall mount DS-1293ZJ-XX(B)	Hik white Aluminum alloy 49.3×246×88mm 480g	Hik white Steel Ø160 x 109.3mm 6200g	Hik white Steel 126×103.5×83mm 790	Hik white Steel 96×95×92.5mm	Hik white Stainless Steel 126×105×250mm 2280g Match up with wall mount DS-1293ZJ-XX(B)







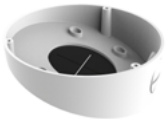
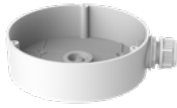





Appearance	Model	Recommended brackets for Hikvision analog camera		
		Relevant brackets and housings--- Indoor/Outdoor		
	DS-2CC12D9T-AIT3ZE DS-2CE16D8T-(A)IT3Z(F) DS-2CE16D8T-IT3ZE			
	DS-2CE16H0T-(A)IT3ZF DS-2CE19H8T-(A)IT3ZF DS-2CE19U1T-(A)IT3ZF DS-2CE19U7T-(A)IT3ZF DS-2CE19D3T-(A)IT3ZF	DS-1275ZJ-SUS	DS-1280ZJ-S	DS-1276ZJ-SUS
	DS-2CE16C2T-VFIR3 DS-2CE16D0T-VFIR3F/E	Vertical pole mount	Junction box	Corner mount
	DS-2CE19U8T-(A)IT3Z	Hik white Stainless Steel 127×46×250mm Diameter of clamp: Ø67-127mm 1480g	Hik white Aluminum alloy Ø137 x 53.4x 164.8mm 527g	Hik white Stainless Steel 126×105×250mm 2280g
	DS-2CE16C5T-AIT3Z			







Appearance	Model	Recommended brackets for Hikvision analog camera				
		Relevant brackets and housings--- Indoor/Outdoor				
	DS-2CE59U7T-(A)VPIT3ZF DS-2CE59H8T-(A)VPIT3ZF DS-2CE59U1T-(A)VPIT3ZF DS-2CE56D8T-(A)VPIT3Z(F)/(E)					
		DS-1271ZJ-140	DS-1273ZJ-140	DS-1273ZJ-140B	DS-1241ZJ	DS-1240ZJ
		Pendant Mount	Wall mount	Wall mount	In-ceiling mount	Inclined ceiling mount
	DS-2CC52D9T-AVPIT3ZE DS-2CE56HOT-(A)VPIT3Z(F)/(E) DS-2CE59U8T-(A)VPIT3Z					
		DS-1275ZJ-SUS	DS-1276ZJ-SUS	DS-1253ZJ-L	DS-1250ZJ	
		Vertical pole mount	Corner mount	Rain shade	Rain shade	
		Hik white Aluminum alloy Ø150×565mm 1900g	Hik white Aluminum alloy 140×183.5×232mm 703g	Hik white Aluminum alloy with junction box 140×243×292mm 1488g	Hik white Aluminum alloy Ø200×26.8mm 300g	Hik white Aluminum alloy Ø145×63mm 440g
		Hik white Stainless Steel 127×46×250mm Diameter of clamp: Ø67-127mm 1480g Match up with wall mount[DS-1273ZJ-XX(B)]	Hik white Stainless Steel 126X105X250mm 2280g Match up with wall mount[DS-1273ZJ-XX(B)]	Hik white Composite Fiber Ø225.1×98mm 198g Match up with wall mount[DS-1273ZJ-140]	Hik white Composite Fiber 264.7*152*189.6 mm 199g	

Appearance	Model	Recommended brackets for Hikvision analog camera			
		Relevant brackets and housings--- Indoor			
	DS-2CE56H8T-(A)ITZF DS-2CE56U1T-(A)ITZF DS-2CE56D8T-(A)ITZF DS-2CE56D8T-ITZE				
		DS-1271ZJ-130 Pendant Mount Hik white Aluminum alloy Ø150×565mm 1900g	DS-1273ZJ-130 Wall mount Hik white Aluminum alloy 132×183.5×228.5mm 690g	DS-1273ZJ-130B Wall mount Hik white Aluminum alloy with junction box 132×243×288.5mm 1475g	DS-1249ZJ In-ceiling mount Hik white ABS plastic Ø169.4×14.6mm 60g
	DS-2CE56D0T-VFIR(F)/ (E)				
		DS-1275ZJ-SUS Vertical pole mount Hik white Stainless Steel 127×46×250mm Diameter of clamp: Ø67-127mm 1480g Match up with wall mount(DS-1273ZJ-XX(B))	DS-1276ZJ-SUS Corner mount Hik white Stainless Steel 126X105X250mm 2280g Match up with wall mount(DS-1273ZJ-XX(B))	DS-1253ZJ-L Rain shade Hik white Composite fiber Ø225.1×98mm 198g Match up with wall mount(DS-1273ZJ-130)	DS-1250ZJ Rain shade Hik white Composite fiber 264.7*152*189.6 mm 199g
	DS-2CC52D9T-AITZE DS-2CE56H5T-(A)ITZ(E) DS-2CE56H0T-(A)ITZF DS-2CE56H0T-ITZE DS-2CE56D8T-(A)ITZ				
		DS-1275ZJ-SUS Vertical pole mount Hik white Stainless Steel 127×46×250mm Diameter of clamp: Ø67-127mm 1480g Match up with wall mount(DS-1273ZJ-XX(B))	DS-1276ZJ-SUS Corner mount Hik white Stainless Steel 126X105X250mm 2280g Match up with wall mount(DS-1273ZJ-XX(B))	DS-1253ZJ-L Rain shade Hik white Composite fiber Ø225.1×98mm 198g Match up with wall mount(DS-1273ZJ-130)	DS-1250ZJ Rain shade Hik white Composite fiber 264.7*152*189.6 mm 199g

Appearance	Model	Recommended brackets for Hikvision analog camera				
		Relevant brackets and housings--- Indoor				
	DS-2CE56D8T-VPIT(E)					
		DS-1259ZJ	DS-1271ZJ-110	DS-1272ZJ-110	DS-1272ZJ-110B	DS-1275ZJ-SUS
		Inclined ceiling mount	Pendant mount	Wall mount	Wall mount	Vertical pole mount
	DS-2CE57U0T-VPIT(F)	<p>Hik white ABS Plastic Ø111×39.2mm 200g</p>	<p>DS-1258ZJHik white Aluminum alloy Ø150×560mm 1900g</p>	<p>Hik white Aluminum alloy 120×122×169mm 420g</p>	<p>Hik white Aluminum alloy with junction box 123×180×227.8mm 1205g</p>	<p>Hik white Stainless Steel 127×46×250mm Diameter of clamp: Ø67-127mm 1480g Match up with wall mount(DS-1272ZJ-XX(B))</p>
		DS-1259ZJ	DS-1271ZJ-110	DS-1272ZJ-110	DS-1272ZJ-110B	DS-1275ZJ-SUS
		Inclined ceiling mount	Pendant mount	Wall mount	Wall mount	Vertical pole mount
	DS-2CE56C0T-VPIR					
		DS-1276ZJ-SUS	DS-1280ZJ-DM18	DS-1258ZJ	DS-1253ZJ-M	DS-1250ZJ
		Corner mount	Junction box	Wall mount	Rain shade	Rain shade
		<p>Hik white Stainless Steel 126×105×250mm 2280g Match up with wall mount(DS-1272ZJ-XX(B))</p>	<p>Hik white Aluminum alloy Ø115,4×43.8mm 450g</p>	<p>Hik white ABS plastic 120×111×161.5mm 200g</p>	<p>Hik white Composite fiber Ø191.1×76mm 133g Match up with wall mount(DS-1272ZJ-110)</p>	<p>Hik white Composite fiber 264.7*152*189.6 mm 199g</p>







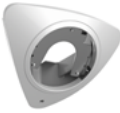

Appearance	Model	Recommended brackets for Hikvision analog camera			
		Relevant brackets and housings--- Indoor/Outdoor			
	DS-2CE5AU1T-(A)VPIT3ZF DS-2CE5AU7T-(A)VPIT3ZF DS-2CE5AD8T-(A)VPIT3Z(F)/(E)				
		DS-1273ZJ-140-DM45	DS-1271ZJ-140-DM45	DS-1275ZJ-SUS	DS-1276ZJ-SUS
		Wall mount	Pendant mount	Vertical pole mount	Corner mount
		Hik white Aluminum alloy Φ140×182×120mm	Hik white Aluminum alloy Φ140×545mm	Hik white Stainless Steel 117×143×194mm(Diameter of clamp 67-127mm) 1480g Match up with wall mount(DS-1273ZJ-XX(B))	Hik white Stainless Steel 158X173mm Match up with wall mount (DS-1273ZJ-XX(B))
	DS-2CE5AH0T-(A)VPIT3ZF DS-2CE5AH0T-VPIT3ZE DS-2CE5AD3T-(A)VPIT3ZF DS-2CE5AH8T-(A)VPIT3ZF				
		DS-1281ZJ-DM45	DS-1280ZJ-DM45	DS-1253ZJ-L	
		Inclined ceiling mount	Junction box	Rain shade	
		Hik white Aluminum alloy Φ140×49mm	Hik white Aluminum alloy 168×140×40mm	Hik white Composite fiber Match up with wall mount(DS-1273ZJ-140-DM45)	

Appearance	Model	Recommended brackets for Hikvision analog camera					
		Relevant brackets and housings--- Indoor/Outdoor					
	DS-2CE5AD0T-VPIT3F DS-2CE5AD8T-VPIT3Z						
		DS-1271ZJ-135	DS-1273ZJ-135	DS-1473ZJ-135B	DS-1275ZJ-SUS	DS-1276ZJ-SUS	DS-1227ZJ
		Pendant mount	Wall mount	Wall mount with junction box	Vertical pole mount	Corner mount	In-ceiling mount
		Hik white Aluminum alloy 150×150×565mm 1900g	Hik white Aluminum alloy 136×183.5×230mm 704g	Hik white Aluminum alloy with junction box 136×243×290mm 1490g	Hik white Stainless Steel 127×46×250mm Diameter of clamp: Ø67-127mm 1480g Match up with wall mount(DS-1273ZJ-135)	Hik white Stainless Steel 126×105×250mm 2280g Match up with wall mount(DS-1273ZJ-135)	Hik white Aluminum alloy & ABS Plastic Ø210×90mm 540g
							
		DS-1280ZJ-DM21	DS-1281ZJ-DM23	DS-1253ZJ-L	DS-1250ZJ	DS-1258ZJ-L	
		Junction box	Inclined ceiling mount	Rain shade	Rain shade	Wall mount	
Hik white Aluminum alloy 162×137×42mm 250g	Hik white Aluminum alloy 136.3×136.3×48mm 245g	Hik white Composite fiber Ø225.1×98mm 198g Match up with wall mount(DS-1273ZJ-135)	Hik white Composite fiber 264.7*152*189.6 mm 199g	Hik white Plastic 136×183×213mm 260g			

Recommended brackets for Hikvision analog camera					
Relevant brackets and housings--- Indoor					
					
DS-1294ZJ	DS-1281ZJ-DM27	DS-1297ZJ	DS-1299ZJ	DS-1297ZJ-ES	DS-1297ZJ-M
Wall mount	Inclined ceiling mount	Pendant mount (extendable)	Pendant Mount	Pendant mount (extendable)	Pendant mount (extendable)
Hik white Toughened Plastic 223.9×80×125.8mm 450g	Hik white Plastic 111.8×40.5×108.3mm 45.8g	Hik white Aluminum alloy (Height 1000-2000mm)	Hik white Aluminum Alloy 77×77×198mm 165g	Hikvision White Aluminum Alloy ∅ 97 mm × 270 mm to 400 mm (∅ 3.82" × 10.63" to 15.75") 500 g (1.10 lb.)	Hikvision White Aluminum Alloy ∅ 120 mm × 650 mm to 1200 mm (∅ 4.72" × 25.59" to 47.24") 800 g (1.76 lb.)



Appearance	Model	Recommended brackets for Hikvision analog camera	
		Relevant brackets and housings---Indoor/Outdoor	
	DS-2CE56C2T-IRM DS-2CE56C0T-IRM(F) DS-2CE56D0T-IRM(F)		DS-1280ZJ-TR3
		Junction box	
	DS-2CE56D0T-IRM(F)(C)	Hik white ADC12 ∅119.68 x 82.58 x 41.02mm 107g	

Recommended brackets for Hikvision analog camera	
Relevant brackets and housings---Indoor/Outdoor	
	DS-1274ZJ-DM28
	Corner mount
	Hik white Aluminum alloy 233×201×96mm

Appearance	Model	Recommended brackets for Hikvision analog camera			
		Relevant brackets and housings---Indoor/Outdoor			
	DS-2CE56H0T-ITPF DS-2CE76D3T-ITPF				
	DS-2CE76U1T-ITPF DS-2CE76U0T-ITPF DS-2CE76D0T-EXIPF	DS-1272ZJ-110-TRS	DS-1275ZJ-SUS	DS-1276ZJ-SUS	DS-1280ZJ-XS
		Wall mount	Vertical pole mount	Corner mount	Junction box
	DS-2CE76D0T-ITPF				
	DS-2CE56C0T-IR(P)(F) DS-2CE56C2T-IR(P)	Hik white Aluminum alloy 120×122×169mm 420g	Hik white Stainless Steel 127×46×250mm Diameter of clamp: Ø67-127mm 1480g Match up with wall mount{DS-1272ZJ-XX(B)}	Hik white Stainless Steel 126×105×250mm 2280g Match up with wall mount{DS-1272ZJ-XX(B)}	Hik white Aluminum Alloy Ø100 x 43.2 x 129mm 320g
	DS-2CE56D0T-IR(P)(F) DS-2CE56D0T-I2(P)(F) DS-2CE56D0T-I2(P)(FB)				

Recommended brackets for Hikvision analog camera







Relevant brackets and housings--- Indoor/Outdoor



						
DS-1272ZJ-120	DS-1272ZJ-120B	DS-1271ZJ-120	DS-1275ZJ-SUS	DS-1276ZJ-SUS	DS-1282ZJ-DM(mini)	DS-1280ZJ-DM22
Wall mount	Wall mount	Pendant mount	Vertical pole mount	Corner mount	Gang box	Junction box
Hik white Aluminum alloy 120×122×173.5mm 430g	Hik white Aluminum alloy with junction box 123×180×223mm 1225g	Hik white Aluminum alloy Φ150×573mm 1900g	Hik white Stainless Steel 127×46×250mm Diameter of clamp: Φ67-127mm 1480g Match up with wall mount[DS-1272ZJ-XX(B)]	Hik white Stainless Steel 126×105×250mm 2280g Match up with wall mount[DS-1272ZJ-XX(B)]	Hik white Plastic Φ120 mm	Hik white Aluminum alloy 164.8×137×53.4mm 520g







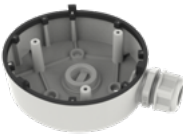







Recommended brackets for Hikvision analog camera

Relevant brackets and housings--- Indoor/Outdoor







						
DS-1272ZJ-110	DS-1275ZJ-SUS	DS-1276ZJ-SUS	DS-1258ZJ	DS-1280ZJ-S	DS-1281ZJ-S	DS-1271ZJ-110
Hik white Aluminum alloy 120×122×169mm 420g	Hik white Stainless Steel 127×46×250mm Diameter of clamp: Φ67-127mm 1480g Match up with wall mount[DS-1272ZJ-XX(B)]	Hik white Stainless Steel 126×105×250mm 2280g Match up with wall mount [DS-1272ZJ-XX(B)]	Hik white ABS plastic 120×111×161.5mm 200g Suitable for indoor	Hik white Aluminum alloy 137×53.4×164.8mm 527g	Hik white Aluminum alloy 137×56.5×147mm 472g	Hik white Aluminum alloy Φ150×560mm 1900g

Appearance	Model	Recommended brackets for Hikvision analog camera					
		Relevant brackets and housings---Indoor/Outdoor					
	DS-2CE56C2T-VFIR3 DS-2CE56DOT-VFIR3F/E						
		DS-1273ZJ-130-TRL	DS-1275ZJ-SUS	DS-1276ZJ-SUS	DS-1280ZJ-M	DS-1281ZJ-M	DS-1271ZJ-130-TRL
		Wall mount	Vertical pole mount	Corner mount	Junction box	Inclined ceiling mount	Pendant mount
		Hik white Aluminum alloy 131×183.5×228.5mm 890g	Hik white Stainless Steel 127×46×250mm Diameter of clamp: Ø67-127mm 1480g Match up with wall mount(DS-1273ZJ-XX(B))	Hik white Stainless Steel 126X105X250mm 2280g Match up with wall mount(DS-1273ZJ-XX(B))	Hik white Aluminum alloy 157×184.8×53.4mm 621g	Hik white Aluminum alloy 157×165.7×61.8mm 586g	Hik white Aluminum alloy Ø150×567mm







Appearance	Model	Recommended brackets for Hikvision analog camera	
		Relevant brackets and housings---Indoor/Outdoor	
	DS-2CE56D8T-IT3Z(F)(E)		
	DS-2CE79U7T-AIT3ZF DS-2CE79H8T-AIT3ZF	DS-1280ZJ-TR12	
	DS-2CE56H0T-IT3Z(F)(E) DS-2CE79U8T-IT3Z DS-2CE79D3T-IT3ZF DS-2CE79H8T-IT3ZF DS-2CE79U1T-IT3ZF DS-2CE79U7T-IT3ZF	Hikvision White Alloy 123.06 mm × 168.24 mm × 45 mm [4.84" × 6.62" × 1.77"] 215 g [0.47 lb.]	





Appearance	Model	Recommended brackets for Hikvision analog camera		
		Relevant brackets and housings---Indoor/Outdoor		
	DS-2CE78D3T-IT3F DS-2CE78H8T-IT1/3F DS-2CE78U1T-IT1/3F DS-2CE78U7T-IT1/3F DS-2CE78U0T-IT3F			
	DS-2CE56C0T-IT1(F)/IT3(F) DS-2CE56D0T -IT1(F)(E)/IT3(F)(E) DS-2CE56H1T-IT1(E)/IT3(E) DS-2CE52D9T-IT3E DS-2CE56D8T -IT1(F)(E)/IT3(F)(E) DS-2CE56H5T-IT1(E)/IT3(E) DS-2CE56H0T-IT1/3(F)/(E) DS-2CE56C5T-IT3	DS-1272ZJ-110-TRS	DS-1275ZJ-SUS	DS-1276ZJ-SUS
	DS-2CE78D0T-IT3FS	Wall mount	Vertical pole mount	Corner mount
	DS-2CE56D0T-IT1(F)/IT3(F)(C)	Hik white Aluminum alloy 110×120×120mm 420g	Hik white Stainless Steel 127×46×250mm Diameter of clamp: Ø67-127mm 1480g Match up with wall mount (DS-1272ZJ-XX(B))	Hik white Stainless Steel 126×105×250mm 2280g Match up with wall mount (DS-1272ZJ-XX(B))
	DS-2CE71D8T-PIRL(O) DS-2CE71D0T-PIRL(P)(O) DS-2CE71H0T-PIRL(P)(O)			
	DS-2CE78U8T-IT3	DS-1280ZJ-S	DS-1281ZJ-S	DS-1280ZJ-TR13
	DS-2CE72DFT-F	Junction box	Inclined ceiling mount	Junction box
	DS-2CE72HFT-F	Hik white Aluminum alloy 137×53.4×164.8mm 527g	Hik white Aluminum alloy 137×56.5×147mm 472g	Hikvision White Aluminium Alloy Ø 110 mm × 144.3 mm × 48 mm (Ø 4.33" × 5.68" × 1.89") Approx. 187 g (0.41 lb.)
	DS-2CE72DFT-PIRXOF			







Appearance	Model	Relevant brackets and housings					
		Indoor		Indoor housing		Outdoor housing	
	DS-2CD2821G0						
		DS-1299ZJ	DS-1292ZJ	DS-1332HZ	DS-1330HZ	DS-1331HZ series	DS-1340HZ
		Pendant Mount	Wall mount	Indoor housing	Indoor housing	Outdoor housing	Outdoor housing
		Hik white Aluminum Alloy 77×77×198mm 165g	Hik white Aluminum alloy 70×97.1×217.9mm 201g	Hik white Aluminum alloy 288×149×100mm 800g	Hik white Complex fiber 290×142×92mm 640g	Hik white Aluminum alloy	Three-axis adjustment Containing combined wires and fan IK10



Appearance	Model	Appearance	Model	Appearance	Model
	DS-2CD2085FWD-I DS-2CD2055FWD-I DS-2CD2045FWD-I DS-2CD2035FWD-I DS-2CD2025F(H)WD-I DS-2CD2083G0-I DS-2CD2063G0-I DS-2CD2043G0-I DS-2CD2023G0-I		DS-2CD2065G1-I DS-2CD2085G1-I DS-2CD2021G1-I(D)(W) DS-2CD2021G1-I(D)(W)(B)		DS-2CD2026G2-I(U) DS-2CD2046G2-I(U) DS-2CD2086G2-I(U)
	DS-2CV2021G2-IDW DS-2CV2041G2-IDW DS-2CV2026G0-IDW DS-2CV2046G0-IDW		DS-2CD1T23G0-I DS-2CD1T43G0-I		DS-2CD1023G0-I DS-2CD1023G0E-I DS-2CD1023G0-IU DS-2CD1043G0-I DS-2CD1053G0-I



Appearance	Model	Appearance	Model	Relevant brackets and housings---Indoor/Outdoor	
	DS-2CV1021G0-IDW1		DS-2CD2051G1-IDW1 DS-2CD2041G1-IDW1 DS-2CD2021G1-IDW1		DS-1280ZJ-XS Junction box Hik white Aluminum Alloy Ø100 x 43.2 x 129mm 320g













Appearance	Model	Relevant brackets and housings				
		Indoor/Outdoor				
	DS-2CD1621G0-I(Z) DS-2CD1631G0-I(Z) DS-2CD1623G0-I(Z) DS-2CD1643G0-I(Z) DS-2CD1623G1-I(Z)(S) DS-2CD1653G0-I(Z)					
		DS-1260ZJ	DS-1280ZJ-S	DS-1275ZJ-SUS	DS-1276ZJ-SUS	DS-1275ZJ-S-SUS
		Junction box	Junction box	Vertical pole mount	Corner mount	Vertical pole mount
	DS-2CD2621G0-I(Z)(S)	Hikvision White Aluminum Alloy Ø88.5 mm 251g	Hik white Aluminum alloy Ø137 x 53.4x 164.8mm 527g	Hikvision White Stainless Steel 127 mm × 46 mm × 250 mm (5" × 1.81" × 9.84") 1480 g (3.26 lb.)	Hik white Stainless Steel 126×105×250mm 2280g	Hik white Stainless Steel 144 mm × 131.6 mm × 44.3 mm (5.67" × 5.18" × 1.74") 760 g (1.68 lb.) Match up with DS-1260ZJ













Appearance	Model	Relevant brackets and housings		
		Indoor/Outdoor		
	DS-2CD2047G1-L DS-2CD2027G1-L			
		302700579	302701533	302701678
		Junction box	Vertical pole mount	Corner mount
		Hik white Aluminum alloy Ø137 x 53.4x 164.8mm 527g	Hikvision White Stainless Steel 127 mm × 46 mm × 250 mm (5" × 1.81" × 9.84") 1480 g (3.26 lb.)	Hik white Stainless Steel 126×105×250mm 2280g







Appearance	Model	Relevant brackets and housings			
		Indoor/Outdoor			
	DS-2CD2626G2-IZS DS-2CD2646G2-IZS DS-2CD2686G2-IZS DS-2CD2685G0-IZS DS-2CD2665G0-IZS DS-2CD2685FWD-IZS DS-2CD2655FWD-IZS(B) DS-2CD2645FWD-IZS DS-2CD2635FWD-IZS DS-2CD2625FWD-IZS DS-2CD2625FHW-IZS DS-2CD2683G0-IZS DS-2CD2663G0-IZS DS-2CD2643G0-IZS DS-2CD2623G0-IZS				
		DS-1475ZJ-SUS Vertical pole mount Hik white Stainless Steel 250 mm × 127 mm × 46 mm Diameter of clamp: Ø67-127mm 1205g	DS-1476ZJ-SUS Corner mount Hik white Stainless Steel 126×105×250mm 2280g	DS-1275ZJ-S-SUS Vertical pole mount Hik white Stainless Steel 144 mm × 131.6 mm × 44.3 mm (5.67" × 5.18" × 1.74") 760 g (1.68 lb.)	DS-2551ZJ Column Mount Hikvision White Alloy Ø 250 mm × 1570.08 mm (Ø 9.84" × 61.81") Approx. 3308 g (7.29 lb.)
	DS-2CD2626G2-IZSU/SL DS-2CD2646G2-IZSU/SL DS-2CD2686G2-IZSU/SL				







Appearance	Model	Relevant brackets and housings
		Indoor/Outdoor
	DS-2CD2085FWD-I DS-2CD2055FWD-I DS-2CD2045FWD-I DS-2CD2025FWD-I DS-2CD2043G0-I DS-2CD2023G0-I	
		DS-1280ZJ-XS(Black) Junction box
	DS-2CD2065G1-I DS-2CD2085G1-I	Hik Black Aluminum Alloy Ø100 x 43.2 x 129mm 320g







Appearance	Model	Relevant brackets and housings
		Indoor/Outdoor
	DS-2CD2685G0-IZS DS-2CD2665G0-IZS DS-2CD2685FWD-IZS DS-2CD2645FWD-IZS DS-2CD2635FWD-IZS DS-2CD2625FWD-IZS	
		DS-1475ZJ-SUS(Black) Vertical pole mount Hik Black Stainless Steel 250 mm × 127 mm × 46 mm Diameter of clamp: Ø67-127mm 1205g
		Other brackets are the same as Hik white camera











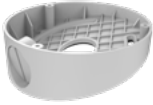



Appearance	Model	Relevant brackets and housings				
		Indoor/Outdoor				
	DS-2CD2T42WD-13/15/18 DS-2CD2T22WD-13/15/18 DS-2CD2T85FWD-15/18 DS-2CD2T55FWD-15/18 DS-2CD2T45FWD-15/18 DS-2CD2T35FWD-15/18 DS-2CD2T25FWD-15/18 DS-2CD2T25FHW-15/18 DS-2CD2T83G0-15/18 DS-2CD2T63G0-15/18 DS-2CD2T43G0-15/18 DS-2CD2T23G0-15/18					
		DS-1275ZJ-SUS	DS-1260ZJ	DS-1276ZJ-SUS	DS-1280ZJ-S	DS-1275ZJ-S-SUS
	DS-2CD2T85G1-15/18 DS-2CD2T65G1-15/18 DS-2CD2T26G1-21/41 DS-2CD2T46G1-21/41					
	DS-2CD2T26G2-ISU/SL DS-2CD2T46G2-ISU/SL DS-2CD2T86G2-ISU/SL	Vertical pole mount	Junction box	Corner mount	Junction box	Vertical pole mount
	DS-2CD2626G2T-IZS DS-2CD2646G2T-IZS DS-2CD2686G2T-IZS DS-2CD2685G1-IZ(S) DS-2CD2665G1-IZ(S) DS-2CD2645G1-IZ(S) DS-2CD2625G1-IZ(S) DS-2CD2646G1-IZ(S) DS-2CD2626G1-IZ(S)					
	DS-2CD2683G1-IZ(S) DS-2CD2663G1-IZ(S) DS-2CD2643G1-IZ(S) DS-2CD2623G1-IZ(S)	Hikvision White Stainless Steel 127 mm × 46 mm × 250 mm (5" × 1.81" × 9.84") 1480 g (3.26 lb.)	Hikvision White Aluminum Alloy Ø88.5 mm 251g	Hik white Stainless Steel 126×105×250mm 2280g	Hik white Aluminum alloy Ø137 x 53.4x 164.8mm 527g	Hik white Stainless Steel 144 mm × 131.6 mm × 44.3 mm (5.67" × 5.18" × 1.74") 760 g (1.68 lb.) Match up with DS-1260ZJ
	DS-2CD2T45G0P-I					
	DS-2CD2T46G1-4/SL DS-2CD2T26G1-4/SL					
	DS-2CD2T47G1-L DS-2CD2T27G1-L					

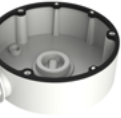







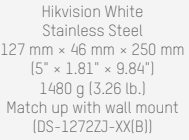

Appearance	Model	Relevant brackets and housings					
		Indoor/Outdoor					
	DS-2CD2T2160-III(S)						
		DS-1296ZJ	DS-1292ZJ	DS-1203ZJ	DS-1297ZJ	DS-1214ZJ-T	DS-1275ZJ-SUS
		Wall mount	Wall mount	Pendant Mount	Pendant Mount	Horizontal pole mount	Vertical pole mount
		Hik white Plastic 70x79.1x196.5mm Included in the package	Hik white Aluminum alloy 70x97.1x217.9mm 201g	Hik white 70.4x84x200.5mm 220g	Hik white Aluminum Alloy Ø120x200mm 1035g	Hik white Steel(mounting board) & Stainless Steel(clamp) 194 mm × 117 mm × 138.5 mm (7.64" × 4.61" × 5.45") 1900 g (4.19 lb.)	Hikvision White Stainless Steel 127 mm × 46 mm × 250 mm (5" × 1.81" × 9.84") 1480 g (3.26 lb.) Match up with wall mount (DS-1292ZJ-XX(B))
							
		DS-1276ZJ-SUS	DS-1232ZJ	DS-1232ZJ-T	DS-1297ZJ-ES	DS-1297ZJ-M	
		Corner mount	Cardan Joint	Cardan Joint	Pendant mount (extendable)	Pendant mount (extendable)	
		Hik white Stainless Steel 126×105×250mm 2280g Match up with wall mount(DS-1292ZJ-XX(B))	Hik white Steel 126x103.5x83mm 790	Hik white Steel 96x95x92.5mm	Hikvision White Aluminum Alloy Ø 97 mm × 270 mm to 400 mm (Ø 3.82" × 10.63" to 15.75") 500 g (1.10 lb.)	Hikvision White Aluminum Alloy Ø 120 mm × 650 mm to 1200 mm (Ø 4.72" × 25.59" to 47.24") 800 g (1.76 lb.)	







Appearance	Model	Relevant brackets and housings			
		Indoor/Outdoor			
	DS-2CD2555FWD-I(W)(S) DS-2CD2545FWD-I(W)(S) DS-2CD2535FWD-I(W)(S) DS-2CD2525FWD-I(W)(S) DS-2CD2525FHW-I(W)(S) DS-2CD2563G0-I(W)(S) DS-2CD2543G0-I(W)(S) DS-2CD2523G0-I(W)(S)				
		DS-1272ZJ-120	DS-1271ZJ-120	DS-1276ZJ-SUS	DS-1280ZJ-DM46
		Wall mount	Pendant mount	Corner mount	Junction box
		Hik white Aluminum alloy 120×122×173.5mm 430g	Hik white Aluminum alloy Ø150×573mm 1900g	Hik white Stainless Steel 126X105X250mm 2280g Match up with wall mount (DS-1272ZJ-XX(B))	Hik white Aluminum alloy Ø 120 mm × 37.2 mm (Ø 4.72" × 1.46") 250g
					
		DS-1275ZJ-SUS	DS-1272ZJ-120B		
Vertical pole mount	Wall mount				
Hikvision White Stainless Steel 127 mm × 46 mm × 250 mm (5" × 1.81" × 9.84") 1480 g (3.26 lb.) Match up with wall mount (DS-1272ZJ-XX(B))	Hik white Aluminum alloy with junction box 123×180×223mm 1225g				







Appearance	Model	Relevant brackets and housings			
		Indoor/Outdoor			
	DS-2CD2T85FWD-I8 DS-2CD2T55FWD-I8 DS-2CD2T45FWD-I5/I8 DS-2CD2T35FWD-I8 DS-2CD2T25FWD-I5/I8				
		DS-1275ZJ-SUS(Black)	DS-1260ZJ(Black)	DS-1276ZJ-SUS(Black)	DS-1280ZJ-S(Black)
		Vertical pole mount	Junction box	Corner mount	Junction box
	DS-2CD2T65G1-I5 DS-2CD2T85G1-I5	Hik Black Stainless Steel 127×46×250mm Diameter of clamp: Ø67-127mm 1480g	Hik Black Alloy Ø 88.5 mm × 36 mm (Ø 3.48" × 1.42") Approx. 251 g (0.55 lb.)	Hik Black Stainless Steel 126×105×250mm 2280g	Hik Black Aluminum alloy Ø137 × 53.4× 164.8mm 527g
		Other brackets are the same as Hik white camera			













Appearance	Model	Relevant brackets and housings				
		Indoor/Outdoor				
	DS-2CD2545FWD-I(S) DS-2CD2525FWD-I(S) DS-2CD2563G0-I(S) DS-2CD2543G0-I(S) DS-2CD2523G0-I(S)					
		DS-1272ZJ-120(Black)	DS-1271ZJ-120(Black)	DS-1276ZJ-SUS(Black)	DS-1280ZJ-DM46(Black)	DS-1275ZJ-SUS(Black)
		Wall mount	Pendant mount	Corner mount	Junction box	Vertical pole mount
		Hik Black Aluminum alloy 120×122×173.5mm 430g	Hik Black Aluminum alloy Ø150×573mm 1900g	Hik Black Stainless Steel 126X105X250mm 2280g Match up with wall mount (DS-1272ZJ-XX(B))	Hik Black Aluminum alloy Ø 120 mm × 37.2 mm (Ø 4.72" × 1.46") 250g	Hik Black Stainless Steel 127 mm × 46 mm × 250 mm (5" × 1.81" × 9.84") 1480 g (3.26 lb.) Match up with wall mount (DS-1272ZJ-XX(B))
Other brackets are the same as Hik white camera						





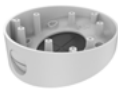



Appearance	Model	Relevant brackets and housings				
		Indoor/Outdoor(suitable for indoor)				
	DS-2CD1123G0-I DS-2CD1123G0E-I DS-2CD1143G0-I DS-2CD1153G0-I					
		DS-1259ZJ	DS-1271ZJ-110	DS-1272ZJ-110	DS-1272ZJ-110B	DS-1276ZJ-SUS
		Inclined ceiling mount	Pendant mount	Wall mount	Wall mount	Corner mount
	DS-2CD1143G0E-IF					
		DS-1280ZJ-DM18	DS-1258ZJ	DS-1250ZJ	DS-1275ZJ-SUS	
		Junction box	Wall mount	Rain shade	Vertical pole mount	
	DS-2CD2121G0-I(W)(S) DS-2CD2165G0-I(S) DS-2CD2185FWD-I(S) DS-2CD2155FWD-I(S) DS-2CD2145FWD-I(S) DS-2CD2135FWD-I(S) DS-2CD2125FWD-I(S) DS-2CD2125FHD-I(S) DS-2CD2183G0-I(S) DS-2CD2163G0-I(S) DS-2CD2143G0-I(S) DS-2CD2123G0-I(S)					
		DS-1280ZJ-DM18	DS-1258ZJ	DS-1250ZJ	DS-1275ZJ-SUS	
		Junction box	Wall mount	Rain shade	Vertical pole mount	
		Hik white ABS Plastic Ø111×39.2mm 200g	Hik white Aluminum alloy Ø150×560mm 1900g	Hik white Aluminum alloy 120×122×169mm 420g	Hik white Aluminum alloy with junction box 123×180×227.8mm 1205g	Hik white Stainless Steel 126X105X250mm 2280g Match up with wall mount [DS-1272ZJ-XX(B)]
		Hik white Aluminum alloy Ø115.4×43.8mm 450g	Hik white ABS plastic 120×111×161.5mm 200g	Hik white Composite Fibre 264.7*152*189.6 mm 199g	Hikvision White Stainless Steel 127 mm × 46 mm × 250 mm (5" × 1.81" × 9.84") 1480 g (3.26 lb.) Match up with wall mount [DS-1272ZJ-XX(B)]	





Appearance	Model	Relevant brackets and housings				
		Indoor/Outdoor(suitable for indoor)				
	DS-2CD2165G0-I DS-2CD2185FWD-I DS-2CD2155FWD-I DS-2CD2145FWD-I(S) DS-2CD2125FWD-I DS-2CD2183G0-I(S) DS-2CD2163G0-I(S) DS-2CD2143G0-I(S) DS-2CD2123G0-I(S)					
		DS-1259ZJ(Black)	DS-1271ZJ-110(Black)	DS-1272ZJ-110(Black)	DS-1272ZJ-110B(Black)	DS-1276ZJ-SUS(Black)
		Inclined ceiling mount	Pendant mount	Wall mount	Wall mount	Corner mount
		Hik Black ABS Plastic Φ111×39.2mm 200g	Hik Black Aluminum alloy Φ150×560mm 1900g	Hik Black Aluminum alloy 120×122×169mm 420g	Hik Black Aluminum alloy with junction box 123×180×227.8mm 1205g	Hik Black Stainless Steel 126×105×250mm 2280g Match up with wall mount [DS-1272ZJ-XX(B)]
						
		DS-1280ZJ-DM18(Black)	DS-1258ZJ(Black)	DS-1250ZJ(Black)	DS-1275ZJ-SUS(Black)	
		Junction box	Wall mount	Rain shade	Vertical pole mount	
		Hik Black Aluminum alloy Φ115.4×43.8mm 450g	Hik Black ABS plastic 120×111×161.5mm 200g	Hik Black Composite Fibre 264.7*152*189.6 mm 199g	Hik Black Stainless Steel 127×46×250mm Diameter of clamp: Φ67-127mm 1480g Match up with wall mount [DS-1272ZJ-XX(B)]	









Appearance	Model	Relevant brackets and housings					
		Indoor/Outdoor					
	DS-2CD2146G1-I(S) DS-2CD2126G1-I(S)						
	DS-2CD2123G0-IU DS-2CD2143G0-IU DS-2CD2163G0-IU DS-2CD2183G0-IU	DS-1272ZJ-120	DS-1272ZJ-120B	DS-1271ZJ-120	DS-1276ZJ-SUS	DS-1275ZJ-SUS	DS-1253ZJ-M
	DS-2CD2126G2-I(SU) DS-2CD2146G2-I(SU)	Wall mount	Wall mount	Pendant mount	Corner mount	Vertical pole mount	Rain Shade for Outdoor Dome Camera
		Hik white Aluminum alloy 120×122×173.5mm 430g	Hik white Aluminum alloy with junction box 123×180×223mm 1225g	Hik white Aluminum alloy Φ150×573mm 1900g	Hik white Stainless Steel 126X105X250mm 2280g Match up with wall mount (DS-1272ZJ-XX(B))	Hikvision White Stainless Steel 127 mm × 46 mm × 250 mm (5" × 1.81" × 9.84") 1480 g (3.26 lb.) Match up with wall mount (DS-1272ZJ-XX(B))	Hikvision White PP+30%GF Φ191.1×76mm 133g





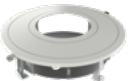

Appearance	Model	Relevant brackets and housings				
		Indoor/Outdoor				
	DS-2CD2185G0-IMS DS-2CD2125G0-IMS					
		DS-1272ZJ-120-TR15	DS-1272ZJ-120B	DS-1271ZJ-120	DS-1276ZJ-SUS	DS-1275ZJ-SUS
		Hikvision White Aluminium Alloy 120 mm × 122 mm × 173 mm (4.72" × 4.80" × 6.81") Approx. 460 g (1.01 lb.)	Hik white Aluminum alloy with junction box 123×180×223mm 1225g	Hik white Aluminum alloy Φ150×573mm 1900g	Hik white Stainless Steel 126X105X250mm 2280g Match up with wall mount (DS-1272ZJ-XX(B))	Hikvision White Stainless Steel 127 mm × 46 mm × 250 mm (5" × 1.81" × 9.84") 1480 g (3.26 lb.) Match up with wall mount (DS-1272ZJ-XX(B))







Appearance	Model	Relevant brackets and housings					
		Indoor/Outdoor(suitable for indoor)					
	DS-2CD172360-I(Z) DS-2CD174360-I(Z) DS-2CD175360-I(Z)						
		DS-1271ZJ-135	DS-1273ZJ-135	DS-1473ZJ-135B	DS-1275ZJ-SUS	DS-1276ZJ-SUS	DS-1227ZJ
		Pendant mount	Wall mount	Wall mount with junction box	Vertical pole mount	Corner mount	In-ceiling mount
		Hik white Aluminum alloy 150×150×565mm 1900g	Hik white Aluminum alloy 136×183.5×230mm 704g	Hik white Aluminum alloy with junction box 136×243×290mm 1490g	Hikvision White Stainless Steel 127 mm × 46 mm × 250 mm (5" × 1.81" × 9.84") 1480 g (3.26 lb.) Match up with wall mount (DS-1273ZJ-XX(B))	Hik white Stainless Steel 126X105X250mm 2280g Match up with wall mount (DS-1273ZJ-XX(B))	Hik white Aluminum alloy & ABS Plastic Φ210×90mm 540g Match up with D20-AP for 17XX models
							
		D20-AP	DS-1280ZJ-DM21	DS-1281ZJ-DM23	DS-1253ZJ-L	DS-1250ZJ	DS-1258ZJ-L
		Adapter Plate	Junction box	Inclined ceiling mount	Rain shade	Rain shade	Wall mount
Hik white Match up with DS-1227ZJ for 17XX models	Hik white Aluminum alloy 162×137×42mm 250g	Hik white Aluminum alloy 136.3×136.3×48mm 245g	Hik white Composite Fibre Φ225.1×98mm 198g Match up with wall mount (DS-1273ZJ-135)	Hik white Composite Fibre 264.7*152*189.6 mm 199g	Hik white Plastic 136×183×213mm 260g		









Appearance	Model	Relevant brackets and housings					
		Indoor/Outdoor					
	DS-2CD2785G0-IZS DS-2CD2785G0-IZS DS-2CD2785FWD-IZS DS-2CD2755FWD-IZS(B) DS-2CD2745FWD-IZS DS-2CD2735FWD-IZS DS-2CD2725FWD-IZS DS-2CD2725FWD-IZS DS-2CD2725FHW-IZS DS-2CD2783G0-IZS DS-2CD2763G0-IZS DS-2CD2743G0-IZS DS-2CD2723G0-IZS						
		DS-1471ZJ-155	DS-1473ZJ-155	DS-1475ZJ-SUS	DS-1473ZJ-155B	DS-1476ZJ-SUS	DS-1227ZJ-DM37
		Pendant Mount	Wall Mount	Vertical pole mount	Wall Mount	Corner mount	In-Ceiling Mount
	DS-2CD2726G2-IZS DS-2CD2746G2-IZS DS-2CD2786G2-IZS	Hik white Aluminum alloy Ø155×150×565mm	Hik white Aluminum alloy 155×183.5×240mm	Hik white Stainless Steel 250 mm × 127 mm × 46 mm Diameter of clamp: Ø67-127mm 1205g Match up with wall mount (DS-1473Z-XX(B))	Hik white Aluminum alloy 243×123×300mm 1750 g (3.86 lb.)	Hik white Stainless Steel 126X105X250mm 2280g Match up with wall mount (DS-1473ZJ-XX(B))	Hik white Steel and Plastic Ø 225 mm × 98.2 mm [8.86" × 3.87"] 700 g (1.54 lb.)







Appearance	Model	Relevant brackets and housings				
		Indoor/Outdoor				
	DS-2CD2785G0-IZS DS-2CD2785G0-IZS DS-2CD2785FWD-IZS DS-2CD2745FWD-IZS DS-2CD2735FWD-IZS DS-2CD2725FWD-IZS					Other brackets are the same as Hik white camera
		DS-1471ZJ-155(Black)	DS-1473ZJ-155(Black)	DS-1475ZJ-SUS(Black)	DS-1473ZJ-155B(Black)	
		Pendant Mount	Wall Mount	Vertical pole mount	Wall Mount	
		Hik Black Aluminum alloy Ø155×150×565mm	Hik Black Aluminum alloy 155×183.5×240mm	Hik white Stainless Steel 250 mm × 127 mm × 46 mm Diameter of clamp: Ø67-127mm 1205g Match up with wall mount (DS-1473Z-XX(B))	Hik Black Aluminum alloy 243×123×300mm 1750 g (3.86 lb.)	











Appearance	Model	Relevant brackets and housings						
		Indoor/Outdoor						
	DS-2CD2785G1-IZ(S) DS-2CD2765G1-IZ(S) DS-2CD2745G1-IZ(S) DS-2CD2725G1-IZ(S) DS-2CD2783G1-IZ(S) DS-2CD2763G1-IZ(S) DS-2CD2743G1-IZ(S) DS-2CD2723G1-IZ(S) DS-2CD2746G1-IZ(S) DS-2CD2726G1-IZ(S)							
		DS-1471ZJ-155	DS-1473ZJ-155	DS-1475ZJ-SUS	DS-1280ZJ-DM55	DS-1473ZJ-155B	DS-1476ZJ-SUS	DS-1227ZJ-DM44
		Pendant Mount	Wall Mount	Vertical pole mount	Junction Box	Wall Mount	Corner mount	In-Ceiling Mount
	DS-2CD2721G0-IZ(S)	Hik white Aluminum alloy Ø155×150×565mm	Hik white Aluminum alloy 155×183.5×240mm	Hik white Stainless Steel 250 mm × 127 mm × 46 mm Diameter of clamp: Ø67-127mm 1205g Match up with wall mount(DS-1473Z-XX(B))	Hikvision White Aluminum Alloy Ø 155 mm × 36 mm (Ø 6.1" × 1.42") 300 g (0.66 lb.)	Hik white Aluminum alloy 243×123×300mm 1750 g (3.86 lb.)	Hik white Stainless Steel 126X105X250mm 2280g Match up with wall mount(DS-1473ZJ-XX(B))	Hikvision White SECC, PC&ABS Ø 256.1 mm × 75.9 mm (Ø 10.08" × 2.99") Approx. 608.5 g (1.34 lb.)







Appearance	Model	Relevant brackets and housings					
		Indoor/Outdoor					
	DS-2CD2783G1-IZ(S) DS-2CD2763G1-IZ(S) DS-2CD2743G1-IZ(S) DS-2CD2723G1-IZ(S)						Other brackets are the same as Hik white camera
		DS-1471ZJ-155(Black)	DS-1473ZJ-155(Black)	DS-1475ZJ-SUS(Black)	DS-1280ZJ-DM55(Black)	DS-1473ZJ-155B(Black)	
		Pendant Mount	Wall Mount	Vertical pole mount	Junction Box	Wall Mount	
		Hik Black Aluminum alloy Ø155×150×565mm	Hik Black Aluminum alloy 155×183.5×240mm	Hik Black Stainless Steel 250 mm × 127 mm × 46 mm Diameter of clamp: Ø67-127mm 1205g Match up with wall mount(DS-1473Z-XX(B))	Hik Black Aluminum Alloy Ø 155 mm × 36 mm (Ø 6.1" × 1.42") 300 g (0.66 lb.)	Hik Black Aluminum alloy 243×123×300mm 1750 g (3.86 lb.)	









Appearance	Model	Relevant brackets and housings					
		Indoor					
	DS-2CD2935FWD-IS(S) DS-2CD2955FWD-IS						
		DS-1294ZJ	DS-1281ZJ-DM27	DS-1297ZJ	DS-1299ZJ	DS-1297ZJ-ES	DS-1297ZJ-M
		Wall mount	Inclined ceiling mount	Pendant mount (extendable)	Pendant Mount	Pendant mount (extendable)	Pendant mount (extendable)
		Hik white Toughened Plastic 223.9×80×125.8mm 450g	Hik white Plastic 111.8×40.5×108.3mm 45.8g	Hik white Aluminum alloy (Height 1000-2000mm)	Hik white Aluminum Alloy 77×77×198mm 165g	Hikvision White Aluminum Alloy Ø 97 mm × 270 mm to 400 mm (Ø 3.82" × 10.63" to 15.75") 500 g (1.10 lb.)	Hikvision White Aluminum Alloy Ø 120 mm × 650 mm to 1200 mm (Ø 4.72" × 25.59" to 47.24") 800 g (1.76 lb.)







Appearance	Model	Relevant brackets and housings						
		Indoor/Outdoor						
	DS-2CD2383G0-I(U) DS-2CD2363G0-I(U) DS-2CD2343G0-I(U) DS-2CD2323G0-I(U) DS-2CD2385FWD-I DS-2CD2355FWD-I DS-2CD2345FWD-I DS-2CD2335FWD-I DS-2CD2325FWD-I DS-2CD2325FHW-I							
		DS-1273ZJ-130-TRL	DS-1275ZJ-SUS	DS-1276ZJ-SUS	DS-1280ZJ-DM8	DS-1281ZJ-M	DS-1271ZJ-130-TRL	DS-1273ZJ-130B-TRL
		Wall mount	Vertical pole mount	Corner mount	Junction box	Inclined ceiling mount	Pendant mount	Wall mount
	DS-2CD2345G0P-I	Hik white Aluminum alloy 131×183.5×228.5mm 890g	Hikvision White Stainless Steel 127 mm × 46 mm × 250 mm (5" × 1.81" × 9.84") 1480 g (3.26 lb.) Match up with wall mount(DS-1273ZJ-XX(B))	Hik white Stainless Steel 126X105X250mm 2280g Match up with wall mount(DS-1273ZJ-J-XX(B))	Hik white Aluminum alloy Ø126.7mm×35mm Approx.: 210 g (0.46 lb.)	Hik white Aluminum alloy 157×165.7×61.8mm 586g	Hikvision white Aluminum alloy Ø150×567mm	Hikvision White Aluminum Alloy Ø 132 mm × 242.9 mm × 288.5mm (5.20" × 9.56" × 11.36") 1690 g (3.73 lb.)





Appearance	Model	Relevant brackets and housings					
		Indoor/Outdoor					
	DS-2CD2385FWD-I DS-2CD2355FWD-I DS-2CD2345FWD-I DS-2CD2325FWD-I DS-2CD238360-I(U) DS-2CD236360-I(U) DS-2CD234360-I(U) DS-2CD232360-I(U)DS-2CD282160						
		DS-1273ZJ-130-TRL(Black)	DS-1275ZJ-SUS(Black)	DS-1276ZJ-SUS(Black)	DS-1280ZJ-DM8(Black)	DS-1281ZJ-M(Black)	DS-1271ZJ-130-TRL(Black)
		Wall mount	Vertical pole mount	Corner mount	Junction box	Inclined ceiling mount	Pendant mount
		Hik Black Aluminum alloy 131×183.5×228.5mm 890g	Hik Black Stainless Steel 250 mm × 127 mm × 46 mm Diameter of clamp: Ø67-127mm 1480g Match up with wall mount (DS-1273ZJ-XX(B))	Hik Black Stainless Steel 126X105X250mm 2280g Match up with wall mount (DS-1273ZJ-J-XX(B))	Hik Black Aluminum alloy Ø126.7mm×35mm	Hik Black Aluminum alloy 157×165.7×61.8mm 586g	Hik Black Aluminum alloy Ø150×567mm
Other brackets are the same as Hik white camera							









Appearance	Model	Relevant brackets and housings					
		Indoor/Outdoor					
	DS-2CD2346G1-I(SL) DS-2CD2326G1-I(SL) DS-2CD2326G2-ISU/SL DS-2CD2346G2-ISU/SL DS-2CD2386G2-ISU/SL						
		DS-1271ZJ-140	DS-1273ZJ-140	DS-1280ZJ-DM21	DS-1275ZJ-SUS	DS-1276ZJ-SUS	DS-1273ZJ-140B
	DS-2CD2326G2-I(U) DS-2CD2346G2-I(U) DS-2CD2386G2-I(U)	Pendant Mount	Wall mount	Junction box	Vertical pole mount	Corner mount	Wall mount
	DS-2CD2385G1-I DS-2CD2365G1-I						
	DS-2CD2H25G1-I(ZS) DS-2CD2H45G1-I(ZS) DS-2CD2H65G1-I(ZS) DS-2CD2H85G1-I(ZS) DS-2CD2H23G1-I(ZS) DS-2CD2H43G1-I(ZS) DS-2CD2H63G1-I(ZS) DS-2CD2H83G1-I(ZS)	Hik white Aluminum alloy Ø150×565mm 1900g	Hik white Aluminum alloy 140×183.5×232mm 703g	Hik white Aluminum alloy 162×137×42mm 250g	Hik white Stainless Steel 127×46×250mm Diameter of clamp: Ø67-127mm 1480g Match up with wall mount (DS-1273ZJ-XX(B))	Hik white Stainless Steel 126×105×250mm 2280g Match up with wall mount (DS-1273ZJ-XX(B))	Hik white Aluminum alloy with junction box 140×243×292mm 1488g
	DS-2CD2347G1-L DS-2CD2347G1-LU DS-2CD2327G1-L DS-2CD2327G1-LU						





Appearance	Model	Relevant brackets and housings					Other brackets are the same as Hik white camera
		Indoor/Outdoor					
	DS-2CD2385G1-I DS-2CD2365G1-I						
		DS-1271ZJ-140(Black)	DS-1273ZJ-140(Black)	DS-1280ZJ-DM21(Black)	DS-1275ZJ-SUS(Black)	DS-1276ZJ-SUS(Black)	
		Pendant Mount	Wall mount	Junction box	Vertical pole mount	Corner mount	
		Hik Black Aluminum alloy Φ150×565mm 1900g	Hik Black Aluminum alloy 140×183.5×232mm 703g	Hik Black Aluminum alloy 162×137×42mm 250g	Hik Black Stainless Steel 250 mm × 127 mm × 46 mm Diameter of clamp: Φ67-127mm 1480g Match up with wall mount (DS-1273ZJ-XX(B))	Hik Black Stainless Steel 126X105X250mm 2280g Match up with wall mount (DS-1273ZJ-J-XX(B))	







Appearance	Model	Relevant brackets and housings						
		Indoor/Outdoor						
	DS-2CD2321G0-I/NF							
		DS-1272ZJ-110	DS-1275ZJ-SUS	DS-1276ZJ-SUS	DS-1280ZJ-S	DS-1281ZJ-S	DS-1271ZJ-110	DS-1272ZJ-110B
		Wall mount	Vertical pole mount	Corner mount	Junction box	Inclined ceiling mount	Pendant mount	Wall mount
		Hik white Aluminum alloy 120×122×169mm 420g	Hikvision White Stainless Steel 127 mm × 46 mm × 250 mm (5" × 1.81" × 9.84") 1480 g (3.26 lb.) Match up with wall mount (DS-1272ZJ-110(B))	Hik white Stainless Steel 126X105X250mm 2280g Match up with wall mount (DS-1272ZJ-110(B))	Hik white Aluminum alloy 137×53.4×164.8mm 527g	Hik white Aluminum alloy 137×56.5×147mm 472g	Hik white Aluminum alloy Φ150×560mm 1900g	Hik white Aluminum alloy with junction box 123×180×227.8mm 1205g

Appearance	Model	Relevant brackets and housings					
		Indoor/Outdoor					
	DS-2CD2H85FWD-IZS DS-2CD2H55FWD-IZS(B) DS-2CD2H45FWD-IZS DS-2CD2H35FWD-IZS DS-2CD2H25FWD-IZS DS-2CD2H25FHWD-IZS DS-2CD2H83G0-IZS DS-2CD2H63G0-IZS DS-2CD2H43G0-IZS DS-2CD2H23G0-IZS						
		DS-1473ZJ-135	DS-1471ZJ-135	DS-1281ZJ-DM23	DS-1475ZJ-SUS	DS-1476ZJ-SUS	DS-1473ZJ-135B
		Wall mount	Pendant mount	Inclined ceiling mount	Vertical pole mount	Corner mount	Wall mount with junction box
		Hik white Aluminum alloy 136×183.5×230mm 704g	Hik white Aluminum alloy 150×150×565mm 1900g	Hik white Aluminum alloy 136.3×136.3×48mm 245g	Hik white Stainless Steel 250 mm × 127 mm × 46 mm Diameter of clamp: Ø67-127mm 1205g Match up with wall mount (DS-1473ZJ-XX(B))	Hik white Stainless Steel 126X105X250mm 2280g Match up with wall mount (DS-1473ZJ-XX(B))	Hik white Aluminum alloy with junction box 136×243×290mm 1490g







Appearance	Model	Relevant brackets and housings				
		Indoor/Outdoor				
	DS-2CD2H85FWD-IZS DS-2CD2H45FWD-IZS DS-2CD2H35FWD-IZS DS-2CD2H25FWD-IZS					Other brackets are the same as Hik white camera
		DS-1473ZJ-135(Black)	DS-1471ZJ-135(Black)	DS-1281ZJ-DM23(Black)	DS-1475ZJ-SUS(Black)	
		Wall mount	Pendant mount	Inclined ceiling mount	Vertical pole mount	
		Hik Black Aluminum alloy 136×183.5×230mm 704g	Hik Black Aluminum alloy 150×150×565mm 1900g	Hik Black Aluminum alloy 136.3×136.3×48mm 245g	Hik Black Stainless Steel 250 mm × 127 mm × 46 mm Diameter of clamp: Ø67-127mm 1205g Match up with wall mount(DS-1473ZJ-XX(B))	













Appearance	Model	Relevant brackets and housings			
		Indoor/Outdoor			
	DS-2CD1H2160-IZ DS-2CD1H3160-IZ DS-2CD1H2360-IZ DS-2CD1H4360-IZ DS-2CD1H5360-IZ				
		DS-1273ZJ-130-TRL	DS-1275ZJ-SUS	DS-1276ZJ-SUS	DS-1280ZJ-M
		Wall mount	Vertical pole mount	Corner mount	Junction box
		Hik white Aluminum alloy 131×183.5×228.5mm 890g	Hikvision White Stainless Steel 127 mm × 46 mm × 250 mm [5" × 1.81" × 9.84"] 1480 g (3.26 lb.) Match up with wall mount(DS-1273ZJ-XX(B))	Hik white Stainless Steel 126X105X250mm 2280g Match up with wall mount(DS-1273ZJ-XX(B))	Hik white Aluminum alloy 157×184.8×53.4mm 621g
	DS-2CD234763E-L DS-2CD232763E-L				
		DS-1281ZJ-M	DS-1271ZJ-130-TRL	DS-1273ZJ-130B-TRL	
		Inclined ceiling mount	Pendant mount	Wall mount	
		Hik white Aluminum alloy 157×165.7×61.8mm 586g	Hikvision white Aluminum alloy Ø150×567mm	Hikvision White Aluminum Alloy Ø 132 mm × 242.9 mm × 288.5mm (5.20" × 9.56" × 11.36") 1690 g (3.73 lb.)	













Appearance	Model	Relevant brackets and housings			
		Indoor/Outdoor			
	DS-2CD1321-(D) DS-2CD1321-(E) DS-2CD1331-(D) DS-2CD1331-I DS-2CD1341-I DS-2CD1313G0-I DS-2CD1323G0-I DS-2CD1323G0E-I DS-2CD1323G0-IU DS-2CD1343G0-I DS-2CD1353G0-I				
		DS-1272ZJ-110-TRS	DS-1275ZJ-SUS	DS-1276ZJ-SUS	DS-1280ZJ-S
		Wall mount	Vertical pole mount	Corner mount	Junction box
		Hik white Aluminum alloy 120×122×169mm 420g	Hikvision White Stainless Steel 127 mm × 46 mm × 250 mm (5" × 1.81" × 9.84") 1480 g (3.26 lb.) Match up with wall mount(DS-1272ZJ-XX(B))	Hik white Stainless Steel 126X105X250mm 2280g Match up with wall mount(DS-1272ZJ-XX(B))	Hik white Aluminum alloy Ø137 x 53.4x 164.8mm 527g







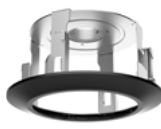

Appearance	Model	Relevant brackets and housings				
		Indoor				
	DS-2DE2A204(I)W-DE3 DS-2DE2A404(I)W-DE3					
		DS-1294ZJ-PT	DS-1297ZJ	DS-1299ZJ	DS-1297ZJ-ES	DS-1297ZJ-M
		Wall Mount	Pendant mount (extendable)	Pendant Mount	Pendant mount (extendable)	Pendant mount (extendable)
		Hikvision White Plastic and Steel 223.5 mm × 125.8 mm × 80 mm (8.8" × 4.95" × 3.15") 480 g (1.06 lb.)	Hik white Aluminum alloy (Height 1000-2000mm)	Hik white Aluminum Alloy 77×77×198mm 165g	Hikvision White Aluminum Alloy Ø 97 mm × 270 mm to 400 mm (Ø 3.82" × 10.63" to 15.75") 500 g (1.10 lb.)	Hikvision White Aluminum Alloy Ø 120 mm × 650 mm to 1200 mm (Ø 4.72" × 25.59" to 47.24") 800 g (1.76 lb.)

















Appearance	Model	Relevant brackets and housings
		Indoor
	DS-2DE2204IW-DE3 DS-2DE2204IW-DE3/W	
		DS-1294ZJ
		Wall mount
	DS-2DE2106IW-DE3	Hik white Toughened Plastic 223.9×80×125.8mm 450g







Appearance	Model	Relevant brackets and housings				
		Indoor/Outdoor				
	DS-2DE3204W-DE DS-2DE3304W-DE					
		DS-1227ZJ-PT6	DS-1273ZJ-PT6	DS-1280ZJ-PT6	DS-1275ZJ-SUS	DS-1276ZJ-SUS
		In-ceiling mount	Wall mount	Junction Box	Vertical pole mount	Corner mount
		Hik white Steel+Plastic Ø210×79.3mm 520 g	Hik white 183.5×140×232mm	Hik white Aluminum alloy 136.5×42×162.5mm 280g	Hik white Stainless Steel 127×46×250mm Diameter of clamp: Ø67-127mm 1205g Match up with DS_1273ZJ-PT6	Hik white Stainless Steel 126×105×250mm 2280g Match up with DS_1273ZJ-PT6







Appearance	Model	Relevant brackets and housings					
		Outdoor(only available for outdoor PTZ model)					
	DS-2DE4225W-DE DS-2DE4225W-DE DS-2AE4225T-D(C) DS-2AE4215T-D(C)						
		DS-1661ZJ	DS-1662ZJ	DS-1663ZJ	DS-1618ZJ	DS-1660ZJ	DS-1604ZJ
		Pendant mount	Pendant mount	Ceiling mount	Wall mount(short arm)	Parapet wall mount	Wall Mount with junction box
		Hik white Aluminum alloy Φ116.5×200mm 600g	Hik white Aluminum alloy Φ116.5×500mm 960g	Hik white Aluminum alloy Φ116.5×57mm 380g	Hik white Aluminum alloy 110×145×189mm 550g	Hik white Aluminum alloy 180×950×800mm 2900g	Hik white Aluminum alloy 255×171×355.5mm 2150g
							
		DS-1604ZJ-pole	DS-1604ZJ-corner	DS-1604ZJ-box	DS-1604ZJ-BOX-POLE	DS-1604ZJ-BOX-CORNER	DS-1619ZJ
Vertical pole mount	Corner mount	Wall mount with junction box	Vertical Pole Mount with junction box	Wall Mount with junction box	Gooseneck mount		
Hik white Aluminum alloy 170.7×261.8×355.5mm	Hik white Aluminum alloy 206.8×261.8×465mm	Hik white Aluminum alloy 281.2×170.7×395.5mm 2.15 Kg (4.74 lb.)	Hik white Aluminum alloy & steel 222×139.3×422mm	Hik white Aluminum alloy & steel 255.5×314×542.5mm	Hik white Aluminum alloy 455.2×130.4×841.5mm		







Appearance	Model	Relevant brackets and housings						
		Outdoor(only available for outdoor PTZ model)						
	DS-2AE4225TI-D(C) DS-2AE4215TI-D(C) DS-2DE4425IW-DE DS-2DE4415IW-DE DS-2DE4225IW-DE DS-2DE4215IW-DE							
		DS-1661ZJ	DS-1662ZJ	DS-1663ZJ	DS-1618ZJ	DS-1660ZJ	DS-1604ZJ	DS-1604ZJ-pole
		Pendant mount	Pendant mount	Ceiling mount	Wall mount(short arm)	Parapet wall mount	Wall Mount with junction box	Vertical pole mount
		Hik white Aluminum alloy Ø116.5×200mm 600g	Hik white Aluminum alloy Ø116.5×500mm 960g	Hik white Aluminum alloy Ø116.5×57mm 380g	Hik white Aluminum alloy 110×145×189mm 550g	Hik white Aluminum alloy 180×950×800mm 2900g	Hik white Aluminum alloy 255×171×355.5mm 2150g	Hik white Aluminum alloy 170.7×261.8×355.5mm
								
		DS-1604ZJ-corner	DS-1604ZJ-box	DS-1604ZJ-BOX-POLE	DS-1604ZJ-BOX-CORNER	DS-1619ZJ	DS-1671ZJ-SDM9	
		Corner mount	Wall mount with junction box	Vertical Pole Mount with junction box	Wall Mount with junction box	Gooseneck mount	In-ceiling mount	
		Hik white Aluminum alloy 206.8×261.8×465mm	Hik white Aluminum alloy 281.2×170.7×395.5mm	Hik white Aluminum alloy & steel 222×139.3×422mm 5.7 kg (12.57 lb.)	Hik white Aluminum alloy & steel 255.5×314×542.5mm 6.2 kg (13.67 lb.)	Hik white Aluminum alloy 455.2×130.4×841.5mm	Hik Black Steel + plastic Ø232.9×142.6mm	





Appearance	Model	Relevant brackets and housings			
		Outdoor(only available for outdoor PTZ model)			
	DS-2DE4A220IW-DE DS-2DE4A320IW-DE DS-2DE4A42SIW-DE DS-2DE4A404IW-DE DS-2DE4A225IW-DE DS-2DE4A215IW-DE DS-2DE4A204IW-DE				
		DS-1605ZJ	DS-1671ZJ-SD11	DS-1280ZJ-SD11	DS-1691ZJ-L
		Wall Mount Bracket	In-ceiling Mount Bracket	Junction Box	Pendant mount
		Hik white Aluminum alloy 183.5×120×228.6mm 1120g	Hik white Aluminum alloy Φ233×85mm 640 g [1.4 lb.]	Hik white Aluminum alloy Φ157.7 mm × 39.7 mm [6.2" × 1.6"] 450 g [0.99 lb.]	Hik white Steel 124x84x1000mm 2175g
					
		DS-1691ZJ-M	DS-1691ZJ	DS-1275ZJ-SUS	DS-1276ZJ-SUS
		Pendant mount	Pendant mount	Vertical pole mount	Corner mount
		Hik white Steel 124x84x500mm 1175g	Hik white Aluminum alloy 84×124×335mm 980g	Hik white Stainless Steel 127×46×250mm Diameter of clamp: Φ67-127mm 1205g Match up with DS_1605ZJ	Hik white Stainless Steel 126×105×250mm 2280g Match up with DS_1605ZJ





Appearance	Model	Relevant brackets and housings						
		Outdoor(only available for outdoor PTZ model)						
	DS-2DE5432IW-AE DS-2DE5425IW-AE DS-2DE5232IW-AE DS-2DE5225IW-AE DS-2AE5232TI-A(C) DS-2AE5225TI-A(C)							
		DS-1661ZJ	DS-1662ZJ	DS-1663ZJ	DS-1660ZJ	DS-1604ZJ	DS-1604ZJ-pole	DS-1604ZJ-corner
		Pendant mount	Pendant mount	Ceiling mount	Parapet wall mount	Wall mount	Vertical pole mount	Corner mount
		Hik white Aluminum alloy Φ116.5×200mm 600g	Hik white Aluminum alloy Φ116.5×500mm 960g	Hik white Aluminum alloy Φ116.5×57mm 380g	Hik white Aluminum alloy 180×950×800mm 2900g	Hik white Aluminum alloy 255×171×355.5mm 2150g	Hik white Aluminum alloy 170.7×261.8×355.5mm	Hik white Aluminum alloy 206.8×261.8×465mm
	DS-2DE5425W-AE DS-2DE5330W-AE DS-2DE5320W-AE DS-2DE5232W-AE DS-2DE5225W-AE DS-2AE5232T-A(C) DS-2AE5225T-A(C)							
		DS-1604ZJ-box	DS-1604ZJ-BOX-POLE	DS-1604ZJ-BOX-CORNER	DS-1619ZJ	DS-1667ZJ	DS-1602ZJ	
		Wall mount with junction box	Vertical Pole Mount with junction box	Wall Mount with junction box	Gooseneck mount	Extendable pole for Pendant mount	Wall Mount	
	DS-2AE7232TI-A(C) DS-2AE7225TI-A(C)							
		Hik white Aluminum alloy 281.2×170.7×395.5mm	Hik white Aluminum alloy & steel 222×139.3×422mm	Hik white Aluminum alloy & steel 255.5×314×542.5mm	Hik white Aluminum alloy 455.2×130.4×841.5mm	Hik white Galvanized steel pipe 1500-2500mm	Hik white Aluminum alloy 97X182X305mm	





Appearance	Model	Relevant brackets and housings					
		Outdoor					
	DS-2PT5326IZ-DE						
		DS-1604ZJ	DS-1604ZJ-pole	DS-1604ZJ-corner	DS-1661ZJ	DS-1619ZJ-H2	DS-1602ZJ
		Wall Mount with junction box	Vertical pole mount	Corner mount	Pendant mount	Gooseneck Mount	Wall Mount
	DS-2PT5306IZ-DE DS-2PT5306BZ-DE	Hik white Aluminum alloy 255×171×355.5mm 2150g	Hik white Aluminum alloy 170.7×261.8×355.5mm	Hik white Aluminum alloy 206.8×261.8×465mm	Hik white Aluminum alloy Ø116.5×200mm 600g	Hik white Stainless Steel Ø 130 mm × 455 mm × 526 mm (5.12" × 17.91" × 20.71") 5200 g (12.46 lb.)	Hik white Aluminum alloy 97X182X305mm

Appearance	Model	Relevant brackets and housings			
		Indoor			
	DS-2PT3326IZ-DE3 DS-2PT3122IZ-DE3			DS-1682ZJ	DS-1673ZJ
		DS-1294ZJ-TRL	DS-1271ZJ-PT10		
		Wall Mount	Pendant Mount	Extendable pole for Pendant mount	horizontal pole mount
	DS-2PT3306IZ-DE3	Hik white PC+ABS	Hik white Aluminum Alloy and Plastic Ø 160.6 mm × 532 mm (6.32" × 20.9") 1300 g (2.87 lb.)	Hik white Aluminum alloy 500mm Match up with pendant mount (DS-1661ZJ.DS-1662ZJ)	Hik white Steel(mounting board) & Stainless Steel(clamp) Diameter of clamp: Ø67-127mm Match up with pendant mount

















Appearance	Model	Relevant brackets and housings					
	DS-2TD1217/V1						
		DS-1271ZJ-140	DS-1273ZJ-140	DS-1275ZJ-SUS	DS-1276ZJ-SUS	DS-1273ZJ-140B	DS-1280ZJ-DM21
		Pendant Mount	Wall mount	Vertical pole mount	Corner mount	Wall mount	Junction box
		Hik white Aluminum alloy Ø150×565mm 1900g	Hik white Aluminum alloy 140×183.5×232mm 703g	Hik white Stainless Steel 127×46×250mm Diameter of clamp: Ø67-127mm 1480g Match up with wall mount (DS-1273ZJ-XX(B))	Hik white Stainless Steel 126X105X250mm 2280g Match up with wall mount (DS-1273ZJ-XX(B))	Hik white Aluminum alloy with junction box 140×243×292mm 1488g	Hik white Aluminum alloy 162×137×42mm 250g







Appearance	Model	Relevant brackets and housings		
	DS-2TD2617V1			
		DS-1275ZJ-SUS	DS-1276ZJ-SUS	DS-1260ZJ
		Vertical pole mount	Corner mount	Junction box
	DS-2TD2117V1	Hik white Stainless steel 127 mm × 46 mm × 250 mm [5" × 1.81" × 9.84"] 1480 g [3.26 lb.]	Hik white Stainless steel 126X105X250mm 2280g	Hik white Aluminum alloy Ø 88.5 mm × 36 mm [Ø 3.48" × 1.42"] 251g



Indoor housing							
Appearance	Housing	Model	Key Feature	Available Camera Models	Bracket Model		
	DS-1330HZ	DS-1330HZ	Hik white Complex fiber 290×142×92 mm 640 g	DS-2CD2821G0 DS-2CC12D9T-[A] DS-2CC12D9T-E DS-2CE37U8T-A			
					DS-1293ZJ	DS-1299ZJ	DS-1269ZJ
					Wall mount	Pendant Mount	Pendant mount
					Hik white Aluminum alloy 88×116.6×297.3mm 473g	Hik white Aluminum Alloy 77×77×198mm 165g	Hik white Aluminum alloy 493×246×88mm 480g

Indoor housing							
Appearance	Housing	Model	Key Feature	Available Camera Models	Bracket Model		
	DS-1332HZ	DS-1332HZ	Hik white Aluminum alloy 288×149×100mm 800g	DS-2CD2821G0 DS-2CC12D9T-[A] DS-2CC12D9T-E DS-2CE37U8T-A			
					DS-1293ZJ	DS-1299ZJ	DS-1269ZJ
					Wall mount	Pendant Mount	Pendant mount
					Hik white Aluminum alloy 88×116.6×297.3mm 473g	Hik white Aluminum Alloy 77×77×198mm 165g	Hik white Aluminum alloy 493×246×88mm 480g

Outdoor Housing

Appearance	Housing	Model	Key Feature	Available Camera Models	Bracket Model				
	DS-1331HZ series	DS-1331HZ-C	Hik white Aluminum alloy Containing fan DC12V IP66 110×165×445mm 1900g	DS-2CD2821G0 DS-2CC12D9T-(A) DS-2CC12D9T-E DS-2CE37U8T-A					
		DS-1331HZ-H	Hik white Aluminum alloy Containing fan and heater AC24V IP66 110×165×445mm 1900g		DS-1293ZJ	DS-1269ZJ	DS-1214ZJ	DS-1214ZJ-T	DS-1233ZJ
		DS-1331HZ-W	Hik white Aluminum alloy Containing fan and wiper AC24V IP66 445×165×170mm 1900g		Wall mount	Pendant mount	Horizontal pole mount	Horizontal pole mount	Column Mount
		DS-1331HZ-HW	Hik white Aluminum alloy Containing fan, wiper and heater AC24V IP66 445×165×170mm 2500g		Hik white Aluminum alloy 88×116.6×297.3mm 473g	Hik white Aluminum alloy 493×246×88mm 480g	Hik white Steel(mounting board) & Stainless Steel(clamp) 117×226×194mm Diameter of clamp: Ø67-127mm 1895g	Hik white Steel(mounting board) & Stainless Steel(clamp)	Hik white Steel Ø160 x 1093mm 6200g
		DS-1331HZ-CI	Hik white Aluminum alloy Containing fan DC12V IP66 IK10 445×140×94mm 1900g						
		DS-1331HZ-HI	Hik white Aluminum alloy Containing fan and heater AC 24V(DC 12V) IP66 IK10 110×165×445mm 1900g		DS-1232ZJ	DS-1232ZJ-T	DS-1275ZJ-SUS	DS-2204ZJ	
		DS-1331HZ-T	Hik white Aluminum alloy Containing fan and heater AC 24V(DC 12V) IP66 suitable for wide angle lens and fish-eye lens 454.2×169.2×114.6mm 1900g		Cardan Joint	Cardan Joint	Vertical pole mount	Wall mount	
		DS-1331HZ-R	Hik white Aluminum alloy Containing fan and heater AC 24V(DC 12V) IP66 suitable for wide angle lens and fish-eye lens 454.2×169.2×114.6mm 1900g		Hik white Steel 126×103.5×83mm 790	Hik white Steel 96×95×92.5mm	Hik white Stainless Steel 127×46×250mm Diameter of clamp: Ø67-127mm 1205g Match up with wall mount(DS-1293ZJ)	Hik white Aluminum alloy 413.5×228.7×120mm 1859g	

Outdoor housing							
Appearance	Housing	Model	Key Feature	Available Camera Models	Bracket Model		
	DS-4718HZ	DS-4718HZ-K	Hik white Aluminum alloy Containing fan and heater AC 24V(DC 12V) IP66 174×153×550mm 2500g	DS-2CD2821G0 DS-2CC12D9T-(A) DS-2CC12D9T-E DS-2CE37U8T-A			
					DS-1293ZJ	DS-1269ZJ	DS-1214ZJ
					Wall mount	Pendant mount	Horizontal pole mount
					Hik white Aluminum alloy 88×116.6×297.3mm 473g	Hik white Aluminum alloy 493×246×88mm 480g	Hik white Steel(mounting board) & Stainless Steel(clamp) 117×226×194mm Diameter of clamp: Ø67- 127mm 1895g
							
					DS-1214ZJ-T	DS-1275ZJ-SUS	
Horizontal pole mount	Vertical pole mount						
Hik white Steel(mounting board) & Stainless Steel(clamp)	Hik white Stainless Steel 127×46×250mm	Diameter of clamp: Ø67- 127mm 1205g Match up with wall mount [DS-1293ZJ]					

Outdoor housing							
Appearance	Housing	Model	Key Feature	Available Camera Models	Bracket Model		
	DS-1340HZ	DS-1340HZ	Three-axis adjustment Containing combined wires and fan IK10	DS-2CD2821G0 DS-2CC12D9T-(A) DS-2CC12D9T-E DS-2CE37U8T-A			
					DS-1275ZJ-4626		
					Vertical Pole Mount		
					Hik white		
					Steel(mounting board) & Stainless Steel(clamp) 127×46×250mm 1235g For 40 series box camera		

Accessories

Power Adapter



Power Adapters

Power Adapter	Details	Available Models
DC12V 1A Hikvision Brand	DS-2FA1201-DL,12V/1A,American standard,Φ2.1	Most IPC, analog camera and DS-2DE3/2xxx series mini PTZ models
	DS-2FA1201-DL,12V/1A,European standard,Φ2.1	
	DS-2FA1201-DL,12V/1A,Indian standard,Φ2.1	
DC12V 1A	ADS-12FG-12N 12012EPG,12V/1A,European standard,Two-wire, WHITE PACKAGE	Most IPC, analog camera and DS-2DE3/2xxx series mini PTZ models WHITE PACKAGE model is recommended for selling power adaptor alone, normal model is recommended for selling power adaptor with camera.
	ADS-12FG-12N 12012EPG,12V/1A,European standard,Φ2.1, WHITE PACKAGE	
	ADS-12FG-12N 12012EPCU,12V/1A,American standard,Two-wire, WHITE PACKAGE	
	ADS-12FG-12N 12012EPCU,12V/1A,American standard,Φ2.1, WHITE PACKAGE	
	ADS-12FG-12N 12012EPB,12V/1A,British standard,Two-wire, WHITE PACKAGE	
	ADS-12FG-12N 12012EPB,12V/1A,British standard,Φ2.1, WHITE PACKAGE	
DC12V 1.5A	MSA-C1500IC12.0-18P-US, DC12V/1.5A, American standard plug, Φ2.1	
	MSA-C1500IC12.0-18P-DE, DC12V/1.5A, Europe standard plug, Φ2.1	
	MSA-C1500IC12.0-18P-GB, DC12V/1.5A, British standard plug, Φ2.1	
DC12V 2A	MSA-C2000IC12.0-24P-GB,British standard,12V2A,Φ2.1	Indoor mini PanoVu and high power consumption IPC and analog camera
	MSA-C2000IC12.0-24P-DE,European standard,12V2A,Φ2.1	
	MSA-C2000IC12.0-24P-US,American standard,12V2A,Φ2.1	
Waterproof	DS-2PA1201-WRD, 12 VDC/1 A, Wall Mount	
SMPS	DS-2FA1225-D4(EUR), 4 Channels, 12 VDC/1 A per channel, European standard	
	DS-2FA1225-D4(IND), 4 Channels, 12 VDC/1 A per channel, Indian standard	
	DS-2FA1225-D4(UK), 4 Channels, 12 VDC/1 A per channel, British standard	
	DS-2FA1205-D8(EUR), 8 Channels, 12 VDC/1 A per channel, European standard	
	DS-2FA1205-D8(IND), 8 Channels, 12 VDC/1 A per channel, Indian standard	
	DS-2FA1205-D8(UK), 8 Channels, 12 VDC/1 A per channel, British standard	

Accessories

Camera Tester

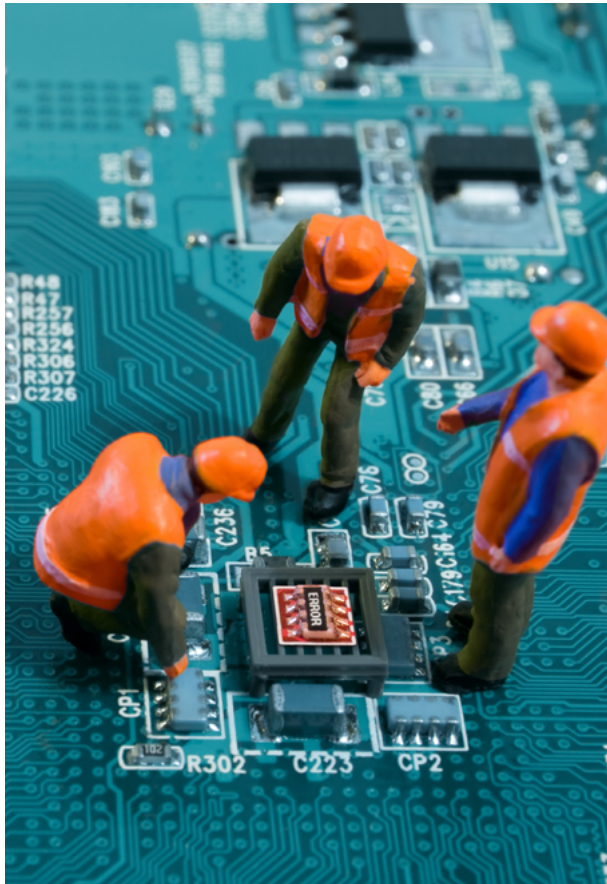

IPC-4300H

Network camera tester, 4.3" Screen, with ANSI/EN/BS/AS power supply, Support IP/CVBS/TVI(AHD/CVI) input

Accessories

Pickup



Pickup

Picture	Models	Key Features
	<p>DS-2FP2020</p>	<p>Pickup range:70 sq.m, Audio transmission distance:3000m, Frequency response:20Hz ~ 20KHz, SNR:60dB(1m40 dB audio tone SPL)40dB(10m 40 dB audio tone SPL)1KHz at 1 Pa, Dynamic Range:70dB(1KHz at Max dB SPL)</p>
	<p>DS-2FP4021-B</p>	<p>Pickup Scope:60 m2 / continuously adjustable, Gain Adjustment Scope:30dB/ continuous, Pickup Direction:Full Directions / 360°, Frequency Response:100Hz ~ 16KHz(1kHz@94db SPL), Dynamic Range:85dB, Output Impedance:600 Ohm unbalanced</p>
	<p>3.5mm plug adapter</p>	<p>match up with pick up for camera with 3.5mm jack</p>

DORI Distance (D/O/R/I)

NETWORK CAMERA

Pro Series

Find the Optimal Camera for Your Individual Security Needs

The DORI distance is a "general proximity" of distance which makes it easy to pinpoint the right camera for your needs. The DORI distance is calculated based on sensor specification and lab test results according to EN 62676-4 which defines the criteria for Detect, Observe, Recognize, and Identify, respectively.

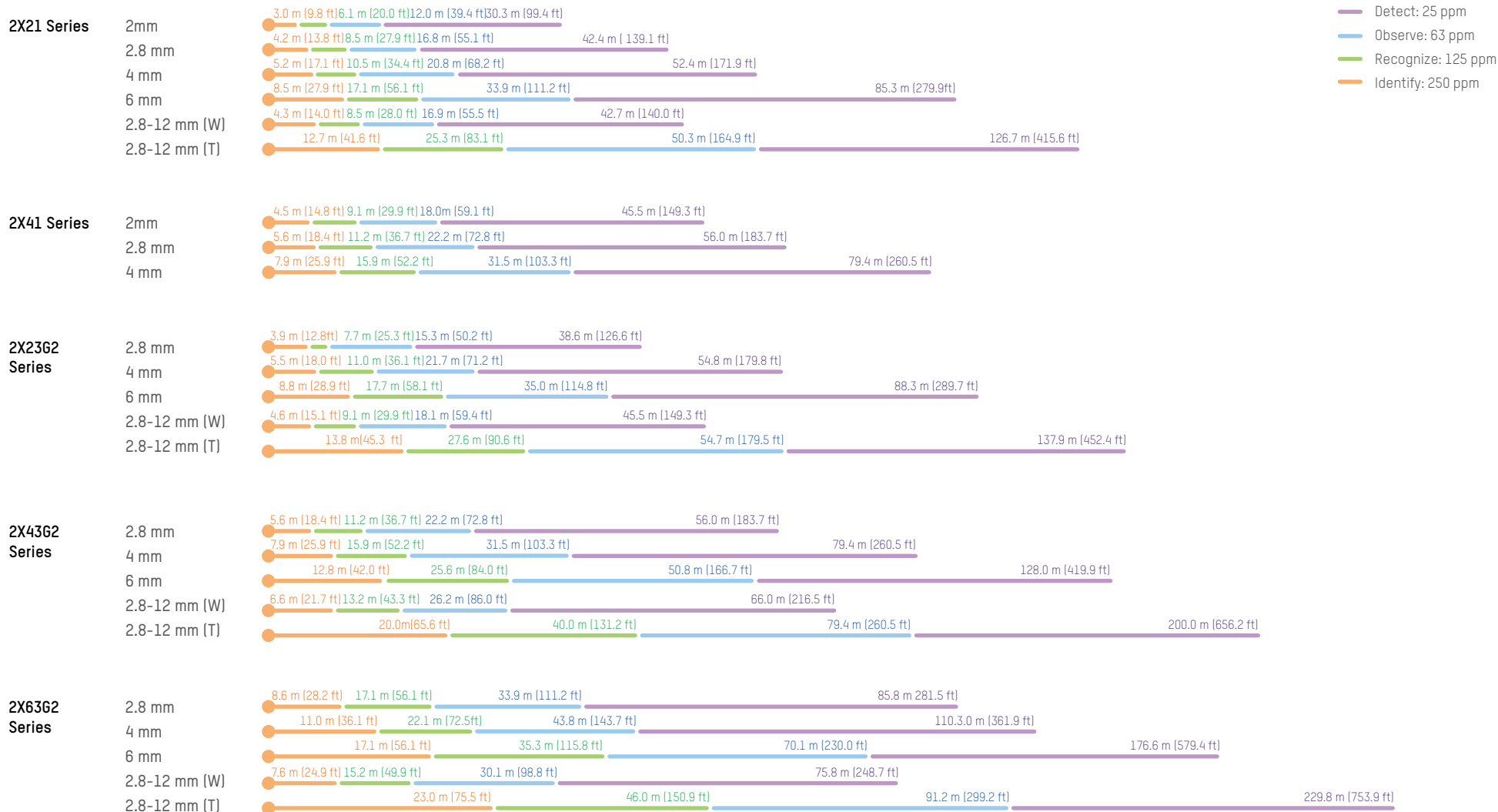

Find the Optimal Camera for Your Individual Security Needs

The DORI distance is a "general proximity" of distance which makes it easy to pinpoint the right camera for your needs. The DORI distance is calculated based on sensor specification and lab test result according to EN 62676-4 which defines the criteria for Detect, Observe, Recognize and Identify respectively.

DORI Distance (D/O/R/I)

- Detect: 25 ppm
- Observe: 63 ppm
- Recognize: 125 ppm
- Identify: 250 ppm

NETWORK CAMERA

Pro Series



Find the Optimal Camera for Your Individual Security Needs

The DORI distance is a "general proximity" of distance which makes it easy to pinpoint the right camera for your needs. The DORI distance is calculated based on sensor specification and lab test result according to EN 62676-4 which defines the criteria for Detect, Observe, Recognize and Identify respectively.

NETWORK CAMERA

Pro Series

DORI Distance (D/O/R/I)

- Detect: 25 ppm
- Observe: 63 ppm
- Recognize: 125 ppm
- Identify: 250 ppm

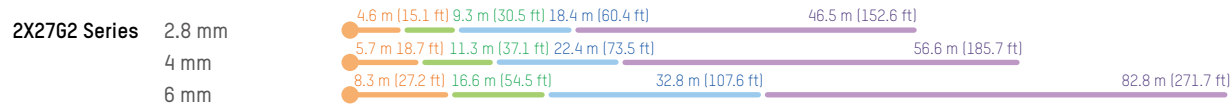
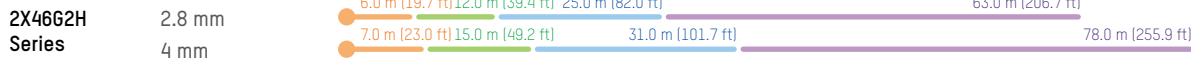
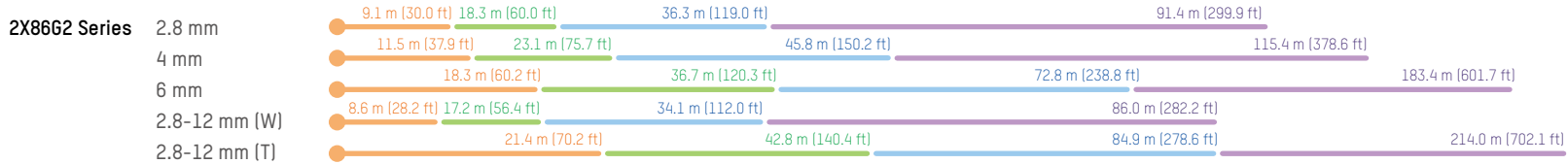
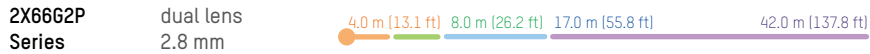
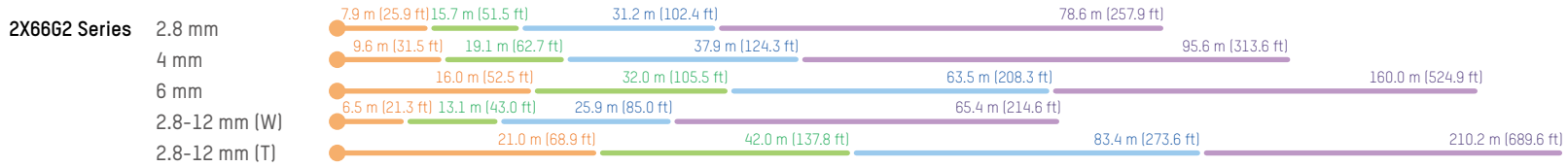

Find the Optimal Camera for Your Individual Security Needs

The DORI distance is a “general proximity” of distance which makes it easy to pinpoint the right camera for your needs. The DORI distance is calculated based on sensor specification and lab test result according to EN 62676-4 which defines the criteria for Detect, Observe, Recognize and Identify respectively.

DORI Distance (D/O/R/I)

- Detect: 25 ppm
- Observe: 63 ppm
- Recognize: 125 ppm
- Identify: 250 ppm

NETWORK CAMERA

Pro Series



Find the Optimal Camera for Your Individual Security Needs

The DORI distance is a “general proximity” of distance which makes it easy to pinpoint the right camera for your needs. The DORI distance is calculated based on sensor specification and lab test result according to EN 62676-4 which defines the criteria for Detect, Observe, Recognize and Identify respectively.

NETWORK CAMERA

Pro Series

DORI Distance (D/O/R/I)

- Detect: 25 ppm
- Observe: 63 ppm
- Recognize: 125 ppm
- Identify: 250 ppm

2X4762H Series

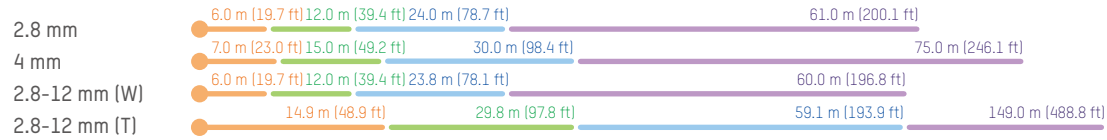

2X6762H Series

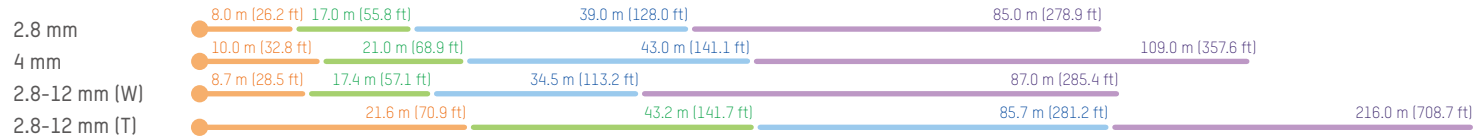

2X8762H Series

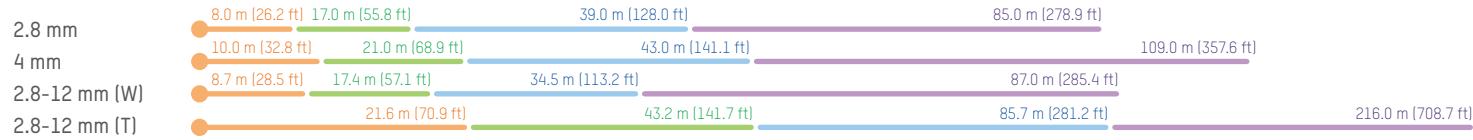

2T4761 2T4161 304761



Find the Optimal Camera for Your Individual Security Needs

The DORI distance is a "general proximity" of distance which makes it easy to pinpoint the right camera for your needs. The DORI distance is calculated based on sensor specification and lab test result according to EN 62676-4 which defines the criteria for Detect, Observe, Recognize and Identify respectively.

DORI Distance (D/O/R/I)

- Detect: 25 ppm
- Observe: 63 ppm
- Recognize: 125 ppm
- Identify: 250 ppm

NETWORK CAMERA

Value Series



Find the Optimal Camera for Your Individual Security Needs

The DORI distance is a “general proximity” of distance which makes it easy to pinpoint the right camera for your needs. The DORI distance is calculated based on sensor specification and lab test result according to EN 62676-4 which defines the criteria for Detect, Observe, Recognize and Identify respectively.

DORI Distance (D/O/R/I)

- Detect: 25 ppm
- Observe: 63 ppm
- Recognize: 125 ppm
- Identify: 250 ppm

NETWORK CAMERA

Value Series

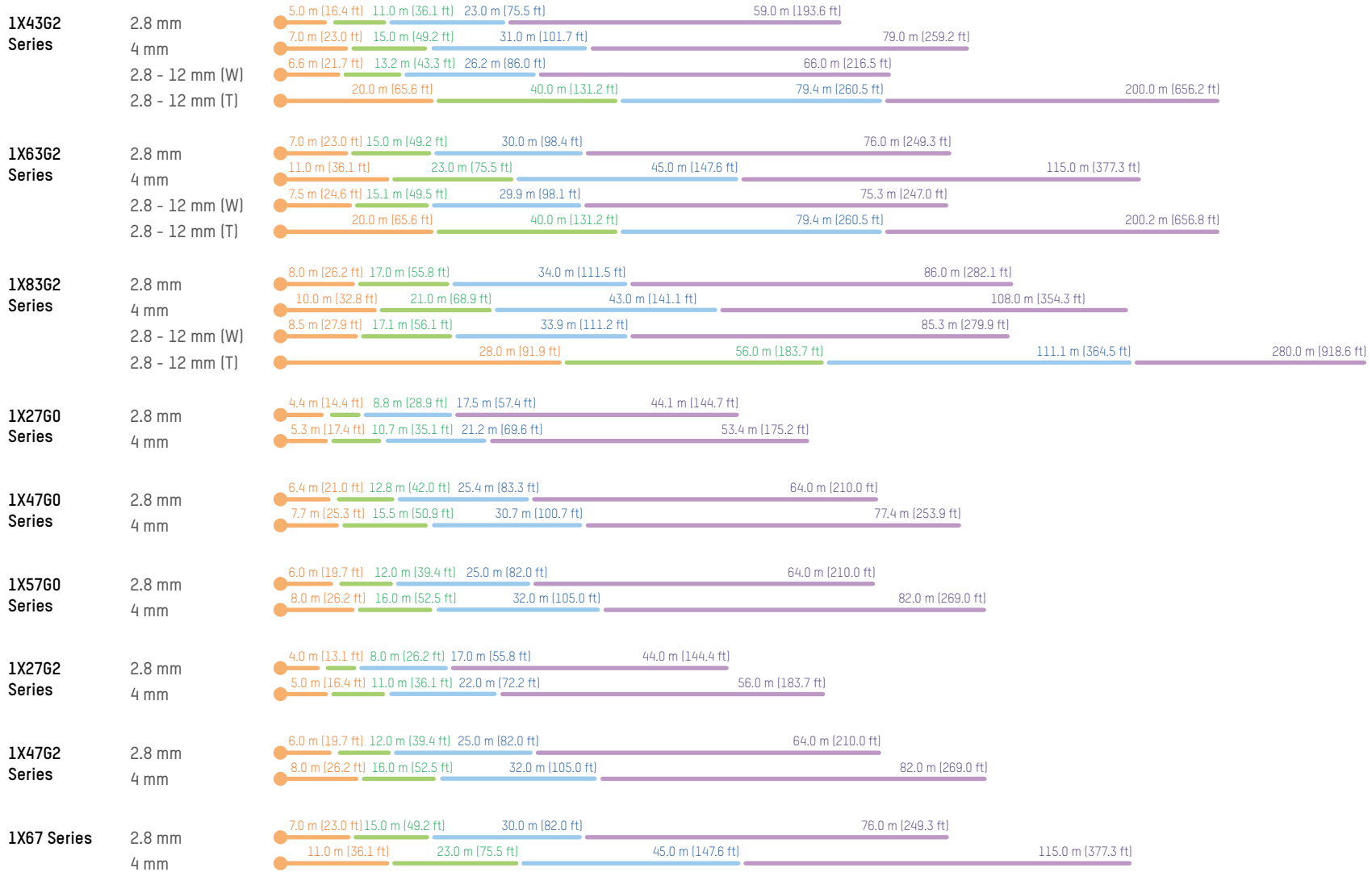

Find the Optimal Camera for Your Individual Security Needs

The DORI distance is a "general proximity" of distance which makes it easy to pinpoint the right camera for your needs. The DORI distance is calculated based on sensor specification and lab test result according to EN 62676-4 which defines the criteria for Detect, Observe, Recognize and Identify respectively.

DORI Distance (D/O/R/I)

- Detect: 25 ppm
- Observe: 63 ppm
- Recognize: 125 ppm
- Identify: 250 ppm

NETWORK CAMERA

Value Series



Find the Optimal Camera for Your Individual Security Needs

The DORI distance is a “general proximity” of distance which makes it easy to pinpoint the right camera for your needs. The DORI distance is calculated based on sensor specification and lab test result according to EN 62676-4 which defines the criteria for Detect, Observe, Recognize and Identify respectively.

DORI Distance (D/O/R/I)

- Detect: 25 ppm
- Observe: 63 ppm
- Recognize: 125 ppm
- Identify: 250 ppm

NETWORK PTZ CAMERA

Pro Series

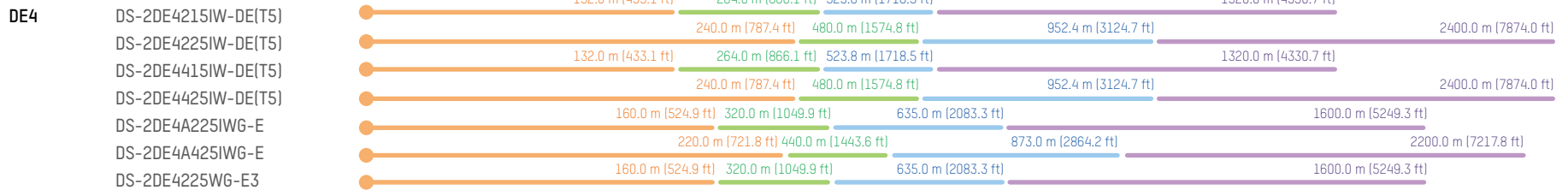
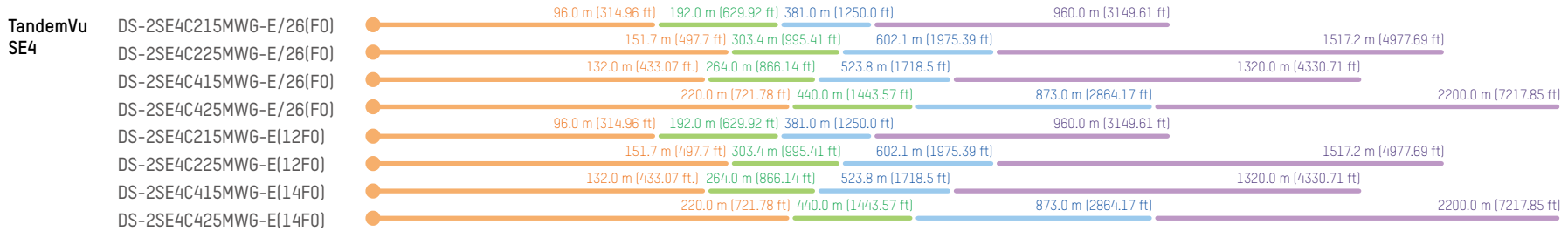
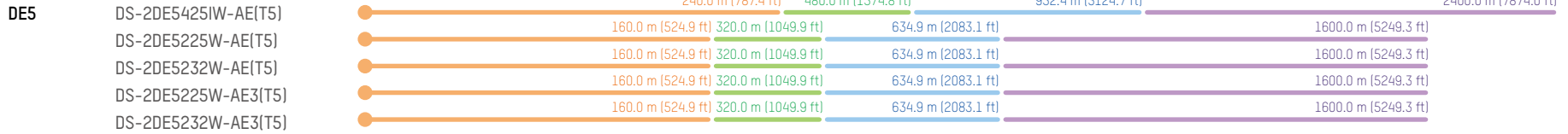

Find the Optimal Camera for Your Individual Security Needs

The DORI distance is a "general proximity" of distance which makes it easy to pinpoint the right camera for your needs. The DORI distance is calculated based on sensor specification and lab test result according to EN 62676-4 which defines the criteria for Detect, Observe, Recognize and Identify respectively.

DORI Distance (D/O/R/I)

- Detect: 25 ppm
- Observe: 63 ppm
- Recognize: 125 ppm
- Identify: 250 ppm

NETWORK PTZ CAMERA

Value Series

- DE3** DS-2DE3A404IWG-E
 DS-2DE3A404IWG-E/W
 DS-2DE3A400BW-DE(F1)(T5)
 DS-2DE3A400BW-DE/W(F1)(T5)



- DE2** DS-2DE2A204IW-DE3(S6)
 DS-2DE2A204IW-DE3/W(S6)
 DS-2DE2A404IW-DE3(S6)
 DS-2DE2A404IW-DE3/W(S6)
 DS-2DE2C200MW-DE(F0)(S7)
 DS-2DE2C200MW-DE(F1)(S7)
 DS-2DE2C400MW-DE(F0)(S7)
 DS-2DE2C400MW-DE(F1)(S7)
 DS-2DE2C200SCG-E(F0)
 DS-2DE2C200SCG-E(F1)
 DS-2DE2C400SCG-E(F0)
 DS-2DE2C400SCG-E(F1)

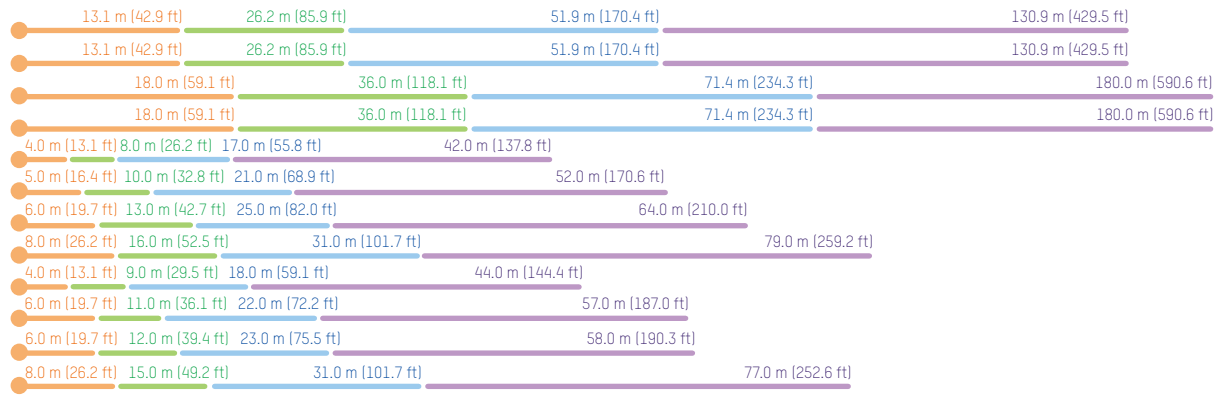

DORI Distance (D/O/R/I)

DORI Distance (D/O/R/I)

- Detection distance
- VCA distance
- Recognition distance
- Identification distance

Thermal

DS-2TDxxx7

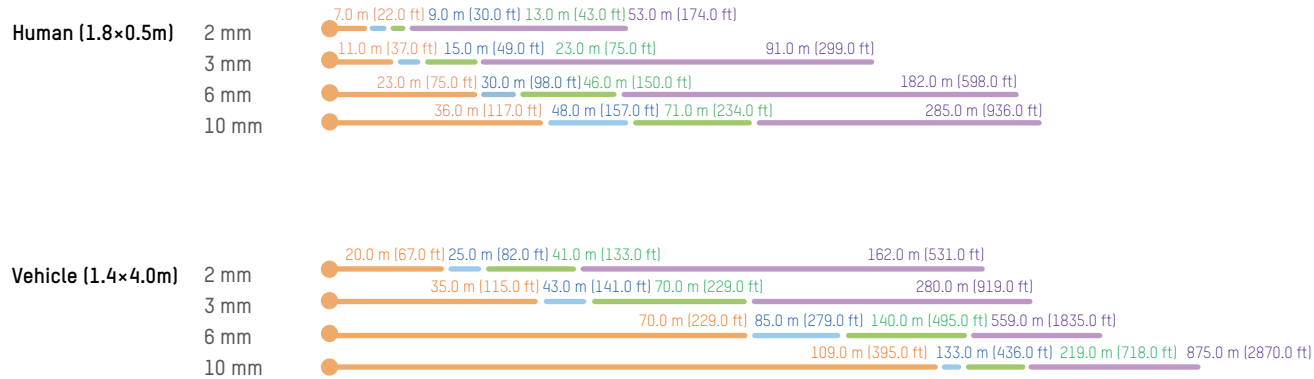

Thermal

DS-2TDxxx8

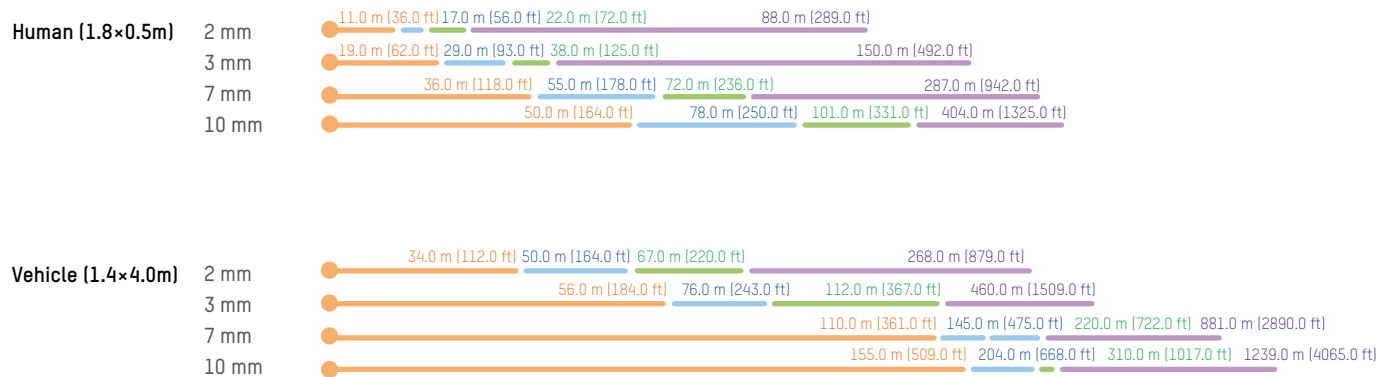



Hikvision Headquarters

No.555 Qianmo Road, Binjiang District, Hangzhou 310051, China
T +86-571-8807-5998
Business: overseasbusiness@hikvision.com
Technical Support: support@hikvision.com

Hikvision Australia
T +61-2-8599-4233
salesau@hikvision.com

Hikvision Azerbaijan
T +994 50 369 81 57
Azerbaijan.CATC@hikvision.com

Hikvision Brazil
T +55-11-3318-0050
Latam.support@hikvision.com

Hikvision Canada
T +1-866-200-6690
sales.canada@hikvision.com

Hikvision Colombia
sales.colombia@hikvision.com

Hikvision Czech
T +420 29 6182640
info.cz@hikvision.com

Hikvision Egypt
T +20223066117
sales.eg@hikvision.com

Hikvision Europe
T +31 23 5542770
sales.eu@hikvision.com

Hikvision France
T +33(0)1 85 330 450
info.fr@hikvision.com

Hikvision Germany
sales.dach@hikvision.com

Hikvision Hong Kong , China
sales.hk@hikvision.com

Hikvision Hungary KFT
info.hu@hikvision.com

Hikvision India
T +91-22-6855 9944
sales@pramahikvision.com

Hikvision Indonesia
T +6221 2933 9366
Sales.Indonesia@hikvision.com

Hikvision Israel
T +972 79 5555590
sales.israel@hikvision.com

Hikvision Italy
T +39 0438 6902
info.it@hikvision.com

Hikvision Kazakhstan
T +7 (727) 291-75-88
support@hikvision.kz

Hikvision Kenya
wangchengbin@hikvision.com

Hikvision Korea
T +82-1661-8138
sales.korea@hikvision.com

Hikvision Malaysia
T +60327224000
sales.my@hikvision.com

Hikvision Mexico
T +52 55 2624 0110
sales.mexico@hikvision.com

Hikvision New Zealand
T 09 217 3127
salesnz@hikvision.com

Hikvision New Panama
Sales.centralamerica@hikvision.com

Hikvision Pakistan
T +92-2135147526
support.pk@hikvision.com

Hikvision Philippines
support.ph@hikvision.com

Hikvision Poland
T +48 22 460 01 50
info.pl@hikvision.com

Hikvision Russia
T +7-495-669-67-99
saleru@hikvision.com

Hikvision Romania
marketing.ro@hikvision.com

Hikvision Singapore
T +65 6684 4718
sg@hikvision.com

Hikvision South Africa
T +27 877018113
sale.africa@hikvision.com

Hikvision Spain
T +34 91 737 16 55
info.es@hikvision.com

Hikvision Tashkent
T +99-87-1238-9438
uzb@hikvision.ru

Hikvision Thailand
sales.thailand@hikvision.com

Hikvision Turkey
T +90 216 521 70 70
support.tr@hikvision.com

Hikvision UAE
T +971-4-4432090
salesme@hikvision.com

Hikvision UK & Ireland
T +44(0)1628 902 140
info.uk@hikvision.com

Hikvision Uzbekistan
T +998-71-233-55-50
uzbekistan@hikvision.com

Hikvision USA
T +1-909-895-0400
sales.usa@hikvision.com

Hikvision Vietnam
T +84 24 7300 7586
sale.vn@hikvision.com

Follow us on social media to get the latest product and solution information



HIKVISION®

PRODUCT QUICK GUIDE

CCTV CHANNEL PRODUCTS

January-June 2023

Distributed by



Follow us on social media to get the latest product and solution information



Hikvision



HikvisionOverseas



HikvisionHQ



Hikvision



HikvisionHQ



Hikvision Corporate Channel



www.hikvision.com