

203-235-1200 | 2 COMMERCE BLVD PALM COAST, FL | SS396.COM

SS396.COM

A GROUND UP MOTORS COMPANY

VOL 24A

CELEBRATING
30+
YEARS



Monte Carlo

1970-1988
PARTS & ACCESSORIES
CATALOG

2024



OUR MISSION: WE GET IT CAUSE WE'VE BEEN THERE BEFORE.

Whether you shop online or over the phone you can be confident that our team is devoted to keeping your classic American muscle running and looking its best. With over 30 completed Ground Up restorations under our belt, we don't just sell our parts we use them. That's why we stand behind our products as being the best quality detailing and restoration parts.

“
**Helping Restore
Classic American
Muscle Since 1990**
”

CONTACT US

Call Us:

U.S. & Canada: (866) 358-2277

International: (203)-235-1200

Call Center Hours (ET):

Monday-Thursday: 9am-6pm

Friday: 9am-3pm

Saturday: 9am-1pm

Sunday: Closed

Shop Online 24/7 @ ss396.com

GROUND UP
MOTORS

A proud part of the Ground Up
Motors family of brands

WHY SHOP WITH US?

- **HELP WITH THE PROJECT, NOT JUST THE PART.**

We have thousands of parts available in our inventory, ready to ship. Making it easy for us to help you find the perfect fit and get your project moving.

- **EVERYDAY SUPER SAVINGS!**

We're here to help you save with Free Shipping or 10% Off available all year and exclusive kits and bundles to save you time & money.

- **FAST SHIPPING & SATISFACTION GUARANTEE:**

Most orders are packed, shipped, and delivered within 3 days from Miami to New York and as far West as Colorado and Texas. If you are not satisfied with your purchase you can return it for an exchange or refund.



Table of Contents

INTERIOR PARTS & TRIM 2-41	HEATING & COOLING..... 94-101	LIGHTING..... 159-161
STEREO & SPEAKERS 42-44	ENGINE PARTS 102-121	LOCKS 162-163
CONVERTIBLE..... N/A	ENGINE COMPARTMENT 122-126	EMBLEMS..... 164-165
TRUNK 45	HARDWARE..... 127-135	STENCILS & STRIPES..... 164-165
WHEELS & TIRES 46-49	EXTERIOR PARTS & TRIM..... 136-139	DECALS & PAINT 166-168
BRAKES..... 50-59	SHEETMETAL & RELATED..... 140-146	BOOKS & MANUALS..... 169
STEERING & SUSPENSION 60-76	GLASS 147-148	INDEX..... N/A
TRANSMISSION 77-86	WEATHERSTRIP..... 149-150	ORDER FORMS & POLICIES..... 170-175
FUEL & EXHAUST 87-93	ELECTRICAL..... 151-158	



TRUSTED BRANDS
THROUGH OUT THE CATALOG



Follow Us on Social Media

Let's Get Connected for Our Latest News & Updates



KEEP A LOOK OUT FOR THESE LOGOS THROUGHOUT THE CATALOG.



BUY & SAVE
WITH SS396.COM PRE-BUILT KITS

Find exclusive products found only at ss396.com. Save yourself the trouble of searching for parts and purchase pre-built kits to save time.

Call Us:

U.S. & Canada: (866) 358-2277 · International: (203) 235-1200

Call Center Hours (ET):

Monday-Thursday: 9am-6pm · Friday: 9am-3pm · Saturday: 9am-1pm · Sunday: Closed

Shop Online 24/7 @ ss396.com



1970 Monte Carlo

This is a set of high quality Monte Carlo seat covers which are constructed of the finest materials available. These Madrid grain vinyl seat covers feature the correct sporty design twin dielectrically bonded elk grain stripes in each insert.

Black

IUP-70MS10U	Front Buckets	SEE WEB
IUP-70MS10B	Front Bench.....	SEE WEB
IUP-70MS10C	Rear	SEE WEB



1971-72 Monte Carlo

This is a set of high quality PUI Monte Carlo seat covers which are constructed of the finest materials available. These Madrid grain vinyl seat covers feature the correct sporty design twin dielectrically bonded elk grain stripes in each insert.

Black

IUP-71MS10U	Front Buckets	SEE WEB
IUP-71MS10B	Front Bench.....	SEE WEB
IUP-71MS10C	Rear	SEE WEB



PUI Seat Covers

PUI seat covers are constructed of the finest quality materials and feature the best craftsmanship ensuring a perfect replacement for your damaged originals. These seat covers feature the correct grains and materials as original and are perfect for all cars from daily drivers to trailer queens. All factory colors are available.



1973-74 Monte Carlo

This is a set of high quality PUI Monte Carlo seat covers which are constructed of the finest materials available. These Madrid grain vinyl seat covers feature the correct sporty design twin dielectrically bonded elk grain stripes in each insert.

Black

IUP-73MS10U	Front Swivel Buckets	SEE WEB
IUP-73MS10C	Rear	SEE WEB

1975-76 Monte Carlo

This is a set of high quality PUI Monte Carlo seat covers which are constructed of the finest materials available. These Madrid grain vinyl seat covers feature the correct sporty design twin dielectrically bonded Walrus grain stripes in each insert.

Black

IUP-75MS10U	Front Swivel Buckets	SEE WEB
IUP-76MS10B	Front Bench.....	SEE WEB
IUP-76MS10C	Rear	SEE WEB

1977 Monte Carlo

This is a set of high quality PUI Monte Carlo seat covers which are constructed of the finest materials available. These Sierra grain vinyl seat covers feature the correct sporty design twin dielectrically bonded Krinkle grain stripes in each insert.

Black

IUP-77MS70U	Front Buckets	SEE WEB
-------------	---------------------	---------



1981 Monte Carlo

If your original seat covers are ripped or just plain worn looking then replacing them with these new seat covers by PUI is an excellent way to get your interior looking fresh and new again! These seat covers feature Sierra grain vinyl with sewn vertical pleats. Headrest and armrest covers are included on fronts.

Colors

Fill in color code below.

IUP-81MS01B1	Front Bench.....	SEE WEB
IUP-81MS01C	Rear.....	SEE WEB

· Saddle (36) · Navy Blue (18) · Camel (48) · Oyster (86) · Claret (01)



1982-86 Monte Carlo CL

If your original seat covers are ripped or just plain worn looking then replacing them with these new seat covers by PUI is an excellent way to get your interior looking fresh and new again! These seat covers feature Empress cloth with sewn vertical pleats with pillow style inserts. Headrest and armrest covers are included on fronts.

Colors

Fill in color code below.

IUP-86MSCLO1B	Front Bench.....	SEE WEB
IUP-86MSCLO1C	Rear	SEE WEB

· Maroon/Maple (01) · Grey (02) · Blue (03) · Saddle (04) · Black (05)



1983 Monte Carlo SS

If your original seat covers are ripped or just plain worn looking then replacing them with these new seat covers by PUI is an excellent way to get your interior looking fresh and new again! These seat covers feature Sierra grain white vinyl with blue Empress cloth inserts and sewn vertical pleats. Headrest and armrest covers are included on bench fronts. Embroidered headrest covers are included on front buckets.

Blue & White

- IUP-83MSC03B Front Bench.....SEE WEB
- IUP-83MSC03B1 Front Bench 55/45.....SEE WEB
- IUP-83MSC03U Front Bucket.....SEE WEB
- IUP-83MSC03C Rear.....SEE WEB



1984 Monte Carlo SS

If your original seat covers are ripped or just plain worn looking then replacing them with these new seat covers by PUI is an excellent way to get your interior looking fresh and new again! These seat covers feature Sierra grain blue vinyl with Brandon cloth inserts and sewn vertical pleats. Headrest and armrest covers are included on bench fronts. Headrest covers are included on front buckets.

Blue

- IUP-84MSC03B-1 Front Bench.....SEE WEB
- IUP-84MSC03U Front Bucket.....SEE WEB
- IUP-84MSC03C Rear.....SEE WEB



1987-88 Monte Carlo

If your original seat covers are ripped or just plain worn looking then replacing them with these new seat covers by PUI is an excellent way to get your interior looking fresh and new again! These seat covers feature Empress cloth with sewn vertical pleats with pillow style inserts. Headrest and armrest covers are included on bench fronts.

Colors

- Fill in color code below.
- IUP-87MSCLO5B Front Bench 55/45.....SEE WEB
 - IUP-87MSCLO5C Rear.....SEE WEB

1985-86 Monte Carlo

This is a set of high quality PUI Monte Carlo seat covers which are constructed of the finest materials available. These Madrid grain vinyl seat covers feature the correct sporty design twin dielectricly bonded elk grain stripes in each insert.

Colors

- Fill in color code below.
- IUP-86MSC01U Front Buckets.....SEE WEB
 - IUP-86MSC01B Front Bench 55/45.....SEE WEB
 - IUP-86MSC01B-1 Front Bench Split.....SEE WEB
 - IUP-86MSC01C Rear.....SEE WEB

· Maroon/Maple (01) · Grey (02) · Blue (03) · Saddle (04) · Black (05)

· Maple/Maroon (01) · Grey (02) · Blue (03) · Saddle (04) · Black (05)



IAS-70MS10U-P



IAS-71MS10U-P

Pre-Assembled Bucket Seats

If you're thinking about having your original bucket seats reupholstered, consider these pre-assembled bucket seats from PUI instead! Seat backs, side covers and seat tracks are included. Just open the box and bolt them in. It's that simple. This saves hours of time and money over buying seat covers, foam and paying an interior shop a premium price to upholster your seats. Available in all factory PUI colors.

- IAS-70MS10U-P 1970 All.....SEE WEB
 - IAS-71MS10U-P 1971-72 All.....SEE WEB
- Headrests are not included. No Volume Discount. Ships in two oversize boxes. Not eligible for free shipping.



Black (05)



Blue (03) - (09)



Bright Red (32)



Saddle (36) - (04)



Camel (48)



Neutral (29)

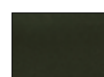

Dark Green (25)



Firethorn (45)



Gold (43)



Maple/Maroon (01)



Dark Metallic Blue (16)



Dark Metallic Green (24)

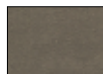

Navy Blue (18)

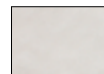

Oyster (86)

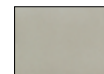

Sandlewood (41)



White (37)



Jade Green (19)



Grey (02)



IST-1561

Bucket Seat Tracks

Beautiful reproduction seat tracks.

IST-1560	1970-72 Driver Side.....	SEE WEB
IST-1561	1970-72 Passenger Side.....	SEE WEB
IST-15K	1970-72 Kit	SEE WEB
BSM-516	Track to Floor Bolt	SEE WEB
IBX-RELO	All (4 pc*).....	SEE WEB

*Does one seat.



BST-12655

Seat Track to Seat Bolt

BST-12655	All (8pc)	SEE WEB
-----------	-----------------	---------



BSM-REAR

Rear Seat Back Mounting Hardware

Seat retainer bolts which keep the upper portion of the rear seat in place. These bolts feature a built-in washer and are black phosphate plated just like original.

BSM-REAR	1970-72 All.....	SEE WEB
----------	------------------	---------



ICC-001

IBX-89K

Bucket Seat Brackets

Choose from either universal weld-in bucket seat brackets or OE style reproductions of the original brackets.

IBX-89K	1970-72 Exact OE.....	SEE WEB
IBX-89K-FR	OE Style Front & Rear.....	SEE WEB
ICC-001	1970-72 Universal (2pc)	SEE WEB
IBX-RELO	All (4pc) Relocation Brackets....	SEE WEB



ISE-662

Bucket Seat Extenders

Mounts to drivers side floor to offset seat tracks about two inches giving more leg room.

ISE-662	1970-72 Drivers Side.....	SEE WEB
---------	---------------------------	---------

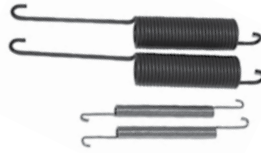

IZ-12815

Seat Frame to Track Springs

These springs go from the seat tracks to the seat frames to provide tension to the adjustment bracket.

IZ-12814	1970-72 Bench (2pc)	SEE WEB
IZ-12815	1970-72 Bucket (4pc)	SEE WEB



ISA-669

Bucket Seat Frames

Complete bucket seat frame assemblies with seat springs already installed!

ISA-669	1970-72 All.....	SEE WEB
---------	------------------	---------

No Volume Discount. Ships Oversize. Not eligible for free shipping.



BSW-180070

Bench Seat Washers

These washers go between the seat and the hinge on all bench seat cars. It keeps the hinge from damaging the seat material.

BSW-180070	All.....	SEE WEB
------------	----------	---------



IHG-7

Seat Installation Kit

Complete set of hog rings and pliers for seat cover installation.

IHG-7	All.....	SEE WEB
-------	----------	---------



ILA-1402B

Seat Back Lock Assembly

Complete seat back lock assembly including seat release button.

ILA-1402B	1970-72	SEE WEB
-----------	---------------	---------



IRG-1042C

Headrest Guides

Correct guides which headrest bars are inserted into on all Strato Bucket seats.

IRG-1042C	1970-72	SEE WEB
-----------	---------------	---------



ITC-4321B

1970-72 Bucket Seat Headrest Trim

This is the inner trim panel that mounts onto the bottom of the bucket seat headrest in the correct pebble grain.

ITC-4321B	1970-72 Buckets.....	SEE WEB
-----------	----------------------	---------



ITW-3775

Bucket Seat Headrests

OE style reproduction injection molded headrests. Black only.

ITW-3775	1970-72	SEE WEB
----------	---------------	---------



IFC-521

Seat Release Buttons

IFC-521	1970-72 Buckets.....	SEE WEB
IFC-521K	1970-72 Buckets.....	SEE WEB



ISS-5085

Seatback Bumpers

Correct rubber coated steel.

ISS-5085	1970-72 All.....	SEE WEB
----------	------------------	---------

Two pairs required per car.



ISF-72-WIRE

Seat Foams

OEM Style Foam With Listing Wire Buckets

Correct density injection molded seat foam with molded in listing wire. Each set contains one back and one bottom. The kits come with 2 sets of foams, enough for a pair of bucket seats.

ISF-72-WIRE	1970 Buckets 1 Back 1 Bottom.....	SEE WEB
ISF-72-WIRE-KIT	1970 Buckets 2 Backs 2 Bottoms.....	SEE WEB
ISF-737AU	1973-77 Swivel w/ Wires	SEE WEB

OEM Style Replacement Foam No Wire Buckets

Replacement style correct density injection molded seat foam. Each set contains one back and one bottom. The kits come with 2 sets of foams, enough for a pair of bucket seats.

ISF-72	1970 Buckets 1 Back 1 Bottom.....	SEE WEB
ISF-72K	1970 Buckets 2 Backs 2 Bottoms.....	SEE WEB
ISF-73	1971-72 Buckets 1 Back 1 Bottom.....	SEE WEB
ISF-73K	1971-72 Buckets 2 Backs 2 Bottoms	SEE WEB
ISF-7888GU	1978-83 High Back	SEE WEB
ISF-8488MU	1984-88 Low Back.....	SEE WEB

OEM Style Replacement Foam Bench Seat

ISF-A68B	1970 Bench.....	SEE WEB
ISF-A71B	1971-72 Bench	SEE WEB
ISF-72RR	1970-72 Rear Bench.....	SEE WEB
ISF-BUNREAR	1970-77 Universal Bench Front or Rear	SEE WEB

No Volume Discount. Ships Oversize. Not eligible for free shipping.



Bucket Seat Backs & Side Covers - OE style reproductions with chrome edge piping.

Complete Kits

BACK-KITA6910	1970-72 Black.....	SEE WEB
BACK-KITA6911	1970-72 Red.....	SEE WEB
BACK-KITA6912	1970-72 Dark Blue	SEE WEB
BACK-KITA6913	1970-72 Bright Blue	SEE WEB
BACK-KITA6914	1970-72 Parchment.....	SEE WEB
BACK-KITA6915	1970-72 Dark Green	SEE WEB
BACK-KITA6916	1970-72 Light Saddle.....	SEE WEB
BACK-KITA6917	1970-72 Dark Saddle.....	SEE WEB
BACK-KITA6918	1970-72 Sandalwood	SEE WEB
BACK-KITA6919	1970-72 White	SEE WEB
BACK-KITA6920	1970-72 Pearl	SEE WEB

No Volume Discount. Ships Oversize. Not eligible for free shipping.



ICC-0259K

Bucket Seat Chrome Kit

This is a one step kit to replace all the chrome on your bucket seats. This kit includes the correct chrome piping, 12 end caps, 4 headrest locks and 2 seat back release buttons.

ICC-0259K	1970-72	SEE WEB
-----------	---------------	---------



Molded OE Style Bucket Seat Trim Kit

Correct OE style molded metal bucket seat trim. This kit features the thick clear plastic coating just like the originals. This kit comes with 2 seat back chrome moldings and 4 side moldings, enough for both seats!

ICC-0259-OE	1970-72 Buckets	SEE WEB
-------------	-----------------------	---------



ICI-5263K

Headrest Locks

Correct chrome plated headrest locks.

ICI-5263K	1970-72 (4pc).....	SEE WEB
ICI-5263	1970-72	SEE WEB



BACK-HDP

Bucket Seat Back and Side Mounting Hardware

This 22 piece mounting kit provides all the correct hardware to mount the side and back plastics to the seats.

BACK-HDP	1970-72 Buckets.....	SEE WEB
----------	----------------------	---------

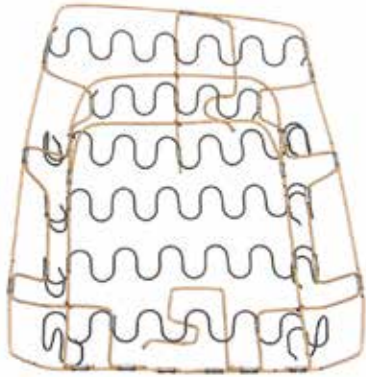

IZ-209

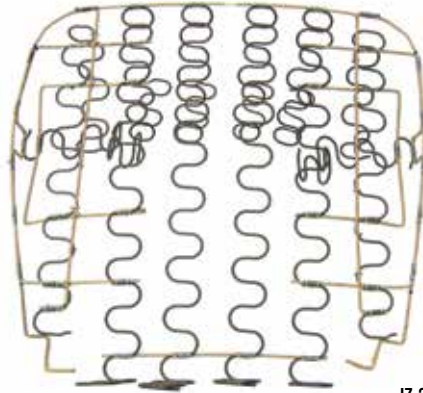

IZ-206

Bucket Seat Springs

Restore the comfort of your buckets with brand new springs!

IZ-206	1970-72 Bottom.....	SEE WEB
IZ-209	1970-72 Back.....	SEE WEB
IZ-103	1970-72 Side Supports.....	SEE WEB

No Volume Discount. Ships Oversize. Not eligible for free shipping.



ICC-0259



ICC-0254

Bucket Seat Trim

Correct chrome piping kit for both seat backs and sides and chrome end caps.

ICC-0259	1970-72 Trim*	SEE WEB
ICC-0254	1970-72 Caps.....	SEE WEB

**For reproduction back and sides*



IT-3890

Side Hinge Covers

New injection molded seat side covers.

IT-3890	1970-72 Bench.....	SEE WEB
---------	--------------------	---------



ICI-315



ICE-4636

Seat Adjustment Knobs

ICI-315	1970-72 Chrome	SEE WEB
ICE-4636	1970-72 Black.....	SEE WEB



OER Interior Paint

OER's revolutionary formula provides 40% more coverage than standard dyes and lacquers and actually penetrates and molecularly bonds to the surface to permanently seal in the color. Dries to the touch in 45 seconds, forms a complete bond in just 10 minutes. UV stable and color fast, it will not crack, flake or peel. For use on vinyl, leather, ABS plastic, polycarbonate, polypropylene, polyurethane, acrylic, lexan, fiberglass and recycled plastics. These paints are designed to match our colored PUI interior products. 12oz aerosol can.

HPP-802RED	M30 Red	SEE WEB
HPP-804BBLU	M14 Bright Blue	SEE WEB
HPP-808MBLU	M17 Medium Blue.....	SEE WEB
HPP-809IGLD	M46 Ivy Gold.....	SEE WEB
HPP-810WHITE	M37 White	SEE WEB
HPP-8110RNG	M126 Hugger Orange.....	SEE WEB
HPP-813DGRN	M24 Dark Green	SEE WEB
HPP-820CAMEL	Z48 Camel Tan	SEE WEB
HPP-829FTHR	Z45 Firethorn Red.....	SEE WEB
HPP-830CARME	Z38 Carmine	SEE WEB
HPP-1009	Surface Prep	SEE WEB

Paint can not be shipped via air. Ground shipping only.



BRS-12659

Seat Back Release Screws

Correct screws to hold the folding seat back assembly in the seat back.

BRS-12659	1970-72 (8pc).....	SEE WEB
-----------	--------------------	---------



IBR-732

Shoulder Belt Retainers

Correct roof mounted shoulder belt retainers.

IBR-732	1970-72 All.....	SEE WEB
---------	------------------	---------



ICV-4575

Seat Belt Holders

New seat belt holders which attach to console.

ICV-4575	1970-72	SEE WEB
----------	---------------	---------



BSB-56

Seat Belt Bolts

Correct shanked style seat belt bolts.

BSB-56	All Front Outer.....	SEE WEB
BSB-561	1970-72 Front Inner	SEE WEB
BSB-561	All Rear.....	SEE WEB
BSB-5-SBL	1970-77 All Fully Threaded.....	SEE WEB



SBL-CHEV68721000S



SBL-CHEV6872KIT1000S



SBL-CHEV68721000P



SBL-CHEV6872KIT1000P



SBL-1600GM1000

SBL-1600GMKIT1000

Standard Style GM Logo Seat Belts

OE style reproduction seat belt set featuring correct retractor, seat belt and buckle assembly with GM emblem.

Front Sets Lap

SBL-CHEV68721000S	1970-72 Black.....	SEE WEB
SBL-CHEV68722007S	1970-72 Red.....	SEE WEB
SBL-CHEV68722006S	1970-72 Bright Red.....	SEE WEB
SBL-CHEV68723008S	1970-72 Medium Saddle.....	SEE WEB
SBL-CHEV68724003S	1970-72 Medium Blue.....	SEE WEB
SBL-CHEV68724004S	1970-72 Navy Blue.....	SEE WEB
SBL-CHEV68725002S	1970-72 Dark Green.....	SEE WEB

Front & Rear Sets Lap

SBL-CHEV6872FR1000S	1970-72 Black.....	SEE WEB
SBL-CHEV6872FR2007S	1970-72 Red.....	SEE WEB
SBL-CHEV6872FR2006S	1970-72 Bright Red.....	SEE WEB
SBL-CHEV6872FR3008S	1970-72 Medium Saddle.....	SEE WEB
SBL-CHEV6872FR4003S	1970-72 Medium Blue.....	SEE WEB
SBL-CHEV6872FR4004S	1970-72 Navy Blue.....	SEE WEB
SBL-CHEV6872FR5002S	1970-72 Dark Green.....	SEE WEB

Front & Rear Sets Lap & Shoulder

SBL-CHEV6872KIT1000S	1970-72 Black.....	SEE WEB
SBL-CHEV6872KIT2007S	1970-72 Red.....	SEE WEB
SBL-CHEV6872KIT2006S	1970-72 Bright Red.....	SEE WEB
SBL-CHEV6872KIT3008S	1970-72 Medium Saddle.....	SEE WEB
SBL-CHEV6872KIT4003S	1970-72 Medium Blue.....	SEE WEB
SBL-CHEV6872KIT4004S	1970-72 Navy Blue.....	SEE WEB
SBL-CHEV6872KIT5002S	1970-72 Dark Green.....	SEE WEB

Front Shoulder Sets

SBL-CHEV6872SH1000S	1970-72 Black.....	SEE WEB
SBL-CHEV6872SH2007S	1970-72 Red.....	SEE WEB
SBL-CHEV6872SH2006S	1970-72 Bright Red.....	SEE WEB
SBL-CHEV6872SH3008S	1970-72 Medium Saddle.....	SEE WEB
SBL-CHEV6872SH4003S	1970-72 Medium Blue.....	SEE WEB
SBL-CHEV6872SH4004S	1970-72 Navy Blue.....	SEE WEB
SBL-CHEV6872SH5002S	1970-72 Dark Green.....	SEE WEB

No Volume Discount.

Deluxe Style GM Logo Seat Belts w/ Large Buckle

OE style reproduction seat belt set featuring correct retractor, seat belt and large buckle assembly with GM emblem.

Front Sets Lap

SBL-CHEV68721000P	1970-72 Black.....	SEE WEB
SBL-CHEV68722007P	1970-72 Red.....	SEE WEB
SBL-CHEV68722006P	1970-72 Bright Red.....	SEE WEB
SBL-CHEV68723008P	1970-72 Medium Saddle.....	SEE WEB
SBL-CHEV68724003P	1970-72 Medium Blue.....	SEE WEB
SBL-CHEV68724004P	1970-72 Navy Blue.....	SEE WEB
SBL-CHEV68725002P	1970-72 Dark Green.....	SEE WEB

Front & Rear Sets Lap

SBL-CHEV6872FR1000P	1970-72 Black.....	SEE WEB
SBL-CHEV6872FR2007P	1970-72 Red.....	SEE WEB
SBL-CHEV6872FR2006P	1970-72 Bright Red.....	SEE WEB
SBL-CHEV6872FR3008P	1970-72 Medium Saddle.....	SEE WEB
SBL-CHEV6872FR4003P	1970-72 Medium Blue.....	SEE WEB
SBL-CHEV6872FR4004P	1970-72 Navy Blue.....	SEE WEB
SBL-CHEV6872FR5002P	1970-72 Dark Green.....	SEE WEB

Front & Rear Sets Lap & Shoulder

SBL-CHEV6872KIT1000P	1970-72 Black.....	SEE WEB
SBL-CHEV6872KIT2007P	1970-72 Red.....	SEE WEB
SBL-CHEV6872KIT2006P	1970-72 Bright Red.....	SEE WEB
SBL-CHEV6872KIT3008P	1970-72 Medium Saddle.....	SEE WEB
SBL-CHEV6872KIT4003P	1970-72 Medium Blue.....	SEE WEB
SBL-CHEV6872KIT4004P	1970-72 Navy Blue.....	SEE WEB
SBL-CHEV6872KIT5002P	1970-72 Dark Green.....	SEE WEB

Front Shoulder Sets

SBL-CHEV6872SH1000P	1970-72 Black.....	SEE WEB
SBL-CHEV6872SH2007P	1970-72 Red.....	SEE WEB
SBL-CHEV6872SH2006P	1970-72 Bright Red.....	SEE WEB
SBL-CHEV6872SH3008P	1970-72 Medium Saddle.....	SEE WEB
SBL-CHEV6872SH4003P	1970-72 Medium Blue.....	SEE WEB
SBL-CHEV6872SH4004P	1970-72 Navy Blue.....	SEE WEB
SBL-CHEV6872SH5002P	1970-72 Dark Green.....	SEE WEB

No Volume Discount.

Deluxe Style GM Logo Seat Belts w/ Small Buckle

OE Style reproduction seat belt set featuring correct retractor, seat belt and small buckle assembly with GM emblem.

Front Sets Lap

SBL-1600GM1000	1970-72 Black.....	SEE WEB
SBL-1600GM2007	1970-72 Red.....	SEE WEB
SBL-1600GM4002	1970-72 Navy Blue.....	SEE WEB
SBL-1600GM5002	1970-72 Dark Green.....	SEE WEB

Front & Rear Sets Lap

SBL-1600GMFR1000	1970-72 Black.....	SEE WEB
SBL-1600GMFR2007	1970-72 Red.....	SEE WEB
SBL-1600GMFR4002	1970-72 Navy Blue.....	SEE WEB
SBL-1600GMFR5002	1970-72 Dark Green.....	SEE WEB

Front & Rear Sets Lap & Shoulder

SBL-1600GMKIT1000	1970-72 Black.....	SEE WEB
SBL-1600GMKIT2007	1970-72 Red.....	SEE WEB
SBL-1600GMKIT4002	1970-72 Navy Blue.....	SEE WEB
SBL-1600GMKIT5002	1970-72 Dark Green.....	SEE WEB

Front Shoulder Sets

SBL-1600GMSH1000	1970-72 Black.....	SEE WEB
SBL-1600GMSH2007	1970-72 Red.....	SEE WEB
SBL-1600GMSH4002	1970-72 Navy Blue.....	SEE WEB
SBL-1600GMSH5002	1970-72 Dark Green.....	SEE WEB

No Volume Discount.



GM Push Button Style



Bowtie Lift Latch Style



GM Plastic Push Button Style



Chrome Lift Latch Style



Starburst Push Button Style

Vintage Style Seat Belts

Now you can have the styling of muscle-era GM seat belts without the high price! Choose from plain chrome lift latch style belts, Starburst push button style belts, Bowtie logo lift latch belts or GM push button style belts. Any of these belts will look right at home in your muscle car. Perfect for daily drivers, weekend warriors, pro touring, pro street or any other muscle car! Available individually or as a complete 4 piece kit! Hardware is included with all vintage style seat belts.

Fill blank with your color choice.*

SBL-1800-1000-74	Chrome Lift Latch Style 74"	SEE WEB
SBL-1800-1000-60	Chrome Lift Latch Style 60"	SEE WEB
SBL-1800-1000-K	Chrome Lift Latch Style 4 Piece (2) 74" & (2) 60"	SEE WEB
SBL-1256-1000-74	Starburst Push Button Style 74"	SEE WEB
SBL-1256-1000-60	Starburst Push Button Style 60"	SEE WEB
SBL-1256-1000-K	Starburst Push Button Style 4 Piece (2) 74" & (2) 60"	SEE WEB
SBL-1205-1000-74	GM Push Button Style 74"	SEE WEB
SBL-1205-1000-60	GM Push Button Style 60"	SEE WEB
SBL-1205-1000-K	GM Push Button Style 4 Piece (2) 74" & (2) 60"	SEE WEB
SBL-305-1000-74	GM Plastic Push Button Style 74"	SEE WEB
SBL-305-1000-60	GM Plastic Push Button Style 60"	SEE WEB
SBL-305-1000-K	GM Plastic Push Button 4 Piece (2) 74" & (2) 60"	SEE WEB
SBL-1803-1000-74	Bowtie Lift Latch Style 74"	SEE WEB
SBL-1803-1000-60	Bowtie Lift Latch Style 60"	SEE WEB
SBL-1803-1000-K	Bowtie Lift Latch Style 4 Piece (2) 74" & (2) 60"	SEE WEB

Black_1000, Flame Red_2006, Red_2007, Maroon_2008, Red Wine_2009, Purple_2010, Tan_3000, Brown_3004, Dark Brown_3005, Medium Beige_3008, Desert Tan_3009, Electric Blue_4000, Blue_4002, Dark Blue_4004, Powder Blue_4005, Cobalt Blue_4006, Turquoise_4009, Military Green_5002, Lime Green_5004, Dark Green_5006, Gray_6005, Silver_6007, Charcoal_6009, Orange_7001, Yellow_7500, Ivory_8000, White_9000

*Kits available in black only. Colors are special order and are non-returnable. See ss396.com for color swatches. Not all colors available for all styles. Ask your sales rep for color availability.

Recommended Hardware

BSB-5-SBL	1970-77 All Fully Threaded	7.95 ea.
-----------	----------------------------	----------



Shown with GM logo buckles.

BUY & SAVE
WITH SS396.COM PRE-BUILT KITS

1970-73 3 Point Front Seat Belts

Add comfort and safety to your muscle car while still keeping a stock look with Ground Up's 3 point retractable seat belts! These three point belts feature a vintage style lap belt and chest belt so you can get new car safety with old car looks. Each kit includes two seat belts, grade 8 mounting hardware and powder coated mounting brackets all assembled and ready to Bolt-in to your Monte Carlo. Instructions are also included. These seat belts mount in the factory locations meaning there is no drilling required. Seat belts meet FMVSS standards. Fill blank with your color choice.*

SBL-68CH3-1000	1970-73 Buckets with Starburst	SEE WEB
SBL-68CH3B-1000	1970-73 Bench with Starburst	SEE WEB
SBL-68CH3GM-1000	1970-73 Buckets with GM logo	SEE WEB
SBL-68CH3BGM-1000	1970-73 Bench with GM logo	SEE WEB

Black_1000, Flame Red_2006, Red_2007, Maroon_2008, Red Wine_2009, Purple_2010, Tan_3000, Brown_3004, Dark Brown_3005, Medium Beige_3008, Desert Tan_3009, Electric Blue_4000, Blue_4002, Dark Blue_4004, Powder Blue_4005, Cobalt Blue_4006, Turquoise_4009, Military Green_5002, Lime Green_5004, Dark Green_5006, Gray_6005, Silver_6007, Charcoal_6009, Orange_7001, Yellow_7500, Ivory_8000, White_9000

Colors are special order and are non-returnable. See ss396.com for color swatches. Not all colors available for all styles. Ask your sales rep for color availability.



Shown with GM logo buckles.

Original Style Seat Belts

OE style belts feature a correct fit and function like your factory originals. These belts feature the correct front retractors and GM logo like originals. Also available for the first time correct factory shoulder harness belts. Made in the USA

SBL-CHEV6772-1000	1970-72 Front w/Retractor	SEE WEB
SBL-CHEV6772SH-1000	1970-72 All Shoulder Harness	SEE WEB

Buy the complete Kits and Save

SBL-CHEV6772FR-1000	1970-72 2-Fronts, 3-Rears (5 pc.)	SEE WEB
SBL-CHEV6772KIT-1000	1970-72 2-Fronts, 3-Rears, 2-Shoulder (7 pc.)	SEE WEB

Recommended Hardware

BSB-5-SBL	1970-77 All Fully Threaded.....	SEE WEB
-----------	---------------------------------	---------



Standard Seat Belt Covers

Factory replacement plastic seat belt cover.

IBC-672B	1970-72 Black.....	SEE WEB
IBC-672R	1970-72 Red.....	SEE WEB
IBC-672G	1970-72 Green.....	SEE WEB
IBC-672B	1970-72 Blue.....	SEE WEB



SBL-BLADE

Factory Style Seat Belts

Excellent reproduction seat belts complete with buckle and emblem for the purist.

8700758	1970-72 Front RH	SEE WEB
8700759	1970-72 Front LH	SEE WEB
IK-320	1970-72 Rear	SEE WEB

No Volume Discount.

Standard Seat Belt Blade

This male blade piece is used on the end of the seat belt lap belt to snap into the female receiver for both front and rear belts.

SBL-BLADE	1970-72	SEE WEB
-----------	---------------	---------

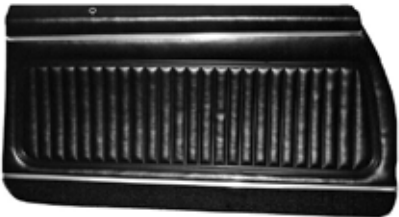

IPA-70MD10-P



IPA-70MD10C-P

1970 Monte Carlo

This is a pair of exact reproduction door panels. These door panels are Madrid grain vinyl with molded vertical lines and mylar chrome trim. These PUI door panels are constructed of the finest quality materials available.

Black

IPA-70MD10-P Front SEE WEB
 IPA-70MD10C-P Rear SEE WEB

Colors

Fill in color code below.

IPA-70MD16-P Front SEE WEB
 IPA-70MD16C-P Rear SEE WEB

· Saddle (36) · Sandalwood (41) · Gold (43) · Dark Metallic Green (24) · Dark Metallic Blue (16)

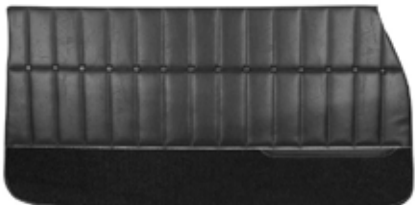

IPA-71MD10-P



IPA-71MD10C-P

1971-72 Monte Carlo

This is a pair of exact reproduction door panels. These door panels are Madrid grain vinyl with molded vertical lines and mylar chrome trim. These PUI door panels are constructed of the finest quality materials available.

Black

IPA-71MD10-P Front SEE WEB
 IPA-71MD10C-P Rear SEE WEB

Colors

Fill in color code below.

IPA-71MD__P Front SEE WEB
 IPA-71MD__C-P Rear SEE WEB

· Saddle(42) · Sandalwood (41) · Neutral (29)
 · Dark Green (25) · Jade Green (19) · Blue (09)



IPA-53

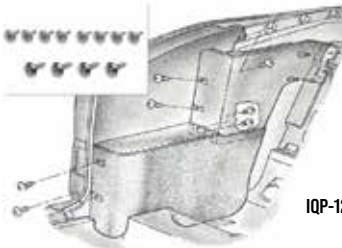

IQP-12526

Rear Side Panels

This is a set of correct plastic Monte Carlo rear side panels for coupes.

IPA-53 1970-72 Rear Side Panels..... SEE WEB
 IQP-12526 Rear Arm Rest Trim Panel Screw Kit SEE WEB

1976 Monte Carlo

This is a pair of exact reproduction door panels. These door panels are Madrid grain vinyl with molded vertical lines and mylar chrome trim. These PUI door panels are constructed of the finest quality materials available.

Black

IPA-76MD10 Front SEE WEB
 IPA-76MD10C Rear SEE WEB

Colors

Fill in color code below.

IPA-76MD19 Front SEE WEB
 IPA-76MD19C Rear SEE WEB

· Saddle (36) · Neutral (29) · Bright Red (32) · Jade Green (19) · White (37)

1983 Monte Carlo SS

If your original door panels are ripped or just plain worn looking then replacing them with these new door panels by PUI is an excellent way to get your interior looking fresh and new again! These door panels feature Sierra grain vinyl with dielectrically sealed vertical lines and chrome mylar accents around the lines. Front pre-assembled panels include metal top rails, window felts, and door lock ferrules.

Color

IPA-83MD81-P Front White SEE WEB
 IPA-83MD81C Rear White SEE WEB



IPA-84MD03C

1984 Monte Carlo

If your original door panels are ripped or just plain worn looking then replacing them with these new door panels by PUI is an excellent way to get your interior looking fresh and new again! These door panels feature Sierra grain blue vinyl with dielectrically sealed vertical lines and chrome mylar accents around the lines. Front pre-assembled panels include metal top rails, window felts, and door lock ferrules.

Color

IPA-84MD03-P Front Blue SEE WEB
 IPA-84MD03C Rear Blue..... SEE WEB

1985 Monte Carlo

If your original door panels are ripped or just plain worn looking then replacing them with these new door panels by PUI is an excellent way to get your interior looking fresh and new again! These door panels feature Sierra grain vinyl with dielectrically sealed vertical lines and chrome Mylar accents around the lines. Front pre-assembled panels include metal top rails, window felts, and door lock ferrules.

Black

IPA-85MD05-P Front SEE WEB
 IPA-85MD05C Rear SEE WEB

Colors

Fill in color code below.

IPA-85MD01-P Front Bench..... SEE WEB
 IPA-85MD01C Rear SEE WEB

· Maple/Maroon (01) · Grey (02)

1986-88 Monte Carlo

If your original seat covers are ripped or just plain worn looking then replacing them with these new seat covers by PUI is an excellent way to get your interior looking fresh and new again! These seat covers feature Empress cloth with sewn vertical pleats with pillow style inserts. Headrest and armrest covers are included on fronts.

Black

IPA-86MDC05-P Front SEE WEB
 IPA-86MDC05C Rear SEE WEB

Colors

Fill in color code below.

IPA-86MDC__P Front Bench..... SEE WEB
 IPA-86MDC__C Rear SEE WEB

· Maple/Maroon (01) · Grey (02) · Blue (03) · Saddle (04)



IHK-68C

Window Crank & Door Handle Kits

Save when you buy the kit! This is a set of reproduction window cranks and inside door handles. Including (4) cranks, (4) clips and (4) gaskets, (2) handles with clips.

- IHK-68B 1970-72 Black Knob KitSEE WEB
- IHK-68C 1970-72 Clear Knob KitSEE WEB



ICE-3520X

Door Handles

Excellent quality reproduction door handles.

- ICE-3520X 1970-72SEE WEB
- ICE-3520L 1970-72 LH.....SEE WEB
- ICE-3520R 1970-72 RHSEE WEB
- IDH-786L 1978-88 LH.....SEE WEB
- IDH-786R 1978-88 RH.....SEE WEB



PT-203

Clayton Machine Works Handles

Easily add a nice custom touch to your interior with these custom handles from Clayton Machine Works! These handles are CNC machined and powder coated a satin silver. The perimeters and inside truss edges are then re-machined for subtle yet dynamic highlight. A great match for Clayton pedals!

- PT-202 Door Handles.....SEE WEB
- PT-203 Window CranksSEE WEB

No Volume Discount.



IPS-158



IPS-254



1970-1988 Door Pull Handles & Covers

These Monte Carlo door pull handle kits are made Sierra grain vinyl. These kits include two straps with four chrome-type end caps and necessary screws for installing on the door shell. Available in 16, 19, and 21 inches long. These pull handles can also be used on cars that did not come with them from the factory.

Handles

- IPH-PULL16G01 01 Maroon 16"SEE WEB
- IPH-PULL16G02 02 Grey 16"SEE WEB
- IPH-PULL16G03 03 Blue 16"SEE WEB
- IPH-PULL16G36 36 Buckskin 16"SEE WEB
- IPH-PULL16G70 70 Black 16"SEE WEB
- IPH-PULL19G01 01 Maroon 19"SEE WEB
- IPH-PULL19G02 02 Grey 19"SEE WEB
- IPH-PULL19G03 03 Blue 19"SEE WEB
- IPH-PULL19G36 36 Buckskin 19"SEE WEB
- IPH-PULL19G70 70 Black 19"SEE WEB
- IPH-PULL21G01 01 Maroon 21"SEE WEB
- IPH-PULL21G02 02 Grey 21"SEE WEB
- IPH-PULL21G03 03 Blue 21"SEE WEB
- IPH-PULL21G36 36 Buckskin 21"SEE WEB
- IPH-PULL21G70 70 Black 21"SEE WEB

End Caps

- IPS-158 1981-85 All Cap CoverSEE WEB
- IPS-254 1981-85 All CapSEE WEB



JTE-8235

Door Jamb Vents

OE style reproduction with correct rubber vent seal.

- JTE-8235 1970-72 All.....SEE WEB
- BJV-11366 ScrewsSEE WEB

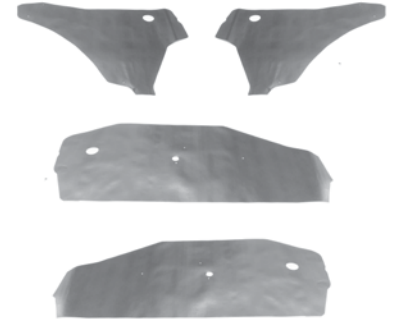

ICK-124

Door Panel Water Shields

Correct pre-cut water resistant material for prevention of door panel damage.

- ICK-124 1970-72 All (4pc)SEE WEB
- ICK-117 1973-77 All (2pc)SEE WEB
- MCK-114 1978-88 All (2pc).....SEE WEB



DPI-7377

Door Panel Insulation

This insulation is precut and constructed of the high quality jute material.

- DPI-7377 1973-77 All (2pc)SEE WEB
- DPI-250 1978-88 All (2pc).....SEE WEB



IXP-33

Door Panel Clips

Correct clips for attaching panels.

- IXP-33 All Clips (12pc).....SEE WEB



MS277-20M

EMS Stainless Strikers

Replace your plain steel strikers with these attractive Eddie Motorsports Monte Carlo stainless steel door striker bolts. These billet striker bolts are cut with a Torx head and fit most GM muscle cars.

- MS277-20M MachinedSEE WEB
- MS277-20P PolishedSEE WEB



IXP-18

Door Panel Plugs

Correct plugs for attaching door panel clips. Buy the kit and save!

- | | | |
|---------|----------------------|---------|
| IXP-18K | Plug Kit (12pc)..... | SEE WEB |
| IXP-18 | All Plug..... | SEE WEB |

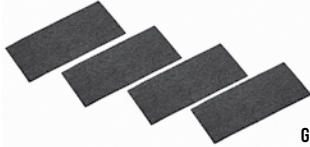

GGF-557

Door Glass Guide Felt

Front door window glass guides fabric covering. Stick over existing brackets.

- | | | |
|---------|--------------------|---------|
| GGF-557 | 1970-72 (4pc)..... | SEE WEB |
|---------|--------------------|---------|



IDP-109

Door Panel Screws

Correct size attaching screw for door panels.

- | | | |
|---------|----------|---------|
| IDP-109 | All..... | SEE WEB |
|---------|----------|---------|



IBB-2829

SS Door Panel Emblems

Reproduction emblems for your SS.

- | | | |
|----------|-----------------|---------|
| IBB-2829 | 1970-72 SS..... | SEE WEB |
|----------|-----------------|---------|



IFW-2

Door Panel Washers

Foam washers used under the door panels to seal door handles and window cranks.

- | | | |
|-------|--------------|---------|
| IFW-2 | Most GM..... | SEE WEB |
|-------|--------------|---------|



IDP-14465



IDP-14464

Door Panel Adjustment Clips

Correct upper door panel adjustment clips that are used to hold the door panel to the upper door frame.

- | | | |
|-----------|--------------------|---------|
| IDP-14464 | 1970-72 Front..... | SEE WEB |
| IDP-14465 | 1970-72 Rear..... | SEE WEB |



IV-113



IFF-600

Door Lock Knobs & Ferrules

OE style reproduction door lock knobs & ferrules.

- | | | |
|----------|--------------------------------------|---------|
| IFF-600 | 1970-72 All Ferrule..... | SEE WEB |
| IFF-700 | 1978-88 All Ferrule..... | SEE WEB |
| ICE-6400 | 1970 Chrome Lock Knob..... | SEE WEB |
| IV-113 | 1971-1972 Chrome Door Lock Knob..... | SEE WEB |



DPM-6472

Lower Door Panel Moldings

Reproduction polished aluminum lower door panel moldings.

- | | | |
|----------|------------------|---------|
| DPM-6472 | 1970-72 All..... | SEE WEB |
|----------|------------------|---------|



IDH-901

Standard Door Handle Mechanisms

Reproduction plated mechanisms.

- | | | |
|------------|---------------------------------------|---------|
| IDH-901 | 1970-72 All..... | SEE WEB |
| IDH-68BP-L | 1970 LH w/ Chrome Backing Plates..... | SEE WEB |
| IDH-68BP-R | 1970 RH w/ Chrome Backing Plates..... | SEE WEB |



GWS-634



GWS-635

Power Window Switch Retainers

- | | | |
|---------|-----------------------|---------|
| GWS-634 | 1970-77 1 Button..... | SEE WEB |
| GWS-635 | 1970-77 4 Button..... | SEE WEB |



GWS-712

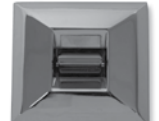

GWS-711

Power Window Switch

Correct OEM style power window switch.

- | | | |
|---------|-----------------------|---------|
| GWS-711 | 1971-77 1 Window..... | SEE WEB |
| GWS-712 | 1971-77 2 Window..... | SEE WEB |
| GWS-714 | 1971-72 4 Window..... | SEE WEB |
| GWS-016 | 1978-88 1 Window..... | SEE WEB |
| GWS-017 | 1978-88 2 Window..... | SEE WEB |



GLS-71

Power Lock Switch

Die cast and chrome plated. It reads LOCK and has the correct square corners and profile. Replaces GM number 1725099.

- | | | |
|--------|--------------|---------|
| GLS-71 | 1971-77..... | SEE WEB |
|--------|--------------|---------|



GWM-22

Power Window Motors

This is a high quality brand new power window motor. These fit front or rear windows.

- | | | |
|---------|--------------------|---------|
| GWM-22 | 1970-72 RH..... | SEE WEB |
| GWM-23 | 1970-72 LH..... | SEE WEB |
| GWM-79G | 1979-88 LH/RH..... | SEE WEB |



TRIM-02



TRIM-01



TRIM-KIT-DLX



TRIM-WR



TRIM-MAG

Trim Removal Tools

- | | | |
|--------------|---------------------------------------|-----------|
| TRIM-01 | Door Panel Removal Tool..... | 9.97 ea. |
| TRIM-02 | Window Crank/Door Handle Removal..... | 6.99 ea. |
| TRIM-WR | Window Roller Removal Tool..... | 18.99 ea. |
| TRIM-MAG | Mirror & Magnet Kit 2pc..... | 14.95 set |
| TRIM-KIT-DLX | Trim Removal Tools 3pc..... | 29.99 ea. |



BUY & SAVE
WITH SS396.COM PRE-BUILT KITS



IPQ-4078B



IPQ-4080B



IPQ-4080C

Window Cranks & Hardware

OE style reproduction window cranks in kits or individually! Include 4 cranks, 4 clips and 4 gaskets.

- IPX-4078C 1970-77 Clear Knob Kit..... SEE WEB
- IPX-4078B 1970-77 Black Knob Kit..... SEE WEB
- IPQ-4080C 1970-88 Clear Knob..... SEE WEB
- IPQ-4080B 1970-88 Black Knob..... SEE WEB
- IPX-3850 All Gasket..... SEE WEB
- IPX-39 All Spring..... SEE WEB
- IPX-38 All Clip..... SEE WEB

No Volume Discount on kits.



IPQ-67GMB

1970-72 Factory Correct Window Cranks

Quality die cast. Correct spline depth and clip engagement. Shorter and with a flatter curvature than later years with correct thin knob. 1970-72 features cast number 9715291.

- IPQ-686MB 1970-72 Black Knob.....SEE WEB
- IPQ-686MC 1970-72 Clear Knob.....SEE WEB



IAM-6872

Arm Rest Base Moldings

Correct chrome arm rest base found on some Monte Carlos.

- IAM-6872 1970-72 All 9.25" In Long.....SEE WEB



IAT-68C

Arm Rest Ash Trays

Correct chrome ash tray for rear arm rests.

- IAT-68C 1970-72 Ribbed.....SEE WEB



IAT-70C

Rear Arm Rest Ash Trays

Correct chrome ash tray for rear arm rests.

- IAT-70C 1970-72 Coupe.....SEE WEB



ARM-KIT4

1970-72 Front Arm Rest Pad & Base Kits

Complete kits with 2 arm rest bases and 2 front arm rest pads.

- ARM-KIT4 1970-72 Black.....SEE WEB
- ARM-KITA10 1970-72 White.....SEE WEB
- ARM-KITA20 1970-72 Pearl.....SEE WEB
- ARM-KITA30 1970-72 Red.....SEE WEB
- ARM-KITA40 1970-72 Parchment.....SEE WEB
- ARM-KITA50 1970-72 Light Saddle.....SEE WEB
- ARM-KITA60 1970-72 Dark Saddle.....SEE WEB
- ARM-KITA65 1970-72 Light Blue.....SEE WEB
- ARM-KITA70 1970-72 Dark Blue.....SEE WEB
- ARM-KITA75 1970-72 Bright Blue.....SEE WEB
- ARM-KITA80 1970-72 Dark Green.....SEE WEB
- ARM-KITA85 1970-72 Sandalwood.....SEE WEB



ICI-1960L



ICI-1960R

Arm Rest Bases

OE style reproduction chrome plated and plastic arm rest bases.

- ICI-1960L 1970-72 LH Black.....SEE WEB
- ICI-1960R 1970-72 RH Black.....SEE WEB
- IPX-997 Attaching Screw.....SEE WEB



ICC-5101R



ICC-5101L

Arm Rest Pads

OE style reproduction arm rest pads.

- ICI-5101R 1970-67 Front Black.....SEE WEB
- ICI-5101L 1970-67 Rear Black.....SEE WEB



ARMBASE-DBLUE



ARMBASE-DGREEN



ARMBASE-RED



ARMBASE-PARCH



1970-72 Arm Rest Bases - Colors

Replacement arm rest bases now available in colors!

- ARMBASE-PARCH Parchment.....SEE WEB
- ARMBASE-RED Red.....SEE WEB
- ARMBASE-BBLUE Bright Blue.....SEE WEB
- ARMBASE-DGREEN Dark Green.....SEE WEB
- ARMBASE-WHITE White.....SEE WEB
- ARMBASE-DBLUE Dark Blue.....SEE WEB



ICC-7072M

Dash Pads

Unlike cheap aftermarket urethane dashes, our OEM style dashes feature solid fiberglass cores surrounded by vinyl wrapped foam to assure you the best look and fit on the market! All of the factory colors are available and will match your new PUI colored interior exactly.

- ICC-7072M 1970-72 Mono BlackSEE WEB
- ICC-7072S 1970-72 Stereo Black.....SEE WEB

Available in factory PUI colors. Ask your sales rep for color selection. Ships Oversize. Not eligible for free shipping. No Volume Discount.



DT-225

Dashtop Replacement Dash Covers

This molded plastic dash cover simply fits right over the existing dash to cover unsightly cracks! An easier and more economical alternative to complete dash replacement.

- DT-225 1970-72 All w/ Mono BlackSEE WEB
- DT-226 1970-72 All w/ Stereo BlackSEE WEB
- DT-204 1973-77 w/ AC Black.....SEE WEB
- DT-220 1973-77 w/o AC Black.....SEE WEB

Call for colors. Note: Add \$33.00 for colors other than black. Colors are not returnable. Ships Oversize.



IDJ-83

Dash Insulation

Correct die-stamped factory installed jute material for under dash.

- IDJ-83 1970-72 All.....SEE WEB



3965462

Dash Pad Clips

Correct replacement clips.

- 3965462 1970-72 LargeSEE WEB
- 3965463 1970-72 Small.....SEE WEB

Note: 2 large and 4 small required per car.



ICV-702



IT-701

Center Air Vents AC

Correct center air conditioning vents.

- IT-701 1970-72 w/ ACSEE WEB
- ICV-702 1970-72 Vents/ Housing w/ AC...SEE WEB



IJ-3272

Side Air Vents And Assemblies

OE style reproduction side air vents with correct accenting. Complete assemblies ready to install.

- IJ-800 1970 Smooth Vent OnlySEE WEB
- IJ-872 1971-72 Pebble Vent OnlySEE WEB
- IJ-3272 1970 All AssemblySEE WEB
- IJ-3274 1971-72 All AssemblySEE WEB

Note: Differs slightly from original AC cars.



AAP-1452B

Air Conditioning Plenum Passenger Side

This is a reproduction lower passenger side AC plenum with air diverter.

- AAP-1452B 1970-72 SEE WEB



IJ-3277



IJ-3279

AC Vacuum Pod & Door

Correct vacuum pods for activating under dash and cowl doors.

- IJ-3277 1970-72 Under Dash Door.....SEE WEB
- IJ-3279 1970-72 Cowl Air PodSEE WEB
- IJ-3278 1970-72 Dash Door Pod.....SEE WEB



IVC-13001

Vent Clips

Snaps to the vent tube so the door cannot fall out.

- IVC-13001 1970-72SEE WEB



S157

1970-72 Dash Indicator

These new indicators stick over the originals for a factory look.

- S157 1970-72 Overdrive 4 SpeedSEE WEB



ISI-70SS

1970-72 Dash Column Shift Indicator

Reproduction dash column shift indicators. These come complete with the cable to attach to the column.

- ISI-70SS 1970 SS Green Letters 3 Speed SEE WEB
- ISI-712SS 1971-72 SS White Letters 3 Speed.....SEE WEB



ISI-3731

1979-85 Shift Indicators and Parts

This is a complete shift indicator assembly made with original GM tooling. Fits all 1979-1985 Monte Carlo with gauges and automatic transmission.

- ISI-3731 CompleteSEE WEB
- ISI-3732 Red Pointer OnlySEE WEB
- ISI-3733 Orange Pointer OnlySEE WEB



IK-712DF

Dash Defroster Vent Plenum

This is a brand new improved OE style replacement defroster duct. Fits AC and heat only cars.

IK-712DF 1970-72SEE WEB



IGH-70SS

Dash Gauge Housing

OE style reproduction injection molded housing which supports the dash gauges. This piece is detailed to perfection with correct colors.

IGH-70SS 1970-72SEE WEB



IGH-7072

Dash Housing Backing Plate

Correct stamped steel plate which attaches to the rear of your housing where the printed circuit goes.

IGH-7072 1970-72SEE WEB



IJ-902

Dash Lenses

Replace that worn or scratched lens with a new clear lens. Most feature correct screened indicators where applicable.

IJ-902 1970-72SEE WEB



IDB-7888

1978-1988 Monte Carlo Polished Aluminum Ring Set For Gauge Bezels

This set of six polished aluminum rings/bezels highlight the six factory gauge holes found in 1978-88 Chevrolet Monte Carlo. These rings will fit original and reproduction gauge housings. A clever appearance upgrade that enhances the factory dash cluster while still retaining the original basic appearance.

IDB-7888 1978-88 MonteSEE WEB



GHR-88

Headlamp Switch Nut

Correct special nut used for retaining switch to the dash.

GHR-88 1970-72 AllSEE WEB



IRL-2120

Radio Lenses

Authentic reproduction radio lenses with correct lettering and colors.

IRL-2120 1970 Mono, 1970 AM/FMSEE WEB
IRL-4616 1971-76 AM/FM StereoSEE WEB



IQ-05

Wiper Knobs

OE style chrome reproduction wiper knobs with correct textures and designs.

IQ-05 1970-71 AllSEE WEB



IK-353

IHL-722

IHL-780

Headlight Knobs

Correct chrome knobs with rods.

IK-353 1970 AllSEE WEB
IHL-712 1971-72 w/ LogoSEE WEB
IHL-722 1971-72 w/o LogoSEE WEB
IHL-837 1977 AllSEE WEB
IHL-780 1978-81SEE WEB



IK-231



IK-245



IRT-7S



IRK-712

Radio Knobs

Correct inner and outer radio knobs.

IK-231 1970 Inner MonoSEE WEB
IK-231S 1970 Inner StereoSEE WEB
IK-245 1970 OuterSEE WEB
IRT-712 1971-72 Inner MonoSEE WEB
IRT-7S 1971-72 Inner StereoSEE WEB
IRK-712 1971-72 Outer w/ LogoSEE WEB



TRIM-HL



TRIM-GB

Interior Dash Tools

Handy tools for easily removing and installing dash nuts.

- TRIM-HL 1970-72 Headlamp NutSEE WEB
 TRIM-GB 1970-77 Glove Box Nut.....SEE WEB



ICG-70



ICG-71

Cigarette Lighter Assemblies

Brand new cigarette lighter assemblies.

- ICG-70 1970 AllSEE WEB
 ICG-71 1971-72 AllSEE WEB
 ICG-78 1978-88 AllSEE WEB



ICH-64K

Cigarette Lighter Housings

Correct 2 piece dash housings for lighter assemblies.

- ICH-64K 1970 AllSEE WEB
 ICH-72K 1971-72 AllSEE WEB



ICA-70

Dash Ash Tray

Complete ash tray assembly for the dash.

- ICA-70 1970-72SEE WEB
 ICS-70S 1970-72 SpringSEE WEB



ILS-A70

Glove Box Latch Striker

A new latch striker will ease the opening and closing of your glove box door.

- ILS-A70 1970-72 All.....SEE WEB



IGB-023

Glove Box Door Arm Bumper

Installs on the glove box door arm to prevent rattling.

- IGB-023 1970-72SEE WEB



IGD-1454

Glove Box Door

OE style reproduction with swing arm.

- IGD-1454 1970-72 All.....SEE WEB



GCL-702

Glove Box Lamp Kit

Correct lamp with harness, switch, & bulb.

- 33830 1970-71 HarnessSEE WEB
 GCL-702 1970-71 Housing and SwitchSEE WEB
 GCL-702K 1970-71 Housing, Switch, Harness Kit .SEE WEB



28950

Courtesy Lamp Harness

Correct harness for under dash light.

- 28950 1970 AllSEE WEB
 15295 1971-72 AllSEE WEB



ICB-9

Courtesy Lamp Bracket

Correct under dash bracket for lamp.

- ICB-9 1970-72 All.....SEE WEB

2 required per car



ITT-609

1970-72 Temp & Fuel Gauges

OE style reproduction temp & fuel gauges complete with housing.

- ITT-609 1970SEE WEB
 ITT-610 1971-72SEE WEB



S535-G

1970-72 Volt Gauge Conversion

This is a Shiftworks voltmeter that replaces the ammeter.

- S535-G 1970SEE WEB

No Volume Discount.



ITT-603

1970-72 Amp Gauge

OE style reproduction amp gauge complete with housing.

- ITT-603 1970SEE WEB



EHT-335

Dixco Style Hood Tach

These were used on several aftermarket applications for super cars including Yenko and Motion. White, paint to match.

- EHT-335 1970-77 User Sets Red LineSEE WEB



S514-1G

Dash Tach Conversions

Now you can convert your non-gauge stock dash to our new in tach tachometer setup! All tachs feature a 6000 RPM red line and typically mount where the factory clock is. No modifications to the dash are necessary!

- S514-1G 1970SEE WEB
 S514-1W 1971-72SEE WEB

No Volume Discount.



1970-72 Dashes

Our Deluxe Dash Conversion Kit includes the dash carrier with side vent assemblies, dash lens, ash tray, glove box door, steering column cover, dash housing, steel backing panel, speedometer, tachometer, clock, temp/fuel gauge, amp gauge, instrument sockets, printed circuit board, OEM or modern ATO type dash harness with fuse box and OEM forward lamp harness or engine harness and correct hardware.

Add "ATO" at end of part number for ATO style dash harness.

SSDASH-7055	1970 Deluxe 5500 RPM Tach	SEE WEB
SSDASH-7065	1970 Deluxe 6500 RPM Tach	SEE WEB
SSDASH-7155	1971 Deluxe 5500 RPM Tach	SEE WEB
SSDASH-72400	1972 Deluxe 307, 350, TH400	SEE WEB
SSDASH-7255	1972 Deluxe 307, 350 PG TH350	SEE WEB
SSDASH-72BBA	1972 Deluxe BB Automatic.....	SEE WEB
SSDASH-72BBM	1972 Deluxe BB 4 Speed.....	SEE WEB



IBK-70SS

Our Dash Carrier is also available separately and features correct grain with bright chrome trim.

IJ-70VC	1970-72 Carrier Only	SEE WEB
---------	----------------------------	---------

*All dashes & kits ship Oversize. Not eligible for free shipping. No Additional Discounting.
Hardware not included.*

Our Junior Dash Carrier Kit includes dash carrier, ash tray, glove box door, steering cover and dash lens.

IBK-70SS	1970-72 Junior Kit.....	SEE WEB
----------	-------------------------	---------



IHP-70SS



IHP-702

1970-72 Center Dash AC Delete Plate

AC delete plate with the Chevrolet logo which fills the hole above the heater controls.

IHP-702	1970-72	SEE WEB
IHP-70SS	1970-72	SEE WEB



Instrument Socket

GAC-70SS	1970-72	SEE WEB
GAC-70SS-KIT	1970-72 (14pc)	SEE WEB



Brake Light Lens

OE style reproduction of this hard to find lens.

IBL-702	1970-72 All.....	SEE WEB
---------	------------------	---------



1970-72 Light Switch/Gauge Ground Strap

Used on all cars with factory round gauges to assure proper gauge operation. Includes plastic head lamp switch retaining nut.

GGS-70A	1970-72 w/ Gauges.....	SEE WEB
---------	------------------------	---------



1970-72 Dash Hardware Kit

The kit includes the hardware required to install your dash conversion.

SSDASH-HRDW-KIT	1970-72	SEE WEB
-----------------	---------------	---------



1970-72 Dash Carrier Clips

These are the correct clips used to fasten the heater controls to the plastic dash carrier.

IDC-67F	1970-72	SEE WEB
---------	---------------	---------



6493057W

1970-72 Speedometers

OE style reproductions with correct letters.

6493057A	1970	SEE WEB
6493057W	1971-72	SEE WEB
6493057A-AC	1970*	SEE WEB
6493057W-AC	1971-72*	SEE WEB

*For cars with automatic on the column. No Volume Discount.



6469985

1970-72 Tachometers

OE style reproduction tachometer for manufactured to exact factory specs.

6469985	1970 5500 Red Line	SEE WEB
6469983	1970 6500 Red Line	SEE WEB
5657405	1971-72 5000 Red Line	SEE WEB
5657406	1971-72 5500 Red Line	SEE WEB
5657407	1971 6500 Red Line	SEE WEB



3973633W

1970-72 Dash Clocks

OE style reproductions with correct letters.

3973633A	1970	SEE WEB
3973633W	1971-72	SEE WEB

No Volume Discount.



SSDASH-GAUGE-5500

1970-72 Complete Gauge Cluster

These dash cluster kits come complete with new gauges, tachometer, printed circuit board, lens and housing. This cluster is for cars with floor shift and no dash mounted gear indicator. All 1970 gauges have green letters 1971-72 have white letters

SSDASH-GAUGE-5500	1970 5500 RPM Tach	SEE WEB
SSDASH-GAUGE-6500	1970 6500 RPM Tach	SEE WEB
SSDASH-GAUGE-5500-W	1971-72 5500 RPM Tach	SEE WEB
SSDASH-GAUGE-6500-W	1971-72 6500 RPM Tach	SEE WEB



SSDASH-5500-UP-G

1970-72 Gauge Kits

This Monte Carlo dash gauge upgrade kits comes with new gauges, tachometer, oil pressure, fuel and amp gauges. These gauges are as close to OE original as you can get. They feature the correct fonts, colors, the tach has the correct three screws and not two rivets like other incorrect reproduction. The tach also does not have a needle stop just like the original GM gauge. The fuel, oil and amp gauge come complete with their metal mounting plates. This kit is for cars with floor shift and no dash mounted gear indicator. 1970 gauges have green letters 1971-72 have white letters.

SSDASH-5500-UP-G	1970 5500 RPM Tach	SEE WEB
SSDASH-6500-UP-G	1970 6500 RPM Tach	SEE WEB
SSDASH-5000-UP-W	1971-72 5000 RPM Tach	SEE WEB
SSDASH-5500-UP-W	1971-72 5500 RPM Tach	SEE WEB
SSDASH-6500-UP-W	1971-72 6500 RPM Tach	SEE WEB

This kit does not come with a clock or speedometer.



RTX-70C-CVL-X

Dakota Digital RTX Gauge Kits

The RTX series is the latest from Dakota Digital, focused on retaining that stock look without sacrificing the late-model features you love. Every effort has been put forth to incorporate OEM design elements regarding the layout, face styling and indicators. A casual glance may dismiss these as original equipment, but once you hit the switch and the LED back lighting comes on in your favorite color scheme, all doubts will be removed.

RTX-70C-CVL-X	1970-72	SEE WEB
---------------	---------	-------	---------

No Volume Discount.



LED-194US



LED-194RUS

LED Dash Bulbs

A simple direct replacement for your original 194 style dash light bulbs. Excellent to increase brightness and reduce heat and power consumption.

LED-194RUS	194 Red Led Bulb	SEE WEB
LED-194US	White Led Bulb	SEE WEB
LED-194AUS	Amber Led Bulb	SEE WEB

1970-1972 Monte Carlo Dash Conversion Kits w/ Dakota Digital Gauges

Whether you are replacing an original dash or converting from a sweep style dash but want more modern functionality from your instrumentation than stock gauges can provide, Ground Up has you covered! This deluxe 1970-1972 Monte Carlo dash conversion kit includes a Dakota Digital VFD3, VHX, RTX or HDX Series Instrument System, as well as the standard components featured in our factory SS dash conversion kits!

VFD3 KITS

SSDASH-VFD-B	Blue Illumination	SEE WEB
SSDASH-VFD-T	Teal Illumination	SEE WEB

HDX KITS

Each HDX user selectable illumination kit allows the user to select independent illumination colors for the gauge readings and needles, as well as the message centers.

SSDASH-HDX-K	Black Face	SEE WEB
SSDASH-HDX-S	Silver Face	SEE WEB

RTX KIT

30 Color User Selectable illumination.

SSDASH-RTX	Black Face	SEE WEB
------------	------------------	---------



Blue Illumination



White Illumination w/ Blue Needles



Teal Illumination



Green Illumination



Red Illumination



White Illumination w/ Red Needles

VHX KITS

SSDASH-VHX-KB	Blue Illumination Black Face	SEE WEB
SSDASH-VHX-KR	Red Illumination Black Face	SEE WEB
SSDASH-VHX-KW	White Illumination Black Face	SEE WEB
SSDASH-VHX-SB	Blue Illumination Silver Face	SEE WEB
SSDASH-VHX-SR	Red Illumination Silver Face	SEE WEB
SSDASH-VHX-SW	White Illumination Silver Face	SEE WEB
SSDASH-VHX-CB	Blue Illumination Carbon Fiber Face	SEE WEB
SSDASH-VHX-CR	Red Illumination Carbon Fiber Face	SEE WEB

This kit ship oversize. No Volume Discount.



SSDASH-VFD-B



SSDASH-VHX-SR



VFD3-70C-CVL-B



VFD3-81C-MC-B

Dakota Digital VFD3 Instrument Cluster

Choose from blue or teal numbers, MPH or KPH and degrees Fahrenheit or Celsius. Dakota Digital Series III instrument systems offer the latest technology and features for your custom vehicle. High brightness vacuum fluorescent displays provide a lifetime of trouble free use while offering increased accuracy and features! For a full list of features visit www.ss396.com or ask your sales rep.

1970-72 Dakota Digital Instrument Cluster

- VFD3-70C-CVL-B Blue, MPH, FahrenheitSEE WEB
- VFD3-70C-CVL-T Teal, MPH, FahrenheitSEE WEB
- VFD3-70C-CVL-T-K Teal, KPH, FahrenheitSEE WEB

No Volume Discount. Does Not include gauge bezel. Fits into existing bezel.

1978-88 Dakota Digital Instrument Cluster

- VFD3-81C-MC-B Blue, MPH, FahrenheitSEE WEB
- VFD3-81C-MC-T Teal, MPH, FahrenheitSEE WEB
- VFD3-81C-MC-T-K Teal, KPH, FahrenheitSEE WEB

No Volume Discount. Does Not include gauge bezel. Fits into existing bezel.



VHX-70C-CVL-K-W



VHX-78C-MC-S-B

Dakota Digital VHX Instruments

Fully lit needles, backlit faces and highly visible LCD message centers are a few of the things that you can see which set the VHX Series apart from yesterday's traditional approach to instrumentation. A few of the features which you don't normally see are the micro-controlled precision stepper motors, solid state sensors for unparalleled accuracy and user-customizable display feedback, all supported by an unrivaled limited lifetime warranty which has become the standard for Dakota Digital instrumentation systems. Completely engineered and manufactured in the USA, the VHX Series has completely revolutionized the instrumentation industry!

1970-72 VHX Instrument System

- VHX-70C-CVL-S-R Silver Alloy Faces, Red NumbersSEE WEB
- VHX-70C-CVL-S-B Silver Alloy Faces, Blue NumbersSEE WEB
- VHX-70C-CVL-C-R Carbon Fiber Faces, Red NumbersSEE WEB
- VHX-70C-CVL-C-B Carbon Fiber Faces, Blue NumbersSEE WEB
- VHX-70C-CVL-K-R Black Alloy Faces, Red NumbersSEE WEB
- VHX-70C-CVL-K-B Black Alloy Faces, Blue NumbersSEE WEB
- VHX-70C-CVL-K-W Black Alloy Faces, White NumbersSEE WEB

Fits directly into stock bezel (not included).

1978-88 Super Sport VHX Instrument System

- VHX-78C-MC-S-R Silver Alloy Faces, Red NumbersSEE WEB
- VHX-78C-MC-S-B Silver Alloy Faces, Blue NumbersSEE WEB
- VHX-78C-MC-S-W Silver Alloy Faces, White NumbersSEE WEB
- VHX-78C-MC-C-R Carbon Fiber Faces, Red NumbersSEE WEB
- VHX-78C-MC-C-B Carbon Fiber Faces, Blue NumbersSEE WEB
- VHX-78C-MC-K-R Black Alloy Faces, Red NumbersSEE WEB
- VHX-78C-MC-K-B Black Alloy Faces, Blue NumbersSEE WEB
- VHX-78C-MC-K-W Black Alloy faces, White NumbersSEE WEB

Fits directly into stock bezel (not included).



HDX-70C-CVL-S



HDX-78C-MC-K

Dakota Digital HDX Gauge Kits

Ushering in a new era of muscle machines, Monte Carlos have long been turned into hot rods. Keep the tradition alive and bring yours up to spec with this direct-fit instrument system! It attaches directly to a stock or reproduction bezel (available separately) and supplies you with six analog gauge sweeps and a pair of high visibility TFT message centers. Available with your choice of black or silver alloy gauge-face styling, each HDX system allows the user to select independent illumination colors for the gauge readings and needles, as well as the message centers.

- HDX-70C-CVL-S 1970-72 Silver Alloy FaceSEE WEB
- HDX-70C-CVL-K 1970-72 Black Alloy FaceSEE WEB
- HDX-78C-MC-K 1978-88 Black Alloy FaceSEE WEB
- HDX-78C-MC-S 1978-88 Silver Alloy FaceSEE WEB

No Volume Discount.



IJ-660

Heater Control Knobs

Chrome heater control knobs.

- IJ-660 1970-72 AllSEE WEB
- IJ-426 1970-72 All Set of 4SEE WEB



IAC-1456



IAC-1457

Heater Control Assembly

Excellent quality reproduction heater control assemblies with lenses, knobs and levers.

- IAC-1456 1970 w/ ACSEE WEB
- IAC-1457 1971-72 w/ ACSEE WEB



IM-301



IM-297

Heater Control Lenses

Correct letters and backgrounds.

IM-296	1970 w/o AC	SEE WEB
IM-297	1970 w/ AC	SEE WEB
IM-301	1971-72 w/o AC	SEE WEB
IM-303	1971-72 w/ AC	SEE WEB
IM-0377	1978-82 w/ AC	SEE WEB



I-702

Heater Control Levers

Complete set of sliding levers and include all hardware with instructions.

I-702	1970-72 Heater	SEE WEB
-------	----------------------	---------

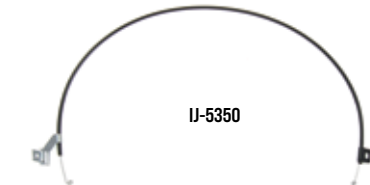

IJ-5350



BCR-12658

BCS-12657

Dash Blower Cables

New dash blower cables w/ correct ends and retaining brackets.

1970-72 Without Factory Air Conditioning

IJ-5350	"AIR"	SEE WEB
IJ-5360	"TEMP"	SEE WEB
IJ-5370	"DEFROST"	SEE WEB
IJB-6872	1970-72 Heater Cable Box Brackets w/o AC	SEE WEB
BCS-12657	1970-72 Screws (6pc)	SEE WEB
BCR-12658	1970-72 Clips (6pc)	SEE WEB



KPS-6872-80

Ground Up's Premium Quality Kick Panel Speakers

These Ground Up kick panel speakers offer great sound quality for your Monte Carlo. These kick panels are as true to the originals as possible while offering a modern speaker in a convenient location. No cutting of the body required! Made of ABS textured plastic they can be painted to match any interior for a clean look. All speakers are 6.5" with either a 80 watt three way or a 300 watt two way speaker driver.

KPS-6872-80	1970-72 w/o AC 80 Watt 3 Way	SEE WEB
KPS-6872-300	1970-72 w/o AC 300 Watt 2 Way ..	SEE WEB
KPS-6872-80AC	1970-72 w/ AC 80 Watt 3 Way	SEE WEB
KPS-6872-300AC	1970-72 w/ AC 300 Watt 2 Way	SEE WEB



IKP-1440

Kick Panels

Complete OE style reproduction kick panel assemblies.

IKP-1440	1970-72 w/o AC	SEE WEB
IKP-1750DB	1978-87 LH Black Paint to Match .	SEE WEB
IKP-1740DB	1978-87 RH Black Paint to Match. .	SEE WEB
IKP-12522	Black Screws (10pc)	SEE WEB
IKP-12523	Silver Screws (10pc)	SEE WEB

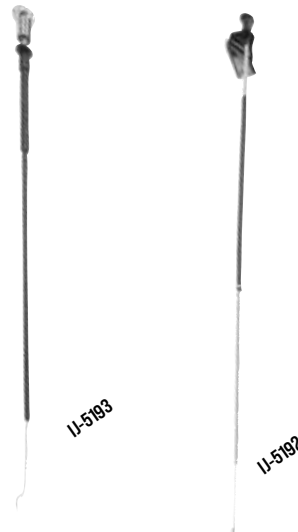

IJ-5193

IJ-5192

Air Vent Cables

OE style reproduction air vent cables to open and close air vents. Complete with knobs.

IJ-5192	1970-72 Loop End	SEE WEB
IJ-5193	1970-72 "Z" End	SEE WEB



IV-4550

Vent Pull Knobs

OE style reproduction chrome vent pull knobs.

IV-4550	1970-72 All	SEE WEB
IV-4560	1970-72 All (4pc)	SEE WEB



INL-15145

1970-72 Cowl Vent Flaps

These are the flaps that direct air inside the cowl to the kick panels.

INL-15145	1970-72	SEE WEB
-----------	---------------	---------



IKJ-2

Kick Panel Insulation

Correct die-stamped jute material.

IKJ-2	1970-72 All	SEE WEB
-------	-------------------	---------



ICC-546

Kick Panel Cable Clip

Used to keep the kick panel cable in place.

ICC-546	1970-77	SEE WEB
---------	---------------	---------



IBA-1495A

E Brake Assemblies

OE style reproduction parking brake assemblies complete with correct pad and trim.

IBA-1495A 1970-72 All.....SEE WEB



IBH-1403

E Brake Knobs

OE style reproduction pull handles & knobs.

IBH-1403 1970-72 Handle w/ KnobSEE WEB
 IEB-110 1970-72 Knob Only Black SEE WEB
 IEB-110-CH 1970-72 Knob Only Chrome SEE WEB



ICE-3611



ICE-0483

Accelerator Pad & Trim

OE style reproduction pads with correct ribbing and stainless trim to finish them off.

ICE-3611 1970-72 TrimSEE WEB
 ICE-0483 1978-88 PadSEE WEB



IHQ-0229



IHQ-0108

E Brake Pedal

OE style reproduction emergency brake pedal and stainless trim.

IHQ-0229 1970-72 Pad..... SEE WEB
 IHQ-0108 1970-72 TrimSEE WEB
 IHQ-0486 1978-88SEE WEB



AZC-88



ICE-8078

Accelerator Hardware

Correct hardware for pad and cable.

ICE-8078 1970-72 Spring/PinSEE WEB
 AZC-88 Cable ClipSEE WEB



IHQ-0191



IHQ-0120



IC-578



IC-525



IHQ-0486



IHQ-0192



IC-525-TRIM



IHQ-0191



IHQ-0192

Brake Pads & Trim

OE style reproduction pads with correct ribs and medallions where applicable.

IC-578 All Auto Drum 5.5"SEE WEB
 IC-525 All Auto Disc 5.5"SEE WEB
 IC-525-TRIM All Auto Trim 5.5"SEE WEB
 IHQ-0191 4 Speed Drum Brake.....SEE WEB
 IHQ-0120 4 Speed Disc Brake.....SEE WEB
 IHQ-0192 4 Speed TrimSEE WEB

Pedal Pads

OE style reproduction pedal pads.

IHQ-0191 Brake/Clutch Pad.....SEE WEB
 IHQ-0120 Disc Brake PadSEE WEB
 IHQ-0192 Trim.....SEE WEB
 IHQ-0486 1978-88 Manual.....SEE WEB
 ICE-0487 1978-88 All AutoSEE WEB



APA-1499A

Accelerator Pedal Assembly

New OE style reproduction of the original accelerator assembly including pedal, Z bar and mounting plate.

APA-1499A 1970-72SEE WEB



FPS-6810

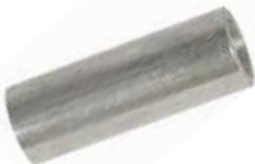

FPS-6816



FC-78K

Clutch & Brake Pedal Assemblies

Complete reproduction brake/clutch pedals.

FC-682	1970-72 Manual Brake & Clutch.....	SEE WEB
FC-78K	1978-88 Manual Brake & Clutch.....	SEE WEB
FC-78C	1978-88 Clutch Pedal Only.....	SEE WEB
FC-78B	1978-88 Brake Pedal Only.....	SEE WEB
FPS-6816	1978-88 Pivot Sleeve*.....	SEE WEB
FPS-6810	1978-88 Pedal Bump Stop.....	SEE WEB

* One required for automatic transmissions and two for manual



FCI-88A

Automatic Brake Pedal

Correct 5.5" pedal

FCI-88A	1970-72 Auto All.....	SEE WEB
IBP-628	1970-77 Auto Pedal Pivot Pin.....	SEE WEB
IC-525	Pad w/ Disc.....	SEE WEB
IC-578	Pad w/ Drum.....	SEE WEB
IBP-628	1970-72 Pivot Pin Automatic.....	SEE WEB



FPB-97



FPB-103

Clutch Pedal Bushing & Bumper

Correct nylon bushing used for ease of pedal.

FPB-97	All Bushing.....	SEE WEB
FPB-103	All Bumper.....	SEE WEB



GBL-852



GBL-852-CC

Brake Light Switches

OE style brake light switches located above the brake pedal.

GBL-852	1970-77 All w/o Cruise Control....	SEE WEB
GBL-852-CC	1970-77 All w/ Cruise Control....	SEE WEB
GSR-12999	Retainer.....	SEE WEB



TA-206-BKM3



Billet Throttle Assemblies & Pedal Pads

Billet throttle assemblies CNC machined and anodized in black with machined highlights and rubber pads. Matching pedal covers are CNC machined and require no drilling for installation.

Automatic

TA-206-BKA3 1970-72 Black.....SEE WEB

Manual

TA-206-BKM3 1970-72 Black.....SEE WEB

No Volume Discount.



IPA-682AM

Muscle Car Billet Pedal Assemblies

This pedal assembly by Clayton Machine Works is machined from forged aluminum and comes complete with pedal arms, pedals with dimpled rubber pads and all necessary hardware for installation. This means that you'll have that one-off custom look without the one-off price all in a complete easy to install Bolt-in package. Graphite powder coat finish. DBW= drive by wire throttle.

IPA-682AA	1970-72 Automatic.....	SEE WEB
IPA-682AAD	1970-72 Automatic DBW.....	SEE WEB
IPA-682AM	1970-72 Manual.....	SEE WEB
IPA-682AMD	1970-72 Manual DBW.....	SEE WEB

Does not include pedal hanger. Bolts into stock location. No Volume Discount.



IPA-EB

Muscle Car E-Brake Cover

This Muscle Car e-brake cover is meant to match your new Chevrolet Muscle Car series forged aluminum pedal assembly by Clayton Machine Works. Installation hardware is included.

IPA-EB	1970-74.....	SEE WEB
--------	--------------	---------

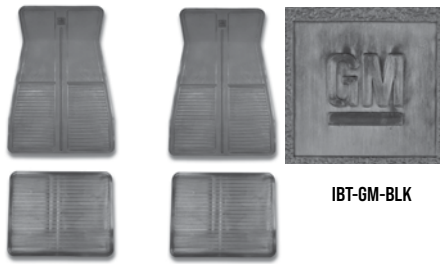

IBT-6M-BLK

OEM Style Rubber Floor Mats

Correct factory style rubber floor mats with ribbing and GM logo.

IBT-GM-BLK	2nd Design Black.....	SEE WEB
IBT-GM-CAR	2nd Design Carmine.....	SEE WEB
IBT-GM-TAN	2nd Design Tan.....	SEE WEB
IBT-GM-GRY	2nd Design Gray.....	SEE WEB
IBT-GM-BLU	2nd Design Dark Blue.....	SEE WEB
IBT-GM-LTBLU	2nd Design Light Blue.....	SEE WEB
IBT-GM-RED	2nd Design Red.....	SEE WEB

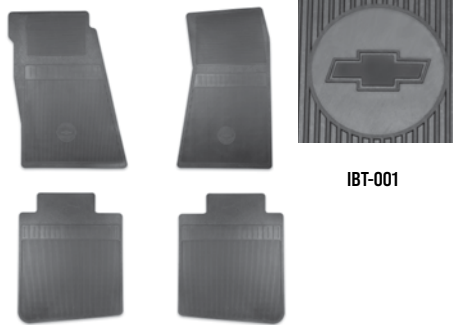

IBT-001

Vinyl Floor Mats

Restoration vinyl floor mats complete with raised "bowtie" and correct grain.

IBT-001	1st Design (4pc).....	SEE WEB
---------	-----------------------	---------



Carpeted Floor Mats

This set of ACC carpeted floor mats is the perfect finishing touch for your interior! These floor mats are constructed of 80/20 looped carpet (1970-1973) or cutpile carpet (1974-1977) and feature nibbed backing so that they won't slide around under your feet.

Use the all new ACC Carpet Configurator on SS396.com.



USE YOUR PHONES CAMERA OR ANY QR APP & SCAN NOW TO SHOP FOR THE MATS YOU NEED!



HURST-6370002

Hurst Logo Floor Mats

Show off your Hurst pride with a set of these high quality embroidered Hurst logo floor mats. The embroidered Hurst logo on the front set of mats features the iconic accented Hurst logo. These mats are cut to an exact OEM cut fit with OEM-style attachment points (when applicable) and non-slip backing.

HURST-6370002	1970-72 Front/Rear Red Logo.....	SEE WEB
---------------	----------------------------------	---------

No Volume Discount.



ISP-72RR



ISP-68K

Carpet Sill Plates

Authentic "Body by Fisher" sill plates available with or without factory rivets.

ISP-737K	1973-77 2 Door.....	SEE WEB
ISP-0200	1978-88 2 Door.....	SEE WEB
ISP-0200K	1978-88 2 Door Pair.....	SEE WEB
ISP-KIT	Screw Kit (8pc).....	SEE WEB

SAVE OVER 20% KIT SPECIAL

Complete Kit with two sill plates.

ISP-68K	1970-72 Sill Plate Kit.....	SEE WEB
---------	-----------------------------	---------

No Volume Discount. Not eligible for free shipping.

QuietRide AcoustiShield

The QuietRide AcoustiShield kit is a multi-stage automotive and sound dampening system to give your muscle car the quiet riding comfort found in today's new cars. AcoustiSHIELD kits are designed on current state of the art auto acoustic technology to insulate and control the noise, vibration and heat in the passenger cabin. Kits are pre-cut and come with easy to follow installation instructions: Everything you need to do the job right!

The first stage consists of pre-trimmed, self-adhesive sound damper pads which are bonded to strategically located trouble spots to control body panel vibration and noise. These spots are mapped and labeled in the detailed instructions.



Complete Kits include Body, Cowl, Floor, Roof and Trunk Floor Kits.

1970-72 Monte Carlo

GMA-6872-CAK	Complete Kit.....	SEE WEB
GMA-6872-CBPK	Body Kit.....	SEE WEB
GMA-6872-CCK	Cowl Kit.....	SEE WEB
GMA-6872-CFK	Floor Kit.....	SEE WEB
GMA-6872-CRK	Roof Kit.....	SEE WEB
GMA-6872-CTK	Trunk Floor Kit.....	SEE WEB

1973-77 Monte Carlo

GMA-7377-CAK	Complete Kit.....	SEE WEB
GMA-7377-CBPK	Body Kit.....	SEE WEB
GMA-7377-CCK	Cowl Kit.....	SEE WEB
GMA-7377-CFK	Floor Kit.....	SEE WEB
GMA-7377-CRK	Roof Kit.....	SEE WEB
GMA-7377-CTK	Trunk Floor Kit.....	SEE WEB

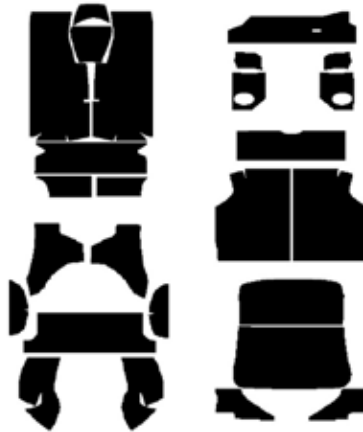

GMA-6872-CAK

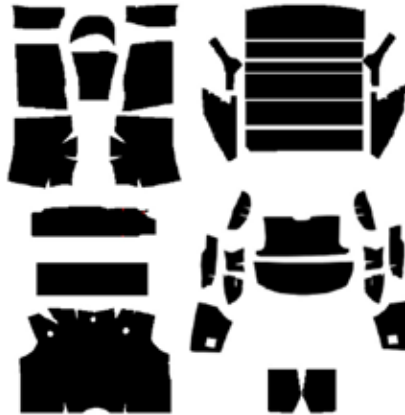

GMA-7377-CAK



GMA-6872-AC

Firewall Insulators

A Firewall Insulator panel by QuietRide Solutions is your first line of defense to stop engine noise and heat from entering the passenger cabin. This firewall panel is an exact OEM replacement and is year, make and model specific. It is molded to fit the engine setback and firewall contours and fits like a glove.

GMA-6872-HC	1970-72 Heater Only Cars.....	SEE WEB
GMA-6872-AC	1970-72 Factory AC Cars.....	SEE WEB
GMA-7377-AC	1973-77 Factory AC Cars.....	SEE WEB



IRE-7282

Firewall Insulation Pad

Correct die-stamped original material complete with clips.

IRE-7282	1970-72 w/o AC.....	SEE WEB
IRE-7282A	1970-72 w/ AC.....	SEE WEB
IRE-316	1973-77 All.....	SEE WEB
IN-197	1970-72 All Screws.....	SEE WEB



IXK-19

Carpet Firewall Guard

Correct plastic injection molded piece which installs below steering column.

IXK-19	1970-72 All.....	SEE WEB
IN-197	1970-72 All Screws.....	SEE WEB

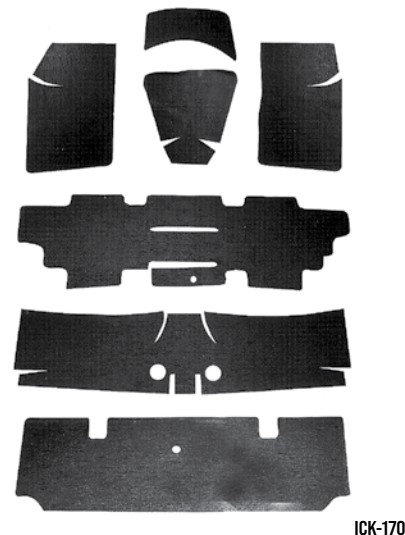

ICK-170

OEM Style Carpet Sound Deadener

ICK-170	1973-77 Sound Deadener.....	SEE WEB
---------	-----------------------------	---------



Flatline Barriers

Flatline Barriers is the new leader in automotive thermal acoustic insulation products. Utilizing cutting edge technology and materials, Flatline is able to offer a solution that significantly reduces unwanted sound and heat. Did we mention that the product is ultra-lightweight as well? Extremely lighter than other insulation products, packing the same punch in sound and heat control properties. The material is offered in pre-cut kits and universal options. Our designs were created by in house automotive enthusiasts and DIYers. Making our kits easy to install, logical in layout and highly effective. Provided to you at an extreme value.

1970-72 Monte Carlo

IFL-TABA1012	Complete Kit Coupe.....	SEE WEB
IFL-TABA1014	Complete Kit Convertible.....	SEE WEB
IFL-TABA1004	Doors/Quarter Panel.....	SEE WEB
IFL-TABA1001	Roof.....	SEE WEB
IFL-TABA1006	Floor.....	SEE WEB
IFL-TABA1008	Trunk.....	SEE WEB

Looking to replace your Monte Carlo or Monte Carlo carpet with something that meets your quality and originality standards? Look no further than our ACC brand OEM carpet sets. We are proud to offer these carpets in several styles, from factory original 80/20 rayon and nylon looped blend (cut pile for 1974-77 models) to our new ESSEX Style for those who are looking for a "modern" auto style carpet seen in high end Mercedes or Porsche cars, to our "Mass Backing" carpet sets which offer factory installed sound deadening material built-in for an overall quieter, cooler and more comfortable interior. ALL of our ACC brand carpets are factory molded with correct heel pad & dimmer switch grommet for a model specific fit.



Essex

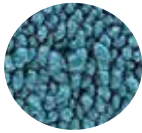

80/20 Looped



Dielectrically Molded & Attached Heel Pad

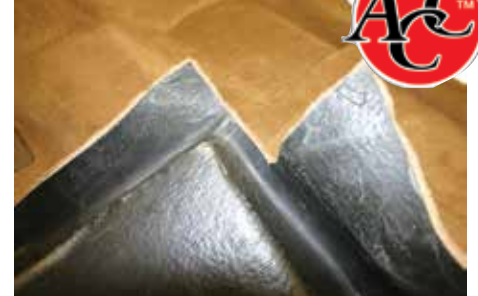

Mass-Backed Carpet Shown which offer factory installed sound deadening material built-in.



1970-1972 Monte Carlo

ICC-682	1970-72 Black 80/20.....	SEE WEB
ICC-6821001A	1970-72 Black Essex.....	SEE WEB
ICC-7301	1973 Black 80/20.....	SEE WEB
ICC-747801	1974-77 Black Cut-Pile.....	SEE WEB

1970-77 Monte Carlo

ICC-647MB	1970-77 Black Mass-Backed.....	SEE WEB
ICC-682MB	1970-77 Black Mass-Backed.....	SEE WEB
ICC-73MB01	1973 Black Mass-Backed.....	SEE WEB
ICC-747MB801	1974-77 Black Mass-Backed.....	SEE WEB

1970-77 80/20 Looped Carpet Colors



1970-77 Cutpiled Carpet Colors



USE YOUR PHONES CAMERA OR ANY QR APP & SCAN NOW TO SHOP FOR THE CARPET YOU NEED!



Use the all new ACC Carpet Configurator on SS396.com

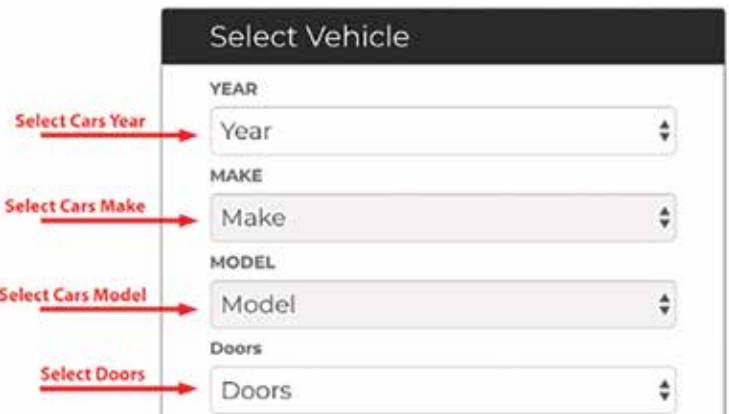

Please state color at time of order. No Volume Discount. All carpets ship oversize. Colors other than black are non-returnable. We will be happy to mail you a color swatch before you order.

Molded Carpet Kits

Save money on two of our most popular Monte Carlo carpet kits. Both feature ACC brand carpet pre-formed in 80/20 black loop.

Molded Carpet w/ Sound Deadener

IXC-682A	1970-72 Black.....	SEE WEB
IXC-73A	1973 Black.....	SEE WEB
IXC-747A	1974-77* Black.....	SEE WEB

* Original Cut-Pile

Molded Carpet w/ Sill Plates

ACC-53131K	1970-72 All.....	SEE WEB
------------	------------------	---------

Black only on kits. Ships oversize. No Volume Discount.

Note: Due to variations in printing, it is impossible to perfectly represent carpet colors in this catalog. Use our color swatch chart as a guide only. We will gladly mail you a color sample before you place your order upon request. Please note that colors other than black are non-returnable.





Premium Quality Console Kits

Ground Up's Exclusive Premium Console Kits offer a superior design! Our console bases start with a heavy and more distinct "Pebble Grain" finish like original GM. Both automatic and 4spd top plates are detailed and finished in a high quality chrome plating w/ correct flat black insert accenting. Rear lamp assembly has an even contoured fit and finish.

1970 Automatic

- Premium quality console shell w/ correct grain and trim
- Pre-assembled lid and hinge
- Hardware for final assembly
- Top plate w/ correct brushed accent and black paint
- Pre-assembled shift indicator plate w/ correct lettering

IX-68A-HQ	1970 w/o Push Button Lock (Green Lettering)SEE WEB
IX-68A-HQ-LOCK	1970 w/ Push Button Lock (Green Lettering)SEE WEB

1970-72 4-Speed

- Premium quality console shell w/ correct grain and trim
- Pre-assembled lid and hinge
- Top plate w/ correct brushed accent and black paint
- Die cast 4 speed emblem
- Hardware for final assembly

IX-68M-HQ	1970-72 w/o Push Button LockSEE WEB
IX-68M-HQ-LOCK	1970-72 w/ Push Button LockSEE WEB

Note: These kits are meant to replace your existing console. If your car did not come with a console additional parts may be needed. Such as: mounting brackets, harness, shifter assembly, etc.



IX-68AKIT-BM

Console Kit With B&M Quicksilver Shifter

If you want the stock look with a little extra performance this console kit is the choice for you! This kit includes everything you need to get the job done. Comes with a console door with or without a lock. Works with GM 3 or 4 speed automatics. TH350, TH400, TH200R4, TH700R4.

IX-68AKIT-BM	1970-72 w/o LockSEE WEB
IX-68AKIT-BM-PB	1970-72 Push ButtonSEE WEB
IX-68AKIT-BM-LOCK	1970-72 W/ LockSEE WEB

No Volume Discount.



SHIFTKIT-350

Console Shifter Kit

Complete kit to convert to an automatic console shifter. Kit includes factory style staple shifter, cable, brackets & all correct hardware.

SHIFTKIT-350	1970-72 TH350SEE WEB
SHIFTKIT-400	1970-72 TH400SEE WEB
SHIFTKIT-A6870-0D	1970 TH200R4-700R4, 4L60ESEE WEB
SHIFTKIT-A7172-0D	1971-72 TH200R4-700R4, 4L60ESEE WEB



ISSFT-1

Staple Shifter

Complete staple shifter assembly with chrome plated handle, spring loaded lock out trigger and mounting base. Ready to install.

ISSFT-1	1970-72 ShifterSEE WEB
ISH-3X	1970-72 Handle OnlySEE WEB
GDR-411	1970-72 Auto Neutral SwitchSEE WEB
ISSFT-HRDW	1970-72 Repair KitSEE WEB

No Volume Discount.



BM-81125

B&M Quicksilver Shifter For Factory Console

This ratcheting shifter is designed to fit the factory console. This kit works with most 3-4 speed automatic transmissions. Kit includes: Shifter with bezel, cable with cable mounting brackets, reverse/neutral switches and mounting hardware.

BM-81125	1970-72 w/ ConsoleSEE WEB
----------	--------------------	--------------

No Volume Discount.



4 Speed Overdrive Kits

SC2243

This kit makes it easy to install a modern overdrive automatic in place of your old Powerglide, TH350 or TH400 for improved performance and gas mileage. Each kit includes a new laser cut detent, indicator, hardware and brackets. This kit works with a TH700, TH200 or 4L60 transmission.

- SC2242 1970 AII SEE WEB
 SC2243 1971-72 AII SEE WEB



Hurst Shifter & Installation Kit

This complete Hurst Competition Plus shifter and linkage kit includes a famous Hurst Competition Plus shifter, chrome Hurst shifter handle and white shifter ball with 4 speed pattern as well as a complete Hurst installation kit with all rods, levers, swivels and hardware. This kit will provide you with that vintage muscle car look as well as provide reliable shifts every time!

HURST-KITA69M 1970-72 Muncie SEE WEB

Part Notes: Please verify that the year of your transmission matches the year of your car before ordering. 1970 to 1972 Muncie 4-speed transmissions can be identified from later models by the way the transmission arms attach. Early Muncie side covers had a stud and the shift arm attached with a nut on the stud while the 1970 and later model side covers had a hole and the shift arms attached with a bolt.



SH-203-8



SH-202-8



SH-204-10

Billet Shifter Handles

These billet aluminum shifter handles from Clayton Machine work with any Hurst or Tremec, TK500 TK0600 2 bolt shifter mount and are a great finishing touch for your custom ride! Available in three styles. Basic black anodized, truss style with grey powder coat, truss style adjustable grey powder coat. Shift knob not included. Requires knob with 3/8-16" thread. Same as most Hurst knobs.

- SH-203-8 8" Black Anno 30 Degree Kick Back ...SEE WEB
 SH-203-10 10" Black Anno 30 Degree Kick Back...SEE WEB
 SH-202-8 8" Grey PC Truss Style 30 Degree Kick Back
SEE WEB
 SH-202-10 10" Grey PC Truss Style 30 Degree Kick Back ...
SEE WEB
 SH-204-10 10" Grey PC Truss Style Adjustable Kick Back ..
SEE WEB

No Volume Discount.

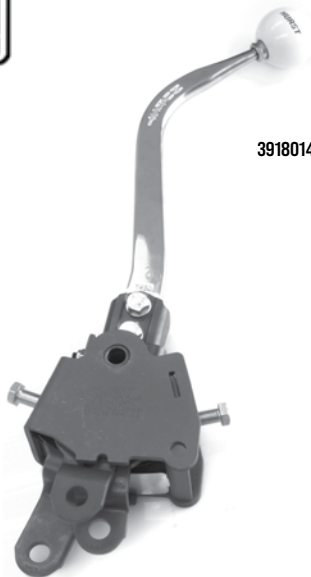

3918014

Hurst Shifters

New Hurst Competition Plus shifter complete with Hurst handle and shifter ball.

- 3918014 1970-72 w/ Muncie.....SEE WEB
 3916848 1973-74 w/ Muncie.....SEE WEB
 3918794 1978-79 w/ Saginaw.....SEE WEB

No Volume Discount.

FSH-1498



Detail

1970-72 Muncie Shifter Handles

OE style reproduction chrome shifter handles.

- FSH-1498 1970-72 w/o Console..... SEE WEB
 FSH-1499 1970-72 w/ Console..... SEE WEB

SHIFTWORKS®



Shiftworks Console Shifter Kits **SW1003**

These reproduction shifters are offered complete with the neutral safety/back-up light switch, console indicator, slider, shifter cable and all required installation hardware. Multiple linkage styles are available to best suit your chosen transmission.

SW1003	1970 TH350-400.....	SEE WEB
SW1013	1970 TH200-700R4, 4L60.....	SEE WEB
SW1017	1970 4L60-65-70E.....	SEE WEB
SW1023	1970 4L80E.....	SEE WEB
SW1027	1970 6L80, 6L90.....	SEE WEB
SW1004	1971-72 TH350-400.....	SEE WEB
SW1014	1971-72 TH200-700R4, 4L60.....	SEE WEB
SW1018	1971-72 4L60-65-70E.....	SEE WEB
SW1024	1971-72 4L80E.....	SEE WEB
SW1028	1971-72 6L80, 6L90.....	SEE WEB

The shifters below include a Thompson Performance slap shift detent gate. This detent will enable positive shifts from low to drive/overdrive without the risk of missing a gear.

SW1003-R	1970 TH350-400.....	SEE WEB
SW1013-R	1970 TH200-700R4, 4L60.....	SEE WEB
SW1017-R	1970 4L60-65-70E.....	SEE WEB
SW1023-R	1970 4L80E.....	SEE WEB
SW1004-R	1971-72 TH350-400.....	SEE WEB
SW1014-R	1971-71 TH200-700R4, 4L60.....	SEE WEB
SW1018-R	1971-72 4L60-65-70E.....	SEE WEB
SW1024-R	1971-72 4L80E.....	SEE WEB

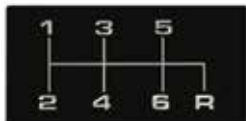

ISP-A686T



ICE-6824

Console Shift Emblems

Correct 4 speed console emblems and 5 speed emblems that look like factory!

4 Speed		
ICE-6824	1970-72 4 Speed.....	SEE WEB

5 Speed		
ISP-A685T	1970-72 Tremec.....	SEE WEB
ISP-A685R	1970-72 Richmond.....	SEE WEB

6 Speed		
ISP-A686T	1970-72 Tremec.....	SEE WEB
ISP-A686R	1970-72 Richmond.....	SEE WEB

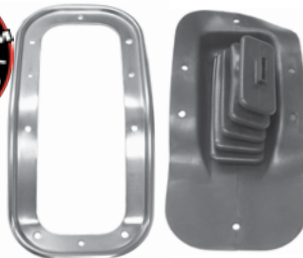

IT-1360K

Boot & Retainer Kit

Buy a correct shift boot and retainer for your 1970-72 Monte Carlo with console and save!!!

IT-1360K	1970-72 w/ Console.....	SEE WEB
----------	-------------------------	---------



ICE-5356



ICE-5405

Shifter Boots

Brand new injection molded boots.

ICE-5356	1970-72 w/ Console.....	SEE WEB
ICE-5405	1970-72 w/o Console.....	SEE WEB
IE-4010	1978-88 w/o Console.....	SEE WEB



IT-1360



NT-196

Shift Boot Retainers

Correct die stamped steel boot retainers.

IT-1360	1970-72 Console.....	SEE WEB
NT-196	1970-72 w/o Console (2pc).....	SEE WEB
IT-3954	1978-88 w/o Console.....	SEE WEB



ICE-HURST



ICE-INDY

Hurst Shifter Boots

Brand new injection molded boots.

ICE-HURST	Universal.....	SEE WEB
ICE-INDY	Universal Indy Shift Boot.....	SEE WEB

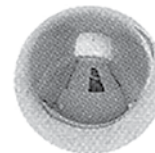

FW-117



FZ-1420



FW-157

Shifter Balls

OE style reproduction shifter balls.

FZ-1420	1970-72 White 5/16".....	SEE WEB
FZ-1424	1970-72 White 3/8".....	SEE WEB
FW-115	Chrome 5/16".....	SEE WEB
FW-117	Chrome 3/8".....	SEE WEB
FW-157	Black/Chrome 5/16".....	SEE WEB
FW-159	Black/Chrome 3/8".....	SEE WEB



FW-HURST

Hurst T-Handle Shifter Knob

This brushed aluminum t-handle provides a positive feel for accurate gear selection. A favorite in the performance world for years! Includes adapters for most popular shift handles.

FW-HURST	T-Handle.....	SEE WEB
----------	---------------	---------



BM-80534



BM-46112

B&M Automatic Shifter Knobs

Adapters included with these knobs fit 1/2-20, 3/8-24, 3/8-16 and 5/16-18 SAE threads.

BM-80534 Quicksilver Billet Aluminum SilverSEE WEB

BM-46112 Round White w/ 12v Switch*SEE WEB

**Works with 12 volt and 16 volt systems and may be used to activate transbrake, launch control, nitrous or two step. No Volume Discount.*



HURST-1531000



HURST-1536210

Hurst Replacement Shifter Handles

These handles all feature a universal installation kit with SAE 1/2-20, 7/16-20, 3/8-16 and also Metric M10x1.25, M10x1.50, M12x1.25, M12x1.75 and M16x1.50 thread size.

HURST-1531000 Pistol Grip Silver SEE WEB

HURST-1536200 Pistol Grip Silver w/ 12v Switch. SEE WEB

HURST-1536210 Pistol Grip Black w/ 12v Switch. SEE WEB

HURST-1539000 Pistol Grip Silver SEE WEB

HURST-1630050 Round Black* w/ 12v Switch SEE WEB

**7/16 - 20 threads only. No Volume Discount.*



BM-80658

B&M Universal Shift Handle w/ Button

This B&M Universal Button T-handle fits most B&M and aftermarket shifters.

Includes: Thread inserts to fit 1/2-20, 3/8-24, 3/8-16 & 5/16-18 SAE. A 12v momentary switch to activate Line-Lock, transbrake or nitrous.

BM-80658 Aluminum PolishedSEE WEB

BM-80659 Aluminum Chrome.....SEE WEB

No Volume Discount.



NJ-1105

Shifter Tunnel

Correct molded plastic which installs on inside of console.

NJ-1105 1970-72SEE WEB

RST-73D 1973-77 AllSEE WEB



RST-72A

Shifter Tunnel Pans

Stamped steel shifter tunnel pans.

RST-72D 1970-72 w/Console SEE WEB

RST-72A 1970-72 w/o ConsoleSEE WEB

IQ-4015 1978-88 w/o Console Plastic..... SEE WEB



IO-8001

Console Shells

OE style reproduction injection molded console shells featuring the correct grain and mounting points just like factory. 1970-72 bases include the correct chrome trim.

IO-8001 1970-72 All.....SEE WEB

IO-78886-BK 1978-88SEE WEB

Ships Oversize. Not eligible for free shipping. No Volume Discount. Black only. Paint to match.



IOP-80

Console Top Plates

OE style reproduction die-cast top plates with correct brushed aluminum inserts and semi black paint.

IOP-80 1970-72 AutomaticSEE WEB

IAP-0530-HQ 1970-72 4 SpeedSEE WEB

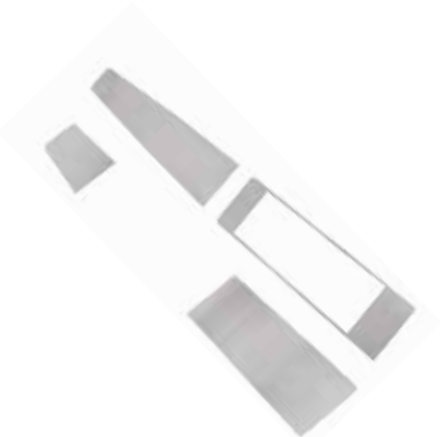

ICC-1412

Console Inserts

Correct die-stamped brushed aluminum inserts for your console.

ICC-1412 1970-72 AutomaticSEE WEB

ICC-1410 1970-72 4 SpeedSEE WEB



IM-2915

Console Brackets

Correct stamped steel brackets for attaching console to floor.

IM-2915 1970-72 All.....SEE WEB



IC-4572



IC-4570

Console Lids

Correct injection molded door complete with flocked lined inner backing plate and chrome trim.

IC-4570 1970-72 w/o Lock Hole.....SEE WEB
 IC-4572 1970-72 w/ Lock Hole.....SEE WEB



ICH-457

Console Hinges

Brand new steel door hinges.

ICH-457 1970-72SEE WEB



ICK-70



ICL-13

Console Locks

Correct console locks with keys.

ICK-70 1970-72 Lock CatchSEE WEB
 ICL-13 1970-72 LockSEE WEB
 ICL-13K 1970-72 Lock & Retainer Set.....SEE WEB
 ICL-13-PB 1970-1972 Push Button.....SEE WEB



ICV-4575

Seat Belt Holders

New seat belt holders which attach to console.

ICV-4575 1970-72SEE WEB

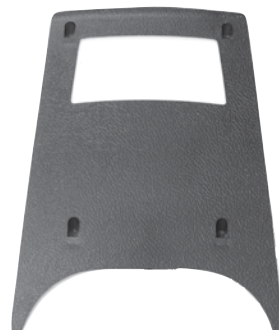

IC-4574

Rear Lens Assembly

Correct injection molded assembly featuring the correct grain with molded in lens.

IC-4574 1970-72SEE WEB



IOA-57

Automatic Shift Plate

Die-cast console dial plate complete with aluminum insert.

IOA-57 1970-72 AutomaticSEE WEB



WHITE TEXT
 ICC-5409



ICC-4508

Console Shift Lenses

New clear plastic lenses with silk screened letters.

ICC-4508 1970 Powerglide.....SEE WEB
 ICC-4519 1970 TH350/TH400SEE WEB
 S118 1970 Overdrive AutoSEE WEB
 ICC-5409 1971-72 TH350/TH400.....SEE WEB
 S119 1971-72 Overdrive Auto.....SEE WEB



IHT-5059

Console Sealing Strips

Correct die cut molded strips to seal dial.

IHT-5059 1970-72 (4pc).....SEE WEB



ICS-421

Shifter Sliders

Machined plastic slider plates.

ICS-421 1970-72SEE WEB

PUI Headliners

These high quality PUI headliners duplicate the original colors and grains perfectly and come ready to install with material to re-cover the side sails.



IRC-70MH100B

1970-72 Monte Carlo

Crafted in the correct perforated material.

IRC-70MH100B	Black.....	SEE WEB
IRC-70MH101B	White.....	SEE WEB
IRC-70MH105B	Dark Blue.....	SEE WEB
IRC-70MH108B	Dark Saddle.....	SEE WEB
IRC-70MH109B	Dark Green.....	SEE WEB
IRC-70MH111B	Sandalwood.....	SEE WEB
IRC-70MH112B	Buckskin.....	SEE WEB

Please call and get a color sample if unsure.



IRC-78GHT28

1978-88 Monte Carlo 2 Door T-Tops

Substrate and correct fabric material.

IRC-78GHT00	Medium Gray.....	SEE WEB
IRC-78GHT02	Maple/Maroon.....	SEE WEB
IRC-78GHT08	Light Gray.....	SEE WEB
IRC-78GHT1666	Dark Claret.....	SEE WEB
IRC-78GHT1711	Doeskin.....	SEE WEB
IRC-78GHT1968	Slate Blue.....	SEE WEB
IRC-78GHT2095	Opaline Grey.....	SEE WEB
IRC-78GHT28	Black.....	SEE WEB
IRC-78GHT71	Shadow Blue.....	SEE WEB
IRC-78GHT72	Carmine Red.....	SEE WEB
IRC-78GHT85	Camel.....	SEE WEB
IRC-78GHT90	Dark Blue.....	SEE WEB
IRC-78GHT971	Dark Sand.....	SEE WEB

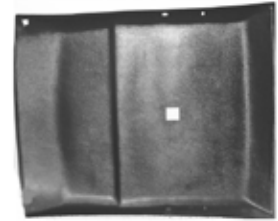

1978-88 Monte Carlo 2 Door Coupe

IRC-78GHC28

Substrate and correct fabric material.

IRC-78GHC00	Medium Gray.....	SEE WEB
IRC-78GHC02	Maple/Maroon.....	SEE WEB
IRC-78GHC08	Light Gray.....	SEE WEB
IRC-78GHC1666	Dark Claret.....	SEE WEB
IRC-78GHC1711	Doeskin.....	SEE WEB
IRC-78GHC1968	Slate Blue.....	SEE WEB
IRC-78GHC2095	Opaline Grey.....	SEE WEB
IRC-78GHC28	Black.....	SEE WEB
IRC-78GHC71	Shadow Blue.....	SEE WEB
IRC-78GHC72	Carmine Red.....	SEE WEB
IRC-78GHC85	Camel.....	SEE WEB
IRC-78GHC90	Dark Blue.....	SEE WEB
IRC-78GHC971	Dark Sand.....	SEE WEB



IHI-68



IBC-20



IBC-73

Headliner Bow Clips

Correct style plastic bow retaining clips.

IBC-20	1970-72 Small.....	SEE WEB
IBC-73	1970-72 Large.....	SEE WEB

Headliner Insulation

Correct factory style insulation to help keep noise and heat from entering car. Cut to fit.

IHI-68	1970-77 All.....	SEE WEB
--------	------------------	---------

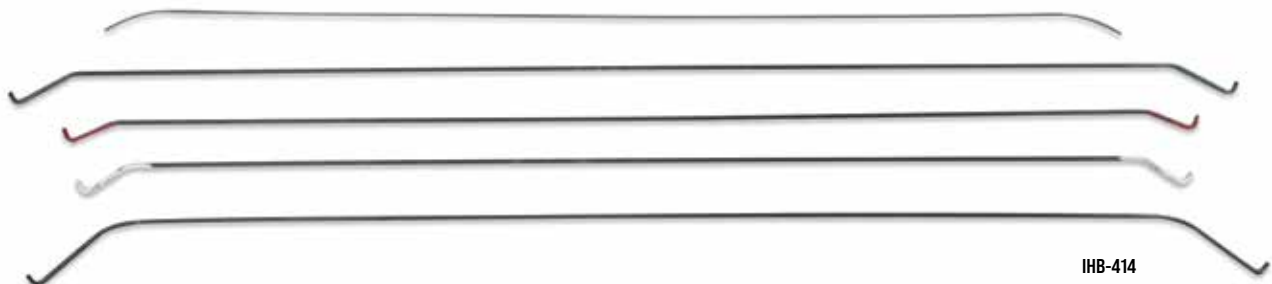

IHB-414

Headliner Wire Bows

OE style reproduction of these often damaged or missing steel bows.

IHB-414	1970-72 All 5 Bow.....	SEE WEB
---------	------------------------	---------

PUI Sunvisors

Superior quality sun visors complete and ready to install. 1970-72 are the perforated material. 1978-88 are cloth.



IRS-450



IRS-78GVC28

1970 Monte Carlo

IRS-450	Black	SEE WEB
IRS-450SVS101BC	White	SEE WEB
IRS-450SVS102BC	Bright Red.....	SEE WEB
IRS-450SVS105BC	Dark Blue.....	SEE WEB
IRS-450SVS108BC	Dark Saddle	SEE WEB
IRS-450SVS109BC	Dark Green.....	SEE WEB
IRS-450SVS112BC	Buckskin.....	SEE WEB

1971-72 Monte Carlo

IRS-451	Black	SEE WEB
IRS-451SVS101BC	White	SEE WEB
IRS-451SVS103BC	Dark Red.....	SEE WEB
IRS-451SVS105BC	Dark Blue.....	SEE WEB
IRS-451SVS108BC	Dark Saddle	SEE WEB
IRS-451SVS109BC	Dark Green.....	SEE WEB
IRS-451SVS112BC	Buckskin.....	SEE WEB
IRS-451SVS111BC	Sandalwood.....	SEE WEB

1978-88 Monte Carlo

IRS-78GVC00	Medium Grey.....	SEE WEB
IRS-78GVC02	Maple/Maroon.....	SEE WEB
IRS-78GVC08	Light Grey	SEE WEB
IRS-78GVC1666	Dark Claret	SEE WEB
IRS-78GVC1711	Doeskin	SEE WEB
IRS-78GVC1968	Slate Blue	SEE WEB
IRS-78GVC2095	Opaline Grey	SEE WEB
IRS-78GVC28	Black	SEE WEB
IRS-78GVC72	Carmine/Red	SEE WEB
IRS-78GVC85	Camel	SEE WEB
IRS-78GVC90	Dark Blue.....	SEE WEB
IRS-78GVC901	Dark Sand	SEE WEB



IBB-0753

Sunvisor Supports

Reproduction chrome plated supports complete with screws and nylon bushing.

IBB-0753	1970-72 All.....	SEE WEB
IBB-7388	1973-88 Chrome.....	SEE WEB
ISS-12545	Screws (6pc).....	SEE WEB



ICC-0089K

Dome Lamp Lens Assembly

Includes base, lens, bulb, clips and wire leads.

ICC-0089K	1970	SEE WEB
ICE-0351K	1971-77 All	SEE WEB



ICC-0089

Dome Lens Bezels

New plastic molded chrome plated as original.

ICC-0089	1970	SEE WEB
----------	------------	---------



IBB-0138

Dome Light Lenses

Correct white plastic lenses.

IBB-0138	1970	SEE WEB
----------	------------	---------



LED-211US

LED Dome Light Bulb

A simple direct replacement for your dome light bulb. This LED bulb features 3 super bright LEDs in a 211 bulb package. Excellent to increase brightness and reduce heat and power.

LED-211US	211 Led Bulb	SEE WEB
-----------	--------------------	---------



30205



30205-PIGTAIL

Dome Light Harnesses

Correct dome light harness.

30205	1970-72 All.....	SEE WEB
30205-PIGTAIL	All Repair Harness.....	SEE WEB
IBU-11A	All Bulb	SEE WEB



GCS-S6065

Billet Rear View Mirror

Show quality polished billet aluminum rear view mirror features ball milled grooves and a day/night lever.

GCS-S6065	All.....	SEE WEB
-----------	----------	---------

Note: Glues to the windshield glass.



GCS-S6160

Chrome Rear View Mirror w/ Flames

Show quality chrome plated rear view mirrors feature embossed flames and a day/night lever.

GCS-S6160	w/ Red Flames	SEE WEB
GCS-S6161	w/ Blue Flames	SEE WEB
GCS-S6162	w/ Silver Flames	SEE WEB
GCS-S6163	w/ Black Flames	SEE WEB

Note: Glues to the windshield glass.



IM-6810-ML

Rear View Mirror w/ Map Light

Custom factory style mirror featuring a built-in map light day/night lever. Mounts easily in place of your factory mirror and features correct terminal to plug into your factory fuse block.

IM-6810-ML	1970-72 10" All.....	SEE WEB
IM-6812-ML	1970-72 12" All.....	SEE WEB



IM-6812

Rear View Mirrors

Reproduction polished stainless steel mirrors with day/night levers.

IM-6812	1970-72 12"	SEE WEB
IE-842	Adjusting Screw	SEE WEB



IBC-68C



IK-18

Rear View Mirror Bracket & Boot

Correct bracket for supporting rear view mirror.

Bracket

- IK-18 1970-72 Coupe.....SEE WEB
- IMP-1Z 1973-88 Mount AllSEE WEB

Boot

- IBC-68C 1970 Coupe.....SEE WEB
- IBC-712C 1971-72 CoupeSEE WEB



IXM-68L



IXM-68R

Windshield Pillar Moldings

New injection molded moldings in correct factory styles and grains.

- IXM-68L 1970-72 Steel LH.....SEE WEB
- IXM-68R 1970-72 Steel RHSEE WEB
- IXM-68K 1970-72 Steel PairSEE WEB
- IXM-12524 A-Pillar Screws (8pc)SEE WEB



IV-4585

Rear Window Corners

Reproduction lower rear window corners.

- IV-4585 1970-72 All.....SEE WEB



ICH-511



ICH-753

Coat Hooks

- IHT-KITICH-511 1970-72 Black.....SEE WEB
- ICH-511K 1970-72 Black Pair*.....SEE WEB
- ICH-753 1970-72 ChromeSEE WEB
- ICH-753K 1970-72 Chrome Pair*SEE WEB

* No Volume Discount.



IT-3333

Front Upper Windshield Moldings

Correct upper windshield moldings to finish off your interior.

- IT-3333 1970-72SEE WEB



IJ-3212

Inner Rear Window Trim

Correct molded plastic rear inner window trim.

- IHT-70 1970-72SEE WEB

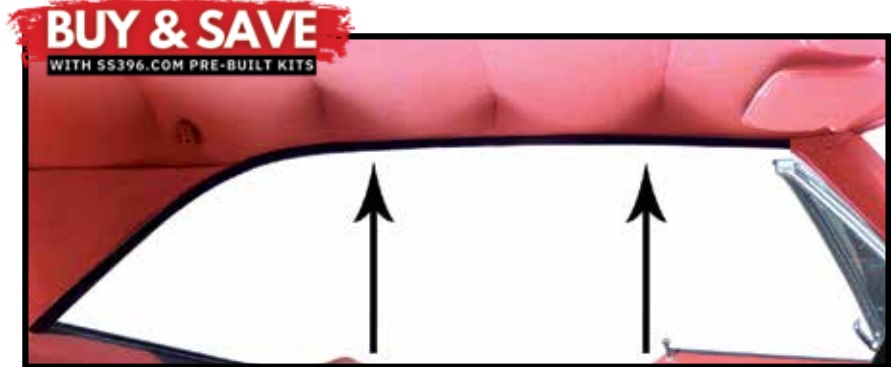

1970-72 Molded Headliner Side Trim

Correct molded urethane headliner side trim.

IHT-70

- IHT-70 1970-72 All.....SEE WEB



IHT-KIT

1970-72 Trim Kit

This is a complete inner trim kit including headliner side trim, upper windshield molding and rear window trim.

- IHT-KIT 1970-72 Coupe.....SEE WEB



IJ-44



IK-623



IM-379

Standard Steering Wheels

Reproduction standard wheels.

- IJ-44 1970 All SEE WEB
- IJ-32 1970 Dark Blue SEE WEB
- IJ-33 1970 Red SEE WEB
- IJ-35 1970 Dark Green SEE WEB



IK-7Z

1970+ 4 Spoke Steering Wheel-Simulated Rope Wrap

- IK-7Z 1970+ 4 Spoke Wheel.....SEE WEB



IM-370-BLKSPK



IM-370

Sport Steering Wheels

OE style reproduction sport steering wheels to replace your originals or upgrade from standard.

- IK-623 1970 Rosewood SEE WEB
- IM-379 1970 Black w/ Silver Spokes w/ Slots..... SEE WEB
- IM-377 1970 Black w/ Silver Spokes w/ Holes..... SEE WEB
- IM-370 1970-81 Black SEE WEB
- IM-370-RED 1970-77 Red SEE WEB
- IM-370-BLUE 1970-77 Blue SEE WEB
- IM-370-SADDLE 1970-77 Saddle Tan SEE WEB
- IM-370-BLKSPK 1970-77 Black w/ Black Spokes SEE WEB



Optional SS Cap



Optional Yenko Cap



BUY & SAVE

WITH SS396.COM PRE-BUILT KITS

Wood Steering Wheel Kits

Add one of these beautiful wood grain steering wheels to your car with one of our kits. Each kit includes steering wheel, hub, contacts, horn cap, cam and hardware.

- IRW-KIT 1970-72 Rosewood w/o Tilt SEE WEB
- IRW-9T 1970-72 Rosewood w/ Tilt..... SEE WEB
- IRW-SSKIT 1970-72 Rosewood w/o Tilt w/ SS Cap..... SEE WEB
- IRW-SS9T 1970-72 Rosewood w/ Tilt w/ SS Cap SEE WEB
- IRW-KIT-YENKO 1970-72 Rosewood w/o Tilt SEE WEB
- IRW-9T-YENKO 1970-72 Rosewood w/Tilt..... SEE WEB

No Volume Discount.



IXS-69T-BLK



IXS-69T-H



IXS-SS6970-BLK



IXS-SS6970-S

BUY & SAVE
WITH SS396.COM PRE-BUILT KITS

Comfortgrip Steering Wheel Kits

Add some muscle to your interior with our black Comfortgrip steering wheel kit. Each kit includes steering wheel, hub, contacts, horn cap, cam and hardware. This kit will work on all 1970+ but is correct for 1970 models.

IXS-6970-S	1970-72 Black w/ Silver Spokes w/ Slots w/o Tilt.....	SEE WEB
IXS-6970-H	1970-72 Black w/ Silver Spokes w/ Holes w/o Tilt	SEE WEB
IXS-69T-S	1970-72 Black w/ Silver Spokes w/ Slots w/ Tilt.....	SEE WEB
IXS-69T-H	1970-72 Black w/ Silver Spokes w/ Holes w/ Tilt.....	SEE WEB
IXS-6970-BLK	1970-72 Black w/ Black Spokes w/o Tilt	SEE WEB
IXS-69T-BLK	1970-72 Black w/ Black Spokes w/ Tilt.....	SEE WEB
IXS-6970	1970-72 Black w/o Tilt	SEE WEB
IXS-69T	1970-72 Black w/ Tilt	SEE WEB
IXS-SS6970-S	1970-72 Black w/ Silver Spokes w/ Slots w/o Tilt & SS Cap.....	SEE WEB
IXS-SS6970-H	1970-72 Black w/ Silver Spokes w/ Holes w/o Tilt & SS Cap.....	SEE WEB
IXS-SS69T-S	1970-72 Black w/ Silver Spokes w/ Slots w/ Tilt & SS Cap.....	SEE WEB
IXS-SS69T-H	1970-72 Black w/ Silver Spokes w/ Holes w/ Tilt & SS Cap.....	SEE WEB
IXS-SS678-BLK	1970-72 Black w/ Silver Spokes w/ SS Cap.....	SEE WEB
IXS-SS6970-BLK	1970-72 Black w/ Black Spokes w/o Tilt w/ SS Cap.....	SEE WEB
IXS-SS69T-BLK	1970-72 Black w/ Black Spokes w/ Tilt w/ SS Cap	SEE WEB
IXS-SS6970	1970-72 Black w/o Tilt w/ SS Cap.....	SEE WEB
IXS-SS69T	1970-72 Black w/ Tilt w/ SS Cap	SEE WEB
IXS-6970-YENKO	1970-72 Black w/o Tilt Yenko Cap	SEE WEB
IXS-69T-YENKO	1970-72 Black w/ Tilt Yenko Cap	SEE WEB
IXS-6970-BLUE	1970-72 Bright Blue w/o Tilt.....	SEE WEB
IXS-69T-BLUE	1970-72 Bright Blue w/ Tilt	SEE WEB
IXS-6970-RED	1970-72 Red w/o Tilt	SEE WEB
IXS-69T-RED	1970-72 Red w/ Tilt	SEE WEB
IXS-SS6970-BLUE	1970-72 Bright Blue w/o Tilt w/ SS Cap.....	SEE WEB
IXS-SS69T-BLUE	1970-72 Bright Blue w/ Tilt w/ SS Cap.....	SEE WEB
IXS-SS6970-RED	1970-72 Red w/o Tilt w/ SS Cap	SEE WEB
IXS-SS69T-RED	1970-72 Red w/ Tilt w/ SS Cap	SEE WEB

No Volume Discount.

BUY & SAVE
WITH SS396.COM PRE-BUILT KITS

GT Performance™



GT14-4331-2K



GT36-5459-2K

GT Performance Steering Wheel Kits

Our exclusive GT Performance steering wheel kits take away all guess work! Upgrade your worn out original steering wheel with this exclusive GT Performance steering wheel kits! They include everything you'll need to make the swap: steering wheel, hub and horn button.

GT14-4331-2K	1970-77 Classic Black Foam Wheel	SEE WEB
GT14-5437-2K	1970-77 Classic Wood Wheel	SEE WEB
GT36-5431-2K	1970-77 Retro Black Foam Wheel w/ Chrome Spokes	SEE WEB
GT36-5451-2K	1970-77 Retro Black Foam Wheel w/ Stainless Spokes	SEE WEB
GT36-5457-2K	1970-77 Retro Light Wood Wheel	SEE WEB
GT36-5459-2K	1970-77 Retro Dark Wood Wheel	SEE WEB

No Volume Discount. Not eligible for shipping discount.



NR-492



BUY & SAVE
WITH SS396.COM PRE-BUILT KITS

1970 Standard Wheel Kits

Everything you need to replace your original wheel! High quality reproduction steering wheel, center shroud, horn buttons, & contacts.

NR-492	1970 Black*	SEE WEB
NR-493	1970 Wood*	SEE WEB
NR-70	1970 Black	SEE WEB

*Correct for 1969 but can be used on all 1970-72.
No Volume Discount.



IK-712SS

1971-72 SS Steering Wheel

OE style reproduction of this hard to find wheel.

IK-712SS	1971-72 SS Wheel	SEE WEB
----------	------------------	---------



NK-126



NK-127



NK-213



NK-292



IY-31

Standard Shroud

Excellent high quality reproduction.

NK-126	1970 Shroud Black	SEE WEB
NJ-127	1970 Shroud Wood	SEE WEB
NK-213	1970 Horn Buttons	SEE WEB
NK-292	1970 Horn Contacts	SEE WEB
ICC-7172	1971-72 Horn Contact Wire	SEE WEB
IY-31	1970 SS Emblem	SEE WEB

Note: Grain is correct for 1969, but differs slightly from 1970.



IC-3380

Sport Horn Buttons

IC-3380	1970 Sport Wheel	SEE WEB
---------	------------------	---------



IHC-SS

SS Horn Button

Awesome brushed aluminum cap with SS logo for all sport wheels.

IHC-SS	1970 w/ Sport	SEE WEB
--------	---------------	---------



IHC-YENKO

Yenko Horn Button

Custom brushed aluminum cap with Yenko logo for all sport wheels.

IHC-YENKO	1970 w/ Sport	SEE WEB
-----------	---------------	---------



IHC-71

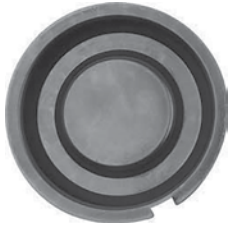

ICR-71



ICE-742



ICE-886

1971-79 NK4 Horn Caps

Reproduction caps and accessories for your optional NK4 sport wheel.

IHC-71	1971-77 Horn Cap.....	SEE WEB
ICR-71	1971-77 Cap Retainer.....	SEE WEB
ICE-742	1971-77 Bowtie Emblem.....	SEE WEB
ICE-737	1971-77 Bowtie Circle.....	SEE WEB
ICE-886	1971-77 SS.....	SEE WEB



IJ-3520

Steering Wheel Hub

Correct cast steering wheel mounting hub for all cars with sport wheels.

IJ-3520	1970 All.....	SEE WEB
---------	---------------	---------



IK-8

Horn Contact Kits

Complete kit for repairing horn contacts.

IK-579	1970 Sport w/o Tilt.....	SEE WEB
IK-8	1970 Sport w/ Tilt.....	SEE WEB
ICS-3	1970 Sport Spring/Pin.....	SEE WEB
IHC-KIT	1970-71 w/ 4 Spoke Wheel.....	SEE WEB



ICC-9



ICC-93

Turn Signal Cancel Cam

Correct cam which turns off signal light.

ICC-9	1970 w/o Tilt.....	SEE WEB
ICC-93	1970 w/ Tilt.....	SEE WEB



ISC-6981

Tilt Steering Column Housing Sleeve

Reproduction tilt steering column housing sleeve. Used to replace a column shift sleeve to convert your column to floor shift manual or automatic.

ISC-6981	1970-81 w/ Tilt Floor Shift.....	SEE WEB
----------	----------------------------------	---------

No Volume Discount.



TILT-68A

Original Tilt Steering Columns

These steering columns are the real deal! Each original GM unit is professionally rebuilt using OEM parts. We even include the turn signal switch! Limited supply!

TILT-69AA	1970-72 Auto Floor.....	SEE WEB
TILT-69AM	1970-72 Manual Floor.....	SEE WEB
TILT-69AOC	1970-72 Auto on Column.....	SEE WEB
TILT-736A	1973-76 Floor Shift.....	SEE WEB

No Volume Discount. Ships Oversize.



FBK-7572

1970-1977 Steering Column Lower Bearing Upgrade Kits

You would want to replace this bearing if you are changing the lower steering shaft or replacing the steering coupler that attaches to the gear box, as the lower steering shaft has to be removed to slip the old bearing assembly out and install the new one.

FBK-7572	1970-77 All w/ Tilt.....	SEE WEB
----------	--------------------------	---------

No Volume Discount.



FBK-TILT

1970-75 Tilt Column Upper Bearing

This is a brand new upper steering column bearing for tilt columns only. This part commonly fails and is an easy way to make a worn out column like new again.

FBK-TILT	1970-75.....	SEE WEB
----------	--------------	---------



IT-5168

Tilt Wheel Levers

Reproduction tilt wheel release levers.

- | | | |
|---------|---------|--------------|
| IT-5168 | 1970 |SEE WEB |
| IT-2951 | 1971-74 |SEE WEB |



IT-5174

Turn Signal Levers

Reproduction turn signal levers.

- | | | |
|---------|-------------|--------------|
| IT-5174 | 1970 All |SEE WEB |
| IT-5176 | 1971-74 All |SEE WEB |



GCS-S6062

Steering Column Dress Up Kit

A great way to personalize your interior! Includes turn signal lever, tilt wheel lever and emergency flasher knob.

- | | | |
|-----------|---------|--------------|
| GCS-S6062 | 1970-72 |SEE WEB |
|-----------|---------|--------------|



GCS-S6063

Billet Column Shifter Lever

A great upgrade to any column shifted car!

- | | | |
|-----------|---------|--------------|
| GCS-S6063 | 1970-72 |SEE WEB |
|-----------|---------|--------------|



ICC-12005

Steering Column Cap

Used to hold the end of the column together.

- | | | |
|-----------|-------------|--------------|
| ICC-12005 | 1970-77 All |SEE WEB |
|-----------|-------------|--------------|



RSC-1400L



RSC-68AM



BCS-68A

Steering Column Clamp Plates

- | | | |
|-----------|----------------------|--------------|
| RSC-1400L | 1970-72 Auto |SEE WEB |
| RSC-68AM | 1970-72 4 Speed |SEE WEB |
| BCS-68A | 1970-72 All Hardware |SEE WEB |



ISC-4576

Steering Column Covers

Correct injection molded lower covers.

- | | | |
|----------|---------|--------------|
| ISC-4576 | 1970-72 |SEE WEB |
|----------|---------|--------------|



ISB-1498D

Steering Column Bracket

Bolts to the bottom of the dash to hold up steering column.

- | | | |
|-----------|---------|--------------|
| ISB-1498D | 1970-72 |SEE WEB |
|-----------|---------|--------------|



JSS-5151

Steering Column Seal

Correct neoprene firewall seal.

- | | | |
|----------|-------------|--------------|
| JSS-5151 | 1970-72 All |SEE WEB |
|----------|-------------|--------------|



FSG-22



FSG-786

Speedo / Cruise Cable Grommet

Correct cable grommet.

- | | | |
|---------|-------------|--------------|
| FSG-22 | 1970-72 All |SEE WEB |
| FSG-786 | 1982-88 All |SEE WEB |



INL-15429

1970-1972 Monte Carlo Package Tray Blow Out Clip

This clip is correct for all Monte Carlos to hold the package tray to the metal under-body. When the trunk was slammed, the package tray would blow up and this clip prevented that from happening.

- | | | |
|-----------|---------|--------------|
| INL-15429 | 1970-72 |SEE WEB |
|-----------|---------|--------------|



USA-74CH69

USA 740AM/FM 300 Watts

The USA-740 offers the same classic look that Custom AutoSound has always been known for with today's latest features. Now, with built-in Bluetooth (microphone included), answer calls and get Bluetooth streaming music from your Bluetooth capable phone or Bluetooth compatible device. A solid 300-watt peak power should be all the juice you need, yet the USA-740 has Hi 4 volt, 4 channel RCA pre-outs and a subwoofer RCA pre-out for additional amplifiers. The USB input allows you to plug in a USB flash drive for playback of MP3/WMA/FLAC/WAV song files. A front 3.5mm mini jack auxiliary audio input and a rear RCA auxiliary audio input provide versatility for options like satellite radio, iPod or any portable player you wish to use. Match the dominant color of your instrument cluster with user selectable multiple LCD color choices with LCD dimmer control. The AM/FM RDS tuner shows station, song and artist on the LCD display. For those of us committed to music collections on compact disc, the USA-740 fully controls the optional Custom AutoSound CD-1 CD player. Classic style with today's sound and performance taking every road and curve with you in your Monte Carlo.

USA-74CH69	1970-72 All.....	SEE WEB
USA-74CH73	1973-77 All.....	SEE WEB



USA-230 AM/FM 200 Watts

A great look and sound at an awesome price. This Concours series USA-230 radio has no cassette but comes with Auxiliary Input for iPod, MP3, Satellite radio, etc. Classic features with a classic look. These exciting features include:

- AM/FM Stereo - 200 Watts (4 x 50) - Auxiliary Input
- Digital Clock - Electronic Tuner - 30 Pre-sets (12AM-18FM)
- 4 Channel RCA Pre-Outs - 4 Way Fader - Power Antenna Lead

USA-230CH69	1970-72 All.....	SEE WEB
-------------	------------------	---------



Secret Audio SST

Secretaudio SST is a hidden audio system that offers great flexibility for mounting in any type of vehicle. The main receiver/amplifier unit is usually hidden under the seat or behind the dash. A 10ft cord from the Tuner/Amp plugs into a LCD display. The system can be operated from up to 40 feet away with the included RF (radio frequency remote.)

Included with the system is a flush mount bezel for console or dash mounting. The small dimensions of the flush mount system allow you to install the LCD display almost anywhere. The LCD also comes with a bracket mount for easy installation in the glove box, under the dash, in the ashtray, sunvisor, console or wherever you choose. Since its only 1" deep its especially handy for custom or streetrod applications where there may be wiring or ducting routed behind the panels you wish to utilize for mounting. When your installation is finished you'll be rewarded with a quality professionally installed look.

Features:

- AM/FM Stereo 200 watts 4x50 - RF Remote Control (radio frequency no line of sight required, up to 40' range)
- USB MP3/WMA Flash Drive Player - iPod® Direct Control Interface (built-into tuner/amp unit) iPod Docking Cable Included
- Alpha Numeric LCD Display Shows Artist / Song Titles for USB, iPod® and Satellite Radio
- Satellite Radio Input (for optional Sirius® satellite radio tuner) - Direct CD Changer Control (CD changer optional)
- Auxiliary Audio Input - 4 Channel 3 Volt RCA Pre-Outs (for optional Amplifiers)
- Subwoofer Pre-Input (for optional Subwoofer (Amplifier)
- Electronic Volume, Bass, Treble, Balance, Fader - 5 Selectable iEQ Curves - pop/jazz/classic/beat/rock
- Zero Memory Current Draw (will not drain car battery when unit not in use) - 24 Station pre-sets (18FM / 6AM)
- 10 Foot Cable from LCD Control Panel to Black Box (tuner/amp unit) - Power Antenna 12V Trigger Lead
- Blue LED Illumination on Buttons and LCD Display with Contrast Control
- LCD Flush Mount Trim Bezel Included - LCD Swivel Mount Bracket Included

SECRET-SST	1970-72	SEE WEB
------------	---------------	---------



Custom Autosound USA-630 AM/FM 240 Watts

The USA-630 is the pinnacle of 30 years of evolution in Custom Autosound's quest for the perfect classic car radio. This radio has large OEM style push-buttons that give a perfect look in a classic dash. Although it looks classic it has the latest modern features. USB input on the back of the radio. This jack is on an 18" extension which allows you to place it in the glove box or ash tray for easy access (no unsightly wires or plugs hanging out of the front of the radio). The new alpha numeric display (30% larger than previous models) shows the song/artist/album (id3) titles during playback of MP3/WMA files. With the built-in CD controller you have complete control (no FM modulation) of CAS's 10 disc CD changer. This same CD controller also facilitates the optional iCAMKIT iPod® interface that turns your iPod on/off and charges it while giving you control to advance songs or playlist from the buttons on the radio. A great feature so you can keep the iPod hidden away in your glove box or console.

With 240 watts the radio should have all the power you may need, if you want more there are four pre-outs jacks on the back of the radio for optional amplifiers. The back of the radio also has auxiliary audio input for satellite radio or any portable player you may wish to use.

- AM-FM Stereo - USA/Euro Tuner - Power Antenna Lead - Alpha Numeric id3 Display for MP3/WMA files - Electronic Tuning and Volume Control - 4 way Fader - Left Right Balance - Digital Clock - 16 Pre-sets (12FM-4AM) - 4 Channel RCA Pre-outs
- Separate Bass and Treble - 2 Channel RCA Auxiliary Input for Satellite / iPod etc.

USA-63CH69	1970-72 All.....	SEE WEB
------------	------------------	---------



AAR-70-SS



Antique Auto Radios

If you are looking for a radio that sounds great and looks just like your original this Antique Auto Radio is perfect for you! Max power 180 watts RMS, 45W x 4 MOSFET on board power amplifier. Analog controls look and feel just like your original. AM dial scale in foreground looks original with an FM dial scale in background. All controls easily accessible. Volume, bass, treble, balance, fader and tuning from original looking controls. Digitally tuned AM/FM/Stereo front end provides stable, high quality reception. Shafts are the original size, for quick and accurate mounting just like your original. Also included are additional line outs and output options: 3 RCA jacks for left channel, right channel and sub-woofer, a 6 foot 3.5mm male-to-male auxiliary cable, 3.5 mm phone jack for input from iPod, satellite radio or MP3 player, switch selectable for 1,2,3 or 4 speakers, switch selectable for North America or Europe mode. Doesn't include a remote or a USB for a flashdrive or SD card port.

All Antique Automobile Radios now feature built-in Bluetooth 3.0 EDR compliance; Place and answer calls or stream your favorite programs while maintaining the original appearance! Includes a built-in microphone for HFP (hands free profile calling). HSP, A2DP, AVRCP profiles are also supported.

AAR-70-SS 1970 All SEE WEB
 AAR-71-SS 1971-72 All SEE WEB



1006

Dash Speakers

Since at least 2 speakers are required for true stereo sound, these speakers are a perfect upgrade to OEM and do not require any modification to your dash. The 1000 series are held in place by the original screws and the 2000 series are held in place by the original bracket.

1006 1970-77 MonoSEE WEB



KNW-1006

Kenwood Upgraded Dash Speakers

These Custom Autosound speakers feature Kenwood quality upgrade replacement speakers for your original front in-dash speakers. These great quality speakers can handle up to 60 watts and are built and designed to fit directly under the dash including all correct mounting brackets and wiring. Each assembly includes two speakers.

KNW-1006 1970-72 MonoSEE WEB



KPS-6872-300AC

KPS-6872-80



Ground Up's Premium Quality Kick Panel Speakers

These Ground Up kick panel speakers offer great sound quality for your Monte Carlo. These kick panels are as true to the originals as possible while offering a modern speaker in a convenient location. No cutting of the body required! Made of ABS textured plastic they can be painted to match any interior for a clean look. All speakers are 6.5" with either a 100 watt three way, or a 300 watt two way speaker driver.

KPS-6872-80 1970-72 w/o AC 100 Watt 3 WaySEE WEB
 KPS-6872-300 1970-72 w/o AC 300 Watt 2 WaySEE WEB
 KPS-6872-80AC 1970-72 w/ AC 100 Watt 3 WaySEE WEB
 KPS-6872-300AC 1970-72 w/ AC 300 Watt 2 WaySEE WEB



1013

Factory Stereo Replacement Speakers

These 3.5" 30 Watt speakers are made specifically to replace the stock stereo dash speakers in your 1970-77 Monte Carlo.

1013 1970-77 AllSEE WEB



3006

Dual Voice Coil Speakers

These DVC speakers will give you the best possible sound and power handling from your stock speaker locations. They give up to 70% more cone area than a conventional dual speaker setup with 140 Watt power capacity, left and right channel hook up and tweeters.

3006 1970-77 MonoSEE WEB



KCHV-68-2

Kick Panel Speakers

Enhance your sound quality with these custom molded ABS panels fitted with 6.5", 60 watt speakers or 6.5" coaxial 120 watt speakers. They fit directly in place of your stock kicks with no modification necessary.

KCHV-68-2 68-72 no AC 100 W SEE WEB
 PKCHV-68-2 68-72 no AC 250 W SEE WEB
 KCHV-68-2A 68-72 w/ AC 100 W SEE WEB
 PKCHV-68-2A 68-72 w/ AC 250 W SEE WEB

KEEP A LOOK OUT FOR THESE LOGOS BELOW THROUGHOUT THE CATALOG FOR BIG SAVINGS AND DISCOUNTS ON KITS!

BUY & SAVE
 WITH SS396.COM PRE-BUILT KITS





The System by Custom Autosound

The System solves the age old problem of where to put speakers in classics, customs and streetrods. The System allows you to keep the integrity of your vehicle intact yet enjoy quality sound like many of us have in our new cars. Satellite speakers look like AC vents and can be mounted under the dash, on the kickpanels or even the back package tray. The woofer is optionally mounted under the seat but can be mounted in the trunk if space requires it.



CAS-SYSTEM1

System 1

Flat active aluminum subwoofer enclosure with 3 channel amplifier. Two 3" mid-tweeter satellite speakers in die cast metal housings and 8" woofer. Wire remote for bass level. Amplifier installation kit included.
Amplifier power: 150 watt subwoofer / 2x50 watt mid/tweeter
Dimensions: Amp / Sub: 2.8" x 13.5" x 9.8"
Satellite: 3.2" x 3.75"

CAS-SYSTEM1 System 1..... SEE WEB



BSD-CHL-682

Backseat Driver

Add some bottom end power to your system with our custom bass speaker panel. This panel comes equipped with two Custom Autosound 8" subwoofers and the Boss 500 watt amp. Panel mounts to the back of the rear seat from the trunk. All cables & wires needed are included for a quick and easy install!

BSD-CHL-682 1970-72SEE WEB



SPUV-693C



Rear Speakers

These rear speakers are a high performance replacement for your originals and includes grilles, wires and hardware.

SPUV-693C 6x9 3 Way 200WSEE WEB



UNDERCOVER1

Undercover Speakers

These compact speakers are specifically made for under seat installation and they pack a 120 Watt punch! Each unit features a 5 1/2" woofer and piezo tweeter. 3" H X 8-1/4" W X 11-1/4" L.

UNDERCOVER1 1970-72 All.....SEE WEB



UNDERCOVER2

Undercover II Speakers

Want a little more from your hidden speaker system? This is it! Each unit features an 8" woofer and 2 Piezo tweeters. With the 8" woofer in UNDERCOVERII you get a much fuller deeper sound with a 200 Watt capability! 11"W x 12.5"D x 3"H

UNDERCOVER2 1970-72 All.....SEE WEB



BLUKIT

Bluetooth Interface for USA-630, Secretaudio

This adapter plugs into the CD changer port of your radio and gives you the ability to do hands free calling from your Bluetooth capable phone. You can listen to music stored on your A2DP enabled Bluetooth device. You can still use your CD changer with the adapter plugged in.

BLUKIT Bluetooth Interface.....SEE WEB

Note: Works with Custom Autosound USA-630 and Secretaudio systems.



ANT-7088

Antenna Lead Wire

Correct lead that mounts to the top of the dash. The windshield antenna plugs into this and the lead goes to the radio.

ANT-7088 1970-77 All.....SEE WEB



ANT-HIDE

Hidden Antenna

For the best AM/FM reception, nothing works better than this hidden amplified antenna! You can mount this anywhere and plug it into your new Custom Autosound stereo for the best reception quality!

ANT-HIDE 1970-88 AllSEE WEB

KEEP A LOOK OUT FOR THESE LOGOS BELOW THROUGHOUT THE CATALOG FOR BIG SAVINGS AND DISCOUNTS ON KITS!

BUY & SAVE
WITH SS396.COM PRE-BUILT KITS





PLW-KIT

Lug Nut Wrench & Sleeve

Lug wrench and rubber sleeve for retaining it to the jack.

- PLW-3 1970-72 Wrench.....SEE WEB
- PLS 1970-72 SleeveSEE WEB
- BHE-1970 1970-72 Spare Tire Hold DownSEE WEB
- PLW-KIT 1970-72 Sleeve Wrench, Hold DownSEE WEB



RDP-100

Trunk Floor Drain Plug

Correct stamped plug for trunk floor.

- RDP-100 1970-72 All.....SEE WEB

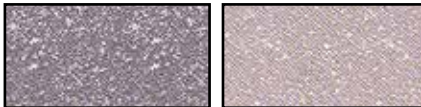

Trunk Spatter Paint

Correct OEM aerosol spray to detail your trunk floor.

- DUP-DM109 Aqua/Black.....SEE WEB
- DUP-DM100 Gray/WhiteSEE WEB
- DUP-DM102 Black/Grey.....SEE WEB
- DUP-DAL1695 Clear Coat.....SEE WEB

Clear coat must be used to seal paint!



CTPM-518-5

Custom Trunk Panel Kit

This pre-cut custom trunk panel set makes it easy to clean up your trunk. Each kit includes pre-cut hardboard panels to cover the floor, trunk divider area and the sides of the trunk, saving you or your upholstery shop hours over hand trimming your own custom panels. Add your choice of finishing material such as carpet (not included) and you will have a clean and modern looking trunk to set your muscle car apart from the crowd!

- CTPM-518-5 1970-72SEE WEB

Note: Based on your particular car, you may find it necessary to custom trim here and there depending upon the type of material you choose to cover the panels with. Finishing material is not included. This kit includes the hardboard panels only. Ships Oversize. Not eligible for free shipping.



1970-1972 Chevrolet Monte Carlo

Carpeted Trunk Mats

This carpet is an awesome finishing touch to your muscle car! This trunk carpet is constructed of 80/20 looped carpet so it is a perfect match to your ACC interior carpet.

Note: These Carpets do not cover entire trunk floor

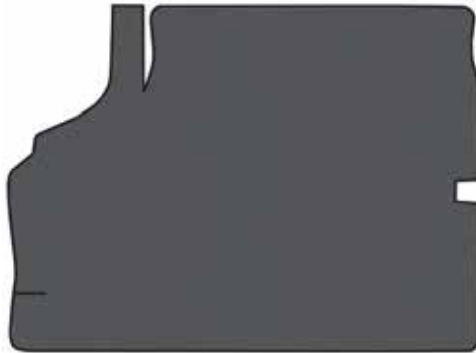

1970-72 80/20 Looped Carpet Colors



USE YOUR PHONES CAMERA OR ANY QR APP & SCAN NOW TO SHOP FOR THE TRUNK MATS YOU NEED!



Note: Due to variations in printing, it is impossible to perfectly represent carpet colors in this catalog. Use our color swatch chart as a guide only. We will gladly mail you a color sample before you place your order upon request. Please note that colors other than black are non-returnable.



MBJ-70A



MBJ-71A

Bumper Jacks

OE style reproduction of this often damaged or missing jack. This kit comes complete with jack, base and load base for bumper.

- MBJ-70A 1970 Monte Carlo SEE WEB
- MBJ-71A 1971-72 Monte Carlo SEE WEB

**These jacks are for display purposes only and are not intended for use.*



PLB-70A



PLB-71A

Monte Carlo Jack Load Base

Correct cradle for lifting car which inserts into bumper jack.

- PLB-70A 1970SEE WEB
- PLB-71A 1971-72.....SEE WEB



NRK-146



BUY & SAVE
WITH SS396.COM PRE-BUILT KITS



NJ-150K
Detail



NJ-152K
Detail

Complete Rally Wheel Kits

Why sift through the junkyard for a used set of wheels or try to repair your originals? Ground Up offers complete wheel kits including a complete set of rims, caps, trim rings and a set of lug nuts! These kits include everything you need to get your muscle car rolling in style.

With Chevrolet Motor Division Flat Caps

NRK-146	14 x 6	SEE WEB
NRK-146DB	14 x 6 w/ Factory Disc	SEE WEB
NRK-147	14 x 7	SEE WEB
NRK-157	15 x 7	SEE WEB
NRK-158	15 x 8	SEE WEB

NRK-247	14 x 7	SEE WEB
NRK-257	15 x 7	SEE WEB
NRK-258	15 x 8	SEE WEB

With Turbine Style Raised Caps (1968+ Style)

NRK-346	14 x 6	SEE WEB
NRK-346DB	14 x 6 w/ Factory Disc	SEE WEB
NRK-347	14 x 7	SEE WEB
NRK-357	15 x 7	SEE WEB
NRK-358	15 x 8	SEE WEB

With Chevrolet Disc Brakes Flat Caps

NRK-246	14 x 6	SEE WEB
NRK-246DB	14 x 6 w/ Factory Disc	SEE WEB



NVW-70K



BUY & SAVE
WITH SS396.COM PRE-BUILT KITS

Complete Super Sport Wheels Kits

This kit includes a complete set of SS rims, center caps with retainers, trim rings and a set of lug nuts to get your Super Sport rolling!

NVW-70K	14 x 7	SEE WEB
NVW-71K15	15 x 7	SEE WEB

No Volume Discount. All wheel kits ship in multiple Oversize Boxes. Not eligible for free shipping.



BUY & SAVE
WITH SS396.COM PRE-BUILT KITS

NVW-4837-MAG-KIT4

Retro Magnum Alloy SS Wheels

Constructed of aluminum these brand new retro 15 x 7 Super Sport wheels will give your muscle car a more modern look while keeping the old school styling! These awesome new wheels are black powder coated on the inside and feature machined lips. Accepts original style lug nuts.

NVW-4837-MAG-KIT4	15 x 7 Kit	SEE WEB
NVW-4837-MAG	15 x 7, Spare	SEE WEB
NVW-MAG-17X7	17 x 7	SEE WEB
NVW-MAG-17X8	17 x 8	SEE WEB

Ships Oversize. Not eligible for free shipping. No Volume Discount. 17 inch rims come with a blank center cap.



NCE-8984

Rally Wheels

Our rally wheels come correctly powder coated in Argent Silver assuring you not only a great appearance but quality as well.

NCE-8984	14 x 6, 4" Backspace	SEE WEB
NCE-8985	14 x 6 Disc, 4" Backspace*	SEE WEB
NCE-0530	14 x 7, 4-1/4" Backspace	SEE WEB
NCE-0535	15 x 7, 4-1/4" Backspace	SEE WEB
NCE-0540	15 x 8, 4-1/2" Backspace	SEE WEB

*Fits factory disc brakes only. Ships Oversize.



NCE-0530C

Chrome Rally Wheels

This reproduction Rally Wheel comes in high quality chrome plated steel for a custom look. This wheel is ready to install right out of the box.

NCE-8984C	14x6, 4" Backspace	SEE WEB
NCE-0530C	14x7, 4-1/8" Backspace	SEE WEB
NCE-0535C	15x7, 4-1/4" Backspace	SEE WEB
NCE-0540C	15x8, 4-1/2" Backspace	SEE WEB

Fits cars with 5 lug axles. These wheels do not include center caps or lug nuts. Ships Oversize.



NVW-4832

Super Sport Wheels

Reproduction SS wheel which comes correctly painted and ready to install.

- NVW-4832 14 x 7, 4.25" Backspace.....SEE WEB
 - NVW-4837 15 x 7, 4.25" Backspace.....SEE WEB
 - NVW-4838 15 x 8, 4.5" BackspaceSEE WEB
- Ships Oversize.*



NVW-4831C

Chrome Super Sport Wheels

This reproduction Monte Carlo Super Sport Wheel is made in the USA and comes in high quality chrome plated steel for a custom look. This Monte Carlo wheel is ready to install right out of the box.

- NVW-4831C 14 x 6, 4" Backspace.....SEE WEB
 - NVW-4832C 14 x 7, 4.12" Backspace.....SEE WEB
 - NVW-4837C 15 x 7, 4.25" Backspace.....SEE WEB
 - NVW-4838C 15 x 8, 4.5" BackspaceSEE WEB
- These wheels do not include center caps or lug nuts. Ships Oversize.*



NSW-146

Steel COPO Wheels

This is a brand new factory style steel Monte Carlo wheel which was usually standard equipment on six cylinder cars, Special High Performance Cars and COPO cars. These steel wheels were usually discarded over the years in favor of rally wheels or super sport wheels and are tough to find. This rim is perfect for your bone stock restoration, COPO recreation or sleeper.

- NSW-146 14 x 6, 4-1/2" BackspaceSEE WEB
 - NSW-147 14 x 7, 4-3/4" BackspaceSEE WEB
 - NSW-157 15 x 7, 4-3/4" Backspace.....SEE WEB
- Only fits 1970-72 Monte Carlo. Ships Oversize.*



NW1785SLV

17 Inch N90 Wheels

Add a modern stance to your muscle car while keeping with its classic styling! This is a 17 inch version of the N90 wheel that originally came on 1980-1981 Z/28 and 1986-1988 Monte Carlo models. Accepts original style center caps and lug nuts.

- NW1784SLV 17 x 8, 4.25" B/S.....SEE WEB
- NW1785SLV 17 x 8, 5" B/S.....SEE WEB



CMW178BLK

17 Inch SS Mag Wheels

Add a modern stance to your muscle car while keeping with its classic styling! This is a 17 inch version of the Super Sport Wheel that originally came on various GM models. Accepts original style center caps and lug nuts.

- CMW178BLK 17 x 8, 4.5" B/SSEE WEB
- CMW179BLK 17 x 9, 5.125" B/S.....SEE WEB
- MWR2 Center Cap RetainersSEE WEB
- C5782 Screws (10pc.)SEE WEB

Note: If using your existing center caps you will need to use MWR2 center cap retainers and C5782 screws to fit these retainers.



ZW1784GUN

17 Inch 5 Spoke Rally Wheels

Add a modern stance to your muscle car while keeping with its classic styling! This is a 17 inch version of the 5 spoke Z/28 wheel that originally came on 1970-1981 Camaro. Accepts original style center caps and lug nuts.

- ZW1784GUN 17 x 8, Gunmetal, 4.25" B/SSEE WEB
- ZW179GUN 17 x 9, Gunmetal, 5" B/SSEE WEB



NZW-157

1971-74 5 Spoke SS Wheel

Reproduction 5 spoke steel wheel which was originally installed on 1970-1981 GM performance models.

- NZW-157 15 x 7.....SEE WEB
- Ships Oversize*



HMK-6970

SS Wheel Restoration Supplies

Ground Up offers everything you need to restore your original Super Sport Wheels. Order our 4 piece paint mask kit along with Argent Silver and SS Insert gray paint for a complete job.

- HMK-6970 Paint MaskSEE WEB
- DUP-HWP101 Argent Silver Paint (11oz. can).....SEE WEB
- HDP-1214 Insert Gray Paint (11oz. can).....SEE WEB



NWB-781

1978-81 Rally Wheel Bezel

This is the correct chrome bezel that inserts into the slots on your ZJ7 6 slot rally wheels.

- NWB-781 1978-81 w/ Rally WheelSEE WEB
- 6 required per wheel.*



NJT-665

NJT-716

NJT-135

Lug Nuts

Correct style lug nuts for your wheels.

- NJT-716 Acorn 7/16SEE WEB
- NJT-665 Stainless SSSEE WEB
- NJT-665KIT SS 20pcSEE WEB
- NJT-135 All* w/ Aluminum RimsSEE WEB

**Factory GM Rims 1976-85*



HK WHEELS

HK Magnum Wheels
HK Magnum wheels offer classic good looks in a larger, more modern 17 inch diameter. HK Magnum wheels are manufactured in cast aluminum with black powder coated inserts and deep diamond machined lip clear powder coated for durability and low maintenance. HK Magnum wheels include a chromed lightweight polymer cone style center with HK Wheels decal with a style that complements the classic looks of the wheel. BS = Back Spacing.

HK-MW1775475	17x7 4.25" BS.....	SEE WEB
HK-MW1785475	17x9 4.25" BS.....	SEE WEB
HK-MW1795475	17x9 5" BS.....	SEE WEB

No Volume Discount.

American Racing Wheel Kits

American Racing is the brand that started it all with their revolutionary Torq Thrust wheels. For the first time Ground Up® is offering these wheels. BS = BACKSPACE



ARKIT-TT2G-147



ARKIT-TDB-157



Classic Torq Thrust II One Piece Mag Gray Machined Lip

ARKIT-TT2G-146	14x6 3.42" BS	SEE WEB
ARKIT-TT2G-147	14x7 4.0" BS	SEE WEB
ARKIT-TT2G-157	15x7 3.76" BS.....	SEE WEB
ARKIT-TT2G-158	15x8 4.5" BS.....	SEE WEB
ARKIT-TT2G-1578	15x7 Front 15x8 Rear.....	SEE WEB

Torq Thrust II One Piece Chrome

ARKIT-TT2C-147	14x7 4.0" BS	SEE WEB
ARKIT-TT2C-157	15x7 3.76" BS.....	SEE WEB
ARKIT-TT2C-158	15x8 4.5" BS.....	SEE WEB
ARKIT-TT2C-1578	15x7 Front 15x8 Rear	SEE WEB
ARKIT-TT2C-177	17x7 4.0" BS.....	SEE WEB
ARKIT-TT2C-178	17x8 4.81" BS.....	SEE WEB
ARKIT-TT2C-1778	17x7 Front 17x8 Rear.....	SEE WEB

Torq Thrust II One Piece PVD Chrome

ARKIT-TT2CPVD-157	15x7 3.76" BS.....	SEE WEB
ARKIT-TT2CPVD-158	15x8 4.5" BS.....	SEE WEB
ARKIT-TT2CPVD-1578	15x7 Front 15x8 Rear.....	SEE WEB
ARKIT-TT2CPVD-177	17x7 4.0" BS.....	SEE WEB
ARKIT-TT2CPVD-178	17x8 4.81" BS.....	SEE WEB
ARKIT-TT2CPVD-1778	17x7 Front 17x8 Rear.....	SEE WEB

Torq Thrust II One Piece Polished

ARKIT-TT2POL-157	15x7 3.76" BS.....	SEE WEB
ARKIT-TT2POL-158	15x8 4.5" BS.....	SEE WEB
ARKIT-TT2POL-1578	15x7 Front 15x8 Rear.....	SEE WEB
ARKIT-TT2POL-177	17x7 4.0" BS.....	SEE WEB

Torq Thrust D Chrome

ARKIT-TTDC-157	15x7 3.76" BS	SEE WEB
ARKIT-TTDC-158	15x8 4.5" BS.....	SEE WEB
ARKIT-TTDC-1578	15x7 Front 15x8 Rear	SEE WEB

Torq Thrust D Black w/ Machined Lip

ARKIT-TTDB-157	15x7 3.76" BS	SEE WEB
ARKIT-TTDB-158	15x8 4.5" BS.....	SEE WEB
ARKIT-TTDB-1578	15x7 Front 15x8 Rear	SEE WEB

Torq Thrust M Anthracite w/ Machined Lip

ARKIT-TTMMG-177	17x7 4.0" BS.....	SEE WEB
ARKIT-TTMMG-178	17x8 4.5" BS.....	SEE WEB
ARKIT-TTMMG-1778	17x7 Front 17x8 Rear	SEE WEB



Factory Style Tires

If authenticity is your goal, then look no further. All of our tires feature the same tread patterns and raised white lettering as the originals.

Goodyear Polyglas

GE-7014	E70 x 14.....	SEE WEB
GF-7014	F70 x 14.....	SEE WEB
GF-7114	F70 x 14*.....	SEE WEB
GF-6015	F60 x 15.....	SEE WEB
GG-7014	G70 x 15.....	SEE WEB
GG-6015	G60 x 15.....	SEE WEB

**1970 - early 1970 w/o tire size in RWL No Volume Discount. Ships Oversize. Not eligible for free shipping.*

Firestone Wide Oval

FE-7014	E70 x 14.....	SEE WEB
FF-7014	F70 x 14.....	SEE WEB
FG-7014	F70 x 14.....	SEE WEB
FF-7015	F70 x 15.....	SEE WEB
FG-7015	G70 x 15.....	SEE WEB
FF-6015	F60 x 15.....	SEE WEB

Firestone Redline

RF-7014	F70 x 14.....	SEE WEB
RG-7014	G70 x 14.....	SEE WEB
RF-7015	F70 x 15.....	SEE WEB
RG-7015	G70 x 15.....	SEE WEB



ER-7014RL

ER-7014RW

Factory Style Radial Tires

If you're going for an authentic Chevrolet restoration, be sure that you don't overlook the tires! Previously, this meant sacrificing modern ride quality and handling characteristics for an authentic appearance, but now you can have the best of both worlds with these modern radial tires that have a period correct appearance. This factory style Firestone Wide Oval tire is an almost exact replica of the original, engineered from the ground up to provide excellent ride quality, tread life and safety, while retaining the correct tread pattern and raised white lettering.

Firestone Wide Oval

ER-7014RW	ER70-14.....	SEE WEB
FR-7014RW	FR70-14.....	SEE WEB
GR-7014RW	GR70-14.....	SEE WEB
FR-7015RW	FR70-15.....	SEE WEB
FR-6015RW	FR60-15.....	SEE WEB
GR-7015RW	GR70-15.....	SEE WEB

Firestone Redline

ER-7014RL	ER70-14.....	SEE WEB
FR-7014RL	FR70-14.....	SEE WEB
GR-7014RL	GR70-14.....	SEE WEB
FR-7015RL	FR70-15.....	SEE WEB
GR-7015RL	GR70-15.....	SEE WEB



NTR-157

NTR-146

Trim Ring Sets

OE style reproduction trim ring kits at an affordable price.

NTR-146	14 x 6 Rally	SEE WEB
NTR-147	14 x 7 Rally	SEE WEB
NTR-157	15 x 7 Rally	SEE WEB
NTR-157-B	15 x 7 Rally w/ Bowtie	SEE WEB
NTR-158	15 x 8 Rally	SEE WEB
NTR-158-B	15 x 8 Rally w/ Bowtie	SEE WEB

SS Trim Ring Sets

OE style reproduction trim rings packaged in convenient sets for your Super Sport.

NTW-1090	1970 14 x 7	SEE WEB
NTW-1095	1970 15 x 7	SEE WEB
NTR-70Z	1971-75 15 x 7*	SEE WEB

*Gray 5 Spoke Style



NJT-671K

Center Cap Kit

This complete set includes (4) nice reproduction center caps with retainers (where applicable) for your SS wheels.

NJT-671K	1970 (8pc)	SEE WEB
NJT-63K	1971-72 (4pc)	SEE WEB



NJT-YENKO

Yenko Center Cap Kit SS Wheels

This is a complete Yenko tribute wheel center cap kit which includes (4) reproduction SS center caps with Yenko decals and (4) retainers. These caps fit 1970 Super Sport and Olds SS1 wheels.

NJT-YENKO	1970 Complete	SEE WEB
-----------	---------------------	---------



NSS-70K

OEM Style SS Center Cap Kit

These center caps are reserved for the true purist because they feature a deep indented SS center cap like factory OEM. These metal caps are made of high-quality cast aluminum just like they came from the factory! These caps are a little pricier but are clearly the obvious choice when going for a totally stock restoration.

NSS-70K	1970 Complete	SEE WEB
---------	---------------------	---------

Super Sport Center Caps

OE style reproduction retainers and caps to freshen up your Super Sport Wheels.



NCX-396

NCE-6770

NCX-454

NCX-396	SS396 Cap	SEE WEB
NCX-454	SS454 Cap	SEE WEB
NCE-6770	SS Cap	SEE WEB



NCD-396

NCE-700

NCD-454

NCD-396	SS396 Decal Only	SEE WEB
NCD-454	SS454 Decal Only	SEE WEB
NCE-700	SS Decal Only	SEE WEB



NCE-671

NCE-671	SS Cap Retainer	SEE WEB
---------	-----------------------	---------



NDD-230

Dog Dish Hubcaps

These are reproduction hub cap sets that were commonly found on many high performance cars. They feature excellent stamping, paint and chrome which ensures not only aggressive looks, but excellent quality. (We have installed these on our own 1969 L89 Camaro.)

NDD-230	1970 Chevrolet	SEE WEB
---------	----------------------	---------

*These will only fit stock steel wheels. They will not fit Rally Wheels or SS Wheels.

Super Sport Center Caps

OE style reproduction retainers and caps to freshen up your Super Sport Wheels.



NCE-9479

NCE-9479	1971-75 SS	SEE WEB
----------	------------------	---------



NYC-105

Rally II Wheel Cap

OE style reproduction chrome wheel center cap for use with Yenko models equipped with Pontiac Rally II wheels.

NYC-105	1970	SEE WEB
---------	------------	---------



NCD-106

Yenko Wheel Ornament Decal

Correct pressure sensitive decal for use on 1970 Yenko models equipped with Torque Thrust wheels.

NCD-106	Yenko	SEE WEB
---------	-------------	---------



NJ-151K

Rally Wheel Cap Kits

Ground up offers complete rally wheel kits which include center caps, bases and hardware to do all four wheels.

NJ-150K	Chevrolet Motor Division	SEE WEB
NJ-151K	Chevrolet Disc Brakes	SEE WEB
NJ-152K	Motor Division Raised	SEE WEB



NJ-1530

Rally Wheel Center Cap

Correct turbine style raised style center cap with "Chevrolet Motor Division".

NJ-1530	Motor Division Cap 1960+	SEE WEB
NJ-1530-BTK	Bowtie	SEE WEB

TRSD Performance Series Disc Brake Conversions

These all new disc brake conversions from The Right Stuff feature Wilwood 2 piston calipers, street performance brake pads, stainless braided flex hoses, spindles, caliper brackets, dust shields, proportioning valve, brake booster with master cylinder and factory size drilled and slotted rotors making for a super easy installation. These kits fit with most 15" or larger wheels.



Street Performance Series Upgrade Featuring Wilwood Calipers

The Right Stuff Detailing's new Street Performance Series front disc brake upgrade kit is an easy way to add a nice finishing touch to your car. This kit features Wilwood dual piston black powder coated calipers, fully loaded with pads and hardware, drilled & slotted rotors and spindles. No booster, master cylinder or pro-valve included. Installation hardware and instructions are included.



4 Wheel Kits

4 Wheel Kits Stock Height

AFXSD21CS	1970-72 Black Calipers Manual.....	SEE WEB
AFXSD21CZ	1970-72 Red Calipers Manual.....	SEE WEB
AFXDC21CS	1970-72 Black Calipers 9" Gold Booster.....	SEE WEB
AFXDC21CZ	1970-72 Red Calipers 9" Gold Booster.....	SEE WEB
AFXDC26CS	1970-72 Black Calipers 11" Gold Booster.....	SEE WEB
AFXDC26CZ	1970-72 Red Calipers 11" Gold Booster.....	SEE WEB
AFXSD21CSX	1970-72 Black Calipers Manual Chrome Master.....	SEE WEB
AFXSD21CZX	1970-72 Red Calipers Manual Chrome Master.....	SEE WEB
AFXDC21CSX	1970-72 Black Calipers 8" Chrome Booster.....	SEE WEB
AFXDC21CZX	1970-72 Red Calipers 8" Chrome Booster.....	SEE WEB

2" Drop Spindle

AFXSD21DS	1970-72 Black Calipers Manual.....	SEE WEB
AFXSD21DZ	1970-72 Red Calipers Manual.....	SEE WEB
AFXDC21DS	1970-72 Black Calipers 9" Gold Booster.....	SEE WEB
AFXDC26DZ	1970-72 Red Calipers 9" Gold Booster.....	SEE WEB
AFXDC26DS	1970-72 Black Calipers 11" Gold Booster.....	SEE WEB
AFXDC26DZ	1970-72 Red Calipers 11" Gold Booster.....	SEE WEB
AFXSD21DSX	1970-72 Black Calipers Manual Chrome Master.....	SEE WEB
AFXSD21DZX	1970-72 Red Calipers Manual Chrome Master.....	SEE WEB
AFXDC21DSX	1970-72 Black Calipers 8" Chrome Booster.....	SEE WEB
AFXDC21DZX	1970-72 Red Calipers 8" Chrome Booster.....	SEE WEB

Front End Kits Stock Height

AFXDC32S	1970-72 Black Calipers 11" Gold Booster.....	SEE WEB
AFXDC32Z	1970-72 Red Calipers 11" Gold Booster.....	SEE WEB
AFXDC32SX	1970-72 Black Calipers 8" Chrome Booster.....	SEE WEB
AFXDC32ZX	1970-72 Red Calipers 8" Chrome Booster.....	SEE WEB

Front End Kits 2" Drop Spindle

AFXDC32DS	1970-72 Black Calipers 11" Gold Booster.....	SEE WEB
AFXDC32DZ	1970-72 Red Calipers 11" Gold Booster.....	SEE WEB
AFXDC32DSX	1970-72 Black Calipers 8" Chrome Booster.....	SEE WEB
AFXDC32DZX	1970-72 Red Calipers 8" Chrome Booster.....	SEE WEB

Front End Upgrade Kits

These kits come with drilled and slotted rotors, calipers, spindles and hardware.

AFXWK32S	1970-72 Black Calipers Stock Height.....	SEE WEB
AFXWK32Z	1970-72 Red Calipers Stock Height.....	SEE WEB
AFXWK32DS	1970-72 Black Calipers 2" Drop Spindle.....	SEE WEB
AFXWK32DZ	1970-72 Red Calipers 2" Drop Spindle.....	SEE WEB

These kits come with drilled and slotted rotors, loaded calipers and hardware.

RCP69S	1970-72 Black Calipers.....	SEE WEB
RCP69Z	1970-72 Red Calipers.....	SEE WEB

Rear End Kits

AFXRDM21S	1970-72 Black Calipers.....	SEE WEB
AFXRDM21Z	1970-72 Red Calipers.....	SEE WEB
AFXRDM278S	1978-88 Black Calipers.....	SEE WEB
AFXRDM278Z	1978-88 Red Calipers.....	SEE WEB

Rear Kits With Front Upgrade Kits

These kits come with a complete rear kit and a front kit with drilled and slotted rotors, loaded calipers and hardware.

A69RDM21S	1970-72 Black Calipers.....	SEE WEB
A69RDM21Z	1970-72 Red Calipers.....	SEE WEB
A73RDM21S	1973-77 Black Calipers.....	SEE WEB
A73RDM21Z	1973-77 Red Calipers.....	SEE WEB
A78RDM278S	1978 Black Calipers.....	SEE WEB
A78RDM278Z	1978 Red Calipers.....	SEE WEB
A79RDM278S	1979 Black Calipers.....	SEE WEB
A79RDM21Z	1979 Red Calipers.....	SEE WEB
A82RDM278S	1982-88 Black Calipers.....	SEE WEB
A82RDM21Z	1982-88 Red Calipers.....	SEE WEB

These kits ship oversize. No Volume Discount.

THE RIGHT Stuff BUY & SAVE

WITH SS396.COM PRE-BUILT KITS



AFXDC41CZX

Four Wheel Power Disc Brake Conversion Kits

Upgrade your classic to the ultimate in stopping power. Our 4 wheel kits are the most complete kits in the industry at rock bottom prices. Upgrade packages available- see ledger below. Add our No Brainer- Disc Brake line kit for a care-free installation.

Stock Height

AFXDC41C	1970-72, 9" PB	SEE WEB
AFXDC46C	1970-72, 11" PB	SEE WEB
AFXDC41CS	1970-72, 9" PB, DS, BPC	SEE WEB
AFXDC46CS	1970-72, 11" PB, DS, BPC	SEE WEB
AFXDC41CZ	1970-72, 9" PB, DS, RPC	SEE WEB
AFXDC46CZ	1970-72, 11" PB, DS, RPC	SEE WEB
AFXDC41CSX	1970-72, 8" CH, DS, BPC	SEE WEB
AFXDC41CZX	1970-72, 8" CH, DS, RPC	SEE WEB

2" Dropped Spindle Height

AFXDC41D	1970-72, 2" Drop W/ 9" PB	SEE WEB
AFXDC41DS	1970-72, 2" Drop, 9" PB, DS, BPC	SEE WEB
AFXDC41DSX	1970-72, 2" Drop, 9" CH, DS, BPC	SEE WEB
AFXDC46D	1970-72, 2" Drop W/ 11" PB	SEE WEB
AFXDC46DS	1970-72, 2" Drop, 11" PB, DS, BPC	SEE WEB
AFXDC46DSX	1970-72, 2" Drop, 11" CH, DS, BPC	SEE WEB

*PB- Gold Power Booster, DS- Drilled & Slotted Rotors, BPC-black powder coated calipers, RPC-red powder coated calipers CH-Chrome power assembly (booster, master, pro-valve)

THE RIGHT Stuff



AFXDC51CSX



SIGNATURE* BY TRSD 4-WHEEL DISC BRAKE CONVERSION KITS *FOR 17" OR LARGER WHEELS - LIFETIME WARRANTY!!!

Bold looks define the Signature line of Brake Kits. Large diameter (13") zinc plated rotors, powder coated calipers and USA made Timken bearings: Only premium quality components make the grade. These are amazing brakes at a great price. Add the No Brainer Brake Line Kit for true Bolt-in installation. Requires minimum 17" wheel. Bolts to stock drum or disc spindles. Complete kit includes:

- 13" Front drilled/slotted zinc plated rotors · 12" rear drilled/slotted zinc plated rotors · Fully machined caliper brackets
- 2024-Tk Forged aluminum hubs w/ 7/16" and 1/2" studs for multiple apps · Twin piston aluminum powder coated calipers- red or black
- Ceramic brake pads · Braided stainless steel hoses · Integrated parking brake
- Premium quality hardware · OEM style master cylinder w/combination valve · Chrome master/booster/ valve upgrade available.

*PB- Gold Power Booster, DS- Drilled & Slotted Rotors, BPC-black powder coated calipers, RPC-red powder coated calipers CH-Chrome power assembly (booster, master, pro-valve)

STOCK HEIGHT SIGNATURE KITS (Reuse Original Spindles)

AFXDC51CS	1970-72 Monte Carlo w/ PB, DS, BPC	SEE WEB
AFXDC51CZ	1970-72 Monte Carlo w/ PB, DS, RPC	SEE WEB
AFXDC51CSX	1970-72 Monte Carlo w/ PB, DS, BPC, CH*	SEE WEB
AFXDC51CZX	1970-72 Monte Carlo w/ PB, DS, RPC, CH*	SEE WEB

2" DROPPED SIGNATURE KITS

AFXDC51DS	1970-72 Monte Carlo w/ PB, DS, BPC	SEE WEB
AFXDC51DZ	1970-72 Monte Carlo w/ PB, DS, RPC	SEE WEB
AFXDC51DSX	1970-72 Monte Carlo w/ PB, DS, BPC, CH*	SEE WEB
AFXDC51DZX	1970-72 Monte Carlo w/ PB, DS, RPC, CH*	SEE WEB

4 WHEEL DISC BRAKE CONVERSION LINE KITS - "NO BRAINER" (Reuse Original Spindles)

Simplify your installation when doing a 4-wheel disc brake conversion with all the brake lines and clips you will need. Includes: Front line kit, Front to Rear line, Rear axle line set, rear flex hoses, clip set

AFXDC46C-GUPX



1970-1972 Monte Carlo Ground Up Exclusive 4 Wheel Disc Brake Conversions

Upgrading your Monte Carlo to four-wheel disc brakes is one of the easiest and most cost-effective things you can do for more driving enjoyment and increased safety. Classic Monte Carlos had great performance and styling from the factory but left a lot to be desired in the braking department. Upgrade your outdated braking system today with this convenient Ground Up Exclusive four-wheel disc brake kit and cruise with peace of mind. This kit is complete with a front brake kit and a rear brake kit.

AFXDC46C-GUPX	1970-72 All 11" PB	SEE WEB
AFXDC41C-GUPX	1970-72 All 9" PB	SEE WEB
AFXDC4WDS09-GUPX	1970-72 All 9" PB DS Rotors SS Flex Hoses	SEE WEB
AFXDC4WDS11-GUPX	1970-72 All 11" PB DS Rotors SS Flex Hoses	SEE WEB

Note: This kit requires 15 inch diameter wheels or larger. Rear kit will not fit 14.5 inch inner diameter wheels such as reproduction Super Sport / Olds SSI wheels. Will fit 15 inch or larger rally wheels or after market aluminum Super Sport wheels.



Show n Go Upgrade

This package adds drilled and slotted rotors and red or black powder coated calipers.

FM-1790AS-UP-S	1970-72 D/B Kit with Show N Go Black	SEE WEB
FM-1790AS-UP-Z	1970-72 D/B Kit with Show N Go Red	SEE WEB
FM-1790DSS	1970-72 2" Drop Kit-11" w/ Show N Go Black	SEE WEB
FM-1790DSZ	1970-72 2" Drop Kit-11" w/ Show N Go Red	SEE WEB

1973-77 Front disc upgrade to drilled and slotted rotors with powder coated calipers.

This kit contains the rotors and calipers only.

AFXWK70DS	1973-77 Black Calipers	SEE WEB
AFXWK70DZ	1973-77 Red Calipers	SEE WEB

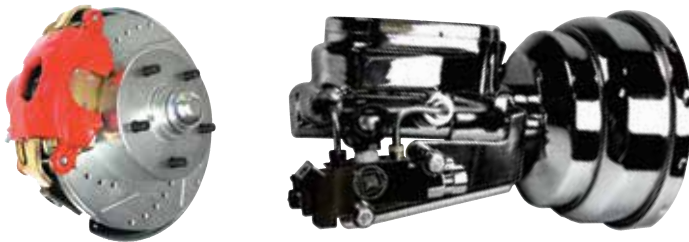

Best of Show Upgrade

Adds drilled & slotted rotors, 8" chrome master, booster, pro-valve assembly and powder coated calipers.

FM-1790AS-UP-SX	1970-72 D/B Kit with Best of Show Black	SEE WEB
FM-1790AS-UP-ZX	1970-72 D/B Kit with Best of Show Red	SEE WEB
FM-1790DSX	1970-72 2" Drop Kit- w/ Best of Show Black	SEE WEB
FM-1790DZX	1970-72 2" Drop Kit- w/ Best of Show Red	SEE WEB



Show Stopper Upgrade

Adds drilled & slotted rotors and a chrome master, booster, pro-valve assembly

FM-1790AS-UP-X	D/B Kit with Show Stopper Chrome	SEE WEB
----------------	--	---------



Rear Disc Brake Conversion Kit

Complete rear disc brake conversion kit for the ultimate stopping power. This kit includes rotors, loaded calipers, caliper brackets, bracket hardware, flex hoses and rear brake cables.

To add drilled and slotted rotors and painted calipers, add the following letters.

S for Black Calipers, Z for Red Calipers.

Ex. AFXRD01S is 1970-72 w/ Black Calipers.

AFXRD01_	1970-72 Standard Calipers	SEE WEB
----------	---------------------------------	---------

No Volume Discount. Ships in multiple Oversize boxes.



FSK-69KIT

Deluxe Disc Brake Mini Kit

This deluxe disc brake mini kit contains essential parts to convert to your own disc brake setup or refurbish your factory setup. Includes spindles, caliper brackets, caliper backing plates, flex hoses, pro valve kit, bearing and seal kit and hardware.

FSK-69KIT	1970-72 w/ Single Piston Calipers	SEE WEB
-----------	--	---------



FSK-69

Basic Disc Brake Mini Kit

Basic kit for converting to disc brakes or restoring factory disc brake setup. Complete with 2 spindles, 2 caliper brackets, 2 caliper backing plates and 2 bolts.

FSK-69	1970-72	SEE WEB
--------	---------------	---------

No Volume Discount.

THE RIGHT Stuff

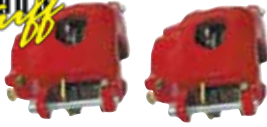

FRC-69AR

Powdercoated Calipers

Add a nice finishing touch with these loaded calipers complete with pads and hardware.

FRC-69AR	1970-72 Red.....	SEE WEB
FRC-69AB	1970-72 Black.....	SEE WEB
FRC-73AR	1973-77 Red.....	SEE WEB
FRC-73AB	1973-77 Black.....	SEE WEB



FMP-0200

Disc Brake Pads

New brake pad set.

FMP-0200	1970-72 Single Piston	SEE WEB
----------	-----------------------------	---------



EVP01

Electric Vacuum Kit

If you have a big cam and low vacuum is making it tough for your power disc brakes to work properly, then this electric vacuum pump kit will solve your problems! This kit includes an efficient electric pump, relay switch, distributor with vacuum switch, wiring, hoses and brackets. This system requires a 12V negative ground system for operation.

EVP01	Vacuum Pump Kit.....	SEE WEB
-------	----------------------	---------



FBK-67D

Bearing & Seal Kit

New GM bearing & seal kit (2) inners, (2) outers, and (2) grease seals.

FBK-67D	1970-72 All w/ Disc.....	SEE WEB
---------	--------------------------	---------



FBC-605

Bearing Cap

Original GM style bearing & dust shield cap.

FBC-605	1970-72 All.....	SEE WEB
---------	------------------	---------



FNW-103

Bearing Nut/Washer Kit

Correct castle nut, thrust washer and cotter pin. 2 kits are required per car.

FNW-103	1970-72 All.....	SEE WEB
---------	------------------	---------



FMM-1021

Single Piston Brake Calipers

New single piston loaded calipers complete with pads and all new hardware. Ready to install!

FMM-1021	1970-72 LH.....	SEE WEB
FMM-1022	1970-72 RH	SEE WEB
FRC-12N	1978-88 LH.....	SEE WEB
FRC-13N	1978-88 RH.....	SEE WEB

No Volume Discount.



FPP-11J

Caliper Backing Plates

Reproduction zinc backing plates.

FPP-11J	1970-72 Single Piston	SEE WEB
FPP-11GSK	1970-72 Gasket.....	SEE WEB

No Volume Discount.



FM-2501

Caliper Mounting Brackets

Reproduction caliper mounting brackets.

FM-2501	1970-72 Single Piston	SEE WEB
---------	-----------------------------	---------



BCP-373

Backing Plate Bolt

Correct bolt for attaching plate to spindle.

BCP-373	1970-72 Single Piston	SEE WEB
---------	-----------------------------	---------



BMP-1000

Brake Caliper Bolts

Correct bolts/pins for mounting caliper to bracket. Two per caliper.

BMP-1000	1970-77 Single Piston	SEE WEB
----------	-----------------------------	---------



FSA-01

Steering Arms

Reproduction steering arms for your worn or missing originals.

FSA-01	1970-72	SEE WEB
--------	---------------	---------



FM-373B



FM-3712

Spindles

New OEM spindles

FM-3712	1970-72 Disc	SEE WEB
FM-37DR0P	1970-72 Disc Brake Drop Spindles	SEE WEB
FM-373B	Attaching Bolts.....	SEE WEB



FCDR-66

Drilled & Slotted Rotors

Drilled and slotted for maximum cooling and reduced fade; the ultimate in high performance braking and looks.

FCDR-66	1970-72*	SEE WEB
FCDR-7377	1973-77	SEE WEB
FCDR-78G	1978	SEE WEB
FCDR-79G	1979-81	SEE WEB
FCDR-82G	1982-88.....	SEE WEB

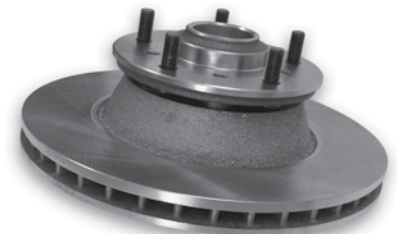

FBR-2P

2 Piece Rotors

Available for the first time! All cars from 1970-72 originally came with 2 piece rotors from the factory. These 2 piece rotors duplicate the originals and are a must for a concours restoration.

FBR-2P	1970-72 All.....	SEE WEB
FBR-2PK	1970-72 All Pair.....	SEE WEB



FBR-880

Rotors

New OEM style one piece rotors.

- FBR-880 1970-72 All.....SEE WEB
- FBR-880KIT 1970-72 Pair.....SEE WEB
- FBR-03C 1973-77 All.....SEE WEB



DBK68R2

Rear Drum Brake Kit

This is the complete kit and all parts are plated and color coated factory correct. The best part is that it comes completely assembled ready to bolt on to the axle housing. Take the frustration out of your project with this kit. This kit includes: Backing plates, Wheel Cylinder, Drums, Shoes. All of the hardware: Springs, Adjuster, Space bar, Special Washer, Cylinder pins and parking brake lever.

- DBK68R2 1970-72.....SEE WEB



FDB-95R

Brake Drums

Brand new finned brake drums.

- FDB-95R 1970-72 Rear Finned.....SEE WEB



FBP-41L

Backing Plates

New replacement rear drum backing plates.

- FBP-41L All LH.....SEE WEB
- FBP-41R All RH.....SEE WEB
- FBP-41K All Kit.....SEE WEB
- FPB-BOLT Retaining Bolt/Nut.....SEE WEB

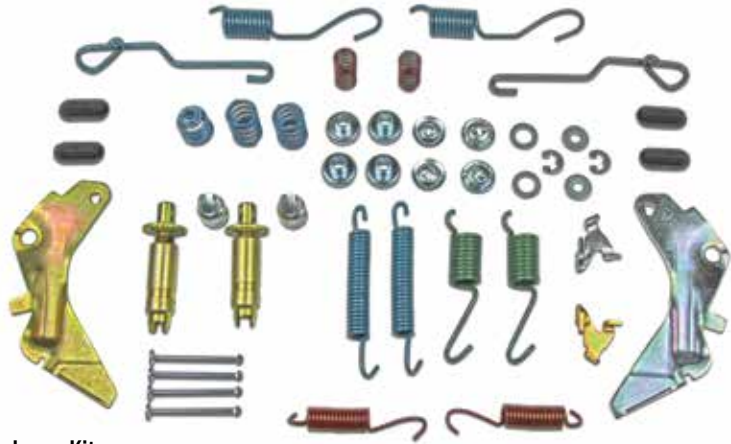

FPK-2642

Brake Hardware Kit

Correct springs, rods, retainer, adjuster and clamp for mounting shoes to car. Does 2 wheels.

- FPK-2642 All Rear.....SEE WEB
- FPK-REAR-KIT All 9.5 Drums.....SEE WEB



F5-64R

Brake Shoes

Complete shoes for 2 drums.

- F5-64R All Rear.....SEE WEB



FBG-17

FAP-2R

Drum Brake Guide/Pin

- FBG-17 Upper Guide Plate.....SEE WEB
- FAP-2R Attaching Pin Rear.....SEE WEB



FMC-6800

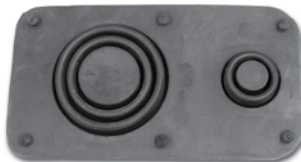

FG-695

Master Cylinder Caps & Gaskets

New correct gold cadmium plated caps & rubber gasket.

- FMC-6800 1970-73 Disc Cap.....SEE WEB
- FG-695 1970-73 Disc Gasket.....SEE WEB



FMR-12441



FLN-12968



FMP-12046

Master Cylinder Hardware

Master Cylinder Firewall Reinforcement Plate

Used only on manual brakes to provide support at the firewall for the master cylinder.

- FMP-12046 1970-72.....SEE WEB

Master Cylinder Clevis Lock Nut

Equipped on all factory manual or power disc cars to prevent the rod from spinning so that the clevis does not fall off.

- FLN-12968 1970-72.....SEE WEB

Master Cylinder Rod Assembly

Correct master cylinder push rod assembly used when converting to manual disc or if the car is manual drum.

- FMR-12441 1970-72.....SEE WEB



FMP-070



FMP-1970

OEM Style Master Cylinders

Choose from a wide variety of master cylinders to suit your needs. OEM style master cylinders feature cast bodies with caps as original. Choose a master with bleeders for the ultimate in authenticity.

FMP-1970	1970-72 Power Disc	SEE WEB
FMP-070	1970-72 Power Disc w/ Bleeders	SEE WEB



FMP-1970C



FMP-51C

Chrome Master Cylinders

A chrome master cylinder will add a beautiful finishing detail to your engine compartment so you will be proud to pop your hood at any car show!

Chrome

FMP-1967C	1970-72 Round Disc/Drum 1-1/8" Bore	SEE WEB
FMP-04C	1970-72 Round Disc/Disc 1" Bore	SEE WEB
FMP-51C	1970-72 Slimline Disc/Drum 1-1/8" Bore	SEE WEB
FMP-56C	1970-72 Slimline Disc/Disc 1" Bore	SEE WEB



AXP-0656

Power Brake Hose Kit

OEM style hose with correct double circle Delco check valve, gasket and black phosphate clamps.

AXP-0656	1970-77	SEE WEB
----------	---------------	---------



AXP-1CV

Brake Booster Check Valves

New replacement check valves complete with grommet.

AXP-1CV	All, White.....	SEE WEB
GCS-S7800	All, Chrome.....	SEE WEB



FBB-3715

Power Booster Boot

Reproduction of this often missing boot.

FBB-3715	1970-72 All.....	SEE WEB
----------	------------------	---------



APJ-1217



APN-0270

Power Brake Tube

Correct "pre-bent" tube with bracket for cars with power brakes (high quality zinc plated as original)

APN-0270	1970 All BB.....	SEE WEB
APN-71	1971-72 All BB	SEE WEB
APN-7301	1973 350.....	SEE WEB
APJ-1217	Bracket SB w/ PB	SEE WEB

BUY & SAVE
WITH SS396.COM PRE-BUILT KITS



BMK-9SB

Booster/Master Kits

Replace your old booster and master in one shot and save! These kits are available in many configurations to suit your restoration needs. If you are restoring a car to original specs, the factory style bleeder screws featured in this master cylinder are a must. The booster is available in 9" or 11" configurations and with or without the Delco Moraine stamp. 1970-72 includes square master.

BMK-9S	1970-72 w/ 9" Booster	SEE WEB
BMK-11S	1970-72 w/ 11" Booster	SEE WEB
BMK-9SD	1970-72 w/ 9" Booster Delco Stamp	SEE WEB
BMK-11SD	1970-72 w/ 11" Booster Delco Stamp	SEE WEB
BMK-9SB	1970-72 w/ Bleeder Screws w/ 9" Booster	SEE WEB
BMK-11SB	1970-72 w/ Bleeder Screws w/ 11" Booster	SEE WEB
BMK-9SBD	1970-72 w/ Bleeder Screws w/ 9" Booster Delco Stamp	SEE WEB
BMK-11SBD	1970-72 w/ Bleeder Screws w/ 11" Booster Delco Stamp	SEE WEB

No Volume Discount.



SLIM-8C-4



SLIM-8G-2



Slimline Booster / Master / Pro-Valve Kits

These Slimline kits allow you to replace your booster, master cylinder and proportioning valve in one simple step! All kits feature an 8" booster.

SLIM-8G-2	1970-72 Disc/Drum 8" Booster Gold	SEE WEB
SLIM-8G-4	1970-72 Disc/Disc 8" Booster Gold	SEE WEB
SLIM-8C-2	1970-72 Disc/Drum 8" Booster Chrome	SEE WEB
SLIM-8C-4	1970-72 Disc/Disc 8" Booster Chrome	SEE WEB

THE RIGHT Stuff



BMK-SHOW11R



BMK-SHOW9R4W

Chrome Booster/Master/Pro Valve Kit

This show quality chrome plated power brake master cylinder and brake booster kit also includes a polished and chromed proportioning valve with stainless steel valve to master cylinder lines. This kit will be a great finishing touch for your classic Monte Carlo.

BMK-SHOW9R	1970-72 Disc/Drum, 9" Booster	SEE WEB
BMK-SHOW11R	1970-72 Disc/Drum, 11" Booster	SEE WEB
BMK-SHOW9R4W	1970-72 Disc/Disc, 9" Booster	SEE WEB
BMK-SHOW11R4W	1970-72 Disc/Disc, 11" Booster	SEE WEB

No Volume Discount.





FBB-6



11" Delco Moraine Booster

Crafted with the same gold cadmium plating as original as well as the Delco Moraine logo stamping for the ultimate in authenticity.

FBB-6 1970-72SEE WEB



FBB-3



9" Delco Moraine Booster

Crafted with the same gold cadmium plating and Delco Moraine logo as our 11" booster, this 9" booster allows more clearance when running tall valve covers.

FBB-3 1970-72SEE WEB



FBB-6-UP



Power Booster w/ Upside Down Logo

Correct 11" power brake booster featuring the "upside down" Delco Moraine logo for the ultimate in authenticity. Gold cadmium plated. Include factory correct check valve.

FBB-6-UP 1970-72 11"SEE WEB



FPB-1102

11" Delco Style Booster

This is a brand new power brake booster crafted with the same gold cadmium plating as original.

FPB-1102 1970-72SEE WEB



FPB-9022

9" Delco Style Booster

This is a brand new power brake booster crafted with the same gold cadmium plating as original. This 9" booster allows more clearance when running tall valve covers.

FPB-9022 1970-72SEE WEB



FPB-1003C

Chrome Booster

This is a brand new power brake booster crafted with chrome plating to set your car apart from others.

FPB-9021C 1970-72 9"SEE WEB
 FPB-1003C 1970-72 11"SEE WEB



FPB-7137C

7" Dual Slimline Booster

A good booster when room is tight. Great for big block cars with tall valve covers. Roughly the same assist as a 9" single booster.

FPB-7137 1970-72 GoldSEE WEB
 FPB-7137C 1970-72 ChromeSEE WEB
 FPB-7137S 1970-72 StainlessSEE WEB



FPB-8131

8" Dual Slimline Booster

Our most powerful Slimline booster. 10-15% more assist than a 9" single. Compact enough to fit most applications.

FPB-8131 1970-72 GoldSEE WEB
 FPB-8131C 1970-72 ChromeSEE WEB
 FPB-8131S 1970-72 StainlessSEE WEB



FPB-9002S

9" Single Slimline Booster

Nice clean looks and performance that won't disappoint. A good choice if you're undecided on which booster to get.

FPB-9102 1970-72 GoldSEE WEB



FPR-107

1970-72 Distribution Block

Correct block located on the driver side frame rail for 1970-72 drum and 1970 disc cars.

FPR-107 1970-72 AllSEE WEB



FPR-104D

Hold Off Valve

Originally used to hold pressure to the rear brakes so the front brakes could engage a split second earlier to prevent fishtailing.

FPR-104D 1970 DiscSEE WEB



FPVB-3



FPV-BOOT

Proportioning Valve Bracket & Boot

Correct gold plated pro-valve bracket.

FPVB-3 1970 BracketSEE WEB
 FPV-BOOT All BootSEE WEB



FPV-7

1970 Pro Valve

Correct brake proportioning valve for factory original disc brakes. This valve is located under the master cylinder and includes the bracket.

FPV-7 1970 w/ PDBSEE WEB



FPR-102

1971-72 Pro Valve

Exact to original concourse level proportioning valve with correct wire lead for direct replacement.

FPR-102 1971-72 w/ PDB.....SEE WEB



PVK-71COMBOKIT

GM Style Replacement Pro Valve Kit

These are the same pro-valve kits that are used in our disc brake conversion kits to provide correct front to rear balancing. Complete with valve, bracket, hardware and brake warning light harness.

PVK-71COMBOKIT Front Disc SEE WEB
 PVK-72COMBO-KIT 4 Wheel Disc SEE WEB

No Volume Discount.



PVK-71CK

Chrome Pro Valve Kit

Includes a new valve, bracket, hardware and a brake warning light harness. This kit is meant for someone putting together their own non-original disc brake setup and is required for proper front to rear balancing.

PVK-71CK Front DiscSEE WEB
 PVK-72CK 4 Wheel Disc.....SEE WEB

Will NOT work with original lines!



FBRK-04

1971-72 Valve Bracket

Correct reproduction of this proportioning valve bracket unique to 1971-72 Monte Carlos.

FBRK-04 1971-72.....SEE WEB



HURST-1745000



HURST-5671510

Hurst Roll Control Line Lock

Used primarily in drag racing to provide positive locking action to the front wheels of race cars, reducing the chance of "Rolling the Lights" and producing more effective "Burn Outs" for heating up the tires. Rigorous testing has proved a 1/100,000 of a second release time and vibration tests have seen up to 30 G's applied without mechanical failure. Adaptable to most domestic and import hydraulic brake systems.

HURST-567152 All SEE WEB
 HURST-1745000 All Universal.....SEE WEB
 HURST-5671510 Installation Kit.....SEE WEB

No Volume Discount.



ELC-316



ELC-1316



ELC-516



ELC-1516



ELC-10P



BLC-056

Brake Line Clips

Correct clips for attaching hard brake lines to frame. (Tabbed clips push into frame holes.)

ELC-316 3/16" FrontSEE WEB
 ELC-1316 3/16" w/ Tab.....SEE WEB
 ELC-1516 5/16" MainSEE WEB
 ELC-516 5/16" w/ Tab.....SEE WEB
 ELC-10P Double Push-In.....SEE WEB
 BLC-056 Clip Bolt.....SEE WEB

**Use on main line with armor shielding.*



EBH-79BS



EBH-166BS



EBH-164



EBH-06



Front Flex Hoses

New OEM front flex hoses exact to original.

EBH-020 1970-72 Disc SEE WEB
 EBH-162 1973-75 All SEE WEB
 EBH-163 1976 All SEE WEB
 EBH-008 1977 All SEE WEB
 EBH-164 1978 All SEE WEB
 EBH-79 1979-88 All SEE WEB

Front Stainless Flex Hoses

EBH-020SS 1970-72 Disc, Stainless SEE WEB
 EBH-162S 1973-75 All, Stainless..... SEE WEB
 EBH-163S 1976 All, Stainless..... SEE WEB
 EBH-008S 1977 All, Stainless..... SEE WEB
 EBH-79BS 1979-88 All, Stainless SEE WEB

Rear Flex Hoses

New OEM rear flex hoses exact to original.

EBH-06 1970-72 All SEE WEB
 EBH-165 1973 All SEE WEB
 EBH-13 1974-77 All SEE WEB
 EBH-166 1978-88 All SEE WEB

Rear Stainless Flex Hoses

EBH-06S 1970-72 All, Stainless..... SEE WEB
 EBH-165S 1973 All, Stainless..... SEE WEB
 EBH-13S 1974-77 All, Stainless SEE WEB
 EBH-166BS 1979-88 All, Stainless SEE WEB



FHB-499

Flex Hose Brackets

Correct flex hose brackets mounted at frame.

- FHB-499 1970-72 DiscSEE WEB
- BLC-056 Attaching BoltSEE WEB



EBB-691

Flex Hose Bolts

Correct OEM brake fluid bolt with hollow center and (2) special washers for attaching flex hose to caliper.

- EBB-691 All w/ Disc BrakesSEE WEB



FHB-699

Flex Hose Bracket

Correct stamped steel bracket for retaining flex hose to rear end.

- FHB-699 1970-72 All.....SEE WEB



EBC-22

Flex Hose Clip

Correct clip for retaining flex hose.

- EBC-22 All SEE WEB



IPB-513

Parking Brake Guide Bar Springs

Correct green springs for 9.5 inch rear brakes.

- IPB-513 1970-77SEE WEB

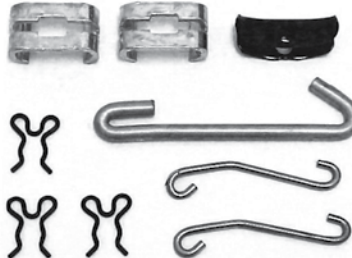

PBCK-1A

Brake Cable Support Kit

Complete kit with all hooks and clips for retaining parking brake cables.

- PBCK-1A 1970-72 w/ TH400SEE WEB
- PBCK-2A 1970-72 w/o TH400SEE WEB



NJP-133



FJ-472

Brake Cable Guides

Correct hooks for supporting cables to crossmember.

- FJ-472 1970-72 w/o TH400SEE WEB
- FJ-400 1970-72 with TH400SEE WEB
- NJP-133 1970-72 Side Body BraceSEE WEB



NJ-4675

Brake Cable Connector

Correct U shaped zinc connector for connecting intermediate cable to rear cables.

- NJ-4675 1970-72 All.....SEE WEB



NJ-525

Brake Cable Equalizer

Correct support for connecting front cable to intermediate cable and provides equalizing tension for rear cables.

- NJ-525 1970-72 All..... 4.95 ea.



FWC-08R

Wheel Cylinders

New wheel cylinders exact to original.

- FWC-08R 1970-72 All RearSEE WEB
- BWC-100 Attaching Bolts (2)SEE WEB



NX-281

Brake Cable Retainer

Correct clip for all cars (3 required).

- NX-281 1970-72 All.....SEE WEB



DIX-70V



6870SFK-P

Deluxe OEM Front Suspension Kit

This is the ultimate suspension kit! Each kit includes the finest quality OEM components. Be sure to check which type of lower control arm bushings you have.

- 2 Upper Ball Joints · 4 Lower Control Arm Bushings · 2 Lower Ball Joints · 4 Upper Control Arm Bushings · 2 Outer Tie Rods
- 2 Stabilizer Ends Links · 2 Inner Tie Rods · 2 Adjuster Sleeves · 1 Idler Arm

DIX-70	1970 w/ Round Bushings.....	SEE WEB
DIX-70V	1970 w/ Oval Bushings.....	SEE WEB
DIX-72	1971-72 w/ Round Bushings.....	SEE WEB
DIX-72V	1971-72 w/ Oval Bushings.....	SEE WEB

No Volume Discount.

Polygraphite Deluxe Front End Rebuild Kit

For the ultimate in performance, install our polygraphite front end kit featuring Energy Suspension parts! This kit offers increased longevity and better performance than the stock rubber front end components. Kits includes upper and lower ball joints, inner and outer tie rods, tie rod adjusting sleeves, idler arm bushings and control arm bushing kit and bump stops.

6870SFK-P	1970	SEE WEB
7172SFK-PM	1971-72.....	SEE WEB

End link kit sold separately. No Volume Discount.

ENERGY SUSPENSION

Performance POLYURETHANE Components



6770FK-PM

Polygraphite Basic Front End Rebuild Kit

Polygraphite bushings used in this kit are the ultimate combination of polyurethane and graphite. You get performance and durability with superior lubricating qualities which provides smooth operation. Kits include upper and lower ball joints, outer tie rods, control arm bushing kit and lower bump stops.

6770FK-PM	1970	SEE WEB
7172FK-P	1971-72.....	SEE WEB

No Volume Discount.



DSE03131

DSE Pro Touring Front Speed Kit 1

This exclusive DSE Speed Kit is a complete bolt-on suspension upgrade system designed for ease of installation with no modification to frame. This kit includes:

- Tubular Upper & Lower Control Arms
- Koni Classic Shocks
- Forged 2" Drop Spindles
- Coil Springs
- Tubular Sway Bar Kit

DSE03131	1970-72 SB or LSSEE WEB
DSE03134	1970-72 BBSEE WEB
DSE031333	1978-88 SB or LSSEE WEB

No Volume Discount.



DSE031318

DSE Pro Touring Front Speed Kit 2

Speed Kit 2 improves the handling and performance to the next level and offers ride height adjustment. This kit includes:

- Tubular Upper & Lower Control Arms
- Coilover Springs
- Forged 2" Drop Spindles
- Tubular Sway Bar Kit
- DSE Aluminum Body Shocks

DSE031318	1970-72 SB or LSSEE WEB
DSE031320	1970-72 BBSEE WEB
DSE031335	1978-88 BBSEE WEB

No Volume Discount.



DSE031324

DSE Pro Touring Front Speed Kit 3

Speed Kit 3 is the most advanced handling system that you can buy for your stock subframe and gives you the steering performance of today's modern cars.

- Tubular Upper & Lower Control Arms
- DSE 600 Steering Gear w/ Rag Joint
- Forged 2" Drop Spindles
- DSE Tubular Tie Rod Adjusters
- DSE Aluminum Body Shocks
- Inner Tie Rods
- Coilover Springs
- Outer Tie Rods
- DSE Splined Front Sway Bar Kit
- Idle Arm

DSE031324	1970 SB or LSSEE WEB
DSE031327	1970 BBSEE WEB
DSE031325	1971-72 SB or LSSEE WEB
DSE031328	1971-72 BBSEE WEB
DSE031337	1978-88 SB or LSSEE WEB

No Volume Discount.



ES-681

Inner Tie Rods

Correct OE style cast steel tie outer rods with correct grease fit locations. The highest quality original style suspension products on the market!

ES-681	1970 LH/RHSEE WEB
ES-406L	1971-72 LH/RHSEE WEB
ES-2034	1978-88 LH/RHSEE WEB



ES-333

Outer Tie Rods

Correct OE style cast steel tie outer rods with correct grease fit locations. The highest quality original style suspension products on the market! Fits LH or RH.

ES-333	1970 LH/RHSEE WEB
ES-406R	1971-72 LH/RHSEE WEB
ES-2033	1978-88 LH/RHSEE WEB



DS-749

Center Drag Links

DS-749	1970-72 AllSEE WEB
--------	-------------	--------------

No Volume Discount.



BPX-9873



D-18634

Idler Arms

D-18634	1970-72 13/16"SEE WEB
D-6187	1978-88 AllSEE WEB
BPX-9873	BoltsSEE WEB



FA-487



DRVT-33



FA-993

Ball Joints

FA-487	1970-72 All UpperSEE WEB
FA-993	1970-72 All LowerSEE WEB
FA-688	1978-88 UpperSEE WEB
FA-921	1978-88 LowerSEE WEB
DRVT-33	Ball Joint Rivets (8pc)SEE WEB



ES-2032

Adjustment Sleeves

OEM style adjustment sleeve for proper adjustment of tie rods.

ES-2032	1970 LH/RHSEE WEB
ES-2004	1971-72 LH/RHSEE WEB
ES-2032S	1978-88 LH/RHSEE WEB



DSE090103B

DSE Tubular Adjustment Sleeves

Tubular tie rod adjusters improve the strength and integrity of your steering system over stock. The tubular design is stiffer than the OEM split clamp adjuster and weighs less.

DSE090103B	1970 BlackSEE WEB
DSE090102B	1971-77 BlackSEE WEB

No Volume Discount.



UMI-2103

UMI Tie Rod Adjusters

These heavy duty tie rod adjusters from UMI Performance are designed to eliminate the factory clamp style design making adjustments easy and hassle free while adding enhanced steering. Works with the factory tie rod ends.

UMI-2103HD	1970 BilletSEE WEB
UMI-2103	1970 Mild SteelSEE WEB
UMI-2104HD	1971-72 BilletSEE WEB
UMI-2104	1971-72 Mild SteelSEE WEB
UMI-2103HD	1978-88 BilletSEE WEB
UMI-2103	1978-88 Mild SteelSEE WEB



UMI-ABF801-1-B

UMI Performance Stage 1 Handling Kit

This inexpensive kit offers great ride quality and improved handling while giving your muscle car the stance you want. Available in a durable red or black powder coat finish. Springs are black and shocks are red.

Insert color choice in __ R = Red B = Black

Stage 1 Handling Kits

- UMI-ABF801-0- 1970-72 Stock Height SEE WEB
- UMI-ABF801-1- 1970-72 1" Drop SEE WEB
- UMI-ABF801-2- 1970-72 2" Drop SEE WEB

Stage 1.5 Handling Kits

w/ upgraded adjustable shocks.

- UMI-ABF815-1- 1970-72 1" Drop SEE WEB
- UMI-ABF815-2- 1970-72 2" Drop SEE WEB

Ships oversize. No Volume Discount.



UMI Performance Stage 2 Handling Kit

Includes everything needed to rebuild the suspension on your classic 1970-1972 GM A-Body. This kit will make any classic cruiser feel like a modern day muscle car!

Stage 2 Kit Includes:

- Tubular upper and lower front A-arms
- Heavy Duty Sway bars with bushings and end links
- Set of (4) UMI S series performance monotube shocks
- 1" or 2" premium UMI lowering springs
- Tubular upper and lower rear control arms
- Tubular frame braces
- Replacement rear end housing bushings
- All new Grade 8 hardware and lock nuts

Insert color choice in __ R = Red B = Black

- UMI-ABF803-1- 1970-72, 1" Lowering SEE WEB
- UMI-ABF803-2- 1970-72, 2" Lowering SEE WEB

Ships Oversize. No Volume Discount.



UMI-ABF805-1-B

UMI Performance Stage 3 Handling Kit

UMI's Stage 3 kit has been made with great street manners combined with Pro-Touring handling capability. In this newest revision we've refined our parts list to provide the most common options in one convenient package.

Insert color choice in __ R = Red B = Black

Stage 3 Handling Kits

- w/ Standard 1" Bolt-in rear sway bar & non-adjustable Ridetech shocks.
- UMI-ABF805-1- 1970-72, 1" Lowering SEE WEB
- UMI-ABF805-2- 1970-72, 2" Lowering SEE WEB

Stage 3.5 Handling Kits

w/ Pro-touring 1" chassis mount rear sway bar & Ridetech 8-way rebound adjustable shocks.

- UMI-ABF806-1- 1970-72, 1" Lowering SEE WEB
- UMI-ABF806-2- 1970-72, 2" Lowering SEE WEB

Ships Oversize. No Volume Discount.



UMI-ABF807-1-R

UMI Performance Stage 4 Handling Kit

Who says you can't have it all? UMI's Stage 4 kit transforms your A-body into a handling machine with the adjustability to perform well at the strip or haul your family comfortably - to the autocross.

Front Spring Rate Options:

- 450lb- Small block cruise
- 550lb- Small block handling, all big blocks

Insert color choice in __ R = Red B = Black

- 450 lb. Front Spring Rate, 1" Rear Drop
- UMI-ABF807-1- 1970-72 SEE WEB

- 550 lb. Front Spring Rate, 1" Rear Drop
- UMI-ABF808-1- 1970-72 SEE WEB

- 450 lb. Front Spring Rate, 2" Rear Drop
- UMI-ABF807-2- 1970-72 SEE WEB

- 550 lb. Front Spring Rate, 2" Rear Drop
- UMI-ABF808-2- 1970-72 SEE WEB

Ships Oversize. No Volume Discount.



UMI-ABF809-1-R

UMI Performance Stage 5 Handling Kit

UMI's new Stage 5 kit includes all of our high-end Pro-Touring products and will turn your A-body into a corner carving machine.

Insert color choice in __ R = Red B = Black

- 450 lb. Front Spring Rate, 1" Rear Drop
- UMI-ABF809-1- 1970-72 SEE WEB

- 550 lb. Front Spring Rate, 1" Rear Drop
- UMI-ABF810-1- 1970-72 SEE WEB

- 450 lb. Front Spring Rate, 2" Rear Drop
- UMI-ABF809-2- 1970-72 SEE WEB

- 550 lb. Front Spring Rate, 2" Rear Drop
- UMI-ABF810-2- 1970-72 SEE WEB

Ships Oversize. No Volume Discount.



UMI Corner Max Handling Kit

UMI's Corner Max front end kits are a comprehensive system with our best corner carving parts under one easy to find part number. The Corner Max system combines geometry corrected a-arms with tall ball joints, higher rate springs, UMI rebound adjustable monotube shocks, heavy duty sway bar and a bump steer kit. The foundation of the kit includes our coilover-only lower a-arms featuring caster improvement, tall ball joints and the ability to remove the spring and shock without taking the spindle apart. The upper a-arm features rod ends for smooth operation and the ability to adjust without shims. The 1-5/16th inch sway bar upgrade complete with UMI's fabricated end links reduces body roll and helps speed transitions. Racing coilover springs are paired with UMI's rebound adjustable coilover monotube shocks. Fine tuning is accomplished with a UMI bump steer kit.

Insert color choice in __ R = Red B = Black

Kits That Reuse Factory Spindles

- UMI-406402- 1970 SEE WEB
- UMI-406403- 1971-72 SEE WEB

Kits That Come With Taller 2" Drop Spindles

- UMI-406502- 1970 SEE WEB
- UMI-406503-B 1971-72 SEE WEB

No Volume Discount.



BUY & SAVE

WITH SS396.COM PRE-BUILT KITS



Control Arms

Reproduction control arms ready to install with bushings and ball joints. These brand new loaded arms feature correct semi gloss paint. The lower arms feature the improved GM 2nd design oval bushings and the upper arms include the bushing shafts.

KAL-KIT	1970-72 Complete KitSEE WEB
KAU-3L	1970-72 Upper LHSEE WEB
KAU-3R	1970-72 Upper RHSEE WEB
KAL-3L	1970-72 Lower LHSEE WEB
KAL-3R	1970-72 Lower RHSEE WEB
KAU-78L	1978-88 Upper LHSEE WEB
KAU-78R	1978-88 Upper RHSEE WEB
KAL-78L	1978-88 Lower LHSEE WEB
KAL-78R	1978-88 Lower RHSEE WEB
KAL-78K	1978-88 Lower LH/RHSEE WEB

Ships Oversized. Not eligible for free shipping. No Volume Discount.



Lower Arm Bushings

FB-6076	1970-72SEE WEB
FB-5149	1970-72 OvalSEE WEB
FB-6177	1978-88 AllSEE WEB



Upper Arm Bushings

FB-149	1970-72 AllSEE WEB
FB-6176	1978-88 AllSEE WEB



DCE-2410



DCE-4220

Control Arm Bumpers

Correct upper and lower control arm bumpers.

DCE-4220K	1970-72 Kit (4)SEE WEB
DCE-4220	1970-72 UpperSEE WEB
DCE-2410	1970-72 LowerSEE WEB
DCE-9222	1978-88 LowerSEE WEB



BPX-0918

Upper Control Arm Bolt Kit

Correct OEM serrated bolts with special locking nuts.

BPX-0918	1970-72 AllSEE WEB
----------	-------------	--------------



DS-594

Control Arm Alignment Shims

DS-594	1/16"SEE WEB
DS-595	1/8"SEE WEB



BPB-1430

Lower Control Arm Bolt

Original GM bolt with correct reduced body shaft and pointed end. Includes correct locking nut.

BPB-1430	1970-72 AllSEE WEB
----------	-------------	--------------



BPX-8542

Upper Control Arm Bolt & Washer Kit

Correct heavy cup washers and correct OEM bolts for retaining upper bushings into arms.

BPX-8542	1970-72 AllSEE WEB
----------	-------------	--------------



FA-1019

Control Arm Shaft Kit

New OEM shaft, bushings, washers, & nuts.

FA-1019	1970-72 AllSEE WEB
FA-1391	1978-88 AllSEE WEB

One kit does one control arm.



ENGKIT-1B



ENGKIT-1R

Energy Suspension Control Arm Bumpers

9-9151R	Red UpperSEE WEB
9-9151G	Black UpperSEE WEB
9-9154R	Red LowerSEE WEB
9-9154G	Black LowerSEE WEB
ENGKIT-1R	Red Upper/Lower (4pc)SEE WEB
ENGKIT-1B	Black Upper/Lower (4pc)SEE WEB

ENERGY SUSPENSION

Performance POLYURETHANE Components



3-3132G

Polygraphite Control Arm Bushings

These Poly Graphite bushings from Energy Suspension offer better handling than stock and are impervious to the elements.

Add G to the part number for black. Add R to part number for red. Example. 3-4111G is for 65-67 in black.

Front

3-3101_	1970-72 W/ Round Lower BushingsSEE WEB
3-3172_	1970-72 W/ Oval Lower Rear BushingsSEE WEB
3-3156_	1978-88SEE WEB

Rear

3-3132_	1970-88SEE WEB
---------	---------	--------------

No Volume Discount.

ENERGY SUSPENSION

Performance POLYURETHANE Components



Energy Suspension Hyperflex Kit

These complete Hyperflex kits include all the bushings for the suspension, subframe and include a transmission mount. Add G to the part number for black. Add R to part number for red.

Example. 3-18113G is for 68-72 in black.

3-18113_	1970-72SEE WEB
3-18111_	1974-77SEE WEB
3-18110_	1978-88SEE WEB

No Volume Discount.



UMI-4004

UMI A-Arm Bolts

Includes Grade 8 bolts, flat washers and lock nuts. All hardware is zinc coated to prevent corrosion while adding a great look to your installation. Works on UMI & factory control arms.

UMI-4004	1970-72 Upper & LowerSEE WEB
UMI-4001	1970-72 LowerSEE WEB
UMI-4003	1970-72 UpperSEE WEB

Tubular Control Arm and Forged Spindle Kit

The DSE spindle is 1-1/2 inches taller than the stock Monte Carlo spindle and provides 2 inches of drop from stock height. The taller spindle height improves handling by modifying the camber curve resulting in a negative camber gain during suspension compression. The stock steering arms mount in the optimal location to minimize bump steer. Detroit Speed's tubular upper control arms provide increased strength and additional positive caster. DSE's lower tubular control arms feature a robust tubular design with gussets and a cross brace. Uppers and lowers feature five axis laser cut tube ends and ball joint pockets for a precise fit.



DSE030105

DSE031714

DSE030105 1970-72 All..... SEE WEB

Installation should be followed by a professional alignment.

When using stock disc brakes, the stock caliper brackets will have to be notched out slightly to fit the DSE spindles. Ships Oversized. Not eligible for free shipping. No Volume Discount.

DSE Camber/Caster Kit

This kit allows you to adjust camber easily with our one-piece slotted camber shims. Each shim is machined from 6061 aluminum and is then anodized black for durability. Includes four 1/16" shims, four 1/8" shims and two 1/4" shims.

DSE031714 1970-72 SEE WEB

DSE031715 1973-77 SEE WEB



UCA6472-KIT



Economy Tubular Control Arms Upper/Lower

Economy upper and lower control arms come complete with ball joints and cross shafts and sway bar endlinks. Improve your front suspension with increased caster built-into the arm. Arms are made from large diameter DOM tubing. These specially made arms are designed to fix camber angle problems caused from using drop spindles or drop coils. This set is for the budget minded guy looking to install a set of upper and lower tubular arms without breaking the bank.

UCA6472-KIT 1970-72 SEE WEB

KAU-78L 1978-88 Upper LH SEE WEB

KAU-78R 1978-88 Upper RH SEE WEB

KAL-78L 1978-88 Lower LH SEE WEB

KAL-78R 1978-88 Lower RH SEE WEB

KAL-78K 1978-88 Lower LH/RH SEE WEB

UMI Upper & Lower Tubular A-Arms

Improve the street and track performance of your A-body and achieve that precise Pro-Touring feel by adding a set of fabricated tubular A-Arms. The stock geometry lower a-arms, which work with most popular springs and coil-overs, feature tough tubular construction with greasable polyurethane bushings for precise handling and smooth suspension motion. Optional Delrin® bushings offer additional precision and decreased friction. The ball joint mount is angled slightly from stock to permit usage with lowered vehicles and the design offers additional wheel clearance. The tubular upper a-arms feature Delrin® bushings as well as billet chromoly cross shafts. The relocated ball joint mounting pad increases caster, steering feel and stability without excessive shims and can be loaded with 1/2" taller upper ball joints to improve camber performance. The ultra tough red or black powder coat finish guarantees your performance parts stay looking new. Included with each kit are recommended alignment specs along with detailed installation instructions.

Insert color choice in __, R = Red B = Black

Lower A-Arms w/ Polyurethane Bushings Upper Lower Kits

UMI-403133-__ 1970-72 Standard Ball Joints SEE WEB

UMI-403133-1-__ 1970-72 0.5" Taller Upper Ball Joints SEE WEB

UMI-303133-__ 1978-88 Standard Ball Joints SEE WEB

UMI-303133-1-__ 1978-88 0.5" Taller Ball Joints SEE WEB

Lower A-Arms w/ Delrin® Bushings Upper Kits

UMI-403233-__ 1970-72 Standard Ball Joints SEE WEB

UMI-403233-1-__ 1970-72 0.5" Taller Upper Ball Joints SEE WEB

UMI-403233-3-__ 1970-72 0.9" Taller Upper, 0.5" Taller Lower SEE WEB

UMI-303233-__ 1978-88 Standard Ball Joints SEE WEB

UMI-303233-1-B 1978-88 0.5" Taller Ball Joints SEE WEB

Upper Arms Only

UMI-4033-__ 1970-72 Tubular Upper Non/Adjustable Standard Ball Joint SEE WEB

UMI-4033-1-__ 1970-72 Tubular Upper Non/Adjustable .5" Taller Ball Joint SEE WEB

UMI-4056-1-__ 1970-72 Tubular Upper Adjustable Standard Ball Joint SEE WEB

UMI-4056-2-__ 1970-72 Tubular Upper Adjustable .5" Taller Ball Joint SEE WEB

UMI-4056-3-__ 1970-72 Tubular Upper Adjustable .5" Taller Ball Joint SEE WEB

UMI-3033-__ 1978-88 Tubular Upper Non/Adjustable Standard Ball Joint SEE WEB

UMI-3033-1-__ 1978-88 Tubular Upper Non/Adjustable .5" Taller Ball Joint SEE WEB

UMI-3056-1-__ 1978-88 Tubular Upper Adjustable Standard Ball Joint SEE WEB

UMI-3056-2-__ 1978-88 Tubular Upper Adjustable .5" Taller Ball Joint SEE WEB

UMI-3056-1-__ 1978-88 Tubular Upper Adjustable 1" Taller Ball Joint SEE WEB

Lower Arms Only

UMI-4031-__ 1970-72 Tubular Lower Poly Bushings Standard Ball Joint SEE WEB

UMI-4031-1-__ 1970-72 Tubular Lower Poly Bushings .5" Taller Ball Joint SEE WEB

UMI-4032-__ 1970-72 Tubular Lower Delrin Bushings Standard Ball Joint SEE WEB

UMI-4032-1-__ 1970-72 Tubular Lower Delrin Bushings .5" Taller Ball Joint SEE WEB

UMI-3031-__ 1978-88 Tubular Lower Poly Bushings Standard Ball Joint SEE WEB

UMI-3031-1-__ 1978-88 Tubular Lower Poly Bushings .5" Taller Ball Joint SEE WEB

UMI-3032-__ 1978-88 Tubular Lower Delrin Bushings Standard Ball Joint SEE WEB

UMI-3032-1-__ 1978-88 Tubular Lower Delrin Bushings .5" Taller Ball Joint SEE WEB

Tall Ball Joint Option: UMI is proud to offer a number of tall ball joint options. In addition to standard height ball joints, we offer 0.5" tall lower and both 0.5" and 0.9" tall upper. Additional ball joint height functions the same as adding a taller spindle at a fraction of the cost. Drag and cruising oriented cars work fine with standard height while tall ball joints optimize cornering ability. No Volume Discount. Not eligible for free shipping.



UMI-403133-R



UMI-403133-B



UMI-4054

Coilover Conversion Brackets

UMI-4054

1970-72 Front Coilover Conversion Brackets, Weld-in SEE WEB



OEM Front Sway Bar Kit

Eliminate poor handling by installing one of these sway bars!
It includes sway bar, brackets, bushings and end links to replace your old, small bar.

DAA-324	1970-77 1-1/4" Kit.....	SEE WEB
DAA-525	1970-77 1-1/8" Kit.....	SEE WEB
DAA-9SS	1 1/8" Sway Bar Only.....	SEE WEB
DAA-8A	1 1/4" Sway Bar Only.....	SEE WEB
DAA-898	1978-88 1-1/8" Kit.....	SEE WEB

No Volume Discount. Ships Oversize 2. Not eligible for free shipping.



1970 - 1972 Energy Suspension Sway Bar Kits

Do you want to find an easy way to improve poor handling? This complete Monte Carlo sway bar kit allows you to lose that small diameter front sway bar and replace it with a large diameter sway bar and all of the necessary components in one shot!

ENG-6472-118-KITB	1-1/8" Black Bushings.....	SEE WEB
ENG-6472-118-KITR	1-1/8" Red Bushings.....	SEE WEB
ENG-6472-114-KITB	1-1/4" Black Bushings.....	SEE WEB
ENG-6472-114-KITR	1-1/4" Red Bushings.....	SEE WEB

No Volume Discount. Ships Oversize 2. Not eligible for free shipping.



UMI Front & Rear Sway Bars

UMI Performance Monte Carlo solid sway bars are designed to reduce body roll, understeer and increase cornering capabilities resulting in a more balanced suspension. UMI Performance sway bars are manufactured from 4140 chrome moly steel and formed as one piece to ensure maximum strength and performance. The rear sway bar is heat treated to maintain longer memory than a cold bent sway bar. The front sway bar is CNC bent for a precision fit. Comes with poly end links and bushings. Available powder coated bright red or gloss black for a durable long lasting finish. Insert your color choice at the end of the part number in __. R = Red B = Black

Front & Rear Kit

UMI-403534-__	1970-72 Front 1-1/4" Rear 7/8".....	SEE WEB
UMI-303534-__	1978-88 Front 1-1/4" Rear 1".....	SEE WEB

Front OE Style Mounts

UMI-4035-__	1970-72 1-1/4" Bar.....	SEE WEB
UMI-4067-__	1970-77 Front 1-5/16" Bar.....	SEE WEB
UMI-3035-__	1978-88 1-1/4" Bar.....	SEE WEB

Front Billet Style Mounts

UMI-4066-__	1970-77 Front 1-5/16" Bar.....	SEE WEB
-------------	--------------------------------	---------

Rear OE Style Mounts

UMI-4034-__	1970-72 1" Bar.....	SEE WEB
UMI-3034-__	1978-88 1" Bar.....	SEE WEB

Rear Chassis Style Mounts

UMI-4047-300-__	1970-72 1" Bar 3" Axle.....	SEE WEB
UMI-4047-300-__	1970-72 1" Bar 3" Axle.....	SEE WEB
UMI-3044-275-__	1978-88 1" Bar 2 3/4" Axle.....	SEE WEB
UMI-3044-300-__	1978-88 1" Bar 3" Axle.....	SEE WEB
UMI-3045-275-__	1978-88 1-3/8" Bar 2 3/4" Axle.....	SEE WEB
UMI-3045-300-__	1978-88 1-3/8" Bar 3" Axle.....	SEE WEB

Front Billet Mounts Only (no bar)

UMI-90047	1970-77 1-1/4" Red.....	SEE WEB
UMI-90066	1970-77 1-5/16" Red.....	SEE WEB

No Volume Discount. Ships oversize.

Stabilizer End Links

Complete kit for one car.

DSL-72	1970-77 All OEM.....	SEE WEB
9-8118G	1970-77 Polyplus Black Kit.....	SEE WEB
9-8118R	1970-77 Polyplus Red Kit.....	SEE WEB
DSL-88	1978-88 All OEM.....	SEE WEB
9-8119G	1978-88 Polyplus Black Kit.....	SEE WEB



DSL-72

Sway Bar Bushings

OEM rubber bushings.

DMG-681	1970-77 SB.....	SEE WEB
DMG-683	1970-77 1-1/16".....	SEE WEB
DMG-1516	1978-88 15/16" w/ Tabs On Bracket.....	SEE WEB
DMG-1116	1978-88 1-1/16" w/ Tabs On Bracket.....	SEE WEB
DMG-118	1978-88 1-1/8" w/o Tabs On Bracket.....	SEE WEB
DMG-1316	1978-88 1-1/8" w/o Tabs On Bracket.....	SEE WEB



DMG-683

Sway Bar Brackets

Correct mounting bracket for stock front sway bar.



DBB-157

MK52-KIT

BAR-1295

DBB-157	1970-77 1-1/16".....	SEE WEB
BAR-1295	Correct Bolt.....	SEE WEB
MK52-KIT	1970-72 Brackets/Bushings 1-1/4" (For use with 1.25 bar only).....	SEE WEB



DSE031402

DSE Tubular Front Sway Bar Kit

DSE's tubular 1 3/8 inch front sway bar kit is designed to address the shortcomings of the small factory A body sway bar. Includes greasable polyurethane bushings, mounts and end links giving you dramatic improvement over your stock suspension and even better results when you combine this sway bar kit with other DSE suspension components.

DSE031402	1970-72 1-3/8" Tubular.....	SEE WEB
DSE031406	1973-77 1-3/8" Tubular.....	SEE WEB
DSE031408	1978-88 1-3/8" Tubular Includes Braces.....	SEE WEB

On 1970 models, the existing sway bar mounting bracket holes will need to be drilled and tapped to 3/8". No Volume Discount. Ships Oversize 2. Not eligible for free shipping.



DSE031404

DSE Splined Front Sway Bar Kit

DSE's tubular 1-3/8 inch front sway bar kit is designed to address the shortcomings of the small factory A-body sway bar. Includes greasable polyurethane bushings, mounts and end links giving you dramatic improvement over your stock suspension and even better results when you combine this sway bar kit with other DSE suspension components.

DSE031404	1970-72 1-1/2" Splined.....	SEE WEB
-----------	-----------------------------	---------

On 1970 models, the existing sway bar mounting bracket holes will need to be drilled and tapped to 3/8". No Volume Discount. Ships Oversize 2. Not eligible for free shipping.



EXCLUSIVE PRODUCT

DCC-1516

Body Mounting Kits
Complete with everything you need to mount your body to the frame including correct rubber bushings with steel inserts and factory style OEM flanged head frame bolts with washers! Remember, your entire body rides on this hardware, so replacing your worn out body bushings and hardware is extremely important not only for looks but for safety!

DCC-1516 1970-72 Coupe/Monte Carlo w/ Rad Support BushingsSEE WEB



EXCLUSIVE PRODUCT

DCC-7377A

1973-77 Body Bushings
Complete 28 piece body bushing kit constructed out of rubber with steel inserts. Two of them are solid rubber plugs and the top cap bushings have steel washers molded into them just like factory. Featuring GM numbers (4) 330942, (12) 330955, (2) 377801, (2) 627662 and (4) 330951.

DCC-7377A 1973-77 (28 pc.) *SEE WEB
BHP-7377 Bolt KitSEE WEB

**Note: Hardware not included.*



DCC-1519

Body Bushing Supplement Kit
Various big blocks required an additional 2 body bushings, so we put together this supplement kit complete with mounting hardware for these applications.

DCC-1519 1970-72 AllSEE WEB
BPB-6472F 1970-72 Bolt OnlySEE WEB



DCC-1500

Body Bushing Spacer
New correct style frame to body spacers for all cars except convertibles.

DCC-1500 1970-72SEE WEB



ENERGY SUSPENSION
Performance POLYURETHANE Components

3-4115G

Polygraphite Body Mount Kit
These polyurethane body mounts offer increased performance and longevity over stock rubber bushings. Used for mounting body and radiator support to frame.
Add G to the part number for black Add R to part number for red.
Example: 3-4115G is for 70-42 in black.

3-4115_ 1970-72 CoupeSEE WEB
3-4170_ 1970-72 Coupe w/ HardwareSEE WEB
3-4141_ 1978-88 G-BodySEE WEB

No bolts or sleeves included unless noted. No Volume Discount.



DCC-0522

Radiator Support Bushing
Complete kit with all bushings and hardware for mounting radiator support to car.

DCC-0522 1970-72 AllSEE WEB
BPB-6472RS 1970-72 Bolt OnlySEE WEB
DCC-0523 1973-77 AllSEE WEB

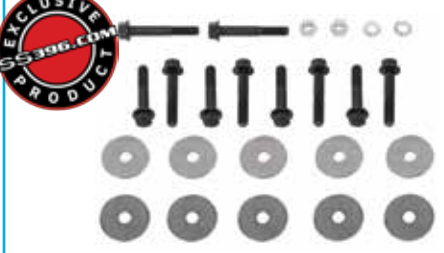

EXCLUSIVE PRODUCT

BHP-0516

Body Bolt Kits
Correct black flanged head bolts and washers.

BHP-0516 1970-72 Coupe/Monte CarloSEE WEB



RFR-21159

Body to Frame Repair
Complete kit of 14 large washers with the correct size hole for body bushings. Once welded in, these repair washers will provide your rusty old frame with the correct size hole.

RFR-21159 1970-72 AllSEE WEB



UMI-4058-R

UMI-4058-B

UMI Performance Rear Chassis Brace
This brace ties the two sides of the frame together between the shock towers over the rear axle.

UMI-4058-R 1970-72 RedSEE WEB
UMI-4058-B 1970-72 BlackSEE WEB
UMI-3055-R 1978-88 RedSEE WEB
UMI-3055-B 1978-88 BlackSEE WEB

Ships oversize. No Volume Discount.



UMI Performance Rear Control Arms

UMI's direct replacement lower control arms are designed to improve traction by replacing worn out factory bushings and weak stamped material. UMI offers a large variety of rear control arms designed for virtually any application. All control arms feature reinforced sway bar holes and are supplied with polyurethane bushings or Teflon® lined rod ends. Roto-Joints, which offer a good compromise between firm polyurethane bushings, soft rubber bushings and spherical rod ends are also available. The upper control arms are direct replacements to minimize wheel hop, improve cornering and help track consistency. They feature TIG and MIG welded construction and are assembled with polyurethane bushings, spherical rod ends or Roto-Joints.

Insert color choice in __. R = Red B = Black

1970-72

UMI-401516-__	Tubular Rear.....	SEE WEB
UMI-401525-__	Tubular Rear, Adjustable Uppers.....	SEE WEB
UMI-402125-__	Boxed Rear, Adjustable Uppers.....	SEE WEB
UMI-402416-__	Non Adjustable Upper Poly F/R.....	SEE WEB
UMI-401517-__	Tubular Rear, On-Car Adjustable Uppers.....	SEE WEB
UMI-402116-__	Tubular Upper, Box Lower.....	SEE WEB
UMI-402117-__	Boxed Rear, On-Car Adjustable Uppers.....	SEE WEB
UMI-401417-__	Adjustable Upper & Lower.....	SEE WEB
UMI-402717-__	Double Adjustable Upper & Lower.....	SEE WEB

1978-88

UMI-301516-__	Tubular.....	SEE WEB
UMI-301517-__	Tubular Adjustable Uppers.....	SEE WEB
UMI-301417-__	Tubular Adjustable Uppers & Lower.....	SEE WEB
UMI-301717-__	Tubular Double Adjustable Uppers & Lower.....	SEE WEB
UMI-302117-__	Boxed Adjustable Uppers.....	SEE WEB

Uppers and Lower Sold Separately

Uppers

UMI-302117-__	1970-72 Non Adjustable Roto Front Bushing Only.....	SEE WEB
UMI-4017-__	1970-72 Adjustable Rod End Front Bushing Only.....	SEE WEB
UMI-4037-__	1970-72 Adjustable Roto Front Bushing Only.....	SEE WEB
UMI-4025-__	1970-72 Adjustable Poly Front Bushing Only.....	SEE WEB
UMI-402500-__	1970-72 Adjustable Poly F/R Bushings.....	SEE WEB
UMI-4019-__	1970-67 Adjustable Rod End Front Bushing Only.....	SEE WEB
UMI-3025-__	1973-77 Adjustable Poly Front Bushing Only.....	SEE WEB
UMI-3016-__	1978-88 Non Adjustable Poly Front Bushing Only.....	SEE WEB
UMI-3036-__	1978-88 Non Adjustable Roto Front Bushing Only.....	SEE WEB
UMI-3025-__	1978-88 Adjustable Poly Front Bushing Only.....	SEE WEB
UMI-3017-__	1978-88 Adjustable Rod End Front Bushing Only.....	SEE WEB
UMI-3037-__	1978-88 Adjustable Roto Front Bushing Only.....	SEE WEB
UMI-302500-__	1978-88 Adjustable Poly F&R Bushing.....	SEE WEB

Lower Standards

UMI-4015-__	1970-72 Standard Tubular Poly F/R.....	SEE WEB
UMI-4014-__	1970-72 Standard Tubular Poly F Rod End R.....	SEE WEB
UMI-4043-__	1970-72 Standard Tubular Rod Ends F/R.....	SEE WEB
UMI-4038-__	1970-72 Standard Tubular Poly F Roto R.....	SEE WEB
UMI-4040-__	1970-72 Standard Tubular Roto F/R.....	SEE WEB
UMI-4024-__	1970-72 Standard Boxed Poly F/R.....	SEE WEB
UMI-4021-__	1970-72 Premium Boxed Poly F/R.....	SEE WEB
UMI-4027-__	1970-72 Double Adjustable Rod Ends F/R.....	SEE WEB
UMI-4041-__	1970-72 Standard Boxed Poly F Roto R.....	SEE WEB
UMI-4042-__	1970-72 Standard Boxed Roto F/R.....	SEE WEB
UMI-3015-__	1978-88 Tubular Non Adjustable Poly F/R.....	SEE WEB
UMI-3014-__	1978-88 Tubular Adjustable Poly F Rod End R.....	SEE WEB
UMI-3027-__	1978-88 Tubular Double Adjustable Rod End F/R.....	SEE WEB
UMI-3038-__	1978-88 Tubular Non Adjustable Rod End F Roto.....	SEE WEB
UMI-3040-__	1978-88 Tubular Non Adjustable Roto F/R.....	SEE WEB
UMI-3024-__	1978-88 Boxed Non Adjustable Poly F/R.....	SEE WEB
UMI-3041-__	1978-88 Boxed Non Adjustable Poly F Roto R.....	SEE WEB
UMI-3042-__	1978-88 Boxed Non Adjustable Roto F/R.....	SEE WEB

Lower Heavy Duty Cromoly

These race style control arms are designed for aftermarket sway bars that do not attach to the control arms; control arms are supplied with no sway bar holes.

UMI-4023CM-__	1970-72 Double Adjustable Rod Ends F/R.....	SEE WEB
UMI-40230FCM-__	1970-72 Double Adjustable Rod Ends F/R Offset Ends*.....	SEE WEB

*These features offset aluminum bushings and smaller diameter tubing that place the control arm inward for additional clearance when running large tires. No Volume Discount.





UMI-4022-B



UMI-3020-R

UMI Lower Control Lift Bars

The UMI rear lift bars replace the factory rear control arms adding traction while not changing vehicle ride height. Lift bars work with axle torque to load the chassis of the car, forcing the rear wheels downward pushing the tires into the ground, resulting in harder launches and improved 60-foot times. Lift bars are designed to improve traction and reduce unwanted wheel hop. Lift bars feature greaseable polyurethane bushings which are designed to reduce bushing deflection while being street able. Lift bar kit features the correct provisions for adding a stock or aftermarket sway bar, the sway bar holes are placed in the correct pattern to maintain the sway bar level with the rear end while the lift bar is in the lowest hole. The rear mounting brackets feature three settings that allow the lift bar to be lowered 2, 2-3/4 or 3-1/4.

UMI-4022-R	1970-72 Bolt-in Red	SEE WEB
UMI-4022-B	1970-72 Bolt-in Black	SEE WEB
UMI-4020-R	1970-72 Weld-in Red	SEE WEB
UMI-4020-B	1970-72 Weld-in Black	SEE WEB
UMI-3022-R	1978-88 Bolt-in Red	SEE WEB
UMI-3022-B	1978-88 Bolt-in Black	SEE WEB
UMI-3020-R	1978-88 Weld-in Red	SEE WEB
UMI-3020-B	1978-88 Weld-in Black	SEE WEB

No Volume Discount.



UMI-4012-R



UMI-4012-B

UMI Lower Control Arm Relocation Kits

Optimize your Monte Carlo's instant center and improve forward traction by lowering the rear of the lower control arm 2, 2-3/4 or 3-1/4. These brackets are CAD designed to accommodate factory lower control arms as well as all popular aftermarket styles. Robust flanges inside the brackets add reinforcement and ensure factory bushings bolt right in. Brackets installed can provide an average 0.10 second (or better) 60-foot reduction and an overall improvement in launch consistency. Brackets are constructed of 3/16 mild steel and CNC laser cut for precision tolerances. Relocation brackets are designed to work on both lowered and non-lowered vehicles and feature multiple settings to optimize vehicle handling and traction.

UMI-4012-R	1970-72 Bolt-in Red	SEE WEB
UMI-4012-B	1970-72 Bolt-in Black	SEE WEB
UMI-4010	1970-72 Weld-in Red	SEE WEB
UMI-3018-R	1978-88 Bolt-in Red	SEE WEB
UMI-3018-B	1978-88 Bolt-in Black	SEE WEB
UMI-3010	1978-88 Weld-in Bare	SEE WEB

No Volume Discount.



UMI-3000-B



UMI-4004



UMI-2999



UMI Control Arm Hardware

Replacement hardware and bushings for your UMI control arms.

UMI-4002	1970-72 Rear Control Arm Bolts Factory Upgrade Set of 8	SEE WEB
UMI-4004	1970-72 Front Control Arm Bolts W/ Aftermarket Arms Set of 8 ..	SEE WEB
UMI-4001	1970-72 Rear Control Arm Bolts Factory Upgrade Set of 4	SEE WEB
UMI-4003	1970-72 Rear Control Arm Bolts Upper Set of 4	SEE WEB
UMI-3002	1978-88 Rear Control Arm Bolts Factory Upgrade Set Of 8	SEE WEB
UMI-3001	1978-88 Rear Control Arm Bolts Factory Upgrade Set Of 4	SEE WEB
UMI-3013	1978-88 Front Control Arm Bolts Factory Upgrade Set Of 8	SEE WEB
UMI-3011	1978-88 Front Control Arm Bolts Factory Upgrade Set Of 4	SEE WEB
UMI-3012	1978-88 Front Upper Control Arm Bolts Factory Upgrade Set Of 4	SEE WEB
UMI-3000-R	1970-72 Rear End Housing Bushing Red Poly W/ Shell	SEE WEB
UMI-3000-B	1970-72 Rear End Housing Bushing Black Poly W/ Shell	SEE WEB
UMI-2999	1970-88 Rear End Housing Bushing Roto Joint	SEE WEB

No Volume Discount.



UMI-4028-R

UMI Trailing Arm Reinforcements/Frame Braces

Trailing arm mount braces are designed to reinforce the upper and lower front control arm mounts on your classic Monte Carlo. The more power your ride makes the better chance of bending or breaking the rear control arm mounts. These tubular reinforcements tie the upper and lower control arm mounts together for added strength and driving performance. Control arm braces are manufactured from DOM steel; TIG welded and feature adjustment for a perfect fit on all Monte Carlos. Kit includes new longer Grade 8 hardware, nuts and washers.

UMI-4028-R	1970-72 Red	SEE WEB
UMI-4028-B	1970-72 Black	SEE WEB



DZ-4500

Rear Frame Crossmember Brackets

Dealer installed on most cars with manual transmissions to provide extra frame strength.

DZ-4500 1970-72 All.....SEE WEB



NMX-1600

Rear Control Arm Bushings

New GM rubber rear control arm bushings.

NMX-1600 1970-77 AllSEE WEB
 NMX-1600K 1970-77 All (8pc).....SEE WEB



BPB-1430

Control Arm Bolt Rear

BPB-1430 All.....SEE WEB



NT-1810



NT-073

Rear End Bumpers

Correct OEM rubber stop bumpers.

NT-1810K 1970-72 All 3.....SEE WEB
 NT-1810 1970-72 UpperSEE WEB
 NT-073K 1970-72 Axle TubeSEE WEB
 NT-073 1970-72 Axle TubeSEE WEB
 NT-987 1973-77 Axle TubeSEE WEB



NTK-6472

Rear Axle Weld-On Bump Stop Brackets & Bumpers

If you plan on installing an aftermarket rear axle you'll want to pick up a set of these weld-on bump stop brackets & bumpers. Aftermarket axles do not have these bump stops.

NTK-6472 1970-72SEE WEB



DCA-680K

Rear Upper Control Arms

New OEM rear upper control arms complete with original GM rubber bushings. Buy the pair and save!

DCA-680K 1970-72 Upper PairSEE WEB
 DCA-680 1970-72 UpperSEE WEB
 BPB-1430 Mounting Bolt.....SEE WEB

No Volume Discount.



BPB-1430



NXJ-571

Rear Lower Control Arms

These boxed lower arms were originally installed on most SS models and cars with F-41 suspension. All arms feature correct GM rubber bushings and are finished in semi gloss black.

NXJ-571 1970-72 Lower.....SEE WEB
 BPB-1430 Mounting Bolt.....SEE WEB

No Volume Discount.



NXJ-6472

Billet Rear Lower Control Arms With Polyurethane Bushings

These new billet lower control arms with polyurethane bushings will help dial in your Monte Carlo's rear suspension for firmer, more controlled handling over stock components.

NXJ-6472 1970-72 All.....SEE WEB
 NXJ-7888 1978-88 AllSEE WEB

No Volume Discount. Not eligible for free shipping.



NJ-394

Rear Sway Bar

Correct size original rear sway bar for F41. Add our mounting kit with OEM bolts, nuts and GM style shims.

NJ-394 1970-72 All Sway Bar.....SEE WEB
 NJ-394K 1970-72 All w/ Hardware.....SEE WEB
 NPX-911 1970-72 All Hardware Kit.....SEE WEB
 DSB-696 1978-88 1" KitSEE WEB
 BSB-786 1978-88 Shim.....SEE WEB

No Volume Discount. Not eligible for free shipping. Ships Oversized.



DCK-1515

Rear Sway Bar & Boxed Control Arms

Complete kit to convert your stock rear end to the F-41 Heavy Duty option. Kit includes rear sway bar, boxed lower control arms and correct attaching kit.

DCK-1515 1970-72 All.....SEE WEB
Ships Oversized. Not eligible for free shipping. No Volume Discount.



DRSK-1A

Rear Suspension Kit Complete

This F41 upgrade kit complete with rear sway bar with hardware, upper/lower boxed control arms and correct mounting bolts.

DRSK-1A 1970-72 All.....SEE WEB
Ships oversized. Not eligible for free shipping. No Volume Discount.



DSB-12959

Sway Bar Washers

Correct washers used on the nut side so that the nuts do not dig into the arms.

DSB-12959 1970-72 (4pc).....SEE WEB



DSE042201

DSE Tubular Rear Sway Bar Kit

Unlike the factory A body sway bar, DSE's rear sway bar attaches to the rear end housing and to the chassis crossmember as opposed to the stock lower control arm mounted bar. By using the chassis to stabilize the rear axle as opposed to the stock lower control arm, deflection is minimized as the car is placed under a heavy cornering load.

- DSE042201 1970-72 All..... SEE WEB
- DSE042202 1973-77 All..... SEE WEB
- DSE042206 1978-88 All 1" Bar..... SEE WEB
- DSE042206 1978-88 All 1-1/8" Bar..... SEE WEB

Ships Oversized. Not eligible for free shipping. No Volume Discount.



DSE041604



DSE Rear Speed Kit 1

Detroit Speed and Engineering's rear Speed Kits are designed to make your Monte Carlo maintain optimum geometry and tire contact through the full range of rear suspension travel. Through the use of DSE's patented Swivel Links, the rear end housing becomes fully articulated, without the use of noisy spherical heim joints. Speed Kit 1 contains:

- Swivel Link Rear Control Arms · DSE Chassis Brace Kit

- DSE041604 1970-72 All..... SEE WEB
- DSE043101 1978-88 All* SEE WEB

**Does not include chassis brace. Ships in Multiple Oversize Boxes. Not eligible for free shipping. No Volume Discount.*



DSE041608

DSE Rear Speed Kit 2

DSE's Speed Kit 2 includes everything in Speed Kit 1, but also gives you a DSE tubular rear sway bar which attaches to the chassis for a substantial improvement in cornering ability. Speed Kit 2 contains:

- Swivel Link Rear Control Arms
- Koni Classic Shock Absorbers
- DSE Chassis Brace Kit
- DSE Tubular Rear Sway Bar Kit
- DSE Rear Coil Springs

- DSE041608 1970-72 All..... SEE WEB
- DSE041610 1973-77 All..... SEE WEB
- DSE043110 1978-88 All 2" Axle Tube..... SEE WEB
- DSE043111 1978-88 All 3" Axle Tube..... SEE WEB

Ships in Multiple Oversize Boxes. Not eligible for free shipping. No Volume Discount.



DSE041612

DSE Rear Speed Kit 3

DSE's Speed Kit 3 is simply the best rear suspension available for a stock frame. This kit includes everything in Speed Kit 1 and Speed Kit 2.

Speed Kit 3 contains:

- Swivel Link Rear Control Arms
- DSE Specific Rear Coilover Shocks and Springs
- DSE Tubular Rear Sway Bar Kit.
- DSE Chassis Brace Kit



- DSE041612 1970-72 w/ Stock Axle SEE WEB
- DSE041622 1970-72 w/ Moser Axle..... SEE WEB
- DSE043120 1978-88 All 2" Axle Tube..... SEE WEB
- DSE043121 1978-88 All 3" Axle Tube..... SEE WEB

Ships in Multiple Oversize Boxes. Not eligible for free shipping. No Volume Discount.



DSE042106

DSE Swivel Link Kit

DSE's unique A/G Body rear trailing links incorporate our patented Swivel-Link™ system. These Swivel-Links™ eliminate bind and allows the suspension to fully articulate without the use of noisy spherical rod ends. Swivel-Link™ Rear Links allow for easy pinion angle adjustment for improved traction and lower driveline vibrations.

- DSE042106 1973-77 All..... SEE WEB
- Not eligible for free shipping. No Volume Discount.*



DSE042301

DSE Chassis Brace Kit

DSE's chassis brace kit offers substantial improvements over the original rear chassis braces. By triangulating the rear crossmember, frame rail and upper control arm mount, rear chassis deflection is reduced.

- DSE042301 1970-72 All..... SEE WEB
- Designed as a bolt-in for cars originally equipped with chassis braces, but can be installed on cars without original chassis braces with minimal effort.*



DSE031120

DSE Drop Coil Springs

Give your Monte Carlo a modern pro touring stance while improving ride and handling with Detroit Speed and Engineering's new A-body coil springs! These 2 inch dropped springs offer improvement in both ride and handling over soft factory coils.

Front

DSE031120	1970-72 BB	SEE WEB
DSE031123	1973-77 SB or LS	SEE WEB
DSE031124	1973-77 BB	SEE WEB
DSE031132	1978-88 SB	SEE WEB

Rear

DSE041804	1970-72 All 1" Drop	SEE WEB
DSE041807	1973-77 All 1.5" Drop	SEE WEB
DSE041813	1978-88 All	SEE WEB

No Volume Discount.



Rears

Fronts

UMI Performance Springs

UMI's springs are designed to add modern handling and a crisp ride while maintaining the factory muscle car appearance. They have a tough, black powder coat finish and UMI proudly manufactures these premium quality springs in the USA.

Factory Height

UMI-4049	1970-72 Front/Rear Kit	SEE WEB
UMI-4049F	1970-72 Front	SEE WEB
UMI-4049R	1970-72 Rear	SEE WEB

Lowering Springs

UMI-4050	1970-72 Front/Rear Kit 1" Drop	SEE WEB
UMI-4051	1970-72 Front/Rear Kit 2" Drop	SEE WEB
UMI-3050	1978-88 Front/Rear 1" Drop	SEE WEB
UMI-3051	1978-88 Front/Rear 2" Drop	SEE WEB
UMI-4050F	1970-72 Front Set 1" Drop	SEE WEB
UMI-4051F	1970-72 Front Set 2" Drop	SEE WEB
UMI-3050F	1978-88 Front 1" Drop	SEE WEB
UMI-3051F	1978-88 Front 2" Drop	SEE WEB
UMI-4050R	1970-72 Rear Set 1" Drop	SEE WEB
UMI-4051R	1970-72 Rear Set 2" Drop	SEE WEB

No Volume Discount.

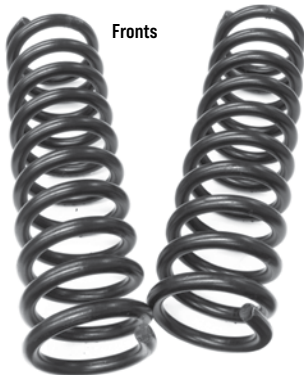

Fronts

Coil Springs

Brand new OEM replacement coil springs sold in matched pairs. These are not cheap aftermarket springs. These springs will restore your car to the original ride height.

Front

DCS-1168	1970-72 Monte Carlo SB w/o AC	SEE WEB
DCS-1169	1970-72 Monte Carlo SB w/ AC	SEE WEB
DCS-0360	1970-72 Monte Carlo BB w/o AC	SEE WEB
DCS-0360AC	1970-72 Monte Carlo BB w/ AC	SEE WEB
DCS-5606	1978-88 421lb Rate HD V8	SEE WEB

Rears



Rear

DCS-0362	1970-72 Monte Carlo All BB & SB	SEE WEB
DCS-6321	1978-88 Monte Carlo	SEE WEB



DSI-370

Coil Spring Insulators

Correct rubber insulators for rear coil springs with embedded fiber material as original.

DSI-370	1970-77 All Rear	SEE WEB
DSI-170	1970-88 All Front	SEE WEB



DSE Front Coilover Kit

DSE030306

Detroit Speed and Engineering's Coilover Conversion Kit allows the latest in coilover spring and shock technology to be bolted to any A-body, bringing handling and ride into the 21st century! Perfect for your stocker or protouring Monte Carlo!

DSE030306	1970-72 SB or LS	SEE WEB
DSE030307	1970-72 BB	SEE WEB
DSE030310	1978-88 All	SEE WEB

No Volume Discount.

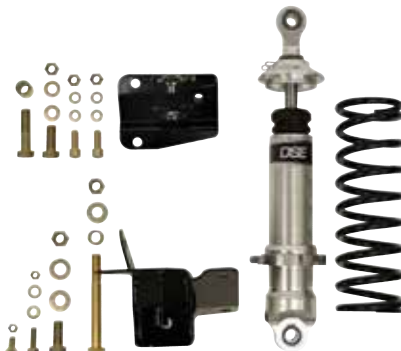
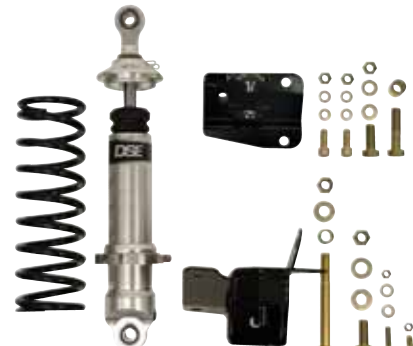

DSE042405

DSE Rear Coilover Kit

Detroit Speed and Engineering's A body coilover conversion kit allows the latest in coilover spring and shock technology to be bolted on to any A Body, bringing your Monte Carlo's handling and ride into the 21st century! This package offers extensive ride height adjustability and DSE valving.

DSE042405	1970-72 All	SEE WEB
DSE042420	1978-88 All	SEE WEB

Ships Oversized. Not eligible for free shipping.
No Volume Discount.



UMI-SS203050

UMI Performance Shock And Spring Kits

The UMI Performance Monte Carlo spring and shock kit is designed to provide a huge improvement in handling and control. These kits feature our race quality springs which provide a high performance foundation for your ride. Every component in this kit, as with all UMI products, is Made In USA.

- UMI-SS103049 1970-72 Stock HeightSEE WEB
- UMI-SS103050 1970-72 1" DropSEE WEB
- UMI-SS103051 1970-72 2" DropSEE WEB
- UMI-SS103050G 1978-88 1" DropSEE WEB
- UMI-SS103051G 1978-88 2" DropSEE WEB

Ships Oversize. No Volume Discount.



Detroit Speed Rear Replacement Shocks

Replace your stock or worn factory shock absorbers with these shocks for improved ride and handling on your Monte Carlo. These shock absorbers Bolt-in with a bow-tie style top mount and stud type lower mount. These shock absorbers use the latest in shock absorber technology to give your car a modern feel while maintaining comfortable ride characteristics.

- DSE041312 1978-88 All Black..... SEE WEB



DSS-R72

DSS-F72

Spiral Shocks

Reproductions of the original spiral twist shocks in correct gray color.

- DSS-F72 1970-72 All FrontSEE WEB
- DSS-R72 1970-72 All RearSEE WEB

No Volume Discount.



GM Shock Kit

Complete kit featuring 4 gas charged shocks, correct front & rear hardware, shock gray paint, & 4 shock ID decals.

- DPX-440 1970-77 All.....SEE WEB
- NT-2005 1970-77 Front OnlySEE WEB
- NT-2201 1970-77 Rear OnlySEE WEB

No Volume Discount.



KYB Excel-G Shock Kit

Are you looking for more performance from your shocks and a smooth ride? This KYB shock kit is the answer! They feature velocity sensing valving, hard chrome piston rods, twin tube design, low pressure nitrogen gas to prevent foaming of the oil, iron pistons & guide tubes. These shocks are great for normal to moderate driving! Our kit includes: (2) front shocks, (2) rear shocks and hardware.

- KYB-68A-KIT 1970-77 All Front & RearSEE WEB
- KYB-68F 1970-77 Front OnlySEE WEB
- KYB-68R 1970-77 Rear Only.....SEE WEB

No Volume Discount.



DSR-384

Shock Mounting Hardware

Correct GM rubber bushings, cup washer and nut for one shock.

- DSR-384 1970-77 All FrontSEE WEB



DR-041

Shock Mounting Stud

Correct rear shock mounting stud.

- DR-041 1970-77 RearSEE WEB



BPX-9715-REAR



BPX-9715

Shock Mounting Kit

- BPX-9715 1970-88 All FrontSEE WEB
- BPX-9715-REAR 1970-88 Rear Upper Shock Mounting Hardware.....SEE WEB



9-81016



9-8101R

Poly Upper Front Shock Bushings

If you want to upgrade to a more durable upper shock bushing these are the way to go.

- 9-81016 1970-88 All Black.....SEE WEB
- 9-8101R 1970-88 All RedSEE WEB

One pair does one shock. Two required per car.



TUF-6193A



TUF-6193B

Tuff Stuff Power Steering Pumps

GM Saginaw style pumps feature all new components: reservoir, pump assembly, cap, dipstick and hardware when it applies. Rated at 1200 psi rated to work with most gearbox systems.

- TUF-6193A 1970 All Chrome Banjo StyleSEE WEB
- TUF-6193B 1970 All Black Banjo Style.....SEE WEB
- TUF-6183A 1970-74 All Chrome.....SEE WEB
- TUF-6183B 1970-74 All BlackSEE WEB

No Volume Discount.

NO CORE CHARGE



APS-6001R

Power Steering Pumps Replacement

Completely rebuilt second design power steering pumps. These pumps will differ in appearance from our originals, but will fit and function the same. No core charge!

- APS-6001R 1970-72 All.....SEE WEB

No Volume Discount.



NO CORE CHARGE



APS-6165

Concourse Series "Banjo" Style Power Steering Pumps

Brand New GM pumps with correct original style reservoirs. No core charge! Made in the USA!

- APS-6165 1970-72 All*.....SEE WEB

*Use with 1970 hose & brackets. No Volume Discount.



PSKIT-70L



PSKIT-70LAC

Big Block Power Steering Conversion Kit

Are you tired of getting a workout every time you want to turn? Ground Up makes it easy to convert to power steering with this Monte Carlo power steering conversion kit! We have taken all of the guesswork out of selecting the parts to convert with this all in one solution! Includes: OEM Banjo Style Power Steering Pump, Pump Cap, Brackets, Hardware, Pulley, Pulley Nut, Pressure Hose, Return Hose.

- PSKIT-70L 1970-72 BB w/o ACSEE WEB
- PSKIT-70LAC 1970-72 BB w/ ACSEE WEB

Note: For use with long water pump only.



ADR-077

Power Steering Pump Cap

Quality replacement power steering pump cap.

- ADR-077 1970-77 All.....SEE WEB



APC-42

OE Power Steering Pump Cap

Reproduction metal cap.

- APC-42 1970-77 All.....SEE WEB



ASC-128

Power Steering Hose Retaining Clip

Correct clip for retaining hose to steering box

- ASC-128 All V8.....SEE WEB



ASP-107

Power Steering Pump Pulleys

Reproduction power steering pulleys.

- ASP-107 1970-72 2 Groove w/ AC.....SEE WEB
- ASP-1395 1970-72 1 Groove SHPSEE WEB
- 23-28 Pulley Nut.....SEE WEB



23-28



GCS-S8848



GCS-S8848POL



GCS-S8847POL

Billet Power Steering Pulleys

These show quality billet power steering pulleys will set your show car apart from the crowd. Made of high quality aircraft aluminum.

- GCS-S8848 1 Groove, SatinSEE WEB
- GCS-S8848POL 1 Groove, PolishedSEE WEB
- GCS-S8948 1 Groove, ChromeSEE WEB
- GCS-S8847 2 Groove, SatinSEE WEB
- GCS-S8847POL 2 Groove, PolishedSEE WEB
- GCS-S8947 2 Groove, ChromeSEE WEB



BSB-1970

Power Steering Hardware Kits

Our kits feature all correct hardware to attach power steering brackets to engine. A MUST!

- BSB-1970 1970-72 All BBSEE WEB
- BSB-69SB 1970-72 SBSEE WEB



BUY & SAVE
WITH SS396.COM PRE-BUILT KITS



ASB-7KIT

1970-72 Big Block Power Steering Bracket Kit

Complete kit with cradle, adjustment brackets and hardware.

- ASB-7KIT 1970-72 All BBSEE WEB

*Will work on most BB engines with long pump.
May need some modification.*



ASB-9KIT

1970-72 Small Block Power Steering Bracket Kit

Complete kit with all three brackets.

- ASB-9KIT 1970-72 SBSEE WEB

Power Steering Brackets

Original style reproduction and original GM brackets



ASB-3941

- ASB-3941 1970-72 All SB CradleSEE WEB



ASB-874

- ASB-874 1970-72 SB Rear SupportSEE WEB



AAB-2610

- AAB-2610 1970-72 SB AdjusterSEE WEB



ASB-422

- ASB-422 1970-74 All BB CradleSEE WEB



ASB-931

- ASB-931 1970-72 All BB (adjuster)SEE WEB

Power Steering OEM High Pressure Hose

New correctly bent OEM high pressure hoses with correct fittings.



CPX-6618

- CPX-6618 1970-72 AllSEE WEB





ARK-70A



BUY & SAVE

WITH SS396.COM PRE-BUILT KITS

Power Steering Hose Kits

This kit comes with OEM high pressure hose, low pressure return tube, hose and correct clamps. Made in USA!

- ARK-70A 1970-72 All SB.....SEE WEB
- ARK-70B 1970-72 All BB.....SEE WEB



NPX-16

Power Steering Return Hose

Complete with correct pre bent flared tube, OEM hose and correct clamps.

- NPX-16 1970-72 All V8.....SEE WEB
- CPS-038 OEM Return Hose.....SEE WEB
- CPN-512 OEM Clamps Screw Type.....SEE WEB



DSE091202

DSE Power Steering Hose Kit

Includes fittings to convert your steering gear to -6 AN fittings. High quality stainless steel hoses are Teflon lined to handle the high pressure demands of the steering system. The hoses come with pre-crimped stainless steel fittings to attach to the -6 AN fittings at the steering gear. Each kit includes 30 inches of hose length that can be routed and cut to length at the pump end.

- DSE091202 1970-72SEE WEB

No Volume Discount.



BUY & SAVE

WITH SS396.COM PRE-BUILT KITS



GBK-1A

Power Steering Gear Box Kits

Add on one of these awesome "close ratio" gear boxes to your conversion or on its own. These boxes are re-manufactured GM units and will add the ultimate handling to your ride. Our kit comes with steering box, steering coupler (rag joint) and correct attaching bolts. Choose from fast ratio or super fast ratio! Fits all 1970-72 Monte Carlo. No core charge!

- GBK-1A 3 - 3.5 FastSEE WEB
- GBK-1SFA 2.5 Super FastSEE WEB

*No Volume Discount. Ships UPS Oversized.
Not eligible for free shipping.*



ARC-12BK

Manual Steering Gear Box Kits

Add one of these newly rebuilt correct style standard ratio manual steering gearboxes, including the correct steering coupler/rag joint and steering box mounting bolts. These boxes are re-manufactured GM units. Our kits come complete with the box, rag joint and mounting bolts to the chassis. No core charge!

- ARC-12BK 1970-72 Standard RatioSEE WEB
- ARC-12SFK 1970-72 Super Fast RatioSEE WEB

No Volume Discount. Not eligible for free shipping.



IIS-702M

Intermediate Steering Shaft

Restore proper steering stability and safety with this newly re-manufactured intermediate steering shaft. This shaft goes from the steering column down the steering box and wears out over time causing sloppy steering feel. This unit will fix that problem. This is a re-manufactured original GM unit that has been tested and painted.

IIS-702M 1970-72 SEE WEB
 DSB-83 1970-72 Upper Boot Only SEE WEB

No Volume Discount.



DSE090205

Detroit Speed Rag Joint For 600 Steering Gear

Detroit Speed replacement rag joint with 3/4 in. -30 spline coupling to be used with the DSE 600 series steering gear and your stock 1970-1972 Monte Carlo column. It comes complete with a clinch bolt.

DSE090205 1970-72 SEE WEB

NO CORE CHARGE

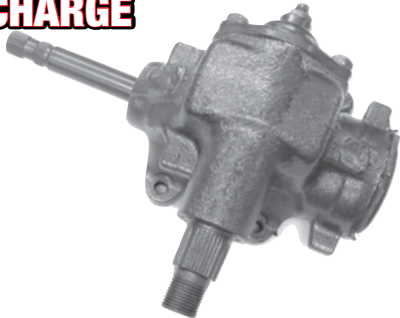

ARC-12SF

Manual Gear Boxes

Complete re-manufactured original Saginaw assemblies. No core charge

ARC-12B 1970-72 24:1 Standard SEE WEB
 ARC-12SF 1970-72 16:1 Quick SEE WEB

Use ATE-8869B coupler with ARC-12SF.
 No Volume Discount.



ATE-8869A



ATE-8871

Steering Coupler

Complete joint for connecting column to box. 1970-72 with manual steering features coarse spline.

ATE-8869B 1970-72 Manual SEE WEB
 ATE-8871 1970-72 Power SEE WEB



DSE091202

Detroit Speed Power Steering Hose Kit For 600 Steering Gear

This Detroit Speed and Engineering power steering hose kit includes fittings to convert your steering gear to -6 AN fittings. High quality stainless steel hoses are Teflon lined to handle the high pressure demands of the steering system. The hoses come with pre-cripped stainless steel fittings to attach to the -6 AN fittings at the steering gear. Each kit includes 30 inches of hose length that can be routed and cut to length at the pump end.

DSE091202 1970-72 SEE WEB

Ships Oversize. No Volume Discount.



BSB-759

Steering Box Bolt

Complete with correct thick washer and bolt.

BSB-759 1970-72 All SEE WEB



F-6859

BX-64K

Pitman Arms

F-6859M 1970-72 13/16 M/S SEE WEB
 F-6859 1970-72 13/16 P/S SEE WEB
 BX-64K Nut w/ Washer Fits All SEE WEB



ATJ-411

Steering Coupler Bolt

Correct OEM bolt for coupler.

ATJ-411 1970-72 All SEE WEB





SHIFTKIT-350



BUY & SAVE
WITH SS396.COM PRE-BUILT KITS

Console Shifter Kit

Complete kit to convert to an automatic console shifter. Kit includes factory style staple shifter, cable, brackets, & all correct hardware.

- SHIFTKIT-350 1970-72 TH350SEE WEB
- SHIFTKIT-400 1970-72 TH400SEE WEB



SC2041

4 Speed Overdrive Kits

This kit makes it easy to install a modern overdrive automatic in place of your old Powerglide, TH350 or TH400 for improved performance and gas mileage. Each kit includes a new laser cut and hardened detent, indicator plate, hardware and brackets to allow the use of your factory shifter. This kit works with a TH700, TH200 or 4L60 transmission.

- SC2242 1970 AllSEE WEB
- SC2243 1971-72 AllSEE WEB



FTH-973R

Shifter Cables

Original GM or high quality reproduction shifter cables for floor mounted TH shifter.

- FTH-973R 1970-72 ReproSEE WEB
- FTH-88G 1982-88 G-body Shifter Cable.....SEE WEB



Staple Shifter

Complete staple shifter assembly with chrome plated handle, spring loaded lock out trigger and mounting base. Ready to install.

- ISSFT-1 1970-72 ShifterSEE WEB
- ISH-3X 1970-72 Handle OnlySEE WEB

No Volume Discount.

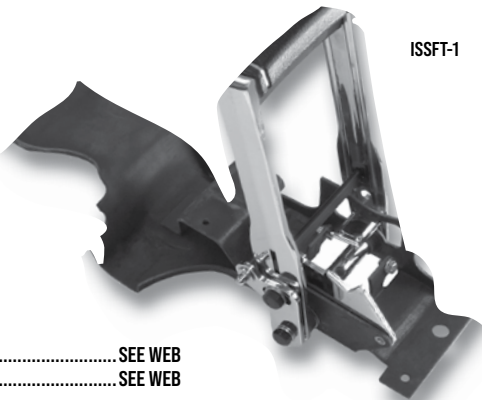

ISSFT-1

ISSFT-HRDW



SW-DT3



Ratchet Shifter Detent

Converts your factory shifter to a ratchet type shifter. Simple installation.

- SW-DT3 1970-72 Powerglide, TH350, TH400SEE WEB
- SW-DT4 1970-72 700-R4, 200-4R, 4L60, 4L65, 4L80SEE WEB

Staple Shifter Repair Kit

All the hardware needed to bring a worn out staple shifter back to life.

- ISSFT-HRDW 1970-72 ALLSEE WEB

No Volume Discount.



EBC-22

Shifter Cable Clip

Correct clip for mounting cable.

- EBC-22 Mounting ClipSEE WEB



FTH-049

Shifter Cable Mounting Clip

Correct push-on clip which mounts to shifter.

- FTH-049 Push-on Clip (to shifter).....SEE WEB

G/FORCE PERFORMANCE PRODUCTS

GForce Transmission Crossmembers

When you need extra exhaust clearance or just want to make your car handle better, these crossmembers are for you!

FCM-RCAE	1970-72 Coupe TH200R4, Muncie, TH350, TH400 Short Tail.....	SEE WEB
FCM-RCAE-4	1970-72 Coupe 4L80E, 4L85E.....	SEE WEB
FCM-RCG-350	1978-88 TH350.....	SEE WEB
FCM-RCG-400K	1978-83 TH200R4 TH400 Short Tail.....	SEE WEB
FCM-RCG-400	1984-88 TH200R4 TH400 Short Tail.....	SEE WEB
FCM-RCG-700	1978-88 TH700R4 4L60E.....	SEE WEB
FCM-RCG-4L80K	1978-83 4L60E 6L80E.....	SEE WEB
FCM-RCG-4L80	1984-88 4L60E 6L80E.....	SEE WEB
FCM-RCG-T56K	1978-83 T56 6 Speed.....	SEE WEB
FCM-RCG-T56	1984-88 T56 6 Speed.....	SEE WEB

No Volume Discount.



FCM-RCAE

DIRECT FIT



FCM-88N

Transmission Crossmember

Reproduction crossmembers for mounting your transmission.

FCM-88N	1970-72 TH350/4 Speed.....	SEE WEB
BPC-7000	1970-72 Mounting Bolts (16 pc.).....	SEE WEB



BPC-7000



HURST-67510020

Hurst Transmission Swap Crossmembers

These ultra-trick Hurst transmission crossmembers have painstakingly been designed and fabricated from thick steel plate and heavy gauge steel tubing for a perfect fit and finish that has no equal. These Bolt-in units are much stronger than the factory stock crossmembers and help maintain the correct transmission and driveshaft angle. Precision cut and fully MIG-welded, then given a durable black powder coating finish to last a lifetime and give you peace of mind knowing you're buying the best parts available for your Tremec TKO 5-Speed or Magnum 6-Speed conversions. You can surely trust the company that originally started out making conversion mounts back in 1958, Hurst Performance.

HURST-67510020	70-72 Magnum 6, TKO 5-6, TH350,400,700R4.....	SEE WEB
HURST-67510018	78-88 Magnum 6, TKO 5-6.....	SEE WEB
HURST-67510019	78-83 Magnum 6 Speed Adapter Kit*.....	SEE WEB

No Volume Discount. *Adapter only. Crossmember Not included.



NTR-235

Transmission Mounts

NPG-100	1970-72 Powerglide.....	SEE WEB
NTR-235	1970-72 TH350/Manual.....	SEE WEB
NTR-225	1970-72 TH400.....	SEE WEB
BTE-7939	Mounting Bolt.....	SEE WEB



FCB-1210

Cable Mounting Bracket

Correct bracket for mounting cable to transmission.

FCB-1210	1970-72 TH350.....	SEE WEB
FCB-220	1970-72 TH400.....	SEE WEB
FCB-193	1974-75 TH400.....	SEE WEB



3-11086

Poly Graphite Transmission Mount

Poly graphite mounts outlast OEM mounts and are also able to absorb most driveline vibrations.

3-11086	1970-88 All Black.....	SEE WEB
3-1108R	1970-88 All Red.....	SEE WEB



FTB-13433

Column Shift Transmission Bracket

Correct column shift transmission bracket which mounts on all column shift GM cars from 1970-1977.

FTB-13433	1970-77.....	SEE WEB
-----------	--------------	---------



FCB-222

FCB-322

Shifter Cable Lever Brackets

Correct cable lever brackets which mount to transmission.

FCB-322	1970-71 1st Design.....	SEE WEB
FCB-222	1972 2nd Design.....	SEE WEB



FTH-050

Shifter Cable Stud

Correct cable stud which mounts to bracket.

FTH-050	Mounting Stud (to bracket).....	SEE WEB
---------	---------------------------------	---------



ACC-8555

ATE-2101

Kickdown

Correct kickdown switch for TH400.

ATE-2101	1970-72 TH400 Switch.....	SEE WEB
ACC-8555	1970-72 Switch Bracket.....	SEE WEB
17565	1971-72 TH400 Harness.....	SEE WEB



S530

S531

Kickdown Cable & Bracket

Correct kickdown cable and bracket for cars with a TH350 transmission.

S530KIT	All Cable & Bracket Kit.....	SEE WEB
S530	All Cable.....	SEE WEB
S531	All Bracket.....	SEE WEB



FBF-799

Clutch Pedal Booster Rod & Clip

FBF-799	Booster Rod Clip.....	SEE WEB
FBF-606	Booster Rod Fork.....	SEE WEB

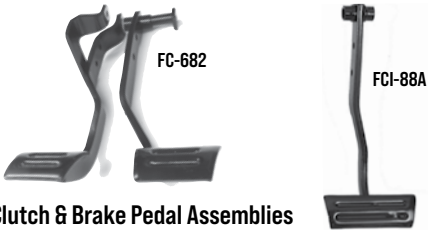

Clutch & Brake Pedal Assemblies

Complete reproduction brake/clutch pedals.

- FC-682 1970-72 AllSEE WEB
- FCI-88A 1970-72 Auto Brake PedalSEE WEB
- IBP-628 1970-77 Auto Pedal Pivot Pin.....SEE WEB
- FC-78K 1978-88 Manual Brake & ClutchSEE WEB
- FC-78C 1978-88 Clutch Pedal OnlySEE WEB
- FC-78B 1978-88 Brake Pedal OnlySEE WEB
- FPS-6816 1978-88 Pivot Sleeve*SEE WEB

* One required for automatic transmissions and two for manual.



Back Drive Components

Correct bracket, spring, nylon bushing and mounting bolts that mount to the driver's side frame rail. Provides a pivot point for the automatic on the column shift linkage.

- NT-391A 1970-72 Complete KitSEE WEB
- NT-Z833 1970-72 Bracket OnlySEE WEB
- NT-69BU 1970-72 Bushing OnlySEE WEB
- FB-69SP 1970-72 Back Drive Spring.....SEE WEB



Clutch Pedal Bushing & Bumper

Correct nylon bushing used for ease of pedal.

- FPB-97 All BushingSEE WEB
- FPB-103 All BumperSEE WEB
- FPS-6810 1978-88 Pedal Bump Stop.....SEE WEB



Transmission Cooler Hose Kit

These flexible braided stainless steel transmission cooler hoses fit either single or dual pass cooler set ups. Includes fittings.

- GCS-S5047 AllSEE WEB
- 48" hose length.



Dipstick & Tubes

GM replacement dipstick and tubes.

- FDT-350 TH350 TubeSEE WEB
- FDT-400 TH400 TubeSEE WEB
- FDS-3 TH350 Stick.....SEE WEB
- FDS-4 TH400 StickSEE WEB



BUY & SAVE
WITH SS396.COM PRE-BUILT KITS

FBH-621SUPERKIT



621 Bellhousing Kit

Complete kit with reproduction "621" bellhousing, clutch fork, fork boot, throwout bearing, bolts and inspection cover. Fits cars with 11" clutch.

- FBH-621SUPERKIT Complete KitSEE WEB
- FBH-621K Bellhousing and CoverSEE WEB
- FBH-621 Bellhousing OnlySEE WEB

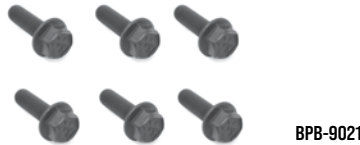

Bellhousing Hardware

- BPB-9021 Bellhousing to Block (6pc)SEE WEB
- BTE-307 Bellhousing to Trans 4 Speed (4pc)SEE WEB



Flywheels

Original GM flywheels.

- FFW-105 10.5" w/o 454.....SEE WEB
- HAYS-10-010 168t 57-85 SBC 65-70 BBC*SEE WEB
- HAYS-10-020 168t SBC 70-90 BBC**SEE WEB

*Internally balanced. **Externally balanced.

12 Piece Bolts

- BPB-5116 1970-72 Flywheel to Crank 4 Speed .SEE WEB
- BPB-5118 1970-72 Flex Plate to Crank AutoSEE WEB
- BPP-8386 1970-72 Flywheel to Pressure Plate .SEE WEB

No Volume Discount.

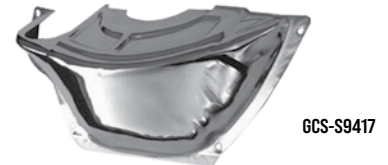

Custom Flywheel Inspection Covers

Looks great on any show car!

- GCS-S9417 PG Chrome.....SEE WEB
- GCS-S8607 TH350/TH400 PolishedSEE WEB
- GCS-S9588 TH350/TH400 ChromeSEE WEB
- GCS-S9587 TH700-R4 ChromeSEE WEB



Heavy Duty Clutch Kits

All HD clutch kits include clutch disc, pressure plate, throwout bearing, pilot bushing, alignment tool and grease pack.

- FCK-258 11" 10 Spline BBSEE WEB
- FCK-260 11" 26 Spline BBSEE WEB
- FCK-105 10.5" 10 Spline SBSEE WEB
- FCK-108 10.5" 26 Spline SBSEE WEB

No Volume Discount.

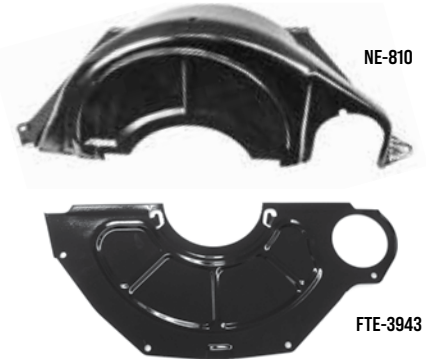

Flywheel Inspection Covers

OE style reproduction flywheel covers.

- FTE-3943 1970-72 Manual 11"SEE WEB
- NK-4497 1970-72 Manual 10.5"SEE WEB
- NJ-088 All PowerglideSEE WEB
- NE-810 All TH350SEE WEB
- NJ-089 All TH400.....SEE WEB
- BFW-506K Attaching Bolts (4pc)SEE WEB



Pilot Bushing

New input shaft bushing that goes into the crankshaft.

- FPB-667 1970-77 All BrassSEE WEB
- FPB-ROLLER 1970-77 All Roller.....SEE WEB



FTO-641

Throut Bearing

Original OEM style throut bearing.

FTO-641 1970-77 All.....SEE WEB



FTE-9000-ADJ



FTE-9000

Clutch Fork Ball

Original GM clutch fork mounting/pivot ball for inside the bellhousing. We also now offer adjustable pivot ball for after market pressure plates where alignment can be an issue.

FTE-9000 1970-77 All.....SEE WEB

FTE-9000-ADJ 1970-77 Adjustable.....SEE WEB



FV-1521

Firewall Boot Retainer

FV-1521 1970-72 All.....SEE WEB



FW-68



FRC-100

Clutch Firewall Rods

FW-68 1970-72 All.....SEE WEB

FW-78G 1978-88 All.....SEE WEB

FRC-100 Attaching Clip.....SEE WEB



FSS-5053

Firewall Rod Boots

OE style reproduction rubber boots for firewall.

FSS-5053 1970-72 All.....SEE WEB

FSS-78G 1978-88 All.....SEE WEB

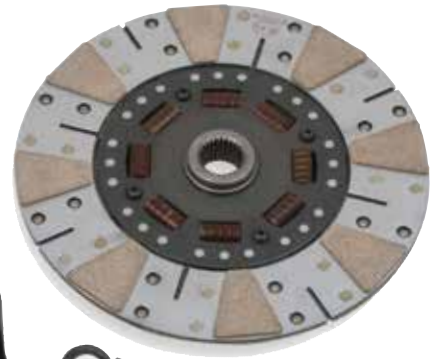

HAYS-92-1003

Hays Manual Clutches

Hays Street 450 single disc kits are an excellent upgrade offering up to 30% more holding power over your stock clutch, designed to handle stock and mildly modified engines up to 450 horsepower. This is a great clutch where drivability is the most important factor along with a stock pedal feel.

HAYS-91-1003	10.5" 26 Spline.....	SEE WEB
HAYS-91-1002	10.5" 10 Spline.....	SEE WEB
HAYS-91-1004	11" 10 Spline.....	SEE WEB
HAYS-91-1005	11" 26 Spline.....	SEE WEB

Hays Street 650 single disc kits are designed to handle highly modified naturally aspirated engines up to 650 horsepower. Designed as a true street/strip clutch for spirited high performance driving or frequent track use.

HAYS-92-1003	10.5" 26 Spline.....	SEE WEB
HAYS-92-1002	10.5" 10 Spline.....	SEE WEB
HAYS-92-1004	11" 10 Spline.....	SEE WEB
HAYS-92-1005	11" 26 Spline.....	SEE WEB

No Volume Discount.



LW-15000LKW



FEH-397



FKW-11LW



FKW-4999

Lakewood Bellhousing

The Lakewood 15000LKW bellhousing connects Monte Carlo small and big block engines to transmissions utilizing the standard GM pattern such as the Muncie, Saginaw, Borg Warner T10 and Tremec TKO transmissions. This bellhousing is hydro formed to fit '58-'87 GM full and midsized cars, 67-81 F-body vehicles and 68-79 Novas. This bellhousing is S.F.I. 6.1 certified which is required by many sanctioning bodies for cars running 11.49 or faster in the quarter mile. The Lakewood 15000 comes complete with engine block plate and Grade 8 mounting hardware.

LW-15000LKW	1970-1977 SBC, BBC.....	SEE WEB
FEH-397	1970-72 All Resto Clutch Fork.....	SEE WEB
FKW-4999	1970-75 All Clutch Fork Boot.....	SEE WEB
FKW-11LW	1970-1977 All Clutch Fork Boot.....	SEE WEB
FTE-9000-ADJ	1970-1972 All Adjustable Clutch Fork Ball.....	SEE WEB

No Volume Discount.



HAYS-10-010

Hays Automatic Flexplate

Hays heavy duty Flexplate for high performance competition Monte Carlo engines are constructed of a thicker than stock steel plate. This enables them to withstand the stress of high-stall torque converters and high-RPM engines. These flexplates are supplied with a ring gear that is securely welded in place and feature a dual bolt pattern for use with a Powerglide or Turbo style torque converter.

HAYS-10-010 168t 57-85 SBC 65-70 BBC* SEE WEB

HAYS-10-020 168t SBC 70-90 BBC** SEE WEB

*Internally balanced. **Externally balanced.

No Volume Discount.



BM-20230

B&M Automatic Flexplate

Heavy duty flexplate for extreme racing or street applications. SFI certified for NHRA & IHRA.

BM-20230 55-85 168t SBC up to 1991 BBC SEE WEB

BM-20232 55-85 168t SBC 400 SEE WEB

BM-20233 55-85 168t BBC 454 SEE WEB

BM-20232 55-85 153t SBC SEE WEB

*Except SBC 400 and BBC 454. No Volume Discount.



FEH-397

Clutch Fork

New GM style clutch fork.

FEH-397 1970-72 All Resto SEE WEB

FEH-397-GM 1970-72 All Original GM SEE WEB



FB-786



FB-566



BFB-605

Clutch Frame Brackets

Correct bracket for mounting Z bar to frame.

FB-566 1970-72 SEE WEB

FB-786 1978-88 All SEE WEB

BFB-605 Attaching Bolt SEE WEB



FCE-0681

Clutch Adjustment Rod Kits

FCE-0681 1970-72 All V8 SEE WEB

FRC-100 Attaching Clip SEE WEB



FWK-4999

Clutch Fork Boot

Original clutch fork dust boot.

FWK-4999 1970-75 All SEE WEB



FRB-172

Clutch Pedal Push Rod Bushing

This injection molded plastic bushing installs on the clutch pedal and retains the clutch push rod.

FRB-172 1973-75 SEE WEB



FRZ-19

Clutch Z Bar

Reproduction "zerk" bar.

FRZ-19 1970-72 All SEE WEB

FZ-78G 1978-88 All SEE WEB

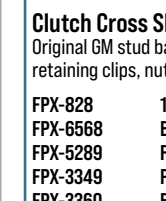

FPX-828

FPX-0696

FPX-6568

Clutch Cross Shaft Kit

Original GM stud balls, nylon seats, protective felts, retaining clips, nuts and washers.

FPX-828 1970-72 SEE WEB

FPX-6568 Block Ball Only SEE WEB

FPX-5289 Frame Ball Only SEE WEB

FPX-3349 Plastic Seat Only SEE WEB

FPX-3360 Ball Felt SEE WEB

FPX-0696 Retaining Clip SEE WEB

FPX-33K Cross Shaft Seat & Seal Kit SEE WEB



FCE-3920

Clutch Return Springs

Original return springs for clutch fork, etc.

FCE-3920 1970-72 All SEE WEB

FCS-78G 1978-88 All SEE WEB



Hurst Shifter & Installation Kit

This complete Hurst Competition Plus shifter and linkage kit includes a famous Hurst Competition Plus shifter, chrome Hurst shifter handle and white shifter ball with 4 speed pattern as well as a complete Hurst installation kit with all rods, levers, swivels and hardware. This kit will provide you with that vintage muscle car look as well as provide reliable shifts every time!

HURST-KITA69M 1970-72 Muncie SEE WEB

Part Notes: Please verify that the year of your transmission matches the year of your car before ordering. 1970 Muncie 4-speed transmissions can be identified from later models by the way the transmission arms attach. Early Muncie side covers had a stud and the shift arm attached with a nut on the stud while the 1970 and later model side covers had a hole and the shift arms attached with a bolt.



FHM-69K

Hurst/Muncie Shifter Kit

This Ground Up exclusive Hurst/Muncie shifter kit allows you to keep an original style Muncie shifter handle and mate it to a Hurst shifter and linkage. Original Muncie shifters performed very poorly, so we created this exclusive kit to keep your car looking original while utilizing the strength and reliability of a bullet proof Hurst Competition Plus shifter. Everything under the shifter handle is covered by your shifter boot so no one will be able to tell it isn't stock.

FHM-69K All 1970-72 w/ Console and/or Buckets ... SEE WEB

FHM-69 All 1970-72 w/ Bench SEE WEB

** No Volume Discount.*



3737834

Hurst Installation Kits

Complete kit with rods, levers, swivels and hardware.

3737834 1970-72 w/ Muncie.....SEE WEB

3737897 1973-74 w/ Muncie.....SEE WEB

No Volume Discount.



SH-203-8

SH-202-8

SH-204-10

Billet Shifter Handles

These billet aluminum shifter handles from Clayton Machine work with any Hurst or Tremec, TK500 TK0600 2 bolt shifter mount and are a great finishing touch for your custom ride! Available in three styles: Basic black anodized, truss style with grey powder coat, truss style adjustable grey powder coat. Shift knob not included. Requires knob with 3/8-16" thread. Same as most Hurst knobs.

SH-203-8 8" Black Ano 30 Degree Kick Back SEE WEB

SH-203-10 10" Black Ano 30 Degree Kick Back.....SEE WEB

SH-202-8 8" Grey PC Truss Style 30 Degree Kick Back.....SEE WEB

SH-202-10 10" Grey PC Truss Style 30 Degree Kick Back.....SEE WEB

SH-204-10 10" Grey PC Truss Style Adjustable Kick Back.....SEE WEB

No Volume Discount.



NT-390

Reverse Lockout Kit

Complete with 2 rods and swivel mechanism.

NT-390 1970-72 w/ Muncie.....SEE WEB



FZ-1420



FW-157

Shifter Balls

Reproduction shifter balls.

FZ-1420 1970-72 White 5/16"SEE WEB

FZ-1424 1970-72 White 3/8"SEE WEB

FW-115 Chrome 5/16"SEE WEB

FW-117 Chrome 3/8"SEE WEB

FW-157 Black/Chrome 5/16"SEE WEB

FW-159 Black/Chrome 3/8"SEE WEB



FSH-1499

FSH-1498

1970-72 Muncie Shifter Handles

OE style reproduction chrome shifter handles.

FSH-1498 1970-72 w/o Console..... SEE WEB

FSH-1499 1970-72 w/ Console..... SEE WEB



BM-80675



BM-80706

BGM Automatic Floor Shifters

From the originator of high performance manual shifters our line of performance, street and racing shifters for automatic transmissions won't let you down. With classic good looks and proven mechanical designs giving choices of either positive ratcheting actions or gated racing shifters, provide positive shifts guaranteeing you won't miss a shift when it counts.

Starshifter

Features include NHRA/ IHRA reverse lockout, backup light switch, neutral safety switch, polished T-handle. Cable operated for quick installation and accurate shifting.

BM-80675 All 2&3 SpeedSEE WEB

Megashifter

The BGM Megashifter has it all, form, function and classic style. This all adds up to bring you a quality shifter that's been one of the most popular automatic shifters of all time. First off let's talk function. The Megashifter's positive ratcheting function won't allow you to over shift and miss a gear at that critical moment, along with the reverse lockout feature meets NHRA/ IHRA safety rules for those weekend grudge races at the track. The look and feel of the T-handle and accordion style shift boot really shows off the racing heritage of the Megashifter.

BM-80690 All 2,3,4 SpeedSEE WEB

Quicksilver

The BGM Quicksilver features a ratcheting action for positive shifts, Chrome Knob, neutral safety switch, NHRA/IHRA approved reverse lockout.

BM-80683 All 2,3,4 SpeedSEE WEB

Hammer

The Hammer shifter may just be the most comfortable and versatile shifter available. The unique design of the shift handle easily fits all sizes of hands providing the best wrist angle and feel when shifting.

BM-80885 All 2,3,4 SpeedSEE WEB

Pro Stick

The Original Pro Stick shifter delivers rock-solid performance, mixed with clean design cues and compact size. This is why you see so many Pro Stick shifters at the race track.

BM-80706 All 2,3,4 SpeedSEE WEB

Stealth Magnum Pro Stick

The Stealth Magnum Grip Pro Stick shifter delivers rock-solid performance, mixed with clean design cues and compact size.

BM-81052 All 2,3,4 SpeedSEE WEB

Pro Ratchet

The Pro Ratchet shifter is one of our most popular and easiest to operate race shifters. Features include a positive ratcheting design that self-centers the handle after each shift giving you maximum clearance behind the shifter and won't allow you to miss a shift by over-shifting a gear. This versatile shifter will operate both forward and reverse shift patterns.

BM-80840 All Silver 2 Speed Powerglide.....SEE WEB

BM-80842 All Silver 3,4 Speed*SEE WEB

BM-80843 All Carbon 3,4 Speed*SEE WEB

BM-81120 All Stealth 3,4 Speed*SEE WEB

*May require PRNDL switch for some applications. No Volume Discount.



HURST-3838530



HURST-3160001

Hurst Automatic Shifters

From the originator of high performance manual shifters, is our line of performance street and racing shifters for automatic transmissions that won't let you down. With classic good looks and proven mechanical designs giving choices of either positive ratcheting actions, or gated racing shifters providing positive shifts guaranteeing you won't miss a shift when it counts.

Pro-Matic 2

Ratchet-action shifter with its chrome-plated stick and black knob is quality engineered for years of precise, trouble-free operation. Once the shifter is installed, the textured console and brilliant top cover that can be trimmed to fit any floor contour integrates the shifter with the interior.

HURST-3838500 All 3 Speed.....SEE WEB

V-Matic 3 Shifter

Designed with a park and reverse lock trigger actuating system that allows smooth and flawless ratcheting through the forward gears.

HURST-3838530 All 3 & 4 SpeedSEE WEB

Quarter Stick

The Quarter Stick shifter provides positive gear change control for both street and race applications. Its compact size fits easily in racecars with limited space and is very lightweight at only 2.5 pounds. Features include black oxide coated steel construction, 1018 hardened steel gate plate, forged aluminum shift stick with 7/16-20 tpi and a classic white Hurst shift knob.

HURST-3160001 All 2 Speed*SEE WEB

HURST-3160006 All 3 Speed**SEE WEB

HURST-3160020 All 3 Speed*SEE WEB

*Reverse valve body. **Forward valve body.



FW-HURST

Hurst T Handle Shifter Knob

This brushed aluminum t-handle provides a positive feel for accurate gear selection. A favorite in the performance world for years! Includes adapters for most popular shift handles.

FW-HURST T-HandleSEE WEB



HURST-5389020

HURST-5389023

Hurst Billet Shifter Handles

This is a great way to add a contemporary performance look to your muscle car. Billet Aluminum construction is precision CNC machined for a modern look and feel. Fits classic Hurst shifters with a 2 bolt pattern.

HURST-5389020 6" Straight..... SEE WEB

HURST-5389021 8" Straight..... SEE WEB

HURST-5389022 10" Straight..... SEE WEB

HURST-5389023 6" Lay Back..... SEE WEB

HURST-5389024 8" Lay Back..... SEE WEB

HURST-5389025 10" Lay Back..... SEE WEB

No Volume Discount.



ICE-HURST



ICE-INDY

Hurst Shifter Boots

Brand new injection molded boots.

ICE-HURST Universal.....SEE WEB

ICE-INDY Universal Indy Shift Boot.....SEE WEB





IT-1360K

BUY & SAVE
WITH SS396.COM PRE-BUILT KITS

Boot & Retainer Kit
Buy a correct shift boot and retainer for your 1970-72 Monte Carlo with console and save!!!

IT-1360K 1970-72 w/ Console.....SEE WEB



Shift Boot Retainers

Correct die stamped steel boot retainers.

IT-1360	1970-72 w/ Console.....	SEE WEB
NT-196	1970-72 w/o Console (2pc).....	SEE WEB
IT-3954	1978-88 w/o Console	SEE WEB

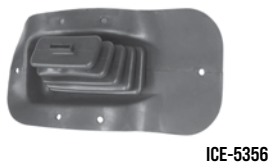

Shifter Boots

Brand new injection molded boots.

ICE-5356	1970-72 w/ Console.....	SEE WEB
ICE-5405	1970-72 w/o Console.....	SEE WEB
IE-4010	1978-88 w/o Console	SEE WEB



Hurst Shifter Cables

These premium quality cables feature a solid 303 stainless steel inner wire core encased within a nylon liner wrapped with helical lay wires and swaged ends for superior strength. The core is lubricated with Teflon prior to assembly and then sealed in a heavy plastic outer casing for a lifetime of durability and smooth operation.

Single eyelet on one end and threaded on the other end.

HURST-5000023	3 Feet	SEE WEB
HURST-5000025	5 Feet	SEE WEB
HURST-5000028	8 Feet	SEE WEB

Single eyelet on one end and threaded on the other end. For Pro-Matic & V-Matic shifters

HURST-5008555	5 Feet	SEE WEB
----------------------	--------------	---------

Eyelets on both ends for quarter stick.

HURST-5000029	5 Feet	SEE WEB
----------------------	--------------	---------

No Volume Discount.



Speedometer Cables

New complete cables with casings and correct ends ready to install. Check your speedometer fitting and length before ordering.

FCC-202	1970-77 100" (Clip on speedo end)	SEE WEB
FCC-205	1970-77 80" (Clip on speedo end)	SEE WEB
FCC-305	1970-77 61" (Clip on speedo end)	SEE WEB
FCC-309	1970-77 41" (Clip on speedo end)	SEE WEB
FSG-22	1970-72 Grommet.....	SEE WEB
FSG-78G	1978-88 All Grommet.....	SEE WEB

Note: Longer cables are for cars with passenger side screw ins on transmission.



Neutral Safety Switch

Correct steering column switch for proper engine and reverse light activation.

GNS-33	1970-72 Manual.....	SEE WEB
GDR-411	1970-72 Auto Console.....	SEE WEB
GNS-35	1970-73 Auto Column.....	SEE WEB



Neutral Start Switch

Correct safety switch located at pedal which prevents your car from being started in gear.

GNS-1588	1970 4 Speed.....	SEE WEB
GNS-1589	1971-72 4 Speed.....	SEE WEB



Speedometer Cable Clip

Bolts to the bottom of the transmission tail shaft bolt to keep the speedometer cable from hanging down.

FHB-13653	1970-79 4 Speed.....	SEE WEB
------------------	----------------------	---------



B&M Transmission Coolers & Kits

B&M Super Coolers are 100% aluminum stacked plate style core which is ideal for additional transmission cooling. With oven brazed construction this sturdy cooler design is practically impervious to flying rocks or other debris.

Small

BM-70265	All 7,500 BTU Polished.....	SEE WEB
BM-70273	All 15,000 BTU Black	SEE WEB

Medium

BM-70268	All 13,000 BTU Black	SEE WEB
BM-70266	All 20,500 BTU Black.....	SEE WEB
BM-70272	All 20,500 BTU Polished.....	SEE WEB

Large

BM-70264	All 14,400 BTU Black	SEE WEB
BM-70274	All 29,200 BTU Black.....	SEE WEB

No Volume Discount.



BM-70298

B&M HiTek Cooling Systems

Hi-Tek Super Coolers are fitted with a high quality 12 Volt electric fans and built-in mounting brackets which makes it ideal for maximum cooling. Suitable for many fluids including ATF, Engine Oil, Differential Oil and power steering fluid.

- BM-70298 All 350 CFM BlackSEE WEB
 BM-70297 All 590 CFM BlackSEE WEB
No Volume Discount.



FR-158RM

FR-158SS



FR-158RK

FR-158SH

Transmission Speedometer Gears

These are the correct speedometer drive gears which go inside the transmission case. Please compare the gear you have to what you are ordering as the color or tooth count may vary from original. We do not have an application chart for these so if changing axle ratios or tire size please consult various online resources.

Muncie M20, M21, M22, Saginaw 3 & 4 Speed and Powerglide

- FR-158RB 17 Tooth Purple SEE WEB
 FR-158RD 18 Tooth Brown SEE WEB
 FR-158RF 19 Tooth Natural SEE WEB
 FR-158RH 20 Tooth Blue SEE WEB
 FR-158RK 21 Tooth Red SEE WEB
 FR-158RM 22 Tooth Gray SEE WEB
 FR-158RS 23 Tooth Black SEE WEB
 FR-158RV 24 Tooth Orange SEE WEB

TH350, TH375, TH400, TH475

- FR-158SB 35 Tooth Pink SEE WEB
 FR-158SD 36 Tooth White SEE WEB
 FR-158SF 37 Tooth Red SEE WEB
 FR-158SH 38 Tooth Blue SEE WEB
 FR-158SM 40 Tooth Black SEE WEB
 FR-158SP 41 Tooth Yellow SEE WEB
 FR-158SS 42 Tooth Green SEE WEB
 FR-158SV 43 Tooth Purple SEE WEB
 FR-158SX 44 Tooth Dark Gray SEE WEB
 FR-158SZ 45 Tooth Light Blue SEE WEB

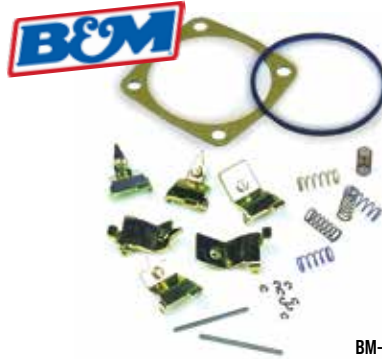

BM-20248

B&M Governor Recalibration Kit

This kit allows you to adjust the shift points of your transmission after it is installed in your vehicle. The Governor Recalibration Kit is very useful if you have a vehicle that is very light; has a low rear-end gear ratio.

- BM-20248 55-85 TH350, TH400, TH700R4...SEE WEB
No Volume Discount.



BM-30229

B&M Transpak, Transkit & Master Overhaul Kits

B&M Transpak has all the features in the Shift Improver Kit, plus it provides additional driver manual control. Retain full automatic features and standard shift points with selector in Drive.

- BM-30228 1970-77 TH350SEE WEB

B&M Transkits give you the same high-quality components that are used in all B&M Street and Strip transmissions. They also include special directions on how to modify your case, pump, and components.

- BM-30229 1970-77 TH350SEE WEB

B&M Master Racing overhaul kits are supplied with all of the gaskets, seals, bushings, and friction material required for a complete high performance or racing trans overhaul.

- BM-21042 1970-77 TH350SEE WEB

- BM-21041 1970-77 TH400SEE WEB

No Volume Discount.



REVSKIT-UNI

Universal Reverse Lamp Switch Manual

This kit allows you to add a reverse light switch to non-stock applications. If you have a Hurst shifter this kit is a must.

- REVSKIT-UNI AllSEE WEB



BPU-337

BPU-334

U Joint Attaching Kits

Correct straps and bolts for attaching the drive shaft to rear yoke.

- BPU-337 All Straps w/ BoltsSEE WEB
 BPU-334 All U Bolts w/ NutsSEE WEB



FTS-350

Tail Seals

Correct tail shaft yoke seals.

- FTS-PG PowerglideSEE WEB
 FTS-350 TH350SEE WEB
 FTS-400 TH400SEE WEB



BSB-12925

Tail Shaft Bolts

Correct TR head markings & black phosphate plating.

- BSB-12925 PG, TH350, TH400 (6pc)SEE WEB



FY-935

Yokes

New front drive shaft & rear differential yokes.

- FY-123 Front Yoke TH400SEE WEB
 FY-935 Front Yoke TH350/4 SpeedSEE WEB



UMI-4500-B

UMI Driveshaft Safety Loops

This one-piece NHRA legal driveshaft safety loop is a Bolt-in or weld-in application for your Monte Carlo. This driveshaft loop is contoured for the A-Body floor pan and bolts or welds into the reinforcement rib located behind the transmission. This is a must for tracks that require a safety loop for cars running faster than 13.99 in the quarter mile. The entire loop is constructed of 0.250 thick mild steel, CNC machined mounting points for a superb fit and fully MIG welded for outstanding strength.

- UMI-4500-B 1970-72 All BlackSEE WEB
 UMI-4500-R 1970-72 All RedSEE WEB
 UMI-3500-B 1978-88 All BlackSEE WEB
 UMI-3500-R 1978-88 All RedSEE WEB



GCS-S7120

Universal Driveshaft Loop

- GCS-S7120 UniversalSEE WEB



Turbo HydraMatic Transmission ID Tags

Turbo HydraMatic transmission ID tag with rivet, measuring 1-1/8 inch x 1-15/16 inch. This installs on the side of the transmission case with the rivet. You must punch your own info onto the tag.

TTP-70	1970 Black.....	SEE WEB
TTP-71	1971 Light Blue.....	SEE WEB
TTP-6972	1972 Yellow.....	SEE WEB



Rear End Plugs & Posi Tag

Reproduction plugs and posi tag.

HBB-5847	All Metal Tag.....	SEE WEB
FDP-3R	1970-72 Plug 3/4".....	SEE WEB
FPT-1	1970-72 Posi Tag 3/4".....	SEE WEB
N-7081	1970-72 Vent Plug.....	SEE WEB



TCS Wire Retainer

Correct reproduction for Muncie.

ATS-653	1970-74 w/ Muncie.....	SEE WEB
---------	------------------------	---------



B&M Differential Covers

B&M Cast Aluminum Differential Covers are designed to strengthen the differential by preventing case distortion and ring gear & bearing cap deflection. Constructed of A356.0-T6 aluminum, these rugged covers significantly increase the fluid capacity and dissipate heat much faster than the stock factory unit to prolong the life of your ring and pinion gears.

BM-70500	12 Bolt 8.875" Ring Gear Silver.....	SEE WEB
BM-70502	10 Bolt 8.2.5, 6" Ring Gear Silver.....	SEE WEB
BM-71502	10 Bolt 8.2.5, 6" Ring Gear Black.....	SEE WEB
BM-70503	10 Bolt 8.2" BOP Ring Gear Silver.....	SEE WEB

No Volume Discount.



B&M Deep Transmission Pan Cast

These B&M automatic transmission deep pans provide additional fluid capacity and cooling ability. No modifications to the dipstick are needed. They include a drain plug for clean and easy fluid changes. Adds 2-3 quarts to the transmission.

BM-30280	All TH350, TH250 3Qts.....	SEE WEB
BM-20280	All TH400 2Qts.....	SEE WEB
BM-70280	All Powerglide 2Qts.....	SEE WEB
BM-70260	All TH700RH, 4L60/65E 3Qts.....	SEE WEB

No Volume Discount.

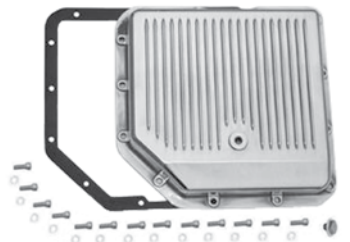

Polished Fined Transmission Pans

Show quality polished stock depth pan crafted from cast aluminum and polished to a bright finish. Includes gasket, drain plug and bolts.

GCS-S8491	TH350.....	SEE WEB
GCS-S8492	TH400.....	SEE WEB
GCS-S8493	TH700-R4.....	SEE WEB



Chrome Transmission Pans

Stock depth. Chrome plated steel for a show quality finish.

GCS-S9074	TH350.....	SEE WEB
GCS-S7599	TH700-R4.....	SEE WEB
GCS-S9124	Powerglide w/ Fins.....	SEE WEB
GCS-S9122	TH350 Turbo w/ Fins.....	SEE WEB
GCS-S9121	TH400 Turbo w/ Fins.....	SEE WEB
GCS-S9712	TH700-R4 w/ Fins.....	SEE WEB

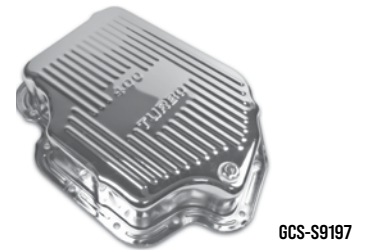

Extra Capacity Fined Transmission Pans

Same quality show finish as our stock pans but with extra fluid capacity for better cooling.

GCS-S9197	400 Turbo 1.5 Extra Qts.....	SEE WEB
GCS-S9196	400 Turbo 2.5 Extra Qts.....	SEE WEB
GCS-S9197BK	400 Turbo 1.5 Extra Qts. Black....	SEE WEB
GCS-S9198BK	350 Turbo 1.5 Extra Qts. Black....	SEE WEB
GCS-S9712BK	700-R4 Turbo 1.5 Extra Qts. Black	SEE WEB

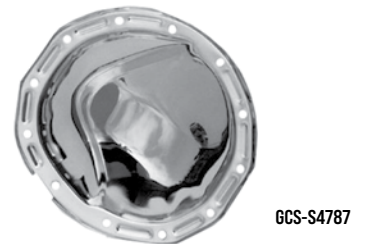

Custom Rear End Covers

Choose from high quality chrome or bright polished aluminum. A great finishing touch!

GCS-S4786	10 Bolt Chrome.....	SEE WEB
GCS-S4787	12 Bolt Chrome.....	SEE WEB
GCS-S5082	12 Bolt Polished.....	SEE WEB
GCS-R0002X	Bolt Kit.....	SEE WEB

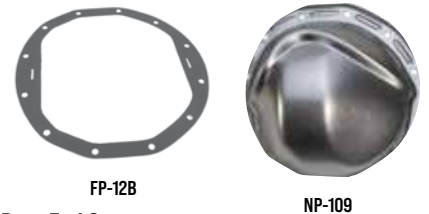

Rear End Cover

Reproduction 12 bolt cover.

NP-109	All 12 Bolt Cover.....	SEE WEB
FPF-10B	10 Bolt Gasket.....	SEE WEB
FPF-12B	12 Bolt Gasket.....	SEE WEB
BRE-2008	Cover Bolt.....	SEE WEB



Rear End Fluid

AC Delco special fluid and posi additive.

FPF-668	Rear End Fluid.....	SEE WEB
FPF-49	Posi Additive.....	SEE WEB

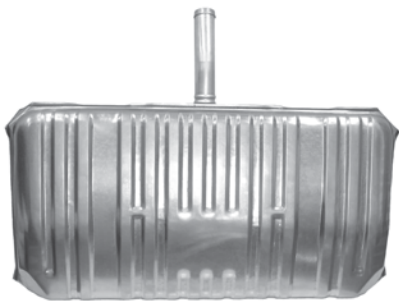

XTR-70A

Fuel Tanks

The same fuel tanks in our kits above available separately.

OEM Tanks

XT-70A	1970-72 w/o EECSEE WEB
XT-70E	1970-72 w/ EECSEE WEB
XTR-306A	1987-88 17 Gal CarbSEE WEB
XTR-306C	1985-88 17 Gal Fuel InjectionSEE WEB

Import Tanks

High quality shiny zinc plate Imports, great quality at a great price.

XTR-70A	1970-72 w/o EESEE WEB
XTR-70E	1970-72 w/ EECSEE WEB

Ships Oversize 2. Not eligible for free shipping.



XTS-70A

Stainless Steel Fuel Tanks

These stainless steel fuel tanks are shiny enough for any show car and rust proof enough for any daily driver! Installation is easy because this tank is a direct Bolt-in replacement for your OEM tank.

XTS-70A	1970-72 w/o EECSEE WEB
XTS-70E	1970-72 w/ EECSEE WEB

Ships Oversize 2. Not eligible for free shipping.



HOL-19-107



HOL-19-444



HOL-526-10

1970-88 Sniper Fuel Injection Fuel Tanks

Converting the carbureted fuel system on your car or truck over to EFI can be a daunting task. We have made this conversion easy with our complete tank and fuel system kits! The heart of a fuel system begins with the fuel tank. When converting to EFI, it is crucial that you do not contaminate your new parts with dirt, rust, and sludge from an old fuel tank. Sniper fuel tanks are designed to meet or exceed the quality of your factory fuel tank. Sniper tanks are made from steel with a galvanized finish that are manufactured to the OEM specifications for your Monte Carlo.

HOL-19-107	1970-72 550HPSEE WEB
HOL-19-407	1970-72 750HPSEE WEB
HOL-19-144	1978-88 550HPSEE WEB
HOL-19-444	1978-88 750HPSEE WEB
HOL-526-10	1970-77 EFI Fuel System Install KitSEE WEB

No Volume Discount. Ships Oversize. Not eligible for free shipping.



XTC-149



XTC-33

Fuel Tank Caps

OEM caps designed to work with original tanks only. Repro caps designed to work with import tanks only.

XTC-149	1970-72 OEM VentedSEE WEB
XTC-33	1970-72 OEM Non-VentedSEE WEB
XTC-06	1970-72 Import TankSEE WEB
XTC-06	1970-74 Deep TangsSEE WEB



NH-4381

Fuel Tank Insulation

Correct foam insulation which is glued to the top of the fuel tank to prevent squeaks and rattles, and tar paper which goes between the tank and the straps.

NH-4381	1970-72 AllSEE WEB
NH-UNI	All Universal 36x21" PadSEE WEB



BPX-4755

Fuel Tank Hardware

Correct OEM bolts and clips.

BPX-4755	1970-72 AllSEE WEB
----------	-------------	--------------



XTD-1630



BTB-56

Fuel Tank Door

Correct spring loaded fuel tank door.



XTD-108

XTD-1630	1970-72 DoorSEE WEB
XTD-108	Door BumperSEE WEB
BTB-56	Door BoltSEE WEB



ELC-516



ELC-1438T



BLC-056

Fuel Line Clips

Correct clips for attaching fuel lines to frame.

ELC-1516	5/16" LineSEE WEB
ELC-516	5/16" w/ TabSEE WEB
ELC-038	3/8" LineSEE WEB
ELC-1438	1/4" - 3/8" LineSEE WEB
ELC-1438T	1/4" - 3/8" w/ TabSEE WEB
BLC-056	Correct BoltSEE WEB



AXP-3800

AXP-1438

Fuel Tank Hose Kits

Correct GM hose and pinch clamps.

AXP-3800	All 3/8"SEE WEB
AXP-1438	All 3/8" - 1/4"SEE WEB



AAC-427



AAC-455

Fuel Filters

Original GM AC Delco

- AAC-427 Q-Jet Short StyleSEE WEB
- AAC-455 All Holley Brass.....SEE WEB



HOL-12834

Holley Chrome Fuel Pumps

Mechanical pumps designed to work with stock or mildly modified engines.

Free-flow output of 80 GPH (SB) or 80-130 GPH (BB). Body castings can be rotated 360-degrees to ease mounting in difficult places. Heavy duty construction can withstand long periods at high RPM. 1/4" (SB) 3/8" (BB) pipe thread inlet and outlet ports.

- HOL-12834 Small Block SEE WEB
- HOL-12835 Big Block..... SEE WEB

Note: Not compatible with methanol or alcohol. Cannot be used with fuel injection systems.



QF-30-350QFT

Quick Fuel Technology Fuel Pumps

For the street cruiser, it's tough to beat the simplicity and reliability of a mechanical fuel pump. Quick Fuel Technology's mechanical pumps flow 110 gallons per hour and utilize lightweight aluminum housings. They feature integrated shutoff valves that are preset at 6.5- to 8 psi, eliminating the need for a separate pressure regulator. For added installation flexibility, the pump casting can be rotated to accommodate various plumbing configurations. 3/8" NPT threads. Gasoline only.

- QF-30-350QFT Small BlockSEE WEB
- QF-30-454QFT Big BlockSEE WEB

No Volume Discount.



QF-30-125-1QFT

Quick Fuel Technology Electric Fuel Pumps

QFT's electric fuel pumps are perfect for combinations that are neither stock nor all out race cars. These pumps flow more than enough fuel to support between 400-750 hp. Mounting hardware and brackets are included.

- 125 GPH Flow Rate
- 14 PSI Maximum Pressure
- Features 3/8" NPT Inlets and Outlets
- Draws 4 Amps or Less at Full Load
- For Carbureted Gasoline Applications Only

- QF-30-125-1QFT Pump OnlySEE WEB
 - QF-30-125-1RQFT Pump/RegulatorSEE WEB
- No Volume Discount.*

Holley



HOL-12-426

Holley Electric Fuel Pumps

Holley is proud to introduce the all new Holley Mighty Mite™ electric fuel pumps! They're big on performance, but small in size! They're quiet, easy to install and work with gas, diesel, blended alcohol and E85!

12 volt operation, 25 gal/hr flow. Good for up to 300HP naturally aspirated. Simple 2 wire hookup. Self-priming and regulating. Quiet operation - 65db. Hose barbs fit 5/16" Fuel Hose. Made in the USA

- HOL-12-426 All 25 GPH 1.5-4 PSI..... SEE WEB
- HOL-12-427 All 32 GPH 4-7 PSI..... SEE WEB

No Volume Discount.

Holley



HOL-12-803BP

Holley Fuel Pressure Regulator

Holley fuel pressure regulators are designed to precisely control the fuel pressure from the fuel pump to the carburetor. Too much fuel pressure for a given needle and seat assembly will overload and may cause flooding or drivability problems. Each Holley fuel pressure regulator is fully adjustable so regulating the fuel pressure to your engine's needs is simple.

12 volt operation. Preset to 7psi. 3/8" NPT ports (1 in, 1 out, 1 bypass or return). Used in systems with a return line back to the fuel tank

- HOL-12-803BP All Carbureted.....SEE WEB

No Volume Discount.



GCS-S4297



GCS-S9245



GCS-S9407



GCS-S9177

Chrome Inline Fuel Filters

Choose from a variety of show quality chrome fuel filters to dress up your engine.

Carburetor

- GCS-S9407 Bronze Element, 3/8", Chrome SEE WEB
 - GCS-S9177 Paper Element, 3/8", Chrome SEE WEB
 - GCS-S9177BK Paper Element, 3/8", Black..... SEE WEB
 - GCS-S9245 Glass Element, 3/8", Chrome SEE WEB
- Not for fuel injection.*

Red Top High Capacity Chrome Fuel Filters

Show quality chrome plated fuel filter with paper element and pipe fittings.

- GCS-S4297 Small.....SEE WEB
- GCS-S4295 Large.....SEE WEB



AJE-395



ACE-4867



ACE-9599

Fuel Pump Hardware

- AJE-395 All Activating Rod.....SEE WEB
- ACE-9599 All SB Plate.....SEE WEB
- ACE-4867 Fuel Pump BoltsSEE WEB



AXP-3800

AXP-6400

Fuel Pump Hose Kit

Correct GM hose for connecting fuel pump to main fuel line. Complete with correct "colored" pinch clamps.

- AXP-3800 All 3/8" (3 pc.)SEE WEB
- AXP-1438 All 3/8"-1/4" (6pc).....SEE WEB
- AXP-6400 All 3/8" 90 degree bendSEE WEB



AFT-238

Fuel Line Brace

Correct factory installed brace for carb line.

- AFT-238 1970 L-78, LS-6SEE WEB



AXD-69

Exhaust Manifolds SB

Restoration manifolds. These brand new manifolds are sold in matched pairs and come with GM cast numbers.

- AXD-69 1970-72 SB non-SMOG
3932376 / 3942529 SEE WEB
- AXD-69S 1970-72 SB with SMOG
3946826 / 3942527 SEE WEB

No Volume Discount. Ships Oversize. Not eligible for free shipping.



AXD-396

Exhaust Manifolds BB

New GM restoration manifolds. Sold in matched pairs with GM cast numbers (3909879-3916178). Correct for most Monte Carlos.

- AXD-396 BB non-SMOG
3916178 / 3909879 SEE WEB
- AXD-396S BB with SMOG
3916178 / 3909879 SEE WEB

No Volume Discount. Ships Oversize. Not eligible for free shipping.



EHS-128



EHS-471



EHS-473

Upper Heat Stove

Works in conjunction with the air heat tube to preheat the air cleaner thermo-sensor. This item mounts on the right hand (passenger side) exhaust manifold. Manufactured to original specifications featuring the correct zinc plating.

- EHS-471 1970-76 Small BlockSEE WEB
- EHS-473 1970-77 V8SEE WEB
- EHS-128 1970-77 Heat Stove TubeSEE WEB



XD-500



XE-153



XG-225

Exhaust Gaskets & Donuts

- XG-20 Riser Gasket 2" SB.....SEE WEB
- XG-225 Riser Gasket 2.5" BBSEE WEB
- XD-400 Donut 2" SB.....SEE WEB
- XD-500 Donut 2.5" BB.....SEE WEB
- XE-152 Extension 2" SB.....SEE WEB
- XE-153 Extension 2.5" BB.....SEE WEB
- GCS-S7501 Collector Gaskets, 2.5"SEE WEB
- GCS-S7502 Collector Gaskets, 3"SEE WEB
- GCS-S7503 Collector Gaskets, 3.5"SEE WEB
- GCS-S7504 SB Manifold GasketsSEE WEB
- GCS-S7507 BB Manifold Gaskets, Round PortSEE WEB
- GCS-S7508 BB Manifold Gaskets, Rectangle PortSEE WEB



ALI-2228

Exhaust Stud Kit

Correct studs for mounting exhaust pipe to manifold. Our kit comes complete with 3 long & 3 short studs and 6 correct locking nuts.

- ALI-2228 All SB - BB.....SEE WEB



AHR-1190

AHR-1180

Heat Riser Valves

Correct valve for pre-heating engine on cold start.

- AHR-1190 Valve SB 2"SEE WEB
- AHR-1180 Valve BB 2.5".....SEE WEB



N-660

Heat Riser Spacers

Takes the place of the heat riser for increased flow.

- N-660 Spacer SBSEE WEB
- N-733 Spacer BB.....SEE WEB



APB-1382

OEM Exhaust Manifold Bolts

Correct head marked and colored bolts for mounting exhaust manifolds to block.

- APB-1382 SB w/ Washers (24 pc.)SEE WEB
- APB-1821 BB Flanged Head (16 pc.)SEE WEB
- APB-3506 BB Loose Washer (32 pc.)SEE WEB



EXL-200

Exhaust French Locks

This kit is a correct set of four stainless steel stamped french locks for corners of exhaust manifold as installed by factory.

- EXL-100 1970-77 SB.....SEE WEB
 - EXL-200 1970-73 BB*SEE WEB
- *Not for flanged bolts.*



XET-321



Detail

Exhaust Tips Stock

Reproduction exhaust tips featuring correct GM part numbers for your 1970-72 Monte Carlo SS. Beautiful triple chrome finish.

- XET-321 1970-72 2.5" w/ Numbers SEE WEB
- NX-766 1970-72 2.5" w/o Numbers..... SEE WEB
- XET-3213 1970-72 3" w/ Numbers SEE WEB
- NX-7663 1970-72 3" w/o Numbers..... SEE WEB

No Volume Discount.



EVT56



EVT49

Pypes Exhaust Tips

Add the finishing touch to your exhaust system with a set of triple chrome plated tips from Pypes! All tips are slip fit.

- EVT54 2.5" OE style..... SEE WEB
- EVT56 3" OE style..... SEE WEB
- EVT49 2.5" Angle Cut SEE WEB
- EVT50 3" Angle Cut SEE WEB



XHP-642

Exhaust Hanger Kits

Complete with all necessary hardware to install your new OEM style exhaust system.

XHP-642 1970-72 OM.....SEE WEB



DGU14S

Downpipes

If you are using stock manifolds, you will need a pair of these downpipes to connect to the system. 409 Stainless steel.

DGU14S 1970-77 SB.....SEE WEB
DGU20S 1970-77 BB.....SEE WEB



PVR10S

Collector Reducers

These act as connectors from your header collectors to intermediate pipes for a clean look.

PVR10S 3" Header to 3" Pipe.....SEE WEB
PVR13S 3.5" Header to 3" Pipe.....SEE WEB
PVR16S 3" Header to 2.5" Pipe.....SEE WEB
PVR19S 3.5" Header to 2.5" Pipe.....SEE WEB



PVD13

Turn Downs

These universal downturns are perfect for off road applications when tail pipes are not desired.

PVD10 2.5" 409 Stainless.....SEE WEB
PVD13 3" Aluminized.....SEE WEB

XMH-64A

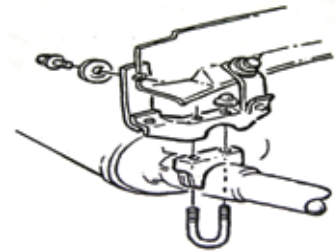

XPH-69CH

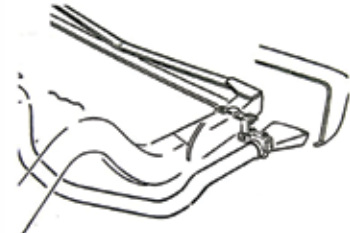

XPH-70CH

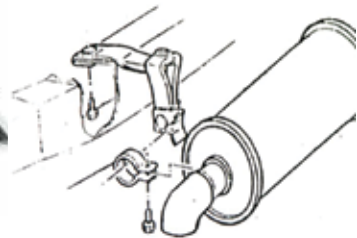

XPH-68CH

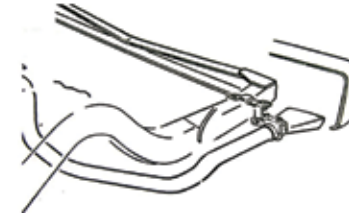

XPH-70SS

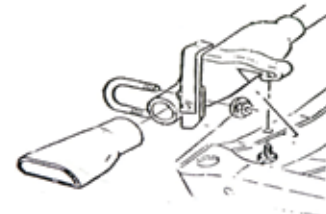

Exhaust Hangers

Factory reproduction exhaust hangers are a great way to finish off your restoration. Can be used with exhaust size 2 inch, 2 1/4 inch, 2 1/2 inch or larger.

XMH-64A	1970-72 Muffler Hanger	SEE WEB
XPH-69CH	1970-72 Tail Pipe Hanger	SEE WEB
XPH-70CH	1970-72 Tail Pipe Hanger	SEE WEB
XPH-68CH	1970-72 Tail Pipe Hanger	SEE WEB
XPH-70SS	1970-72 Tail Pipe Hanger*	SEE WEB

* Correct for LS3, LS5 and LS6 Super Sport



HKR-11051HKR

Hooker Dual Exhaust Cut-Out Kits

The choice is yours - Tease the Street or Please the Track with Hooker's new "Street-Tease" exhaust cut-outs! Good and "old" ideas improved with new materials, that's what we have here! These cut-outs will provide years of worry free use with a mixture of stainless steel and aluminum. The materials will keep the elements out, and the sound, Well that's up to you, with a flip of the toggle or a push of the remote button.

- TIG-welded T-304 stainless steel tubing for a clean and weather resistant finish
- 6061 aircraft aluminum motor and valve bracket
- Instant performance gains when opened
- Stainless tip can be positioned for any direction of exhaust
- Simple 12v cigarette lighter plug-in for main power supply
- Welding Required

HKR-11051HKR Dual 2.5" KitSEE WEB
 HKR-11052HKR Dual 3" KitSEE WEB

No Volume Discount.



HKR-8501-1HKR



HKR-8501-4HKR



HKR-8501HKR

Hooker Cast Iron LS Exhaust Manifolds

Hooker cast iron exhaust manifolds have been designed to hug close to the engine block so they fit into a wide variety of replacement and engine-swap applications. Their contoured design aims the exhaust directly at the exit port for improved flow. Being cast iron means they will provide years of leak-free performance with less under hood noise than traditional headers. Plus, their shorty design means you can route exhaust tubing close to your frame/floor pan for maximum ground clearance. "Hook" up your GM LS engine with Hooker cast iron manifolds today!

- Intended for all GM LS (except LS7 and LS9) engine swap applications where durability, quiet operation, emissions compliance and leak-free sealing is desired
- Cast from Hi-Silicon-Moly Ductile Iron to provide durability and corrosion resistance
- 2.25-inch outlet diameter
- Free-flowing for good performance and catalytic converter efficiency
- Recommended for strong performance on engines making up to 500 horsepower

HKR-8501-1HKR	Silver Ceramic Coated	SEE WEB
HKR-8501-3HKR	Black Ceramic Coated	SEE WEB
HKR-8501-4HKR	Titanium Ceramic Coated	SEE WEB
HKR-8501HKR	Natural Cast Finish	SEE WEB
HKR-8510HKR	Natural Cast Finish Turbo*	SEE WEB

*For use with a turbo charger. No Volume Discount.



FLOW-17119

Flowmaster American Thunder Dual Exhaust Systems

With easy fit in mind, these systems are mandrel bent for maximum performance and include specially selected mufflers. American Thunder systems deliver a moderate to aggressive interior and exterior tone.

- Mandrel bent 16 gauge aluminized tubing - Includes hangers and hardware for easy installation
- Made in the USA

Below includes Super 40 Series Mufflers; Moderate to Aggressive Sound

FLOW-17119 1970-72, 2.5", Aluminized, Dual Rear Exit SEE WEB

Below includes Super 40 Series Mufflers; Aggressive & Powerful Sound

FLOW-817409 1970-72, 2.5", Stainless, Dual Rear Exit SEE WEB

FLOW-17200 1970-72, 3", Aluminized, Dual Rear Exit SEE WEB

FLOW-817200 1970-72, 3", Stainless, Dual Rear Exit SEE WEB



FLOW-15819

Flowmaster Pre-Bent Tail Pipes

These 16 gauge mandrel bent pipe kits are designed to fit perfectly onto your vehicle with all the quality and performance that you would expect from Flowmaster.

- Premium Flowmaster Quality
- Mandrel bent 16 Gauge Tubing - Rear Exit

Aluminized Steel

FLOW-15802 1970-72 2.5" Rear ExitSEE WEB

FLOW-15818 1970-72 3" Rear ExitSEE WEB

FLOW-15819 1970-72 3" Rear ExitSEE WEB

FLOW-15817 1978-88 3" Rear ExitSEE WEB

409 Stainless Steel

FLOW-815802 1970-72 2.5" Rear ExitSEE WEB

No Volume Discount.



FLOW-81068

Flowmaster Downpipes

Flowmaster's manifold downpipe kits are designed for the person who wants to use a Header-back exhaust system while using the factory exhaust manifolds. Utilizing mandrel bent 409S stainless steel tubing and high quality flange gaskets, Flowmaster's manifold downpipe kits are designed for the perfect leak free fit.

- Pipes designed to be used without heat riser
- 2.50 in manifold downpipe
- Mandrel bent 16 gauge 409 stainless steel tubing

FLOW-81068 1970-74 Small BlockSEE WEB

FLOW-81071 1970-74 Big BlockSEE WEB

No Volume Discount.



Flowmaster Scavenger Series Elite Shorty Headers

Flowmaster's Scavenger Series Elite shorty headers are designed to replace the restrictive factory manifolds. These high quality headers are manufactured from stainless steel and are ceramic coated for maximum durability. They feature 1-3/4 in primary tubes, 3/8 in thick laser cut flanges and factory collector connections, ensuring a direct-fit, leak free installation. Like all Flowmaster products, the benefits include improved throttle response, power and engine efficiency.

- 3/8" laser cut flanges
- Dyno tuned for maximum performance
- High temperature ceramic coating
- 409 stainless steel construction

FLOW-814111 1970-77 Big Block 1-3/4" Primary.....SEE WEB
No Volume Discount.



FLOW-814110



FLOW-814114

Flowmaster Scavenger Series Elite Long Tube Headers

Scavenger Series Elite long tube headers deliver maximum performance and are suited to the enthusiast who wants the best. Like all Flowmaster products the benefits include improved throttle response, power and engine efficiency. Designed for an easy fit these headers include gaskets and necessary hardware for easy installation.

- Ball & socket collector
- Ceramic coated
- 0.375 thick laser cut flanges
- 3 inch collector outlet

FLOW-814110 1970-77 SB 1-5/8" SEE WEB
FLOW-814114 1970-74 BB 2" SEE WEB



FLOW-814116



Flowmaster LS Swap Headers

Flowmaster's Scavenger Series Elite headers feature heavy duty 3/8 in laser cut flanges, 16 gauge stainless steel primary pipes and gasket free ball flange exhaust connectors. These full length headers provide an exact fit and increased performance. Please note these headers are not emissions legal and are designed for off-road use only.

- Gasket free ball style collectors
- Ceramic coating
- Stainless steel construction
- Collector included
- Dyno tuned for maximum performance

FLOW-814116 1970-72 All 1-3/4" Primaries, 3" Exit.....SEE WEB
No Volume Discount.



FT-11108FLT



Flowtech Mid-Length Headers

Flowtech headers are the perfect combination of performance and value. Flowtech Mid-Length headers are precision engineered using mandrel bent tubing, formed collectors and 5/16" flanges with sealing rings for a leak-free seal.

- Tuned-length primary tubes for street performance
- Mandrel-bent tubing for smooth exhaust flow
- Light weight & sturdy 16 gauge tubing
- Mandrel-Formed Power Plenum collector for low back pressure
- Sturdy, leak-tested O-Ring port seals
- Engineered for an easy, trouble-free precision fit
- Includes all mounting hardware and premium gaskets

Small Block

FT-11108FLT 1970-88 Black Paint 1-1/2" Tubes 2.5" Collector SEE WEB
FT-11102FLT 1978-88* Black Paint 1-1/2" Tubes 2.5" Collector SEE WEB

*Features O2 oxygen sensor bung. No Volume Discount.



FT-49100FLT



Flowtech Afterburner Headers

Flowtech's Afterburner Turbo Chamber Headers represent the first new major design change in exhaust technology in decades. This design combines the race-proven 4 into 1 design with the torque managing capabilities of a Tri-Y header. The turbo chamber helps smooth out exhaust turbulence for increased performance and a broad power curve.

- Horsepower and torque increased over conventional header design
- Big 3" secondary collector for reduced back pressure
- Tuned-length primary tubes combine with velocity tube to smooth out exhaust pulses
- All hardware and premium gaskets included for a complete installation
- Patented Velocity tube increases cylinder scavenging

FT-49100FLT 1970-88 Black Paint 1-5/8" 3" Collector..... SEE WEB
FT-49100-1FLT 1970-88 Silver Ceramic 1-5/8" 3" Collector..... SEE WEB
No Volume Discount.



FT-11100FLT

Flowtech Long Tube Headers

Flowtech headers are the perfect combination of performance and value. Flowtech long tube headers are precision engineered using mandrel bent tubing, formed collectors and 5/16" flanges with sealing rings for a leak-free seal. All mounting hardware and gaskets are included for a simple installation. This header is coated in a high heat resistant black paint for a stealthy appearance. Instant performance gains when opened.

Tuned-length primary tubes for street performance · Mandrel-bent tubing for smooth exhaust flow · Light weight & sturdy 16 gauge tubing · Mandrel-formed Power Plenum collector for low back pressure · Sturdy, leak-tested O-Ring port seals · Engineered for an easy, trouble-free precision fit · Includes all mounting hardware and premium gaskets

Small Block

FT-11100FLT	1970-88 Black Paint 1-5/8" Tubes 3" Collector.....	SEE WEB
FT-31100FLT	1970-88 Silver Ceramic 1-5/8" Tubes 3" Collector.....	SEE WEB
FT-11104FLT	1970-88 Black Paint 1-5/8" Tubes 3" Collector.....	SEE WEB

Big Block

FT-11130FLT	1970-74 Black Paint 1-3/4" Tubes 3" Collector.....	SEE WEB
FT-11132FLT	1970-74 Black Paint 1-7/8" Tubes 3.5" Collector.....	SEE WEB

No Volume Discount.



FT-11000FLT

Flowtech Block Hugger Headers

Flowtech Block Hugger headers are ideal for street rods where fit and finish is really important. Block Huggers make performance and style easy for engine swaps, and with our new Hugger Tools you can hook up to an existing system with ease.

Computer-controlled mandrel-bent tubing for smooth exhaust flow · Sturdy 16 gauge tubing · Easy installation - can be used with stock motor mounts · Precision die-cut exhaust port flanges · Engineered and tested for a leak-proof seal · All necessary hardware included for a complete installation

Small Block

FT-11000FLT	1970-88 Black Paint 1-5/8" Tubes 2.5" Collector.....	SEE WEB
FT-31000FLT	1970-78 Silver Ceramic 1-5/8" Tubes 2.5" Collector.....	SEE WEB

Big Block

FT-11030FLT	1970-88 Black Paint 1-3/4" Tubes 2.5" Collector.....	SEE WEB
FT-31030FLT	1970-78 Silver Ceramic 1-3/4" Tubes 2.5" Collector.....	SEE WEB

Big Block Tight Fit

FT-11701FLT	1970-88 Black Paint 1-3/4" Tubes 2.5" Collector.....	SEE WEB
FT-11701-1FLT	1970-88 Silver Ceramic 1-3/4" Tubes 2.5" Collector.....	SEE WEB
FT-11701-7FLT	1970-88 Stainless 1-3/4" Tubes 2.5" Collector.....	SEE WEB
FT-11701-2FLT	1970-78 Chrome 1-3/4" Tubes 2.5" Collector.....	SEE WEB

No Volume Discount.



HKR-2451HKR

HKR-2455-2HKR

Hooker Competition Headers

Hooker Competition headers offer the best value in the high performance header market. Designed for the value-conscious buyer who is running either a "stock" or "mildly-modified" engine, these headers offer premium features at a very competitive price. Made of durable 16 gauge mild steel tubing, header design utilizes a long transition collector to reduce back pressure and increase exhaust flow. A perfect sealing surface is assured with the 5/16" machined flanges, with welded O-ring seals. Experience has proven that this flange size is ideal to maintain header integrity and be pliable enough to seal each exhaust port. Tubing is mandrel-bent to maintain metal strength and provide consistent tube diameter at radii to maximize performance.

All necessary hardware included for a complete installation · Designed for easy, trouble-free fit · Industry's best welds for durability · Long transition collector for decreased back pressure · Tuned-length primary tubes for street performance

Hooker Long Tubes

Small Block

HKR-2451HKR	1970-77 Black Paint 1-5/8" Tubes 3" Collector.....	SEE WEB
HKR-2451-1HKR	1970-77 Silver Ceramic 1-5/8" Tubes 3" Collector.....	SEE WEB
HKR-2451-3HKR	1970-77 Black Ceramic 1-5/8" Tubes 3" Collector.....	SEE WEB
HKR-2451-2HKR	1970-77 Stainless 1-5/8" Tubes 3" Collector.....	SEE WEB

Big Block

HKR-2455-1HKR	1970-74 Silver Ceramic 2" Tubes 3.5" Collector.....	SEE WEB
HKR-2455-3HKR	1970-74 Black Ceramic 2" Tubes 3.5" Collector.....	SEE WEB
HKR-2455-2HKR	1970-74 Stainless 2" Tubes 3.5" Collector.....	SEE WEB

No Volume Discount.



FLOW-15938

Flowmaster Header Collector Ball Flange

This header collector kit takes the place of three bolt flange type connections and allows for a leak free and gasket free ball flange type connection.

FLOW-15938	1970-88 All 2.5" to 2.5".....	SEE WEB
FLOW-15925	1970-88 All 2.5" to 3".....	SEE WEB
FLOW-15925	1970-88 All 3" to 3".....	SEE WEB

No Volume Discount.



CCS-CC162



CCS-CCFK10



CCS-CCFKRL



AKY-6872A

Aluminum Radiators by Champion Cooling Systems

These aluminum radiators are made to the highest of standards paired with unequaled quality precision and workmanship. The highest of aluminum grades available are used in all manufacturing processes. All Champion aluminum radiators are constructed using 100% welded seams brazed core technology and absolutely no epoxy. All Champion radiators come with a lifetime limited warranty and are made to install with little or no modifications using your original mounts giving you the confidence you deserve. Choose from the following series:

EC Economy Core Series - 2Row - Two Rows of 3/4 inch Tubes = Approx. 400-600+ Horsepower Cooling Capacity.
 CC Champion Core Series - 3Row - Three Rows of 5/8 inch Tubes = Approx. 600-800+ Horsepower Cooling Capacity.
 MC Monster Core Series - 4Row - Four Rows of 5/8 inch Tubes = Approx. 800-1200+ Horsepower Cooling Capacity.

Requires 2 - 14" fans +2 relays

CCS-EC161	1970-77 Economy Core Series 33 x 18-5/8 OD	SEE WEB
CCS-CC161	1970-77 Champion Core Series 33 x 18-5/8 OD	SEE WEB
CCS-MC161	1970-77 Monster Core Series 33 x 18-5/8 OD	SEE WEB

Requires 2 - 10" fans +1 relay

CCS-EC571	1970-77 Economy Core Series 27 x 19 OD	SEE WEB
CCS-MC571	1970-77 Monster Core Series 27 x 19 OD	SEE WEB

Requires 2- 10" fans +1 relay

CCS-EC162	1978-88 Economy Core Series 18 1/4 x 31-5/8 OD	SEE WEB
CCS-CC162	1978-88 Champion Core Series 18 1/4 x 31-5/8 OD	SEE WEB
CCS-MC162	1978-88 Monster Core Series 18 1/4 x 31-5/8 OD	SEE WEB

Requires 2- 12" fans +1 relay

CCS-EC571	1978-88 Economy Core Series 19 x 27 OD	SEE WEB
CCS-MC571	1978-88 Monster Core Series 19 x 27 OD	SEE WEB
CCS-CC571DP	1978-88 Champion Core Series 18-1/2 x 27 OD LS Swap*	SEE WEB

*Dual pass core for LS swaps. All radiators include petcock and 16 or 19 lb cap depending on application.

Electric Cooling Fans

Features a reversible swept blade design meaning it can be configured as a puller or pusher. The blades are computer balanced.

CCS-CCFK10	10", 7.5 Amp Draw, 650 CFM	SEE WEB
CCS-CCFK12	12", 10 Amp Draw, 870 CFM	SEE WEB
CCS-CCFK14	14", 12 Amp Draw, 1200 CFM	SEE WEB
CCS-CCFK16	16", 14 Amp Draw, 1600 CFM	SEE WEB

Electric Fan Relay

Recommended for all electric fan applications. Only one relay is needed for single or dual fans.

CCS-CCFKRL	Fan Relay	SEE WEB
------------	-----------------	---------

Note: 10 and 12 inch fans require one relay, 14 and 16 inch fans require two relays.

1970-72 Aluminum Radiator

This new high quality aluminum radiator is a great light weight alternative to a traditional brass and copper radiator. This 2 core aluminum radiator provides excellent cooling for all engines from mild to high performance. It is made for automatic transmissions and also includes plugs so it can be used with manual transmissions.

AKY-6872A	1970-72 All	SEE WEB
VHT-SP139	Radiator Paint	SEE WEB

Radiators are shipped Oversized. Not eligible for free shipping.



AKY-6872A-KIT



1970-72 Aluminum Radiator Kits

If you are planning to upgrade your Monte Carlos cooling performance, look no further than this Ground Up exclusive kit! All the essentials are included, such as a 2 core aluminum radiator, chrome fan, fan shroud and thermal kit. Aluminum radiators are a great lightweight alternative to traditional brass and copper radiators, with increased cooling efficiency via dual high flow aluminum tubes, suitable for mild to high performance applications. This radiator can be used for either automatic or manual transmissions with the included stoppers. Inlet is 1-1/2 inch, while outlet is 1-3/4 inch.

AKY-6872A-KIT	1970-72 All	SEE WEB
VHT-SP139	Radiator Paint	SEE WEB

No Volume Discount.



O.E.M.

AKY-844M

US Radiators

These direct factory replacement Desert Cooler radiators from US Radiator come complete with new high density cores, correct screw-in fittings for automatics, correct mounting brackets where applicable and are ready to install.

AKY-844A	1970-72 4 Row HD Automatic	SEE WEB
AKY-844M	1970-72 4 Row HD Manual	SEE WEB
AKY-843M	1970-72 3 Row HD Manual	SEE WEB

Radiators are shipped Oversized. Not eligible for free shipping. No Volume Discount.





COLD-42M



COLD-42MFK

Cold Case Radiators

These COLD-CASE radiators are TIG welded 100% aluminum. These radiators have dual oversize 1" cooling rows making them more efficient than four 1/2" rows seen on 4 row models. Cold Case aluminum radiators cool 20% better than OEM copper radiators and are more than 50% lighter. They are original in appearance with OEM style stamped tanks for strength and that OEM original look. Once painted, they look like originals to all but the concourse fanatic. Each radiator is pressure tested, direct fit and carries a Lifetime Warranty!

COLD-42M	1970-72 ManualSEE WEB
COLD-44A	1970-72 AutomaticSEE WEB
COLD-546A	1970-72 All Manual LS SwapSEE WEB
COLD-544A	1978-88 All G-BodySEE WEB
VHT-SP139	Radiator PaintSEE WEB

Kits With Electric Fan And Shroud

Cold Case made it easy with kits that include the radiator, fan and shroud. All kits come with the transmission cooler fittings in the radiator.

COLD-42MFK	1970-72 All Dual 12" FansSEE WEB
COLD-42AFK	1970-72 All Dual 12" FansSEE WEB
COLD-RC100	Radiator Cap AllSEE WEB
COLD-FAN12	12 Inch Cooling Fan 1400 CFMSEE WEB
COLD-FAN16	16 Inch Cooling Fan 2500 CFMSEE WEB
COLD-EF1	Fan Wiring Kit AllSEE WEB

All radiators are shipped Oversize. Not eligible for free shipping. * No Volume Discount.



Frostbite Performance Cooling

High-Horsepower street cars and race cars can be a challenge to keep cool. A proper cooling system starts with Frostbite.

When it comes to keeping your ride cool, Make it Frostbite!

Aluminum Radiators

Our line of Performance Aluminum Radiators are available in 2, 3, and 4-row sizes as well as specific LS-Swap applications.

- 100% TIG welded (brazed) seams
- Aircraft quality aluminum core, fittings, and tanks (up to 30% weight savings)
- Billet Aluminum Filler Neck and OEM style Brass Petcock
- Custom Frostbite High Performance 16lb. radiator cap
- Polished top and tanks for custom show appearance
- 2-Row Radiators supporting applications with 300-500 horsepower
- Transmission cooler provisions

Direct Fit

FROST-FB132	70-77 V8 All 2 Row	28.25" WideSEE WEB
FROST-FB133	70-77 V8 All 3 Row 2	8.25" WideSEE WEB
FROST-FB134	70-77 V8 All 4 Row	28.25" WideSEE WEB
FROST-FB162	78-88 V8 All 2 Row 26" WideSEE WEB	
FROST-FB163	78-88 V8 All 3 Row 26" WideSEE WEB	
FROST-FB164	78-88 V8 All 4 Row 26" WideSEE WEB	

LS Swap

Hose fittings sold separately.

FROST-FB304	70-72 LS All 2 Row 17" TallSEE WEB
FROST-FB302	78-88 LS All 2 Row 17" TallSEE WEB

Electric Fan & Shroud Kits

Fans and Shroud Kits E= Economy H= High Performance

FROST-FB501E	Dual 14" Fits FB132, 133, 134, 304 RadiatorsSEE WEB
FROST-FB501H	Dual 14" Fits FB132, 133, 134, 304 RadiatorsSEE WEB
FROST-FB502E	Dual 12" Fits FB162, 163, 164, 302 RadiatorsSEE WEB
FROST-FB502H	Dual 12" Fits FB162, 163, 164, 302 RadiatorsSEE WEB

Shroud Only Dual Opening

FROST-FB508	Fits FB123, 124, 125 Radiators*SEE WEB
FROST-FB501	Fits FB132, 133, 134, 304 Radiators**SEE WEB
FROST-FB502	Fits FB162, 163, 164, 302 Radiators*SEE WEB

*Dual 12" fan openings. **Dual 14" fan openings.

Note: Width and height measurements are for the core not overall.

No Volume Discount.

Fan Relay & Wiring Kit

This relay kit will allow you to custom configure your fans as pusher or puller resulting in increased cooling performance and a reduction in noise/vibration in your engine bay. Does 1 or 2 fans.

FROST-FB403	All With Electric FansSEE WEB
-------------	------------------------	--------------

No Volume Discount.

Hose Fittings

FROST-FB400	LS Swap 1.25"SEE WEB
FROST-FB401	LS Swap 1.5"SEE WEB
FROST-FB402	LS Swap 1.75"SEE WEB

No Volume Discount.



FROST-FB132



FROST-FB501E



FROST-FB508



FROST-FB400



FROST-FB401



FROST-FB402



FANKIT-7BL

Fan Clutch Kits

Complete kit to convert your car to this heavy duty GM fan clutch option. This kit includes fan, fan clutch and all necessary hardware.

FANKIT-7BL 1970-72 All (w/ Long WP)SEE WEB



ABR-2710



BKP-516

Fan Clutches

Heavy duty fan clutch with gold cadmium coloring.

ABR-2710 1970-72 Long PumpSEE WEB
 BKP-516 Correct Attaching Nuts (4)SEE WEB



AX-3970

Fan Shroud Attaching Kits

Correct OEM clips and screws for attaching the fan shroud.

AX-3970 1970-72 AllSEE WEB



APC-0100

BPX-2792

Fan and Shroud Attaching Kits

Correct style bolts/studs for attaching fan to water pump.

BPX-2792 Attaching Stud Kit 12 PieceSEE WEB
 BPX-2791 Attaching Bolt Kit 8 PieceSEE WEB
 APC-0100 1970-72 AllSEE WEB



INL-15090

Fan Spacers

Correct cooling fan spacers for cars that did not come equipped with a fan clutch.

INL-15090 2" 1970-77 AllSEE WEB
 INL-15091 1.5" 1970-77 AllSEE WEB
 INL-15092 1" 1970-77 AllSEE WEB



AEF-14

Electric Cooling Fans

This electric radiator cooling fan is perfect for older muscle cars where an electric water pump is being used or as supplemental cooling.

AEF-12 12" UniversalSEE WEB
 AEF-14 14" UniversalSEE WEB
 AEF-16 16" UniversalSEE WEB



PAC-2800BT

Dakota Digital Electronic Fan Controller

This controller was designed for the ultimate in flexibility and to be a simple add-on in any application using an electric fan. Included is a 70amp relay, enough for even the most power hungry of cooling fans. Fully programmable, the PAC-2800BT will work with your existing water temp gauge, operating from the temperature sending unit already installed.



PAC-2800BT All w/ Electric Cooling FansSEE WEB
No Volume Discount.



AVG-70AB

Cowl Vent Grille Covers

Dress up the cowl area of your Monte Carlo with this trick new cover from Undercover Innovations! Made out of 14 gauge aluminum, it's one piece design covers all three cowl vent holes making them look much more symmetrical. Stainless steel fasteners included.

AVG-70AC 1970-72 Clear Anodized SEE WEB
 AVG-70AB 1970-72 Black Anodized SEE WEB
 AVG-70AP 1970-72 Polished SEE WEB
No Volume Discount.



ARP-68A4B

Custom Radiator Covers

This custom radiator top panel offers a totally unique look and will keep your engine compartment neat and clean looking!

ARP-68A3B 1970-75 3 Bolt Black Anodized SEE WEB
 ARP-68A3C 1970-75 3 Bolt Clear Anodized SEE WEB
 ARP-68A3P 1970-75 3 Bolt Polished SEE WEB
 ARP-68A4B 1970-75 4 Bolt Black Anodized SEE WEB
 ARP-68A4C 1970-75 4 Bolt Clear Anodized SEE WEB
 ARP-68A4P 1970-75 4 Bolt Polished SEE WEB
No Volume Discount.

KEEP A LOOK OUT FOR THESE LOGOS BELOW THROUGHOUT THE CATALOG FOR BIG SAVINGS AND DISCOUNTS ON KITS!

BUY & SAVE
 WITH SS396.COM PRE-BUILT KITS





AAC-6415 AAC-6072

Radiator Caps

Your choice of reproduction GM RC15 cap with correct large ears and correct wording or new GM replacement.

- AAC-6072 1970-72 ReproductionSEE WEB
 AAC-6415 1970-72 Replacement.....SEE WEB



GCS-S5010 GCS-S5012

Custom Radiator Caps

Show quality radiator caps with 16 lb. of opening pressure.

- GCS-S5010 Polished AluminumSEE WEB
 GCS-S5011 ChromeSEE WEB
 GCS-S5009 Chrome w/ Flames.....SEE WEB
 GCS-S5012 Polished AluminumSEE WEB

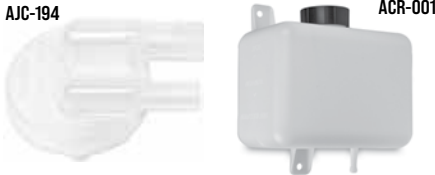

AJC-194 ACR-001

Universal Coolant Reservoir

Perfect for muscle cars that did not come with a factory reservoir. Compact size. Easy to mount anywhere. 6" wide, 4" deep, 5" tall.

- ACR-001 All.....SEE WEB

Radiator Overflow Jar Cap

Correct reproduction featuring "ENGINE COOLANT ONLY".

- AJC-194 1974 All.....SEE WEB

1978-88 Radiator Overflow Jar

Excellent reproduction of the radiator overflow jar. Replaces GM # 14085692.

- AQJ-692 1978-88 All SEE WEB

Cap not included.



AOF-172

Stainless Overflow Tank

This polished stainless steel universal fluid reservoir is perfect for older muscle cars that did not come from the factory with a coolant recovery tank.

- AOF-103 10" x 3"SEE WEB
 AOF-132 13" x 2"SEE WEB
 AOF-152 15" x 2"SEE WEB
 AOF-172 17" x 2"SEE WEB

Note: 1/4 in. Hose Barb Inlet/Outlet



GCS-S9427

Chrome Radiator Top Panel

This chrome plated steel radiator top panel will add a nice custom touch to your show car! Complete with hardware.

- GCS-S9427 1970-73 3 Bolt 24"SEE WEB
 GCS-S9428 1970-73 4 Bolt 31 1/8"SEE WEB

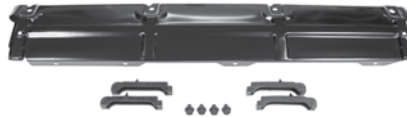

AP-789K

Radiator Install Kit

This kit will make it easy to install the radiator on your Monte Carlo. Includes a brand new radiator top mounting panel, bolts and mounting pads.

- AP-789K 1970-72 w/ 4 Row..... SEE WEB



AP-789

Radiator Top Panel

Correct 4 bolt hole reproduction radiator top panel.

- AP-789 1970-72 All.....SEE WEB
 AP-789-0E 1970-72 All OEM StyleSEE WEB
 AP-70 1970-72 All 3 Bolt w/o AC.....SEE WEB
 AB-6872 Retaining Bolts (4)SEE WEB



ATE-4100

ATE-6041

Radiator Mounting Pads

Correct upper and lower rubber pads for mounting your radiator into the support. Lower pads feature steel cores.

- ATE-6041 1970-72 UpperSEE WEB
 ATE-4100 1970-72 Lower.....SEE WEB
 ATE-6SB 1970-72 3 Row & Small BlockSEE WEB

CPN-0638



Radiator Overflow Hose OEM

Correct thin walled ribbed hose as original.

- CPN-0638 1970-72 SEE WEB

AXP-1106



Radiator Petcock

Correct gold colored fluted end drain valve for radiator.

- AXP-1106 1970-72 All..... SEE WEB

CPX-8739



Radiator Hose Retaining Clip

Correct clip for retaining overflow hose.

- CPX-8739 1970-72.....SEE WEB



Plain Anodized Shown

Radiator Support Show Panels

This radiator support show panel seals up the unsightly area between the front of the radiator support and the header panel. It can be installed in about 15 minutes with no modification and will really make your engine compartment look clean and neat. Available with a number of popular logos. Add the appropriate letter for your choice of finish. B = Black Anodized C = Clear Anodized P = Polished

1970-72 Monte Carlo

- | | | B or C | P |
|-----------|------------------------------|---------|---------|
| ASP-70ASS | 1970-72 SS | SEE WEB | SEE WEB |
| ASP-70ABW | 1970-72 Bowtie | SEE WEB | SEE WEB |
| ASP-70ABC | 1970-72 Bowtie/Chevrolet | SEE WEB | SEE WEB |
| ASP-70ACH | 1970-72 Chevrolet | SEE WEB | SEE WEB |
| ASP-70AHC | 1970-72 Chevrolet | SEE WEB | SEE WEB |
| ASP-70AHB | 1970-72 Heartbeat of America | SEE WEB | SEE WEB |
| ASP-70ABM | 1970-72 Ball Milled | SEE WEB | SEE WEB |
| ASP-70A | 1970-72 Plain | SEE WEB | SEE WEB |





Heater Hose - Bypass Nipples

Reproduction zinc plated fitting.

AWN-058	5/8" ShortSEE WEB
AWN-034	3/4" ShortSEE WEB
AWN-134	3/4" Long w/ ACSEE WEB
APN-1060	3/4" Bypass SlottedSEE WEB



Tuff Stuff Chrome Heater Hose/Bypass Nipples

Chrome plated heater hose/ bypass hose fittings.

TUF-4450A	3/4" LongSEE WEB
TUF-4450B	3/4" ShortSEE WEB
TUF-4450C	5/8" ShortSEE WEB



Tower Clamp Kits

Original Witek Tower style clamps. These factory installed clamps were used on most GM cars. 1962-68 used tower clamps on the radiator hoses and spring clamps on the heater hoses. Cars built 1970 or later used all tower clamps.

CPX-4796	1970-72 (8)SEE WEB
----------	-------------	--------------



Heater Hoses

Restoration heater hose sets. 1970-72 features correct black ribbed design.

CPR-5834	1970-72SEE WEB
----------	---------	--------------



Braided Hose Sleeve Kit

An economical way to get the look of braided hoses without the high cost! Kit includes 3' of vacuum line sleeve, 4' of fuel line sleeve, 4' of radiator hose sleeve, 12' of heater hose sleeve and matching aluminum clamp covers.

GCS-S6676	Kit w/ Red FittingsSEE WEB
GCS-S6677	Kit w/ Blue FittingsSEE WEB
GCS-S6678	Kit w/ Chrome FittingsSEE WEB

Note: Sleeves can be cut with scissors. Vacuum line uses shrink tubing instead of aluminum fittings. Hose clamps are not included.



OEM Quality Heater Cores

These OEM quality heater cores are made to factory specifications featuring copper brass cores soldered to the tanks as original. The seal kits are made from die cut foam as original to ensure a perfect seal.

Heater Cores

AHC-9066	1970-72 w/o ACSEE WEB
AHC-9063	1970-72 w/ ACSEE WEB
AHC-CLAMP	1970-77 All*SEE WEB

**Not all cars came with the clamps. Please check your car before ordering.*

Seals

JHC-7364	1970-72 w/o ACSEE WEB
JHC-7468	1970-72 w/ ACSEE WEB
JHC-7887E	1978-87 w/ ACSEE WEB

Heater Core Clips

Correct spring steel heater core retaining clips that are used to mount the heater core into the heater box.

AHC-13641	1970-72SEE WEB
-----------	---------	--------------

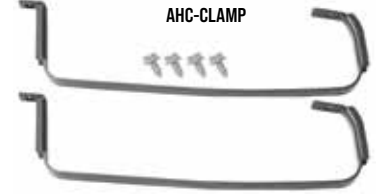

Heater Cores & Box Seal Kits

This kit includes an OEM heater core and neoprene seals. Components also available separately.

Kits

AHC-KIT7	1970-72 w/o ACSEE WEB
AHC-KIT8	1970-72 w/ ACSEE WEB



AHC-SUPERKIT7-SC



Heater Core & Box Super Kits

These new convenient heater core kits come with all the major components you need to refresh your ride.

These kits include a new OEM heater core, heater box cover, seal kit and factory caulking material.

AHC-SUPERKIT7-S	1970-72 w/o AC Black CoverSEE WEB
AHC-SUPERKIT7-SC	1970-72 w/o AC Chrome CoverSEE WEB

No Volume Discount.



ACV-1901

Heater Control Valve

New GM heater control valve for all Monte Carlos with air conditioning. Correct gold plating

ACV-1901 1970 w/ ACSEE WEB
 AV-560 Screws (2).....SEE WEB

ATE-2059



ATE-5416

Heater Hose Retainers

Correct heater hose retainers for inside of passenger fender and top of alternator bracket.

ATE-2059 1970-75 RH FenderSEE WEB
 ATE-5416 1970-75 Alt Bracket.....SEE WEB



AFG-64



ABM-1041W



Heater Blower Motor

New OEM replacement heater blower motor for cars with or without AC.

Motor Only

ABM-870 1970-72SEE WEB

Motor with Cage

ABM-1041W 1970-72SEE WEB

Blower Motor Cage Only

ABM-CAGE All.....SEE WEB

Note: 5-1/8" diameter, and 2-3/8" deep

Grommets

AFG-70 1970-72SEE WEB

Wire Clips

GWC-SPK 1970-77SEE WEB



AV-1400G

Air Conditioning Plenum

Brand new air conditioning plenum.

AV-1400G 1970-72 w/ ACSEE WEB

Heater box not included.



IK-712DF

Dash Defroster Vent Plenum

This is a brand new improved OE style replacement defroster duct. Fits AC and heat only cars.

IK-712DF 1970-72SEE WEB



AHT-2328

Cowl Wiring Gutter

Correct plastic gutter used to hold engine harness against firewall.

AHT-2328 1970-72SEE WEB
 ABH-10? Screws.....SEE WEB



ABR-77

Heater Blower Motor Resistors

Correct blower motor resistors.

ABR-77 1970-72 w/o ACSEE WEB
 ARS-304 Mounting ScrewsSEE WEB



DSE010902

DSE Heater Delete Plate

This Bolt-in heater delete plate is an easy way to smooth your factory firewall when installing an aftermarket air conditioning system like Vintage Air. It can also give your Monte Carlo that rare original heater delete look. This panel is made of 18-gauge steel and stamped with pride in the USA. For original heater only cars.

DSE010902 1970-72SEE WEB



AEC-73D

AC Evaporator Case Drain Hose

This is the correct hose that goes into the bottom of the under hood AC evaporator case.

AEC-73D AllSEE WEB



AHB-1400

Air Conditioning Box Cover

New injection molded condenser cover which mounts to the firewall.

AHB-1400 1970-72 w/ ACSEE WEB



AXB-64-AC-DELETE



AXB-15241

1970-72 AC Delete Panels

These are Bolt-in panels to block off the AC openings on the firewall.

AXB-64-AC-DELETE AluminumSEE WEB

AXB-15241 SteelSEE WEB



UMI-4030

UMI-4030-B

UMI-4030-R

UMI Heater Box Delete Panels Aluminum

This heater delete panel is designed to eliminate both the heater box and blower unit from the engine bay. Removal of the heater box instantly removes 17 pounds from the front of your vehicle while cleaning up unwanted engine bay clutter. Product is CNC machined from 0.125 Aluminum plate. Installation: Requires removal of heater box. No drilling required and uses factory holes, some new hardware included. This item is for vehicles equipped without air conditioning.

UMI-4030 1970-72 w/o AC Bare AluminumSEE WEB

UMI-4030-R 1970-72 w/o AC RedSEE WEB

UMI-4030-B 1970-72 w/o AC BlackSEE WEB

Not eligible for free shipping.



ACC-1400D

Heater Boxes

New complete inner heater box assemblies for under the dash.

ACC-1400D 1970-72 w/o ACSEE WEB

AC-1400F 1970-72 w/ ACSEE WEB

No Volume Discount.



IHD-14359

Heater Box Deflector

Used to deflect heat at the floor center hump.

IHD-14359 1970-72SEE WEB



AXB-9B

AC Delete Cover

This covers the large hole where your AC used to be and allows you to use your factory heater core when removing your AC.

AXB-9B 1970-72SEE WEB



AL-304-CHROME



AL-304



JCS-10459

Heater Box Cover

Brand new firewall heater box cover for all cars without air conditioning.

AL-304 1970-72SEE WEB

AL-304-CHROME 1970-72 ChromeSEE WEB

ALS-27 Retaining NutSEE WEB

JCS-10459 Sealant.....SEE WEB



ZAC-5

AC Receiver Dryers

New Delco dryers.

ZAC-5 1970-72SEE WEB



ZAC-1470

AC Condenser Radiator

New GM service replacement condensers. These units will require some modification.

ZAC-1470 1970-72SEE WEB



TUF-4515NADP7

Tuff Stuff AC Compressors

Tuff Stuff's black chrome plated AC compressor is quality built-in Cleveland, Ohio with 100% new components. The understated black chrome look complements any engine compartment. Black chrome finish will not discolor, rust or fade over time. Provides a consistent, eye-appealing finish for under hood accessories. These compressors are designed to fit late model or custom applications. These will not work with original factory brackets on your Monte Carlo.

TUF-4517NA6G7 "Peanut Style"6 Groove PulleySEE WEB

TUF-4517NADP7 "Peanut Style"2 Groove PulleySEE WEB

TUF-4515NA6G7 "Sanden 508 Style"6 Groove PulleySEE WEB

TUF-4515NADP7 "Sanden 508 Style"2 Groove PulleySEE WEB

No Volume Discount.

Air Conditioning Brackets Small Block

OE style reproduction brackets for installing original Delco air conditioning compressors in all 1970-77 Monte Carlos with small block engines.



ZAC-SB1

ZAC-SB1 1970 Rear Compressor BracketSEE WEB



ZAC-SB5

ZAC-SB5 1970-77 Rear Compressor PlateSEE WEB



ZAC-SB2

ZAC-SB2 1970-75 Front Compressor Support....SEE WEB



ZAC-A4

ZAC-A4 1970 Rear Compressor BracketSEE WEB



ZAC-SB3

ZAC-SB3 1970-77 Front Compressor Bracket....SEE WEB













ZAC-A6

ZAC-A6 1970 Rear Compressor Spacer.....SEE WEB

Air Conditioning Brackets Big Block

OE style reproduction brackets for installing original Delco air conditioning compressors in all 1970-72 Monte Carlos with big blocks using long water pumps.

	ZAC-A1		ZAC-A4		ZAC-B2
ZAC-A1	1970 Rear Compressor Bracket.....SEE WEB	ZAC-A4	1970 Rear Compressor PlateSEE WEB	ZAC-B2	1970+ Front Bracket (on head).....SEE WEB
	ZAC-A2		ZAC-A5		ZAC-B3
ZAC-A2	1970 Front Bracket (on head)..... SEE WEB	ZAC-A5	1970 Lower Bracket (to head).....SEE WEB	ZAC-B3	1970+ Front Compressor Bracket.....SEE WEB
	ZAC-A3		ZAC-A6		ZAC-B4
ZAC-A3	1970 Front Compressor Bracket.....SEE WEB	ZAC-A6	1970 Rear Compressor Spacer.....SEE WEB	ZAC-B4	1970+ Rear Compressor PlateSEE WEB
			ZAC-B1		ZAC-B5
		ZAC-B1	1970+ Compressor to Intake Bracket .SEE WEB	ZAC-B5	1972+ Lower Bracket (to head).....SEE WEB

BUY & SAVE

WITH SS396.COM PRE-BUILT KITS

Buy a complete set of big block air conditioning brackets and save! The design changed midway through 1970, so be sure to check your original brackets for early style (ZAC-AKIT) or late style (ZAC-BKIT).

ZAC-AKIT	1970 BB	SEE WEB
ZAC-BKIT	1970-71 BB.....	SEE WEB
ZAC-BKIT2	1972 BB	SEE WEB

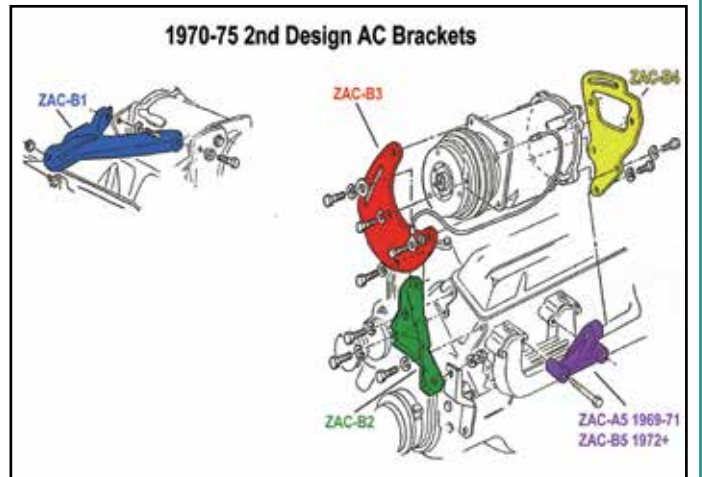
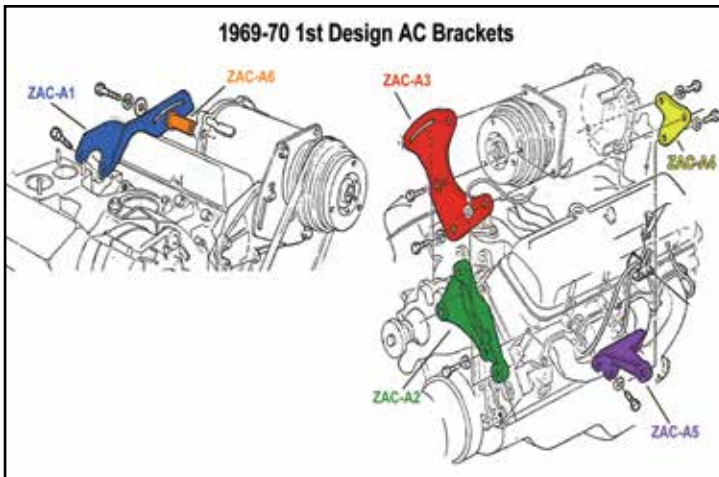



GCS-S6813C

GCS-S6915



Ball Milled Air Cleaner

Highly polished ball milled aluminum 14" air cleaner. Includes washable 3" filter.

- GCS-S6813C Flat BaseSEE WEB
- GCS-S6815C Drop Base.....SEE WEB
- GCS-S6915 Flat Base Flames.....SEE WEB
- GCS-S6905X Drop Base Flames.....SEE WEB

Note: 5-1/8" carb opening. Does not include stud, wing nut or gasket.



GCS-S2194



GCS-S2194C

Retro Style Air Cleaner

This retro style hot rod air cleaner assembly is constructed of steel and is a great inexpensive custom touch to any street machine or sleeper. This filter kit includes a 3" paper air filter and the mounting stud with chrome wing nut.

- GCS-S2194 All BlackSEE WEB
- GCS-S2194C All Chrome.....SEE WEB



GCS-S8005X

Stainless Steel Air Cleaner

Highly polished stainless steel 14" air cleaner. Includes washable 3" filter.

- GCS-S8005X Drop Base Stainless.....SEE WEB
- GCS-10095 Holley BlackSEE WEB
- GCS-10099 Edelbrock BlackSEE WEB

Note: 5-1/8" carb opening. Includes mounting stud and chrome wing nut. Does not include gasket.



GCS-S6723

Finned Aluminum Air Cleaner - Round

Highly polished finned aluminum 14" air cleaner. Includes washable 3" filter.

- GCS-S6723 Flat Base RoundSEE WEB
- GCS-S6725 Drop Base RoundSEE WEB

Note: 5-1/8" carb opening. Includes mounting stud. Does not include wing nut or gasket.



GCS-S6320

Finned Aluminum Air Cleaner - Oval

Highly polished finned aluminum 12" air cleaner. Includes washable 3" filter.

- GCS-S6320 Flat BaseSEE WEB

Note: 5-1/8" carb opening. Includes mounting stud. Does not include wing nut or gasket.



ACQ-1220N

ATE-3907



Open Element Air Cleaner

Excellent reproduction of the original GM open element air cleaner assembly. Complete base with elbow assembly, chrome plated lid and AC Delco filter. Will fit most V8s with 4 bbl. carburetor.

- ATE-3907 Complete KitSEE WEB
- ACQ-1224 Chrome Lid Only 14"SEE WEB
- ACQ-1220N Chrome Lid Only
w/ Service InstructionsSEE WEB
- AAC-8864 Base Only w/ Elbow Assembly....SEE WEB



ACC-569



1970-72 Dual Snorkel Air Cleaner

Reproduction complete with base and chrome lid. Originally equipped on non-cowl induction cars with L78 and L89 engine. Features correct snout with notch and PCV dimple.

- ACC-569 1970-72SEE WEB

Note: Will not work with HEI.



ACQ-1260

Cowl Induction Air Cleaner

Reproduction of original GM including base, lid and filter.

- ACQ-1260 Complete Kit w/ Black LidSEE WEB
- ACQ-1260Z Complete Kit w/ Chrome LidSEE WEB
- ACQ-60 Black Lid Only 14"SEE WEB
- ACQ-1224 Chrome Lid Only 14"SEE WEB

*Will not work with HEI



GCS-S2008

Air Cleaner Risers

CNC machined aluminum air cleaner riser with O-ring.

- GCS-S2008 1/4"SEE WEB
- GCS-S2009 1/2"SEE WEB



ACL-1267

Air Cleaner Rubber Seal

Reproduction rubber seal.

ACL-1267 1970-72 Cowl InductionSEE WEB



ACX-400



Air Cleaner Flange

Correct steel flange for top of air cleaner.

ACX-400 1970-72 FlangeSEE WEB
HOJ-409 1970-72 Decal.....SEE WEB



AP-2B

Air Cleaner Gasket

Correct paper gasket for sealing air cleaner base to carburetor.

AP-2B All 2 bblSEE WEB
AP-4B All 4 bblSEE WEB



ACQ-396



ACQ-454-425

"Turbo Jet" Air Cleaner Lids

Our chrome 14" air cleaner lid (ACQ-1224) featuring high quality die cast "Turbo Jet" medallions.

ACQ-396 396 SEE WEB
ACQ-454 454 SEE WEB
ACQ-396-375 396, 375 Hp SEE WEB
ACQ-454-425 454, 425 Hp SEE WEB
ACQ-454-450 454, 450 Hp SEE WEB

Can be used with open element air cleaners or cowl induction.



APX-1400



APX-7700



ATE-5695



APJ-2153



AP-315



AP-317

Wing Nuts, Flame Arrestor & Studs

APX-1400 Chrome Wing NutSEE WEB
APX-7700 Black Wing NutSEE WEB
ATE-5695 Flame Arrestor.....SEE WEB

Carburetor Studs

APJ-2153 All w/ Holley Open Element.....SEE WEB
AP-315 All w/ Q-JetSEE WEB
AP-315 1970-72 Holley w/ Cowl Induction.....SEE WEB
AP-317 1970-72 Q-Jet w/ Cowl Induction.....SEE WEB
ATE-5256 Universal w/ Point EndSEE WEB



N-1010

Air Filter Reproduction

Reproduction of the original style with "square mesh" design and original GM wording (silk screened) or AC Delco replacement style air filters.

N-1010 1970-72 Horizontal MeshSEE WEB
ACW-212 All 14" AC DelcoSEE WEB

K&N Air Filter Kits

K&N's custom air cleaner assemblies are designed with the racer in mind. They incorporate good looks as well as the superior air flow that you expect from K&N. These custom air cleaner assemblies are designed for use with any engine that uses a round element air cleaner housing. They incorporate K&N Air Filters and provide more air flow than other assemblies of this type. Each complete assembly comes with base, element and top plate. Provides more air flow to the engine, designed to increase horsepower, washable and reusable air filters.



KN-60-1260



KN-66-3060



KN-E3770



KN-99-5000

Chrome Lid Drop Base

KN-60-1280 1970-88 14X3", 1-1/4" Drop Base.....SEE WEB
KN-60-1290 1970-88 14X4", 1-1/4" Drop Base.....SEE WEB
KN-60-1300 1970-88 14X5", 1-1/4" Drop Base.....SEE WEB
KN-60-1310 1970-88 14X6", 1-1/4" Drop Base.....SEE WEB
KN-60-1430 1970-88 14X3", 7/8" Drop BaseSEE WEB
KN-60-1440 1970-88 14X4", 7/8" Drop BaseSEE WEB
KN-60-1450 1970-88 14X5", 7/8" Drop BaseSEE WEB
KN-60-1460 1970-88 14X6", 7/8" Drop BaseSEE WEB

Chrome Lid Raised Base

KN-60-1263 1970-88 14X2 5/16", 9/16" Raised Base.....SEE WEB
KN-60-1264 1970-88 14X3", 9/16" Raised Base .SEE WEB
KN-60-1260 1970-88 14X4", 9/16" Raised Base .SEE WEB
KN-60-1270 1970-88 14X4", 9/16" Raised Base .SEE WEB

X-Stream w/ Dropped Base

KN-66-3050 1970-88 14X3" 7/8" Drop BaseSEE WEB
KN-66-3040 1970-88 14X3", 1-1/4" Drop Base.....SEE WEB
KN-66-3060 1970-88 14X4", 1-1/4" Drop Base.....SEE WEB
KN-66-3070 1970-88 14X5", 1-1/4" Drop Base.....SEE WEB

X-Stream w/ Raised Base

KN-66-3000 1970-88 14X2 5/16", 9/16" Raised Base.....SEE WEB
KN-66-3010 1970-88 14X3", 9/16" Raised Base .SEE WEB
KN-66-3020 1970-88 14X4", 9/16" Raised Base .SEE WEB
KN-66-3030 1970-88 14X5", 9/16" Raised Base .SEE WEB

X-Stream Lid Only

KN-66-1401XB 1970-88 14" w/ Blue Trim RingSEE WEB
KN-66-1401XP 1970-88 14" w/ Chrome Trim Ring ..SEE WEB
KN-66-1401XR 1970-88 14" w/ Red Trim RingSEE WEB
KN-66-1401 1970-88 14" w/ Black Trim RingSEE WEB

Replacement Air Filter Only

KN-E3750 1970-88 14x4 Washable FilterSEE WEB
KN-E3760 1970-88 14x5 Washable Filter.....SEE WEB
KN-E3770 1970-88 14x6 Washable Filter.....SEE WEB

Recharger Care Kits

KN-99-5000 1970-88 w/ Aerosol CanSEE WEB
KN-99-5050 1970-88 w/ Squeeze BottleSEE WEB

No Volume Discount.



ACC-8555

ATE-2101

Kickdown

Correct GM kickdown switch for TH400.

ATE-2101	1970-72 TH400 Switch	SEE WEB
ACC-8555	1970-72 Switch Bracket	SEE WEB
ATE-2101K	1970-72 TH400 Switch Bracket Kit.....	SEE WEB
17565	1971-72 TH400 Harness	SEE WEB



APX-3944K



Vacuum Advance Kits

Our kits come complete with correct pre-bent tapered tube(s), correct white stripe vacuum hose and correct clip.

APX-3944K	1970 BB Q-Jet TCS	SEE WEB
APX-4946K	1970 BB Holley TCS	SEE WEB



APR-4060 AX-301 CPN-100

Vacuum Advance Clips

Correct clip to retain tube to intake manifold.

APR-4060	All V8	SEE WEB
AX-301	1970 w/ TCS	SEE WEB
CPN-100	Hose	SEE WEB



GCS-S4973

Vacuum Advance Cover

This vacuum advance pod cover will give your distributor that show car look. Fits most GM distributors.

GCS-S4973	Chrome	SEE WEB
-----------	--------------	---------

Carburetor Base Gaskets & Shields

Correct "stamped" gasket and stainless steel shield.

Gaskets

AFP-4221	1970-69 4 bbl. Q-Jet.....	SEE WEB
AFP-4219	1970-72 4 bbl. Q-Jet.....	SEE WEB
AFP-4222	1970-72 All Holley	SEE WEB

Shield

ABB-7401	1970-72 All Q-Jet.....	SEE WEB
----------	------------------------	---------



AFP-4221



DEMON-1900



Demon Carburetors

WICKED POWER! The ALL NEW Street Demon® redefines the street carburetor with clean looks and ease of use! The Street Demon offers enthusiasts a straightforward carburetor designed to deliver a stable idle, amazingly crisp throttle response and smooth performance. Its optimized calibration and dual mounting pattern make it Run-Ready™ Designed for use on most stock to mildly modified V8s! These carbs feature vacuum secondaries and an electric choke.

625 CFM Carburetors

DEMON-1900	Silver, w/ Aluminum Float Bowl	SEE WEB
DEMON-1901	Silver, w/ Composite Float Bowl	SEE WEB
DEMON-1901BK	Black, w/ Aluminum Float Bowl	SEE WEB

750 CFM Carburetors

DEMON-1903	Silver, w/ Aluminum Float Bowl	SEE WEB
DEMON-1904	Silver, w/ Composite Float Bowl	SEE WEB

No Volume Discount.



HOL-0-1850SA



Holley Carburetors

Holley is one of the most trusted carburetors of all time! Its 600 CFM of airflow, vacuum secondaries, single fuel inlet and mechanical or electric choke makes it amazingly universal. The 4160 carbs are constructed from aluminum which compared to its zinc counterpart equates to a weight savings of 40%! Being aluminum also means it will hold its shine and can be hand polished for a custom look! Don't trust your performance to just anyone, Holley is the only modular carburetor company that has been in business for over 100 years and has powered every NASCAR champion since the 60's.

HOL-0-1850SA	All 4160 600 CFM Manual Choke	SEE WEB
HOL-0-80457SA	All 4160 600 CFM Electric Choke	SEE WEB
HOL-0-80670	All 4150 670 CFM Electric Choke.....	SEE WEB

No Volume Discount.



"Innovators in fuel systems" is more than just a by-line. Quick Fuel Technology, since it's inception in 1998, has grown exponentially in its 21 years of business culminating into the benchmark by which performance carburetors are measured.

Quick Fuel Technology Carburetors



QF-HR-600



QF-SS-650



QF-Q-750

The Hot Rod Series is a versatile performer designed for the most discerning street enthusiast. Featuring lightweight die-cast aluminum components, the HR-Series offer all the tunability you would expect from more expensive racing carburetors, including changeable bleeds, idle feed, power valve channel restrictions, and four-corner idle. Offered in either vacuum or mechanical secondary models, all Hot Rod Series carburetors feature electric chokes and dual metering blocks for added performance. Now available in a 450 cfm model for applications with small displacement engines.

- All models feature a fully adjustable electric choke for easy starting
- Dual metering blocks w/4-corner idle for smooth and efficient idle quality
- Screw-in air bleeds and idle feed restrictions for quick unsurpassed tuning capability
- Dual inlet fuel bowls with sight glass windows for safe, easy float adjustment
- Universal throttle lever with sealed throttle shafts for smooth operation
- Tunable secondary opening rate
- Tumble polished for long lasting shine

4150 Carburetors Square Bore

QF-HR-600	600CFM Mechanical	SEE WEB
QF-HR-650	650CFM Mechanical	SEE WEB
QF-HR-750	750CFM Mechanical	SEE WEB
QF-HR-850	850CFM Mechanical	SEE WEB
QF-HR-680-VS	680CFM Vacuum	SEE WEB
QF-HR-780-VS	780CFM Vacuum	SEE WEB

No Volume Discount.

Super Street Series carburetors combine street-friendly drivability and track-capable performance in a single value-oriented package. Setting them apart from ordinary street carbs, they feature billet dual metering blocks and throttle-bodies that offer tighter tolerances and eliminate porosity. Not only are Super Street Series carbs available with both vacuum or mechanical secondaries, QFT™ also offers models designed and calibrated specifically for E85 fuel and blow-through forced induction applications. Running alternative fuel or boost no longer requires an expensive custom carburetor. All SS-Series carburetors are equipped with universal throttle levers to accommodate a variety of models. Bolting on the ultimate street/strip carburetor has never been easier.

- Red billet dual metering blocks & silver billet throttle bodies for improved durability
- Changeable idle, high-speed air bleeds & power valve restrictions
- Dual inlet fuel bowls with dual sight glass windows for easy float adjustment
- 4-Corner idle for precise idle and smooth transition
- Fully-adjustable electric choke with easy one wire hookup
- Race-ready with notched secondary floats and jet extensions
- Polished or Black Diamond™ finish available (some models)

4150 Carburetors Square Bore

QF-SS-650	650CFM Mechanical Silver	SEE WEB
QF-SS-750	750CFM Mechanical Silver	SEE WEB
QF-SS-850	850CFM Mechanical Silver	SEE WEB
QF-BD-750	750CFM Mechanical Black	SEE WEB
QF-SS-680-VS	680CFM Vacuum Silver	SEE WEB
QF-SS-780-VS	780CFM Vacuum Silver	SEE WEB

No Volume Discount.

Q-Series Race carburetors are purpose-built for the dragstrip. To combat the g's experienced during hard launches, Q-Series carbs are equipped with notched floats and secondary jet extensions. The high-flow aluminum main body isn't just lightweight, but it also features recessed air bleed cavities for improved air flow. Die-cast venturi are machined to exacting tolerances for outstanding throttle response. Billet metering blocks ensure a uniform fuel curve, while throttle-bodies enhance durability. For those days when track conditions vary from one pass to the next, QFT's QuickLink system makes adjusting the secondaries easy on models equipped with mechanical secondaries. The Q-Series is our most comprehensive line of carburetors, with applications available for use with gasoline, methanol, and E85 fuels, forced induction, drag race, circle track, and comes in both vacuum and mechanical secondary models.

- Lightweight aluminum main body
- Mechanical secondary
- Aluminum fuel bowls with dual sight glass windows
- Billet metering blocks with 4-corner idle system
- Changeable idle feed and power valve channel restrictions
- PTFE coated and sealed shafts that have been slabbed for added air flow
- Red anodized billet metering blocks and throttle plate

4150 Carburetors Square Bore

QF-Q-750	750CFM Mechanical Silver/Red	SEE WEB
QF-Q-750-B2	750CFM Mechanical Silver/Red*	SEE WEB
QF-Q-850	850CFM Mechanical Silver/Red	SEE WEB
QF-Q-950	950CFM Mechanical Silver/Red	SEE WEB
QF-BDQ-750	750CFM Mechanical Black/Black	SEE WEB

*Draw thru supercharger applications with 2 carbs. No Volume Discount.



QF-SL-450-VS



QF-SQ-650



QF-FX-4710

Slayer Series street carburetors are designed with many of the same innovations and features that are built-into all QFT™ race-winning carburetors, including changeable air bleeds and power valve channel restrictions. It's designed with a secondary metering plate with changeable jets, and features all aluminum components for additional weight savings. All Slayer Series carburetors are equipped with universal throttle lever to accommodate a variety of models.

- Vacuum Secondaries - Electric Choke
- Single Metering Block - Secondary Metering Plate
- Cast Aluminum Throttle Body - Single Sight Glass Windows
- Changeable Air Bleeds - Adjustable Needles & Seats
- Adjustable Needles & Seats

4160 Carburetors Square Bore Dual Inlet

QF-SL-450-VS	450CFM Vacuum	SEE WEB
QF-SL-600-VS	600CFM Vacuum	SEE WEB
QF-SL-750-VS	750CFM Vacuum	SEE WEB

4160 Carburetors Square Bore Single Inlet

QF-SL-1957E	600CFM Vacuum Silver	SEE WEB
QF-BD-1957	600CFM Vacuum Black	SEE WEB

No Volume Discount.

Street-Q carburetor is intended to deliver legendary Q-Series performance to hardcore street enthusiasts at a reduced price. The major differences between the Street-Q and the race-bred Q-Series is the substitution of cast metering blocks and a cast throttle body in place of fully-machined billet components. All of the critical functionality is retained - 2-circuit metering, downleg boosters, changeable idle and high-speed air bleeds and 4-corner idle. A universal throttle lever to accommodate a variety of models.

- Lightweight die-cast aluminum components
- Changeable idle and high-speed air bleeds
- 2-circuit metering - 4-Corner idle system
- Downleg boosters
- 700-R4 mounting holes

4150 Carburetors Square Bore

QF-SQ-650	650CFM Mechanical Silver	SEE WEB
QF-SQ-750	750CFM Mechanical Silver	SEE WEB
QF-SQ-850	850CFM Mechanical Silver	SEE WEB
QF-SQ-950	950CFM Mechanical Silver	SEE WEB

No Volume Discount.

QFX-Series stands as the flagship model in QFT's lineup. Raised air horns improve entry angle into the venturi while ensuring undisrupted flow over the air bleeds. Annular boosters with CNC-machined billet aluminum inserts provide increased air flow, a stronger signal, and less turbulence. QFX carbs offer unparalleled fuel atomization with annular boosters specific for either gas, methanol, or E85 fuels. Five-emulsion billet metering blocks and four-corner idle circuits offer flexible tunability that today's high-horsepower engines demand. Ready to run out of the box, the QFX-Series carburetor will help you get to the winner's circle.

- QFX aluminum main body w/ raised venturi
- Billet aluminum metering blocks with screw in restrictions
- Aluminum fuel bowls with dual sight windows and fuel inlets
- Viton .130" Needles and Seats
- Billet Aluminum annular booster inserts
- QuickLink™ adjustable secondary opening adjustment
- Hand assembled and engine tested

4500 Spread Bore Dominator Style

QF-FX-4710	1150CFM Mechanical Black/Black	SEE WEB
------------	--------------------------------	-------	---------

No Volume Discount.



BTE-1475



BMG-0095

Carb Attaching Kits

Correct OEM bolt kit for attaching carburetor to intake manifold.

- BMG-0095 All w/HolleySEE WEB
- BTE-1475 All w/Q-JetSEE WEB



AHL-516

Carburetor Inlet Nuts

Correct Holley carb fuel inlet nuts & washers.

- AHL-516 5/16" (stock)SEE WEB
- AHL-38 3/8"SEE WEB



GCS-S2105

Carburetor Velocity Stack

High grade, chrome plated steel with a washable filter element.

- GCS-S2105 Most 4 bblSEE WEB

Note: 5 1/8" carb opening.



MS142-08R



MS142-08CA

EMS Billet Throttle Cable Brackets

These Eddie Motorsports billet GM throttle cable brackets mount to the base of Holley carburetors. The kit includes the cable mount bracket, return springs and bracket and installation hardware.

With 4150/4160 Series Carburetor

- MS142-08B 1970-77 BlueSEE WEB
- MS142-08R 1970-77 RedSEE WEB
- MS142-08BA 1970-77 Black AnodizedSEE WEB
- MS142-08CA 1970-77 Clear AnodizedSEE WEB

With 4500 Series Carburetor

- MS142-09B 1970-77 BlueSEE WEB
- MS142-09R 1970-77 RedSEE WEB
- MS142-09BA 1970-77 Black AnodizedSEE WEB
- MS142-09CA 1970-77 Clear AnodizedSEE WEB

No Volume Discount.



1114432

TCS Solenoid

Correct TCS solenoids which mount to the carburetor stud. Includes correct brackets.

- 1114432 1970-71 350/400SEE WEB
- 1114434 1970 BBSEE WEB



3992376



3972619

Accelerator Brackets

Your choice of brackets with GM numbers or without GM numbers. Both fit as original.

- 3992376 1970-72 Q-Jet w/ GM NumbersSEE WEB
- 3972619 1970-72 Holley w/ GM NumbersSEE WEB
- AXK-68 1970-72 Q-Jet w/o GM NumbersSEE WEB
- ADT-0014 1970-72 Holley w/o GM NumbersSEE WEB

ATH-3369KIT-H



Accelerator Cable & Bracket Kit

This new accelerator cable and bracket kit is the perfect solution for smooth operation when your originals are either worn or missing. This kit includes a reproduction accelerator cable, bracket and retaining clip.

- ATH-3369KIT-H 1970-72 All BB/SB w/ SHP HolleySEE WEB

No Volume Discount.



ATH-3369



AXJ-CE



AZC-88

Accelerator Cables

Choose from GM service replacement cables or new reproductions complete with casings and bushings as original.

- ATH-3863 1970-72 SB 2 bbl GMSEE WEB
- ATH-2679 1970-72 SB 4 bbl GMSEE WEB
- ATH-3862 1970-72 BB Q-Jet GMSEE WEB
- ATH-3369 1970-72 BB Holley GMSEE WEB
- 336969R 1970-72 Repro for HolleySEE WEB
- 3972679R 1970-72 Repro for Q-JetSEE WEB
- AZC-88 1970-72 Cable Clip GMSEE WEB
- AXJ-CE Cable DecalSEE WEB



ACS-7454



ACS-0069



ATE-0068

Carb Return Springs

New correct color coded springs.

- ACS-7454 1970-72 Holley L78 LS6SEE WEB
- ACS-0069 1968-69SEE WEB
- ATE-0068 1970-72 Q JetSEE WEB

BUY & SAVE

WITH SS396.COM PRE-BUILT KITS

CPX-9038



PCV Hose & Filter Kit

Complete with hose, filter and black pinch clamp. Pieces also available separately.

- CPX-9038 1970-72 CompleteSEE WEB
- CPH-9038 Hose OnlySEE WEB
- CTC-1132 Pinch Clamp OnlySEE WEB
- CAC-3800 PCV Filter OnlySEE WEB



3963569

Intake Manifold

This is a reproduction intake manifold with the correct W Snowflake for your Special High Performance engine!

- 3963569 1970 BB Low Rise LS6 / L78 / L89SEE WEB

No Volume Discount.



WND-8120WND

Weiland Street Warrior Intake Manifolds

The Weiland Street Warrior is designed for use on stock or stroker combinations that feature efficient cylinder heads. The latest advances in cam design necessitated the design of a new intake manifold, and the Weiland Street Warrior manifolds fill that void.

Square Bore Carburetors

- WND-8120WND Small Block w/ 55-86 HeadsSEE WEB
- WND-8121 Small Block w/ Vortec HeadsSEE WEB

No Volume Discount.



WND-8150

Weiland Speed Warrior Intake Manifolds

The Weiland Speed Warrior features long, separated runners for bottom-end and mid-range power, plus a special runner design and larger plenum to flow the air needed for high-rpm horsepower. All of this usable power makes this intake perfect for your street and strip hot rod!

- WND-8150 Small Block w/ 55-86 HeadsSEE WEB
- WND-8170WND Small Block w/ 87-95 HeadsSEE WEB

No Volume Discount.



BPS-3679



BPS-7432

Intake Studs

Correct intake manifold studs for various uses: alternator, solenoid and power brake tube. Includes correct nut.

BPS-3679 All 3/8" x 3/8" (Zinc).....SEE WEB
(p.s. bracket, alternator mount, etc.)

BPS-7432 All 5/16" x 3/8" (Black)SEE WEB
(TCS, P.B. tube, etc.)



APN-0138



APN-0238



APN-0038



APN-638



APN-738



APN-838

Intake Manifold Vacuum Fittings

Reproduction!! These high quality fittings for rear of intake manifold have correct "slip on" and threaded ends. These fittings have a variety of uses: power brake hose, auto transmission, air conditioning, cruise control, etc. Guaranteed to look, fit and function exactly as original.

- APN-0138 (1) Slip On Fitting.....SEE WEB
- APN-0238 (2) Slip On Fittings.....SEE WEB
- APN-0038 (1) Threaded PortSEE WEB
- APN-638 (1) Threaded (1) Slip OnSEE WEB
- APN-738 (1) Threaded (2) Slip OnSEE WEB
- APN-838 (1) Threaded (3) Slip OnSEE WEB



BPI-2271

Intake Manifold Bolts OEM

Our OEM intake bolts feature correct size, coloring and head markings.

- BPI-4400 All SB "M" Flanged (12pc) SEE WEB
- BPI-9140 All BB "M" Cast Intake (16 pc.) ...SEE WEB
- BPI-2271 All BB "A" Aluminum Intake (16 pc.).....SEE WEB



ACT-180

Thermostat

High quality replacement thermostat.

- ACT-180 180-85 Degrees.....SEE WEB
- ACT-190 190-95 Degrees.....SEE WEB



Tuff Stuff Performance Thermostats

These thermostats flow up to 56 gallons per minute, as compared to ordinary thermostats that flow 37 gallons per minute, to maintain stated temperature. The 50 percent increased coolant flow reduces the delay in engine warm-up times, allowing trapped air in the cooling system to escape and stabilize the pressure of the cooling system. The stainless steel construction with an extra-large center port assures increased coolant flow and bridge design increases strength, stability & reliability and incorporates a bypass valve that allows a small amount of coolant to circulate before fully opening, assuring a fast warm-up. Ideal for high performance muscle cars, street rods and customs.

- TUF-900160 160 Degree SEE WEB
- TUF-900180 180 Degree SEE WEB
- TUF-900195 195 Degree SEE WEB

No Volume Discount.



ACI-7660

Thermostat Housing

Correct thermostat housing for high performance engines with aluminum intake manifolds. GM #3877660.

- ACI-7660 Aluminum.....SEE WEB



ABR-7660

Thermostat Housing

Correct thermostat housing for cast iron manifolds. This was the most common housing and was found on most V8s.

- ABR-7660 Most V8SEE WEB
- GCS-S9468 Most V8, 1/2" NPT PortSEE WEB



GCS-S9229

Chrome Thermostat Housing

Chrome steel thermostat housing with o-ring and bolts. Water neck points toward the driver side of the radiator.

- GCS-S9229 Most V8SEE WEB



ATR-2039



ATR-1039

Thermostat Housing Bolts

Correct TR head marked bolts for attaching to intake.

- ATR-1039 1970-72 SBSEE WEB
- ATR-2039 1970-72 BBSEE WEB



GAC-560



GAC-760



GAC-660

Temp Sending Units

Correct screw in sending units.

- GAC-250 1970-72 w/o Gauges.....SEE WEB
- GAC-560 1970-72 w/ Gauges*.....SEE WEB
- GAC-760 1970 w/ Gauges..... SEE WEB
- GAC-660 1970-72 TCS Sender**.....SEE WEB

**Can be used with CPX-999 harness. **Correct 2 prong sending unit mounts on right side cylinder head.*



ABR-1002

AC Delco Water Pumps

Brand new AC Delco water pumps.

- ABR-1109 1970-72 SB (Long Style).....SEE WEB
- ABR-1002 1970-72 BB (Long Style)SEE WEB



ATR-4334

Water Pump OEM Attaching Bolt Kits

Correct style attaching bolts with "TR" head markings.

- ATR-4334 1970-72 All 4 Bolts M Mark.....SEE WEB
- AWS-301S Stud Only (Short)SEE WEB
- AWS-302L Stud Only (Long)SEE WEB

Tuff Stuff Water Pumps

Tuff Stuff water pumps are available in multiple different finishes. Available in standard flow or high flow (Super Cool) version for high power applications. Also available in "Smoothie" version, which features flat top casting with no top water port or plug.

Small Block

TUF-1449NA	1970+ Long Style, Chrome.....	SEE WEB
TUF-1511NC	1970+ Long Style, Platinum, Cast Finish.....	SEE WEB
TUF-1449N	1970+ Long Style, SC, Cast Finish.....	SEE WEB
TUF-1449NC	1970+ Long Style, SC, Black.....	SEE WEB
TUF-1449NB	1970+ Long Style, SC, Chrome.....	SEE WEB
TUF-1448NC	1970+ Long Style, SC, Smoothie, Cast Finish.....	SEE WEB
TUF-1448NB	1970+ Long Style, SC, Smoothie, Polished Alum.....	SEE WEB
TUF-1448NA7	1970-77 Long Style Smoothie Black Chrome.....	SEE WEB

Big Block

TUF-1461NA	1970+ Long Style, Chrome.....	SEE WEB
TUF-1461N	1970+ Long Style, SC, Cast Finish.....	SEE WEB
TUF-1461NC	1970+ Long Style, SC, Black.....	SEE WEB
TUF-1459NA7	1970-77 Long Style Smoothie Black Chrome.....	SEE WEB
TUF-1448NA7	1970-77 Long Style, SC, Smoothie Black Chrome.....	SEE WEB

No Volume Discount.

TUF-1448NA7



TUF-4450A



Tuff Stuff Chrome Heater Hose/Bypass Nipples

Chrome plated heater hose/bypass hose fittings.

TUF-4450A	3/4" Long.....	8.95 ea.
TUF-4450B	3/4" Short.....	8.95 ea.
TUF-4450C	5/8" Short.....	8.95 ea.



CPH-1672



Water Pump Bypass Hose Kits

Correct OEM GM marked bypass hose with correct clamps.

CPH-1672	1970-72 BB (Ribbed).....	SEE WEB
CPH-034	1970-72 BB Clamp (NOS).....	SEE WEB

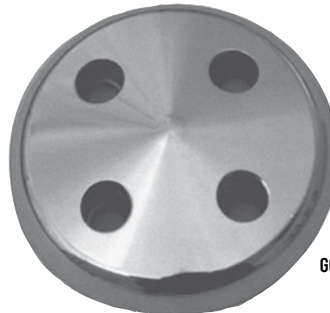

GCS-S9489

Water Pump Pulley Nose

Finish off your pulley set in style with this show quality nose. Bolts to the front of your water pump pulley when using electric fans.

GCS-S9489	LWP, Satin.....	SEE WEB
GCS-S9489POL	LWP, Polished.....	SEE WEB

LWP = Long Water Pump.



GCS-S9482



GCS-S9482POL



AWP-949



AWP-1394

Water Pump Pulley

Reproduction original water pump pulleys.

AWP-796	1970+ All V8 (1 Groove).....	SEE WEB
AWP-1394	1970+ BB (1 Groove Deep).....	SEE WEB
AWP-949	1970+ All (2 Groove w/ AC).....	SEE WEB
AWP-6060	1970-72 LS6 Deep.....	SEE WEB

Billet Water Pump Pulleys

These show quality billet aluminum water pump pulleys will set your show car apart from the crowd. Made of high quality aircraft aluminum.

GCS-S9482	SB, LWP, 1 Groove, Satin.....	SEE WEB
GCS-S9482POL	SB, LWP, 1 Groove, Polished.....	SEE WEB
GCS-S9604	SB, LWP, 1 Groove, Chrome.....	SEE WEB
GCS-S9483	SB, LWP, 2 Groove, Satin.....	SEE WEB
GCS-S9483POL	SB, LWP, 2 Groove, Polished.....	SEE WEB
GCS-S9605	SB, LWP, 2 Groove, Chrome.....	SEE WEB
GCS-S8844	BB, LWP, 2 Groove, Satin.....	SEE WEB
GCS-S8844POL	BB, LWP, 2 Groove, Polished.....	SEE WEB
GCS-S9723	BB, LWP, 2 Groove, Chrome.....	SEE WEB
GCS-S0005	Tapered Seat Bolts.....	SEE WEB

LWP = Long Water Pump.



AHQ-1396



ACP-330

Crank Pulleys

All pulleys are original GM or the highest quality reproductions on the market. Each pulley is finished in factory matte black like the originals.

ACP-414	1970-72 SB 3 Groove LWP.....	SEE WEB
NQ-457	1970-72 350 2 Groove Deep LWP.....	SEE WEB
AHQ-1396	1970-72 396 2 Groove Deep LWP.....	SEE WEB
ACP-330	1970-72 396/454 3 Groove w/ AC LWP.....	SEE WEB
ACP-404	1970-72 SB 2 Groove LWP.....	SEE WEB

*Without Power Steering

**For all with power steering use with ADP-61



BFC-333

Crank Pulley OEM Attaching Bolt Kit

BFC-333	All w/ Fine Thread.....	SEE WEB
BRB-100	All w/ Coarse Thread.....	SEE WEB



BPB-5933



BPB-5934

Harmonic Balancer Attaching Bolt-Washer

BPB-5933	1970-72 Most SB.....	SEE WEB
BPB-5934	1970-72 All BB.....	SEE WEB



ASM-10A



ASM-20M

Starter Motor

We carry original AC Delco USA re-manufactured starter motors complete with warranty. No core charge.

ASM-10A	1970-72 SB Auto.....	SEE WEB
ASM-10M	1970-72 SB Manual.....	SEE WEB
ASM-20A	1970-72 BB Auto.....	SEE WEB
ASM-20M	1970-72 BB Manual.....	SEE WEB

No Volume Discount.



TUF-6550B

Tuff Stuff Gear Reduction Starters

These gear reduction starters will allow you to easily crank over your high performance engine. They use less draw than traditional replacement starters and gear reduction allows them to crank over engines with higher compression. These starters will work on both Small Block Monte Carlo and Big Block Monte Carlo Engines using 153 or 168 tooth flywheels. Please be sure to check your flywheel tooth count before ordering.

TUF-6550B	1.6 H.P., 11:1 Compression, White Zinc.....	SEE WEB
TUF-6550A	1.6 H.P., 11:1 Compression, Chrome.....	SEE WEB
TUF-6584B	1.9 H.P., 12:1 Compression, Black.....	SEE WEB
TUF-6772B	2.6 H.P., 18:1 Compression, Black.....	SEE WEB
TUF-3193NB	3 H.P., 18:1 Compression, White Zinc.....	SEE WEB
TUF-3510A	1.9 H.P., 18:1 Compression, Chrome*.....	SEE WEB
TUF-3510B	1.9 H.P., 18:1 Compression, Black*.....	SEE WEB

*Offset mounting bolts, 168 tooth flywheel only.



TUF-7629

Tuff Stuff Hot Start Remote Solenoid Kit

Give your starter an extra 12V boost with these hot start kits from Tuff Stuff! This kit is designed to eliminate hot start problems that are common with starter-mounted solenoids. Ideal for GM full-size OEM starters.

TUF-7629	1970-88 All.....	SEE WEB
----------	------------------	---------

No Volume Discount.

BV-2070



BV-2072



BV-2074



Starter Motor Bolts OEM

Correct "Knurled" bolts for attaching starter motor to block.

BV-2070	SB 3/8-16 x 1 7/8" (Short).....	SEE WEB
BV-2072	BB 3/8-16 x 3 5/8" (Long).....	SEE WEB
BV-2074	3/8-16 x 4 11/16" (X-Long).....	SEE WEB



APX-1443

Starter Heat Shield

Correct starter heat shield for most BB.

APX-1443	All BB.....	SEE WEB
----------	-------------	---------

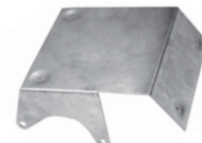

GCS-S6077

Satin Finish Starter Heat Shield

Protect your starter in style with this satin aluminum starter heat shield.

GCS-S6077	Satin.....	SEE WEB
-----------	------------	---------

Note: May require some custom fitting. May not clear larger starters.



ATE-4353



ABB-9655

Starter Motor Brace

Correct brace for attaching starter to block.

- ATE-4353 1970-72 SB w/o 350.....SEE WEB
- ATW-2516 1970-72 SB 350.....SEE WEB
- ABB-9655 1970-72 All BB.....SEE WEB
- AP0-516 Attaching Screw.....SEE WEB



ABB-5790



ABN-105

Alternator Pulleys

- ABB-5799 Standard (2-3/4" OD).....SEE WEB
- ABB-5790 All w/ SHP (3-1/4" OD) Deep.....SEE WEB
- ABN-105 Correct Retaining Nut.....SEE WEB



APX-1724



APX-2559



AVC-1144

Alternator Accessories

- APX-1724 All Fan w/ Nut.....SEE WEB
- AVC-1144 1970-72 Pigtail.....SEE WEB
- APX-2559 Rear Alternator Boot.....SEE WEB



BN-339

- BN-339 1970-72 BB Lower Stud/Nut.....SEE WEB
- BRB-938 1970-72 SB Lower Bolt.....SEE WEB

Alternator Hardware

All of the correct hardware needed to mount your alternator!



APX-1138

- APX-1138 1970-72 SB Spacer Brace.....SEE WEB



APX-1038

- APX-1038 1970-72 BB Spacer/Brace.....SEE WEB



AWB-1114

- AWB-1114 1970-72 Upper Adjustment Kit w/ W Bolt.....SEE WEB



AW-506

- AW-506 1970-72 Neg Cable Ground Bolt/Washer.....SEE WEB



ABC-23

- ABC-23 1970-72 Battery Cable Clip SB.....SEE WEB

For top of alternator



ATE-5416

- ATE-5416 1970-72 Heater Hose RetainerSEE WEB

For top of alternator



TUF-7127ND

Tuff Stuff Internally Regulated Alternators

Designed to handle the demand for power needed for today's electronics, Tuff Stuff's high powered internally regulated alternators are perfect if you have added a set of high powered headlights or a high powered stereo system or any other electronic systems to your Monte Carlo. Although meant for 1971 and newer internally regulated set ups, they can be used on older models that have been converted from external to internally regulated.

- TUF-7127NB 80 Amp, 1 Wire, Chrome.....SEE WEB
- TUF-7127D 100 Amp, 1 Wire, Cast Finish.....SEE WEB
- TUF-7127NF 100 Amp, 1 Wire, Black.....SEE WEB
- TUF-7127ND 100 Amp, 1 Wire, Chrome.....SEE WEB
- TUF-7127NDP 100 Amp, 1 Wire, Polished Aluminum.....SEE WEB
- TUF-7127K 140 Amp, 1 Wire, Cast Finish.....SEE WEB
- TUF-7127NK 140 Amp, 1 Wire, Chrome.....SEE WEB
- TUF-7139ABULL 100 Amp, Silver Bullet, 1 Wire, Chrome.....SEE WEB
- TUF-7140FBULL 140 Amp, Silver Bullet, 1 Wire, Black.....SEE WEB
- TUF-7140ABULL 140 Amp, Silver Bullet, 1 Wire, Chrome.....SEE WEB
- TUF-7127ND7 100 Amp 1 Wire Black Chrome V-Belt.....SEE WEB
- TUF-7127ND6G7 100 Amp 1 Wire Black Chrome Serpentine Belt.....SEE WEB
- TUF-7139ABULL7 100 Amp Silver Bullet 1 Wire Black ... Chrome V-Belt.....SEE WEB
- TUF-7139ABULL6G7 100 Amp Silver Bullet 1 Wire Black ... Chrome Serpentine Belt.....SEE WEB
- TUF-7127NK7 140 Amp 1 Wire Black Chrome V-Belt.....SEE WEB
- TUF-7127NK6G7 140 Amp 1 Wire Black Chrome Serpentine Belt.....SEE WEB
- TUF-7140ABULL7 140 Amp Silver Bullet 1 Wire Black ... Chrome V-Belt.....SEE WEB
- TUF-7140ABULL6G7 140 Amp Silver Bullet 1 Wire Black ... Chrome Serpentine Belt.....SEE WEB

Tuff Stuff Alternator Accessories

- TUF-7500A Chrome Alternator Case Kit.....SEE WEB
- TUF-7600A Chrome Fan and Pulley Kit, Single Groove.....SEE WEB
- TUF-7600B Chrome Fan and Pulley Kit, Double Groove.....SEE WEB
- SEE WEB
- TUF-7610E Chrome Alternator Pulley, Single Groove.....SEE WEB



TUF-7102



TUF-7102NF



TUF-7102NA

Tuff Stuff Externally Regulated Alternators

All Tuff Stuff alternators are hand built-in Cleveland, Ohio and are tested to meet or exceed OEM specifications. All Tuff Stuff alternators are made from 100% new components and carry a one year limited warranty. All alternators are for 12 volt, negative ground systems, except where noted.

TUF-7102	80 Amp Cast Aluminum V-Belt	SEE WEB
TUF-7102NA	80 Amp Chrome V-Belt.....	SEE WEB
TUF-7102NAP	80 Amp Polished Aluminum V-Belt	SEE WEB
TUF-7102NF	80 Amp Black V-Belt	SEE WEB
TUF-7102NC	100 Amp Chrome V-Belt	SEE WEB
TUF-7102NCP	100 Amp Polished Aluminum V-Belt	SEE WEB
TUF-7102NE	100 Amp Black V-Belt	SEE WEB
TUF-7102NFBW	100 Amp Black Wrinkle V-Belt	SEE WEB
TUF-7102NKBW	140 Amp Black Wrinkle V-Belt	SEE WEB

No Volume Discount.

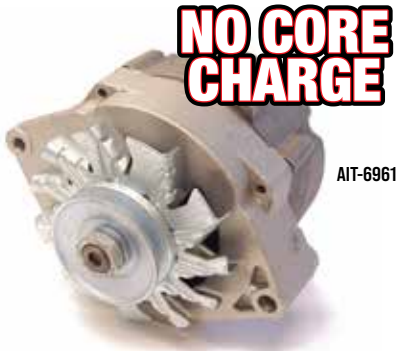

AIT-6961

Alternators

Rebuilt alternator made in the USA. Each alternator is 100% tested and rebuilt to exceed OEM specs.

AIT-6961	41 Amp External Reg	SEE WEB
AIT-6963	55 Amp External Reg	SEE WEB
AIT-3342	63 Amp Internal Reg	SEE WEB

No Volume Discount.



TUF-7520A



TUF-7520B

Tuff Stuff Alternator Pigtails

Replace worn or broken alternator connectors with Tuff Stuff's replacement pigtails to eliminate any electrical issues. These will fit factory alternators.

TUF-7520B	Externally Regulated 10DN	SEE WEB
TUF-7520A	Internally Regulated 10SI	SEE WEB



GCS-S6679

Alternator Dress Up Kit

This kit is designed to take your stock internally regulated alternator and make it show ready. This kit includes a chrome alternator case, pulley, fan and hardware.

GCS-S6679	1973-85 GM	SEE WEB
-----------	------------------	---------

Note: For 1973-85 internal regulated alternators only.



GCS-S9487

Billet Alternator Pulleys

Show quality billet alternator pulleys.

GCS-S9487	1 Groove, Satin	SEE WEB
GCS-S9487POL	1 Groove, Polished	SEE WEB
GCS-S9447	2 Groove, Chrome	SEE WEB



GCS-S8867

Billet Alternator Fan

Polished billet aluminum.

GCS-S8867	Polished	SEE WEB
-----------	----------------	---------



GCS-S9446

Chrome Alternator Fan w/ Pulley

Chrome plated steel OEM style alternator fan with chrome single groove pulley. Includes nut.

GCS-S9446	Chrome.....	SEE WEB
-----------	-------------	---------



APX-ALT-CAP

Alternator Positive Terminal Cap Red

This is a new reproduction red plastic GM style alternator positive terminal cap and retainer kit. Check alternator to cylinder head clearance before ordering. Some applications are tight.

APX-ALT-CAP	1970-88.....	SEE WEB
-------------	--------------	---------

OE Style Chrome Alternator Brackets

High quality brackets will give your show car that finishing touch!



GCS-S9316 SB Upper LWP (69-75).....SEE WEB



GCS-S9317 SB Upper LWP (76-86)SEE WEB



GCS-S9637 SB Lower LWP (69-75)SEE WEB



GCS-S9318 BB Upper LWP (69-92)SEE WEB



GCS-S9638 BB Lower LWP (69-92).....SEE WEB



GCS-S9254 Bracket for HeadersSEE WEB

LWP = Long Water Pump.



AJ-408

Timing Covers

New covers complete with crankshaft seal.

- AJ-408 1970-76 All Small BlockSEE WEB
- AJ-850 1970-72 All Big BlockSEE WEB
- BTC-650 Correct Attaching Bolts.....SEE WEB

Custom Style Alternator Brackets

These chrome plated steel alternator brackets will give your engine a unique custom look that will stand out from the crowd.



GCS-S9320 V8 Upper LWP (69-75).....SEE WEB



GCS-S9321 SB Upper LWP (76-86)SEE WEB



GCS-S1637 SB Upper LWP (76-86)SEE WEB



GCS-S1647 BB Upper LWP (69-92)SEE WEB

Small/Big Block Alternator Brackets

OE style reproduction alternator brackets for your small or big block Monte Carlo.



ACE-5333 1970-72 SB LowerSEE WEB



ACE-2956 1970-72 SB UpperSEE WEB



AK-173 1970-72 BB UpperSEE WEB



AK-175 1970-72 BB LowerSEE WEB



AKK-301

BUY & SAVE
WITH SS396.COM PRE-BUILT KITS

Big Block Alternator Mounting Kit

Reproduction of upper-lower brackets, lower mounting stud, lower spacer-brace and upper adjustment bolt w/ special washer.

AKK-301 1970-72 All BBSEE WEB



GCS-S4935

Chrome Timing Covers

Brilliantly polished timing cover with a rigid sealing surface.

- GCS-S4934 SB LWP ChromeSEE WEB
- GCS-S4935 BB All Chrome.....SEE WEB
- GCS-S4935R BB All Unfinished SteelSEE WEB

Note: These covers may not work with some double roller timing chains. Check clearance before starting engine. Doubling of the gaskets or shims may be required to use cover with a short water pump. LWP = Long water pump.



GCS-S6040C

2 Piece Aluminum Timing Covers

An excellent upgrade for your engine. Rigid sealing surface for positive seal and it looks great, too!

- GCS-S6040 SB Polished BilletSEE WEB
- GCS-S6040C SB Chrome Billet.....SEE WEB
- GCS-S8422 BB Polished BilletSEE WEB
- GCS-S8422C BB Chrome BilletSEE WEB

Note: These covers may not work with some double roller timing chains. Check clearance before starting engine. Doubling of the gaskets or shims may be required to use cover with a short water pump.



ATP-07

Timing Cover Pointers

Correct pointer for adjustment of engine timing.

- ATP-36 1970-72 SBSEE WEB
- ATP-47 1970-72 SB w/ 7" Bal.....SEE WEB
- ATP-07 1970-72 BB SHP w/ 8" Bal.....SEE WEB



GCS-S4961

Chrome Adjustable Timing Pointers

Provides a convenient way to adjust and verify your engines ignition timing. Finished brilliant chrome plated steel.

- GCS-S9178 SB 7"SEE WEB
- GCS-S9179 SB 8"SEE WEB
- GCS-S4961 BB 8"SEE WEB
- GCS-S9180 BB 8" AdjustableSEE WEB



GCS-S6041

GCS-S6042C

SB Billet Timing Cover Pointer

Provides a convenient way to adjust and verify your engine's ignition timing. Adjustable and can be used with 6" or 7" balancers.

- GCS-S6041C Chrome Plated Billet.....SEE WEB
- GCS-S6042 Ball MilledSEE WEB
- GCS-S6042C Ball Milled Chrome.....SEE WEB
- GCS-S4960 Chrome Plated Steel.....SEE WEB
- GCS-S6041 BilletSEE WEB



GCS-S2083

Chrome Holley Carburetor Throttle Return Kit

Designed to make mounting the spring a snap! Works on most Holley carburetor applications.

- GCS-S2083 Holley.....SEE WEB
- Note: Due to the universal nature of this part fitting and/or modifications may be required.*



ACE-1400

Distributor Hold Down

Correct retaining hardware for distributors.

- ACE-1400 All V8SEE WEB



GCS-S5116

Custom Distributor Hold Down Kit

Designed to secure your distributor settings and look good doing it. Choose from chrome or billet.

- GCS-S4116 ChromeSEE WEB
- GCS-S5116 BilletSEE WEB



GRC-12835

Radio Capacitor

Came from the factory on all cars with radio. Correct length lead wire & brass connector. Stamped 1970452 "DR" & ".3MF" as original.

- GRC-12834 1970-71 Voltage Regulator.....SEE WEB
- GRC-12835 1970-74 Coil.....SEE WEB



N-2441

Tune Up Kit

Tune up kit with new points, condenser and rotor.

- N-2441 1970-72 All.....SEE WEB



ALI-3119



BAN-516

Coil Bracket

Reproduction of original comes with retaining screw.

- ALI-3119 All V8.....SEE WEB
- BAN-516 Correct SEMS Bolts.....SEE WEB



A-193

Starter Solenoid Wire Clip

Correct clip for retaining wire harness to solenoid.

- A-193 1970-72 All V8.....SEE WEB



GCS-S9366

Chrome Ignition Coil Bracket

This brightly chrome plated ignition coil bracket will look great in your engine compartment. Fits most round cylinder style ignition coils.

- GCS-S9366 Coil Bracket.....SEE WEB



GCS-S3112

HEI Distributor Pigtail

- GCS-S3112 All.....SEE WEB



1971244

Distributor Cap

Choose from AC Delco replacement distributor cap or reproduction distributor cap with GM numbers.

- 1971244 GM Black Cap79.99 ea.
- AAD-308 Replacement22.95 ea.



ADS-2100-SC-CLEAR



ADS-2100-SC-RED

HEI Distributor

Chrome aluminum HEI electronic distributor w/ built-in 50K coil.

- ADS-2100 All V8..... SEE WEB
- ADS-2100-SC-RED All V8, Red Super Cap SEE WEB
- ADS-2100-SC-CLEAR All V8, Clear Super Cap SEE WEB
- GCS-S3938-BLUE I6 Blue Super Cap* SEE WEB

* For 292 Inline 6 cyl. only.



ACCEL-59107

Accel Replacement HEI Distributor

Using all new components, these distributors feature: High performance ACCEL Electronics. All new components-housing castings, ce. Direct plug in replacement with factory type connector. Fits standard deck height small and big block engines. Coil Not Included!

- ACCEL-59107 All w/ HEI SEE WEB

No Volume Discount.



MSD-8362

MSD HEI Distributor

For value conscious enthusiasts, the Street Fire HEI is a great choice! We know the importance of a centrifugal advance in a distributor so our engineers made sure that the Street Fire received an advance assembly with coated weights and welded weight pins (not just pressed in like other models). Another area that you cannot afford to scrimp on is with a distributor gear. The Street Fire is fit with the same gear that is used on our Pro-Billet models. The metallurgy of this gear has been refined for years to perform through the harshest conditions

- MSD-8362 All, Red Cap 4 Pin* SEE WEB
- MSD-8365 All Billet, Red Cap 4 Pin* SEE WEB

Note: Standard deck height blocks only. Will not fit gen 5 and 6 big blocks. *Refers to the amount of terminals on the ignition module. No Volume Discount.



MSD-8360



MSD Pro Billet Distributor

The Pro-Billet Ready-to-Run distributor is the perfect upgrade for outdated points distributors or bulky HEIs. Simply install the distributor in the engine, connect three wires, the coil, and fire it up!

- MSD-8360 Monte Carlo V8* SEE WEB
- MSD-85551 Monte Carlo V8** SEE WEB

*Does not have nor can accept a vacuum advance canister.

**Must be used with a MSD 6,7, or 8 ignition box.

Note: Standard deck height blocks only. Will not fit gen 5 and 6 big blocks. No Volume Discount.



Mallory Unilite Distributor

A legend returns - the tried and true Mallory Unilite Distributor line is back! The easy three wire hookup of the Unilite makes running a stock coil, a Mallory performance coil and even a Mallory HyFire CD ignition a snap. Supplied with a quality cap and rotor, the Mallory Unilite also provides a fully adjustable mechanical advance to dial in the perfect timing curve for a multitude of engine combinations. The Unilite features a compact housing that lends itself well to applications where space is a premium due to tight firewall clearance or blower applications.

- MAL-3748201 All SBC, BBC* SEE WEB

*Standard deck height blocks only. Will not fit gen 5 and 6 big blocks. No Volume Discount.



MSD-6201



MSD Ignition

An MSD Ignition will improve the overall performance of your engine thanks to its high output capacitive discharge sparks. Below 3,000 rpm the ignition delivers multiple sparks that will clean up the idle, improve starting and throttle response. If you're looking to improve the performance of your modified mill, we have the answer. Whether you've done a cam swap, or bolted on a carb, intake and headers the 6A is a surefire way to harness all the ponies under your hood. Step up to the 6AL to have an engine saving rev limiter.

- MSD-6201 Red All 6A SEE WEB
- MSD-6425 Red All 6AL SEE WEB
- MSD-64253 Black All 6AL SEE WEB
- MSD-6421 Red All 6AL-2 SEE WEB

No Volume Discount.



Detail

Coil

Choose from our new reproduction Delco coils with GM numbers or GM replacement coil.

- 1115287 1970-72 BB SEE WEB
- 1115270 1970-72 SB SEE WEB
- 1115263 1970-72 Trans. Ignition.* SEE WEB
- 1115293 1970-72 Most V8 SEE WEB
- GAC-505 1970-72 All Replace SEE WEB

*427/454 transistor ignition. No Volume Discount.



GCS-S2039BK

External Ignition Coils

Choose from our upgraded external ignition coils. 45,000-volt output. Anodized finish, includes pigtailed and hardware for installation.

- GCS-S2039BK All, Black SEE WEB
- GCS-S2039BLU All, Blue SEE WEB
- GCS-S2039C All, Chrome SEE WEB
- GCS-S2039RED All, Red SEE WEB

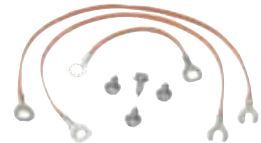

APJ-5240

Ground Strap Kit

Correct braided copper wire and ends complete with OEM screws.

- APJ-5240 1970+ (3 pc.) SEE WEB



APX-1300



APX-8100



APX-1200

Wire Separators

Correct spark plug wire separators

- APX-1300 1970-72 SB/BB Left Rear SEE WEB
- APX-1200 1970-72 SB Left Front SEE WEB
- APX-8100 All BB Right Side SEE WEB



AX-423



AX-486

Spark Plug Wire Stands

New reproduction of originals.

- AX-423 All SB (Right Side) SEE WEB
- AX-486 1970-72 All SB (Left Side) SEE WEB



APX-5022

APX-5023

Valve Cover Spark Plug Wire Loom Kits

Correct spark plug wire separators for valve covers.

APX-5022	SB (6pc)	SEE WEB
APX-5023	BB (4pc)	SEE WEB

Flaming River Single Wire Timing Light

This self-powered timing light is designed to work without an auxiliary power source, which makes it ideal for use with magnets, rear battery mount race cars and all spark ignition systems for hassle-free timing. The Light is equipped with a xenon bulb which generates a bright strobe as well as a convenient work light. Durable construction includes a rubber encased lens and 48 degree pickup lead. State of the art single wire design is operated by two D-Cell batteries. Accurate timing up to 14,000 RPM.



FR1001	Universal	SEE WEB
--------	-----------	---------

No Volume Discount.



"Dated" Spark Plug Wire Set

New reproduction wire set correctly dated for your specific car, pre-cut and ready to install! Each set features correct colored wires and correct angle "cut" boots. Please give your sales rep your desired date. Non-HEI cars only.

Here's how to order:

ALL-70BB1Q	SEE WEB
------------	---------

**For example, if the build date of your car was on or before January 15th of the model year order 3rd quarter of the previous year. If the build date was after January 15th of the model year order 1st quarter of that year. i.e. A 1970 Monte Carlo built on or before Jan 15th of 1970 would receive 3-Q-69 and after would be 1-Q-70.*



AHC-1508

Spark Plug Wire Sets

New pre-cut OEM replacements.

AHC-1508	All SB	SEE WEB
AHC-2508	All BB	SEE WEB
AHC-3508	All w/ HEI	SEE WEB



MSD-35593

MSD Ignition Spark Plug Wires

Engineered from the inside out, the 8.5 offers everything you have ever wanted in a wire; incredibly low resistance without electronic interference! In a single 12 inch length of Super Conductor Wire there is only 40 - 50 ohms of resistance!

Without Headers

MSD-31359 Red, SBC 350 HEI w/o Headers... SEE WEB

With Headers

MSD-35593	Black, SBC 350 HEI* Cap	SEE WEB
MSD-35599	Red, SBC 350 HEI* Cap	SEE WEB
MSD-35603	Black, BBC 350 HEI* Tower Cap	SEE WEB
MSD-35609	Red, BBC 350 HEI* Tower Cap	SEE WEB
MSD-35653	Black, SBC 350 HEI* Tower Cap	SEE WEB
MSD-35659	Black, SBC 350 HEI* Cap	SEE WEB

**Works on any HEI or MSD style cap with male terminals.*

No Volume Discount.



GCS-S6038



GCS-S6038X

Billet Spark Plug Wire Looms

These wire looms will keep your spark plug wires neat and organized, minimizing wear on the wires. Also prevents cross firing and grounding of the wires. Choose from plain, ball milled or milled flames in either polished billet or chrome billet. Includes mounting hardware.

GCS-S6039	Plain, Polished	SEE WEB
GCS-S6039C	Plain, Chrome	SEE WEB
GCS-S6038	Ball Mill, Polished	SEE WEB
GCS-S6038C	Ball Mill, Chrome	SEE WEB
GCS-S6038X	Flames, Polished	SEE WEB
GCS-S6038XC	Flames, Chrome	SEE WEB

Note: Fits up to 9.5 mm wires.



GCS-S7251

Universal Chrome Wire Looms

These wire looms will keep your spark plug wires neat and organized, minimizing wear on the wires. Also prevents cross firing and grounding of the wires.

GCS-S7251	Universal	SEE WEB
-----------	-----------	---------

Note: Fits up to 9 mm wires.



AC43

AC Delco Spark Plugs

This is a brand new set of 8 spark plugs for your Chevrolet. These high quality reproduction AC Delco spark plugs feature the correct green AC and markings as original.

AC43	1970 #43	SEE WEB
AC44	1970 #44	SEE WEB
AC45	1970 #45	SEE WEB

Note: The number on the plug refers to it's operating temperature. The lower number is a cooler running plug which is typically found on the SHP high performance engines. A hotter, higher numbered plug would be used in engines where plug fouling may be or is a problem.



APX-650

Spark Plug Heat Shield Kit SB

Correct die stamped shields and arms for most small blocks without Rams Horn style manifolds. Complete with mounting hardware.

APX-650	1970-72 SB	SEE WEB
BXX-650	Bolts (4)	SEE WEB

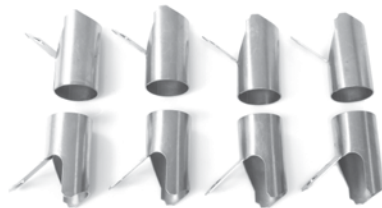

AT-3030

OEM Style Spark Plug Heat Shield Kit BB

This is a set of correctly stamped spark plug heat shields which are silver Cadmium plated just as original.

AT-3030	1970-72 BB	SEE WEB
---------	------------	---------



APX-6584

Spark Plug Heat Shield Kit BB

Correct stamped shields for various Chevrolet cars with BB engines (8pcs)

APX-6584	1970-72 BB	SEE WEB
----------	------------	---------



AD-052



AZ-840



ASH-695

Smog Tube & Extension

Correct pre-bent powder coated AIR smog tubes and extensions.

AD-252	1970-72 SB Tubes w/o AC	SEE WEB
AD-052	1970-72 BB Tubes w/o AC	SEE WEB
AZ-840	1970-72 Extension	SEE WEB

Smog Hose Kit

Original OEM ribbed hose complete with white stripe vacuum hose, T fittings and clamps.

ASH-695	All SB Complete	SEE WEB
ASH-69B	All BB Complete	SEE WEB
CPN-100	OEM Vacuum Hose Only	SEE WEB



AVC-100



MOTION-VC



"Motion" Valve Covers

Original style Cal Custom finned valve covers featuring the notorious Baldwin Motion die cast logos.

AVC-100	Most BB (Blank)	SEE WEB
MOTION-VC	Most BB "Motion"	SEE WEB

Note: 2-5/8" - 3" inside clearance.



ATE-4207



HVC-28

Finned Aluminum Valve Covers

Reproduction of original GM high performance valve covers.

ATE-4207	SB	SEE WEB
HVC-28	Flag Decal	SEE WEB

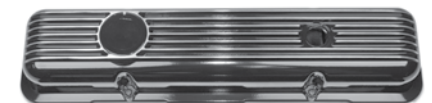

ATE-4207-BLK



Finned Aluminum Valve Covers - Black

Black finned aluminum valve covers based on the popular LT-1 covers.

ATE-4207-BLK	SB	SEE WEB
--------------	----------	---------



GCS-S6142



GCS-S6142G

Fabricated LS1 Valve Covers

2.5" height to clear aftermarket valve train. Includes oil cap, O-ring type gasket and bolts. Available with or without mounts for coil brackets.

GCS-S6141	LS1, No Coil Bracket Mounts, Anodized	SEE WEB
GCS-S6141C	LS1, No Coil Bracket Mounts, Chrome	SEE WEB
GCS-S6141POL	LS1, No Coil Bracket Mounts, Polished	SEE WEB
GCS-S6142	LS1, w/ Coil Bracket Mounts, Anodized	SEE WEB
GCS-S6142C	LS1, w/ Coil Bracket Mounts, Chrome	SEE WEB
GCS-S6142POL	LS1, w/ Coil Bracket Mounts, Polished	SEE WEB
GCS-S6142G	LS1 O-Ring Type Gasket	SEE WEB
GCS-S6142BOLT	LS1 Valve Cover Bolt Kit	SEE WEB
GCS-S6143	LS1 Coil Mounting Brackets	SEE WEB



GCS-S6145BK



GCS-S6145POL

Fabricated Tall Height Valve Covers

High quality fabricated aluminum valve covers. Mounting hardware included. Available with or without breather holes.

GCS-S6144C	SB, No Hole, Chrome	SEE WEB
GCS-S6144POL	SB, No Hole, Polished	SEE WEB
3-3/4" height		
GCS-S6145	SB, Flat Top, w/ Hole, Anodized	SEE WEB
GCS-S6145C	SB, Flat Top, w/ Hole, Chrome	SEE WEB
GCS-S6145POL	SB, Flat Top, w/ Hole, Polished	SEE WEB
GCS-S6145BK	SB, Flat Top, w/ Hole, Black	SEE WEB
GCS-S6147	SB, Flat Top, No Hole, Anodized	SEE WEB
GCS-S6147C	SB, Flat Top, No Hole, Chrome	SEE WEB
GCS-S6147POL	SB, Flat Top, No Hole, Polished	SEE WEB
3-7/8" height		
GCS-S6244	BB, Long Screw, No Hole, Anodized	SEE WEB
GCS-S6244C	BB, Long Screw, No Hole, Chrome	SEE WEB
GCS-S6244POL	BB, Long Screw, No Hole, Polished	SEE WEB
3-1/2" height		
GCS-S6248	BB, Short Screw, w/ Hole, Anodized	SEE WEB
GCS-S6248POL	BB, Short Screw, w/ Hole, Polished	SEE WEB



GCS-S6047BK

Small Block Center Bolt Ball Milled Valve Covers

These aluminum valve covers are a great custom touch to any street machine or sleeper.

GCS-S6047BK Center Bolt Small Block..... SEE WEB

Fits 1987 and newer small block with center bolt heads except LS.



GCS-S6336



GCS-S7617



GCS-S7619



Small Block Tall Valve Covers

These high quality small block Monte Carlo valve covers are a great way to dress up your motor, as well as gain some extra clearance for roller rockers.

- GCS-S6336 Chevrolet Logo, Black SEE WEB
- GCS-S7618 Chevrolet Logo Orange SEE WEB
- GCS-S6341POL Chevrolet Logo, Polished..... SEE WEB
- GCS-S7617 383 Stroker Logo, Black SEE WEB
- GCS-S7619 383 Stroker Logo Orange SEE WEB



XA-101S-OE



BUY & SAVE

WITH SS396.COM PRE-BUILT KITS

Big Block Valve Cover Kit

Save money on our complete kit! All kits come complete with the following items: (2) valve covers, (2) gaskets, valve cover retainers and TR bolts, (2) V.C. grommets, V.C. oil cap, V.C. elbow and hose and V.C. wire separators.

- XA-101 w/o Left Slant SEE WEB
- XA-101S w/ Left Side Slant* SEE WEB

**Use slanted valve covers when brake booster clearance may be an issue.*

OE kits with silver gaskets, correct oil cap and Tonawanda decal.

- XA-101-OE w/o Left Slant SEE WEB
- XA-101S-OE w/ Left Slant SEE WEB

**Use slanted valve covers when brake booster clearance may be an issue.*



ALS-1065

Original Style Chrome Valve Covers

These reproduction covers offer the highest quality chrome plating, correct wire stands and factory oil deflectors "drippers". Valve covers are available with a left side slant to increase booster clearance in tight engine compartments. Also available in tall style to fit roller rockers.

- ALS-1065 All BB w/o Slant SEE WEB
- ALS-1165 All BB w/ Left Side Slant SEE WEB
- ACC-3362 All BB w/o Drippers SEE WEB
- ACC-3365 All BB w/ Slant w/o Drippers..... SEE WEB
- ALS-1065XT All BB Tall w/o Left Slant SEE WEB
- ALS-1165XT All BB Tall w/ Left Slant..... SEE WEB



396TJVC-1

"Turbo Jet" Valve Covers

Cal Custom finned valve covers featuring the famous "Turbo Jet" medallions.

396TJVC-1	All BB "396"	SEE WEB
427TJVC-1	All BB "427"	SEE WEB
454TJVC-1	All BB "454"	SEE WEB
502TJVC-1	All BB "502"	SEE WEB
572TJVC-1	All BB "572"	SEE WEB

2-5/8" - 3" inside clearance. Will work with most roller rockers.



454VC-R

"454" Valve Covers

Original Cal Custom style valve covers featuring red "454" medallions.

454VC-R	Most BB "454"	SEE WEB
---------	---------------------	---------

2-5/8" - 3" inside clearance. Will work with most roller rockers.



SS427VC-R

"SS 427" Valve Covers

Original Cal Custom style valve covers featuring red "SS 427" medallions.

SS427VC-R	Most BB "SS 427"	SEE WEB
-----------	------------------------	---------

2-5/8" - 3" inside clearance. Will work with most roller rockers.



427VC-1

"427" Valve Covers

Like our "YENKO" covers with cast "427" medallions.

427VC-1	Most BB "427"	SEE WEB
427VC-R	Most BB "427" Red	SEE WEB

2-5/8" - 3" inside clearance. Will work with roller rockers.



HARREL-VC

Dick Harrel Aluminum Valve Covers

"Cal Custom" finned aluminum covers feature the notorious Dick Harrel die cast medallions.

HARREL-VC	Most BB	SEE WEB
-----------	---------------	---------

2-5/8" - 3" inside clearance. Will work with most roller rockers.



YSCVC-1

"Yenko" Valve Covers

These "Cal Custom" style finned aluminum covers feature the notorious "YENKO" Red, White and Blue die cast logos.

YSCVC-1	Most BB "YENKO"	SEE WEB
---------	-----------------------	---------

2-5/8" - 3" inside clearance



AT-3662



AT-3666

Small Block Valve Covers

New original style early small block Chevrolet covers. These covers come ready to install in correct Chevrolet Orange or chrome plated.

AT-3662	SB Chrome Covers	SEE WEB
AT-3666	SB Orange Covers	SEE WEB



GCS-9215B

Black Painted Valve Covers

This is a pair of high quality tall black painted valve covers. A great inexpensive custom touch to any street machine or sleeper!

GCS-9215B	1970-77 SB	SEE WEB
-----------	------------------	---------



ALS-1165-OJ

Big Block Valve Covers - Chevrolet Orange

This is a pair of brand new big block valve covers painted in Chevrolet orange. These valve covers are correct for most big blocks and will fit cars with power brakes.

ALS-1165-OJ	All Big Block	SEE WEB
-------------	---------------------	---------

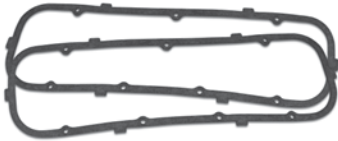

AFP-059

Valve Cover Gaskets

- AFP-057 All SB.....SEE WEB
- AFP-059 All BB.....SEE WEB



APB-1023

Valve Cover Retainers OEM Bolt Kits

Correct steel stamped zinc plated retainers & OEM bolts.

- APB-1023 SB TR Bolts (16 pc.).....SEE WEB
- APB-2023 BB TR Bolts (28 pc.).....SEE WEB



APO-2043



APR-2136

Valve Cover Oil Caps

Choose from either chrome GM replacement, chrome reproduction with correct "S" or black rubber push in cap.

- APX-5763 Replacement.....SEE WEB
- APR-2136 Reproduction "S".....SEE WEB
- APO-2043 Rubber "OIL".....SEE WEB



APB-3508



APB-3509

Valve Cover Grommet Original GM

- APB-3508 All SB.....SEE WEB
- APB-3509 All BB.....SEE WEB



APT-3509



APT-3960

Valve Cover Elbows

Correct GM steel valve cover elbows.

- APT-3960 All SB.....SEE WEB
- APT-3509 All BB.....SEE WEB



APH-3843

Valve Cover Hose

Correct marked OEM hose which extends from valve cover to air cleaner base.

- APH-3843 All BB Open Element.....SEE WEB



AEH-999

Oil Pans

OEM supplier.

- AJ-221 1970-72 SB w/out SHP.....SEE WEB
- AEH-999 1970-72 All BB.....SEE WEB



GCS-S8442BK

Small Block Finned Aluminum Oil Pans

These finned aluminum oil pans will help keep your oil cooler and add some custom style to your street machine or sleeper. New mounting bolts and drain plug are included.

- GCS-S8442BK 1955-79 SB.....SEE WEB
2-piece rear main seal, drivers side dipstick.
- GCS-S8443BK 1980-85 SB.....SEE WEB
2-piece rear main seal, passenger side dipstick.
- GCS-S8444BK 1986 + SB.....SEE WEB
1-piece rear main seal, passenger side dipstick.



APC-744

Oil Pan Clip

Correct clip for retaining positive battery cable routing to solenoid.

- APC-744 All SB-BB.....SEE WEB



BPO-1988

Oil Drain Bolt/Washer

Original GM.

- BPO-1988 All SB/BB.....SEE WEB



BOP-2002

Oil Pan Attaching OEM Bolt Kit

Correct "L" head marked bolts for attaching pan to block.

- BOP-2001 All SB (18 pc.).....SEE WEB
- BOP-2002 All BB (24 pc.).....SEE WEB



AJ-4

Oil Pan Baffle / Windage Tray

Often installed on most High Performance cars, this "windage tray" was used to keep oil from splashing the crankshaft. A MUST!

- AJ-4 Small Block.....SEE WEB
- AJ-6 Big Block.....SEE WEB



NF-25



NF-25

Oil Canister - Filter

Reproduction of early canister style filter.

- NF-25 PF-25 AC Filter "White".....SEE WEB
- NF-25 PF-25F AC Filter "Blue".....SEE WEB



KN-HP2002



KN-PS2002

K&N Oil Filters

K&N Performance Oil Filters have been specially designed for professional installers and service providers. Their high flow design can help to improve engine performance by reducing oil filter restriction. Performance Gold Oil Filters have a Premium Wrench-Off design and have become a favorite among consumers for its durability and easy removal. Our Performance Silver Oil Filters have a fluted canister shape so they can be removed with a traditional oil filter wrench commonly available to commercial installers. These Performance Silver Oil Filters provide outstanding filtration and engine protection throughout their service life. They are engineered to handle all grades of synthetic, conventional and blended motor oils. The pleated media provides high capacity making them suitable for extended oil change intervals when, used in accordance with the vehicle and motor oil manufacturers recommendation.

- KN-HP2002 1970-88 Gold Wrench Off.....SEE WEB
- KN-PS2002 1970-88 Silver Standard Fluted.....SEE WEB

No Volume Discount.



Oil Pressure Fittings

N-137	1970+ All SB.....	SEE WEB
N-133	All BB w/o SHP.....	SEE WEB
N-142	All BB w/ SHP.....	SEE WEB
N-A6474	Back of Gauge Fitting.....	SEE WEB



Oil Pressure Lines

Correct material lines with correct fittings for all cars with gauges.

CHQ-3200 1970+ (Black Plastic)SEE WEB



Oil Pressure Switches

Correct GM switches for cars without manual gauges.

GAC-110 1970-72 w/ Electrical Gauges.....SEE WEB



Chrome Transmission Dipsticks and Tubes

Show quality dipsticks are an excellent upgrade to any engine compartment. Includes dipstick & tube.

GCS-S4994BA

Chrome Transmission Dipsticks and Tubes

Show quality dipsticks are an excellent upgrade to any engine compartment. Includes dipstick & tube.

GCS-S9422	Powerglide.....	SEE WEB
GCS-S9421	TH350.....	SEE WEB
GCS-S9421BA	TH350 Billet Handle.....	SEE WEB
GCS-S4994	TH350 34".....	SEE WEB
GCS-S4994BA	TH350 34" Billet Handle.....	SEE WEB
GCS-S4995	TH400 24".....	SEE WEB
GCS-S4995BA	TH400 24" Billet Handle.....	SEE WEB



Oil Dipstick Kits

Complete with tube and gauge (stick).

ATE-1567	1970-79 SB (Green Dot).....	SEE WEB
ATE-1576	1970-72 BB (Yellow Dot).....	SEE WEB

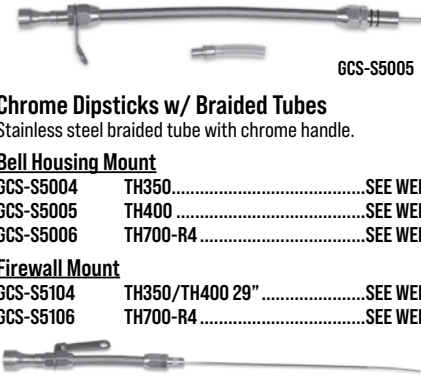

Chrome Dipsticks w/ Braided Tubes

Stainless steel braided tube with chrome handle.

Bell Housing Mount

GCS-S5004	TH350.....	SEE WEB
GCS-S5005	TH400.....	SEE WEB
GCS-S5006	TH700-R4.....	SEE WEB

Firewall Mount

GCS-S5104	TH350/TH400 29".....	SEE WEB
GCS-S5106	TH700-R4.....	SEE WEB



Billet Engine Dipstick with Braided Tube

Show quality billet aluminum dipstick with braided tube.

GCS-S5002	1955-79 SB.....	SEE WEB
GCS-S5001	1980-95 SB.....	SEE WEB
GCS-S5003	1970-90 BB.....	SEE WEB

Note: Oil level varies depending on the oil pan used. You may need to mark the dipstick with your own new full level mark.

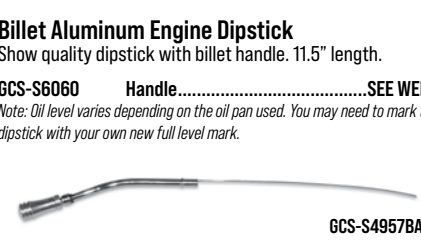

Billet Aluminum Engine Dipstick

Show quality dipstick with billet handle. 11.5" length.

GCS-S6060 Handle.....SEE WEB

Note: Oil level varies depending on the oil pan used. You may need to mark the dipstick with your own new full level mark.

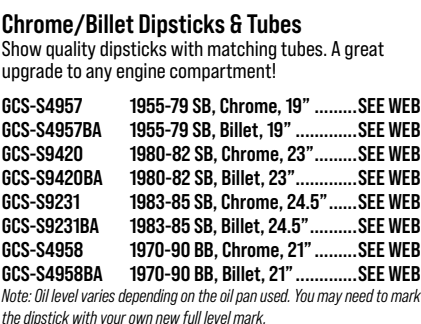

Chrome/Billet Dipsticks & Tubes

Show quality dipsticks with matching tubes. A great upgrade to any engine compartment!

GCS-S4957	1955-79 SB, Chrome, 19".....	SEE WEB
GCS-S4957BA	1955-79 SB, Billet, 19".....	SEE WEB
GCS-S9420	1980-82 SB, Chrome, 23".....	SEE WEB
GCS-S9420BA	1980-82 SB, Billet, 23".....	SEE WEB
GCS-S9231	1983-85 SB, Chrome, 24.5".....	SEE WEB
GCS-S9231BA	1983-85 SB, Billet, 24.5".....	SEE WEB
GCS-S4958	1970-90 BB, Chrome, 21".....	SEE WEB
GCS-S4958BA	1970-90 BB, Billet, 21".....	SEE WEB

Note: Oil level varies depending on the oil pan used. You may need to mark the dipstick with your own new full level mark.



PCV Retaining Hose Clip

Reproduction of original PCV hose retaining clip, with correct bends and black phosphate coating.

CPN-3819 All w/ Holley.....SEE WEB



TCS Littlefuse Relay

This is a reproduction of the correct littlefuse TCS relay. This authentic reproduction features 4 prongs as original.

ATCS-33R 1970-72.....SEE WEB



TCS Transmission Switches

Correct TCS switch located on transmission.

ATS-21MP	1970-75 Pin Style.....	SEE WEB
ATS-21MS	1970-75 Spade Style.....	SEE WEB



TCS Wire Retainer

Correct reproduction for Muncie.

ATS-653 1970-74 w/ Muncie.....SEE WEB



Engine Block Lifting Ring

These correct steel stamped lifting rings were installed at the engine plant for ease of installation.

APX-1015	Most SB.....	SEE WEB
APX-1115	All BB.....	SEE WEB
BPX-230	Lifting Ring Bolt.....	SEE WEB



Motor Mount Clip

Correct clip for attaching positive cable to right side motor mount.

ATW-2853 Most V8's.....SEE WEB



Engine Mounting Kits

Perfect for converting to a V8 or for upgrading your small block to a big block! Each kit includes all of the necessary motor mounts, frame brackets, motor mount thru bolts, frame bracket bolts and motor mount to block bolts so you can do the job right!

ACE-9794KIT 1970-72 V8SEE WEB
No Volume Discount.

ACE-9794KIT



ENG-9794KIT-G

Poly Engine Mount Kits

Same as our OE style engine mount kits with upgraded Energy Suspension Poly motor mounts. The poly mounts can take the abuse of today's high performance engines, yet still absorb driveline vibrations. They are available in Poly Graphite black or red.

ENG-9794KIT-G 1970-72 All V8* BlackSEE WEB
ENG-9794KIT-R 1970-72 All V8* RedSEE WEB

*Except 307. No Volume Discount.



ACE-9794

Frame Brackets

Reproduction of the long discontinued GM brackets for mounting the engine to frame of car. Sold in matched pairs.

ACE-9794 1970-72 All V8SEE WEB
APX-2339 1970-72 All V8 Bolts To FameSEE WEB



AMX-96

Motor Mounts OEM

These new motor mounts are from GM's original supplier! **MADE IN USA!!!**

AMX-96 1970-72 Most V8SEE WEB
Please measure your frame brackets before ordering.

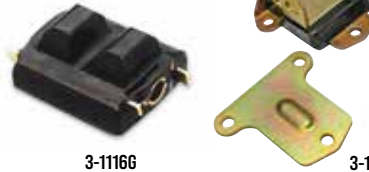

3-1116G

3-1117G

Poly Graphite Motor Mounts

Energy Suspension mounts can take the abuse of today's high performance engines. Poly Graphite bushings can last longer than stock rubber mounts while handling more power, yet able to absorb most driveline vibrations. Add G to the part number for black. Add R to part number for red. Example. 3-4114G is for 65-67 in black.

3-1117_ 1970-72 2-3/8" W x 1-3/16" HSEE WEB
3-1116_ 1973-88*SEE WEB

Two mounts required per car.

*You must reuse your original clamshells on the 1973-88 by drilling out the rivets and replacing the rubber insert with the new Poly Graphite mount.



BJ-998

Motor Mount Attaching Bolt Kit

Correct style bolts for attaching mount to block.

BJ-998 All (12pc) 8.95 kit



APB-7057

Motor Mount "Thru" Bolt Kit

Correct OEM bolts for retaining mount to frame bracket. Comes complete with special high strength washers and cadmium plated locking nuts as original

APB-7057 1970-72 All 3.5"SEE WEB



GCS-S6053

Stainless Steel Kickdown Cables

Show quality look with more adjustability than your factory cable.

GCS-S6053 TH350SEE WEB
GCS-S6051 TH700-R4SEE WEB

Note: For carburetor applications only.



GCS-S9620

GCS-S9619

Chrome Throttle Cable Brackets

Designed to work with your GM throttle cable on most carburetor applications. Available with or without kickdown provision.

GCS-S9619 w/o KickdownSEE WEB
GCS-S9620 w/ KickdownSEE WEB

Note: Due to the universal nature of this part, fitting and/or modifications may be required.



GCS-S2291

Chrome Universal Carburetor Throttle Return Kit

Designed to make mounting the spring a snap! Works on most carburetors.

GCS-S2291 UniversalSEE WEB

Note: Due to the universal nature of this part, fitting and/or modifications may be required.



CE CE CE CE

AXJ-CE

AZC-88

ATH-3369

Accelerator Cables

Choose from GM service replacement cables or new reproductions complete with casings and bushings as original.

ATH-3863 1970-72 SB 2 bbl GMSEE WEB
ATH-2679 1970-72 SB 4 bbl GMSEE WEB
ATH-3862 1970-72 BB Q-Jet GMSEE WEB
ATH-3369 1970-72 BB Holley GMSEE WEB
336969R 1970-72 Repro for HolleySEE WEB
3972679R 1970-72 Repro for Q-JetSEE WEB
AZC-88 1970-72 Cable Clip GMSEE WEB
AXJ-CE Cable DecalSEE WEB



AWM-4169K

Wiper Motor

New correct wiper motor assembly and washer pump ready to install.

- AWM-4169 1970-72 w/ Hidden Wipers
1st Design Motor OnlySEE WEB
- AWM-4169K 1970-72 w/ Hidden Wipers
1st Design with Washer PumpSEE WEB

Windshield Wiper Motors

Original AC Delco re-manufactured units built with original cores.



AWM-8242

- AWM-8242 1970-72 w/o HiddenSEE WEB

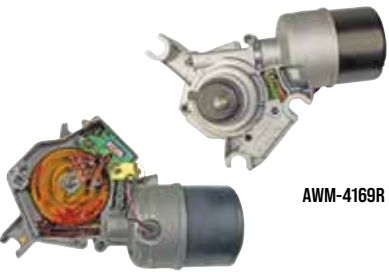

AWM-4169R

- AWM-4169R 1970-72 w/ Hidden*SEE WEB
- *Replacement style. Plug is not in original location. * Second design with slot for electrical connector in the base plate.



AWP-6971W

OEM Style Washer Pump

New OE style reproduction washer pump with correct white nozzles!

- AWP-6971W 1970-72 w/ Hidden Wipers SEE WEB
- AWP-64C 1970-77 Cover Only SEE WEB



AWP-6971



AWP-6971-2D

Washer Pumps

Original washer pumps.

- AWP-6971 1970-72 w/o HiddenSEE WEB
 - AWP-64C 1970-77 Cover OnlySEE WEB
 - AWP-6971-2D 1970-72 w/ Hidden 2nd Design*SEE WEB
- * Second design with slot for electrical connector in the base plate.



WIPERKIT-HIDE-C

Hidden Wiper Arm & Transmission Kits

Looking to refurbish or replace major components of your wiper system? Look no further with Ground Up's exclusive wiper kits! This hidden wiper kit includes two wiper arms, two wiper blades and the wiper transmission arm. Deluxe kits include a wiper motor.

- WIPERKIT-HIDE-C 1970-72 Chrome ArmsSEE WEB
- WIPERKIT-HIDE 1970-72 Satin ArmsSEE WEB

Deluxe Kits

- WIPERKIT-HIDE-DLX-C 1970-72 Chrome ArmsSEE WEB
- WIPERKIT-HIDE-DLX 1970-72 Satin ArmsSEE WEB

No Volume Discount.



APW-STRAP-L



APW-2401

Wiper Motor Mount Kit

Correct steel rubber grommets & screws for mounting motor to firewall.

- APW-2401 1970-72 All.....SEE WEB
- AWS-2002 1970-77 All Screws Only.....SEE WEB
- APW-STRAP W/o Hidden Wipers.....SEE WEB
- APW-STRAP-L W/ Hidden Wipers.....SEE WEB



AWS-992

Wiper Motor Seals

Correct foam rubber seal for firewall.

- AWS-792 1970-72 w/o HiddenSEE WEB
- AWS-992 1970-72 w/ HiddenSEE WEB

LWA-1400K CLOSE UP

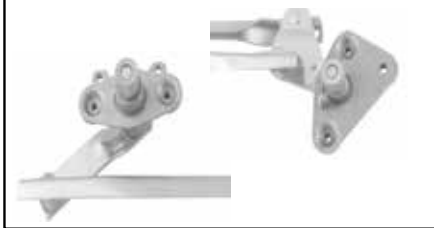

LWA-1400K



LWA-68-PIN

Wiper Transmission Arm

Finally available, Reproduction wiper transmission arm.

- LWA-1400K 1970-72SEE WEB
- LWA-68-PIN 1970-72 w/ HiddenSEE WEB
- FMP-CLIP 1970-77 Clip.....SEE WEB



AWA-688

Wiper Motor Arm

Correct wiper motor arm with ball stud.

- AWA-688 1970-72SEE WEB

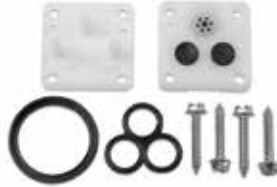

AHL-5400

Washer Pump Repair Kit

Correct white plastic nozzle, rubber seals and screws to repair your original washer pump.

- AHL-5400 1970-72 All.....SEE WEB



AWJ-0892

Washer Jars

Correct white plastic washer jars.

- AWJ-0892 1970-72 All.....SEE WEB
- AWJ-0892K 1970-72 Jar & Cap KitSEE WEB
- AWJ-10M 1970-72 Mounting ScrewsSEE WEB



APX-9738

Washer Cap Kit

Correct GM cap, ribbed hose and pick up screen.

- APX-9738 1970-72 All Cap Kit.....SEE WEB
- AWJ-8372 1970-72 Cap OnlySEE WEB
- AWJ-100 1970-72 Screen OnlySEE WEB



APH-1132

Washer Hose Kit

Ribbed thin walled style washer hose in pre cut lengths (7/32 - 11/32 diameter). This kit does one car.

- APH-1132 1970-72 All.....SEE WEB

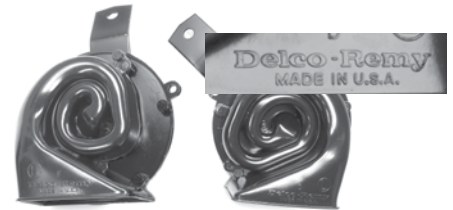

ADR-3H



ADR-3-CHROME

Horns

Reproduction Delco Remy horns correct for most Monte Carlos. These horns feature the correct high and low notes. Brackets included.

- ADR-3-GM 1970-72 Universal Horn Set SEE WEB
- ADR-3-CHROME 1970-72 Repro Chrome SEE WEB
- ADR-3H 1970-77 Horn Set* SEE WEB

*Brackets may require some modification.



GAC-723

Horn Relay

New reproduction of the original GM Delco style relay.

- GAC-723 1970-71.....SEE WEB
- GAC-775 1972-73SEE WEB
- AVN-506 Mounting ScrewSEE WEB



ACY-100

Marking Crayons

Original crayons used to mark the frame and firewall. Includes (1) yellow crayon and (1) white crayon.

- ACY-100 All.....SEE WEB



ACY-KIT

Frame & Body Marking Crayon Kit

These paint sticks are used for final detailing to replicate the marks left on the frame and other parts of the car, just like when it came down the factory assembly line.

- ACY-KIT All (12pc).....SEE WEB



AMH-15

Underhood Lamp

Complete with bracket, hardware, harness and built-in switch.

AMH-15 1970-77 All.....SEE WEB



GRC-12834

Radio Capacitor

Came from the factory on all cars with radio. Correct length lead wire & white connector. Stamped 1970086 "DR" & ".5MF" as original.

GRC-12834 1970-71 Voltage Regulator.....SEE WEB
GRC-12835 1970-74 Coil.....SEE WEB



R89-TOP



R59-TOP

Battery Toppers

This new plastic injection molded cover will give your modern battery the look and feel of an original! This topper works with Group 24-60 sized batteries only. Inside size = 6-7/8 x 10-3/8.

R59-TOP 1970-72 R-59.....SEE WEB
R89-TOP 1970-72 R-89 Side.....SEE WEB



ASR-69ABB



ASR-69ASB

Spring Ring Cables

Reproduction of the original factory installed spring type cables sold as a matched pair with GM numbers.

ASR-69ASB 1970-72 SB.....SEE WEB
ASR-69ABB 1970-72 BB.....SEE WEB



AST-1001

Side Terminal Battery Cables

Correct cables for cars with the heavy duty R-89 batteries with correct GM part numbers.

AST-1001 1970-72 HD.....SEE WEB



GAC-515

Voltage Regulator

New correct GM replacement.

GAC-515 1970-71 All D635.....SEE WEB
GAC-515GM 1970-71 All D635 OE Style.....SEE WEB
AVX-515 1970-71 Screws (2).....SEE WEB



GQH-118

Electric Junction Block

Original GM junction block for attaching positive lead from battery to main harness. Mounts to radiator support. Includes correct nut.

GQH-118 1970-72 All.....SEE WEB



ABR-9533

Battery Retainer Kits

Complete battery retainer kits with all correct hardware.

ABR-9533 1970-72 All.....SEE WEB



ABT-6872

Battery Trays

Reproduction EDP coated battery trays.

ABT-6872 1970-72 All (Tray Only).....SEE WEB
ABT-682K 1970-72 Kit (Tray & Retainer).....SEE WEB
ABT-7888 1978-88 All (Tray Only).....SEE WEB



TENDER-0128

Battery Tender

The Battery Tender Plus is a 1.25 amp battery charger designed to fully charge a battery and maintain it at proper storage voltage without the damaging effects caused by trickle chargers. Included is a quick connect harness for hard to reach areas. Temperature compensated to ensure optimum charge voltage according to ambient temperature. Automatically switches from full charge to float charging mode. Battery Tender at 1.25 amps will charge as fast or faster than any 3 amp charger available. Reverse Polarity Protection to ensure user safety. Red & Green Lights Alternately Flash in this condition. Complete 4-step charging program (Initialization, Bulk Charge, Absorption Mode, Float Mode).

TENDER-0128 Battery Tender.....SEE WEB



FG2001



FG2005



FG2031



FG2044



FG2003



FG2007



FG2042



FG2046

Fender Gripper

If you spend a lot of time working under the hood but don't want to scratch your paint a Fender Gripper is the answer! Made of non-slip material the Fender Gripper will not slide off slick surfaces.

- Soft and cushioned for protection
- Tools will not slip off fender cover
- Completely washable 22 X 34 standard size
- Strong PVC product reinforced with nylon mesh
- Impervious to motor oil, coolant, lacquer thinner, brake fluid, etc.
- Many favorite brand logos are available
- Will not harm your paint

FG2001	Bowtie.....	SEE WEB
FG2003	Genuine Chevrolet.....	SEE WEB
FG2005	Heartbeat of America.....	SEE WEB
FG2007	Chevrolet Racing.....	SEE WEB
FG2048	El Camino.....	SEE WEB
FG2031	Chevelle.....	SEE WEB
FG2042	General Motors.....	SEE WEB
FG2044	SS.....	SEE WEB
FG2046	Super Sport.....	SEE WEB



Eddie Motorsports Billet Hood Hinges

These billet hood hinges are machined from 6061-T6 aluminum and will add an awesome custom touch to your engine compartment. They Bolt-in and require no cutting of your sheet metal. Complete with stainless steel nitrogen gas shocks and all stainless steel fasteners.

M= Machined
P= Polished
R= Red Fusioncoat
B= Blue Fusioncoat

W = White Fusioncoat
PR= Purple Fusioncoat
BK= Gloss Black Fusioncoat
BKA= Gloss Black Anodized

MB= Matte Black Fusioncoat
MBA= Matte Black Anodized
CL= Clear Coat
CA= Clear Anodized

M

P

R, B, W, PR, BK,
BKA, MB, MBA,
CL, CA

MS149-57_	1970-72 All.....	SEE WEB.....	SEE WEB.....	SEE WEB.....
-----------	------------------	--------------	--------------	--------------



RHG-BH13

Billet Hood Hinges

Give your engine bay a custom touch with these affordable billet hood hinges! These hood hinges come complete with heavy duty struts and hardware. Sold as a pair with hardware.

RHG-BH13	1970-72 All.....	SEE WEB
----------	------------------	---------

No Volume Discount.



RHG-998K

OE style Pre-Assembled Hood Hinges

These hood hinges are for the purist who won't settle for anything less than the best! Sold each or as a set of left and right hinges with the correct springs pre-installed. They feature an OE correct black phosphate coating just like the OEM.

RHG-998K	1970-72 All LH & RH.....	SEE WEB
RHG-998L	1970-72 All LH.....	SEE WEB
RHG-998R	1970-72 All RH.....	SEE WEB
BPA-381	3/8" x 1" Bolt.....	SEE WEB

Note: Bolts are not included.



RHG-70L

RHS-642

Hood Hinges

High quality, reproduction hood hinges.

RHG-70L	1970-72 All LH.....	SEE WEB
RHG-70R	1970-72 All RH.....	SEE WEB
RHG-73L	1973-77 All LH.....	SEE WEB
RHG-73R	1973-77 All RH.....	SEE WEB
RHS-642	1970-77 Hood Hinge Spring.....	SEE WEB



RHG-70KWS

Hood Hinge Kit 1970-72 Repro Style

These are high quality reproduction hood hinges complete with springs and featuring a black EDP coating.

RHG-70KWS	1970-72 All LH & RH.....	SEE WEB
BPA-381	3/8" x 1" Bolt.....	SEE WEB

Note: Bolts are not included.



Eddie Motorsports Billet Hood Latch Assembly

CNC machined from a solid chunk of 6061-T6 aluminum and stainless steel. This is a direct replacement for your cheap stock stamped steel hood latch. The EMS billet hood latch kit comes complete with a billet aluminum base plate and billet stainless steel pilot bolt and retaining cup. Stainless steel fasteners and billet aluminum finishing washers are also included.

M = Machined Fusioncoat
P = Polished
R = Red
B = Blue Fusioncoat

W = White Fusioncoat
PR = Purple Fusioncoat
BK = Gloss Black Fusioncoat
BKA = Gloss Black Anodized

MB = Matte Black Fusioncoat
MBA = Matte Black Anodized
CL = Clear Coat
CA = Clear Anodized



MS276-12_ 1970-72 **M** SEE WEB **P** SEE WEB **OTHER** SEE WEB



RHR-70



RHR-L70

Hood Catch

Correct catch which mounts on underside of hood.

RHR-L70 1970-72 All.....SEE WEB
 RHR-70 1970-72 All OE Correct.....SEE WEB



GCS-S4051

Hood Pin Kit - Hair Pin Style

Universal chrome hood pin kit for use on any vehicle.

GCS-S4051 All.....9.95 kit



HPK-BC



HPK-BB

Billet Aluminum Hood Pin Kits Peel N Stick

These hood pin kits are a great way to add that protouring/ racing look without drilling or cutting your hood. The pin mounts are either chrome plated or black aluminum with chrome pins and feature rubber coated cables. They attach with high quality double sided 3M adhesive tape.

HPK-CHROME Chrome All.....SEE WEB
 HPK-BLACK Black All.....SEE WEB



RVL-70A

Hood Latch Support

Correct support that runs vertically and attaches to the radiator support.

RVL-70A 1970-72 All.....SEE WEB



Eddie Motorsports Billet Hood Latch Assembly

CNC machined from a solid chunk of 6061-T6 aluminum and stainless steel. This is a direct replacement for your cheap stock stamped steel hood latch. The EMS billet hood latch kit comes complete with a billet aluminum base plate and billet stainless steel pilot bolt and retaining cup. Stainless steel fasteners and billet aluminum finishing washers are also included.

M = Machined Fusioncoat
P = Polished
R = Red
B = Blue Fusioncoat

W = White Fusioncoat
PR = Purple Fusioncoat
BK = Gloss Black Fusioncoat
BKA = Gloss Black Anodized

MB = Matte Black Fusioncoat
MBA = Matte Black Anodized
CL = Clear Coat
CA = Clear Anodized



MS276-12_ 1970-72 **M** SEE WEB **P** SEE WEB **OTHER** SEE WEB



RHR-70X

Hood Release Handle

Reproduction of this often missing or broken pull handle.

RHR-70X 1970-72 All.....SEE WEB



RHR-59

1970-72 Hood Release

Reproduction hood release assembly.

RHR-59 1970-72 All.....SEE WEB



Detail shot of a Master Body Hardware kit. These kits have all of the hard to find items that are not available anywhere else!



AMK Master Body Hardware Kit

Master body kits contain just about every piece of hardware to assemble the body of your Monte Carlo. Each kit contains hardware for your battery tray, bumpers, filler panel, filler panel moldings, bumper brackets, cowl vent panel, door latches, emblems, eyebrows, fender braces, fenders, front tie bar, grille, grille brackets, grille moldings, headlamps, headlamps bezels, hood, hood hinges, hood latch, hood latch support, license plate, mirrors, parking lamps, tail lamps, trunk latch, trunk lid hinges, wheel opening moldings, wheel houses, radiator support and more! This kit truly has it all!

- 70AB 1970 SEE WEB
- 71AB 1971 SEE WEB

Engine Master Hardware Kits

The authentic hardware you need to correctly reassemble the engine components that attach to the long block. Typical kits include fasteners for: air cleaner, carburetor & choke cover, crank pulley & damper, distributor, exhaust manifold, exhaust pipe, engine fan, fuel pump plate, and plug, heat shield, ignition coil & strap, intake manifold & plug, oil filter valve, oil pan, PCV adapter, PCV hose clamps, timing cover, valve covers, water neck, water pump.

- 69-BBH 1970-72 BB Aluminum Intake (149 pc).....SEE WEB
- 69-BBS 1970-72 BB Cast Iron Intake (143 pc).....SEE WEB
- 72-SB 1972-73 SB (139 pc).....SEE WEB
- 72-Z28 1972-73 (145 pc)SEE WEB

No Volume Discount.

OEM Bolts - They Just Make Sense!

It makes sense to use new bolts on new or restored parts! From bumper to bumper, we cover your entire vehicle. We have made our name and reputation on providing those hard to find detailing parts that separates your classic from the rest. All of our bolts are either original, OEM parts from original GM manufacturers or top quality reproductions. Manufactured with original head markings and correct plating (zinc, black phosphate and oiled, gold cadmium and silver cadmium), these bolts make assembly a breeze! Like our OEM paints, new bolt sets are what make a top flight restoration!



AMK Interior Screw Kit

- 70AN-CP 1970-72SEE WEB

AC Box Under Hood Hardware

All the hardware related to the AC under the hood on the firewall forwards.

- 70AA-F 1970-72SEE WEB

AC On Engine Hardware

All the hardware related to the AC brackets on the engine.

- 70AA-SB 1970 SBSEE WEB
- 70AA-BB 1970-72 BBSEE WEB
- 71AA-SB 1971 SBSEE WEB
- 72AA-SB 1972 SBSEE WEB

Master Chassis Kit

Typical kit includes fasteners to attach: accelerator lever & support, axle housing, springs, axle retainer plates, brake booster & hose, brake cables, brake plates, brake hose retainers & brackets, brake valve & pressure switch, calipers & brackets & shields, upper & lower control arms, control arm bushings, differential cover, driveshaft, engine mounts, fuel filler neck cover, fuel hoses, gas tank, grease fittings, idler arm, master cylinder & push rod, parking brake control, pitman arm, radius rod & bracket & bumper, shocks & brackets, stabilizer bar brackets and end links (includes rubber), steering gear & rag joint, steering linkage & ball joints, speedometer cable, trans, suspension bumper, transmission crossmember & insulator, wheel cylinders.

- 70AS-DCSB 1970 SB Disc Brakes (333 pc) SEE WEB
- 70AS-BB 1970 BB Disc Brakes (349 pc) SEE WEB
- 71AS-DCSB 1971-72 SB Disc Brakes (337 pc)..... SEE WEB
- 71AS-BB 1971-72 BB Disc Brakes (352 pc) SEE WEB

No Volume Discount.

AC Box Under Dash Hardware

All the hardware related to the AC under the dash.

- 70AA-R 1970SEE WEB
- 71AA-R 1971SEE WEB
- 72AA-R 1972SEE WEB

BFE-8002

Front End Fastener Kits

Over 175 pieces individually bagged! Includes everything you need to assemble your front end!

- BFE-8002 1970-72 All.....SEE WEB

ISK-70A

Interior Screw Kits

Basic

- ISK-70A 1970-72SEE WEB

OEM Complete

- 70AN-CP 1970-72SEE WEB



AWB-1114

Alternator Upper Adjustment Kit

Correct WB head marked bolt with washers.

AWB-1114 1970-72 All.....SEE WEB



BN-339



BRB-938

Alternator Lower Attaching Hardware

BRB-938 1970-72 SB BoltSEE WEB
BN-339 1970-72 BB StudSEE WEB



APX-1038

Alternator Spacer Brace

APX-1038 1970-72 BBSEE WEB



AW-506

Alternator Neg Cable Bolt

AW-506 All.....SEE WEB



ABN-105

Alternator Fan Nut

ABN-105 All.....SEE WEB



IXP-03

Arm Rest Pads Screws

OE style reproduction arm rest pad screws.

IXP-03 Attaching Screw.....SEE WEB



NX-281

Brake Cable Retainer

Correct clip for all cars (3 required)

NX-281 1970-77 All.....SEE WEB

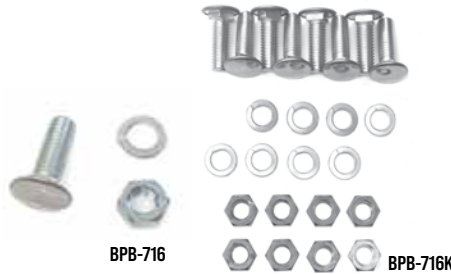

BPB-716

BPB-716K

Bumper Bolts

Correct chrome pan head bumper bolts complete with hardware. 7/16" x 1".

BPB-716 AllSEE WEB
BPB-716K All (8pc)SEE WEB



BMP-1000

Brake Caliper Bolts

Correct bolts/pins for mounting caliper to bracket. Two per caliper.

BMP-1000 1970-72 Single PistonSEE WEB
Single piston calipers only.



ELC-316



ELC-1316



ELC-516



ELC-10P



ELC-1516



BLC-056

Brake Line Clips

Correct clips for attaching hard brake lines to frame. (Tabbed clips push into frame holes.)

ELC-316 3/16" FrontSEE WEB
ELC-1316 3/16" w/ TabSEE WEB
ELC-1516 5/16" MainSEE WEB
ELC-516 5/16" w/ TabSEE WEB
ELC-038T 3/8" w/ Tab*SEE WEB
ELC-10P Double Push InSEE WEB
BLC-056 Clip BoltSEE WEB

**Use on main line with armor shielding.*

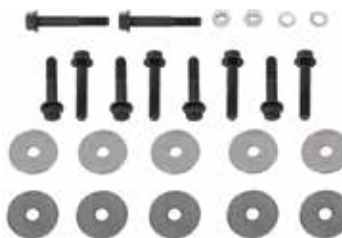

BHP-0516

Body Bolt Kit

Correct black flanged head bolts and washers.

BHP-0516 1970-72SEE WEB



BCN-716

Body Cage Nuts

BCN-716 All 7/16"SEE WEB



BBF-13

Bumper Bracket Bolts

New bumper bracket bolts with correct teeth washers and nut.

BBF-13 AllSEE WEB



BAG-D2

Bezel Attaching Kits

Basic hardware kit for installation of bezels.

BAG-D2 1970-72 AllSEE WEB



ABR-9533

Battery Retainer Kits

ABR-9533 1970-72 AllSEE WEB

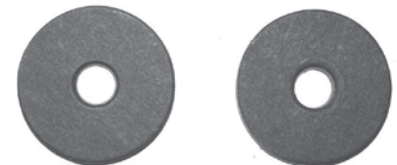

BSW-180070

Bench Seat Washers

These washers go between the seat and the hinge on all bench seat cars. It keeps the hinge from damaging the seat material.

BSW-180070 AllSEE WEB



BPB-9021

Bellhousing Attaching Kit

BPB-9021 1970-72 All (6pc)SEE WEB



AP-317



AP-315

Carb Studs

Correct carb studs for cowl induction.

AP-315 HolleySEE WEB
 AP-317 Q-Jet.....SEE WEB



BAN-516

Coil Bracket Screws

BAN-516 All.....SEE WEB



BTE-1475



BMG-0095

Carburetor Attaching Kits

BTE-1475 All Q-JetSEE WEB
 BMG-0095 All HolleySEE WEB



FBC-799

Clutch Pedal Booster Rod & Clip

For use with power disc brakes.

FBC-799 Booster Rod ClipSEE WEB
 FBF-606 Booster Rod Fork.....SEE WEB



BCP-373

Caliper Backing Plate Bolt

BCP-373 Plate to SpindleSEE WEB



NRM-1888



Cylinder Head Bolts

NRM-1888 1970-72 BB (32 pc.)SEE WEB



DS-595

Control Arm Shims

DS-594 1/16"SEE WEB
 DS-595 1/8"SEE WEB



FPB-97



FPB-103

Clutch Pedal Bushing & Bumper

Correct nylon bushing used for ease of pedal.

FPB-97 All BushingSEE WEB
 FPB-103 All BumperSEE WEB



BPX-0918

Control Arm to Frame Bolts

4 serrated bolts and 4 locking nuts for one car.

BPX-0918 1970-72 All.....SEE WEB



BPX-8542

Control Arm Upper Washers

Complete kit to do one car.

BPX-8542 1970-72 All.....SEE WEB



BPB-1430

Control Arm Bolts-Lower Front & Rear

BPB-1430 All.....SEE WEB



BPC-7000



BTE-7939

Crossmember Bolts

BPC-7000 To FrameSEE WEB
 BTE-7939 To TransmissionSEE WEB



AX-907

Cowl Hood Screen Screws

This is a set of 8 correct cowl hood screen attaching screws.

AX-907 1970-72SEE WEB



ACE-1400

Distributor Hold Down

Correct retaining hardware for distributor.

ACE-1400 All.....SEE WEB



BPX-1275

BPX-1299

Door Strikers w/ Washer

BPX-1275 GM Replacement.....SEE WEB
 BPX-1299 Reproduction*.....SEE WEB
 BPX-1299K Reproduction Pair.....SEE WEB

*Correct Allen Head Zinc Plated



MS277-20M

EMS Stainless Strikers

Replace your plain steel strikers with these attractive Eddie Motorsports Monte Carlo stainless steel door striker bolts. These billet striker bolts are cut with a Torx head and fit most Chevrolet muscle cars.

MS277-20M Machined.....SEE WEB
 MS277-20P Polished.....SEE WEB



RBR-067

Door Lock Rod Bellcrank Retainer Clip

Two required to mount one bellcrank to door frame.

RBR-067 1970-72.....SEE WEB



IXP-18

Door Panel Plugs

Correct plugs for attaching door panel clips. Buy the kit and save!

IXP-18K Plug Kit (12pc).....SEE WEB
 IXP-18 All Plug.....SEE WEB



IDP-109

Door Panel Screws

Correct size attaching screw for door panels.

IDP-109 All.....SEE WEB



BAV-2623



RHS-9

Door Hinge Hardware

Correct OEM bolts and heavy spring.

BAV-2623 1970-72 Hex.....SEE WEB
 RHS-9 1970-72 Spring.....SEE WEB
 BAV-2623K Hex (24).....SEE WEB



BPX-2225

Door Hinge Pin Kits

Correct hinge pins and brass bushings for repairing all 4 of your door hinges.

BPX-2225 1970-72 (12pc).....SEE WEB

*May require slight modification to hinges.



GDB-68-REG

Door Track Hardware

This bolt kit is used to attach the window regulator, window tracks, door latch and other internal pieces to the door.

GDB-68-REG 1970-72 Small Washer (12pc).....SEE WEB
 GDB-68-REG-LRG 1970-72 Large Washer (8pc).....SEE WEB



RRI-11360

Door Rod Insulators

This is a set of two correct door lock rod insulator shields which protect the long door opening rods in the doors.

RRI-11360 1970-72.....SEE WEB



RW-069-A-REAR

Door Window Hardware Kit

These convenient door window hardware kits include all of the necessary parts to rebuild the rollers, guides and bushings on the quarter window regulators. Made in USA.

RW-069-A-REAR 1970-72 1/4 Window.....SEE WEB
 RW-070-A 1970-72 Door.....SEE WEB



GGG-761

Door Glass Guide Screws

GGG-761 1970-72 (8pc).....SEE WEB

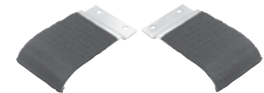

GGP-1485Y

Door Glass Guide Plates

Correct front door glass guide plates.

GGP-1485Y 1970-72 Felt Covered Steel.....SEE WEB
 GGP-7072 1970-72 Plastic.....SEE WEB



GGF-557

Door Glass Guide Felts

GGF-557 (4pc).....SEE WEB

GGG-1485Q

Door Glass Stabilizers

Correct front door glass stabilizers

GGG-1485Q 1970-72.....SEE WEB

GCS-1485N

Door Glass Support

Correct front door glass support.

GCS-1485N 1970-72.....SEE WEB



GWR-15365

GWR-15366

Door Glass Washers

Plastic washer that is used to protect the door. Mounts between the glass and the metal fasteners within the door. 1.5 inch diameter.

GWR-15365 1970-77 w/ Step.....SEE WEB
 GWR-15366 1970-77.....SEE WEB



GDS-15231



GDS-1485P

Door Glass Stopper

Correct front door glass stopper.

- GDS-15231 1970-72SEE WEB
 GDS-1485P 1970-72SEE WEB



ALI-2228

Exhaust Stud Kit

Correct studs for mounting exhaust pipe to manifold. Our kit comes complete with 3 long & 3 short studs and 6 correct locking nuts.

- ALI-2228 All SB - BBSEE WEB



APB-1382

OEM Exhaust Manifold Bolts

Correct head marked and colored bolts for mounting exhaust manifolds to block.

- APB-1382 SB w/ Washers (24 pc.)SEE WEB
 APB-1821 BB Flanged Head (16 pc.)SEE WEB
 APB-3506 BB Loose Washer (32 pc.)SEE WEB



MS275-38

EMS Stainless Hood Adjusters

Eddie Motorsports stainless steel hood adjusters are machined completely from stainless steel. They will not rust or corrode. Sold individually.

- MS275-38 MachinedSEE WEB
 MS275-38P PolishedSEE WEB



APC-0100



BPX-2792

Fan and Shroud Attaching Kits

Correct style bolts/studs for attaching fan to water pump.

- BPX-2792 Attaching Stud Kit 12 PieceSEE WEB
 BPX-2791 Attaching Bolt Kit 8 PieceSEE WEB
 APC-0100 1970-72 All Lower Shroud Clips...SEE WEB



BPX-4755

Fuel Tank Hardware

Correct OEM bolts and clips.

- BPX-4755 1970-72 AllSEE WEB



ACE-4867

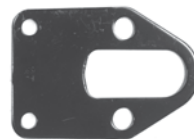

ACE-9599

Fuel Pump Hardware

- AJE-395 All Activating RodSEE WEB
 ACE-9599 All SB PlateSEE WEB
 ACE-4867 Fuel Pump BoltsSEE WEB



BPA-5160



BPA-5161



BPA-381



BPA-385

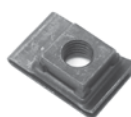

BFJ-516

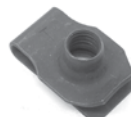

BFJ-038

Fender Front End Bolts

- BPA-5160 5/16" Bolt w/o WasherSEE WEB
 BPA-5161 5/16" Bolt w/ WasherSEE WEB
 BPA-381 3/8" x 1" BoltSEE WEB
 BPA-385 3/8" x 1-1/2" BoltSEE WEB
 BFJ-516 Fender J Clip 5/16"SEE WEB
 BFJ-038 Fender J Clip 3/8"SEE WEB

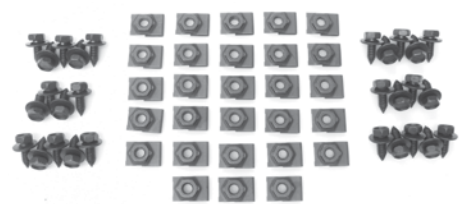

BIF-64K

Fender Inner Bolt Kit

- BIF-64K 1970-72 All (56 pc.)*SEE WEB
 *5/16" Bolts



EBB-691

Flex Hose Bolts

Correct OEM brake fluid bolt with hollow center and (2) special washers for attaching flex hose to caliper.

- EBB-691 All w/ Disc BrakesSEE WEB



GDS-707

Front Door Glass Side Stop

- GDS-707 1970-72SEE WEB

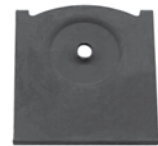

GGP-706

Front Door Glass Glide Plate

- GGP-706 1970-72SEE WEB



BCW-51

Fender Cup Washers

- BCW-51 1970-72 All ZincSEE WEB



BPB-5116

Flywheel Attaching Kit

- BPB-5116 1970-72 4 SpeedSEE WEB
 BPB-5118 1970-72 AutoSEE WEB



APX-2339

Frame Bracket Bolt Kit

APX-2339 1970-77 To FrameSEE WEB



BAG-D2

Grille Attaching Kits

BAG-D2 1970-72SEE WEB



BPB-5934

Harmonic Balancer Bolt

BPB-5933 All SB w/ WasherSEE WEB
BPB-5934 All BB w/ WasherSEE WEB



LHS-67



LHS-70

Headlamp Springs

Correct spring used for proper adjustment.

LHS-70 1970 AllSEE WEB
LHS-67 1971-72 AllSEE WEB



LHA-73K

Headlamp Adjustment Kit

Plastic nuts and screws for headlamp adjustment. Each kit does one car.

LHA-73K 1970-72 (4pc)SEE WEB
LHA-789K 1978-79 (6pc)SEE WEB
LHA-801K 1980-81 (6pc)SEE WEB
LHA-827K 1982-87 (6pc)SEE WEB



RDR-72K

Hinge Detent Rollers

Correct machined detent rollers for lower hinges.

RDR-72K 1970-72 AllSEE WEB



BCX-130

Hood Valve Frame Screws

This is a set of 6 correct screws to attach the hood valve frame.

BCX-130 1970-72SEE WEB



BPQ-4011

Hood Adjustment Bolts

BPQ-4011 1970-72 AllSEE WEB



BPQ-41-REAR

Hood Stop Studs

New hood stop studs that mount on cowl firewall. Special head with "C". 2 are used per car.

BPQ-41-REAR 1970-77SEE WEB



BPQ-BUMPER-REAR

Hood Bumpers Rear

These hard to find rubber hood bump stops are finally available! Sold in pairs, they slide into a groove on both sides of the hood and rest on the cowl when the hood is closed to stop the hood from shaking.

BPQ-BUMPER-REAR 1970-72SEE WEB

BX-1070



Hood Door Bracket Hardware

Correct set of four screws for attaching bracket to hood.

BX-1070 1970-72SEE WEB

BPA-381



Hood Hinge Bolt

BPA-381 3/8" x 1"SEE WEB

ACL-5588



Hood Door Attaching Kit

Correct shouldered bolts with P head markings with nylon bushings.

ACL-5588 1970-72SEE WEB



BPS-3679

BPS-7432

Intake Studs

Correct intake manifold studs for various uses: alternator, solenoid and power brake tube. Includes correct nut.

BPS-3679 All 3/8" x 3/8" (Zinc)SEE WEB
(p.s. bracket, alternator mount, etc.)

BPS-7432 All 5/16" x 3/8" (Black)SEE WEB
(TCS, P.B. tube, etc.)



BPI-4400



BPI-2271

Intake Manifold Kits

BPI-4400 1970-72 SB "M" (12pc)SEE WEB
BPI-9140 BB Cast "M" (16 pc.)SEE WEB
BPI-2271 BB Alum. "A" (16 pc.)SEE WEB



BPX-9873

Idler Arm Bolts

BPX-9873 To FrameSEE WEB



BHE-1970

Jack/Tire Retainer Kit

BHE-1970 1970-72 AllSEE WEB



BPA-53K

License Plate Attaching Kit

BPA-53K All (4pc)SEE WEB



APB-7057

Motor Mount "Thru" Bolt Kit

Correct OEM bolts for retaining mount to frame bracket. Comes complete with special high strength washers and cadmium plated locking nuts as original.

APB-7057 1970-72 All 3.5"SEE WEB



BJ-998

Motor Mount Attaching Bolt Kit

Correct style bolts for attaching mount to block.

BJ-998 All (12pc)SEE WEB



ATW-2853

Motor Mount Clip

Correct clip for attaching positive cable to right side motor mount.

ATW-2853 Most V8'sSEE WEB



MT-1970

Mirror Mounting Kit

Complete with bracket, gaskets, & screws.

MT-1970 1970-72SEE WEB

Non-remote mirror.



BSL-516

Nuts Self Locking

BSL-516 5/16" ZincSEE WEB
 BSL-38 3/8" ZincSEE WEB
 BSL-716 7/16" ZincSEE WEB
 BSL-12 1/2" ZincSEE WEB



BPO-1988

Oil Drain Bolt w/ Washer

BPO-1988 AllSEE WEB



BOP-2001

Oil Pan Attaching OEM Bolt Kit

Correct "L" head marked bolts for attaching pan to block

BOP-2001 All SB (18 pc.)SEE WEB
 BOP-2002 All BB (24 pc.)SEE WEB



BOP-2002

Pulley Attaching Bolts

BFC-333 All Fine (6pc)SEE WEB
 BRB-100 All Coarse (6pc)SEE WEB



BFC-333

Quarter Window Roller Assembly

Complete window roller assembly for rear quarter including center lower guide roller and threaded stud assembly.

GWR-060 1970-72 AllSEE WEB



BSB-1970

Power Steering Hardware Kits

Our kits feature all correct hardware to attach power steering brackets to engine. A MUST!

BSB-69SB 1970-72 All SBSEE WEB
 BSB-1970 1970-72 All BBSEE WEB



BPP-12

BPP-10

BPP-34

Push-In Plugs

BPP-12 1/2" Cowl Top, etcSEE WEB
 BPP-34 3/4" WheelhouseSEE WEB
 BPP-10 1" Trunk ExtensionSEE WEB
 BPP-138 1.3/8" Rubber PlugSEE WEB



BPP-8386

Pressure Plate Bolts

BPP-8386 All Manual (12pc)SEE WEB



GTS-177

Quarter Window Roller Tension Spring

This commonly missing spring is used to keep tension on the window roller so that the window goes up and down smoothly.

GTS-177 1970-72SEE WEB



GGG-15232

Quarter Window Stop

Correct reproduction of the quarter window stop, with the correct plastic coated end and correct bolt hole as original.

GGG-15232 1970-72SEE WEB



GWR-060

GWR-060

Quarter Window Roller Backing Washer

Correct backing washer for roller.

GWR-060A 1970-72SEE WEB



GWR-060A

Quarter Window Roller Nylon Bushing

Correct nylon bushing for roller.

GWR-060B 1970-72SEE WEB



GWR-060B

Quarter Plug

Correct plug and orange gasket used to plug the rear quarter panel drain hole.

BPP-70Q 1970-72SEE WEB



BPP-70Q



BRE-2008

Rear End Cover Bolt

BRE-2008 All FlangedSEE WEB



GGS-746

Rear 1/4 Window Glass Side Stop

GGS-746 1970-72SEE WEB



GGP-707-REAR

Rear Side Glass Glide Plate

GGP-707-REAR 1970-72SEE WEB



GDS-708

Rear 1/4 Window Lower Stop

GDS-708 1970-72SEE WEB



BPP-084

Rubber Body Plugs

Reproduction body plugs. GM licensed.

BPP-084 1970-72 1"SEE WEB



BSB-759

Steering Box Bolt

BSB-759 AllSEE WEB



GCS-S0005

Stainless Water Pump Bolts

Tapered head bolts used to mount the pulley to the water pump when using an electric cooling fan in place of a water pump mounted fan.

GCS-S0005 BoltsSEE WEB



DSB-12959

Rear Sway Bar Washers

Correct washers used on the nut side so that the nuts do not dig into the arms.

DSB-12959 1970-72 (4pc)SEE WEB



BV-2072



BV-2074



BV-2070

Starter Bolts

BV-2070 3/8" x 1 7/8" ShortSEE WEB

BV-2072 3/8" x 3 5/8" LongSEE WEB

BV-2074 3/8" x 4 11/16" Extra LongSEE WEB



BPX-1950

Sheet Metal Screw Kit

Over 20 pieces for small under hood items.

BPX-1950 AllSEE WEB



BPX-9715



BPX-9715-REAR

Shock Mounting Kit

Correct GM front shock mounting kit with (4) clips and (4) OEM bolts/washers.

BPX-9715 1970-72 All FrontSEE WEB

BPX-9715-REAR 1970-72 Rear Upper Shock Mounting HardwareSEE WEB



BRS-12659

Seat Back Release Screws

Correct screws to hold the folding seat back assembly in the seat back.

BRS-12659 1970-72 (8pc)SEE WEB



KMC-15KWS

Trim Stud Repair Kit OE GM

OEM GM replacement trim studs for mounting front and rear window moldings and some rocker moldings. These studs come with a sealant to prevent corrosion.

KMC-15KWS 1970-88 All (8 pc)SEE WEB



ATJ-411

Steering Coupler Bolt

Correct OEM Style bolt for coupler.

ATJ-411 1970-72 AllSEE WEB



BAR-1295

Sway Bar Bolt

Correct mounting bolt for stock front sway bar.

BAR-1295 Correct BoltSEE WEB



FTH-049

Shifter Cable Clip

Correct push on clip which mounts to shifter.

FTH-049 Push on Clip (to shifter)SEE WEB



EBC-22

Shifter Cable Clip

Correct clip for mounting cable.

EBC-22 Mounting ClipSEE WEB



BSB-561



BSB-56



BSB-5-SBL

Seat Belt Anchor Bolts

BSB-56 All Front OuterSEE WEB

BSB-561 1970-72 Front InnerSEE WEB

BSB-561 All RearSEE WEB

BSB-5-SBL All Fully Threaded ShankSEE WEB

1970-72 used (2) front seat belts.



BSM-5NT



BSM-516

Seat Mounting Bolts

BSM-516 All Front BoltsSEE WEB

BSM-5NT All Rear NutsSEE WEB



Thermostat Housing

- ATR-1039 Most SB Bolt/Stud.....SEE WEB
- ATR-2039 All SB-BB BoltSEE WEB



Transmission Mounting Hardware

- BTE-307 To Bellhousing (8pc).....SEE WEB
- BTE-7939 To Rear MountSEE WEB



Timing Cover Bolt Kit

- BTC-650 "L" Sems BoltsSEE WEB



Valve Cover Bolts

- APB-1023 SB "TR" (16 pc.).....SEE WEB
- APB-2023 BB "TR" (28 pc.).....SEE WEB
- APB-1027 SB "M" (8pc)SEE WEB

M bolts were used on finned aluminum valve covers.



Voltage Regulator Nuts and Screws

- AVX-515 1970-71 AllSEE WEB



Water Pump OEM Attaching Bolt Kits

Correct style attaching bolts with "TR" head markings.

- ATR-3232 1970-68 3 Bolts 1 StudSEE WEB
- ATR-4334 1970-72 All 4 Bolts M Mark.....SEE WEB
- AWS-302L Stud Only (Long)SEE WEB



Wing Nuts, Flame Arrestor & Studs

- APX-1400 Chrome Wing Nut.....SEE WEB
- APX-7700 Black Wing NutSEE WEB
- ATE-5695 Flame ArrestorSEE WEB

Carburetor Studs

- APJ-2153 All w/ Holley Open ElementSEE WEB
- AP-315 All w/ Q-Jet.....SEE WEB
- AP-315 1970-72 Holley w/ Cowl InductionSEE WEB
- AP-317 1970-72 Q-Jet w/ Cowl InductionSEE WEB
- ATE-5256 Universal w/ Point End.....SEE WEB



Window Roller Tool

Allows you to easily install window rollers.

- TRIM-WR AllSEE WEB



Window Retainers

Two piece window glass retainer used to hold the side window glass to the regulator.

- GWR-12660 1970-72SEE WEB
- GWR-15365 1970-88 Plastic Washer OnlySEE WEB



Window Rollers

Correct replacement window rollers.

- WR-76 1970-72 Lower Rear 1/4.....SEE WEB
- WR-78 1970-72 DoorSEE WEB
- WR-065 1970-72 Lower Rear 1/4.....SEE WEB

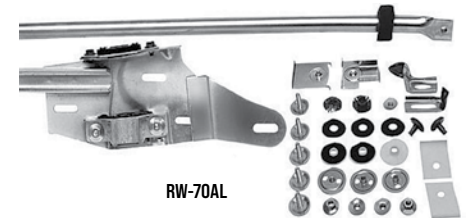

Window Track And Hardware Kits

This convenient door window track & hardware kit is great for when you are changing out your door glass.

- RW-70AL 1970-72 LH.....SEE WEB
- RW-70AR 1970-72 RHSEE WEB

Ships Oversize. No Volume Discount.



Window Molding Stud/Pin Kit

Self tapping screws replace the original body studs used to retain factory window or vinyl top molding clips.

- KMC-15 1970-88 (12pc)SEE WEB



BUY & SAVE
WITH SS396.COM PRE-BUILT KITS

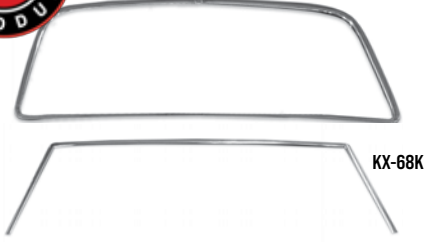

Front and Rear Window Molding Kits
These high quality window moldings are our own tooling and have been used on our own restoration projects, so you can be sure that they are the highest quality on the market!

- KX-68R 1970-72 Coupe Front SEE WEB
- KX-68G 1970-72 All Rear SEE WEB
- KX-68K 1970-72 All Front & Rear SEE WEB
- KX-F 1978-88 Front SEE WEB
- KX-88R 1982-88 Rear SEE WEB

All window moldings ship oversize and well protected. Not eligible for free shipping.



Lower Windshield Molding
Beautiful reproduction of the often missing or damaged wide lower windshield molding. This stainless steel piece is manufactured to exact factory specs.

- KLM-3A 1970-72 Molding SEE WEB
- KLM-3SK Attaching Screws (7 pc.) SEE WEB
- KLM-10533 End Clips w/ Screws SEE WEB

These moldings ship Oversize and well protected. Not eligible for free shipping.



Windshield Molding Clips
Complete set of clips for one car.

- KMC-68KITA 1970-72 Front Windshield SEE WEB
- KMC-678K 1970-72 Rear Window SEE WEB

Some clips may vary slightly from factory, but will fit and function as original.



Vinyl Top Corner Molding End Caps
This is a pair of reproduction die-cast chrome plated 1970-1972 Monte Carlo vinyl top corner moldings, which are the finishing touch to your vinyl top restoration.

- KT-7072M 1970-72 SEE WEB



Monte Carlo A-Pillar Roof Drip Moldings
This is a set of exact replacement Monte Carlo stainless steel A-pillar roof drip moldings which run up your a-pillar to the roof drip molding and will replace your originals exactly.

- KDX-70A 1970-72 SEE WEB



Roof Drip Molding Escutcheon
This is a set of exact replacement Monte Carlo stainless steel roof drip moldings.

- KDX-70C 1970-72 SEE WEB



Rocker Panel Molding Set & Clips
Monte Carlo rocker panel moldings are notorious for receiving their fair share of dings and dents over the years. Now you can replace your originals with these exact reproduction, highly detailed rocker moldings.

- KRP-7072M 1970-72 Rocker Panel Molding SEE WEB
- KRP-7079-CLIP 1970-72 Clips SEE WEB



Lower Side Molding Kit
This is a complete Monte Carlo body side molding kit complete with correct mounting hardware. Features a bright dipped finish with correct black accents. We know all too well that these original body moldings can be victims of shopping carts or opened doors over the years, so replacing your damaged original moldings is an easy way to really get your Monte Carlo looking like new again.

- KLM-7072M 1970-72 SEE WEB



Lower Panel Molding Extension
If you need to ask "where does it fit?" you probably need it. This Monte Carlo lower chrome molding shows across the back panel between the tail light and trunk.

- TC-1646 1970-71 SEE WEB

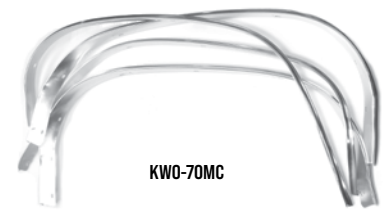

Wheel Opening Moldings
Reproduction extruded aluminum moldings sold in sets of four.

- KWO-70MC 1970-72 SEE WEB

Ships Oversize. Not eligible for free shipping. No Volume Discount.



Top of Fender Moldings
Reproduction moldings which mount to the top of the fenders to "connect" to the rear hood edge molding.

- KH-2901-GM 1970-72 w/ Seals SEE WEB



Cowl Vent Grilles
Correct plastic grilles to keep debris out of cowl.

- N-4510 1970-72 Non-AC SEE WEB
- N-4512 1970-72 w/ AC SEE WEB
- N-2054 1973-77 All SEE WEB



LWB-72

Wiper Arms & Blades

LWB-72 1970-72 16" Blade.....SEE WEB



LWA-68K

Windshield Wiper Arm & Blade Kits

If your original wiper arms and blades were damaged or have gone missing over the years, finding good replacements was a major headache until now. These kits include a pair of wiper arms, complete with blades.

LWA-68K 1970-72 w/ Hidden Satin SEE WEB

LWA-68K-C 1970-72 w/ Hidden Chrome SEE WEB

No Volume Discount.



WIPERKIT-HIDE-C

Hidden Wiper Arm & Transmission Kits

Looking to refurbish or replace major components of your wiper system? Look no further with Ground Up's exclusive wiper kits! This hidden wiper kit includes two wiper arms, two wiper blades and the wiper transmission arm. Deluxe kits include a wiper motor.

WIPERKIT-HIDE-C 1970-72 Chrome Arms.....SEE WEB

WIPERKIT-HIDE 1970-72 Satin Arms.....SEE WEB

FMP-CLIP 1970-77 ClipSEE WEB

Deluxe Kits With Wiper Motor

WIPERKIT-HIDE-DLX-C 1970-72 Chrome Arms.....SEE WEB

WIPERKIT-HIDE-DLX 1970-72 Satin Arms.....SEE WEB

FMP-CLIP 1970-77 ClipSEE WEB

No Volume Discount.



MHQ-1316L-PQ

1970-72 Premium Mirror

Premium upgrade mirror. Features correct rib line on top of the base. Will not droop like aftermarket mirrors.

MHQ-1316R-PQ 1970-72 RHSEE WEB
 MHQ-1316L-PQ 1970-72 LH.....SEE WEB



MIR-7377L

Rear View Mirrors

Reproduction triple chrome plated rear view mirror. There are many different mirrors on the market, but these are tried and true. We use them on our own cars!

MA-1812 1970-72 LH or RHSEE WEB
 MIR-7377L 1973-77 LH.....SEE WEB
 MIR-7377R 1973-77 RHSEE WEB
 MK-546L 1978-81 LH Chrome..... SEE WEB



MA-70R

1970-72 Remote Rear View Mirror

Long discontinued by GM, this OE style reproduction remote rear view mirror offers a perfect replacement or upgrade to your original mirror. Each mirror comes ready to install with cable and switch. We also offer a matching non-functional mirror for the passenger side.

MA-70R 1970-72 RemoteSEE WEB
 MA-70XR 1970-72 RHSEE WEB

No Volume Discount.



MIR-70K

Mirror Kits

Complete kit with (2) rear view mirrors and (2) mirror mounting kits.

MIR-70K 1970-72SEE WEB



MT-1970

Mirror Mounting Kits

Complete with bracket, gasket and screws.

MT-1970 1970-72 All.....SEE WEB
 MHQ-7377 1973-77 All.....SEE WEB



MEH-4551

Door Handle Gasket Set

Complete set of die stamped gaskets for both door handles and lock cylinders.

MEH-4551 1970-72 All.....SEE WEB



EMG-231

1973-77 Mirror Glass

Correct reproduction bullet mirror glass.

EMG-231 1973-77 LHSEE WEB
 EMG-156 1973-77 RH.....SEE WEB

Note: Does not feature wording.



MPX-4155

TrimParts Door Handle Kits

High quality door handles made exclusively by TrimParts in the USA. Fit and function is exact to original. Highest quality on the market!

MPX-4155 1970-72 GM 9706526SEE WEB



MPX-6967

Door Handle Kits

Complete kit with (2) door handles, (1) gasket set, and (1) push button set.

MPX-6967 1970-72 All.....SEE WEB

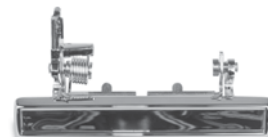

MPX-786R

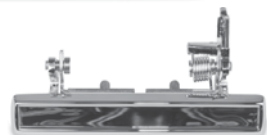

MPX-786L

1978-88 Door Handles

This brand new outer door handle is a perfect replacement for your missing or pitted original. This door handle will really help to freshen up the exterior of your 2 door coupe.

MPX-786L 1978-88 LH..... SEE WEB
 MPX-786R 1978-88 RH SEE WEB



MCC-5255

Door Handle Push Buttons

This is a complete door handle push button kit. This kit includes (2) buttons, (2) rubber rings, (2) springs and (2) retainers for a complete replacement.

MCC-5255 1970-72 All.....SEE WEB



ANT-7088

Antenna Lead Wire

Correct lead that mounts to the top of the dash. The windshield antenna plugs into this and the lead goes to the radio.

ANT-7088 1970-77 All.....SEE WEB



LEH-83MC

Grille

Reproduction grille is the perfect replacement. This is an easy and inexpensive fix to make the front of your car look new again.

LEH-83MC 1983-86 Monte Carlo*SEE WEB
*Non SS/LS



LHA-73K



LHS-67

Headlamp Adjustment Kit

Plastic nuts and screws for headlamp adjustment. Each kit does one car.

LHA-73K 1970-72 All (4pc).....SEE WEB
LHA-789K 1978-79 (6pc).....SEE WEB

Headlamp Springs

Correct spring used for proper adjustment.

LHS-67 1970-72 All.....SEE WEB



BAG-D2

Bezel Attaching Kits

Basic hardware kit for installation of bezels.

BAG-D2 1970-72 All.....SEE WEB



LHB-989

1970-72 Headlamp Buckets

Reproduction headlamp buckets

LHB-989 1970-72 LH.....SEE WEB
LHB-988 1970-72 RH.....SEE WEB



LHR-10K

Headlamp Retainer

Correct stainless steel rings and attaching screws.

LHR-663 1970-72 All.....SEE WEB
LHR-10K Screws (3 pc.).....SEE WEB



MAU-MC71F



MAU-MC72F



MAU-70MC-REAR



RIB-81



Monte Carlo Bumpers

Excellent quality triple chrome plated bumpers for your Monte Carlo.

MAU-E70 1970 Front Bumper.....SEE WEB
MAU-MC71F 1971 Front Bumper.....SEE WEB
MAU-MC72F 1972 Front Bumper.....SEE WEB
MAU-70MC-REAR 1970-72 Monte All Rear.....SEE WEB
RIB-81 1981-82 Monte Front Impact Bar*.....SEE WEB
RIB-83 1983-86 Monte Front Impact Bar*.....SEE WEB
RIB-81R 1981-88 Monte Rear Impact Bar*.....SEE WEB

*Except LS & SS. Ships Oversize 2. Not eligible for free shipping.



MCF-71

Rear Bumper Pads

These are reproductions of the original GM rear bumper pads found on SS models.

MCF-71 1971 Monte Carlo SS.....SEE WEB

Front Bumper Bracket Reinforcement Rubber Insulator

Correct front bumper bracket reinforcement rubber insulator.

MRI-70A 1970-72.....SEE WEB



Bumper Bracket Bolts

New bumper bracket bolts with correct teeth washers and nut.

BBF-13 All.....SEE WEB



BTB-56



XTD-10B



XTD-1630

Fuel Tank Door

Correct spring loaded fuel tank door.

XTD-1630 1970-72 Door.....SEE WEB
XTD-10B Door Bumper.....SEE WEB
BTB-56 Door Bolt.....SEE WEB



MLB-70



XTD-8287

License Plate Brackets

Reproduction brackets for mounting license plates.

MLB-70 1970-72 Front.....SEE WEB
XTD-8287 1981-87 Monte Front.....SEE WEB

Fenders

Our reproduction fenders are manufactured to duplicate the originals in both fit and appearance. All fenders come EDP coated. Just as with original GM fenders, we recommend test fitting before painting or modifying.

No Volume Discount. All fenders ship Truck Freight to a commercial address. Not eligible for free shipping.



RIF-73P



RIFS-787

Front Inner Fenders

Brand new die-stamped inner fender wells.

RIF-73P 1973-77 All PlasticSEE WEB

BIF-64K Hardware KitSEE WEB

RIFS-787 1978-88 All Inner Fender Shields ..SEE WEB

Ships Oversize 2. Not eligible for free shipping.



RF-81MCL



RF-81MCR

Monte Carlo Fenders

This is an exact reproduction 1981-1988 Monte Carlo fender which is constructed of heavy gauge steel and features all of the correct bracing as original. This is a great replacement for your original dented or rusty fender and it is black EDP coated for rust prevention.

RF-81MCL 1981-88 All*SEE WEB

RF-81MCR 1981-88 All*SEE WEB

**Except LS*



RFB-3900

Lower Fender Support Braces

These lower fender braces connect the lower fenders to the radiator support for rigidity. Includes hardware.

RFB-3900 1970-72 All.....SEE WEB



BFE-8002

Front End Fastener Kit

Over 175 pieces all individually bagged to attach all of your front end sheet metal including fenders, grille, inner fenders, hood, etc.

BFE-8002 1970-72 All.....SEE WEB



RH-812

Cowl Induction Hood

These are the hoods that GM should have made! Let people know your ride means business with one of these 2" cowl hoods!

RH-812 1981-88 2" CowlSEE WEB

No Volume Discount. Ships Truck Freight to a commercial address. Not eligible for free shipping.

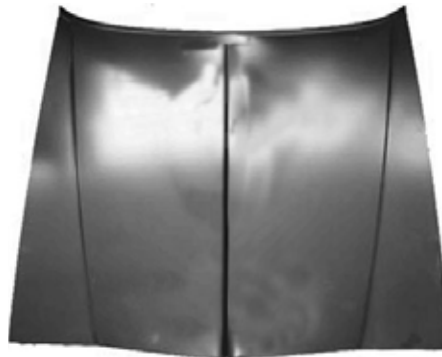

RH-818

Standard Hood

Reproduction hood, each hood is finished in a protective EDP coating to prevent rust and is ready to be prepped and painted. You can be sure you are receiving the highest quality hood on the market.

RH-818 1981-88SEE WEB

No Volume Discount. Ships Truck Freight to a commercial address. Not eligible for free shipping.



RRS-8188



RSB-1330

Radiator Supports

Reproduction radiator supports.

RRS-8188 1981-88SEE WEB

RSB-1330 1981-88 3pc Support Brace KitSEE WEB

No Volume Discount.



Firewall Brackets

Reproduction firewall brackets (where your body bushings attach)

RFP-1461F

RFP-1461F 1970-72SEE WEB

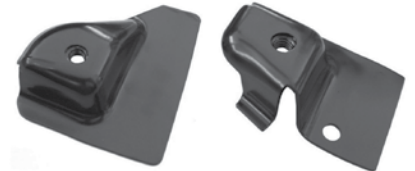

RFB-3468

Fender to Firewall Brackets

These brackets provide the mounting points for the fenders.

RFB-3468 1970-72 All.....SEE WEB



RFP-1461B

Firewalls

Brand new complete firewalls.

RFP-1461A 1970-72 Firewall w/ AC.....SEE WEB

RFP-1461B 1970-72 Firewall w/o AC.....SEE WEB

RFP-1461C 1970-72 Firewall Heater DeleteSEE WEB

Ships Truck Freight to a commercial address. Not eligible for free shipping. No Volume Discount.



RDS-81MCL



RDS-86MCL

Door Skins

Door skins are perfect for repairing doors that have not rusted through the inner shell. These stamped steel panels replace your old rusty skin.

RDS-81MCL	1981-85 LH.....	SEE WEB
RDS-81MCR	1981-85 RH.....	SEE WEB
RDS-86MCL	1986-88 LH.....	SEE WEB
RDS-86MCR	1986-88 RH.....	SEE WEB

No Volume Discount. Ships Oversize 2. Not eligible for free shipping.



RSH-81MCL

Door Shells

These full door shells feature the outer door skin welded to the shell as original. Perfect when your entire door has rusted through.

RSH-81MCL	1981-85 LH.....	SEE WEB
RSH-81MCR	1981-85 RH.....	SEE WEB
RSH-86MCL	1986-88 LH.....	SEE WEB
RSH-86MCR	1986-88 RH.....	SEE WEB

No Volume Discount. Ships Truck Freight to a commercial address. Not eligible for free shipping.



RHS-9

BAV-2623

Door Hinge Hardware

Correct OEM bolts and heavy spring.

BAV-2623	1970-72 Hex.....	SEE WEB
RHS-9	1970-72 Spring.....	SEE WEB
BAV-2623K	Hex (24 pc.).....	SEE WEB

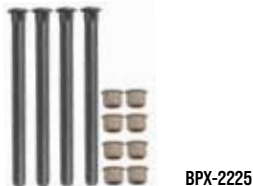

BPX-2225

Door Hinge Pin Kits

Correct hinge pins and brass bushings for repairing all 4 of your door hinges.

BPX-2225	1970-72 (12pc).....	SEE WEB
----------	---------------------	---------

May require slight modification to hinges.



RDR-72K

Hinge Detent Rollers

Correct machined detent rollers for lower hinges.

RDR-72K	1970-72 All.....	SEE WEB
---------	------------------	---------

RDH-088LL



Door Hinges

Reproduction door hinges.

Upper

RDH-170U	1970-72 All RH/LH.....	SEE WEB
RDH-78UL	1978-88 All LH.....	SEE WEB
RDH-78UR	1978-88 All RH.....	SEE WEB

Lower

RDH-088LL	1970-72 LH.....	SEE WEB
RDH-088LR	1970-72 RH.....	SEE WEB
RDH-78L	1978-88 All LH/RH.....	SEE WEB



RDL-70AR

RDL-SCREW

Door Latch Assemblies

Reproduction door latch assemblies.

RDL-70AL	1970-72 LH.....	SEE WEB
RDL-70AR	1970-72 RH.....	SEE WEB
RDL-70AK	1970-72 Kit (Both Sides).....	SEE WEB
RDL-828L	1982-88 All LH.....	SEE WEB
RDL-828R	1982-88 All RH.....	SEE WEB
RDL-SCREW	1970-77 Screw 3 pc*.....	SEE WEB

*Part Notes: This kit does one door latch. 1 kit required per door.



BPX-1275

BPX-1299

Door Strikers w/ Washer

BPX-1275	GM Replacement.....	SEE WEB
BPX-1299	Reproduction*.....	SEE WEB
BPX-1299K	Reproduction Pair.....	SEE WEB

*Correct Allen Head Zinc Plated.



RTT-7888

Roof Panel

This is a correct 8 piece set of stainless steel T-top trim for 1978-1988 Monte Carlo.

RTT-7888 1978-88 T-Top Trim.....SEE WEB
Ships Truck Freight to a commercial address. Not eligible for free shipping. No Volume Discount.



RCS-68R

Cowl Shoulder Assembly

Complete replacement for this often rotted out area.

RCS-68L	1970-72 LH.....	SEE WEB
RCS-68R	1970-72 RH.....	SEE WEB



RCP-7L

1970-72 Cowl Side Panel

RCP-7L	1970-72 LH.....	SEE WEB
RCP-7R	1970-72 RH.....	SEE WEB



RCP-1471CWT

1970-72 Cowl Grille Panel

Reproduction perfect for replacing this commonly rotted area. Features Weld-Thru primer.

RCP-1471CWT	1970-72.....	SEE WEB
-------------	--------------	---------

Ships Oversize 2.

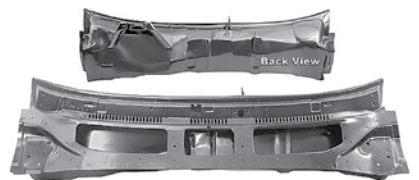

RCP-1419WT

1970-72 Cowl Panel

This lower cowl panel offers a complete replacement for this often rotted out area. This complete cowl panel includes the entire wiper valley so you can be sure to eliminate any rust or rot all in one shot.

RCP-1419WT	1970-72.....	SEE WEB
------------	--------------	---------

Ships Oversize 2. Not eligible for free shipping.



RWH-818AL

Complete Monte Carlo Wheelhouse Assemblies

These complete wheelhouse assemblies feature the inners and outers already welded together, saving you a lot of time and money!

- RWH-818AL 1981-88 LHSEE WEB
- RWH-818AR 1981-88 RHSEE WEB

Ships Oversize 2. Not eligible for free shipping. No Volume Discount.



RWH-291L



RWH-813L

Monte Carlo Inner Rear Wheelhouses

New inner rear section of wheelhouse which installs between the trunk area and seams to the outer wheelhouse. It is always a good idea to replace your wheelhouses when you replace your quarter panels!

- RWH-291L 1970-72 LH.....SEE WEB
- RWH-291R 1970-72 RHSEE WEB
- RWH-813L 1983-1988 LH.....SEE WEB
- RWH-813R 1983-1988 RHSEE WEB

Ships Oversize 2. Not eligible for free shipping. No Volume Discount.



RWH-818MCOL

Outer Rear Wheelhouses

Correct steel wheelhouses which attach to the inside of the quarter panel. It is always a good idea to replace your wheelhouses when you replace your quarter panels! Buy the pair and save 10%. Just ask your sales rep!

- RWH-818MCOL 1981-88 Monte Carlo LH.....SEE WEB
- RWH-818MCCR 1981-88 Monte Carlo RH.....SEE WEB

Ships Oversize. Not eligible for free shipping. No Volume Discount.



RFQ-MC702L



RFQ-818L

1970-1988 Quarter Panels

This OE quality quarter panel is the perfect replacement! There is no need to spend a fortune on an NOS quarter. These are extremely high quality pieces, so you can be sure to get the best fit possible.

- RFQ-MC702L 1970-1972 LH OE Quality SEE WEB
- RFQ-MC702R 1970-1972 RH OE Quality SEE WEB
- RFQ-818L 1981-88 LH OE Quality SEE WEB
- RFQ-818R 1981-88 RH OE Quality SEE WEB

Ships Truck. Not eligible for free shipping. No Volume Discount.



RQE-70ML



RQE-70MR

1970-1972 Quarter Panels Extensions

Reproduction of the original 1970-1972 Monte Carlo quarter panel extension (or drop off) which connects the inside lower rear of the quarter panel to the outside of the trunk. It is recommended to replace this piece when replacing a trunk or a quarter panel. Odds are high your trunk floor extensions (drop offs) will need replacement or repair if your quarter panels and wheelhouses contain rust. It's very common to need all three items since they are all connected. Our trunk floor extensions are direct replacements of originals and feature correct flanges, tabs, holes and bends.

- RQE-70ML 1970-1972 LH SEE WEB
- RQE-70MR 1970-1972 RH SEE WEB

Ships Oversize. Not eligible for free shipping. No Volume Discount.



1970-72 Full Floor Pan w/ Braces, Rear Seat Pan & Rockers

This floor pan featuring all braces, rear seat panel and rocker panels completely assembled saving you a ton of time and money over individually piecing together a floor!

- RFP-1462Y 1970-72SEE WEB

No Volume Discount. Ships Truck Freight to a commercial address. Not eligible for free shipping.



1970-72 Full Floor Pan w/ Braces & Rear Seat Pan

This complete floor pan features all braces as well as rear seat panel already installed! This will save you hours over welding in individual pieces of floor pan!

- RFP-1462X 1970-72SEE WEB

No Volume Discount. Ships Truck Freight to a commercial address. Not eligible for free shipping.

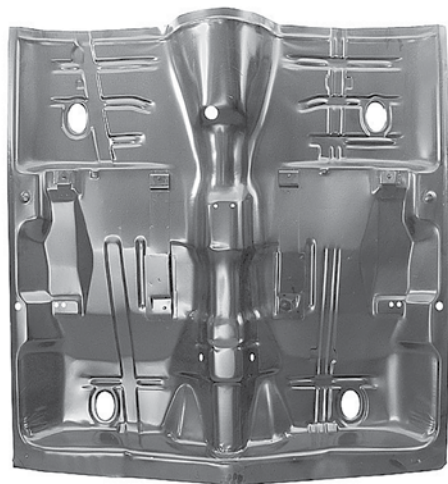

1970-72 Full Floor Pan

This is an excellent basic replacement full floor minus the braces, rear seat pan and rocker panels.

RFP-1462 1970-72SEE WEB

No Volume Discount. Ships Truck Freight to a commercial address. Not eligible for free shipping.



1978-88 Monte Carlo, Malibu Full Floor

The days of welding together pieces of floors are finally over. This new Monte Carlo, Caballero and Malibu full floor pan is a direct replacement for your old, rotted floor and will save you tons of time and money because you won't have to weld-in and finish individual pieces.

RFP-7888 1978-88 All * SEE WEB

**Direct replacement for 1978-87 El Camino. May require some cutting on the rear for Malibu, Monte Carlo, Regal, Cutlass and Grand Prix. This is the floor pan only. It does not include any braces or brackets.*

Ships Truck Freight To A Commercial Address.

Not eligible for free shipping.



Half Side Floor Pans

Full half side floor panels which seam in the middle. All 1970-67 floor panels feature wiring harness retainers as well as gas pedal mounting plate as original.

RP-68FL 1970-72 Monte Carlo LH SEE WEB

RP-68FR 1970-72 Monte Carlo RH SEE WEB

RFP-78L 1978-88 Monte Carlo LH** SEE WEB

RFP-78R 1978-88 Monte Carlo RH** SEE WEB

*** Can be cut to fit Malibu and Monte Carlo*

Ships Truck Freight to a commercial address.

Not eligible for free shipping.



Floor Pan Patch Kit

This Monte Carlo floor pan patch kit includes front left and right floor pan patches and rear left and right floor pan patches. This is a great lower cost alternative to a full floor pan because this kit can ship via UPS instead of truck freight.

RFP-72K 1970-72SEE WEB

RFP-737K 1973-77 SEE WEB

Ships Oversize 2. Not eligible for free shipping.

No Volume Discount.



RFP-72FL

RFP-72FR



RFP-72RL

RFP-72RR

Floor Pan Patches

These front floor patches are high quality and constructed of heavy gauge steel. Perfect when only portions of your floor are rotted out.

RFP-72FL 1970-72 Front LHSEE WEB

RFP-72FR 1970-72 Front RHSEE WEB

RFP-72RL 1970-72 Rear LHSEE WEB

RFP-72RR 1970-72 Rear RHSEE WEB

RFP-73FL 1973-77 Front LH SEE WEB

RFP-73FR 1973-77 Front RH SEE WEB

RFP-73RL 1973-77 Rear LH SEE WEB

RFP-73RR 1973-77 Rear RH SEE WEB

RFP-78FL 1978-88 Front LH*SEE WEB

RFP-78FR 1978-88 Front RH*SEE WEB

RFP-78RL 1978-88 Rear LH*SEE WEB

RFP-78RR 1978-88 Rear RH*SEE WEB

**Can be used on other G-bodies with modifications.*

Ships Oversize. Not eligible for free shipping.

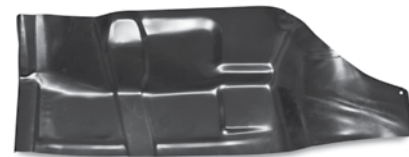

Toe Boards

This toe board or floor pan extension connects the front of the floor pan to the firewall and is a commonly rotted out area. Now includes part of the transmission hump.

RTB-68L 1970-72 LHSEE WEB

RTB-68R 1970-72 RHSEE WEB



ISA-669

Bucket Seat Frames

Complete bucket seat frame assemblies with seat springs already installed!

ISA-669 1970-72 All.....SEE WEB
No Volume Discount. Ships Oversize 2. Not eligible for free shipping.

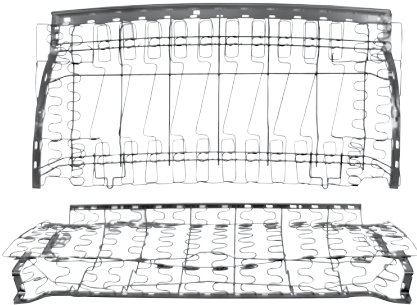

ISF-1402H

Rear Seat Frames

This is a reproduction rear seat frame which includes the back and bottom. This is a complete replacement for your worn out original springs.

ISF-1402H 1970-72SEE WEB
No Volume Discount. Ships Truck Not eligible for free shipping.



Rear Seat Retainer Kit

This rear seat retainer kit contains all four of the necessary retainers to hold the rear seat of your in place.

IBX-99KR 1970-72SEE WEB
 BSM-REAR 1970-72 Seat Back Bolts.....SEE WEB



Bucket Seat Brackets

This is a reproduction bucket seat mounting bracket kit which will correctly mount both seats.

IBX-89K 1970-72 All.....SEE WEB
 IBX-89K-FR 1970-72 All Front/Rear Set.....SEE WEB
 IBX-RELO All (4pc) Relocation Brackets.....SEE WEB



Inner Rocker Panels

Reproduction die stamped inner rocker panels for an exact replacement.

RIP-1489T 1970-72 LH.....SEE WEB
 RIP-1489S 1970-72 RHSEE WEB
 RIP-78L 1978-88 LHSEE WEB
 RIP-78R 1978-88 RHSEE WEB
 RIP-5970 1970-72 All Drain PlugsSEE WEB
 RIP-5970 1970-72 Inner Rocker Drain PlugsSEE WEB

Ships Oversize. Not eligible for free shipping.



Outer Rocker Panels

Correct gauge stamped steel full outer rocker panels with original mounting points.

RRP-682L 1970-72 LH.....SEE WEB
 RRP-682R 1970-72 RHSEE WEB
 RRP-78L 1978-88 LHSEE WEB
 RRP-78R 1978-88 RHSEE WEB

Ships Oversize. Not eligible for free shipping.



Rocker to Cowl Reinforcements

Heavy gauge rocker to cowl reinforcement panels. Features Weld-Thru primer.

RCR-1419 1970-72SEE WEB



RST-72D



RST-73D

Shifter Tunnel Pans

Correct stamped steel hump which was factory installed on all 3 or 4 speed cars.

RST-72D 1970-72 w/ Console.....SEE WEB
 RST-72A 1970-72 w/o Console.....SEE WEB
 RST-73D 1973-77 AllSEE WEB
 IQ-4015 1978-88 All Plastic.....SEE WEB



RPP-78AL



RPP-78BL

Door Jamb Repair Patches

These patches repair the commonly rusted area at the front and back of the door jamb at the bottom of the A and B pillars.

RPP-78AL 1978-88 LH A-PillarSEE WEB
 RPP-78AR 1978-88 RH A-PillarSEE WEB
 RPP-78BL 1978-88 LH B-PillarSEE WEB
 RPP-78BR 1978-88 RH B-PillarSEE WEB

Fits 2 door only.



P-2200



P-2000

Spare Tire Anchor Plates

Correct spare tire hold down and jack floor brackets.

P-2000 1970-72 Anchor PlateSEE WEB
 P-2200 1970-72 Jack BracketSEE WEB



RTB-682

Fuel Tank Braces

Correct braces that attach to the trunk floor and support the tank straps.

RTB-682 1970-72 LH & RH SEE WEB
 RTB-73 1973-77 LH/RH SEE WEB



RBB-68R

Trunk Floor Braces

Correct stamped steel braces that support the trunk floor. All braces include correct cage nuts.

RBB-68L 1970-72 LH.....SEE WEB
 RBB-68R 1970-72 RHSEE WEB



Lower Frame Braces

Now you can give your Monte Carlo some added strength with this pair of exact reproduction rear frame braces. These braces were originally installed on cars with heavy duty suspensions and were used to stiffen the chassis from the lower rear control arms forward mounting point. These braces help to eliminate breaking of the cross member in high performance applications.

DZ-4500 1970-72 Rear Lower.....SEE WEB



RFB-86RR



RFB-87RR

Above Axle Crossmembers

Correct steel crossmembers which go under the front of the trunk directly above the rear end.

- RFB-86RR 1970SEE WEB
- RFB-87RR 1971-72SEE WEB

Ships Oversize. Not eligible for free shipping.



RFB-84F



RFB-85M



RFB-85R

Floor Pan Braces

These braces are a must when replacing any parts of your floor pan! These often rusted body braces support the floor pans under the front, middle and rear seats and offer the necessary support. All braces feature correct contours and cage nuts.

- RFB-84F 1970-72 FrontSEE WEB
- RFB-85M 1970-72 MiddleSEE WEB
- RFB-85R 1970-72 RearSEE WEB

Ships Oversize. Not eligible for free shipping.



Rear Frame Crossmember

Ties the back of the frame together.

- RFR-68A 1970-72SEE WEB

Ships Oversize.



BCN-716

RCH-86L

Partial Floor Pan Braces

These partial braces extend approximately 16" from the outboard sides to the driveshaft. Cage nuts are included.

- RCH-86L 1970-72 All Front LHSEE WEB
- RCH-86R 1970-72 All Front RHSEE WEB
- RCH-87L 1970-72 All Middle LHSEE WEB
- RCH-87R 1970-72 All Middle RHSEE WEB
- BCN-716 1970-72 All Cage Nut OnlySEE WEB

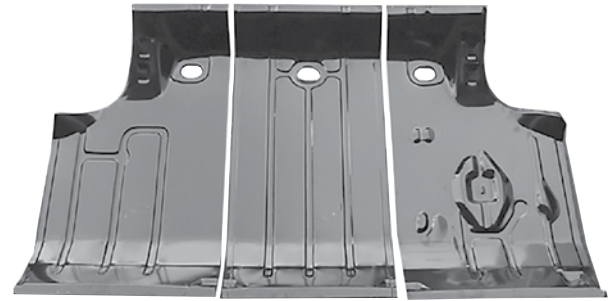

RFK-82K

Trunk Floor Repair Patches

These individual trunk floor pieces are perfect when your entire trunk isn't rotted out and also allows you to save on shipping as opposed to a full trunk floor. Buy the set of all 3 and save!

- RTF-68L 1970-72 LHSEE WEB
- RTF-68C 1970-72 CenterSEE WEB
- RTF-68R 1970-72 RHSEE WEB
- RFK-82K 1970-72 (3 pc.)SEE WEB
- RTF-73L 1973-77 LHSEE WEB
- RTF-73C 1973-77 CenterSEE WEB
- RTF-73R 1973-77 RHSEE WEB
- RTF-737-3P 1973-77 (3pc)SEE WEB

No Volume Discount. Ships Oversize. Not eligible for free shipping.



RTF-682K

Trunk Floor Kits

This 7 piece kit includes (3) trunk floor sections, (2) frame braces and (2) fuel tank braces so you can do the job right while saving money.

- RTF-682K 1970-72 (7 pc.)SEE WEB
- RTF-737K 1973-77 (5pc)SEE WEB

No Volume Discount. Ships Oversize. Not eligible for free shipping.



Trunk Floor Center Pan

This is a correct die stamped Monte Carlo center floor section which is perfect when only the center of your trunk floor is rotted out. Features all of the factory lines and contours. Measures 46W x 34L.

- RTF-68U 1970-72SEE WEB

No Volume Discount. Ships Oversize. Not eligible for free shipping.



RPT-3468

Rear Package Tray Panel

Features correct details and heavy gauge steel as original. This panel will save you time and money over trying to fabricate patch panels for this commonly rusted out area.

RPT-3468 1970-72SEE WEB
Oversize 2. Not eligible for free shipping. No Volume Discount.



RFR-786L



RFR-786R



RFB-786

1978-88 Rear Frame Rails & Floor Pan Repair

Perfect for repairing the often rotted rear section of the chassis and trunk floor behind the rear wheels.

Partial Replacement Rear Frame Rails

RFR-786L 1978-88 2 Door Coupe LH SEE WEB
RFR-786R 1978-88 2 Door Coupe RH SEE WEB

Trunk Floor To Frame Repair Plates

RFB-786 1978-88 2 Door Coupe SEE WEB
BCN-788 1978-88 Body Cage Nut Only Fits All SEE WEB
Ships Oversize. Not eligible for free shipping.



RTG-8A

Trunk Weatherstrip Gutter

This trunk weatherstrip gutter set includes both of the metal channels which are required to properly mount your trunk weatherstrip.

RTG-8A 1970-72SEE WEB



RTL-6872

Trunk Lids

Reproduction of the often rotted or damaged trunk lid.

RTL-6872 1970-72 Monte Carlo SEE WEB

No Volume Discount. Ships Truck Freight to a commercial address. Not eligible for free shipping.



RWP-682

Rear Window to Trunk Panel

Reproduction stamped steel panel which fits between the rear window and the trunk lid.

RWP-682 1970-72 SEE WEB

Ships Oversize 2. Not eligible for free shipping.



RDP-100

Trunk/Floor Pan Drain Plug

Correct die stamped floor drain plug.

RDP-100 1970-72 AllSEE WEB

RDP-7488 1978-88 AllSEE WEB



MS149-10

Eddie Motorsports Billet Trunk Hinges

These billet trunk hinges are CNC machined from high quality 6061-T6 aluminum. They utilize Nitrogen filled gas struts that replace the stock torsion springs and high quality Delrin bushings for smooth reliable operation. The hinges are designed as direct fit, "bolt on" parts with some minor drilling required for fastening of the strut mount. The hinges come complete with mounting hardware, brackets (where required) and gas struts.

M = Machined
P = Polished
R = Red Fusioncoat
B = Blue Fusioncoat

W = White Fusioncoat
PR = Purple Fusioncoat
BK = Gloss Black Fusioncoat
BKA = Gloss Black Anodized

MB = Matte Black Fusioncoat
MBA = Matte Black Anodized
CL = Clear Coat
CA = Clear Anodized

MS149-10_ 1970-72 All SEE WEB SEE WEB SEE WEB SEE WEB



RTH-1489DA

1970-72 Trunk Hinges

Reproduction trunk hinges to replace your worn out originals.

RTH-1489DA 1970-72SEE WEB



GWC-SPK

Trunk Wire Clip

Correct clips used to hold the power trunk or trunk light wires to the hinge.

GWC-SPK 1970-77 AllSEE WEB



RTL-1462U

Trunk Catch (Striker)

Mounts inside the trunk to catch the trunk latch.

RLC-1462U 1970-72SEE WEB

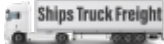

Windshield Glass

Monte Carlo Softray tinted windshield glass is the perfect replacement for your cracked or damaged original. All of our glass features the correct green tint as original.

GL-68AF	1970-72 w/o Antenna	SEE WEB
GL-68AFA	1970-72 With Antenna	SEE WEB
GL-737M	1973-77 w/o Antenna	SEE WEB
GL-737MA	1973-77 With Antenna	SEE WEB

No Volume Discount. Ships truck freight to a commercial address. Not eligible for free shipping.



GL-70ADL



GL-70ADR

Door Window Glass

Monte Carlo Softray tinted door window glass which is an exact replacement for your cracked or damaged original. All of our glass is properly marked and features the correct green tint as original

GL-70ADL	1970-72 LH	SEE WEB
GL-70ADR	1970-72 RH	SEE WEB

Ships Oversize 2. Not eligible for free shipping.



Quarter Window Glass

Monte Carlo Softray tinted quarter window glass is the perfect replacement for your cracked or damaged original. All of our glass features the correct green tint as original.

GL-70MQR	1970-72 RH	SEE WEB
GL-70MQL	1970-72 LH	SEE WEB

No Volume Discount. Ships Truck Freight to a Commercial Address. Not eligible for free shipping.



Rear Windshield Glass

Monte Carlo Softray tinted rear windshield glass is the perfect replacement for your cracked or damaged original. All of our glass features the correct green tint as original.

GL-70MR	1970-72 Rear	SEE WEB
---------	--------------------	---------

No Volume Discount. Ships truck freight to a commercial address. Not eligible for free shipping



GWM-22

Power Window Motors

This is a high quality brand new power window motor. These fit front or rear windows.

GWM-22	1970-72 LH	SEE WEB
GWM-23	1970-72 RH	SEE WEB

Power Window Retrofit Kits

Ground Ups exclusive power window kits are the best available on the market today! They Bolt-into the original mounting holes making for a hassle free installation. Using 1018 cold-roll steel, bronze oilite thrust bearing at all the pivot points and heat treated metal for all gears results in a quality smooth operating regulator that will last for many years. The motors are all brand new and have been thoroughly tested for quality and feature a strong dependable motor. Kits include: new regulators, new ACI window motors, a new completed wiring harness, your choice of switches and the conduit from the a-pillar to the door. Our kits feature detailed instructions with helpful diagrams and photos. F/R= Front and Rear Kit



PWK-73CH-BLACK



PWK-7887G-CHROME



Monte Carlo Kits

PWK-70CH	1970-72 All F/R Chrome Switches	SEE WEB
PWK-70CH-NOST	1970-72 All F/R Nostalgic Switches	SEE WEB
PWK-70CH-CRANK	1970-72 All F/R Crank Switches	SEE WEB
PWK-70CH-2-CHROME	1970-72 All Front Only Chrome Switches	SEE WEB
PWK-70CH-2-BLACK	1970-72 All Front Only Black Switches	SEE WEB
PWK-70CH-2-NOST	1970-72 All Front Only Nostalgic Switches	SEE WEB
PWK-70CH-2-CRANK	1970-72 All Front Only Crank Switches	SEE WEB
PWK-73CH-CHROME	1973-77 Front Only Chrome Switches	SEE WEB
PWK-73CH-BLACK	1973-77 Front Only Black Switches	SEE WEB
PWK-73CH-NOST	1973-77 Front Only Nostalgic Switches	SEE WEB
PWK-73CH-CRANK	1973-77 Front Only Crank Switches	SEE WEB

G-Body Monte Carlo

PWK-7887G-CHROME	1978-87 Front Chrome Switches	SEE WEB
PWK-7887G-BLACK	1978-87 Front Black Switches	SEE WEB
PWK-7887G-NOST	1978-87 Front Nostalgic Switches	SEE WEB
PWK-7887G-CRANK	1978-87 Front Crank Switches	SEE WEB

No Volume Discount. Not eligible for free shipping.

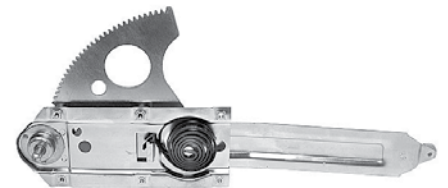

REG-1463C

Window Regulators

Complete regulators with rollers.

Monte Carlo Front Manual

REG-70FL	1970-72 LH	SEE WEB
REG-70FR	1970-72 RH	SEE WEB

Monte Carlo Rear Manual

REG-R68L	1970-72 LH	SEE WEB
REG-R68R	1970-72 RH	SEE WEB



GHB-488



GHB-6481

Power Window Grommets & Conduits

These are the correct conduits and grommets that run from the A-pillar to the door on cars with power windows and/or locks.

- GHB-488 1970-72 All.....SEE WEB
- GHB-6481 1970-77 Grommet Only.....SEE WEB



RW-069-A

Door Window Hardware Kits

This convenient door window hardware kit includes all of the necessary hardware to rebuild the rollers, guides and bushings on the quarter window regulators. Made in USA.

- RW-069-A 1970-72 Door.....SEE WEB
- RW-069-A-REAR 1970-72 1/4 Window.....SEE WEB



GDS-708

Rear 1/4 Window Lower Stop

- GDS-708 1970-72.....SEE WEB



GDS-707

Front Door Glass Side Stop

- GDS-707 1970-72.....SEE WEB



GGP-706

Front Door Glass Glide Plate

- GGP-706 1970-72.....SEE WEB



GGS-761

Door Glass Guide Screws

- GGS-761 1970-72 (8pc).....SEE WEB



GGS-746

Rear 1/4 Window Glass Side Stop

- GGS-746 1970-72.....SEE WEB



GGP-707-REAR

Rear Side Glass Glide Plate

- GGP-707-REAR 1970-72.....SEE WEB

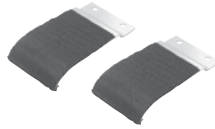

GGP-1485Y



GGP-7072

Door Glass Guide Plates & Felts

Correct front door glass guide plates.

- GGP-1485Y 1970-72 Felt Covered Steel.....SEE WEB
- GGP-7072 1970-72 Plastic.....SEE WEB
- GGF-557 (4pc) Felt Only.....SEE WEB



GGS-1485Q

Door Glass Stabilizers

Correct front door glass stabilizers.

- GGS-1485Q 1970-72.....SEE WEB



GDS-1485P



GDS-15231



GCS-1485N

Door Glass Stopper & Support

Correct front door glass stopper.

- GDS-1485P 1970-72 Front.....SEE WEB
- GDS-15231 1970-72.....SEE WEB
- GCS-1485N 1970-72 Front Support.....SEE WEB



GTS-177

Quarter Window Roller Tension Spring

This commonly missing spring is used to keep tension on the window roller so that the window goes up and down smoothly.

- GTS-177 1970-72.....SEE WEB



WR-76



WR-78

Window Rollers

Correct replacement window rollers.

- WR-76 1970-72 Lower Rear 1/4.....SEE WEB
- WR-78 1970-72 Door.....SEE WEB
- WR-065 1970-72 Lower Rear 1/4.....SEE WEB



GWR-060



GWR-060A



GWR-060B

Quarter Window Roller Assembly

Complete window roller assembly for rear quarter including center lower guide roller and threaded stud assembly.

- GWR-060 1970-72 All Roller Assembly.....SEE WEB
- GWR-060A 1970-72 Backing Washer.....SEE WEB
- GWR-060B 1970-72 Nylon Bushing.....SEE WEB



GGS-15232

Quarter Window Stop

Correct reproduction of the quarter window stop, with the correct plastic coated end and correct bolt hole as original.

- GGS-15232 1970-72.....SEE WEB



GWR-15365



GWR-15366

Door Glass Washers & Retainer

Plastic washer that is used to protect the door. Mounts between the glass and the metal fasteners within the door. 1.5 inch diameter.

- GWR-15365 1970-77 w/ Step.....SEE WEB
- GWR-15366 1970-77.....SEE WEB
- GWR-12660 1970-72 Retainer.....SEE WEB

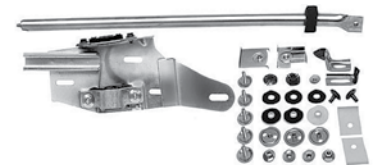

Door Window Track And Hardware Kit

This convenient door window track & hardware kit is great for when you are changing out your door glass.

- RW-70AL All 1970-72 LH.....SEE WEB
- RW-70AR All 1970-72 RH.....SEE WEB

No Volume Discount.



TRIM-02



TRIM-01



TRIM-KIT-DLX



TRIM-WR

TRIM-MAG

Trim Removal Tools

- TRIM-01 Door Panel Removal Tool..... 9.97 ea.
- TRIM-02 Window Crank/Door Handle Removal 6.99 ea.
- TRIM-WR Window Roller Removal Tool.....18.99 ea.
- TRIM-MAG Mirror & Magnet Kit 2pc..... 14.95 set
- TRIM-KIT-DLX Trim Removal Tools 3pc..... 29.99 ea.



Junior Weatherstrip Kit

Our most popular weatherstrip kit includes all of the basic soft trim components that commonly crack and wear out on your Monte Carlo. Included are (2) door opening weatherstrips, (2) roof rail weatherstrips and (1) trunk weatherstrip.

JR-69K 1970-72SEE WEB

No Volume Discount.



JSK-739K



JSK-808K

Rubber Stopper Kits

Complete set of rubber stoppers including doors, trunk lid, hood, side of hood and fuel tank door.

JSK-82K 1970-72SEE WEB

JSK-739K 1973-79SEE WEB

JSK-808K 1980-88SEE WEB



JSS-16JM

Door Opening Weatherstrip

This brand new state of the art door weatherstrip features correct extruded rubber with correct molded ends and push in clips just like original.

JSS-5022 1970-72 AllSEE WEB

JSS-12Y 1973-77 AllSEE WEB

JSS-16JM 1978-81 2 DoorSEE WEB

JSS-16JG 1982-88 2 DoorSEE WEB



JSS-5115

Door Jamb U Rubbers

Correct steel core rubber.

JSS-5115 1970-72 AllSEE WEB



JSS-4579

Roof Rail Weatherstrip Guides

Correct rear guides for your roof rail weatherstrip.

JSS-4579 1970-72 AllSEE WEB



JSS-5024

Roof Rail Weatherstrip

Correct extruded rubber that seals the roof line of the car in from the elements.

JSS-5024 1970-72SEE WEB

JSS-5020M 1978-88 2 DoorSEE WEB



BRR-221

Roof Rail Weatherstrip Screws

Accurate reproduction of original roof rail weatherstrip screws. Correct head diameter and profile. Screws attach coupe roof rail weatherstrip channel, and pillars.

BRR-221 1970-72 (36 pc.)SEE WEB



JSS-78SR

Sunroof Weatherstrip

This is a correct glass seal and drain pan gasket set for your Monte Carlo with factory installed sunroof or moonroof.

JSS-78SR 1978-88 AllSEE WEB



AWS-992



AWS-138

Wiper Motor Seals

This is a wiper motor to cowl gasket.

AWS-992 1970-72 w/ HiddenSEE WEB

AWS-138 1973-77 w/ HiddenSEE WEB



JSS-5023

1970-72 Vertical Quarter Glass Seals

Correct quarter glass seals which run vertically on the rear edges of the quarter windows.

JSS-5023 1970-72SEE WEB



JSS-5112

Quarter Glass Seals

Correct rubber seal which attaches to the quarter window and seals the front and rear windows. Available in high quality molded rubber or steel core with rubber coating as factory.

JSS-5112 1970-72 RubberSEE WEB

JSS-2525 1970-72 Steel CoreSEE WEB



JHC-815



JHC-330

"A" Arm Dust Shields

Correct die stamped material that seals the engine compartment. Mounts to inner fender wells complete with staples.

JHC-101 1970-72 Steel Inner FendersSEE WEB

JHC-815 1970-72 Plastic FendersSEE WEB

JHC-330 1973-77 AllSEE WEB

JHC-109 1978-88 AllSEE WEB



JFS-68A

Inner Fender To Cowl Seal

This is a pair of correct, molded rubber inner fender to frame seals which attach to the inner fenders to protect the engine compartment from debris. Staples are included.

JFS-68A 1970-72 All.....SEE WEB

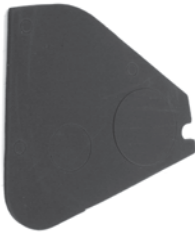

JSS-5151



JSS-309



JSS-101

Trunk Weatherstrip

Correct molded trunk weatherstrip.

JSS-309 1970-77SEE WEB
 JSS-T7377 1973-77 All.....SEE WEB
 JSS-101 1978-88.....SEE WEB

Steering Column Seal

Correct neoprene seal for firewall.

JSS-5151 1970-72 All.....SEE WEB
 JSS-115 1978-81SEE WEB



FSG-22



FSG-78G

Speedometer Cable Grommets

This is a cable grommet that installs on the firewall and keeps the cable from chafing and the engine air out of the cabin.

FSG-22 1970-72 All.....SEE WEB
 FSG-78G 1978-88 All.....SEE WEB



JFP-68A2



JFP-68A1

Firewall Plug

Correct plug used to fill extra hole in the firewall at the throttle cable location on all TH400 and manual transmission cars.

JFP-68A1 1970-72 1st Design Triangular.....SEE WEB
 JFP-68A2 1970-72 2nd Design SquareSEE WEB



MT122A



MT110A

Outer Window Felt Kits

These reproduction window felts feature correct stainless round beads with flocked rubber sealing strips. All include the correct anti-rattle bumpers attached.

Outer Replacement Style Felt Kits (2pc)

MT121A 1981-88 2 Door w/ Special Molding SEE WEB
 MT122A 1981-88 2 Door w/o Special Molding..... SEE WEB

Complete Replacement Style Felt Kits (4pc)

MT110A 1978-79 2 Door w/o Special Molding..... SEE WEB
 MT126A 1978-80 2 Door w/ Special Molding SEE WEB
 MT111A 1981-88 SS 2 Door w/ Special Molding... SEE WEB
 MT112A 1981-88 SS 2 Door w/o Special Molding ... SEE WEB



Hood to Cowl Seal

Correct style rubber seals which mount on the rear hood edge and top of cowl to seal in the engine compartment.

JSS-5075 1970-72SEE WEB
 JSS-5071 1970-72 Rear On HoodSEE WEB
 JSS-0570 1978-88 All.....SEE WEB

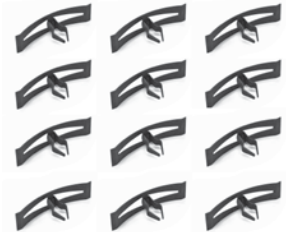

JCS-5077

Hood to Cowl Seal Clips

Correct clips for attaching seal to top of cowl.

JCS-5075 1970-72 Plastic.....SEE WEB
 JCS-5077 1970-72 Steel.....SEE WEB

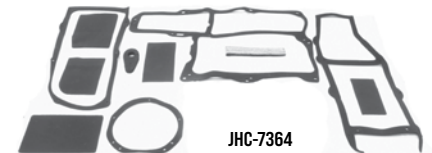

JHC-7364

Heater Box Seal Kit

Correct die stamped kit contains all inner and outer box seals.

JHC-7364 1970-72 w/o ACSEE WEB
 JHC-7468 1970-72 w/ AC.....SEE WEB



BPQ-BUMPER-REAR

Hood Bumpers Rear

These slide into a groove on both sides of the hood and rest on the cowl when the hood is closed.

BPQ-BUMPER-REAR 1970-72SEE WEB



DSB-83

Steering Shaft Boot

This hard to find rubber boot covers the steering column knuckle.

DSB-83 1970-72 AllSEE WEB
 DBR-647 1970-77 Retainer.....SEE WEB



**American
Autowire**

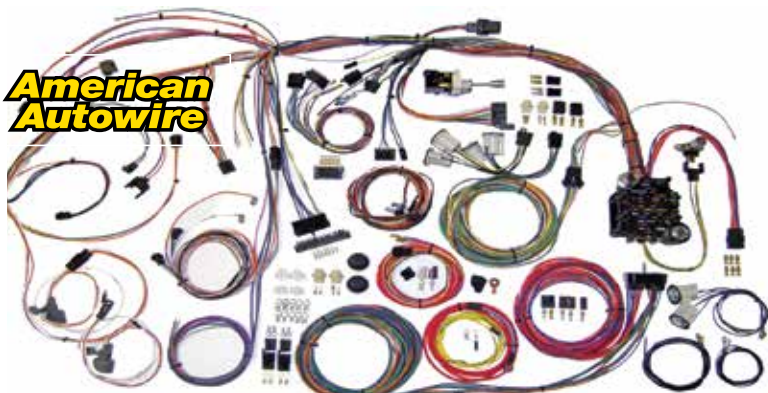

American Autowire Classic Update Series Kits

Classic Update complete wiring kits are made for the restoration enthusiast who wants some modern amenities in their classic vehicle. These kits include everything you need to modernize your classic vehicle: Headlight, Dimmer and Ignition Switches; Boots, Tubes and Grommets; Fuses, Relays- and Flashers; Original Connectors, Terminals and Disconnects.

1970-72 Monte Carlo

- Replacement headlight switch with internal 30 amp circuit breaker included. Retention collar nut, adjustable length shaft and custom knob are also included.
 - Standard turn signal flasher, hazard flasher and horn relay mounted on fuse panel.
 - Fuse box designed to fit in original location. All required hardware supplied. New ATO fuse allows easy fuse and circuit breaker accessibility. Harness is laid out and formed to allow for nearly all aftermarket accessories such as; gauge packages, wiper systems, heat and air conditioning systems, etc.
 - Original switch connector bodies! (Exclusive to American Autowire)
 - Original Dash Panel instrument cluster connector.
 - Steering column connectors can plug directly into most aftermarket steering columns or stock 1968-1970 GM columns that use stock GM turn signal switches.
 - Under dash courtesy lamps for use in addition to your original dome/interior lighting.
 - Instrument Cluster wiring has a "cluster harness disconnect" system for easy service and assembly. Original terminals and connectors (another American Autowire exclusive) are provided for stock cluster connections. Connects into most popular aftermarket gauges such as AUTOMETER, CLASSIC INSTRUMENTS, DAKOTA DIGITAL, STEWART WARNER, VDO and others.
 - Rear body harness assembly plugs into the main harness in the stock location. Longer leads allow for stock/custom routing of the wires. Rear body wiring has backup light lead wires with correct lamp sockets, stop and tail light lead wires with correct lamp sockets, terminals to mate with the license plate connection wire, side marker lead and ground wires with lamp sockets and fuel tank sender wire with trunk grommet and tank connection.
 - GM bulkhead connectors for the engine and front light wiring (another American Autowire exclusive) and allow for easy installation with original or custom routing.
 - Engine wiring includes connectors for original points type as well as H.E.I. distributors. Power and Tach connectors supplied for GM H.E.I. distributors. Alternator connectors are supplied for GM "SI" series internally regulated alternators. GM "CS" series alternator adapter is available separately.
 - Original style light sockets, switch body connectors, terminals, etc.
 - Front lighting includes extra long leads that can be routed for stock or optional appearances.
- All headlight, parking and directional light connectors (lamp socket pigtails are also provided for 1971-72 applications) and terminals are provided along with a switched trigger wire for an electric fan relay (usually recommended with AC).

510105 1970-72 SEE WEB

American Autowire Highway 22 Wiring Kit

The Highway 22 Complete Modular wiring system wiring kit includes all the necessary wiring for headlights including: a three position headlight switch; a 40 amp electric fan or fuel pump relay; heavy duty power and accessory expansion; micro-relays for horns and turn signals; an accessory harness for radio, electric wipers, heater, air conditioning, fuel pump and interior lighting. This kit also contains a floor mounted dimmer switch; an ignition switch that has been designed for either dash or column mounting and includes all the connectors and terminals. The Highway 22 was designed to promote complete mounting flexibility and creativity in specialty electrical systems. These kits are perfect if you plan to do a LS/EFI swap as this kit includes dedicated battery and ignition circuits for electronic fuel injection (EFI).



500695 1970-75 All Universal GMSEE WEB

No Volume Discount.



Wiring Harnesses

When you are looking to restore your electrical system, look no further than Ground Up! All of our harnesses are hand assembled in the USA and are guaranteed exactly as original. Our harnesses always match the factory color code and gauge sizes using correct connectors, terminals and non-adhesive and cloth tape. Our restoration harnesses are simply the best in the industry.

AC Harness

14965	1970 All	SEE WEB
15440	1971 All	SEE WEB
16465	1972 All.....	SEE WEB

Console Ext Harness

28190	1970-72 Auto Transmission	SEE WEB
11920	1970-72 Manual Transmission	SEE WEB

Console Harness

11925	1970-72 Auto	SEE WEB
11915	1970-72 4 Speed	SEE WEB

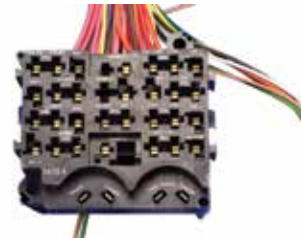
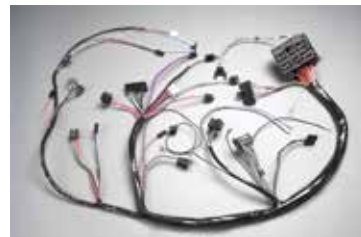

Dash Harness Classic Auto Fuse Series

Our new Classic Auto Fuse Series dash harnesses allow you to maintain the easy plug and play function of original factory type harnesses, while converting the entire fuse block to an Auto Fuse Series (ATO Type) fuse block. This gives you the flexibility to add additional power circuits without the installation headaches normally associated with this type of fuse box conversion. There is no cutting or modifying of any sort. Just plug it in and turn it on. It is completely compatible with the other original harnesses in your car.

39410	1970 Round Gauges w/ Warning Lights	SEE WEB
39377	1970 Round Gauges w/ Gauges	SEE WEB
39413	1971 Round Gauges w/ Warning Lights.....	SEE WEB
39414	1971 Round Gauges w/ Gauges	SEE WEB
39416	1972 Round Gauges w/ Warning Lights	SEE WEB
39417	1972 RoundGauges w/ Gauges	SEE WEB
39418	1972 Round Gauges w/ Warning Lights & Seatbelt Light	SEE WEB
39419	1972 Round Gauges w/ Gauges & Seatbelt Light	SEE WEB

No Volume Discount.



Spare Fuse Power Wiring Extension

Used to add the functionality of the three extra spare fuses if desired.

39383 All.....SEE WEB



Accessory Terminal & Connector Kit

Used to access the front of the ATO fuse block accessory ports, while maintaining the indexing capability of the cavities on the fuse block.

39384 All.....SEE WEB



Glass Fuse Series Accessory Adapter Kit

Converts old accessory style indexed connectors to new ATO style connectors so you can plug your old accessories into your ATO fusebox with no modifications to connectors.

39385 All.....SEE WEB



Fuse & Flasher Kit

Includes (2) flashers, (1) complete set of ATO fuses, plus (1) spare of each amperage.

39463 1970.....SEE WEB
 39465 1972.....SEE WEB
 39466 1970,1971.....SEE WEB



Courtesy Lamp Harness

28950 1970 Dash All.....SEE WEB
 15295 1971-72 Dash All.....SEE WEB

Reuse your original connector.



Cowl Induction Harness

Reproduction of original GM.

AMH-8922 1970-72.....SEE WEB



Cruise Control Harness

13185 1970-72.....SEE WEB



Dash Harness

Complete with fuse box.

15075 1970 w/ W. Lights.....SEE WEB
 15065 1970 w/ Gauges.....SEE WEB
 15265 1971 w/ W. Lights.....SEE WEB
 15270 1971 w/ Gauges.....SEE WEB
 16420 1972 w/ W. Lights.....SEE WEB
 16425 1972 w/ Gauges.....SEE WEB
 15490 1973 Lower Half w/ Gauges*.....SEE WEB

(Includes fuse box.)

15495 1973 Upper Half w/ Gauges*.....SEE WEB

**Requires use of original harness.*

20740 1974 w/ Gauges.....SEE WEB

No Volume Discount.



Engine Harness

14700 1970 SB Auto.....SEE WEB
 15090 1970 SB 4 Speed.....SEE WEB
 15100 1970 BB Auto.....SEE WEB
 15095 1970 BB 4 Speed.....SEE WEB
 17435 1971 SB Auto.....SEE WEB
 17455 1971 SB 4 Speed.....SEE WEB
 17440 1971 SB TH400.....SEE WEB
 17445 1971 BB Auto.....SEE WEB
 17450 1971 BB 4 Speed.....SEE WEB
 16435 1972 V8 Warning Lights*.....SEE WEB
 16450 1972 V8 Gauges*.....SEE WEB

**17365 required for 4 Speed.*

17490 1972 TH400 W. Lights.....SEE WEB
 17645 1972 V8, TH400, Gauges.....SEE WEB
 17430 1972 BB, TH400, Lights.....SEE WEB
 17415 1972 BB, Auto, Gauges.....SEE WEB
 17425 1972 BB 4 Speed, Lights.....SEE WEB
 17420 1972 BB 4 Speed, Gauges.....SEE WEB
 15500 1973 SB W. Lights*.....SEE WEB
 15505 1973 SB Gauges*.....SEE WEB

**17365 required for 4 Speed.*

16565 1973 SB, TH400, W. Lights.....SEE WEB
 16570 1973 SB, TH400, Gauges.....SEE WEB
 19010 1973 BB Auto W. Lights.....SEE WEB
 19005 1973 BB Manual W. Lights.....SEE WEB
 19020 1973 BB Auto Gauges.....SEE WEB
 19015 1973 BB Manual Gauges.....SEE WEB
 22605 1974 SB Auto W. Lights.....SEE WEB
 22590 1974 SB Auto Gauges.....SEE WEB
 22610 1974 SB Manual W. Lights.....SEE WEB
 22595 1974 SB Manual Gauges.....SEE WEB
 19010 1974 BB Auto W. Lights.....SEE WEB
 19005 1974 BB Manual W. Lights.....SEE WEB
 19020 1974 BB Auto Gauges.....SEE WEB
 19015 1974 BB Manual Gauges.....SEE WEB
 36007 1975 V8.....SEE WEB
 19045 1975 V8, TH400, HEI.....SEE WEB



Engine Harness For HEI

Specially modified harnesses for use with your retrofitted HEI ignition for an easy installation.

38934 1970 SB Auto Trans.....SEE WEB
 39023 1970 SB Manual Trans.....SEE WEB
 38928 1970 BB Auto Trans.....SEE WEB
 38931 1970 BB Manual Trans.....SEE WEB
 38948 1971 SB Auto Trans.....SEE WEB
 39041 1971 SB Manual Trans.....SEE WEB
 39031 1971 350 w/ TH400.....SEE WEB
 38975 1971 BB Auto Trans.....SEE WEB
 38990 1971 BB Manual Trans.....SEE WEB
 41330 1972 SB Warning Lights.....SEE WEB
 41332 1972 SB Gauges.....SEE WEB
 41334 1972 SB W/TH400 Warning Lights.....SEE WEB
 41335 1972 SB W/TH400 Gauges.....SEE WEB
 41336 1972 BB Auto Warning Lights.....SEE WEB
 41338 1972 BB Auto Gauges.....SEE WEB
 41340 1972 BB Manual Warning Lights.....SEE WEB
 41342 1972 BB Manual Gauges.....SEE WEB



Forward Lamp Harness

15160	1970 Warning Lights SBSEE WEB
14685	1970 Warning Lights ACSEE WEB
14690	1970 Gauges AllSEE WEB
17465	1971 Warning LightsSEE WEB
15275	1971 Warning Lights ACSEE WEB
17460	1971 GaugesSEE WEB
16455	1972 AllSEE WEB
19035	1973 AllSEE WEB
19040	1974 All Ex. LagunaSEE WEB



Fuel Sender Harness

28940	1970-72SEE WEB
-------	---------	--------------



Glove Box Harness

Plugs into glove box light switch assembly.

33830	1970 AllSEE WEB
-------	----------	--------------



Headlight Extension Harness

39668	1976-77SEE WEB
-------	---------	--------------



Horn Wire Harness

15055	1970-72 Single HornSEE WEB
27730	1970-72 Dual HornSEE WEB

Idle Stop Solenoid Wire

Fits all V8 except big block with manual trans.

17495	1970SEE WEB
-------	------	--------------

Intermediate Harness

17715	1970-72 Coupe AllSEE WEB
-------	-------------------	--------------



Kickdown Extension Harness

Goes from gas pedal switch to engine harness.

17565	1971-72 TH400SEE WEB
-------	---------------	--------------



Neutral Safety Switch Extension Harness

From dash to clutch switch.

28240	1970-73SEE WEB
-------	---------	--------------

Power Accessory Feed Wire

28215	1970-72 Circuit Breaker to Main Harness, (1) pwr window, top, & seatSEE WEB
36861	1970-72 Circuit Breaker to Main Harness, multi pwr window, top, & seatSEE WEB



Power Seat Motor Relay and Adapter Harness

Includes new standard type relay and adapter to mate to factory harness.

40146	1970-75SEE WEB
-------	---------	--------------

Power Window Relay & Adapter Harness

Includes new standard type relay and adapter to mate to factory harness.

39440	1970-72SEE WEB
-------	---------	--------------



Radio & Speaker Harness

With 4 speaker stereo.

36251	1970-72SEE WEB
-------	---------	--------------

Does not fit Monte Carlo



Rear Lamp Harness

14745	1970SEE WEB
17695	1971-72SEE WEB

Seat Belt Warning Extension Harness

From intermediate body connector to seat belt.

19955	1972SEE WEB
-------	------	--------------

TCS Jumper Wire

Connects to passenger side temp sending unit on cars with gauges or AC only.

17740	1971SEE WEB
-------	------	--------------

TCS Transmission Switch Extension Harness

Connect engine harness to switch on manual transmission.

17365	1972SEE WEB
-------	------	--------------

For use with engine harness 16430, 19635, 16450.

17355	1973SEE WEB
-------	------	--------------

For use with engine harness 15500, 15505.



Trunk Lamp Assembly

Complete light harness with bulb and extension harness.

36380	1970-72 AllSEE WEB
-------	-------------	--------------

Wiper Motor Harness

28255	1970 Electro-Tip WipersSEE WEB
-------	-------------------------	--------------



AC Delco Spark Plugs

This is a brand new set of 8 spark plugs for your Monte Carlo. These high quality reproduction AC Delco spark plugs feature the correct green AC and number markings as original.

AC43	1970 #43SEE WEB
AC44	1970 #44SEE WEB
AC45	1970 #45SEE WEB

Note: The number on the plug refers to it's operating temperature. The lower number is a cooler running plug which is typically found on the SHP high performance engines. A hotter, higher numbered plug would be used in engines where plug fouling may be or is a problem.

PACKARD RADIO TVRS LR 3-

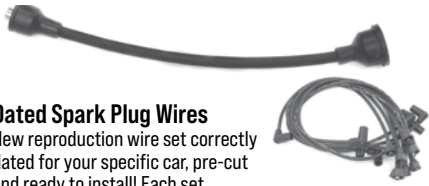

Dated Spark Plug Wires

New reproduction wire set correctly dated for your specific car, pre-cut and ready to install! Each set features correct colored wires and correct angle "cut" boots. The date coding identified the quarter and year in which the wires were produced. As an example, a wire date coded as 1-Q-67 would have been produced in the first quarter of 1970. Research has shown that most cars had spark plug wires installed that were dated from 1 to 4 quarters prior to the build date of the car.

ALL-70SB3Q	1970 SB "3-Q-69"	SEE WEB
ALL-70SB1Q	1970 SB "1-Q-70"	SEE WEB
ALL-70BB3Q	1970 BB "3-Q-69"	SEE WEB
ALL-70BB1Q	1970 BB "1-Q-70"	SEE WEB
ALL-71SB3Q	1971 SB "3-Q-70"	SEE WEB
ALL-71SB1Q	1971 SB "1-Q-71"	SEE WEB
ALL-72SB3Q	1972 SB "3-Q-71"	SEE WEB
ALL-72SB1Q	1972 SB "1-Q-72"	SEE WEB
ALL-73SB3Q	1973 SB "3-Q-72"	SEE WEB
ALL-73SB1Q	1973 SB "1-Q-73"	SEE WEB



AHC-1508

Spark Plug Wire Sets

New pre-cut OEM replacements.

AHC-1508	All SB w/o HEI	SEE WEB
AHC-2508	All BB w/o HEI	SEE WEB
AHC-3508	1973-77 HEI	SEE WEB



Retaining Straps

Correct push in style plastic retainers

BPX-2350	All	SEE WEB
----------	-----------	---------



Harness Retaining Clips

Correct retaining clips for harness.

AHC-1	Clip Style #1	SEE WEB
AHC-2	Clip Style #2	SEE WEB



Harness Wire Ties

Original GM wire ties used for various hoses, cables and harnesses.

BJN-300	Short	SEE WEB
BJN-600	Long	SEE WEB



Breakerless SE Ignition Conversion

The Breakerless SE ignition kit is designed to convert GM V8 engines originally equipped with breaker points, windowed style distributor cap and stock coil to solid-state electronic ignition. No distributor modification, disassembly or removal is required. Easier starting.

38131	Breakerless SE Conversion	SEE WEB
-------	---------------------------------	---------

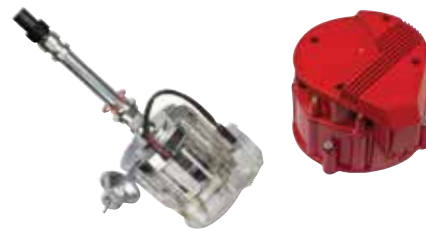

HEI Distributor

Chrome aluminum HEI electronic distributor with built-in 50K coil.

ADS-2100	All V8	SEE WEB
ADS-2100-SC-RED	All V8, Red Super Cap	SEE WEB
ADS-2100-SC-CLEAR	All V8, Clear Super Cap	SEE WEB



External Ignition Coils

Choose from our upgraded external ignition coils. 45,000-volt output. Anodized finish, includes pigtails and hardware for installation.

GCS-S2039BK	All, Black	SEE WEB
GCS-S2039BLU	All, Blue	SEE WEB
GCS-S2039C	All, Chrome	SEE WEB
GCS-S2039RED	All, Red	SEE WEB

Flaming River Single Wire Timing Light

This self-powered timing light is designed to work without an auxiliary power source, which makes it ideal for use with magnetos, rear battery mount race cars and all spark ignition systems for hassle-free timing. The Light is equipped with a xenon bulb which generates a bright strobe as well as a convenient work light. Durable construction includes a rubber encased lens and 48 degree pickup lead. State of the art single wire design is operated by two D-Cell batteries. Accurate timing up to 14,000 RPM.



FR1001	Universal	SEE WEB
--------	-----------------	---------

No Volume Discount.

Flaming River Professional Jumper Cables

These Professional Jumper Cables are heavy-duty, 23 feet long and ultra-flexible. Robust brass clamps are designed to hold firm and thick, yet flexible cables allow you to safely jump start your vehicle. The jumper cable set comes with one black and one red cable with clamps. Conveniently stores in a rugged carrying case.



FR1070	Universal	SEE WEB
--------	-----------------	---------

No Volume Discount.



HEI Distributor Pigtail

GCS-S3112	All	SEE WEB
-----------	-----------	---------



ASR-69ABB

Spring Ring Cables

Reproduction of the original factory installed spring type cables sold as a matched pair with GM numbers.

ASR-69ASB	1970-72 SB	SEE WEB
ASR-69ABB	1970-72 BB	SEE WEB



Side Terminal Battery Cables

Correct cables for cars with the heavy duty R-89 batteries with correct GM part numbers.

AST-1001	1970-72 HD	SEE WEB
----------	------------------	---------



GCS-S6323

Billet Aluminum Battery Trays

Secure your battery in style! Fits Optima batteries.

GCS-S6323	Optima Group 34/78 Top/Side Post	SEE WEB
GCS-S6324	Optima Group 35 Top Post	SEE WEB
GCS-S6325	Optima Group 75/25 Top/Side Post	SEE WEB



GCS-S9323

Universal Stainless Battery Tray

This polished stainless steel tray will secure your battery in style! Fits batteries measuring 7.5" L x 13.25" W x 9.25" tall.

GCS-S9323 Battery TraySEE WEB



1115287

Coil

Choose from our new reproduction Delco coils with GM numbers or GM replacement coil.

- 1115287 1970-72 BBSEE WEB
- 1115263 1970-72 Trans. Ign.*SEE WEB
- 1115293 1970-72 Most V8SEE WEB
- GAC-505 1970-72 All ReplaceSEE WEB

*427/454 transistor ignition



ALI-3119



BAN-516

Coil Bracket

Reproduction of original comes with retaining screw

- ALI-3119 All V8SEE WEB
- BAN-516 SEMS BoltsSEE WEB



N-2441

Tune Up Kit

Tune up kit with new points, condenser and rotor.

- N-2441 1970-73 AllSEE WEB



1971244

Distributor Cap

Choose from AC Delco replacement distributor cap or reproduction distributor cap with GM numbers.

- 1971244 GM Black CapSEE WEB
- AAD-308 ReplacementSEE WEB



ACE-1400

Distributor Hold Down

Correct retaining hardware for distributors

- ACE-1400 All V8SEE WEB



GRA-885

Air Conditioner Relay

Correct GM blower motor relay.

- GRA-885 1970-72 w/ ACSEE WEB



GBS-712

Blower Motor Switches

- GBS-712 1970-72 w/o ACSEE WEB
- GAC-383 1970-72 w/ ACSEE WEB



GBL-852



GBL-852-CC



GSR-12999

Brake Light Switches

OE style brake light switches located above the brake pedal.

- GBL-852 1970-72 All w/o Cruise Control ...SEE WEB
- GBL-852-CC 1970-77 All w/ Cruise ControlSEE WEB
- GSR-12999 RetainerSEE WEB



GRW-016

Circuit Breaker

Correct 30 amp breaker used for power windows, power doors, power tailgates and power tops.

- GRW-016 1970-71SEE WEB



GWC-68A

Under Dash Wire Clip

Holds the main harness under the dash where it comes through the firewall.

- GWC-68A 1970-72 AllSEE WEB



GSR-6076

Power Seat Relay

Correct for cars with 4 or 6 way seats. Replaces OEM 5717528.

- GSR-6076 1970-76 AllSEE WEB



ATE-2101

Cowl Induction Kick Down Throttle Switch

Operates the opening of door.

- ATE-2101 1970-72SEE WEB



ACC-8555

Cowl Induction Throttle Switch Bracket

Correct bracket with hardware.

- ACC-8555 1970-72SEE WEB



GDJ-11



GDJ-10



GDJ-3F

Door Jamb Switches

- GDJ-11 Dual Pin (Male)SEE WEB
- GDJ-10 Single Pin (Male)SEE WEB
- GDJ-3F Single Pin (Female)SEE WEB



GHB-488



GHB-6481

Power Window Grommets & Conduits

These are the correct conduits and grommets that run from the A-pillar to the door on cars with power windows and/or locks.

- GHB-488 1970-72 All.....SEE WEB
 GHB-6481 1970-77 Grommet OnlySEE WEB



GAC-515

Voltage Regulator

New correct replacement.

- GAC-515 1970-71 All D635SEE WEB
 GAC-515GM GM Reproduction.....SEE WEB
 AVX-515 1970-71 Screws (2)SEE WEB



GQH-118

Electric Junction Block

Original GM junction block for attaching positive lead from battery to main harness. Mounts to radiator support. Includes correct nut.

- GQH-118 1970-72 All.....SEE WEB



GDT-0330

Electrical Harness Tape

Correct non-stick factory style tape. Over 100 feet.

- GDT-0330 All.....SEE WEB



33830

Glove Box Lamp

Complete assembly with socket, switch, bulb and correct harness.

- 33830 1970-71 Harness Only.....SEE WEB



APJ-5240

Ground Strap Kit

Correct braided copper wire and ends complete with OEM screws

- APJ-5240 1970+ (3 pc)SEE WEB



GFS-502

Turn Signal & Hazard Light Switch

Correct flasher switch that plugs into fuse box.

- GFS-502 1970-77SEE WEB



GAC-808



GAC-808-HARNS

Headlight Dimmer Switch

Correct floor mounted high beam switch located on floor.

- GAC-808 1970-77 All.....SEE WEB
 GAC-808-HARNS 1970-77 All Harness.....SEE WEB



GHR-88

Headlamp Switch Nut

Correct special metal nut used for retaining switch to the dash.

- GHR-88 1970-72 All.....SEE WEB



GHS-588

Headlight Switch

- GHS-217 1970 All w/ Terminals.....SEE WEB
 GHS-588 1971-72 AllSEE WEB



GGG-70A

1970-72 Headlight Switch & Gauge Ground Strap

This ground strap is a must for assuring proper gauge operation as well as making sure the headlamps are not back fed into the system. This is a commonly missing item.

- GGG-70A All.....SEE WEB



1970-71 Horn Relay

Reproduction featuring Delco Remy logo and correct coloring.

- GAC-723 1970-71.....SEE WEB



1972-73 Horn Relay

Replacement for GM numbers 3996283 and 6273328.

- GAC-775 1972-73SEE WEB



GIS-042



GIS-052

Ignition Switch

- GIS-042 1970-72 w/o TiltSEE WEB
 GIS-052 1970-72 w/ TiltSEE WEB



ISB-1498D

Steering Column Bracket

Correct bracket which retains the steering column to the dash.

- ISB-1498D 1970-72SEE WEB



GAC-70SS

Instrument Socket

Correct plastic twist in socket for actuating printed circuit board.

- GAC-70SS 1970-72SEE WEB
- GAC-70SS-KIT 1970-72(14pc) SEE WEB



GPC-521

Printed Circuit Boards

Reproduction instrument board.

- GPC-521 1970-72 w/ Gauges.....SEE WEB
- GPC-523 1970-72 w/ LightsSEE WEB
- GPC-7886 1978-81 w/ Rally Gauges SEE WEB



GNS-1588

Neutral Start Switch

Correct safety switch located at pedal which prevents your car from being started in gear.

- GNS-1588 1970 4 SpeedSEE WEB
- GNS-1589 1971-72 4 Speed.....SEE WEB



GNS-35

Neutral Safety Switch

Correct switch at base of steering column for proper engine & reverse light activation.

- GNS-33 1970-72 4 Speed ReverseSEE WEB
- GDR-411 1970-72 Auto ConsoleSEE WEB
- GNS-35 1970-73 Auto Column.....SEE WEB



Power Window Relay

Correct reproduction of this hard to find relay.

- GWR-772 1970-72SEE WEB



4432791



GWS-712



GWS-711

Power Window Switch

Correct OEM style power window switch.

- 4432790 1970 1 WindowSEE WEB
- 4432793 1970 2 WindowSEE WEB
- 4432791 1970 4 WindowSEE WEB
- GWS-711 1971-77 1 WindowSEE WEB
- GWS-712 1971-77 2 WindowSEE WEB
- GWS-714 1971-77 4 WindowSEE WEB
- GRW-016 All Circuit Breaker 30 Amp.....SEE WEB

Power Window Switch Retainer

- GWS-634 1970-77 1 ButtonSEE WEB
- GWS-635 1970-77 4 ButtonSEE WEB



Power Lock Switch

Die cast and chrome plated. It reads LOCK and has the correct square corners and profile. Replaces GM number 1725099

- GLS-71 1971-77SEE WEB



Body Wiring Hold Down

Interior body floor panel wiring hold down clip used to hold body harness to floor pan.

- GHD-6472 1970-72 All.....SEE WEB

Note: Typically 3 required.



Fuel Sending Unit Harness

New reproduction with correct boot.

- 28940 1970-72 Monte Carlo.....SEE WEB



1114432

TCS Solenoid

Correct TCS solenoids which mount to the carburetor stud. Includes correct brackets.

- 1114432 1970-71 350/400SEE WEB
- 1114434 1970 BBSEE WEB



TCS Wire Retainer

Correct reproduction for Muncie.

- ATS-653 1970-74 w/ MuncieSEE WEB

Note: Mounts to transmission.



Firewall Wiring Clip

Holds main harness to firewall.

- GWC-70F 1970-72 All.....SEE WEB



TCS Littlefuse Relay

This is a reproduction of the correct littlefuse TCS relay. This authentic reproduction features 4 prongs as original.

- ATCS-33R 1970-72SEE WEB



ATS-21MP

ATS-21MS

TCS Transmission Switches

Correct TCS switch located on transmission.

- ATS-21MP 1970-75 Pin StyleSEE WEB
- ATS-21MS 1970-75 Spade StyleSEE WEB



TCS Temp Sending Unit

Correct 2 prong sending unit mounts on right side cylinder head.

- GAC-660 1970 AllSEE WEB



GTR-305

Turn Signal Repair

Correct white plastic repair arm that the turn signal handle attaches to.

GTR-305 1970-72 All.....SEE WEB



GWC-SPK

Speaker/Trunk/Blower Motor Wire Clips

Used to hold the wiring under the dash, power trunk or trunk light wires to hinge, speaker wires to package tray or blower motor wire to vent.

GWC-SPK 1970-77 All.....SEE WEB



GWS-106

Wiper Switch

GWS-106 1970-71 w/o Hidden.....SEE WEB
 GWS-107 1970-71 w/ Hidden.....SEE WEB
 1994180 1972 w/o HiddenSEE WEB
 1994131 1972 w/ HiddenSEE WEB



GTS-6208

Turn Signal Switches

Complete switch assemblies with correct plug in harnesses.

GTS-6208 1970-72SEE WEB
 GTS-6208GM 1970-76 OEM Style.....SEE WEB



GRC-12834

Voltage Regulator Radio Capacitor

Came from the factory on all cars with radio. Correct length lead wire & white connector. Stamped 1970086 "DR" & ".5MF" as original.

GRC-12834 1970-71 Voltage Regulator.....SEE WEB
 GRC-12835 1970-74 Coil.....SEE WEB



500626

Classic Dash LED and Terminal Kit

This is the same LED kit for your turn signals, high beam indicator and brake light that is included with our complete Classic Dash panel kits. It can be used when buying a blank panel only.

500626 1970-72SEE WEB

No Volume Discount.



TENDER-0128

Battery Tender

The Battery Tender Plus is a 1.25 amp battery charger designed to fully charge a battery and maintain it at proper storage voltage without the damaging effects caused by trickle chargers. Included is a quick connect harness for hard to reach areas. Temperature compensated to ensure optimum charge voltage according to ambient temperature. Automatically switches from full charge to float charging mode. Battery Tender at 1.25 amps will charge as fast or faster than any 3 amp charger available. Reverse Polarity Protection to ensure user safety. Red & Green Lights Alternately Flash in this condition. Complete 4-step charging program (Initialization, Bulk Charge, Absorption Mode, Float Mode).

TENDER-0128 Battery TenderSEE WEB



28950

Courtesy Lamp Harness

Correct harness for under dash light.

28950 1970 AllSEE WEB
 15295 1971-72 AllSEE WEB



5289

Auto Meter GPS Speedometer Interface Module

This interface module can turn any electronic speedometer into a GPS speedometer with the push of a button. It is plug and play for any Auto Meter electronic speedometer. It can also be used with nearly any other brand of electronic speedometer with a quick calibration. It features IP67 construction and is fully sealed against water and dust. It includes a paintable magnetic micro antenna.

5289 All Electronic SpeedoSEE WEB



GSS-883

Side Marker Socket

GSS-883 1970-72 All.....SEE WEB
 GSS-893 1970-77 All 90 Degree (158 & 194 Bulb)SEE WEB



Classic Dash Wiring Harness

This is the same wiring harness that is included with our complete Classic Dash panel kits. It can be used when buying a blank panel only. Includes LED and terminal kit.

120-70-5200 1970-72SEE WEB

No Volume Discount.



Electronic Speedometer Sender

This speedometer sending unit is required for correct operation of your electronic speedometer.

FSU1000 1970-72SEE WEB

No Volume Discount.



GLS-154

Tail Lamp Socket

Correct socket for bulb.

GLS-154 1970-72 All (1157 Bulb).....SEE WEB
 GLS-70 1970-77 All 2nd Design (1156 Bulb)SEE WEB



GPS-558

License Plate Socket

Correct socket for license plate bulb.

GPS-558 1970-72 All.....SEE WEB



LED-7



LED-7-HALO



LED-7-AMBER

LED Headlamps

Upgrade your weak old headlights with a pair of high-performance LED headlights! Producing 4,000 lumens at 6,000 Kelvin color temperature, these LED headlights are rated for 22,000 operating hours at 25 watts and only 2-amp draw. Made In the USA!

LED-7	1970-75 LED.....	SEE WEB
LED-7-HI	1970-75 LED.....	SEE WEB
LED-7-HALO	1970-75 LED White Halo.....	SEE WEB
LED-7-AMBER	1970-75 LED Amber Halo.....	SEE WEB

No Volume Discount.

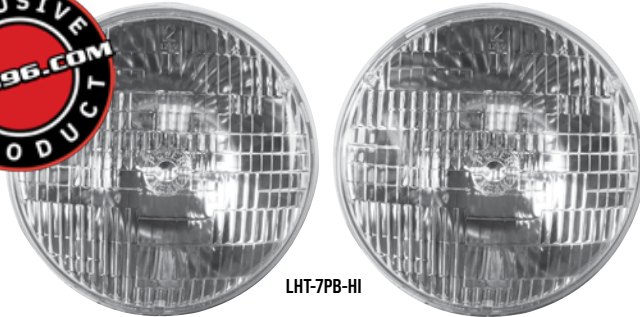

LHT-7PB-HI



LHT-7PB-HI Detail



LHT-7T-HI Detail



FACTORY T3

HI-INTENSITY T3

T3 Headlamps

Upgrade your weak old original T3 and Power Beam headlights with a pair of high performance headlights from Ground Up! These headlamps utilize modern bulb filaments with a much brighter high/low beam, which are considerably brighter than the original factory and Power Beam units. These fit and function exactly as original which makes installing these a breeze. They feature a T3 or Power Beam logo and look just like the originals! We tested these on our own 1970 Camaro in our warehouse and you can really see the difference!

LHT-7PB-HI	1970-75 All.....	SEE WEB
LHT-7T-HI	1970-75 All.....	SEE WEB

No Volume Discount.



EZH-7



EZH-7-HALO

Xenon Headlamps

Upgrade your weak old headlights with a pair of high performance Xenon headlights from Ground Up! These xenon headlamps utilize modern H4 bulbs with a 60/55 high/low beam, and are twice as bright as the original sealed beam units. The bulbs also last much longer. Plug and play wiring connector makes installing these a breeze. Available with Amber Blinker Light, DRL Light or LED City Light. Made In the USA.

EZH-7	1970-75.....	SEE WEB
EZH-7-HALO	1970-75.....	SEE WEB

No Volume Discount.



SS Parking Lamp Lens

This is a correct 1983-1988 Monte Carlo SS parking lamp lens. This is a great replacement for your broken or missing original lens and will help restore the front of your Monte Carlo.

- LPL-83MCSSL 1983-88 LH.....SEE WEB
- LPL-83MCSSR 1983-88 RH.....SEE WEB

No Volume Discount.



LPB-72M

Parking Lamp Bezels

This is a pair of high quality reproduction parking lamp bezels which feature the correct finish and will replace your originals perfectly.

- LPB-72M 1972.....SEE WEB

No Volume Discount.



DT-2100470

Digi-Tails LED Parking Light Kits

Dramatically enhance your front lights with high intensity wide-angled LEDs that maximize light output, making your lights safer and brighter. Easy to install!

- DT-2100470 1970 Monte Carlo.....SEE WEB

Note: See note under led flasher.



DT-200002

Electronic LED Flasher

This electronic LED flasher is recommended for use with LED tail lights and parking lights.

- DT-200002 LED Flasher 2 Prong.....SEE WEB
- DT-200003 LED Flasher 3 Prong.....SEE WEB

Note: If LED front parking lights are the ONLY LED lights you're installing, then you do not need an electronic LED flasher. If you are installing both LED tail light AND LED front lights then two electronic LED flashers are required. Housing and lenses are not included.



LED-1157AUS

LED Turn Signal Bulbs

These LED light bulbs are the perfect complement to your tail lights for applications where specific parking light kits are not available.

- LED-1157US 1157 LED White BulbSEE WEB
- LED-1157AUS 1157 LED Yellow BulbSEE WEB



Monte Carlo LS Side Marker Lamp Assembly

Replace your cracked or missing original side markers with these brand new assemblies made from original GM tooling! Original GM part number 5974357 LH, 5974358 RH.

- LSM-4086L 1986-88 LH.....SEE WEB
- LSM-4086R 1986-88 RH.....SEE WEB



LSM-A1678

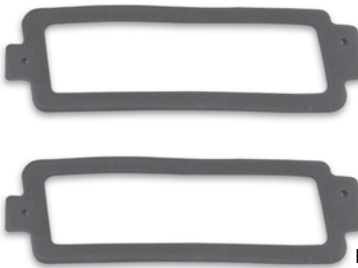

LMG-119

Monte Carlo Side Marker Lamp Assemblies

Replace your cracked or missing original side markers with these brand new assemblies made from original GM tooling! Original GM part #'s 5972203 and 5972205. Made in USA.

- LSM-A1678 1981-88*SEE WEB
- LMG-119 1981-88 Gaskets.....SEE WEB

** Except 86 LS*



LMG-145

Rear Side Marker Bezel Gaskets

When replacing your Monte Carlo side markers, it is always a good idea to replace your old gaskets. This pair of side marker bezels gaskets will replace your originals exactly.

- LMG-145 1973-77SEE WEB



LED-194US

LED Side Marker Bulbs

A simple direct replacement for your side marker light bulb. This LED bulb features 6 super bright LEDs in a 194/T10/160 bulb package. Excellent to increase brightness and reduce heat and power consumption.

- LED-194RUS 194 Red Led Bulb.....SEE WEB
- LED-194US White Led BulbSEE WEB
- LED-194AUS Amber Led BulbSEE WEB



GSS-883

Side Marker Sockets

Correct side marker sockets.

- GSS-883 1970-72 All.....SEE WEB
- GSS-893 1970-77 All 90 Degree (158 & 194 Bulb)SEE WEB



GLS-154

Tail Lamp Sockets

Correct sockets for bulb.

- GLS-154 1970-72 All.....SEE WEB



LED-194RUS



LED-194US

LED Dash Bulbs

A simple direct replacement for your original 194 style dash light bulbs. Excellent to increase brightness and reduce heat and power consumption.

- LED-194RUS 194 Red Led Bulb SEE WEB
- LED-194US White Led Bulb SEE WEB
- LED-194AUS Amber Led Bulb SEE WEB



500626

Classic Dash LED and Terminal Kit

This is the same LED kit for your turn signals, high beam indicator and brake light that is included with our complete Classic Dash panel kits. It can be used when buying a blank panel only.

- 500626 1970-72 SEE WEB
- No Volume Discount.*



LTL-8187L

LTL-8387R

Tail Lamp Lens

These are complete assemblies with red lenses, black housing, clear backup lens and all D.O.T. and Guide markings. 100% original made with the GM tooling and licensed by GM Restoration Parts. Monte Carlo lenses come with center emblem.

- LTL-8187L 1981-86 Non SS LH SEE WEB
- LTL-8187R 1981-86 Non SS RH SEE WEB
- LTL-8387L 1983-88 SS LH SEE WEB
- LTL-8387R 1983-88 SS RH SEE WEB



LS / SS LED Tail Lamp Kit

Dramatically enhance your tail lights with safer, brighter, and fully sequential LED light-panels that are easy to install.

- DT-1101086 1986-88 LS/1987-88 SS SEE WEB



TC-1647

Upper Tail Lamp Bezel

This die cast, chrome plated tail light bezel will brighten up the rear view of your Monte Carlo!

- TC-1647 1971-1972 SEE WEB



LED-1157AUS



LED-194US

LED Bulbs Side Marker

- DT-200008 194 Red LED Bulbs SEE WEB
- LED-194US White Led Bulb SEE WEB
- LED-194AUS Amber Led Bulb SEE WEB

Turn Signal

- LED-1157US 1157 White Led Bulb SEE WEB
- LED-1157AUS Amber Led Bulb SEE WEB
- LED-1156AUS 1156 Amber Led Bulb SEE WEB

Reverse Lights

- LED-1156US White Led Bulb SEE WEB

License Plate

- LED-194US White Led Bulb SEE WEB



TC-A1601



TC-A1602

Reverse Lamp Lens

Replace your faded Monte Carlo lenses with Trim Parts lenses. Our lenses are molded with UV stabilized acrylic to prevent color fade. Not everyone can say that about their lenses.

- TC-A1601 1970 SEE WEB
- TC-A1602 1971-1973 SEE WEB



LED-194US

LED License Plate Bulbs

A simple direct replacement for your side marker or license plate light bulb. This WHITE LED bulb features 5 dual super bright LEDs in a 194 bulb package. Excellent to increase brightness and reduce heat and power consumption.

- LED-194US 194 White Led Bulb SEE WEB

Note: Also can be used for side marker or dash.



GPS-558

License Plate Socket

Correct socket for license plate bulb.

- GPS-558 1970-72 All SEE WEB



LPL-338



LPL-16

License Plate Lenses

Correct SAE lenses.

- LPL-338 1970-72 All SEE WEB
- LPL-16 1970-72 Gasket SEE WEB
- LPL-0810 1978-88 Monte Carlo SEE WEB



MEH-1576

License Plate Lamps

Complete lamp assemblies with lenses.

- MEH-1576 1970-72 All SEE WEB



LTS-58-1P

Lens Screws

Correct GM style screws for parking lamp lenses and tail lenses.

- LTS-58-1P 5/8" Long SEE WEB
- LTS-34-1P 3/4" Long SEE WEB
- LTS-78-1P 7/8" Long SEE WEB
- LTS-10-1P 1" Long SEE WEB
- LTS-16-1P 1-1/8" Long SEE WEB
- LTS-12-1P 1-1/4" Long SEE WEB
- LTS-712-1P 1-1/4" Long, Stainless SEE WEB
- LTS-130-1P 1-5/16" Long SEE WEB



LD-79-0E

Door Lock Sets

Brand new door lock cylinders complete with the correct attaching clips and gaskets.

- LDL-X62RK 1970-81 Late Style Round Key SEE WEB
- LD-79-0E 1977-79 Round Key..... SEE WEB



LDT-X69

Door & Trunk Lock Sets OE Style Keys

Brand new door and trunk lock cylinders keyed alike.

- LDT-X69 1970-77 Monte Carlo/Malibu Late Style Square Key SEE WEB



LCK-X69IDT

Ignition Door & Trunk Lock Sets One Key Opens All

Brand new ignition, door and trunk lock cylinders keyed alike. Although not factory correct, we all can agree that one key makes it easier!

- LCK-X69IDT 1970-77 Square Style Key SEE WEB



LID-69F

Ignition & Door Locks

Brand new lock cylinders and "keyed" alike keys complete with correct attaching clips and gaskets.

- LID-69F 1970-72 All Square Key SEE WEB
- LID-79-0E 1978-81 Square Key..... SEE WEB



LI-69-0E

Ignition Lock Sets OE Style Keys

Brand new OE style ignition lock.

- LI-69-0E 1970-77 All Square Shaped Key w/o Knockout SEE WEB
- LI-69-0EKO 1970-77 All Square Shaped Key w/ Knockout SEE WEB
- LI-79-0E 1979-84 All Square Shaped Key w/o Knockout..... SEE WEB



LGT-70A

Glove Box & Trunk Locks

Brand new lock cylinders and "keyed" alike keys complete with correct attaching clips and gaskets.

- LGT-70A 1970-72 SEE WEB



LGC-6881

Glove Box Lock Sets OE Style Keys

Brand new OE style correct glove box lock set with keys.

- LGT-70-0E 1970-77 All Round Keys SEE WEB
- LGC-6881 1970-77 All Lock Casing Only SEE WEB



LGC-70-0E

Glove Box Trunk & Console Lock Sets OE Style Keys

Brand new OE style correct glove box, trunk and console lock set keyed alike. Although not factory correct we all can agree that one key makes it easier!

- LGC-70-0E 1970-72 Monte Carlo Round Style Key SEE WEB

**Without glove box lock casing.*



ICL-13K

Console Locks

Correct console locks with keys.

- ICL-13K 1970-72 Lock & Retainer Set SEE WEB
- ICL-13-PB 1970-72 Push Button SEE WEB



BUY & SAVE
WITH SS396.COM PRE-BUILT KITS



LCK-70A

Complete Lock Kits

Our lock kits come complete with ignition and doors keyed alike and glove box and trunk keyed alike just as original. We also include all necessary clips & gaskets.

LCK-70A 1970-72SEE WEB

BUY & SAVE
WITH SS396.COM PRE-BUILT KITS



LID-70-OE

Concours Lock Sets

This is a complete ignition and door lock set which includes OEM lock cylinders, keys, clips and gaskets. These concours correct lock sets are accepted by most judges as original. The keys have the correct knockouts and the code stamped into the key.

LID-70-OE 1970SEE WEB
LID-71-OE 1971SEE WEB
LID-72-OE 1972SEE WEB



LCK-70A-OE

Complete Lock Sets OE Style Keys One Key Opens All

Brand new ignition, door, glove box and trunk lock cylinders key alike. Although not factory correct we all can agree that one key makes it easier!

LCK-70A-OE 1970-77 Monte Carlo Octagon KeySEE WEB
LCK-78E 1978-87 Monte Carlo Square KeySEE WEB



RLR-247

Inner Door Lock Rod & Bellcrank

Plated reproduction threaded inner lock rod with attached bellcrank fits, RH or LH door.

RLR-247 1970-72SEE WEB



LPC-7

Door Lock Pawls

Correct bracket that attaches to the end tip of the door lock cylinder. The pawl trips the inner door latch assembly to open the door.

LP-1108 1970-72 RHSEE WEB
LP-1109 1970-72 LHSEE WEB
LPC-7 1970-72 All Door Lock Pawl ClipSEE WEB



LTB-90

Door/Trunk Lock Bracket

Correct bracket for retaining lock cylinder in place.

LTB-90 1970-72 AllSEE WEB



LTR-5

Trunk Lock Retainer

Reproduction of this hard to find bracket.

LTR-5 1970-72 Monte CarloSEE WEB



LT-67RD

Trunk Lock Sets

Brand new OE style trunk lock. Complete with retainer and lock rod.

LT-67RD 1978-88 Round KeySEE WEB



RTL-1019

Trunk Lid Latch

Correct locking latch which installs inside the trunk lid.

RTL-1019 1970-72SEE WEB



TLR-478

Trunk Lock Rods

Correct rod/shaft that connects the cylinder to the lock assembly.

TLR-478 1970-72SEE WEB

Grille Emblems

High quality reproduction and GM original grille emblems to freshen up your front end.



TC-1600



TC-1654



TC-1655



TC-1680



TG-1695

Monte Carlo Grille Emblem

This is a high quality reproduction Monte Carlo grille emblem which features the correct finish and will replace your originals perfectly.

TC-1600	1970SEE WEB
TC-1654	1971SEE WEB
TC-1655	1972SEE WEB
TC-1680	1973-75SEE WEB
TG-1695	1980 & 1982*SEE WEB

* Not correct for 1981 models.



TK-427

427 Super Car Emblem

This emblem (GM number 3901932) was originally used on 1970 427 Impalas but it was also used by super car dealers on a lot of their conversions on fenders, hoods and trunk lids. Baldwin Motion used these emblems on the fenders of their super cars in 1970. Perfect for any super car, tribute car or custom!

TK-427	AllSEE WEB
--------	-----	--------------



TG-502

Universal Cross Flag Emblems

These universal cross flag emblems can be mounted anywhere on your car for a nice custom touch while still looking vintage. Universal. Measures 2-7/8" x 4-1/2" with 3 pins on back.

TG-454	454SEE WEB
TG-502	502SEE WEB
TG-572	572SEE WEB

Fender Emblems

Reproduction emblems to freshen up your fenders.



TK-MOTION

Motion Emblem

This universal Baldwin Motion die-cast emblem is perfect for custom projects.

TK-MOTION	AllSEE WEB
-----------	-----	--------------



5th Gen Camaro Emblems

These peel & stick factory GM emblems can be applied to any vintage muscle car for a powerful modern look. Perfect for pro touring cars!

T-12SSW	SS WhiteSEE WEB
T-12SSR	SS RedSEE WEB
T-ZL1	ZL1SEE WEB



T0-773	1970-72 SS (Per Side)SEE WEB
T0-773K	1970-72 SS (2 Fenders)SEE WEB
T0-773-PS	Universal Chrome Peel N StickSEE WEB



T0-773B	1970-72 SS BlackSEE WEB
---------	------------------	--------------

Order two pairs per car.



T0-773R	1970-72 SS RedSEE WEB
---------	----------------	--------------

Order two pairs per car.



T-3100	1973 SSSEE WEB
--------	---------	--------------

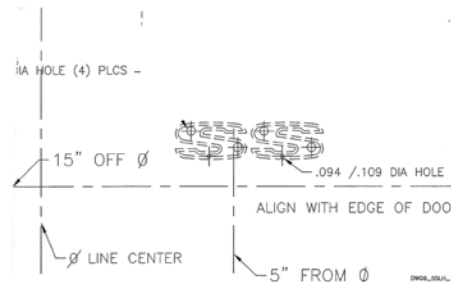

SS Fender Template

Convenient template which shows precise locations of SS emblems making installation of emblems on new fenders painless.

TFT-69SS	1970-72SEE WEB
----------	---------	--------------



TT-679	1970-72 396SEE WEB
--------	-------------	--------------



TT-1500	1970-72 454SEE WEB
---------	-------------	--------------



TT-502	Universal Peel N StickSEE WEB
--------	------------------------	--------------



TC-1650



TC-1650A

Rocker Panel Emblems

Monte Carlo means "class" and that is what you get with these molded emblems. Expect a smooth, clean, flawless emblem from Trim Parts! Includes fasteners. The white SS logos are OEM. The red ones are for a custom look.

TC-1650	1970-72 WhiteSEE WEB
TC-1650A	1970-72 RedSEE WEB

No Volume Discount.

Hood Emblems



TK-8013 YenkoSEE WEB



Chrome Yenko Emblem

While the original emblem was white this cool chrome emblem is the perfect touch to any custom.

TK-8013-C YenkoSEE WEB



TK-678 Yenko 427SEE WEB



Dick Harrell Emblem

This universal diecast emblem is perfect for custom projects.

DH1018 All.....SEE WEB



Baldwin Motion SS427 Emblem

This emblem (GM number 7752254) was originally used on the deck lid of 1968 427 Impalas but it was also used by super car dealers on a lot of their conversions on fenders, hoods and trunk lids. Baldwin Motion often used these emblems on the valve covers of their super cars. Perfect for any super car, tribute car or custom!

TK-SS427 All.....SEE WEB

Trunk/Rear Emblems



TC-1651

Trunk Emblem

Do you have a 71 Monte Carlo SS? Then you will want to add this to your list. Die cast, chrome plated and beautiful; another master piece from Trim Parts! Includes fasteners.

TC-1651 1971 SSSEE WEB



TC-1652

TC-1660

Trunk Lock Emblem

Be proud when you unlock your Monte Carlo trunk with this trunk lock bezel. Made by Trim Parts, with attention to details as our quality standard!

TC-1652 1971SEE WEB
TC-1660 1972SEE WEB



TC-1635



TC-1649



TC-1662



TC-1675

Rear Emblem

Made by Trim Parts, with attention to details as our quality standard!

SEE WEB 1970 w/ FastenersSEE WEB
SEE WEB 1971 w/ FastenersSEE WEB
SEE WEB 1971-72 w/ Mounting StudsSEE WEB
SEE WEB 1971-72 Peel n StickSEE WEB
SEE WEB 1976-77 w/ Mounting StudsSEE WEB



Universal Rally Stripe Stencil Kit

This universal rally stripe kit makes it easy to add stripes to any year Monte Carlo. Based off of the 1970-1972 Camaro Z/28 stripes this complete kit includes; (2) sets of front hood stencils, (2) trunk stencils and (1) 9/32 x 38-1/2 foot roll of stripe masking which can be cut to desired length depending on car.

MSS-0688 All.....SEE WEB

Note: This is a universal stencil kit. Simply cut the roll of stripe masking to your desired length to add stripes to any car.



1983-1988 Monte Carlo SS Stripe and Decal Kit

This is a complete Monte Carlo SS decal and stripe kit which is manufactured to meet or exceed factory specs. This GM style stripe kit will help restore your Monte Carlo SS to showroom specs. This kit includes (1) front bumper stripe, (2) front fender stripes, (2) door stripes, (2) rear quarter panel stripes, (3) Monte Carlo SS names, squeegee and instructions.

MSS-8384MCSS-BLUE 1983-84 Blue SEE WEB
MSS-8586MCSS-RED 1985-86 Red SEE WEB
MSS-8886MCSS-ORG 1985-86 Orange SEE WEB
MSS-8788MCSS-GOLD-A 1987-88 Lt, Med, Drk* SEE WEB
MSS-8788MCSS-GOLD-B 1987-88 Drk, Med, Lt* SEE WEB
MSS-8788MCSS-GRAY 1987-88 Gray SEE WEB
MSS-8788MCSS-RED 1987-88 Red SEE WEB

* Colors from top of car to bottom.

Pre-Application Surface Cleaner

Remove contaminants like silicones, wax, tree sap and bug guts for a clean and adherent surface.

PREAPP 4 oz. Pre-App CleanerSEE WEB



SLIDE-ON Application Gel

Slide-On contains a special formula that resists drying until you are ready to squeegee the graphic into place. Only then does the decal "set up".

SOAG 16 oz. Application GelSEE WEB



SLIDE-OVER UV Protectant

Help protect your decal from harsh elements and natural aging by applying our revolutionary Slide-Over UV Protectant & Conditioner.

SOPC 8 oz. Uv ProtectantSEE WEB





Air Cleaner Decals SB
HOJ-(Engine Horsepower)SEE WEB
Ex. HOJ-350250 for decal above.



Cross Flag Decals BB
HOJ-(Engine).....SEE WEB
Ex. HOJ-396 for decal above.



Diecast Air Cleaner Decals
HOJ-(Engine)-DC Diecast.....SEE WEB
Ex. HOJ-396-DC for decal above.



Turbo Jet Decals BB
HOJ-375SEE WEB
Ex. HOJ-375 for decal above.



Diecast Turbo Jet Decals
HOJ-375-DC Diecast.....SEE WEB
ex. HOJ-375-DC for decal above.



Turbo Jet Decals 1971-74
HOJ-(EngineHorsepower)SEE WEB
Ex. HOJ-396300 for decal above.

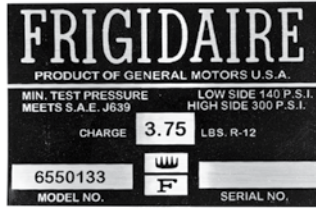

AC Compressor Decals
HOJ-607 1970-72 Red.....SEE WEB
HOJ-738 1970-72 GreenSEE WEB



AC Box Decal
HOJ-550 All HarrisonSEE WEB



Brake Bail Decals
HOJ-226 1970 All CN.....SEE WEB



Brake Check Valve Decal
HOJ-333 1970 All CN.....SEE WEB
HOJ-335 1971-72 All CTSEE WEB



Turbo HydraMatic Transmission ID Tags
Turbo HydraMatic transmission ID tag with rivet, measuring 1-1/8 inch x 1-15/16 inch. This installs on the side of the transmission case with the rivet. You must punch your own info onto the tag.
TTP-70 1970 Black.....SEE WEB
TTP-71 1971 Light BlueSEE WEB
TTP-6972 1972 YellowSEE WEB



Caliper Backing Plate Decals
HDT-70 1970 Code DTSEE WEB
HAS-70 1970 Code ASSEE WEB



Cooling System Decal
HOJ-242 1970-72 All.....SEE WEB



Emission Decals
HE-68H HE-68H All UnivesalSEE WEB
HE-DR HE-DR 1970 396/350 4spd DRSEE WEB
HE-DP HE-DP 1970 LS5 DPSEE WEB
HE-AX HE-AX 1970 SB AX.....SEE WEB
HE-AT HE-AT 1970 396/350 Auto ATSEE WEB
HE-DT HE-DT 1970 454/450 DTSEE WEB
HE-71AT HE-71AT 1971 402 AT.....SEE WEB
HE-71AU HE-71AU 1971 454 AUSEE WEB
HE-72LT HE-72LT 1972 402 LTSEE WEB
HE-72LX HE-72LX 1972 454 LXSEE WEB



Coil Spring Decals
HCS-GB HCS-GB 1970 FrontSEE WEB
HCS-00 HCS-00 1970 RearSEE WEB



Door Jamb Decals
HOJ-706CA HOJ-706CA 1970-76 GM of CanadaSEE WEB



Fan Caution Decal
HFA-930 All.....SEE WEB



HSR-AW

Shock Decals

- HSF-BK 1970 LS-6 Front SEE WEB
- HSR-AW 1970 LS-6 Rear SEE WEB

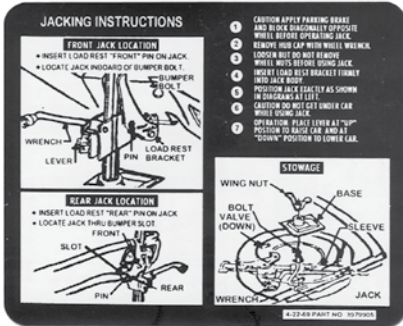

HJC-873

Jacking Instructions

- HJC-873 1970 All SEE WEB
- HJC-891 1971 All SEE WEB
- HJC-892 1972 All SEE WEB



MSKIT-705

Master Decal Kits

Convenient kit for replacing all of your factory decals for a concours restoration. Includes brake & fuel line tags, shock & spring tags, brake cable tags, sway bars and more! Over 50 pieces.

- MSKIT-7001 1970 SS396 SEE WEB
- MSKIT-705 1970 LS5 SEE WEB
- MSKIT-706 1970 LS6 SEE WEB
- MSKIT-7201 1972 LS5 SEE WEB

*Does not include air cleaner decals.



Air Cleaner Side Decal

- H0J-476 1970-72 SEE WEB



Positraction Decal

- HBH-797 1970-72 SEE WEB



HBA-70

Steering Box Decals

- HBA-70 1970 Power Steering BA SEE WEB
- HDL-70 1970 Manual Steering DL SEE WEB



HTP-170



HTP-173

Tire Pressure Decals

- HTP-170 1970 Super Sport, Code AD SEE WEB
- HTP-173 1970-72 Decal SEE WEB



Trans Cooler Decal

- HCL-76 1970 All with TH SEE WEB



AXJ-CE

Accelerator Cable Decal

- AXJ-CE 1970-72 All SEE WEB



Tonawanda Decal

- ATO-3000 All BB SEE WEB



HCRR-70

Valve Cover Decals

- HCRR-70 1970 454/450 Auto SEE WEB



Yenko Decal Fan Shroud

- HY-164 Yenko S/C SEE WEB



Yenko Decal Valve Cover

- HV-225 Yenko S/C SEE WEB



Yenko Decal Window

- HY-069 Yenko S/C SEE WEB



Gas Tank Stencils

Stencil kits for final detailing for gas tank.

- HTS-7001 1970 SEE WEB
- HTS-7101 1971 SEE WEB
- HTS-7201 1972 SEE WEB

Engine Paint

- VHT® High Temperature Engine Enamel; Nu-Cast Aluminum; 11 oz. Aerosol
VHT-SP995 Nu-Cast Aluminum.....SEE WEB
 VHT® High Temperature Engine Enamel; Cast Iron; 11 oz. Aerosol
VHT-SP997 Cast Iron.....SEE WEB
 VHT® High Temperature Engine Enamel; Chevy Orange; 11 oz. Aerosol
VHT-SP123 Chevy Orange.....SEE WEB
 VHT® High Temperature Engine Enamel; Gloss Black; 11 oz. Aerosol
VHT-SP124 Gloss Black.....SEE WEB
 VHT® High Temperature Engine Enamel; Flat Black; 11 oz. Aerosol
VHT-SP130 Flat Black.....SEE WEB
 VHT® High Temperature Engine Enamel; GM Blue; 11 oz. Aerosol
VHT-SP135 GM Blue.....SEE WEB
 VHT® High Temperature Engine Enamel; Motor-Brite Clear; 11 oz. Aerosol
VHT-SP29 Motor-Brite Clear.....SEE WEB
 VHT® Wrinkle Plus; High Temp Wrinkle Finish; Black; 11 oz. Aerosol
VHT-SP201 Black Wrinkle.....SEE WEB
- ## Trunk Paint
- Dupli-Color® Spatter Paint; Black/Gray; 11 oz. Aerosol
DUP-DM102 Black/Gray Spatter.....SEE WEB
 Dupli-Color® Spatter Paint; Gray/White; 11 oz. Aerosol
DUP-DM100 Gray/White Spatter.....SEE WEB
 Dupli-Color® Spatter Paint; Black/Aqua; 11 oz. Aerosol
DUP-DM109 Black/Aqua Spatter.....SEE WEB
 Dupli-Color® Premium Lacquer; Clear; 12 oz. Aerosol
DUP-DAL1695 Clear Coat.....SEE WEB
 AC Delco Splatter Paint Grey/White 13oz Aerosol

Vinyl Paint

- VHT Vinyl Dye Gloss Jet Black; 11 oz. Aerosol
VHT-SP941 Gloss Jet Black.....SEE WEB
 VHT Vinyl Dye White Satin; 11 oz. Aerosol
VHT-SP943 White Satin.....SEE WEB
- ## Primer
- Dupli-Color® Self-Etching Primer; Green; 12 oz. Aerosol
DUP-DAP1690 Self-Etching Primer.....SEE WEB
 VHT® Prime Coat; Red Oxide; 12 oz. Aerosol
VHT-SP303 Red Oxide Primer.....SEE WEB

OER Interior Paint

OER's revolutionary formula provides 40% more coverage than standard dyes and lacquers and actually penetrates and molecularly bonds to the surface to permanently seal in the color. Dries to the touch in 45 seconds, forms a complete bond in just 10 minutes. UV stable and color fast, it will not crack, flake or peel. For use on vinyl, leather, ABS plastic, polycarbonate, polypropylene, polyurethane, acrylic, lexan, fiberglass and recycled plastics.



- | | | |
|---------------------|---------------------------------|---------|
| HPP-802RED | M30 Red | SEE WEB |
| HPP-804BBLU | M14 Bright Blue | SEE WEB |
| HPP-808MBLU | M17 Medium Blue | SEE WEB |
| HPP-809IGLD | M46 Ivy Gold | SEE WEB |
| HPP-810WHITE | M37 White | SEE WEB |
| HPP-811ORNG | M126 Hugger Orange | SEE WEB |
| HPP-813DGRN | M24 Dark Green | SEE WEB |
| HPP-820CAMEL | Z48 Camel Tan | SEE WEB |
| HPP-829FTHRN | Z45 Firethorn Red | SEE WEB |
| HPP-830CARM | Z38 Carmine | SEE WEB |
| HPP-1009 | Surface Prep | SEE WEB |

Paint can not be shipped via air. Ground shipping only.

- | | | | |
|------------------|--------------------|-------------------|------------------|
| DUP-DM100 | DUP-DAL1695 | VHT-SP5251 | VHT-SP995 |
|------------------|--------------------|-------------------|------------------|



Detailing Paint

- Dupli-Color® Premium Enamel; Machinery Gray; 12 oz. Aerosol. Ideal for GM shocks.
DUP-DA1612 Machinery Gray.....SEE WEB
 Dupli-Color® Premium Lacquer; Flat Black; 12 oz. Aerosol
DUP-DAL1607 Flat Black.....SEE WEB
 Dupli-Color® Premium Lacquer; Semi-Gloss Black; 12 oz. Aerosol
DUP-DAL1608 Semi-Gloss Black.....SEE WEB
 Dupli-Color® Premium Lacquer; Gloss Black; 12 oz. Aerosol
DUP-DAL1677 Gloss Black.....SEE WEB
 Dupli-Color® Premium Lacquer; Clear; 12 oz. Aerosol
DUP-DAL1695 Clear.....SEE WEB
 Dupli-Color® Automotive Metallic Coating; Stainless Steel; 11 oz. Aerosol
DUP-SS100 Stainless Steel.....SEE WEB
 Dupli-Color® Trim Paint; Black; 11 oz. Aerosol
DUP-TP70 Black.....SEE WEB
 VHT® Plate Finish; Chrome; 11 oz. Aerosol
VHT-SP5251 Chrome.....SEE WEB
- ## Radiator Paint
- VHT-SP139 Radiator Black**.....SEE WEB
- ## OER Paint
- OER GM Delco Shock Absorber Gray
HDP-532 Shock Gray.....SEE WEB
 OER Gloss Black High Solids Detail Coating
HDP-9577 Gloss Black.....SEE WEB
 OER Stainless Steel High Solids Detail Coating
HDP-9580 Stainless Steel.....SEE WEB



Dupli-Color Spray Adhesive

Ideal for use on vehicle carpets, headliners, accessories & more!

- | | | |
|-------------------|-------------------------------|---------|
| DUP-SAR102 | Adhesive | SEE WEB |
| DUP-SAR100 | Adhesive Remover | SEE WEB |

No volume discount.



Dupli-Color Clear Truck Bed/Trunk Coating

- | | | |
|--------------------|----------------------|---------|
| DUP-CTBA100 | Aerosol | SEE WEB |
|--------------------|----------------------|---------|



DUP-HWP102 Shown

Wheel & Tire Paint

Dupli-Color® Hot Tires Tire Paint; White; 0.5 oz. Paint Pen

Whether your tires are old or new, Dupli-Color® Hot Tires™ gives you a way to add color or personalize your muscle car, truck or sport compact tires. This fast-drying, durable coating allows you to touch-up faded white walls or tattoo your high performance tires. Hot Tires goes on smooth, resists fading and is available in an easy-to-use pen.

- | | | |
|------------------|-------------------------------|---------|
| DUP-HT100 | White Tire Paint | SEE WEB |
|------------------|-------------------------------|---------|

Dupli-Color® Wheel Coating; Silver; 11 oz. Aerosol

Argent Silver for Chevrolet Rally Wheels.

- | | | |
|-------------------|----------------------------|---------|
| DUP-HWP101 | Argent Silver | SEE WEB |
|-------------------|----------------------------|---------|

Details® 1969-70 SS Wheel Insert Gray Paint

Correct gray for 1969-70 SS wheel inserts.

- | | | |
|-----------------|-------------------------------------|---------|
| HDP-1214 | 1969-70 SS Insert Gray | SEE WEB |
|-----------------|-------------------------------------|---------|

Dupli-Color® Wheel Coating; Graphite; 11 oz. Aerosol

Dark gray for SS 5 spoke wheels.

- | | | |
|-------------------|-------------------------------|---------|
| DUP-HWP102 | 1971+ Up SS Gray | SEE WEB |
|-------------------|-------------------------------|---------|



HMK-6970

1969-70 SS Wheel Paint Mask Kit

Die stamped wheel mask kit for correctly painting your SS wheels.

- | | | |
|-----------------|---------------------------------|---------|
| HMK-6970 | 1969-70 Wheel Mask | SEE WEB |
|-----------------|---------------------------------|---------|



Shop Manual Set

This set of factory manuals offers all of the information you need when you are restoring or servicing your car. Each manual is full of pictures and tutorials of everything from simple maintenance to complete removal and installation of virtually everything on the car. These are the same manuals that GM dealers used on most repair and warranty work.

- HMS-70A 1970 AllSEE WEB
- HMS-71A 1971 AllSEE WEB
- HMS-72A 1972 AllSEE WEB



Factory Assembly Manuals

A must for all restorations! These books were used at the factory plants as a reference guide for linemen. This book features all engineering drawings, GM numbers and torque specs.

- HA-A70 1970 AllSEE WEB
- HA-A71 1971 AllSEE WEB
- HA-A72 1972 AllSEE WEB

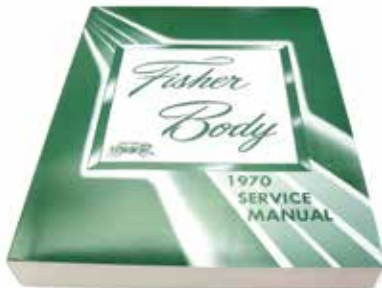

Fisher Body Manuals

Complete information on the actual body of the car including interior, trim, door panels, glass, trunk and more!

- HFB-70 1970SEE WEB
- HFB-71 1971SEE WEB
- HFB-72 1972SEE WEB
- HFB-73 1973SEE WEB



Factory Owner's Manuals

Authentic reproductions of the original factory owner's manuals which came with all cars.

- HDG-70A 1970 AllSEE WEB
- HDG-71A 1971 AllSEE WEB
- HDG-72A 1972 AllSEE WEB



Owner's Manual Bags

Correct factory plastic bag for your owners manual and dealer information.

- HMB-3 1970-72 AllSEE WEB
- HMB-4 1973-88 AllSEE WEB



Factory Service Manuals

This manual was used by GM dealers to service your car when new. From simple maintenance to major component repair, this manual has all of the info needed to service your car.

- HSM-70 1970 AllSEE WEB
- HSM-71 1971 AllSEE WEB
- HSM-72 1972 AllSEE WEB
- HSM-73 1973 AllSEE WEB
- HSM-74 1974 AllSEE WEB
- HSM-75 1975 AllSEE WEB
- HSM-76 1976 AllSEE WEB
- HSM-77 1977 AllSEE WEB
- HSM-78 1978 AllSEE WEB
- HSM-79 1979 AllSEE WEB
- HSM-80 1980 AllSEE WEB
- HSM-81 1981 AllSEE WEB
- HSM-82 1982 AllSEE WEB
- HSM-83 1983 AllSEE WEB
- HSM-84 1984 AllSEE WEB
- HSM-85 1985 AllSEE WEB



Blank Window Stickers

Reproduction of the factory window sticker which allows you to make your own custom paper, perfect for a re-creation car!

- HOB-350 1970-72 AllSEE WEB

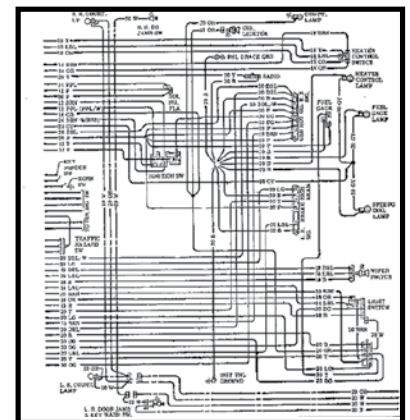

Wiring Diagrams

Original GM wiring schematic from bumper to bumper

- HWD-70A 1970 AllSEE WEB
- HWD-71A 1971 AllSEE WEB
- HWD-72A 1972 AllSEE WEB



Chevrolet Start Sleeve

Reproduction starting instruction sleeve which was installed on the sunvisor.

- HSS-69 1970-72SEE WEB

Company Policies

Hassle Free Returns

Products may be returned for a full refund, credit, or exchange within 30 days of receipt, provided that the product is in its original shipping condition and has not been modified, altered, painted, installed, or damaged. Products returned after 30 days can only be returned for exchange, store credit, or refund check. All returns after 30 days are subject to a 25% restocking fee. Ground Up Motors - SS396.com will not accept returned goods without prior authorization, any returns without prior authorization will be subject to a 25% restocking fee. The customer is responsible for shipping charges on returned merchandise unless otherwise indicated by Ground Up Motors - SS396.com.

Ground Up Motors - SS396.com always recommends professional installation for all the products we sell. Any item that has been altered, painted, installed, or deemed non-resalable by Ground Up Motors - SS396.com will be returned to the customer at the customer's expense. If the customer does not want to pay for return shipping, the item will be field destroyed. Ground Up Motors - SS396.com is not responsible or liable for any labor fees associated with the installation, removal, modification, or repair of any product purchased, regardless of the circumstances. Additionally, Ground Up Motors - SS396.com is not responsible for any damage or discoloration incurred in relation to chemical products, including cleaners, waxes, polishes, paints, and/or similar items.

Product Availability & Pricing

The availability of all items on SS396.com and in our print catalogs is subject to change without prior notice. Ground Up Motors - SS396.com reserves the right to discontinue products, services, accessories, and substitute products of a similar nature (i.e., different manufacturers/brands) without notice. While Ground Up Motors - SS396.com strives to maintain accurate pricing, please note that prices are subject to change due to factors such as increased costs in manufacturing and materials. For the most up-to-date pricing information, please visit our website 24/7 or contact a Ground Up Motors - SS396.com customer service representative by phone or email.

Backorders

Ground Up Motors - SS396.com will try to notify you in the event backorders are present on your order. While back orders are often beyond the control of Ground Up Motors - SS396.com, most out of stock items are shipped within two (2) to six (6) weeks. We generally ship back ordered items as soon as they arrive at our warehouse, without notification. If one of your items has been out of stock for more than 90 days, we will try to contact you before shipping. If you wish to cancel a back order, please contact us as soon as possible to avoid return shipping charges and restocking fees.

Ground Up Motors - SS396.com will keep track of all backorders on products that are "out-of-stock" or unavailable at the time the order is placed. The pricing on a back-ordered product is not guaranteed due to labor, manufacturing, materials, shipping costs, and other unforeseeable issues that may arise requiring a price adjustment. We will maintain the price on any backorder product for 60 days after the order is placed. After 60 days, the product may be subject to a price adjustment. If a price adjustment is necessary on a particular product, we will do our best to inform the customer before the product is shipped.

Kit Products

Our Parts and Accessories catalogs, as well as SS396.com, offer kits that include a variety of products to provide you with the best value. Please note that most of these kit items are exclusive to Ground Up Motors - ss396.com and are not eligible for further discounting or price matching against our competitor's kits.

Occasionally, we may run out of a specific item that is included in a kit. In such cases, we will generally ship the items that are in stock and backorder the ones that are currently unavailable. You can contact our sales department by phone to verify which items are out of stock at the time of placing your order. As our customer, you have the option to accept a partial kit delivery or choose to have the entire kit backordered until it is ready to ship in its entirety, be sure this is either verbally communicated over the phone or specified when placing an order online. Please note that additional freight fees may apply for multiple shipments, if applicable.

Color Matches

Please note that due to multiple manufacturers of products provided by Ground Up Motors - ss396.com, color variations may occur. Slight color variations, especially among interior products, are common and do not constitute a defect. These products are not eligible for return shipping solely based on color variations.

Additionally, there are products noted online and, in our catalog, as non-returnable. This primarily includes colored products such as interior items, as well as special order or built-to-order products like date-coded glass and custom gauge clusters. If you are unsure whether a product is non-returnable, please contact a us via phone or email for clarification. Please be aware that colors displayed on computer monitors and, in our print, catalogs may differ slightly from the actual color of the product. If precise color matching on interior items is a concern, we recommend ordering black and color matching using interior paint or dyes. Returns of colored, special order, or non-returnable items are not permitted and will be subject to 25% restocking fee.

Sales Tax Information

If you live in a state that requires sales tax, Ground Up Motors - SS396.com will collect the appropriate sales tax for your shipping location. Most states currently require sales tax and Ground Up Motors - SS396.com is compliant with all the latest laws associated with state sales tax. Due to regular variations in state sales tax, rates are subject to change without notice based on state and zip code. State sales tax is applied to products as well as shipping fees, handling fees, etc

Ordering Lefts and Rights

Items in this catalog are presented as right hand (RH) or left hand (LH). RH and LH sides are determined by sitting in the vehicle. RH = passenger and LH = driver.

Trademark and Copyright

The content of Ground Up Motors - SS396.com, including the Ground Up Motors - SS396.com Parts and Accessories catalog is copyright 2024, all rights are reserved. No part of this publication including text, photos or illustrations may be reproduced without the prior written permission of Ground Up Motors - SS396.com.

International Orders

Ground Up Motors - SS396.com is happy to ship parts to international customers via International Economy shipping. Shipping can also be arranged per the customer and the packages will be boxed at our dock. Please call our sales department or send an email to logistics@ss396.com to get a shipping quote for the parts that you wish to order.

Oversize Items

We offer shipping for items that are considered Oversize. These items can be shipped via UPS Ground at an Oversize rate, which entails a minimum dimensional weight fee of 30 lbs. for Oversize or 70 lbs. for Oversize 2.

It's important to note that Ground Up Motors - SS396.com reserves the right to charge an Oversize fee on any item that is deemed Oversize, even if it is not explicitly indicated as such. This ensures that the shipping costs associated with handling and transporting these larger items are adequately covered. If a shipping adjustment is necessary on a particular product, we will do our best to inform the customer before the product is shipped.

Truck Freight

Ground Up Motors - SS396.com recognizes that certain products are too large or heavy to be shipped via Ground freight and must be shipped using truck freight. Efforts are made to clearly indicate these items in the print catalogs and website, but there may be instances where an item not specifically marked for truck freight may still require or benefit from this shipping method.

To ensure we are providing our customers with the best possible shipping rate all orders are subject to review by our Truck Department for adequate freight quoting. When placing an order online or over the phone you will not be charged any shipping, and a quote will be provided for your approval which is valid for 10 days from the date it was provided. Orders will remain as a quote until the order has been approved by the customer. Note that products are not reserved until the quote has been approved. Due to the quoting process PayPal payment is not accepted for truck orders. It is crucial to provide us with accurate information regarding the delivery destination. Any fees or charges resulting from the provision of false information or failure to comply with Ground Up Motors - SS396.com's policies are the sole responsibility of the customer and may be applied without notice.

Expedited Shipping

Ground Up Motors - SS396.com provides various expedited shipping options for customers' convenience. To ensure timely delivery, orders must be placed by 2:00 pm from Monday to Thursday, and by 12:00 pm on Fridays. Please note that weekends and holidays are not considered shipping days. It is important to mention that we recommend contacting our sales department to obtain the expedited shipping rates for your order. They will be able to provide you with accurate pricing information based on your specific requirements to ensure you are receiving your expedited order in a timely manner.

APO/FPO Shipping

Please note that for APO or FPO addresses, USPS is the only available shipping method. If you are military personnel with an APO or FPO address, it is important to contact Ground Up Motors - SS396.com prior to placing your order. This will allow them to verify that the desired parts do not exceed the size limit and ensure a smooth shipping process for you. You can reach out to our customer service team by writing, calling, or emailing, be sure to also ask about our Military discounts which we are honored to offer to both active and retired military personnel.

Product Damages & Shortages

We understand that errors and issues can sometimes occur during the fulfillment, shipping, or manufacturing process. If you receive a product that is damaged, missing, or incorrectly shipped, it is important to notify us within three (3) business days of receiving the order. You can do so by contacting us via phone or email. If you are present at the time of delivery and notice any carrier damage it is recommended that you refuse the shipment with the reason of carrier damage. If this is the case notify our customer service team so we can rectify this issue in a timely manner and ensure you are not charged any additional fees.

To ensure a prompt resolution on a damaged or missing claim, we may request additional information, such as images or details about the damaged, missing, or incorrectly shipped product. In most cases, we will provide you with a pre-paid shipping label to return the damaged or incorrectly sent product. Once we receive and inspect the returned item, we will issue a refund or send a replacement, depending on your preference.

Please note that if you report damage, missing items, or incorrect shipments after the 3-day window, you may still be able to make a claim, but will not be eligible for a pre-paid shipping label.

Refusals

In the event of a refused delivery, please note that a restocking fee of 25% will be applied, along with applicable return shipping charges, unless the refusal was due to damage that occurred during shipping (refer to our Damage Claim policy).

For more policies and information on discounts/eligibility please see ss396.com for more information.

Company Policies

Hassle Free Returns

Products may be returned for a full refund, credit, or exchange within 30 days of receipt, provided that the product is in its original shipping condition and has not been modified, altered, painted, installed, or damaged. Products returned after 30 days can only be returned for exchange, store credit, or refund check. All returns after 30 days are subject to a 25% restocking fee. Ground Up Motors – SS396.com will not accept returned goods without prior authorization, any returns without prior authorization will be subject to a 25% restocking fee. The customer is responsible for shipping charges on returned merchandise unless otherwise indicated by Ground Up Motors – SS396.com.

Ground Up Motors – SS396.com always recommends professional installation for all the products we sell. Any item that has been altered, painted, installed, or deemed non-resalable by Ground Up Motors – SS396.com will be returned to the customer at the customer's expense. If the customer does not want to pay for return shipping, the item will be field destroyed. Ground Up Motors – SS396.com is not responsible or liable for any labor fees associated with the installation, removal, modification, or repair of any product purchased, regardless of the circumstances. Additionally, Ground Up Motors – SS396.com is not responsible for any damage or discoloration incurred in relation to chemical products, including cleaners, waxes, polishes, paints, and/or similar items.

Product Availability & Pricing

The availability of all items on SS396.com and in our print catalogs is subject to change without prior notice. Ground Up Motors – SS396.com reserves the right to discontinue products, services, accessories, and substitute products of a similar nature (i.e., different manufacturers/brands) without notice. While Ground Up Motors – SS396.com strives to maintain accurate pricing, please note that prices are subject to change due to factors such as increased costs in manufacturing and materials. For the most up-to-date pricing information, please visit our website 24/7 or contact a Ground Up Motors – SS396.com customer service representative by phone or email.

Backorders

Ground Up Motors – SS396.com will try to notify you in the event backorders are present on your order. While back orders are often beyond the control of Ground Up Motors – SS396.com, most out of stock items are shipped within two (2) to six (6) weeks. We generally ship back ordered items as soon as they arrive at our warehouse, without notification. If one of your items has been out of stock for more than 90 days, we will try to contact you before shipping. If you wish to cancel a back order, please contact us as soon as possible to avoid return shipping charges and restocking fees.

Ground Up Motors – SS396.com will keep track of all backorders on products that are "out-of-stock" or unavailable at the time the order is placed. The pricing on a back-ordered product is not guaranteed due to labor, manufacturing, materials, shipping costs, and other unforeseeable issues that may arise requiring a price adjustment. We will maintain the price on any backorder product for 60 days after the order is placed. After 60 days, the product may be subject to a price adjustment. If a price adjustment is necessary on a particular product, we will do our best to inform the customer before the product is shipped.

Kit Products

Our Parts and Accessories catalogs, as well as SS396.com, offer kits that include a variety of products to provide you with the best value. Please note that most of these kit items are exclusive to Ground Up Motors – ss396.com and are not eligible for further discounting or price matching against our competitor's kits.

Occasionally, we may run out of a specific item that is included in a kit. In such cases, we will generally ship the items that are in stock and backorder the ones that are currently unavailable. You can contact our sales department by phone to verify which items are out of stock at the time of placing your order. As our customer, you have the option to accept a partial kit delivery or choose to have the entire kit backordered until it is ready to ship in its entirety, be sure this is either verbally communicated over the phone or specified when placing an order online. Please note that additional freight fees may apply for multiple shipments, if applicable.

Color Matches

Please note that due to multiple manufacturers of products provided by Ground Up Motors – ss396.com, color variations may occur. Slight color variations, especially among interior products, are common and do not constitute a defect. These products are not eligible for return shipping solely based on color variations.

Additionally, there are products noted online and, in our catalog, as non-returnable. This primarily includes colored products such as interior items, as well as special order or built-to-order products like date-coded glass and custom gauge clusters. If you are unsure whether a product is non-returnable, please contact us via phone or email for clarification. Please be aware that colors displayed on computer monitors and, in our print, catalogs may differ slightly from the actual color of the product. If precise color matching on interior items is a concern, we recommend ordering black and color matching using interior paint or dyes. Returns of colored, special order, or non-returnable items are not permitted and will be subject to 25% restocking fee.

Sales Tax Information

If you live in a state that requires sales tax, Ground Up Motors – SS396.com will collect the appropriate sales tax for your shipping location. Most states currently require sales tax and Ground Up Motors – SS396.com is compliant with all the latest laws associated with state sales tax. Due to regular variations in state sales tax, rates are subject to change without notice based on state and zip code. State sales tax is applied to products as well as shipping fees, handling fees, etc

For more policies and information on discounts/eligibility please see ss396.com for more information.

Ordering Lefts and Rights

Items in this catalog are presented as right hand (RH) or left hand (LH). RH and LH sides are determined by sitting in the vehicle. RH = passenger and LH = driver.

Trademark and Copyright

The content of Ground Up Motors – SS396.com, including the Ground Up Motors – SS396.com Parts and Accessories catalog is copyright 2024, all rights are reserved. No part of this publication including text, photos or illustrations may be reproduced without the prior written permission of Ground Up Motors – SS396.com.

International Orders

Ground Up Motors – SS396.com is happy to ship parts to international customers via International Economy shipping. Shipping can also be arranged per the customer and the packages will be boxed at our dock. Please call our sales department or send an email to logistics@ss396.com to get a shipping quote for the parts that you wish to order.

Oversize Items

We offer shipping for items that are considered Oversize. These items can be shipped via UPS Ground at an Oversize rate, which entails a minimum dimensional weight fee of 30 lbs. for Oversize or 70 lbs. for Oversize 2.

It's important to note that Ground Up Motors – SS396.com reserves the right to charge an Oversize fee on any item that is deemed Oversize, even if it is not explicitly indicated as such. This ensures that the shipping costs associated with handling and transporting these larger items are adequately covered. If a shipping adjustment is necessary on a particular product, we will do our best to inform the customer before the product is shipped.

Truck Freight

Ground Up Motors – SS396.com recognizes that certain products are too large or heavy to be shipped via Ground freight and must be shipped using truck freight. Efforts are made to clearly indicate these items in the print catalogs and website, but there may be instances where an item not specifically marked for truck freight may still require or benefit from this shipping method.

To ensure we are providing our customers with the best possible shipping rate all orders are subject to review by our Truck Department for adequate freight quoting. When placing an order online or over the phone you will not be charged any shipping, and a quote will be provided for your approval which is valid for 10 days from the date it was provided. Orders will remain as a quote until the order has been approved by the customer. Note that products are not reserved until the quote has been approved. Due to the quoting process PayPal payment is not accepted for truck orders. It is crucial to provide us with accurate information regarding the delivery destination. Any fees or charges resulting from the provision of false information or failure to comply with Ground Up Motors – SS396.com's policies are the sole responsibility of the customer and may be applied without notice.

Expedited Shipping

Ground Up Motors – SS396.com provides various expedited shipping options for customers' convenience. To ensure timely delivery, orders must be placed by 2:00 pm from Monday to Thursday, and by 12:00 pm on Fridays. Please note that weekends and holidays are not considered shipping days. It is important to mention that we recommend contacting our sales department to obtain the expedited shipping rates for your order. They will be able to provide you with accurate pricing information based on your specific requirements to ensure you are receiving your expedited order in a timely manner.

APO/FPO Shipping

Please note that for APO or FPO addresses, USPS is the only available shipping method. If you are military personnel with an APO or FPO address, it is important to contact Ground Up Motors – SS396.com prior to placing your order. This will allow them to verify that the desired parts do not exceed the size limit and ensure a smooth shipping process for you. You can reach out to our customer service team by writing, calling, or emailing, be sure to also ask about our Military discounts which we are honored to offer to both active and retired military personnel.

Product Damages & Shortages

We understand that errors and issues can sometimes occur during the fulfillment, shipping, or manufacturing process. If you receive a product that is damaged, missing, or incorrectly shipped, it is important to notify us within three (3) business days of receiving the order. You can do so by contacting us via phone or email. If you are present at the time of delivery and notice any carrier damage it is recommended that you refuse the shipment with the reason of carrier damage. If this is the case notify our customer service team so we can rectify this issue in a timely manner and ensure you are not charged any additional fees.

To ensure a prompt resolution on a damaged or missing claim, we may request additional information, such as images or details about the damaged, missing, or incorrectly shipped product. In most cases, we will provide you with a pre-paid shipping label to return the damaged or incorrectly sent product. Once we receive and inspect the returned item, we will issue a refund or send a replacement, depending on your preference.

Please note that if you report damage, missing items, or incorrect shipments after the 3-day window, you may still be able to make a claim, but will not be eligible for a pre-paid shipping label.

Refusals

In the event of a refused delivery, please note that a restocking fee of 25% will be applied, along with applicable return shipping charges, unless the refusal was due to damage that occurred during shipping (refer to our Damage Claim policy).

Company Policies

Hassle Free Returns

Products may be returned for a full refund, credit, or exchange within 30 days of receipt, provided that the product is in its original shipping condition and has not been modified, altered, painted, installed, or damaged. Products returned after 30 days can only be returned for exchange, store credit, or refund check. All returns after 30 days are subject to a 25% restocking fee. Ground Up Motors – SS396.com will not accept returned goods without prior authorization, any returns without prior authorization will be subject to a 25% restocking fee. The customer is responsible for shipping charges on returned merchandise unless otherwise indicated by Ground Up Motors – SS396.com.

Ground Up Motors – SS396.com always recommends professional installation for all the products we sell. Any item that has been altered, painted, installed, or deemed non-resalable by Ground Up Motors – SS396.com will be returned to the customer at the customer's expense. If the customer does not want to pay for return shipping, the item will be field destroyed. Ground Up Motors – SS396.com is not responsible or liable for any labor fees associated with the installation, removal, modification, or repair of any product purchased, regardless of the circumstances. Additionally, Ground Up Motors – SS396.com is not responsible for any damage or discoloration incurred in relation to chemical products, including cleaners, waxes, polishes, paints, and/or similar items.

Product Availability & Pricing

The availability of all items on SS396.com and in our print catalogs is subject to change without prior notice. Ground Up Motors – SS396.com reserves the right to discontinue products, services, accessories, and substitute products of a similar nature (i.e., different manufacturers/brands) without notice. While Ground Up Motors – SS396.com strives to maintain accurate pricing, please note that prices are subject to change due to factors such as increased costs in manufacturing and materials. For the most up-to-date pricing information, please visit our website 24/7 or contact a Ground Up Motors – SS396.com customer service representative by phone or email.

Backorders

Ground Up Motors – SS396.com will try to notify you in the event backorders are present on your order. While back orders are often beyond the control of Ground Up Motors – SS396.com, most out of stock items are shipped within two (2) to six (6) weeks. We generally ship back ordered items as soon as they arrive at our warehouse, without notification. If one of your items has been out of stock for more than 90 days, we will try to contact you before shipping. If you wish to cancel a back order, please contact us as soon as possible to avoid return shipping charges and restocking fees.

Ground Up Motors – SS396.com will keep track of all backorders on products that are "out-of-stock" or unavailable at the time the order is placed. The pricing on a back-ordered product is not guaranteed due to labor, manufacturing, materials, shipping costs, and other unforeseeable issues that may arise requiring a price adjustment. We will maintain the price on any backorder product for 60 days after the order is placed. After 60 days, the product may be subject to a price adjustment. If a price adjustment is necessary on a particular product, we will do our best to inform the customer before the product is shipped.

Kit Products

Our Parts and Accessories catalogs, as well as SS396.com, offer kits that include a variety of products to provide you with the best value. Please note that most of these kit items are exclusive to Ground Up Motors – ss396.com and are not eligible for further discounting or price matching against our competitor's kits.

Occasionally, we may run out of a specific item that is included in a kit. In such cases, we will generally ship the items that are in stock and backorder the ones that are currently unavailable. You can contact our sales department by phone to verify which items are out of stock at the time of placing your order. As our customer, you have the option to accept a partial kit delivery or choose to have the entire kit backordered until it is ready to ship in its entirety, be sure this is either verbally communicated over the phone or specified when placing an order online. Please note that additional freight fees may apply for multiple shipments, if applicable.

Color Matches

Please note that due to multiple manufacturers of products provided by Ground Up Motors – ss396.com, color variations may occur. Slight color variations, especially among interior products, are common and do not constitute a defect. These products are not eligible for return shipping solely based on color variations.

Additionally, there are products noted online and, in our catalog, as non-returnable. This primarily includes colored products such as interior items, as well as special order or built-to-order products like date-coded glass and custom gauge clusters. If you are unsure whether a product is non-returnable, please contact a us via phone or email for clarification. Please be aware that colors displayed on computer monitors and, in our print, catalogs may differ slightly from the actual color of the product. If precise color matching on interior items is a concern, we recommend ordering black and color matching using interior paint or dyes. Returns of colored, special order, or non-returnable items are not permitted and will be subject to 25% restocking fee.

Sales Tax Information

If you live in a state that requires sales tax, Ground Up Motors – SS396.com will collect the appropriate sales tax for your shipping location. Most states currently require sales tax and Ground Up Motors – SS396.com is compliant with all the latest laws associated with state sales tax. Due to regular variations in state sales tax, rates are subject to change without notice based on state and zip code. State sales tax is applied to products as well as shipping fees, handling fees, etc

For more policies and information on discounts/eligibility please see ss396.com for more information.

Ordering Lefts and Rights

Items in this catalog are presented as right hand (RH) or left hand (LH). RH and LH sides are determined by sitting in the vehicle. RH = passenger and LH = driver.

Trademark and Copyright

The content of Ground Up Motors – SS396.com, including the Ground Up Motors – SS396.com Parts and Accessories catalog is copyright 2024, all rights are reserved. No part of this publication including text, photos or illustrations may be reproduced without the prior written permission of Ground Up Motors – SS396.com.

International Orders

Ground Up Motors – SS396.com is happy to ship parts to international customers via International Economy shipping. Shipping can also be arranged per the customer and the packages will be boxed at our dock. Please call our sales department or send an email to logistics@ss396.com to get a shipping quote for the parts that you wish to order.

Oversize Items

We offer shipping for items that are considered Oversize. These items can be shipped via UPS Ground at an Oversize rate, which entails a minimum dimensional weight fee of 30 lbs. for Oversize or 70 lbs. for Oversize 2.

It's important to note that Ground Up Motors – SS396.com reserves the right to charge an Oversize fee on any item that is deemed Oversize, even if it is not explicitly indicated as such. This ensures that the shipping costs associated with handling and transporting these larger items are adequately covered. If a shipping adjustment is necessary on a particular product, we will do our best to inform the customer before the product is shipped.

Truck Freight

Ground Up Motors – SS396.com recognizes that certain products are too large or heavy to be shipped via Ground freight and must be shipped using truck freight. Efforts are made to clearly indicate these items in the print catalogs and website, but there may be instances where an item not specifically marked for truck freight may still require or benefit from this shipping method.

To ensure we are providing our customers with the best possible shipping rate all orders are subject to review by our Truck Department for adequate freight quoting. When placing an order online or over the phone you will not be charged any shipping, and a quote will be provided for your approval which is valid for 10 days from the date it was provided. Orders will remain as a quote until the order has been approved by the customer. Note that products are not reserved until the quote has been approved. Due to the quoting process PayPal payment is not accepted for truck orders. It is crucial to provide us with accurate information regarding the delivery destination. Any fees or charges resulting from the provision of false information or failure to comply with Ground Up Motors – SS396.com's policies are the sole responsibility of the customer and may be applied without notice.

Expedited Shipping

Ground Up Motors – SS396.com provides various expedited shipping options for customers' convenience. To ensure timely delivery, orders must be placed by 2:00 pm from Monday to Thursday, and by 12:00 pm on Fridays. Please note that weekends and holidays are not considered shipping days. It is important to mention that we recommend contacting our sales department to obtain the expedited shipping rates for your order. They will be able to provide you with accurate pricing information based on your specific requirements to ensure you are receiving your expedited order in a timely manner.

APO/FPO Shipping

Please note that for APO or FPO addresses, USPS is the only available shipping method. If you are military personnel with an APO or FPO address, it is important to contact Ground Up Motors – SS396.com prior to placing your order. This will allow them to verify that the desired parts do not exceed the size limit and ensure a smooth shipping process for you. You can reach out to our customer service team by writing, calling, or emailing, be sure to also ask about our Military discounts which we are honored to offer to both active and retired military personnel.

Product Damages & Shortages

We understand that errors and issues can sometimes occur during the fulfillment, shipping, or manufacturing process. If you receive a product that is damaged, missing, or incorrectly shipped, it is important to notify us within three (3) business days of receiving the order. You can do so by contacting us via phone or email. If you are present at the time of delivery and notice any carrier damage it is recommended that you refuse the shipment with the reason of carrier damage. If this is the case notify our customer service team so we can rectify this issue in a timely manner and ensure you are not charged any additional fees.

To ensure a prompt resolution on a damaged or missing claim, we may request additional information, such as images or details about the damaged, missing, or incorrectly shipped product. In most cases, we will provide you with a pre-paid shipping label to return the damaged or incorrectly sent product. Once we receive and inspect the returned item, we will issue a refund or send a replacement, depending on your preference.

Please note that if you report damage, missing items, or incorrect shipments after the 3-day window, you may still be able to make a claim, but will not be eligible for a pre-paid shipping label.

Refusals

In the event of a refused delivery, please note that a restocking fee of 25% will be applied, along with applicable return shipping charges, unless the refusal was due to damage that occurred during shipping (refer to our Damage Claim policy).



FREE CATALOGS

Have another car? You can request additional high-quality print catalogs packed with thousands of restoration parts at ss396.com!

DISCOVER MORE RESOURCES ONLINE!

Browse our collection of guides, technical resources, and articles to get the job done right the first time! At ss396.com, our goal is to keep the passion for classic American muscle alive. As part of this mission, we have curated an extensive library of content for our valued customers. Visit our website to learn more!

PART NOT IN OUR CATALOG?

Visit ss396.com or give us a call to shop for thousands of parts & accessories just for your Camaro!



#builtfromthegroundup



"I LOVE YOUR SITE!!"
- RAUL V
1987 MONTE CARLO

We take pride in our customers' vehicles and the tales behind them. Submit your own story today, and you could be featured in our quarterly customer car email, showcasing your prized ride! Visit ss396.com to share your story now.

Ground Up Motors - SS396.COM
2 Commerce Blvd
Palm Coast, FL 32164

PRSR STD
U.S. POSTAGE PAID
PALM COAST FL 32164
PERMIT NO. 114

CURRENT RESIDENT OR:

ADDICTIVE FLOW

KEEPING THE PASSION OF CLASSIC AMERICAN MUSCLE RUNNING.

At Addictive Flow, our goal is simple, to provide modern enhancements for classic American cars that are cost-effective, easy to install, and ready for shipment through our growing dealer network. Established in 2020, Addictive Flow is quickly becoming the first choice for muscle car enthusiasts looking to modernize their beloved classic without breaking the bank. With an extensive research and development team, we are constantly growing our product offering and adding more styles, applications, and designs!

WHAT ARE YOU WAITING FOR? GET THE ADDICTION WITH ADDICTIVE FLOW TODAY



FRONT SPOILERS.

Completely change the look of your classic with an Addictive Flow front spoiler. Easy to install and even easier on the wallet!



REAR SPOILERS.

Our Rear Spoilers complement our other products to give your classic a complete look.



ADDICTIVE TRIM.

Stand out from the crowd with Addictive Trim!