

# LockerWall

**BISLEY**



# Contents

03 Why choose us?

05 Flexible solutions

Wall space

Open space

Third space

08 How to specify

09 Range overview

Locker modules

Storage cupboards and bookshelves

Perch units

Top boxes

Finishing panels

14 Accessories

16 Locking technology

18 Finishes

20 Our commitments

21 Contact us





LockerWall by Bisley is the fully integrated, optimum storage and smart locker system that delivers dependable security, without dominating your space or sacrificing your style. Utilising the latest smart locking software, including networked and hard-wired locks, personal storage and facility management has never been simpler and safer.

The rise in personal storage requirements is at the forefront of a modern, productive workplace. What was once banished to cloakrooms or basements is now a firmly established part of the front office landscape.

Our personal storage solutions can help free up space, promote productivity and give everyone a sense of belonging.

All doors, plinths and top panels in Fjorde Green 638.

# Why choose us?

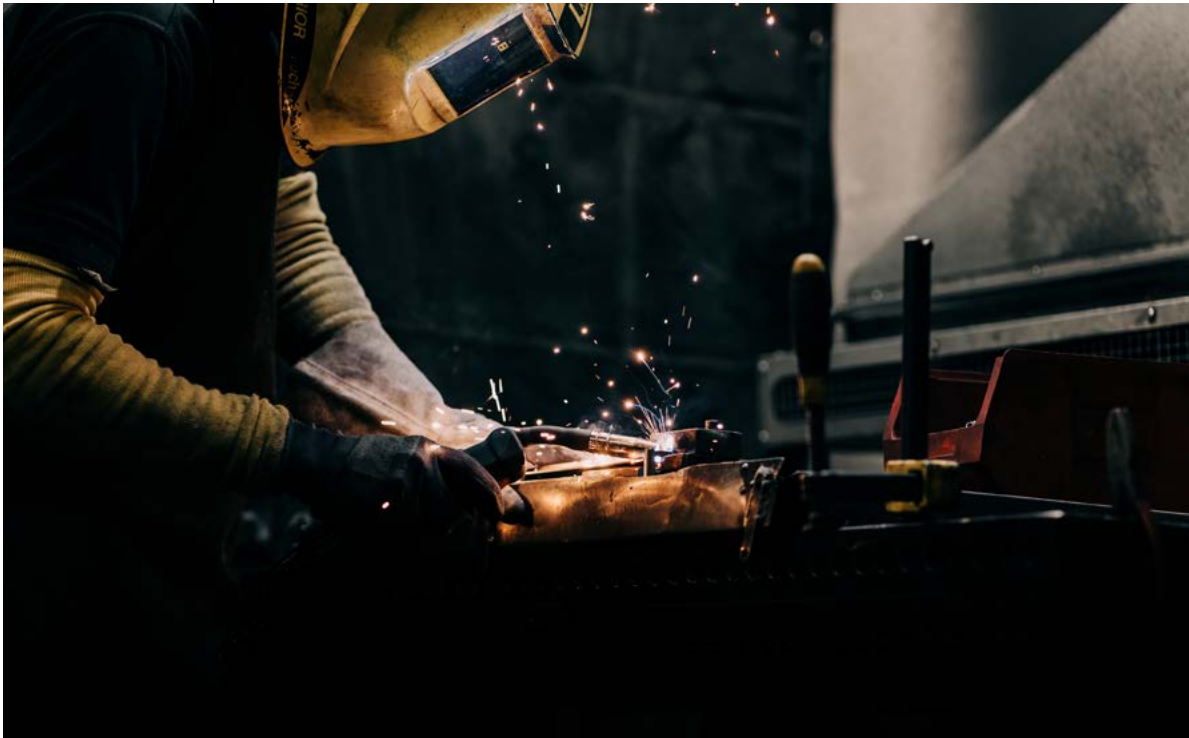

## A greener Bisley

View the Bisley Green Book to learn about our sustainability achievements and commitments.

Manufacturing excellence

We're proud to be a full manufacturer - we manufacture all our products in our South Wales factory and our UK distribution centres.

We practice Lean Manufacturing and have invested over £2m in machinery, to ensure we have the most efficient processes and technology for our products and designs.



Over 80 years of  
award-winning  
design expertise

Europe's leading  
manufacturer of steel  
storage with a state-  
of-the-art wood plant

15,000 products leave  
our South Wales  
factory every week

ence that's engineered around you.

ll manufacturer that really is Made in Britain  
our own steel and wooden furniture in our  
and export worldwide.

ufacturing, and have recently invested over  
ensure we are using the latest manufacturing  
ologies, continually seeking to improve our

Our knowledge and expertise is unrivalled and continues to grow. Our team is here to guide you through all the options – from dimensions and finishes, to putting together a precise design specification. Whatever the project requirement, we're on hand to ensure you achieve exactly what you want.

We create furniture that lasts a lifetime for our customers; made from the highest quality materials, using the latest innovative technologies and processes with minimum impact on our environment.





Download Images 



# Flexible solutions

## Wall space

A smarter use of your space.

Inspired by the traditional locker system, but re-imagined for the contemporary office, LockerWall does what it says on the tin; delivering optimum storage in a sleek, stylish system to suit your organisation's aesthetic. Connect locker and storage modules together to run along empty walls or fill existing alcoves, making the best use of your space and giving colleagues peace of mind while at work.





#### Left

- All doors specified in Olive Green BX6 painted steel.
- Plinth specified in Soft Black 621 MFC.

#### Right

- All doors, drawers, finishing panels and plinths specified in Front White 001 MFC.
- End panels specified in Verade Oak 002 MFC.

## Open space

Storage that works harder.

LockerWall is not only a storage system - the lower height lockers can create zoning and space division, giving a workplace defined neighbourhoods. The standing height options double up as an impromptu work surface, or they can be accessorised with planters to bring in mood boosting biophilia.



Left

Locker doors specified in Goose Grey AV4.  
Top and end panels specified in Natural Kendal Oak 018.

Below

Steel locker doors specified in Palest Pink CB2.  
All MFC locker doors, finishing panels and plinth specified in  
Verona Cherry 019.



@coffeeworks





## Third space

Designed to fit around you.

LockerWall is modular and entirely bespoke, meaning it can flex to create a variety of different workplace settings, outside of the desk. Each column is individual so you can select every unit with your colleagues' needs in mind.

Not only is there a huge choice of lockers, but you can mix and match with larger storage cupboards, coat cupboards, bookshelves and soft seating nooks. Whether you want to create a beautiful guest welcome area, dedicated spaces to catch up between meetings or pleasant, functional breakout zones, LockerWall delivers so much more than just storage.

Left

Locker doors, top panels and plinths specified in Natural Rockford Hickory 644

# How to specify LockerWall

## 1 Select your modules

There are 3 heights of LockerWall modules available: 1900mm, 1540mm and 1180mm high.

- Storage cupboards, coat cupboards and bookcase modules are all available in 1900mm high only.
- All locker modules have a choice of 3 lock options as standard: AB, E4, or M3. Storage cupboards and coat cupboards are fitted with AB locks as standard.
- Other lock options including electronic locks are available and our team is on hand to find the best choice for your needs.

 [Visit our smart locking page.](#)

## 2 Select your finishing panels

Whether you are designing a freestanding LockerWall or planning to scribe your corner to an alcove, you will need to select MFC finishing panels.

 [Jump to our Finishing Panels guide.](#)

\*Surcharges may apply. Please refer to the LockerWall price list.



### 3 Customise your creation

ending bank of  
figuration into  
ishing panels.

When specifying your LockerWall finishes, there are 4 stages: module doors, carcass, finishing panels and perch pad material (if applicable).

- All carcasses and finishing panels including plinths, fascia panels, top, end and back panels are available in wood (MFC) only.\*
- All locker doors are available in either wood (MFC), CGL or the Vision painted steel palette.\*
- Z doors are only available in CGL.\*
- Coat cupboards and storage cupboards are only available in MFC.\*
- If you have included a perch pad, the carcass and fascia panel finish must be specified (MFC only).\*
- There are over 50 perch pad fabric colours to choose from.

 [Jump to our Finishes page.](#)

### 4 Add accessories

Add additional accessories to your storage to perfectly suit the needs of your workforce.

- Add MFC planter tops to your 1180mm and 1540mm high units.
- Additional internal shelves.
- USB power.
- A4 postal slot trays are available.
- Label holders for locker doors.
- Self-adhesive coat hooks.

**Thinking about adding a graphic to your LockerWall?**

Speak to our team about the options available to create something unique to your brand!

# LockerWall range overview

## Lockers

All lockers are 500mm (19.7") deep with the exception of the Z door option which is 600mm (23.6") deep.

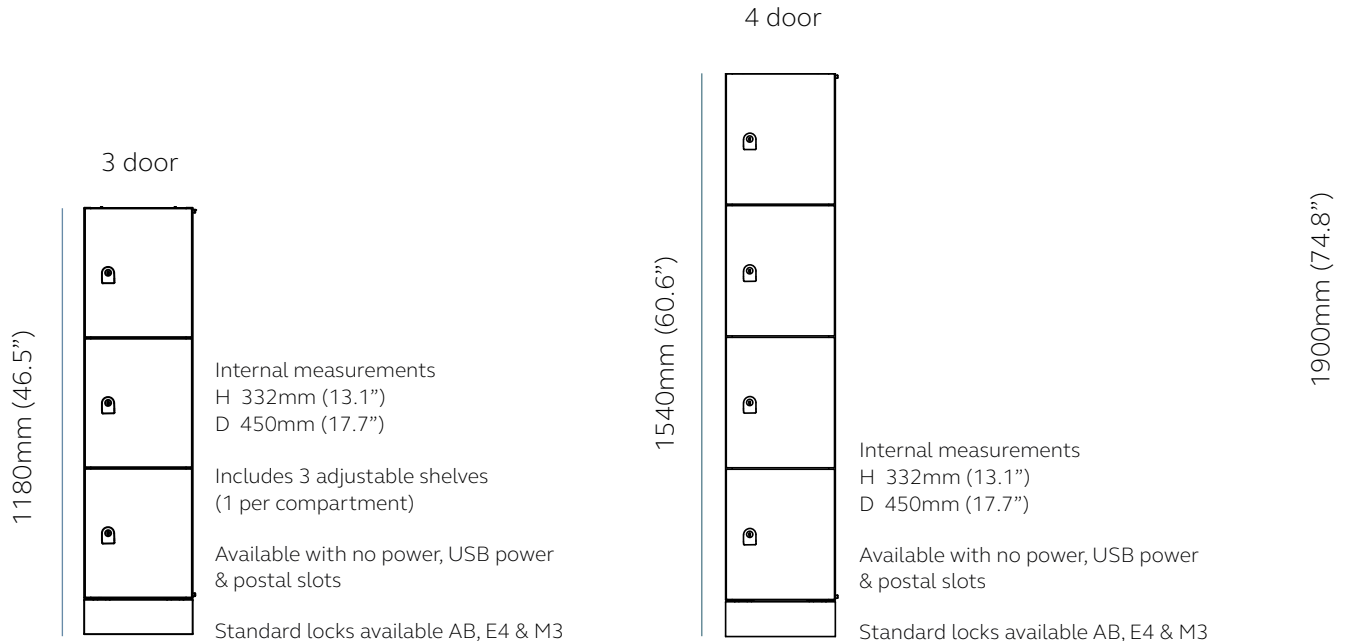

Available in three widths: 300mm (11.8")

Internal widths: 264mm (10.4"), 300mm (11.8")

Line drawings are for illustrative purposes only.

Please note plinth panels need to be ordered separately. Please see the finishing panels page.

1 door

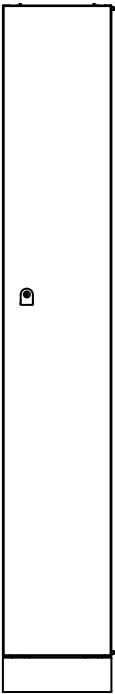

Internal measurements  
 H 1763mm (69.4")  
 D 450mm (17.7")

Includes 5 adjustable shelves

No power

Standard locks available AB, E4 & M3

2 door



Internal measurements  
 H 872mm (34.3")  
 D 450mm (17.7")

Includes 4 adjustable shelves  
 (2 per compartment)

No power

Standard locks available AB, E4 & M3

3 door

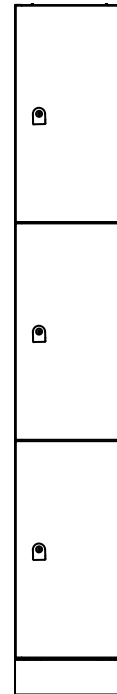

Internal measurements  
 H 572mm (22.5")  
 D 450mm (17.7")

Includes 3 adjustable shelves  
 (1 per compartment)

No power

Standard locks available AB, E4 & M3

8") , 400mm (15.7") & 500mm (19.7")  
 364mm (14.3") & 464mm (18.3")

## Lockers

All lockers are 500mm (19.7") deep with the exception of the Z door option which is 600mm (23.6") deep.

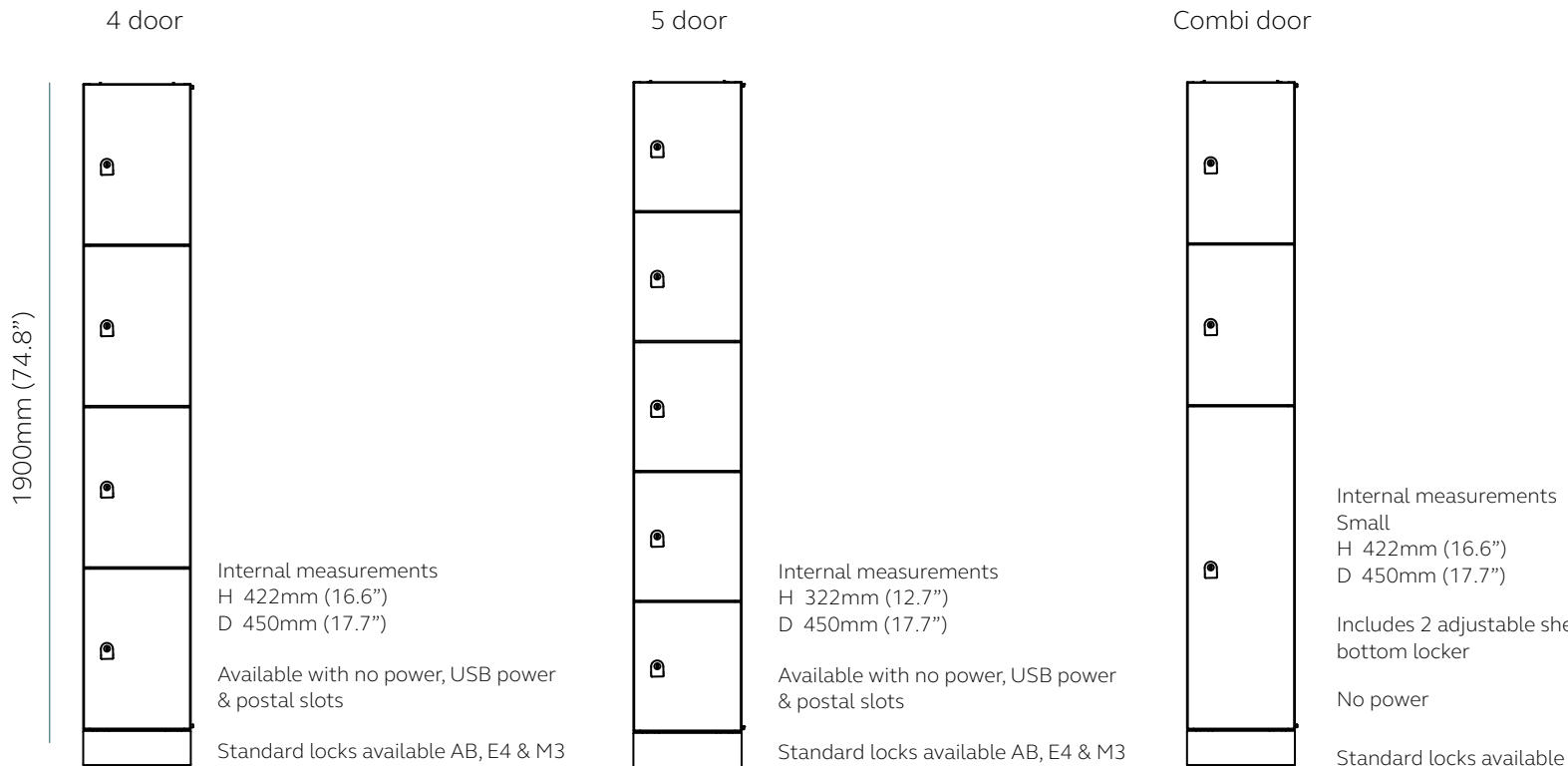

Available in three widths: 300mm (11.8"), 400mm (15.7") & 500mm (19.7")

Internal widths: 264mm (10.4"), 364mm (14.3") & 464mm (18.3")

Line drawings are for illustrative purposes only.

Please note plinth panels need to be ordered separately. Please see the finishing panels page.

4 door/1 drawer combi

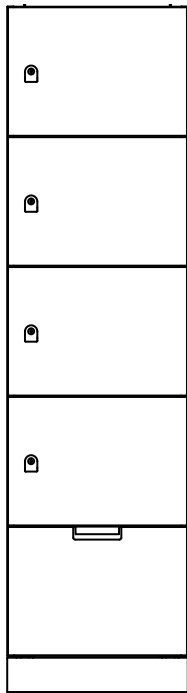

Internal measurements

Doors	Drawer
H 332mm (13.1")	H 302mm (11.9")
D 450mm (17.7")	D 335mm (13.2")

Includes 2 adjustable shelves in bottom locker

Available with no power & USB Power (locker doors only)

Standard locks available AB, E4 & M3 (No lock on drawer as standard)

Large  
H 872mm (34.3")  
D 450mm (17.7")

elves in

AB, E4 & M3

Available in 500mm (19.7")

Internal width: 464mm (18.3")

Z door

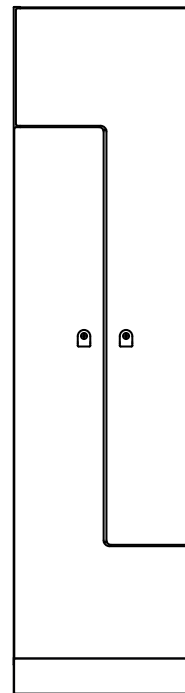

Internal measurements

Narrow section	Wide section
H 1128mm (44.4")	H 299mm (11.8")
D 558mm (22")	D 558mm (22")

No power

Standard locks available AB, E4 & M3

Available in 600mm (23.6")

Internal width: 464mm (18.3")

## Storage

Coat cupboards are 600mm (23.6") deep, storage cupboards and bookshelves are 500mm (19.7") deep.

Coat cupboard

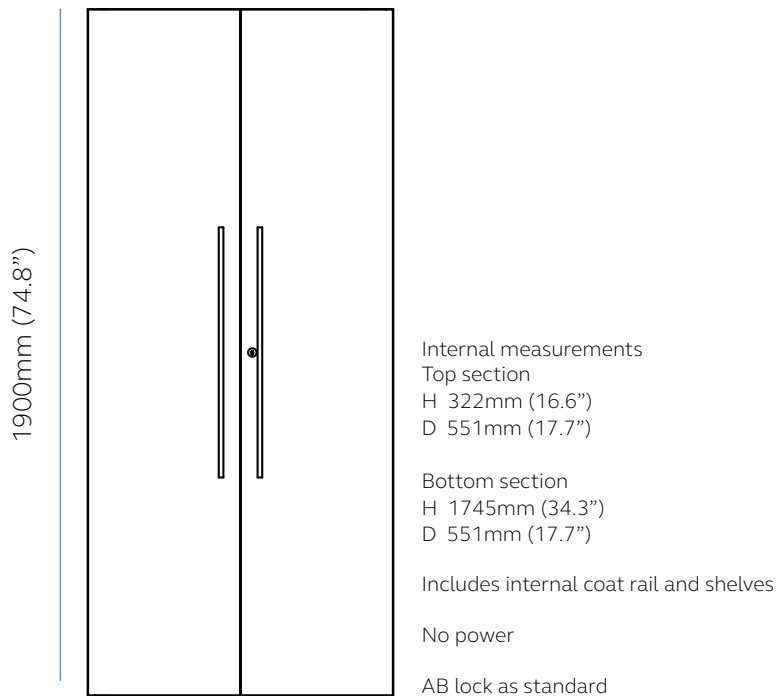

Storage cupboard

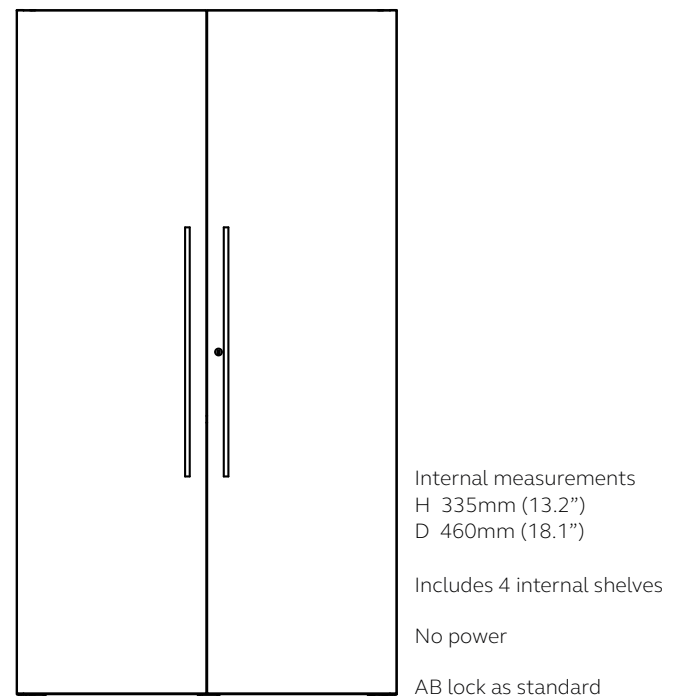

Available in three widths: 500mm (19.7"),  
800mm (31.5") & 1000mm (39.4")

Available in two widths: 800mm (31.5") or 1000mm (39.4")

## Bookshelf



Internal measurements  
H 335mm (13.2")  
D 460mm (18.1")

Includes 4 fixed shelves

No power

000mm (39.4")

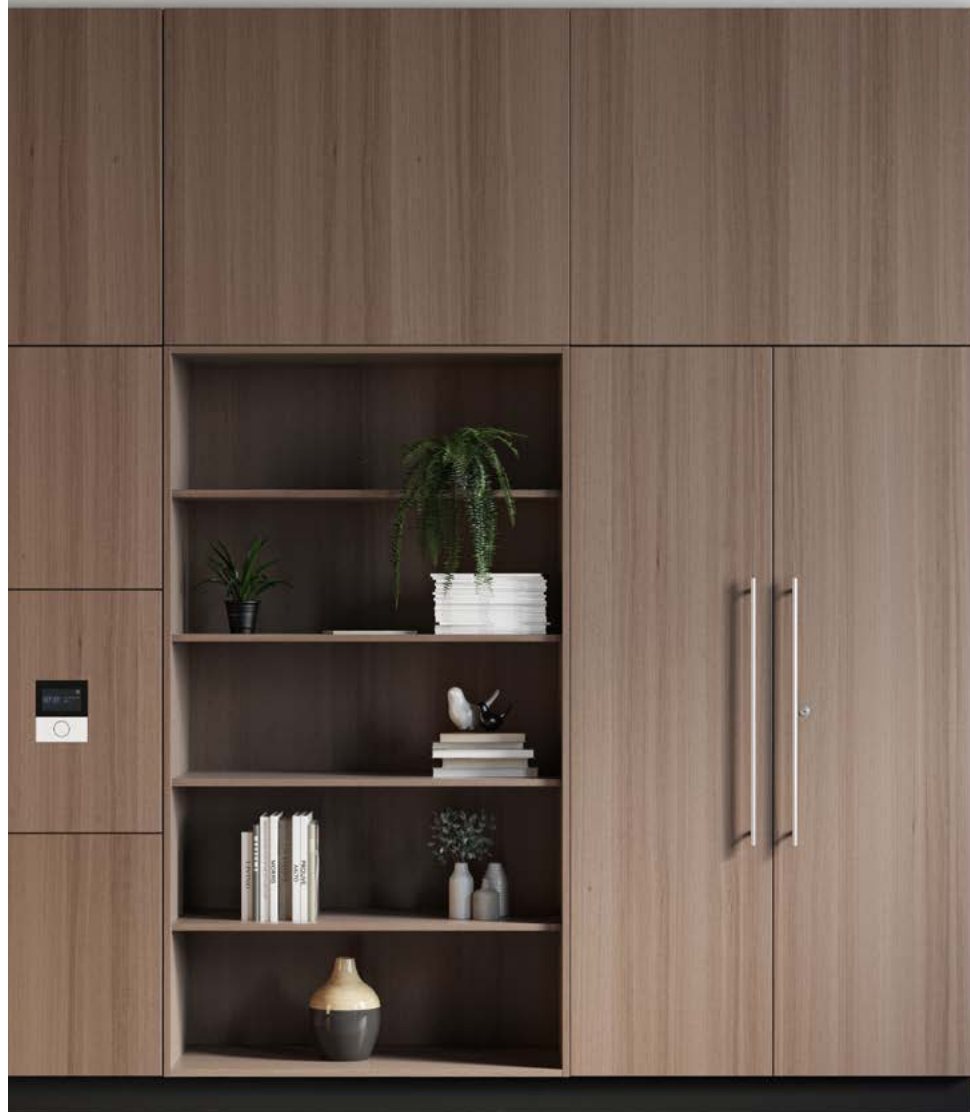



## Perch units

H 1900mm (74.8")

W 1000mm (39.4") or 2000mm (78.7") \*Corner unit is 2000mm (78.7")

D 500mm (19.7")

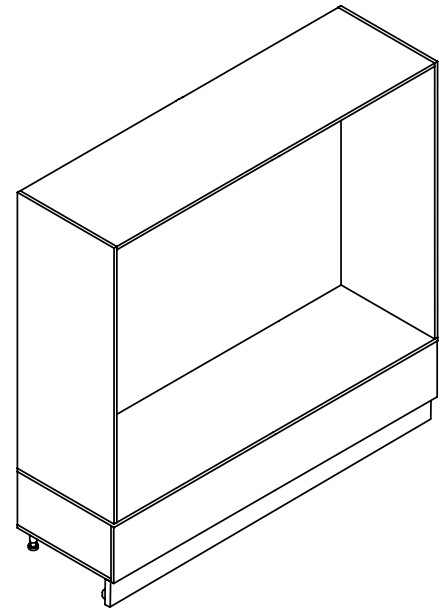

Line drawings are for illustrative purposes only.

Please note plinth panels need to be ordered separately. Please see



8.7") by 2000mm (78.7")

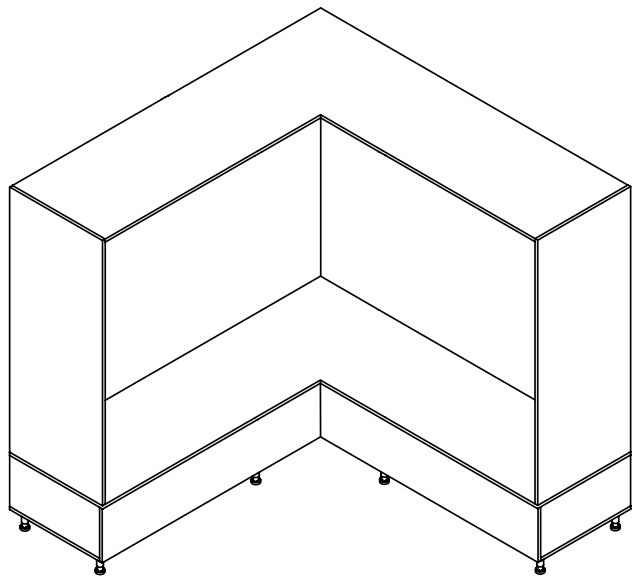

## Top boxes

H 400mm (15.7")  
W 300mm (11.8"), 400mm (15.7") & 500mm (19.7")  
D 500mm (19.7")

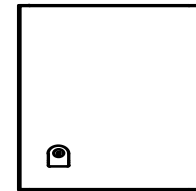
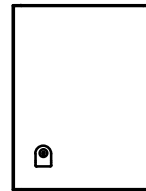

Internal measurements

H 363mm (14.3")  
D 450mm (17.7")

No power

Standard locks available AB, E4 & M3

# Finishing panels

Whether you are designing a freestanding bank of LockerWall or planning to scribe your configuration into an alcove, you will need to select a variety of MFC finishing panels.

This guide illustrates the panels needed for each LockerWall setting e.g. freestanding, against a wall or scribed into an alcove.

Please contact your Bisley representative for all finishing panel sizes.

## Scenario example one: Scribed LockerWall bank

For this scenario we recommend specifying:

- End panels
- Top fascia panel/s
- Plinth/s
- Plinth/s
- Infill panel/s if required

## Scenario example

For this scenario w

- Top panel/s
- End panels
- Plinth/s

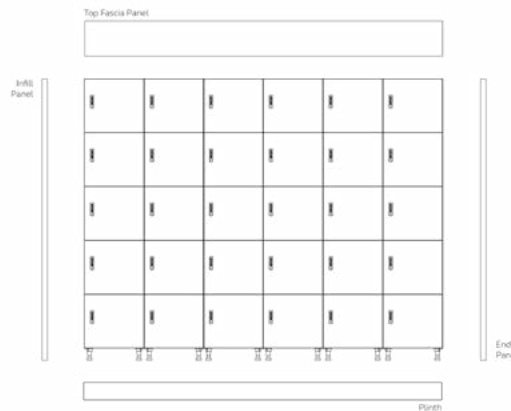

Please note

All additional panels (plinth, infill panels, top fascia panels and end panels) are available in MFC only.

Scenario example two: LockerWall bank against a wall  
We recommend specifying:

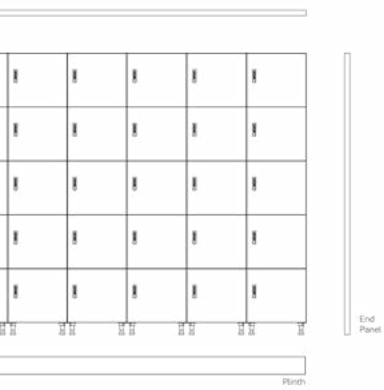

Scenario example three: Freestanding LockerWall bank  
For this scenario we recommend specifying:

- End panels
- Top panel/s
- Plinth/s
- Back panel

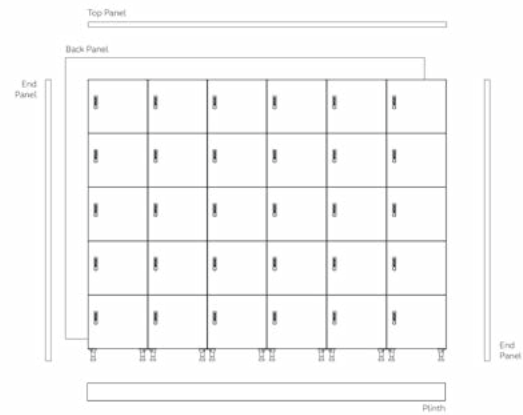

# Accessories

LockerWall helps you reinvent how your office looks, works and flows. And once you've specified your bespoke configuration, you can accessories with all the essential amenities to provide your workforce with everything they need to be comfortable, organised, and productive while at work.



### Planter boxes – for 1180mm and 1540mm lockers

Let us know if you would like to add a planter box to your configuration and we can build one to perfectly suit.

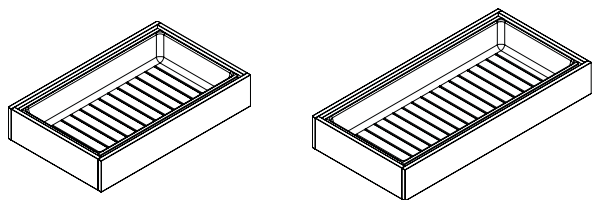

### Additional internal shelves

Available in three widths: 300mm (11.8”), 400mm (15.7”) & 500mm (19.7”)

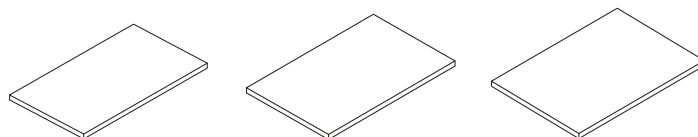

### A4 steel postal slot tray \*

\*Please refer to the range overview to find out which modules are compatible.

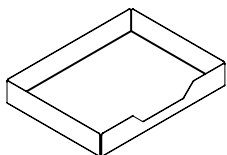

### USB power within lockers \*

Please note that USB power cannot be retrofitted.

### Self-adhesive coat hook

### Label holder





# Locking technology

We design and manufacture the highest quality personal storage lockers, but we also have the knowledge and expertise on hand to advise you on the best lock choice.

Our wide range of secure locking options for LockerWall gives all employees – whether permanent, mobile or nomadic – a sense of control, peace of mind and belonging.

Utilising our many years of experience, we can recommend a selection of the highest quality options, but we will always accommodate customer specific security requirements, working with a variety of trusted lock providers.

Our range of lockers and lock partners, both electronic and mechanical, can meet even the most challenging privacy and security needs of modern workplaces and beyond.

## Hard-wired smart locks

The latest locking technology software. Take away the hassles of traditional locks and offer sub-par security with smart locks.

Control tablets can be embedded in the locker application with maximum efficiency. In real-time smart locking wireless network, by phone or device, you can control access.

Managers can even remotely control access with personalised features to be configured to permit and deny access. From the locker from private to public, we offer the highest level of security.



**Keynius**



... comes in the form of hard-wired smart lock  
... le of key management, on-site presence, and  
... ck software that puts you in complete control.

... dded into your storage, or for an even slicker  
... fficiency, some locks can now be linked up to  
... ess networks. Controlled via an app on your  
... ol storage from anywhere in the world.

... y control access, limit contact, and allow for  
... added. Hard-wired locking systems can be  
... y access for users and to switch the control of  
... blic to sharing mode when required. They also  
... ity with automatic anti-theft alarms.



Digilock®



## RFID locks

As personal storage solutions advance, the security element is following suit, and touch free, RFID locks are becoming increasingly popular for workspace installs as well as leisure and hospitality environments. Trading in lock and key entry for hassle free RFID access brings control and peace of mind to flexible workforces.



Digilock®



Digilock®



Keynius



Gantner



ojmar®

## Combination locks

Combination locks seamlessly integrate with many Bisley products while providing enhanced security and protection. With both shared and assigned user options, combination locks are a reliable, cost-effective solution for personal storage.



Digilock®



Digilock®



Keynius



ojmar®



Digilock®



LEHMANN®

# Finishes

## MFC finishes

### Palette one

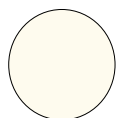

Platinum  
White  
562  
W980 ST7



Light Grey  
554  
U708 ST9



Sand Beige  
899  
U156 ST9



Pearl Grey  
634  
U763 ST9



Graphite Grey  
521  
U961 ST7



Black  
574  
U999 ST7



Pebble Grey  
630  
U201 ST9

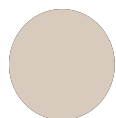

Cashmere  
Grey  
741  
U702 ST9



Stone Grey  
557  
U727 ST9



Dakar Grey  
639  
U717 ST9



Carbon Grey  
635  
U968 ST9



Rusty Red  
058  
U335 ST9

### Palette two

\*A surcharge may apply, please contact your Bisley representative.



Antique Rose  
200  
U325 ST9



Stone Green  
047  
U665 ST9



Dark Brown  
059  
U818 ST9



Petrol  
641  
244 SU



Natural  
Kendal Oak  
018  
H3170 ST12



Lincoln  
Walnut  
998  
H1714 ST19



Grey Beige  
Spree  
796  
H1357 ST10



Sevilla Ash  
060  
H1223 ST19



Parona  
Walnut  
036  
H1715 ST12



Anthracite  
Metallic  
032  
H3190 ST12

### Palette three

\*A surcharge may apply, please contact your Bisley representative.

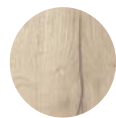

White  
Halifax Oak  
751  
H1176 ST37



Brown  
Orleans Oak  
061  
H1379 ST36

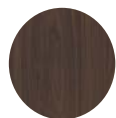

Marone  
Casella Oak  
062  
H1369 ST40

### Perfect sense

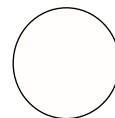

Alpine White  
063  
W1100 TM9



Pebble Grey  
064  
U201 TM9



Indigo Blue  
065  
U599 TM9



Reed Green  
066  
U604 TM9



Fir Green  
067  
U699 TM9



Soft Black  
068  
U899 TM9



LockerWall gives you the scope to create an efficient, stylish storage system for any kind of environment.

It can be customised to fit entirely with you and your aesthetic. And with its vast range of materials and finishes, including premium wood and CGL palettes and steel paints, LockerWall is entirely bespoke, allowing you to design a sleek system that suits your space.

## Steel paint finishes

Choose from an extensive range of 37 steel paints for your LockerWall. Design your storage to suite with your existing office aesthetic or introduce a bold addition and focal point to your space.

Black, Light Grey and Traffic White are also available in Biocote, which is an anti-microbial paint that works actively against microbes with the aim of preventing them appearing by up to 99.99%. Other colours available on request. Please note there is a surcharge for these finishes.

## Fabric finishes

There are over 50 Camira Blazer fabrics to choose from for the perch units. We have selected 24 that best match some of our most popular steel paint colours as a helpful guide.

Please contact your Bisley representative for information on the full Camira Blazer range.

Palette one

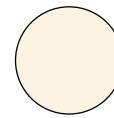

Chalk  
AB9



Cream  
AV6

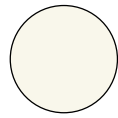

Traffic White  
BA5



Light  
A

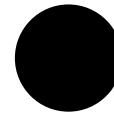

Black  
AV1



Oxford Blue  
AY7



Azure  
BP5



Bisley  
E



Sunflower  
Yellow  
CD1



Bisley Orange  
BN6



Cardinal Red  
AY8



B  
C



Napier



Stonebridge



Silverdale



Dartm



Goldsmith

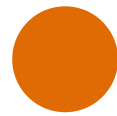

Leeds



Wesley



Eyn

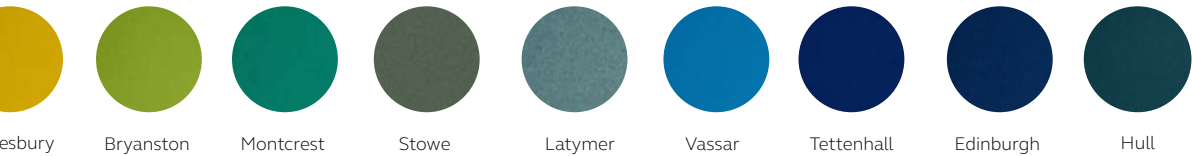
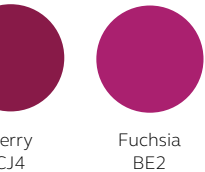
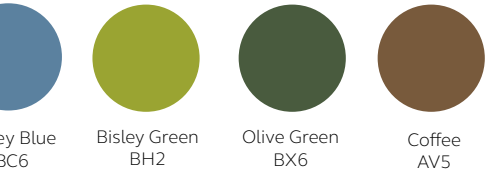
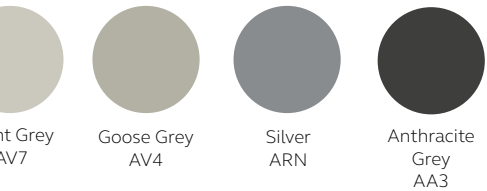

Palette two

\*A surcharge may apply, please contact your Bisley representative.

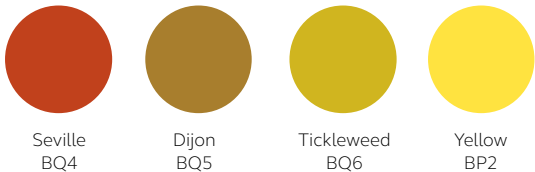
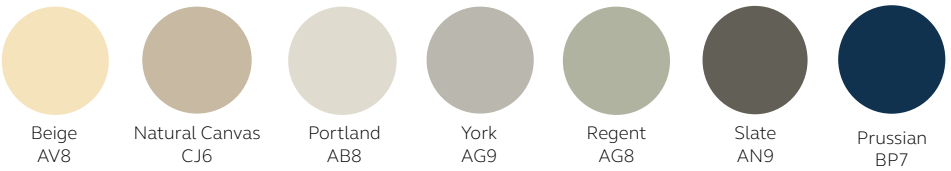

# Our commitments

As a proud British manufacturer, we take our responsibilities towards the environment very seriously, ensuring that sustainability runs through everything we do. Our dedicated Sustainability team ensures that our facilities are as sustainable as possible, while making sure that our products last and are sustainably sourced.

Bisley products are designed for functionality, durability, and a long service life. They are all tested rigorously to British and European harmonised standards for safety, strength and stability.







We have also invested in the undertaking of Life Cycle Analyses (LCA) for much of our steel product portfolio, to fully understand their environmental impacts in terms of global warming, acidification, eutrophication, ozone depletion and other indicators across all phases of a product's life cycle - from cradle-to-grave. Our wood products are also FSC™ and PEFC certified which supports responsible forestry management.

As for electricity, we source all of the electricity that powers our manufacturing activities through renewable energy tariff. We also participate in the Energy Savings Opportunity Scheme (ESOS), which has led to substantial investment in procurement and installation of energy efficient machinery and equipment.

The team is constantly reviewing how we do things and how we might improve.

[View LockerWall's EPD here.](#)

Visit [bisley.com](https://www.bisley.com) to find out more, or contact your Bisley representative for more information on LockerWall.

Get in touch  
[www.bisley.com/get-in-touch](https://www.bisley.com/get-in-touch)

### Head Office

Caswell Way,  
Reevesland Ind Est,  
Newport, South Wales  
NP19 4PW

+44 (0)1633 637 383

### London

32 Dallington Street,  
London,  
EC1V 0BB

+44 (0)203 952 4000

### Manchester

Calico Building,  
55 Mosely Street,  
Manchester,  
M2 3HQ

+44 (0)161 543 0850

### Bray

Bisley House  
IDA Bray Business Park,  
Southern Cross Road,  
Bray,  
Co. Wicklow,  
Ireland

00353 1 2769100

### Dublin

Bridgewater Business  
Centre, Bridgewater Quay,  
Islandbridge,  
D08 T9NH

 @wearebisley

 @wearebisley

**BISLEY**

## France

Immeuble le Corosa  
1-3 rue Eugène  
et Armand Peugeot  
92500 Rueil Malmaison

+33 (0)1 41 39 97 20

## North America

1140 Broadway  
Suite 902, New York  
New York  
10001

1-212-675-3055

## Germany

Hauptsitz und Showroom  
Wiesenstraße 70 A3  
40549 Düsseldorf

+49 (0)211 87541 600

## Dubai

Office 4501  
U-Bora Tower  
Marasi Drive  
Business Bay  
Dubai  
United Arab Emirates

00971 (4) 450 3747

## Netherlands

Burg. Stekelenburgplein  
199  
Unit 2.4  
5041 SC  
Tilburg

+31 (0)13 590 10 03

carebisley



Bisley Storage

LEY