



MNROSIE7048 MANUAL

Rosie Inverter / Charger Owner's Manual

MNROSIE7048RE - MNROSIE7048M



This entire manual is printed without color but is available for download—with many of the diagrams available in color—on our website at midnitesolar.com.



MNROSIE7048 MANUAL

Table of Contents

Introduction	3
Safety Instructions & Precautions	4
How to KILL Your Batteries	8
How an Inverter/Charger Works	9
Wiring Requirements	10
DC Wiring and Over-Current Protection	11
AC Wiring and Over-Current Protection	13
Grounding / Arc Fault / Ground Fault	15
Special Instructions for MNROSIE7048M Mobile Installations	15
Installation	18
Mounting.....	20
Wiring the Rosie	20
DC Wiring.....	20
AC Wiring.....	22
Grounding.....	22
Torque Values.....	25
External Sensors	25
Battery Temperature Sensor.....	25
Current Transformers.....	26
AUX Terminals	26
Whiz Bang Jr	26
Battery Sense.....	27
Energizing the Rosie	27
Rosie Programming	29
Rosie MNGP2 Menu Maps	36
Battery Charging	43
AUX Modes	45
Firmware Update	46
Technical Drawings and Specifications (CSA TABLE 65.1)	49
Warranty	56



MNROSIE7048 MANUAL

INTRODUCTION

The Rosie Inverter/Charger is a battery-based, DC-to-AC inverter and AC-to-DC charger for off-grid and mobile systems. MidNite offers two Rosie models:

MNROSIE7048RE – a 7000-watt inverter/charger with 60-amp AC transfer relay and 120-amp, multi-stage PFC battery charger. The AC IN and OUT have common Neutrals for use in renewable energy (RE) systems (homes/cabins). The AC Neutral and Ground do not have an internal bond. The bond must be made in the AC system (commonly at the AC service panel).

MNROSIE7048M – a 7000-watt inverter/charger with 60-amp AC transfer relay and 120-amp, multi-stage PFC battery charger. The AC IN and OUT Neutrals are **NOT** common to allow automatic neutral-to-ground switching for Mobile applications (RV, truck, or marine).

- Both models Listed to UL1741, UL458, and CSA 107.01 Standards
 - UL458 and CSA - PENDING
- Two AUX terminals with 15 AUX Options per AUX terminal
- 120A DC Maximum Batt Charging Current
- State-of-Charge % via the Whiz Bang Jr.
- 120/240VAC/60Hz split-phase AC OUT
- Audio Annunciations with Quiet Time
- Battery Temperature Compensation
- Mates with optional Rosie E-panel
- 60A transfer relay per 120VAC leg
- Battery Voltage Sense Circuit
- Auto-Gen Start (AGS) menu
- 7000W pure sinewave AC
- 40 – 65VDC battery IN
- MNGP2 Required
- 48V battery bank



The optional Rosie E-Panel offers NEC required OCP and DC disconnects but is **NOT** a required component. See page 48 for more information on a pre-wired Rosie system.



IMPORTANT SAFETY INSTRUCTIONS SAVE THESE INSTRUCTIONS

THIS MANUAL CONTAINS IMPORTANT SAFETY INSTRUCTIONS FOR THE MIDNITE SOLAR ROSIE INVERTER/CHARGER THAT SHALL BE FOLLOWED DURING INSTALLATION AND OPERATION.

If you do not fully understand any of the concepts, terminology, or hazards outlined in these instructions, please refer installation to a qualified dealer, electrician, or installer. These instructions are not meant to be a complete explanation of a renewable energy system. Before using the Rosie, read all instructions and cautionary markings. The installation instructions are for use by qualified personnel only. Do not perform any installation other than that specified in this manual unless you are qualified to do so. Incorrect installation may result in a risk of electric shock, fire, or other safety hazard.

Safety Symbols

The following safety symbols have been placed throughout this manual to indicate dangerous and important safety instructions.

WARNING!

WARNING indicates a hazardous situation which, if not avoided, could result in death or serious injury.

CAUTION!

CAUTION indicates conditions or practices that could result in damage to the unit or other equipment.

INFO: Indicates information that emphasizes or supplements important points of the main text.



MNROSIE7048 MANUAL

SAFETY PRECAUTIONS

- Live power may be present at more than one point since an inverter utilizes both DC (batteries) and AC (utility or generator) power. To reduce risk of electric shock, ensure all DC and AC wiring is disconnected prior to installing or performing maintenance on the inverter. Turning off the inverter will **NOT** reduce this risk; the inverter must be totally disconnected from all sources.
- Over-current protection for the AC & DC wiring is not provided as an integral part of this inverter. Over-current protection of the AC & DC wiring must be provided as part of the system installation.
- The AC output neutral conductor and the DC negative conductors are not connected (bonded) to the inverter chassis. Both the input and output conductors are isolated from the enclosure and each other.
- Battery cables should be no less than **#4/0 AWG**. Crimped and sealed copper ring terminal lugs with a 5/16" hole should be used to connect to the DC terminals on the inverter.
- *Per CSA 22.2 No. 107.1 Version 2016, Edition 4, Para 5.44*, the Rosie regulates within 5% of its nominal AC output voltage and at 29AAC per 120VAC and 29AAC at 240VAC.
- AC and DC circuit breakers installed as a part of this Rosie inverter/charger system shall comply with *CSA C22.2 No. 235* and meet all the following:
 - Have a short-circuit application code of U3;
 - Have a tripping current application code of TC3;
 - Have an overload code of OL0 or OL1;
 - OL0 – 1.5 times the ampere rating for general use; or
 - OL1 – 6 times the AC current rating or 10 times the DC current rating for motor starting applications.
 - Be an over-current type or a shunt trip over-current type;
 - Have a short circuit current rating not less than the maximum available fault current under Rosie operating modes;
 - Be of a type appropriate for the Rosie's intended use application.
- System grounding is the responsibility of the system installer and must comply with local and national electrical codes and standards.
- *Per CSA 22.2 No. 107.1 Version 2016, Edition 4, Para 5.37*, the voltage rating from circuit board to ground is no more than 300VAC.
- This product is listed as a Type 1 enclosure, designed for indoor/compartment installation. It must not be exposed to rain, snow, moisture, or liquids of any type.
- Listed or labeled equipment shall be installed and used in accordance with any instructions included in the listing or labeling.
- All electrical work must be performed in accordance with local and national electrical codes.
- Use Class 1 wiring methods for field wiring connections to terminals of a Class 2 circuit.



MNROSIE7048 MANUAL

- Rosie's Class 2 circuits: CANBUS, Batt Temp Sensor; AUX terminals; WBJr terminal.
- Use insulated tools to reduce the chance of electrical shock or accidental short circuits.
- Turn off all breakers prior to removing front cover and working on the inside of Rosie.
- Only qualified service personnel can remove cover, shock hazards are present.
- The maximum voltage from the printed circuit board to ground is 300VDC.
- Torque all wiring and cable connections to the required torque values.
- All unused conduit holes must be filled with a UL listed conduit plug.
- Use only copper wires with a minimum temperature rating of 90°C.
- The Rosie is provided with integral protection against overloads.
- There are no user-serviceable parts contained in the Rosie.
- Always verify proper wiring prior to starting the inverter.
- The inverter must be properly mounted.

CAUTION!

To reduce the risk of fire, connect only to a circuit provided with 60 AC amperes and/or 300 DC amperes maximum branch-circuit over-current protection in accordance with the *National Electrical Code, ANSI/NFPA 70*.

WARNING!

To reduce the risk of fire, do **NOT** wire the Rosie to an AC load center (circuit breaker panel) having multiwire branch circuits connected.

CAUTION!

There may be a risk of electric shock from energy stored in capacitors.
Wait 5 minutes after disconnecting battery cables before servicing the Rosie.

BATTERY SAFETY

- Wear eye protection and avoid touching your eyes and face when working with batteries to keep any fluid/corrosion on the battery from contact with eyes and skin. Have plenty of fresh



MNROSIE7048 MANUAL

water and soap nearby and thoroughly wash in case battery acid contacts skin, clothing, or eyes. In the event of exposure to the eyes, flood them for at least 15 minutes with running water and seek immediate medical attention. Baking soda neutralizes lead acid battery electrolyte and vinegar neutralizes spilled NiCad and NiFe battery electrolyte; depending on your battery type, keep a supply on hand near the batteries.

- Read and follow the battery manufacturer's safety precautions before installing the inverter and batteries. Always verify proper polarity and voltage before connecting the batteries to the inverter. Once the batteries are connected to the inverter, ensure the maintenance and charging requirements (i.e., charge voltage and charge rate) provided by the battery manufacturer are followed to extend the life of the batteries and to prevent damage to the batteries while charging.
- The battery bank should be installed in a clean, dry, ventilated environment that is protected from high and low temperatures. If installed in a vehicle/boat, the batteries must be mounted upright (if using liquid batteries) and securely fastened. The location must be fully accessible and protected from exposure to heat producing devices, and away from any fuel tanks.
- Batteries can produce explosive gasses, so install batteries in a well-ventilated area. For compartment or enclosure installations, always vent batteries from the highest point to the outside. Design the battery enclosure to prevent accumulation and concentration of hydrogen gas in pockets at the top of the compartment.
- Remove all jewelry such as rings, watches, bracelets, etc., when installing or performing maintenance on the batteries and inverter. A battery can produce a short-circuit current high enough to weld metal jewelry, causing severe burns.
- Use insulated tools and be very careful when working around batteries, they can produce extremely high currents if short-circuited (e.g., dropping a metal tool across the battery terminal), which could cause a fire or explosion.
- When replacing some of the batteries in a bank, always replace with the **same** model, size, Ah capacity, charging voltages, and type of the old batteries. Types include: (Flooded, Lithium, NiFe, sealed, etc.).
- The Rosie will operate with any battery type/form factor (L-16, 2V, golf cart, rectangular, etc.) or chemistry (lead-acid, Lithium, Nickel Iron, etc.), comprised in a 48VDC nominal bank.
- To prevent a spark at the battery and to reduce the chance of explosion, always connect the cables to the batteries first. Then connect the cables to the inverter.
- Never work alone. Always have someone within the range of your voice or close enough to come to your aid when working around batteries.
- Never use old or untested batteries. Check each battery's label for age, type, and date code to ensure all batteries are identical.
- Proper disposal of batteries is required. Refer to your local codes for disposal requirements.
- Batteries are sensitive to changes in temperature. Install batteries in a stable environment.



MNROSIE7048 MANUAL

- Provide at least one inch of air space between batteries to provide optimum cooling.
- For batteries that require the addition of water, follow these important safety tips:
 - Electrolyte Level – NO exposed plates! Ensure plates are covered in electrolyte and slightly below the bottom “funnel” of the battery fill hole.
 - Add distilled water as needed. Do **NOT** fill to the bottom of the funnel neck before you equalize. The electrolyte will probably spill out.
 - Use the MidNite Solar’s MNHYDROMETER to measure the specific gravity. Check with your battery manufacturer for the specific gravity values.
- Use proper lifting techniques when working with batteries.
- Never smoke or allow a spark near batteries.
- Never charge a frozen battery.

WARNING!

A battery can present a risk of electrical shock, burn from high short-circuit current, or fire or explosion from vented gases with flooded lead-acid batteries. (**NOTE** - Sealed batteries do not vent.)

STANDARDS

The **MNROSIE7048RE** Inverter/Charger and the **MNROSIE7048M** Inverter/Charger are Listed to *UL 1741, 3rd Edition - UL Standard for Safety Inverters, Converters, Controllers, and Interconnection System Equipment for Use with Distributed Energy Resources*; to *UL 458:2015Ed.6 Power Converters/Inverters and Power Converter/Inverter Systems for Land Vehicles and Marine Crafts*; and, to *CSA 22.2, No. 107.1, 4th Edition - Power Conversion Equipment* are pending.

HOW TO KILL YOUR BATTERIES

Batteries are delicate and require proper attention, especially when off-grid. Think of your batteries and solar equipment as a small nuclear power plant, hydro dam, or natural gas-fired power plant. Just like any of those, your system needs DAILY attention to ensure it is performing correctly and safely. We recommend the use of an independent battery monitor/alarm if you have an expensive battery bank. Below is a list of some of the most common ways we have seen people kill their battery bank.

- Using more than three parallel strings and not using common bus bars. With lead-acid batteries, when you use more than three strings, it is very hard to properly charge the middle strings. The only safe way to do this is to wire each string with equal length cables to a common bus bar. Connect inverter cables to the farthest points on the busbars.
- Not watching to verify the Absorb or EQ times are set properly, and that the equipment



MNROSIE7048 MANUAL

actually charges for that period of time. Some equipment will have settings like “End Amps” that can terminate Absorb early and, if set up wrong, can damage a battery.

- Not using ALL EQUAL LENGTH interconnect cables on each string. It is important that ALL strings be wired EXACTLY the same. Any variance in resistance on one string versus another will cause an imbalance and the batteries will suffer a shortened lifespan.
- Trusting a State of Charge (SOC) meter, which can lose calibration over time and give you false readings. You need to verify specific gravity and or verify the charge voltage is being met. Never fully rely on the SOC %; it is just a good, quick reference.
- Routinely using more than 50% of the capacity of the lead acid battery. Using more than half the battery capacity drastically shortens the batteries life; occasionally is fine, but daily will kill lead acid batteries in months.
- Not leaving ample space between cells for cooling. We recommend at least one inch between the cells for cooling. Ask the battery manufacturer what they recommend.
- Not having enough charge current to properly charge the size of the battery you have. Consult the battery manufacturer for the minimum charge current.
- Using tap water or other liquids instead of distilled water in a flooded battery. The minerals in the tap water will destroy a battery.
- Not verifying the temperature compensation neutral point (typically 25°C) and the milli volts per degree C per cell (typically -5mV).
- Not verifying you are charging to the voltage supplied by the battery manufacturer.
- Not fully charging your lead acid batteries at least once a week.
- Failing to keep all connections clean.

HOW AN INVERTER/CHARGER WORKS

Inverter Mode

When the inverter is properly connected to batteries and turned on, the direct current (DC) from the batteries is transformed into a pure sine wave alternating current (AC). This AC is similar to the voltage provided by your utility and is used to power any electrical appliances (AC loads) connected to the inverter’s output.

Standby (Charger) Mode

When an external source of AC power (utility power or generator) is connected and qualified on the inverter’s AC input, it operates in Standby mode. In Standby mode, the unit operates as a battery charger to convert the incoming AC power into DC power to recharge the batteries; at the same time, the inverter automatically closes an internal AC transfer relay to pass the incoming AC power directly to the inverter’s output to continue powering the connected electrical appliances.



MNROSIE7048 MANUAL

INVERTER APPLICATIONS

Permanent Installations

- An inverter can be used for backup power in a permanent location that normally uses utility power, such as a home or office. When utility power is available, the inverter keeps the batteries charged. When the utility power fails, the inverter automatically supplies AC power to your home or office during the power failure.
- Where utility power is not available, an inverter can be used in a standalone renewable energy system. The inverter allows AC electrical appliances to be run from the storage battery bank. When the battery bank becomes discharged, renewable DC sources (solar, wind, or hydro power) can be used to recharge the batteries via a charge controller, or a generator can be connected to the inverter to power the system while the batteries recharge.

Mobile Installations

Inverters can also be used to provide power in mobile situations, such as in an RV, truck, or marine. In these applications, the inverter provides power to the AC loads using the energy stored in the batteries and recharges the batteries when shorepower or an onboard generator is available.

WIRING REQUIREMENTS

- The NEC (*National Electric Code, ANSI/NFPA 70*) for the United States and the CEC (*Canadian Electrical Code, Part 1*) for Canada provide standards for safely wiring residential and commercial installations. The NEC and CEC list the requirements for wire size, over-current protection, and installation methods.
- AC and DC wires to and from the inverter must be protected as required by code. This can be done by using jacketed wires or by feeding the wires through conduit or a conduit box.
- Always check for existing electrical, plumbing, or other areas of potential damage prior to making cuts in structural surfaces or walls.
- Wiring should meet all local codes and standards and be performed by qualified personnel such as a licensed electrician.
- The inverter requires a reliable negative and ground return path directly to the battery.
- Both AC and DC over-current protection must be provided as part of the installation.
 - Coordination of conductor sizes and over-current protection shall be done in accordance with the *Canadian Electrical Code, Part 1*.
 - **NOTE** – Breakers protect the wire, not the equipment.



MNROSIE7048 MANUAL

- Use only copper wires with a minimum temperature rating of 90°C.
- The equipment ground is marked with this symbol:

CAUTION!

The Rosie is designed for indoor installation or installation inside a weatherproof enclosure. It must not be exposed to rain and should be installed out of direct sunlight.

WARNING!

Wait **5 minutes** after deenergizing (breakers opened, fuses removed) all sources of DC power (batteries) and AC power (utility or AC generator) to the Rosie inverter before opening the cover and/or touching any circuits.

DC Wiring

- Minimize the number of connections between the Rosie and the battery bank. Exceptions are the DC breaker —required at the battery to protect the DC wiring—in the positive line, and a DC shunt—to allow battery charge state monitoring—in the negative line. Additional connections will contribute to voltage drops, and these extra connection points may loosen during use.
- DC cables should be tied together with wire ties or electrical tape approximately every 6". This helps improve the surge capability and reduces the effects of inductance, which improves the inverter waveform and reduces wear of the inverter's filter capacitors.
- All wiring to the battery terminals should be checked monthly for proper torque/tightness. If you don't have a torque wrench, ensure all DC terminals are tight and cannot move.
- The DC cables/wires must be color coded with colored tape or heat shrink tubing: RED for positive (+); WHITE for negative (-) if solidly grounded or BLACK if using a GFP breaker; and GREEN for DC ground.
- Use the correct DC cable and corresponding circuit breaker to achieve maximum efficiency from the system and reduce fire hazards associated with overheating.
- The DC cables must be fine strand, super flexible, such as Cobra cable (or equivalent) and be approved for residential wiring per the NEC (THW for example).
- Do not use the inverter's chassis in place of the battery negative connection for grounding. The inverter requires a reliable return path directly to the battery.
- Use tinned copper 5/16" terminal lugs on the DC cables. Crimp the lugs on, then heat-shrink the union of cable to lug.



MNROSIE7048 MANUAL

- A readily accessible battery disconnect is required and must be located within sight of the battery system (NEC 480.7).
 - If the batteries are external to the location of the Rosie, then the battery installation must be done in accordance with the storage battery rules of the *Canadian Electrical Code, Part 1*.
- Ensure cables have a smooth bend radius and do not become kinked. Follow existing wire runs where possible.
- Ensure both DC cables pass through the same knockout and conduit to allow the inductive currents to cancel.
- Install a **300A** DC breaker (or fuse) between the Rosie and the battery bank on the positive cable.
- Limit cable length to 6' or less from Rosie to battery bank.
- **The battery bank voltage MUST be 48V!**

WARNING!

Verify correct polarity with a multimeter **BEFORE** connecting the battery cables to the Rosie.
The Rosie will trip the battery breaker if wired reverse polarity.

DC Over-Current Protection

- The NEC requires both over-current protection (UL489 standards) and a disconnect switch. If a circuit breaker is used as the over-current protection device, it can also be used as the required DC disconnect. If a fuse is used as an over-current device, a Class-T type or equivalent is highly recommended. This fuse type is rated for DC operation, can handle high short-circuit currents, and has a time delay that allows for momentary current surges from the inverter without opening the fuse. Because the fuse can be energized from both directions, the NEC requires that it be installed in a manner that the power must be disconnected on both ends of the fuse before servicing.
- The DC over-current protection device must be installed on the positive DC cable, and it must be correctly sized according to the size of DC cables being used, which means it is required to open before the cable reaches its maximum current carrying capability.
- DC over-current protection is not included with the Rosie and must be provided as part of the inverter installation. **Use a 300A DC breaker or fuse.**



MNROSIE7048 MANUAL

AC Wiring

- When wiring the AC input and output circuits, we recommend a full system Inverter Bypass Switch, which provides a convenient means to isolate the inverter for battery maintenance and to continuously power AC loads without any re-wiring.
- The wire sizes recommended in this manual are based on the ampacities given in Table 310.17 (in free air) of the NEC, ANSI/NFPA 70, for 90°C copper wire based on an ambient temperature of 30°C (86°F).
- Always use properly rated circuit breakers. If using an electrical sub-panel, circuit breakers can be moved from the main electrical panel to the sub-panel only if the breakers are also listed to be installed in the sub-panel.
- The AC wiring must be protected from short circuits and overloads by an over-current protection device (UL1077 standards) and have a means to disconnect the AC circuits.
- An AC generator wired into the Rosie must have an emergency shutdown device located outside the dwelling at a readily accessible location (NEC 445.18).
- **DO NOT** connect the inverter's output to an external AC power source. This could cause severe damage to the inverter and is not covered under warranty.
- AC loads powered by the inverter will need to be installed into an electrical sub-panel with branch breakers to power the AC loads.
- The AC IN and OUT neutrals are common and may be wired to a common neutral bus.

Mobile Installations (MNROSIE7048M)

- The AC IN and OUT neutrals must be isolated from each other. Do not route the AC IN and OUT neutrals to a common neutral bus. See page 15 for important information on Mobile Installations.
- Use #6 AWG (or larger), 600V wire for the AC IN and AC OUT wires.

WARNING!

Do **NOT** connect the Rosie's AC OUT to an external AC power source.

CAUTION!

- AC wiring must be no smaller than **#6 AWG** gauge copper wire.
- The Rosie's internal AC transfer relay is rated at **60A**. The pass-through current cannot exceed 60A or damage to the relay will occur.



MNROSIE7048 MANUAL

AC Ground Fault Circuit Interruption (GFCI)

UL standards require the use of GFCI outlets or breakers on the AC output of an inverter.

WARNING!

RISK OF ELECTRIC SHOCK! Use only ground-fault circuit interrupters [receptacle(s) or circuit breaker(s)] compatible with your inverter/charger.

AC Over-Current Protection

- Over-current protection for power-feeder conductors from the inverter shall be within seven inches of the output connections or may be within 40 inches of the output connections if the unprotected insulated conductors are contained throughout their entire distance in a sheath or enclosure such as a conduit/junction box or enclosed panel. The optional Rosie Breaker Box satisfies this requirement.
- The full AC continuous pass-thru capacity of the Rosie inverter/charger is limited to 60A. **AC IN to AND AC OUT from the inverter require 60A continuous duty rated breakers**, which corresponds to a minimum cable size of **#6 AWG**.
- The AC over-current protection device must be a circuit breaker or a fuse/disconnect and be properly sized and branch circuit rated for the wire it is protecting and the appliances being powered.
- AC over-current protection is not included with the Rosie and must be provided as part of the inverter installation.

Grounding

- The negative battery conductor should be solidly bonded to the grounding system at only one point in the system. The size for the conductor is determined by the size of the largest phase conductor, per the NEC/CEC.
- The AC neutral and equipment ground should only be bonded in one location for the entire system.
- More grounding information provided on pages 22-25.

CAUTION!

The Rosie may be used in a positive grounded or negative grounded installation. For a grounded system, bond either Battery Negative to Ground, or bond Battery Positive to Ground (but not both at the same time!!).



MNROSIE7048 MANUAL

Arc Fault - The NEC requires any PV system DC circuit operating at 80VDC or greater must be protected by an arc fault (AF) circuit interrupter.

Ground Fault - Since 2008 the NEC requires a DC Ground Fault (GF) Protection device on all PV systems to indicate when a GF condition exists.

Protecting Wire – ROSIE Breaker Box (MNE300ROSIE-240)

The AC and DC wires to and from the Rosie must be protected as required by code. This can be done by using jacketed wires or by feeding the wires through conduit. Midnite offers a breaker box that includes the necessary AC and DC inverter breakers that allow both the AC and DC conduit to be connected to the inverter.

SPECIAL INSTRUCTIONS FOR MNROSIE7048M INSTALLATIONS

Marine Grounding

When installing the **MNROSIE7048M** on a marine craft, there are several considerations that must be followed when grounding to ensure a safe installation, to prevent galvanic corrosion, and to adhere to American Boat and Yacht Council (ABYC) standards.

Ensure a Safe Ground Connection

- When AC on the marine craft is being supplied by shorepower, the onboard neutral should be connected to safety ground on the dock. Consequently, neutral and safety ground should not be connected anywhere on the marine craft when shorepower is present. When AC on the marine craft is being supplied by the Rosie, the Rosie's output neutral is connected to safety ground through an internal relay, using its neutral-to-ground connection.
- The DC ground terminal on the Rosie must also be connected to the marine craft's safety ground bus. This ensures that both the inverter's AC and DC ground terminals are connected to the craft's safety ground bus as a safety measure to provide protection against faults, and to provide a path for AC fault currents while the marine craft is connected to shorepower.

Preventing the Risk of Corrosion

- The inverter's AC and DC ground terminals must be connected to the marine craft's safety ground to provide an important safety feature. However, this ground connection introduces the risk of galvanic corrosion and/or electrolysis of the craft's underwater metallic hardware. Two possible solutions are typically used to maintain the correct



MNROSIE7048 MANUAL

onboard grounding requirements while greatly reducing (if not eliminating) the risk of galvanic corrosion. These solutions would be either using a galvanic isolator or an onboard isolation transformer. Galvanic isolators allow high AC voltage faults to pass but block low voltage corrosion/electrolysis currents from conducting.

- Marine isolation transformers allow the shorepower to be connected to one side of the transformer, and the marine craft’s AC wiring system is connected to the other side. Since transformers do not allow DC currents to pass, the problem with galvanic corrosion is eliminated.

ABYC Inverter/Charger Grounding Requirements

DC Grounding Connections:

- The DC grounding conductor (equipment ground) shall be:
 - Connected from the metallic case or chassis of the inverter/charger to the engine negative terminal or its bus,
 - of an ampacity equal to that of the DC positive conductor (under certain conditions, there is an exception to allow this conductor to be one size smaller—refer to the ABYC standard).
- The inverter/charger’s negative battery terminal and DC grounded conductor (negative cable) shall not be connected to the inverter case or chassis at the inverter/charger itself.

CAUTION!

The converter/inverter is intended to recharge batteries. The battery that is connected to this product is only suitable if it complies with the given battery standard for that battery type and is provided with a battery management system that will monitor and control the electrical and thermal health of the battery during charging. When installing this converter/inverter, the battery is to be verified as in compliance with the applicable battery standard.

AC Grounding Connections:

- The AC grounding conductor (green) shall be connected to the inverter/charger in a manner so that the AC ground connection will not be disconnected in servicing. This conductor is in addition to and independent of the DC grounding conductor.

The onboard neutral is not directly connected to safety ground on the dock if an isolation transformer is installed. See the ABYC Standard for complete AC/DC grounding requirements.

- The neutral for AC power sources shall be grounded only at the following points:
 - The shorepower neutral is grounded only through the shorepower cable and not grounded on board the marine craft.
 - The inverter neutral shall be grounded at the inverter, and the output neutral shall be disconnected from ground when the inverter is operating in the charger/pass-through mode.
 - On systems using an isolation transformer or a polarization transformer, the inverter neutral (and the transformer secondary neutral) may be grounded at the AC main grounding bus instead of at the inverter.

Neutral to Safety Ground Bonding

- The standards for safely wiring residential, commercial, RV/truck, and marine installations in the United States require the neutral and safety ground to be connected at the AC source; whether it is the utility feed in your home, an inverter, or a generator. This ensures a circuit breaker will activate if a hot wire-to-ground fault occurs. The Standards also require that the AC neutral be connected to safety ground (often called a “bond”) in one, **and only one**, place at any time. The single bond is established to make the electrical panel’s neutral line safe, by connecting it to ground. Without this bond, the neutral can have up to 60VAC with respect to ground. If more than one bond is established, currents can circulate between neutral and ground and cause “ground-loop” currents, which can trip GFCIs and/or cause an electric shock hazard.
- In applications where you are using an inverter as one of your AC sources along with another AC source (i.e., utility power or generator), there is the potential of having multiple connections (bonds) between neutral and ground. Therefore, you **MUST** ensure that the inverter does not also connect the neutral-to-ground while the other AC source is actively powering the inverter loads. This can be prevented if your inverter is equipped with automatic neutral-to-ground switching, which the Rosie offers.

- The **MNROSIE7048M** has automatic neutral-to-ground switching to specifically work in mobile (i.e., truck/RV/marine) applications.
- The **MNROSIE7048M** uses an internal relay (**Figure 1**) that automatically connects the AC neutral output terminal to the vehicle/ boat’s ground while inverting (Inverter mode) to provide the neutral-to-ground bond. However, when an external AC source (i.e., shorepower or a generator) is connected, another neutral-to-ground connection is introduced in the system.

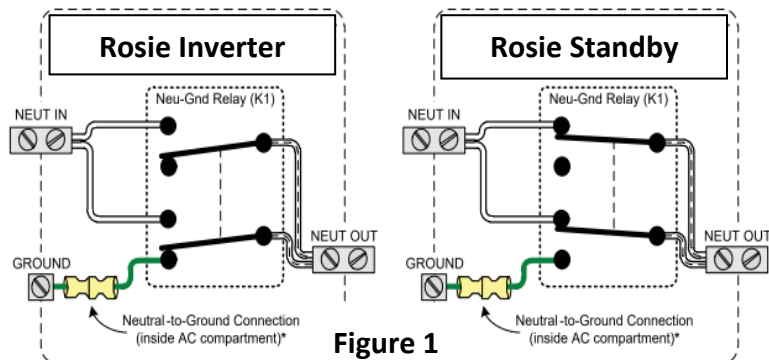



MNROSIE7048 MANUAL

- When the **MNROSIE7048M** is connected to this external AC source and goes into Standby mode, the internal relay automatically opens the neutral-to-ground connection. This design keeps two neutral-to-ground connections from occurring at the same time, thereby preventing an electrical shock hazard between the vehicle/marine craft's neutral and the external AC source's neutral.

WARNING!

In most electrical systems, the neutral-to-ground bond is located in the main utility service entrance panel. Remove any bond downstream from the inverter to prevent multiple bonds. If there is an inverter sub-panel—separate from a main electrical panel—it should have a removable wire that allows the neutral bus to be unbonded from the ground busbar.

INSTALLATION

Before installing, read the entire installation section to determine how you are going to install your Rosie. The more thoroughly you plan in the beginning, the better your overall system needs will be met.

Location Considerations

- Locate the Rosie as close to the batteries as possible. Long DC wires tend to lose efficiency and reduce the overall performance of an inverter. However, the unit should not be mounted where it will be exposed to gases produced by the batteries. These gases are corrosive and will damage the inverter; also, if these gases are not ventilated and if allowed to collect, they could ignite and cause an explosion.
- The NEC requires 30" clear on the wall. The Rosie may be located anywhere within this 30". The NEC also requires 36" free and clear of obstructions in front of the charge controller. The 36" clear area in front of all electrical panels is to provide a space to fall back into in case of electrical shock.
- Do not cover or block the Rosie's ventilation openings or install in an area with limited airflow. The Rosie uses four fans to provide forced air cooling; allow at the minimum an airspace clearance of 6" at the vents and 3" everywhere else to provide adequate ventilation.
- The area must be free from any risk of condensation, water, or any other liquid that can enter or fall on the inverter. The Rosie is indoor rated and should not be placed outside unless precautions are taken to keep rain and moisture off the system.



MNROSIE7048 MANUAL

- Ensure the Rosie is accessible after it is mounted. The Rosie is programmed and data points monitored via a remotely-mounted MNGP2 (MidNite Graphics Panel). You will need to access the MNGP2 during and after installation.
- The Rosie should be protected from direct sun exposure or equipment that produces extreme heat. The ambient temperature around the Rosie must not exceed 77°F (25°C) to meet power specifications.
- If installed in an enclosure, a fresh air intake opening must be provided directly to the bottom side (intake vents) of the inverter and an exhaust opening on the top side (exhaust vents) of the inverter.
- Keep any flammable/combustible material (e.g., paper, cloth, plastic, etc.) that may be ignited by heat, sparks, or flames at a minimum distance of 2' away from the inverter.
- Mount at least 2' from any flammable or combustible fluid or components (i.e., paper, cloth, plastic, etc.) that may be ignited by heat, sparks, or flames.

WARNING!

- Do **NOT** install the Rosie in an area that contains extremely flammable liquids like gasoline or propane.
- The Rosie is for use in non-hazardous locations in accordance with the rules of CSA C22.1, *Canadian Electrical Code, Part I*.

CAUTION!

Do **NOT** mount this inverter in a zero-clearance compartment, nor cover or obstruct the ventilation openings—overheating may result.

- The Rosie should not be installed in an area that allows dust, fumes, insects, or rodents to enter or block the ventilation openings.
- The Rosie weighs 43.5 pounds. The mounting surface and hardware must be capable of supporting at least twice the weight.
- Plan any conduit runs now. Typical wiring and routing examples:
 - AC IN from Grid or Genny or transfer switch



MNROSIE7048 MANUAL

- AC OUT to service or sub-panel
- DC cables to battery bank
- Battery Temp Sensor
- Mount vertically on a flat, **non-combustible** surface with DC terminals pointing down.

Mounting – Rosie (Figure 2)

1. Determine mounting location.
2. Hold Rosie to wall, mark bolt holes; set Rosie aside.
3. Install top two lag bolts to wall, leaving about ¼” exposed.
4. Hang Rosie on top two bolts, install bottom two bolts.
5. Tighten lag bolts.

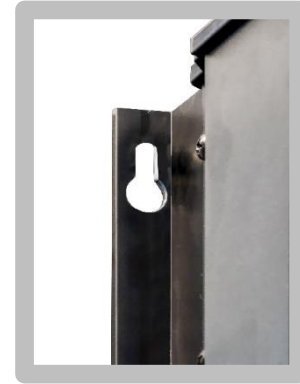

Figure 2

Mounting – Rosie and E-Panel -If mating the Rosie with the E-panel, refer to the E-Panel Manual for installation and wiring.

WIRING THE ROSIE

- Take note of the terminal blocks and wiring connection points of the Rosie, **Figures 3 & 4.**
- There are no servicing (adjustment) points for the system owner inside the Rosie.
- Always turn off circuit breakers (remove fuses) **BEFORE** wiring the Rosie.
- After the Rosie is wired and operational, and with the front cover removed, be mindful that the active circuit boards and terminal blocks contain AC and DC voltages and current!

DC Wiring (Figures 5 & 6)

1. Connect **#4/0 AWG** Batt+ and Batt- cables to the Rosie DC terminals.
2. Pass the Batt+ cable through a **300A** circuit breaker (UL489). Turn OFF the 300A breaker.
3. Connect battery cables to the battery bank master positive and negative terminals.
4. Torque Rosie terminal nuts to 10-12 ft-lbs. Page 25 for torque specs.
5. Install DC terminal safety caps. **(Figure 6)**
6. Torque batt bank connections to batt manufacturer specs.

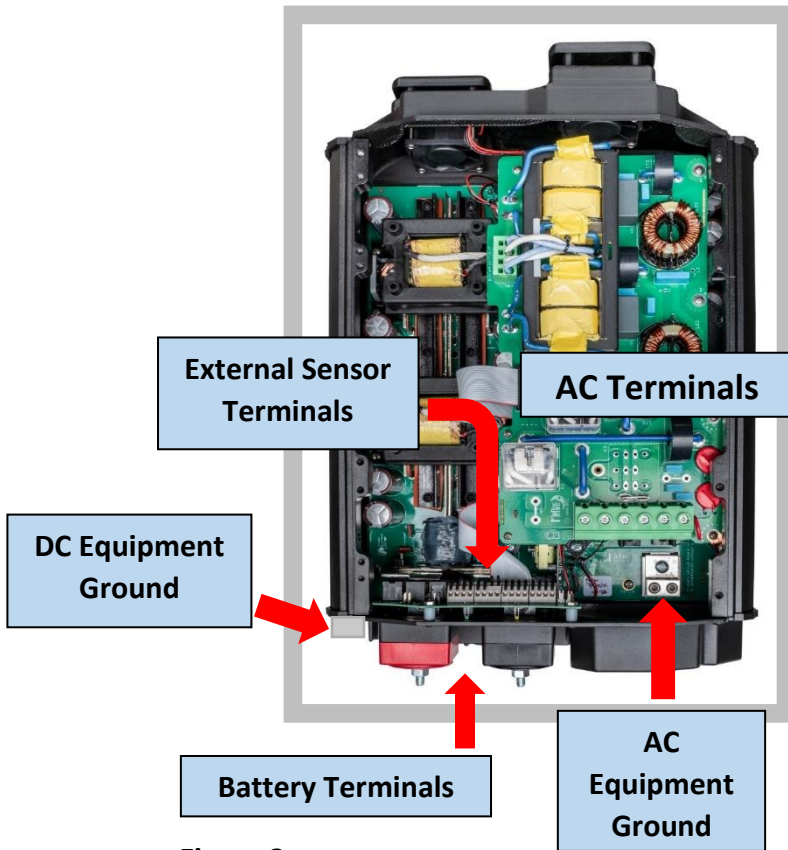

Figure 3

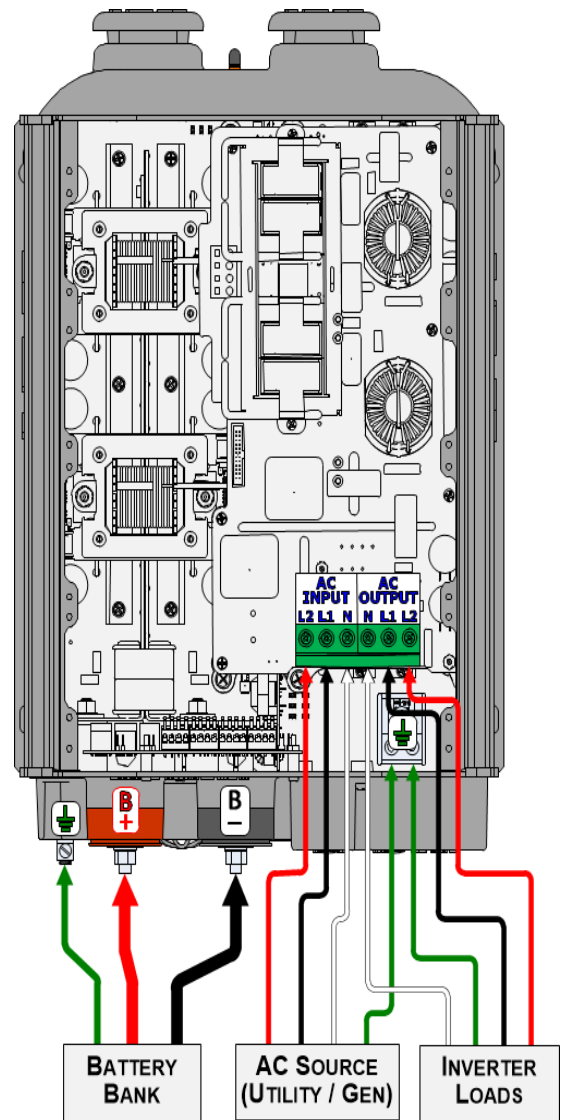

Figure 4

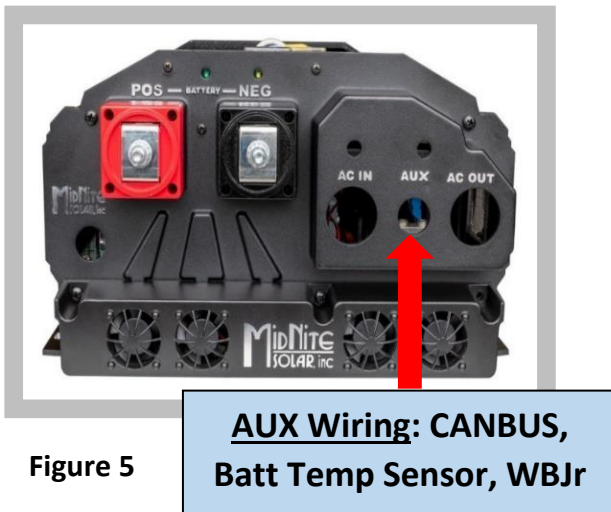

Figure 5



Figure 6



MNROSIE7048 MANUAL

AC IN Wiring (Figure 7)

1. Connect **#6 AWG** wire from AC Source (Grid or Generator) to the AC IN terminal block, L1 and L2.
2. Pass AC IN wires through a **60A 2P AC circuit breaker (UL1077)**.
3. The Rosie can accept either 120VAC IN (L1) or 240VAC IN (L1 and L2)
4. Connect **#6 AWG** Neutral to the AC Source and the AC IN terminal block, N.
5. Torque AC terminal block. Page 25 for torque specs.

AC OUT Wiring (Figure 7)

1. Connect **#6 AWG** wire from AC OUT terminal block to the AC electrical panel.
2. Pass AC OUT wires through a **60A 2P AC circuit breaker (UL1077)**.
3. The Rosie can output either 120VAC (L1) or 240VAC (L1 and L2).
4. Connect **#6 AWG** Neutral to the AC electrical panel and the AC OUT terminal block, N.
5. Torque AC terminal block. Page 25 for torque specs.

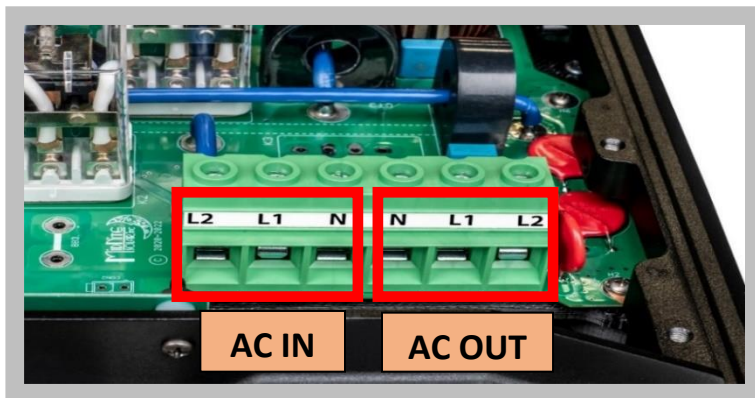

Figure 7

CAUTION!

Only **ONE** Neutral-to-ground bond can exist in this AC system wiring. Pick a spot: 1) At the AC source; or 2) At the critical load panel (sub-panel).

Grounding

- Proper grounding is critically important for several reasons:
 - Ensures voltages present throughout the system are all at the same ground reference point.
 - Adheres to *National Electrical Code (NEC)* requirements.
 - Safety – ensures all metal components are touch-safe.
 - Allows stray current a return path to its source.
- The Rosie has two separate electrical systems – AC and DC; therefore, each electrical system is required to be connected to a permanent, common, ground or earth reference.

- There are two types of grounding: Equipment Grounding and System Grounding.
 - **Equipment Grounding** – Grounding for exposed metal parts, like the inverter chassis, solar panel frames, etc. **See Figure 8.**
 - **System Grounding** – The bonding of a current-carrying wire to earth ground, such as the two SBJs shown in **Figure 8** or the single SBJ shown in **Figure 9.**

Reference **Figure 8** below for grounding system terminology.

Grounded Conductor (GC) – A current-carrying wire (AC Neutral or DC Negative) that is connected or “bonded” to ground.

Equipment Grounding

Conductor (EGC) – A wire or cable that does not carry current and connects exposed equipment metal to earth ground (Grounding Electrode).

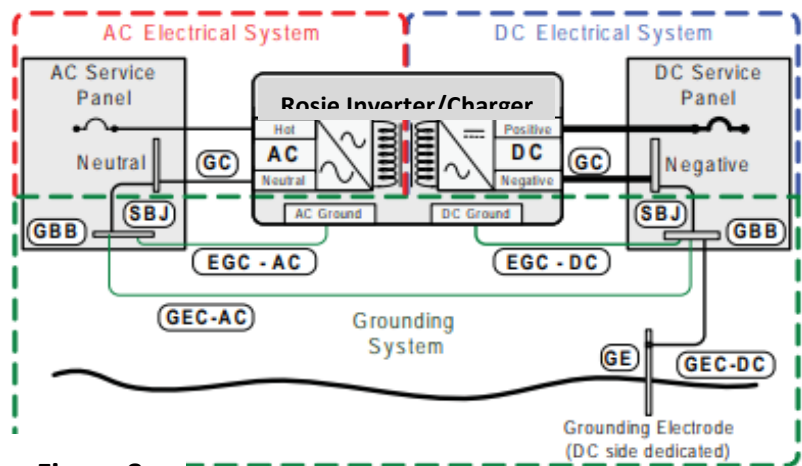

Figure 8

Grounding Electrode

Conductor (GEC) – A wire or cable that does not carry current and connects the Grounding Electrode (GE; ground rod) to the Grounded Conductor (GC) and the Equipment Grounding Conductor (EGC).

Grounding Electrode (GE) – ground rod.

System Bonding Jumper (SBJ) – The connection between the Grounded Conductor (GC) and the Equipment Grounding Conductor (EGC). **Figure 9** shows an SBJ from a MidNite E-panel, in this case it’s a Neutral-to-Ground bond.

Sizing the Grounding Electrode Conductor (GEC)

- Sizing the GEC depends on how the entire AC and DC system is grounded to the ground rod (Grounding Electrode).
- If the GEC-AC connects directly to the ground rod **AND** the GEC-DC connects directly to the ground rod, **then ...**
 - The size of the GEC depends on the largest current-carrying wire.
 - Refer to NEC tables for wire/cable gauge.

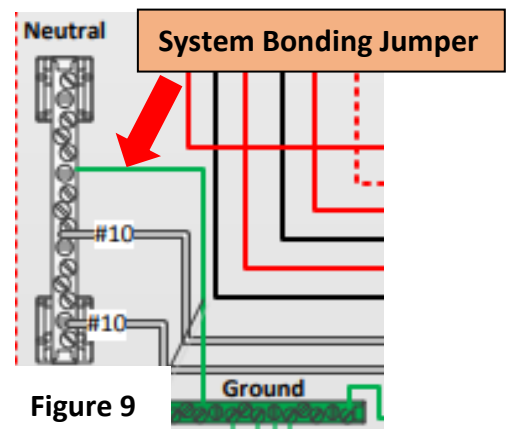

Figure 9

- If you have two ground rods - AC goes to one and DC goes to the other - then you **HAVE** to bond those two ground rods together with a Bonding Conductor (BC). The NEC also dictates the proper size of that BC.
- The **easiest** way to wire your ground system, and one that the NEC allows the smallest size of GEC, is shown in **Figure 10** below.
 - Notice the single GEC-DC conductor (**#8**) – one connection in this entire system to the ground rod.

Ground Wire Gauges for Rosie

- **#1 – #6 AWG.** System Bonding Jumper (SBJ). Determined by the size of the AC current carrying wire, which is also **#6 AWG**.
- **#2 – #6 AWG.** Grounding Conductor (GC). AC wiring (Neutral and Hots) on the Rosie need to be a minimum of **#6 AWG**. If you elect to go larger, then the SBJ can still be **#6 AWG**.
- **#3 – #8 AWG.** Grounding Electrode Conductor (GEC). Determined by the gauge of the GC-AC. NEC allows **#8 AWG** GEC if the GC-AC is **#6 AWG**.
- **#4 – #8 AWG.** Equipment Grounding Conductor (EGC-AC). Determined by the size of the over-current device, which is the **60A** AC breakers.
- **#5 – #4 AWG.** Equipment Grounding Conductor (EGC-DC). Determined by the size of the DC over-current device, which is Rosie's **300A** battery breaker.
- **#6 – #4/0 AWG.** Grounding Conductor (GC). Rosie Batt+ and Batt- cables are **#4/0 AWG**. Determined by the max current the Rosie can demand from the battery bank.
- **#7 – #6 AWG.** System Bonding Jumper (SBJ). Sizing is determined by the size of the GEC (GEC-DC), **#8**, due to this system having a common ground busbar amongst the AC and DC systems **AND** only **ONE** GEC (the GEC-DC).
- **#8 – #6 AWG.** Grounding Electrode Conductor (GEC-DC). Because the grounding system has a common ground busbar (in the DC panel) and all EGCs, SBJs, and GECs are connected to that ground busbar, and the system has only one GEC (the GEC-DC) to the ground rod, the NEC allows for **#6 AWG** wire.

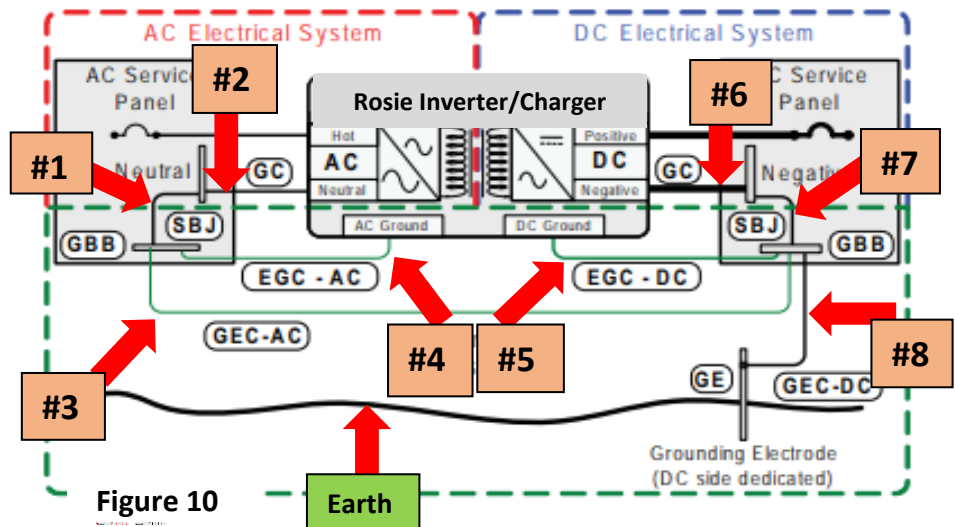

Figure 10

Grounding in Marine Installations (MNROSIE7048M)

- DC Equipment Grounding Conductor (EGC-DC) – must be equal in ampacity to the DC positive conductor, which is **#4/0 AWG**. In certain circumstances, the cable size may be one gauge smaller. Refer to the ABYC Standard for more information.
- The DC Equipment Ground terminal on the Rosie accommodates up to **#1/0 AWG** cable. For a marine application, remove the terminal and secure the larger gauge cable directly to the Rosie chassis with a suitable bolt and nut, refer to **Figure 11**.
- AC Equipment Grounding Conductor (EGC-AC) – Must not be wired in such a manner that it can be disconnected during servicing.

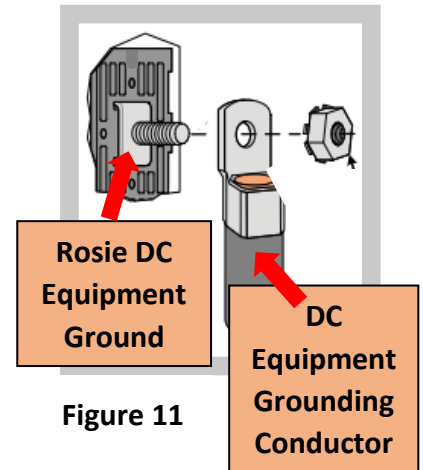

Figure 11

Torque Values

- **AC Terminal Block**
 - For **#6 AWG** wire, torque to 22 in-lbs.
- **AC Ground Terminal Block**
 - For **#8 AWG** wire, torque to 40 in-lbs
 - For **#4-6 AWG** wire, torque to 45 in-lbs
- **DC Battery Terminals**
 - Torque to 10-12 ft-lbs
- **DC Grounding Terminal Block**
 - For **#4-6 AWG** wire, torque to 45 in-lbs
 - For **#3-#1/0 AWG** wire, torque to 50 in-lbs.

CAUTION!

Recheck all torques after an hour. Conduct a pull test. Copper is a relatively soft metal and will continue to move under inadequate clamping pressure.

EXTERNAL SENSORS (Figure 12)

CANBUS Terminals (#1)

Connect Ethernet cable between the Rosie and the MNGPS and/or between other CANBUS-enabled devices. If only using the MNGPs CANBUS, then insert a CANBUS terminator plug into the unused CANBUS receptacle.

Battery Temperature Sensor (#2)

The Rosie comes with a Battery Temperature Sensor (BTS). This sensor provides the battery's ambient (exterior battery casing) temperature to the Rosie, which is used to raise or lower the charge voltage setpoints relative to a reference temperature. If the BTS is disconnected or



MNROSIE7048 MANUAL

shorted, the Rosie will default to a neutral temperature of 25C and will not temp-comp the charging voltages. In addition to temp-adjusting the charging voltages as mentioned above, the Rosie can be programmed to stop charging based on either a high or low battery temp setpoint.

Connecting the BTS:

1. Connect the phone jack of the BTS into the BTS receptacle on the Rosie's control board.
2. Pick a battery in the middle of your battery bank. About halfway up the side of the selected battery case, clean that area, remove the protective tape, and affix the BTS sensor to the battery wall. Consult battery manufacturer for optimal placement.

Current Transformer (CT)

Terminals (#3) Two terminals available for remote current transformers to measure AC branch or grid-connect currents. (Not yet active, future firmware release.)

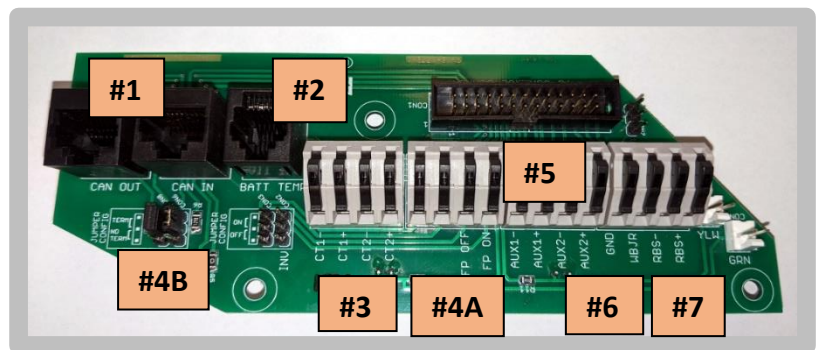

Figure 12

Front Panel (FP) ON/OFF Terminals (#4A/4B)

The Rosie ships with the INV ON/OFF shunt in the ON position. That means the FP ON/OFF switch is disabled and the Rosie will turn on when power is applied. If you want to wire up a light switch, you can move the INV shunt to the OFF position and wire a toggle switch to the FP ON/OFF terminals (**#4B**). Now you can turn on and off the inverter output without actually turning off the battery and the rest of the system. Cycling the FP ON/OFF switch also resets most faults.

AUX Terminals (#5)

Connect **#22 AWG** between the AUX terminals (polarity sensitive) and the external device (i.e., a relay) to be controlled by the AUX. AUX programming discussed on page 45.

Whiz Bang Jr. (#6)

The Whiz Bang Jr (WBJr) is a current-sensing device that mounts to the side of a standard 500A/50mV shunt. The WBJr measures the current across the shunt into (and out of) the battery bank and reports this current flow to the Rosie to be used in calculating an accurate State of Charge (SOC) percentage and to monitor for Ending Amps, which is a targeted setpoint to terminate the Absorb charge cycle.

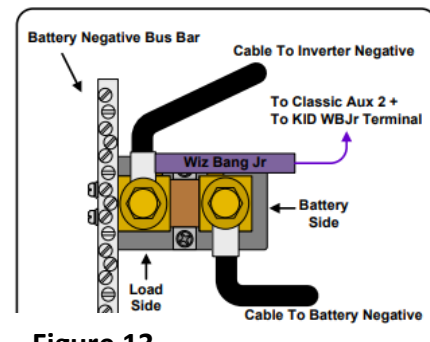

Figure 13



MNROSIE7048 MANUAL

The shunt is wired in series on the electric low side, or negative side, of your system. The wire marked “Cable to Inverter Negative” (**Figure 13**) shows the shunt connection point for **ALL** negative wires from the Rosie, additional charge controllers, wind turbine negative, DC refrigerator, etc. All negatives land there. The other shunt bolt connection is the single cable from the shunt to the battery bank’s master negative terminal.

The WBJr can be installed with the purple wire pointing left or right. BUT ... the battery negative cable must be on the same side as the purple wire!

Connecting the WBJr:

1. Connect the WBJr’s purple wire to the terminal block, marked “WBJR.”
2. Reference **Figure 13**:
 - a. If the WBJr purple wire is pointing to the right as shown, then the shunt’s big right bolt is connected to the battery bank’s master negative terminal. There can **ONLY** be **ONE** wire connected to this shunt bolt.
 - b. Connect the Rosie’s Batt- cable and all other DC- cables to the left bolt of the shunt.

Battery Sense Circuit (#7)

The Rosie measures battery bank voltage via the Batt+ and Batt- cables connected to the batt bank, and it compares and refines that measured voltage with the Battery Sense Circuit connection. Connect two **#22 AWG** wires directly to the battery bank master positive and negative terminals. Use a **1A** breaker on the positive wire. Shortest length of wire possible reduces voltage drop and improves accuracy. Crimp terminal lugs (ring connectors) on the ends that connect to the battery terminals. No Menu programming required.

ENERGIZING THE ROSIE

Before the Rosie can be programmed for final operation, the Rosie must be connected to the battery bank and energized.

- Ensure all breakers are off.
 - Turn off (open) the AC OUT and AC IN circuit breakers.
 - Turn off (open) the battery bank DC circuit breaker.

Step #1 – Battery DC

- **Voltmeter** – Measure for battery bank voltage (40-65VDC) between the Rosie’s battery breaker (at bottom of breaker) and the battery bank negative terminal.
 - Battery bank voltage present?
 - **Yes** – Good (40-65VDC)



MNROSIE7048 MANUAL

- **No** – Check DC wiring to the battery. Check batteries.
- Correct polarity shown on the voltmeter?
 - **Yes** – Good
 - **No** – Reverse the DC wiring.
- Turn on (close) the Rosie’s battery breaker.
- **Voltmeter** – Measure for battery bank voltage between the Rosie’s Batt+ and Batt- terminals.
 - Battery bank voltage present?
 - **Yes** – Good. The Rosie will automatically turn on now.
 - **No** – Check DC wiring or battery breaker.

Step #2 – AC IN

- Turn on AC IN source (grid or genny). Close AC IN breaker.
- **Voltmeter** – Measure for 120VAC between AC L1 IN and AC IN Neutral terminals.
 - 120VAC present?
 - **Yes** – Good
 - **No** – Check AC source or connections.
- **Voltmeter** – Measure for 120VAC between AC L2 IN and AC IN Neutral terminals.
 - 120VAC present?
 - **Yes** – Good
 - **No** – Check AC source or connections.
- **Voltmeter** – Measure for 240VAC between AC L1 IN and AC L2 IN terminals.
 - 240VAC present?
 - **Yes** – Good
 - **No** – Check AC source or connections.

Step #3 – AC OUT

- **Voltmeter** – Measure for 120VAC between AC L1 OUT and AC OUT Neutral terminals.
 - 120VAC present?
 - **Yes** – Good
 - **No** – Check Rosie programming.
- **Voltmeter** – Measure for 120VAC between AC L2 OUT and AC OUT Neutral terminals.
 - 120VAC present?
 - **Yes** – Good
 - **No** – Check Rosie programming.
- **Voltmeter** – Measure for 240VAC between AC L1 OUT and AC L2 OUT terminals.



MNROSIE7048 MANUAL

- 240VAC present?
 - **Yes** – Good
 - **No** – Check Rosie programming.

Step #4 – AC Electrical Panel

- Close AC OUT breaker.
- **Voltmeter** – Measure for 120VAC between AC L1 and AC Neutral terminals at the AC electrical panel.
 - 120VAC present?
 - **Yes** – Good
 - **No** – Check wiring, breakers, or connections.
- **Voltmeter** – Measure for 120VAC between AC L2 and AC Neutral terminals at the AC electrical panel.
 - 120VAC present?
 - **Yes** – Good
 - **No** – Check wiring, breakers, or connections.
- **Voltmeter** – Measure for 240VAC between AC L1 and AC L2 terminals at the AC electrical panel.
 - 240VAC present?
 - **Yes** – Good
 - **No** – Check wiring, breakers, or connections.

ROSIE PROGRAMMING

The MidNite Graphics Panel 2 (MNGP2) (**Figure 14**) is required to navigate the many menus for programming the Rosie and displaying data points, historical data points, and system warnings. Review the MNGP2 Rosie menu maps starting on page 36 for a directory layout of all the menu maps. Below are explanations of the various programmable menu items.



Figure 14



MNROSIE7048 MANUAL

VOICE

- **Levels of Chattiness:**
 - **Off** - No voice.
 - **Rick Mode** – Not used with the Rosie.
 - **Errors**- Any errors such as "Over voltage," "Battery High Temp," etc.
 - **Warnings** - All errors and warnings.
 - **Verbose** - Menu help messages the first time the menus are accessed. Information messages such as status, charge stage and all warnings and errors.
 - **Chatty Cathy** - Menu help messages every time the menus are accessed, all the warnings, errors and status info as described above, plus random hidden messages.
- **Quiet Time:**
 - **Quiet Time Disable** = Talks 24 hours a day.
 - **Quiet Time Enable** = Has Start Quiet and End Quiet time settings. When activated, Voice will be silenced between the times listed during a 24-hour period.

SETUP / BATTERY CONFIG

- **Absorb** – Sets the Absorb charge cycle voltage. This comes from the battery manufacturer. Sometimes called "Bulk," "Constant Voltage," or "Boost" charge voltage.
- **Absorb Time** – Amount of time the Rosie stays in the Absorb charging cycle. Lithium batts usually have no to little Absorb time. Flooded and sealed usually use this formula:
$$(\text{Batt Bank 20hr Ah rating} / \text{Charging Amps}) \times 0.42 = \text{Absorb Time}$$
- **Absorb Skip Days** – Rosie goes to Float for XX days, as programmed.
- **Float** – Sets the Float voltage. Float is like a trickle charger, occurs after the Absorb cycle. Keeps batts full remainder of day.
- **Float Time** – Amount of time Rosie stays in Float.
- **EQ** – Sets the Equalization (EQ) battery maintenance cycle voltage. Not applicable with Lithium batteries.
- **EQ Time** – Amount of time in EQ. Best to EQ in one-hour cycles, let batts rest, measure the specific gravity of every cell. EQ until the cells are at or less than 0.025 S.G. apart.
- **Rebulk** – Battery voltage setpoint, below Float, that once reached causes the Rosie to start a new charge cycle ... Bulk – Absorb – Float.
- **Ending Amps** – Amp setpoint at which the batts are fully charged. Commonly 1 – 3% of the bank's (20-hr) Ah rating. The Rosie will go to Float when the Absorb Timer counts down to 0 or when Ending Amps is reached, whichever occurs first. Using Ending Amps is a better way to charge the batt bank properly and fully.



MNROSIE7048 MANUAL

- **Battery Capacity** - Enter the bank's 20-hr, Ah rating. If the bank consists of parallel strings, multiple the 20-hr rating of one battery by the number of parallel strings.
- **Amp Hour Efficiency** – Set to Auto and will consider the Batt Chemistry type selected. Or manually program a specific %. Most Flooded batts start at 80%; Sealed/Gel batts at 95%; Lithium – 94%.
- **Chemistry** - Loads up typical, default charging voltages for the selected chemistry. Useful if the batt specs are unknown.
- **Max Charge** - This limits the Rosie's DC amps to the batt bank. Check the batt specs. If the max charging amps for one batt is 50A, for example, and you have one string of batts, then the max is 50A. If you have two strings, then the max is 100A (2 x 50A). Internal PCB temps will limit (reduce) the charging amps starting at 75C.
- **Master Whizbang Jr.** – If using multiple CANBUS-connected MidNite devices, this tells the system which one is connected to the WBJr.
 - **Battery** – Only one WBJr in system monitoring current to/from the battery bank.
 - **Additive** – If more than one WBJr in the system, the SOC% readings are amalgamated.
 - **3rd Party** – Stand-alone current monitoring.
- **Charge Timers** – Count-down timers for Absorb, EQ, and Float; count-up timer for Time-in-Float.
- **Min/Max Temp Comp** – Sets low and high voltage caps that the Rosie will not exceed when temperature compensating the batteries. When the batts are cold, T-comp raises the charge (i.e., Absorb) voltage setpoint. The Max Temp Comp setting comes into play here. Conversely, when the batts are warmer than the reference temp, the Rosie will lower the set charge voltages.
- **EQ Temp Comp** – Turns ON or OFF T-comp during the EQ cycle. Be mindful of an elevated batt bank voltage in the winter when equalizing. This high batt voltage may exceed the DC IN voltage limit on some inverters. Max DC IN for the Rosie is 65V.
- **Temp Comp mV/Deg C** – This is called the Temp Coefficient Factor. Commonly at -5mV. Check with your batt manufacturer. Set to 0mV for Lithium batts; Lithium does not want T-comp from the Rosie – the BMS handles T-comp.
- **Temp Comp Ref** – Commonly 25C but check with the battery manufacturer. This is the neutral or reference temp at which the Rose T-comps around. If batts are colder than the Ref Temp, then the Rosie will elevate the charge voltage. If warmer, then it will lower the charge voltage.
- **LBCO CON** – Battery voltage setpoint for the Rosie to invert.
- **LBCO DISC** – Low battery voltage at which the Rosie stops inverting.



MNROSIE7048 MANUAL

- **LBCO DISC Time** – Minutes to count-down once LBCO DISC is reached before the Rosie stops inverting.

SETUP / INVERTER CONFIG

- **AC Input 1**
 - **AC Mode** – Grid or Genny.
 - **Charger** – Enabled / Disabled. Allows charging from the AC IN source.
 - **Charge Rate** – Max charging amps to the batt bank.
 - **Breaker Size** – Specify the amp size of the AC IN circuit breaker. The Rosie will not allow charging amps to exceed the max ampacity of this AC IN breaker.
- **Inverter Specific**
 - **AUX Functions** – Select desired AUX modes for AUX 1 and/or AUX 2.
 - **External Sensors**
 - **Temperature** – Disable or use the batt temp sensor.
 - **Low / High Temp Warning** – Set to alarm at selected low/high batt temps.
 - **WBJR**
 - **Disabled**
 - **Battery** – Device connected to WBJr, shared throughout System.
 - **Low / High Current Warning** – Set to alarm at selected low / high amp limits. Applicable when optional CTs are installed.
 - **Voltage**
 - **Disabled**
 - **Battery**
 - **DC Source**
 - **AC Source**
 - **Low / High Voltage Warning** – Set to alarm at selected low / high voltage limits.
 - **Current**
 - **Disabled**
 - **Battery**
 - **DC Source**
 - **AC Source**
 - **Generator**
 - **Low / High Current Warning** – Set to alarm at selected low / high current limits.



MNROSIE7048 MANUAL

- **Set Name** – Assign custom name to Rosie
- **Temperatures** – Shows FET temperatures, control board temp, battery temp, and temperature compensated target.
- **Faults & Warnings**
- **Battery Voltage Offset** – To tweak displayed battery voltage.
- **Reset to Default**
- **Grid Support** – Rosie uses grid AC for loads based on SOC % or Battery Voltage.
 - **SOC%:**
 - **Low SOC %** - Rosie uses AC IN (grid) to charge batts and run loads.
 - **High SOC %** - Rosie disables AC IN and uses batt bank to run loads.
 - **Battery Voltage:**
 - **LBX** – Set to low Batt V setpoint. If Batt V drops below the LBX threshold for 1 minute and if the grid is valid, connect to the grid. If the charger is enabled, it will charge, if not set to charge but in grid mode, standby. If the voltage pops above the threshold before the grid becomes valid, LBX will be reset and will not connect to grid.
 - **HBX** – Set to high Batt V setpoint. If the voltage goes above HBX threshold for 1 minute and if connected, then Rosie disconnects from grid.
- **Auto Gen Start**
 - **Start Voltage** – Battery voltage at which genny starts. Usually set to the 50% DOD level for flooded or sealed batts, or to the 20% DOD for Lithium batts.
 - **Stop Voltage** – Battery voltage at which genny turns off. Commonly set to the Absorb voltage setpoint.
 - **Start Delay** – Delay in minutes before genny starts, once the Start Voltage is reached.
 - **Stop Delay** – Delay in minutes before genny shuts-down once the Stop Voltage is reached.
 - **Connect Time**
 - **Disconnect Time**
 - **Max Run Time** – Maximum time the genny will stay on regardless of other settings.
 - **Quiet Start** – Time of day/night setting to ensure quiet operations, such as if living in a noise-covenant neighborhood.
 - **Quiet Stop** – Time of day/night to disable quiet time or to allow normal genny operations.



MNROSIE7048 MANUAL

- **Exercise INT** – Exercise means to run the genny on a schedule, to cycle it occasionally for testing, to cycle the engine oil, etc. The interval will be the days between the exercise cycles.
- **Exercise Start** – Commence the Exercise program.
- **Exercise Stop** – Stop or cease the Exercise program.
- **Warmup Period** – Time to allow the genny to turn on and warm-up before the Rosie places a load on the genny.
- **Cooldown Period** – Inverse of warmup period. At end of genny use, Rosie will cease demanding energy from the genny, but the genny will still be running, allowing it to cool-down.

SETUP / SYSTEM CONFIG

- **Output** – AC OUT voltage and frequency.
- **Mode**
 - **Off-Grid** – No AC IN from grid, usually AC IN from a generator. AC OUT to dedicated sub-panel or main service without any other AC IN source.
- **Parallel Threshold – ON or OFF.** Power % setting determines when additional inverters are brought online to power loads.
- **Power Save Search** – ON or OFF. When ON, idles Rosie to save energy from self-consumption. Range is user selectable, No Power Save equals 0W. Rosie looks for the setpoint wattage in terms of demand, then wakes up and outputs AC to the load. Delay time between search pulses is programmable.
- **Search Delay** – Delay in seconds (10 – 120 secs) before Rosie turns ON from Power Save Mode.

SETUP

- **Start Charge** – To commence batt charging using the Rosie.
- **EQ Charge** – To commence or cease EQ charging.

USER

- **Auto GEN Start** – Manual on or off selection of AGS; or to automatically enable AGS based on setpoints.
- **Battery Equalize** - Manual on or off selection of EQ charge; or to automatically enable EQ based on setpoints.
- **MNGP2 Info**
- **Firmware Versions** – Shows latest firmware version.



MNROSIE7048 MANUAL

USER / TECH MENU

- **Knob Sensitivity** – Adjusts sensitivity of MNGP2 rotary knob.
- **Firmware** – Shows latest firmware version.
- **Firmware Statistics**
- **Last Fault** – Shows last fault to impact Rosie or other MNGP2 connected devices.
- **Set Factory Defaults** – Restores Rosie to factory default settings.
- **Bluetooth Status**
- **CANBUS Statistics**

USER / TIME DATE – Set time on 24-hour clock; set date so that data logging is correct.

USER / DISPLAY

- **Contrast** – Adjust sharpness of letters and numbers.
- **Brightness** – Adjust intensity of LCD backlight.
- **Light Timeout** – Set time to turn off LCD backlight or leave it always on.
- **Menu Timeout** - Disables stops the display from reverting back to the main status page.

USER / PASSWORD – Password of 1 – 4 – 2 allows setting changes.

USER / SET MNGP2 NAME – To change assigned custom name for your system.

INV

- **Inverter Status**
- **All Inverters**

AC

- **Select AC Source** – Enable or disable selected AC Source.

MPPT

- **MPPT Control** – Allows programming of charge controller that uses the MNGP2 (i.e., Hawke's Bay or Barcelona).



MNROSIE7048 MANUAL

ROSIE MNGP2 MENU MAP Rev - 3 MidNite Solar Inc.

1 of 7

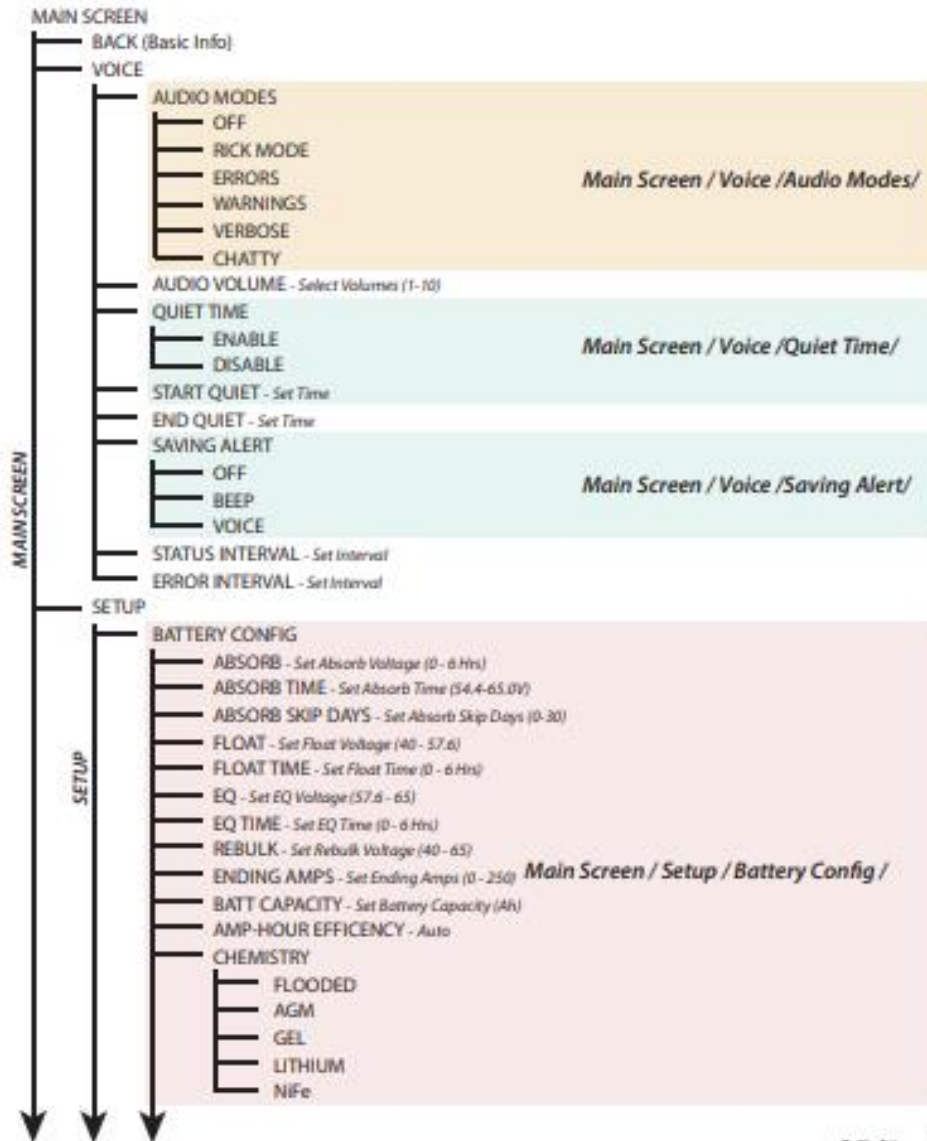

Continued to page 2

www.midnitesolar.com

19115- 62nd Ave NE Arlington, WA 98223 PH. 360-403-7207





MNROSIE7048 MANUAL

ROSIE MNGP2 MENU MAP

MidNite Solar Inc.

2 of 7

Continued from page 1

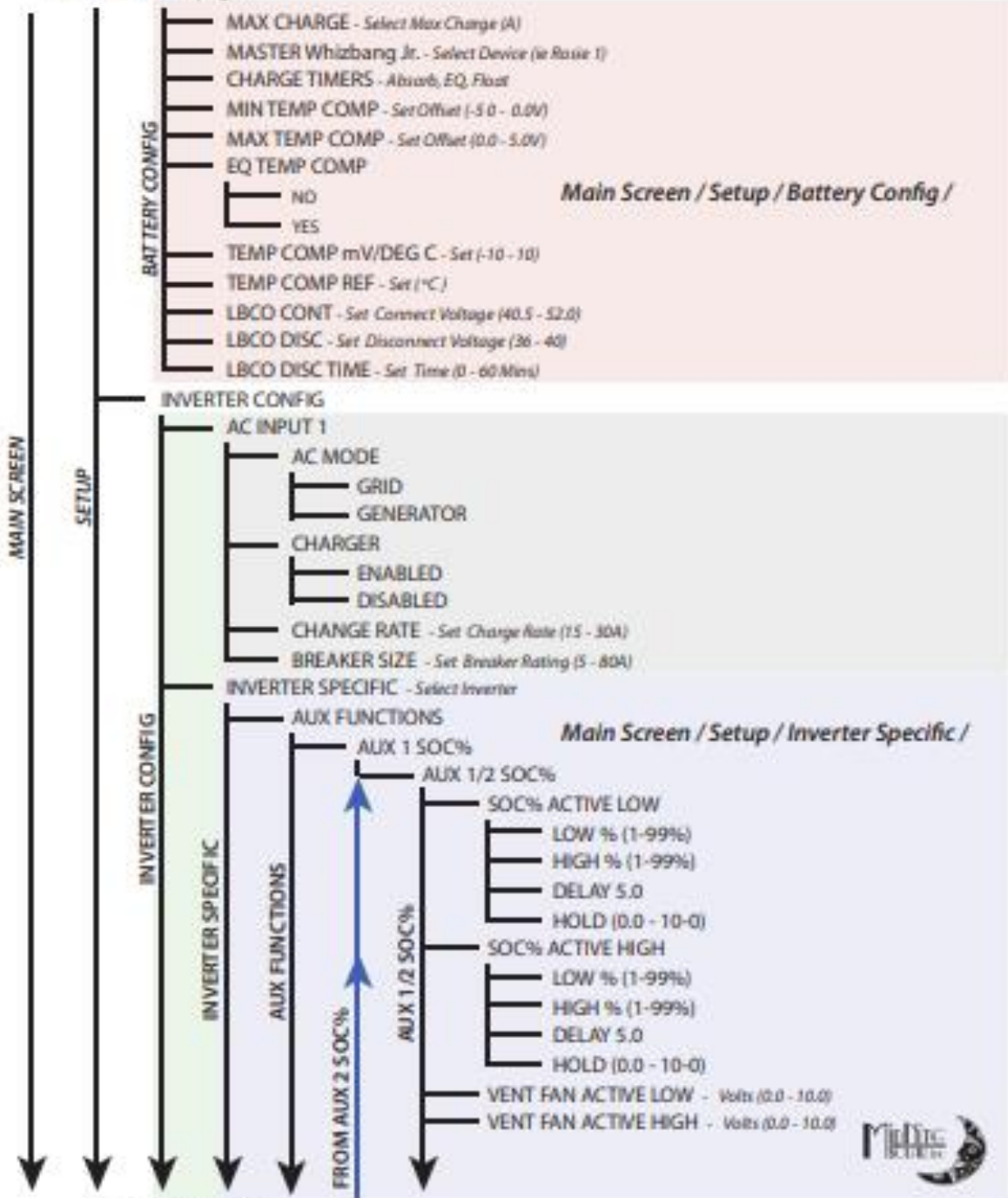

Continued to page 3

www.midnitesolar.com

19115- 62nd Ave NE Arlington, WA 98223 PH. 360-403-7207





MNROSIE7048 MANUAL

ROSIE MNGP2 MENU MAP

MidNite Solar Inc.

Continued from page 3

FROM
AUX 1/2 SOC%

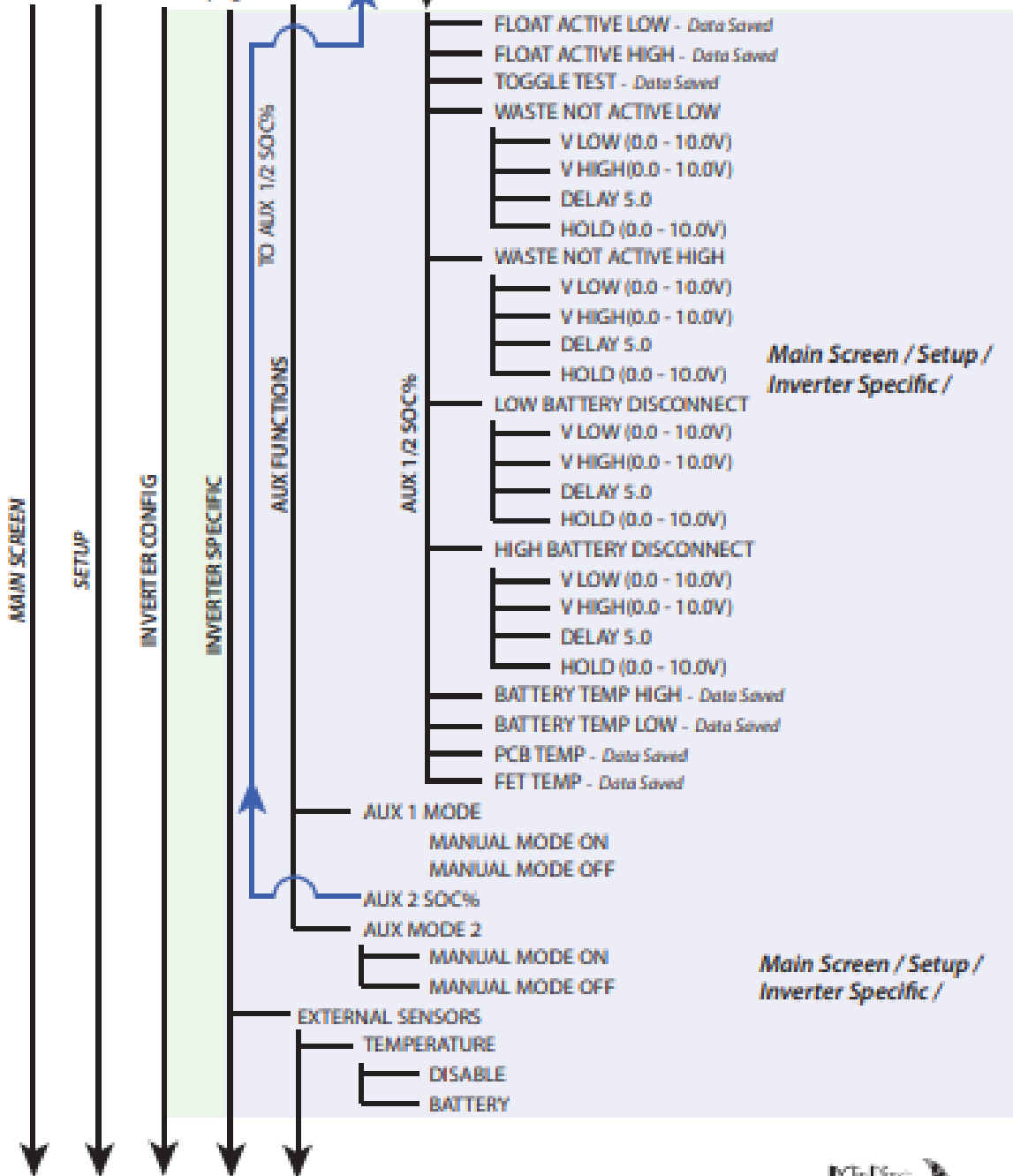

Main Screen / Setup /
Inverter Specific /

Main Screen / Setup /
Inverter Specific /

Continued to page 4

www.midnitesolar.com

19115- 62nd Ave NE Arlington, WA 98223 PH. 360-403-7207





MNROSIE7048 MANUAL

ROSIE MNGP2 MENU MAP

MidNite Solar Inc.

Continued from page 3

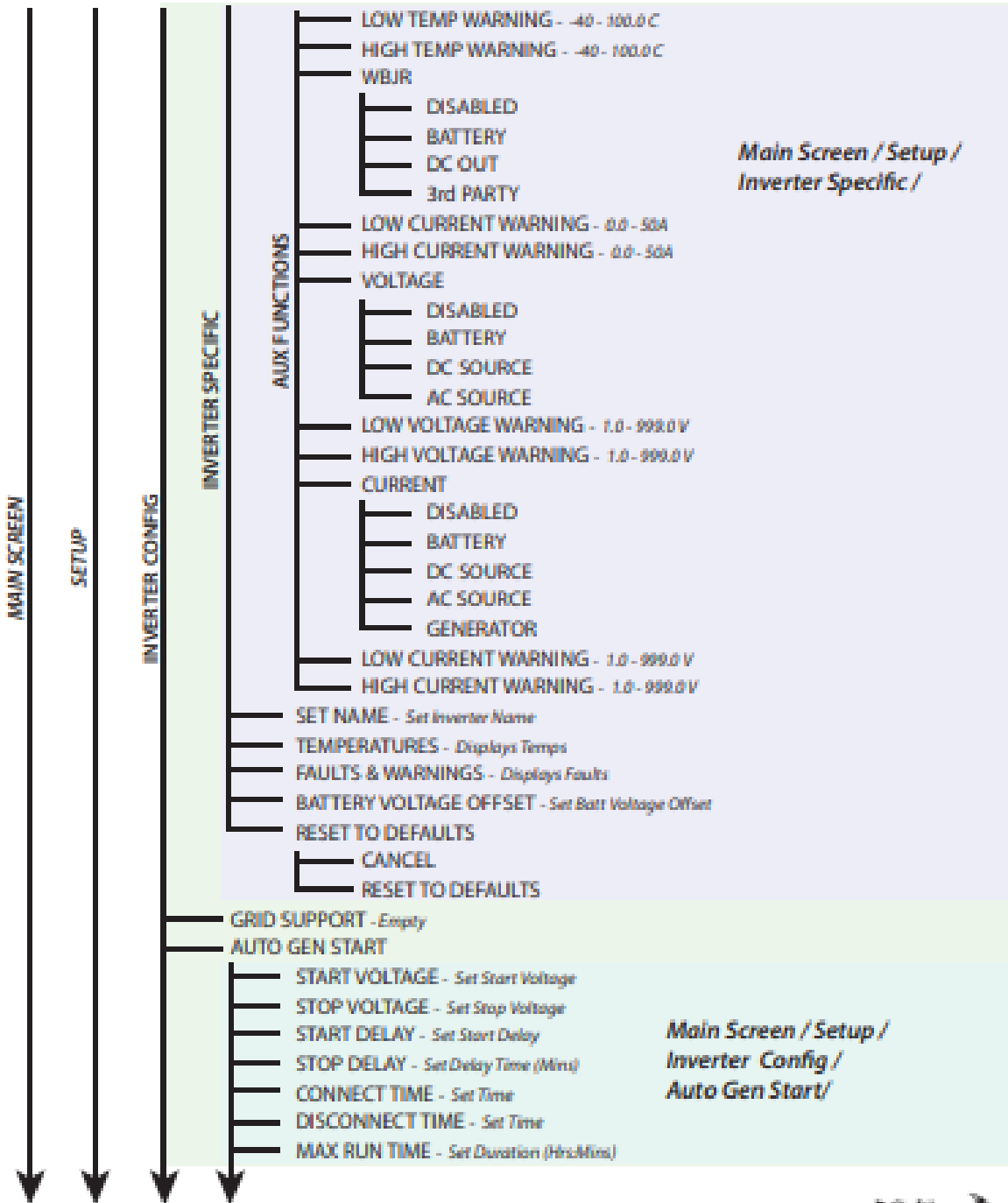

Continued to page 5

www.midnitesolar.com

191 15- 62nd Ave NE Arlington, WA 98223 PH. 360-403-7207





MNROSIE7048 MANUAL

ROSIE MNGP2 MENU MAP

MidNite Solar Inc.

Continued from page 4

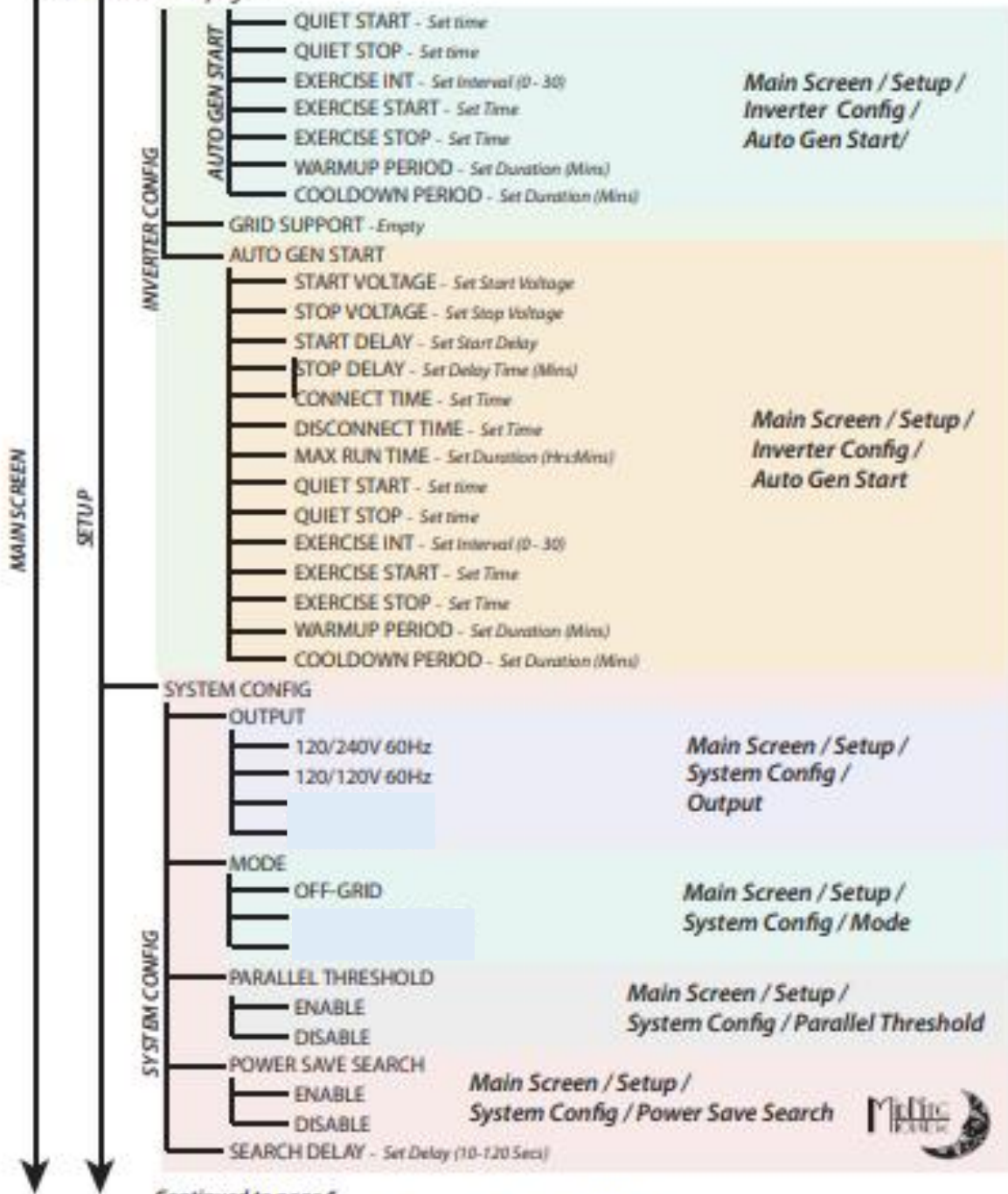

Continued to page 6

www.midnitesolar.com

19115- 62nd Ave NE Arlington, WA 98223 PH. 360-403-7207





MNROSIE7048 MANUAL

6 of 7

ROSIE MNGP2 MENU MAP

MidNite Solar Inc.

Continued from page 5

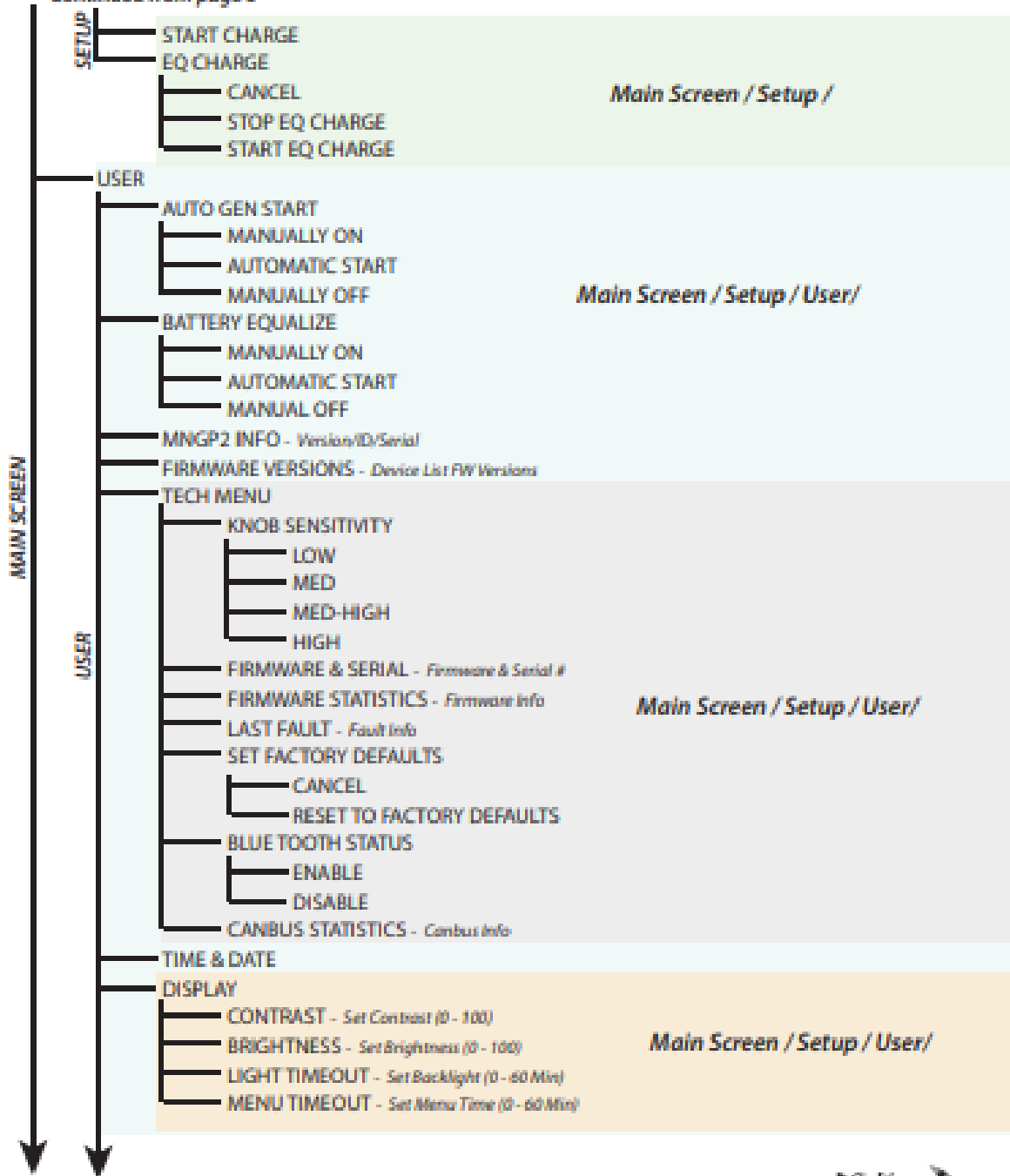

Continued to page 7

www.midnitesolar.com

19115- 62nd Ave NE Arlington, WA 98223 PH. 360-403-7207





MNROSIE7048 MANUAL

ROSIE MNGP2 MENU MAP

Continued from page 6

7 of 7

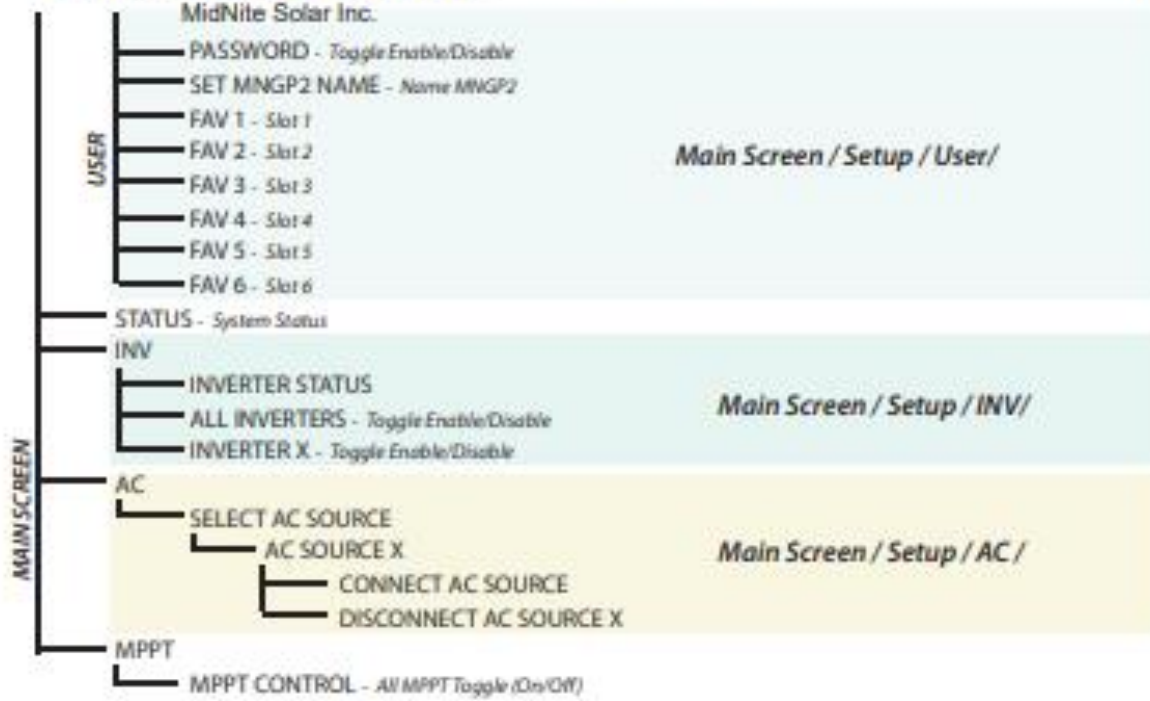

www.midnitesolar.com
 19115- 62nd Ave NE Arlington, WA 98223 PH. 360-403-7207





BATTERY CHARGING

Bulk

This charging stage is called the Constant Current Mode, and it means the Rosie will send to the batteries as much current as is programmed (Max AC Charge Amps) until the battery voltage rises to the Absorb Voltage setpoint.

Absorb

The Rosie will maintain the Absorb voltage setpoint until the batteries are charged. This stage is terminated at the end of the Absorb Timer or when the Ending Amps setpoint is reached, whichever occurs first. The Absorb cycle is called the Constant Voltage Mode, and because the Absorb voltage is held at a constant value, the current into the batteries will be decreasing as the batteries fill up.

The Absorb cycle commonly commences on most flooded and sealed batteries when the battery is 75% full (+/-) and maintains for a specified period of time called the Absorb Time.

Lithium batteries commonly do not have an Absorb time. When the Lithium batteries reach the Absorb voltage setpoint, they are normally full and done charging. Check with your Lithium battery manufacturer for further guidance on the amount of Absorb Time.

Absorb Charge Time

For the Absorb timer, use the formula $\text{Charge Time} = (\text{Bank Ah} / \text{Charge rate}) \times 0.42$.

For example:

1. Your battery bank total amp-hour capacity is 400Ah
2. Rosie charging amps set to 65A.
3. Charge Time = $(400 \text{ Ah} / 65\text{A}) \times 0.42 = 6.15 \text{ hours} \times 0.42 = 2.6 \text{ hours}$.

For the EQ timer, refer to your battery manufacturer specifications.

Ending Amps

Used in conjunction with the MidNite Whiz Bang Jr current-sensing device. Ending Amps set by the battery manufacturer and means the point at which the battery bank is full. During the Absorb charge cycle, the Rosie holds the voltage at the preset charge level. As the batteries fill up, the current into the batteries decreases. When the decreasing current reaches the preset End Amps point, the Rosie stops the Absorb cycle and transitions to Float. In the absence of specifications from your battery manufacturer, you can use 1 – 3% of the total bank amp-hour capacity for Ending Amps for most flooded and sealed batteries.



MNROSIE7048 MANUAL

Float

The Float cycle follows the Absorb cycle. Think of Float as a trickle charger to keep the batteries full and topped off all day. The Rosie will hold the batteries at the Float voltage setpoint for the amount of programmed Float Time.

Rebulk

Forces the Rosie back into Bulk mode if the battery voltage is less than the REBULK setting for 60 seconds. If the battery voltage moves above the REBULK setting, timer starts again for 60 seconds.

Equalize

Equalization, or EQ, is a maintenance cycle, performed as needed to equalize the internal resistance of the battery cells. During the EQ cycle, the Rosie applies to the battery bank an elevated charge voltage, which is needed to remove sulfates from the battery's lead plates. The objective of EQ is to bring all the cells to a near-same level of internal resistance, so that all the cells will take the same charging and discharging voltages during normal operation. For the cells to "see" the same voltage amongst the cells promotes battery health and longevity. Confirm with your battery manufacturer if your batteries need EQ or not.

EQ Dos & Don'ts

- Ensure electrolyte solution covers lead plates before EQ.
- Do **NOT** fill the cells before EQ. EQ will cause the volume of solution to increase and may spill out.
- Check electrolyte solution after EQ, add distilled water as needed.
- EQing with a charge controller ... your inverter may alarm with an over-voltage condition. Turn off the Rosie before EQ.

Temperature Compensation (T-comp)

There is only one setting in the Rosie that can influence a different voltage than what you programmed (i.e., Absorb, Float, or EQ) and that is temperature compensation.

As a battery gets colder than 25 degrees Celsius, the temperature needs to be elevated. As a battery gets warmer than 25C, the temperature needs to be lowered. You should check with your battery manufacturer and get the following three values:

1. Millivolts per degree C per cell to compensate (Default is -5mv).



MNROSIE7048 MANUAL

2. Reference temperature for the battery (Default is 25C).
3. The maximum voltage to ever compensate to.

No temp comp or improperly programmed temp-comp may be harmful to your battery bank. In the winter, temp-comp will raise the charging voltage. This elevated voltage may cause an inverter to alarm on a high battery voltage condition. The battery manufacturer may specify a high charging voltage limit, yet temp comp may, if cold enough, want to exceed this maximum charging limit. Conversely, in the warm months, temp comp needs to lower the charging voltage. If not lowered enough, the batteries will be over-charged. Proper temp comp is important for battery health and longevity.

AUXILIARY MODES

The Rosie offers two Auxiliary terminals (AUX1 & AUX2) to be used as a DC trigger voltage source for accessories such as battery vent fan, diversion loads, lights. The AUX circuit outputs 12VDC nominal at a maximum of 250mA, thus an external relay is required between the accessory and a power source. The AUX circuit will trigger this relay on/off.

The Rosie has many different AUX modes to choose from based on how you want your accessory turned on or off. The AUX2 terminal output can be pulse-modulated if that type of varying output is desired. Certain AUX modes allow a start-delay and off-delay timer if it is desired to hold the start function for a period of time, or to prevent the inverse function from occurring for a defined period of time.

Most of the AUX modes have an inverse mode, such as SOC % High and SOC % Low. The “High” of SOC % High infers the AUX terminal is OFF, then turns to ON. The “Low” of SOC % Low infers the AUX terminal is ON, then turns to OFF.

How to read the AUX Mode table below ...

MODE	PWM	ON / OFF	When ON (OFF)?	When OFF (ON)?
SOC % High	Y/N	ON	SOC % (Timer till ON)	SOC % (Timer till OFF)

1. Function is “SOC % High”
2. SOC % High can either be in PWM or no PWM
3. SOC % High is normally OFF and turns to ON
4. To initially turn ON, set the “When ON? SOC %.”
5. To eventually turn OFF, set the “When OFF? SOC %.”
6. To delay when it turns ON, set the timer.
7. To delay when it turns OFF, set the timer.



MNROSIE7048 MANUAL

MODE	PWM	ON / OFF	When ON (OFF)?	When OFF (ON)?
SOC % High	Y/N	ON	SOC % (Timer till ON)	SOC % (Timer till OFF)
SOC % Low	Y/N	OFF	SOC % (Timer till OFF)	SOC % (Timer till ON)
Vent Fan High	Y/N	ON	Batt V	0.2V < Batt V
Vent Fan Low	Y/N	OFF	Batt V	0.2V < Batt V
Float High	Y/N	ON	Float	0.3V < Float
Float Low	Y/N	OFF	Float	0.3V < Float
Toggle Test	Y/N	ON	(Manual ON)	(Manual OFF)
Waste Not High	Y/N	ON	-X.X V (Timer till ON)	-X.X V (Timer till OFF)
Waste Not Low	Y/N	OFF	-X.X V (Timer till OFF)	-X.X V (Timer till ON)
Batt V Disc High	Y/N	ON	Batt V (Timer till ON)	Batt V (Timer till OFF)
Batt V Disc Low	Y/N	OFF	Batt V (Timer till OFF)	Batt V (Timer till ON)
Batt Temp High	Y/N	ON	XX F/C	XX F/C
Batt Temp Low	Y/N	OFF	XX F/C	XX F/C
PCB Temp	Y/N	ON	XX F/C	XX F/C
FET Temp	Y/N	ON	XX F/C	XX F/C

FIRMWARE UPDATE

1. Download to your cell phone the MNGP2 Rosie firmware (FW) from the MidNite Solar website using this link ... <https://www.midnitesolar.com/firmwareIndex.php>
2. Install the FW on your phone.
3. Energize the Rosie by closing the battery breaker.
4. FW app will appear as shown in **Figure 15**.
5. Tap the label that reads MNGP2.
6. The FW app will connect to the MNGP2, then the app will appear as shown in **Figure 16**.
7. Tap the box that reads MNGP2 Standard.
8. FW app will appear as shown in **Figure 17**, select OK.
9. FW app will show transfer progress, **Figure 18**.
10. FW app will indicate when done, **Figure 19**. Select OK.

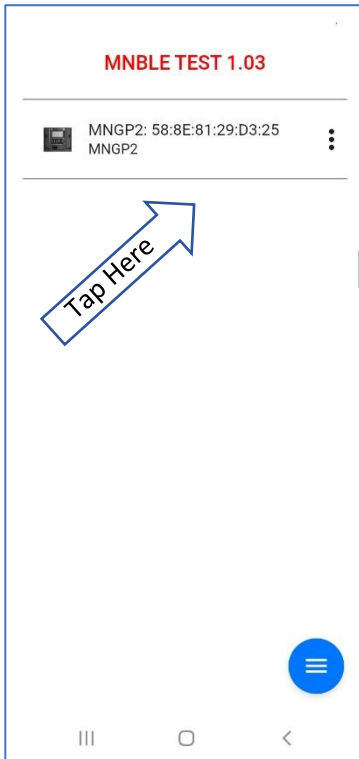

Figure 15

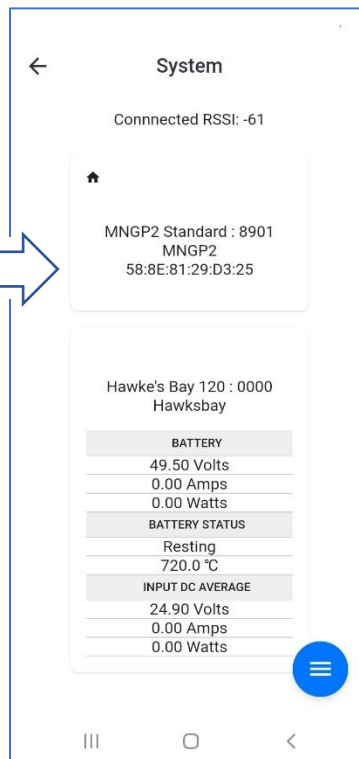

Figure 16

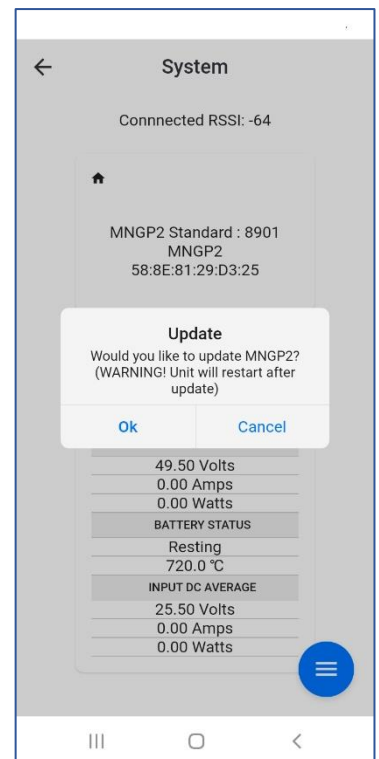

Figure 17

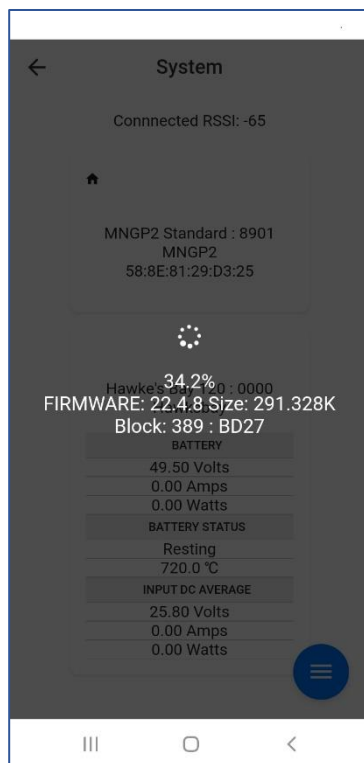

Figure 18

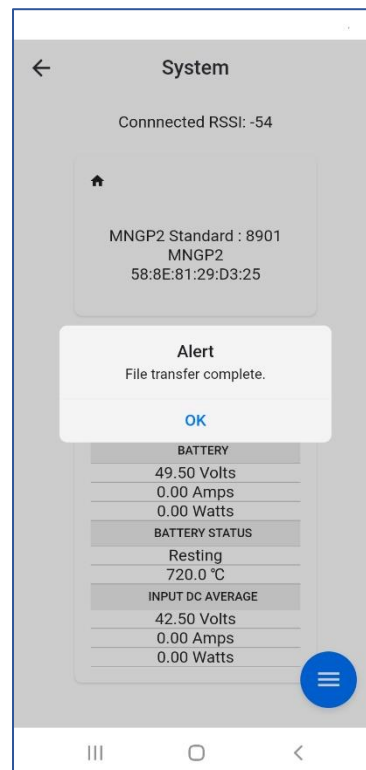
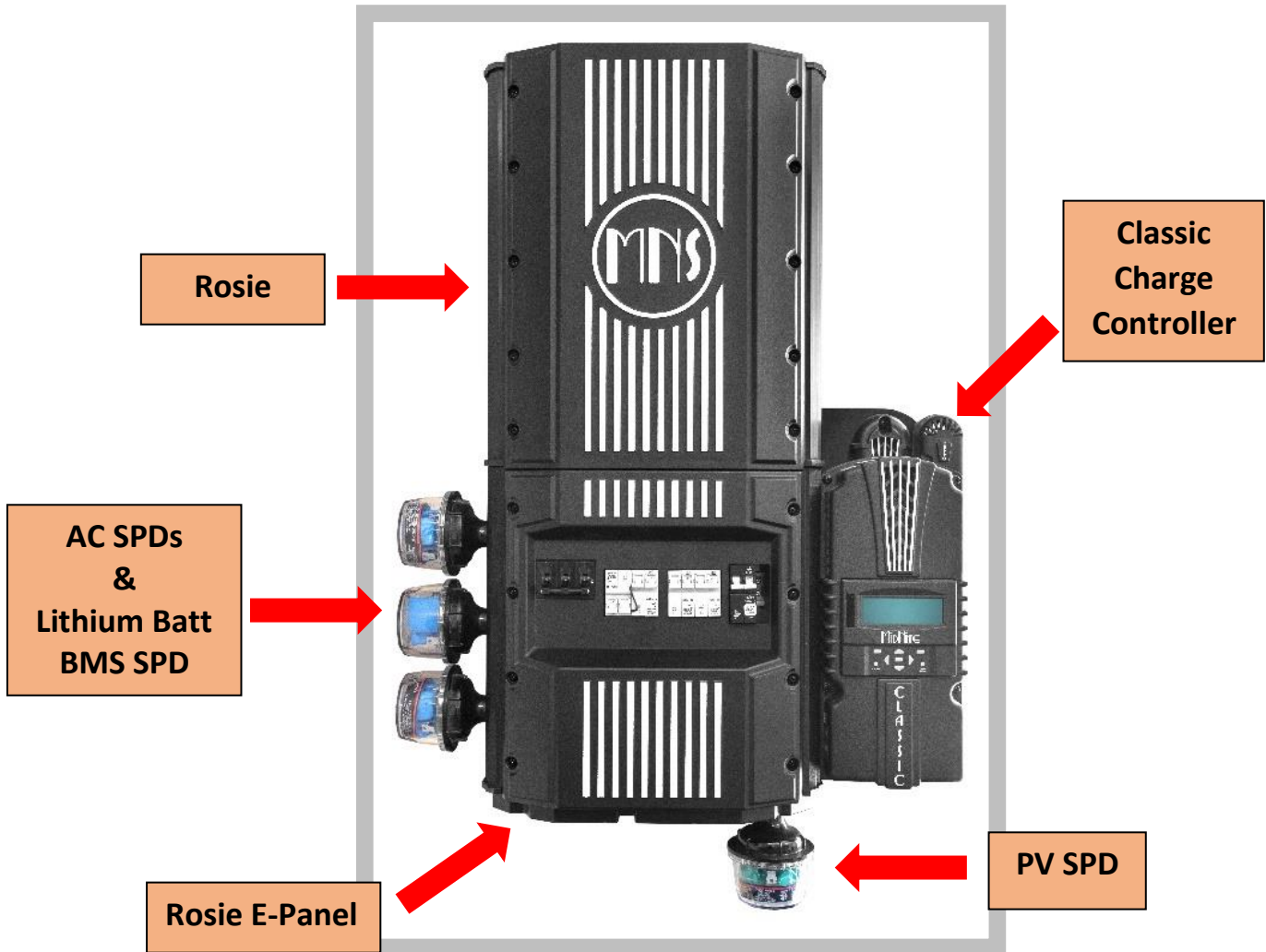
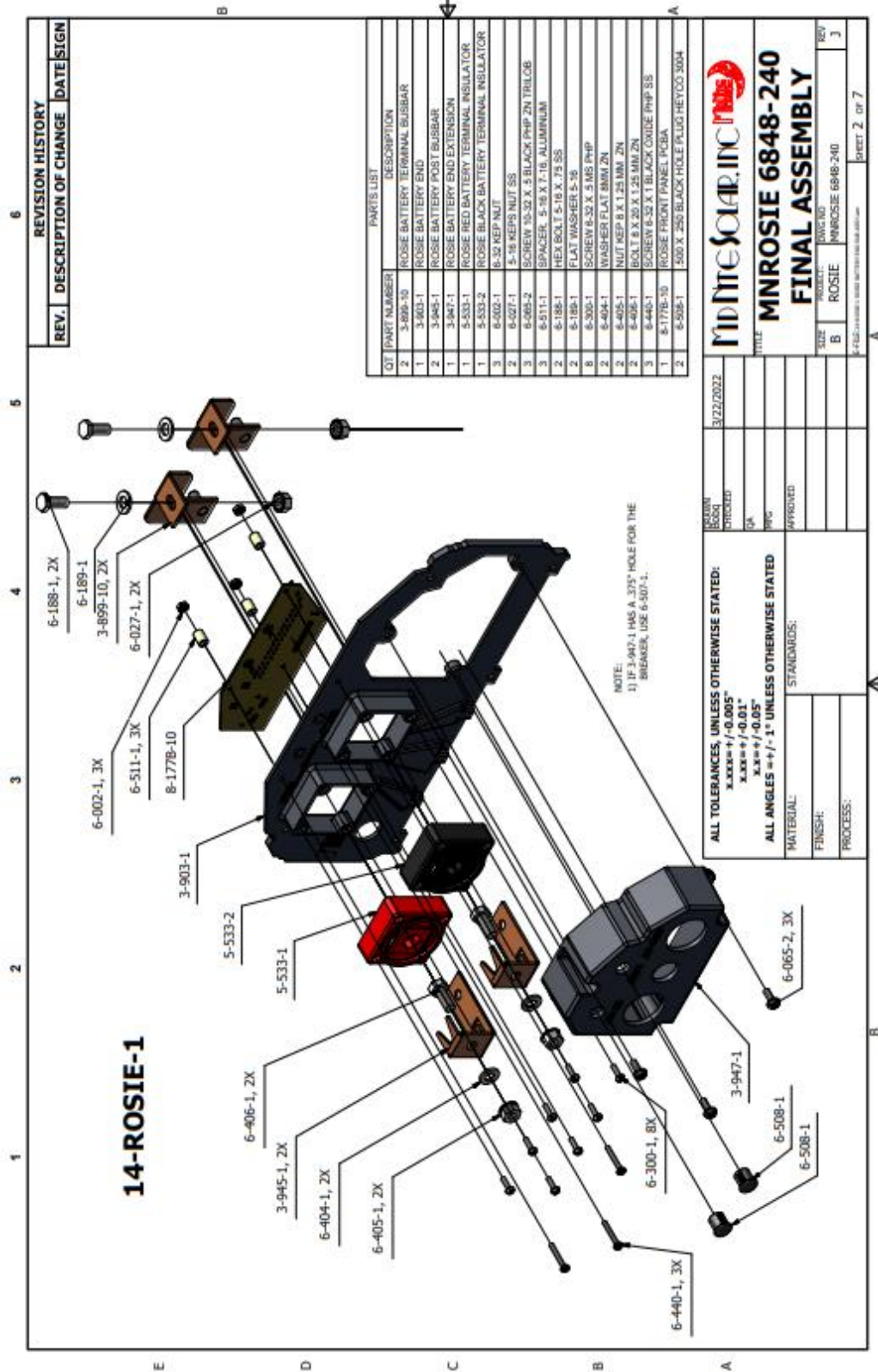

Figure 19

ROSIE PRE-WIRED SYSTEM



The Rosie Inverter/Charger may be combined with the optional Rosie E-panel, Classic charge controller, and (lightening) surge protection as an intergrated PV/AC system. The Rosie E-Panel offers AC OCP, AC bypass (grid/generator-direct-to-loads), DC OCP, and additional DIN rail mounts for auxillary AC or DC OCP.



REV.	DESCRIPTION OF CHANGE	DATE	SIGN

QTY	PART NUMBER	DESCRIPTION
2	3-899-10	ROSIE BATTERY TERMINAL BUSBAR
1	3-803-1	ROSIE BATTERY END
2	3-945-1	ROSIE BATTERY POST BUSBAR
1	3-947-1	ROSIE BATTERY END EXTENSION
1	5-533-1	ROSIE RED BATTERY TERMINAL INSULATOR
1	5-533-2	ROSIE BLACK BATTERY TERMINAL INSULATOR
3	6-002-1	8-32 KEEP NUT
2	6-027-1	5-16 KEEP NUT SS
3	6-406-2	SCREW 10-32 X .5 BLACK PMP ZN TRILLOB
3	6-511-1	SPACER 5.78 X 7.16 ALUMINUM
2	6-188-1	HEX BOLT 5-16 X .75 SS
2	6-189-1	FLAT WASHER 5-16
8	6-300-1	SCREW 6-32 X .5 MS PMP
2	6-404-1	WASHER FLAT 8MM ZN
2	6-405-1	NUT KEEP 8 X 1.25 MM ZN
2	6-406-1	BOLT 8 X 20 X 1.25 MM ZN
3	6-440-1	SCREW 6-32 X 1 BLACK OXIDE PMP SS
1	8-1778-10	ROSIE FRONT PANEL PCB/A
2	6-508-1	500 X 250 BLACK HOLE PLUS HEYCO 3004

MIDNITESOLAR.INC

TITLE: MNROSIE 6848-240
FINAL ASSEMBLY

DATE: 3/22/2022

DESIGN: []
CHECKED: []
QA: []
PMP: []
APPROVED: []

STANDARDS: []

MATERIAL: []
FINISH: []
PROCESS: []

ALL TOLERANCES, UNLESS OTHERWISE STATED:
 XXXX[±] ±0.005"
 XXXX[±] ±0.01"
 XXXX[±] ±0.05"
 ALL ANGLES [±] ±1° UNLESS OTHERWISE STATED

SIZE: B
PROJECT: MNROSIE 6848-240
REV: J

3-FILE: []
SHEET 2 of 7

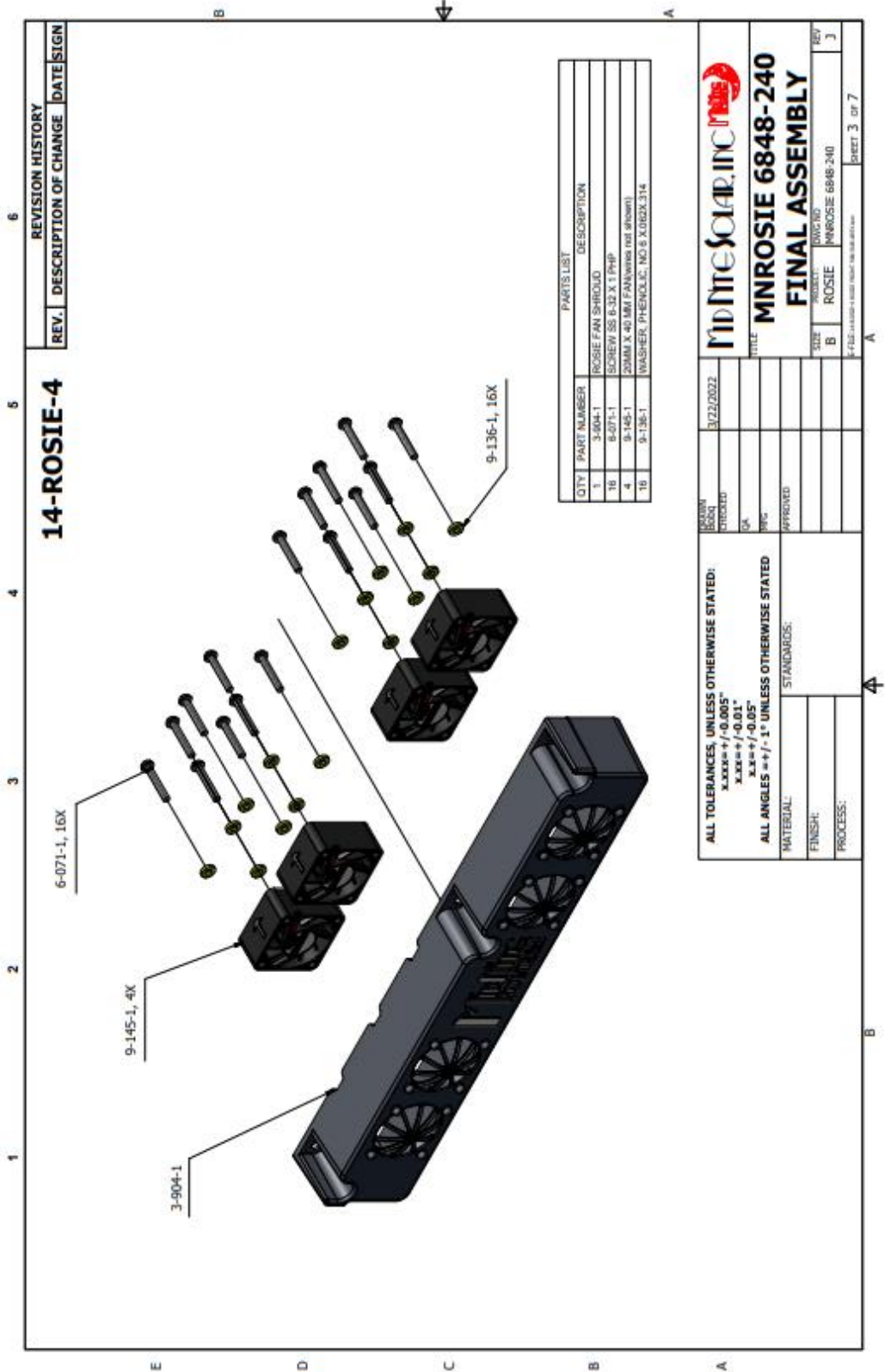

REVISION HISTORY		
REV.	DESCRIPTION OF CHANGE	DATE/SIGN

14-ROSIE-4

PARTS LIST	
QTY	PART NUMBER DESCRIPTION
1	3-904-1 ROSIE FAN SHROUD
16	6-071-1 SCREW SS 6-32 X 1 PHF
4	9-145-1 20MM X 40 MM FAN/WHEEL (not shown)
16	9-136-1 WASHER, PHENOLIC, NO 6 X 0.02X.314

TITLE MNROSIE 6848-240 FINAL ASSEMBLY	
DATE 3/22/2022	REV J
DESIGNER J. [unreadable]	APPROVED [signature]
ALL TOLERANCES, UNLESS OTHERWISE STATED: X.XXX = +/- 0.005" X.XX = +/- 0.01" X.X = +/- 0.05" ALL ANGLES = +/- 1° UNLESS OTHERWISE STATED	STANDARDS: [blank]
MATERIAL: [blank]	FINISH: [blank]
PROCESS: [blank]	FILE: MNROSIE 6848-240
SHEET 3 OF 7	

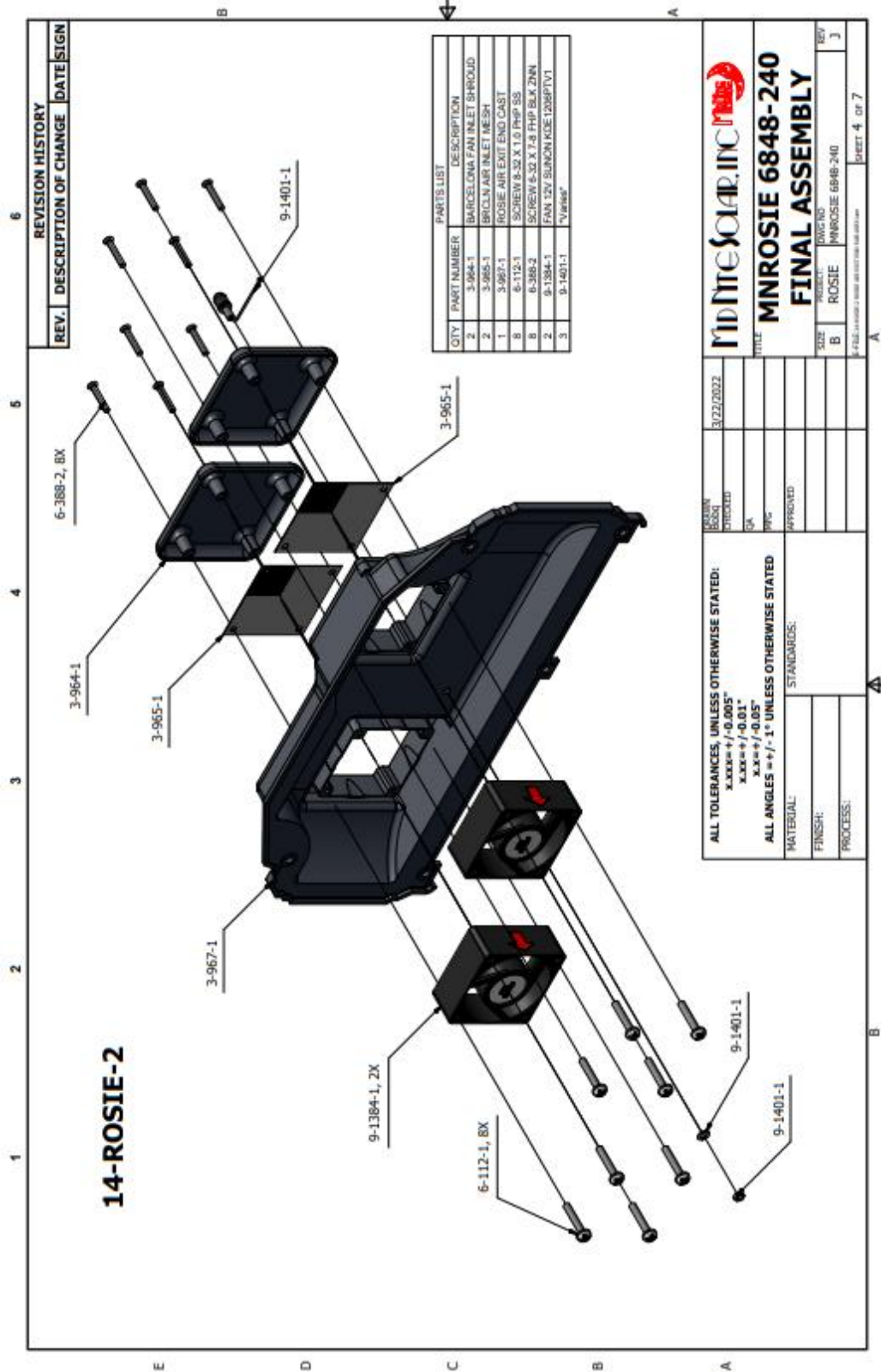

REV.	DESCRIPTION OF CHANGE	DATE/SIGN

MIDNITESOLAR, INC.

3/22/2022

DESIGN: 3/22/2022
 CHECKED: []
 QA: []
 PPC: []
 APPROVED: []

TITLE: MNROSIE 6848-240
FINAL ASSEMBLY

SIZE: B
 PRODUCT: ROSIE
 DWG NO: MNROSIE 6848-240
 REV: 3

ALL TOLERANCES, UNLESS OTHERWISE STATED:
 X.XXX = +/- 0.005"
 X.XX = +/- 0.01"
 X.X = +/- 0.05"
 ALL ANGLES = +/- 1° UNLESS OTHERWISE STATED

MATERIAL: []
 FINISH: []
 PROCESS: []

STANDARDS: []

DATE: 3/22/2022

REV: 3

SHEET 4 OF 7



MNROSIE7048 MANUAL

UL1741 TABLE 65.1

Unit Ratings (Per UL1741, Table 65.1)	
Rating Type	Standalone (SA)
Max input voltage (DC)	68V
Range of input operating voltage (DC)	40 to 65VDC
Max input current (AC or DC)	210ADC
Max input short circuit current	210ADC
Output power factor rating	7000W w/PF=0.95
Operating voltage range (AC)	82 to 140VAC
Operating frequency range or single frequency	48 to 72Hz
Nominal output voltage (AC)	120/240V _{RMS}
Nominal output frequency	60Hz
Max continuous output current (AC)	29A _{RMS}
Max continuous output power (AC)	7000VA
Max output fault current / duration (AC)	160AAC (≤180msecs)
Max output overcurrent protection (amps)	300ADC
Nominal output voltage (DC)	48VDC
Charging output voltage (DC)	40 to 65VDC
Normal operating temperature range	-20 to 60°C
Output power temp derate/max power ambient	75% derated @ 60°C ambient (75°C Internal)
Conductor AWG range	20 to #4/0 AWG (minimum)

All ratings based on 25°C ambient, unless otherwise noted.



MNROSIE7048 MANUAL

TECHNICAL SPECIFICATIONS - DECAL SET

MNROSIE7048M

MNROSIE7048RE

OPERATING RANGE -20°C TO +60°C
Inverter Operation
 Continuous Output Power (25°C): 7000 W or VA
 DC Input Range: 40V to 65V (48 V nom.)
 Maximum DC Input: 68V
 Maximum DC Input Current: 210ADC
 Use #10 or larger Battery cables
 AC Output Voltage / Frequency: Default as shipped
 120/240 V (-5%) / 60 Hz (-0.1 Hz)
 User Selectable 230 V (-5%) / 50 Hz (-0.1 Hz)
 Maximum AC Continuous Output Current: 20 A @ 240 VAC
 Surge Power: 15 kVA (5 seconds)
 Maximum output fault current: 160 AAC for 180ms
 AC Voltage Distortion at Rated Power: <5% THD
 Power Factor: >0.95

Charger Operation
 DC Continuous Charger Current (25°C): 120 ADC
 Input AC Voltage Range: 82 to 140 VAC per leg
 Input Frequency Range: 48 to 72 Hz
 Maximum AC Input Current: 60 AAC per leg
 Maximum AC Input Short Circuit Current: 60 AAC
 AC Input Use 6 AWG Wire with 60 Amp Breaker - See Manual
 DC Output Range (25°C): 40 to 65 VDC
 Maximum DC Output Current: 120 ADC
 Use #10 or larger Battery cable

WARNING: - This unit employs components that tend to produce arcs or sparks. - To prevent fire or explosion, do not install in compartments containing batteries or flammable materials

CAUTION: - To prevent fire, do not cover or obstruct ventilation openings
 Provide with integral protection against overloads
 Do not mount in zero clearance compartment
 Overheating may result
 To Reduce the Risk of Fire, Use only battery packs that include the battery management system and all necessary protection for the battery pack integral to the pack.
 Overcurrent protection required as part of the installation.
 Approved breakers are:
 AC Breakers MidNite Solar MNEAC series breakers
 DC Breaker MidNite Solar MNEDC100 series breakers
 The breakers protect the wiring
 Select Breaker size to match wire ampacity.
 To reduce risk of electric shock do not expose to rain or spray.
 Ne pas exposer aux intempéries

Conforms to: UL 1741, 3rd Edition - UL Standard for Safety Inverters, Converters, Controllers and Interconnection System Equipment for Use with Distributed Energy Resources

19115 62nd Ave NE
 Arlington, Wa
 98223 USA

MANUFACTURE DATE

Q1	Q2	Q3	Q4
23	24	25	26
27	28	29	30

www.midnitesolar.com

Torque Terminal Block to:
2.5 Nm 22.13 In.-lbs Min
4.5 Nm 39.83 Max

ATTENTION: - Avant procéder à l'installation, ne pas retirer le couvercle, à moins d'être sûr qu'il n'y a pas de danger de choc électrique. - Avant de commencer l'installation, ne pas retirer le couvercle, à moins d'être sûr qu'il n'y a pas de danger de choc électrique. - Avant de commencer l'installation, ne pas retirer le couvercle, à moins d'être sûr qu'il n'y a pas de danger de choc électrique.

AVERTISSEMENT: - Avant de commencer l'installation, ne pas retirer le couvercle, à moins d'être sûr qu'il n'y a pas de danger de choc électrique. - Avant de commencer l'installation, ne pas retirer le couvercle, à moins d'être sûr qu'il n'y a pas de danger de choc électrique. - Avant de commencer l'installation, ne pas retirer le couvercle, à moins d'être sûr qu'il n'y a pas de danger de choc électrique.

CAUTION: - Risk of electric shock - more than one disconnect switch may be required to de-energize the equipment before servicing.

CAUTION: BONDING BETWEEN CONDUIT CONNECTION IS NOT AUTOMATIC AND MUST BE PROVIDED AS PART OF THE INSTALLATION.
 USE ONLY WITH COPPER CONDUCTORS RATED 90°C MIN.

ATTENTION: L'INTERCONNEXION DES CONDUITS NE SUFFIT PAS POUR ASSURER LA MISE À LA MASSE; ELLE DOIT FAIRE PARTIE INTÉGRANTE DE L'INSTALLATION.
 UTILISER UNIQUEMENT AVEC CONDUCTEURS DE CUIVRE NOMINALE MINIMALE DE 90° C.

AVERTISSEMENT: CET ÉQUIPEMENT REQUIÈRE PLUSIEURS CIRCUITS SOUS TENSION, VOIR LE SCHEMA.

CAUTION: Wait at least 5 minutes after removing power before removing cover



MNROSIE7048 MANUAL

MIDNITE SOLAR INC. LIMITED WARRANTY

MidNite Solar Power electronics, sheet metal enclosures and accessories

MidNite Solar Inc. warrants to the original customer that its products shall be free from defects in materials and workmanship. This warranty will be valid for a period of five (5) years.

MidNite Solar will not warranty third party inverter components used in MidNite's pre-wired systems. Those components are warranted by the original manufacturer.

At its option, MidNite Solar will repair or replace at no charge any MidNite product that proves to be defective within such warranty period. This warranty shall not apply if the MidNite Solar product has been damaged by unreasonable use, accident, negligence, service, or modification by anyone other than MidNite Solar, or by any other causes unrelated to materials and workmanship. The original consumer purchaser must retain original purchase receipt for proof of purchase as a condition precedent to warranty coverage. To receive in-warranty service, the defective product must be received no later than two (2) weeks after the end of the warranty period. The product must be accompanied by proof of purchase and Return Authorization (RA) number issued by MidNite Solar. For an RMA number contact MidNite Solar Inc., (360) 403-7207. Purchasers must prepay all delivery costs or shipping charges to return any defective MidNite Solar product under this warranty policy. Except for the warranty that the products are made in accordance with, the specifications therefore supplied or agreed to by customer:

MIDNITE SOLAR MAKES NO WARRANTY EXPRESSED OR IMPLIED, AND ANY IMPLIED WARRANTY OF MERCHANTABILITY OR FITNESS FOR A PARTICULAR PURPOSE WHICH EXCEEDS THE FOREGOING WARRANTY IS HEREBY DISCLAIMED BY MIDNITE SOLAR AND EXCLUDED FROM ANY AGREEMENT MADE BY ACCEPTANCE OF ANY ORDER PURSUANT TO THIS QUOTATION. MIDNITE SOLAR WILL NOT BE LIABLE FOR ANY CONSEQUENTIAL DAMAGES, LOSS OR EXPENSE ARISING IN CONNECTION WITH THE USE OF OR THE INABILITY TO USE ITS GOODS FOR ANY PURPOSE WHATSOEVER. MIDNITE SOLAR'S MAXIMUM LIABILITY SHALL NOT IN ANY CASE EXCEED THE CONTRACT PRICE FOR THE GOODS CLAIMED TO BE DEFECTIVE OR UNSUITABLE.

Products will be considered accepted by customer unless written notice to the contrary is given to MidNite Solar within ten (10) days of such delivery to customer. MIDNITE SOLAR is not responsible for loss or damage to products owned by customer and located on MIDNITE SOLAR'S premises caused by fire or other casualties beyond MIDNITE SOLAR'S control. This warranty is in lieu of all other warranties expressed or implied.

MIDNITE SOLAR INC.

NOTICE OF COPYRIGHT

MidNite Solar's Rosie Inverter/Charger MNROSIE7048RE – MNROSIE7048M User's Manual.
Copyright © 2023 All rights reserved.

MidNite Solar, Inc. reserves the right to revise this document and to periodically make changes to the content hereof without obligation or organization of such revisions or changes unless required to do so by prior arrangement.



MNROSIE7048 MANUAL

DISCLAIMER

Unless specifically agreed to in writing, MidNite Solar Inc.: (a) Makes no warranty as to the accuracy, sufficiency, or suitability of any technical or other information provided in its manuals or other documentation; (b) Assumes no responsibility or liability for loss or damage whether direct, indirect, consequential, or incidental, which might arise out of use of such information. The use of any such information will be entirely at the user's risk.

CONTACT

360.403.7207

customerservice@midnitesolar.com

www.midnitesolar.com

