

PROFESIONAL 2026
UTILLAJE
Catálogo



Duproflex

ÍNDICE

04	Utillaje
80	Moldes de silicona
97	Moldes de chocolate
111	Maquinaria
138	Expositores
146	Envases
160	Almacenaje
165	Útiles de tienda

UTILLAJE

Pastery tools



Mango de plástico reforzado con fibra de vidrio, con **16 varillas** finas de acero inoxidable. Resistente a altas temperaturas. Especial para masas densas.

Fiberglass reinforced plastic handle, with 16 thin stainless steel rods. High temperature resistant. / Special for soft doughs.

Cod.	mm	Material	Pack	Filo
AO1529	250	Inox. - Sst.	1	1,5mm
AO1530	300	Inox. - Sst.	1	1,8mm
AO1531	350	Inox. - Sst.	1	1,8mm
AO0932	400	Inox. - Sst.	1	1,8mm
AO0933	450	Inox. - Sst.	1	2 mm
AO0959	500	Inox - Sst	1	2 mm

Mango de plástico reforzado con fibra de vidrio, con **16 varillas** finas de acero inoxidable. Resistente a altas temperaturas. Con asa para colgar de forma higiénica.

Fiberglass reinforced plastic handle, with 16 thin stainless steel rods. High temperature resistant. / Special for soft doughs. With a handle for hygienic hanging.

Cod.	mm	Material	Pack	Filo
AO0586	250	Inox. - Sst.	1	1,5mm
AO0587	300	Inox. - Sst.	1	1,8mm
AO0584	350	Inox. - Sst.	1	1,8mm
AO0578	400	Inox. - Sst.	1	1,8mm
AO0585	450	Inox. - Sst.	1	2 mm
AO0588	500	Inox - Sst	1	2 mm

Mango inoxidable, con varillas de **2,3 mm.** de acero inoxidable. Resistente a altas temperaturas. Especial para masas densas.

Stainless handle, with 2.3 mm rods. Stainless steel. High temperature resistant. Special for dense masses.

Cod.	mm	Material	Pack	Filo
WW30	300	Inox. - Sst.	1	2,3 mm
WW35	350	Inox. - Sst.	1	2,3 mm
WW40	400	Inox. - Sst.	1	2,3 mm
WW45	450	Inox. - Sst.	1	2,3 mm
WW50	500	Inox. - Sst.	1	2,3 mm



Mango de plástico con **6 varillas** finas de acero inoxidable. Resistente a altas temperaturas. Especial para masas densas.

Plastic handle with 6 thin stainless steel rods. High temperature resistant. Special for dense masses.

Cod.	mm	Material	Pack	Filo
AO1529N	250	Inox. - Sst.	1	1,4 mm.
AO1530N	300	Inox. - Sst.	1	1,4mm
AO1531N	350	Inox. - Sst.	1	1,4mm
AO0932N	400	Inox. - Sst.	1	1,4mm
AO0933N	450	Inox. - Sst.	1	1,4mm

Mango de plástico reforzado con fibra de vidrio, con varillas finas de acero inoxidable de **2 mm.** Resistente a altas temperaturas. Especial para masas suaves.

Fiberglass reinforced plastic handle, with thin 2 mm stainless steel rods. High temperature resistant. Special for soft doughs.

Cod.	mm	Material	Pack	Filo
AO0555	450	Inox. - Sst.	1	2 mm

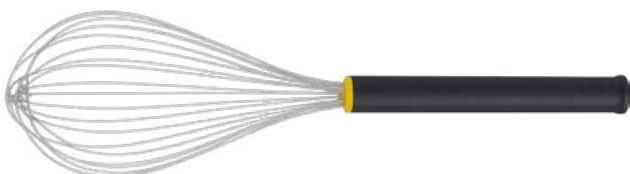



Medidas: Ancho de la brocha. - Measures: Brush width.
Medidas cerdas: 60 mm. - Sows measures: 60 mm.

Cerdas 100% naturales, para una mejor absorción.
100% natural bristles, for better absorption.

Cod.	mm	Material	Pack
AO0590N	40	P.V.C.	12
AO0579N	60	P.V.C.	12
AO0589N	70	P.V.C.	12
AO0591N	80	P.V.C.	12



Medidas: Ancho de la brocha. - Measures: Brush width.
Grosor de 15 mm. - Thick 15 mm.

Cerdas 100% Sintética con diseño anti-caída
100% Synthetic bristles, designed to not lose bristles.
Ideal para chocolate. - Ideal for chocolate.

Cod.	mm	Material	Pack
AO0367	30	P.V.C.	12
AO0579	60	P.V.C.	12
AO0529	50	P.V.C.	12



Cepillo multiuso con cerdas de alta calidad y mango de plástico combinado con goma para mayor comodidad.
Resistente hasta 120°C y apto para el lavavajillas.

Multi-purpose brush with high-quality bristles and a plastic handle combined with rubber for greater comfort. Heat resistant up to 120 °C and dishwasher safe.

Cod.	mm	Material	Pack
AO1077	168x53x30	P.V.C.	1
AO1078	170x53x40	P.V.C.	1
AO1079	173x60x50	P.V.C.	1
AO1080	175x65x60	P.V.C.	1
AO1081	178x65x70	P.V.C.	1



Ideal para restauración. - Ideal for catering.

Cod.	mm	Material	Pack
AO0764	210 x 33	Silicona-Silicone	6
AO0765	280 x 45	Silicona-Silicone	6
AO1605	90 x 210	Silicona-Silicone	6



Cerdas de nylon. Apto hasta 120°C.
Nylon bristles. Up to 120°C.

Cod.	mm	Material	Pack
AO0755	24 x 7,5	P.V.C	1



Cerdas de nylon. Apto hasta 120°C.
Nylon bristles. Up to 120°C.

Cod.	mm	Material	Pack
AO0752	24 x 7,5	P.V.C.	1



Cerdas naturales. Apto hasta 90°C.
Natural bristles. Up to 90°C.

Cod.	mm	Material	Pack
AO0753	40 x 400	Madera - Wood	1



Cerdas de nylon. Apto hasta 120°C.
Nylon bristles. Up to 120°C.

Cod.	mm	Material	Pack
AO0754	40 x 400	P.V.C.	1

Recogedor de migas.
Remainder of leftovers.

Cod.	mm	Material	Pack
AO0760	160 x 170	Inox./Sst.	1



FABRICACIÓN DE MANGAS

SLEEVE MANUFACTURING PROCESS

Fabricación de nuestras mangas desechables **DUPROFLEX**. Diseñadas en diferentes modelos para adaptarse al profesional más exigente, facilitando el laborioso trabajo del pastelero.

Manufacture of our disposable sleeves **DUPROFLEX**. Designed in different models to adapt to the most demanding professional. Facilitating the careful daily work of the baker.

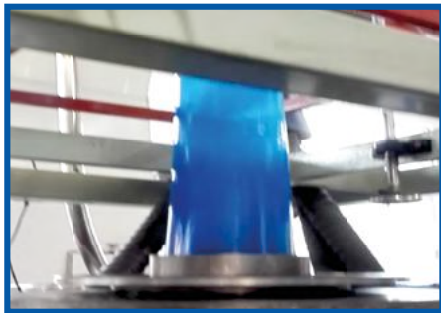

Soplado tubular

Tubular blowing

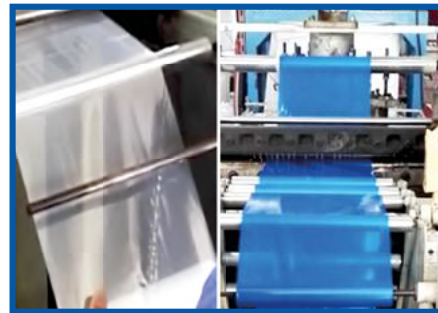

Bobinado

Winding



Corte individual

Individual cut

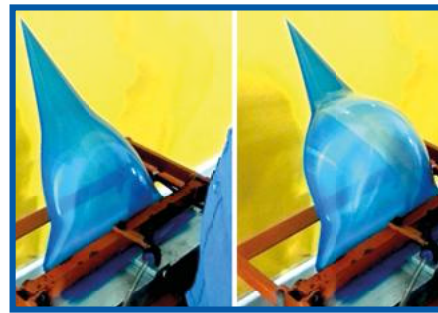

Test de resistencia

Resistance test



Empaquetado

Packaging



Envíos

Order preparation

Mangas fabricadas como material principal el nylon.
 Termosellada de alta resistencia.
 Transpirable e impermeable,
 con doble costura reforzada.
 Gancho para fácil almacenaje.

Sleeves made of nylon as the main material.
 Great heat-sealing resistance.
 Breathable and waterproof, with double reinforced seam.
 Easy storage hook.

Cod.	mm	Material	Pack
AO0531	300	Nylon	10
AO0532	350	Nylon	10
AO0533	400	Nylon	10
AO0534	450	Nylon	10
AO0535	500	Nylon	10
AO0536	550	Nylon	10
AO0537	600	Nylon	10
AO0538	650	Nylon	10
AO0539	700	Nylon	10
AO0777	760	Nylon	10

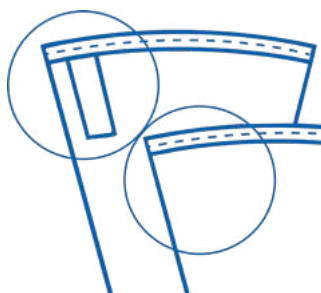

Borde Rim



Gancho Hook

Mangas fabricadas como material principal el poliéster y algodón.
 Termosellada de alta resistencia.
 Transpirable e impermeable, con costura invisible reforzada.
 Gancho para fácil almacenaje.

Sleeves made of polyester and cotton as the main material.
 Great heat-sealing resistance.
 Breathable and waterproof, with reinforced invisible seam.
 Easy storage hook.

Cod.	mm	Material	Pack
AO0533S	400	Poliéster y algodón Polyester and cotton	10
AO0535S	500	Poliéster y algodón Polyester and cotton	10
AO0537S	600	Poliéster y algodón Polyester and cotton	10
AO0539S	700	Poliéster y algodón Polyester and cotton	10





Manga pastelera- pastry bag.
Fácil adaptación al uso- Easily adaptable for the use.
Gancho de fácil almacenaje- Easy storage hook.

Cod.	mm	Material	Pack
AO7065	340	Silicona-Silicone	6
AO7066	450	Silicona-Silicone	6
AO7067	500	Silicona-Silicone	6



Manga pastelera doble - Double pastry bag.
Fácil adaptación al uso- Easily adaptable for the use.
Gancho de fácil almacenaje- Easy storage hook.

Cod.	mm	Material	Pack
AO7063	500	Silicona-Silicone	6



Manga pastelera triple- Triple pastry bag.
Fácil adaptación al uso- Easily adaptable for the use.
Gancho de fácil almacenaje- Easy storage hook.

Cod.	mm	Material	Pack
AO7064	500	Silicona-Silicone	6



50 Mangas pastelera doble- 50 Double pastry bags.
Fácil adaptación al uso- Easily adaptable for the use.

Cod.	mm	Material	Pack
AO7062	550	P.V.C. - 60 µm	1



Set adaptador manga doble con 6 boquillas.
 Double sleeve adapter set with 6 nozzles.

Cod.	mm	Material	Pack
TC4303	-	P.V.C.	6

Model Clear

100 Mangas opaca de forma triángular con tapa interna deslizante para una mejor expulsión del producto. Ideal para la decoración y todo tipo de cremas y masas.

100 Opaque triangular pastry bags with inner sliding layer for a better ejection of product. /Ideal for decoration and every kinds of creams and doughes.

Cod.	mm	Material	Pack
AO7050	400 x 250	P.V.C. - 75 µm	10
AO7051	550 x 290	P.V.C. - 75 µm	10
AO7052	650 x 340	P.V.C. - 75 µm	10

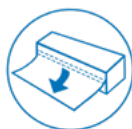

Caja dispensadora
Dispenser box



Model Crystal

100 Mangas transparente económica en forma triángular, fabricada en plástico con una flexibilidad óptima para obtener un rendimiento excelente. Ideal para todo tipos de cremas, masas, merengues y chocolates.

100 Economical transparent pastry bags in triangular shape, made of plastic with optimal flexibility for excellent performance. Ideal for all types of creams, doughs, meringues and chocolates.

Cod.	mm	Material	Pack
AO7059	400 x 250	P.V.C. - 60 µm	10
AO7060	550 x 290	P.V.C. - 65 µm	10
AO7061	650 x 340	P.V.C. - 65 µm	10
AO7068	300 x 210	P.V.C. - 60 µm	10



Caja dispensadora
Dispenser box



Model Blue

100 Mangas azules de diseño más alargado, facilitando la manipulación en grandes cargas de producto, posee una capa interna deslizante para una mejor expulsión del producto. Ideal para todo tipo de cremas, masas y merengues.

100 Blue pastry bags with extended design that makes the manipulation easier for big amounts of product. Ideal for every creams, doughes and meringues.

Cod.	mm	Material	Pack
AO7057	550 x 290 + 50	P.V.C. - 75 µm	10
AO7058	650 x 340 + 180	P.V.C. - 75 µm	10

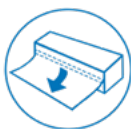

Caja dispensadora
Dispenser box

Modelo con corte en ángulo: diseño optimizado que proporciona mayor capacidad de carga y mejor aprovechamiento del volumen interno



Model Green

100 Modernas mangas envolventes en color verde, creando un ambiente más relajante. Forma triangular con una capa interna deslizante para una mejor expulsión del producto. Ideal para todo tipo de cremas y masas.

100 Modern wraparound green pastry bags, creating a relaxing atmosphere. Triangular shape with inner sliding layer for a better ejection of product. Ideal for every creams and doughes.

Cod.	mm	Material	Pack
AO7054	550 x 290	P.V.C. - 75 µm	10
AO7055	650 x 340	P.V.C. - 75 µm	10



Caja dispensadora
Dispenser box



Thermo^{model}



100 Modernas mangas envolventes en color rojo, capa externa antideslizante, capa interna deslizante para una mejor expulsión del producto.

Especial para productos calientes (85 micras) 🔥

100 modern red shrink sleeves, with a non-slip outer layer and a sliding inner layer for better product release. Specially designed for hot products (+ microns).

Cod.	mm	Material	Pack
AO7070	600 x 290	P.V.C. - 85 µm	10

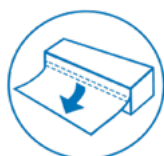

Caja dispensadora
Dispenser box

Boquillas para el uso de decoración en pastelería

Nozzles for use in pastry decoration, made of **stainless steel**.

Fabricadas en acero inoxidable



Cod.	mm	Pack	Cod.	mm	Pack
AO0001.02	2	6	AO0001.10	10	6
AO0001.03	3	6	AO0001.11	11	6
AO0001.04	4	6	AO0001.12	12	6
AO0001.05	5	6	AO0001.13	13	6
AO0001.06	6	6	AO0001.15	15	6
AO0001.07	7	6	AO0001.20	20	6
AO0001.08	8	6	AO0001.25	25	6
AO0001.09	9	6			

Cod.	mm	Pack	Cod.	mm	Pack
AO0002.02	2	6	AO0002.09	9	6
AO0002.03	3	6	AO0002.10	10	6
AO0002.04	4	6	AO0002.11	11	6
AO0002.05	5	6	AO0002.12	12	6
AO0002.06	6	6	AO0002.13	13	6
AO0002.07	7	6	AO0002.15	15	6
AO0002.08	8	6			

Cod.	mm	Pack
BP0	0.5	6
BP1	1	6
BP2	2	6
BP4	4	6
BP6	6	6
BP8	8	6
BP10	10	6
BP12	12	6
BP14	14	6
BP16	16	6
BP18	18	6

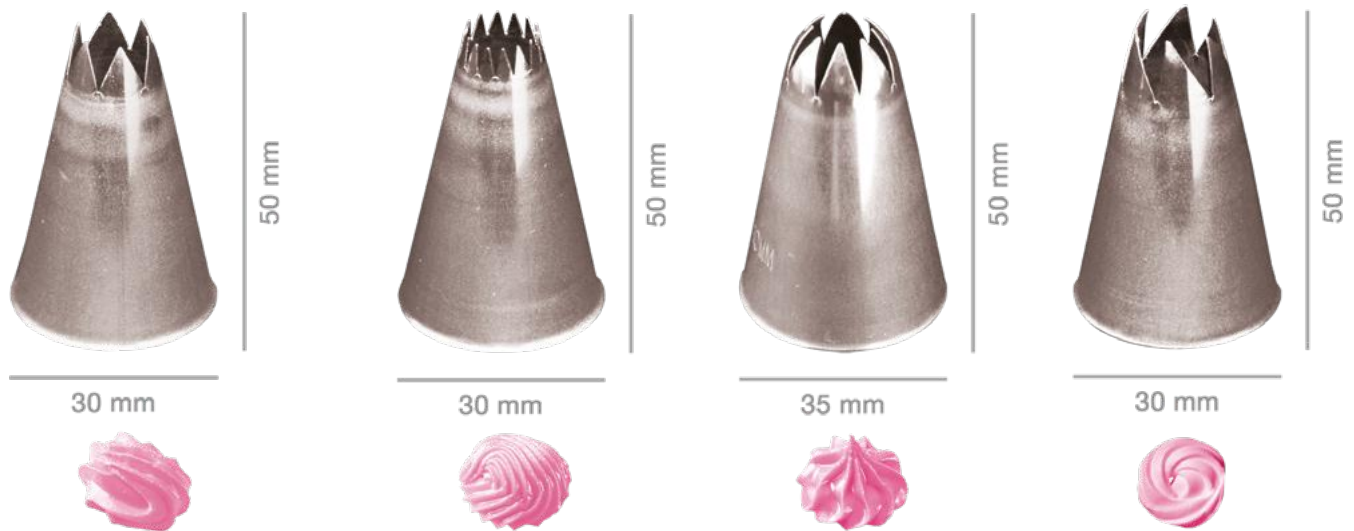

Cod.	mm	Pack
BS2	2	6
BS4	4	6
BS6	6	6
BS8	8	6
BS10	10	6
BS12	12	6
BS14	14	6
BS16	16	6
BS18	18	6

Cod.	mm	Pack
BF2	2	6
BF4	4	6
BF6	6	6
BF8	8	6
BF10	10	6
BF12	12	6
BF14	14	6
BF16	16	6
BF18	18	6

Cod.	mm	Pack
BC2	2	6
BC4	4	6
BC6	6	6
BC8	8	6
BC10	10	6
BC12	12	6

Cod.	mm	Pack
BXT11	11	6
BXT13	13	6
BXT15	15	6



Ideal para forrar tartas
Ideal for linings cakes

Cod.	mm	Pack
------	----	------

BX789	50 x 8	6
-------	--------	---

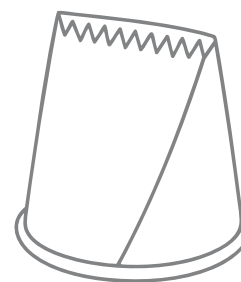

55 mm.

55 mm.



Ideal para sultanas
Ideal for sultanas

Cod.	mm	Pack
------	----	------

BX796	25 x 30,4	6
-------	-----------	---

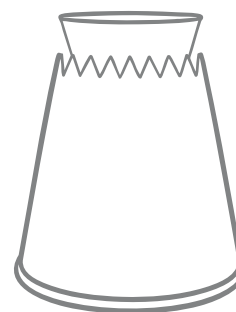

61 mm.

53 mm.



Ideal para rellenar / inyectar
Ideal for filling / inject

Cod.	mm	Pack
------	----	------

AO0519	4	6
AO0530	8	6

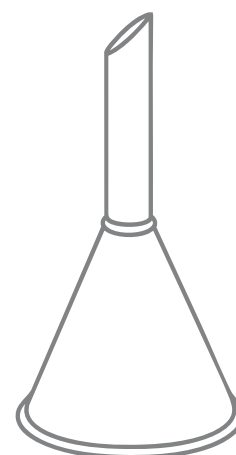

93 mm.

27 mm.

Envasadas en paquetes de 6 unidades.

Las boquillas están clasificadas según su forma y tamaño (Pequeña, mediana y grande).

Packaged in 6 units.

The nozzles are classified according to their side and shape (Small, Medium and Large). Pack. 6 uds.

Pack. 6 uds.

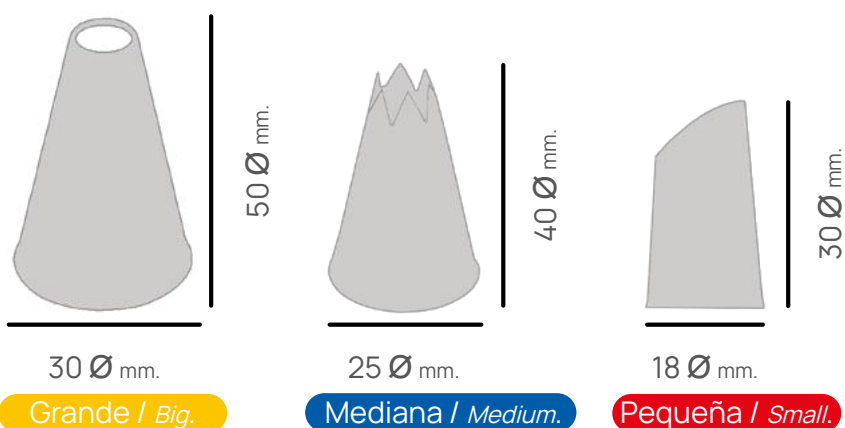

Boquillas para pétalos / Petals nozzles

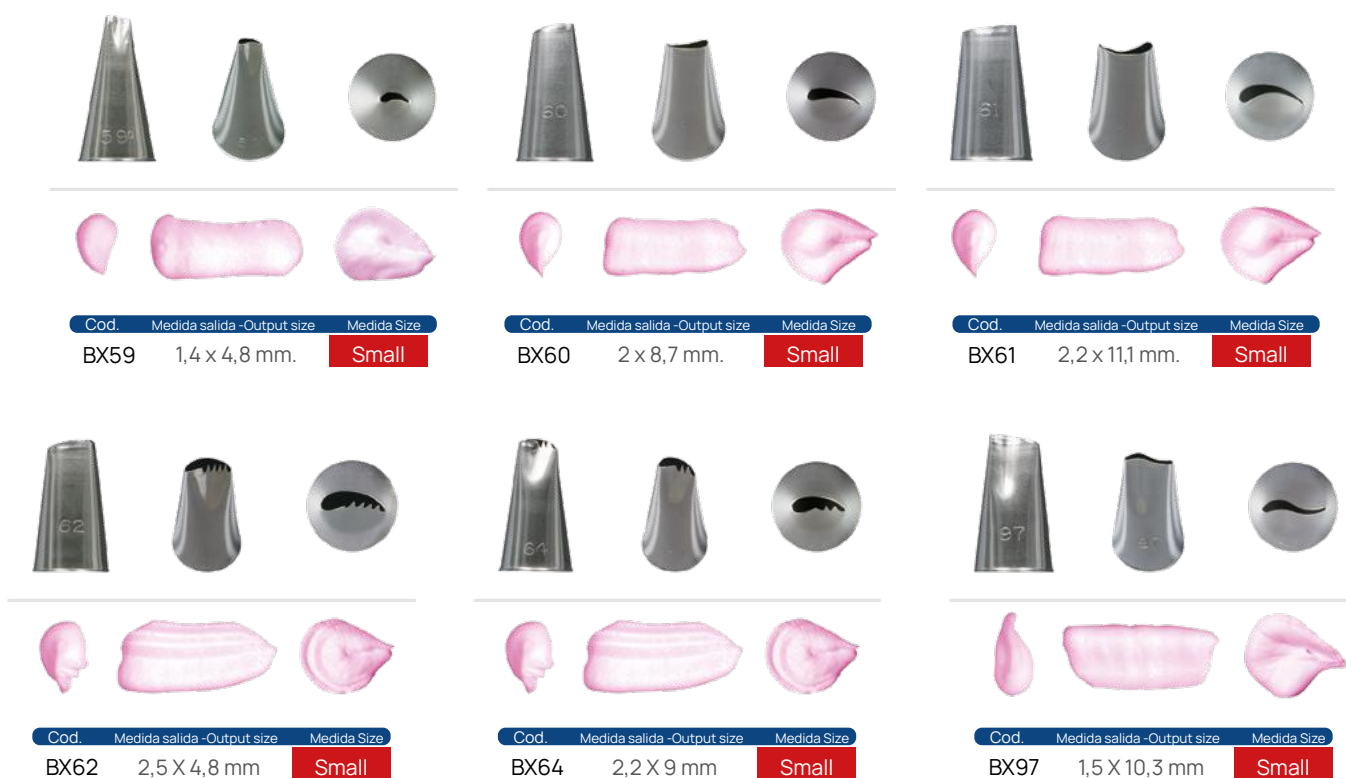



Cod.	Medida salida -Output size	Medida Size
BX101	1,5 X 7,4 mm	Small



Cod.	Medida salida -Output size	Medida Size
BX102	2 X 9,1 mm	Small



Cod.	Medida salida -Output size	Medida Size
BX103	2,5 X 10,3 mm	Small



Cod.	Medida salida -Output size	Medida Size
BX104	3 X 12,5 mm	Small



Cod.	Medida salida -Output size	Medida Size
BX150	1,5 X 11,8 mm	Small



Cod.	Medida salida -Output size	Medida Size
BX7520	1,5 X 11,8 mm	Big



Cod.	Medida salida -Output size	Medida Size
BX121	3 x 14 mm	Medium



Cod.	Medida salida -Output size	Medida Size
BX117	3,5 x 16 mm	Medium



Cod.	Medida salida -Output size	Medida Size
BX119	4,5 x 19 mm	Medium



Cod.	Medida salida -Output size	Medida Size
BX124	3 x 14,5 mm	Medium



Cod.	Medida salida -Output size	Medida Size
BX122	3,5 x 15,5 mm	Medium



Cod.	Medida salida -Output size	Medida Size
BX123	4 x 17 mm	Medium

Cod.	Medida salida -Output size	Medida Size
BX127	4,5 x 19 mm	Medium

Cod.	Medida salida -Output size	Medida Size
BX125	3,5 x 16 mm	Medium

Cod.	Medida salida -Output size	Medida Size
BX126	4 x 17,5 mm	Medium

Cod.	Medida salida -Output size	Medida Size
BX1217	4,5 x 19 mm	Medium

Cod.	Medida salida -Output size	Medida Size
BX1405	6,5 x 20,5mm	Medium

Cod.	Medida salida -Output size	Medida Size
BX128	5 x 23 mm	Big

Boquillas para hoja / Leaves nozzle

Cod.	Medida salida -Output size	Medida Size
BX65	0,6 x 5,3 mm	Small

Cod.	Medida salida -Output size	Medida Size
BX67	1 x 7,3 mm	Small

Cod.	Medida salida -Output size	Medida Size
BX68	1,3 x 9,3 mm	Small

Cod.	Medida salida -Output size	Medida Size
BX69	1,6 x 10,5 mm	Small

Cod.	Medida salida -Output size	Medida Size
BX70	1,9 x 12,1 mm	Small

Cod.	Medida salida -Output size	Medida Size
BX73	5,7 mm	Small

Cod. Medida salida -Output size Medida Size BX349 4,5 x 3,5 mm Small	Cod. Medida salida -Output size Medida Size BX352 5,5 x 6 mm Small	Cod. Medida salida -Output size Medida Size BX112 1,8 x 14,5 mm Medium

Cod. Medida salida -Output size Medida Size BX113 2,2 x 16 mm Medium	Cod. Medida salida -Output size Medida Size BX114 2,6 x 17,5 mm Medium	Cod. Medida salida -Output size Medida Size BX115 3 x 19 mm Medium

Boquillas corte en "V" / Cut "V" nozzles

Cod. Medida salida -Output size Medida Size BX480 8 x 16 mm. Medium	Cod. Medida salida -Output size Medida Size BX580 9 x 17 mm. Medium
Cod. Medida salida -Output size Medida Size BX682 12 x 25 mm. Medium	Cod. Medida salida -Output size Medida Size BX684 15 x 35 mm. Big

Boquillas multiapertura / Multi opening nozzles



Cod. Medida salida -Output size Medida Size
 BX42 7 mm. Small



Cod. Medida salida -Output size Medida Size
 BX89 7,6 mm. Small



Cod. Medida salida -Output size Medida Size
 BX134 7,6 mm. Small



Cod. Medida salida -Output size Medida Size
 BX234 2,5 mm. Medium



Cod. Medida salida -Output size Medida Size
 BX2010 4 mm. Medium

Boquillas "Volante" / Ruffle nozzles



Cod. Medida salida -Output size Medida Size
 BX40 1,8 mm. Small



Cod. Medida salida -Output size Medida Size
 BX86 1,7 x 10,1 mm. Small



Cod. Medida salida -Output size Medida Size
 BX87 1,7 x 10,1 mm. Small



Cod. Medida salida -Output size Medida Size
 BX88 2,6 x 10,1 mm. Small



Cod. Medida salida -Output size Medida Size
 BX90 18 mm. Small



Cod. Medida salida -Output size Medida Size
 BX100 18 mm. Small



Cod. Medida salida -Output size Medida Size
 BX401 1,2 x 10,6 mm. Small



Cod. Medida salida -Output size Medida Size
 BX402 2 x 15,8 mm. Medium

Boquillas especiales / Special nozzles



Cod. Medida salida -Output size Medida Size
 BX77 0,9 mm. Small



Cod. Medida salida -Output size Medida Size
 BX78 2,4 mm. Small



Cod. Medida salida -Output size Medida Size
 BX79 1,2 x 8 mm. Small



Cod. Medida salida -Output size Medida Size
 BX80 1,2 x 7 mm. Small



Cod. Medida salida -Output size Medida Size
 BX81 0,8 x 5,8 mm. Small



Cod. Medida salida -Output size Medida Size
 BX83 5 mm. Small



Cod. Medida salida -Output size Medida Size
 BX96 5 mm. Small



Cod. Medida salida -Output size Medida Size
 BX105 7,8 mm. Small



Cod. Medida salida -Output size Medida Size
 BX106 8,3 mm. Small



Cod. Medida salida -Output size Medida Size
 BX107 8,4 mm. Small



Cod. Medida salida -Output size Medida Size
 BX129 8,2 mm. Small



Cod. Medida salida -Output size Medida Size
 BX225 6,2 mm. Small



Cod. Medida salida -Output size Medida Size
 BX109 12,2 mm. Medium



Cod. Medida salida -Output size Medida Size
 BX190 12,4 mm. Medium



Cod. Medida salida -Output size Medida Size
 BX509 5 x 19 mm. Big

Boquillas para bordes / Nozzles for edges



Cod.	Medida salida -Output size	Medida Size
BX44	1 x 7,2 mm.	Small



Cod.	Medida salida -Output size	Medida Size
BX45	1,4 x 10,7 mm.	Small



Cod.	Medida salida -Output size	Medida Size
BX46	1 x 7,8 mm.	Small



Cod.	Medida salida -Output size	Medida Size
BX47	1,2 x 9,3 mm.	Small



Cod.	Medida salida -Output size	Medida Size
BX48	1,4 x 11,5 mm.	Small



Cod.	Medida salida -Output size	Medida Size
BX892	1 x 20,5 mm.	Small



Cod.	Medida salida -Output size	Medida Size
BX897	3 x 21,5 mm.	Medium



Cod.	Medida salida -Output size	Medida Size
BX898	3,5 x 26,5 mm.	Big

Boquillas Rusas / Russian nozzles



Cod.	mm	Material	Pack
AO1351	35 x 42	Inox. - Sst.	Kit 6 uds.



Kit boquillas de 26 piezas.
Nozzles kit of 26 pzs.

Cod.	mm	Material
AO1380	15 x 35	Inox. - Sst.



Cod.	mm	Material
52	30 x 60	Inox. - Sst.

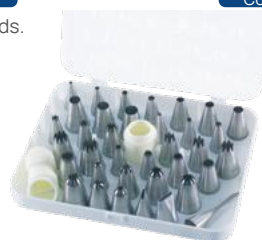

Kit boquillas de 36 piezas.
Nozzles kit of 36 pzs.

Cod.	mm	Material
AO1381	30 x 50	Inox. - Sst.

Kit boquillas de 52 piezas.
Nozzles kit of 52 pzs.

Cod.	mm	Material
AO1382	15 x 35	Inox. - Sst.

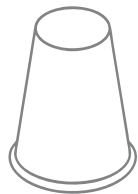

35 mm.

60 mm.

Cod.	mm	Pack
AO0005.5	5	6
AO0005.7	7	6
AO0005.9	9	6
AO0005.11	11	6
AO0005.13	13	6
AO0005.15	15	6
AO0005.17	17	6
AO0005.19	19	6
AO0005.23	23	6

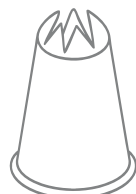

35 mm.

60 mm.

Cod.	mm	Pack
AO0006.3	3	6
AO0006.5	5	6
AO0006.7	7	6
AO0006.9	9	6
AO0006.11	11	6
AO0006.13	13	6
AO0006.15	15	6
AO0006.17	17	6



Tapón silicona para todo tipo de boquillas. Silicone lid for every kinds of nozzles.

Cod.	mm	Pack
AO1300	34 x 39	6



Adaptador de boquillas pequeñas. Adapter for small nozzles.

Cod.	Material	Pack
TC4301	P.V.C.	6



Adaptador de boquillas medianas y grandes. Adapter for medium and big nozzles.

Cod.	Material	Pack
TC4302	P.V.C.	6



Set limpia boquillas 6 piezas.

Cod.	mm	Pack
AO64410	25 x 130	6



Cod.	Material	Pack
AO0541	P.V.C.	2



Cod.	Material	Pack
TC9085	P.V.C.	2



Cod.	Material	Pack
AO0542	P.V.C.	1



Cod.	Material	Pack
AO0543	P.V.C.	1
AO0544	Inox. - Sst.	1



Termómetro digital con batería recargable por USB.
Posibilidad de guardar un registro de temperaturas.
Digital thermometer with USB rechargeable battery.
Possibility of keeping a temperature log.

Cod.	Sonda - Lead	Medición - Measurement	Pack
AO1481	100 mm.	- 50°C / + 300°C	1



Termómetro digital con batería recargable.
Cable 1 metro
Digital thermometer with rechargeable battery.
1 Meter wire

Cod.	Sonda - Lead	Medición - Measurement	Pack
AO0524	150 mm.	- 50°C / + 300°C	1



Cod.	Sonda - Lead	Medición - Measurement	Pack
AO1480	150 mm.	- 50°C / + 330°C	1



Cable 1,2 metro - 1,2 Meter wire.

Cod.	Sonda - Lead	Medición - Measurement	Pack
AO1482	180 mm.	-0°C / + 250°C	1



Cod.	Sonda - Lead	Medición - Measurement	Pack
AO0525	210 mm.	- 50°C / + 300°C	1



Termómetro caramelo inoxidable.
Stainless caramel thermometer.

Cod.	Sonda - Lead	Medición - Measurement	Pack
AO0523	300 mm.	+ 80°C / + 200°C	1

Para el control del contenido de azúcar: 2 escalas graduadas de 0 a 50 % para sorbetes, helados y jugos de fruta concentrados al 50 %, así como para caramelos de fruta, mermeladas y jarabes concentrados. *Se entrega en un estuche rígido.*

For the control of sugar content: 2 graduations of 0th 50% for sorbet, ice cream, 50 % concentrated fruit juice for fruit drops, jams, concentrated syrups. *Comes in a hard case.*



NEW

Sorbetómetro.
Sorbetometer.

Cod.	Medida - Size	Bolsa - Bag	Caja - Box
AO69002	130 mm.	1 kg.	14 kg.



Termómetro caramelo con soporte.
Candy thermometer with support.

Cod.	Medida - Size	Medición - Measurement	Pack
AO1486	310 x 5,1 mm.	40°C / + 200°C	1



Soporte para termómetro caramelo.
Candy thermometer holder.

Cod.	Medición - Measurement	Material	Pack
AO0468	137 mm.	Inox. - Sst.	1



Soporte para termómetro caramelo.
Candy thermometer holder.

Cod.	Medición - Measurement	Material	Pack
AO3580	450 mm.	Inox. - Sst.	1



Probeta para densímetro
Test tube for densimeter

Cod.	Medida - Size	Medición - Measurement	Material
AO0520	Ø30 x 250 mm.	100 ml.	P.V.C.



Densímetro pesa jarabes. Grados Baumé.
Densimeter weighs syrups. Baumé degrees.

Cod.	Medición - Measurement	Pack
AO0488	1100/1400 g/l.	100 ml.



Termómetro digital cámaras frigoríficas.
Digital thermometer for cold stores.

Cod.	Medida - Size	Medición - Measurement	Pack
AO1484	67 x 25 x 43 mm.	-20°C / +60°C	1



Termómetro analógico cámaras frigoríficas.
Analogic thermometer for cold stores.

Cod.	Medición - Measurement	Material
AO0577	-40°C / +80°C	P.V.C.



Termómetro láser - 1 punto.
Laser thermometer - 1 point.

Cod.	Medición - Measurement	Pack
AO1487	- 50°C / + 380°C	1



Termómetro analógico cámaras frigoríficas.
Analogic thermometer for cold stores.

Cod.	Medición - Measurement	Pack
AO62450	- 20°C / + 80°C	1



Termómetro para cámara congelación, sonda 1m.
Thermometer for freezing chamber, probe 1 m.

Cod.	Medida - Size	Medición - Measurement	Pack
AO1483	47 x 29 x 15 mm.	- 50°C / + 110°C	1



Termómetro para horno - Oven thermo-

Cod.	Medición - Measurement	Material
AO0489	- 50°C / + 300°C	Inox. - Sst.



Avisador Acústico.
Acoustic Warning

Cod.	mm	Pack
AO60805	105 x 70	1

Características:
- Función hora
- Alarma sonora programable
- Dispone de memoria

Characteristics:
- Time function
- Programmable audible alarm
- It has memory



Termómetro para aceite - Oil thermometer.

Cod.	Medida - Size	Medición - Measurement	Pack
AO1485	300 mm.	0°C / 300°C	1



Termómetro de leche para cafeterías.
Milk thermometer for coffee shop.

Cod.	Medición - Measurement
AO0950	- 10°C / + 110°C



Termómetro de aceite para freidoras.
Oil thermometer for fryers.

Cod.	Medición - Measurement	Pack
AO0985	0°C / + 300°C	1

**Balanza profesional división 1 gr.**

Professional scale division 1 gr.

Cod.	Material	Capacidad
AO0938	Inox.-Sst	30Kg

CARACTERÍSTICAS / FEATURES

- Plato en acero inoxidable. / Stainless steel plate
- Dimensiones del plato: 290 x 230 mm.
Plate dimensions: 290 x 230 mm.
- Protección IP44. / IP44 protection.
- Protección contra sobrecargas. / Overload protection.
- Nivel burbuja. / Spirit level.
- Unidades: gr. / Kg. / lb. / oz. / Units: g / Kg / lb / oz.
- 4 pies de altura regulable. / 4 height-adjustable feet.
- Batería interna recargable. / Internal rechargeable battery.
- Alimentación de 230 Vac. / 230 Vac poer supply.

FUNCIONES / FUNCTIONS

- Acumulación. / Accumulation.
- Cero / Tara. / Zero / Tare.
- Bruto / Neto. / Gross / Net.
- Cuenta piezas. / Piece counting.

**Balanza profesional división 1 gr.**

Professional scale division 1 gr.

Cod.	Material	Capacidad
AO0944	Inox.-Sst	5Kg

CARACTERÍSTICAS / FEATURES

- Plato en acero inoxidable. / Stainless steel plate
- Unidades: Kg. / lb. / Units: Kg / lb
- Alimentación con 4 pilas AA (No incluida) / Powered by 4 AA batteries (not included)

FUNCIONES / FUNCTIONS

- Tara. / Tare.
- Autoapagado / Auto power off

**Balanza profesional analógica.**

Analog scale division.

Cod.	Material	Capacidad
AO61714	Inox.-Sst	20 gr-5kg



Medidor con graduación en relieve.
Measure with raised graduation.

Cod.	Medición - Measurement	Material
AO0084	500 ml.	P.V.C.
AO0080	1000 ml.	P.V.C.
AO0081	2000 ml.	P.V.C.
AO0083	3000 ml.	P.V.C.
AO0085	5000 ml.	P.V.C.



Medidor con graduación en relieve.
Measure with raised graduation.

Cod.	Medición - Measurement	Material
AO0687	1000 ml.	P.V.C.
AO0688	2000 ml.	P.V.C.
AO0689	3000 ml.	P.V.C.
AO0690	5000 ml.	P.V.C.



Medidor con graduación serigrafiada.
Graded screen measure.

Cod.	Medición - Measurement	Material
AO1389	500 ml.	P.V.C.
AO1390	1000 ml.	P.V.C.
AO1391	2000 ml.	P.V.C.
AO1392	3000 ml.	P.V.C.

Cod.	Medición - Measurement	Material.
AO0780	200 ml.	P.V.C.
AO0781	300 ml.	P.V.C.
AO0782	600 ml.	P.V.C.
AO0783	900 ml.	P.V.C.
AO0784	1500 ml.	P.V.C.



Cod.	Cantidad-Quantity	Material.
AO0903	3 uds.	P.V.C.



Cod.	Medición - Measurement	Material.
AO1151	350 ml.	Inox. - Sst.
AO1152	700 ml.	Inox. - Sst.
AO1153	1100 ml.	Inox. - Sst.
AO1154	1700 ml.	Inox. - Sst.



Medidor con graduación serigráfica.
Graded screen measure.

Cod.	Medición - Measurement	Material.
AO1425	100 cc.	P.V.C.
AO1426	250 cc.	P.V.C.
AO1427	500 cc.	P.V.C.
AO1428	1000 cc.	P.V.C.

Botella para calado graduada.
Graduated draught bottle.

Cod.	Medición - Measurement	Material.
AO1429	1000 ml.	P.V.C.



Recipiente con fondo oval.
Container with oval bottom.

Cod.	Capacidad - Capacity	Medida - Size	Material.
AO0676	2,5 l.	Ø 23 cm.	P.V.C.
AO0677	4 l.	Ø 28 cm.	P.V.C.
AO0678	8 l.	Ø 32 cm.	P.V.C.
AO0679	10 l.	Ø 38 cm.	P.V.C.



Medidor con graduación en relieve.
Gauge with raised gradation.

Cod.	Capacidad - Capacity	Material.
AO0455	250 cc.	Inox. - Sst.
AO0456	500 cc.	Inox. - Sst.
AO0457	1000 cc.	Inox. - Sst.

Juego de medidores.
Set of measures.

Cod.	Medidas	Material.
AO0213	60-80-125-250ml.	Inox. - Sst.



Contenedor alimentario para harina,
azúcar, etc.
Food container for flour, sugar, etc.

Cod.	Medidas	Material.
AO1100	100l.	P.V.C.



Contenedores alimentarios para harina,
azúcar, etc.
Food containers for flour, sugar, etc.

Cod.	Medidas	Material.
AO1144	30l. x3	P.V.C.



Cedazo para azúcar y harina.
Strainer for sugar and flour.

Cod.	Medida - Size	Filtro - Filter	Material.
AO0070	Ø 160 mm.	Azúcar - Sugar	Inox. - Sst.
AO0071	Ø 200 mm.	Azúcar - Sugar	Inox. - Sst.
AO0072	Ø 260 mm.	Azúcar - Sugar	Inox. - Sst.
AO0652	Ø 300 mm.	Azúcar - Sugar	Inox. - Sst.
AO1317	Ø 220 mm.	Harina - Flour	Inox. - Sst.
AO0074	Ø 300 mm.	Harina - Flour	Inox. - Sst.
AO0075	Ø 400 mm.	Harina - Flour	Inox. - Sst.



Colador reforzado con gancho.
Reinforced hook sieve.

Cod.	Medición - Measurement	Material.
AO0396	Ø 160 mm.	Inox. - Sst.
AO24019	Ø 190 mm.	Inox. - Sst.
AO24022	Ø 220 mm.	Inox. - Sst.
AO24025	Ø 250 mm.	Inox. - Sst.



Colador con gancho.
Strainer with hook.

Cod.	Medida - Size	Material.
AO0078	Ø 160 mm.	Inox. - Sst.
AO0747	Ø 180 mm.	Inox. - Sst.
AO0079	Ø 200 mm.	Inox. - Sst.
AO0068	Ø 240 mm.	Inox. - Sst.



Lustrero con gatillo.
Sugar sprinkling with trigger.

Cod.	Medida - Size	Material.
ACC01	110 mm.	Inox. - Sst.



A Lustrero.
B Sugar sprinkling.

Cod.	Medida - Size	Material.
A AT0134	70 x 95 mm.	Inox. - Sst.
B AO62903	70 x 95 mm.	Inox. - Sst.



Dosificador con soporte.
Boquilla de salida 6 Ø mm.
Dispenser with stand.
Outlet nozzles 6 Ø mm.

Cod.	Capacidad - Capacity	Material.
TC8020	1000 ml.	Inox. - Sst.



Dosificador con soporte.
Contiene dos boquillas (4 y 6 Ø mm.)
Dispenser with stand.
Cotains two nozzles (4 y 6 Ø mm.)

Cod.	Capacidad - Capacity	Material.
AO1273	1000 ml.	Inox. - Sst.



Hilahuevo 5 boquillas.
5 nozzles dispenser.

Cod.	Capacidad - Capacity	Material.
AO0597	500 ml.	Inox. - Sst.



Hilahuevo 8 boquillas.
8 nozzles dispenser.

Cod.	Capacidad - Capacity	Material.
AO0313	500 ml.	Inox. - Sst.

NEW



Hilahuevo 5 boquillas.
5 nozzles dispenser.

Cod.	Capacidad - Capacity	Material.
AO0311	1 L.	Inox. - Sst.



Cacillo Inox. 18/10.
Ladle Stainless 18/10.

Cod.	Medida - Size	Material.
AO1274	Ø 100 mm.	Inox. - Sst.
AO1275	Ø 120 mm.	Inox. - Sst.
AO1276	Ø 140 mm.	Inox. - Sst.



Cacillo Inox. 18/10. Modelo ECO
Ladle Stainless 18/10. ECO model

Cod.	Medida - Size	Material.
AO0217	Ø 100 mm.	Inox. - Sst.
AO60312	Ø 120 mm.	Inox. - Sst.
AO0218	Ø 140 mm.	Inox. - Sst.



Espumadera con refuerzo. Inox. 18/10.
Slotted spoon reinforced. Stainless 18/10.

Cod.	Medida - Size	Material.
AO0460	Ø 100 mm.	Inox. - Sst.
AO60412	Ø 120 mm.	Inox. - Sst.
AO0461	Ø 150 mm.	Inox. - Sst.
AO0967	Ø 180 mm.	Inox. - Sst.
AO0462	Ø 200 mm.	Inox. - Sst.



Espumadera. Inox. 18/10.
Slotted spoon. Stainless 18/10.

Cod.	Medida - Size	Material.
AO60409	Ø 100 mm.	Inox. - Sst.
AO60411	Ø 120 mm.	Inox. - Sst.
AO60413	Ø 140 mm.	Inox. - Sst.
AO60417	Ø 180 mm.	Inox. - Sst.
AO60419	Ø 200 mm.	Inox. - Sst.



Espumadera Inox. 18/10.
Slotted spoon. Stainless 18/10.

Cod.	Medida - Size	Material.
AO0102	Ø 120 mm.	Inox. - Sst.
AO0114	Ø 140 mm.	Inox. - Sst.
AO0115	Ø 180 mm.	Inox. - Sst.



Espumadera araña con refuerzo. Inox. 18/10.
Spider slotted spoon with reinforced. Stainless 18/10.

Cod.	Medida - Size	Material.
AO1236	Ø 130 mm.	Inox. - Sst.
AO1237	Ø 180 mm.	Inox. - Sst.
AO1238	Ø 220 mm.	Inox. - Sst.

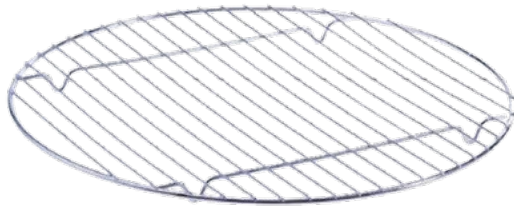

Cod.	Medida - Size	Material.
AO0820	Ø 300 mm.	Inox. - Sst.
AO0821	Ø 400 mm.	Inox. - Sst.

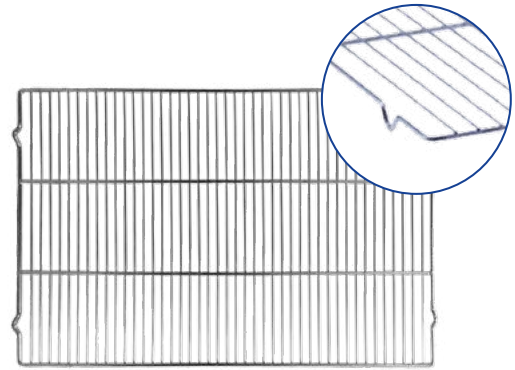

Cod.	Medida - Size	Material.
AO0822	400 x 600mm.	Inox. - Sst.

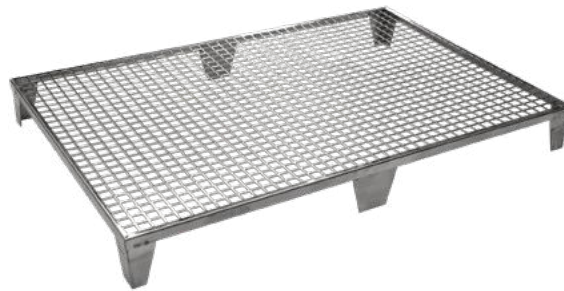

Rejilla - Grid.

Cod.	Medida - Size	Material.
AO0319	300 x 400 x 60mm.	Inox. - Sst.
AO0320	400 x 600 x 60mm.	Inox. - Sst.



Candidera con asas.
Mold with handles

Cod.	Medida - Size	Material.
AO0317	300 x 400 x 60mm.	Inox. - Sst.
AO0318	400 x 600 x 60mm.	Inox. - Sst.



Kit candidera + rejilla.
Mold + grid kit.

Cod.	Medida - Size	Material.
AO1277	300 x 400 x 60mm.	Inox. - Sst.
AO1279	400 x 600 x 60mm.	Inox. - Sst.

Bandeja embutidas / Rounded tra

Las bandejas pueden fabricarse también con una capa de silicona o una capa de teflón, generando así una alta durabilidad. Servicio mínimo para siliconar o teflonar las bandejas son de 10 unidades por modelo.

The trays can also be manufactured with a silicone layer or a teflon layer, generating high durability. Minimum service for silicone or teflon trays are 10 units per model.

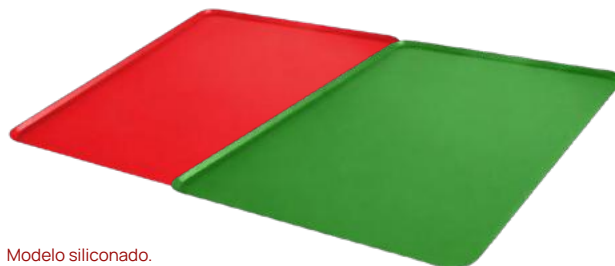

Modelo siliconado.

Silicone model.

Modelo teflonado.

Teflon model.

Cod.	Medida - Size	Material.
AO0628	400 x 600 x 10 h mm.	Siliconado
AO0400	400 x 600 x 10 h mm.	Teflonado

Bandeja de cantos embutidos con grosor de 0,12 mm.
Rounded boulders tray. Thickness: 0,12 mm.

Cod.	Medida - Size	Material.	Pack.
AO0627	400 x 600 x 10 h mm.	Aluminio - Aluminum	10
AO0660	600 x 800 x 10 h mm.	Aluminio - Aluminum	5
AO0661	800 x 1000 x 10 h mm.	Aluminio - Aluminum	5

Bandeja de cantos embutidos con grosor de 0,12 mm.
Rounded boulders tray. Thickness: 0,12 mm.

Cod.	Medida - Size	Material.	Pack.
AO0623	400 x 600 x 10 h mm.	Hierro Pavonado Blued iron	5

Bandeja 2 bordes rectos con grosor de 0,12 mm.
Straight 2 edges tray. Thickness: 0,12 mm.

Cod.	Medida - Size	Material.	Pack.
AO1374	400 x 600 x 10 h mm.	Hierro Pavonado Blued iron	5



Bolsa estándar cubre bandejas, 50 bolsas.
Standard bag covers trays, 50 bags.

Cod.	Medida - Size	Material.	Pack.
AO1543	460 x 720 + 100 h mm.	P.V.C. 20 µm.	1

Bandeja cantos rectos / Straight edges tray



Bandeja de cantos rectos con grosor de 0,12 mm.
Straight edges tray. Thickness: 0,12 mm.

Cod.	Medida - Size	Material	Pack.
AO0312	400 x 600 x 10 h mm.	Hierro Pavonado - Blued iron	5
AO0407	300 x 400 x 10 h mm.	Aluminio - Aluminum	5
AO0490	400 x 600 x 10 h mm.	Aluminio - Aluminum	5
AO0304	300 x 400 x 10 h mm.	Inoxidable - Stainless	5
AO0805	400 x 600 x 10 h mm.	Inoxidable - Stainless	5

Bandeja perforada / Perforated tray



Bandeja perforada de cantos embutidos con grosor de 0,12 mm.
Perforated rounded boulders tray. Thickness: 0,12 mm.

Cod.	Medida - Size	Material.
AO0629	400 x 600 x 10 h mm.	Aluminio - Aluminum
AO0662	600 x 800 x 10 h mm.	Aluminio - Aluminum
AO0674	800 x 1000 x 10 h mm.	Aluminio - Aluminum



Bandeja perforada para pan con grosor de 0,12 mm.
Perforated tray for bread. Thickness: 0,12 mm.

Cod.	Medida - Size	Material.	Pack.
A AO0493	400 x 600 mm.	Aluminio - Aluminum	5
A AO0680	600 x 800 mm.	Aluminio - Aluminum	5
A AO0681	800 x 1000 mm.	Aluminio - Aluminum	5
B AO0493B	400 x 600 mm.	Aluminio - Aluminum	5
B AO0680B	600 x 800 mm.	Aluminio - Aluminum	5
B AO0681B	800 x 1000 mm.	Aluminio - Aluminum	5

Bandeja especial / Special tray



Bandeja electrolítica siliconada.
Electrolytic silicone tray.

Cod.	Medida - Size	Material.	Pack.
AO0915	400 x 600 x 5 h mm.	Chapa - Sheet iron	10



Bandeja rejada para pizza.
Tray for pizza.

Cod.	Medida - Size	Material.	Pack.
AO63030	300 Ø mm.	Aluminio - Aluminum	5
AO63035	350 Ø mm.	Aluminio - Aluminum	5
AO63040	400 Ø mm.	Aluminio - Aluminum	5

Láminas para horno / Baking sheets



Lámina teflonada con fibra de vidrio.
 Temperatura máxima 250 °C.
Tefloned sheet with fiberglass.
Maximum temperature 250 °C.

ESPECIAL PASTELERÍA

Cod.	Medida - Size	Material.	Pack.
TEFLONPAT	400 x 600 x 0,12 h mm.	Fiberglass	11
TEFLONPATSUP	400 x 600 x 0,20 h mm.	Fiberglass	11



Lámina teflonada con fibra de vidrio.
 Temperatura máxima 250 °C.
Tefloned sheet with fiberglass.
Maximum temperature 250 °C.

ESPECIAL PANADERÍA

Cod.	Medida - Size	Material.	Pack.
TEFLONPATSP	490 x 740 x 0,12 h mm.	Fiberglass	6



Lámina teflonada con fibra de vidrio. Borde redondo.
 Temperatura máxima 250 °C.
Tefloned sheet with fiberglass. Round edge.
Maximum temperature 250 °C.

Cod.	Medida - Size	Material.	Pack.
TEFLONPATBR	400 x 600 x 0,12 h mm.	Fiberglass	11



Lámina teflonada con fibra de vidrio. Borde redondo.
 Temperatura máxima 250 °C.
Tefloned sheet with fiberglass. Round edge.
Maximum temperature 250 °C.

Cod.	Medida - Size	Material.	Pack.
TEFLONPATPQ	300 x 400 x 0,12 h mm.	Fiberglass	3

APTO PARA PASTELERÍA O PANADERÍA
 SUITABLE FOR PASTRY OR BAKERY



Lámina siliconada perforada.
Perforated silicone sheet.

Cod.	Medida - Size	Material.	Pack.
TC3079	395 x 595 mm.	Silicona - Silicone	1

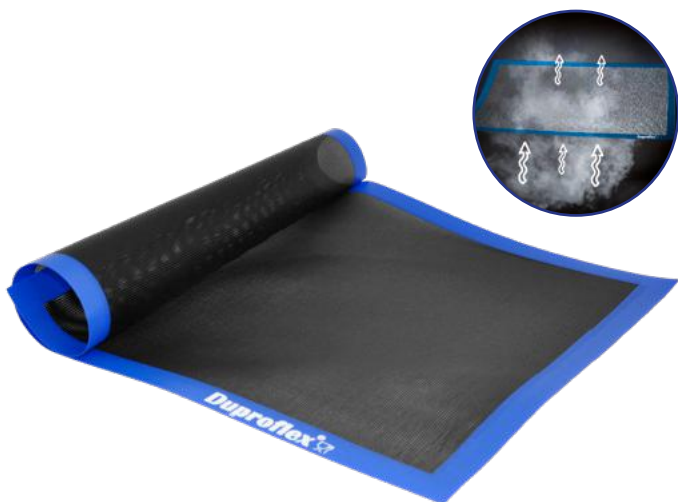

Lámina siliconada perforada eclair.
Eclair perforated silicone sheet.

Cod.	Medida - Size	Material.	Pack.
TC3079C	395 x 595 mm.	Silicona - Silicone	1

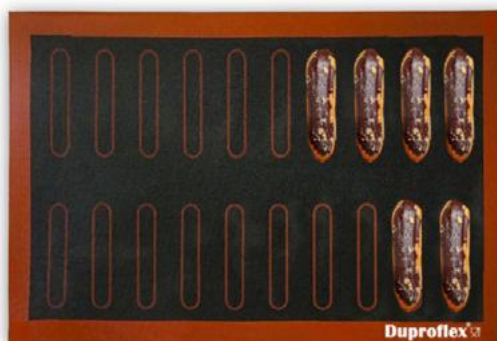

Lámina siliconada con borde alto.
Silicone sheet with high edge.

Cod.	Medida - Size	Material.	Pack.
TAPISROUL02	350 x 540 x 80 h mm.	Silicona - Silicone	1



Lámina siliconada lisa.
Smooth silicone sheet.

Cod.	Medida - Size	Material.	Pack.
SILICOPAT1/R	395 x 595 mm.	Silicona - Silicone	1



Lámina siliconada con fibra en su interior para una mayor duración.
-Silicone sheet with fiber inside for a longer duration.

Cod.	Medida - Size	Material.	Pack.
TC3078	395 x 595 mm.	Silicona - Silicone	1



Lámina siliconada de medición.
Silicone measuring sheet.

Cod.	Medida - Size	Material.	Pack.
TC3080	400 x 600 mm.	Silicona - Silicone	1

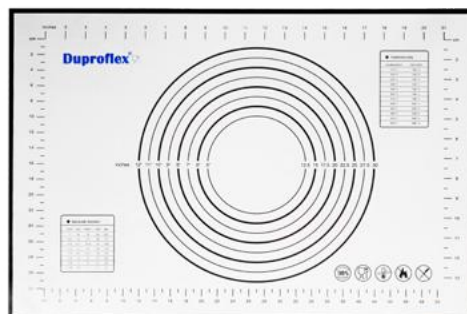

Papel siliconado blanco, especial horno.
Con gramaje de 40 gramos.-
White silicone paper, special oven.
With grammage of 40grams.

Cod.	Medida - Size	Cantidad - Quantity	Pack.
CA0799	400m x 6 cm.	400	1



Papel siliconado redondo para horno. 40 grs.
Round silicone paper for oven. 40 grs.

Cod.	Medida - Size	Material.	Pack.
CA0805	Ø 180 mm.	Papel - Paper	500
CA0806	Ø 200 mm.	Papel - Paper	500
CA0807	Ø 220 mm.	Papel - Paper	500
CA0808	Ø 240 mm.	Papel - Paper	500
CA0809	Ø 260 mm.	Papel - Paper	500



Papel siliconado blanco, especial horno.
Con gramaje de 41 gramos y siliconao ambas
caras.- *White silicone paper, special oven.*
With grammage of 41 grams and silicone both sides.

Cod.	Medida - Size	Resmas - Reams.	Pack.
CA0261	400 x 600 mm.	500	1





Estantería para bandejas.
Ruedas de alto rendimiento.
Capacidad: 21 Bandejas.
Medidas de bandejas: 40 x 60cm.

*Shelving for trays.
High performance wheels
Capacity: 21 Trays.
Tray measures: 40 x 60 cm.*

Cod.	Medida - Size	Material.
AO1593	47 x 62 x 185 h cm.	18/10 Inox. 18/10 Sst.



Estantería para bandejas.
 Ruedas de alto rendimiento.
 Capacidad: 22 Bandejas.
 Medidas de bandejas: 40 x 60cm.
 Opción apertura 60 cm.
 Opción a fabricar medidas especiales.

Shelving for trays.
 High performance wheels
 Capacity: 22 or 25 Trays.
 Tray measures: 40 x 60 cm.
 60 cm opening option. Option to manufacture special measures.

Cod.	Medida - Size	Material.
AO0275	45 x 65 x 185 h cm.	18/10 Inox. 18/10 Sst.

OPCIÓN DE APERTURA
A 60 CM

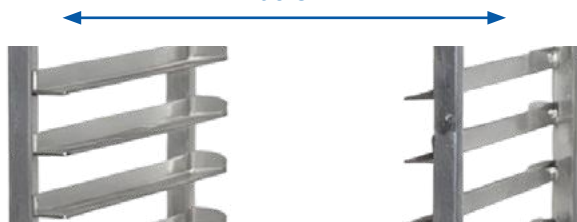

Ventajas de la opción de apertura 60 cm

- Permite introducir bandejas de 40x60 cm, por el lado de 60 cm.
- Facilita escoger la orientación de colocación (longitudinal o transversal) en su fabricación.

Advantages of the 60 cm opening option
 -Allows inserting 40x60 cm trays by supporting their long side (60 cm).
 -Makes it easy to choose the tray orientation (longitudinal or transverse).



Varillero para bandejas.
Ruedas de alto rendimiento.
Capacidad: 32 Bandejas.
Medidas de bandejas: 40 x 60 cm.

*Rack for trays.
High performance wheels
Capacity: 32 Trays
Tray measures: 40 x 60 cm.*

Cod.	Medida - Size	Material.
AO0298	65 x 90 x 175 h cm.	Hierro Galvanizado Galvanized iron

Mesa con bandejero.
Ruedas de alto rendimiento.
Capacidad: 20 Bandejas.
Medidas de bandejas: 400 x 600 mm.
Altura entre bandejas de 7 h cm.
Opción fabricar medidas especiales.

*Table with bandejero.
High performance wheels
Capacity: 20 Trays.
Tray measures: 400 x 600 mm.
Height between trays of 7 h cm.
Option to manufacture special measures.*



Cod.	Medida - Size	Capacidad - Capacity	Material.
AO1423	60 x 90 x 90 h cm.	20 Bandejas 20 Trays	18/10 Inox. 18/10 Sst.

Funda para estantería de 22 bandejas.
Apertura de 40 cm.
Opción medidas especiales.
Medidas: 46 x 67 x 185 h cm.

*Shelf for 22 shelves.
40 cm opening.
Special measures option.
Measures: 46 x 67 x 185 h cm.*

Cod.	Apertura - Opening	Cierre - Lock	Material.
AO0596	40 cm.	Cremallera - Zipper	P.V.C.
AO0596B	60 cm.	Cremallera - Zipper	P.V.C.
AO0647	40 cm.	Velcro	P.V.C.
AO0647B	60 cm.	Velcro	P.V.C.



50 Fundas desechables para estanterías.
Bolsas individuales.
*50 disposable shelving covers.
Individual bags.*

Cod.	Medida - Size	Material.
AO1544	680 x 520 x 2100 mm.	P.V.C. 20 µm.

Manopla reforzada. Especial horno.
Reinforced pastry mitten. Special oven.

Cod.	Medida - Size	Material.	Pack.
AO0616	360 mm.	Cuero - Leather	1



Manopla reforzada con anillas inoxidable. Especial horno.
Reinforced pastry mitten with steel pins. Special oven.

Cod.	Medida - Size	Material.	Pack.
AO0615	360 mm.	Cuero - Leather	1



Manopla modelo ECO. Especial horno.
ECO model mitten. Special oven.

Cod.	Medida - Size	Material.	Pack.
GL2	390 mm.	Cuero - Leather	1





Paño anti-calórico. Especial horno.
Anti-caloric cloth. Special oven.

Cod.	Medida - Size	Pack.
AO0619	250 x 300 mm.	P.V.C.



Guantes para hornos.
Oven gloves.

Cod.	Medida - Size	Material.	Pack.
AO0613	Estándar - Standar	Cuero - Leather	1



Guantes para cámaras frigoríficas.
Gloves for cold stores.

Cod.	Medida - Size	Material.	Pack.
AO0617	Estándar - Standar	Cuero - Leather	1



Gancho para extraer latas del horno.
Hook for removing the cans from the oven.

Cod.	Medida - Size	Material.
AO0478	300 mm.	Inox. - Sst.
AO0480	600 mm.	Inox. - Sst.



Comandero de aluminio sujeta notas.
Aluminum note holder

Cod.	Medida - Size	Material.	Pack.
AO0484	615x50x20 mm.	Aluminio-Aluminium	1





Caldero fondo bombeado. Apto para el fuego.
Pumped bottom cauldron. Suitable for fire.

Cod.	Medida - Size	Litros - Liters.	Material.
AO1318	Ø 250 x 130 h mm.	3,8	18/10 Inox. - Sst.
AO0974	Ø 300 x 160 h mm.	6,5	18/10 Inox. - Sst.
AO0996	Ø 400 x 190 h mm.	13	18/10 Inox. - Sst.
AO0997	Ø 500 x 235 h mm.	25	18/10 Inox. - Sst.



Caldero cónico de fondo plano. Modelo ECO. Apto para el fuego.
Flat bottom conical cauldron. ECO model. Suitable for fire.

Cod.	Medida - Size	Litros - Liters.	Material.
AO50828	Ø 280 x 132 h mm.	5	18/10 Inox. - Sst.
AO50832	Ø 320 x 145 h mm.	7	18/10 Inox. - Sst.
AO50836	Ø 360 x 160 h mm.	11	18/10 Inox. - Sst.
AO50840	Ø 400 x 180 h mm.	15	18/10 Inox. - Sst.
AO50845	Ø 450 x 200 h mm.	22	18/10 Inox. - Sst.



Caldero de fondo bombeado "Timbal". Apto para el fuego.
Pumped bottom cauldron "Kettledrum". Suitable for fire.

Cod.	Medida - Size	Litros - Liters.	Material.
AO50323	Ø 220 x 110 h mm.	2,7	18/10 Inox. - Sst.
AO50327	Ø 260 x 130 h mm.	4	18/10 Inox. - Sst.
AO50333	Ø 320 x 170 h mm.	9,5	18/10 Inox. - Sst.
AO50337	Ø 360 x 180 h mm.	12	18/10 Inox. - Sst.
AO50341	Ø 400 x 210 h mm.	14,5	18/10 Inox. - Sst.



Caldero de fondo plano. Apto para el fuego.
Flat bottom cauldron. Suitable for fire.

Cod.	Medida - Size	Litros - Liters.	Material.
AO0199	Ø 200 mm.	2,2	18/10 Inox. - Sst.
AO0200	Ø 250 mm.	3,5	18/10 Inox. - Sst.
AO0201	Ø 300 mm.	6	18/10 Inox. - Sst.
AO0202	Ø 350 mm.	8,5	18/10 Inox. - Sst.
AO0203	Ø 400 mm.	13	18/10 Inox. - Sst.
AO0204	Ø 450 mm.	20	18/10 Inox. - Sst.
AO0205	Ø 500 mm.	25	18/10 Inox. - Sst.
AO0206	Ø 550 mm.	35	18/10 Inox. - Sst.
AO0207	Ø 600 mm.	45	18/10 Inox. - Sst.
AO0208	Ø 650 mm.	55	18/10 Inox. - Sst.
AO0209	Ø 700 mm.	65	18/10 Inox. - Sst.



Caldero de fondo plano. Apto para el fuego.
Flat bottom cauldron. Suitable for fire.

Cod.	Medida - Size	Litros - Liters.	Material.
AO14016	Ø 160 x 65 h mm.	0,9	18/10 Inox. - Sst.
AO14019	Ø 200 x 75 h mm.	1,4	18/10 Inox. - Sst.
AO14025	Ø 240 x 90 h mm.	2,5	18/10 Inox. - Sst.
AO14029	Ø 300 x 110 h mm.	4,3	18/10 Inox. - Sst.
AO14033	Ø 340 x 135 h mm.	7,5	18/10 Inox. - Sst.



Soporte sobremesa para calderos.
Table support for cauldrons.

Cod.	Medida - Size	Material.
AO50300	-	Inox. - Sst.
AO751100	-	Silicona - Silicone



Cazo con doble pico de Inducción
Cauldron with double peak. for induction

Cod.	Litros - Liters.	Material.
AO0731	1,5	Inox. - Sst.
AO0826	3,1	Inox. - Sst.



Cazo con pico. Apto para el fuego.
Cauldron with peak. Suitable for fire.

Cod.	Medida - Size	Litros - Liters.	Material.
AO0195	160 Ø x 75 h mm.	1	18/10 Inox. - Sst.
AO0196	180 Ø x 80 h mm.	1,5	18/10 Inox. - Sst.
AO0197	200 Ø x 100 h mm.	2,5	18/10 Inox. - Sst.
AO0198	220 Ø x 115 h mm.	3,5	18/10 Inox. - Sst.
AO0500	240 Ø x 120 h mm.	4,5	18/10 Inox. - Sst.



Soporte estándar para todas las medidas de calderos.
Standard holder for every pots measures.

Cod.	Medida - Size	Material.
AO0401	-	Inox. - Sst.



Cubo con asa.
Bucket with

Cod.	Medida - Size	Litros - Liters.	Material.
AO0485	240 Ø x 200 h mm.	6	Inox. - Sst.
AO0486	280 Ø x 260 h mm.	12	Inox. - Sst.



Cubo con pico y asa.
Bucket with pick and handle.

Cod.	Litros - Liters.	Material.
AO0691	12	P.V.C.
AO0692	15	P.V.C.
AO0693	18	P.V.C.



Las medidas del rodillo son sin mangos.
Rolling pins measures are without handles.

Cod.	Medida - Size	Material.
AO1431	80 Ø x 500 mm.	Madera - Wood
AO1432	70 Ø x 600 mm.	Madera - Wood
AO1433	80 Ø x 600 mm.	Madera - Wood



Rodillo mangos giratorios.
Las medidas del rodillo son sin mangos.
Rotary handles rolling pin.
Rolling pins measures are without handles.

Cod.	Medida - Size	Material.
AO1640	80 Ø x 400 mm.	Madera - Wood
AO1641	80 Ø x 500 mm.	Madera - Wood
AO1642	80 Ø x 500 mm.	Madera - Wood



Rodillo mangos giratorios.
Las medidas del rodillo son sin mangos.
Rotary handles rolling pin.
Rolling pins measures are without handles.

Cod.	Medida - Size	Material.
AO1434	70 Ø x 300 mm.	Nylon
AO1435	70 Ø x 400 mm.	Nylon
AO1436	70 Ø x 500 mm.	Nylon



Cod.	Medida - Size	Material.
AO1140	30 Ø x 400 mm.	Nylon
AO1141	40 Ø x 350 mm.	Nylon
AO1142	30 Ø x 190 mm.	Nylon

Cod.	Medida - Size	Material.
AO68142	45 Ø x 430 mm.	Madera - Wood



Cod.	Medida - Size	Material.
AO1443	120 mm.	Inox. - Sst.



Cod.	Medida - Size	Material.
AO1444	120 mm.	Inox. - Sst.



Cod.	Medida - Size	Material.
RFP12	120 mm.	P.V.C.



Cod.	Medida - Size	Material.
AO1441	120 mm.	P.V.C.



Cod.	Medida - Size	Material.
AO1442	60 mm.	P.V.C.



Cod.	Medida - Size	Porciones - Portions	Material.
AO1445	320 Ø mm.	8	Inox. - Sst.
AO1446	320 Ø mm.	10	Inox. - Sst.
AO1447	320 Ø mm.	12	Inox. - Sst.
AO1448	320 Ø mm.	14	Inox. - Sst.
AO1449	320 Ø mm.	16	Inox. - Sst.
AO1450	320 Ø mm.	18	Inox. - Sst.



Cod.	Medida - Size	Porciones - Portions	Material.
AO1532	265 Ø mm.	10 - 12	P.V.C.



Marcador de porciones para tartas.
Portion marker for cakes.

Cod.	Medida - Size	Porciones - Portions	Material.
AO1049	230 Ø mm.	6	Aluminio - Aluminum
AO0125	230 Ø mm.	8	Aluminio - Aluminum
AO0126	230 Ø mm.	10	Aluminio - Aluminum
AO0127	230 Ø mm.	12	Aluminio - Aluminum

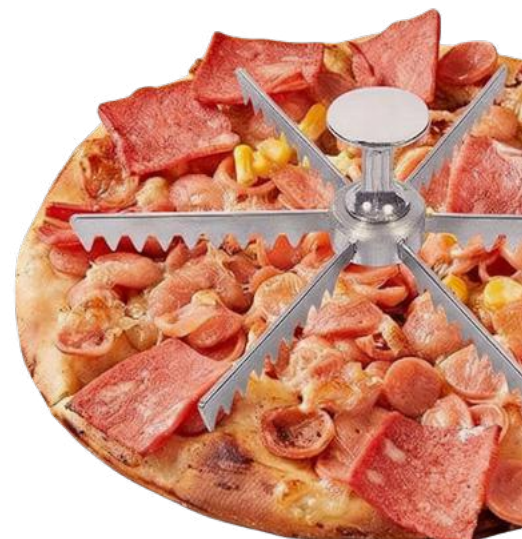

Cod.	Medida - Size	Material.
AO1457	300 Ø mm.	P.V.C.



Medidas de corte para croissant.
Cutting measures for croissant.



Cod.	Medida - Size	Corte - Cut	Material.
AO1462	410 mm.	a 110 x h 150 mm.	Inox. - Sst.

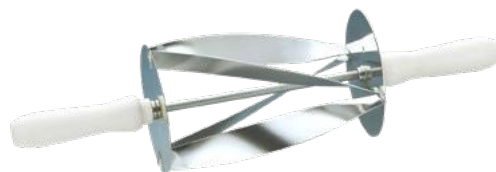

Cod.	Medida - Size	Corte - Cut	Material.
AO1464	450 mm.	a 180 x h 200 mm.	Inox. - Sst.



Cod.	Medida - Size	Corte - Cut	Material.
AO1465	460 mm.	a 97 x h 210 mm.	Inox. - Sst.



Cod.	Medida - Size	Corte - Cut	Material.
AO1461	660 mm.	a 180 x h 200 mm.	Inox. - Sst.



Cod.	Rueda de corte - Cutting wheel	Material.
AO1458	5 ruedas lisas - 5 Flat wheels	Inox. - Sst.
AO0833	7 ruedas lisas - 7 Flat wheels	Inox. - Sst.
	Doble - Double	
AO0836	5 ruedas lisas - 5 Flat wheels 5 ruedas onduladas - 5 Wavy wheels	Inox. - Sst.
	Doble - Double	
AO0835	7 ruedas lisas - 7 Flat wheels 7 ruedas onduladas - 7 Wavy wheels	Inox. - Sst.



Cod.	Medida - Size	Material.
AO1474	60 Ø mm.	P.V.C.



Cod.	Medida - Size	Material.
AO1470	55 Ø mm.	P.V.C.



Cod.	Medida - Size	Material.
AO1473	120 Ø mm.	P.V.C.

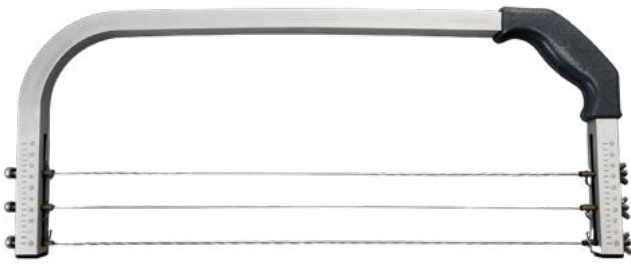

Segueta triple cuchilla, ideal para bizcochos.
Triple blade hacksaw, ideal for sponge cake.

Cod.	Medida - Size	Material.
AO1490	460 mm.	Inox. - Sst.



Cod.	Material.	Pack.
AO0035	Inox. - Sst.	5



Cod.	Material.	Pack.
AO1494	Inox. - Sst.	5



Pack con 10 unidades.
Pack with 10 units.

Cod.	Material.	Pack.
AO0037	Inox. - Sst.	1



Cutter con 25 repuestos
Cutter with 25 replacements

Cod.	Material.	Pack.
AO1491	Inox. - Sst.	1



Cod.	Material.	Pack.
TC1700	Inox. - Sst.	5



Cod.	Material.	Pack.
AO1497	Inox. - Sst.	5



Cod.	Material.	Pack.
AO1495	Inox. - Sst.	5



Cod.	Material.	Pack.
AO1496	Inox. - Sst.	5

Cestas de ratán para la fermentación de masas. *Rattan baskets for dough proofing.*

NEW



Cesta de fermentación de ratán
Rattan proofing basket

Cod.	Medida - Size	Material
AO01003	85 h 220 Ø	Ratán
AO01004	85 h 250 Ø	Ratán
AO01005	80 h 280 Ø	Ratán
AO01006	440 x 100 x 55 h cm.	Ratán
AO01007	290 x 150 x 80 h cm.	Ratán
AO01008	270 x 130 x 65 h cm.	Ratán



Todas las medidas son de la hoja.
All measurements are from the sheet.



Sierra con terminación en punta, para una mejor terminación en el corte de bizcochos.
Saw with tip termination, for better termination in biscuit cutting.

Cuchillos inoxidables con mango de fhenolkraft.
Stainless knives with fhenolkraft handles.

Cod.	Medida - Size	Material.
AO0091	38 x 280 mm.	Inox. - Sst.
AO0497	40 x 330 mm.	Inox. - Sst.



Cod.	Medida - Size	Material.
AO0801	32 x 250 mm.	Inox. - Sst.
AO0092	32 x 330 mm.	Inox. - Sst.
AO0093	32 x 460 mm.	Inox. - Sst.



Cod.	Medida - Size	Material.
AO1309	35 x 250 mm.	Inox. - Sst.
AO1310	35 x 300 mm.	Inox. - Sst.



Cod.	Medida - Size	Material.
AO0095	26 x 200 mm.	Inox. - Sst.



Cod.	Medida - Size	Material.
AO0094	45 x 200 mm.	Inox. - Sst.
AO0565	50 x 250 mm.	Inox. - Sst.
AO0817	60 x 300 mm.	Inox. - Sst.
AO1327	85 x 350 mm.	Inox. - Sst.



Cod.	Medida - Size	Material.
AO1312	45 x 250 mm.	Inox. - Sst.
AO1313	50 x 300 mm.	Inox. - Sst.
AO0412	55 x 350 mm.	Inox. - Sst.



Cod.	Medida - Size	Material.
AO0299	60 x 410 mm.	Inox. - Sst.



NEW

Cod.	Medida - Size	Material.
AO1006	600mm	Inox. - Sst.



Colgador magnético para pared.
Magnetic hook for walls.

Cod.	Medida - Size	Material.
AO39009A	410 mm.	P.V.C.





Cod.	Medida - Size	Material.
AO0182	180 mm.	Inox. - Sst.
AO0470	200 mm.	Inox. - Sst.



Cod.	Medida - Size	Material.
AO0482	180 mm.	Inox. - Sst.



Mango de P.V.C.
P.V.C. Handle.

Cod.	Medida - Size	Material.
AO0041	210 mm.	Inox. - Sst.



Mango de P.V.C.
P.V.C. Handle.

Cod.	Medida - Size	Material.
AT0272	210 mm.	Inox. - Sst.



Cota de malla para corte estándar.
Chain mail glove for standard cut.

Cod.	Medida - Size	Material.
AO69001	-	Inox. - Sst.



Cota de malla para corte estándar.
Chain mail glove for standard cut.

Cod.	Medida - Size	Material.
AO1643	-	Inox. - Sst.



Abrelatas de mesa.
Table opener.

Cod.	Medida - Size	Material.
AO63005	-	Inox. - Sst.

NEW

Fabricado en España.
Made in Spain.



Abrelatas.
Opener.

Cod.	Medida - Size	Material.
AO0193	7,5 cm.	Inox. - Sst.



Abrelatas.
Opener.

Cod.	Medida - Size	Material.
AO62689	200 mm.	Inox. - Sst.

- Pela, quita el corazón y corta en un sólo paso.
- Eficiencia: 5 manzanas en un minuto.
- Sin pérdidas: Peladuras finas.
- La cuchilla "Cortador" quita el corazón y corta en espiral mientras que la cuchilla "pelador" pela.
- Para obtener rebanadas: Cortar verticalmente un lado de la espiral.
- Para obtener medio rebanadas (Tarta de manzana): Cortar verticalmente un lado y el lado opuesto, de la espiral.
- Función zest cuando se quita la "Cuchilla cortadora".

- To peel, core and slice in one operation.
- Efficiency: 5 apples in a minute.
- No loss: Thin peelings.
- The "Cutting" blade cores and cuts in spiral while the "Peeling" blade peels.
- To get slices: Cut vertically one side of the spiral.
- To get half-slices (apple pie): Cut vertically one side and the opposite side, of the spiral.
- Zest function when taking off the "Cutting blade".

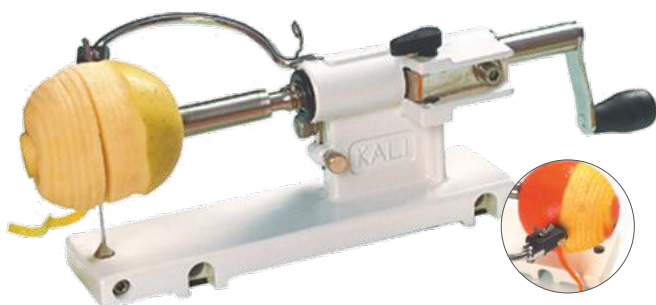
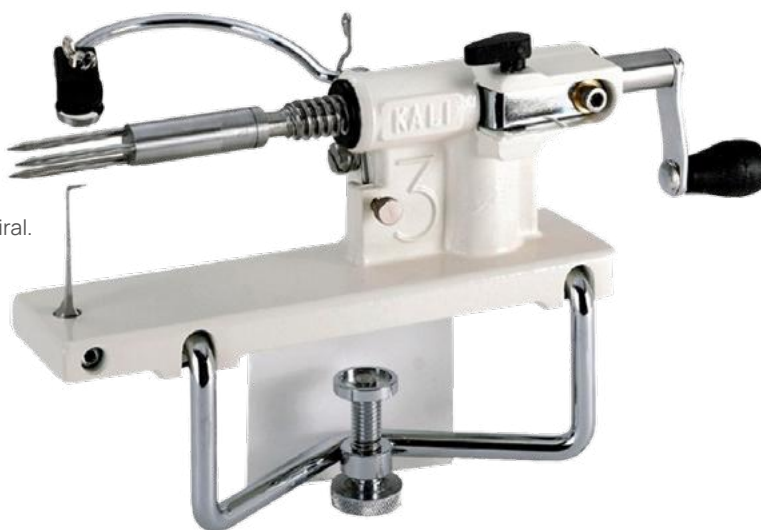

Pela manzanas profesional "Mod. KALI".
Peel apples professional "Mod. KALI".

Cod.	Medida - Size	Material.
AO1373	Estándar / Standard	Inox. - Sst.



Recambio Cuchilla "Mod. KALI".
Consultar otras piezas disponibles
Spare Blade "Mod. KALI". Consult other available pieces

Cod.	Medida - Size	Material.
AO1373R	200 mm.	Inox. - Sst.



Pela manzanas sobremesa con ventosa.
Peel apples desktop with suction cup.

Cod.	Medida - Size
AO0302	Estándar / Standard



Pela manzanas con tornillo para mesa.
Peel apples with table screw.

Cod.	Medida - Size
AO0614	Estándar / Standard



Mandolina con 5 cuchillas diferentes.
Mandolin with 5 different blades.

Cod.	Medida - Size	Material.
AO60356	140 x 420 mm.	Inox. - Sst.



Rallador de 4 caras diferentes.
Multi slides grater.

Cod.	Medida - Size	Material.
AO0459	230 h mm.	Inox. - Sst.



Rallador corte grueso.
Grater cut thick.

Cod.	Medida - Size	Material.
AO60302	110 x 260 mm.	Inox. - Sst.



Rallador corte fino.
Grater cut fine.

Cod.	Medida - Size	Material.
AO60303	110 x 260 mm.	Inox. - Sst.



Pelador.
Peeler.

Cod.	Medida - Size	Material.
AO62688	200 mm.	Inox. - Sst.



Pelador doble.
Double peeler.

Cod.	Medida - Size	Material.
AO60347	100 x 120 mm.	Inox. - Sst.



Cortador doble para huevos.
Double cutter for eggs.

Cod.	Medida - Size	Material.
AO68307	100 x 150 mm.	Inox. - Sst.



Cortador para Melón.
Cutter for Melon.

Cod.	Medida - Size	Material.
AO0761	200 Ø mm.	Inox. - Sst.



12 Cortadores
12 Cutters

29-36-43-50-57-64-71-77-84-91-98-104

Cod.	Medida - Size	Material.
AO68069	52 h mm.	Inox. - Sst.



12 Cortadores
12 Cutters

29-36-43-50-57-64-71-77-84-91-98-104

Cod.	Medida - Size	Material.
AO68070	52 h mm.	Inox. - Sst.



9 Cortadores
9 Cutters

37-51-66-82-96-110-125-137-150 Ø

Cod.	Material.
AO0701	Inox. - Sst.



7 Cortadores
7 Cutters

30-42-53-55-65-80-90

Cod.	Material.
AO0702	Inox. - Sst.



9 Cortadores
9 Cutters

Cod.	Medida - Size	Material.
AO0712	46 x 20 h mm.	Inox. - Sst.



26 Cortadores
26 Cutters

Cod.	Medida - Size	Material.
AO0713	30 x 20 h mm.	Inox. - Sst.

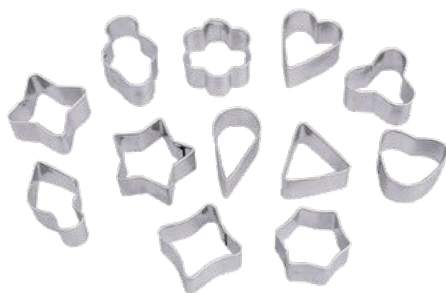

12 Cortadores
12 Cutters

Cod.	Medida - Size	Material.
AO0854	18 h mm.	Inox. - Sst.



Mazapán
Marzipan

Cod.	Medida - Size	Material.
AO1541	50 h mm.	Inox. - Sst.



Cortador expulsión con muelle.
Ejection cutter with spring.

Cod.	Medida - Size	Material.
AO0767A	50 Ø mm.	Inox. - Sst.
AO0767	73 Ø mm.	Inox. - Sst.
AO0766	100 Ø mm.	Inox. - Sst.



Cod.	Medida - Size	Material.
AO0014	75 Ø mm.	Inox. - Sst.



Kit 3 cortadores rizados con asa.
Kit 3 curly cutters with handle.

Cod.	Medida - Size	Material.
AO0720	60 Ø x 35 h mm.	Inox. - Sst.
	70 Ø x 35 h mm.	
	80 Ø x 35 h mm.	



Kit 3 cortadores lisos con asa.
Kit 3 smooth cutters with handle.

Cod.	Medida - Size	Material.
AO0721	60 Ø x 35 h mm.	Inox. - Sst.
	70 Ø x 35 h mm.	
	80 Ø x 35 h mm.	



Kit 9 cortadores lisos. Kit 9 smooth cutters.

Cod.	Medida - Size	Material.
AO0723	36-43-52-60-70-80-90-100-110 Ø mm. x 35 h mm.	Inox. - Sst.



Cod.	Medida - Size	Material.
AO0741	89 Ø x 20 h mm.	Inox. - Sst.



Kit 9 cortadores rizados. Kit 9 curly cutters.

Cod.	Medida - Size	Material.
AO0730	60-70-80-90-100-110-120-130-140 Ø x 35 h mm.	Inox. - Sst.



Cod.	Medida - Size	Material.
AO0416	150 x 55 x 45 h mm.	Inox. - Sst.
TC1023	28 x 67 h mm.	Aluminio - Aluminum



20-30-40-50-60-70-80-90-100

	Cod.	Material.
9 Cortadores 9 Cutters	AO1130	P.V.C.



20-30-40-50-60-70-80-90-100

	Cod.	Material.
9 Cortadores 9 Cutters	AO1129	P.V.C.



20-35-50-65-80-95-110 Ø mm.

	Cod.	Material.
7 Cortadores 7 Cutters	AO1131	P.V.C.



	Cod.	Material.
6 Cortadores Liso - Rizado 6 Straight - Curly Cutters	TC2066	P.V.C.

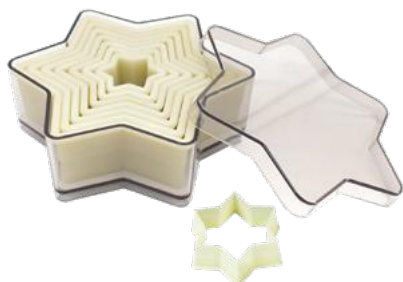

30-40-60-70-85-100-120

	Cod.	Material.
7 Cortadores 7 Cutters	AO1143	P.V.C.

Cortadores modelo ALFABETO

	Cod.	Medida - Size	Material.
26 Cortadores 26 Cutters	AO1128	25 x 25 x 30 h mm.	P.V.C.



Cortadores modelo NÚMEROS

	Cod.	Medida - Size	Material.
10 Cortadores 10 Cutters	AO1127	52 x 40 x 15 h mm.	P.V.C.





Cod.	Medida - Size	Material.
TS1	280 Ø mm.	Inox. - Sst.

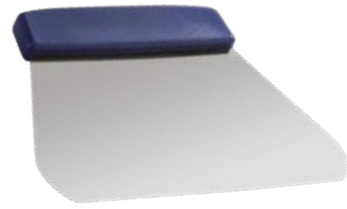

Cod.	Medida - Size	Material.
AO0778	145 x 195 mm.	Inox. - Sst.



Cod.	Medida - Size	Material.
AO0787	100 x 130 mm.	Inox. - Sst.
AO0795	100 x 175 mm.	Inox. - Sst.



Cod.	Medida - Size	Material.
AO0796	150 x 170 mm.	Inox. - Sst.



Cod.	Medida - Size	Material.
AO0798	145 x 210 mm.	Inox. - Sst.
AO0802	200 x 225 mm.	Inox. - Sst.



Cod.	Medida - Size	Material.
AO0838	245 mm.	Inox. - Sst.
AO0954	300 mm.	Inox. - Sst.



Cod.	Medida - Size	Material.
AO0857	110 x 120 mm.	Inox. - Sst.
AO0866	115 x 120 mm.	Inox. - Sst.

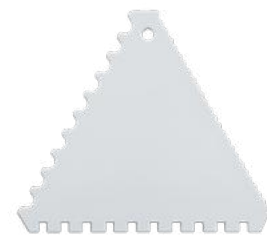

Cod.	Medida - Size	Material.
AO68136	110.	P.V.C

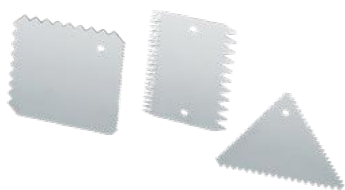

Ideal para chocolate.
Ideal for chocolate.

Cod.	Medida - Size	Material.
AO0867	100 x 100 mm.	Inox. - Sst.



P.V.C. Pack 10 pzs.

Cod.	Medida - Size	Material.
AO0874	90 x 125 mm.	Rígido - Rigid.
AO0891	90 x 125 mm.	Flexible



P.V.C. Pack 10 pzs.

Cod.	Medida - Size	Material.
AO0904	110 x 150 mm.	Rígido - Rigid.
AO0963	110 x 150 mm.	Flexible



P.V.C. Pack 10 pzs.

Cod.	Medida - Size	Material.
AO0964	90 x 120 mm.	Rígido - Rigid.
AO0983	90 x 120 mm.	Flexible



P.V.C. Pack 10 pzs.

Cod.	Medida - Size	Material.
AO0934	95 x 145 mm.	Rígido - Rigid.
AO0935	95 x 145 mm.	Flexible



P.V.C. Pack 10 pzs.

Cod.	Medida - Size	Material.
AO0936	90 x 140 mm.	Rígido - Rigid.
AO0937	90 x 140 mm.	Flexible



P.V.C. Pack 10 pzs.

Cod.	Medida - Size	Material.
AO0945	95 x 145 mm.	Rígido - Rigid.



P.V.C. Pack 5 pzs.

Cod.	Medida - Size	Material.
AO0946	130 x 215 mm.	Rígido - Rigid.



P.V.C. Pack 5 pzs.

Cod.	Medida - Size	Material.
AO0947	150 x 200 mm.	Rígido - Rigid.



Rasquetas personalizables bajo pedido.
Personalizables en color dorado o hendido.
Mínimo 500 pzs.
Customizable pastry scrapers on order.
Customizable in gold color or debossed
Minimum 500 pzs.



P.V.C. Pack 5 pzs.

Cod.	Medida - Size	Material.
AO0951	150 x 195 mm.	Rígido - Rigid.

Todas las medidas son de la hoja.
All measurements are from the sheet.



Espátula con mango de Fenolkraft.
Spatula with Fenolkraft handle.

Cod.	Medida - Size	Material.
AO0314	70 mm.	Inox. - Sst.



Espátula con mango de Fenolkraft.
Spatula with Fenolkraft handle.

Cod.	Medida - Size	Material.
AO0067	110 mm.	Inox. - Sst.
AO0105	150 mm.	Inox. - Sst.
AO0106	200 mm.	Inox. - Sst.
AO0107	260 mm.	Inox. - Sst.
AO0108	310 mm.	Inox. - Sst.
AO0109	360 mm.	Inox. - Sst.



Espátula triangular con mango de Fenolkraft.

Cod.	Medida - Size	Material.
AO0110	100 x 130 mm.	Inox. - Sst.



Espátula ángulo con mango de Fenolkraft.
Angular spatula with Fenolkraft handle.

Cod.	Medida - Size	Material.
AO0122	200 mm.	Inox. - Sst.
AO0104	260 mm.	Inox. - Sst.
AO1269	300 mm.	Inox. - Sst.



Espátula ángulo con mango de Fenolkraft.
Angular spatula with Fenolkraft handle.

Cod.	Medida - Size	Material.
AO60420	75 x 215 mm.	Inox. - Sst.



Espátula recta con mango de P.V.C.
Straight spatula with P.V.C.

Cod.	Medida - Size	Material.
AO1358B	120 mm.	Inox. - Sst.

Espátula ángulo con mango de P.V.C.
Angular spatula with P.V.C.

Cod.	Medida - Size	Material.
AO1358A	120 mm.	Inox. - Sst.

Espátula ángulo de pico con mango de P.V.C.
Tip angle spatula with P.V.C.

Cod.	Medida - Size	Material.
AO1358C	120 mm.	Inox. - Sst.





Espátula silicona. Resistente hasta 110°C.
Silicone spatula. Heat resistant up to 110°C.

Cod.	Medida - Size	Material.
AO0929	280 mm.	Silicona - Silicone.
AO0930	350 mm.	Silicona - Silicone.
AO0931	400 mm.	Silicona - Silicone.



Espátula de goma. Resistente hasta 110°C.
Rubber spatula. Heat resistant up to 110°C.

Cod.	Medida - Size	Material.
PVS25	250 mm.	Goma - Rubber.
PVS35	350 mm.	Goma - Rubber.
PVS40	400 mm.	Goma - Rubber.

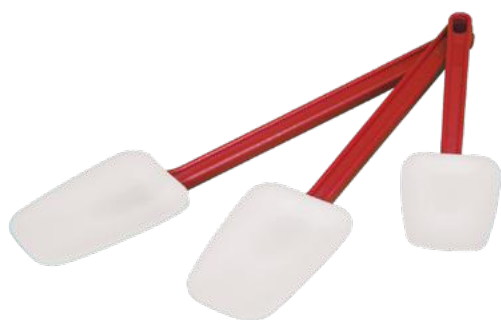

Espátula silicona. Modelo cuchara. Resistente hasta 180°C.
Silicone spatula. Spoon model. Heat resistant up to 180°C.

Cod.	Medida - Size	Material.
BSS25	250 mm.	Silicona - Silicone.
BSS35	350 mm.	Silicona - Silicone.
BSS40	400 mm.	Silicona - Silicone.

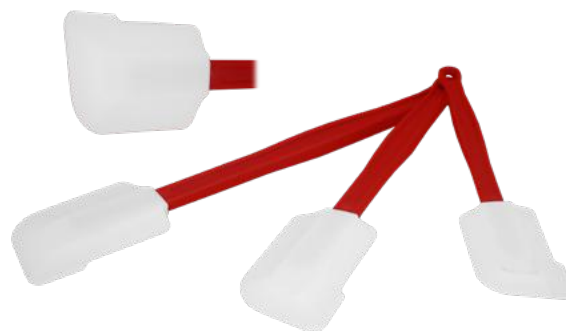

Espátula silicona. Resistente hasta 180°C.
Silicone spatula. Heat resistant up to 180°C.

Cod.	Medida - Size	Material.
SIS25	250 mm.	Silicona - Silicone.
AO0906	280 mm.	Silicona - Silicone.
AO0907	350 mm.	Silicona - Silicone.
AO0908	420 mm.	Silicona - Silicone.



Espátula de silicona. Resistente hasta 250°C.
Silicone spatula. Heat resistant up to 250°C.

Cod.	Medida - Size	Material.
AO1603	280 mm.	Silicona - Silicone.
AO1604	350 mm.	Silicona - Silicone.



Espátula de goma. Resistente hasta 110°C.
Rubber spatula. Heat resistant up to 110°C.

Cod.	Medida - Size	Material.
AO1478	250 mm.	Goma - Rubber.
AO1479	350 mm.	Goma - Rubber.



Espátula rígida de polyglass. Resistente hasta 220°C.
Polyglass rigid spatula. Heat resistant up to 220°C.

Cod.	Medida - Size	Material.
AO0632	250 mm.	P.V.C.
AO0633	300 mm.	P.V.C.
AO0634	350 mm.	P.V.C.
AO0635	400 mm.	P.V.C.
AO0636	450 mm.	P.V.C.
AO0637	500 mm.	P.V.C.

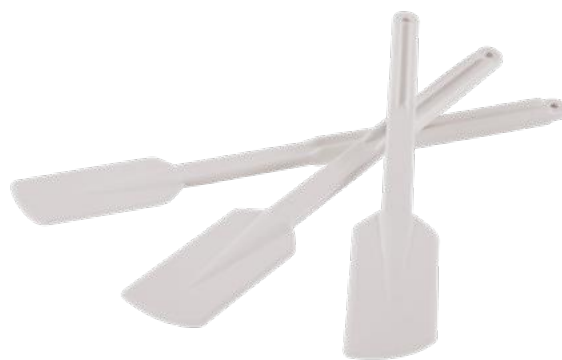

Espátula rígida de ABS. Resistente hasta 140°C.
ABS rigid spatula. Heat resistant up to 140°C.

Cod.	Medida - Size	Material.
AO1475	300 mm.	P.V.C.
AO1476	350 mm.	P.V.C.
AO1477	400 mm.	P.V.C.



Remos para mover grandes cantidades.
Rewing to mix big amounts.

Cod.	Medida - Size	Material.
AO1239	700 mm.	Inox. - Sst.
AO1240	1000 mm.	Inox. - Sst.



Remos para mover grandes cantidades.
Rewing to mix big amounts.

Cod.	Medida - Size	Material.
AO61481	800 mm.	Inox. - Sst.
AO61421	1200 mm.	Inox. - Sst.



Molde nido. *Nest mold*

Cod.	Medida - Size	Material.
AO0279	85 mm.	Inox. - Sst.



Molde buñuelos. *Mold fritters.*

Cod.	Medida - Size	Material.
AO0740	75 mm.	Inox. - Sst.



Molde florón. *Flower mold.*

Cod.	Medida - Size	Material.
AO0746	93 mm.	Inox. - Sst.

Molde recto ideal para bizcochos de tartas.

Straight mould ideal for sponge cakes.

Molde recto Hojalata.

Tin straight mould.

Cod.	Medida - Size
AO0406	120 x 40 h mm.
AO0140	140 x 45 h mm.
AO1202	160 x 45 h mm.
AO1200	180 x 45 h mm.
AO1201	200 x 45 h mm.
AO1306	220 x 50 h mm.
AO0145	240 x 50 h mm.
AO1186	260 x 55 h mm.
AO1224	300 x 55 h mm.

Molde recto Aluminio.

Aluminum straight mould.

Cod.	Medida - Size
AO0141	160 x 60 h mm.
AO0142	180 x 70 h mm.
AO0143	200 x 70 h mm.
AO1241	220 x 70 h mm.
AO1242	240 x 70 h mm.
AO0146	260 x 70 h mm.
AO0148	300 x 70 h mm.



Molde recto ideal para bizcochos altos.

Tinplate straight mould ideal for high cakes.

Molde recto Aluminio.

Aluminum straight mould.

Cod.	Medida - Size
AO1360	140 x 100 h mm.
AO1361	160 x 100 h mm.
AO1362	180 x 100 h mm.
AO1363	200 x 100 h mm.
AO1364	220 x 100 h mm.
AO1365	240 x 100 h mm.
AO1366	260 x 100 h mm.
AO1367	280 x 100 h mm.
AO1368	300 x 100 h mm.



Molde aluminio cónico ideal para bizcochos tradicionales.

Aluminum conical mould, ideal for traditional cakes.

Cod.	Medida - Size
AO1243	120 x 35 h mm.
AO1244	140 x 35 h mm.
AO0499	160 x 35 h mm.
AO0429	180 x 40 h mm.
AO0428	200 x 50 h mm.
AO0430	220 x 50 h mm.
AO0426	240 x 50 h mm.
AO0437	260 x 55 h mm.
AO0438	280 x 55 h mm.
AO0436	300 x 60 h mm.
AO0435	320 x 65 h mm.



Molde aluminio Savarín tradicional.
Aluminum Savarin traditional mould.

Cod.	Medida - Size
AO1250	120 x 40 h mm.
AO1251	140 x 40 h mm.
AO1252	160 x 40 h mm.
AO0445	180 x 45 h mm.
AO0446	200 x 55 h mm.
AO0447	220 x 60 h mm.
AO0448	240 x 65 h mm.
AO0449	260 x 65 h mm.
AO0726	280 x 65 h mm.



Molde bajo cónico, ideal para tarta de manzana.
Small conical baking mould, ideal to apple pie.

Molde de Hojalata.
Tin mould.

Cod.	Medida - Size
AO0373	180 x 25 h mm.
AO0374	200 x 25 h mm.
AO0375	220 x 25 h mm.
AO0376	240 x 25 h mm.
AO0377	260 x 25 h mm.
AO0378	280 x 25 h mm.
AO0379	300 x 25 h mm.
AO0380	320 x 25 h mm.

Molde de Aluminio.
Aluminum mould.

Cod.	Medida - Size
AO1253	180 x 25 h mm.
AO1254	200 x 25 h mm.
AO1255	220 x 25 h mm.
AO1256	240 x 25 h mm.
AO1257	260 x 25 h mm.
AO1258	280 x 25 h mm.
AO1259	300 x 25 h mm.
AO1260	320 x 25 h mm.



Molde bajo de hojalata.
Small baking tin mould.

Cod.	Medida - Size
AO0483	230 x 20 h mm.
AO0597	400 x 20 h mm.



Molde cónico desmontable aluminio.
Removable conical aluminum mould.

Cod.	Medida - Size
AO1245	220 x 50 h mm.
AO1246	240 x 50 h mm.
AO1247	260 x 55 h mm.
AO1248	280 x 55 h mm.
AO1249	300 x 60 h mm.





Molde rizado con fondo desmontable,
ideal para tarta de manzana.
Curly mold with removable bottom, ideal for apple pie.

Molde rizado de Acero Inox.
Stainless curly mould.

Cod.	Medida - Size
AO0474	200 Ø x 30 h mm.
AO0475	220 Ø x 30 h mm.
AO0476	240 Ø x 30 h mm.

Molde rizado antihaderente Aluminio.
Aluminum non-stick curly mold.

Cod.	Medida - Size
AO0474A	200 Ø x 30 h mm.
AO0475A	220 Ø x 30 h mm.
AO0476A	240 Ø x 30 h mm.



Molde bajo cónico desmontable.
Removable small conical mould.

Molde de Hojalata.
Tin mould.

Cod.	Medida - Size
AO0387	220 x 25 h mm.
AO0388	240 x 25 h mm.
AO0389	260 x 25 h mm.
AO0390	280 x 25 h mm.
AO0391	300 x 25 h mm.
AO0392	320 x 25 h mm.

Molde de Aluminio.
Aluminum mould.

Cod.	Medida - Size
AO1261	220 x 25 h mm.
AO1262	240 x 25 h mm.
AO1263	260 x 25 h mm.
AO1264	280 x 25 h mm.
AO1265	300 x 25 h mm.
AO1266	320 x 25 h mm.



Molde recto desmontable.
Removable straight mould.

Molde de Hojalata.
Tin mould.

Cod.	Medida - Size
AO0465	220 x 70 h mm.
AO0467	240 x 70 h mm.
AO1150	260 x 70 h mm.

Molde inoxidable.
Stainless mould.

Cod.	Medida - Size
AO0506	220 x 70 h mm.
AO0466	240 x 70 h mm.
AO0192	260 x 70 h mm.



Molde inoxidable, ideal para Plum Cake.
Stainless mould, ideal for Plum Cake.

Cod.	Medida - Size
AO0157	140 x 250 x 80 h mm.
AO0158	140 x 300 x 80 h mm.
AO0159	140 x 350 x 80 h mm.
AO1321	140 x 400 x 80 h mm.



Molde inoxidable, ideal para pan de molde.
Stainless mould, ideal for sliced bread.

Cod.	Medida - Size
AO0659	100 x 250 x 100 h mm.
AO0610	100 x 300 x 100 h mm.
AO0620	110 x 350 x 110 h mm.
AO0612	120 x 400 x 120 h mm.

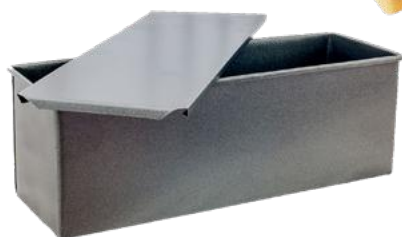

Molde antihaderente, ideal para pan de molde.
Non-stick mould, ideal for sliced bread.

Cod.	Medida - Size
AO0659A	100 x 250 x 100 h mm.
AO0610A	100 x 300 x 100 h mm.
AO0620A	110 x 350 x 110 h mm.
AO0612A	120 x 400 x 120 h mm.



Molde antihaderente, forma de cubo.
Non-stick mould, cube shape.

Cod.	Medida - Size
AO0613A	103 x 83 x 86 h mm.



Molde con asas y tapadera de chapa anodizada, ideal para pan Inglés. Con tratamiento siliconado para una larga duración.
Mould with handles and aluminum plate cover, ideal for English bread. With siliconized treatment for a long duration.

Cod.	Medida - Size
AO2001	100 x 300 x 100 h mm.
AO2002	100 x 350 x 100 h mm.
AO2003	100 x 400 x 100 h mm.

Molde inoxidable flan Chino.
Chinese flan stainless mould.

Cod.	Medida - Size	Cod.	Medida - Size
AO0325	180 x 240 x 40 h mm.	AO0161	250 x 250 x 40 h mm.
AO0160	200 x 200 x 40 h mm.	AO0329	280 x 350 x 40 h mm.
AO0326	200 x 260 x 40 h mm.	AO0162	300 x 300 x 40 h mm.
AO0808	200 x 280 x 40 h mm.	AO0306	300 x 400 x 40 h mm.
AO0328	200 x 350 x 40 h mm.	AO0163	350 x 350 x 40 h mm.
AO0210	220 x 280 x 40 h mm.	AO0164	400 x 400 x 40 h mm.
AO0327	240 x 300 x 40 h mm.	AO0165	450 x 450 x 40 h mm.
AO0276	240 x 360 x 40 h mm.	AO0170	500 x 500 x 40 h mm.



Posibilidad de realizar medidas especiales.

Molde cuadrado inoxidable.
Stainless square mould.

Cod.	Medida - Size
AO0913	100 x 100 x 45 h mm.
AO0792	120 x 120 x 45 h mm.
AO0819	180 x 180 x 45 h mm.
AO0791	200 x 200 x 45 h mm.
AO0790	240 x 240 x 45 h mm.

Molde corazón inoxidable.
Stainless heart mould.

Cod.	Medida - Size
AO0957	100 x 100 x 45 h mm.
AO0832	120 x 120 x 45 h mm.
AO0271	140 x 140 x 45 h mm.
AO0806	160 x 160 x 45 h mm.
AO0419	180 x 180 x 45 h mm.
AO0962	200 x 200 x 45 h mm.
AO0496	220 x 220 x 45 h mm.
AO0273	240 x 240 x 45 h mm.
AO0592	260 x 260 x 45 h mm.
AO0274	280 x 280 x 45 h mm.
AO0807	300 x 300 x 45 h mm.



Molde aro inoxidable.
Stainless ring mould.

Cod.	Medida - Size
AO68506	60 x 45 h mm.
AO0123	80 x 45 h mm.
AO0129	100 x 45 h mm.
AO0130	120 x 45 h mm.
AO0131	140 x 45 h mm.
AO0132	160 x 45 h mm.
AO0133	180 x 45 h mm.
AO0134	200 x 45 h mm.
AO0135	220 x 45 h mm.
AO0136	240 x 45 h mm.
AO0137	260 x 45 h mm.
AO0138	280 x 45 h mm.
AO0139	300 x 45 h mm.



NEW



Molde aro perforado inoxidable.
Stainless perforated ring mould.

Cod.	Medida - Size
AO68536	160 x 20 h mm.
AO68538	180 x 20 h mm.
AO68540	200 x 20 h mm.
AO68544	240 x 20 h mm.
AO68546	160 x 35 h mm.
AO68548	180 x 35 h mm.
AO68550	200 x 35 h mm.
AO68554	240 x 35 h mm.



Aro acanalado perforado de acero inoxidable
Stainless steel perforated fluted circle

Cod.	Medida - Size
AO1204	80 x 30 h mm.
AO1209	80 x 20 h mm.
AO1210	90 x 20 h mm.
AO1211	120 x 25 h mm.
AO1213	140 x 25 h mm.

AO1188

AO1180

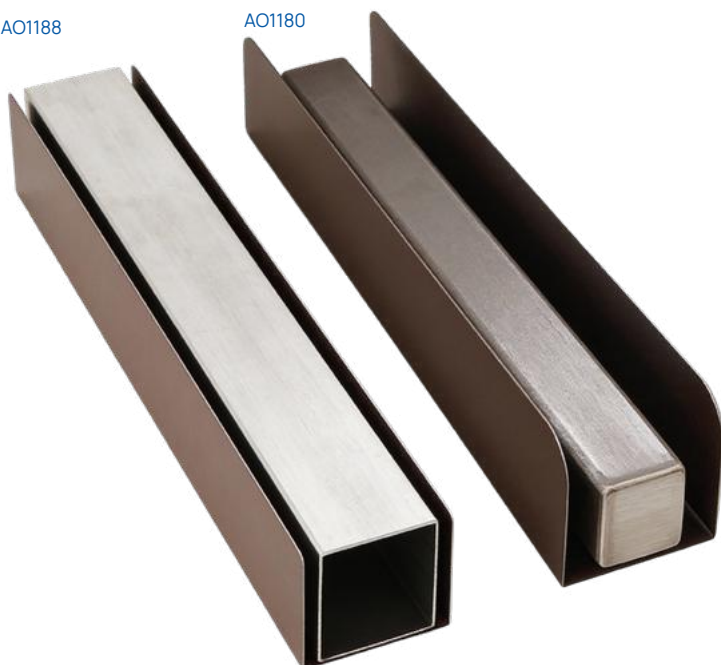

KITS Moldes antiadhesivo viennoiserie
Viennoiserie bar mold KIT

Cod.	Medida - Size
AO1188	250 x 76 x 60 h mm.
AO1180	250 x 42 x 40 h mm.



Posibilidad de realizar medidas especiales.



Molde rectangular "Sin bandeja".
Rectangular mould "without tray".

Cod.	Medida - Size	Material.
AO0069	300 x 400 x 30 h mm.	Inox. - Sst.
AO0899	300 x 400 x 40 h mm.	Inox. - Sst.
AO0984	300 x 400 x 45 h mm.	Inox. - Sst.
AO0813	300 x 400 x 50 h mm.	Inox. - Sst.
AO0919	300 x 400 x 70 h mm.	Inox. - Sst.
AO1332	400 x 600 x 30 h mm.	Inox. - Sst.
AO1003	400 x 600 x 40 h mm.	Inox. - Sst.
AO0887	400 x 600 x 45 h mm.	Inox. - Sst.
AO0812	400 x 600 x 50 h mm.	Inox. - Sst.
AO1045	400 x 600 x 55 h mm.	Inox. - Sst.
AO1322	400 x 600 x 60 h mm.	Inox. - Sst.
AO0814	400 x 600 x 70 h mm.	Inox. - Sst.

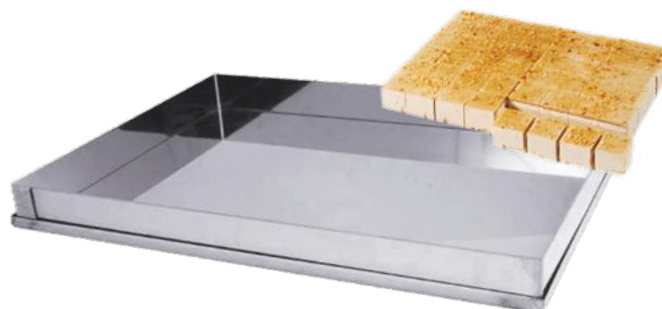

Molde rectangular "Con bandeja".
Rectangular mould "with tray".

Cod.	Medida - Size	Material.
AO0675	300 x 400 x 30 h mm.	Inox. - Sst.
AO0724	300 x 400 x 40 h mm.	Inox. - Sst.
AO0889	300 x 400 x 45 h mm.	Inox. - Sst.
AO0420	300 x 400 x 50 h mm.	Inox. - Sst.
AO0421	300 x 400 x 70 h mm.	Inox. - Sst.
AO0888	400 x 600 x 30 h mm.	Inox. - Sst.
AO1014	400 x 600 x 40 h mm.	Inox. - Sst.
AO0948	400 x 600 x 45 h mm.	Inox. - Sst.
AO0422	400 x 600 x 50 h mm.	Inox. - Sst.
AO0940	400 x 600 x 55 h mm.	Inox. - Sst.
AO0725	400 x 600 x 60 h mm.	Inox. - Sst.
AO0431	400 x 600 x 70 h mm.	Inox. - Sst.



Bandeja de bordes rectos con grosor de 1,2 mm.
Straight edges tray. Thickness: 1,2 mm.

Cod.	Medida - Size	Material.
AO0304	300 x 400 x 10 h mm.	Inox. - Sst.
AO0805	400 x 600 x 10 h mm.	Inox. - Sst.



Molde número gigante inoxidable.
Giant stainless number mold.

Cod.	Medida - Size	Número - Number	Capacidad - Capacity
AO1503	160 x 300 x 40 h mm.	Nº0	1937 ml.
AO1504	93 x 300 x 40 h mm.	Nº1	1171 ml.
AO1505	160 x 300 x 40 h mm.	Nº2	1823 ml.
AO1506	160 x 300 x 40 h mm.	Nº3	1663 ml.
AO1507	170 x 300 x 40 h mm.	Nº4	1757 ml.
AO1508	160 x 300 x 40 h mm.	Nº5	1809 ml.
AO1509	160 x 300 x 40 h mm.	Nº6	1968 ml.
AO1510	160 x 300 x 40 h mm.	Nº7	1356 ml.
AO1511	160 x 300 x 40 h mm.	Nº8	2017 ml.
AO1512	160 x 300 x 40 h mm.	Nº9	1968 ml.

Molde rectangular extensible.
Extensible rectangular mould.

Cod.	Medida - Size	Material.
RETSPECIAL1	305 x 305 x 40 h mm. 570 x 570 x 40 h mm.	Inox. - Sst.
RETSPECIAL2	305 x 305 x 50 h mm. 570 x 570 x 50 h mm.	Inox. - Sst.

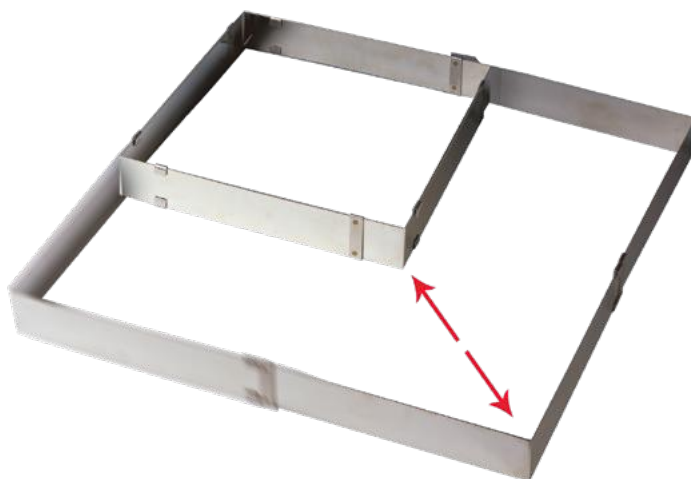

Molde rectangular extensible.
Extensible rectangular mould.

Cod.	Medida - Size	Material.
TC4073	340 x 275 x 50 h mm. 340 x 525 x 50 h mm.	Inox. - Sst.

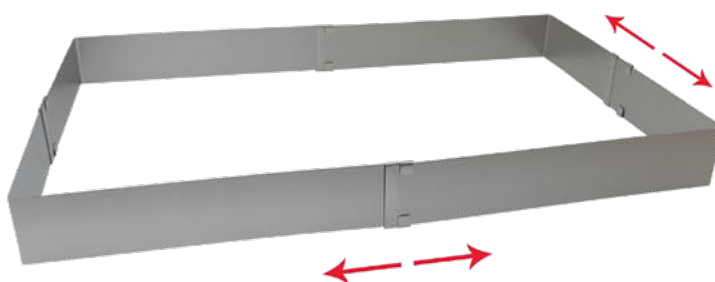

Molde redondo extensible con graduación.
Extensible round mould with graduation.

Cod.	Medida - Size	Material.
TC4074	160 Ø x 95 h mm. 300 Ø x 95 h mm.	Inox. - Sst.

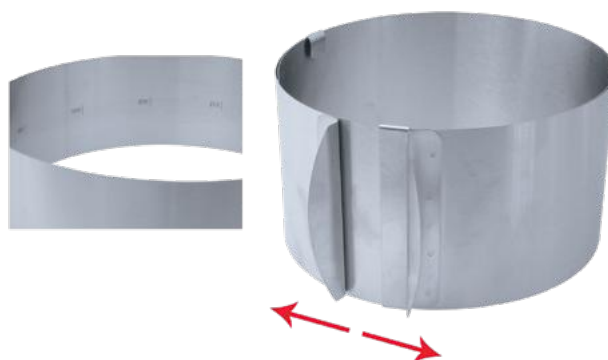

Molde corazón extensible con graduación.
Extensible heart mould with graduation.

Cod.	Medida - Size	Material.
TC4077	120 x 50 h mm. 260 x 50 h mm.	Inox. - Sst.





Molde canastilla "Onda normal".
Individual pie mould. Model: Normal waves.

Cod.	Medida - Size	Material.	Pack
AO0303	40 Ø x 18 h mm.	Hojalata - Tin.	12
AO0368	50 Ø x 22 h mm.	Hojalata - Tin.	12
AO0340	60 Ø x 22 h mm.	Hojalata - Tin.	12
AO0176	70 Ø x 28 h mm.	Hojalata - Tin.	12
AO0178	80 Ø x 28 h mm.	Hojalata - Tin.	12
AO0341	100 Ø x 30 h mm.	Hojalata - Tin.	12



Molde canastilla rectangular.
Individual pie mould. Model: Rectangular.

Cod.	Medida - Size	Material.	Pack
AO0345	45 x 95 x 20 h mm.	Hojalata - Tin.	12
AO0346	50 x 125 x 20 h mm.	Hojalata - Tin.	12
AO0347	55 x 145 x 20 h mm.	Hojalata - Tin.	12



Molde canastilla "Onda estrecha".
Individual pie mould. Model: Narrow waves.

Cod.	Medida - Size	Material.	Pack
AO0342	55 Ø x 22 h mm.	Hojalata - Tin.	12
AO0343	65 Ø x 24 h mm.	Hojalata - Tin.	12
AO0344	75 Ø x 25 h mm.	Hojalata - Tin.	12



Molde tartaleta con "Bordón".
Individual pie mould with "Edge".

Cod.	Medida - Size	Material.	Pack
AO0330	50 Ø x 20 h mm.	Aluminio - Aluminum	12
AO0076	65 Ø x 25 h mm.	Aluminio - Aluminum	12
AO0332	85 Ø x 30 h mm.	Aluminio - Aluminum	12
AO0333	100 Ø x 35 h mm.	Aluminio - Aluminum	12
AO0316	110 Ø x 35 h mm.	Aluminio - Aluminum	12



Molde tartaleta baja lisa.
Small individual pie mould. Model: Flat.

Cod.	Medida - Size	Material.	Pack
AO0336	50 Ø x 15 h mm.	Hojalata - Tin.	12
AO0337	60 Ø x 15 h mm.	Hojalata - Tin.	12
AO0338	70 Ø x 15 h mm.	Hojalata - Tin.	12
AO0631	90 Ø x 15 h mm.	Hojalata - Tin.	12
AO0339	100 Ø x 15 h mm.	Hojalata - Tin.	12



Molde ideal para flanes individuales.
Ideal mould for individual creme caramel.

Cod.	Medida - Size	Material.	Pack
AO0603	25 x 25 h mm.	Aluminio - Aluminum.	12
AO0604	30 x 30 h mm.	Aluminio - Aluminum.	12
AO0605	40 x 40 h mm.	Aluminio - Aluminum.	12
AO0601	50 x 50 h mm.	Aluminio - Aluminum.	12
AO0433	60 x 60 h mm.	Aluminio - Aluminum.	12
AO0602	70 x 70 h mm.	Aluminio - Aluminum.	12



Molde tartaleta alta lisa.
High individual pie mould. Model: Flat.

Cod.	Medida - Size	Material.	Pack
AO0334	40 Ø x 20 h mm.	Hojalata - Tin.	12
AO0308	50 Ø x 20 h mm.	Hojalata - Tin.	12
AO0335	60 Ø x 20 h mm.	Hojalata - Tin.	12
AO0349	70 Ø x 20 h mm.	Hojalata - Tin.	12
AO0305	100 Ø x 25 h mm.	Hojalata - Tin.	12



Molde canastilla forma de barco.
Boat shaped basket mould.

Cod.	Medida - Size	Material.	Pack
AO0362	27 x 75 x 10 h mm.	Hojalata - Tin.	12
AO0363	40 x 95 x 12 h mm.	Hojalata - Tin.	12
AO0364	50 x 110 x 15 h mm.	Hojalata - Tin.	12
AO0365	60 x 130 x 20 h mm.	Hojalata - Tin.	12



Molde para "Caracola".
Apto para congelación y para hornear.
Pack 10 pzs.
*Snail mould.
Suitable for freezing and oven. Pack 10 pcs.*

Cod.	Medida - Size	Material.
AO1513	145 x 30 Ø mm.	P.V.C.



Molde para "Caracola".
Corte recto, con posibilidad de corte en ángulo.
Snail mould. Straight cut. Angled cutting (Optional).

Cod.	Medida - Size	Material.	Pack
AO0172	90 x 30 Ø mm.	Inox. - Sst.	12
AO0173	120 x 40 Ø mm.	Inox. - Sst.	12
AO0174	150 x 40 Ø mm.	Inox. - Sst.	12



Molde cilíndrico para "Cañas". *Cylindrical cane mould.*

Cod.	Medida - Size	Material.	Pack
AO0166	80 x 20 Ø mm.	Hojalata - Tin.	12
AO0167	100 x 20 Ø mm.	Hojalata - Tin.	12
AO0168	120 x 20 Ø mm.	Hojalata - Tin.	12
AO0169	140 x 20 Ø mm.	Hojalata - Tin.	12
AO0171	160 x 20 Ø mm.	Hojalata - Tin.	12

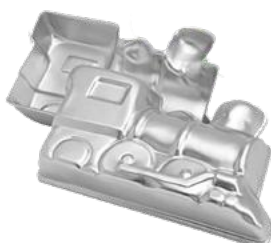

Molde ideal para cumpleaños.
Ideal mould for birthdays cakes.

Cod.	Medida - Size	Material.
TC8046	280 x 160 x 80 h mm.	Aluminio - Aluminum.



Molde ideal para cumpleaños.
Ideal mould for birthdays cakes.

Cod.	Medida - Size	Material.
TC1070	270 x 140 x 75 h mm.	Aluminio - Aluminum.



Molde libro. Ideal para tartas de Comunión.
Book shaped mould, ideal for communion cakes.

Cod.	Medida - Size	Material.
TC1156	220 x 250 x 60 h mm.	Aluminio - Aluminum.



Molde ideal para bautizos.
Ideal mould for baptism cakes.

Cod.	Medida - Size	Material.
TC1157	245 x 245 x 50 h mm.	Aluminio - Aluminum.



Molde ideal para cumpleaños.
Mould ideal for birthdays cakes.

Cod.	Medida - Size	Material.
TC1155	190 x 240 x 50 h mm.	Aluminio - Aluminum.



Molde ideal para cumpleaños.
Mould ideal for birthdays cakes.

Cod.	Medida - Size	Material.
TC1069	230 x 228 x 70 h mm.	Aluminio - Aluminum.

SEMIFRÍO SEMICOLD

Molde ideal para pastelería fría.
El molde se compone de:
* 1 Bandeja de 400x600x20h mm.
* 7 Moldes del mismo modelo.
Medida del pastel Ø 65 mm.
35 piezas por molde.

*Ideal mould for cold bakery.
The mould consist of:
* 1 Tray 400x600x20h mm.
* 7 Identic models.
Cake 's size Ø 65 mm.
35 Pieces per mould.*



Bandeja - Tray

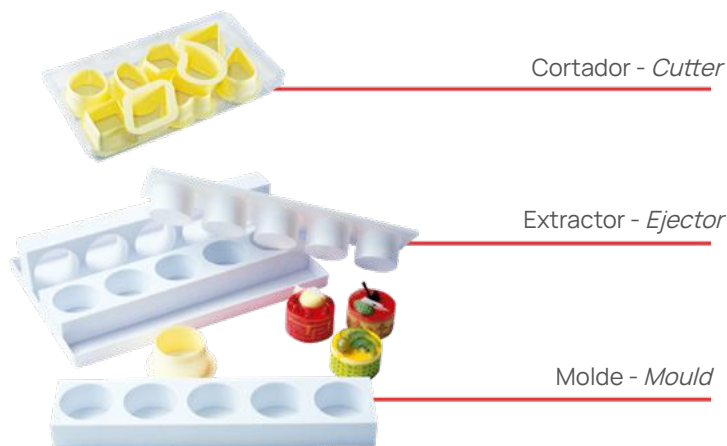

Cortador - Cutter

Extractor - Ejector

Molde - Mould

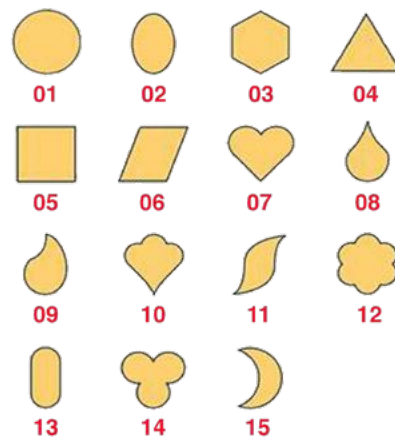

Forma Shape	Código molde Mould code	Medida molde Mould measure	Medida pieza Measure piece	Piezas por molde Pieces for mould	Volumen pieza Piece volumen	Código Extractor Extractor code	Código Cortador Cutter code
01	MONOPC001	400 x 600 x 40 h mm.	60 Ø x 45 mm.	35	75 gr.	EM1	TPG1
02	MONOPC002	400 x 600 x 40 h mm.	60 Ø x 45 mm.	35	75 gr.	EM2	TPG2
03	MONOPC003	400 x 600 x 40 h mm.	60 Ø x 45 mm.	35	75 gr.	EM3	TPG3
04	MONOPC004	400 x 600 x 40 h mm.	60 Ø x 45 mm.	35	75 gr.	EM4	TPG4
05	MONOPC005	400 x 600 x 40 h mm.	60 Ø x 45 mm.	35	75 gr.	EM5	TPG5
06	MONOPC006	400 x 600 x 40 h mm.	60 Ø x 45 mm.	35	75 gr.	EM6	TPG6
07	MONOPC007	400 x 600 x 40 h mm.	60 Ø x 45 mm.	35	75 gr.	EM7	TPG7
08	MONOPC008	400 x 600 x 40 h mm.	60 Ø x 45 mm.	35	75 gr.	EM8	TPG8
09	MONOPC009	400 x 600 x 40 h mm.	60 Ø x 45 mm.	35	75 gr.	EM9	TPG9
10	MONOPC010	400 x 600 x 40 h mm.	60 Ø x 45 mm.	35	75 gr.	EM10	TPG10
11	MONOPC011	400 x 600 x 40 h mm.	60 Ø x 45 mm.	35	75 gr.	EM11	TPG11
12	MONOPC012	400 x 600 x 40 h mm.	60 Ø x 45 mm.	35	75 gr.	EM12	TPG12
13	MONOPC013	400 x 600 x 40 h mm.	60 Ø x 45 mm.	35	75 gr.	EM13	TPG13
14	MONOPC014	400 x 600 x 40 h mm.	60 Ø x 45 mm.	35	75 gr.	EM14	TPG14
15	MONOPC015	400 x 600 x 40 h mm.	60 Ø x 45 mm.	35	75 gr.	EM15	TPG15
Bandeja - Tray	VASSOIOCMO	400 x 600 x 20 h mm.					

P.V.C. ALIMENTARIO *FOODGRADE P.V.C.*

Opción para
la personalización
de micras.

Acetato en bobinas de 100 metros (200 micras).
Acetate roll 100 meters (200 microns).

Cod.	Medida - Size	Material.
AO0705	30 h mm.	Acetato - Acetate
AO0710	35 h mm.	Acetato - Acetate
AO0706	40 h mm.	Acetato - Acetate
AO0707	45 h mm.	Acetato - Acetate
AO0708	50 h mm.	Acetato - Acetate
AO0709	60 h mm.	Acetato - Acetate
AO0454	-	Acetato - Acetate

* **AO0454** - Acetato personalizado para personalizar sus tartas y postres de semifrio.

* **AO0454** - *Personalized acetate to customize your semi-cold cakes and desserts.*

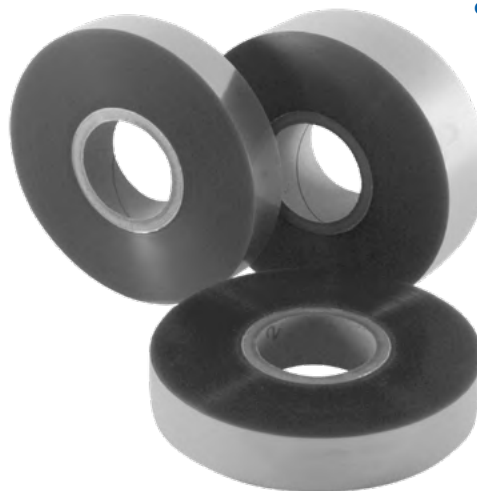

Pack de 1000 láminas cortadas para postres (90 micras).
Otras medidas consultar
*Pack 1000 sheets for desserts (90 microns).
Consult other measures*

Cod.	Medida - Size	Material.
AO1514	240 x 40 h mm.	Acetato - Acetate



Pack de 50 láminas cortadas (90 micras).
Pack 50 sheets (90 microns).

Cod.	Medida - Size	Material.
AO1515	400 x 600 mm.	Acetato - Acetate



Acetato en bobinas de 50 metros (150 micras).
Acetate roll 50 meters (150 microns).

Cod.	Medida - Size	Material.
AO1566	100 mm x 50 m.	Acetato - Acetate
AO1567	120 mm x 50 m.	Acetato - Acetate
AO1566B	100 mm x 100 m.	Acetato - Acetate
AO1567B	120 mm x 100 m.	Acetato - Acetate



Pack de 100 láminas cortadas (55 micras).
Pack 100 sheets (90 microns).

Cod.	Medida - Size	Material.
AO0013	400 x 600 mm.	Polipropileno - Polypropylene

Base giratoria azul. - *Blue rotatory base.*

Cod.	Medida - Size	Material.
AO1516	300 Ø x 135 h mm.	Inox. - Sst.

Base giratoria rosa. - *Pink rotatory base.*

Cod.	Medida - Size	Material.
AO1517	300 Ø x 135 h mm.	Inox. - Sst.

Base giratoria naranja. - *Orange rotatory base.*

Cod.	Medida - Size	Material.
AO1518	300 Ø x 135 h mm.	Inox. - Sst.

Base giratoria profesional.
Professional rotatory base.

Cod.	Medida - Size	Material.
AO1501	320 Ø x 110 h mm.	Inox. - Sst.

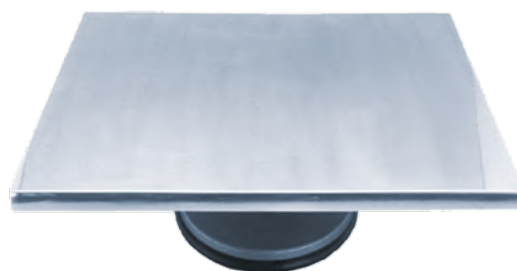
Base giratoria profesional.
Professional rotatory base.

Cod.	Medida - Size	Material.
AO1502	410 x 310 x 110 h mm.	Inox. - Sst.

Base giratoria. - *Rotatory base.*

Cod.	Medida - Size	Material.
AO1519	310 Ø x 125 h mm.	P.V.C.

Base giratoria. - *Rotatory base.*

Cod.	Medida - Size	Material.
AO0277	280 Ø x 80 h mm.	P.V.C.

Base giratoria. - *Rotatory base.*

Cod.	Medida - Size	Material.
TC8053	290 Ø x 136 h mm.	P.V.C.

Base giratoria inclinable y antideslizante.
Tilt and non-slip swivel base.

Cod.	Medida - Size	Material.
TC9072	290 Ø x 136 h mm.	P.V.C.

MOLDES DE SILICONA

Silicone molds



FABRICACIÓN DE MOLDES

MOLDS MANUFACTURING PROCESS

Fabricación de nuestros moldes de silicona DUPROFLEX, diseñados en varios modelos para adaptarse a los profesionales más exigentes. Elaborados con materiales de alta calidad y rigurosos controles para ofrecer a nuestros clientes los mejores productos del mercado.

Manufacturing of our DUPROFLEX silicone molds, designed in various models to meet the needs of demanding professionals. Made with top-quality materials and strict quality controls to offer our customers the best products on the market.



Diseño previo
Previous design



Creación de troquel
Die creation



Inspección e inyectado
Inspection and injected

NEW



Cod.	Medida - Size	Volumen - Volume
PRIMAVERA	220 Ø x 50 h mm.	1500 ml.



Cod.	Medida - Size	Volumen - Volume
MOMENTS	160 Ø x 60 h mm.	1000 ml.



Cod.	Medida - Size	Volumen - Volume
ABBRACCIO	263 x 299 x 65 h - 220 Ø mm.	1690 ml.



Cod.	Medida - Size	Volumen - Volume
DOT	200 Ø x 60 h mm.	1500ml.



Cod.	Medida - Size	Volumen - Volume
MATELASSE	160 x 160 x 53 h mm.	1000 ml.



Cod.	Medida - Size	Volumen - Volume
GEM1000	160 x 160 x 50 h mm.	1000 ml.
GEM600	132 x 132 x 40 h mm.	600 ml.



TARTAS
CAKES

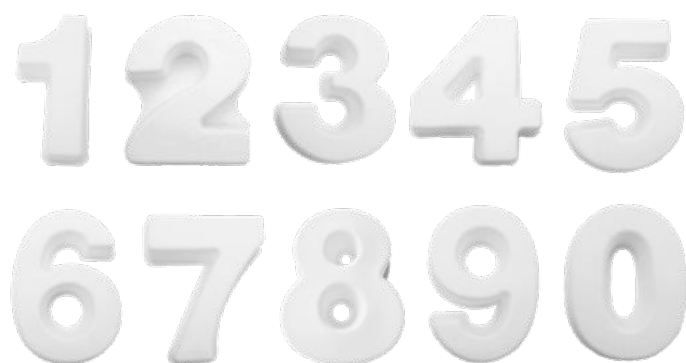

Set molde numeros del 0 al 9 (10 uds).
Set mould numbers from 0 to 9 (10 units).

Cod.	Medida - Size
AO1520	250 x 215 x 57 h mm.

MOLDES SILICONA PARA PIEZAS INDIVIDUALES GRAN TAMAÑO
SILICONE MOLDS FOR LARGE INDIVIDUAL PIECES.

DESMTABLE
REMOVABLE

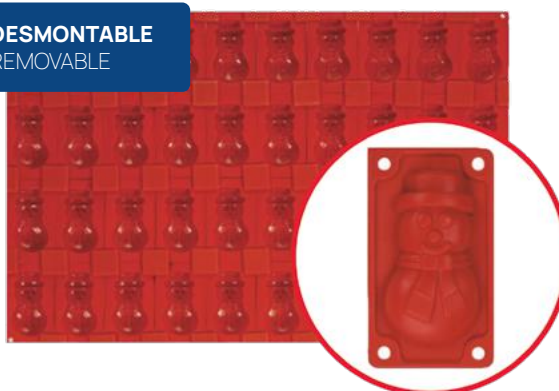

Cod.	Medida - Size	Pcs.
K025	75 x 40 x 15 h mm.	40

DESMTABLE
REMOVABLE



Cod.	Medida - Size	Pcs.
K007	65 Ø x 25 h mm.	35

TARTAS CAKES



Cod.	Medida - Size
SFT424	240 Ø x 30 h mm.
SFT426	260 Ø x 30 h mm.
SFT428	280 Ø x 30 h mm.



Cod.	Medida - Size
SFT118	180 Ø x 40 h mm.
SFT120	200 Ø x 40 h mm.
SFT122	220 Ø x 42 h mm.
SFT124	240 Ø x 42 h mm.
SFT126	260 Ø x 45 h mm.
SFT128	280 Ø x 47 h mm.



Cod.	Medida - Size
SFT249	200 Ø x 90 h mm.
SFT250	220 Ø x 110 h mm.
SFT224	240 Ø x 60 h mm.



Cod.	Medida - Size
SFT205	240 Ø x 55 h mm.



Cod.	Medida - Size
SFT326	240 x 105 x 65 h mm.
SFT330	260 x 100 x 70 h mm.
SFT331	300 x 100 x 70 h mm.



Cod.	Medida - Size
SFT313	180 Ø x 95 h mm.

MONOPORCIONES SINGLE PORTIONS



Cod.	Medida - Size	Volumen - Volume	Pcs.
CYLINDRE75	126 x 27 x 27 h mm.	76 ml.	10



Cod.	Medida - Size	Volumen - Volume	Pcs.
PILLOW80	82 x 43 x 32 h mm.	80 ml.	8
PILLOW30	58 x 30 x 23 h mm.	30 ml.	12



Cod.	Medida - Size	Volumen - Volume	Pcs.
FINGERS75	130 x 27 x 27 h mm.	75 ml.	8



Cod.	Medida - Size	Volumen - Volume	Pcs.
BUCHETTE	75 x 50 x 46 h mm.	140 ml.	8

MONOPORCIONES SINGLE PORTIONS



Cod.	Medida - Size	Volumen - Volume	Pcs.
AO4407	45 Ø x 60 h mm.	100 ml.	8

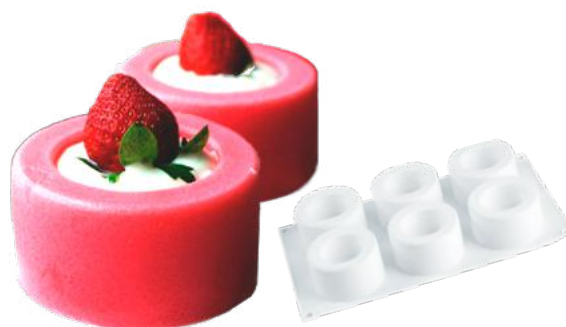

Cod.	Medida - Size	Volumen - Volume	Pcs.
AO4411	75 Ø x 48 h mm.	90 ml.	6



Cod.	Medida - Size	Volumen - Volume	Pcs.
GEM100	61 x 61 x 30 h mm.	100 ml.	8



Cod.	Medida - Size	Volumen - Volume	Pcs.
UNIVERSO90	67 Ø x 27 h mm.	90 ml.	6



Cod.	Medida - Size	Volumen - Volume	Pcs.
TRUFFLES5	22 Ø x 19,5 h mm.	5 ml.	35
TRUFFLES20	32 Ø x 28 h mm.	20 ml.	15
TRUFFLES40	42 Ø x 36 h mm.	40 ml.	15
TRUFFLES70	52 Ø x 45 h mm.	70 ml.	8
TRUFFLES120	62 Ø x 52 h mm.	120 ml.	8

MONOPORCIONES SINGLE PORTIONS



Cod.	Medida - Size	Volumen - Volume	Pcs.
AO4406	60 Ø x 76 h mm.	115 ml.	8



Cod.	Medida - Size	Volumen - Volume	Pcs.
FRAGOLE	59 Ø x 61 h mm.	95 ml.	6



Cod.	Medida - Size	Volumen - Volume	Pcs.
LIMONE	85 x 59 x 42 h mm.	106 ml.	6



medidas exteriores 30 x 17,5 cm.

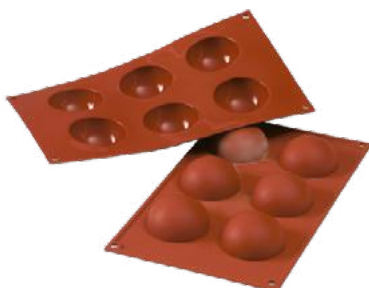

Cod.	Medida - Size	Vol.	Pcs.
SF001	80 Ø x 40 h mm.	120 ml.	5
SF002	70 Ø x 35 h mm.	80 ml.	6
SF003	60 Ø x 30 h mm.	60 ml.	6
SF004	50 Ø x 25 h mm.	30 ml.	8
SF005	40 Ø x 20 h mm.	20 ml.	15

Cod.	Medida - Size	Vol.	Pcs.
SF010	41 Ø x 12 h mm.	18 ml.	18
SF011	65 Ø x 21 h mm.	50 ml.	8
SF012	72 Ø x 23 h mm.	62 ml.	6

Cod.	Medida - Size	Vol.	Pcs.
SF013	45 Ø x 10 h mm.	20 ml.	15
SF014	50 Ø x 15 h mm.	25 ml.	15
SF015	60 Ø x 17 h mm.	40 ml.	8
SF016	70 Ø x 20 h mm.	70 ml.	6

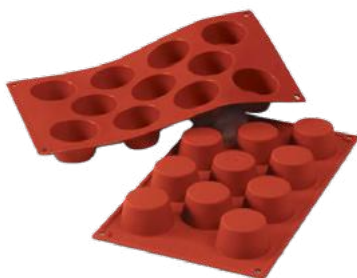

Cod.	Medida - Size	Vol.	Pcs.
SF022	51 Ø x 28 h mm.	50 ml.	11
SF023	69 Ø x 35 h mm.	100 ml.	6
SF024	81 Ø x 32 h mm.	135 ml.	5

Cod.	Medida - Size	Vol.	Pcs.
SF027	40 Ø x 20 h mm.	30 ml.	15
SF028	60 Ø x 35 h mm.	90 ml.	8
SF098	48 Ø x 50 h mm.	83 ml.	12
SF119	63 Ø x 40 h mm.	123 ml.	8
SF127	70 Ø x 35 h mm.	133 ml.	6

Cod.	Medida - Size	Vol.	Pcs.
SF029	60 Ø x 12 h mm.	35 ml.	8
SF030	35 Ø x 5 h mm.	5 ml.	24

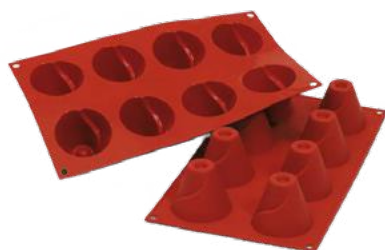

Cod.	Medida - Size	Vol.	Pcs.
SF093	60 Ø x 51 h mm.	72 ml.	8
SF094	49 Ø x 43 h mm.	41 ml.	15
SF095	36 Ø x 31 h mm.	16 ml.	24

Cod.	Medida - Size	Pcs.
TC2005	280 Ø x 60 h mm.	10



medidas exteriores 30 x 17,5 cm.
external size 30 x 17,5 cm.



Cod.	Medida - Size	Vol.	Pcs.
SF017	55 x 33 x 20 h mm.	30 ml.	16
SF018	70 x 50 x 20 h mm.	50 ml.	9
SF055	75 x 55 x 35 h mm.	110 ml.	8
SF111	88 x 53 x 24 h mm.	85 ml.	6

Cod.	Medida - Size	Vol.	Pcs.
SF038	72 x 30 x 12 h mm.	20 ml.	12
SF039	100 x 44 x 15 h mm.	40 ml.	9

Cod.	Medida - Size	Vol.	Pcs.
SF083	41 x 29 x 20 h mm.	16 ml.	24
SF084	67 x 49 x 23 h mm.	48 ml.	10
SF085	74 x 57 x 27 h mm.	72 ml.	8



Cod.	Medida - Size	Vol.	Pcs.
SF036	65 x 40 h mm.	130 ml.	6
SF040	60 x 35 h mm.	90 ml.	8

Cod.	Medida - Size	Vol.	Pcs.
SF087	59 x 62 x 32 h mm.	72 ml.	8
SF088	49 x 54 x 28 h mm.	45 ml.	10
SF089	33 x 35 x 22 h mm.	16 ml.	24
SF124	69 x 72 x 39 h mm.	125 ml.	6



Cod.	Medida - Size	Vol.	Pcs.
SF031	44 x 34 x 10 h mm.	10 ml.	15
SF032	68 x 45 x 17 h mm.	30 ml.	9

Cod.	Medida - Size	Vol.	Pcs.
SF034	79 Ø x 37 h mm.	110 ml.	6
SF035	79 Ø x 30 h mm.	110 ml.	6
SF109	58 Ø x 22 h mm.	33 ml.	12



medidas exteriores 30 x 17,5 cm.
external size 30 x 17,5 cm.



Cod.	Medida - Size	Vol.	Pcs.
SF007	71 x 71 x 40 h mm.	90 ml.	6
SF008	36 x 36 x 22 h mm.	20 ml.	15



Cod.	Medida - Size	Vol.	Pcs.
SF080	32,5 x 32,5 x 20 h mm.	16 ml.	24
SF081	42,5 x 42,5 x 28 h mm.	45 ml.	15
SF082	62,5 x 62,5 x 25 h mm.	73 ml.	8



Cod.	Medida - Size	Vol.	Pcs.
SF025	49 x 26 x 11 h mm.	20 ml.	20
SF054	95 x 45 x 12 h mm.	50 ml.	7



Cod.	Medida - Size	Vol.	Pcs.
SF090	72 x 45 x 26 h mm.	72 ml.	8
SF091	58 x 37 x 25 h mm.	45 ml.	10
SF092	41 x 23 x 21 h mm.	16 ml.	25

Cod.	Medida - Size	Vol.	Pcs.
SQ014	495 x 80 x 63 h mm.	2137 ml.	4
KITWOOD	250 x 185 x 70 h mm.	250 ml.	1

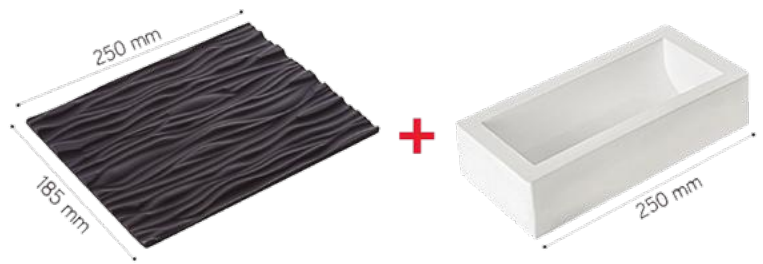
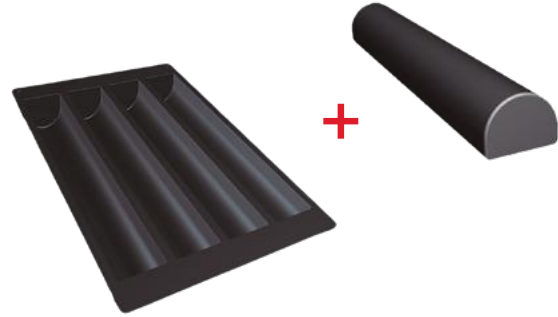
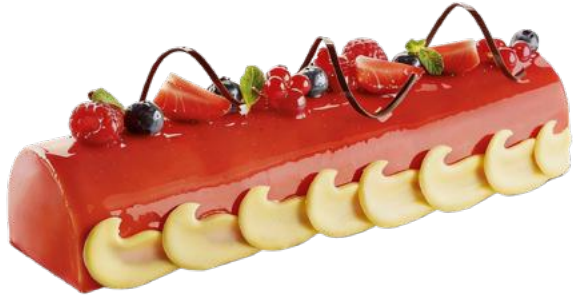

MOLDES SILICONA PARA PIEZAS INDIVIDUALES GRAN TAMAÑO
SILICONE MOLDS FOR LARGE INDIVIDUAL PIECES.



medidas externas 40 x 60 cm.
external size 40 x 60 cm.



Cod.	Medida - Size	Pcs.
SQ001	75 x 40 h mm.	35



Cod.	Medida - Size	Pcs.
K002	80 Ø x 40 h mm.	20



Cod.	Medida - Size	Pcs.
K003	70 Ø x 35 h mm.	24



Cod.	Medida - Size	Pcs.
SQ009	69 Ø x 39 h mm.	24



Cod.	Medida - Size	Pcs.
K036	80 x 53 x 40 h mm.	25



Cod.	Medida - Size	Pcs.
SQ005	77 x 44 x 18 h mm.	44



Cod.	Medida - Size	Pcs.
K035	52 x 52 x 36 h mm.	35

MOLDES SILICONA PARA PIEZAS INDIVIDUALES GRAN TAMAÑO
 SILICONE MOLDS FOR LARGE INDIVIDUAL PIECES.



Cod.	Medida - Size	Pcs.
K041	65 Ø x 50 h mm.	24



Cod.	Medida - Size	Pcs.
K043	57 x 51 x 50 h mm.	35



Cod.	Medida - Size	Pcs.
K038	60 Ø x 70 h mm.	28



Cod.	Medida - Size	Pcs.
K039	124 x 31 x 36 h mm.	28



Cod.	Medida - Size	Pcs.
K045	60 Ø x 45 h mm.	28



Cod.	Medida - Size	Pcs.
K037	120 x 33 x 32 h mm.	24

MOLDES SILICONA PARA PIEZAS INDIVIDUALES GRAN TAMAÑO
SILICONE MOLDS FOR LARGE INDIVIDUAL PIECES.



medidas externas 40 x 60 cm.
external size 40 x 60 cm.



Cod.	Medida - Size	Pcs.
K049	157 x 41 h mm.	35



Cod.	Medida - Size	Pcs.
K050	95 x 53 x 35 h mm.	25



Cod.	Medida - Size	Pcs.
K052	70 x 70 x 36 h mm.	24

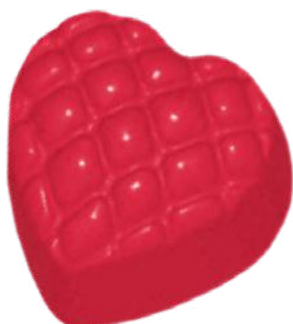

Cod.	Medida - Size	Pcs.
K059	65 x 65 x 35 h mm.	28



Cod.	Medida - Size	Pcs.
K054	120 x 39 x 31 h mm.	24



Cod.	Medida - Size	Pcs.
K061	120 x 60 x 35 h mm.	20



Cod.	Medida - Size	Pcs.
K063	70 x 45 x 35 h mm.	36



Cod.	Medida - Size	Pcs.
K071	75 x 67 x 35 h mm.	36

MOLDES 100% RECICLABLES 100% RECYCLABLE MOLDS



Prácticos, económicos y rápidos, los moldes desechables para semifreídos, monodosis y tartas individuales permiten agilizar la producción, ahorrar tiempo y reducir costes.

Practical, economical and fast, the disposable molds for semifreddos, single doses and individual cakes allow you to speed up production, save time and reduce costs.

Cod.	Medida - Size	Pack
ONE16	160 Ø x 40 h mm.	100uds.
ONE18	180 Ø x 40 h mm.	100uds.
ONE20	200 Ø x 40 h mm.	100uds.
ONE22	220 Ø x 40 h mm.	100uds.

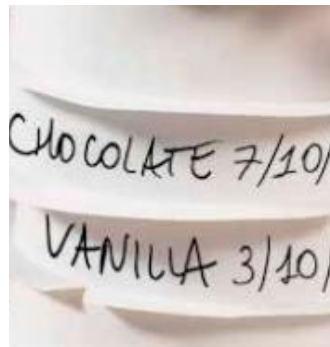

MOLDES
DE CHOCOLATE

Chocolate molds



medidas externas molde 13,50 x 17,5 cm.
external size mold 13,50 x 17,5 cm.

Moldes de policarbonato para chocolate.
Polycarbonate moulds for chocolate.



MA1001
19x30x15h mm.
7 gr. / 21 pz.



MA1002
Ø24x16h mm.
7 gr. / 21 pz.



MA1003
25x35x19h mm.
5 gr. / 24 pz.



MA1019
20x20x19h mm.
7 gr. / 36 pz.

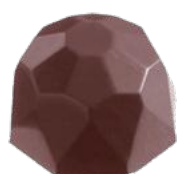

MA1024
25x25x16h mm.
8 gr. / 21 pz.



MA1025
18x29x16h mm.
8 gr. / 24 pz.



MA1028
22x27x15h mm.
7 gr. / 24 pz.



MA1032
18x30x11h mm.
5 gr. / 25 pz.



MA1036
26x26x19h mm.
13 gr. / 24 pz.



MA1045
28x25x18h mm.
12 gr. / 24 pz.



MA1047
Ø27x34h mm.
12 gr. / 21 pz.



MA1064
21x32x14h mm.
8 gr. / 24 pz.



MA1065
Ø28x20h mm.
12 gr. / 24 pz.



MA1080
28x14x11h mm.
5 gr. / 24 pz.



MA1082
28x33x17h mm.
11 gr. / 30 pz.



MA1088
28x32x23h mm.
15 gr. / 28 pz.



MA1093
29x37x14h mm.
8 gr. / 24 pz.



MA1113
30x28x15h mm.
10 gr. / 24 pz.



MA1134
21x27x17h mm.
8 gr. / 24 pz.

medidas externas molde 13,50 x 17,5 cm.
external size mold 13,50 x 17,5 cm.



MA1218
28x24x16h mm.
6 gr. / 21 pz.



MA1219
21x18x13h mm.
5 gr. / 24 pz.



MA1327
19x29x13h mm.
6 gr. / 24 pz.



MA1334
27x16x13h mm.
6 gr. / 24 pz.



MA1555
Ø30x21h mm.
12 gr. / 21 pz.



MA1557
26x26x19h mm.
12 gr. / 24 pz.



MA1564
Ø32x16h mm.
13 gr. / 21 pz.



MA1637
29x25x20h mm.
12 gr. / 28 pz.



MA1701
26x26x16h mm.
11 gr. / 24 pz.



MA1708
30x21x15h mm.
10 gr. / 27 pz.



MA1709
25x25x12h mm.
10 gr. / 27 pz.



MA1710
28x28x17h mm.
11 gr. / 21 pz.



MA1717
Ø29x18h mm.
9 gr. / 21 pz.



MA1719
26x26x19h mm.
13 gr. / 21 pz.



MA1722
27x27x18h mm.
11 gr. / 21 pz.



MA1729
30x15x25h mm.
9 gr. / 24 pz.



MA1738
34x34x9h mm.
7 gr. / 21 pz.



MA1760
37x17x17h mm.
10 gr. / 30 pz.



MA1761
15x37x15h mm.
10 gr. / 30 pz.



MA1762
37x17x17h mm.
10 gr. / 30 pz.



MA1763
16x37x16h mm.
10 gr. / 30 pz.



MA1764
Ø26x17h mm.
10 gr. / 21 pz.



MA1765
23x26x21h mm.
10 gr. / 24 pz.



MA1766
22x16x28h mm.
10 gr. / 32 pz.



MA1768
18x18x28h mm.
10 gr. / 36 pz.

Especial relleno / Special filling

medidas externas molde 13,50 x 17,5 cm.
external size mold 13,50 x 17,5 cm.

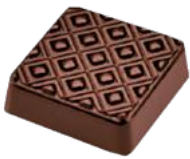

MA1770

30x30x11h mm.
11 gr. / 18 pz.



MA1771

50x25x13 mm.
9 gr. / 16 pz.



MA1772

33x33x17 h mm.
21 pz.



MA1773

48x25x17 h mm.
15 gr. / 21 pz.



MA1774

31x24x15h mm.
8 gr. / 21 pz.



MA1775

30Øx19h mm.
12 gr. / 21 pz.



MA1776

Ø35x19h mm.
15 gr. / 15 pz.



MA1777

55x25x17h mm.
11 gr. / 18 pz.



MA1780

48x25x17 h mm.
15 gr. / 21 pz.



MA1215

46x23x13h mm.
10 gr. / 22 pz.



MA1778

35x39x6h mm.
5 gr. / 26 pz.



MA1779

25x40x8h mm.
5 gr. / 30 pz.



MA1644

55x27x21h mm.
9 gr. / 2x8 pz.



MA1656

38x28x15h mm.
15 gr. / 18 pz.



MA1680

50x38x15h mm.
19 gr. / 10 pz.



MA3061

40x50x8h mm.
8 gr. / 12 pz.

Moldes de policarbonato para chocolate "Magnéticos".

Magnetics polycarbonate moulds for chocolate.

medidas externas 175 x 275 x 2,5 h mm.
external size 175 x 275 x 2,5 h mm.



Cod.	Medida - Size	Vol.	Pcs.
MA8004	30x30x10h mm.	11 gr.	20

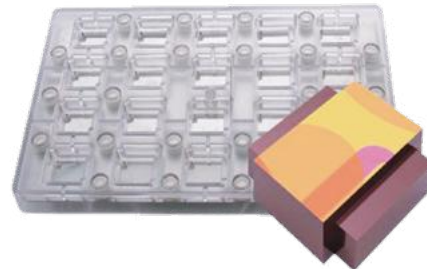

Cod.	Medida - Size	Vol.	Pcs.
MA8002	30x30x10h mm.	11 gr.	20



Molde rígido piruleta - Rigid lollipop mould

Cod.	Medida - Size	Vol.	Pcs.
MA2463	32x50x24h mm.	8 gr.	9

MA2463 32x50x24h mm. 8 gr. 9



Molde rígido piruleta - Rigid lollipop mould

Cod.	Medida - Size	Vol.	Pcs.
MA2464	36x50x13h mm.	12 gr.	9

MA2464 36x50x13h mm. 12 gr. 9



Molde rígido piruleta - Rigid lollipop mould

Cod.	Medida - Size	Vol.	Pcs.
MA2465	35x50x15h mm.	20 gr.	7

MA2465 35x50x15h mm. 20 gr. 7

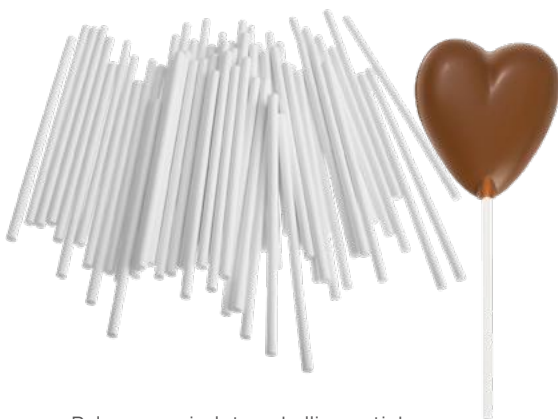

Palos para piruletas - Lollipop sticks

Cod.	Medida - Size	Mat.	Pcs.
A0Σ666	Ø4 x 150 mm.	Papel - Paper	100

A0Σ666 Ø4 x 150 mm. Papel - Paper 100



Cod.	Medida - Size	Vol.	Pcs.
MA1781	115x25x8h mm.	9 gr.	10

MA1781 115x25x8h mm. 9 gr. 10

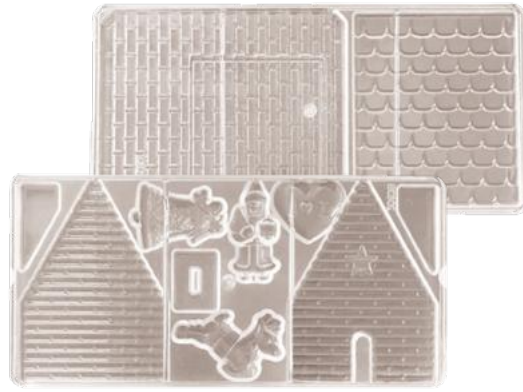

MA1782

88x150x125h mm.
2pz.



MAC800S

160h mm. 2pz.

MAC801S

205h mm. 1pz.



MAC823S

160h mm. 1pz.



MA0020

75x12,7x35h mm. 2 pz.
36x63x17,5h mm.



MA0004

120x115x53h mm. 1 pz.



MA0005

88x58x60h mm.

65x58x46h mm. 3 pz.



MA0030

150x130x70h mm. 1pz.



MA0326

95x105x40h mm. 1pz.



MA0031

150x135x65h mm. 1pz.



MA0033

150x130x70h mm. 1pz.



MA0001

218x93x75h mm. 1pz.



MA0032

170x55x55h mm. 1pz.



MA0021

160x120x30h mm.
1pz.



MA0034

125x120x60h mm.
91x87x45h mm. 3pz.



MA0022

134x120x60h mm.
70x72x30h mm. 2pz.

Moldes para "Pascua".
Moulds for "Easter."



Cod.	Medida - Size	Vol.
MA0050	90x67x74h mm.	1 pz.



Moldes rígidos grandes - Large rigid mould

Cod.	Medida - Size	Vol.
SUT25X17	250x170 mm.	0,5 - 1 kg. / 1 pz.
SUT28X18	280x185 mm.	0,8 - 1,2 kg. / 1 pz.
SUT34X25	325x240 mm.	1,5 - 2 kg. / 1 pz.
SUT40X27	390x265 mm.	2 - 2,5 kg. / 1 pz.
SUT45X32	435x310 mm.	2,5 - 3,5 kg. / 1 pz.
SUT54X36	520x350 mm.	4 - 6 kg. / 1 pz.

Elaboración



medidas externas 13,50 x 17,5 cm.
external size 13,50 x 17,5 cm.



Moldes rígidos - Rigid moulds

Cod.	Medida - Size	Vol.
MA1661	96x64x32h mm.	126 gr. / 4 pz.
MA2442	110x74x37h mm.	190 gr. / 3 pz.
MA1665	140x94x47h mm.	405 gr. / 2 pz.
MA1666	180x120x60h mm.	865 gr. / 1 pz.



Moldes rígidos - Rigid moulds

Cod.	Medida - Size	Vol.
MA2462	75x50x25h mm.	66 gr. / 8 pz.
MA1663	96x63x32h mm.	132 gr. / 4 pz.
MA2460	110x75x35h mm.	198 gr. / 3 pz.
MA1669	140x94x47h mm.	405 gr. / 2 pz.
MA1670	180x120x60h mm.	865 gr. / 1 pz.



Moldes rígidos - Rigid moulds

Cod.	Medida - Size	Vol.
MA2451	70x47x24h mm.	50 gr. / 8 pz.
MA1651	81x54x27h mm.	80 gr. / 6 pz.
MA1652	100x67x33h mm.	137 gr. / 4 pz.
MA1667	140x94x47h mm.	405 gr. / 2 pz.
MA1668	180 x 120 x 60 h mm.	865 gr. / 1 pz.



Moldes flexibles forma huevo liso.
Flexible moulds form plain egg.

Cod.	Medida - Size	Cant.
422	25x40h mm.	5 pzs.
415	40x60h mm.	3 pzs.
410	60x85h mm.	1 pz.
412	85x120h mm.	1 pz.
404	105x165h mm.	1 pz.
402	130x190h mm.	1 pz.
437	170x245h mm.	1 pz.
401	205x275h mm.	1 pz.
423	220x360h mm.	1 pz.
424	300x425h mm.	1 pz.



Moldes flexibles forma huevo decorado.
Flexible moulds form decorate egg.

Cod.	Medida - Size	Cant.
416	35x50h mm.	3 pzs.
430	70x95h mm.	1 pz.
428	95x140h mm.	1 pz.
435	120x170h mm.	1 pz.
433	150x210h mm.	1 pz.



Cod.	Medida - Size
90-13453	55x35x18h mm.



Kit 10 pcs

Cod.	Medida - Size
AO1206	100x80x7h mm.

medidas externas molde 13,50 x 17,5 cm.
external mold size 13,50 x 17,5 cm.

Moldes de policarbonato para tabletas de chocolate
Polycarbonate moulds for chocolate tablets.



MA2020 130x65x9h mm.
40 gr. / 4 pz.



MA1431 100x62x9h mm.
62 gr. / 3 pz.



MA2110 150x74x8h mm.
86 gr. / 3 pz.

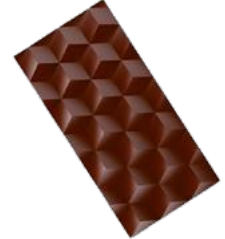

MA2381 148x74x9h mm.
96 gr. / 3 pz.



MA2016 120x60x9h mm.
54 gr. / 3 pz.



MA2010 102x22x10h mm.
22 gr. / 7 pz.



MA2902 150x75x15h mm.
175 gr. / 3 pz.

Moldes flexibles para tabletas de chocolate y turrón. Posibilidad de personalización.
Flexible moulds for chocolate and nougat tablets. Possibility of customization.



Cod. Medida - Size
80-1301 196x83x20h mm.



Cod. Medida - Size
80-1316 195x83x20h mm.



Cod. Medida - Size
80-1328 195x82x20h mm.



Cod. Medida - Size
80-1335 195x82x20h mm.



Cod. Medida - Size
80-1056 164x84x12h mm.

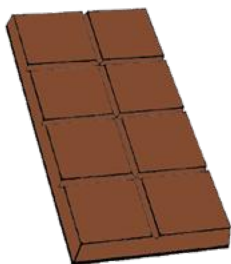

Cod. Medida - Size
80-1081 243x102x16h mm.



Cod. Medida - Size
80-1307 196x83x17h mm.



Cod. Medida - Size
80-1615 193x81x18h mm.



Cod. Medida - Size
80-1344 196x82x19h mm.



Cod. Medida - Size
80-1621 193x80x19h mm.



Moldes de silicona para caramelo y chocolate. 258x135x3,3h mm.
Silicone moulds for caramel and chocolate.



QM001 55x57x1,8h mm. 8 pz.



QM007 55x105x1,8h mm. 8 pz.

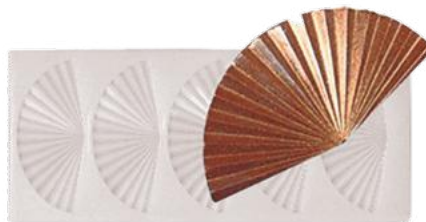

QM011 40x85x1,8h mm. 5 pz.



QM012 44x95x1,8h mm. 7 pz.



QM013 45x110x1,8h mm. 8 pz.



QM016 48x75x1,8h mm. 8 pz.



QM017 Ø57x2,5h mm. 8 pz.

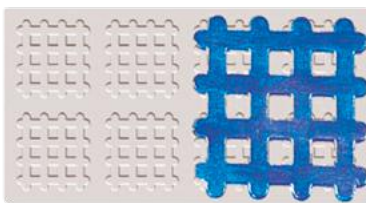

QM025 45x45x2,5h mm. 8 pz.



QM031 40x40x1,8h mm. 15 pz.

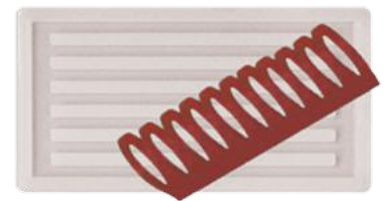

QM033 65x125x1,8h mm. 1 pz.



QM038 55x55x1,8h mm. 8 pz.



QM039 40x50x2,5h mm. 12 pz.



QM040 50x50x2,5h mm. 8 pz.

Moldes de Acrílicos de relieve para Chocolate. 258x135x6h mm.
Acrylic embossed moulds for chocolate. 258x135x6h mm.

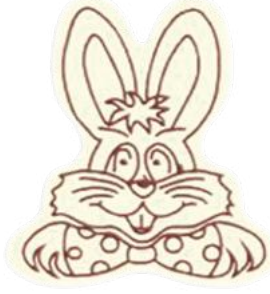
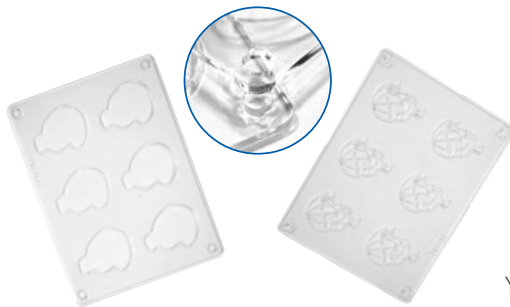

YY0029 37x43x5h mm. 6 pz.



YY0033 34x39x5h mm. 6 pz.



YY0048 38x39x5h mm. 6 pz.



YY0140 82x112x5h mm. 2 pz.



YY0173 41x55x5h mm. 6 pz.



YY0176 46x51x5h mm. 6 pz.



YY0177 42x51x5h mm. 6 pz.



YY0180 42x52x5h mm. 6 pz.



YY0183 38x55x5h mm. 6 pz.

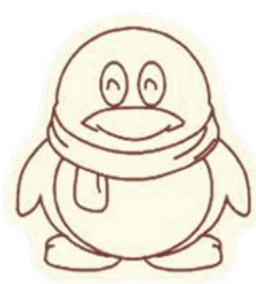

YY0184 43x45x5h mm. 6 pz.



YY0261 40x55x5h mm. 8 pz.



YY0271 35x65x5h mm. 7 pz.



YY0277 35x55x5h mm. 8 pz.

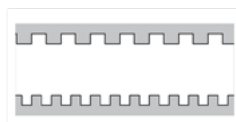

Peines para el chocolate.
Chocolate combs

Cod.	Medida - Size	Material.
PDM1/2	340 mm.	Goma - Rubber
PD1/2	700 mm.	Goma - Rubber

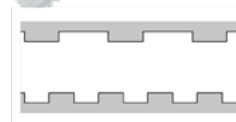

Peines para el chocolate.
Chocolate combs

Cod.	Medida - Size	Material.
PDM3/4	340 mm.	Goma - Rubber
PD3/4	700 mm.	Goma - Rubber



Ideal para chocolate.
Ideal for chocolate.

Cod.	Medida - Size	Material.
AO0867	100 x 100 mm.	Inox. - Sst.



Tenedores para bañar en chocolate.
Forks to bathe in chocolate.

Cod.	Medida - Size	Material.
AO1024	-	Inox. - Sst.

P.V.C. ALIMENTARIO *FOODGRADE P.V.C.*



Pack de 50 láminas cortadas (90 micras).
Pack 50 sheets (90 microns).

Cod.	Medida - Size	Material.
AO1515	400 x 600 mm.	Acetato - Acetate.



Pack de 100 láminas cortadas (55 micras).
Pack 100 sheets (55 microns).

Cod.	Medida - Size	Material.
AO0013	400 x 600 mm.	Polipropileno - Polypropylene.

DECORACIÓN EN GELATINA JELLY DECORATION



Juego completo de agujas con formas y jeringuilla.
Complete set of needles with shapes and syringe.

Cod.	Medida - Size	Material
AO1607	-	Inox. - Sst.

3D



Gelatina neutra en láminas Gold. Gold neutral sheet gelatin.

Presentada en hojas rectangulares con apariencia plástica y rígidas.
Una vez hidratadas en agua fría se vuelven maleables y están listas para ser usadas.
Se puede utilizar para gelificar un producto completamente o solo para darle espesor y densidad.

*Presented in rectangular sheets with a plastic and rigid appearance.
Once hydrated in cold water, they become malleable and ready to be used.
It can be used to gel a product completely or just to give it thickness and density.*



Cod.	Capacidad - Capacity
MA-063	1kg.

MAQUINARIA

Machinery





25 l.



7,5 l.



4 l.

Cazos eléctricos. Electric coppers.

- Cazos eléctricos de cobre con baño de acero inoxidable.
- Resistencia exterior soldada en la parte inferior de los cazos, para una perfecta difusión del calor gracias al material de cobre proporcionando el mismo calor en la parte inferior que en la superior.
- Cable de conexión eléctrico desmontable de silicona.
- Asa plastificada y mango para uso directo al fuego.

- *Electric copper saucepans with stainless steel bath.*
- *External resistance welded in the bottom of the buckets, for a perfect heat diffusion thanks to the copper material providing the same heat at the bottom as at the top.*
- *Detachable silicone electrical connection cable.*
- *Plasticized handle and handle for direct use on fire.*

Cod.	Medida Size	Litros Liters	Material	Conexión desmontable Removable connection	Voltaje Voltage	Potencia Max. Max. Power	Peso Weight
AO0694	395 Ø x 290 h mm.	25 l.	Cobre - Cooper	Monofásico (Opción trifásico) Monophase (Three-phase)	220 V (Opción 380 V) (Option 380 V)	Min. 3000 W Max. 6000 W	9,6 Kg.
AO0292	265 Ø x 205 h mm.	7,5 l.	Cobre - Cooper	Monofásico Monophase	220 V	2000 W	4 Kg.
AO0646	210 Ø x 170 h mm.	4 l.	Cobre - Cooper	Monofásico Monophase	220 V	1500 W	3 Kg.

En nuestro taller disponemos de servicio de reparación. *In our workshop we have repair service.*

- Baños de acero inoxidable.
- Reparación conexión del mango.
- Recambio de resistencias.

- *Stainless steel bathrooms.*
- *Repair handle connection.*
- *Resistance replacement.*



Quemadores eléctricos.
Electric burners.

- Quemadores eléctricos en forma redonda y rectangular.
- Resistencia blindada en tubos de acero soldada en la parte superior de la plancha de acero inoxidable.
- Cable de conexión eléctrica desmontable de silicona.

Cuadro eléctrico regulador de temperatura con temporizador.
Electric panel temperature regulator with timer.

- Electric burners in round and rectangular shape.
- Shielded resistance in steel tubes welded on the part top of the stainless steel plate.
- Detachable silicone electrical connection cable.

Cod.	Medida plancha Size griddle	Material	Resistencia Resistance	Conexión desmontable Removable connection	Voltaje Voltage	Potencia Max. Max. Power	Peso Weight
AO0288D	105 Ø mm.	Inox. - Sst.	Doble - Double.	Monofásico Monophase	220 V	900 W	1,2 Kg.
AO0366	75 x 235 x 5 h mm.	Inox. - Sst.	Triple - Triple.	Monofásico Monophase	230 V	2000 W	1,7 Kg.
AO0289	70 x 230 x 3 h mm.	Inox. - Sst.	Doble - Double.	Monofásico Monophase	230 V	1500 W	1,2 Kg.



Cuadro eléctrico regulador de temperatura con temporizador.
Electric panel temperature regulator with timer.

Cod.	Material	Uso - Use
AO0717	P.V.C	Quemadores - Electric burners
AO0717C	P.V.C	Cazos - Electric Copper



Soporte de sobremesa para quemadores.
Desktop support for electric burners.



Cable para quemadores y cazos - Cable for burners and coopers.

Cod.	Características - Characteristic
AO0600	2 Bornas - 2 Terminals
AO0599	3 Bornas - 3 Terminals
AO0639	3 Bornas "Rosca" - 3 Terminals "Threads"

Cod.	Medida - Size	Material
AO0008	Estándar - Standard	Inox. - Sst.

Freidora industrial. Industrial fryer.

Fabricada en acero inoxidable. Con una cuba amplia embutida. Sus resistencias especiales de acero inoxidable de alta duración, alcanzan la temperatura de trabajo en un tiempo muy corto. Sus resistencias extra-grandes permiten un calentamiento más homogéneo del aceite, optimizando el rendimiento a una potencia determinada. Además hace posible trabajar sin quemar el aceite, obteniendo un ahorro de aceite de hasta el 60%.

Made of stainless steel. With a large embedded tank. Its special long-lasting stainless steel resistors reach working temperature in a very short time. Its extra-large resistances allow a more homogeneous heating of the oil, optimizing performance at a given power. It also makes it possible to work without burning the oil, obtaining an oil saving of up to 60%.

Freidora industrial para uso diario.

- Control de temperatura regulable.
- Resistencia blindada en tubos de acero.
- Grifo para vaciado.
- Tapa inoxidable.
- Cesta inoxidable con asas.
- Reja inoxidable para sumergir el producto.

Industrial fryer for daily use.

- Adjustable temperature control.
- Armored resistance in steel tubes.
- Drain tap.
- Stainless lid
- Stainless basket with handles.
- Stainless grill to submerge the product.



AO0786



AO1350



AO1326



AO1324 - AO1324B



AO1356



AO1325 - AO1325B

Cod.	Descripción Description	Medida Size	Material	Conexión Connection	Voltaje Voltage	Potencia Max. Max. Power	Capacidad aceite Oil capacity
AO0786	Freidora completa Full fryer	Cesta - Basket 420 x 420 x 170 h mm. Freidora - Fryer 530 x 480 x 230 h mm.	Inox. Sst.	Monofásico (Opción trifásico) Monophase (Three-phase)	220 V (Opción 380 V) (Option 380 V)	5500 W	Max.: 20 l. Trabajo - Work: 12 l.
AO1350	Freidora completa Full fryer	Cesta - Basket 1000 x 520 x 170 h mm. Freidora - Fryer 1110 x 580 x 230 h mm.	Inox. Sst.	Monofásico (Opción trifásico) Monophase (Three-phase)	220 V (Opción 380 V) (Option 380 V)	11000 W	Max.: 60 l. Trabajo - Work: 32 l.
AO1325	Tapadera - Cover	500 x 500 mm.	Inox- Sst.				
AO1325B	Tapadera - Cover	500 x 1000 mm.	Inox- Sst.				
AO1326	Grifo - Tap	-	Inox- Sst.				
AO1324	Cesta - Basket	420 x 420 x 170 h mm.	Inox- Sst.				
AO1324B	Cesta - Basket	1000 x 520 x 170 h mm.	Inox- Sst.				

* Las referencias AO0786 y AO1350 son freidoras completas que contienen tapadera, grifo y cesta.

* The references AO0786 and AO1350 are deep fryers complete with cover, tap and basket.

Freidora profesional. *Professional fryer.*

Fabricada en acero inoxidable. Con una cuba amplia embutida. Sus resistencias especiales de acero inoxidable de alta duración, alcanzan la temperatura de trabajo en un tiempo muy corto.

Sus resistencias extra-grandes permiten un calentamiento más homogéneo del aceite, optimizando el rendimiento a una potencia determinada. Además hace posible trabajar sin quemar el aceite, obteniendo un ahorro de aceite de hasta el 60%.

Made of stainless steel. With a large embedded tank.

Its special long-lasting stainless steel resistors reach working temperature in a very short time.

Its extra-large resistances allow a more homogeneous heating of the oil, optimizing performance at a given power. It also makes it possible to work without burning the oil, obtaining an oil saving of up to 60%.



Freidora profesional para uso diario.

- Control de temperatura regulable.
- Resistencia blindada en tubos de acero.
- Grifo para vaciado.
- Tapa inoxidable.
- Cesta inoxidable con asas.

Industrial fryer for daily use.

- Adjustable temperature control.
- Armored resistance in steel tubes.
- Drain tap.
- Stainless lid
- Stainless basket with handles.

Cod.	Descripción Description	Medida Size	Material	Conexión Connection	Voltaje Voltage	Potencia Max. Max. Power	Peso Weight	Capacidad aceite Oil capacity
AO1589	Freidora completa Full fryer	Cesta - Basket - Freidora - Fryer 590 x 540 x 360 h mm.	Inox. Sst.	Monofásico Monophase	220 V/240V	3KW	18Kg.	20 l.
AO1597	Freidora completa Full fryer	Cesta - Basket - Freidora - Fryer 600 x 580 x 430 h mm.	Inox. Sst.	Monofásico Monophase	220 V/240V	6KW	22Kg.	30 l.
AO1612	Freidora completa Full fryer	Cesta - Basket - Freidora - Fryer 425 x 285 x 350 h mm.	Inox. Sst.	Monofásico Monophase	220 V/240V	2KW	10Kg.	4 l.

Duproflex®

Equipamiento profesional
Professional 5 l. /10 l.



Accesorios para batidora 5l./10l.
5 l. / 10l. Mixer accessories.



Bol de acero inoxidable.
Stainless steel bowl.



Batidor inoxidable "Varilla"
Stainless "Rod" Beater.



Batidor "Gancho"
"Hook" Beater.



Batidor "Mariposa"
"Butterfly" Beater.

DUPROFLEX 5 l.

AO1587

DUPROFLEX 10 l.

AO1588

Contiene - Contains:

- Bol de acero inoxidable - Stainless steel bowl.
- Batidor inoxidable "Varilla" - Stainless "Rod" Beater.
- Batidor "Gancho" - "Hook" Beater.
- Batidor "Mariposa" - "Butterfly" Beater.
- Tapadera protección - Protection cover.

Cod.	Descripción Description	Medida Size	Voltaje V Voltage V	Potencia Power	Capacidad Capacity	Peso Weight
AO1587	Batidora 5 l. completa - Mixer 5 l. complete	380 x 240 x 375 h mm.	220-240	0,5 KW	5l.	13 Kg.
AO1588	Batidora 10 l. completa - Mixer 10 l. complete	390 x 260 x 445 h mm.	220-240	0,5 KW	10l.	15 Kg.
AO1587B	Bol de acero inoxidable - Stainless steel bowl	-	-	-	5l.	-
AO1588B	Bol de acero inoxidable - Stainless steel bowl	-	-	-	10l.	-
AO1587V	Batidor inoxidable "Varilla" - Stainless "Rod" Beater	-	-	-	5l.	-
AO1588V	Batidor inoxidable "Varilla" - Stainless "Rod" Beater	-	-	-	10l.	-
AO1587G	Batidor "Gancho" - "Hook" Beater	-	-	-	5l.	-
AO1588G	Batidor "Gancho" - "Hook" Beater	-	-	-	10l.	-
AO1587M	Batidor "Mariposa" - "Butterfly" Beater	-	-	-	5l.	-
AO1588M	Batidor "Mariposa" - "Butterfly" Beater	-	-	-	10l.	-
AO1587E	Recambio de escobillas	-	-	-	-	-



OPCIÓN DE REPUESTOS

Montadora de natas. *Whipped cream machine.*

Monta la nata entre 3 y 6 minutos, aumentando el volumen de la nata.

La nata debe de estar fría al incorporarla a la máquina.

Se aconseja que la máquina se utilice en el lugar más fresco del lugar de trabajo.

Pour the cream between 3 and 6 minutes, increasing the volume of the cream.

The cream must be cold when incorporated into the machine.

It is advisable to use the machine in the coolest place in the workplace.

Cod.	Material	Conexión Connection	Voltaje Voltage	Capacidad Capacity
AO0258	Inox. Sst.	Monofásico (Opción trifásico) Monophase (Three-phase)	220 V (Opción 380 V) (Option 380 V)	5 l.



AO1323
Bandeja - Tray



Cocedor de tocinillos. *Electric cooker.*

Cocedor eléctrico con las resistencias en seco.
Tiene una capacidad para 3 bandejas.
Regulador de temperatura.

*Electric cooker with dry resistors.
It has a capacity for 3 trays.
With thermostat.*

Cod.	Descripción Description	Medida Size	Material	Conexión Connection	Voltaje Voltage	Capacidad Capacity
AO0598	Cocedor eléctrico Electric cooker	300 x 500 x 260 h mm.	Inox. Sst.	Monofásico Monophase	230 V	3 Bandejas 3 Trays
AO1323	Bandeja Tray	270 x 400 x 40 h mm.	Inox. Sst.	-	-	-

Niveladoras de bizcochos. Cake leveling machine.

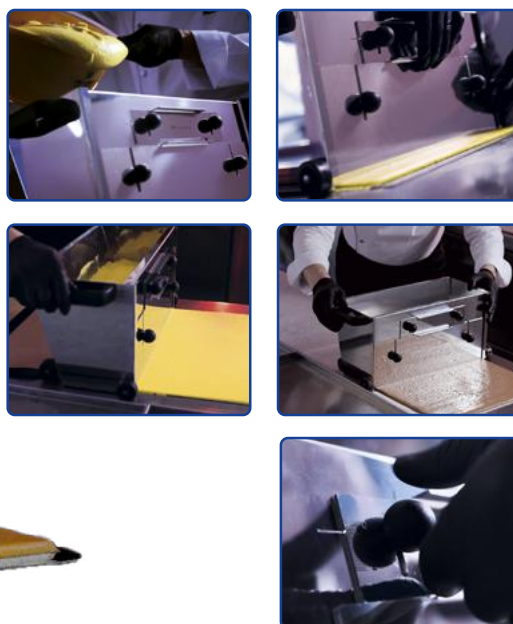

Cod.	Descripción Description	Medida Size	Material	Pack.
AO0649C	Nivelador 480 mm. - 480 mm. Leveling	480 mm.	Inox. - Sst.	1



Cod.	Descripción Description	Medida Size	Material	Pack.
AO0649	Nivelador 370 mm. - 370 mm. Leveling	370 mm.	Inox. - Sst.	1
AO0649B	Nivelador 400 mm. - 400 mm. Leveling	400 mm.	Inox. - Sst.	1
AO0649P	Peine recambio 370 mm. - <i>Spare comb 370 mm.</i>	370 mm.	Inox. - Sst.	1
AO0649G	Peine recambio 400 mm. - <i>Spare comb 400 mm.</i>	400 mm.	Inox. - Sst.	1
AO0287	Bobina papel 370 mm. - <i>Paper roll 370 mm.</i>	1 (4,16 kg.)	Papel kraft - <i>Kraft paper</i>	1
AO0290	Bobina papel 380 mm. - <i>Paper roll 380 mm.</i>	1 (4,16 kg.)	Papel kraft - <i>Kraft paper</i>	1
AO0828	Bobina papel 400 mm. - <i>Paper roll 400 mm.</i>	1 (4,16 kg.)	Papel kraft - <i>Kraft paper</i>	1
AO0828B	Bobina papel 400 mm. - <i>Paper roll 400 mm.</i>	1 (15 kg.)	Papel kraft - <i>Kraft paper</i>	1
AO1328	Resma papel 400 x 600 mm. - <i>Sheet paper 400 x 600 mm.</i>	10 kg.	Papel kraft - <i>Kraft paper</i>	1

Inyectora manual. Manual desktop.

Inyectora manual de sobremesa.
Fácil desmontable para su limpieza.
Contiene 3 boquillas diferentes.
Tornillos adaptables a la mesa.

*Manual desktop injector.
Easy removable for cleaning.
It contains 3 different nozzles.
Screws adaptable to the table.*



AO0775



AO0775B

Cod.	Descripción Description	Capacidad Capacity	Material
AO0775	Inyectora manual Manual injector	9L	Inox. - Sst.
AO07751	Recambio muelle Spring replacement	-	Inox. - Sst.
AO0775B	Inyectora manual Manual injector	3L	Inox. - Sst.

Cod.	Descripción Description	Potencia Power	Material
AO1598	Molinillo picador almendras, 3Kg. Almond chopper, 3 Kg.	220V / 3.75KW 25000 r.p.m.	Inox. - Sst.



NEW



Inyectora automática. *Automatic injector.*

Inyectora automática inoxidable de sobremesa.
Regulador electrónico de cantidad.
Fácil desmontable para su limpieza.
Contiene boquillas de diferentes tamaños.

*Automatic stainless tabletop injector.
Electronic quantity regulator.
Easy removable for cleaning.
It contains nozzles of different sizes.*

Cod.	Medida Size	Voltaje Voltage	Potencia Max. Max. Power	Capacidad Capacity	Peso Weight
AO0775A	450 x 300 x 630 h mm.	240 V	180 W	8,5 l.	27 Kg.



Alisadora profesional. Professional straightener.

Posee una estética moderna y atractiva con recubrimiento en polvo. Su espátula está hecha de acero inoxidable 304 y la plataforma es de alta calidad realizada en aleación de aluminio. Fácil de utilizar gracias a sus controles digitales, regulable en altura mediante control analógico, con un rendimiento extraordinario sin apenas ruido y de bajo consumo. El sentido de rotación puede ser cambiado de las agujas del reloj al sentido contrario. Ideal para alisar todo tipo de pasteles con diferentes coberturas suaves (merengues, glazas, natas, etc...).

It has a modern and attractive powder-coated aesthetic. Its spatula is made of 304 stainless steel and the platform is of high quality made of aluminum alloy. Easy to use thanks to its digital controls, adjustable in height by analog control, with extraordinary performance with little noise and low consumption. The direction of rotation can be changed from clockwise to counterclockwise. Ideal for smoothing all kinds of cakes with different soft toppings (meringues, glazes, creams, etc...).

Regulador Manual Perfiles



Cod.	Medida Size	Medidas Base Base Size	Voltaje V Voltage V	Potencia Power	Capacidad Capacity	Peso Weight
AO1586	360X500X570 mm.	360mm.	220-240	0,2KW	100/300mm	28 Kg.

Rociadora de gelatina. *Jelly sprinkler.*



Apta para congelación.
Suitable for freezing.

Máquina de sobremesa ideal para rociar gelatina a gran velocidad reduciendo el tiempo del trabajo.

Con regulador de presión de 0,5 a 3,5 bar.

También se puede regular la temperatura digitalmente hasta los 90°C.

La rociadora aspira el producto de una caldera que calienta la gelatina ubicada en el interior de la máquina.

La rociadora emplea tubos calentados eléctricamente que, combinados con el control digital, mantienen constantemente la temperatura configurada.

Ideal desktop machine for spraying gelatine at high speed reducing the time of work.

With pressure regulator from 0.5 to 3.5 bar.

The temperature can also be regulated digitally up to 90 °C.

The sprayer sucks the product from a boiler that heats the gelatine inside the machine.

The sprayer uses electrically heated tubes which, combined with the digital control, constantly maintain the set temperature.

Cod.	Descripción Description	Medida Size	Conexión Connection	Voltaje V Voltage V	Potencia Power	Capacidad Capacity	Peso Weight
AO1417	Rociadora gelatina - Jelly sprinkler	340 x 450 x 430 h mm.	Monofásico Monophase	220 - 240	1,1 Kw	2,5 l.	29 Kg.
AO1417P	Pistola de recambio - Replacement gun	-	-	-	-	-	-
AO1417M	Manguera de recambio - Replacement hose	-	-	-	-	-	-
A0602	Spraygel - Gelatina especial rociadora	-	-	-	-	-	12 Kg.

Lámpara para caramelo. Candy lamp.

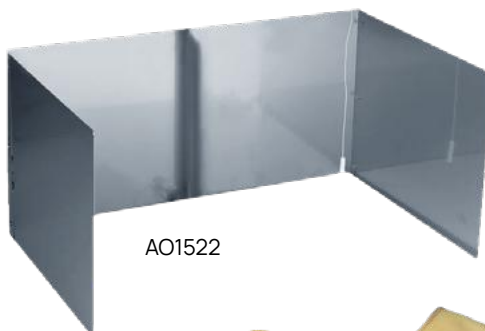

Cod.	Descripción Description	Medida de trabajo Work size	Conexión Connection	Potencia Power
AO1521	Lámpara para caramelo - Candy lamp	450 x 625 mm.	Monofásico Monophase	2 x 600 W
AO1522	Protector - Protector	-	-	-
AO1523	Perilla de aire en cobre - Air pump made of cooper	-	-	-
AO1524	Soporte perilla de aire - Air pump support	-	-	-
AO1525	Tijera para azúcar - Sugar scissors	-	-	-
AO1526	Guantes - Gloves	Talla 7 - Size 7	-	-
AO1527	Guantes - Gloves	Talla 9 - Size 9	-	-
AO0468	Soporte termómetro - Candy thermometer holder	137 h mm.	-	-
AO1486	Termómetro para caramelo - Candy thermometer	310 h mm. + 40°C / + 200°C	-	-
AO0523	Termómetro para caramelo - Candy thermometer	300 h mm. + 80°C / + 200°C	-	-



Mechero recargable de gas semiprofesional.
Gas rechargeable lighter semiprofessional use.

Mechero recargable de gas profesional.
Gas rechargeable lighter professional use.

Mechero de gas uso industrial.
Bombona no incluida.
Gas lighter industrial use.
Gas cylinder not included.

Cod. Medida - Size
AO1600 69 x 103 x 142 h mm.

Cod. Medida - Size
AO1601 74 x 154 x 198 h mm.

Cod. Potencia - Power
AO1602 1,9 Kw

Atemperadores Digitales para chocolate con calor en seco. Digital chocolate melters with dry heat.

Realizado en material plástico termoresistente, así como una bandeja y una tapa extraíbles en acero inoxidable y un sensor térmico para la adecuada regulación de la temperatura del chocolate. La placa electrónica controla la temperatura interna asegurándose de conseguir los mejores resultados, además detecta la temperatura externa del chocolate mediante un sensor de temperatura dedicado a ayudarlo a templar el chocolate rápidamente y de un modo mucho más preciso. Posee un panel frontal para controlar de temperatura, el cual puede ser regulado manualmente mediante 3 programas diferentes dependiendo del tipo de chocolate que vaya a utilizar: blanco, con leche u oscuro. Las indicaciones en la pantalla le ayudará a controlar la temperatura y templar el chocolate.

Made of heat-resistant plastic material, as well as a removable tray, a stainless steel cover and a thermal sensor for the proper regulation of the chocolate's temperature. The electronic board controls the internal temperature ensuring the best results. It also detects the external temperature of the chocolate thanks to a thermal sensor dedicated to make quickly the chocolate milder and in a much more precise way. It has a front panel to control the temperature, which can be regulated manually by 3 different programs depending on the type of chocolate you are going to use: white, milk or dark. The indications on the screen will help you to control the temperature and temper the chocolate.

Cubetas y tapas de repuesto disponibles
Código:AO1591R



Cod.	Medida exterior Exterior size	Medida Bañera Basin size	Capacidad Capacity
AO1550	240 x 400 x 135 h mm.	180 x 325 x 100 h mm.	3,6 l.

Cod.	Medida exterior Exterior size	Medida Bañera Basin size	Capacidad Capacity
AO1551	330 x 400 x 135 h mm.	265 x 320 x 100 h mm.	6 l.



Cod.	Medida exterior Exterior size	Medida Bañera Basin size	Capacidad Capacity
AO1552	395 x 450 x 135 h mm.	320 x 353 x 100 h mm.	9 l.



Cod.	Medida exterior Exterior size	Medida Bañera Basin size	Capacidad Capacity
AO1553	395 x 620 x 135 h mm.	325 x 530 x 100 h mm.	13,7 l.

Atemperadores Analógicos para chocolate con calor en seco.

Analogic chocolate melters with dry heat.



Cod.	Medida exterior Exterior size	Medida Bañera Basin size	Capacidad Capacity
AO1554	240 x 260 x 135 h mm.	140 x 155 x 100 h mm.	1,5 l.
AO1555	240 x 400 x 135 h mm.	180 x 325 x 100 h mm.	3,6 l.
AO1556	330 x 400 x 135 h mm.	265 x 320 x 100 h mm.	6 l.
AO1557	395 x 450 x 135 h mm.	320 x 353 x 100 h mm.	9 l.



Cod.	Medida exterior Exterior size	Medida Bañera Basin size	Capacidad Capacity
AO1559	420 x 260 x 135 h mm.	140 x 155 x 100 h mm.	2 x 1,5 l.

Cod.	Medida exterior Exterior size	Medida Bañera Basin size	Capacidad Capacity
AO1560	610 x 260 x 135 h mm.	140 x 155 x 100 h mm.	3 x 1,5 l.

Atemperador digital para chocolate

Digital chocolate melters.

Cuerpo realizado en acero inoxidable de primera calidad, así como la tapa extraíble. Con un sensor térmico y controlador digital para la adecuada regulación de la temperatura del chocolate. La placa electrónica controla la temperatura interna asegurándose de conseguir los mejores resultados, además detecta la temperatura externa del chocolate mediante un sensor dedicado a ayudarle a templarlo rápidamente (entre 0° y 90°) y de un modo mucho más estable.

Las indicaciones en la pantalla le ayudará a controlar la temperatura y templar el chocolate.

Ponemos a su disposición dos modelos independientes, con una sola cubeta de 12 l. o como segunda opción con doble cubetala de 6 l.+ 6 l.

Body made of top quality stainless steel, as well as the removable lid. With a thermal sensor and digital controller for the proper regulation of the temperature of the chocolate. The electronic board controls the internal temperature making sure to achieve the best results, it also detects the external temperature of the chocolate through a dedicated sensor to help it temper it quickly (between 0° and 90°) and in a much more stable way.

The indications on the screen will help you control the temperature and temper the chocolate.

We put at your disposal two independent models, with a single 12 l tank. or as a second option with a double bucket of 6 l. + 6 l.

Cubetas y tapas de repuesto disponibles

Código:AO1591R



AO1591



AO1592



AO1606

Cod.	Medida exterior Exterior size	Medida Bañera Basin size	Capacidad Capacity	Voltaje Voltage	Potencia Power	Temperatura Temperature	Peso Weight
AO1591	465 x 355 x 260 h mm.	353 x 325 x 150 h mm.	12 l.	220V	1 KW.	0°-95°	10Kg.
AO1592	465 x 355 x 260 h mm.	325 x 176 x 150 h mm.	6 + 6 l.	220V	1 KW.	0°-95°	10Kg
AO1606	465 x 355 x 260 h mm.	325 x 176 x 150 h mm.	4 + 4 + 4 l.	220V	1 KW.	0°-95°	10Kg

Atemperadora profesional de sobremesa para chocolate.

Professional melter table top for chocolate.

Templadoras de mostrador, con capacidad de 5,5 y 11 Kg, que permiten templar el chocolate de modo profesional al igual que las máquinas más grandes, pero con inversiones y estorbos reducidos.

Sólida estructura de acero inoxidable.

Dos motores independientes, uno para la cóclea y uno para el agitador, para una mayor duración por largo tiempo.

Cóclea removible de serie de acero inoxidable para facilitar la limpieza y para cambiar rápidamente el chocolate.

Posibilidad de controlar el flujo de chocolate mediante el pedal.

Pantalla táctil con diversas opciones:

- Dosificaciones automáticas para erogar la correcta cantidad de chocolate.

- Modalidad nocturna para mantener el chocolate fundido, limitando el consumo durante la noche.

- Rotación contraria de la cóclea, útil durante la limpieza y para vaciar la boquilla.

Table top melters machines with a capacity of 5.5 and 11 Kg, that make it easy to temper chocolate in a professional manner as if using larger machines, but with a space efficient equipment and at lower costs.

Robust stainless steel structure.

Two motors, one for the auger screw and the other for the stirrer, for enhanced motor life over the long-term.

Removable stainless steel auger screw as standard to facilitate cleaning the equipment and for a quick chocolate change.

Pedal to control the chocolate flow.

Touch-screen panel with different options:

- Automatic dosing to dispense the right amount of chocolate.

- Night-mode to keep chocolate melted and to keep consumption

under control when the equipment is not used.

- Auger screw can rotate in the opposite direction, a highly useful function to clean and to empty the nozzle.



Cod.	Medida Size	Conexión Connection	Voltaje V Voltage V	Potencia Power	Capacidad Capacity	Peso Weight
AO1418	460 x 480 x 620 h mm.	Monofásico Monophase	110 - 240	1,1 Kw	5,5 l.	52 Kg.
AO141811L	550 x 500 x 720 h mm.	Monofásico Monophase	110 - 240	1,75 Kw	11 l.	63 Kg.

Olla eléctrica para coberturas / gelatinas.

Electric pot for toppings / jellies.

Olla eléctrica profesional para la realización de todo tipo de coberturas y/o gelatinas. Con una capacidad de 5l., un termostato regulable y un volumen reducido se convierte en la herramienta perfecta para dar ese toque profesional a todas sus coberturas.

Professional electric pot for making all kinds of toppings and/or jellies. With a 5l capacity, an adjustable thermostat and a reduced volume, it becomes the perfect tool to give that professional touch to all your toppings.



Cod.	Medida Size	Conexión Connection	Voltaje V Voltage V	Potencia Power	Capacidad Capacity
AO0116	Ø 24x14 cms	Monofásico Monophase	230	0,6 Kw	5 l.

Atemperadora profesional con pedal para chocolate.

Professional melter with chocolate pedal.

Sólida estructura de acero inoxidable.

Dos motores independientes, uno para la cóclea y uno para el agitador, para una mayor duración por largo tiempo.

Cóclea removible de serie de acero inoxidable para facilitar la limpieza y para cambiar rápidamente el chocolate.

Posibilidad de controlar el flujo de chocolate mediante el pedal.

Pantalla táctil con diversas opciones:

- Dosificaciones automáticas para erogar la correcta cantidad de chocolate.
- Modalidad nocturna para mantener el chocolate fundido, limitando el consumo durante la noche.
- Rotación contraria de la cóclea, útil durante la limpieza y para vaciar la boquilla.

Robust stainless steel structure.

Two motors, one for the auger screw and the other for the stirrer, for enhanced motor life over the long-term.

Removable stainless steel auger screw as standard to facilitate cleaning the equipment and for a quick chocolate change.

Pedal to control the chocolate flow.

Touch-screen panel with different options:

- Automatic dosing to dispense the right amount of chocolate.
- Night-mode to keep chocolate melted and to keep consumption under control when the equipment is not used.
- Auger screw can rotate in the opposite direction, a highly useful function to clean and to empty the nozzle.



Cod.	Medida Size	Voltaje V Voltage V	Potencia Power	Capacidad Capacity	Peso Weight
AO1418P12L	520 x 800 x 1540 h mm.	380 - 400	2,6 Kw	12 l.	159 Kg.
AO1418P24L	620 x 900 x 1540 h mm.	380 - 400	3 Kw	24 l.	185 Kg.

Dispensadora de chocolate profesional.

Professional Chocolate Dispenser.

Dispensadora de chocolate de banco, creada para integrarse en los mostradores de pastelerías, heladerías, chocolaterías.

Se puede utilizar para llenar conos y copas, realizar decoraciones, etc...

Cóclea removible de acero inoxidable para facilitar la limpieza y para cambiar rápidamente el chocolate utilizado.

Dos motores independientes, uno para la cóclea y uno para el agitador, para una mayor duración por largo tiempo.

Posibilidad de encajar la máquina en el mostrador gracias al kit de encaje.

Dosificaciones automáticas y posibilidad de controlar el flujo de chocolate mediante el pedal o el botón pertinente

Modalidad nocturna para mantener el chocolate fundido,

limitando el consumo durante los lapsos de no empleo.

Rotación contraria de la cóclea, útil durante la limpieza y para vaciar la boquilla.

A disposición cinco boquillas especiales y aparadores portátiles.

Dispenser invented specifically for ice cream parlours and chocolate shops and can be used to top ice cream cones and tubs, to make pretty decorations, etc...

Removable stainless steel auger screw to facilitate cleaning the equipment and for a quick chocolate change.

Two motors, one for the auger screw and the other for the stirrer, for enhanced motor life over the long-term.

Thanks to a practical kit the machine can be built in the counter.

Automatic dosing, button and pedal to control the chocolate flow.

Night-mode to keep chocolate melted and to keep consumption under control when the equipment is not used.

Auger screw can rotate in the opposite direction, a highly useful function to clean and empty the nozzle.

Five special nozzles and mobile counters available.



Cod.	Medida Size	Voltaje V Voltage V	Potencia Power	Capacidad Capacity	Peso Weight
AO1418D	390 x 460 x 830 h mm.	110 - 240	0,95 Kw	5,5 l.	37 Kg.

Rociadora profesional para chocolate. *Professional chocolate sprayer.*

Máquina para rociar chocolate, sucedáneo y manteca de cacao. Es la solución ideal para rociar chocolate en tartas, moldes, praliné, y para obtener en pocos minutos productos decorados perfectamente y con un aspecto atractivo.

Mediante la regulación de la presión, de la cantidad de chocolate y del ángulo del inyector es posible obtener diferentes efectos decorativos: terciopelo, nieve, piel de naranja, líneas, puntos, etc...

Cabina porta pistola calentada a temperatura regulable para mantener el chocolate fundido en los lapsos de no empleo y evitar obstrucciones del inyector.

El compresor no está incluido, se suministra bajo pedido.

Machine for spraying chocolate, substitute and cocoa butter. It is the ideal solution to sprinkle chocolate on cakes, molds, praline, and to obtain in a few minutes perfectly decorated products with an attractive appearance.

By regulating the pressure, the amount of chocolate and the angle of the injector it is possible to obtain different decorative effects: velvet, snow, orange peel, lines, points, etc ...

Gun carrier booth heated to adjustable temperature to keep molten chocolate in periods of non-use and avoid clogging of the injector.

The compressor is not included, it is supplied upon request.



Cod.	Presión regulable Adjustable pressure	Conexión Connection	Voltaje V Voltage V	Potencia Power	Capacidad Capacity	Peso Weight
AO1416	0,5 - 3,5 bar.	Monofásico Monophase	110 - 240	0,55 Kw	1l.	12 Kg.

Mesa vibradora para moldes de chocolate. *Vibrating table for chocolate moulds.*

Máquina vibradora ideas para creaciones con moldes de policarbonato para chocolate.
Rápida y fácil de utilizar.

Vibrating machine ideas for creations with polycarbonate molds for chocolate. Quick and easy to use.

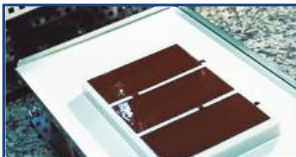

Cod.	Medida Size	Conexión Connection	Voltaje V Voltage V
AO1419	540 x 320 x 125 h mm.	Monofásico Monophase	110 - 240

Fuentes para chocolate.

Chocolate fountains.



AO69319



AO69321



AO69320

Cod.	Descripción Description	Medida Size	Conexión Connection	Voltaje V Voltage V	Potencia Power	Capacidad Capacity	Temperatura Temperature
AO69320	Fuente - Fount	380 Ø x 800 h mm.	Monofásico - Monophase	230	370 W	6,5 - 7 l.	36°C - 39°C
AO69321	Fuente - Fount	280 Ø x 630 h mm.	Monofásico - Monophase	220 - 240	-	4,5 - 5 l.	36°C - 39°C
AO69319	Fuente - Fount	230 Ø x 380 h mm.	Monofásico - Monophase	220 - 240	80 W	1,8 l.	40°C - 50°C

Máquina de algodón de azúcar

Cotton candy floss machine.



Equipada con una potencia de calentamiento de 900 W y un robusto motor de 35 W, nuestra máquina comercial de algodón de azúcar puede trabajar de forma continua y sólo le cuesta 30 segundos producir un algodón de azúcar. Funcionamiento sencillo con control de temperatura. Estructura fiable y fácil de limpiar.

Equipped with 900W heating power and 35W strong motor, our commercial cotton candy machine can work continuously and it only takes 30 seconds to produce one cotton candy. Simple operation with temperature control. Reliable structure and easy to clean.

Cod.	Material	Conexión Connection	Potencia Power	Capacidad Capacity
AO1590	Inox. Sst.	Monofásico (Opción trifásico) Monophase (Three-phase)	900W	4 oz.



Armario conservador de coberturas.
Conservative coverings cabinet.

Cod.	Medida Size	Capacidad Capacity
------	-------------	--------------------

AO1375 2 Pisos - 2 Floors 4 Boles 350 Ø mm.
420 x 855 x 617 h mm. 4 Bowls 350 Ø mm.



Placa calentamiento para chocolate.
Heating plate for chocolate.

Cod.	Medida Size	Potencia Power	Temperatura Temperature
------	-------------	----------------	-------------------------

AO1272 320 x 400 x 115 h mm. 80 W 0 - 90 °C



Kit bombón almadrado.
Almond chocolate kit.

Composición:
1 Base de polietileno sin fondo.
2 Bandejas de 60 orificios.
1 Espátula P.V.C. rectangular.

Elements:
1 Polyethylene base.
2 Trays of 60 holes.
1 Rectangular P.V.C. spatula.

Cod.	Medida Size
------	-------------

AO1549 400 x 600 x 50 h mm.



Kit bombón cortado.
Cut chocolate kit

Composición:
1 Base de polietileno 480x600mm.
1 Regla de P.V.C.
2 Marcos en P.V.C. de 365x365x3h mm.
2 Marcos en P.V.C. de 365x365x5h mm.

Elements:
1 Polyethylene base 480x600mm.
1 Rule P.V.C.
2 Frames in P.V.C. of 365x365x3h mm.
2 Frames in P.V.C. of 365x365x5h mm.

Cod.	Medida Size
------	-------------

TLSPECIAL 480 x 600 mm.



Máquina para hacer bolas de mazapán. Machine for making marzipan balls.

Ideal para elaborar bolas de mazapán de manera rápida y efectiva.
Ideal for making marzipan balls quickly and effectively.

Modo de uso / How to use :

1. Preparar la masa con un grosor de 24h mm.
2. Posicionar la masa en la base de la máquina de bolas y presionar con la cobertura para obtener tiras de masa.
3. Posicionar las tiras de masa horizontalmente.
4. Presionar nuevamente la cobertura contra la base y deslizar para obtener las bolas.

1. Prepare the dough with thickness of 24h mm.
2. Set the dough on the base of your ball machine and press with the cover to obtain strips.
3. Lay the strips of dough horizontally.
4. Press the cover up and down in order to obtain balls.



Cod.	Dimensiones de la bola Ball dimensions
PALL3	24 Ø mm.

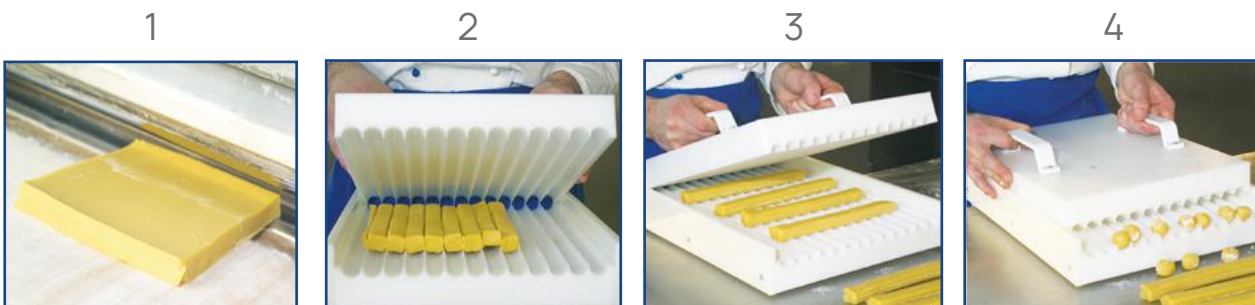

Cod.	Medida - Size	Pcs.
AO1541	-	9



Cod.	Medida - Size	Pcs.
MARSET12	-	15



Cod.	Medida - Size	Pcs.
AO1125	140 mm.	12

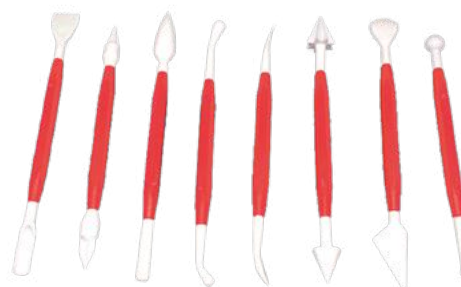

Cod.	Medida - Size	Pcs.
AO1126	160 mm.	8

Máquina de sellado

Sealing machine.

Fabricada en Acero inoxidable y ABS de gran duración, asegurándonos un correcto funcionamiento y un sellado rápido y eficaz. Es una selladora térmica ideal para cualquier utilidad, compatible con diferentes materiales, como plástico, papel o aluminio. Dependiendo del material ajustaremos la intensidad de la selladora térmica.

Made of long-lasting stainless steel and ABS, ensuring correct operation and a fast and effective seal. It is an ideal heat sealer for any utility, Compatible with different materials, such as plastic, paper or aluminum. Depending on the material we will adjust the intensity of the heat sealer.

Cod.	Material	Conexión Connection	Voltaje Voltage	Capacidad Capacity
AO1594	Inox. Sst.	Monofásico (Opción trifásico) Monophase (Three-phase)	220 V (Opción 380 V) (Option 380 V)	5 l.



Kit aerógrafo con pistola inoxidable.

Airbrush kit with stainless mechanism.

Kit ideal para la iniciación en el mundo de la aereografía pastelera. Tiene una alta precisión gracias a su regulador de potencia.

Ideal kit for initiation in the world of pastry aereography. It has high precision thanks to its power regulator.

Cod.	Precisión Precision	Voltaje Voltage
AO1400	0,3 mm.	220 V



Compresor aerógrafo estándar.

Standard airbrush compressor.

Compresor profesional con presión Medio - Alta. Tiene una alta precisión gracias a su regulador de potencia. Fácil de manejar gracias a su peso de 2,4 kg. y al cable de 1,5 m.

Professional compressor with medium - high pressure. It has high precision thanks to its power regulator. Easy to handle thanks to its weight of 2.4 kg. and to the wire 1.5 m.

Cod.	Medida Tamaño - Size	BAR	Voltaje Voltage
AO1401	190 x 130 x 170 h mm.	Start 2,4 Stop 3,1	220 - 240 V 50 Hz.

Pistolas de aerografía para pastelería. Airbrush guns for pastry.

Medida - Size: 155 mm.
Cable conexión al compresor no incluido.
Compressor wire connection not included.



Cod.	Precisión Precision	Capacidad Capacity	Material
AO1403	0,3 mm.	7 c.c.	Inox. - Sst.



Cod.	Precisión Precision	Capacidad Capacity	Material
AO1404	0,3 mm.	9 c.c.	Inox. - Sst.



Cod.	Precisión Precision	Capacidad Capacity	Material
AO1405	0,3 mm.	9 c.c. + 20c.c.	Inox. - Sst.

Accesorios para pistolas de aerógrafo. Accessories for airbrush guns.

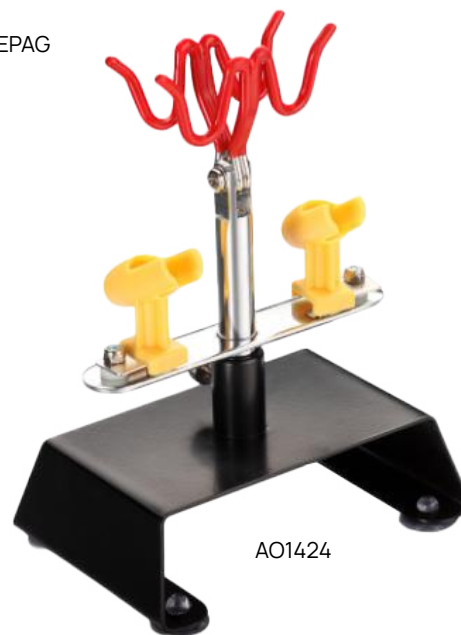

Cod.	Descripción - Description	Medida - Size
AO1406	Recipiente limpiador - Cleaner container	7
AO1408	Set 5 limpiadores - Set 5 cleaners	100 mm.
AO1407	Cable conexión - Wire connection	1,8 m.
AOREPAG	Aguja repuesto pistola - Spare needle gun	-
AO1424	Soporte para 2 pistolas - Support for 2 guns	450 x 395 x 315 h mm.



Colorante en pasta. Coloring in paste form.



(SIN E171)

Colorantes en pastas ideal para la decoración de pastelería en general. Los colorantes en pastas son fundamentales en el mundo pastelero ya que nos permiten colorear cualquier tipo de masas, cremas, mazapanes, galletas, caramelos etc...

Dyes in pastes ideal for decorating pastry in general. Dyes in pastes are essential in the pastry world since they allow us to color any type of dough, cream, marzipan, cookie, candy etc...

Cod.	Color	Capacidad - Capacity
OF33100	Rojo fresa - Strawberry red	200 gr.
OF33108	Rojo vivo - Deep red	200 gr.
OF33101	Amarillo limón - Lemon yellow	200 gr.
OF33102	Verde menta - Mint green	200 gr.
OF33103	Azul - Blue	200 gr.
OF33105	Violeta - Violet	200 gr.
OF33106	Marrón - Brown	200 gr.
OF33104	Naranja - Orange	200 gr.

Colorante en spray mate. Coloring in matte spray form.



(SIN E171)

Colorante en spray opaco con base de alcohol para superficies de producto alimenticios. Ideal para colorear superficies de: Chocolate, pasta de azúcar, pastillaje, pasta de almendras, repostería, natas y cremas.

Listo para usar. Agite bien antes de usar. Pulverizar desde una distancia de 25/30 cm manteniendo la botella lo más vertical posible.

Matt colouring spray alcohol based for the surface of foodstuff. Ideal for colouring the surface of chocolate, sugarpaste, gumpaste, almond paste, bakery products and cream. Ready to use. Shake well before use. Spray from a distance of 25/30 cm maintaining the can as vertical as possible.

Cod.	Color	Capacidad - Capacity
A0975	Rosa - Pink	150 ml.
A0976	Azul - Blue	150 ml.
A0977	Rojo - Red	150 ml.
A0978	Verde - Green	150 ml.
A0979	Amarillo - Yellow	150 ml.
A0980	Marrón - Brown	150 ml.
A0983	Oro - Gold	150 ml.
A0982	Plata - Silver	150 ml.

Colorante en polvo liposoluble. Fat-soluble powder coloring.



(SIN E171)

Colorante concentrado liposoluble en polvo. Ideal para la coloración de masas y superficies de: chocolate, crema de mantequilla, merengues, Fondant, masas grasas en general. Listo para usar. Vierta el tinte en la mezcla y mezcle bien. Para superficies, aplicar el polvo seco con brocha o diluido en alcohol alimentario o aceite.

Liposoluble concentrated colouring powder. Ideal for colouring the surface of chocolate, buttercream, swiss meringue, sugarpaste, fat masses in general. Ready to use. Pour the colouring into the dough and mix well. For surfaces apply the dry colouring powder with a brush or diluted in alcohol or oil.

Cod.	Color	Capacidad - Capacity
A0986	Rojo - Red	50 gr.
A0987	Gris - Grey	50 gr.
A0988	Verde - Green	50 gr.
A0989	Naranja - Orange	50 gr.
A0990	Amarillo - Yellow	50 gr.
A0991	Azul - Blue	50 gr.
A0936	Blanco - White	50 gr.
A0937	Choc. Leche - Milk Choc.	50 gr.
A0994	Oro - Gold	40 gr.
A0993	Plata - Silver	40 gr.
A0961	Bronce - Bronze	1 Kg.
A0994	Oro Real - Royal Gold	1 Kg.
A0962	Cobre - Copper	1 Kg.

Gelatina Neutra en frío. *Liposoluble liquid (Airbrush).*

Gelatina concentrada de textura cremosa que permite ser aplicada directamente. Insípida e incolora. Ideal para fijar láminas de oblea y de azúcar al instante creando así una protección e intensificando los colores impresos.

Creamy texture concentrated gelatin that can be applied directly. Tasteless and colorless. Ideal for fixing wafer and sugar sheets instantly creating protection and intensifying printed colors.

Cod.	Capacidad - Capacity
------	----------------------

MA-234	1Kg.
MA-235	6Kg.
MA-063	Láminas (1Kg.)



Spray desmoldeante. *Release spray.*



Desmoldeante alimentario en spray fabricado con aceites vegetales de alta calidad.

Food release spray made with high quality vegetable oils.

Cod.	Capacidad - Capacity
------	----------------------

A0780	600ml.
-------	--------

Spray brillo. *Shine spray.*



Spray alimentario ideal para dar brillo a decoraciones artísticas en chocolate, azúcar, mazapán etc.

Food spray ideal for giving shine to artistic decorations in chocolate, sugar, marzipan etc.

Cod.	Capacidad - Capacity
------	----------------------

A0985	400 ml.
-------	---------

Spray secado. *Dry spray.*



Spray alimentario ideal para refrigerar rápidamente decoraciones artísticas en chocolate y azúcar.

Food spray ideal for quickly refrigerating artistic decorations in chocolate and sugar.

(SIN E171)

Cod.	Capacidad - Capacity
------	----------------------

A0984	400 ml.
-------	---------

Cartuchos tinta alimentaria. Food ink cartridges.



COMPATIBLES CON IMPRESORAS
Comsumibles compatibles para
impresoras de la marca Canon.

Compatible consumables
for Canon brand printers.



Modelo Cartucho 580 / 581 Modelo Cartucho 570 / 571

Cod.	Color	Cod.	Color
OG000581	Negro fino Thin black	OG000571	Negro fino Thin black
OG001581	Negro ancho Width black	OG001571	Negro ancho Width black
OG002581	Magenta Magenta	OG002571	Magenta Magenta
OG003581	Amarillo Yellow	OG003571	Amarillo Yellow
OG004581	Cian Cyan	OG004571	Cian Cyan



Hoja comestible con alta resolución de impresión.
Edible sheet with high print resolution.

Cod.	Medida - Size	Pack	Box
A0890	210 x 297 mm. A4	25 uds.	25 pack

Hoja flexible, ligera, sin azúcar, y perfecta para cortar. Se puede utilizar sobre cualquier soporte para la decoración de productos alimentarios, mediante tecnología ink-jet. Soporta diferentes temperaturas.

Flexible, light, sugar-free blade, and perfect for cutting. It can be used on any support to decorate food products, using ink-jet technology. Withstands different temperatures.



Láminas Impresión Printing sheets.



Lámina de oblea para impresora.
Absorbe muy bien la gelatina neutra.
Wafer sheet for printer.
Absorbs neutral gelatin very well.

Cod.	Medida - Size	Material	Pcs.
O0009	210 x 297 mm. A4	Oblea Wafer	50
O0019	297 x 420 mm. A3	Oblea Wafer	50



Lámina plástica con manteca de cacao para impresora. "Chocotransfer".
Absorbe muy bien la gelatina neutra.
Chocotransfer sheet for printer.
Absorbs neutral gelatin very well.

Cod.	Medida - Size	Material	Pcs.
A00890	210 x 297 mm. A4	Transfer	25



Lámina de azúcar para impresora.
Absorbe muy bien la gelatina neutra.
Sugar sheet for printer.
Absorbs neutral gelatin very well.

Cod.	Description	Medida - Size	Material	Pcs.
A0132	Estándar Standard	210 x 297 mm. A4	Azúcar Sugar	20
A0138	Gruesa Gross	210 x 297 mm. A4	Azúcar Sugar	25

EXPOSITORES

Stands





Cod.	Medida - Size	Material
AO1376	590 x 220 X 270 mm.	Inox. - Sst.



LED incluido.
LED included.

Cod.	Medida - Size	Material
AO1216	3 x 250 Ø mm. 1 x 300 Ø mm.	Inox. - Sst.

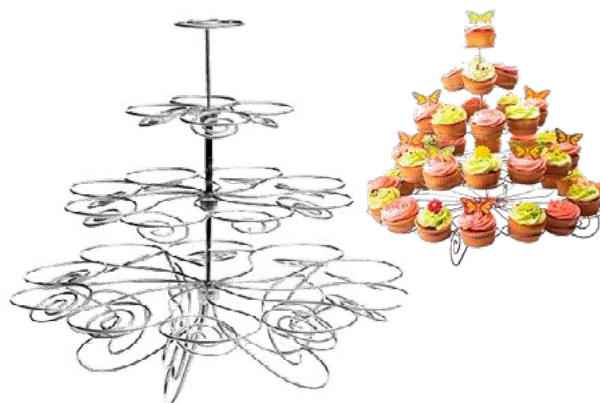

Cod.	Medida - Size	Material
TC8009	450 Ø x 360 h mm.	Metal



Soporte con espejo.
Cake stand with mirror.



Cod.	Medida - Size	Material
AO1215	310 Ø x 90 h mm.	Inox. - Sst.



Cod.	Medida - Size	Material
AO1220	310 Ø x 140 h mm.	Inox. - Sst.



LED incluido.
LED included.

Cod.	Medida - Size	Material
AO1218	400 Ø x 200 h mm.	Inox. - Sst.



Cod.	Medida - Size	Material
AO0872	145 x 910 h mm.	Metal
	1 pz 300 Ø mm.	
	2 pzs 300 x 400 mm.	
	1 pz 400 x 600 mm.	

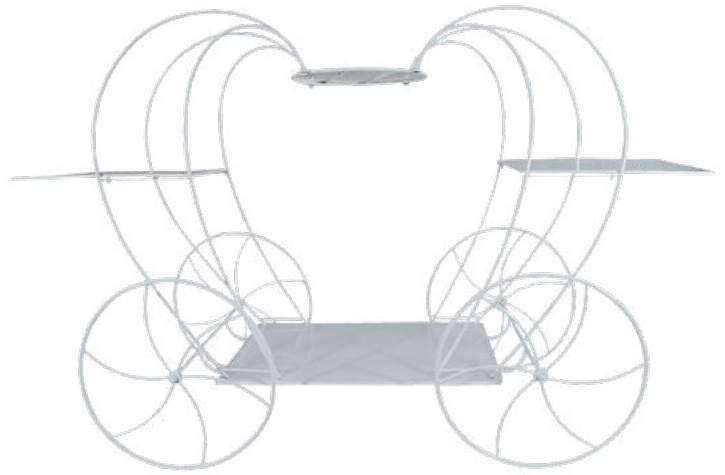

Cod.	Medida - Size	Material
AO0880	145 x 910 h mm.	Metal
	1 pz 300 Ø mm.	
	2 pzs 300 x 400 mm.	
	1 pz 400 x 600 mm.	

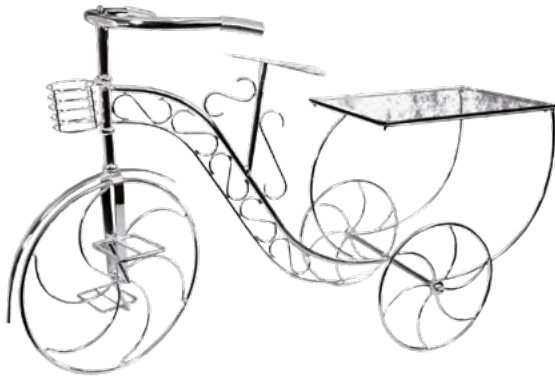

Platos de cristal.
Glass dishes.

Cod.	Medida - Size	Material
AO0892	340 x 990 x 620 h mm.	Metal
	1 pz 295 x 370 mm.	

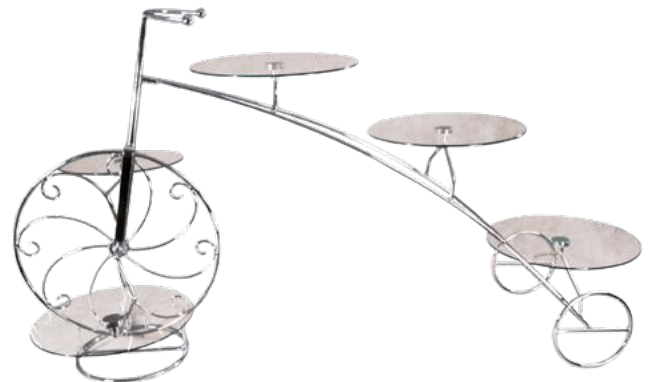

Platos de cristal.
Glass dishes.

Cod.	Medida - Size	Material
AO0879	1200 x 660 h mm.	Metal
	2 pzs x 260 Ø mm.	
	3 pzs x 300 Ø mm.	



Cod.	Medida - Size	Material
AO0870	1200 x 660 h mm.	Metal
	2 pzs x 260 Ø mm.	
	3 pzs x 300 Ø mm.	



Cod.	Medida - Size	Material
AO0873	620 x 680 h mm. 1 pz 200 Ø mm. 2 pzs 300 Ø mm. 1 pz 350 Ø mm.	Metal



Cod.	Medida - Size	Material
AO0895	300 x 110 h mm.	Metal



Platos de cristal.
Glass dishes.

Cod.	Medida - Size	Material
AO0875	840 x 840 x 740 h mm.	Metal

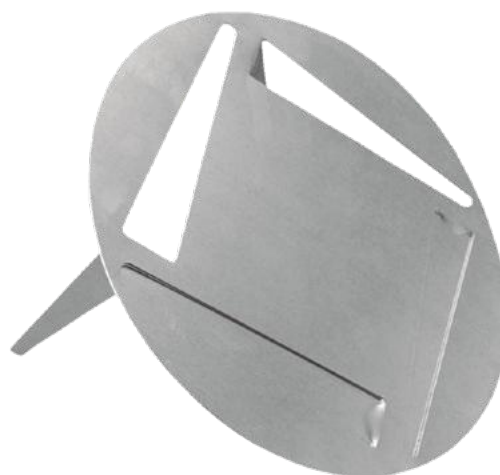

Soporte con patas plegables.
Support with folding legs.

Cod.	Medida - Size	Material	Pack
AO0255	160 Ø mm.	Aluminio - Aluminium	25
AO0256	200 Ø mm.	Aluminio - Aluminium	25
AO0257	240 Ø mm.	Aluminio - Aluminium	25

Soporte "Genuino Inglés", varios pisos con base de 30 Ø cm.
"English Genuine" Cake stand, several floors with base of Ø30 cm.

Cod.	Medida - Size	Descripción - Description	Material
AO0222	Base 30 Ø cm.	3 Pisos - floors	Inox.- Sst.
	Plato - Plate	20Ø 25Ø cm.	

Cod.	Medida - Size	Descripción - Description	Material
AO0223	Base 30 Ø cm.	5 Pisos - floors	Inox.- Sst.
	Plato - Plate	15Ø 20Ø 25Ø 30Ø 35Ø cm.	

Cod.	Medida - Size	Descripción - Description	Material
AO0224	Base 30 Ø cm.	6 Pisos - floors	Inox.- Sst.
	Plato - Plate	15Ø 20Ø 25Ø 30Ø 35Ø 40Ø cm.	

Cod.	Medida - Size	Descripción - Description	Material
AO0225	Base 30 Ø cm.	7 Pisos - floors	Inox.- Sst.
	Plato - Plate	15Ø 20Ø 25Ø 30Ø 35Ø 40Ø 45Ø cm.	

Cod.	Medida - Size	Descripción - Description	Material
AO0226	Base 30 Ø cm.	8 Pisos - floors	Inox.- Sst.
	Plato - Plate	15Ø 20Ø 25Ø 30Ø 35Ø 40Ø 45Ø 50Ø cm.	

Cod.	Medida - Size	Descripción - Description	Material
AO0227	Base 30 Ø cm.	10 Pisos - floors	Inox.- Sst.
	Plato - Plate	15Ø 20Ø 25Ø 30Ø 35Ø 40Ø 45Ø 50Ø 55Ø 60Ø cm.	



Base soporte.
Base for the cake stand.

Cod.	Medida - Size	Material
AO0230	30 Ø cm.	Inox. - Sst.



Base soporte.
Base for the cake stand.

Cod.	Medida - Size	Material
AO2015	30 Ø cm.	Inox. - Sst.



Discos redondos para soporte "Genuino Inglés".
Round disc for "English Genuine" Cake stand.

Cod.	Medida - Size	Material
AO0232	15 Ø cm.	Aluminio - Aluminum.
AO0233	20 Ø cm.	Aluminio - Aluminum.
AO0234	25 Ø cm.	Aluminio - Aluminum.
AO0235	30 Ø cm.	Aluminio - Aluminum.
AO0236	35 Ø cm.	Aluminio - Aluminum.
AO0237	40 Ø cm.	Aluminio - Aluminum.
AO0238	45 Ø cm.	Aluminio - Aluminum.
AO0239	50 Ø cm.	Aluminio - Aluminum.
AO0240	55 Ø cm.	Aluminio - Aluminum.
AO0241	60 Ø cm.	Aluminio - Aluminum.
AO0284	65 Ø cm.	Aluminio - Aluminum.

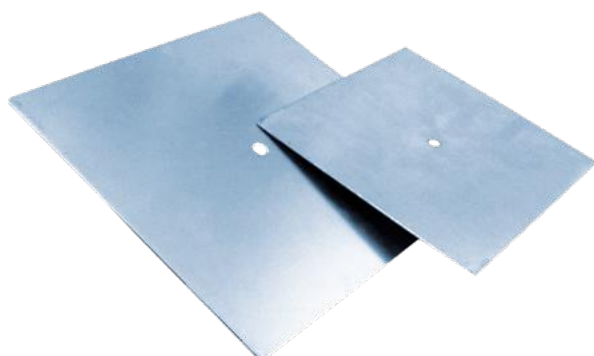

Discos cuadrados para soporte "Genuino Inglés".
Squared disc for "English Genuine" Cake stand.

Cod.	Medida - Size	Material
AO0354	15 x 15 cm.	Aluminio - Aluminum.
AO0355	20 x 20 cm.	Aluminio - Aluminum.
AO0356	25 x 25 cm.	Aluminio - Aluminum.
AO0357	30 x 30 cm.	Aluminio - Aluminum.
AO0358	35 x 35 cm.	Aluminio - Aluminum.
AO0359	40 x 40 cm.	Aluminio - Aluminum.
AO0360	45 x 45 cm.	Aluminio - Aluminum.
AO0361	50 x 50 cm.	Aluminio - Aluminum.



Tija para soportes.
Shank for cake stands.

Cod.	Medida - Size	Descripción - Description	Material
AO0248	11h cm.	Tija terminal - Final shank	Inox. - Sst.
AO0910	18h cm.	Tija terminal - Final shank	Inox. - Sst.
AO0249	-	Tornillo terminal - Final screw	Inox. - Sst.
AO0281	-	Arandela "Florón" - Washer "Floron"	Inox. - Sst.



Tija con arandela.
Shank with washer.

Cod.	Medida - Size	Material
AO0242	12 h cm.	Inox. - Sst.
AO0243	14 h cm.	Inox. - Sst.
AO0244	16 h cm.	Inox. - Sst.
AO0245	18 h cm.	Inox. - Sst.
AO0246	20 h cm.	Inox. - Sst.
AO0247	22 h cm.	Inox. - Sst.



Soporte curvo "3 Pisos".
Curved cake stand "3 Floors".

Cod.	Medida - Size	Material
P6816	3 x 28 Ø cm.	P.V.C.

Soporte cuna.
Curved cake stand "3 Floors".

Cod.	Medida - Size	Material
COD117	35 x 47 x 50 h cm.	Plástico



Cod.	Medida - Size	Descripción - Description	Material	Platos - Plates
P06812	34 Ø x 20 h cm.	2 Pisos - Floors	P.V.C.	20 Ø - 34 Ø cm.
P06813	34 Ø x 34 h cm.	3 Pisos - Floors	P.V.C.	20 Ø - 30 Ø - 34 Ø cm.
P06814	34 Ø x 51 h cm.	4 Pisos - Floors	P.V.C.	20 Ø - 25 Ø - 30 Ø - 34 Ø cm.
P06815	34 Ø x 66 h cm.	5 Pisos - Floors	P.V.C.	20 Ø - 23 Ø - 25 Ø - 30 Ø - 34 Ø cm.

ENVASES

Packaging



Cápsula papel "Standar" 50gr.
Thick paper capsule "Standar" 50 gr.

Cod.	Nº	W	H	Pcs.
AO0058	3	28 mm.	21 mm.	1000
AO0059	4	32 mm.	24 mm.	1000
AO0060	5	38 mm.	24 mm.	1000
AO0061	6	40 mm.	25 mm.	1000
AO0062	7	45 mm.	27 mm.	1000
AO0063	8	53 mm.	28 mm.	1000

Cápsula papel "Barba Extra" 85gr.
Thick paper capsule "Barba Extra" 85 gr.

Cod.	Nº	W	H	Pcs.
AO1184	5	38 mm.	24 mm.	1000
AO1291	6	40 mm.	25 mm.	1000
AO1334	7	45 mm.	27 mm.	1000
AO0504	8	53 mm.	28 mm.	1000
AO1302	9	55 mm.	32 mm.	1000
AO1539	10	60 mm.	35 mm.	1000



Cápsula papel "Super Extra" 70gr.
Thick paper capsule "Super"Extra 70 gr.

Cod.	Nº	W	H	Pcs.
AO0031	5	38 mm.	24 mm.	1000
AO0023	6	40 mm.	25 mm.	1000
AO0503	7	45 mm.	27 mm.	1000
AO0215	8	53 mm.	28 mm.	1000
AO0057	9	55 mm.	32 mm.	1000
AO0098	10	60 mm.	35 mm.	1000
AO0772	12	68 mm.	31 mm.	1000

Cápsula papel pastelería pergamino 35gr.
Capsule paper pastry 35gr.

Cod.	Nº	W	H	Pcs.
AO0082	3	30 mm.	21 mm.	1000
AO0560	4	32 mm.	24 mm.	1000
AO1305	5	38 mm.	24 mm.	1000
AO0064	6	40 mm.	24 mm.	1000
AO0027	7	45 mm.	27 mm.	1000
AO0824	8	50 mm.	30 mm.	1000



Cápsula alargada papel "Barba Extra" pastelería 85 gr.
Elongated pastry paper "Barba Extra" capsule 85 gr.

Cod.	Nº	W	H	Pcs.
AO1357	8	82 x 26 mm.	23 mm.	1000
AO0066	12	106 x 37 mm.	28 mm.	1000

Cápsula papel "Muffin".
"Muffin" paper capsule.

Cod.	W	H	Pcs.	Color
AO1093	50 mm.	90 mm.	1000	Marrón - Brown
AO1092	50 mm.	90 mm.	1000	Blanco - White
AO1067	50 mm.	80 mm.	1000	Marrón - Brown
AO1095	50 mm.	80 mm.	1000	Blanco - White

Cápsula papel pastelería pergamino 35gr.
Capsule paper pastry 35gr.

Cod.	Nº	W	H	Pcs.
AO0054	2	26 mm.	17 mm.	1000
AO0055	3	30 mm.	21 mm.	1000
AO0056	7	45 mm.	27 mm.	1000
AO0033	8	50 mm.	30 mm.	1000



Cápsula colores 50 grs.
Capsule colors 50 grs.

Cod.	Nº	W	H	Pcs.
CA0482	2	26 mm.	17 mm.	1000
CA0481	3	30 mm.	21 mm.	1000



Cápsula colores 60 grs.
Capsule colors 60 gr.

Cod.	Nº	W	H	Pcs.
CA0478	9,5	50 mm.	38 mm.	1000



Cápsula papel kraft 130 grs.
Capsule kraft paper 130 gr.

Cod.	Nº	W	H	Pcs.
CA0475	7	68 mm.	16 mm.	1000
CA0483	10	60 mm.	35 mm.	1000
CA0480	14	50 mm.	38 mm.	1000



Platito cartulina dorada 200 gr.
Gold cardboard plate 200 gr.

Cod.	Nº	W	H	Pcs.
AO1060	4	52 mm.	14 mm.	1000
AO1061	6	68 mm.	11 mm.	1000
AO0029	45/8	45 mm.	8 mm.	1000



Bandejita cartulina dorada 200 gr.
Gold cardboard plate 200 gr.

Cod.	Nº	W	H	Pcs.
AO1055	2	40x40 mm.	10 mm.	1000
AO1059	4	60x60 mm.	10 mm.	1000
AO0025	70/10	70 mm.	10 mm.	1000

Cápsula papel metalizado 60grs.
Capsule metallic paper 60 grs.

Cod.	Nº	W	H	Pcs.
AO1301	2	26 mm.	17 mm.	1000
AO1304	3	28 mm.	16 mm.	1000
AO1377	4	33 mm.	17 mm.	1000



Personalización de Cápsulas de papel

Personalized paper capsule.

Paso 1. Cliché.

Step 1. Cliche

Imagen o texto proporcionado por el cliente para personalización.
Image or text provided by the client for personalization.

Paso 2. Color.

Step 2. Colour

Colores disponibles sobre fondo claro:
Colors available on light background:



Colores disponibles sobre fondo oscuro:
Colors available on dark background:



Paso 3. Decoración.

Step 3. Decoration.



BORDE TRIPLE



BORDE ONDULADO

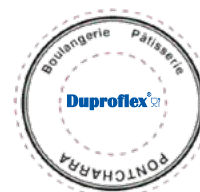

BORDE DOBLE



BORDE SIMPLE



BORDE CORTE TRIPLE



BORDE TRIPLE DIVIDIDO

Paso 4. Tipografía de impresión.

Step 4. Print typography.



Paso 5. Texto a imprimir.

Step 5. Print text.

Alrededor o Fondo
Around or Bottom

Cod.	Nº	Ø	▽	▽	Pcs.
AO1528	2	53mm.	20 mm.	16 mm.	10000
AO1563	3	57mm.	23 mm.	17 mm.	10000
AO1576	4	61mm.	25 mm.	18 mm.	10000
AO1359	5	68mm.	28 mm.	20 mm.	10000
AO1577	6	73mm.	33 mm.	20 mm.	10000
AO1341	7	81mm.	35 mm.	23 mm.	10000
AO0774	8	90mm.	40 mm.	25 mm.	10000
AO1585	9	97mm.	43 mm.	27 mm.	10000
AO1608	10	108mm.	48 mm.	30 mm.	10000

Cod.	Nº	Ø	▽	▽	Pcs.
AO0575	10b	117mm.	53 mm.	32 mm.	10000
AO0576	1201	110mm.	60 mm.	25 mm.	10000
AO1578	1201f	110mm.	70 mm.	20 mm.	10000
AO1579	1202	61mm.	35 mm.	13 mm.	10000
AO1580	1203	70mm.	40 mm.	15 mm.	10000
AO1581	1204	81mm.	45 mm.	18 mm.	10000
AO1582	1205	90mm.	70 mm.	30 mm.	10000
AO1583	1207	130mm.	80 mm.	30 mm.	10000
AO1584	1208	140mm.	90 mm.	25 mm.	10000

Molde redondo papel para horno.
Round baking paper mold.



Cod.	Cap.	Alto	Color	Pcs.
CA0433	175 mm.	25 mm.	Natural	250
CA0434	214 mm.	20 mm.	Natural	300
CA0435	250 mm.	24 mm.	Natural	250
CA0436	300 mm.	15 mm.	Natural	125
CA0433M	175 mm.	25 mm.	Marrón	250
CA0434M	214 mm.	20 mm.	Marrón	300
CA0435M	250 mm.	24 mm.	Marrón	250
CA0436M	300 mm.	15 mm.	Marrón	125



Cod.	Medida - Size	Alto	Pcs.
CA0211	79 x 40 mm.	40 mm.	2040
CA0199	175 x 85 mm.	40 mm.	600
CA0198	197 x 65 mm.	48 mm.	300
CA0212	240 x 80 mm.	70 mm.	300



Molde PANETTONE de papel para horno.
PANETTONE baking paper mold, directly.

Cod.	Cap.	Alto	Cap.	Pcs.	Pack
CA1007	70 mm.	50 mm.	90 gr.	100	2000
CA1024	100 mm.	80 mm.	300 gr.	100	2000
CA1005	135 mm.	95 mm.	500 gr.	100	1200
CA1023	160 mm.	130 mm.	900 gr.	100	1200



Bolsa para PANETTONE. PANETTONE

Cod.	Cap.	Alto	Cap.	Pcs.	Pack
CA1001	270 mm.	330 mm.	300-500	200	1000
CA1001B	270 mm.	330 mm.	900	200	2000

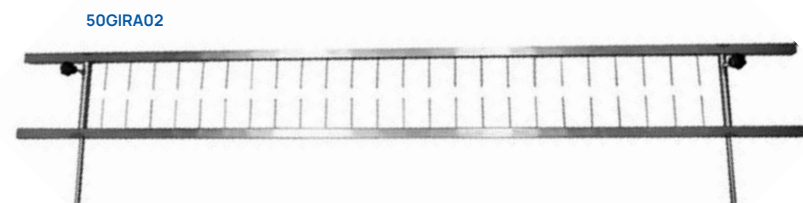

50GIRA02

50GIRA01

Soporte gira PANETTONE.
PANETTONE tour support.

Pincho gira PANETTONE.
Skewer rotates PANETTONE.

Cod.	Medida - Size	Material
50GIRA02	200 cm.	Inox. - Sst.
50GIRA01	60 cm.	Inox. - Sst.



Molde aluminio PANDORO.
PANDORO aluminum mould.

Cod.	Medida - Size
A01396	500 grs.
A01397	1000 grs.

Molde cocer madera ideal para presentación de bizcochos artesanales.
Cada molde contiene un papel siliconado.

*Wooden baking mould ideal for presenting artisanal cakes.
Each mould contains a silicone paper.*

Código molde Mould code	Medida molde Mould measure	Piezas por paquete Pieces for pack
CA0411	140 x 90 x 45h mm.	200
CA0412	185 x 115 x 55h mm.	100
CA0413	250 x 120 x 70h mm.	100



Molde cocer madera ideal para presentación de tartas en horno.
Soporta cocción hasta 220°C y congelación de -40°C
Cada molde contiene un papel siliconado por ambas caras.

*Wooden baking pan ideal for presentation of cakes in the oven.
Withstands baking up to 220°C and freezing up to -40°C.
Each mold contains a silicone paper on both sides.*

Código molde Mould code	Medida molde Mould measure	Piezas por paquete Pieces for pack
CA0765	60 Ø x 30h mm.	50
CA0766	80 Ø x 30h mm.	40
CA0767	100 Ø x 30h mm.	40
CA0768	110 Ø x 40h mm.	30
CA0769	120 Ø x 30h mm.	30
CA0770	140 Ø x 40h mm.	25
CA0771	160 Ø x 35h mm.	25



Molde cocer madera ideal para presentación de tartas en horno.
Cada molde contiene una cápsula de papel/PET.

*Wooden baking pan ideal for presentation of cakes in the oven.
Each mold contains paper capsule/PET.*

Código molde Mould code	Medida molde Mould measure	Piezas por paquete Pieces for pack
CA0772	53 Ø x 32h mm.	100
CA0773	82 Ø x 40h mm.	100
CA0774	120 Ø x 50h mm.	50
CA0775	135 Ø x 50h mm.	50
CA0776	163 Ø x 60h mm.	25



Cápsula papel color kraft.
Kraft paper capsule.

Cápsula papel blanco con borde
White paper capsule with border



Código molde Mould code	Medida molde Mould measure	Piezas por paquete Pieces for pack	Bordes Edges
● CA0777	90 Ø x 25h mm.	1200	Si
● CA0778	130 Ø x 40h mm.	2000	Si
● CA0779	160 Ø x 40h mm.	1600	No
● CA0782	230 Ø x 30h mm.	900	No
○ CA0344	125 Ø x 40h mm.	800	Si



Ø30 Ø24 Ø19

Cod. Pcs.

AO0415 1000



Ø31 Ø26 Ø16

Cod. Pcs.

AO0052 4000



Ø38 Ø28 Ø17

Cod. Pcs.

AO0065 2000



Ø46 Ø33 Ø17

Cod. Pcs.

AO0053 1000



Ø47 Ø40 Ø12

Cod. Pcs.

AO0994 4000



Ø80 Ø70 Ø20

Cod. Pcs.

AO0648 5000



Ø90 Ø70 Ø20

Cod. Pcs.

AO0043 3000



Ø68 Ø60 Ø30

Cod. Pcs.

AO1181 2200

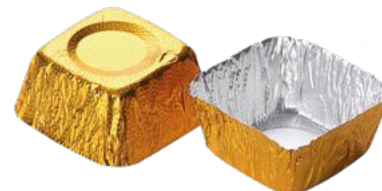

36x36 28x28 Ø17

Cod. Pcs.

AO0045 1000

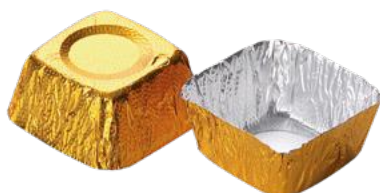

40x40 35x35 Ø16

Cod. Pcs.

AO1414 2000



30x50 25x45 Ø16

Cod. Pcs.

AO0980 2600



35x45 42x52 Ø15

Cod. Pcs.

AO0981 3000



55x100 45x90 Ø20

Cod. Pcs.

AO0650 1200



Ø22 Ø22 Ø60

Cod. Pcs.

AO0771 4000





Cod.    Pcs.
 AO0050 82 mm. 38 mm. 23 mm. 3000





Cod.    Pcs.
 AO0047 112 mm. 86 mm. 15 mm. 5500





Cod.    Pcs.
 AO0049 93 mm. 72 mm. 15 mm. 2000



Cod.    Pcs.
 AO01240 200 mm. 190 mm. 15 mm. 1500



Cod.    Pcs.
 AO0089 74x74mm. 52x52mm. 10 mm. 6000



Cod.    Pcs.
 AO05510 72 mm. 48 mm. 47 mm. 1000



Cod.    Pcs.
 AO01110 295 mm. 270 mm. 17 mm. 800



Cod.    Pcs.
 AO01113 330 mm. 307 mm. 15 mm. 400



Cod. Pcs.
AO01790 250 mm. 220 mm. 15 mm. 600



Cod. Pcs.
AO04220 315x212 mm. 280x175 mm. 44 mm. 500



Cod. Pcs.
AO01115 278 mm. 248 mm. 24 mm. -



Cod. Pcs.
AO04650 221 mm. 203 mm. 14 mm. -



Cod. Pcs.
AO05100 230x175 mm. 194x138 mm. 34 mm. -



Cod. Pcs.
AO05077 210x140 mm. 175x105 mm. 38 mm. -



Cod. Pcs.
AO00640 203x94 mm. 168x58 mm. 53 mm. -



Cod. Pcs.
AO04590 187x137 mm. 158x109 mm. 33 mm. 1500



Vasito postre P.V.C. - P.V.C. Cup dessert.

Cod.	Medida - Size	Cap.	Pcs.
PMOCO001	65 Ø x 55h mm.	90 ml.	100
PMOCO002	70 Ø x 67h mm.	135 ml.	100
PMOCO003	75 Ø x 73h mm.	150 ml.	100



Vasito postre P.V.C. - P.V.C. Cup dessert.

Cod.	Medida - Size	Cap.	Pcs.
PMOCU001	40 x 40 x 55h mm.	60 ml.	100
PMOCU002	50 x 50 x 70h mm.	120 ml.	100
PMOCU003	55 x 55 x 80h cm.	175 ml.	100



Tapadera P.V.C. - P.V.C. Lid.

Cod.	Pcs.
PMOCU002/C	100
PMOCU003/C	100



Vasito postre P.V.C. - P.V.C. Cup dessert.

Cod.	Medida - Size	Cap.	Pcs.
PMOTO001	42 Ø x 65h mm.	65 ml.	100
PMOTO002	50 Ø x 65h mm.	90 ml.	100
PMOTO003	55 Ø x 70h mm.	120 ml.	100
PMOTO004	60 Ø x 90h mm.	170 ml.	100



Vasito postre P.V.C. - P.V.C. Cup dessert.

Cod.	Medida - Size	Cap.	Pcs.
PMO07.00	85 Ø x 65h mm.	175 ml.	100



Tapadera P.V.C. - P.V.C.

Cod.	Pcs.
PMO07/C	100

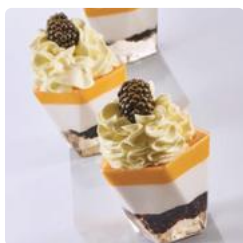

Vasito postre P.V.C. - P.V.C. Cup

Cod.	Medida - Size	Cap.	Pcs.
PMOPE001	68x65x56h mm.	120 ml.	100



Vasito postre P.V.C. - P.V.C. Cup

Cod.	Medida - Size	Cap.	Pcs.
PMOCL001	137x37x41h mm.	120 ml.	100



Tapadera P.V.C. - P.V.C. Lid.

Cod.	Pcs.
PMOCL001/C	100



Vasito postre P.V.C. - P.V.C. Cup

Cod.	Medida - Size	Cap.	Pcs.
PMOCO004	90 Ø x 75h mm.	215 ml.	100



Vasito postre P.V.C. - P.V.C. Cup

Cod.	Medida - Size	Cap.	Pcs.
PMOCO005	90 Ø x 75h mm.	165 ml.	100



Vasito postre P.V.C. - P.V.C. Cup

Cod.	Medida - Size	Cap.	Pcs.
PMOCO006	75 Ø x 85h mm.	150 ml.	100



Vasito postre P.V.C. - P.V.C. Cup dessert.

Cod.	Medida - Size	Cap.	Pcs.
PMOCO007	75 Ø x 85h mm.	190 ml.	100



Vasito postre P.V.C. - P.V.C. Cup dessert.

Cod.	Medida - Size	Cap.	Pcs.
PMOCO008	50 Ø x 57h mm.	50 ml.	100
PMOCO009	73 Ø x 61h mm.	120 ml.	100
PMOCO010	92 Ø x 75h mm.	190 ml.	100



Vasito postre P.V.C. - P.V.C. Cup dessert.

Cod.	Medida - Size	Cap.	Pcs.
PMOCE001	64 x 46 x 53h mm.	50 ml.	100
PMOCE002	85 x 60 x 70h mm.	120 ml.	100
PMOCE003	90 x 83 x 74h mm.	200 ml.	100



Vasito postre P.V.C. - P.V.C. Cup dessert.

Cod.	Medida - Size	Cap.	Pcs.
PMOCO011	63 x 69 x 57h mm.	85 ml.	100
PMOCO012	73 x 81 x 67h mm.	140 ml.	100
PMOCO013	90 x 83 x 74h mm.	200 ml.	100



Vasito postre P.V.C. - P.V.C. Cup dessert.

Cod.	Medida - Size	Cap.	Pcs.
PMOTO005	78 Ø x 57h mm.	210 ml.	100

Cod. Pcs. Tapadera P.V.C. - P.V.C. Lid.
PMOTO005/C 100



Vasito redondo postre "ECO" P.V.C.
P.V.C. Cup dessert round "ECO".

Cod.	Medida - Size	Cap.	Pcs.
P04603	42 Ø x 56h mm.	50 cc.	100
P04606	55 Ø x 65h mm.	120 cc.	100



Vasito cuadrado postre "ECO" P.V.C.
P.V.C. Cup dessert square "ECO".

Cod.	Medida - Size	Cap.	Pcs.
P04600	50 x 50 x 42h mm.	60 cc.	100
P04601	60 x 60 x 55h mm.	120 cc.	100
P04602	72 x 72 x 72h mm.	200 cc.	100



Vasito hexagonal postre "ECO" P.V.C.
P.V.C. Cup dessert hexagonal "ECO".

Cod.	Medida - Size	Cap.	Pcs.
P04609	55 x 55 x 42h mm.	60 cc.	100



Vasito hexagonal postre "ECO" P.V.C.
P.V.C. Cup dessert hexagonal "ECO".

Cod.	Medida - Size	Cap.	Pcs.
P04610	66 x 66 x 72h mm.	130 cc.	100



Platos individuales P.V.C.
P.V.C. Individual dishes.

Cod.	Medida - Size	Material	Pcs.
PM05	110 x 105 x 6h mm.	P.V.C.	100



Platos individuales P.V.C.
P.V.C. Individual dishes.

Cod.	Medida - Size	Material	Pcs.
PM06	120 x 100 x 6h mm.	P.V.C.	100



Platos individuales P.V.C.
P.V.C. Individual dishes.

Cod.	Medida - Size	Material	Pcs.
PM04	110 x 75 x 6h mm.	P.V.C.	100



Formatos de cartón para pasteles individuales.
Cardboard formats for individual cakes.

Cod.	Medida - Size	Descripción - Description	Pcs.
CA0064	80 Ø mm.	Redondo - Round	100
CA0065	60 x 105 mm.	Rectángular	100
CA0414	95 mm.	Triángular	100
CA0427	90 x 100 mm.	Corazón - Heart	100
CA0610	75 x 75 mm.	Cuadrado - Square	100

*Opción personalización en Stamping.
*Stamping customization option.



Bandeja cartón grueso "Alta resistencia" para tartas.
Gold tray strong cardboard "High resistance" for cakes.

Cod.	Medida - Size	Color	Pack
CA0517	25 x 35 x 0,4h cm.	Dorada - Gold	54
CA0599	30 x 40 x 0,4h cm.	Dorada - Gold	39
CA0598	34 x 44 x 0,4h cm.	Dorada - Gold	32
CA0607	35 x 50 x 0,4h cm.	Dorada - Gold	27
CA0732	40 x 50 x 0,4h cm.	Dorada - Gold	24
CA0518	40 x 60 x 0,4h cm.	Dorada - Gold	20
CA0608	45 x 55 x 0,4h cm.	Dorada - Gold	19
CA0609	45 x 65 x 0,4h cm.	Dorada - Gold	16

Blonda de cartón grueso "Alta resistencia" para tartas.
Tray with thick cardboard "High resistance" for cakes.

Cod.	Medida - Size	Color	Pack
CA0496	22 x 27 cm.	Dorada - Gold	50
CA0497	27 x 32 cm.	Dorada - Gold	50
CA0498	31 x 39 cm.	Dorada - Gold	50
CA0489	35 x 41 cm.	Dorada - Gold	50
CA0464	15 x 31 cm.	Dorada - Gold	100
CA0465	15 x 38 cm.	Dorada - Gold	100
CA0466	17 x 42 cm.	Dorada - Gold	100

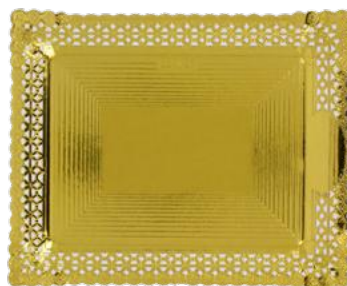

Bandeja "Alta resistencia" para tartas.
Exhibition tray "High resistance" for cakes.

Cod.	Medida - Size	Color	Pack
P5727A	30 x 40 x 1h cm.	P.V.C.	32
P05728	37 x 48 x 1h cm.	P.V.C.	25
P05729	43 x 53 x 1h cm.	P.V.C.	22



Bandeja cartón grueso para tartas.
Tray strong cardboard for cakes.

Cod.	Medida - Size	Color	Pack
CA0049	28 x 36 cm.	Blanca - White	50
CA0050	31 x 38 cm.	Blanca - White	50
CA0051	34 x 42 cm.	Blanca - White	50
CA0053	40 x 50 cm.	Blanca - White	25
CA0054	45 x 55 cm.	Blanca - White	25
CA0430	12 x 34 cm.	Blanca - White	100
CA0056	12,5 x 38 cm.	Blanca - White	100
CA0252	13 x 45 cm.	Blanca - White	100
CA0107	28 x 36 cm.	Dorada - Gold	50
CA0106	31 x 38 cm.	Dorada - Gold	50
CA0122	34 x 42 cm.	Dorada - Gold	50
CA0387	40 x 50 cm.	Dorada - Gold	25
CA0386	45 x 55 cm.	Dorada - Gold	25
CA0373	12 x 34 cm.	Dorada - Gold	100
CA0350	12,5 x 38 cm.	Dorada - Gold	100
CA0348	13 x 45 cm.	Dorada - Gold	100



Platos de cartón para tartas.
Cardboard plates for cakes.

Blanco - White	Cod. Dorado - Gold	Cod. Plata - Silver	Medida - Size	Pcs.
CA0000	CA0457	-	10 Ø cm.	100
CA0001	CA0367	-	12 Ø cm.	100
CA0002	-	-	14 Ø cm.	100
CA0003	-	-	16 Ø cm.	100
CA0004	-	-	18 Ø cm.	100
CA0005	CA0033	CA0251	21 Ø cm.	100
CA0006	CA0015	CA0260	23 Ø cm.	100
CA0007	CA0034	CA0258	25 Ø cm.	100
CA0008	CA0123	CA0017	27 Ø cm.	100
CA0009	CA0355	CA0018	30 Ø cm.	100
CA0010	CA0108	CA0325	32 Ø cm.	50
CA0011	-	-	34 Ø cm.	50
CA0237	CA0334	CA0371	35 Ø cm.	50
CA0012	CA0263	CA0382	38 Ø cm.	50
CA0013	CA0392	CA0390	40 Ø cm.	25
CA0014	CA0393	CA0391	44 Ø cm.	25



Plato exposición cartón grueso
"Alta resistencia" para tartas.
Gold exhibition plate strong cardboard
"High resistance" for cakes.

*Opción personalización en Stamping.
*Stamping customization option.

Cod.	Medida - Size	Pcs.
CA0631	24 Ø cm.	104
CA0632	26 Ø cm.	89
CA0633	28 Ø cm.	76
CA0634	30 Ø cm.	65
CA0635	32 Ø cm.	58
CA0636	34 Ø cm.	51
CA0637	36 Ø cm.	45
CA0638	38 Ø cm.	41
CA0639	40 Ø cm.	38
CA0640	42 Ø cm.	35
CA0641	45 Ø cm.	29



Plato cartón grueso con blonda para tartas.
Thick cardboard plate with lace for cakes.

Cod.	Medida - Size	Pcs.
CA0557	23 Ø cm.	100
CA0558	26 Ø cm.	100
CA0559	29 Ø cm.	100
CA0560	31 Ø cm.	100
CA0561	33 Ø cm.	100
CA0380	35 Ø cm.	100
CA0236	38 Ø cm.	100



Disco cartón grueso cuadrado para tartas.
Square thick cardboard disc for cakes.

*Opción personalización en Stamping.
*Stamping customization option.

Cod.	Medida - Size	Pcs.
CA0643	23 x 23 cm.	91
CA0644	25 x 25 cm.	75
CA0645	28 x 28 cm.	60
CA0646	32 x 32 cm.	46
CA0647	35 x 35 cm.	39
CA0648	39 x 39 cm.	31
CA0649	45 x 45 cm.	23



Plato exposición P.V.C. para tartas.
Exhibition plate P.V.C. for cakes.

Cod.	Medida - Size	Pcs.
CA0626	20 Ø cm.	120
CA0023	24 Ø cm.	100
CA0024	27 Ø cm.	100
CA0026	30 Ø cm.	100
CA0027	32 Ø cm.	100
CA0028	35 Ø cm.	100
CA0029	37 Ø cm.	100



Discos de cartón ligeros para tartas.
Light cardboard discs for cakes.

Cod.	Medida - Size	Pcs.
CA0579	16 Ø cm.	100
CA0452	18 Ø cm.	100
CA0061	20 Ø cm.	100
CA0226	22 Ø cm.	100
CA0153	24 Ø cm.	100
CA0154	26 Ø cm.	100
CA0169	28 Ø cm.	100
CA0180	30 Ø cm.	100
CA0372	32 Ø cm.	100



Caja cartón hexagonal.
Hexagonal cardboard box.

Cod.	Medida - Size	Pcs.
CA0282	24 Ø x 12 h cm.	50
CA0283	27 Ø x 14 h cm.	50
CA0289	28 Ø x 14 h cm.	50
CA0284	31 Ø x 15 h cm.	50
CA0288	33 Ø x 16 h cm.	50
CA0285	35 Ø x 16 h cm.	50
CA0286	37 Ø x 17 h cm.	50
CA0287	41 Ø x 17 h cm.	50



Caja cartón cuadrada.
Square cardboard box.

*Opción personalización en Stamping / Serigrafía.
*Stamping / Serigraphy customization option.

Cod.	Medida - Size	Pcs.
CA0613	22 x 22 x 10 h cm.	100
CA0614	24 x 24 x 10 h cm.	100
CA0615	28 x 28 x 10 h cm.	100
CA0624	30 x 30 x 10 h cm.	100
CA0616	32 x 32 x 10 h cm.	100
CA0628	34 x 34 x 10 h cm.	100
CA0629	36 x 36 x 10 h cm.	100
CA0630	38 x 38 x 10 h cm.	100



Caja cartón cuadrada.
Square cardboard box.

Cod.	Medida - Size	Pcs.
CA0650	24 x 24 x 10 h cm.	50
CA0651	26 x 26 x 10 h cm.	50
CA0652	28 x 28 x 10 h cm.	50
CA0653	31 x 31 x 10 h cm.	50
CA0654	33 x 33 x 10 h cm.	50
CA0655	37 x 37 x 10 h cm.	50



Caja cartón cuadrada / rectangular dorada.
Golden square / rectangular cardboard box.

Cod.	Medida - Size	Pcs.
CA0326	25 x 19 x 8 h cm.	100
CA0327	30 x 23,5 x 8 h cm.	100
CA0328	35,5 x 26,5 x 8 h cm.	100
CA0329	39,5 x 32,5 x 8 h cm.	100
CA0330	38,5 x 12 x 10,5 h cm.	100
CA0331	45,5 x 12,5 x 10,5 h cm.	100
CA0332	44 x 16 x 10,5 h cm.	100
CA0320	24 x 24 cm.	50
CA0321	27 x 27 cm.	50
CA0322	30 x 30 cm.	50
CA0323	32 x 32 cm.	50
CA0324	34 x 34 cm.	50



Caja cartón rectangular.
Rectangular cardboard box.

Cod.	Medida - Size	Pcs.
CA0656	35 x 27 x 10 h cm.	50
CA0657	38 x 30 x 10 h cm.	50
CA0658	40 x 33 x 10 h cm.	50
CA0659	45 x 36 x 11 h cm.	50



Caja cartón "Mona".
Rectangular cardboard box.

Cod.	Medida - Size	Pcs.
CA0760	24 Ø x 19 h cm.	50
CA0444	28 Ø x 19 h cm.	50
CA0443	31 Ø x 19 h cm.	50
CA0762	35 Ø x 19 h cm.	50



Tiras de cartón protectoras de pasteles.
Protective cardboard strips of cakes.

Cod.	Medida - Size	Kgs.
CA0035	75 x 3,5 cm.	10
CA0453	62 x 3,5 cm.	10
CA0036	52 x 3,5 cm.	10



Caja cartón rectangular con ventana.
Rectangular cardboard box with window.

Cod.	Medida - Size	Pcs.
CA0539	44 x 30 x 8 h cm.	25
CA0538	44 x 30 x 12 h cm.	25
CA0537	62 x 42 x 8 h cm.	25
CA0661	62 x 42 x 13 h cm.	25

* Las cajas de 62 x 42 x 13h cm + 62 x 42 x 8h cm son cajas en 2 partes: fondo microcanal + tapa cartón compacta con ventana.

* The 62 x 42 x 13h cm + 62 x 42 x 8h cm boxes are boxes in 2 parts: microchannel bottom + compact cardboard lid with window.

ALMACENAJE Y

TRANSPORTE

Storage & transport



Cesta apilable isotérmica de polypropileno para uso alimentario.
Fácil acceso en el interior de la cesta.
Densidad del material: 45 gr./l.

*Isothermal polypropylene basket for food use
stackable.
Easy acces inside the basket.*



Tapaderas.
Lids.



Cestas.
Baskets.

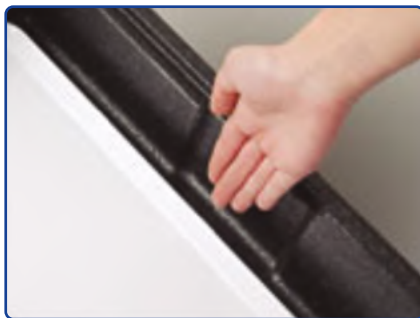

Cestas con hueco especial para acceder a las bandejas con facilidad.
Baskets with special hole to access the trays with easy.

Cod.	Medida - Size	Pcs.	Descripción - Description
AO05529	44,5 x 62,5 x 12 h cm.	1	Cesta - Basket
AO05528	-	1	Tapadera - Lid



Apilable y con opción a base con ruedas para su fácil desplazamiento.
Stackable and option based on wheels for easy movement.



Asas inoxidable incorporadas para su fácil colocación.
Built-in stainless handles for easy placement.



Contenedor isotérmico profesional apilable.
Idóneo para el contacto alimentario.
Fácilmente lavable.
No deja olores y no altera los sabores de los alimentos.
Higiénico y reciclable al 100%.
Ideal para el transporte de pasteles y tartas.

*Isothermal professional stackable container.
It doesn't leave smellings and doesn't alter the taste of the food.
Suitable for food containers without any smelling or taste.
Hygienic and 100% recyclable.*



Cod.	Medida de bandeja - Size of tray	Capacidad - Capacity	Descripción - Description	Pcs.
AO0719	40 x 60 x 5 h cm.	6 Bandejas - 6 Trays	Contenedor - Container	1
AO0716	40 x 60 x 12 h cm.	10 Bandejas - 10 Trays	Contenedor - Container	1
AO1000	-	-	Base con ruedas - Wheeled base	1



Contenedor apilable de aluminio con asas para el transporte.
Stackable aluminum container with handles for transport.

Cod.	Medida de bandeja - Size of tray	Capacidad - Capacity	Descripción - Description	Pcs.
AO0017	40 x 60 x 6 h cm.	8 Bandejas - 8 Trays	Contenedor - Container	1
AO0018	40 x 60 x 12 h cm.	-	Base con ruedas - Wheeled base	1

Cesta apilables fondo liso P.V.C.
Flat bottom stackable basket P.V.C.

Cod.	Medida interior Interior measure	Descripción Description	Pcs.
AO0696	36,5 x 56,5 x 9,5 h cm.	Bandeja - Tray	1
AO0697	36,5 x 56,5 x 12,7 h cm.	Bandeja - Tray	1
AO0684	40 x 60 x 11 h cm.	Bandeja - Tray	1
AO0698	36,5 x 56,5 cm.	Tapa - Lid	1
AO0700	42 x 62 x 14 h cm.	Base	1

* La base con ruedas y la tapa no son adaptables a las cestas de 40 x 60 x 11 h cm de interior.

* *The base with wheels and the lid are not adaptable to baskets 40 x 60 x 11 h cm inside.*



Cesta apilable con asas de cartón.
Stackable basket with cardboard handles.

Cod.	Medida de bandeja - Size of tray	Pcs.
CA0490	58 x 33,5 x 8,5 h cm.	50



Tapadera con bandejas apilables. Fabricadas en P.V.C. duro y resistente.
Lid with stackable trays. Manufactured in P.V.C. hard and resistant.

Cod.	Bandeja	Descripción	Pcs
TOTALIGLOO5	40 x 60 x 5,5 h cm.	Tapa + Bandeja Lid + Tray	1
TOTALIGLOO8	40 x 60 x 8,5 h cm.	Tapa + Bandeja Lid + Tray	1
IGLOO5	40 x 60 x 5,5 h cm.	Tapa - Lid	1
IGLOO8	40 x 60 x 8,5 h cm.	Tapa - Lid	1
VGEL02	40 x 60 x 2,2 h cm.	Bandeja - Tray	1



Bobina film manual de 23 micras.
23 micron manual film reel.

Cod.	Medidas - Size	Pack	Caja - Box	
AO3001	115 m.	1	8	Transparente - <i>Transparent</i>
AO3002	115 m.	1	8	Negro - <i>Black</i>



Pack con 10 unidades.
Pack with 10 units.



Cod.	Material.	Pack.
TC1700	Inox. - Sst.	5

Cod.	Material.	Pack.
AO0037	Inox. - Sst.	1

Cod.	Material.	Pack.
AO1495	Inox. - Sst.	5

Cod.	Material.	Pack.
AO1496	Inox. - Sst.	5



Apto para rollos de 50 mm. x 66 m.
Suitable for 50 mm. x 66 m. rolls.

Cod.	Material.	Pack.
AT0107	Inox. - Sst.	1

Blanco
White
AT0110

Transparente
Transparent
AT0110T

Blanco
White
AT0115



Apto para rollos de 75 mm. x 172 m.
Suitable for 75 mm. x 172 m. rolls.

Cod.	Material.	Pack.
AT0114	Inox. - Sst.	1

Apto para soportes de 50 mm. x 66 m.
Suitable for supports of 50 mm. x 66 m.

Cod.	Medidas - Size	Pack	Caja - Box	
AT0110	50 mm. x 66 m.	6	36	Blanco - <i>White</i>
AT0110T	50 mm. x 66 m.	6	36	Trans. - <i>Trans.</i>
AT0115	75 mm. x 172 m.	6	32	Blanco - <i>White</i>



ÚTILES
DE TIENDA
Storage useful





Bandeja aluminio negra de exposición para vitrinas.
Fácil limpieza.

Black aluminum display tray for display cases. Easy cleaning.

Cod.	Medida - Size	Material
AT0361	15 x 40 x 1 h cm.	Aluminio - Aluminum
AT0360	20 x 60 x 1 h cm.	Aluminio - Aluminum
AT0354	17,5 x 25,5 x 1 h cm.	Aluminio - Aluminum
AT0355	21 x 27,5 x 1 h cm.	Aluminio - Aluminum
AT0356	24 x 32 x 1 h cm.	Aluminio - Aluminum
AT0357	25,5 x 30 x 1 h cm.	Aluminio - Aluminum
AT0358	26 x 35 x 1 h cm.	Aluminio - Aluminum
AT0359	30 x 40 x 1 h cm.	Aluminio - Aluminum
AT0364	34 x 48 x 1 h cm.	Aluminio - Aluminum



Bandeja aluminio anodizada dorada de exposición para vitrinas. Fácil limpieza.

Gold aluminum display tray for display cases. Easy cleaning.

Cod.	Medida - Size	Material
AT0346	21 x 27,5 cm.	Aluminio - Aluminum
AT0345	17,5 x 25,5 cm.	Aluminio - Aluminum
AT0351	30 x 40 cm.	Aluminio - Aluminum
AT0349	26 x 35 cm.	Aluminio - Aluminum
AT0348	25,5 x 30 cm.	Aluminio - Aluminum
AT0347	24 x 32 cm.	Aluminio - Aluminum
AT0352	20 x 60 cm.	Aluminio - Aluminum
AT0353	15 x 40 cm.	Aluminio - Aluminum
AT0368	19 x 29 cm.	Aluminio - Aluminum
AT0363	10,5 x 31,2 cm.	Aluminio - Aluminum



Bandeja aluminio anodizada de exposición para vitrinas.
Fácil limpieza.

Anodized aluminum tray for display cases. Easy cleaning.

Cod.	Medida - Size	Material
AT0327	21 x 27,5 cm.	Aluminio - Aluminum
AT0326	17,5 x 25,5 cm.	Aluminio - Aluminum
AT0337	30 x 40 cm.	Aluminio - Aluminum
AT0002	26 x 35 cm.	Aluminio - Aluminum
AT0329	25,5 x 30 cm.	Aluminio - Aluminum
AT0328	24 x 32 cm.	Aluminio - Aluminum
AT0343	20 x 60 cm.	Aluminio - Aluminum
AT0344	15 x 40 cm.	Aluminio - Aluminum



Bandeja P.V.C. de exposición para vitrinas.
P.V.C. Exhibition tray for showcases.

Cod.	Medida - Size	Material
CA0303	20 x 25 cm.	P.V.C.
CA0304	25 x 32 cm.	P.V.C.
CA0305	28 x 35 cm.	P.V.C.
CA0306	33 x 40 cm.	P.V.C.
CA0020	12 x 37 cm.	P.V.C.
CA0021	15 x 44 cm.	P.V.C.



Bandeja acero de exposición para vitrinas.
Steel exhibition tray for showcases.

Cod.	Medida - Size	Material
AT0317	15 x 40 x 1 h cm.	Inox. - Sst.
AT0224	20 x 60 x 1 h cm.	Inox. - Sst.
AT0221	17,5 x 25,5 x 1 h cm.	Inox. - Sst.
AT0225	21 x 27,5 x 1 h cm.	Inox. - Sst.
AT0220	24 x 32 x 1 h cm.	Inox. - Sst.
AT0222	25,5 x 30 x 1 h cm.	Inox. - Sst.
AT0226	26 x 35 x 1 h cm.	Inox. - Sst.



Bandeja P.V.C. de exposición para vitrinas.
P.V.C. Exhibition tray for showcases.

Cod.	Medida - Size	Material	Color
AT0710	19 x 28 x 1,2 cm.	P.V.C.	B-W
AT0711	24 x 35 x 1,2 cm.	P.V.C.	B-W
AT0712	30 x 42 x 1,2 cm.	P.V.C.	B-W
AT0713	19 x 28 x 1,2 cm.	P.V.C.	N-B
AT0714	24 x 35 x 1,2 cm.	P.V.C.	N-B
AT0715	30 x 42 x 1,2 cm.	P.V.C.	N-B



Alza platos para vitrina.
Raise dishes for showcase.

Cod.	Medida - Size	Material
AT0028	10 x 10 h cm.	Inox. - Sst.
AT0049	10 x 15 h cm.	Inox. - Sst.



Expovitrina.
Expovitrina.

Cod.	Medida - Size	Material
AT9289	26,5 x 32,5 x 11,8 h cm.	Policarbonato - Policarbonato
AT9288	32,5 x 53,5 x 8,2 h cm.	Policarbonato - Policarbonato



Bandeja de cartón para pasteles "Blanca".
Cardboard tray for cakes "White".

Cod.	Medida - Size	Nº Ref.	Pack
CA0040	10 x 17 cm.	Nº 2	100
CA0041	12 x 19 cm.	Nº 3	100
CA0042	14 x 21 cm.	Nº 4	100
CA0043	16 x 23 cm.	Nº 5	100
CA0044	18 x 25 cm.	Nº 6	100
CA0045	20 x 27 cm.	Nº 7	100
CA0046	22 x 28 cm.	Nº 8	100
CA0047	24 x 30 cm.	Nº 9	100
CA0048	25 x 33 cm.	Nº 10	100
CA0049	28 x 36 cm.	Nº 11	50
CA0050	31 x 38 cm.	Nº 12	50
CA0051	34 x 42 cm.	Nº 13	50
CA0052	37 x 47 cm.	Nº 13B	50
CA0053	40 x 50 cm.	Nº 14	25
CA0054	45 x 55 cm.	Nº 15	25



Bandeja de cartón para pasteles "Dorada".
Cardboard tray for cakes "Golden".

Cod.	Medida - Size	Nº Ref.	Pack
CA0104	10 x 16 cm.	Nº 2	100
CA0062	12 x 19 cm.	Nº 3	100
CA0063	14 x 21 cm.	Nº 4	100
CA0066	16 x 22 cm.	Nº 5	100
CA0103	18 x 24 cm.	Nº 6	100
CA0068	20 x 27 cm.	Nº 7	100
CA0069	22 x 28 cm.	Nº 8	100
CA0067	24 x 30 cm.	Nº 9	100
CA0105	25 x 34 cm.	Nº 10	100
CA0107	28 x 36 cm.	Nº 11	100
CA0106	31 x 38 cm.	Nº 12	50
CA0122	34 x 42 cm.	Nº 13	50
CA0387	40 x 50 cm.	Nº 14	25
CA0386	45 x 55 cm.	Nº 15	25



Bandeja de cartón para pasteles "Plateada".
Cardboard tray for cakes "Silver".

Cod.	Medida - Size	Nº Ref.	Pack
CA0070	10 x 16 cm.	Nº 2	100
CA0071	12 x 19 cm.	Nº 3	100
CA0072	14 x 21 cm.	Nº 4	100
CA0073	16 x 22 cm.	Nº 5	100
CA0074	18 x 24 cm.	Nº 6	100
CA0075	20 x 27 cm.	Nº 7	100
CA0076	22 x 28 cm.	Nº 8	100
CA0077	24 x 30 cm.	Nº 9	100
CA0078	25 x 34 cm.	Nº 10	100
CA0079	28 x 36 cm.	Nº 11	100
CA0182	31 x 38 cm.	Nº 12	50
CA0181	34 x 42 cm.	Nº 13	50
CA0400	40 x 50 cm.	Nº 14	25



Bandeja de cartón kraft para pasteles.
Kraft cardboard tray for cakes

Cod.	Medida - Size	Nº Ref.	Pack
CA0461	10 x 17 cm.	Nº 2	100
CA0462	14 x 21 cm.	Nº 4	100
CA0463	18 x 25 cm.	Nº 6	100
CA0447	22 x 28 cm.	Nº 8	100



Batea cartón con asas "Negra".
Tray cardboard with handles "Black".

Cod.	Medida - Size	Pack
CA0750	16 x 23 x 2,5 h cm.	100
CA0751	18 x 25 x 2,5 h cm.	100
CA0752	22 x 28 x 2,5 h cm.	100
CA0753	25 x 34 x 2,5 h cm.	100
CA0754	12 x 30 x 2,5 h cm.	100
CA0755	12 x 35 x 2,5 h cm.	100

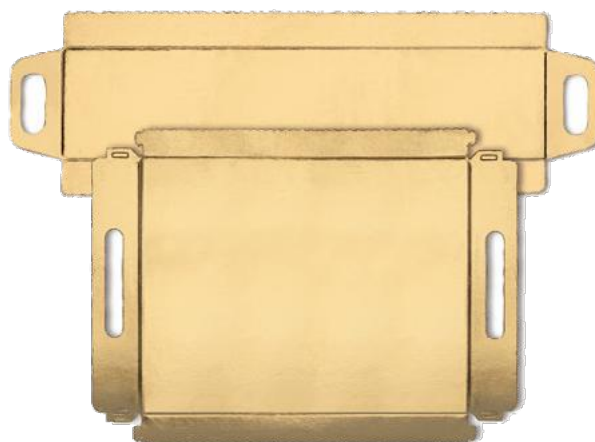

Batea cartón con asas "Dorada".
Tray cardboard with handles "Golden".

Cod.	Medida - Size	Pack
CA0680	16 x 23 x 2,5 h cm.	100
CA0417	18 x 25 x 2,5 h cm.	100
CA0681	22 x 28 x 2,5 h cm.	100
CA0758	25 x 34 x 2,5 h cm.	100
CA0759	12 x 30 x 2,5 h cm.	100
CA0683	12 x 35 x 2,5 h cm.	100



Rodal parafinado blanco.
White paraffined stand.

Cod.	Medida - Size	Pack
CA0110	18 Ø cm.	100
CA0111	21 Ø cm.	100
CA0224	23 Ø cm.	100
CA0112	25 Ø cm.	100
CA0113	28 Ø cm.	100
CA0114	30 Ø cm.	100
CA0115	32 Ø cm.	100
CA0116	35 Ø cm.	100
CA0117	38 Ø cm.	100
CA0225	40 Ø cm.	100
CA0118	42 Ø cm.	100
CA0119	45 Ø cm.	100
CA0120	50 Ø cm.	100



Blonda parafinada blanca.
White paraffined lace.

Cod.	Medida - Size	Pack
CA0185	16 x 22 cm.	100
CA0188	19 x 25 cm.	100
CA0189	21 x 27 cm.	100
CA0190	26 x 32 cm.	100
CA0191	28 x 36 cm.	100
CA0192	31 x 38 cm.	100
CA0193	34 x 43 cm.	100
CA0196	36 x 41 cm.	100
CA0368	40 x 47 cm.	100
CA0195	45 x 55 cm.	100
CA0456	50 x 60 cm.	100



Caja cartón pasteles sin ventana "Blanca".
Cakes cardboard box without window "White".

Cod.	Medida - Size	Capacidad - Capacity	Pack
CA0277	17,5 x 11,5 x 4,7 h cm.	1/4 Kg.	100
CA0280	18,2 x 13,5 x 5,4 h cm.	1/2 Kg.	100
CA0519	19 x 15,6 x 6 h cm.	3/4 Kg.	100
CA0281	20,2 x 15,7 x 6 h cm.	1 Kg.	100
CA0684	22 x 16,3 x 6,3 h cm.	1 1/2 Kg.	100
CA0290	26 x 19 x 8 h cm.	2 Kg.	100
CA0685	30 x 20 x 9 h cm.	3 Kg.	100
CA0686	30,5 x 24,2 x 9,5 h cm.	4 Kg.	100



Caja cartón pasteles con ventana "Blanca".
Cakes cardboard box with window "White".

Cod.	Medida - Size	Capacidad - Capacity	Pack
CA0687	18,2 x 13,5 x 5,4 h cm.	1/2 Kg.	100
CA0688	20,2 x 15,7 x 6 h cm.	1 Kg.	100
CA0689	22 x 16,3 x 6,3 h cm.	1 1/2 Kg.	100
CA0690	26 x 19 x 8 h cm.	2 Kg.	100
CA0691	30 x 20 x 9 h cm.	3 Kg.	100



Caja cartón pasteles sin ventana "Kraft".
Cakes cardboard box without window "Kraft".

Cod.	Medida - Size	Capacidad - Capacity	Pack
CA0523	18,2 x 13,5 x 5,4 h cm.	500 g.	100
CA0524	20,2 x 15,7 x 6 h cm.	1 Kg.	100
CA0515	22 x 16,3 x 6,3 h cm.	1,5 Kg.	100
CA0525	26 x 19 x 8 h cm.	2 Kg.	100



Caja cartón pasteles sin ventana cuadrada.
Cakes cardboard box without square window.

Cod.	Medida - Size	Pack	Cod.	Medida - Size	Pack
CA0581	18 x 18 x 8 h cm.	50	CA0709	18 x 18 x 13 h cm.	50
CA0520	20 x 20 x 8 h cm.	50	CA0710	20 x 20 x 13 h cm.	50
CA0522	22 x 22 x 8 h cm.	50	CA0711	23 x 23 x 13 h cm.	50
CA0521	25 x 25 x 8 h cm.	50	CA0712	26 x 26 x 13 h cm.	50
CA0623	28 x 28 x 8 h cm.	50	CA0713	29 x 29 x 13 h cm.	50
CA0708	32 x 32 x 8 h cm.	50	CA0714	32 x 32 x 13 h cm.	25

Personalización de cajas de cartón

Personalized cardboard box.



Caja cartón pasteles sin ventana rectangular
"Blanca" o "Personalizada".
*Cardboard cake box without rectangular window
"White" or "Customized".*

Cod.	Medida - Size	Pack
CA0741	17 x 14 x 6 h cm.	50
CA0743	20 x 15 x 7 h cm.	50
CA0744	23 x 16 x 7 h cm.	50
CA0745	26 x 18 x 8 h cm.	50

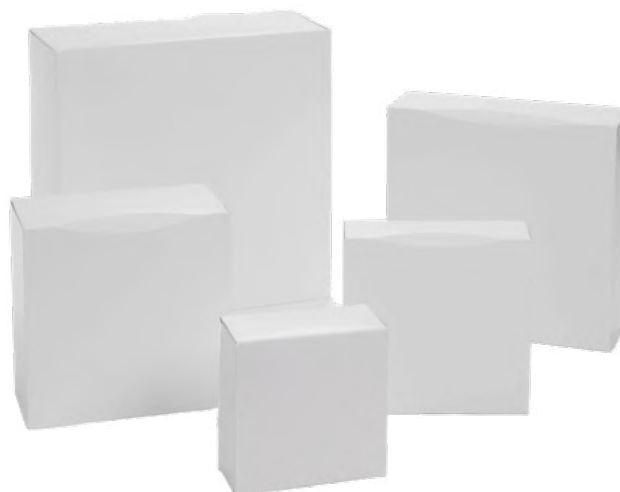

Caja cartón pasteles sin ventana cuadrada "Blanca".
Cakes cardboard box without square window "White".

Cod.	Medida - Size	Pack	Cod.	Medida - Size	Pack
CA0692	18 x 18 x 8 h cm.	50	CA0696	32 x 32 x 8 h cm.	50
CA0693	20 x 20 x 8 h cm.	50	CA0699	23 x 23 x 13 h cm.	50
CA0694	22 x 22 x 8 h cm.	50	CA0700	26 x 26 x 13 h cm.	50
CA0730	25 x 25 x 8 h cm.	50	CA0702	32 x 32 x 13 h cm.	50
CA0695	28 x 28 x 8 h cm.	50			

Caja cartón anónima blanca.
Posibilidad de Personalización en
Digital o Stamping.
*Anonymous white cardboard box.
Possibility of Customization in Digital or Stamping.*





Caja cartón brazo "Tronco".
Cardboard box "Trunk" arm.

Cod.	Medida - Size	Pack
CA0468	29 x 11 x 10 h cm.	100
CA0469	35,5 x 13 x 10 h cm.	100
CA0470	38,5 x 13 x 10 h cm.	100
CA0491	45,5 x 14 x 10 h cm.	100



Blonda parafinada brazo "Tronco".
Blond paraffin arm "Trunk".

Cod.	Medida - Size	Pack
CA0717	13 x 31 cm.	100
CA0718	14 x 39 cm.	100
CA0186	16 x 42 cm.	100
CA0187	18 x 50 cm.	100

Bandeja cartón dorada brazo "Tronco".
Golden cardboard tray arm "Trunk".

Cod.	Medida - Size	Pack
CA0349	12 x 34 cm.	100
CA0374	12,5 x 38 cm.	100
CA0348	13 x 45 cm.	100



Caja cartón con alveolo para bombones.
Cardboard box with socket for chocolates.

Cod.	Medida - Size	Pack
CA0532	11,5 x 20 cm.	25
CA0527	22,5 x 20 cm.	25
CA0540	33,5 x 20 cm.	25



Batea dorada con tapa.
Golden bowl with lid.

Cod.	Medida - Size	Pack
CA0502	21 x 14 x 5 cm.	100
CA0504	23 x 16 x 5 cm.	100
CA0503	25 x 18 x 5 cm.	100
CA0505	26 x 20 x 5 cm.	100
CA0516	28 x 22 x 5 cm.	100
CA0506	34 x 25 x 5 cm.	100

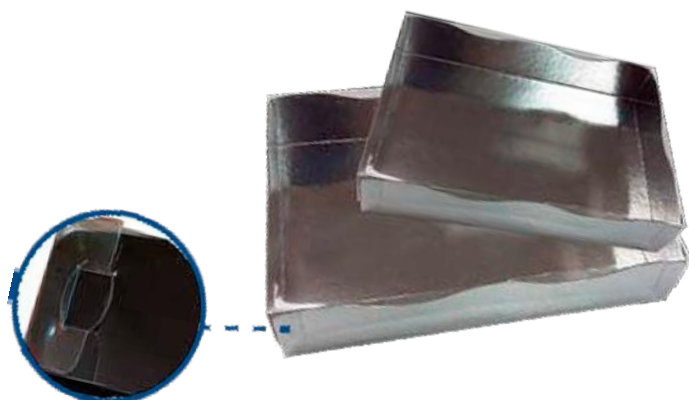

Caja con tapa automontable.
Posibilidad de personalización.
Box with self-assembling lid.
Possibility of customization.

Cod.	Medida - Size	Pack
CA0620	19 x 13 x 6 cm.	100
CA0621	23 x 17 x 6 cm.	100
CA0622	27 x 21 x 6 cm.	100

Bolsas de papel variadas personalizables

Assorted customizable paper bags.



Bolsa papel blanca o Kraft para panes y bollería.
White or Kraft paper bag for breads and pastries.

Cod.	Cod.	Medida - Size	Pack
CA0509	CA0510	12 + 6 x 20 h cm.	1000
CA0275	CA0510B	14 + 6 x 26 h cm.	1000
CA0353	CA0535	18 + 5 x 32 h cm.	1000



Bolsa papel blanca para bocadillos.
White paper bag for sandwiches.

Cod.	Medida - Size	Pack
CA0541	9 + 5 x 24 h cm.	1000
CA0542	9 + 5 x 32 h cm.	1000

Bolsa papel Kraft para panes y bollería.
Kraft paper bag for breads and pastries.

Cod.	Medida - Size	Descripción Description	Pack
CA0500	10 + 3 x 50 h cm.	1 Barra - Bread	1000
CA0508	12 + 9 x 50 h cm.	2 Barras - Breads	1000
CA0228	17 + 7 x 50 h cm.	3 Barras - Breads	1000
CA0352	30 + 11 x 60 h cm.	+3 Barras - Breads	500



*Opción personalización en Serigrafía.

**Serigraphy customization option.*

Bolsas de papel con fondo ancho. Posibilidad de Personalización.

Wide bottom paper bags. Possibility of Personalization.

Cod.	Medida - Size	Color	Material
CA0801	26 x 17 x 26 h cm.	Kraft - Kraft	Papel 80 gr. - Paper 80 gr.
CA0429	26 x 17 x 26 h cm.	Granate - Maroon	Papel 80 gr. - Paper 80 gr.
CA0416	26 x 17 x 26 h cm.	Blanco - White	Papel 80 gr. - Paper 80 gr.
CA0445	32 x 22 x 26 h cm.	Kraft - Kraft	Papel 80 gr. - Paper 80 gr.
CA0409	32 x 22 x 26 h cm.	Granate - Maroon	Papel 80 gr. - Paper 80 gr.
CA0602	32 x 22 x 26 h cm.	Blanco - White	Papel 80 gr. - Paper 80 gr.



NEW

**Bolsa formato
especial para cajas
de tartas y pasteles.**

Bolsa transparente de polietileno.
Transparent polyethylene bag.

Cod.	Medida - Size	Pack	Unidades
AT0565	450X150X600	5	100





Papel aluminio dorado, ideal para conservar pasteles cortados.
Gold aluminium paper, ideal to keep the cut cakes.

Cod.	Medidas - Size	Material	Pack
AO0425	100 x 120 mm.	Papel aluminio - Aluminium paper	1 Kg.



Papel aluminio colores, ideal para conservar pasteles cortados.
Colors aluminium paper, ideal to keep the cut cakes.

Cod.	Medidas - Size	Material	Pack
AO1046	100 x 120 mm.	Papel aluminio - Aluminum paper	1 Kg.



Papel antigrasa 50grs.
Greaseproof paper

Cod.	Medidas - Size	Material	Pack
AO2410	290 x 300 mm.	Papel - paper	500 uds.

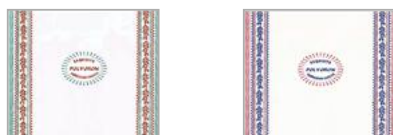

Papel polvorón.
Polvoron paper.



Cod.	Medidas - Size	Material	Pack
AO2411	290 x 300 mm.	Papel - paper	1000 uds.



Papel parafinado cristal, ideal para conservar pasteles cortados.
Waxed paper, ideal to keep the cut cakes.

Cod.	Medidas - Size	Material	Pack
AO0410	100 x 120 mm.	Papel parafinado - Waxed paper	2 Kg.



Papel celofán incoloro, ideal para conservar pasteles cortados.
Colorless cellophane paper, ideal to keep the cut cakes.

Cod.	Medidas - Size	Material	Pack
AO0574	100 x 120 mm.	Papel celofán - Cellophane paper	1000uds.



Las bolsas son aptas para estar en contacto con los alimentos, disponen de la declaración de conformidad MOCA, como productos adecuados para el contacto directo con alimentos.

The bags are suitable for contact with food, they have the MOCA declaration of conformity, as suitable products for direct contact with food.

* Las medidas son ancho x altura (h) + fondo.

* Measurements are width x height (h) + depth.



Bolsa incolora con base, ideal para pastas, caramelos, chocolates, etc...

Colorless bag with base, ideal for pasta, candy, chocolates, etc...

Bobina incolora de celofán, ideal para envolver regalos.

Cod.	Medidas - Size	Material	Box	Pack
AT0502	60 x 200 h + 50 mm.	Polipropileno-Polypropylene	1500	100
AT0506	80 x 240 h + 40 mm.	Polipropileno-Polypropylene	1500	100
AT0507	100 x 300 h + 60 mm.	Polipropileno-Polypropylene	1500	100
AT0511	120 x 370 h + 70 mm.	Polipropileno-Polypropylene	1500	100
AT0008	45 x 210 h + 30 mm.	Celofán - Cellophane	1000	100
AT0058	75 x 170 h + 30 mm.	Celofán - Cellophane	1000	100
AT0012	85 x 190 h + 30 mm.	Celofán - Cellophane	1000	100
AT0127	95 x 210 h + 35 mm.	Celofán - Cellophane	1000	100
AT0059	100 x 230 h + 40 mm.	Celofán - Cellophane	1000	100

Cod.	Medidas - Size	Material	Pack
AT0095	60 x 1000 cm.	Celofán - Cellophane	1
AT0099	60 x 5000 cm.	Celofán - Cellophane	1
AT0097	90 x 1000 cm.	Celofán - Cellophane	1



Soporte para 2 bobinas de papel para envolver.
Support for 2 rolls of paper to wrap.

Cod.	Medidas - Size	Material	Pack
AT0140	31 - 62 cm.	Inox. - Sst.	1



Soporte para 2 bobinas de papel para envolver.
Support for 2 rolls of paper to wrap.

Cod.	Medidas - Size	Material	Pack
AT0140	31 - 62 cm.	Inox. - Sst.	1



* Posibilidad de personalizar.
* Ability to customize.

Papel blanco alimentario para envolver 30 grs.
White food wrapping paper 30grs.

Cod.	Medidas - Size	Pcs.	Pack
CA03018	62 x 86 cm.	500	1



* Posibilidad de personalizar.
* Ability to customize.

Papel alimentario con estampado 40grs.
Food paper to wrap with print 40grs.

Cod.	Medidas - Size	Pcs.	Pack
CA03015	31 cm.	1	2
CA0302	62 cm.	1	1



Papel fantasía para regalos. "Modelos variados".
Fantasy paper for gifts. "Varied models".

Cod.	Medidas - Size	Pcs.	Pack
AT0350	70 x 99 cm.	100	1



* Con adhesivo.
* With adhesive.

Lazos metalizados para regalos. "Colores variados".
Metallic gift bows. "Assorted colors".

Cod.	Medidas - Size	Pcs.	Pack
L0042	6,5 Ø cm.	100	1



Pegatina plateada "Felicidades".
Silver sticker "Felicidades".

Cod.	Medidas - Size	Pack
AT0900	40 x 15 h mm.	500



Pegatina dorada "Felicidades".
Golden sticker "Felicidades".

Cod.	Medidas - Size	Pack
AT0901	40 x 15 h mm.	500



Pegatina plateada "Felicidades".
Silver sticker "Felicidades".

Cod.	Medidas - Size	Pack
AT0904	40 x 15 h mm.	500



Pegatina dorada "Deseo que...".
Golden sticker "Deseo que...".

Cod.	Medidas - Size	Pack
AT0903	40 x 15 h mm.	500



Pegatina plateada "Deseo que...".
Silver sticker "Deseo que...".

Cod.	Medidas - Size	Pack
AT0902	40 x 15 h mm.	500

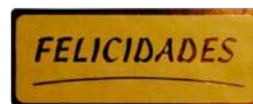

Pegatina dorada "Felicidades".
Golden sticker "Felicidades".

Cod.	Medidas - Size	Pack
AT0905	40 x 15 h mm.	500



Pegatina silueta "Felicidades".
Silhouette sticker "Felicidades".

Cod.	Medidas - Size	Pack
AT0906	30 x 50 mm.	250



Pegatina cuadrada "Deseo que...".
Square sticker "Deseo que...".

Cod.	Medidas - Size	Pack
AT0907	40 x 40 h mm.	500

REFERENCIAS PARA IMPRESIONES A 1 TINTA

Etiquetas adhesivas personalizadas.

Custom adhesive labels.

Le ofrecemos la posibilidad de personalizar con su logo o marca los diferentes modelos de etiquetas adhesivas en varias técnicas de estampación como "hot stamping" o "impresión digital".

We offer you the possibility of customizing the different models of adhesive labels with your logo or brand in various printing techniques such as "hot stamping" or "digital printing".



DE REF. N°9 A REF. N°25. + 30% adicional
 2 TINTAS. + 30% adicional
 3 TINTAS. + 50% adicional

REF. N°9 TO REF. N°25. + 30% additional
 2 INKS. + 30% additional
 3 INKS. + 50% additional
 Printing More than 50% of the mass +30%

Paso 1: Elegir la forma de tu etiqueta



Paso 2: Elegir el color tanto de fondo como de tu marca.



*Consultar para más colores.



Paso 4: Elegir el tamaño de tus pegatinas

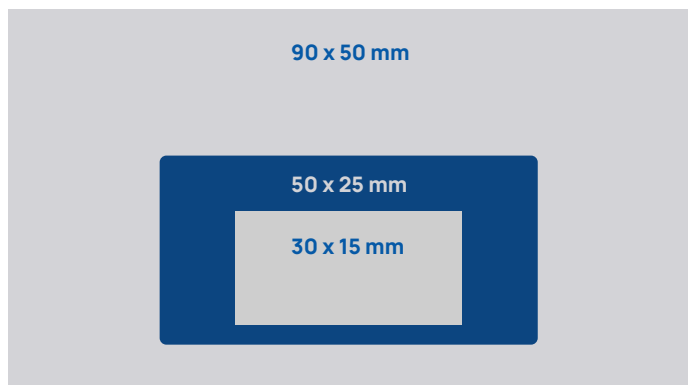
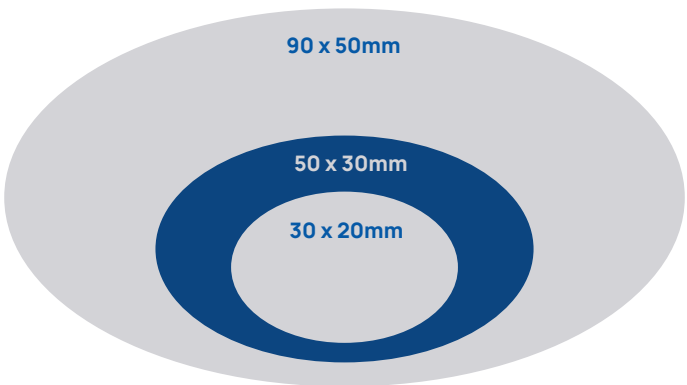
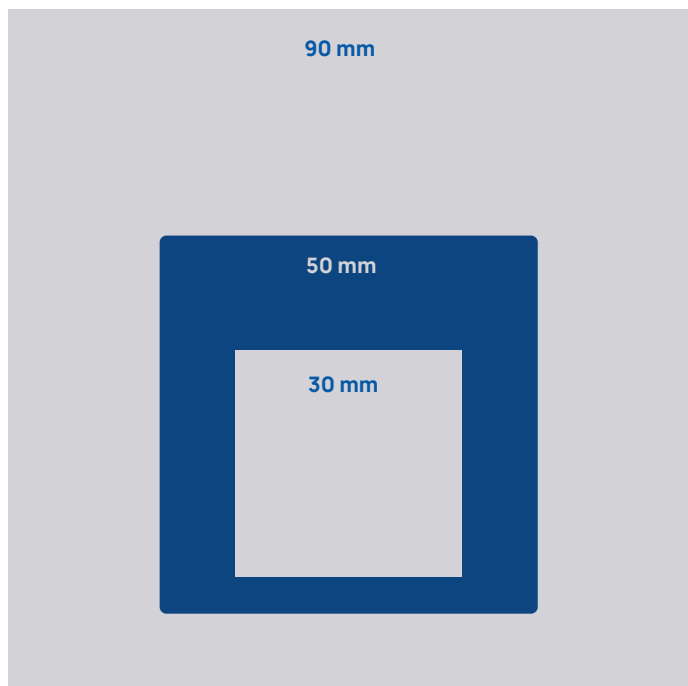
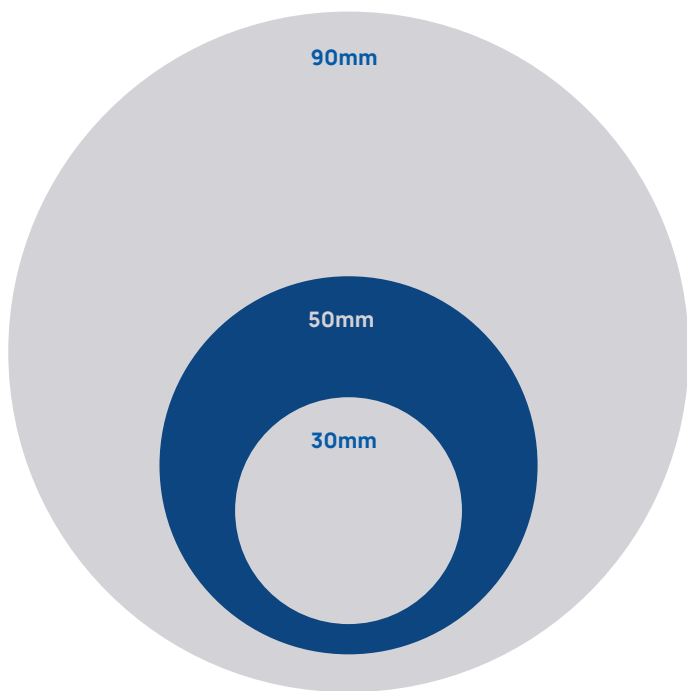

Cod.	Medidas - Size	Digital	Cod.	Medidas - Size	Stamping
AT0905D3	30 Ø mm.	3000uds.	AT0905S3	30 Ø mm.	3000uds.
AT0905D5	50 Ø mm.	3000uds.	AT0905S5	50 Ø mm.	3000uds.
AT0905D9	90 Ø mm.	3000uds.	AT0905S9	90 Ø mm.	3000uds.



Cod.	Medidas - Size	Digital	Cod.	Medidas - Size	Stamping
AT0907D3	30 x 30 mm.	3000uds.	AT0907S3	30 x 30 mm.	3000uds.
AT0907D5	50 x 50 mm.	3000uds.	AT0907S5	50 x 50 mm.	3000uds.
AT0907D9	90 x 90 mm.	3000uds.	AT0907S9	90 x 90 mm.	3000uds.



Cod.	Medidas - Size	Digital	Cod.	Medidas - Size	Stamping
AT0906D3	30 x 20 mm.	3000uds.	AT0906S3	30 x 20 mm.	3000uds.
AT0906D5	50 x 30 mm.	3000uds.	AT0906S5	50 x 30 mm.	3000uds.
AT0906D9	90 x 50 mm.	3000uds.	AT0906S9	90 x 50 mm.	3000uds.



Cod.	Medidas - Size	Digital	Cod.	Medidas - Size	Stamping
AT0908D3	30 x 15 mm.	3000uds.	AT0908S3	30 x 15 mm.	3000uds.
AT0908D5	50 x 25 mm.	3000uds.	AT0908S5	50 x 25 mm.	3000uds.
AT0908D9	90 x 50 mm.	3000uds.	AT0908S9	90 x 50 mm.	3000uds.



Cod.	Medidas - Size	Material	Pack
SEG002	6 x 8 cm.	P.V.C.	25



Cod.	Medidas - Size	Material	Pack
SEG006	6 x 5 cm.	P.V.C.	50



Cod.	Medidas - Size	Material	Pack
AT0271	2,5 x 2,5 x 11h cm.	P.V.C.	25



Cod.	Medidas - Size	Material	Pack
J0148	8 h cm.	Inox. - Sst	12



Cod.	Medidas - Size	Material	Pack
SEG027	6,5 x 6,2 cm.	P.V.C.	15

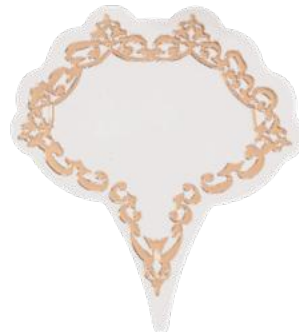

Cod.	Medidas - Size	Material	Pack
SEG004	3,5 x 4 cm.	P.V.C.	30



Cod.	Medidas - Size	Material	Pack
AT0119	3,4 x 5,3 cm.	P.V.C.	100

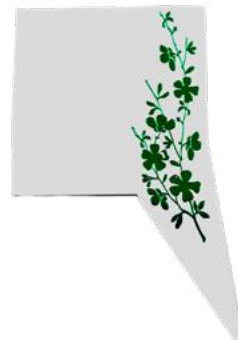

Cod.	Medidas - Size	Material	Pack
SEG028	9 h cm.	Inox. - Sst	100



* Posibilidad de elegir el pack de un sólo color.
* Possibility of choosing the single color pack.

Cinta P.V.C. para envolver.
P.V.C. Strip for wrapping.

Cod.	Medidas - Size	Material	Pack
L0008	5mm x 500 m.	P.V.C.	5



* Posibilidad de elegir el pack de un sólo color.
* Possibility of choosing the single color pack.

Cinta vegetal para envolver. Pack con 12 ovillos.
Vegetable strip for wrapping. Pack with 12 rolls.

Cod.	Medidas - Size	Material	Pack
AT0022	800 m.	Vegetal / Vegetable	1



Alambre cierrabolsas de P.V.C.
P.V.C. Wire bag closers

Cod.	Medidas - Size	Material	Pack
AO0563	9,5 h cm.	P.V.C.	1000



Hilo de algodón para envolver. Pack con 12 ovillos.
Cotton thread for wrapping. Pack with 12 rolls.

Cod.	Medidas - Size	Material	Pack
AT0274	1 kg.	Algodón / Cotton	1



Lazo elástico dorado.
Golden elastic bow.

Cod.	Medidas - Size	Pack
L0045	50 cm.	100



Cordón elástico dorado.
Golden elastic cord.

Cod.	Medidas - Size	Pack
L0032	1 mm. x 100 m.	1
L0043	2 mm. x 50 m.	1



Cinta. - *Ribbon.*

Color metalizado dorado.
Gold metallic color.

Cod.	Medidas - Size	Pack	
L0007	30 mm. x 100 m.	1	Cinta. - <i>Ribbon.</i>
L0051	30 mm. x 30 uds.	1	Lazo automático. - <i>Automatic loop.</i>

Color metalizado rojo.
Red metallic color.

Cod.	Medidas - Size	Pack	
L0006	30 mm. x 100 m.	1	Cinta. - <i>Ribbon.</i>
L0052	30 mm. x 30 uds.	1	Lazo automático. - <i>Automatic loop.</i>



Lazo automático. - *Automatic loop.*

Color metalizado azul.
Blue metallic color.

Cod.	Medidas - Size	Pack	
L0050	30 mm. x 100 m.	1	Cinta. - <i>Ribbon.</i>
L0054	30 mm. x 30 uds.	1	Lazo automático. - <i>Automatic loop.</i>

Color metalizado verde.
Green metallic color.

Cod.	Medidas - Size	Pack	
L0048	30 mm. x 100 m.	1	Cinta. - <i>Ribbon.</i>
L0053	30 mm. x 30 uds.	1	Lazo automático. - <i>Automatic loop.</i>

Color metalizado marrón.
Brown metallic color.

Cod.	Medidas - Size	Pack	
L0047	30 mm. x 100 m.	1	Cinta. - <i>Ribbon.</i>
L0056	30 mm. x 30 uds.	1	Lazo automático. - <i>Automatic loop.</i>



Apto para soportes de 66 m.
Suitable for supports of 66 m.

Cod.	Medidas - Size	Pack	Caja - Box
AT0109	12 mm. x 66 m.	9	108
AT0020	19 mm. x 66 m.	8	96



Apto para soportes de 33 m.
Suitable for supports of 33 m.

Cod.	Medidas - Size	Pack	Caja - Box
AT0138	19 mm. x 33 m.	16	192



Apto para soportes de 12 mm x 66 m.
Suitable for supports of 12 mm. x 66 m.

Cod.	Medidas - Size	Pack	Caja - Box	
AT0021R	12 mm. x 66 m.	24	144	Rojo - Red
AT0021Y	12 mm. x 66 m.	24	144	Amarillo - Yellow
AT0021B	12 mm. x 66 m.	24	144	Azul - Blue
AT0021G	12 mm. x 66 m.	24	144	Verde - Green

Blanco
White

Transparente
Transparent



Apto para soportes de 50 mm. x 66 m.
Suitable for supports of 50 mm. x 66 m.

Cod.	Medidas - Size	Pack	Caja - Box	
AT0110	50 mm. x 66 m.	6	36	Blanco - White
AT0110T	50 mm. x 66 m.	6	36	Transparente Transparent

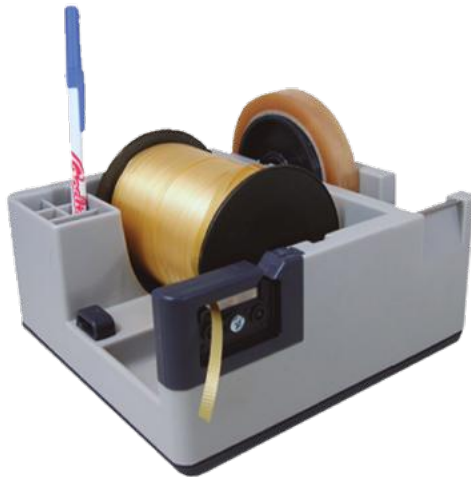

Apto para rollos de 33 m. y 66 m.
Suitable for 33 m. and 66 m rolls.

Cod.	Pack
AT0113	1



Apto para cintas de 500 m. y 800 m.
Suitable for tapes of 500 m. and 800 m.

Cod.	Material	Pack
AT0011	Inox. - Sst.	1

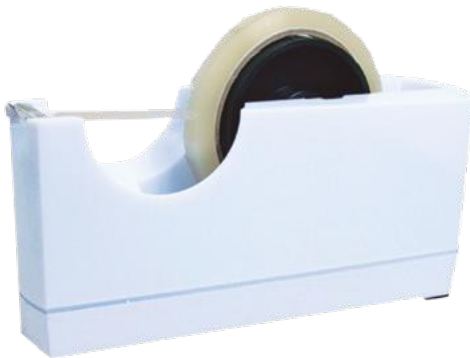

Apto para rollos de 33 m. y 66 m.
Suitable for 33 m. and 66 m rolls.

Cod.	Pack
AT0112	1



Apto para rollos de 33 m.
Suitable for 33 m. rolls.

Cod.	Pack
AT0111	1



Apto para rollos de 12 mm. x 66 m.
Suitable for 12 mm. x 66 m rolls.

Cod.	Material	Pack
AT0137	Metal	1
AT0106	P.V.C.	1



Apto para rollos de 50 mm. x 66 m.
Suitable for 50 mm. x 60 m. rolls.

Cod.	Material	Pack
AT0107	Inox. - Sst.	1



Guante especial para panadería con imán.
Special bakery glove with magnet.

Cod.	Descripción - Description	Material
AT0108	Kit con 3 recambios Kit with 3 replacement	P.V.C.
AT0205	100 recambios 100 Replacement gloves	P.V.C.



Pinza pastelera especial para pasteles delicados.
Special pastry clamp for delicate cakes.

Cod.	Medidas - Size	Material
AT0047	200 mm.	Inox. - Sst.



Pinza pastelera especial para pasteles resistentes.
Special pastry clamp for solid cakes.

Cod.	Medidas - Size	Material
AT0031	160 mm.	Inox. - Sst.



Pinza pastelera rejada.
Grilled pastry clamp.

Cod.	Medidas - Size	Material
AT0034	190 mm.	Inox. - Sst.



Pala serrada para tartas.
Blade for cakes.

Cod.	Medidas - Size	Material
AT0025	100 x 290 mm.	Inox. - Sst.



Pinza especial para tartas.
Special pastry clamp cakes.

Cod.	Medidas - Size	Material
AT0026	50 x 240 mm.	Inox. - Sst.



Lustrero con palanca.
Sieve with lever.

Cod.	Medidas - Size	Material	Pack
ACC01	11 h cm.	Inox. - Sst.	1



Lustrero malla fina.
Sieve of fine mesh.

Cod.	Medidas - Size	Material	Pack
AO62903	7 Ø x 9,5 h cm.	Inox. - Sst.	1



Lustrero malla gruesa.
Sieve of coarse mesh.

Cod.	Medidas - Size	Material	Pack
AT0134	7 Ø x 9,5 h cm.	Inox. - Sst.	1



Lechera con asa.
Milkmaid with handle.

Cod.	Medidas - Size	Material	Pack
AT0700	600 ml.	Inox. - Sst.	1
AT0701	1000 ml.	Inox. - Sst.	1
AT0702	1500 ml.	Inox. - Sst.	1



Tetera con asa.
Teapot with handle.

Cod.	Medidas - Size	Material	Pack
AT0703	150 ml.	Inox. - Sst.	1
	250 ml.	Inox. - Sst.	1
	350 ml.	Inox. - Sst.	1

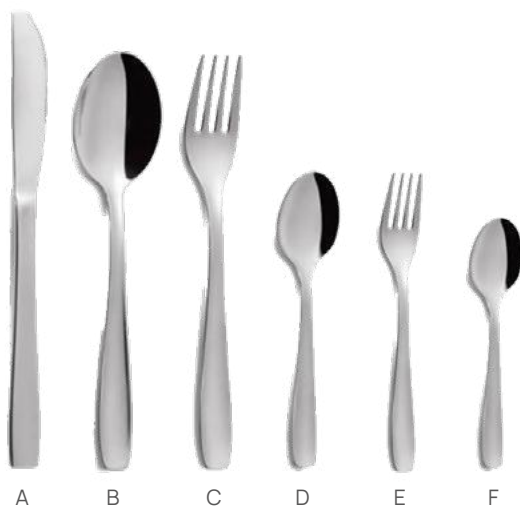

Cubertería.
Cutlery.

Cod.	Descripción - Description	Material	Pack
A AO33403	A. Cuchillo postre - Dessert knife	Inox. - Sst.	12
B AO34107	B. Cuchara mesa - Table spoon	Inox. - Sst.	12
C AO34102	C. Tenedor mesa - Table fork	Inox. - Sst.	12
D AO33404	D. Cuchara postre - Dessert spoon	Inox. - Sst.	12
E AO34104	E. Tenedor postre - Dessert fork	Inox. - Sst.	12
F AO33107	F. Cuchara moka - Moka spoon	Inox. - Sst.	12

HELADERÍAS
ICE CREAM SHOP

Racionador bola de helado.
Ice cream scooper.

Cod.	Medidas - Size	Volumen - Volume	Material	Pack
AT0065	4 Ø cm.	15 cc.	Inox. - Sst.	1
AT0085	5 Ø cm.	32 cc.	Inox. - Sst.	1
AT0086	6 Ø cm.	54 cc.	Inox. - Sst.	1
AT0087	7 Ø cm.	90 cc.	Inox. - Sst.	1



Paleta para servir helado.
Palette to serve ice cream.

Cod.	Medidas - Size	Material	Pack
AT0082	27 h cm.	Inox. - Sst.	1

El arte del helado enrollado.
The art of rolled ice cream.



Espátula triangular con mango de Fenolkraft.
Triangle spatula with Fenolkraft handle.

Cod.	Medidas - Size	Material	Pack
AO0110	100 x 130 mm.	Inox. - Sst.	1



Cacillo para granizada
Ladle for iced drinks

Cod.	Medidas - Size	Material	Pack
AT0079	11,5 x 6 x 50 h cm.	Inox. - Sst.	1



Cacillo para horchata
Ladle for tiger nut milk drink

Cod.	Medidas - Size	Material	Pack
AT0078	9 x 7,5 x 50 h cm.	Inox. - Sst.	1

HELADERÍAS ICE CREAM SHOP

Versión ecológica que respeta el medio ambiente, de productos dedicados a la heladería.

An eco-friendly version of disposable items dedicated to catering. Suitable either for pastry shops and events, they are made of PLA.

CALIDAD Y RESPETO POR EL PLANETA

Gracias al uso de este material ecológico de alta calidad y versatilidad, las características que hacen que los productos de la línea sean únicos permanecen inalterados y cumplen con los estándares europeos de idoneidad para el contacto con alimentos.

QUALITY AND RESPECT FOR THE PLANET

By using this high quality and versatility eco-friendly material, the features that make these products range unique remain unchanged and respectful of European laws of suitability for food contact.



Paleta reutilizable heladería.
Reusable ice cream palette.

Cod.	Medida - Size	Bolsa - Bag	Caja - Box
P04030	95 mm.	1 kg.	10 kg.



Cuchara reutilizable.
Reusable spoon.

Cod.	Medida - Size	Bolsa - Bag	Caja - Box
P04634C	130 mm.	1 kg.	14 kg.



HELADERÍAS
ICE CREAM SHOP



Batidora para helados.
Blender for Ice Cream.

Cod.	Medida - Size	Capacidad - Capacity	Voltaje - Voltage
AO69111	21x15x51cm.	600 ml.	400W.

AO68402
Pack 10 uds.

AO68605

Sifón para nata.
Cream siphon.

Cod.	Capacidad - Capacity
AO68605	1000 ml.
AO68402	8 grs.



La línea de crepes eléctricos. Ideal para preparaciones dulces y saladas, nuestras creperas están equipadas con una placa de cocción antiadherente de hierro fundido de 30 / 40 cm. de diámetro (según modelo).

The line of electric crepes. Ideal for sweet and savory preparations, our crepes are equipped with a 30 / 40 cm cast iron non-stick cooking plate. in diameter (depending on

Cod.	Descripción. Description.	Medidas Size	Conexión Connection	Voltaje V Voltage V	Potencia Power	Peso Weight
AO69122	Simple	40 x 36 x 11 cm Útil - Useful 30 Ø cm.	Monofásico Monopha- se	220/240	1 Kw	2,12 Kg.

HELADERÍAS ICE CREAM SHOP



Medidor con graduación en relieve.
Measure with raised graduation.

Cod.	Medición - Measurement	Material	Pack
AO0084	500 ml.	P.V.C.	1
AO0080	1000 ml.	P.V.C.	1
AO0081	2000 ml.	P.V.C.	1
AO0083	3000 ml.	P.V.C.	1



Medidor con graduación en relieve.
Measure with raised graduation.

Cod.	Medición - Measurement	Material	Pack
AO0687	1000 ml.	P.V.C.	1
AO0688	2000 ml.	P.V.C.	1
AO0689	3000 ml.	P.V.C.	1



Soporte para 3 cucuruchos.
Support for 3 cones.

Cod.	Medidas - Size	Material	Pack
AT0704	21 x 7 x 8,5 h cm.	Inox. - Sst.	1



Cubo con graduación en relieve.
Cube with relief graduation.

Cod.	Medición - Measurement	Material
AO0691	12 l.	P.V.C.
AO0692	15 l.	P.V.C.
AO0693	18 l.	P.V.C.



Cubeta para helados.
Ice cream bucket.

Cod.	Medidas Size	Volumen Volume	Material	Pack
AO2007	36 x 25 x 8 h cm.	5,4 l.	Inox. - Sst.	1



Cubeta para helados.
Ice cream bucket.

Cod.	Medidas Size	Volumen Volume	Material	Pack
AO2006	36 x 16,5 x 8 h cm.	3,4 l.	Inox. - Sst.	1
AO2004	36 x 16,5 x 12 h cm.	5 l.	Inox. - Sst.	1
AO2005	36 x 16,5 x 15 h cm.	7 l.	Inox. - Sst.	1

HELADERÍAS
ICE CREAM SHOPVelas de barco.
Ship sails.

Cod.	Medidas - Size	Material	Pack	Box
A0112	11 h cm.	Papel - Paper	144	12

Isla con palmera.
Island with palm tree.

Cod.	Medidas - Size	Material	Pack	Box
A0229	12 h cm.	Papel - Paper	144	12

Pavo real.
Peacock.

Cod.	Medidas - Size	Material	Pack	Box
A0212	11 h cm.	Papel - Paper	144	12

Círculo.
Ring.

Cod.	Medidas - Size	Material	Pack	Box
A0201	12 h cm.	Papel - Paper	144	12

Sombrilla.
Umbrella.

Cod.	Medidas - Size	Material	Pack	Box
A0219	10 h cm.	Papel - Paper	144	12

Payaso.
Clown.

Cod.	Medidas - Size	Material	Pack	Box
A0084	12 h cm.	Papel - Paper	50	12

HELADERÍAS ICE CREAM SHOP



Sombrillas.
Umbrellas.

Cod.	Medidas - Size	Material	Pack	Box
A0240	12 h cm.	P.V.C.	144	12



Molinos.
Mills.

Cod.	Medidas - Size	Material	Pack	Box
A0211	12 h cm.	P.V.C.	50	12



Mariposas.
Butterflies.

Cod.	Medidas - Size	Material	Pack	Box
A0223	12 h cm.	Papel - Paper	144	12

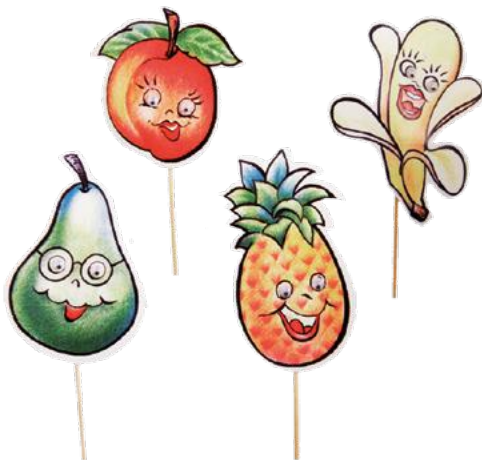

Frutas.
Fruits.

Cod.	Medidas - Size	Material	Pack	Box
AT0210	10 h cm.	Papel - Paper	144	12



Peces.
Fishes.

Cod.	Medidas - Size	Material	Pack	Box
AT0208	10 h cm.	Papel - Paper	144	12

HIGIENE
HYGIENE



Cubre zapatos ajustables desechables.
Covers disposable adjustable shoes.

Cod.	Material	Pcs.
VZ016	Polietileno - Polyethylene	100



Guantes de nitrilo, idela para el trabajo.
Nitrile gloves, ideal for work.

Cod.	Material	Espesor - Thickness	Medidas - Sizes	Pcs.
VZ021	Nitrilo - Nitrile	3.5 grs.	Standar	100
VZ022	Nitrilo - Nitrile	4,5 grs.	Standar	100



Delantal pastelero.
Pastry apron.

Cod.	Material	Pcs.
AO0100	P.V.C.	1
AO0101	Tela - Cloth	1



Delantal pastelero desechable.
Disposable pastry apron.

Cod.	Medida - Size	Material	Pack.	Box
AO1207	70 x 107 h cm.	P.V.C.	100	10



Mascarillas desechables.
Disposable mask.

Cod.	Material	Pcs.
VZ019	Polipropileno Polypropilene	50



Gorros desechables.
Disposable hats.

Cod.	Material	Pcs.
VZ020	Polipropileno Polypropilene	100



Batas desechables.
Disposable Coats.

Cod.	Material	Pcs.
VZ017	Polipropileno Polypropilene	10

HIGIENE

HYGIENE

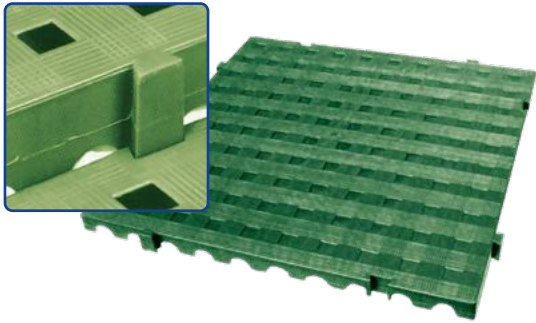

Suelo encajable.
Fitted floor.

Cod.	Medida - Size	Material	Max.	Pcs.
AO0417	50 x 50 x 2,5 h cm.	P.V.C.	1250 Kg.	1



Palet almacenaje.
Storage pallet.

Cod.	Medida - Size	Material	Max.	Pcs.
AO0403	40 x 60 x 13 h cm.	P.V.C.	250 Kg.	1



Palet almacenaje.
Storage pallet.

Cod.	Medida - Size	Material	Max.	Pcs.
AO0402	80 x 1200 x 13 h cm.	P.V.C.	500 Kg.	1



Palet almacenaje.
Storage pallet.

Cod.	Medida - Size	Material	Max.	Pcs.
AO0404	80 x 1200 x 16 h cm.	P.V.C.	4000 Kg.	1

HIGIENE
HYGIENE

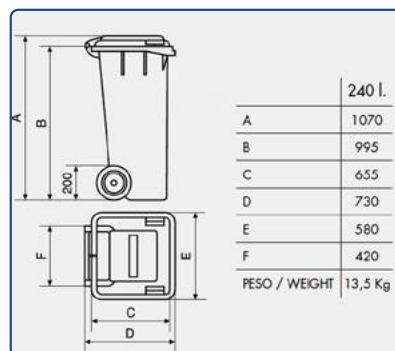
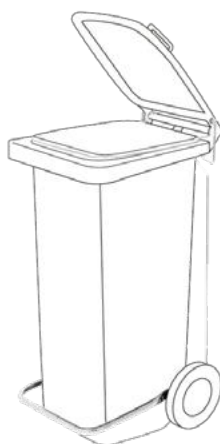

240 L.

Cubo residuos con ruedas y pedal inoxidable.
Waste bin with wheels and stainless pedal.

Aro y pedal inoxidable.
Stainless rim and pedal.

Cod. Material Pack

AO0672 P.V.C. y Inox. 1

Medidas - Sizes
460x560x940 h

120 L.

Cubo residuos con ruedas y pedal inoxidable.
Waste bin with wheels and stainless pedal.

Cod. Material Pack

AO0672B P.V.C. y Inox. 1

Medidas - Sizes
450x500x780 h mm.

80 L.

Cubo residuos con ruedas y pedal inoxidable.
Waste bin with wheels and stainless pedal.

Cod. Material Pack

AO0672C P.V.C. y Inox. 1



Aro y pedal inoxidable.
Stainless rim and pedal.

UTILLAJE

2026

Duproflex www.fantasiagodie.com
(+34) 956 805 280