

CATALOGUE

CATÁLOGO

Fastener drive tool manufacturer for industrial tightening

Fabricantes de accesorios para el apriete industrial

SPEEDRILL



Your satisfaction is our priority

Tu satisfacción es nuestra prioridad

ABOUT US QUIÉNES SOMOS

Fastener drive tool manufacturer since 1946.

Offering our customers solutions and products of the highest quality for a wide range of industrial markets. Our long professional career, as well as our international recognition supports our quality, reliability and innovation in our range of products.

We work hard to adapt our company to the non-stop technological changes in the different assembly areas to offer the highest precision and speed at work.

Our company's philosophy is based in three words:

Quality - Competitiveness - Service

We offer a wide range of tools, sockets, bits, adapters, extensions, universal wrenches, and special accessories under technical requests. Made with materials of the highest quality, strong magnets and protection coverings. These protection covers are adapted to all our products increasing security and quality at work.

We work day to day to offer the best results.

Do not hesitate to contact us to solve any technical issue you could have or if you don't find the tools or accessories required. We will be pleased to solve it offering the best solutions.

Fabricante de accesorios de apriete desde 1946.

Ofrecemos a nuestros clientes soluciones y productos de la más alta calidad para una amplia gama de mercados industriales.

Nuestra larga trayectoria profesional, así como nuestro reconocimiento internacional avalan nuestra calidad, fiabilidad e innovación en nuestra gama de productos.

Trabajamos duro para adaptar nuestra empresa a los incesantes cambios tecnológicos en las diferentes áreas de montaje para ofrecer la máxima precisión y rapidez en el trabajo.

La filosofía de nuestra empresa se basa en tres palabras:

Calidad, competitividad y servicio

Ofrecemos una amplia gama de herramientas, bocas, puntas, adaptadores, extensiones, rótulas y accesorios especiales bajo solicitud técnica. Fabricadas con materiales de la más alta calidad, imanes y protecciones.

Estas protecciones se adaptan a todos nuestros productos aumentando la seguridad y calidad en el trabajo.

Trabajamos día a día para ofrecer los mejores resultados.

No dude en ponerse en contacto con nosotros para resolver cualquier cuestión técnica que pueda tener o si no encuentra las herramientas o accesorios necesarios. Estaremos encantados de resolverlo ofreciéndole las mejores soluciones.



SUMMARY

SUMARIO

06

1. BITS *PUNTAS*



- 10 STANDARD
ESTÁNDAR
- 18 SCREWDRIVERS
ATORNILLADORES
- 19 MAGNETIC RINGS
ANILLOS MAGNÉTICOS
- 20 PROTECTED
PROTEGIDAS

32

2. BIT-HOLDERS *PORTA-PUNTAS*



- 34 STANDARD
ESTÁNDAR
- 37 BIT SOCKETS IN TWO PIECES
PUNTAS CON CUADRO DE ARRASTRE EN DOS PIEZAS
- 38 PROTECTED
PROTEGIDAS

40

3. BIT-SOCKETS *PUNTAS CON CUADRO DE ARRASTRE*



- 42 STANDARD
ESTÁNDAR
- 46 PROTECTED
PROTEGIDAS

50

4. SOCKETS *EMBOCADURAS*



- 52 STANDARD
ESTÁNDAR
- 74 PROTECTED
PROTEGIDAS

90

5. ADAPTERS & EXTENSIONS *ADAPTADORES Y EXTENSIONES*

- 92 STANDARD
ESTÁNDAR
- 98 PROTECTED
PROTEGIDAS

104 **6. UNIVERSAL WRENCHES** *RÓTULAS*



- 106 STANDARD
ESTÁNDAR
- 109 WOBBLE SOCKET ADAPTERS
ADAPTADORES BASCULANTES
- 110 PROTECTED
PROTEGIDAS

112 **7. ANTI-VIBRATION** *ANTI-VIBRACIÓN*



- 114 STANDARD
ESTÁNDAR
- 122 PROTECTED
PROTEGIDAS

128 **8.SPINDLES** *HUSILLOS*

- 130 STANDARD
ESTÁNDAR
- ANTI-VIBRATION
ANTI-VIBRACIÓN

132 **9.INSULATED 1000V (IEC 60900)** *AISLADAS 1000V*



- 134 STANDARD
ESTÁNDAR

138 **10.CUSTOM SOLUTIONS** *ESPECIALES*



- 140 DOUBLE SOCKETS
EMBOCADURAS DOBLES
- 141 OPEN SOCKETS
EMBOCADURAS ABIERTAS

143 **CONVERSION TABLE** *TABLA DE CONVERSIÓN*

144 **PART NUMBER INDEX** *ÍNDICE POR REFERENCIA*

PART NUMBER GUIDE

NOMENCLATURA

Sockets:
Embocaduras:



Adapters & extensions:
Adaptadores y extensiones:



1 SQUARE DRIVE TAMAÑO DE CUADRADILLO

#	SIZE TALLA
R	1/4"
J	3/8"
S	1/2"
N	5/8"
K	3/4"
L	1"

First letter defines the female square
La primera letra define el cuadradillo hembra

3 SIZE TALLA

SOCKETS
EMBOCADURAS



ADAPTERS & EXTENSIONS
ADAPTADORES Y EXTENSIONES

1/4"		3/8"		1/2"		3/4"	
#	L	#	L	#	L	#	L
01	32	20	32	50	40	03	75
02	50	22	50	52	50	04	100
03	75	23	75	53	75	05	125
04	100	24	100	54	100	06	150
05	125	25	125	55	125	08	200
06	150	26	150	56	150	10	250
08	200	27	175	57	175	12	300
10	250	28	200	58	200		
		30	250	60	250		

5 LENGTH LONGITUD

SOCKETS EMBOCADURAS							
1/4"		3/8"		1/2"		3/4"	
#	L	#	L	#	L	#	L
-		C	26 mm	-		-	
-		-		JL	50 mm	-	
L	50 mm	L	50 mm	L	80 mm	L	50 mm
-		XL	90 mm	-		-	

Standard lengths
Longitudes estándar

2 PRODUCT TYPE TIPO DE PIEZA

#	DESCRIPTION DESCRIPCIÓN
23	SOCKET EMBOCADURA
29	ADAPTER > ADAPTADOR >
31	ADAPTER < ADAPTADOR <
30	EXTENSION EXTENSIÓN
40	UNIVERSAL WRENCH RÓTULA
32	EXTENSION WRENCH EXTENSIÓN RÓTULADA

4 DRIVE HUELLA

#	DESCRIPTION DESCRIPCIÓN
H	HEXAGONAL HEXAGONAL
HER	FAST LEAD ENCARE RÁPIDO
SD	SURFACE DRIVE SURFACE DRIVE
BH	DOUBLE HEXAGON BIHEXAGONAL
E	TORX TORX
SQ	SQUARE CUADRADA

Choose the type of drive that best suits your tightening
Elija el tipo de huella que mejor se adapte a su apriete

6 MAGNET & RETENTION IMÁN Y RETENCIÓN

SOCKETS EMBOCADURAS		ADAPTERS & EXTENSIONS ADAPTADORES Y EXTENSIONES	
REF	DESCRIPTION DESCRIPCIÓN	REF	DESCRIPTION DESCRIPCIÓN
M	FIXED FIJO	A	BALL BOLA
HRM	SPRING LOADED RETRÁCTIL	B	PIN PIN
APM*	SIDE LATERAL	C	HOLE PASANTE
MR	MAGNETIC RING ANILLO MAGNÉTICO		

* On request Bajo demanda

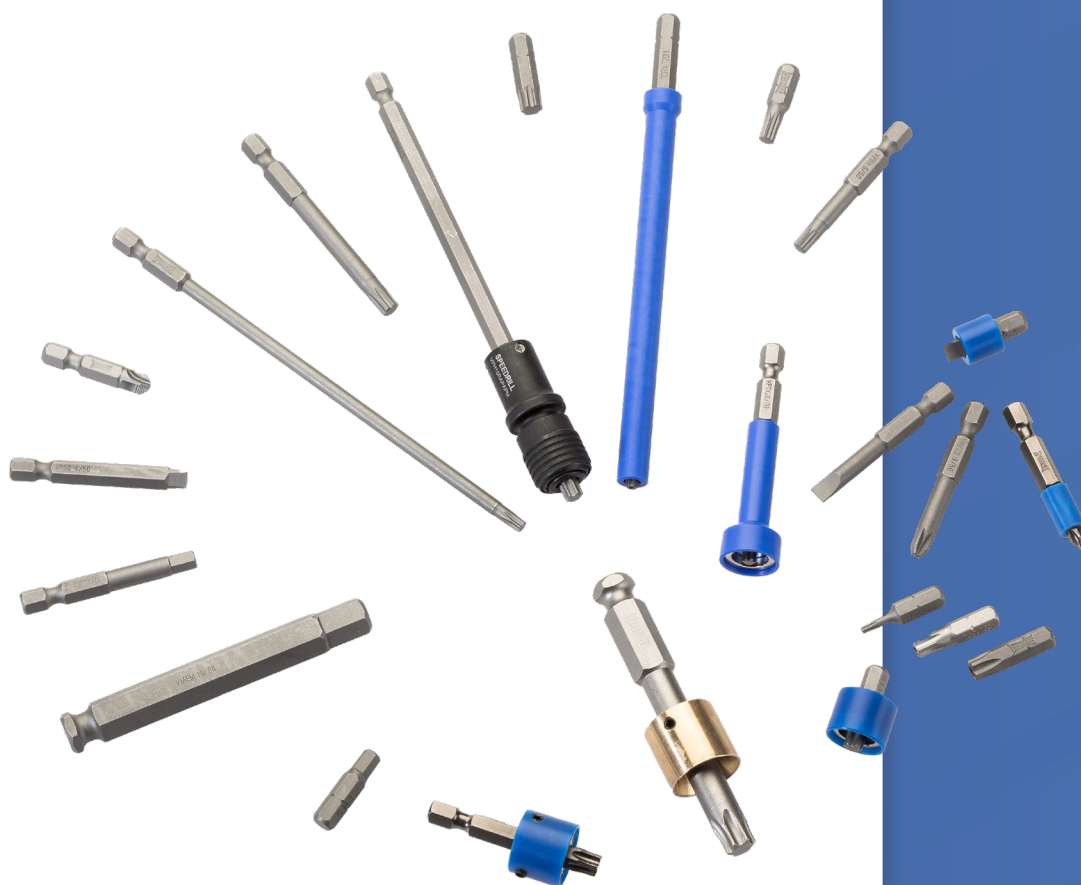

BITS

PUNTAS

Speedrill offers high quality bits for an Industrial tightening use in accordance with international security standards.

We carry a large portfolio of bits for various applications. If you don't find what you need, we also offer productions under your specifications.

Speedrill ofrece puntas industriales de la más alta calidad cumpliendo los estándares internacionales.

Amplia variedad de modelos y acabados para adaptarnos a sus necesidades.

En caso de que no encuentre la punta adecuada, póngase en contacto con nosotros para que podamos ofrecerle la mejor solución en relación a longitud, huella, tipo de retención y revestimiento adecuado.

01

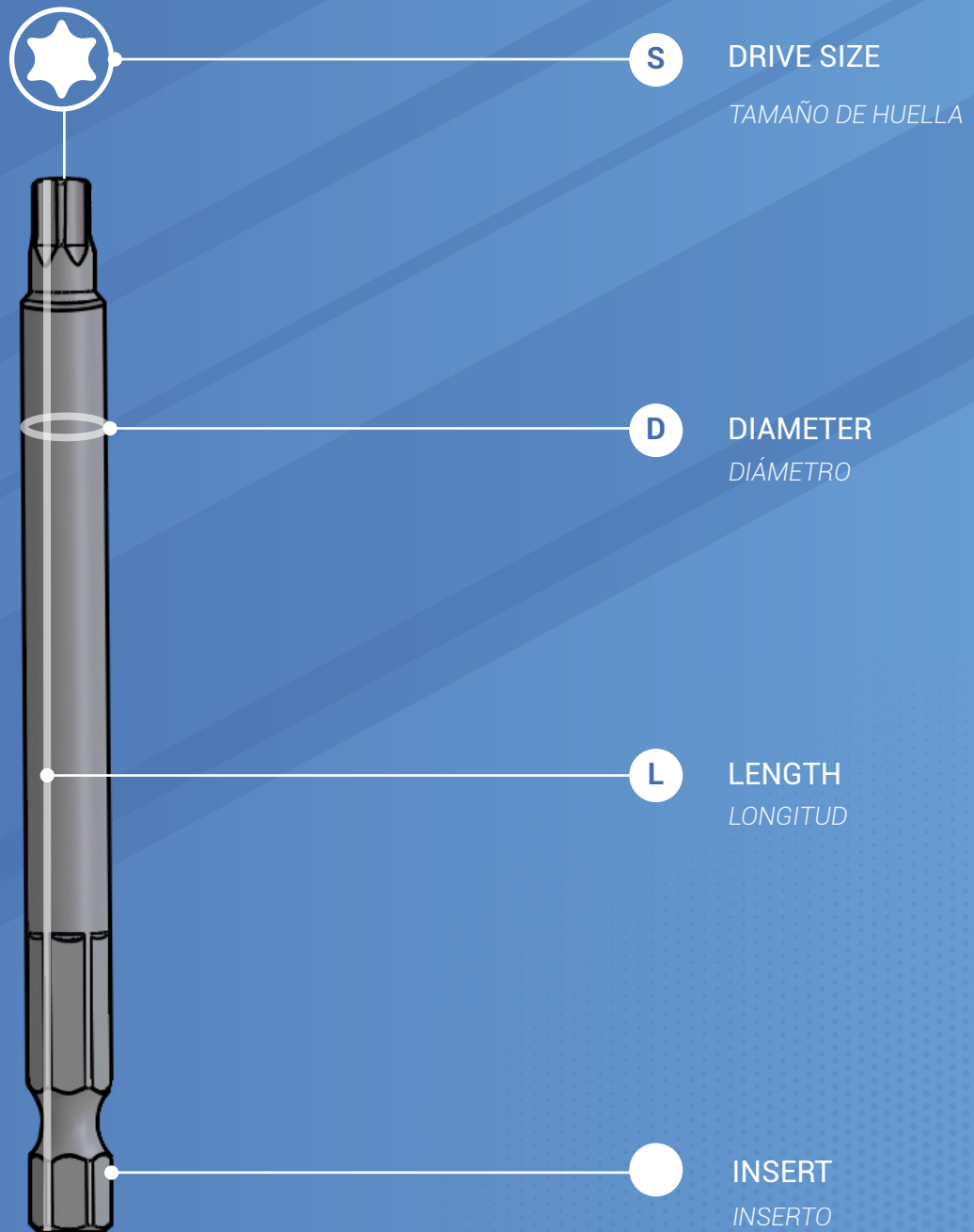

TYPE OF BITS

TIPO DE PUNTAS

PHILLIPS

PHILLIPS



Page 11
standard

Page 20
protected

They are the most commonly used in industry. These have pointed cross-head that matches a self-centering cross head screw, which prevents against cam-out.

Son las más utilizadas en la industria. Estas puntas tienen forma de cruz y también una mayor profundidad en el centro que en los extremos, lo que evita que la herramienta resbale.

POZIDRIV

POZIDRIV



Page 16
standard

Page 28
protected

These bits perform better than PHILLIPS bits. Their shape consists firstly of a cross-head tip and a second cross-head offset by 45° that grasps screws even more securely to avoid cam-outs.

Estas puntas tienen mejor rendimiento que las PHILLIPS. Su forma consiste, en primer lugar, en una cruz a la que se añade una segunda cruz desplazada 45° para obtener un mejor agarre.

HEXAGON

HEXAGONAL



Page 14
standard

Page 26
protected

The use of hexagon bits is increasing in mechanical engineering, general industry and the automotive industry. They are very effective because they ensure good contact with the screw, also known as "ALLEN".

Las puntas hexagonales se utilizan cada vez más en ingeniería mecánica, industria general y automoción. Son muy eficaces porque garantizan un buen contacto con el tornillo. También se conocen como "ALLEN".

TORX

TORX



Page 12
standard

Page 22
protected

Six-pointed star shape bits that resist slippage or cam-out better than other designs. They have a high resistance that allows them to be used for higher torques. Their use is very common in automotive, electronic components and devices, mechanical components...

Incorporan una estrella de seis puntas y, sin ningún ángulo aplicado, ofrecen un área de contacto lo suficientemente amplia como para evitar deslizamientos indeseados. Tienen una alta resistencia que permite utilizarlos para pares más elevados. Su uso son muy comunes en automoción, componentes y dispositivos electrónicos, componentes mecánicos...

TORX-PLUS

TORX-PLUS



Page 13
standard

Page 25
protected

It is an adjustment to Torx, they squared off the edges to increase the surface-contact area. It can be used for higher tightening torques and wears less than TORX. TORX PLUS is typically used for applications such as injection pumps, air conditioning, dashboards, etc.

Puede utilizarse para pares de apriete más altos y se desgasta menos que TORX. TORX PLUS se utiliza habitualmente para aplicaciones como bombas de inyección, aire acondicionado, salpicaderos, etc.

SLOTTED 
PLANAS



Page 11
standard

Page 21
protected

One of the oldest type of screwdrivers, the advantage is its simplicity. These tips are mainly used in workshops. Industries use other designs for better and more precise tightening.

Estas puntas se utilizan principalmente en talleres. Las industrias utilizan otros diseños para lograr una mejor sujeción y más precisa.

SQUARE 
CUADRADA



Page 16
standard

Page 30
protected

This type of tip is mainly used in furniture assembly.

Este tipo de punta se utiliza principalmente en el montaje de muebles.

TORQ-SET 
TORQ-SET

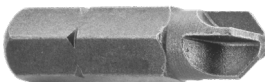

Page 17
standard

Page 29
protected

They are suitable for high tightening torques. Their stronger flanks can tighten up to 70% higher torque than TORX design and have a very precise positioning in the screw.

Son adecuados para pares de apriete elevados. Sus flancos más fuertes soportan un 70% más de par de apriete que el perfil TORX y tienen un posicionamiento muy preciso en el tornillo.

TRI-WING 
TRI-WING



Page 14
standard

Page 26
protected

3-pointed star design. Mainly used in electronics and aviation.

Diseño de estrella de 3 puntas. Se utiliza principalmente en electrónica y aviación.

DOUBLE-HEXAGON 
BIHEXAGONAL



Page 15
standard

Page 27
protected

Appear mostly in German automotive applications. They work very well for high torque tightening's with rounded head bolts. Used especially for vehicle safety bolts, such as seats and belts.

Comunmente utilizado en la Industria de la automoción alemana. Uso para aprietes altos. Se utiliza especialmente para tornillos de seguridad de vehículos, como asientos y cinturones.



PHILLIPS
PHILLIPS



1/4"



1/4"

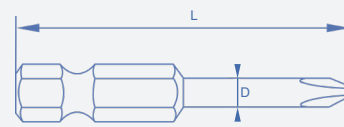

#	S	L
PH1	1	25
PH2	2	25
PH3	3	25
PH4	4	25

#	S	L	D
VPPH0/50	0	50	3
VPPH1/50	1	50	4,5
VPPH2/50	2	50	6
VPPH3/50	3	50	6
VPPH4/50	4	50	9
VPPH0/70	0	70	3
VPPH1/70	1	70	4,5
VPPH2/70	2	70	6
VPPH3/70	3	70	6
VPPH4/70	4	70	9
VPPH0/90	0	90	3
VPPH1/90	1	90	4,5
VPPH2/90	2	90	6
VPPH3/90	3	90	6
VPPH4/90	4	90	9

REDUCED TIP
CABEZA REDUCIDA

1/4"



#	S	L
PH2NR	2	25

STRAIGHT BODY
CUERPO RECTO

1/4"

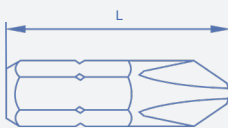

#	S	L
PH1ND	1	25
PH2ND	2	25



NR Reduced tip Cabeza reducida



ND Straight body Cuerpo recto

SLOTTED
PLANAS



1/4"



1/4"

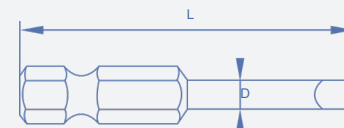

#	S	L
PL2.5	0,4 x 2,5	25
PL3.5	0,6 x 3,5	25
PL4.0	0,5 x 4,0	25
PL4.5	0,6 x 4,5	25
PL5.0	0,7 x 5,0	25
PL5.5	0,8 x 5,5	25
PL6.0	1,0 x 6,0	25
PL6.5	1,2 x 6,5	25
PL8.0	1,2 x 8,0	25

#	S	L	D
VPPL4.0/50	0,5 x 4,0	50	4
VPPL4.5/50	0,6 x 4,5	50	4,5
VPPL5.0/50	0,7 x 5,0	50	5
VPPL5.5/90	0,8 x 5,5	50	5,5
VPPL6.0/50	1,0 x 6,0	50	6
VPPL6.5/50	1,2 x 6,5	50	6,5
VPPL7.0/50	1,2 x 7,0	50	7
VPPL7.5/50	1,2 X 7,5	50	7,5
VPPL8.0/50	1,6 x 8,0	50	8
VPPL4.0/75	0,5 x 4,0	75	4
VPPL5.5/90	0,7 x 5,5	90	5,5
VPPL10/75	1,5 x 9,5	75	9,7

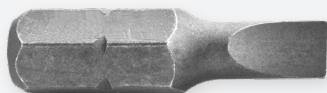

STANDARD



1 / 4 "			1 / 4 "			
#	S	L	#	S	L	D
TX2	T2	25	VPTX5/50	T5	50	3,2
TX3	T3	25	VPTX6/50	T6	50	3,2
TX4	T4	25	VPTX7/50	T7	50	3,2
TX5	T5	25	VPTX8/50	T8	50	3,2
TX6	T6	25	VPTX9/50	T9	50	3,2
TX7	T7	25	VPTX10/50	T10	50	4
TX8	T8	25	VPTX15/50	T15	50	4
TX9	T9	25	VPTX20/50	T20	50	4,8
TX10	T10	25	VPTX25/50	T25	50	4,8
TX15	T15	25	VPTX27/50	T27	50	6
TX20	T20	25	VPTX30/50	T30	50	6
TX25	T25	25	VPTX40/50	T40	50	7
TX27	T27	25	VPTX6/70	T6	70	3,2
TX30	T30	25	VPTX7/70	T7	70	3,2
TX40	T40	25	VPTX8/70	T8	70	3,2
			VPTX9/70	T9	70	3,2
			VPTX10/70	T10	70	4
			VPTX15/70	T15	70	4
			VPTX20/70	T20	70	4,8
			VPTX25/70	T25	70	4,8
			VPTX27/70	T27	70	6
			VPTX30/70	T30	70	6
			VPTX40/70	T40	70	7
			VPTX45/75	T45	75	8
			VPTX6/90	T6	90	3,2
			VPTX7/90	T7	90	3,2
			VPTX8/90	T8	90	3,2
			VPTX9/90	T9	90	3,2
			VPTX10/90	T10	90	4
			VPTX15/90	T15	90	4
			VPTX20/90	T20	90	4,8
			VPTX25/90	T25	90	4,8
			VPTX27/90	T27	90	6
			VPTX30/90	T30	90	6
			VPTX40/90	T40	90	7
			VPTX6/150	T6	150	3,2
			VPTX7/150	T7	150	3,2
			VPTX8/150	T8	150	3,2
			VPTX9/150	T9	150	3,2
			VPTX10/150	T10	150	4,8
			VPTX15/150	T15	150	4
			VPTX20/150	T20	150	4,8
			VPTX25/150	T25	150	4,8
			VPTX27/150	T27	150	6
			VPTX30/150	T30	150	6
			VPTX40/150	T40	150	7

1 / 4 "			1 / 4 "			
#	S	L	#	S	L	D
VPTX30/100ND	T30	100				
VPTX30/150ND	T30	150				

5 / 16 "			5 / 16 "			
#	S	L	#	S	L	D
TX20A	T20	35				
TX25A	T25	35				
TX30A	T30	35				
TX40A	T40	35				
TX45A	T45	35				
TX50A	T50	35				
TX55A	T55	35				

1 / 2 "			1 / 2 "			
#	S	L	#	S	L	D
TX50B	T50	50				
TX55B	T55	50				
TX60B	T60	50				

WITH THROUGH HOLE CON AGUJERO PASANTE

7 / 16 "



7 / 16 "

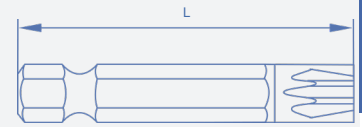

#	S	L
VMTX40TP	T40	43
VMTX50TP	T50	33
VMTX30TP/TT*	T30	33
VMTX50TP/TT*	T50	33

*Titanium Titanio

SECURITY TORX TORX DE SEGURIDAD



1 / 4 "

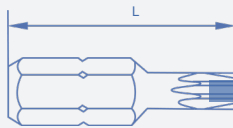

1 / 4 "

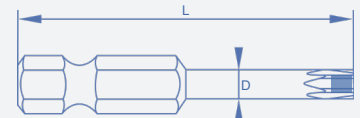

#	S	L
TX10P	T10	25
TX15P	T15	25
TX20P	T20	25
TX25P	T25	25
TX27P	T27	25
TX30P	T30	25
TX40P	T40	25

#	S	L
VMTX55/75	T55	75
VMTX40/90	T40	90
VMTX50/90	T50	90
VMTX55/90	T55	90
VMTX55/92TT*	T55	92
VMTX55/100	T55	100

*Titanium Titanio

TORX-PLUS TORX-PLUS



1 / 4 "



1 / 4 "

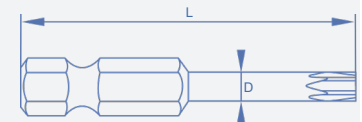

#	S	L
TP3	T3	25
TP6	T6	25
TP7	T7	25
TP8	T8	25
TP9	T9	25
TP10	T10	25
TP15	T15	25
TP20	T20	25
TP25	T25	25
TP27	T27	25
TP30	T30	25
TP40	T40	25

#	S	L	D
VPTP10/50	T10	50	4
VPTP15/50	T15	50	4
VPTP20/50	T20	50	4,8
VPTP25/50	T25	50	4,8
VPTP30/50	T30	50	6
VPTP40/50	T40	50	7
VPTP6/70	T6	70	3,2
VPTP10/70	T10	70	4
VPTP15/70	T15	70	4
VPTP20/70	T20	70	4,8
VPTP25/70	T25	70	4,8
VPTP30/70	T30	70	6
VPTP40/70	T40	70	7
VPTP8/90	T8	90	3,2
VPTP9/90	T9	90	3,2
VPTP10/90	T10	90	4
VPTP15/90	T15	90	4
VPTP20/90	T20	90	4,8
VPTP25/90	T25	90	4,8
VPTP30/90	T30	90	6
VPTP40/90	T40	90	7

5 / 16 "



#	S	L
TP55A	T55	32

STANDARD

TRI-WING TRI-WING



1/4"



1/4"

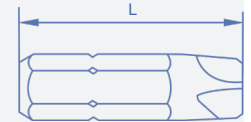

#	S	L
TW1	1	25
TW2	2	25
TW3	3	25
TW4	4	25
TW5	5	25
TW6	6	25

#	S	L
TW6/33	6	33



HEXAGON HEXAGONAL



1/4"



1/4"

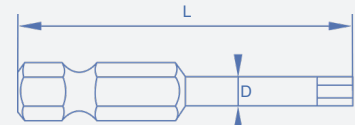

#	S	L
EM2	2	25
EM2.5	2,5	25
EM3	3	25
EM4	4	25
EM5	5	25
EM6	6	25
EM7	7	25
EM8	8	25
EM10	10	25
EM1/4	1/4	25
EM1/8	1/8	25
EM3/16	3/16	25
EM5/32	5/32	25
EM7/32	7/32	25
EM7/64	7/64	25
EM9/64	9/64	25

#	S	L	D
VPEM2/50	2	50	2,7
VPEM2.5/50	2,5	50	3,3
VPEM3/50	3	50	3,7
VPEM4/50	4	50	4,8
VPEM5/50	5	50	5,8
VPEM6/50	6	50	7
VPEM7/50	7	50	7,8
VPEM8/50	8	50	8,7
VPEM10/50	10	50	11,8
VPEM3/90	3	90	3,2
VPEM4/90	4	90	4,3
VPEM5/100	5	100	5,8
VPEM6/100	6	100	6,9
VPEM6/150	6	150	6,9
VPEM4/240	4	240	4,6
VPEM4/340	4	340	4,6

5 / 16 "

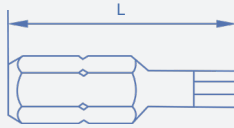

7 / 16 "

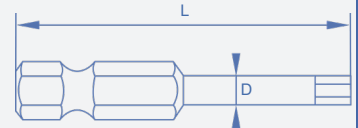

#	S	L
EM4A	4	32
EM5A	5	32
EM6A	6	32
EM7A	7	32
EM8A	8	32
EM10A	10	32
EM1/4A	1/4	32
EM3/8A	3/8	32
EM5/16A	5/16	32
EM7/32A	7/32	32

#	S	L	D
VMEM6/90	6	90	6,8
VMEM10/90	10	90	11

HEXAGON WITH THROUGH-HOLE
HEXAGONAL CON PASANTE

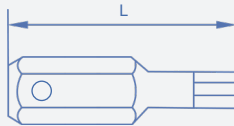

HEXAGON BALL
HEXAGONAL BOLA

1 / 4 "

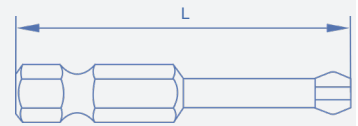

#	INSERT	S	L
EM6CM	7/16	6	32
EM10CM	7/16	10	32
EM10CV	5/8	10	32

#	S	L
VPEM2.5SW/50	2,5	50
VPEM2.5SW/70	2,5	70
VPEM5SW/122	5	122

DOUBLE-HEXAGON
BIHEXAGONAL



1 / 4 "

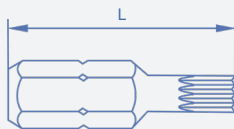

1 / 4 "

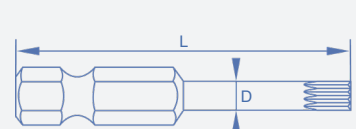

#	S	L
BH4	M4	25
BH5	M5	25
BH6	M6	25
BH8	M8	25
BH9	M9	25
BH10	M10	25

#	S	L	D
VPBH4/50	M4	50	3
VPBH5/50	M5	50	4
VPBH6/50	M6	50	5
VPBH8/50	M8	50	6
VPBH10/50	M10	50	8

5 / 16 "

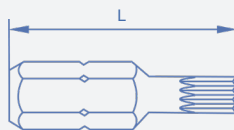

7 / 16 "

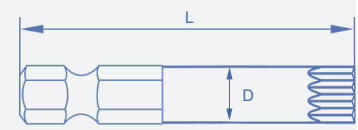

#	S	L
BH6A	M6	30
BH8A	M8	30
BH10A	M10	30
BH12A	M12	30
BH14A	M14	30

#	S	L	D
VMBH10/90	M10	90	12
VMBH12/90	M12	90	14
VMBH14/90	M14	90	17

STANDARD

SQUARE CUADRADA



1/4"

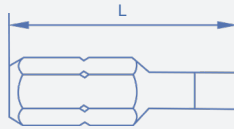

1/4"

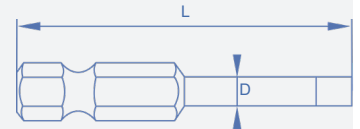

#	S	L
SQ0	0	25
SQ1	1	25
SQ2	2	25
SQ3	3	25
SQ4	4	25

#	S	L	D
VPSQ2/50	2	50	5,6
VPSQ3/50	3	50	5,8
VPSQ4/50	4	50	6,9

POZIDRIV POZIDRIV



1/4"

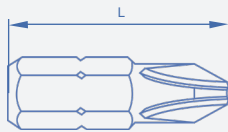

1/4"

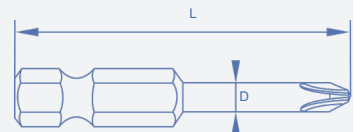

#	S	L
PZD0	0	25
PZD1	1	25
PZD2	2	25
PZD3	3	25

#	S	L	D
VPPZD0/50	0	50	3
VPPZD1/50	1	50	4,5
VPPZD2/50	2	50	6
VPPZD3/50	3	50	6
VPPZD4/50	4	50	9
VPPZD0/70	0	70	3
VPPZD1/70	1	70	4,5
VPPZD2/70	2	70	6
VPPZD3/70	3	70	6
VPPZD0/90	0	90	3
VPPZD1/90	1	90	4,5
VPPZD2/90	2	90	6
VPPZD3/90	3	90	6
VPPZD0/150	0	150	3
VPPZD1/150	1	150	4,5
VPPZD2/150	2	150	6

STRAIGHT BODY CABEZA RECTA

1/4"

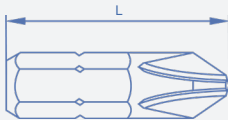

#	S	L
PZD2ND	2	25
PZD3ND	3	25



ND Straight body *Cuerpo recto*

POZIDRIV



8 Contact points
8 Puntos de contacto

PHILLIPS

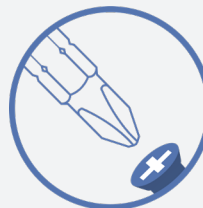

4 Contact points
4 Puntos de contacto

TORQ-SET
TORQ-SET 

1/4"

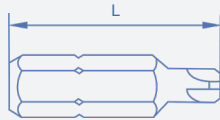

1/4"



#	S	L
TS6	6	25
TS10	10	25

#	S	L
VPTS1/4/33	1/4	33

ACR
ACR

1/4"



IP
IP 

1/4"



#	S	L
VPTS8ACR/33	8	33
VPTS10ACR/33	10	33

#	S	L
IP10P	T10	25
IP15P	T15	25
IP20P	T20	25
IP25P	T25	25
IP27P	T27	25
IP30P	T30	25
IP40P	T40	25
IP27**	T27	25

**Without central hole Sin agujero central

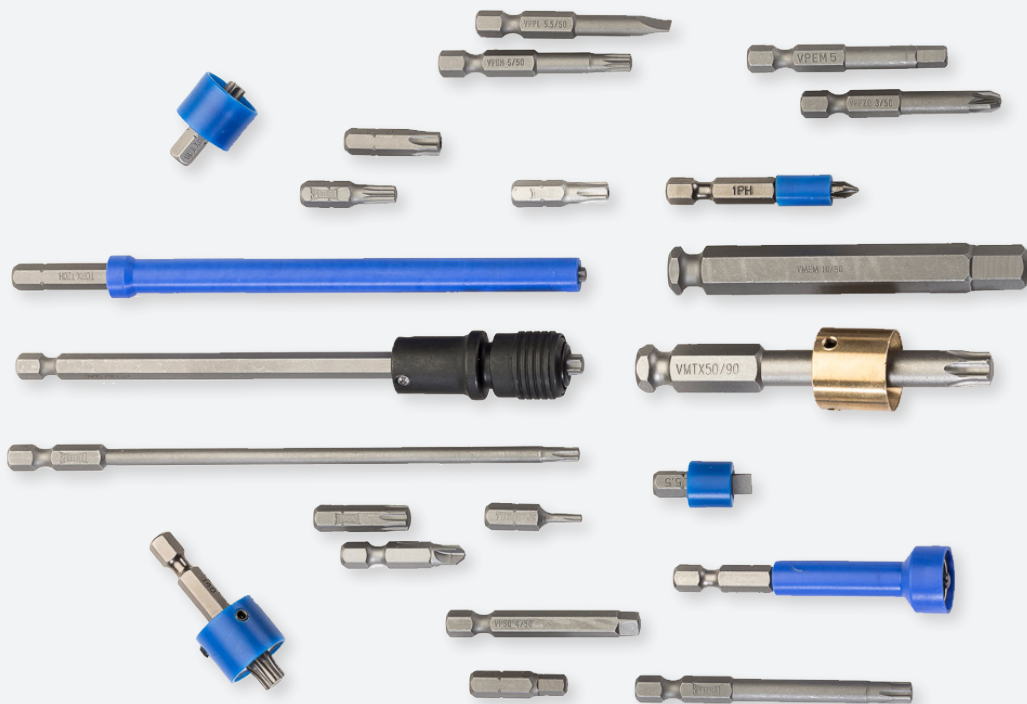

SCREWDRIVERS

ATORNILLADORES

#	L	TYPE
1 RL81M	81	MAGNET IMAN
2 RL134M	134	MAGNET IMAN
3 RL188M	188	MAGNET IMAN
4 RL134VP	134	QUICK CHANGE CAMBIO RÁPIDO
5 RL188VP	188	QUICK CHANGE CAMBIO RÁPIDO



BIT BOX

CAJA DE PUNTAS

#	# SPBBST1	QUANTITY	TYPE
PH1	⊕	x1	BIT PUNTA
PH2	⊕	x2	BIT PUNTA
PH3	⊕	x1	BIT PUNTA
PZ1	⊛	x1	BIT PUNTA
PZ2	⊛	x2	BIT PUNTA
PZ3	⊛	x1	BIT PUNTA
T10	⊛⊛	x2	BIT PUNTA
T15	⊛⊛	x3	BIT PUNTA
T20	⊛⊛	x3	BIT PUNTA
T25	⊛⊛	x3	BIT PUNTA
T27	⊛	x1	BIT PUNTA
T30	⊛⊛	x2	BIT PUNTA
T40	⊛	x2	BIT PUNTA
EM3	⊙	x1	BIT PUNTA
EM4	⊙	x1	BIT PUNTA
EM5	⊙	x1	BIT PUNTA
EM6	⊙	x1	BIT PUNTA
PL4,5	⊖	x1	BIT PUNTA
PL6,5	⊖	x1	BIT PUNTA
553RAP		x1	BIT-HOLDER PORTA-PUNTAS
Countersink		x1	COUNTERSINK AVELLANADOR

BITS
30
PUNTAS



MAGNETIC RINGS

ANILLOS MAGNÉTICOS

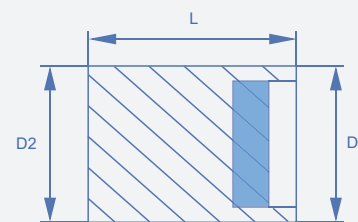

Our magnetic adapters fit different types and sizes of tips adding a magnetic hold on the posts that require it.

They are tightened by a set screw allowing them to be reused in the event of tip breakage.

If you do not find the size you are looking for, please contact us to offer you the best solution.

Nuestros anillos magnéticos se adaptan a diferentes tipos y tamaños de puntas para darles una sujeción magnética a los puestos que lo precisen.

Se ajustan mediante un prisionero permitiendo que sean reutilizados en el caso de rotura en la punta.

Si no encuentra el tamaño que busca, póngase en contacto con nosotros para fabricarle uno a medida.

#	MATERIAL	L	D1	D2	RETENTION
SPTEFMGRTX30L	PLASTIC PLÁSTICO	22,8	20,8	20,8	SCREW TORNILLO
SPTEFMGRTX40	PLASTIC PLÁSTICO	15	7,6	18	SCREW TORNILLO
SPTEFMGRTX50	PLASTIC PLÁSTICO	22	9,96	21	SCREW TORNILLO
SPCOPMGR	BRASS LATÓN	13	13,3	13,3	
SPCOPMGRTX50	BRASS LATÓN	21	9,6	19	SCREW TORNILLO
SPCOPMGRTX55	BRASS LATÓN	20	12,1	29,5	SCREW TORNILLO



PROTECTED

PHILLIPS
PHILLIPS



1/4"

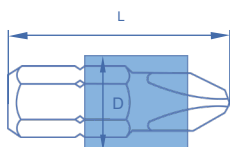

1/4"

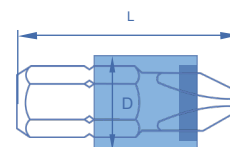

#	S	L	D	MAGNETIC	S	L	D
PH1/TEF	1	25	12	PH1/TEFM	1	25	15
PH2/TEF	2	25	12	PH2/TEFM	2	25	15
PH3/TEF	3	25	12	PH3/TEFM	3	25	15
PH4/TEF	4	25	12	PH4/TEFM	4	25	15

1/4"

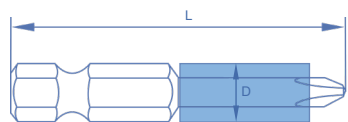

1/4"

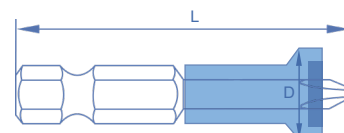

#	S	L	D	MAGNETIC	S	L	D
VPPH0/50/TEF	0	50	7	VPPH0/50/TEFM	0	50	17
VPPH1/50/TEF	1	50	7	VPPH1/50/TEFM	1	50	17
VPPH2/50/TEF	2	50	9	VPPH2/50/TEFM	2	50	17
VPPH3/50/TEF	3	50	9	VPPH3/50/TEFM	3	50	17
VPPH4/50/TEF	4	50	10	VPPH4/50/TEFM	4	50	17
VPPH0/70/TEF	0	70	7	VPPH0/70/TEFM	0	70	17
VPPH1/70/TEF	1	70	7	VPPH1/70/TEFM	1	70	17
VPPH2/70/TEF	2	70	9	VPPH2/70/TEFM	2	70	17
VPPH3/70/TEF	3	70	9	VPPH3/70/TEFM	3	70	17
VPPH4/70/TEF	4	70	10	VPPH4/70/TEFM	4	70	17
VPPH0/90/TEF	0	90	7	VPPH0/90/TEFM	0	90	17
VPPH1/90/TEF	1	90	7	VPPH1/90/TEFM	1	90	17
VPPH2/90/TEF	2	90	9	VPPH2/90/TEFM	2	90	17
VPPH3/90/TEF	3	90	9	VPPH3/90/TEFM	3	90	17
VPPH4/90/TEF	4	90	10	VPPH4/90/TEFM	4	90	17
VPPH2/150/TEF	2	150	9	VPPH2/150/TEFM	2	150	17

STRAIGHT BODY

CABEZA RECTA

1/4"

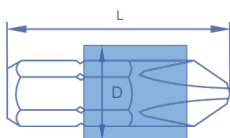

1/4"

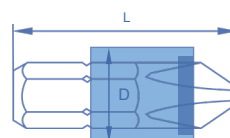

#	S	L	D	MAGNETIC	S	L	D
PH1ND/TEF	1	25	12	PH1ND/TEFM	1	25	17
PH2ND/TEF	2	25	12	PH2ND/TEFM	2	25	17

REDUCED TIP

CABEZA REDUCIDA

1/4"

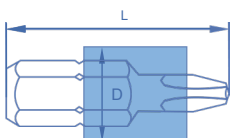

1/4"

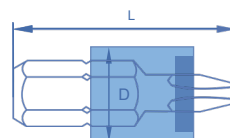

#	S	L	D	MAGNETIC	S	L	D
PH2NR/TEF	2	25	12	PH2NR/TEFM	2	25	17

SLOTTED
PLANAS



1/4"

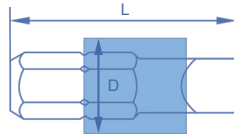

1/4"

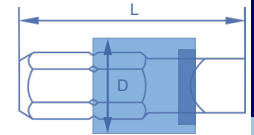

BITS
PUNTAS

#	S	L	D	MAGNETIC	S	L	D
PL2.5/TEF	0,4 x 2,5	25	12	PL2.5/TEFM	0,4 x 2,5	25	15
PL3.5/TEF	0,6 x 3,5	25	12	PL3.5/TEFM	0,6 x 3,5	25	15
PL4.0/TEF	0,5 x 4,0	25	12	PL4.0/TEFM	0,5 x 4,0	25	15
PL4.5/TEF	0,6 x 4,5	25	12	PL4.5/TEFM	0,6 x 4,5	25	15
PL5.0/TEF	0,7 x 5,0	25	12	PL5.0/TEFM	0,7 x 5,0	25	15
PL5.5/TEF	0,8 x 5,5	25	12	PL5.5/TEFM	0,8 x 5,5	25	15
PL6.0/TEF	1,0 x 6,0	25	12	PL6.0/TEFM	1,0 x 6,0	25	15
PL6.5/TEF	1,2 x 6,5	25	12	PL6.5/TEFM	1,2 x 6,5	25	15

1/4"

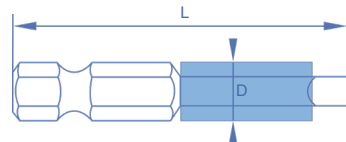

1/4"

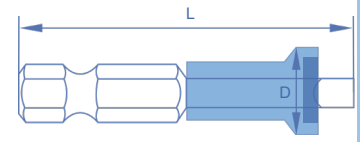

#	S	L	D	MAGNETIC	S	L	D
VPPL4.0/50/TEF	0,5 x 4,0	50	7	VPPL4.0/50/TEFM	0,5 x 4,0	50	17
VPPL4.5/50/TEF	0,6 x 4,5	50	7	VPPL4.5/50/TEFM	0,6 x 4,5	50	17
VPPL5.0/50/TEF	0,7 x 5,0	50	8	VPPL5.0/50/TEFM	0,7 x 5,0	50	17
VPPL5.5/50/TEF	0,8 x 5,5	50	8	VPPL5.5/50/TEFM	0,8 x 5,5	50	17
VPPL6.0/50/TEF	1,0 x 6,0	50	9	VPPL6.0/50/TEFM	1,0 x 6,0	50	17
VPPL6.5/50/TEF	1,2 x 6,5	50	9	VPPL6.5/50/TEFM	1,2 x 6,5	50	17
VPPL7.0/50/TEF	1,2 x 7,0	50	10	VPPL7.0/50/TEFM	1,2 x 7,0	50	17
VPPL7.5/50/TEF	1,2 x 7,5	50	10	VPPL7.5/50/TEFM	1,2 x 7,5	50	17
VPPL8.0/50/TEF	1,2 x 8,0	50	11	VPPL8.0/50/TEFM	1,2 x 8,0	50	17
VPPL4.0/75/TEF	0,5 x 4,0	75	7	VPPL4.0/75/TEFM	0,5 x 4,0	75	17
VPPL10.0/75/TEF	1,6 x 10	75	13	VPPL10.0/75/TEFM	1,6 x 10	75	17
VPPL5.5/90/TEF	0,7 x 5,5	90	8	VPPL5.5/90/TEFM	0,7 x 5,5	90	17



1 / 4 "

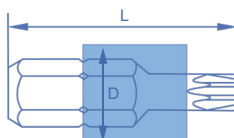

1 / 4 "

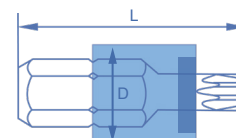

#	S	L	D	MAGNETIC	S	L	D
TX2/TEF	T2	25	12	TX2/TEFM	T2	25	15
TX3/TEF	T3	25	12	TX3/TEFM	T3	25	15
TX4/TEF	T4	25	12	TX4/TEFM	T4	25	15
TX5/TEF	T5	25	12	TX5/TEFM	T5	25	15
TX6/TEF	T6	25	12	TX6/TEFM	T6	25	15
TX7/TEF	T7	25	12	TX7/TEFM	T7	25	15
TX8/TEF	T8	25	12	TX8/TEFM	T8	25	15
TX9/TEF	T9	25	12	TX9/TEFM	T9	25	15
TX10/TEF	T10	25	12	TX10/TEFM	T10	25	15
TX15/TEF	T15	25	12	TX15/TEFM	T15	25	15
TX20/TEF	T20	25	12	TX20/TEFM	T20	25	15
TX25/TEF	T25	25	12	TX25/TEFM	T25	25	15
TX27/TEF	T27	25	12	TX27/TEFM	T27	25	15
TX30/TEF	T30	25	12	TX30/TEFM	T30	25	15
TX40/TEF	T40	25	12	TX40/TEFM	T40	25	15

5 / 16 "

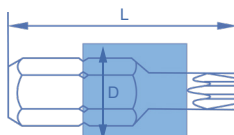

5 / 16 "

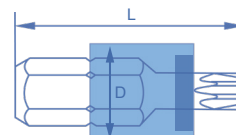

#	S	L	D	MAGNETIC	S	L	D
TX20A/TEF	T20	35	16	TX20A/TEFM	T20	35	17
TX25A/TEF	T25	35	16	TX25A/TEFM	T25	35	17
TX30A/TEF	T30	35	16	TX30A/TEFM	T30	35	17
TX40A/TEF	T40	35	16	TX40A/TEFM	T40	35	17
TX45A/TEF	T45	35	16	TX45A/TEFM	T45	35	17
TX50A/TEF	T50	35	16	TX50A/TEFM	T50	35	17

1 / 2 "

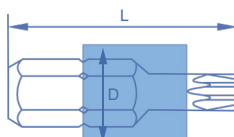

1 / 2 "

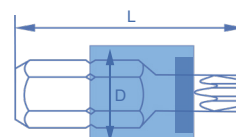

#	S	L	D	MAGNETIC	S	L	D
TX50B/TEF	T50	50	17	TX50B/TEFM	T50	50	19
TX55B/TEF	T55	50	17	TX55B/TEFM	T55	50	19
TX60B/TEF	T60	50	17	TX60B/TEFM	T60	50	19



1 / 4 "

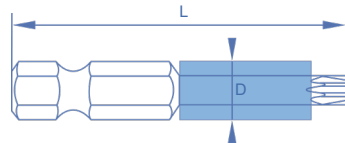

1 / 4 "

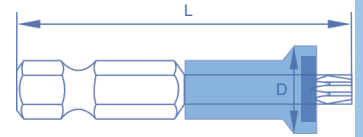

#	S	L	D	MAGNETIC	S	L	D
VPTX5/50/TEF	T5	50	6	VPTX5/50/TEFM	T5	50	17
VPTX6/50/TEF	T6	50	6	VPTX6/50/TEFM	T6	50	17
VPTX7/50/TEF	T7	50	6	VPTX7/50/TEFM	T7	50	17
VPTX8/50/TEF	T8	50	6	VPTX8/50/TEFM	T8	50	17
VPTX9/50/TEF	T9	50	6	VPTX9/50/TEFM	T9	50	17
VPTX10/50/TEF	T10	50	7	VPTX10/50/TEFM	T10	50	17
VPTX15/50/TEF	T15	50	7	VPTX15/50/TEFM	T15	50	17
VPTX20/50/TEF	T20	50	7	VPTX20/50/TEFM	T20	50	17
VPTX25/50/TEF	T25	50	9	VPTX25/50/TEFM	T25	50	17
VPTX30/50/TEF	T30	50	9	VPTX30/50/TEFM	T30	50	17
VPTX40/50/TEF	T40	50	10	VPTX40/50/TEFM	T40	50	17
VPTX8/70/TEF	T8	70	7	VPTX8/70/TEFM	T8	70	17
VPTX9/70/TEF	T7	70	7	VPTX9/70/TEFM	T7	70	17
VPTX10/70/TEF	T10	70	7	VPTX10/70/TEFM	T10	70	17
VPTX15/70/TEF	T15	70	7	VPTX15/70/TEFM	T15	70	17
VPTX20/70/TEF	T20	70	7	VPTX20/70/TEFM	T20	70	17
VPTX25/70/TEF	T25	70	9	VPTX25/70/TEFM	T25	70	17
VPTX30/70/TEF	T30	70	9	VPTX30/70/TEFM	T30	70	17
VPTX40/70/TEF	T40	70	10	VPTX40/70/TEFM	T40	70	17
VPTX45/70/TEF	T45	70	11	VPTX45/70/TEFM	T45	70	17
VPTX20/90/TEF	T20	90	7	VPTX20/90/TEFM	T20	90	17
VPTX25/90/TEF	T25	90	9	VPTX25/90/TEFM	T25	90	17
VPTX30/90/TEF	T30	90	9	VPTX30/90/TEFM	T30	90	17
VPTX40/90/TEF	T40	90	10	VPTX40/90/TEFM	T40	90	17
VPTX6/150/TEF	T6	150	7	VPTX6/150/TEFM	T6	150	17
VPTX7/150/TEF	T7	150	7	VPTX7/150/TEFM	T7	150	17
VPTX8/150/TEF	T8	150	7	VPTX8/150/TEFM	T8	150	17
VPTX10/150/TEF	T10	150	7	VPTX10/150/TEFM	T10	150	17
VPTX15/150/TEF	T15	150	7	VPTX15/150/TEFM	T15	150	17
VPTX20/150/TEF	T20	150	7	VPTX20/150/TEFM	T20	150	17
VPTX25/150/TEF	T25	150	9	VPTX25/150/TEFM	T25	150	17
VPTX27/150/TEF	T27	150	9	VPTX27/150/TEFM	T27	150	17
VPTX30/150/TEF	T30	150	9	VPTX30/150/TEFM	T30	150	17
VPTX40/150/TEF	T40	150	10	VPTX40/150/TEFM	T40	150	17

PROTECTED

7/16"

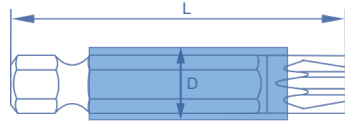

7/16"

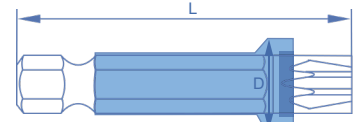

#	S	L	D	MAGNETIC	S	L	D
VMTX40/90/TEF	T40	90	15	VMTX40/90/TEFM	T40	90	20
VMTX50/90/TEF	T50	90	13	VMTX50/90/TEFM	T50	90	17
VMTX55/90/TEF	T55	90	15	VMTX55/90/TEFM	T55	90	20
VMTX55/100/TEF	T55	100	15	VMTX55/100/TEFM	T55	100	20

SECURITY TORX
TORX DE SEGURIDAD



1/4"

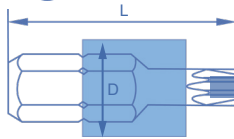

1/4"

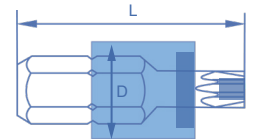

#	S	L	D	MAGNETIC	S	L	D
TX10P/TEF	T10	25	12	TX10P/TEFM	T10	25	15
TX15P/TEF	T15	25	12	TX15P/TEFM	T15	25	15
TX20P/TEF	T20	25	12	TX20P/TEFM	T20	25	15
TX25P/TEF	T25	25	12	TX25P/TEFM	T25	25	15
TX27P/TEF	T27	25	12	TX27P/TEFM	T27	25	15
TX30P/TEF	T30	25	12	TX30P/TEFM	T30	25	15
TX40P/TEF	T40	25	12	TX40P/TEFM	T40	25	15

1/4"

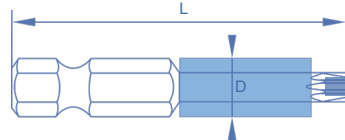

1/4"

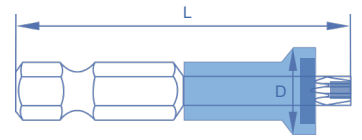

#	S	L	D	MAGNETIC	S	L	D
VPTX10P/50/TEF	T10	50	7	VPTX10P/50/TEFM	T10	50	17
VPTX20P/150/TEF	T20	150	7	VPTX20P/150/TEFM	T20	150	17



1 / 4 "

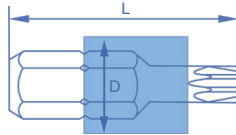

1 / 4 "

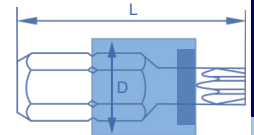

#	S	L	D	MAGNETIC	S	L	D
TP3/TEF	T3	25	12	TP3/TEFM	T3	25	15
TP6/TEF	T6	25	12	TP6/TEFM	T6	25	15
TP7/TEF	T7	25	12	TP7/TEFM	T7	25	15
TP8/TEF	T8	25	12	TP8/TEFM	T8	25	15
TP9/TEF	T9	25	12	TP9/TEFM	T9	25	15
TP10/TEF	T10	25	12	TP10/TEFM	T10	25	15
TP15/TEF	T15	25	12	TP15/TEFM	T15	25	15
TP20/TEF	T20	25	12	TP20/TEFM	T20	25	15
TP25/TEF	T25	25	12	TP25/TEFM	T25	25	15
TP27/TEF	T27	25	12	TP27/TEFM	T27	25	15
TP30/TEF	T30	25	12	TP30/TEFM	T30	25	15
TP40/TEF	T40	25	12	TP40/TEFM	T40	25	15

1 / 4 "

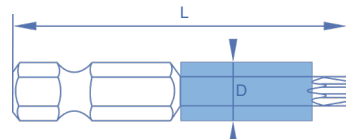

1 / 4 "

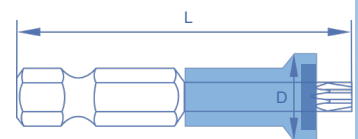

#	S	L	D	MAGNETIC	S	L	D
VPTP10/50/TEF	T10	50	7	VPTP10/50/TEFM	T10	50	17
VPTP15/50/TEF	T15	50	7	VPTP15/50/TEFM	T15	50	17
VPTP20/50/TEF	T20	50	7	VPTP20/50/TEFM	T20	50	17
VPTP25/50/TEF	T25	50	8	VPTP25/50/TEFM	T25	50	17
VPTP30/50/TEF	T30	50	9	VPTP30/50/TEFM	T30	50	17
VPTP40/50/TEF	T40	50	10	VPTP40/50/TEFM	T40	50	17
VPTP6/70/TEF	T6	70	7	VPTP6/70/TEFM	T6	70	17
VPTP10/70/TEF	T10	70	7	VPTP10/70/TEFM	T10	70	17
VPTP15/70/TEF	T15	70	7	VPTP15/70/TEFM	T15	70	17
VPTP20/70/TEF	T20	70	7	VPTP20/70/TEFM	T20	70	17
VPTP25/70/TEF	T25	70	8	VPTP25/70/TEFM	T25	70	17
VPTP30/70/TEF	T30	70	9	VPTP30/70/TEFM	T30	70	17
VPTP40/70/TEF	T40	70	10	VPTP40/70/TEFM	T40	70	17
VPTP9/90/TEF	T9	90	7	VPTP9/90/TEFM	T9	90	17
VPTP10/90/TEF	T10	90	7	VPTP10/90/TEFM	T10	90	17
VPTP15/90/TEF	T15	90	7	VPTP15/90/TEFM	T15	90	17
VPTP20/90/TEF	T20	90	7	VPTP20/90/TEFM	T20	90	17
VPTP25/90/TEF	T25	90	8	VPTP25/90/TEFM	T25	90	17
VPTP30/90/TEF	T30	90	9	VPTP30/90/TEFM	T30	90	17
VPTP40/90/TEF	T40	90	10	VPTP40/90/TEFM	T40	90	17

PROTECTED

TRI-WING
TRI-WING



1 / 4 "

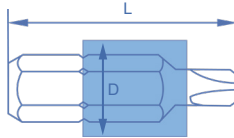

1 / 4 "

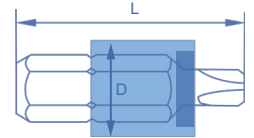

#	S	L	D	MAGNETIC	S	L	D
TW1/TEF	1	25	12	TW1/TEFM	1	25	15
TW2/TEF	2	25	12	TW2/TEFM	2	25	15
TW3/TEF	3	25	12	TW3/TEFM	3	25	15
TW4/TEF	4	25	12	TW4/TEFM	4	25	15
TW5/TEF	5	25	12	TW5/TEFM	5	25	15

HEXAGON
HEXAGONAL



1 / 4 "

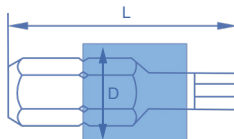

1 / 4 "

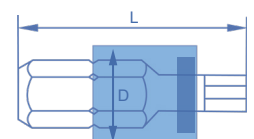

#	S	L	D	MAGNETIC	S	L	D
EM2/TEF	2	25	12	EM2/TEFM	2	25	15
EM2.5/TEF	2,5	25	12	EM2.5/TEFM	2,5	25	15
EM3/TEF	3	25	12	EM3/TEFM	3	25	15
EM4/TEF	4	25	12	EM4/TEFM	4	25	15
EM5/TEF	5	25	12	EM5/TEFM	5	25	15
EM6/TEF	6	25	12	EM6/TEFM	6	25	15
EM1/4/TEF	1/4	25	12	EM1/4/TEFM	1/4	25	15
EM1/8/TEF	1/8	25	12	EM1/8/TEFM	1/8	25	15
EM3/16/TEF	3/16	25	12	EM3/16/TEFM	3/16	25	15
EM5/32/TEF	5/32	25	12	EM5/32/TEFM	5/32	25	15
EM7/32/TEF	7/32	25	12	EM7/32/TEFM	7/32	25	15
EM7/64/TEF	7/64	25	12	EM7/64/TEFM	7/64	25	15

1 / 4 "

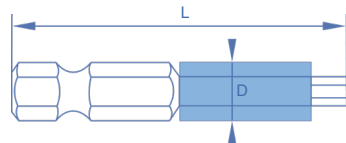

1 / 4 "

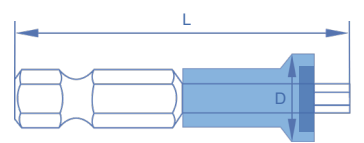

#	S	L	D	MAGNETIC	S	L	D
VPEM2.5/50/TEF	2,5	50	6	VPEM2.5/50/TEFM	2,5	50	17
VPEM3/50/TEF	3	50	7	VPEM3/50/TEFM	3	50	17
VPEM4/50/TEF	4	50	8	VPEM4/50/TEFM	4	50	17
VPEM5/50/TEF	5	50	9	VPEM5/50/TEFM	5	50	17
VPEM6/50/TEF	6	50	10	VPEM6/50/TEFM	6	50	17
VPEM7/50/TEF	7	50	11	VPEM7/50/TEFM	7	50	17
VPEM8/50/TEF	8	50	16	VPEM8/50/TEFM	8	50	17

5 / 16 "

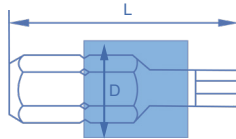

5 / 16 "

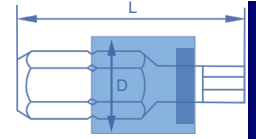

#	S	L	D	MAGNETIC	S	L	D
EM4A/TEF	4	32	16	EM4A/TEFM	4	32	17
EM5A/TEF	5	32	16	EM5A/TEFM	5	32	17
EM6A/TEF	6	32	16	EM6A/TEFM	6	32	17
EM7A/TEF	7	32	16	EM7A/TEFM	7	32	17
EM8A/TEF	8	32	16	EM8A/TEFM	8	32	17
EM1/4A/TEF	1/4	32	16	EM1/4A/TEFM	1/4	32	17
EM5/16A/TEF	5/16	32	16	EM5/16A/TEFM	5/16	32	17
EM7/32A/TEF	7/32	32	16	EM7/32A/TEFM	7/32	32	17

HEXAGON BALL HEXÁGONO DE BOLA

1 / 4 "

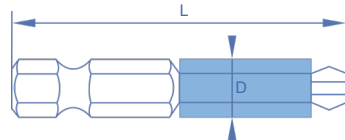

1 / 4 "

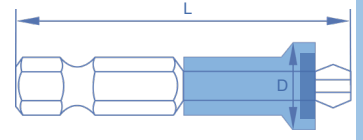

#	S	L	D	MAGNETIC	S	L	D
VPEM2.5SW/50/TEF	2,5	50	7	VPEM2.5SW/50/TEFM	2,5	50	17
VPEM2.5SW/70/TEF	2,5	70	7	VPEM2.5SW/70/TEFM	2,5	70	17
VPEM5SW/122/TEF	5	122	7	VPEM5SW/122/TEFM	5	122	17

DOUBLE-HEXAGON BIHEXAGONAL

1 / 4 "

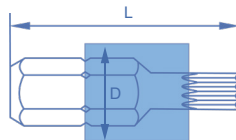

1 / 4 "

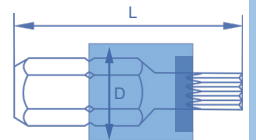

#	S	L	D	MAGNETIC	S	L	D
BH4/TEF	M4	25	12	BH4/TEFM	M4	25	17
BH5/TEF	M5	25	12	BH5/TEFM	M5	25	17
BH6/TEF	M6	25	12	BH6/TEFM	M6	25	17

1 / 4 "

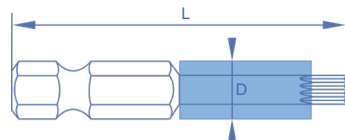

1 / 4 "

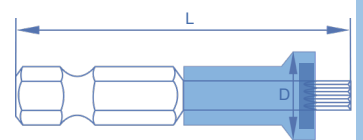

#	S	L	D	MAGNETIC	S	L	D
VPBH4/50/TEF	M4	50	7	VPBH4/50/TEFM	M4	50	17
VPBH5/50/TEF	M5	50	8	VPBH5/50/TEFM	M5	50	17
VPBH6/50/TEF	M6	50	9	VPBH6/50/TEFM	M6	50	17
VPBH8/50/TEF	M8	50	10	VPBH8/50/TEFM	M8	50	17
VPBH9/50/TEF	M9	50	11	VPBH9/50/TEFM	M9	50	17
VPBH10/50/TEF	M10	50	12	VPBH10/50/TEFM	M10	50	17

PROTECTED

7 / 16 "

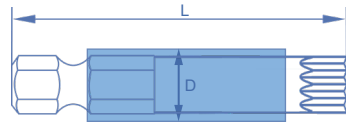

7 / 16 "



#	S	L	D
VMBH10/90/TEF	M10	90	15
VMBH12/90/TEF	M12	90	15
VMBH14/90/TEF	M14	90	15

MAGNETIC	S	L	D
VMBH10/90/TEFM	M10	90	20
VMBH12/90/TEFM	M12	90	20
VMBH14/90/TEFM	M14	90	20

POZIDRIV
POZIDRIV



1 / 4 "

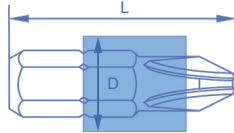

1 / 4 "

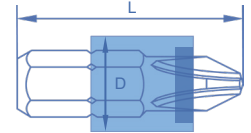

#	S	L	D
PZD0/TEF	0	25	12
PZD1/TEF	1	25	12
PZD2/TEF	2	25	12
PZD3/TEF	3	25	12
PZD4/TEF	4	25	12

MAGNETIC	S	L	D
PZD0/TEFM	0	25	17
PZD1/TEFM	1	25	17
PZD2/TEFM	2	25	17
PZD3/TEFM	3	25	17
PZD4/TEFM	4	25	17

STRAIGHT BODY
CUERPO RECTO

1 / 4 "

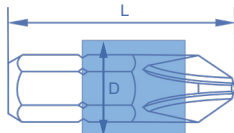

1 / 4 "

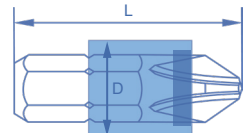

#	S	L	D
PZD1ND/TEF	1	25	12
PZD2ND/TEF	2	25	12

MAGNETIC	S	L	D
PZD1ND/TEFM	1	25	17
PZD2ND/TEFM	2	25	17

1 / 4 "

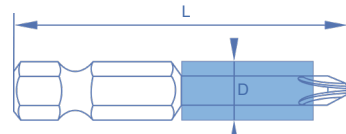

1 / 4 "

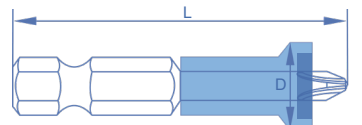

#	S	L	D
VPPZD0/50/TEF	0	50	7
VPPZD1/50/TEF	1	50	7
VPPZD2/50/TEF	2	50	9
VPPZD3/50/TEF	3	50	9
VPPZD4/50/TEF	4	50	10
VPPZD0/70/TEF	0	70	7
VPPZD1/70/TEF	1	70	7
VPPZD2/70/TEF	2	70	9
VPPZD3/70/TEF	3	70	9
VPPZD4/70/TEF	4	70	10
VPPZD0/90/TEF	0	90	7
VPPZD1/90/TEF	1	90	7
VPPZD2/90/TEF	2	90	9
VPPZD3/90/TEF	3	90	9
VPPZD0/150/TEF	0	150	7
VPPZD1/150/TEF	1	150	7
VPPZD2/150/TEF	2	150	9

MAGNETIC	S	L	D
VPPZD0/50/TEFM	0	50	17
VPPZD1/50/TEFM	1	50	17
VPPZD2/50/TEFM	2	50	17
VPPZD3/50/TEFM	3	50	17
VPPZD4/50/TEFM	4	50	17
VPPZD0/70/TEFM	0	70	17
VPPZD1/70/TEFM	1	70	17
VPPZD2/70/TEFM	2	70	17
VPPZD3/70/TEFM	3	70	17
VPPZD4/70/TEFM	4	70	17
VPPZD0/90/TEFM	0	90	17
VPPZD1/90/TEFM	1	90	17
VPPZD2/90/TEFM	2	90	17
VPPZD3/90/TEFM	3	90	17
VPPZD0/150/TEFM	0	150	17
VPPZD1/150/TEFM	1	150	17
VPPZD2/150/TEFM	2	150	17



TORQ-SET
TORQ-SET



1 / 4 "

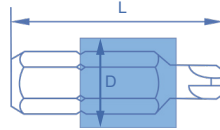

1 / 4 "

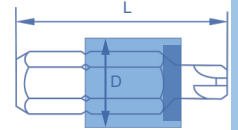

#	S	L	D	MAGNETIC	S	L	D
TS6/TEF	6	25	12	TS6/TEFM	6	25	17
TS10/TEF	10	25	12	TS10/TEFM	10	25	17

ACR
ACR

1 / 4 "

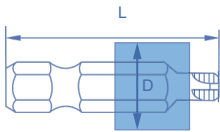

1 / 4 "

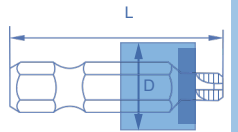

#	S	L	D	MAGNETIC	S	L	D
VPTS8ACR/33/TEF	8	33	12	VPTS8ACR/33/TEFM	8	33	17
VPTS10ACR/33/TEF	10	33	12	VPTS10ACR/33/TEFM	10	33	17
VPTS1/4ACR/33/TEF	1/4	33	12	VPTS1/4ACR/33/TEFM	1/4	33	17

PROTECTED

SQUARE
CUADRADA 

1/4"

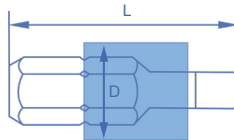

1/4"

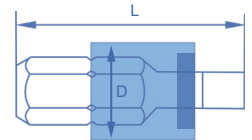

#	S	L	D	MAGNETIC	S	L	D
SQ0/TEF	0	25	12	SQ0/TEFM	0	25	17
SQ1/TEF	1	25	12	SQ1/TEFM	1	25	17
SQ2/TEF	2	25	12	SQ2/TEFM	2	25	17
SQ3/TEF	3	25	12	SQ3/TEFM	3	25	17
SQ4/TEF	4	25	12	SQ4/TEFM	4	25	17

1/4"

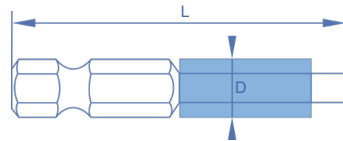

1/4"

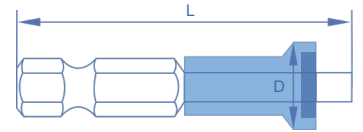

#	S	L	D	MAGNETIC	S	L	D
VPSQ2/50/TEF	2	50	7	VPSQ2/50/TEFM	2	50	17
VPSQ3/50/TEF	3	50	7	VPSQ3/50/TEFM	3	50	17
VPSQ4/50/TEF	4	50	8	VPSQ4/50/TEFM	4	50	17

IP
IP 

1/4"

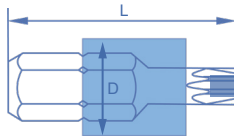

1/4"

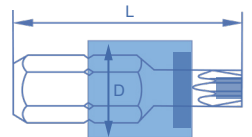

#	S	L	D	MAGNETIC	S	L	D
IP10P/TEF	T10	25	12	IP10P/TEFM	T10	25	17
IP15P/TEF	T15	25	12	IP15P/TEFM	T15	25	17
IP20P/TEF	T20	25	12	IP20P/TEFM	T20	25	17
IP25P/TEF	T25	25	12	IP25P/TEFM	T25	25	17
IP27P/TEF	T27	25	12	IP27P/TEFM	T27	25	17
IP30P/TEF	T30	25	12	IP30P/TEFM	T30	25	17
IP40P/TEF	T40	25	12	IP40P/TEFM	T40	25	17
IP27/TEF **	T27	27	12	IP27/TEFM**	T27	27	17

**Without central hole Sin agujero central

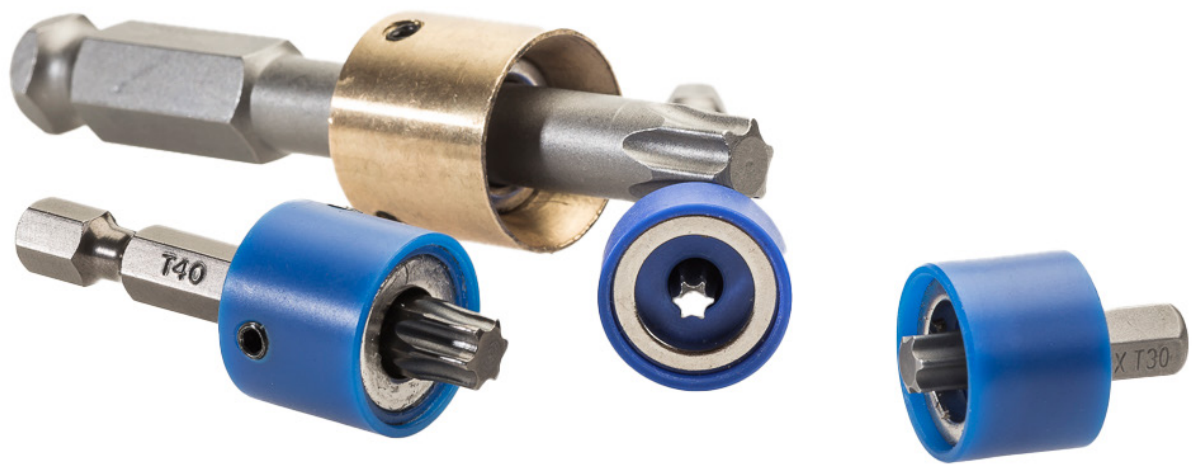



BIT-HOLDERS

PORTA-PUNTAS

We offer a wide variety of bit holders according to insert type, bit size, length and retention.

To increase operator safety we offer these same products with our rotating protection covers, which you will find at the end of this section.

Ofrecemos una gran variedad de portapuntas según el tipo de inserción, tamaño de punta, longitud y retención.

Para aumentar la seguridad del operario ofrecemos estos mismos productos con nuestras protecciones giratorias, que encontrará al final de esta sección.

02

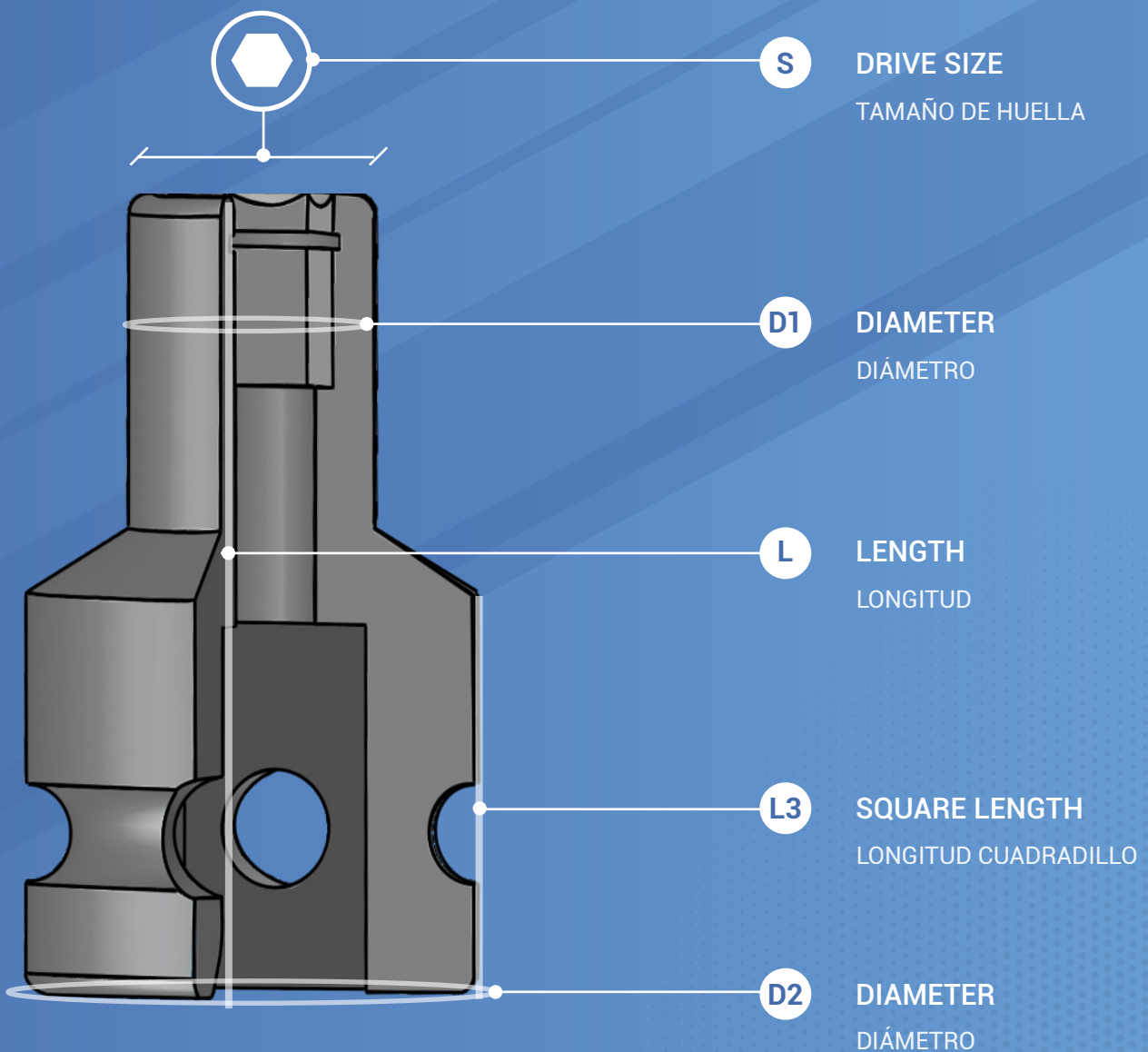



RETENTION RING

ANILLO DE RETENCIÓN

1/4"

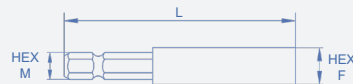

#	L	HEX M	HEX F
2570	55	1/4	1/4

QUICK CHANGE

CAMBIO RÁPIDO

1/4"

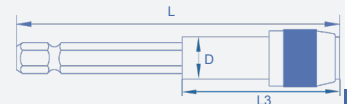

#	L	D	L3
553/3RAP	75	10,5	35

MAGNETIC 1/4"

MAGNÉTICO 1/4"

WITHOUT RETENTION RING

SIN ANILLO DE RETENCIÓN

1/4"

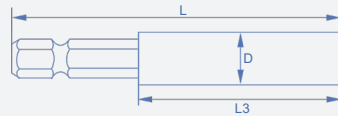

#	L	D	L3
553/3NR	75	10	47
553/8NR	200	10	47
553/10NR	250	10	47
553/12NR	300	10	47

WITH RETENTION RING

CON ANILLO DE RETENCIÓN

1/4"

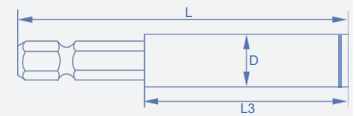

#	L	D	L3
553	60	11	35
553/3	75	11	47
553/4	100	11	47
553/5	127	11	47
553/6	150	11	47
553/8	200	11	47
553/10	250	11	47
553/12	300	11	47

RETENTION RING
ANILLO DE RETENCIÓN

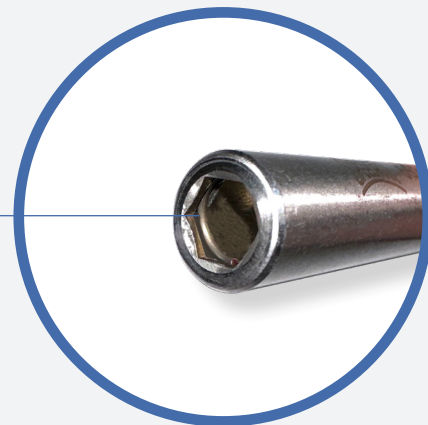

QUICK CHANGE

CAMBIO RÁPIDO

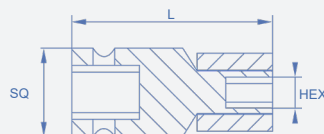

#	L	SQ	HEX
R100VP	38	1/4	1/4
J100VP	44,5	3/8	1/4
J100VI	50	3/8	5/16
J100VM	50,8	3/8	7/16
S100VP	54	1/2	1/4

STANDARD

RETENTION RING ANILLO DE RETENCIÓN

1/4"

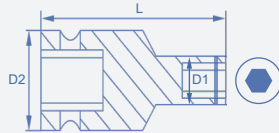

#	L	HEX	D2	D1
R28-1/4	25	1/4	13	12,5
R28-5/16	25	5/16	13	13

MAGNETIC WITH RING IMANTADO CON ANILLO

1/4"

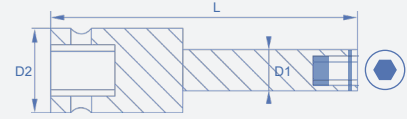

#	L	HEX	D2	D1
R51-1/4	57	1/4	14	11

SET SCREW TORNILLO DE SUJECIÓN

1/4"

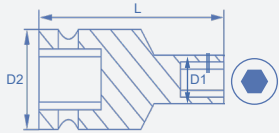

#	L	HEX	D2	D1
R28-1/4V	25	1/4	13	12,5

RETENTION RING ANILLO DE RETENCIÓN

3/8"

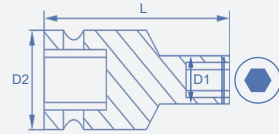

#	L	HEX	D2	D1
J28-1/4	30	1/4	19	11
J28-5/16	30	5/16	19	14

MAGNETIC WITH RING IMANTADO CON ANILLO

3/8"

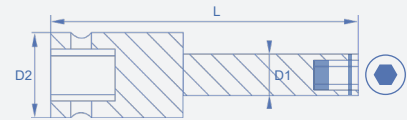

#	L	HEX	D2	D1
J51-1/4	67	1/4	19	11
J51-5/16	70	5/16	19	14
J51-5/16/95	95	5/16	18	11

SET SCREW AND MAGNET TORNILLO DE SUJECIÓN E IMÁN

3/8"

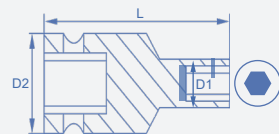

#	L	HEX	D2	D1
J28V-1/4/125	125	1/4	11	19

RETENTION RING ANILLO DE RETENCIÓN

1/2"

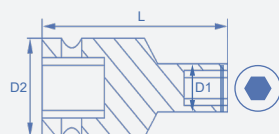

#	L	HEX	D2	D1
S28-1/4	40	1/4	25	11
S28-5/16	40	5/16	25	14
S28-1/2	40	1/2	25	21

MAGNETIC WITH RING IMANTADO CON ANILLO

1/2"

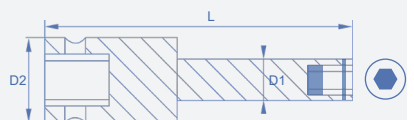

#	L	HEX	D2	D1
S51-5/16	75	5/16	25	13
S51-5/16-230	230	5/16	25	11,8

SET SCREW
TORNILLO DE SUJECCIÓN

1/2"

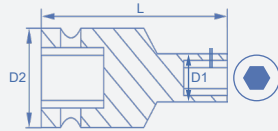

SET SCREW
TORNILLO DE SUJECCIÓN

3/4"

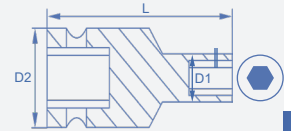

#	L	HEX	D2	D1
S28-7/16V	38	7/16	25	19
S28-1/2V	38	1/2	25	21

#	L	HEX	D2	D1
K28-5/8V	50	5/8	44	30

BIT-HOLDERS
PORTA-PUNTAS

BIT HOLDERS + BITS
(BIT SOCKETS IN TWO PIECES)

PORTA-PUNTAS + PUNTAS
(PUNTA CON CUADRO DE ARRASTRE EN DOS PIEZAS)

The two-piece tips offer the possibility to change the tip and increase durability.

Los porta-puntas de dos piezas ofrecen la posibilidad de cambiar la punta y aumentar la vida útil.

For the most demanding tightening processes, we offer our Titanium coating. The bit can be retained by a pressure pin instead of a set screw.

Para los procesos de apriete más exigentes, ofrecemos nuestro revestimiento de Titanio. Las puntas puede retenerse mediante un pasador de presión en lugar de un prisionero.

BIT-HOLDERS
PORTA-PUNTAS

HOLE	SET SCREW	TYPE	L	SQ	HEX	D1	D2
J23-SQD	J23-SQDV	STANDARD	40	3/8"	7/16"	21	21
S23-SQD	S23-SQDV	STANDARD	41	1/2"	7/16"	25	25
K23-SQD	K23-SQDV	STANDARD	43	3/4"	5/8"	38,2	38,2
JIM-SQD	JIM-SQDV	ANTI-VIB	45	3/8"	7/16"	19	19
SIM-SQD	SIM-SQDV	ANTI-VIB	51	1/2"	7/16"	25	25
NIM-SQD	NIM-SQDV	ANTI-VIB	41,5	5/8"	7/16"	25	33



THROUGH-HOLE BITS
PUNTAS CON AGUJERO PASANTE



7/16"

5/8"

7/16"

#	S	L
VMTX40TP	T40	43
VMTX50TP	T50	33
VMTX30TP/TT*	T30	33
VMTX50TP/TT*	T50	33

#	S	L
TX55CV	T55	40

#	S	L
EM6CM	6	32
EM10CM	10	32

5/8"

#	S	L
EM10CV	10	40

*Titanium Titanio

TOTAL LENGTH = BIT-HOLDER LENGTH + BIT LENGTH - 13 mm
LONGITUD TOTAL = LONGITUD PORTA-PUNTAS + LONGITUD PUNTA - 13 mm

PROTECTED

TOP PROTECTION

PROTECCIÓN SUPERIOR

MAGNETIC

IMANTADO

1/4"

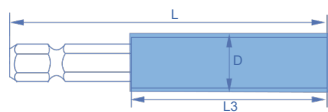

#	L	D	L3
553/3NR/TEF	75	16	44
553/8NR/TEF	200	16	44
553/10NR/TEF	250	16	44
553/12NR/TEF	300	16	44

MAGNETIC WITH RING

IMANTADO CON ANILLO

1/4"

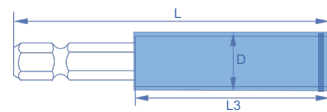

#	L	D	L3
553/TEF	60	16	44
553/3/TEF	75	16	44
553/4/TEF	100	16	44
553/5/TEF	125	16	44
553/6/TEF	150	16	44
553/8/TEF	200	16	44
553/10/TEF	250	16	44
553/12/TEF	300	16	44

COMPLETE PROTECTION

PROTECCIÓN COMPLETA

MAGNETIC WITH RING

IMANTADO CON ANILLO

1/4"

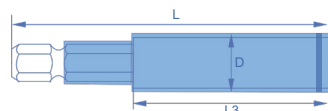

#	L	D	L3
553/TEFC	60	16	44
553/3/TEFC	75	16	44
553/4/TEFC	100	16	44
553/5/TEFC	125	16	44
553/6/TEFC	150	16	44
553/8/TEFC	200	16	44

FEMALE SQUARE BIT HOLDER

PORTA-PUNTAS DE CUADRADILLO HEMBRA

RETENTION RING

ANILLO DE RETENCIÓN

1/4"

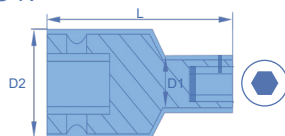

#	L	HEX	D2	D1
R28-1/4/TEF	25	1/4	16	16
R28-5/16/TEF	25	5/16	16	16

MAGNETIC WITH RING

IMANTADO CON ANILLO

1/4"

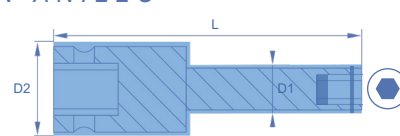

#	L	M	HEX	D2	D1
R51-1/4/TEF	57	1/4	1/4	14,5	18

SET SCREW
TORNILLO DE SUJECIÓN

1/4"

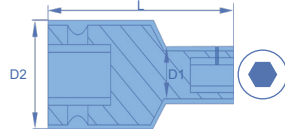

#	L	HEX	D2	D1
R28-1/4V/TEF	32	1/4	16	16
R28-5/16V/TEF	32	5/16	16	16

RETENTION RING
ANILLO DE RETENCIÓN

3/8"

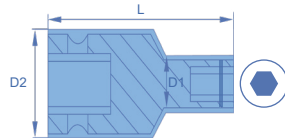

#	L	HEX	D2	D1
J28-1/4/TEF	33	1/4	22	17
J28-5/16/TEF	33	5/16	22	17

MAGNETIC WITH RING
IMANTADO CON ANILLO

3/8"

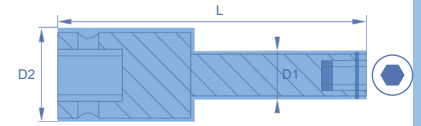

#	L	HEX	D2	D1
J51-1/4/TEF	67	1/4	22	14
J51-5/16/TEF	70	5/16	22	17
J51-5/16/95/TEF	95	5/16	22	14

SET SCREW
TORNILLO DE SUJECIÓN

3/8"

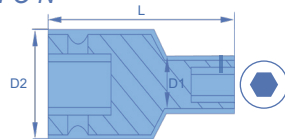

#	L	HEX	D2	D1
J28-1/4V/TEF	40	1/4	22	17
J28-5/16V/TEF	40	5/16	22	17

SET SCREW AND MAGNET
TORNILLO DE SUJECIÓN E IMÁN

3/8"

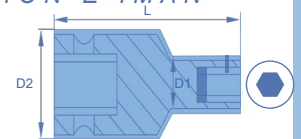

#	L	HEX	D2	D1
J28-1/4V/125/TEF	125	1/4	22	17

RETENTION RING
ANILLO DE RETENCIÓN

1/2"

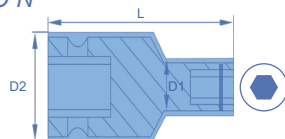

#	L	HEX	D2	D1
S28-1/4/TEF	40	1/4	28	14
S28-5/16/TEF	40	5/16	28	17

SET SCREW
TORNILLO DE SUJECIÓN

1/2"

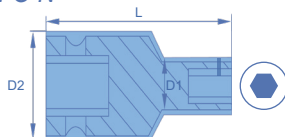

#	L	HEX	D2	D1
S28-7/16V/TEF	40	7/16	28	22
S28-1/2V/TEF	40	1/2	28	24



BIT-SOCKETS

PUNTAS CON CUADRO DE ARRASTRE

With our square drive bits, you can achieve the desired length by reducing the number of elements in one piece.

Con las puntas con cuadradillo ya integradas, se reduce la unión de varios elementos, mejorando la calidad del apriete.

03

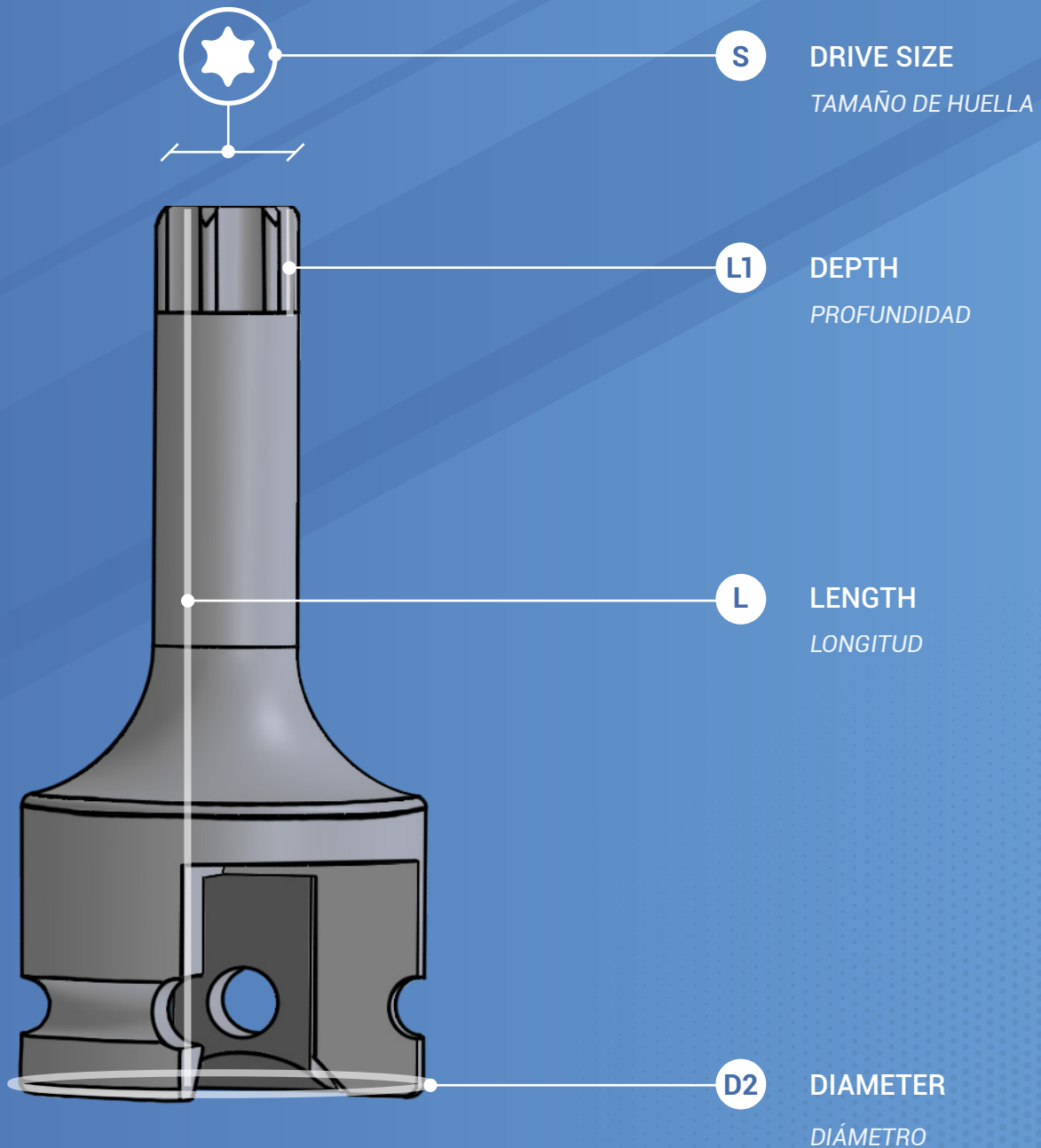



HEXAGON
HEXAGONAL



3 / 8 "

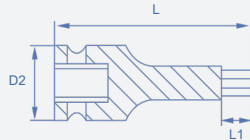

3 / 8 "

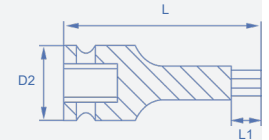

#	S	L	D2	L1	#	S	L	D2	L1
J23-EM3	3	50	19	11	J23-EM10/100	10	100	19	16
J23-EM4	4	50	19	11	J23-EM11/100	11	100	19	16
J23-EM5	5	50	19	11	J23-EM12/100	12	100	19	16
J23-EM6	6	50	19	11	J23-EM13/100	13	100	19	16
J23-EM7	7	50	19	16	J23-EM14/100	14	100	19	16
J23-EM8	8	50	19	16	J23-EM15/100	15	100	19	16
J23-EM9	9	50	19	16	J23-EM16/100	16	100	19	16
J23-EM10	10	50	19	16	J23-EM4/150	4	150	19	11
J23-EM11	11	50	19	16	J23-EM5/150	5	150	19	11
J23-EM12	12	50	19	16	J23-EM6/150	6	150	19	11
J23-EM13	13	50	19	16	J23-EM7/150	7	150	19	16
J23-EM14	14	50	19	16	J23-EM8/150	8	150	19	16
J23-EM15	15	50	19	16	J23-EM9/150	9	150	19	16
J23-EM16	16	50	19	16	J23-EM10/150	10	150	19	16
J23-EM4/100	4	100	19	11	J23-EM11/150	11	150	19	16
J23-EM5/100	5	100	19	11	J23-EM12/150	12	150	19	16
J23-EM6/100	6	100	19	11	J23-EM13/150	13	150	19	16
J23-EM7/100	7	100	19	16	J23-EM14/150	14	150	19	16
J23-EM8/100	8	100	19	16	J23-EM15/150	15	150	19	16
J23-EM9/100	9	100	19	16	J23-EM16/150	16	150	19	16

BIT-SOCKETS
PUNTAS CON CUADRO
DE ARRASTRE

DOUBLE-HEXAGON
BIHEXAGONAL



3 / 8 "

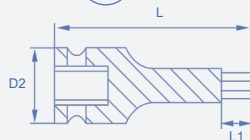

TORX
TORX



3 / 8 "

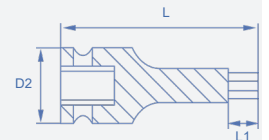

#	S	L	D2	L1	#	S	L	D2	L1
J23-BH5	M5	50	19	7	J23-TX9	TX9	50	19	8
J23-BH6	M6	50	19	7	J23-TX10	TX10	50	19	8
J23-BH8	M8	50	19	9	J23-TX15	TX15	50	19	8
J23-BH10	M10	50	19	9	J23-TX20	TX20	50	19	8
J23-BH12	M12	50	19	11	J23-TX25	TX25	50	19	8
J23-BH14	M14	50	19	11	J23-TX27	TX27	50	19	8
J23-BH16	M16	50	19	13	J23-TX30	TX30	50	19	8
J23-BH5/100	M5	100	19	7	J23-TX40	TX40	50	19	10,5
J23-BH6/100	M6	100	19	7	J23-TX45	TX45	50	19	10,5
J23-BH8/100	M8	100	19	9	J23-TX47	TX47	50	19	10,5
J23-BH10/100	M10	100	19	9	J23-TX50	TX50	50	19	13
J23-BH12/100	M12	100	19	11					
J23-BH14/100	M14	100	19	11					
J23-BH16/100	M16	100	19	13					

STANDARD

HEXAGON
HEXAGONAL



1/2"

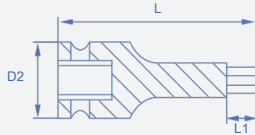

1/2"

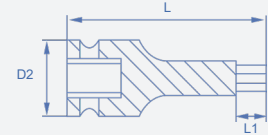

#	S	L	D2	L1	#	S	L	D2	L1
S23-EM4	4	55	25	11	S23-EM13/100	13	100	25	25
S23-EM5	5	55	25	15	S23-EM14/100	14	100	25	25
S23-EM6	6	55	25	15	S23-EM15/100	15	100	25	25
S23-EM7	7	55	25	15	S23-EM16/100	16	100	25	25
S23-EM8	8	55	25	16	S23-EM17/100	17	100	25	25
S23-EM9	9	55	25	16	S23-EM18/100	18	100	25	25
S23-EM10	10	55	25	16	S23-EM19/100	19	100	25	25
S23-EM11	11	55	25	16	S23-EM20/100	20	100	25	25
S23-EM12	12	55	25	16	S23-EM21/100	21	100	25	25
S23-EM13	13	55	25	20	S23-EM22/100	22	100	25	25
S23-EM14	14	55	25	20	S23-EM4/150	4	150	25	11
S23-EM15	15	55	25	20	S23-EM5/150	5	150	25	15
S23-EM16	16	55	25	20	S23-EM6/150	6	150	25	15
S23-EM17	17	55	25	20	S23-EM7/150	7	150	25	20
S23-EM18	18	55	25	20	S23-EM8/150	8	150	25	25
S23-EM19	19	55	25	20	S23-EM9/150	9	150	25	25
S23-EM20	20	55	25	20	S23-EM10/150	10	150	25	25
S23-EM21	21	55	25	20	S23-EM11/150	11	150	25	25
S23-EM22	22	55	25	20	S23-EM12/150	12	150	25	25
S23-EM4/100	4	100	25	11	S23-EM13/150	13	150	25	25
S23-EM5/100	5	100	25	15	S23-EM14/150	14	150	25	25
S23-EM6/100	6	100	25	15	S23-EM15/150	15	150	25	25
S23-EM7/100	7	100	25	20	S23-EM16/150	16	150	25	25
S23-EM8/100	8	100	25	25	S23-EM17/150	17	150	25	25
S23-EM9/100	9	100	25	25	S23-EM18/150	18	150	25	25
S23-EM10/100	10	100	25	25	S23-EM19/150	19	150	25	25
S23-EM11/100	11	100	25	25	S23-EM20/150	20	150	25	25
S23-EM12/100	12	100	25	25	S23-EM21/150	21	150	25	25

DOUBLE-HEXAGON
BIHEXAGONAL



1/2"

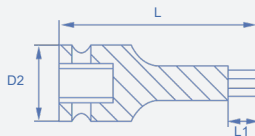

1/2"

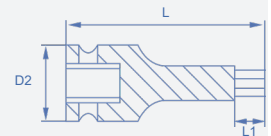

#	S	L	D2	L1	#	S	L	D2	L1
S23-BH5	M5	55	25	7	S23-BH5/100	M5	100	25	7
S23-BH6	M6	55	25	7	S23-BH6/100	M6	100	25	7
S23-BH8	M8	55	25	9	S23-BH8/100	M8	100	25	9
S23-BH10	M10	55	25	9	S23-BH10/100	M10	100	25	9
S23-BH12	M12	55	25	11	S23-BH12/100	M12	100	25	11
S23-BH14	M14	55	25	11	S23-BH14/100	M14	100	25	11
S23-BH16	M16	55	25	13	S23-BH16/100	M16	100	25	13

TORX
TORX



1/2"

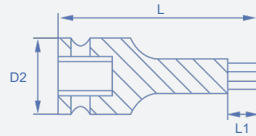

#	S	L	D2	L1
S23-TX20	TX20	75	25	9
S23-TX25	TX25	75	25	9
S23-TX27	TX27	75	25	10
S23-TX30	TX30	75	25	10
S23-TX40	TX40	75	25	10,5
S23-TX45	TX45	75	25	11
S23-TX47	TX47	75	25	12,5
S23-TX50	TX50	75	25	14,5
S23-TX55	TX55	75	25	15,5



BIT-SOCKETS
PUNTAS CON CUADRO
DE ARRASTRE

HEXAGON
HEXAGONAL



3/4"

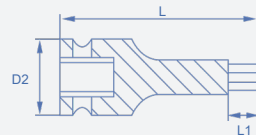

3/4"

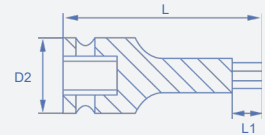

#	S	L	D2	L1
K23-EM10	10	62	44	20
K23-EM11	11	62	44	20
K23-EM12	12	62	44	20
K23-EM13	13	62	44	20
K23-EM14	14	62	44	20
K23-EM15	15	62	44	20
K23-EM16	16	62	44	20
K23-EM17	17	62	44	20
K23-EM18	18	62	44	20
K23-EM19	19	62	44	20
K23-EM20	20	62	44	20
K23-EM21	21	62	44	20
K23-EM22	22	62	44	20
K23-EM24	24	62	44	20
K23-EM25	25	62	44	20

#	S	L	D2	L1
K23-EM10/100	10	100	44	20
K23-EM11/100	11	100	44	20
K23-EM12/100	12	100	44	20
K23-EM13/100	13	100	44	20
K23-EM14/100	14	100	44	20
K23-EM15/100	15	100	44	20
K23-EM16/100	16	100	44	20
K23-EM17/100	17	100	44	20
K23-EM18/100	18	100	44	20
K23-EM19/100	19	100	44	20
K23-EM20/100	20	100	44	20
K23-EM21/100	21	100	44	20
K23-EM22/100	22	100	44	20
K23-EM24/100	24	100	44	20
K23-EM25/100	25	100	44	20



1/2"

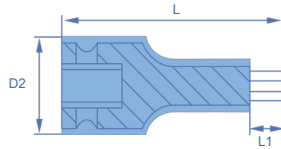

1/2"

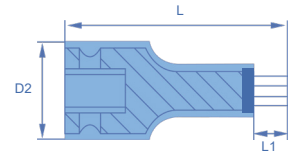

#	S	L	D2	L1	MAGNETIC	S	L	D2	L1
S23-EM4/TEF	4	55	29	11	S23-EM4/TEFM	4	55	29	11
S23-EM5/TEF	5	55	29	11	S23-EM5/TEFM	5	55	29	11
S23-EM6/TEF	6	55	29	11	S23-EM6/TEFM	6	55	29	11
S23-EM7/TEF	7	55	29	16	S23-EM7/TEFM	7	55	29	16
S23-EM8/TEF	8	55	29	16	S23-EM8/TEFM	8	55	29	16
S23-EM9/TEF	9	55	29	16	S23-EM9/TEFM	9	55	29	16
S23-EM10/TEF	10	55	29	16	S23-EM10/TEFM	10	55	29	16
S23-EM11/TEF	11	55	29	16	S23-EM11/TEFM	11	55	29	16
S23-EM12/TEF	12	55	29	16	S23-EM12/TEFM	12	55	29	16
S23-EM13/TEF	131	55	29	20	S23-EM13/TEFM	131	55	29	20
S23-EM14/TEF	14	55	29	20	S23-EM14/TEFM	14	55	29	20
S23-EM15/TEF	15	55	29	20	S23-EM15/TEFM	15	55	29	20
S23-EM16/TEF	16	55	29	20	S23-EM16/TEFM	16	55	29	20
S23-EM17/TEF	17	55	29	20	S23-EM17/TEFM	17	55	29	20
S23-EM18/TEF	18	55	29	20	S23-EM18/TEFM	18	55	29	20
S23-EM19/TEF	19	55	29	20	S23-EM19/TEFM	19	55	29	20
S23-EM20/TEF	20	55	29	20	S23-EM20/TEFM	20	55	29	20
S23-EM21/TEF	21	55	29	20	S23-EM21/TEFM	21	55	29	20
S23-EM22/TEF	22	55	29	20	S23-EM22/TEFM	22	55	29	20
S23-EM4/100/TEF	4	100	29	11	S23-EM4/100/TEFM	4	100	29	11
S23-EM5/100/TEF	5	100	29	15	S23-EM5/100/TEFM	5	100	29	15
S23-EM6/100/TEF	6	100	29	15	S23-EM6/100/TEFM	6	100	29	15
S23-EM7/100/TEF	7	100	29	20	S23-EM7/100/TEFM	7	100	29	20
S23-EM8/100/TEF	8	100	29	25	S23-EM8/100/TEFM	8	100	29	25
S23-EM9/100/TEF	9	100	29	25	S23-EM9/100/TEFM	9	100	29	25
S23-EM10/100/TEF	10	100	29	25	S23-EM10/100/TEFM	10	100	29	25
S23-EM11/100/TEF	11	100	29	25	S23-EM11/100/TEFM	11	100	29	25
S23-EM12/100/TEF	12	100	29	25	S23-EM12/100/TEFM	12	100	29	25
S23-EM13/100/TEF	13	100	29	25	S23-EM13/100/TEFM	13	100	29	25
S23-EM14/100/TEF	14	100	29	25	S23-EM14/100/TEFM	14	100	29	25
S23-EM15/100/TEF	15	100	29	25	S23-EM15/100/TEFM	15	100	29	25
S23-EM16/100/TEF	16	100	29	25	S23-EM16/100/TEFM	16	100	29	25
S23-EM17/100/TEF	17	100	29	25	S23-EM17/100/TEFM	17	100	29	25
S23-EM18/100/TEF	18	100	29	25	S23-EM18/100/TEFM	18	100	29	25
S23-EM19/100/TEF	19	100	29	25	S23-EM19/100/TEFM	19	100	29	25
S23-EM20/100/TEF	20	100	29	25	S23-EM20/100/TEFM	20	100	29	25
S23-EM21/100/TEF	21	100	29	25	S23-EM21/100/TEFM	21	100	29	25
S23-EM22/100/TEF	22	100	29	25	S23-EM22/100/TEFM	22	100	29	25
S23-EM4/150/TEF	4	150	29	11	S23-EM4/150/TEFM	4	150	29	11
S23-EM5/150/TEF	5	150	29	11	S23-EM5/150/TEFM	5	150	29	11
S23-EM6/150/TEF	6	150	29	11	S23-EM6/150/TEFM	6	150	29	11
S23-EM7/150/TEF	7	150	29	25	S23-EM7/150/TEFM	7	150	29	25
S23-EM8/150/TEF	8	150	29	25	S23-EM8/150/TEFM	8	150	29	25
S23-EM9/150/TEF	9	150	29	25	S23-EM9/150/TEFM	9	150	29	25

#	S	L	D2	L1	MAGNETIC	S	L	D2	L1
S23-EM10/150/TEF	10	150	29	25	S23-EM10/150/TEFM	10	150	29	25
S23-EM11/150/TEF	11	150	29	25	S23-EM11/150/TEFM	11	150	29	25
S23-EM12/150/TEF	12	150	29	25	S23-EM12/150/TEFM	12	150	29	25
S23-EM13/150/TEF	13	150	29	25	S23-EM13/150/TEFM	13	150	29	25
S23-EM14/150/TEF	14	150	29	25	S23-EM14/150/TEFM	14	150	29	25
S23-EM15/150/TEF	15	150	29	25	S23-EM15/150/TEFM	15	150	29	25
S23-EM16/150/TEF	16	150	29	25	S23-EM16/150/TEFM	16	150	29	25
S23-EM17/150/TEF	17	150	29	25	S23-EM17/150/TEFM	17	150	29	25
S23-EM18/150/TEF	18	150	29	25	S23-EM18/150/TEFM	18	150	29	25
S23-EM19/150/TEF	19	150	29	25	S23-EM19/150/TEFM	19	150	29	25
S23-EM20/150/TEF	20	150	29	25	S23-EM20/150/TEFM	20	150	29	25
S23-EM21/150/TEF	21	150	29	25	S23-EM21/150/TEFM	21	150	29	25
S23-EM22/150/TEF	22	150	29	25	S23-EM22/150/TEFM	22	150	29	25

DOUBLE-HEXAGON
BIHEXAGONAL



1 / 2 "

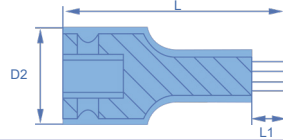

1 / 2 "

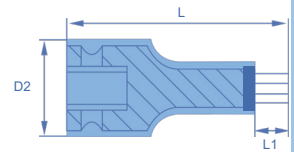

#	S	L	D2	L1	MAGNETIC	S	L	D2	L1
S23-BH5/TEF	M5	55	29	7	S23-BH5/TEFM	M5	55	29	7
S23-BH6/TEF	M6	55	29	7	S23-BH6/TEFM	M6	55	29	7
S23-BH8/TEF	M8	55	29	9	S23-BH8/TEFM	M8	55	29	9
S23-BH10/TEF	M10	55	29	9	S23-BH10/TEFM	M10	55	29	9
S23-BH12/TEF	M12	55	29	11	S23-BH12/TEFM	M12	55	29	11
S23-BH14/TEF	M14	55	29	11	S23-BH14/TEFM	M14	55	29	11
S23-BH16/TEF	M16	55	29	13	S23-BH16/TEFM	M16	55	29	13
S23-BH5/100/TEF	M5	100	29	7	S23-BH5/100/TEFM	M5	100	29	7
S23-BH6/100/TEF	M6	100	29	7	S23-BH6/100/TEFM	M6	100	29	7
S23-BH8/100/TEF	M8	100	29	9	S23-BH8/100/TEFM	M8	100	29	9
S23-BH10/100/TEF	M10	100	29	9	S23-BH10/100/TEFM	M10	100	29	9
S23-BH12/100/TEF	M12	100	29	11	S23-BH12/100/TEFM	M12	100	29	11
S23-BH14/100/TEF	M14	100	29	11	S23-BH14/100/TEFM	M14	100	29	11
S23-BH16/100/TEF	M16	100	29	13	S23-BH16/100/TEFM	M16	100	29	13

TORX
TORX



1 / 2 "

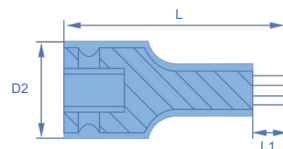

1 / 2 "

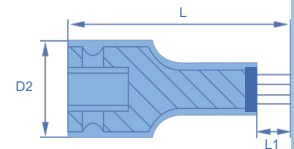

#	S	L	D2	L1	MAGNETIC	S	L	D2	L1
S23-TX20/TEF	TX20	75	29	9	S23-TX20/TEFM	TX20	75	29	9
S23-TX25/TEF	TX25	75	29	9	S23-TX25/TEFM	TX25	75	29	9
S23-TX27/TEF	TX27	75	29	9,5	S23-TX27/TEFM	TX27	75	29	9,5
S23-TX30/TEF	TX30	75	29	10	S23-TX30/TEFM	TX30	75	29	10
S23-TX40/TEF	TX40	75	29	11	S23-TX40/TEFM	TX40	75	29	11
S23-TX50/TEF	TX50	75	29	14,5	S23-TX50/TEFM	TX50	75	29	14,5
S23-TX55/TEF	TX55	75	29	15,5	S23-TX55/TEFM	TX55	75	29	15,5
S23-TX60/TEF	TX60	75	29	16,5	S23-TX60/TEFM	TX60	75	29	16,5



3 / 4 "

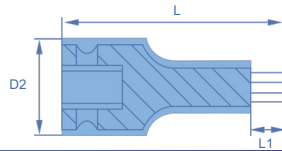

3 / 4 "

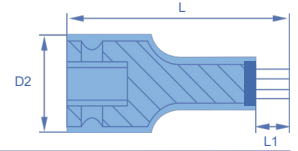

#	S	L	D2	L1	MAGNETIC	S	L	D2	L1
K23-EM10/TEF	10	62	48	20	K23-EM10/TEFM	10	62	48	20
K23-EM11/TEF	11	62	48	20	K23-EM11/TEFM	11	62	48	20
K23-EM12/TEF	12	62	48	20	K23-EM12/TEFM	12	62	48	20
K23-EM13/TEF	13	62	48	20	K23-EM13/TEFM	13	62	48	20
K23-EM14/TEF	14	62	48	20	K23-EM14/TEFM	14	62	48	20
K23-EM15/TEF	15	62	48	20	K23-EM15/TEFM	15	62	48	20
K23-EM16/TEF	16	62	48	20	K23-EM16/TEFM	16	62	48	20
K23-EM17/TEF	17	62	48	20	K23-EM17/TEFM	17	62	48	20
K23-EM18/TEF	18	62	48	20	K23-EM18/TEFM	18	62	48	20
K23-EM19/TEF	19	62	48	20	K23-EM19/TEFM	19	62	48	20
K23-EM20/TEF	20	62	48	20	K23-EM20/TEFM	20	62	48	20
K23-EM21/TEF	21	62	48	20	K23-EM21/TEFM	21	62	48	20
K23-EM22/TEF	22	62	48	20	K23-EM22/TEFM	22	62	48	20
K23-EM24/TEF	24	62	48	20	K23-EM24/TEFM	24	62	48	20
K23-EM25/TEF	25	62	48	20	K23-EM25/TEFM	25	62	48	20
K23-EM10/100/TEF	10	100	48	20	K23-EM10/100/TEFM	10	100	48	20
K23-EM11/100/TEF	11	100	48	20	K23-EM11/100/TEFM	11	100	48	20
K23-EM12/100/TEF	12	100	48	20	K23-EM12/100/TEFM	12	100	48	20
K23-EM13/100/TEF	13	100	48	20	K23-EM13/100/TEFM	13	100	48	20
K23-EM14/100/TEF	14	100	48	20	K23-EM14/100/TEFM	14	100	48	20
K23-EM15/100/TEF	15	100	48	20	K23-EM15/100/TEFM	15	100	48	20
K23-EM16/100/TEF	16	100	48	20	K23-EM16/100/TEFM	16	100	48	20
K23-EM17/100/TEF	17	100	48	20	K23-EM17/100/TEFM	17	100	48	20
K23-EM18/100/TEF	18	100	48	20	K23-EM18/100/TEFM	18	100	48	20
K23-EM19/100/TEF	19	100	48	20	K23-EM19/100/TEFM	19	100	48	20
K23-EM20/100/TEF	20	100	48	20	K23-EM20/100/TEFM	20	100	48	20
K23-EM21/100/TEF	21	100	48	20	K23-EM21/100/TEFM	21	100	48	20
K23-EM22/100/TEF	22	100	48	20	K23-EM22/100/TEFM	22	100	48	20
K23-EM24/100/TEF	24	100	48	20	K23-EM24/100/TEFM	24	100	48	20
K23-EM25/100/TEF	25	100	48	20	K23-EM25/100/TEFM	25	100	48	20





SOCKETS

EMBOCADURAS

To improve the fastening between the socket and screw, we have included in our catalogue Surface drive and Fast Lead sockets.

We offer a complete range of sockets, with a wide variety of lengths, square drives, drives, as well as different magnetic options. They can be supplied with fixed (M), retractable (RM) or lateral (APM) magnets.

Para mejorar el encare entre accesorio y tornillo, contamos con la huella hexagonal en Surface drive y Encare rápido (Fast Lead). Pueden suministrarse con imán fijo (M), retráctil (RM) o laterales (APM).

04

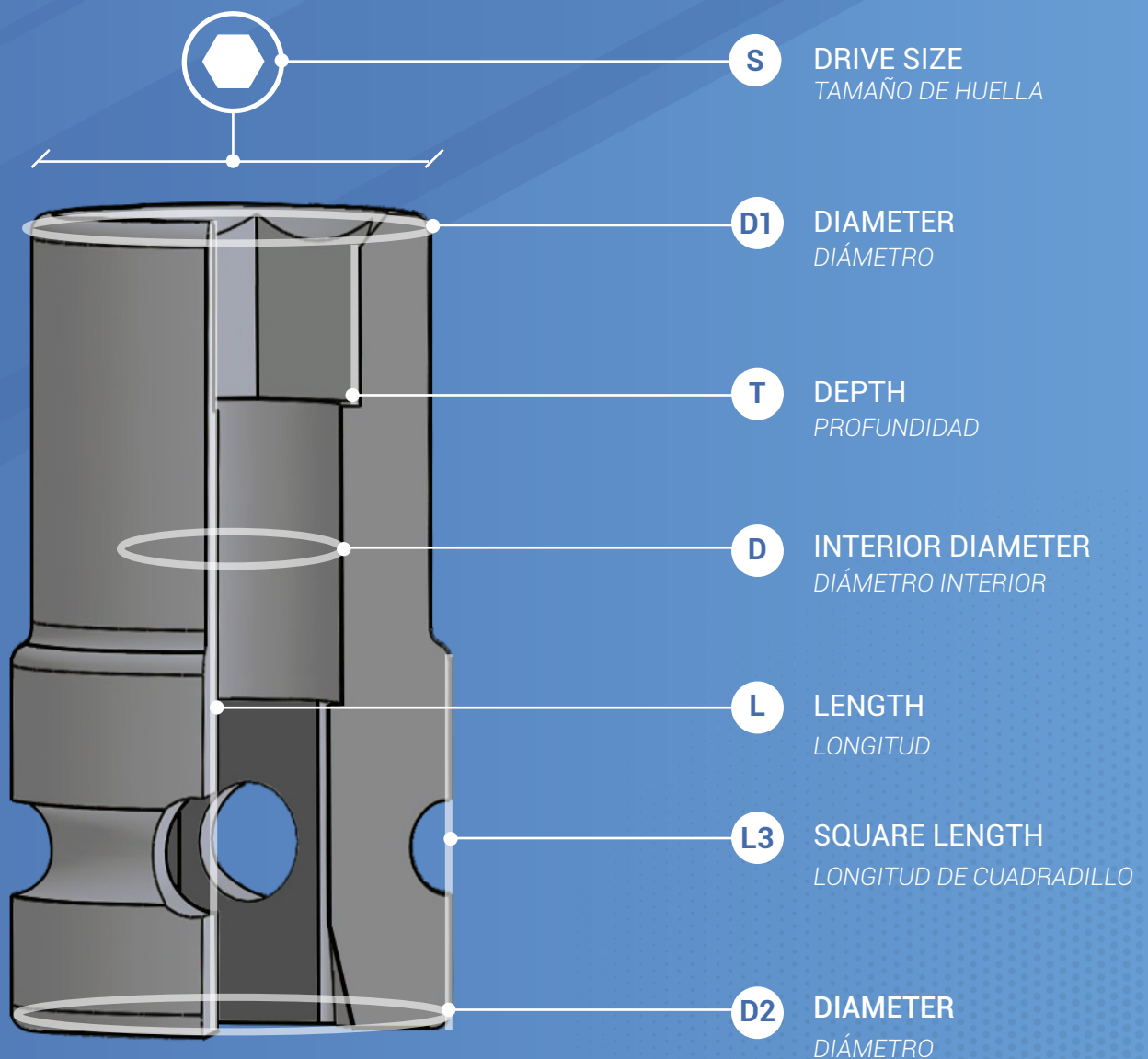



1/4"

HEXAGON
HEXAGONAL



1/4"

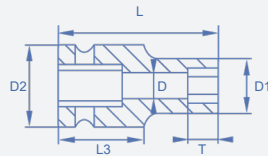

1/4"

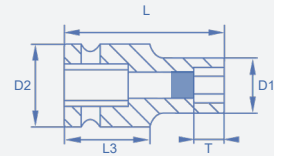

#	S	L	D1	D2	ØD	L3	T	MAGNETIC	S	L	D1	D2	L3	T
R2304H	4	25	7,8	13	3	13	4,5	R2304HM	4	25	7,8	13	13	2
R2305H	5	25	9	13	5	13	5,5	R2305HM	5	25	9	13	13	2
R2305.5H	5,5	25	9,6	13	5	13	5,5	R2305.5HM	5,5	25	9,6	13	13	2
R2306H	6	25	10	13	6	13	5,5	R2306HM	6	25	10	13	13	2,4
R2307H	7	25	12	13	6	13	5,5	R2307HM	7	25	12,5	13	13	2,8
R2308H	8	25	13	13	6	13	5,5	R2308HM	8	25	13	13	13	3,5
R2309H	9	25	14	13	7	7	6,5	R2309HM	9	25	14	13	7	3,5
R2310H	10	25	15	13	8	7	6,5	R2310HM	10	25	15	13	7	4
R2311H	11	25	17	13	9	7	7,5	R2311HM	11	25	17	13	7	5
R2312H	12	25	18	13	10	7	7,5	R2312HM	12	25	18	13	7	5
R2313H	13	25	19	13	11	7	8,5	R2313HM	13	25	19	13	7	5,5

HEXAGON (LONG)
HEXAGONAL (LARGA)



1/4"

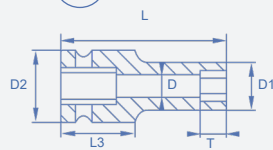

1/4"

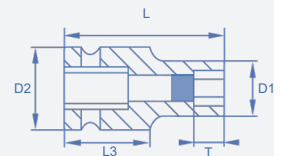

#	S	L	D1	D2	ØD	L3	T	MAGNETIC	S	L	D1	D2	L3	T
R2305HL	5	50	8,8	13	5	13	5	R2305HLM	5	50	8,8	13	13	2
R2305.5HL	5,5	50	9,4	13	5	13	5	R2305.5HLM	5,5	50	9,4	13	13	2
R2306HL	6	50	10	13	6	13		R2306HLM	6	50	10	13	13	2,4
R2307HL	7	50	11,4	13	6	13	5	R2307HLM	7	50	11,4	13	13	2,8
R2308HL	8	50	12,5	13	6	13	5	R2308HLM	8	50	12,5	13	13	3,5
R2309HL	9	50	14	13	7	7	6	R2309HLM	9	50	14	13	7	3,5
R2310HL	10	50	15	13	8	7	6	R2310HLM	10	50	15	13	7	4
R2311HL	11	50	16,3	13	9	7	7	R2311HLM	11	50	16,3	13	7	5
R2312HL	12	50	17,5	13	10	7	7	R2312HLM	12	50	17,5	13	7	5
R2313HL	13	50	18,7	13	11	7	8	R2313HLM	13	50	18,7	13	7	5,5

SAE
SAE



1/4"

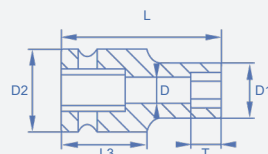

1/4"

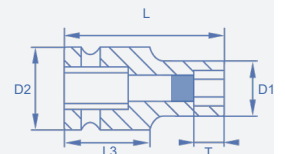

#	S	L	D1	D2	ØD	L3	T	MAGNETIC	S	L	D1	D2	L3	T
R23-1/4H	1/4	25	10,4	13	6	13	5	R23-1/4HM	1/4	25	10,4	13	13	2
R23-3/8H	3/8	25	14,4	13	7	13	6	R23-3/8HM	3/8	25	14,4	13	13	4
R23-5/16H	5/16	25	12,4	13	6	13	4,5	R23-5/16HM	5/16	25	12,4	13	13	2,5
R23-1/2H	1/2	25	18,4	13	10	7	7	R23-1/2HM	1/2	25	18,4	13	7	4,5

STANDARD

SPRING LOADED IMÁN RETRÁCTIL



1/4"

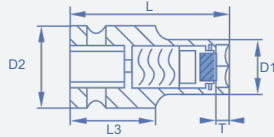

MAGNETIC	S	L	D1	D2	L3	T
R2307HRM	7	50	11	13	13	3
R2308HRM	8	50	12	13	13	4
R2309HRM	9	50	14	13	13	4,5
R2310HRM	10	50	15	13	7	5
R2311HRM	11	50	16	13	7	5
R2312HRM	12	50	17	13	7	6
R2313HRM	13	50	19	13	7	6

DOUBLE-HEXAGON BIHEXAGONAL



1/4"

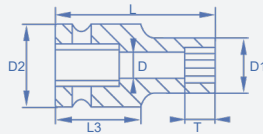

1/4"

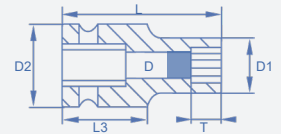

#	S	L	D1	D2	ØD	L3	T	MAGNETIC	S	L	D1	D2	L3	T
R2306BH	6	25	10	13	5	13	5	R2306BHM	6	25	10	13	13	2,4
R2307BH	7	25	12	13	5	13	5	R2307BHM	7	25	12	13	13	2,8
R2308BH	8	25	12,5	13	6	13	5	R2308BHM	8	25	12,5	13	13	3,5
R2309BH	9	25	14	13	7	7	5	R2309BHM	9	25	14	13	7	3,5
R2310BH	10	25	15	13	8	7	5	R2310BHM	10	25	15	13	7	4

FAST LEAD ENCARE RÁPIDO



1/4"

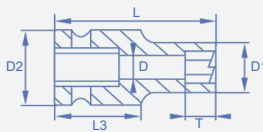

1/4"

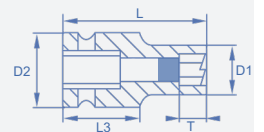

#	S	L	D1	D2	ØD	L3	T	MAGNETIC	S	L	D1	D2	L3	T
R2306HER	6	25	10	13	5	13	5	R2306HERM	6	25	10	13	13	2,4
R2307HER	7	25	12	13	5	13	5	R2307HERM	7	25	12	13	13	2,8
R2308HER	8	25	12,5	13	6	13	5	R2308HERM	8	25	12,5	13	13	3,5
R2309HER	9	25	14	13	7	7	5	R2309HERM	9	25	14	13	7	3,5
R2310HER	10	25	15	13	8	7	5,9	R2310HERM	10	25	15	13	7	4



1 / 4 "

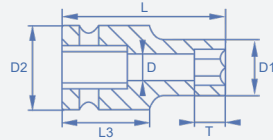

1 / 4 "

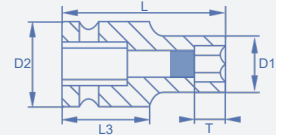

#	S	D1	D2	ØD	L3	T	MAGNETIC	S	L	D1	D2	L3	T
RE4	E4	6	13	1,5	13	3,6	RE4M	E4	25	6	13	13	2
RE5	E5	7	13	2	13	4,5	RE5M	E5	25	7	13	13	2
RE6	E6	8,5	13	3	13	4,5	RE6M	E6	25	8,5	13	13	2,4
RE7	E7	9,5	13	4	13	6	RE7M	E7	25	9,5	13	13	2,8
RE8	E8	10	13	4	13	6	RE8M	E8	25	10	13	13	3,5
RE10	E10	14	13	4,5	13	8	RE10M	E10	25	14	13	13	4
RE12	E12	15,9	13	6	13	8,5	RE12M	E12	25	15,9	13	13	5

SOCKETS
EMBUCADURAS



STANDARD

SOCKET HEX MALE EMBOCADURA HEX MACHO



1/4"

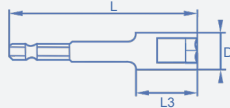

1/4"

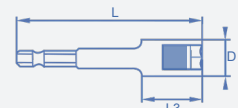

#	S	L	D	L3	MAGNETIC	S	L	D	L3
2004/1*	4	30	7,6	12	2004/1M*	4	30	7,6	12
2005/1*	5	30	10	12	2005/1M*	5	30	10	12
2006/1*	6	30	11	12	2006/1M*	6	30	11	12
2007/1*	7	30	11	12	2007/1M*	7	30	11	12
2008/1*	8	30	12,5	12	2008/1M*	8	30	12,5	12
2009/1*	9	30	12,5	12	2009/1M*	9	30	12,5	12
2010/1*	10	30	15	12	2010/1M*	10	30	15	12
2004VPC	4	50	8	18	2004VPCM	4	50	9	18
2005VPC	5	50	9	18	2005VPCM	5	50	9	18
2005.5VPC	5,5	50	9,5	18	2005.5VPCM	5,5	50	9,5	18
2006VPC	6	50	10	18	2006VPCM	6	50	10	18
2007VPC	7	50	12	18	2007VPCM	7	50	12	18
2008VPC	8	50	12,5	19	2008VPCM	8	50	12,5	19
2009VPC	9	50	14	19	2009VPCM	9	50	14	19
2010VPC	10	50	14,5	19	2010VPCM	10	50	14,5	19
2011VPC	11	50	18	16,5	2011VPCM	11	50	18	16,5
2012VPC	12	50	18	18,5	2012VPCM	12	50	18	18,5
2013VPC	13	50	19	18,5	2013VPCM	13	50	19	18,5
2014VPC	14	50	20	19,5	2014VPCM	14	50	20	19,5
2004VP	4	80	9	9	2004VPM	4	80	9	9
2005VP	5	80	10	13	2005VPM	5	80	10	13
2005.5VP	5,5	80	10	12,5	2005.5VPM	5,5	80	10	12,5
2006VP	6	80	11	11,5	2006VPM	6	80	11	11,5
2007VP	7	80	13	12	2007VPM	7	80	13	12
2008VP	8	80	14	14,5	2008VPM	8	80	14	14,5
2009VP	9	80	15	14,5	2009VPM	9	80	15	14,5
2010VP	10	80	16	15	2010VPM	10	80	16	15
2011VP	11	80	18	16	2011VPM	11	80	18	16
2012VP	12	80	19	16	2012VPM	12	80	19	16
2013VP	13	80	18	20	2013VPM	13	80	18	20
2015VP	15	80	22	30	2015VPM	15	80	22	30
2016VP	16	80	24	30	2016VPM	16	80	24	30
20-5/16VP	5/16	80	13	15	20-5/16VPM	5/16	80	13	15
2007VP/100	7	100	11	12	2007VPM/100	7	100	13	12
2008VP/100	8	100	13	14,5	2008VPM/100	8	100	14	14,5
2010VP/100	10	100	14	15	2010VPM/100	10	100	16	15
2013VP/100	13	100	18	16	2013VPM/100	13	100	19	16

*Insert Type C *Inserto Tipo c*

TYPE C

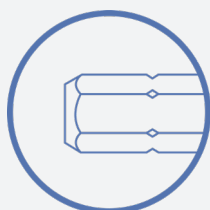

TYPE E

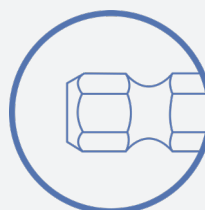

WITH BALL RETAINER

EMBOCADURA HEX MACHO BOLA



1/4"

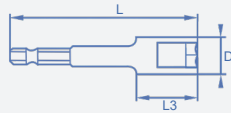

1/4"

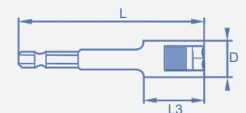

#	S	L	D	L3	MAGNETIC	S	L	D	L3
2004VPCJ	4	50	7	18	2004VPCJM	4	50	7	18
2005VPCJ	5	50	7	18	2005VPCJM	5	50	7	18
2006VPCJ	6	50	11	18	2006VPCJM	6	50	11	18
2007VPCJ	7	50	11	19	2007VPCJM	7	50	11	19
2008VPCJ	8	50	19	19	2008VPCJM	8	50	19	19
2009VPCJ	9	50	14	19	2009VPCJM	9	50	14	19
2010VPCJ	10	50	14	19	2010VPCJM	10	50	14	19
2013VPCJ	13	50	17	19	2013VPCJM	13	50	17	19
2014VPCJ	14	50	20	19	2014VPCJM	14	50	20	19

SPRING LOADED

IMÁN RETRÁCTIL



1/4"

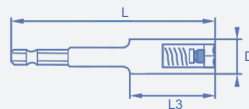

MAGNETIC	S	L	D	L3
R8MM75	8	75	12,5	47,5
R8MM150	8	150	13	40
R8MM200	8	200	13	40
R10MM75	10	75	14,5	48
R10MM100	10	100	14,5	48
R10MM200	10	200	14,5	48
R10MM300	10	300	14,5	40,5
R12MM300	12	300	18	40



STANDARD

3 / 8 "

HEXAGON (SHORT)
HEXAGONAL (CORTA)

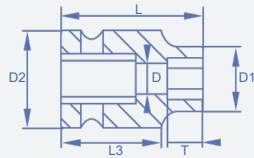

3 / 8 "

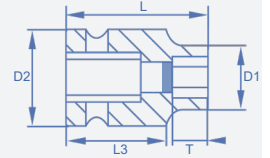

#	S	L	D1	D2	ØD	L3	T	MAGNETIC	S	L	D1	D2	L3	T
J2306HC	6	26	11,5	19	5	18	3	J2306HCM	6	26	11,5	19	18	2,4
J2307HC	7	26	12,5	19	5	18	5	J2307HCM	7	26	12,5	19	18	2,8
J2308HC	8	26	13,8	19	6	18	6	J2308HCM	8	26	13,8	19	18	3,5
J2310HC	10	26	15,6	19	8	18	6	J2310HCM	10	26	15,6	19	18	4
J2311HC	11	26	17,5	19	9	18	7	J2311HCM	11	26	17,5	19	18	5
J2312HC	12	26	19	19	10	18	7	J2312HCM	12	26	19	19	18	5
J2313HC	13	26	20	19	11	18	8	J2313HCM	13	26	20	19	18	5,5
J2314HC	14	26	21,3	22	12	18	8,5	J2314HCM	14	26	21,3	22	18	6
J2315HC	15	26	22	22	13	10	7,5	J2315HCM	15	26	22	22	10	6
J2316HC	16	26	23,8	22	14	10	9	J2316HCM	16	26	23,8	22	10	6
J2317HC	17	26	25	22	15	10	10	J2317HCM	17	26	25	22	10	7
J2319HC	19	26	25	22	16	10	12	J2319HCM	19	26	25	22	10	9
J2321HC	21	26	31	22	17	10	13	J2321HCM	21	26	31	22	10	10

HEXAGON
HEXAGONAL

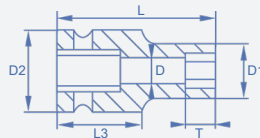

3 / 8 "

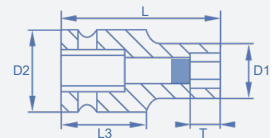

#	S	L	D1	D2	ØD	L3	T	MAGNETIC	S	L	D1	D2	L3	T
J2306H	6	34	10	19	5	10	5	J2306HM	6	34	10	19	10	2,4
J2307H	7	34	12,5	19	5	10	5	J2307HM	7	34	12,5	19	10	2,8
J2308H	8	34	13,8	19	6	10	5	J2308HM	8	34	13,8	19	10	3,5
J2309H	9	34	15	19	7	10	6	J2309HM	9	34	15	19	10	3,5
J2310H	10	34	15,8	19	8	10	6	J2310HM	10	34	15,8	19	10	4
J2311H	11	34	17,5	19	9	10	7	J2311HM	11	34	17,5	19	10	5
J2312H	12	34	18,6	19	10	10	7	J2312HM	12	34	18,6	19	10	5
J2313H	13	34	20	19	11	10	8	J2313HM	13	34	20	19	10	5,5
J2314H	14	34	20,8	22	12	10	8	J2314HM	14	34	20,8	22	10	6
J2315H	15	34	22	22	13	10	9	J2315HM	15	34	22	22	10	6
J2316H	16	34	23,8	22	14	10	9	J2316HM	16	34	23,8	22	10	6
J2317H	17	34	25	22	15	10	10	J2317HM	17	34	25	22	10	7
J2318H	18	34	26	22	16	10	10	J2318HM	18	34	26	22	10	7
J2319H	19	34	27	22	17	10	12	J2319HM	19	34	27	22	10	8
J2321H	21	34	30	22	18	10	12	J2321HM	21	34	30	22	10	8,5
J2322H	22	34	32	22	19	10	12	J2322HM	22	34	32	22	10	9
J2323H	23	34	34	22	20	10	12							
J2324H	24	34	35	22	21	10	15							

HEXAGON (LONG)
HEXAGONAL (LARGA)



3 / 8 "

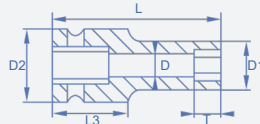

3 / 8 "

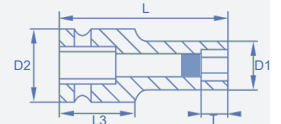

#	S	L	D1	D2	ØD	L3	T	MAGNETIC	S	L	D1	D2	L3	T
J2306HL	6	50	10,8	19	6	18	5	J2306HLM	6	50	10,8	19	18	2,4
J2307HL	7	50	12,5	19	6	18	6	J2307HLM	7	50	12,5	19	18	2,8
J2308HL	8	50	13,8	19	6	18	6	J2308HLM	8	50	13,8	19	18	3,5
J2309HL	9	50	15	19	7	18	7	J2309HLM	9	50	15	19	18	3,5
J2310HL	10	50	16	19	8	18	7	J2310HLM	10	50	16	19	18	4
J2311HL	11	50	17,5	19	9	18	8	J2311HLM	11	50	17,5	19	18	5
J2312HL	12	50	19	19	10	18	9	J2312HLM	12	50	19	19	18	5
J2313HL	13	50	20	19	11	18	9	J2313HLM	13	50	20	19	18	5,5
J2314HL	14	50	21,3	22	12	18	12	J2314HLM	14	50	21,3	22	18	6
J2315HL	15	50	22	22	13	10	13	J2315HLM	15	50	22	22	10	6
J2316HL	16	50	24	22	14	10	14	J2316HLM	16	50	24	22	10	6
J2317HL	17	50	25	22	15	10	14	J2317HLM	17	50	25	22	10	7
J2318HL	18	50	26	22	16	10	14	J2318HLM	18	50	26	22	10	7
J2319HL	19	50	27,5	22	17	10	14	J2319HLM	19	50	27,5	22	10	8
J2321HL	21	50	30	22	18	10	14	J2321HLM	21	50	30	22	10	8,5
J2322HL	22	50	32	22	19	10	14	J2322HLM	22	50	32	22	10	9
J2323HL	23	50	34	22	20	10	14							
J2324HL	24	50	35	22	21	10	14							
J2327HL	27	50	38	22	24	10	15							

SOCKETS
EMBOCADURAS

HEXAGON (EXTRA-LONG)
HEXAGONAL (EXTRA-LARGA)



3 / 8 "

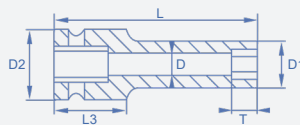

3 / 8 "

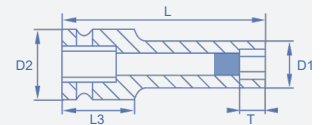

#	S	L	D1	D2	ØD	L3	T	MAGNETIC	S	L	D1	D2	L3	T
J2307HXL	7	90	12,5	19	5	18	5	J2307HXLM	7	90	12,5	19	18	2,8
J2308HXL	8	90	13,8	19	6	18	6	J2308HXLM	8	90	13,8	19	18	3,5
J2309HXL	9	90	15	19	7	18	6	J2309HXLM	9	90	15	19	18	3,5
J2310HXL	10	90	16	19	8	18	7	J2310HXLM	10	90	16	19	18	4
J2311HXL	11	90	17,5	19	9	18	7	J2311HXLM	11	90	17,5	19	18	5
J2312HXL	12	90	19	19	10	18	8	J2312HXLM	12	90	19	19	18	5
J2313HXL	13	90	20	19	11	18	14	J2313HXLM	13	90	20	19	18	11
J2314HXL	14	90	21,3	22	12	18	14	J2314HXLM	14	90	21,3	22	18	11
J2315HXL	15	90	22	22	13	10	15	J2315HXLM	15	90	22	22	10	12
J2316HXL	16	90	23,8	22	14	10	15	J2316HXLM	16	90	23,8	22	10	12
J2317HXL	17	90	25	22	15	10	15	J2317HXLM	17	90	25	22	10	12
J2318HXL	18	90	26	22	16	10	16	J2318HXLM	18	90	26	22	10	13
J2319HXL	19	90	27,5	22	17	10	16	J2319HXLM	19	90	27,5	22	10	13
J2321HXL	21	90	30	22	18	10	16	J2321HXLM	21	90	30	22	10	13
J2322HXL	22	90	32	22	19	10	16	J2322HXLM	22	90	32	22	10	13

STANDARD



3 / 8 "

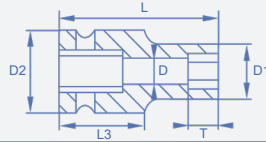

3 / 8 "

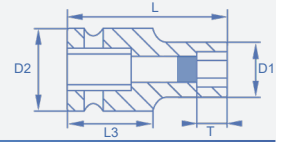

#	S	L	D1	D2	ØD	L3	T
J23-1/4H	1/4	34	10	19	6	16	5
J23-5/16H	5/16	34	12,7	19	6	16	6
J23-3/8H	3/8	34	14,5	19	7	16	6
J23-7/16H	7/16	34	17,4	19	9	16	7
J23-1/2H	1/2	34	20,6	22	10	16	8
J23-3/4H	3/4	34	26,9	22	17	10	11

MAGNETIC	S	L	D1	D2	L3	T
J23-1/4HM	1/4	34	10	19	16	3
J23-5/16HM	5/16	34	12,7	19	16	4
J23-3/8HM	3/8	34	14,5	19	16	4
J23-7/16HM	7/16	34	17,4	19	16	5
J23-1/2HM	1/2	34	20,6	22	16	6
J23-3/4HM	3/4	34	26,9	22	10	8

SPRING LOADED IMÁN RETRÁCTIL



3 / 8 "

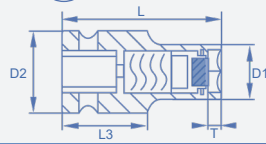

MAGNETIC	S	L	D1	D2	L3	T
J2307HRM	7	50	12,5	19	18	2,85
J2308HRM	8	50	13,8	19	18	2,85
J2309HRM	9	50	15	19	18	2,85
J2310HRM	10	50	16,3	19	18	3,3
J2311HRM	11	50	17,5	19	18	3,3
J2312HRM	12	50	18	19	18	4,9
J2313HRM	13	50	20	22	18	4,9
J2314HRM	14	50	21,3	22	18	5,3
J2315HRM	15	50	22,5	22	10	5,3
J2316HRM	16	50	23,8	22	10	6
J2317HRM	17	50	25	22	10	6



DOUBLE-HEXAGON BIHEXAGONAL



3 / 8 "

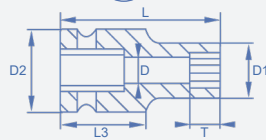

3 / 8 "

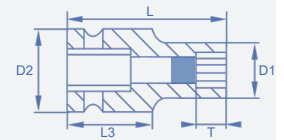

#	S	L	D1	D2	ØD	L3	T
J2307BH	7	34	12,5	19	5	18	3,5
J2308BH	8	34	13,8	19	6	18	4
J2309BH	9	34	15	19	7	18	4,5
J2310BH	10	34	16,3	19	8	18	6,3
J2311BH	11	34	17,5	19	9	18	7,6
J2312BH	12	34	19	19	10	18	8
J2313BH	13	34	20	22	11	18	8
J2314BH	14	34	21,3	22	12	18	8
J2315BH	15	34	22	22	13	18	9
J2316BH	16	34	23,8	22	14	10	9
J2317BH	17	34	25	22	15	10	9,5
J2318BH	18	34	26	22	16	10	9,5

MAGNETIC	S	L	D1	D2	L3	T
J2307BHM	7	34	12,5	19	18	2,8
J2308BHM	8	34	13,8	19	18	3
J2309BHM	9	34	15	19	18	3,5
J2310BHM	10	34	16,3	19	18	4
J2311BHM	11	34	17,5	19	18	5
J2312BHM	12	34	19	19	18	5
J2313BHM	13	34	20	22	18	6
J2314BHM	14	34	21,3	22	18	6
J2315BHM	15	34	22	22	18	7
J2316BHM	16	34	23,8	22	10	7
J2317BHM	17	34	25	22	10	7,5
J2318BHM	18	34	26	22	10	7,5

FAST LEAD
ENCARE RÁPIDO



3 / 8 "

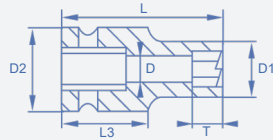

3 / 8 "

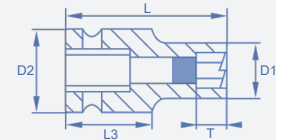

#	S	L	D1	D2	ØD	L3	T	MAGNETIC	S	L	D1	D2	L3	T
J2308HER	8	34	13,8	19	6	18	5	J2308HERM	8	34	13,8	19	18	3,5
J2309HER	9	34	15	19	7	18	6	J2309HERM	9	34	15	19	18	3,5
J2310HER	10	34	16,3	19	8	18	6	J2310HERM	10	34	16,3	19	18	4
J2311HER	11	34	17,5	19	9	18	7	J2311HERM	11	34	17,5	19	18	5
J2312HER	12	34	19	19	10	18	7	J2312HERM	12	34	19	19	18	5
J2313HER	13	34	20	22	11	18	8	J2313HERM	13	34	20	22	18	5,5
J2314HER	14	34	21,3	22	12	18	8	J2314HERM	14	34	21,3	22	18	6
J2315HER	15	34	22	22	13	10	9	J2315HERM	15	34	22	22	10	6
J2316HER	16	34	23,8	22	14	10	9	J2316HERM	16	34	23,8	22	10	6
J2317HER	17	34	25	22	15	10	10	J2317HERM	17	34	25	22	10	7
J2318HER	18	34	26	22	16	10	11	J2318HERM	18	34	26	22	10	8
J2319HER	19	34	27,5	22	17	10	12	J2319HERM	19	34	27,5	22	10	8
J2321HER	21	34	30	22	18	10	13	J2321HERM	21	34	30	22	10	9,5

SURFACE DRIVE
SURFACE DRIVE



3 / 8 "

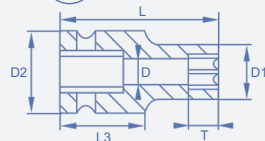

3 / 8 "

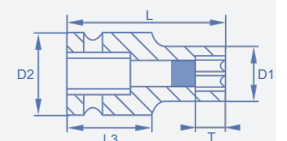

#	S	L	D1	D2	ØD	L3	T	MAGNETIC	S	L	D1	D2	L3	T
J2307SD	7	34	12,5	19	6	18	5	J2307SDM	7	34	12,5	19	18	2,8
J2308SD	8	34	14,5	19	6	18	5	J2308SDM	8	34	14,5	19	18	3
J2309SD	9	34	15	19	7	18	6	J2309SDM	9	34	15	19	18	3,5
J2310SD	10	34	16,3	19	8	18	6,3	J2310SDM	10	34	16,3	19	18	4,3
J2311SD	11	34	17,5	19	9	18	7	J2311SDM	11	34	17,5	19	18	5
J2312SD	12	34	19	19	10	18	7	J2312SDM	12	34	19	19	18	5
J2313SD	13	34	20	22	11	18	8	J2313SDM	13	34	20	22	18	5,5
J2314SD	14	34	21,3	22	12	18	8	J2314SDM	14	34	21,3	22	18	6
J2315SD	15	34	22	22	13	18	9	J2315SDM	15	34	22	22	18	6
J2316SD	16	34	23,8	22	14	10	9	J2316SDM	16	34	23,8	22	10	6
J2317SD	17	34	25	22	15	10	10	J2317SDM	17	34	25	22	10	7
J2318SD	18	34	26	22	16	10	10	J2318SDM	18	34	26	22	10	7
J2319SD	19	34	27,5	22	17	10	10	J2319SDM	19	34	27,5	22	10	7

SOCKETS
EMBOCADURAS





3 / 8 "

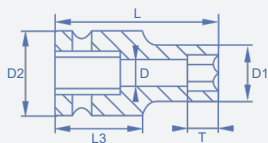

3 / 8 "

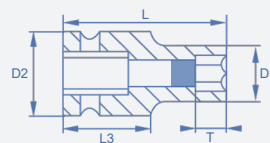

#	S	L	D1	D2	ØD	L3	T
JE5	E5	30	8	19	-	18	4,2
JE6	E6	30	9	19	-	18	5,3
JE7	E7	30	10	19	-	18	6,8
JE8	E8	30	11,5	19	4	18	6
JE10	E10	37,5	13,5	19	5	18	8,5
JE12	E12	37,5	15	19	7	18	8,5
JE14	E14	37,5	17	19	8	18	12,2

MAGNETIC	S	L	D1	D2	L3	T
JE8M	E8	30	11,5	19	18	3,5
JE10M	E10	37,5	13,5	19	18	4
JE12M	E12	37,5	15	19	18	5
JE14M	E14	37,5	17	19	18	6



1 / 2 "



1 / 2 "

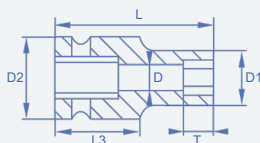

1 / 2 "

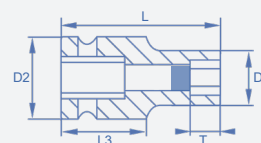

#	S	L	D1	D2	ØD	L3	T
S2308H	8	38	15	25	6	20	5
S2309H	9	38	16	25	7	20	6
S2310H	10	38	17	25	8	20	7
S2311H	11	38	18,5	25	9	20	8,6
S2312H	12	38	20	25	10	20	9
S2313H	13	38	21	25	11	20	9,4
S2314H	14	38	22,5	25	12	20	7,6
S2315H	15	38	23	30	13	20	8
S2316H	16	38	25	30	14	20	9,2
S2317H	17	38	26	30	15	20	10
S2318H	18	38	27,5	30	16	20	11
S2319H	19	38	28,5	30	17	20	13,8
S2320H	20	38	30	30	18	13	12
S2321H	21	38	31	30	18	13	12,4
S2322H	22	38	32,5	30	19	13	12,7
S2323H	23	38	34	30	20	13	12,7
S2324H	24	38	35	30	21	13	19
S2325H	25	45	36	30	22	13	17
S2326H	26	45	37,5	30	23	13	19
S2327H	27	50	38,5	30	23	13	20,6
S2328H	28	49	40	30	24	13	22
S2329H	29	47	41	30	25	13	20
S2330H	30	50	42	30	25	13	21,5

MAGNETIC	S	L	D1	D2	L3	T
S2308HM	8	38	15	25	20	3,5
S2309HM	9	38	16	25	20	3,5
S2310HM	10	38	17	25	20	4
S2311HM	11	38	18,5	25	20	5
S2312HM	12	38	20	25	20	5
S2313HM	13	38	21	25	20	5,5
S2314HM	14	38	22,5	25	20	6
S2315HM	15	38	23	30	20	6
S2316HM	16	38	25	30	20	6
S2317HM	17	38	26	30	20	7
S2318HM	18	38	27,5	30	20	7
S2319HM	19	38	28,5	30	20	8
S2320HM	20	38	30	30	13	8,5
S2321HM	21	38	31	30	13	8,5
S2322HM	22	38	32,5	30	13	9

SOCKETS
EMBOCADURAS

STANDARD

HEXAGON (LONG)
HEXAGONAL (LARGA)



1/2"

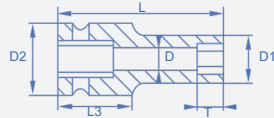

1/2"

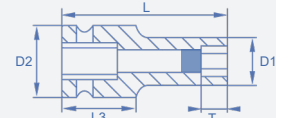

#	S	L	D1	D2	ØD	L3	T	MAGNETIC	S	L	D1	D2	L3	T
S2310HJL	10	50	17	25	8	20	6	S2310HJLM	10	50	17	25	20	4
S2311HJL	11	50	18,5	25	9	20	7	S2311HJLM	11	50	18,5	25	20	5
S2312HJL	12	50	20	25	10	20	7	S2312HJLM	12	50	20	25	20	5
S2313HJL	13	50	21	25	11	20	8	S2313HJLM	13	50	21	25	20	5,5
S2314HJL	14	50	22,5	25	12	20	9	S2314HJLM	14	50	22,5	25	20	6
S2315HJL	15	50	23	30	13	20	9	S2315HJLM	15	50	23	30	20	6
S2316HJL	16	50	25	30	14	20	10	S2316HJLM	16	50	25	30	20	6
S2317HJL	17	50	26	30	15	20	11	S2317HJLM	17	50	26	30	20	7
S2318HJL	18	50	27,5	30	16	20	12	S2318HJLM	18	50	27,5	30	20	7
S2319HJL	19	50	28,5	30	17	20	13	S2319HJLM	19	50	28,5	30	20	8
S2320HJL	20	50	30	30	18	20	13	S2320HJLM	20	50	30	30	20	8,5
S2321HJL	21	50	31	30	18	13	13,7	S2321HJLM	21	50	31	30	13	8,5
S2322HJL	22	50	32,5	30	19	13	14	S2322HJLM	22	50	32,5	30	13	9
S2323HJL	23	50	34	30	20	13	15							
S2324HJL	24	50	35	30	21	13	17							
S2332HJL	32	50	44	30	26	13	22							

HEXAGON (EXTRA-LONG)
HEXAGONAL (EXTRA-LARGA)



1/2"

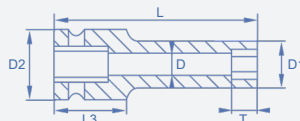

1/2"

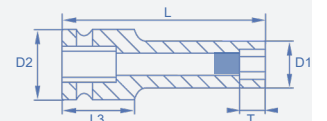

#	S	L	D1	D2	ØD	L3	T	MAGNETIC	S	L	D1	D2	L3	T
S2308HL	8	80	15	25	6	25	12	S2308HLM	8	80	15	25	25	5
S2309HL	9	80	16	25	7	25	12	S2309HLM	9	80	16	25	25	5
S2310HL	10	80	17	25	8	25	12	S2310HLM	10	80	17	25	25	6
S2311HL	11	80	18,5	25	9	25	15	S2311HLM	11	80	18,5	25	25	6
S2312HL	12	80	20	25	10	25	15	S2312HLM	12	80	20	25	25	7
S2313HL	13	80	21	25	11	25	15	S2313HLM	13	80	21	25	25	8
S2314HL	14	80	22,5	25	12	25	16	S2314HLM	14	80	22,5	25	25	9
S2315HL	15	80	23	30	13	25	14	S2315HLM	15	80	23	30	25	9
S2316HL	16	80	25	30	14	25	14	S2316HLM	16	80	25	30	25	10
S2317HL	17	80	26	30	15	25	14	S2317HLM	17	80	26	30	25	11
S2318HL	18	80	27,5	30	16	25	17	S2318HLM	18	80	27,5	30	25	12
S2319HL	19	80	28,5	30	17	25	21	S2319HLM	19	80	28,5	30	25	13
S2320HL	20	80	30	30	18	25	19	S2320HLM	20	80	30	30	25	14
S2321HL	21	80	31	30	18	13	21	S2321HLM	21	80	31	30	13	14
S2322HL	22	80	32,5	30	19	13	21	S2322HLM	22	80	32,5	30	13	15
S2323HL	23	80	34	30	20	13	23							
S2324HL	24	80	35	30	21	13	26							
S2325HL	25	80	36	30	22	13	27							
S2326HL	26	80	37,5	30	23	13	28							
S2327HL	27	80	38,5	30	23	13	29							
S2328HL	28	80	40	30	24	13	30							
S2329HL	29	80	41	30	25	13	31							
S2330HL	30	80	42	30	25	13	31							



1/2"

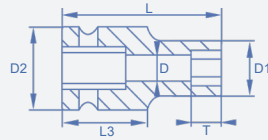

1/2"

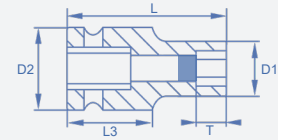

#	S	L	D1	D2	ØD	L3	T	MAGNETIC	S	L	D1	D2	L3	T
S23-3/8H	3/8	38	17	25	7	20	6	S23-3/8HM	3/8	38	17	25	20	4
S23-7/16H	7/16	38	19	25	9	20	7	S23-7/16HM	7/16	38	19	25	20	5
S23-1/2H	1/2	38	21	25	10	20	7	S23-1/2HM	1/2	38	21	25	20	5
S23-3/4H	3/4	38	29	30	17	20	12	S23-3/4HM	3/4	38	29	30	20	10
S23-15/16H	15/16	38	35	30	21	13	15	S23-15/16HM	15/16	38	35	30	13	13
S23-1H	1	38	37	30	22	13	16	S23-1HM	1	38	37	30	13	14

SPRING LOADED
IMÁN RETRÁCTIL



1/2"

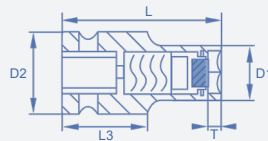

MAGNETIC	S	L	D1	D2	L3	T
S2310HRM	10	50	17	25	20	6
S2311HRM	11	50	18,5	25	20	7
S2312HRM	12	50	20	25	20	7
S2313HRM	13	50	21	25	20	8
S2314HRM	14	50	22,5	25	20	8
S2315HRM	15	50	23	30	20	10
S2316HRM	16	50	25	30	20	10
S2316HRM/80	16	80	25	30	25	10
S2317HRM	17	50	26	30	25	10
S2317HRM/80	17	80	26	30	25	10
S2318HRM	18	50	27,5	30	25	11
S2318HRM/80	18	80	27,5	30	25	11
S2319HRM/80	19	80	27,5	30	25	12
S2320HRM/80	20	80	30	30	25	12
S2321HRM/80	21	80	31	30	13	12
S2322HRM	22	80	32,5	30	13	12



STANDARD

DOUBLE-HEXAGON
BIHEXAGONAL



1/2"

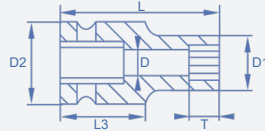

1/2"

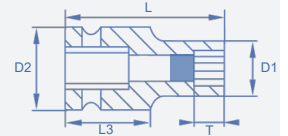

#	S	L	D1	D2	ØD	L3	T	MAGNETIC	S	L	D1	D2	L3	T
S2308BH	8	38	15	25	6	20	5	S2308BHM	8	38	15	25	20	3,5
S2309BH	9	38	16	25	7	20	6	S2309BHM	9	38	16	25	20	3,5
S2310BH	10	38	17	25	8	20	7	S2310BHM	10	38	17	25	20	5
S2311BH	11	38	18,5	25	9	20	7	S2311BHM	11	38	18,5	25	20	5
S2312BH	12	38	20	25	10	20	7	S2312BHM	12	38	20	25	20	5
S2313BH	13	38	21	25	11	20	8	S2313BHM	13	38	21	25	20	5,5
S2314BH	14	38	22,5	25	12	20	8,4	S2314BHM	14	38	22,5	25	20	6
S2315BH	15	38	23	30	13	20	10	S2315BHM	15	38	23	30	20	7
S2316BH	16	38	25	30	14	20	10	S2316BHM	16	38	25	30	20	7
S2317BH	17	38	26	30	15	20	10	S2317BHM	17	38	26	30	20	7
S2318BH	18	38	27,5	30	16	20	12	S2318BHM	18	38	27,5	30	20	9
S2319BH	19	38	28,5	30	17	20	13	S2319BHM	19	38	28,5	30	20	10
S2320BH	20	38	30	30	18	13	13,5	S2320BHM	20	38	30	30	13	10,5
S2321BH	21	38	31	30	18	13	14	S2321BHM	21	38	31	30	13	11
S2322BH	22	38	32,5	30	19	13	15	S2322BHM	22	38	32,5	30	13	12
S2323BH	23	38	34	30	20	13	16							
S2324BH	24	38	35	30	21	13	17							

FAST LEAD
ENCARE RÁPIDO



1/2"

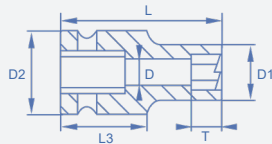

1/2"

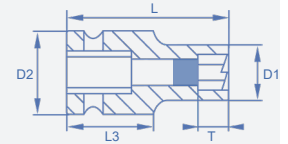

#	S	L	D1	D2	ØD	L3	T	MAGNETIC	S	L	D1	D2	L3	T
S2308HER	8	38	15	25	7	20	5	S2308HERM	8	38	15	25	20	3
S2310HER	10	38	17	25	8	20	7	S2310HERM	10	38	17	25	20	5
S2311HER	11	38	18,5	25	9	20	7	S2311HERM	11	38	18,5	25	20	5
S2312HER	12	38	20	25	10	20	8	S2312HERM	12	38	20	25	20	6
S2313HER	13	38	21	25	11	20	9	S2313HERM	13	38	21	25	20	7
S2314HER	14	38	22,5	30	12	20	9,5	S2314HERM	14	38	22,5	30	20	7,5
S2315HER	15	38	23	30	13	20	10	S2315HERM	15	38	23	30	20	8
S2316HER	16	38	25	30	14	20	10	S2316HERM	16	38	25	30	20	9
S2317HER	17	38	26	30	15	20	11	S2317HERM	17	38	26	30	20	9
S2318HER	18	38	27,5	30	16	20	11	S2318HERM	18	38	27,5	30	20	9
S2319HER	19	38	28,5	30	17	20	14	S2319HERM	19	38	28,5	30	20	10
S2320HER	20	38	30	30	18	13	14	S2320HERM	20	38	30	30	13	10,5
S2321HER	21	38	31	30	18	13	14	S2321HERM	21	38	31	30	13	10,5
S2322HER	22	38	32,5	30	19	13	14	S2322HERM	22	38	32,5	30	13	10,5
S2323HER	23	38	34	30	20	13	14							

SURFACE DRIVE
SURFACE DRIVE

1/2"

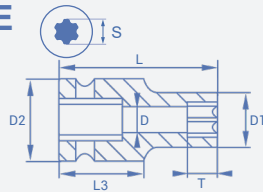

1/2"

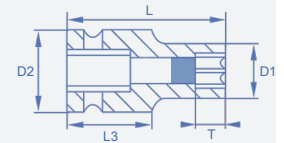

#	S	L	D1	D2	ØD	L3	T	MAGNETIC	S	L	D1	D2	L3	T
S2310SD	10	38	17	25	8	20	7,2	S2310SDM	10	38	17	25	20	4
S2311SD	11	38	18,5	25	9	20	7,3	S2311SDM	11	38	18,5	25	20	5
S2312SD	12	38	20	25	10	20	7,5	S2312SDM	12	38	20	25	20	5
S2313SD	13	38	21	25	11	20	7,6	S2313SDM	13	38	21	25	20	5
S2314SD	14	38	22,5	25	12	20	8,6	S2314SDM	14	38	22,5	25	20	6
S2315SD	15	38	23	30	13	20	8,6	S2315SDM	15	38	23	30	20	6
S2316SD	16	38	25	30	14	20	10,5	S2316SDM	16	38	25	30	20	6
S2317SD	17	38	26	30	15	20	12	S2317SDM	17	38	26	30	20	7
S2318SD	18	38	27,5	30	16	20	12	S2318SDM	18	38	27,5	30	20	7
S2319SD	19	38	28,5	30	17	20	12,3	S2319SDM	19	38	28,5	30	20	8
S2320SD	20	38	30	30	18	13	12,5	S2320SDM	20	38	30	30	13	8,5
S2321SD	21	38	31	30	18	13	12,6	S2321SDM	21	38	31	30	13	8,5
S2322SD	22	38	32,5	30	20	13	12,7	S2322SDM	22	38	32,5	30	13	9

SOCKETS
EMBOCADURAS

TORX
TORX

1/2"

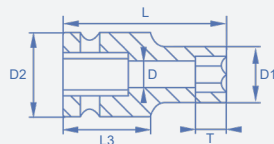

1/2"

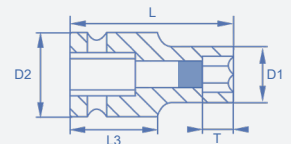

#	S	L	D1	D2	ØD	L3	T	MAGNETIC	S	L	D1	D2	L3	T
SE10	E10	38	14	25	5	20	9	SE10M	E10	38	14	25	20	7
SE11	E11	38	15	25	5	20	9	SE11M	E11	38	15	25	20	7
SE12	E12	38	15,9	25	6	20	10	SE12M	E12	38	15,9	25	20	8
SE14	E14	38	17,7	25	7	20	10,2	SE14M	E14	38	17,7	25	20	8,5
SE16	E16	38	20	25	8	20	11	SE16M	E16	38	20	25	20	9
SE18	E18	38	22	25	8	20	11,3	SE18M	E18	38	22	25	20	9,5
SE20	E20	38	25	25	11	20	15,7	SE20M	E20	38	25	25	20	12
SE22	E22	38	26	30	11	20	16	SE22M	E22	38	26	30	20	13
SE24	E24	38	30	30	12	20	16,2	SE24M	E24	38	30	30	20	13

STANDARD

SQUARE CUADRADA



1 / 2 "

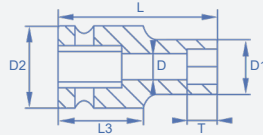

1 / 2 "

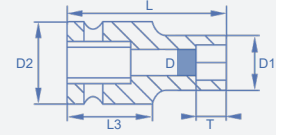

#	S	L	D1	D2	ØD	L3	T	MAGNETIC	S	L	D1	D2	L3	T
S2308SQ	8	38	18,6	25	6	20	7	S2308SQM	8	38	18,6	25	20	3
S2310SQ	10	38	21,5	25	8	20	7,5	S2310SQM	10	38	21,5	25	20	4
S2312SQ	12	38	25	25	10	20	8	S2312SQM	12	38	25	25	20	5
S2313SQ	13	38	25,7	25	11	20	9	S2313SQM	13	38	25,7	25	20	5
S2314SQ	14	38	27,5	30	12	20	9,5	S2314SQM	14	38	27,5	30	20	5
S2315SQ	15	38	29	30	13	20	10,5	S2315SQM	15	38	29	30	20	6
S2317SQ	17	38	32	30	15	13	11,5	S2317SQM	17	38	32	30	13	7
S2319SQ	19	38	35	30	17	13	13,5	S2319SQM	19	38	35	30	13	8,5
S2322SQ	22	38	39,2	30	19	13	15	S2322SQM	22	38	39,2	30	13	9
S2323SQ	23	38	41	30	20	13	15	S2323SQM	23	38	41	30	13	10

3 / 4 "

HEXAGON HEXAGONAL



3 / 4 "

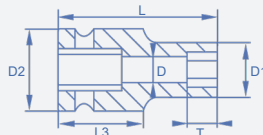

3 / 4 "

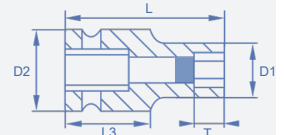

#	S	L	D1	D2	ØD	L3	T	MAGNETIC	S	L	D1	D2	L3	T
K2315H	15	50	26	38	13	30	13	K2315HM	15	50	26	38	30	8
K2316H	16	50	27	44	14	24	13	K2316HM	16	50	27	44	24	8
K2317H	17	51	31	44	15	24	14	K2317HM	17	51	31	44	24	9
K2318H	18	51	32	44	16	24	15	K2318HM	18	51	32	44	24	9
K2319H	19	51	32,5	44	17	24	15	K2319HM	19	51	32,5	44	24	9
K2320H	20	51	33,5	44	18	24	16	K2320HM	20	51	33,5	44	24	10
K2321H	21	51	35	44	18	24	16	K2321HM	21	51	35	44	24	10
K2322H	22	51	36	44	19	24	16	K2322HM	22	51	36	44	24	11
K2323H	23	51	37,5	44	20	24	16	K2323HM	23	51	37,5	44	24	12
K2324H	24	51	38,5	44	21	24	16	K2324HM	24	51	38,5	44	24	13
K2325H	25	53	40	44	21	24	18	K2325HM	25	53	40	44	24	14
K2326H	26	53	41	44	22	24	18	K2326HM	26	53	41	44	24	14
K2327H	27	53	42,5	44	23	24	19	K2327HM	27	53	42,5	44	24	15
K2328H	28	53	44	44	24	24	20							
K2330H	30	53	46	44	25	24	21							
K2332H	32	57	48,5	44	26	24	22							
K2336H	36	57	53,5	44	28	25	25							
K2341H	41	58	60	44	32	26	25							
K2346H	46	62	66	44	37	27	25							

HEXAGON (LONG)
HEXAGONAL (LARGA)



3/4"

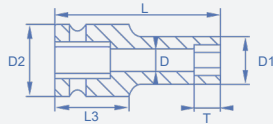

3/4"

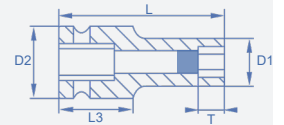

#	S	L	D1	D2	ØD	L3	T	MAGNETIC	S	L	D1	D2	L3	T
K2315HL	15	80	26	38	13	30	11	K2315HLM	15	80	26	38	30	6
K2316HL	16	80	27	44	14	24	14	K2316HLM	16	80	27	44	24	6
K2317HL	17	80	31	44	15	24	14	K2317HLM	17	80	31	44	24	7
K2318HL	18	80	32	44	16	24	14	K2318HLM	18	80	32	44	24	7
K2319HL	19	80	32,5	44	17	24	14	K2319HLM	19	80	32,5	44	24	8
K2320HL	20	80	33,5	44	18	24	14	K2320HLM	20	80	33,5	44	24	8,5
K2321HL	21	80	35	44	18	24	14	K2321HLM	21	80	35	44	24	8,5
K2322HL	22	80	36	44	19	24	14	K2322HLM	22	80	36	44	24	9
K2323HL	23	80	37,5	44	20	24	14	K2323HLM	23	80	37,5	44	24	9,5
K2324HL	24	80	38,5	44	21	24	14	K2324HLM	24	80	38,5	44	24	10
K2325HL	25	80	40	44	21	24	16	K2325HLM	25	80	40	44	24	11
K2326HL	26	80	41	44	22	24	16	K2326HLM	26	80	41	44	24	11
K2327HL	27	80	42,5	44	23	24	20	K2327HLM	27	80	42,5	44	24	12
K2328HL	28	80	44	44	24	17	20							
K2330HL	30	80	46	44	25	17	20							
K2332HL	32	80	48,5	44	26	17	21							
K2334HL	34	80	51	44	28	17	21							
K2336HL	36	95	54	44	29	17	38							

SOCKETS
EMBOCADURAS

FAST LEAD
ENCARE RÁPIDO



3/4"

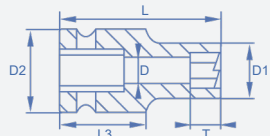

3/4"

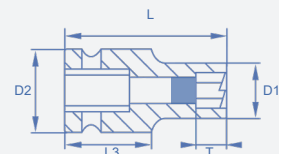

#	S	L	D1	D2	ØD	L3	T	MAGNETIC	S	L	D1	D2	L3	T
K2316HER	16	51	27	44	14	30	12	K2316HERM	16	51	27	44	24	6,5
K2318HER	18	51	31	44	16	27	14	K2318HERM	18	51	31	44	24	7
K2321HER	21	51	35	44	18	24	15	K2321HERM	21	51	35	44	24	8,5

SURFACE DRIVE
SURFACE DRIVE



3/4"

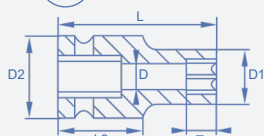

3/4"

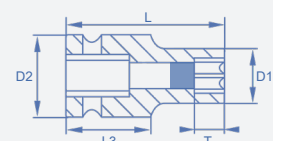

#	S	L	D1	D2	ØD	L3	T	MAGNETIC	S	L	D1	D2	L3	T
K2318SD	18	51	32	44	16	24	14	K2318SDM	18	51	32	44	24	7
K2319SD	19	50	33	44	17	24	14	K2319SDM	19	50	33	44	24	8
K2321SD	21	50	35	44	19	25	14	K2321SDM	21	50	35	44	25	8,5

STANDARD

1"

HEXAGON
HEXAGONAL



1"

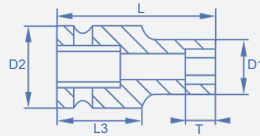

1"

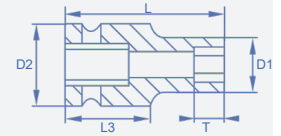

#	S	L	D1	D2	T	#	S	L	D1	D2	T
L2316H	16	58	32	51	12	L23-5/8H	5/8"	58	32	51	11
L2317H	17	58	34	51	13	L23-11/16H	11/16"	58	34	51	12
L2318H	18	58	35	51	13	L23-3/4H	3/4"	58	36	51	13
L2319H	19	58	36	51	13	L23-13/16H	13/16"	58	38	51	15
L2320H	20	58	37	51	14	L23-7/8H	7/8"	58	39	51	15
L2321H	21	58	38	51	15	L23-15/16H	15/16"	58	40	51	18
L2322H	22	58	39	51	15	L23-1H	1"	58	42	51	18
L2323H	23	58	40	51	16	L23-1-1/16H	1-1/16"	58	44	51	19
L2324H	24	58	40	51	18	L23-1-1/8H	1-1/8"	58	46	51	19
L2325H	25	58	41	51	18	L23-1-3/16H	1-3/16"	60	48	51	21
L2326H	26	58	42,5	51	18	L23-1-1/4H	1-1/4"	60	51	51	22
L2327H	27	58	44	51	19	L23-15/16H	1-5/16"	62	53	52	22
L2328H	28	58	45	51	19	L23-1-3/8H	1-3/8"	62	54	52	22
L2329H	29	58	46	51	19	L23-1-7/16H	1-7/16"	62	56	52	25
L2330H	30	60	48	51	21	L23-1-1/2H	1-1/2"	62	58	52	25
L2331H	31	62	51	54	21	L23-1-9/16H	1-9/16"	62	60	52	25
L2332H	32	62	52	54	22	L23-1-5/8H	1-5/8"	62	61,5	52	27
L2333H	33	62	53	54	22	L23-1-11/16H	1-11/16"	64	65	52	27
L2334H	34	62	55	54	22	L23-1-3/4H	1-3/4"	64	66	58	27
L2335H	35	65	56	54	22	L23-1-13/16H	1-13/16"	64	68	58	30
L2336H	36	67	57	54	25	L23-1-7/8H	1-7/8"	66	70	58	32
L2337H	37	67	59	54	25	L23-1-15/16H	1-15/16"	68	72	58	32
L2338H	38	67	60	54	25	L23-2H	2"	70	74	58	35
L2341H	41	70	63	54	27	L23-2-1/16H	2-1/16"	70	75	58	35
L2342H	42	74	65	54	27	L23-2-1/8H	2-1/8"	70	78	58	35
L2346H	46	76	70	54	30	L23-2-3/16H	2-3/16"	72	80	62	35
L2348H	48	76	72,5	54	32	L23-2-1/4H	2-1/4"	75	84	62	40
L2350H	50	80	75	62	35	L23-2-5/16H	2-5/16"	75	86	62	40
L2355H	55	84	81	62	35	L23-2-3/8H	2-3/8"	78	87	62	42
L2360H	60	87	87	62	42	L23-2-7/16H	2-7/16"	78	89	62	42
L2365H	65	90	93	62	42	L23-2-1/2H	2-1/2"	80	91	62	42
L2370H	70	96	100	62	42	L23-2-9/16H	2-9/16"	80	93	62	42
L2375H	75	98	106	86	45	L23-2-5/8H	2-5/8"	82	95	62	42
L2380H	80	100	112	86	48	L23-2-11/16H	2-11/16"	82	97	62	42
L2385H	85	105	118	86	52	L23-2-3/4H	2-3/4"	96	100	62	42
L2390H	90	105	125	86	52	L23-2-13/16H	2-13/16"	96	102	62	45
L2395H	95	115	131	86	52	L23-2-7/8H	2-7/8"	96	104	86	45
L23100H	100	115	137	95	58	L23-2-15/16H	2-15/16"	98	105	86	45
L23-105H	105	115	143	95	58	L23-3H	3"	100	107	86	48
L23-110H	110	115	149	95	60	L23-3-1/8H	3-1/8"	100	111	86	48

HEXAGON (LONG)
HEXAGONAL (LARGA)



1''

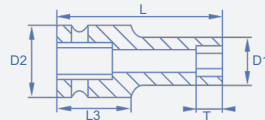

1''

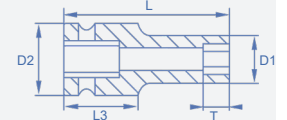

#	S	L	D1	D2	T	#	S	L	D1	D2	T
L2316HL	16	100	32	54	16	L23-5/8HL	5/8"	90	32	51	16
L2317HL	17	100	34	54	17	L23-11/16HL	11/16"	90	34	51	17
L2318HL	18	100	35	54	18	L23-3/4HL	3/4"	90	36	51	19
L2319HL	19	100	36	54	19	L23-13/16HL	13/16"	90	38	51	22
L2320HL	20	100	37	54	20	L23-7/8HL	7/8"	90	39	51	22
L2321HL	21	100	38	54	21	L23-15/16HL	15/16"	90	40	51	24
L2322HL	22	100	40	54	22	L23-1HL	1"	90	42	51	25
L2323HL	23	100	41	54	23	L23-1-1/16HL	1-1/16"	90	44	51	27
L2324HL	24	100	42	54	24	L23-1-1/8HL	1-1/8"	90	46	51	29
L2325HL	25	100	43	54	25	L23-1-3/16HL	1-3/16"	90	48	51	30
L2326HL	26	100	44,5	54	26	L23-1-1/4HL	1-1/4"	90	51	51	32
L2327HL	27	100	46	54	27	L23-1-15/16HL	1-15/16"	90	53	52	34
L2328HL	28	100	47	54	28	L23-1-3/8HL	1-3/8"	90	54	52	35
L2329HL	29	100	48	54	29	L23-1-7/16HL	1-7/16"	90	56	52	37
L2330HL	30	100	50	54	30	L23-1-1/2HL	1-1/2"	92	58	52	38
L2331HL	31	100	51	54	31	L23-1-9/16HL	1-9/16"	92	60	52	38
L2332HL	32	100	52	54	32	L23-1-5/8HL	1-5/8"	92	61,5	52	38
L2333HL	33	100	53	54	33	L23-1-11/16HL	1-11/16"	92	65	52	38
L2334HL	34	100	55	54	34	L23-1-3/4HL	1-3/4"	92	66	58	38
L2335HL	35	100	56	54	35	L23-1-13/16HL	1-13/16"	92	68	58	38
L2336HL	36	100	57	54	36	L23-1-7/8HL	1-7/8"	92	70	58	38
L2337HL	37	100	59	54	37	L23-1-15/16HL	1-15/16"	92	72	58	38
L2338HL	38	100	60	54	38	L23-2HL	2"	95	74	58	40
L2341HL	41	100	63	54	38	L23-2-1/16HL	2-1/16"	95	75	58	40
L2342HL	42	100	65	54	38	L23-2-1/8HL	2-1/8"	100	78	58	40
L2346HL	46	100	70	54	38	L23-2-3/16HL	2-3/16"	100	80	62	40
L2348HL	48	100	72,5	54	38	L23-2-1/4HL	2-1/4"	100	84	62	40
L2350HL	50	100	75	54	38	L23-2-5/16HL	2-5/16"	105	86	62	40
L2355HL	55	100	81	54	40	L23-2-3/8HL	2-3/8"	105	87	62	42
L2360HL	60	120	87	54	42	L23-2-7/16HL	2-7/16"	110	89	62	42
L2365HL	65	125	93	54	42	L23-2-1/2HL	2-1/2"	110	91	62	42
L2370HL	70	125	100	54	42	L23-2-9/16HL	2-9/16"	125	93	62	42
L2375HL	75	135	106	86	45	L23-2-5/8HL	2-5/8"	125	95	62	42
L2380HL	80	135	112	86	48	L23-2-11/16HL	2-11/16"	125	97	62	42
L2385HL	85	140	118	86	52	L23-2-3/4HL	2-3/4"	125	100	62	42
L2390HL	90	140	125	86	52	L23-2-13/16HL	2-13/16"	125	102	62	45
L2395HL	95	140	131	86	52	L23-2-7/8HL	2-7/8"	125	104	86	45
L23100HL	100	140	137	95	58	L23-2-15/16HL	2-15/16"	135	105	86	45
L23105HL	105	155	143	95	58	L23-3HL	3"	135	107	86	48
L23110HL	110	155	149	95	60	L23-3-1/8HL	3-1/8"	135	111	86	48

SOCKETS
EMB/CADURAS

STANDARD

HEXAGON (THIN WALL)
HEXAGONAL (PARED FINA)



1"

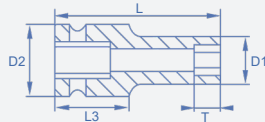

DOUBLE-HEXAGON
BIHEXAGONAL



1"

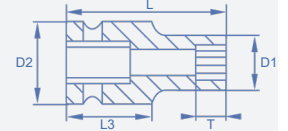

#	S	L	D1	D2	T
L2321HLF	21	88	38	51	25
L2322HLF	22	88	39	51	25
L2323HLF	24	88	42	51	25
L2324HLF	27	88	45	51	28
L2325HLF	29	88	48	51	28
L2326HLF	30	88	50	54	30
L2327HLF	32	88	52	54	32
L2328HLF	33	88	53	54	32
L2329HLF	34	88	54	54	33
L2330HLF	35	88	55	54	34
L2331HLF	36	88	56	54	40
L2338HLF	38	88	59	54	40
L2341HLF	41	88	63	54	40
L2346HLF	46	100	69	54	50
L2350HLF	50	100	74	54	50
L2355HLF	55	110	80	56	60
L2360HLF	60	110	87	60	60
L2365HLF	65	120	93	65	65
L2370HLF	70	125	99	70	65
L2375HLF	75	125	105	75	65
L2380HLF	80	135	109	86	75

#	S	L	D1	D2	T
L2316BH	16	60	32	54	11
L2317BH	17	60	34	54	12
L2318BH	18	60	35	54	13
L2319BH	19	60	36	54	13
L2320BH	20	60	37	54	14
L2321BH	21	60	38	54	15
L2322BH	22	60	40	54	15
L2324BH	24	60	42	54	18
L2325BH	25	60	43	54	18
L2326BH	26	60	44,5	54	18
L2327BH	27	62	46	54	19
L2329BH	29	62	48	54	19
L2330BH	30	62	50	54	21
L2331BH	31	62	51	54	21
L2332BH	32	62	52	54	22
L2333BH	33	62	53	54	22
L2334BH	34	62	55	54	22
L2335BH	35	65	56	54	22
L2336BH	36	67	57	54	25
L2338BH	38	67	60	54	25
L2346BH	46	76	70	58	30
L2350BH	50	80	75	62	35



1 - 1/2"

HEXAGON
 HEXAGONAL
 

1 - 1/2"

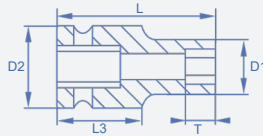

1 - 1/2"

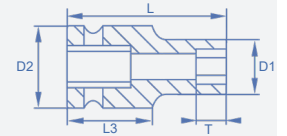

#	S	L	D1	D2	T	#	S	L	D1	D2	T
M2332H	32	78	58	86	22	M2375H	75	108	112	86	49
M2334H	34	78	61	86	22	M2378H	78	115	115	86	53
M2336H	36	78	64	86	24	M2380H	80	115	119	86	53
M2338H	38	80	66	86	26	M2385H	85	118	125	86	56
M2340H	40	80	68	86	28	M2388H	88	118	128	86	56
M2341H	41	80	70	86	28	M2390H	90	123	131	86	59
M2342H	42	82	71	86	28	M2395H	95	123	137	95	61
M2345H	45	84	75	86	30	M23100H	100	130	144	95	65
M2346H	46	84	76	86	30	M23105H	105	130	154	95	68
M2347H	47	87	77	86	32	M23110H	110	135	157	95	72
M2348H	48	87	79	86	32	M23115H	115	140	164	95	77
M2350H	50	87	81	86	32	M23120H	120	140	167	95	77
M2352H	52	87	83	86	34	M23125H	125	140	174	127	77
M2354H	54	90	86	86	37	M23185H	185	190	254	127	100
M2355H	55	90	87	86	37	M23130H	130	145	184	127	80
M2356H	56	92	88	86	37	M23135H	135	150	194	127	85
M2358H	58	95	92	86	39	M23140H	140	160	197	127	90
M2360H	60	95	94	86	39	M23145H	145	160	204	127	90
M2361H	61	100	95	86	42	M23150H	150	165	207	127	90
M2362H	62	100	96	86	42	M23155H	155	165	214	127	90
M2363H	63	100	97	86	42	M23160H	160	170	224	127	90
M2365H	65	100	100	86	42	M23165H	165	175	227	127	95
M2368H	68	105	104	86	46	M23170H	170	180	234	127	95
M2370H	70	105	106	86	46	M23175H	175	185	244	127	100
M2372H	72	108	108	86	49						

PROTECTED

1/4"

HEXAGON
HEXAGONAL



1/4"

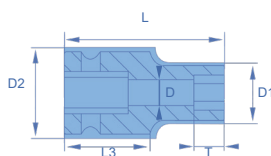

1/4"

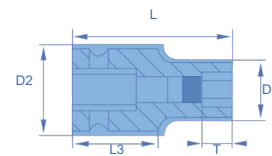

#	S	L	D1	D2	ØD	L3	T	MAGNETIC	S	L	D1	D2	L3	T
R2304H/TEF	4	25	10,8	16	3	13	4,5	R2304HM/TEF	4	25	10,8	16	13	2
R2305H/TEF	5	25	12	16	5	13	5,5	R2305HM/TEF	5	25	12	16	13	2
R2305.5H/TEF	5,5	25	12,6	16	5	13	5,5	R2305.5HM/TEF	5,5	25	12,6	16	13	2
R2306H/TEF	6	25	13	16	6	13	5,5	R2306HM/TEF	6	25	13	16	13	2,4
R2307H/TEF	7	25	15	16	6	13	5,5	R2307HM/TEF	7	25	15	16	13	2,8
R2308H/TEF	8	25	15,5	16	6	13	5,5	R2308HM/TEF	8	25	15,5	16	13	3,5
R2309H/TEF	9	25	17	16	7	7	6,5	R2309HM/TEF	9	25	17	16	7	3,5
R2310H/TEF	10	25	18	16	8	7	6,5	R2310HM/TEF	10	25	18	16	7	4
R2311H/TEF	11	25	20	16	9	7	7,5	R2311HM/TEF	11	25	20	16	7	5
R2312H/TEF	12	25	21	16	10	7	7,5	R2312HM/TEF	12	25	21	16	7	5
R2313H/TEF	13	25	22	16	11	7	8,5	R2313HM/TEF	13	25	22	16	7	5,5

HEXAGON (LONG)
HEXAGONAL (LARGA)



1/4"

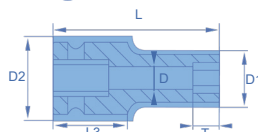

1/4"

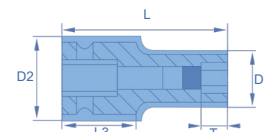

#	S	L	D1	D2	ØD	L3	T	MAGNETIC	S	L	D1	D2	L3	T
R2305HL/TEF	5	50	11,8	16	5	13	5	R2305HLM/TEF	5	50	11,8	16	13	2
R2305.5HL/TEF	5,5	50	12,4	16	5	13	5	R2305.5HLM/TEF	5,5	50	12,4	16	13	2
R2306HL/TEF	6	50	13	16	6	13	5	R2306HLM/TEF	6	50	13	16	13	2,4
R2307HL/TEF	7	50	14,4	16	6	13	5	R2307HLM/TEF	7	50	14,4	16	13	2,8
R2308HL/TEF	8	50	15,5	16	6	13	5	R2308HLM/TEF	8	50	15,5	16	13	3,5
R2309HL/TEF	9	50	17	16	7	7	6	R2309HLM/TEF	9	50	17	16	7	3,5
R2310HL/TEF	10	50	18	16	8	7	6	R2310HLM/TEF	10	50	18	16	7	4
R2311HL/TEF	11	50	19,3	16	9	7	7	R2311HLM/TEF	11	50	19,3	16	7	5
R2312HL/TEF	12	50	20,5	16	10	7	7	R2312HLM/TEF	12	50	20,5	16	7	5
R2313HL/TEF	13	50	21,7	16	11	7	8	R2313HLM/TEF	13	50	21,7	16	7	5,5

SAE
SAE



1/4"

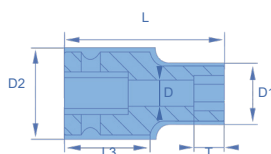

1/4"

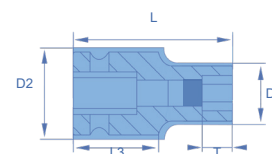

#	S	L	D1	D2	ØD	L3	T	MAGNETIC	S	L	D1	D2	L3	T
R23-1/4H/TEF	1/4	25	13,4	16	6	13	4	R23-1/4HM/TEF	1/4	25	13,4	16	13	2
R23-5/16H/TEF	5/16	25	15,4	16	6	13	4,5	R23-5/16HM/TEF	5/16	25	15,4	16	13	2,5
R23-3/8H/TEF	3/8	25	17,4	16	7	13	6	R23-3/8HM/TEF	3/8	25	17,4	16	13	4
R23-1/2H/TEF	1/2	25	21,4	16	10	7	7	R23-1/2HM/TEF	1/2	25	21,4	16	7	5

SPRING LOADED
IMÁN RETRÁCTIL

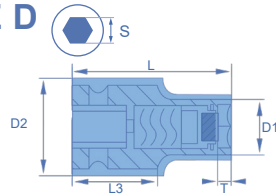

1/4"



MAGNETIC	S	L	D1	D2	L3	T
R2307HRM/TEF	7	50	14	16	13	3
R2308HRM/TEF	8	50	15	16	13	4
R2309HRM/TEF	9	50	17	16	13	4,5
R2310HRM/TEF	10	50	18	16	7	5
R2311HRM/TEF	11	50	19	16	7	5
R2312HRM/TEF	12	50	20	16	7	6
R2313HRM/TEF	13	50	22	16	7	6

DOUBLE-HEXAGON
BIHEXAGONAL

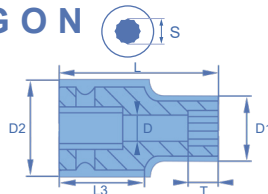

1/4"

1/4"

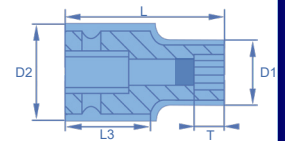

#	S	L	D1	D2	ØD	L3	T
R2306BH/TEF	6	25	13	16	5	13	5
R2307BH/TEF	7	25	15	16	5	13	5
R2308BH/TEF	8	25	15,5	16	6	13	5
R2309BH/TEF	9	25	17	16	7	7	5
R2310BH/TEF	10	25	18	16	8	7	6

MAGNETIC	S	L	D1	D2	L3	T
R2306BHM/TEF	6	25	13	16	13	2,4
R2307BHM/TEF	7	25	15	16	13	2,8
R2308BHM/TEF	8	25	15,5	16	13	3,5
R2309BHM/TEF	9	25	17	16	7	3,5
R2310BHM/TEF	10	25	18	16	7	4

FAST LEAD
ENCARE RÁPIDO

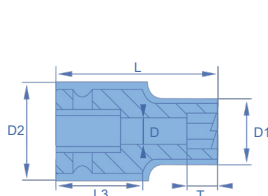

1/4"

1/4"

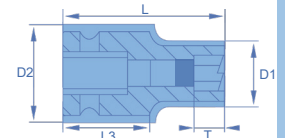

#	S	L	D1	D2	ØD	L3	T
R2306HER/TEF	6	25	13	16	5	13	5
R2307HER/TEF	7	25	15	16	5	13	5
R2308HER/TEF	8	25	15,5	16	6	13	5
R2309HER/TEF	9	25	17	16	7	7	6
R2310HER/TEF	10	25	18	16	8	7	6

MAGNETIC	S	L	D1	D2	L3	T
R2306HERM/TEF	6	25	13	16	13	2,4
R2307HERM/TEF	7	25	15	16	13	2,8
R2308HERM/TEF	8	25	15,5	16	13	3,5
R2309HERM/TEF	9	25	17	16	7	3,5
R2310HERM/TEF	10	25	18	16	7	4

TORX
TORX

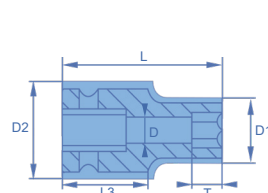

1/4"

1/4"

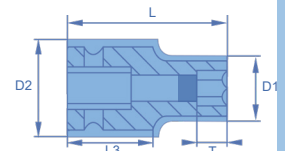

#	S	L	D1	D2	ØD	L3	T
RE4/TEF	E4	25	9	16	1,5	13	3,6
RE5/TEF	E5	25	10	16	2	13	4,5
RE6/TEF	E6	25	11,5	16	3	13	4,5
RE7/TEF	E7	25	12,5	16	4	13	6
RE8/TEF	E8	25	13	16	4	13	6
RE10/TEF	E10	25	17	16	4,5	13	8
RE12/TEF	E12	25	18,9	16	6	13	8,5

MAGNETIC	S	L	D1	D2	L3	T
RE4M/TEF	E4	25	9	16	13	2
RE5M/TEF	E5	25	10	16	13	2
RE6M/TEF	E6	25	11,5	16	13	2,4
RE7M/TEF	E7	25	12,5	16	13	2,8
RE8M/TEF	E8	25	13	16	13	3,5
RE10M/TEF	E10	25	17	16	13	4
RE12M/TEF	E12	25	18,9	16	13	5

PROTECTED

SOCKET HEX MALE
EMBOCADURA HEX MACHO



1 / 4 "

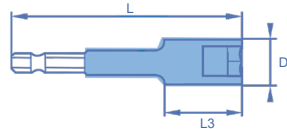

1 / 4 "

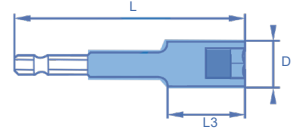

#	S	L	D	MAGNETIC	S	L	D
2004VPC/TEF	4	50	12	2004VPCM/TEF	4	50	12
2005VPC/TEF	5	50	12	2005VPCM/TEF	5	50	12
2006VPC/TEF	6	50	13	2006VPCM/TEF	6	50	13
2007VPC/TEF	7	50	15	2007VPCM/TEF	7	50	15
2008VPC/TEF	8	50	15,5	2008VPCM/TEF	8	50	15,5
2009VPC/TEF	9	50	17	2009VPCM/TEF	9	50	17
2010VPC/TEF	10	50	17,5	2010VPCM/TEF	10	50	17,5
2011VPC/TEF	11	50	21	2011VPCM/TEF	11	50	21
2013VPC/TEF	13	50	22	2013VPCM/TEF	13	50	22
2004VP/TEF	4	70	12	2004VPM/TEF	4	70	12
2005VP/TEF	5	70	13	2005VPM/TEF	5	70	13
2005.5VP/TEF	5,5	70	13	2005.5VPM/TEF	5,5	70	13
2006VP/TEF	6	70	14	2006VPM/TEF	6	70	14
2007VP/TEF	7	70	16	2007VPM/TEF	7	70	16
2008VP/TEF	8	70	17	2008VPM/TEF	8	70	17
2009VP/TEF	9	70	18	2009VPM/TEF	9	70	18
2010VP/TEF	10	70	19	2010VPM/TEF	10	70	19
2011VP/TEF	11	70	21	2011VPM/TEF	11	70	21
2012VP/TEF	12	70	22	2012VPM/TEF	12	70	22
2013VP/TEF	13	70	22	2013VPM/TEF	13	70	22
2014VP/TEF	14	70	24	2014VPM/TEF	14	70	24
2015VP/TEF	15	70	32	2015VPM/TEF	15	70	32
2016VP/TEF	16	70	32	2016VPM/TEF	16	70	32
20-5/16VP/TEF	5/16	80	16	20-5/16VPM/TEF	5/16	80	16
2007VP/100/TEF	7	100	15	2007VPM/100/TEF	7	100	16
2008VP/100/TEF	8	100	16	2008VPM/100/TEF	8	100	17
2010VP/100/TEF	10	100	18	2010VPM/100/TEF	10	100	19
2013VP/100/TEF	13	100	22	2013VPM/100/TEF	13	100	22

SOCKET HEX MALE FOR DIFFICULT ACCESS
EMBOCADURA HEX MACHO ACCESOS DIFÍCILES



1 / 4 "

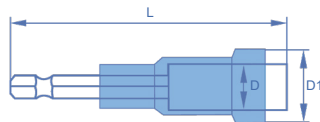

#	S	L	D	D1
2007VP/TEFSP	7	70	12	16,5
2007VP/100/TEFSP	7	100	12	16,5
2008VP/TEFSP	8	70	13	17,5
2008VP/100/TEFSP	8	100	13	17,5
2010VP/100/TEFSP	10	100	15	19,5
2010VP/150/TEFSP	10	150	15	19,5
2013VP/100/TEFSP	13	100	17	21,5

WITH BALL RETAINER
EMBOCADURA HEX MACHO



1/4"

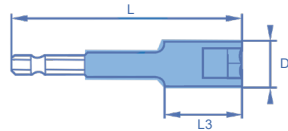

1/4"

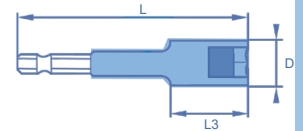

#	S	L	D	MAGNETIC	S	L	D
2004VPCJ/TEF	4	50	11	2004VPCJM/TEF	4	50	11
2005VPCJ/TEF	5	50	11	2005VPCJM/TEF	5	50	11
2006VPCJ/TEF	6	50	15	2006VPCJM/TEF	6	50	15
2007VPCJ/TEF	7	50	14	2007VPCJM/TEF	7	50	14
2008VPCJ/TEF	8	50	22	2008VPCJM/TEF	8	50	22
2009VPCJ/TEF	9	50	17	2009VPCJM/TEF	9	50	17
2010VPCJ/TEF	10	50	19	2010VPCJM/TEF	10	50	19
2013VPCJ/TEF	13	50	21	2013VPCJM/TEF	13	50	21
2014VPCJ/TEF	14	50	23	2014VPCJM/TEF	14	50	23

SPRING LOADED
IMÁN RETRÁCTIL



1/4"

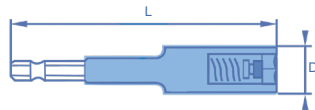

MAGNETIC	S	L	D
R8MM75/TEF	8	75	15,5
R8MM150/TEF	8	150	16
R8MM200/TEF	8	200	16
R10MM75/TEF	10	75	17,5
R10MM100/TEF	10	100	17,5
R10MM200/TEF	10	200	17,5
R10MM300/TEF	10	300	17,5
R12MM300/TEF	12	300	21



3 / 8 "

HEXAGON (SHORT)
HEXAGONAL (CORTA)



3 / 8 "

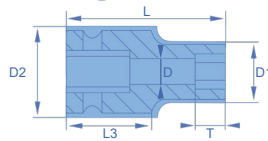

3 / 8 "

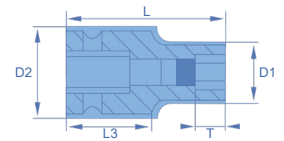

#	S	L	D1	D2	ØD	L3	T	MAGNETIC	S	L	D1	D2	L3	T
J2306HC/TEF	6	26	14,5	22	5	18	3	J2306HCM/TEF	6	26	14,5	22	18	2,4
J2307HC/TEF	7	26	16,5	22	5	18	5	J2307HCM/TEF	7	26	16,5	22	18	2,8
J2308HC/TEF	8	26	19,8	22	6	18	6	J2308HCM/TEF	8	26	19,8	22	18	3,5
J2310HC/TEF	10	26	18,6	22	8	18	6	J2310HCM/TEF	10	26	18,6	22	18	4
J2311HC/TEF	11	26	20,5	22	9	18	7	J2311HCM/TEF	11	26	20,5	22	18	5
J2312HC/TEF	12	26	22	22	10	18	7	J2312HCM/TEF	12	26	22	22	18	5
J2313HC/TEF	13	26	23	22	11	18	8	J2313HCM/TEF	13	26	23	22	18	5,5
J2314HC/TEF	14	26	24,3	25	12	18	6,5	J2314HCM/TEF	14	26	24,3	25	18	6
J2315HC/TEF	15	26	25	25	13	10	7,5	J2315HCM/TEF	15	26	25	25	10	6
J2316HC/TEF	16	26	26,8	25	14	10	9	J2316HCM/TEF	16	26	26,8	25	10	6
J2317HC/TEF	17	26	28	25	15	10	10	J2317HCM/TEF	17	26	28	25	10	7
J2319HC/TEF	19	26	28	25	16	10	12	J2319HCM/TEF	19	26	28	25	10	9
J2321HC/TEF	21	26	34	25	17	10	13	J2321HCM/TEF	21	26	34	25	10	10

HEXAGON
HEXAGONAL



3 / 8 "

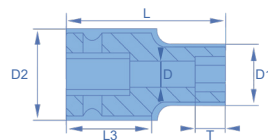

3 / 8 "

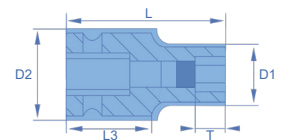

#	S	L	D1	D2	ØD	L3	T	MAGNETIC	S	L	D1	D2	L3	T
J2306H/TEF	6	34	14	22,5	5	10	5	J2306HM/TEF	6	34	14	22,5	10	2,4
J2307H/TEF	7	34	16,5	22,5	5	10	5	J2307HM/TEF	7	34	16,5	22,5	10	2,8
J2308H/TEF	8	34	17,8	22,5	6	10	5	J2308HM/TEF	8	34	17,8	22,5	10	3,5
J2309H/TEF	9	34	19	22,5	7	10	6	J2309HM/TEF	9	34	19	22,5	10	3,5
J2310H/TEF	10	34	19,8	22,5	8	10	6	J2310HM/TEF	10	34	19,8	22,5	10	4
J2311H/TEF	11	34	21,5	22,5	9	10	7	J2311HM/TEF	11	34	21,5	22,5	10	5
J2312H/TEF	12	34	22,6	22,5	10	10	7	J2312HM/TEF	12	34	22,6	22,5	10	5
J2313H/TEF	13	34	24	22,5	11	10	8	J2313HM/TEF	13	34	24	22,5	10	5,5
J2314H/TEF	14	34	25	25	12	10	8	J2314HM/TEF	14	34	25	25	10	6
J2315H/TEF	15	34	26	25	13	10	9	J2315HM/TEF	15	34	26	25	10	6
J2316H/TEF	16	34	27,8	25	14	10	9	J2316HM/TEF	16	34	27,8	25	10	6
J2317H/TEF	17	34	29	25	15	10	10	J2317HM/TEF	17	34	29	25	10	7
J2318H/TEF	18	34	30	25	16	10	10	J2318HM/TEF	18	34	30	25	10	7
J2319H/TEF	19	34	31	25	17	10	12	J2319HM/TEF	19	34	31	25	10	8
J2321H/TEF	21	34	34	25	18	10	12	J2321HM/TEF	21	34	34	25	10	8,5
J2322H/TEF	22	34	36	25	19	10	12	J2322HM/TEF	22	34	36	25	10	9
J2323H/TEF	23	34	38	25	20	10	12							
J2324H/TEF	24	34	39	25	21	10	15							

HEXAGON (LONG)
HEXAGONAL (LARGA)



3 / 8 "

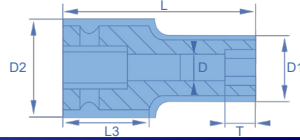

3 / 8 "

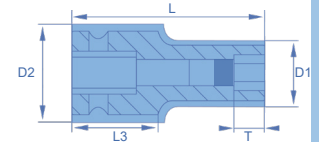

#	S	L	D1	D2	ØD	L3	T	MAGNETIC	S	L	D1	D2	L3	T
J2306HL/TEF	6	50	15	22,5	6	18	5	J2306HLM/TEF	6	50	15	22,5	18	2,4
J2307HL/TEF	7	50	16	22,5	6	18	6	J2307HLM/TEF	7	50	16	22,5	18	2,8
J2308HL/TEF	8	50	17,3	22,5	6	18	6	J2308HLM/TEF	8	50	17,3	22,5	18	3,5
J2309HL/TEF	9	50	18,5	22,5	7	18	7	J2309HLM/TEF	9	50	18,5	22,5	18	3,5
J2310HL/TEF	10	50	19	22,5	8	18	7	J2310HLM/TEF	10	50	19	22,5	18	4
J2311HL/TEF	11	50	21	22,5	9	18	8	J2311HLM/TEF	11	50	21	22,5	18	5
J2312HL/TEF	12	50	22,5	22,5	10	18	9	J2312HLM/TEF	12	50	22,5	22,5	18	5
J2313HL/TEF	13	50	23,5	25,5	11	18	9	J2313HLM/TEF	13	50	23,5	25,5	18	5,5
J2314HL/TEF	14	50	24,8	25,5	12	18	12	J2314HLM/TEF	14	50	24,8	25,5	18	6
J2315HL/TEF	15	50	25,5	25,5	13	10	13	J2315HLM/TEF	15	50	25,5	25,5	10	6
J2316HL/TEF	16	50	27	25,5	14	10	14	J2316HLM/TEF	16	50	27	25,5	10	6
J2317HL/TEF	17	50	28,5	25,5	15	10	14	J2317HLM/TEF	17	50	28,5	25,5	10	7
J2318HL/TEF	18	50	29,5	25,5	16	10	14	J2318HLM/TEF	18	50	29,5	25,5	10	7
J2319HL/TEF	19	50	31	25,5	17	10	14	J2319HLM/TEF	19	50	31	25,5	10	8
J2321HL/TEF	21	50	33,5	25,5	18	10	14	J2321HLM/TEF	21	50	33,5	25,5	10	8,5
J2322HL/TEF	22	50	35,5	25,5	19	10	14	J2322HLM/TEF	22	50	35,5	25,5	10	9
J2323HL/TEF	23	50	37,5	25,5	20	10	14	J2323HLM/TEF	23	50	37,5	25,5	10	9,5
J2324HL/TEF	24	50	38,5	25,5	21	10	14	J2324HLM/TEF	24	50	38,5	25,5	10	10
J2327HL/TEF	27	50	41	25,5	24	10	15							

HEXAGON (EXTRA-LONG)
HEXAGONAL (EXTRA-LARGA)



3 / 8 "

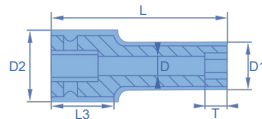

3 / 8 "

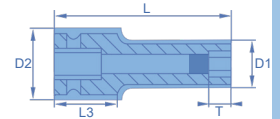

#	S	L	D1	D2	ØD	L3	T	MAGNETIC	S	L	D1	D2	L3	T
J2307HXL/TEF	7	90	16	22,5	6	18	5	J2307HXLM/TEF	7	90	16	22,5	18	2,8
J2308HXL/TEF	8	90	17,3	22,5	6	18	6	J2308HXLM/TEF	8	90	17,3	22,5	18	3,5
J2309HXL/TEF	9	90	18,5	22,5	6	18	6	J2309HXLM/TEF	9	90	18,5	22,5	18	3,5
J2310HXL/TEF	10	90	19,5	22,5	7	18	7	J2310HXLM/TEF	10	90	19,5	22,5	18	4
J2311HXL/TEF	11	90	21	22,5	8	18	7	J2311HXLM/TEF	11	90	21	22,5	18	5
J2312HXL/TEF	12	90	22,5	22,5	9	18	8	J2312HXLM/TEF	12	90	22,5	22,5	18	5
J2313HXL/TEF	13	90	23,5	25,5	10	18	14	J2313HXLM/TEF	13	90	23,5	25,5	18	11
J2314HXL/TEF	14	90	24,8	25,5	11	18	14	J2314HXLM/TEF	14	90	24,8	25,5	18	11
J2315HXL/TEF	15	90	25,5	25,5	12	18	15	J2315HXLM/TEF	15	90	25,5	25,5	10	12
J2316HXL/TEF	16	90	27,3	25,5	13	10	15	J2316HXLM/TEF	16	90	27,3	25,5	10	12
J2317HXL/TEF	17	90	28,5	25,5	14	10	15	J2317HXLM/TEF	17	90	28,5	25,5	10	12
J2318HXL/TEF	18	90	29,5	25,5	15	10	16	J2318HXLM/TEF	18	90	29,5	25,5	10	13
J2319HXL/TEF	19	90	31	25,5	16	10	16	J2319HXLM/TEF	19	90	31	25,5	10	13
J2321HXL/TEF	21	90	33,5	25,5	17	10	16	J2321HXLM/TEF	21	90	33,5	25,5	10	13
J2322HXL/TEF	22	90	35,5	25,5	18	10	16	J2322HXLM/TEF	22	90	35,5	25,5	10	13



3 / 8 "

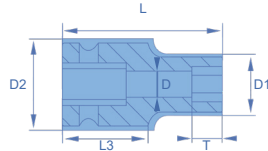

3 / 8 "

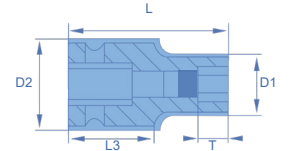

#	S	L	D1	D2	ØD	L3	T
J23-1/4H/TEF	1/4	34	13	22	6	16	5
J23-5/16H/TEF	5/16	34	15,7	22	6	16	6
J23-3/8H/TEF	3/8	34	17,5	22	7	16	6
J23-7/16H/TEF	7/16	34	20,4	22	9	16	7
J23-1/2H/TEF	1/2	34	23,6	25	10	16	8
J23-3/4H/TEF	3/4	34	29,9	25	17	10	11

MAGNETIC	S	L	D1	D2	L3	T
J23-1/4HM/TEF	1/4	34	13	22	16	3
J23-5/16HM/TEF	5/16	34	15,7	22	16	4
J23-3/8HM/TEF	3/8	34	17,5	22	16	4
J23-7/16HM/TEF	7/16	34	20,4	22	16	5
J23-1/2HM/TEF	1/2	34	23,6	25	16	6
J23-3/4HM/TEF	3/4	34	29,9	25	10	8

SPRING LOADED
IMÁN RETRÁCTIL



3 / 8 "

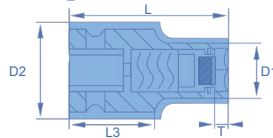

MAGNETIC	S	L	D1	D2	L3	T
J2307HRM/TEF	7	50	16	22,5	18	2,85
J2308HRM/TEF	8	50	17	22,5	18	2,85
J2309HRM/TEF	9	50	19	22,5	18	2,85
J2310HRM/TEF	10	50	20	22,5	18	3,3
J2311HRM/TEF	11	50	21,5	22,5	18	3,3
J2312HRM/TEF	12	50	22	22,5	18	4,9
J2313HRM/TEF	13	50	24	25,5	18	4,9
J2314HRM/TEF	14	50	25	25,5	18	5,3
J2315HRM/TEF	15	50	26,5	25,5	10	5,3
J2316HRM/TEF	16	50	27,8	25,5	10	6
J2317HRM/TEF	17	50	29	25,5	10	6



DOUBLE-HEXAGON
BIHEXAGONAL



3 / 8 "

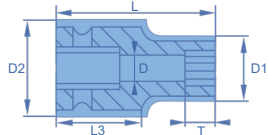

3 / 8 "

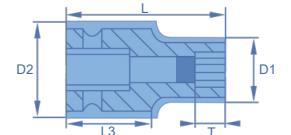

#	S	L	D1	D2	ØD	L3	T
J2307BH/TEF	7	34	16	22,5	5	18	3,5
J2308BH/TEF	8	34	17,3	22,5	6	18	4
J2309BH/TEF	9	34	18,5	22,5	7	18	4,5
J2310BH/TEF	10	34	19,8	22,5	8	18	6,3
J2311BH/TEF	11	34	21	22,5	9	18	7,6
J2312BH/TEF	12	34	22,5	22,5	10	18	8
J2313BH/TEF	13	34	23,5	25,5	11	18	8
J2314BH/TEF	14	34	24,8	25,5	12	18	8
J2315BH/TEF	15	34	25,5	25,5	13	10	9
J2316BH/TEF	16	34	27,3	25,5	14	10	9
J2317BH/TEF	17	34	28,5	25,5	15	10	9,5
J2318BH/TEF	18	34	29,5	25,5	16	10	9,5

MAGNETIC	S	L	D1	D2	L3	T
J2307BHM/TEF	7	34	16	22,5	18	2,8
J2308BHM/TEF	8	34	17,3	22,5	18	3
J2309BHM/TEF	9	34	18,5	22,5	18	3,5
J2310BHM/TEF	10	34	19,8	22,5	18	4
J2311BHM/TEF	11	34	21	22,5	18	5
J2312BHM/TEF	12	34	22,5	22,5	18	5
J2313BHM/TEF	13	34	23,5	25,5	18	6
J2314BHM/TEF	14	34	24,8	25,5	18	6
J2315BHM/TEF	15	34	25,5	25,5	10	7
J2316BHM/TEF	16	34	27,3	25,5	10	7
J2317BHM/TEF	17	34	28,5	25,5	10	7,5
J2318BHM/TEF	18	34	29,5	25,5	10	7,5

FAST LEAD
ENCARE RÁPIDO



3/8"

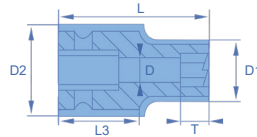

3/8"

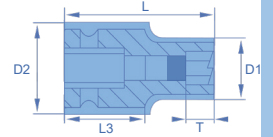

#	S	L	D1	D2	ØD	L3	T	MAGNETIC	S	L	D1	D2	L3	T
J2308HER/TEF	8	34	17,3	22,5	6	18	5	J2308HERM/TEF	8	34	17,3	22,5	18	3,5
J2309HER/TEF	9	34	18,5	22,5	7	18	6	J2309HERM/TEF	9	34	18,5	22,5	18	3,5
J2310HER/TEF	10	34	19,8	22,5	8	18	6	J2310HERM/TEF	10	34	19,8	22,5	18	4
J2311HER/TEF	11	34	21	22,5	9	18	7	J2311HERM/TEF	11	34	21	22,5	18	5
J2312HER/TEF	12	34	22,5	22,5	10	18	7	J2312HERM/TEF	12	34	22,5	22,5	18	5
J2313HER/TEF	13	34	23,5	25,5	11	18	8	J2313HERM/TEF	13	34	23,5	25,5	18	5,5
J2314HER/TEF	14	34	24,8	25,5	12	18	8	J2314HERM/TEF	14	34	24,8	25,5	18	6
J2315HER/TEF	15	34	25,5	25,5	13	10	9	J2315HERM/TEF	15	34	25,5	25,5	18	6
J2316HER/TEF	16	34	27,3	25,5	14	10	9	J2316HERM/TEF	16	34	27,3	25,5	10	6
J2317HER/TEF	17	34	28,5	25,5	15	10	10	J2317HERM/TEF	17	34	28,5	25,5	10	7
J2318HER/TEF	18	34	29,5	25,5	16	10	11	J2318HERM/TEF	18	34	29,5	25,5	10	8
J2319HER/TEF	19	34	31	25,5	17	10	12	J2319HERM/TEF	19	34	31	25,5	10	8
J2321HER/TEF	21	34	33,5	25,5	18	10	13	J2321HERM/TEF	21	34	33,5	25,5	10	9,5

SURFACE DRIVE
SURFACE DRIVE



3/8"

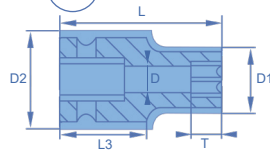

3/8"

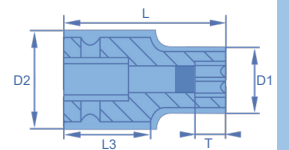

#	S	L	D1	D2	ØD	L3	T	MAGNETIC	S	L	D1	D2	L3	T
J2307SD/TEF	7	34	16	22,5	6	18	5	J2307SDM/TEF	7	34	17,3	22,5	18	2,8
J2308SD/TEF	8	34	17,3	22,5	6	18	5	J2308SDM/TEF	8	34	18,5	22,5	18	3,5
J2309SD/TEF	9	34	18,5	22,5	7	18	6	J2309SDM/TEF	9	34	19,8	22,5	18	3,5
J2310SD/TEF	10	34	19,8	22,5	8	18	6,3	J2310SDM/TEF	10	34	21	22,5	18	4,3
J2311SD/TEF	11	34	21	22,5	9	18	7	J2311SDM/TEF	11	34	22,5	22,5	18	5
J2312SD/TEF	12	34	22,5	25,5	10	18	7	J2312SDM/TEF	12	34	23,5	25,5	18	5
J2313SD/TEF	13	34	23,5	25,5	11	18	8	J2313SDM/TEF	13	34	24,8	25,5	18	5,5
J2314SD/TEF	14	34	24,8	25,5	12	18	8	J2314SDM/TEF	14	34	25,5	25,5	18	6
J2315SD/TEF	15	34	25,5	25,5	13	10	9	J2315SDM/TEF	15	34	27,3	25,5	10	6
J2316SD/TEF	16	34	27,3	25,5	14	10	9	J2316SDM/TEF	16	34	28,5	25,5	10	6
J2317SD/TEF	17	34	28,5	25,5	15	10	10	J2317SDM/TEF	17	34	29,5	25,5	10	7
J2318SD/TEF	18	34	29,5	25,5	16	10	10	J2318SDM/TEF	18	34	31	25,5	10	7
J2319SD/TEF	19	34	31	25,5	17	10	10	J2319SDM/TEF	19	34	33,5	25,5	10	7



3 / 8 "

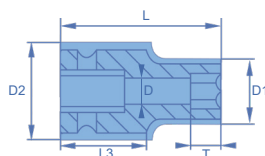

3 / 8 "

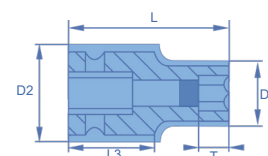

#	S	L	D1	D2	ØD	L3	T
JE5/TEF	E5	30	11	22,5	-	18	4,2
JE6/TEF	E6	30	12,3	22,5	-	18	5,3
JE7/TEF	E7	30	15,5	22,5	-	18	6,8
JE8/TEF	E8	30	14,8	22,5	4	18	6
JE10/TEF	E10	37,5	16	22,5	5	18	8,5
JE12/TEF	E12	37,5	17,5	22,5	7	18	8,5
JE14/TEF	E14	37,5	18,5	22,5	8	18	12,2

MAGNETIC	S	L	D1	D2	L3	T
JE8M/TEF	E8	30	14,8	22,5	18	3,5
JE10M/TEF	E10	37,5	16	22,5	18	4
JE12M/TEF	E12	37,5	17,5	22,5	18	5
JE14M/TEF	E14	37,5	18,5	22,5	18	6

1 / 2 "



1 / 2 "

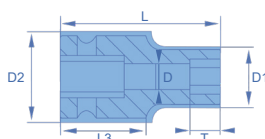

1 / 2 "

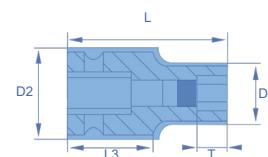

#	S	L	D1	D2	ØD	L3	T
S2308H/TEF	8	38	18,5	28,5	6	20	5
S2309H/TEF	9	38	19,5	28,5	7	20	6
S2310H/TEF	10	38	20,5	28,5	8	20	7
S2311H/TEF	11	38	22	28,5	9	20	8,6
S2312H/TEF	12	38	23,5	28,5	10	20	9
S2313H/TEF	13	38	24,5	28,5	11	20	9,4
S2314H/TEF	14	38	26	28,5	12	20	7,6
S2315H/TEF	15	38	26,5	33,5	13	20	8
S2316H/TEF	16	38	28,5	33,5	14	20	9,2
S2317H/TEF	17	38	29,5	33,5	15	20	10
S2318H/TEF	18	38	31	33,5	16	20	11
S2319H/TEF	19	38	32	33,5	17	20	13,8
S2320H/TEF	20	38	33,5	33,5	18	13	12
S2321H/TEF	21	38	34,5	33,5	18	13	12,4
S2322H/TEF	22	38	36	33,5	19	13	12,7
S2323H/TEF	23	38	37,5	33,5	20	13	12,7
S2324H/TEF	24	38	38,5	33,5	21	13	19
S2325H/TEF	25	45	39,5	33,5	22	13	17
S2326H/TEF	26	45	41	33,5	23	13	19
S2327H/TEF	27	45	42	33,5	23	13	20,6
S2328H/TEF	28	47	43,5	33,5	24	13	22
S2329H/TEF	29	47	44,5	33,5	25	13	20
S2330H/TEF	30	50	45,5	33,5	25	13	21,5

MAGNETIC	S	L	D1	D2	L3	T
S2308HM/TEF	8	38	18,5	28,5	20	5
S2309HM/TEF	9	38	19,5	28,5	20	3,5
S2310HM/TEF	10	38	20,5	28,5	20	4
S2311HM/TEF	11	38	22	28,5	20	5
S2312HM/TEF	12	38	23,5	28,5	20	5
S2313HM/TEF	13	38	24,5	28,5	20	5,5
S2314HM/TEF	14	38	26	28,5	20	6
S2315HM/TEF	15	38	26,5	33,5	20	6
S2316HM/TEF	16	38	28,5	33,5	20	6
S2317HM/TEF	17	38	29,5	33,5	20	7
S2318HM/TEF	18	38	31	33,5	20	7
S2319HM/TEF	19	38	32	33,5	20	8
S2320HM/TEF	20	38	33,5	33,5	13	8,5
S2321HM/TEF	21	38	34,5	33,5	13	8,5
S2322HM/TEF	22	38	36	33,5	13	9
S2323HM/TEF	23	38	37,5	33,5	13	9,5

HEXAGON (LONG)
HEXAGONAL (LARGA)



1/2"

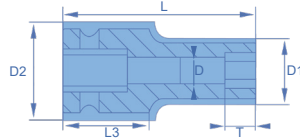

1/2"

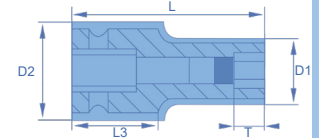

#	S	L	D1	D2	ØD	L3	T
S2310HJL/TEF	10	50	20,5	28,5	8	20	6
S2311HJL/TEF	11	50	22	28,5	9	20	7
S2312HJL/TEF	12	50	23,5	28,5	10	20	7
S2313HJL/TEF	13	50	24,5	28,5	11	20	8
S2314HJL/TEF	14	50	26	28,5	12	20	9
S2315HJL/TEF	15	50	26,5	33,5	13	20	9
S2316HJL/TEF	16	50	28,5	33,5	14	20	10
S2317HJL/TEF	17	50	29,5	33,5	15	20	11
S2318HJL/TEF	18	50	31	33,5	16	20	12
S2319HJL/TEF	19	50	32	33,5	17	20	13
S2320HJL/TEF	20	50	33,5	33,5	18	13	13
S2321HJL/TEF	21	50	34,5	33,5	18	13	13,7
S2322HJL/TEF	22	50	36	33,5	19	13	14
S2323HJL/TEF	23	50	37,5	33,5	20	13	15
S2324HJL/TEF	24	50	38,5	33,5	21	13	17
S2332HJL/TEF	32	50	47,5	33,5	26	13	22

MAGNETIC	S	L	D1	D2	L3	T
S2310HJLM/TEF	10	50	20,5	28,5	20	4
S2311HJLM/TEF	11	50	22	28,5	20	5
S2312HJLM/TEF	12	50	23,5	28,5	20	5
S2313HJLM/TEF	13	50	24,5	28,5	20	5,5
S2314HJLM/TEF	14	50	26	28,5	20	6
S2315HJLM/TEF	15	50	26,5	33,5	20	6
S2316HJLM/TEF	16	50	28,5	33,5	20	6
S2317HJLM/TEF	17	50	29,5	33,5	20	7
S2318HJLM/TEF	18	50	31	33,5	20	7
S2319HJLM/TEF	19	50	32	33,5	20	8
S2320HJLM/TEF	20	50	33,5	33,5	13	8,5
S2321HJLM/TEF	21	50	34,5	33,5	13	8,5
S2322HJLM/TEF	22	50	36	33,5	13	9

HEXAGON (EXTRA-LONG)
HEXAGONAL (EXTRA-LARGA)



1/2"

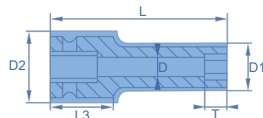

1/2"

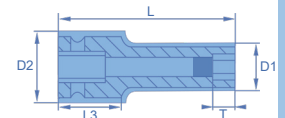

#	S	L	D1	D2	ØD	L3	T
S2308HL/TEF	8	80	18,5	28,5	6	25	12
S2309HL/TEF	9	80	19,5	28,5	7	25	12
S2310HL/TEF	10	80	20,5	28,5	8	25	12
S2311HL/TEF	11	80	22	28,5	9	25	15
S2312HL/TEF	12	80	23,5	28,5	10	25	15
S2313HL/TEF	13	80	24,5	28,5	11	25	15
S2314HL/TEF	14	80	26	28,5	12	25	16
S2315HL/TEF	15	80	26,5	33,5	13	25	14
S2316HL/TEF	16	80	28,5	33,5	14	25	14
S2317HL/TEF	17	80	29,5	33,5	15	25	14
S2318HL/TEF	18	80	31	33,5	16	25	17
S2319HL/TEF	19	80	32	33,5	17	25	21
S2320HL/TEF	20	80	33,5	33,5	18	13	19
S2321HL/TEF	21	80	34,5	33,5	18	13	21
S2322HL/TEF	22	80	36	33,5	19	13	21
S2323HL/TEF	23	80	37,5	33,5	20	13	23
S2324HL/TEF	24	80	38,5	33,5	21	13	26
S2325HL/TEF	25	80	39,5	33,5	22	13	27
S2326HL/TEF	26	80	41	33,5	23	13	28
S2327HL/TEF	27	80	42	33,5	23	13	29
S2328HL/TEF	28	80	43,5	33,5	24	13	30
S2329HL/TEF	29	80	44,5	33,5	25	13	31
S2330HL/TEF	30	80	45,5	33,5	25	13	31

MAGNETIC	S	L	D1	D2	L3	T
S2308HLM/TEF	8	80	18,5	28,5	25	5
S2309HLM/TEF	9	80	19,5	28,5	25	5
S2310HLM/TEF	10	80	20,5	28,5	25	6
S2311HLM/TEF	11	80	22	28,5	25	6
S2312HLM/TEF	12	80	23,5	28,5	25	7
S2313HLM/TEF	13	80	24,5	28,5	25	8
S2314HLM/TEF	14	80	26	28,5	25	9
S2315HLM/TEF	15	80	26,5	33,5	25	9
S2316HLM/TEF	16	80	28,5	33,5	25	10
S2317HLM/TEF	17	80	29,5	33,5	25	11
S2318HLM/TEF	18	80	31	33,5	25	12
S2319HLM/TEF	19	80	32	33,5	25	13
S2320HLM/TEF	20	80	33,5	33,5	25	14
S2321HLM/TEF	21	80	34,5	33,5	13	14
S2322HLM/TEF	22	80	36	33,5	13	15



1/2"

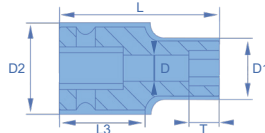

1/2"

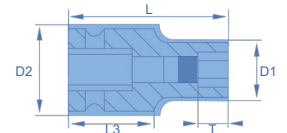

#	S	L	D1	D2	ØD	L3	T
S23-3/8H/TEF	3/8	38	20,5	28,5	7	20	6
S23-7/16H/TEF	7/16	38	22,5	28,5	9	20	7
S23-1/2H/TEF	1/2	38	24,5	28,5	10	20	7
S23-3/4H/TEF	3/4	38	32,5	33,5	17	20	12
S23-15/16H/TEF	15/16	38	38,5	33,5	21	13	15
S23-1H/TEF	1	38	40,5	33,5	22	13	16

MAGNETIC	S	L	D1	D2	L3	T
S23-3/8HM/TEF	3/8	38	20,5	28,5	20	4
S23-7/16HM/TEF	7/16	38	22,5	28,5	20	5
S23-1/2HM/TEF	1/2	38	24,5	28,5	20	5
S23-3/4HM/TEF	3/4	38	32,5	33,5	20	10
S23-15/16HM/TEF	15/16	38	38,5	33,5	13	13
S23-1HM/TEF	1	38	40,5	5	13	14

SPRING LOADED
IMÁN RETRÁCTIL



1/2"

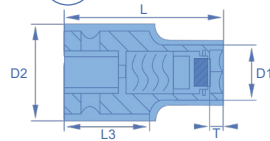

MAGNETIC	S	L	D1	D2	L3	T
S2310HRM/TEF	10	50	20	28	20	6
S2311HRM/TEF	11	50	21,5	28	20	7
S2312HRM/TEF	12	50	23	28	20	7
S2313HRM/TEF	13	50	24	28	20	8
S2314HRM/TEF	14	50	25,5	28	20	8
S2315HRM/TEF	15	50	26	33	20	8
S2316HRM/TEF	16	50	28	33	25	10
S2317HRM/TEF	17	50	29	33	25	11
S2318HRM/TEF	18	50	30,5	33	25	13



DOUBLE-HEXAGON
BIHEXAGONAL



1/2"

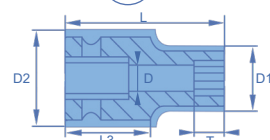

1/2"

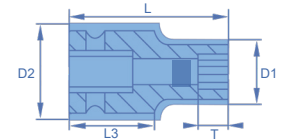

#	S	L	D1	D2	ØD	L3	T
S2308BH/TEF	8	38	18,5	28,5	6	25	5
S2309BH/TEF	9	38	19,5	28,5	7	25	6
S2310BH/TEF	10	38	20,5	28,5	8	25	7
S2311BH/TEF	11	38	22	28,5	9	25	7
S2312BH/TEF	12	38	23,5	28,5	10	25	7
S2313BH/TEF	13	38	24,5	28,5	11	25	8
S2314BH/TEF	14	38	26	28,5	12	25	8,4
S2315BH/TEF	15	38	26,5	33,5	13	25	10
S2316BH/TEF	16	38	28,5	33,5	14	25	10
S2317BH/TEF	17	38	29,5	33,5	15	25	10
S2318BH/TEF	18	38	31	33,5	16	25	12
S2319BH/TEF	19	38	32	33,5	17	25	13
S2320BH/TEF	20	38	33,5	33,5	18	13	13,5
S2321BH/TEF	21	38	34,5	33,5	18	13	14
S2322BH/TEF	22	38	36	33,5	19	13	15
S2323BH/TEF	23	38	37,5	33,5	20	13	16
S2324BH/TEF	24	38	38,5	33,5	21	13	17

MAGNETIC	S	L	D1	D2	L3	T
S2308BHM/TEF	8	38	18,5	28,5	25	3,5
S2309BHM/TEF	9	38	19,5	28,5	25	3,5
S2310BHM/TEF	10	38	20,5	28,5	25	5
S2311BHM/TEF	11	38	22	28,5	25	5
S2312BHM/TEF	12	38	23,5	28,5	25	5
S2313BHM/TEF	13	38	24,5	28,5	25	5,5
S2314BHM/TEF	14	38	26	28,5	25	6
S2315BHM/TEF	15	38	26,5	33,5	25	7
S2316BHM/TEF	16	38	28,5	33,5	25	7
S2317BHM/TEF	17	38	29,5	33,5	25	7
S2318BHM/TEF	18	38	31	33,5	25	9
S2319BHM/TEF	19	38	32	33,5	25	10
S2320BHM/TEF	20	38	33,5	33,5	13	10,5
S2321BHM/TEF	21	38	34,5	33,5	13	11
S2322BHM/TEF	22	38	36	33,5	13	12

FAST LEAD
ENCARE RÁPIDO



1/2"

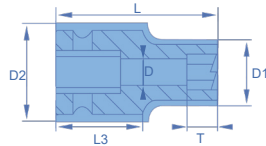

1/2"

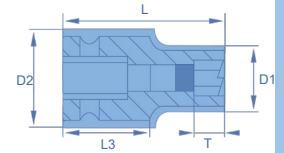

#	S	L	D1	D2	ØD	L3	T
S2310HER/TEF	10	38	20,5	28,5	8	20	7
S2311HER/TEF	11	38	22	28,5	9	20	7
S2312HER/TEF	12	38	23,5	28,5	10	20	8
S2313HER/TEF	13	38	24,5	28,5	11	20	9
S2314HER/TEF	14	38	26	28,5	12	20	9,5
S2315HER/TEF	15	38	26,5	33,5	13	20	10
S2316HER/TEF	16	38	28,5	33,5	14	20	10
S2317HER/TEF	17	38	29,5	33,5	15	20	11
S2318HER/TEF	18	38	31	33,5	16	20	11
S2319HER/TEF	19	38	32	33,5	17	20	14
S2320HER/TEF	20	38	33,5	33,5	18	13	14
S2321HER/TEF	21	38	34,5	33,5	18	13	14
S2322HER/TEF	22	38	36	33,5	19	13	14
S2323HER/TEF	23	38	37,5	33,5	20	13	14
S2324HER/TEF	24	38	38,5	33,5	21	13	17
S2325HER/TEF	25	38	39,5	33,5	22	13	17

MAGNETIC	S	L	D1	D2	L3	T
S2310HERM/TEF	10	38	20,5	28,5	20	5
S2311HERM/TEF	11	38	22	28,5	20	5
S2312HERM/TEF	12	38	23,5	28,5	20	6
S2313HERM/TEF	13	38	24,5	28,5	20	7
S2314HERM/TEF	14	38	26	28,5	20	7,5
S2315HERM/TEF	15	38	26,5	33,5	20	8
S2316HERM/TEF	16	38	28,5	33,5	20	9
S2317HERM/TEF	17	38	29,5	33,5	20	9
S2318HERM/TEF	18	38	31	33,5	20	9
S2319HERM/TEF	19	38	32	33,5	20	10
S2320HERM/TEF	20	38	33,5	33,5	13	10,5
S2321HERM/TEF	21	38	34,5	33,5	13	10,5
S2322HERM/TEF	22	38	36	33,5	13	10,5

SURFACE DRIVE
SURFACE DRIVE



1/2"

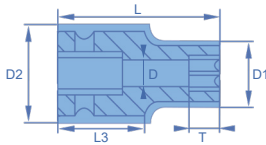

1/2"

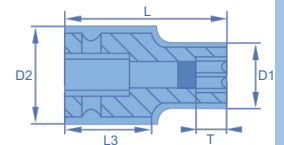

#	S	L	D1	D2	ØD	L3	T
S2310SD/TEF	10	38	20,5	28,5	8	20	7,2
S2311SD/TEF	11	38	22	28,5	9	20	7,3
S2312SD/TEF	12	38	23,5	28,5	10	20	7,5
S2313SD/TEF	13	38	24,5	28,5	11	20	7,6
S2314SD/TEF	14	38	26	28,5	12	20	8,6
S2315SD/TEF	15	38	26,5	33,5	13	20	8,6
S2316SD/TEF	16	38	28,5	33,5	14	20	10,5
S2317SD/TEF	17	38	29,5	33,5	15	20	12
S2318SD/TEF	18	38	31	33,5	16	20	12
S2319SD/TEF	19	38	32	33,5	17	20	12,3
S2320SD/TEF	20	38	33,5	33,5	18	13	12,5
S2321SD/TEF	21	38	34,5	33,5	18	13	12,6
S2322SD/TEF	22	38	36	33,5	20	13	12,7

MAGNETIC	S	L	D1	D2	L3	T
S2310SDM/TEF	10	38	20,5	28,5	20	4
S2311SDM/TEF	11	38	22	28,5	20	5
S2312SDM/TEF	12	38	23,5	28,5	20	5
S2313SDM/TEF	13	38	24,5	28,5	20	5
S2314SDM/TEF	14	38	26	28,5	20	6
S2315SDM/TEF	15	38	26,5	33,5	20	6
S2316SDM/TEF	16	38	28,5	33,5	20	6
S2317SDM/TEF	17	38	29,5	33,5	20	7
S2318SDM/TEF	18	38	31	33,5	20	7
S2319SDM/TEF	19	38	32	33,5	20	8
S2320SDM/TEF	20	38	33,5	33,5	13	8,5
S2321SDM/TEF	21	38	34,5	33,5	13	8,5
S2322SDM/TEF	22	38	36	33,5	13	9



1 / 2 "

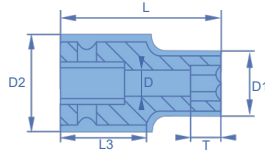

1 / 2 "

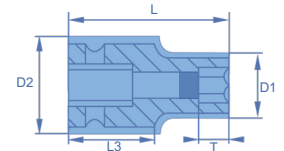

#	S	L	D1	D2	ØD	L3	T	MAGNETIC	S	L	D1	D2	L3	T
SE10/TEF	E10	38	17,5	28,5	5	20	9	SE10M/TEF	E10	38	17,5	28,5	20	7
SE11/TEF	E11	38	18,5	28,5	5	20	9	SE11M/TEF	E11	38	18,5	28,5	20	7
SE12/TEF	E12	38	19,4	28,5	6	20	10	SE12M/TEF	E12	38	19,4	28,5	20	8
SE14/TEF	E14	38	21,2	28,5	7	20	10,2	SE14M/TEF	E14	38	21,2	28,5	20	8,5
SE16/TEF	E16	38	23,5	28,5	8	20	11	SE16M/TEF	E16	38	23,5	28,5	20	9
SE18/TEF	E18	38	25,5	28,5	8	20	11,3	SE18M/TEF	E18	38	25,5	28,5	20	9,5
SE20/TEF	E20	40	28,5	28,5	11	20	15,7	SE20M/TEF	E20	40	28,5	28,5	20	12
SE22/TEF	E22	40	29,5	33,5	11	20	16	SE22M/TEF	E22	40	29,5	33,5	20	13
SE24/TEF	E24	40	33,5	33,5	12	20	16,2	SE24M/TEF	E24	40	33,5	33,5	20	13



1 / 2 "

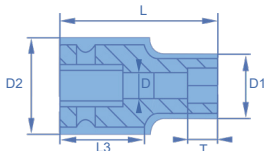

1 / 2 "

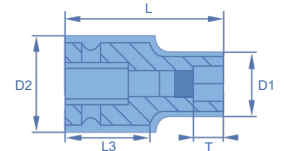

#	S	L	D1	D2	ØD	L3	T	MAGNETIC	S	L	D1	D2	L3	T
S2308SQ/TEF	8	38	22	28,5	6	20	7	S2308SQM/TEF	8	38	18,6	25	20	3
S2310SQ/TEF	10	38	25	28,5	8	20	7,5	S2310SQM/TEF	10	38	21,5	25	20	4
S2312SQ/TEF	12	38	28,5	28,5	10	20	8	S2312SQM/TEF	12	38	25	25	20	5
S2313SQ/TEF	13	38	32,5	28,5	11	20	9	S2313SQM/TEF	13	38	25,7	25	20	5
S2314SQ/TEF	14	38	31	28,5	12	20	9,5	S2314SQM/TEF	14	38	27,5	30	20	5
S2315SQ/TEF	15	38	32,5	28,5	13	20	10,5	S2315SQM/TEF	15	38	29	30	20	6
S2317SQ/TEF	17	38	35,5	28,5	15	13	11,5	S2317SQM/TEF	17	38	32	30	13	7
S2319SQ/TEF	19	38	38,5	33,5	17	13	13,5	S2319SQM/TEF	19	38	35	30	13	8,5
S2322SQ/TEF	22	38	43	33,5	19	13	15	S2322SQM/TEF	22	38	39,2	30	13	9
S2323SQ/TEF	23	38	44,5	30	20	13	15	S2323SQM/TEF	23	38	41	30	13	10



3 / 4 "

HEXAGON
HEXAGONAL



3 / 4 "

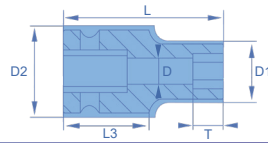

3 / 4 "

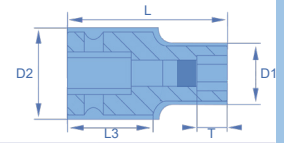

#	S	L	D1	D2	ØD	L3	T
K2315H/TEF	15	50	29,5	41,5	13	30	13
K2316H/TEF	16	50	30,5	47,5	14	24	13
K2317H/TEF	17	51	34,5	47,5	15	24	14
K2318H/TEF	18	51	35,5	47,5	16	24	15
K2319H/TEF	19	51	36	47,5	17	24	15
K2320H/TEF	20	51	37	47,5	18	24	16
K2321H/TEF	21	51	38,5	47,5	18	24	16
K2322H/TEF	22	51	39,5	47,5	19	24	16
K2323H/TEF	23	51	41	47,5	20	24	16
K2324H/TEF	24	51	42	47,5	21	24	16
K2325H/TEF	25	53	43,5	47,5	21	24	18
K2326H/TEF	26	53	44,5	47,5	22	24	18
K2327H/TEF	27	53	46	47,5	23	24	19
K2328H/TEF	28	53	47,5	47,5	24	24	20
K2330H/TEF	30	53	49,5	47,5	25	24	21
K2332H/TEF	32	57	52	47,5	26	24	22
K2336H/TEF	36	57	57	47,5	28	25	25
K2341H/TEF	41	58	63,5	47,5	32	26	25
K2346H/TEF	46	62	69,5	47,5	37	27	25

MAGNETIC	S	L	D1	D2	L3	T
K2315HM/TEF	15	50	29,5	41,5	30	8
K2316HM/TEF	16	50	30,5	47,5	24	8
K2317HM/TEF	17	51	34,5	47,5	24	9
K2318HM/TEF	18	51	35,5	47,5	24	9
K2319HM/TEF	19	51	36	47,5	24	9
K2320HM/TEF	20	51	37	47,5	24	10
K2321HM/TEF	21	51	38,5	47,5	24	10
K2322HM/TEF	22	51	39,5	47,5	24	11
K2323HM/TEF	23	51	41	47,5	24	12
K2324HM/TEF	24	51	42	47,5	24	13
K2325HM/TEF	25	53	43,5	47,5	24	14
K2326HM/TEF	26	53	44,5	47,5	24	14
K2327HM/TEF	27	53	46	47,5	24	15

HEXAGON (LONG)
HEXAGONAL (LARGA)



3 / 4 "

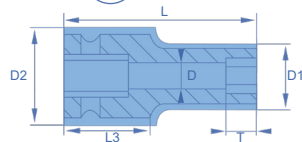

3 / 4 "

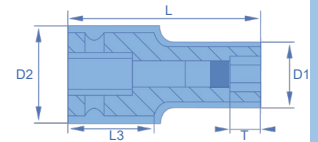

#	S	L	D1	D2	ØD	L3	T
K2315HL/TEF	15	80	29,5	41,5	13	30	11
K2316HL/TEF	16	80	30,5	47,5	14	24	14
K2317HL/TEF	17	80	34,5	47,5	15	24	14
K2318HL/TEF	18	80	35,5	47,5	16	24	14
K2319HL/TEF	19	80	36	47,5	17	24	14
K2320HL/TEF	20	80	37	47,5	18	24	14
K2321HL/TEF	21	80	38,5	47,5	18	24	14
K2322HL/TEF	22	80	39,5	47,5	19	24	14
K2323HL/TEF	23	80	41	47,5	20	24	14
K2324HL/TEF	24	80	42	47,5	21	24	14
K2325HL/TEF	25	80	43,5	47,5	21	24	16
K2326HL/TEF	26	80	44,5	47,5	22	24	16
K2327HL/TEF	27	80	46	47,5	23	24	20
K2328HL/TEF	28	80	47,5	47,5	24	17	20
K2330HL/TEF	30	80	49,5	47,5	25	17	20
K2332HL/TEF	32	80	52	47,5	26	17	21
K2334HL/TEF	34	80	57	47,5	28	17	21
K2336HL/TEF	36	95	60	48	29	17	38

MAGNETIC	S	L	D1	D2	L3	T
K2315HLM/TEF	15	80	29,5	41,5	30	6
K2316HLM/TEF	16	80	30,5	47,5	24	6
K2317HLM/TEF	17	80	34,5	47,5	24	7
K2318HLM/TEF	18	80	35,5	47,5	24	7
K2319HLM/TEF	19	80	36	47,5	24	8
K2320HLM/TEF	20	80	37	47,5	24	8,5
K2321HLM/TEF	21	80	38,5	47,5	24	8,5
K2322HLM/TEF	22	80	39,5	47,5	24	9
K2323HLM/TEF	23	80	41	47,5	24	9,5
K2324HLM/TEF	24	80	42	47,5	24	10
K2325HLM/TEF	25	80	43,5	47,5	24	11
K2326HLM/TEF	26	80	44,5	47,5	24	11
K2327HLM/TEF	27	80	46	47,5	24	12

PROTECTED

FAST LEAD
ENCARE RÁPIDO 

3 / 4 "

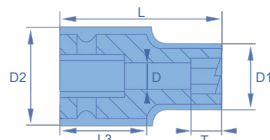

3 / 4 "

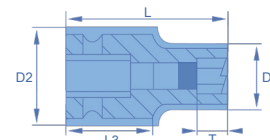

#	S	L	D1	D2	ØD	L3	T	MAGNETIC	S	L	D1	D2	L3	T
K2316HER/TEF	16	51	33,5	47,5	17	30	14	K2316HERM/TEFM	16	51	33,5	47,5	24	7
K2318HER/TEF	18	51	34,5	47,5	16	27	14	K2318HERM/TEFM	18	51	34,5	47,5	24	8
K2321HER/TEF	21	51	38,5	47,5	18	24	15	K2321HERM/TEFM	21	51	38,5	47,5	24	8,5

SURFACE DRIVE
SURFACE DRIVE 

3 / 4 "

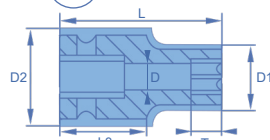

3 / 4 "

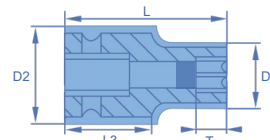

#	S	L	D1	D2	ØD	L3	T	MAGNETIC	S	L	D1	D2	L3	T
K2318SD/TEF	18	51	35,5	47,5	16	24	14	K2318SDM/TEF	18	51	35,5	47,5	24	7
K2319SD/TEF	19	50	36,5	47,5	17	24	14	K2319SDM/TEF	19	50	36,5	47,5	24	8
K2321SD/TEF	21	50	38,5	47,5	19	24	14	K2321SDM/TEF	21	50	38,5	47,5	24	8,5







ADAPTERS & EXTENSIONS

ADAPTADORES Y EXTENSIONES

We offer a wide variety of extensions and adapters to suit your needs. With different types of retention and lengths.

If you have a specific length or access requirements, please contact us to find a solution.

Ofrecemos una amplia variedad de extensiones y adaptadores que se adaptan a sus necesidades.

Con distintos tipos de retención y longitudes. Si tiene necesidades específicas de longitud o acceso, póngase en contacto con nosotros para encontrar una solución.

05

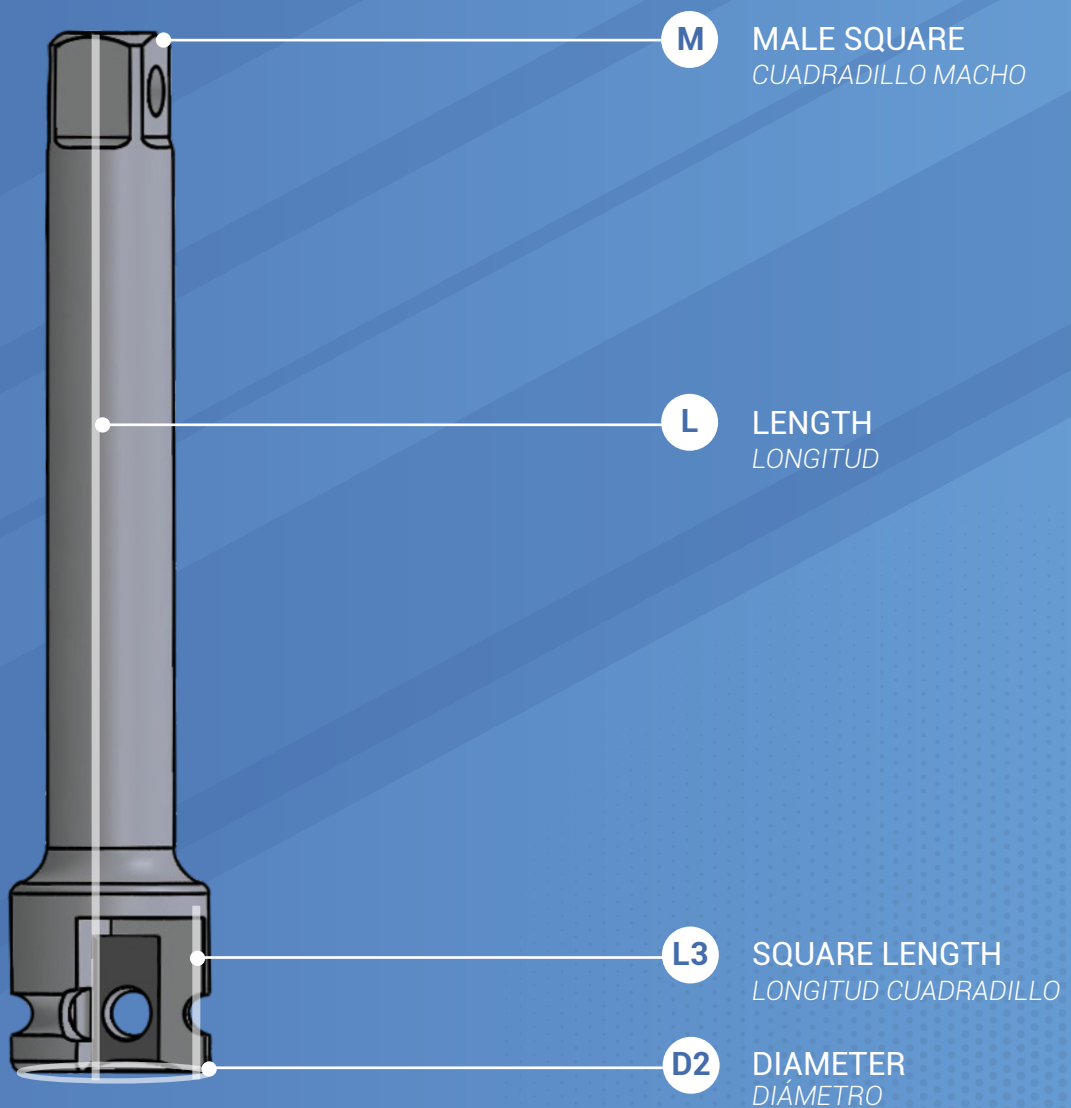



ADAPTER HEX TO SQUARE DRIVE

ADAPTADORES HEX A CUADRADILLO

1/4"

BALL BOLA

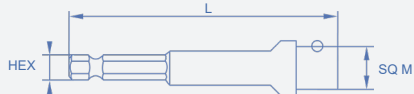

PIN PIN

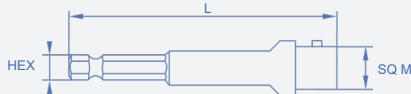

HOLE PASANTE

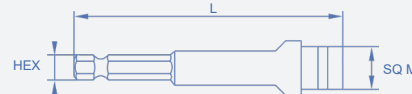

#	L	HEX	SQ M	#	L	HEX	SQ M	#	L	HEX	SQ M
2520/2A	50	1/4	1/4	2520/2B	50	1/4	1/4	2520/2C	50	1/4	1/4
2520/3A	75	1/4	1/4	2520/3B	75	1/4	1/4	2520/3C	75	1/4	1/4
2520/4A	100	1/4	1/4	2520/4B	100	1/4	1/4	2520/4C	100	1/4	1/4
2520/5A	125	1/4	1/4	2520/5B	125	1/4	1/4	2520/5C	125	1/4	1/4
2520/6A	150	1/4	1/4	2520/6B	150	1/4	1/4	2520/6C	150	1/4	1/4
2520/8A	200	1/4	1/4	2520/8B	200	1/4	1/4	2520/8C	200	1/4	1/4
2520/10A	250	1/4	1/4	2520/10B	250	1/4	1/4	2520/10C	250	1/4	1/4
2520/12A	300	1/4	1/4	2520/12B	300	1/4	1/4	2520/12C	300	1/4	1/4
2521/2A	50	1/4	3/8	2521/2B	50	1/4	3/8	2521/2C	50	1/4	3/8
2521/3A	75	1/4	3/8	2521/3B	75	1/4	3/8	2521/3C	75	1/4	3/8
2521/4A	100	1/4	3/8	2521/4B	100	1/4	3/8	2521/4C	100	1/4	3/8
2521/5A	125	1/4	3/8	2521/5B	125	1/4	3/8	2521/5C	125	1/4	3/8
2521/6A	150	1/4	3/8	2521/6B	150	1/4	3/8	2521/6C	150	1/4	3/8
2521/8A	200	1/4	3/8	2521/8B	200	1/4	3/8	2521/8C	200	1/4	3/8
2521/10A	250	1/4	3/8	2521/10B	250	1/4	3/8	2521/10C	250	1/4	3/8
2528/2A	50	7/16	3/8	2522/2B	50	1/4	1/2	2528/2C	50	7/16	3/8
2528/3A	75	7/16	3/8	2528/2B	50	7/16	3/8	2528/3C	75	7/16	3/8
2528/4A	100	7/16	3/8	2528/3B	75	7/16	3/8	2528/4C	100	7/16	3/8
2528/5A	125	7/16	3/8	2528/4B	100	7/16	3/8	2528/5C	125	7/16	3/8
2529/2A	50	7/16	1/2	2528/5B	125	7/16	3/8	2529/2C	50	7/16	1/2
2529/3A	75	7/16	1/2	2529/2B	50	7/16	1/2	2529/3C	75	7/16	1/2
2529/4A	100	7/16	1/2	2529/3B	75	7/16	1/2	2529/4C	100	7/16	1/2
2529/5A	125	7/16	1/2	2529/4B	100	7/16	1/2	2529/5C	125	7/16	1/2
				2529/5B	125	7/16	1/2				

ADAPTERS & EXTENSIONS
ADAPTADORES Y EXTENSIONES

ADAPTERS HEX TO MALE SQUARE

ADAPTADORES HEX A CUADRADILLO MACHO

3/8"

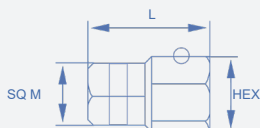

1/2"

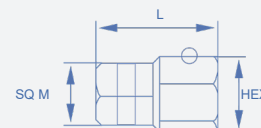

#	L	SQ M	HEX	#	L	SQ M	HEX
CMJ-H10	19	3/8	10	CMS-H11	26	1/2	11
CMJ-H11	19	3/8	11	CMS-H13	26	1/2	13
CMJ-H12	19	3/8	12	CMS-H14	26	1/2	14
CMJ-H13	19	3/8	13	CMS-H15	29	1/2	15
CMJ-H14	24	3/8	14	CMS-H16	29	1/2	16
CMJ-H15	24	3/8	15	CMS-H17	29	1/2	17
CMJ-H16	24	3/8	16	CMS-H18	29	1/2	18
CMJ-H17	24	3/8	17	CMS-H20	29	1/2	20
				CMS-H21	29	1/2	21
				CMS-H22	29	1/2	22

STANDARD

ADAPTERS
ADAPTADORES

1/4"

BALL *BOLA*

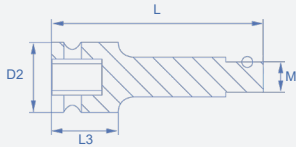

PIN *PIN*

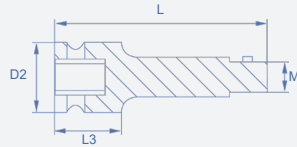

HOLE *PASANTE*

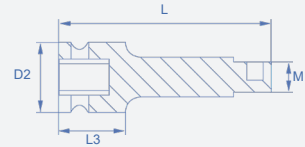

#	L	D2	L3	M
R3100A	25	13	14	3/8

#	L	D2	L3	M
R3100B	25	13	14	3/8

#	L	D2	L3	M
R3100C	25	13	14	3/8

3/8"

BALL *BOLA*

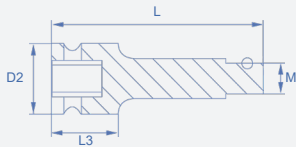

PIN *PIN*

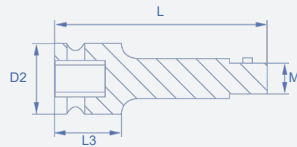

HOLE *PASANTE*

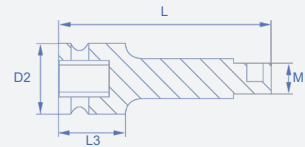

#	L	D2	L3	M
J2920A	32	19	18	1/4
J2922A	50	19	18	1/4
J2923A	75	19	18	1/4
J2924A	100	19	18	1/4
J2925A	125	19	18	1/4
J2926A	150	19	18	1/4
J2928A	200	19	18	1/4
J3120A	32	19	18	1/2
J3122A	50	19	18	1/2
J3124A	100	19	18	1/2
J3126A	150	19	18	1/2

#	L	D2	L3	M
J2920B	32	19	18	1/4
J2922B	50	19	18	1/4
J2923B	75	19	18	1/4
J2924B	100	19	18	1/4
J2925B	125	19	18	1/4
J2926B	150	19	18	1/4
J2928B	200	19	18	1/4
J3120B	32	19	18	1/2
J3122B	50	19	18	1/2
J3124B	100	19	18	1/2
J3126B	150	19	18	1/2

#	L	D2	L3	M
J2920C	32	19	18	1/4
J2922C	50	19	18	1/4
J2923C	75	19	18	1/4
J2924C	100	19	18	1/4
J2925C	125	19	18	1/4
J2926C	150	19	18	1/4
J2928C	200	19	18	1/4
J3120C	32	19	18	1/2
J3122C	50	19	18	1/2
J3124C	100	19	18	1/2
J3126C	150	19	18	1/2

1/2"

BALL *BOLA*

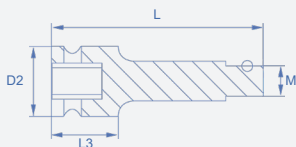

PIN *PIN*

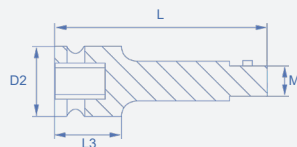

HOLE *PASANTE*

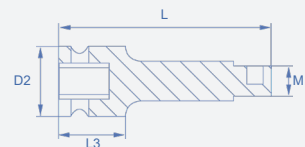

#	L	D2	L3	M
S2950A	38	25	24	3/8
S2952A	50	25	24	3/8
S2953A	75	25	24	3/8
S2954A	100	25	24	3/8
S2955A	125	25	24	3/8
S2956A	150	25	24	3/8
S2958A	200	25	24	3/8
S2960A	250	25	24	3/8
S3152A	50	25	24	3/4
S3153A	75	25	24	3/4
S3154A	100	25	24	3/4

#	L	D2	L3	M
S2950B	38	25	24	3/8
S2952B	50	25	24	3/8
S2953B	75	25	24	3/8
S2954B	100	25	24	3/8
S2955B	125	25	24	3/8
S2956B	150	25	24	3/8
S2958B	200	25	24	3/8
S2960B	250	25	24	3/8
S3152B	50	25	24	3/4
S3153B	75	25	24	3/4
S3154B	100	25	24	3/4

#	L	D2	L3	M
S2950C	38	25	24	3/8
S2952C	50	25	24	3/8
S2953C	75	25	24	3/8
S2954C	100	25	24	3/8
S2955C	125	25	24	3/8
S2956C	150	25	24	3/8
S2958C	200	25	24	3/8
S2960C	250	25	24	3/8
S3152C	50	25	24	3/4
S3153C	75	25	24	3/4
S3154C	100	25	24	3/4

3/4"

BALL BOLA

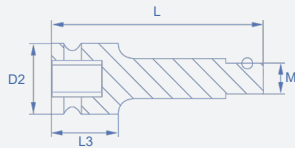

PIN PIN

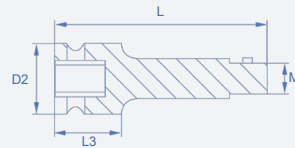

HOLE PASANTE

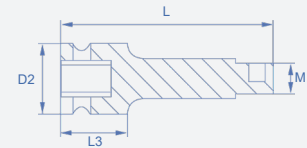

#	L	D2	L3	M
K2903A	75	44	34	1/2
K2904A	100	44	34	1/2
K2905A	125	44	34	1/2
K2906A	150	44	34	1/2
K2908A	200	44	34	1/2
K2912A	300	44	34	1/2
K3103A	75	44	34	1
K3104A	100	44	34	1
K3105A	125	44	34	1
K3106A	150	44	34	1

#	L	D2	L3	M
K2903B	75	44	34	1/2
K2904B	100	44	34	1/2
K2905B	125	44	34	1/2
K2906B	150	44	34	1/2
K2908B	200	44	34	1/2
K3103B	75	44	34	1
K3104B	100	44	34	1
K3105B	125	44	34	1
K3106B	150	44	34	1

#	L	D2	L3	M
K2903C	75	44	34	1/2
K2904C	100	44	34	1/2
K2905C	125	44	34	1/2
K2906C	150	44	34	1/2
K2908C	200	44	34	1/2
K3102C	62	44	34	1
K3103C	75	44	34	1
K3104C	100	44	34	1
K3105C	125	44	34	1
K3106C	150	44	34	1

EXTENSIONS
EXTENSIONES

1/4"

BALL BOLA

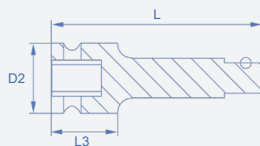

PIN PIN

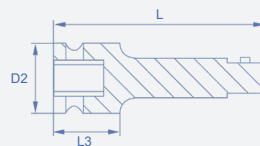

HOLE PASANTE

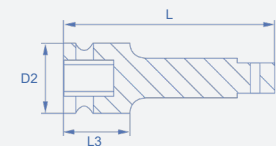

#	L	D2	L3
R3001A	25	13	13
R3002A	50	13	13
R3003A	75	13	13
R3004A	100	13	13
R3005A	125	13	13
R3006A	150	13	13
R3008A	200	13	13
R3010A	250	13	13

#	L	D2	L3
R3001B	25	13	13
R3002B	50	13	13
R3003B	75	13	13
R3004B	100	13	13
R3005B	125	13	13
R3006B	150	13	13
R3008B	200	13	13
R3010B	250	13	13
R3014B	350	13	13

#	L	D2	L3
R3001C	25	13	13
R3002C	50	13	13
R3003C	75	13	13
R3004C	100	13	13
R3005C	125	13	13
R3006C	150	13	13
R3008C	200	13	13
R3010C	250	13	13

ADAPTERS &
EXTENSIONS
ADAPTADORES Y
EXTENSIONES

STANDARD

3/8"

BALL *BOLA*

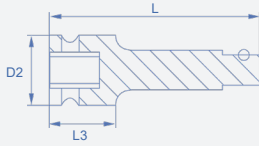

PIN *PIN*

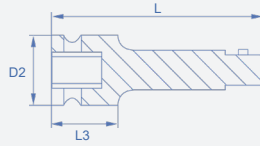

HOLE *PASANTE*

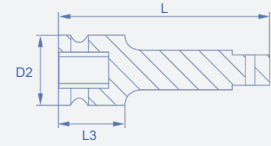

#	L	D2	L3	#	L	D2	L3	#	L	D2	L3
J3020A	32	19	18	J3020B	32	19	18	J3020C	32	19	18
J3022A	50	19	18	J3022B	50	19	18	J3022C	50	19	18
J3023A	75	19	18	J3023B	75	19	18	J3023C	75	19	18
J3024A	100	19	18	J3024B	100	19	18	J3024C	100	19	18
J3025A	125	19	18	J3025B	125	19	18	J3025C	125	19	18
J3026A	150	19	18	J3026B	150	19	18	J3026C	150	19	18
J3027A	175	19	18	J3027B	175	19	18	J3027C	175	19	18
J3028A	200	19	18	J3028B	200	19	18	J3028C	200	19	18
J3030A	250	19	18	J3030B	250	19	18	J3030C	250	19	18
J3032A	300	19	18	J3032B	300	19	18	J3032C	300	19	18
J3036A	400	18	18	J3036B	400	18	18	J3036C	00	18	18

1/2"

BALL *BOLA*

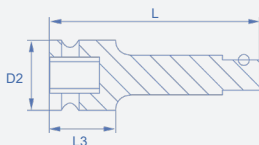

PIN *PIN*

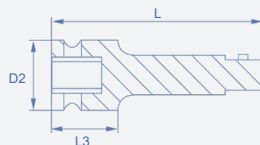

HOLE *PASANTE*

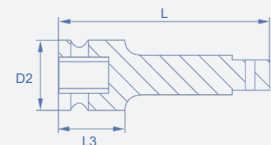

#	L	D2	L3	#	L	D2	L3	#	L	D2	L3
S3050A	40	25	24	S3050B	40	25	24	S3050C	40	25	24
S3052A	50	25	24	S3052B	50	25	24	S3052C	50	25	24
S3053A	75	25	24	S3053B	75	25	24	S3053C	75	25	24
S3054A	100	25	24	S3054B	100	25	24	S3054C	100	25	24
S3055A	125	25	24	S3055B	125	25	24	S3055C	125	25	24
S3056A	150	25	24	S3056B	150	25	24	S3056C	150	25	24
S3057A	175	25	24	S3057B	175	25	24	S3057C	175	25	24
S3058A	200	25	24	S3058B	200	25	24	S3058C	200	25	24
S3060A	250	25	24	S3060B	250	25	24	S3060C	250	25	24
S3062A	300	25	24	S3062B	300	25	24	S3062C	300	25	24
				S3064B	350	25	24				

3/4"

BALL BOLA

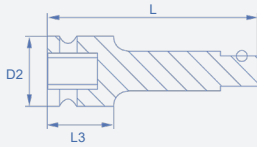

PIN PIN

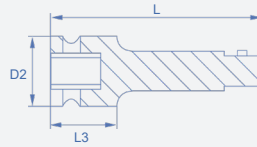

HOLE PASANTE

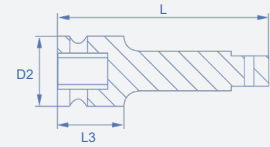

#	L	D2	L3	#	L	D2	L3	#	L	D2	L3
K3003A	75	44	34	K3003B	75	44	34	K3003C	75	44	34
K3004A	100	44	34	K3004B	100	44	34	K3004C	100	44	34
K3005A	125	44	34	K3005B	125	44	34	K3005C	125	44	34
K3006A	150	44	34	K3006B	150	44	34	K3006C	150	44	34
K3008A	200	44	34	K3008B	200	44	34	K3008C	200	44	34
K3010A	250	44	34	K3010B	250	44	34	K3010C	250	44	34
K3012A	300	44	34	K3012B	300	44	34	K3012C	300	44	34

1"

BALL BOLA

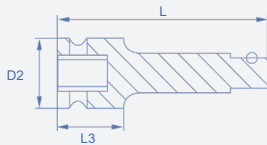

#	L	D2	L3
L3004A	100	54	42
L3005A	125	54	42
L3006A	150	54	42
L3008A	200	54	42
L3010A	250	54	42
L3012A	300	54	42
L3016A	400	54	42



ADAPTERS & EXTENSIONS
ADAPTADORES Y EXTENSIONES

EXTENSIONS WITH QUICK CHANGE
EXTENSIONES CON CAMBIO RÁPIDO

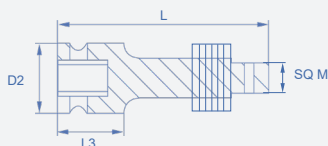

#	SQ F	SQ M	L	D1	D2
J3022VP	3/8"	3/8"	46	20	20
J3024VP	3/8"	3/8"	100	20	20
J3026VP	3/8"	3/8"	150	20	20
S3052VP	1/2"	1/2"	60	24,8	24,5

HEX MALE TO SQUARE DRIVE

HEX A CUADRADILLO MACHO

1/4"

BALL BOLA

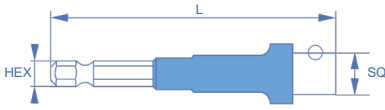

PIN PIN

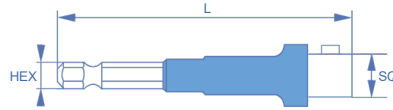

HOLE PASANTE

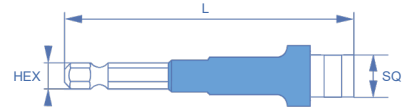

#	L	HEX	SQ	#	L	HEX	SQ	#	L	HEX	SQ
2520/2A/TEF	50	1/4	1/4	2520/2B/TEF	50	1/4	1/4	2520/2C/TEF	50	1/4	1/4
2520/3A/TEF	75	1/4	1/4	2520/3B/TEF	75	1/4	1/4	2520/3C/TEF	75	1/4	1/4
2520/4A/TEF	100	1/4	1/4	2520/4B/TEF	100	1/4	1/4	2520/4C/TEF	100	1/4	1/4
2520/5A/TEF	125	1/4	1/4	2520/5B/TEF	125	1/4	1/4	2520/5C/TEF	125	1/4	1/4
2520/6A/TEF	150	1/4	1/4	2520/6B/TEF	150	1/4	1/4	2520/6C/TEF	150	1/4	1/4
2520/8A/TEF	200	1/4	1/4	2520/8B/TEF	200	1/4	1/4	2520/8C/TEF	200	1/4	1/4
2520/10A/TEF	250	1/4	1/4	2520/10B/TEF	250	1/4	1/4	2520/10C/TEF	250	1/4	1/4
2520/12A/TEF	300	1/4	1/4	2520/12B/TEF	300	1/4	1/4	2520/12C/TEF	300	1/4	1/4
2521/2A/TEF	50	1/4	3/8	2521/2B/TEF	50	1/4	3/8	2521/2C/TEF	50	1/4	3/8
2521/3A/TEF	75	1/4	3/8	2521/3B/TEF	75	1/4	3/8	2521/3C/TEF	75	1/4	3/8
2521/4A/TEF	100	1/4	3/8	2521/4B/TEF	100	1/4	3/8	2521/4C/TEF	100	1/4	3/8
2521/6A/TEF	150	1/4	3/8	2521/6B/TEF	150	1/4	3/8	2521/6C/TEF	150	1/4	3/8
2521/8A/TEF	200	1/4	3/8	2521/8B/TEF	200	1/4	3/8	2521/8C/TEF	200	1/4	3/8
2521/10A/TEF	250	1/4	3/8	2521/10B/TEF	250	1/4	3/8	2521/10C/TEF	250	1/4	3/8
2528/2A/TEF	50	7/16	3/8	2528/2B/TEF	50	7/16	3/8	2528/2C/TEF	50	7/16	3/8
2528/3A/TEF	75	7/16	3/8	2528/3B/TEF	75	7/16	3/8	2528/3C/TEF	75	7/16	3/8
2528/4A/TEF	100	7/16	3/8	2528/4B/TEF	100	7/16	3/8	2528/4C/TEF	100	7/16	3/8
2528/5A/TEF	150	7/16	3/8	2528/5B/TEF	150	7/16	3/8	2528/5C/TEF	150	7/16	3/8
2529/2A/TEF	50	7/16	1/2	2529/2B/TEF	50	7/16	1/2	2529/2C/TEF	50	7/16	1/2
2529/3A/TEF	75	7/16	1/2	2529/3B/TEF	75	7/16	1/2	2529/3C/TEF	75	7/16	1/2
2529/4A/TEF	100	7/16	1/2	2529/4B/TEF	100	7/16	1/2	2529/4C/TEF	100	7/16	1/2
2529/5A/TEF	150	7/16	1/2	2529/5B/TEF	150	7/16	1/2	2529/5C/TEF	150	7/16	1/2



ADAPTERS
ADAPTADORES

1/4"

BALL BOLA

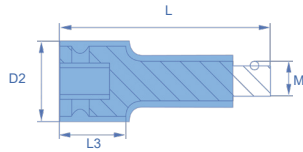

PIN PIN

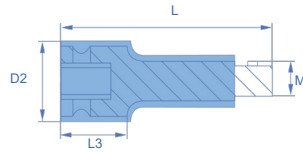

HOLE PASANTE

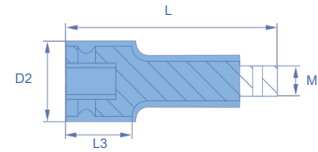

#	L	D2	L3	M
R3100A	32	13	14	3/8

#	L	D2	L3	M
R3100B	32	13	14	3/8

#	L	D2	L3	M
R3100C	32	13	14	3/8

3/8"

BALL BOLA

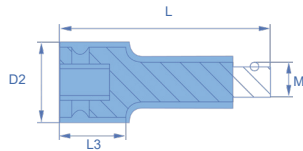

PIN PIN

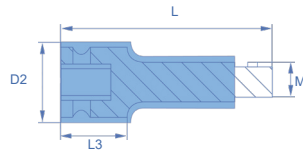

HOLE PASANTE

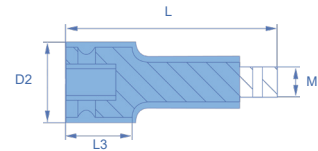

#	L	D2	L3	M
J2920A/TEF	32	23	18	1/4
J2922A/TEF	50	23	18	1/4
J2923A/TEF	75	23	18	1/4
J2924A/TEF	100	23	18	1/4
J3120A/TEF	32	23	18	1/2
J3122A/TEF	50	23	18	1/2
J3124A/TEF	100	23	18	1/2
J3126A/TEF	150	23	18	1/2

#	L	D2	L3	M
J2920B/TEF	32	23	18	1/4
J2922B/TEF	50	23	18	1/4
J2923B/TEF	75	23	18	1/4
J2924B/TEF	100	23	18	1/4
J3120B/TEF	32	23	18	1/2
J3122B/TEF	50	23	18	1/2
J3124B/TEF	100	23	18	1/2
J3126B/TEF	150	23	18	1/2

#	L	D2	L3	M
J2920C/TEF	32	23	18	1/4
J2922C/TEF	50	23	18	1/4
J2923C/TEF	75	23	18	1/4
J2924C/TEF	100	23	18	1/4
J3120C/TEF	32	23	18	1/2
J3122C/TEF	50	23	18	1/2
J3124C/TEF	100	23	18	1/2
J3126C/TEF	150	23	18	1/2

1/2"

BALL BOLA

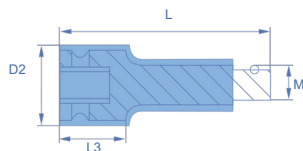

PIN PIN

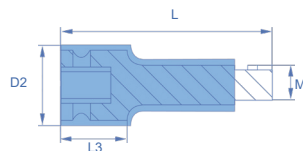

HOLE PASANTE

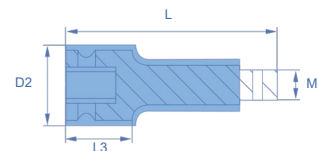

#	L	D2	L3	M
S2950A/TEF	38	29	28	3/8
S2952A/TEF	50	29	28	3/8
S2953A/TEF	75	29	28	3/8
S2954A/TEF	100	29	28	3/8
S2955A/TEF	125	29	28	3/8
S2956A/TEF	150	29	28	3/8
S2958A/TEF	200	29	28	3/8
S2960A/TEF	250	29	28	3/8
S3152A/TEF	50	29	28	3/4
S3153A/TEF	75	29	28	3/4
S3154A/TEF	100	29	28	3/4

#	L	D2	L3	M
S2950B/TEF	38	29	28	3/8
S2952B/TEF	50	29	28	3/8
S2953B/TEF	75	29	28	3/8
S2954B/TEF	100	29	28	3/8
S2955B/TEF	125	29	28	3/8
S2956B/TEF	150	29	28	3/8
S2958B/TEF	200	29	28	3/8
S2960B/TEF	250	29	28	3/8
S3152B/TEF	50	29	28	3/4
S3153B/TEF	75	29	28	3/4
S3154B/TEF	100	29	28	3/4

#	L	D2	L3	M
S2950C/TEF	38	29	28	3/8
S2952C/TEF	50	29	28	3/8
S2953C/TEF	75	29	28	3/8
S2954C/TEF	100	29	28	3/8
S2955C/TEF	125	29	28	3/8
S2956C/TEF	150	29	28	3/8
S2958C/TEF	200	29	28	3/8
S2960C/TEF	250	29	28	3/8
S3152C/TEF	50	29	28	3/4
S3153C/TEF	75	29	28	3/4
S3154C/TEF	100	29	28	3/4

ADAPTERS & EXTENSIONS Y ADAPTADORES Y EXTENSIONES

PROTECTED

3/4"

BALL BOLA

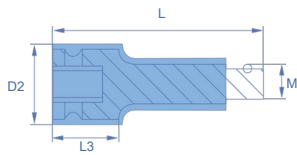

PIN PIN

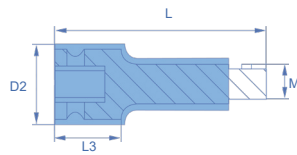

HOLE PASANTE

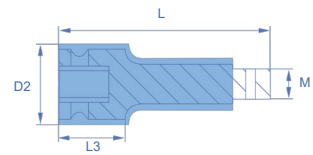

#	L	D2	L3	M	#	L	D2	L3	M	#	L	D2	L3	M
K2903A/TEF	75	48	34	1/2	K2903B/TEF	75	48	34	1/2	K2903C/TEF	75	48	34	1/2
K2904A/TEF	100	48	34	1/2	K2904B/TEF	100	48	34	1/2	K2904C/TEF	100	48	34	1/2
K2905A/TEF	125	48	34	1/2	K2905B/TEF	125	48	34	1/2	K2905C/TEF	125	48	34	1/2
K2906A/TEF	150	48	34	1/2	K2906B/TEF	150	48	34	1/2	K2906C/TEF	150	48	34	1/2
K2908A/TEF	200	48	34	1/2	K2908B/TEF	200	48	34	1/2	K2908C/TEF	200	48	34	1/2
K3103A/TEF	75	48	34	1	K3103B/TEF	75	48	34	1	K3103C/TEF	75	48	34	1
K3104A/TEF	100	48	34	1	K3104B/TEF	100	48	34	1	K3104C/TEF	100	48	34	1
K3105A/TEF	125	48	34	1	K3105B/TEF	125	48	34	1	K3105C/TEF	125	48	34	1
K3106A/TEF	150	48	34	1	K3106B/TEF	150	48	34	1	K3106C/TEF	150	48	34	1



EXTENSIONS EXTENSIONES

1/4"

BALL BOLA

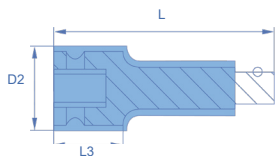

PIN PIN

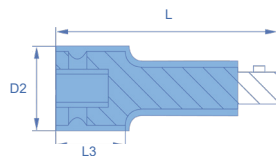

HOLE PASANTE

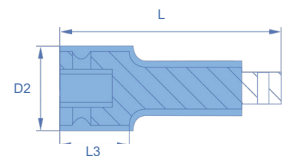

#	L	D2	L3	#	L	D2	L3	#	L	D2	L3
R3001A/TEF	32	16	13	R3001B/TEF	32	16	13	R3001C/TEF	32	16	13
R3002A/TEF	50	16	13	R3002B/TEF	50	16	13	R3002C/TEF	50	16	13
R3003A/TEF	75	16	13	R3003B/TEF	75	16	13	R3003C/TEF	75	16	13
R3004A/TEF	100	16	13	R3004B/TEF	100	16	13	R3004C/TEF	100	16	13
R3005A/TEF	125	16	13	R3005B/TEF	125	16	13	R3005C/TEF	125	16	13
R3006A/TEF	150	16	13	R3006B/TEF	150	16	13	R3006C/TEF	150	16	13

3/8"

BALL *BOLA*

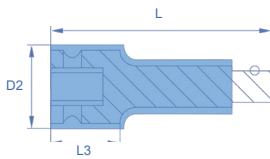

PIN *PIN*

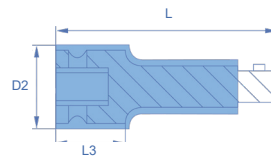

HOLE *PASANTE*

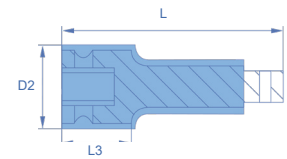

#	L	D2	L3	#	L	D2	L3	#	L	D2	L3
J3020A/TEF	32	23	18	J3020B/TEF	32	23	18	J3020C/TEF	32	23	18
J3022A/TEF	50	23	18	J3022B/TEF	50	23	18	J3022C/TEF	50	23	18
J3023A/TEF	75	23	18	J3023B/TEF	75	23	18	J3023C/TEF	75	23	18
J3024A/TEF	100	23	18	J3024B/TEF	100	23	18	J3024C/TEF	100	23	18
J3025A/TEF	125	23	18	J3025B/TEF	125	23	18	J3025C/TEF	125	23	18
J3026A/TEF	150	23	18	J3026B/TEF	150	23	18	J3026C/TEF	150	23	18
J3027A/TEF	175	23	18	J3027B/TEF	175	23	18	J3027C/TEF	175	23	18
J3028A/TEF	200	23	18	J3028B/TEF	200	23	18	J3028C/TEF	200	23	18
J3030A/TEF	250	23	18	J3030B/TEF	250	23	18	J3030C/TEF	250	23	18
J3032A/TEF	300	23	18	J3032B/TEF	300	23	18	J3032C/TEF	300	23	18
				J3036B/TEF	600	23	18				

1/2"

BALL *BOLA*

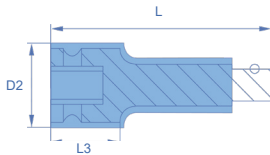

PIN *PIN*

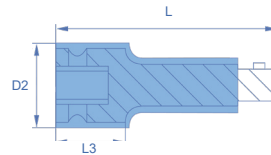

HOLE *PASANTE*

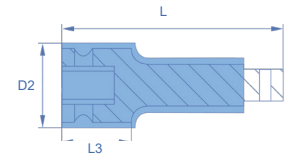

#	L	D2	L3	#	L	D2	L3	#	L	D2	L3
S3050A/TEF	40	29	24	S3050B/TEF	40	29	24	S3050C/TEF	40	29	24
S3052A/TEF	50	29	24	S3052B/TEF	50	29	24	S3052C/TEF	50	29	24
S3053A/TEF	75	29	24	S3053B/TEF	75	29	24	S3053C/TEF	75	29	24
S3054A/TEF	100	29	24	S3054B/TEF	100	29	24	S3054C/TEF	100	29	24
S3055A/TEF	125	29	24	S3055B/TEF	125	29	24	S3055C/TEF	125	29	24
S3056A/TEF	150	29	24	S3056B/TEF	150	29	24	S3056C/TEF	150	29	24
S3057A/TEF	175	29	24	S3057B/TEF	175	29	24	S3057C/TEF	175	29	24
S3058A/TEF	200	29	24	S3058B/TEF	200	29	24	S3058C/TEF	200	29	24
S3060A/TEF	250	29	24	S3060B/TEF	250	29	24	S3060C/TEF	250	29	24
S3062A/TEF	300	29	24	S3062B/TEF	300	29	24	S3062C/TEF	300	29	24

ADAPTERS &
EXTENSIONS
ADAPTADORES Y
EXTENSIONES

PROTECTED

3/4"

BALL *BOLA*

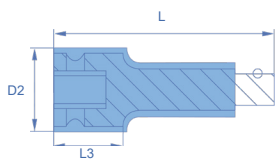

PIN *PIN*

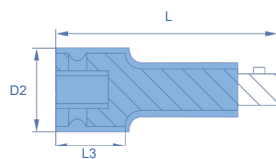

HOLE *PASANTE*

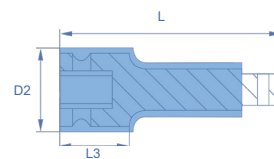

#	L	D2	L3	#	L	D2	L3	#	L	D2	L3
K3003A/TEF	75	48	34	K3003B/TEF	75	48	34	K3003C/TEF	75	48	34
K3004A/TEF	100	48	34	K3004B/TEF	100	48	34	K3004C/TEF	100	48	34
K3005A/TEF	125	48	34	K3005B/TEF	125	48	34	K3005C/TEF	125	48	34
K3006A/TEF	150	48	34	K3006B/TEF	150	48	34	K3006C/TEF	150	48	34
K3008A/TEF	200	48	34	K3008B/TEF	200	48	34	K3008C/TEF	200	48	34
K3010A/TEF	250	48	34	K3010B/TEF	250	48	34	K3010C/TEF	250	48	34
K3012A/TEF	300	48	34	K3012B/TEF	300	48	34	K3012C/TEF	300	48	34

1"

BALL *BOLA*

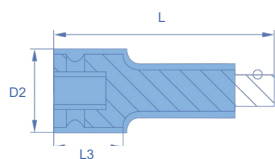

#	L	D2	L3
L3004A/TEF	100	60	45
L3005A/TEF	125	60	45
L3006A/TEF	150	60	45
L3008A/TEF	200	60	45
L3010A/TEF	250	60	45
L3012A/TEF	300	60	45
L3016A/TEF	400	60	45





UNIVERSAL WRENCHES

RÓTULAS

For difficult angle or access tightenings, it is recommended the use of universal wrenches improving the coupling due to its angle.

Para aquellos procesos con difícil acceso o ángulo, se recomienda el uso de rótula gracias a su cabeza basculante.

06

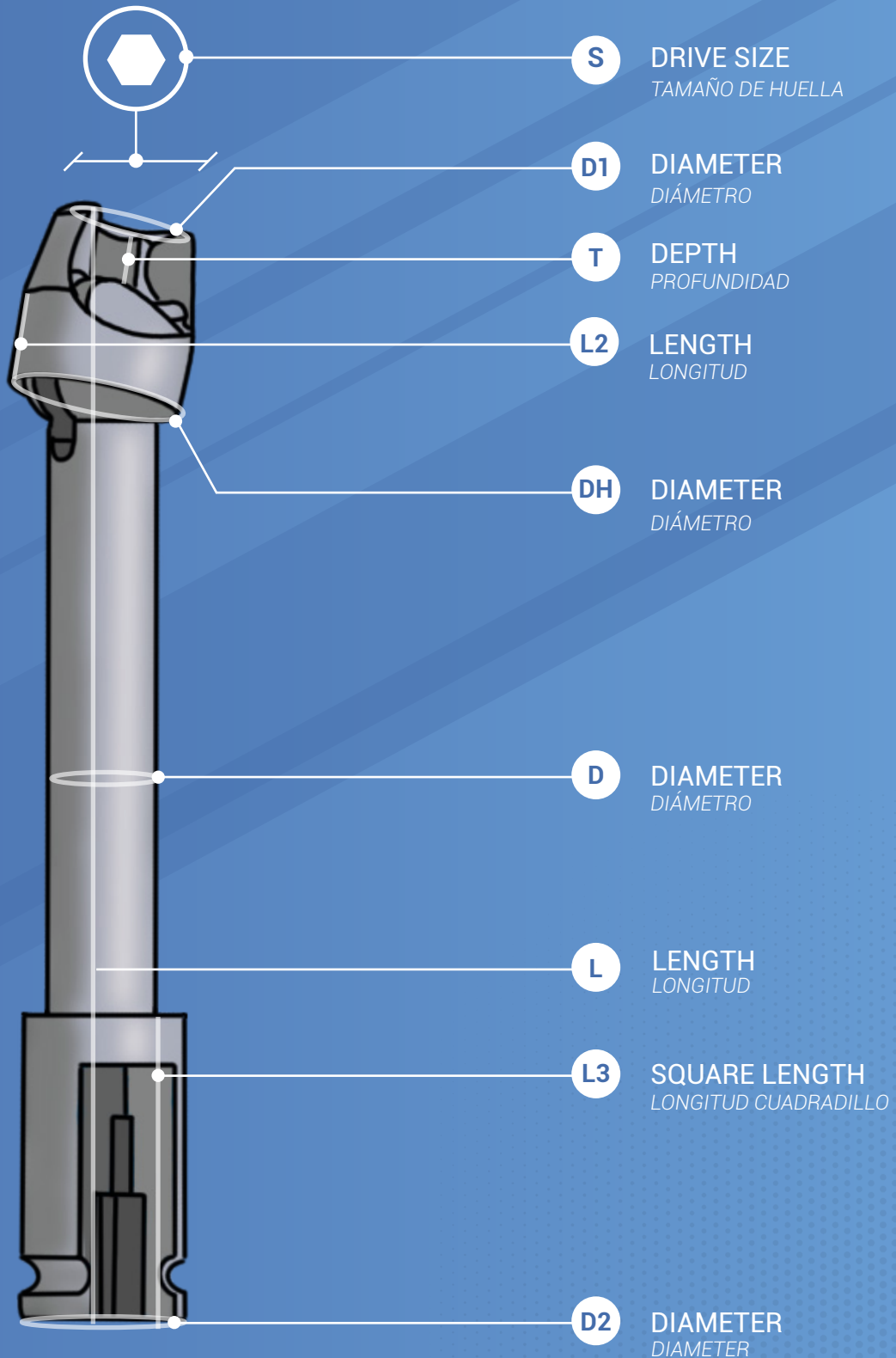



EXTENSION WRENCHES

EXTENSIONES ROTULADAS

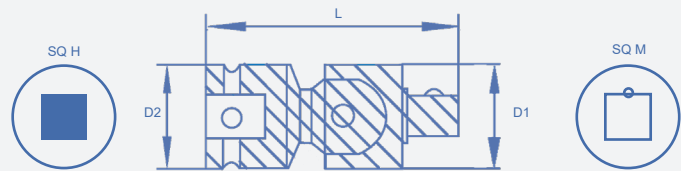
WITHOUT TENSOR
SIN TENSOR

#	SQ H	SQ M	L	D1	D2	RETENTION
R3200B	1/4	1/4	40	14	13	PIN
J3202B	3/8	3/8	64	19	19	PIN
S3202A	1/2	1/2	68	25	25	BALL
S3202B	1/2	1/2	68	25	25	PIN
S3203A	1/2	1/2	78	32	32	BALL
K3204C	3/4	3/4	101	38	38	HOLE

WITH TENSOR
CON TENSOR

#	SQ H	SQ M	L	D1	D2	RETENTION
J3209BT	3/8	3/8	250	19,5	19	PIN
S3206BT	1/2	1/2	188,4	28,5	25	PIN
S3209BT	1/2	1/2	246,6	28,5	25	PIN

SOCKET WRENCHES
EMBOCADURAS ROTULADASHEXAGON
HEXAGONAL

3/8"

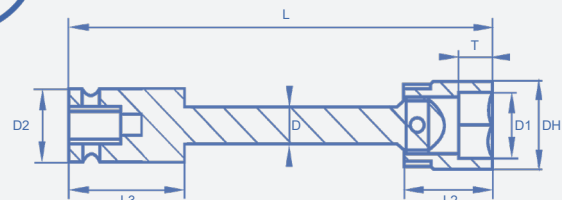

#	S	L	SQ	D1	DH	D2	D	L2	L3	T
J4010H/6T*	10	150	3/8	11,6	19,6	19	12,7	21	35	12
J4013H/3	13	104	3/8	17,5	25,5	19	12,7	25,2	35	12
J4013H/3T*	13	104	3/8	17,5	25,5	19	12,7	25,2	35	12
J4013H/6	13	180	3/8	17,5	25,5	19	12,7	25,2	35	12
J4013H/9	13	256	3/8	17,5	25,5	19	12,7	25,2	35	12
J4015H/3	15	108	3/8	20	28,5	19	12,7	29	35	12
J4015H/6	15	184	3/8	20	28,5	19	12,7	29	35	12
J4015H/9	15	260	3/8	20	28,5	19	12,7	29	35	12
J4016H	16	58	3/8	21,4	28,5	19	12,7	30	35	12
J4016H/6	16	185	3/8	21,4	28,5	19	12,7	30	35	12
J4017H	17	53	3/8	20	25	21,8	12,7	26	19,4	12
J4018H/3	18	111	3/8	25,5	28,5	19	12,7	29	35	12
J4018H/6	18	187	3/8	25,5	28,5	19	12,7	29	35	12
J4018H/9	18	260	3/8	25,5	28,5	19	12,7	29	35	12
J4021H/6	21	188	3/8	30	30	19	12,7	32	35	12
J4021H/9	21	260	3/8	30	30	19	12,7	32	35	12
J4022H/4	22	136	3/8	35	35	19	12,7	32	35	12
J4024H	24	73	3/8	35	35	19	12,7	38	35	18

*Tensor

STANDARD

HEXAGON
HEXAGONAL



1/2"

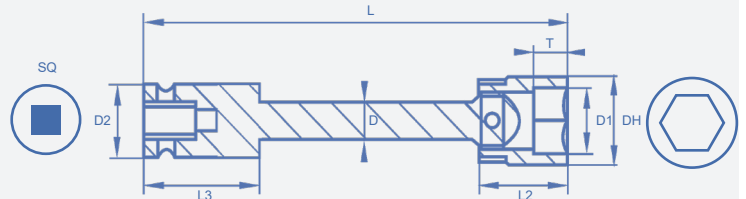

#	S	L	SQ	D1	DH	D2	D	L2	L3	T
S4013H/3	13	110	1/2	17,5	25,5	25	11	25,2	41	12
S4013H/3T*	13	110	1/2	17,5	25,5	25	11	25,2	41	12
S4013H/6	13	186	1/2	17,5	25,5	25	11	25,2	41	12
S4013H/9	13	262	1/2	17,5	25,5	25	11	25,2	41	12
S4015H/3	15	114	1/2	20	28,5	25	11	29	41	12
S4015H/6	15	190	1/2	20	28,5	25	11	29	41	12
S4015H/9	15	266	1/2	20	28,5	25	11	29	41	12
S4016H	16	63,5	1/2	21,4	28,5	25	11	30	41	12
S4016H/4T*	16	144	1/2	19	25,7	25	12,7	30	41	12
S4016H/6	16	191	1/2	21,4	28,5	25	11	30	41	12
S4016H/12T*	16	305	1/2	19	26	25	12,5	45	41	12
S4017H/6	17	150	1/2	18,7	25,6	25	12	36	25	12
S4017H/9	17	126	1/2	20,5	28	25	12,5	32	46	12
S4018H	18	63	1/2	21,3	28	25	12	30	25,5	1S
S4018H/3	18	117	1/2	25,5	28,5	25	11	32	41	12
S4018H/3T*	18	130	1/2	21	26	25	12,5	40	41	21
S4018H/6	18	193	1/2	25,5	28,5	25	11	32	41	12
S4018H/9	18	266	1/2	25,5	28,5	25	11	32	41	12
S4019H/3	19	116	1/2	21,3	28	25	12,5	32	46	12
S4021H/6	21	194	1/2	30	30	25	11	32	41	12
S4021H/9	21	266	1/2	30	30	25	11	32	41	12
S4022H/4	22	143	1/2	30	30	25	11	32	41	12
S4022H	22	73	1/2	35	35	25	11	38	41	18
S4022H/9	22	265	1/2	26	36	29	21	35	52	17
S4024H	24	73	1/2	28	35	25	16	38	26	18

*Tensor

DOUBLE-HEXAGON
BIHEXAGONAL



1/2"

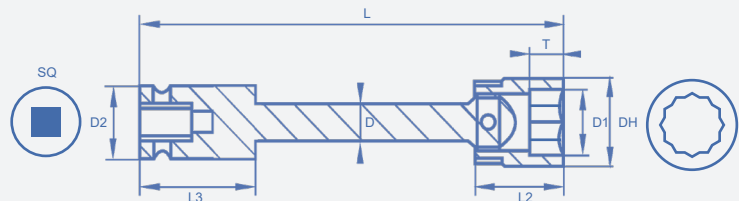

#	S	L	SQ	D1	DH	D2	D	L2	L3	T
S4010BH/6	10	175	1/2	11,8	21	25	11	21	48	12
S4011BH/6	11	175	1/2	12,8	21	25	11	21	48	12
S4018BH/9T*	18	266	1/2	21	25,8	25	12,5	32	41	13,4

*Tensor

HEXAGON
 HEXAGONAL
 

3/4"

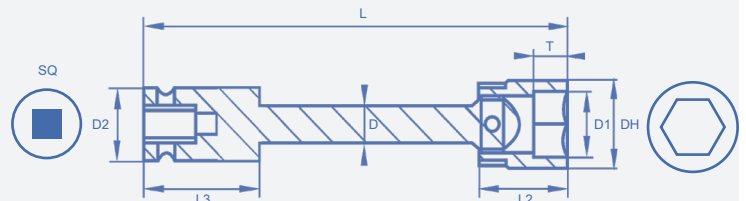

#	S	L	SQ	D1	DH	D2	D	L2	L3	T
K4018H/6	18	195	3/4	21	31,7	37	19	29	49	12
K4018H/9	18	265	3/4	32	28,5	38,3	17	29	36	12
K4021H/9	21	265	3/4	24,3	32	38,3	19	29	49	12
K4022H/4	22	135	3/4	32	32	38,3	17	29	36	12
K4024H/9	24	270	3/4	28,3	35	37	19	36	49	18,2

*Tensor

WOBBLE SOCKET ADAPTERS

ADAPTADORES BASCULANTES

Our Speedrill WOBBLE adapters allow you to reach applications in a confined space, improving productivity, engaging faster thanks to their flexible angles while correcting misalignments. They can be used with any of our standard or special sockets and include a spring, pin and O-ring.

Nuestros adaptadores WOBBLE Speedrill le permiten llegar a aplicaciones en un espacio reducido, mejorando la productividad, y se acoplan más rápidamente gracias a sus ángulos flexibles a la vez que corrigen las desalineaciones.

Pueden utilizarse con cualquiera de nuestros encajes estándar o especiales e incluyen un muelle, un pasador y una junta tórica

PIN PIN

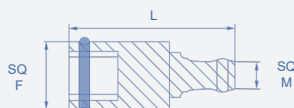

#	SQ F	SQ M	L
JOB	3/8	3/8	38
SOB	1/2	1/2	48
KOB	3/4	3/4	75

BALL BOLA

#	SQ F	SQ M	L
SOB300A	1/2	1/2	300



SOCKET WRENCHES 1/4" MALE

EMBOCADURAS ROTULADAS 1/4" MACHO

3/4"

#	S	L	D1	D
2007VPROT	7	126	7	12
2008VPROT	8	126	7	12,5
2010VPROT	10	126	7	15
2013VPROT	13	100	8	19,5



PROTECTED

SOCKET WRENCHES
EMBOCADURAS ROTULADAS

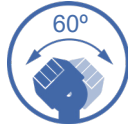

HEXAGON
HEXAGONAL



3 / 8 "

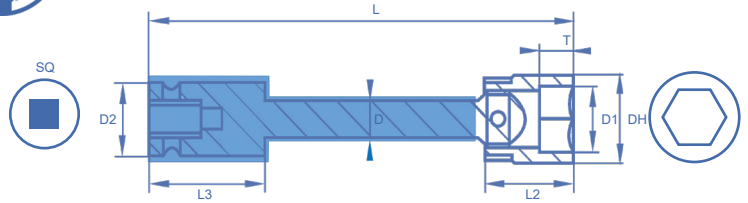

#	S	L	SQ	D1	DH	D2	D	L2	L3	T
J4010H/6T/TEF*	10	150	3/8	11,6	19,6	24	18	21	37	12
J4013H/3/TEF	13	104	3/8	17,5	25,5	24	18	25,2	37	12
J4013H/3T/TEF*	13	104	3/8	17,5	25,5	24	18	25,2	37	12
J4013H/6/TEF	13	180	3/8	17,5	25,5	24	18	25,2	37	12
J4013H/9/TEF	13	256	3/8	17,5	25,5	24	18	25,2	37	12
J4015H/3/TEF	15	108	3/8	20	28,5	24	18	29	37	12
J4015H/6/TEF	15	184	3/8	20	28,5	24	18	29	37	12
J4015H/9/TEF	15	260	3/8	20	28,5	24	18	29	37	12
J4016H/TEF	16	58	3/8	21,4	28,5	24	18	30	37	12
J4016H/6/TEF	16	185	3/8	21,4	28,5	24	18	30	37	12
J4017H/TEF	17	53	3/8	20	25	27	18	26	22,4	12
J4018H/3/TEF	18	111	3/8	25,5	28,5	24	18	29	37	12
J4018H/6/TEF	18	187	3/8	25,5	28,5	24	18	29	37	12
J4018H/9/TEF	18	260	3/8	25,5	28,5	24	18	29	37	12
J4021H/6/TEF	21	188	3/8	30	30	24	18	32	37	12
J4021H/9/TEF	21	260	3/8	30	30	24	18	32	37	12
J4022H/4/TEF	22	136	3/8	35	35	24	18	32	37	12
J4024H/TEF	24	73	3/8	35	35	24	18	38	37	18

*Tensor

HEXAGON
HEXAGONAL



3 / 4 "

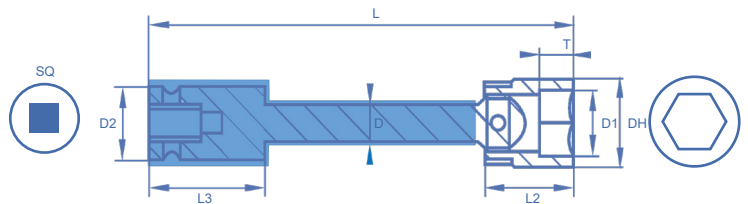

#	S	L	SQ	D1	DH	D2	D	L2	L3	T
K4018H/6/TEF	18	195	3/4	21	31,7	42	25	29	65	12
K4018H/9/TEF	18	265	3/4	32	28,5	43	23	29	52	12
K4021H/9/TEF	21	265	3/4	24,3	32	43	25	29	65	12
K4022H/4/TEF	22	135	3/4	32	32	43	23	29	52	12
K4024H/9/TEF	24	270	3/4	28,3	35	42	25	36	65	18,2

HEXAGON
HEXAGONAL



1/2"

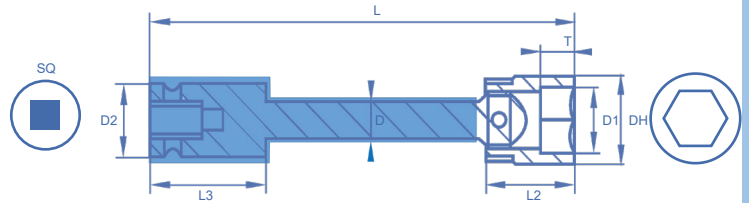

#	S	L	SQ	D1	DH	D2	D	L2	L3	T
S4013H/3/TEF	13	110	1/2	17,5	25,5	30	17	25,2	49	12
S4013H/3T/TEF*	13	110	1/2	17,5	25,5	30	17	25,2	49	12
S4013H/6/TEF	13	186	1/2	17,5	25,5	30	17	25,2	49	12
S4013H/9/TEF	13	262	1/2	17,5	25,5	30	17	25,2	49	12
S4015H/3/TEF	15	114	1/2	20	28,5	30	17	29	49	12
S4015H/6/TEF	15	190	1/2	20	28,5	30	17	29	49	12
S4015H/9/TEF	15	266	1/2	20	28,5	30	17	29	49	12
S4016H/TEF	16	63,5	1/2	21,4	28,5	30	17	30	49	12
S4016H/4T/TEF*	16	144	1/2	19	25,7	30	18,7	30	49	12
S4016H/6/TEF	16	191	1/2	21,4	28,5	30	17	30	49	12
S4016H/12T/TEF*	16	305	1/2	19	26	30	18,5	45	49	12
S4017H/6/TEF	17	150	1/2	18,7	25,6	30	18	36	33	12
S4017H/9/TEF	17	126	1/2	20,5	28	30	18,5	32	54	12
S4018H/TEF	18	63	1/2	21,3	28	30	18	30	33	1S
S4018H/3/TEF	18	117	1/2	25,5	28,5	30	17	32	49	12
S4018H/3T/TEF*	18	130	1/2	21	26	30	18,5	40	49	21
S4018H/6/TEF	18	193	1/2	25,5	28,5	30	17	32	49	12
S4018H/9/TEF	18	266	1/2	25,5	28,5	30	17	32	49	12
S4019H/3/TEF	19	116	1/2	21,3	28	30	18,5	32	54	12
S4021H/6/TEF	21	194	1/2	30	30	30	17	32	49	12
S4021H/9/TEF	21	266	1/2	30	30	30	17	32	49	12
S4022H/4/TEF	22	143	1/2	30	30	30	17	32	49	12
S4022H/TEF	22	73	1/2	35	35	30	17	38	49	18
S4022H/9/TEF	22	265	1/2	26	36	34	27	35	60	17
S4024H/TEF	24	73	1/2	28	35	30	24	38	33	18

*Tensor

DOUBLE-HEXAGON
BIHEXAGONAL



1/2"

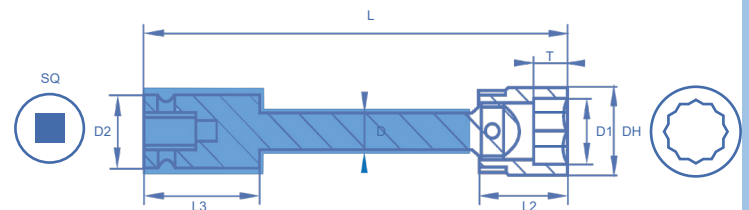

#	S	L	SQ	D1	DH	D2	D	L2	L3	T
S4010BH/6/TEF	10	175	1/2	11,8	21	30	17	21	56	12
S4011BH/6/TEF	11	175	1/2	12,8	21	30	17	21	56	12
S4018BH/9T/TEF*	18	266	1/2	21	25,8	30	18,5	32	49	13,4

*Tensor

UNIVERSAL
WRENCHES
ROTULAS



ANTI-VIBRATION

ANTI-VIBRACIÓN

Our range of anti-vibration products are focused on improving the quality of tightening and improving ergonomics, reducing the oscillation of accessories during tightening.

Nuestra gama de productos anti-vibratorios están enfocados a la mejora de la calidad del apriete y mejora de la ergonomía, reduciendo considerablemente la oscilación de accesorios en los aprietes.

SQUARE DRIVE DIAMETER <small>DIÁMETRO DE CUADRADILLO</small>			
DIAMETER <small>DIÁMETRO</small>	3/8	1/2	3/4
SPEEDRILL	12	16	25
OTHERS <small>OTROS</small>	13	18	25

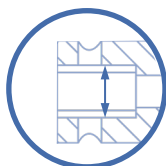

Diameter
Diámetro

07

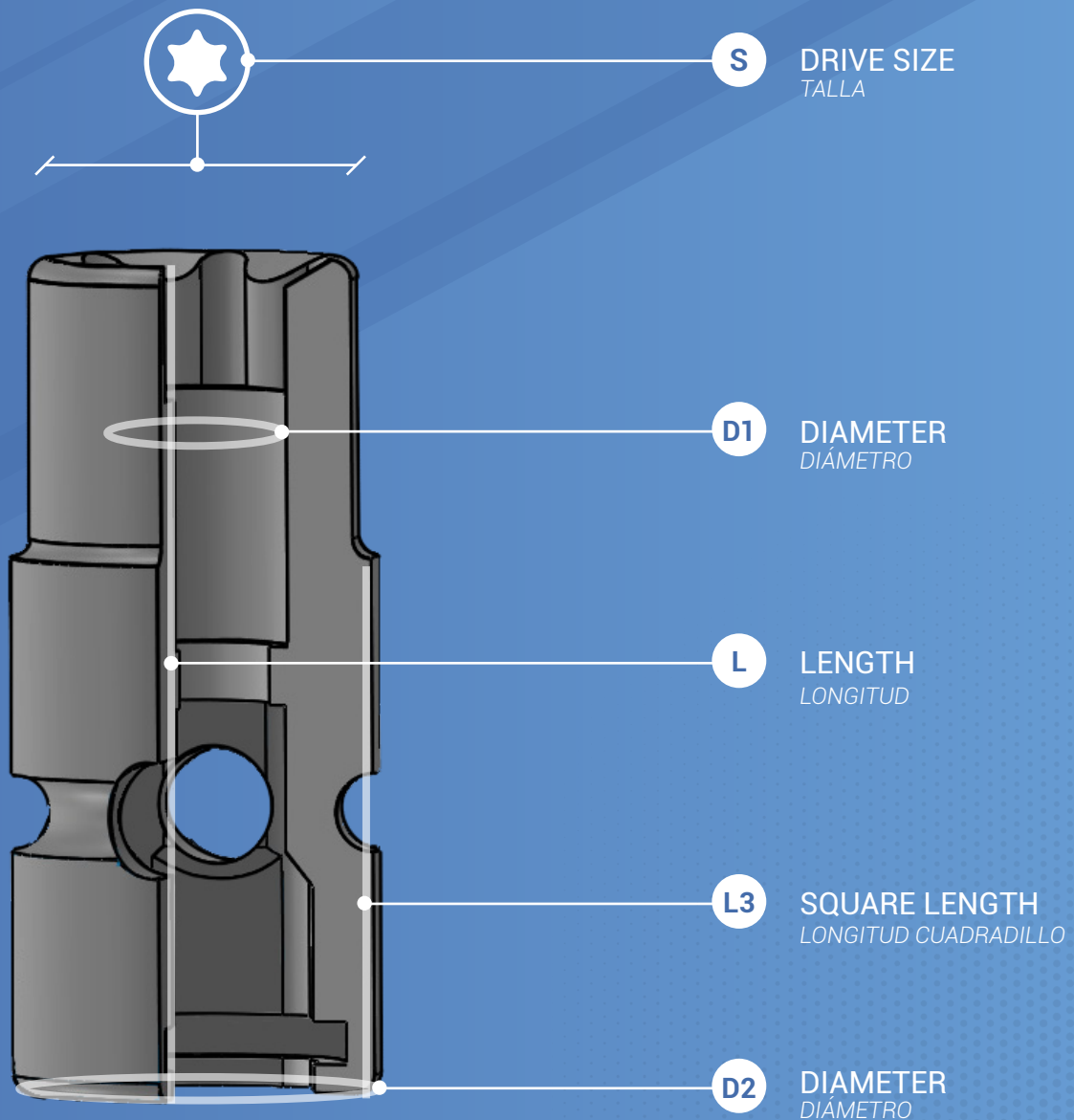



ANTI-VIBRATION SOCKETS

EMBOCADURAS ANTI-VIBRATORIAS

HEXAGON
HEXAGONAL



3 / 8 "

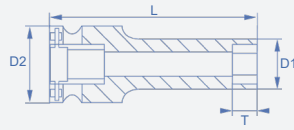

3 / 8 "

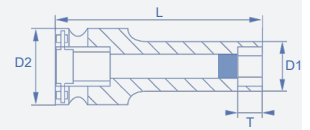

#	S	L	D2	D1	T	MAGNETIC	S	L	D2	D1	T
JIM2306H	6	43	19	10,5	5	JIM2306HM	6	43	19	10,5	5
JIM2307H	7	43	19	11,5	5	JIM2307HM	7	43	19	11,5	5
JIM2308H	8	43	19	12	7	JIM2308HM	8	43	19	12	5
JIM2309H	9	43	19	15	7	JIM2309HM	9	43	19	15	5
JIM2310H	10	43	19	15	7	JIM2310HM	10	43	19	15	5
JIM2311H	11	43	19	18	8	JIM2311HM	11	43	19	18	6
JIM2312H	12	43	19	17	9	JIM2312HM	12	43	19	17	7
JIM2313H	13	43	19	19	9	JIM2313HM	13	43	19	19	7
JIM2314H	14	43	20	20	9	JIM2314HM	14	43	20	20	7
JIM2315H	15	43	22	22	12	JIM2315HM	15	43	22	22	8
JIM2316H	16	43	22	24	12	JIM2316HM	16	43	22	24	8
JIM2317H	17	43	22	25	12	JIM2317HM	17	43	22	25	8
JIM2318H	18	43	22	26	12	JIM2318HM	18	43	22	26	8
JIM2319H	19	43	22	27	12	JIM2319HM	19	43	22	27	8
JIM2320H	20	43	22	28	13	JIM2320HM	20	43	22	28	9
JIM2321H	21	43	22	30	13	JIM2321HM	21	43	22	30	9
JIM2322H	22	43	22	32	14	JIM2322HM	22	43	22	32	10
JIM2336H	36	50	22	48	19						

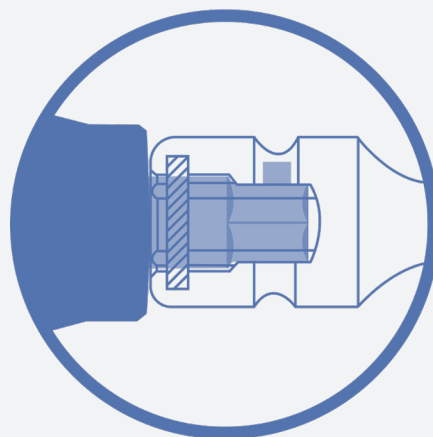

Our square-guided products drastically reduce oscillation, improving processes by 90%.

Nuestros productos con cuadrado guiado reducen drásticamente la oscilación, mejorando los procesos en un 90%

STANDARD

HEXAGON (LONG)
HEXAGONAL (LARGA)



3/8"

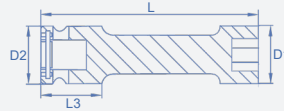

3/8"

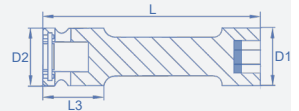

#	S	L	D2	D1	L3	MAGNETIC	S	L	D2	D1	L3
JIM2308HL/100	8	100	19	12,5	8	JIM2308HLM/100	8	100	19	12,5	8
JIM2310HL/100	10	100	19	15,5	8	JIM2310HLM/100	10	100	19	15,5	8
JIM2312HL/100	12	100	19	18	9	JIM2312HLM/100	12	100	19	18	9
JIM2313HL/100	13	100	19	20	9	JIM2313HLM/100	13	100	19	20	9
JIM2314HL/100	14	100	19	21	9	JIM2314HLM/100	14	100	19	21	9
JIM2315HL/100	15	100	22	22	11	JIM2315HLM/100	15	100	22	22	11
JIM2316HL/100	16	100	22	24	11	JIM2316HLM/100	16	100	22	24	11
JIM2317HL/100	17	100	22	25	11	JIM2317HLM/100	17	100	22	25	11
JIM2308HL/150	8	150	19	12,5	8	JIM2308HLM/150	8	150	19	12,5	8
JIM2310HL/150	10	150	19	15,5	8	JIM2310HLM/150	10	150	19	15,5	8
JIM2312HL/150	12	150	19	18	9	JIM2312HLM/150	12	150	19	18	9
JIM2313HL/150	13	150	19	20	9	JIM2313HLM/150	13	150	19	20	9
JIM2314HL/150	14	150	19	21	9	JIM2314HLM/150	14	150	19	21	9
JIM2315HL/150	15	150	22	22	11	JIM2315HLM/150	15	150	22	22	11
JIM2316HL/150	16	150	22	24	11	JIM2316HLM/150	16	150	22	24	11
JIM2317HL/150	17	150	22	25	11	JIM2317HLM/150	17	150	22	25	11
JIM2308HL/200	8	200	19	12,5	8	JIM2310HLM/175	10	175	19	25	8
JIM2310HL/200	10	200	19	15,5	8	JIM2308HLM/200	8	200	19	12,5	8
JIM2312HL/200	12	200	19	18	9	JIM2310HLM/200	10	200	19	15,5	8
JIM2313HL/200	13	200	19	20	9	JIM2312HLM/200	12	200	19	18	9
JIM2314HL/200	14	200	19	21	9	JIM2313HLM/200	13	200	19	20	9
JIM2315HL/200	15	200	22	22	11	JIM2314HLM/200	14	200	19	21	9
JIM2316HL/200	16	200	22	24	11	JIM2315HLM/200	15	200	22	22	11
JIM2317HL/200	17	200	22	25	11	JIM2316HLM/200	16	200	22	24	11
JIM2314HL/300	14	300	19	25	10	JIM2317HLM/200	17	200	22	25	11



1 / 2 "

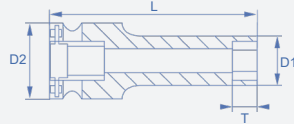

1 / 2 "

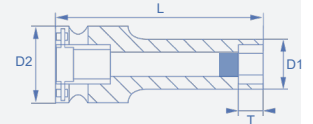

#	S	L	D2	D1	T	MAGNETIC	S	L	D2	D1	T
SIM2306H	6	52	25	13	6	SIM2306HM	6	52	25	13	4
SIM2307H	7	52	25	13,5	7	SIM2307HM	7	52	25	13,5	5
SIM2308H	8	52	25	14	9	SIM2308HM	8	52	25	14	7
SIM2309H	9	52	25	16	12	SIM2309HM	9	52	25	16	7
SIM2310H	10	52	25	16	12	SIM2310HM	10	52	25	16	7
SIM2311H	11	52	25	18,7	12	SIM2311HM	11	52	25	18,7	7
SIM2312H	12	52	25	19	12	SIM2312HM	12	52	25	19	7
SIM2313H	13	52	25	20	12	SIM2313HM	13	52	25	20	7
SIM2314H	14	52	25	22	12	SIM2314HM	14	52	25	22	7
SIM2315H	15	52	25	22	12	SIM2315HM	15	52	25	22	8
SIM2316H	16	52	25	25	12	SIM2316HM	16	52	25	25	8
SIM2317H	17	52	26	26	13	SIM2317HM	17	52	26	26	8
SIM2318H	18	52	26	26	13	SIM2318HM	18	52	26	26	8
SIM2319H	19	52	28	28	13	SIM2319HM	19	52	28	28	8
SIM2320H	20	52	30	30	14	SIM2320HM	20	52	30	30	8
SIM2321H	21	52	30	30	14	SIM2321HM	21	52	30	30	8
SIM2322H	22	52	30	32	14	SIM2322HM	22	52	30	32	8
SIM2323H	23	52	30	32	14	SIM2323HM	23	52	30	32	8
SIM2324H	24	52	30	35	15						
SIM2325H	25	57	30	36	15						
SIM2326H	26	57	30	38	17						
SIM2327H	27	57	30	38	17						
SIM2328H	28	57	30	40	17						
SIM2329H	29	57	30	40	18						
SIM2330H	30	57	30	41	18						



STANDARD

HEXAGON (LONG)
HEXAGONAL (LARGA)



1/2"

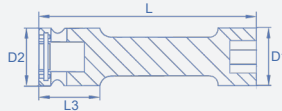

1/2"

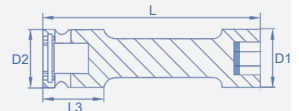

#	S	L	D2	D1	L3	MAGNETIC	S	L	D2	D1	L3
SIM2308HL/100	8	100	25	15	10	SIM2308HLM/100	8	100	25	15	10
SIM2310HL/100	10	100	25	17	12	SIM2310HLM/100	10	100	25	17	12
SIM2312HL/100	12	100	25	19,5	12	SIM2312HLM/100	12	100	25	19,5	12
SIM2313HL/100	13	100	25	21	12	SIM2313HLM/100	13	100	25	21	12
SIM2314HL/100	14	100	25	22	12	SIM2314HLM/100	14	100	25	22	12
SIM2315HL/100	15	100	25	23	12	SIM2315HLM/100	15	100	25	23	12
SIM2316HL/100	16	100	25	25	13	SIM2316HLM/100	16	100	25	25	13
SIM2317HL/100	17	100	25	26	13	SIM2317HLM/100	17	100	25	26	13
SIM2318HL/100	18	100	25	27	13	SIM2318HLM/100	18	100	25	27	13
SIM2319HL/100	19	100	25	28	13	SIM2319HLM/100	19	100	25	28	13
SIM2321HL/100	21	100	25	30	13	SIM2321HLM/100	21	100	25	30	13
SIM2322HL/100	22	100	25	31	14	SIM2322HLM/100	22	100	25	31	14
SIM2323HL/100	23	100	25	34	14	SIM2323HLM/100	23	100	25	34	14
SIM2324HL/100	24	100	30	35	15	SIM2324HLM/100	24	100	30	35	15
SIM2308HL/150	8	150	25	15	10	SIM2308HLM/150	8	150	25	15	10
SIM2310HL/150	10	150	25	17	12	SIM2310HLM/150	10	150	25	17	12
SIM2312HL/150	12	150	25	19,5	12	SIM2312HLM/150	12	150	25	19,5	12
SIM2313HL/150	13	150	25	21	12	SIM2313HLM/150	13	150	25	21	12
SIM2314HL/150	14	150	25	22	12	SIM2314HLM/150	14	150	25	22	12
SIM2315HL/150	15	150	25	23	12	SIM2315HLM/150	15	150	25	23	12
SIM2316HL/150	16	150	25	25	13	SIM2316HLM/150	16	150	25	25	13
SIM2317HL/150	17	150	25	26	13	SIM2317HLM/150	17	150	25	26	13
SIM2318HL/150	18	150	25	27	13	SIM2318HLM/150	18	150	25	27	13
SIM2319HL/150	19	150	25	28	13	SIM2319HLM/150	19	150	25	28	13
SIM2321HL/150	21	150	25	30	13	SIM2321HLM/150	21	150	25	30	13
SIM2322HL/150	22	150	25	31	14	SIM2322HLM/150	22	150	25	31	14
SIM2323HL/150	23	150	25	34	14	SIM2323HLM/150	23	150	25	34	14
SIM2324HL/150	24	150	30	35	15	SIM2324HLM/150	24	150	30	35	15
SIM2308HL/200	8	200	25	15	10	SIM2308HLM/200	8	200	25	15	10
SIM2310HL/200	10	200	25	17	12	SIM2310HLM/200	10	200	25	17	12
SIM2312HL/200	12	200	25	19,5	12	SIM2312HLM/200	12	200	25	19,5	12
SIM2313HL/200	13	200	25	21	12	SIM2313HLM/200	13	200	25	21	12
SIM2314HL/200	14	200	25	22	12	SIM2314HLM/200	14	200	25	22	12
SIM2315HL/200	15	200	25	23	12	SIM2315HLM/200	15	200	25	23	12
SIM2316HL/200	16	200	25	25	13	SIM2316HLM/200	16	200	25	25	13
SIM2317HL/200	17	200	25	26	13	SIM2317HLM/200	17	200	25	26	13
SIM2318HL/200	18	200	25	27	13	SIM2318HLM/200	18	200	25	27	13
SIM2319HL/200	19	200	25	28	13	SIM2319HLM/200	19	200	25	28	13
SIM2321HL/200	21	200	25	30	13	SIM2321HLM/200	21	200	25	30	13
SIM2322HL/200	22	200	25	31	14	SIM2322HLM/200	22	200	25	31	14
SIM2323HL/200	23	200	25	34	14	SIM2323HLM/200	23	200	25	34	14
SIM2324HL/200	24	200	30	35	15	SIM2324HLM/200	24	200	30	35	15
						SIM2312HLM/230	12	230	25	19,5	12

ANTI-VIBRATION ADAPTERS

ADAPTADORES ANTI-VIBRACIÓN

3/8"

PIN PIN

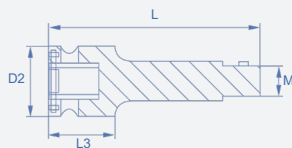

HOLE PASANTE

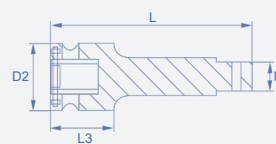

#	L	M	L3	#	L	M	L3
JIM3122B	50	1/2	26	JIM3122C	50	1/2	26
JIM3124B	100	1/2	26	JIM3124C	100	1/2	26

1/2"

PIN PIN

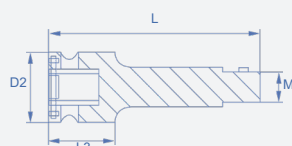

HOLE PASANTE

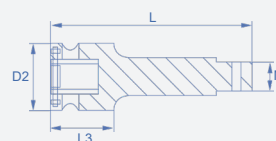

#	L	M	L3	#	L	M	L3
SIM2952B	50	3/8	34	SIM2952C	50	3/8	34
SIM2954B	100	3/8	34				
SIM2956B	150	3/8	34				
SIM2958B	200	3/8	34				

3/4"

PIN PIN

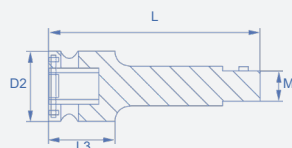

#	L	M	L3
KIM2903B	75	1/2	44

ANTI-VIBRATION EXTENSIONS

EXTENSIONES ANTIVIBRATORIAS

3/8"

PIN PIN

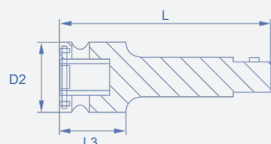

HOLE PASANTE

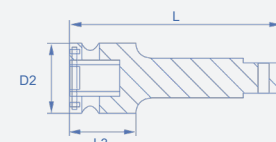

#	L	D2	L3	#	L	D2	L3
JIM3022B	50	19	29	JIM3022C	50	19	29
JIM3024B	100	19	29	JIM3024C	100	19	29
JIM3025B	125	19	29	JIM3026C	150	19	29
JIM3026B	150	19	29	JIM3028C	200	19	29
JIM3028B	200	19	29	JIM3030C	250	19	29
JIM3030B	250	19	29				

STANDARD

1/2"

PIN PIN

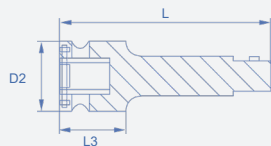

HOLE PASANTE

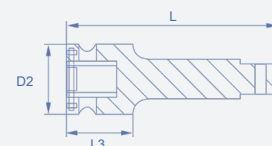

#	L	D2	L3	#	L	D2	L3
SIM3054B	100	25	34	SIM3054C	100	25	34
SIM3056B	150	25	34				
SIM3058B	200	25	34				
SIM3060B	250	25	34				
SIM3062B	300	25	34				

ANTI-VIBRATION WRENCHES RÓTULAS ANTI-VIBRATORIAS

HEXAGON
HEXAGONAL 

3/8"

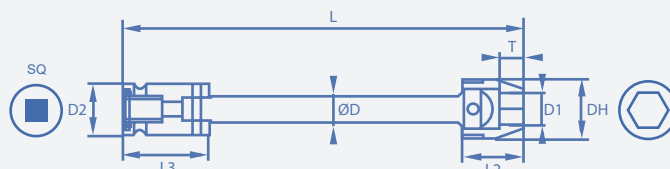

#	S	L	SQ	D1	DH	D2	D	L2	L3	T
JIM4010H/6T*	10	160	3/8	11,6	19,6	19	12,7	21	45	12
JIM4013H/3	13	114	3/8	17,5	25,5	19	12,7	25,2	45	12
JIM4013H/3T*	13	114	3/8	17,5	25,5	19	12,7	25,2	45	12
JIM4013H/6	13	190	3/8	17,5	25,5	19	12,7	25,2	45	12
JIM4013H/9	13	266	3/8	17,5	25,5	19	12,7	25,2	45	12
JIM4015H/3	15	118	3/8	20	28,5	19	12,7	29	45	12
JIM4015H/6	15	194	3/8	20	28,5	19	12,7	29	45	12
JIM4015H/9	15	270	3/8	20	28,5	19	12,7	29	45	12
JIM4016H/6	16	195	3/8	21,4	28,5	19	12,7	30	45	12
JIM4018H/3	18	121	3/8	25,5	28,5	19	12,7	29	45	12
JIM4018H/6	18	197	3/8	25,5	28,5	19	12,7	29	45	12
JIM4018H/9	18	270	3/8	25,5	28,5	19	12,7	29	45	12
JIM4021H/6	21	198	3/8	30	30	19	12,7	32	45	12
JIM4021H/9	21	270	3/8	30	30	19	12,7	32	45	12
JIM4022H/4	22	146	3/8	35	35	19	12,7	32	45	12

*Tensor

DOUBLE-HEXAGON
BIHEXAGONAL 

1/2"

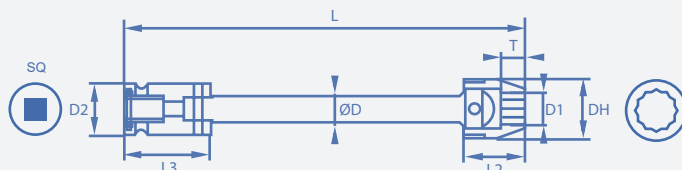

#	S	L	SQ	D1	DH	D2	D	L2	L3	T
SIM4010BH/6	10	185	1/2	11,8	21	25	11	21	58	12
SIM4011BH/6	11	185	1/2	12,8	21	25	11	21	58	12
SIM4016BH/3	16	124	1/2	19	28,5	25	12,5	30	58	12
SIM4018BH/9T*	18	276	1/2	21	25,8	25	12,5	32	51	13,4

*Tensor

HEXAGON
HEXAGONAL



1/2"

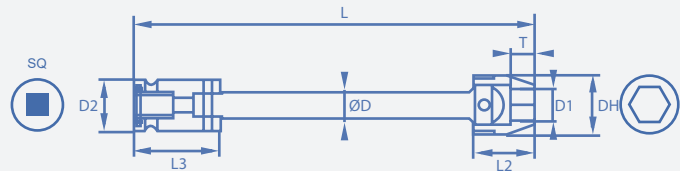

#	S	L	SQ	D1	DH	D2	D	L2	L3	T
SIM4013H/3	13	120	1/2	17,5	25,5	25	11	25,2	51	12
SIM4013H/3T*	13	120	1/2	17,5	25,5	25	11	25,2	51	12
SIM4013H/6	13	196	1/2	17,5	25,5	25	11	25,2	51	12
SIM4013H/9	13	272	1/2	17,5	25,5	25	11	25,2	51	12
SIM4015H/3	15	124	1/2	20	28,5	25	11	29	51	12
SIM4015H/6	15	200	1/2	20	28,5	25	11	29	51	12
SIM4015H/9	15	276	1/2	20	28,5	25	11	29	51	12
SIM4016H/4T*	16	154	1/2	19	25,7	25	12,7	30	51	12
SIM4016H/6	16	201	1/2	21,4	28,5	25	11	30	51	12
SIM4016H/12T*	16	315	1/2	19	26	25	12,5	45	51	12
SIM4017H/6	17	160	1/2	18,7	25,6	25	12	36	35	12
SIM4017H/9	17	136	1/2	20,5	28	25	12,5	32	56	12
SIM4018H/3	18	127	1/2	25,5	28,5	25	11	32	51	12
SIM4018H/3T*	18	140	1/2	21	26	25	12,5	40	51	21
SIM4018H/6	18	203	1/2	25,5	28,5	25	11	32	51	12
SIM4018H/9	18	276	1/2	25,5	28,5	25	11	32	51	12
SIM4019H/3	19	126	1/2	21,3	28	25	12,5	32	56	12
SIM4021H/6	21	204	1/2	30	30	25	11	32	51	12
SIM4021H/9	21	276	1/2	30	30	25	11	32	51	12
SIM4022H/4	22	153	1/2	30	30	25	11	32	51	12
SIM4022H/9	22	275	1/2	26	36	29	21	35	62	17

*Tensor

HEXAGON
HEXAGONAL



3/4"

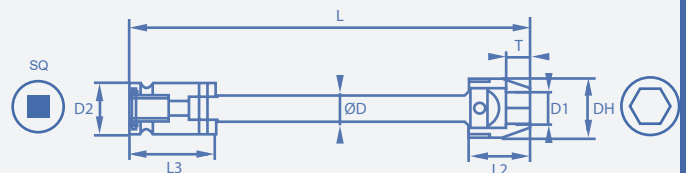

#	S	L	SQ	D1	DH	D2	D	L2	L3	T
KIM4018H/6	18	205	3/4	21	31,7	37	19	29	59	12
KIM4018H/9	18	275	3/4	32	28,5	38,3	17	29	46	12
KIM4021H/9	21	275	3/4	24,3	32	38,3	19	29	59	12
KIM4022H/4	22	145	3/4	32	32	38,3	17	29	46	12
KIM4024H/9	24	280	3/4	28,3	35	37	19	36	59	18,2

ANTI-VIBRATION
ANTI-VIBRATORIAS

ANTI-VIBRATION SOCKETS

EMBOCADURAS ANTI-VIBRATORIAS

HEXAGON
HEXAGONAL



3 / 8 "

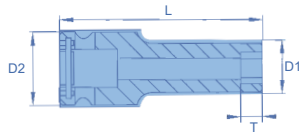

3 / 8 "

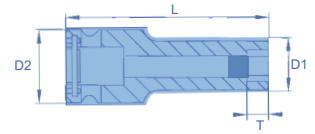

#	S	L	D2	D1	T	MAGNETIC	S	L	D2	D1	T
JIM2306H/TEF	6	43	22,5	14	5	JIM2306HM/TEF	6	43	22,5	14	5
JIM2307H/TEF	7	43	22,5	15	5	JIM2307HM/TEF	7	43	22,5	15	5
JIM2308H/TEF	8	43	22,5	15,5	7	JIM2308HM/TEF	8	43	22,5	15,5	7
JIM2309H/TEF	9	43	22,5	18,5	7	JIM2309HM/TEF	9	43	22,5	18,5	7
JIM2310H/TEF	10	43	22,5	18,5	7	JIM2310HM/TEF	10	43	22,5	18,5	7
JIM2311H/TEF	11	43	22,5	21,5	8	JIM2311HM/TEF	11	43	22,5	21,5	8
JIM2312H/TEF	12	43	22,5	20,5	9	JIM2312HM/TEF	12	43	22,5	20,5	9
JIM2313H/TEF	13	43	22,5	22,5	9	JIM2313HM/TEF	13	43	22,5	22,5	9
JIM2314H/TEF	14	43	23,5	23,5	9	JIM2314HM/TEF	14	43	23,5	23,5	9
JIM2315H/TEF	15	43	25,5	25,5	12	JIM2315HM/TEF	15	43	25,5	25,5	12
JIM2316H/TEF	16	43	25,5	27,5	12	JIM2316HM/TEF	16	43	25,5	27,5	12
JIM2317H/TEF	17	43	25,5	28,5	12	JIM2317HM/TEF	17	43	25,5	28,5	12
JIM2318H/TEF	18	43	25,5	29,5	12	JIM2318HM/TEF	18	43	25,5	29,5	12
JIM2319H/TEF	19	43	25,5	30,5	12	JIM2319HM/TEF	19	43	25,5	30,5	12
JIM2320H/TEF	20	43	25,5	31,5	13	JIM2320HM/TEF	20	43	25,5	31,5	13
JIM2321H/TEF	21	43	25,5	33,5	13	JIM2321HM/TEF	21	43	25,5	33,5	13
JIM2322H/TEF	22	43	25,5	35,5	14	JIM2322HM/TEF	22	43	25,5	35,5	14

O-RING
ANILLO TÓRICO

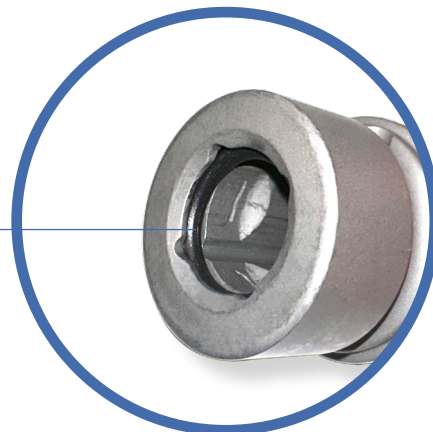

HEXAGON (LONG)
HEXAGONAL (LARGA)



3 / 8 "

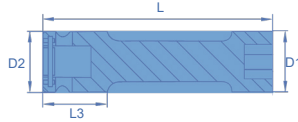

3 / 8 "

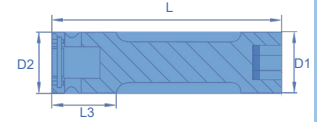

#	S	L	D2	D1	L3	MAGNETIC	S	L	D2	D1	L3
JIM2308HL/100/TEF	8	100	22,5	16	8	JIM2308HLM/100/TEF	8	100	22,5	16	8
JIM2310HL/100/TEF	10	100	22,5	19	8	JIM2310HLM/100/TEF	10	100	22,5	19	8
JIM2312HL/100/TEF	12	100	22,5	21,5	9	JIM2312HLM/100/TEF	12	100	22,5	21,5	9
JIM2313HL/100/TEF	13	100	22,5	23,5	9	JIM2313HLM/100/TEF	13	100	22,5	23,5	9
JIM2314HL/100/TEF	14	100	22,5	24,5	9	JIM2314HLM/100/TEF	14	100	22,5	24,5	9
JIM2315HL/100/TEF	15	100	25,5	25,5	11	JIM2315HLM/100/TEF	15	100	25,5	25,5	11
JIM2316HL/100/TEF	16	100	25,5	27,5	11	JIM2316HLM/100/TEF	16	100	25,5	27,5	11
JIM2317HL/100/TEF	17	100	25,5	28,5	11	JIM2317HLM/100/TEF	17	100	25,5	28,5	11
JIM2308HL/150/TEF	8	150	22,5	16	8	JIM2308HLM/150/TEF	8	150	22,5	16	8
JIM2310HL/150/TEF	10	150	22,5	19	8	JIM2310HLM/150/TEF	10	150	22,5	19	8
JIM2312HL/150/TEF	12	150	22,5	21,5	9	JIM2312HLM/150/TEF	12	150	22,5	21,5	9
JIM2313HL/150/TEF	13	150	22,5	23,5	9	JIM2313HLM/150/TEF	13	150	22,5	23,5	9
JIM2314HL/150/TEF	14	150	22,5	24,5	9	JIM2314HLM/150/TEF	14	150	22,5	24,5	9
JIM2315HL/150/TEF	15	150	25,5	25,5	11	JIM2315HLM/150/TEF	15	150	25,5	25,5	11
JIM2316HL/150/TEF	16	150	25,5	27,5	11	JIM2316HLM/150/TEF	16	150	25,5	27,5	11
JIM2317HL/150/TEF	17	150	25,5	28,5	11	JIM2317HLM/150/TEF	17	150	25,5	28,5	11
JIM2308HL/200/TEF	8	200	22,5	16	8	JIM2308HLM/200/TEF	8	200	22,5	16	8
JIM2310HL/200/TEF	10	200	22,5	19	8	JIM2310HLM/200/TEF	10	200	22,5	19	8
JIM2312HL/200/TEF	12	200	22,5	21,5	9	JIM2312HLM/200/TEF	12	200	22,5	21,5	9
JIM2313HL/200/TEF	13	200	22,5	23,5	9	JIM2313HLM/200/TEF	13	200	22,5	23,5	9
JIM2314HL/200/TEF	14	200	22,5	24,5	9	JIM2314HLM/200/TEF	14	200	22,5	24,5	9
JIM2315HL/200/TEF	15	200	25,5	25,5	11	JIM2315HLM/200/TEF	15	200	25,5	25,5	11
JIM2316HL/200/TEF	16	200	25,5	27,5	11	JIM2316HLM/200/TEF	16	200	25,5	27,5	11
JIM2317HL/200/TEF	17	200	25,5	28,5	11	JIM2317HLM/200/TEF	17	200	25,5	28,5	11



1/2"

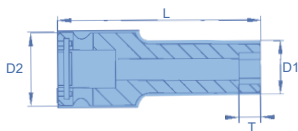

1/2"

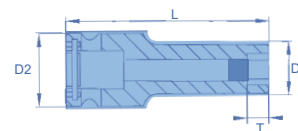

#	S	L	D2	D1	T	MAGNETIC	S	L	D2	D1	T
SIM2306H/TEF	6	52	29	17	6	SIM2306HM/TEF	6	52	29	17	4
SIM2307H/TEF	7	52	29	17,5	7	SIM2307HM/TEF	7	52	29	17,5	5
SIM2308H/TEF	8	52	29	18	9	SIM2308HM/TEF	8	52	29	18	7
SIM2309H/TEF	9	52	29	20	12	SIM2309HM/TEF	9	52	29	20	7
SIM2310H/TEF	10	52	29	20	12	SIM2310HM/TEF	10	52	29	20	7
SIM2311H/TEF	11	52	29	22,7	12	SIM2311HM/TEF	11	52	29	22,7	7
SIM2312H/TEF	12	52	29	23	12	SIM2312HM/TEF	12	52	29	23	7
SIM2313H/TEF	13	52	29	24	12	SIM2313HM/TEF	13	52	29	24	7
SIM2314H/TEF	14	52	29	26	12	SIM2314HM/TEF	14	52	29	26	7
SIM2315H/TEF	15	52	30	26	12	SIM2315HM/TEF	15	52	30	26	8
SIM2316H/TEF	16	52	32	29	12	SIM2316HM/TEF	16	52	32	29	8
SIM2317H/TEF	17	52	34	30	13	SIM2317HM/TEF	17	52	34	30	8
SIM2318H/TEF	18	52	34	30	13	SIM2318HM/TEF	18	52	34	30	8
SIM2319H/TEF	19	52	34	32	13	SIM2319HM/TEF	19	52	34	32	8
SIM2320H/TEF	20	52	34	34	14	SIM2320HM/TEF	20	52	34	34	8
SIM2321H/TEF	21	52	34	34	14	SIM2321HM/TEF	21	52	34	34	8
SIM2322H/TEF	22	52	34	36	14	SIM2322HM/TEF	22	52	34	36	8
SIM2323H/TEF	23	52	34	36	14	SIM2323HM/TEF	23	52	34	36	8
SIM2324H/TEF	24	52	34	39	15	SIM2324HM/TEF	24	52	34	39	10
SIM2325H/TEF	25	57	34	40	15	SIM2325HM/TEF	25	57	34	40	10
SIM2326H/TEF	26	57	34	42	17	SIM2326HM/TEF	26	57	34	42	12
SIM2327H/TEF	27	57	34	42	17	SIM2327HM/TEF	27	57	34	42	12
SIM2328H/TEF	28	57	34	44	17	SIM2328HM/TEF	28	57	34	44	12
SIM2329H/TEF	29	57	34	44	18	SIM2329HM/TEF	29	57	34	44	12
SIM2330H/TEF	30	57	34	45	18	SIM2330HM/TEF	30	57	34	45	12
SIM2331H/TEF	31	57	34	47	18	SIM2331HM/TEF	31	57	34	47	12
SIM2332H/TEF	32	57	34	48	18	SIM2332HM/TEF	32	57	34	48	12



HEXAGON (LONG)
HEXAGONAL (LARGA)



1/2"

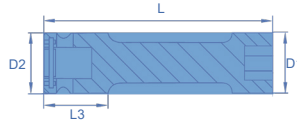

1/2"

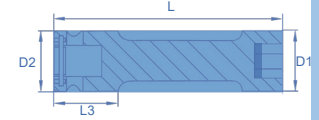

#	S	L	D2	D1	L3	MAGNETIC	S	L	D2	D1	L3
SIM2308HL/100/TEF	8	100	25	15	10	SIM2308HLM/100/TEF	8	100	25	15	10
SIM2310HL/100/TEF	10	100	25	17	12	SIM2310HLM/100/TEF	10	100	25	17	12
SIM2312HL/100/TEF	12	100	25	19,5	12	SIM2312HLM/100/TEF	12	100	25	19,5	12
SIM2313HL/100/TEF	13	100	25	21	12	SIM2313HLM/100/TEF	13	100	25	21	12
SIM2314HL/100/TEF	14	100	25	22	12	SIM2314HLM/100/TEF	14	100	25	22	12
SIM2315HL/100/TEF	15	100	25	23	12	SIM2315HLM/100/TEF	15	100	25	23	12
SIM2316HL/100/TEF	16	100	25	25	13	SIM2316HLM/100/TEF	16	100	25	25	13
SIM2317HL/100/TEF	17	100	25	26	13	SIM2317HLM/100/TEF	17	100	25	26	13
SIM2318HL/100/TEF	18	100	25	27	13	SIM2318HLM/100/TEF	18	100	25	27	13
SIM2319HL/100/TEF	19	100	25	28	13	SIM2319HLM/100/TEF	19	100	25	28	13
SIM2321HL/100/TEF	21	100	25	30	13	SIM2321HLM/100/TEF	21	100	25	30	13
SIM2322HL/100/TEF	22	100	25	31	14	SIM2322HLM/100/TEF	22	100	25	31	14
SIM2323HL/100/TEF	23	100	25	34	14	SIM2323HLM/100/TEF	23	100	25	34	14
SIM2324HL/100/TEF	24	100	30	35	15	SIM2324HLM/100/TEF	24	100	30	35	15
SIM2308HL/150/TEF	8	150	25	15	10	SIM2308HLM/150/TEF	8	150	25	15	10
SIM2310HL/150/TEF	10	150	25	17	12	SIM2310HLM/150/TEF	10	150	25	17	12
SIM2312HL/150/TEF	12	150	25	19,5	12	SIM2312HLM/150/TEF	12	150	25	19,5	12
SIM2313HL/150/TEF	13	150	25	21	12	SIM2313HLM/150/TEF	13	150	25	21	12
SIM2314HL/150/TEF	14	150	25	22	12	SIM2314HLM/150/TEF	14	150	25	22	12
SIM2315HL/150/TEF	15	150	25	23	12	SIM2315HLM/150/TEF	15	150	25	23	12
SIM2316HL/150/TEF	16	150	25	25	13	SIM2316HLM/150/TEF	16	150	25	25	13
SIM2317HL/150/TEF	17	150	25	26	13	SIM2317HLM/150/TEF	17	150	25	26	13
SIM2318HL/150/TEF	18	150	25	27	13	SIM2318HLM/150/TEF	18	150	25	27	13
SIM2319HL/150/TEF	19	150	25	28	13	SIM2319HLM/150/TEF	19	150	25	28	13
SIM2321HL/150/TEF	21	150	25	30	13	SIM2321HLM/150/TEF	21	150	25	30	13
SIM2322HL/150/TEF	22	150	25	31	14	SIM2322HLM/150/TEF	22	150	25	31	14
SIM2323HL/150/TEF	23	150	25	34	14	SIM2323HLM/150/TEF	23	150	25	34	14
SIM2324HL/150/TEF	24	150	30	35	15	SIM2324HLM/150/TEF	24	150	30	35	15
SIM2308HL/200/TEF	8	200	25	15	10	SIM2308HLM/200/TEF	8	200	25	15	10
SIM2310HL/200/TEF	10	200	25	17	12	SIM2310HLM/200/TEF	10	200	25	17	12
SIM2312HL/200/TEF	12	200	25	19,5	12	SIM2312HLM/200/TEF	12	200	25	19,5	12
SIM2313HL/200/TEF	13	200	25	21	12	SIM2313HLM/200/TEF	13	200	25	21	12
SIM2314HL/200/TEF	14	200	25	22	12	SIM2314HLM/200/TEF	14	200	25	22	12
SIM2315HL/200/TEF	15	200	25	23	12	SIM2315HLM/200/TEF	15	200	25	23	12
SIM2316HL/200/TEF	16	200	25	25	13	SIM2316HLM/200/TEF	16	200	25	25	13
SIM2317HL/200/TEF	17	200	25	26	13	SIM2317HLM/200/TEF	17	200	25	26	13
SIM2318HL/200/TEF	18	200	25	27	13	SIM2318HLM/200/TEF	18	200	25	27	13
SIM2319HL/200/TEF	19	200	25	28	13	SIM2319HLM/200/TEF	19	200	25	28	13
SIM2321HL/200/TEF	21	200	25	30	13	SIM2321HLM/200/TEF	21	200	25	30	13
SIM2322HL/200/TEF	22	200	25	31	14	SIM2322HLM/200/TEF	22	200	25	31	14
SIM2323HL/200/TEF	23	200	25	34	14	SIM2323HLM/200/TEF	23	200	25	34	14
SIM2324HL/200/TEF	24	200	30	35	15	SIM2324HLM/200/TEF	24	200	30	35	15

ANTI-VIBRATION
ANTI-VIBRATORIAS

PROTECTED

ANTI-VIBRATION ADAPTERS

ADAPTADORES ANTI-VIBRATORIOS

3/8"

PIN PIN

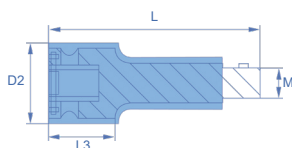

HOLE PASANTE

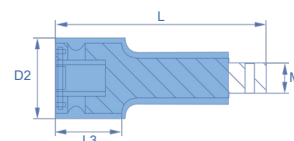

#	L	D2	M	#	L	D2	M
JIM3122B/TEF	50	22,5	1/2	JIM3122C/TEF	50	22,5	1/2
JIM3124B/TEF	100	22,5	1/2	JIM3124C/TEF	100	22,5	1/2

1/2"

PIN PIN

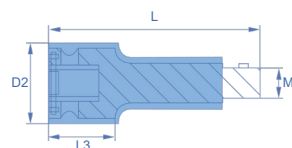

HOLE PASANTE

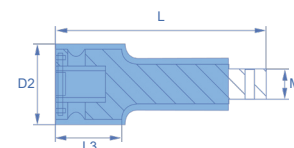

#	L	D2	M	#	L	D2	M
SIM2952B/TEF	50	29	3/8	SIM2952C/TEF	50	29	3/8
SIM2954B/TEF	100	29	3/8	SIM2954C/TEF	100	29	3/8

ANTI-VIBRATION EXTENSIONS

EXTENSIONES ANTI-VIBRATORIAS

3/8"

PIN PIN

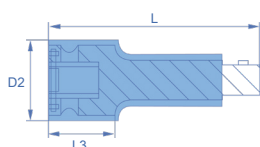

HOLE PASANTE

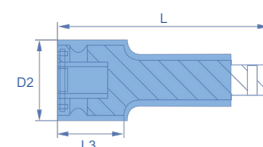

#	L	D2	#	L	D2
JIM3022B/TEF	50	22,5	JIM3022C/TEF	50	22,5
JIM3024B/TEF	100	22,5	JIM3024C/TEF	100	22,5
JIM3026B/TEF	150	22,5	JIM3026C/TEF	150	22,5
JIM3028B/TEF	200	22,5	JIM3028C/TEF	200	22,5
JIM3030B/TEF	250	22,5	JIM3030C/TEF	250	22,5

1/2"

PIN PIN

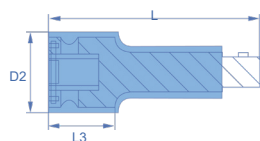

HOLE PASANTE

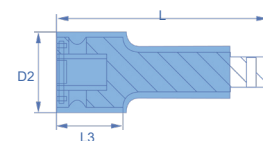

#	L	D2	#	L	D2
SIM3054B/TEF	100	29	SIM3054C/TEF	100	29
SIM3056B/TEF	150	29	SIM3056C/TEF	150	29
SIM3058B/TEF	200	29	SIM3058C/TEF	200	29
SIM3060B/TEF	250	29			



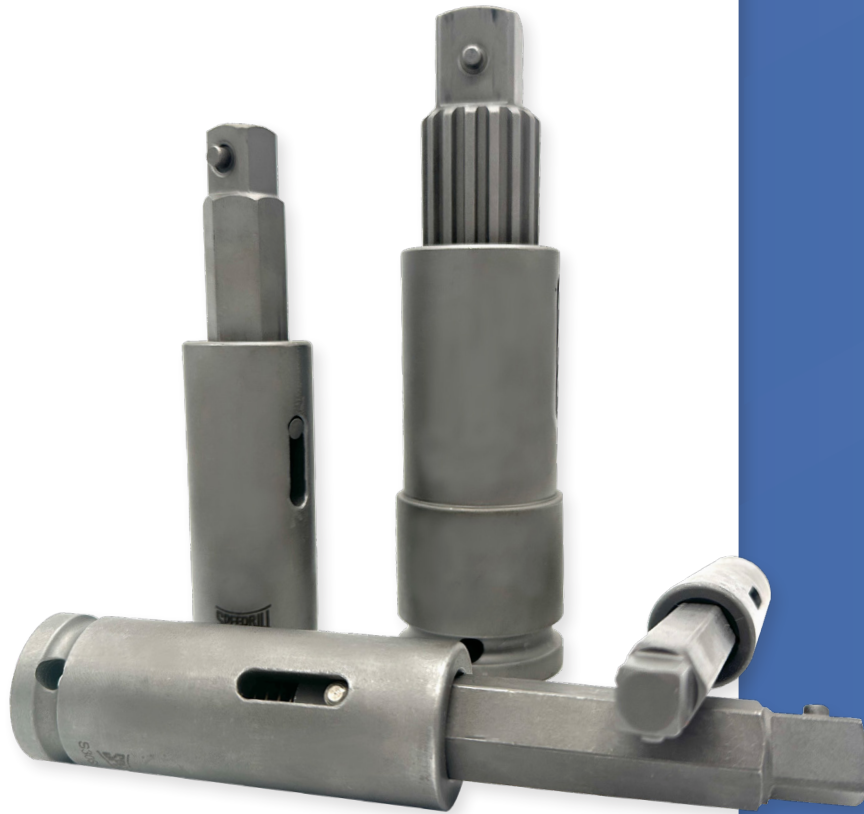

SPINDLES

HUSILLOS

Our spindles are ideal for automated workstations with high tightening torques.

Fully custom made: length, travel, body design as well as spring hardness.

Nuestros husillos son ideales para puestos de trabajo automatizados con pares de apriete elevados.

Totalmente personalizables: En longitud, recorrido, diseño de cuerpo, así como, la dureza del muelle.

08

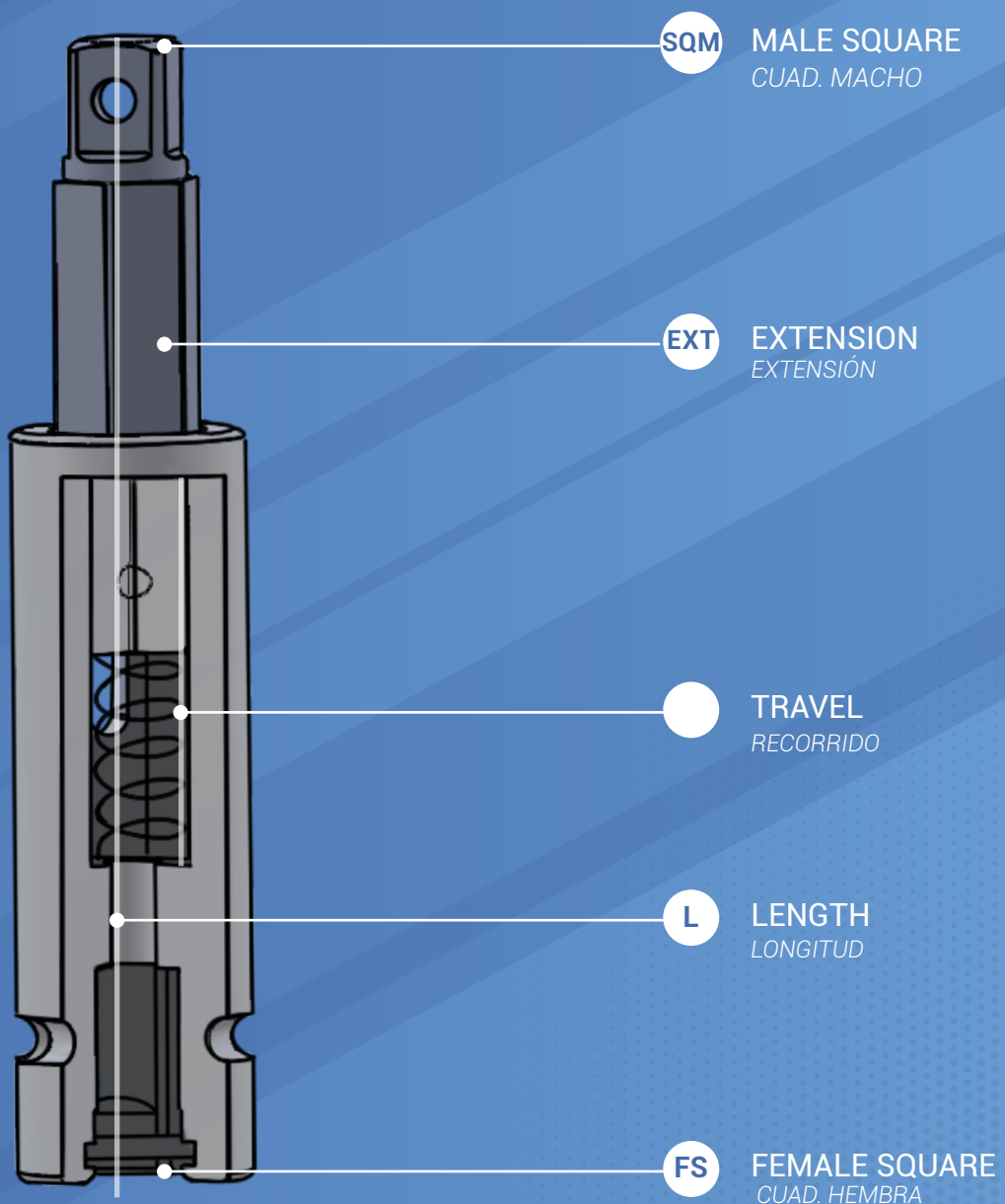

STANDARD



STANDARD SPINDLES

HUSILLOS ESTÁNDAR

3/8"

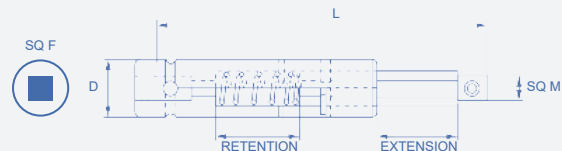

#	SQ F	SQ M	D	L	RETENTION	EXTENSION	TRAVEL
J30SPL127B	3/8"	3/8"	22	127	PIN	HEXAGONAL	16 mm
J30SPL150B	3/8"	3/8"	22	150	PIN	HEXAGONAL	16 mm

1/2"

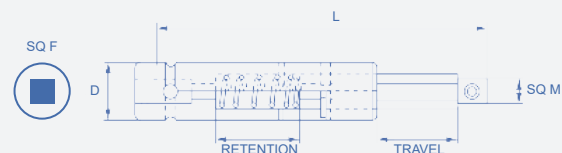

#	SQ F	SQ M	D	L	RETENTION	EXTENSION	TRAVEL
S30SPL133B	1/2"	1/2"	30	133	PIN	HEXAGONAL	16 mm
S30SPL156B	1/2"	1/2"	30	156	PIN	HEXAGONAL	16 mm

3/4"

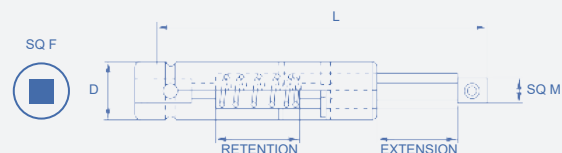

#	SQ F	SQ M	D	L	RETENTION	EXTENSION	TRAVEL
K30SPL162B	3/4"	3/4"	44	162	PIN	SPLINE	30 mm

ANTI-VIBRATION SPINDLES

HUSILLOS ANTI-VIBRACIÓN

1/2"

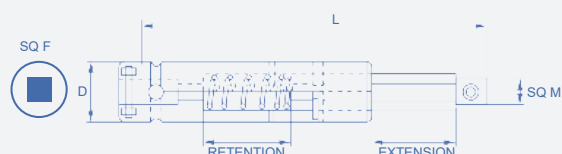

#	SQ F	SQ M	D	L	RETENTION	EXTENSION	TRAVEL
SIM30SPL143B	30	1/2	30	143	PIN	HEXAGONAL	16 mm

3/4"

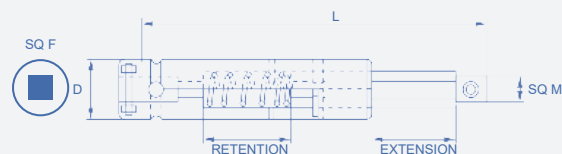

#	SQ F	SQ M	D	L	RETENTION	EXTENSION	TRAVEL
KIM30SPL180PB	44	3/4	44	180	PIN	SPLINE	50 mm

SPINDLES
HUSILLOS



INSULATED 1000V

AISLADAS 1000V

Our range of insulated products meets the international standard IEC60900.

Our pieces are manufactured individually and personalized according to the needs of our clients, with the highest quality materials.

The hexagons and squares are original Speedrill, we have combined them with 1000V axial and radial insulating material to achieve total insulation and thus, guarantee the safety of the operator, the battery and the tool.

Nuestra gama de productos aislados cumple la norma internacional IEC 60900.

Nuestras piezas son fabricadas individualmente y personalizadas según las necesidades de nuestros clientes, con materiales de la más alta calidad.

Los Hexágonos y cuadradillos son originales Speedrill, los hemos combinado con material aislante axial y radial de 1000V, para alcanzar el aislamiento total y así garantizar la seguridad del operario, la batería y la herramienta.

RADIAL ISOLATION *AISLAMIENTO RADIAL*

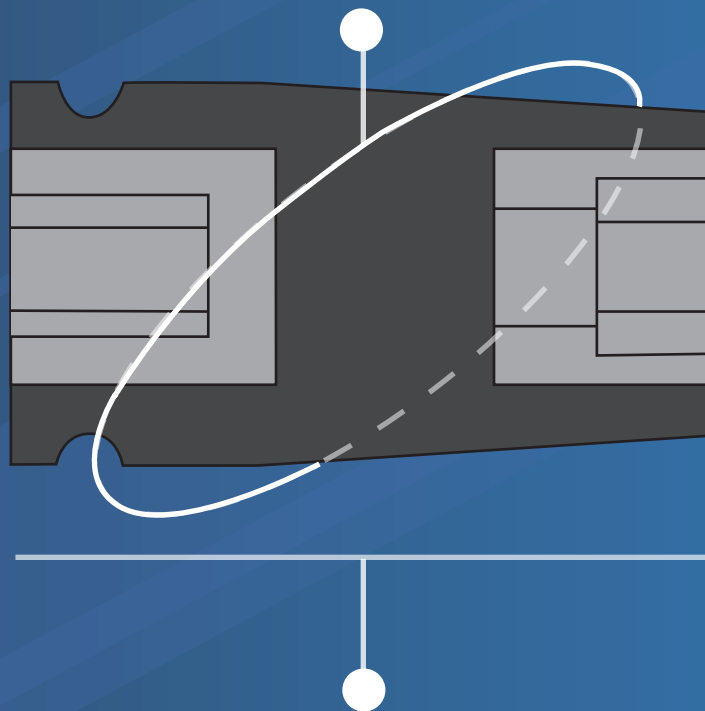

AXIAL ISOLATION *AISLAMIENTO AXIAL*

HIGH VOLTAGE PROTECTION
PROTECCIÓN CONTRA LA ALTA TENSIÓN

SIDE MAGNETS
IMANES LATERALES

FIXED MAGNETS
IMANES FIJOS

FULL CUSTOMIZATION
COMPLETA PERSONALIZACIÓN





HEXAGON
HEXAGONAL



3/8"

STANDARD
ESTÁNDAR

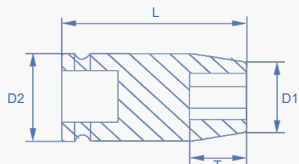

SIDE MAGNETS
IMANES LATERALES

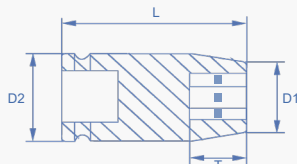

FIXED MAGNETS
IMÁN FIJO

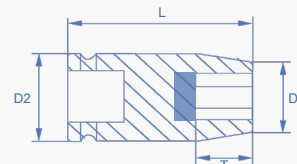

#	S	L	D1	D2	T	MAGNETIC	S	L	D1	D2	T	MAGNETIC	S	L	D1	D2	T
J2308HL/INS	8	46	23	27	6	J2308HLAPM/INS	8	46	23	27	6	J2308HLM/INS	8	46	23	27	6
J2310HL/INS	10	46	26	27	7	J2310HLAPM/INS	10	46	26	27	7	J2310HLM/INS	10	46	26	27	7
J2313HL/INS	13	46	30	27	9	J2313HLAPM/INS	13	46	30	27	9	J2313HLM/INS	13	46	30	27	9
J2316HL/INS	16	46	33	27	14	J2316HLAPM/INS	16	46	33	27	14	J2316HLM/INS	16	46	33	27	14
J2308HXL/INS	8	70	22	27	6	J2308HXLAPM/INS	8	70	22	27	6	J2308HXML/INS	8	70	22	27	6
J2310HXL/INS	10	70	24	27	8	J2310HXLAPM/INS	10	70	24	27	8	J2310HXML/INS	10	70	24	27	8
J2313HXL/INS	13	70	28	27	14	J2313HXLAPM/INS	13	70	28	27	14	J2313HXML/INS	13	70	28	27	14
J2316HXL/INS	16	70	32	27	14	J2316HXLAPM/INS	16	70	32	27	14	J2316HXML/INS	16	70	32	27	14

SURFACE DRIVE
SURFACE DRIVE



3/8"

STANDARD
ESTÁNDAR

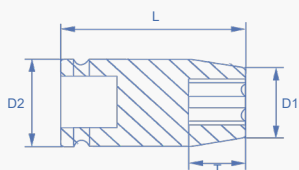

SIDE MAGNETS
IMANES LATERALES

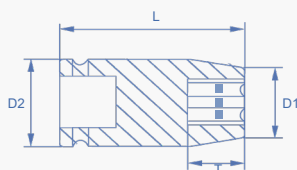

FIXED MAGNETS
IMÁN FIJO

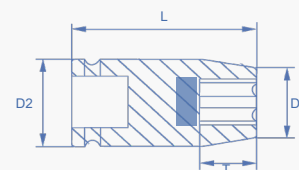

#	S	L	D1	D2	T
J2310SDL/INS	10	46	26	27	6
J2313SDL/INS	13	46	30	27	8
J2316SDL/INS	16	46	33	27	9

MAGNETIC	S	L	D1	D2	T
J2310SDLAPM/INS	10	46	26	27	6
J2313SDLAPM/INS	13	46	30	27	8
J2316SDLAPM/INS	16	46	33	27	9
J2310SDXLAPM/INS	10	70	26	27	6

MAGNETIC	S	L	D1	D2	T
J2310SDLM/INS	10	46	26	27	6
J2313SDLM/INS	13	46	30	27	8
J2316SDLM/INS	16	46	33	27	9

TORX
TORX



3/8"

STANDARD
ESTÁNDAR

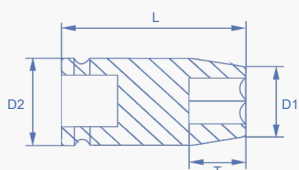

SIDE MAGNETS
IMANES LATERALES

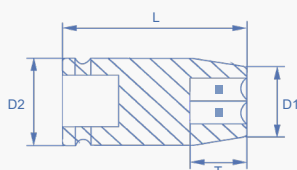

FIXED MAGNETS
IMÁN FIJO

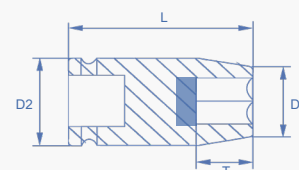

#	S	L	D1	D2	T
JE12/INS	E12	46	29	27	9
JE12/70/INS	E12	70	29	27	9

MAGNETIC	S	L	D1	D2	T
JE12APM/INS	E12	46	29	27	9
JE12APM/70/INS	E12	70	29	27	9

MAGNETIC	S	L	D1	D2	T
JE12M/INS	E12	46	29	27	9
JE12M/70/INS	E12	70	29	27	9



INSULATED 1000V
AI SLADAS 1000V

INSULATED



HEXAGON HEXAGONAL



1/2"

STANDARD ESTÁNDAR

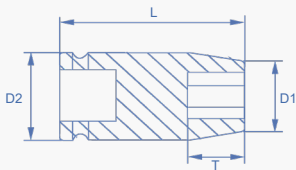

SIDE MAGNETS IMANES LATERALES

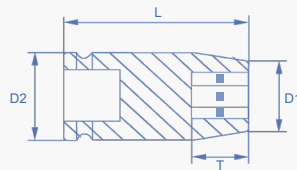

FIXED MAGNETS IMÁN FIJO

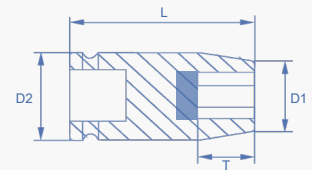

#	S	L	D1	D2	T	MAGNETIC	S	L	D1	D2	T	MAGNETIC	S	L	D1	D2	T	
S2313HJL/INS	13	65	30	27	8	S2313HJLAPM/INS	13	65	30	27	8	S2313HJLM/INS	13	65	30	27	8	5,5
S2315HJL/INS	15	65	32	27	8	S2315HJLAPM/INS	15	65	32	27	8	S2315HJLM/INS	15	65	32	27	8	6
S2316HJL/INS	16	65	34	27	10	S2316HJLAPM/INS	16	65	34	27	10	S2316HJLM/INS	16	65	34	27	10	6
S2318HJL/INS	18	65	36	27	11	S2318HJLAPM/INS	18	65	36	27	11	S2318HJLM/INS	18	65	36	27	11	7
S2321HJL/INS	21	65	40	27	12	S2321HJLAPM/INS	21	65	40	27	12	S2321HJLM/INS	21	65	40	27	12	7

ADAPTERS ADAPTADORES

3/8"

BALL BOLA

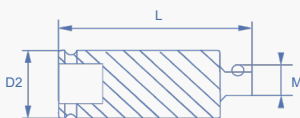

PIN PIN

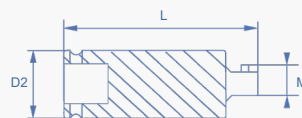

HOLE PASANTE

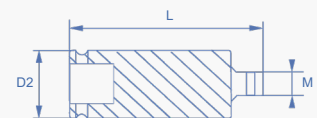

#	L	D2	M	#	L	D2	M	#	L	D2	M
J2922A/INS	50	27	1/4	J2922B/INS	50	27	1/4	J2922C/INS	50	27	1/4
J2923A/INS	75	27	1/4	J2923B/INS	75	27	1/4	J2923C/INS	75	27	1/4
J2924A/INS	100	27	1/4	J2924B/INS	100	27	1/4	J2924C/INS	100	27	1/4
J3122A/INS	50	27	1/2	J3122B/INS	50	27	1/2	J3122C/INS	50	27	1/2

QUICK CHANGE BIT-HOLDER

PORTA-PUNTAS CAMBIO RÁPIDO

3/8"

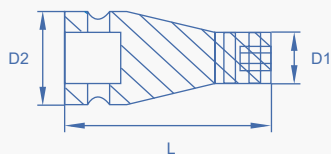

IEC 60900

PROTECTION UP TO

1000V ⚡

PROTECCIÓN HASTA

#	L	D1	D2
J100VP/56/INS	56	22,5	27
J100VP/INS	77	22,5	27

EXTENSIONS

EXTENSIONES

3/8"

BALL BOLA

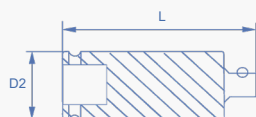

PIN PIN

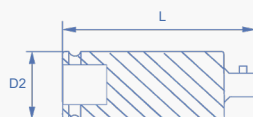

HOLE PASANTE

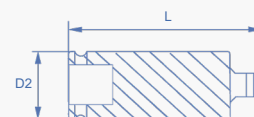

#	L	D2
J3022A/INS	50	27
J3023A/INS	75	27
J3024A/INS	100	27
J3025A/INS	125	27
J3026A/INS	150	27

#	L	D2
J3022B/INS	50	27
J3023B/INS	75	27
J3024B/INS	100	27
J3025B/INS	125	27
J3026B/INS	150	27

#	L	D2
J3022C/INS	50	27
J3023C/INS	75	27
J3024C/INS	100	27
J3025C/INS	125	27
J3026C/INS	150	27

QUICK CHANGE EXTENSIONS

EXTENSIONES CAMBIO RÁPIDO

3/8"

BALL BOLA

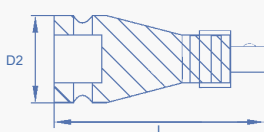

#	L	D2
J3023VP/INS	75	27
J3024VP/INS	100	27



INSULATED 1000V
AI SLADAS 1000V

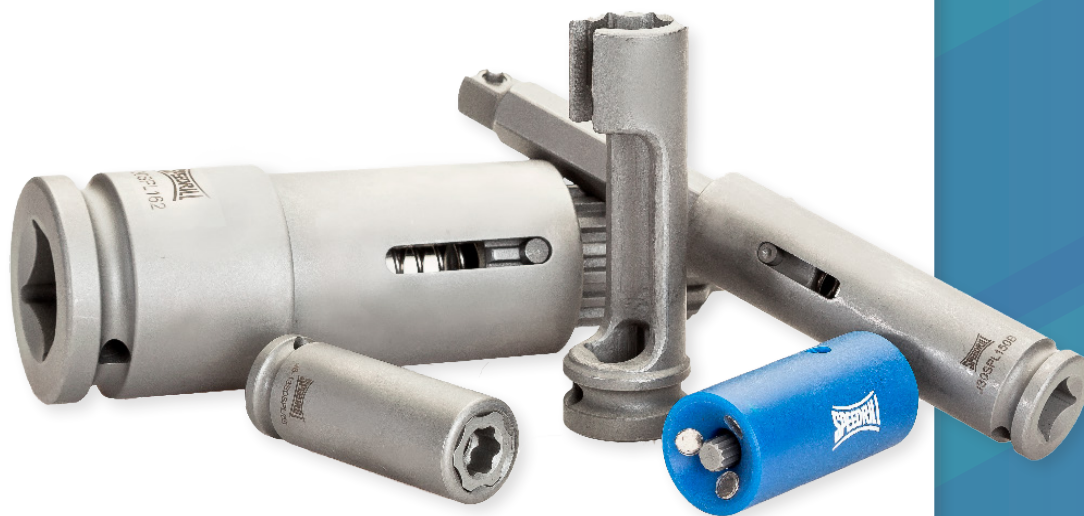

CUSTOM SOLUTIONS

ESPECIALES

We are particularly aware of the importance of good advice in the search for the right tightening accessory for the most critical situations. Our Technical department will start working from a sketch or drawing and will offer the best solution in your assembly process.

Estamos especialmente concienciados de la importancia que un buen asesoramiento tiene en la búsqueda de un accesorio de apriete adecuado para las situaciones más críticas.

Nuestro equipo técnico dará respuesta a sus necesidades más complejas, partiendo de un plano o croquis, le ofrecemos la solución que mejor se adapte a sus procesos de montaje.

10



MAGNET:
IMÁN:

FIXED
FIJO

SPRING
RETRÁCTIL

RING
ANILLO

SIDE
LATERALES

COLOUR:
COLOR:



RED
ROJO



BLUE
AZUL



WHITE
BLANCO



DOUBLE SOCKETS

EMBOCADURAS DOBLES

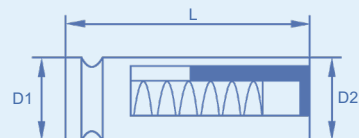

#	SQ	TYPE	S1	DRIVE 1	S2	DRIVE 2	D1	D2	L
J8-13SDSPL/50	3/8	SPRING	8	SURFACE DRIVE	13	SURFACE DRIVE	20	20	50
J8-13SDSPL/55	3/8	SPRING	8	SURFACE DRIVE	13	SURFACE DRIVE	20	20	55
J10-12HSPL/60	3/8	SPRING	10	HEX	12	HEX	19	19	60
J10-13SDSPLM/60*	3/8	SPRING	10	SURFACE DRIVE	13	SURFACE DRIVE	20	20	60
J10-13SDSPLM/100SP*	3/8	SPRING	10	SURFACE DRIVE	13	SURFACE DRIVE	20	20	100
J10-13SDSPL/90	3/8	SPRING	10	SURFACE DRIVE	13	SURFACE DRIVE	20	20	90
J10-13SDSPL/150	3/8	SPRING	10	SURFACE DRIVE	13	SURFACE DRIVE	20,55	25,5	150
J10-16SDSPLM/60*	3/8	SPRING	10	SURFACE DRIVE	16	SURFACE DRIVE	24	24	60
J10-17HMSPL/90*	3/8	SPRING	10	HEX	17	HEX	25	25	90
J13-16SDSPLM/60*	3/8	SPRING	13	SURFACE DRIVE	16	SURFACE DRIVE	24	24	60
J13SD-TX45MSPLTEF*	3/8	SPRING	TX45	TORX MAGNET	13	SURFACE DRIVE	23,5	23,5	65
J13H-BH10SPL/90	3/8	SPRING	13	HEX H	10	BIHEXAGONAL	20	20	90
J14-17HSPL/50	3/8	SPRING	14	HEX	17	HEX	21,7	25	50
JE7-8SD/38	3/8	FIXED	E7	TORX H	8	SURFACE DRIVE	15	19	38
JE7-8SD/70	3/8	FIXED	E7	TORX H	8	SURFACE DRIVE	15	19	70
JE7-8SD/80	3/8	FIXED	E7	TORX H	8	SURFACE DRIVE	15	19	80
S8-13SDSPL/60	1/2	SPRING	8	SURFACE DRIVE	13	SURFACE DRIVE	20	25	60
S8-13SDSPL/65	1/2	SPRING	8	SURFACE DRIVE	13	SURFACE DRIVE	20	25	65
S14-17SDPL/60	1/2	SPRING	14	SURFACE DRIVE	17	SURFACE DRIVE	26	26	60
S16-19SDSPLM/105*	1/2	SPRING	16	SURFACE DRIVE	19	SURFACE DRIVE	28	28	105
S17-19SDSPL/82	1/2	SPRING	17	SURFACE DRIVE	19	SURFACE DRIVE	31,6	31,6	82
S18-21HSPL	1/2	FIXED	18	HEX	21	HEX	30	30	60
SE16-TX55SPL/65	1/2	SPRING	TX55	TORX M	E16	TORX H	20	25	65
SE20-TX55SPL/65	1/2	SPRING	E20	TORX H	T55	TORX M	25	25	65

* MAGNET *IMANTADA*

These are our measurements in stock, for any other measurements, please contact us

Estas son nuestras medidas en stock, para cualquier otra medida, póngase en contacto con nosotros



OPEN SOCKETS
EMBOCADURAS ABIERTAS

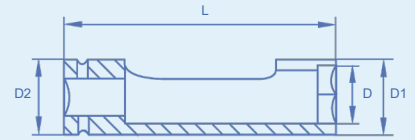

#	SQ	S	L	S2	D1	D2	D
OSJ2322BH/120	3/8	22	120	13	31	22	21,5
OSS2314HL	1/2	14	80	13	23	25	13,5
OSS2322HL/80	1/2	22	80	13	30,7	30	21
OSS2322HL/90	1/2	22	90	13	30,7	30	21
OSS2322HL/97	1/2	22	97	16	30,7	30	21
OSS2322HL/100	1/2	22	100	17	31	30	20,5
OSS2322BH/120	1/2	22	120	16	31,7	25	21,5

DOUBLE-HEXAGON
BIHEXAGONAL

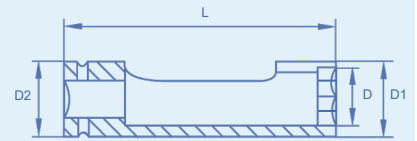

#	SQ	S	L	S2	D1	D2	D
OSJ2322BH/120	3/8	22	120	13	31	22	21,5
OSS2322BH/120	1/2	22	120	16	31,7	25	21,5

CUSTOMIZABLE
100%
PERSONALIZABLE



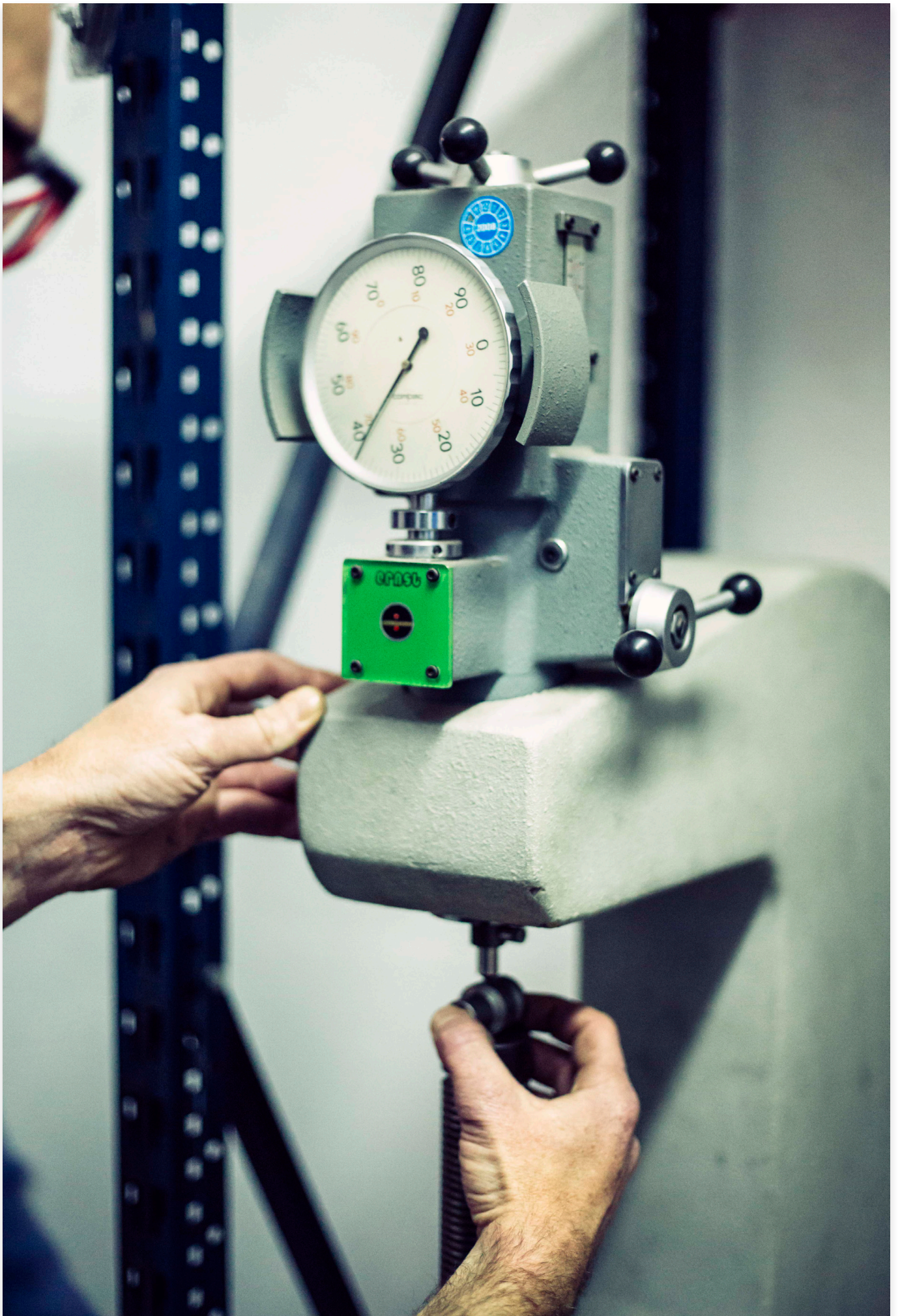

CONVERSION TABLE

TABLA DE CONVERSIÓN

MM	DEC.	IN.	MM	DEC.	IN.	MM	DEC.	IN.	MM	DEC.	IN.	MM	DEC.	IN.
0.100	.0039		5.159	.2031	13/64	10.200	.4016		15.300	.6024		20.300	.7992	
0.200	.0079		5.200	.2047		10.300	.4055		15.400	.6063		20.400	.8031	
0.300	.0118		5.300	.2087		10.319	.4063	13/32	15.478	.6094	39/64	20.500	.8071	
0.397	.0156	1/64	5.400	.2126		10.400	.4094		15.500	.6102		20.600	.8110	
0.400	.0157		5.500	.2165		10.500	.4134		15.600	.6142		20.638	.8125	13/16
0.500	.0197		5.556	.2188	7/32	10.600	.4173		15.700	.6181		20.700	.8150	
0.600	.0236		5.600	.2205		10.700	.4219		15.800	.6220		20.800	.8189	
0.700	.0276		5.700	.2244		10.716	.4219	27/64	15.875	.6250	5/8	20.900	.8228	
0.794	.0313	1/32	5.800	.2283		10.800	.4252		15.900	.6250		21.000	.8268	
0.800	.0315		5.900	.2323		10.900	.4291		16.000	.6299		21.034	.8261	53/64
0.900	.0354		5.953	.2344	15/64	11.000	.4331		16.100	.6339		21.100	.8307	
1.000	.0394		6.000	.2362		11.100	.4370		16.200	.6378		21.200	.8346	
1.100	.0433		6.100	.2402		11.113	.4375	7/16	16.272	.6406	41/64	21.300	.8386	
1.191	.0469	3/64	6.200	.2441		11.200	.4409		16.300	.6417		21.400	.8425	
1.200	.0472		6.300	.2480		11.300	.4449		16.400	.6457		21.431	.8438	27/32
1.300	.0512		6.350	.2500	1/4	11.400	.4488		16.500	.6496		21.500	.8465	
1.400	.0551		6.400	.2520		11.500	.4528		16.600	.6535		21.600	.8504	
1.500	.0591		6.500	.2559		11.509	.4531	29/64	16.669	.6563	21/32	21.700	.8543	
1.588	.0625	1/16	6.600	.2598		11.600	.4567		16.700	.6575		21.800	.8583	
1.600	.0630		6.700	.2638		11.700	.4606		16.800	.6614		21.828	.8594	55/64
1.700	.0669		6.747	.2656	17/64	11.800	.4646		16.900	.6654		21.900	.8622	
1.800	.0709		6.800	.2677		11.900	.4685		17.000	.6693		22.000	.8661	
1.900	.0748		6.900	.2717		11.906	.4688	15/32	17.066	.6716	43/64	22.100	.8701	
1.984	.0781	5/64	7.000	.2756		12.000	.4724		17.100	.6732		22.200	.8740	
2.000	.0878		7.100	.2795		12.100	.4764		17.200	.6772		22.225	.8750	7/8
2.100	.0827		7.144	.2813	9/32	12.200	.4803		17.300	.6811		22.300	.8780	
2.200	.0866		7.200	.2835		12.300	.4843		17.400	.6850		22.400	.8819	
2.300	.0906		7.300	.2874		12.303	.4844	31/64	17.463	.6875	11/16	22.500	.8858	
2.381	.0938	3/32	7.400	.2913		12.400	.4882		17.500	.6890		22.600	.8898	
2.400	.0945		7.500	.2953		12.500	.4921		17.600	.6929		22.622	.8906	57/64
2.500	.0984		7.541	.2969	19/64	12.600	.4961		17.700	.6968		22.700	.8937	
2.600	.1024		7.600	.2992		12.700	.5000	1/2	17.800	.7008		22.800	.8976	
2.700	.1063		7.700	.3031		12.800	.5039		17.859	.7031	45/64	22.900	.9016	
2.778	.1094	7/64	7.800	.3071		12.900	.5079		19.900	.7047		23.000	.9055	
2.800	.1102		7.900	.3110		13.000	.5118		18.000	.7087		23.019	.9063	29/32
2.900	.1142		7.938	.3125	5/16	13.097	.5156	33/64	18.100	.7126		23.100	.9094	
3.000	.1181		8.000	.3150		13.100	.5157		18.200	.7165		23.200	.9134	
3.100	.1220		8.100	.3189		13.200	.5197		18.256	.7188	23/32	23.300	.9173	
3.175	.1250	1/8	8.200	.3228		13.300	.5236		18.300	.7205		23.400	.9213	
3.200	.1260		8.300	.3268		13.400	.5276		18.400	.7244		23.416	.9219	59/64
3.300	.1299		8.334	.3281	21/64	13.494	.5313	17/32	18.500	.7283		23.500	.9252	
3.400	.1339		8.400	.3307		13.500	.5315		18.600	.7323		23.600	.9291	
3.500	.1378		8.500	.3346		13.600	.5354		18.653	.7344	47/64	23.700	.9331	
3.572	.1406	9/64	8.600	.3386		13.700	.5394		18.700	.7362		23.800	.9370	
3.600	.1417		8.700	.3425		13.800	.5433		18.800	.7402		23.900	.9409	
3.700	.1457		8.731	.3438	11/32	13.891	.5469	35/64	18.900	.7441		24.000	.9449	
3.800	.1496		8.800	.3465		13.900	.5472		19.000	.7480		24.100	.9488	
3.900	.1535		8.900	.3504		14.000	.5512		19.050	.7500	3/4	24.200	.9528	
3.969	.1563	5/32	9.000	.3543		14.100	.5551		19.100	.7520		24.209	.9531	61/64
4.000	.1575		9.100	.3583		14.200	.5591		19.200	.7559		24.300	.9567	
4.100	.1624		9.128	.3594	23/64	14.288	.5625	9/16	19.300	.7598		24.400	.9606	
4.200	.1654		9.200	.3622		14.300	.5630		19.400	.7936		24.500	.9646	
4.300	.1693		9.300	.3661		14.400	.5669		19.447	.7656	49/64	24.600	.9685	
4.366	.1719	11/64	9.400	.3701		14.500	.5709		19.500	.7677		24.606	.9688	31/32
4.400	.1732		9.500	.3740		14.600	.5748		19.600	.7717		24.700	.9724	
4.500	.1772		9.525	.3750	3/8	14.684	.5781	37/64	19.700	.7756		24.800	.9764	
4.600	.1811		9.600	.3780		14.700	.5787		19.800	.7795		24.900	.9803	
4.700	.1850		9.700	.3819		14.800	.5827		19.844	.7813	25/32	25.000	.9843	
4.763	.1875	3/16	9.800	.3858		14.900	.5866		19.900	.7835		25.003	.9844	63/64
4.800	.1890		9.900	.3898		15.000	.5906		20.000	.7874		25.100	.9882	
4.900	.1929		9.922	.3908	25/64	15.081	.5938	19/32	20.100	.7913		25.200	.9921	
5.000	.1969		10.000	.3937		15.100	.5945		20.200	.7953		25.300	.9961	
5.100	.2008		10.100	.3976		15.200	.5984		20.241	.7969	51/64	25.400	1.000	1

INDEX BY REFERENCE

ÍNDICE POR REFERENCIA

#	P.	#	P.	#	P.	#	P.	#	P.
553	35	2007VP/TEFSP	77	2010VPCJ/TEF	77	20-5/16VP/TEF	76	2521/2B/TEF	98
2570	35	2007VPC	56	2010VPCJM	57	20-5/16VPM	56	2521/2C	93
L2348H	70	2007VPC/TEF	76	2010VPCJM/TEF	77	20-5/16VPM/TEF	76	2521/2C/TEF	98
L2385H	70	2007VPCJ	57	2010VPCM	56	2520/10A	93	2521/3A	93
2004/1	56	2007VPCJ/TEF	77	2010VPCM/TEF	76	2520/10A/TEF	98	2521/3A/TEF	98
2004/1M	56	2007VPCJM	57	2010VPM	56	2520/10B	93	2521/3B	93
2004VP	56	2007VPCJM/TEF	77	2010VPM/100	56	2520/10B/TEF	98	2521/3B/TEF	98
2004VP/TEF	76	2007VPCM	56	2010VPM/TEF	76	2520/10C	93	2521/3C	93
2004VPC	56	2007VPCM/TEF	76	2010VPROT	109	2520/10C/TEF	98	2521/3C/TEF	98
2004VPC/TEF	76	2007VPM	56	2011VP	56	2520/12A	93	2521/4A	93
2004VPCJ	57	2007VPM/100	56	2011VP/TEF	76	2520/12A/TEF	98	2521/4A/TEF	98
2004VPCJ/TEF	77	2007VPM/TEF	76	2011VPC	56	2520/12B	93	2521/4B	93
2004VPCJM	57	2007VPROT	109	2011VPC/TEF	76	2520/12B/TEF	98	2521/4B/TEF	98
2004VPCJM/TEF	77	2008/1	56	2011VPCM	56	2520/12C	93	2521/4C	93
2004VPCM	56	2008/100VPM/TEF	76	2011VPCM/TEF	76	2520/12C/TEF	98	2521/4C/TEF	98
2004VPCM/TEF	76	2008/1M	56	2011VPM	56	2520/2A	93	2521/5A	93
2004VPM	56	2008VP	56	2011VPM/TEF	76	2520/2A/TEF	98	2521/5B	93
2004VPM/TEF	76	2008VP/100	56	2012VP	56	2520/2B	93	2521/5C	93
2005.5VP	56	2008VP/100/TEF	76	2012VP/TEF	76	2520/2B/TEF	98	2521/6A	93
2005.5VP/TEF	76	2008VP/100/TEFSP	77	2012VPC	56	2520/2C	93	2521/6A/TEF	98
2005.5VPC	56	2008VP/TEF	76	2012VPCM	56	2520/2C/TEF	98	2521/6B	93
2005.5VPCM	56	2008VP/TEFSP	77	2012VPM	56	2520/3A	93	2521/6B/TEF	98
2005.5VPM	56	2008VPC	56	2012VPM/TEF	76	2520/3A/TEF	98	2521/6C	93
2005.5VPM/TEF	76	2008VPC/TEF	76	2013/100VPM/TEF	76	2520/3B	93	2521/6C/TEF	98
2005/1	56	2008VPCJ	57	2013VP	56	2520/3B/TEF	98	2521/8A	93
2005/1M	56	2008VPCJ/TEF	77	2013VP/100	56	2520/3C	93	2521/8A/TEF	98
2005VP	56	2008VPCJM	57	2013VP/100	56	2520/3C/TEF	98	2521/8B	93
2005VP/TEF	76	2008VPCJM/TEF	77	2013VP/100/TEF	76	2520/4A	93	2521/8B/TEF	98
2005VPC	56	2008VPCM	56	2013VP/100/TEFSP	77	2520/4A/TEF	98	2521/8C	93
2005VPC/TEF	76	2008VPCM/TEF	76	2013VP/TEF	76	2520/4B	93	2521/8C/TEF	98
2005VPCJ	57	2008VPM	56	2013VPC	56	2520/4B/TEF	98	2528/2A	93
2005VPCJ/TEF	77	2008VPM/100	56	2013VPC/TEF	76	2520/4C	93	2528/2A/TEF	98
2005VPCJM	57	2008VPM/TEF	76	2013VPCJ	57	2520/4C/TEF	98	2528/2B	93
2005VPCJM/TEF	77	2008VPROT	109	2013VPCJ/TEF	77	2520/5A	93	2528/2B/TEF	98
2005VPCM	56	2009/1	56	2013VPCJM	57	2520/5A/TEF	98	2528/2C	93
2005VPCM/TEF	76	2009/1M	56	2013VPCJM/TEF	77	2520/5B	93	2528/2C/TEF	98
2005VPM	56	2009VP	56	2013VPCM	56	2520/5B/TEF	98	2528/3A	93
2005VPM/TEF	76	2009VP/TEF	76	2013VPCM/TEF	76	2520/5C	93	2528/3A/TEF	98
2006/1	56	2009VPC	56	2013VPM	56	2520/5C/TEF	98	2528/3B	93
2006/1M	56	2009VPC/TEF	76	2013VPM/100	56	2520/6A	93	2528/3B/TEF	98
2006VP	56	2009VPCJ	57	2013VPM/100	56	2520/6A/TEF	98	2528/3C	93
2006VP/TEF	76	2009VPCJ/TEF	77	2013VPM/TEF	76	2520/6B	93	2528/3C/TEF	98
2006VPC	56	2009VPCJM	57	2013VPROT	109	2520/6B/TEF	98	2528/4A	93
2006VPC/TEF	76	2009VPCJM/TEF	77	2014VP/TEF	76	2520/6C	93	2528/4A/TEF	98
2006VPCJ	57	2009VPCM	56	2014VPC	56	2520/6C/TEF	98	2528/4B	93
2006VPCJ/TEF	77	2009VPCM/TEF	76	2014VPCJ	57	2520/8A	93	2528/4B/TEF	98
2006VPCJM	57	2009VPM	56	2014VPCJ/TEF	77	2520/8A/TEF	98	2528/4C	93
2006VPCJM/TEF	77	2009VPM/TEF	76	2014VPCJM	57	2520/8B	93	2528/4C/TEF	98
2006VPCM	56	2010/1	56	2014VPCJM/TEF	77	2520/8B/TEF	98	2528/5A	93
2006VPCM/TEF	76	2010/100VPM/TEF	76	2014VPCM	56	2520/8C	93	2528/5A/TEF	98
2006VPM	56	2010/1M	56	2014VPM/TEF	76	2520/8C/TEF	98	2528/5B	93
2006VPM/TEF	76	2010VP	56	2015VP	56	2521/10A	93	2528/5B/TEF	98
2007/1	56	2010VP/100	56	2015VP/TEF	76	2521/10A/TEF	98	2528/5C	93
2007/100VPM/TEF	76	2010VP/100/TEF	76	2015VPM	56	2521/10B	93	2528/5C/TEF	98
2007/1M	56	2010VP/100/TEFSP	77	2015VPM/TEF	76	2521/10B/TEF	98	2529/2A	93
2007VP	56	2010VP/150/TEFSP	77	2016VP	56	2521/10C	93	2529/2A/TEF	98
2007VP/100	56	2010VP/TEF	76	2016VP/TEF	76	2521/10C/TEF	98	2529/2B	93
2007VP/100/TEF	76	2010VPC	56	2016VPM	56	2521/2A	93	2529/2B/TEF	98
2007VP/100/TEFSP	77	2010VPC/TEF	76	2016VPM/TEF	76	2521/2A/TEF	98	2529/2C	93
2007VP/TEF	76	2010VPCJ	57	20-5/16VP	56	2521/2B	93	2529/2C/TEF	98

THE TIGHTENING THAT SUITS YOU

EL APRIETE A TU MEDIDA

#	P.	#	P.	#	P.	#	P.	#	P.
2529/3A	93	BH6/TEFM	27	EM5/16A/TEF	27	J100VM	35	J2308HC/TEF	78
2529/3A/TEF	98	BH6A	15	EM5/16A/TEFM	27	J100VP	35	J2308HCM	58
2529/3B	93	BH8	15	EM5/32	14	J100VP/56/INS	137	J2308HCM/TEF	78
2529/3B/TEF	98	BH8A	15	EM5/32/TEF	26	J100VP/INS	137	J2308HER	61
2529/3C	93	BH9	15	EM5/32/TEFM	26	J10-12HSPL/60	142	J2308HER/TEF	81
2529/3C/TEF	98	CMJ-H10	93	EM5/TEF	26	J10-13SDSPL/150	142	J2308HERM	61
2529/4A	93	CMJ-H11	93	EM5/TEFM	26	J10-13SDSPL/90	142	J2308HERM/TEF	81
2529/4A/TEF	98	CMJ-H12	93	EM5A	15	J10-13SDSPLM/100SP*	142	J2308HL	59
2529/4B	93	CMJ-H13	93	EM5A/TEF	27	J10-13SDSPLM/60*	142	J2308HL/INS	134
2529/4B/TEF	98	CMJ-H14	93	EM5A/TEFM	27	J10-16SDSPLM/60*	142	J2308HL/TEF	79
2529/4C	93	CMJ-H15	93	EM6	14	J10-17HMSPL/90*	142	J2308HLAPM/INS	134
2529/4C/TEF	98	CMJ-H16	93	EM6/TEF	26	J13-16SDSPLM/60*	142	J2308HLM	59
2529/5A	93	CMJ-H17	93	EM6/TEFM	26	J13H-BH10SPL/90	142	J2308HLM/INS	134
2529/5A/TEF	98	CMS-H11	93	EM6A	15	J13SD-TX45MSPLTEF*	142	J2308HLM/TEF	79
2529/5B	93	CMS-H13	93	EM6A/TEF	27	J14-17HSPL/50	142	J2308HM	58
2529/5B/TEF	98	CMS-H14	93	EM6A/TEFM	27	J2306H	58	J2308HM/TEF	78
2529/5C	93	CMS-H15	93	EM6CM	15	J2306H/TEF	78	J2308HRM	60
2529/5C/TEF	98	CMS-H16	93	EM6CM	37	J2306HC	58	J2308HRM/TEF	80
553/10	35	CMS-H17	93	EM7	14	J2306HC/TEF	78	J2308HXL	59
553/10/TEF	38	CMS-H18	93	EM7/32	14	J2306HCM	58	J2308HXL/INS	134
553/10NR	35	CMS-H20	93	EM7/32/TEF	26	J2306HCM/TEF	78	J2308HXL/TEF	79
553/10NR/TEF	38	CMS-H21	93	EM7/32/TEFM	26	J2306HL	59	J2308HXLAPM/INS	134
553/12	35	CMS-H22	93	EM7/32A	15	J2306HL/TEF	79	J2308HXML	59
553/12/TEF	38	EM1/4	14	EM7/32A/TEF	27	J2306HLM	59	J2308HXML/INS	134
553/12NR	35	EM1/4/TEF	26	EM7/32A/TEFM	27	J2306HLM/TEF	79	J2308HXML/TEF	79
553/12NR/TEF	38	EM1/4/TEFM	26	EM7/64	14	J2306HM	58	J2308SD	61
553/3	35	EM1/4A	15	EM7/64/TEF	26	J2306HM/TEF	78	J2308SD/TEF	81
553/3/TEF	38	EM1/4A/TEF	27	EM7/64/TEFM	26	J2307BH	60	J2308SDM/TEF	81
553/3/TEFC	38	EM1/4A/TEFM	27	EM7A	15	J2307BH/TEF	80	J2309BH	60
553/3NR	35	EM1/8	14	EM7A/TEF	27	J2307BHM	60	J2309BH/TEF	80
553/3NR/TEF	38	EM1/8/TEF	26	EM7A/TEFM	27	J2307BHM/TEF	80	J2309BHM	60
553/3RAP	35	EM1/8/TEFM	26	EM8	14	J2307H	58	J2309BHM/TEF	80
553/4	35	EM10	14	EM8A	15	J2307H/TEF	78	J2309H	58
553/4/TEF	38	EM10A	15	EM8A/TEF	27	J2307HC	58	J2309H/TEF	78
553/4/TEFC	38	EM10CM	15	EM8A/TEFM	27	J2307HC/TEF	78	J2309HER	61
553/5	35	EM10CM	37	EM9/64	14	J2307HCM	58	J2309HER/TEF	81
553/5/TEF	38	EM10CV	15	IP10P	17	J2307HCM/TEF	78	J2309HERM	61
553/5/TEFC	38	EM10CV	37	IP10P/TEF	30	J2307HL	59	J2309HERM/TEF	81
553/6	35	EM10CV/10/40	38	IP10P/TEFM	30	J2307HL/TEF	79	J2309HL	59
553/6/TEF	38	EM2	14	IP15P	17	J2307HLM	59	J2309HL/TEF	79
553/6/TEFC	38	EM2.5	14	IP15P/TEF	30	J2307HLM/TEF	79	J2309HLM	59
553/8	35	EM2.5/TEF	26	IP15P/TEFM	30	J2307HM	58	J2309HLM/TEF	79
553/8/TEF	38	EM2.5/TEFM	26	IP20P	17	J2307HM/TEF	78	J2309HM	58
553/8/TEFC	38	EM2/TEF	26	IP20P/TEF	30	J2307HRM	60	J2309HM/TEF	78
553/8NR	35	EM2/TEFM	26	IP20P/TEFM	30	J2307HRM/TEF	80	J2309HRM	60
553/8NR/TEF	38	EM3	14	IP25P	17	J2307HXL	59	J2309HRM/TEF	80
553/TEF	38	EM3/16	14	IP25P/TEF	30	J2307HXL/TEF	79	J2309HXL	59
553/TEFC	38	EM3/16/TEF	26	IP25P/TEFM	30	J2307HXML	59	J2309HXL/TEF	79
BH10	15	EM3/16/TEFM	26	IP27	17	J2307HXML/TEF	79	J2309HXML	59
BH10A	15	EM3/8A	15	IP27/TEF	30	J2307SD	61	J2309HXML/TEF	79
BH12A	15	EM3/TEF	26	IP27/TEFM	30	J2307SD/TEF	81	J2309SD	61
BH14A	15	EM3/TEFM	26	IP27P	17	J2307SDM	61	J2309SD/TEF	81
BH4	15	EM4	14	IP27P/TEF	30	J2307SDM/TEF	81	J2309SDM	61
BH4/TEF	27	EM4/TEF	26	IP27P/TEFM	30	J2308BH	60	J2309SDM/TEF	81
BH4/TEFM	27	EM4/TEFM	26	IP30P	17	J2308BH/TEF	80	J230bSDM	61
BH5	15	EM4A	15	IP30P/TEF	30	J2308BHM	60	J23-1/2H	60
BH5/TEF	27	EM4A/TEF	27	IP30P/TEFM	30	J2308BHM/TEF	80	J23-1/2H/TEF	80
BH5/TEFM	27	EM4A/TEFM	27	IP40P	17	J2308H	58	J23-1/2HM	60
BH6	15	EM5	14	IP40P/TEF	30	J2308H/TEF	78	J23-1/2HM/TEF	80
BH6/TEF	27	EM5/16A	15	IP40P/TEFM	30	J2308HC	58	J23-1/4H	60

#	P.	#	P.	#	P.	#	P.	#	P.
J23-1/4H/TEF	80	J2311HXML/TEF	79	J2313SD	61	J2316BH	60	J2317SDM	61
J23-1/4HM	60	J2311SD	61	J2313SD/TEF	81	J2316BH/TEF	80	J2317SDM/TEF	81
J23-1/4HM/TEF	80	J2311SD/TEF	81	J2313SDL/INS	135	J2316BHM	60	J2318BH	60
J2310BH	60	J2311SDM	61	J2313SDLAPM/INS	135	J2316BHM/TEF	80	J2318BH/TEF	80
J2310BH/TEF	80	J2311SDM/TEF	81	J2313SDLM/INS	135	J2316H	58	J2318BHM	60
J2310BHM	60	J2312BH	60	J2313SDM	61	J2316H/TEF	78	J2318BHM/TEF	80
J2310BHM/TEF	80	J2312BH/TEF	80	J2313SDM/TEF	81	J2316HC	58	J2318H	58
J2310H	58	J2312BHM	60	J2314BH	60	J2316HC/TEF	78	J2318H/TEF	78
J2310H/TEF	78	J2312BHM/TEF	80	J2314BH/TEF	80	J2316HCM	58	J2318HER	61
J2310HC	58	J2312H	58	J2314BHM	60	J2316HCM/TEF	78	J2318HER/TEF	81
J2310HC/TEF	78	J2312H/TEF	78	J2314BHM/TEF	80	J2316HER	61	J2318HERM	61
J2310HCM	58	J2312HC	58	J2314H	58	J2316HER/TEF	81	J2318HERM/TEF	81
J2310HCM/TEF	78	J2312HC/TEF	78	J2314H/TEF	78	J2316HERM	61	J2318HL	59
J2310HER	61	J2312HCM	58	J2314HC	58	J2316HERM/TEF	81	J2318HL/TEF	79
J2310HER/TEF	81	J2312HCM/TEF	78	J2314HC/TEF	78	J2316HL	59	J2318HLM	59
J2310HERM	61	J2312HER	61	J2314HCM	58	J2316HL/INS	134	J2318HLM/TEF	79
J2310HERM/TEF	81	J2312HER/TEF	81	J2314HCM/TEF	78	J2316HL/TEF	79	J2318HM	58
J2310HL	59	J2312HERM	61	J2314HER	61	J2316HLM/INS	134	J2318HM/TEF	78
J2310HL/INS	134	J2312HERM/TEF	81	J2314HER/TEF	81	J2316HLM	59	J2318HXL	59
J2310HL/TEF	79	J2312HL	59	J2314HERM	61	J2316HLM/INS	134	J2318HXL/TEF	79
J2310HLAPM/INS	134	J2312HL/TEF	79	J2314HERM/TEF	81	J2316HLM/TEF	79	J2318HXML	59
J2310HLM	59	J2312HLM	59	J2314HL	59	J2316HM	58	J2318HXML/TEF	79
J2310HLM/INS	134	J2312HLM/TEF	79	J2314HL/TEF	79	J2316HM/TEF	78	J2318SD	61
J2310HLM/TEF	79	J2312HM	58	J2314HLM	59	J2316HRM	60	J2318SD/TEF	81
J2310HM	58	J2312HM/TEF	78	J2314HLM/TEF	79	J2316HRM/TEF	80	J2318SDM	61
J2310HM/TEF	78	J2312HRM	60	J2314HM	58	J2316HXL	59	J2318SDM/TEF	81
J2310HRM	60	J2312HRM/TEF	80	J2314HM/TEF	78	J2316HXL/INS	135	J2319H	58
J2310HRM/TEF	80	J2312HXL	59	J2314HRM	60	J2316HXL/TEF	79	J2319H/TEF	78
J2310HXL	59	J2312HXL/TEF	79	J2314HRM/TEF	80	J2316HXLAPM/INS	135	J2319HC	58
J2310HXL/INS	134	J2312HXLM	59	J2314HXL	59	J2316HXLM	59	J2319HC/TEF	78
J2310HXL/TEF	79	J2312HXLM/TEF	79	J2314HXL/TEF	79	J2316HXLM/INS	135	J2319HCM	58
J2310HXLAPM/INS	134	J2312SD	61	J2314HXML	59	J2316HXL/TEF	79	J2319HCM/TEF	78
J2310HXLM	59	J2312SD/TEF	81	J2314HXML/TEF	79	J2316SD	61	J2319HER	61
J2310HXLM/INS	134	J2312SDM	61	J2314SD	61	J2316SD/TEF	81	J2319HER/TEF	81
J2310HXLM/TEF	79	J2312SDM/TEF	81	J2314SD/TEF	81	J2316SDL/INS	135	J2319HERM	61
J2310SD	61	J2313BH	60	J2314SDM	61	J2316SDLAPM/INS	135	J2319HERM/TEF	81
J2310SD/TEF	81	J2313BH/TEF	80	J2314SDM/TEF	81	J2316SDLM/INS	135	J2319HL	59
J2310SDL/INS	135	J2313BHM	60	J2315BH	60	J2316SDM	61	J2319HL/TEF	79
J2310SDLAPM/INS	135	J2313BHM/TEF	80	J2315BH/TEF	80	J2316SDM/TEF	81	J2319HLM	59
J2310SDLM/INS	135	J2313H	58	J2315BH-M	60	J2317BH	60	J2319HLM/TEF	79
J2310SDM	61	J2313H/TEF	78	J2315BHM/TEF	80	J2317BH/TEF	80	J2319HM	58
J2310SDM/TEF	81	J2313HC	58	J2315H	58	J2317BHM	60	J2319HM/TEF	78
J2311BH	60	J2313HC/TEF	78	J2315H/TEF	78	J2317BHM/TEF	80	J2319HXL	59
J2311BH/TEF	80	J2313HCM	58	J2315HC	58	J2317H	58	J2319HXL/TEF	79
J2311BHM	60	J2313HCM/TEF	78	J2315HC/TEF	78	J2317H/TEF	78	J2319HXML	59
J2311BHM/TEF	80	J2313HER	61	J2315HCM	58	J2317HC	58	J2319HXML/TEF	79
J2311H	58	J2313HER/TEF	81	J2315HCM/TEF	78	J2317HC/TEF	78	J2319SD	61
J2311H/TEF	78	J2313HERM	61	J2315HER	61	J2317HCM	58	J2319SD/TEF	81
J2311HC	58	J2313HERM/TEF	81	J2315HER/TEF	81	J2317HCM/TEF	78	J2319SDM	61
J2311HC/TEF	78	J2313HL	59	J2315HERM	61	J2317HER	61	J2319SDM/TEF	81
J2311HCM	58	J2313HL/INS	134	J2315HERM/TEF	81	J2317HER/TEF	81	J2321H	58
J2311HCM/TEF	78	J2313HL/TEF	79	J2315HL	59	J2317HERM	61	J2321H/TEF	78
J2311HER	61	J2313HLAPM/INS	134	J2315HL/TEF	79	J2317HERM/TEF	81	J2321HC	58
J2311HER/TEF	81	J2313HLM	59	J2315HLM	59	J2317HL	59	J2321HC/TEF	78
J2311HERM	61	J2313HLM/INS	134	J2315HLM/TEF	79	J2317HL/TEF	79	J2321HCM	58
J2311HERM/TEF	81	J2313HLM/TEF	79	J2315HM	58	J2317HLM	59	J2321HCM/TEF	78
J2311HL	59	J2313HM	58	J2315HM/TEF	78	J2317HLM/TEF	79	J2321HER	61
J2311HL/TEF	79	J2313HM/TEF	78	J2315HRM	60	J2317HM	58	J2321HER/TEF	81
J2311HLM	59	J2313HRM	60	J2315HRM/TEF	80	J2317HM/TEF	78	J2321HERM	61
J2311HLM/TEF	79	J2313HRM/TEF	80	J2315HXL	59	J2317HRM	60	J2321HERM/TEF	81
J2311HM	58	J2313HXL	59	J2315HXL/TEF	79	J2317HRM/TEF	80	J2321HL	59
J2311HM/TEF	78	J2313HXL/INS	134	J2315HXML	59	J2317HXL	59	J2321HL/TEF	79
J2311HRM	60	J2313HXL/TEF	79	J2315HXML/TEF	79	J2317HXL/TEF	79	J2321HLM	59
J2311HRM/TEF	80	J2313HXLAPM/INS	134	J2315SD	61	J2317HXL	59	J2321HLM/TEF	79
J2311HXL	59	J2313HXML	59	J2315SD/TEF	81	J2317HXML	59	J2321HM	58
J2311HXL/TEF	79	J2313HXML/INS	134	J2315SDM	61	J2317SD	61	J2321HM/TEF	78
J2311HXML	59	J2313HXML/TEF	79	J2315SDM/TEF	81	J2317SD/TEF	81	J2321HXL	59

#	P.	#	P.	#	P.	#	P.	#	P.
J2321HXL/TEF	79	J23-EM13/100	43	J2923A/INS	136	J3025B/INS	137	J3124C/TEF	99
J2321HXLM	59	J23-EM13/150	43	J2923A/TEF	99	J3025B/TEF	101	J3126A	94
J2321HXLM/TEF	79	J23-EM14	43	J2923B	94	J3025C	96	J3126A/TEF	99
J2322H	58	J23-EM14/100	43	J2923B/INS	136	J3025C/INS	134	J3126B	94
J2322H/TEF	78	J23-EM14/150	43	J2923B/TEF	99	J3025C/TEF	101	J3126B/TEF	99
J2322HL	59	J23-EM15	43	J2923C	94	J3026A	96	J3126C	94
J2322HL/TEF	79	J23-EM15/100	43	J2923C/INS	136	J3026A/INS	137	J3126C/TEF	99
J2322HLM	59	J23-EM15/150	43	J2923C/TEF	99	J3026A/TEF	101	J3202B	107
J2322HLM/TEF	79	J23-EM16	43	J2924A	94	J3026B	96	J3209BT	107
J2322HM	58	J23-EM16/100	43	J2924A/INS	136	J3026B/INS	137	J4010H/6T*	107
J2322HM/TEF	78	J23-EM16/150	43	J2924A/TEF	99	J3026B/TEF	101	J4010H/6T/TEF*	110
J2322HXL	59	J23-EM3	43	J2924B	94	J3026C	96	J4013H/3	107
J2322HXL/TEF	79	J23-EM4	43	J2924B/INS	136	J3026C/INS	137	J4013H/3/TEF	110
J2322HXLM	59	J23-EM4/100	43	J2924B/TEF	99	J3026C/TEF	101	J4013H/3T*	107
J2322HXLM/TEF	79	J23-EM4/150	43	J2924C	94	J3026VP	97	J4013H/3T/TEF*	110
J2323H	58	J23-EM5	43	J2924C/INS	136	J3027A	96	J4013H/6	107
J2323H/TEF	78	J23-EM5/100	43	J2924C/TEF	99	J3027A/TEF	101	J4013H/6/TEF	110
J2323HL	59	J23-EM5/150	43	J2925A	94	J3027B	96	J4013H/9	107
J2323HL/TEF	79	J23-EM6	43	J2925B	94	J3027B/TEF	101	J4013H/9/TEF	110
J2323HLM/TEF	79	J23-EM6/100	43	J2925C	94	J3027C	96	J4015H/3	107
J2324H	58	J23-EM6/150	43	J2926A	94	J3027C/TEF	101	J4015H/3/TEF	110
J2324H/TEF	78	J23-EM7	43	J2926B	94	J3028A	96	J4015H/6	107
J2324HL	59	J23-EM7/100	43	J2926C	94	J3028A/TEF	101	J4015H/6/TEF	110
J2324HL/TEF	79	J23-EM7/150	43	J2928A	94	J3028B	96	J4015H/9	107
J2324HLM/TEF	79	J23-EM8	43	J2928B	94	J3028B/TEF	101	J4015H/9/TEF	110
J2327HL	59	J23-EM8/100	43	J2928C	94	J3028B/TEF	101	J4016H	107
J2327HL/TEF	79	J23-EM8/150	43	J3020A	96	J3028C	96	J4016H/6	107
J23-3/4H	60	J23-EM9	43	J3020A/TEF	101	J3028C/TEF	101	J4016H/6/TEF	110
J23-3/4H/TEF	80	J23-EM9/100	43	J3020B	96	J3028C/TEF	101	J4016H/TEF	110
J23-3/4HM	60	J23-EM9/150	43	J3020B/TEF	101	J3030A	96	J4017H	107
J23-3/4HM/TEF	80	J23-SQD	37	J3020C	96	J3030A/TEF	101	J4017H/TEF	110
J23-3/8H	60	J23-SQDV	37	J3020C/TEF	101	J3030B	96	J4018H/3	107
J23-3/8H/TEF	80	J23-TX10	43	J3022A	96	J3030B/TEF	101	J4018H/3/TEF	110
J23-3/8HM	60	J23-TX15	43	J3022A/INS	137	J3030C	96	J4018H/6	107
J23-3/8HM/TEF	80	J23-TX20	43	J3022A/TEF	101	J3030C/TEF	101	J4018H/6/TEF	110
J23-5/16H	60	J23-TX25	43	J3022B	96	J3032A	96	J4018H/9	107
J23-5/16H/TEF	80	J23-TX27	43	J3022B/INS	137	J3032A/TEF	101	J4018H/9/TEF	110
J23-5/16HM	60	J23-TX30	43	J3022B/TEF	101	J3032B	96	J4021H/6	107
J23-5/16HM/TEF	80	J23-TX40	43	J3022C	96	J3032B/TEF	101	J4021H/6/TEF	110
J23-7/16H	60	J23-TX45	43	J3022C/INS	137	J3032C	96	J4021H/9	107
J23-7/16H/TEF	80	J23-TX47	43	J3022C/TEF	101	J3032C/TEF	101	J4021H/9/TEF	110
J23-7/16HM	60	J23-TX50	43	J3022VP	97	J3036A	96	J4022H/4	107
J23-7/16HM/TEF	80	J23-TX9	43	J3023A	96	J3036B	96	J4022H/4/TEF	110
J23-BH10	43	J28-1/4	36	J3023A/INS	137	J3036B/TEF	101	J4024H	107
J23-BH10/100	43	J28-1/4/TEF	39	J3023A/TEF	101	J3036C	96	J4024H/TEF	110
J23-BH12	43	J28-1/4V/125/TEF	39	J3023B	96	J30SPL127B	131	J51-1/4	36
J23-BH12/100	43	J28-1/4V/TEF	39	J3023B/INS	137	J30SPL150B	131	J51-1/4/TEF	39
J23-BH14	43	J28-5/16	36	J3023B/TEF	101	J3120A	94	J51-5/16	36
J23-BH14/100	43	J28-5/16/TEF	39	J3023C	96	J3120A/TEF	99	J51-5/16/95	36
J23-BH16	43	J28-5/16V/TEF	39	J3023C/INS	137	J3120B	94	J51-5/16/95/TEFM	39
J23-BH16/100	43	J28V-1/4/125	36	J3023C/TEF	101	J3120B/TEF	99	J51-5/16/TEF	39
J23-BH5	43	J2920A	94	J3023VP/INS	137	J3120C	94	J8-13SDSPL/50	142
J23-BH5/100	43	J2920A/TEF	99	J3024A	96	J3120C/TEF	99	J8-13SDSPL/55	142
J23-BH6	43	J2920B	94	J3024A/INS	137	J3122A	94	JET0	63
J23-BH6/100	43	J2920B/TEF	99	J3024A/TEF	101	J3122A/INS	136	JET0/TEF	82
J23-BH8	43	J2920C	94	J3024B	96	J3122A/TEF	99	JET0M	63
J23-BH8/100	43	J2920C/TEF	99	J3024B/INS	137	J3122B	94	JET0M/TEF	82
J23-EM10	43	J2922A	94	J3024B/TEF	101	J3122B/INS	136	JET2	63
J23-EM10/100	43	J2922A/INS	136	J3024C	96	J3122B/TEF	99	JET2/70/INS	135
J23-EM10/150	43	J2922A/TEF	99	J3024C/INS	137	J3122C	94	JET2/INS	135
J23-EM11	43	J2922B	94	J3024C/TEF	101	J3122C/INS	136	JET2/TEF	82
J23-EM11/100	43	J2922B/INS	136	J3024VP	97	J3122C/TEF	99	JET2APM/70/INS	135
J23-EM11/150	43	J2922B/TEF	99	J3024VP/INS	137	J3124A	94	JET2APM/INS	135
J23-EM12	43	J2922C	94	J3025A	96	J3124A/TEF	99	JET2M	63
J23-EM12/100	43	J2922C/INS	136	J3025A/INS	137	J3124B	94	JET2M/70/INS	135
J23-EM12/150	43	J2922C/TEF	99	J3025A/TEF	101	J3124B/TEF	99	JET2M/INS	135
J23-EM13	43	J2923A	94	J3025B	96	J3124C	94	JET2M/TEF	82

#	P.	#	P.	#	P.	#	P.	#	P.
JE14	63	JIM2312H/TEF	122	JIM2316HL/100	116	JIM3030B	119	K2318HLM/TEF	87
JE14/TEF	82	JIM2312H/TEF	122	JIM2316HL/100/TEF	123	JIM3030B/TEF	126	K2318HM	68
JE14M	63	JIM2312HL/100	116	JIM2316HL/100/TEFM	123	JIM3030C	119	K2318HM/TEF	87
JE14M/TEF	82	JIM2312HL/100/TEF	123	JIM2316HL/150	116	JIM3030C/TEF	126	K2318SD	69
JE5	63	JIM2312HL/100/TEFM	123	JIM2316HL/150/TEF	123	JIM3122B	119	K2318SD/TEF	88
JE5/TEF	82	JIM2312HL/150	116	JIM2316HL/150/TEFM	123	JIM3122B/TEF	126	K2318SDM	69
JE6	63	JIM2312HL/150/TEF	123	JIM2316HL/200	116	JIM3122C	119	K2318SDM/TEF	88
JE6/TEF	82	JIM2312HL/150/TEFM	123	JIM2316HL/200/TEF	123	JIM3122C/TEF	126	K2319H	68
JE7	63	JIM2312HL/200	116	JIM2316HL/200/TEFM	123	JIM3124B	119	K2319H/TEF	87
JE7/TEF	82	JIM2312HL/200/TEF	123	JIM2316HLM/100	116	JIM3124B/TEF	126	K2319HL	69
JE7-8SD/38	142	JIM2312HL/200/TEFM	123	JIM2316HLM/150	116	JIM3124C	119	K2319HL/TEF	87
JE7-8SD/70	142	JIM2312HLM/100	116	JIM2316HLM/200	116	JIM3124C/TEF	126	K2319HLM	69
JE7-8SD/80	142	JIM2312HLM/150	116	JIM2316HM	115	JIM4010H/6T*	120	K2319HLM/TEF	87
JE8	63	JIM2312HLM/200	116	JIM2317H	115	JIM4013H/3	120	K2319HM	68
JE8/TEF	82	JIM2312HM	115	JIM2317H/TEF	122	JIM4013H/3T*	120	K2319HM/TEF	87
JE8M	63	JIM2313H	115	JIM2317H/TEF	122	JIM4013H/6	120	K2319SD	69
JE8M/TEF	82	JIM2313H/TEF	122	JIM2317HL/100	116	JIM4013H/9	120	K2319SD/TEF	88
JIM2306H	115	JIM2313H/TEF	122	JIM2317HL/100/TEF	123	JIM4015H/3	120	K2319SDM	69
JIM2306H/TEF	122	JIM2313HL/100	116	JIM2317HL/100/TEFM	123	JIM4015H/6	120	K2319SDM/TEF	88
JIM2306H/TEF	122	JIM2313HL/100/TEF	123	JIM2317HL/150	116	JIM4015H/9	120	K2320H	68
JIM2306HM	115	JIM2313HL/100/TEFM	123	JIM2317HL/150/TEF	123	JIM4016H/6	120	K2320H/TEF	87
JIM2307H	115	JIM2313HL/150	116	JIM2317HL/150/TEFM	123	JIM4018H/3	120	K2320HL	69
JIM2307H/TEF	122	JIM2313HL/150/TEF	123	JIM2317HL/200	116	JIM4018H/6	120	K2320HL/TEF	87
JIM2307H/TEF	122	JIM2313HL/150/TEFM	123	JIM2317HL/200/TEF	123	JIM4018H/9	120	K2320HLM	69
JIM2307HM	115	JIM2313HL/200	116	JIM2317HL/200/TEFM	123	JIM4021H/6	120	K2320HLM/TEF	87
JIM2308H	115	JIM2313HL/200/TEF	123	JIM2317HLM/100	116	JIM4021H/9	120	K2320HM	68
JIM2308H/TEF	122	JIM2313HLM/200/TEFM	123	JIM2317HLM/150	116	JIM4022H/4	120	K2320HM/TEF	87
JIM2308H/TEF	122	JIM2313HLM/100	116	JIM2317HLM/200	116	JIM-SQD	37	K2321H	68
JIM2308HL/100	116	JIM2313HLM/150	116	JIM2317HM	115	JIM-SQDV	37	K2321H/TEF	87
JIM2308HL/100/TEF	123	JIM2313HLM/200	116	JIM2318H	115	JOB	109	K2321HER	69
JIM2308HL/100/TEFM	123	JIM2313HM	115	JIM2318H/TEF	122	K2315H	68	K2321HER/TEF	88
JIM2308HL/150	116	JIM2314H	115	JIM2318H/TEF	122	K2315H/TEF	87	K2321HERM	69
JIM2308HL/150/TEF	123	JIM2314H/TEF	122	JIM2318HM	115	K2315HL	69	K2321HERM/TEFM	88
JIM2308HL/150/TEFM	123	JIM2314H/TEF	122	JIM2319H	115	K2315HL/TEF	87	K2321HL	69
JIM2308HL/200	116	JIM2314HL/100	116	JIM2319H/TEF	122	K2315HLM	69	K2321HL/TEF	87
JIM2308HL/200/TEF	123	JIM2314HL/100/TEF	123	JIM2319H/TEF	122	K2315HLM/TEF	87	K2321HLM	69
JIM2308HL/200/TEFM	123	JIM2314HL/100/TEFM	123	JIM2319HM	115	K2315HM	68	K2321HLM/TEF	87
JIM2308HLM/100	116	JIM2314HL/150	116	JIM2320H	115	K2315HM/TEF	87	K2321HM	68
JIM2308HLM/150	116	JIM2314HL/150/TEF	123	JIM2320H/TEF	122	K2316H	68	K2321HM/TEF	87
JIM2308HLM/200	116	JIM2314HL/150/TEFM	123	JIM2320H/TEF	122	K2316H/TEF	87	K2321SD	69
JIM2308HM	115	JIM2314HL/200	116	JIM2320HM	115	K2316HER	69	K2321SD/TEF	88
JIM2309H	115	JIM2314HL/200/TEF	123	JIM2321H	115	K2316HER/TEF	88	K2321SDM	69
JIM2309H/TEF	122	JIM2314HL/200/TEFM	123	JIM2321H/TEF	122	K2316HERM	69	K2321SDM/TEF	88
JIM2309H/TEF	122	JIM2314HL/300	116	JIM2321H/TEF	122	K2316HERM/TEFM	88	K2322H	68
JIM2309HM	115	JIM2314HLM/100	116	JIM2321HM	115	K2316HL	69	K2322H/TEF	87
JIM2310H	115	JIM2314HLM/150	116	JIM2322H	115	K2316HL/TEF	87	K2322HL	69
JIM2310H/TEF	122	JIM2314HLM/200	116	JIM2322H/TEF	122	K2316HLM	69	K2322HL/TEF	87
JIM2310H/TEF	122	JIM2314HM	115	JIM2322H/TEF	122	K2316HLM/TEF	87	K2322HLM	69
JIM2310HL/100	116	JIM2315H	115	JIM2322HM	115	K2316HM	68	K2322HLM/TEF	87
JIM2310HL/100/TEF	123	JIM2315H/TEF	122	JIM2336H	115	K2316HM/TEF	87	K2322HM	68
JIM2310HL/100/TEFM	123	JIM2315H/TEF	122	JIM3022B	119	K2317H	68	K2322HM/TEF	87
JIM2310HL/150	116	JIM2315HL/100	116	JIM3022B/TEF	126	K2317H/TEF	87	K2323H	68
JIM2310HL/150/TEF	123	JIM2315HL/100/TEF	123	JIM3022C	119	K2317HL	69	K2323H/TEF	87
JIM2310HL/150/TEFM	123	JIM2315HL/100/TEFM	123	JIM3022C/TEF	126	K2317HL/TEF	87	K2323HL	69
JIM2310HL/200	116	JIM2315HL/150	116	JIM3024B	119	K2317HLM	69	K2323HL/TEF	87
JIM2310HL/200/TEF	123	JIM2315HL/150/TEF	123	JIM3024B/TEF	126	K2317HLM/TEF	87	K2323HLM	69
JIM2310HL/200/TEFM	123	JIM2315HL/150/TEFM	123	JIM3024C	119	K2317HM	68	K2323HLM/TEF	87
JIM2310HLM/100	116	JIM2315HL/200	116	JIM3024C/TEF	126	K2317HM/TEF	87	K2323HM	68
JIM2310HLM/150	116	JIM2315HL/200/TEF	123	JIM3025B	119	K2318H	68	K2323HM/TEF	87
JIM2310HLM/175	116	JIM2315HL/200/TEFM	123	JIM3026B	119	K2318H/TEF	87	K2324H	68
JIM2310HLM/200	116	JIM2315HLM/100	116	JIM3026B/TEF	126	K2318HER	69	K2324H/TEF	87
JIM2310HM	115	JIM2315HLM/150	116	JIM3026C	119	K2318HER/TEF	88	K2324HL	69
JIM2311H	115	JIM2315HLM/200	116	JIM3026C/TEF	126	K2318HERM	69	K2324HL/TEF	87
JIM2311H/TEF	122	JIM2315HM	115	JIM3028B	119	K2318HERM/TEFM	88	K2324HLM	69
JIM2311H/TEF	122	JIM2316H	115	JIM3028B/TEF	126	K2318HL	69	K2324HLM/TEF	87
JIM2311HM	115	JIM2316H/TEF	122	JIM3028C	119	K2318HL/TEF	87	K2324HM	68
JIM2312H	115	JIM2316H/TEF	122	JIM3028C/TEF	126	K2318HLM	69	K2324HM/TEF	87

#	P.	#	P.	#	P.	#	P.	#	P.
K2325H	68	K23-EM13/100/TEFM	48	K23-EM25/TEF	48	K3010A/TEF	102	L23-1-1/4HL	71
K2325H/TEF	87	K23-EM13/TEF	48	K23-EM25/TEFM	48	K3010B	97	L23-1-1/8H	70
K2325HL	69	K23-EM13/TEFM	48	K23-SQD	37	K3010B/TEF	102	L23-1-1/8HL	71
K2325HL/TEF	87	K23-EM14	45	K23-SQDV	37	K3010C	97	L23-110H	70
K2325HLM	69	K23-EM14/100	45	K28-5/8V	37	K3010C/TEF	102	L23110HL	71
K2325HLM/TEF	87	K23-EM14/100/TEF	48	K2903A	95	K3012A	97	L23-1-11/16H	70
K2325HM	68	K23-EM14/100/TEFM	48	K2903A/TEF	100	K3012A/TEF	102	L23-1-11/16HL	71
K2325HM/TEF	87	K23-EM14/TEF	48	K2903B	95	K3012B	97	L23-1-13/16H	70
K2326H	68	K23-EM14/TEFM	48	K2903B/TEF	100	K3012B/TEF	102	L23-1-13/16HL	71
K2326H/TEF	87	K23-EM15	45	K2903C	95	K3012C	97	L23-1-15/16H	70
K2326HL	69	K23-EM15/100	45	K2903C/TEF	100	K3012C/TEF	102	L23-1-15/16HL	71
K2326HL/TEF	87	K23-EM15/100/TEF	48	K2904A	95	K30SPL162B	131	L23-1-15/16HL	71
K2326HLM	69	K23-EM15/100/TEFM	48	K2904A/TEF	100	K3102C	95	L23-13/16H	70
K2326HLM/TEF	87	K23-EM15/TEF	48	K2904B	95	K3103A	95	L23-1-3/16H	70
K2326HM	68	K23-EM15/TEFM	48	K2904B/TEF	100	K3103A/TEF	100	L23-13/16HL	71
K2326HM/TEF	87	K23-EM16	45	K2904C	95	K3103B	95	L23-1-3/16HL	71
K2327H	68	K23-EM16/100	45	K2904C/TEF	100	K3103B/TEF	100	L23-1-3/4H	70
K2327H/TEF	87	K23-EM16/100/TEF	48	K2905A	95	K3103C	95	L23-1-3/4HL	71
K2327HL	69	K23-EM16/100/TEFM	48	K2905A/TEF	100	K3103C/TEF	100	L23-1-3/8H	70
K2327HL/TEF	87	K23-EM16/TEF	48	K2905B	95	K3104A	95	L23-1-3/8HL	71
K2327HLM	69	K23-EM16/TEFM	48	K2905B/TEF	100	K3104A/TEF	100	L23-15/16H	70
K2327HLM/TEF	87	K23-EM17	45	K2905C	95	K3104B	95	L23-15/16H	70
K2327HM	68	K23-EM17/100	45	K2905C/TEF	100	K3104B/TEF	100	L23-15/16HL	71
K2327HM/TEF	87	K23-EM17/100/TEF	48	K2906A	95	K3104C	95	L23-1-5/8H	70
K2328H	68	K23-EM17/100/TEFM	48	K2906A/TEF	100	K3104C/TEF	100	L23-1-5/8HL	71
K2328H/TEF	87	K23-EM17/TEF	48	K2906B	95	K3105A	95	L2316BH	72
K2328HL	69	K23-EM17/TEFM	48	K2906B/TEF	100	K3105A/TEF	100	L2316H	70
K2328HL/TEF	87	K23-EM18	45	K2906C	95	K3105B	95	L2316HL	71
K2330H	68	K23-EM18/100	45	K2906C/TEF	100	K3105B/TEF	100	L23-1-7/16H	70
K2330H/TEF	87	K23-EM18/100/TEF	48	K2908A	95	K3105C	95	L23-1-7/16HL	71
K2330HL	69	K23-EM18/100/TEFM	48	K2908A/TEF	100	K3105C/TEF	100	L23-1-7/8H	70
K2330HL/TEF	87	K23-EM18/TEF	48	K2908B	95	K3106A	95	L23-1-7/8HL	71
K2332H	68	K23-EM18/TEFM	48	K2908B/TEF	100	K3106A/TEF	100	L2317BH	72
K2332H/TEF	87	K23-EM19	45	K2908C	95	K3106B	95	L2317H	70
K2332HL	69	K23-EM19/100	45	K2908C/TEF	100	K3106B/TEF	100	L2317HL	71
K2332HL/TEF	87	K23-EM19/100/TEF	48	K2912A	95	K3106C	95	L2318BH	72
K2334HL	69	K23-EM19/100/TEFM	48	K3003A	95	K3106C/TEF	100	L2318H	70
K2334HL/TEF	87	K23-EM19/TEF	48	K3003A/TEF	102	K3204C	107	L2318HL	71
K2336H	68	K23-EM19/TEFM	48	K3003B	97	K4018H/6	109	L23-1-9/16H	70
K2336H/TEF	87	K23-EM20	45	K3003B/TEF	102	K4018H/6/TEF	110	L23-1-9/16HL	71
K2336HL	69	K23-EM20/100	45	K3003C	97	K4018H/9	109	L2319BH	72
K2336HL/TEF	87	K23-EM20/100/TEF	48	K3003C/TEF	102	K4018H/9/TEF	110	L2319H	70
K2341H	68	K23-EM20/100/TEFM	48	K3004A	97	K4021H/9	109	L2319HL	71
K2341H/TEF	87	K23-EM20/TEF	48	K3004A/TEF	102	K4021H/9/TEF	110	L23-1H	70
K2346H	68	K23-EM20/TEFM	48	K3004B	97	K4022H/4	109	L23-1HL	71
K2346H/TEF	87	K23-EM21	45	K3004B/TEF	102	K4022H/4/TEF	110	L2320BH	72
K23-EM10	45	K23-EM21/100	45	K3004C	97	K4024H/9	109	L2320H	70
K23-EM10/100	45	K23-EM21/100/TEF	48	K3004C/TEF	102	K4024H/9/TEF	110	L2320HL	71
K23-EM10/100/TEF	48	K23-EM21/100/TEFM	48	K3005A	97	KIM2903B	119	L23-2-1/16H	70
K23-EM10/100/TEFM	48	K23-EM21/TEF	48	K3005A/TEF	102	KIM30SPL180PB	131	L23-2-1/16HL	71
K23-EM10/TEF	48	K23-EM21/TEFM	48	K3005B	97	KIM4018H/6	121	L23-2-1/2H	70
K23-EM10/TEFM	48	K23-EM22	45	K3005B/TEF	102	KIM4018H/9	121	L23-2-1/2HL	71
K23-EM11	45	K23-EM22/100	45	K3005C	97	KIM4021H/9	121	L23-2-1/4H	70
K23-EM11/100	45	K23-EM22/100/TEF	48	K3005C/TEF	102	KIM4022H/4	121	L23-2-1/4HL	71
K23-EM11/100/TEF	48	K23-EM22/100/TEFM	48	K3006A	97	KIM4024H/9	121	L23-2-1/8H	70
K23-EM11/100/TEFM	48	K23-EM22/TEF	48	K3006A/TEF	102	KOB	109	L23-2-1/8HL	71
K23-EM11/TEF	48	K23-EM22/TEFM	48	K3006B	97	L23100H	70	L23-2-11/16H	70
K23-EM11/TEFM	48	K23-EM24	45	K3006B/TEF	102	L23100HL	71	L23-2-11/16HL	71
K23-EM12	45	K23-EM24/100	45	K3006C	97	L23-105H	70	L23-2-13/16H	70
K23-EM12/100	45	K23-EM24/100/TEF	48	K3006C/TEF	102	L23105HL	71	L23-2-13/16HL	71
K23-EM12/100/TEF	48	K23-EM24/100/TEFM	48	K3008A	97	L23-11/16H	70	L23-2-15/16H	70
K23-EM12/100/TEFM	48	K23-EM24/TEF	48	K3008A/TEF	102	L23-1-1/16H	70	L23-2-15/16HL	71
K23-EM12/TEF	48	K23-EM24/TEFM	48	K3008B	97	L23-11/16HL	71	L2321BH	72
K23-EM12/TEFM	48	K23-EM25	45	K3008B/TEF	102	L23-1-1/16HL	71	L2321H	70
K23-EM13	45	K23-EM25/100	45	K3008C	97	L23-1-1/2H	70	L2321HL	71
K23-EM13/100	45	K23-EM25/100/TEF	48	K3008C/TEF	102	L23-1-1/2HL	71	L2321HLF	72
K23-EM13/100/TEF	48	K23-EM25/100/TEFM	48	K3010A	97	L23-1-1/4H	70	L2322BH	72

#	P.	#	P.	#	P.	#	P.	#	P.
L2322H	70	L2334HL	71	L3012A/TEF	102	PH2	11	R2304H/TEF	74
L2322HL	71	L2335BH	72	L3016A	97	PH2/TEF	20	R2304HM	53
L2322HLF	72	L2335H	70	L3016A/TEF	102	PH2/TEFM	20	R2304HM/TEF	74
L23-2-3/16H	70	L2335HL	71	M23100H	73	PH2ND	11	R2305.5H	53
L23-2-3/16HL	71	L2336BH	72	M23105H	73	PH2ND/TEF	20	R2305.5H/TEF	74
L23-2-3/4H	70	L2336H	70	M23110H	73	PH2ND/TEFM	20	R2305.5HL	53
L23-2-3/4HL	71	L2336HL	71	M23115H	73	PH2NR	11	R2305.5HL/TEF	74
L23-2-3/8H	70	L2337H	70	M23120H	73	PH2NR/TEF	20	R2305.5HLM	53
L23-2-3/8HL	71	L2337HL	71	M23125H	73	PH2NR/TEFM	20	R2305.5HLM/TEF	74
L2323H	70	L2338BH	72	M23130H	73	PH3	11	R2305.5HM	53
L2323HL	71	L2338H	70	M23135H	73	PH3/TEF	20	R2305.5HM/TEF	74
L2323HLF	72	L2338HL	71	M23140H	73	PH3/TEFM	20	R2305H	53
L2324BH	72	L2338HLF	72	M23145H	73	PH4	11	R2305H/TEF	74
L2324H	70	L23-3H	70	M23150H	73	PH4/TEF	20	R2305HL	53
L2324HL	71	L23-3HL	71	M23155H	73	PH4/TEFM	20	R2305HL/TEF	74
L2324HLF	72	L2341H	70	M23160H	73	PL2.5	11	R2305HLM	53
L23-2-5/16H	70	L2341HL	71	M23165H	73	PL2.5/TEF	21	R2305HLM/TEF	74
L23-2-5/16HL	71	L2341HLF	72	M23170H	73	PL2.5/TEFM	21	R2305HM	53
L23-2-5/8H	70	L2342H	70	M23175H	73	PL3.5	11	R2305HM/TEF	74
L23-2-5/8HL	71	L2342HL	71	M23185H	73	PL3.5/TEF	21	R2306BH	54
L2325BH	72	L2346BH	72	M2332H	73	PL3.5/TEFM	21	R2306BH/TEF	75
L2325H	70	L2346H	70	M2334H	73	PL4.0	11	R2306BHM	54
L2325HL	71	L2346HL	71	M2336H	73	PL4.0/TEF	21	R2306BHM/TEF	75
L2325HLF	72	L2346HLF	72	M2338H	73	PL4.0/TEFM	21	R2306H	53
L2326BH	72	L2348HL	71	M2340H	73	PL4.5	11	R2306H/LTEF	74
L2326H	70	L23-5/8H	70	M2341H	73	PL4.5/TEF	21	R2306H/TEF	74
L2326HL	71	L23-5/8HL	71	M2342H	73	PL4.5/TEFM	21	R2306HER	54
L2326HLF	72	L2350BH	72	M2345H	73	PL5.0	11	R2306HER/TEF	75
L23-2-7/16H	70	L2350H	70	M2346H	73	PL5.0/TEF	21	R2306HERM	54
L23-2-7/16HL	71	L2350HL	71	M2347H	73	PL5.0/TEFM	21	R2306HERM/TEF	75
L23-2-7/8H	70	L2350HLF	72	M2348H	73	PL5.5	11	R2306HL	53
L23-2-7/8HL	71	L2355H	70	M2350H	73	PL5.5/TEF	21	R2306HLM	53
L2327BH	72	L2355HL	71	M2352H	73	PL5.5/TEFM	21	R2306HLM/TEF	74
L2327H	70	L2355HLF	72	M2354H	73	PL6.0	11	R2306HM	53
L2327HL	71	L2360H	70	M2355H	73	PL6.0/TEF	21	R2306HM/TEF	74
L2327HLF	72	L2360HL	71	M2356H	73	PL6.0/TEFM	21	R2307BH	54
L2328H	70	L2360HLF	72	M2358H	73	PL6.5	11	R2307BH/TEF	75
L2328HL	71	L2365H	70	M2360H	73	PL6.5/TEF	21	R2307BHM	54
L2328HLF	72	L2365HL	71	M2361H	73	PL6.5/TEFM	21	R2307BHM/TEF	75
L23-2-9/16H	70	L2365HLF	72	M2362H	73	PL8.0	11	R2307H	53
L23-2-9/16HL	71	L23-7/8H	70	M2363H	73	PZD0	16	R2307H/TEF	74
L2329BH	72	L23-7/8HL	71	M2365H	73	PZD0/TEF	28	R2307HER	54
L2329H	70	L2370H	70	M2368H	73	PZD0/TEFM	28	R2307HER/TEF	75
L2329HL	71	L2370HL	71	M2370H	73	PZD1	16	R2307HERM	54
L2329HLF	72	L2370HLF	72	M2372H	73	PZD1/TEF	28	R2307HERM/TEF	75
L23-2H	70	L2375H	70	M2375H	73	PZD1/TEFM	28	R2307HL	53
L23-2HL	71	L2375HL	71	M2378H	73	PZD1ND/TEF	28	R2307HL/TEF	74
L23-3/4H	70	L2375HLF	72	M2380H	73	PZD1ND/TEFM	28	R2307HLM	53
L23-3/4HL	71	L2380H	70	M2385H	73	PZD2	16	R2307HLM/TEF	74
L2330BH	72	L2380HL	71	M2388H	73	PZD2/TEF	28	R2307HM	53
L2330H	70	L2380HLF	72	M2390H	73	PZD2/TEFM	28	R2307HM/TEF	74
L2330HL	71	L2385HL	71	M2395H	73	PZD2ND	16	R2307HRM	54
L2330HLF	72	L2390H	70	NIM-SQD	37	PZD2ND/TEF	28	R2307HRM/TEF	75
L23-3-1/8H	70	L2390HL	71	NIM-SQDV	37	PZD2ND/TEFM	28	R2308BH	54
L23-3-1/8HL	71	L2395H	70	OSJ2322BH/120	141	PZD3	16	R2308BH/TEF	75
L2331BH	72	L2395HL	71	OSS2314HL	141	PZD3/TEF	28	R2308BHM	54
L2331H	70	L3004A	97	OSS2322BH/120	141	PZD3/TEFM	28	R2308BHM/TEF	75
L2331HL	71	L3004A/TEF	102	OSS2322HL/100	141	PZD3ND	16	R2308H	53
L2331HLF	72	L3005A	97	OSS2322HL/80	141	PZD4/TEF	28	R2308H/TEF	74
L2332BH	72	L3005A/TEF	102	OSS2322HL/90	141	PZD4/TEFM	28	R2308HER	54
L2332H	70	L3006A	97	OSS2322HL/97	141	R100VP	35	R2308HER/TEF	75
L2332HL	71	L3006A/TEF	102	PH1	11	R10MM100	57	R2308HERM	54
L2333BH	72	L3008A	97	PH1/TEF	20	R10MM200	57	R2308HERM/TEF	75
L2333H	70	L3008A/TEF	102	PH1/TEFM	20	R10MM300	57	R2308HL	53
L2333HL	71	L3010A	97	PH1ND	11	R10MM75	57	R2308HL/TEF	74
L2334BH	72	L3010A/TEF	102	PH1ND/TEF	20	R12MM300	57	R2308HLM	53
L2334H	70	L3012A	97	PH1ND/TEFM	20	R2304H	53	R2308HLM/TEF	74

#	P.	#	P.	#	P.	#	P.	#	P.
R2308HM	53	R2312HRM/TEF	75	R3010C	95	S2308HM/TEF	82	S2311HLM	64
R2308HM/TEF	74	R2313H	53	R3014A	95	S2308SQ	68	S2311HLM/TEF	83
R2308HRM	54	R2313H/TEF	74	R3014B	95	S2308SQ/TEF	86	S2311HM	63
R2308HRM/TEF	75	R2313HL	53	R3014C	95	S2308SQM	68	S2311HM/TEF	82
R2309BH	54	R2313HL/TEF	74	R3100A	94	S2308SQM/TEF	86	S2311HRM	65
R2309BH/TEF	75	R2313HLM	53	R3100A	99	S2309BH	66	S2311HRM/TEF	84
R2309BHM	54	R2313HLM/TEF	74	R3100B	94	S2309BH/TEF	84	S2311SD	67
R2309BHM/TEF	75	R2313HM	53	R3100B	99	S2309BHM	66	S2311SD/TEF	85
R2309H	53	R2313HM/TEF	74	R3100C	94	S2309BHM/TEF	84	S2311SDM	67
R2309H/TEF	74	R2313HRM	54	R3100C	99	S2309H	63	S2311SDM/TEF	85
R2309HER	54	R2313HRM/TEF	75	R3200B	107	S2309H/TEF	82	S2312BH	66
R2309HER/TEF	75	R23-3/8H	53	R51-1/4	36	S2309HL	64	S2312BH/TEF	84
R2309HERM	54	R23-3/8H/TEF	74	R51-1/4/TEF	38	S2309HL/TEF	83	S2312BHM	66
R2309HERM/TEF	75	R23-3/8HM	53	R8MM150	57	S2309HLM	64	S2312BHM/TEF	84
R2309HL	53	R23-3/8HM/TEF	74	R8MM200	57	S2309HLM/TEF	83	S2312H	63
R2309HL/TEF	74	R23-5/16H	53	R8MM75	57	S2309HM	63	S2312H/TEF	82
R2309HLM	53	R23-5/16H/TEF	74	RE10	55	S2309HM/TEF	82	S2312HER	66
R2309HLM/TEF	74	R23-5/16HM	53	RE10/TEF	75	S23-1/2H	65	S2312HER/TEF	85
R2309HM	53	R23-5/16HM/TEF	74	RE10M	55	S23-1/2H/TEF	84	S2312HERM	66
R2309HM/TEF	74	R28-1/4	36	RE10M/TEF	75	S23-1/2HM	65	S2312HERM/TEF	85
R2309HRM	54	R28-1/4/TEF	38	RE12	55	S23-1/2HM/TEF	84	S2312HJL	64
R2309HRM/TEF	75	R28-1/4V	36	RE12/TEF	75	S2310BH	66	S2312HJL/TEF	83
R23-1/2H	53	R28-1/4V/TEF	39	RE12M	55	S2310BH/TEF	84	S2312HJLM	64
R23-1/2H/TEF	74	R28-5/16	36	RE12M/TEF	75	S2310BHM	66	S2312HJLM/TEF	83
R23-1/2HM	53	R28-5/16/TEF	38	RE4	55	S2310BHM/TEF	84	S2312HL	64
R23-1/2HM/TEF	74	R28-5/16V/TEF	39	RE4/TEF	75	S2310H	63	S2312HL/TEF	83
R23-1/4H	53	R3001A	95	RE4M	55	S2310H/TEF	82	S2312HLM	64
R23-1/4H/TEF	74	R3001A/TEF	100	RE4M/TEF	75	S2310HER	66	S2312HLM/TEF	83
R23-1/4HM	53	R3001B	95	RE5	55	S2310HER/TEF	85	S2312HM	63
R23-1/4HM/TEF	74	R3001B/TEF	100	RE5/TEF	75	S2310HERM	66	S2312HM/TEF	82
R2310BH	54	R3001C	95	RE5M	55	S2310HERM/TEF	85	S2312HRM	65
R2310BH/TEF	75	R3001C/TEF	100	RE5M/TEF	75	S2310HJL	64	S2312HRM/TEF	84
R2310BHM	54	R3002A	95	RE6	55	S2310HJL/TEF	83	S2312SD	67
R2310BHM/TEF	75	R3002A/TEF	100	RE6/TEF	75	S2310HJLM	64	S2312SD/TEF	85
R2310H	53	R3002B	95	RE6M	55	S2310HJLM/TEF	83	S2312SDM	67
R2310H/TEF	74	R3002B/TEF	100	RE6M/TEF	75	S2310HL	64	S2312SDM/TEF	85
R2310HER	54	R3002C	95	RE7	55	S2310HL/TEF	83	S2312SQ	68
R2310HER/TEF	75	R3002C/TEF	100	RE7/TEF	75	S2310HLM	64	S2312SQ/TEF	86
R2310HERM	54	R3003A	95	RE7M	55	S2310HLM/TEF	83	S2312SQM	68
R2310HERM/TEF	75	R3003A/TEF	100	RE7M/TEF	75	S2310HM	63	S2312SQM/TEF	86
R2310HL	53	R3003B	95	RE8	55	S2310HM/TEF	82	S2313BH	66
R2310HL/TEF	74	R3003B/TEF	100	RE8/TEF	75	S2310HRM	65	S2313BH/TEF	84
R2310HLM	53	R3003C	95	RE8M	55	S2310HRM/TEF	84	S2313BHM	66
R2310HLM/TEF	74	R3003C/TEF	100	RE8M/TEF	75	S2310SD	67	S2313BHM/TEF	84
R2310HM	53	R3004A	95	RL134M	18	S2310SD/TEF	85	S2313H	63
R2310HM/TEF	74	R3004A/TEF	100	RL134VP	18	S2310SDM	67	S2313H/TEF	82
R2310HRM	54	R3004B	95	RL188M	18	S2310SDM/TEF	85	S2313HER	66
R2310HRM/TEF	75	R3004B/TEF	100	RL188VP	18	S2310SQ	68	S2313HER/TEF	85
R2311H	53	R3004C	95	RL81M	18	S2310SQ/TEF	86	S2313HERM	66
R2311H/TEF	74	R3004C/TEF	100	S100VP	35	S2310SQM	68	S2313HERM/TEF	85
R2311HL	53	R3005A	95	S14-17SDPL/60	142	S2310SQM/TEF	86	S2313HJL	64
R2311HL/TEF	74	R3005A/TEF	100	S16-19SDSPLM/105*	142	S2311BH	66	S2313HJL/INS	136
R2311HLM	53	R3005B	95	S17-19SDSPL/82	142	S2311BH/TEF	84	S2313HJL/TEF	83
R2311HLM/TEF	74	R3005B/TEF	100	S18-21HSPL	142	S2311BHM	66	S2313HJLAPM/INS	136
R2311HM	53	R3005C	95	S2308BH	66	S2311BHM/TEF	84	S2313HJLM	64
R2311HM/TEF	74	R3005C/TEF	100	S2308BH/TEF	84	S2311H	63	S2313HJLM/INS	136
R2311HRM	54	R3006A	95	S2308BHM	66	S2311H/TEF	82	S2313HJLM/TEF	83
R2311HRM/TEF	75	R3006A/TEF	100	S2308BHM/TEF	84	S2311HER	66	S2313HL	64
R2312H	53	R3006B	95	S2308H	63	S2311HER/TEF	85	S2313HL/TEF	83
R2312H/TEF	74	R3006B/TEF	100	S2308H/TEF	82	S2311HERM	66	S2313HLM	64
R2312HL	53	R3006C	95	S2308HER	66	S2311HERM/TEF	85	S2313HLM/TEF	83
R2312HL/TEF	74	R3006C/TEF	100	S2308HER	66	S2311HJL	64	S2313HM	63
R2312HLM	53	R3008A	95	S2308HL	64	S2311HJL/TEF	83	S2313HM/TEF	82
R2312HLM/TEF	74	R3008B	95	S2308HL/TEF	83	S2311HJLM	64	S2313HRM	65
R2312HM	53	R3008C	95	S2308HLM	64	S2311HJLM/TEF	83	S2313HRM/TEF	84
R2312HM/TEF	74	R3010A	95	S2308HLM/TEF	83	S2311HL	64	S2313SD	67
R2312HRM	54	R3010B	95	S2308HM	63	S2311HL/TEF	83	S2313SD/TEF	85

#	P.	#	P.	#	P.	#	P.	#	P.
S2313SDM	67	S2315SDM	67	S2318BH	66	S2320H	63	S2322HM	63
S2313SDM/TEF	85	S2315SDM/TEF	85	S2318BH/TEF	84	S2320H/TEF	82	S2322HM/TEF	82
S2313SQ	68	S2315SQ	68	S2318BHM	66	S2320HER	66	S2322HRM	65
S2313SQ/TEF	86	S2315SQ/TEF	86	S2318BHM/TEF	84	S2320HER/TEF	85	S2322SD	67
S2313SQM	68	S2315SQM	68	S2318H	63	S2320HERM	66	S2322SD/TEF	85
S2313SQM/TEF	86	S2315SQM/TEF	86	S2318H/TEF	82	S2320HERM/TEF	85	S2322SDM	67
S2314BH	66	S2316BH	66	S2318HER	66	S2320HJL	64	S2322SDM/TEF	85
S2314BH/TEF	84	S2316BH/TEF	84	S2318HER/TEF	85	S2320HJL/TEF	83	S2322SQ	68
S2314BHM	66	S2316BHM	66	S2318HERM	66	S2320HJLM	64	S2322SQ/TEF	86
S2314BHM/TEF	84	S2316BHM/TEF	84	S2318HERM/TEF	85	S2320HJLM/TEF	83	S2322SQM	68
S2314H	63	S2316H	63	S2318HJL	64	S2320HL	64	S2322SQM/TEF	86
S2314H/TEF	82	S2316H/TEF	82	S2318HJL/INS	138	S2320HL/TEF	83	S2323BH	66
S2314HER	66	S2316HER	66	S2318HJL/TEF	83	S2320HLM	64	S2323BH/TEF	84
S2314HER/TEF	85	S2316HER/TEF	85	S2318HJLAPM/INS	136	S2320HLM/TEF	83	S2323H	63
S2314HERM	66	S2316HERM	66	S2318HJLM	64	S2320HM	63	S2323H/TEF	82
S2314HERM/TEF	85	S2316HERM/TEF	85	S2318HJLM/INS	136	S2320HM/TEF	82	S2323HER	66
S2314HJL	64	S2316HJL	64	S2318HJLM/TEF	83	S2320HRM/80	65	S2323HER/TEF	85
S2314HJL/TEF	83	S2316HJL/INS	136	S2318HL	64	S2320SD	67	S2323HJL	64
S2314HJLM	64	S2316HJL/TEF	83	S2318HL/TEF	83	S2320SD/TEF	85	S2323HJL/TEF	83
S2314HJLM/TEF	83	S2316HJLAPM/INS	136	S2318HLM	64	S2320SDM	67	S2323HL	64
S2314HL	64	S2316HJLM	64	S2318HLM/TEF	83	S2320SDM/TEF	85	S2323HL/TEF	83
S2314HL/TEF	83	S2316HJLM/INS	136	S2318HM	63	S2321BH	66	S2323HM/TEF	82
S2314HLM	64	S2316HJLM/TEF	83	S2318HM/TEF	82	S2321BH/TEF	84	S2323SQ	68
S2314HLM/TEF	83	S2316HL	64	S2318HRM	65	S2321BHM	66	S2323SQ/TEF	86
S2314HM	63	S2316HL/TEF	83	S2318HRM/80	65	S2321BHM/TEF	84	S2323SQM	68
S2314HM/TEF	82	S2316HLM	64	S2318HRM/TEF	84	S2321H	63	S2323SQM/TEF	86
S2314HRM	65	S2316HLM/TEF	83	S2318SD	67	S2321H/TEF	82	S2324BH	66
S2314HRM/TEF	84	S2316HM	63	S2318SD/TEF	85	S2321HER	66	S2324BH/TEF	84
S2314SD	67	S2316HM/TEF	82	S2318SDM	67	S2321HER/TEF	85	S2324H	63
S2314SD/TEF	85	S2316HRM	65	S2318SDM/TEF	85	S2321HERM	66	S2324H/TEF	82
S2314SDM	67	S2316HRM/80	65	S2319BH	66	S2321HERM/TEF	85	S2324HER/TEF	85
S2314SDM/TEF	85	S2316HRM/TEF	84	S2319BH/TEF	84	S2321HJL	64	S2324HJL	64
S2314SQ	68	S2316SD	67	S2319BHM	66	S2321HJL/INS	136	S2324HJL/TEF	83
S2314SQ/TEF	86	S2316SD/TEF	85	S2319BHM/TEF	84	S2321HJL/TEF	83	S2324HL	64
S2314SQM	68	S2316SDM	67	S2319H	63	S2321HJLAPM/INS	136	S2324HL/TEF	83
S2314SQM/TEF	86	S2316SDM/TEF	85	S2319H/TEF	82	S2321HJLM	64	S2325H	63
S23-15/16H	65	S2317BH	66	S2319HER	66	S2321HJLM/INS	136	S2325H/TEF	82
S23-15/16H/TEF	84	S2317BH/TEF	84	S2319HER/TEF	85	S2321HJLM/TEF	83	S2325HER/TEF	85
S23-15/16HM	65	S2317BHM	66	S2319HERM	66	S2321HL	64	S2325HL	64
S23-15/16HM/TEF	84	S2317BHM/TEF	84	S2319HERM/TEF	85	S2321HL/TEF	83	S2325HL/TEF	83
S2315BH	66	S2317H	63	S2319HJL	64	S2321HLM	64	S2326H	63
S2315BH/TEF	84	S2317H/TEF	82	S2319HJL/TEF	83	S2321HLM/TEF	83	S2326H/TEF	82
S2315BHM	66	S2317HER	66	S2319HJLM	64	S2321HM	63	S2326HL	64
S2315BHM/TEF	84	S2317HER/TEF	85	S2319HJLM/TEF	83	S2321HM/TEF	82	S2326HL/TEF	83
S2315H	63	S2317HERM	66	S2319HL	64	S2321HRM/80	65	S2327H	63
S2315H/TEF	82	S2317HERM/TEF	85	S2319HL/TEF	83	S2321SD	67	S2327H/TEF	82
S2315HER	66	S2317HJL	64	S2319HLM	64	S2321SD/TEF	85	S2327HL	64
S2315HER/TEF	85	S2317HJL/TEF	83	S2319HLM/TEF	83	S2321SDM	67	S2327HL/TEF	83
S2315HERM	66	S2317HJLM	64	S2319HLM	63	S2321SDM/TEF	85	S2328H	63
S2315HERM/TEF	85	S2317HJLM/TEF	83	S2319HM	82	S2322BH	66	S2328H/TEF	82
S2315HJL	64	S2317HL	64	S2319HRM/80	65	S2322BH/TEF	84	S2328HL	64
S2315HJL/INS	136	S2317HL/TEF	83	S2319SD	67	S2322BHM	66	S2328HL/TEF	83
S2315HJL/TEF	83	S2317HLM	64	S2319SD/TEF	85	S2322BHM/TEF	84	S2329H	63
S2315HJLAPM/INS	136	S2317HLM/TEF	83	S2319SDM	67	S2322H	63	S2329H/TEF	82
S2315HJLM	64	S2317HM	63	S2319SDM/TEF	85	S2322H/TEF	82	S2329HL	64
S2315HJLM/INS	136	S2317HM/TEF	82	S2319SQ	68	S2322HER	66	S2329HL/TEF	83
S2315HJLM/TEF	83	S2317HRM	65	S2319SQ/TEF	86	S2322HER/TEF	85	S23-3/4H	65
S2315HL	64	S2317HRM/80	65	S2319SQM	68	S2322HERM	66	S23-3/4H/TEF	84
S2315HL/TEF	83	S2317HRM/TEF	84	S2319SQM/TEF	86	S2322HERM/TEF	85	S23-3/4HM	65
S2315HLM	64	S2317SD	67	S23-1H	65	S2322HJL	64	S23-3/4HM/TEF	84
S2315HLM/TEF	83	S2317SD/TEF	85	S23-1H/TEF	84	S2322HJL/TEF	83	S23-3/8H	65
S2315HM	63	S2317SDM	67	S23-1HM	65	S2322HJLM	64	S23-3/8H/TEF	84
S2315HM/TEF	82	S2317SDM/TEF	85	S23-1HM/TEF	84	S2322HJLM/TEF	83	S23-3/8HM	65
S2315HRM	65	S2317SQ	68	S2320BH	66	S2322HL	64	S23-3/8HM/TEF	84
S2315HRM/TEF	84	S2317SQ/TEF	86	S2320BH/TEF	84	S2322HL/TEF	83	S2330H	63
S2315SD	67	S2317SQM	68	S2320BHM	66	S2322HLM	64	S2330H/TEF	82
S2315SD/TEF	85	S2317SQM/TEF	86	S2320BHM/TEF	84	S2322HLM/TEF	83	S2330HL	64

#	P.	#	P.	#	P.	#	P.	#	P.
S2330HL/TEF	83	S23-EM12	44	S23-EM19/150	44	S23-EM8	44	S2953A/TEF	99
S2332HJL	64	S23-EM12/100	44	S23-EM19/150/TEF	47	S23-EM8/100	44	S2953B	94
S2332HJL/TEF	83	S23-EM12/100/TEF	46	S23-EM19/150/TEFM	47	S23-EM8/100/TEF	46	S2953B/TEF	99
S23-7/16H	65	S23-EM12/100/TEFM	46	S23-EM19/TEF	46	S23-EM8/100/TEFM	46	S2953C	94
S23-7/16H/TEF	84	S23-EM12/150	44	S23-EM19/TEFM	46	S23-EM8/150	44	S2953C/TEF	99
S23-7/16HM	65	S23-EM12/150/TEF	47	S23-EM20	44	S23-EM8/150/TEF	46	S2954A	94
S23-7/16HM/TEF	84	S23-EM12/150/TEFM	47	S23-EM20/100	44	S23-EM8/150/TEFM	46	S2954A/TEF	99
S23-BH10	44	S23-EM12/TEF	46	S23-EM20/100/TEF	46	S23-EM8/TEF	46	S2954B	94
S23-BH10/100	44	S23-EM12/TEFM	46	S23-EM20/100/TEFM	46	S23-EM8/TEFM	46	S2954B/TEF	99
S23-BH10/100/TEF	47	S23-EM13	44	S23-EM20/150	44	S23-EM9	44	S2954C	94
S23-BH10/100/TEFM	47	S23-EM13/100	44	S23-EM20/150/TEF	47	S23-EM9/100	44	S2954C/TEF	99
S23-BH10/TEF	47	S23-EM13/100/TEF	46	S23-EM20/150/TEFM	47	S23-EM9/100/TEF	46	S2955A	94
S23-BH10/TEFM	47	S23-EM13/100/TEFM	46	S23-EM20/TEF	46	S23-EM9/100/TEFM	46	S2955A/TEF	99
S23-BH12	44	S23-EM13/150	44	S23-EM20/TEFM	46	S23-EM9/150	44	S2955B	94
S23-BH12/100	44	S23-EM13/150/TEF	47	S23-EM21	44	S23-EM9/150/TEF	46	S2955B/TEF	99
S23-BH12/100/TEF	47	S23-EM13/150/TEFM	47	S23-EM21/100	44	S23-EM9/150/TEFM	46	S2955C	94
S23-BH12/100/TEFM	47	S23-EM13/TEF	46	S23-EM21/100/TEF	46	S23-EM9/TEF	46	S2955C/TEF	99
S23-BH12/TEF	47	S23-EM13/TEFM	46	S23-EM21/100/TEFM	46	S23-EM9/TEFM	46	S2956A	94
S23-BH12/TEFM	47	S23-EM14	44	S23-EM21/150	44	S23-SQD	37	S2956A/TEF	99
S23-BH14	44	S23-EM14/100	44	S23-EM21/150/TEF	47	S23-SQDV	37	S2956B	94
S23-BH14/100	44	S23-EM14/100/TEF	46	S23-EM21/150/TEFM	47	S23-TX20	45	S2956B/TEF	99
S23-BH14/100/TEF	47	S23-EM14/100/TEFM	46	S23-EM21/TEF	46	S23-TX20/TEF	47	S2956C	94
S23-BH14/100/TEFM	47	S23-EM14/150	44	S23-EM21/TEFM	46	S23-TX20/TEFM	47	S2956C/TEF	99
S23-BH14/TEF	47	S23-EM14/150/TEF	47	S23-EM22	44	S23-TX25	45	S2958A	94
S23-BH14/TEFM	47	S23-EM14/150/TEFM	47	S23-EM22/100	44	S23-TX25/TEF	47	S2958A/TEF	99
S23-BH16	44	S23-EM14/TEF	46	S23-EM22/100/TEF	46	S23-TX25/TEFM	47	S2958B	94
S23-BH16/100	44	S23-EM14/TEFM	46	S23-EM22/100/TEFM	46	S23-TX27	45	S2958B/TEF	99
S23-BH16/100/TEF	47	S23-EM15	44	S23-EM22/150/TEF	47	S23-TX27/TEF	47	S2958C	94
S23-BH16/100/TEFM	47	S23-EM15/100	44	S23-EM22/150/TEFM	47	S23-TX27/TEFM	47	S2958C/TEF	99
S23-BH16/TEF	47	S23-EM15/100/TEF	46	S23-EM22/TEF	46	S23-TX30	45	S2960A	94
S23-BH16/TEFM	47	S23-EM15/100/TEFM	46	S23-EM22/TEFM	46	S23-TX30/TEF	47	S2960A/TEF	99
S23-BH5	44	S23-EM15/150	44	S23-EM4	44	S23-TX30/TEFM	47	S2960B	94
S23-BH5/100	44	S23-EM15/150/TEF	47	S23-EM4/100	44	S23-TX40	45	S2960B/TEF	99
S23-BH5/100/TEF	47	S23-EM15/150/TEFM	47	S23-EM4/100/TEF	46	S23-TX40/TEF	47	S2960C	94
S23-BH5/100/TEFM	47	S23-EM15/TEF	46	S23-EM4/100/TEFM	46	S23-TX40/TEFM	47	S2960C/TEF	99
S23-BH5/TEF	47	S23-EM15/TEFM	46	S23-EM4/150	44	S23-TX45	45	S3050A	96
S23-BH5/TEFM	47	S23-EM16	44	S23-EM4/150/TEF	46	S23-TX47	45	S3050A/TEF	101
S23-BH6	44	S23-EM16/100	44	S23-EM4/150/TEFM	46	S23-TX50	45	S3050B	96
S23-BH6/100	44	S23-EM16/100/TEF	46	S23-EM4/TEF	46	S23-TX50/TEF	47	S3050B/TEF	101
S23-BH6/100/TEF	47	S23-EM16/100/TEFM	46	S23-EM4/TEFM	46	S23-TX50/TEFM	47	S3050C	96
S23-BH6/100/TEFM	47	S23-EM16/150	44	S23-EM5	44	S23-TX55	45	S3050C/TEF	101
S23-BH6/TEF	47	S23-EM16/150/TEF	47	S23-EM5/100	44	S23-TX55/TEF	47	S3052A	96
S23-BH6/TEFM	47	S23-EM16/150/TEFM	47	S23-EM5/100/TEF	46	S23-TX55/TEFM	47	S3052A/TEF	101
S23-BH8	44	S23-EM16/TEF	46	S23-EM5/100/TEFM	46	S23-TX60/TEF	47	S3052B	96
S23-BH8/100	44	S23-EM16/TEFM	46	S23-EM5/150	44	S23-TX60/TEFM	47	S3052B/TEF	101
S23-BH8/100/TEF	47	S23-EM17	44	S23-EM5/150/TEF	46	S28-1/2	36	S3052C	96
S23-BH8/100/TEFM	47	S23-EM17/100	44	S23-EM5/150/TEFM	46	S28-1/2V	37	S3052C/TEF	101
S23-BH8/TEF	47	S23-EM17/100/TEF	46	S23-EM5/TEF	46	S28-1/2V/TEF	39	S3052VP	97
S23-BH8/TEFM	47	S23-EM17/100/TEFM	46	S23-EM5/TEFM	46	S28-1/4	36	S3053A	96
S23-EM10	44	S23-EM17/150	44	S23-EM6	44	S28-1/4/TEF	39	S3053A/TEF	101
S23-EM10/100	44	S23-EM17/150/TEF	47	S23-EM6/100	44	S28-5/16	36	S3053B	96
S23-EM10/100/TEF	46	S23-EM17/150/TEFM	47	S23-EM6/100/TEF	46	S28-5/16/TEF	39	S3053B/TEF	101
S23-EM10/100/TEFM	46	S23-EM17/TEF	46	S23-EM6/100/TEFM	46	S28-7/16V	37	S3053C	96
S23-EM10/150	44	S23-EM17/TEFM	46	S23-EM6/150	44	S28-7/16V/TEF	39	S3053C/TEF	101
S23-EM10/150/TEF	47	S23-EM18	44	S23-EM6/150/TEF	46	S2950A	94	S3054A	96
S23-EM10/150/TEFM	47	S23-EM18/100	44	S23-EM6/150/TEFM	46	S2950ATEF	99	S3054A/TEF	101
S23-EM10/TEF	46	S23-EM18/100/TEF	46	S23-EM6/TEF	46	S2950B	94	S3054B	96
S23-EM10/TEFM	46	S23-EM18/100/TEFM	46	S23-EM6/TEFM	46	S2950BTEF	99	S3054B/TEF	101
S23-EM11	44	S23-EM18/150	44	S23-EM7	44	S2950C	94	S3054C	96
S23-EM11/100	44	S23-EM18/150/TEF	47	S23-EM7/100	44	S2950CTEF	99	S3054C/TEF	101
S23-EM11/100/TEF	46	S23-EM18/150/TEFM	47	S23-EM7/100/TEF	46	S2952A	94	S3055A	96
S23-EM11/100/TEFM	46	S23-EM18/TEF	46	S23-EM7/100/TEFM	46	S2952A/TEF	99	S3055A/TEF	101
S23-EM11/150	44	S23-EM18/TEFM	46	S23-EM7/150	44	S2952B	94	S3055B	96
S23-EM11/150/TEF	47	S23-EM19	44	S23-EM7/150/TEF	46	S3055B/TEF	101	S3055B/TEF	101
S23-EM11/150/TEFM	47	S23-EM19/100	44	S23-EM7/150/TEFM	46	S3055C	96	S3055C	96
S23-EM11/TEF	46	S23-EM19/100/TEF	46	S23-EM7/TEF	46	S3055C/TEF	101	S3055C/TEF	101
S23-EM11/TEFM	46	S23-EM19/100/TEFM	46	S23-EM7/TEFM	46	S3056A	96	S3056A	96

#	P.	#	P.	#	P.	#	P.	#	P.
S3056A/TEF	101	S4015H/3	108	SE16M/TEF	86	SIM2312H	117	SIM2316HL/100	118
S3056B	96	S4015H/3/TEF	111	SE16-TX55SPL/65	142	SIM2312H/TEF	124	SIM2316HL/100/TEF	125
S3056B/TEF	101	S4015H/6	108	SE18	67	SIM2312HL/100	118	SIM2316HL/150	118
S3056C	96	S4015H/6/TEF	111	SE18/TEF	86	SIM2312HL/100/TEF	125	SIM2316HL/150/TEF	125
S3056C/TEF	101	S4015H/9	108	SE18M	67	SIM2312HL/150	118	SIM2316HL/200	118
S3057A	96	S4015H/9/TEF	111	SE18M/TEF	86	SIM2312HL/150/TEF	125	SIM2316HL/200/TEF	125
S3057A/TEF	101	S4016H	108	SE20	67	SIM2312HL/200	118	SIM2316HLM/100	118
S3057B	96	S4016H/12T*	108	SE20/TEF	86	SIM2312HL/200/TEF	125	SIM2316HLM/100/TEF	125
S3057B/TEF	101	S4016H/12T/TEF*	111	SE20M	67	SIM2312HLM/100	118	SIM2316HLM/150	118
S3057C	96	S4016H/4T*	108	SE20M/TEF	86	SIM2312HLM/100/TEF	125	SIM2316HLM/150/TEF	125
S3057C/TEF	101	S4016H/4T/TEF*	111	SE20-TX55SPL/65	142	SIM2312HLM/150	118	SIM2316HLM/200	118
S3058A	96	S4016H/6	108	SE22	67	SIM2312HLM/150/TEF	125	SIM2316HLM/200/TEF	125
S3058A/TEF	101	S4016H/6/TEF	111	SE22/TEF	86	SIM2312HLM/200	118	SIM2316HM	117
S3058B	96	S4016H/TEF	111	SE22M	67	SIM2312HLM/200/TEF	125	SIM2316HM/TEF	124
S3058B/TEF	101	S4017H/6	108	SE22M/TEF	86	SIM2312HLM/230	118	SIM2317H	117
S3058C	96	S4017H/6/TEF	111	SE24	67	SIM2312HM	117	SIM2317H/TEF	124
S3058C/TEF	101	S4017H/9	108	SE24/TEF	86	SIM2312HM/TEF	124	SIM2317HL/100	118
S3060A	96	S4017H/9/TEF	111	SE24M	67	SIM2313H	117	SIM2317HL/100/TEF	125
S3060A/TEF	101	S4018BH/9T*	108	SE24M/TEF	86	SIM2313H/TEF	124	SIM2317HL/150	118
S3060B	96	S4018BH/9T/TEF*	111	SIM2306H	117	SIM2313HL/100	118	SIM2317HL/150/TEF	125
S3060B/TEF	101	S4018H	108	SIM2306H/TEF	124	SIM2313HL/100/TEF	125	SIM2317HL/200	118
S3060C	96	S4018H/3	108	SIM2306HM	117	SIM2313HL/150	118	SIM2317HL/200/TEF	125
S3060C/TEF	101	S4018H/3/TEF	111	SIM2306HM/TEF	124	SIM2313HL/150/TEF	125	SIM2317HLM/100	118
S3062A	96	S4018H/3T*	108	SIM2307H	117	SIM2313HL/200	118	SIM2317HLM/100/TEF	125
S3062A/TEF	101	S4018H/3T/TEF*	111	SIM2307H/TEF	124	SIM2313HL/200/TEF	125	SIM2317HLM/150	118
S3062B	96	S4018H/6	108	SIM2307HM	117	SIM2313HLM/100	118	SIM2317HLM/150/TEF	125
S3062B/TEF	101	S4018H/6/TEF	111	SIM2307HM/TEF	124	SIM2313HLM/100/TEF	125	SIM2317HLM/200	118
S3062C	96	S4018H/9	108	SIM2308H	117	SIM2313HLM/150	118	SIM2317HLM/200/TEF	125
S3062C/TEF	101	S4018H/9/TEF	111	SIM2308H/TEF	124	SIM2313HLM/150/TEF	125	SIM2317HM	117
S3064B	96	S4018H/TEF	111	SIM2308HL/100	118	SIM2313HLM/200	118	SIM2317HM/TEF	124
S30SPL133B	131	S4019H/3	108	SIM2308HL/100/TEF	125	SIM2313HLM/200/TEF	125	SIM2318H	117
S30SPL156B	131	S4019H/3/TEF	111	SIM2308HL/150	118	SIM2313HM	117	SIM2318H/TEF	124
S3152A	94	S4021H/6	108	SIM2308HL/150/TEF	125	SIM2313HM/TEF	124	SIM2318HL/100	118
S3152A/TEF	99	S4021H/6/TEF	111	SIM2308HL/200	118	SIM2314H	117	SIM2318HL/100/TEF	125
S3152B	94	S4021H/9	108	SIM2308HL/200/TEF	125	SIM2314H/TEF	124	SIM2318HL/150	118
S3152B/TEF	99	S4021H/9/TEF	111	SIM2308HLM/100	118	SIM2314HL/100	118	SIM2318HL/150/TEF	125
S3152C	94	S4022H	108	SIM2308HLM/100/TEF	125	SIM2314HL/100/TEF	125	SIM2318HL/200	118
S3152C/TEF	99	S4022H/4	108	SIM2308HLM/150	118	SIM2314HL/150	118	SIM2318HL/200/TEF	125
S3153A	94	S4022H/4/TEF	111	SIM2308HLM/150/TEF	125	SIM2314HL/150/TEF	125	SIM2318HLM/100	118
S3153A/TEF	99	S4022H/9	108	SIM2308HLM/200	118	SIM2314HL/200	118	SIM2318HLM/100/TEF	125
S3153B	94	S4022H/9/TEF	111	SIM2308HLM/200/TEF	125	SIM2314HL/200/TEF	125	SIM2318HLM/150	118
S3153B/TEF	99	S4022H/TEF	111	SIM2308HM	117	SIM2314HLM/100	118	SIM2318HLM/150/TEF	125
S3153C	94	S4024H	108	SIM2308HM/TEF	124	SIM2314HLM/100/TEF	125	SIM2318HLM/200	118
S3153C/TEF	99	S4024H/TEF	111	SIM2309H	117	SIM2314HLM/150	118	SIM2318HLM/200/TEF	125
S3154A	94	S51-5/16	36	SIM2309H/TEF	124	SIM2314HLM/150/TEF	125	SIM2318HM	117
S3154A/TEF	99	S51-5/16-230	36	SIM2309HM	117	SIM2314HLM/200	118	SIM2318HM/TEF	124
S3154B	94	S8-13SDSPL/60	142	SIM2309HM/TEF	124	SIM2314HLM/200/TEF	125	SIM2319H	117
S3154B/TEF	99	S8-13SDSPL/65	142	SIM2310H	117	SIM2314HM	117	SIM2319H/TEF	124
S3154C	94	SE10	67	SIM2310H/TEF	124	SIM2314HM/TEF	124	SIM2319HL/100	118
S3154C/TEF	99	SE10/TEF	86	SIM2310HL/100	118	SIM2315H	117	SIM2319HL/100/TEF	125
S3202A	107	SE10M	67	SIM2310HL/100/TEF	125	SIM2315H/TEF	124	SIM2319HL/150	118
S3202B	107	SE10M/TEF	86	SIM2310HL/150	118	SIM2315HL/100	118	SIM2319HL/150/TEF	125
S3203A	107	SE11	67	SIM2310HL/150/TEF	125	SIM2315HL/100/TEF	125	SIM2319HL/200	118
S3206BT	107	SE11/TEF	86	SIM2310HL/200	118	SIM2315HL/150	118	SIM2319HL/200/TEF	125
S3209BT	107	SE11M	67	SIM2310HL/200/TEF	125	SIM2315HL/150/TEF	125	SIM2319HLM/100	118
S4010BH/6	108	SE11M/TEF	86	SIM2310HLM/100	118	SIM2315HL/200	118	SIM2319HLM/100/TEF	125
S4010BH/6/TEF	111	SE12	67	SIM2310HLM/100/TEF	125	SIM2315HL/200/TEF	125	SIM2319HLM/150	118
S4011BH/6	108	SE12/TEF	86	SIM2310HLM/150	118	SIM2315HLM/100	118	SIM2319HLM/150/TEF	125
S4011BH/6/TEF	111	SE12M	67	SIM2310HLM/150/TEF	125	SIM2315HLM/100/TEF	125	SIM2319HLM/200	118
S4013H/3	108	SE12M/TEF	86	SIM2310HLM/200	118	SIM2315HLM/150	118	SIM2319HLM/200/TEF	125
S4013H/3/TEF	111	SE14	67	SIM2310HLM/200/TEF	125	SIM2315HLM/150/TEF	125	SIM2319HM	117
S4013H/3T*	108	SE14/TEF	86	SIM2310HM	117	SIM2315HLM/200	118	SIM2319HM/TEF	124
S4013H/3T/TEF*	111	SE14M	67	SIM2310HM/TEF	124	SIM2315HLM/200/TEF	125	SIM2320H	117
S4013H/6	108	SE14M/TEF	86	SIM2311H	117	SIM2315HM	117	SIM2320H/TEF	124
S4013H/6/TEF	111	SE16	67	SIM2311H/TEF	124	SIM2315HM/TEF	124	SIM2320HM	117
S4013H/9	108	SE16/TEF	86	SIM2311HM	117	SIM2316H	117	SIM2320HM/TEF	124
S4013H/9/TEF	111	SE16M	67	SIM2311HM/TEF	124	SIM2316H/TEF	124	SIM2321H	117

#	P.	#	P.	#	P.	#	P.	#	P.
SIM2321H/TEF	124	SIM2326H	117	SIM4018H/3	121	TP8/TEFM	25	TX3/TEF	22
SIM2321HL/100	118	SIM2326H/TEF	124	SIM4018H/3T*	121	TP9	13	TX3/TEFM	22
SIM2321HL/100/TEF	125	SIM2326HM	117	SIM4018H/6	121	TP9/TEF	25	TX30	12
SIM2321HL/150	118	SIM2326HM/TEF	124	SIM4018H/9	121	TP9/TEFM	25	TX30/TEF	22
SIM2321HL/150/TEF	125	SIM2327H	117	SIM4019H/3	121	TS10	17	TX30/TEFM	22
SIM2321HL/200	118	SIM2327H/TEF	124	SIM4021H/6	121	TS10/TEF	29	TX30A	12
SIM2321HL/200/TEF	125	SIM2327HM	117	SIM4021H/9	121	TS10/TEFM	29	TX30A/TEF	22
SIM2321HLM/100	118	SIM2327HM/TEF	124	SIM4022H/4	121	TS6	17	TX30A/TEFM	22
SIM2321HLM/100/TEF	125	SIM2328H	117	SIM4022H/9	121	TS6/TEF	29	TX30P	13
SIM2321HLM/150	118	SIM2328H/TEF	124	SIM-SQD	37	TS6/TEFM	29	TX30P/TEF	24
SIM2321HLM/150/TEF	125	SIM2328HM	117	SIM-SQDV	37	TW1	14	TX30P/TEFM	24
SIM2321HLM/200	118	SIM2328HM/TEF	124	SOB	109	TW1/TEF	26	TX4	12
SIM2321HLM/200/TEF	125	SIM2329H	117	SOB300A	109	TW1/TEFM	26	TX4/TEF	22
SIM2321HM	117	SIM2329H/TEF	124	SPCOPMGR	19	TW2	14	TX4/TEFM	22
SIM2321HM/TEF	124	SIM2329HM	117	SPCOPMGRTX50	19	TW2/TEF	26	TX40	12
SIM2322H	117	SIM2329HM/TEF	124	SPCOPMGRTX55	19	TW2/TEFM	26	TX40/TEF	22
SIM2322H/TEF	124	SIM2330H	117	SPTFEMGRTX30L	19	TW3	14	TX40/TEFM	22
SIM2322HL/100	118	SIM2330H/TEF	124	SPTFEMGRTX40	19	TW3/TEF	26	TX40A	12
SIM2322HL/100/TEF	125	SIM2330HM	117	SPTFEMGRTX50	19	TW3/TEFM	26	TX40A/TEF	22
SIM2322HL/150	118	SIM2330HM/TEF	124	SQ0	16	TW4	14	TX40A/TEFM	22
SIM2322HL/150/TEF	125	SIM2331H	117	SQ0/TEF	30	TW4/TEF	26	TX40P	13
SIM2322HL/200	118	SIM2331H/TEF	124	SQ0/TEFM	30	TW4/TEFM	26	TX40P/TEF	24
SIM2322HL/200/TEF	125	SIM2331HM	117	SQ1	16	TW5	14	TX40P/TEFM	24
SIM2322HLM/100	118	SIM2331HM/TEF	124	SQ1/TEF	30	TW5/TEF	26	TX45A	12
SIM2322HLM/100/TEF	125	SIM2332H	117	SQ1/TEFM	30	TW5/TEFM	26	TX45A/TEF	22
SIM2322HLM/150	118	SIM2332H/TEF	124	SQ2	16	TW6	14	TX45A/TEFM	22
SIM2322HLM/150/TEF	125	SIM2332HM	117	SQ2/TEF	30	TW6/33	14	TX5	12
SIM2322HLM/200	118	SIM2332HM/TEF	124	SQ2/TEFM	30	TX10	12	TX5/TEF	22
SIM2322HLM/200/TEF	125	SIM2952B	119	SQ3	16	TX10/TEF	22	TX5/TEFM	22
SIM2322HM	117	SIM2952B/TEF	126	SQ3/TEF	30	TX10/TEFM	22	TX50A	12
SIM2322HM/TEF	124	SIM2952C	119	SQ3/TEFM	30	TX10P	13	TX50A/TEF	22
SIM2323H	117	SIM2952C/TEF	126	SQ4	16	TX10P/TEF	24	TX50A/TEFM	22
SIM2323H/TEF	124	SIM2954B	119	SQ4/TEF	30	TX10P/TEFM	24	TX50B	12
SIM2323HL/100	118	SIM2954B/TEF	126	SQ4/TEFM	30	TX15	12	TX50B/TEF	22
SIM2323HL/100/TEF	125	SIM2954C/TEF	126	TP10	13	TX15/TEF	22	TX50B/TEFM	22
SIM2323HL/150	118	SIM2956B	119	TP10/TEF	25	TX15/TEFM	22	TX55A	12
SIM2323HL/150/TEF	125	SIM2958B	119	TP10/TEFM	25	TX15P	13	TX55B	12
SIM2323HL/200	118	SIM3054B	120	TP15	13	TX15P/TEF	24	TX55B/TEF	22
SIM2323HL/200/TEF	125	SIM3054B/TEF	126	TP15/TEF	25	TX15P/TEFM	24	TX55B/TEFM	22
SIM2323HLM/100	118	SIM3054C	120	TP15/TEFM	25	TX2	12	TX55CV	37
SIM2323HLM/100/TEF	125	SIM3054C/TEF	126	TP20	13	TX2/TEF	22	TX6	12
SIM2323HLM/150	118	SIM3056B	120	TP20/TEF	25	TX2/TEFM	22	TX6/TEF	22
SIM2323HLM/150/TEF	125	SIM3056B/TEF	126	TP20/TEFM	25	TX20	12	TX6/TEFM	22
SIM2323HLM/200	118	SIM3056C/TEF	126	TP25	13	TX20/TEF	22	TX60B	12
SIM2323HLM/200/TEF	125	SIM3058B	120	TP25/TEF	25	TX20/TEFM	22	TX60B/TEF	22
SIM2323HM	117	SIM3058B/TEF	126	TP25/TEFM	25	TX20A	12	TX60B/TEFM	22
SIM2323HM/TEF	124	SIM3058C/TEF	126	TP27	13	TX20A/TEF	22	TX7	12
SIM2324H	117	SIM3060B	120	TP27/TEF	25	TX20A/TEFM	22	TX7/TEF	22
SIM2324H/TEF	124	SIM3060B/TEF	126	TP27/TEFM	25	TX20P	13	TX7/TEFM	22
SIM2324HL/100	118	SIM3062B	120	TP3	13	TX20P/TEF	24	TX8	12
SIM2324HL/100/TEF	125	SIM30SPL143B	131	TP3/TEF	25	TX20P/TEFM	24	TX8/TEF	22
SIM2324HL/150	118	SIM4010BH/6	120	TP3/TEFM	25	TX25	12	TX8/TEFM	22
SIM2324HL/150/TEF	125	SIM4011BH/6	120	TP30	13	TX25/TEF	22	TX9	12
SIM2324HL/200	118	SIM4013H/3	121	TP30/TEF	25	TX25/TEFM	22	TX9/TEF	22
SIM2324HL/200/TEF	125	SIM4013H/3T*	121	TP30/TEFM	25	TX25A	12	TX9/TEFM	22
SIM2324HLM/100	118	SIM4013H/6	121	TP40	13	TX25A/TEF	22	VMBH10/90	15
SIM2324HLM/100/TEF	125	SIM4013H/9	121	TP40/TEF	25	TX25A/TEFM	22	VMBH10/90/TEF	28
SIM2324HLM/150	118	SIM4015H/3	121	TP40/TEFM	25	TX25P	13	VMBH10/90/TEFM	28
SIM2324HLM/150/TEF	125	SIM4015H/6	121	TP55A	13	TX25P/TEF	24	VMBH12/90	15
SIM2324HLM/200	118	SIM4015H/9	121	TP6	13	TX25P/TEFM	24	VMBH12/90/TEF	28
SIM2324HLM/200/TEF	125	SIM4016BH/3	120	TP6/TEF	25	TX27	12	VMBH12/90/TEFM	28
SIM2324HM	117	SIM4016H/12T*	121	TP6/TEFM	25	TX27/TEF	22	VMBH14/90	15
SIM2324HM/TEF	124	SIM4016H/4T*	121	TP7	13	TX27/TEFM	22	VMBH14/90/TEF	28
SIM2325H	117	SIM4016H/6	121	TP7/TEF	25	TX27P	13	VMBH14/90/TEFM	28
SIM2325H/TEF	124	SIM4017H/6	121	TP7/TEFM	25	TX27P/TEF	24	VMEM10/90	15
SIM2325HM	117	SIM4017H/9	121	TP8	13	TX27P/TEFM	24	VMEM6/90	15
SIM2325HM/TEF	124	SIM4018BH/9T*	120	TP8/TEF	25	TX3	12	VMTX30TP/TT	37

#	P.	#	P.	#	P.	#	P.	#	P.
VMTX30TP/TT*	13	VPEM6/150	14	VPPL4.0/90/TEFM	21	VPPZD3/70	16	VPTP40/50/TEFM	25
VMTX40/90	13	VPEM6/50	14	VPPL4.5/50	11	VPPZD3/70/TEF	28	VPTP40/70	13
VMTX40/90/TEF	24	VPEM6/50/TEF	26	VPPL4.5/50/TEF	21	VPPZD3/70/TEFM	28	VPTP40/70/TEF	25
VMTX40/90/TEFM	24	VPEM6/50/TEFM	26	VPPL4.5/50/TEFM	21	VPPZD3/90	16	VPTP40/70/TEFM	25
VMTX40TP	13	VPEM7/50	14	VPPL5.0/50	11	VPPZD3/90/TEF	28	VPTP40/90	13
VMTX40TP	37	VPEM7/50/TEF	26	VPPL5.0/50/TEF	21	VPPZD3/90/TEFM	28	VPTP40/90/TEF	25
VMTX50/90	13	VPEM7/50/TEFM	26	VPPL5.0/50/TEFM	21	VPPZD4/50	16	VPTP40/90/TEFM	25
VMTX50/90/TEF	24	VPEM8/50	14	VPPL5.5/50/TEF	21	VPPZD4/50/TEF	28	VPTP6/70	13
VMTX50/90/TEFM	24	VPEM8/50/TEF	26	VPPL5.5/50/TEFM	21	VPPZD4/50/TEFM	28	VPTP6/70/TEF	25
VMTX50TP	13	VPEM8/50/TEFM	26	VPPL5.5/90	11	VPPZD4/70/TEF	28	VPTP6/70/TEFM	25
VMTX50TP	37	VPPH0/50	11	VPPL5.5/90	11	VPPZD4/70/TEFM	28	VPTP8/90	13
VMTX50TP/TT	37	VPPH0/50/TEF	20	VPPL5.5/90/TEF	21	VPSQ2/50	16	VPTP9/90	13
VMTX50TP/TT*	13	VPPH0/50/TEFM	20	VPPL5.5/90/TEFM	21	VPSQ2/50/TEF	30	VPTP9/90/TEF	25
VMTX55/100	13	VPPH0/70	11	VPPL6.0/50	11	VPSQ2/50/TEFM	30	VPTP9/90/TEFM	25
VMTX55/100/TEF	24	VPPH0/70/TEF	20	VPPL6.0/50/TEF	21	VPSQ3/50	16	VPTS1/4/33	17
VMTX55/100/TEFM	24	VPPH0/70/TEFM	20	VPPL6.0/50/TEFM	21	VPSQ3/50/TEF	30	VPTS1/4ACR/33/TEF	29
VMTX55/75	13	VPPH0/90	11	VPPL6.5/50	11	VPSQ3/50/TEFM	30	VPTS1/4ACR/33/TEFM	29
VMTX55/90	13	VPPH0/90/TEF	20	VPPL6.5/50/TEF	21	VPSQ4/50	16	VPTS10ACR/33	17
VMTX55/90/TEF	24	VPPH0/90/TEFM	20	VPPL6.5/50/TEFM	21	VPSQ4/50/TEF	30	VPTS10ACR/33/TEF	29
VMTX55/90/TEFM	24	VPPH1/50	11	VPPL7.0/50	11	VPSQ4/50/TEFM	30	VPTS10ACR/33/TEFM	29
VMTX55/92TT*	13	VPPH1/50/TEF	20	VPPL7.0/50/TEF	21	VPTP10/50	13	VPTS8ACR/33	17
VPBH10/50	15	VPPH1/50/TEFM	20	VPPL7.0/50/TEFM	21	VPTP10/50/TEF	25	VPTS8ACR/33/TEF	29
VPBH10/50/TEF	27	VPPH1/70	11	VPPL7.5/50	11	VPTP10/50/TEFM	25	VPTS8ACR/33/TEFM	29
VPBH10/50/TEFM	27	VPPH1/70/TEF	20	VPPL7.5/50/TEF	21	VPTP10/70	13	VPTX10/150	12
VPBH4/50	15	VPPH1/70/TEFM	20	VPPL7.5/50/TEFM	21	VPTP10/70/TEF	25	VPTX10/150/TEF	23
VPBH4/50/TEF	27	VPPH1/90	11	VPPL8.0/50	11	VPTP10/70/TEFM	25	VPTX10/150/TEFM	23
VPBH4/50/TEFM	27	VPPH1/90/TEF	20	VPPL8.0/50/TEF	21	VPTP10/90	13	VPTX10/50	12
VPBH5/50	15	VPPH1/90/TEFM	20	VPPL8.0/50/TEFM	21	VPTP10/90/TEF	25	VPTX10/50/TEF	23
VPBH5/50/TEF	27	VPPH2/150/TEF	20	VPPZD0/150	16	VPTP10/90/TEFM	25	VPTX10/50/TEFM	23
VPBH5/50/TEFM	27	VPPH2/150/TEFM	20	VPPZD0/150/TEF	28	VPTP15/50	13	VPTX10/70	12
VPBH6/50	15	VPPH2/50	11	VPPZD0/150/TEFM	28	VPTP15/50/TEF	25	VPTX10/70/TEF	23
VPBH6/50/TEF	27	VPPH2/50/TEF	20	VPPZD0/50	16	VPTP15/50/TEFM	25	VPTX10/70/TEFM	23
VPBH6/50/TEFM	27	VPPH2/50/TEFM	20	VPPZD0/50/TEF	28	VPTP15/70	13	VPTX10/90	12
VPBH8/50	15	VPPH2/70	11	VPPZD0/50/TEFM	28	VPTP15/70/TEF	25	VPTX10P/50	13
VPBH8/50/TEF	27	VPPH2/70/TEF	20	VPPZD0/70	16	VPTP15/70/TEFM	25	VPTX10P/50/TEF	24
VPBH8/50/TEFM	27	VPPH2/70/TEFM	20	VPPZD0/70/TEF	28	VPTP15/90	13	VPTX10P/50/TEFM	24
VPBH9/50/TEF	27	VPPH2/90	11	VPPZD0/70/TEFM	28	VPTP15/90/TEF	25	VPTX15/150	12
VPBH9/50/TEFM	27	VPPH2/90/TEF	20	VPPZD0/90	16	VPTP15/90/TEFM	25	VPTX15/150/TEF	23
VPEM10/50	14	VPPH2/90/TEFM	20	VPPZD0/90/TEF	28	VPTP20/50	13	VPTX15/150/TEFM	23
VPEM2.5/50	14	VPPH3/50	11	VPPZD0/90/TEFM	28	VPTP20/50/TEF	25	VPTX15/50	12
VPEM2.5/50/TEF	26	VPPH3/50/TEF	20	VPPZD1/150	16	VPTP20/50/TEFM	25	VPTX15/50/TEF	23
VPEM2.5/50/TEFM	26	VPPH3/50/TEFM	20	VPPZD1/150/TEF	28	VPTP20/70	13	VPTX15/50/TEFM	23
VPEM2.5SW/50	15	VPPH3/70	11	VPPZD1/150/TEFM	28	VPTP20/70/TEF	25	VPTX15/70	12
VPEM2.5SW/50/TEF	27	VPPH3/70/TEF	20	VPPZD1/50	16	VPTP20/70/TEFM	25	VPTX15/70/TEF	23
VPEM2.5SW/50/TEFM	27	VPPH3/70/TEFM	20	VPPZD1/50/TEF	28	VPTP20/90	13	VPTX15/70/TEFM	23
VPEM2.5SW/70	15	VPPH3/90	11	VPPZD1/50/TEFM	28	VPTP20/90/TEF	25	VPTX15/90	12
VPEM2.5SW/70/TEF	27	VPPH3/90/TEF	20	VPPZD1/70	16	VPTP20/90/TEFM	25	VPTX20/150	12
VPEM2.5SW/70/TEFM	27	VPPH3/90/TEFM	20	VPPZD1/70/TEF	28	VPTP25/50	13	VPTX20/150/TEF	23
VPEM2/50	14	VPPH4/50	11	VPPZD1/70/TEFM	28	VPTP25/50/TEF	25	VPTX20/150/TEFM	23
VPEM3/50	14	VPPH4/50/TEF	20	VPPZD1/90	16	VPTP25/50/TEFM	25	VPTX20/50	12
VPEM3/50/TEF	26	VPPH4/50/TEFM	20	VPPZD1/90/TEF	28	VPTP25/70	13	VPTX20/50/TEF	23
VPEM3/50/TEFM	26	VPPH4/70	11	VPPZD1/90/TEFM	28	VPTP25/70/TEF	25	VPTX20/50/TEFM	23
VPEM3/90	14	VPPH4/70/TEF	20	VPPZD2/150	16	VPTP25/70/TEFM	25	VPTX20/70	12
VPEM4/240	14	VPPH4/70/TEFM	20	VPPZD2/150/TEF	28	VPTP25/90	13	VPTX20/70/TEF	23
VPEM4/340	14	VPPH4/90	11	VPPZD2/150/TEFM	28	VPTP25/90/TEF	25	VPTX20/70/TEFM	23
VPEM4/50	14	VPPH4/90/TEF	20	VPPZD2/50	16	VPTP25/90/TEFM	25	VPTX20/90	12
VPEM4/50/TEF	26	VPPH4/90/TEFM	20	VPPZD2/50/TEF	28	VPTP30/50	13	VPTX20/90/TEF	23
VPEM4/50/TEFM	26	VPPL10.0/75/TEF	21	VPPZD2/50/TEFM	28	VPTP30/50/TEF	25	VPTX20/90/TEFM	23
VPEM4/90	14	VPPL10.0/75/TEFM	21	VPPZD2/70	16	VPTP30/50/TEFM	25	VPTX20P/150	13
VPEM5/100	14	VPPL10/75	11	VPPZD2/70/TEF	28	VPTP30/70	13	VPTX20P/150/TEF	24
VPEM5/50	14	VPPL4.0/50	11	VPPZD2/70/TEFM	28	VPTP30/70/TEF	25	VPTX20P/150/TEFM	24
VPEM5/50/TEF	26	VPPL4.0/50/TEF	21	VPPZD2/90	16	VPTP30/70/TEFM	25	VPTX25/150	12
VPEM5/50/TEFM	26	VPPL4.0/50/TEFM	21	VPPZD2/90/TEF	28	VPTP30/90	13	VPTX25/150/TEF	23
VPEM5SW/122	15	VPPL4.0/75	11	VPPZD2/90/TEFM	28	VPTP30/90/TEF	25	VPTX25/150/TEFM	23
VPEM5SW/122/TEF	27	VPPL4.0/75/TEF	21	VPPZD3/50	16	VPTP30/90/TEFM	25	VPTX25/50	12
VPEM5SW/122/TEFM	27	VPPL4.0/75/TEFM	21	VPPZD3/50/TEF	28	VPTP40/50	13	VPTX25/50/TEF	23
VPEM6/100	14	VPPL4.0/90/TEF	21	VPPZD3/50/TEFM	28	VPTP40/50/TEF	25	VPTX25/50/TEFM	23

#	P.	#	P.	#	P.	#	P.	#	P.
VPTX25/70	12	VPTX30/150ND	12	VPTX40/70	12	VPTX6/50/TEF	23	VPTX8/50/TEF	23
VPTX25/70/TEF	23	VPTX30/50	12	VPTX40/70/TEF	23	VPTX6/50/TEFM	23	VPTX8/50/TEFM	23
VPTX25/70/TEFM	23	VPTX30/50/TEF	23	VPTX40/70/TEFM	23	VPTX6/70	12	VPTX8/70	12
VPTX25/90	12	VPTX30/50/TEFM	23	VPTX40/90	12	VPTX6/90	12	VPTX8/70/TEF	23
VPTX25/90/TEF	23	VPTX30/70	12	VPTX40/90/TEF	23	VPTX7/150	12	VPTX8/70/TEFM	23
VPTX25/90/TEFM	23	VPTX30/70/TEF	23	VPTX40/90/TEFM	23	VPTX7/150/TEF	23	VPTX8/90	12
VPTX27/150	12	VPTX30/70/TEFM	23	VPTX45/70/TEF	23	VPTX7/150/TEFM	23	VPTX9/150	12
VPTX27/150/TEF	23	VPTX30/90	12	VPTX45/70/TEFM	23	VPTX7/50	12	VPTX9/50	12
VPTX27/150/TEFM	23	VPTX30/90/TEF	23	VPTX45/75	12	VPTX7/50/TEF	23	VPTX9/50/TEF	23
VPTX27/50	12	VPTX30/90/TEFM	23	VPTX5/50	12	VPTX7/50/TEFM	23	VPTX9/50/TEFM	23
VPTX27/70	12	VPTX40/150	12	VPTX5/50/TEF	23	VPTX7/70	12	VPTX9/70	12
VPTX27/90	12	VPTX40/150/TEF	23	VPTX5/50/TEFM	23	VPTX7/90	12	VPTX9/70/TEF	23
VPTX30/100ND	12	VPTX40/150/TEFM	23	VPTX6/150	12	VPTX8/150	12	VPTX9/70/TEFM	23
VPTX30/150	12	VPTX40/50	12	VPTX6/150/TEF	23	VPTX8/150/TEF	23	VPTX9/90	12
VPTX30/150/TEF	23	VPTX40/50/TEF	23	VPTX6/150/TEFM	23	VPTX8/150/TEFM	23		
VPTX30/150/TEFM	23	VPTX40/50/TEFM	23	VPTX6/50	12	VPTX8/50	12		



