

48V Magnetic Track System

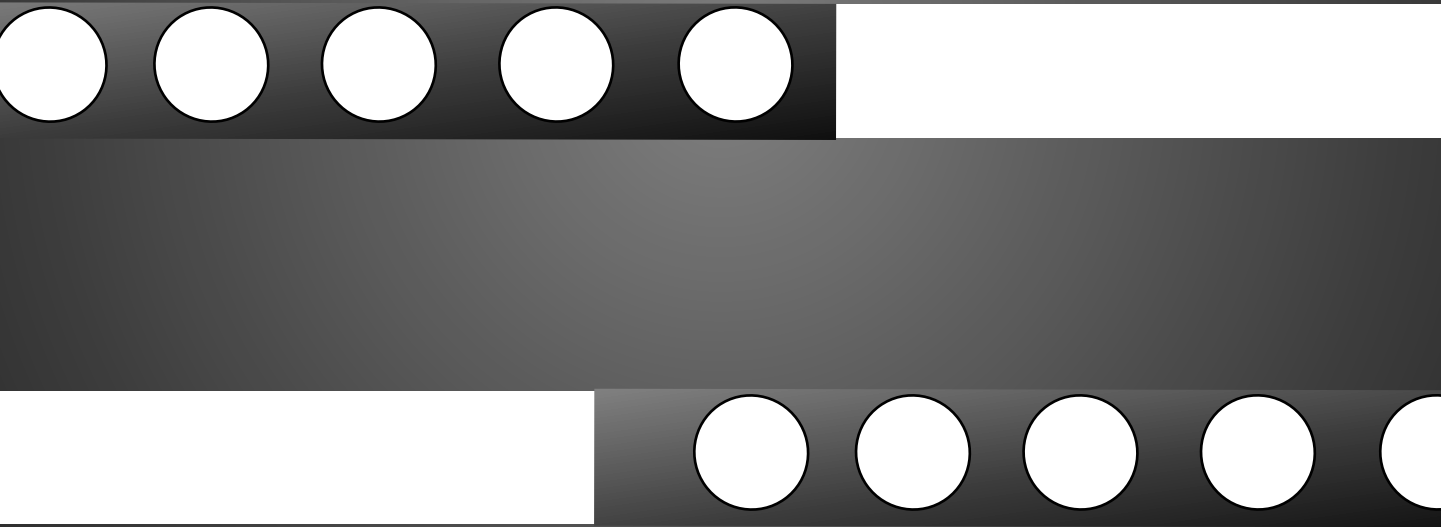



Magnets make life simple

Different light fixtures are held in place by magnetic force along the entire track. No tools are needed to install them. Rotate, Slide into any position, and adjust at any time— all it takes is one hand movement to highlight objects according to requirements



Designed with M20A rail and
MS900,CFC1045 light



Designed with M20C rail and
CFC1045 light



Designed with M20C rail and
MS12 grille light



Designed with M20C rail and
MS600 Linear light



Designed with M20C rail and
CFC1045, TS20 spotlight

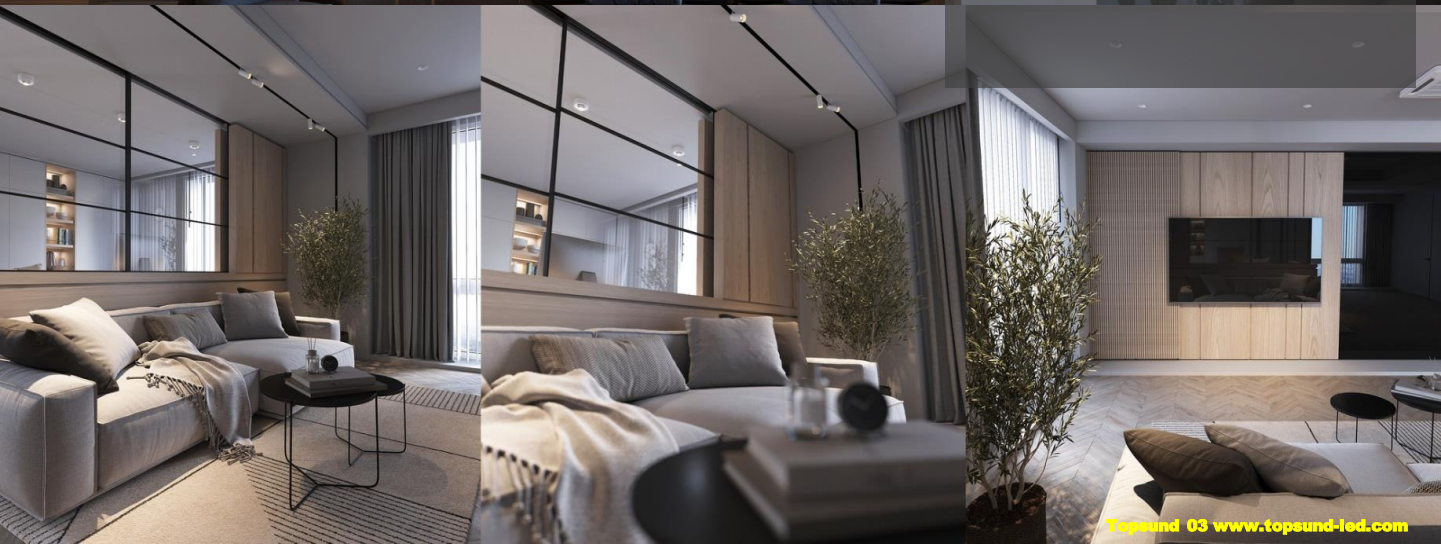

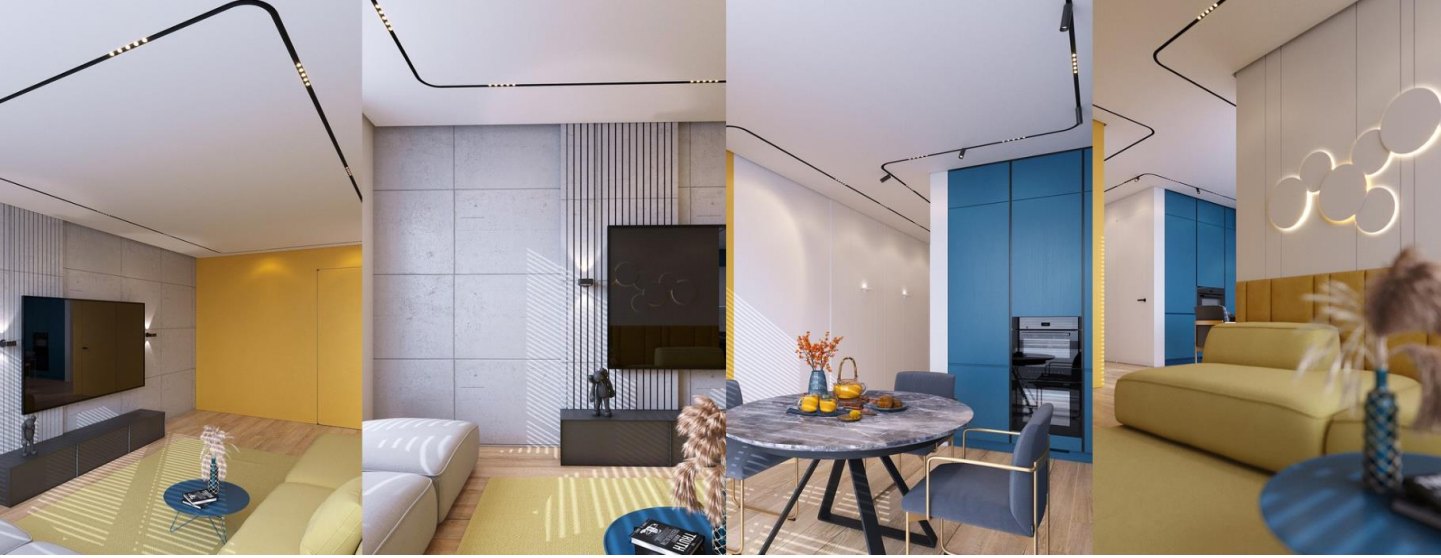

Designed with M20C rail and

CFC40 pendant light





The effect in space

Magnetic track light system has the flexibility to adapt to every new situation and react to changing requirements in a room- whether you want to evenly light an entire wall or accentuate a particular object. maximum flexibility within the room is ensured since no tools are needed for adjustment, spots are easy to swivel and tilt, and beams can be focused. Light fixtures can be analog-dimmed with no flickering to create the optimal setting.

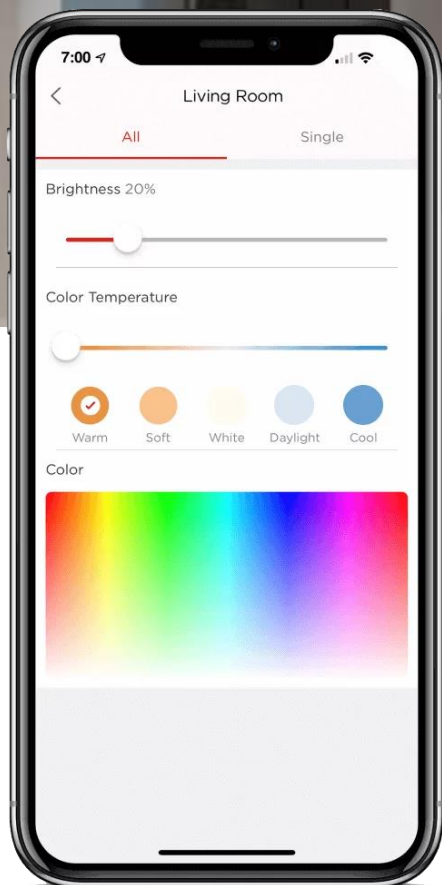

Wireless control by Philips Hue Bridge

Control your lighting from anywhere, any time by your smartphone or tablet. Not only dim the brightness, but set different scenes as your needs.



Home Automation

An intelligent solution for networking and controlling intelligent building technology. Due to the targeted linking of devices and functions in accordance with the KNX standard, both living and working have not only become more convenient and secure but also more energy efficient and economical

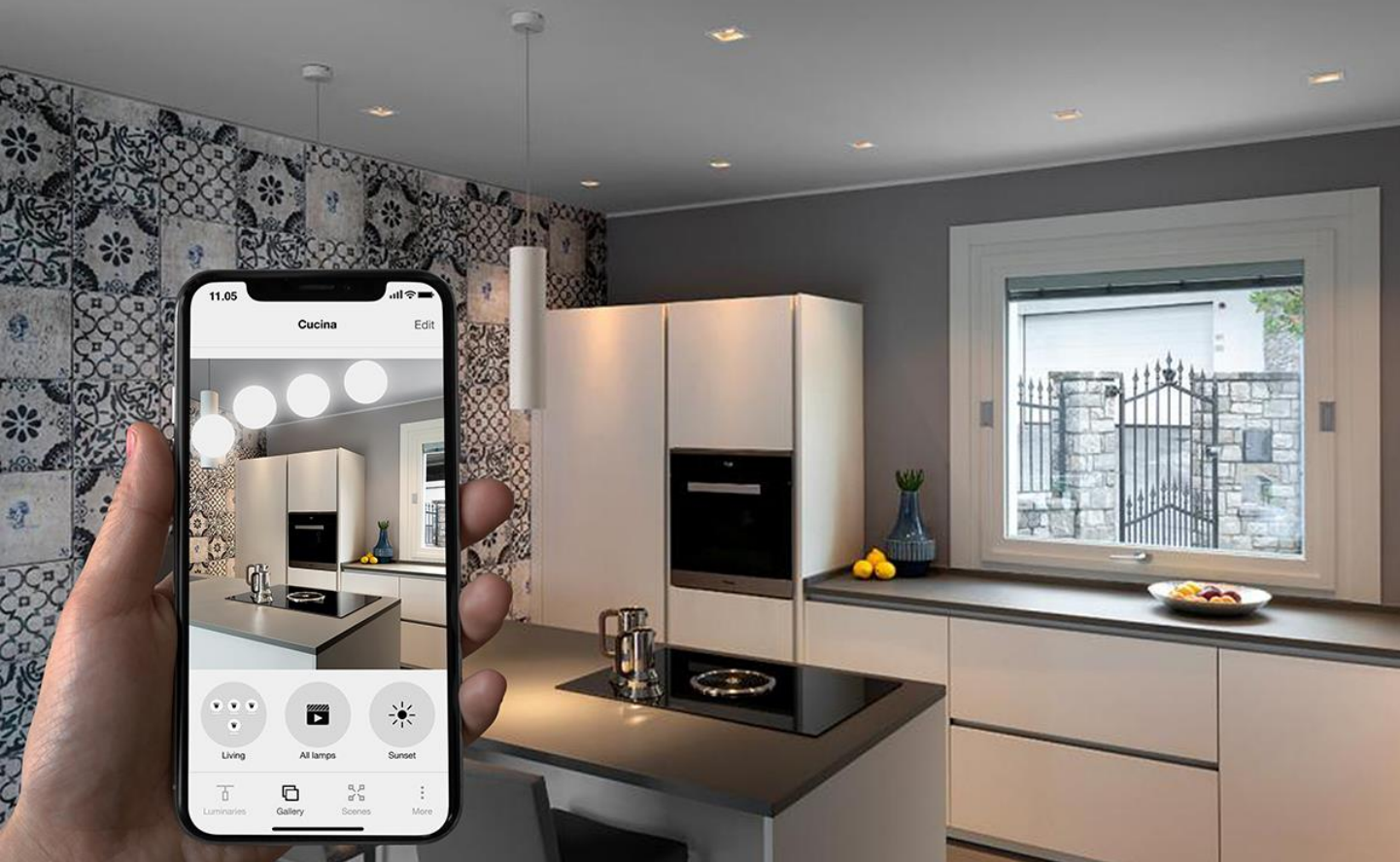

Smart Lighting

Casambi gives you a complete lighting control solution with a dynamic and reliable user experience. The system is based on modern wireless mesh technology, allowing it to be fully future-proofed and adaptable while allowing you to create a full ecosystem.

CASAMBI

Casambi uses an intelligent control hierarchy in order to adapt the lighting to best suit your needs. From dimming to colour temperature control, you have full control with just a touch. This scene-based control approach also enables optimum energy efficiency and user-friendliness.

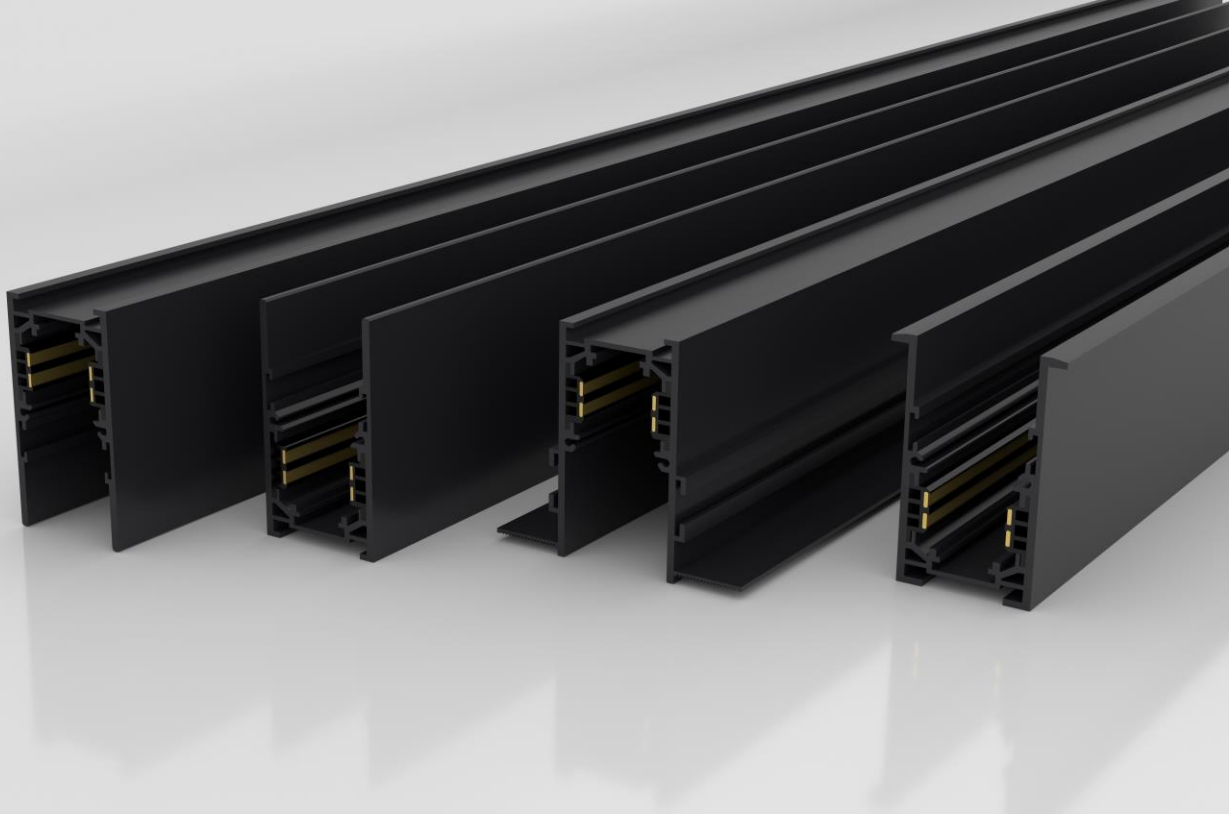

Channel Variety

The magnetic track system is available as a recessed, surface-mounted, and suspended option. The suspended direct/indirect model also enables optional indirect lighting. The power track system use 48V. Each spot can be switched on and off and dimmed individually wirelessly via WIFI, Zigbee or using a DALI signal.

Track

M20A

DC 48V	IP 20
-----------	----------

OPTIONS

Color	RAL9004
Length	1000mm / 2000mm
Installation	Suspended / surface mounted

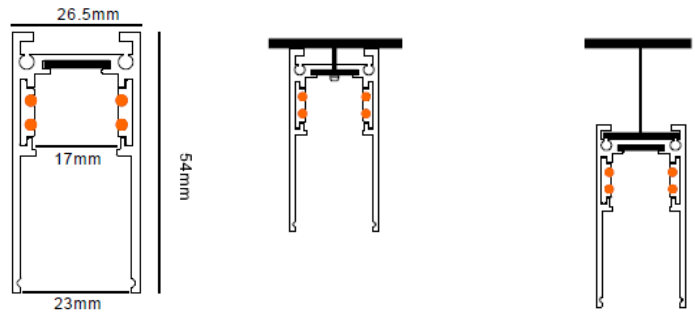

M20B

DC 48V	IP 20
-----------	----------

OPTIONS

Color	RAL9004 / RAL9003
Length	1000mm / 2000mm
Installation	Trimless recessed

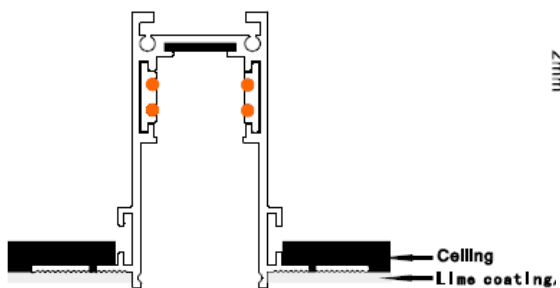
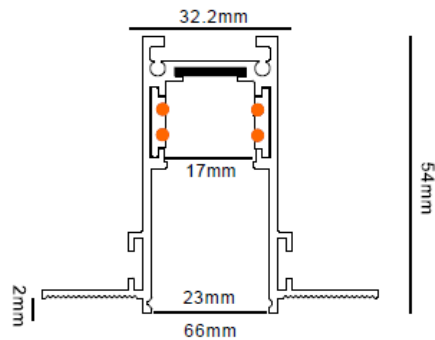

Track



M20C

DC
48V

IP
20

OPTIONS

Color RAL9003 / RAL9004

Length 1000mm / 2000mm

Installation Recessed

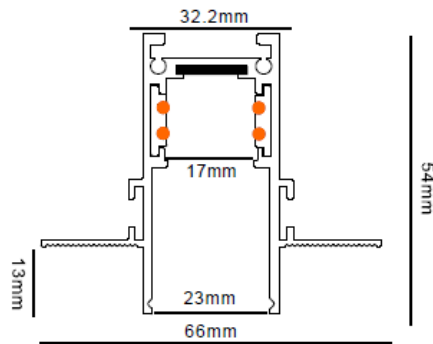
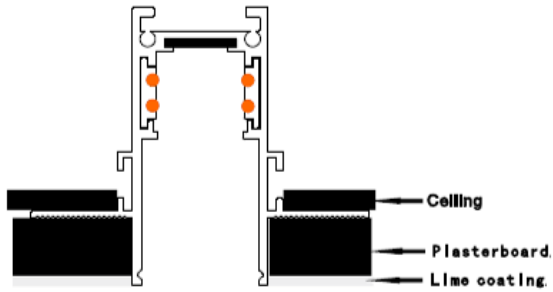

M20D

DC
48V

IP
20

OPTIONS

Color RAL9003 / RAL9004

Length 1000mm / 2000mm

Installation Recessed

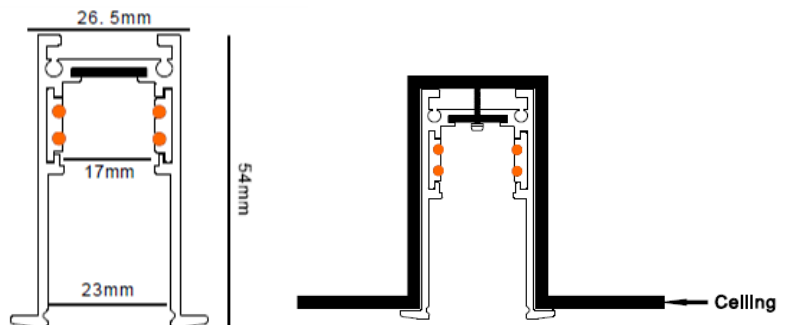

Mini Track

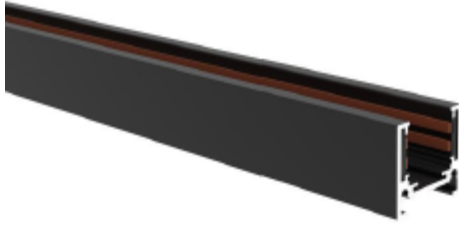

M01

DC
48V

IP
20

OPTIONS

Color RAL9003 / RAL9004

Length 1000mm / 2000mm

Installation Surface mount

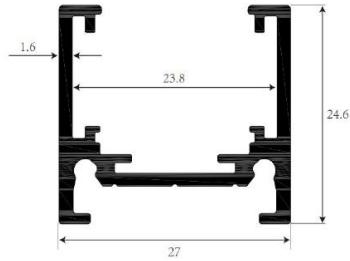

M02

DC
48V

IP
20

OPTIONS

Color RAL9003 / RAL9004

Length 1000mm / 2000mm

Installation Surface mount

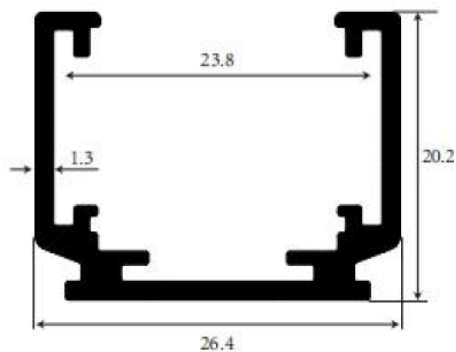

Mini Track

M03

DC
48V

IP
20

OPTIONS

Color RAL9003 / RAL9004

Length 1000mm / 2000mm

Installation Recessed

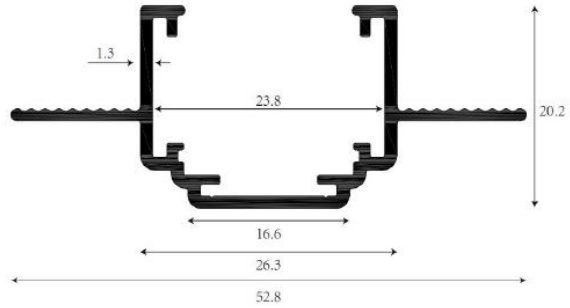

M04

DC
48V

IP
20

OPTIONS

Color RAL9003 / RAL9004

Length 1000mm / 2000mm

Installation Recessed

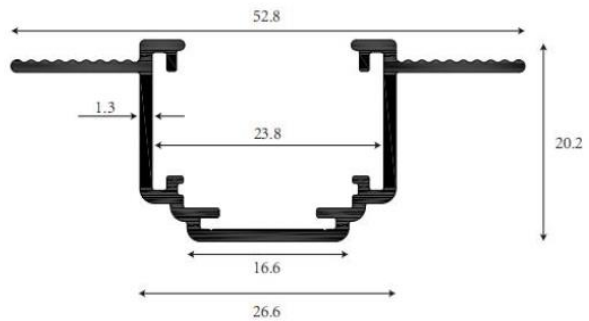



Spotlight

The popular spotlight series is available in various modifications. The key difference between them lies in the light characteristics and dimensions. Stylish and laconic design combined with technical functionality are perfect for most interiors as a main or additional light source.

A special Pro version of the luminaire allows you to focus light from a narrow angle to a medium one. An exclusive mechanism for changing the angle of light allows you to place accents in the interior.

Spotlight

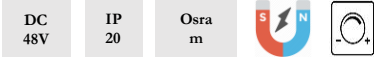

Model	W	LUM	CCT	CRI
CFC1035	5	325	3000K	90

CFC1035

OPTIONS

Color	RAL9004 / RAL9003
Beam angle	24° / 36°
CCT	2700K / 3000K / 4000K / 5000K
CRI	90Ra
Electrical option	Non Dim / DALI / 1-10V / Zigbee / Casambi

Dimension (mm)

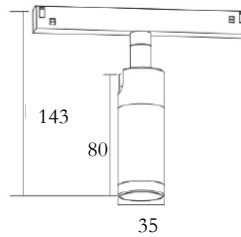

Model	W	LUM	CCT	CRI
CFC1045	10	650	3000K	90

CFC1045

OPTIONS

Color	RAL9004 / RAL9003
Beam angle	24° / 36°
CCT	2700K / 3000K / 4000K / 5000K
CRI	90Ra
Electrical option	Non Dim / DALI / 1-10V / Zigbee / Casambi

Dimension (mm)

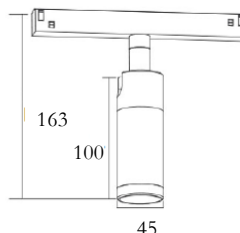

Spotlight

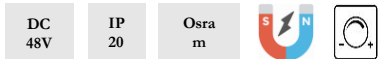

Model	W	LUM	CCT	CRI
TS20	20	1300	3000K	90

TS20

OPTIONS

Color	RAL9004 / RAL9003
Beam angle	24° / 36°
CCT	2700K / 3000K / 4000K / 5000K
CRI	90Ra
Electrical option	Non Dim / DALI / 1-10V / Zigbee / Casambi

Dimension (mm)

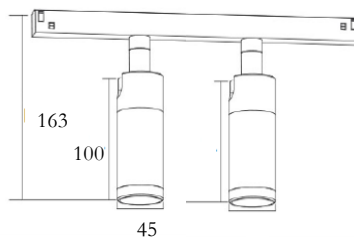

CFC1060

OPTIONS

Color	Black / Golden
Beam angle	15° / 24° / 36°
CCT	2700K / 3000K / 4000K / 5000K
CRI	90Ra
Electrical option	Non Dim / DALI / 1-10V / Zigbee / Casambi

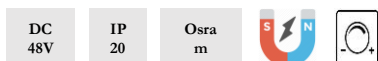

Model	W	LUM	CCT	CRI
CFC1060	7	550	3000K	90

Dimension (mm)

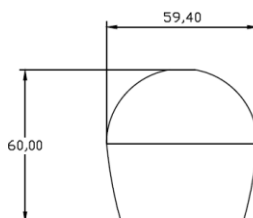

Spotlight

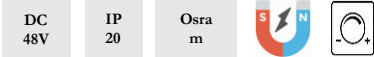

Model	W	LUM	CCT	CRI
R90	16	1350	3000K	90

R90

OPTIONS

Color	RAL9004 / RAL9003
Beam angle	24° / 36°
CCT	2700K / 3000K / 4000K / 5000K
CRI	90Ra
Electrical option	Non Dim / DALI / 1-10V / Zigbee / Casambi

Dimension (mm)

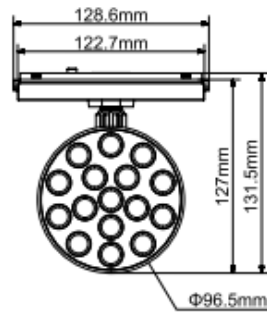

RF90

OPTIONS

Color	RAL9004 / RAL9003
Beam angle	110°
CCT	2700K / 3000K / 4000K / 5000K
CRI	90Ra
Electrical option	Non Dim / DALI / 1-10V / Zigbee / Casambi

Dimension (mm)

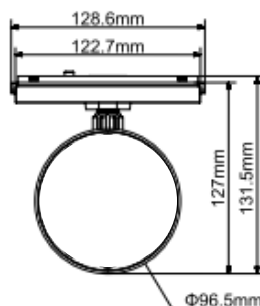

Model	W	LUM	CCT	CRI
RF90	16	1150	3000K	90

Spotlight

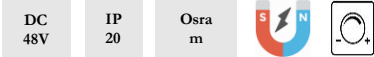

Model	W	LUM	CCT	CRI
R16	16	1350	3000K	90

R16

OPTIONS

Color	RAL9004 / RAL9003
Beam angle	24° / 36°
CCT	2700K / 3000K / 4000K / 5000K
CRI	90Ra
Electrical option	Non Dim / DALI / 1-10V / Zigbee / Casambi

Dimension (mm)

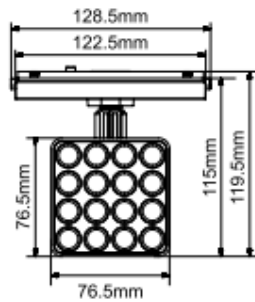

R24

OPTIONS

Color	RAL9004 / RAL9003
Beam angle	24° / 36°
CCT	2700K / 3000K / 4000K / 5000K
CRI	90Ra
Electrical option	Non Dim / DALI / 1-10V / Zigbee / Casambi

Dimension (mm)

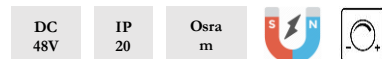
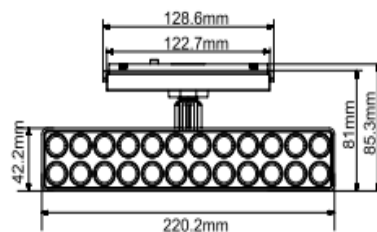

Model	W	LUM	CCT	CRI
R24	24	2050	3000K	90

Zoom



CFC1043

OPTIONS

Color	RAL9004 / RAL9003
Beam angle	10-55°
CCT	2700K / 3000K / 4000K / 5000K
CRI	90Ra
Electrical option	Non Dim / DALI / 1-10V / Zigbee / Casambi

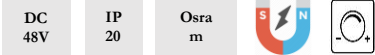

Dimension (mm)

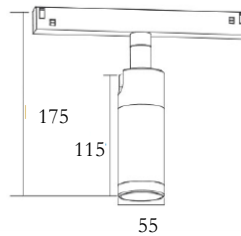

Model	W	LUM	CCT	CRI
CFC1043	10	750	3000K	90

CFC1044

OPTIONS

Color	RAL9004 / RAL9003
Beam angle	10-55°
CCT	2700K / 3000K / 4000K / 5000K
CRI	90Ra
Electrical option	Non Dim / DALI / 1-10V / Zigbee / Casambi



Dimension (mm)

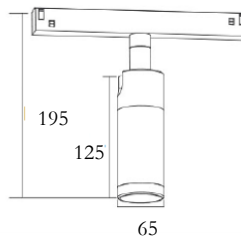

Model	W	LUM	CCT	CRI
CFC1044	15	1250	3000K	90



Van Gogh

Van Gogh offers precision light exactly where it is needed. The Framing Projector has four adjustable arms allowing the beam to be framed to the desired size shape (square/rectangle or irregular 4 sided shapes).

Projector



Z2035

OPTIONS

Color	RAL9004 / RAL9003
Beam angle	20-35°
CCT	2700K / 3000K / 4000K / 5000K
CRI	90Ra
Electrical option	Non Dim / DALI / 1-10V / Zigbee / Casambi

DC
48V

IP
20

Osram



Model	W	LUM	CCT	CRI
Z2035	10	1000	3000K	90

Dimension (mm)

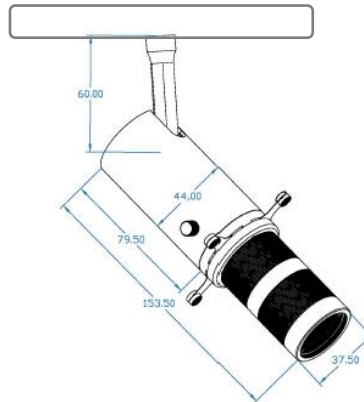



Linear

Linear makes an impact with their streamlined design and generate base lighting that illuminates objects and rooms especially evenly. The matte diffuser is comfortable for the eyes and eliminates glare. A wide angle of light evenly illuminates even the most distant parts of the room, without creating shadows and glare.

Linear

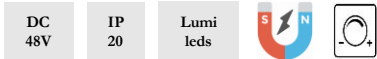

MS600

OPTIONS

Color	RAL9004 / RAL9003
Beam angle	120°
CCT	2700K / 3000K / 4000K / 5000K
CRI	90Ra
Electrical option	Non Dim / DALI / 1-10V / Zigbee / Casambi

Dimension (mm)

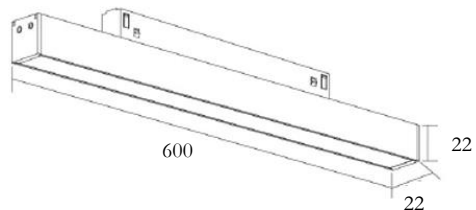

Model	W	LUM	CCT	CRI
-------	---	-----	-----	-----

MS600	15	900	3000K	90
-------	----	-----	-------	----

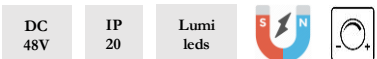

MS900

OPTIONS

Color	RAL9004 / RAL9003
Beam angle	120°
CCT	2700K / 3000K / 4000K / 5000K
CRI	90Ra
Electrical option	Non Dim / DALI / 1-10V / Zigbee / Casambi

Dimension (mm)

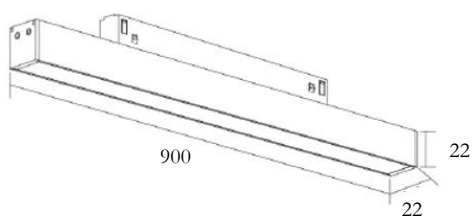

Model	W	LUM	CCT	CRI
-------	---	-----	-----	-----

MS900	20	1200	3000K	90
-------	----	------	-------	----



Dots

The dots series of luminaires is suitable for zoning a room or as a decorative light source. The lamp harmoniously looks in space and creates additional volume in the room.

The special design of the luminaire reflector minimizes glare.

Dots

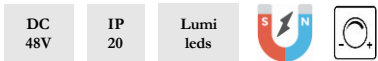

Model	W	LUM	CCT	CRI
MS06	6	360	3000K	90

MS06

OPTIONS

Color	RAL9004 RAL9003
Beam angle	24° / 36°
CCT	2700K / 3000K / 4000K / 5000K
CRI	90Ra
Electrical option	Non Dim / DALI / 1-10V / Zigbee / Casambi

Dimension (mm)

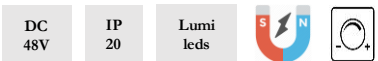
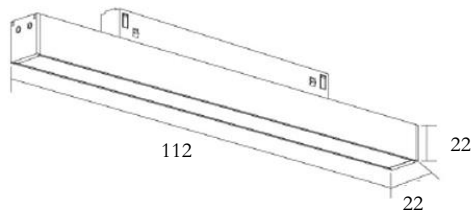

Model	W	LUM	CCT	CRI
MS12	12	720	3000K	90

MS12

OPTIONS

Color	RAL9004 / RAL9003
Beam angle	24° / 36°
CCT	2700K / 3000K / 4000K / 5000K
CRI	80Ra / 90Ra
Electrical option	Non Dim / DALI / 1-10V / Zigbee / Casambi

Dimension (mm)

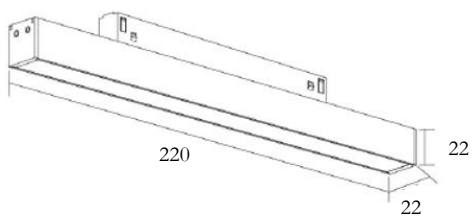



WallWasher

The wallwasher series are for creating a cozy atmosphere. Presented in various modifications of diffused or directional light.

The swivel body of the lamp allows you to place accents in the interior.

Bright light, most accurately emphasizes the color and exquisite finish of the surrounding objects.

Wallwasher



DC
48V

IP
20

Lumi
leds



CWW06

OPTIONS

Color RAL9003 / RAL9004

Beam angle 120° / 36°

CCT 2700K / 3000K / 4000K / 5000K

CRI 90Ra

Electrical option Non Dim / DALI / 1-10V / Zigbee / Casambi

Dimension (mm)

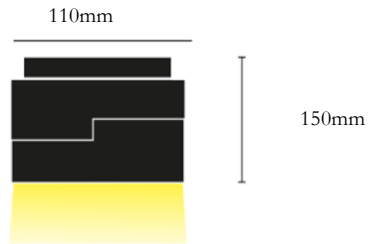

Model	W	LUM	CCT	CRI
CWW06	6	360	3000K	90



DC
48V

IP
20

Lumi
leds



CWW12

OPTIONS

Color RAL9003 / RAL9004

Beam angle 120° / 36°

CCT 2700K / 3000K / 4000K / 5000K

CRI 90Ra

Electrical option Non Dim / DALI / 1-10V / Zigbee / Casambi

Dimension (mm)

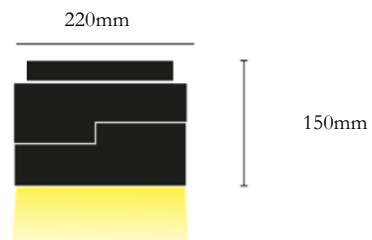

Model	W	LUM	CCT	CRI
CWW12	12	720	3000K	90



Pendant

Suspended luminaires, which are integrated directly into the tracks, allow the magnetic track system to do even more - including for living areas, bars, and reception areas. TULA and decorative accents distribution and its remarkably slim design. It also fully protects LEDs from contact and is easy to install.

Pendant

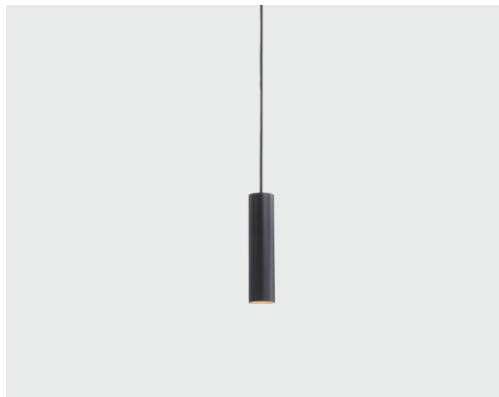

DC
48V

IP
20

Osram



Model	W	LUM	CCT	CRI
-------	---	-----	-----	-----

CFC40* 300	10	650	3000K	90
---------------	----	-----	-------	----

CFC40*300

OPTIONS

Color RAL9004

Beam angle 24° / 36°

CCT 2700K / 3000K / 4000K / 5000K

CRI 90Ra

Electrical option Non Dim / DALI / 1-10V / Zigbee / Casambi

Dimension (mm)

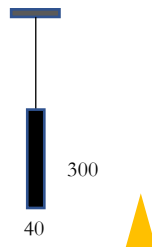

DC
48V

IP
20

Lumi
leds



Model	W	LUM	CCT	CRI
-------	---	-----	-----	-----

CFC30* 300	10	850	3000K	90
---------------	----	-----	-------	----

CFC30*300

OPTIONS

Color RAL9003 / RAL9004

Beam angle 24°

CCT 2700K / 3000K / 4000K / 5000K

CRI 90Ra

Electrical option Non Dim / DALI / 1-10V / Zigbee / Casambi

Dimension (mm)



Pendant

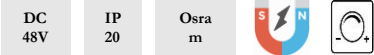

CFC60S

OPTIONS

Color	Black / Golden
Beam angle	15 / 24 / 36°
CCT	2700K / 3000K / 4000K / 5000K
CRI	90Ra
Electrical option	Non Dim / DALI / 1-10V / Zigbee / Casambi

Dimension (mm)

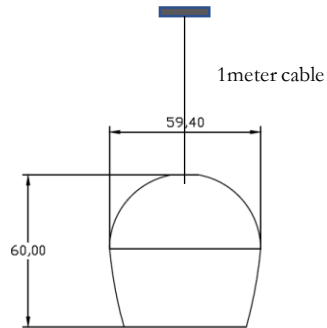

Model	W	LUM	CCT	CRI
CFC60S	7	500	3000K	90



Universe ball

The Universe ball range is available in different versions for main or local lighting. The frosted diffuser is comfortable for the eye and eliminates a glare effect. The spherical shape of the luminaire illuminates even the most distant parts of the room without casting shadows or glare.

Universe Ball

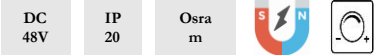

Model	W	LUM	CCT	CRI
CFC100	10	600	3000K	90

CFC100

OPTIONS

Color	RAL9004
Beam angle	180°
CCT	2700K / 3000K / 4000K / 5000K
CRI	90Ra
Electrical option	Non Dim / DALI / 1-10V / Zigbee / Casambi

Dimension (mm)

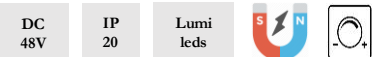
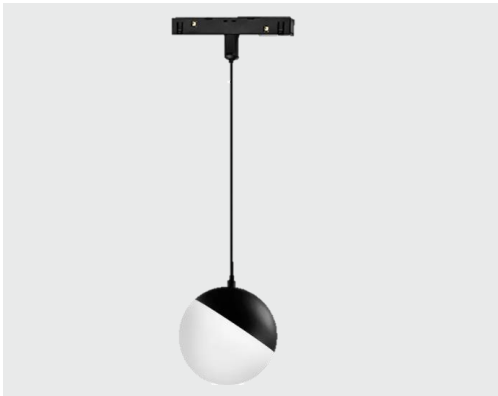
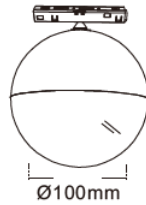

Model	W	LUM	CCT	CRI
CFC100S	10	600	3000K	90

CFC100S

OPTIONS

Color	RAL9004
Beam angle	180°
CCT	2700K / 3000K / 4000K / 5000K
CRI	90Ra
Electrical option	Non Dim / DALI / 1-10V / Zigbee / Casambi

Dimension (mm)

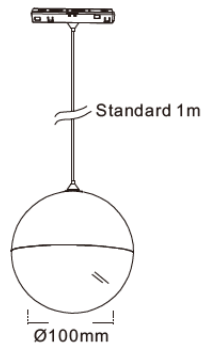



Neon Strip

Magnetic Neon strip with 360 degree light beam for the most efficient lighting of your space. It delivers 2700-5000K lighting performance and a CRI >90 color benchmark for flawless color rendering of illuminated objects in space. Neon strip allows you to experiment and perfectly adapt it to your needs. The magnetic rail can give an industrial tone to your space or just a modern note with a combination of lighting fixtures and spotlights.

Neon Strip



DC
48V

IP
20

Osram



Model	W	LUM	CCT	Length
NS100	15	900	3000K	1000mm

NS100

OPTIONS

Color	RAL9003
Beam angle	360°
CCT	2700K / 3000K / 4000K / 5000K / 2700-5000K
CRI	90Ra
Electrical option	Non Dim / DALI / 1-10V / Zigbee / Casambi

Dimension (mm)

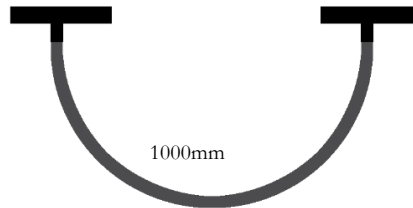

NS150

OPTIONS

Color	RAL9003
Beam angle	360°
CCT	2700K / 3000K / 4000K / 5000K / 2700-5000K
CRI	90Ra
Electrical option	Non Dim / DALI / 1-10V / Zigbee / Casambi

Dimension (mm)

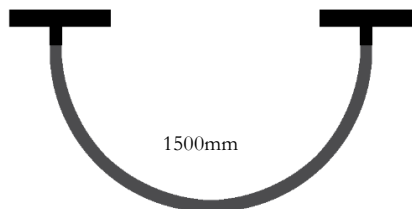

DC
48V

IP
20

Osram



Model	W	LUM	CCT	Length
NS150	20	1200	3000K	1500mm

Accessory

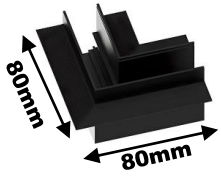

**horizontal L connector
SD-573**

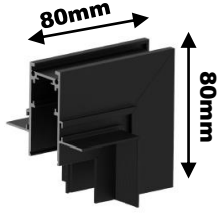

**Vertical L connector
SD-572**

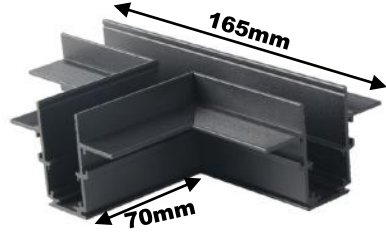

**T connector
SD-574**



Feed in SD-562



**Jointing connector
SD-567**



**Adjustable Jointing connector
SD-565**



L Feed SD-568



T Feed SD-563



**Intrack Power supply 100w
SD-10048**



Curved Track Rail

Except straight line track rail, curved or circle track rail is also customized in your project. The shape can be customized according to your request. Let's DIY it.

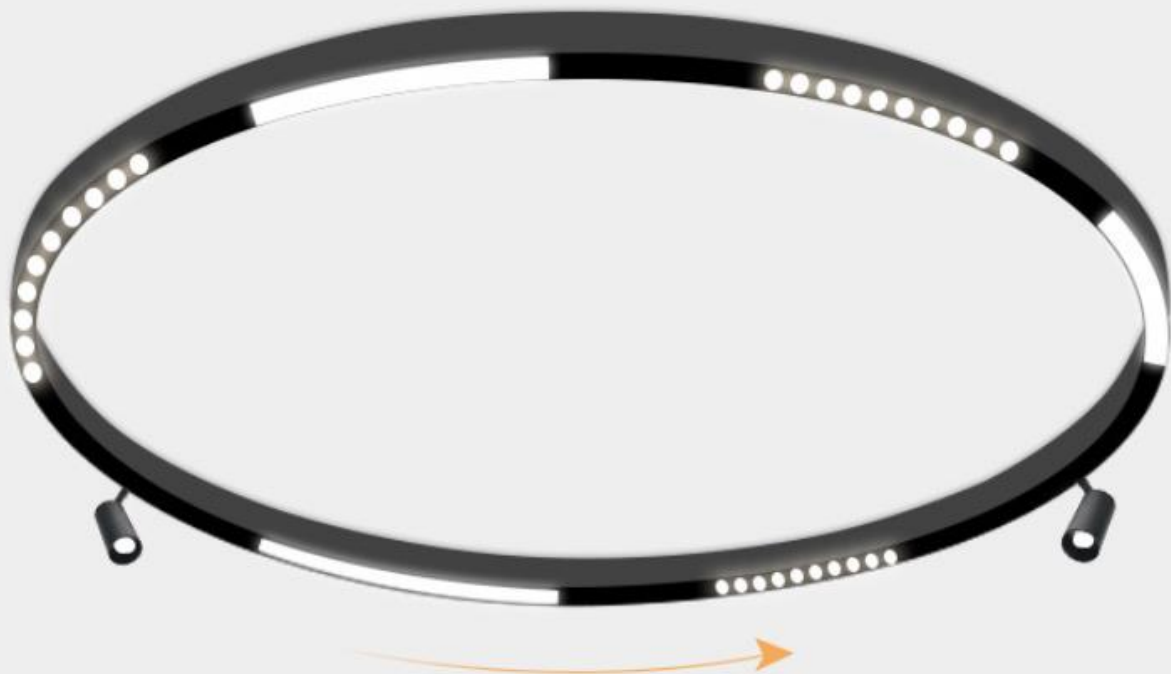

Circle Magnetic track rail

There are 3 installation ways for the circle magnetic track rail: surface mounted, pendant and recessed installation. The standard diameter is 600mm, 900mm, 1200mm.

Linear



DC
48V

IP
20

Osram



MS180

OPTIONS

Color RAL9004/RAL9003

Beam angle 120°

CCT 2700K / 3000K / 4000K / 5000K

CRI 90Ra

Electrical option Non Dim

Dimension L180*W23*H26mm

Model	W	LUM	CCT	CRI
-------	---	-----	-----	-----

MS180	6	360	3000K	90
-------	---	-----	-------	----

MS360

OPTIONS

Color RAL9004/RAL9003

Beam angle 120°

CCT 2700K / 3000K / 4000K / 5000K

CRI 90Ra

Electrical option Non Dim

Dimension L360*W23*H26mm

Model	W	LUM	CCT	CRI
-------	---	-----	-----	-----

MS360	12	720	3000K	90
-------	----	-----	-------	----

Grille



DC
48V

IP
20

Osram



MS06

OPTIONS

Color RAL9004/RAL9003

Beam angle 24°

CCT 2700K / 3000K / 4000K / 5000K

CRI 90Ra

Electrical option Non Dim

Dimension L180*W23*H26mm

Model	W	LUM	CCT	CRI
-------	---	-----	-----	-----

MS06	6	390	3000K	90
------	---	-----	-------	----

MS12

OPTIONS

Color RAL9004/RAL9003

Beam angle 24°

CCT 2700K / 3000K / 4000K / 5000K

CRI 90Ra

Electrical option Non Dim

Dimension L360*W23*H26mm

Model	W	LUM	CCT	CRI
-------	---	-----	-----	-----

MS12	12	780	3000K	90
------	----	-----	-------	----



DC
48V

IP
20

Osram



Spotlight



DC
48V

IP
20

Osram



R1045

OPTIONS

Color RAL9004/RAL9003

Beam angle 24°

CCT 2700K / 3000K / 4000K / 5000K

CRI 90Ra

Electrical option Non Dim

Dimension D45*H103mm

Model	W	LUM	CCT	CRI
-------	---	-----	-----	-----

R1045	10	650	3000K	90
-------	----	-----	-------	----

D03

OPTIONS

Color RAL9004/RAL9003

Beam angle 24°

CCT 2700K / 3000K / 4000K / 5000K

CRI 90Ra

Electrical option Non Dim

Dimension L35*W22*H45mm

Model	W	LUM	CCT	CRI
-------	---	-----	-----	-----

D03	3	300	3000K	90
-----	---	-----	-------	----



DC
48V

IP
20

Osram





Topsund Lighting Co.,LTD

www.topsund-led.com

info@topsund-led.com

6Floor,Xinggong Road,Yutang street

Guangming District