

Inspiration Brochure



THE WINDOW OF
THE FUTURE HAS

idealcore™

Lasts longer
Insulates better

idealcombi

BETTER WINDOWS. BETTER HOMES.



What makes us different?

Driving quality and innovation in the building industry since 1973.

Idealcombi was formed in 1973 and have been pushing boundaries of window and door innovation and quality in the building industry ever since. We combine quality, Danish craftsmanship and tradition with modern technology. This is why Idealcombi is a market leader.

Idealcombi employ over 600 people. Our knowledgeable, honest and professional team has a passion for great craftsmanship and doing things right.

Idealcombi is still a family run business.

Idealcombi was founded in 1973 by the two brothers Henning & Bent Søgaard, and it all began in their parents barn in Hurup, on the west coast of Denmark. The small barn has now grown into a 100,000m² state of the art manufacturing facility and the ownership handed over to the next generation, Martin & Mikael Søgaard.

Idealcombi is built on the principle of quality in everything we do.

Our benchmark is to provide each customer with not just exceptional product's but also an enjoyable and stress-free experience, from initial meeting through to installation and aftersales.

At Idealcombi we understand that choosing a window and door supplier can be a daunting task, but we try to simplify the process and guide you as much as possible.

We look forward to hearing from you and working with you on your project.

Yours sincerely

Martin Søgaard
CFO/Owner





At Idealcombi we have since the beginning in 1973 put all our professional pride into developing a better window. Improving durability, insulation, minimising maintenance and improving the aesthetics by exploring new materials, new designs and new manufacturing methods.

The first big milestone was in 1988 when we were the first to launch the aluminium clad sash/frame timber window. It was designed as a traditional timber window with external frame and sash profiles in aluminium and timber internally.

We have now, once again, developed an innovative window solution. This time by creating a unique frame design using the imperishable and superinsulating material polyurethane (PUR) to add unmatched properties to our windows and doors.

Manufactured with care by skilled Danes

At the largest window factory in Denmark on the west coast, facing the North Sea, we develop, test and manufacture all the Idealcombi product ranges.

600 dedicated employees take care of all aspects of manufacturing a wide range of products in our window and door series. The state of the art production facility is of great importance to the local community as well.



Idealcore™

The window of the future

Through the years we have developed and tested many different frame designs. All in a quest to solve the four basic challenges in window design. Our development team has finally cracked the code by creating ground breaking frame design with an imperishable and highly insulating frame rebate in polyurethane - also known as thermal PUR.

We have named the new solution **idealcore™**, because that is exactly what it is. An ideal core that unlike any other design on the market solves all four challenges at once.

1. Long life-span

Thermal PUR is an imperishable material. The compact rebate moulded from **idealcore™** will not deteriorate or break when being exposed to water. The window is designed for a life-span of 70 years - provided it is maintained as instructed in our manual.

2. Minimal heat loss

idealcore™ is a highly insulating material with a lambda value of just 0,074 W/mK. This ensures no thermal bridging from the outside to the inside of the frame. Windows with **idealcore™** therefore have an energy performance that comfortably exceeds building regulations and can be used for any type of build.

3. Easy to clean

The **idealcore™** rebate is solid and does not have any cavities which eliminates the need of any drainage holes. This means the frame rebate has a smooth surface that is very easy to clean with a damp cloth and offers no shelter for bugs to nest in.

4. Does not need replacing

Using an imperishable material in the frame rebate significantly extends the life-span of windows and doors with **idealcore™**. It will therefore not be necessary to replace the frame that is fixed to the building.

**Imperishable
idealcore™ rebate
extends life.**

**Highly insulating
for low heat loss**

**Smooth surface
without drainage
holes is easier to
clean**

**Reduced risk of
condensation**

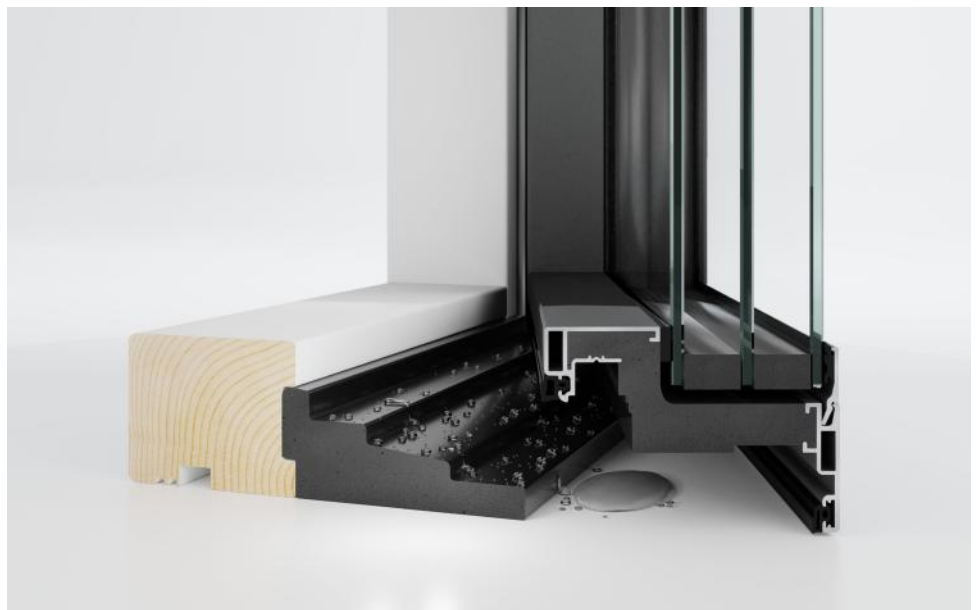

What is Thermal PUR?

Thermal PUR (polyurethane) is a synthetic resin in which the polymer units are linked by urethane groups. Polyurethane foams can be both soft and rigid and with different masses and properties.

Thermal PUR excels in many ways. It is strong, flexible, has a low weight and most importantly PUR has excellent insulating properties. At the same time there is no health related risks associated with the use of PUR and it can be fully recycled as part of other PUR products or broken down in base components and used for moulding new PUR products.





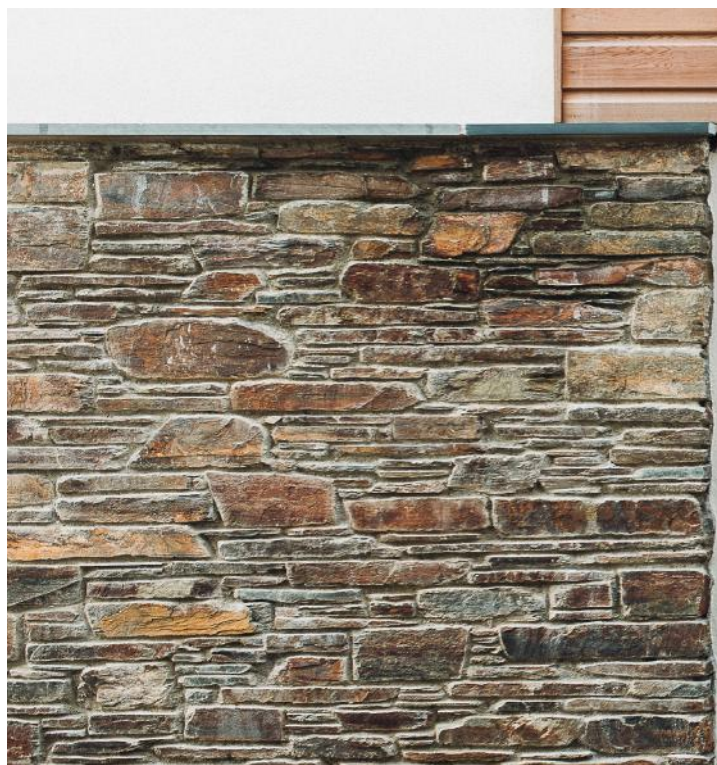

Futura+

Timber, aluminium and **idealcore™** composite

THE WINDOW OF
THE FUTURE HAS

idealcore™

Lasts longer
Insulates better

Slim sightlines

...excellent energy performance

Futura+ has an external 53 mm slim aluminium profile making it the perfect choice for any contemporary projects.

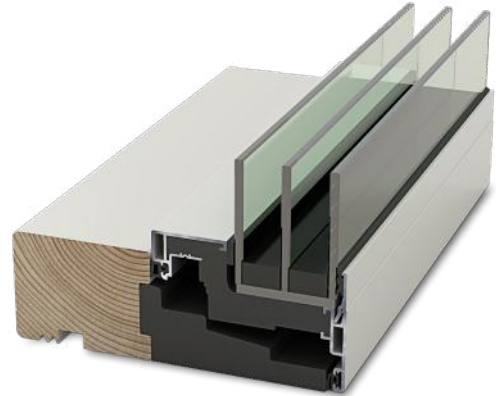
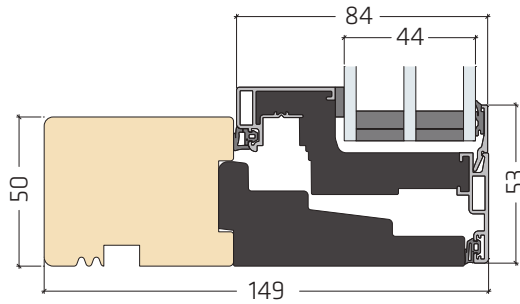



Window Functions (SBD)



Top Guided Window



Top Swing Reversible Window



Side Hung Window



Side Guided Window



Glass to Glass Corner Window



Fixed Light



Louvre Shutter



Acoustic Window



Door Functions



Outward Opening Terrace Door



Sliding Door



Double Sliding Door



Low Threshold Sliding Door

Double Glazed

U_w : from 1,31 W/m²K

Triple Glazed

U_w : from 0,74 W/m²K

Full specification :



Futura+i

Aluminium and **idealcore™** composite

THE WINDOW OF
THE FUTURE HAS

idealcore™

Lasts longer
Insulates better

Elegant, slim sightlines and inward opening
... minimal maintenance

Futura+i tilt and turn windows have the same 53mm slim external profile as Futura+, which means you can combine inward and outward opening windows in your project.

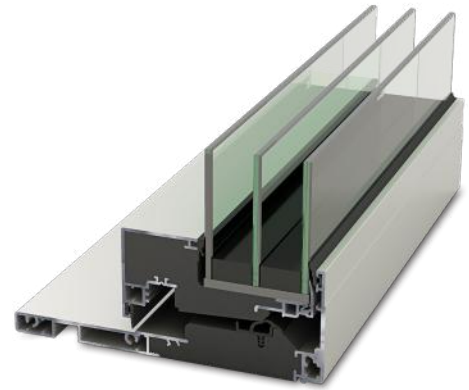
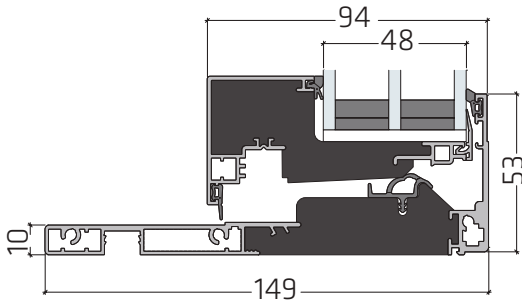



Window Functions (SBD)



Tilt only Window



Tilt and turn Window



Turn only Window



Turn and tilt Window



Fixed Light



Door Functions



Tilt and Turn Terrace Door



Turn and tilt Door



Turn only Door

Double Glazed

U_w : from 1,38 W/m²K

Triple Glazed

U_w : from 0,74 W/m²K

Full specification :



Nation IC and Frame IC

Timber, aluminium and **idealcore™** composite

THE WINDOW OF
THE FUTURE HAS

idealcore™

Lasts longer
Insulates better

Traditional single glazed aesthetics with great energy performance, designed to last 70+ years. ...with a minimum of maintenance.

Nation IC has a traditional external putty-like look and is used for all types of buildings, new builds as well as renovations and extensions

Frame IC has an external look-a-like glazing bead and is used for all types of buildings, new builds as well as renovations and extensions.

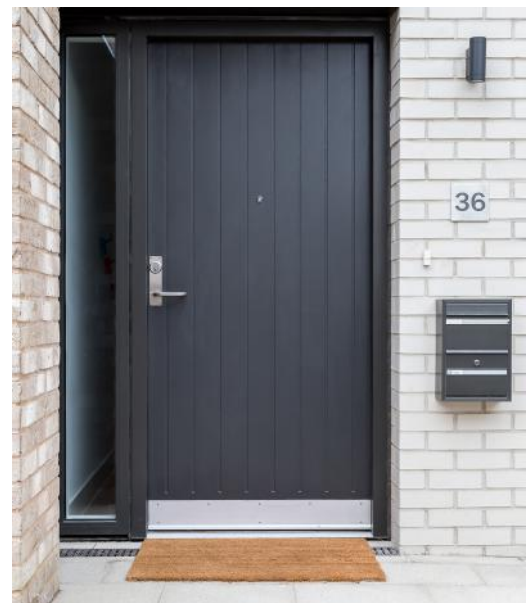
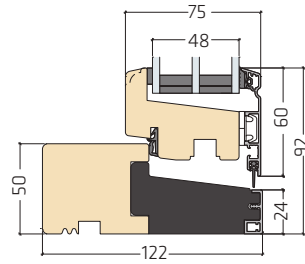
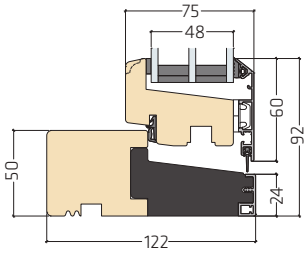



Window Functions



Top Guided Window



Top Swing Reversible



Side Hung Window



Side Guided Window



Glass to Glass Corner Window



Fixed Light



Louvre Shutter



Door Functions (SBD)



Outward Opening Front Door



Inward Opening Front Door



Outward Opening Terrace Door



Inward Opening Terrace Door



Outward Opening Stable Door



Outward Opening Flush Panel Door



Inward Opening Flush Panel Door



Sliding Door with Low Threshold



Double Glazed

U_w : from 1,38 W/m²K

Triple Glazed

U_w : from 0,74 W/m²K

Full specification :







PureView

In partnership with ultraline®

Idealcombi have partnered with Ultraline to bring PureView sliding door systems to the UK market. PureView enhances contemporary living environments with no visual compromise.

The pure lines of the PureView system maximises your views and provides great openings to the outside. With multi pane slider, pocket sliders or corner sliding doors the PureView system can be the feature that sets your project apart from the rest.

Exclusive solutions for high end projects

U_w : from 1,0 W/m²K

- **Made in the UK**
- **Sliding open corners**
- **Slim 20mm sightlines**
- **Multi pane sliding door**
- **Max aperture 16 metres**
- **PAS 24:2016, Part Q compliance**
- **Up to 8 sliding panes and 4 tracks**
- **Survey and installation by Idealcombi**
- **Max. individual pane size is 4.2m high or 3.2m wide and up to 9m²**

Idealcombi Direct will both survey and install your PureView sliding door system. This is done to ensure the product is designed and installed to the highest standard. Our installation team will also visit site and make considerations for installation access.

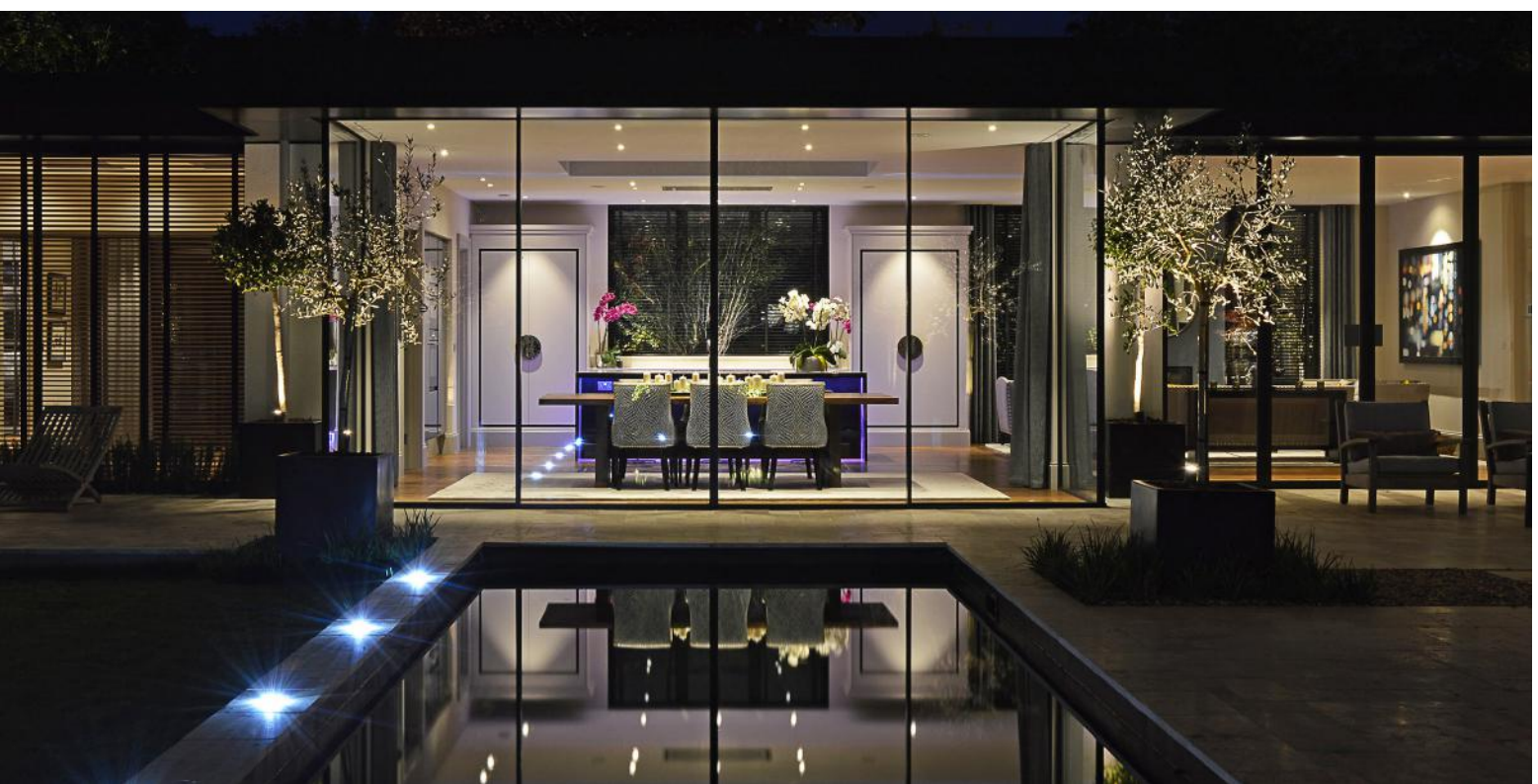





Accessories



Futura+
Design Handle



Frame IC & Nation IC
Front Door Handle

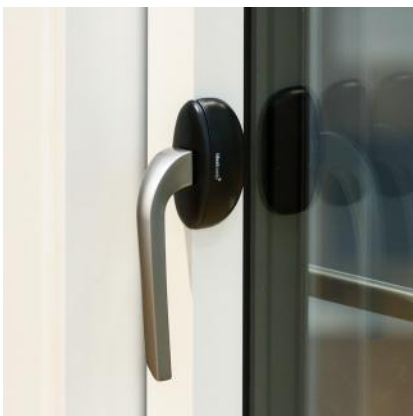

Futura+i
Design Handle



Frame IC & Nation IC
Front Door Thumb Turn



Futura+ Trickle Vent





Secure as standard

Easy for you ...difficult for the intruder

If the thief wants in, he will find a way. Security features are therefore specifically about making it as difficult as possible for the thief. The more time-consuming, difficult and noisy it is to force a window or a door open, the higher the chance that he will give up. Safety measures are standard in all of Idealcombi's one-handle series.

Bolts and keeps

The mushroom bolts which are part of the espagnolette locking of the window and the keeps make sure that the element is tightly closed. Windows and terrace doors are equipped with adjustable mushroom bolts and solid security keeps while the entrance doors have solid forged hook bolts and adjustable security keeps.

The security keeps for windows as well as doors are designed specifically for the bolts and are mounted with front screws as well as inclined screws in the frame which strengthens the keep against twists and strains. The bolts and keeps are continuously adjustable so the correct locking pressure can be found. This ensures an optimal tightness between sash and frame.

Three locking points in all doors

As standard, all of Idealcombi's entrance and terrace doors are equipped with an espagnolette lock and 3 locking points. The three point locking seals the door and secures it effectively against burglary. The entrance doors are also equipped with a hook bolt in the middle of the espagnolette by the rebate in the lock case which makes it even harder to break open the door.

Secured by Design / Approved document Q

Approved Document Q sets out the minimum standard for windows and doors being installed in all new dwellings and extensions. Windows installed which are easily accessible i.e. ground floor/ basements, must meet or exceed the security requirements of PAS 24:2012. This requirement is designed to ensure windows and doors resist physical attack by a casual or opportunist burglar by being sufficiently robust and fitted with appropriate hardware. To ensure compliance, Idealcombi are members of the UK Police initiative 'Secure by Design', which ensure all tested products are third party accredited.

Let Idealcombi help you find a solution which will make you and your family feel safe.



Secured by Design



Police Preferred Specification



10 Years warranty

10 Years warranty on elements and glass

Idealcombi offers a 10-year warranty on all wood/ alu composite windows and doors. Furthermore, there is a 10-year warranty on all window panes, not including thermal fracture which are covered by the property insurance.



Glass ...the critical choice

The proper choice of glass and coating in the composition of the window pane is of major importance to the comfort and the total insulation property of the window.

Solar Reflective Glass

SRG reduces the amount of thermal energy and/or light which is admitted through the unit. This type of glass is often used for large surfaces where the aim is to make full use of the sunlight while at the same time keeping out the solar heat.

Solar reflective glass is available in a variety of options; colour neutral, coloured and with various degrees of reflection.

All these factors determine the amount of light and heat admitted through the glass. If you choose solar reflective glass for aesthetic reasons the design is entirely up to you. In all other cases it depends on how highly you value low solar energy transmission in relation to high light admittance.

Acoustic Glass

Acoustic insulating glass reduces uncomfortable noise from heavy traffic and regular city noise. It is the distance between the unit's individual glass panes and the panes' individual thickness that helps define the unit's acoustic insulator properties.

When selecting the right type of acoustic glass, it is important to determine the source of the noise you want to reduce

Obscure Glass

Obscure glass can either be patterned and cast, clear or coloured with varying degrees of light transmission and vision control.

Obscure glass is suitable for uses where the blocking of unwanted views is desired and for creating special and decorative effects.

See our obscure glass option below.



Mastercarre

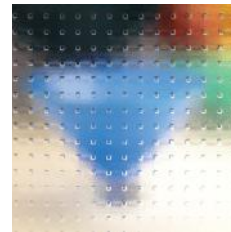

Matt laminated



Masterligne



Masterpoint

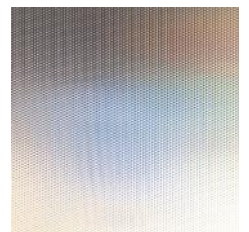

Cotswold

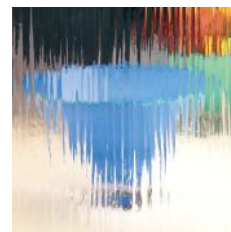

Clear Glas C



Satinato

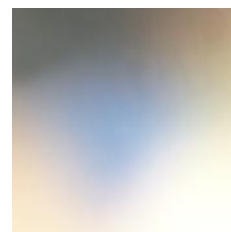

Colours ...with thoughts

Ral colours

Aluminium and powder coating

In our product series, the outside of the construction, which is exposed to bad weather, consists of a powder-coated aluminium profile.

The aluminium profiles are pre-processed with a wash off, in-depth cleaning and degreasing after which a chrome-free primer will protect them against corrosion. The process is ended with a powder coating of the profiles in the colour requested.

The powder coating gives the aluminium profiles a nice, smooth and even surface which is extremely resistant to the sometimes harsh, Northern European climate and which ensures a long life for the windows and doors while reducing the need for maintenance to a minimum.

Colours and surfaces

Elements from Idealcombi are supplied with a finished surface treatment. We have chosen 15 standard colours for all inside and outside elements. We only work with RAL colours, and in addition to the standard colours, we also offer other RAL colours at an additional charge. Wooden parts are primed and coated, and this results in a durable surface smooth as silk and with a beautiful lustre. As standard, the outside aluminium profile is made with a shiny surface but is also available with a matt surface.

We also offer Sable surfaces at an additional charge. The sable treatment of the aluminium gives a rustic, sandblast structure to the surface unlike the smooth, powder-coated surfaces.



As alternative to the plain RAL colours Idealcombi offers a range of textured finishes.

Anodized aluminium

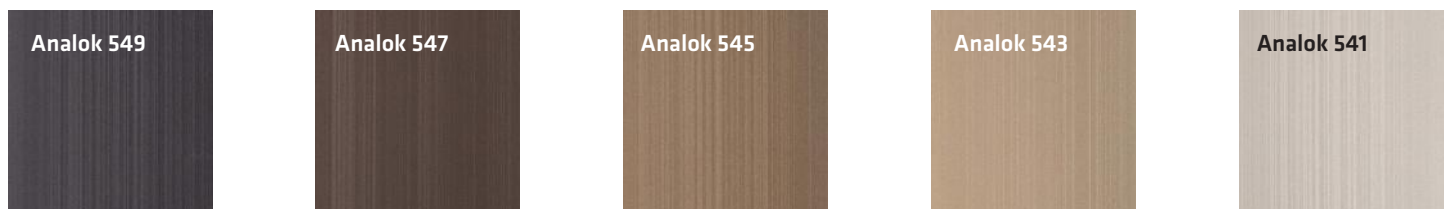

IC Granite colours



These represent our standard colours, but please note that this is a printed representation of the original colours and therefore may deviate from the real colours. The final selection of colour and surface should always be made based on a surface sample



Milton Keynes Showroom

Our showroom in Milton Keynes is our UK headquarters & knowledge centre for Idealcombi windows & doors.

The showroom enables us to get close to our customers by allowing us to demonstrate the options & quality of our products, and also act as our training centre.

We prioritise on offering the very best guidance to professionals & private customers in every aspect from detailing aesthetics through to energy performance.



Idealcombi UK

Chancery Pavilion
Boycott Avenue
Milton Keynes
MK6 2TA

Opening Hours

Mon-thurs: 8:00am-4:30pm
Friday: 8:00am-2:30pm

Commercial Contact

Tel: +44 (0) 01582 860 940
UK@idealcombi.com

Domestic Contact

Tel: +44 (0) 01582 869 010
direct@idealcombi.com

Book appointment



Today Idealcombi is owned and run by Martin and Mikael Søgaaard, who are sons of the founders of Idealcombi

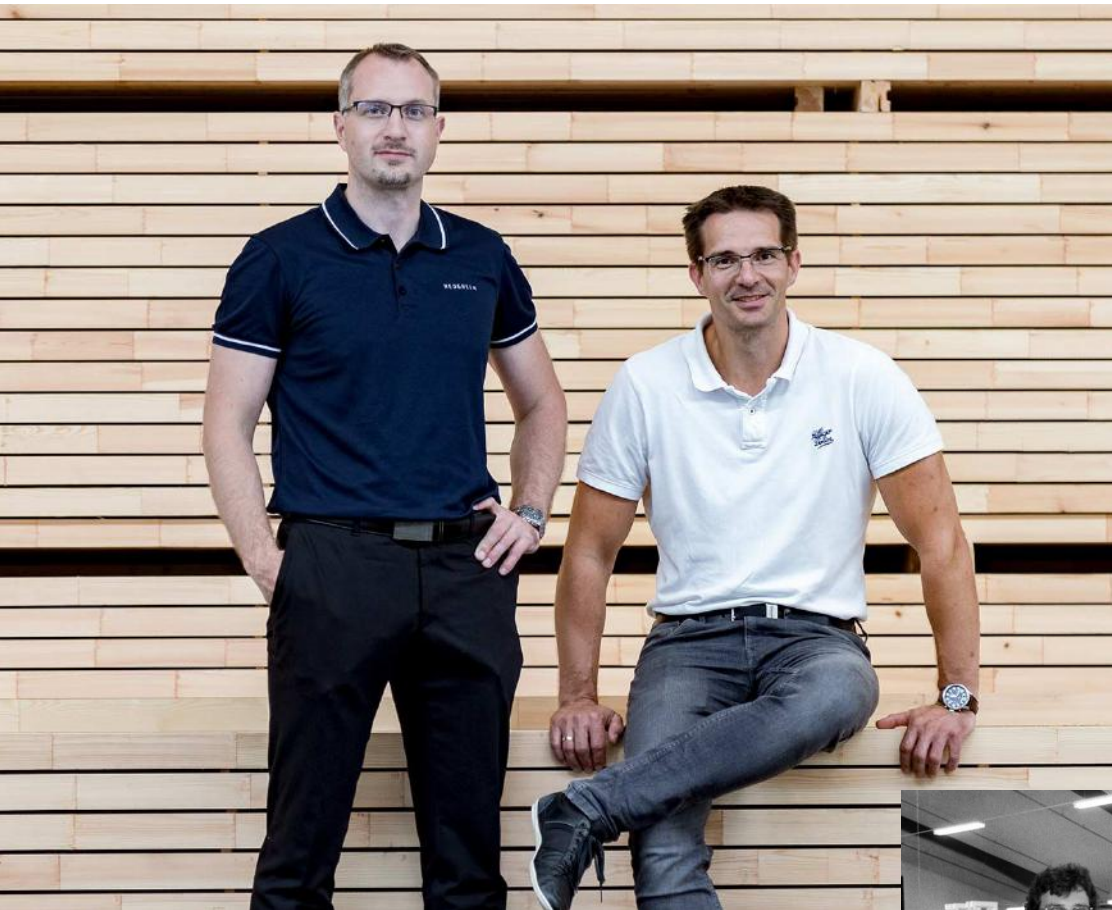

The brothers Bent and Henning Søgaaard founded Idealcombi in 1973

Idealcombi was started in a barn by two brothers

The story of Idealcombi starts with two entrepreneurial brothers, Henning and Bent Søgaaard. In 1973 they started manufacturing windows in their parents' barn in the most western part of Denmark. And they did it well!

It didn't take long before the company started growing. And growing. And growing. Until achieving its current status as the largest window factory in Denmark with over 100,000 m² and over 550 skilled employees.

All thanks to the two Danes' sense of quality and their distinctive eye for innovation and product development.

Today Idealcombi's future is in the hands of the next generation, the cousins Martin and Mikael Søgaaard.



Quality assurance and certificates

At Idealcombi we have made a focussed effort to create the best possible window systems - at all levels. Our in-house test lab performs water, wind and air-tightness tests, to ensure our windows meet current and future demands. It is also in our test lab we ensure our windows and doors can be accredited with independent third party certifications like Secured by Design and CWCT. To document this work we have a number of certifications. We are proud of them all as they are an expression of our dedication to quality.



ISO 9001:2015 (Quality)

We are ISO 9001:2015 certified and ensures hereby that all our business procedures meet this standard. This includes continuous improvements of our operations. In the ISO certification customer satisfaction is a focus area and ensures focus on continued customer related business development.



DVV (Danish Window Verification)

Idealcombi's windows and doors are DVV-certified, which is requirement for all members of the Association of Danish Window Manufacturers. The DVV certification means that windows and doors are manufactured according to the Technical Requirements of the Association.



ISO 14001:2015 (Environmental)

We are ISO 14001:2015 certified and ensures hereby a uniformed and continuous effort in quality and environmental management.



Secured by Design

An increasingly important issue for our customers is the security of their projects. For this reason we have sought Secured by Design status for a selection of our windows and doors.



CE-Marking

Idealcombi's products are CE-marked



Association of Danish Window Manufacturers and DVV

Idealcombi is a member of the Association of Danish Window Manufacturers and is therefore affiliated to Danish Window Verification

(DVV), which is the body checking that the products as a minimum meet the requirements set out in the Technical Requirements of the Association.



FSC® certified

Idealcombi uses FSC®-certified pine wood. This means that all pine-based windows and doors can be delivered with FSC labelling.

Miljømærket for ansvarligt skovbrug

In an FSC-certified forest, no more wood is felled than the forest can naturally reproduce. At the same time, FSC is a guarantee that animals and plant life are protected, and that the people who work in the forest are guaranteed training, safety equipment and a decent salary

Idealcombi UK

Chancery Pavilion
Boycott Avenue
Milton Keynes
MK6 2TA

Opening Hours

Mon-thurs: 8:00am-4:30pm
Friday: 8:00am-2:30pm

Commercial Contact

Tel: +44 (0) 01582 860 940
UK@idealcombi.com

Domestic Contact

Tel: +44 (0) 01582 869 010
direct@idealcombi.com

