

ويفز للتجارة والمقاولات ك. م. م .
WAVES TRADING & CONTRACTING W.L.L.

Tel: +974 4441 6319, Fax: +974 44416312
P.O.Box: 82431, Doha - Qatar
Email: info@waves-qatar.com
Website: www.waves-qatar.com



CATALOG

Sports Equipment
2016/17

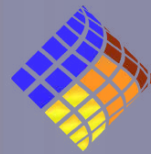

ويغز للتجارة والمقاولات ك. م . م .
WAVES TRADING & CONTRACTING W.L.L.

Tel: +974 4441 6319, Fax: +974 44416312
P.O.Box: 82431, Doha - Qatar
Email: info@waves-qatar.com
Website: www.waves-qatar.com

About Us..

AFN Sports is one of the biggest manufacturers of sports equipment in South East Asia and also the OEM to various companies in the Europe and Australian market.

We have more than 25 years experience in the industry.

The philosophy of AFN Sports is to produce high quality aluminium sports & athletic products and accessories for the Global market. AFN Sports supplies, delivers, installs and also organize the biggest events.

We are certified by IAAF, German TUV & BWF.

Today, AFN Sports has set its base in Malaysia to take advantage of the economical production costs and at the same time is in a better position to serve the emerging regional market in Asia and around the world.

AFN Sports Sdn Bhd
Lot 10998, Jalan Sungai Jati,
41000 Klang,
Selangor, Malaysia

info@afnsports.com.my
+603 3372 2008
+603 3382 1008



WITH GREAT QUALITY,
GOES A LONG WAY

SYSTEMATIC QUALITY SERVICE

**GERMAN QUALITY AND STANDARDS //
RESEARCH & DEVELOPMENT //
PRODUCTION // SYSTEM DESIGN //
QUALITY MANAGEMENT //
SUSTAINABILITY //
CONSULTING AND CUSTOMER
SERVICE // INSTALLATION AND ASSEMBLY //
MAINTENANCE, REPAIRS AND REMOVAL //**

QUALITY IS OUR GAME..

Our Certification



CONTENTS

01	Track & Field Equipment	
02	High Jump & Pole Vault	
03	Hammer, Discus, Shot Put, Javelin	
04	Long Jump & Triple Jump	
05	Volleyball	
06	Badminton	
07	Handball	
08	Tennis	
09	Hockey	
10	Basketball	
11	Soccer & Rugby	
12	Sports Net & Divider Curtain	
13	Benches	
14	Drainage System	
15	Scoreboard	
16	Electronic Measurement & Display Equipment	
17	Softball & Cricket Equipment	
18	Advanced Maintenance Equipment	
19	Sports Hall Equipment	



ويفز للتجارة والمقاولات ك.م.م.
WAVES TRADING & CONTRACTING W.L.L.

Tel: +974 4441 6319, Fax: +974 44416312
P.O.Box: 82431, Doha- Qatar
Email: info@waves-qatar.com
Website: www.waves-qatar.com

ATHLETICS

Track & Field Equipment

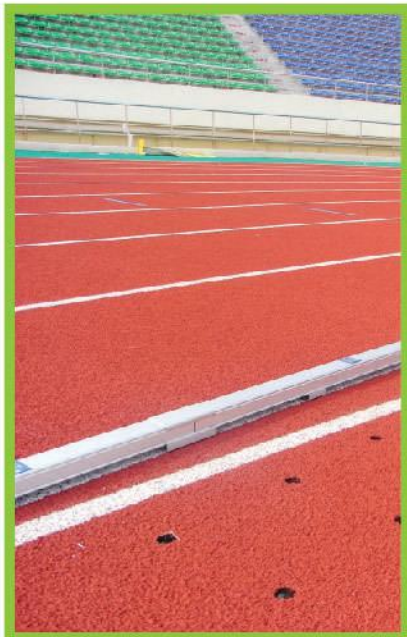

ويفز للتجارة والمقاولات ك.م.م.
WAVES TRADING & CONTRACTING W.L.L.
 Tel: +974 4441 6319, Fax: +974 44416312
 P.O. Box: 92431, Doha - Qatar
 Email: info@wavesqatar.com
 Website: www.waves-qatar.com

Aluminium Curbing

Order No. 11260

The aluminium curbing is made from special made anodized aluminium profiles. It is a mobile marker and separator of the running track. The set measures a total length of 400 m. The curbing is 60 mm wide and 50 mm high. The product is certified by the IAAF.



Curbing Socket

Order No. 11320

The curbing socket is made from aluminium. It is sized to match the curbing bolt. The socket is inserted in the ground to receive the curbing bolt.

Curbing Bolt

Order No. 11330

The curbing bolt is made from stainless steel. The curbing bolt is installed at the curbing holder drilled and is fixed inside the curbing socket.

Curbing Holder Drilled

Order 11310

The curbing holder drilled is made from a special anodized aluminium profile. This holder fixes the curbing in the ground. It is fixed via the curbing bolt. The curbing holder drilled measures a total length of 60 mm.

Curbing Holder Non Drilled

Order 11300

The curbing holder non drilled is made from a special anodized aluminium profile. This holder supports the curbing to stay in place correctly. The curbing holder non drilled measures a total length of 60 mm.

Curbing Connector

Order 11290

The curbing connector is made from a special anodized aluminium profile. The part connects two curbing parts which each other. It also supports the curbing parts at their ends for more stability. The curbing connector measures a total length of 120 mm.

Curbing Cover

Order 11280

The curbing cover is made from a special anodized aluminium profile. The part covers the join between two curbing parts.



ويوز للتجارة والمقاولات ك.م.م.
WAVES TRADING & CONTRACTING W.L.L.

Tel: +974 4441 6319, Fax: +974 44416312
P.O.Box: 82431, Doha - Qatar
Email: info@waves-qatar.com
Website: www.waves-qatar.com

IAAF 400 METRE STANDARD TRACK, MARKING PLAN

M-1-209

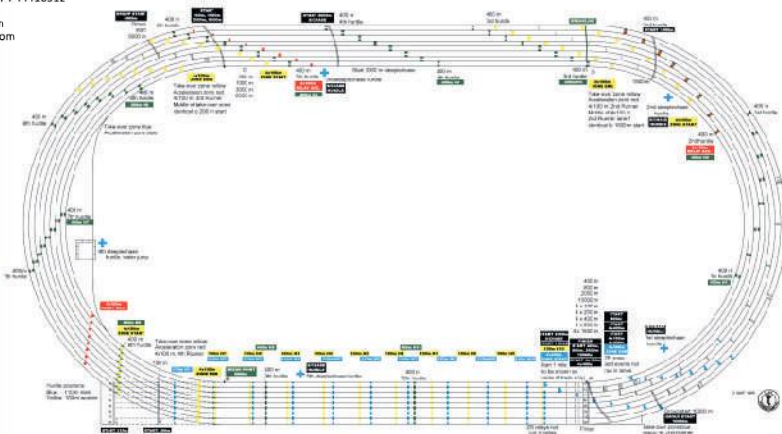

Running Track Signs

Order No. 10790

Running track signs, made from aluminium , 8 lanes

Order No. 10810

Running track signs, made from aluminium, 6 lanes

Order No. 10820

Running track signs, made from aluminium, 9 lanes

The running track signs are made from aluminium. All signs are coloured anodized. The set consists of all required signs for all IAAF certified events.



Ramp for Vehicle

Order NO. 10260

The ramp for vehicle is made from extra strong aluminium. Each ramp measure a width of 500 mm. The ramp is placed on the aluminium curbing to protect it from crossing vehicles. Therefore vehicles can cross the curbing without detaching it.





Water Ditch kit

Order No. 10285

The water ditch kit is made from extra stable aluminium profiles. The water ditch kit consists of several parts. The head piece and side pieces are equipped with angles, which indicates the concrete level at the installation. The angle can be adjusted according to the thickness of the installed flooring system. The two side pieces are also held in place by two cross bars. The crossbars assure that the whole water ditch is aligned correctly. All dimension follow the IAAF regulations.



Water Ditch supply shaft

Order No. 10280



ويفز للتجارة والمقاولات ك.م.م.
WAVES TRADING & CONTRACTING W.L.L.

Tel: +974 4441 6319 - Fax: +974 44416312
P.O.Box: 82431, Doha - Qatar
Email: info@waves-qatar.com
Website: www.waves-qatar.com



Water Ditch Covering with Rim

Order No. 10270

The water ditch cover with rim is made from heavy duty aluminium profiles. The cover is put on top of the under frame for water ditch cover. The water ditch cover is used to cover the water ditch when not in use. The parts of the cover are connected with tongue and grooves joints. The last piece of the cover is slanted to assure a smooth surface level. The rim allows the item to be covered with the surrounding surface material.



Underframe For water Ditch Covering

Order No. 10310

The under frame for water ditch cover is made from aluminium. The under frame supports and puts the water ditch cover in place. It consists of three parts. All parts can be adjusted horizontally and vertically according to the condition on site.



Water Ditch Hurdle

Order No. 10410

The water ditch hurdle is made from aluminium and a multi layered laminated timber wood crossbar. The water ditch hurdle can be adjusted in height. The heights are 76.2 and 91.4 cm. The crossbar measures a total length of 3.66 m. The crossbar is a square 12.7 cm. The wood is painted with a special paint, which is long lasting even in a strong weather influence.



Standard Ground Socket

Order No: 10330

The standard ground socket for water ditch hurdle is made from aluminium. The socket is designed to match the square hollow profile 80x80 of the water ditch hurdle. The depth of this socket is 350 mm. The cover for this socket cannot be coated. If ordered together with the water ditch kit, the sockets are welded directly to the kit.



Special Ground Socket

Order No: 10340

The special ground socket for water ditch hurdle is made from aluminium. The socket is designed to match the square hollow profile 80x80 of the water ditch hurdle. The depth of this socket is 350 mm. The cover for this socket can be coated with the surrounding material. If ordered together with the water ditch kit, the sockets are welded directly to the kit.



شركة موجز للتجارة والمقاولات
WAVES TRADING & CONTRACTING W.L.L.
 Tel: +974 4441 6319, Fax: +974 44416312
 P.O.Box: 82431, Doha - Qatar
 Email: info@waves-qatar.com
 Website: www.waves-qatar.com



Steeplechase Hurdle

Order No. 10390

Steeplechase hurdles for the 3000 m distance. Length 3.96 m. Easily and quickly adjustable to international competition heights for both women (0.762 m) and men (0.914 m).

- The black and white upper crossbars are made from timber wood
- Weights are welded into the frame thereby ensuring high stability.
- Conforming to IAAF rules and IAAF certified.

Aluminium basic frame profile:
 Total weight approx 80-100 Kg



100390: Steeplechase hurdles for the 3000 m distance. Length 3.96 m. Without crossbar

100390: Steeplechase hurdles for the 3000 m distance. Length 3.96 m. With crossbar

10350: Steeplechase hurdles for the 3000 m distance. Length 5.00 m. Without crossbar

10360: Steeplechase hurdles for the 3000 m distance. Length 5.00 m. With crossbar



Trolley For Steeplechase Hurdle

Order No. 10400

The trolley for steeplechase hurdle is made from an extra strong aluminium profiles. The trolley is used to store and move the steeplechase hurdles. It provides space for one set of hurdles. It is equipped with 200 mm wheels, which allow easy manoeuvring of the trolley on track.

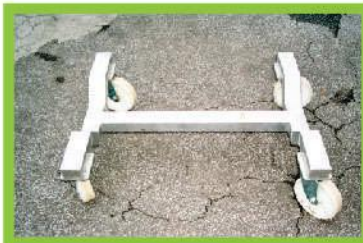

Transport Cart for Steeplechase Hurdles

Order No. 10401

Transport cart for steeplechase hurdles. Made from aluminium with swivel castors and holder for the hurdle base. (1 Set = 2 Piece)



Hurdle Competition

Order No. 10470

The competition hurdle is made from high grade aluminium profiles. The base profiles measure a cross section of 50x50x3 mm. The vertical profiles measure a cross section of 40x40x3 mm. The profile for the height adjustment is 33 x 33 x 3 mm. The crossbar is made from high quality, durable and extremely flexible wood. The wood is painted with a special paint, which is long lasting even in a strong weather influence.

The height of the hurdle can be adjusted in steps from 0.685 m to 0.762 m to 0.838 m to 0.914 m to 0.991 to 1.067 m. The scale for height adjustment is placed in a groove, so it can't be scratched will adjusting the height. The counterweight has to be adjusted depending on the adjusted hurdle height. The product is certified by the IAAF.



The height of the hurdles can be adjusted to all heights which are used in competition. The special laser cut slot provides an exact adjustment of the height. The measuring of the adjusted height is no longer necessary.



The full fill IAAF regulations of the different heights needs different placement of the weight in the hurdle turning moment. For an easy handling a sticker shows which setup is the correct for the adjusted height.



The sticker for the weight adjustment is places in a special slot of the profile. This was done to prevent the sticker from being scratched or destroyed when the hurdles are stacked.



ويفز للتجارة والمقاولات ك.م.م.
WAVES TRADING & CONTRACTING W.L.L.

Tel: +974 4441 6319, Fax: +974 44416312
P.O.Box: 82731, Doha, Qatar
Email: info@waves-qatar.com
Website: www.waves-qatar.com



Hurdle Trolley for 20 Hurdles

Order No. 10520

Made from special aluminium profiles. It provides place for up to 20 hurdles. The trolley is easy to be moved and the turning wheels enable to store in any direction.

Hurdle Trolley for 40 Hurdles

Order No. 10530

Made from special aluminium profiles. It provides place for up to 40 hurdles. The trolley is easy to be moved and the turning wheels enable to store in any direction.



Order No. 10510

Made from special aluminium profiles. It provides place for up to 10 hurdles. The trolley is easy to be moved and the turning wheels enable to store in any direction.



Judges Stand

Platform for judges, to seat 6, 8, 10 or 12 people, made of aluminium. The basic framework is constructed from aluminium profiles (80 x 60 x 3 mm) with highly rounded edges. The steps consist of aluminium side profiles which are inserted all around into an end section profile. The guard rails can be screwed on so that the platform takes up less space when stored. The wheels, with a diameter of 250 mm, allow the whole platform to be moved easily by one person. The axes for the wheels are inserted in the basic frame and welded all around.

On request our judges stand available in different colors

- 10010 Stand for 10 people
- 10020 Stand for 10 people with plastic seat
- 10030 Stand for 6 people
- 10040 Stand for 6 people with plastic seat
- 10050 Stand for 8 people
- 10060 Stand for 8 people with plastic seat
- 10070 Stand for 12 people
- 10080 Stand for 12 people with plastic seat
- 10081 Stand for 24 people with plastic seat

Bucket seats available in different colours.



Team Podium

Order No. 10251

The Team podium is made from extra strong special aluminium profiles. It is delivered in three parts. Each piece measures a length of 200 cm and a depth of 60 cm. Its heights are 30 cm, 40 cm & 50 cm. The podium is white powder coated. The top surface is covered with EPDM rubber, which provides anti slip properties. The parts are labelled with the respective numbers 1, 2, 3.



ويفز للتجارة والمقاولات ك.م.م.
WAVES TRADING & CONTRACTING W.L.L.

Tel: +974 4441 6319, Fax: +974 44416312
P.O.Box: 82431, Doha, Qatar
Email: info@waves-qatar.com
Website: www.waves-qatar.com



Starter Podium

Order No. 10170

The starter podium is made from aluminium. The construction is extra strong and durable.



Starter Podium With Display

Order No. 10180

Same like Order No. 30110. Further there is a display board attached to provide more information.



Winner Podium

Order No. 10240

The Team podium is made from extra strong special aluminium profiles. It is delivered in three parts. Each piece measures a length of 200 cm and a depth of 60 cm. Its heights are 30 cm, 40 cm & 50 cm. The parts are labelled with the respective numbers 1, 2, 3.



Winner Podium Team

Order No. 10250

Same like Order No. 30160 but this one provides space for a whole team for each placement.



Starting Boxes

Order No. 10580

The starting boxes are made from fibreglass reinforced plastic. The boxes also provide space to place indicator for false starts. The boxes are stackable.

Finishing Post

Order No. 10200

The finishing post is made from aluminium. The post is free standing. It can be placed without further preparation of the ground. The post is used to show the finishing line. There is placed a holder for the finishing line on the post.





بيتر التجارة والمقاولات ك.م.م.
WAVES TRADING & CONTRACTING W.L.L.

Tel: +974 4441 6319, Fax: +974 44416319
P.O.Box: 82431, Doha - Qatar
Email: info@waves-qatar.com
Website: www.waves-qatar.com



Starting Block Model 'Olympia'

Order No. 10560

Starting Block Model 'Olympia' with handle. Made from aluminium casting with spikes. The height of the blocks can be adjusted. IAAF certified.



Starting Block Competition

Order No. 10550

Starting Block ; Competition made from aluminium casting with spikes. The height of the blocks can be adjusted. IAAF certified.



Transport Cart For Starting Blocks

Order No. 10570

Transport Cart for starting Blocks. Made from aluminium with extra wide turning wheels.



Marker Cones (28 cm, Synthetic)

The maker cones are made from plastic. Their height is 28 cm. The cones are available in assorted colours.

Order No	Color
11120	Blue
11130	Yellow
11140	Red
11150	Green

Marker Cones (40 cm, Synthetic)

The maker cones are made from plastic. Their height is 40 cm. The cones are available in assorted colours.

Order No	Color
11170	Blue
11180	Yellow
11190	Red
11200	Green



Relay Rods

Order No. 10780

The relay batons are available in different materials and price categories. The lengths of the batons is 30 cm, The diameter is 40 mm, Each kind of the relay baton is available in assorted colours.

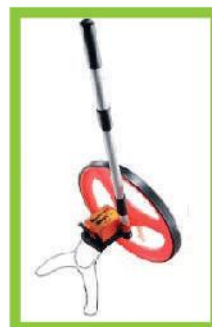

Lightweight Measuring Wheel

Order No. 11100

Lightweight Measuring Wheel is handy precision wheel with telescopic guide pole and hinged stand. Great to measure larger distances of risk, running tracks, cross-country courses, courses, etc. Graduation 0.1m. Measuring range 9999.9 m, forward and backward measuring possible, weight approx. 1 kg.



ويفر للتجارة والمقاولات
WAVES TRADING & CONTRACTING W.L.L.
 Tel: +974 4441 5319, Fax: +974 44416312
 P.O.Box: 52431, Doha-Catar
 Email: info@waves-qatar.com
 Website: www.waves-qatar.com



Referee Flags

The referee flags are made for referees to signalize their decisions. The flag measures 40 x 40 cm. It is attached to a handle pole. They are available in assorted colours.

Order No	Color
10830	Red
10840	White
10850	Blue
10860	Yellow
10870	Green

Runner Up Marker

Order No. 11410

The runner up markers are used to help the athletes to mark their personal starting position for the run up. Therefore they are used in many athletic categories. The markers are available in assorted colours.



Marking Tapes

The sector marking tapes show the sector for the javelin competition. The tape is made from PVC and has a width of 5 cm. The length of one roll is 65 m. The tape is available in three colours.

Order No	Color
10900	White
10910	Yellow
10920	Red

Measurement Tapes (Fiberglass)

These measurement tapes are made from fiberglass. The material is tear resistant and waterproof. The width of the tape is 14 mm. The cover and the handle are made from plastics. The tapes are available in different lengths.

Order No	Details
10970	5 m
10980	10 m
10990	15 m
11000	20 m
11010	30 m
11020	50 m
11030	100 m

Measurement Tapes (Steel)

These measurement tapes are made from steel with a special white coating. The frame and the reel are made metal. The handle is made from impact resistant PVC. The tapes are available in different lengths.

Order No	Details
11040	10 m
11050	20 m
11060	30 m
11070	50 m
11080	50 m, triangular
11090	100 m, triangular



Display Board with Display (Mobile System)

Order No. 10110

The display board without display is a free standing system. This item is made from aluminium. The aluminium construction is lightweight and therefore easy to move. This order number includes a display.



Lap Indicator Without Display Board

Order No. 10160

The number's table is used for the display boards. The background is white colored. The numbers are from 0 to 9.



Wind Control Stand

Order No. 10620

The wind control stand is made from aluminium. The stand is equipped with a wind sock to show the wind direction.



ويفز التجارة والمقاولات ك.م.م.

WAVES TRADING & CONTRACTING W.L.L.

Tel: +974 4441 6319, Fax: +974 44416

P.O.Box: 82431, Doha - Qatar

Email: info@waves-qatar.com

Website: www.waves-qatar.com

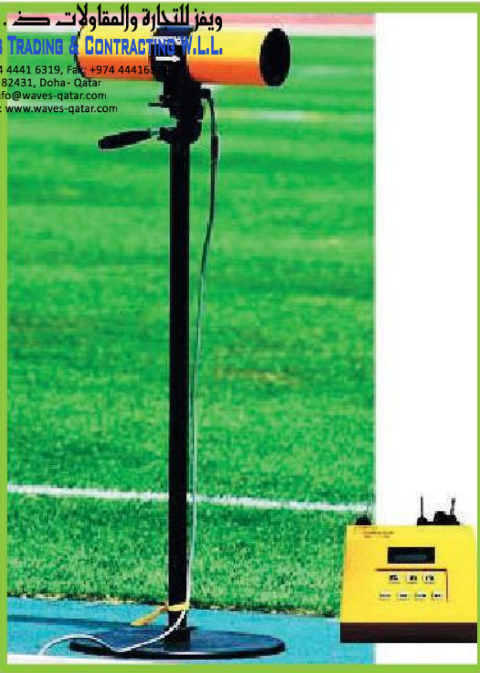

Electronic Measurement & Display Equipment

Order No. 270080

Measures both Tail and Head winds instantly
[Selectable measurement duration]
Measurement duration can be selected from 5, 10 and 13 seconds according to the type of events.
[Real-time display of measurements]
The result of measurement can be displayed instantly on the wind velocity display board (option)
[Power by battery]
Relocation of the display board can be made easily



Electronic Wind Meter

Order No. 10610

The electronic wind meter is an electronic wind measurement device. The recording interval can be adjusted between 5 to 13 seconds. The meter is placed on a telescopic. The item also includes a sturdy transport case.

Display For Electronic Wind Control

Order No. 10630

The display for electronic wind control is used together with Order No. 30430. The display is battery operated. The display is placed on a telescopic tripod. The digit height is 10 cm.



Equipment Trolley

Order No. 10460

Equipment Trolley. Made from aluminium. Platform dimensions: 2 x 1 m, load capacity: 1,000 kg. The sides are 20 cm high, and can be folded down.

Wind Speed Display Board

Order No. 10615

Made from stabile special aluminium profile. White/Blue powder coated.

Our Manuel Wind Speed Display illustrates actual wind speed using two digits and +/- sign. Included 2 digital plastic units.



Athletic Benches

Order No. 11220

Athletic bench made from special aluminium profile. Length 2.50 m, height approx 2.10 m, This bench is absolute weather resistant . the roof is collapsible for a less spacious storage. 4 extra large nylon wheels provide more handling comfort.



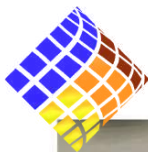

م. م. م.
WAVES TRADING & CONTRACTING W.L.L.

Tel: +974 4441 6319, Fax: +974 44416312
P.O.Box: 92431, Doha - Qatar
Email: info@waves-qatar.com
Website: www.waves-qatar.com



Starting clapper

Order No. 10662

Athletics starting clapper with large surface made of shatterproof powder coated aluminium plate. Clap made of hard wood. Excellent sound intensity. Diameter approx. 30 cm.



Running Track Drying Machine "WATER STAR"

Order No. 11850

Suction Roll WATER STAR. Water absorbing roller. The specially designed, foam covered roller absorbs water and then releases it into a plastic bucket. It operates forwards and backwards, and can be easily used by one person. Roller width: 80 cm. Water capacity of bucket: About 17 litres. Weighs (about 50 Kg)



Time Control Unit Digital

Order No. 11371

- Digit size: 15 cm. optimal viewing distance 60 metres with a viewing angle of 160°.
- Display of time, date and temperature, counting / countdown, rate of chlorine, rate of humidity. Fix or alternate (manual input for the rate of chlorine and humidity).
- Automatic setting of luminosity according to light exposure (sun, cloud or night).
- Setting of alternation duration (2 to 6 seconds).
- Time display: 12h or 24 h mode. Automatic summer/winter time changeover.
- Temperature display in Celsius (°C) or Fahrenheit (°F) from -99° to +99, 9°.
- Selection °C or °F in the menu. Display resolution: 0, 1°C.
- Accuracy: +0, 5°C from -10 to +85°C.
- Offset adjustment, possible from - 9, 9° to + 9,9°. u Display test menu.
- NTP transmission mode: multicast only

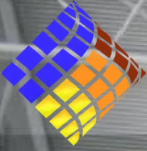

ويفز للتجارة والمقاولات ك.م.م.
WAVES TRADING & CONTRACTING W.L.L.

Tel: +974 4441 6319, Fax: +974 44416312
P.O.Box: 82431, Doha - Qatar
Email: info@waves-qatar.com
Website: www.waves-qatar.com



ATHLETICS

High Jump & Pole Vault





Crossbar Fiberglass

Order No. 20130

Pole vault crossbar is made from fibreglass. The length is 4.50 m. This item is certified by IAAF.



Pole Vault Box

Order No. 20290

The pole vault box is made from stainless steel. It is made from steel to sustain the big forces which need to be transferred from the pole to the ground. The box is equipped with a drainage system. So in case of rain the water can flow off immediately.



Cover For Pole Vault Box

Order No. 20130

The cover for the pole vault box is made from aluminium. The cover has a rim on top and can be covered with surface of the surrounding.





Pole Vault Upright

Order No. 20010

The pole vault uprights are made from extra stable aluminium. The height for the crossbar can be adjusted between 1.8 and 6.3 m. This item is certified by IAAF.



Guide Rail For Pole Vault

Order No. 20040

The guide rail for pole vault is made from extra strong aluminium profiles. The rail is used for the free standing pole vault uprights. The rail allows an easy positioning of the uprights. The rail needs to be fixed with ground anchors or additional weights.



Ground Anchor For Pole Vault

Order No. 20030

The ground anchor is made from aluminium. The anchors are placed inside the ground. They allow an easy fixing of the guide rail on to the floor. One set consists of eight ground anchors.

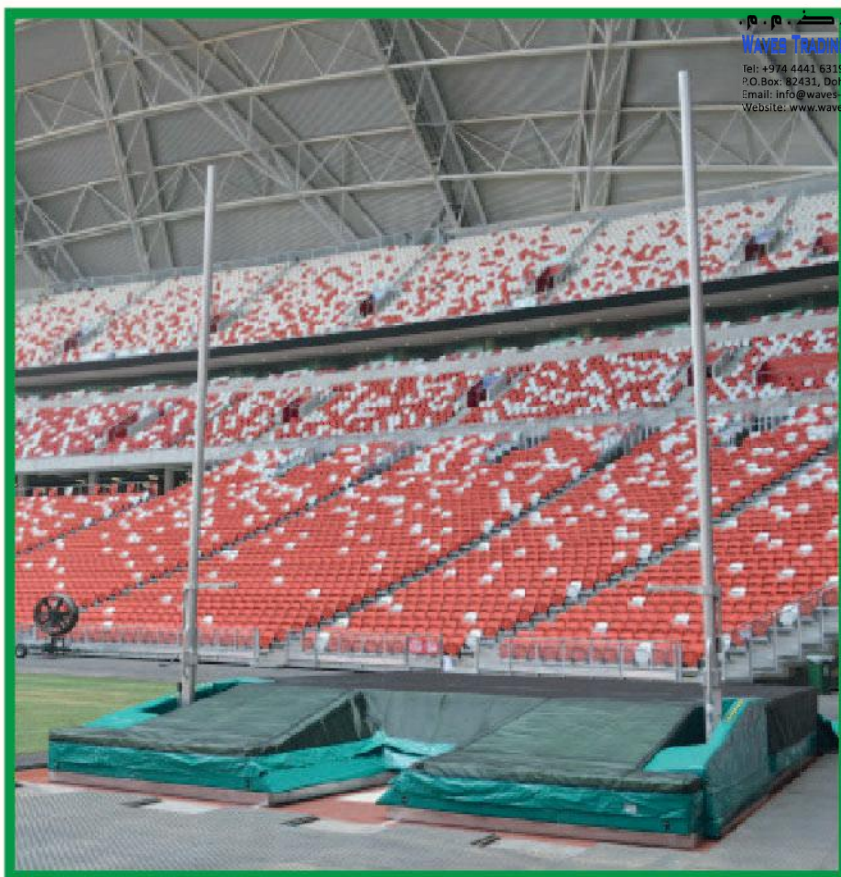

Pole Vault Mat

Order No. 20080

Pole vault mat, size 8 x 6 m, with protective mesh lath, designed to be spike-proof throughout the complete landing surface including the wedge padding and at the sides down to the ground – guaranteed optimal air circulation. Wear mat firmly attached. Gap protection in the landing area via additional intermediate layer. Two-part overall cover with reinforced box area. Highly elastic, stable poly foam blocks (hollow chamber foam). Included aluminium bar frame



Pole vault mat for training

Order No. 20060

Pole vault mat, size 8 x 6 m, with protective mesh lath, designed to be spike-proof throughout the complete landing surface including the wedge padding and at the sides down to the ground – guaranteed optimal air circulation. Wear mat firmly attached. Gap protection in the landing area via additional intermediate layer. Two-part overall cover with reinforced box area. Highly elastic, stable poly foam blocks (hollow chamber foam). Included aluminium bar frame

Brand : Vennikel Germany

Size: 6.50 x 5.00 m,



ويفر للتجارة والمقاولات ك.م.م.
WAVES TRADING & CONTRACTING W.L.L.

Tel: +974 4441 6319; Fax: +974 44416317
P.O. Box: 82431, Doha - Qatar
Email: info@waves-qatar.com
Website: www.waves-qatar.com



Pole Vault Rain Cover

Order No. 20090 (650 x 500 x 90cm)
Order No. 20100 (800 x 600 x 90cm)

The pole vault rain cover is made from water proof PVC. It prevents the mat from getting wet during rain or watering. It is available in different sizes.



pole vault bar frame

Order No. 20200 - (8.00 x 6.00m)
Order No. 20210 (6.50 x 5.00m)

The pole vault bar frame is made from aluminium. For this product special aluminium profiles are used. The profile ensures good support on the bottom of the mat. It raises the mat, so it will not soak wet if water is on the track. Additionally it also allows the air to circulate underneath the mat. The bar frame also ensures that the mat stays in place. It is available in different sizes.



High Jump Mat

High jump landing mat., with protective mesh lath, designed to be spike-proof throughout the complete landing surface including the wedge padding and at the sides down to the ground – guaranteed optimal air circulation. Wear mat firmly attached. Gap protection in the landing area via additional intermediate layer. Two-part overall-cover with reinforced box area. Highly elastic, stable poly foam blocks. (hollow chamber foam). Including aluminium bar frame.

Order No	Size (cm)	Intermediate Layer
20370	600 x 300 x 60	No
20380	600 x 400 x 70	No
20400	600 x 400 x 70	Yes 
20430	500 x 300 x 60	Yes
20440	400 x 300 x 60	Yes
20450	400 x 300 x 50	Yes
20460	400 x 300 x 60	Yes



ويتر للتجارة والمقاولات ك.م.م.
WAVES TRADING & CONTRACTING W.L.L.
 Tel: +974 4441 6319, Fax: +974 44416312
 P.O.Box: 82431, Doha - Qatar
 Email: info@waves-qatar.com
 Website: www.waves-qatar.com



high jump bar frame

The high jump bar frame is made from aluminium. For this product special aluminium profiles are used. The profile ensures good support on the bottom of the mat. It raises the mat, so it will not soak wet if water is on the track. Additionally it also allows the air to circulate underneath the mat. The bar frame also ensures that the mat stays in place. It is available in different sizes.

Order No	Size (cm)
20520	300 x 400
20530	300 x 500
20540	600 x 300
20550	600 x 400



Order No	Size (cm)
20521	400 x 300
20531	500 x 300
20541	600 x 300

High Jump Bar Frame Mobile

The aluminium bar frame serves as the perfect base for high jump mats. The aluminium bar frame is absolutely essential for facilities which have to be assembled and taken apart or combined with a safety cover.

high jump rain cover

The high jump rain cover is made from water proof PVC. It prevents the mat from getting wet during rain or watering. It is available in different sizes.

Order No	Size (cm)
20470	400 x 300 x 60
20480	500 x 300 x 60
20490	600 x 300 x 60
20500	600 x 400 x 60





High Jump Stands

Order No. 20560

High jump uprights. Manufactured completely from high-grade aluminium profiles. Made from a profile with the dimensions 50 x 50 x 3 mm and with rounded edges. The bar holders and uprights are completely anodised. The measuring scale is inserted in the profile (in a groove) and so protected from scratches even when the height is being regularly adjusted. All the screws are made of stainless steel. The height can be adjusted from 50 to 300 cm.

Order No. 20510

High jump uprights.
 Height 2.50 m



High jump lath, fiber-glass material

Order No. 20350

The crossbar for pole vault is made from fibreglass. Length: 4.00 meter





شركة أمواج للتدريب والعقود
WAVES TRAINING & CONTRACTING W.L.L.
Tel: +974 4441 6319, Fax: +974 44416312
P.O.Box: 82431, Doha- Qatar
Email: info@waves-qatar.com
Website: www.waves-qatar.com



Mobile Aluminium Safety Cover

Order No. 24000

Mobile safety cover, for pole vault landing mat, Made from aluminium, for Pole Vault Landing Mat Size: 8.00 x 6.00 m

Order No. 24010

Mobile safety cover, for High Jump Landing mat, Made from aluminium, For High Jump Landing Mat Size: 4.00 x 3.00 m

Order No. 24020

Mobile safety cover, for High Jump Landing mat, Made from aluminium, For High Jump Landing Mat Size: 5.00 x 3.00 m

Order No. 24030

Mobile safety cover, for High Jump Landing mat, Made from aluminium, For High Jump Landing Mat Size: 5.00 x 4.00 m

Order No. 24040

Mobile safety cover, for High Jump Landing mat, Made from aluminium, For High Jump Landing Mat Size: 6.00 x 4.00 m

Safety covers for high jump & pole vault landing mat. Made from extra strongspecial aluminium profiles. The internal framework is constructed to ensure that the cover can withstand the highest physical demands despite having a significantly reduced weight in contrast to standard covers.

Available in all dimensions The advantages of our cover at a glance:

- Cover surface is made from extra strong, silicon-sealed aluminium profiles (can withstand a load of over 300 kg / m²).
- Cover surface is slightly sloped – for optimal drainage.
- Inset double wheels (Ø 200 x 50 mm) ensure easy movement
- Welded handles.
- The two-section facilities come with an integrated drip moulding.
- Include parking rail to make sure there is no impact at the surface.



Zacharias Crossbar SUPER WINDFEST

Order No. 20330

The "Zacharias "crossbar is the safest practice crossbar available. It is made of vinyl tube with rubber cables at both ends which are fixed to the stands. Zacharias Crossbar SUPER WINDFEST, inflatable, more flexible, does not vibrate during wind. Includes new nozzle! Stample, leak-proof and safe!

- Perfect visibility (like a competition crossbar)
- Expands more than 1 m, and bounces back
- Harmless
- Does not break or cause the posts to fall
- Inflatable (type: "SUPER WINDPROOF") for increased stability in wind



Run Up Marker

Order No. 11410

The run up marker is made from stainless steel. It is used to mark the begin of the run up of the athlete. The marker is available in different colours.



20250

Height Measuring Stick

Order No. 20250

Height Measuring Stick for High Jump, aluminium, telescopic adjustability from 0.85 to 3.00 m with spirit level. Height display through window.



20260

Order No.20260

Height Measuring Stick for pole vault, aluminium, telescopic adjustability from 1.70 to 8.00 m with spirit level. Height display through window.



ويجز للتجارة والمقاولات ك.م.م.

WAVES TRADING & CONTRACTING W.L.L.

Tel: +974 4441 6319, Fax: +974 44416312
P.O. Box: 82431, Doha - Qatar
Email: info@waves-qatar.com
Website: www.waves-qatar.com



Rack for Poles

Order No. 20590

The rack for poles is made from aluminium. It provides storage space for vaulting poles. It is free standing and can be moved easily. The frame is powder coated and assorted colours are available.



Poles

The poles are made from fiberflax. They are lightweight and offer a unique kickback. The poles are available in different lengths for the different weights. The poles are available between 3.1 and 5.1m. The different lengths are suitable for different weights. We offer poles from 30 up to 90kg.

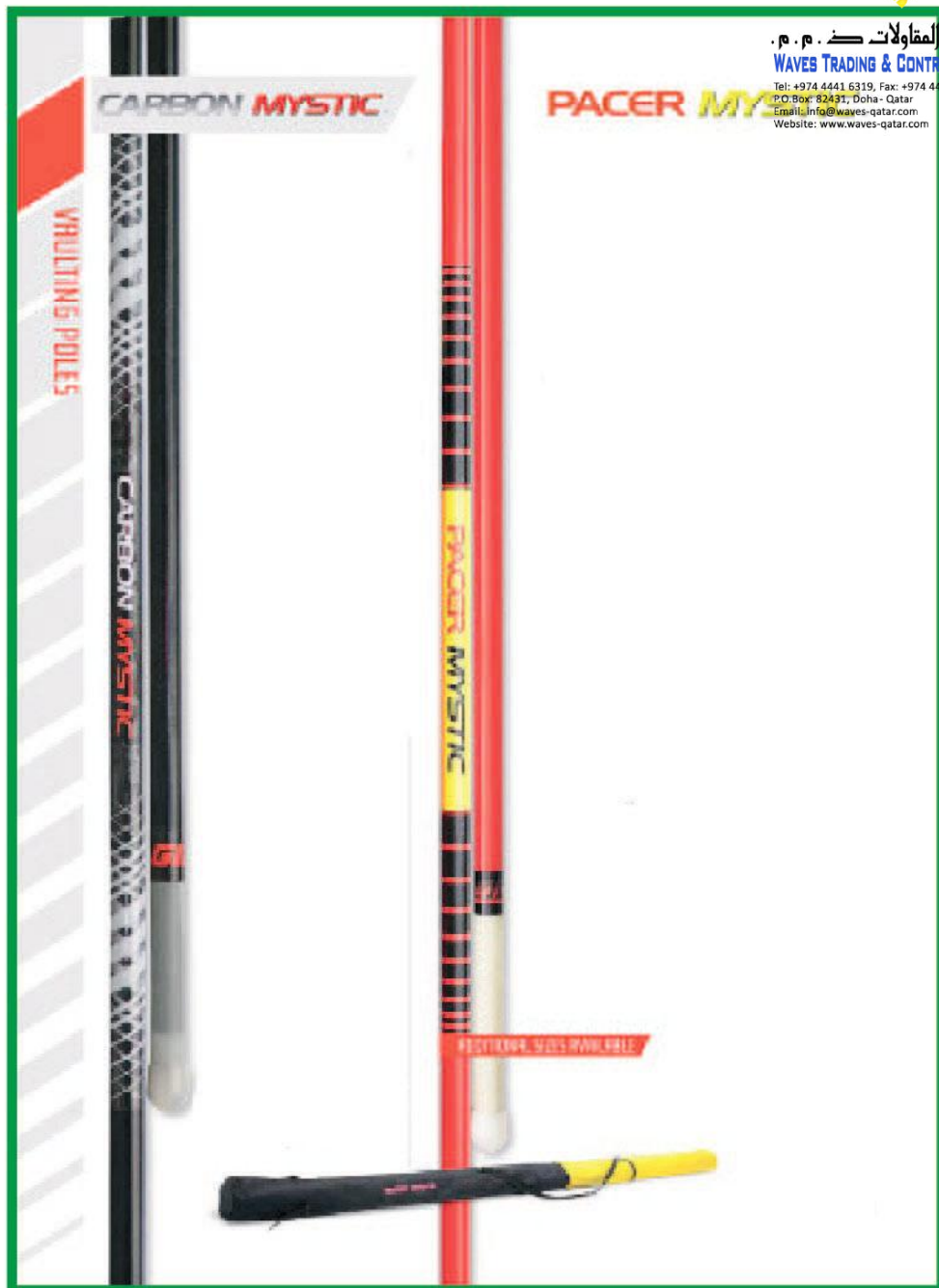

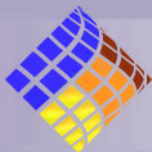

Carbon FX Pole

Order No	Lenght (m)	Test Weight (kg)
41010	4.60	64
41020	4.60	66
41030	4.60	68
41040	4.60	70
41050	4.60	73
41060	4.60	75
41070	4.60	77
41080	4.60	79
41090	4.60	82
41100	4.60	84
41110	4.60	86
41120	4.70	68
41130	4.70	70
41140	4.70	73
41150	4.70	75
41160	4.70	77
41170	4.70	79
41180	4.70	82
41190	4.70	84
41200	4.70	86
41210	4.70	88
41230	4.90	73
41240	4.90	75
41250	4.90	77
41260	4.90	79
41270	4.90	82
41280	4.90	84
41290	4.90	86
41300	4.90	88
41310	4.90	90
41320	5.00	77
41330	5.00	79
41340	5.00	82
41350	5.00	84
41360	5.00	86
41370	5.00	88
41380	5.00	90
41390	5.00	93
41400	5.00	95
41410	5.10	84
41420	5.10	86
41430	5.10	88
41440	5.10	90
41450	5.10	93
41460	5.10	95

Carbon Mystic

Order No	Lenght (m)	Test Weight (kg)
43000	4.00	54
43010	4.00	57
43020	4.00	59
43030	4.00	61
43040	4.00	64
43050	4.00	66
43060	4.00	68
43070	4.00	70
43080	4.00	73
43090	4.15	57
43100	4.15	59
43110	4.15	61
43120	4.15	64
43130	4.15	66
43140	4.15	68
43150	4.15	70
43160	4.15	73
43170	4.15	75
43180	4.15	77
43190	4.25	59
43200	4.25	61
43210	4.25	64
43220	4.25	66
43230	4.25	68
43240	4.25	70
43250	4.25	73
43260	4.25	75
43270	4.25	77
43280	4.25	79
43290	4.25	82
43300	4.40	61
43310	4.40	64
43320	4.40	66
43330	4.40	68
43340	4.40	70
43350	4.40	73
43360	4.40	75
43370	4.40	77
43380	4.40	79
43390	4.40	82

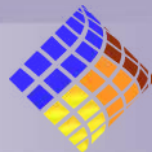

Pacer FX Pole

Order No	Lenght (m)	Test Weight (kg)	Order No	Lenght (m)	Test Weight (kg)	Order No	Lenght (m)	Test Weight (kg)
41500	3.50	41	41970	4.25	57	42430	4.90	73
41510	3.50	45	41980	4.25	59	42440	4.90	75
41520	3.50	50	41990	4.25	61	42450	4.90	77
41530	3.50	54	42000	4.25	64	42460	4.90	79
41540	3.50	59	42010	4.25	66	42470	4.90	82
41550	3.50	64	42020	4.25	68	42480	4.90	84
			42030	4.25	70	42490	4.90	86
41560	3.60	41	42040	4.25	73	42500	4.90	88
41570	3.60	45	42050	4.25	75	42510	4.90	90
41580	3.60	50	42060	4.25	77			
41590	3.60	54	42070	4.25	79	42520	5.0	73
41600	3.60	59	42080	4.25	82	42530	5.0	75
41610	3.60	64				42540	5.0	77
			42090	4.40	59	42550	5.0	79
41620	3.75	45	42100	4.40	61	42560	5.0	82
41630	3.75	48	42110	4.40	64	42570	5.0	84
41640	3.75	50	42120	4.40	66	42580	5.0	86
41650	3.75	52	42130	4.40	68	42590	5.0	88
41660	3.75	54	42140	4.40	70	42600	5.0	90
41670	3.75	57	42150	4.40	73			
41680	3.75	59	42160	4.40	75	42610	5.1	84
41690	3.75	61	42170	4.40	77	42620	5.1	86
41700	3.75	64	42180	4.40	79	42630	5.1	88
41710	3.75	66	42190	4.40	82	42640	5.1	90
41720	3.75	68	42200	4.40	84	42650	5.1	93
41730	3.75	70						
			42210	4.60	57			
41740	4.00	50	42220	4.60	59			
41750	4.00	52	42230	4.60	61			
41760	4.00	54	42240	4.60	64			
41770	4.00	57	42250	4.60	66			
41780	4.00	59	42260	4.60	68			
41790	4.00	61	42270	4.60	70			
41800	4.00	64	42280	4.60	73			
41810	4.00	66	42290	4.60	75			
41820	4.00	68	42300	4.60	77			
41830	4.00	70	42310	4.60	79			
41840	4.00	73	42320	4.60	82			
41850	4.15	54	42330	4.70	68			
41860	4.15	57	42340	4.70	70			
41870	4.15	59	42350	4.70	73			
41880	4.15	61	42360	4.70	75			
41890	4.15	64	42370	4.70	77			
41900	4.15	66	42380	4.70	79			
41910	4.15	68	42390	4.70	82			
41920	4.15	70	42400	4.70	84			
41930	4.15	73	42410	4.70	86			
41940	4.15	75	42420	4.70	88			
41950	4.15	77						
41960	4.15	79						

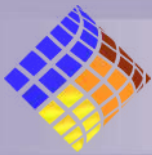

Pacer Mystic

Order No	Lengths (m)	Test Weight (kg)
43500	3.10	32
43510	3.10	41
43520	3.10	50
43530	3.10	59
43540	3.25	36
43550	3.25	41
43560	3.25	45
43570	3.25	50
43580	3.25	54
43590	3.25	59
43600	3.25	64
43610	3.35	36
43620	3.35	41
43630	3.35	45
43640	3.35	50
43650	3.35	54
43660	3.35	59
43670	3.35	64
43680	3.35	68
43690	3.50	41
43700	3.50	45
43710	3.50	50
43720	3.50	54
43730	3.50	59
43740	3.50	64
43750	3.50	68
43760	3.60	41
43770	3.60	43
43780	3.60	45
43790	3.60	48
43800	3.60	50
43810	3.60	52
43820	3.60	54
43830	3.60	57
43840	3.60	59
43850	3.60	61
43860	3.60	64
43870	3.60	66
43880	3.60	68

Order No	Lengths (m)	Test Weight (kg)
43890	3.75	745
43900	3.75	48
43910	3.75	50
43920	3.75	52
43930	3.75	54
43940	3.75	57
43950	3.75	59
43960	3.75	61
43970	3.75	64
43980	3.75	66
43990	3.75	68
44000	3.75	70
44010	3.75	73
44020	4.00	50
44030	4.00	52
44040	4.00	54
44050	4.00	57
44060	4.00	59
44070	4.00	61
44080	4.00	64
44090	4.00	66
44100	4.00	68
44110	4.00	70
44120	4.00	73



ويفز للتجارة والمقاولات ك.م.م.
WAVES TRADING & CONTRACTING W.L.L.

Tel: +974 4441 6319, Fax: +974 44416312
P.O. Box: 82431, Doha - Qatar
Email: info@waves-qatar.com
Website: www.waves-qatar.com



Hammer, Discus,
Shot Put, Javelin



competition aluminium discus and hammer cage 7/10 m

Order No. 30290

Order No. 30290 D (Double Net)

Competition aluminium discus and hammer cage 7/10 m

The competition aluminium discus and hammer cage is made from extra sturdy aluminium profiles. The profile measures a cross section of 120x100 mm. The wall thickness rises from four to six mm. In the lower part the 10 m posts are additionally reinforced with a cross bracket. The gate of the cage can be adjusted by one person only. All posts are equipped with a spacer to keep the net in the correct position. The cage is equipped with a knotless UV protected PP net. The net measures a thickness of 5 mm and a mesh width of 45 mm. The net can be raised and lowered by devices on each post. One set consists of six 7 m posts, four 10 m posts and two gates with trolley.





ويفز للتجارة والمقاولات ك.م.م.

WAVES TRADING & CONTRACTING W.L.L.

Tel: +974 4433 3333 / 4433 4444 / 4444 3333
P.O.Box: 82431, Doha, Qatar
Email: info@waves-qatar.com
Website: www.waves-qatar.com



Free standing safety cage for discus & hammer throwing, continuous 5.5

Order No. 30040

Free standing safety cage for discus & hammer throwing, continuous 5.5 metres high incl. net (made in Europe). This safety cage are made from aluminium Profiles (\varnothing 120 x 100 mm, wall thickness 2.5 mm). Suitable for training purposes and competitions without IAAF status.



ويفز للتجارة والمقاولات ك.م.م.

WAVES TRADING & CONTRACTING W.L.L.

Tel: +974 4441 6319, Fax: +974 44416312

P.O. Box: 82431, Doha - Qatar

Email: info@waves-qatar.com

Website: www.waves-qatar.com

Hammer Inlay Ring Fibreglass

Order No. 30140

The hammer inlay ring is made from white fibreglass. The inlay can fit in the discus ring. The inside diameter of the inlay ring measures 213.5 cm. The ring consists of four pieces. The parts are joined with slot and key.



Hammer inlay ring wood

Order No. 30150

Hammer throwing circle, with IAAF-certification, This two-section hammer throwing circle reduces the diameter (of a discus circle) to 2.135 m and is made from weatherproof multiplex laminate. The edges of the circle are protected by special aluminium profiles. The hinges between the two sections of the circle are made



Competition discus cage 4 m

Manufactured from stable aluminium and fitted with a high-quality safety net. Made in conformance to IAAF and with IAAF certification! Safety cages for discus throwing manufactured to international specifications and certified by the IAAF. The 7 uprights for this safety cage are made from aluminium Profiles (Ø 120 x 100 mm, wall thickness 2.5 mm) and as a result combine stability with ease of handling. The advantages of these safety cages:

- With these safety cages dangerous work with ladders is not necessary because the assembly process (including attaching the net) Takes place from the ground.

- The oval profile prevents the twisting of the uprights.

30070: 4.3 meters high, Incl. net and sand bags, Post profiles (Ø 120 x 100 mm, wall thickness 2.5 mm) IAAF certified

30080: 4.3 meters high, Incl. net and sand bags, Post profiles (Ø 120 x 100 mm, wall thickness 4-6 mm) IAAF certified

30060: Free standing version





ويفز للتجارة والمقاولات ك.م.م.
WAVES TRAINING & CONTRACTING LLC

Tel: +974 4441 6339 Fax: +974 44416312
P.O.Box: 82431, Doha - Qatar
Email: info@waves-qatar.com
Website: www.waves-qatar.com



Shot Put stop board wood

Order No. 30340

Shot put stop board made of wood, with IAAF certification, Made of solid, weather-proof hardwood, lacquered white.



Order No. 30440

Shot put stop board made synthetic material, with IAAF certification, Weather-proof white colour.



Javelin stop board

Order No. 30460

The javelin stop board is made from aluminium. It is an 7 cm wide arc. The arc is 4 m wide and measures an inside diameter of 8 m. The stop board is kept in position by spikes on the bottom side. The stop board marks the end of the run way. The item complies with IAAF regulation 187.



shot put ring

Order No. 30210

The shot put ring is made from aluminium. It is a circle with an inside diameter of 213.5 cm. The ring is installed in the ground to mark the area from where the shot is put. It is equipped indicator to mark the surface level on the inside of the ring.



discus ring

Order No. 30220

The discus ring is made from aluminium. It is a circle with an inside diameter of 250 cm. The ring is installed in the ground to mark the area from where the discus is thrown. It is equipped indicator to mark the surface level on the inside of the ring.



Shot put Cover

Order No. 30430

The shot put cover is made from special aluminium profiles. The cover is equipped with handles, which allows an easy transport. The cover canopies the ring completely.

Standard Ground Socket for Hammer Cage



Order No. 30090

Standard ground socket, made from aluminium, For discus and hammer cage 4.m & 5.5 m meter high, Profile 120 x 100 mm.

Order No. 30100

Standard ground socket, made from aluminium, For discus and hammer cage 7-10 meter high, Profile 120 x 100 mm.

Special Ground Socket For Hammer Cage



Order No. 30110

Special ground socket for discus and hammer cage 5.50 m high, Dimension: 120 x 100 x 500 mm, with coatable cover, made from aluminium.

Order No. 30120

Special ground socket for discus and hammer cage 7-10 m high, Dimension: 100 x 120 x 800 mm, with coatable cover, made from aluminium

Hinged Ground Socket

Order No. 30130

Hinged special ground socket sytem for discus and hammer cage 7-10 m high, Dimension: 100 x 120 x 800 mm, with coatable cover, made from aluminium.

The hinged aluminium ground socket is fitted with a to and fro swivel element which allows the hammer cage post to be set up quickly and easily. With lid chamber and attached lid which can be covered on site to suit the various running track surfaces.





ويفز للتجارة والمقاولات ك.م.م .

WAVES TRADING & CONTRACTING W.L.L.

Tel: +974 4441 6319, Fax: +974 44416312
P.O.Box: 82433, Doha - Qatar
Email: info@waves-qatar.com
Website: www.waves-qatar.com



training steel shot put

The training steel shot put is made from steel. It is filled with a special mixture of lead and fine shot. The surface is powder coated. The shot is available in different weights and diameters.

Order No	Weight
20431	1.00 kg
20432	1.50 kg
20433	1.80 kg
20434	2.00 kg
20435	2.27 kg
20436	2.70 kg
20437	2.72 kg
20438	2.72 kg, Diameter: 90 mm
20371	3.00 kg
20372	4.00 kg
20373	5.00 kg
20374	6.00 kg

competition steel shot put

The competition steel shot put is made from steel. It is filled with a special mixture of lead and fine shot. The surface is completely turned. The surface is powder coated. The shot is available in different weights and diameters. The item is certified by the IAAF.



Order No	Weight
20375	7.26 kg
20380	4.00 kg, Diameter: 95 mm, IAAF Certified
20390	5.00 kg, Diameter: 110 mm, IAAF Certified
20400	6.00 kg, Diameter: 115 mm, IAAF Certified
20410	7.26 kg, Diameter: 113 mm, IAAF Certified
20420	6.00 kg, Diameter: 120 mm, IAAF Certified
20430	7.26 kg, Diameter: 128 mm, IAAF Certified

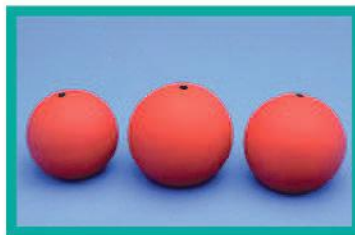

indoor shot put

Indoor Shot Put is designed for all skill levels. It is ideal for indoor training. The indoor shot put features a durable elastic PVC shell that completely covers the shot put.

Order No	Weight
30500	1.50 kg
30510	2.00 kg
30520	2.50 kg
30530	3.00 kg
30540	3.50 kg
30550	4.00 kg
30560	4.5 kg
30570	5.00 kg
30580	6.00 kg
30590	7.26 kg

indoor shot put mat

The indoor shot put mat is made from a special foam in a sandwich construction. The construction minimizes the rebound and leaves a visible mark of the impact.

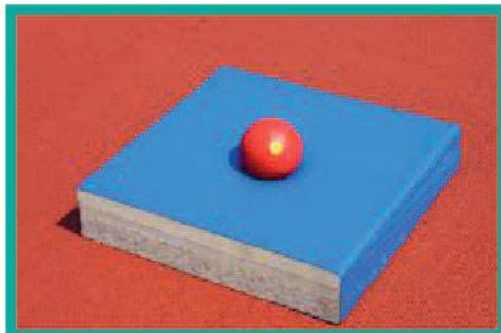

shot put bag

Order No. 31860

The shot put bag is made from a waterproof synthetic material. It can hold one implement only. It is equipped with a sturdy handle and can be closed with a Velcro. The bag is available in different sizes.



brass shot put

The brass shot put is made from brass. It is filled with a special mixture of lead and fine shot. The surface is completely turned. It is polished and covered in petroleum jelly. The shot is available in different weights and diameters.



Order No	Weight
30660	4.00 kg, Diameter: 100 mm, IAAF certified
30670	5.00 kg, Diameter: 110 mm, IAAF certified
30680	6.00 kg, Diameter: 110 mm, IAAF certified
30690	7.26 kg, Diameter: 115 mm, IAAF certified

stainless steel shot put

The stainless steel shot put is made from stainless steel. It is filled with a special mixture of lead and fine shot. The surface is completely turned. It is polished and covered in petroleum jelly. The shot is available in different weights and diameters.



Order No	Weight
30910	3.00 kg, Diameter: 105 mm
30920	3.00 kg, Diameter: 110 mm
30930	4.00 kg, Diameter: 95 mm, IAAF Certified
30940	4.00 kg, Diameter: 100 mm, IAAF Certified
30950	4.00 kg, Diameter: 105 mm, IAAF Certified
30960	5.00 kg, Diameter: 105 mm, IAAF Certified
30970	5.00 kg, Diameter: 110 mm, IAAF Certified
30980	5.00 kg, Diameter: 115 mm, IAAF Certified
30990	5.45 kg, Diameter: 105 mm, IAAF Certified
31000	6.00 kg, Diameter: 105 mm, IAAF Certified
31010	6.00 kg, Diameter: 110 mm, IAAF Certified
31020	7.26 kg, Diameter: 115 mm, IAAF Certified





ويغز التجارة والمقاولات ك.م.م.
WAVE TRAINING & CONTRACTING W.L.L.

Tel: +974 4441 6319, Fax: +974 44416312
P.O.Box: 82431, Doha- Qatar
Email: info@waves-qatar.com
Website: www.waves-qatar.com



competition plastic discus

The competition plastic discus is made from corrosion free special alloy with plastic side plates. The side plates are reinforced with fibreglass. The modern construction does not require a traditional centre plate. It is available in different weights. The item is certified by the IAAF.



Order No	Weight
31280	0.75 kg
31290	0.80 kg
31330	1.00 kg, IAAF Certified
31310	1.50 kg, IAAF Certified
31320	1.75 kg, IAAF Certified
31330	2.00 kg, IAAF Certified



Hard Rubber Discus

The hard rubber discus is made from rubber. It is very durable and resistant to unfavourable conditions. It is designed for serial throwing with a risk of hitting other disci. The discus is available in different weights.

Order No	Weight
31340	0.75 kg
31350	1.00 kg
31370	1.50 kg
31380	1.75 kg
31390	2.00 kg

Soft Rubber Discus

The soft rubber discus is made from non marking rubber. It is designed for indoor training. The discus is available in different weights.

Order No	Weight
31400	1.00 kg
31410	1.25 kg
31420	1.50 kg
31430	1.75 kg
31440	2.00 kg



ويفز للتجارة والمقاولات ك.م.م.
 WAVES TRADING & TRANSPORTING MALL
 Tel: +974 4441 6319, Fax: +974 44416312
 P.O.Box: 92431, Doha- Qatar
 Email: info@waves-qatar.com
 Website: www.waves-qatar.com

Carbon Discus

The carbon discus is made from a brass rim with steel core with polyester epoxy resins, carbon fibre and fibreglass side plates. The side are very light and thin to increase the rim weight. The modern construction does not require a traditional centre plate. The increased rim weight increases the discus' aerodynamics. It is available in different weights.

Order No	Weight
31450	1.00 kg, IAAF Certified
31460	1.50 kg, IAAF Certified
31470	1.75 kg, IAAF Certified
31480	2.00 kg, IAAF Certified



Plywood Discus

The plywood discus is made from corrosion free special alloy core with wood and resin side plates. The side plates are pressed under high pressure. The modern construction does not require a traditional centre plate. It is resistant to unfavourable weather conditions. It is available in different weights.

Order No	Weight
31490	1.00 kg
31500	1.50 kg
31510	1.75 kg
31520	2.00 kg



Discus Bag

Order No. 31890

Bag for discus, Size: Up to 1.00 kg.

Order No. 31900

Bag for discus, Size: Up to 1.50 kg

Order No. 31910

Bag for discus, Size: Up to 2.00 kg

Bags for Discus is made from waterproof synthetic fabricate. Each bag provides space for one discus. The bag can be closed with a Velcro and is easy to carry, because of the sturdy handle



ويتم للتجارة والمقاولات
Waves Trading & Contracting W.L.L.

Tel: +974 4441 6319, Fax: +974 44416312
P.O.Box: 82431, Doha - Qatar
Email: info@waves-qatar.com
Website: www.waves-qatar.com

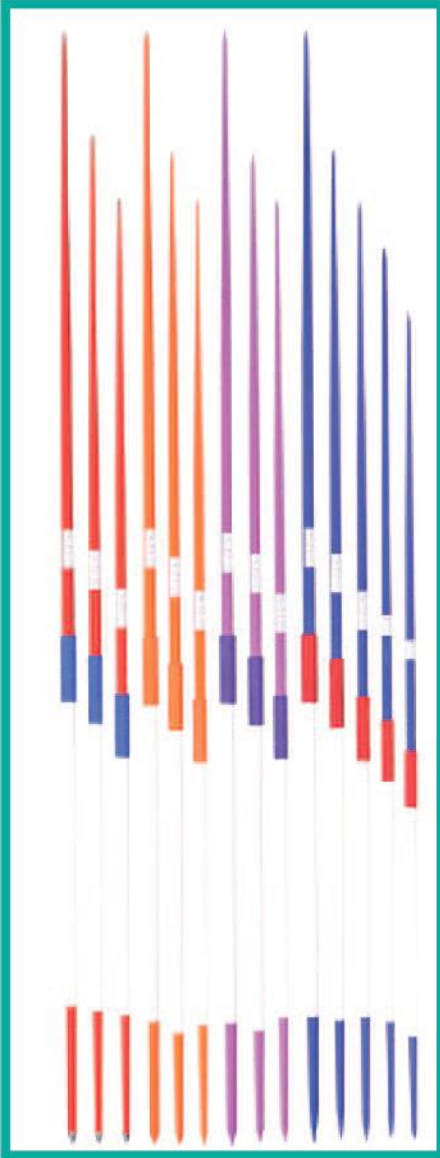

Training Javelin

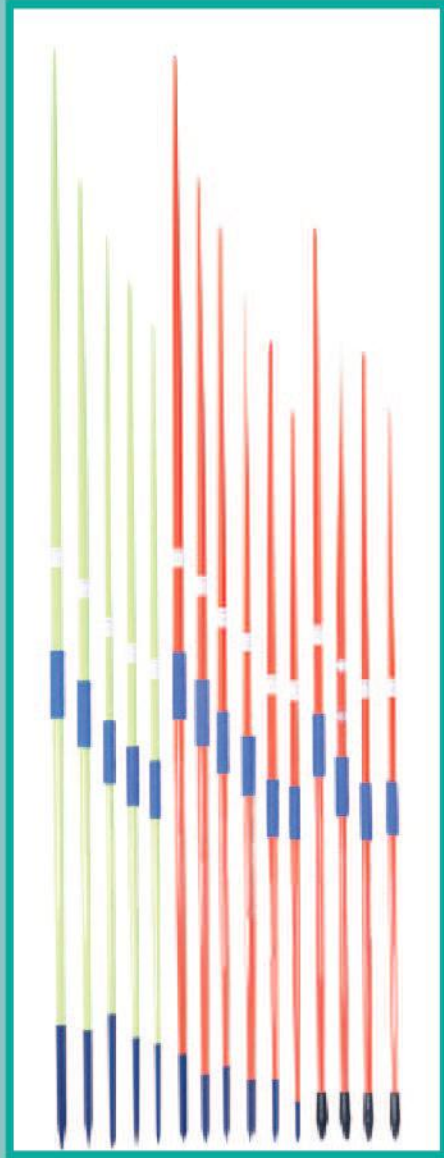

Competition Javelin

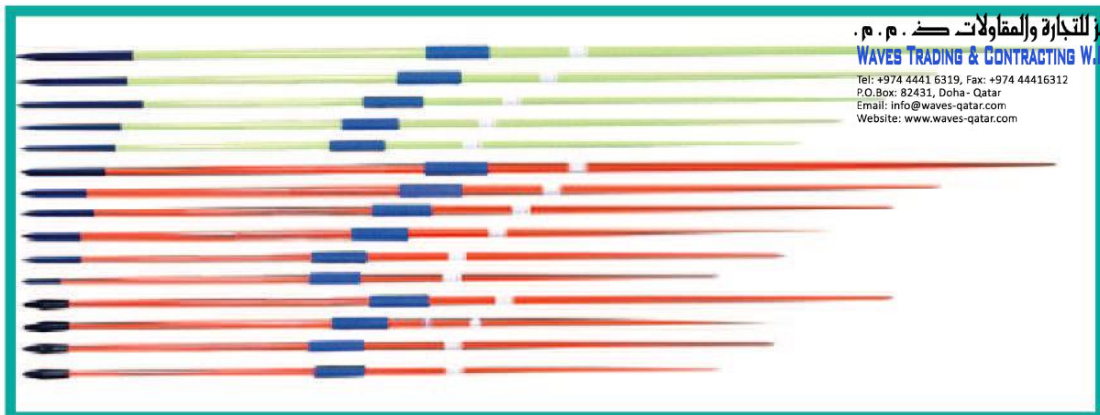

Competition Javelin

Order No.	Details
35500	FULL CARBON 600g competition javelin IAAF certified
35510	FULL CARBON 800g competition javelin IAAF certified
35520	Air Flyer 400g base model for beginners
35530	Air Flyer 500g base model for beginners IAAF certificate
35540	Air Flyer 600g base model for beginners IAAF certificate
35550	Air Flyer 700g base model for beginners IAAF certificate
35560	Air Flyer 800g base model for beginners IAAF certificate
35570	Sky Challenger 500g model for advanced competitors IAAF certificate
35580	Sky Challenger 600g model for advanced competitors IAAF certificate
35590	Sky Challenger 700g model for advanced competitors IAAF certificate
35600	Sky Challenger 800g model for advanced competitors IAAF certificate
35610	Space Master 600g top competition javelin model IAAF
35620	Space Master 600g top competition javelin model IAAF
35630	Space Master 700g top competition javelin model IAAF
35640	Space Master 800g top competition javelin model IAAF certificate
35650	Space Master 500g, 2013 model, top competition javelin model with cigar head, IAAF certificate
35660	Space Master 600g, 2013 model, top competition javelin model with cigar head, IAAF certificate
35670	Space Master 700g, 2013 model, top competition javelin model with cigar head, IAAF certificate
35680	Space Master 800g, 2013 model, top competition javelin model with cigar head, IAA



ويوز التتاراة والمقاولات ك. م. م .

WAVES Competition stainless steel hammer

Tel: +974 4441 6319, Fax: +974 44416312
P.O.Box: 82433, Doha, Qatar
Email: info@waves-qatar.com
Website: www.waves-qatar.com

The competition stainless steel hammer is made from stainless steel. It is designed for competition purpose. The whole surface is turned. The hammers are powder coated. The swivel is made from high quality hardened steel.



Order No	Weight
31720	3.00 kg, Diameter 95 mm
31730	4.00 kg, Diameter 95 mm, IAAF certified
31740	5.00 kg, Diameter 100 mm, IAAF certified
31750	5.45 kg, Diameter 105 mm, IAAF certified
31760	5.45 kg, Diameter 110 mm, IAAF certified
31770	6.00 kg, Diameter 110 mm, IAAF certified
31780	7.26 kg, Diameter 110 mm



Training steel hammer

The training steel hammer is made from steel. It is designed for training purpose. The hammers are powder coated. The swivel is made from high quality hardened steel.

Order No	Weight
32080	1.00 kg
32090	2.00 kg
32100	2.50 kg
32110	2.80 kg
32120	3.00 kg



Competition steel hammer

The competition steel hammer is made from steel. It is designed for competition purpose. The whole surface is turned. The hammers are powder coated. The swivel is made from high quality hardened steel.



Order No	Weight
31590	4.00 kg, Diameter 95 mm, IAAF certified
31610	5.00 kg, Diameter 100 mm, IAAF certified
31630	6.00 kg, Diameter 105 mm, IAAF certified
31640	6.00 kg, Diameter 110 mm, IAAF certified
31650	7.26 kg, Diameter 110 mm, IAAF certified

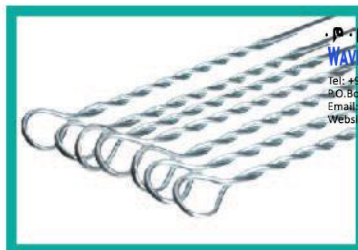

Hammer glove

Order No. 32000

The hammer glove is made from genuine leather. It is available in four different sizes. There are gloves for left-handed and right-handed throwers.

Hammer handle

Order No. 31700 - straight

The hammer handle is made from duraluminium and steel wire. It is powder coated. The light and very durable structure is available in a straight and a curved version.



Competition brass hammer

The competition brass hammer is made from brass. It is designed for competition purpose. The whole surface is turned and sanded. The swivel is made from high quality hardened steel



Order No	Details
31530	3.00 kg, Diameter: 95 mm
31540	4.00 kg, Diameter: 95 mm, IAAF certified
31550	5.00 kg, Diameter: 100 mm, IAAF certified
31560	5.45 kg, Diameter: 110 mm, IAAF certified
31570	6.00 kg, Diameter: 105 mm, IAAF certified
31580	7.26 kg, Diameter: 110 mm, IAAF certified



Hammer Wire

Order No. 31700

The hammer wire is made from galvanized steel. The diameter of the wire is 3 mm. The wire is available in different lengths from 360 to 1000 mm.



Hammer bag

Order No. 31870

The bag is made from waterproof synthetic fabric. For closing the bag a Velcro is attached. the handle is made from special sturdy material. the bag can be used for shot put and hammer.



ويغز للتجارة والمقاولات ك.م.م.
WAVES TRADING & CONTRACTING W.L.L.

Tel: +974 4441 6319, Fax: +974 44416312
P.O.Box: 82431, Doha - Qatar
Email: info@waves-qatar.com
Website: www.waves-qatar.com



Shot Put Rack

The shot put rack is made from aluminium. The sturdy construction is welded in one piece. The turning wheels increase the handling comfort of this rack. It provides space for up to 10 shots.

Order No. 30350

Shot put rack, made from aluminium, mobile system

Order No. 30360

Shot rack, made from aluminium, stationary version

Discus Rack

The discus rack is made from aluminium. The sturdy construction is welded in one piece. The turning wheels increase the handling comfort of this rack. It provides space for up to 14 discuses.

Order No. 30370

Discus rack, made from aluminium, mobile system

Order No. 30380

Discus rack, made from aluminium, stationary version



Javelin Rack

The javelin rack is made from aluminium. The sturdy construction is welded in one piece. The turning wheels increase the handling comfort of this rack. It provides space for up to 15 javelins.

Order No. 30390

Javelin rack, made from aluminium, mobile system

Order No. 30400

Javelin rack, made from aluminium, stationary version

Hammer Rack

The hammerrack is made from aluminium. The sturdy construction is welded together. This rack is free standing. It can be placed anywhere, where needed. It provides space for up to 6 hammers.

Order No. 30410

Hammer rack, made from aluminium, mobile system

Order No. 30420

Hammer rack, made from aluminium, stationary version



Combo Rack for Discus, Hammer, Shot

Order No. 30425

Made from aluminium special profile. Made of mill-finished aluminium with 2 swivel castors and 2 fixed wheels, wheel diameter approx. 120 mm and powder painted. Holds 12 javelin, 14 discus, 8 hammers and approx.16 shot puts.

Tel: +974 4441 6319, Fax: +974 44416312
P.O.Box: 82431, Doha - Qatar
Email: info@waves-qatar.com
Website: www.waves-qatar.com



Distance Marker Boxes

Made from fibreglass-reinforced plastic for shot-put, discus, hammer and javelin throw. Triangular numbered, stackable. With single-digit numbers, height 35 cm, numbers 20 cm high.

Order No. 31810

Distance marker boxes for shot put. Numbers 12, 14, 16, 18, 20, 22 m (1 Set 12 PCS)

Order No. 31800

Distance marker boxes for hammer, discus, and javelins. Numbers 40, 45, 50, 55, 60, 65, 70, 75, 80, 85, 90 m (1 Set 22 PCS)





Marker

Order No. 10891

Field marker set. Set of 10 markers to be put on the ground, made of steel, white powder coated, dark blue visible digits.

Order No.10892

Field marker set. Set of 1 markers to be put on the ground, made of steel, white powder coated, dark blue visible digits

Order No.10889

Sheet Aluminium Distance Marker, Square, 20 x 18 cm. White powder coated, with numbers on both sides. Numbered 1 – 12

Order No.10890

Marker spikes, made from steel. Powder coated. Numbered 1 -12, length: 40 cm



Disabled Shot Put & Discus circle

Order No. 30170

Disabled accessible shot put circle. Made of aluminium. Diameter 213.5cm, in two parts with additional struts. Incl. bolts, nuts and 6 special socket heads

Order No. 30180

disabled accessible discus circle. Made of aluminium. Diameter 250 cm , in two parts with additional struts. Incl. bolts, nuts and 6 special socket heads

Order No. 30165

Ground socket special for disable wheelchair. Made from aluminium with coatable cover



Mobile throwing circles

Order No. 30165

Mobile throwing circle with fastenings for throwers chair. The plate provide various attachment points which guarantee a firm hold. Made from Aluminium.



Mobile throwing circles

Order No. 30210

Mobile shot put circle, handicapped accessible. With additional 6 socket heads with lid where the wheelchair user can fix on the lashing belt. Made from timber wood.

Order No. 30220

Mobile discus circle, handicapped accessible. With additional 6 socket heads with lid where the wheelchair user can fix on the lashing belt. Made from timber wood.



ويوز للتجارة والمقاولات ك.م.م.

WAVES TRADING & CONTRACTING W.L.L.

Tel: +974 4441 6319, Fax: +974 44416312

P.O.Box: 82431, Doha - Qatar

Email: info@waves-qatar.com

Website: www.waves-qatar.com



Roll Back Rail

Order No. 30470

Roll back rail for Shots. Robust aluminium construction with large supports. Length 20 m. Channel width 100 mm, channel ends with rubber stoppers. On request: The channel can be purchased in assorted colours



Chalk Stand

Order No. 33080

Mobile Chalk Stand made of aluminium material, powder coated, 71 cm high. Funnel diameter about 38 cm. Includes casters.



ويفز للتجارة والمقاولات ك.م.م.
WAVES TRADING & CONTRACTING W.L.L.

Tel: +974 4441 6319, Fax: +974 44416312
P.O.Box: 82431, Doha - Qatar
Email: info@waves-qatar.com
Website: www.waves-qatar.com

Long Jump & Triple Jump

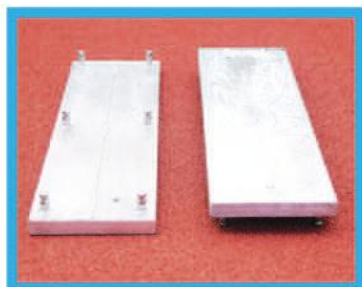

Blanking Beam without Rubber

Order No. 40010

(Dimension: 122 x 34 x 10 cm)

The blanking beam without rubber measures 122 x 34 x 10 cm. It is made from special aluminium profile. The system is easy to adjustable by screws.



Blanking Beam with Rubber

Order No. 40290

(Dimension: 122 x 34 x 10 cm)

The blanking beam with rubber is similar to Order No. 10010. Additionally the surface is covered with rubber.

Order No. 40300

(Dimension: 122 x 30 x 10 cm)

The blanking beam with rubber is similar to Order No. 13350. The items differ in the size. The width of this blanking beam is 30 cm only.



Installation through for Take-Off Board

Order No. 40030

(Dimension: 122 x 34 x 10 cm)

The installation through is made from aluminium. This item measures 122 x 34 x 10 cm. The sturdy aluminium construction is extremely durable.

Order No. 40060

(Dimension: 122 x 30 x 10 cm)

Order No. 40040

(Dimension: 122 x 34 x 10 cm)

The height adjustable installation through is similar to Order No. 10030. Additionally, the height can be adjusted with screws easily.

Order No. 40050

Height adjustable installation through

(Dimension 122 x 30 x 10 cm)





ويفز للتجارة والمقاولات ك.م.م.
WAVES TRADING & CONTRACTING W.L.L.

Tel: +974 4441 6319, Fax: +974 44416312
P.O. Box: 82431, Doha - Qatar
Email: info@waves-qatar.com
Website: www.waves-qatar.com



Competition Take-Off Board (Synthetic Material)

Order No. 40140

The competition take-off board synthetic material is made from UV resistant synthetic PE. The PE is long lasting and maintenance free. The board measures 122 x 34 x 10 cm. The parts of the board are connected with screws. The board includes item no. 10070. This item is certified by the IAAF.



Competition Take-Off Board (Hardwood)

Order No. 40130

The competition take-off board hardwood is made from multilayer laminated hardwood. The wood is painted. The board measures 122 x 34 x 10 cm. The parts of the board are connected with screws. The board includes item no. 10070. This item is certified by the IAAF.



① Blanking Board

② Training

③ Competition

Take-Off Board as a turning beam for Training and Competition

Order No. 40150

Take-off board. The "three in one" (122 x 34 x 10 cm) take-off board provides maximum flexibility. The individual segments can be simply taken out and turned around so that the take-off boards can be used in three separate ways.

1. Take-off board for competitions, reversible profile with an inlay for the indicator board.
2. Take-off board for school sports or training. In this case the reversible profile just has to be turned round.
3. Take-off board used as a blanking board.

The aluminium carrier profile of the "three in one" take-off board is covered with a hardened running track synthetic. Both the running track synthetic and the white plastic on the take-off surface are additionally UV stabilised to prevent the colours from fading.



Control Strip With Synthetic Material Filling

Order No. 40090

The control strip is made from synthetic material. The strip is used for competition purpose only. The control strip is in accordance with the IAAF Rule 185.



Inlay Profile From Timber Wood

Order No. 40080

The inlay profile is made from timber wood. The profile is shaped to match with the take off board exactly. This item is used for training purpose only.

Inlay Profile From Rubber And Aluminium

Order No. 40100

The inlay profile is made from aluminium and rubber. The profile is strengthened by a aluminium structure. It is filled with synthetic material. This item is used for training purpose only.

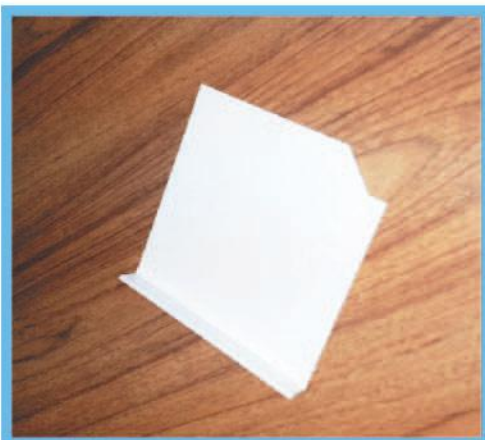

Proof Puller

Order No. 40270

The proof puller is made from aluminium. It is designed to ensure the correct shape of the plasticine.



Template Timber

Order No. 40120

Template timber, for exact positioning of plasticine



ويمز للتجارة والمقاولات ك.م.م.
WAVES TRADING & CONTRACTING W.L.L.

Tel: +974 4441 6319, Fax: +974 49116312
P.O.Box: 82431, Doha - Qatar
Email: info@waves-qatar.com
Website: www.waves-qatar.com



Run Up Markers

Order No. 40220

The run up markers are made from aluminum. They are welded in a single piece. The item is used to mark the starting point for the run up. The markers are available in assorted colors.

Take Off Markers

Order No. 40210

The take-off markers are made from aluminium. They are roof shaped. The marker has white with black stripes on both sides.

Tape Measurement

Order No. 10980

The measurement tape is made from fiberglass. The length of the measurement tape is 10 meter.



Long Jump Sand Pit Covering

Order No. 40180

The long jump sand pit covering is made from polyester net fabric. The synthetic material is surrounded by seam. The used materials are water permeable and spike proof. The seam is supported by an link chain to increase the weight of the covering. The weight is about 400 g/sqm.



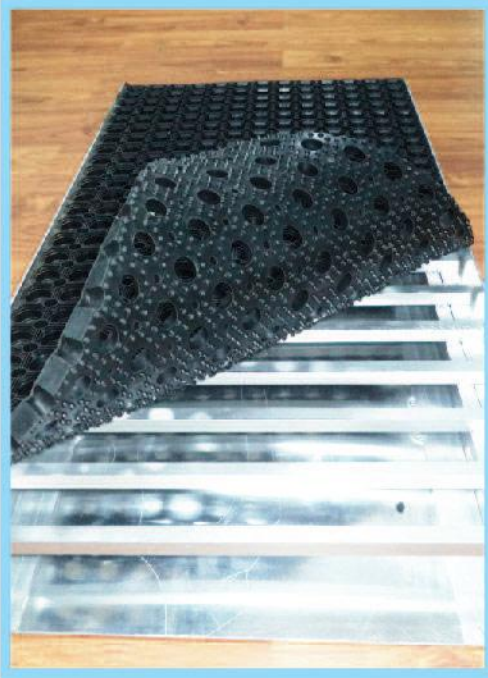

Aluminium Sand Trap

Order No. 40420

The aluminium sand trap is made from special aluminium profile. The dimension of the sand trap is 100 x 50 x 12 cm. The sand trap consists of the trap and aluminium grate and a rubber mat. Due to the lightweight the sand traps are easy to handle during the installation.



Measuring Board for Long Jump

Order No. 40190

The measuring board for long jump is made from aluminium. The surface is white powder coated. The board shows distances from 3 to 9 m. The distance is marked on both sides of the board.

Measuring Board for Triple Jump

Order No. 40200

The measuring board for triple jump is made from aluminium. The surface is white powder coated. The board shows distances from 3 to 9 m. The distance is marked on both sides of the board.



ويغز للتجارة والمقاولات ك.م.م.
WAVES TRADING & CONTRACTING W.L.L.

Tel: +974 4441 6319
P.O.Box: 82431, Doha - Qatar
Email: info@waves-qatar.com
Website: www.waves-qatar.com

Order No. 10302

This rake and shovel is highly recommended for professional use. It is engineered to the specifications of the landscapers. Extended striking edge on this rake was designed specially for grading.

② Rake with handle

Order No. 10300

This rake is highly recommended for professional use. The rake is equipped with a handle. It is engineered to the specifications of landscapers. The rake is designed especially for sand surfaces.



③ Sand Smoothing with Handle

Order No. 10301

This Sand Rake is highly recommended for professional use. Engineered to the specifications of landscapers and sand ground. Extended striking edge on this rake was designed specifically for grading.

④ Track Broom

Order No. 40260

The track broom is made to clean the track. It is completed with a handle. The width is 1000 mm. This track broom is highly recommended for professional use. It is engineered to the specifications of landscapers. The broom makes it easy to keep the track clean.

Elastic Curbing

Soft Curbing of polymer concrete with EPDM rubber profile in black or white are special structural elements for bordering tracks, separating fields and setting boundaries of jumpa pits or shotput areas. The rubber profile is encapsulated in the polymer concrete and provides the highest degree of safety due to the elasticity of the material and the rounded edges. Cross-sections of 5 cm provide numerous means of individual design.

Accessories :

Adjustment piece, 1 = 50 cm

Corner piece, leg length 25 cm

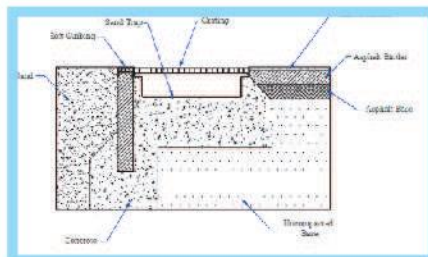

Order No. 40330

White Colour

Size 100 x 5 x 250 cm

Order No. 40340

Black Colour

Size 100 x 5 x 250 cm

Order No. 40530

White Colour

Size 100 x 5 x 40 cm

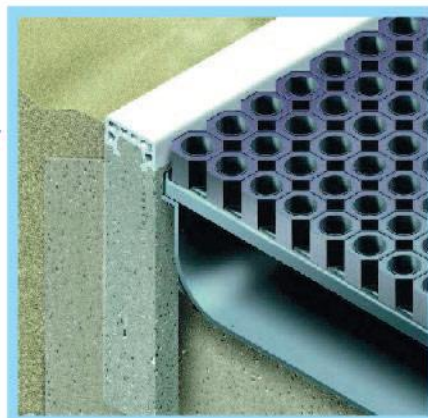

Order No. 40360

White Colour

Corner Part

Size L = 30 x 30 x W x 5 = 25 cm

Order No. 40370

Black Colour

Corner Part

Size L = 30 x 30 x W x 5 = 25 cm

Order No. 40380

White Colour

Corner Part

Size L = 30 x 30 x W x 6 = 40cm



ويفز للتجارة والمقاولات ك. م. م .

WAVES TRADING & CONTRACTING W.L.L.

Tel: +974 4441 6319, Fax: +974 44416312
P.O. Box: 82431, Doha - Qatar
Email: info@waves-qatar.com
Website: www.waves-qatar.com



Volleyball





Volleyball Post Training & School Sports

Order No. 50200

the Volleyball post for training is made from special aluminium profile. The volleyball post is 250cm High and made 100 x 120mm aluminium profile. The mechanism for the height adjustment is placed outside the post.
 Powder coated.

2 Years Warrenty



ويتم للتجارة والمقاولات ك. م. م.
WAVES TRADING & CONTRACTING W.L.L.

Tel: +974 4441 6319, Fax: +974 44416312
P.O.Box: 82431, Doha - Qatar
Email: info@waves-qatar.com
Website: www.waves-qatar.com



Volleyball Post Competition 1

Order No. 50310

Made from aluminium. Our competition posts have a 120 x 100 mm cross-section and a wall thickness of 4 to 6 mm. The net tensioning device and height adjustment mechanism are incorporated in the competition posts. The height adjustment is done by hand. Yellow powder coated.

2 Years warranty

Volleyball Post Competition 2

Order No. 50320

made from aluminium. Our competition posts have a 120 x 100 mm cross-section and a wall thickness of 4 to 6 mm. The net tensioning device and height adjustment mechanism are incorporated in the competition posts. The height can be easily and smoothly adjusted using a crank handle which can be removed during a game or for storage. Yellow powder coated.

2 Years warranty





Mobile Volleyball Post

Order No. 50210

The Mobile Volleyball Post is made from special aluminium profile. This post suits all net games. (Volleyball, Badminton, Tennis) Can be used for in-and -out door. The game post is 250cm high and made 120 x 120mm aluminium profile. The weight is approx 120kg/post. Concealed tension mechanism. The fold-away crank is fixed in place to prevent loose. Large transport wheels on the heavy base for easy transport.

8 Years Warranty



شركة التجارة والمقاولات
WAVES TRADING & CONTRACTING W.L.L.

Tel: +974 7433 6633
P.O.Box: 52433, Doha, Qatar
Email: info@waves-qatar.com
Website: www.waves-qatar.com



Beach Volleyball Post for Training

Order No. 50370

Made from special aluminium profile. For in-and-out door, The volleyball post is 250cm high and made 100 x 120mm aluminium profile. The mechanism for the height adjustment outside the post. Yellow Powder coated.

2 Years warranty





Beach Volleyball Competition Post

Order No. 50330

Made from aluminium. Our competition posts have a 120 x 100 mm cross-section and a wall thickness of 4 to 6 mm. The net tensioning device and height adjustment mechanism are incorporated in the competition posts. Competition 1 please mark height adjustment done by hand Yellow powder coated. 2 Years warranty.

Order No. 50340

Made from aluminium. Our competition posts have a 120 x 100 mm cross-section and a wall thickness of 4 to 6 mm. The net tensioning device and height adjustment mechanism are incorporated in the competition posts. The height can be easily and smoothly adjusted using a crank handle which can be removed during a game or for storage. Competition 2 please mark height adjustment when the net is stretched. Yellow powder coated. 2 Years warranty.

Order No. 50345

Padding for beach volleyball. Yellow color.



ويفز للتجارة والمقاولات ك.م.م.
WAVES TRADING & CONTRACTING W.L.L.

Tel: +974 4441 6319, Fax: +974 44416312
P.O.Box: 82431, Doha- Qatar
Email: info@waves-qatar.com
Website: www.waves-qatar.com



Volleyball Padding

Order No. 50270

PVC covered padding with foam core for volleyball posts. The padding has been specially designed so that it does not have to be loosened or removed when the net is being tightened or the height adjusted.

Volleyball Chair

Order No. 50180

Competition Volleyball Umpire chair. Made from special aluminium profile with padding. Powder coated. Height adjustable version. The chair can be transported easy due to the attached transport wheel.

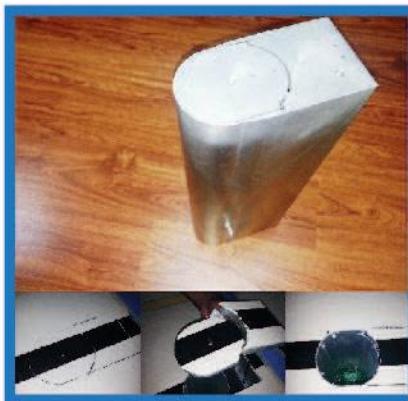

Order No. 50395

Standard ground socket for Soccer Goal Post with lid. Made from aluminum, Depth 350 mm.

Length 400 mm.

Order No. 50450

Special ground socket for Soccer Goal Post, length 800 mm. With coat able cover. Depth 350 mm.

Length 400 mm.



Beach Volleyball Marking Kit for Training

Order No. 50080
Marking Kit Training
White color



Beach Volleyball Marking Kit for Competition

Order No. 50069
Beach volleyball court marking kit, marking kit 8 x 16m.
Blue color

Order No. 50070
Beach volleyball court marking kit, marking kit 8 x 16m.
Blue color



Beach Volleyball Net Training

Order No. 50040
Beach volleyball net.
Made from PP 3 mm. Yellow

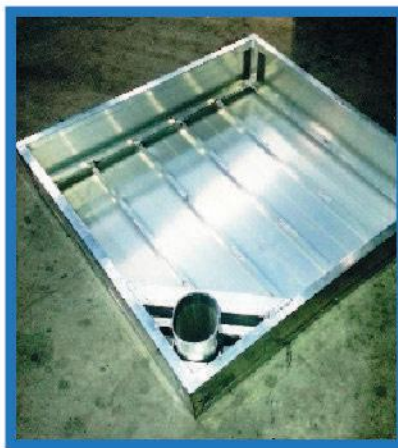

Beach Volleyball Installation Box

Order No. 50500
Aluminium installation box for burying in the sand surface.
The receptacles for the upright posts are just hooked on. This means that no base plates are needed.



ويغز للتجارة والمقاولات ك.م.م.
WAVES TRADING & CONTRACTING W.L.L.

Tel: +974 4441 6319, Fax: +974 44416312
P.O.Box: 82431, Doha - Qatar
Email: info@waves-qatar.com
Website: www.waves-qatar.com



Beach Volleyball Net Tournament

Order No. 50050

Beach volleyball tournament net in approx. 3 mm knotless polypropylene with a 10.70 m Kevlar cord at the top and tensioning rope at the bottom. polyester band at the sides with fibreglass dowel reinforcement, 4-point suspension and 4 tensioning cords with snap lock. 80 mm wide, neon yellow band all the way round.



Volleyball Nets

Regulation dimensions : 9.50 m long, 1 m high, mesh size 10 cm, steel or Kevlar cable, or nylon tie cord (11.70 m long).

Order No. 50000

Volleyball training net in approx. 3 mm polyethylene cord, 9.50 m long, 1 m high. Colour black.

Order No. 50010

Volleyball training net in approx. 2 mm polyethylene cord 9.50 m long, 1 m high. Colour black.

Order No. 50020

Volleyball competition net, made by PP Ø 3 mm. 9.50 m long, 6-point suspension, fibreglass-reinforced polyester rods sewn into the sides at each end and Kevlar cable (11.70 m long) with tension pulley above. 70 mm wide headband and continuous 50 mm wide band along

the bottom. Black.

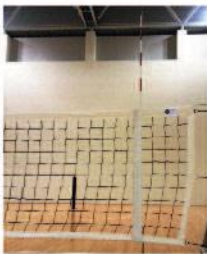

Volleyball Net Antenna

Order No. 50130

One-piece volleyball antennae. Length 1.80 m. Supplied complete with coated polyester pockets and boundary marker.

According to the rules of international volleyball, antenna pockets must incorporate a white strip, 5 cm wide, which serves as a boundary marker, and a black pouch for the antenna. The white boundary marker and black pouch must form a complete unit.



Mobile floor Apparatus

Order No. 50590

Mobile floor apparatus for Volleyball post. Made from steel and powder coated. Easy handling since weight can be removed separately. Incl padding to cover the apparatus complete after installation.

50590 Weight 350 Kg

50595 Weight 650 Kg

50600 Weight 1050 Kg



ويفز للتجارة والمقاولات ك. م. م.
WAVES TRADING & CONTRACTING W.L.L.

Tel: +974 4441 6319, Fax: +974 44416312
P.O.Box: 82431, Doha - Qatar
Email: info@waves-qatar.com
Website: www.waves-qatar.com



Badminton





Badminton Post Mobile

Order No. 60040

Conforms to Regulations, (BWF Approved)! Extremely strong, powder-coated sectional aluminium construction. 40 x 40 mm aluminium posts with stable T-base, adjustable pulleys on top for fine adjustment of the net height. Heavy counterweights with large wheels, rubber floor pads and threaded inserts for attachment of an additional weight block for even more stability. Supplied with net stretching strap. Weight per post about 70 kg, for great stability. Posts do not protrude onto the court!

Order No. 60070

Badminton post, TOURNAMENT system. Included belt. Each post weight about 110 kg. Without badminton net. Powder coated blue color. Made by aluminium. Stable T-base, adjustable pulleys on top for fine adjustment of the regulation net height.





ويغز للتجارة والمقاولات ك.م.م.

WAVES TRAINING & CONTRACTING W.L.L.

Tel: +974 4441 6319, Fax: +974 44416319
P.O.Box: 82431, Doha, Qatar
Email: info@waves-qatar.com
Website: www.waves-qatar.com



Order No. 60090
Ground socket for Takraw Post
Standard System D = 40 x 40 mm,
made by Aluminium



Order No. 60100
Ground socket for Takraw Post
Special System D = 40 x 40 mm, with
coatable cover, made by Aluminium



Order No. 60110
Ground Socket Cover for Sprung
Floor, light metal flange &
plastic lid (without floor covering)

Badminton Post in Ground Sockets

Order No. 60080

Badminton post for ground socket. Extremely strong, powder-coated sectional aluminium construction. 40 x 40 mm aluminium posts adjustable pulleys on top for fine adjustment of the net height. Our adjustable pulley guarantees always the appropriate competition height. Incl. pulley net stretching strap for easy net tensioning.

Delivery not include Ground Sockets and Lids.



Badminton Umpire Chair, Power Coated

Order No. 60120

Badminton umpire chair: Made from aluminium with stable ladder. Writing board can be folded away. Light UV resistant plastic moulded seat.(Alternative powder coated aluminium seat)
 Space-saving storage (foldable) and easy to transport. The protectors on the end of the legs ensure there is no damage to the playing surface. Weatherproof and maintenance- free.

Seat height: 155 cm, Total height: About 195 cm.

Powder coated.



Badminton Mat

Order No. 60200

Overall play area: 15meter x 7.2meter Make by high quality PVC with thickness 7mm.
A court separated by 4 rolls with 1.8meter width.

Top layer 1.5mm

Pattern: Sand Surface Shelf

Remarks: 1 Special UV treatment is applied for the surface, better wear- resisting and anti-fouling performance.

Remarks:

1 Special UV treatment is applied for the surface, better wear-resisting and anti fouling ability elevation.



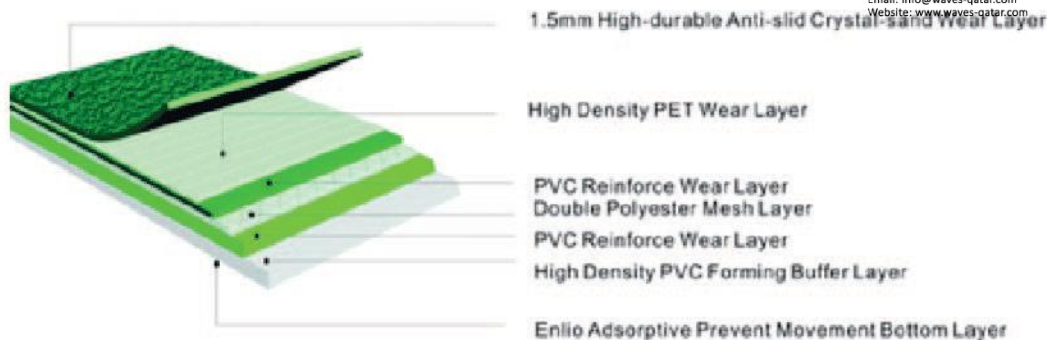

The materials of the floor are virgin materials instead of recycled materials to make sure the high quality of our floors. The price of our floors is the most competitive in the market in the same quality products.

The application occasions:

- 1, This model is applied to badminton; gymnasium; dancing room and others
- 2, Our other pvc flooring are applicable for all kinds of sports court; universities and colleges; elementary and junior school; kindergarten; gym; dancing room; shopping center; hotel; relaxation room of enterprises and multifunction rooms.

Advantage:

- 1, mobile installation, easy cleaning and comfortable feeling.
- 2, we are manufacturer, so specification and color can as be your requirement if your order is over 800SQM.
- 3, our PVC floor is 100% pure PVC material instead of recycled materials
- 4, we are the PVC flooring supplier of 2008 Beijing Olympic Games
- 5, Taking everything into consideration, you will find that our prices are comparably favorable with the quotations you can get else where.

BWF certificate in Progress



Badminton Net

Badminton tournament nets in international dimensions: length 6.02 m,height 0.76 m, mesh size approx. 18 mm, 6.60 m long steel or Kevlar cable.

Order No. 60000

Badminton net, made from PP \varnothing 1.8 mm. Black color.

Order No.60010

Badminton net, made from nylon \varnothing 1, 2 mm. Black color.

Order No.60015

Badminton tournament net in approx. 1.2 mm high tenacity polypropylene, mesh size approx. 18 mm, with polyester rods, 6.60 m long. Black color.



ويفز للتجارة والمقاولات ك.م.م.
WAVES TRADING & CONTRACTING W.L.L.

Tel: +974 4441 6319, Fax: +974 44416312
P.O.Box: 82431, Doha - Qatar
Email: info@waves-qatar.com
Website: www.waves-qatar.com

NO
2011



Badminton





Badminton Post Mobile

Order No. 60040

Conforms to Regulations, (BWF Approved)! Extremely strong, powder-coated sectional aluminium construction. 40 x 40 mm aluminium posts with stable T-base, adjustable pulleys on top for fine adjustment of the net height. Heavy counterweights with large wheels, rubber floor pads and threaded inserts for attachment of an additional weight block for even more stability. Supplied with net stretching strap. Weight per post about 70 kg, for great stability. Posts do not protrude onto the court!

Order No. 60070

Badminton post, TOURNAMENT system. Included belt. Each post weight about 110 kg. Without badminton net. Powder coated blue color. Made by aluminium. Stable T-base, adjustable pulleys on top for fine adjustment of the regulation net height.





ويفز للتجارة والمقاولات ك.م.م.
WAVES TRADING & CONTRACTING W.L.L.

Tel: +974 4441 6319, Fax: +974 44416312
P.O.Box: 87431, Doha, Qatar
Email: info@waves-qatar.com
Website: www.waves-qatar.com



Order No. **60090**
Ground socket for Takraw Post
Standard System D = 40 x 40 mm,
made by Aluminium



Order No. **60100**
Ground socket for Takraw Post
Special System D = 40 x 40 mm, with
coatable cover, made by Aluminium



Order No. **60110**
Ground Socket Cover for Sprung
Floor, light metal flange &
plastic lid (without floor covering)

Badminton Post in Ground Sockets

Order No. 60080

Badminton post for ground socket. Extremely strong, powder-coated sectional aluminium construction. 40 x 40 mm aluminium posts adjustable pulleys on top for fine adjustment of the net height. Our adjustable pulley guarantees always the appropriate competition height. Incl. pulley net stretching strap for easy net tensioning.

Delivery not include Ground Sockets and Lids.



Badminton Umpire Chair, Power Coated

Order No. 60120

Badminton umpire chair: Made from aluminium with stable ladder. Writing board can be folded away. Light UV resistant plastic moulded seat.(Alternative powder coated aluminium seat)
 Space-saving storage (foldable) and easy to transport. The protectors on the end of the legs ensure there is no damage to the playing surface. Weatherproof and maintenance- free.

Seat height: 155 cm, Total height: About 195 cm.

Powder coated.



ويفز للتجارة والمقاولات كذ . م . م .
WAVES TRADING & CONTRACTING W.L.L.

Tel: +974 4441 6319, Fax: +974 44416312
P.O.Box: 82431, Doha - Qatar
Email: info@waves-qatar.com
Website: www.waves-qatar.com



Badminton Mat

Order No. 60200

Overall play area: 15meter x 7.2meter Make by high quality PVC with thickness 7mm.
A court separated by 4 rolls with 1.8meter width.

Top layer 1.5mm

Pattern: Sand Surface Shelf

Remarks: 1 Special UV treatment is applied for the surface, better wear- resisting and anti-fouling performance.

Remarks:

1 Special UV treatment is applied for the surface, better wear-resisting and anti fouling ability elevation.



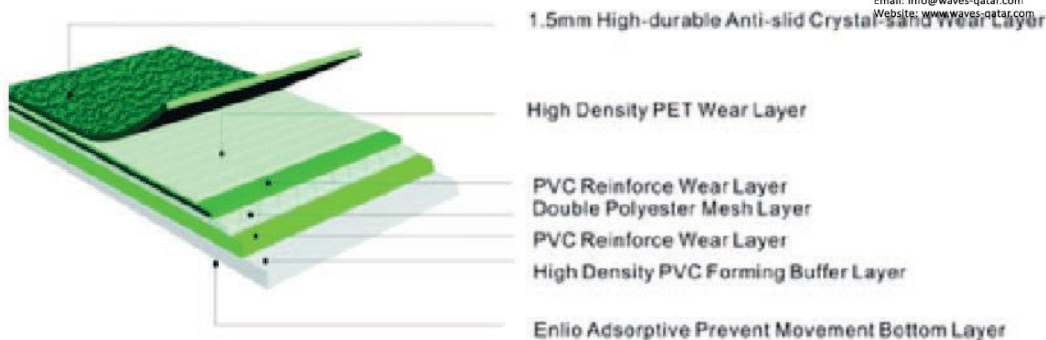

The materials of the floor are virgin materials instead of recycled materials to make sure the high quality of our floors. The price of our floors is the most competitive in the market in the same quality products.

The application occasions:

- 1, This model is applied to badminton; gymnasium; dancing room and others
- 2, Our other pvc flooring are applicable for all kinds of sports court; universities and colleges; elementary and junior school; kindergarten; gym; dancing room; shopping center; hotel; relaxation room of enterprises and multifunction rooms.

Advantage:

- 1, mobile installation, easy cleaning and comfortable feeling.
- 2, we are manufacturer, so specification and color can as be your requirement if your order is over 800SQM.
- 3, our PVC floor is 100% pure PVC material instead of recycled materials
- 4, we are the PVC flooring supplier of 2008 Beijing Olympic Games
- 5, Taking everything into consideration, you will find that our prices are comparably favorable with the quotations you can get else where.

BWF certificate in Progress



Badminton Net

Badminton tournament nets in international dimensions: length 6.02 m,height 0.76 m, mesh size approx. 18 mm, 6.60 m long steel or Kevlar cable.

Order No. 60000

Badminton net, made from PP \varnothing 1.8 mm. Black color.

Order No.60010

Badminton net, made from nylon \varnothing 1, 2 mm. Black color.

Order No.60015

Badminton tournament net in approx. 1.2 mm high tenacity polypropylene, mesh size approx. 18 mm, with polyester rods, 6.60 m long. Black color.



ويفر للتجارة والمقاولات ك.م.م
WAVES TRAINING & CONTRACTING W.L.L.

Phone: +974 3319, Fax: +974 44416312
PO-Box: 82431, Doha - Qatar
Email: info@waves-qatar.com
Website: www.waves-qatar.com



Handball



ويفز للتجارة والمقاولات ك.م.م.
WAVES TRADING & CONTRACTING W.L.L.
 Tel: +974 4441 6319, Fax: +974 44418312
 PO Box: 32433, Doha - Qatar
 Email: info@wavesqatar.com
 Website: www.waves-qatar.com

Handball Goal Post

Order No. 70000

Foldable System Upper projection; 1.25 m. Red-white stripes powder coated.

Order No. 70001

Foldable System Upper projection; 1.25 m. Blue-white stripes powder coated.

Order No. 70001

Foldable System Upper projection; 1.25 m. Black-white stripes powder coated

Order No. 70005

Foldable System Upper projection; 1.40 m. Red-white stripes powder coated.

Order No. 70006

Foldable System Upper projection; 1.40 m. Blue-white stripes powder coated

Order No. 70007

Foldable System Upper projection; 1.40 m. Black-white stripes powder coated

Order No. 70000

Handball Goal Post, 3.00 x 2.00 m. Made from aluminum. Free-standing. Upper projection; 1.25 m. Red-white stripes powder coated.

Order No. 70010

Handball Goal Post, 3.00 x 2.00 m. Made from aluminum. Free-standing. Foldable System Upper projection; 1.25 m. Red-white stripes powder coated.

Order No. 70011

Handball Goal Post, 3.00 x 2.00 m. Made from aluminum. Free-standing. Upper projection; 1.25 m. Blue-white stripes powder coated.

Order No. 70020

Handball Goal Post, 3.00 x 2.00 m. Made from aluminum. Free-standing. Upper projection; 1.40 m. Red-white stripes powder coated.

Order No. 70021

Handball Goal Post, 3.00 x 2.00 m. Made from aluminum. Free-standing. Upper projection; 1.40 m. Blue-white stripes powder coated.



ويفز للتجارة والمقاولات ك.م.م.
WAVES TRADING & CONTRACTING W.L.L.

Tel: +974 4441 6339, Fax: +974 44416312
P.O.Box: 82431, Doha - Qatar
Email: info@waves-qatar.com
Website: www.waves-qatar.com



Order No. 70080

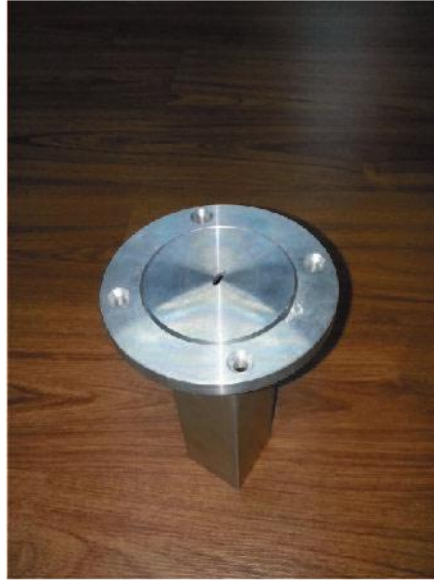

Order No. 70155

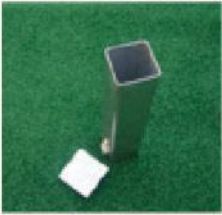

Order No. 70070

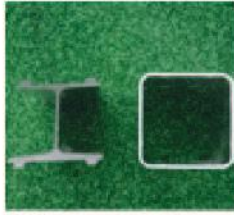

Order No. 70080



Order No. 70150



Order No. 70180 & 70190

Order No. 70070

Standard ground socket for handball, dim; 80 x 80 x 350 mm.

Order No. 70080

Adapter, for free-standing goal post

Order No. 70150

Special Ground socket for handball goal post. With coat able cover

Order No. 70155

Ground Socket Cover for Sprung Floor, light metal flange and lid. Lockable. For Indoor use.

Order No. 70180

Floor Plate, Special anchor and ground plate for installation after the gym floor has been laid

Order No. 70190

Safety Screw for floor plate

Order No. 70250

Handball goal net, white color. Projection 0.80/1.00 m.PP 4 mm

Order No. 70260

Handball Goal Net, black color. Projection 0.80/1.00 m.PP 4 mm

Order No. 70270

Handball Goal Net, green color. Projection 0.80/1.00 m.PP 4 mm

Order No. 70280

Handball Goal Net, white color. Projection 0.80/1.00 m PP 5 mm

Order No. 70290

Handball Goal Net, green color. Projection 0.80/1.00 m.PP 5 mm

Order No. 70300

Handball Goal Net, blue color. Projection 0.80/1.00 m .PP 5 mm

Order No. 70310

Handball Goal Net, red color. Projection 0.80/1.00 m PP 5 mm

Order No. 70320

Handball Goal Net, yellow color. Projection 0.80/1.00 m PP 5 mm



ويفز للتجارة والمقاولات ك. م . م .
WAVES TRADING & CONTRACTING W.L.L.

تلف: +974 4441 6319, فاكس: +974 44416312
© Box: 82431, Doha - Qatar
mail: info@waves-qatar.com
Website: www.waves-qatar.com

Tennis



Tennis Post In Ground Sockets Profile 80 x80 mm

Tennis post system made from special aluminium profiles. External Dimension 80 x 80 mm. Material thickness 3 mm. As with our tennis post, all tension and mounting mechanism are set into the profile. With removable crank handle, standard ground socket with lid and insertable rod system for securing the net.

Order No. 80040

Surface anodized

Order No. 80050

Black powder coated

Order No. 80060

Green Powder coated

Order No. 80080

White powder coated



ويجز للتجارة والمقاولات ك.م.م.
WAVES TRADING & CONTRACTING W.L.L.

Tel: +974 4441 6319, Fax: +974 44416312
P.O.Box: 82431, Doha - Qatar
Email: info@waves-qatar.com
Website: www.waves-qatar.com



Tennis Post Mobile System

Mobile tennis post system made from special aluminium square profiles. Profile 80 x 80 mm. As with our tennis post, all tension and mounting mechanism are set into the profile. With removable crank handle and insertable rod system for securing the net. The weights set into the feet provide the necessary stability.

Order No. 80310
white powder coated

Order No. 80320
aluminium surface

Order No. 80330
transport wheels for tennis post mobile system



Tennis Bench "ALUC" PARIS

Aluminium Bench Model "PARIS" Very sturdy and weatherproof aluminium benches Available in 1.50 & 2.0 m

Warranty 8 years

Order No. 80490 Aluminium bench "PARIS", white color. Length 150 cm

Order No. 80500 Aluminium bench "PARIS", green color. Length 150 cm

Order No. 80510 Aluminium bench "PARIS", white color. Length 200 cm

Order No. 80520 Aluminium bench "PARIS", green color. Length 200 cm



Tennis Umpire Chair, White Powder Coated

Order No. 80160

Tennis umpire chair: Made from aluminium with stable ladder. Writing board can be folded away. Light UV resistant plastic moulded seat.

Space-saving storage (foldable) and easy to transport. The protectors on the end of the legs ensure there is no damage to the playing surface.

Weatherproof and maintenance- free.

Seat height : 190 cm

Total height : About 230 cm.

White powder coated

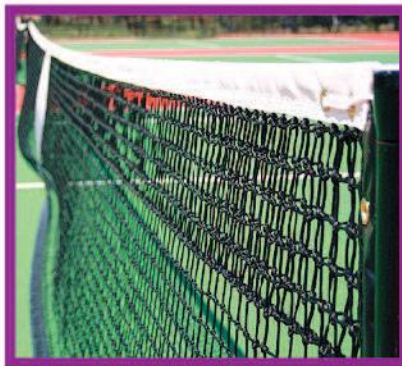

Tennis Nets

The dimensions of our standard nets for doubles courts conform to ITF (International Tennis Federation) regulations: 12.72 m x 1.07 m (imperial: 42 ft x 3.5 ft) for installation dimensions that comply with DIN EN 1510. The headband is made of extremely durable woven polyester and UV-resistant. The nets are fitted with a steel wire cable (13.20 m long) and can be used with all new net posts.

Order No. 80405

Tennis net PP 4 mm. 10 row double mesh. Imported from Europe

Order No. 80390

Tennis net PET 3.5 mm, black color

Order No. 80370

Tennis net PP 3 mm, green color

Order No. 80420

Tennis net PP 4 mm. Black color

Order No. 80425

Tennis net PP 4 mm. Green color



وبعض للتجارة والمقاولات ك.م.م.
WAVES TENTS & CONTAINERS QATAR
 Tel: +974 4441 6319, Fax: +974 44416312
 P.O.Box: 82431, Doha - Qatar
 Email: info@waves-qatar.com
 Website: www.waves-qatar.com



Colour 010 : Light Green
 Colour 015 : Dark Green
 Colour 04 : Blue
 Colour 07 : Red
 Colour 86 : Cream

Surcharge for smaller nets:
 For each net below 5 m² + 100 %
 For each net below 10 m²+ 35 %
 For each net below 20 m² + 20 % per single net.

Tennis Court Surrounds

Standard tennis court surround, 200 g/m², 12 m long, 2 m high, breathable. Reinforced all the way round with metal eyelets about every 50 cm. Our surrounds and indoor panelling are manufactured from breathable polyethylene and therefore do not damage fencing. Made in Europe.

- 80170: Wind breaker, 18 x 2 m, dark green
- 80171: Wind breaker, dark green (Dimension on request SQM)
- 80180: Wind breaker, 12 x 2 m, light green
- 80190: Wind breaker, 12 x 2 m dark green
- 80200: Wind breaker, 12 x 2 m blue
- 80210 : Wind breaker, 12x 2 m red



Centre Strap With Weight

Order No. 80140
 Centre Strap of Nylon with adjustable loops and snap hooks.

Order No. 80130
 Weight for centre strap. Made from aluminium. Weight approx 7 Kg

Single Net Supports

Order No. 80340
 Net Supports, made of aluminium with floor-protecting, large round base and net bracket made of aluminium for adjustment of the mandatory net height of single games. White powder coated.





ويغز للتجارة والمقاولات ك.م.م.
WAVES TRADING & CONTRACTING W.L.L.
 Tel: +974 4441 6319, Fax: +974 44416319
 P.O. Box- 82451, Doha - Qatar
 Email: info@waves-qatar.com
 Website: www.waves-qatar.com

Tennis Post Mobile Model T base

Order No. 80331

Tennis Post Mobile Model T Base

External Dimension 80 x 80 mm. Material thickness 3 mm

All tension and mounting mechanism are set into the profile. With removable crank handle, and insert able rod system for securing the net extremely strong, powder-coated sectional aluminium construction. With stable T-base, Heavy counterweights with large wheels, rubber floor pads and threaded inserts for attachment of an additional weight block for even more stability. Weight per post about 100 kg, for great stability. (1 pair = 2 piece) Posts do not protrude onto the court!

Half Court Tennis

Order No. 80410

Half court tennis mobile, dismantle free standing made by aluminium length 6, 10m High 0,80 m,





ويفز للتجارة والمقاولات ك. م. م.
WAVES TRADING & CONTRACTING W.L.L.

Tel: +974 4441 6319, Fax: +974 44416312
P.O.Box: 82431, Doha- Qatar
Email: info@waves-qatar.com
Website: www.waves-qatar.com



Match Aluminium Pointer Free Standing

Order No. 80980

Weatherproof aluminium powder coated match pointer. With 6 adjustment discs for 3 sets. Numbers about 5 cm high. Included powder coated aluminium Stand. (Free standing version). Hard-wearing UV-resistant and weatherproof powder coated aluminium with corrosion-resistant fittings.

Order No. 80980

Hanging system, Dimension: 35 x 50 cm

Order No. 80990

Hanging system, Dimension: 50 x 65 cm

Order No. 81000

Hanging system, Dimension: 65 x 95 cm

Order No. 81005

Free standing system, Dimension: 35 x 50 cm

Order No. 81006

Free standing system, Dimension: 50 x 65 cm

Order No. 81007

Free standing system, Dimension: 65 x 95 cm



Tennis Divider Net

Order No. 80490

Dividing net in approx. 2.3 mm high tenacity polypropylene, mesh size 4.5 cm.

Dimensions: approx. 40 x 2.50 m.

Colour 01: Green

Colour 015: Dark Green

Colour 02: White

Additional features

- Steel wire cable, approx. 4 mm thick and 38 mm long, with a turnbuckle at each end.
- Lead cord weighting, 200 g per m, encased in PES webbing and attached to the net.
- Split nylon rings, 3 per m, attached to net.
- Freestanding telescopic support posts for standard dividing nets. Fully adjustable between 2 and 3 m

We recommend dark green (colour 015) and white (colour 02) for indoor courts and green (colour 01) for outdoors.

Shine Dry Court Squeegees

Order No. 82000

The Shine Dry Court Squeegee is a lightweight durable water removal device for drying tennis courts. The Dry Court will dry your court much faster than a rolling squeegee. Works on all types of hard surfaces. Removes leaves and debris while simultaneously drying your court. Use the Shine Dry Court Squeegee and your court is playable minutes even after the heaviest rain. Replaceable rubber sponge, no scraping or damage to tennis court. Adjustable rubber sponge. One spare rubber sponge included in each kit. Replacement rubber sponge also available. Easy to assemble





ويفز للتجارة والمقاولات ك.م.م.
WAVES TRADING & CONTRACTING W.L.L.

Tel: +974 4441 6319, Fax: +974 44416312
P.O.Box: 82431, Doha - Qatar
Email: info@waves-qatar.com
Website: www.waves-qatar.com

Hockey



Hockey Goal Post (Dismantle)

Order No. 90080

Hockey goals (3.66 x 2.14 m), 'Competition. Dismantle version for export. Complies with latest FIH regulations and requirements for international competitions.

Hockey goals, 'Competition' model, made of aluminium, white powder coated and with freely hanging net suspension. With this construction the net hangs freely in the goal frame so that the ball cannot bounce back out from the net support tubes. For quality and ease of handling this hockey goal is unrivalled and the following features set it apart:

1. The net hangs freely in the goal frame so that the ball cannot bounce back out from the net support tubes.
2. Goal frame profile (75 x 50 x 5 mm) which significantly reduces denting due to ball impacts
3. 30 mm thick side and backboards made of wood-reinforced aluminium profiles, coated with EPDM to reduce ball rebounds.
4. Double transport rollers for easy moving.



Field Hockey Goal Net

Order No. 90010

Knotless field hockey goal net in approx. 3 mm high tenacity. Made from polypropylene. Mesh size 4.5 cm, width 3.66 m, height 1.80 m, top depth 90 cm, bottom depth 120 cm. Green colour. Made in Spain.

Order No. 90000

Knotless field hockey goal net in approx. 2.5 mm high tenacity. Made from polypropylene. Mesh size 2.5 cm, width 3.66 m, height 1.80 m, top depth 90 cm, bottom depth 120 cm. Green colour. Made in Spain.



ويفز للتجارة والمقاولات
WAVES TRADING & CONTRACTING W.L.L.
Tel: +974 4441 6319, Fax: +974 4416991
P.O.Box: 82431, Doha - Qatar
Email: info@waves-qatar.com
Website: www.waves-qatar.com



Technical Shelter 2.5m

Order No. 90280

Technical Shelter for Hockey, made from high-grade aluminium profiles and welded in a one-piece construction. The robust construction and easy handling of our high quality Technical Shelter make them most impressive. The whole rear side of this cabin is made from plastic sheets. Lower section lined with aluminium,

Further features:

- Curved roof.
- Synthetic glass (Acryl) all around.
- Included writing table.

Standard size:

Standard length: 244 cm

Height: 250 cm

Roof overhang: 40 cm

Ground depth: 150 cm

Weight: approx. 220 kg

Order No. 90285

Length on request





Outdoor Hockey Barrier

Impact Board for Hockey Fields

For attachment to barriers and fences. Made from EPDM with aluminium core. The board is sloped so that the hockey ball is deflected downwards. The individual boards are connected with internal adapters. Dimensions: height 20.5 cm, thickness 8.5 cm top, 4.5 cm bottom. The hockey board is available in red, blue and green color.

Huge problems are experienced on many hockey pitches with extreme damage to the fence and barriers caused by the impact or the hockey ball. The hockey board protects the lower area.



Indoor Hockey Barrier, wooden/aluminium construction with special connecting mechanism. Barrier inner side with plastic-impact protection profile. Set consists of 32 barriers à 2.50 m (Weight à approx. 14 kg), easy set-up, space-saving storage.

Order No. 90240

Length 2.50 m (1Set included 32 pieces)

Order No. 90230

Length 2.00 m (1Set included 40 pieces)

Order No. 90250

Transport trolley for indoor hockey barrier. The transport cart for indoor hockey barrier is made from aluminium. It is equipped with four wheels, which allow a comfortable manoeuvring. The trolley provides space for a complete set of indoor hockey barrier.

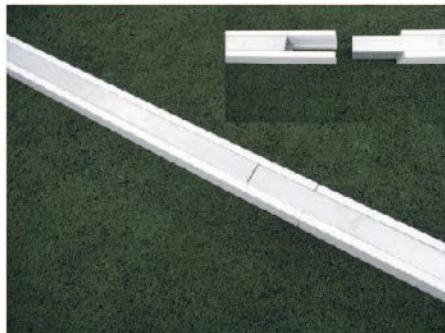

Protective Nets for Hockey Pitches

Order No. 92200/92250

Protective nets for hockey pitches. The net is made from polypropylene 4 mm, mesh size 44 mm high tenacity and available in different colors. The lower area contains a lead cord weighting approx 600g per meter. The spacer bracket (92250) is made from aluminium and produced in dimensions corresponding to the dimensions of the fence post.

Huge problems are experienced on many hockey pitches with extreme damage to the fence and barriers caused by the impact or the hockey ball. The backstop net protects the fencing.

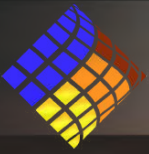

ويفز للتجارة والمقاولات ك.م.م.
WAVES TRADING & CONTRACTING W.L.L.

tel: +974 4441 6319, Fax: +974 44416312
P.O.Box: 82431, Doha - Qatar
Email: info@waves-qatar.com
Website: www.waves-qatar.com

Basketball



Netball Post Mobile Systems

Product Code :10540

Netball Post Mobile Systems. Made from high grade aluminium special profile. Powder coated in white colour. Height adjustable version. The post is attached with a weight of 40 Kg. Included ring and nylon net. Conforms to AENA regulations.

White powder coated

Order No. 100541
 Height Adjustable

Product Code :100530

Netball Post Mobile Systems. Made from high grade aluminium special profile. Aluminium surface. Height adjustable version. The post is attached with a weight of 40 Kg. Included ring and nylon net.

Aluminium Surface

Order No. 100531
 Height Adjustable



Basketball Single Post System

Basketball single-post made of aluminium profiles with a standard 2,25 m overhang. Our Single-post basketball stand is made with oval aluminium profiles with a cross-section of 120 x 100 mm. The wall thickness of this robust apparatus is 4 to 6 mm in the direction of tension. The basketball stand has an impressive visual appearance due to its delicate construction but despite that is exceptionally stable and resilient.

Delivery includes: Backboard made from white powder coated aluminium double hollow profile 180 x 105 c), ring made of galvanized and powder coated steel and nylon net are all included. Ground sockets and safety padding not include.

8 years warranty.

Order No.

100190 Basketball single-post Projection 1.65 m

100180 Basketball single-post Projection 1.25 m

1002170 Basketball single-post Projection 1.65 m

100155 Padding for Basketball Double & Single Post (available in different colours)

100460 Standard Ground Socket for Basketball Single Post Aluminium

100470 Special Ground Socket for Basketball Single Post with coat able cover



ويفز للتجارة والمقاولات ك.م.م.
WAVES TRADING & CONTRACTING W.L.L.

Tel: +974 4441 6319, Fax: +974 44416317
P.O.Box: 82431, Doha - Qatar
Email: info@waves-qatar.com
Website: www.waves-qatar.com



Basketball Double Post System

Basketball double-post with aluminium backboard. Made of aluminium profiles overhang. Our double-post basketball stand is made with oval aluminium profiles with a cross-section of 120 x 100 mm. The wall thickness of this robust apparatus is 4 to 6 mm in the direction of tension. The basketball stand has an impressive visual appearance due to its delicate construction but despite that is exceptionally stable and resilient.

Delivery includes: Backboard made from white powder coated aluminium double hollow profile 180 x 105 c), ring made of galvanized and powder coated steel and nylon net are all included.

Ground sockets and safety padding not include. **8 years warranty.**

100210 Basketball double-post Projection 0.90 m. With aluminium backboard

100220 Basketball double-post Projection 1.25 m. With aluminium backboard

100230 Basketball double-post Projection 1.65 m. With aluminium backboard

100240 Basketball double-post Projection 2.25 m. With aluminium backboard

100212 Basketball double-post Projection 0.90 m. With 15 mm acrylic backboard

100222 Basketball double-post Projection 1.25 m. With 15 mm acrylic backboard

100232 Basketball double-post Projection 1.65 m. With 15 mm acrylic backboard

100242 Basketball double-post Projection 2.25 m. With 15 mm acrylic backboard

100155 Padding for Basketball Double & Single Post (available in different colours)

100480 Standard Ground Socket for Basketball Double Post Aluminium

100490 Special Ground Socket for Basketball Double Post with coat able cover

100246 Foldable systems for basketball double post to one side.

100245. Height adjustable systems for basketball single & double post

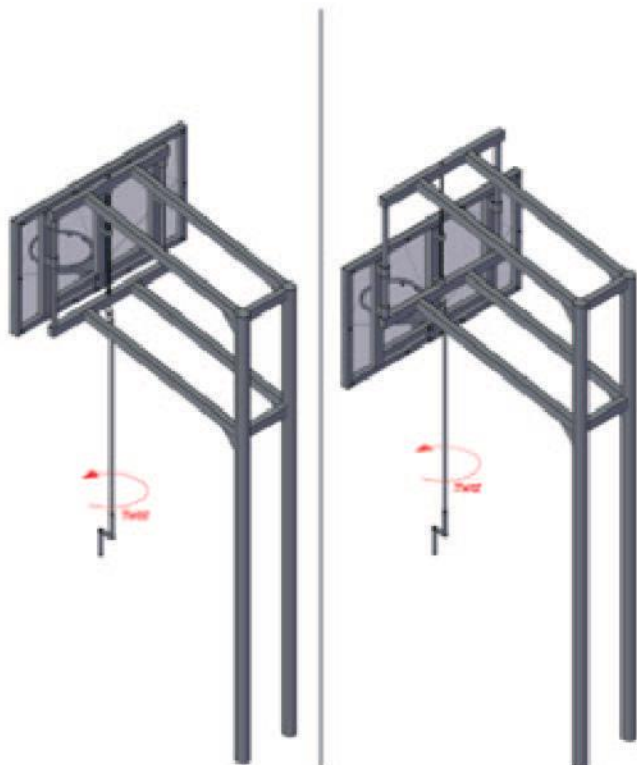

Order No. 100245
 (height adjustable system)

Order No. 100510
 PVC covered padding with foam core For basketball posts. The padding has been Specially designed so that it does not have to be Loosened or removed.



Order No. 100480



Order No. 100490





ويغز للتجارة والمقاولات ك.م.م.
WAVES TRADING & CONTRACTING W.L.L.

Tel: +974 4441 6319, Fax: +974 44416312
P.O.Box: 82431, Doha- Qatar
Email: info@waves-qatar.com
Website: www.waves-qatar.com



100250: with aluminium backboard



100251: with acrylic backboard 180 x 105 cm

Our movable basketball stand (overhang 1.65 m) is designed especially for outdoor playing fields. The basic frame is made from aluminium profiles. The galvanised and powder coated steel basketball ring is bolted through the backboard into the main frame construction. The backboard is made from white powder coated special aluminium profile (1.80 x 1.05 m). Counterweights can insert into the stand and secured. The net is made of nylon (white) and is 6 mm thick. The big transport wheels (6 pieces per post) and transport pulley provide a good handling comfort. If the system must be moved through a low area the backboard can be flapped down easily. Delivery includes: movable frame construction, steel ring, weights, a backboard (1.80x 1.05 cm), nylon net and a trolley (provided with each purchase of one stand or a pair).

100270: Padding for basketball mobile system. The padding is linked to the frame .It fits exactly to hide the post.



100261: Lifting roller. The lifting roller for basketball mobile is made from aluminium. It is used to move the basketball mobile version around easily. It is equipped with two wheels to lift the backstop up and move it around on its wheels.



Delate Glass



Tempered Safety Glass

ويفز للتجارة والمقاولات ك.م.م.
WAVES TRADING & CONTRACTING W.L.L.
 Tel: +974 4441 6319, Fax: +974 44416312
 P.O. Box: 22431, Doha - Qatar
 Email: info@wavesqatar.com
 Website: www.wavesqatar.com

Backboards

Order No.

100050: Safety tempered glass basketball backboard with protective film, dimensions 1800x1050x12 mm with ring cut-out, mounted onto varnished steel frame

100100: Backboard pad. Made from PE foam. The pads are designed for 180 cm backboards

100060: Basket: ball backboard, made by acrylic. 120 x 90 cm.

100070: Basketball backboard, made by acrylic. 180 x 105 cm.

100080: Basketball backboard, made by acrylic. 180 x 120 cm.



Aluminium Backboard

Basketball backboard, made by special aluminium profile, white powder coated. The boards for these aluminium backboards are made of aluminium side profiles (double-walled, wall thickness 2.3 mm) bordered in a U-profile with a radius of 2 mm and completely welded. The backboard offers the same bounce back properties like the acrylic one and it is suitable for long-time outdoor. 8 years warranty

100090: Size 180 x 105 cm.

100100: Size 180 x 120 cm



Basketball Double Post System With Safety Glass Backboard

Basketball double-post made of aluminium profiles. Our double-post basketball stand is made with oval aluminium profiles with a cross-section of 120 x 100 mm. The wall thickness of our post s is 4 to 6 mm in the direction of tension. Delivery includes: Backboard 1800 x 1050 x 12 mm single pane safety glass with splinter proof foil, with glass cut-out according to governing FIBA regulations ring made of galvanized & powder coated steel and nylon net .Ground sockets and safety padding not include.

Order No. 100211

Basketball double-post Projection 0.90 m

Order No. 100221

Basketball double-post Projection 1.25 m

Order No. 100231

Basketball double-post Projection 1.65 m

Order No. 100241

Basketball double-post Projection 2.25 m

Order No. 100510

Padding for Basketball Double & Single Post (available in different colours)

Order No. 100480

Standard Ground Socket for Basketball Double Post Aluminium

Order No. 100490

Special Ground Socket for Basketball Double Post with coat able cover PVC covered padding with foam core for basketball posts. UV protected.



Basketball Wall Mounted FOLDABLE TO ONE SIDE (Acrylic / Tempered Glass)

Basketball Wall Mounted, made from special aluminium profile. FOLDABLE to one side. Included basketball backboard 180 x 105 cm. Included non-foldable basketball ring and nylon net. For indoor use.

8 years warranty.

These wall-mounted practice backboards are supplied WITHOUT mounting hardware

Order No.

100441: Projection 0.90 m

100401: Projection on request

100411: Projection 3.25 m

100421: Projection 2.25 m

100431: Projection 1.65

100465: High adjustable system for basketball wall mounted and single/double post. Adjustable height from 2.50-3.05 m.

100401: Projection on request. Acrylic basketball board. Can be folded to one side.

100400: Projection on request. Aluminium basketball board. Can be folded to one side.

100410: Projection 3.25 meters. Aluminium basketball board. Can be folded to one side.

100411: Projection 3.25 meters. acrylic basketball board. Can be folded to one side.

100421: Projection 2.25 meters. safety tempered glass backboard. Can be folded to one side.

100420: Projection 2.25 meters. Aluminium basketball board. Can be folded to one side.

100421: Projection 2.25 meters. acrylic basketball board. Can be folded to one side.

100422: Projection 2.25 meters. safety tempered glass backboard. Can be folded to one side.

100430: Projection 1.65 meters. Aluminium basketball board. Can be folded to one side.

100431: Projection 1.65 meters. acrylic basketball board. Can be folded to one side.

100432: Projection 1.65 meters. safety tempered glass backboard. Can be folded to one side.

100450: Projection 0.90 meters. Aluminium basketball board. Can be folded to one side.

100451: Projection 0.90 meters. acrylic basketball board. Can be folded to one side.

100452: Projection 0.90 meters. safety tempered glass backboard. Can be folded to one side.

100460: Projection on request. Acrylic basketball board. Can be folded to one side.

100465: high adjustable system for basketball wall mounted and post. Adjustable l from 2.50 -3.05 m



ويفز للتجارة والمقاولات ك.م.م.
WAVES TRADING & CONTRACTING W.L.L.

Tel: +974 4441 6319, Fax: +974 44416312
P.O.Box: 82431, Doha - Qatar
Email: info@waves-qatar.com
Website: www.waves-qatar.com



Basketball Wall Mounted NON - FOLDABLE

Order No.

- 100340: Projection 0.90 m
- 100400: Projection 0.90 m, Height adjustable
- 100350: Projection on request
- 100410: Projection on request, Height adjustable
- 100360: Projection 3.25 m
- 100700: Projection 3.25 m, Height adjustable
- 100370: Projection 2.25 m
- 100380: Projection 2.25 m, Height adjustable
- 100380: Projection 1.65
- 100390: Projection 1.65 m, Height adjustable

Basketball Wall Mounted, made from special aluminium profile. Included basketball backboard 180 x 105 cm Included non-foldable basketball ring and nylon net. For indoor and outdoor use.

8 years warranty.

These wall-mounted practice backboards are supplied WITHOUT mounting hardware

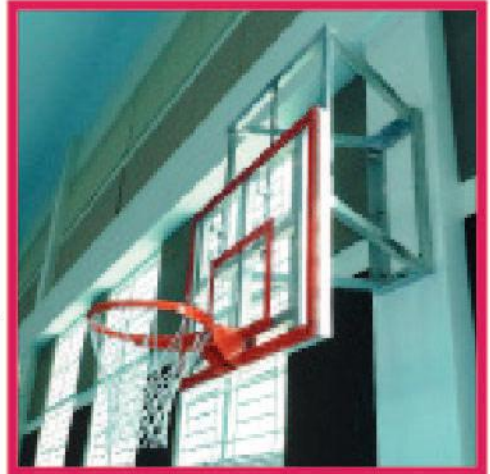

- 100350: Projection 0.90 m, Aluminium Backboard
 - 100351: Projection 0.90 m. Acryl backboard
 - 100340: Projection on request, Aluminium Backboard
 - 100341: Projection on request, Acryl backboard
 - 100310: Projection 3.25 m, Aluminium Backboard
 - 100311: Projection 3.25 m, Acryl backboard
 - 100320: Projection 2.25 m Aluminium Backboard
 - 100380: Projection 2.25 m, Acryl backboard
 - 100330: Projection 1.65 Aluminium Backboard
 - 100331: Projection 1.65 m, Acryl backboard
 - 100310: Projection 3.25 meters. aluminium basketball board "NON FOLDABLE"
 - 100311: Projection 3.25 meters. acrylic basketball board "NON FOLDABLE"
 - 100320: Projection 2.25 meters. aluminium basketball board "NON FOLDABLE"
 - 100321: Projection 2.25 meters. acrylic basketball board "NON FOLDABLE"
 - 100330: Projection 1.65 meters. aluminium basketball board. "NON FOLDABLE"
 - 100331: Projection 1.65 meters. acrylic basketball board "NON FOLDABLE"
 - 100340: Projection on request. aluminium basketball board "NON FOLDABLE"
 - 100341: Projection on request. acrylic basketball board. "NON FOLDABLE"
 - 100350: Projection 0.90 meters. basketball aluminium board "NON FOLDABLE"
 - 100351: Projection 0.90 meters. basketball board made from acrylic "NON FOLDABLE"
 - 100465: high adjustable system for basketball wall mountend and post. Adjsuatbel from 2.50 -3.05 m
- On request our backboards are available made from acryl, aluminium & tempered glass.
- 100465; High adjustable system for basketball wall mounted and single/double post. Adjustable height from 2.50-3.05 m.



ويفز للتجارة والمقاولات ك.م.م.

WAVES TRADING & CONTRACTING W.L.L.

Tel: +974 4441 6319, Fax: +974 44416312
P.O.Box: 32431, Doha - Qatar
Email: info@waves-qatar.com
Website: www.waves-qatar.com

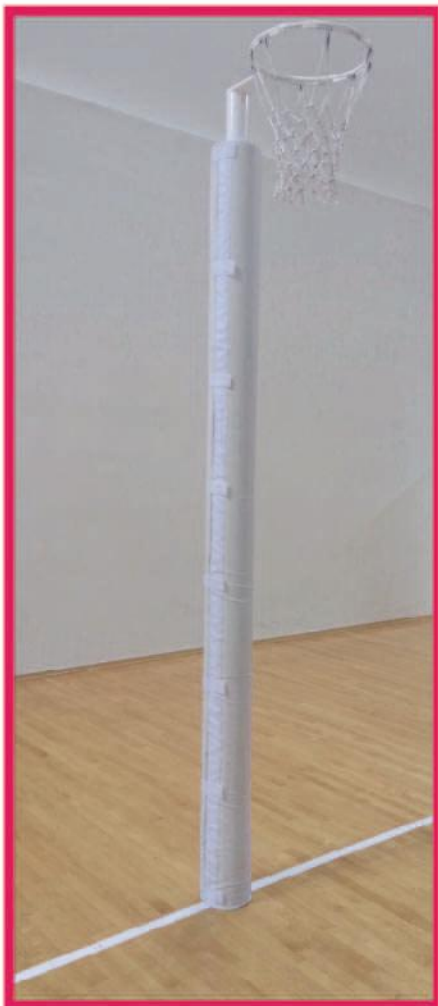

Product Code :

100560

Netball Post in Ground Sockets.
Made from high grade aluminium special profile.
Aluminium surface. Height adjustable version. Included
ring and nylon net.

100551

Netball Post in Ground Sockets.
Made from high grade aluminium special profile. White
Powder coated. Height adjustable version. Included
ring and nylon net

Padding for Netball Post

Product Code: 100575

Padding for Netball Post, PVC
covered padding with foam core
for netball posts. The padding
has been specially designed
so that it does not have to be
loosened or removed. Available
in white color.



Basketball foldable

Product Code: 10040

Basketball rings, foldable. Pressure centre 105 kg. The diameter is 45cm. The ring is hot galvanised and orange powder coated. The ring is produced in accordance to the international basketball regulation

Basketball ring non foldable

Product Code: 100030

The non foldable basketball ring is welded in one piece. The diameter is 45cm. The ring is hot galvanised and orange powder coated. The ring is produced in accordance to the international basketball regulations.



Basketball steel

The net is extra stable. The diameter of the links is 5mm. This kind of netting can stand any kind of weather and is developed especially for the outdoor use.

Product Code :

- 100010 Basketball net hot galvanised**
- 100020 Basketball net stainless-steel Ø 5 mm**



ويفز للتجارة والمقاولات ك.م.م.
WAVES TRADING & CONTRACTING W.L.L.

Tel: +974 44416319, Fax: +974 44416312
P.O.Box: 82431, Doha - Qatar
Email: info@waves-qatar.com
Website: www.waves-qatar.com



Standard ground socket

Product Code : 100470

Standard ground socket with lid for basketball single post. Made from special aluminium profile.



Special ground socket

Product Code : 100480

Special ground socket for basketball single post with coat able cover. Made from aluminium.



Standard Ground Socket For Basketball Double Post

Product Code : 100490

Standard ground socket with lid for basketball double post. Made from special aluminium profile.



Special Ground Socket For Basketball Double Post

Product Code : 100500

Special Ground Socket for Basketball Double Post with coat able cover. Made from aluminium.



Standard ground socket

Product Code: 100561

standard ground socket with lid for netball post.



Mobile floor apparatus

Product Code: 100550

Mobile floor apparatus for netball post, Aluminium.



ويغز للتجارة والمقاولات ك. م. م.
WAVES TRADING & CONTRACTING W.L.L.

Tel: +974 4441 6313, Fax: +974 44416312
P.O. Box: 32421, Doha, Qatar
Email: info@waves-qatar.com
Website: www.waves-qatar.com

Soccer & Rugby





Competition Soccer Goal Post Free Hanging System

Order No. 110120

Professional football goal type, Dimension 7.32 x 2.44 m. Compliant with the latest FIFA requirements. The goal post frames (100 x 120 mm), with a 2.5 mm wall thickness, are fitted with our integrated net suspension system. Goal corners (with corner strengthening on the insides). The goalposts are joined to the crossbar by means of a connecting plug and this guarantees enormous stability along with the option of dismantling the goal (for example for space-saving storage). The net hooks are integrated directly into the goal frame. This means that there are no external hooks, screwed or welded on, the net can be hung up or taken down easily and there is a significantly reduced danger of injury. Two net support poles are included. The goal post is white powder coated. 8 years warranty

110130: Aluminium surface

Ground Socket

Order no. 110140

Standard ground socket with lid, For goal post, Dimension: 120 x 100 x 400 mm

Order no. 110150

Special ground socket, with coat- able cover, For Junior goal post, Dimension 120 x 100 x 400 mm

Order no. 110160

Standard ground socket with lid, for net pole for **Order no. 110100,110120,110130**

Order no. 110170

Special ground socket with lid, for net pole, coat- able cover for **Order no. 110100,110120,110130**





ويوز للتجارة والمقاولات ك.م.م.
WAVES TRADING & CONTRACTING W.L.L.
Tel: +974 4441 6319, Fax: +974 44415312
P.O.Box: 82431, Doha - Qatar
Email: info@waves-qatar.com
Website: www.waves-qatar.com



Bar Frame

Order No. 110121

Ground frame type competition goal post .The bar frame is made of three components and can be completely dismantled.The side rods are manufactured from round aluminium tubes and the rear crossbar is made from rectangular profiles with welded-on rings for securing the net. Projection 2.00 m

Bar Frame with Attached Net Poles

Order No. 110122

Ground frame,Dismantle in three-parts with attached net pole.Manu- factured from high-grade aluminium profiles 80x60.Wall thickness 3 mm. The ground socket are welded on top of the frame and the net poles are easy installed.The bar frame is made of three components and can be completely dismantled.The side rods are manufactured from round aluminium tubes and the rear crossbar is made from rectangular profiles with welded-on rings for securing the net. All screws are made from stainless steel. Projection 2.00 m.The net pole is powder coated.



Training Goals



Movable football goals type 3 (7.32 x 2.44 m) made of high-grade aluminium profiles, fully welded construction. Our goals are manufactured from high-grade aluminium profiles with various depths. Compliant with the latest.FIFA requirements. Oval goal post frames, 120 x 100 x 2,5 mm; rectangular ground frame profile, 75 x 50 x 3 mm. The net hangers, with a diameter of 60 mm, underline the goal's stability and along with our integrated net support system ensure that the net hangs perfectly. The following features make us unique:

Practice Soccer Goal Dismantle & White Frame

1. Our integrated net suspension system, which ensures that:
 - the nets hang perfectly
 - nets are easy to hang up and take down
2. Reinforcing profiles can also be used as carrying handles.
3. Goal frame corners are reinforced with internal corner rods.
4. Equipment for anchoring available as a standard.
5. 8 years warranty



Order No. 110040

Movable football goals type 3 (7.32 x 2.44 m) made of high-grade aluminium profiles, FRAME WHITE POWDER COATED. Our goals are manufactured from high-grade aluminium profiles with various depths. Compliant with the latest. FIFA requirements. Oval goal post frames, 120 x 100 x 2,5 mm; rectangular ground frame profile, 80 x 60 x 3 mm. Dismantled version for easy transportation
 The following features make us unique:



ويفز للتجارة والمقاولات ك.م.م.
WAVES TRADING & CONTRACTING W.L.L.

Tel: +974 4441 6319, Fax: +974 4441 6312
P.O.Box: 82431, Doha - Qatar
Email: info@waves-qatar.com
Website: www.waves-qatar.com



Transport Wheel

Order No. 110060

Transport wheel made from polyamide. Diameter 200 mm. White colour included stainless steel screw. For easy transport

Transport Wheel for Goal Post

Order No. 110061

Aluminium transport wheel made from polyamide. Can be easily attached various type of goal post. Diameter 200 mm. White colour included stainless steel screw. For easy transport



Counterweights

Order No. 110070

Counterweights. Made from aluminium and filled with weight approx 125 Kg/Set. Counterweights which can be screwed on to our junior goals. The weight can also be used for existing AFN junior goals as it fits exactly. The 4 polyamide wheels allow a junior goal which is fitted with this weight to be moved forwards and backwards.

INFO

SECURING GOALS

Caution: danger of tipping! According to the regulations of local accident prevention federations and DIN/EN, movable goals must be secured against tipping. For example, with a junior goal with a 1.5 m base depth, a 125 kg counterweight

is necessary to ensure a stability of 1100 N in accordance with DIN/EN.

For junior goals with ground frames of rectangular profiles

100 kg – for a depth of 2 m

125 kg – for a depth of 1.5 m



Ground Anchors

Order No. 111210

If the goals have to be anchored into the ground: Ground anchors made from aluminium, with threaded socket and stainless steel screw. (1 Set, 4 piece)



ويفز للتجارة والمقاولات ك.م.م.
WAVES TRADING & CONTRACTING W.L.L.
 Tel: +974 44416319, Fax: +974 44416312
 P.O. Box: 82433, Doha - Qatar
 Email: info@waves-qatar.com
 Website: www.waves-qatar.com

Junior Goal Post (5 x 2 m)

Junior Goal Post (5 x 2 m) made of high-grade aluminium profiles, Welded in one piece. Our junior football goal is manufactured from high-grade aluminium profiles. Oval goal frame profile (100 x 120 x 2.5 mm), Rectangular ground frame profile (80 x 60 x 3 mm). The goal is extremely robust and durable. The aluminium construction also guarantees that they are easy to handle and have the typical aluminium stability. Compared to similar products the following

1. All round integrated net hook "INTERLOOK" system which ensures that: - the nets hang perfectly - nets are easy to hang up and take down
2. Goal frame and ground frame corners are reinforced with an internal corner rod.
3. 8 years warranty.

Order No.

110210: Projection 1.00 m

110220: Projection 1.50 m



110230: Projection 2.00 m

110240: Projection 1.00 m (Dismantle Version)

110250: Projection 1.50 m (Dismantle Version)

110260: Projection 2.00 m (Dismantle Version)



Futsal Goal Post

Futsal Goal Post, Made of aluminium. Extremely robust. Dimension 3.00 x 2.00 m. The front frames are rectangle 80 x 80 mm. Net hangers and ground frames are completely welded to one another. The upper projection is 0.80 m, where the lower is 1.00 m. included integrated safety net hook system. The size follows the international Futsal regulation.

Order No.

- 110370:** Futsal Goal Post:Welded on one piece. Foldable version. Aluminium surface
- 110371:** Futsal Goal Post:Welded on one piece. Foldable version. Aluminium surface
- 110380:** Futsal Goal Post:Dismantle and detachable. Foldable version. Aluminium surface
- 110381:** Futsal Goal Post:Dismantle and detachable. Foldable version. Aluminium surface
- 110390:** Futsal Goal Post:Welded on one piece. Aluminium surface
- 110390:** Futsal Goal Post: Dismantle and detachable. Aluminium surface
- 110410:** Futsal Goal Post:Welded on one piece Frame white powder coated.
- 110420:** Futsal Goal Post: Dismantle and detachable. Frame white powder coated,
- 110450:** Net for Futsal : Made from Polypropylene 4 mm Mesh 100 mm Green colour.
- 110450 :** Net for Futsal : Made from Polypropylene 4 mm. Mesh 100 mm White colour.



Mini Goal Post Fully Welded & Foldable

Mini-football goals, fully welded or fold-away, made of aluminium. Extremely robust mini-football goals, made of aluminium, fully welded or fold-away in various sizes. In the fully welded varieties, the front frames, net hangers and ground frames are completely welded to one another. With the fold-away variant, the front frames are also fully welded. However, ground frames and net hangers can be folded away, if necessary, so that the goal can easily be transported or stored.

Order No.

- 111240: Football goal, 120 x 80 cm, fully-welded
- 111250: Football goal, 120 x 80 cm, foldable
- 111270: Football goal, 180 x 120 cm, fully-welded
- 111280: Football goal, 180 x 120 cm, foldable
- 111300: Football goal, 150 x 100 cm, fully-welded
- 111310: Football goal, 150 x 100 cm, foldable
- 111320: Net for mini street soccer goal 120 x 80 cm. Projection 0.50 m.
- 111330: Net for mini street soccer goal 180 x 120 cm. Projection 0.50 m.
- 111331: Net for mini street soccer goal 150 x 100 cm. Projection 0.50 m.



ويفز للتجارة والمقاولات ك.م.م.
WAVES TRADING & CONTRACTING W.L.L.

Tel: +974 4441 6319, Fax: +974 44416312
P.O.Box: 82431, Doha - Qatar
Email: info@wavesqatar.com
Website: www.waves-qatar.com



Free standing version

Beach soccer goal post

110400: Beach soccer goal post free standing. Made from special aluminium profiles. Dimension 5.50 x 2.20 m. Oval goal post frames, 120 x 100 x 2, 5 mm. Included integrated safety net hook system. Yellow powder coated.

113292: Frame dimension 3.00 x 2.00 m.

110410: Beach soccer goal post fixed version included sockets. Made from special aluminium profiles. Dimension 5.50 x 2.20 m. . Oval goal post frames, 120 x 100 x 2, 5 mm. Included integrated safety net hook system. **Yellow powder coated.**

113291: Frame dimension 3.00 x 2.00 m.

8 Years Warranty

114015: Beach Soccer Goal free hanging net. Portable (5.5 m)

The portable beach soccer goal post is made of high-grade aluminium profiles. The inside dimension of this goal are 5.5x2.2 m. The front frame of the goal is made from oval 120x100x2.5 mm profile. The bottom frame is made from a rectangular hollow 80x60x3 mm. The top projection of the goal is 0.8 m. The lower projection can be chosen between three options (1.0 m, 1.5 m, and 2.0 m). Our goal post is completely powder coated in yellow colour. The item is available in a fully welded version and in a dismantle version for export. The goal is extremely robust and durable. It is equipped with the INTERLOCK net hook system, which ensures that the nets hangs perfectly.

114016: Frame dimension 3.00 x 2.00 m.

114010: Beach Soccer Goal Fixed Type, free hanging net. Portable (5.5 m)

Beach soccer goal post fixed version included sockets. Made from special aluminium profiles. Dimension 5.50 x 2.20 m. . Oval goal post frames, 120 x 100 x 2, 5 mm. Included integrated safety net hook system. Yellow powder coated.

113291: Frame dimension 3.00 x 2.00 m.
All our goal post included 8 Years Warranty



Fixed version





Beach Soccer Post

114000: Portable Beach Soccer Goal (5.5 m)

The portable beach soccer goal post is made of high-grade aluminium profiles. The inside dimension of this goal are 5.5x2.2 m. The front frame of the goal is made from oval 120x100x2.5 mm profile. The bottom frame is made from a rectangular hollow 80x60x3 mm. The top projection of the goal is 0.8 m. The lower projection can be chosen between three options (1.0 m, 1.5 m, and 2.0 m). The goal is completely powder coated in yellow colour. The item is available in a fully welded version and in a dismantle version for export. The goal is extremely robust and durable. It is equipped with the INTERLOCK net hook system, which ensures that the nets hangs perfectly.

113292: Frame dimension 3.00 x 2.00 m



Rugby Goal Post

Rugby goal posts. Made from aluminum, in a part welded construction. The dimensions of the goal posts are compliant with the requirements of the IRB. The distance between the two long posts is 5.6 m; the top edge of the crossbar is 3 m above the ground. In the standard version, the total height of the goal posts is 6.05 m. The vertical posts is available in different heights. The goal is comes in three parts for assembly. The aluminum profile, with a 100 x 120 mm cross section guarantees not only that the goalposts stand securely but also are highly durable. The goal is available in natural aluminum surface or white powder coated.

8 years warranty.

Order No.

- 112050: Rugby Goal Post 6.05 m height. Aluminium surface
- 112051: Rugby Goal Post 6.05 m height, White powder coated.
- 112000: Rugby Goal Post 9 m height. Aluminium surface
- 112001: Rugby Goal Post 9m height, White powder coated.
- 112040: Rugby Goal Post 10 m height. Aluminium surface
- 112041: Rugby Goal Post 10 m height, White powder coated.
- 112030: Rugby Goal Post 11 m height. Aluminium surface
- 112031: Rugby Goal Post 11m height ,White powder coated.
- 112010: Rugby Goal Post 12 m height. Aluminium surface
- 112011: Rugby Goal Post 12 m height, White powder coated.
- 112090: Rugby Goal Post 17 m height. Aluminium surface
- 112091: Rugby Goal Post 17 m height, White powder coated.
 More heights on request!



Padding for Rugby Goal Post

Order No. 112080

Padding for rugby goal post. PVC covered padding with foam core.
 Height 2.00 m. Diameter 0.51 cm. Available in different colors.



ويفز للتجارة والمقاولات ك.م.م.
WAVES TRADING & CONTRACTING W.L.L.

Tel: +974 4441 6319, Fax: +974 44416312
P.O.Box: 82431, Doha - Qatar
Email: info@waves-qatar.com
Website: www.waves-qatar.com



Ground Socket For Rugby

Order No. 112070

Standard ground socket for Rugby Goal Post, length 800 mm.

Order No. 112065

Hinged special ground socket system for rugby post m high, Dimension: 100 x 120 x 400 mm, with coat able cover, made from aluminum

Order No. 112060

Special ground socket for Rugby Goal Post, length 800 mm. With coat able cover.

Order No. 110275

Hinge for Rugby Goal Post. The hinge for rugby goal post is made from special extra strong aluminium profiles. The structure is reinforced with stainless steel bars. All screws are made from stainless steel as well. The structure allows a more comfortable erecting of the goal post. The hinge can be slotted in the ground socket easily. The post is slotted in the socket on top of the hinge. This leads to an increased stability during the installation of the goal.

One set consists of two pieces to equip one rugby goal. On request this item can be powder coated.



Backstop Post for Soccer Height 4, 5,6,7,8 m

The backstop in ground sockets is in a ground socket fixed backstop system.

Backstop Post in Ground Socket System included (for 25 m length!)

- 6 piece post m made from Aluminium 120 x 100 x 2.5 mm
- Lower part included aluminium special profile
- 6 piece ground socket made from aluminium 120 x 120 x 800 mm
- 2 piece cross bar for start & end post
- 3 piece stainless steel cable incl. turnbuckle
- Net made by polypropylene 4 mm, green colour, mesh 100 mm

UV protected, Imported from Europe

On request the backstop post system is available in other dimensions.



ويفز للتجارة والمقاولات ك. م. م.
WAVES TRADING & CONTRACTING W.L.L.

Tel: +974 4441 6319, Fax: +974 44416312
P.O.Box: 82431, Doha- Qatar
Email: info@waves-qatar.com
Website: www.waves-qatar.com



Hobby Goal Post "CLOSED BACK"

Order No. 111170

Hobby Soccer Goal Post (3x2m) "Close Back"

Fully welded recreational goal made of high-grade aluminium profiles.

Due to its robust construction, the goal is almost completely vandalism-proof and as a result well suited for use on public playing fields or in playgrounds. The goal frame is made from our oval profiles (120 x 100mm) with a wall thickness of 2.5mm. The rear wall of our recreational goal consists of fully inserted round tubes with a diameter of 38mm and a wall thickness of 3.0mm.

Strut spacing 89mm compliant with latest DIN 1176/. Supplied with 4 ground anchors.



Player Cabin Curved Roof

Player and Coaches Cabins. Team and coaches cabins made from high-grade aluminium profiles and welded in a one-piece construction.(For export in dismantle version) The robust construction and easy handling of our high quality Player and coaches cabins, make them most impressive. The whole rear side of this cabin is made from plastic sheets. Lower section lined with aluminium. Powder coating available on request.

Further features:

- Curved roof.
- Synthetic glass (Acryl) all around.
- Back rests made of anodized aluminium profile.

Height: 225 cm. Roof overhang: 20 cm. Ground depth: 100 cm

- 117010**; Length 2.00 m
- 114000**; Length 3.00 m
- 114020**; Length 4.00 m
- 114040**; Length 5.00 m
- 114050**; Length 6.00 m
- 114060**; Length 7.00 m

Other dimensions request.





ويفز للتجارة والمقاولات ك.م.م.
WAVES TRADING & CONTRACTING W.L.L.

Tel: +974 4441 6319, Fax: +974 44416312
P.O.Box: 82431, Doha - Qatar
Email: info@waves-qatar.com
Website: www.waves-qatar.com



Dimensions

Height: 2m / 206 cm
Roof overhang: 15 cm
Ground depth: 83 cm

117570: Length 2.00 m
117575: Length 3.00 m
117580: Length 4.00 m
117585: Length 5.00 m
117590: Length 6.00 m
117595: Length 7.00m

Other dimension on request.

Player Cabin Model "ECO 1"

The player cabin for team & coaches model 'ECO 1' is made from high-grade aluminium profiles. It is available fully welded and for export, dismantle. The rear side is completely closed with polycarbonate sheets. The player cabin measures 220 cm height. Its ground depth is 83 cm. The cabin's curved roof has an overhang of 15 cm. The item is available in various lengths.



Player Cabin Model "ECO"

Player and Coaches Cabins Model "ECO". Team and coaches cabins made from high-grade aluminium profiles and welded in a one-piece construction. The whole rear side of this cabin is made from plastic sheets. Further features. Curved roof. Synthetic glass (Acryl) all around. Included plastic seats low back rests. Available in different colours. Welded in one piece and for export available in dismantle system.

Standard size:
Height: 225 cm
Roof overhang: 20 cm
Ground depth: 1.00 m

117500: Length 2.00 m
117510: Length 3.00 m
117520: Length 4.00 m
117530: Length 5.00 m
117540: Length 6.00 m
117560: Length 7.00m

Other dimension on request.



ويفز للتجارة والمقاولات ك.م.م.
WAVES TRADING & CONTRACTING W.L.L.
 Phone: 974 4416312
 P.O. Box: 82431, Doha - Qatar
 Email: info@waves-qatar.com
 Website: www.waves-qatar.com

Reserve Player Bench 11.5 m Model "Champ"

Reserve Player Bench. Model "Champ"

Team and coaches cabins made from high-grade aluminium profiles Dismantle construction. The robust construction and easy handling of our high quality Player and coaches cabins, make them most impressive, the whole rear side of this cabin is made from plastic sheets.

Lower section lined with aluminium

Further features:

- Curved roof.
- synthetic glass (Acryl) all around.
- 23 piece MODEL SEATS which can be quickly and easily set up

Standard size:

Standard length: 11500 cm

Height: 200 cm

Roof overhang: 5 cm

Ground depth: 200 cm

Cabins with fittings for ground anchors as a standard.

Player & Coaches Cabin. Model CLASSIC with Wheels



Order No. 116990:
 Transport Wheels for Player cabins



Player Tunnel

Made with structure of aluminium anodized. Profile of 43 x 35 mm. For the arches, which it allows to be able to replace the cloths of canvas between arch and arch of an independent way on the part of the own client, avoiding to have to send the tunnel to factory in case of break of someone of the same ones. Set of spikes of assembly in stainless steel AISI 304.

Movement of opening and closing by means of scissors of aluminium of 50 x 13.5 mm.; The heads of draft are of alloy of aluminium of smelting.

4 tension points extra to fix and to stretch the canvas (only one on the market)

Skates of slide of the scissors in POLIZENE 500 that allow minimizing the rubbing in 60 %, which minimizes the work in the task of extension and withdrawal of the tunnel.

Canvas in fabric of polyester of high tenacity, covered with PVC for both faces. Fireproof M-2 of 620 grs. Colour of the canvas to choose.

Order No.

113000 Portable player tunnel.Width 2.00 m. High 2.30 m Import from Europe.

113010 Portable player tunnel.Width 2.50 m. High 2.30 m Import from Europe.

113020 Width 3.00 m Height 2.30 m



Multi Soccer Court

The boards for these soccer courts are made of aluminium side profiles (double-walled, wall thickness 2.3 mm) bordered in a U-profile with a radius of 2 mm and completely welded. The boards are approx. 1 metre high. The individual boards are screwed in front of the upright posts with stainless steel screws (M10). These upright posts, 3 metre high altogether, are made of rectangular aluminium profiles (80 x 60 mm, thickness 3 mm, radius 5 mm). Rubber mats are placed under each fastening position to reduce the noise levels. For the freestanding version, counterweights (each weight approx 20 kg) are placed on the base frames of the posts. Sockets or weights are included. The net is hung up via rings which are fitted onto the outsides of the boards through which a rope can be threaded. The entrance door (in the standard version: width 1 m, height 3 m) is a part of one board (for an additional charge more doors can be fitted) and is opened outwards. Fully welded doors, 3 x 2 m, made from high-grade aluminium. The front frame is made of square profiles (80 x 80 mm x 2.5 mm, radius 5 mm). Our AFN integrated net hooks are used for the net suspension. In the standard version, the nets are made of polypropylene (PP), 4 mm thick, with a mesh size of 120 x 120 mm. The net is fixed on via rings welded on to the boards and on the upper parts of the upright posts. The net encloses the court completely up to a total height of 3 metres. On request and for an additional price, the 'flexible' soccer court can be extended with further board elements, but also with mini-goals, basketball rings or volleyball equipment. The complete construction is made from aluminium and that makes it extremely robust and weather-resistant.

Order No.

- 115005** Multiplaycourt, Dimension on request
- 115000** Multiplaycourt, Dimension 30 x 10 m.
- 115010** Multiplaycourt, Dimension 20 x 10 m.
- 115020** Multiplaycourt, Dimension 18 x 10 m.
- 115030** Multiplaycourt, Dimension 15 x 10 m.

Bear in mind when comparing products.

- Completely from aluminium.
- Low noise level.
- Flexibly extendible.

Other dimensions on request.



ويفز للتجارة والمقاولات ك. م. م.

WAVES TRADING & CONTRACTING W.L.L.

Tel: +974 4441 6319, Fax: +974 44416312

P.O.Box: 82431, Doha - Qatar

Email: info@waves-qatar.com

Website: www.waves-qatar.com



Linesman Flag

Order No.

110535: Linesman's Flag. Red colour. Fluorescent nylon, approx. 40 x 40 cm, with lightweight plastic handle.

110730: Linesman's Flag. Yellow colour. Fluorescent nylon, approx. 40 x 40 cm, with lightweight plastic handle.

110746: Linesman's Flag INTERNATIONAL made of fluorescent fabric red/yellow plaid. Approx. 40 x 40 cm with plastic stick and soft grip handle.

110745: Linesman's Flag QUADRO II made of fluorescent nylon, Red/Yellow, approx. 37 x 39 cm, PVC stick with soft-grip handle.



Flag Poles

110510: Pole base made from stainless steel. Weight approx 3 Kg. Included plastic corner pole 160 mm long, Diameter 50 mm. Very solid and shatterproof. Flag 40 x 40 cm. Yellow colour. For corner.

For Sideline

Corner poles in ground sockets made of plastic. Diameter 50 mm & Flags

- 110610 Corner Poles yellow colour
- 110620 Corner poles white colour
- 110530 Corner poles flexible System
- 110560 Corner flag yellow colour

110610	Corner Poles yellow colour
110620	Corner poles white colour
110530	Corner poles flexible System
110560	Corner flag yellow colour
110540	Corner flag red colour
110550	Corner flag white colour
110560	Corner flag yellow colour
110270	Corner flag red/white colour
110580	Corner flag blue/white colour
110590	Corner flag yellow/orange colour
110600	Corner flag orange colour





Standard Ground Socket

Order No. 110480
 Standard ground socket with lid for corner pole.
 Made from aluminium

Special Ground Socket

110490: Special ground socket with coat able cover for corner pole. Made from aluminium

110500: Universal pole base made from solid plastic. Weight about 2.7 Kg. Base diameter about Ø 27 cm. This pole base is suitable for the pole diameter: Ø 50 mm.

110505: Universal pole base made from solid plastic. Weight about 2.7 Kg. Base diameter about Ø 27 cm. Included corner pole diameter 50 mm and flag.



Transport Cart for Soccer Goal Post

Order No. 110125

Transport carts for soccer goal post are made of high-grade aluminium profiles. The aluminium construction guarantees a high loading capacity along with simple and problem-free use. The goal post can easy and safety stored with our transport cart

110125: Transport Trolley for Competition Soccer Goal Post

110126: Transport Trolley for Training Goal Post Foldable



ويفز للتجارة والمقاولات ك.م.م.
WAVES TRADING & CONTRACTING W.L.L.

Tel: +974 4441 6319 / Fax: +974 44416312
P.O.Box: 82431, Doha, Qatar
Email: info@waves-qatar.com
Website: www.waves-qatar.com

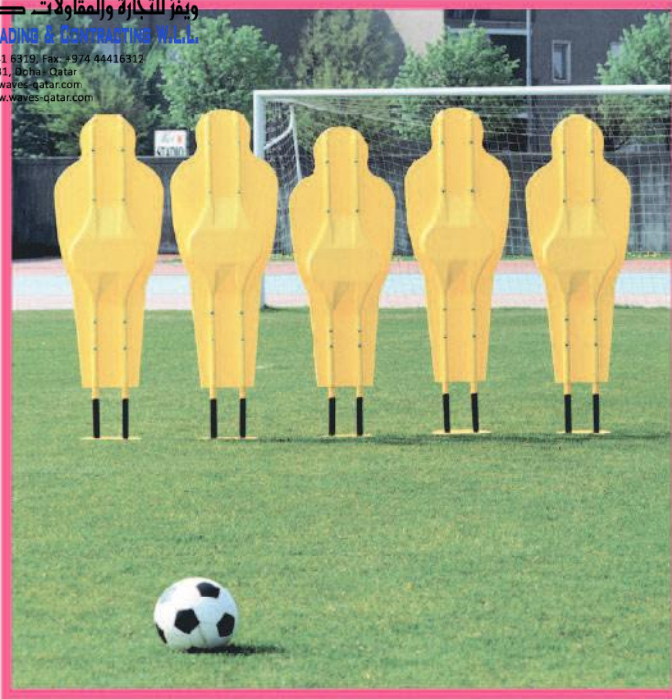

Dummy's

Order No.113060

Dummy free standing version.
Made of UV resistant firm plastic,
resistant to heat and bright yellow.
Size about 150 x 47 cm.

Trolley for Dummy

Order No.113040

Trolley for Dummy. Made
from aluminium.
Length approx 2.60 m

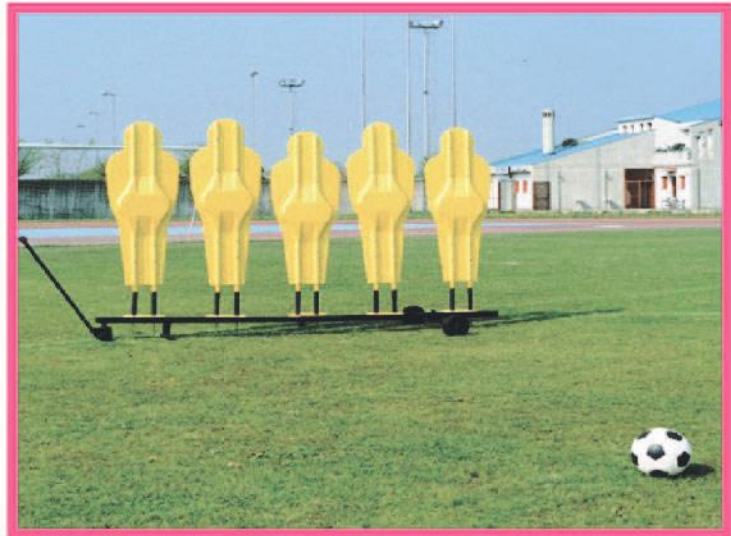



Delta F Electronic Score Board

Order No. 116000

Electronic Luminous Board for the Substitution of Players during Football match.

Technical Features:

- pre Selectable
- Two Colour
- Two sided to allow for player & spectator viewing
- additional advertising panel available
- Green Nos show player entering - red Nos for player leaving
- Complete with carry case and battery charger

Delta 2 F Electronic Score Board

Order No. 116010

Electronic Luminous Board for the Substitution of Players during Football match

- Double Side luminous Red-green Board
- Red Player "OFF"- Green Player "ON"
- Signal Extra time in Colour Choice
- High Luminous Leds

Technical Features:

- Measurement 64.5 x 39 x 2.5 cm
- Weight 3 Kg
- Measurement of Luminous Numbers 25 x 11 cm
- Power supply 12 V
- Rechargeable batteries with battery recharger 220V-110 V 50 Hz.
- Duration batteries in continues on mode 60 Minutes
- "TEST BATTERY" key to Check power
- "MEMORY" Key to set two player changes in automatic
- Advertising Space 13 x 48 cm



Manuel Score Board Handy

Order No. 116055

Manual Scoreboard HANDY. Manufactured of shock- and weatherproof plastic.

Suitable for the display for substitutes (INs and OUTs), extra time, scores, time-outs etc.

- Simple and quick display from 0-99 by flipping over single coloured plates that are hinged to the board.
- Two-side display :Neon Red = OUT, Neon Yellow = IN Size (W x H): 40.5 x 33 cm, number height 26 cm, weighs about 1 kg.





ويفز للتجارة والمقاولات ك. م. م.
WAVES TRADING & CONTRACTING W.L.L.

Tel: +974 4441 6319, Fax: +974 44416312
P.O.Box: 82431, Doha - Qatar
Email: info@waves-qatar.com
Website: www.waves-qatar.com



Football/Soccer Substitute Board

Order No. 115910

Substitution board for Football/Soccer. Useful for displaying the number of players entering and exiting and for displaying the final recovery time

Common features

- Height of digits: 23.5cm. Readability distance: 100m.
- Use of high brightness LEDs suitable for outdoors: red for exiting player and green for entering player.
- Typical brightness: 6000cd/sq.m.
- Sturdy numerical membrane keyboard for easy insertion of numbers. Lifespan for each key: more than 2 million operations.
- Rechargeable internal battery. With a charged battery about 150 displays of 20 seconds each can be effectuated for the INOUT-4, and about 80 displays for the INOUT-8.
- Display of battery level via a specific key.
- Pre-programming of substitutions. You can pre-program up to 6 player substitutions so that you can then quickly recall them using the keys
- Automatic off function for battery saving.
- Battery charger provided.
- Space for sponsor stickers: front 45x8cm, back 31x8cm.
- Sturdy plastic container with a pleasing design.
- Complied with the regulation EN60950-1 for crash tests
- Size: 55.5x36x4cm. Weight INOUT-4: 2.75 kg. Weight INOUT-8: 3.25 kg.
- Protection class: IP54. For outdoor use, resistant to bad weather.
- Warranty: 2 years



Spray Line Marker F 300

Order No. 110770

Spray Line Marker TPYE F300. Due to pushing the line marker the spray painting takes place by a rugged alu cog wheel which results an high capacitance and great pressure build-up. The sturdy steel pipe construction with height-adjustable guide pins and 4 air-filled tyres guarantee a smooth running and exact lines. Line width adjustable from 50 mm to 120 mm. Two 10 litre plastic tanks for 20 litres of colour or 10 litres of colour and 10 litres of water for cleaning afterwards. Net weight approx. 21 kg.

Dimensions: Approx. 83 x 54 x 90 cm.

Line Marking Trolley ROLL-LINER

Order No. 110760

The line marking trolley ROLL-LINER is made from aluminium. The trolley is powder coated and measures 95 x 63 x 90 cm. The trolley is equipped with two pneumatic wheels. The trolley marks the line via its rollers in the front section of the trolley. The rollers are available in 50, 100 and 120 mm width. The handle for the trolley is height adjustable. The weight of the trolley is 21 kg. Its filling capacity is 15 litres. The balance of the marking fluid can be removed easily by the use of water.





Soccer Goal Net for Competition Goal Post: Dimension 7.50 x 2.50 m, Top depth 2.00 m, and bottom depth 2.00 m
Mesh 100 mm. High tenacity Polypropylene, Brand Technologia Deportiva

(Appointed supplier for the FIFA World Cup 2010 & 2014)



Order No.

111090 Green Color. PP 4 mm Projection 2,00/2,00 Meters.

111100 White Color. PP 4 mm Projection 2,00/2,00 Meters.

111130 White Color. PP 4 mm Projection 2,00/2,00 Meters. MW 60 x 60 mm

111160 Green Color. PP 3 mm Projection 2,00/2,00 Meters.

111170 White Color. PP 3 mm Projection 2,00/2,00 Meters.

Soccer Goal Net Hexagonal.

Our Football nets that contain the initials EN are manufactured according to the Standard UNE EN 748; summarizing it says: the net mesh maximum size is 120mm; the diameter of the top braid is 2mm. It comes with a tensile string in the top runback for better fastening of the net to the goal and avoids displacement.



Order No.

111110 White Color. PP 4 mm Projection 2,00/2,00 Meters. Hexagon net

111120 Green Color. PP 4 mm Projection 2,00/2,00 Meters. Hexagon net

111121 Bicolor White / green EN PP 4 mm Projection 2,00/2,00 Meters. Hexagon net

111122 Bicolor White / blue EN PP 4 mm Projection 2,00/2,00 Meters. Hexagon net

111123 Bicolor White / red EN PP 4 mm Projection 2,00/2,00 Meters. Hexagon net

111124 Bicolor Blue/ red EN PP 4 mm Projection 2,00/2,00 Meters. Hexagon net



ويفز للتجارة والمقاولات ك. م. م.
WAVES TRADING & CONTRACTING W.L.L.

Tel: +974 4441 6319, Fax: +974 44416312
P.O.Box: 82431, Doha- Qatar
Email: info@waves-qatar.com
Website: www.waves-qatar.com

Sports Net & Divider Curtains



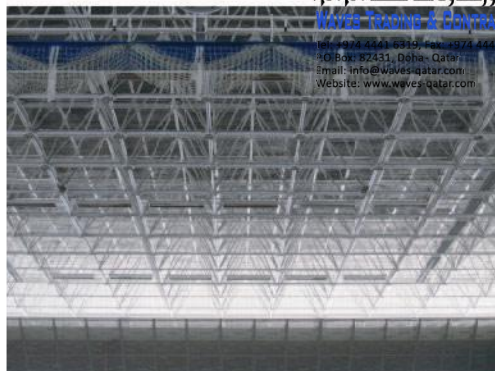

DIVIDING CURTAINS - SIMPLE SYSTEM

Order No. 121190

Technical features

- An electric motor positioned in the centre
- A rotor axle equipped with take up reels for the tapes.
- A set of tapes that will support the lower counterweight whilst simultaneously transferring the rotary movement of the shaft
- A canvas screen made from polyester and covered in PVC (the curtain)
- A lower counterweight which provides the canvas with the appropriate tautness or rigidity when rolled
- An anchoring system that is designed and measured specifically for each facility.

Engine features

- Driving torque 300 NM.
- Speed 12 RPM.
- Absorbed power 1000 W.
- Tension 380/3
- Protection index IP-45
- Final of career(race) 25 returns
- Operation by means of buttons, placed in place to being convenient.
- Operation by remote control (optional) / Keypad

Features of the canvas

Support	Pes. AT 1.100 d.tex.	
Construction	(h/cm-P/cm)	8 x 8
Weigh	(gr/m2)	650
PVC		2 faces
Completion		lacquer
Resistance to the traction	(daN/5cm)	250
Resistance to the tear		30
Adherence	(daN/cm)	2
Solidity of the color to the light	(din 53388)	7
fireproof Treatment		M-2





ويفز للتجارة والمقاولات **م. م. م.**
WAVES TRADING & CONTRACTING W.L.L.

Tel: +974 4441 6319, Fax: +974 4441 6312
 P.O.Box: 82431, Doha - Qatar
 Email: info@waves-qatar.com
 Website: www.waves-qatar.com

COLORES LONA PVC IGNÍFUGO M-2 650 gr.
M-2 FIREPROOF CANVAS 650 gr.



REF : LO92252
 RAL : 4019 aprox.



REF : LO92205
 RAL : 3020 aprox.



REF : LO92204
 RAL : 2004 aprox.



REF : LO92203
 RAL : 1929



REF : LO92232
 RAL : 8017



REF : LO92253
 RAL : 1001 aprox.



REF : LO92220
 RAL : 1014



REF : LO92214
 RAL : 1015



REF : LO92238
 RAL : 3005



REF : LO92248
 RAL : 6005



REF : LO92216
 RAL : 6026



REF : LO92213
 RAL : 6024 aprox.



REF : LO92253
 RAL : Pitecho



REF : LO92251
 RAL : 5003 aprox.



REF : LO92210
 RAL : 5010



REF : LO92215
 RAL : 5015



REF : LO92217
 RAL : 9017



REF : LO92208
 RAL : 7050



REF : LO92253
 RAL : 7038 / metal



REF : LO92237
 RAL : 7037



REF : LO92256
 RAL : 7547 / silver



REF : LO92201
 RAL : 9016

Los colores mostrados son meramente informativos
 RAL es aproximado al color real.
 The colours shown are merely for informative purposes.
 The RAL is the approximate colour.





DIVIDING CURTAINS ELECTRIC

Technical features

An electric motor positioned in the centre

A rotor axle equipped with take up reels for the tapes.

A set of tapes that will support the lower counterweight whilst simultaneously transferring the rotary movement of the shaft

A canvas screen made from polyester and covered in PVC (the curtain)

A lower counterweight which provides the canvas with the appropriate tautness or rigidity when rolled

An anchoring system that is designed and measured specifically for each facility.

With two doors opening means Velcro-zip or similar

Engine features

Driving torque	300 NM.
Speed	12 RPM.
Absorbed power	1000 W.
Tension	380/3
Protection index	IP-45
Final of career(race)	25 returns

Operation by means of buttons, placed in place to being convenient.

Features of the canvas

Support	Pes. AT 1.100 d.tex.
Construction (h/cm-P/cm)	8 x 8
Weigh (gr/m2)	650
PVC	2 faces
Completion	lacquer
Resistance to the traction (daN/5cm)	250
Resistance to the tear	30
Adherence (daN/cm)	2
Solidity of the color to the light (din 53388)	7
fireproof Treatment	M2

Features of the net

Made of thread of nylon of 3.0 mm and mesh 100x100 mm. Vertical reinforcements with strips of vinilon to avoid the expansion of the net. Perimetral reinforcement with thread of 8 mm.





COLORS LONA PVC IGNIFUGO M-2 M-2 FIREPROOF CANVAS 650 gr.

650 gr.



REF : LO92252
RAL : 4010 aprox.



REF : LO92205
RAL : 3020 aprox.



REF : LO92204
RAL : 2004 aprox.



REF : LO92203
RAL : 1023



REF : LO92232
RAL : 9017



REF : LO92255
RAL : 8001 aprox.



REF : LO92220
RAL : 1014



REF : LO92214
RAL : 8015



REF : LO92238
RAL : 3005



REF : LO92245
RAL : 6005



REF : LO92216
RAL : 6026



REF : LO92213
RAL : 6024 aprox.

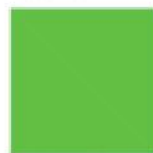

REF : LO92253
RAL : Pilsacho



REF : LO92251
RAL : 5003 aprox.



REF : LO92210
RAL : 5010



REF : LO92215
RAL : 5015



REF : LO92217
RAL : 9017



REF : LO92208
RAL : 7030



REF : LO92259
RAL : 7038 / metal



REF : LO92237
RAL : 7037



REF : LO92236
RAL : 7047 / silver



REF : LO92201
RAL : 9016

Los colores mostrados son meramente informativos
RAL es aproximado al color real.

The colours shown are merely for informative purposes.
The RAL is the approximate colour.

Draws required for the development of the curtain
Auxiliary substructures are included for a curtain hung on a beam.



Manual Divider Curtain "Walk Draw" Mixed Net & Canvas PVC

AFN Sports divider curtain is designed and manufactured to divide the indoor sports facility into more than one court in order to hold multiple sport activities at the same time without interference. As it is a product of great use in facilities, it has been designed to work in a very simple manner without the need for complex maintenance.

The manual curtain is manufactured to be hung and rolled through a rail. The guide rail is made from special aluminium profile; the roller (every 30 cm) is made from nylon and specially designed for long lifetime.

Net made from high tenacity polypropylene 3 mm, mesh 45 mm, knotless.

Canvas made from PVC 650 gr/sqm.

Fireproof and available in different colours.





ويف التجارة والمقاولات ك. م. م.
WAVES TRADING & CONTRACTING W.L.L.
Tel: +974 4441 6319, Fax: +974 4441 6319
P.O.Box: 82431, Doha- Qatar
Email: info@waves-qatar.com
Website: www.waves-qatar.com



Backstop Post Mobile

Backstop Post Mobile
Made from special aluminium profile. Dismantle system.
Included 4 piece nylon turning wheels with brake.
Available in different heights.



Backstop Post for Soccer Height 4, 5,6,7,8 m

The backstop in ground sockets is in a ground socket fixed backstop system.
Backstop Post in Ground Socket System included (for 25 m length!)
6 piece post m made from Aluminium 120 x 100 x 2.5 mm
Lower part included aluminium special profile
6 piece ground socket made from aluminium 120 x 120 x 800 mm
2 piece cross bar for start & end post
3 piece stainless steel cable incl. turnbuckle
Net made by polypropylene 4 mm, green colour, mesh 100 mm
UV protected, Imported from Europe
On request the backstop post system is available in other dimensions.



ويفز للتجارة والمقاولات ك.م.م.
WAVES TRADING & CONTRACTING W.L.L.

Tel: +974 4441 6319, Fax: +974 44416912
P.O. Box: 27831, Doha - Qatar
Email: info@waves-qatar.com
Website: www.waves-qatar.com



Benches





ويفز التجارة والمقاولات - م. ق. -
WAVES TRADING & CONTRACTING W.L.L.
 Tel: +974 44416312 Fax: +974 44416312
 P.O. Box: 92431, Doha - Qatar
 Email: info@waves-qatar.com
 Website: www.waves-qatar.com

3, 4 & 5 Row Benches

Our multi-use aluminium spectator stand is manufactured in the standard version with three levels of seats 3 metres long. There is ample space for up to 18 persons (6 persons per level). The different levels also guarantee a good view of the events taking place. The complete construction of our versatile spectator stand is manufactured from aluminium. The seating area and the steps are made from special aluminium profiles and are additionally anodised and treated to be non-slip. The stand comes in kit form which can be assembled (3 supporting legs, 3 benches, 2 foot rests and the necessary screws and bolts). The robust construction means not only that on-site assembly is quick, it also guarantees that the spectator stand is highly durable.

- Order No. 130035
- Transport wheel for Bleacher
- Made from Nylon Diameter 200 mm.
- Order No. 130070
- Aluminium bleacher 4 row length 3m
- Order No. 130100
- Aluminium bleacher 4 row length 4m
- Order No. 130110
- Aluminium bleacher 4 row length 5m
- Order No. 130120
- Aluminium bleacher 4 row length 6m
- Order No. 130130
- Aluminium bleacher 5 row length 3m
- Order No. 130140
- Aluminium bleacher 5 row length 4m
- Order No. 130150
- Aluminium bleacher 5 row length 5m
- Order No. 130160
- Aluminium bleacher 5 row length 6m
- Order No. 130039
- Aluminium bleacher 3 row length 2.4 m
- Order No. 130040
- Aluminium bleacher 3 row length 3 m
- Order No. 130050
- Aluminium bleacher 3 row length 4m
- Order No. 130060
- Aluminium bleacher 3 row length 5m





ويفز للتجارة والمقاولات ك.م.م.
WAVES TRADING & CONTRACTING W.L.L.

Tel: +974 4441 6319, Fax: +974 44416312
P.O.Box: 82431, Doha- Qatar
Email: info@waves-qatar.com
Website: www.waves-qatar.com



Swedish Bench (ALULINE)

Swedish bench, made by aluminium special profile, 30 cm wide High 30 cm, seat anodised color.

Order No.

130180 : Length 3.00 m

130190 : Length 4.00 m

130170 : Length 5.00 m

130200 : Length 6.00 m



Aluminium Bench (PARIS)

The locker bench is made from special aluminium profiles. All profiles are designed with rounded edges. The seating profile measures an extra-large width of 300 mm. It measures a height of 45 cm. The bench is welded in one piece. It is also equipped with a shoe tray. The item is powder coated. There are assorted colours to choose from. The bench is available in different lengths:

130500: Length 2.00 m

130510: Length 3.00 m

130520: Length 4.00 m

130530: Length 5.00 m

130540: Length 6.00 m

130550: Length on request



Bleacher Mobile TOP

Order No. 130250

Our "MOBILTOP" bleacher can be used unlimited - in- and outdoors for every kind of activity. Within a short time 50 seats become available! By simple add-on of the sets the seat capacity can be increased. Another advantage is the little storage room. Due to a special moving system the single bleacher parts can be put into each other, so the whole system only requires a storage area of approx. 4 m². The seats and walkways are made from special aluminium profiles and are additionally anodised and treated to be non-slip. One complete set consists of 5 blocks of different lengths (one of which is a staircase).

Total length 8.75 m. Depth 1.85 m. Height 0.85 m.





شركة التجارة والمقاولات
WAVES TRADING & CONTRACTING W.L.L.

Tel: +974 4441 5319, Fax: +974 44416312
P.O.Box: 82431, Doha - Qatar
Email: info@waves-qatar.com
Website: www.waves-qatar.com

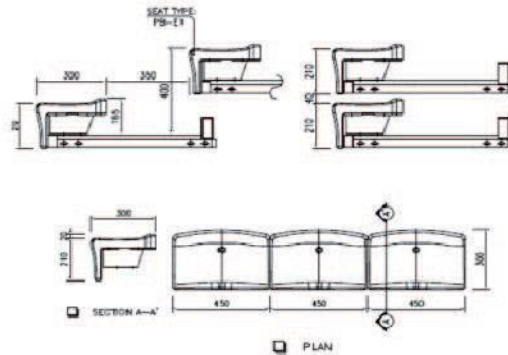

Retractable Seating

SPECIFICATION

BENCH SHELL : HIGH DENSITY POLYETHYLENE BLOW-MOLD.

Deck Frame : Steel deck frame is base on platform that will cover loading of spectators. It is composed of front girder (60 x 40x 2.3mmT), rear girder (125 x 75 x 3.2mmT) and intermediate steel connector (60 x 40 2.3mmT), which is strong enough to maximum load of spectators on the platform and space of every intermediate steel connector less than 500mm distance for safety & stable and is welded properly to front & rear girder. Front channel steel sheet (200 x 80 7.5mmT), of first row is for connecting the operation device i.e. Electrical operation units. Deck Frame can be connected parallel direction another one and fixed the Handrails one side. The size of deck frame is 5250mm width and 1800mm (2row) depth follow to type of scales required.

Platform : The deck frame welded firmly shall be covered with 18mm thickness plywood for sound absorption. The platform shall be also finished by carpet with wooden colour or other various colour with section. Manufactures standard size of platform is same as deck frame.

Finish Of Under structure : Main steel parts of under structure, i.e. Deck Frame, Support Column & Braces etc. shall be painted with alkyd primer (1st Coat) and finish urethane paint (2nd coat) for rust and dust free under the cruel environment, such as seaside, swimming pool, etc..

Manual Pulling Unit : Manual pulling unit included for one (1) or two (2) person and two (2) wheels (PVC/rubber Ø 3" x 1¼" T) and shall be connected into the hole on front face or first row. Its dimension will be available to change follow to length of row and height of blocks.



ويفز للتجارة والمقاولات ك. م. م.
WAVES TRADING & CONTRACTING W.L.L.

Tel: +974 4441 6319, Fax: +974 44416312
P.O. Box: 82431, Doha - Qatar
Email: info@waves-qatar.com
Website: www.waves-qatar.com

Drainage System

SPORTFIX Slotted Channel



Slotted Channel SUPER

Order No. HA 7810

SPORTFIX Slotted Channel SUPER, nominal width 100,
weight : 5.8kg



SPORTFIX Slotted Channel SUPER With Upstand

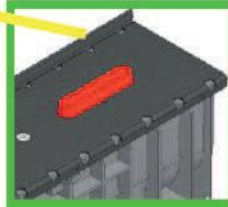

The upstand is used on the straight section where the lawn is connected to the channel.

Order No. HA 7820

SPORTFIX Slotted channel SUPER with upstand, nominal width 100, weight : 5,9 kg

SPORTFIX Trash Box

Order No. HA 7830 + 7785

SPORTFIX Trash Box type order no. HA 7830
Access Cover order no. HA 7785

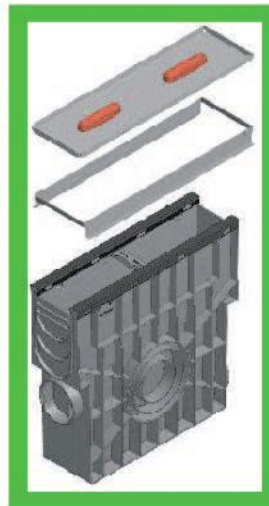



ويفز للتجارة والمقاولات ك.م.م.
WAVES TRADING & CONTRACTING W.L.L.

Tel: +974 4441 6319, Fax: +974 44416312
P.O.Box: 82431, Doha - Qatar
Email: info@waves-qatar.com
Website: www.waves-qatar.com



SPORTFIX PRO 100

Order No. HA 7510

SPORTFIX PRO100 Type 010 Channel with GUGI-Grating made of PA-GF, MW 15/25, black, cl. B 125, length 1 m, locked, weight : 4.655kg

SPORTFIX PRO 100 Trash Box

Order No. HA 7515

SPORTFIX PRO100 Trash Box with mud bucket and GUGI-Grating made of PA-GF, MW 15/25, black, cl. B 125, length 0.5m, locked, weight : 5.85 kg

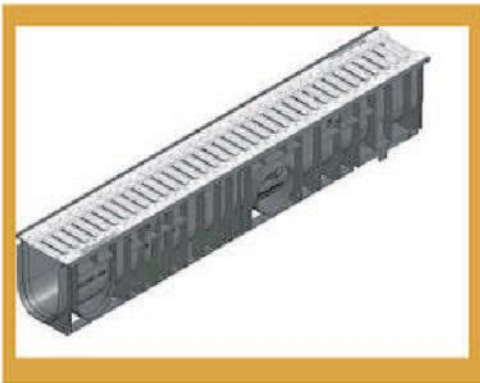

SPORTFIX STANDARD 100

Order No. HA 7530

SPORTFIX STANDARD 100 Channel Type 010 with slotted grating, galvanised, trafficable, with locking device, length 1,0m, weight : 5,3 kg

SPORTFIX STANDARD 100 Trash Box

Order No. HA 7535

RECYFIX STANDARD 100 Trash Box with plastic bucket and slotted grating, galvanised, trafficable, with locking device, L. 0,5m, weight : 5,2 kg



SPORTFIX Channel Type ROME I

ويفز للتجارة والمقاولات ك.م.م.
WAVES TRADING & CONTRACTING W.L.L.
 Tel: +974 4441 6319, Fax: +974 44416312
 P.O.Box: 82431, Doha - Qatar
 Email: info@waves-qatar.com
 Website: www.waves-qatar.com

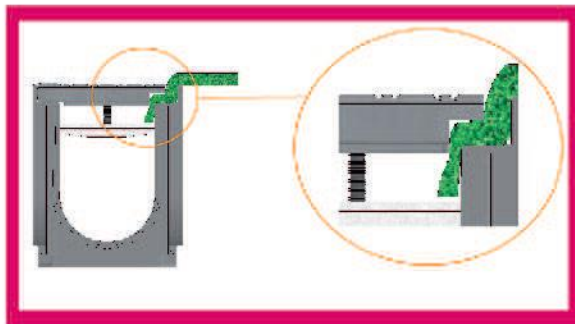

SPORTFIX Channel Type ROME I

Order No. HA 7862

SPORTFIX ROME I 100 channel, type 010
 with GUGI-Grating made of PA-GF, for artificial
 turf from 3 to 15mm, weight : 4,7 kg

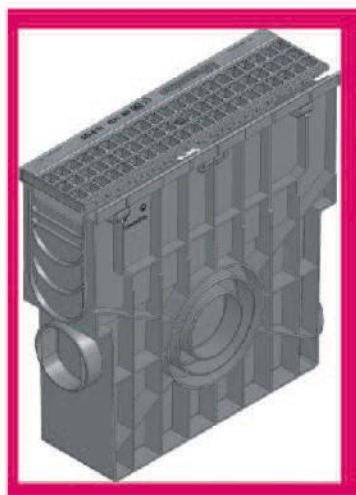
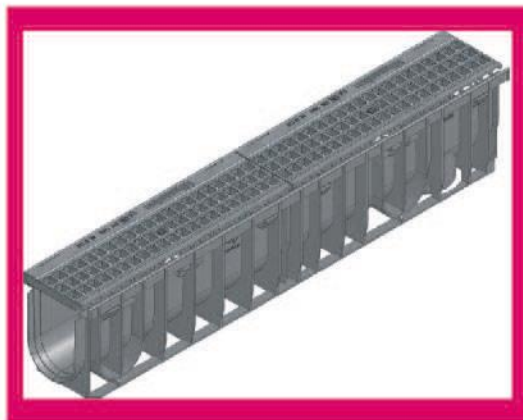

SPORTFIX ROME I Trash Box

Order No. HA 7870

Trash Box Type ROME with GUGI- Grating
 made of PA-GF, for artificial turf from 6 to 18
 mm height, weight : 5,4 kg



ويوز للتجارة والمقاولات ك.م.م.

WAVES TRADING & CONSTRUCTION W.L.L.

Tel: +974 4441 6319, Fax: +974 44416312
P.O.Box: 82431, Doha - Qatar
Email: info@waves-qatar.com
Website: www.waves-qatar.com

Drainage Cover "ALU"

The drainage cover is made from aluminium. It measures a width of 160 mm and a total height of 50 mm. The cover is white powder coated. On the bottom side there are angles attached to fit in the drainage channel. The drainage cover complies with the regulations of the IAAF.

- 142000 White powder coated. OPEN CHANNEL: 160 x 40 x 1000 mm,
- 142003 White powder coated. CLOSED CHANNEL: 160 x 40 x 1000 mm,
- 142001 Aluminium surface. OPEN CHANNEL: 160 x 40 x 1000 mm,
- 142004 Aluminium surface,. CLOSED CHANNEL: 160 x 40 x 1000 mm,
- 142006 White powder coated. OPEN CHANNEL: 143 x 40 x 1000 mm,
- 142007 White powder coated. CLOSED CHANNEL: 143 x 40 x 1000 mm,
- 142008 Aluminium surface. OPEN CHANNEL: 143 x 40 x 1000 mm,
- 142009 Aluminium surface,. CLOSED CHANNEL: 143 x 40 x 1000 mm,

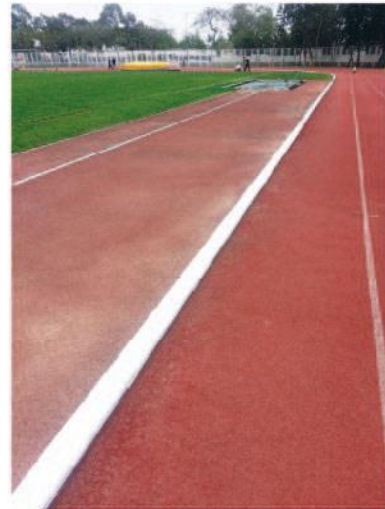
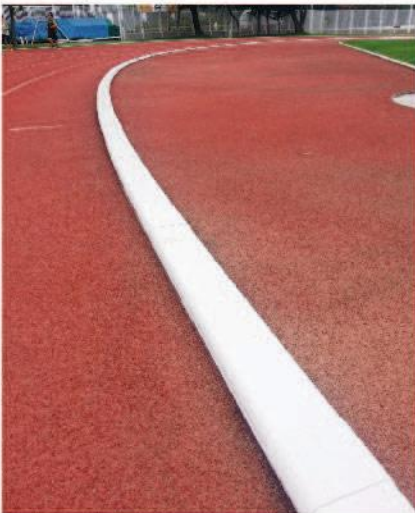



ويفز للتجارة والمقاولات ك.م.م.
WAVES TRADING & CONTRACTING W.L.L.

Tel: +974 4441 6319, Fax: +974 44416312
P.O.Box: 82431, Doha - Qatar
Email: info@waves-qatar.com
Website: www.waves-qatar.com



Scoreboard



Substitution Display Panel

Description:

- High luminosity LED technology.
- Automatic shutdown after 15 min.
- Battery level indicator.
- Advertisement space (450 x 80 mm)
- Displays the number of the player coming in and the number of the player going out or the additional time in minutes.

Uses:

- Indoor or outdoor use.
- Dedicated to the practice of football or rugby.



DISPLAY

	Number of Digits	Height of Digits	Colour of the Digits
Number of the player going out	2	25 cm	red
Number of the player coming in	2	25 cm	green

TECHNICAL CHARACTERISTICS

	Dimensions L x H (mm)	Weight	Construction	Optimal viewing distance	Viewing angle
Display panel	555 x 360 x 40	3 kg	Plastic casing with protective glass cover	120 m	160°

Afficheur	Power supply	Electrical protection
	6V DC battery (rechargeable)	1.2 A Circuit breaker

Keyboard > Display panel communication	The keyboard is integrated in the back of the panel
--	---

REFERENCE

- Display panel: 915770 (battery charger included).

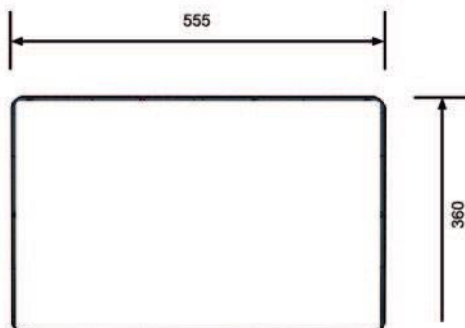



BTX6015 - Indoor or outdoor multi-sport scoreboard

Description:

- High luminosity SMD LED technology.
- Luminosity adjustment from the Pocket keyboard at any time during the game.
- HF radio (868 MHz) communication.
- Integrated horn, 90dB at 1 metre.
- Tropicalised electronics.

Certification and Standard Conformity:

- IR & TTE (radio).
- CE marking.
- Electromagnetic compatibility (CEM).
- Low voltage.



www.bodet-sport.com

DISPLAY

BTX6015	Number of Digits	Height of Digits	Colour of the Digits
Game clock or Time of Day clock	4	15 cm	Yellow
Scores (0 to 99)	2 per team	15 cm	Red
End of period indicator	1 cluster	Ø36 mm	Red

TECHNICAL CHARACTERISTICS

	Dimensions L x H x D (mm)	Weight	Construction	Protection Index	Optimal viewing distance	Viewing angle
BTX6015	1079 x 385 x 90.5	8 kg	Aluminium casing with protective front glass cover	IP54 IK07	60 m	160°

	Power supply	Power consumption	Electrical protection
BTX6015	100 ~ 240V / 50 ~ 60Hz	78W	16 A Circuit breaker

Keyboard > Display panel BTX6015	HF Radio 868MHz
----------------------------------	-----------------

- Option: 12V DC/ 230V AC power inverter when using a battery as the power source.

REFERENCES

- BTX6015:915795 (Pocket keyboard included).
- Tripod:915293.
- 12V DC / 230V AC power inverter:.....915291.

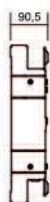

BTX6015 side view

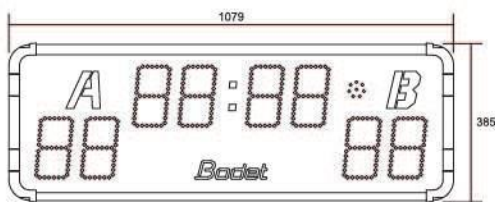

BTX6015 front view



Tripod

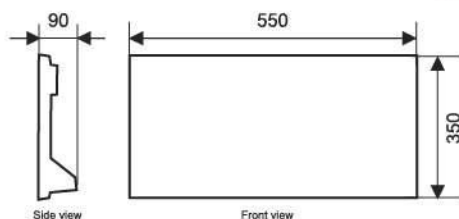

Chronotop - Indoor Multisport Scoreboard

Description:

- High luminosity SMD LED technology.
- Integrated keyboard on the rear of the display.
- Integrated horn (3 different types of sound and 3 volume levels).

Certifications and Standard Conformity

- CE marking.
- Electromagnetic compatibility (CEM).
- Low voltage.



DISPLAY

Chronotop	Number of Digits	Height of Digits	LED color
Game clock	4	10 cm	Yellow
Score (0 to 199)	3 per team	10 cm	Red
Period number	1	10 cm	Green
Team fouls	1 per team	10 cm	Red
Time-out indicator	4 clusters per team	Ø36 mm	Red
End of period indicator	1 cluster	Ø36 mm	Red

TECHNICAL CHARACTERISTICS

	Dimensions L x H x D (mm)	Weight	Construction	Protection Index	Viewing distance	Viewing angle
Chronotop	550 x 350 x 90	3,6 kg	Polycarbonate casing with protective front glass cover	IP20 IK09	40 m	160°
	Power supply			Electrical protection		
Chronotop	100-240V (50-60Hz) / 12V DC power adapter			16A circuit breaker		

- Options: the scoreboard can be powered by a 12V battery.

REFERENCES

- Chronotop Export:915761.
- 12V rechargeable battery:915766.
- Battery charger:915767.



**BT 2025 Classic V2 -
Indoor or outdoor multi-sport scoreboard**

Description:

- High luminosity SMD LED technology.
- Luminosity adjustment from the keyboard at any
- Wired or HF radio (868 MHz) communication (Pocket-
Tropicalised electronics.
- **Option: Temperature probe.**

Certifications and Standard Conformity

- IR & TTE (radio).
- CE marking.
- Electromagnetic compatibility (CEM).
- Low voltage.



or



ALPHASCORE Keyboard

POCKET Keyboard



DISPLAY

<i>BT2025 Classic</i>	<i>Number of Digits</i>	<i>Height of Digits</i>	<i>LED colour</i>
Game clock (mm:ss) or Local time (hh:mm) or Temperature	4	25 cm	
Score (0 to 99)	2 per team	25 cm	

TECHNICAL CHARACTERISTICS

	<i>Dimensions L x H x D (mm)</i>	<i>Weight</i>	<i>Construction</i>	<i>Protection Index</i>	<i>Optimal viewing distance</i>	<i>Viewing angle</i>
BT2025 Classic	1500 x 1130 x 84,5	34 kg	Aluminium casing with protective front glass cover	IP54 IK07	120 m	160°
	<i>Power supply</i>	<i>Power consumption</i>	<i>Electrical protection</i>	<i>Operating temperature range</i>		
BT2025 Classic	230V - 50/60Hz	30W	16 A Circuit breaker	- 20 to +50°C		

	<i>Power supply</i>	<i>Communication with scoreboard</i>	<i>Use</i>
Alphascore keyboard	230V AC adapter	Wired or 868 MHz HF Radio	Indoor or under shelter
Pocket keyboard	2 x 1.5V batteries	868 MHz HF Radio	Indoor or Outdoor

REFERENCES

- BT2025 Classic scoreboard:915147 (keyboard not included).
- Support:consult with BODET.

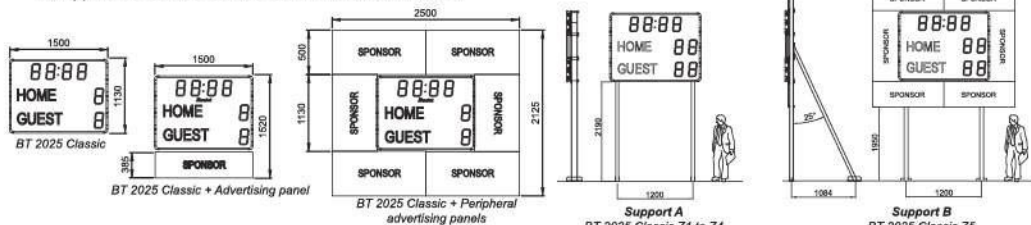

	Normal speed	Extreme speed
Zone 1	102,9 km/h	136,1 km/h
Zone 2	112,7 km/h	149,1 km/h
Zone 3	126,0 km/h	166,6 km/h
Zone 4	138,0 km/h	182,6 km/h
Zone 5	174,6 km/h	230,9 km/h

BT 2025 Classic+ Advertising panel Z1 to Z5
BT 2025 Classic + Peripheral advertising panels Z1 to Z5

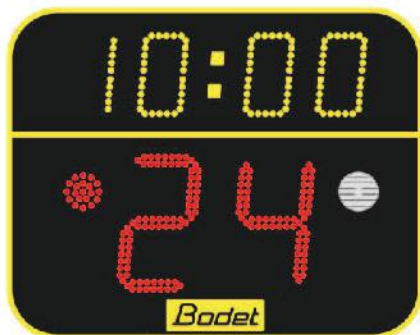

BT6006 Shot Clock



14/24 sec shot clock Time Pad keyboard

BT 6006 - Indoor shot clock display panel dedicated to Basketball

Description:

- Display indicating the time left to attempt a goal.
- High luminosity SMD LED technology.
- Luminosity adjustment from the Time Pad keyboard at any time during the game.
- Wired or HF radio (868 MHz) communication.
- Integrated horn (100dB at 1m).

Certifications and Standard Conformity

- IR & TTE (radio).
- CE marking.
- Electromagnetic compatibility (CEM).
- Low voltage.



www.bodet-sport.com



DISPLAY

BT6006	Number of Digits	Height of Digits	LED colour
Shot clock (14/24sec to 0)	2	25 cm	Red
Game clock	4	15 cm	Yellow
End of period indicator	1 dot	Ø66 mm	Red

	Dimensions L x H x D (mm)	Weight	Construction	Protection Index	Optimal viewing distance	Viewing angle
BT6006	720 x 610 x 80	15 kg	Aluminium casing	IP20 IK09	120 m	160°

	Power supply	Power consumption	Electrical protection
BT6006	230V - 50/60Hz	70W	16 A Circuit breaker
Time Pad keyboard	Power supplied by the main keyboard		
Time Pad Keyboard ⇨ Display panel BT6006 communication	Wired or HF Radio 868MHz		

REFERENCES

- BT6006: 915815
- Backboard mounting kit:915870

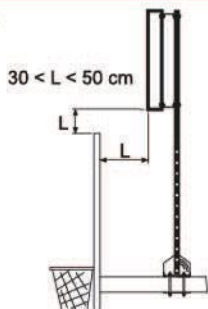

Side view behind backboard

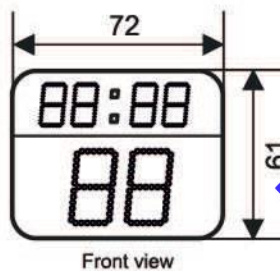

Front view





BT6015 scoreboard



Main keyboard

BT 6015 - Indoor multisport Scoreboard

Description:

- High luminosity SMD LED technology.
- Luminosity adjustment from the keyboard at any time during the game.
- Wired or HF radio (868 MHz) communication.
- Integrated horn (120dB at 1m).

Certifications and Standard Conformity

- IR & TTE (radio).
- CE marking.
- Electromagnetic compatibility (CEM).
- Low voltage.



DISPLAY

BT6015	Number of Digits	Height of Digits	LED Colour
Game clock or Local Time or Time-out timer	4	15 cm	Yellow
Score (0 to 999)	3 per team	15 cm	Red
Period number	1	10 cm	Yellow
Team fouls	1 per team	10 cm	Red
Time-out indicators	3 dots per team	Ø36 mm	Yellow
Game clock stopped indicator	1 dot	Ø66 mm	Red

TECHNICAL CHARACTERISTICS

	Dimensions L x H x D (mm)	Weight	Construction	Protection Index	Optimal viewing distance	Viewing angle
BT6015	1150 x 750 x 80	27 kg	Shockproof steel casing	IP20 IK09	60 m	160°

	Power supply	Power consumption	Electrical protection
BT6015	230V 50/60Hz	78W	16 A Circuit breaker

Main keyboard → BT6015 scoreboard communication	Wired or HF radio 868 MHz
---	---------------------------

REFERENCE

• BT6015 scoreboard: ...915714 (keyboard not included).

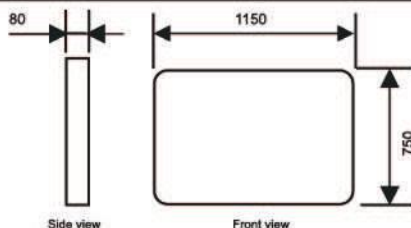



BT6015 COMPAK scoreboard



Pocket keyboard

BT 6015 Compak - Indoor multisport Scoreboard

Description:

- High luminosity SMD LED technology.
- Luminosity adjustment from the keyboard at any time during the game.
- Wired or HF radio (868 MHz) communication.
- Integrated horn (120dB at 1m).

Certifications and Standard Conformity

- IR & TTE (radio).
- CE marking.
- Electromagnetic compatibility (CEM).
- Low voltage.



DISPLAY

BT6015 Compak	Number of Digits	Height of Digits	LED colour
Game clock or Time of Day clock	4	15 cm	Yellow
Score (0 to 99)	2 per team	15 cm	Red
Game clock stopped indicator	1 dot	Ø66 mm	Red

TECHNICAL CHARACTERISTICS

	Dimensions L x H x D (mm)	Weight	Construction	Protection Index	Optimal viewing distance	Viewing angle
BT6015 Compak	860 x 600 x 80	15 kg	Shockproof steel casing	IP20 IK09	60 m	160°

	Power supply	Power consumption	Electrical protection
BT6015 Compak	230V - 50/60Hz	60W	16 A Circuit breaker
Pocket keyboard	2 x 1.5V Batteries		

Pocket Keyboard ↔ BT6015 scoreboard communication	HF radio 868 MHz
---	------------------

REFERENCES

- BT6015 COMPAK:915775 (Pocket keyboard included)

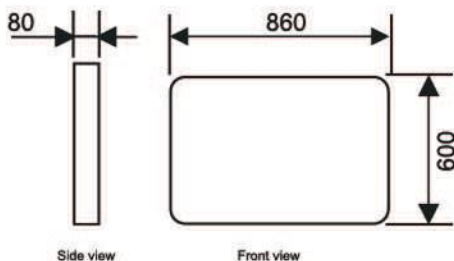



Second Timer - Timer dedicated to swimming training

Presentation:

- Second timer for swimming practice allowing swimmers to check their own performances.
- White laquered aluminium dial.
- Blue metal casing, plexiglas cristal.
- 4 hands of different colours allowing for a different swimmer to start every 15 seconds. Hands colours: yellow, green, red and black.

Characteristics:

- 24V synchronois movement, 1 tr/min.
- Power supply inside a case mounted on the back of the dial.
- Duplex installation : junction box for 2 timers + non waterproof power supply to be located in a dry room + control pad with a 10 metre cable for timers synchronisation and timers reset.
- Optimal viewing distance: 50m.



www.bodet-sport.com

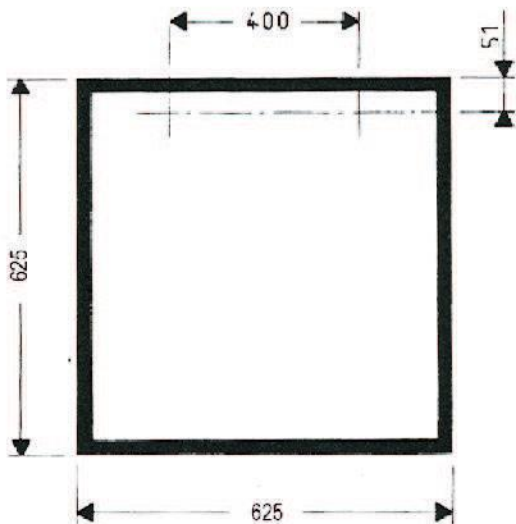

Front view

Electrical Characteristics:

- Power supply : the transformer (230VAC to 24VAC) is included in an IP54 box connected to the second timer by a 30cm cable.

Mechanical Characteristics:

- Dimensions: 625x625x100 mm.
- IP 65.
- Weight: 13 kg.

Reference:

- Second timer: 915011.

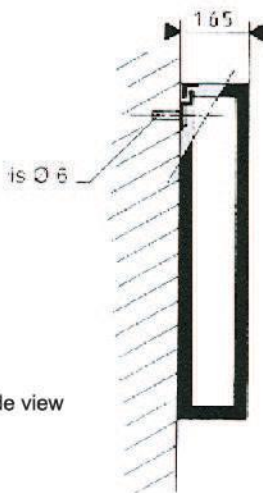

Side view



Main keyboard

Secondary keyboard

Example of scrolling message



BT 66215 Alpha - Indoor multi-sport Scoreboard

Description:

- High luminosity SMD LED technology.
- Luminosity adjustment from the keyboard at any time during the game.
- Teams' names or scrolling message (before or after the game) can be programmed from the main keyboard.
- Wired or HF radio (868 MHz) communication.
- Integrated horn (120dB at 1m).

Certifications and Standard Conformity

- IR & TTE (radio).
- CE marking.
- Electromagnetic compatibility (CEM).
- Low voltage.





DISPLAY

BT6215 Alpha		Number of digits	Height of digits	LED
Panel A	Game clock or Local time or Time-out timer	4	15 cm	Yellow
	Score (0 to 999)	3 per team	15 cm	Red
	Teams' names..... Scorlling message.....	max. 7 char. per team max. 60 char.	10 cm	Yellow
	Period number	1	10 cm	Yellow
	Team fouls	1 per team	10 cm	Red
	Time-out indicators	3 dots per team	Ø 36 mm	Yellow
	Game clock stopped indicator	1 dot	Ø 66 mm	Red
Panel B	Personal fouls (players' number 4 to 15)	4 dots per player	Ø 36 mm	Yellow
		1 dot per player		Red

TECHNICAL CHARACTERISTICS

	Dimensions L x H x D (mm)	Weight	Construction	Protection Index	Optimal viewing distance	Viewing angle
BT6215 Alpha	2150 x 1000 x 80	65kg	Shockproof steel casing	IP20 IK09	60 m	160°

	Power supply	Power consumption	Electrical protection
BT6215 Alpha	230V 50/60Hz	230W	16 A Circuit breaker

Main keyboard ↔ BT6215 scoreboard communication	Wired or HF radio 868 MHz
---	---------------------------

REFERENCE

• BT6215 Alpha:915713 (keyboards not included).

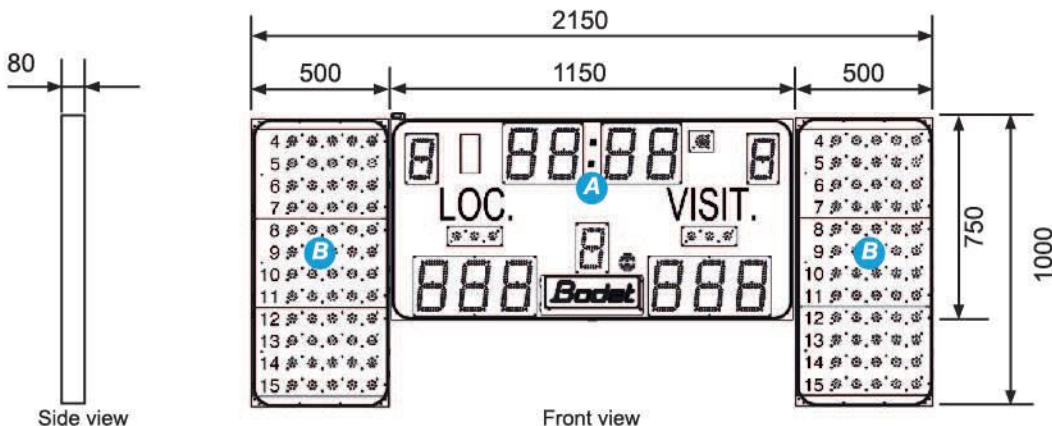



Main keyboard

Secondary keyboard

**BT 66215 -
Indoor multi-sport Scoreboard**

Description:

- High luminosity SMD LED technology.
- Luminosity adjustment from the keyboard at any time during the game.
- Wired or HF radio (868 MHz) communication.
- Integrated horn (120dB at 1m).

Certifications and Standard Conformity

- IR & TTE (radio).
- CE marking.
- Electromagnetic compatibility (CEM).
- Low voltage.





DISPLAY

BT6215		Number of digits	Height of digits	LED
Panel A	Game clock or Local time or Time-out timer	4	15 cm	Yellow
	Score (0 to 999)	3 per team	15 cm	Red
	Period number	1	10 cm	Yellow
	Team fouls	1 per team	10 cm	Red
	Time-out indicators	3 dots per team	Ø 36 mm	Yellow
	Game clock stopped indicator	1 dot	Ø 66 mm	Red
Panel B	Personal fouls (players' number 4 to 15)	4 dots per player	Ø 36 mm	Yellow
		1 dot per player		Red

TECHNICAL CHARACTERISTICS

	Dimensions L x H x D (mm)	Weight	Construction	Protection Index	Optimal viewing distance	Viewing angle
BT6215	2150 x 1000 x 80	60 kg	Shockproof steel casing	IP20 IK09	60 m	160°

	Power supply	Power consumption	Electrical protection
BT6215	230V 50/60Hz	170W	16 A Circuit breaker

Main keyboard → BT6215 scoreboard communication	Wired or HF radio 868 MHz
---	---------------------------

REFERENCE

• BT6215:915716 (keyboards not included).

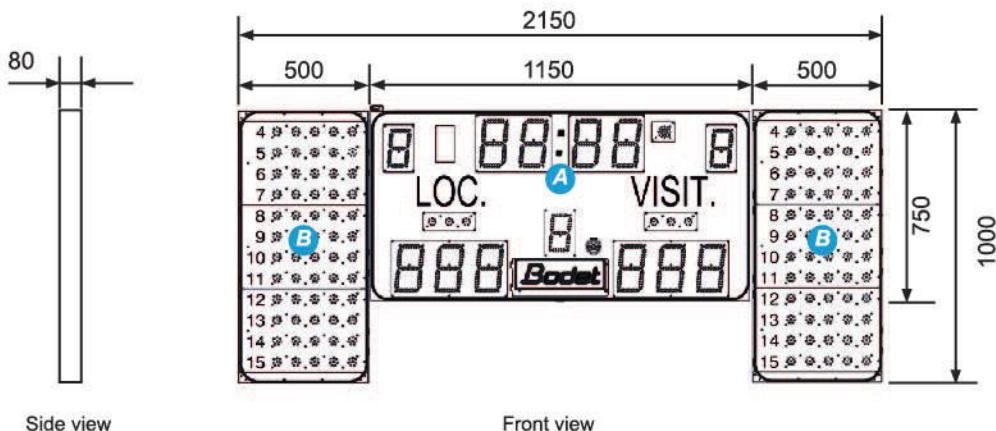

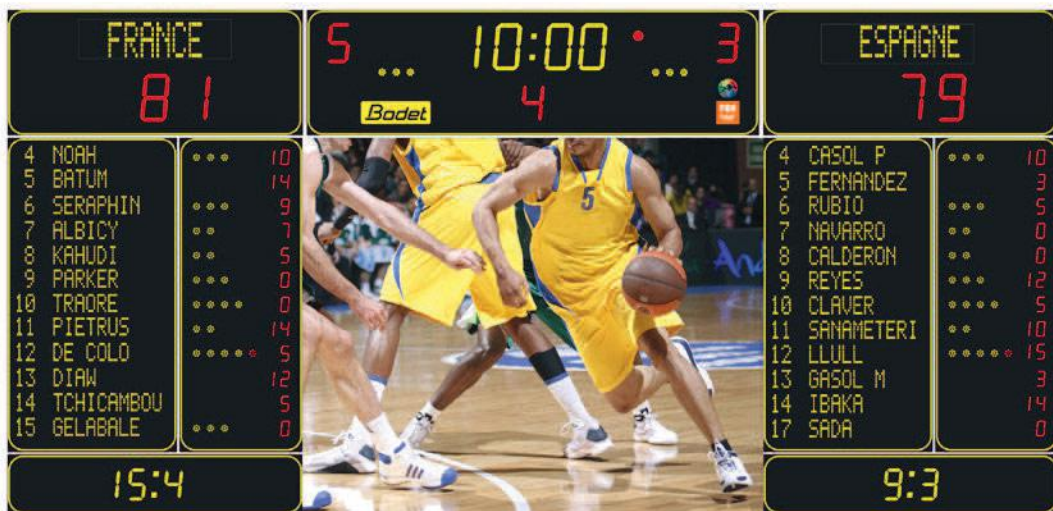

BT 6730 Video 7M 12P H10 -

Indoor multisport scoreboard for sporting venues and indoor arenas

Basketball FIBA levels 2 and 3, international level volleyball, national level handball

LED Scoreboard Main Features:

- 12 players per team scoreboard with 10 cm high names and numbers.
- High luminosity SMD LED technology.
- Luminosity adjustment from the main keyboard at any time during the game.
- Teams' names, players' names and players' numbers can be programmed from a PC connected to the main keyboard through a serial port.
- The PC software manages the teams' names, the players' names and numbers and the display luminosity.
- Wired communication via the video control system.
- Integrated horn (120dB at 1 m).

Video Screen Main Features:

- SMD LED technology (10 mm pitch).
- 9 (960mm x 800mm) video modules.
- Total screen area: 6.9 m².

Certifications and Standard Conformity

- IR & TTE (radio).
- CE marking.
- Electromagnetic compatibility (CEM).
- Low voltage.



www.bodet-sport.com



Netball



Rink hockey



Floorball



Futsal



Cricket



Basketball



Handball



Volleyball



Tennis



Table tennis



Badminton



SCOREBOARD DISPLAY

BT6730 Video 7M 12P H10 (The displays of all panels are sport dependent)		Number of Digits	Height of Digits	LED
A	Game clock, Local time and Rest period timer (or Time-out timer for volley)	4	30 cm	Yellow
	Period number or Current set number	1	25 cm	Red
	Number of team fouls or Number of won sets	1 per team	25 cm	Red
	Time-out indicators	3 dots per team	Ø36 mm	Yellow
	Game clock stopped indicator	1 dot	Ø66 mm	Red
B	Teams' names	Max. 10 characters / team	20 cm	Yellow
	Score (0 to 999)	3 per team	30 cm	Red
C	Last individual foul (Player's nber + nber of fouls) and Time-out timer or 1 Penalty timer per team.	4 per team	20 cm	Yellow
D	Players' numbers (0 to 99 - 12 players per team)	2 per player	10 cm	Yellow
	Players' names	Max. 12 characters per name	10 cm	Yellow
E	Individual fouls indicators (Basketball only)	4 dots per player	Ø36 mm	Yellow
		Fifth foul: 1 dot per player	Ø36 mm	Red
	Points per player (12 players per team) (Basketball only)	2 per player	10 cm	Red

TECHNICAL CHARACTERISTICS

	Dimensions L x H x D (mm)	Weight	Construction	Protection Index	Optimal viewing distance	Viewing angle
BT6730 Video 12P H10	6690 x 3215 x 80	785 kg	Shockproof steel casing	IP20 IK09	150 m	160°
7 m² Video Screen	2880 x 2400 X 107					
		Power supply	Power consumption	Electrical protection		
BT6730 Video 12P H10	230VAC ±10%, 50/60Hz		2155W	10 A Circuit breaker - D curve		
7 m² Video Screen			4100W	19A Circuit breaker - D curve		
Main keyboard → BT6730 Alpha scoreboard communication				Wired		

REFERENCES

- BT6730 Alpha 12P H10 scoreboard: ... 915782 (including software).
- Main keyboard: 915809.
- Secondary keyboard: 915805.
- 7 m² Video screen: consult BODET

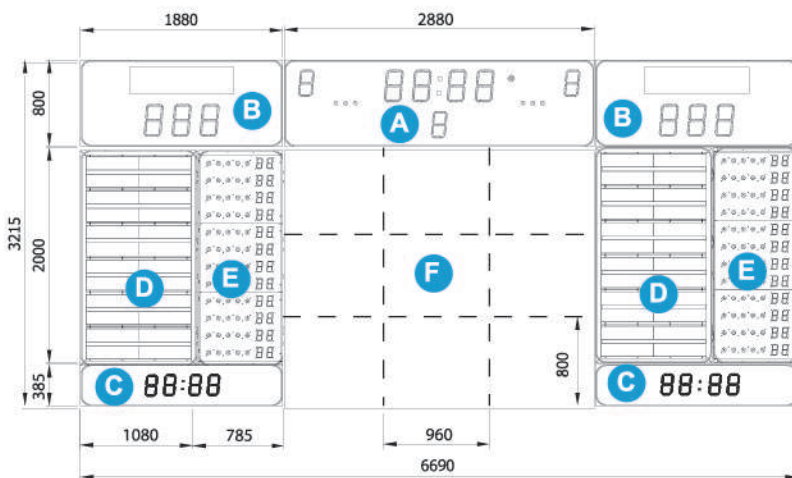



ويفز للتجارة والمقاولات ك. م. م.
WAVES TRADING & CONTRACTING W.L.L.

Tel: +9744441 6389, Fax: +974 44416312
P.O. Box: 82433, Doha - Qatar
Email: info@waves-qatar.com
Website: www.waves-qatar.com

SEIKO

HIGH JUMP M DECA.

Wei Sheng Lance TAN 
SIN

1:1



1.50

Electronic Measurement
& Display Equipment



Seiko W073 Stopwatch – (S23589J)

Features :

- Measurable up to 100 hours in 1/100 seconds for the first hour and in seconds thereafter
- Split/lap time measurement
- Store and recall of up to 10 split/lap times
- Memory recall during operation
- Two separate displays for split and lap time measurements
- Time and full automatic calendar
- Water resistant

Recommended for :

Track events, Road races, Swimming and Motor Sports



Seiko S056 Stopwatch – (S23601P)

Features :

- Measurable up to 100 hours in 1/100 of a second
- Displays split time, lap time, lap time in progress
- Displays up to 999 split / lap times
- Store and recall of up to 100 split / lap times
- Memory recalled after or even during the measurement by easier button operation
- Two separate displays for split / total time, lap / total time, and lap / lap time in progress
- Time and full automatic calendar
- Battery life indicator
- 5-bar water resistant
- Automatic shut off function to save a battery power
- On / off confirmation sound for button operation

Recommended for :

Track events, Road races, Swimming, Ski, Skate and Motor Sports



Seiko S057 Stopwatch 100 Lap Memory

Features :

- Two channel countdown timer
- Each channel can be preset for up to 100 hours
- Measurable up to 100 hours in 1/100 of a second
- Split/lap time measurement
- Store and recall of up to 100 split/lap times
- Memory recall and countdown timer can be used during stopwatch operation
- Two separate displays for split and lap time measurements
- On/off confirmation sound
- Dot-matrix mode display
- Time and full automatic calendar
- Battery life indicator
- Automatic shut-off function
- Water resistant



Seiko S141 - 300 Lap Memory

Features :

- Measurable up to 10 hours in 1/100 of a second
- Split/lap time measurement
- Store and recall of up to 300 split/lap times
- Memory segregated by event
- Multiple event memory
- Memory recall during operation
- Memory overflow warning
- Measures strokes per minute for events such as swimming and rowing
- Large-sized three row display panel
- Time and automatic calendar
- Battery life indicator
- 10-bar water resistant



ويغز للتجارة والمقاولات ك.م.م.
WAVES TRADING & CONTRACTING W.L.L.

Tel: +974 4441 6319, Fax: +974 44416312
P.O. Box: 82431, Doha - Qatar
Email: info@waves-qatar.com
Website: www.waves-qatar.com



Seiko S143 Stopwatch (S23569J)

The SEIKO Cal. S143 stopwatch is a digital stopwatch featuring a print-out function when connected to an SP12 printer. The stopwatch is also equipped with a large-sized three-row display panel that can display the split time, lap time and total elapsed time or lap time in progress at the same time in separate rows, and a memory function that stores the measurements. In addition the stopwatch is water resistant and can withstand up to 3 bar. Therefore, it is suitable for aquatic sports or use in rainy weather.

Features :

- 300 Split/Lap Memory with Printer Port
- Measurable up to 10 hours in 1/100 of a second
- Split/lap time measurement
- Store and recall of up to 300 split/lap times
- Memory segregated by block
- ID No. function useful for storing the data of individual users
- Memory recall during operation
- Connectable with printer SFD001J[Cal.No.SP12]
- Large-sized three row display panel for split, lap and total time
- Time and automatic calendar
- Battery life indicator
- Memory capacity indicator
- Water resistant
- The fastest lap time recall function

Recommended for :

Track events, Road races, Ski, Skate, Motor Sports and Swimming



SEIKO SP12 Printer

Features :

- Prints 13 digits per line
- Printing speed of 1.5 lines per second
- Large clear print
- Connectable with S143 & S123 stopwatches to be used as a system
- Printout selection of split only or lap times
- Optional paper holder to install larger amount of paper
- Automatic printout of year, month, date and time



Seiko Large Paper Holder (S23549JA)

Features :

- Holds larger rolls of thermal paper (Seiko S951) and can be used with Seiko S149 and SP12 Printer.



Seiko S149 - 300 Lap Printer Stopwatch (S23571J)

Features :

- Measurable up to 10 hours in 1/100 of a second
- Split/lap time measurement
- Store and recall of up to 300 split/lap times
- Memory segregated by block
- ID No. function useful for storing the data of individual users
- Memory recall during operation
- Large-sized three row display panel for split, lap and total time
- Time and automatic calendar
- Battery life indicator
- Memory capacity indicator
- Prints 13 digits per line
- Printing speed of 1.5 lines per second
- Large and clear print
- Printout selection of split only or with lap times
- Optional paper holder S23549J to install larger amount of paper S951
- Automatic printout of year, month, date, and time
- The fastest lap time recall function
- Compatible with SEIKO Gripswitch - Model S23547J.
- Compatible with SEIKO Paper Holder - Model S23549.

Recommended for :

Track events, Road races, Swimming, Ski, Skate and Motor Sports



Sports Timer ST-306

Sports Timer (ST-306): 1 unit **Battery Box: 1 unit**
Grip Switch: 1 unit

•Features

Being able to serve as either a count-up or count-down timer, ST-306 can be used as timing display system for various sports events including swimming, track race, marathon, walking race, skiing, cycling, and soccer, rugby and basketball and other game.

It can also display game points and deuce points in tennis.

It can measure lap time, split time and finish time.

Either lap or split times of up to 25 runners can be stored in memory for later recall.

It has an auto repeat function.

That counts up/down a preset time repeatedly at given intervals and sounds a buzzer every time the preset time has been counted up/down.

ST-306 can be used as a pace-clock.

Being battery-powered, it can be used both indoors and outdoors.



Stand / ST-020
 W1,000 x H1,000 x D1,000mm

Main Functions

- ST-306 can be set to count up/down to 99 hours 59 minutes 59 seconds, 59 minutes 59 seconds 9 or 59 minutes 59 seconds 99 as required, being able to cover a wide range of sports events.
- The count-up timer can be set to start counting up from either zero or a preset time.
- The count-down timer can also be set to start counting up as soon as it has counted down the set time. This function is useful for the start of a marathon or other races.
- ST-306 can be used in combination with various SEIKO sports timing devices.

■ Specifications

Display	Magnetic rotary bar, yellow, character height 200mm, 6	
Time accuracy	±0.04 sec/hr.(+5°C~+35°C)	
Measuring function	Counting- Maximum measuring	99h 59m 59s (59m 59s 9, 59m 59s 99)
	Memory and memory	Lap or split time.Up to 25 measurements can be stored.
	Counting-down Preset time	99h 59m 59s ~ 1s
Auto repeat (REPEAT)	A preset time is counted up/down repeatedly, with a buzzer sounding for approx. 5 sec. each time a count-up/-down of the	
Power supply	"AA" dry cell x 8 pcs.	
Battery service life under continuous duty	LR06"AA" alkaline dry cell: approx. 50 hrs. (at +25°C)	
Operating Location	Indoors and outdoors (provided that permanent outdoor installation is	
environment Temperature for use	0°C~+50°C (non-condensing)	
For storage	-10°C~+55°C (non-condensing)	
Appearance/Dimensions	W1,230 x H330 x D150mm	
Material	Aluminum, yellow	
Weight	12.5kg (including dry cells)	
Grip switch	Cord length, 5m, φ 60; w/START/STOP and LAP/SPLIT/RESET	
Devices available for connection with ST-306	PS-110/109/107/105, CT-2000/1000/916 CT-500/400/300, PT-8000/7000/6000 ST-2000/900/800 series, RT-120 WG-300/200, DM-400/200, KT-601, JT-601	

● A guideline when the timer is used to count up the time continuously. It should be noted that the battery service life varies depending on such factors as operating conditions, function settings, ambient temperature and other environmental conditions, and place of use.

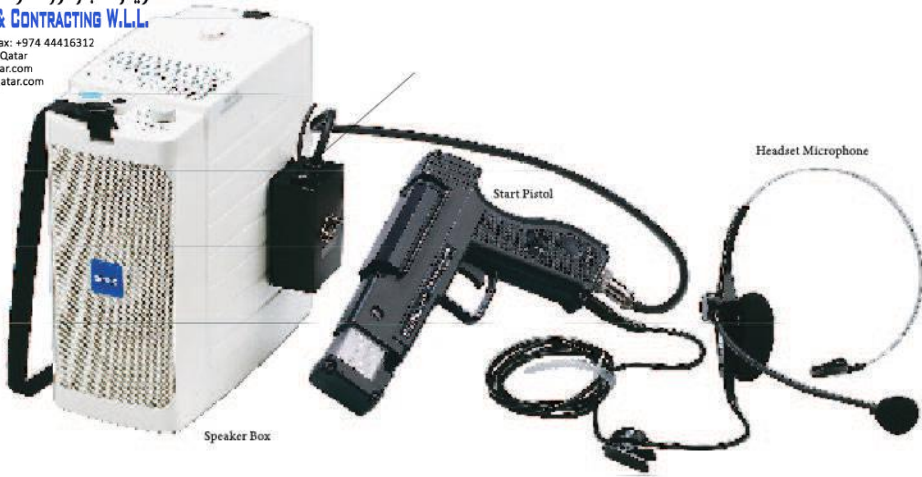

Electronic Starter PS-110

System Components

Start Pistol (PS-78): 1 unit Speaker Box (PS-56): 1 unit
 Headset Microphone (PS-61): 1 unit Cable with a termination box (PS-81): 1 unit

Features

PS-110 is an electronic audio-visual start signal generator that can be used for various types of sports events. It generates a start signal with both sound and flashlight.

It does not use gunpowder, and is safe for handling and storage.

Problems involved in the use of a gunpowder pistol such as misfire and powder smoke have been eliminated.

A synthesized firing signal or an electronic beep can be generated, as required.

The Headset Microphone can be used to amplify and communicate the starter's voice to the athletes.

PS-110 can be used alone, with other units of PS-110, or in combination with other devices, to suit your needs.

Specifications

Start Pistol (PS-78)

Strobe	Xenon lamp
Power supply	LR06 "AA" alkaline dry cell x 2 pcs. (DC 3V)
Battery life (alkaline dry cells)	Approx. 1,200 times (Number of times light can be emitted continuously in 1-minute)
Temperature	For use: -10 50 (non-condensing) For storage: -15 60 (non-condensing)
Appearance	Dimensions: W210 x H40 x D145mm
	Material: Aluminum, black gray
Weight	Approx. 410g (excluding dry cells, cord)

Headset Microphone (PS-61)

Output	Impedance, 1.6kΩ, ±30%
Sensitivity	-68dBdB
Type	Condenser microphone
Appearance	Dimensions: W160 x H68 x D170mm
	Material: ABS resin, black
Weight	Approx. 45g (including cord)

Speaker Box (PS-56)

Audio input	-20dB (100kΩ)
Rated output	6W (max. 10W)
Power supply	LR06 "AA" alkaline dry cell x 8 pcs. [DC 12V]
Battery life (alkaline dry cells)	Pistol sound: approx. 8,000 operations until sound pressure falls below 91dB (at a distance of 10m)
Operating sound pressure level	93dB (at a distance of 10m)
Temperature	For use: -5 40 (non-condensing) For storage: -15 50 (non-condensing)
Appearance	Dimensions: W102 x H258 x D216mm
	Material: ABS resin, ivory
Weight	Approx. 1.6kg (excluding dry cells)

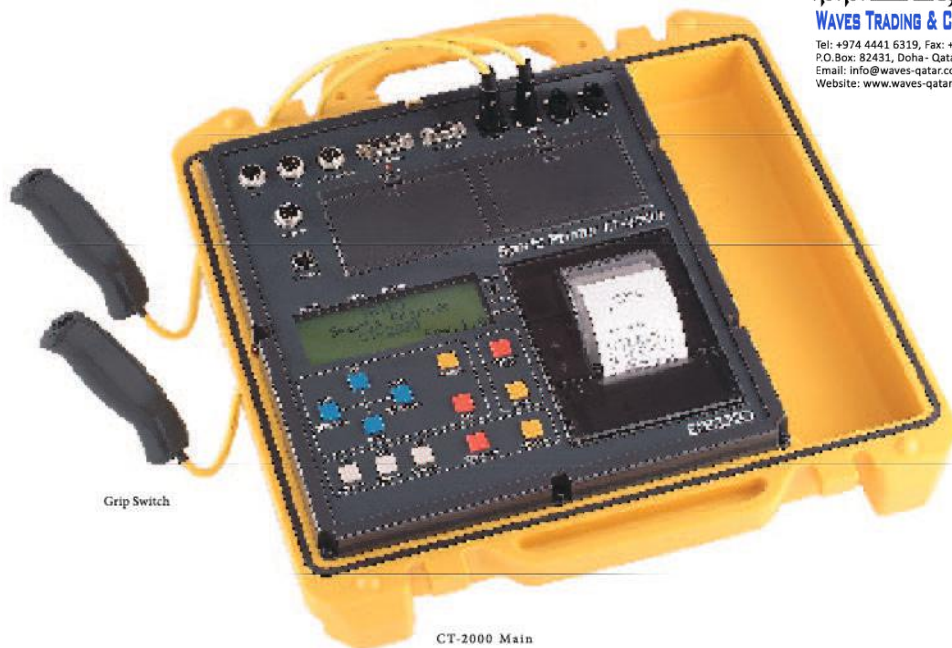

Grip Switch

CT-2000 Main

Sports Printer CT-2000

System Components

Sports Printer (CT-2000): 1 unit Grip switch with 2.5m cable (GS-51): 2 units
 AC adapter with 5m cable: 1 unit Roll Paper (RP-03): 1 roll Ribbon Cassette (ERC-22): 1 unit

Features

Being equipped with various measurement modes, CT-2000 can be used for timing of all types of sports events.

Timing down to 1/1,000 of a second is possible.

The method of calculating the fraction of a second can be selected from 10 types including rounding up, rounding down and rounding off, thus making it possible to comply with various timing rules adopted in different sports events.

A large-sized LCD monitor is used to make it easier to check various types of information displayed on it.
 (20 characters x 4 lines)

The design of the grip switch is renewed so that it better fits into your palm and provides easier switch operation.

By using resin case, high durability has been achieved.

If the dry batteries are installed when CT-2000 is powered by AC adapter, the power source can be quickly switched over to the batteries in case of failure of AC power supply, to ensure constant operation.*

Two sets of dry batteries (6 AA size cells per set) can be installed in the main body, and the power source is switched over automatically between them. By replacing the unused set of dry batteries with new ones, CT-2000 can be powered by the dry batteries continuously for a long time.*

Rechargeable batteries can be used in place of alkaline dry batteries.*

CT-2000 can also be powered by external battery.*

* Dry batteries, rechargeable batteries and external battery are not included with CT-2000, and they should be purchased separately if required.



ويجز للتجارة والمقاولات ك.م.م.
WAVES TRADING & CONTRACTING W.L.L.

Tel: +974 4441 6319, Fax: +974 44416312
P.O.Box: 82431, Doha - Qatar
Email: info@waves-qatar.com
Website: www.waves-qatar.com



Main Functions

The Auto Measurement Mode enables the measurement during individual practices performed alone.

Reaction time (start reaction time: time after the start signal until swimmer's feet have left the starting block), lap time, and split time can be measured during swimming practices.

Lap time and split time can be measured during practices of speed skating, track, and other races.

By outputting a signal to an external buzzer device, CT-2000 can control the device to generate a starting sound automatically.

Even if the actual start time has differed from the scheduled time, the Time Correction Mode (inputting time difference from start time) corrects the scheduled start time set in advance in the secondary CT-2000 units, enabling them to synchronize with the master CT-2000 unit.

The Speed Measurement Mode measures the average speed over a given section of the entire distance.

By connecting a Bib No. input device with CT-2000, the measured times can be printed out together with the Bib No.

CT-2000 can be connected with a personal computer via USB interface.

Two types of time signals (RS-422) are output to the scoreboard (with or without running time data).

A synchronization signal can be output to external devices.

As CT-2000 is compatible with CT-1000, the grip switches, extension unit, synchronization cables, and cables to connect with scoreboard used previously with CT-1000 can also be



Options for CT-2000



Expansion Unit
EX-916

An input channel can be expanded up to

Synchronization Cable / SY-456
Roll Paper / RP-03
Ribbon Cassette / ERC-22

Grip Switch
GS-51 (with 2.5m cable)
GS-52 (with 5.5m cable)
GS-53 (with 10m cable)



Specifications

Time accuracy	Accuracy of crystal oscillator: ± 1 ppm (at a temperature of 25°C)		
Maximum measurement duration	23 hours, 59 minutes, 59 seconds 999: Start time can also be set in hour, minutes and seconds up to the maximum duration.		
Measurement unit	Method of calculation	Data and printout	
	10 types of calculator methods are available!	1/1000 sec. digit is retained 1/1000 sec. digit is rounded down 1/1000 sec. digit is rounded up	1/1000 sec. increments 1/100 sec. increments 1/100 sec. increments
Number of input channels	From panel: 3 channels	1/1000 sec. digit is rounded off 1/100 sec. digit is rounded down 1/100 sec. digit is rounded up	1/100 sec. increments 1/100 sec. increments 1/10 sec. increments 1/10 sec. increments
	From connectors: 2 channels (up to 10 channels when extension unit is used)		
Number of data storable	Up to 3,000 data contained in up to 100 blocks		
Speed measurement	Distance of section: 1~100m in 0.1m increments		
	Measurement unit: km/h, mph and m/s Measurement range: 1~1000km/h, 1~250mph, 1~600m/s Number of input channels: Up to 10 channels when extension unit is used		

Monitor display	Display device: LCD
	Number of characters: 20 characters x 4 lines Character height: 9.2mm
Printer section	Printer type: Dot impact printer (5 x 7 dot matrix, 24 characters/line) Printing speed: 2.5 lines/sec. Roll paper: 57.5 \pm 0.5mm (width) x 70mm (outer diameter) or a smaller size; Plain paper type
	Power supply
Battery life	1. AC 100V ~ AC 240V (used with AC adapter) 2. Built-in battery (2 sets of 6 AA size dry cells) *Rechargeable type batteries can also be used. 3. External battery (DC 12V) *Do not use AC power supply at the same time.
	Alkaline dry batter: Approximately 8 hours (at +25°C) Nickel-metal hydride rechargeable battery: Approximately 14 hours (at +25°C) *The above battery lives may be shorter if measurement/printing is performed more than once in 10 seconds.
Temperature range	During operation: -5°C ~ +40°C (non-condensing) *0°C ~ +40°C for AC adapter
	During storage: -15°C ~ +55°C (non-condensing)
Appearance	Dimensions: W440 x H467 x D120mm
	Material: Resin
Weight	Approximately 5.5kg (excluding batteries)

TABLE-TOP SCORE BOARD

Game timer / score counter for indoor sports events



SPORTS COUNTER

KT-601

System Components

Sports Counter (KT-601): 1 unit
 Adapter with 5m power cable (KT-ADP01): 1 piece
 Wireless remote controller with holder (KT-601RC): 1 unit

Features

Infrared wireless remote control is available as standard.

Clear multi-color LED display (white, orange, red and green) without uneven color contrast has been achieved.

User-friendly button layout of the operation panel allows intuitive operation.

The monitor on the operation panel shows the same display as shown on the score board, allowing easy checking of operation.

Main Functions

event / function	Items shown on display panel	Ex.	event / function	Items shown on display panel	Ex.
1 Basketball	10:00 123 24 100	• Contest timer • Home • Guest Possession • Period • Points • 24/30-sec. timer	8 Boxing	1:55 2	• Contest timer • Interval timer • Round No.
2 Basketball (time out, futsal, hand ball)	10:00 123 24 100	• Contest timer • Home • Guest Possession • Period • Points • Timeout timer	9 Programmable Timer	2:00 1P 4	• Timer • No. of times repeated • Program
3 Basketball (Team fouls)	10:00 123 35 100	• Contest timer • Home • Guest Possession • Period • Points • Team fouls	10 Pace Setter	52 4 110	• No. of times repeated • Rhythm • Tempo
4 Volleyball, Table tennis, Badminton	20 18 2 30 1	• Points • Serve • Set • Sets won • Time out timer	11 Stopwatch	0:25 0 95	• Minute and second digits of time • Hour digits of time • LP/SP mark • 1/100-second digits of time
5 Judo	5:00 30	• Contest timer • Osaekomi timer	12 Timer	10:00	• Minutes, seconds and 1/10 second digits of time
6 Tennis	15:30 4 21 2	• Points • 1st or 2nd serve • Serve • Games won • Sets won	13 Clock & Alarm	10:08 59	• Hour and minute digits of time • Second digits of time
7 Soft tennis	A : 1 3	• Points • 1st or 2nd serve • Serve • Games won			

Specifications

Display		High-intensity LED
Character height	Timer section	130mm
	Point section	120mm
	Second timer section	110mm
Power supply		AC 100V ~ 240V, 50/60Hz (maximum power consumption: 30W)
Appearance	Main unit	Approx. W650 x H400 x D220mm
	Wireless remote controller	Approx. W44 x H115 x D20mm
	Material	ABS resin
Weight		4.3kg (main unit), 0.7kg (adapter with power cable)

* The dry batteries included with the infrared wireless remote controller are intended for checking its function, and their lives may be shorter than specified.

* If cannot be interlocked with KT-101/01A.

* By using interlocking cable KT-041(80m: option), up to four units of KT-601 can be connected as secondary units to the master KT-601 unit.

* Sports Counter KT-601 is designed for indoor use only.



SHOT Clock

Basketball 24-/30-second timer provided with a large-sized, highly visible display board using high-intensity LED

SHOOTING TIMER KT-401

System Components

- 24-sec. Display Board (KT-401DP): 2 units
- 24-sec. Display Operation Board (KT-401OP): 1 unit
- AC Adapter with 5m power cable (KT-ADP01): 1 piece
- Signal Cable [50m](KT-401CA50): 1 piece
- Signal Cable [30m](KT-401CA30): 1 piece

Features

Display board has a character height of 25 cm in conformity with the International Basketball Federation (FIBA) Official Basketball Rules.

The timer starts counting down from 24/30 seconds, and the buzzer sounds when the time is up.

Start, stop and restart of the timer can be performed easily with a press of a button.

"+" and "-" buttons allow easy adjustment of countdown time.



Example use with tabletop stand KT-022

Specifications

Display	High-intensity LED	
Character height	250mm	
Power supply	AC 100V ~ 240V, 50/60Hz	
Appearance	Display board	Approx. W500 x H338 x D55mm
	Operation board	Approx. W186 x H73 x D182mm
Weight	Material	Display board: ABS resin/Operation board: Steel plate with baked finish
	Display board	Approx. 2.6kg
	Operation board	Approx. 1.1kg/Adapter with power cable 0.7kg
	30 m cable	Approx. 1.4kg
50 m cable	Approx. 2.1kg	

*Shooting Timer KT-401 is designed for indoor use only.
*Stand KT-022 for exclusive with KT-401 (optional).
*To use with KT-401, two units of KT-022 are required.

Game Shot Clock KT-501

System Components

- Display Board (KT-501DP): 2 units
- Game clock Operation Board (KT-501GC): 1 unit
- Shot clock Operation Board (KT-501SC): 1 unit
- AC Adapter with 5m power cable (KT-ADP01): 4 pcs
- Signal Cable [80m](KT-501CA80): 2 pcs
- GC-SC Cable [2m](KT-501CA02): 1 piece

Specifications

Display	High-intensity LED	
Character height	24/30	250mm
	Game Time	130mm
	Time UP	φ 100mm
Buzzer	With two pitches and no volume control (it builds in an indicator)	
Power supply	AC 100V ~ 240V	
Appearance	Game - Shot Clock	W630 x H510 x D70mm
	Game Clock	W186 x H73 x D182mm
	Shot Clock	W186 x H73 x D182mm
	Stand	W520 x H1,400 x D750mm (Option)
	Material	Display board: ABS resin Operation board: steel plate with baked finish
Weight	Game - Shot Clock	6.5kg
	Game Clock	1.1kg
	Shot Clock	1.1kg

Features

A countdown timer that serves as a game clock as well as a 24-second clock for basketball. (It also supports the requirements of the 30-second rule of mini-basketball.)

When the time is up, the buzzer sounds at the same time as the red LED lights up.



* Backboard attachment lug is optional (custom-made item).



KT-501GC

KT-501SC

Example use with KT-501 and dedicated stand KT-013
* Stand KT-013 for exclusive use with KT-501 (optional).

JUDO Timer

A wide range of uses from physical education class in school and judo practice as an extracurricular activity to a full-fledged judo competition

JUDO Timer

JT-601

System Components

JUDO Timer (JT-601): 1 unit
AC Adapter with 5m power cable (KT-ADP01): 1 piece
Magnet plate: 2 pcs



Features

7 modes are provided that are convenient not only for contests but also for training.

- ① Judo 1 (for IJF Rules) ④ Pace setter ⑦ Clock & alarm
② Judo 2 (for Kodokan Rules) ⑤ Stopwatch
③ Programmable Timer ⑥ Timer

Clear multi-color LED display (white, orange, red and green) without uneven color contrast has been achieved.

The color of each contestant (blue, white or red) is indicated by LED.

During Osaekomi, the LED indicating the color of the contestant applying the hold flashes.

Contest and Osaekomi times can be set as desired, and they are retained in memory.

"Golden Score" contest time can also be set as desired.

Point is awarded automatically according to the lapse of Osaekomi time. (Manual awarding can be selected.)

When the contest is ended, the point and color of the winner flash.

Main Functions

event / function	Items shown on display panel	Ex.
1 Judo 1 (for IJF Rules)		<ul style="list-style-type: none"> Contest timer "Golden Score" contest timer Osaekomi timer Point (I: Ippon, W: Waza-ari, Y: Yuko)
2 JUDO 2 (for Kodokan rules)		<ul style="list-style-type: none"> Contest timer "Golden Score" contest timer Osaekomi timer Point (I: Ippon, W: Waza-ari, Y: Yuko) Shido (S1, S2, S3)
3 Programmable Timer		<ul style="list-style-type: none"> Timer that counts from 0 up to 99 minutes 59 seconds No. of times repeated (up to 199 times) Program No.
4 Pace Setter		<ul style="list-style-type: none"> Rhythm (1~9) Tempo (30~255 times/minute) No. of times repeated ● marks on both sides of the display panel visually indicate the tempo
5 Stopwatch		<ul style="list-style-type: none"> Up 199 hours, 59 minutes, and 59 seconds 99 can be measured and displayed Lap time (LP)/split time (SP) mark
6 Timer (with Warning Buzzer)		<ul style="list-style-type: none"> Count down or up timer (Any desired amount of time up to 99 minutes and 59 seconds can be set for the Timer) Measurement in one or 1/10 second increments
7 Clock & Alarm		<ul style="list-style-type: none"> Current time (hour, minutes and seconds are displayed)

Specifications

Display		High-intensity LED
Character height	Contest time section	130mm
	Point section	120mm
	Osaekomi time section	110mm
Power supply		AC 100V ~ 240V, 50/60Hz (maximum power consumption: 30W)
Appearance	Main unit	Approx. W650 x H400 x D220mm
	Material	ABS resin
Weight		Approx. 4.3kg (main unit), 0.7kg (adapter with power cable)

*By using interlocking cable KT-041 (80m: option), up to four units of JT-601 can be connected as secondary units to the master JT-601 unit.

*JUDO Timer JT-601 is designed for indoor use only.



Capable of displaying scores and other information in various indoor sports events.

Multiple-purpose game display system

Available for basketball, volleyball, badminton, table tennis, judo, and karate.

■ Features

Multi-purpose scoreboard equipped with a large-sized full-color display.

Capable of displaying scores and other information in indoor games including basketball (supporting period system, two-halves system, and mini basketball), volleyball, badminton, table tennis, judo, and karate.

Easy time measurement and score input via a dedicated operation board.

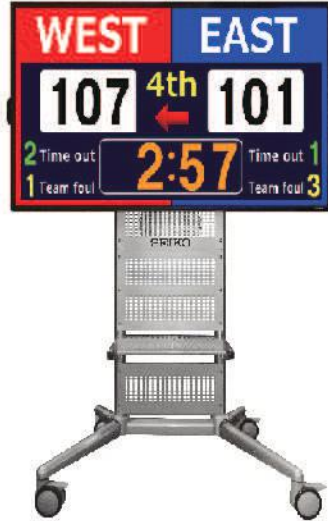

* Example use with a stand to guard against balls.

■ Example displays



Basketball



Volleyball



Badminton



Table tennis



Judo



Karate

System configuration

- Game Operation Board: 1 unit
- Time Operation Board: 1 unit
- Team Name/Score Input Device: 1 unit
- Budo (martial arts) Time Operation Board: 1 unit
- Carrying case: 1 unit
- Accessory cables: 1 set

OPTION

- Multi-Purpose Game Display Board (including a floor stand): 2 units
- Stand to guard against balls: 2 units
- Megaphone (large-volume horn): 1 unit



From left, Budo Time Operation Board, Game Operation Board, Time Operation Board, and Team Name/Score Input Device



ويفز للتجارة والمقاولات ك.م.م.
WAVES TRADING & CONTRACTING W.L.L.

Tel: +974 4441 6319, Fax: +974 44416312
P.O.Box: 82431, Doha - Qatar
Email: info@waves-qatar.com
Website: www.waves-qatar.com



Softball & Cricket
Equipment



Cricket Cage

Cage:

The cricket cage is made from aluminium. The post dimension is 80 x 80 x 3 m with rounded edges. The cage can be installed free stand and in ground sockets.

All screws are made from stainless steel.

Net:

Knotless high tenacity Polypropylene, Thickness 3 mm, Mesh 45 mm

Knotless, White colour. Weight g per sqm 150 g. Burst strength (kn) 1.25.

Polypropylene is recommended for outdoor use. All nets have a fixed selvage of approx. 5-7 mm. Made in Europe.





ويفز للتجارة والمقاولات ك. م . م .
WAVES TRADING & CONTRACTING W.L.L.
Tel: +974 4441 6319, Fax: +974 44416312
P.O.Box: 82431, Doha- Qatar
Email: info@waves-qatar.com
Website: www.waves-qatar.com



Mobile Softball Cage

The mobile cricket cage is made from aluminium. Dimension 8.00 x 4.00 m. The netting is available in in different colors. The net is made from polypropylene thickness 3 mm, mesh 45 mm. The Cage is easy to be moved and the turning wheels enable to store in any direction.





ويفز للتجارة والمقاولات ك. م. م.
WAVES TRADING & CONTRACTING W.L.L.

Tel: +974 4441 6319, Fax: +974 44416312
P.O.Box: 82431, Doha - Qatar
Email: info@waves-qatar.com
Website: www.waves-qatar.com



Advanced Maintenance
Equipment



SportChamp - SC2D/SC2D4HL

Multifunctional ride-on machine for the maintenance of artificial turf.

Technical information:

Drive:	SC2D / SC2D 4HL: 3-cylinder diesel engine, water-cooled/ 18,4
kW (22 HP)	
Traction drive:	hydrostatic, driving Speed up to 10 km/h, hydraulic lifting device for accessory attachments and filter box; differential lock
Capacity of tank:	approx. 30 Litre
Brush working width:	according to the brush: 900 - 1.600 mm
Weight:	starting at approx. 680 kg
Dimensions:	L 2.800 x B 1.320 x H 1.283 mm

Details



Clearly arranged display - easy to operate



SC2D4HL: hydraulic high level emptying up to 2000 mm



SC2D: hydraulic lifting for tipping the filter box



The vibrating screen separates dirt from the infill and spreads the infill on the artificial turf again at the same time



Tires especially for use on grassy surfaces ensure low pressure on the ground



Practical coupling system for mounting all attachments without tools



ويفز للتجارة والمقاولات ك.م.م.
WAVES TRADING & CONTRACTING W.L.L.

Tel: +974 4441 6319, Fax: +974 44416312
 P.O.Box: 82431, Doha - Qatar
 Email: info@waves-qatar.com
 Website: www.waves-qatar.com



SportChamp - SC2BL

Multifunctional ride-on machine for the maintenance of artificial turf.

Technical information:

Drive:	SC2BL: 2-cylinder petrol engine, air-cooled, 22 PS
Traction drive:	hydrostatic, driving Speed up to 10 km/h, hydraulic lifting device for accessory attachments and filter box; Differential lock
Capacity of tank:	approx. 30 litre
Brush working width:	according to brush: 900 - 1.600 mm
Weight:	starting at approx. 680 kg
Dimensions:	L 2.800 x B 1.320 x H 1.283 mm

Removable attachments



Rotating brush 1.000 mm Art. No. 6400029



Rotating brush 1.500 mm Art. No. 6400017



Rotating brush 1.200 mm Art. No. 6211213



Cooped brush Art. No. 6400177



Decompacting brush Art. No. 6400132



Right brush - Front mount attachment Art. No. 6400073



Sweeping brush Art. No. 6400027



Decompacting / Levelling device - Rear-mount attachment Art. No. 6400080



Spreading device 800 mm Art. No. 6400133



TurfBoy - TB1

TurfBoy TB1 is driven by a 2-cylinder 16 HP air-cooled petrol engine. The ground-driven rotary brush eliminates suspended particles, abrasion and dirt particles from the top surfaces. Its working width is 700 mm.

Technical information:

Drive:	2-cylinder petrol engine, air-cooled / 12 kW (16 HP)
Traction drive:	hydrostatic, driving Speed up to 12 km/h
Working width:	700 mm
Weight:	380 kg
Dimensions:	L 1.800 x B 900 x H 1.200 mm

Details



Expanded drag brush, working width 1.600 mm



Ground driven rotary brush with adjustable vibrating screen from 4-10 mm



TurfBoy TB1 with drag brush DB1600



TurfBoy - TB2

TurfBoy TB2 is driven by a 16 HP air-cooled petrol engine. Due to its very compact design the machine is ideal for the work on sand infilled tennis courts or sand/rubber infilled pitches such as futsal courts. The working depth of the rotary brush can be adjusted via two spindles. The vibrating screen can be precisely adjusted, with variable settings from 4 to 10 mm, depending and in accordance with the condition of the infill material. You can easily clean the filter by turning the handwheel.

Technical information:

Drive:	2-cylinder petrol engine, air-cooled / 12 kW (16 HP)
Traction drive:	hydrostatic, driving speed up to 12 km/h
Working width:	900 mm
Weight:	380 kg
Dimensions:	L 1.800 x B 900 x H 1.200 mm

Details



Adjustable sieve from 4 - 10 mm



Hand wheel for dedusting of the permanent filter



Unilateral overlapped drag brush row



TurfKing - TK1502

TurfKing TK1502 brush and vacuum system guarantees clean sports surfaces and optimum playing conditions. Conventional brush rows and/or drag mats are not suitable for thorough cleaning of floor coverings/deep cleaning and loosening of sand-filled and/or rubber-filled artificial turf. The 3-point rear-mount type accessory for compact tractors goes with any type of tractors with a power of at least 20 to 25 HP and combines all important basic functions in one machine. The device compact and easy to connect.

Technical information:

Working width:	TK1100 = 1.100 mm TK1500/TK1502 = 1.500 mm
Drive:	PTO adaptor 540 rpm
Weight:	TK1100 = 225 kg TK1500 = 300 kg TK1502 = 270 kg
Dimensions:	TK1100: L 900 x B 1.195 x H 830 mm TK1500: L 1.195 x B 1.655 x H 765 mm TK1502: L 900 x B 1.670 x H 830 mm

Details



Permanent filter with continuous de-dusting of filtered suspended particles



Drag brush with guide pulley



Steel springs for gently loosening of the infilling material



ويفز للتجارة والمقاولات ك. م. م.
WAVES TRADING & CONTRACTING W.L.L.

Tel: +974 4441 6319, Fax: +974 4441 6317
P.O.Box: 82431, Doha - Qatar
Email: info@waves-qatar.com
Website: www.waves-qatar.com



TurfCare - TCA1400

TurfCare TCA1400 maintains any kind of infilled synthetic turf pitches. The wheel drive makes the equipment independent from any hydraulic or power shaft drives. Therefore the TurfCare can be pulled by various vehicles such as small compact tractors or quads.

The working depth can be precisely set and locked via two adjusting spindles.

Technical information:

Working width:	1.400 mm
Weight:	170 kg
Dimensions:	L 1.300 x B 1.800 x H 510 mm

Details



Vibrating screen adjustable from 4 - 10 mm

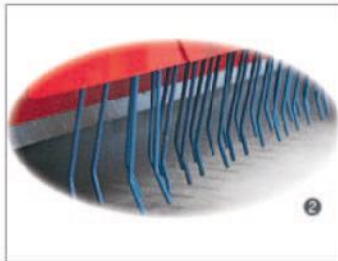

Tires for gently loosening of the infilling material



Fold-out transport rollers for transverse drive



TurfSoft - TS2

TurfSoft TS2 is a solution as simple as effective for the joy in the game and maintaining the value of small areas with infilled surfaces (sand and sand/rubber). Using this machine you can eliminate suspended particles, abrasion and dirt particles from the top surfaces. The manoeuvrable TurfSoft is ideal for areas with little space to move, where stairs, steps and narrow doorways complicate the access to the artificial turf pitches.

Technical information:

Drive:	1-cylinder petrol engine / 3.2 kW (4 HP)
Filter box :	permanent filter approx. 5 m ²
Working width:	800 mm
Weight:	approx. 85 kg
Dimensions:	L 980 x B 750 x H 570 mm



Details



Foldable steering arm for easy transport and storing in a small place



Extractable filter sieve different sieve sizes available



ويفز للتجارة والمقاولات ك.م.م.
WAVES TRADING & CONTRACTING W.L.L.

Tel: +974 4441 6319, Fax: +974 44416312
P.O.Box: 82431, Doha - Qatar
Email: info@waves-qatar.com
Website: www.waves-qatar.com

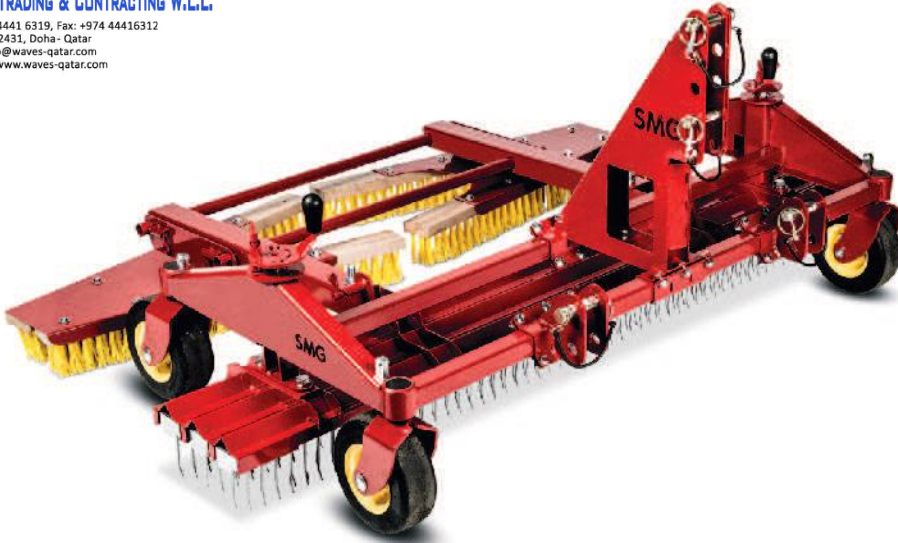

TurfTuner - TT1600

3-point rear-mount type accessory with variable hitches fits all commercially available utility tractors. It is used for loosening of infilled artificial turf and to straighten the fibres. The infill material is equalized with the trailing drag brush.

The working width is 1.600 mm, the working depth can be precisely regulated by two adjustment spindles. The tines can be replaced on request / if necessary by rows of brushes.

Technical information:

Working width:	ca. 1.600 mm
Weight:	135 kg
Dimensions:	L 1.750 x B 1.400 x H 800 mm

Details

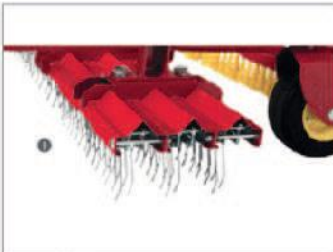

Rows of tines



Adjustment spindle lock mechanism for Working depth



Trailing drag brush, can be folded



CareMax - CM2D

CareMax CM2D is driven by a 17 HP water-cooled diesel engine and can be equipped with several proven attachments for the cleaning and maintenance of artificial turf pitches.

Technical information:

Drive:	3-cylinder diesel engine, water-cooled / 12.5 kW (17 HP)
Traction drive:	hydrostatic, driving speed up to 15 km/h
Weight:	530 kg
Dimensions:	L 2.000 x B 1.300 x H 1.200 mm

Details



3-point rear attachment system



Controls for attachments at the front and rear



ويوز للتجارة والمقاولات ك.م.م.
WAVES TRADING & CONTRACTING W.L.L.

Tel: +974 4441 6319, Fax: +974 44416312
P.O.Box: 82491, Doha - Qatar
Email: info@waves-qatar.com
Website: www.waves-qatar.com



Tools and Devices / TurfGrip - TurfGrip TG30, TG60

Gripping tongs for a fast and easy installation of artificial turf
TG 30 Art.-No. 8900048
TG 60 Art.-No. 8900049



Tools and Devices / TurfFix - TurfFix

TurfClutch for fixing the joints of artificial turf strips while glueing
Art.-No. 8900054



Tools and Devices / LineCutter - LineCutter

Tool for cutting of variable width of straight lines and circular lines in artificial turf
Art.-No. 6400081

Tools and Devices / CircleCutter CircleCutter CC1

Tool for circular cutting in artificial turf
Art.-No. 6400095



Tools and Devices / CircleCutter CircleCutter CC2

Tool for circular cutting in artificial turf
Art.-No. 6400208





Tools and Devices / GlueFix
GlueFix GF300

Glue applicator for glue coating of seam tape for artificial turf.
Stationary version
Art.-No. 6400098

Tools and Devices / GlueFix
GlueFix GF150

Glue applicator for glue coating of seam tape for artificial turf.
Mobile version
Art.-No. 6400153



Tools and Devices / SeamFix
SeamFix

Pressure tool for the solidified connection of the seams of artificial turf and glue coated seam tape
Art.-No. 8900056

Tools and Devices / TurfRoller
TR5000

Cart with hydraulic lifter for the transport and rolling out of artificial turf



Tools and Devices / TurfSet
Tool set

Tool set for the installation of artificial turf

SeamFix -



ويفز للتجارة والمقاولات ك.م.م.
WAVES TRADING & CONTRACTING W.L.L.

Tel: +974 4441 6319, Fax: +974 44416312
P.O.Box: 82431, Doha - Qatar
Email: info@waves-qatar.com
Website: www.waves-qatar.com



**Tools and Devices / GrassCutter
GrassCutter**

**For proper cutting alongside of existing track seams
of artificial turf
Art.-No. 6400196**



**Tools and Devices / EdgeTrimmer
EdgeTrimmer**

Art.-No. 8900059





ويفز للتجارة والمقاولات ك.م.م.
WAVES TRADING & CONTRACTING W.L.L.

Tel: +974 4441 6319, Fax: +974 44416302
P.O.Box: 82431, Doha - Qatar
Email: info@waves-qatar.com
Website: www.waves-qatar.com

Sports Hall Equipment

Locker Bench "ALUEX" with Back Rest & Clothes Hook

Order No. 130410

Locker Bench "ALUEX"

Sturdy construction in standard length of 2 m
Shapely design of square anodized aluminium special profile.
Shoe rack) made of thick-walled aluminium tube.
The Seat Laths, Backrests are manufactured from anodized aluminium special profile. Inside are laminated plastic sheets.
Available in different colours.

- Double coat hooks made of plastic
- Legs feature floor protecting plastic endings for levelling
- Components are pre-assembled, for easy self-assembly.
- Size: Length 200 cm or customized length up to 270 cm, Seat Depth 33.6 cm, Seating Height 45 cm, Overall Height (incl. coat rails): 165 cm.

For safety reason we recommend to fix the locker bench to the wall!



ABS Plastic Locker

ABS is a plastic formula derived from Acrylonitrile Butadiene Styrene. Altogether these elements produce a tough and high impact resistant plastic material. This is what our ABS lockers are made from. ABS lockers does not support combustion as its properties does not fail rapidly in high temperature.

Futures:

- Lockers are made up of Engineering grade ABS (Acrylonitrile Butadiene Styrene)
- Sturdy and strong
- Stackable
- Can place side by side
- Resistance to scratch
- Rust proof
- Textured surface furnishing
- Adjustable shelves (optional)
- 5 colour choices for Doors
- Ideal application for factories, hospitals, hotels, restaurants & recreational places
- Multiple locking options with keyless lock, key lock, coin return lock, RFID (digital) lock and padlock
- Recyclable





ويغز للتجارة والمقاولات ك. م. م.
WAVES TRADING & CONTRACTING W.L.L.

Tel: +974 4441 6319, Fax: +974 44416312
P.O.Box: 82431, Doha - Qatar
Email: info@waves-qatar.com
Website: www.waves-qatar.com

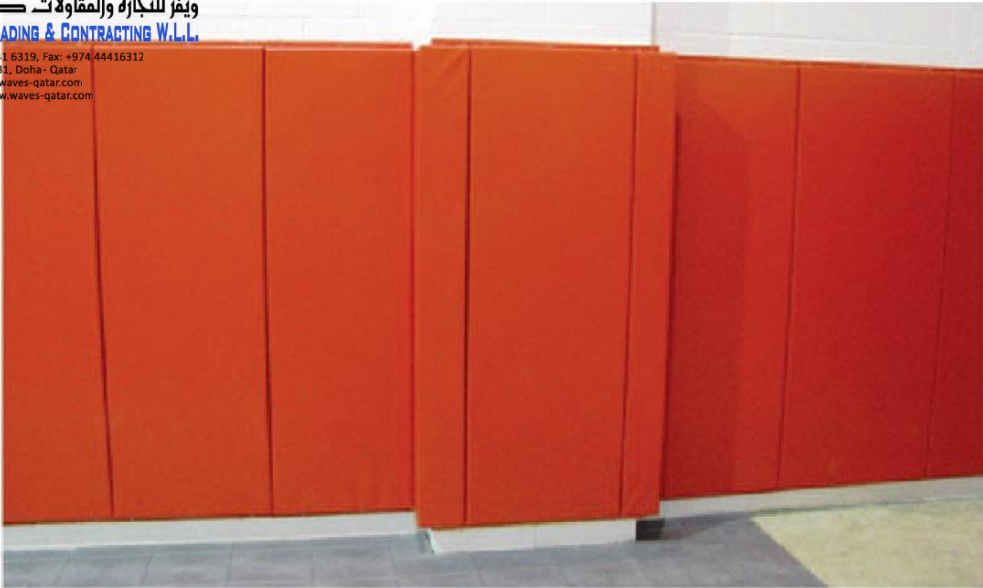

Wall Padding for Indoor(1.90 m)

Wall and column padding is an important health and safety feature in any sports hall. Each pad is made from flame retardant foam covered in canvas .The pads come 2.5 m high as standard and can be made to suit requirement. Wall pads are permanent wood-backed panels that provide protection against wall collisions and add the feature of sound absorption. Our firm 4 cm & 6 cm thick polyurethane foam wall pad provides excellent protection at a great value. Cut outs for electrical outlets and custom designed pads are crafted in our factory. 4 cm nailer lips at the top and bottom of the pad allow for easy installation

240010: Standard dimension 1.90 x 1.00 m (H x W) 6 cm thick foam.

Physical Properties of Polyurethane Foam According to ASTM D3574 test method

SUBJECT CODE : PX35

Density (kg/m ³)	: 33
Porosity (mmEtOH)	: 10
Resilience (%)	: 35
CLD 40% (kPa)	: 6.5
ILD 25% (N)	: 201
ILD 40% (N)	: 255
ILD 65% (N)	: 523
Tensile strength (kPa)	: 124
Elongation (%)	: 85
Tear strength (N/m)	: 218
Compression set	
75% (70oC 22hr) (%)	: 3.5

All foam manufactured foam are certified to be free from CFCs, by the Malaysian Ministry of Science, Technology and Environment and also by the United Nations.



ويفز للتجارة والمعاملات ك . م . م .
WAVES TRADING & CONTRACTING W.L.L.

Tel: +974 4441 6319, Fax: +974 44416312
P.O.Box: 82431, Doha - Qatar
Email: info@waves-qatar.com
Website: www.waves-qatar.com



afnsports.com.my