

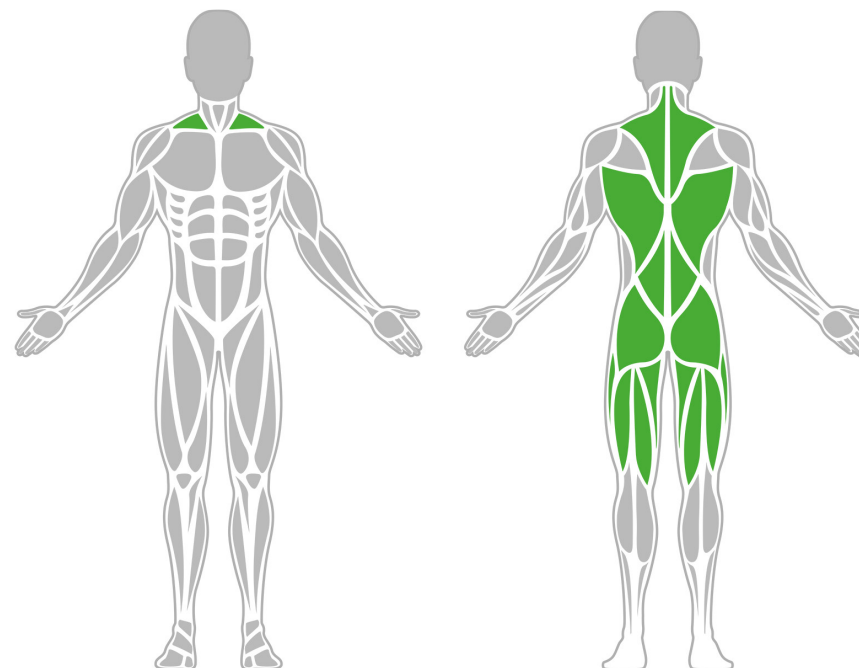

Muscle Groups Focus



Double Back Training Bench 1500

The back muscle trainer is specifically designed to effectively train the muscles of the back. During bodyweight training, back training is a constant necessity for beginners and experienced exercisers alike, which is why it is important to have a suitable fitness equipment such as this back muscle strengthener for regular training. This is a great way to develop a large number of muscles, and several people can train on this equipment at the same time. The support sections can be installed at any width.

Attributes

Product code	1-1-023
Certificate	EN 16630
Age group	14 + years
Capacity	2 people
Max. weight load	99 kg
Type	Fitness
Difficulty level	Easy

QR Code



Side View

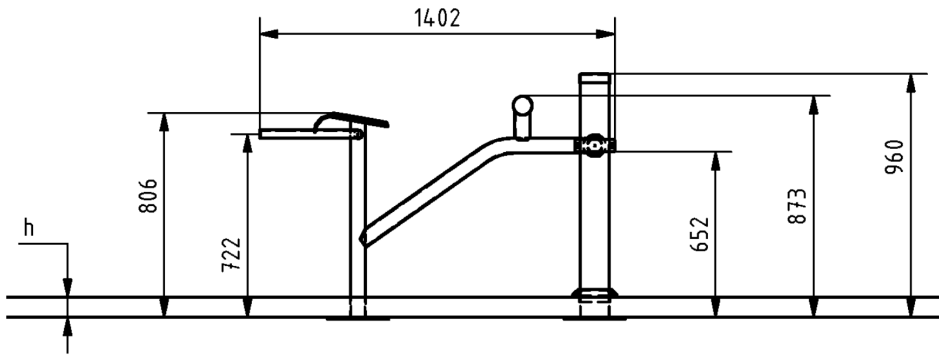

Plan View

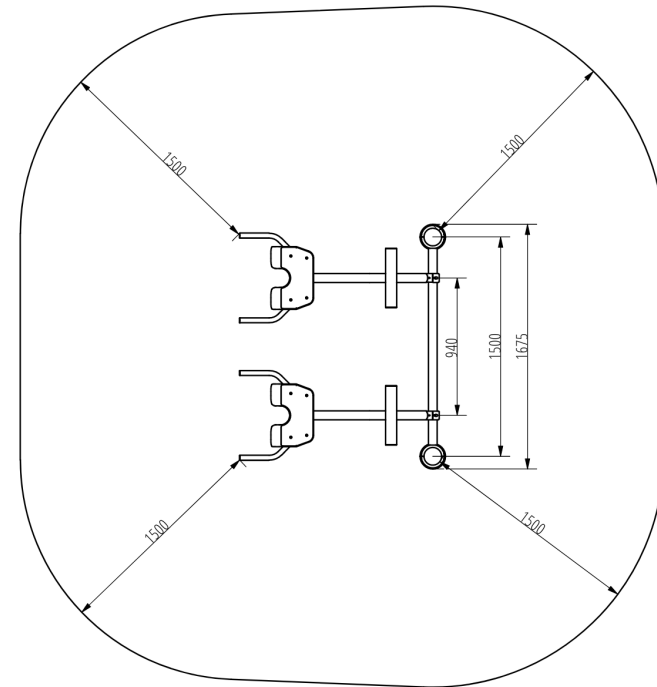

Installation information

Number of installers (concrete)	At least 2 people
Total installation time (concrete)	60-120 min.
Number of installers (equipment)	At least 2 people
Total installation time (equipment)	30-60 min.
Excavation volume	0.8 m ³
Concrete volume	0.8 m ³
Size of the base structure	4pc 0,5 x 0,5 x 0,8 m
Anchoring options	In-ground or surface
In combined structures, the volume of concrete required varies.	

Technical specification

Safety surface area	Around 1,5 m radius
Net weight	64 kg
Material	S235
Critic fall height	880 mm
Color options	

For more color options, discuss with your sales representative.

Warranty

Structure	10 years
Steel	5-10 years
Paint	2 years
Plastic	5-10 years
Rubber	1-3 years
Moving parts	2 years
Detailed information in the warranty document	

Material specification

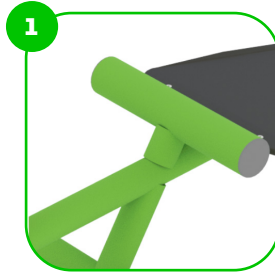
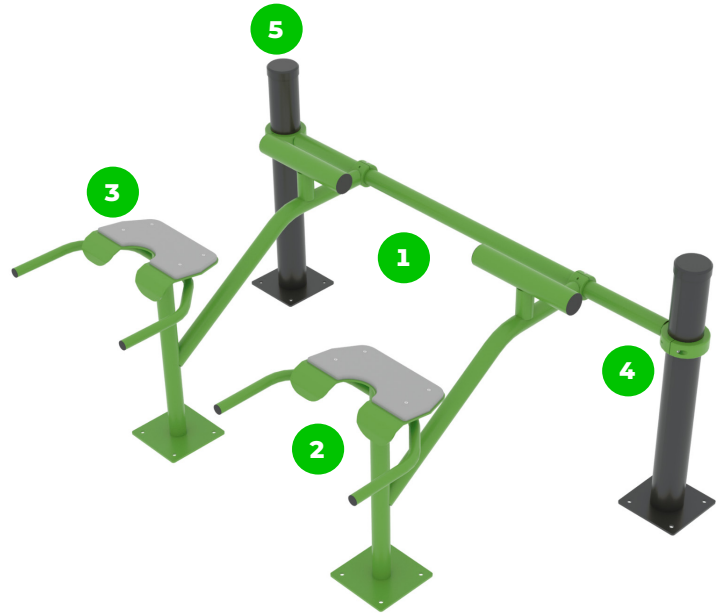

The element is made of high quality S235 steel, which has been cleaned via sandblasting. A corrosion resistant powder coating finish is then applied. Also available with galvanized surface for even greater protection and longevity!

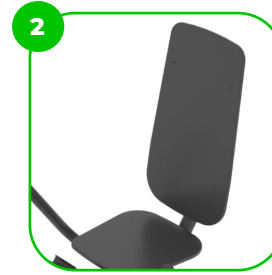

The seats and backrests are made of strong HDPE material. Which is fully heat, moisture and UV resistant.

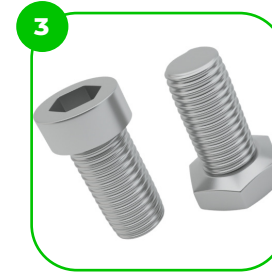

The connecting elements are fastened with vandal-proof stainless steel screws and nuts.



The ends of the bars and posts are sealed with injection-moulded plastic caps.



The clamp system allows for easy assembly and extreme stability.

