

- ✓ Quality
- ✓ Reliability
- ✓ Excellence



30+
Over 30 Years of Quality

**ROLL
WITH
CONFIDENCE** *Moving You Forward...*



LIGHT DUTY CASTERS



MEDIUM DUTY CASTERS



HEAVY DUTY CASTERS



Service Caster Corporation, based in West Reading, Pennsylvania, is a testament to the vision of founder Ronald T. Manz. Over 30 years, it has grown into the world's largest caster and wheel manufacturer, offering solutions from light-duty furniture casters to heavy-duty industrial wheels.

Ronald's expertise and commitment to innovation have helped the company exceed customer expectations, transforming it from a modest enterprise into a global leader. Serving industries like healthcare, food service, and manufacturing, Service Caster remains true to its family-operated roots and values of community and quality.

As it continues to grow, Service Caster stays inspired by Ronald's leadership, providing reliable, innovative mobility solutions and honoring his legacy for years to come.



Service Caster & Truck Company
Historical 1940 photos

Ronald T. Manz



Custom Caster & Wheel Solutions – Service Caster Machine Shop

Welcome to our dedicated machine shop, where we specialize in custom caster and wheel manufacturing. Whether you need same-day keyway wheels or custom-built casters for light to heavy-duty applications, our expert team is equipped to deliver.

Our machine shop handles a wide range of projects, from residential needs to heavy-duty industrial and naval applications. We're committed to providing high-quality, precise work to meet your exact specifications.

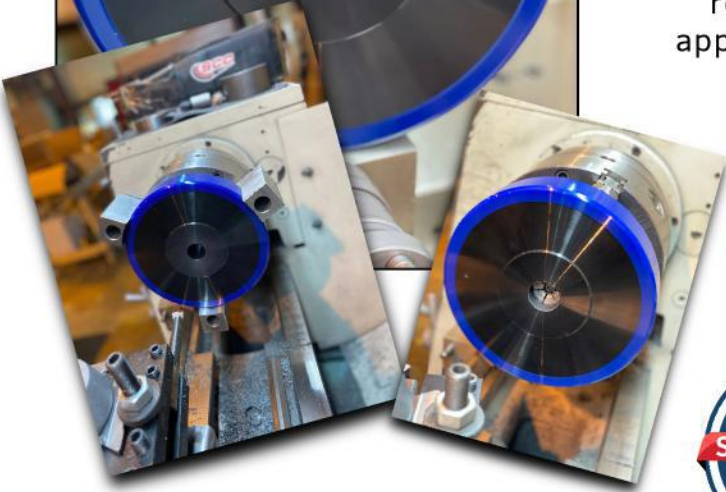
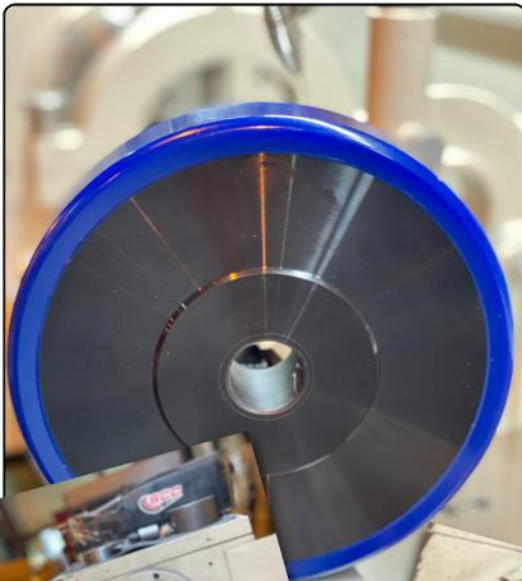

Key Services:

- **Same-Day Keyway Wheels:** Quick turnaround on standard and custom keyways to keep your operations running smoothly.
- **Custom Caster Fabrication:** From light-duty to heavy-duty, we craft casters tailored to your specific needs, ensuring durability and performance.
- **Versatile Applications:** Our products are designed to suit a variety of environments, including:
 - Residential equipment
 - Warehouse carts and dollies
 - Industrial machinery
 - Naval vessels and marine equipment

Trust the Badge: Certified Quality

At Service Caster Corporation, we are dedicated to quality, safety, and compliance, supported by a variety of industry certifications.



PART # [SCC-DW900S360200-PUR-8PSL-BRK-SP](#)

At Service Caster, we've built some of the toughest and largest casters, each with a 100,000-pound capacity. Designed for a federal contractor, these 52-inch tall, 8,000-pound casters achieve a total capacity of 200 tons.

Quality. Reliability. Excellence.



At Service Caster, quality is driven by well-established processes, supported by a team of highly experienced employees. We use advanced manufacturing techniques to produce our casters, ensuring both cost efficiency and superior quality. With one of the most knowledgeable caster teams in the industry, we consistently deliver reliable, high-value products. When customers demand dependable quality, they trust Service Caster – the name they can rely on!



Over 30 Years of Quality

Production Abilities



Manufacturing Capabilities

- Service Caster operates a modern, state-of-the-art manufacturing facility.
- Our comprehensive and integrated value chain offers both engineered and standard solutions, meeting demands for quick shipping, a diverse product line, in-stock inventory, custom solutions, and fast quote turnaround.
- Our facility and processes are highly flexible – we thrive on custom manufacturing!

Table of Contents

Service Caster Brand

Service Caster provides durable, versatile caster and wheel solutions for both industrial and commercial use. Their products are designed to meet a wide range of needs, from heavy-duty industrial equipment to light-duty furniture applications.



#01 SERIES

Decorative, durable ball casters for chairs, tables, medical carts, and more.

Capacity to 100lbs.



#02 SERIES

Reliable casters for seating and fixtures, with various finishes and floor protection.

Capacity to 225lbs.



#03 SERIES

High-performance casters with multiple wheel options and chrome accents.

Capacity to 120lbs.



#04 SERIES

Low-profile casters offer mobility for heavy equipment without raising height.

Capacity to 1,000lbs.



#05 SERIES

Light-duty casters for furniture, electronics, food service, and store fixtures.

Capacity to 175lbs.



#10 SERIES

Affordable casters for light-duty applications and retail displays.

Capacity to 500lbs.



#20 SERIES

Great for trolleys, carts, chairs, and displays, with many finishes and options.

Capacity to 350lbs.



#30 SERIES

Versatile casters with finishes like stainless and multiple wheel options.

Capacity to 1,250lbs.



#35 SERIES

Larger top plate, zinc finish, easy-maintenance casters with grease fittings.

Capacity to 1,500lbs.



#60 SERIES

Heat-stabilized wheels resist oils, solvents, acids, roll easily, and withstand heat.

Capacity to 2,000lbs.



#90 SERIES

Great for heavy-duty use with smooth swivel action and easy maintenance.

Capacity to 3,500lbs.



#KP91 SERIES

Great for heavy-duty use, offering durability, strength, and smooth swivel.

Capacity to 6,000lbs.



#KP92 SERIES

Great for heavy-duty applications needing durability and shock load handling.

Capacity to 7,000lbs.



#KP93 SERIES

Great for heavy-duty industrial use needing strength, durability, and smooth swiveling.

Capacity to 20,000lbs.



#KP94 SERIES

Ideal for extreme-duty applications needing strength, durability, and smooth swiveling.

Capacity to 40,000lbs.



#100 SERIES

Ideal for all-terrain, indoor/outdoor use with quiet, smooth, durable performance.

Capacity to 7,200lbs.



WHEELS

Perfect for any application, offering versatile, durable, and reliable performance.

Materials are endless.



BRAKES

Swivel locks, floor locks, and brakes ensure stability and control for casters.

Total Control, Stability



#PARTS

Discover caster parts including locks, bearings, axles, and more.

Built to Roll.



OEM

Casters for all applications: durable, versatile, and built for performance.

Moving You Forward...

Standard Top Plate & Bolt Pattern

At Service Caster, we offer a range of standard top plates to fit your needs. Available in small, medium, and large sizes, our top plates ensure secure and reliable attachment for your casters.

Overview of our Standard Top Plates

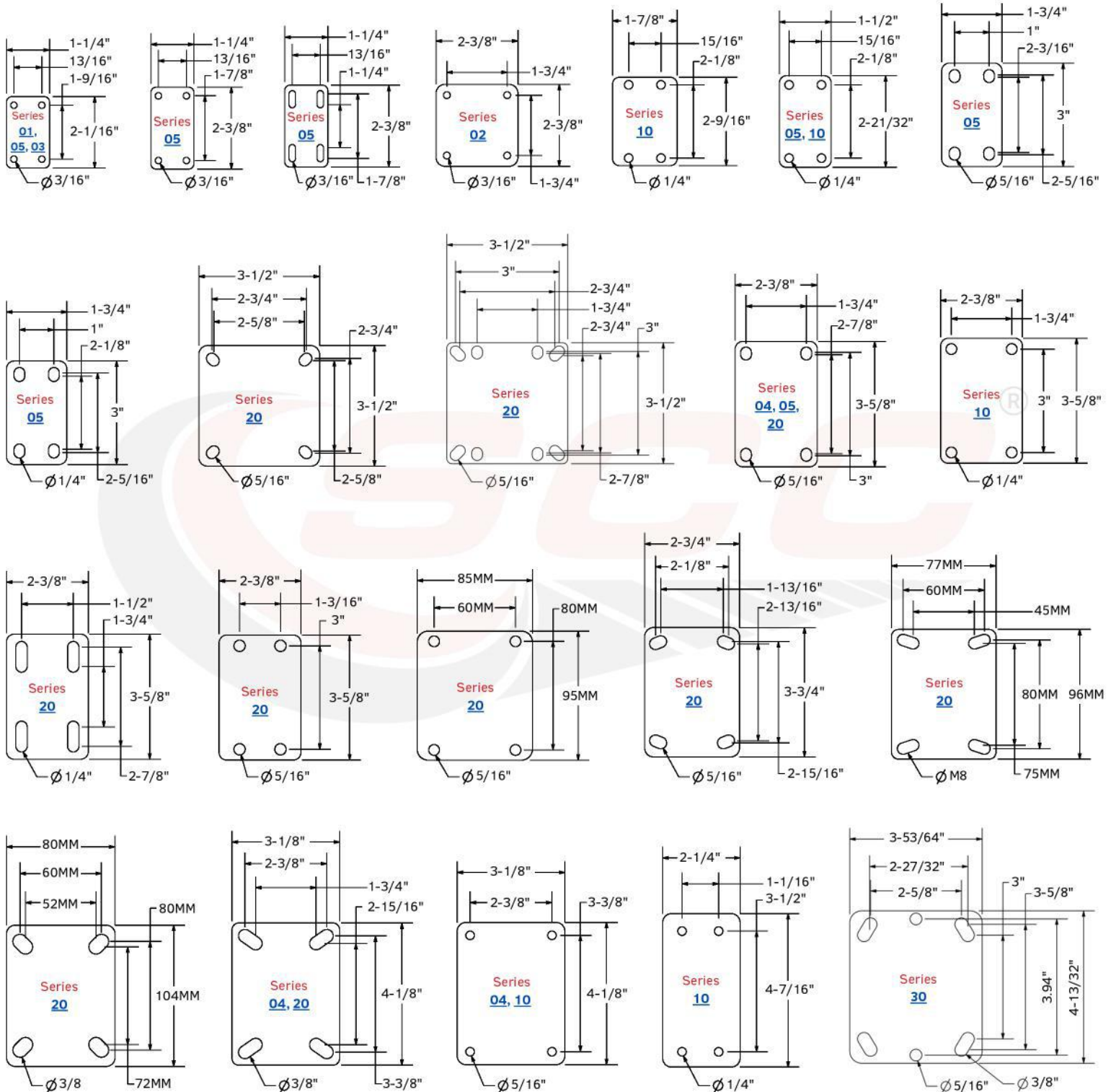

New Swag Alert: Place Your Orders Now!

At Service Caster, we offer a range of standard top plates to fit your needs. Available in small, medium, and large sizes, our top plates ensure secure and reliable attachment for your casters.

Standard Top Plate & Bolt Pattern

Overview of our Standard **Top Plates**

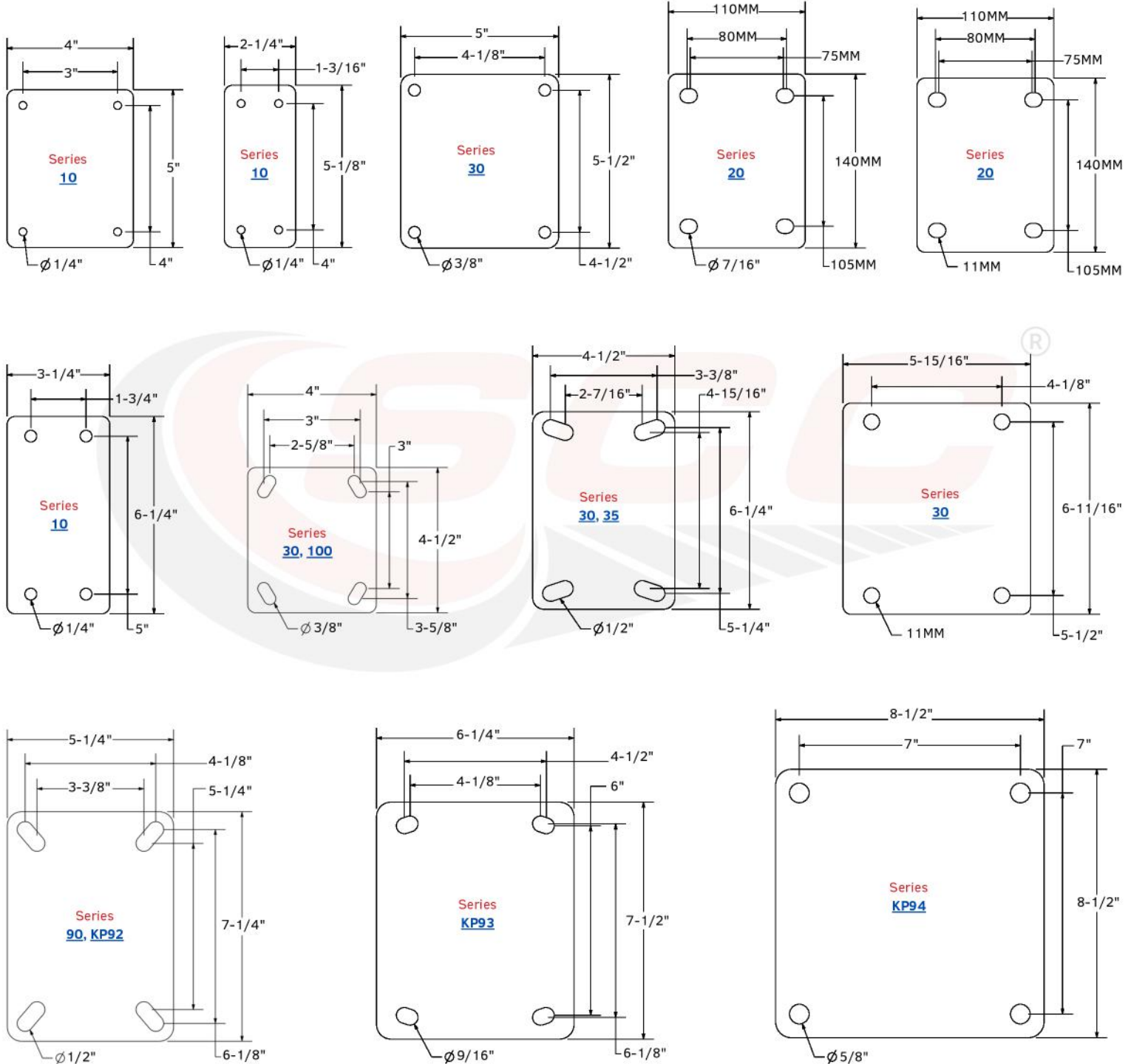

Don't see the size you need? Get in touch with our **customer service** team for assistance. We're here to help you find the perfect fit for your project.

At Service Caster, we offer a range of threaded stems to fit your needs. Available in various sizes, our threaded stems ensure secure and reliable attachment for your casters.

Standard Threaded Stem

Threaded Stem Overview

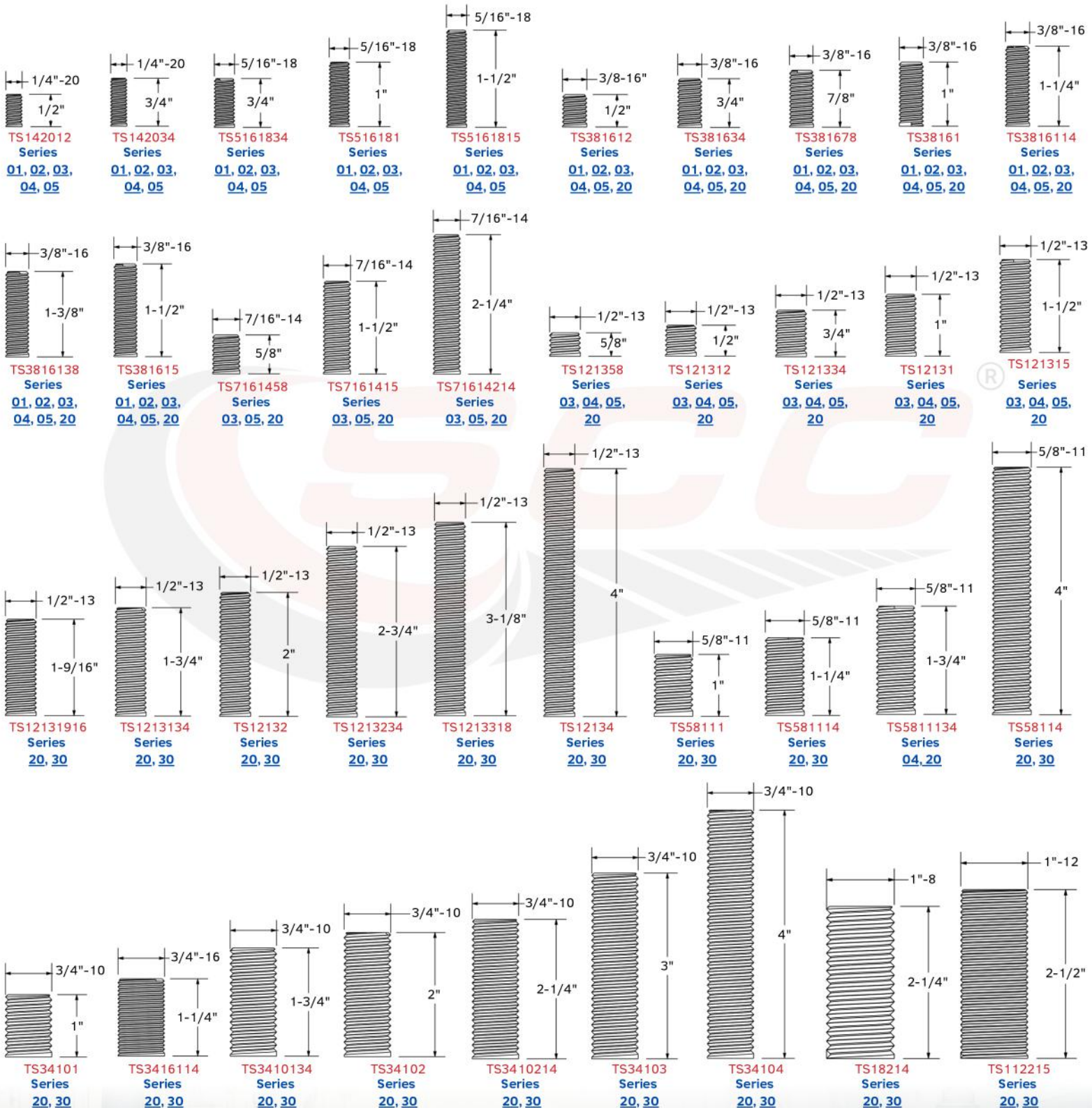

Series	Series	Series	Series	Series	Series	Series	Series	Series	Series
TS142012 Series 01, 02, 03, 04, 05	TS142034 Series 01, 02, 03, 04, 05	TS5161834 Series 01, 02, 03, 04, 05	TS516181 Series 01, 02, 03, 04, 05	TS5161815 Series 01, 02, 03, 04, 05	TS381612 Series 01, 02, 03, 04, 05, 20	TS381634 Series 01, 02, 03, 04, 05, 20	TS381678 Series 01, 02, 03, 04, 05, 20	TS38161 Series 01, 02, 03, 04, 05, 20	TS3816114 Series 01, 02, 03, 04, 05, 20
TS3816138 Series 01, 02, 03, 04, 05, 20	TS381615 Series 01, 02, 03, 04, 05, 20	TS7161458 Series 03, 05, 20	TS7161415 Series 03, 05, 20	TS71614214 Series 03, 05, 20	TS121358 Series 03, 04, 05, 20	TS121312 Series 03, 04, 05, 20	TS121334 Series 03, 04, 05, 20	TS12131 Series 03, 04, 05, 20	TS121315 Series 03, 04, 05, 20
TS12131916 Series 20, 30	TS1213134 Series 20, 30	TS12132 Series 20, 30	TS1213234 Series 20, 30	TS1213318 Series 20, 30	TS12134 Series 20, 30	TS58111 Series 20, 30	TS581114 Series 20, 30	TS5811134 Series 04, 20	TS58114 Series 20, 30
TS34101 Series 20, 30	TS3416114 Series 20, 30	TS3410134 Series 20, 30	TS34102 Series 20, 30	TS3410214 Series 20, 30	TS34103 Series 20, 30	TS34104 Series 20, 30	TS18214 Series 20, 30	TS112215 Series 20, 30	

Don't see the size you need? Get in touch with our **customer service** team for assistance. We're here to help you find the perfect fit for your project.

Standard Threaded Stem

At Service Caster, we offer a range of threaded stems to fit your needs. Available in various sizes, our threaded stems ensure secure and reliable attachment for your casters.

Threaded Stem Overview

3/4"-10

10"

3/4"-10

8"

1"-8

8"

1"-8

7"

3/4"-10

6"

1"-8

4"

3/4"-10

5-1/2"

NSF

RoHS COMPLIANT

REACH COMPLIANT

Inch or Metric?

Measure Up!

Useful Tools for Measuring Threaded Stems

How to Identify Thread Pitch

TS341010 Series 20, 30

TS34108 Series 20, 30

TS188 Series 20, 30

TS187 Series 20, 30

TS34106 Series 20, 30

TS184 Series 20, 30

TS3410515 Series 20, 30

Metric Threaded Stem

M8-1.25

1-1/2"

M10-1.5

1-1/2"

M12-1.75

1"

M12-1.75

1-1/4"

M12-1.75

1-3/4"

M16-2.0

1-1/2"

M20-2.5

1-3/4"

TSM815 Series 02, 03, 05

TSM1015 Series 20

TSM121 Series 20, 30

TSM12114 Series 20, 30

TSM12134 Series 20, 30

TSM1615 Series 20, 30

TSM20134 Series 20, 30

Don't see the size you need? Get in touch with our **customer service** team for assistance. We're here to help you find the perfect fit for your project.

Grip Ring & Cross-Drilled Stems

Here's a premium selection of our grip ring and cross-drilled stem casters, engineered for secure, reliable performance.

Grip Ring Stem Overview

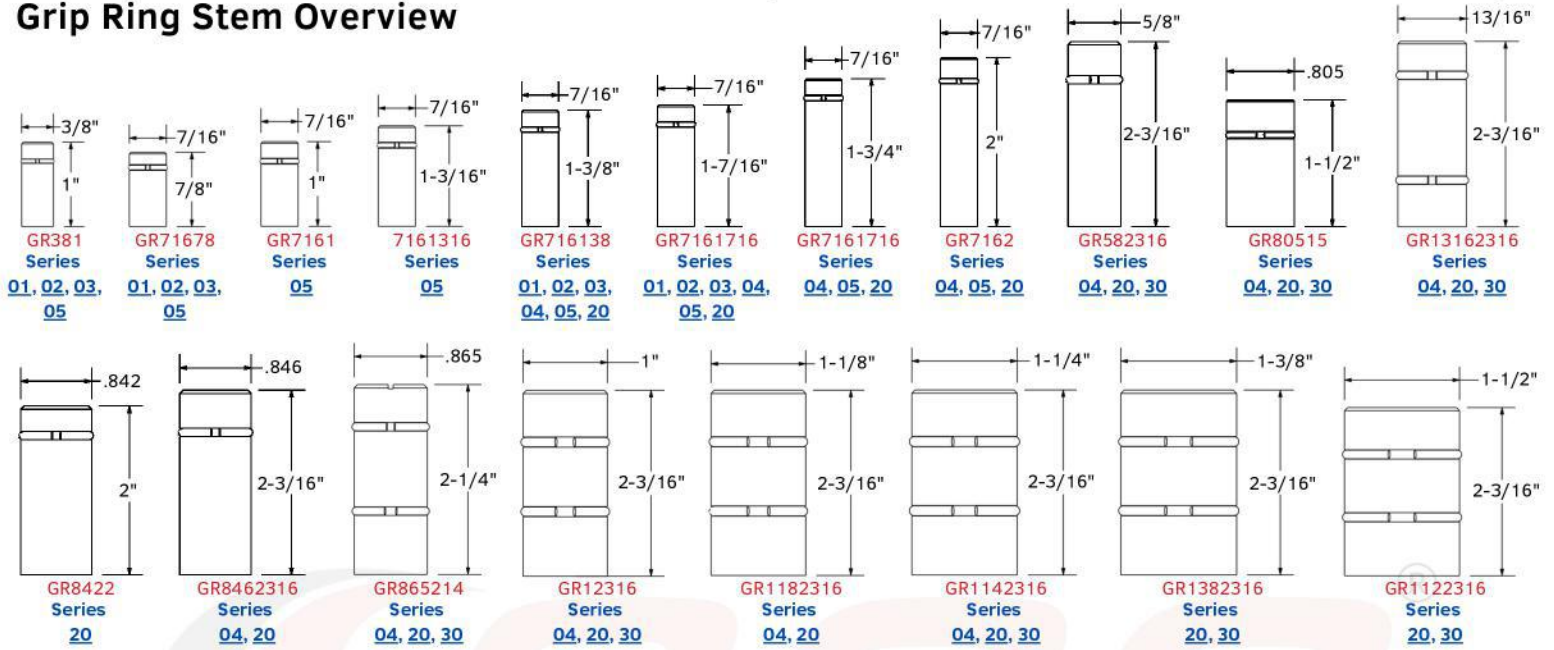

Cross-Drilled Stems Overview

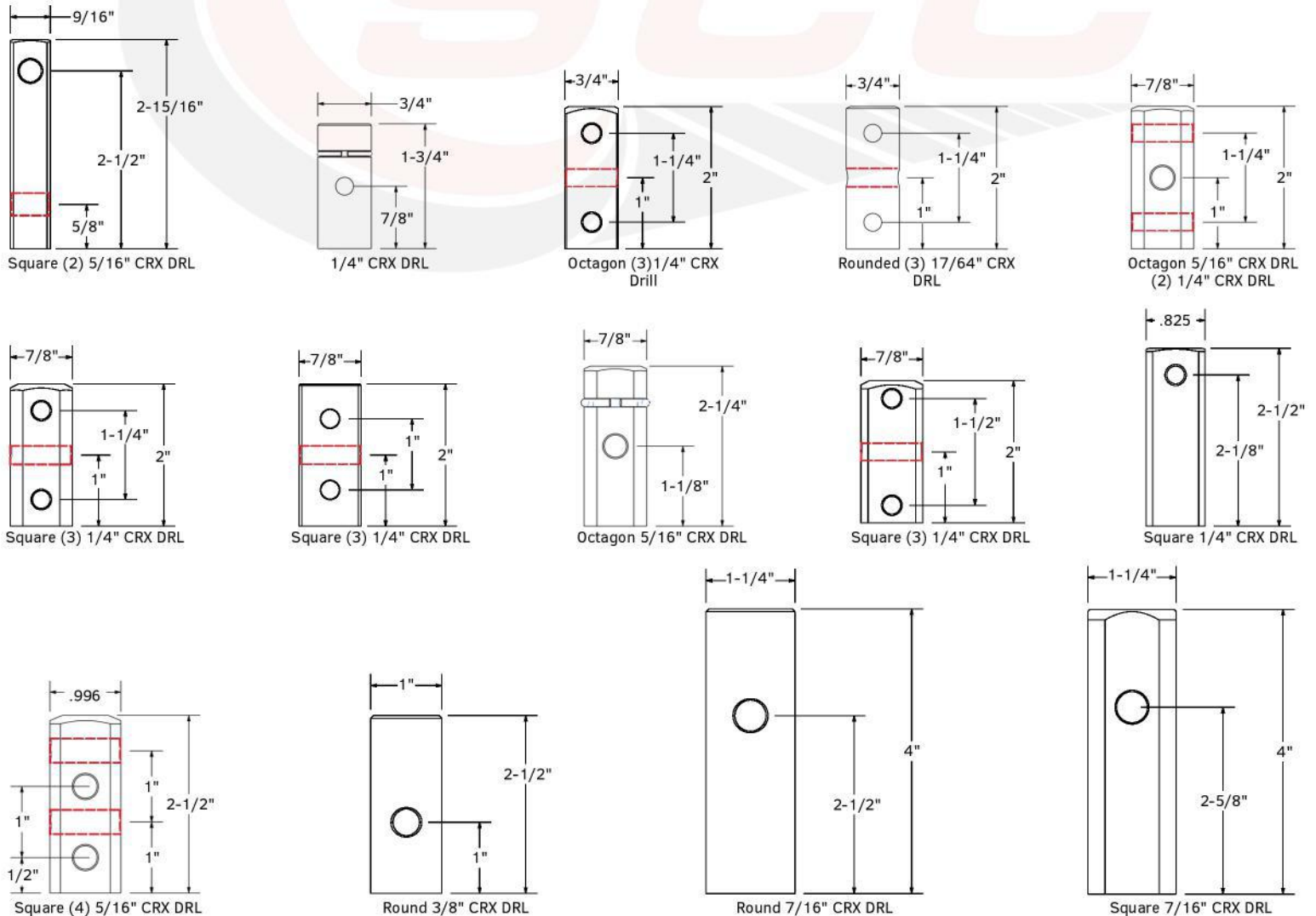

Here's a premium selection of our adjustable and special stem casters, designed for secure and reliable performance.

Adjustable & Special Stems

Adjustable Stems Overview

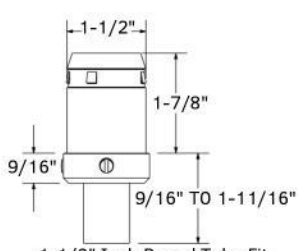

1-1/2" Inch Round Tube Fit
Adjustable Range: 1-1/8"
Additional Adjustable Height:
9/16" to 1-11/16"

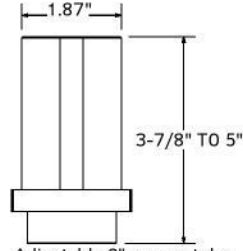

Adjustable 2" square tube
with height adjustment from
1-1/8" to 3-7/8".

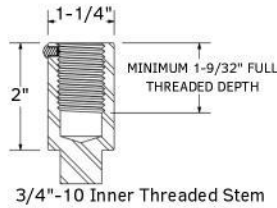

Great for leveling on **uneven** floors or adjusting height. Just twist the top to activate. Perfect for kitchen and industrial equipment!

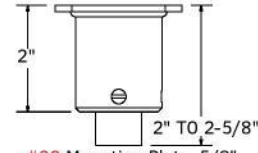

#20 Mounting Plate, 5/8"
adjustment range, with height
adjustable from 2" to 2-5/8"



#TPU1 Mounting Plate, 5/8"
adjustment range, with height
adjustable from 2" to 2-5/8"

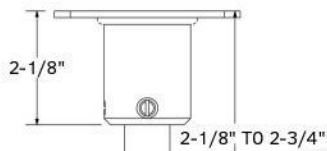

#TPU1 Mounting Plate, 5/8"
adjustment range, with height
adjustable from 2-1/8" to 2-3/4"

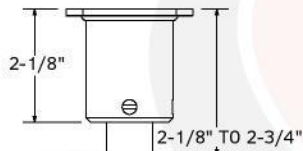

#20 Mounting Plate, 5/8"
adjustment range, with height
adjustable from 2-1/8" to 2-3/4"



#20 Mounting Plate, 5/8"
adjustment range, with
height adjustable from 3-
5/8" to 4-1/4"

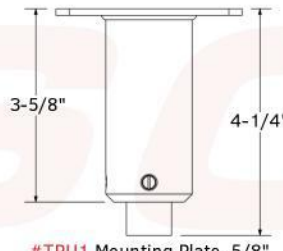

#TPU1 Mounting Plate, 5/8"
adjustment range, with height
adjustable from 3-5/8" to 4-
1/4"

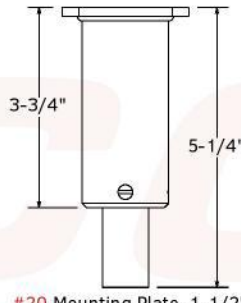

#20 Mounting Plate, 1-1/2"
adjustment range, with
height adjustable from 3-
3/4" to 5-1/4"



#TPU1 Mounting Plate, 1-1/2"
adjustment range, with height
adjustable from 3-3/4" to 5-1/4"

Expanding Adapter Stems Overview

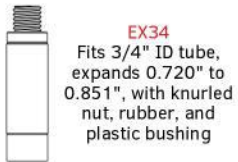

EX34
Fits 3/4" ID tube,
expands 0.720" to
0.851", with knurled
nut, rubber, and
plastic bushing

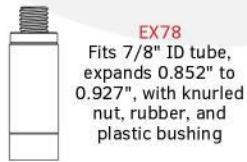

EX78
Fits 7/8" ID tube,
expands 0.852" to
0.927", with knurled
nut, rubber, and
plastic bushing

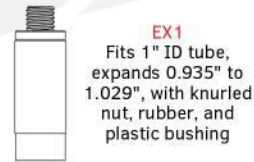

EX1
Fits 1" ID tube,
expands 0.935" to
1.029", with knurled
nut, rubber, and
plastic bushing

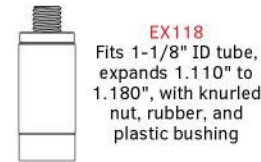

EX118
Fits 1-1/8" ID tube,
expands 1.110" to
1.180", with knurled
nut, rubber, and
plastic bushing

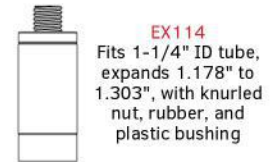

EX114
Fits 1-1/4" ID tube,
expands 1.178" to
1.303", with knurled
nut, rubber, and
plastic bushing

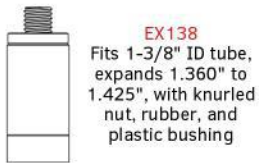

EX138
Fits 1-3/8" ID tube,
expands 1.360" to
1.425", with knurled
nut, rubber, and
plastic bushing

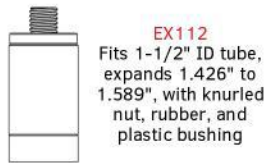

EX112
Fits 1-1/2" ID tube,
expands 1.426" to
1.589", with knurled
nut, rubber, and
plastic bushing

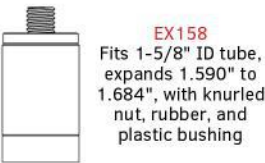

EX158
Fits 1-5/8" ID tube,
expands 1.590" to
1.684", with knurled
nut, rubber, and
plastic bushing

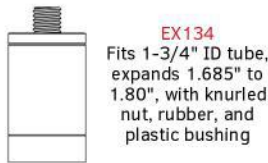

EX134
Fits 1-3/4" ID tube,
expands 1.685" to
1.80", with knurled
nut, rubber, and
plastic bushing

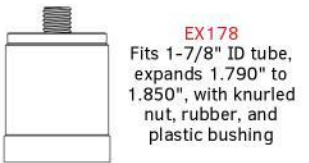

EX178
Fits 1-7/8" ID tube,
expands 1.790" to
1.850", with knurled
nut, rubber, and
plastic bushing

Special Stems Overview

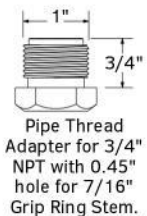

Pipe Thread
Adapter for 3/4"
NPT with 0.45"
hole for 7/16"
Grip Ring Stem.

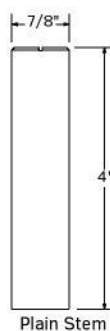

Plain Stem



Plain Stem

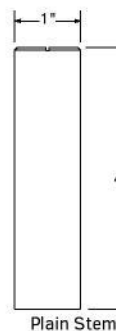

Plain Stem

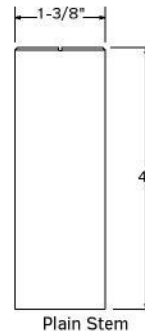

Plain Stem

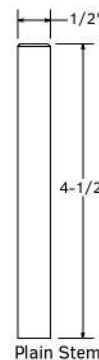

Plain Stem

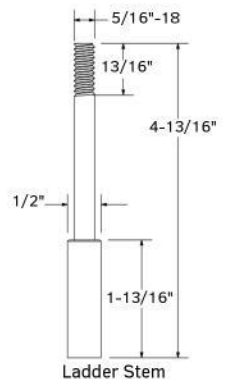

Ladder Stem

Chair & Furniture Casters

Series #01 Metal & Rubber Ball Casters

Capacity up to 100 lbs.

Crafted with top-notch quality and timeless style, these decorative ball casters are ideal for chairs, tables, medical carts, and more. Built to last with premium materials, they offer dependable functionality and effortless mobility.

Applications

- Retail Display Stands
- Office Furniture
- Medical Equipment
- POP Displays
- Store Fixtures
- Seating
- Mobile Furniture
- Hospitality
- Office Equipment
- Conveyor Systems

Features

- Variety of finishes: Bright Chrome, Bright Brass, Windsor Antique, Satin Chrome, and unfinished models
- Made with a die-cast zinc body and available in hard or soft tread options
- Available in various sizes and fastening options to meet your mobility needs

Finish Options

- Metalized Brass
- Windsor Antique
- Bright Chrome

Shield-Guard protects the tread from scratches and damage.

SCC-GN01S20-DCS-WA-B-516



Ready to roll?
The 01 Series
has it all!



CLICK TO PICK



Mounting Options

More Options

Discover more fastening sizes and wheel options if you can't find what you need. And remember, we're always here to **help!**

Brand	Series	Mounting Type	Rig Type	Wheel Diameter	Wheel Material	Finish Type	Brake Option	Stem Size
Service Caster	01	Grip Neck (GN)	Swivel (S)	2" (20)	Die Cast Steel (DCS)	Windsor Antique (WA)	Brake (B)	Grip Neck - 5/16" x 1-1/2" (516)
		Grip Ring (GR)		2-1/4" (214)	Die Cast Rubber (DCR)	Bright Chrome (BC)		Grip Ring - 7/16" x 7/8" (71678)
		Threaded Stem (TS)		3" (30)		Bright Brass (BB)		Grip Ring - 7/16" x 1-7/8" (716178)
		Top Plate (TP)						Threaded - 5/16" -18 x 1 (516181)
								Threaded - 3/8" -16 x 1 (38161)

Threaded Stems

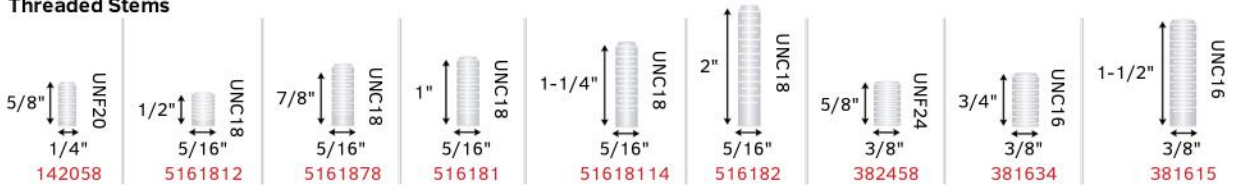

Socket Options

Service Caster has many solutions to help you mount your casters to your equipment quickly and easily.



Grip Neck

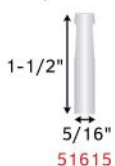

Grip Rings



Top Plates

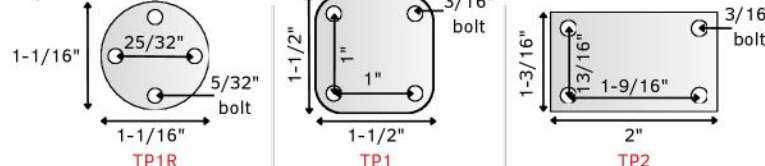

Corner Brackets



Wood Sockets

Grip Neck Stem

- Fits 5/16" x 1-1/2" Grip Neck Stem Only
- 5/16" x 1-1/2" (516112) • For Installation: Drill 3/8" x 1-5/8" Hole

[CLICK TO ORDER NOW](#)

GRIP NECK STEM CASTERS

Wheel Diameter	Tread Material	Finish	Dynamic Load (lbs.)	Mounting Height	Swivel Radius	Part Number	Brakes
2"	Steel	Bright Chrome	75	2-3/16"	1-1/2"	SCC-GN01S20-DCS-BC-516	SCC-GN01S20-DCS-BC-B-516
	Steel	Windsor Antique	75	2-3/16"	1-1/2"	SCC-GN01S20-DCS-WA-516	SCC-GN01S20-DCS-WA-B-516
2-1/4"	Rubber	Bright Chrome	75	2-5/16"	1-9/16"	SCC-GN01S214-DCR-BC-516	SCC-GN01S214-DCR-BC-B-516
	Rubber	Windsor Antique	75	2-5/16"	1-9/16"	SCC-GN01S214-DCR-WA-516	SCC-GN01S214-DCR-WA-B-516
2-1/2"	Steel	Bright Chrome	100	2-13/16"	1-7/8"	SCC-GN01S25-DCS-BC-516	SCC-GN01S25-DCS-BC-B-516
	Steel	Windsor Antique	100	2-13/16"	1-7/8"	SCC-GN01S25-DCS-WA-516	SCC-GN01S25-DCS-WA-B-516
3"	Rubber	Bright Chrome	100	2-7/8"	2-1/16"	SCC-GN01S30-DCR-BC-516	SCC-GN01S30-DCR-BC-B-516
	Rubber	Windsor Antique	100	2-7/8"	2-1/16"	SCC-GN01S30-DCR-WA-516	SCC-GN01S30-DCR-WA-B-516



NOTE: METAL SOCKETS FOR INSTALLATION INTO WOOD INCLUDED WITH GRIP NECK STEM MODELS

Grip Ring Stem

- 3/8" x 1" (381)
- 7/16" x 7/8" (71678)
- 7/16" x 1-7/16" (7161716)

[CLICK TO ORDER NOW](#)

GRIP RING STEM CASTERS



Wheel Diameter	Tread Material	Finish	Dynamic Load (lbs.)	Mounting Height	Swivel Radius	Part Number	Brakes
2"	Steel	Bright Chrome	75	2-3/16"	1-1/2"	SCC-GR01S20-DCS-BC-*	SCC-GR01S20-DCS-BC-B-*
	Steel	Windsor Antique	75	2-3/16"	1-1/2"	SCC-GR01S20-DCS-WA-*	SCC-GR01S20-DCS-WA-B-*
2-1/4"	Rubber	Bright Chrome	75	2-5/16"	1-9/16"	SCC-GR01S214-DCR-BC-*	SCC-GR01S214-DCR-BC-B-*
	Rubber	Windsor Antique	75	2-5/16"	1-9/16"	SCC-GR01S214-DCR-WA-*	SCC-GR01S214-DCR-WA-B-*
2-1/2"	Steel	Bright Chrome	100	2-13/16"	1-7/8"	SCC-GR01S25-DCS-BC-*	SCC-GR01S25-DCS-BC-B-*
	Steel	Windsor Antique	100	2-13/16"	1-7/8"	SCC-GR01S25-DCS-WA-*	SCC-GR01S25-DCS-WA-B-*
3"	Rubber	Bright Chrome	100	2-7/8"	2-1/16"	SCC-GR01S30-DCR-BC-*	SCC-GR01S30-DCR-BC-B-*
	Rubber	Windsor Antique	100	2-7/8"	2-1/16"	SCC-GR01S30-DCR-WA-*	SCC-GR01S30-DCR-WA-B-*

NOTE: SERVICE CASTER OFFERS QUICK MOUNTING SOLUTIONS. REPLACE * WITH THE CODE FOR SIZE. CONTACT CUSTOMER SERVICE FOR DETAILS.

Top Plates

- 1-1/2" x 1-1/2" (TP1)
- 2" x 1-3/16" (TP2)

[CLICK TO ORDER NOW](#)

TOP PLATE CASTERS

Wheel Diameter	Tread Material	Finish	Dynamic Load (lbs.)	Mounting Height	Swivel Radius	Part Number	Brakes
2"	Steel	Bright Chrome	75	2-3/16"	1-1/2"	SCC-TP01S20-DCS-BC	SCC-TP01S20-DCS-BC-B-*
	Steel	Windsor Antique	75	2-3/16"	1-1/2"	SCC-TP01S20-DCS-WA	SCC-TP01S20-DCS-WA-B-*
2-1/4"	Rubber	Bright Chrome	75	2-5/16"	1-9/16"	SCC-TP01S214-DCR-BC	SCC-TP01S214-DCR-BC-B-*
	Rubber	Windsor Antique	75	2-5/16"	1-9/16"	SCC-TP01S214-DCR-WA	SCC-TP01S214-DCR-WA-B-*
2-1/2"	Steel	Bright Chrome	100	2-13/16"	1-7/8"	SCC-TP01S25-DCS-BC	SCC-TP01S25-DCS-BC-B-*
	Steel	Windsor Antique	100	2-13/16"	1-7/8"	SCC-TP01S25-DCS-WA	SCC-TP01S25-DCS-WA-B-*
3"	Rubber	Bright Chrome	100	2-7/8"	2-1/16"	SCC-TP01S30-DCR-BC	SCC-TP01S30-DCR-BC-B-*
	Rubber	Windsor Antique	100	2-7/8"	2-1/16"	SCC-TP01S30-DCR-WA	SCC-TP01S30-DCR-WA-B-*



NOTE: FOUR BOLTS NEEDED (NOT INCLUDED). REPLACE * WITH THE BOLT CODE FOR SIZE. CONTACT SERVICE CASTER FOR MOUNTING SOLUTIONS.

Threaded Stems

- 5/16"-18 x 3/4" (5161834) • 3/8"-16 x 1" (38161)
- 5/16"-18 x 1" (516181) • 3/8"-16 x 1-1/2" (3816112)

[CLICK TO ORDER NOW](#)

THREADED STEM CASTERS



Wheel Diameter	Tread Material	Finish	Dynamic Load (lbs.)	Mounting Height	Swivel Radius	Part Number	Brakes
2"	Steel	Bright Chrome	75	2-3/16"	1-1/2"	SCC-TS01S20-DCS-BC-*	SCC-TS01S20-DCS-BC-B-*
	Steel	Windsor Antique	75	2-3/16"	1-1/2"	SCC-TS01S20-DCS-WA-*	SCC-TS01S20-DCS-WA-B-*
2-1/4"	Rubber	Bright Chrome	75	2-5/16"	1-9/16"	SCC-TS01S214-DCR-BC-*	SCC-TS01S214-DCR-BC-B-*
	Rubber	Windsor Antique	75	2-5/16"	1-9/16"	SCC-TS01S214-DCR-WA-*	SCC-TS01S214-DCR-WA-B-*
2-1/2"	Steel	Bright Chrome	100	2-13/16"	1-7/8"	SCC-TS01S25-DCS-BC-*	SCC-TS01S25-DCS-BC-B-*
	Steel	Windsor Antique	100	2-13/16"	1-7/8"	SCC-TS01S25-DCS-WA-*	SCC-TS01S25-DCS-WA-B-*
3"	Rubber	Bright Chrome	100	2-7/8"	2-1/16"	SCC-TS01S30-DCR-BC-*	SCC-TS01S30-DCR-BC-B-*
	Rubber	Windsor Antique	100	2-7/8"	2-1/16"	SCC-TS01S30-DCR-WA-*	SCC-TS01S30-DCR-WA-B-*

NOTE: REPLACE * WITH STEM CODE FOR SIZE. ACCURATE MEASURING NEEDS PROPER TOOLS. CONTACT CUSTOMER SERVICE FOR HELP.

Decorative Hooded Ball Casters

Series #01 Metal & Rubber Ball Casters

The 01 #Decorative Hooded Ball Casters offer stylish, smooth mobility with versatile finishes. Ideal for light-duty applications in offices, healthcare, and retail. Made in the USA for quality and durability.

Applications

- Office Chairs
- Store Fixtures
- Medical Equipment
- POP Displays
- Seating Furniture
- Mobile Cabinets
- Hospitality Furniture
- Retail Displays
- Institutional Equipment
- Horticulture Carts

Features

- Heat-treated yoke, double ball bearing raceways, and self-lubricating bushings for long-lasting performance.
- Available in Metalized Brass, Windsor Antique, and Bright Chrome to enhance aesthetics.
- Rubber, Urethane or Polyolefin options for various surfaces.

Finish Options

- Metalized Brass
- Windsor Antique
- Bright Chrome
- Glossy Black
- Flat Black

Brake Option

- Side-locking brake offers secure, easy stopping for light-duty use.

SCC-GR01S20-POS-FB-SLB-716

BRAND
STEM TYPE
SERIES
RIG TYPE
WHEEL WIDTH
WHEEL MATERIAL
FINISH
BRAKE OPTION
STEM SIZE

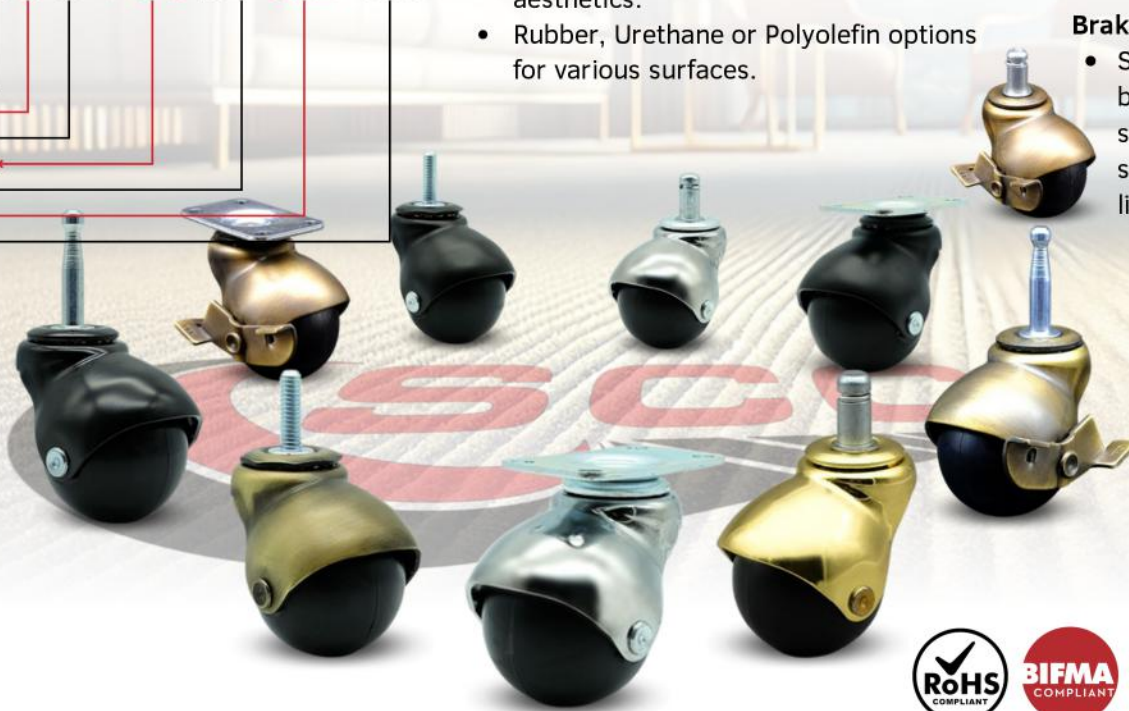

Ready to roll?
The 01 Series

has it all!



CLICK TO PICK



Mounting Options

More Options

Discover more fastening sizes and wheel options if you can't find what you need. And remember, we're always here to **help!**

Brand	Series	Mounting Type	Rig Type	Wheel Diameter	Wheel Material	Finish Type	Brake Option	Stem Size
Service Caster	01	Grip Neck (GN)	Swivel (S)	1-5/8" (158)	Soft Rubber (SRS)	Windsor Antique (WA)	Brake (SLB)	Grip Neck - 5/16" x 1-1/2" (516)
		Grip Ring (GR)		1-3/4" (134)	Urethane (PUS)	Bright Chrome (BC)		Grip Ring - 7/16" x 7/8" (71678)
		Threaded Stem (TS)		2" (20)	Polyolefin (POS)	Metalized Brass (MB)		Grip Ring - 7/16" x 1-7/8" (716178)
		Top Plate (TP)			Glossy Black (GB)	Grip Ring - 3/8" x 1" (381)		
						Flat Black (FB)	Threaded - 5/16"-18 x 1 (516181)	
							Threaded - 5/16"-18 x 3/4" (5161834)	
							Threaded - 3/8"-16 x 1 (38161)	
							Threaded - 3/8"-16 x 1-1/2 (381615)	
							Plate - 1-3/16" x 2" (TP2)	

Threaded Stems

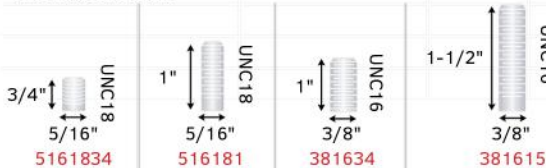

Socket Options

Service Caster offers various solutions for quick and easy caster mounting, including connections to wood, round or square tubes, PVC pipe legs, and weldable mounts.



Grip Neck

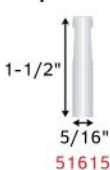

Grip Rings



Top Plates

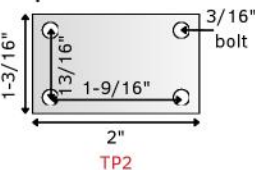

Corner Brackets



Wheels

Urethane is durable for carpets and tiles, polyolefin resists impact and moisture, and soft rubber offers quiet, cushioned movement.



Wood Sockets

Grip Neck Stem

- Fits 5/16" x 1-1/2" Grip Neck Stem Only
- 5/16" x 1-1/2" (516112) • For Installation: Drill 3/8" x 1-5/8" Hole

[CLICK TO ORDER NOW](#)

GRIP NECK STEM CASTERS

Wheel Diameter	Tread Material	Finish	Dynamic Load (lbs.)	Mounting Height	Swivel Radius	Part Number	Brakes
1-5/8"	Soft Rubber	Bright Brass	70	2-5/16"	1-3/4"	SCC-GN01S158-SRS-BB-516	Contact Customer Service
		Windsor Antique	70	2-5/16"	1-3/4"	SCC-GN01S158-SRS-WA-516	Contact Customer Service
1-3/4"	Polyolefin	Variety Finishes	70	2-1/2"	1-13/16"	SCC-GN01S134-POS-*516	Contact Customer Service
	Urethane	Variety Finishes	70	2-1/2"	1-13/16"	SCC-GN01S314-PUS-*516	Contact Customer Service
2"	Polyolefin	Bright Brass	80	2-5/8"	1-7/8"	SCC-GN01S20-POS-BB-516	Contact Customer Service
		Bright Chrome	80	2-5/8"	1-7/8"	SCC-GN01S20-POS-BC-516	Contact Customer Service
		Flat Black	80	2-5/8"	1-7/8"	SCC-GN01S20-POS-FB-516	Contact Customer Service
		Glossy Black	80	2-5/8"	1-7/8"	SCC-GN01S20-POS-GB-516	Contact Customer Service
		Windsor Antique	80	2-5/8"	1-7/8"	SCC-GN01S20-POS-WA-516	SCC-GN01S20-POS-WA-SLB-516



NOTE: METAL SOCKETS FOR INSTALLATION INTO WOOD INCLUDED WITH GRIP NECK STEM MODELS

Grip Ring Stem

- 3/8" x 1" (381)
- 7/16" x 7/8" (71678)
- 7/16" x 1-7/16" (7161716)

[CLICK TO ORDER NOW](#)

GRIP RING STEM CASTERS



Wheel Diameter	Tread Material	Finish	Dynamic Load (lbs.)	Mounting Height	Swivel Radius	Part Number	Brakes
1-5/8"	Soft Rubber	Bright Brass	70	2-5/16"	1-3/4"	SCC-GR01S158-SRS-BB-*	Contact Customer Service
		Windsor Antique	70	2-5/16"	1-3/4"	SCC-GR01S158-SRS-WA-*	Contact Customer Service
1-3/4"	Polyolefin	Variety Finishes	70	2-1/2"	1-13/16"	SCC-GN01S134-POS-*	Contact Customer Service
	Urethane	Variety Finishes	70	2-1/2"	1-13/16"	SCC-GN01S314-PUS-*	Contact Customer Service
2"	Polyolefin	Bright Brass	80	2-5/8"	1-7/8"	SCC-GR01S20-POS-BB-*	SCC-GN01S20-DCS-BB-SLB-*
		Bright Chrome	80	2-5/8"	1-7/8"	SCC-GR01S20-POS-BC-*	SCC-GN01S20-DCS-BC-SLB-*
		Flat Black	80	2-5/8"	1-7/8"	SCC-GR01S20-POS-FB-*	SCC-GN01S20-DCS-FB-SLB-*
		Glossy Black	80	2-5/8"	1-7/8"	SCC-GR01S20-POS-GB-*	SCC-GN01S20-DCS-GB-SLB-*
		Windsor Antique	80	2-5/8"	1-7/8"	SCC-GR01S20-POS-WA-*	SCC-GR01S20-POS-WA-SLB-*

NOTE: SERVICE CASTER OFFERS QUICK MOUNTING SOLUTIONS. REPLACE * WITH THE CODE FOR SIZE. CONTACT CUSTOMER SERVICE FOR DETAILS.

Top Plates

- 2" x 1-3/16 (TP2)

[CLICK TO ORDER NOW](#)

TOP PLATE CASTERS

Wheel Diameter	Tread Material	Finish	Dynamic Load (lbs.)	Mounting Height	Swivel Radius	Part Number	Brakes
1-5/8"	Soft Rubber	Bright Brass	70	2-5/16"	1-3/4"	SCC-TP01S158-SRS-BB	Contact Customer Service
		Windsor Antique	70	2-5/16"	1-3/4"	SCC-TP01S158-SRS-WA	Contact Customer Service
1-3/4"	Polyolefin	Variety Finishes	70	2-1/2"	1-13/16"	SCC-TP01S134-POS*	Contact Customer Service
	Urethane	Variety Finishes	70	2-1/2"	1-13/16"	SCC-TP01S314-PUS*	Contact Customer Service
2"	Polyolefin	Bright Brass	80	2-5/8"	1-7/8"	SCC-TP01S20-POS-BB	SCC-TP01S20-DCS-BB-SLB
		Bright Chrome	80	2-5/8"	1-7/8"	SCC-TP01S20-POS-BC	SCC-TP01S20-DCS-BC-SLB
		Flat Black	80	2-5/8"	1-7/8"	SCC-TP01S20-POS-FB	SCC-TP01S20-DCS-FB-SLB
		Glossy Black	80	2-5/8"	1-7/8"	SCC-TP01S20-POS-GB	SCC-TP01S20-DCS-GB-SLB
		Windsor Antique	80	2-5/8"	1-7/8"	SCC-TP01S20-POS-WA	SCC-TP01S20-POS-WA-SLB



NOTE: FOUR BOLTS NEEDED (NOT INCLUDED). REPLACE * WITH THE BOLT CODE FOR COLOR. CONTACT SERVICE CASTER FOR MOUNTING SOLUTIONS.

Threaded Stems

- 5/16"-18 x 3/4" (5161834) • 3/8"-16 x 1" (38161)
- 5/16"-18 x 1" (516181) • 3/8"-16 x 1-1/2" (3816112)

[CLICK TO ORDER NOW](#)

THREADED STEM CASTERS

Wheel Diameter	Tread Material	Finish	Dynamic Load (lbs.)	Mounting Height	Swivel Radius	Part Number	Brakes
1-5/8"	Soft Rubber	Bright Brass	70	2-5/16"	1-3/4"	SCC-TS01S158-SRS-BB*	Contact Customer Service
		Windsor Antique	70	2-5/16"	1-3/4"	SCC-TS01S158-SRS-WA*	Contact Customer Service
1-3/4"	Polyolefin	Variety Finishes	70	2-1/2"	1-13/16"	SCC-TS01S134-POS-*	Contact Customer Service
	Urethane	Variety Finishes	70	2-1/2"	1-13/16"	SCC-TS01S314-PUS-*	Contact Customer Service
2"	Polyolefin	Bright Brass	80	2-5/8"	1-7/8"	SCC-TS01S20-POS-BB*	SCC-TS01S20-DCS-BB-SLB*
		Bright Chrome	80	2-5/8"	1-7/8"	SCC-TS01S20-POS-BC*	SCC-TS01S20-DCS-BC-SLB*
		Flat Black	80	2-5/8"	1-7/8"	SCC-TS01S20-POS-FB*	SCC-TS01S20-DCS-FB-SLB*
		Glossy Black	80	2-5/8"	1-7/8"	SCC-TS01S20-POS-GB*	SCC-TS01S20-DCS-GB-SLB*
		Windsor Antique	80	2-5/8"	1-7/8"	SCC-TS01S20-POS-WA*	SCC-TS01S20-POS-WA-SLB*

NOTE: REPLACE * WITH STEM CODE FOR SIZE. ACCURATE MEASURING NEEDS PROPER TOOLS. CONTACT CUSTOMER SERVICE FOR HELP.



Decorative Twin Wheel Casters

Twin Wheel Casters

Introducing our popular O2 Twin Wheel Series: A durable choice for seating and store fixtures. With various finishes and sizes, find the perfect fit for your

Applications

- Computer equipment Furniture
- Office equipment
- POP displays
- Seating
- Store fixtures
- Displays
- Electronics
- Electronics storage

SCC-GR02S50D-NYS-FB-B-71678



Features

- REACH-Certified
- RoHS Compliant
- Zinc Die-Cast Body & Hood
- Concealed Axle

Shield-Guard protects the tread from scratches and damage.



Finish Options

- Metalized Brass
- Windsor Antique
- Bright Chrome

Mounting Options More Options

Brand	Mounting Type	Series	Rig Type	Wheel Diameter	Hood Type	Wheel Material	Finish Type	Brake Option	Stem Size
Service Caster	Grip Neck (GN)	02	Swivel	2" (50)	Die Cast Steel (D)	Nylon (NYS)	Windsor Antique (WA)	Brake (B)	Grip Neck 5/16" x 1-1/2" (516)
	Grip Ring (GR)			2-3/8" (60)	Plastic	Urethane (NYU)	Bright Chrome (BC)		Grip Ring - 7/16" x 7/8" (71678)
	Threaded Stem (TS)					Flat Black (FB)	Grip Ring - 7/16" x 1-7/16" (7161716)		
	Top Plate (TP)						Threaded - 1/4"-20 x 5/8" (142058)		
								Threaded - 5/16"-18 x 1" (5161810)	
								Threaded - 5/16"-18 x 1/2" (5161812)	
								Threaded - 3/8"-16 x 3/4" (381634)	
								Threaded - 3/8"-16 x 1-1/2" (381615)	
								Threaded - 3/8"-24 x 5/8" (382458)	
								Top Plate - 1-1/2" x 1-1/2" (TP1)	
								Top Plate - 1-3/16" x 2" (TP2)	

Threaded Stem

- 1/4"-20 x 5/8"
- 5/16"-18 x 3/4"
- 5/16"-18 x 1"
- 3/8"-16 x 1"
- 3/8"-16 x 1-1/2"
- 3/8"-24 x 5/8"

Top Plate

- 2" x 1-3/16" Plate with 1-9/16" x 13/16" Bolt pattern
- 1-1/2" x 1-1/2" Plate with 1" x 1" Bolt Pattern

Grip Neck 5/16" x 1-1/2" (516)
Grip Ring - 7/16" x 7/8" (71678)
Grip Ring - 7/16" x 1-7/16" (7161716)
Threaded - 1/4"-20 x 5/8" (142058)
Threaded - 5/16"-18 x 1" (5161810)
Threaded - 5/16"-18 x 1/2" (5161812)
Threaded - 3/8"-16 x 3/4" (381634)
Threaded - 3/8"-16 x 1-1/2" (381615)
Threaded - 3/8"-24 x 5/8" (382458)
Top Plate - 1-1/2" x 1-1/2" (TP1)
Top Plate - 1-3/16" x 2" (TP2)

Grip Ring Stem

- 3/8" x 1"
- 7/16" x 7/8"
- 7/16" x 1-7/16"

Brake Option

- Brake option available

Socket Options

- Service Caster has many solutions to help you mount your casters to your equipment quickly and easily.

Grip Neck Stem

- 5/16" x 1-1/2"

Finish Options

- Flat Black
- Windsor Antique
- Bright Chrome

Corner Brackets

- Angle & Straight



GRIP NECK STEM CASTERS

Wheel Diameter	Dynamic Load	Mounting Height	Swivel Radius	Tread Material	Finish	Part Number <small>CLICK TO ORDER NOW</small>
2" (50)	75 lbs.	2-3/8"	1-3/4"	Nylon	Flat Black	SCC-GN02S50D-NYS-FB-516
				Nylon	Flat Black	SCC-GN02S50D-NYS-FB-B-516
				Nylon	Windsor Antique	SCC-GN02S50D-NYS-WA-B-516
				Urethane	Flat Black	SCC-GN02S50D-NYU-FB-516
				Urethane	Windsor Antique	SCC-GN02S50D-NYU-WA-516 <small>CLICK TO ORDER NOW</small>
				Nylon	Black	SCC-GN02S50-NYS-B-516
2-3/8" (60)	100 lbs.	2-3/4"	2-3/16"	Urethane	Flat Black	SCC-GN02S60D-NYU-FB-516
				Urethane	Windsor Antique	SCC-GN02S60D-NYU-WA-516
				Nylon	Black	SCC-GN02S60-NYS-516
				Nylon	Black	SCC-GN02S60-NYS-B-516

GRIP RING STEM CASTERS

Wheel Diameter	Dynamic Load	Mounting Height	Swivel Radius	Tread Material	Finish	Part Number <small>CLICK TO ORDER NOW</small>
2" (50)	75 lbs.	2-1/2"	1-3/4"	Nylon	Flat Black	SCC-GR02S50D-NYS-FB-*
				Nylon	Flat Black	SCC-GR02S50D-NYS-FB-B-*
				Nylon	Windsor Antique	SCC-GR02S50D-NYS-WA-*
				Nylon	Windsor Antique	SCC-GR02S50D-NYS-WA-B-*
				Urethane	Bright Chrome	SCC-GR02S50D-NYU-BC-*
				Urethane	Flat Black	SCC-GR02S50D-NYU-FB-*
				Urethane	Windsor Antique	SCC-GR02S50D-NYU-WA-*
				Nylon	Black	SCC-GR02S50-NYS-*
2-3/8" (60)	100 lbs.	2-3/4"	2-3/16"	Nylon	Windsor Antique	SCC-GR02S60D-NYS-WA-*
				Urethane	Flat Black	SCC-GR02S60D-NYU-FB-*
				Urethane	Windsor Antique	SCC-GR02S60D-NYU-WA-*
				Nylon	Black	SCC-GR02S60-NYS-*
				Nylon	Black	SCC-GR02S60-NYS-B-*

NOTE: FOR YOUR STEM CHOICE, REPLACE * IN PART NUMBER WITH THE STEM CODE SHOWN IN STEM CHOICES.

Grip Ring Stem

- 3/8" x 1" ([381](#))
- 7/16" x 7/8" ([71678](#))
- 7/16" x 1-7/16" ([7161716](#))



Wood Sockets

- For use in wood applications
- Fits 5/16" x 1-1/2" Grip Neck Stem Only
- For Installation: Drill 3/8" x 1-5/8" Hole



Grip Neck Stem

- 5/16" x 1-1/2" ([516112](#))



NOTE: METAL SOCKETS FOR INSTALLATION INTO WOOD INCLUDED WITH GRIP NECK STEM MODELS

Brake Option

- Brake option available (-B)



Corner Brackets

- 90 Degree Angle ([CB90](#))
- 180 Degree Straight ([CB180](#))



TOP PLATE CASTERS

Wheel Diameter	Dynamic Load	Mounting Height	Swivel Radius	Tread Material	Finish	Part Number <small>CLICK TO ORDER NOW</small>
2" (50)	75 lbs.	2-11/16"	1-3/4"	Nylon	Flat Black	SCC-TP02S50D-NYS-FB-B
					Flat Black	SCC-TP02S50D-NYS-FB-B-TP2
					Flat Black	SCC-TP02S50D-NYS-FB-TP2
					Windsor Antique	SCC-TP02S50D-NYS-WA-B
					Windsor Antique	SCC-TP02S50D-NYS-WA-B-TP2
				Urethane	Windsor Antique	SCC-TP02S50D-NYU-BC
					Bright Chrome	SCC-TP02S50D-NYU-BC-TP2
					Bright Chrome	SCC-TP02S50D-NYU-FB
					Flat Black	SCC-TP02S50D-NYU-FB-TP2
					Windsor Antique	SCC-TP02S50D-NYU-WA
2-3/8" (60)	100 lbs.	3-1/16"	2-3/16"	Urethane	Windsor Antique	SCC-TP02S60D-NYU-FB
					Flat Black	SCC-TP02S60D-NYU-FB-TP2
					Windsor Antique	SCC-TP02S60D-NYU-WA
					Windsor Antique	SCC-TP02S60D-NYU-WA-TP2

THREADED STEM CASTERS

Wheel Diameter	Dynamic Load	Mounting Height	Swivel Radius	Tread Material	Finish	Part Number <small>CLICK TO ORDER NOW</small>
2" (50)	75 lbs.	2-1/2"	1-3/4"	Nylon	Flat Black	SCC-TS02S50D-NYS-FB-*
					Flat Black	SCC-TS02S50D-NYS-FB-B-*
					Windsor Antique	SCC-TS02S50D-NYS-WA-*
					Windsor Antique	SCC-TS02S50D-NYS-WA-B-*
				Urethane	Bright Chrome	SCC-TS02S50D-NYU-BC-*
					Flat Black	SCC-TS02S50D-NYU-FB-*
2-3/8" (60)	100 lbs.	2-7/8"	2-3/16"	Urethane	Windsor Antique	SCC-TS02S50D-NYU-WA-*
					Flat Black	SCC-TS02S60D-NYU-FB-*
					Windsor Antique	SCC-TS02S60D-NYU-WA-*

NOTE: FOR YOUR STEM CHOICE, REPLACE * IN PART NUMBER WITH THE STEM CODE SHOWN IN STEM CHOICES.

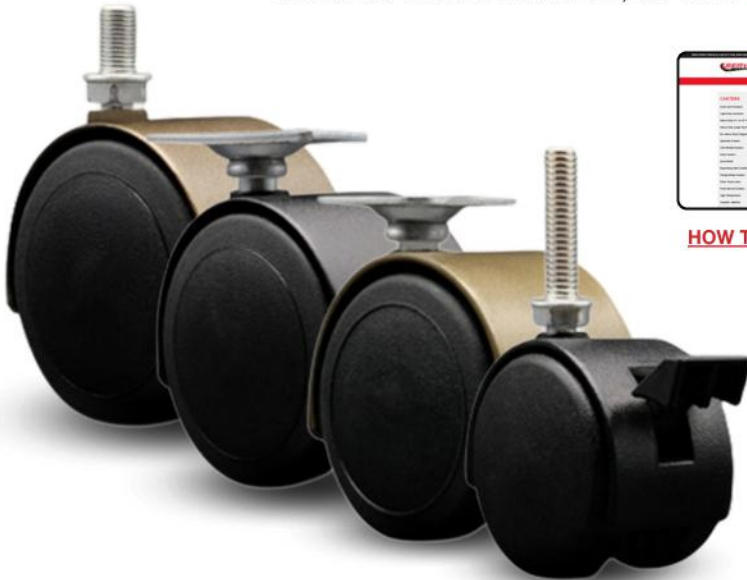

HOW TO MEASURE CASTER STEMS

Brake Option

- Brake option available (-B)



Threaded Stem

- 5/16"-18 x 3/4" ([5161834](#))
- 5/16"-18 x 1" ([516181](#))
- 3/8"-16 x 1" ([38161](#))
- 3/8"-16 x 1-1/2" ([3816112](#))



Top Plate

- 1-1/2" x 1-1/2" Plate with 1" x 1" Bolt Pattern
- 2" x 1-3/16" Plate with 1-9/16" x 13/16" Bolt pattern ([TP2](#))



Floor Safe Twin Wheel Casters

Twin Wheel Casters

Choose our soft wheel furniture and office chair casters for durable, floor-protecting solutions, ideal for various hard flooring types and compatible with top chair brands like Herman Miller and Hon.

Applications

- Office Chairs
- Display Stands
- Medical Carts
- Home Furniture
- Electric Equipment
- Shelving Units
- Mobile Workstations
- Seating
- Store fixtures

Features

- REACH-Certified
- RoHS Compliant
- Quiet Mobility
- Soft 70-75/A durometer tread



PART NUMBER KEY: HOW TO ORDER THE CORRECT CASTER:

SCC-GR02S75-TPR-GRY-B-716176

Brand	Mounting Type	Series	Rig Type	Wheel Diameter	Hood Type	Wheel Material	Brake Option	Stem Size
Service Caster	Grip Neck (GN)	02	Swivel	2" (50)	Thermoplastic Rubber (TPR)	Gray (GRY)	Brake (B)	Grip Neck 5/16" x 1-1/2" (516)
	Grip Ring (GR)			2-3/8" (60)		Black (BLK)		Grip Ring - 7/16" x 7/8" (71678)
	Threaded Stem (TS)			3" (75)				Grip Ring - 7/16" x 1-7/16" (716176)
	Top Plate (TP)			4" (100)				Threaded - 5/16"-18 x 1" (5161810)
				5" (125)				Threaded - 3/8"-16 x 3/4" (381634)
								Threaded - 3/8"-16 x 1" (381610)
								Threaded - 1/2"-13 x 1" (121310)
								Threaded - 1/2"-13 x 1-1/2" (121315)
								Top Plate - 1-1/2" x 1-1/2" (2"-3" wheel dia.)
								Top Plate - 2-5/8" x 3-3/4" (3"-5" wheel dia.)
								Top Plate - 2-3/16" x 2-9/16" (3"-5" wheel dia.)

Non-Marking Thermoplastic Elastomer Rubber is offered in Black and Gray options.



Mounting Options

Threaded Stem

- 1/4"-20 x 5/8"
- 5/16"-18 x 3/4"
- 5/16"-18 x 1"
- 3/8"-16 x 1"
- 3/8"-16 x 1-1/2"
- 3/8"-24 x 5/8"
- 1/2"-13 x 1"
- 1/2"-13 x 1-1/2"



Grip Ring Stem

- 3/8" x 1"
- 7/16" x 7/8"
- 7/16" x 1-7/16"



Grip Neck Stem

- 5/16" x 1-1/2"



Top Plate

- 1-1/2" x 1-1/2" Plate with 1" x 1" Bolt Pattern (3/16" hole)
- 2" x 1-3/16" Plate with 1-9/16" x 13/16" Bolt pattern (5/16" hole)
- 2-5/8" x 3-3/4" Plate with 1-3/4" x 2-3/4" to 3" (5/16" hole)



Brake Option

- Brake option available



Corner Brackets

- Angle & Straight



Socket Options

- Service Caster has many solutions to help you mount your casters to your equipment quickly and easily.





Wood Sockets

- For use in wood applications
- Fits 5/16" x 1-1/2" Grip Neck Stem Only
- For Installation: Drill 3/8" x 1-5/8" Hole



NOTE: METAL SOCKETS FOR INSTALLATION INTO WOOD INCLUDED WITH GRIP NECK STEM MODELS

Grip Neck Stem

- 5/16" x 1-1/2" ([516112](#))



GRIP NECK STEM CASTERS

Wheel Diameter	Dynamic Load	Mounting Height	Swivel Radius	Tread Material	Finish	Part Number <small>CLICK TO ORDER NOW</small>
2" (50)	75 lbs.	2-1/4"	1-13/16"	Thermoplastic Rubber	Black	SCC-GN02S50-TPR-BLK
					Black	SCC-GN02S50-TPR-BLK-B
					Gray	SCC-GN02S50-TPR-GRY
2-3/8" (60)	100 lbs.	2-5/8"	2-1/16"	Thermoplastic Rubber	Black	SCC-GN02S60-TPR-BLK
					Gray	SCC-GN02S60-TPR-GRY
3" (75)	165 lbs.	3-3/16"	2-1/2"	Thermoplastic Rubber	Black	SCC-GN02S75-TPR-BLK
					Gray	SCC-GN02S75-TPR-GRY



GRIP RING STEM CASTERS

Grip Ring Stem

- 3/8" x 1" ([381](#))
- 7/16" x 7/8" ([71678](#))
- 7/16" x 1-7/16" ([7161716](#))



Wheel Diameter	Dynamic Load	Mounting Height	Swivel Radius	Tread Material	Finish	Part Number <small>CLICK TO ORDER NOW</small>
2" (50)	75 lbs.	2-1/4"	1-13/16"	Thermoplastic Rubber	Black	SCC-GR02S50-TPR-BLK-*
					Black	SCC-GR02S50-TPR-BLK-B-*
					Gray	SCC-GR02S50-TPR-GRY-*
2-3/8" (60)	100 lbs.	2-5/8"	2-1/16"	Thermoplastic Rubber	Black	SCC-GR02S60-TPR-BLK-*
					Gray	SCC-GR02S60-TPR-GRY-*
3" (75)	165 lbs.	3-3/16"	2-1/2"	Thermoplastic Rubber	Black	SCC-GR02S75-TPR-BLK-*
					Gray	SCC-GR02S75-TPR-GRY-*
4" (100)	225 lbs.	4-5/16"	3-5/8"	Thermoplastic Rubber	Black	SCC-GR02S100-TPR-BLK-*
					Black	SCC-GR02S100-TPR-GRY-*

NOTE: FOR YOUR STEM CHOICE, REPLACE * IN PART NUMBER WITH THE STEM CODE SHOWN IN STEM CHOICES.



Excellent



Based on 11,674 reviews



Any Questions?



Corner Brackets

- 90 Degree Angle ([CB90](#))
- 180 Degree Straight ([CB180](#))



Brake Option

- Brake option available ([-B](#))



All Models Available with Brake



TOP PLATE CASTERS

Top Plate

- 1-1/2" x 1-1/2" Plate with 1" x 1" Bolt Pattern (3/16" hole) ([TP1](#))
- 2" x 1-3/16" Plate with 1-9/16" x 13/16" Bolt pattern (5/16" hole) ([TP2](#))
- 2-5/8" x 3-3/4" Plate with 1-3/4" x 2-3/4" to 3" (5/16" hole) ([TP3](#))



Wheel Diameter	Dynamic Load	Mounting Height	Swivel Radius	Tread Material	Finish	Part Number <small>CLICK TO ORDER NOW</small>
2" (50)	75 lbs.	2-3/8"	1-13/16"	Thermoplastic Rubber	Black	SCC-TP02S50-TPR-BLK-*
					Black	SCC-TP02S50-TPR-BLK-B-*
					Gray	SCC-TP02S50-TPR-GRY-*
2-3/8" (60)	100 lbs.	2-3/4"	2-1/16"	Thermoplastic Rubber	Black	SCC-TP02S60-TPR-BLK-*
					Gray	SCC-TP02S60-TPR-GRY-*
3" (75)	165 lbs.	3-1/2"	2-1/2"	Thermoplastic Rubber	Black	SCC-TP02S75-TPR-BLK-*
					Gray	SCC-TP02S75-TPR-GRY-*
4" (100)	225 lbs.	4-5/8"	3-5/8"	Thermoplastic Rubber	Black	SCC-TP02S100-TPR-BLK-*
					Gray	SCC-TP02S100-TPR-GRY-*

THREADED STEM CASTERS

Threaded Stem

- 5/16"-18 x 3/4" ([5161834](#))
- 5/16"-18 x 1" ([516181](#))
- 3/8"-16 x 1" ([38161](#))
- 3/8"-16 x 1-1/2" ([3816112](#))
- 1/2"-13 x 1" ([12131](#))
- 1/2"-13 x 1-1/2" ([121315](#))



Wheel Diameter	Dynamic Load	Mounting Height	Swivel Radius	Tread Material	Finish	Part Number <small>CLICK TO ORDER NOW</small>
2" (50)	75 lbs.	2-3/8"	1-13/16"	Thermoplastic Rubber	Black	SCC-TS02S50-TPR-BLK-*
					Black	SCC-TS02S50-TPR-BLK-B-*
					Gray	SCC-TS02S50-TPR-GRY-*
2-3/8" (60)	100 lbs.	2-3/4"	2-1/16"	Thermoplastic Rubber	Black	SCC-TS02S60-TPR-BLK-*
					Gray	SCC-TS02S60-TPR-GRY-*
3" (75)	165 lbs.	3-1/2"	2-1/2"	Thermoplastic Rubber	Black	SCC-TS02S75-TPR-BLK-*
					Gray	SCC-TS02S75-TPR-GRY-*
4" (100)	225 lbs.	4-5/16"	3-5/8"	Thermoplastic Rubber	Black	SCC-TS02S100-TPR-BLK-*
					Gray	SCC-TS02S100-TPR-GRY-*

NOTE: FOR YOUR STEM CHOICE, REPLACE * IN PART NUMBER WITH THE STEM CODE SHOWN IN STEM CHOICES.



Brake Option

- Brake option available ([-B](#))



Suitable for
all types of
hard flooring.



Unhooded Nylon Twin Wheel Casters

Unhooded Twin Wheel Casters

Our nylon construction offers nylon or urethane wheel treads for floor protection. Solid axles ensure retention and high load ratings, with zinc plating for corrosion resistance.

Applications

- Utility Carts
- Furniture
- Office Equipment
- Medical Equipment
- Store Fixtures



Features

- Modern Design
- Option of Nylon or Urethane Wheel
- Riveted Axle for Secure Wheel Retention



PART NUMBER KEY: HOW TO ORDER THE CORRECT CASTER:

SCC-UHTS02S100-NYS-B-5161810

Brand	Caster Style	Mounting Type	Series	Rig Type	Wheel Diameter	Wheel Material	Brake Option	Stem Size
Service Caster	Unhooded (UH)	Threaded Stem (TS)	02	Swivel	2" (50)	Nylon (NYS)	Brake (B)	Grip Neck 5/16" x 1-1/2" (516)
		Grip Neck (GN)			2-3/8" (60)	Nylon (NYS)		Grip Ring - 7/16" x 7/8" (71678)
		Grip Ring (GR)			3" (75)			Grip Ring - 7/16" x 1-7/16" (7161716)
		Top Plate (TP)			4" (100)			Threaded - 5/16"-18 x 1" (5161810)
								Threaded - 3/8"-16 x 3/4" (381634)
								Threaded - 3/8"-16 x 1" (381610)
								Threaded - 1/2"-13 x 1" (121310)
								Threaded - 1/2"-13 x 1-1/2" (121315)
								Top Plate - 1-1/2" x 1-1/2" (2"-3" wheel dia.)
								Top Plate - 2-5/8" x 3-3/4" (3"-5" wheel dia.)
								Top Plate - 2-3/16" x 2-9/16" (3"-5" wheel dia.)



Locking Caster Option

Mounting Options

More Options

Threaded Stem

- 1/4"-20 x 5/8"
- 5/16"-18 x 3/4"
- 5/16"-18 x 1"
- 3/8"-16 x 1"
- 3/8"-16 x 1-1/2"
- 3/8"-24 x 5/8"
- 1/2"-13 x 1"
- 1/2"-13 x 1-1/2"



Top Plate

- 1-1/2" x 1-1/2" Plate with 1" x 1" Bolt Pattern (3/16" hole)
- 2" x 1-3/16" Plate with 1-9/16" x 13/16" Bolt pattern (5/16" hole)
- 2-5/8" x 3-3/4" Plate with 1-3/4" x 2-3/4" to 3" (5/16" hole)



Brake Option

- Brake option available



Corner Brackets

- Angle & Straight



Socket Options

- Service Caster has many solutions to help you mount your casters to your equipment quickly and easily.



Grip Ring Stem

- 3/8" x 1"
- 7/16" x 7/8"
- 7/16" x 1-7/16"



Grip Neck Stem

- 5/16" x 1-1/2"





GRIP NECK STEM CASTERS

Wood Sockets

- For use in wood applications
- Fits 5/16" x 1-1/2" Grip Neck Stem Only
- For Installation: Drill 3/8" x 1-5/8" Hole

NOTE: METAL SOCKETS FOR INSTALLATION INTO WOOD INCLUDED WITH GRIP NECK STEM MODELS



Grip Neck Stem

- 5/16" x 1-1/2" ([516112](#))



Wheel Diameter	Dynamic Load	Mounting Height	Swivel Radius	Tread Material	Finish	Part Number <small>CLICK TO ORDER NOW</small>
2" (50)	75 lbs.	2-1/4"	1-13/16"	Nylon	Black	SCC-UHGN02S50-NYS SCC-UHGN02S50-NYS-B
2-3/8" (60)	100 lbs.	2-5/8"	2-1/16"	Nylon	Black	SCC-UHGN02S60-NYS SCC-UHGN02S60-NYS-B
3" (75)	165 lbs.	3-3/16"	2-1/2"	Nylon	Black	SCC-UHGN02S75-NYS SCC-UHGN02S75-NYS-B

GRIP RING STEM CASTERS

Grip Ring Stem

- 3/8" x 1" ([381](#))
- 7/16" x 7/8" ([71678](#))
- 7/16" x 1-7/16" ([7161716](#))



Wheel Diameter	Dynamic Load	Mounting Height	Swivel Radius	Tread Material	Finish	Part Number <small>CLICK TO ORDER NOW</small>
2" (50)	75 lbs.	2-1/4"	1-13/16"	Nylon	Black	SCC-UHGR02S50-NYS-* SCC-UHGR02S50-NYS-B-*
2-3/8" (60)	100 lbs.	2-5/8"	2-1/16"	Nylon	Black	SCC-UHGR02S60-NYS-* SCC-UHGR02S60-NYS-B-*
3" (75)	165 lbs.	3-3/16"	2-1/2"	Nylon	Black	SCC-UHGR02S75-NYS-* SCC-UHGR02S75-NYS-B-*
4" (100)	175 lbs.	4-5/16"	3-5/8"	Nylon	Black	SCC-UHGR02S100-NYS-* SCC-UHGR02S100-NYS-B-*

NOTE: FOR YOUR STEM CHOICE, REPLACE * IN PART NUMBER WITH THE STEM CODE SHOWN IN STEM CHOICES.



SOCIAL MEDIA

- FOLLOW US ON FACEBOOK
- FOLLOW US ON X
- LOCATE US ON LINKEDIN.
- LIKE US ON INSTAGRAM

Corner Brackets

- 90 Degree Angle ([CB90](#))
- 180 Degree Straight ([CB180](#))



Brake Option

- Brake option available (-B)

All Models Available with Brake



Any Questions?





TOP PLATE CASTERS

Top Plate

- 1-1/2" x 1-1/2" Plate with 1" x 1" Bolt Pattern (3/16" hole) ([TP1](#))
- 2" x 1-3/16" Plate with 1-9/16" x 13/16" Bolt pattern (5/16" hole) ([TP2](#))
- 2-5/8" x 3-3/4" Plate with 1-3/4" x 2-3/4" to 3" (5/16" hole) ([TP3](#))



Wheel Diameter	Dynamic Load	Mounting Height	Swivel Radius	Tread Material	Finish	Part Number <small>CLICK TO ORDER NOW</small>
2" (50)	75 lbs.	2-3/8"	1-13/16"	Nylon	Black	SCC-UHTP02S50-NYS-* SCC-UHTP02S50-NYS-B-*
2-3/8" (60)	100 lbs.	2-3/4"	2-1/16"	Nylon	Black	SCC-UHTP02S60-NYS-* SCC-UHTP02S60-NYS-B-*
3" (75)	165 lbs.	3-1/2"	2-1/2"	Nylon	Black	SCC-UHTP02S75-NYS-* SCC-UHTP02S75-NYS-B-*
4" (100)	175 lbs.	4-5/8"	3-5/8"	Nylon	Black	SCC-UHTP02S100-NYS-* SCC-UHTP02S100-NYS-B-*

THREADED STEM CASTERS

Threaded Stem

- 5/16"-18 x 3/4" ([5161834](#))
- 5/16"-18 x 1" ([516181](#))
- 3/8"-16 x 1" ([38161](#))
- 3/8"-16 x 1-1/2" ([3816112](#))
- 1/2"-13 x 1" ([12131](#))
- 1/2"-13 x 1-1/2" ([121315](#))



Wheel Diameter	Dynamic Load	Mounting Height	Swivel Radius	Tread Material	Finish	Part Number <small>CLICK TO ORDER NOW</small>
2" (50)	75 lbs.	2-1/4"	1-13/16"	Nylon	Black	SCC-UHTS02S50-NYS-* SCC-UHTS02S50-NYS-B-*
2-3/8" (60)	100 lbs.	2-5/8"	2-1/16"	Nylon	Black	SCC-UHTS02S60-NYS-* SCC-UHTS02S60-NYS-B-*
3" (75)	165 lbs.	3-1/4"	2-1/2"	Nylon	Black	SCC-UHTS02S75-NYS-* SCC-UHTS02S75-NYS-B-*
4" (100)	175 lbs.	4-3/8"	3-5/8"	Nylon	Black	SCC-UHTS02S100-NYS-* SCC-UHTS02S100-NYS-B-*

NOTE: FOR YOUR STEM CHOICE, REPLACE * IN PART NUMBER WITH THE STEM CODE SHOWN IN STEM CHOICES.



Brake Option

- Brake option available ([-B](#))

[All Models Available with Brake](#)



Measuring chair caster stems before ordering is essential! Visit our "[How to Measure Caster Stems](#)" page or contact us for assistance. Send us a caster sample (mounting included), and we'll ensure you get the right replacement.

Medical Casters

Twin Wheel MRI Casters

Service Caster's MRI Safe Series 02 twin wheel casters are MRI Conditional, making them ideal for medical equipment near MRI machines and non-corrosive environments. Trust us for quality, reliability, and excellent service.

Applications

- Medical Equipment
- Hospitals and Clinics
- Research Laboratories
- Veterinary Clinics

Features

- REACH-Certified
- Quiet Rolling
- Non-Marking
- RoHS Compliant



#02 Series

PART NUMBER KEY: HOW TO ORDER THE CORRECT CASTER:

SCC-GR02S75-TPR-GRY-B-71678-MRI

Brand	Mounting Type	Series	Rig Type	Wheel Diameter	Wheel Material	Wheel Color	Brake Option	Stem Size	Caster Type
Service Caster	Grip Ring (GR) Threaded Stem (TS)	02	Swivel	2" (50) 2-3/8" (60) 3" (75)	Thermoplastic Rubber (TPR)	Gray (GRY)	Brake (B)	Grip Ring - 7/16" x 7/8" (71678) Grip Ring - 7/16" x 1-3/8" (716138) Threaded - 3/8" -16 x 3/4 (381634) Threaded - M10-1.5 x 22MM (M10X22) Threaded - M12 - 1.75 x 22MM (M12X22)	MRI (MRI)

Mounting Options

More Options

Threaded Stem

- 3/8"-16 x 3/4" (381634)
- M10-1.5 x 22MM (M10X22)
- M12-1.75x22MM (M12X22)



Grip Ring Stem

- 7/16" x 7/8" (71678)
- 7/16" x 1-3/8" (716138)



Brake Option

- Brake option available



Non-magnetic casters are specifically engineered for environments exposed to strong magnetic forces, such as MRI rooms and other scientific facilities.

SCAN FOR SERVICE



CALL US FOR MORE OPTIONS 1-800-215-8220

GRIP RING STEM CASTERS

Wheel Diameter	Tread Material	Color	Dynamic Load	Mounting Height	Part Number <small>CLICK TO ORDER NOW</small>
2" (50)	Thermoplastic Rubber	Gray	66 lbs.	2-5/16"	SCC-GR02S50-TPR-GRY-*
2" (50)	Thermoplastic Rubber	Gray	66 lbs.	2-5/16"	SCC-GR02S50-TPR-GRY-B-*
2-3/8" (60)	Thermoplastic Rubber	Gray	66 lbs.	2-11/16"	SCC-GR02S60-TPR-GRY-*
2-3/8" (60)	Thermoplastic Rubber	Gray	66 lbs.	2-11/16"	SCC-GR02S60-TPR-GRY-B-*
3" (75)	Thermoplastic Rubber	Gray	66 lbs.	3-5/16"	SCC-GR02S75-TPR-GRY-*
3" (75)	Thermoplastic Rubber	Gray	66 lbs.	3-5/16"	SCC-GR02S75-TPR-GRY-B-*

THREADED STEM CASTERS

Wheel Diameter	Tread Material	Color	Dynamic Load	Mounting Height	Part Number <small>CLICK TO ORDER NOW</small>
2" (50)	Thermoplastic Rubber	Gray	66 lbs.	2-5/16"	SCC-TS02S50-TPR-GRY-*
2" (50)	Thermoplastic Rubber	Gray	66 lbs.	2-5/16"	SCC-TS02S50-TPR-GRY-B-*
2-3/8" (60)	Thermoplastic Rubber	Gray	66 lbs.	2-11/16"	SCC-TS02S60-TPR-GRY-*
2-3/8" (60)	Thermoplastic Rubber	Gray	66 lbs.	2-11/16"	SCC-TS02S60-TPR-GRY-B-*
3" (75)	Thermoplastic Rubber	Gray	66 lbs.	3-5/16"	SCC-TS02S75-TPR-GRY-*
3" (75)	Thermoplastic Rubber	Gray	66 lbs.	3-5/16"	SCC-TS02S75-TPR-GRY-B-*

NOTE: FOR YOUR STEM CHOICE, REPLACE * IN PART NUMBER WITH THE STEM CODE SHOWN IN STEM CHOICES.



Threaded Stem

- 3/8"-16 x 3/4" (**381634**)
- M10-1.5 x 22MM (**M10X22**)
- M12-1.75x22MM (**M12X22**)



Grip Ring Stem

- 7/16" x 7/8" (**71678**)
- 7/16" x 1-3/8" (**716138**)



- Tailored for Medical Technology
- Washable Version Now Offered
- Download Free 3D Models
- Top-Quality Casters



**ROLL WITH
CONFIDENCE
EVERYWHERE.**



CALL US FOR MORE OPTIONS 1-800-215-8220

Twin Wheel Casters

Compression brake casters prevent rolling under weight, offering stability. Decompression safety casters restrict movement when unoccupied, enhancing safety.

Applications

- Store Fixtures
- Furniture
- Office Equipment
- Medical Equipment

Features

- Self-lubricating acetyl resin bearing
- No exposed axle

Grip Ring Stem

- 7/16" x 7/8"



Twin wheel casters featuring special braking options.

PART NUMBER KEY: HOW TO ORDER THE CORRECT CASTER:

SCC-COMGR02S50-NYU-716X78

Brand	Caster Style	Mounting Type	Series	Rig Type	Wheel Diameter	Wheel Material	Stem Size
Service Caster	Compression (COM) Decompression (DEC)	Grip Ring (GR)	02	Swivel	2" (50)	Urethane (NYU)	Grip Ring - 7/16" x 7/8" (71678)

Pick your Caster

Wheel Diameter	Tread Material	Color	Dynamic Load	Mounting Height Range	Swivel Radius	Part Number
2" (50)	Urethane	Black	75 lbs.	2-7/16" - 2-1/2"	2-1/16	SCC-COMGR02S50-NYU-716X78
2" (50)	Urethane	Black	75 lbs.	2-7/16" - 2-1/2"	2-1/16	SCC-DECGR02S50-NYU-716X78

Compression brake casters are engineered to prevent rolling when weight is applied, ensuring stability and security in various seating applications. In contrast, **Decompression** safety casters are designed to restrict rolling when no weight is applied to the seating, enhancing safety and preventing unintended movement in both occupied and unoccupied states.

Additional Stem Options and Sizes Offered
Contact Customer Service for Help.



Medical & Furniture Casters

Series #03 Casters

Introducing Service Caster's Series #03 Casters: durable, smooth, and ideal for medium to heavy duty use.

Features

- Ball Bearing Wheels
- Heat-Treated for durability.
- Polished Chrome or Black Hood Finish
- Smooth and Quiet Ride
- Non-Marking



SCC-GR03S310-NPRB-BC-B-71678

BRAND
 STEM TYPE
 SERIES
 RIG TYPE
 WHEEL WIDTH
 WHEEL MATERIAL
 FINISH
 BRAKE OPTION
 STEM SIZE

Applications

- Chairs
- Tables
- Medical Carts
- Home Furniture
- Office Furniture



Mounting Options

More Options

Brand	Mounting Type	Series	Rig Type	Wheel Size	Wheel Material	Finish	Brake Type	Stem Size
Service Caster	Threaded Stem (TS)	03	Swivel (S)	2" x 1" (210)	Neoprene Rubber (NPRB)	Bright Chrome (BC)	Tread Brake (B)	Threaded - 5/16" - 18 x 1" (5161810)
	Grip Ring (GR)			3" x 1" (310)	Polyurethane (PPUDB)	Black (BK)		Threaded - 5/16" - 18 x 1-1/2" (5161815)
	Grip Neck (GN)							Threaded - 8mm - 1.25 x 1-1/2" (M815)
	Top Plate							Threaded - 3/8" - 16 x 1" (381610)
								Threaded - 3/8" - 16 x 1-1/2" (381615)
								Threaded - 10mm - 1.50 x 1-1/2" (M1015)
								Threaded - 12mm - 1.75 x 1-1/2" (M1215)
								Threaded - 1/2" - 13 x 1-1/2" (121315)
								Top Plate - 1-1/4" x 2-3/8" Overall 13/16" x 1-9/16" Bolt Hole Spacing

Grip Neck (GN)

- 5/16" x 1-1/2"



Corner Brackets

- Angle & Straight



Brake Option

- Brake option available



Finish Options

- Black
- Chrome

Grip Ring (GR)

- 7/16" x 7/8" (71678)
- 7/16" x 1-3/8" (716138)



Top Plate

- 1-1/4" x 2-3/8" Overall
Top Plate with 13/16" x 1-7/8" Bolt Hole Spacing



Threaded Stem (TS)

- 5/16"-18 x 1" (5161810)
- 5/16"-18 x 1-1/2" (5161815)
- 8mm-1.25 x 1-1/2" (M815)
- 3/8"-16 x 1" (381610)
- 3/8"-16 x 1-1/2" (381615)
- 10mm-1.50 x 1-1/2" (M1015)
- 1/2"-13 x 1-1/2" (121315)
- 12mm-1.75 x 1-1/2" (M1215)



Socket Options

- Service Caster makes mounting your casters quick and easy.





Take a Look **Metric** Sizes Available

Metric

- 8mm - 1.25 X 1-1/2" (M815)
- 10mm - 1.50 x 1-1/2" (M1015)
- 12mm - 1.75 x 1-1/2" (M1215)

Threaded Stem

- 3/8" - 16 x 1" (381610)
- 3/8" - 16 x 1- 1/2 " (381615)
- 1/2" - 13 x 1-1/2" (121315)
- 5/16" - 18 X 1" (5161810)
- 5/16" - 18 X 1- 1/2" (5161815)



THREADED STEM CASTERS

[CLICK TO ORDER NOW](#)

Wheel Size	Mounting Height	Wheel Material	Capacity Per	Finish	Part Number
3"	3-7/8"	Neoprene Rubber	110 lbs.	Bright Chrome	SCC-TS03S310-NPRB-BC*
				Black	SCC-TS03S310-NPRB-BC-B*
		Polyurethane	120 lbs.	Bright Chrome	SCC-TS03S310-NPRB-BK*
					SCC-TS03S310-PPUBD-BC*



[CLICK TO ORDER NOW](#)



Grip Neck Stem

- 5/16" x 1-1/2" (516112)

Wood Sockets

- For use in wood applications
- Fits 5/16" x 1-1/2" Grip Neck Stem Only
- For Installation: Drill 3/8" x 1-5/8" Hole

NOTE: METAL SOCKETS FOR INSTALLATION INTO WOOD INCLUDED WITH GRIP NECK STEM MODELS



GRIP NECK CASTERS

[CLICK TO ORDER NOW](#)

Wheel Size	Mounting Height	Wheel Material	Capacity Per	Finish	Part Number
3"	3-7/8"	Neoprene Rubber	110 lbs.	Bright Chrome	SCC-GN03S310-NPRB-BC
				Black	SCC-GN03S310-NPRB-BC-B
		Polyurethane	120 lbs.	Bright Chrome	SCC-GN03S310-NPRB-BK
					SCC-GN03S310-PPUBD-BC



Top Plate

- 1-1/4" x 2-3/8" Overall Top Plate with 13/16" x 1-7/8" Bolt Hole Spacing



TOP PLATE CASTERS

[CLICK TO ORDER NOW](#)

Wheel Size	Mounting Height	Wheel Material	Capacity Per	Finish	Part Number
3"	3-7/8"	Neoprene Rubber	110 lbs.	Bright Chrome	SCC-03S310-NPRB-BC
				Black	SCC-03S310-NPRB-BC-B
		Polyurethane	120 lbs.	Bright Chrome	SCC-03S310-NPRB-BK
					SCC-03S310-PPUBD-BC



Suitable for **all** types of flooring.



Grip Ring (GR)

- 7/16" x 7/8" (71678)
- 7/16" x 1-3/8" (716138)



GRIP RING CASTERS

[CLICK TO ORDER NOW](#)

Wheel Size	Wheel Material	Capacity Per	Mounting Height	Finish	Part Number
2"	Neoprene Rubber	75 lbs.	2-3/4"	Bright Chrome	SCC-GR03S210-NPRB-BC-*
3"		110 lbs.	3-7/8"		SCC-GR03S310-NPRB-BC-*
				Black	SCC-GR03S310-NPRB-BC-B-*
		Polyurethane	110 lbs.	3-7/8"	Bright Chrome
				Bright Chrome	SCC-GR03S310-PPUBD-BC-*



Inside Corner & Side Mount Brackets

- Inside Corner: 1-1/4" x 1-3/4" (CB90)
- Side Mount: 2-3/16" x 1-21/32" (CB180)



BRACKET CASTERS

[CLICK TO ORDER NOW](#)

Wheel Size	Wheel Material	Capacity Per	Mounting Height	Finish	Swivel Part Number
2"	Neoprene Rubber	75 lbs.	2-3/4"	Bright Chrome	SCC-GR03S210-NPRB-BC-71678-CB180
3"		110 lbs.	3-7/8"		SCC-GR03S210-NPRB-BC-71678-CB90
				Black	SCC-GR03S310-NPRB-BC-B-71678-CB180
		Polyurethane	120 lbs.		3-7/8"
Bright Chrome	SCC-GR03S310-NPRB-BK-71678-CB180				
				Bright Chrome	SCC-GR03S310-NPRB-BK-71678-CB90
				Bright Chrome	SCC-GR03S310-PPUBD-BC-71678-CB180
				Bright Chrome	SCC-GR03S310-PPUBD-BC-71678-CB90

REVIEW US ON
 Trustpilot
 SHARE YOUR THOUGHTS! WE VALUE YOUR FEEDBACK. >>>

The Casters & Service You Need

- EASY ORDERING
- EXPERT SERVICE
- FAST SHIPPING
- CUSTOM ORDERS

LIKE, SHARE & SUBSCRIBE

SERVICE CASTER CORPORATION

Low Profile Casters

Series #04 Casters

Applications

- Office Equipment
- Vending Machines
- Displays
- Institutional Usage

Features

- Smooth and Quiet Ride
- Numerous Mounting Options
- Non-Marking

Service Caster's Series #04 Casters, Ideal for office equipment, displays, vending machines, and institutional use, these casters provide a wider stance and higher weight capacities with smaller wheel diameters.

SCC-TS04S211316-POS-SLB-121315



Mounting Options

More Options

Brand	Mounting Type	Series	Rig Type	Wheel Size	Wheel Material	Brake Type	Stem Size
Service Caster	Threaded Stem (TS)	04	Swivel (S)	1-3/8" x 1-1/16" (13810)	Polyolefin (POS)	Side Lock Brake (SLB)	Threaded - 5/16" - 18 x 1" (5161810)
	Grip Ring (GR)		Rigid (R)	2" x 13/16" (21316)	Thermo-Plastic Rubber (TPRS)		Threaded - 5/16" - 18 x 1-1/2" (5161815)
	Grip Neck (GN)		2" x 1-13/16" (211316)	Glass Filled Nylon (GFNR/GFNB)	Threaded - 8mm - 1.25 x 1-1/2" (M815)		
	Expanding Stem (EX)		2-1/2" x 1-3/4" (25175)	Polyurethane (PUB)	Threaded - 3/8" - 16 x 1" (381610)		
	Top Plate		3" x 1-3/4" (3175)		Threaded - 3/8" - 16 x 1-1/2" (381615)		
	Dual Wheel (DW)		3" x 1-13/16" (311316)		Threaded - 10mm - 1.50 x 1-1/2" (M1015)		
	Bolt Hole (BH)				Threaded - 12mm - 1.75 x 1-1/2" (M1215)		
					Threaded - 1/2" - 13 x 1-1/2" (121315)		
				Top Plate - 1-1/4" x 2-3/8" Overall 13/16" x 1-9/16" Bolt Hole Spacing			

SHOP NOW



Threaded Stem

- 5/16"-18 X 1- 1/2" (5161815)
- 3/8"-16 x 1-1/2" (381615)
- 1/2"-13 x 1-1/2" (121315)
- 8mm-1.25 X 1-1/2" (M815)
- 10mm-1.50 x 1-1/2" (M1015)
- 12mm-1.75 x 1-1/2" (M1215)



Expanding Stem (EX)

- 3/4" (34)
- 7/8" (78)
- 1" (1)
- 1-1/8" (118)
- 1-1/4" (114)
- 1-3/8" (138)
- 1-1/2" (112)
- 1-5/8" (158)
- 1-3/4" (134)
- 1-7/8" (178)



Wheel Tread

- Thermoplastic Rubber (TPRS)
- Polyolefin (POS)
- Polyurethane (PUB)
- Glass Filled Nylon (GFNR/GFNB)



Top Plate

- 3-1/8" x 4-1/8" Top Plate with 2-3/8" x 3-3/8" Bolt Pattern
- 2-1/2" x 3-5/8" Top Plate with 1-3/4" x 2-3/4" Bolt Pattern
- 2-5/8" x 3-3/4" Top Plate with 1-3/4" x 2-3/4" Bolt Pattern
- 2-3/8" x 2-3/8" Top Plate with 1-1/2" x 1-1/2" Bolt Pattern



Grip Ring Stem

- 7/16" x 7/8" (71678)
- 7/16" x 1-3/8" (716138)



Brake Option

- Brake option available

Side Lock Brake (SLB)

The side lock brake places a positive locking force against the wheel hub locking the wheel only.



Expanding Stem Size

3/4" (34)	1-3/8" (138)
7/8" (78)	1-1/2" (112)
1" (1)	1-5/8" (158)
1-1/8" (118)	1-3/4" (134)
1-1/4" (114)	1-7/8" (178)

Bolt Hole

- 11mm



Low Profile Casters

Series #04 Casters

Service Caster's Series #04 Casters, Ideal for office equipment, displays, vending machines, and institutional use, these casters provide a wider stance and higher weight capacities with smaller wheel diameters.

Applications

- Office Equipment
- Vending Machines
- Displays
- Institutional Usage

Features

- Smooth and Quiet Ride
- Numerous Mounting Options
- Non-Marking



PART NUMBER KEY: HOW TO ORDER THE CORRECT CASTER:

SCC-TS04S211316-POS-SLB-121315

Brand	Mounting Type	Series	Rig Type	Wheel Size	Wheel Material	Brake Type	Stem Size
Service Caster	Threaded Stem (TS)	04	Swivel (S)	1-3/8" x 1-1/16" (13810)	Polyolefin (POS)	Side Lock Brake (SLB)	Threaded - 5/16" - 18 x 1" (5161810)
	Grip Ring (GR)		Rigid (R)	2" x 13/16" (21316)	Thermo-Plastic Rubber (TPRS)		Threaded - 5/16" - 18 x 1-1/2" (5161815)
	Grip Neck (GN)			2" x 1-13/16" (211316)	Glass Filled Nylon (GFNR/GFNB)		Threaded - 8mm - 1.25 x 1-1/2" (M815)
	Expanding Stem (EX)			2-1/2" x 1-3/4" (25175)	Polyurethane (PUB)		Threaded - 3/8" - 16 x 1" (381610)
	Top Plate			3" x 1-3/4" (3175)			Threaded - 3/8" - 16 x 1-1/2" (381615)
	Dual Wheel (DW)			3" x 1-13/16" (311316)			Threaded - 10mm - 1.50 x 1-1/2" (M1015)
	Bolt Hole (BH)						Threaded - 12mm - 1.75 x 1-1/2" (M1215)
							Threaded - 1/2" - 13 x 1-1/2" (121315)
							Top Plate - 1-1/4" x 2-3/8" Overall 13/16" x 1-9/16" Bolt Hole Spacing

Find your perfect fit with our **expanding stem** casters, designed to match your unique needs.

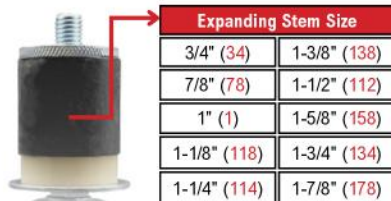

Mounting Options

More Options

Threaded Stem

- 5/16"-18 X 1- 1/2" (5161815)
- 3/8"-16 x 1-1/2" (381615)
- 1/2"-13 x 1-1/2" (121315)
- 8mm-1.25 X 1-1/2" (M815)
- 10mm-1.50 x 1-1/2" (M1015)
- 12mm-1.75 x 1-1/2" (M1215)



Expanding Stem (EX)

- 3/4" (34)
- 7/8" (78)
- 1" (1)
- 1-1/8" (118)
- 1-1/4" (114)
- 1-3/8" (138)
- 1-1/2" (112)
- 1-5/8" (158)
- 1-3/4" (134)
- 1-7/8" (178)



Brake Option

- Brake option available

Side Lock Brake (SLB)

The side lock brake places a positive locking force against the wheel hub locking the wheel only.



Top Plate

- 3-1/8" x 4-1/8" Top Plate with 2-3/8" x 3-3/8" Bolt Pattern
- 2-1/2" x 3-5/8" Top Plate with 1-3/4" x 2-3/4" Bolt Pattern
- 2-5/8" x 3-3/4" Top Plate with 1-3/4" x 2-3/4" Bolt Pattern
- 2-3/8" x 2-3/8" Top Plate with 1-1/2" x 1-1/2" Bolt Pattern



Grip Ring Stem

- 7/16" x 7/8" (71678)
- 7/16" x 1-3/8" (716138)



Bolt Hole

- 11mm



SHOP NOW

Wheel Tread

- Thermoplastic Rubber (TPRS)
- Polyolefin (POS)
- Polyurethane (PUB)
- Glass Filled Nylon (GFNR/GFNB)





GRIP RING CASTERS

Grip Ring Stem

- 7/16" x 7/8" (71678)
- 7/16" x 1-3/8" (716138)



Wheel Diameter	Wheel Material	Dynamic Load	Mounting Height	Part Number <small>CLICK TO ORDER NOW</small>
3"	Polyurethane	220 lbs.	2"	SCC-GR04S13810-PUB-716138
				SCC-GR04S13810-PUB-71678



BOLT HOLE CASTERS

Bolt Hole

- 11mm



Wheel Diameter	Wheel Material	Dynamic Load	Mounting Height	Part Number <small>CLICK TO ORDER NOW</small>
3"	Polyurethane	220 lbs.	2"	SCC-BH04S13810-PUB



EXPANDING STEM CASTERS

Expanding Stem (EX) CLICK TO ORDER NOW

- 3/4" (34)
- 7/8" (78)
- 1" (1)
- 1-1/8" (118)
- 1-1/4" (114)
- 1-3/8" (138)
- 1-1/2" (112)
- 1-5/8" (158)
- 1-3/4" (134)
- 1-7/8" (178)



Wheel Diameter	Wheel Material	Dynamic Load	Mounting Height	Part Number <small>CLICK TO ORDER NOW</small>
3"	Polyurethane	220 lbs.	2"	SCC-EX04S13810-PUB-*

NOTE: FOR YOUR STEM CHOICE, REPLACE * IN PART NUMBER WITH THE STEM CODE SHOWN IN STEM CHOICES.

Wheel: **Non-marking** Polyurethane
Tread: Light brown color, 92 Shore A hardness, non-marking and non-staining
Wheel Center: Steel

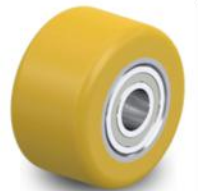

Rolling Resistance

 very good

Tire and Wheel Firmness

 92 Shore A

Protecting floors and minimizing noise

 good

Resistance to Wear

 excellent

Brake Option

- Brake option available



Any Questions?

[CLICK HERE](#)

TOP PLATE CASTERS

Top Plate

- 3-1/8" x 4-1/8" Overall Top Plate with 2-3/8" x 3-3/8" Bolt Pattern
- 2-1/2" x 3-5/8" Overall Top Plate with 1-3/4" x 2-3/4" Bolt Pattern
- 2-5/8" x 3-3/4" Overall Top Plate with 1-3/4" x 2-3/4" Bolt Pattern
- 2.4" x 2.4" Overall Top Plate with 1.5" x 1.9" Bolt Pattern



Wheel Diameter	Tread Width	Mounting Height	Wheel Material	Capacity Per	Part Number <small>CLICK TO ORDER NOW</small>
2"	13/16"	2-13/16"	Thermoplastic Rubber	180 lbs.	SCC-DW04S21316-TPRS
					SCC-DW04S21316-TPRS-SLB
					SCC-DW04S21316-TPRS
					SCC-DW04S21316-TPRS-SLB
1-3/8" (35mm)	1-1/16" (27mm)	2" (52mm)	Polyurethane	220 lbs.	SCC-04S13810-PUB
2"	13/16"	2-13/16"	Polyolefin	300 lbs.	SCC-04S211316-POS
	1-13/16"				SCC-04S211316-POS-SLB
2-1/2"	1-3/4"	3-5/16"		400 lbs.	SCC-04R25175-POR
3"	1-13/16"	3-31/32"	Solid Polyurethane	700 lbs.	SCC-04S311316-SPUR
		4-1/32"	Glass Filled Nylon	1,000 lbs.	SCC-04S311316-GFNB SCC-04S3175-GFNR



THREADED STEM CASTERS

Take a Look **Metric** Sizes Available

Metric

- 8mm - 1.25 X 1-1/2" (**M815**)
- 10mm - 1.50 x 1-1/2" (**M1015**)
- 12mm - 1.75 x 1-1/2" (**M1215**)

Threaded Stem

- 3/8" - 16 x 1" (**381610**)
- 3/8" - 16 x 1- 1/2" (**381615**)
- 1/2" - 13 x 1-1/2" (**121315**)
- 5/16" - 18 X 1" (**5161810**)
- 5/16" - 18 X 1- 1/2" (**5161815**)



Wheel Size	Tread Width	Mounting Height	Wheel Material	Capacity Per	Part Number
2"	13/16"	2-3/4"	Thermoplastic Rubber (Dual)	180 lbs.	SCC-DWTS04S21316-TPRS-*
					SCC-DWTS04S21316-TPRS-SLB-*
1-3/8" (35mm)	1-1/16" (27mm)	2" (52mm)	Polyurethane	220 lbs.	SCC-TS04S13810-PUB-*
2"	1-13/16"	2-3/4"	Polyolefin	300 lbs.	SCC-TS04S211316-POS-SLB-*
					SCC-TS04S211316-POS-*



Wheel Tread

- Thermoplastic Rubber (**TPRS**)
- Polyolefin (**POS**)
- Polyurethane (**PUB**)
- Glass Filled Nylon (**GFNR/GFNB**)



Wheel Characteristic

Wheel Characteristic	Rating
Floor Protection	★★★★★
Non-Marking	★★★★★
Durability	★★★★★
Ease of Rolling	★★★★★
Chemical Resistance	★★★★★

Low Profile Casters

Series #04 Casters

Service Caster's Series #04 Casters, Ideal for office equipment, displays, vending machines, and institutional use, these casters provide a wider stance and higher weight capacities with smaller wheel diameters.

Applications

- Office Equipment
- Vending Machines
- Displays
- Institutional Usage



Features

- Smooth and Quiet Ride
- Numerous Mounting Options
- Non-Marking

PART NUMBER KEY: HOW TO ORDER THE CORRECT CASTER:

SCC-TS04S211316-POS-SLB-121315

Brand	Mounting Type	Series	Rig Type	Wheel Size	Wheel Material	Brake Type	Stem Size
Service Caster	Threaded Stem (TS)	04	Swivel (S)	1-3/8" x 1-1/16" (13810)	Polyolefin (POS)	Side Lock Brake (SLB)	Top Plate - 2-3/8" x 3-5/8" Overall 1-3/4" x 2-7/8" to 3" Bolt Hole Spacing
	Grip Ring (GR)		Rigid (R)	2" x 13/16" (21316)	Thermo-Plastic Rubber (TPRS)		Threaded - 5/16" - 18 x 1-1/2" (5161815)
	Grip Neck (GN)			2" x 1-13/16" (211316)	Glass Filled Nylon (GFNR/GFNB)		Threaded - 8mm - 1.25 x 1-1/2" (M815)
	Expanding Stem (EX)			2-1/2" x 1-3/4" (25175)	Polyurethane (PUB)		Threaded - 3/8" - 16 x 1" (381610)
	Top Plate			3" x 1-3/4" (3175)	Hard Rubber (HRS)		Threaded - 3/8" - 16 x 1-1/2" (381615)
	Dual Wheel (DW)			3" x 1-13/16" (311316)			Threaded - 10mm - 1.50 x 1-1/2" (M1015)
	Bolt Hole (BH)						Threaded - 12mm - 1.75 x 1-1/2" (M1215)

Service Caster Chart Guide

Place your Order

Wheel Diameter	Tread Width	Mounting Height	Wheel Material	Capacity Per	Bearing Type	Part Number	Price
2"	13/16" x 2	2-31/32"	Glass Filled Nylon	400	Plain Bore	SCC-DW04S21316-GFNS	\$16.23

NEED MORE OPTIONS? FOR FURTHER ASSISTANCE, CONTACT OUR [CUSTOMER SERVICE](#).

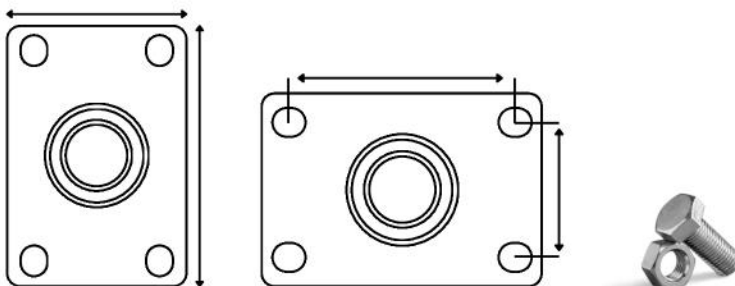

Standard Plate Size	Bolt Pattern	Bolt Diameter
2-3/8" x 3-5/8"	1-3/4" x 2-7/8" to 3"	5/16"

Low Profile Casters

Series #04 Casters

Service Caster's Series #04 Casters, Ideal for office equipment, displays, vending machines, and institutional use, these casters provide a wider stance and higher weight capacities with smaller wheel diameters.

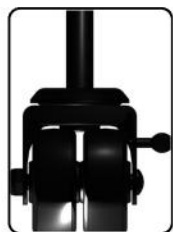

Description

This versatile and budget-friendly low-profile caster is an excellent choice when cost efficiency is essential. It provides superior floor protection and exceptional mobility. We also offer custom orders to meet your specific needs.

Options/Components

Select from a range of wheel options. A double-wheel configuration and a thumb screw brake are also available. The Series 04 model can be tailored with different stem types to suit your needs.

Threaded Stem

- 1/2" - 13 x 1-1/2" (121315)

Finish

- Black Oxide Finish (BO)



Wheel Diameter	Tread Width	Mounting Height	Wheel Material	Load Capacity (lbs.)	Bearing Type	Swivel Radius	Part Number <small>CLICK TO ORDER NOW</small>	Price (ea.)
2"	13/16" x 2	2-3/4"	Hard Rubber	225	Plain Bore	1-7/8"	SCC-DW04S21316BO-HRS-121315	\$4.89
2"	13/16" x 2	2-3/4"	Hard Rubber	225	Plain Bore	1-7/8"	SCC-DW04S21316BO-HRS-TSB-121315	\$5.07

NEED MORE OPTIONS? FOR FURTHER ASSISTANCE, CONTACT OUR [CUSTOMER SERVICE](#).

Craft Your Perfect **CASTERS!**

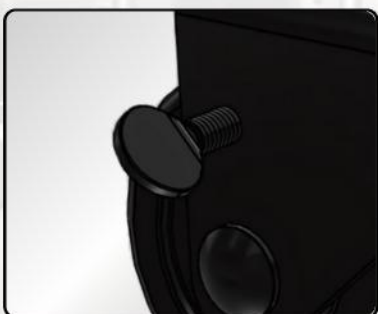

The **thumb screw brake** on casters allows you to securely lock the wheel, providing stable and safe operation by preventing any unwanted movement.



Threaded stem casters provide a secure and stable connection, ensuring reliable performance and easy installation across various applications.



The option for finishes like **black oxide** is valuable, offering enhanced durability, corrosion resistance, and the ability to match specific needs.



Dual wheel casters provide increased load capacity and improved stability, making them ideal for heavy-duty applications and smooth, even movement.

Light Duty Industrial Casters

Series #05 Casters

Service Caster's #05 Series casters. Ideal for various applications, these casters offer stability and durability in institutional environments.

Applications

- Furniture
- Fixtures
- Displays
- Dollies
- Carts
- Racks
- Light Duty Industrial Projects



Features

- Bright Zinc Plated Finish
- Dual-Raceway
- Quiet & Easy Rolling
- Non-Marking



PART NUMBER KEY: HOW TO ORDER THE CORRECT CASTER:

SCC-TS05S510-TPRS-SLB-121315

Brand	Mounting Type	Series	Rig Type	Wheel Size	Wheel Material	Brake Type	Stem Size
Service Caster	Threaded Stem (TS)	05	Swivel (S)	2" x 1" (210)	Polyolefin (POS)	Side Lock Brake (SLB)	Threaded - 5/16" - 18 x 1" (5161810)
	Grip Ring (GR)		Rigid (R)	3" x 1" (310)	Thermo-Plastic Rubber (TPRS)		Threaded - 5/16" - 18 x 1-1/2" (5161815)
	Grip Neck (GN)			4" x 1" (410)	Soft Rubber (SRS)		Threaded - 8mm - 1.25 x 1-1/2" (M815)
	Expanding Stem (EX)			5" x 1" (510)	Hard Rubber (HRS)		Threaded - 3/8" - 16 x 1" (381610)
	Top Plate				Polyurethane (TPUS)		Threaded - 3/8" - 16 x 1-1/2" (381615)
	Bolt Hole (BH)						Threaded - 10mm - 1.50 x 1-1/2" (M1015)
	Pipe Stem (PS)						Threaded - 12mm - 1.75 x 1-1/2" (M1215)
							Threaded - 1/2" - 13 x 1-1/2" (121315)
							Pipe Stem (3/4NPT)
							Top Plate (See Size Chart Below)
							Expanding Stem (See Size Chart Below)

Looking for customized caster stems? Email our top-notch customer service team for assistance!



Mounting Options

More Options

Threaded Stem

- 5/16"-18 X 1- 1/2" (5161810)
- 5/16"-18 X 1- 1/2" (5161815)
- 3/8"-16 x 1-1/2" (381615)
- 1/2"-13 x 1-1/2" (121315)
- 8mm-1.25 X 1-1/2" (M815)
- 10mm-1.50 x 1-1/2" (M1015)
- 12mm-1.75 x 1-1/2" (M1215)



Expanding Stem

- 3/4" (34)
- 7/8" (78)
- 1" (1)
- 1-1/8" (118)
- 1-1/4" (114)
- 1-3/8" (138)
- 1-1/2" (112)
- 1-5/8" (158)
- 1-3/4" (134)
- 1-7/8" (178)



Brake Option

- Brake option available

Side Lock Brake (SLB)

The side lock brake places a positive locking force against the wheel hub locking the wheel only.



Top Plate

- 1-3/16" x 2" Top Plate with 13/16" x 1-9/16" Bolt Pattern
- 1-3/4" x 2-5/8" Top Plate with 31/32" x 2-1/8" Bolt Pattern
- 2-5/8" x 3-3/4" Top Plate with 1-3/4" x 2-3/4 to 3" Bolt Pattern



Grip Ring Stem

- 7/16" x 7/8" (71678)
- 7/16" x 1-3/8" (716138)



Bolt Hole

- 3/8"



Wheel Tread

- Thermoplastic Rubber (TPRS)
- Polyolefin (POS)
- Polyurethane (TPUS)
- Hard/Soft Rubber (HRS/SRS)





GRIP RING CASTERS

Grip Ring Stem

- 7/16" x 7/8" (71678)
- 7/16" x 1-3/8" (716138)



Wheel Diameter	Wheel Material	Dynamic Load	Mounting Height	Swivel Part Number <small>CLICK TO ORDER NOW</small>	Swivel with Brake Part Number <small>CLICK TO ORDER NOW</small>
2"	TPR	80 lbs.	2-5/8"	SCC-GR05S210-TPRS-*	SCC-GR05S210-TPRS-SLB-*
3"	TPR	110 lbs.	3-1/2"	SCC-GR05S310-TPRS-*	SCC-GR05S310-TPRS-SLB-*
4"	TPR	125 lbs.	4-3/4"	SCC-GR05S410-TPRS-*	SCC-GR05S410-TPRS-SLB-*
5"	TPR	130 lbs.	5-3/4"	SCC-GR05S510-TPRS-*	SCC-GR05S510-TPRS-SLB-*

NOTE: FOR YOUR STEM CHOICE, REPLACE * IN PART NUMBER WITH THE STEM CODE SHOWN IN STEM CHOICES.



EXPANDING STEM CASTERS

Expanding Stem

- 3/4" (34)
- 7/8" (78)
- 1" (1)
- 1-1/8" (118)
- 1-1/4" (114)
- 1-3/8" (138)
- 1-1/2" (112)
- 1-5/8" (158)
- 1-3/4" (134)
- 1-7/8" (178)

THE STEM SIZE IS DETERMINED BY THE INSIDE DIAMETER OF THE TUBING BEING USED. ALL STEMS MEASURE 2-11/16" IN LENGTH.



Wheel Diameter	Wheel Material	Dynamic Load	Mounting Height	Swivel Part Number <small>CLICK TO ORDER NOW</small>	Swivel with Brake Part Number <small>CLICK TO ORDER NOW</small>
2"	TPR	80 lbs.	2-5/8"	SCC-EX05S210-TPRS-*	SCC-EX05S210-TPRS-SLB-*
3"	TPR	110 lbs.	3-1/2"	SCC-EX05S310-TPRS-*	SCC-EX05S310-TPRS-SLB-*
4"	TPR	125 lbs.	4-3/4"	SCC-EX05S410-TPRS-*	SCC-EX05S410-TPRS-SLB-*
5"	TPR	130 lbs.	5-3/4"	SCC-EX05S510-TPRS-*	SCC-EX05S510-TPRS-SLB-*

NOTE: FOR YOUR STEM CHOICE, REPLACE * IN PART NUMBER WITH THE STEM CODE SHOWN IN STEM CHOICES.



Ideal Selection of Mop Bucket Equipment Series

An additional option is our plastic body featuring a 3" non-marking wheel, which serves as an excellent replacement caster for RubberMaid/SpecialMade products.



LEARN MORE >

**ROLL WITH
CONFIDENCE
EVERYWHERE.**





Take a Look **Metric** Sizes Available

Metric

- 8mm - 1.25 X 1-1/2" (M815)
- 10mm - 1.50 x 1-1/2" (M1015)
- 12mm - 1.75 x 1-1/2" (M1215)

Threaded Stem

- 5/16"-18 X 1- 1/2" (5161810)
- 5/16"-18 X 1- 1/2" (5161815)
- 3/8"-16 x 1-1/2" (381615)
- 1/2"-13 x 1-1/2" (121315)



THREADED STEM CASTERS

Wheel Diameter	Wheel Material	Dynamic Load	Mounting Height	Swivel Part Number <small>CLICK TO ORDER NOW</small>	Swivel with Brake Part Number <small>CLICK TO ORDER NOW</small>
2"	TPR	80 lbs.	2-5/8"	SCC-TS05S210-TPRS-*	SCC-TS05S210-TPRS-SLB-*
2"	Polyurethane	90 lbs.	2-5/8"	SCC-TS05S210-TPUS-*	SCC-TS05S210-TPUS-SLB-*
3"	TPR	110 lbs.	3-1/2"	SCC-TS05S310-TPRS-*	SCC-TS05S310-TPRS-SLB-*
3"	Polyurethane	120 lbs.	3-1/2"	SCC-TS05S310-TPUS-*	SCC-TS05S310-TPUS-SLB-*
4"	TPR	125 lbs.	4-3/4"	SCC-TS05S410-TPRS-*	SCC-TS05S410-TPRS-SLB-*
5"	TPR	130 lbs.	5-3/4"	SCC-TS05S510-TPRS-*	SCC-TS05S510-TPRS-SLB-*

NOTE: FOR YOUR STEM CHOICE, REPLACE * IN PART NUMBER WITH THE STEM CODE SHOWN IN STEM CHOICES.



GRIP NECK CASTERS

Wood Sockets

- For use in wood applications
- Fits 5/16" x 1-1/2" Grip Neck Stem Only
- For Installation: Drill 3/8" x 1-5/8" Hole



NOTE: METAL SOCKETS FOR INSTALLATION INTO WOOD INCLUDED WITH GRIP NECK STEM MODELS

Grip Neck Stem

- 5/16" x 1-1/2"



Wheel Diameter	Wheel Material	Dynamic Load	Mounting Height	Swivel Part Number <small>CLICK TO ORDER NOW</small>	Swivel with Brake Part Number <small>CLICK TO ORDER NOW</small>
2"	Soft Rubber	80 lbs.	2-5/8"	SCC-GN05S210-SRS-516	SCC-GN05S210-SRS-SLB-516
2"	Polyurethane	90 lbs.	2-5/8"	SCC-GN05S210-TPUS-516	SCC-GN05S210-TPUS-SLB-516
3"	TPR	110 lbs.	3-1/2"	SCC-GN05S310-TPRS-516	SCC-GN05S310-TPRS-SLB-516
4"	TPR	125 lbs.	4-3/4"	SCC-GN05S410-TPRS-516	SCC-GN05S410-TPRS-SLB-516
5"	TPR	130 lbs.	5-3/4"	SCC-GN05S510-TPRS-516	SCC-GN05S510-TPRS-SLB-516

SERVICE CASTER CLASSROOM - MEASURING FURNITURE STEMS



If you're unsure about the measurements, you can visit our "How to Measure Caster Stems" page or reach out for help by calling 1-800-215-8220.





TOP PLATE CASTERS

Top Plate

- 1-3/16" x 2" Top Plate with 13/16" x 1-9/16" Bolt Pattern (TP1)
- 1-3/4" x 2-5/8" Top Plate with 31/32" x 2-1/8" Bolt Pattern (TP2)
- 2-3/8" x 3-5/8" Top Plate with 1-3/4" x 2-3/4 to 3" Bolt Pattern (TP3)



Wheel Diameter	Wheel Material	Dynamic Load	Mounting Height	Caster Type	Part Number <small>CLICK TO ORDER NOW</small>
2"	Thermoplastic Rubber Tread On Polyolefin Core	80 lbs.	2-5/8"	Rigid	SCC-05R210-TPRS-*
				Swivel	SCC-05S210-TPRS-*
				Single Lock Brake	SCC-05S210-TPRS-SLB-*
3"	Thermoplastic Rubber Tread On Polyolefin Core	110 lbs.	3-1/2"	Rigid	SCC-05R310-TPRS-*
				Swivel	SCC-05S310-TPRS-*
				Single Lock Brake	SCC-05S310-TPRS-SLB-*
4"	Thermoplastic Rubber Tread On Polyolefin Core	125 lbs.	4-3/4"	Rigid	SCC-05R410-TPRS-*
				Swivel	SCC-05S410-TPRS-*
				Single Lock Brake	SCC-05S410-TPRS-SLB-*
5"	Thermoplastic Rubber Tread On Polyolefin Core	130 lbs.	5-3/4"	Rigid	SCC-05R510-TPRS-*
				Swivel	SCC-05S510-TPRS-*
				Single Lock Brake	SCC-05S510-TPRS-SLB-*

NOTE: FOR YOUR STEM CHOICE, REPLACE * IN PART NUMBER WITH THE STEM CODE SHOWN IN STEM CHOICES.

Wheel Option

- Numerous wheel material options available ([see wheel chart](#))



Polyolefin (POS)
Resilient, easy-to-clean, protective, reliable, low-maintenance, sleek.
[SCC-05S210-POS](#)

Discover the perfect upgrade for your *RubberMaid* carts and *kitchen fryer* stands with **Service Caster's** premium replacement casters. Engineered for superior mobility, durability, and floor protection, these casters are tailored to meet the demanding environments of commercial kitchens and utility services. Experience seamless movement, reduced noise, and enhanced longevity, ensuring your equipment operates at peak efficiency. Ideal for both RubberMaid utility products and heavy-duty kitchen fryers, our casters offer the ultimate solution in reliability and ease of maintenance, making them the smart choice for professionals seeking to optimize their operations.

Finish Option

- Different finish options available ([email support](#))



Bright Chrome (BC)



Polished Nickel (PN)



Black Oxide (BO)



Copper Oxide (CO)



Any Questions?



General Duty Casters

Series #10 Casters

Dolly caster wheels come in various materials like nylon, neoprene, rubber, thermoplastic rubber, phenolic, polyurethane, and semi steel to suit different needs. Inform your sales rep of any extreme conditions your equipment might face.

Applications

- Dollies
- Store Fixtures
- Furniture
- Material Handling Equipment
- Institutional Equipment
- Industrial Equipment

Features

- Zinc finish
- RoHS Compliant
- Nickel-Plated Kingpin



PART NUMBER KEY: HOW TO ORDER THE CORRECT CASTER:

SCC-10S415-HRS-SLB

Brand	Series	Rig Type	Wheel Size	Wheel Material	Brake Type
Service Caster	10	Swivel (S)	2" x 13/16" (210)	Soft Rubber (SRS)	Side Lock Brake (SLB)
		Rigid (R)	2-1/2" x 1-1/8" (2510)	Hard Rubber (HRS)	
			3" x 1-1/4" (314)	Polyolefin (POS)	
			4" x 1-1/2" (415)	Polyurethane (PPUS)	
				Semi-Steel (SSS)	
				Thermo Plastic Rubber (TPRS)	



How to Measure your Caster Plate

Mounting Options

More Options

Wheel Diameter	Caster Type	Overall Top Plate Size	Bolt Hole Pattern	Mounting Bolt Size
2"	Swivel	1-7/8" x 2-9/16"	15/16" x 2-1/8"	1/4"
	Rigid	1-1/2" x 2-21/32"	15/16" x 2-1/8"	
2-1/2"	Swivel	2-5/8" x 3-11/16"	1-3/4" x 3"	5/16"
	Rigid	2-1/4" x 4-7/16"	1-1/16" x 3-1/2"	
3"	Swivel	3-1/8" x 4-1/8"	2-3/8" x 3-3/8"	5/16"
	Rigid	3-1/8" x 4-1/2"	2-3/8" x 3-3/8"	
4"	Swivel	4" x 5"	3" x 4"	3/8"
	Rigid	3-1/4" x 6-1/4"	1-3/4" x 5"	

Wheel Tread



TOP PLATE CASTERS

Wheel Diameter	Tread Width	Wheel Type	Load Capacity	Swivel Part Number	Rigid Part Number	Overall Height	Swivel Radius
2"	15/16"	TPR	75	SCC-10S210-TPRS	SCC-10R210-TPRS	2-7/16"	1-3/4"
		Soft Rubber	100	SCC-10S210-SRS	SCC-10R210-SRS		
		Polyurethane	125	SCC-10S210-PPUS	SCC-10R210-PPUS		
		Hard Rubber	125	SCC-10S210-HRS	SCC-10R210-HRS		
		Polyolefin	125	SCC-10S210-POS	SCC-10R210-POS		
		Semi-Steel	150	SCC-10S210-SSS	SCC-10R210-SSS		
2-1/2"	1-1/16"	TPR	125	SCC-10S2510-TPRS	SCC-10R2510-TPRS	3-1/4"	2-1/4"
		Soft Rubber	150	SCC-10S2510-SRS	SCC-10R2510-SRS		
		Polyurethane	150	SCC-10S2510-PPUS	SCC-10R2510-PPUS		
		Hard Rubber	175	SCC-10S2510-HRS	SCC-10R2510-HRS		
		Polyolefin	175	SCC-10S2510-POS	SCC-10R2510-POS		
		Semi-Steel	200	SCC-10S2510-SSS	SCC-10R2510-SSS		
3"	1-1/4"	TPR	200	SCC-10S314-TPRS	SCC-10R314-TPRS	3-3/4"	2-1/4"
		Soft Rubber	200	SCC-10S314-SRS	SCC-10R314-SRS		
		Polyurethane	210	SCC-10S314-PPUS	SCC-10R314-PPUS		
		Hard Rubber	300	SCC-10S314-HRS	SCC-10R314-HRS		
		Polyolefin	300	SCC-10S314-POS	SCC-10R314-POS		
		Semi-Steel	300	SCC-10S314-SSS	SCC-10R314-SSS		
4"	1-1/2"	Soft Rubber	240	SCC-10S415-TPRS	SCC-10R415-TPRS	5"	3-1/4"
		TPR	325	SCC-10S415-SRS	SCC-10R415-SRS		
		Polyurethane	400	SCC-10S415-PPUS	SCC-10R415-PPUS		
		Hard Rubber	400	SCC-10S415-HRS	SCC-10R415-HRS		
		Polyolefin	400	SCC-10S415-POS	SCC-10R415-POS		
		Semi-Steel	500	SCC-10S415-SSS	SCC-10R415-SSS		

MANY OTHER OPTIONS IN WHEEL MATERIAL AND MOUNTING TYPES ARE AVAILABLE. REACH OUT TO [CUSTOMER SERVICE](#) FOR FURTHER ASSISTANCE.

Bearing Type



Roller Bearing Ball Bearing Delrin Bearing Plain Bore

Brake Option

- Brake option available

Side Lock Brake (SLB)
The side lock brake places a positive locking force against the wheel hub locking the wheel only.



REVIEW US ON



SHARE YOUR THOUGHTS! WE VALUE YOUR FEEDBACK. >>>

Medium Duty Casters

Series #20 Plate Casters

Our #20 Series industrial casters, with heat-treated double ball bearing raceways, are versatile and ideal for various applications.

- Applications
- Bakery equipment
- Stocking carts
- Moving dollies
- Food service operations
- Office equipment
- Laboratory equipment



Features

- Heat treated double ball bearing raceways for durability
- 1/2" precision kingpin for stability
- Versatile design suitable for various applications
- Ideal for light duty industrial use

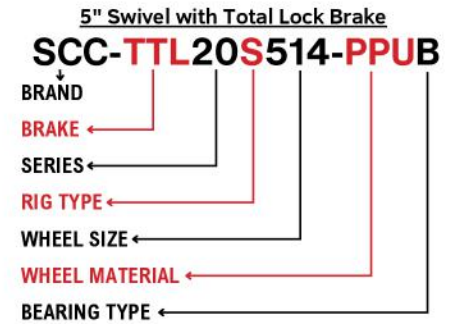
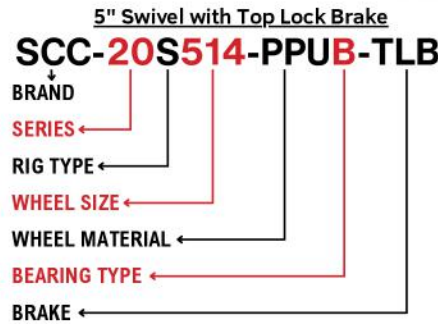
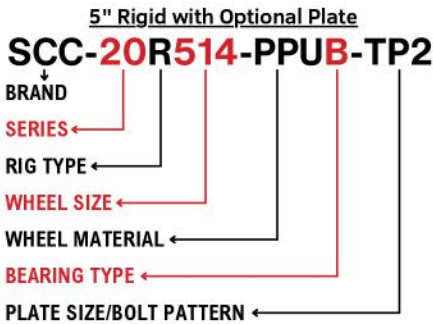

Our part numbers are adaptable to suit your requirements. The diagram above serves as a reference to assist you in understanding the breakdown. If you require any help, please don't hesitate to contact our [customer service](#) team.

Service Caster Chart Guide

Build You Caster

Discover more fastening sizes and wheel options if you can't find what you need. And remember, we're always here to [help!](#)

Brand	Series	Plate Size	Bolt Pattern	Rig Type	Bearing Type	Brake	Wheel Size	Wheel Material
Service Caster	20	2-1/2" x 3-5/8" (Standard Plate)	1-3/4" x 2-7/8" to 3"	Swivel (S)	Ball Bearing (B)	Top Lock (TLB)	2-1/2" x 1-1/4" (2514)	Soft Rubber (SR)
				Rigid (R)	Plain Bore (S)	Posi Lock (PLB)	3-1/2" x 1-1/4" (3514)	Thermo Plastic Rubber (TPR)
					Delrin Bearing (D)	Total Lock (TTL)	3" x 1-1/4" (314)	Polyurethane (PPU)
						Directional Lock (DL)	4" x 1-1/4" (414)	Phenolic (PH)
							5" x 1-1/4" (514)	Solid Polyurethane (SPU)
							6" x 1-1/4" (614)	Hard Rubber (HR)
								Glass Filled Nylon (GFN)
								Rubber on Aluminum (RA)
								Semi Steel (SS)
								Nylon (NY)
								Polyolefin (PO)
								High Temp (HT)

Choose Your Color



Wheel Tread



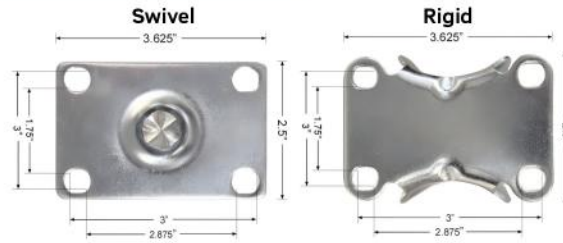

Wheel Diameter	Overall Height	Swivel Radius	Aproximate Weight
3"	4-1/8"	2-15/16"	1.45
3-1/2"	4-5/8"	3-3/16"	1.6
4"	5-1/8"	3-1/2"	1.7
5"	6-1/8"	4"	2
6"	7-1/8"	4-9/16"	2.95

STANDARD TOP PLATE CASTERS

Wheel Dia	Tread Width	Wheel Type	Load Capacity	Bearing Type	Swivel Caster	Rigid Caster	Overall Height	Color
3"	1-1/4"	Soft Rubber	175	Plain Bore	SCC-20S314-SRS	SCC-20R314-SRS	4-1/8"	Black
		Thermo Plastic Rubber	210	Ball Bearing	SCC-20S314-TPRB	SCC-20R314-TPRB		Gray
		Hard Rubber	275	Plain Bore	SCC-20S314-HRS	SCC-20R314-HRS		Black
		Nylon	300	Plain Bore	SCC-20S314-NYS	SCC-20R314-NYS		White
		Phenolic		Roller Bearing	SCC-20S314-PHR	SCC-20R314-PHR		Black
		Phenolic		Plain Bore	SCC-20S314-PHS	SCC-20R314-PHS		Black
		HT Phenolic		Roller Bearing	SCC-20S314-PHRHT	SCC-20R314-PHRHT		Brown
		HT Phenolic		Plain Bore	SCC-20S314-PHSHT	SCC-20R314-PHSHT		Brown
		Polyolefin		Plain Bore	SCC-20S314-POS	SCC-20R314-POS		Black
		Polyurethane		Ball Bearing	SCC-20S314-PPUB	SCC-20R314-PPUB		Black
		Solid Polyurethane	Plain Bore	SCC-20S314-SPUS	SCC-20R314-SPUS	Blue		
		Semi Steel	Plain Bore	SCC-20S314-SSS	SCC-20R314-SSS	Silver		
		HT Glass Filled Nylon	350	Plain Bore	SCC-20S314-GFNSHT	SCC-20R314-GFNSHT		Black or Brown
3-1/2"	1-1/4"	Soft Rubber	200	Plain Bore	SCC-20S3514-SRS	SCC-20R3514-SRS	4-5/8"	Black
		Thermo Plastic Rubber	230	Plain Bore	SCC-20S3514-TPRB	SCC-20R3514-TPRB		Gray
		Hard Rubber	285	Plain Bore	SCC-20S3514-HRS	SCC-20R3514-HRS		Black
		Phenolic	300	Roller Bearing	SCC-20S3514-PHR	SCC-20R3514-PHR		Black
		Phenolic		Plain Bore	SCC-20S3514-PHS	SCC-20R3514-PHS		Black
		Polyolefin		Bushing	SCC-20S3514-POS	SCC-20R3514-POS		Black
		Polyurethane		Ball Bearing	SCC-20S3514-PPUB	SCC-20R3514-PPUB		Black
		Solid Polyurethane	Bushing	SCC-20S3514-SPUS	SCC-20R3514-SPUS	Blue		
		HT Glass Filled Nylon	350	Plain Bore	SCC-20S3514-GFNSHT	SCC-20R3514-GFNSHT		Black or Brown
4"	1-1/4"	Soft Rubber	200	Plain Bore	SCC-20S414-SRS	SCC-20R414-SRS	5-1/8"	Black
		Thermo Plastic Rubber	250	Ball Bearing	SCC-20S414-TPRB	SCC-20R414-TPRB		Gray
		Hard Rubber	300	Plain Bore	SCC-20S414-HRS	SCC-20R414-HRS		Black
		Nylon		Plain Bore	SCC-20S414-NYS	SCC-20R414-NYS		White
		Phenolic		Roller Bearing	SCC-20S414-PHR	SCC-20R414-PHR		Black
		Phenolic		Plain Bore	SCC-20S414-PHS	SCC-20R414-PHS		Black
		HT Phenolic	Roller Bearing	SCC-20S414-PHRHT	SCC-20R414-PHRHT	Brown		
		Semi Steel	Plain Bore	SCC-20S414-PHSHT	SCC-20R414-PHSHT	Brown		
		Polyolefin	Plain Bore	SCC-20S414-POS	SCC-20R414-POS	Black		
		Polyurethane	Ball Bearing	SCC-20S414-PPUB	SCC-20R414-PPUB	Black		
		Solid Polyurethane	350	Plain Bore	SCC-20S414-SPUS	SCC-20R414-SPUS		Blue
		Sem Steel	Plain Bore	SCC-20S414-SSS	SCC-20R414-SSS	Silver		
		HT Glass Filled Nylon	Plain Bore	SCC-20S414-GFNSHT	SCC-20R414-GFNSHT	Black or Brown		
5"	1-1/4"	Soft Rubber	275	Plain Bore	SCC-20S514-SRS	SCC-20R514-SRS	6-1/8"	Black
		Thermo Plastic Rubber	300	Ball Bearing	SCC-20S514-TPRB	SCC-20R514-TPRB		Gray
		Hard Rubber		Plain Bore	SCC-20S514-HRS	SCC-20R514-HRS		Black
		Nylon		Plain Bore	SCC-20S514-NYS	SCC-20R514-NYS		White
		Phenolic		Roller Bearing	SCC-20S514-PHR	SCC-20R514-PHR		Black
		Phenolic	Plain Bore	SCC-20S514-PHS	SCC-20R514-PHS	Black		
		HT Phenolic	Roller Bearing	SCC-20S514-PHRHT	SCC-20R514-PHRHT	Brown		
		HT Phenolic	Plain Bore	SCC-20S514-PHSHT	SCC-20S514-PHSHT	Brown		
		Polyolefin	Plain Bore	SCC-20S514-POS	SCC-20R514-POS	Black		
		Polyurethane	Ball Bearing	SCC-20S514-PPUB	SCC-20R514-PPUB	Black		
		Solid Polyurethane	350	Plain Bore	SCC-20S514-SPUS	SCC-20R514-SPUS		Blue
		Semi Steel	Plain Bore	SCC-20S514-SSS	SCC-20R514-SSS	Silver		
		HT Glass Filled Nylon	Plain Bore	SCC-20S514-GFNSHT	SCC-20R514-GFNSHT	Black or Brown		
6"	1-1/4"	Thermo Plastic Rubber	300	Ball Bearing	SCC-20S614-TPRB	SCC-20R614-TPRB	7-1/8"	Gray
		Polyurethane	350	Ball Bearing	SCC-20S614-PPUB	SCC-20R614-PPUB		Gray

CLICK TO ORDER NOW



For more choices, please proceed to the following page.



Wheel Diameter	Overall Height	Swivel Radius	Aproximate Weight
3"	4-1/8"	2-15/16"	1.45
3-1/2"	4-5/8"	3-3/16"	1.6
4"	5-1/8"	3-1/2"	1.7
5"	6-1/8"	4"	2
6"	7-1/8"	4-9/16"	2.95

STANDARD TOP PLATE CASTERS *with Brakes*

Wheel Dia	Tread Width	Wheel Type	Load Capacity	Bearing Type	Top Lock Brake (TLB)	Posi Lock Brake (PLB)	Total Lock Brake (TTL)	
3"	1-1/4"	Soft Rubber	175	Plain Bore	SCC-20S314-SRS-TLB	SCC-20S314-SRS-PLB	SCC-TTL20S314-SRS	
		Thermo Plastic Rubber	210	Ball Bearing	SCC-20S314-TPRB-TLB	SCC-20S314-TPRB-PLB	SCC-TTL20S314-TPRB	
		Hard Rubber	275	Plain Bore	SCC-20S314-HRS-TLB	SCC-20S314-HRS-PLB	SCC-TTL20S314-HRS	
		Nylon	300	Plain Bore	SCC-20S314-NYS-TLB	SCC-20S314-NYS-PLB	SCC-TTL20S314-NYS	
		Phenolic		Roller Bearing	SCC-20S314-PHR-TLB	SCC-20S314-PHR-PLB	SCC-TTL20S314-PHR	
		Phenolic		Plain Bore	SCC-20S314-PHS-TLB	SCC-20S314-PHS-PLB	SCC-TTL20S314-PHS	
		HT Phenolic		Roller Bearing	SCC-20S314-PHRHT-TLB	SCC-20S314-PHRHT-PLB	SCC-TTL20S314-PHRHT	
		HT Phenolic		Plain Bore	SCC-20S314-PHRHT-TLB	SCC-20R314-PHSHT-PLB	SCC-TTL20S314-PHSHT	
		Polyolefin		Plain Bore	SCC-20S314-POS-TLB	SCC-20S314-POS-PLB	SCC-TTL20S314-POS	
		Polyurethane		Ball Bearing	SCC-20S314-PPUB-TLB	SCC-20S314-PPUB-PLB	SCC-TTL20S314-PPUB	
		Solid Polyurethane		Plain Bore	SCC-20S314-SPUS-TLB	SCC-20S314-SPUS-PLB	SCC-TTL20S314-SPUS	
		Semi Steel		Plain Bore	SCC-20S314-SSS-TLB	SCC-20S314-SSS-PLB	SCC-TTL20S314-SSS	
		HT Glass Filled Nylon		350	Plain Bore	SCC-20S314-GFNSHT-TLB	SCC-20S314-GFNSHT-PLB	SCC-TTL20S314-GFNSHT
3-1/2"	1-1/4"	Soft Rubber	200	Plain Bore	SCC-20S3514-SRS-TLB	SCC-20S3514-SRS-PLB	SCC-TTL20S3514-SRS	
		Thermo Plastic Rubber	230	Plain Bore	SCC-20S3514-TPRB-TLB	SCC-20S3514-TPRB-PLB	SCC-TTL20S3514-TPRB	
		Hard Rubber	285	Plain Bore	SCC-20S3514-HRS-TLB	SCC-20S3514-HRS-PLB	SCC-TTL20S3514-HRS	
		Phenolic	300	Roller Bearing	SCC-20S3514-PHR-TLB	SCC-20S3514-PHR-PLB	SCC-TTL20S3514-PHR	
		Phenolic		Plain Bore	SCC-20S3514-PHS-TLB	SCC-20S3514-PHS-PLB	SCC-TTL20S3514-PHS	
		Polyolefin		Bushing	SCC-20S3514-POS-TLB	SCC-20R3514-POS-PLB	SCC-TTL20S3514-POS	
		Polyurethane		Ball Bearing	SCC-20S3514-PPUB-TLB	SCC-20S3514-PPUB-PLB	SCC-TTL20S3514-PPUB	
		Solid Polyurethane	Bushing	SCC-20S3514-SPUS-TLB	SCC-20S3514-SPUS-PLB	SCC-TTL20S3514-SPUS		
		HT Glass Filled Nylon	350	Plain Bore	SCC-20S3514-GFNSHT-TLB	SCC-20R3514-GFNSHT	SCC-TTL20S3514-GFNSHT	
		4"	1-1/4"	Soft Rubber	200	Plain Bore	SCC-20S414-SRS-TLB	SCC-20S414-SRS-PLB
Thermo Plastic Rubber	250			Ball Bearing	SCC-20S414-TPRB-TLB	SCC-20S414-TPRB-PLB	SCC-TTL20S414-TPRB	
Hard Rubber	300			Plain Bore	SCC-20S414-HRS-TLB	SCC-20S414-HRS-PLB	SCC-TTL20S414-HRS	
Nylon				Plain Bore	SCC-20S414-NYS-TLB	SCC-20S414-NYS-PLB	SCC-TTL20S414-NYS	
Phenolic				Roller Bearing	SCC-20S414-PHR-TLB	SCC-20S414-PHR-PLB	SCC-TTL20S414-PHR	
Phenolic				Plain Bore	SCC-20S414-PHS-TLB	SCC-20S414-PHS-PLB	SCC-TTL20S414-PHS	
HT Phenolic				Roller Bearing	SCC-20S414-PHRHT-TLB	SCC-20R414-PHRHT	SCC-TTL20S414-PHRHT	
Semi Steel				Plain Bore	SCC-20S414-PHSHT-TLB	SCC-20R414-PHSHT	SCC-TTL20S414-PHSHT	
Polyolefin				Plain Bore	SCC-20S414-POS-TLB	SCC-20S414-POS-PLB	SCC-TTL20S414-POS	
Polyurethane				Ball Bearing	SCC-20S414-PPUB-TLB	SCC-20S414-PPUB-PLB	SCC-TTL20S414-PPUB	
Solid Polyurethane				350	Plain Bore	SCC-20S414-SPUS-TLB	SCC-20S414-SPUS-PLB	SCC-TTL20S414-SPUS
Sem Steel				Plain Bore	SCC-20S414-SSS-TLB	SCC-20S414-SSS-PLB	SCC-TTL20S414-SSS	
HT Glass Filled Nylon	Plain Bore			SCC-20S414-GFNSHT-TLB	SCC-20R414-GFNSHT-PLB	SCC-TTL20S414-GFNSHT		
5"	1-1/4"	Soft Rubber	275	Plain Bore	SCC-20S514-SRS-TLB	SCC-20S514-SRS-PLB	SCC-TTL20S514-SRS	
		Thermo Plastic Rubber	300	Ball Bearing	SCC-20S514-TPRB-TLB	SCC-20S514-TPRB-PLB	SCC-TTL20S514-TPRB	
		Hard Rubber		Plain Bore	SCC-20S514-HRS-TLB	SCC-20S514-HRS-PLB	SCC-TTL20S514-HRS	
		Nylon		Plain Bore	SCC-20S514-NYS-TLB	SCC-20S514-NYS-PLB	SCC-TTL20S514-NYS	
		Phenolic		Roller Bearing	SCC-20S514-PHR-TLB	SCC-20S514-PHR-PLB	SCC-TTL20S514-PHR	
		Phenolic		Plain Bore	SCC-20S514-PHS-TLB	SCC-20S514-PHS-PLB	SCC-TTL20S514-PHS	
		HT Phenolic		Roller Bearing	SCC-20S514-PHRHT-TLB	SCC-20R514-PHRHT-PLB	SCC-TTL20S514-PHRHT	
		HT Phenolic		Plain Bore	SCC-20S514-PHSHT-TLB	SCC-20S514-PHSHT-PLB	SCC-TTL20S514-PHSHT	
		Polyolefin		Plain Bore	SCC-20S514-POS-TLB	SCC-20S514-POS-PLB	SCC-TTL20S514-POS	
		Polyurethane		Ball Bearing	SCC-20S514-PPUB-TLB	SCC-20S514-PPUB-PLB	SCC-TTL20S514-PPUB	
		Solid Polyurethane		350	Plain Bore	SCC-20S514-SPUS-TLB	SCC-20S514-SPUS-PLB	SCC-TTL20S514-SPUS
		Semi Steel	Plain Bore	SCC-20S514-SSS-TLB	SCC-20S514-SSS-PLB	SCC-TTL20S514-SSS		
		HT Glass Filled Nylon	Plain Bore	SCC-20S514-GFNSHT-TLB	SCC-20R514-GFNSHT-PLB	SCC-TTL20S514-GFNSHT		
6"	1-1/4"	Thermo Plastic Rubber	300	Ball Bearing	SCC-20S614-TPRB-TLB	SCC-20S614-TPRB-PLB	SCC-TTL20S614-TPRB	
		Polyurethane	350	Ball Bearing	SCC-20S614-PPUB-TLB	SCC-20S614-PPUB-PLB	SCC-TTL20S614-PPUB	



For more choices, please proceed to the following page.

CALL OR EMAIL US FOR MORE OPTIONS 1-800-215-8220 / info@servicecaster.com



TOP PLATE CASTERS *with Optional Plate #2*

Optional Plate Size	Bolt Pattern
3-1/8" x 4-1/8" (TP2)	1-3/4" x 2-15/16" to 2-3/8" x 3-3/8"

Wheel Diameter	Overall Height	Swivel Radius	Aproximate Weight ^{lbs}
3"	4-1/8"	2-15/16"	1.45
3-1/2"	4-5/8"	3-3/16"	1.6
4"	5-1/8"	3-1/2"	1.7
5"	6-1/8"	4"	2
6"	7-1/8"	4-9/16"	2.95

Wheel Dia	Tread Width	Wheel Type	Load Capacity	Bearing Type	Swivel Caster	Rigid Caster	Swivel with Brake (TLB)
3"	1-1/4"	Soft Rubber	175	Plain Bore	SCC-20S314-SRS-TP2	SCC-20R314-SRS-TP2	SCC-20S314-SRS-TLB-TP2
		Thermo Plastic Rubber	210	Ball Bearing	SCC-20S314-TPRB-TP2	SCC-20R314-TPRB-TP2	SCC-20S314-TPRB-TLB-TP2
		Hard Rubber	275	Plain Bore	SCC-20S314-HRS-TP2	SCC-20R314-HRS-TP2	SCC-20S314-HRS-TLB-TP2
		Nylon	300	Plain Bore	SCC-20S314-NYS-TP2	SCC-20R314-NYS-TP2	SCC-20S314-NYS-TLB-TP2
		Phenolic		Roller Bearing	SCC-20S314-PHR-TP2	SCC-20R314-PHR-TP2	SCC-20S314-PHR-TLB-TP2
		Phenolic		Plain Bore	SCC-20S314-PHS-TP2	SCC-20R314-PHS-TP2	SCC-20S314-PHS-TLB-TP2
		HT Phenolic		Roller Bearing	SCC-20S314-PHRHT-TP2	SCC-20R314-PHRHT-TP2	SCC-20S314-PHRHT-TLB-TP2
		HT Phenolic		Plain Bore	SCC-20S314-PHSHT-TP2	SCC-20R314-PHSHT-TP2	SCC-20S314-PHSHT-TLB-TP2
		Polyolefin		Plain Bore	SCC-20S314-POS-TP2	SCC-20R314-POS-TP2	SCC-20S314-POS-TLB-TP2
		Polyurethane		Ball Bearing	SCC-20S314-PPUB-TP2	SCC-20R314-PPUB-TP2	SCC-20S314-PPUB-TLB-TP2
		Solid Polyurethane		Plain Bore	SCC-20S314-SPUS-TP2	SCC-20R314-SPUS-TP2	SCC-20S314-SPUS-TLB-TP2
		Semi Steel		Plain Bore	SCC-20S314-SSS-TP2	SCC-20R314-SSS-TP2	SCC-20S314-SSS-TLB-TP2
		HT Glass Filled Nylon		350	Plain Bore	SCC-20S314-GFNSHT-TP2	SCC-20R314-GFNSHT-TP2
3-1/2"	1-1/4"	Soft Rubber	200	Plain Bore	SCC-20S3514-SRS-TP2	SCC-20R3514-SRS-TP2	SCC-20S3514-SRS-TLB-TP2
		Thermo Plastic Rubber	230	Plain Bore	SCC-20S3514-TPRB-TP2	SCC-20R3514-TPRB-TP2	SCC-20S3514-TPRB-TLB-TP2
		Hard Rubber	285	Plain Bore	SCC-20S3514-HRS-TP2	SCC-20R3514-HRS-TP2	SCC-20S3514-HRS-TLB-TP2
		Phenolic	300	Roller Bearing	SCC-20S3514-PHR-TP2	SCC-20R3514-PHR-TP2	SCC-20S3514-PHR-TLB-TP2
		Phenolic		Plain Bore	SCC-20S3514-PHS-TP2	SCC-20R3514-PHS-TP2	SCC-20S3514-PHS-TLB-TP2
		Polyolefin		Bushing	SCC-20S3514-POS-TP2	SCC-20R3514-POS-TP2	SCC-20S3514-POS-TLB-TP2
		Polyurethane		Ball Bearing	SCC-20S3514-PPUB-TP2	SCC-20R3514-PPUB-TP2	SCC-20S3514-PPUB-TLB-TP2
		Solid Polyurethane	350	Bushing	SCC-20S3514-SPUS-TP2	SCC-20R3514-SPUS-TP2	SCC-20S3514-SPUS-TLB-TP2
HT Glass Filled Nylon	350	Plain Bore	SCC-20S3514-GFNSHT-TP2	SCC-20R3514-GFNSHT-TP2	SCC-20S3514-GFNSHT-TLB-TP2		
4"	1-1/4"	Soft Rubber	200	Plain Bore	SCC-20S414-SRS-TP2	SCC-20R414-SRS-TP2	SCC-20S414-SRS-TLB-TP2
		Thermo Plastic Rubber	250	Ball Bearing	SCC-20S414-TPRB-TP2	SCC-20R414-TPRB-TP2	SCC-20S414-TPRB-TLB-TP2
		Hard Rubber	300	Plain Bore	SCC-20S414-HRS-TP2	SCC-20R414-HRS-TP2	SCC-20S414-HRS-TLB-TP2
		Nylon		Plain Bore	SCC-20S414-NYS-TP2	SCC-20R414-NYS-TP2	SCC-20S414-NYS-TLB-TP2
		Phenolic		Roller Bearing	SCC-20S414-PHR-TP2	SCC-20R414-PHR-TP2	SCC-20S414-PHR-TLB-TP2
		Phenolic		Plain Bore	SCC-20S414-PHS-TP2	SCC-20R414-PHS-TP2	SCC-20S414-PHS-TLB-TP2
		HT Phenolic	350	Roller Bearing	SCC-20S414-PHRHT-TP2	SCC-20R414-PHRHT-TP2	SCC-20S414-PHRHT-TLB-TP2
		Semi Steel	Plain Bore	SCC-20S414-PHSHT-TP2	SCC-20R414-PHSHT-TP2	SCC-20S414-PHSHT-TLB-TP2	
		Polyolefin	Plain Bore	SCC-20S414-POS-TP2	SCC-20R414-POS-TP2	SCC-20S414-POS-TLB-TP2	
		Polyurethane	Ball Bearing	SCC-20S414-PPUB-TP2	SCC-20R414-PPUB-TP2	SCC-20S414-PPUB-TLB-TP2	
		Solid Polyurethane	350	Plain Bore	SCC-20S414-SPUS-TP2	SCC-20R414-SPUS-TP2	SCC-20S414-SPUS-TLB-TP2
		Sem Steel	Plain Bore	SCC-20S414-SSS-TP2	SCC-20R414-SSS-TP2	SCC-20S414-SSS-TLB-TP2	
HT Glass Filled Nylon	350	Plain Bore	SCC-20S414-GFNSHT-TP2	SCC-20R414-GFNSHT-TP2	SCC-20S414-GFNSHT-TLB-TP2		
5"	1-1/4"	Soft Rubber	275	Plain Bore	SCC-20S514-SRS-TP2	SCC-20R514-SRS-TP2	SCC-20S514-SRS-TLB-TP2
		Thermo Plastic Rubber	300	Ball Bearing	SCC-20S514-TPRB-TP2	SCC-20R514-TPRB-TP2	SCC-20S514-TPRB-TLB-TP2
		Hard Rubber		Plain Bore	SCC-20S514-HRS-TP2	SCC-20R514-HRS-TP2	SCC-20S514-HRS-TLB-TP2
		Nylon		Plain Bore	SCC-20S514-NYS-TP2	SCC-20R514-NYS-TP2	SCC-20S514-NYS-TLB-TP2
		Phenolic		Roller Bearing	SCC-20S514-PHR-TP2	SCC-20R514-PHR-TP2	SCC-20S514-PHR-TLB-TP2
		Phenolic		Plain Bore	SCC-20S514-PHS-TP2	SCC-20R514-PHS-TP2	SCC-20S514-PHS-TLB-TP2
		HT Phenolic		Roller Bearing	SCC-20S514-PHRHT-TP2	SCC-20R514-PHRHT-TP2	SCC-20S514-PHRHT-TLB-TP2
		HT Phenolic		Plain Bore	SCC-20S514-PHSHT-TP2	SCC-20R514-PHSHT-TP2	SCC-20S514-PHSHT-TLB-TP2
		Polyolefin		Plain Bore	SCC-20S514-POS-TP2	SCC-20R514-POS-TP2	SCC-20S514-POS-TLB-TP2
		Polyurethane		Ball Bearing	SCC-20S514-PPUB-TP2	SCC-20R514-PPUB-TP2	SCC-20S514-PPUB-TLB-TP2
		Solid Polyurethane		350	Plain Bore	SCC-20S514-SPUS-TP2	SCC-20R514-SPUS-TP2
		Semi Steel	Plain Bore	SCC-20S514-SSS-TP2	SCC-20R514-SSS-TP2	SCC-20S514-SSS-TLB-TP2	
		HT Glass Filled Nylon	350	Plain Bore	SCC-20S514-GFNSHT-TP2	SCC-20R514-GFNSHT-TP2	SCC-20S514-GFNSHT-TLB-TP2
6"	1-1/4"	Thermo Plastic Rubber	300	Ball Bearing	SCC-20S614-TPRB-TP2	SCC-20R614-TPRB-TP2	SCC-20S614-TPRB-TLB-TP2
		Polyurethane	350	Ball Bearing	SCC-20S614-PPUB-TP2	SCC-20R614-PPUB-TP2	SCC-20S614-PPUB-TLB-TP2



For more choices, please proceed to the following page.



TOP PLATE CASTERS *with Optional Plate #3*

Optional Plate Size	Bolt Pattern
4" x 4-1/2" (TP3)	2-5/8" x 3-5/8" to 3" x 3"

Wheel Diameter	Overall Height	Swivel Radius	Aproximate Weight ^{lbs}
3"	4-1/8"	2-15/16"	1.45
3-1/2"	4-5/8"	3-3/16"	1.6
4"	5-1/8"	3-1/2"	1.7
5"	6-1/8"	4"	2
6"	7-1/8"	4-9/16"	2.95

Wheel Dia	Tread Width	Wheel Type	Load Capacity	Bearing Type	Swivel Caster	Rigid Caster	Swivel with Brake (TLB)
3"	1-1/4"	Soft Rubber	175	Plain Bore	SCC-20S314-SRS-TP3	SCC-20R314-SRS-TP3	SCC-20S314-SRS-TLB-TP3
		Thermo Plastic Rubber	210	Ball Bearing	SCC-20S314-TPRB-TP3	SCC-20R314-TPRB-TP3	SCC-20S314-TPRB-TLB-TP3
		Hard Rubber	275	Plain Bore	SCC-20S314-HRS-TP3	SCC-20R314-HRS-TP3	SCC-20S314-HRS-TLB-TP3
		Nylon	300	Plain Bore	SCC-20S314-NYS-TP3	SCC-20R314-NYS-TP3	SCC-20S314-NYS-TLB-TP3
		Phenolic		Roller Bearing	SCC-20S314-PHR-TP3	SCC-20R314-PHR-TP3	SCC-20S314-PHR-TLB-TP3
		Phenolic		Plain Bore	SCC-20S314-PHS-TP3	SCC-20R314-PHS-TP3	SCC-20S314-PHS-TLB-TP3
		HT Phenolic		Roller Bearing	SCC-20S314-PHRHT-TP3	SCC-20R314-PHRHT-TP3	SCC-20S314-PHRHT-TLB-TP3
		HT Phenolic		Plain Bore	SCC-20S314-PHSHT-TP3	SCC-20R314-PHSHT-TP3	SCC-20S314-PHSHT-TLB-TP3
		Polyolefin		Plain Bore	SCC-20S314-POS-TP3	SCC-20R314-POS-TP3	SCC-20S314-POS-TLB-TP3
		Polyurethane		Ball Bearing	SCC-20S314-PPUB-TP3	SCC-20R314-PPUB-TP3	SCC-20S314-PPUB-TLB-TP3
		Solid Polyurethane		Plain Bore	SCC-20S314-SPUS-TP3	SCC-20R314-SPUS-TP3	SCC-20S314-SPUS-TLB-TP3
		Semi Steel		Plain Bore	SCC-20S314-SSS-TP3	SCC-20R314-SSS-TP3	SCC-20S314-SSS-TLB-TP3
		HT Glass Filled Nylon		350	Plain Bore	SCC-20S314-GFNSHT-TP3	SCC-20R314-GFNSHT-TP3
3-1/2"	1-1/4"	Soft Rubber	200	Plain Bore	SCC-20S3514-SRS-TP3	SCC-20R3514-SRS-TP3	SCC-20S3514-SRS-TLB-TP3
		Thermo Plastic Rubber	230	Plain Bore	SCC-20S3514-TPRB-TP3	SCC-20R3514-TPRB-TP3	SCC-20S3514-TPRB-TLB-TP3
		Hard Rubber	285	Plain Bore	SCC-20S3514-HRS-TP3	SCC-20R3514-HRS-TP3	SCC-20S3514-HRS-TLB-TP3
		Phenolic	300	Roller Bearing	SCC-20S3514-PHR-TP3	SCC-20R3514-PHR-TP3	SCC-20S3514-PHR-TLB-TP3
		Phenolic		Plain Bore	SCC-20S3514-PHS-TP3	SCC-20R3514-PHS-TP3	SCC-20S3514-PHS-TLB-TP3
		Polyolefin		Bushing	SCC-20S3514-POS-TP3	SCC-20R3514-POS-TP3	SCC-20S3514-POS-TLB-TP3
		Polyurethane		Ball Bearing	SCC-20S3514-PPUB-TP3	SCC-20R3514-PPUB-TP3	SCC-20S3514-PPUB-TLB-TP3
		Solid Polyurethane	Bushing	SCC-20S3514-SPUS-TP3	SCC-20R3514-SPUS-TP3	SCC-20S3514-SPUS-TLB-TP3	
HT Glass Filled Nylon	350	Plain Bore	SCC-20S3514-GFNSHT-TP3	SCC-20R3514-GFNSHT-TP3	SCC-20S3514-GFNSHT-TLB-TP3		
4"	1-1/4"	Soft Rubber	200	Plain Bore	SCC-20S414-SRS-TP3	SCC-20R414-SRS-TP3	SCC-20S414-SRS-TLB-TP3
		Thermo Plastic Rubber	250	Ball Bearing	SCC-20S414-TPRB-TP3	SCC-20R414-TPRB-TP3	SCC-20S414-TPRB-TLB-TP3
		Hard Rubber	300	Plain Bore	SCC-20S414-HRS-TP3	SCC-20R414-HRS-TP3	SCC-20S414-HRS-TLB-TP3
		Nylon		Plain Bore	SCC-20S414-NYS-TP3	SCC-20R414-NYS-TP3	SCC-20S414-NYS-TLB-TP3
		Phenolic		Roller Bearing	SCC-20S414-PHR-TP3	SCC-20R414-PHR-TP3	SCC-20S414-PHR-TLB-TP3
		Phenolic		Plain Bore	SCC-20S414-PHS-TP3	SCC-20R414-PHS-TP3	SCC-20S414-PHS-TLB-TP3
		HT Phenolic		Roller Bearing	SCC-20S414-PHRHT-TP3	SCC-20R414-PHRHT-TP3	SCC-20S414-PHRHT-TLB-TP3
		Semi Steel		Plain Bore	SCC-20S414-PHSHT-TP3	SCC-20R414-PHSHT-TP3	SCC-20S414-PHSHT-TLB-TP3
		Polyolefin		Plain Bore	SCC-20S414-POS-TP3	SCC-20R414-POS-TP3	SCC-20S414-POS-TLB-TP3
		Polyurethane		Ball Bearing	SCC-20S414-PPUB-TP3	SCC-20R414-PPUB-TP3	SCC-20S414-PPUB-TLB-TP3
		Solid Polyurethane		Plain Bore	SCC-20S414-SPUS-TP3	SCC-20R414-SPUS-TP3	SCC-20S414-SPUS-TLB-TP3
		Sem Steel		Plain Bore	SCC-20S414-SSS-TP3	SCC-20R414-SSS-TP3	SCC-20S414-SSS-TLB-TP3
		HT Glass Filled Nylon	350	Plain Bore	SCC-20S414-GFNSHT-TP3	SCC-20R414-GFNSHT-TP3	SCC-20S414-GFNSHT-TLB-TP3
5"	1-1/4"	Soft Rubber	275	Plain Bore	SCC-20S514-SRS-TP3	SCC-20R514-SRS-TP3	SCC-20S514-SRS-TLB-TP3
		Thermo Plastic Rubber	300	Ball Bearing	SCC-20S514-TPRB-TP3	SCC-20R514-TPRB-TP3	SCC-20S514-TPRB-TLB-TP3
		Hard Rubber		Plain Bore	SCC-20S514-HRS-TP3	SCC-20R514-HRS-TP3	SCC-20S514-HRS-TLB-TP3
		Nylon		Plain Bore	SCC-20S514-NYS-TP3	SCC-20R514-NYS-TP3	SCC-20S514-NYS-TLB-TP3
		Phenolic		Roller Bearing	SCC-20S514-PHR-TP3	SCC-20R514-PHR-TP3	SCC-20S514-PHR-TLB-TP3
		Phenolic		Plain Bore	SCC-20S514-PHS-TP3	SCC-20R514-PHS-TP3	SCC-20S514-PHS-TLB-TP3
		HT Phenolic		Roller Bearing	SCC-20S514-PHRHT-TP3	SCC-20R514-PHRHT-TP3	SCC-20S514-PHRHT-TLB-TP3
		HT Phenolic		Plain Bore	SCC-20S514-PHSHT-TP3	SCC-20R514-PHSHT-TP3	SCC-20S514-PHSHT-TLB-TP3
		Polyolefin		Plain Bore	SCC-20S514-POS-TP3	SCC-20R514-POS-TP3	SCC-20S514-POS-TLB-TP3
		Polyurethane		Ball Bearing	SCC-20S514-PPUB-TP3	SCC-20R514-PPUB-TP3	SCC-20S514-PPUB-TLB-TP3
		Solid Polyurethane		Plain Bore	SCC-20S514-SPUS-TP3	SCC-20R514-SPUS-TP3	SCC-20S514-SPUS-TLB-TP3
		Semi Steel	Plain Bore	SCC-20S514-SSS-TP3	SCC-20R514-SSS-TP3	SCC-20S514-SSS-TLB-TP3	
		HT Glass Filled Nylon	350	Plain Bore	SCC-20S514-GFNSHT-TP3	SCC-20R514-GFNSHT-TP3	SCC-20S514-GFNSHT-TLB-TP3
6"	1-1/4"	Thermo Plastic Rubber	300	Ball Bearing	SCC-20S614-TPRB-TP3	SCC-20R614-TPRB-TP3	SCC-20S614-TPRB-TLB-TP3
		Polyurethane	350	Ball Bearing	SCC-20S614-PPUB-TP3	SCC-20R614-PPUB-TP3	SCC-20S614-PPUB-TLB-TP3



For more choices, please proceed to the following page.

Medium Duty Casters

Series #20 Plate Casters

Ideal for dollies, platform trucks, warehouse carts, and more, our versatile casters ensure a smooth and secure ride. From food service carts to industrial equipment, Series 20 keeps you rolling forward.

Applications

1-1/2" & 2" Wide Wheels

- Bakery equipment
- Stocking carts
- Moving dollies
- Food service operations
- Office equipment
- Laboratory equipment



Features

- Heat treated double ball bearing raceways for durability
- 1/2" precision kingpin for stability
- Versatile design suitable for various applications
- Ideal for light and medium duty industrial use



PART NUMBER KEY: HOW TO ORDER THE CORRECT CASTER:

SCC-20S420-GFNBZHT-TLB

Brand	Series	Rig Type	Wheel Size	Wheel Material	Bearings	Brake Type
Service Caster	20	Swivel (S)	3" x 1-1/2" (315)	Polyolefin (PO)	Roller Bearing (R)	Top Lock Brake (TLB)
			Rigid (R)	4" x 1-1/2" (415)	Thermo-Plastic Rubber (TPRD/TPRF)	
			4" x 2" (420)	Glass Filled Nylon (GFN)	Delrin Bearing (D)	
			5" x 1-1/2" (515)	Nylon (NY)	Bronze Bearing (BZ)	
			5" x 2" (520)	Polyurethane on Aluminum (PA)		
			6" x 1-1/2" (615)	Phenolic (PH)		
			6" x 2" (620)	High Temp Phenolic (PH*HT)		
				Polyurethane on Polyolefin (PPU)		
		Polyurethane on Cast Iron (PU)				
		Rubber on Aluminum (RA)				
		Rubber on Steel (RS)				
		Solid Polyurethane (SPU)				
		Semi Steel (SS)				
		V-Groove (VG)				
		High Temp Glass Filled Nylon (GFN*HT)				

Standard Plate Size	Bolt Pattern	Bolt Diameter
2-3/8" x 3-5/8"	1-3/4" x 2-7/8" to 3"	5/16"

Bronze caster bearings endure harsh conditions, resisting porosity and heat up to 525°F. They're ideal for tough environments with water exposure or corrosion risks, and some options include spanner bushings for added strength.

Service Caster Chart Guide

Choose Your Wheel

At **Service Caster**, we have a wide selection of standard caster wheels. If you don't see what you need, just reach out to our **Service Caster Crew** for help.



Standard Plate Size	Bolt Pattern	Bolt Diameter
2-3/8" x 3-5/8"	1-3/4" x 2-7/8" to 3"	5/16"

Wheel Diameter	Overall Height	Swivel Radius	Approximate Weight ^{lbs}
3"	4-1/8"	2-15/16"	1.45
4"	5-1/8"	3-1/4"	1.6
5"	6-1/4"	4"	1.7
6"	7-1/2"	4-5/8"	2



TOP PLATE CASTERS *Roller Bearing Wheels*

[CLICK TO ORDER NOW](#)

Wheel Dia	Tread Width	Wheel Type	Load Capacity	Swivel Caster	Rigid Caster	Swivel with Brake (TLB)	
3"	1-1/2"	Semi Steel	300 lbs.	SCC-20S315-SSR	SCC-20R315-SSR	SCC-20S315-SSR-TLB	
4"	1-1/2"	Semi Steel	300 lbs.	SCC-20S415-SSR	SCC-20R415-SSR	SCC-20S415-SSR-TLB	
4"	2"	Thermo-Plastic Rubber (Flat)	300 lbs.	SCC-20S420-TPRRF	SCC-20R420-TPRRF	SCC-20S420-TPRRF-TLB	
		Thermo-Plastic Rubber (Donut)		SCC-20S420-TPRRD	SCC-20R420-TPRRD	SCC-20S420-TPRRD-TLB	
		Rubber on Cast Iron	400 lbs.	SCC-20S420-RSR	SCC-20R420-RSR	SCC-20S420-RSR-TLB	
		Rubber on Aluminum		SCC-20S420-RAR	SCC-20R420-RAR	SCC-20S420-RAR-TLB	
		Semi Steel	450 lbs.	SCC-20S420-SSR	SCC-20R420-SSR	SCC-20S420-SSR-TLB	
		Solid Polyurethane		SCC-20S420-SPUR	SCC-20R420-SPUR	SCC-20S420-SPUR-TLB	
		Polyurethane on Cast Iron (Red)		SCC-20S420-PUR-RS	SCC-20R420-PUR-RS	SCC-20S420-PUR-RS-TLB	
		Polyurethane on Cast Iron (Green)		SCC-20S420-PUR-GB	SCC-20R420-PUR-GB	SCC-20S420-PUR-GB-TLB	
		Polyurethane on Polyolefin		SCC-20S420-PPUR	SCC-20R420-PPUR	SCC-20S420-PPUR-TLB	
		Polyolefin		SCC-20S420-POR	SCC-20R420-POR	SCC-20S420-POR-TLB	
		High Temp Phenolic		SCC-20S420-PHRHT	SCC-20R420-PHRHT	SCC-20S420-PHRHT-TLB	
		Phenolic		SCC-20S420-PHR	SCC-20R420-PHR	SCC-20S420-PHR-TLB	
		Polyurethane on Aluminum		SCC-20S420-PAR	SCC-20R420-PAR	SCC-20S420-PAR-TLB	
		Nylon		SCC-20S420-NYR	SCC-20R420-NYR	SCC-20S420-NYR-TLB	
Glass Filled Nylon	SCC-20S420-GFNR	SCC-20R420-GFNR		SCC-20S420-GFNR-TLB			
V-Groove	SCC-20S420-VGR	SCC-20R420-VGR		SCC-20S420-VGR-TLB			
5"	1-1/2"	Semi Steel		300 lbs.	SCC-20S515-SSR	SCC-20R515-SSR	SCC-20S515-SSR-TLB
5"	2"	Thermo-Plastic Rubber (Flat)		350 lbs.	SCC-20S520-TPRRF	SCC-20R520-TPRRF	SCC-20S520-TPRRF-TLB
		Thermo-Plastic Rubber (Donut)	SCC-20S520-TPRRD		SCC-20R520-TPRRD	SCC-20S520-TPRRD-TLB	
		Rubber on Cast Iron	400 lbs.	SCC-20S520-RSR	SCC-20R520-RSR	SCC-20S520-RSR-TLB	
		Rubber on Aluminum		SCC-20S520-RAR	SCC-20R520-RAR	SCC-20S520-RAR-TLB	
		Semi Steel	450 lbs.	SCC-20S520-SSR	SCC-20R520-SSR	SCC-20S520-SSR-TLB	
		Solid Polyurethane		SCC-20S520-SPUR	SCC-20R520-SPUR	SCC-20S520-SPUR-TLB	
		Polyurethane on Cast Iron (Red)		SCC-20S520-PUR-RS	SCC-20R520-PUR-RS	SCC-20S520-PUR-RS-TLB	
		Polyurethane on Cast Iron (Green)		SCC-20S520-PUR-GB	SCC-20R520-PUR-GB	SCC-20S520-PUR-GB-TLB	
		Polyurethane on Polyolefin		SCC-20S520-PPUR	SCC-20R520-PPUR	SCC-20S520-PPUR-TLB	
		Polyolefin		SCC-20S520-POR	SCC-20R520-POR	SCC-20S520-POR-TLB	
		High Temp Phenolic		SCC-20S520-PHRHT	SCC-20R520-PHRHT	SCC-20S520-PHRHT-TLB	
		Phenolic		SCC-20S520-PHR	SCC-20R520-PHR	SCC-20S520-PHR-TLB	
		Polyurethane on Aluminum		SCC-20S520-PAR	SCC-20R520-PAR	SCC-20S520-PAR-TLB	
		Nylon		SCC-20S520-NYR	SCC-20R520-NYR	SCC-20S520-NYR-TLB	
Glass Filled Nylon	SCC-20S520-GFNR	SCC-20R520-GFNR		SCC-20S520-GFNR-TLB			
V-Groove	SCC-20S520-VGR	SCC-20R520-VGR		SCC-20S520-VGR-TLB			
High Temp Glass Filled Nylon	SCC-20S520-GFNRHT	SCC-20R520-GFNRHT		SCC-20S520-GFNRHT-TLB			

IF YOU PREFER TO ORDER IN SETS, SIMPLY [CONTACT US](#), AND WE WILL TAILOR YOUR ORDERING PROCESS TO YOUR NEEDS.



Consider Service Caster's Series 20 for reliable and durable casters. Ideal for various applications like dollies, platform trucks, and warehouse carts, these versatile casters ensure a smooth ride for food service carts, hotel housekeeping carts, and more. Trust Service Caster for quality and excellent customer service to keep you moving forward.



Standard Plate Size	Bolt Pattern	Bolt Diameter
2-3/8" x 3-5/8"	1-3/4" x 2-7/8" to 3"	5/16"

Wheel Diameter	Overall Height	Swivel Radius	Approximate Weight <small>lbs</small>
3"	4-1/8"	2-15/16"	1.45
4"	4-5/8"	3-3/16"	1.6
5"	5-1/8"	3-1/2"	1.7
6"	6-1/8"	4"	2



TOP PLATE CASTERS *Roller Bearing Wheels*

[CLICK TO ORDER NOW](#)

Wheel Dia	Tread Width	Wheel Type	Load Capacity	Swivel Caster	Rigid Caster	Swivel with Brake (TLB)
6"	1-1/2"	Phenolic	300 lbs.	SCC-20S615-PHR	SCC-20R615-PHR	SCC-20S615-PHR-TLB
		High Temp Phenolic	300 lbs.	SCC-20S615-PHRHT	SCC-20R615-PHRHT	SCC-20S615-PHRHT-TLB
6"	2"	Thermo-Plastic Rubber (Flat)	450 lbs.	SCC-20S620-TPRRF	SCC-20R620-TPRRF	SCC-20S620-TPRRF-TLB
		Thermo-Plastic Rubber (Donut)		SCC-20S620-TPRRD	SCC-20R620-TPRRD	SCC-20S620-TPRRD-TLB
		Rubber on Cast Iron		SCC-20S620-RSR	SCC-20R620-RSR	SCC-20S620-RSR-TLB
		Rubber on Aluminum		SCC-20S620-RAR	SCC-20R620-RAR	SCC-20S620-RAR-TLB
		Semi Steel		SCC-20S620-SSR	SCC-20R620-SSR	SCC-20S620-SSR-TLB
		Solid Polyurethane		SCC-20S620-SPUR	SCC-20R620-SPUR	SCC-20S620-SPUR-TLB
		Polyurethane on Cast Iron (Red)		SCC-20S620-PUR-RS	SCC-20R620-PUR-RS	SCC-20S620-PUR-RS-TLB
		Polyurethane on Cast Iron (Green)		SCC-20S620-PUR-GB	SCC-20R620-PUR-GB	SCC-20S620-PUR-GB-TLB
		Polyurethane on Polyolefin		SCC-20S620-PPUR	SCC-20R620-PPUR	SCC-20S620-PPUR-TLB
		Polyolefin		SCC-20S620-POR	SCC-20R620-POR	SCC-20S620-POR-TLB
		High Temp Phenolic		SCC-20S620-PHRHT	SCC-20R620-PHRHT	SCC-20S620-PHRHT-TLB
		Phenolic		SCC-20S620-PHR	SCC-20R620-PHR	SCC-20S620-PHR-TLB
		Polyurethane on Aluminum		SCC-20S620-PAR	SCC-20R620-PAR	SCC-20S620-PAR-TLB
		Nylon		SCC-20S620-NYR	SCC-20R620-NYR	SCC-20S620-NYR-TLB
		Glass Filled Nylon		SCC-20S620-GFNR	SCC-20R620-GFNR	SCC-20S620-GFNR-TLB
V-Groove	SCC-20S620-VGR	SCC-20R620-VGR	SCC-20S620-VGR-TLB			
High Temp Glass Filled Nylon	SCC-20S620-GFNRHT	SCC-20R620-GFNRHT	SCC-20S620-SSR-TLB			

IF YOU PREFER TO ORDER IN SETS, SIMPLY [CONTACT US](#), AND WE WILL TAILOR YOUR ORDERING PROCESS TO YOUR NEEDS.

Bearing Type(s)



Brake Option

- Brake option available

Top Lock Brake (TLB)

The **Top lock brake** places a positive locking force against the wheel hub locking the wheel only.



Choose Your Movement

- Rigid and Swivel Available



RIGID



SWIVEL



For additional options, please navigate to the next page.



Standard Plate Size	Bolt Pattern	Bolt Diameter	Wheel Diameter	Overall Height	Swivel Radius	Approximate Weight
2-3/8" x 3-5/8"	1-3/4" x 2-7/8" to 3"	5/16"	3"	4-1/8"	2-15/16"	1.45
			4"	4-5/8"	3-3/16"	1.6
			5"	5-1/8"	3-1/2"	1.7
			6"	6-1/8"	4"	2

TOP PLATE CASTERS *Ball Bearing Wheels*

[CLICK TO ORDER NOW](#)

Wheel Dia	Tread Width	Wheel Type	Load Capacity	Swivel Caster	Rigid Caster	Swivel with Brake (TLB)	
4"	2"	Thermo-Plastic Rubber (Flat)	300 lbs.	SCC-20420-TPRBF	SCC-20R420-TPRBF	SCC-20420-TPRBF-TLB	
		Thermo-Plastic Rubber (Donut)		SCC-20420-TPRBD	SCC-20R420-TPRBD	SCC-20420-TPRBF-TLB	
		Rubber on Cast Iron	400 lbs.	SCC-20420-RSB	SCC-20R420-RSB	SCC-20420-RSB-TLB	
		Rubber on Aluminum		SCC-20420-RAB	SCC-20R420-RAB	SCC-20420-RAB-TLB	
		Semi Steel	450 lbs.	SCC-20420-SSB	SCC-20R420-SSB	SCC-20420-SSB-TLB	
		Solid Polyurethane		SCC-20420-SPUB	SCC-20R420-SPUB	SCC-20420-SPUB-TLB	
		Polyurethane on Cast Iron (Red)		SCC-20420-PUB-RS	SCC-20R420-PUB-RS	SCC-20420-PUB-RS-TLB	
		Polyurethane on Cast Iron (Green)		SCC-20420-PUB-GB	SCC-20R420-PUB-GB	SCC-20420-PUB-GB-TLB	
		Polyurethane on Polyolefin		SCC-20420-PPUB	SCC-20R420-PPUB	SCC-20420-PPUB-TLB	
		Polyolefin		SCC-20420-POB	SCC-20R420-POB	SCC-20420-POB-TLB	
		High Temp Phenolic		SCC-20420-PHBHT	SCC-20R620-PHBHT	SCC-20420-PHBHT-TLB	
		Phenolic		SCC-20420-PHB	SCC-20R420-PHB	SCC-20420-PHB-TLB	
		Polyurethane on Aluminum		SCC-20420-PAB	SCC-20R420-PAB	SCC-20420-PAB-TLB	
		Nylon		SCC-20420-NYB	SCC-20R420-NYB	SCC-20420-NYB-TLB	
		Glass Filled Nylon		SCC-20420-GFNB	SCC-20R420-GFNB	SCC-20420-GFNB-TLB	
		V-Groove		SCC-20420-VGB	SCC-20R420-VGB	SCC-20420-VGB-TLB	
High Temp Glass Filled Nylon	SCC-20420-GFNBHT	SCC-20R420-GFNBHT		SCC-20S420-SSB-TLB			
5"	2"	Thermoplastic Rubber (Flat)		350 lbs.	SCC-20S520-TPRBF	SCC-20R520-TPRBF	SCC-20S520-TPRBF-TLB
		Thermoplastic Rubber (Donut)			SCC-20S520-TPRBD	SCC-20R520-TPRBD	SCC-20S520-TPRBD-TLB
		Rubber on Cast Iron		400 lbs.	SCC-20S520-RSB	SCC-20R520-RSB	SCC-20S520-RSB-TLB
		Rubber on Aluminum	SCC-20S520-RAB		SCC-20R520-RAB	SCC-20S520-RAB-TLB	
		Semi Steel	450 lbs.	SCC-20S520-SSB	SCC-20R520-SSB	SCC-20S520-SSB-TLB	
		Solid Polyurethane		SCC-20S520-SPUB	SCC-20R520-SPUB	SCC-20S520-SPUB-TLB	
		Polyurethane on Cast Iron (Red)		SCC-20S520-PUB-RS	SCC-20R520-PUB-RS	SCC-20S520-PUB-RS-TLB	
		Polyurethane on Cast Iron (Green)		SCC-20S520-PUB-GB	SCC-20R520-PUB-GB	SCC-20S520-PUB-GB-TLB	
		Polyurethane on Polyolefin		SCC-20S520-PPUB	SCC-20R520-PPUB	SCC-20S520-PPUB-TLB	
		Polyolefin		SCC-20S520-POB	SCC-20R520-POB	SCC-20S520-POB-TLB	
		High Temp Phenolic		SCC-20S520-PHBHT	SCC-20R520-PHBHT	SCC-20S520-PHBHT-TLB	
		Phenolic		SCC-20S520-PHB	SCC-20R520-PHB	SCC-20S520-PHB-TLB	
		Polyurethane on Aluminum		SCC-20S520-PAB	SCC-20R520-PAB	SCC-20S520-PAB-TLB	
		Nylon		SCC-20S520-NYB	SCC-20R520-NYB	SCC-20S520-NYB-TLB	
		Glass Filled Nylon		SCC-20S520-GFNB	SCC-20R520-GFNB	SCC-20S520-GFNB-TLB	
		V-Groove		SCC-20S520-VGB	SCC-20R520-VGB	SCC-20S520-VGB-TLB	
High Temp Glass Filled Nylon	SCC-20S520-GFNBHT	SCC-20R520-GFNBHT		SCC-20S520-GFNBHT-TLB			

IF YOU PREFER TO ORDER IN SETS, SIMPLY [CONTACT US](#), AND WE WILL TAILOR YOUR ORDERING PROCESS TO YOUR NEEDS.



Q34 features a **Sealed Precision Flanged Ball Bearing**, renowned for its sealed, hardened inner and outer raceways, along with hardened steel balls press-fitted into the hub. Designed for medium to heavy load capacities, higher operating speeds, and enhanced ergonomics, it outperforms roller bearings. This sealed Precision Ball Bearing presents a significant upgrade from industry-standard roller bearings.

Rubber wheels that won't scuff your floors and keep things quiet – ideal for any medical setting!



More ways to spin! Head over to the next page for the full scoop!



Standard Plate Size	Bolt Pattern	Bolt Diameter
2-3/8" x 3-5/8"	1-3/4" x 2-7/8" to 3"	5/16"

Wheel Diameter	Overall Height	Swivel Radius	Approximate Weight <small>lbs</small>
3"	4-1/8"	2-15/16"	1.45
4"	4-5/8"	3-3/16"	1.6
5"	5-1/8"	3-1/2"	1.7
6"	6-1/8"	4"	2



TOP PLATE CASTERS *Ball Bearing Wheels*

[CLICK TO ORDER NOW](#)

Wheel Dia	Tread Width	Wheel Type	Load Capacity	Swivel Caster	Rigid Caster	Swivel with Brake (TLB)
6"	2"	Thermoplastic Rubber (Flat)	450 lbs.	SCC-20S620-TPRBF	SCC-20R620-TPRBF	SCC-20S620-TPRBF-TLB
		Thermoplastic Rubber (Donut)		SCC-20S620-TPRBD	SCC-20R620-TPRBD	SCC-20S620-TPRBD-TLB
		Rubber on Cast Iron		SCC-20S620-RSB	SCC-20R620-RSB	SCC-20S620-RSB-TLB
		Rubber on Aluminum		SCC-20S620-RAB	SCC-20R620-RAB	SCC-20S620-RAB-TLB
		Semi Steel		SCC-20S620-SSB	SCC-20R620-SSB	SCC-20S620-SSB-TLB
		Solid Polyurethane		SCC-20S620-SPUB	SCC-20R620-SPUB	SCC-20S620-SPUB-TLB
		Polyurethane on Cast Iron (Red)		SCC-20S620-PUB-RS	SCC-20R620-PUB-RS	SCC-20S620-PUB-RS-TLB
		Polyurethane on Cast Iron (Green)		SCC-20S620-PUB-GB	SCC-20R620-PUB-GB	SCC-20S620-PUB-GB-TLB
		Polyurethane on Polyolefin		SCC-20S620-PPUB	SCC-20R620-PPUB	SCC-20S620-PPUB-TLB
		Polyolefin		SCC-20S620-POB	SCC-20R620-POB	SCC-20S620-POB-TLB
		High Temp Phenolic		SCC-20S620-PHBHT	SCC-20R620-PHBHT	SCC-20S620-PHBHT-TLB
		Phenolic		SCC-20S620-PHB	SCC-20R620-PHB	SCC-20S620-PHB-TLB
		Polyurethane on Aluminum		SCC-20S620-PAB	SCC-20R620-PAB	SCC-20S620-PAB-TLB
		Nylon		SCC-20S620-NYB	SCC-20R620-NYB	SCC-20S620-NYB-TLB
		Glass Filled Nylon		SCC-20S620-GFNB	SCC-20R620-GFNB	SCC-20S620-GFNB-TLB
		V-Groove		SCC-20S620-VGB	SCC-20R620-VGB	SCC-20S620-VGB-TLB
High Temp Glass Filled Nylon	SCC-20S620-GFNBHT	SCC-20R620-GFNBHT	SCC-20S620-SSB-TLB			



CHOOSE SERVICE CASTER CORPORATION CASTERS AND WHEELS FOR **HIGH-TEMPERATURE** ENVIRONMENTS. OPTIONS INCLUDE HEAT-RESISTANT CASTERS FOR BAKERIES, AUTOCLAVE WHEELS, POWDER COAT ROOM CASTERS, AND ROLLING OVEN RACK WHEELS. MAKE SURE TO SELECT THE RIGHT LUBRICANT FOR YOUR SPECIFIC APPLICATION.

TOP PLATE CASTERS *Bronze Bearing Wheels*

[CLICK TO ORDER NOW](#)

Wheel Dia	Tread Width	Wheel Type	Load Capacity	Swivel Caster	Rigid Caster	Swivel with Brake (TLB)
4"	2"	V-Groove	450 lbs.	SCC-20S420-VGBZ	SCC-20R420-VGBZ	SCC-20S420-VGBZ-TLB
		Semi Steel		SCC-20S420-SSBZ	SCC-20R420-SSBZ	SCC-20S420-SSBZ-TLB
		High Temp Phenolic		SCC-20S420-PHBZHT	SCC-20R420-PHBZHT	SCC-20S420-PHBZHT-TLB
		High Temp Glass Filled Nylon		SCC-20S420-GFNBZHT	SCC-20R420-GFNBZHT	SCC-20S420-GFNBZHT-TLB
5"	2"	V-Groove		SCC-20S520-VGBZ	SCC-20R520-VGBZ	SCC-20S520-VGBZ-TLB
		Semi Steel		SCC-20S520-SSBZ	SCC-20R520-SSBZ	SCC-20S520-SSBZ-TLB
		High Temp Phenolic		SCC-20S520-PHBZHT	SCC-20R520-PHBZHT	SCC-20S520-PHBZHT-TLB
		High Temp Glass Filled Nylon		SCC-20S520-GFNBZHT	SCC-20R520-GFNBZHT	SCC-20S520-GFNBZHT-TLB
6"	2"	V-Groove		SCC-20S620-VGBZ	SCC-20R620-VGBZ	SCC-20S620-VGBZ-TLB
		Semi Steel		SCC-20S620-SSBZ	SCC-20R620-SSBZ	SCC-20S620-SSBZ-TLB
		High Temp Phenolic		SCC-20S620-PHBZHT	SCC-20R620-PHBZHT	SCC-20S620-PHBZHT-TLB
		High Temp Glass Filled Nylon		SCC-20S620-GFNBZHT	SCC-20R620-GFNBZHT	SCC-20S620-GFNBZHT-TLB

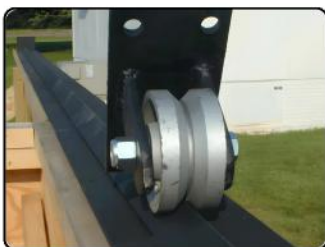

V GROOVE WHEELS PROVIDE HIGH-CAPACITY TRACKED WORKFLOW SOLUTIONS AND CAN ALSO BE USED WITHOUT A TRACK. THE WHEELS LISTED BELOW FOR IMMEDIATE PURCHASE REPRESENT JUST A SMALL PORTION OF OUR FULL RANGE OF V-GROOVE AND U-GROOVE OPTIONS.

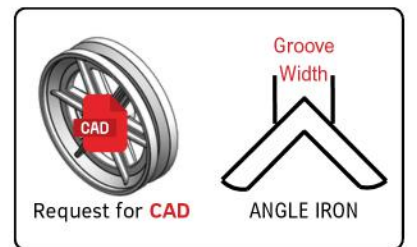

Roll into the next exciting chapter of **Series 20** mounting options for casters and wheels!

Medium Duty Casters

Series #20 Bolt Hole Casters

Discover our #20 Series bolt hole casters: strong, versatile, and perfect for a range of applications. Built with high-strength steel and double ball bearing raceways, they offer durability and reliability.

Applications

- Bakery equipment
- Stocking carts
- Moving dollies
- Food service operations
- Office equipment
- Laboratory equipment



Features

- Heat treated double ball bearing raceways for durability
- 1/2" Bolt Hole
- Versatile design suitable for various applications
- Explore our wide selection of 1-1/4" wheel mounting stems.

3" Swivel Bolt Hole with Top Lock Brake

SCC-BH20S314-PPUB-TLB

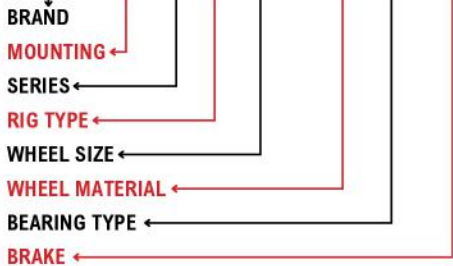

4" Swivel Bolt Hole with Total Lock Brake

SCC-BHTTL20S414-PPUB

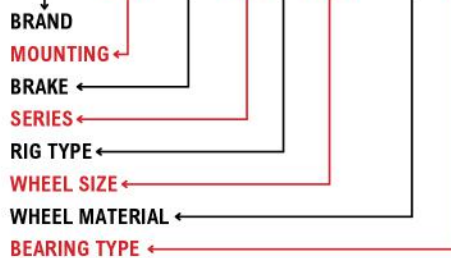

Our part numbers are adaptable to suit your requirements. The diagram above serves as a reference to assist you in understanding the breakdown. If you require any help, please don't hesitate to contact our [customer service](#) team.

Service Caster Chart Guide

Build You Caster

Discover more fastening sizes and wheel options if you can't find what you need. And remember, we're always here to [help!](#)

Brand	Series	Rig Type	Wheel Size	Wheel Material	Bearing Type	Brake	Mounting
Service Caster	20	Swivel (S)	2-1/2" x 1-1/4" (2514)	Soft Rubber (SR)	Ball Bearing (B)	Top Lock (TLB)	1/2" Bolt Hole (BH)
			3-1/2" x 1-1/4" (3514)	Thermo Plastic Rubber (TPR)	Plain Bore (S)	Posi Lock (PLB)	
			3" x 1-1/4" (314)	Polyurethane (PPU)	Delrin Bearing (D)	Total Lock (TTL)	
			4" x 1-1/4" (414)	Phenolic (PH)		Directional Lock (DL)	
			5" x 1-1/4" (514)	Solid Polyurethane (SPU)			
			6" x 1-1/4" (614)	Hard Rubber (HR)			
				Glass Filled Nylon (GFN)			
				Rubber on Aluminum (RA)			
				Semi Steel (SS)			
				Nylon (NY)			
				Polyolefin (PO)			
				High Temp (HT)			

So many ways to showcase your style!



Choose Your Color



Wheel Tread





BOLT HOLE (HOLLOW KINGPIN) CASTERS

Wheel Diameter	Overall Height	Swivel Radius	Approximate Weight <small>lbs</small>
3"	4-1/8"	2-15/16"	1.45
3-1/2"	4-5/8"	3-3/16"	1.6
4"	5-1/8"	3-1/2"	1.7
5"	6-1/8"	4"	2
6"	7-1/8"	4-9/16"	2.95

Wheel Dia	Tread Width	Wheel Type	Load Capacity	Bearing Type	Swivel Caster	Overall Height	Color			
3"	1-1/4"	Soft Rubber	175 lbs.	Plain Bore	SCC-BH20S314-SRS	4-1/8"	Black			
		Thermoplastic Rubber	210 lbs.	Ball Bearing	SCC-BH20S314-TPRB		Gray			
		Hard Rubber	275 lbs.	Plain Bore	SCC-BH20S314-HRS		Black			
		Nylon	300 lbs.	Plain Bore	SCC-BH20S314-NYS		White			
		Phenolic		Roller Bearing	SCC-BH20S314-PHR		Black			
		HT Phenolic		Roller Bearing	SCC-BH20S314-PHRHT		Brown			
		Polyolefin		Plain Bore	SCC-BH20S314-POS		Black			
		Phenolic		Plain Bore	SCC-BH20S314-PHS		Black			
		HT Phenolic		Plain Bore	SCC-BH20S314-PHSHT		Brown			
		Polyurethane		Ball Bearing	SCC-BH20S314-PPUB					
		Solid Polyurethane		Plain Bore	SCC-BH20S314-SPUS		Blue			
		Semi Steel		Plain Bore	SCC-BH20S314-SSS		Silver			
		HT Glass Filled Nylon		Plain Bore	SCC-BH20S314-GFNSHT		Brown or Black			
3-1/2"	1-1/4"	Soft Rubber	200 lbs.	Plain Bore	SCC-BH20S3514-SRS	4-5/8"	Black			
		Thermoplastic Rubber	230 lbs.	Ball Bearing	SCC-BH20S3514-TPRB		Gray			
		Hard Rubber	285 lbs.	Plain Bore	SCC-BH20S3514-HRS		Black			
		Solid Polyurethane	300 lbs.	Plain Bore	SCC-BH20S3514-SPUS		Blue			
		Polyurethane		Ball Bearing	SCC-BH20S3514-PPUB					
		Phenolic		Plain Bore	SCC-BH20S3514-PHS		Black			
		Phenolic		Roller Bearing	SCC-BH20S3514-PHR		Black			
		HT Glass Filled Nylon		Plain Bore	SCC-BH20S3514-GFNSHT		Black or Brown			
		4"		1-1/4"	Soft Rubber		200 lbs.	Plain Bore	SCC-BH20S414-SRS	5-1/8"
			Thermoplastic Rubber		250 lbs.		Ball Bearing	SCC-BH20S414-TPRB	Gray	
Hard Rubber	300 lbs.		Plain Bore		SCC-BH20S414-HRS	Black				
Nylon			Plain Bore		SCC-BH20S414-NYS	White				
Semi Steel			Plain Bore		SCC-BH20S414-SSS	Silver				
Solid Polyurethane			Plain Bore		SCC-BH20S414-SPUS	Blue				
Phenolic			Roller Bearing		SCC-BH20S414-PHR	Black				
HT Phenolic			Plain Bore		SCC-BH20S414-PHRHT	Brown				
Phenolic			Plain Bore		SCC-BH20S414-PHS	Black				
HT Phenolic			Plain Bore		SCC-BH20S414-PHSHT	Brown				
Polyurethane			Ball Bearing		SCC-BH20S414-PPUB					
Polyolefin			Plain Bore		SCC-BH20S414-POS	Black				
HT Glass Filled Nylon	Plain Bore		SCC-BH20S414-GFNSHT		Black or Brown					
5"	1-1/4"	Soft Rubber	275 lbs.	Plain Bore	SCC-BH20S514-SRS	6-1/8"	Black			
		Thermoplastic Rubber	300 lbs.	Ball Bearing	SCC-BH20S514-TPRB		Gray			
		Hard Rubber		Plain Bore	SCC-BH20S514-HRS		Black			
		Nylon		Plain Bore	SCC-BH20S514-NYS		White			
		Phenolic		Roller Bearing	SCC-BH20S514-PHR		Black			
		HT Phenolic		Roller Bearing	SCC-BH20S514-PHRHT		Brown			
		Phenolic		Plain Bore	SCC-BH20S514-PHS		Black			
		HT Phenolic		Plain Bore	SCC-BH20S514-PHSHT		Brown			
		Semi Steel		Plain Bore	SCC-BH20S514-SSS		Silver			
		Solid Polyurethane		Plain Bore	SCC-BH20S514-SPUS		Blue			
		Polyolefin		Plain Bore	SCC-BH20S514-POS		Black			
		Polyurethane	Ball Bearing	SCC-BH20S514-PPUB						
		HT Glass Filled Nylon	Plain Bore	SCC-BH20S514-GFNSHT	Black or Brown					
6"	1-1/4"	Thermoplastic Rubber	300 lbs.	Ball Bearing	SCC-BH20S614-TPRB	7-1/8"	Gray			
		Polyurethane	350 lbs.	Ball Bearing	SCC-BH20S614-PPUB		Gray			
	1-1/2"	Phenolic	300 lbs.	Plain Bore	SCC-BH20S615-PHS		Black			
		Phenolic		Roller Bearing	SCC-BH20S615-PHR		Black			
		High Temp Phenolic		Plain Bore	SCC-BH20S615-PHSHT		Brown			
		High Temp Phenolic		Roller Bearing	SCC-BH20S615-PHRHT		Brown			

EXPLORE OUR DIVERSE MOUNTING OPTIONS IN OUR BOLT HOLE CASTER SERIES. FOR FURTHER ASSISTANCE, CONTACT OUR [CUSTOMER SERVICE](#).



"New Swag Alert: Place Your Orders Now!"

CALL OR EMAIL US FOR MORE OPTIONS 1-800-215-8220 / info@servicecaster.com

Need more options? Simply flip the page for a world of possibilities!



BOLT HOLE (HOLLOW KINGPIN) CASTERS *with Brakes*

Wheel Diameter	Overall Height	Swivel Radius	Approximate Weight
3"	4-1/8"	2-15/16"	1.45
3-1/2"	4-5/8"	3-3/16"	1.6
4"	5-1/8"	3-1/2"	1.7
5"	6-1/8"	4"	2
6"	7-1/8"	4-9/16"	2.95

Wheel Dia	Tread Width	Wheel Type	Load Capacity	Bearing Type	Top Lock Brake (TLB)	Posi Lock Brake (PLB)	Total Lock (TTL)
3"	1-1/4"	Soft Rubber	175 lbs.	Plain Bore	SCC-BH20S314-SRS-TLB	SCC-BH20S314-SRS-PLB	SCC-BHTTL20S314-SRS
		Thermoplastic Rubber	210 lbs.	Ball Bearing	SCC-BH20S314-TPRB-TLB	SCC-BH20S314-TPRB-PLB	SCC-BHTTL20S314-TPRB
		Hard Rubber	275 lbs.	Plain Bore	SCC-BH20S314-HRS-TLB	SCC-BH20S314-HRS-PLB	SCC-BHTTL20S314-HRS
		Nylon	300 lbs.	Plain Bore	SCC-BH20S314-NYS-TLB	SCC-BH20S314-NYS-PLB	SCC-BHTTL20S314-NYS
		Phenolic		Roller Bearing	SCC-BH20S314-PHR-TLB	SCC-BH20S314-PHR-PLB	SCC-BHTTL20S314-PHR
		HT Phenolic		Plain Bore	SCC-BH20S314-PHRHT-TLB	SCC-BH20S314-PHRHT-PLB	SCC-BHTTL20S314-PHRHT
		Phenolic		Plain Bore	SCC-BH20S314-PHS-TLB	SCC-BH20S314-PHS-PLB	SCC-BHTTL20S314-PHS
		HT Phenolic		Plain Bore	SCC-BH20S314-PHSHT-TLB	SCC-BH20S314-PHSHT-PLB	SCC-BHTTL20S314-PHSHT
		Polyurethane		Ball Bearing	SCC-BH20S314-PPUB-TLB	SCC-BH20S314-PPUB-PLB	SCC-BHTTL20S314-PPUB
		Solid Polyurethane		Plain Bore	SCC-BH20S314-SPUS-TLB	SCC-BH20S314-SPUS-PLB	SCC-BHTTL20S314-SPUS
		Semi Steel	Plain Bore	SCC-BH20S314-SSS-TLB	SCC-BH20S314-SSS-PLB	SCC-BHTTL20S314-SSS	
HT Glass Filled Nylon	350 lbs.	Plain Bore	SCC-BH20S314-GFNSHT-TLB	SCC-BH20S314-GFNSHT-PLB	SCC-BHTTL20S314-GFNSHT		
3-1/2"	1-1/4"	Soft Rubber	200 lbs.	Plain Bore	SCC-BH20S3514-SRS-TLB	SCC-BH20S3514-SRS-PLB	SCC-BHTTL20S3514-SRS
		Thermoplastic Rubber	230 lbs.	Ball Bearing	SCC-BH20S3514-TPRB-TLB	SCC-BH20S3514-TPRB-PLB	SCC-BHTTL20S3514-TPRB
		Hard Rubber	285 lbs.	Plain Bore	SCC-BH20S3514-HRS-TLB	SCC-BH20S3514-HRS-PLB	SCC-BHTTL20S3514-HRS
		Phenolic	300 lbs.	Roller Bearing	SCC-BH20S3514-PHR-TLB	SCC-BH20S3514-PHR-PLB	SCC-BHTTL20S3514-PHR
		Phenolic		Plain Bore	SCC-BH20S3514-PHS-TLB	SCC-BH20S3514-PHS-PLB	SCC-BHTTL20S3514-PHS
		Polyurethane		Ball Bearing	SCC-BH20S3514-PPUB-TLB	SCC-BH20S3514-PPUB-PLB	SCC-BHTTL20S3514-PPUB
		Solid Polyurethane	Plain Bore	SCC-BH20S3514-SPUS-TLB	SCC-BH20S3514-SPUS-PLB	SCC-BHTTL20S3514-SPUS	
HT Glass Filled Nylon	350 lbs.	Plain Bore	SCC-BH20S3514-GFNSHT-TLB	SCC-BH20S3514-GFNSHT-PLB	SCC-BHTTL20S3514-GFNSHT		
4"	1-1/4"	Soft Rubber	200 lbs.	Plain Bore	SCC-BH20S414-SRS-TLB	SCC-BH20S414-SRS-PLB	SCC-BHTTL20S414-SRS
		Thermoplastic Rubber	250 lbs.	Ball Bearing	SCC-BH20S414-TPRB-TLB	SCC-BH20S414-TPRB-PLB	SCC-BHTTL20S414-TPRB
		Hard Rubber	300 lbs.	Plain Bore	SCC-BH20S414-HRS-TLB	SCC-BH20S414-HRS-PLB	SCC-BHTTL20S414-HRS
		Phenolic		Roller Bearing	SCC-BH20S414-PHR-TLB	SCC-BH20S414-PHR-PLB	SCC-BHTTL20S414-PHR
		Phenolic		Plain Bore	SCC-BH20S414-PHS-TLB	SCC-BH20S414-PHS-PLB	SCC-BHTTL20S414-PHS
		Semi Steel		Plain Bore	SCC-BH20S414-SSS-TLB	SCC-BH20S414-SSS-PLB	SCC-BHTTL20S414-SSS
		Solid Polyurethane		Plain Bore	SCC-BH20S414-SPUS-TLB	SCC-BH20S414-SPUS-PLB	SCC-BHTTL20S414-SPUS
		High Temp Phenolic		Roller Bearing	SCC-BH20S414-PHRHT-TLB	SCC-BH20S414-PHRHT-PLB	SCC-BHTTL20S414-PHRHT
		Nylon		Plain Bore	SCC-BH20S414-NYS-TLB	SCC-BH20S414-NYS-PLB	SCC-BHTTL20S414-NYS
		High Temp Phenolic	Plain Bore	SCC-BH20S414-PHSHT-TLB	SCC-BH20S414-PHSHT-PLB	SCC-BHTTL20S414-PHSHT	
		Polyurethane	350 lbs.	Ball Bearing	SCC-BH20S414-PPUB-TLB	SCC-BH20S414-PPUB-PLB	SCC-BHTTL20S414-PPUB
HT Glass Filled Nylon	Plain Bore	SCC-BH20S414-GFNSHT-TLB	SCC-BH20S414-GFNSHT-PLB	SCC-BHTTL20S414-GFNSHT			
5"	1-1/4"	Soft Rubber	275 lbs.	Plain Bore	SCC-BH20S514-SRS-TLB	SCC-BH20S514-SRS-PLB	SCC-BHTTL20S514-SRS
		Thermoplastic Rubber	300 lbs.	Ball Bearing	SCC-BH20S514-TPRB-TLB	SCC-BH20S514-TPRB-PLB	SCC-BHTTL20S514-TPRB
		Hard Rubber		Plain Bore	SCC-BH20S514-HRS-TLB	SCC-BH20S514-HRS-PLB	SCC-BHTTL20S514-HRS
		Nylon		Plain Bore	SCC-BH20S514-NYS-TLB	SCC-BH20S514-NYS-PLB	SCC-BHTTL20S514-NYS
		Phenolic		Roller Bearing	SCC-BH20S514-PHR-TLB	SCC-BH20S514-PHR-PLB	SCC-BHTTL20S514-PHR
		High Temp Phenolic		Roller Bearing	SCC-BH20S514-PHRHT-TLB	SCC-BH20S514-PHRHT-PLB	SCC-BHTTL20S514-PHRHT
		Phenolic		Plain Bore	SCC-BH20S514-PHS-TLB	SCC-BH20S514-PHS-PLB	SCC-BHTTL20S514-PHS
		High Temp Phenolic		Plain Bore	SCC-BH20S514-PHSHT-TLB	SCC-BH20S514-PHSHT-PLB	SCC-BHTTL20S514-PHSHT
		Solid Polyurethane	Plain Bore	SCC-BH20S514-SPUS-TLB	SCC-BH20S514-SPUS-PLB	SCC-BHTTL20S514-SPUS	
		Semi Steel	Plain Bore	SCC-BH20S514-SSS-TLB	SCC-BH20S514-SSS-PLB	SCC-BHTTL20S514-SSS	
		Polyurethane	350 lbs.	Ball Bearing	SCC-BH20S514-PPUB-TLB	SCC-BH20S514-PPUB-PLB	SCC-BHTTL20S514-PPUB
		HT Glass Filled Nylon	Plain Bore	SCC-BH20S514-GFNSHT-TLB	SCC-BH20S514-GFNSHT-PLB	SCC-BHTTL20S514-GFNSHT	
	1-1/2"	Semi Steel	300 lbs.	Roller Bearing	SCC-BH20S515-SSR-TLB	SCC-BH20S515-SSR-PLB	SCC-BHTTL20S515-SSR
6"	1-1/4"	Thermoplastic Rubber	300 lbs.	Ball Bearing	SCC-BHTTL20S614-TPRB-TLB	SCC-BHTTL20S614-TPRB-PLB	SCC-BHTTL20S614-TPRB

EXPLORE OUR DIVERSE MOUNTING OPTIONS IN OUR BOLT HOLE CASTER SERIES. FOR FURTHER ASSISTANCE, CONTACT OUR [CUSTOMER SERVICE](#).

What are Swivel Casters?

Swivel Casters, Also known as Swivel Castors, consist of a wheel mounted into a fork with a ball bearing swivel mechanism, allowing the wheel to rotate 360° around its pivotal point.



This Rotation Enables the Wheel and the equipment it supports to move in any desired direction effortlessly, allowing operators to maneuver equipment without changing its orientation.

Explore our web-based storefront. www.servicacaster.com

Medium Duty Casters

Series #20 Expanding Adapter Casters

Our expanding adapter stem casters fit both square and round tube legs, adapting to various inside diameters. Ideal for prep tables, work tables, racks, and shop projects, they offer a variety of wheel types, including floor-safe polyurethane for easy rolling.

Applications

- Bakery equipment
- Stocking carts
- Moving dollies
- Food service operations
- Office equipment
- Laboratory equipment

Features

- Heat treated double ball bearing raceways for durability
- 1/2" precision kingpin for stability
- Versatile design suitable for various applications
- Ideal for light duty industrial use

Excellent Verified



4" Swivel Expanding Stem Caster with Posi Lock Brake

SCC-EX20S414-TPRB-PLB-78

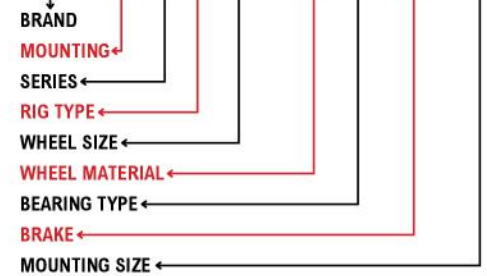

4" Swivel Expanding Stem Caster with Total Lock Brake

SCC-EXTTL20S414-PPUB-34

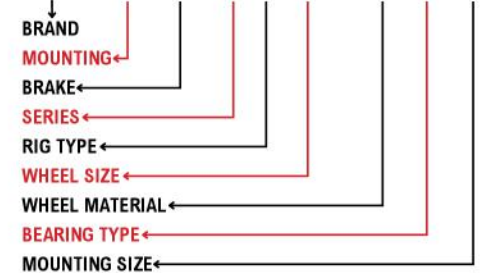

Our part numbers are adaptable to suit your requirements. The diagram above serves as a reference to assist you in understanding the breakdown. If you require any help, please don't hesitate to contact our [customer service](#) team.

Service Caster Chart Guide

Build You Caster

Discover more fastening sizes and wheel options if you can't find what you need. And remember, we're always here to [help!](#)

Brand	Mounting	Series	Rig Type	Bearing Type	Brake	Wheel Size	Mounting Size	Wheel Material
Service Caster	Expanding Adapter (EX)	20	Swivel (S)	Ball Bearing (B)	Top Lock (TLB)	2-1/2" x 1-1/4" (2514)	3/4" (34)	Soft Rubber (SR)
			Rigid (R)	Plain Bore (S)	Posi Lock (PLB)	3-1/2" x 1-1/4" (3514)	7/8" (78)	Thermo Plastic Rubber (TPR)
				Delrin Bearing (D)	Total Lock (TTL)	3" x 1-1/4" (314)	1" (1)	Polyurethane (PPU)
				Roller Bearing (R)	Directional Lock (DL)	4" x 1-1/4" (414)	1-1/8" (118)	Phenolic (PH)
						5" x 1-1/4" (514)	1-1/4" (114)	Solid Polyurethane (SPU)
						6" x 1-1/4" (614)	1-3/8" (138)	Hard Rubber (HR)
							1-1/2" (112)	Glass Filled Nylon (GFN)
							1-5/8" (158)	Rubber on Aluminum (RA)
							1-3/4" (134)	Semi Steel (SS)
							1-7/8" (178)	Nylon (NY)
					Polyolefin (PO)			
					High Temp (HT)			



Wheel Tread

Choose Your Color

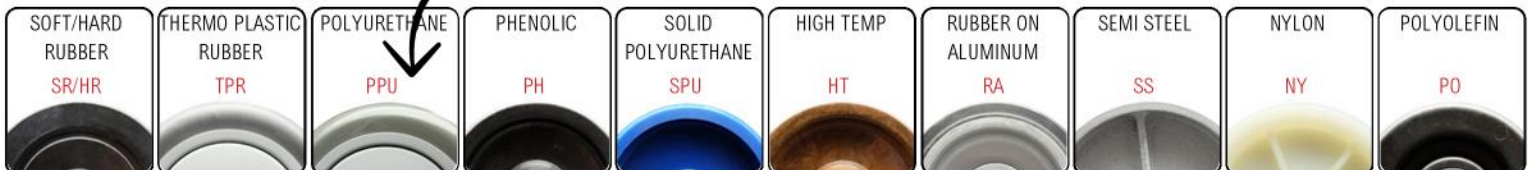



Choose Your Size

Mounting Size	Mounting Size	Wheel Diameter	Overall Height	Swivel Radius	Approximate Weight
3/4" (34)	1-3/8" (138)	3"	4-1/8"	2-15/16"	1.45
7/8" (78)	1-1/2" (112)	3-1/2"	4-5/8"	3-3/16"	1.6
1" (1)	1-5/8" (158)	4"	5-1/8"	3-1/2"	1.7
1-1/8" (118)	1-3/4" (134)	5"	6-1/8"	4"	2
1-1/4" (114)	1-7/8" (178)	6"	7-1/8"	4-9/16"	2.95

EXPANDING STEM CASTERS

Wheel Dia	Tread Width	Wheel Type	Load Capacity	Bearing Type	Swivel Caster	Stem Size (Expanding Adapter)	Color
3"	1-1/4"	Soft Rubber	175 lbs.	Plain Bore	SCC-EX20S314-SRS-*	34 , 78 , 118 , 114 , 138 , 112 , 158 , 134 , 178	Black
		Thermoplastic Rubber	210 lbs.	Ball Bearing	SCC-EX20S314-TPRB-*	34 , 78 , 118 , 114 , 138 , 112 , 158 , 134 , 178	Gray
		Hard Rubber	275 lbs.	Plain Bore	SCC-EX20S314-HRS-*	34 , 78 , 118 , 114 , 138 , 112 , 158 , 134 , 178	Black
		Nylon	300 lbs.	Plain Bore	SCC-EX20S314-NYS-*	34 , 78 , 118 , 114 , 138 , 112 , 158 , 134 , 178	White
		Semi Steel		Plain Bore	SCC-EX20S314-SSS-*	34 , 78 , 118 , 114 , 138 , 112 , 158 , 134 , 178	Silver
		Phenolic		Roller Bearing	SCC-EX20S314-PHR-*	34 , 78 , 118 , 114 , 138 , 112 , 158 , 134 , 178	Black
		Phenolic		Plain Bore	SCC-EX20S314-PHS-*	34 , 78 , 118 , 114 , 138 , 112 , 158 , 134 , 178	Black
		Polyurethane		Ball Bearing	SCC-EX20S314-PPUB-*	34 , 78 , 118 , 114 , 138 , 112 , 158 , 134 , 178	
	Solid Polyurethane	Plain Bore		SCC-EX20S314-SPUS-*	34 , 78 , 118 , 114 , 138 , 112 , 158 , 134 , 178	Blue	
	1-1/2"	Semi Steel	Roller Bearing	SCC-EX20S315-SSR-*	34 , 78 , 118 , 114 , 138 , 112 , 158 , 134 , 178	Silver	
3-1/2"	1-1/4"	Soft Rubber	200 lbs.	Plain Bore	SCC-EX20S3514-SRS-*	34 , 78 , 118 , 114 , 138 , 112 , 158 , 134 , 178	Black
		Thermoplastic Rubber	230 lbs.	Ball Bearing	SCC-EX20S3514-TPRB-*	34 , 78 , 118 , 114 , 138 , 112 , 158 , 134 , 178	Gray
		Hard Rubber	285 lbs.	Plain Bore	SCC-EX20S3514-HRS-*	34 , 78 , 118 , 114 , 138 , 112 , 158 , 134 , 178	Black
		Phenolic	300 lbs.	Roller Bearing	SCC-EX20S3514-PHR-*	34 , 78 , 118 , 114 , 138 , 112 , 158 , 134 , 178	Black
		Phenolic		Plain Bore	SCC-EX20S3514-PHS-*	34 , 78 , 118 , 114 , 138 , 112 , 158 , 134 , 178	Black
		Polyurethane		Ball Bearing	SCC-EX20S3514-PPUB-*	34 , 78 , 118 , 114 , 138 , 112 , 158 , 134 , 178	
		Solid Polyurethane		Plain Bore	SCC-EX20S3514-SPUS-*	34 , 78 , 118 , 114 , 138 , 112 , 158 , 134 , 178	Blue
4"	1-1/4"	Soft Rubber		200 lbs.	Plain Bore	SCC-EX20S414-SRS-*	34 , 78 , 118 , 114 , 138 , 112 , 158 , 134 , 178
		Thermoplastic Rubber	250 lbs.	Ball Bearing	SCC-EX20S414-TPRB-*	34 , 78 , 118 , 114 , 138 , 112 , 158 , 134 , 178	Gray
		Hard Rubber	300 lbs.	Plain Bore	SCC-EX20S414-HRS-*	34 , 78 , 118 , 114 , 138 , 112 , 158 , 134 , 178	Black
		Semi Steel		Plain Bore	SCC-EX20S414-SSS-*	34 , 78 , 118 , 114 , 138 , 112 , 158 , 134 , 178	Silver
		Solid Polyurethane		Plain Bore	SCC-EX20S414-SPUS-*	34 , 78 , 118 , 114 , 138 , 112 , 158 , 134 , 178	Blue
		Nylon		Plain Bore	SCC-EX20S414-NYS-*	34 , 78 , 118 , 114 , 138 , 112 , 158 , 134 , 178	White
		Phenolic		Roller Bearing	SCC-EX20S414-PHR-*	34 , 78 , 118 , 114 , 138 , 112 , 158 , 134 , 178	Black
		Semi Steel		Roller Bearing	SCC-EX20S414-SSR-*	34 , 78 , 118 , 114 , 138 , 112 , 158 , 134 , 178	Silver
		Phenolic		Plain Bore	SCC-EX20S414-PHS-*	34 , 78 , 118 , 114 , 138 , 112 , 158 , 134 , 178	Black
		Polyurethane		350 lbs.	Ball Bearing	SCC-EX20S414-PPUB-*	34 , 78 , 118 , 114 , 138 , 112 , 158 , 134 , 178
5"	1-1/4"	Soft Rubber	275 lbs.	Plain Bore	SCC-EX20S514-SRS-*	34 , 78 , 118 , 114 , 138 , 112 , 158 , 134 , 178	Black
		Thermoplastic	300 lbs.	Ball Bearing	SCC-EX20S514-TPRB-*	34 , 78 , 118 , 114 , 138 , 112 , 158 , 134 , 178	Gray
		Hard Rubber	350 lbs.	Plain Bore	SCC-EX20S514-HRS-*	34 , 78 , 118 , 114 , 138 , 112 , 158 , 134 , 178	Black
		Nylon		Plain Bore	SCC-EX20S514-NYS-*	34 , 78 , 118 , 114 , 138 , 112 , 158 , 134 , 178	White
		Solid Polyurethane		Plain Bore	SCC-EX20S514-SPUS-*	34 , 78 , 118 , 114 , 138 , 112 , 158 , 134 , 178	Blue
		Phenolic		Roller Bearing	SCC-EX20S514-PHR-*	34 , 78 , 118 , 114 , 138 , 112 , 158 , 134 , 178	Black
		Semi Steel		Plain Bore	SCC-EX20S514-SSS-*	34 , 78 , 118 , 114 , 138 , 112 , 158 , 134 , 178	Silver
		Phenolic		Plain Bore	SCC-EX20S514-PHS-*	34 , 78 , 118 , 114 , 138 , 112 , 158 , 134 , 178	Black
		Polyurethane		Ball Bearing	SCC-EX20S514-PPUB-*	34 , 78 , 118 , 114 , 138 , 112 , 158 , 134 , 178	
	1-1/2"	Semi Steel		Roller Bearing	SCC-EX20S515-SSR-*	34 , 78 , 118 , 114 , 138 , 112 , 158 , 134 , 178	Silver
6"	1-1/4"	Thermoplastic Rubber	300 lbs.	Ball Bearing	SCC-EX20S614-TPRB-*	34 , 78 , 118 , 114 , 138 , 112 , 158 , 134 , 178	Gray

EXPLORE OUR DIVERSE MOUNTING OPTIONS IN OUR EXPANDING STEM CASTER SERIES. FOR FURTHER ASSISTANCE, CONTACT OUR [CUSTOMER SERVICE](#).

Use this chart to determine stem size and its corresponding part number.



Looking for **Locking** Casters? Roll on Over to the Next Page!



Choose Your Size →

Mounting Size	Mounting Size	Wheel Diameter	Overall Height	Swivel Radius	Aproximate Weight
3/4" (34)	1-3/8" (138)	3"	4-1/8"	2-15/16"	1.45
7/8" (78)	1-1/2" (112)	3-1/2"	4-5/8"	3-3/16"	1.6
1" (1)	1-5/8" (158)	4"	5-1/8"	3-1/2"	1.7
1-1/8" (118)	1-3/4" (134)	5"	6-1/8"	4"	2
1-1/4" (114)	1-7/8" (178)	6"	7-1/8"	4-9/16"	2.95

EXPANDING STEM CASTERS *with Total Lock Brakes*

Wheel Dia	Tread Width	Wheel Type	Load Capacity	Bearing Type	TTL	Stem Size (Expanding Adapter)	Color
3"	1-1/4"	Soft Rubber	175 lbs.	Plain Bore	SCC-EXTTL20S314-SRS-*	34, 78, 1, 118, 114, 138, 112, 158, 134, 178	Black
		Thermoplastic Rubber	210 lbs.	Ball Bearing	SCC-EXTTL20S314-TPRB-*	34, 78, 1, 118, 114, 138, 112, 158, 134, 178	Gray
		Hard Rubber	275 lbs.	Plain Bore	SCC-EXTTL20S314-HRS-*	34, 78, 1, 118, 114, 138, 112, 158, 134, 178	Black
		Nylon	300 lbs.	Plain Bore	SCC-EXTTL20S314-NYS-*	34, 78, 1, 118, 114, 138, 112, 158, 134, 178	White
		Phenolic		Roller Bearing	SCC-EXTTL20S314-PHR-*	34, 78, 1, 118, 114, 138, 112, 158, 134, 178	Black
		Phenolic		Plain Bore	SCC-EXTTL20S314-PHS-*	34, 78, 1, 118, 114, 138, 112, 158, 134, 178	Black
		Polyurethane		Ball Bearing	SCC-EXTTL20S314-PPUB-*	34, 78, 1, 118, 114, 138, 112, 158, 134, 178	
		Solid Polyurethane		Plain Bore	SCC-EXTTL20S314-SPUS-*	34, 78, 1, 118, 114, 138, 112, 158, 134, 178	Blue
	Semi Steel	Plain Bore		SCC-EXTTL20S314-SSS-*	34, 78, 1, 118, 114, 138, 112, 158, 134, 178	Silver	
	1-1/2"	Semi Steel	Roller Bearing	SCC-EXTTL20S315-SSR-*	34, 78, 1, 118, 114, 138, 112, 158, 134, 178	Silver	
3-1/2"	1-1/4"	Soft Rubber	200 lbs.	Plain Bore	SCC-EXTTL20S3514-SRS-*	34, 78, 1, 118, 114, 138, 112, 158, 134, 178	Black
		Thermoplastic Rubber	230 lbs.	Ball Bearing	SCC-EXTTL20S3514-TPRB-*	34, 78, 1, 118, 114, 138, 112, 158, 134, 178	Gray
		Hard Rubber	285 lbs.	Plain Bore	SCC-EXTTL20S3514-HRS-*	34, 78, 1, 118, 114, 138, 112, 158, 134, 178	Black
		Phenolic	300 lbs.	Roller Bearing	SCC-EXTTL20S3514-PHR-*	34, 78, 1, 118, 114, 138, 112, 158, 134, 178	Black
		Phenolic		Plain Bore	SCC-EXTTL20S3514-PHS-*	34, 78, 1, 118, 114, 138, 112, 158, 134, 178	Black
		Polyurethane		Ball Bearing	SCC-EXTTL20S3514-PPUB-*	34, 78, 1, 118, 114, 138, 112, 158, 134, 178	
Solid Polyurethane	Plain Bore	SCC-EXTTL20S3514-SPUS-*		34, 78, 1, 118, 114, 138, 112, 158, 134, 178	Blue		
4"	1-1/4"	Soft Rubber	200lbs.	Plain Bore	SCC-EXTTL20S414-SRS-*	34, 78, 1, 118, 114, 138, 112, 158, 134, 178	Black
		Thermoplastic Rubber	250 lbs.	Ball Bearing	SCC-EXTTL20S414-TPRB-*	34, 78, 1, 118, 114, 138, 112, 158, 134, 178	Gray
		Hard Rubber	300 lbs.	Plain Bore	SCC-EXTTL20S414-HRS-*	34, 78, 1, 118, 114, 138, 112, 158, 134, 178	Black
		Nylon		Plain Bore	SCC-EXTTL20S414-NYS-*	34, 78, 1, 118, 114, 138, 112, 158, 134, 178	White
		Phenolic		Roller Bearing	SCC-EXTTL20S414-PHR-*	34, 78, 1, 118, 114, 138, 112, 158, 134, 178	Black
		Phenolic		Plain Bore	SCC-EXTTL20S414-PHS-*	34, 78, 1, 118, 114, 138, 112, 158, 134, 178	Black
		Solid Polyurethane		Plain Bore	SCC-EXTTL20S414-SPUS-*	34, 78, 1, 118, 114, 138, 112, 158, 134, 178	Blue
		Semi Steel		Plain Bore	SCC-EXTTL20S414-SSS-*	34, 78, 1, 118, 114, 138, 112, 158, 134, 178	Silver
	1-1/2"	Polyurethane	350 lbs.	Ball Bearing	SCC-EXTTL20S414-PPUB-*	34, 78, 1, 118, 114, 138, 112, 158, 134, 178	
	1-1/2"	Semi Steel	300 lbs.	Roller Bearing	SCC-EXTTL20S415-SSR-*	34, 78, 1, 118, 114, 138, 112, 158, 134, 178	Silver
5"	1-1/4"	Soft Rubber	275 lbs.	Plain Bore	SCC-EXTTL20S514-SRS-*	34, 78, 1, 118, 114, 138, 112, 158, 134, 178	Black
		Thermoplastic Rubber	300 lbs.	Plain Bore	SCC-EXTTL20S514-TPRB-*	34, 78, 1, 118, 114, 138, 112, 158, 134, 178	Gray
		Hard Rubber		Plain Bore	SCC-EXTTL20S514-HRS-*	34, 78, 1, 118, 114, 138, 112, 158, 134, 178	Black
		Nylon		Plain Bore	SCC-EXTTL20S514-NYS-*	34, 78, 1, 118, 114, 138, 112, 158, 134, 178	White
		Phenolic		Roller Bearing	SCC-EXTTL20S514-PHR-*	34, 78, 1, 118, 114, 138, 112, 158, 134, 178	Black
		Phenolic		Plain Bore	SCC-EXTTL20S514-PHS-*	34, 78, 1, 118, 114, 138, 112, 158, 134, 178	Black
		Solid Polyurethane		Plain Bore	SCC-EXTTL20S514-SPUS-*	34, 78, 1, 118, 114, 138, 112, 158, 134, 178	Blue
		1-1/2"	Polyurethane	350 lbs.	Ball Bearing	SCC-EX20S514-PPUB-TLB-*	34, 78, 1, 118, 114, 138, 112, 158, 134, 178
	1-1/2"	Semi Steel	300 lbs.	Roller Bearing	SCC-EXTTL20S515-SSR-*	34, 78, 1, 118, 114, 138, 112, 158, 134, 178	Silver
	6"	1-1/4"	Thermoplastic Rubber	300 lbs	Ball Bearing	SCC-EXTTL20S614-TPRB-*	34, 78, 1, 118, 114, 138, 112, 158, 134, 178
Polyurethane			350 lbs.	Ball Bearing	SCC-EXTTL20S614-PPUB-*	34, 78, 1, 118, 114, 138, 112, 158, 134, 178	Gray
1-1/2"		Phenolic	300 lbs.	Plain Bore	SCC-EXTTL20S615-PHS-*	34, 78, 1, 118, 114, 138, 112, 158, 134, 178	Black
		Phenolic		Roller Bearing	SCC-EXTTL20S615-PHR*	34, 78, 1, 118, 114, 138, 112, 158, 134, 178	Black

EXPLORE OUR DIVERSE MOUNTING OPTIONS IN OUR EXPANDING STEM CASTER SERIES. FOR FURTHER ASSISTANCE, CONTACT OUR [CUSTOMER SERVICE](#).

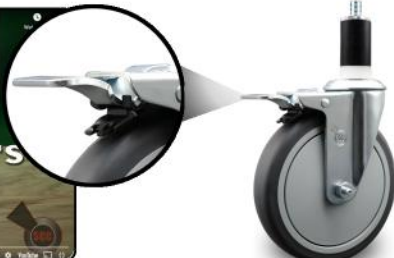

Total Lock Brakes: Effectiveness and Uses

Total lock brakes are perfect for securing carts firmly in place, making them great for stable workspaces or transporting between locations. Choose the best solution based on your specific needs.



Choose Your Size →

Mounting Size	Mounting Size	Wheel Diameter	Overall Height	Swivel Radius	Aproximate Weight
3/4" (34)	1-3/8" (138)	3"	4-1/8"	2-15/16"	1.45
7/8" (78)	1-1/2" (112)	3-1/2"	4-5/8"	3-3/16"	1.6
1" (1)	1-5/8" (158)	4"	5-1/8"	3-1/2"	1.7
1-1/8" (118)	1-3/4" (134)	5"	6-1/8"	4"	2
1-1/4" (114)	1-7/8" (178)	6"	7-1/8"	4-9/16"	2.95

EXPANDING STEM CASTERS with Top Lock Brakes

Wheel Dia	Tread Width	Wheel Type	Load Capacity	Bearing Type	TLB	Stem Size (Expanding Adapter)	Color
3"	1-1/4"	Soft Rubber	175 lbs.	Plain Bore	SCC-EX20S314-SRS-TLB-*	34, 78, 1, 118, 114, 138, 112, 158, 134, 178	Black
		Thermoplastic Rubber	210 lbs.	Ball Bearing	SCC-EX20S314-TPRB-TLB-*	34, 78, 1, 118, 114, 138, 112, 158, 134, 178	Gray
		Hard Rubber	275 lbs.	Plain Bore	SCC-EX20S314-HRS-TLB-*	34, 78, 1, 118, 114, 138, 112, 158, 134, 178	Black
		Nylon	300 lbs.	Plain Bore	SCC-EX20S314-NYS-TLB-*	34, 78, 1, 118, 114, 138, 112, 158, 134, 178	White
		Phenolic		Roller Bearing	SCC-EX20S314-PHR-TLB-*	34, 78, 1, 118, 114, 138, 112, 158, 134, 178	Black
		Phenolic		Plain Bore	SCC-EX20S314-PHS-TLB-*	34, 78, 1, 118, 114, 138, 112, 158, 134, 178	Black
		Polyurethane		Ball Bearing	SCC-EX20S314-PPUB-TLB-*	34, 78, 1, 118, 114, 138, 112, 158, 134, 178	●●●●●●●●
		Solid Polyurethane		Plain Bore	SCC-EX20S314-SPUS-TLB-*	34, 78, 1, 118, 114, 138, 112, 158, 134, 178	Blue
	Semi Steel	Plain Bore		SCC-EX20S314-SSS-TLB-*	34, 78, 1, 118, 114, 138, 112, 158, 134, 178	Silver	
	1-1/2"	Semi Steel	300 lbs.	Roller Bearing	SCC-EX20S315-SSR-TLB-*	34, 78, 1, 118, 114, 138, 112, 158, 134, 178	Silver
3-1/2"	1-1/4"	Soft Rubber	200 lbs.	Plain Bore	SCC-EX20S3514-SRS-TLB-*	34, 78, 1, 118, 114, 138, 112, 158, 134, 178	Black
		Thermoplastic Rubber	230 lbs.	Ball Bearing	SCC-EX20S3514-TPRB-TLB-*	34, 78, 1, 118, 114, 138, 112, 158, 134, 178	Gray
		Hard Rubber	285 lbs.	Plain Bore	SCC-EX20S3514-HRS-TLB-*	34, 78, 1, 118, 114, 138, 112, 158, 134, 178	Black
		Phenolic	300 lbs.	Roller Bearing	SCC-EX20S3514-PHR-TLB-*	34, 78, 1, 118, 114, 138, 112, 158, 134, 178	Black
		Phenolic		Plain Bore	SCC-EX20S3514-PHS-TLB-*	34, 78, 1, 118, 114, 138, 112, 158, 134, 178	Black
		Polyurethane		Ball Bearing	SCC-EX20S3514-PPUB-TLB-*	34, 78, 1, 118, 114, 138, 112, 158, 134, 178	●●●●●●●●
	Solid Polyurethane	Plain Bore		SCC-EX20S3514-SPUS-TLB-*	34, 78, 1, 118, 114, 138, 112, 158, 134, 178	Blue	
1-1/2"	Semi Steel	300 lbs.	Roller Bearing	SCC-EX20S415-SSR-TLB-*	34, 78, 1, 118, 114, 138, 112, 158, 134, 178	Silver	
4"	1-1/4"	Soft Rubber	200 lbs.	Plain Bore	SCC-EX20S414-SRS-TLB-*	34, 78, 1, 118, 114, 138, 112, 158, 134, 178	Black
		Thermoplastic Rubber	250 lbs.	Ball Bearing	SCC-EX20S414-TPRB-TLB-*	34, 78, 1, 118, 114, 138, 112, 158, 134, 178	Gray
		Hard Rubber	300 lbs.	Plain Bore	SCC-EX20S414-HRS-TLB-*	34, 78, 1, 118, 114, 138, 112, 158, 134, 178	Black
		Nylon		Plain Bore	SCC-EX20S414-NYS-TLB-*	34, 78, 1, 118, 114, 138, 112, 158, 134, 178	White
		Phenolic		Roller Bearing	SCC-EX20S414-PHR-TLB-*	34, 78, 1, 118, 114, 138, 112, 158, 134, 178	Black
		Phenolic		Plain Bore	SCC-EX20S414-PHS-TLB-*	34, 78, 1, 118, 114, 138, 112, 158, 134, 178	Black
		Solid Polyurethane		Plain Bore	SCC-EX20S414-SPUS-TLB-*	34, 78, 1, 118, 114, 138, 112, 158, 134, 178	Blue
		Semi Steel		Plain Bore	SCC-EX20S414-SSS-TLB-*	34, 78, 1, 118, 114, 138, 112, 158, 134, 178	Silver
	Polyurethane	350 lbs.	Ball Bearing	SCC-EX20S414-PPUB-TLB-*	34, 78, 1, 118, 114, 138, 112, 158, 134, 178	●●●●●●●●	
	1-1/2"	Semi Steel	300 lbs.	Roller Bearing	SCC-EX20S415-SSR-TLB-*	34, 78, 1, 118, 114, 138, 112, 158, 134, 178	Silver
5"	1-1/4"	Soft Rubber	275 lbs.	Plain Bore	SCC-EX20S514-SRS-TLB-*	34, 78, 1, 118, 114, 138, 112, 158, 134, 178	Black
		Hard Rubber	300 lbs.	Plain Bore	SCC-EX20S514-HRS-TLB-*	34, 78, 1, 118, 114, 138, 112, 158, 134, 178	Black
		Nylon		Plain Bore	SCC-EX20S514-NYS-TLB-*	34, 78, 1, 118, 114, 138, 112, 158, 134, 178	White
		Phenolic		Roller Bearing	SCC-EX20S514-PHR-TLB-*	34, 78, 1, 118, 114, 138, 112, 158, 134, 178	Black
		Phenolic		Plain Bore	SCC-EX20S514-PHS-TLB-*	34, 78, 1, 118, 114, 138, 112, 158, 134, 178	Black
		Solid Polyurethane		Plain Bore	SCC-EX20S514-SPUS-TLB-*	34, 78, 1, 118, 114, 138, 112, 158, 134, 178	Blue
		Semi Steel		Plain Bore	SCC-EX20S514-SSS-TLB-*	34, 78, 1, 118, 114, 138, 112, 158, 134, 178	Silver
		Thermoplastic Rubber	350 lbs.	Ball Bearing	SCC-EX20S514-PPUB-TLB-*	34, 78, 1, 118, 114, 138, 112, 158, 134, 178	●●●●●●●●
	1-1/2"	Semi Steel	300 lbs.	Roller Bearing	SCC-EX20S515-SSR-TLB-*	34, 78, 1, 118, 114, 138, 112, 158, 134, 178	Silver

EXPLORE OUR DIVERSE MOUNTING OPTIONS IN OUR EXPANDING STEM CASTER SERIES. FOR FURTHER ASSISTANCE, CONTACT OUR [CUSTOMER SERVICE](#).

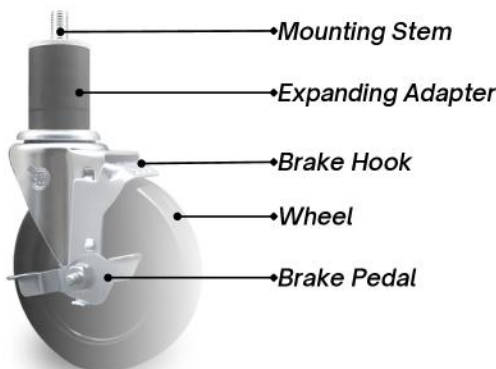

Easy to Install Expanding Adapter Stem Casters

Tighten the topmost ring on the expanding caster adapter stem before insertion to compress rubber until it fits snugly into the tube. The expanded stem can be inserted into round or square tubing. It may be necessary to further tighten the nut under the swivel with a wrench until adequately secured.





Choose Your Size →

Mounting Size	Mounting Size	Wheel Diameter	Overall Height	Swivel Radius	Aproximate Weight
3/4" (34)	1-3/8" (138)	3"	4-1/8"	2-15/16"	1.45
7/8" (78)	1-1/2" (112)	3-1/2"	4-5/8"	3-3/16"	1.6
1" (1)	1-5/8" (158)	4"	5-1/8"	3-1/2"	1.7
1-1/8" (118)	1-3/4" (134)	5"	6-1/8"	4"	2
1-1/4" (114)	1-7/8" (178)	6"	7-1/8"	4-9/16"	2.95

EXPANDING STEM CASTERS with Posi Lock Brakes

Wheel Dia	Tread Width	Wheel Type	Load Capacity	Bearing Type	TLB	Stem Size (Expanding Adapter)	Color
3"	1-1/4"	Soft Rubber	175 lbs.	Plain Bore	SCC-EX20S314-SRS-PLB-*	34, 78, 1, 118, 114, 138, 112, 158, 134, 178	Black
		Thermoplastic Rubber	210 lbs.	Ball Bearing	SCC-EX20S314-TPRB-PLB-*	34, 78, 1, 118, 114, 138, 112, 158, 134, 178	Gray
		Hard Rubber	275 lbs.	Plain Bore	SCC-EX20S314-HRS-PLB-*	34, 78, 1, 118, 114, 138, 112, 158, 134, 178	Black
		Nylon	300 lbs.	Plain Bore	SCC-EX20S314-NYS-PLB-*	34, 78, 1, 118, 114, 138, 112, 158, 134, 178	White
		Phenolic		Roller Bearing	SCC-EX20S314-PHR-PLB-*	34, 78, 1, 118, 114, 138, 112, 158, 134, 178	Black
		Phenolic		Plain Bore	SCC-EX20S314-PHS-PLB-*	34, 78, 1, 118, 114, 138, 112, 158, 134, 178	Black
		Polyurethane		Ball Bearing	SCC-EX20S314-PPUB-PLB-*	34, 78, 1, 118, 114, 138, 112, 158, 134, 178	●●●●●●●●
		Solid Polyurethane		Plain Bore	SCC-EX20S314-SPUS-PLB-*	34, 78, 1, 118, 114, 138, 112, 158, 134, 178	Blue
	Semi Steel	Plain Bore		SCC-EX20S314-SSS-PLB-*	34, 78, 1, 118, 114, 138, 112, 158, 134, 178	Silver	
	1-1/2"	Semi Steel	300 lbs.	Roller Bearing	SCC-EX20S315-SSR-PLB-*	34, 78, 1, 118, 114, 138, 112, 158, 134, 178	Silver
3-1/2"	1-1/4"	Soft Rubber	200 lbs.	Plain Bore	SCC-EX20S3514-SRS-PLB-*	34, 78, 1, 118, 114, 138, 112, 158, 134, 178	Black
		Thermoplastic Rubber	230 lbs.	Ball Bearing	SCC-EX20S3514-TPRB-PLB-*	34, 78, 1, 118, 114, 138, 112, 158, 134, 178	Gray
		Hard Rubber	285 lbs.	Plain Bore	SCC-EX20S3514-HRS-PLB-*	34, 78, 1, 118, 114, 138, 112, 158, 134, 178	Black
		Phenolic	300 lbs.	Roller Bearing	SCC-EX20S3514-PHR-PLB-*	34, 78, 1, 118, 114, 138, 112, 158, 134, 178	Black
		Phenolic		Plain Bore	SCC-EX20S3514-PHS-PLB-*	34, 78, 1, 118, 114, 138, 112, 158, 134, 178	Black
		Polyurethane		Ball Bearing	SCC-EX20S3514-PPUB-PLB-*	34, 78, 1, 118, 114, 138, 112, 158, 134, 178	●●●●●●●●
	Solid Polyurethane	Plain Bore		SCC-EX20S3514-SPUS-PLB-*	34, 78, 1, 118, 114, 138, 112, 158, 134, 178	Blue	
1-1/2"	Semi Steel	300 lbs.	Roller Bearing	SCC-EX20S414-SSR-PLB-*	34, 78, 1, 118, 114, 138, 112, 158, 134, 178	Silver	
4"	1-1/4"	Soft Rubber	200 lbs.	Plain Bore	SCC-EX20S414-SRS-PLB-*	34, 78, 1, 118, 114, 138, 112, 158, 134, 178	Black
		Thermoplastic Rubber	250 lbs.	Ball Bearing	SCC-EX20S414-TPRB-PLB-*	34, 78, 1, 118, 114, 138, 112, 158, 134, 178	Gray
		Hard Rubber	300 lbs.	Plain Bore	SCC-EX20S414-HRS-PLB-*	34, 78, 1, 118, 114, 138, 112, 158, 134, 178	Black
		Nylon		Plain Bore	SCC-EX20S414-NYS-PLB-*	34, 78, 1, 118, 114, 138, 112, 158, 134, 178	White
		Phenolic		Roller Bearing	SCC-EX20S414-PHR-PLB-*	34, 78, 1, 118, 114, 138, 112, 158, 134, 178	Black
		Phenolic		Plain Bore	SCC-EX20S414-PHS-PLB-*	34, 78, 1, 118, 114, 138, 112, 158, 134, 178	Black
		Solid Polyurethane		Plain Bore	SCC-EX20S414-SPUS-PLB-*	34, 78, 1, 118, 114, 138, 112, 158, 134, 178	Blue
		Semi Steel		Plain Bore	SCC-EX20S414-SSS-PLB-*	34, 78, 1, 118, 114, 138, 112, 158, 134, 178	Silver
	Polyurethane	350 lbs.	Ball Bearing	SCC-EX20S414-PPUB-PLB-*	34, 78, 1, 118, 114, 138, 112, 158, 134, 178	●●●●●●●●	
	1-1/2"	Semi Steel	300 lbs.	Roller Bearing	SCC-EX20S415-SSR-PLB-*	34, 78, 1, 118, 114, 138, 112, 158, 134, 178	Silver
5"	1-1/4"	Soft Rubber	275 lbs.	Plain Bore	SCC-EX20S514-SRS-PLB-*	34, 78, 1, 118, 114, 138, 112, 158, 134, 178	Black
		Hard Rubber	300 lbs.	Plain Bore	SCC-EX20S514-HRS-PLB-*	34, 78, 1, 118, 114, 138, 112, 158, 134, 178	Black
		Nylon		Plain Bore	SCC-EX20S514-NYS-PLB-*	34, 78, 1, 118, 114, 138, 112, 158, 134, 178	White
		Phenolic		Roller Bearing	SCC-EX20S514-PHR-PLB-*	34, 78, 1, 118, 114, 138, 112, 158, 134, 178	Black
		Phenolic		Plain Bore	SCC-EX20S514-PHS-PLB-*	34, 78, 1, 118, 114, 138, 112, 158, 134, 178	Black
		Solid Polyurethane		Plain Bore	SCC-EX20S514-SPUS-PLB-*	34, 78, 1, 118, 114, 138, 112, 158, 134, 178	Blue
		Semi Steel		Plain Bore	SCC-EX20S514-SSS-PLB-*	34, 78, 1, 118, 114, 138, 112, 158, 134, 178	Silver
		Thermoplastic Rubber	350 lbs.	Ball Bearing	SCC-EX20S514-PPUB-PLB-*	34, 78, 1, 118, 114, 138, 112, 158, 134, 178	●●●●●●●●
	1-1/2"	Semi Steel	300 lbs.	Roller Bearing	SCC-EX20S515-SSR-PLB-*	34, 78, 1, 118, 114, 138, 112, 158, 134, 178	Silver
6"	1-1/4"	Thermoplastic Rubber	300 lbs.	Ball Bearing	SCC-EX20S614-TPRB-PLB-*	34, 78, 1, 118, 114, 138, 112, 158, 134, 178	Gray
		Polyurethane	350 lbs.	Ball Bearing	SCC-EX20S614-PPUB-PLB-134	34, 78, 1, 118, 114, 138, 112, 158, 134, 178	Gray
	1-1/2"	Phenolic	300 lbs.	Plain Bore	SCC-EX20S615-PHS-PLB-134	34, 78, 1, 118, 114, 138, 112, 158, 134, 178	Black
		Phenolic		Roller Bearing	SCC-EX20S615-PHR-PLB-134	34, 78, 1, 118, 114, 138, 112, 158, 134, 178	Black

EXPLORE OUR DIVERSE MOUNTING OPTIONS IN OUR EXPANDING STEM CASTER SERIES. FOR FURTHER ASSISTANCE, CONTACT OUR [CUSTOMER SERVICE](#).

Explore our variety of locking casters with brakes!

Whether you need side lock brakes, top lock brakes, or posi-lock brakes, we've got you covered. Total Lock casters offer the convenience of braking the wheel and locking the swivel simultaneously. Check out our compression brake casters and decompression safety casters for weight-activated options.

Posi Lock Brake (PLB)

Accessible Tread Lock for all sizes and fastenings.



Top Lock Brake (TLB)

Side access tread lock is offered in all sizes and fastenings.



Total Lock Brake (TTL)

Locks Both swivel and wheel. Available on all sizes and fastenings.



Medium Duty Casters

Series #20 Threaded Stem Casters

#20 Series threaded stem casters: Double ball bearing raceways, standard and metric thread options. Ideal for racks, displays, shelving, dollies, food service, and office equipment.

Find your fit with our **metric stems!** ←

3" Swivel Threaded Stem Caster with Top Lock Brake

SCC-TS20S314-TPRB-TLB-M1015

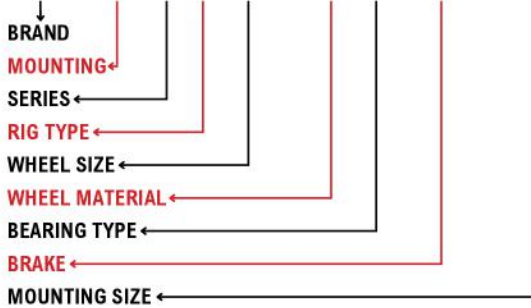

Applications

- Racks
- Store Display
- Moving dollies
- Food service operations
- Office equipment
- Laboratory equipment

Features

- Heat treated double ball bearing raceways for durability
- Available in Stainless Steel
- Versatile design suitable for various applications
- Ideal for light duty industrial use



5" Swivel Threaded Stem Caster with Total Lock

SCC-TSTTL20S514-PPUB-121315

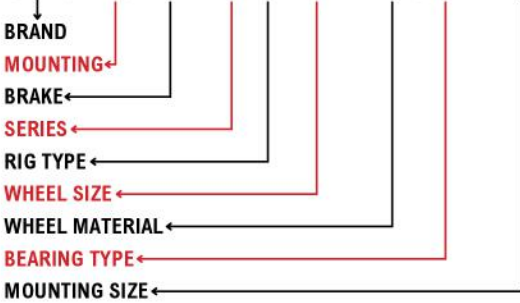

Our part numbers are adaptable to suit your requirements. The diagram above serves as a reference to assist you in understanding the breakdown. If you require any help, please don't hesitate to contact our [customer service](#) team.

Service Caster Chart Guide

Build You Caster

Discover more fastening sizes and wheel options if you can't find what you need. And remember, we're always here to [help!](#)

Brand	Series	Mounting	Rig Type	Bearing Type	Brake	Wheel Size	Mounting Size	Wheel Material
Service Caster	20	Threaded Stem (TS)	Swivel (S)	Ball Bearing (B)	Top Lock (TLB)	2-1/2" x 1-1/4" (2514)	3/8"-16 x 1" (38161)	Soft Rubber (SR)
			Rigid (R)	Plain Bore (S)	Posi Lock (PLB)	3-1/2" x 1-1/4" (3514)	3/8"-16 x 1-1/2" (381615)	Thermo Plastic Rubber (TPR)
				Delrin Bearing (D)	Total Lock (TTL)	3" x 1-1/4" (314)	1/2"-13 x 1" (12131)	Polyurethane (PPU)
				Roller Bearing (R)	Directional Lock (DL)	4" x 1-1/4" (414)	1/2"-13 x 1-1/2" (121315)	Phenolic (PH)
						5" x 1-1/4" (514)	5/8"-11 x 2-1/2" (5811215)	Solid Polyurethane (SPU)
						6" x 1-1/4" (614)	3/4"-10 x 2-1/2" (3410215)	Hard Rubber (HR)
							M10-1.5 x 25MM (M101)	Glass Filled Nylon (GFN)
							M10-1.5 x 38MM (M1015)	Rubber on Aluminum (RA)
							M12-1.75 x 25MM (M121)	Semi Steel (SS)
							M12-1.75 x 38MM (M1215)	Nylon (NY)
					Polyolefin (PO)			
					High Temp (HT)			

Measuring a Threaded Stem
Threaded stems need precise measuring tools to determine the correct diameter and thread pitch. With various sizes and types (metric, standard), using a **thread gauge** is the most reliable method. If you don't have one, hardware stores usually offer assistance.

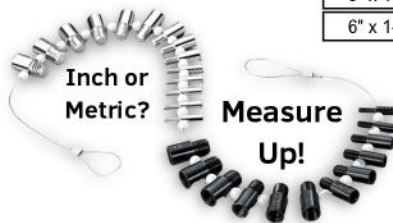

Wheel Tread

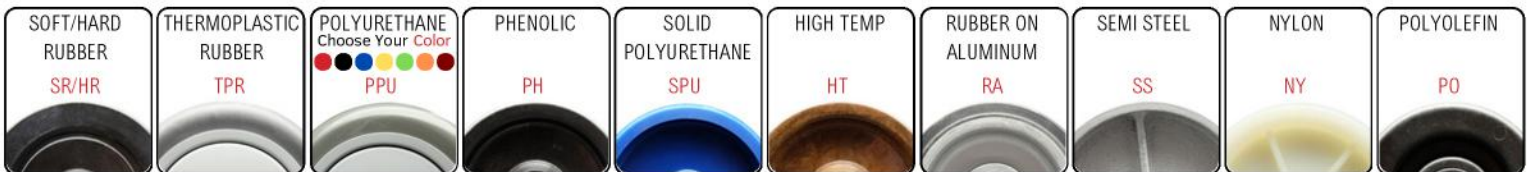

Metric Sizes Available!



Mounting Size (Metric)	Mounting Size (Inch)	Wheel Diameter	Overall Height	Swivel Radius	Aproximate Weight
M10-1.5 x 25MM (M101)	3/8"-16 x 1" (38161)	3"	4-1/8"	2-15/16"	1.45 lbs.
M10-1.5 x 38MM (M1015)	3/8"-16 x 1-1/2" (381615)	3-1/2"	4-5/8"	3-3/16"	1.6 lbs.
M12-1.75 x 25MM (M121)	1/2"-13 x 1" (12131)	4"	5-1/8"	3-1/2"	1.7 lbs.
M12-1.75 x 38MM (M1215)	1/2"-13 x 1-1/2" (121315)	5"	6-1/8"	4"	2 lbs.
	5/8"-11 x 2-1/2" (5811215)	6"	7-1/8"	4-9/16"	2.95 lbs.
	3/4"-10 x 2-1/2" (3410215)				

THREADED STEM CASTERS

Wheel Dia	Tread Width	Wheel Type	Load Capacity	Bearing Type	Swivel Caster	Stem Code (Inch Threaded Stem)	Stem Code (Metric Threaded Stem)
3"	1-1/4"	Soft Rubber	175 lbs.	Plain Bore	SCC-TS20S314-SRS-*	38161 , 381615 , 12131 , 121315 , 5811215 , 3410215	M101 , M1015 , M121 , M1215
		Thermoplastic Rubber	210 lbs.	Ball Bearing	SCC-TS20S314-TPRB-*	38161 , 381615 , 12131 , 121315 , 5811215 , 3410215	M101 , M1015 , M121 , M1215
		Hard Rubber	275 lbs.	Plain Bore	SCC-TS20S314-HRS-*	38161 , 381615 , 12131 , 121315 , 5811215 , 3410215	M101 , M1015 , M121 , M1215
		Nylon	300 lbs.	Plain Bore	SCC-TS20S314-NYS-*	38161 , 381615 , 12131 , 121315 , 5811215 , 3410215	M101 , M1015 , M121 , M1215
		Semi Steel		Plain Bore	SCC-TS20S314-SSS-*	38161 , 381615 , 12131 , 121315 , 5811215 , 3410215	M101 , M1015 , M121 , M1215
		Phenolic		Roller Bearing	SCC-TS20S314-PHR-*	38161 , 381615 , 12131 , 121315 , 5811215 , 3410215	M101 , M1015 , M121 , M1215
		Phenolic		Plain Bore	SCC-TS20S314-PHS-*	38161 , 381615 , 12131 , 121315 , 5811215 , 3410215	M101 , M1015 , M121 , M1215
		Polyurethane		Ball Bearing	SCC-TS20S314-PPUB-*	38161 , 381615 , 12131 , 121315 , 5811215 , 3410215	M101 , M1015 , M121 , M1215
		Solid Polyurethane		Plain Bore	SCC-TS20S314-SPUS-*	38161 , 381615 , 12131 , 121315 , 5811215 , 3410215	M101 , M1015 , M121 , M1215
		HT Phenolic		Roller Bearing	SCC-TS20S314-PHRHT-*	38161 , 381615 , 12131 , 121315 , 5811215 , 3410215	M101 , M1015 , M121 , M1215
		HT Phenolic		Plain Bore	SCC-TS20S314-PHSHT-*	38161 , 381615 , 12131 , 121315 , 5811215 , 3410215	M101 , M1015 , M121 , M1215
	HT Glass Filled Nylon	350 lbs.		Plain Bore	SCC-TS20S314-GFNSHT-*	38161 , 381615 , 12131 , 121315 , 5811215 , 3410215	M101 , M1015 , M121 , M1215
1-1/2"	Semi Steel	300 lbs.		Roller Bearing	SCC-TS20S315-SSR-*	38161 , 381615 , 12131 , 121315 , 5811215 , 3410215	M101 , M1015 , M121 , M1215
3-1/2"	1-1/4"	Soft Rubber	200 lbs.	Plain Bore	SCC-TS20S3514-SRS-*	38161 , 381615 , 12131 , 121315 , 5811215 , 3410215	M101 , M1015 , M121 , M1215
		Thermoplastic Rubber	230 lbs.	Ball Bearing	SCC-TS20S3514-TPRB-*	38161 , 381615 , 12131 , 121315 , 5811215 , 3410215	M101 , M1015 , M121 , M1215
		Hard Rubber	285 lbs.	Plain Bore	SCC-TS20S3514-HRS-*	38161 , 381615 , 12131 , 121315 , 5811215 , 3410215	M101 , M1015 , M121 , M1215
		Phenolic	300 lbs.	Roller Bearing	SCC-TS20S3514-PHR-*	38161 , 381615 , 12131 , 121315 , 5811215 , 3410215	M101 , M1015 , M121 , M1215
		Phenolic		Plain Bore	SCC-TS20S3514-PHS-*	38161 , 381615 , 12131 , 121315 , 5811215 , 3410215	M101 , M1015 , M121 , M1215
		Polyurethane		Ball Bearing	SCC-TS20S3514-PPUB-*	38161 , 381615 , 12131 , 121315 , 5811215 , 3410215	M101 , M1015 , M121 , M1215
		Solid Polyurethane		Plain Bore	SCC-TS20S3514-SPUS-*	38161 , 381615 , 12131 , 121315 , 5811215 , 3410215	M101 , M1015 , M121 , M1215
		HT Glass Filled Nylon		Plain Bore	SCC-TS20S3514-GFNSHT-*	38161 , 381615 , 12131 , 121315 , 5811215 , 3410215	M101 , M1015 , M121 , M1215
4"	1-1/4"	Soft Rubber	200 lbs.	Plain Bore	SCC-TS20S414-SRS-*	38161 , 381615 , 12131 , 121315 , 5811215 , 3410215	M101 , M1015 , M121 , M1215
		Thermoplastic Rubber	250 lbs.	Ball Bearing	SCC-TS20S414-TPRB-*	38161 , 381615 , 12131 , 121315 , 5811215 , 3410215	M101 , M1015 , M121 , M1215
		Hard Rubber	300 lbs.	Plain Bore	SCC-TS20S414-HRS-*	38161 , 381615 , 12131 , 121315 , 5811215 , 3410215	M101 , M1015 , M121 , M1215
		Semi Steel		Plain Bore	SCC-TS20S414-SSS-*	38161 , 381615 , 12131 , 121315 , 5811215 , 3410215	M101 , M1015 , M121 , M1215
		Solid Polyurethane		Plain Bore	SCC-TS20S414-SPUS-*	38161 , 381615 , 12131 , 121315 , 5811215 , 3410215	M101 , M1015 , M121 , M1215
		Nylon		Plain Bore	SCC-TS20S414-NYS-*	38161 , 381615 , 12131 , 121315 , 5811215 , 3410215	M101 , M1015 , M121 , M1215
		Phenolic		Roller Bearing	SCC-TS20S414-PHR-*	38161 , 381615 , 12131 , 121315 , 5811215 , 3410215	M101 , M1015 , M121 , M1215
		Semi Steel		Roller Bearing	SCC-TS20S414-SSR-*	38161 , 381615 , 12131 , 121315 , 5811215 , 3410215	M101 , M1015 , M121 , M1215
		Phenolic		Plain Bore	SCC-TS20S414-PHS-*	38161 , 381615 , 12131 , 121315 , 5811215 , 3410215	M101 , M1015 , M121 , M1215
		Polyurethane		350 lbs.	Ball Bearing	SCC-TS20S414-PPUB-*	38161 , 381615 , 12131 , 121315 , 5811215 , 3410215
5"	1-1/4"	Soft Rubber	275 lbs.	Plain Bore	SCC-TS20S514-SRS-*	38161 , 381615 , 12131 , 121315 , 5811215 , 3410215	M101 , M1015 , M121 , M1215
		Thermoplastic	300 lbs.	Ball Bearing	SCC-TS20S514-TPRB-*	38161 , 381615 , 12131 , 121315 , 5811215 , 3410215	M101 , M1015 , M121 , M1215
		Hard Rubber	Plain Bore	SCC-TS20S514-HRS-*	38161 , 381615 , 12131 , 121315 , 5811215 , 3410215	M101 , M1015 , M121 , M1215	
		Nylon	Plain Bore	SCC-TS20S514-NYS-*	38161 , 381615 , 12131 , 121315 , 5811215 , 3410215	M101 , M1015 , M121 , M1215	
		Solid Polyurethane	Plain Bore	SCC-TS20S514-SPUS-*	38161 , 381615 , 12131 , 121315 , 5811215 , 3410215	M101 , M1015 , M121 , M1215	
		Phenolic	Roller Bearing	SCC-TS20S514-PHR-*	38161 , 381615 , 12131 , 121315 , 5811215 , 3410215	M101 , M1015 , M121 , M1215	
		Semi Steel	Plain Bore	SCC-TS20S514-SSS-*	38161 , 381615 , 12131 , 121315 , 5811215 , 3410215	M101 , M1015 , M121 , M1215	
		Phenolic	Plain Bore	SCC-TS20S514-PHS-*	38161 , 381615 , 12131 , 121315 , 5811215 , 3410215	M101 , M1015 , M121 , M1215	
		Polyurethane	Ball Bearing	SCC-TS20S514-PPUB-*	38161 , 381615 , 12131 , 121315 , 5811215 , 3410215	M101 , M1015 , M121 , M1215	
	1-1/2"	Semi Steel	Roller Bearing	SCC-TS20S515-SSR-*	38161 , 381615 , 12131 , 121315 , 5811215 , 3410215	M101 , M1015 , M121 , M1215	
6"	1-1/4"	Thermoplastic Rubber	300 lbs.	Ball Bearing	SCC-TS20S614-TPRB-*	38161 , 381615 , 12131 , 121315 , 5811215 , 3410215	M101 , M1015 , M121 , M1215

EXPLORE OUR DIVERSE MOUNTING OPTIONS IN OUR THREADED STEM CASTER SERIES. FOR FURTHER ASSISTANCE, CONTACT OUR [CUSTOMER SERVICE](#).

Tired of rolling? Hit the brakes with our options!

Ensure safety and stability by easily stopping your equipment with caster brakes, providing control and preventing unwanted movement.

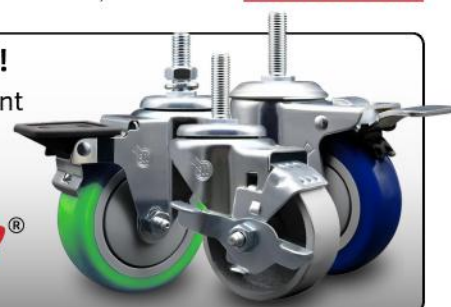



Metric Sizes Available!



Mounting Size (Metric)	Mounting Size (Inch)	Wheel Diameter	Overall Height	Swivel Radius	Approximate Weight
M10-1.5 x 25MM (M101)	3/8"-16 x 1" (38161)	3"	4-1/8"	2-15/16"	1.45 lbs.
M10-1.5 x 38MM (M1015)	3/8"-16 x 1-1/2" (381615)	3-1/2"	4-5/8"	3-3/16"	1.6 lbs.
M12-1.75 x 25MM (M121)	1/2"-13 x 1" (12131)	4"	5-1/8"	3-1/2"	1.7 lbs.
M12-1.75 x 38MM (M1215)	1/2"-13 x 1-1/2" (121315)	5"	6-1/8"	4"	2 lbs.
	5/8"-11 x 2-1/2" (5811215)	6"	7-1/8"	4-9/16"	2.95 lbs.
	3/4"-10 x 2-1/2" (3410215)				

THREADED STEM CASTERS *with Top Lock Brakes*

Wheel Dia	Tread Width	Wheel Type	Load Capacity	Bearing Type	Part Number	Stem Code (Inch Threaded Stem)	Stem Code (Metric Threaded Stem)			
3"	1-1/4"	Soft Rubber	175 lbs.	Plain Bore	SCC-TS20S314-SRS-TLB-*	38161, 381615, 12131, 121315, 5811215, 3410215	M101, M1015, M121, M1215			
		Thermoplastic Rubber	210 lbs.	Ball Bearing	SCC-TS20S314-TPRB-TLB-*	38161, 381615, 12131, 121315, 5811215, 3410215	M101, M1015, M121, M1215			
		Hard Rubber	275 lbs.	Plain Bore	SCC-TS20S314-HRS-TLB-*	38161, 381615, 12131, 121315, 5811215, 3410215	M101, M1015, M121, M1215			
		Nylon	300 lbs.	Plain Bore	SCC-TS20S314-NYS-TLB-*	38161, 381615, 12131, 121315, 5811215, 3410215	M101, M1015, M121, M1215			
		HT Phenolic		Roller Bearing	SCC-TS20S314-PHRHT-TLB-*	38161, 381615, 12131, 121315, 5811215, 3410215	M101, M1015, M121, M1215			
		HT Phenolic		Plain Bore	SCC-TS20S314-PHS-TLB-*	38161, 381615, 12131, 121315, 5811215, 3410215	M101, M1015, M121, M1215			
		Phenolic		Plain Bore	SCC-TS20S314-PHT-TLB-*	38161, 381615, 12131, 121315, 5811215, 3410215	M101, M1015, M121, M1215			
		Phenolic		Roller Bearing	SCC-TS20S314-PHR-TLB-*	38161, 381615, 12131, 121315, 5811215, 3410215	M101, M1015, M121, M1215			
		Polyurethane		Ball Bearing	SCC-TS20S314-PPUB-TLB-*	38161, 381615, 12131, 121315, 5811215, 3410215	M101, M1015, M121, M1215			
		Solid Polyurethane		Plain Bore	SCC-TS20S314-SPUS-TLB-*	38161, 381615, 12131, 121315, 5811215, 3410215	M101, M1015, M121, M1215			
		Semi Steel		Plain Bore	SCC-TS20S314-SSS-TLB-*	38161, 381615, 12131, 121315, 5811215, 3410215	M101, M1015, M121, M1215			
		HT Glass Filled Nylon		350 lbs.	Plain Bore	SCC-TS20S314-GFNSHT-TLB-*	38161, 381615, 12131, 121315, 5811215, 3410215	M101, M1015, M121, M1215		
1-1/2"	Semi Steel	300 lbs.		Roller Bearing	SCC-TS20S315-SSR-TLB-*	38161, 381615, 12131, 121315, 5811215, 3410215	M101, M1015, M121, M1215			
3-1/2"	1-1/4"	Soft Rubber		200 lbs.	Plain Bore	SCC-TS20S314-SRS-TLB-*	38161, 381615, 12131, 121315, 5811215, 3410215	M101, M1015, M121, M1215		
		Thermoplastic Rubber		230 lbs.	Ball Bearing	SCC-TS20S314-TPRB-TLB-*	38161, 381615, 12131, 121315, 5811215, 3410215	M101, M1015, M121, M1215		
		Hard Rubber	285 lbs.	Plain Bore	SCC-TS20S314-HRS-TLB-*	38161, 381615, 12131, 121315, 5811215, 3410215	M101, M1015, M121, M1215			
		Phenolic	300 lbs.	Plain Bore	SCC-TS20S314-PHS-TLB-*	38161, 381615, 12131, 121315, 5811215, 3410215	M101, M1015, M121, M1215			
		Phenolic		Roller Bearing	SCC-TS20S314-PHR-TLB-*	38161, 381615, 12131, 121315, 5811215, 3410215	M101, M1015, M121, M1215			
		Polyurethane		Ball Bearing	SCC-TS20S314-PPUB-TLB-*	38161, 381615, 12131, 121315, 5811215, 3410215	M101, M1015, M121, M1215			
		Solid Polyurethane		Plain Bore	SCC-TS20S314-SPUS-TLB-*	38161, 381615, 12131, 121315, 5811215, 3410215	M101, M1015, M121, M1215			
		HT Glass Filled Nylon		350 lbs.	Plain Bore	SCC-TS20S314-GFNSHT-TLB-*	38161, 381615, 12131, 121315, 5811215, 3410215	M101, M1015, M121, M1215		
		4"		1-1/4"	Soft Rubber	200 lbs.	Plain Bore	SCC-TS20S414-SRS-TLB-*	38161, 381615, 12131, 121315, 5811215, 3410215	M101, M1015, M121, M1215
					Thermoplastic Rubber	250 lbs.	Ball Bearing	SCC-TS20S414-TPRB-TLB-*	38161, 381615, 12131, 121315, 5811215, 3410215	M101, M1015, M121, M1215
					Hard Rubber	300 lbs.	Plain Bore	SCC-TS20S414-HRS-TLB-*	38161, 381615, 12131, 121315, 5811215, 3410215	M101, M1015, M121, M1215
					Nylon		Plain Bore	SCC-TS20S414-NYS-TLB-*	38161, 381615, 12131, 121315, 5811215, 3410215	M101, M1015, M121, M1215
HT Phenolic	Roller Bearing				SCC-TS20S414-PHRHT-TLB-*		38161, 381615, 12131, 121315, 5811215, 3410215	M101, M1015, M121, M1215		
HT Phenolic	Plain Bore				SCC-TS20S414-PHS-TLB-*		38161, 381615, 12131, 121315, 5811215, 3410215	M101, M1015, M121, M1215		
Phenolic	Plain Bore				SCC-TS20S414-PHT-TLB-*		38161, 381615, 12131, 121315, 5811215, 3410215	M101, M1015, M121, M1215		
Phenolic	Roller Bearing		SCC-TS20S414-PHR-TLB-*		38161, 381615, 12131, 121315, 5811215, 3410215		M101, M1015, M121, M1215			
Semi Steel	Plain Bore		SCC-TS20S414-SSS-TLB-*		38161, 381615, 12131, 121315, 5811215, 3410215		M101, M1015, M121, M1215			
Solid Polyurethane	Plain Bore		SCC-TS20S414-SPUS-TLB-*		38161, 381615, 12131, 121315, 5811215, 3410215		M101, M1015, M121, M1215			
Polyurethane	Ball Bearing		SCC-TS20S414-PPUB-TLB-*		38161, 381615, 12131, 121315, 5811215, 3410215		M101, M1015, M121, M1215			
Polyolefin	Plain Bore		SCC-TS20S414-POS-TLB-*		38161, 381615, 12131, 121315, 5811215, 3410215		M101, M1015, M121, M1215			
HT Glass Filled Nylon	350 lbs.	Plain Bore	SCC-TS20S414-GFNSHT-TLB-*	38161, 381615, 12131, 121315, 5811215, 3410215	M101, M1015, M121, M1215					
1-1/2"	Semi Steel	300 lbs.	Roller Bearing	SCC-TS20S415-SSS-TLB-*	38161, 381615, 12131, 121315, 5811215, 3410215		M101, M1015, M121, M1215			
5"	1-1/4"	Soft Rubber	275 lbs.	Plain Bore	SCC-TS20S514-SRS-TLB-*	38161, 381615, 12131, 121315, 5811215, 3410215	M101, M1015, M121, M1215			
		Thermoplastic Rubber	300 lbs.	Ball Bearing	SCC-TS20S514-TPRB-TLB-*	38161, 381615, 12131, 121315, 5811215, 3410215	M101, M1015, M121, M1215			
		Hard Rubber		Plain Bore	SCC-TS20S514-HRS-TLB-*	38161, 381615, 12131, 121315, 5811215, 3410215	M101, M1015, M121, M1215			
		Nylon		Plain Bore	SCC-TS20S514-NYS-TLB-*	38161, 381615, 12131, 121315, 5811215, 3410215	M101, M1015, M121, M1215			
		HT Phenolic		Roller Bearing	SCC-TS20S514-PHRHT-TLB-*	38161, 381615, 12131, 121315, 5811215, 3410215	M101, M1015, M121, M1215			
		HT Phenolic		Plain Bore	SCC-TS20S514-PHS-TLB-*	38161, 381615, 12131, 121315, 5811215, 3410215	M101, M1015, M121, M1215			
		Phenolic		Plain Bore	SCC-TS20S514-PHT-TLB-*	38161, 381615, 12131, 121315, 5811215, 3410215	M101, M1015, M121, M1215			
		Phenolic		Roller Bearing	SCC-TS20S514-PHR-TLB-*	38161, 381615, 12131, 121315, 5811215, 3410215	M101, M1015, M121, M1215			
		Solid Polyurethane		Plain Bore	SCC-TS20S514-SPUS-TLB-*	38161, 381615, 12131, 121315, 5811215, 3410215	M101, M1015, M121, M1215			
		Polyolefin		Plain Bore	SCC-TS20S514-POS-TLB-*	38161, 381615, 12131, 121315, 5811215, 3410215	M101, M1015, M121, M1215			
		Polyurethane		Ball Bearing	SCC-TS20S514-PPUB-TLB-*	38161, 381615, 12131, 121315, 5811215, 3410215	M101, M1015, M121, M1215			
		Semi Steel		350 lbs.	Plain Bore	SCC-TS20S514-SSS-TLB-*	38161, 381615, 12131, 121315, 5811215, 3410215	M101, M1015, M121, M1215		
HT Glass Filled Nylon	Plain Bore	SCC-TS20S514-GFNSHT-TLB-*		38161, 381615, 12131, 121315, 5811215, 3410215	M101, M1015, M121, M1215					
1-1/2"	Semi Steel	300 lbs.	Roller Bearing	SCC-TS20S515-SSR-TLB-*	38161, 381615, 12131, 121315, 5811215, 3410215	M101, M1015, M121, M1215				
6"	1-1/4"	Thermoplastic Rubber	300 lbs.	Ball Bearing	SCC-TS20S614-TPRB-TLB-*	38161, 381615, 12131, 121315, 5811215, 3410215	M101, M1015, M121, M1215			
		Phenolic		Plain Bore	SCC-TS20S615-PHS-TLB-*	38161, 381615, 12131, 121315, 5811215, 3410215	M101, M1015, M121, M1215			
		Phenolic		Roller Bearing	SCC-TS20S615-PHR-TLB-*	38161, 381615, 12131, 121315, 5811215, 3410215	M101, M1015, M121, M1215			

EXPLORE OUR DIVERSE MOUNTING OPTIONS IN OUR THREADED STEM CASTER SERIES. FOR FURTHER ASSISTANCE, CONTACT OUR [CUSTOMER SERVICE](#).





Metric Sizes Available!



Mounting Size (Metric)	Mounting Size (Inch)	Wheel Diameter	Overall Height	Swivel Radius	Approximate Weight
M10-1.5 x 25MM (M101)	3/8"-16 x 1" (38161)	3"	4-1/8"	2-15/16"	1.45 lbs.
M10-1.5 x 38MM (M1015)	3/8"-16 x 1-1/2" (381615)	3-1/2"	4-5/8"	3-3/16"	1.6 lbs.
M12-1.75 x 25MM (M121)	1/2"-13 x 1" (12131)	4"	5-1/8"	3-1/2"	1.7 lbs.
M12-1.75 x 38MM (M1215)	1/2"-13 x 1-1/2" (121315)	5"	6-1/8"	4"	2 lbs.
	5/8"-11 x 2-1/2" (5811215)	6"	7-1/8"	4-9/16"	2.95 lbs.
	3/4"-10 x 2-1/2" (3410215)				

THREADED STEM CASTERS with Posi Lock Brakes

Wheel Dia	Tread Width	Wheel Type	Load Capacity	Bearing Type	Part Number	Stem Code (Inch Threaded Stem)	Stem Code (Metric Threaded Stem)	
3"	1-1/4"	Soft Rubber	175 lbs.	Plain Bore	SCC-TS20S314-SRS-PLB-*	38161, 381615, 12131, 121315, 5811215, 3410215	M101, M1015, M121, M1215	
		Thermoplastic Rubber	210 lbs.	Ball Bearing	SCC-TS20S314-TPRB-PLB-*	38161, 381615, 12131, 121315, 5811215, 3410215	M101, M1015, M121, M1215	
		Hard Rubber	275 lbs.	Plain Bore	SCC-TS20S314-HRS-PLB-*	38161, 381615, 12131, 121315, 5811215, 3410215	M101, M1015, M121, M1215	
		Nylon	300 lbs.	Plain Bore	SCC-TS20S314-NYS-PLB-*	38161, 381615, 12131, 121315, 5811215, 3410215	M101, M1015, M121, M1215	
		HT Phenolic		Roller Bearing	SCC-TS20S314-PHRHT-PLB-*	38161, 381615, 12131, 121315, 5811215, 3410215	M101, M1015, M121, M1215	
		HT Phenolic		Plain Bore	SCC-TS20S314-PHSHT-PLB-*	38161, 381615, 12131, 121315, 5811215, 3410215	M101, M1015, M121, M1215	
		Phenolic		Plain Bore	SCC-TS20S314-PHS-PLB-*	38161, 381615, 12131, 121315, 5811215, 3410215	M101, M1015, M121, M1215	
		Phenolic		Roller Bearing	SCC-TS20S314-PHR-PLB-*	38161, 381615, 12131, 121315, 5811215, 3410215	M101, M1015, M121, M1215	
		Polyurethane		Ball Bearing	SCC-TS20S314-PPUB-PLB-*	38161, 381615, 12131, 121315, 5811215, 3410215	M101, M1015, M121, M1215	
		Solid Polyurethane		Plain Bore	SCC-TS20S314-SPUS-PLB-*	38161, 381615, 12131, 121315, 5811215, 3410215	M101, M1015, M121, M1215	
		Semi Steel		Plain Bore	SCC-TS20S314-SSS-PLB-*	38161, 381615, 12131, 121315, 5811215, 3410215	M101, M1015, M121, M1215	
		HT Glass Filled Nylon		350 lbs.	Plain Bore	SCC-TS20S314-GFNSHT-PLB-*	38161, 381615, 12131, 121315, 5811215, 3410215	M101, M1015, M121, M1215
1-1/2"	Semi Steel	300 lbs.		Roller Bearing	SCC-TS20S315-SSR-PLB-*	38161, 381615, 12131, 121315, 5811215, 3410215	M101, M1015, M121, M1215	
3-1/2"	1-1/4"	Soft Rubber	200 lbs.	Plain Bore	SCC-TS20S3514-SRS-PLB-*	38161, 381615, 12131, 121315, 5811215, 3410215	M101, M1015, M121, M1215	
		Thermoplastic Rubber	230 lbs.	Ball Bearing	SCC-TS20S3514-TPRB-PLB-*	38161, 381615, 12131, 121315, 5811215, 3410215	M101, M1015, M121, M1215	
		Hard Rubber	285 lbs.	Plain Bore	SCC-TS20S3514-HRS-PLB-*	38161, 381615, 12131, 121315, 5811215, 3410215	M101, M1015, M121, M1215	
		Phenolic	300 lbs.	Plain Bore	SCC-TS20S3514-PHS-PLB-*	38161, 381615, 12131, 121315, 5811215, 3410215	M101, M1015, M121, M1215	
		Phenolic		Roller Bearing	SCC-TS20S3514-PHR-PLB-*	38161, 381615, 12131, 121315, 5811215, 3410215	M101, M1015, M121, M1215	
		Polyurethane		Ball Bearing	SCC-TS20S3514-PPUB-PLB-*	38161, 381615, 12131, 121315, 5811215, 3410215	M101, M1015, M121, M1215	
		Solid Polyurethane		Plain Bore	SCC-TS20S3514-SPUS-PLB-*	38161, 381615, 12131, 121315, 5811215, 3410215	M101, M1015, M121, M1215	
		HT Glass Filled Nylon		350 lbs.	Plain Bore	SCC-TS20S3514-GFNSHT-PLB-*	38161, 381615, 12131, 121315, 5811215, 3410215	M101, M1015, M121, M1215
		Soft Rubber		200 lbs.	Plain Bore	SCC-TS20S414-SRS-PLB-*	38161, 381615, 12131, 121315, 5811215, 3410215	M101, M1015, M121, M1215
		Thermoplastic Rubber		250 lbs.	Ball Bearing	SCC-TS20S414-TPRB-PLB-*	38161, 381615, 12131, 121315, 5811215, 3410215	M101, M1015, M121, M1215
		Hard Rubber		Plain Bore	SCC-TS20S414-HRS-PLB-*	38161, 381615, 12131, 121315, 5811215, 3410215	M101, M1015, M121, M1215	
		Nylon		Plain Bore	SCC-TS20S414-NYS-PLB-*	38161, 381615, 12131, 121315, 5811215, 3410215	M101, M1015, M121, M1215	
HT Phenolic	Roller Bearing	SCC-TS20S414-PHRHT-PLB-*		38161, 381615, 12131, 121315, 5811215, 3410215	M101, M1015, M121, M1215			
HT Phenolic	Plain Bore	SCC-TS20S414-PHSHT-PLB-*	38161, 381615, 12131, 121315, 5811215, 3410215	M101, M1015, M121, M1215				
Phenolic	Plain Bore	SCC-TS20S414-PHS-PLB-*	38161, 381615, 12131, 121315, 5811215, 3410215	M101, M1015, M121, M1215				
Phenolic	Roller Bearing	SCC-TS20S414-PHR-PLB-*	38161, 381615, 12131, 121315, 5811215, 3410215	M101, M1015, M121, M1215				
Semi Steel	Plain Bore	SCC-TS20S414-SSS-PLB-*	38161, 381615, 12131, 121315, 5811215, 3410215	M101, M1015, M121, M1215				
Solid Polyurethane	Plain Bore	SCC-TS20S414-SPUS-PLB-*	38161, 381615, 12131, 121315, 5811215, 3410215	M101, M1015, M121, M1215				
Polyurethane	Ball Bearing	SCC-TS20S414-PPUB-PLB-*	38161, 381615, 12131, 121315, 5811215, 3410215	M101, M1015, M121, M1215				
Polyolefin	Plain Bore	SCC-TS20S414-POS-PLB-*	38161, 381615, 12131, 121315, 5811215, 3410215	M101, M1015, M121, M1215				
HT Glass Filled Nylon	350 lbs.	Plain Bore	SCC-TS20S414-GFNSHT-PLB-*	38161, 381615, 12131, 121315, 5811215, 3410215	M101, M1015, M121, M1215			
1-1/2"	Semi Steel	300 lbs.	Roller Bearing	SCC-TS20S415-SSS-PLB-*	38161, 381615, 12131, 121315, 5811215, 3410215	M101, M1015, M121, M1215		
5"	1-1/4"	Soft Rubber	275 lbs.	Plain Bore	SCC-TS20S514-SRS-PLB-*	38161, 381615, 12131, 121315, 5811215, 3410215	M101, M1015, M121, M1215	
		Thermoplastic Rubber	300 lbs.	Ball Bearing	SCC-TS20S514-TPRB-PLB-*	38161, 381615, 12131, 121315, 5811215, 3410215	M101, M1015, M121, M1215	
		Hard Rubber		Plain Bore	SCC-TS20S514-HRS-PLB-*	38161, 381615, 12131, 121315, 5811215, 3410215	M101, M1015, M121, M1215	
		Nylon		Plain Bore	SCC-TS20S514-NYS-PLB-*	38161, 381615, 12131, 121315, 5811215, 3410215	M101, M1015, M121, M1215	
		HT Phenolic		Roller Bearing	SCC-TS20S514-PHRHT-PLB-*	38161, 381615, 12131, 121315, 5811215, 3410215	M101, M1015, M121, M1215	
		HT Phenolic		Plain Bore	SCC-TS20S514-PHSHT-PLB-*	38161, 381615, 12131, 121315, 5811215, 3410215	M101, M1015, M121, M1215	
		Phenolic		Plain Bore	SCC-TS20S514-PHS-PLB-*	38161, 381615, 12131, 121315, 5811215, 3410215	M101, M1015, M121, M1215	
		Phenolic		Roller Bearing	SCC-TS20S514-PHR-PLB-*	38161, 381615, 12131, 121315, 5811215, 3410215	M101, M1015, M121, M1215	
		Solid Polyurethane		Plain Bore	SCC-TS20S514-SPUS-PLB-*	38161, 381615, 12131, 121315, 5811215, 3410215	M101, M1015, M121, M1215	
		Polyolefin		Plain Bore	SCC-TS20S514-POS-PLB-*	38161, 381615, 12131, 121315, 5811215, 3410215	M101, M1015, M121, M1215	
		Polyurethane		Ball Bearing	SCC-TS20S514-PPUB-PLB-*	38161, 381615, 12131, 121315, 5811215, 3410215	M101, M1015, M121, M1215	
		Semi Steel	350 lbs.	Plain Bore	SCC-TS20S514-SSS-PLB-*	38161, 381615, 12131, 121315, 5811215, 3410215	M101, M1015, M121, M1215	
		HT Glass Filled Nylon	Plain Bore	SCC-TS20S514-GFNSHT-PLB-*	38161, 381615, 12131, 121315, 5811215, 3410215	M101, M1015, M121, M1215		
		1-1/2"	Semi Steel	300 lbs.	Roller Bearing	SCC-TS20S515-SSR-PLB-*	38161, 381615, 12131, 121315, 5811215, 3410215	M101, M1015, M121, M1215
		6"	1-1/4"	Thermoplastic Rubber	300 lbs.	Ball Bearing	SCC-TS20S614-TPRB-PLB-*	38161, 381615, 12131, 121315, 5811215, 3410215
Phenolic	Plain Bore			SCC-TS20S615-PHS-PLB-*		38161, 381615, 12131, 121315, 5811215, 3410215	M101, M1015, M121, M1215	
Phenolic	Roller Bearing			SCC-TS20S615-PHR-PLB-*		38161, 381615, 12131, 121315, 5811215, 3410215	M101, M1015, M121, M1215	

EXPLORE OUR DIVERSE MOUNTING OPTIONS IN OUR THREADED STEM CASTER SERIES. FOR FURTHER ASSISTANCE, CONTACT OUR [CUSTOMER SERVICE](#).



Metric Sizes Available!



Mounting Size (Metric)	Mounting Size (Inch)	Wheel Diameter	Overall Height	Swivel Radius	Approximate Weight
M10-1.5 x 25MM (M101)	3/8"-16 x 1" (38161)	3"	4-1/8"	2-15/16"	1.45 lbs.
M10-1.5 x 38MM (M1015)	3/8"-16 x 1-1/2" (381615)	3-1/2"	4-5/8"	3-3/16"	1.6 lbs.
M12-1.75 x 25MM (M121)	1/2"-13 x 1" (12131)	4"	5-1/8"	3-1/2"	1.7 lbs.
M12-1.75 x 38MM (M1215)	1/2"-13 x 1-1/2" (121315)	5"	6-1/8"	4"	2 lbs.
	5/8"-11 x 2-1/2" (5811215)	6"	7-1/8"	4-9/16"	2.95 lbs.
	3/4"-10 x 2-1/2" (3410215)				

THREADED STEM CASTERS with Total Lock Brakes

Wheel Dia	Tread Width	Wheel Type	Load Capacity	Bearing Type	Part Number	Stem Code (Inch Threaded Stem)	Stem Code (Metric Threaded Stem)		
3"	1-1/4"	Soft Rubber	175 lbs.	Plain Bore	SCC-TSTTL20S314-SRS-PLB-*	38161, 381615, 12131, 121315, 5811215, 3410215	M101, M1015, M121, M1215		
		Thermoplastic Rubber	210 lbs.	Ball Bearing	SCC-TSTTL20S314-TPRB-PLB-*	38161, 381615, 12131, 121315, 5811215, 3410215	M101, M1015, M121, M1215		
		Hard Rubber	275 lbs.	Plain Bore	SCC-TSTTL20S314-HRS-PLB-*	38161, 381615, 12131, 121315, 5811215, 3410215	M101, M1015, M121, M1215		
		Nylon	300 lbs.	Plain Bore	SCC-TSTTL20S314-NYS-PLB-*	38161, 381615, 12131, 121315, 5811215, 3410215	M101, M1015, M121, M1215		
		HT Phenolic		Roller Bearing	SCC-TSTTL20S314-PHRHT-PLB-*	38161, 381615, 12131, 121315, 5811215, 3410215	M101, M1015, M121, M1215		
		HT Phenolic		Plain Bore	SCC-TSTTL20S314-PHSHT-PLB-*	38161, 381615, 12131, 121315, 5811215, 3410215	M101, M1015, M121, M1215		
		Phenolic		Plain Bore	SCC-TSTTL20S314-PHS-PLB-*	38161, 381615, 12131, 121315, 5811215, 3410215	M101, M1015, M121, M1215		
		Phenolic		Roller Bearing	SCC-TSTTL20S314-PHR-PLB-*	38161, 381615, 12131, 121315, 5811215, 3410215	M101, M1015, M121, M1215		
		Polyurethane		Ball Bearing	SCC-TSTTL20S314-PPUB-PLB-*	38161, 381615, 12131, 121315, 5811215, 3410215	M101, M1015, M121, M1215		
		Solid Polyurethane		Plain Bore	SCC-TSTTL20S314-SPUS-PLB-*	38161, 381615, 12131, 121315, 5811215, 3410215	M101, M1015, M121, M1215		
		Semi Steel		Plain Bore	SCC-TSTTL20S314-SSS-PLB-*	38161, 381615, 12131, 121315, 5811215, 3410215	M101, M1015, M121, M1215		
		HT Glass Filled Nylon		350 lbs.	Plain Bore	SCC-TSTTL20S314-GFNSHT-PLB-*	38161, 381615, 12131, 121315, 5811215, 3410215	M101, M1015, M121, M1215	
1-1/2"	Semi Steel	300 lbs.		Roller Bearing	SCC-TSTTL20S315-SSR-PLB-*	38161, 381615, 12131, 121315, 5811215, 3410215	M101, M1015, M121, M1215		
3-1/2"	1-1/4"	Soft Rubber	200 lbs.	Plain Bore	SCC-TSTTL20S3514-SRS-PLB-*	38161, 381615, 12131, 121315, 5811215, 3410215	M101, M1015, M121, M1215		
		Thermoplastic Rubber	230 lbs.	Ball Bearing	SCC-TSTTL20S3514-TPRB-PLB-*	38161, 381615, 12131, 121315, 5811215, 3410215	M101, M1015, M121, M1215		
		Hard Rubber	285 lbs.	Plain Bore	SCC-TSTTL20S3514-HRS-PLB-*	38161, 381615, 12131, 121315, 5811215, 3410215	M101, M1015, M121, M1215		
		Phenolic	300 lbs.	Plain Bore	SCC-TSTTL20S3514-PHS-PLB-*	38161, 381615, 12131, 121315, 5811215, 3410215	M101, M1015, M121, M1215		
		Phenolic		Roller Bearing	SCC-TSTTL20S3514-PHR-PLB-*	38161, 381615, 12131, 121315, 5811215, 3410215	M101, M1015, M121, M1215		
		Polyurethane		Ball Bearing	SCC-TSTTL20S3514-PPUB-PLB-*	38161, 381615, 12131, 121315, 5811215, 3410215	M101, M1015, M121, M1215		
		Solid Polyurethane		Plain Bore	SCC-TSTTL20S3514-SPUS-PLB-*	38161, 381615, 12131, 121315, 5811215, 3410215	M101, M1015, M121, M1215		
		HT Glass Filled Nylon		350 lbs.	Plain Bore	SCC-TSTTL20S3514-GFNSHT-PLB-*	38161, 381615, 12131, 121315, 5811215, 3410215	M101, M1015, M121, M1215	
		Soft Rubber		200 lbs.	Plain Bore	SCC-TSTTL20S414-SRS-PLB-*	38161, 381615, 12131, 121315, 5811215, 3410215	M101, M1015, M121, M1215	
		Thermoplastic Rubber		250 lbs.	Ball Bearing	SCC-TSTTL20S414-TPRB-PLB-*	38161, 381615, 12131, 121315, 5811215, 3410215	M101, M1015, M121, M1215	
		Hard Rubber		Plain Bore	SCC-TSTTL20S414-HRS-PLB-*	38161, 381615, 12131, 121315, 5811215, 3410215	M101, M1015, M121, M1215		
		Nylon		Plain Bore	SCC-TSTTL20S414-NYS-PLB-*	38161, 381615, 12131, 121315, 5811215, 3410215	M101, M1015, M121, M1215		
HT Phenolic	Roller Bearing	SCC-TSTTL20S414-PHRHT-PLB-*		38161, 381615, 12131, 121315, 5811215, 3410215	M101, M1015, M121, M1215				
HT Phenolic	Plain Bore	SCC-TSTTL20S414-PHSHT-PLB-*	38161, 381615, 12131, 121315, 5811215, 3410215	M101, M1015, M121, M1215					
Phenolic	Plain Bore	SCC-TSTTL20S414-PHS-PLB-*	38161, 381615, 12131, 121315, 5811215, 3410215	M101, M1015, M121, M1215					
Phenolic	Roller Bearing	SCC-TSTTL20S414-PHR-PLB-*	38161, 381615, 12131, 121315, 5811215, 3410215	M101, M1015, M121, M1215					
Semi Steel	Plain Bore	SCC-TSTTL20S414-SSS-PLB-*	38161, 381615, 12131, 121315, 5811215, 3410215	M101, M1015, M121, M1215					
Solid Polyurethane	Plain Bore	SCC-TSTTL20S414-SPUS-PLB-*	38161, 381615, 12131, 121315, 5811215, 3410215	M101, M1015, M121, M1215					
Polyurethane	Ball Bearing	SCC-TSTTL20S414-PPUB-PLB-*	38161, 381615, 12131, 121315, 5811215, 3410215	M101, M1015, M121, M1215					
Polyolefin	Plain Bore	SCC-TSTTL20S414-POS-PLB-*	38161, 381615, 12131, 121315, 5811215, 3410215	M101, M1015, M121, M1215					
HT Glass Filled Nylon	350 lbs.	Plain Bore	SCC-TSTTL20S414-GFNSHT-PLB-*	38161, 381615, 12131, 121315, 5811215, 3410215	M101, M1015, M121, M1215				
1-1/2"	Semi Steel	300 lbs.	Roller Bearing	SCC-TSTTL20S415-SSS-PLB-*	38161, 381615, 12131, 121315, 5811215, 3410215	M101, M1015, M121, M1215			
5"	1-1/4"	Soft Rubber	275 lbs.	Plain Bore	SCC-TSTTL20S514-SRS-PLB-*	38161, 381615, 12131, 121315, 5811215, 3410215	M101, M1015, M121, M1215		
		Thermoplastic Rubber	300 lbs.	Ball Bearing	SCC-TSTTL20S514-TPRB-PLB-*	38161, 381615, 12131, 121315, 5811215, 3410215	M101, M1015, M121, M1215		
		Hard Rubber		Plain Bore	SCC-TSTTL20S514-HRS-PLB-*	38161, 381615, 12131, 121315, 5811215, 3410215	M101, M1015, M121, M1215		
		Nylon		Plain Bore	SCC-TSTTL20S514-NYS-PLB-*	38161, 381615, 12131, 121315, 5811215, 3410215	M101, M1015, M121, M1215		
		HT Phenolic		Roller Bearing	SCC-TSTTL20S514-PHRHT-PLB-*	38161, 381615, 12131, 121315, 5811215, 3410215	M101, M1015, M121, M1215		
		HT Phenolic		Plain Bore	SCC-TSTTL20S514-PHSHT-PLB-*	38161, 381615, 12131, 121315, 5811215, 3410215	M101, M1015, M121, M1215		
		Phenolic		Plain Bore	SCC-TSTTL20S514-PHS-PLB-*	38161, 381615, 12131, 121315, 5811215, 3410215	M101, M1015, M121, M1215		
		Phenolic		Roller Bearing	SCC-TSTTL20S514-PHR-PLB-*	38161, 381615, 12131, 121315, 5811215, 3410215	M101, M1015, M121, M1215		
		Solid Polyurethane		Plain Bore	SCC-TSTTL20S514-SPUS-PLB-*	38161, 381615, 12131, 121315, 5811215, 3410215	M101, M1015, M121, M1215		
		Polyolefin		Plain Bore	SCC-TSTTL20S514-POS-PLB-*	38161, 381615, 12131, 121315, 5811215, 3410215	M101, M1015, M121, M1215		
		Polyurethane		Ball Bearing	SCC-TS20S514-PPUB-PLB-*	38161, 381615, 12131, 121315, 5811215, 3410215	M101, M1015, M121, M1215		
		Semi Steel	350 lbs.	Plain Bore	SCC-TS20S514-SSS-PLB-*	38161, 381615, 12131, 121315, 5811215, 3410215	M101, M1015, M121, M1215		
		HT Glass Filled Nylon	Plain Bore	SCC-TS20S514-GFNSHT-PLB-*	38161, 381615, 12131, 121315, 5811215, 3410215	M101, M1015, M121, M1215			
		1-1/2"	Semi Steel	300 lbs.	Roller Bearing	SCC-TS20S515-SSR-PLB-*	38161, 381615, 12131, 121315, 5811215, 3410215	M101, M1015, M121, M1215	
		6"	1-1/4"	Thermoplastic Rubber	300 lbs.	Ball Bearing	SCC-TS20S614-TPRB-PLB-*	38161, 381615, 12131, 121315, 5811215, 3410215	M101, M1015, M121, M1215
				Phenolic		Plain Bore	SCC-TS20S615-PHS-PLB-*	38161, 381615, 12131, 121315, 5811215, 3410215	M101, M1015, M121, M1215
				Phenolic		Roller Bearing	SCC-TS20S615-PHR-PLB-*	38161, 381615, 12131, 121315, 5811215, 3410215	M101, M1015, M121, M1215

EXPLORE OUR DIVERSE MOUNTING OPTIONS IN OUR THREADED STEM CASTER SERIES. FOR FURTHER ASSISTANCE, CONTACT OUR [CUSTOMER SERVICE](#).

STAINLESS STEEL AVAILABLE



SHOP NOW

Medium Duty Casters

Series #20 Grip Ring Stem Casters

Consider Service Caster's Series 20 grip ring stem wheel casters: reliable, durable, and resistant to water, oil, and grease. Great for Metro shelving replacement casters.

Applications

- Racks
- Storage Bins
- Wire Shelving
- Food service operations
- Utility Carts
- Medical Carts



Features

- Heat treated double ball bearing raceways for durability
- Available in Stainless Steel
- Versatile design suitable for various applications
- Ideal for light duty industrial use



Our part numbers are adaptable to suit your requirements. The diagram above serves as a reference to assist you in understanding the breakdown. If you require any help, please don't hesitate to contact our [customer service](#) team.

5" Swivel Grip Ring Stem Caster with Total Lock

SCC-GR20S514-PPUB-716138

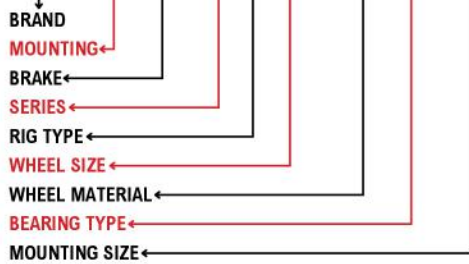

3" Swivel Grip Ring Stem Caster with Top Lock Brake

SCC-GR20S314-TPRB-TLB-845

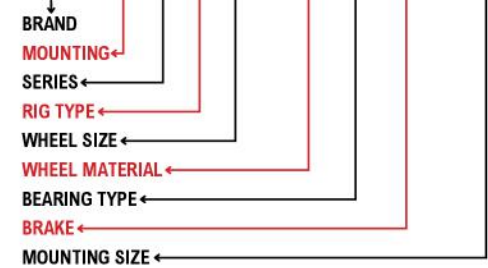

Service Caster Chart Guide

Build You Caster

Discover more fastening sizes and wheel options if you can't find what you need. And remember, we're always here to [help!](#)

Brand	Series	Mounting	Rig Type	Bearing Type	Brake	Wheel Size	Mounting Size	Wheel Material
Service Caster	20	Grip Ring (GR)	Swivel (S)	Ball Bearing (B)	Top Lock (TLB)	2-1/2" x 1-1/4" (2514)	7/16" x 1-3/8" (716138)	Soft Rubber (SR)
			Rigid (R)	Plain Bore (S)	Posi Lock (PLB)	3-1/2" x 1-1/4" (3514)	.845" x 2-3/16" (845)	Thermo Plastic Rubber (TPR)
				Delrin Bearing (D)	Total Lock (TTL)	3" x 1-1/4" (314)	3/4" x 2-3/16" (342316)	Polyurethane (PPU)
				Roller Bearing (R)	Directional Lock (DL)	4" x 1-1/4" (414)	13/16" x 2-3/16" (1316)	Phenolic (PH)
						5" x 1-1/4" (514)	.865" x 2-3/16" (865)	Solid Polyurethane (SPU)
						6" x 1-1/4" (614)	1" x 2-3/16" (1)	Hard Rubber (HR)
						Glass Filled Nylon (GFN)		
							Rubber on Aluminum (RA)	
							Semi Steel (SS)	
							Nylon (NY)	
							Polyolefin (PO)	
							High Temp (HT)	

Measuring a Grip Ring Stem

To measure the diameter accurately, it's best to use a micrometer or caliper. However, we'll guide you on how to use household items for this purpose. For increased accuracy, use at least two different measurement methods.

Measuring with a Wrench

To measure a Grip Ring stem, try fitting both a 7/16" and 3/8" wrench on the stem. The best fit indicates the stem size, though slight wiggle room is normal.



If you still require assistance, feel free to [reach out](#).

Wheel Tread

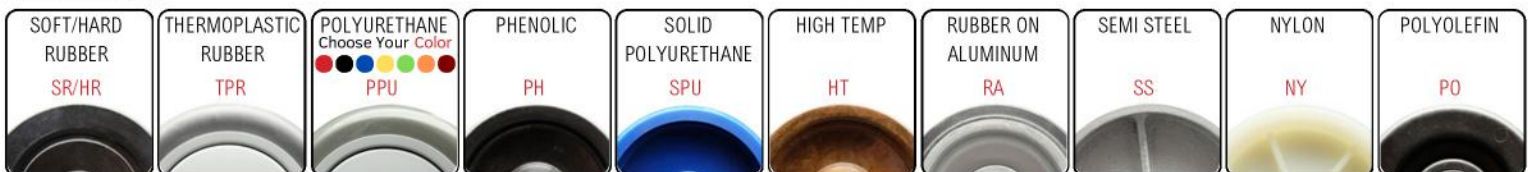



GRIP RING CASTERS

Mounting Size	Mounting Size	Wheel Diameter	Overall Height	Swivel Radius	Approximate Weight
.845" x 2-3/16" (845)	7/16" x 1-3/8" (716138)	3"	4-1/8"	2-15/16"	1.45
.865" x 2-3/16" (865)	3/4" x 2-3/16" (342316)	3-1/2"	4-5/8"	3-3/16"	1.6
	13/16" x 2-3/16" (1316)	4"	5-1/8"	3-1/2"	1.7
	1" x 2-3/16" (12316)	5"	6-1/8"	4"	2
		6"	7-1/8"	4-9/16"	2.95

Wheel Dia	Tread Width	Wheel Type	Load Capacity	Bearing Type	Swivel Caster	Stem Code (Grip Ring Stem)
3"	1-1/4"	Soft Rubber	210 lbs.	Plain Bore	SCC-GR20S314-SRS-*	716138 , 342316 , 13162316 , 12316 , 845 , 865
		Thermoplastic Rubber	210 lbs.	Ball Bearing	SCC-GR20S314-TPRB-*	716138 , 342316 , 13162316 , 12316 , 845 , 865
		Hard Rubber	275 lbs	Plain Bore	SCC-GR20S314-HRS-*	716138 , 342316 , 13162316 , 12316 , 845 , 865
		Nylon	300 lbs.	Plain Bore	SCC-GR20S314-NYS-*	716138 , 342316 , 13162316 , 12316 , 845 , 865
		Phenolic		Roller Bearing	SCC-GR20S314-PHR-*	716138 , 342316 , 13162316 , 12316 , 845 , 865
		High Temp Phenolic		Roller Bearing	SCC-GR20S314-PHRHT-*	716138 , 342316 , 13162316 , 12316 , 845 , 865
		Phenolic		Plain Bore	SCC-GR20S314-PHS-*	716138 , 342316 , 13162316 , 12316 , 845 , 865
		High Temp Phenolic		Plain Bore	SCC-GR20S314-PHSHT-*	716138 , 342316 , 13162316 , 12316 , 845 , 865
		Polyurethane		Ball Bearing	SCC-GR20S314-PPUB-*	716138 , 342316 , 13162316 , 12316 , 845 , 865
		Solid Polyurethane	Plain Bore	SCC-GR20S314-SPUS-*	716138 , 342316 , 13162316 , 12316 , 845 , 865	
		Semi Steel	Plain Bore	SCC-GR20S314-SSS-*	716138 , 342316 , 13162316 , 12316 , 845 , 865	
		HT Glass Filled Nylon	350 lbs.	Plain Bore	SCC-GR20S314-GFNSHT-*	716138 , 342316 , 13162316 , 12316 , 845 , 865
	1-1/2"	Semi Steel	300 lbs.	Roller Bearing	SCC-GR20S315-SSR-*	716138 , 342316 , 13162316 , 12316 , 845 , 865
	3-1/2"	1-1/4"	Soft Rubber	200 lbs.	Plain Bore	SCC-GR20S3514-SRS-*
Thermoplastic Rubber			230 lbs.	Ball Bearing	SCC-GR20S3514-TPRB-*	716138 , 342316 , 13162316 , 12316 , 845 , 865
Hard Rubber			285 lbs.	Plain Bore	SCC-GR20S3514-HRS-*	716138 , 342316 , 13162316 , 12316 , 845 , 865
Phenolic			300 lbs.	Roller Bearing	SCC-GR20S3514-PHR-*	716138 , 342316 , 13162316 , 12316 , 845 , 865
Phenolic				Plain Bore	SCC-GR20S3514-PHS-*	716138 , 342316 , 13162316 , 12316 , 845 , 865
Polyurethane				Ball Bearing	SCC-GR20S3514-PPUB-*	716138 , 342316 , 13162316 , 12316 , 845 , 865
Solid Polyurethane				Plain Bore	SCC-GR20S3514-SPUS-*	716138 , 342316 , 13162316 , 12316 , 845 , 865
HT Glass Filled Nylon			350 lbs.	Plain Bore	SCC-GR20S3514-GFNSHT-*	716138 , 342316 , 13162316 , 12316 , 845 , 865
4"	1-1/4"	Soft Rubber	200 lbs.	Plain Bore	SCC-GR20S414-SRS-*	716138 , 342316 , 13162316 , 12316 , 845 , 865
		Thermoplastic Rubber	250 lbs.	Ball Bearing	SCC-GR20S414-TPRB-*	716138 , 342316 , 13162316 , 12316 , 845 , 865
		Hard Rubber	300 lbs.	Plain Bore	SCC-GR20S414-HRS-*	716138 , 342316 , 13162316 , 12316 , 845 , 865
		Nylon		Plain Bore	SCC-GR20S414-NYS-*	716138 , 342316 , 13162316 , 12316 , 845 , 865
		Phenolic		Roller Bearing	SCC-GR20S414-PHR-*	716138 , 342316 , 13162316 , 12316 , 845 , 865
		Phenolic		Plain Bore	SCC-GR20S414-PHS-*	716138 , 342316 , 13162316 , 12316 , 845 , 865
		High Temp Phenolic		Roller Bearing	SCC-GR20S414-PHRHT-*	716138 , 342316 , 13162316 , 12316 , 845 , 865
		Solid Polyurethane		Plain Bore	SCC-GR20S414-SPUS-*	716138 , 342316 , 13162316 , 12316 , 845 , 865
		Semi Steel	Plain Bore	SCC-GR20S414-SSS-*	716138 , 342316 , 13162316 , 12316 , 845 , 865	
		High Temp Phenolic	Plain Bore	SCC-GR20S414-PHSHT-*	716138 , 342316 , 13162316 , 12316 , 845 , 865	
		Polyurethane	350 lbs.	Ball Bearing	SCC-GR20S414-PPUB-*	716138 , 342316 , 13162316 , 12316 , 845 , 865
		HT Glass Filled Nylon	Plain Bore	SCC-GR20S414-GFNSHT-*	716138 , 342316 , 13162316 , 12316 , 845 , 865	
	1-1/2"	Semi Steel	300 lbs.	Roller Bearing	SCC-GR20S415-SSR-*	716138 , 342316 , 13162316 , 12316 , 845 , 865
	5"	1-1/4"	Soft Rubber	275 lbs.	Plain Bore	SCC-GR20S514-SRS-*
Thermoplastic Rubber			300 lbs.	Ball Bearing	SCC-GR20S514-TPRB-*	716138 , 342316 , 13162316 , 12316 , 845 , 865
Hard Rubber				Plain Bore	SCC-GR20S514-HRS-*	716138 , 342316 , 13162316 , 12316 , 845 , 865
Nylon				Plain Bore	SCC-GR20S514-NYS-*	716138 , 342316 , 13162316 , 12316 , 845 , 865
Phenolic				Roller Bearing	SCC-GR20S514-PHR-*	716138 , 342316 , 13162316 , 12316 , 845 , 865
Phenolic				Plain Bore	SCC-GR20S514-PHS-*	716138 , 342316 , 13162316 , 12316 , 845 , 865
High Temp Phenolic				Roller Bearing	SCC-GR20S514-PHRHT-*	716138 , 342316 , 13162316 , 12316 , 845 , 865
High Temp Phenolic			Plain Bore	SCC-GR20S514-PHSHT-*	716138 , 342316 , 13162316 , 12316 , 845 , 865	
Solid Polyurethane			Plain Bore	SCC-GR20S514-SPUS-*	716138 , 342316 , 13162316 , 12316 , 845 , 865	
Semi Steel			Plain Bore	SCC-GR20S514-SSS-*	716138 , 342316 , 13162316 , 12316 , 845 , 865	
Polyurethane			Ball Bearing	SCC-GR20S514-PPUB-*	716138 , 342316 , 13162316 , 12316 , 845 , 865	
HT Glass Filled Nylon			350 lbs.	Plain Bore	SCC-GR20S514-GFNSHT-*	716138 , 342316 , 13162316 , 12316 , 845 , 865
1-1/2"		Semi Steel	300 lbs.	Roller Bearing	SCC-GR20S515-SSR-*	716138 , 342316 , 13162316 , 12316 , 845 , 865
6"		1-1/4"	Thermoplastic Rubber	300 lbs.	Ball Bearing	SCC-GR20S614-TPRB-*
	Polyurethane		350 lbs.	Ball Bearing	SCC-GR20S614-PPUB-*	716138 , 342316 , 13162316 , 12316 , 845 , 865
	1-1/2"	Phenolic	300 lbs.	Plain Bore	SCC-GR20S615-PHS-*	716138 , 342316 , 13162316 , 12316 , 845 , 865
		Phenolic		Roller Bearing	SCC-GR20S615-PHR-*	716138 , 342316 , 13162316 , 12316 , 845 , 865
		High Temp Phenolic		Plain Bore	SCC-GR20S615-PHSHT-*	716138 , 342316 , 13162316 , 12316 , 845 , 865
		High Temp Phenolic		Roller Bearing	SCC-GR20S615-PHRHT-*	716138 , 342316 , 13162316 , 12316 , 845 , 865



GRIP RING CASTERS with Top Lock Brakes

Mounting Size	Mounting Size	Wheel Diameter	Overall Height	Swivel Radius	Approximate Weight
.845" x 2-3/16" (845)	7/16" x 1-3/8" (716138)	3"	4-1/8"	2-15/16"	1.45
.865" x 2-3/16" (865)	3/4" x 2-3/16" (342316)	3-1/2"	4-5/8"	3-3/16"	1.6
	13/16" x 2-3/16" (1316)	4"	5-1/8"	3-1/2"	1.7
	1" x 2-3/16" (12316)	5"	6-1/8"	4"	2
		6"	7-1/8"	4-9/16"	2.95

Wheel Dia	Tread Width	Wheel Type	Load Capacity	Bearing Type	Swivel Caster	Stem Code (Grip Ring Stem)
3"	1-1/4"	Soft Rubber	210 lbs.	Plain Bore	SCC-GR20S314-SRS-TLB*	716138 , 342316 , 13162316 , 12316 , 845 , 865
		Thermoplastic Rubber	210 lbs.	Ball Bearing	SCC-GR20S314-TPRB-TLB*	716138 , 342316 , 13162316 , 12316 , 845 , 865
		Hard Rubber	275 lbs	Plain Bore	SCC-GR20S314-HRS-TLB*	716138 , 342316 , 13162316 , 12316 , 845 , 865
		Nylon	300 lbs.	Plain Bore	SCC-GR20S314-NYS-TLB*	716138 , 342316 , 13162316 , 12316 , 845 , 865
		Phenolic		Roller Bearing	SCC-GR20S314-PHR-TLB*	716138 , 342316 , 13162316 , 12316 , 845 , 865
		High Temp Phenolic		Roller Bearing	SCC-GR20S314-PHRHT-TLB*	716138 , 342316 , 13162316 , 12316 , 845 , 865
		Phenolic		Plain Bore	SCC-GR20S314-PHS-TLB*	716138 , 342316 , 13162316 , 12316 , 845 , 865
		High Temp Phenolic		Plain Bore	SCC-GR20S314-PHSHT-TLB*	716138 , 342316 , 13162316 , 12316 , 845 , 865
		Polyurethane		Ball Bearing	SCC-GR20S314-PPUB-TLB*	716138 , 342316 , 13162316 , 12316 , 845 , 865
		Solid Polyurethane		Plain Bore	SCC-GR20S314-SPUS-TLB*	716138 , 342316 , 13162316 , 12316 , 845 , 865
		Semi Steel	Plain Bore	SCC-GR20S314-SSS-TLB*	716138 , 342316 , 13162316 , 12316 , 845 , 865	
	HT Glass Filled Nylon	350 lbs.	Plain Bore	SCC-GR20S314-GFNSHT-TLB*	716138 , 342316 , 13162316 , 12316 , 845 , 865	
	1-1/2"	Semi Steel	300 lbs.	Roller Bearing	SCC-GR20S315-SSR-TLB*	716138 , 342316 , 13162316 , 12316 , 845 , 865
	3-1/2"	1-1/4"	Soft Rubber	200 lbs.	Plain Bore	SCC-GR20S3514-SRS-TLB*
Thermoplastic Rubber			230 lbs.	Ball Bearing	SCC-GR20S3514-TPRB-TLB*	716138 , 342316 , 13162316 , 12316 , 845 , 865
Hard Rubber			285 lbs.	Plain Bore	SCC-GR20S3514-HRS-TLB*	716138 , 342316 , 13162316 , 12316 , 845 , 865
Phenolic			300 lbs.	Roller Bearing	SCC-GR20S3514-PHR-TLB*	716138 , 342316 , 13162316 , 12316 , 845 , 865
Phenolic				Plain Bore	SCC-GR20S3514-PHS-TLB*	716138 , 342316 , 13162316 , 12316 , 845 , 865
Polyurethane				Ball Bearing	SCC-GR20S3514-PPUB-TLB*	716138 , 342316 , 13162316 , 12316 , 845 , 865
Solid Polyurethane			Plain Bore	SCC-GR20S3514-SPUS-TLB*	716138 , 342316 , 13162316 , 12316 , 845 , 865	
HT Glass Filled Nylon	350 lbs.	Plain Bore	SCC-GR20S3514-GFNSHT-TLB*	716138 , 342316 , 13162316 , 12316 , 845 , 865		
4"	1-1/4"	Soft Rubber	200 lbs.	Plain Bore	SCC-GR20S414-SRS-TLB*	716138 , 342316 , 13162316 , 12316 , 845 , 865
		Thermoplastic Rubber	250 lbs.	Ball Bearing	SCC-GR20S414-TPRB-TLB*	716138 , 342316 , 13162316 , 12316 , 845 , 865
		Hard Rubber	300 lbs.	Plain Bore	SCC-GR20S414-HRS-TLB*	716138 , 342316 , 13162316 , 12316 , 845 , 865
		Nylon		Plain Bore	SCC-GR20S414-NYS-TLB*	716138 , 342316 , 13162316 , 12316 , 845 , 865
		Phenolic		Roller Bearing	SCC-GR20S414-PHR-TLB*	716138 , 342316 , 13162316 , 12316 , 845 , 865
		Phenolic		Plain Bore	SCC-GR20S414-PHS-TLB*	716138 , 342316 , 13162316 , 12316 , 845 , 865
		High Temp Phenolic		Roller Bearing	SCC-GR20S414-PHRHT-TLB*	716138 , 342316 , 13162316 , 12316 , 845 , 865
		Solid Polyurethane		Plain Bore	SCC-GR20S414-SPUS-TLB*	716138 , 342316 , 13162316 , 12316 , 845 , 865
		Semi Steel		Plain Bore	SCC-GR20S414-SSS-TLB*	716138 , 342316 , 13162316 , 12316 , 845 , 865
		High Temp Phenolic	Plain Bore	SCC-GR20S414-PHSHT-TLB*	716138 , 342316 , 13162316 , 12316 , 845 , 865	
		Polyurethane	350 lbs.	Ball Bearing	SCC-GR20S414-PPUB-TLB*	716138 , 342316 , 13162316 , 12316 , 845 , 865
	HT Glass Filled Nylon	Plain Bore	SCC-GR20S414-GFNSHT-TLB*	716138 , 342316 , 13162316 , 12316 , 845 , 865		
	1-1/2"	Semi Steel	300 lbs.	Roller Bearing	SCC-GR20S415-SSR-TLB*	716138 , 342316 , 13162316 , 12316 , 845 , 865
	5"	1-1/4"	Soft Rubber	275 lbs.	Plain Bore	SCC-GR20S514-SRS-TLB*
Thermoplastic Rubber			300 lbs.	Ball Bearing	SCC-GR20S514-TPRB-TLB*	716138 , 342316 , 13162316 , 12316 , 845 , 865
Hard Rubber				Plain Bore	SCC-GR20S514-HRS-TLB*	716138 , 342316 , 13162316 , 12316 , 845 , 865
Nylon				Plain Bore	SCC-GR20S514-NYS-TLB*	716138 , 342316 , 13162316 , 12316 , 845 , 865
Phenolic				Roller Bearing	SCC-GR20S514-PHR-TLB*	716138 , 342316 , 13162316 , 12316 , 845 , 865
Phenolic				Plain Bore	SCC-GR20S514-PHS-TLB*	716138 , 342316 , 13162316 , 12316 , 845 , 865
High Temp Phenolic				Roller Bearing	SCC-GR20S514-PHRHT-TLB*	716138 , 342316 , 13162316 , 12316 , 845 , 865
High Temp Phenolic				Plain Bore	SCC-GR20S514-PHSHT-TLB*	716138 , 342316 , 13162316 , 12316 , 845 , 865
Solid Polyurethane			Plain Bore	SCC-GR20S514-SPUS-TLB*	716138 , 342316 , 13162316 , 12316 , 845 , 865	
Semi Steel			Plain Bore	SCC-GR20S514-SSS-TLB*	716138 , 342316 , 13162316 , 12316 , 845 , 865	
Polyurethane			Ball Bearing	SCC-GR20S514-PPUB-TLB*	716138 , 342316 , 13162316 , 12316 , 845 , 865	
HT Glass Filled Nylon		350 lbs.	Plain Bore	SCC-GR20S514-GFNSHT-TLB*	716138 , 342316 , 13162316 , 12316 , 845 , 865	
1-1/2"		Semi Steel	300 lbs.	Roller Bearing	SCC-GR20S515-SSR-TLB*	716138 , 342316 , 13162316 , 12316 , 845 , 865
6"		1-1/4"	Thermoplastic Rubber	300 lbs.	Ball Bearing	SCC-GR20S614-TPRB-TLB*
	Polyurethane		350 lbs.	Ball Bearing	SCC-GR20S614-PPUB-TLB*	716138 , 342316 , 13162316 , 12316 , 845 , 865
	1-1/2"	Phenolic	300 lbs.	Plain Bore	SCC-GR20S615-PHS-TLB*	716138 , 342316 , 13162316 , 12316 , 845 , 865
		Phenolic		Roller Bearing	SCC-GR20S615-PHR-TLB*	716138 , 342316 , 13162316 , 12316 , 845 , 865
		High Temp Phenolic		Plain Bore	SCC-GR20S615-PHSHT-TLB*	716138 , 342316 , 13162316 , 12316 , 845 , 865
		High Temp Phenolic		Roller Bearing	SCC-GR20S615-PHRHT-TLB*	716138 , 342316 , 13162316 , 12316 , 845 , 865



GRIP RING CASTERS *with Posi Lock Brakes*

Mounting Size	Mounting Size	Wheel Diameter	Overall Height	Swivel Radius	Approximate Weight
.845" x 2-3/16" (845)	7/16" x 1-3/8" (716138)	3"	4-1/8"	2-15/16"	1.45
.865" x 2-3/16" (865)	3/4" x 2-3/16" (342316)	3-1/2"	4-5/8"	3-3/16"	1.6
	13/16" x 2-3/16" (1316)	4"	5-1/8"	3-1/2"	1.7
	1" x 2-3/16" (12316)	5"	6-1/8"	4"	2
		6"	7-1/8"	4-9/16"	2.95

Wheel Dia	Tread Width	Wheel Type	Load Capacity	Bearing Type	Swivel Caster	Stem Code (Grip Ring Stem)
3"	1-1/4"	Soft Rubber	210 lbs.	Plain Bore	SCC-GR20S314-SRS-PLB*	716138 , 342316 , 13162316 , 12316 , 845 , 865
		Thermoplastic Rubber	210 lbs.	Ball Bearing	SCC-GR20S314-TPRB-PLB*	716138 , 342316 , 13162316 , 12316 , 845 , 865
		Hard Rubber	275 lbs	Plain Bore	SCC-GR20S314-HRS-PLB*	716138 , 342316 , 13162316 , 12316 , 845 , 865
		Nylon	300 lbs.	Plain Bore	SCC-GR20S314-NYS-PLB*	716138 , 342316 , 13162316 , 12316 , 845 , 865
		Phenolic		Roller Bearing	SCC-GR20S314-PHR-PLB*	716138 , 342316 , 13162316 , 12316 , 845 , 865
		High Temp Phenolic		Roller Bearing	SCC-GR20S314-PHRHT-PLB*	716138 , 342316 , 13162316 , 12316 , 845 , 865
		Phenolic		Plain Bore	SCC-GR20S314-PHS-PLB*	716138 , 342316 , 13162316 , 12316 , 845 , 865
		High Temp Phenolic		Plain Bore	SCC-GR20S314-PHSHT-PLB*	716138 , 342316 , 13162316 , 12316 , 845 , 865
		Polyurethane		Ball Bearing	SCC-GR20S314-PPUB-PLB*	716138 , 342316 , 13162316 , 12316 , 845 , 865
		Solid Polyurethane	Plain Bore	SCC-GR20S314-SPUS-PLB*	716138 , 342316 , 13162316 , 12316 , 845 , 865	
		Semi Steel	Plain Bore	SCC-GR20S314-SSS-PLB*	716138 , 342316 , 13162316 , 12316 , 845 , 865	
		HT Glass Filled Nylon	350 lbs.	Plain Bore	SCC-GR20S314-GFNSHT-PLB*	716138 , 342316 , 13162316 , 12316 , 845 , 865
	1-1/2"	Semi Steel	300 lbs.	Roller Bearing	SCC-GR20S315-SSR-PLB*	716138 , 342316 , 13162316 , 12316 , 845 , 865
	3-1/2"	1-1/4"	Soft Rubber	200 lbs.	Plain Bore	SCC-GR20S3514-SRS-PLB*
Thermoplastic Rubber			230 lbs.	Ball Bearing	SCC-GR20S3514-TPRB-PLB*	716138 , 342316 , 13162316 , 12316 , 845 , 865
Hard Rubber			285 lbs.	Plain Bore	SCC-GR20S3514-HRS-PLB*	716138 , 342316 , 13162316 , 12316 , 845 , 865
Phenolic			300 lbs.	Roller Bearing	SCC-GR20S3514-PHR-PLB*	716138 , 342316 , 13162316 , 12316 , 845 , 865
Phenolic				Plain Bore	SCC-GR20S3514-PHS-PLB*	716138 , 342316 , 13162316 , 12316 , 845 , 865
Polyurethane				Ball Bearing	SCC-GR20S3514-PPUB-PLB*	716138 , 342316 , 13162316 , 12316 , 845 , 865
Solid Polyurethane				Plain Bore	SCC-GR20S3514-SPUS-PLB*	716138 , 342316 , 13162316 , 12316 , 845 , 865
HT Glass Filled Nylon			350 lbs.	Plain Bore	SCC-GR20S3514-GFNSHT-PLB*	716138 , 342316 , 13162316 , 12316 , 845 , 865
4"	1-1/4"	Soft Rubber	200 lbs.	Plain Bore	SCC-GR20S414-SRS-PLB*	716138 , 342316 , 13162316 , 12316 , 845 , 865
		Thermoplastic Rubber	250 lbs.	Ball Bearing	SCC-GR20S414-TPRB-PLB*	716138 , 342316 , 13162316 , 12316 , 845 , 865
		Hard Rubber	300 lbs.	Plain Bore	SCC-GR20S414-HRS-PLB*	716138 , 342316 , 13162316 , 12316 , 845 , 865
		Nylon		Plain Bore	SCC-GR20S414-NYS-PLB*	716138 , 342316 , 13162316 , 12316 , 845 , 865
		Phenolic		Roller Bearing	SCC-GR20S414-PHR-PLB*	716138 , 342316 , 13162316 , 12316 , 845 , 865
		Phenolic		Plain Bore	SCC-GR20S414-PHS-PLB*	716138 , 342316 , 13162316 , 12316 , 845 , 865
		High Temp Phenolic		Roller Bearing	SCC-GR20S414-PHRHT-PLB*	716138 , 342316 , 13162316 , 12316 , 845 , 865
		Solid Polyurethane		Plain Bore	SCC-GR20S414-SPUS-PLB*	716138 , 342316 , 13162316 , 12316 , 845 , 865
		Semi Steel	Plain Bore	SCC-GR20S414-SSS-PLB*	716138 , 342316 , 13162316 , 12316 , 845 , 865	
		High Temp Phenolic	Plain Bore	SCC-GR20S414-PHSHT-PLB*	716138 , 342316 , 13162316 , 12316 , 845 , 865	
		Polyurethane	350 lbs.	Ball Bearing	SCC-GR20S414-PPUB-PLB*	716138 , 342316 , 13162316 , 12316 , 845 , 865
		HT Glass Filled Nylon	Plain Bore	SCC-GR20S414-GFNSHT-PLB*	716138 , 342316 , 13162316 , 12316 , 845 , 865	
	1-1/2"	Semi Steel	300 lbs.	Roller Bearing	SCC-GR20S415-SSR-PLB*	716138 , 342316 , 13162316 , 12316 , 845 , 865
	5"	1-1/4"	Soft Rubber	275 lbs.	Plain Bore	SCC-GR20S514-SRS-PLB*
Thermoplastic Rubber			300 lbs.	Ball Bearing	SCC-GR20S514-TPRB-PLB*	716138 , 342316 , 13162316 , 12316 , 845 , 865
Hard Rubber				Plain Bore	SCC-GR20S514-HRS-PLB*	716138 , 342316 , 13162316 , 12316 , 845 , 865
Nylon				Plain Bore	SCC-GR20S514-NYS-PLB*	716138 , 342316 , 13162316 , 12316 , 845 , 865
Phenolic				Roller Bearing	SCC-GR20S514-PHR-PLB*	716138 , 342316 , 13162316 , 12316 , 845 , 865
Phenolic				Plain Bore	SCC-GR20S514-PHS-PLB*	716138 , 342316 , 13162316 , 12316 , 845 , 865
High Temp Phenolic				Roller Bearing	SCC-GR20S514-PHRHT-PLB*	716138 , 342316 , 13162316 , 12316 , 845 , 865
High Temp Phenolic			Plain Bore	SCC-GR20S514-PHSHT-PLB*	716138 , 342316 , 13162316 , 12316 , 845 , 865	
Solid Polyurethane			Plain Bore	SCC-GR20S514-SPUS-PLB*	716138 , 342316 , 13162316 , 12316 , 845 , 865	
Semi Steel			Plain Bore	SCC-GR20S514-SSS-PLB*	716138 , 342316 , 13162316 , 12316 , 845 , 865	
Polyurethane			350 lbs.	Ball Bearing	SCC-GR20S514-PPUB-PLB*	716138 , 342316 , 13162316 , 12316 , 845 , 865
HT Glass Filled Nylon			Plain Bore	SCC-GR20S514-GFNSHT-PLB*	716138 , 342316 , 13162316 , 12316 , 845 , 865	
1-1/2"		Semi Steel	300 lbs.	Roller Bearing	SCC-GR20S515-SSR-PLB*	716138 , 342316 , 13162316 , 12316 , 845 , 865
6"		1-1/4"	Thermoplastic Rubber	300 lbs.	Ball Bearing	SCC-GR20S614-TPRB-PLB*
	Polyurethane		350 lbs.	Ball Bearing	SCC-GR20S614-PPUB-PLB*	716138 , 342316 , 13162316 , 12316 , 845 , 865
	1-1/2"	Phenolic	300 lbs.	Plain Bore	SCC-GR20S615-PHS-PLB*	716138 , 342316 , 13162316 , 12316 , 845 , 865
		Phenolic		Roller Bearing	SCC-GR20S615-PHR-PLB*	716138 , 342316 , 13162316 , 12316 , 845 , 865
		High Temp Phenolic		Plain Bore	SCC-GR20S615-PHSHT-PLB*	716138 , 342316 , 13162316 , 12316 , 845 , 865
		High Temp Phenolic		Roller Bearing	SCC-GR20S615-PHRHT-PLB*	716138 , 342316 , 13162316 , 12316 , 845 , 865



GRIP RING CASTERS *with Total Lock Brakes*

Mounting Size	Mounting Size	Wheel Diameter	Overall Height	Swivel Radius	Approximate Weight
.845" x 2-3/16" (845)	7/16" x 1-3/8" (716138)	3"	4-1/8"	2-15/16"	1.45
.865" x 2-3/16" (865)	3/4" x 2-3/16" (342316)	3-1/2"	4-5/8"	3-3/16"	1.6
	13/16" x 2-3/16" (1316)	4"	5-1/8"	3-1/2"	1.7
	1" x 2-3/16" (12316)	5"	6-1/8"	4"	2
		6"	7-1/8"	4-9/16"	2.95

Wheel Dia	Tread Width	Wheel Type	Load Capacity	Bearing Type	Swivel Caster	Stem Code (Grip Ring Stem)
3"	1-1/4"	Soft Rubber	210 lbs.	Plain Bore	SCC-GRITL20S314-SRS-*	716138 , 342316 , 13162316 , 12316 , 845 , 865
		Thermoplastic Rubber	210 lbs.	Ball Bearing	SCC-GRITL20S314-TPRB-*	716138 , 342316 , 13162316 , 12316 , 845 , 865
		Hard Rubber	275 lbs	Plain Bore	SCC-GRITL20S314-HRS-*	716138 , 342316 , 13162316 , 12316 , 845 , 865
		Nylon	300 lbs.	Plain Bore	SCC-GRITL20S314-NYS-*	716138 , 342316 , 13162316 , 12316 , 845 , 865
		Phenolic		Roller Bearing	SCC-GRITL20S314-PHR-*	716138 , 342316 , 13162316 , 12316 , 845 , 865
		High Temp Phenolic		Roller Bearing	SCC-GRITL20S314-PHRHT-*	716138 , 342316 , 13162316 , 12316 , 845 , 865
		Phenolic		Plain Bore	SCC-GRITL20S314-PHS-*	716138 , 342316 , 13162316 , 12316 , 845 , 865
		High Temp Phenolic		Plain Bore	SCC-GRITL20S314-PHSHT-*	716138 , 342316 , 13162316 , 12316 , 845 , 865
		Polyurethane		Ball Bearing	SCC-GRITL20S314-PPUB-*	716138 , 342316 , 13162316 , 12316 , 845 , 865
		Solid Polyurethane	Plain Bore	SCC-GRITL20S314-SPUS-*	716138 , 342316 , 13162316 , 12316 , 845 , 865	
		Semi Steel	Plain Bore	SCC-GRITL20S314-SSS-*	716138 , 342316 , 13162316 , 12316 , 845 , 865	
		HT Glass Filled Nylon	350 lbs.	Plain Bore	SCC-GRITL20S314-GFNSHT-*	716138 , 342316 , 13162316 , 12316 , 845 , 865
	1-1/2"	Semi Steel	300 lbs.	Roller Bearing	SCC-GRITL20S315-SSR-*	716138 , 342316 , 13162316 , 12316 , 845 , 865
	3-1/2"	1-1/4"	Soft Rubber	200 lbs.	Plain Bore	SCC-GRITL20S3514-SRS-*
Thermoplastic Rubber			230 lbs.	Ball Bearing	SCC-GRITL20S3514-TPRB-*	716138 , 342316 , 13162316 , 12316 , 845 , 865
Hard Rubber			285 lbs.	Plain Bore	SCC-GRITL20S3514-HRS-*	716138 , 342316 , 13162316 , 12316 , 845 , 865
Phenolic			300 lbs.	Roller Bearing	SCC-GRITL20S3514-PHR-*	716138 , 342316 , 13162316 , 12316 , 845 , 865
Phenolic				Plain Bore	SCC-GRITL20S3514-PHS-*	716138 , 342316 , 13162316 , 12316 , 845 , 865
Polyurethane				Ball Bearing	SCC-GRITL20S3514-PPUB-*	716138 , 342316 , 13162316 , 12316 , 845 , 865
Solid Polyurethane				Plain Bore	SCC-GRITL20S3514-SPUS-*	716138 , 342316 , 13162316 , 12316 , 845 , 865
HT Glass Filled Nylon			350 lbs.	Plain Bore	SCC-GRITL20S3514-GFNSHT-*	716138 , 342316 , 13162316 , 12316 , 845 , 865
4"	1-1/4"	Soft Rubber	200 lbs.	Plain Bore	SCC-GRITL20S414-SRS-*	716138 , 342316 , 13162316 , 12316 , 845 , 865
		Thermoplastic Rubber	250 lbs.	Ball Bearing	SCC-GRITL20S414-TPRB-*	716138 , 342316 , 13162316 , 12316 , 845 , 865
		Hard Rubber	300 lbs.	Plain Bore	SCC-GRITL20S414-HRS-*	716138 , 342316 , 13162316 , 12316 , 845 , 865
		Nylon		Plain Bore	SCC-GRITL20S414-NYS-*	716138 , 342316 , 13162316 , 12316 , 845 , 865
		Phenolic		Roller Bearing	SCC-GRITL20S414-PHR-*	716138 , 342316 , 13162316 , 12316 , 845 , 865
		Phenolic		Plain Bore	SCC-GRITL20S414-PHS-*	716138 , 342316 , 13162316 , 12316 , 845 , 865
		High Temp Phenolic		Roller Bearing	SCC-GRITL20S414-PHRHT-*	716138 , 342316 , 13162316 , 12316 , 845 , 865
		Solid Polyurethane		Plain Bore	SCC-GRITL20S414-SPUS-*	716138 , 342316 , 13162316 , 12316 , 845 , 865
		Semi Steel	Plain Bore	SCC-GRITL20S414-SSS-*	716138 , 342316 , 13162316 , 12316 , 845 , 865	
		High Temp Phenolic	Plain Bore	SCC-GRITL20S414-PHSHT-*	716138 , 342316 , 13162316 , 12316 , 845 , 865	
		Polyurethane	350 lbs.	Ball Bearing	SCC-GRITL20S414-PPUB-*	716138 , 342316 , 13162316 , 12316 , 845 , 865
		HT Glass Filled Nylon	Plain Bore	SCC-GRITL20S414-GFNSHT-*	716138 , 342316 , 13162316 , 12316 , 845 , 865	
	1-1/2"	Semi Steel	300 lbs.	Roller Bearing	SCC-GRITL20S415-SSR-*	716138 , 342316 , 13162316 , 12316 , 845 , 865
	5"	1-1/4"	Soft Rubber	275 lbs.	Plain Bore	SCC-GRITL20S514-SRS-*
Thermoplastic Rubber			300 lbs.	Ball Bearing	SCC-GRITL20S514-TPRB-*	716138 , 342316 , 13162316 , 12316 , 845 , 865
Hard Rubber				Plain Bore	SCC-GRITL20S514-HRS-*	716138 , 342316 , 13162316 , 12316 , 845 , 865
Nylon				Plain Bore	SCC-GRITL20S514-NYS-*	716138 , 342316 , 13162316 , 12316 , 845 , 865
Phenolic				Roller Bearing	SCC-GRITL20S514-PHR-*	716138 , 342316 , 13162316 , 12316 , 845 , 865
Phenolic				Plain Bore	SCC-GRITL20S514-PHS-*	716138 , 342316 , 13162316 , 12316 , 845 , 865
High Temp Phenolic				Roller Bearing	SCC-GRITL20S514-PHRHT-*	716138 , 342316 , 13162316 , 12316 , 845 , 865
High Temp Phenolic			Plain Bore	SCC-GRITL20S514-PHSHT-*	716138 , 342316 , 13162316 , 12316 , 845 , 865	
Solid Polyurethane			Plain Bore	SCC-GRITL20S514-SPUS-*	716138 , 342316 , 13162316 , 12316 , 845 , 865	
Semi Steel			Plain Bore	SCC-GRITL20S514-SSS-*	716138 , 342316 , 13162316 , 12316 , 845 , 865	
Polyurethane			Ball Bearing	SCC-GRITL20S514-PPUB-*	716138 , 342316 , 13162316 , 12316 , 845 , 865	
HT Glass Filled Nylon			350 lbs.	Plain Bore	SCC-GRITL20S514-GFNSHT-*	716138 , 342316 , 13162316 , 12316 , 845 , 865
1-1/2"		Semi Steel	300 lbs.	Roller Bearing	SCC-GRITL20S515-SSR-*	716138 , 342316 , 13162316 , 12316 , 845 , 865
6"		1-1/4"	Thermoplastic Rubber	300 lbs.	Ball Bearing	SCC-GRITL20S614-TPRB-*
	Polyurethane		350 lbs.	Ball Bearing	SCC-GRITL20S614-PPUB-*	716138 , 342316 , 13162316 , 12316 , 845 , 865
	1-1/2"	Phenolic	300 lbs.	Plain Bore	SCC-GRITL20S615-PHS-*	716138 , 342316 , 13162316 , 12316 , 845 , 865
		Phenolic		Roller Bearing	SCC-GRITL20S615-PHR-*	716138 , 342316 , 13162316 , 12316 , 845 , 865
		High Temp Phenolic		Plain Bore	SCC-GRITL20S615-PHSHT-*	716138 , 342316 , 13162316 , 12316 , 845 , 865
		High Temp Phenolic		Roller Bearing	SCC-GRITL20S615-PHRHT-*	716138 , 342316 , 13162316 , 12316 , 845 , 865

Medium Duty Casters

Series #20 Square Stem Casters

Our 20 series square stem caster offers versatile and durable mobility for various applications, ensuring stability and ease of use.

Applications

- Racks
- Storage Bins
- Displays
- Food service operations
- Utility Carts
- Medical Carts



Features

- Heat treated double ball bearing raceways for durability
- Available in Stainless Steel
- Versatile design suitable for various applications
- Ideal for light duty industrial use

Our part numbers are adaptable to suit your requirements. The diagram above serves as a reference to assist you in understanding the breakdown. If you require any help, please don't hesitate to contact our [customer service](#) team.

5" Swivel Square Stem Caster with Total Lock

SCC-SQTTL20S514-PPUB-34

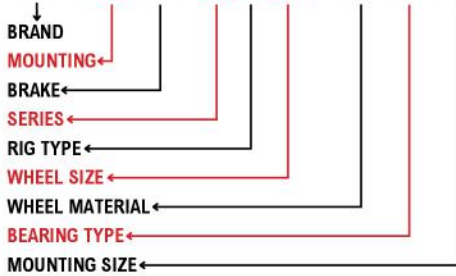

3" Swivel Square Stem Caster with Top Lock Brake

SCC-SQ20S314-TPRB-TLB-78

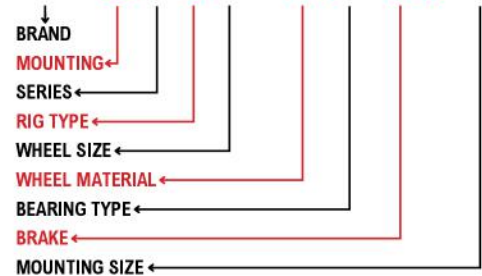

Service Caster Chart Guide

Build You Caster

Discover more fastening sizes and wheel options if you can't find what you need. And remember, we're always here to [help!](#)

Brand	Series	Mounting	Rig Type	Mounting Size	Bearing Type	Brake	Wheel Size	Wheel Material
Service Caster	20	Square (SQ)	Swivel (S)	3/4" x 2" (3/4)	Ball Bearing (B)	Top Lock (TLB)	2-1/2" x 1-1/4" (2514)	Soft Rubber (SR)
			Rigid (R)	7/8" x 2" (7/8)	Plain Bore (S)	Posi Lock (PLB)	3-1/2" x 1-1/4" (3514)	Thermo Plastic Rubber (TPR)
					Delrin Bearing (D)	Total Lock (TTL)	3" x 1-1/4" (314)	Polyurethane (PPU)
					Roller Bearing (R)	Directional Lock (DL)	4" x 1-1/4" (414)	Phenolic (PH)
							5" x 1-1/4" (514)	Solid Polyurethane (SPU)
							6" x 1-1/4" (614)	Hard Rubber (HR)
								Glass Filled Nylon (GFN)
								Rubber on Aluminum (RA)
								Semi Steel (SS)
								Nylon (NY)
								Polyolefin (PO)
								High Temp (HT)

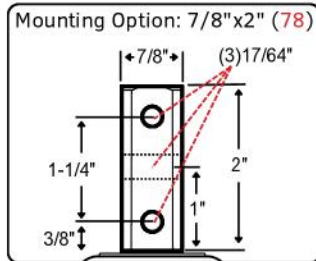
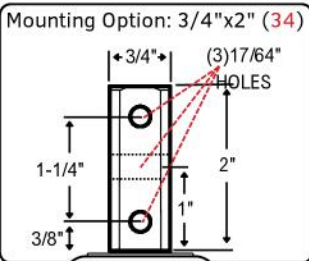

If you still require assistance, feel free to [reach out](#).

Wheel Tread

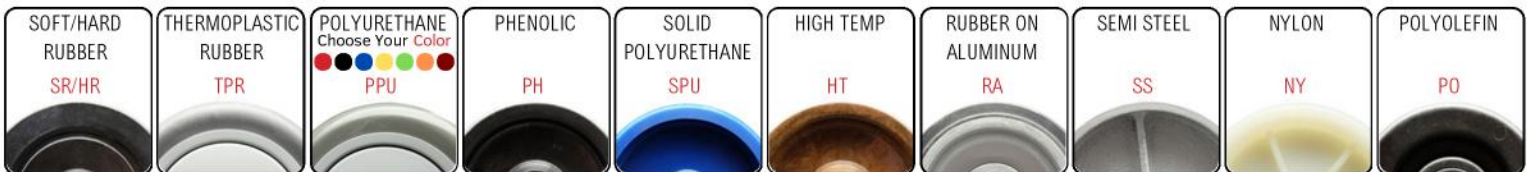



SQUARE STEM CASTERS

Mounting Size
3/4" x 2" Square with 3 mounting holes 17/64" diameter (34)
7/8" x 2" Square with 3 mounting holes 17/64" diameter (78)

Wheel Diameter	Overall Height	Swivel Radius	Approximate Weight
3"	4-1/8"	2-15/16"	1.45
3-1/2"	4-5/8"	3-3/16"	1.6
4"	5-1/8"	3-1/2"	1.7
5"	6-1/8"	4"	2
6"	7-1/8"	4-9/16"	2.95

Wheel Dia	Tread Width	Wheel Type	Load Capacity	Bearing Type	Swivel Caster	Stem Code (Grip Ring Stem)
3"	1-1/4"	Soft Rubber	210 lbs.	Plain Bore	SCC-SQ20S314-SRS-*	34, 78
		Thermoplastic Rubber	210 lbs.	Ball Bearing	SCC-SQ20S314-TPRB-*	34, 78
		Hard Rubber	275 lbs	Plain Bore	SCC-SQ20S314-HRS-*	34, 78
		Nylon	300 lbs.	Plain Bore	SCC-SQ20S314-NYS-*	34, 78
		Phenolic		Roller Bearing	SCC-SQ20S314-PHR-*	34, 78
		High Temp Phenolic		Roller Bearing	SCC-SQ20S314-PHRHT-*	34, 78
		Phenolic		Plain Bore	SCC-SQ20S314-PHS-*	34, 78
		High Temp Phenolic		Plain Bore	SCC-SQ20S314-PHSHT-*	34, 78
		Polyurethane		Ball Bearing	SCC-SQ20S314-PPUB-*	34, 78
		Solid Polyurethane	Plain Bore	SCC-SQ20S314-SPUS-*	34, 78	
		Semi Steel	Plain Bore	SCC-SQ20S314-SSS-*	34, 78	
		HT Glass Filled Nylon	350 lbs.	Plain Bore	SCC-SQ20S314-GFNSHT-*	34, 78
	1-1/2"	Semi Steel	300 lbs.	Roller Bearing	SCC-SQ20S315-SSR-*	34, 78
	3-1/2"	1-1/4"	Soft Rubber	200 lbs.	Plain Bore	SCC-SQ20S3514-SRS-*
Thermoplastic Rubber			230 lbs.	Ball Bearing	SCC-SQ20S3514-TPRB-*	34, 78
Hard Rubber			285 lbs.	Plain Bore	SCC-SQ20S3514-HRS-*	34, 78
Phenolic			300 lbs.	Roller Bearing	SCC-SQ20S3514-PHR-*	34, 78
Phenolic				Plain Bore	SCC-SQ20S3514-PHS-*	34, 78
Polyurethane				Ball Bearing	SCC-SQ20S3514-PPUB-*	34, 78
Solid Polyurethane			Plain Bore	SCC-SQ20S3514-SPUS-*	34, 78	
HT Glass Filled Nylon	350 lbs.	Plain Bore	SCC-SQ20S3514-GFNSHT-*	34, 78		
4"	1-1/4"	Soft Rubber	200 lbs.	Plain Bore	SCC-SQ20S414-SRS-*	34, 78
		Thermoplastic Rubber	250 lbs.	Ball Bearing	SCC-SQ20S414-TPRB-*	34, 78
		Hard Rubber	300 lbs.	Plain Bore	SCC-SQ20S414-HRS-*	34, 78
		Nylon		Plain Bore	SCC-SQ20S414-NYS-*	34, 78
		Phenolic		Roller Bearing	SCC-SQ20S414-PHR-*	34, 78
		Phenolic		Plain Bore	SCC-SQ20S414-PHS-*	34, 78
		High Temp Phenolic		Roller Bearing	SCC-SQ20S414-PHRHT-*	34, 78
		Solid Polyurethane		Plain Bore	SCC-SQ20S414-SPUS-*	34, 78
		Semi Steel	Plain Bore	SCC-SQ20S414-SSS-*	34, 78	
		High Temp Phenolic	Plain Bore	SCC-SQ20S414-PHSHT-*	34, 78	
		Polyurethane	350 lbs.	Ball Bearing	SCC-SQ20S414-PPUB-*	34, 78
		HT Glass Filled Nylon	Plain Bore	SCC-SQ20S414-GFNSHT-*	34, 78	
	1-1/2"	Semi Steel	300 lbs.	Roller Bearing	SCC-SQ20S415-SSR-*	34, 78
	5"	1-1/4"	Soft Rubber	275 lbs.	Plain Bore	SCC-SQ20S514-SRS-*
Thermoplastic Rubber			300 lbs.	Ball Bearing	SCC-SQ20S514-TPRB-*	34, 78
Hard Rubber				Plain Bore	SCC-SQ20S514-HRS-*	34, 78
Nylon				Plain Bore	SCC-SQ20S514-NYS-*	34, 78
Phenolic				Roller Bearing	SCC-SQ20S514-PHR-*	34, 78
Phenolic				Plain Bore	SCC-SQ20S514-PHS-*	34, 78
High Temp Phenolic				Roller Bearing	SCC-SQ20S514-PHRHT-*	34, 78
High Temp Phenolic			Plain Bore	SCC-SQ20S514-PHSHT-*	34, 78	
Solid Polyurethane			Plain Bore	SCC-SQ20S514-SPUS-*	34, 78	
Semi Steel			Plain Bore	SCC-SQ20S514-SSS-*	34, 78	
Polyurethane			Ball Bearing	SCC-SQ20S514-PPUB-*	34, 78	
HT Glass Filled Nylon			350 lbs.	Plain Bore	SCC-SQ20S514-GFNSHT-*	34, 78
1-1/2"		Semi Steel	300 lbs.	Roller Bearing	SCC-SQ20S515-SSR-*	34, 78
6"		1-1/4"	Thermoplastic Rubber	300 lbs.	Ball Bearing	SCC-SQ20S614-TPRB-*
	Polyurethane		350 lbs.	Ball Bearing	SCC-SQ20S614-PPUB-*	34, 78
	1-1/2"	Phenolic	300 lbs.	Plain Bore	SCC-SQ20S615-PHS-*	34, 78
		Phenolic		Roller Bearing	SCC-SQ20S615-PHR-*	34, 78
		High Temp Phenolic		Plain Bore	SCC-SQ20S615-PHSHT-*	34, 78
		High Temp Phenolic		Roller Bearing	SCC-SQ20S615-PHRHT-*	34, 78



Mounting Size
3/4" x 2" Square with 3 mounting holes 17/64" diameter (34)
7/8" x 2" Square with 3 mounting holes 17/64" diameter (78)

Wheel Diameter	Overall Height	Swivel Radius	Approximate Weight
3"	4-1/8"	2-15/16"	1.45
3-1/2"	4-5/8"	3-3/16"	1.6
4"	5-1/8"	3-1/2"	1.7
5"	6-1/8"	4"	2
6"	7-1/8"	4-9/16"	2.95

SQUARE STEM CASTERS *with Top Lock Brakes*

Wheel Dia	Tread Width	Wheel Type	Load Capacity	Bearing Type	Swivel Caster	Stem Code (Grip Ring Stem)
3"	1-1/4"	Soft Rubber	210 lbs.	Plain Bore	SCC-SQ20S314-SRS-TLB*	34, 78
		Thermoplastic Rubber	210 lbs.	Ball Bearing	SCC-SQ20S314-TPRB-TLB*	34, 78
		Hard Rubber	275 lbs	Plain Bore	SCC-SQ20S314-HRS-TLB*	34, 78
		Nylon	300 lbs.	Plain Bore	SCC-SQ20S314-NYS-TLB*	34, 78
		Phenolic		Roller Bearing	SCC-SQ20S314-PHR-TLB*	34, 78
		High Temp Phenolic		Roller Bearing	SCC-SQ20S314-PHRHT-TLB*	34, 78
		Phenolic		Plain Bore	SCC-SQ20S314-PHS-TLB*	34, 78
		High Temp Phenolic		Plain Bore	SCC-SQ20S314-PHSHT-TLB*	34, 78
		Polyurethane		Ball Bearing	SCC-SQ20S314-PPUB-TLB*	34, 78
		Solid Polyurethane	Plain Bore	SCC-SQ20S314-SPUS-TLB*	34, 78	
		Semi Steel	Plain Bore	SCC-SQ20S314-SSS-TLB*	34, 78	
	HT Glass Filled Nylon	350 lbs.	Plain Bore	SCC-SQ20S314-GFNSHT-TLB*	34, 78	
	1-1/2"	Semi Steel	300 lbs.	Roller Bearing	SCC-SQ20S315-SSR-TLB*	34, 78
	3-1/2"	1-1/4"	Soft Rubber	200 lbs.	Plain Bore	SCC-SQ20S3514-SRS-TLB*
Thermoplastic Rubber			230 lbs.	Ball Bearing	SCC-SQ20S3514-TPRB-TLB*	34, 78
Hard Rubber			285 lbs.	Plain Bore	SCC-SQ20S3514-HRS-TLB*	34, 78
Phenolic			300 lbs.	Roller Bearing	SCC-SQ20S3514-PHR-TLB*	34, 78
Phenolic				Plain Bore	SCC-SQ20S3514-PHS-TLB*	34, 78
Polyurethane				Ball Bearing	SCC-SQ20S3514-PPUB-TLB*	34, 78
Solid Polyurethane				Plain Bore	SCC-SQ20S3514-SPUS-TLB*	34, 78
HT Glass Filled Nylon			350 lbs.	Plain Bore	SCC-SQ20S3514-GFNSHT-TLB*	34, 78
4"	1-1/4"	Soft Rubber	200 lbs.	Plain Bore	SCC-SQ20S414-SRS-TLB*	34, 78
		Thermoplastic Rubber	250 lbs.	Ball Bearing	SCC-SQ20S414-TPRB-TLB*	34, 78
		Hard Rubber	300 lbs.	Plain Bore	SCC-SQ20S414-HRS-TLB*	34, 78
		Nylon		Plain Bore	SCC-SQ20S414-NYS-TLB*	34, 78
		Phenolic		Roller Bearing	SCC-SQ20S414-PHR-TLB*	34, 78
		Phenolic		Plain Bore	SCC-SQ20S414-PHS-TLB*	34, 78
		High Temp Phenolic		Roller Bearing	SCC-SQ20S414-PHRHT-TLB*	34, 78
		Solid Polyurethane		Plain Bore	SCC-SQ20S414-SPUS-TLB*	34, 78
		Semi Steel	Plain Bore	SCC-SQ20S414-SSS-TLB*	34, 78	
		High Temp Phenolic	Plain Bore	SCC-SQ20S414-PHSHT-TLB*	34, 78	
		Polyurethane	350 lbs.	Ball Bearing	SCC-SQ20S414-PPUB-TLB*	34, 78
	HT Glass Filled Nylon	Plain Bore	SCC-SQ20S414-GFNSHT-TLB*	34, 78		
	1-1/2"	Semi Steel	300 lbs.	Roller Bearing	SCC-SQ20S415-SSR-TLB*	34, 78
	5"	1-1/4"	Soft Rubber	275 lbs.	Plain Bore	SCC-SQ20S514-SRS-TLB*
Thermoplastic Rubber			300 lbs.	Ball Bearing	SCC-SQ20S514-TPRB-TLB*	34, 78
Hard Rubber				Plain Bore	SCC-SQ20S514-HRS-TLB*	34, 78
Nylon				Plain Bore	SCC-SQ20S514-NYS-TLB*	34, 78
Phenolic				Roller Bearing	SCC-SQ20S514-PHR-TLB*	34, 78
Phenolic				Plain Bore	SCC-SQ20S514-PHS-TLB*	34, 78
High Temp Phenolic				Roller Bearing	SCC-SQ20S514-PHRHT-TLB*	34, 78
High Temp Phenolic			Plain Bore	SCC-SQ20S514-PHSHT-TLB*	34, 78	
Solid Polyurethane			Plain Bore	SCC-SQ20S514-SPUS-TLB*	34, 78	
Semi Steel			Plain Bore	SCC-SQ20S514-SSS-TLB*	34, 78	
Polyurethane			Ball Bearing	SCC-SQ20S514-PPUB-TLB*	34, 78	
HT Glass Filled Nylon		350 lbs.	Plain Bore	SCC-SQ20S514-GFNSHT-TLB*	34, 78	
1-1/2"		Semi Steel	300 lbs.	Roller Bearing	SCC-SQ20S515-SSR-TLB*	34, 78
6"		1-1/4"	Thermoplastic Rubber	300 lbs.	Ball Bearing	SCC-SQ20S614-TPRB-TLB*
	Polyurethane		350 lbs.	Ball Bearing	SCC-SQ20S614-PPUB-TLB*	34, 78
	1-1/2"	Phenolic	300 lbs.	Plain Bore	SCC-SQ20S615-PHS-TLB*	34, 78
		Phenolic		Roller Bearing	SCC-SQ20S615-PHR-TLB*	34, 78
		High Temp Phenolic		Plain Bore	SCC-SQ20S615-PHSHT-TLB*	34, 78
		High Temp Phenolic		Roller Bearing	SCC-SQ20S615-PHRHT-TLB*	34, 78



SQUARE STEM CASTERS *with Posi Lock Brakes*

Mounting Size
3/4" x 2" Square with 3 mounting holes 17/64" diameter (34)
7/8" x 2" Square with 3 mounting holes 17/64" diameter (78)

Wheel Diameter	Overall Height	Swivel Radius	Approximate Weight
3"	4-1/8"	2-15/16"	1.45
3-1/2"	4-5/8"	3-3/16"	1.6
4"	5-1/8"	3-1/2"	1.7
5"	6-1/8"	4"	2
6"	7-1/8"	4-9/16"	2.95

Wheel Dia	Tread Width	Wheel Type	Load Capacity	Bearing Type	Swivel Caster	Stem Code (Grip Ring Stem)
3"	1-1/4"	Soft Rubber	210 lbs.	Plain Bore	SCC-SQ20S314-SRS-PLB*	34, 78
		Thermoplastic Rubber	210 lbs.	Ball Bearing	SCC-SQ20S314-TPRB-PLB*	34, 78
		Hard Rubber	275 lbs	Plain Bore	SCC-SQ20S314-HRS-PLB*	34, 78
		Nylon	300 lbs.	Plain Bore	SCC-SQ20S314-NYS-PLB*	34, 78
		Phenolic		Roller Bearing	SCC-SQ20S314-PHR-PLB*	34, 78
		High Temp Phenolic		Roller Bearing	SCC-SQ20S314-PHRHT-PLB*	34, 78
		Phenolic		Plain Bore	SCC-SQ20S314-PHS-PLB*	34, 78
		High Temp Phenolic		Plain Bore	SCC-SQ20S314-PHSHT-PLB*	34, 78
		Polyurethane		Ball Bearing	SCC-SQ20S314-PPUB-PLB*	34, 78
		Solid Polyurethane		Plain Bore	SCC-SQ20S314-SPUS-PLB*	34, 78
		Semi Steel	Plain Bore	SCC-SQ20S314-SSS-PLB*	34, 78	
	HT Glass Filled Nylon	350 lbs.	Plain Bore	SCC-SQ20S314-GFNSHT-PLB*	34, 78	
	1-1/2"	Semi Steel	300 lbs.	Roller Bearing	SCC-SQ20S315-SSR-PLB*	34, 78
	3-1/2"	1-1/4"	Soft Rubber	200 lbs.	Plain Bore	SCC-SQ20S3514-SRS-PLB*
Thermoplastic Rubber			230 lbs.	Ball Bearing	SCC-SQ20S3514-TPRB-PLB*	34, 78
Hard Rubber			285 lbs.	Plain Bore	SCC-SQ20S3514-HRS-PLB*	34, 78
Phenolic			300 lbs.	Roller Bearing	SCC-SQ20S3514-PHR-PLB*	34, 78
Phenolic				Plain Bore	SCC-SQ20S3514-PHS-PLB*	34, 78
Polyurethane				Ball Bearing	SCC-SQ20S3514-PPUB-PLB*	34, 78
Solid Polyurethane				Plain Bore	SCC-SQ20S3514-SPUS-PLB*	34, 78
HT Glass Filled Nylon			350 lbs.	Plain Bore	SCC-SQ20S3514-GFNSHT-PLB*	34, 78
4"	1-1/4"	Soft Rubber	200 lbs.	Plain Bore	SCC-SQ20S414-SRS-PLB*	34, 78
		Thermoplastic Rubber	250 lbs.	Ball Bearing	SCC-SQ20S414-TPRB-PLB*	34, 78
		Hard Rubber	300 lbs.	Plain Bore	SCC-SQ20S414-HRS-PLB*	34, 78
		Nylon		Plain Bore	SCC-SQ20S414-NYS-PLB*	34, 78
		Phenolic		Roller Bearing	SCC-SQ20S414-PHR-PLB*	34, 78
		Phenolic		Plain Bore	SCC-SQ20S414-PHS-PLB*	34, 78
		High Temp Phenolic		Roller Bearing	SCC-SQ20S414-PHRHT-PLB*	34, 78
		Solid Polyurethane		Plain Bore	SCC-SQ20S414-SPUS-PLB*	34, 78
		Semi Steel		Plain Bore	SCC-SQ20S414-SSS-PLB*	34, 78
		High Temp Phenolic	Plain Bore	SCC-SQ20S414-PHSHT-PLB*	34, 78	
		Polyurethane	350 lbs.	Ball Bearing	SCC-SQ20S414-PPUB-PLB*	34, 78
	HT Glass Filled Nylon	Plain Bore	SCC-SQ20S414-GFNSHT-PLB*	34, 78		
	1-1/2"	Semi Steel	300 lbs.	Roller Bearing	SCC-SQ20S415-SSR-PLB*	34, 78
	5"	1-1/4"	Soft Rubber	275 lbs.	Plain Bore	SCC-SQ20S514-SRS-PLB*
Thermoplastic Rubber			300 lbs.	Ball Bearing	SCC-SQ20S514-TPRB-PLB*	34, 78
Hard Rubber				Plain Bore	SCC-SQ20S514-HRS-PLB*	34, 78
Nylon				Plain Bore	SCC-SQ20S514-NYS-PLB*	34, 78
Phenolic				Roller Bearing	SCC-SQ20S514-PHR-PLB*	34, 78
Phenolic				Plain Bore	SCC-SQ20S514-PHS-PLB*	34, 78
High Temp Phenolic				Roller Bearing	SCC-SQ20S514-PHRHT-PLB*	34, 78
High Temp Phenolic				Plain Bore	SCC-SQ20S514-PHSHT-PLB*	34, 78
Solid Polyurethane			Plain Bore	SCC-SQ20S514-SPUS-PLB*	34, 78	
Semi Steel			Plain Bore	SCC-SQ20S514-SSS-PLB*	34, 78	
Polyurethane			Ball Bearing	SCC-SQ20S514-PPUB-PLB*	34, 78	
HT Glass Filled Nylon		350 lbs.	Plain Bore	SCC-SQ20S514-GFNSHT-PLB*	34, 78	
1-1/2"		Semi Steel	300 lbs.	Roller Bearing	SCC-SQ20S515-SSR-PLB*	34, 78
6"		1-1/4"	Thermoplastic Rubber	300 lbs.	Ball Bearing	SCC-SQ20S614-TPRB-PLB*
	Polyurethane		350 lbs.	Ball Bearing	SCC-SQ20S614-PPUB-PLB*	34, 78
	1-1/2"	Phenolic	300 lbs.	Plain Bore	SCC-SQ20S615-PHS-PLB*	34, 78
		Phenolic		Roller Bearing	SCC-SQ20S615-PHR-PLB*	34, 78
		High Temp Phenolic		Plain Bore	SCC-SQ20S615-PHSHT-PLB*	34, 78
		High Temp Phenolic		Roller Bearing	SCC-SQ20S615-PHRHT-PLB*	34, 78



Mounting Size
3/4" x 2" Square with 3 mounting holes 17/64" diameter (34)
7/8" x 2" Square with 3 mounting holes 17/64" diameter (78)

Wheel Diameter	Overall Height	Swivel Radius	Approximate Weight
3"	4-1/8"	2-15/16"	1.45
3-1/2"	4-5/8"	3-3/16"	1.6
4"	5-1/8"	3-1/2"	1.7
5"	6-1/8"	4"	2
6"	7-1/8"	4-9/16"	2.95

SQUARE STEM CASTERS *with Total Lock Brakes*

Wheel Dia	Tread Width	Wheel Type	Load Capacity	Bearing Type	Swivel Caster	Stem Code (Grip Ring Stem)
3"	1-1/4"	Soft Rubber	210 lbs.	Plain Bore	SCC-SQTTL20S314-SRS-*	34, 78
		Thermoplastic Rubber	210 lbs.	Ball Bearing	SCC-SQTTL20S314-TPRB-*	34, 78
		Hard Rubber	275 lbs	Plain Bore	SCC-SQTTL20S314-HRS-*	34, 78
		Nylon	300 lbs.	Plain Bore	SCC-SQTTL20S314-NYS-*	34, 78
		Phenolic		Roller Bearing	SCC-SQTTL20S314-PHR-*	34, 78
		High Temp Phenolic		Roller Bearing	SCC-SQTTL20S314-PHRHT-*	34, 78
		Phenolic		Plain Bore	SCC-SQTTL20S314-PHS-*	34, 78
		High Temp Phenolic		Plain Bore	SCC-SQTTL20S314-PHSHT-*	34, 78
		Polyurethane		Ball Bearing	SCC-SQTTL20S314-PPUB-*	34, 78
		Solid Polyurethane		Plain Bore	SCC-SQTTL20S314-SPUS-*	34, 78
		Semi Steel	Plain Bore	SCC-SQTTL20S314-SSS-*	34, 78	
	HT Glass Filled Nylon	350 lbs.	Plain Bore	SCC-SQTTL20S314-GFNSHT-*	34, 78	
	1-1/2"	Semi Steel	300 lbs.	Roller Bearing	SCC-SQTTL20S315-SSR-*	34, 78
	3-1/2"	1-1/4"	Soft Rubber	200 lbs.	Plain Bore	SCC-SQTTL20S3514-SRS-*
Thermoplastic Rubber			230 lbs.	Ball Bearing	SCC-SQTTL20S3514-TPRB-*	34, 78
Hard Rubber			285 lbs.	Plain Bore	SCC-SQTTL20S3514-HRS-*	34, 78
Phenolic			300 lbs.	Roller Bearing	SCC-SQTTL20S3514-PHR-*	34, 78
Phenolic				Plain Bore	SCC-SQTTL20S3514-PHS-*	34, 78
Polyurethane				Ball Bearing	SCC-SQTTL20S3514-PPUB-*	34, 78
Solid Polyurethane				Plain Bore	SCC-SQTTL20S3514-SPUS-*	34, 78
HT Glass Filled Nylon			350 lbs.	Plain Bore	SCC-SQTTL20S3514-GFNSHT-*	34, 78
4"	1-1/4"	Soft Rubber	200 lbs.	Plain Bore	SCC-SQTTL20S414-SRS-*	34, 78
		Thermoplastic Rubber	250 lbs.	Ball Bearing	SCC-SQTTL20S414-TPRB-*	34, 78
		Hard Rubber	300 lbs.	Plain Bore	SCC-SQTTL20S414-HRS-*	34, 78
		Nylon		Plain Bore	SCC-SQTTL20S414-NYS-*	34, 78
		Phenolic		Roller Bearing	SCC-SQTTL20S414-PHR-*	34, 78
		Phenolic		Plain Bore	SCC-SQTTL20S414-PHS-*	34, 78
		High Temp Phenolic		Roller Bearing	SCC-SQTTL20S414-PHRHT-*	34, 78
		Solid Polyurethane		Plain Bore	SCC-SQTTL20S414-SPUS-*	34, 78
		Semi Steel		Plain Bore	SCC-SQTTL20S414-SSS-*	34, 78
		High Temp Phenolic	Plain Bore	SCC-SQTTL20S414-PHSHT-*	34, 78	
		Polyurethane	350 lbs.	Ball Bearing	SCC-SQTTL20S414-PPUB-*	34, 78
	HT Glass Filled Nylon	Plain Bore	SCC-SQTTL20S414-GFNSHT-*	34, 78		
	1-1/2"	Semi Steel	300 lbs.	Roller Bearing	SCC-SQTTL20S415-SSR-*	34, 78
	5"	1-1/4"	Soft Rubber	275 lbs.	Plain Bore	SCC-SQTTL20S514-SRS-*
Thermoplastic Rubber			300 lbs.	Ball Bearing	SCC-SQTTL20S514-TPRB-*	34, 78
Hard Rubber				Plain Bore	SCC-SQTTL20S514-HRS-*	34, 78
Nylon				Plain Bore	SCC-SQTTL20S514-NYS-*	34, 78
Phenolic				Roller Bearing	SCC-SQTTL20S514-PHR-*	34, 78
Phenolic				Plain Bore	SCC-SQTTL20S514-PHS-*	34, 78
High Temp Phenolic				Roller Bearing	SCC-SQTTL20S514-PHRHT-*	34, 78
High Temp Phenolic				Plain Bore	SCC-SQTTL20S514-PHSHT-*	34, 78
Solid Polyurethane			Plain Bore	SCC-SQTTL20S514-SPUS-*	34, 78	
Semi Steel			Plain Bore	SCC-SQTTL20S514-SSS-*	34, 78	
Polyurethane			Ball Bearing	SCC-SQTTL20S514-PPUB-*	34, 78	
HT Glass Filled Nylon		350 lbs.	Plain Bore	SCC-SQTTL20S514-GFNSHT-*	34, 78	
1-1/2"		Semi Steel	300 lbs.	Roller Bearing	SCC-SQTTL20S515-SSR-*	34, 78
6"		1-1/4"	Thermoplastic Rubber	300 lbs.	Ball Bearing	SCC-SQTTL20S614-TPRB-*
	Polyurethane		350 lbs.	Ball Bearing	SCC-SQTTL20S614-PPUB-*	34, 78
	1-1/2"	Phenolic	300 lbs.	Plain Bore	SCC-SQTTL20S615-PHS-*	34, 78
		Phenolic		Roller Bearing	SCC-SQTTL20S615-PHR-*	34, 78
		High Temp Phenolic		Plain Bore	SCC-SQTTL20S615-PHSHT-*	34, 78
		High Temp Phenolic		Roller Bearing	SCC-SQTTL20S615-PHRHT-*	34, 78

Corrosion Resistant Casters

Series #20 Stainless Steel 304 Casters

Introducing Service Caster's #20 Series 304 stainless steel swivel casters with numerous wheels options. Ideal for various applications, these casters offer stability and durability in corrosive environments.

Applications

- Healthcare
- Foodservice
- Laboratories
- Marine
- Pharmaceuticals
- Cleanrooms

Features

- Withstands harsh, wet environments.
- Washable Caster Solution
- Precision bearings for quiet movement.
- Long-lasting construction for tough conditions.
- Ideal for cleanrooms and sterile settings.

Capacity up to 350 lbs.



Service Caster Chart Guide

Build Your Caster

Discover more fastening sizes and wheel options if you can't find what you need. And remember, we're always here to [help!](#)

Brand	Series	Rig Type	Brake	Bearing Type	Wheel Size	Mounting Type	Wheel Material
Service Caster	SS20	Swivel (S)	Top Lock (TLB)	Ball Bearing (B)	3" x 1-1/4" (314)	Top Plate	Soft Rubber (SR)
		Rigid (R)	Total Lock (TTL)	Plain Bore (S)	3-1/2" x 1-1/4" (3514)	Threaded Stem (TS)	Thermo Plastic Rubber (TPR)
				Delrin Bearing (D)	4" x 1-1/4" (414)	Grip Ring (GR)	Polyurethane (PPU)
		5" x 1-1/4" (514)	Expanding Adapter (EX)	Glass-Filled Nylon High Temp (HT)			
			Bolt Hole (BH)	Solid Polyurethane (SPU)			

Is Stainless Steel Non-Magnetic?



Choose Your Color

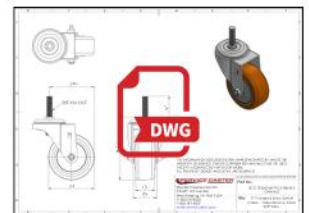

Need a drawing request? Contact customer service, and we'll be happy to help!

Wheel Diameter	Overall Height	Swivel Radius	Aproximate Weight
3"	4-1/8"	2-15/16"	1.45
3-1/2"	4-5/8"	3-3/16"	1.6
4"	5-1/8"	3-1/2"	1.7
5"	6-1/8"	4"	2



SWIVEL & RIGID TOP PLATE CASTERS

Wheel Dia	Tread Width	Wheel Type	Load Capacity	Bearing Type	Swivel Caster	Rigid Caster	Overall Height	Color
3"	1-1/4"	Soft Rubber	175	Plain Bore	SCC-SS20S314-SRS	SCC-SS20R314-SRS	4-1/8"	Black
		Thermo Plastic Rubber	210	Ball Bearing	SCC-SS20S314-TPRB	SCC-SS20R314-TPRB		Gray
		Hard Rubber	275	Plain Bore	SCC-SS20S314-HRS	SCC-SS20R314-HRS		Black
		Nylon	300	Plain Bore	SCC-SS20S314-NYS	SCC-SS20R314-NYS		White
		Polyolefin		Plain Bore	SCC-SS20S314-POS	SCC-SS20R314-POS		Black
		Polyurethane		Ball Bearing	SCC-SS20S314-PPUB	SCC-SS20R314-PPUB		
		Solid Polyurethane		Plain Bore	SCC-SS20S314-SPUS	SCC-SS20R314-SPUS		Blue
		HT Glass Filled Nylon	350	Plain Bore	SCC-SS20S314-GFNSHT	SCC-SS20R314-GFNSHT		Black or Brown
3-1/2"	1-1/4"	Soft Rubber	200	Plain Bore	SCC-SS20S3514-SRS	SCC-SS20R3514-SRS	4-5/8"	Black
		Thermo Plastic Rubber	230	Plain Bore	SCC-SS20S3514-TPRB	SCC-SS20R3514-TPRB		Gray
		Hard Rubber	285	Plain Bore	SCC-SS20S3514-HRS	SCC-SS20R3514-HRS		Black
		Polyolefin	300	Bushing	SCC-SS20S3514-POS	SCC-SS20R3514-POS		Black
		Polyurethane		Ball Bearing	SCC-SS20S3514-PPUB	SCC-SS20R3514-PPUB		
		Solid Polyurethane		Bushing	SCC-SS20S3514-SPUS	SCC-SS20R3514-SPUS		Blue
		HT Glass Filled Nylon	350	Plain Bore	SCC-SS20S3514-GFNSHT	SCC-SS20R3514-GFNSHT		Black or Brown
4"	1-1/4"	Soft Rubber	200	Plain Bore	SCC-SS20S414-SRS	SCC-SS20R414-SRS	5-1/8"	Black
		Thermo Plastic Rubber	250	Ball Bearing	SCC-SS20S414-TPRB	SCC-SS20R414-TPRB		Gray
		Hard Rubber	300	Plain Bore	SCC-SS20S414-HRS	SCC-SS20R414-HRS		Black
		Nylon		Plain Bore	SCC-SS20S414-NYS	SCC-SS20R414-NYS		White
		Polyolefin	350	Plain Bore	SCC-SS20S414-POS	SCC-SS20R414-POS		Black
		Polyurethane		Ball Bearing	SCC-SS20S414-PPUB	SCC-SS20R414-PPUB		
		Solid Polyurethane		Plain Bore	SCC-SS20S414-SPUS	SCC-SS20R414-SPUS		Blue
		HT Glass Filled Nylon	350	Plain Bore	SCC-SS20S414-GFNSHT	SCC-SS20R414-GFNSHT		Black or Brown
5"	1-1/4"	Soft Rubber	275	Plain Bore	SCC-SS20S514-SRS	SCC-SS20R514-SRS	6-1/8"	Black
		Thermo Plastic Rubber	300	Ball Bearing	SCC-SS20S514-TPRB	SCC-SS20R514-TPRB		Gray
		Hard Rubber		Plain Bore	SCC-SS20S514-HRS	SCC-SS20R514-HRS		Black
		Nylon	350	Plain Bore	SCC-SS20S514-NYS	SCC-SS20R514-NYS		White
		Polyolefin		Plain Bore	SCC-SS20S514-POS	SCC-SS20R514-POS		Black
		Polyurethane		Ball Bearing	SCC-SS20S514-PPUB	SCC-SS20R514-PPUB		
		Solid Polyurethane	Plain Bore	SCC-SS20S514-SPUS	SCC-SS20R514-SPUS	Blue		
		HT Glass Filled Nylon	350	Plain Bore	SCC-SS20S514-GFNSHT	SCC-SS20R514-GFNSHT		Black or Brown

Plate Casters: Reliable Movement, Built to Last

Our plate casters deliver robust performance and smooth mobility for various applications. Built to last, they offer exceptional load-bearing capacity and stability across surfaces. Need a custom size plate? Reach out to our [customer service](#) for assistance!

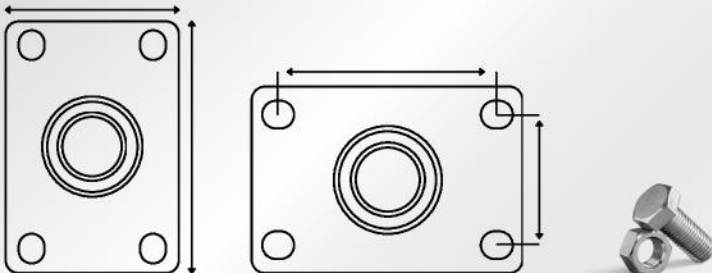

Standard Plate Size	Bolt Pattern	Bolt Diameter
2-3/8" x 3-5/8"	1-3/4" x 2-7/8" to 3"	5/16"

Total Lock Brake (TTL)

The **total lock** on casters secures both the wheel and swivel, ensuring complete stability for reliable and safe use.



[SCC-SS20S414-PPUB-MRN](#)

Top Lock Brake (TLB)

The **Top lock brake** places a positive locking force against the wheel hub locking the wheel only.



[SCC-SS20S314-TPRB-TLB](#)

Wheel Diameter	Overall Height	Swivel Radius	Approximate Weight
3"	4-1/8"	2-15/16"	1.45
3-1/2"	4-5/8"	3-3/16"	1.6
4"	5-1/8"	3-1/2"	1.7
5"	6-1/8"	4"	2

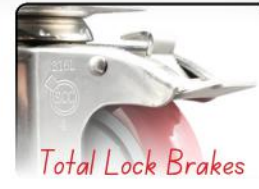

SWIVEL TOP PLATE CASTERS

Wheel Dia	Tread Width	Wheel Type	Load Capacity	Bearing Type	Top Lock Brake (TLB)	Total Lock Brake (TTL)	Color
3"	1-1/4"	Soft Rubber	175	Plain Bore	SCC-SS20S314-SRS-TLB	SCC-SSTTL20S314-SRS	Black
		Thermo Plastic Rubber	210	Ball Bearing	SCC-SS20S314-TPRB-TLB	SCC-SSTTL20S314-TPRB	Gray
		Hard Rubber	275	Plain Bore	SCC-SS20S314-HRS-TLB	SCC-SSTTL20S314-HRS	Black
		Nylon	300	Plain Bore	SCC-SS20S314-NYS-TLB	SCC-SSTTL20S314-NYS	White
		Polyolefin		Plain Bore	SCC-SS20S314-POS-TLB	SCC-SSTTL20S314-POS	Black
		Polyurethane		Ball Bearing	SCC-SS20S314-PPUB-TLB	SCC-SSTTL20S314-PPUB	Blue, Gray, Black, Yellow, Green, Orange, Red
		Solid Polyurethane		Plain Bore	SCC-SS20S314-SPUS-TLB	SCC-SSTTL20S314-SPUS	Blue
		HT Glass Filled Nylon	350	Plain Bore	SCC-SS20S314-GFNSHT-TLB	SCC-SSTTL20S314-GFNSHT	Black or Brown
3-1/2"	1-1/4"	Soft Rubber	200	Plain Bore	SCC-SS20S3514-SRS-TLB	SCC-SSTTL20S3514-SRS	Black
		Thermo Plastic Rubber	230	Plain Bore	SCC-SS20S3514-TPRB-TLB	SCC-SSTTL20S3514-TPRB	Gray
		Hard Rubber	285	Plain Bore	SCC-SS20S3514-HRS-TLB	SCC-SSTTL20S3514-HRS	Black
		Polyolefin	300	Bushing	SCC-SS20S3514-POS-TLB	SCC-SSTTL20S3514-POS	Black
		Polyurethane		Ball Bearing	SCC-SS20S3514-PPUB-TLB	SCC-SSTTL20S3514-PPUB	Blue, Gray, Black, Yellow, Green, Orange, Red
		Solid Polyurethane		Bushing	SCC-SS20S3514-SPUS-TLB	SCC-SSTTL20S3514-SPUS	Blue
		HT Glass Filled Nylon	350	Plain Bore	SCC-SS20S3514-GFNSHT-TLB	SCC-SSTTL20S3514-GFNSHT	Black or Brown
4"	1-1/4"	Soft Rubber	200	Plain Bore	SCC-SS20S414-SRS-TLB	SCC-SSTTL20S414-SRS	Black
		Thermo Plastic Rubber	250	Ball Bearing	SCC-SS20S414-TPRB-TLB	SCC-SSTTL20S414-TPRB	Gray
		Hard Rubber	300	Plain Bore	SCC-SS20S414-HRS-TLB	SCC-SSTTL20S414-HRS	Black
		Nylon		Plain Bore	SCC-SS20S414-NYS-TLB	SCC-SSTTL20S414-NYS	White
		Polyolefin	350	Plain Bore	SCC-SS20S414-POS-TLB	SCC-SSTTL20S414-POS	Black
		Polyurethane		Ball Bearing	SCC-SS20S414-PPUB-TLB	SCC-SSTTL20S414-PPUB	Blue, Gray, Black, Yellow, Green, Orange, Red
		Solid Polyurethane		Plain Bore	SCC-SS20S414-SPUS-TLB	SCC-SSTTL20S414-SPUS	Blue
		HT Glass Filled Nylon		Plain Bore	SCC-SS20S414-GFNSHT-TLB	SCC-SSTTL20S414-GFNSHT	Black or Brown
5"	1-1/4"	Soft Rubber	275	Plain Bore	SCC-SS20S514-SRS-TLB	SCC-SSTTL20S514-SRS	Black
		Thermo Plastic Rubber	300	Ball Bearing	SCC-SS20S514-TPRB-TLB	SCC-SSTTL20S514-TPRB	Gray
		Hard Rubber		Plain Bore	SCC-SS20S514-HRS-TLB	SCC-SSTTL20S514-HRS	Black
		Nylon	350	Plain Bore	SCC-SS20S514-NYS-TLB	SCC-SSTTL20S514-NYS	White
		Polyolefin		Plain Bore	SCC-SS20S514-POS-TLB	SCC-SSTTL20S514-POS	Black
		Polyurethane		Ball Bearing	SCC-SS20S514-PPUB-TLB	SCC-SSTTL20S514-PPUB	Blue, Gray, Black, Yellow, Green, Orange, Red
		Solid Polyurethane		Plain Bore	SCC-SS20S514-SPUS-TLB	SCC-SSTTL20S514-SPUS	Blue
		HT Glass Filled Nylon	350	Plain Bore	SCC-SS20S514-GFNSHT-TLB	SCC-SSTTL20S514-GFNSHT	Black or Brown



Stainless Steel 316

Our **Stainless Steel 316** Casters provide corrosion resistance, smooth mobility, and hygienic design for efficient pharmaceutical operations.



STAINLESS STEEL

METRIC Sizes Available!

Wheel Diameter	Overall Height	Swivel Radius	Approximate Weight
3"	4-1/8"	2-15/16"	1.45
3-1/2"	4-5/8"	3-3/16"	1.6
4"	5-1/8"	3-1/2"	1.7
5"	6-1/8"	4"	2

Mounting Size (Metric)	Mounting Size (Inch)
M10-1.5 x 38MM (M1015)	3/8"-16 x 1-1/2" (381615)
M12-1.75 x 38MM (M1215)	1/2"-13 x 1-1/2" (121315)

THREADED STEM CASTERS

Wheel Dia	Tread Width	Wheel Type	Load Capacity	Bearing Type	Swivel Caster	Stem Code	Overall Height	Color
3"	1-1/4"	Soft Rubber	175	Plain Bore	SCC-SSTS20S314-SRS	381615 , 121315 , M1015 , M1215	4-1/8"	Black
		Thermo Plastic Rubber	210	Ball Bearing	SCC-SSTS20S314-TPRB	381615 , 121315 , M1015 , M1215		Gray
		Hard Rubber	275	Plain Bore	SCC-SSTS20S314-HRS	381615 , 121315 , M1015 , M1215		Black
		Nylon	300	Plain Bore	SCC-SSTS20S314-NYS	381615 , 121315 , M1015 , M1215		White
		Polyolefin		Plain Bore	SCC-SSTS20S314-POS	381615 , 121315 , M1015 , M1215		Black
		Polyurethane		Ball Bearing	SCC-SSTS20S314-PPUB	381615 , 121315 , M1015 , M1215		
		Solid Polyurethane		Plain Bore	SCC-SSTS20S314-SPUS	381615 , 121315 , M1015 , M1215		Blue
		HT Glass Filled Nylon	350	Plain Bore	SCC-SSTS20S314-GFNSHT	381615 , 121315 , M1015 , M1215		Black or Brown
3-1/2"	1-1/4"	Soft Rubber	200	Plain Bore	SCC-SSTS20S3514-SRS	381615 , 121315 , M1015 , M1215	4-5/8"	Black
		Thermo Plastic Rubber	230	Plain Bore	SCC-SSTS20S3514-TPRB	381615 , 121315 , M1015 , M1215		Gray
		Hard Rubber	285	Plain Bore	SCC-SSTS20S3514-HRS	381615 , 121315 , M1015 , M1215		Black
		Polyolefin	300	Bushing	SCC-SSTS20S3514-POS	381615 , 121315 , M1015 , M1215		Black
		Polyurethane		Ball Bearing	SCC-SSTS20S3514-PPUB	381615 , 121315 , M1015 , M1215		
		Solid Polyurethane		Bushing	SCC-SSTS20S3514-SPUS	381615 , 121315 , M1015 , M1215		Blue
		HT Glass Filled Nylon	350	Plain Bore	SCC-SSTS20S3514-GFNSHT	381615 , 121315 , M1015 , M1215		Black or Brown
4"	1-1/4"	Soft Rubber	200	Plain Bore	SCC-SSTS20S414-SRS	381615 , 121315 , M1015 , M1215	5-1/8"	Black
		Thermo Plastic Rubber	250	Ball Bearing	SCC-SSTS20S414-TPRB	381615 , 121315 , M1015 , M1215		Gray
		Hard Rubber	300	Plain Bore	SCC-SSTS20S414-HRS	381615 , 121315 , M1015 , M1215		Black
		Nylon		Plain Bore	SCC-SSTS20S414-NYS	381615 , 121315 , M1015 , M1215		White
		Polyolefin	350	Plain Bore	SCC-SSTS20S414-POS	381615 , 121315 , M1015 , M1215		Black
		Polyurethane		Ball Bearing	SCC-SSTS20S414-PPUB	381615 , 121315 , M1015 , M1215		
		Solid Polyurethane		Plain Bore	SCC-SSTS20S414-SPUS	381615 , 121315 , M1015 , M1215		Blue
		HT Glass Filled Nylon	350	Plain Bore	SCC-SSTS20S414-GFNSHT	381615 , 121315 , M1015 , M1215		Black or Brown
5"	1-1/4"	Soft Rubber	275	Plain Bore	SCC-SSTS20S514-SRS	381615 , 121315 , M1015 , M1215	6-1/8"	Black
		Thermo Plastic Rubber	300	Ball Bearing	SCC-SSTS20S514-TPRB	381615 , 121315 , M1015 , M1215		Gray
		Hard Rubber		Plain Bore	SCC-SSTS20S514-HRS	381615 , 121315 , M1015 , M1215		Black
		Nylon	350	Plain Bore	SCC-SSTS20S514-NYS	381615 , 121315 , M1015 , M1215		White
		Polyolefin		Plain Bore	SCC-SSTS20S514-POS	381615 , 121315 , M1015 , M1215		Black
		Polyurethane		Ball Bearing	SCC-SSTS20S514-PPUB	381615 , 121315 , M1015 , M1215		
		Solid Polyurethane	Plain Bore	SCC-SSTS20S514-SPUS	381615 , 121315 , M1015 , M1215	Blue		
		HT Glass Filled Nylon	350	Plain Bore	SCC-SSTS20S514-GFNSHT	381615 , 121315 , M1015 , M1215		Black or Brown



Precision Ball Bearings
Ensuring Smooth Rolling



Washable Quality
You Can Trust



Food-Grade Quality



Elegant Polished Finish

Total Lock Brake (TTL)

The **total lock** on casters secures both the wheel and swivel, ensuring complete stability for reliable and safe use.



[SCC-SSTS20S414-HRS](#)

Top Lock Brake (TLB)

The **Top lock brake** places a positive locking force against the wheel hub locking the wheel only.

High Temp Wheels (HT)

Designed for high heat: 475°F for 30 mins.



[SCC-SSTS20S514-GFNSHT-TLB](#)

STAINLESS STEEL

Wheel Diameter	Overall Height	Swivel Radius	Aproximate Weight
3"	4-1/8"	2-15/16"	1.45
3-1/2"	4-5/8"	3-3/16"	1.6
4"	5-1/8"	3-1/2"	1.7
5"	6-1/8"	4"	2



METRIC Sizes Available!

Mounting Size (Metric)	Mounting Size (Inch)
M10-1.5 x 38MM (M1015)	3/8"-16 x 1-1/2" (381615)
M12-1.75 x 38MM (M1215)	1/2"-13 x 1-1/2" (121315)

THREADED STEM CASTERS

Wheel Dia	Tread Width	Wheel Type	Load Capacity	Bearing Type	Top Lock Brake (TLB)	Stem Code	Overall Height	Color
3"	1-1/4"	Soft Rubber	175	Plain Bore	SCC-SSTS20S314-SRS-TLB	381615 , 121315 , M1015 , M1215	4-1/8"	Black
		Thermo Plastic Rubber	210	Ball Bearing	SCC-SSTS20S314-TPRB-TLB	381615 , 121315 , M1015 , M1215		Gray
		Hard Rubber	275	Plain Bore	SCC-SSTS20S314-HRS-TLB	381615 , 121315 , M1015 , M1215		Black
		Nylon	300	Plain Bore	SCC-SSTS20S314-NYS-TLB	381615 , 121315 , M1015 , M1215		White
		Polyolefin		Plain Bore	SCC-SSTS20S314-POS-TLB	381615 , 121315 , M1015 , M1215		Black
		Polyurethane		Ball Bearing	SCC-SSTS20S314-PPUB-TLB	381615 , 121315 , M1015 , M1215		Blue
		Solid Polyurethane		Plain Bore	SCC-SSTS20S314-SPUS-TLB	381615 , 121315 , M1015 , M1215		Black or Brown
		HT Glass Filled Nylon	350	Plain Bore	SCC-SSTS20S314-GFNSHT-TLB	381615 , 121315 , M1015 , M1215		
3-1/2"	1-1/4"	Soft Rubber	200	Plain Bore	SCC-SSTS20S3514-SRS-TLB	381615 , 121315 , M1015 , M1215	4-5/8"	Black
		Thermo Plastic Rubber	230	Plain Bore	SCC-SSTS20S3514-TPRB-TLB	381615 , 121315 , M1015 , M1215		Gray
		Hard Rubber	285	Plain Bore	SCC-SSTS20S3514-HRS-TLB	381615 , 121315 , M1015 , M1215		Black
		Polyolefin	300	Bushing	SCC-SSTS20S3514-POS-TLB	381615 , 121315 , M1015 , M1215		Black
		Polyurethane		Ball Bearing	SCC-SSTS20S3514-PPUB-TLB	381615 , 121315 , M1015 , M1215		Blue
		Solid Polyurethane		Bushing	SCC-SSTS20S3514-SPUS-TLB	381615 , 121315 , M1015 , M1215		Black or Brown
		HT Glass Filled Nylon	350	Plain Bore	SCC-SSTS20S3514-GFNSHT-TLB	381615 , 121315 , M1015 , M1215		
4"	1-1/4"	Soft Rubber	200	Plain Bore	SCC-SSTS20S414-SRS-TLB	381615 , 121315 , M1015 , M1215	5-1/8"	Black
		Thermo Plastic Rubber	250	Ball Bearing	SCC-SSTS20S414-TPRB-TLB	381615 , 121315 , M1015 , M1215		Gray
		Hard Rubber	300	Plain Bore	SCC-SSTS20S414-HRS-TLB	381615 , 121315 , M1015 , M1215		Black
		Nylon		Plain Bore	SCC-SSTS20S414-NYS-TLB	381615 , 121315 , M1015 , M1215		White
		Polyolefin	350	Plain Bore	SCC-SSTS20S414-POS-TLB	381615 , 121315 , M1015 , M1215		Black
		Polyurethane		Ball Bearing	SCC-SSTS20S414-PPUB-TLB	381615 , 121315 , M1015 , M1215		Blue
		Solid Polyurethane		Plain Bore	SCC-SSTS20S414-SPUS-TLB	381615 , 121315 , M1015 , M1215		Black or Brown
		HT Glass Filled Nylon	350	Plain Bore	SCC-SSTS20S414-GFNSHT-TLB	381615 , 121315 , M1015 , M1215		
5"	1-1/4"	Soft Rubber	275	Plain Bore	SCC-SSTS20S514-SRS-TLB	381615 , 121315 , M1015 , M1215	6-1/8"	Black
		Thermo Plastic Rubber	300	Ball Bearing	SCC-SSTS20S514-TPRB-TLB	381615 , 121315 , M1015 , M1215		Gray
		Hard Rubber		Plain Bore	SCC-SSTS20S514-HRS-TLB	381615 , 121315 , M1015 , M1215		Black
		Nylon	Plain Bore	SCC-SSTS20S514-NYS-TLB	381615 , 121315 , M1015 , M1215	White		
		Polyolefin	350	Plain Bore	SCC-SSTS20S514-POS-TLB	381615 , 121315 , M1015 , M1215		Black
		Polyurethane		Ball Bearing	SCC-SSTS20S514-PPUB-TLB	381615 , 121315 , M1015 , M1215		Blue
		Solid Polyurethane		Plain Bore	SCC-SSTS20S514-SPUS-TLB	381615 , 121315 , M1015 , M1215		Black or Brown
		HT Glass Filled Nylon	350	Plain Bore	SCC-SSTS20S514-GFNSHT-TLB	381615 , 121315 , M1015 , M1215		



- ✓ Quality
- ✓ Reliability
- ✓ Excellence



Inch or Metric?

Measure Up!

SERVICE CASTER

"THE ADVANTAGE"

www.servicecaster.com

CALL OR EMAIL US FOR MORE OPTIONS 1-800-215-8220 / info@servicecaster.com

[Learn More...](#)

STAINLESS STEEL

Wheel Diameter	Overall Height	Swivel Radius	Aproximate Weight
3"	4-1/8"	2-15/16"	1.45
3-1/2"	4-5/8"	3-3/16"	1.6
4"	5-1/8"	3-1/2"	1.7
5"	6-1/8"	4"	2



Mounting Size (Metric)	Mounting Size (Inch)
M10-1.5 x 38MM (M1015)	3/8"-16 x 1-1/2" (381615)
M12-1.75 x 38MM (M1215)	1/2"-13 x 1-1/2" (121315)

THREADED STEM CASTERS

Wheel Dia	Tread Width	Wheel Type	Load Capacity	Bearing Type	Total Lock Brake (TTL)	Stem Code	Overall Height	Color
3"	1-1/4"	Soft Rubber	175	Plain Bore	SCC-SSTSTTL20S314-SRS	381615 , 121315 , M1015 , M1215	4-1/8"	Black
		Thermo Plastic Rubber	210	Ball Bearing	SCC-SSTSTTL20S314-TPRB	381615 , 121315 , M1015 , M1215		Gray
		Hard Rubber	275	Plain Bore	SCC-SSTSTTL20S314-HRS	381615 , 121315 , M1015 , M1215		Black
		Nylon	300	Plain Bore	SCC-SSTSTTL20S314-NYS	381615 , 121315 , M1015 , M1215		White
		Polyolefin		Plain Bore	SCC-SSTSTTL20S314-POS	381615 , 121315 , M1015 , M1215		Black
		Polyurethane		Ball Bearing	SCC-SSTSTTL20S314-PPUB	381615 , 121315 , M1015 , M1215		
		Solid Polyurethane	Plain Bore	SCC-SSTSTTL20S314-SPUS	381615 , 121315 , M1015 , M1215	Blue		
		HT Glass Filled Nylon	350	Plain Bore	SCC-SSTSTTL20S314-GFNSHT	381615 , 121315 , M1015 , M1215		Black or Brown
3-1/2"	1-1/4"	Soft Rubber	200	Plain Bore	SCC-SSTSTTL20S3514-SRS	381615 , 121315 , M1015 , M1215	4-5/8"	Black
		Thermo Plastic Rubber	230	Plain Bore	SCC-SSTSTTL20S3514-TPRB	381615 , 121315 , M1015 , M1215		Gray
		Hard Rubber	285	Plain Bore	SCC-SSTSTTL20S3514-HRS	381615 , 121315 , M1015 , M1215		Black
		Polyolefin	300	Bushing	SCC-SSTSTTL20S3514-POS	381615 , 121315 , M1015 , M1215		Black
		Polyurethane		Ball Bearing	SCC-SSTSTTL20S3514-PPUB	381615 , 121315 , M1015 , M1215		
		Solid Polyurethane		Bushing	SCC-SSTSTTL20S3514-SPUS	381615 , 121315 , M1015 , M1215		Blue
		HT Glass Filled Nylon	350	Plain Bore	SCC-SSTSTTL20S3514-GFNSHT	381615 , 121315 , M1015 , M1215		Black or Brown
4"	1-1/4"	Soft Rubber	200	Plain Bore	SCC-SSTSTTL20S414-SRS	381615 , 121315 , M1015 , M1215	5-1/8"	Black
		Thermo Plastic Rubber	250	Ball Bearing	SCC-SSTSTTL20S414-TPRB	381615 , 121315 , M1015 , M1215		Gray
		Hard Rubber	300	Plain Bore	SCC-SSTSTTL20S414-HRS	381615 , 121315 , M1015 , M1215		Black
		Nylon		Plain Bore	SCC-SSTSTTL20S414-NYS	381615 , 121315 , M1015 , M1215		White
		Polyolefin	350	Plain Bore	SCC-SSTSTTL20S414-POS	381615 , 121315 , M1015 , M1215		Black
		Polyurethane		Ball Bearing	SCC-SSTSTTL20S414-PPUB	381615 , 121315 , M1015 , M1215		
		Solid Polyurethane		Plain Bore	SCC-SSTSTTL20S414-SPUS	381615 , 121315 , M1015 , M1215		Blue
		HT Glass Filled Nylon	350	Plain Bore	SCC-SSTSTTL20S414-GFNSHT	381615 , 121315 , M1015 , M1215		Black or Brown
5"	1-1/4"	Soft Rubber	275	Plain Bore	SCC-SSTSTTL20S514-SRS	381615 , 121315 , M1015 , M1215	6-1/8"	Black
		Thermo Plastic Rubber	300	Ball Bearing	SCC-SSTSTTL20S514-TPRB	381615 , 121315 , M1015 , M1215		Gray
		Hard Rubber		Plain Bore	SCC-SSTSTTL20S514-HRS	381615 , 121315 , M1015 , M1215		Black
		Nylon	350	Plain Bore	SCC-SSTSTTL20S514-NYS	381615 , 121315 , M1015 , M1215		White
		Polyolefin		Plain Bore	SCC-SSTSTTL20S514-POS	381615 , 121315 , M1015 , M1215		Black
		Polyurethane		Ball Bearing	SCC-SSTSTTL20S514-PPUB	381615 , 121315 , M1015 , M1215		
		Solid Polyurethane	Plain Bore	SCC-SSTSTTL20S514-SPUS	381615 , 121315 , M1015 , M1215	Blue		
		HT Glass Filled Nylon	350	Plain Bore	SCC-SSTSTTL20S514-GFNSHT	381615 , 121315 , M1015 , M1215		Black or Brown

HIGH-END STEM CASTERS!



The **total lock** on casters secures both the wheel and swivel, ensuring complete stability for reliable and safe use.



Stainless **threaded stem** casters provide smooth maneuverability in various sizes, including metric, with excellent corrosion resistance.



Stainless **zerk fittings** ensure easy lubrication access, reduce wear, resist corrosion, and are ideal for high-performance applications.



Polyurethane wheels offer excellent durability, smooth rides, and resist wear. Available in various tread colors for a customized look.

STAINLESS STEEL



BOLT HOLE (HOLLOW KINGPIN) CASTERS

Wheel Diameter	Overall Height	Swivel Radius	Approximate Weight 
3"	4-1/8"	2-15/16"	1.45
3-1/2"	4-5/8"	3-3/16"	1.6
4"	5-1/8"	3-1/2"	1.7
5"	6-1/8"	4"	2

Wheel Dia	Tread Width	Wheel Type	Load Capacity	Bearing Type	Swivel Caster	Overall Height	Color
3"	1-1/4"	Soft Rubber	175	Plain Bore	SCC-SSBH20S314-SRS	4-1/8"	Black
		Thermo Plastic Rubber	210	Ball Bearing	SCC-SSBH20S314-TPRB		Gray
		Hard Rubber	275	Plain Bore	SCC-SSBH20S314-HRS		Black
		Nylon	300	Plain Bore	SCC-SSBH20S314-NYS		White
		Polyolefin		Plain Bore	SCC-SSBH20S314-POS		Black
		Polyurethane		Ball Bearing	SCC-SSBH20S314-PPUB		
		Solid Polyurethane		Plain Bore	SCC-SSBH20S314-SPUS		Blue
		HT Glass Filled Nylon	350	Plain Bore	SCC-SSBH20S314-GFNSHT		Black or Brown
3-1/2"	1-1/4"	Soft Rubber	200	Plain Bore	SCC-SSBH20S3514-SRS	4-5/8"	Black
		Thermo Plastic Rubber	230	Plain Bore	SCC-SSBH20S3514-TPRB		Gray
		Hard Rubber	285	Plain Bore	SCC-SSBH20S3514-HRS		Black
		Polyolefin	300	Bushing	SCC-SSBH20S3514-POS		Black
		Polyurethane		Ball Bearing	SCC-SSBH20S3514-PPUB		
		Solid Polyurethane		Bushing	SCC-SSBH20S3514-SPUS		Blue
		HT Glass Filled Nylon	350	Plain Bore	SCC-SSBH20S3514-GFNSHT		Black or Brown
4"	1-1/4"	Soft Rubber	200	Plain Bore	SCC-SSBH20S414-SRS	5-1/8"	Black
		Thermo Plastic Rubber	250	Ball Bearing	SCC-SSBH20S414-TPRB		Gray
		Hard Rubber	300	Plain Bore	SCC-SSBH20S414-HRS		Black
		Nylon		Plain Bore	SCC-SSBH20S414-NYS		White
		Polyolefin	350	Plain Bore	SCC-SSBH20S414-POS		Black
		Polyurethane		Ball Bearing	SCC-SSBH20S414-PPUB		
		Solid Polyurethane		Plain Bore	SCC-SSBH20S414-SPUS		Blue
		HT Glass Filled Nylon		Plain Bore	SCC-SSBH20S414-GFNSHT		Black or Brown
5"	1-1/4"	Soft Rubber	275	Plain Bore	SCC-SSBH20S514-SRS	6-1/8"	Black
		Thermo Plastic Rubber	300	Ball Bearing	SCC-SSBH20S514-TPRB		Gray
		Hard Rubber		Plain Bore	SCC-SSBH20S514-HRS		Black
		Nylon		Plain Bore	SCC-SSBH20S514-NYS		White
		Polyolefin	350	Plain Bore	SCC-SSBH20S514-POS		Black
		Polyurethane		Ball Bearing	SCC-SSBH20S514-PPUB		
		Solid Polyurethane		Plain Bore	SCC-SSBH20S514-SPUS		Blue
		HT Glass Filled Nylon		Plain Bore	SCC-SSBH20S514-GFNSHT		Black or Brown

So many ways to showcase your style!

Our stainless steel bolt-hole casters are available in a wide variety of **styles** and **stem sizes**, offering the perfect solution for any application. Crafted from high-quality stainless steel, these casters are designed for durability and longevity.

Can't find the size you need? Reach out to our knowledgeable **customer service team**, and they'll help you find the perfect fit for your needs!



THREADED STEM



SQUARE STEM



ROUND STEM



GRIP RING STEM



EXPANDING STEM

STAINLESS STEEL



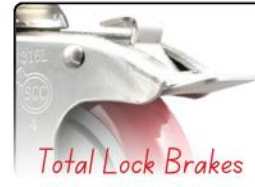

Wheel Diameter	Overall Height	Swivel Radius	Aproximate Weight 
3"	4-1/8"	2-15/16"	1.45
3-1/2"	4-5/8"	3-3/16"	1.6
4"	5-1/8"	3-1/2"	1.7
5"	6-1/8"	4"	2

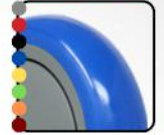

Choose Your Color



BOLT-HOLE CASTERS

Wheel Dia	Tread Width	Wheel Type	Load Capacity	Bearing Type	Top Lock Brake (TLB)	Total Lock Brake (TTL)	Overall Height	Color
3"	1-1/4"	Soft Rubber	175	Plain Bore	SCC-SSBH20S314-SRS-TLB	SCC-SSBH20S314-SRS	4-1/8"	Black
		Thermo Plastic Rubber	210	Ball Bearing	SCC-SSBH20S314-TPRB-TLB	SCC-SSBH20S314-TPRB		Gray
		Hard Rubber	275	Plain Bore	SCC-SSBH20S314-HRS-TLB	SCC-SSBH20S314-HRS		Black
		Nylon	300	Plain Bore	SCC-SSBH20S314-NYS-TLB	SCC-SSBH20S314-NYS		White
		Polyolefin		Plain Bore	SCC-SSBH20S314-POS-TLB	SCC-SSBH20S314-POS		Black
		Polyurethane		Ball Bearing	SCC-SSBH20S314-PPUB-TLB	SCC-SSBH20S314-PPUB		
		Solid Polyurethane		Plain Bore	SCC-SSBH20S314-SPUS-TLB	SCC-SSBH20S314-SPUS		Blue
		HT Glass Filled Nylon	350	Plain Bore	SCC-SSBH20S314-GFNSHT-TLB	SCC-SSBH20S314-GFNSHT		Black or Brown
3-1/2"	1-1/4"	Soft Rubber	200	Plain Bore	SCC-SSBH20S3514-SRS-TLB	SCC-SSBH20S3514-SRS	4-5/8"	Black
		Thermo Plastic Rubber	230	Plain Bore	SCC-SSBH20S3514-TPRB-TLB	SCC-SSBH20S3514-TPRB		Gray
		Hard Rubber	285	Plain Bore	SCC-SSBH20S3514-HRS-TLB	SCC-SSBH20S3514-HRS		Black
		Polyolefin	300	Bushing	SCC-SSBH20S3514-POS-TLB	SCC-SSBH20S3514-POS		Black
		Polyurethane		Ball Bearing	SCC-SSBH20S3514-PPUB-TLB	SCC-SSBH20S3514-PPUB		
		Solid Polyurethane		Bushing	SCC-SSBH20S3514-SPUS-TLB	SCC-SSBH20S3514-SPUS		Blue
		HT Glass Filled Nylon	350	Plain Bore	SCC-SSBH20S3514-GFNSHT-TLB	SCC-SSBH20S3514-GFNSHT		Black or Brown
4"	1-1/4"	Soft Rubber	200	Plain Bore	SCC-SSBH20S414-SRS-TLB	SCC-SSBH20S414-SRS	5-1/8"	Black
		Thermo Plastic Rubber	250	Ball Bearing	SCC-SSBH20S414-TPRB-TLB	SCC-SSBH20S414-TPRB		Gray
		Hard Rubber	300	Plain Bore	SCC-SSBH20S414-HRS-TLB	SCC-SSBH20S414-HRS		Black
		Nylon		Plain Bore	SCC-SSBH20S414-NYS-TLB	SCC-SSBH20S414-NYS		White
		Polyolefin	350	Plain Bore	SCC-SSBH20S414-POS-TLB	SCC-SSBH20S414-POS		Black
		Polyurethane		Ball Bearing	SCC-SSBH20S414-PPUB-TLB	SCC-SSBH20S414-PPUB		
		Solid Polyurethane		Plain Bore	SCC-SSBH20S414-SPUS-TLB	SCC-SSBH20S414-SPUS		Blue
		HT Glass Filled Nylon	350	Plain Bore	SCC-SSBH20S414-GFNSHT-TLB	SCC-SSBH20S414-GFNSHT		Black or Brown
5"	1-1/4"	Soft Rubber	275	Plain Bore	SCC-SSBH20S514-SRS-TLB	SCC-SSBH20S514-SRS	6-1/8"	Black
		Thermo Plastic Rubber	300	Ball Bearing	SCC-SSBH20S514-TPRB-TLB	SCC-SSBH20S514-TPRB		Gray
		Hard Rubber		Plain Bore	SCC-SSBH20S514-HRS-TLB	SCC-SSBH20S514-HRS		Black
		Nylon	350	Plain Bore	SCC-SSBH20S514-NYS-TLB	SCC-SSBH20S514-NYS		White
		Polyolefin		Plain Bore	SCC-SSBH20S514-POS-TLB	SCC-SSBH20S514-POS		Black
		Polyurethane		Ball Bearing	SCC-SSBH20S514-PPUB-TLB	SCC-SSBH20S514-PPUB		
		Solid Polyurethane	Plain Bore	SCC-SSBH20S514-SPUS-TLB	SCC-SSBH20S514-SPUS	Blue		
		HT Glass Filled Nylon	350	Plain Bore	SCC-SSBH20S514-GFNSHT-TLB	SCC-SSBH20S514-GFNSHT		Black or Brown

Unlock Limitless Options with Bolt Hole Casters!

Shop Stemless Casters Today! These Hollow Kingpin Casters let you use your own bolt for endless attachment options, fitting up to a 1/2" bolt. Perfect for unique projects, they offer various wheel sizes and types to suit your needs.





STAINLESS STEEL

Wheel Diameter	Overall Height	Swivel Radius	Approximate Weight ^{lbs}
3"	4-1/8"	2-15/16"	1.45
3-1/2"	4-5/8"	3-3/16"	1.6
4"	5-1/8"	3-1/2"	1.7
5"	6-1/8"	4"	2

Mounting Size	Mounting Size
3/4" (34)	1-3/8" (138)
7/8" (78)	1-1/2" (112)
1" (1)	1-5/8" (158)
1-1/8" (118)	1-3/4" (134)
1-1/4" (114)	1-7/8" (178)

EXPANDING STEM CASTERS

Wheel Dia	Tread Width	Wheel Type	Load Capacity	Bearing Type	Swivel Caster	Stem Code	Color
3"	1-1/4"	Soft Rubber	175	Plain Bore	SCC-SSEX20S314-SRS	34, 78, 1, 118, 114, 138, 112, 158, 134, 178	Black
		Thermo Plastic Rubber	210	Ball Bearing	SCC-SSEX20S314-TPRB	34, 78, 1, 118, 114, 138, 112, 158, 134, 178	Gray
		Hard Rubber	275	Plain Bore	SCC-SSEX20S314-HRS	34, 78, 1, 118, 114, 138, 112, 158, 134, 178	Black
		Nylon	300	Plain Bore	SCC-SSEX20S314-NYS	34, 78, 1, 118, 114, 138, 112, 158, 134, 178	White
		Polyolefin		Plain Bore	SCC-SSEX20S314-POS	34, 78, 1, 118, 114, 138, 112, 158, 134, 178	Black
		Polyurethane		Ball Bearing	SCC-SSEX20S314-PPUB	34, 78, 1, 118, 114, 138, 112, 158, 134, 178	
		Solid Polyurethane	350	Plain Bore	SCC-SSEX20S314-SPUS	34, 78, 1, 118, 114, 138, 112, 158, 134, 178	Blue
HT Glass Filled Nylon	350	Plain Bore	SCC-SSEX20S314-GFNST	34, 78, 1, 118, 114, 138, 112, 158, 134, 178	Black or Brown		
3-1/2"	1-1/4"	Soft Rubber	200	Plain Bore	SCC-SSEX20S3514-SRS	34, 78, 1, 118, 114, 138, 112, 158, 134, 178	Black
		Thermo Plastic Rubber	230	Plain Bore	SCC-SSEX20S3514-TPRB	34, 78, 1, 118, 114, 138, 112, 158, 134, 178	Gray
		Hard Rubber	285	Plain Bore	SCC-SSEX20S3514-HRS	34, 78, 1, 118, 114, 138, 112, 158, 134, 178	Black
		Polyolefin	300	Bushing	SCC-SSEX20S3514-POS	34, 78, 1, 118, 114, 138, 112, 158, 134, 178	Black
		Polyurethane		Ball Bearing	SCC-SSEX20S3514-PPUB	34, 78, 1, 118, 114, 138, 112, 158, 134, 178	
		Solid Polyurethane		Bushing	SCC-SSEX20S3514-SPUS	34, 78, 1, 118, 114, 138, 112, 158, 134, 178	Blue
		HT Glass Filled Nylon	350	Plain Bore	SCC-SSEX20S3514-GFNST	34, 78, 1, 118, 114, 138, 112, 158, 134, 178	Black or Brown
4"	1-1/4"	Soft Rubber	200	Plain Bore	SCC-SSEX20S414-SRS	34, 78, 1, 118, 114, 138, 112, 158, 134, 178	Black
		Thermo Plastic Rubber	250	Ball Bearing	SCC-SSEX20S414-TPRB	34, 78, 1, 118, 114, 138, 112, 158, 134, 178	Gray
		Hard Rubber	300	Plain Bore	SCC-SSEX20S414-HRS	34, 78, 1, 118, 114, 138, 112, 158, 134, 178	Black
		Nylon		Plain Bore	SCC-SSEX20S414-NYS	34, 78, 1, 118, 114, 138, 112, 158, 134, 178	White
		Polyolefin		Plain Bore	SCC-SSEX20S414-POS	34, 78, 1, 118, 114, 138, 112, 158, 134, 178	Black
		Polyurethane	350	Ball Bearing	SCC-SSEX20S414-PPUB	34, 78, 1, 118, 114, 138, 112, 158, 134, 178	
		Solid Polyurethane		Plain Bore	SCC-SSEX20S414-SPUS	34, 78, 1, 118, 114, 138, 112, 158, 134, 178	Blue
HT Glass Filled Nylon	Plain Bore	SCC-SSEX20S414-GFNST		34, 78, 1, 118, 114, 138, 112, 158, 134, 178	Black or Brown		
5"	1-1/4"	Soft Rubber	275	Plain Bore	SCC-SSEX20S514-SRS	34, 78, 1, 118, 114, 138, 112, 158, 134, 178	Black
		Thermo Plastic Rubber	300	Ball Bearing	SCC-SSEX20S514-TPRB	34, 78, 1, 118, 114, 138, 112, 158, 134, 178	Gray
		Hard Rubber		Plain Bore	SCC-SSEX20S514-HRS	34, 78, 1, 118, 114, 138, 112, 158, 134, 178	Black
		Nylon		Plain Bore	SCC-SSEX20S514-NYS	34, 78, 1, 118, 114, 138, 112, 158, 134, 178	White
		Polyolefin	350	Plain Bore	SCC-SSEX20S514-POS	34, 78, 1, 118, 114, 138, 112, 158, 134, 178	Black
		Polyurethane		Ball Bearing	SCC-SSEX20S514-PPUB	34, 78, 1, 118, 114, 138, 112, 158, 134, 178	
		Solid Polyurethane		Plain Bore	SCC-SSEX20S514-SPUS	34, 78, 1, 118, 114, 138, 112, 158, 134, 178	Blue
HT Glass Filled Nylon	350	Plain Bore	SCC-SSEX20S514-GFNST	34, 78, 1, 118, 114, 138, 112, 158, 134, 178	Black or Brown		

EXPLORE OUR DIVERSE MOUNTING OPTIONS IN OUR EXPANDING STEM CASTER SERIES. FOR FURTHER ASSISTANCE, CONTACT OUR [CUSTOMER SERVICE](#).



Expanding Stem Casters for Equipment, Racks, & Prep Tables

Designed to fit a variety of **square** and **round** tube legs by adapting to the tube's inside diameter. Perfect for prep tables, work tables, racks, and shop projects. Choose from a wide range of wheel types, including non-marking, floor-safe, easy-rolling polyurethane.





STAINLESS STEEL

Wheel Diameter	Overall Height	Swivel Radius	Approximate Weight 
3"	4-1/8"	2-15/16"	1.45
3-1/2"	4-5/8"	3-3/16"	1.6
4"	5-1/8"	3-1/2"	1.7
5"	6-1/8"	4"	2



Mounting Size	Mounting Size
3/4" (34)	1-3/8" (138)
7/8" (78)	1-1/2" (112)
1" (1)	1-5/8" (158)
1-1/8" (118)	1-3/4" (134)
1-1/4" (114)	1-7/8" (178)

EXPANDING STEM CASTERS

Wheel Dia	Tread Width	Wheel Type	Load Capacity	Bearing Type	Top Lock Brake (TLB)	Stem Code	Color
3"	1-1/4"	Soft Rubber	175	Plain Bore	SCC-SSEX20S314-SRS-TLB	34, 78, 1, 118, 114, 138, 112, 158, 134, 178	Black
		Thermo Plastic Rubber	210	Ball Bearing	SCC-SSEX20S314-TPRB-TLB	34, 78, 1, 118, 114, 138, 112, 158, 134, 178	Gray
		Hard Rubber	275	Plain Bore	SCC-SSEX20S314-HRS-TLB	34, 78, 1, 118, 114, 138, 112, 158, 134, 178	Black
		Nylon	300	Plain Bore	SCC-SSEX20S314-NYS-TLB	34, 78, 1, 118, 114, 138, 112, 158, 134, 178	White
		Polyolefin		Plain Bore	SCC-SSEX20S314-POS-TLB	34, 78, 1, 118, 114, 138, 112, 158, 134, 178	Black
		Polyurethane		Ball Bearing	SCC-SSEX20S314-PPUB-TLB	34, 78, 1, 118, 114, 138, 112, 158, 134, 178	
		Solid Polyurethane		Plain Bore	SCC-SSEX20S314-SPUS-TLB	34, 78, 1, 118, 114, 138, 112, 158, 134, 178	Blue
		HT Glass Filled Nylon	350	Plain Bore	SCC-SSEX20S314-GFNSHT-TLB	34, 78, 1, 118, 114, 138, 112, 158, 134, 178	Black or Brown
3-1/2"	1-1/4"	Soft Rubber	200	Plain Bore	SCC-SSEX20S3514-SRS-TLB	34, 78, 1, 118, 114, 138, 112, 158, 134, 178	Black
		Thermo Plastic Rubber	230	Plain Bore	SCC-SSEX20S3514-TPRB-TLB	34, 78, 1, 118, 114, 138, 112, 158, 134, 178	Gray
		Hard Rubber	285	Plain Bore	SCC-SSEX20S3514-HRS-TLB	34, 78, 1, 118, 114, 138, 112, 158, 134, 178	Black
		Polyolefin	300	Bushing	SCC-SSEX20S3514-POS-TLB	34, 78, 1, 118, 114, 138, 112, 158, 134, 178	Black
		Polyurethane		Ball Bearing	SCC-SSEX20S3514-PPUB-TLB	34, 78, 1, 118, 114, 138, 112, 158, 134, 178	
		Solid Polyurethane		Bushing	SCC-SSEX20S3514-SPUS-TLB	34, 78, 1, 118, 114, 138, 112, 158, 134, 178	Blue
		HT Glass Filled Nylon	350	Plain Bore	SCC-SSEX20S3514-GFNSHT-TLB	34, 78, 1, 118, 114, 138, 112, 158, 134, 178	Black or Brown
4"	1-1/4"	Soft Rubber	200	Plain Bore	SCC-SSEX20S414-SRS-TLB	34, 78, 1, 118, 114, 138, 112, 158, 134, 178	Black
		Thermo Plastic Rubber	250	Ball Bearing	SCC-SSEX20S414-TPRB-TLB	34, 78, 1, 118, 114, 138, 112, 158, 134, 178	Gray
		Hard Rubber	300	Plain Bore	SCC-SSEX20S414-HRS-TLB	34, 78, 1, 118, 114, 138, 112, 158, 134, 178	Black
		Nylon		Plain Bore	SCC-SSEX20S414-NYS-TLB	34, 78, 1, 118, 114, 138, 112, 158, 134, 178	White
		Polyolefin	350	Plain Bore	SCC-SSEX20S414-POS-TLB	34, 78, 1, 118, 114, 138, 112, 158, 134, 178	Black
		Polyurethane		Ball Bearing	SCC-SSEX20S414-PPUB-TLB	34, 78, 1, 118, 114, 138, 112, 158, 134, 178	
		Solid Polyurethane		Plain Bore	SCC-SSEX20S414-SPUS-TLB	34, 78, 1, 118, 114, 138, 112, 158, 134, 178	Blue
		HT Glass Filled Nylon		Plain Bore	SCC-SSEX20S414-GFNSHT-TLB	34, 78, 1, 118, 114, 138, 112, 158, 134, 178	Black or Brown
5"	1-1/4"	Soft Rubber	275	Plain Bore	SCC-SSEX20S514-SRS-TLB	34, 78, 1, 118, 114, 138, 112, 158, 134, 178	Black
		Thermo Plastic Rubber	300	Ball Bearing	SCC-SSEX20S514-TPRB-TLB	34, 78, 1, 118, 114, 138, 112, 158, 134, 178	Gray
		Hard Rubber		Plain Bore	SCC-SSEX20S514-HRS-TLB	34, 78, 1, 118, 114, 138, 112, 158, 134, 178	Black
		Nylon		Plain Bore	SCC-SSEX20S514-NYS-TLB	34, 78, 1, 118, 114, 138, 112, 158, 134, 178	White
		Polyolefin	350	Plain Bore	SCC-SSEX20S514-POS-TLB	34, 78, 1, 118, 114, 138, 112, 158, 134, 178	Black
		Polyurethane		Ball Bearing	SCC-SSEX20S514-PPUB-TLB	34, 78, 1, 118, 114, 138, 112, 158, 134, 178	
		Solid Polyurethane		Plain Bore	SCC-SSEX20S514-SPUS-TLB	34, 78, 1, 118, 114, 138, 112, 158, 134, 178	Blue
		HT Glass Filled Nylon		Plain Bore	SCC-SSEX20S514-GFNSHT-TLB	34, 78, 1, 118, 114, 138, 112, 158, 134, 178	Black or Brown



Easy to Install Expanding Adapter Stem Casters

Tighten the topmost ring on the expanding caster adapter stem before insertion to compress rubber until it fits snugly into the tube. The **expanded stem** can be inserted into round or square tubing. It may be necessary to further tighten the nut under the swivel with a wrench until adequately secured.

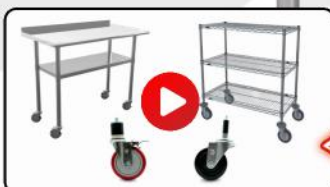

STAINLESS STEEL

Wheel Diameter	Overall Height	Swivel Radius	Approximate Weight
3"	4-1/8"	2-15/16"	1.45
3-1/2"	4-5/8"	3-3/16"	1.6
4"	5-1/8"	3-1/2"	1.7
5"	6-1/8"	4"	2



Mounting Size	Mounting Size
3/4" (34)	1-3/8" (138)
7/8" (78)	1-1/2" (112)
1" (1)	1-5/8" (158)
1-1/8" (118)	1-3/4" (134)
1-1/4" (114)	1-7/8" (178)

EXPANDING STEM CASTERS

Wheel Dia	Tread Width	Wheel Type	Load Capacity	Bearing Type	Total Lock Brake (TTL)	Stem Code	Color
3"	1-1/4"	Soft Rubber	175	Plain Bore	SCC-SSEXTTL20S314-SRS	34, 78, 1, 118, 114, 138, 112, 158, 134, 178	Black
		Thermo Plastic Rubber	210	Ball Bearing	SCC-SSEXTTL20S314-TPRB	34, 78, 1, 118, 114, 138, 112, 158, 134, 178	Gray
		Hard Rubber	275	Plain Bore	SCC-SSEXTTL20S314-HRS	34, 78, 1, 118, 114, 138, 112, 158, 134, 178	Black
		Nylon	300	Plain Bore	SCC-SSEXTTL20S314-NYS	34, 78, 1, 118, 114, 138, 112, 158, 134, 178	White
		Polyolefin		Plain Bore	SCC-SSEXTTL20S314-POS	34, 78, 1, 118, 114, 138, 112, 158, 134, 178	Black
		Polyurethane		Ball Bearing	SCC-SSEXTTL20S314-PPUB	34, 78, 1, 118, 114, 138, 112, 158, 134, 178	Blue
		Solid Polyurethane		Plain Bore	SCC-SSEXTTL20S314-SPUS	34, 78, 1, 118, 114, 138, 112, 158, 134, 178	Blue
		HT Glass Filled Nylon	350	Plain Bore	SCC-SSEXTTL20S314-GFNSHT	34, 78, 1, 118, 114, 138, 112, 158, 134, 178	Black or Brown
3-1/2"	1-1/4"	Soft Rubber	200	Plain Bore	SCC-SSEXTTL20S3514-SRS	34, 78, 1, 118, 114, 138, 112, 158, 134, 178	Black
		Thermo Plastic Rubber	230	Plain Bore	SCC-SSEXTTL20S3514-TPRB	34, 78, 1, 118, 114, 138, 112, 158, 134, 178	Gray
		Hard Rubber	285	Plain Bore	SCC-SSEXTTL20S3514-HRS	34, 78, 1, 118, 114, 138, 112, 158, 134, 178	Black
		Polyolefin	300	Bushing	SCC-SSEXTTL20S3514-POS	34, 78, 1, 118, 114, 138, 112, 158, 134, 178	Black
		Polyurethane		Ball Bearing	SCC-SSEXTTL20S3514-PPUB	34, 78, 1, 118, 114, 138, 112, 158, 134, 178	Blue
		Solid Polyurethane		Bushing	SCC-SSEXTTL20S3514-SPUS	34, 78, 1, 118, 114, 138, 112, 158, 134, 178	Blue
		HT Glass Filled Nylon	350	Plain Bore	SCC-SSEXTTL20S3514-GFNSHT	34, 78, 1, 118, 114, 138, 112, 158, 134, 178	Black or Brown
4"	1-1/4"	Soft Rubber	200	Plain Bore	SCC-SSEXTTL20S414-SRS	34, 78, 1, 118, 114, 138, 112, 158, 134, 178	Black
		Thermo Plastic Rubber	250	Ball Bearing	SCC-SSEXTTL20S414-TPRB	34, 78, 1, 118, 114, 138, 112, 158, 134, 178	Gray
		Hard Rubber	300	Plain Bore	SCC-SSEXTTL20S414-HRS	34, 78, 1, 118, 114, 138, 112, 158, 134, 178	Black
		Nylon		Plain Bore	SCC-SSEXTTL20S414-NYS	34, 78, 1, 118, 114, 138, 112, 158, 134, 178	White
		Polyolefin	350	Plain Bore	SCC-SSEXTTL20S414-POS	34, 78, 1, 118, 114, 138, 112, 158, 134, 178	Black
		Polyurethane		Ball Bearing	SCC-SSEXTTL20S414-PPUB	34, 78, 1, 118, 114, 138, 112, 158, 134, 178	Blue
		Solid Polyurethane		Plain Bore	SCC-SSEXTTL20S414-SPUS	34, 78, 1, 118, 114, 138, 112, 158, 134, 178	Blue
		HT Glass Filled Nylon	350	Plain Bore	SCC-SSEXTTL20S414-GFNSHT	34, 78, 1, 118, 114, 138, 112, 158, 134, 178	Black or Brown
5"	1-1/4"	Soft Rubber	275	Plain Bore	SCC-SSEXTTL20S514-SRS	34, 78, 1, 118, 114, 138, 112, 158, 134, 178	Black
		Thermo Plastic Rubber	300	Ball Bearing	SCC-SSEXTTL20S514-TPRB	34, 78, 1, 118, 114, 138, 112, 158, 134, 178	Gray
		Hard Rubber		Plain Bore	SCC-SSEXTTL20S514-HRS	34, 78, 1, 118, 114, 138, 112, 158, 134, 178	Black
		Nylon	350	Plain Bore	SCC-SSEXTTL20S514-NYS	34, 78, 1, 118, 114, 138, 112, 158, 134, 178	White
		Polyolefin		Plain Bore	SCC-SSEXTTL20S514-POS	34, 78, 1, 118, 114, 138, 112, 158, 134, 178	Black
		Polyurethane		Ball Bearing	SCC-SSEXTTL20S514-PPUB	34, 78, 1, 118, 114, 138, 112, 158, 134, 178	Blue
		Solid Polyurethane	Plain Bore	SCC-SSEXTTL20S514-SPUS	34, 78, 1, 118, 114, 138, 112, 158, 134, 178	Blue	
		HT Glass Filled Nylon	350	Plain Bore	SCC-SSEXTTL20S514-GFNSHT	34, 78, 1, 118, 114, 138, 112, 158, 134, 178	Black or Brown

5" Stainless Swivel Expanding Stem Caster with Total Lock Brake

SCC-SSTLEX20S514-PPUB-34

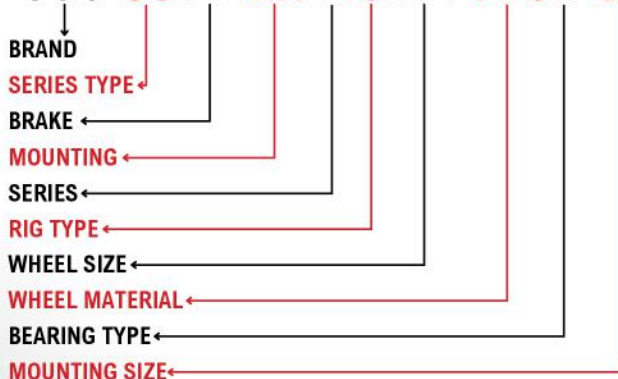

Our part numbers adapt to your needs. Use the diagram below as a reference. For help, contact our customer service team.



Corrosion Resistant Casters

Series #20 Stainless Steel 316 Casters

Introducing Service Caster's #20 Series 316 stainless steel swivel casters with numerous wheels options. Ideal for various applications, these casters offer stability and durability in corrosive environments.

Applications

- Healthcare
- Foodservice
- Laboratories
- Marine
- Pharmaceuticals
- Cleanrooms

Features

- Withstands harsh, wet environments.
- Washable Caster Solution
- Precision bearings for quiet movement.
- Long-lasting construction for tough conditions.
- Ideal for cleanrooms and sterile settings.

Capacity up to 350 lbs.



Service Caster Chart Guide

Build Your Caster

Discover more fastening sizes and wheel options if you can't find what you need. And remember, we're always here to [help!](#)

Brand	Series	Rig Type	Brake	Bearing Type	Wheel Size	Mounting Type	Wheel Material
Service Caster	SS31620	Swivel (S)	Top Lock (TLB)	Ball Bearing (B)	3" x 1-1/4" (314)	Top Plate	Soft Rubber (SR)
		Rigid (R)	Total Lock (TTL)	Plain Bore (S)	3-1/2" x 1-1/4" (3514)	Threaded Stem (TS)	Thermo Plastic Rubber (TPR)
				Delrin Bearing (D)	4" x 1-1/4" (414)	Grip Ring (GR)	Polyurethane (PPU)
		5" x 1-1/4" (514)	Expanding Adapter (EX)	Glass-Filled Nylon High Temp (HT)			
			Bolt Hole (BH)	Solid Polyurethane (SPU)			
		Hard Rubber (HR)					
		Glass Filled Nylon (GFN)					
		Rubber on Aluminum (RA)					
		Polyolefin (PO)					
		Nylon (NY)					

Is Stainless Steel Non-Magnetic?



Choose Your Color

<p>POLYURETHANE</p> <p>PPU</p>	<p>SOLID POLYURETHANE</p> <p>SPU</p>	<p>HIGH TEMP GLASS-FILLED NYLON</p> <p>GFN*HT</p>	<p>SOFT/HARD RUBBER</p> <p>SR/HR</p>
<p>POLYOLEFIN</p> <p>PO</p>	<p>NYLON</p> <p>NY</p>	<p>RUBBER / ALUMINUM</p> <p>NY</p>	<p>THERMO PLASTIC RUBBER</p> <p>TP</p>

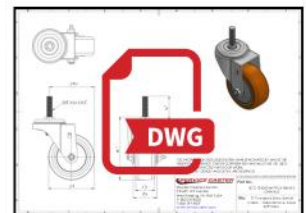

Need a drawing request? Contact customer service, and we'll be happy to help!

316 STAINLESS STEEL

Wheel Diameter	Overall Height	Swivel Radius	Aproximate Weight
3"	4-1/8"	2-15/16"	1.45
3-1/2"	4-5/8"	3-3/16"	1.6
4"	5-1/8"	3-1/2"	1.7
5"	6-1/8"	4"	2



SWIVEL & RIGID TOP PLATE CASTERS

Wheel Dia	Tread Width	Wheel Type	Load Capacity	Bearing Type	Swivel Caster	Rigid Caster	Overall Height	Color
3"	1-1/4"	Soft Rubber	175	Plain Bore	SCC-SS31620S314-SRS	SCC-SS31620R314-SRS	4-1/8"	Black
		Thermo Plastic Rubber	210	Ball Bearing	SCC-SS31620S314-TPRB	SCC-SS31620R314-TPRB		Gray
		Hard Rubber	275	Plain Bore	SCC-SS31620S314-HRS	SCC-SS31620R314-HRS		Black
		Nylon	300	Plain Bore	SCC-SS31620S314-NYS	SCC-SS31620R314-NYS		White
		Polyolefin		Plain Bore	SCC-SS31620S314-POS	SCC-SS31620R314-POS		Black
		Polyurethane		Ball Bearing	SCC-SS31620S314-PPUB	SCC-SS31620R314-PPUB		
		Solid Polyurethane		Plain Bore	SCC-SS31620S314-SPUS	SCC-SS31620R314-SPUS		Blue
		HT Glass Filled Nylon	350	Plain Bore	SCC-SS31620S314-GFNSHT	SCC-SS31620R314-GFNSHT		Black or Brown
3-1/2"	1-1/4"	Soft Rubber	200	Plain Bore	SCC-SS31620S3514-SRS	SCC-SS31620R3514-SRS	4-5/8"	Black
		Thermo Plastic Rubber	230	Plain Bore	SCC-SS31620S3514-TPRB	SCC-SS31620R3514-TPRB		Gray
		Hard Rubber	285	Plain Bore	SCC-SS31620S3514-HRS	SCC-SS31620R3514-HRS		Black
		Polyolefin	300	Bushing	SCC-SS31620S3514-POS	SCC-SS31620R3514-POS		Black
		Polyurethane		Ball Bearing	SCC-SS31620S3514-PPUB	SCC-SS31620R3514-PPUB		
		Solid Polyurethane		Bushing	SCC-SS31620S3514-SPUS	SCC-SS31620R3514-SPUS		Blue
		HT Glass Filled Nylon	350	Plain Bore	SCC-SS31620S3514-GFNSHT	SCC-SS31620R3514-GFNSHT		Black or Brown
4"	1-1/4"	Soft Rubber	200	Plain Bore	SCC-SS31620S414-SRS	SCC-SS31620R414-SRS	5-1/8"	Black
		Thermo Plastic Rubber	250	Ball Bearing	SCC-SS31620S414-TPRB	SCC-SS31620R414-TPRB		Gray
		Hard Rubber	300	Plain Bore	SCC-SS31620S414-HRS	SCC-SS31620R414-HRS		Black
		Nylon		Plain Bore	SCC-SS31620S414-NYS	SCC-SS31620R414-NYS		White
		Polyolefin	350	Plain Bore	SCC-SS31620S414-POS	SCC-SS31620R414-POS		Black
		Polyurethane		Ball Bearing	SCC-SS31620S414-PPUB	SCC-SS31620R414-PPUB		
		Solid Polyurethane		Plain Bore	SCC-SS31620S414-SPUS	SCC-SS31620R414-SPUS		Blue
		HT Glass Filled Nylon	350	Plain Bore	SCC-SS31620S414-GFNSHT	SCC-SS31620R414-GFNSHT		Black or Brown
5"	1-1/4"	Soft Rubber	275	Plain Bore	SCC-SS31620S514-SRS	SCC-SS31620R514-SRS	6-1/8"	Black
		Thermo Plastic Rubber	300	Ball Bearing	SCC-SS31620S514-TPRB	SCC-SS31620R514-TPRB		Gray
		Hard Rubber		Plain Bore	SCC-SS31620S514-HRS	SCC-SS31620R514-HRS		Black
		Nylon	350	Plain Bore	SCC-SS31620S514-NYS	SCC-SS31620R514-NYS		White
		Polyolefin		Plain Bore	SCC-SS31620S514-POS	SCC-SS31620R514-POS		Black
		Polyurethane		Ball Bearing	SCC-SS31620S514-PPUB	SCC-SS31620R514-PPUB		
		Solid Polyurethane	Plain Bore	SCC-SS31620S514-SPUS	SCC-SS31620R514-SPUS	Blue		
		HT Glass Filled Nylon	350	Plain Bore	SCC-SS31620S514-GFNSHT	SCC-SS31620R514-GFNSHT		Black or Brown

Plate Casters: Reliable Movement, Built to Last

Our plate casters deliver robust performance and smooth mobility for various applications. Built to last, they offer exceptional load-bearing capacity and stability across surfaces. Need a custom size plate? Reach out to our [customer service](#) for assistance!

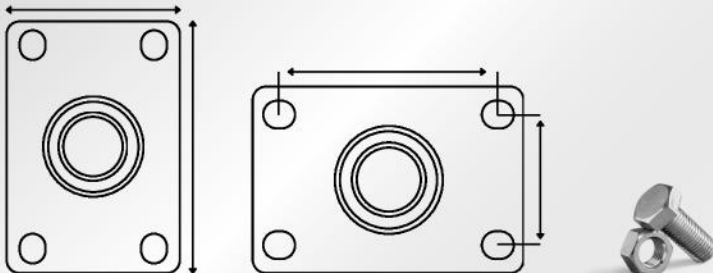

Standard Plate Size	Bolt Pattern	Bolt Diameter
2-3/8" x 3-5/8"	1-3/4" x 2-7/8" to 3"	5/16"

Total Lock Brake (TTL)

The **total lock** on casters secures both the wheel and swivel, ensuring complete stability for reliable and safe use.



[SCC-SS31620S414-PPUB-MRN](#)

Top Lock Brake (TLB)

The **Top lock brake** places a positive locking force against the wheel hub locking the wheel only.



[SCC-SS31620S314-TPRB-TLB](#)

Wheel Diameter	Overall Height	Swivel Radius	Approximate Weight
3"	4-1/8"	2-15/16"	1.45
3-1/2"	4-5/8"	3-3/16"	1.6
4"	5-1/8"	3-1/2"	1.7
5"	6-1/8"	4"	2

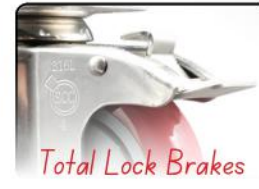

SWIVEL TOP PLATE CASTERS

Wheel Dia	Tread Width	Wheel Type	Load Capacity	Bearing Type	Top Lock Brake (TLB)	Total Lock Brake (TTL)	Color
3"	1-1/4"	Soft Rubber	175	Plain Bore	SCC-SS31620S314-SRS-TLB	SCC-SS316TTL20S314-SRS	Black
		Thermo Plastic Rubber	210	Ball Bearing	SCC-SS31620S314-TPRB-TLB	SCC-SS316TTL20S314-TPRB	Gray
		Hard Rubber	275	Plain Bore	SCC-SS31620S314-HRS-TLB	SCC-SS316TTL20S314-HRS	Black
		Nylon	300	Plain Bore	SCC-SS31620S314-NYS-TLB	SCC-SS316TTL20S314-NYS	White
		Polyolefin		Plain Bore	SCC-SS31620S314-POS-TLB	SCC-SS316TTL20S314-POS	Black
		Polyurethane		Ball Bearing	SCC-SS31620S314-PPUB-TLB	SCC-SS316TTL20S314-PPUB	● ● ● ● ● ● ● ●
		Solid Polyurethane		Plain Bore	SCC-SS31620S314-SPUS-TLB	SCC-SS316TTL20S314-SPUS	Blue
		HT Glass Filled Nylon	350	Plain Bore	SCC-SS31620S314-GFNSHT-TLB	SCC-SS316TTL20S314-GFNSHT	Black or Brown
3-1/2"	1-1/4"	Soft Rubber	200	Plain Bore	SCC-SS31620S3514-SRS-TLB	SCC-SS316TTL20S3514-SRS	Black
		Thermo Plastic Rubber	230	Plain Bore	SCC-SS31620S3514-TPRB-TLB	SCC-SS316TTL20S3514-TPRB	Gray
		Hard Rubber	285	Plain Bore	SCC-SS31620S3514-HRS-TLB	SCC-SS316TTL20S3514-HRS	Black
		Polyolefin	300	Bushing	SCC-SS31620S3514-POS-TLB	SCC-SS316TTL20S3514-POS	Black
		Polyurethane		Ball Bearing	SCC-SS31620S3514-PPUB-TLB	SCC-SS316TTL20S3514-PPUB	● ● ● ● ● ● ● ●
		Solid Polyurethane		Bushing	SCC-SS31620S3514-SPUS-TLB	SCC-SS316TTL20S3514-SPUS	Blue
		HT Glass Filled Nylon		350	Plain Bore	SCC-SS31620S3514-GFNSHT-TLB	SCC-SS316TTL20S3514-GFNSHT
4"	1-1/4"	Soft Rubber	200	Plain Bore	SCC-SS31620S414-SRS-TLB	SCC-SS316TTL20S414-SRS	Black
		Thermo Plastic Rubber	250	Ball Bearing	SCC-SS31620S414-TPRB-TLB	SCC-SS316TTL20S414-TPRB	Gray
		Hard Rubber	300	Plain Bore	SCC-SS31620S414-HRS-TLB	SCC-SS316TTL20S414-HRS	Black
		Nylon		Plain Bore	SCC-SS31620S414-NYS-TLB	SCC-SS316TTL20S414-NYS	White
		Polyolefin	350	Plain Bore	SCC-SS31620S414-POS-TLB	SCC-SS316TTL20S414-POS	Black
		Polyurethane		Ball Bearing	SCC-SS31620S414-PPUB-TLB	SCC-SS316TTL20S414-PPUB	● ● ● ● ● ● ● ●
		Solid Polyurethane		Plain Bore	SCC-SS31620S414-SPUS-TLB	SCC-SS316TTL20S414-SPUS	Blue
		HT Glass Filled Nylon		350	Plain Bore	SCC-SS31620S414-GFNSHT-TLB	SCC-SS316TTL20S414-GFNSHT
5"	1-1/4"	Soft Rubber	275	Plain Bore	SCC-SS31620S514-SRS-TLB	SCC-SS316TTL20S514-SRS	Black
		Thermo Plastic Rubber	300	Ball Bearing	SCC-SS31620S514-TPRB-TLB	SCC-SS316TTL20S514-TPRB	Gray
		Hard Rubber		Plain Bore	SCC-SS31620S514-HRS-TLB	SCC-SS316TTL20S514-HRS	Black
		Nylon	350	Plain Bore	SCC-SS31620S514-NYS-TLB	SCC-SS316TTL20S514-NYS	White
		Polyolefin		Plain Bore	SCC-SS31620S514-POS-TLB	SCC-SS316TTL20S514-POS	Black
		Polyurethane		Ball Bearing	SCC-SS31620S514-PPUB-TLB	SCC-SS316TTL20S514-PPUB	● ● ● ● ● ● ● ●
		Solid Polyurethane		Plain Bore	SCC-SS31620S514-SPUS-TLB	SCC-SS316TTL20S514-SPUS	Blue
		HT Glass Filled Nylon	350	Plain Bore	SCC-SS31620S514-GFNSHT-TLB	SCC-SS316TTL20S514-GFNSHT	Black or Brown



Stainless Steel 316

Our **Stainless Steel 316** Casters provide corrosion resistance, smooth mobility, and hygienic design for efficient pharmaceutical operations.



316 STAINLESS STEEL



Mounting Size (Metric)	Mounting Size (Inch)
M10-1.5 x 38MM (M1015)	3/8"-16 x 1-1/2" (381615)
M12-1.75 x 38MM (M1215)	1/2"-13 x 1-1/2" (121315)

Wheel Diameter	Overall Height	Swivel Radius	Aproximate Weight
3"	4-1/8"	2-15/16"	1.45
3-1/2"	4-5/8"	3-3/16"	1.6
4"	5-1/8"	3-1/2"	1.7
5"	6-1/8"	4"	2



THREADED STEM CASTERS

Wheel Dia	Tread Width	Wheel Type	Load Capacity	Bearing Type	Swivel Caster	Stem Code	Overall Height	Color
3"	1-1/4"	Soft Rubber	175	Plain Bore	SCC-SS316TS20S314-SRS	381615 , 121315 , M1015 , M1215	4-1/8"	Black
		Thermo Plastic Rubber	210	Ball Bearing	SCC-SS316TS20S314-TPRB	381615 , 121315 , M1015 , M1215		Gray
		Hard Rubber	275	Plain Bore	SCC-SS316TS20S314-HRS	381615 , 121315 , M1015 , M1215		Black
		Nylon	300	Plain Bore	SCC-SS316TS20S314-NYS	381615 , 121315 , M1015 , M1215		White
		Polyolefin		Plain Bore	SCC-SS316TS20S314-POS	381615 , 121315 , M1015 , M1215		Black
		Polyurethane		Ball Bearing	SCC-SS316TS20S314-PPUB	381615 , 121315 , M1015 , M1215		
		Solid Polyurethane	350	Plain Bore	SCC-SS316TS20S314-SPUS	381615 , 121315 , M1015 , M1215		Blue
		HT Glass Filled Nylon	350	Plain Bore	SCC-SS316TS20S314-GFNSHT	381615 , 121315 , M1015 , M1215		Black or Brown
3-1/2"	1-1/4"	Soft Rubber	200	Plain Bore	SCC-SS316TS20S3514-SRS	381615 , 121315 , M1015 , M1215	4-5/8"	Black
		Thermo Plastic Rubber	230	Plain Bore	SCC-SS316TS20S3514-TPRB	381615 , 121315 , M1015 , M1215		Gray
		Hard Rubber	285	Plain Bore	SCC-SS316TS20S3514-HRS	381615 , 121315 , M1015 , M1215		Black
		Polyolefin	300	Bushing	SCC-SS316TS20S3514-POS	381615 , 121315 , M1015 , M1215		Black
		Polyurethane		Ball Bearing	SCC-SS316TS20S3514-PPUB	381615 , 121315 , M1015 , M1215		
		Solid Polyurethane		Bushing	SCC-SS316TS20S3514-SPUS	381615 , 121315 , M1015 , M1215		Blue
		HT Glass Filled Nylon	350	Plain Bore	SCC-SS316TS20S3514-GFNSHT	381615 , 121315 , M1015 , M1215		Black or Brown
4"	1-1/4"	Soft Rubber	200	Plain Bore	SCC-SS316TS20S414-SRS	381615 , 121315 , M1015 , M1215	5-1/8"	Black
		Thermo Plastic Rubber	250	Ball Bearing	SCC-SS316TS20S414-TPRB	381615 , 121315 , M1015 , M1215		Gray
		Hard Rubber	300	Plain Bore	SCC-SS316TS20S414-HRS	381615 , 121315 , M1015 , M1215		Black
		Nylon		Plain Bore	SCC-SS316TS20S414-NYS	381615 , 121315 , M1015 , M1215		White
		Polyolefin		Plain Bore	SCC-SS316TS20S414-POS	381615 , 121315 , M1015 , M1215		Black
		Polyurethane	350	Ball Bearing	SCC-SS316TS20S414-PPUB	381615 , 121315 , M1015 , M1215		
		Solid Polyurethane		Plain Bore	SCC-SS316TS20S414-SPUS	381615 , 121315 , M1015 , M1215		Blue
		HT Glass Filled Nylon		Plain Bore	SCC-SS316TS20S414-GFNSHT	381615 , 121315 , M1015 , M1215		Black or Brown
5"	1-1/4"	Soft Rubber	275	Plain Bore	SCC-SS316TS20S514-SRS	381615 , 121315 , M1015 , M1215	6-1/8"	Black
		Thermo Plastic Rubber	300	Ball Bearing	SCC-SS316TS20S514-TPRB	381615 , 121315 , M1015 , M1215		Gray
		Hard Rubber		Plain Bore	SCC-SS316TS20S514-HRS	381615 , 121315 , M1015 , M1215		Black
		Nylon		Plain Bore	SCC-SS316TS20S514-NYS	381615 , 121315 , M1015 , M1215		White
		Polyolefin	350	Plain Bore	SCC-SS316TS20S514-POS	381615 , 121315 , M1015 , M1215		Black
		Polyurethane		Ball Bearing	SCC-SS316TS20S514-PPUB	381615 , 121315 , M1015 , M1215		
		Solid Polyurethane		Plain Bore	SCC-SS316TS20S514-SPUS	381615 , 121315 , M1015 , M1215		Blue
		HT Glass Filled Nylon	350	Plain Bore	SCC-SS316TS20S514-GFNSHT	381615 , 121315 , M1015 , M1215		Black or Brown



Precision Ball Bearings
Ensuring Smooth Rolling



Washable Quality
You Can Trust



Food-Grade Quality



Elegant Polished Finish

Total Lock Brake (TTL)

The **total lock** on casters secures both the wheel and swivel, ensuring complete stability for reliable and safe use.



[SCC-SS316TS20S414-HRS](#)

Top Lock Brake (TLB)

The **Top lock brake** places a positive locking force against the wheel hub locking the wheel only.

High Temp Wheels (HT)

Designed for high heat: 475°F for 30 mins.



[SCC-SS316TS20S514-GFNSHT-TLB](#)

Wheel Diameter	Overall Height	Swivel Radius	Aproximate Weight
3"	4-1/8"	2-15/16"	1.45
3-1/2"	4-5/8"	3-3/16"	1.6
4"	5-1/8"	3-1/2"	1.7
5"	6-1/8"	4"	2



METRIC Sizes Available!

Mounting Size (Metric)	Mounting Size (Inch)
M10-1.5 x 38MM (M1015)	3/8"-16 x 1-1/2" (381615)
M12-1.75 x 38MM (M1215)	1/2"-13 x 1-1/2" (121315)

THREADED STEM CASTERS

Wheel Dia	Tread Width	Wheel Type	Load Capacity	Bearing Type	Top Lock Brake (TLB)	Stem Code	Overall Height	Color
3"	1-1/4"	Soft Rubber	175	Plain Bore	SCC-SS316TS20S314-SRS-TLB	381615 , 121315 , M1015 , M1215	4-1/8"	Black
		Thermo Plastic Rubber	210	Ball Bearing	SCC-SS316TS20S314-TPRB-TLB	381615 , 121315 , M1015 , M1215		Gray
		Hard Rubber	275	Plain Bore	SCC-SS316TS20S314-HRS-TLB	381615 , 121315 , M1015 , M1215		Black
		Nylon	300	Plain Bore	SCC-SS316TS20S314-NYS-TLB	381615 , 121315 , M1015 , M1215		White
		Polyolefin		Plain Bore	SCC-SS316TS20S314-POS-TLB	381615 , 121315 , M1015 , M1215		Black
		Polyurethane		Ball Bearing	SCC-SS316TS20S314-PPUB-TLB	381615 , 121315 , M1015 , M1215		Blue
		Solid Polyurethane		Plain Bore	SCC-SS316TS20S314-SPUS-TLB	381615 , 121315 , M1015 , M1215		Black or Brown
		HT Glass Filled Nylon	350	Plain Bore	SCC-SS316TS20S314-GFNSHT-TLB	381615 , 121315 , M1015 , M1215		
3-1/2"	1-1/4"	Soft Rubber	200	Plain Bore	SCC-SS316TS20S3514-SRS-TLB	381615 , 121315 , M1015 , M1215	4-5/8"	Black
		Thermo Plastic Rubber	230	Plain Bore	SCC-SS316TS20S3514-TPRB-TLB	381615 , 121315 , M1015 , M1215		Gray
		Hard Rubber	285	Plain Bore	SCC-SS316TS20S3514-HRS-TLB	381615 , 121315 , M1015 , M1215		Black
		Polyolefin	300	Bushing	SCC-SS316TS20S3514-POS-TLB	381615 , 121315 , M1015 , M1215		Black
		Polyurethane		Ball Bearing	SCC-SS316TS20S3514-PPUB-TLB	381615 , 121315 , M1015 , M1215		Blue
		Solid Polyurethane		Bushing	SCC-SS316TS20S3514-SPUS-TLB	381615 , 121315 , M1015 , M1215		Black or Brown
		HT Glass Filled Nylon	350	Plain Bore	SCC-SS316TS20S3514-GFNSHT-TLB	381615 , 121315 , M1015 , M1215		
4"	1-1/4"	Soft Rubber	200	Plain Bore	SCC-SS316TS20S414-SRS-TLB	381615 , 121315 , M1015 , M1215	5-1/8"	Black
		Thermo Plastic Rubber	250	Ball Bearing	SCC-SS316TS20S414-TPRB-TLB	381615 , 121315 , M1015 , M1215		Gray
		Hard Rubber	300	Plain Bore	SCC-SS316TS20S414-HRS-TLB	381615 , 121315 , M1015 , M1215		Black
		Nylon		Plain Bore	SCC-SS316TS20S414-NYS-TLB	381615 , 121315 , M1015 , M1215		White
		Polyolefin	350	Plain Bore	SCC-SS316TS20S414-POS-TLB	381615 , 121315 , M1015 , M1215		Black
		Polyurethane		Ball Bearing	SCC-SS316TS20S414-PPUB-TLB	381615 , 121315 , M1015 , M1215		Blue
		Solid Polyurethane		Plain Bore	SCC-SS316TS20S414-SPUS-TLB	381615 , 121315 , M1015 , M1215		Black or Brown
		HT Glass Filled Nylon	350	Plain Bore	SCC-SS316TS20S414-GFNSHT-TLB	381615 , 121315 , M1015 , M1215		
5"	1-1/4"	Soft Rubber	275	Plain Bore	SCC-SS316TS20S514-SRS-TLB	381615 , 121315 , M1015 , M1215	6-1/8"	Black
		Thermo Plastic Rubber	300	Ball Bearing	SCC-SS316TS20S514-TPRB-TLB	381615 , 121315 , M1015 , M1215		Gray
		Hard Rubber		Plain Bore	SCC-SS316TS20S514-HRS-TLB	381615 , 121315 , M1015 , M1215		Black
		Nylon	Plain Bore	SCC-SS316TS20S514-NYS-TLB	381615 , 121315 , M1015 , M1215	White		
		Polyolefin	350	Plain Bore	SCC-SS316TS20S514-POS-TLB	381615 , 121315 , M1015 , M1215		Black
		Polyurethane		Ball Bearing	SCC-SS316TS20S514-PPUB-TLB	381615 , 121315 , M1015 , M1215		Blue
		Solid Polyurethane		Plain Bore	SCC-SS316TS20S514-SPUS-TLB	381615 , 121315 , M1015 , M1215		Black or Brown
		HT Glass Filled Nylon	350	Plain Bore	SCC-SS316TS20S514-GFNSHT-TLB	381615 , 121315 , M1015 , M1215		



- ✓ Quality
- ✓ Reliability
- ✓ Excellence



Inch or Metric?

Measure Up!

SERVICE CASTER

"THE ADVANTAGE"

316 STAINLESS STEEL

Wheel Diameter	Overall Height	Swivel Radius	Aproximate Weight
3"	4-1/8"	2-15/16"	1.45
3-1/2"	4-5/8"	3-3/16"	1.6
4"	5-1/8"	3-1/2"	1.7
5"	6-1/8"	4"	2



Total Lock Brakes

METRIC Sizes Available!

Mounting Size (Metric)	Mounting Size (Inch)
M10-1.5 x 38MM (M1015)	3/8"-16 x 1-1/2" (381615)
M12-1.75 x 38MM (M1215)	1/2"-13 x 1-1/2" (121315)

THREADED STEM CASTERS

Wheel Dia	Tread Width	Wheel Type	Load Capacity	Bearing Type	Total Lock Brake (TTL)	Stem Code	Overall Height	Color
3"	1-1/4"	Soft Rubber	175	Plain Bore	SCC-SS316STTL20S314-SRS	381615 , 121315 , M1015 , M1215	4-1/8"	Black
		Thermo Plastic Rubber	210	Ball Bearing	SCC-SS316STTL20S314-TPRB	381615 , 121315 , M1015 , M1215		Gray
		Hard Rubber	275	Plain Bore	SCC-SS316STTL20S314-HRS	381615 , 121315 , M1015 , M1215		Black
		Nylon	300	Plain Bore	SCC-SS316STTL20S314-NYS	381615 , 121315 , M1015 , M1215		White
		Polyolefin		Plain Bore	SCC-SS316STTL20S314-POS	381615 , 121315 , M1015 , M1215		Black
		Polyurethane		Ball Bearing	SCC-SS316STTL20S314-PPUB	381615 , 121315 , M1015 , M1215		
		Solid Polyurethane		Plain Bore	SCC-SS316STTL20S314-SPUS	381615 , 121315 , M1015 , M1215		Blue
		HT Glass Filled Nylon	350	Plain Bore	SCC-SS316STTL20S314-GFNSHT	381615 , 121315 , M1015 , M1215		Black or Brown
3-1/2"	1-1/4"	Soft Rubber	200	Plain Bore	SCC-SS316STTL20S3514-SRS	381615 , 121315 , M1015 , M1215	4-5/8"	Black
		Thermo Plastic Rubber	230	Plain Bore	SCC-SS316STTL20S3514-TPRB	381615 , 121315 , M1015 , M1215		Gray
		Hard Rubber	285	Plain Bore	SCC-SS316STTL20S3514-HRS	381615 , 121315 , M1015 , M1215		Black
		Polyolefin	300	Bushing	SCC-SS316STTL20S3514-POS	381615 , 121315 , M1015 , M1215		Black
		Polyurethane		Ball Bearing	SCC-SS316STTL20S3514-PPUB	381615 , 121315 , M1015 , M1215		
		Solid Polyurethane		Bushing	SCC-SS316STTL20S3514-SPUS	381615 , 121315 , M1015 , M1215		Blue
		HT Glass Filled Nylon	350	Plain Bore	SCC-SS316STTL20S3514-GFNSHT	381615 , 121315 , M1015 , M1215		Black or Brown
4"	1-1/4"	Soft Rubber	200	Plain Bore	SCC-SS316STTL20S414-SRS	381615 , 121315 , M1015 , M1215	5-1/8"	Black
		Thermo Plastic Rubber	250	Ball Bearing	SCC-SS316STTL20S414-TPRB	381615 , 121315 , M1015 , M1215		Gray
		Hard Rubber	300	Plain Bore	SCC-SS316STTL20S414-HRS	381615 , 121315 , M1015 , M1215		Black
		Nylon		Plain Bore	SCC-SS316STTL20S414-NYS	381615 , 121315 , M1015 , M1215		White
		Polyolefin	350	Plain Bore	SCC-SS316STTL20S414-POS	381615 , 121315 , M1015 , M1215		Black
		Polyurethane		Ball Bearing	SCC-SS316STTL20S414-PPUB	381615 , 121315 , M1015 , M1215		
		Solid Polyurethane		Plain Bore	SCC-SS316STTL20S414-SPUS	381615 , 121315 , M1015 , M1215		Blue
		HT Glass Filled Nylon	350	Plain Bore	SCC-SS316STTL20S414-GFNSHT	381615 , 121315 , M1015 , M1215		Black or Brown
5"	1-1/4"	Soft Rubber	275	Plain Bore	SCC-SS316STTL20S514-SRS	381615 , 121315 , M1015 , M1215	6-1/8"	Black
		Thermo Plastic Rubber	300	Ball Bearing	SCC-SS316STTL20S514-TPRB	381615 , 121315 , M1015 , M1215		Gray
		Hard Rubber		Plain Bore	SCC-SS316STTL20S514-HRS	381615 , 121315 , M1015 , M1215		Black
		Nylon	Plain Bore	SCC-SS316STTL20S514-NYS	381615 , 121315 , M1015 , M1215	White		
		Polyolefin	350	Plain Bore	SCC-SS316STTL20S514-POS	381615 , 121315 , M1015 , M1215		Black
		Polyurethane		Ball Bearing	SCC-SS316STTL20S514-PPUB	381615 , 121315 , M1015 , M1215		
		Solid Polyurethane		Plain Bore	SCC-SS316STTL20S514-SPUS	381615 , 121315 , M1015 , M1215		Blue
		HT Glass Filled Nylon	350	Plain Bore	SCC-SS316STTL20S514-GFNSHT	381615 , 121315 , M1015 , M1215		Black or Brown

HIGH-END STEM CASTERS!



The **total lock** on casters secures both the wheel and swivel, ensuring complete stability for reliable and safe use.



Stainless **threaded stem** casters provide smooth maneuverability in various sizes, including metric, with excellent corrosion resistance.



Stainless **zerk fittings** ensure easy lubrication access, reduce wear, resist corrosion, and are ideal for high-performance applications.



Polyurethane wheels offer excellent durability, smooth rides, and resist wear. Available in various tread colors for a customized look.

316 STAINLESS STEEL



Wheel Diameter	Overall Height	Swivel Radius	Aproximate Weight 
3"	4-1/8"	2-15/16"	1.45
3-1/2"	4-5/8"	3-3/16"	1.6
4"	5-1/8"	3-1/2"	1.7
5"	6-1/8"	4"	2

BOLT HOLE (HOLLOW KINGPIN) CASTERS

Wheel Dia	Tread Width	Wheel Type	Load Capacity	Bearing Type	Swivel Caster	Overall Height	Color
3"	1-1/4"	Soft Rubber	175	Plain Bore	SCC-SS316BH20S314-SRS	4-1/8"	Black
		Thermo Plastic Rubber	210	Ball Bearing	SCC-SS316BH20S314-TPRB		Gray
		Hard Rubber	275	Plain Bore	SCC-SS316BH20S314-HRS		Black
		Nylon	300	Plain Bore	SCC-SS316BH20S314-NYS		White
		Polyolefin		Plain Bore	SCC-SS316BH20S314-POS		Black
		Polyurethane		Ball Bearing	SCC-SS316BH20S314-PPUB		
		Solid Polyurethane		Plain Bore	SCC-SS316BH20S314-SPUS		Blue
		HT Glass Filled Nylon	350	Plain Bore	SCC-SS316BH20S314-GFNSHT		Black or Brown
3-1/2"	1-1/4"	Soft Rubber	200	Plain Bore	SCC-SS316BH20S3514-SRS	4-5/8"	Black
		Thermo Plastic Rubber	230	Plain Bore	SCC-SS316BH20S3514-TPRB		Gray
		Hard Rubber	285	Plain Bore	SCC-SS316BH20S3514-HRS		Black
		Polyolefin	300	Bushing	SCC-SS316BH20S3514-POS		Black
		Polyurethane		Ball Bearing	SCC-SS316BH20S3514-PPUB		
		Solid Polyurethane		Bushing	SCC-SS316BH20S3514-SPUS		Blue
		HT Glass Filled Nylon	350	Plain Bore	SCC-SS316BH20S3514-GFNSHT		Black or Brown
4"	1-1/4"	Soft Rubber	200	Plain Bore	SCC-SS316BH20S414-SRS	5-1/8"	Black
		Thermo Plastic Rubber	250	Ball Bearing	SCC-SS316BH20S414-TPRB		Gray
		Hard Rubber	300	Plain Bore	SCC-SS316BH20S414-HRS		Black
		Nylon		Plain Bore	SCC-SS316BH20S414-NYS		White
		Polyolefin	350	Plain Bore	SCC-SS316BH20S414-POS		Black
		Polyurethane		Ball Bearing	SCC-SS316BH20S414-PPUB		
		Solid Polyurethane		Plain Bore	SCC-SS316BH20S414-SPUS		Blue
		HT Glass Filled Nylon		Plain Bore	SCC-SS316BH20S414-GFNSHT		Black or Brown
5"	1-1/4"	Soft Rubber	275	Plain Bore	SCC-SS316BH20S514-SRS	6-1/8"	Black
		Thermo Plastic Rubber	300	Ball Bearing	SCC-SS316BH20S514-TPRB		Gray
		Hard Rubber		Plain Bore	SCC-SS316BH20S514-HRS		Black
		Nylon		Plain Bore	SCC-SS316BH20S514-NYS		White
		Polyolefin	350	Plain Bore	SCC-SS316BH20S514-POS		Black
		Polyurethane		Ball Bearing	SCC-SS316BH20S514-PPUB		
		Solid Polyurethane		Plain Bore	SCC-SS316BH20S514-SPUS		Blue
		HT Glass Filled Nylon		Plain Bore	SCC-SS316BH20S514-GFNSHT		Black or Brown

So many ways to showcase your style!

Our stainless steel bolt-hole casters are available in a wide variety of **styles** and **stem sizes**, offering the perfect solution for any application. Crafted from high-quality stainless steel, these casters are designed for durability and longevity.

Can't find the size you need? Reach out to our knowledgeable **customer service team**, and they'll help you find the perfect fit for your needs!



THREADED STEM



SQUARE STEM



ROUND STEM



GRIP RING STEM



EXPANDING STEM



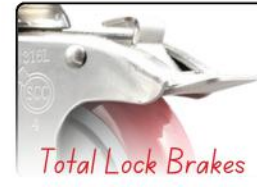

Wheel Diameter	Overall Height	Swivel Radius	Aproximate Weight 
3"	4-1/8"	2-15/16"	1.45
3-1/2"	4-5/8"	3-3/16"	1.6
4"	5-1/8"	3-1/2"	1.7
5"	6-1/8"	4"	2



Choose Your Color



BOLT-HOLE CASTERS

Wheel Dia	Tread Width	Wheel Type	Load Capacity	Bearing Type	Top Lock Brake (TLB)	Total Lock Brake (TTL)	Overall Height	Color
3"	1-1/4"	Soft Rubber	175	Plain Bore	SCC-SS316BH20S314-SRS-TLB	SCC-SS316BH TTL20S314-SRS	4-1/8"	Black
		Thermo Plastic Rubber	210	Ball Bearing	SCC-SS316BH20S314-TPRB-TLB	SCC-SS316BH TTL20S314-TPRB		Gray
		Hard Rubber	275	Plain Bore	SCC-SS316BH20S314-HRS-TLB	SCC-SS316BH TTL20S314-HRS		Black
		Nylon	300	Plain Bore	SCC-SS316BH20S314-NYS-TLB	SCC-SS316BH TTL20S314-NYS		White
		Polyolefin		Plain Bore	SCC-SS316BH20S314-POS-TLB	SCC-SS316BH TTL20S314-POS		Black
		Polyurethane		Ball Bearing	SCC-SS316BH20S314-PPUB-TLB	SCC-SS316BH TTL20S314-PPUB		
		Solid Polyurethane	350	Plain Bore	SCC-SS316BH20S314-SPUS-TLB	SCC-SS316BH TTL20S314-SPUS		Blue
		HT Glass Filled Nylon	350	Plain Bore	SCC-SS316BH20S314-GFNSHT-TLB	SCC-SS316BH TTL20S314-GFNSHT		Black or Brown
3-1/2"	1-1/4"	Soft Rubber	200	Plain Bore	SCC-SS316BH20S3514-SRS-TLB	SCC-SS316BH TTL20S3514-SRS	4-5/8"	Black
		Thermo Plastic Rubber	230	Plain Bore	SCC-SS316BH20S3514-TPRB-TLB	SCC-SS316BH TTL20S3514-TPRB		Gray
		Hard Rubber	285	Plain Bore	SCC-SS316BH20S3514-HRS-TLB	SCC-SS316BH TTL20S3514-HRS		Black
		Polyolefin	300	Bushing	SCC-SS316BH20S3514-POS-TLB	SCC-SS316BH TTL20S3514-POS		Black
		Polyurethane		Ball Bearing	SCC-SS316BH20S3514-PPUB-TLB	SCC-SS316BH TTL20S3514-PPUB		
		Solid Polyurethane		Bushing	SCC-SS316BH20S3514-SPUS-TLB	SCC-SS316BH TTL20S3514-SPUS		Blue
		HT Glass Filled Nylon	350	Plain Bore	SCC-SS316BH20S3514-GFNSHT-TLB	SCC-SS316BH TTL20S3514-GFNSHT		Black or Brown
4"	1-1/4"	Soft Rubber	200	Plain Bore	SCC-SS316BH20S414-SRS-TLB	SCC-SS316BH TTL20S414-SRS	5-1/8"	Black
		Thermo Plastic Rubber	250	Ball Bearing	SCC-SS316BH20S414-TPRB-TLB	SCC-SS316BH TTL20S414-TPRB		Gray
		Hard Rubber	300	Plain Bore	SCC-SS316BH20S414-HRS-TLB	SCC-SS316BH TTL20S414-HRS		Black
		Nylon		Plain Bore	SCC-SS316BH20S414-NYS-TLB	SCC-SS316BH TTL20S414-NYS		White
		Polyolefin		Plain Bore	SCC-SS316BH20S414-POS-TLB	SCC-SS316BH TTL20S414-POS		Black
		Polyurethane	350	Ball Bearing	SCC-SS316BH20S414-PPUB-TLB	SCC-SS316BH TTL20S414-PPUB		
		Solid Polyurethane		Plain Bore	SCC-SS316BH20S414-SPUS-TLB	SCC-SS316BH TTL20S414-SPUS		Blue
		HT Glass Filled Nylon		Plain Bore	SCC-SS316BH20S414-GFNSHT-TLB	SCC-SS316BH TTL20S414-GFNSHT		Black or Brown
5"	1-1/4"	Soft Rubber	275	Plain Bore	SCC-SS316BH20S514-SRS-TLB	SCC-SS316BH TTL20S514-SRS	6-1/8"	Black
		Thermo Plastic Rubber	300	Ball Bearing	SCC-SS316BH20S514-TPRB-TLB	SCC-SS316BH TTL20S514-TPRB		Gray
		Hard Rubber		Plain Bore	SCC-SS316BH20S514-HRS-TLB	SCC-SS316BH TTL20S514-HRS		Black
		Nylon		Plain Bore	SCC-SS316BH20S514-NYS-TLB	SCC-SS316BH TTL20S514-NYS		White
		Polyolefin	350	Plain Bore	SCC-SS316BH20S514-POS-TLB	SCC-SS316BH TTL20S514-POS		Black
		Polyurethane		Ball Bearing	SCC-SS316BH20S514-PPUB-TLB	SCC-SS316BH TTL20S514-PPUB		
		Solid Polyurethane		Plain Bore	SCC-SS316BH20S514-SPUS-TLB	SCC-SS316BH TTL20S514-SPUS		Blue
		HT Glass Filled Nylon	350	Plain Bore	SCC-SS316BH20S514-GFNSHT-TLB	SCC-SS316BH TTL20S514-GFNSHT		Black or Brown

Unlock Limitless Options with Bolt Hole Casters!

Shop Stemless Casters Today! These Hollow Kingpin Casters let you use your own bolt for endless attachment options, fitting up to a **1/2"** bolt. Perfect for unique projects, they offer various wheel sizes and types to suit your needs.





316 STAINLESS STEEL

Wheel Diameter	Overall Height	Swivel Radius	Approximate Weight ^{lbs}
3"	4-1/8"	2-15/16"	1.45
3-1/2"	4-5/8"	3-3/16"	1.6
4"	5-1/8"	3-1/2"	1.7
5"	6-1/8"	4"	2

Mounting Size	Mounting Size
3/4" (34)	1-3/8" (138)
7/8" (78)	1-1/2" (112)
1" (1)	1-5/8" (158)
1-1/8" (118)	1-3/4" (134)
1-1/4" (114)	1-7/8" (178)

EXPANDING STEM CASTERS

Wheel Dia	Tread Width	Wheel Type	Load Capacity	Bearing Type	Swivel Caster	Stem Code	Color
3"	1-1/4"	Soft Rubber	175	Plain Bore	SCC-SS316EX20S314-SRS	34, 78, 1, 118, 114, 138, 112, 158, 134, 178	Black
		Thermo Plastic Rubber	210	Ball Bearing	SCC-SS316EX20S314-TPRB	34, 78, 1, 118, 114, 138, 112, 158, 134, 178	Gray
		Hard Rubber	275	Plain Bore	SCC-SS316EX20S314-HRS	34, 78, 1, 118, 114, 138, 112, 158, 134, 178	Black
		Nylon	300	Plain Bore	SCC-SS316EX20S314-NYS	34, 78, 1, 118, 114, 138, 112, 158, 134, 178	White
		Polyolefin		Plain Bore	SCC-SS316EX20S314-POS	34, 78, 1, 118, 114, 138, 112, 158, 134, 178	Black
		Polyurethane		Ball Bearing	SCC-SS316EX20S314-PPUB	34, 78, 1, 118, 114, 138, 112, 158, 134, 178	
		Solid Polyurethane	350	Plain Bore	SCC-SS316EX20S314-SPUS	34, 78, 1, 118, 114, 138, 112, 158, 134, 178	Blue
HT Glass Filled Nylon	350	Plain Bore	SCC-SS316EX20S314-GFNSHT	34, 78, 1, 118, 114, 138, 112, 158, 134, 178	Black or Brown		
3-1/2"	1-1/4"	Soft Rubber	200	Plain Bore	SCC-SS316EX20S3514-SRS	34, 78, 1, 118, 114, 138, 112, 158, 134, 178	Black
		Thermo Plastic Rubber	230	Plain Bore	SCC-SS316EX20S3514-TPRB	34, 78, 1, 118, 114, 138, 112, 158, 134, 178	Gray
		Hard Rubber	285	Plain Bore	SCC-SS316EX20S3514-HRS	34, 78, 1, 118, 114, 138, 112, 158, 134, 178	Black
		Polyolefin	300	Bushing	SCC-SS316EX20S3514-POS	34, 78, 1, 118, 114, 138, 112, 158, 134, 178	Black
		Polyurethane		Ball Bearing	SCC-SS316EX20S3514-PPUB	34, 78, 1, 118, 114, 138, 112, 158, 134, 178	
		Solid Polyurethane		Bushing	SCC-SS316EX20S3514-SPUS	34, 78, 1, 118, 114, 138, 112, 158, 134, 178	Blue
		HT Glass Filled Nylon	350	Plain Bore	SCC-SS316EX20S3514-GFNSHT	34, 78, 1, 118, 114, 138, 112, 158, 134, 178	Black or Brown
4"	1-1/4"	Soft Rubber	200	Plain Bore	SCC-SS316EX20S414-SRS	34, 78, 1, 118, 114, 138, 112, 158, 134, 178	Black
		Thermo Plastic Rubber	250	Ball Bearing	SCC-SS316EX20S414-TPRB	34, 78, 1, 118, 114, 138, 112, 158, 134, 178	Gray
		Hard Rubber	300	Plain Bore	SCC-SS316EX20S414-HRS	34, 78, 1, 118, 114, 138, 112, 158, 134, 178	Black
		Nylon		Plain Bore	SCC-SS316EX20S414-NYS	34, 78, 1, 118, 114, 138, 112, 158, 134, 178	White
		Polyolefin		Plain Bore	SCC-SS316EX20S414-POS	34, 78, 1, 118, 114, 138, 112, 158, 134, 178	Black
		Polyurethane	350	Ball Bearing	SCC-SS316EX20S414-PPUB	34, 78, 1, 118, 114, 138, 112, 158, 134, 178	
		Solid Polyurethane		Plain Bore	SCC-SS316EX20S414-SPUS	34, 78, 1, 118, 114, 138, 112, 158, 134, 178	Blue
HT Glass Filled Nylon	Plain Bore	SCC-SS316EX20S414-GFNSHT		34, 78, 1, 118, 114, 138, 112, 158, 134, 178	Black or Brown		
5"	1-1/4"	Soft Rubber	275	Plain Bore	SCC-SS316EX20S514-SRS	34, 78, 1, 118, 114, 138, 112, 158, 134, 178	Black
		Thermo Plastic Rubber	300	Ball Bearing	SCC-SS316EX20S514-TPRB	34, 78, 1, 118, 114, 138, 112, 158, 134, 178	Gray
		Hard Rubber		Plain Bore	SCC-SS316EX20S514-HRS	34, 78, 1, 118, 114, 138, 112, 158, 134, 178	Black
		Nylon		Plain Bore	SCC-SS316EX20S514-NYS	34, 78, 1, 118, 114, 138, 112, 158, 134, 178	White
		Polyolefin	350	Plain Bore	SCC-SS316EX20S514-POS	34, 78, 1, 118, 114, 138, 112, 158, 134, 178	Black
		Polyurethane		Ball Bearing	SCC-SS316EX20S514-PPUB	34, 78, 1, 118, 114, 138, 112, 158, 134, 178	
		Solid Polyurethane		Plain Bore	SCC-SS316EX20S514-SPUS	34, 78, 1, 118, 114, 138, 112, 158, 134, 178	Blue
HT Glass Filled Nylon	350	Plain Bore	SCC-SS316EX20S514-GFNSHT	34, 78, 1, 118, 114, 138, 112, 158, 134, 178	Black or Brown		

EXPLORE OUR DIVERSE MOUNTING OPTIONS IN OUR EXPANDING STEM CASTER SERIES. FOR FURTHER ASSISTANCE, CONTACT OUR [CUSTOMER SERVICE](#).



Expanding Stem Casters for Equipment, Racks, & Prep Tables

Designed to fit a variety of **square** and **round** tube legs by adapting to the tube's inside diameter. Perfect for prep tables, work tables, racks, and shop projects. Choose from a wide range of wheel types, including non-marking, floor-safe, easy-rolling polyurethane.





316 STAINLESS STEEL

Wheel Diameter	Overall Height	Swivel Radius	Approximate Weight 
3"	4-1/8"	2-15/16"	1.45
3-1/2"	4-5/8"	3-3/16"	1.6
4"	5-1/8"	3-1/2"	1.7
5"	6-1/8"	4"	2



Mounting Size	Mounting Size
3/4" (34)	1-3/8" (138)
7/8" (78)	1-1/2" (112)
1" (1)	1-5/8" (158)
1-1/8" (118)	1-3/4" (134)
1-1/4" (114)	1-7/8" (178)

EXPANDING STEM CASTERS

Wheel Dia	Tread Width	Wheel Type	Load Capacity	Bearing Type	Top Lock Brake (TLB)	Stem Code	Color
3"	1-1/4"	Soft Rubber	175	Plain Bore	SCC-SS316EX20S314-SRS-TLB	34, 78, 1, 118, 114, 138, 112, 158, 134, 178	Black
		Thermo Plastic Rubber	210	Ball Bearing	SCC-SS316EX20S314-TPRB-TLB	34, 78, 1, 118, 114, 138, 112, 158, 134, 178	Gray
		Hard Rubber	275	Plain Bore	SCC-SS316EX20S314-HRS-TLB	34, 78, 1, 118, 114, 138, 112, 158, 134, 178	Black
		Nylon	300	Plain Bore	SCC-SS316EX20S314-NYS-TLB	34, 78, 1, 118, 114, 138, 112, 158, 134, 178	White
		Polyolefin		Plain Bore	SCC-SS316EX20S314-POS-TLB	34, 78, 1, 118, 114, 138, 112, 158, 134, 178	Black
		Polyurethane		Ball Bearing	SCC-SS316EX20S314-PPUB-TLB	34, 78, 1, 118, 114, 138, 112, 158, 134, 178	
		Solid Polyurethane		Plain Bore	SCC-SS316EX20S314-SPUS-TLB	34, 78, 1, 118, 114, 138, 112, 158, 134, 178	Blue
		HT Glass Filled Nylon	350	Plain Bore	SCC-SS316EX20S314-GFNSHT-TLB	34, 78, 1, 118, 114, 138, 112, 158, 134, 178	Black or Brown
3-1/2"	1-1/4"	Soft Rubber	200	Plain Bore	SCC-SS316EX20S3514-SRS-TLB	34, 78, 1, 118, 114, 138, 112, 158, 134, 178	Black
		Thermo Plastic Rubber	230	Plain Bore	SCC-SS316EX20S3514-TPRB-TLB	34, 78, 1, 118, 114, 138, 112, 158, 134, 178	Gray
		Hard Rubber	285	Plain Bore	SCC-SS316EX20S3514-HRS-TLB	34, 78, 1, 118, 114, 138, 112, 158, 134, 178	Black
		Polyolefin	300	Bushing	SCC-SS316EX20S3514-POS-TLB	34, 78, 1, 118, 114, 138, 112, 158, 134, 178	Black
		Polyurethane		Ball Bearing	SCC-SS316EX20S3514-PPUB-TLB	34, 78, 1, 118, 114, 138, 112, 158, 134, 178	
		Solid Polyurethane		Bushing	SCC-SS316EX20S3514-SPUS-TLB	34, 78, 1, 118, 114, 138, 112, 158, 134, 178	Blue
		HT Glass Filled Nylon	350	Plain Bore	SCC-SS316EX20S3514-GFNSHT-TLB	34, 78, 1, 118, 114, 138, 112, 158, 134, 178	Black or Brown
4"	1-1/4"	Soft Rubber	200	Plain Bore	SCC-SS316EX20S414-SRS-TLB	34, 78, 1, 118, 114, 138, 112, 158, 134, 178	Black
		Thermo Plastic Rubber	250	Ball Bearing	SCC-SS316EX20S414-TPRB-TLB	34, 78, 1, 118, 114, 138, 112, 158, 134, 178	Gray
		Hard Rubber	300	Plain Bore	SCC-SS316EX20S414-HRS-TLB	34, 78, 1, 118, 114, 138, 112, 158, 134, 178	Black
		Nylon		Plain Bore	SCC-SS316EX20S414-NYS-TLB	34, 78, 1, 118, 114, 138, 112, 158, 134, 178	White
		Polyolefin	350	Plain Bore	SCC-SS316EX20S414-POS-TLB	34, 78, 1, 118, 114, 138, 112, 158, 134, 178	Black
		Polyurethane		Ball Bearing	SCC-SS316EX20S414-PPUB-TLB	34, 78, 1, 118, 114, 138, 112, 158, 134, 178	
		Solid Polyurethane		Plain Bore	SCC-SS316EX20S414-SPUS-TLB	34, 78, 1, 118, 114, 138, 112, 158, 134, 178	Blue
		HT Glass Filled Nylon		Plain Bore	SCC-SS316EX20S414-GFNSHT-TLB	34, 78, 1, 118, 114, 138, 112, 158, 134, 178	Black or Brown
5"	1-1/4"	Soft Rubber	275	Plain Bore	SCC-SS316EX20S514-SRS-TLB	34, 78, 1, 118, 114, 138, 112, 158, 134, 178	Black
		Thermo Plastic Rubber	300	Ball Bearing	SCC-SS316EX20S514-TPRB-TLB	34, 78, 1, 118, 114, 138, 112, 158, 134, 178	Gray
		Hard Rubber		Plain Bore	SCC-SS316EX20S514-HRS-TLB	34, 78, 1, 118, 114, 138, 112, 158, 134, 178	Black
		Nylon		Plain Bore	SCC-SS316EX20S514-NYS-TLB	34, 78, 1, 118, 114, 138, 112, 158, 134, 178	White
		Polyolefin	350	Plain Bore	SCC-SS316EX20S514-POS-TLB	34, 78, 1, 118, 114, 138, 112, 158, 134, 178	Black
		Polyurethane		Ball Bearing	SCC-SS316EX20S514-PPUB-TLB	34, 78, 1, 118, 114, 138, 112, 158, 134, 178	
		Solid Polyurethane		Plain Bore	SCC-SS316EX20S514-SPUS-TLB	34, 78, 1, 118, 114, 138, 112, 158, 134, 178	Blue
		HT Glass Filled Nylon		Plain Bore	SCC-SS316EX20S514-GFNSHT-TLB	34, 78, 1, 118, 114, 138, 112, 158, 134, 178	Black or Brown



Easy to Install Expanding Adapter Stem Casters

Tighten the topmost ring on the expanding caster adapter stem before insertion to compress rubber until it fits snugly into the tube. The **expanded stem** can be inserted into round or square tubing. It may be necessary to further tighten the nut under the swivel with a wrench until adequately secured.



316 STAINLESS STEEL

Wheel Diameter	Overall Height	Swivel Radius	Approximate Weight
3"	4-1/8"	2-15/16"	1.45
3-1/2"	4-5/8"	3-3/16"	1.6
4"	5-1/8"	3-1/2"	1.7
5"	6-1/8"	4"	2



Mounting Size	Mounting Size
3/4" (34)	1-3/8" (138)
7/8" (78)	1-1/2" (112)
1" (1)	1-5/8" (158)
1-1/8" (118)	1-3/4" (134)
1-1/4" (114)	1-7/8" (178)

EXPANDING STEM CASTERS

Wheel Dia	Tread Width	Wheel Type	Load Capacity	Bearing Type	Total Lock Brake (TTL)	Stem Code	Color
3"	1-1/4"	Soft Rubber	175	Plain Bore	SCC-SS316EXTTL20S314-SRS	34, 78, 1, 118, 114, 138, 112, 158, 134, 178	Black
		Thermo Plastic Rubber	210	Ball Bearing	SCC-SS316EXTTL20S314-TPRB	34, 78, 1, 118, 114, 138, 112, 158, 134, 178	Gray
		Hard Rubber	275	Plain Bore	SCC-SS316EXTTL20S314-HRS	34, 78, 1, 118, 114, 138, 112, 158, 134, 178	Black
		Nylon	300	Plain Bore	SCC-SS316EXTTL20S314-NYS	34, 78, 1, 118, 114, 138, 112, 158, 134, 178	White
		Polyolefin		Plain Bore	SCC-SS316EXTTL20S314-POS	34, 78, 1, 118, 114, 138, 112, 158, 134, 178	Black
		Polyurethane		Ball Bearing	SCC-SS316EXTTL20S314-PPUB	34, 78, 1, 118, 114, 138, 112, 158, 134, 178	Blue, Red, Yellow, Green, Orange, Purple
		Solid Polyurethane		Plain Bore	SCC-SS316EXTTL20S314-SPUS	34, 78, 1, 118, 114, 138, 112, 158, 134, 178	Blue
		HT Glass Filled Nylon	350	Plain Bore	SCC-SS316EXTTL20S314-GFNSHT	34, 78, 1, 118, 114, 138, 112, 158, 134, 178	Black or Brown
3-1/2"	1-1/4"	Soft Rubber	200	Plain Bore	SCC-SS316EXTTL20S3514-SRS	34, 78, 1, 118, 114, 138, 112, 158, 134, 178	Black
		Thermo Plastic Rubber	230	Plain Bore	SCC-SS316EXTTL20S3514-TPRB	34, 78, 1, 118, 114, 138, 112, 158, 134, 178	Gray
		Hard Rubber	285	Plain Bore	SCC-SS316EXTTL20S3514-HRS	34, 78, 1, 118, 114, 138, 112, 158, 134, 178	Black
		Polyolefin	300	Bushing	SCC-SS316EXTTL20S3514-POS	34, 78, 1, 118, 114, 138, 112, 158, 134, 178	Black
		Polyurethane		Ball Bearing	SCC-SS316EXTTL20S3514-PPUB	34, 78, 1, 118, 114, 138, 112, 158, 134, 178	Blue, Red, Yellow, Green, Orange, Purple
		Solid Polyurethane		Bushing	SCC-SS316EXTTL20S3514-SPUS	34, 78, 1, 118, 114, 138, 112, 158, 134, 178	Blue
		HT Glass Filled Nylon	350	Plain Bore	SCC-SS316EXTTL20S3514-GFNSHT	34, 78, 1, 118, 114, 138, 112, 158, 134, 178	Black or Brown
4"	1-1/4"	Soft Rubber	200	Plain Bore	SCC-SS316EXTTL20S414-SRS	34, 78, 1, 118, 114, 138, 112, 158, 134, 178	Black
		Thermo Plastic Rubber	250	Ball Bearing	SCC-SS316EXTTL20S414-TPRB	34, 78, 1, 118, 114, 138, 112, 158, 134, 178	Gray
		Hard Rubber	300	Plain Bore	SCC-SS316EXTTL20S414-HRS	34, 78, 1, 118, 114, 138, 112, 158, 134, 178	Black
		Nylon		Plain Bore	SCC-SS316EXTTL20S414-NYS	34, 78, 1, 118, 114, 138, 112, 158, 134, 178	White
		Polyolefin	350	Plain Bore	SCC-SS316EXTTL20S414-POS	34, 78, 1, 118, 114, 138, 112, 158, 134, 178	Black
		Polyurethane		Ball Bearing	SCC-SS316EXTTL20S414-PPUB	34, 78, 1, 118, 114, 138, 112, 158, 134, 178	Blue, Red, Yellow, Green, Orange, Purple
		Solid Polyurethane		Plain Bore	SCC-SS316EXTTL20S414-SPUS	34, 78, 1, 118, 114, 138, 112, 158, 134, 178	Blue
		HT Glass Filled Nylon	350	Plain Bore	SCC-SS316EXTTL20S414-GFNSHT	34, 78, 1, 118, 114, 138, 112, 158, 134, 178	Black or Brown
5"	1-1/4"	Soft Rubber	275	Plain Bore	SCC-SS316EXTTL20S514-SRS	34, 78, 1, 118, 114, 138, 112, 158, 134, 178	Black
		Thermo Plastic Rubber	300	Ball Bearing	SCC-SS316EXTTL20S514-TPRB	34, 78, 1, 118, 114, 138, 112, 158, 134, 178	Gray
		Hard Rubber		Plain Bore	SCC-SS316EXTTL20S514-HRS	34, 78, 1, 118, 114, 138, 112, 158, 134, 178	Black
		Nylon	350	Plain Bore	SCC-SS316EXTTL20S514-NYS	34, 78, 1, 118, 114, 138, 112, 158, 134, 178	White
		Polyolefin		Plain Bore	SCC-SS316EXTTL20S514-POS	34, 78, 1, 118, 114, 138, 112, 158, 134, 178	Black
		Polyurethane		Ball Bearing	SCC-SS316EXTTL20S514-PPUB	34, 78, 1, 118, 114, 138, 112, 158, 134, 178	Blue, Red, Yellow, Green, Orange, Purple
		Solid Polyurethane	Plain Bore	SCC-SS316EXTTL20S514-SPUS	34, 78, 1, 118, 114, 138, 112, 158, 134, 178	Blue	
		HT Glass Filled Nylon	350	Plain Bore	SCC-SS316EXTTL20S514-GFNSHT	34, 78, 1, 118, 114, 138, 112, 158, 134, 178	Black or Brown

5" Stainless 316 Swivel Expanding Stem Caster with Total Lock Brake

SCC-SS316TTLEX20S514-PPUB-34

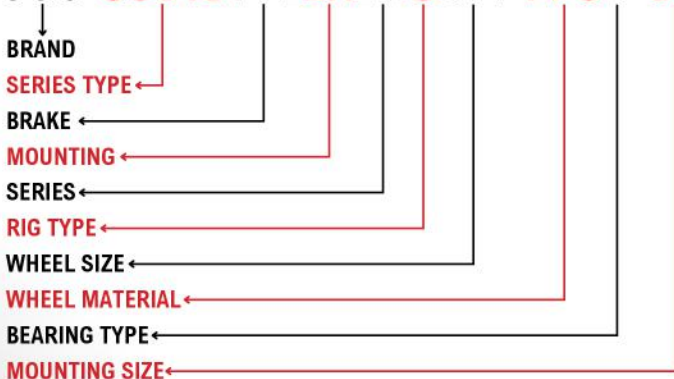

Our part numbers adapt to your needs. Use the diagram below as a reference. For help, contact our [customer service](#) team.



Medium/Heavy Duty Casters

Series #30 Casters

Heavy-duty casters with up to 1,250-pound capacity. Series #30 offers various wheels with high shock absorption. Choose rigid or swivel casters for optimal steering. Ideal for dollies, trucks, and industrial equipment.

Applications

- Platform Trucks
- Warehouse Carts
- Dollies (Machinery)
- Stock Picking Trucks
- Freight Terminal
- Food Service Carts



Features

- Double ball bearing raceway, heat-treated for durability and strength
- Bright zinc plated
- 5/8" bolted kingpin
- 1/2" axle bolt with lock nut
- Grease fittings in swivel raceway and wheel
- Wide selection of wheel types

4" Polyurethane Caster with Total Lock Brake

SCC-TTL30S420-PPUR

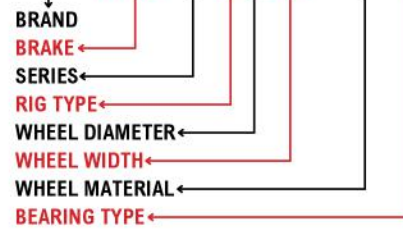

6" Swivel Phenolic Caster with Top Lock Brake

SCC-30CS620-PHR-TLB

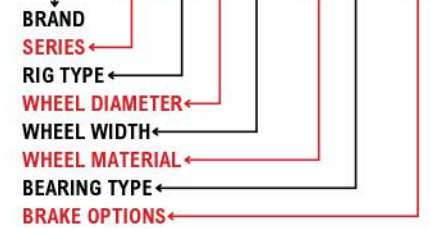

Our part numbers are adaptable to suit your requirements. The diagram above serves as a reference to assist you in understanding the breakdown. If you require any help, please don't hesitate to contact our [customer service](#) team.



Service Caster Chart Guide

Build Your Caster

Discover more fastening sizes and wheel options if you can't find what you need. And remember, we're always here to **help!**

Series	Mounting	Rig Type	Mounting Size	Bolt Pattern	Wheel Size	Bearing Type	Brake	Wheel Material
30	Top Plate	Swivel (S)	4" x 4-1/2"	2-5/8" x 3-5/8" to 3" x 3"	3-1/4" x 2" (3420)	Ball Bearing (B)	Top Lock (TLB)	Soft Rubber (SR)
		Rigid (R)	4-1/2" x 6-1/4" (TP2)	2-7/16" x 4-15/16" to 3-3/8" x 5-1/4"	4" x 2" (420)	Plain Bore (S)	Posi Lock (PLB)	Thermo Plastic Rubber (TPR)
			5" x 5-1/2" (TP3)	4-1/8" x 4-1/2"	5" x 2" (520)	Delrin Bearing (D)	Total Lock (TTL)	Polyurethane (PPU)
		6" x 2" (620)	Roller Bearing (R)	Front Total Lock (FTL)	Phenolic (PH)			
		8" x 2" (820)	Precision Bearing (PB)	Side Lock (SLB)	Solid Polyurethane (SPU)			
		Bronze Bearing (BZ)	Face Contact (FCB)	Hard Rubber (HR)				
	Bolt-on Swivel Lock (BSL)	Glass Filled Nylon (GFN)						
	Weld-on Swivel Lock (WSL)	Rubber on Aluminum (RA)						
		Semi Steel (SS)						
		Nylon (NY)						
		High Temp Phenolic (PH*HT)						
		High Temp Nylon (GF*HT)						
		Rubber on Steel (RS)						

Optional Top Plate
When specifying this option add the **prefix** at the end of the part number

Wheel Tread



Request for CAD



Top Plate Size Option(s)

Heavy-duty casters with up to 1,250-pound capacity. Series #30 offers high shock absorption wheels. Choose rigid or swivel casters for optimal steering. Ideal for dollies, trucks, and industrial equipment.

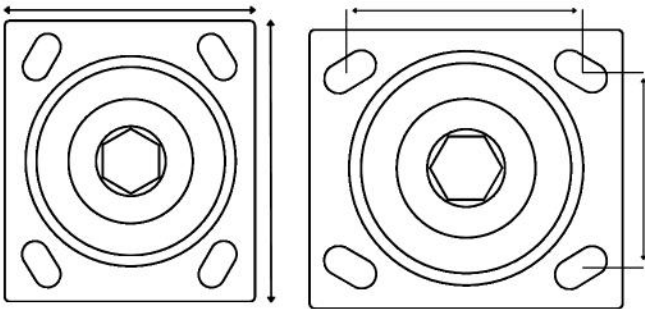

Standard Plate Size	Bolt Pattern	Bolt Diameter
4" x 4-1/2"	2-5/8" x 3-5/8" to 3" x 3"	3/8"
4-1/2" x 6-1/4" (TP2)	2-7/16"x4-15/16" to 3-3/8"x5-1/4"	1/2"
5" x 5-1/2" (TP3)	4-1/8" x 4-1/2"	1/2"

Choose Your Movement

- Rigid and Swivel Available



RIGID



SWIVEL

Bearing Type(s)

Roller Bearing

Anti-friction bearing, ideal for manual applications with prevalent shock loading.



Ball Bearing

Ball bearing provides smooth movement and durability.



Delrin Bearing

Delrin bearings, maintenance-free, ideal for wash-downs, max 180°F.



Bronze Bearing

Bronze bearings are durable, corrosion-resistant, and withstand up to 525°F.



Brake Option(s)

Top Lock Brake (TLB)

The **top lock brake** places a positive locking force against the wheel hub locking the wheel only.



SCC-30CS820-PUR-TLB-RS

Total Lock Brake (TTL)

The **total lock** on casters secures both the wheel and swivel, ensuring complete stability for reliable and safe use.



SCC-TTL30S620-TPRRF

Side Lock Brake (SLB)

The **side lock brake** places a positive locking force against the wheel hub locking the wheel only.



SCC-30CS3420-GFNR-SLB

Bolt-on Swivel Lock (BSL)

The **bolt-on swivel lock** secures swivel casters, preventing unwanted movement. Easy to install, it ensures stability.



SCC-30CS620-NYR-BSL

The Service Caster **Series #30** presents a multitude of possibilities. Should you need assistance finding the perfect match for your needs, our **customer service** team, with over 100 years of collective experience, is at your service.

TOP PLATE CASTERS *Roller Bearing Wheels*



Wheel Dia	Tread Width	Wheel Type	Load Capacity (lbs.)	Overall Height	Swivel Part Number	Swivel Weight (lbs.)	Rigid Part Number	Rigid Weight (lbs.)
3-1/4"	2"	Polyurethane/Steel	600	4-1/4"	SCC-30CS3420-PUR-GB	5	SCC-30R3420-PUR-GB	4.70
		Phenolic	700		SCC-30CS3420-PHR	4.75	SCC-30R3420-PHR	4.45
		Semi Steel Cast Iron	700		SCC-30CS3420-SSR	6.50	SCC-30R3420-SSR	6.20
		Glass Filled Nylon	900		SCC-30CS3420-GFNR	4.5	SCC-30R3420-GFNR	4
4"	2"	Thermoplastic Rubber (Donut)	300	5-5/8"	SCC-30CS420-TPRRD	3.96	SCC-30R420-TPRRD	2.53
		Thermoplastic Rubber (Flat)			SCC-30CS420-TPRRF	3.96	SCC-30R420-TPRRF	2.53
		Rubber on Aluminum	400		SCC-30CS420-RAR	5.06	SCC-30R420-RAR	3.63
		Rubber on Cast Iron			SCC-30CS420-RSR	6.16	SCC-30R420-RSR	1.73
		Polyolefin	500		SCC-30CS420-POR	5.06	SCC-30R420-POR	3.63
		Polyurethane on Polyolefin	600		SCC-30CS420-PPUR	3.96	SCC-30R420-PPUR	2.53
		Polyurethane on Aluminum	700		SCC-30CS420-PAR	5.06	SCC-30R420-PAR	3.63
		Polyurethane/Steel (Green)			SCC-30CS420-PUR-GB	6.16	SCC-30R420-PUR-GB	4.73
		Polyurethane/Steel (Red)			SCC-30CS420-PUR-RS	6.16	SCC-30R420-PUR-RS	4.73
		Solid Polyurethane			SCC-30CS420-SPUR	3.96	SCC-30R420-SPUR	2.53
		Nylon	800		SCC-30CS420-NYR	5.06	SCC-30R420-NYR	3.63
		Phenolic			SCC-30CS420-PHR	5.25	SCC-30R420-PHR	3.82
		Semi Steel V-Groove			SCC-30CS420-VGR	6.71	SCC-30R420-VGR	5.28
		Glass Filled Nylon			SCC-30CS420-GFNR	5.06	SCC-30R420-GFNR	3.63
Semi Steel	1000	SCC-30CS420-SSR	5.72	SCC-30R420-SSR	4.29			
5"	2"	Thermoplastic Rubber (Donut)	350	6-1/2"	SCC-30CS520-TPRRD	4.62	SCC-30R520-TPRRD	3.19
		Thermoplastic Rubber (Flat)			SCC-30CS520-TPRRF	4.62	SCC-30R520-TPRRF	3.19
		Rubber on Cast Iron	400		SCC-30CS520-RSR	6.16	SCC-30R520-RSR	4.73
		Rubber on Aluminum	500		SCC-30CS520-RAR	5.75	SCC-30R520-RAR	4.32
		Polyolefin	650		SCC-30CS520-POR	4.62	SCC-30R520-POR	3.19
		Polyurethane on Polyolefin	750		SCC-30CS520-PPUR	4.62	SCC-30R520-PPUR	3.19
		Nylon	900		SCC-30CS520-NYR	4.62	SCC-30R520-NYR	3.19
		Polyurethane on Aluminum			SCC-30CS520-PAR	5.28	SCC-30R520-PAR	3.85
		Phenolic	1000		SCC-30CS520-PHR	5.75	SCC-30R520-PHR	4.32
		High Temp Phenolic			SCC-30CS520-PHRHT	5.75	SCC-30R520-PHRHT	4.32
		Polyurethane/Steel (Green)			SCC-30CS520-PUR-GB	6.60	SCC-30R520-PUR-GB	5.17
		Polyurethane/Steel (Red)			SCC-30CS520-PUR-RS	6.60	SCC-30R520-PUR-RS	5.17
		Solid Polyurethane	1100		SCC-30CS520-SPUR	4.62	SCC-30R520-SPUR	3.19
		Semi Steel			SCC-30CS520-SSR	7.92	SCC-30R520-SSR	6.49
Semi Steel V-Groove	SCC-30CS520-VGR	8.58		SCC-30R520-VGR	7.15			
Glass Filled Nylon	SCC-30CS520-GFNR	4.62		SCC-30R520-GFNR	3.19			
6"	2"	Rubber on Cast Iron	450	7-1/2"	SCC-30CS620-RSR	7.70	SCC-30R620-RSR	6.27
		Thermoplastic Rubber (Donut)	500		SCC-30CS620-TPRRD	5.06	SCC-30R620-TPRRD	3.63
		Thermoplastic Rubber (Flat)			SCC-30CS620-TPRRF	5.06	SCC-30R620-TPRRF	3.63
		Rubber on Aluminum	550		SCC-30CS620-RAR	6.50	SCC-30R620-RAR	5.07
		Polyolefin	700		SCC-30CS620-POR	5.06	SCC-30R620-POR	3.63
		Polyurethane on Polyolefin	900		SCC-30CS620-PPUR	5.06	SCC-30R620-PPUR	3.63
		Polyurethane on Aluminum	1200		SCC-30CS620-PAR	6.00	SCC-30R620-PAR	4.07
		Phenolic			SCC-30CS620-PHR	7.50	SCC-30R620-PHR	6.07
		High Temp Phenolic			SCC-30CS620-PHRHT	7.50	SCC-30R620-PHRHT	6.50
		Polyurethane/Steel (Green)			SCC-30CS620-PUR-GB	8.58	SCC-30R620-PUR-GB	7.15
		Polyurethane/Steel (Red)	1250		SCC-30CS620-PUR-RS	8.58	SCC-30R620-PUR-RS	7.15
		Solid Polyurethane			SCC-30CS620-SPUR	5.06	SCC-30R620-SPUR	3.63
		Semi Steel			SCC-30CS620-SSR	8.85	SCC-30R620-SSR	7.15
		Semi Steel V-Groove			SCC-30CS620-VGR	10.12	SCC-30R620-VGR	8.69
Glass Filled Nylon	1250	SCC-30CS620-GFNR	5.06	SCC-30R620-GFNR	3.63			
Nylon		SCC-30CS620-NYR	5.06	SCC-30R620-NYR	3.63			

Wheel with an 8" Diameter on the following page.



Roller Bearings: The default standard bearing for caster wheels, sometimes known as needle bearings. Offering high load capacity, long life and easy rolling. Low speeds with short travel and minimal side thrust. Designated with "R" in Service Caster part numbers

TOP PLATE CASTERS *with Roller Bearing Wheels*

Wheel Dia	Tread Width	Wheel Type	Load Capacity (lbs.)	Overall Height	Swivel Part Number	Swivel Weight (lbs.)	Rigid Part Number	Rigid Weight (lbs.)
8"	2"	Rubber on Cast Iron	500	9-1/2"	SCC-30CS820-RSR	9.68	SCC-30R820-RSR	8.25
		Thermoplastic Rubber (Donut)	600		SCC-30CS820-TPRRD	5.50	SCC-30R820-TPRRD	4.07
		Thermoplastic Rubber (Flat)			SCC-30CS820-TPRRF	5.50	SCC-30R820-TPRRF	4.07
		Rubber on Aluminum	800		SCC-30CS820-RAR	7.50	SCC-30R820-RAR	9.04
		Polyurethane on Polyolefin			SCC-30CS820-PPUR	5.50	SCC-30R820-PPUR	4.07
		Polyolefin	900		SCC-30CS820-POR	5.50	SCC-30R820-POR	4.07
		Solid Polyurethane	1200		SCC-30CS820-SPUR	5.50	SCC-30R820-SPUR	4.07
		Glass Filled Nylon	1250		SCC-30CS820-GFNR	5.50	SCC-30R820-GFNR	4.07
		Nylon			SCC-30CS820-NYR	5.50	SCC-30R820-NYR	4.07
		Polyurethane on Aluminum			SCC-30CS820-PAR	5.50	SCC-30R820-PAR	4.07
		Phenolic			SCC-30CS820-PHR	7.75	SCC-30R820-PHR	6.32
		High Temp Phenolic			SCC-30CS820-PHRHT	7.75	SCC-30R820-PHRHT	6.32
		Polyurethane/Steel (Green)			SCC-30CS820-PUR-GB	12.10	SCC-30R820-PUR-GB	10.67
		Polyurethane/Steel (Red)			SCC-30CS820-PUR-RS	12.10	SCC-30R820-PUR-RS	10.67
		Semi Steel			SCC-30CS820-SSR	12.10	SCC-30R820-SSR	10.67
		Semi Steel V-Groove			SCC-30CS820-VGR	12.10	SCC-30R820-VGR	10.67



The Importance of Caster Brakes for Your Application

Caster **brakes** are essential for ensuring safety and stability in various applications. By locking the wheels in place, caster brakes prevent unwanted movement, reducing the risk of accidents and damage. This added control is particularly beneficial in industrial, medical, and commercial settings where precision and safety are paramount. Investing in quality caster brakes enhances the functionality of your equipment, providing peace of mind and increasing operational efficiency.

Total Lock Brakes

This brake locks both the wheel and the swivel, ensuring complete stability. It's an excellent option for stationary loads or when movement needs to be completely restricted.

Side Lock Brake

Mounted on the side of the caster, these brakes are activated by pressing a lever, providing a quick and convenient locking mechanism. They're well-suited for medium-duty use and lighter loads.

Top Lock Brake

These brakes engage directly on the wheel tread, applying pressure to securely stop movement. They're easy to operate and are ideal for most standard applications.



TOP PLATE CASTERS *with Roller Bearings & Brakes*



Wheel Dia.	Tread Width	Wheel Type	Load Capacity (lbs.)	Overall Height	Side Lock Brake (SLB) Top Lock Brake (TLB)	Total Lock Brake (TTL)	Bolt-on Swivel Lock (BSL)
3-1/4"	2"	Polyurethane/Steel (Green)	600	4-1/4"	SCC-30CS3420-PUR-GB-SLB	SCC-TTL30S3420-PUR-GB	SCC-30CS3420-PUR-GB-BSL
		Phenolic	700		SCC-30CS3420-PHR-SLB	SCC-TTL30S3420-PHR	SCC-30CS3420-PHR-BSL
		Semi Steel	700		SCC-30CS3420-SSR-SLB	SCC-TTL30S3420-SSR	SCC-30CS3420-SSR-BSL
		Glass Filled Nylon	900		SCC-30CS3420-GFNR-SLB	SCC-TTL30S3420-GFNR	SCC-30CS3420-GFNR-BSL
4"	2"	Thermoplastic Rubber (Donut)	300	5-5/8"	SCC-30CS420-TPRRD-TLB	SCC-TTL30S420-TPRRD	SCC-30CS420-TPRRD-BSL
		Thermoplastic Rubber (Flat)			SCC-30CS420-TPRRF-TLB	SCC-TTL30S420-TPRRF	SCC-30CS420-TPRRF-BSL
		Rubber on Aluminum	400		SCC-30CS420-RAR-TLB	SCC-TTL30S420-RAR	SCC-30CS420-RAR-BSL
		Rubber on Cast Iron			SCC-30CS420-RSR-TLB	SCC-TTL30S420-RSR	SCC-30CS420-RSR-BSL
		Polyolefin	500		SCC-30CS420-POR-TLB	SCC-TTL30S420-POR	SCC-30CS420-POR-BSL
		Polyurethane on Polyolefin	600		SCC-30CS420-PPUR-TLB	SCC-TTL30S420-PPUR	SCC-30CS420-PPUR-BSL
		Nylon	800		SCC-30CS420-NYR-TLB	SCC-TTL30S420-NYR	SCC-30CS420-NYR-BSL
		Polyurethane on Aluminum	700		SCC-30CS420-PAR-TLB	SCC-TTL30S420-PAR	SCC-30CS420-PAR-BSL
		Polyurethane/Steel (Green)			SCC-30CS420-PUR-GB-TLB	SCC-TTL30S420-PUR-GB	SCC-TTL30S420-PUR-GB
		Polyurethane/Steel (Red)			SCC-30CS420-PUR-RS-TLB	SCC-TTL30S420-PUR-RS	SCC-30CS420-PUR-RS-BSL
		Solid Polyurethane			SCC-30CS420-SPUR-TLB	SCC-TTL30S420-SPUR	SCC-30CS420-SPUR-BSL
		High Temp Phenolic	800		SCC-30CS420-PHRHT-TLB	SCC-TTL30S420-PHRHT	SCC-30CS420-PHRHT-BSL
		Phenolic			SCC-30CS420-PHR-TLB	SCC-TTL30S420-PHR	SCC-30CS420-PHR-BSL
		Semi Steel V-Groove			SCC-30CS420-VGR-TLB	SCC-TTL30S420-VGR	SCC-30CS420-VGR-BSL
		Semi Steel	1000		SCC-30CS420-SSR-TLB	SCC-TTL30S420-SSR	SCC-30CS420-SSR-BSL
		Glass Filled Nylon	1200		SCC-30CS420-GFNR-TLB	SCC-TTL30S420-GFNR	SCC-30CS420-GFNR-BSL
5"	2"	Thermoplastic Rubber (Donut)	350	6-1/2"	SCC-30CS520-TPRRD-TLB	SCC-TTL30S520-TPRRF	SCC-30CS520-TPRRF-BSL
		Thermoplastic Rubber (Flat)			SCC-30CS520-TPRRF-TLB	SCC-TTL30S520-TPRRD	SCC-30CS520-TPRRD-BSL
		Rubber on Cast Iron	400		SCC-30CS520-RSR-TLB	SCC-TTL30S520-RSR	SCC-30CS520-RSR-BSL
		Rubber on Aluminum	500		SCC-30CS520-RAR-TLB	SCC-TTL30S520-RAR	SCC-30CS520-RAR-BSL
		Polyolefin	650		SCC-30CS520-POR-TLB	SCC-TTL30S520-POR	SCC-30CS520-POR-BSL
		Polyurethane on Polyolefin	750		SCC-30CS520-PPUR-TLB	SCC-TTL30S520-PPUR	SCC-30CS520-PPUR-BSL
		Nylon	900		SCC-30CS520-NYR-TLB	SCC-TTL30S520-NYR	SCC-30CS520-NYR-BSL
		Polyurethane on Aluminum	1000		SCC-30CS520-PAR-TLB	SCC-TTL30S520-PAR	SCC-30CS520-PAR-BSL
		High Temp Phenolic			SCC-30CS520-PHRHT-TLB	SCC-TTL30S520-PHRHT	SCC-30CS520-PHRHT-BSL
		Phenolic			SCC-30CS520-PHR-TLB	SCC-TTL30S520-PHR	SCC-30CS520-PHR-BSL
		Polyurethane/Steel (Green)			SCC-30CS520-PUR-GB-TLB	SCC-TTL30S520-PUR-GB	SCC-30CS520-PUR-GB-BSL
		Polyurethane/Steel (Red)	SCC-30CS520-PUR-RS-TLB		SCC-TTL30S520-PUR-RS	SCC-30CS520-PUR-RS-BSL	
		Solid Polyurethane	SCC-30CS520-SPUR-TLB		SCC-TTL30S520-SPUR	SCC-30CS520-SPUR-BSL	
		Semi Steel	SCC-30CS520-SSR-TLB		SCC-TTL30S520-SSR	SCC-30CS520-SSR-BSL	
		Semi Steel V-Groove	SCC-30CS520-VGR-TLB		SCC-TTL30S520-VGR	SCC-30CS520-VGR-BSL	
		Glass Filled Nylon	1250		SCC-30CS520-GFNR-TLB	SCC-TTL30S520-GFNR	SCC-30CS520-GFNR-BSL
6"	2"	Rubber on Cast Iron	450	7-1/2"	SCC-30CS620-RSR-TLB	SCC-TTL30S620-RSR	SCC-30CS620-RSR-BSL
		Thermoplastic Rubber (Donut)	500		SCC-30CS620-TPRRD-TLB	SCC-TTL30S620-TPRRD	SCC-30CS620-TPRRD-BSL
		Thermoplastic Rubber (Flat)			SCC-30CS620-TPRRF-TLB	SCC-TTL30S620-TPRRF	SCC-30CS620-TPRRF-BSL
		Rubber on Aluminum	550		SCC-30CS620-RAR-TLB	SCC-TTL30S620-RAR	SCC-30CS620-RAR-BSL
		Polyolefin	700		SCC-30CS620-POR-TLB	SCC-TTL30S620-POR	SCC-30CS620-POR-BSL
		Polyurethane on Polyolefin	900		SCC-30CS620-PPUR-TLB	SCC-TTL30S620-PPUR	SCC-30CS620-PPUR-BSL
		Polyurethane on Aluminum	1200		SCC-30CS620-PAR-TLB	SCC-TTL30S620-PAR	SCC-30CS620-PAR-BSL
		High Temp Phenolic			SCC-30CS620-PHRHT-TLB	SCC-TTL30S620-PHR	SCC-30CS620-PHR-BSL
		Phenolic			SCC-30CS620-PHR-TLB	SCC-TTL30S620-PHRHT	SCC-30CS620-PHRHT-BSL
		Polyurethane/Steel (Green)			SCC-30CS620-PUR-GB-TLB	SCC-TTL30S620-PUR-GB	SCC-30CS620-PUR-GB-BSL
		Polyurethane/Steel (Red)	SCC-30CS620-PUR-RS-TLB		SCC-TTL30S620-PUR-RS	SCC-30CS620-PUR-RS-BSL	
		Solid Polyurethane	SCC-30CS620-SPUR-TLB		SCC-TTL30S620-SPUR	SCC-30CS620-SPUR-BSL	
		Semi Steel	SCC-30CS620-SSR-TLB		SCC-TTL30S620-SSR	SCC-30CS620-SSR-BSL	
		Semi Steel V-Groove	SCC-30CS620-VGR-TLB		SCC-TTL30S620-VGR	SCC-30CS620-VGR-BSL	
		Glass Filled Nylon	1250		SCC-30CS620-GFNR-TLB	SCC-TTL30S620-GFNR	SCC-30CS620-GFNR-BSL
		Nylon			SCC-30CS620-NYR-TLB	SCC-TTL30S620-NYR	SCC-30CS620-NYR-BSL



8" Diameter Wheel on the following page.

Discover Smooth Mobility with Our Caster Brakes!
 Explore how-to videos and behind-the-scenes exclusives to see our brakes in action, **locking your casters** securely for ultimate stability. Follow and subscribe for updates!



Wheel Dia	Tread Width	Wheel Type	Load Capacity (lbs.)	Overall Height	Side Lock Brake (SLB) Top Lock Brake (TLB)	Total Lock Brake (TTL)	Bolt-on Swivel Lock (BSL)
8"	2"	Rubber on Cast Iron	500	9-1/2"	SCC-30CS820-RSR-TLB	SCC-TTL30S820-RSR	SCC-30CS820-RSR-BSL
		Thermoplastic Rubber (Donut)	600		SCC-30CS820-TPRRD-TLB	SCC-TTL30S820-TPRRD	SCC-30CS820-TPRRD-BSL
		Thermoplastic Rubber (Flat)			SCC-30CS820-TPRRF-TLB	SCC-TTL30S820-TPRRF	SCC-30CS820-TPRRF-BSL
		Rubber on Aluminum	800		SCC-30CS820-RAR-TLB	SCC-TTL30S820-RAR	SCC-30CS820-RAR-BSL
		Polyurethane on Polyolefin			SCC-30CS820-PPUR-TLB	SCC-TTL30S820-PPUR	SCC-30CS820-PPUR-BSL
		Polyolefin	900		SCC-30CS820-POR-TLB	SCC-TTL30S820-POR	SCC-30CS820-POR-BSL
		Solid Polyurethane	1200		SCC-30CS820-SPUR-TLB	SCC-TTL30S820-SPUR	SCC-30CS820-SPUR-BSL
		Glass Filled Nylon	1250		SCC-30CS820-GFNR-TLB	SCC-TTL30S820-GFNR	SCC-30CS820-GFNR-BSL
		Phenolic			SCC-30CS820-PHR-TLB	SCC-TTL30S820-PHR	SCC-30CS820-PHR-BSL
		Polyurethane/Steel (Green)			SCC-30CS820-PUR-GB-TLB	SCC-TTL30S820-PUR-GB	SCC-30CS820-PUR-GB-BSL
		Polyurethane/Steel (Red)			SCC-30CS820-PUR-RS-TLB	SCC-TTL30S820-PUR-RS	SCC-30CS820-PUR-RS-BSL
		High Temp Phenolic			SCC-30CS820-PHRHT-TLB	SCC-TTL30S820-PHRHT	SCC-30CS820-PHRHT-BSL
		Semi Steel			SCC-30CS820-SSR-TLB	SCC-TTL30S820-SSR	SCC-30CS820-SSR-BSL
		Semi Steel V-Groove			SCC-30CS820-VGR-TLB	SCC-TTL30S820-VGR	SCC-30CS820-VGR-BSL
		Polyurethane on Aluminum			SCC-30CS820-PAR-TLB	SCC-TTL30S820-PAR	SCC-30CS820-PAR-BSL
		Nylon			SCC-30CS820-NYR-TLB	SCC-TTL30S820-NYR	SCC-30CS820-NYR-BSL

Elevate to Service Caster Q34 Precision Ball Bearings for Next-Level Caster Wheels!

Effortless Mobility: Flanged Precision Ball Bearings outperform traditional roller bearings by facilitating smoother and easier rolling for your carts and dollies.

Low Maintenance: Enjoy hassle-free operation with maintenance-free bearings that eliminate the need for frequent upkeep.

Protection from Dust and Elements: Sealed design ensures optimal protection against dust and external elements, maintaining the longevity of the bearings and the equipment they support.

Compatibility: Designed for use with non-metallic standard bore wheels, ensuring seamless integration into various equipment setups.

Immediate Availability: We have multiple sizes of these bearings readily available in stock, ensuring prompt delivery to meet your operational needs.

Upgrade your equipment effortlessly with maintenance-free ball bearings, offering a quieter and smoother rolling experience compared to roller bearings. Integrated spanner bushing enhances convenience. Identified by a "B" in Service Caster part number **SCC-30R3420-PHB**.

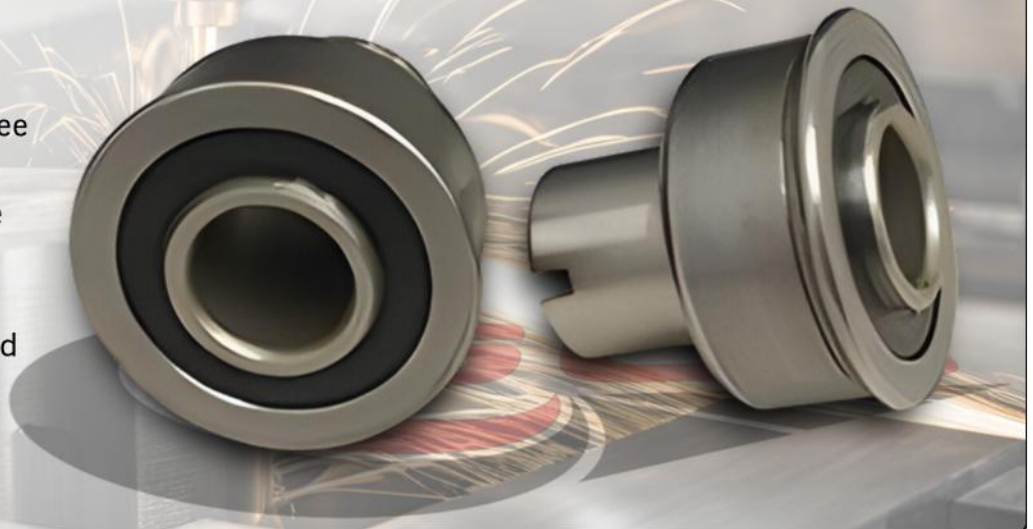



TOP PLATE CASTERS *Ball Bearing Wheels*

Wheel Dia	Tread Width	Wheel Type	Load Capacity (lbs.)	Overall Height	Swivel Part Number	Swivel Weight (lbs.)	Rigid Part Number	Rigid Weight (lbs.)
8"	2"	Rubber on Cast Iron	500	9-1/2"	SCC-30CS820-RSB	9.68	SCC-30R820-RSB	8.25
		Thermoplastic Rubber (Donut)	600		SCC-30CS820-TPRBD	5.50	SCC-30R820-TPRBD	4.07
		Thermoplastic Rubber (Flat)			SCC-30CS820-TPRBF	5.50	SCC-30R820-TPRBF	4.07
		Rubber on Aluminum	800		SCC-30CS820-RAB	7.50	SCC-30R820-RAB	9.04
		Polyurethane on Polyolefin			SCC-30CS820-PPUB	5.50	SCC-30R820-PPUB	4.07
		Polyolefin	900		SCC-30CS820-POB	5.50	SCC-30R820-POB	4.07
		Solid Polyurethane	1200		SCC-30CS820-SPUB	5.50	SCC-30R820-SPUB	4.07
		Glass Filled Nylon	1250		SCC-30CS820-GFNB	5.50	SCC-30R820-GFNB	4.07
		Nylon			SCC-30CS820-NYB	5.50	SCC-30R820-NYB	4.07
		Polyurethane on Aluminum			SCC-30CS820-PAB	5.50	SCC-30R820-PAB	4.07
		Phenolic			SCC-30CS820-PHB	7.75	SCC-30R820-PHB	6.32
		High Temp Phenolic			SCC-30CS820-PHBHT	7.75	SCC-30R820-PHBHT	6.32
		Polyurethane/Steel (Green)			SCC-30CS820-PUB-GB	12.10	SCC-30R820-PUB-GB	10.67
		Polyurethane/Steel (Red)			SCC-30CS820-PUB-RS	12.10	SCC-30R820-PUB-RS	10.67
		Semi Steel			SCC-30CS820-SSB	12.10	SCC-30R820-SSB	10.67
		Semi Steel V-Groove			SCC-30CS820-VGB	12.10	SCC-30R820-VGB	10.67

Question: The Q34 bearings have a built-in shoulder. Why do they have notches?

Answer: The notches on the Q34 bearings create holes when they press together, similar to a spanner bushing, allowing grease to enter. Originally, the semi-precision version of this bearing was open (without a seal) on the part that goes inside the wheel, making it possible to regrease. If a company needed to remove the seal for future regreasing, they could easily do so.



DID YOU KNOW



Discover Our Reliable Brake Option Casters!

Explore our brake option casters, including top-lock for secure positioning, total-lock for wheel and swivel lock, and side-lock for easy access. Each option offers enhanced stability, safety, and convenience.

FAST DELIVERY



TOP PLATE CASTERS *Ball Bearing Wheels*

Wheel Dia	Tread Width	Wheel Type	Load Capacity (lbs.)	Overall Height	Side Lock Brake (SLB) Top Lock Brake (TLB)	Total Lock Brake (TTL)	Bolt-on Swivel Lock (BSL)
8"	2"	Rubber on Cast Iron	500	9-1/2"	SCC-30CS820-RSB-TLB	SCC-TTL30S820-RSB	SCC-30CS820-RSB-BSL
		Thermoplastic Rubber (Donut)	600		SCC-30CS820-TPRBD-TLB	SCC-TTL30S820-TPRBD	SCC-30CS820-TPRBD-BSL
		Thermoplastic Rubber (Flat)			SCC-30CS820-TPRBF-TLB	SCC-TTL30S820-TPRBF	SCC-30CS820-TPRBF-BSL
		Rubber on Aluminum			SCC-30CS820-RAB-TLB	SCC-TTL30S820-RAB	SCC-30CS820-RAB-BSL
		Polyurethane on Polyolefin	800		SCC-30CS820-PPUB-TLB	SCC-TTL30S820-PPUB	SCC-30CS820-PPUB-BSL
		Polyolefin	900		SCC-30CS820-POB-TLB	SCC-TTL30S820-POB	SCC-30CS820-POB-BSL
		Solid Polyurethane	1200		SCC-30CS820-SPUB-TLB	SCC-TTL30S820-SPUB	SCC-30CS820-SPUB-BSL
		Glass Filled Nylon	1250		SCC-30CS820-GFNB-TLB	SCC-TTL30S820-GFNB	SCC-30CS820-GFNB-BSL
		Phenolic			SCC-30CS820-PHB-TLB	SCC-TTL30S820-PHB	SCC-30CS820-PHB-BSL
		Polyurethane/Steel (Green)			SCC-30CS820-PUB-GB-TLB	SCC-TTL30S820-PUB-GB	SCC-30CS820-PUB-GB-BSL
		Polyurethane/Steel (Red)			SCC-30CS820-PUB-RS-TLB	SCC-TTL30S820-PUB-RS	SCC-30CS820-PUB-RS-BSL
		High Temp Phenolic			SCC-30CS820-PHBHT-TLB	SCC-TTL30S820-PHBHT	SCC-30CS820-PHBHT-BSL
		Semi Steel			SCC-30CS820-SSB-TLB	SCC-TTL30S820-SSB	SCC-30CS820-SSB-BSL
		Semi Steel V-Groove			SCC-30CS820-VGB-TLB	SCC-TTL30S820-VGB	SCC-30CS820-VGB-BSL
		Polyurethane on Aluminum			SCC-30CS820-PAB-TLB	SCC-TTL30S820-PAB	SCC-30CS820-PAB-BSL
		Nylon			SCC-30CS820-NYB-TLB	SCC-TTL30S820-NYB	SCC-30CS820-NYB-BSL

Explore Our Comprehensive Finish Options

While our zinc finish casters offer a durable and reliable choice, we understand that different environments and applications demand specific solutions. That's why we are proud to present our extensive range of finishes, including the highly durable **304 Stainless Steel** and the superior **316 Stainless Steel** options.

304 Stainless Steel Finish

Ideal for environments where resistance to corrosion and staining is essential, our 304 Stainless Steel finish provides excellent durability and longevity, making it perfect for various industrial and commercial applications.

316 Stainless Steel Finish

For even more demanding conditions, our new 316 Stainless Steel finish offers enhanced resistance to corrosion, especially against chlorides and industrial solvents. This premium finish is designed for the toughest environments, ensuring maximum performance and lifespan.



Discover More Finish Options

But that's not all. We offer various additional finishes, including electro-polished and custom powder coatings. Stay tuned as we expand our catalog with these new options. Discover the perfect caster for every application. For more details, visit our [website](#) or contact our [customer service](#) team.

Medium/Heavy Duty Casters

Series #30 V-Groove Casters

V Groove casters provide high-capacity options for tracked workflows. The casters listed below for immediate purchase represent just a small selection of our available V-groove (and U-groove) options.

Applications

- Platform Trucks
- Warehouse Carts
- Dollies (Machinery)
- Stock Picking Trucks
- Freight Terminal
- Food Service Carts



Scan QR code to play video

Features

- Double ball bearing raceway, heat-treated for durability and strength
- Bright zinc plated
- 5/8" bolted kingpin
- 1/2" axle bolt with lock nut
- Grease fittings in swivel raceway and wheel
- Wide selection of wheel types

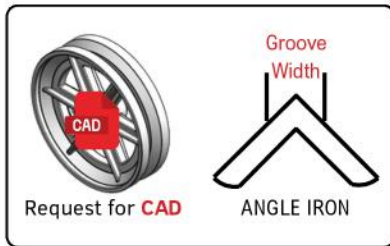
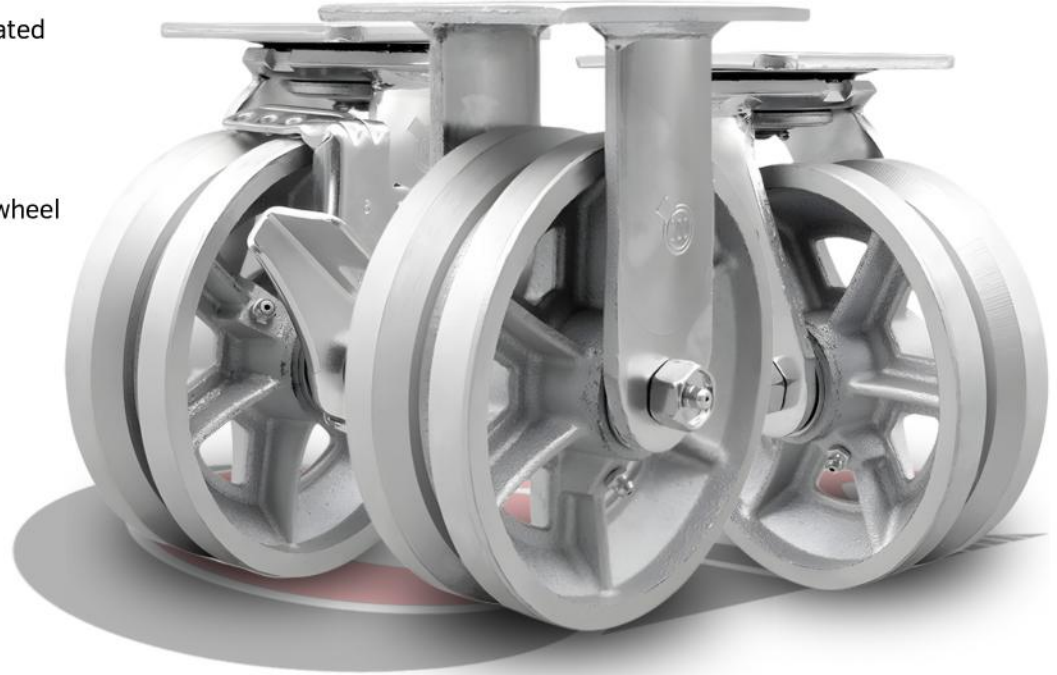

Service Caster Chart Guide

Build You Caster

TOP PLATE CASTERS *Roller Bearing Wheels*

Our part numbers adapt to your needs. The diagram below is for reference. For help, contact our **customer service** team.

Wheel Dia	Tread Width	Wheel Type	Load Capacity (lbs.)	Overall Height	Swivel Part Number	Swivel Weight (lbs.)	Rigid Part Number	Rigid Weight (lbs.)
4"	2"	Semi Steel V-Groove	800	5-5/8"	SCC-30CS420-VGR	6.71	SCC-30R420-VGR	5.28
5"	2"	Semi Steel V-Groove	1100	6-1/2"	SCC-30CS520-VGR	8.58	SCC-30R520-VGR	7.15
6"	2"	Semi Steel V-Groove	1200	7-1/2"	SCC-30CS620-VGR	10.12	SCC-30R620-VGR	8.69
8"	2"	Semi Steel V-Groove	1250	9-1/2"	SCC-30CS820-VGR	10.12	SCC-30R820-VGR	8.69

V GROOVE WHEELS PROVIDE HIGH-CAPACITY TRACKED WORKFLOW SOLUTIONS AND CAN ALSO BE USED WITHOUT A TRACK. THE WHEELS LISTED BELOW FOR IMMEDIATE PURCHASE REPRESENT JUST A SMALL PORTION OF OUR FULL RANGE OF V-GROOVE AND U-GROOVE OPTIONS.



Roller Bearings: The default standard bearing for caster wheels, sometimes known as needle bearings. Offering high load capacity, long life and easy rolling. Low speeds with short travel and minimal side thrust.



CALL OR EMAIL US FOR MORE OPTIONS 1-800-215-8220 / info@servicecaster.com

Medium/Heavy Duty Dual Wheel Casters

Series #30 Dual Wheel Casters

Dual wheel casters offer greater stability, higher capacity, and improved maneuverability compared to single wheels. Available in materials like Polyurethane, Nylon, Semi Steel, and Phenolic.

Applications

- Platform Trucks
- Warehouse Carts
- Dollies (Machinery)
- Stock Picking Trucks
- Freight Terminal
- Food Service Carts

Features

- Double ball bearing raceway, heat-treated for durability and strength
- Bright zinc plated
- 1/2" Axle bolt with lock nut
- Grease fittings in swivel raceway and wheel
- Wide selection of wheel types



Service Caster Chart Guide

Build Your Caster

Discover more fastening sizes and wheel options if you can't find what you need. And remember, we're always here to [help!](#)

Series	Mounting	Mounting Size	Bolt Pattern	Rig Type	Wheel Size	Brake	Bearing Type	Wheel Material
DW30	Top Plate	4" x 4-1/2"	2-5/8" x 3-5/8" to 3" x 3"	Swivel (S)	4" x 2" (420)	Top Lock (TLB)	Ball Bearing (B)	Thermo Plastic Rubber (TPR)
				Rigid (R)	5" x 2" (520)	Side Lock (SLB)	Plain Bore (S)	Polyurethane (PPU)
					6" x 2" (620)	Face Contact (FCB)	Delrin Bearing (D)	Phenolic (PH)
					8" x 2" (820)	Bolt-on Swivel Lock (BSL)	Roller Bearing (R)	Solid Polyurethane (SPU)
				Weld-on Swivel Lock (WSL)		Precision Bearing (PB)	Glass Filled Nylon (GFN)	
						Bronze Bearing (BZ)	Rubber on Aluminum (RA)	

The overall height may vary slightly based on the available options.

Wheel Diameter	Overall Height	Swivel Radius
4"	5-5/8"	3-1/4"
5"	6-1/2"	3-7/8"
6"	7-1/2"	5-1/8"
8"	9-1/2"	6-3/4"



Wheel Tread



Our part numbers adapt to your needs. Use the diagram below as a reference. For help, contact our [customer service team](#).

The 30 Series dual wheel casters provide options in wheel materials, mounting types, and sizes, offering reliable performance for heavy-duty applications in demanding environments.

Top Plate Size Option(s)

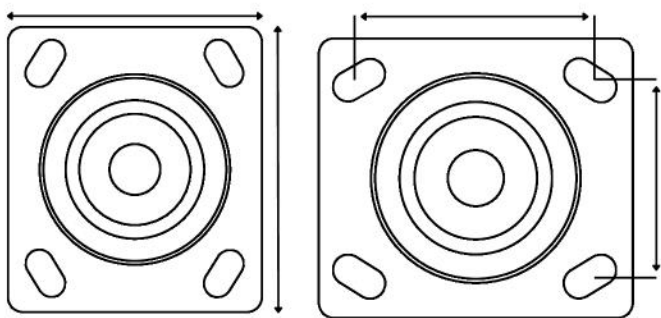

Standard Plate Size	Bolt Pattern	Bolt Diameter
4" x 4-1/2"	2-5/8" x 3-5/8" to 3" x 3"	3/8"
4-1/2" x 6-1/4" (TP2)	2-7/16"x4-15/16" to 3-3/8"x5-1/4"	1/2"
5" x 5-1/2" (TP3)	4-1/8" x 4-1/2"	1/2"

Tailored Casters for Tough Applications

Customers opt for 30 Series **custom casters** when retrofitting legacy operations, maintaining specific equipment heights, or handling heavy, complex loads in industries like aerospace. They're also ideal when catalog options fail to meet durability needs while fitting within existing design parameters.

Bearing Type(s)

Roller Bearing

Anti-friction bearing, ideal for manual applications with prevalent shock loading.



Ball Bearing

Ball bearing provides smooth movement and durability.



Delrin Bearing

Delrin bearings, maintenance-free, ideal for wash-downs, max 180°F.



Bronze Bearing

Bronze bearings are durable, corrosion-resistant, and withstand up to 525°F.



Brake Option(s)

Side Lock Brake (SLB)

The **Side Lock Brake (SLB)** locks the wheel by applying force directly to the hub, ensuring stability. These brakes are **dual-sided**, engaging on both sides of the wheel for added security.



Bolt-on Swivel Lock (BSL)

The **bolt-on swivel lock** secures swivel casters, preventing unwanted movement. Easy to install, it ensures stability.



To ensure you have all the options you need, we also carry different styles such as **face contact brakes** and **toe guards** for our Series DW30. Explore our comprehensive selection to find the perfect solution for your specific requirements.



FACE CONTACT BRAKE



TOE GUARD

WE ARE
SERVICE
CASTER





SWIVEL CASTERS

Wheel Dia	Tread Width	Wheel Type	Load Capacity (lbs.)	Swivel Part Number	Swivel Weight (lbs.)	Rigid Part Number	Rigid Weight (lbs.)	Overall Height
8"	2"	Rubber on Cast Iron	500	SCC-DW30CS820-RSR	9.68	SCC-DW30CS820-RSB	8.25	9-1/2"
		Thermoplastic Rubber (Donut)	600	SCC-DW30CS820-TPRRD	5.50	SCC-DW30CS820-TPRBD	4.07	
		Thermoplastic Rubber (Flat)		SCC-DW30CS820-TPRRF	5.50	SCC-DW30CS820-TPRBF	4.07	
		Rubber on Aluminum	900	SCC-DW30CS820-RAR	7.50	SCC-DW30CS820-RAB	9.04	
		Polyolefin		SCC-DW30CS820-POR	5.50	SCC-DW30CS820-POB	4.07	
		Polyurethane on Polyolefin	1000	SCC-DW30CS820-PPUR	5.50	SCC-DW30CS820-PPUB	4.07	
		High Temp Glass Filled Nylon	1200	SCC-DW30CS820-GFNRHT	5.50	SCC-DW30CS820-GFNHT	4.07	
		Solid Polyurethane		SCC-DW30CS820-SPUR	7.75	SCC-DW30CS820-SPUB	6.32	
		Polyurethane on Aluminum	1400	SCC-DW30CS820-PAR	5.50	SCC-DW30CS820-PAB	4.07	
		Polyurethane/Steel (Green)		SCC-DW30CS820-PUR-GB	5.50	SCC-DW30CS820-PUB-GB	4.07	
		Polyurethane/Steel (Red)		SCC-DW30CS820-PUR-RS	5.50	SCC-DW30CS820-PUB-RS	4.07	
		Phenolic		SCC-DW30CS820-PHR	7.75	SCC-DW30CS820-PHB	6.32	
		High Temp Phenolic		SCC-DW30CS820-PHRHT	12.10	SCC-DW30CS820-PHBHT	10.67	
		Semi Steel		SCC-DW30CS820-SSR	12.10	SCC-DW30CS820-SSB	10.67	
		Semi Steel V-Groove		SCC-DW30CS820-VGR	12.10	SCC-DW30CS820-VGB	10.67	
		Nylon		SCC-DW30CS820-NYR	12.10	SCC-DW30CS820-NYB	10.67	
Glass Filled Nylon	SCC-DW30CS820-GFNR	12.10		SCC-DW30CS820-GFNB	10.67			

YOUR ONE-STOP SHOP FOR HEAVY DUTY WHEELS AND MORE



COMPREHENSIVE WHEEL SOLUTIONS

Service Caster offers wheels for all applications, from light to super heavy duty. We provide a wide range of wheel styles and brands for material handling, cart replacements, and more, all tailored to your specific environment.

FAST AND RELIABLE SERVICE

Explore our catalog for wheels from 3" to 12", with larger sizes available through our specialists. Most orders placed by 3 PM EST ship the same day, ensuring you get the wheels you need quickly and efficiently

Medium/Heavy Duty Kingpinless Casters

Series #KP30 Casters

This caster features a 1/4" top plate, 2-3/8" raceway, 3/8" ball bearings, heat-forged ASTM1045, optional extended swivel lead, NSF Listed options, grease fittings, double-welded legs, zinc finish, and a 1/2" axle.

Applications

- Material Handling
- Manufacturing Plants
- Dollies (Machinery)
- Military Equipment
- Heavy Machinery
- Construction Sites



Features

- Heat-Forged ASTM1045 Construction
- Grease Fittings for Maintenance
- Double-Welded Steel Legs
- 1/2" axle bolt with lock nut
- NSF Listed Options
- Wide selection of wheel types



8" Swivel Steel Caster with Side Lock Brake

SCC-KP30S820-SSR-SLB

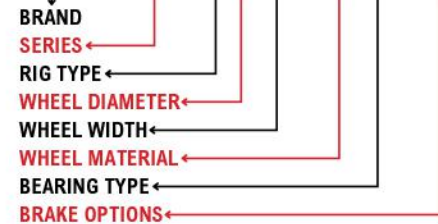

Service Caster Chart Guide

Build Your Caster

Discover more fastening sizes and wheel options if you can't find what you need. And remember, we're always here to [help!](#)

Series	Mounting	Rig Type	Mounting Size	Bolt Pattern	Wheel Size	Brake	Bearing Type	Wheel Material
KP30	Top Plate	Swivel (S)	4" x4-1/2"	2-5/8" x 3-5/8" to 3" x 3"	4" x 2" (420)	Top Lock (TLB)	Ball Bearing (B)	Soft Rubber (SR)
		Rigid (R)	4-1/2" x 6-1/4" (TP2)	2-7/16"x4-15/16" to 3-3/8"x5-1/4"	5" x 2" (520)	Side Lock (SLB)	Plain Bore (S)	Thermo Plastic Rubber (TPR)
	8" x 2" (820)		5" x 5-1/2" (TP3)	4-1/8" x 4-1/2"	6" x 2" (620)	Face Contact (FCB)	Delrin Bearing (D)	Polyurethane (PPU)
					8" x 2" (820)	Bolt-on Swivel Lock (BSL)	Roller Bearing (R)	Phenolic (PH)
						Weld-on Swivel Lock (WSL)	Precision Bearing (PB)	Solid Polyurethane (SPU)
						Bronze Bearing (BZ)	Hard Rubber (HR)	



Optional Top Plate
When specifying this option add the **prefix** at the end of the part number

Wheel Tread



Glass Filled Nylon (GFN)
Rubber on Aluminum (RA)
Semi Steel (SS)
Nylon (NY)
High Temp Phenolic (PH*HT)
High Temp Nylon (GF*HT)
Rubber on Steel (RS)



Request for CAD

This series offers superior shock resistance, durability, and capacity. Available with various wheels, brakes, and mounts, our Series 30 kingpinless casters are made and shipped from Berks County, PA.

Top Plate Size Option(s)

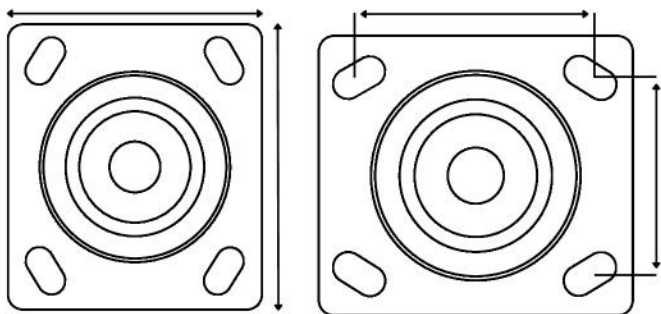

Standard Plate Size	Bolt Pattern	Bolt Diameter
4" x 4-1/2"	2-5/8" x 3-5/8" to 3" x 3"	3/8"
4-1/2" x 6-1/4" (TP2)	2-7/16" x 4-15/16" to 3-3/8" x 5-1/4"	1/2"
5" x 5-1/2" (TP3)	4-1/8" x 4-1/2"	1/2"

Choose Your Movement

- Rigid and Swivel Available



RIGID



SWIVEL

Bearing Type(s)

Roller Bearing

Anti-friction bearing, ideal for manual applications with prevalent shock loading.



Ball Bearing

Ball bearing provides smooth movement and durability.



Delrin Bearing

Delrin bearings, maintenance-free, ideal for wash-downs, max 180°F.



Bronze Bearing

Bronze bearings are durable, corrosion-resistant, and withstand up to 525°F.



Brake Option(s)

Side Lock Brake (SLB)

The side lock brake places a positive locking force against the wheel hub locking the wheel only.



Bolt-on Swivel Lock (BSL)

The bolt-on swivel lock secures swivel casters, preventing unwanted movement. Easy to install, it ensures stability.



To ensure you have all the options you need, we also carry different styles such as face contact brakes and toe guards for our Series KP30. Explore our comprehensive selection to find the perfect solution for your specific requirements.



FACE CONTACT BRAKE



TOE GUARD

POWERLOCK CASTERS

Choose your brake style! The Side Lock Brake (SLB) grips the wheel tight, while the Bolt-On Swivel Lock (BSL) converts your caster to rigid at any 90-degree angle. Use both for ultimate control, locking both swivel and wheel for total immobility.

LIKE, SHARE & SUBSCRIBE





Roller Bearings: Standard for caster wheels, offering high load capacity, long life, and easy rolling at low speeds. Designated with "R" in Service Caster part numbers.

SWIVEL & RIGID CASTERS

Wheel Dia.	Tread Width	Wheel Type	Load Capacity (lbs.)	Swivel Part Number	Swivel Weight (lbs.)	Rigid Part Number	Rigid Weight (lbs.)	Overall Height
4"	2"	Thermoplastic Rubber (Donut)	300	SCC-KP30S420-TPRRD	3.96	SCC-30R420-TPRRD	2.53	5-5/8"
		Thermoplastic Rubber (Flat)		SCC-KP30S420-TPRRF	3.96	SCC-30R420-TPRRF	2.53	
		Rubber on Aluminum	400	SCC-KP30S420-RAR	5.06	SCC-30R420-RAR	3.63	
		Rubber on Cast Iron		SCC-KP30S420-RSR	6.16	SCC-30R420-RSR	1.73	
		Polyolefin	500	SCC-KP30S420-POR	5.06	SCC-30R420-POR	3.63	
		Polyurethane on Polyolefin	600	SCC-KP30S420-PPUR	3.96	SCC-30R420-PPUR	2.53	
		High Temp Glass Filled Nylon		SCC-KP30S420-GFNRHT	5.72	SCC-30R420-GFNRHT	4.29	
		Polyurethane on Aluminum	700	SCC-KP30S420-PAR	5.06	SCC-30R420-PAR	3.63	
		Polyurethane/Steel (Green)		SCC-KP30S420-PUR-GB	6.16	SCC-30R420-PUR-GB	4.73	
		Polyurethane/Steel (Red)		SCC-KP30S420-PUR-RS	6.16	SCC-30R420-PUR-RS	4.73	
		Solid Polyurethane		SCC-KP30S420-SPUR	3.96	SCC-30R420-SPUR	2.53	
		Nylon		SCC-KP30S420-NYR	5.06	SCC-30R420-NYR	3.63	
		Phenolic	800	SCC-KP30S420-PHR	5.25	SCC-30R420-PHR	3.82	
		High Temp Phenolic		SCC-KP30S420-PHRHT	5.25	SCC-30R420-PHRHT	3.82	
		Semi Steel V-Groove		SCC-KP30S420-VGR	6.71	SCC-30R420-VGR	5.28	
Semi Steel	SCC-KP30S420-SSR	5.06		SCC-30R420-SSR	3.63			
Glass Filled Nylon	1200	SCC-KP30S420-GFNR	5.06	SCC-30R420-GFNR	3.63			
5"	2"	Thermoplastic Rubber (Donut)	350	SCC-KP30S520-TPRRD	4.62	SCC-30R520-TPRRD	3.19	6-1/2"
		Thermoplastic Rubber (Flat)		SCC-KP30S520-TPRRF	4.62	SCC-30R520-TPRRF	3.19	
		Rubber on Cast Iron	400	SCC-KP30S520-RSR	6.16	SCC-30R520-RSR	4.73	
		Rubber on Aluminum	500	SCC-KP30S520-RAR	5.75	SCC-30R520-RAR	4.32	
		Polyolefin	650	SCC-KP30S520-POR	4.62	SCC-30R520-POR	3.19	
		Polyurethane on Polyolefin	750	SCC-KP30S520-PPUR	4.62	SCC-30R520-PPUR	3.19	
		Nylon	900	SCC-KP30S520-NYR	4.62	SCC-30R520-NYR	3.19	
		Polyurethane on Aluminum		SCC-KP30S520-PAR	5.28	SCC-30R520-PAR	3.85	
		Polyurethane/Steel (Green)	1000	SCC-KP30S520-PUR-GB	5.75	SCC-30R520-PUR-GB	4.32	
		Polyurethane/Steel (Red)		SCC-KP30S520-PUR-RS	5.75	SCC-30R520-PUR-RS	4.32	
		Solid Polyurethane		SCC-KP30S520-SPUR	6.60	SCC-30R520-SPUR	5.17	
		High Temp Glass Filled Nylon		SCC-KP30S520-GFNRHT	6.60	SCC-30R520-GFNRHT	5.17	
		Phenolic		SCC-KP30S520-PHR	4.62	SCC-30R520-PHR	3.19	
		High Temp Phenolic	SCC-KP30S520-PHRHT	7.92	SCC-30R520-PHRHT	6.49		
		Semi Steel	1100	SCC-KP30S520-SSR	4.62	SCC-30R520-SSR	3.19	
Semi Steel V-Groove	SCC-KP30S520-VGR	8.58		SCC-30R520-VGR	7.15			
Glass Filled Nylon	SCC-KP30S520-GFNR	7.70		SCC-30R520-GFNR	6.27			
6"	2"	Rubber on Cast Iron	450	SCC-KP30S620-RSR	6.50	SCC-30R620-RSR	5.07	7-1/2"
		Thermoplastic Rubber (Donut)	500	SCC-KP30S620-TPRRD	5.06	SCC-30R620-TPRRD	3.63	
		Thermoplastic Rubber (Flat)		SCC-KP30S620-TPRRF	5.06	SCC-30R620-TPRRF	3.63	
		Rubber on Aluminum	550	SCC-KP30S620-RAR	5.06	SCC-30R620-RAR	3.63	
		Polyolefin	700	SCC-KP30S620-POR	5.06	SCC-30R620-POR	3.63	
		Polyurethane on Polyolefin	900	SCC-KP30S620-PPUR	6.00	SCC-30R620-PPUR	4.07	
		High Temp Glass Filled Nylon	1100	SCC-KP30S620-GFNRHT	7.50	SCC-30R620-GFNRHT	6.07	
		Polyurethane on Aluminum	1200	SCC-KP30S620-PAR	7.50	SCC-30R620-PAR	6.50	
		Polyurethane/Steel (Green)		SCC-KP30S620-PUR-GB	8.58	SCC-30R620-PUR-GB	7.15	
		Polyurethane/Steel (Red)		SCC-KP30S620-PUR-RS	8.58	SCC-30R620-PUR-RS	7.15	
		Solid Polyurethane		SCC-KP30S620-SPUR	5.06	SCC-30R620-SPUR	4.63	
		Phenolic		SCC-KP30S620-PHR	10.12	SCC-30R620-PHR	8.69	
		High Temp Phenolic	SCC-KP30S620-PHRHT	5.06	SCC-30R620-PHRHT	6.07		
		Semi Steel	1250	SCC-KP30S620-SSR	8.85	SCC-30R620-SSR	7.15	
		Semi Steel V-Groove		SCC-KP30S620-VGR	8.85	SCC-30R620-VGR	7.15	
Nylon	SCC-KP30S620-NYR	8.85		SCC-30R620-NYR	7.15			
Glass Filled Nylon	1250	SCC-KP30S620-GFNR	7.70	SCC-30R620-GFNR	3.63			

Don't Stop Now – More Casters and **Sizes** Ahead!

SWIVEL & RIGID CASTERS *with Roller Bearing Wheels*

Wheel Dia	Tread Width	Wheel Type	Load Capacity (lbs.)	Swivel Part Number	Swivel Weight (lbs.)	Rigid Part Number	Rigid Weight (lbs.)	Overall Height
8"	2"	Rubber on Cast Iron	500	SCC-KP30S820-RSR	9.68	SCC-30R820-RSR	8.25	9-1/2"
		Thermoplastic Rubber (Donut)	600	SCC-KP30S820-TPRRD	5.50	SCC-30R820-TPRRD	4.07	
		Thermoplastic Rubber (Flat)		SCC-KP30S820-TPRRF	5.50	SCC-30R820-TPRRF	4.07	
		Rubber on Aluminum	900	SCC-KP30S820-RAR	7.50	SCC-30R820-RAR	9.04	
		Polyolefin		SCC-KP30S820-POR	5.50	SCC-30R820-POR	4.07	
		Polyurethane on Polyolefin	1000	SCC-KP30S820-PPUR	5.50	SCC-30R820-PPUR	4.07	
		High Temp Glass Filled Nylon	1200	SCC-KP30S820-GFNRHT	5.50	SCC-30R820-GFNRHT	4.07	
		Solid Polyurethane		SCC-KP30S820-SPUR	7.75	SCC-30R820-SPUR	6.32	
		Polyurethane on Aluminum	1400	SCC-KP30S820-PAR	5.50	SCC-30R820-PAR	4.07	
		Polyurethane/Steel (Green)		SCC-KP30S820-PUR-GB	5.50	SCC-30R820-PUR-GB	4.07	
		Polyurethane/Steel (Red)		SCC-KP30S820-PUR-RS	5.50	SCC-30R820-PUR-RS	4.07	
		Phenolic		SCC-KP30S820-PHR	7.75	SCC-30R820-PHR	6.32	
		High Temp Phenolic		SCC-KP30S820-PHRHT	12.10	SCC-30R820-PHRHT	10.67	
		Semi Steel		SCC-KP30S820-SSR	12.10	SCC-30R820-SSR	10.67	
		Semi Steel V-Groove		SCC-KP30S820-VGR	12.10	SCC-30R820-VGR	10.67	
		Nylon		SCC-KP30S820-NYR	12.10	SCC-30R820-NYR	10.67	
Glass Filled Nylon	SCC-KP30S820-GFNR	12.10	SCC-30R820-GFNR	10.67				

Why Choose Our **Kingpinless?**

SUPERIOR STRENGTH AND LONGEVITY

SMOOTHER AND QUIETER OPERATION

RELIABLE UNDER EXTREME STRESS



SWIVEL CASTERS with Roller Bearings



Wheel Dia.	Tread Width	Wheel Type	Load Capacity (lbs.)	Side Lock Brake (SLB)	Bolt-on Swivel Lock (BSL)	Overall Height
4"	2"	Thermoplastic Rubber (Donut)	300	SCC-KP30S420-TPRRD-SLB	SCC-KP30S420-TPRRD-BSL	5-5/8"
		Thermoplastic Rubber (Flat)		SCC-KP30S420-TPRRF-SLB	SCC-KP30S420-TPRRF-BSL	
		Rubber on Aluminum	400	SCC-KP30S420-RAR-SLB	SCC-KP30S420-RAR-BSL	
		Rubber on Cast Iron		SCC-KP30S420-RSR-SLB	SCC-KP30S420-RSR-BSL	
		Polyolefin	500	SCC-KP30S420-POR-SLB	SCC-KP30S420-POR-BSL	
		Polyurethane on Polyolefin	600	SCC-KP30S420-PPUR-SLB	SCC-KP30S420-PPUR-BSL	
		Nylon	800	SCC-KP30S420-NYR-SLB	SCC-KP30S420-NYR-BSL	
		Polyurethane on Aluminum	700	SCC-KP30S420-PAR-SLB	SCC-KP30S420-PAR-BSL	
		Polyurethane/Steel (Green)		SCC-KP30S420-PUR-GB-SLB	SCC-30S420-PUR-GB-BSL	
		Polyurethane/Steel (Red)		SCC-KP30S420-PUR-RS-SLB	SCC-KP30S420-PUR-RS-BSL	
		Solid Polyurethane		SCC-KP30S420-SPUR-SLB	SCC-KP30S420-SPUR-BSL	
		High Temp Phenolic	800	SCC-KP30S420-PHRHT-SLB	SCC-KP30S420-PHRHT-BSL	
		Phenolic		SCC-KP30S420-PHR-SLB	SCC-KP30S420-PHR-BSL	
		Semi Steel V-Groove	1000	SCC-KP30S420-VGR-SLB	SCC-KP30S420-VGR-BSL	
		Semi Steel	1000	SCC-KP30S420-SSR-SLB	SCC-KP30S420-SSR-BSL	
		Glass Filled Nylon	1200	SCC-KP30S420-GFNR-SLB	SCC-KP30S420-GFNR-BSL	
5"	2"	Thermoplastic Rubber (Donut)	350	SCC-KP30S520-TPRRD-SLB	SCC-KP30S520-TPRRF-BSL	6-1/2"
		Thermoplastic Rubber (Flat)		SCC-KP30S520-TPRRF-SLB	SCC-KP30S520-TPRRD-BSL	
		Rubber on Cast Iron	400	SCC-KP30S520-RSR-SLB	SCC-KP30S520-RSR-BSL	
		Rubber on Aluminum	500	SCC-KP30S520-RAR-SLB	SCC-KP30S520-RAR-BSL	
		Polyolefin	650	SCC-KP30S520-POR-SLB	SCC-KP30S520-POR-BSL	
		Polyurethane on Polyolefin	750	SCC-KP30S520-PPUR-SLB	SCC-KP30S520-PPUR-BSL	
		Nylon	900	SCC-KP30S520-NYR-SLB	SCC-KP30S520-NYR-BSL	
		Polyurethane on Aluminum		SCC-KP30S520-PAR-SLB	SCC-KP30S520-PAR-BSL	
		High Temp Phenolic	1000	SCC-KP30S520-PHRHT-SLB	SCC-KP30S520-PHRHT-BSL	
		Phenolic		SCC-KP30S520-PHR-SLB	SCC-KP30S520-PHR-BSL	
		Polyurethane/Steel (Green)		SCC-KP30S520-PUR-GB-SLB	SCC-KP30S520-PUR-GB-BSL	
		Polyurethane/Steel (Red)		SCC-KP30S520-PUR-RS-SLB	SCC-KP30S520-PUR-RS-BSL	
		Solid Polyurethane	1000	SCC-KP30S520-SPUR-SLB	SCC-KP30S520-SPUR-BSL	
		Semi Steel		SCC-KP30S520-SSR-SLB	SCC-KP30S520-SSR-BSL	
		Semi Steel V-Groove	1250	SCC-KP30S520-VGR-SLB	SCC-KP30S520-VGR-BSL	
		Glass Filled Nylon	1250	SCC-KP30S520-GFNR-SLB	SCC-KP30S520-GFNR-BSL	
6"	2"	Rubber on Cast Iron	450	SCC-KP30S620-RSR-SLB	SCC-KP30S620-RSR-BSL	7-1/2"
		Thermoplastic Rubber (Donut)	500	SCC-KP30S620-TPRRD-SLB	SCC-KP30S620-TPRRD-BSL	
		Thermoplastic Rubber (Flat)		SCC-KP30S620-TPRRF-SLB	SCC-KP30S620-TPRRF-BSL	
		Rubber on Aluminum	550	SCC-KP30S620-RAR-SLB	SCC-KP30S620-RAR-BSL	
		Polyolefin	700	SCC-KP30S620-POR-SLB	SCC-KP30S620-POR-BSL	
		Polyurethane on Polyolefin	900	SCC-KP30S620-PPUR-SLB	SCC-KP30S620-PPUR-BSL	
		Polyurethane on Aluminum	1200	SCC-KP30S620-PAR-SLB	SCC-KP30S620-PAR-BSL	
		High Temp Phenolic		SCC-KP30S620-PHRHT-SLB	SCC-KP30S620-PHR-BSL	
		Phenolic		SCC-KP30S620-PHR-SLB	SCC-KP30S620-PHRHT-BSL	
		Polyurethane/Steel (Green)		SCC-KP30S620-PUR-GB-SLB	SCC-KP30S620-PUR-GB-BSL	
		Polyurethane/Steel (Red)	1200	SCC-KP30S620-PUR-RS-SLB	SCC-KP30S620-PUR-RS-BSL	
		Solid Polyurethane		SCC-KP30S620-SPUR-SLB	SCC-KP30S620-SPUR-BSL	
		Semi Steel	1250	SCC-KP30S620-SSR-SLB	SCC-KP30S620-SSR-BSL	
		Semi Steel V-Groove		SCC-KP30S620-VGR-SLB	SCC-KP30S620-VGR-BSL	
		Glass Filled Nylon	1250	SCC-KP30S620-GFNR-SLB	SCC-KP30S620-GFNR-BSL	
		Nylon		SCC-KP30S620-NYR-SLB	SCC-KP30S620-NYR-BSL	

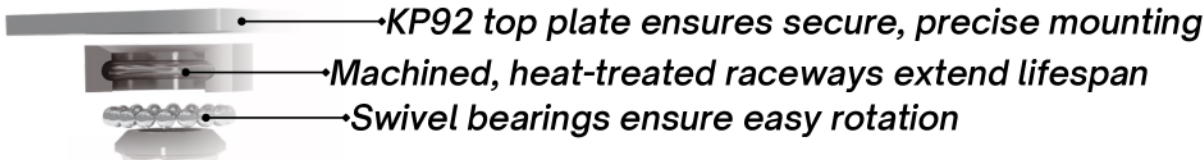



Side Lock Brake



Bolt-on Swivel Lock

SWIVEL CASTERS with Roller Bearings

Wheel Dia	Tread Width	Wheel Type	Load Capacity (lbs.)	Side Lock Brake (SLB)	Bolt-on Swivel Lock (BSL)	Overall Height
8"	2"	Rubber on Cast Iron	500	SCC-KP30S820-RSR-SLB	SCC-KP30S820-RSR-BSL	9-1/2"
		Thermoplastic Rubber (Donut)	600	SCC-KP30S820-TPRRD-SLB	SCC-KP30S820-TPRRD-BSL	
		Thermoplastic Rubber (Flat)		SCC-KP30S820-TPRRF-SLB	SCC-KP30S820-TPRRF-BSL	
		Rubber on Aluminum		SCC-KP30S820-RAR-SLB	SCC-KP30S820-RAR-BSL	
		Polyurethane on Polyolefin	800	SCC-KP30S820-PPUR-SLB	SCC-KP30S820-PPUR-BSL	
		Polyolefin	900	SCC-KP30S820-POR-SLB	SCC-KP30S820-POR-BSL	
		Solid Polyurethane	1200	SCC-KP30S820-SPUR-SLB	SCC-KP30S820-SPUR-BSL	
		Glass Filled Nylon	1250	SCC-KP30S820-GFNR-SLB	SCC-KP30S820-GFNR-BSL	
		Phenolic		SCC-KP30S820-PHR-SLB	SCC-KP30S820-PHR-BSL	
		Polyurethane/Steel (Green)		SCC-KP30S820-PUR-GB-SLB	SCC-KP30S820-PUR-GB-BSL	
		Polyurethane/Steel (Red)		SCC-KP30S820-PUR-RS-SLB	SCC-KP30S820-PUR-RS-BSL	
		High Temp Phenolic		SCC-KP30S820-PHRHT-SLB	SCC-KP30S820-PHRHT-BSL	
		Semi Steel		SCC-KP30S820-SSR-SLB	SCC-KP30S820-SSR-BSL	
		Semi Steel V-Groove		SCC-KP30S820-VGR-SLB	SCC-KP30S820-VGR-BSL	
		Polyurethane on Aluminum		SCC-KP30S820-PAR-SLB	SCC-KP30S820-PAR-BSL	
		Nylon		SCC-KP30S820-NYR-SLB	SCC-KP30S820-NYR-BSL	

WHAT ARE KINGPINLESS CASTERS?

Kingpinless casters lack a kingpin, removing a common weak point found in traditional casters. This design improves durability under heavy stress, making them ideal for heavy-duty applications.



BUILT TO LAST



ENGINEERED FOR EXCELLENCE



RAPID DELIVERY



SATISFACTION GUARANTEED





Ball Bearings: provide smooth rolling and noise reduction, are maintenance-free, and handle high temperatures.

SWIVEL & RIGID CASTERS

Wheel Dia.	Tread Width	Wheel Type	Load Capacity (lbs.)	Swivel Part Number	Swivel Weight (lbs.)	Rigid Part Number	Rigid Weight (lbs.)	Overall Height
4"	2"	Thermoplastic Rubber (Donut)	300	SCC-KP30S420-TPRBD	3.96	SCC-30R420-TPRBD	2.53	5-5/8"
		Thermoplastic Rubber (Flat)		SCC-KP30S420-TPRBF	3.96	SCC-30R420-TPRBF	2.53	
		Rubber on Aluminum	400	SCC-KP30S420-RAB	5.06	SCC-30R420-RAB	3.63	
		Rubber on Cast Iron		SCC-KP30S420-RSB	6.16	SCC-30R420-RSB	1.73	
		Polyolefin	500	SCC-KP30S420-POB	5.06	SCC-30R420-POB	3.63	
		Polyurethane on Polyolefin	600	SCC-KP30S420-PPUB	3.96	SCC-30R420-PPUB	2.53	
		High Temp Glass Filled Nylon		SCC-KP30S420-GFNBHT	5.72	SCC-30R420-GFNBHT	4.29	
		Polyurethane on Aluminum	700	SCC-KP30S420-PAB	5.06	SCC-30R420-PAB	3.63	
		Polyurethane/Steel (Green)		SCC-KP30S420-PUB-GB	6.16	SCC-30R420-PUB-GB	4.73	
		Polyurethane/Steel (Red)		SCC-KP30S420-PUB-RS	6.16	SCC-30R420-PUB-RS	4.73	
		Solid Polyurethane	800	SCC-KP30S420-SPUB	3.96	SCC-30R420-SPUB	2.53	
		Nylon		SCC-KP30S420-NYB	5.06	SCC-30R420-NYB	3.63	
		Phenolic		SCC-KP30S420-PHB	5.25	SCC-30R420-PHB	3.82	
		High Temp Phenolic		SCC-KP30S420-PHBHT	5.25	SCC-30R420-PHBHT	3.82	
		Semi Steel V-Groove		SCC-KP30S420-VGB	6.71	SCC-30R420-VGB	5.28	
Semi Steel	1000	SCC-KP30S420-SSB		5.06	SCC-30R420-SSB	3.63		
Glass Filled Nylon	1200	SCC-KP30S420-GFNB	5.06	SCC-30R420-GFNB	3.63			
5"	2"	Thermoplastic Rubber (Donut)	350	SCC-KP30S520-TPRBD	4.62	SCC-30R520-TPRBD	3.19	6-1/2"
		Thermoplastic Rubber (Flat)		SCC-KP30S520-TPRBF	4.62	SCC-30R520-TPRBF	3.19	
		Rubber on Cast Iron	400	SCC-KP30S520-RSB	6.16	SCC-30R520-RSB	4.73	
		Rubber on Aluminum	500	SCC-KP30S520-RAB	5.75	SCC-30R520-RAB	4.32	
		Polyolefin	650	SCC-KP30S520-POB	4.62	SCC-30R520-POB	3.19	
		Polyurethane on Polyolefin	750	SCC-KP30S520-PPUB	4.62	SCC-30R520-PPUB	3.19	
		Nylon	900	SCC-KP30S520-NYB	4.62	SCC-30R520-NYB	3.19	
		Polyurethane on Aluminum		SCC-KP30S520-PAB	5.28	SCC-30R520-PAB	3.85	
		Polyurethane/Steel (Green)	1000	SCC-KP30S520-PUB-GB	5.75	SCC-30R520-PUB-GB	4.32	
		Polyurethane/Steel (Red)		SCC-KP30S520-PUB-RS	5.75	SCC-30R520-PUB-RS	4.32	
		Solid Polyurethane		SCC-KP30S520-SPUB	6.60	SCC-30R520-SPUB	5.17	
		High Temp Glass Filled Nylon	1100	SCC-KP30S520-GFNBHT	6.60	SCC-30R520-GFNBHT	5.17	
		Phenolic		SCC-KP30S520-PHB	4.62	SCC-30R520-PHB	3.19	
		High Temp Phenolic		SCC-KP30S520-PHBHT	7.92	SCC-30R520-PHBHT	6.49	
		Semi Steel		SCC-KP30S520-SSB	4.62	SCC-30R520-SSB	3.19	
Semi Steel V-Groove	1100	SCC-KP30S520-VGB	8.58	SCC-30R520-VGB	7.15			
Glass Filled Nylon	1250	SCC-KP30S520-GFNB	7.70	SCC-30R520-GFNB	6.27			
6"	2"	Rubber on Cast Iron	450	SCC-KP30S620-RSB	6.50	SCC-30R620-RSB	5.07	7-1/2"
		Thermoplastic Rubber (Donut)	500	SCC-KP30S620-TPRBD	5.06	SCC-30R620-TPRBD	3.63	
		Thermoplastic Rubber (Flat)		SCC-KP30S620-TPRBF	5.06	SCC-30R620-TPRBF	3.63	
		Rubber on Aluminum	550	SCC-KP30S620-RAB	5.06	SCC-30R620-RAB	3.63	
		Polyolefin	700	SCC-KP30S620-POB	5.06	SCC-30R620-POB	3.63	
		Polyurethane on Polyolefin	900	SCC-KP30S620-PPUB	6.00	SCC-30R620-PPUB	4.07	
		High Temp Glass Filled Nylon	1100	SCC-KP30S620-GFNBHT	7.50	SCC-30R620-GFNBHT	6.07	
		Polyurethane on Aluminum	1200	SCC-KP30S620-PAB	7.50	SCC-30R620-PAB	6.50	
		Polyurethane/Steel (Green)		SCC-KP30S620-PUB-GB	8.58	SCC-30R620-PUB-GB	7.15	
		Polyurethane/Steel (Red)		SCC-KP30S620-PUB-RS	8.58	SCC-30R620-PUB-RS	7.15	
		Solid Polyurethane	1200	SCC-KP30S620-SPUB	5.06	SCC-30R620-SPUB	4.63	
		Phenolic		SCC-KP30S620-PHB	10.12	SCC-30R620-PHB	8.69	
		High Temp Phenolic		SCC-KP30S620-PHBHT	5.06	SCC-30R620-PHBHT	6.07	
		Semi Steel		SCC-KP30S620-SSB	8.85	SCC-30R620-SSB	7.15	
		Semi Steel V-Groove	1250	SCC-KP30S620-VGB	8.85	SCC-30R620-VGB	7.15	
Nylon	SCC-KP30S620-NYB	8.85		SCC-30R620-NYB	7.15			
Glass Filled Nylon	SCC-KP30S620-GFNB	7.70		SCC-30R620-GFNB	3.63			

Don't Stop Now – More Casters and **Sizes** Ahead!

SWIVEL & RIGID CASTERS *with Ball Bearing Wheels*

Wheel Dia	Tread Width	Wheel Type	Load Capacity (lbs.)	Swivel Part Number	Swivel Weight (lbs.)	Rigid Part Number	Rigid Weight (lbs.)	Overall Height
8"	2"	Rubber on Cast Iron	500	SCC-KP30S820-RSE	9.68	SCC-30R820-RSB	8.25	9-1/2"
		Thermoplastic Rubber (Donut)	600	SCC-KP30S820-TPRBD	5.50	SCC-30R820-TPRBD	4.07	
		Thermoplastic Rubber (Flat)		SCC-KP30S820-TPRBF	5.50	SCC-30R820-TPRBF	4.07	
		Rubber on Aluminum	900	SCC-KP30S820-RAB	7.50	SCC-30R820-RAB	9.04	
		Polyolefin		SCC-KP30S820-POB	5.50	SCC-30R820-POB	4.07	
		Polyurethane on Polyolefin	1000	SCC-KP30S820-PPUB	5.50	SCC-30R820-PPUB	4.07	
		High Temp Glass Filled Nylon	1200	SCC-KP30S820-GFNBHT	5.50	SCC-30R820-GFNBHT	4.07	
		Solid Polyurethane		SCC-KP30S820-SPUB	7.75	SCC-30R820-SPUB	6.32	
		Polyurethane on Aluminum	1400	SCC-KP30S820-PAB	5.50	SCC-30R820-PAB	4.07	
		Polyurethane/Steel (Green)		SCC-KP30S820-PUB-GB	5.50	SCC-30R820-PUB-GB	4.07	
		Polyurethane/Steel (Red)		SCC-KP30S820-PUB-RS	5.50	SCC-30R820-PUB-RS	4.07	
		Phenolic		SCC-KP30S820-PHB	7.75	SCC-30R820-PHB	6.32	
		High Temp Phenolic		SCC-KP30S820-PHBHT	12.10	SCC-30R820-PHBHT	10.67	
		Semi Steel		SCC-KP30S820-SSB	12.10	SCC-30R820-SSB	10.67	
		Semi Steel V-Groove		SCC-KP30S820-VGB	12.10	SCC-30R820-VGB	10.67	
		Nylon		SCC-KP30S820-NYB	12.10	SCC-30R820-NYB	10.67	
Glass Filled Nylon	SCC-KP30S820-GFNB	12.10		SCC-30R820-GFNB	10.67			

UNIVERSAL SIDE BRAKE



**THE SIDE LOCK BRAKE ON CASTERS
SECURELY LOCKS THE WHEEL, ENSURING
STABILITY AND SAFETY.**

Moving You Forward...



SWIVEL CASTERS with Ball Bearings

Wheel Dia.	Tread Width	Wheel Type	Load Capacity (lbs.)	Side Lock Brake (SLB)	Bolt-on Swivel Lock (BSL)	Overall Height
4"	2"	Thermoplastic Rubber (Donut)	300	SCC-KP30S420-TPRBD-SLB	SCC-KP30S420-TPRBD-BSL	5-5/8"
		Thermoplastic Rubber (Flat)		SCC-KP30S420-TPRBF-SLB	SCC-KP30S420-TPRBF-BSL	
		Rubber on Aluminum		SCC-KP30S420-RAB-SLB	SCC-KP30S420-RAB-BSL	
		Rubber on Cast Iron	400	SCC-KP30S420-RSB-SLB	SCC-KP30S420-RSB-BSL	
		Polyolefin		SCC-KP30S420-POB-SLB	SCC-KP30S420-POB-BSL	
		Polyurethane on Polyolefin		SCC-KP30S420-PPUB-SLB	SCC-KP30S420-PPUB-BSL	
		Nylon	500	SCC-KP30S420-NYB-SLB	SCC-KP30S420-NYB-BSL	
		Polyurethane on Aluminum		SCC-KP30S420-PAB-SLB	SCC-KP30S420-PAB-BSL	
		Polyurethane/Steel (Green)		SCC-KP30S420-PUB-GB-SLB	SCC-KP30S420-PUB-GB-BSL	
		Polyurethane/Steel (Red)	700	SCC-KP30S420-PUB-RS-SLB	SCC-KP30S420-PUB-RS-BSL	
		Solid Polyurethane		SCC-KP30S420-SPUB-SLB	SCC-KP30S420-SPUB-BSL	
		High Temp Phenolic		SCC-KP30S420-PHBHT-SLB	SCC-KP30S420-PHBHT-BSL	
		Phenolic	800	SCC-KP30S420-PHB-SLB	SCC-KP30S420-PHB-BSL	
		Semi Steel V-Groove		SCC-KP30S420-VGB-SLB	SCC-KP30S420-VGB-BSL	
		Semi Steel		SCC-KP30S420-SSB-SLB	SCC-KP30S420-SSB-BSL	
Glass Filled Nylon	1000	SCC-KP30S420-GFNB-SLB	SCC-KP30S420-GFNB-BSL			
			1200	SCC-KP30S420-GFNB-SLB	SCC-KP30S420-GFNB-BSL	
5"	2"	Thermoplastic Rubber (Donut)	350	SCC-KP30S520-TPRBD-SLB	SCC-KP30S520-TPRBF-BSL	6-1/2"
		Thermoplastic Rubber (Flat)		SCC-KP30S520-TPRBF-SLB	SCC-KP30S520-TPRBD-BSL	
		Rubber on Cast Iron		SCC-KP30S520-RSB-SLB	SCC-KP30S520-RSB-BSL	
		Rubber on Aluminum	400	SCC-KP30S520-RAB-SLB	SCC-KP30S520-RAB-BSL	
		Polyolefin		SCC-KP30S520-POB-SLB	SCC-KP30S520-POB-BSL	
		Polyurethane on Polyolefin		SCC-KP30S520-PPUB-SLB	SCC-KP30S520-PPUB-BSL	
		Nylon	650	SCC-KP30S520-NYB-SLB	SCC-KP30S520-NYB-BSL	
		Polyurethane on Aluminum		SCC-KP30S520-PAB-SLB	SCC-KP30S520-PAB-BSL	
		High Temp Phenolic		SCC-KP30S520-PHBHT-SLB	SCC-KP30S520-PHBHT-BSL	
		Phenolic	900	SCC-KP30S520-PHB-SLB	SCC-KP30S520-PHB-BSL	
		Polyurethane/Steel (Green)		SCC-KP30S520-PUB-GB-SLB	SCC-KP30S520-PUB-GB-BSL	
		Polyurethane/Steel (Red)		SCC-KP30S520-PUB-RS-SLB	SCC-KP30S520-PUB-RS-BSL	
		Solid Polyurethane	1000	SCC-KP30S520-SPUB-SLB	SCC-KP30S520-SPUB-BSL	
		Semi Steel		SCC-KP30S520-SSB-SLB	SCC-KP30S520-SSB-BSL	
		Semi Steel V-Groove		SCC-KP30S520-VGB-SLB	SCC-KP30S520-VGB-BSL	
Glass Filled Nylon	1250	SCC-KP30S520-GFNB-SLB	SCC-KP30S520-GFNB-BSL			
				SCC-KP30S520-GFNB-SLB	SCC-KP30S520-GFNB-BSL	
6"	2"	Rubber on Cast Iron	450	SCC-KP30S620-RSB-SLB	SCC-KP30S620-RSB-BSL	7-1/2"
		Thermoplastic Rubber (Donut)		SCC-KP30S620-TPRBD-SLB	SCC-KP30S620-TPRBD-BSL	
		Thermoplastic Rubber (Flat)		SCC-KP30S620-TPRBF-SLB	SCC-KP30S620-TPRBF-BSL	
		Rubber on Aluminum	500	SCC-KP30S620-RAB-SLB	SCC-KP30S620-RAB-BSL	
		Polyolefin		SCC-KP30S620-POB-SLB	SCC-KP30S620-POB-BSL	
		Polyurethane on Polyolefin		SCC-KP30S620-PPUB-SLB	SCC-KP30S620-PPUB-BSL	
		Polyurethane on Aluminum	550	SCC-KP30S620-PAB-SLB	SCC-KP30S620-PAB-BSL	
		High Temp Phenolic		SCC-KP30S620-PHBHT-SLB	SCC-KP30S620-PHBHT-BSL	
		Phenolic		SCC-KP30S620-PHB-SLB	SCC-KP30S620-PHB-BSL	
		Polyurethane/Steel (Green)	700	SCC-KP30S620-PUB-GB-SLB	SCC-KP30S620-PUB-GB-BSL	
		Polyurethane/Steel (Red)		SCC-KP30S620-PUB-RS-SLB	SCC-KP30S620-PUB-RS-BSL	
		Solid Polyurethane		SCC-KP30S620-SPUB-SLB	SCC-KP30S620-SPUB-BSL	
		Semi Steel	900	SCC-KP30S620-SSB-SLB	SCC-KP30S620-SSB-BSL	
		Semi Steel V-Groove		SCC-KP30S620-VGB-SLB	SCC-KP30S620-VGB-BSL	
		Glass Filled Nylon		SCC-KP30S620-GFNB-SLB	SCC-KP30S620-GFNB-BSL	
Nylon	1200	SCC-KP30S620-NYB-SLB	SCC-KP30S620-NYB-BSL			
				SCC-KP30S620-NYB-SLB	SCC-KP30S620-NYB-BSL	





Side Lock Brake



Bolt-on Swivel Lock

TOP PLATE CASTERS *Ball Bearing Wheels*

Wheel Dia	Tread Width	Wheel Type	Load Capacity (lbs.)	Side Lock Brake (SLB)	Bolt-on Swivel Lock (BSL)	Overall Height
8"	2"	Rubber on Cast Iron	500	SCC-KP30S820-RSB-SLB	SCC-KP30S820-RSB-BSL	9-1/2"
		Thermoplastic Rubber (Donut)	600	SCC-KP30S820-TPRBD-SLB	SCC-KP30S820-TPRBD-BSL	
		Thermoplastic Rubber (Flat)		SCC-KP30S820-TPRBF-SLB	SCC-KP30S820-TPRBF-BSL	
		Rubber on Aluminum	800	SCC-KP30S820-RAB-SLB	SCC-KP30S820-RAB-BSL	
		Polyurethane on Polyolefin		SCC-KP30S820-PPUB-SLB	SCC-KP30S820-PPUB-BSL	
		Polyolefin	900	SCC-KP30S820-POB-SLB	SCC-KP30S820-POB-BSL	
		Solid Polyurethane	1200	SCC-KP30S820-SPUB-SLB	SCC-KP30S820-SPUB-BSL	
		Glass Filled Nylon	1250	SCC-KP30S820-GFNB-SLB	SCC-KP30S820-GFNB-BSL	
		Phenolic		SCC-KP30S820-PHB-SLB	SCC-KP30S820-PHB-BSL	
		Polyurethane/Steel (Green)		SCC-KP30S820-PUB-GB-SLB	SCC-KP30S820-PUB-GB-BSL	
		Polyurethane/Steel (Red)		SCC-KP30S820-PUB-RS-SLB	SCC-KP30S820-PUB-RS-BSL	
		High Temp Phenolic		SCC-KP30S820-PHBHT-SLB	SCC-KP30S820-PHBHT-BSL	
		Semi Steel		SCC-KP30S820-SSB-SLB	SCC-KP30S820-SSB-BSL	
		Semi Steel V-Groove		SCC-KP30S820-VGB-SLB	SCC-KP30S820-VGB-BSL	
		Polyurethane on Aluminum		SCC-KP30S820-PAB-SLB	SCC-KP30S820-PAB-BSL	
		Nylon		SCC-KP30S820-NYB-SLB	SCC-KP30S820-NYB-BSL	

If you didn't find exactly what you needed, don't worry—our [customer service](#) team is here to help with even more options!



NEED MORE WEIGHT!?
CHECK OUT OUR
SUPER/EXTREME SERIES

- KP35
- KP91
- KP92
- KP93
- KP94
- KP95

ALSO AVAILABLE IN
DUAL WHEELS

Medium/Heavy Duty Casters

Series #30 Stainless Steel Casters

Capacity up to 1250 lbs.

Featuring all stainless steel caster assemblies, including swivel fork, bearings, axle, and spanner bushing. Series #30 offers durable, washable solutions for wet locations, protecting against corrosion. Read our article on stainless steel and magnetism for more details.

Features

- Quality casters with stainless steel forks and top plates.
- Swivel casters include stainless steel ball bearing raceways.
- Axles and roller bearings made from stainless steel.
- Features spanner bushings and thrust washers in stainless steel.
- Equipped with stainless steel grease fittings for maintenance.

Applications

- Healthcare
- Foodservice
- Laboratories
- Marine
- Pharmaceuticals
- Cleanrooms



Request for CAD



Scan QR code to play video



Service Caster Chart Guide

Build You Caster

Discover more fastening sizes and wheel options if you can't find what you need. And remember, we're always here to [help!](#)

Series	Mounting	Rig Type	Mounting Size	Bolt Pattern	Wheel Size	Bearing Type	Brake	Wheel Material
30	Top Plate	Swivel (S)	4" x 4-1/2"	2-5/8" x 3-5/8" to 3" x 3"	3-1/4" x 2" (3420)	Ball Bearing (B)	Top Lock (TLB)	Soft Rubber (SR)
		Rigid (R)	4-1/2" x 6-1/4" (TP2)	2-7/16" x 4-15/16" to 3-3/8" x 5-1/4"	4" x 2" (420)	Plain Bore (S)	Posi Lock (PLB)	Thermo Plastic Rubber (TPR)
			5" x 5-1/2" (TP3)	4-1/8" x 4-1/2"	5" x 2" (520)	Delrin Bearing (D)	Total Lock (TTL)	Polyurethane (PPU)
					6" x 2" (620)	Roller Bearing (R)	Front Total Lock (FTL)	Phenolic (PH)
					8" x 2" (820)	Precision Bearing (PB)	Side Lock (SLB)	Solid Polyurethane (SPU)
						Bronze Bearing (BZ)	Face Contact (FCB)	Hard Rubber (HR)
							Bolt-on Swivel Lock (BSL)	Glass Filled Nylon (GFN)
							Weld-on Swivel Lock (WSL)	Rubber on Aluminum (RA)
								Semi Steel (SS)
								Nylon (NY)
								High Temp Phenolic (PH*HT)
								High Temp Nylon (GF*HT)

Solid Polyurethane wheels with stainless steel casters are durable, chemical-resistant, and ideal for heavy-duty and hygienic use.



Wheel Treads



Is Stainless Steel Non-Magnetic
Stainless steel casters can be magnetic. Ferritic stainless steel, used in our casters, is magnetic. Non-magnetic steel contains nickel.

Top Plate Size Option(s)

Our Stainless Steel Series #30 Heavy-Duty Casters, with up to 1,250-pound capacity and high shock absorption wheels. Available in rigid or swivel options, with various plate sizes, wheel bearings, and wheel brakes.

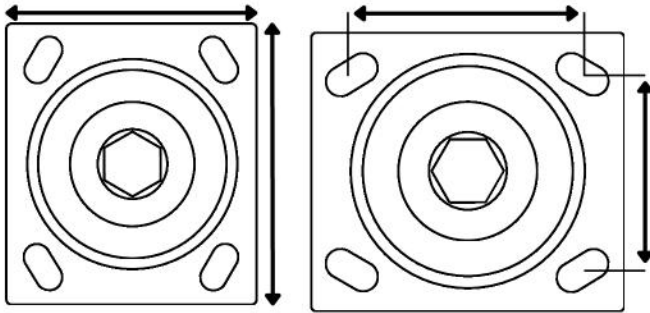

Standard Plate Size	Bolt Pattern	Bolt Diameter
4" x 4-1/2"	2-5/8" x 3-5/8" to 3" x 3"	3/8"
4-1/2" x 6-1/4" (TP2)	2-7/16" x 4-15/16" to 3-3/8" x 5-1/4"	1/2"
5" x 5-1/2" (TP3)	4-1/8" x 4-1/2"	1/2"

Choose Your Movement

- Rigid and Swivel Available



RIGID



SWIVEL

Bearing Type(s)

Roller Bearing

Anti-friction bearing, ideal for manual applications with prevalent shock loading.



Ball Bearing

Ball bearing provides smooth movement and durability.



Delrin Bearing

Delrin bearings, maintenance-free, ideal for wash-downs, max 180°F.



Bronze Bearing

Bronze bearings are durable, corrosion-resistant, and withstand up to 525°F.



Brake Option(s)

Top Lock Brake (TLB)

The **Top lock brake** places a positive locking force against the wheel hub locking the wheel only.



SCC-SS30S820-SPUR-TLB

Total Lock Brake (TTL)

The **total lock** on casters secures both the wheel and swivel, ensuring complete stability for reliable and safe use.



SCC-SSTTL30S620-TPRRF

Side Lock Brake (SLB)

The **side lock brake** on casters securely locks the wheel, ensuring stability and safety.



SCC-SS30S620-NYR-SLB

Bolt-on Swivel Lock (BSL)

The **bolt-on swivel lock** secures swivel casters, preventing unwanted movement. Easy to install, it ensures stability.



SCC-SS30S620-NYR-BSL





STAINLESS STEEL

TOP PLATE CASTERS *Roller Bearing Wheels*

Wheel Dia	Tread Width	Wheel Type	Load Capacity (lbs.)	Overall Height	Swivel Part Number	Swivel Weight (lbs.)	Rigid Part Number	Rigid Weight (lbs.)
4"	2"	Thermoplastic Rubber (Donut)	300	5-5/8"	SCC-SS30S420-TPRRD	3.96	SCC-SS30R420-TPRRD	2.53
		Thermoplastic Rubber (Flat)			SCC-SS30S420-TPRRF	3.96	SCC-SS30R420-TPRRF	2.53
		Rubber on Aluminum	400		SCC-SS30S420-RAR	5.06	SCC-SS30R420-RAR	3.63
		Rubber on Cast Iron			SCC-SS30S420-RSR	6.16	SCC-SS30R420-RSR	1.73
		Polyolefin	500		SCC-SS30S420-POR	5.06	SCC-SS30R420-POR	3.63
		Polyurethane on Polyolefin	600		SCC-SS30S420-PPUR	3.96	SCC-SS30R420-PPUR	2.53
		Polyurethane on Aluminum	700		SCC-SS30S420-PAR	5.06	SCC-SS30R420-PAR	3.63
		Polyurethane/Steel (Green)			SCC-SS30S420-PUR-GB	6.16	SCC-SS30R420-PUR-GB	4.73
		Polyurethane/Steel (Red)			SCC-SS30S420-PUR-RS	6.16	SCC-SS30R420-PUR-RS	4.73
		Solid Polyurethane			SCC-SS30S420-SPUR	3.96	SCC-SS30R420-SPUR	2.53
		Nylon			SCC-SS30S420-NYR	5.06	SCC-SS30R420-NYR	3.63
		Phenolic	800		SCC-SS30S420-PHR	5.25	SCC-SS30R420-PHR	3.82
		Semi Steel V-Groove			SCC-SS30S420-VGR	6.71	SCC-SS30R420-VGR	5.28
		Glass Filled Nylon	900		SCC-SS30S420-GFNR	5.06	SCC-SS30R420-GFNR	3.63
		Semi Steel	1000		SCC-SS30S420-SSR	5.72	SCC-SS30R420-SSR	4.29
5"	2"	Thermoplastic Rubber (Donut)	350	6-1/2"	SCC-SS30S520-TPRRD	4.62	SCC-SS30R520-TPRRD	3.19
		Thermoplastic Rubber (Flat)			SCC-SS30S520-TPRRF	4.62	SCC-SS30R520-TPRRF	3.19
		Rubber on Cast Iron	400		SCC-SS30S520-RSR	6.16	SCC-SS30R520-RSR	4.73
		Rubber on Aluminum	500		SCC-SS30S520-RAR	5.75	SCC-SS30R520-RAR	4.32
		Polyolefin	650		SCC-SS30S520-POR	4.62	SCC-SS30R520-POR	3.19
		Polyurethane on Polyolefin	750		SCC-SS30S520-PPUR	4.62	SCC-SS30R520-PPUR	3.19
		Nylon	900		SCC-SS30S520-NYR	4.62	SCC-SS30R520-NYR	3.19
		Polyurethane on Aluminum			SCC-SS30S520-PAR	5.28	SCC-SS30R520-PAR	3.85
		Phenolic	1000		SCC-SS30S520-PHR	5.75	SCC-SS30R520-PHR	4.32
		High Temp Phenolic			SCC-SS30S520-PHRHT	5.75	SCC-SS30R520-PHRHT	4.32
		Polyurethane/Steel (Green)			SCC-SS30S520-PUR-GB	6.60	SCC-SS30R520-PUR-GB	5.17
		Polyurethane/Steel (Red)			SCC-SS30S520-PUR-RS	6.60	SCC-SS30R520-PUR-RS	5.17
		Solid Polyurethane			SCC-SS30S520-SPUR	4.62	SCC-SS30R520-SPUR	3.19
		Semi Steel	1100		SCC-SS30S520-SSR	7.92	SCC-SS30R520-SSR	6.49
		Semi Steel V-Groove			SCC-SS30S520-VGR	8.58	SCC-SS30R520-VGR	7.15
Glass Filled Nylon	SCC-SS30S520-GFNR	4.62		SCC-SS30R520-GFNR	3.19			
6"	2"	Rubber on Cast Iron	450	7-1/2"	SCC-SS30S620-RSR	7.70	SCC-SS30R620-RSR	6.27
		Thermoplastic Rubber (Donut)	500		SCC-SS30S620-TPRRD	5.06	SCC-SS30R620-TPRRD	3.63
		Thermoplastic Rubber (Flat)			SCC-SS30S620-TPRRF	5.06	SCC-SS30R620-TPRRF	3.63
		Rubber on Aluminum	550		SCC-SS30S620-RAR	6.50	SCC-SS30R620-RAR	5.07
		Polyolefin	700		SCC-SS30S620-POR	5.06	SCC-SS30R620-POR	3.63
		Polyurethane on Polyolefin	900		SCC-SS30S620-PPUR	5.06	SCC-SS30R620-PPUR	3.63
		Polyurethane on Aluminum	1200		SCC-SS30S620-PAR	6.00	SCC-SS30R620-PAR	4.07
		Phenolic			SCC-SS30S620-PHR	7.50	SCC-SS30R620-PHR	6.07
		High Temp Phenolic			SCC-SS30S620-PHRHT	7.50	SCC-SS30R620-PHRHT	6.50
		Polyurethane/Steel (Green)			SCC-SS30S620-PUR-GB	8.58	SCC-SS30R620-PUR-GB	7.15
		Polyurethane/Steel (Red)			SCC-SS30S620-PUR-RS	8.58	SCC-SS30R620-PUR-RS	7.15
		Solid Polyurethane	1250		SCC-SS30S620-SPUR	5.06	SCC-SS30R620-SPUR	3.63
		Semi Steel			SCC-SS30S620-SSR	8.85	SCC-SS30R620-SSR	7.15
		Semi Steel V-Groove			SCC-SS30S620-VGR	10.12	SCC-SS30R620-VGR	8.69
		Glass Filled Nylon	1250		SCC-SS30S620-GFNR	5.06	SCC-SS30R620-GFNR	3.63
Nylon	SCC-SS30S620-NYR	5.06		SCC-SS30R620-NYR	3.63			

Wheel with an 8" Diameter on the following page.



Stainless Steel casters are perfect for food processing, breweries, hospitals, cleanrooms, and marinas. Common uses include pharmaceutical tables, medical equipment, hotel food carts, and laundry carts. We offer Grade 304 and **Grade 316 stainless steel** casters, with Grade 316 being more corrosion-resistant due to added molybdenum and nickel, making it ideal for environments exposed to chlorides, de-icing salts, saltwater, and harsh cleaning agents.

TOP PLATE CASTERS *with Roller Bearing Wheels*

Wheel Dia	Tread Width	Wheel Type	Load Capacity (lbs.)	Overall Height	Swivel Part Number	Swivel Weight (lbs.)	Rigid Part Number	Rigid Weight (lbs.)
8"	2"	Rubber on Cast Iron	500	9-1/2"	SCC-SS30S820-RSR	9.68	SCC-SS30R820-RSR	8.25
		Thermoplastic Rubber (Donut)	600		SCC-SS30S820-TPRRD	5.50	SCC-SS30R820-TPRRD	4.07
		Thermoplastic Rubber (Flat)			SCC-SS30S820-TPRRF	5.50	SCC-SS30R820-TPRRF	4.07
		Rubber on Aluminum	800		SCC-SS30S820-RAR	7.50	SCC-SS30R820-RAR	9.04
		Polyurethane on Polyolefin			SCC-SS30S820-PPUR	5.50	SCC-SS30R820-PPUR	4.07
		Polyolefin	900		SCC-SS30S820-POR	5.50	SCC-SS30R820-POR	4.07
		Solid Polyurethane	1200		SCC-SS30S820-SPUR	5.50	SCC-SS30R820-SPUR	4.07
		Glass Filled Nylon	1250		SCC-SS30S820-GFNR	5.50	SCC-SS30R820-GFNR	4.07
		Nylon			SCC-SS30S820-NYR	5.50	SCC-SS30R820-NYR	4.07
		Polyurethane on Aluminum			SCC-SS30S820-PAR	5.50	SCC-SS30R820-PAR	4.07
		Phenolic			SCC-SS30S820-PHR	7.75	SCC-SS30R820-PHR	6.32
		High Temp Phenolic			SCC-SS30S820-PHRHT	7.75	SCC-SS30R820-PHRHT	6.32
		Polyurethane/Steel (Green)			SCC-SS30S820-PUR-GB	12.10	SCC-SS30R820-PUR-GB	10.67
		Polyurethane/Steel (Red)			SCC-SS30S820-PUR-RS	12.10	SCC-SS30R820-PUR-RS	10.67
		Semi Steel			SCC-SS30S820-SSR	12.10	SCC-SS30R820-SSR	10.67
		Semi Steel V-Groove			SCC-SS30S820-VGR	12.10	SCC-SS30R820-VGR	10.67



Stainless Roller Bearings: Stainless steel bearings combine strength, reliability, and longevity, making them a smart choice for demanding applications.

Scan QR code to play video



Get in the Know: Watch the Video!

Discover the details by watching our video!



Grade 316 Stainless Steel

Contains additional molybdenum and nickel content, making it more corrosion resistant than standard 304 stainless steel

▶ 🔊 0:00 / 0:51
⚙️ 📏

STAINLESS STEEL

TOP PLATE CASTERS with Roller Bearings & Brakes



Wheel Dia.	Tread Width	Wheel Type	Load Capacity (lbs.)	Overall Height	Top Lock Brake (TLB)	Total Lock Brake (TTL)	Bolt-on Swivel Lock (BSL)
4"	2"	Thermoplastic Rubber (Donut)	300	5-5/8"	SCC-SS30S420-TPRRD-TLB	SCC-SSTTL30S420-TPRRD	SCC-SS30S420-TPRRD-BSL
		Thermoplastic Rubber (Flat)			SCC-SS30S420-TPRRF-TLB	SCC-SSTTL30S420-TPRRF	SCC-SS30S420-TPRRF-BSL
		Rubber on Aluminum	400		SCC-SS30S420-RAR-TLB	SCC-SSTTL30S420-RAR	SCC-SS30S420-RAR-BSL
		Rubber on Cast Iron			SCC-SS30S420-RSR-TLB	SCC-SSTTL30S420-RSR	SCC-SS30S420-RSR-BSL
		Polyolefin	500		SCC-SS30S420-POR-TLB	SCC-SSTTL30S420-POR	SCC-SS30S420-POR-BSL
		Polyurethane on Polyolefin	600		SCC-SS30S420-PPUR-TLB	SCC-SSTTL30S420-PPUR	SCC-SS30S420-PPUR-BSL
		Nylon	800		SCC-SS30S420-NYR-TLB	SCC-SSTTL30S420-NYR	SCC-SS30S420-NYR-BSL
		Polyurethane on Aluminum	700		SCC-SS30S420-PAR-TLB	SCC-SSTTL30S420-PAR	SCC-SS30S420-PAR-BSL
		Polyurethane/Steel (Green)			SCC-SS30S420-PUR-GB-TLB	SCC-SSTTL30S420-PUR-GB	SCC-SS30S420-PUR-GB-BSL
		Polyurethane/Steel (Red)			SCC-SS30S420-PUR-RS-TLB	SCC-SSTTL30S420-PUR-RS	SCC-SS30S420-PUR-RS-BSL
		Solid Polyurethane			SCC-SS30S420-SPUR-TLB	SCC-SSTTL30S420-SPUR	SCC-SS30S420-SPUR-BSL
		High Temp Phenolic	800		SCC-SS30S420-PHRHT-TLB	SCC-SSTTL30S420-PHRHT	SCC-SS30S420-PHRHT-BSL
		Phenolic			SCC-SS30S420-PHR-TLB	SCC-SSTTL30S420-PHR	SCC-SS30S420-PHR-BSL
		Semi Steel V-Groove			SCC-SS30S420-VGR-TLB	SCC-SSTTL30S420-VGR	SCC-SS30S420-VGR-BSL
		Semi Steel	1000		SCC-SS30S420-SSR-TLB	SCC-SSTTL30S420-SSR	SCC-SS30S420-SSR-BSL
		Glass Filled Nylon	1200		SCC-SS30S420-GFNR-TLB	SCC-SSTTL30S420-GFNR	SCC-SS30S420-GFNR-BSL
5"	2"	Thermoplastic Rubber (Donut)	350	6-1/2"	SCC-SS30S520-TPRRD-TLB	SCC-SSTTL30S520-TPRRD	SCC-SS30S520-TPRRD-BSL
		Thermoplastic Rubber (Flat)			SCC-SS30S520-TPRRF-TLB	SCC-SSTTL30S520-TPRRF	SCC-SS30S520-TPRRF-BSL
		Rubber on Cast Iron	400		SCC-SS30S520-RSR-TLB	SCC-SSTTL30S520-RSR	SCC-SS30S520-RSR-BSL
		Rubber on Aluminum	500		SCC-SS30S520-RAR-TLB	SCC-SSTTL30S520-RAR	SCC-SS30S520-RAR-BSL
		Polyolefin	650		SCC-SS30S520-POR-TLB	SCC-SSTTL30S520-POR	SCC-SS30S520-POR-BSL
		Polyurethane on Polyolefin	750		SCC-SS30S520-PPUR-TLB	SCC-SSTTL30S520-PPUR	SCC-SS30S520-PPUR-BSL
		Nylon	900		SCC-SS30S520-NYR-TLB	SCC-SSTTL30S520-NYR	SCC-SS30S520-NYR-BSL
		Polyurethane on Aluminum	1000		SCC-SS30S520-PAR-TLB	SCC-SSTTL30S520-PAR	SCC-SS30S520-PAR-BSL
		High Temp Phenolic			SCC-SS30S520-PHRHT-TLB	SCC-SSTTL30S520-PHRHT	SCC-SS30S520-PHRHT-BSL
		Phenolic			SCC-SS30S520-PHR-TLB	SCC-SSTTL30S520-PHR	SCC-SS30S520-PHR-BSL
		Polyurethane/Steel (Green)			SCC-SS30S520-PUR-GB-TLB	SCC-SSTTL30S520-PUR-GB	SCC-SS30S520-PUR-GB-BSL
		Polyurethane/Steel (Red)	SCC-SS30S520-PUR-RS-TLB		SCC-SSTTL30S520-PUR-RS	SCC-SS30S520-PUR-RS-BSL	
		Solid Polyurethane	SCC-SS30S520-SPUR-TLB		SCC-SSTTL30S520-SPUR	SCC-SS30S520-SPUR-BSL	
		Semi Steel	SCC-SS30S520-SSR-TLB		SCC-SSTTL30S520-SSR	SCC-SS30S520-SSR-BSL	
		Semi Steel V-Groove	SCC-SS30S520-VGR-TLB		SCC-SSTTL30S520-VGR	SCC-SS30S520-VGR-BSL	
		Glass Filled Nylon	1250		SCC-SS30S520-GFNR-TLB	SCC-SSTTL30S520-GFNR	SCC-SS30S520-GFNR-BSL
6"	2"	Rubber on Cast Iron	450	7-1/2"	SCC-SS30S620-RSR-TLB	SCC-SSTTL30S620-RSR	SCC-SS30S620-RSR-BSL
		Thermoplastic Rubber (Donut)	500		SCC-SS30S620-TPRRD-TLB	SCC-SSTTL30S620-TPRRD	SCC-SS30S620-TPRRD-BSL
		Thermoplastic Rubber (Flat)			SCC-SS30S620-TPRRF-TLB	SCC-SSTTL30S620-TPRRF	SCC-SS30S620-TPRRF-BSL
		Rubber on Aluminum	550		SCC-SS30S620-RAR-TLB	SCC-SSTTL30S620-RAR	SCC-SS30S620-RAR-BSL
		Polyolefin	700		SCC-SS30S620-POR-TLB	SCC-SSTTL30S620-POR	SCC-SS30S620-POR-BSL
		Polyurethane on Polyolefin	900		SCC-SS30S620-PPUR-TLB	SCC-SSTTL30S620-PPUR	SCC-SS30S620-PPUR-BSL
		Polyurethane on Aluminum	1200		SCC-SS30S620-PAR-TLB	SCC-SSTTL30S620-PAR	SCC-SS30S620-PAR-BSL
		High Temp Phenolic			SCC-SS30S620-PHRHT-TLB	SCC-SSTTL30S620-PHRHT	SCC-SS30S620-PHRHT-BSL
		Phenolic			SCC-SS30S620-PHR-TLB	SCC-SSTTL30S620-PHR	SCC-SS30S620-PHR-BSL
		Polyurethane/Steel (Green)			SCC-SS30S620-PUR-GB-TLB	SCC-SSTTL30S620-PUR-GB	SCC-SS30S620-PUR-GB-BSL
		Polyurethane/Steel (Red)	SCC-SS30S620-PUR-RS-TLB		SCC-SSTTL30S620-PUR-RS	SCC-SS30S620-PUR-RS-BSL	
		Solid Polyurethane	SCC-SS30S620-SPUR-TLB		SCC-SSTTL30S620-SPUR	SCC-SS30S620-SPUR-BSL	
		Semi Steel	SCC-SS30S620-SSR-TLB		SCC-SSTTL30S620-SSR	SCC-SS30S620-SSR-BSL	
		Semi Steel V-Groove	SCC-SS30S620-VGR-TLB		SCC-SSTTL30S620-VGR	SCC-SS30S620-VGR-BSL	
		Glass Filled Nylon	1250		SCC-SS30S620-GFNR-TLB	SCC-SSTTL30S620-GFNR	SCC-SS30S620-GFNR-BSL
		Nylon			SCC-SS30S620-NYR-TLB	SCC-SSTTL30S620-NYR	SCC-SS30S620-NYR-BSL

Wheel with an 8" Diameter on the following page.



"THE UNSEEN HEROES"

Castors and Wheels Revolutionizing Everyday Mobility



READ MORE →



TOP PLATE CASTERS *with Roller Bearings & Brakes*

Wheel Dia	Tread Width	Wheel Type	Load Capacity (lbs.)	Overall Height	Side Lock Brake (SLB) Top Lock Brake (TLB)	Total Lock Brake (TTL)	Bolt-on Swivel Lock (BSL)
8"	2"	Rubber on Cast Iron	500	9-1/2"	SCC-SS30S820-RSR-TLB	SCC-SSTTL30S820-RSR	SCC-SS30S820-RSR-BSL
		Thermoplastic Rubber (Donut)	600		SCC-SS30S820-TPRRD-TLB	SCC-SSTTL30S820-TPRRD	SCC-SS30S820-TPRRD-BSL
		Thermoplastic Rubber (Flat)			SCC-SS30S820-TPRRF-TLB	SCC-SSTTL30S820-TPRRF	SCC-SS30S820-TPRRF-BSL
		Rubber on Aluminum	800		SCC-SS30S820-RAR-TLB	SCC-SSTTL30S820-RAR	SCC-SS30S820-RAR-BSL
		Polyurethane on Polyolefin			SCC-SS30S820-PPUR-TLB	SCC-SSTTL30S820-PPUR	SCC-SS30S820-PPUR-BSL
		Polyolefin	900		SCC-SS30S820-POR-TLB	SCC-SSTTL30S820-POR	SCC-SS30S820-POR-BSL
		Solid Polyurethane	1200		SCC-SS30S820-SPUR-TLB	SCC-SSTTL30S820-SPUR	SCC-SS30S820-SPUR-BSL
		Glass Filled Nylon	1250		SCC-SS30S820-GFNR-TLB	SCC-SSTTL30S820-GFNR	SCC-SS30S820-GFNR-BSL
		Phenolic			SCC-SS30S820-PHR-TLB	SCC-SSTTL30S820-PHR	SCC-SS30S820-PHR-BSL
		Polyurethane/Steel (Green)			SCC-SS30S820-PUR-GB-TLB	SCC-SSTTL30S820-PUR-GB	SCC-SS30S820-PUR-GB-BSL
		Polyurethane/Steel (Red)			SCC-SS30S820-PUR-RS-TLB	SCC-SSTTL30S820-PUR-RS	SCC-SS30S820-PUR-RS-BSL
		High Temp Phenolic			SCC-SS30S820-PHRHT-TLB	SCC-SSTTL30S820-PHRHT	SCC-SS30S820-PHRHT-BSL
		Semi Steel			SCC-SS30S820-SSR-TLB	SCC-SSTTL30S820-SSR	SCC-SS30S820-SSR-BSL
		Semi Steel V-Groove			SCC-SS30S820-VGR-TLB	SCC-SSTTL30S820-VGR	SCC-SS30S820-VGR-BSL
		Polyurethane on Aluminum			SCC-SS30S820-PAR-TLB	SCC-SSTTL30S820-PAR	SCC-SS30S820-PAR-BSL
		Nylon			SCC-SS30S820-NYR-TLB	SCC-SSTTL30S820-NYR	SCC-SS30S820-NYR-BSL

Effortless Rolling Experience

Discover our high-quality wheels available in various sizes and materials, with optional **bearings** and **bushings**. Perfect for a range of applications and casters, our wheels offer smooth, whisper-quiet, long-lasting, and chemical-resistant performance. Browse our selection below to find the perfect wheel for your needs.

AVAILABLE BEARINGS

Bearings are essential in casters for several reasons. They minimize friction between parts, facilitating easier and more efficient movement. This enhances durability, absorbs shock and vibration, and ensures smoother, longer-lasting operation. Investing in bearings is a smart decision that can significantly benefit your business's bottom line.



Need custom casters? Contact our [customer service team](#) for tailored solutions to fit your exact needs. We're here to help!



STAINLESS STEEL

TOP PLATE CASTERS *Ball Bearing Wheels*

Wheel Dia	Tread Width	Wheel Type	Load Capacity (lbs.)	Overall Height	Swivel Part Number	Swivel Weight (lbs.)	Rigid Part Number	Rigid Weight (lbs.)			
4"	2"	Thermoplastic Rubber (Donut)	300	5-5/8"	SCC-SS30S420-TPRBD	3.96	SCC-SS30R420-TPRBD	2.53			
		Thermoplastic Rubber (Flat)			SCC-SS30S420-TPRBF	3.96	SCC-SS30R420-TPRBF	2.53			
		Rubber on Aluminum	400		SCC-SS30S420-RAB	5.06	SCC-SS30R420-RAB	3.63			
		Rubber on Cast Iron			SCC-SS30S420-RSB	6.16	SCC-SS30R420-RSB	1.73			
		Polyolefin	500		SCC-SS30S420-POB	5.06	SCC-SS30R420-POB	3.63			
		Polyurethane on Polyolefin	600		SCC-SS30S420-PPUB	3.96	SCC-SS30R420-PPUB	2.53			
		Polyurethane on Aluminum			SCC-SS30S420-PAB	5.06	SCC-SS30R420-PAB	3.63			
		Polyurethane/Steel (Green)	700		SCC-SS30S420-PUB-GB	6.16	SCC-SS30R420-PUB-GB	4.73			
		Polyurethane/Steel (Red)			SCC-SS30S420-PUB-RS	6.16	SCC-SS30R420-PUB-RS	4.73			
		Solid Polyurethane			SCC-SS30S420-SPUB	3.96	SCC-SS30R420-SPUB	2.53			
		Nylon			SCC-SS30S420-NYB	5.06	SCC-SS30R420-NYB	3.63			
		Phenolic	800		SCC-SS30S420-PHB	5.25	SCC-SS30R420-PHB	3.82			
		Semi Steel V-Groove			SCC-SS30S420-VGB	6.71	SCC-SS30R420-VGB	5.28			
		Glass Filled Nylon	900		SCC-SS30S420-GFNB	5.06	SCC-SS30R420-GFNB	3.63			
		Semi Steel	1000		SCC-SS30S420-SSB	5.72	SCC-SS30R420-SSB	4.29			
		5"	2"		Thermoplastic Rubber (Donut)	350	6-1/2"	SCC-SS30S520-TPRBD	4.62	SCC-SS30R520-TPRBD	3.19
					Thermoplastic Rubber (Flat)			SCC-SS30S520-TPRBF	4.62	SCC-SS30R520-TPRBF	3.19
Rubber on Cast Iron	400			SCC-SS30S520-RSB	6.16	SCC-SS30R520-RSB		4.73			
Rubber on Aluminum	500			SCC-SS30S520-RAB	5.75	SCC-SS30R520-RAB		4.32			
Polyolefin	650			SCC-SS30S520-POB	4.62	SCC-SS30R520-POB		3.19			
Polyurethane on Polyolefin	750			SCC-SS30S520-PPUB	4.62	SCC-SS30R520-PPUB		3.19			
Nylon				SCC-SS30S520-NYB	4.62	SCC-SS30R520-NYB		3.19			
Polyurethane on Aluminum	900			SCC-SS30S520-PAB	5.28	SCC-SS30R520-PAB		3.85			
Phenolic				SCC-SS30S520-PHB	5.75	SCC-SS30R520-PHB		4.32			
High Temp Phenolic				SCC-SS30S520-PHBHT	5.75	SCC-SS30R520-PHBHT		4.32			
Polyurethane/Steel (Green)				1000	SCC-SS30S520-PUB-GB	6.60		SCC-SS30R520-PUB-GB	5.17		
Polyurethane/Steel (Red)	SCC-SS30S520-PUB-RS				6.60	SCC-SS30R520-PUB-RS		5.17			
Solid Polyurethane	SCC-SS30S520-SPUB				4.62	SCC-SS30R520-SPUB		3.19			
Semi Steel	SCC-SS30S520-SSB				7.92	SCC-SS30R520-SSB		6.49			
Semi Steel V-Groove	1100			SCC-SS30S520-VGB	8.58	SCC-SS30R520-VGB		7.15			
Glass Filled Nylon	1250			SCC-SS30S520-GFNB	4.62	SCC-SS30R520-GFNB		3.19			
6"	2"			Rubber on Cast Iron	450	7-1/2"		SCC-SS30S620-RSB	7.70	SCC-SS30R620-RSB	6.27
		Thermoplastic Rubber (Donut)	500	SCC-SS30S620-TPRBD	5.06		SCC-SS30R620-TPRBD	3.63			
		Thermoplastic Rubber (Flat)		SCC-SS30S620-TPRBF	5.06		SCC-SS30R620-TPRBF	3.63			
		Rubber on Aluminum	550	SCC-SS30S620-RAB	6.50		SCC-SS30R620-RAB	5.07			
		Polyolefin	700	SCC-SS30S620-POB	5.06		SCC-SS30R620-POB	3.63			
		Polyurethane on Polyolefin	900	SCC-SS30S620-PPUB	5.06		SCC-SS30R620-PPUB	3.63			
		Polyurethane on Aluminum		SCC-SS30S620-PAB	6.00		SCC-SS30R620-PAB	4.07			
		Phenolic	1200	SCC-SS30S620-PHB	7.50		SCC-SS30R620-PHB	6.07			
		High Temp Phenolic		SCC-SS30S620-PHBHT	7.50		SCC-SS30R620-PHBHT	6.50			
		Polyurethane/Steel (Green)		SCC-SS30S620-PUB-GB	8.58		SCC-SS30R620-PUB-GB	7.15			
		Polyurethane/Steel (Red)		SCC-SS30S620-PUB-RS	8.58		SCC-SS30R620-PUB-RS	7.15			
		Solid Polyurethane	SCC-SS30S620-SPUB	5.06	SCC-SS30R620-SPUB		3.63				
		Semi Steel	SCC-SS30S620-SSB	8.85	SCC-SS30R620-SSB		7.15				
		Semi Steel V-Groove	SCC-SS30S620-VGB	10.12	SCC-SS30R620-VGB		8.69				
		Glass Filled Nylon	1250	SCC-SS30S620-GFNB	5.06		SCC-SS30R620-GFNB	3.63			
		Nylon		SCC-SS30S620-NYB	5.06		SCC-SS30R620-NYB	3.63			

Explore More Options!

Continue reading to discover a wide range of wheel sizes and caster options. Find the perfect match for your specific needs and applications.



The Casters & Service You Need

- EASY ORDERING
- EXPERT SERVICE
- FAST SHIPPING
- CUSTOM ORDERS

LIKE, SHARE & SUBSCRIBE

SERVICE CASTER CORPORATION



STAINLESS STEEL

TOP PLATE CASTERS *Ball Bearing Wheels*

Wheel Dia	Tread Width	Wheel Type	Load Capacity (lbs.)	Overall Height	Swivel Part Number	Swivel Weight (lbs.)	Rigid Part Number	Rigid Weight (lbs.)
8"	2"	Rubber on Cast Iron	500	9-1/2"	SCC-SS30S820-RSB	9.68	SCC-SS30R820-RSB	8.25
		Thermoplastic Rubber (Donut)	600		SCC-SS30S820-TPRBD	5.50	SCC-SS30R820-TPRBD	4.07
		Thermoplastic Rubber (Flat)			SCC-SS30S820-TPRBF	5.50	SCC-SS30R820-TPRBF	4.07
		Rubber on Aluminum	800		SCC-SS30S820-RAB	7.50	SCC-SS30R820-RAB	9.04
		Polyurethane on Polyolefin			SCC-SS30S820-PPUB	5.50	SCC-SS30R820-PPUB	4.07
		Polyolefin	900		SCC-SS30S820-POB	5.50	SCC-SS30R820-POB	4.07
		Solid Polyurethane	1200		SCC-SS30S820-SPUB	5.50	SCC-SS30R820-SPUB	4.07
		Glass Filled Nylon	1250		SCC-SS30S820-GFNB	5.50	SCC-SS30R820-GFNB	4.07
		Nylon			SCC-SS30S820-NYB	5.50	SCC-SS30R820-NYB	4.07
		Polyurethane on Aluminum			SCC-SS30S820-PAB	5.50	SCC-SS30R820-PAB	4.07
		Phenolic			SCC-SS30S820-PHB	7.75	SCC-SS30R820-PHB	6.32
		High Temp Phenolic			SCC-SS30S820-PHBHT	7.75	SCC-SS30R820-PHBHT	6.32
		Polyurethane/Steel (Green)			SCC-SS30S820-PUB-GB	12.10	SCC-SS30R820-PUB-GB	10.67
		Polyurethane/Steel (Red)			SCC-SS30S820-PUB-RS	12.10	SCC-SS30R820-PUB-RS	10.67
		Semi Steel			SCC-SS30S820-SSB	12.10	SCC-SS30R820-SSB	10.67
		Semi Steel V-Groove	SCC-SS30S820-VGB		12.10	SCC-SS30R820-VGB	10.67	



Stainless Ball Bearings: Stainless steel ball bearings are durable and corrosion-resistant, ensuring smooth performance in various applications. Ideal for both heavy-duty and precision tasks, they enhance equipment efficiency and lifespan with minimal maintenance.

Excellent



Based on 11,920 reviews



Great Quality Casters

WHEELS WORK GREAT. LOVE THE NEEDLE BEARINGS USED THEM AS A REPLACEMENT ON A DOCK RAMP.

FAST SHIPPING

EXACTLY WHAT WE NEEDED

"PERFECT FIT"

My order came as promised. I installed the wheels. Perfect fit.

GREAT SELECTION, EASY WEBSITE.

The detailed information about each caster and the terrific selection are my favorite things about this company.

GREAT SERVICE

I use Servicecaster several times a year they always seem to have the inventory and swift delivery.

ORDERING WAS EASY

Ordering was easy. Ship dates were communicated promptly, and product was shipped and delivered on time.

OUR CUSTOMERS ARE SAYING:

Discover Our Reliable Brake Option Casters!
 Explore our brake option casters, including top-lock for secure positioning, total-lock for wheel and swivel lock, and side-lock for easy access. Each option offers enhanced stability, safety, and convenience.



REVIEW US ON



SHARE YOUR THOUGHTS! WE VALUE YOUR FEEDBACK. >>>

STAINLESS STEEL



TOP PLATE CASTERS *Ball Bearing Wheels & Brakes*

Wheel Dia.	Tread Width	Wheel Type	Load Capacity (lbs.)	Overall Height	Side Lock Brake (SLB) Top Lock Brake (TLB)	Total Lock Brake (TTL)	Bolt-on Swivel Lock (BSL)
4"	2"	Thermoplastic Rubber (Donut)	300	5-5/8"	SCC-SS30S420-TPRBD-TLB	SCC-SSTTL30S420-TPRBD	SCC-SS30S420-TPRBD-BSL
		Thermoplastic Rubber (Flat)			SCC-SS30S420-TPRBF-TLB	SCC-SSTTL30S420-TPRBF	SCC-SS30S420-TPRBF-BSL
		Rubber on Aluminum	400		SCC-SS30S420-RAB-TLB	SCC-SSTTL30S420-RAB	SCC-SS30S420-RAB-BSL
		Rubber on Cast Iron			SCC-SS30S420-RSB-TLB	SCC-SSTTL30S420-RSB	SCC-SS30S420-RSB-BSL
		Polyolefin	500		SCC-SS30S420-POB-TLB	SCC-SSTTL30S420-POB	SCC-SS30S420-POB-BSL
		Polyurethane on Polyolefin	600		SCC-SS30S420-PPUB-TLB	SCC-SSTTL30S420-PPUB	SCC-SS30S420-PPUB-BSL
		Nylon	800		SCC-SS30S420-NYB-TLB	SCC-SSTTL30S420-NYB	SCC-SS30S420-NYB-BSL
		Polyurethane on Aluminum	700		SCC-SS30S420-PAB-TLB	SCC-SSTTL30S420-PAB	SCC-SS30S420-PAB-BSL
		Polyurethane/Steel (Green)			SCC-SS30S420-PUB-GB-TLB	SCC-SSTTL30S420-PUB-GB	SCC-SS30S420-PUB-GB-BSL
		Polyurethane/Steel (Red)			SCC-SS30S420-PUB-RS-TLB	SCC-SSTTL30S420-PUB-RS	SCC-SS30S420-PUB-RS-BSL
		Solid Polyurethane			SCC-SS30S420-SPUB-TLB	SCC-SSTTL30S420-SPUB	SCC-SS30S420-SPUB-BSL
		High Temp Phenolic	800		SCC-SS30S420-PHBHT-TLB	SCC-SSTTL30S420-PHBHT	SCC-SS30S420-PHBHT-BSL
		Phenolic			SCC-SS30S420-PHB-TLB	SCC-SSTTL30S420-PHB	SCC-SS30S420-PHB-BSL
		Semi Steel V-Groove			SCC-SS30S420-VGB-TLB	SCC-SSTTL30S420-VGB	SCC-SS30S420-VGB-BSL
		Semi Steel			SCC-SS30S420-SSB-TLB	SCC-SSTTL30S420-SSB	SCC-SS30S420-SSB-BSL
		Glass Filled Nylon	1200		SCC-SS30S420-GFNB-TLB	SCC-SSTTL30S420-GFNB	SCC-SS30S420-GFNB-BSL
5"	2"	Thermoplastic Rubber (Donut)	350	6-1/2"	SCC-SS30S520-TPRBD-TLB	SCC-SSTTL30S520-TPRBF	SCC-SS30S520-TPRBF-BSL
		Thermoplastic Rubber (Flat)			SCC-SS30S520-TPRBF-TLB	SCC-SSTTL30S520-TPRBD	SCC-SS30S520-TPRBD-BSL
		Rubber on Cast Iron	400		SCC-SS30S520-RSB-TLB	SCC-SSTTL30S520-RSB	SCC-SS30S520-RSB-BSL
		Rubber on Aluminum	500		SCC-SS30S520-RAB-TLB	SCC-SSTTL30S520-RAB	SCC-SS30S520-RAB-BSL
		Polyolefin	650		SCC-SS30S520-POB-TLB	SCC-SSTTL30S520-POB	SCC-SS30S520-POB-BSL
		Polyurethane on Polyolefin	750		SCC-SS30S520-PPUB-TLB	SCC-SSTTL30S520-PPUB	SCC-SS30S520-PPUB-BSL
		Nylon	900		SCC-SS30S520-NYB-TLB	SCC-SSTTL30S520-NYB	SCC-SS30S520-NYB-BSL
		Polyurethane on Aluminum	1000		SCC-SS30S520-PAB-TLB	SCC-SSTTL30S520-PAB	SCC-SS30S520-PAB-BSL
		High Temp Phenolic			SCC-SS30S520-PHBHT-TLB	SCC-SSTTL30S520-PHBHT	SCC-SS30S520-PHBHT-BSL
		Phenolic			SCC-SS30S520-PHB-TLB	SCC-SSTTL30S520-PHB	SCC-SS30S520-PHB-BSL
		Polyurethane/Steel (Green)			SCC-SS30S520-PUB-GB-TLB	SCC-SSTTL30S520-PUB-GB	SCC-SS30S520-PUB-GB-BSL
		Polyurethane/Steel (Red)	SCC-SS30S520-PUB-RS-TLB		SCC-SSTTL30S520-PUB-RS	SCC-SS30S520-PUB-RS-BSL	
		Solid Polyurethane	SCC-SS30S520-SPUB-TLB		SCC-SSTTL30S520-SPUB	SCC-SS30S520-SPUB-BSL	
		Semi Steel	SCC-SS30S520-SSB-TLB		SCC-SSTTL30S520-SSB	SCC-SS30S520-SSB-BSL	
		Semi Steel V-Groove	SCC-SS30S520-VGB-TLB		SCC-SSTTL30S520-VGB	SCC-SS30S520-VGB-BSL	
		Glass Filled Nylon	1250		SCC-SS30S520-GFNB-TLB	SCC-SSTTL30S520-GFNB	SCC-SS30S520-GFNB-BSL
6"	2"	Rubber on Cast Iron	450	7-1/2"	SCC-SS30S620-RSB-TLB	SCC-SSTTL30S620-RSB	SCC-SS30S620-RSB-BSL
		Thermoplastic Rubber (Donut)	500		SCC-SS30S620-TPRBD-TLB	SCC-SSTTL30S620-TPRBD	SCC-SS30S620-TPRBD-BSL
		Thermoplastic Rubber (Flat)			SCC-SS30S620-TPRBF-TLB	SCC-SSTTL30S620-TPRBF	SCC-SS30S620-TPRBF-BSL
		Rubber on Aluminum	550		SCC-SS30S620-RAB-TLB	SCC-SSTTL30S620-RAB	SCC-SS30S620-RAB-BSL
		Polyolefin	700		SCC-SS30S620-POB-TLB	SCC-SSTTL30S620-POB	SCC-SS30S620-POB-BSL
		Polyurethane on Polyolefin	900		SCC-SS30S620-PPUB-TLB	SCC-SSTTL30S620-PPUB	SCC-SS30S620-PPUB-BSL
		Polyurethane on Aluminum	1200		SCC-SS30S620-PAB-TLB	SCC-SSTTL30S620-PAB	SCC-SS30S620-PAB-BSL
		High Temp Phenolic			SCC-SS30S620-PHBHT-TLB	SCC-SSTTL30S620-PHBHT	SCC-SS30S620-PHBHT-BSL
		Phenolic			SCC-SS30S620-PHB-TLB	SCC-SSTTL30S620-PHB	SCC-SS30S620-PHB-BSL
		Polyurethane/Steel (Green)			SCC-SS30S620-PUB-GB-TLB	SCC-SSTTL30S620-PUB-GB	SCC-SS30S620-PUB-GB-BSL
		Polyurethane/Steel (Red)	SCC-SS30S620-PUB-RS-TLB		SCC-SSTTL30S620-PUB-RS	SCC-SS30S620-PUB-RS-BSL	
		Solid Polyurethane	SCC-SS30S620-SPUB-TLB		SCC-SSTTL30S620-SPUB	SCC-SS30S620-SPUB-BSL	
		Semi Steel	SCC-SS30S620-SSB-TLB		SCC-SSTTL30S620-SSB	SCC-SS30S620-SSB-BSL	
		Semi Steel V-Groove	SCC-SS30S620-VGB-TLB		SCC-SSTTL30S620-VGB	SCC-SS30S620-VGB-BSL	
		Glass Filled Nylon	1250		SCC-SS30S620-GFNB-TLB	SCC-SSTTL30S620-GFNB	SCC-SS30S620-GFNB-BSL
		Nylon			SCC-SS30S620-NYB-TLB	SCC-SSTTL30S620-NYB	SCC-SS30S620-NYB-BSL

Connect with Us on Social Media!

Join our social media pages to get exclusive behind-the-scenes insights and discover the secrets of Service Caster. Stay updated with our latest innovations, special offers, and expert tips. Connect with us and be a part of our community!

LIKE, SHARE & SUBSCRIBE





TOP PLATE CASTERS *Ball Bearing Wheels & Brakes*

Wheel Dia	Tread Width	Wheel Type	Load Capacity (lbs.)	Overall Height	Side Lock Brake (SLB) Top Lock Brake (TLB)	Total Lock Brake (TTL)	Bolt-on Swivel Lock (BSL)
8"	2"	Rubber on Cast Iron	500	9-1/2"	SCC-SS30S820-RSB-TLB	SCC-SSTTL30S820-RSB	SCC-SS30S820-RSB-BSL
		Thermoplastic Rubber (Donut)	600		SCC-SS30S820-TPRBD-TLB	SCC-SSTTL30S820-TPRBD	SCC-SS30S820-TPRBD-BSL
		Thermoplastic Rubber (Flat)			SCC-SS30S820-TPRBF-TLB	SCC-SSTTL30S820-TPRBF	SCC-SS30S820-TPRBF-BSL
		Rubber on Aluminum	800		SCC-SS30S820-RAB-TLB	SCC-SSTTL30S820-RAB	SCC-SS30S820-RAB-BSL
		Polyurethane on Polyolefin			SCC-SS30S820-PPUB-TLB	SCC-SSTTL30S820-PPUB	SCC-SS30S820-PPUB-BSL
		Polyolefin	900		SCC-SS30S820-POB-TLB	SCC-SSTTL30S820-POB	SCC-SS30S820-POB-BSL
		Solid Polyurethane	1200		SCC-SS30S820-SPUB-TLB	SCC-SSTTL30S820-SPUB	SCC-SS30S820-SPUB-BSL
		Glass Filled Nylon	1250		SCC-SS30S820-GFNB-TLB	SCC-SSTTL30S820-GFNB	SCC-SS30S820-GFNB-BSL
		Phenolic			SCC-SS30S820-PHB-TLB	SCC-SSTTL30S820-PHB	SCC-SS30S820-PHB-BSL
		Polyurethane/Steel (Green)			SCC-SS30S820-PUB-GB-TLB	SCC-SSTTL30S820-PUB-GB	SCC-SS30S820-PUB-GB-BSL
		Polyurethane/Steel (Red)			SCC-SS30S820-PUB-RS-TLB	SCC-SSTTL30S820-PUB-RS	SCC-SS30S820-PUB-RS-BSL
		High Temp Phenolic			SCC-SS30S820-PHBHT-TLB	SCC-SSTTL30S820-PHBHT	SCC-SS30S820-PHBHT-BSL
		Semi Steel			SCC-SS30S820-SSB-TLB	SCC-SSTTL30S820-SSB	SCC-SS30S820-SSB-BSL
		Semi Steel V-Groove			SCC-SS30S820-VGB-TLB	SCC-SSTTL30S820-VGB	SCC-SS30S820-VGB-BSL
		Polyurethane on Aluminum			SCC-SS30S820-PAB-TLB	SCC-SSTTL30S820-PAB	SCC-SS30S820-PAB-BSL
		Nylon	SCC-SS30S820-NYB-TLB		SCC-SSTTL30S820-NYB	SCC-SS30S820-NYB-BSL	

STAINLESS STEEL

316

**Roll With the Best:
The 316 Stainless Steel
Caster Spectacular!**



The 316 Stainless Steel Caster Series!

Introducing Service Caster's **316 Stainless Steel** casters, designed for durability in tough environments. Corrosion, chemical, and temperature resistant, they excel indoors and outdoors. Perfect for food service, medical, and industrial use, they ensure reliable mobility and strength. Choose Service Caster for smooth operations.

Medium/Heavy Duty Casters

Series #30 Stainless Steel 316 Casters

Capacity up to 1250 lbs.

316 Stainless Steel Casters resist corrosion, handle heavy loads, and ensure smooth operation, perfect for wet and harsh conditions in food processing, pharmaceuticals, and marine use.

Features

- Withstands harsh, wet environments.
- Supports substantial weight loads.
- Precision bearings for quiet movement.
- Long-lasting construction for tough conditions.
- Ideal for cleanrooms and sterile settings.

Applications

- Healthcare
- Foodservice
- Laboratories
- Marine
- Pharmaceuticals
- Cleanrooms

WHY CHOOSE 316?



READ MORE >>

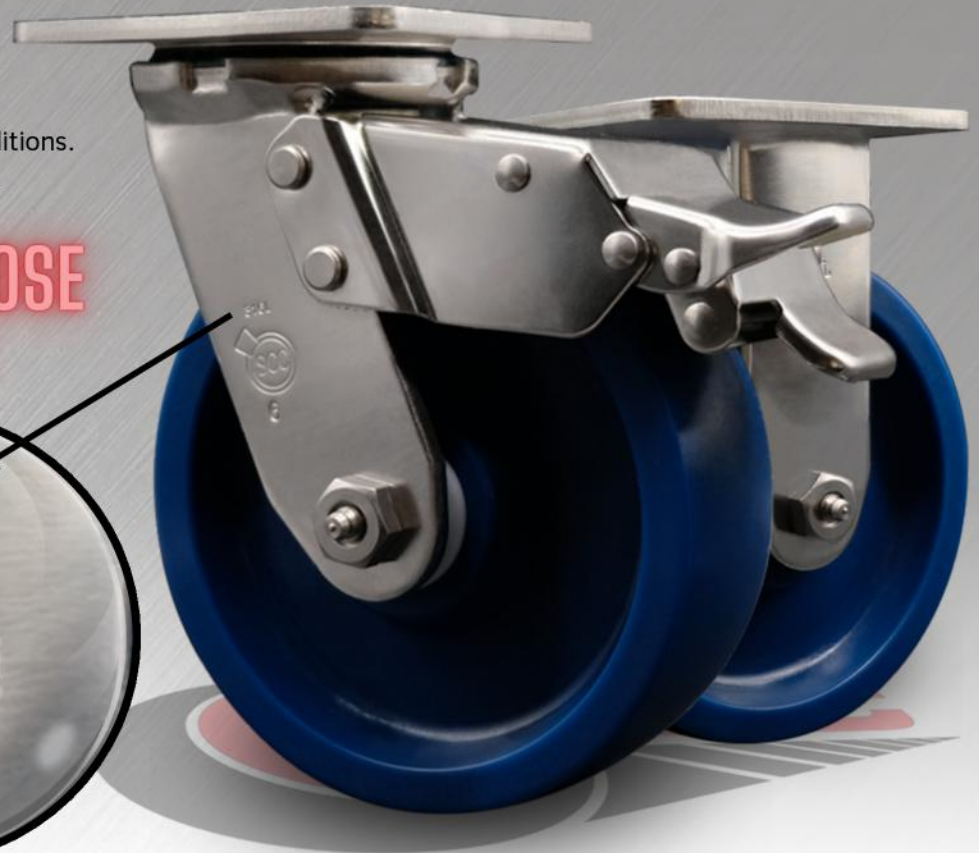

Service Caster Chart Guide

Build Your Caster

Discover more fastening sizes and wheel options if you can't find what you need. And remember, we're always here to [help!](#)

Series	Mounting	Rig Type	Mounting Size	Bolt Pattern	Wheel Size	Bearing Type	Brake	Wheel Material
30	Top Plate	Swivel (S)	4" x 4-1/2"	2-5/8" x 3-5/8" to 3" x 3"	3-1/4" x 2" (3420)	Ball Bearing (B)	Top Lock (TLB)	Soft Rubber (SR)
		Rigid (R)	4-1/2" x 6-1/4" (TP2)	2-7/16" x 4-15/16" to 3-3/8" x 5-1/4"	4" x 2" (420)	Plain Bore (S)	Posi Lock (PLB)	Thermo Plastic Rubber (TPR)
			5" x 5-1/2" (TP3)	4-1/8" x 4-1/2"	5" x 2" (520)	Delrin Bearing (D)	Total Lock (TTL)	Polyurethane (PPU)
			6" x 2" (620)	Roller Bearing (R)	Front Total Lock (FTL)	Phenolic (PH)		
8" x 2" (820)	Precision Bearing (PB)	Side Lock (SLB)	Solid Polyurethane (SPU)					
		Bronze Bearing (BZ)	Face Contact (FCB)	Hard Rubber (HR)				
			Bolt-on Swivel Lock (BSL)	Glass Filled Nylon (GFN)				
			Weld-on Swivel Lock (WSL)	Rubber on Aluminum (RA)				
				Semi Steel (SS)				
				Nylon (NY)				
				High Temp Phenolic (PH*HT)				
				High Temp Nylon (GF*HT)				



HEAT RESISTANT



DURABILITY



CHEMICAL RESISTANT



CORROSION RESISTANT

Wheel Treads

GLASS FILLED NYLON GFN	PHENOLIC PH	SOLID POLYURETHANE SPU	HIGH TEMP PHENOLIC PH*HT	RUBBER ON ALUMINUM RA	SEMI STEEL SS	NYLON NY	POLYOLEFIN PO
POLYURETHANE ON CAST IRON PU	HT GLASS FILLED NYLON GFN*HT	V-GROOVE VG	RUBBER ON STEEL RS	POLYURETHANE ON POLYOLEFIN PPU	POLYURETHANE ON ALUMINUM PA	THERMO PLASTIC RUBBER (DONUT) TPRD	THERMO PLASTIC RUBBER (FLAT) TPRF



Over 30 Years of Quality

Top Plate Size Option(s)

Our 316 Stainless Steel Casters are durable, corrosion-resistant, and hygienic, ideal for harsh environments. They offer smooth operation, noise reduction, and are available in various sizes and mounting options.

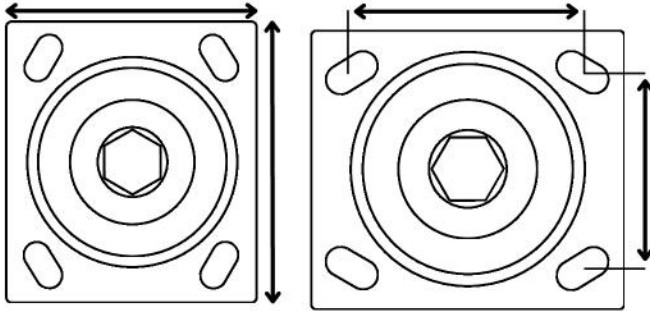

Standard Plate Size	Bolt Pattern	Bolt Diameter
4" x 4-1/2"	2-5/8" x 3-5/8" to 3" x 3"	3/8"
4-1/2" x 6-1/4" (TP2)	2-7/16" x 4-15/16" to 3-3/8" x 5-1/4"	1/2"
5" x 5-1/2" (TP3)	4-1/8" x 4-1/2"	1/2"

Choose Your Movement

- Rigid and Swivel Available



RIGID



SWIVEL

Bearing Type(s)

Roller Bearing

Anti-friction bearing, ideal for manual applications with prevalent shock loading.



Ball Bearing

Ball bearing provides smooth movement and durability.



Delrin Bearing

Delrin bearings, maintenance-free, ideal for wash-downs, max 180°F.



Bronze Bearing

Bronze bearings are durable, corrosion-resistant, and withstand up to 525°F.



Brake Option(s)

Top Lock Brake (TLB)

The **Top lock brake** places a positive locking force against the wheel hub locking the wheel only.



SCC-SS31630S820-SPUR-TLB

Total Lock Brake (TTL)

The **total lock** on casters secures both the wheel and swivel, ensuring complete stability for reliable and safe use.



SCC-SS316-TTL30S620-SPUD

Side Lock Brake (SLB)

The **side lock brake** on casters securely locks the wheel, ensuring stability and safety.



SCC-SS31630S620-NYR-SLB

Bolt-on Swivel Lock (BSL)

The **bolt-on swivel lock** secures swivel casters, preventing unwanted movement. Easy to install, it ensures stability.



SCC-SS31630S620-NYD-BSL

ROLL WITH CONFIDENCE

Quality. Reliability. Excellence.

SERVICE CASTER

@servicecaster



316 STAINLESS STEEL

TOP PLATE CASTERS *Roller Bearing Wheels*

Wheel Dia	Tread Width	Wheel Type	Load Capacity (lbs.)	Overall Height	Swivel Part Number	Swivel Weight (lbs.)	Rigid Part Number	Rigid Weight (lbs.)	
4"	2"	Thermoplastic Rubber (Donut)	300	5-5/8"	SCC-SS31630S420-TPRRD	3.96	SCC-SS31630R420-TPRRD	2.53	
		Thermoplastic Rubber (Flat)			SCC-SS31630S420-TPRRF	3.96	SCC-SS31630R420-TPRRF	2.53	
		Rubber on Aluminum	400		SCC-SS31630S420-RAR	5.06	SCC-SS31630R420-RAR	3.63	
		Rubber on Cast Iron			SCC-SS31630S420-RSR	6.16	SCC-SS31630R420-RSR	1.73	
		Polyolefin	500		SCC-SS31630S420-POR	5.06	SCC-SS31630R420-POR	3.63	
		Polyurethane on Polyolefin	600		SCC-SS31630S420-PPUR	3.96	SCC-SS31630R420-PPUR	2.53	
		Polyurethane on Aluminum	700		SCC-SS31630S420-PAR	5.06	SCC-SS31630R420-PAR	3.63	
		Polyurethane/Steel (Green)			SCC-SS31630S420-PUR-GB	6.16	SCC-SS31630R420-PUR-GB	4.73	
		Polyurethane/Steel (Red)			SCC-SS31630S420-PUR-RS	6.16	SCC-SS31630R420-PUR-RS	4.73	
		Solid Polyurethane			SCC-SS31630S420-SPUR	3.96	SCC-SS31630R420-SPUR	2.53	
		Nylon			800	SCC-SS31630S420-NYR	5.06	SCC-SS31630R420-NYR	3.63
		Phenolic				SCC-SS31630S420-PHR	5.25	SCC-SS31630R420-PHR	3.82
		Semi Steel V-Groove	SCC-SS31630S420-VGR			6.71	SCC-SS31630R420-VGR	5.28	
		Glass Filled Nylon	SCC-SS31630S420-GFNR			5.06	SCC-SS31630R420-GFNR	3.63	
		Semi Steel	1000		SCC-SS31630S420-SSR	5.72	SCC-SS31630R420-SSR	4.29	
		5"	2"		Thermoplastic Rubber (Donut)	350	6-1/2"	SCC-SS31630S520-TPRRD	4.62
Thermoplastic Rubber (Flat)	SCC-SS31630S520-TPRRF			4.62	SCC-SS31630R520-TPRRF			3.19	
Rubber on Cast Iron	400			SCC-SS31630S520-RSR	6.16	SCC-SS31630R520-RSR		4.73	
Rubber on Aluminum	500			SCC-SS31630S520-RAR	5.75	SCC-SS31630R520-RAR		4.32	
Polyolefin	650			SCC-SS31630S520-POR	4.62	SCC-SS31630R520-POR		3.19	
Polyurethane on Polyolefin	750			SCC-SS31630S520-PPUR	4.62	SCC-SS31630R520-PPUR		3.19	
Nylon	900			SCC-SS31630S520-NYR	4.62	SCC-SS31630R520-NYR		3.19	
Polyurethane on Aluminum				SCC-SS31630S520-PAR	5.28	SCC-SS31630R520-PAR		3.85	
Phenolic	1000			SCC-SS31630S520-PHR	5.75	SCC-SS31630R520-PHR		4.32	
High Temp Phenolic				SCC-SS31630S520-PHRHT	5.75	SCC-SS31630R520-PHRHT		4.32	
Polyurethane/Steel (Green)				SCC-SS31630S520-PUR-GB	6.60	SCC-SS31630R520-PUR-GB		5.17	
Polyurethane/Steel (Red)				SCC-SS31630S520-PUR-RS	6.60	SCC-SS31630R520-PUR-RS		5.17	
Solid Polyurethane				SCC-SS31630S520-SPUR	4.62	SCC-SS31630R520-SPUR		3.19	
Semi Steel				SCC-SS31630S520-SSR	7.92	SCC-SS31630R520-SSR		6.49	
Semi Steel V-Groove	1100			SCC-SS31630S520-VGR	8.58	SCC-SS31630R520-VGR		7.15	
Glass Filled Nylon	1250			SCC-SS31630S520-GFNR	4.62	SCC-SS31630R520-GFNR		3.19	
6"	2"	Rubber on Cast Iron	450	7-1/2"	SCC-SS31630S620-RSR	7.70	SCC-SS31630R620-RSR	6.27	
		Thermoplastic Rubber (Donut)	500		SCC-SS31630S620-TPRRD	5.06	SCC-SS31630R620-TPRRD	3.63	
		Thermoplastic Rubber (Flat)			SCC-SS31630S620-TPRRF	5.06	SCC-SS31630R620-TPRRF	3.63	
		Rubber on Aluminum	550		SCC-SS31630S620-RAR	6.50	SCC-SS31630R620-RAR	5.07	
		Polyolefin	700		SCC-SS31630S620-POR	5.06	SCC-SS31630R620-POR	3.63	
		Polyurethane on Polyolefin	900		SCC-SS31630S620-PPUR	5.06	SCC-SS31630R620-PPUR	3.63	
		Polyurethane on Aluminum	1200		SCC-SS31630S620-PAR	6.00	SCC-SS31630R620-PAR	4.07	
		Phenolic			SCC-SS31630S620-PHR	7.50	SCC-SS31630R620-PHR	6.07	
		High Temp Phenolic			SCC-SS31630S620-PHRHT	7.50	SCC-SS31630R620-PHRHT	6.50	
		Polyurethane/Steel (Green)			SCC-SS31630S620-PUR-GB	8.58	SCC-SS31630R620-PUR-GB	7.15	
		Polyurethane/Steel (Red)			SCC-SS31630S620-PUR-RS	8.58	SCC-SS31630R620-PUR-RS	7.15	
		Solid Polyurethane			SCC-SS31630S620-SPUR	5.06	SCC-SS31630R620-SPUR	3.63	
		Semi Steel	1250		SCC-SS31630S620-SSR	8.85	SCC-SS31630R620-SSR	7.15	
		Semi Steel V-Groove			SCC-SS31630S620-VGR	10.12	SCC-SS31630R620-VGR	8.69	
		Glass Filled Nylon			SCC-SS31630S620-GFNR	5.06	SCC-SS31630R620-GFNR	3.63	
		Nylon			SCC-SS31630S620-NYR	5.06	SCC-SS31630R620-NYR	3.63	

Corrosion Resistance

Ideal for harsh and humid environments.



High Durability

Long-lasting performance under heavy loads.



Hygienic Design

Perfect for medical and food service applications.



Heat and Chemical Resistance

Suitable for industrial use.



TOP PLATE CASTERS *with Roller Bearing Wheels*

Wheel Dia	Tread Width	Wheel Type	Load Capacity (lbs.)	Overall Height	Swivel Part Number	Swivel Weight (lbs.)	Rigid Part Number	Rigid Weight (lbs.)
8"	2"	Rubber on Cast Iron	500	9-1/2"	SCC-SS31630S820-RSR	9.68	SCC-SS31630R820-RSR	8.25
		Thermoplastic Rubber (Donut)	600		SCC-SS31630S820-TPRRD	5.50	SCC-SS31630R820-TPRRD	4.07
		Thermoplastic Rubber (Flat)			SCC-SS31630S820-TPRRF	5.50	SCC-SS31630R820-TPRRF	4.07
		Rubber on Aluminum	800		SCC-SS31630S820-RAR	7.50	SCC-SS31630R820-RAR	9.04
		Polyurethane on Polyolefin			SCC-SS31630S820-PPUR	5.50	SCC-SS31630R820-PPUR	4.07
		Polyolefin	900		SCC-SS31630S820-POR	5.50	SCC-SS31630R820-POR	4.07
		Solid Polyurethane	1200		SCC-SS31630S820-SPUR	5.50	SCC-SS31630R820-SPUR	4.07
		Glass Filled Nylon	1250		SCC-SS31630S820-GFNR	5.50	SCC-SS31630R820-GFNR	4.07
		Nylon			SCC-SS31630S820-NYR	5.50	SCC-SS31630R820-NYR	4.07
		Polyurethane on Aluminum			SCC-SS31630S820-PAR	5.50	SCC-SS31630R820-PAR	4.07
		Phenolic			SCC-SS31630S820-PHR	7.75	SCC-SS31630R820-PHR	6.32
		High Temp Phenolic			SCC-SS31630S820-PHRHT	7.75	SCC-SS31630R820-PHRHT	6.32
		Polyurethane/Steel (Green)			SCC-SS31630S820-PUR-GB	12.10	SCC-SS31630R820-PUR-GB	10.67
		Polyurethane/Steel (Red)			SCC-SS31630S820-PUR-RS	12.10	SCC-SS31630R820-PUR-RS	10.67
		Semi Steel			SCC-SS31630S820-SSR	12.10	SCC-SS31630R820-SSR	10.67
		Semi Steel V-Groove			SCC-SS31630S820-VGR	12.10	SCC-SS31630R820-VGR	10.67

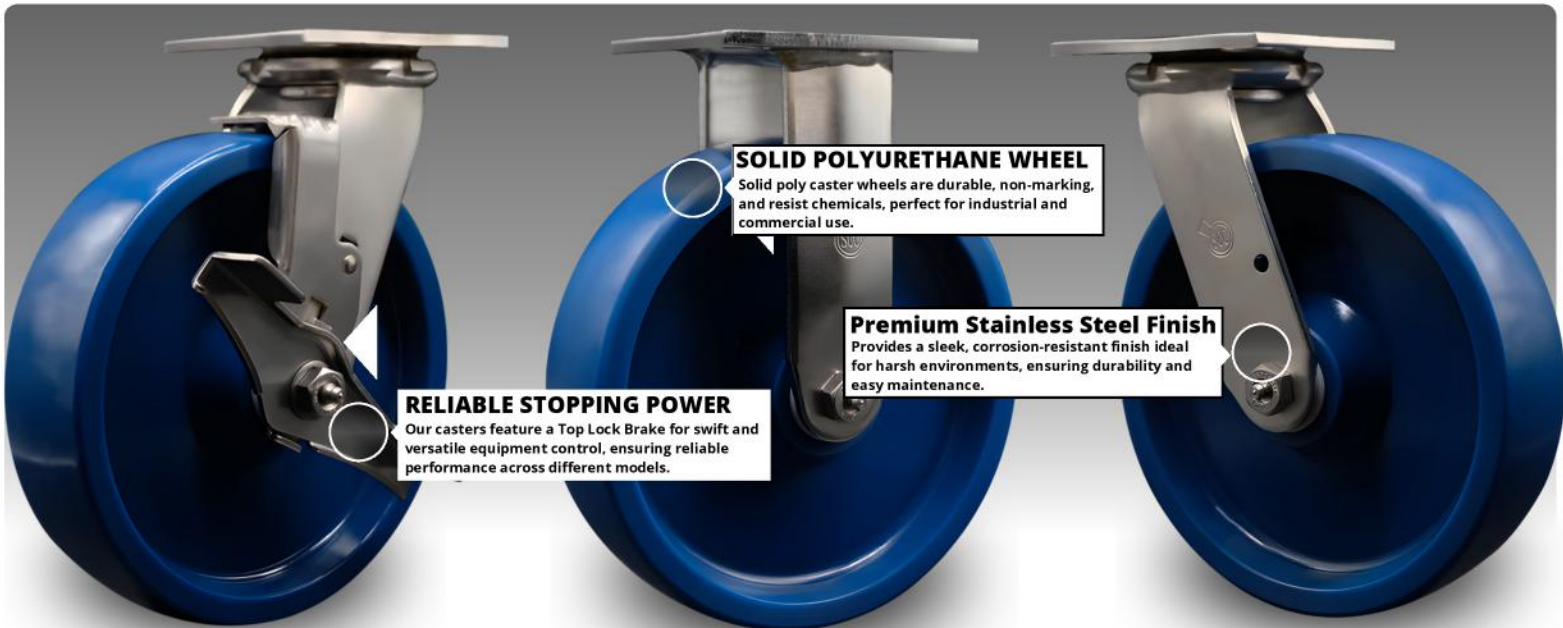

9 S 1st Ave

West Reading, PA 19611-1314 USA

P: 800-215-8220 • F: 800-591-8227

info@servicecaster.com

www.servicecaster.com

316 STAINLESS STEEL

TOP PLATE CASTERS with Roller Bearings & Brakes



Wheel Dia.	Tread Width	Wheel Type	Load Capacity (lbs.)	Overall Height	Top Lock Brake (TLB)	Total Lock Brake (TTL)	Bolt-on Swivel Lock (BSL)
4"	2"	Thermoplastic Rubber (Donut)	300	5-5/8"	SCC-SS31630S420-TPRRD-TLB	SCC-SS316TTL30S420-TPRRD	SCC-SS31630S420-TPRRD-BSL
		Thermoplastic Rubber (Flat)			SCC-SS31630S420-TPRRF-TLB	SCC-SS316TTL30S420-TPRRF	SCC-SS31630S420-TPRRF-BSL
		Rubber on Aluminum	400		SCC-SS31630S420-RAR-TLB	SCC-SS316TTL30S420-RAR	SCC-SS31630S420-RAR-BSL
		Rubber on Cast Iron			SCC-SS31630S420-RSR-TLB	SCC-SS316TTL30S420-RSR	SCC-SS31630S420-RSR-BSL
		Polyolefin	500		SCC-SS31630S420-POR-TLB	SCC-SS316TTL30S420-POR	SCC-SS31630S420-POR-BSL
		Polyurethane on Polyolefin	600		SCC-SS31630S420-PPUR-TLB	SCC-SS316TTL30S420-PPUR	SCC-SS31630S420-PPUR-BSL
		Nylon	800		SCC-SS31630S420-NYR-TLB	SCC-SS316TTL30S420-NYR	SCC-SS31630S420-NYR-BSL
		Polyurethane on Aluminum	700		SCC-SS31630S420-PAR-TLB	SCC-SS316TTL30S420-PAR	SCC-SS31630S420-PAR-BSL
		Polyurethane/Steel (Green)			SCC-SS31630S420-PUR-GB-TLB	SCC-SS316TTL30S420-PUR-GB	SCC-SS31630S420-PUR-GB-BSL
		Polyurethane/Steel (Red)			SCC-SS31630S420-PUR-RS-TLB	SCC-SS316TTL30S420-PUR-RS	SCC-SS31630S420-PUR-RS-BSL
		Solid Polyurethane	800		SCC-SS31630S420-SPUR-TLB	SCC-SS316TTL30S420-SPUR	SCC-SS31630S420-SPUR-BSL
		High Temp Phenolic			SCC-SS31630S420-PHRHT-TLB	SCC-SS316TTL30S420-PHRHT	SCC-SS31630S420-PHRHT-BSL
		Phenolic			SCC-SS31630S420-PHR-TLB	SCC-SS316TTL30S420-PHR	SCC-SS31630S420-PHR-BSL
		Semi Steel V-Groove			SCC-SS31630S420-VGR-TLB	SCC-SS316TTL30S420-VGR	SCC-SS31630S420-VGR-BSL
		Semi Steel	1000		SCC-SS31630S420-SSR-TLB	SCC-SS316TTL30S420-SSR	SCC-SS31630S420-SSR-BSL
		Glass Filled Nylon	1200		SCC-SS31630S420-GFNR-TLB	SCC-SS316TTL30S420-GFNR	SCC-SS31630S420-GFNR-BSL
		5"	2"		Thermoplastic Rubber (Donut)	350	6-1/2"
Thermoplastic Rubber (Flat)	SCC-SS31630S520-TPRRF-TLB			SCC-SS316TTL30S520-TPRRF	SCC-SS31630S520-TPRRD-BSL		
Rubber on Cast Iron	400			SCC-SS31630S520-RSR-TLB	SCC-SS316TTL30S520-RSR	SCC-SS31630S520-RSR-BSL	
Rubber on Aluminum	500			SCC-SS31630S520-RAR-TLB	SCC-SS316TTL30S520-RAR	SCC-SS31630S520-RAR-BSL	
Polyolefin	650			SCC-SS31630S520-POR-TLB	SCC-SS316TTL30S520-POR	SCC-SS31630S520-POR-BSL	
Polyurethane on Polyolefin	750			SCC-SS31630S520-PPUR-TLB	SCC-SS316TTL30S520-PPUR	SCC-SS31630S520-PPUR-BSL	
Nylon	900			SCC-SS31630S520-NYR-TLB	SCC-SS316TTL30S520-NYR	SCC-SS31630S520-NYR-BSL	
Polyurethane on Aluminum	1000			SCC-SS31630S520-PAR-TLB	SCC-SS316TTL30S520-PAR	SCC-SS31630S520-PAR-BSL	
High Temp Phenolic				SCC-SS31630S520-PHRHT-TLB	SCC-SS316TTL30S520-PHRHT	SCC-SS31630S520-PHRHT-BSL	
Phenolic				SCC-SS31630S520-PHR-TLB	SCC-SS316TTL30S520-PHR	SCC-SS31630S520-PHR-BSL	
Polyurethane/Steel (Green)	1000			SCC-SS31630S520-PUR-GB-TLB	SCC-SS316TTL30S520-PUR-GB	SCC-SS31630S520-PUR-GB-BSL	
Polyurethane/Steel (Red)				SCC-SS31630S520-PUR-RS-TLB	SCC-SS316TTL30S520-PUR-RS	SCC-SS31630S520-PUR-RS-BSL	
Solid Polyurethane	1000			SCC-SS31630S520-SPUR-TLB	SCC-SS316TTL30S520-SPUR	SCC-SS31630S520-SPUR-BSL	
Semi Steel	1000			SCC-SS31630S520-SSR-TLB	SCC-SS316TTL30S520-SSR	SCC-SS31630S520-SSR-BSL	
Semi Steel V-Groove	1000			SCC-SS31630S520-VGR-TLB	SCC-SS316TTL30S520-VGR	SCC-SS31630S520-VGR-BSL	
Glass Filled Nylon	1250			SCC-SS31630S520-GFNR-TLB	SCC-SS316TTL30S520-GFNR	SCC-SS31630S520-GFNR-BSL	
6"	2"			Rubber on Cast Iron	450	7-1/2"	
		Thermoplastic Rubber (Donut)	500	SCC-SS31630S620-TPRRD-TLB	SCC-SS316TTL30S620-TPRRD		SCC-SS31630S620-TPRRD-BSL
		Thermoplastic Rubber (Flat)		SCC-SS31630S620-TPRRF-TLB	SCC-SS316TTL30S620-TPRRF		SCC-SS31630S620-TPRRF-BSL
		Rubber on Aluminum	550	SCC-SS31630S620-RAR-TLB	SCC-SS316TTL30S620-RAR		SCC-SS31630S620-RAR-BSL
		Polyolefin	700	SCC-SS31630S620-POR-TLB	SCC-SS316TTL30S620-POR		SCC-SS31630S620-POR-BSL
		Polyurethane on Polyolefin	900	SCC-SS31630S620-PPUR-TLB	SCC-SS316TTL30S620-PPUR		SCC-SS31630S620-PPUR-BSL
		Polyurethane on Aluminum	1200	SCC-SS31630S620-PAR-TLB	SCC-SS316TTL30S620-PAR		SCC-SS31630S620-PAR-BSL
		High Temp Phenolic		SCC-SS31630S620-PHRHT-TLB	SCC-SS316TTL30S620-PHRHT		SCC-SS31630S620-PHRHT-BSL
		Phenolic		SCC-SS31630S620-PHR-TLB	SCC-SS316TTL30S620-PHR		SCC-SS31630S620-PHR-BSL
		Polyurethane/Steel (Green)	1200	SCC-SS31630S620-PUR-GB-TLB	SCC-SS316TTL30S620-PUR-GB		SCC-SS31630S620-PUR-GB-BSL
		Polyurethane/Steel (Red)		SCC-SS31630S620-PUR-RS-TLB	SCC-SS316TTL30S620-PUR-RS		SCC-SS31630S620-PUR-RS-BSL
		Solid Polyurethane	1200	SCC-SS31630S620-SPUR-TLB	SCC-SS316TTL30S620-SPUR		SCC-SS31630S620-SPUR-BSL
		Semi Steel	1200	SCC-SS31630S620-SSR-TLB	SCC-SS316TTL30S620-SSR		SCC-SS31630S620-SSR-BSL
		Semi Steel V-Groove	1200	SCC-SS31630S620-VGR-TLB	SCC-SS316TTL30S620-VGR		SCC-SS31630S620-VGR-BSL
		Glass Filled Nylon	1250	SCC-SS31630S620-GFNR-TLB	SCC-SS316TTL30S620-GFNR		SCC-SS31630S620-GFNR-BSL
		Nylon		SCC-SS31630S620-NYR-TLB	SCC-SS316TTL30S620-NYR		SCC-SS31630S620-NYR-BSL



QUALITY > RELIABILITY > EXCELLENCE

"Your One-Stop Shop for All Caster and Wheel Brands!"

DURABLE. RELIABLE.
CORROSION-RESISTANT.

CLEAN ROOMS.
MARINE ENVIRONMENTS.
LABORATORY EQUIPMENT.



316 STAINLESS STEEL

TOP PLATE CASTERS with Roller Bearings & Brakes

Wheel Dia	Tread Width	Wheel Type	Load Capacity (lbs.)	Overall Height	Side Lock Brake (SLB) Top Lock Brake (TLB)	Total Lock Brake (TTL)	Bolt-on Swivel Lock (BSL)
8"	2"	Rubber on Cast Iron	500	9-1/2"	SCC-SS31630S820-RSR-TLB	SCC-SSTTL30S820-RSR	SCC-SS31630S820-RSR-BSL
		Thermoplastic Rubber (Donut)	600		SCC-SS31630S820-TPRRD-TLB	SCC-SSTTL30S820-TPRRD	SCC-SS31630S820-TPRRD-BSL
		Thermoplastic Rubber (Flat)			SCC-SS31630S820-TPRRF-TLB	SCC-SSTTL30S820-TPRRF	SCC-SS31630S820-TPRRF-BSL
		Rubber on Aluminum			SCC-SS31630S820-RAR-TLB	SCC-SSTTL30S820-RAR	SCC-SS31630S820-RAR-BSL
		Polyurethane on Polyolefin	800		SCC-SS31630S820-PPUR-TLB	SCC-SSTTL30S820-PPUR	SCC-SS31630S820-PPUR-BSL
		Polyolefin	900		SCC-SS31630S820-POR-TLB	SCC-SSTTL30S820-POR	SCC-SS31630S820-POR-BSL
		Solid Polyurethane	1200		SCC-SS31630S820-SPUR-TLB	SCC-SSTTL30S820-SPUR	SCC-SS31630S820-SPUR-BSL
		Glass Filled Nylon	1250		SCC-SS31630S820-GFNR-TLB	SCC-SSTTL30S820-GFNR	SCC-SS31630S820-GFNR-BSL
		Phenolic			SCC-SS31630S820-PHR-TLB	SCC-SSTTL30S820-PHR	SCC-SS31630S820-PHR-BSL
		Polyurethane/Steel (Green)			SCC-SS31630S820-PUR-GB-TLB	SCC-SSTTL30S820-PUR-GB	SCC-SS31630S820-PUR-GB-BSL
		Polyurethane/Steel (Red)			SCC-SS31630S820-PUR-RS-TLB	SCC-SSTTL30S820-PUR-RS	SCC-SS31630S820-PUR-RS-BSL
		High Temp Phenolic			SCC-SS31630S820-PHRHT-TLB	SCC-SSTTL30S820-PHRHT	SCC-SS31630S820-PHRHT-BSL
		Semi Steel			SCC-SS31630S820-SSR-TLB	SCC-SSTTL30S820-SSR	SCC-SS31630S820-SSR-BSL
		Semi Steel V-Groove			SCC-SS31630S820-VGR-TLB	SCC-SSTTL30S820-VGR	SCC-SS31630S820-VGR-BSL
		Polyurethane on Aluminum			SCC-SS31630S820-PAR-TLB	SCC-SSTTL30S820-PAR	SCC-SS31630S820-PAR-BSL
		Nylon			SCC-SS31630S820-NYR-TLB	SCC-SSTTL30S820-NYR	SCC-SS31630S820-NYR-BSL

THE CASTERS AND SERVICE YOU NEED!



GIVE US YOUR PRICE!

WE WILL BEAT IT!

Give us a Part#
THAT'S IT!

- Easy Ordering
- Expert Service
- Fast Shipping
- Custom Orders

SCC-SS30S420-SPUR-SLB-BSL

BRAND

SERIES

RIG TYPE

WHEEL DIAMETER

WHEEL WIDTH

WHEEL MATERIAL

BEARING TYPE

BRAKE TYPE

RIG OPTION



Heavy Duty Series



Light Duty Series



Pneumatic Series

CALL TODAY



316 STAINLESS STEEL

TOP PLATE CASTERS *Ball Bearing Wheels*

Wheel Dia	Tread Width	Wheel Type	Load Capacity (lbs.)	Overall Height	Swivel Part Number	Swivel Weight (lbs.)	Rigid Part Number	Rigid Weight (lbs.)
4"	2"	Thermoplastic Rubber (Donut)	300	5-5/8"	SCC-SS31630S420-TPRBD	3.96	SCC-SS31630R420-TPRBD	2.53
		Thermoplastic Rubber (Flat)			SCC-SS31630S420-TPRBF	3.96	SCC-SS31630R420-TPRBF	2.53
		Rubber on Aluminum	400		SCC-SS31630S420-RAB	5.06	SCC-SS31630R420-RAB	3.63
		Rubber on Cast Iron			SCC-SS31630S420-RSB	6.16	SCC-SS31630R420-RSB	1.73
		Polyolefin	500		SCC-SS31630S420-POB	5.06	SCC-SS31630R420-POB	3.63
		Polyurethane on Polyolefin	600		SCC-SS31630S420-PPUB	3.96	SCC-SS31630R420-PPUB	2.53
		Polyurethane on Aluminum			SCC-SS31630S420-PAB	5.06	SCC-SS31630R420-PAB	3.63
		Polyurethane/Steel (Green)	700		SCC-SS31630S420-PUB-GB	6.16	SCC-SS31630R420-PUB-GB	4.73
		Polyurethane/Steel (Red)			SCC-SS31630S420-PUB-RS	6.16	SCC-SS31630R420-PUB-RS	4.73
		Solid Polyurethane	800		SCC-SS31630S420-SPUB	3.96	SCC-SS31630R420-SPUB	2.53
		Nylon			SCC-SS31630S420-NYB	5.06	SCC-SS31630R420-NYB	3.63
		Phenolic			SCC-SS31630S420-PHB	5.25	SCC-SS31630R420-PHB	3.82
		Semi Steel V-Groove			SCC-SS31630S420-VGB	6.71	SCC-SS31630R420-VGB	5.28
		Glass Filled Nylon	900		SCC-SS31630S420-GFNB	5.06	SCC-SS31630R420-GFNB	3.63
		Semi Steel	1000		SCC-SS31630S420-SSB	5.72	SCC-SS31630R420-SSB	4.29
		5"	2"		Thermoplastic Rubber (Donut)	350	6-1/2"	SCC-SS31630S520-TPRBD
Thermoplastic Rubber (Flat)	SCC-SS31630S520-TPRBF			4.62	SCC-SS31630R520-TPRBF			3.19
Rubber on Cast Iron	400			SCC-SS31630S520-RSB	6.16	SCC-SS31630R520-RSB		4.73
Rubber on Aluminum	500			SCC-SS31630S520-RAB	5.75	SCC-SS31630R520-RAB		4.32
Polyolefin	650			SCC-SS31630S520-POB	4.62	SCC-SS31630R520-POB		3.19
Polyurethane on Polyolefin	750			SCC-SS31630S520-PPUB	4.62	SCC-SS31630R520-PPUB		3.19
Nylon				SCC-SS31630S520-NYB	4.62	SCC-SS31630R520-NYB		3.19
Polyurethane on Aluminum	900			SCC-SS31630S520-PAB	5.28	SCC-SS31630R520-PAB		3.85
Phenolic				SCC-SS31630S520-PHB	5.75	SCC-SS31630R520-PHB		4.32
High Temp Phenolic	1000			SCC-SS31630S520-PHBHT	5.75	SCC-SS31630R520-PHBHT		4.32
Polyurethane/Steel (Green)				SCC-SS31630S520-PUB-GB	6.60	SCC-SS31630R520-PUB-GB		5.17
Polyurethane/Steel (Red)				SCC-SS31630S520-PUB-RS	6.60	SCC-SS31630R520-PUB-RS		5.17
Solid Polyurethane				SCC-SS31630S520-SPUB	4.62	SCC-SS31630R520-SPUB		3.19
Semi Steel	1100			SCC-SS31630S520-SSB	7.92	SCC-SS31630R520-SSB		6.49
Semi Steel V-Groove				SCC-SS31630S520-VGB	8.58	SCC-SS31630R520-VGB		7.15
Glass Filled Nylon	1250			SCC-SS31630S520-GFNB	4.62	SCC-SS31630R520-GFNB		3.19
6"	2"	Rubber on Cast Iron	450	7-1/2"	SCC-SS31630S620-RSB	7.70	SCC-SS31630R620-RSB	6.27
		Thermoplastic Rubber (Donut)	500		SCC-SS31630S620-TPRBD	5.06	SCC-SS31630R620-TPRBD	3.63
		Thermoplastic Rubber (Flat)			SCC-SS31630S620-TPRBF	5.06	SCC-SS31630R620-TPRBF	3.63
		Rubber on Aluminum	550		SCC-SS31630S620-RAB	6.50	SCC-SS31630R620-RAB	5.07
		Polyolefin	700		SCC-SS31630S620-POB	5.06	SCC-SS31630R620-POB	3.63
		Polyurethane on Polyolefin	900		SCC-SS31630S620-PPUB	5.06	SCC-SS31630R620-PPUB	3.63
		Polyurethane on Aluminum			SCC-SS31630S620-PAB	6.00	SCC-SS31630R620-PAB	4.07
		Phenolic	1200		SCC-SS31630S620-PHB	7.50	SCC-SS31630R620-PHB	6.07
		High Temp Phenolic			SCC-SS31630S620-PHBHT	7.50	SCC-SS31630R620-PHBHT	6.50
		Polyurethane/Steel (Green)			SCC-SS31630S620-PUB-GB	8.58	SCC-SS31630R620-PUB-GB	7.15
		Polyurethane/Steel (Red)			SCC-SS31630S620-PUB-RS	8.58	SCC-SS31630R620-PUB-RS	7.15
		Solid Polyurethane	1250		SCC-SS31630S620-SPUB	5.06	SCC-SS31630R620-SPUB	3.63
		Semi Steel			SCC-SS31630S620-SSB	8.85	SCC-SS31630R620-SSB	7.15
		Semi Steel V-Groove			SCC-SS31630S620-VGB	10.12	SCC-SS31630R620-VGB	8.69
		Glass Filled Nylon			SCC-SS31630S620-GFNB	5.06	SCC-SS31630R620-GFNB	3.63
		Nylon			SCC-SS31630S620-NYB	5.06	SCC-SS31630R620-NYB	3.63

Choose your color.



Free samples available



316 STAINLESS STEEL

TOP PLATE CASTERS *Ball Bearing Wheels*

Wheel Dia	Tread Width	Wheel Type	Load Capacity (lbs.)	Overall Height	Swivel Part Number	Swivel Weight (lbs.)	Rigid Part Number	Rigid Weight (lbs.)
8"	2"	Rubber on Cast Iron	500	9-1/2"	SCC-SS31630S820-RSB	9.68	SCC-SS31630R820-RSB	8.25
		Thermoplastic Rubber (Donut)	600		SCC-SS31630S820-TPRBD	5.50	SCC-SS31630R820-TPRBD	4.07
		Thermoplastic Rubber (Flat)			SCC-SS31630S820-TPRBF	5.50	SCC-SS31630R820-TPRBF	4.07
		Rubber on Aluminum	800		SCC-SS31630S820-RAB	7.50	SCC-SS31630R820-RAB	9.04
		Polyurethane on Polyolefin			SCC-SS31630S820-PPUB	5.50	SCC-SS31630R820-PPUB	4.07
		Polyolefin	900		SCC-SS31630S820-POB	5.50	SCC-SS31630R820-POB	4.07
		Solid Polyurethane	1200		SCC-SS31630S820-SPUB	5.50	SCC-SS31630R820-SPUB	4.07
		Glass Filled Nylon	1250		SCC-SS31630S820-GFNB	5.50	SCC-SS31630R820-GFNB	4.07
		Nylon			SCC-SS31630S820-NYB	5.50	SCC-SS31630R820-NYB	4.07
		Polyurethane on Aluminum			SCC-SS31630S820-PAB	5.50	SCC-SS31630R820-PAB	4.07
		Phenolic			SCC-SS31630S820-PHB	7.75	SCC-SS31630R820-PHB	6.32
		High Temp Phenolic			SCC-SS31630S820-PHBHT	7.75	SCC-SS31630R820-PHBHT	6.32
		Polyurethane/Steel (Green)			SCC-SS31630S820-PUB-GB	12.10	SCC-SS31630R820-PUB-GB	10.67
		Polyurethane/Steel (Red)			SCC-SS31630S820-PUB-RS	12.10	SCC-SS31630R820-PUB-RS	10.67
		Semi Steel			SCC-SS31630S820-SSB	12.10	SCC-SS31630R820-SSB	10.67
		Semi Steel V-Groove			SCC-SS31630S820-VGB	12.10	SCC-SS31630R820-VGB	10.67



316 STAINLESS STEEL

CASTERS

Stainless steel casters are perfect for food processing, breweries, hospitals, cleanrooms, and marinas, especially Grade 316. They are commonly used for pharmaceutical tables, medical equipment, hotel food carts, and more. Grade 316, with added molybdenum and nickel, offers superior corrosion resistance, ideal for environments exposed to chlorides, saltwater, and harsh chemicals.



TOP LOCK



RIGID



SWIVEL



TOTAL-LOCK



ORDER NOW

1-800-215-8220

316 STAINLESS STEEL

TOP PLATE CASTERS *Ball Bearing Wheels & Brakes*



Wheel Dia.	Tread Width	Wheel Type	Load Capacity (lbs.)	Overall Height	Side Lock Brake (SLB) Top Lock Brake (TLB)	Total Lock Brake (TTL)	Bolt-on Swivel Lock (BSL)
4"	2"	Thermoplastic Rubber (Donut)	300	5-5/8"	SCC-SS31630S420-TPRBD-TLB	SCC-SSTTL30S420-TPRBD	SCC-SS31630S420-TPRBD-BSL
		Thermoplastic Rubber (Flat)			SCC-SS31630S420-TPRBF-TLB	SCC-SSTTL30S420-TPRBF	SCC-SS31630S420-TPRBF-BSL
		Rubber on Aluminum	400		SCC-SS31630S420-RAB-TLB	SCC-SSTTL30S420-RAB	SCC-SS31630S420-RAB-BSL
		Rubber on Cast Iron			SCC-SS31630S420-RSB-TLB	SCC-SSTTL30S420-RSB	SCC-SS31630S420-RSB-BSL
		Polyolefin	500		SCC-SS31630S420-POB-TLB	SCC-SSTTL30S420-POB	SCC-SS31630S420-POB-BSL
		Polyurethane on Polyolefin	600		SCC-SS31630S420-PPUB-TLB	SCC-SSTTL30S420-PPUB	SCC-SS31630S420-PPUB-BSL
		Nylon	800		SCC-SS31630S420-NYB-TLB	SCC-SSTTL30S420-NYB	SCC-SS31630S420-NYB-BSL
		Polyurethane on Aluminum	700		SCC-SS31630S420-PAB-TLB	SCC-SSTTL30S420-PAB	SCC-SS31630S420-PAB-BSL
		Polyurethane/Steel (Green)			SCC-SS31630S420-PUB-GB-TLB	SCC-SSTTL30S420-PUB-GB	SCC-SS31630S420-PUB-GB-BSL
		Polyurethane/Steel (Red)			SCC-SS31630S420-PUB-RS-TLB	SCC-SSTTL30S420-PUB-RS	SCC-SS31630S420-PUB-RS-BSL
		Solid Polyurethane	800		SCC-SS31630S420-SPUB-TLB	SCC-SSTTL30S420-SPUB	SCC-SS31630S420-SPUB-BSL
		High Temp Phenolic			SCC-SS31630S420-PHBHT-TLB	SCC-SSTTL30S420-PHBHT	SCC-SS31630S420-PHBHT-BSL
		Phenolic			SCC-SS31630S420-PHB-TLB	SCC-SSTTL30S420-PHB	SCC-SS31630S420-PHB-BSL
		Semi Steel V-Groove			SCC-SS31630S420-VGB-TLB	SCC-SSTTL30S420-VGB	SCC-SS31630S420-VGB-BSL
		Semi Steel			1000	SCC-SS31630S420-SSB-TLB	SCC-SSTTL30S420-SSB
Glass Filled Nylon	1200	SCC-SS31630S420-GFNB-TLB	SCC-SSTTL30S420-GFNB	SCC-SS31630S420-GFNB-BSL			
5"	2"	Thermoplastic Rubber (Donut)	350	6-1/2"	SCC-SS31630S520-TPRBD-TLB	SCC-SSTTL30S520-TPRBF	SCC-SS31630S520-TPRBF-BSL
		Thermoplastic Rubber (Flat)			SCC-SS31630S520-TPRBF-TLB	SCC-SSTTL30S520-TPRBD	SCC-SS31630S520-TPRBD-BSL
		Rubber on Cast Iron	400		SCC-SS31630S520-RSB-TLB	SCC-SSTTL30S520-RSB	SCC-SS31630S520-RSB-BSL
		Rubber on Aluminum	500		SCC-SS31630S520-RAB-TLB	SCC-SSTTL30S520-RAB	SCC-SS31630S520-RAB-BSL
		Polyolefin	650		SCC-SS31630S520-POB-TLB	SCC-SSTTL30S520-POB	SCC-SS31630S520-POB-BSL
		Polyurethane on Polyolefin	750		SCC-SS31630S520-PPUB-TLB	SCC-SSTTL30S520-PPUB	SCC-SS31630S520-PPUB-BSL
		Nylon	900		SCC-SS31630S520-NYB-TLB	SCC-SSTTL30S520-NYB	SCC-SS31630S520-NYB-BSL
		Polyurethane on Aluminum			SCC-SS31630S520-PAB-TLB	SCC-SSTTL30S520-PAB	SCC-SS31630S520-PAB-BSL
		High Temp Phenolic			SCC-SS31630S520-PHBHT-TLB	SCC-SSTTL30S520-PHBHT	SCC-SS31630S520-PHBHT-BSL
		Phenolic	1000		SCC-SS31630S520-PHB-TLB	SCC-SSTTL30S520-PHB	SCC-SS31630S520-PHB-BSL
		Polyurethane/Steel (Green)			SCC-SS31630S520-PUB-GB-TLB	SCC-SSTTL30S520-PUB-GB	SCC-SS31630S520-PUB-GB-BSL
		Polyurethane/Steel (Red)			SCC-SS31630S520-PUB-RS-TLB	SCC-SSTTL30S520-PUB-RS	SCC-SS31630S520-PUB-RS-BSL
		Solid Polyurethane			SCC-SS31630S520-SPUB-TLB	SCC-SSTTL30S520-SPUB	SCC-SS31630S520-SPUB-BSL
		Semi Steel			SCC-SS31630S520-SSB-TLB	SCC-SSTTL30S520-SSB	SCC-SS31630S520-SSB-BSL
		Semi Steel V-Groove	1250		SCC-SS31630S520-VGB-TLB	SCC-SSTTL30S520-VGB	SCC-SS31630S520-VGB-BSL
Glass Filled Nylon	SCC-SS31630S520-GFNB-TLB	SCC-SSTTL30S520-GFNB		SCC-SS31630S520-GFNB-BSL			
6"	2"	Rubber on Cast Iron	450	7-1/2"	SCC-SS31630S620-RSB-TLB	SCC-SSTTL30S620-RSB	SCC-SS31630S620-RSB-BSL
		Thermoplastic Rubber (Donut)	500		SCC-SS31630S620-TPRBD-TLB	SCC-SSTTL30S620-TPRBD	SCC-SS31630S620-TPRBD-BSL
		Thermoplastic Rubber (Flat)			SCC-SS31630S620-TPRBF-TLB	SCC-SSTTL30S620-TPRBF	SCC-SS31630S620-TPRBF-BSL
		Rubber on Aluminum	550		SCC-SS31630S620-RAB-TLB	SCC-SSTTL30S620-RAB	SCC-SS31630S620-RAB-BSL
		Polyolefin	700		SCC-SS31630S620-POB-TLB	SCC-SSTTL30S620-POB	SCC-SS31630S620-POB-BSL
		Polyurethane on Polyolefin	900		SCC-SS31630S620-PPUB-TLB	SCC-SSTTL30S620-PPUB	SCC-SS31630S620-PPUB-BSL
		Polyurethane on Aluminum	1200		SCC-SS31630S620-PAB-TLB	SCC-SSTTL30S620-PAB	SCC-SS31630S620-PAB-BSL
		High Temp Phenolic			SCC-SS31630S620-PHBHT-TLB	SCC-SSTTL30S620-PHBHT	SCC-SS31630S620-PHBHT-BSL
		Phenolic			SCC-SS31630S620-PHB-TLB	SCC-SSTTL30S620-PHB	SCC-SS31630S620-PHB-BSL
		Polyurethane/Steel (Green)	1200		SCC-SS31630S620-PUB-GB-TLB	SCC-SSTTL30S620-PUB-GB	SCC-SS31630S620-PUB-GB-BSL
		Polyurethane/Steel (Red)			SCC-SS31630S620-PUB-RS-TLB	SCC-SSTTL30S620-PUB-RS	SCC-SS31630S620-PUB-RS-BSL
		Solid Polyurethane			SCC-SS31630S620-SPUB-TLB	SCC-SSTTL30S620-SPUB	SCC-SS31630S620-SPUB-BSL
		Semi Steel			SCC-SS31630S620-SSB-TLB	SCC-SSTTL30S620-SSB	SCC-SS31630S620-SSB-BSL
		Semi Steel V-Groove			SCC-SS31630S620-VGB-TLB	SCC-SSTTL30S620-VGB	SCC-SS31630S620-VGB-BSL
		Glass Filled Nylon	1250		SCC-SS31630S620-GFNB-TLB	SCC-SSTTL30S620-GFNB	SCC-SS31630S620-GFNB-BSL
Nylon	SCC-SS31630S620-NYB-TLB	SCC-SSTTL30S620-NYB		SCC-SS31630S620-NYB-BSL			



LIKE, SHARE & SUBSCRIBE





TOP PLATE CASTERS *Ball Bearing Wheels & Brakes*

Wheel Dia	Tread Width	Wheel Type	Load Capacity (lbs.)	Overall Height	Side Lock Brake (SLB) Top Lock Brake (TLB)	Total Lock Brake (TTL)	Bolt-on Swivel Lock (BSL)
8"	2"	Rubber on Cast Iron	500	9-1/2"	SCC-SS31630S820-RSB-TLB	SCC-SSTTL30S820-RSB	SCC-SS31630S820-RSB-BSL
		Thermoplastic Rubber (Donut)	600		SCC-SS31630S820-TPRBD-TLB	SCC-SSTTL30S820-TPRBD	SCC-SS31630S820-TPRBD-BSL
		Thermoplastic Rubber (Flat)			SCC-SS31630S820-TPRBF-TLB	SCC-SSTTL30S820-TPRBF	SCC-SS31630S820-TPRBF-BSL
		Rubber on Aluminum	800		SCC-SS31630S820-RAB-TLB	SCC-SSTTL30S820-RAB	SCC-SS31630S820-RAB-BSL
		Polyurethane on Polyolefin			SCC-SS31630S820-PPUB-TLB	SCC-SSTTL30S820-PPUB	SCC-SS31630S820-PPUB-BSL
		Polyolefin	900		SCC-SS31630S820-POB-TLB	SCC-SSTTL30S820-POB	SCC-SS31630S820-POB-BSL
		Solid Polyurethane	1200		SCC-SS31630S820-SPUB-TLB	SCC-SSTTL30S820-SPUB	SCC-SS31630S820-SPUB-BSL
		Glass Filled Nylon	1250		SCC-SS31630S820-GFNB-TLB	SCC-SSTTL30S820-GFNB	SCC-SS31630S820-GFNB-BSL
		Phenolic			SCC-SS31630S820-PHB-TLB	SCC-SSTTL30S820-PHB	SCC-SS31630S820-PHB-BSL
		Polyurethane/Steel (Green)			SCC-SS31630S820-PUB-GB-TLB	SCC-SSTTL30S820-PUB-GB	SCC-SS31630S820-PUB-GB-BSL
		Polyurethane/Steel (Red)			SCC-SS31630S820-PUB-RS-TLB	SCC-SSTTL30S820-PUB-RS	SCC-SS31630S820-PUB-RS-BSL
		High Temp Phenolic			SCC-SS31630S820-PHBHT-TLB	SCC-SSTTL30S820-PHBHT	SCC-SS31630S820-PHBHT-BSL
		Semi Steel			SCC-SS31630S820-SSB-TLB	SCC-SSTTL30S820-SSB	SCC-SS31630S820-SSB-BSL
		Semi Steel V-Groove			SCC-SS31630S820-VGB-TLB	SCC-SSTTL30S820-VGB	SCC-SS31630S820-VGB-BSL
		Polyurethane on Aluminum			SCC-SS31630S820-PAB-TLB	SCC-SSTTL30S820-PAB	SCC-SS31630S820-PAB-BSL
		Nylon			SCC-SS31630S820-NYB-TLB	SCC-SSTTL30S820-NYB	SCC-SS31630S820-NYB-BSL

SERVICE CASTER, WHY NOT?

THE SERVICE CASTER ADVANTAGE: EXCELLENCE YOU CAN TRUST

Choose Service Caster for top-quality and expertise. With over 30 years of experience, we offer a wide range of heavy-duty casters, wheels, and custom mobility systems, all made in the USA. Our commitment to excellence ensures durable, reliable products, backed by knowledgeable service and fast shipping. Trust Service Caster to keep your operations running smoothly.



BUILT TO LAST



**ENGINEERED FOR
EXCELLENCE**



RAPID DELIVERY



**SATISFACTION
GUARANTEED**

Heavy Duty Casters

Series #35 Casters

Applications

- Platform Trucks
- Dollies
- Hotel Housekeeping Carts
- Industrial Equipment
- Towline Carts
- Freight Terminal Carts

Features

- Smooth Rolling
- Secure Ride
- Brake Options

Our part numbers adapt to your needs. Use the diagram below as a reference. For help, contact our [customer service](#) team.

SCC-35S420-PHR-SLB-BSL

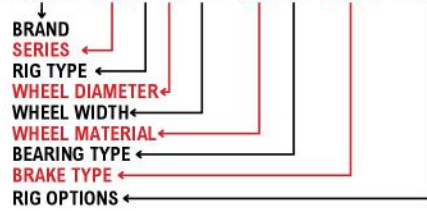

4" Swivel Phenolic Caster with Side Lock Brake

The Service Caster #35 Series is ideal for dollies, platform trucks, warehouse carts, and other heavy-duty applications. Featuring a large double ball bearing raceway, bright zinc plating, grease fittings, and 3/4" bolted kingpins, these industrial casters offer various options to meet your needs.



Service Caster Chart Guide

Build Your Caster

Discover more fastening sizes and wheel options if you can't find what you need. And remember, we're always here to [help!](#)

Series	Mounting	Mounting Size	Bolt Pattern	Rig Type	Brake	Wheel Size	Bearing Type	Wheel Material
35	Top Plate	4-1/2" x 6-1/4"	2-7/16" x 4-15/16" to 3-3/8" x 5-1/4"	Swivel (S)	Side Lock (SLB)	3-1/4" x 2" (3420)	Ball Bearing (B)	Soft Rubber (SR)
				Rigid (R)	Face Contact (FCB)	4" x 2" (420)	Plain Bore (S)	Thermo Plastic Rubber (TPR)
					Bolt-on Swivel Lock (BSL)	5" x 2" (520)	Delrin Bearing (D)	Polyurethane (PPU)
					Weld-on Swivel Lock (WSL)	6" x 2" (620)	Roller Bearing (R)	Phenolic (PH)
						8" x 2" (820)	Precision Bearing (PB)	Solid Polyurethane (SPU)
			Bronze Bearing (BZ)	Hard Rubber (HR)				
							Glass Filled Nylon (GFN)	
							Rubber on Aluminum (RA)	
							Semi Steel (SS)	
							Nylon (NY)	
							High Temp Phenolic (PH*HT)	
							High Temp Nylon (GF*HT)	

More Options

- BSL** (4 Position Swivel Lock)
- SLB** (Side Lock Brake)
- HT** (High Temp Lubrication)
- WS** (Neoprene Wheel Seal)
- TGM/TGP** (Metal/Plastic Thread Guard)

Swivel Head Bearing

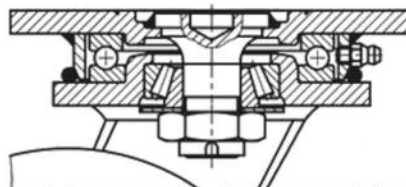

Wheel Tread



Track Wheels Available

Series #35 Casters

The Service Caster #35 Series offers many options, featuring a large double ball bearing raceway, bright zinc plating, grease fittings, and 3/4" bolted kingpins. Ideal for dollies, platform trucks, warehouse carts, and heavy-duty applications.

Choose Your Movement

- Rigid and Swivel Available



RIGID



SWIVEL

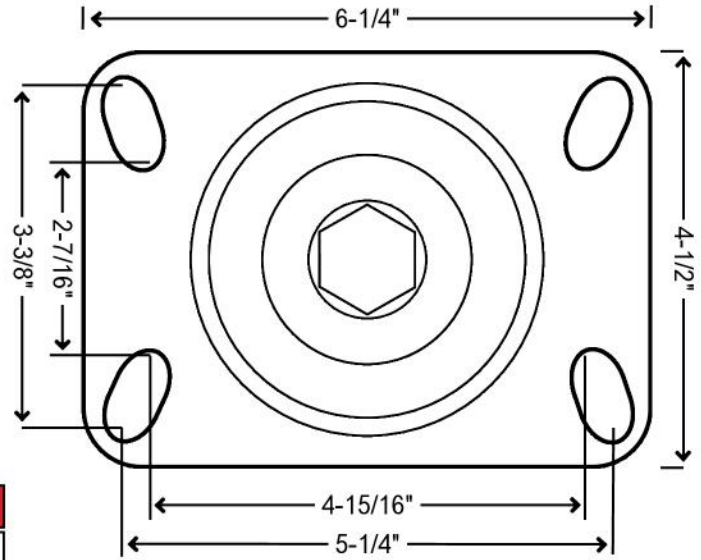

Standard Plate Size	Bolt Pattern	Bolt Diameter
4-1/2" x 6-1/4" (TP2)	2-7/16"x4-15/16" to 3-3/8"x5-1/4"	1/2"

Bearing Type(s)

Roller Bearing

Anti-friction bearing, ideal for manual applications with prevalent shock loading.



Ball Bearing

Ball bearing provides smooth movement and durability.



Delrin Bearing

Delrin bearings, maintenance-free, ideal for wash-downs, max 180°F.



Bronze Bearing

Bronze bearings are durable, corrosion-resistant, and withstand up to 525°F.



Brake Option(s)

Side Lock Brake (SLB)

The side lock brake on casters securely locks the wheel, ensuring stability and safety.



SCC-35S820-PUR-GB-SLB

Bolt-on Swivel Lock (BSL)

The bolt-on swivel lock secures swivel casters, preventing unwanted movement. Easy to install, it ensures stability.



SCC-35820-TPRBD-BSL

Choose your brake style! The Side Lock Brake (SLB) grips the wheel tight, while the Bolt-On Swivel Lock (BSL) converts your caster to rigid at any 90-degree angle. Use both for ultimate control, locking both swivel and wheel for total immobility.

POWERLOCK CASTERS



Capacity up to 1500 lbs.

TOP PLATE RIGID CASTERS *Roller Bearing Wheels*

Wheel Dia.	Tread Width	Wheel Type	Load Capacity (lbs.)	Overall Height	Swivel Part Number	Rigid Part Number
8"	2"	Rubber on Cast Iron	500	9-1/2"	SCC-35S820-RSR	SCC-35R820-PPUR
		Thermoplastic Rubber (Donut)	600		SCC-35S820-TPRRD	SCC-35R820-RSR
		Thermoplastic Rubber (Flat)			SCC-35S820-TPRRF	SCC-35R820-RAR
		Rubber on Aluminum			SCC-35S820-RAR	SCC-35R820-POR
		Polyolefin	900		SCC-35S820-POR	SCC-35R820-SPUR
		Polyurethane on Polyolefin	1000		SCC-35S820-PPUR	SCC-35R820-NYR
		Solid Polyurethane	1200		SCC-35S820-SPUR	SCC-35R820-PUR-RS
		Polyurethane on Aluminum	1250		SCC-35S820-PAR	SCC-35R820-PAR
		Polyurethane/Steel (Green)			SCC-35S820-PUR-GB	SCC-35R820-PHR
		Polyurethane/Steel (Red)			SCC-35S820-PUR-RS	SCC-35R820-PUR-GB
		Nylon			SCC-35S820-NYR	SCC-35R820-SSR
		Phenolic			SCC-35S820-PHR	SCC-35R820-PHR
		Semi Steel V-Groove			SCC-35S820-VGR	SCC-35R820-VGR
		Semi Steel			SCC-35S820-SSR	SCC-35R820-GFNR
		Glass Filled Nylon			1500	SCC-35S820-GFNR

Caster Anatomy: Understanding the Basics

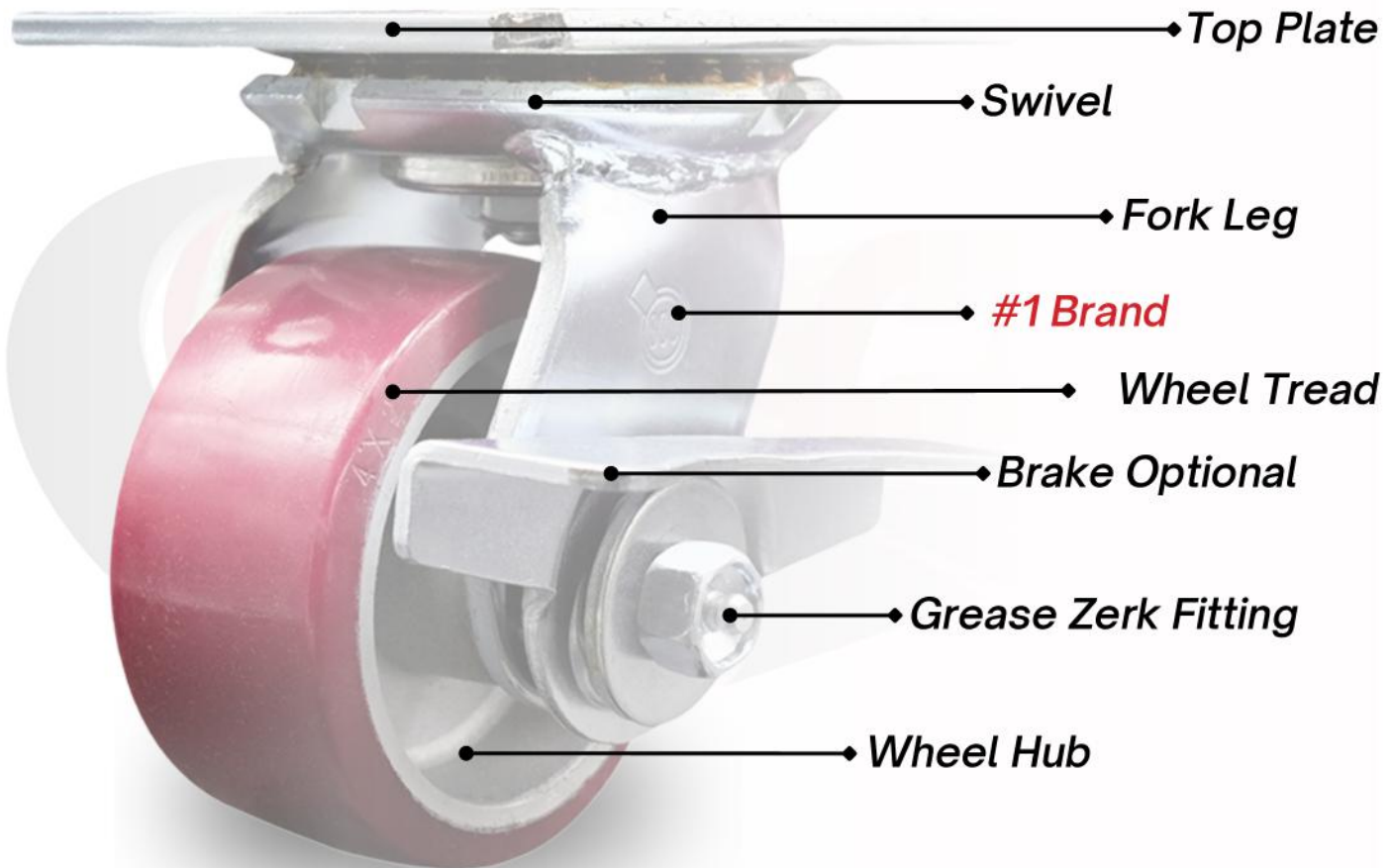

A caster comprises three main parts: the **wheel**, the mounting frame (or **fork/yoke**), and the **swivel** mechanism. The wheel enables movement, the frame provides support, and the swivel mechanism allows for multidirectional maneuverability. There are numerous options available, including wheel brakes and more, making casters essential for flexible and easy movement in various applications.



Roller Bearing Wheels

Roll Smoothly with Roller Bearing Wheels

Upgrade your casters with standard roller bearing wheels for durable, efficient, and reliable performance. Perfect for any application!

TOP PLATE CASTERS

Wheel Dia	Tread Width	Wheel Type	Load Capacity (lbs.)	Overall Height	Swivel Part Number	Rigid Part Number
4"	2"	Thermoplastic Rubber (Donut)	300	5-5/8"	SCC-35S420-TPRRD	SCC-35R420-TPRRD
		Thermoplastic Rubber (Flat)			SCC-35S420-TPRRF	SCC-35R420-TPRRF
		Rubber on Aluminum	400		SCC-35S420-RAR	SCC-35R420-RAR
		Rubber on Cast Iron			SCC-35S420-RSR	SCC-35R420-RSR
		Polyolefin	500		SCC-35S420-POR	SCC-35R420-POR
		Polyurethane on Polyolefin	600		SCC-35S420-PPUR	SCC-35R420-PPUR
		Polyurethane on Aluminum	700		SCC-35S420-PAR	SCC-35R420-PAR
		Polyurethane/Steel (Green)			SCC-35S420-PUR-GB	SCC-35R420-PUR-GB
		Polyurethane/Steel (Red)			SCC-35S420-PUR-RS	SCC-35R420-PUR-RS
		Solid Polyurethane			SCC-35S420-SPUR	SCC-35R420-SPUR
		Nylon	800		SCC-35S420-NYR	SCC-35R420-NYR
		Phenolic			SCC-35S420-PHR	SCC-35R420-PHR
		Semi Steel V-Groove			SCC-35S420-VGR	SCC-35R420-VGR
		Semi Steel			SCC-35S420-SSR	SCC-35R420-SSR
Glass Filled Nylon	1200	SCC-35S420-GFNR	SCC-35R420-GFNR			
5"	2"	Thermoplastic Rubber (Donut)	350	6-1/2"	SCC-35S520-TPRRD	SCC-35R520-TPRRD
		Thermoplastic Rubber (Flat)			SCC-35S520-TPRRF	SCC-35R520-TPRRF
		Rubber on Aluminum	400		SCC-35S520-RSR	SCC-35R520-RSR
		Rubber on Cast Iron	500		SCC-35S520-RAR	SCC-35R520-RAR
		Polyolefin	650		SCC-35S520-POR	SCC-35R520-POR
		Polyurethane on Polyolefin	750		SCC-35S520-PPUR	SCC-35R520-PPUR
		Polyurethane on Aluminum	900		SCC-35S520-NYR	SCC-35R520-NYR
		Polyurethane/Steel (Green)			SCC-35S520-PAR	SCC-35R520-PAR
		Polyurethane/Steel (Red)			SCC-35S520-PHR	SCC-35R520-PHR
		Solid Polyurethane			SCC-35S520-PUR-GB	SCC-35R520-PUR-GB
		Nylon	1000		SCC-35S520-PUR-RS	SCC-35R520-PUR-RS
		Phenolic			SCC-35S520-SPUR	SCC-35R520-SPUR
		Semi Steel V-Groove			SCC-35S520-SSR	SCC-35R520-SSR
		Semi Steel			SCC-35S520-VGR	SCC-35R520-VGR
Glass Filled Nylon	1500	SCC-35S520-GFNR	SCC-35R520-GFNR			
6"	2"	Thermoplastic Rubber (Donut)	450	7-1/2"	SCC-35S620-RSR	SCC-35R620-RSR
		Thermoplastic Rubber (Flat)	500		SCC-35S620-TPRRD	SCC-35R620-TPRRD
		Rubber on Aluminum			SCC-35S620-TPRRF	SCC-35R620-TPRRF
		Rubber on Cast Iron	550		SCC-35S620-RAR	SCC-35R620-RAR
		Polyolefin	700		SCC-35S620-POR	SCC-35R620-POR
		Polyurethane on Polyolefin	900		SCC-35S620-PPUR	SCC-35R620-PPUR
		Polyurethane on Aluminum	1200		SCC-35S620-PAR	SCC-35R620-PAR
		Polyurethane/Steel (Green)			SCC-35S620-PHR	SCC-35R620-PHR
		Polyurethane/Steel (Red)			SCC-35S620-PUR-GB	SCC-35R620-PUR-GB
		Solid Polyurethane			SCC-35S620-PUR-RS	SCC-35R620-PUR-RS
		Nylon	1250		SCC-35S620-SPUR	SCC-35R620-SPUR
		Phenolic			SCC-35S620-SSR	SCC-35R620-SSR
		Semi Steel V-Groove			SCC-35S620-VGR	SCC-35R620-VGR
		Semi Steel			SCC-35S620-NYR	SCC-35R620-NYR
Glass Filled Nylon	1500	SCC-35S620-GFNR	SCC-35R620-GFNR			

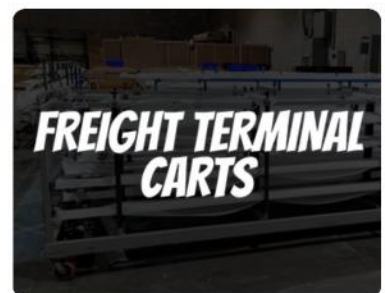
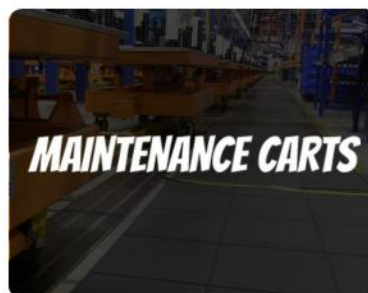
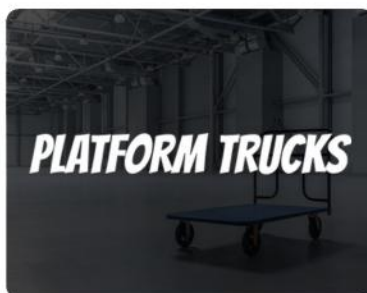



TOP PLATE CASTERS *with Brakes & Roller Bearings*

Wheel Dia.	Tread Width	Wheel Type	Load Capacity (lbs.)	Overall Height	Side Lock Brake (SLB)	Bolt-on Swivel Lock (BSL)
4"	2"	Thermoplastic Rubber (Donut)	300	5-5/8"	SCC-35S420-TPRRD-SLB	SCC-35S420-TPRRD-BSL
		Thermoplastic Rubber (Flat)			SCC-35S420-TPRRF-SLB	SCC-35S420-TPRRF-BSL
		Rubber on Aluminum	400		SCC-35S420-RAR-SLB	SCC-35S420-RAR-BSL
		Rubber on Cast Iron			SCC-35S420-RSR-SLB	SCC-35S420-RSR-BSL
		Polyolefin	500		SCC-35S420-POR-SLB	SCC-35S420-POR-BSL
		Polyurethane on Polyolefin	600		SCC-35S420-PPUR-SLB	SCC-35S420-PPUR-BSL
		Polyurethane on Aluminum	700		SCC-35S420-PAR-SLB	SCC-35S420-PAR-BSL
		Polyurethane/Steel (Green)			SCC-35S420-PUR-GB-SLB	SCC-35S420-PUR-GB-BSL
		Polyurethane/Steel (Red)			SCC-35S420-PUR-RS-SLB	SCC-35S420-PUR-RS-BSL
		Solid Polyurethane			SCC-35S420-SPUR-SLB	SCC-35S420-SPUR-BSL
		Nylon	800		SCC-35S420-NYR-SLB	SCC-35S420-NYR-BSL
		Phenolic			SCC-35S420-PHR-SLB	SCC-35S420-PHR-BSL
		Semi Steel V-Groove			SCC-35S420-VGR-SLB	SCC-35S420-VGR-BSL
		Semi Steel	1000		SCC-35S420-SSR-SLB	SCC-35S420-SSR-BSL
		Glass Filled Nylon	1200		SCC-35S420-GFNR-SLB	SCC-35S420-GFNR-BSL
5"	2"	Thermoplastic Rubber (Donut)	350	6-1/2"	SCC-35S520-TPRRD-SLB	SCC-35S520-TPRRD-BSL
		Thermoplastic Rubber (Flat)			SCC-35S520-TPRRF-SLB	SCC-35S520-TPRRF-BSL
		Rubber on Aluminum	400		SCC-35S520-RSR-SLB	SCC-35S520-RSR-BSL
		Rubber on Cast Iron	500		SCC-35S520-RAR-SLB	SCC-35S520-RAR-BSL
		Polyolefin	650		SCC-35S520-POR-SLB	SCC-35S520-POR-BSL
		Polyurethane on Polyolefin	750		SCC-35S520-PPUR-SLB	SCC-35S520-PPUR-BSL
		Polyurethane on Aluminum	900		SCC-35S520-NYR-SLB	SCC-35S520-NYR-BSL
		Polyurethane/Steel (Green)			SCC-35S520-PAR-SLB	SCC-35S520-PAR-BSL
		Polyurethane/Steel (Red)	1000		SCC-35S520-PHR-SLB	SCC-35S520-PHR-BSL
		Solid Polyurethane	1000		SCC-35S520-PUR-GB-SLB	SCC-35S520-PUR-GB-BSL
		Nylon			SCC-35S520-PUR-RS-SLB	SCC-35S520-PUR-RS-BSL
		Phenolic	1000		SCC-35S520-SPUR-SLB	SCC-35S520-SPUR-BSL
		Semi Steel V-Groove	1100		SCC-35S520-SSR-SLB	SCC-35S520-SSR-BSL
		Semi Steel			SCC-35S520-VGR-SLB	SCC-35S520-VGR-BSL
		Glass Filled Nylon	1500		SCC-35S520-GFNR-SLB	SCC-35S520-GFNR-BSL
6"	2"	Thermoplastic Rubber (Donut)	450	7-1/2"	SCC-35S620-RSR-SLB	SCC-35S620-RSR-BSL
		Thermoplastic Rubber (Flat)	500		SCC-35S620-TPRRD-SLB	SCC-35S620-TPRRD-BSL
		Rubber on Aluminum	550		SCC-35S620-TPRRF-SLB	SCC-35S620-TPRRF-BSL
		Rubber on Cast Iron			SCC-35S620-RAR-SLB	SCC-35S620-RAR-BSL
		Polyolefin	700		SCC-35S620-POR-SLB	SCC-35S620-POR-BSL
		Polyurethane on Polyolefin	900		SCC-35S620-PPUR-SLB	SCC-35S620-PPUR-BSL
		Polyurethane on Aluminum	1200		SCC-35S620-PAR-SLB	SCC-35S620-PAR-BSL
		Polyurethane/Steel (Green)			SCC-35S620-PHR-SLB	SCC-35S620-PHR-BSL
		Polyurethane/Steel (Red)			SCC-35S620-PUR-GB-SLB	SCC-35S620-PUR-GB-BSL
		Solid Polyurethane			SCC-35S620-PUR-RS-SLB	SCC-35S620-PUR-RS-BSL
		Nylon	1250		SCC-35S620-SPUR-SLB	SCC-35S620-SPUR-BSL
		Phenolic			SCC-35S620-SSR-SLB	SCC-35S620-SSR-BSL
		Semi Steel V-Groove			SCC-35S620-VGR-SLB	SCC-35S620-VGR-BSL
		Semi Steel	1500		SCC-35S620-NYR-SLB	SCC-35S620-NYR-BSL
		Glass Filled Nylon	1500		SCC-35S620-GFNR-SLB	SCC-35S620-GFNR-BSL

Side Lock Brake (SLB)

The side lock brake on casters securely locks the wheel, ensuring stability and safety.



SCC-35S820-PUR-GB-SLB

POWERLOCK CASTERS

Choose your brake style! The Side Lock Brake (SLB) grips tight, and the Bolt-On Swivel Lock (BSL) locks at 90 degrees. Combine both for ultimate control and immobility.

Bolt-on Swivel Lock (BSL)

The bolt-on swivel lock secures swivel casters, preventing unwanted movement. Easy to install, it ensures stability.



Capacity up to 1500 lbs.



TOP PLATE CASTERS with Brakes & Roller Bearings

Wheel Dia.	Tread Width	Wheel Type	Load Capacity (lbs.)	Overall Height	Side Lock Brake (SLB)	Bolt-on Swivel Lock (BSL)
8"	2"	Rubber on Cast Iron	500	9-1/2"	SCC-35S820-RSR-SLB	SCC-35S820-RSR-BSL
		Thermoplastic Rubber (Donut)	600		SCC-35S820-RAR-SLB	SCC-35S820-RAR-BSL
		Thermoplastic Rubber (Flat)			SCC-35S820-POR-SLB	SCC-35S820-POR-BSL
		Rubber on Aluminum			SCC-35S820-PPUR-SLB	SCC-35S820-PPUR-BSL
		Polyolefin	900		SCC-35S820-SPUR-SLB	SCC-35S820-SPUR-BSL
		Polyurethane on Polyolefin	1000		SCC-35S820-NYR-SLB	SCC-35S820-NYR-BSL
		Solid Polyurethane	1200		SCC-35S820-PAR-SLB	SCC-35S820-PAR-BSL
		Polyurethane on Aluminum	1250		SCC-35S820-PHR-SLB	SCC-35S820-PHR-BSL
		Polyurethane/Steel (Green)			SCC-35S820-PUR-GB-SLB	SCC-35S820-PUR-GB-BSL
		Polyurethane/Steel (Red)			SCC-35S820-PUR-RS-SLB	SCC-35S820-PUR-RS-BSL
		Nylon			SCC-35S820-SSR-SLB	SCC-35S820-SSR-BSL
		Phenolic			SCC-35S820-GFNR-SLB	SCC-35S820-GFNR-BSL
		Semi Steel V-Groove			SCC-35S820-VGR-SLB	SCC-35S820-VGR-BSL
		Semi Steel	1500		SCC-35S820-SSR-SLB	SCC-35S820-SSR-BSL
Glass Filled Nylon	SCC-35S820-GFNR-SLB	SCC-35S820-GFNR-BSL				

Get the Perfect Fit:

Measuring Your Caster Plate

Size matters when it comes to caster plates. Follow these steps to get the right size:

- 1. Plate Length:** Measure the length of the caster plate.
- 2. Plate Width:** Measure the width of the caster plate.
- 3. Bolt Hole Spacing:** Measure the distance between bolt hole centers.

Ensure a perfect fit for better stability and performance!

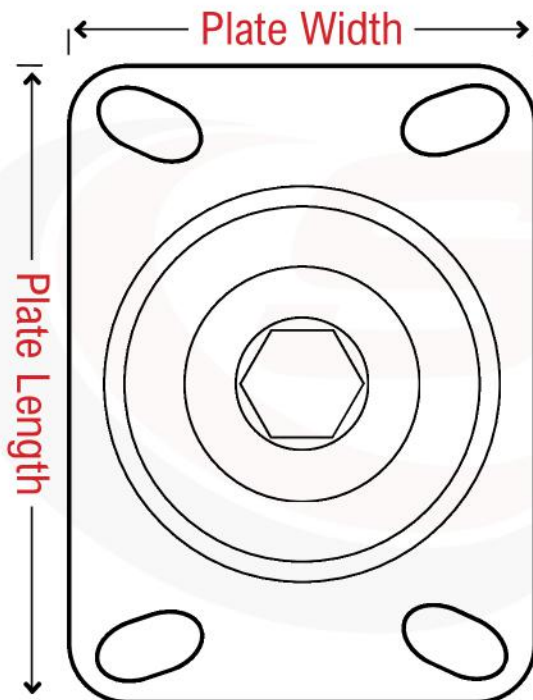

SWIVEL TOP PLATE

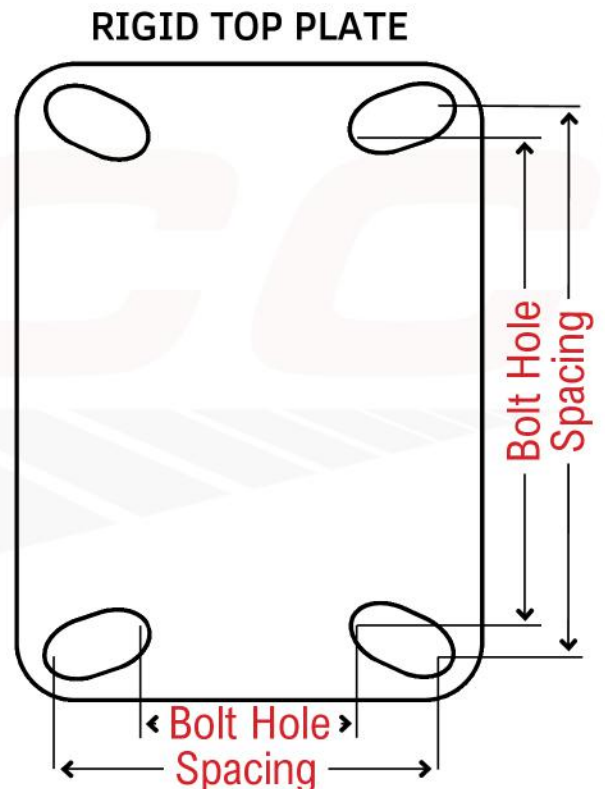

RIGID TOP PLATE



The Benefits of Ball Bearings in Caster Wheels

Ball bearings in caster wheels provide smoother, quieter operation and increased durability. They reduce friction, allowing for easier movement and greater load capacity, making them ideal for heavy-duty applications.

TOP PLATE RIGID CASTERS *Ball Bearing Wheels*

Wheel Dia.	Tread Width	Wheel Type	Load Capacity (lbs.)	Overall Height	Swivel Part Number	Rigid Part Number
4"	2"	Thermoplastic Rubber (Donut)	300	5-5/8"	SCC-35S420-TPRBD	SCC-35R420-TPRBD
		Thermoplastic Rubber (Flat)			SCC-35S420-TPRBF	SCC-35R420-TPRBF
		Rubber on Aluminum	400		SCC-35S420-RAB	SCC-35R420-RAB
		Rubber on Cast Iron			SCC-35S420-RSB	SCC-35R420-RSB
		Polyolefin	500		SCC-35S420-POB	SCC-35R420-POB
		Polyurethane on Polyolefin	600		SCC-35S420-PPUB	SCC-35R420-PPUB
		Polyurethane on Aluminum	700		SCC-35S420-PAB	SCC-35R420-PAB
		Polyurethane/Steel (Green)			SCC-35S420-PUB-GB	SCC-35R420-PUB-GB
		Polyurethane/Steel (Red)			SCC-35S420-PUB-RS	SCC-35R420-PUR-RS
		Solid Polyurethane			SCC-35S420-SPUB	SCC-35R420-SPUR
		Nylon	800		SCC-35S420-NYB	SCC-35R420-NYR
		Phenolic			SCC-35S420-PHB	SCC-35R420-PHR
		Semi Steel V-Groove			SCC-35S420-VGB	SCC-35R420-VGR
		Semi Steel	1000		SCC-35S420-SSB	SCC-35R420-SSR
		Glass Filled Nylon	1200		SCC-35S420-GFNB	SCC-35R420-GFNR
5"	2"	Thermoplastic Rubber (Donut)	350	6-1/2"	SCC-35S520-TPRBD	SCC-35R520-TPRRD
		Thermoplastic Rubber (Flat)			SCC-35S520-TPRBF	SCC-35R520-TPRRF
		Rubber on Aluminum	400		SCC-35S520-RSB	SCC-35R520-RSR
		Rubber on Cast Iron	500		SCC-35S520-RAB	SCC-35R520-RAR
		Polyolefin	650		SCC-35S520-POB	SCC-35R520-POR
		Polyurethane on Polyolefin	750		SCC-35S520-PPUB	SCC-35R520-PPUR
		Polyurethane on Aluminum	900		SCC-35S520-NYB	SCC-35R520-NYR
		Polyurethane/Steel (Green)			SCC-35S520-PAB	SCC-35R520-PAR
		Polyurethane/Steel (Red)			SCC-35S520-PHB	SCC-35R520-PHR
		Solid Polyurethane			SCC-35S520-PUB-GB	SCC-35R520-PUR-GB
		Nylon	1000		SCC-35S520-PUB-RS	SCC-35R520-PUR-RS
		Phenolic			SCC-35S520-SPUB	SCC-35R520-SPUR
		Semi Steel V-Groove			SCC-35S520-SSB	SCC-35R520-SSR
		Semi Steel	1100		SCC-35S520-VGB	SCC-35R520-VGR
		Glass Filled Nylon	1500		SCC-35S520-GFNB	SCC-35R520-GFNR
6"	2"	Thermoplastic Rubber (Donut)	450	7-1/2"	SCC-35S620-RSB	SCC-35R620-RSR
		Thermoplastic Rubber (Flat)	500		SCC-35S620-TPRBD	SCC-35R620-TPRRD
		Rubber on Aluminum			SCC-35S620-TPRBF	SCC-35R620-TPRRF
		Rubber on Cast Iron	550		SCC-35S620-RAB	SCC-35R620-RAR
		Polyolefin	700		SCC-35S620-POB	SCC-35R620-POR
		Polyurethane on Polyolefin	900		SCC-35S620-PPUB	SCC-35R620-PPUR
		Polyurethane on Aluminum	1200		SCC-35S620-PAB	SCC-35R620-PAR
		Polyurethane/Steel (Green)			SCC-35S620-PHB	SCC-35R620-PHR
		Polyurethane/Steel (Red)			SCC-35S620-PUB-GB	SCC-35R620-PUR-GB
		Solid Polyurethane			SCC-35S620-PUB-RS	SCC-35R620-PUR-RS
		Nylon	1250		SCC-35S620-SPUB	SCC-35R620-SPUR
		Phenolic			SCC-35S620-SSB	SCC-35R620-SSR
		Semi Steel V-Groove			SCC-35S620-VGB	SCC-35R620-VGR
		Semi Steel	1250		SCC-35S620-NYB	SCC-35R620-NYR
		Glass Filled Nylon	1500		SCC-35S620-GFNB	SCC-35R620-GFNR

Construction
Capacities
APPLICATIONS

Why Choose Heavy-Duty Casters?

- **Robust Construction:** Reinforced steel and durable materials for longevity.
- **High Load Capacities:** Supports weights from hundreds to thousands of pounds.
- **Versatile Applications:** Ideal for industrial and commercial use.



TOP PLATE RIGID CASTERS *Ball Bearing Wheels*

Wheel Dia.	Tread Width	Wheel Type	Load Capacity (lbs.)	Overall Height	Ball Bearing	Roller Bearing
8"	2"	Rubber on Cast Iron	500	9-1/2"	SCC-35S820-RSB	SCC-35R820-RSB
		Thermoplastic Rubber (Donut)	600		SCC-35S820-TPRBD	SCC-35R820-TPRBD
		Thermoplastic Rubber (Flat)			SCC-35S820-TPRBF	SCC-35R820-TPRBF
		Rubber on Aluminum	900		SCC-35S820-RAB	SCC-35R820-RAB
		Polyolefin			SCC-35S820-POB	SCC-35R820-POB
		Polyurethane on Polyolefin	1000		SCC-35S820-PPUB	SCC-35R820-PPUB
		Solid Polyurethane	1200		SCC-35S820-SPUB	SCC-35R820-SPUB
		Polyurethane on Aluminum	1250		SCC-35S820-PAB	SCC-35R820-PAB
		Polyurethane/Steel (Green)			SCC-35S820-PUB-GB	SCC-35R820-PUB-GB
		Polyurethane/Steel (Red)			SCC-35S820-PUB-RS	SCC-35R820-PUB-RS
		Nylon			SCC-35S820-NYB	SCC-35R820-NYB
		Phenolic			SCC-35S820-PHB	SCC-35R820-PHB
		Semi Steel V-Groove	1500		SCC-35S820-VGB	SCC-35R820-VGB
		Semi Steel			SCC-35S820-SSB	SCC-35R820-SSB
		Glass Filled Nylon			SCC-35S820-GFNB	SCC-35R820-GFNB

Protect Your Casters from Damage



• **Mounting Plate:** The mounting plate attaches the caster to the equipment. Keep it clean and check for any loose screws or bolts. Tighten them as needed to ensure a secure fit.

• **Axle:** The axle holds the wheel in place. Ensure it is free of dirt and debris, and inspect for any signs of damage. Clean with a soft brush and lubricate if necessary.

• **Wheel:** The wheel is the primary component that makes contact with the ground. Clean it regularly to remove dirt and debris that can cause wear and tear. Use a damp cloth and mild detergent for cleaning.

• **Bearing:** The bearing allows the wheel to rotate smoothly. Check for signs of rust or corrosion and apply lubricant as needed to keep it functioning properly.





TOP PLATE CASTERS *with Brakes & Ball Bearings*

Wheel Dia.	Tread Width	Wheel Type	Load Capacity (lbs.)	Overall Height	Side Lock Brake (SLB)	Bolt-on Swivel Lock (BSL)
4"	2"	Thermoplastic Rubber (Donut)	300	5-5/8"	SCC-35S420-TPRBD-SLB	SCC-35S420-TPRBD-BSL
		Thermoplastic Rubber (Flat)			SCC-35S420-TPRBF-SLB	SCC-35S420-TPRBF-BSL
		Rubber on Aluminum			SCC-35S420-RAB-SLB	SCC-35S420-RAB-BSL
		Rubber on Cast Iron	400		SCC-35S420-RSB-SLB	SCC-35S420-RSB-BSL
		Polyolefin			SCC-35S420-POB-SLB	SCC-35S420-POB-BSL
		Polyurethane on Polyolefin	500		SCC-35S420-PPUB-SLB	SCC-35S420-PPUB-BSL
		Polyurethane on Aluminum	600		SCC-35S420-PAB-SLB	SCC-35S420-PAB-BSL
		Polyurethane/Steel (Green)	700		SCC-35S420-PUB-GB-SLB	SCC-35S420-PUB-GB-BSL
		Polyurethane/Steel (Red)			SCC-35S420-PUB-RS-SLB	SCC-35S420-PUB-RS-BSL
		Solid Polyurethane			SCC-35S420-SPUB-SLB	SCC-35S420-SPUB-BSL
		Nylon	800		SCC-35S420-PHB-SLB	SCC-35S420-PHB-BSL
		Phenolic			SCC-35S420-NYB-SLB	SCC-35S420-NYB-BSL
		Semi Steel V-Groove			SCC-35S420-VGB-SLB	SCC-35S420-VGB-BSL
		Semi Steel	1000		SCC-35S420-SSB-SLB	SCC-35S420-SSB-BSL
		Glass Filled Nylon	1200		SCC-35S420-GFNB-SLB	SCC-35S420-GFNB-BSL
5"	2"	Thermoplastic Rubber (Donut)	350	6-1/2"	SCC-35S520-TPRBD-SLB	SCC-35S520-TPRBD-BSL
		Thermoplastic Rubber (Flat)			SCC-35S520-TPRBF-SLB	SCC-35S520-TPRBF-BSL
		Rubber on Aluminum			SCC-35S520-RSB-SLB	SCC-35S520-RSB-BSL
		Rubber on Cast Iron	400		SCC-35S520-RAB-SLB	SCC-35S520-RAB-BSL
		Polyolefin	500		SCC-35S520-POB-SLB	SCC-35S520-POB-BSL
		Polyurethane on Polyolefin	650		SCC-35S520-PPUB-SLB	SCC-35S520-PPUB-BSL
		Polyurethane on Aluminum	750		SCC-35S520-NYB-SLB	SCC-35S520-NYB-BSL
		Polyurethane/Steel (Green)	900		SCC-35S520-PAB-SLB	SCC-35S520-PAB-BSL
		Polyurethane/Steel (Red)			SCC-35S520-PHB-SLB	SCC-35S520-PHB-BSL
		Solid Polyurethane			SCC-35S520-PUB-GB-SLB	SCC-35S520-PUB-GB-BSL
		Nylon	1000		SCC-35S520-PUB-RS-SLB	SCC-35S520-PUB-RS-BSL
		Phenolic	1000		SCC-35S520-SPUB-SLB	SCC-35S520-SPUB-BSL
		Semi Steel V-Groove			SCC-35S520-SSB-SLB	SCC-35S520-SSB-BSL
		Semi Steel			SCC-35S520-VGB-SLB	SCC-35S520-VGB-BSL
		Glass Filled Nylon	1100		SCC-35S520-GFNB-SLB	SCC-35S520-GFNB-BSL
6"	2"	Thermoplastic Rubber (Donut)	1500	7-1/2"	SCC-35S620-RSB-SLB	SCC-35S620-RSB-BSL
		Thermoplastic Rubber (Flat)	500		SCC-35S620-TPRBD-SLB	SCC-35S620-TPRBD-BSL
		Rubber on Aluminum	550		SCC-35S620-TPRBF-SLB	SCC-35S620-TPRBF-BSL
		Rubber on Cast Iron			SCC-35S620-RAB-SLB	SCC-35S620-RAB-BSL
		Polyolefin			SCC-35S620-POB-SLB	SCC-35S620-POB-BSL
		Polyurethane on Polyolefin	700		SCC-35S620-PPUB-SLB	SCC-35S620-PPUB-BSL
		Polyurethane on Aluminum	900		SCC-35S620-PAB-SLB	SCC-35S620-PAB-BSL
		Polyurethane/Steel (Green)	1200		SCC-35S620-PHB-SLB	SCC-35S620-PHB-BSL
		Polyurethane/Steel (Red)			SCC-35S620-PUB-GB-SLB	SCC-35S620-PUB-GB-BSL
		Solid Polyurethane			SCC-35S620-PUB-RS-SLB	SCC-35S620-PUB-RS-BSL
		Nylon	1250		SCC-35S620-SPUB-SLB	SCC-35S620-SPUB-BSL
		Phenolic			SCC-35S620-SSB-SLB	SCC-35S620-SSB-BSL
		Semi Steel V-Groove			SCC-35S620-VGB-SLB	SCC-35S620-VGB-BSL
		Semi Steel	1500		SCC-35S620-NYB-SLB	SCC-35S620-NYB-BSL
		Glass Filled Nylon	1500		SCC-35S620-GFNB-SLB	SCC-35S620-GFNB-BSL



Capacity up to 1500 lbs.



TOP PLATE CASTERS *with Brakes & Roller Bearings*

Wheel Dia.	Tread Width	Wheel Type	Load Capacity (lbs.)	Overall Height	Side Lock Brake (SLB)	Bolt-on Swivel Lock (BSL)
8"	2"	Rubber on Cast Iron	500	9-1/2"	SCC-35S820-RSB-SLB	SCC-35S820-RSB-BSL
		Thermoplastic Rubber (Donut)	600		SCC-35S820-TPRBD-SLB	SCC-35S820-TPRBD-BSL
		Thermoplastic Rubber (Flat)			SCC-35S820-TPRBF-SLB	SCC-35S820-TPRBF-BSL
		Rubber on Aluminum			SCC-35S820-RAB-SLB	SCC-35S820-RAB-BSL
		Polyolefin	900		SCC-35S820-POB-SLB	SCC-35S820-POB-BSL
		Polyurethane on Polyolefin	1000		SCC-35S820-SPUB-SLB	SCC-35S820-SPUB-BSL
		Solid Polyurethane	1200		SCC-35S820-SPUB-SLB	SCC-35S820-SPUB-BSL
		Polyurethane on Aluminum	1250		SCC-35S820-PAB-SLB	SCC-35S820-PAB-BSL
		Polyurethane/Steel (Green)			SCC-35S820-PUB-GB-SLB	SCC-35S820-PUB-GB-BSL
		Polyurethane/Steel (Red)			SCC-35S820-PUB-RS-SLB	SCC-35S820-PUB-RS-BSL
		Nylon			SCC-35S820-NYB-SLB	SCC-35S820-NYB-BSL
		Phenolic			SCC-35S820-PHB-SLB	SCC-35S820-PHB-BSL
		Semi Steel V-Groove			SCC-35S820-VGB-SLB	SCC-35S820-VGB-BSL
		Semi Steel			SCC-35S820-SSB-SLB	SCC-35S820-SSB-BSL
Glass Filled Nylon	1500	SCC-35S820-GFNB-SLB		SCC-35S820-GFNB-BSL		



**DOUBLE LOCK
ZERO
MOVEMENT**



**BUY
NOW**

Choose your brake style! The Side Lock Brake (SLB) grips the wheel tight, while the Bolt-On Swivel Lock (BSL) converts your caster to rigid at any 90-degree angle. Use **both** for ultimate control, locking both swivel and wheel for total immobility.

POWERLOCK  **CASTERS**

Kingpinless Casters

Series #KP92 Casters

Introducing the KP92 Series, extra heavy-duty kingpinless casters with a 3,500-pound capacity each. The kingpinless design ensures added durability, even under shock loading.

Applications

- Heavy Machinery
- Automotive
- Warehousing
- Military
- Mining
- Aerospace

Features

- High load capacity and wear resistance
- Enhanced maneuverability and smooth movement
- Impact resistance and reduced maintenance



Industrial Grade

Strong Durability



Quality Material

Heavy Capacity



360 Degree Rotation



Our part numbers adapt to your needs. Use the diagram below as a reference. For help, contact our customer service team.

SCC-KP92S1230-SSR-SLB-BSL

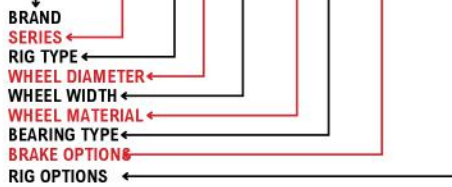

12" Swivel Semi-Steel Caster with Swivel Lock & Side Lock Brake

Service Caster Chart Guide

Build Your Caster

Discover more fastening sizes and wheel options if you can't find what you need. And remember, we're always here to **help!**

Series	Mounting	Mounting Size	Bolt Pattern	Rig Type	Wheel Size	Brake	Bearing Type	Wheel Material
KP92	Top Plate	5-1/4" x 7-1/4"	3-3/8" x 5-1/4" to 4-1/8" x 6-1/8"	Swivel (S)	6"	Side Lock (SLB)	Ball Bearing (B)	Rubber on Cast Iron (RS)
				Rigid (R)	8"	Face Contact (FCB)	Tapered Bearing (T)	Solid Polyurethane (SPU)
					10"	Bolt-on Swivel Lock (BSL)	Delrin Bearing (D)	Polyurethane/Steel (PU)
					12"	Weld-on Swivel Lock (WSL)	Roller Bearing (R)	EZ Rolling Polyurethane (EZPU)
						Precision Bearing (PB)	Semi Steel (SS)	
						Bronze Bearing (BZ)	Ductile Steel (DS)	
							EZ Rolling Ductile Steel (CDS)	
							Semi Steel V-Groove (VG)	
							Ductile V-Groove (DVG)	
							Phenolic (PH)	
							High Temp Phenolic (PH*HT)	
							HD Polyurethane/Steel (EX)	



Watch our video on Series 92 Kingpinless Casters, handling up to 3,500 pounds with enhanced durability and shock load capacity.

Wheel Tread

V-GROOVE VG	DUCTILE STEEL DS	DUCTILE V-GROOVE DVG	CROWN DUCTILE CDS	EZ ROLLING POLY EZPU	HD POLY/STEEL EX
POLY/STEEL PU	PHENOLIC PH	HT PHENOLIC PH*HT	SEMI STEEL SS	RUBBER/STEEL RS	SOLID POLYURETHANE SPU

Request for CAD



Top Plate Size Option(s)

The Series 92 Kingpinless Casters come in various wheel materials (polyurethane, rubber, steel) and sizes (6" to 12"). Options include top plate or stem mounts, precision or standard bearings, brakes, and swivel locks. They handle up to 3,500 pounds per caster for heavy-duty use.

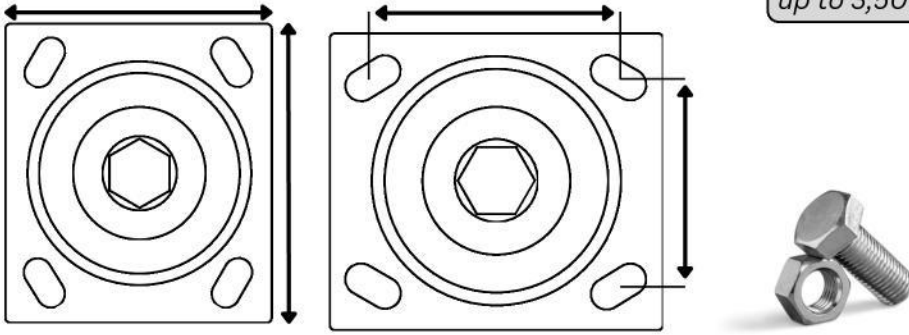

Standard Plate Size	Bolt Pattern	Bolt Diameter
5-1/4" x 7-1/4"	3-3/8" x 5-1/4" to 4-1/8" x 6-1/8"	1/2"

Choose Your Movement

- Rigid and Swivel Available



RIGID



SWIVEL

Bearing Type(s)

Roller Bearing

The roller bearing, strong and rollable, rolls up to 2.5 mph, withstands 350°F, and isn't chemical or water resistant.



Ball Bearing

The ball bearing with a 250°F max temperature is ideal for light duty, offering easy rolling, noise reduction, and no maintenance.



Delrin Bearing

The Delrin® bearing, made of acetal resin, is durable, cost-effective, and fits various wheel sizes, ideal up to 160°F in wet conditions.



Bronze Bearing

Bronze bearings are non-porous, durable, and withstand up to 525°F, water, and corrosion.



Tapered Bearing

The tapered bearing suits high-speed, high-load use, withstands up to 400°F, and requires two bearings and washers per wheel.



Precision Bearing

The sealed precision ball bearing, ideal for medium to heavy duty use, offers easy rolling, minimal noise, and withstands up to 250°F.



Brake Option(s)

Side Lock Brake (SLB)

The side lock brake places a positive locking force against the wheel hub locking the wheel only.



SCC-KP92S830-PHRHT-SLB

Bolt-on Swivel Lock (BSL)

The bolt-on swivel lock secures swivel casters, preventing unwanted movement. Easy to install, it ensures stability.



SCC-KP92S630-PHR-BSL

To ensure you have all the options you need, we also carry different styles such as face contact brakes and toe guards for our Series KP92. Explore our comprehensive selection to find the perfect solution for your specific requirements.



FACE CONTACT BRAKE



TOE GUARD

KINGPINLESS SWIVEL & RIGID CASTERS

Wheel Dia	Tread Width	Wheel Type	Load Capacity (lbs.)	Swivel Part Number	Rigid Part Number	Overall Height	
6"	2-1/2"	Rubber on Cast Iron	700	SCC-KP92S625-RSR	SCC-KP92R625-RSR	8"	
		Polyurethane/Steel (Green)	1600	SCC-KP92S625-PUR-GB	SCC-KP92R625-PUR-GB		
		Polyurethane/Steel (Red)		SCC-KP92S625-PUR-RS	SCC-KP92R625-PUR-RS		
		Phenolic		SCC-KP92S625-PHR	SCC-KP92R625-PHR		
		EZ Rolling Polyurethane		1700	SCC-KP92S625-EZPUR		SCC-KP92R625-EZPUR
		Semi Steel		1800	SCC-KP92S625-SSR		SCC-KP92R625-SSR
		Semi Steel V-Groove		2500	SCC-KP92S625-VGR		SCC-KP92R625-VGR
		Ductile Steel		3500	SCC-KP92S625-DSR		SCC-KP92R625-DSR
		Ductile V-Groove			SCC-KP92S625-DVGR		SCC-KP92R625-DVGR
	Crown Ductile	SCC-KP92S625-CDSR			SCC-KP92R625-DVGR		
	3"	Rubber on Cast Iron	750	SCC-KP92S630-RSR	SCC-KP92R630-RSR		
		Polyurethane/Steel (Green)	2000	SCC-KP92S630-PUR-GB	SCC-KP92R630-PUR-GB		
		Polyurethane/Steel (Red)		SCC-KP92S630-PUR-RS	SCC-KP92R630-PUR-RS		
		Phenolic		SCC-KP92S630-PHR	SCC-KP92R630-PHR		
		High Temp Phenolic		SCC-KP92S630-PHRHT	SCC-KP92R630-PHRHT		
		Solid Polyurethane		SCC-KP92S630-SPUR	SCC-KP92R630-SPUR		
		Polyurethane on Aluminum		SCC-KP92S630-PAR	SCC-KP92R630-PAR		
EZ Rolling Polyurethane		2200		SCC-KP92S630-EZPUR	SCC-KP92R630-EZPUR		
Semi Steel		2500		SCC-KP92S630-SSR	SCC-KP92R630-SSR		
Heavy Duty Polyurethane		3000		SCC-KP92S630-EXR	SCC-KP92R630-EXR		
Polyurethane on Aluminum		SCC-KP92S630-PAR	SCC-KP92R630-PAR				
Semi Steel V-Groove		3500	SCC-KP92S630-VGR	SCC-KP92R630-VGR			
Ductile V-Groove		5000	SCC-KP92S630-DVGR	SCC-KP92R630-DVGR			
Ductile Steel		6000	SCC-KP92S630-DSR	SCC-KP92R630-DSR			
Crown Ductile			SCC-KP92S630-CDSR	SCC-KP92R630-CDSR			
8"	2-1/2"	Rubber on Cast Iron	850	SCC-KP92S825-RSR	SCC-KP92R825-RSR	10-1/2"	
		Semi Steel	1800	SCC-KP92S825-SSR	SCC-KP92R825-SSR		
		Polyurethane/Steel (Green)	2000	SCC-KP92S825-PUR-GB	SCC-KP92R825-PUR-GB		
		Polyurethane/Steel (Red)		SCC-KP92S825-PUR-RS	SCC-KP92R825-PUR-RS		
		Phenolic		SCC-KP92S825-PHR	SCC-KP92R825-PHR		
		EZ Rolling Polyurethane		2200	SCC-KP92S825-EZPUR		SCC-KP92R825-EZPUR
		Semi Steel V-Groove		2500	SCC-KP92S825-VGR		SCC-KP92R825-VGR
		Ductile V-Groove		3500	SCC-KP92S825-DVGR		SCC-KP92R825-DVGR
		Ductile Steel		4000	SCC-KP92S825-DVGR		SCC-KP92R825-DVGR
	Crown Ductile	SCC-KP92S825-CDSR			SCC-KP92R825-DVGR		
	3"	Rubber on Cast Iron	900	SCC-KP92S830-RSR	SCC-KP92R830-RSR		
		High Temp Phenolic	1900	SCC-KP92S830-PHRHT	SCC-KP92R830-PHRHT		
		Polyurethane/Steel (Green)	2500	SCC-KP92S830-PUR-GB	SCC-KP92R830-PUR-GB		
		Polyurethane/Steel (Red)		SCC-KP92S830-PUR-RS	SCC-KP92R830-PUR-RS		
		Phenolic		SCC-KP92S830-PHR	SCC-KP92R830-PHR		
		Solid Polyurethane		SCC-KP92S830-SPUR	SCC-KP92R830-SPUR		
		Semi Steel		SCC-KP92S830-SSR	SCC-KP92R830-SSR		
		Polyurethane on Aluminum		SCC-KP92S830-PAR	SCC-KP92R830-PAR		
		EZ Rolling Polyurethane		2700	SCC-KP92S830-EZPUR		SCC-KP92R830-EZPUR
		Semi Steel V-Groove		3500	SCC-KP92S830-VGR		SCC-KP92R830-VGR
		Heavy Duty Polyurethane			SCC-KP92S830-EXR		SCC-KP92R830-EXR
		Ductile V-Groove	SCC-KP92S830-DVGR		SCC-KP92R830-DVGR		
		Crown Ductile	6000	SCC-KP92S830-CDSR	SCC-KP92R830-CDSR		
Ductile Steel		SCC-KP92S830-DSR		SCC-KP92R830-DSR			

Unmatched Durability

THIS UNIQUE HOT FORGED ASTM1045 STEEL DESIGN ELIMINATES PROBLEMS ASSOCIATED WITH KINGPIN FAILURE DUE TO SEVERE SHOCK LOADING.

KINGPINLESS SWIVEL & RIGID CASTERS

Wheel Dia	Tread Width	Wheel Type	Load Capacity (lbs.)	Swivel Part Number	Rigid Part Number	Overall Height	
10"	2-1/2"	Rubber on Cast Iron	1000	SCC-KP92S1025-RSR	SCC-KP92R1025-RSR	10-1/2"	
		Semi Steel	2000	SCC-KP92S1025-SSR	SCC-KP92R1025-SSR		
		Polyurethane/Steel (Green)	2200	SCC-KP92S1025-PUR-GB	SCC-KP92R1025-PUR-GB		
		Polyurethane/Steel (Red)		SCC-KP92S1025-PUR-RS	SCC-KP92R1025-PUR-RS		
		Phenolic	2500	SCC-KP92S1025-PHR	SCC-KP92R1025-PHR		
		EZ Rolling Polyurethane	2400	SCC-KP92S1025-EZPUR	SCC-KP92R1025-EZPUR		
		Ductile Steel	4000	SCC-KP92S1025-DSR	SCC-KP92R1025-DSR		
	3"	Rubber on Cast Iron	1100	SCC-KP92S1030-RSR	SCC-KP92R1030-RSR		
		High Temp Phenolic	2400	SCC-KP92S1030-PHRHT	SCC-KP92R1030-PHRHT		
		Semi Steel	2500	SCC-KP92S1030-SSR	SCC-KP92R1030-SSR		
		Phenolic	2900	SCC-KP92S1030-PHR	SCC-KP92R1030-PHR		
		Polyurethane/Steel (Green)	3000	SCC-KP92S1030-PUR-GB	SCC-KP92R1030-PUR-GB		
		Polyurethane/Steel (Red)		SCC-KP92S1030-PUR-RS	SCC-KP92R1030-PUR-RS		
		Solid Polyurethane		SCC-KP92S1030-SPUR	SCC-KP92R1030-SPUR		
		Polyurethane on Aluminum		SCC-KP92S1030-PAR	SCC-KP92R1030-PAR		
		Polyurethane on Aluminum		SCC-KP92S1030-PAR	SCC-KP92R1030-PAR		
		EZ Rolling Polyurethane		SCC-KP92S1030-EZPUR	SCC-KP92R1030-EZPUR		
		Semi Steel V-Groove		3500	SCC-KP92S1030-VGR		SCC-KP92R1030-VGR
		6000	Heavy Duty Polyurethane	4000	SCC-KP92S1030-EXR		SCC-KP92R1030-EXR
			Ductile V-Groove	SCC-KP92S1030-DVGR	SCC-KP92R1030-DVGR		
Ductile Steel	SCC-KP92S1030-DSR		SCC-KP92R1030-DSR				
Crown Ductile	SCC-KP92S1030-CDSR		SCC-KP92R1030-CDSR				

Kingpin swivel casters have a top plate, kingpin, races, and bearings. The kingpin, a common weak point, often fails under stress.

Common Failures:

- Towing: High speeds can shear the kingpin.
- Shock Loading/Rough Terrain: Impacts deform the kingpin, causing failure.

Kingpinless casters have a simpler design without a kingpin, using a top plate, races, and ball bearings.

This design reduces failure by better distributing loads, enhancing durability. Ideal for towing and shock loading, they are also cost-effective.



KINGPINLESS SWIVEL *with Brakes*

Wheel Dia	Tread Width	Wheel Type	Load Capacity (lbs.)	Side Lock Brake	Swivel Lock	Overall Height
6"	2-1/2"	Rubber on Cast Iron	700	SCC-KP92S625-RSR-SLB	SCC-KP92S625-RSR-BSL	8"
		Polyurethane/Steel (Green)	1600	SCC-KP92S625-PUR-GB-SLB	SCC-KP92S625-PUR-GB-BSL	
		Polyurethane/Steel (Red)		SCC-KP92S625-PUR-RS-SLB	SCC-KP92S625-PUR-RS-BSL	
		Phenolic		SCC-KP92S625-PHR-SLB	SCC-KP92S625-PHR-BSL	
		EZ Rolling Polyurethane	1700	SCC-KP92S625-EZPUR-SLB	SCC-KP92S625-EZPUR-BSL	
		Semi Steel	1800	SCC-KP92S625-SSR-SLB	SCC-KP92S625-SSR-BSL	
		Semi Steel V-Groove	2500	SCC-KP92S625-VGR-SLB	SCC-KP92S625-VGR-BSL	
		Ductile Steel	3500	SCC-KP92S625-DSR-SLB	SCC-KP92S625-DSR-BSL	
		Ductile V-Groove		SCC-KP92S625-DVGR-SLB	SCC-KP92S625-DVGR-BSL	
	Crown Ductile	SCC-KP92S625-CDSR-SLB		SCC-KP92S625-DVGR-BSL		
	3"	Rubber on Cast Iron	750	SCC-KP92S630-RSR-SLB	SCC-KP92S630-RSR-BSL	
		Polyurethane/Steel (Green)	2000	SCC-KP92S630-PUR-GB-SLB	SCC-KP92S630-PUR-GB-BSL	
		Polyurethane/Steel (Red)		SCC-KP92S630-PUR-RS-SLB	SCC-KP92S630-PUR-RS-BSL	
		Phenolic		SCC-KP92S630-PHR-SLB	SCC-KP92S630-PHR-BSL	
		High Temp Phenolic	SCC-KP92S630-PHRHT-SLB	SCC-KP92S630-PHRHT-BSL		
		Solid Polyurethane	SCC-KP92S630-SPUR-SLB	SCC-KP92S630-SPUR-BSL		
		Polyurethane on Aluminum	SCC-KP92S630-PAR-SLB	SCC-KP92S630-PAR-BSL		
		EZ Rolling Polyurethane	2200	SCC-KP92S630-EZPUR-SLB	SCC-KP92S630-EZPUR-BSL	
		Semi Steel	2500	SCC-KP92S630-SSR-SLB	SCC-KP92S630-SSR-BSL	
		Heavy Duty Polyurethane	3000	SCC-KP92S630-EXR-SLB	SCC-KP92S630-EXR-BSL	
		Polyurethane on Aluminum	SCC-KP92S630-PAR-SLB	SCC-KP92S630-PAR-BSL		
		Semi Steel V-Groove	3500	SCC-KP92S630-VGR-SLB	SCC-KP92S630-VGR-BSL	
		Ductile V-Groove	5000	SCC-KP92S630-DVGR-SLB	SCC-KP92S630-DVGR-BSL	
		Ductile Steel	6000	SCC-KP92S630-DSR-SLB	SCC-KP92S630-DSR-BSL	
Crown Ductile		SCC-KP92S630-CDSR-SLB		SCC-KP92S630-CDSR-BSL		
8"	2-1/2"	Rubber on Cast Iron	850	SCC-KP92S825-RSR-SLB	SCC-KP92S825-RSR-BSL	10-1/2"
		Semi Steel	1800	SCC-KP92S825-SSR-SLB	SCC-KP92S825-SSR-BSL	
		Polyurethane/Steel (Green)	2000	SCC-KP92S825-PUR-GB-SLB	SCC-KP92S825-PUR-GB-BSL	
		Polyurethane/Steel (Red)		SCC-KP92S825-PUR-RS-SLB	SCC-KP92S825-PUR-RS-BSL	
		Phenolic		SCC-KP92S825-PHR-SLB	SCC-KP92S825-PHR-BSL	
		EZ Rolling Polyurethane	2200	SCC-KP92S825-EZPUR-SLB	SCC-KP92S825-EZPUR-BSL	
		Semi Steel V-Groove	2500	SCC-KP92S825-VGR-SLB	SCC-KP92S825-VGR-BSL	
		Ductile V-Groove	3500	SCC-KP92S825-DVGR-SLB	SCC-KP92S825-DVGR-BSL	
		Ductile Steel	4000	SCC-KP92S825-DVGR-SLB	SCC-KP92S825-DVGR-BSL	
	Crown Ductile	SCC-KP92S825-CDSR-SLB		SCC-KP92S825-DVGR-BSL		
	3"	Rubber on Cast Iron	900	SCC-KP92S830-RSR-SLB	SCC-KP92S830-RSR-BSL	
		High Temp Phenolic	1900	SCC-KP92S830-PHRHT-SLB	SCC-KP92S830-PHRHT-BSL	
		Polyurethane/Steel (Green)	2500	SCC-KP92S830-PUR-GB-SLB	SCC-KP92S830-PUR-GB-BSL	
		Polyurethane/Steel (Red)		SCC-KP92S830-PUR-RS-SLB	SCC-KP92S830-PUR-RS-BSL	
		Phenolic		SCC-KP92S830-PHR-SLB	SCC-KP92S830-PHR-BSL	
		Solid Polyurethane	SCC-KP92S830-SPUR-SLB	SCC-KP92S830-SPUR-BSL		
		Semi Steel	SCC-KP92S830-SSR-SLB	SCC-KP92S830-SSR-BSL		
		Polyurethane on Aluminum	SCC-KP92S830-PAR-SLB	SCC-KP92S830-PAR-BSL		
		EZ Rolling Polyurethane	2700	SCC-KP92S830-EZPUR-SLB	SCC-KP92S830-EZPUR-BSL	
		Semi Steel V-Groove	3500	SCC-KP92S830-VGR-SLB	SCC-KP92S830-VGR-BSL	
		Heavy Duty Polyurethane		SCC-KP92S830-EXR-SLB	SCC-KP92S830-EXR-BSL	
		Ductile V-Groove	5000	SCC-KP92S830-DVGR-SLB	SCC-KP92S830-DVGR-BSL	
		Crown Ductile	6000	SCC-KP92S830-CDSR-SLB	SCC-KP92S830-CDSR-BSL	
		Ductile Steel		SCC-KP92S830-DSR-SLB	SCC-KP92S830-DSR-BSL	

Follow Us on Social Media!

Stay connected with Service Caster! Discover new products, get behind-the-scenes insights, and stay updated with our latest innovations. Join us online for exclusive promotions and updates.

LIKE, SHARE & SUBSCRIBE



KINGPINLESS SWIVEL *with Brakes*

Wheel Dia	Tread Width	Wheel Type	Load Capacity (lbs.)	Side Lock Brake	Swivel Lock	Overall Height
10"	2-1/2"	Rubber on Cast Iron	1000	SCC-KP92S1025-RSR-SLB	SCC-KP92S1025-RSR-BSL	10-1/2"
		Semi Steel	2000	SCC-KP92S1025-SSR-SLB	SCC-KP92S1025-SSR-BSL	
		Polyurethane/Steel (Green)	2200	SCC-KP92S1025-PUR-GB-SLB	SCC-KP92S1025-PUR-GB-BSL	
		Polyurethane/Steel (Red)		SCC-KP92S1025-PUR-RS-SLB	SCC-KP92S1025-PUR-RS-BSL	
		Phenolic	2500	SCC-KP92S1025-PHR-SLB	SCC-KP92S1025-PHR-BSL	
		EZ Rolling Polyurethane	2400	SCC-KP92S1025-EZPUR-SLB	SCC-KP92S1025-EZPUR-BSL	
		Ductile Steel	4000	SCC-KP92S1025-DSR-SLB	SCC-KP92S1025-DSR-BSL	
	3"	Rubber on Cast Iron	1100	SCC-KP92S1030-RSR-SLB	SCC-KP92S1030-RSR-BSL	
		High Temp Phenolic	2400	SCC-KP92S1030-PHRHT-SLB	SCC-KP92S1030-PHRHT-BSL	
		Semi Steel	2500	SCC-KP92S1030-SSR-SLB	SCC-KP92S1030-SSR-BSL	
		Phenolic	2900	SCC-KP92S1030-PHR-SLB	SCC-KP92S1030-PHR-BSL	
		Polyurethane/Steel (Green)	3000	SCC-KP92S1030-PUR-GB-SLB	SCC-KP92S1030-PUR-GB-BSL	
		Polyurethane/Steel (Red)		SCC-KP92S1030-PUR-RS-SLB	SCC-KP92S1030-PUR-RS-BSL	
		Solid Polyurethane		SCC-KP92S1030-SPUR-SLB	SCC-KP92S1030-SPUR-BSL	
Polyurethane on Aluminum		SCC-KP92S1030-PAR-SLB		SCC-KP92S1030-PAR-BSL		
Polyurethane on Aluminum		SCC-KP92S1030-PAR-SLB		SCC-KP92S1030-PAR-BSL		
EZ Rolling Polyurethane		SCC-KP92S1030-EZPUR-SLB		SCC-KP92S1030-EZPUR-BSL		
Semi Steel V-Groove		3500		SCC-KP92S1030-VGR-SLB	SCC-KP92S1030-VGR-BSL	
6000		Heavy Duty Polyurethane	4000	SCC-KP92S1030-EXR-SLB	SCC-KP92S1030-EXR-BSL	
		Ductile V-Groove	SCC-KP92S1030-DVGR-SLB	SCC-KP92S1030-DVGR-BSL		
	Ductile Steel	SCC-KP92S1030-DSR-SLB	SCC-KP92S1030-DSR-BSL			
	Crown Ductile	SCC-KP92S1030-CDSR-SLB	SCC-KP92S1030-CDSR-BSL			
12"	2-1/2"	Rubber on Cast Iron	1200	SCC-KP92S1225-RSR-SLB	SCC-KP92S1225-RSR-BSL	15-1/2"
		Semi Steel	2000	SCC-KP92S1225-SSR-SLB	SCC-KP92S1225-SSR-BSL	
		Polyurethane/Steel (Green)	2500	SCC-KP92S1225-PUR-GB-SLB	SCC-KP92S1225-PUR-GB-BSL	
		Polyurethane/Steel (Red)		SCC-KP92S1225-PUR-RS-SLB	SCC-KP92S1225-PUR-RS-BSL	
		EZ Rolling Polyurethane	2700	SCC-KP92S1225-EZPUR-SLB	SCC-KP92S1225-EZPUR-BSL	
		Phenolic	3000	SCC-KP92S1225-PHR-SLB	SCC-KP92S1225-PHR-BSL	
	3"	Rubber on Cast Iron	1300	SCC-KP92S1230-RSR-SLB	SCC-KP92S1230-RSR-BSL	
		High Temp Phenolic	3500	SCC-KP92S1230-PHRHT-SLB	SCC-KP92S1230-PHRHT-BSL	
		Polyurethane/Steel (Green)	3500	SCC-KP92S1230-PUR-GB-SLB	SCC-KP92S1230-PUR-GB-BSL	
		Polyurethane/Steel (Red)	3500	SCC-KP92S1230-PUR-RS-SLB	SCC-KP92S1230-PUR-RS-BSL	
		Phenolic	3500	SCC-KP92S1230-PHR-SLB	SCC-KP92S1230-PHR-BSL	
		Solid Polyurethane	3500	SCC-KP92S1230-SPUR-SLB	SCC-KP92S1230-SPUR-BSL	
		Semi Steel	2500	SCC-KP92S1230-SSR-SLB	SCC-KP92S1230-SSR-BSL	
		Polyurethane on Aluminum	3500	SCC-KP92S1230-PAR-SLB	SCC-KP92S1230-PAR-BSL	
EZ Rolling Polyurethane		3500	SCC-KP92S1230-EZPUR-SLB	SCC-KP92S1230-EZPUR-BSL		
6000		Heavy Duty Polyurethane	5000	SCC-KP92S1230-EXR-SLB	SCC-KP92S1230-EXR-BSL	
	Crown Ductile	SCC-KP92S1230-CDSR-SLB	SCC-KP92S1230-CDSR-BSL			
Ductile Steel	SCC-KP92S1230-DSR-SLB	SCC-KP92S1230-DSR-BSL				



NEED MORE WEIGHT!?

[SHOP NOW](#)

KEY FEATURES

- CRAFTING SOLUTIONS FROM SCRATCH
- INCORPORATING COMPONENTS AND PROCEDURES FOR HEAVY-DUTY TASKS
- SUITABLE FOR LOADS RANGING FROM 5,000 TO 250,000 LBS
- OFFERING THOROUGH PROCESS EVALUATION AND ENGINEERING SERVICES



KINGPINLESS SWIVEL *with Brake & Swivel Lock*

Wheel Dia	Tread Width	Wheel Type	Load Capacity (lbs.)	Side Lock Brake	Overall Height			
6"	2-1/2"	Rubber on Cast Iron	700	SCC-KP92S625-RSR-SLB-BSL	8"			
		Polyurethane/Steel (Green)	1600	SCC-KP92S625-PUR-GB-SLB-BSL				
		Polyurethane/Steel (Red)		SCC-KP92S625-PUR-RS-SLB-BSL				
		Phenolic		SCC-KP92S625-PHR-SLB-BSL				
		EZ Rolling Polyurethane	1700	SCC-KP92S625-EZPUR-SLB-BSL				
		Semi Steel	1800	SCC-KP92S625-SSR-SLB-BSL				
		Semi Steel V-Groove	2500	SCC-KP92S625-VGR-SLB-BSL				
		Ductile Steel	3500	SCC-KP92S625-DSR-SLB-BSL				
		Ductile V-Groove		SCC-KP92S625-DVGR-SLB-BSL				
		Crown Ductile		SCC-KP92S625-CDSR-SLB-BSL				
	3"	Rubber on Cast Iron	750	SCC-KP92S630-RSR-SLB-BSL				
		Polyurethane/Steel (Green)	2000	SCC-KP92S630-PUR-GB-SLB-BSL				
		Polyurethane/Steel (Red)		SCC-KP92S630-PUR-RS-SLB-BSL				
		Phenolic		SCC-KP92S630-PHR-SLB-BSL				
		High Temp Phenolic		SCC-KP92S630-PHRHT-SLB-BSL				
		Solid Polyurethane		SCC-KP92S630-SPUR-SLB-BSL				
		Polyurethane on Aluminum		SCC-KP92S630-PAR-SLB-BSL				
		EZ Rolling Polyurethane	2200	SCC-KP92S630-EZPUR-SLB-BSL				
		Semi Steel	2500	SCC-KP92S630-SSR-SLB-BSL				
		Heavy Duty Polyurethane	3000	SCC-KP92S630-EXR-SLB-BSL				
		Polyurethane on Aluminum	3500	SCC-KP92S630-PAR-SLB-BSL				
		Semi Steel V-Groove		SCC-KP92S630-VGR-SLB-BSL				
		Ductile V-Groove		SCC-KP92S630-DVGR-SLB-BSL				
		Ductile Steel		SCC-KP92S630-DSR-SLB-BSL				
		Crown Ductile		6000		SCC-KP92S630-CDSR-SLB-BSL		
						SCC-KP92S630-CDSR-SLB-BSL		
		8"	2-1/2"	Rubber on Cast Iron		850	SCC-KP92S825-RSR-SLB-BSL	10-1/2"
				Semi Steel		1800	SCC-KP92S825-SSR-SLB-BSL	
Polyurethane/Steel (Green)	2000			SCC-KP92S825-PUR-GB-SLB-BSL				
Polyurethane/Steel (Red)				SCC-KP92S825-PUR-RS-SLB-BSL				
Phenolic				SCC-KP92S825-PHR-SLB-BSL				
EZ Rolling Polyurethane	2200			SCC-KP92S825-EZPUR-SLB-BSL				
Semi Steel V-Groove	2500			SCC-KP92S825-VGR-SLB-BSL				
Ductile V-Groove	3500			SCC-KP92S825-DVGR-SLB-BSL				
Ductile Steel	4000			SCC-KP92S825-DVGR-SLB-BSL				
Crown Ductile				SCC-KP92S825-CDSR-SLB-BSL				
			SCC-KP92S825-CDSR-SLB-BSL					
3"	Rubber on Cast Iron		900	SCC-KP92S830-RSR-SLB-BSL				
	High Temp Phenolic		1900	SCC-KP92S830-PHRHT-SLB-BSL				
	Polyurethane/Steel (Green)		2500	SCC-KP92S830-PUR-GB-SLB-BSL				
	Polyurethane/Steel (Red)			SCC-KP92S830-PUR-RS-SLB-BSL				
	Phenolic			SCC-KP92S830-PHR-SLB-BSL				
	Solid Polyurethane			SCC-KP92S830-SPUR-SLB-BSL				
	Semi Steel			SCC-KP92S830-SSR-SLB-BSL				
	Polyurethane on Aluminum			SCC-KP92S830-PAR-SLB-BSL				
	EZ Rolling Polyurethane		2700	SCC-KP92S830-EZPUR-SLB-BSL				
	Semi Steel V-Groove		3500	SCC-KP92S830-VGR-SLB-BSL				
	Heavy Duty Polyurethane			SCC-KP92S830-EXR-SLB-BSL				
	Ductile V-Groove			SCC-KP92S830-DVGR-SLB-BSL				
	Crown Ductile		6000	SCC-KP92S830-CDSR-SLB-BSL				
	Ductile Steel			SCC-KP92S830-DSR-SLB-BSL				

Choose your brake style! The Side Lock Brake (SLB) grips the wheel tight, while the Bolt-On Swivel Lock (BSL) converts your caster to rigid at any 90-degree angle. Use **both** for ultimate control, locking both swivel and wheel for total immobility.



KINGPINLESS SWIVEL *with Brake & Swivel Lock*

Wheel Dia	Tread Width	Wheel Type	Load Capacity (lbs.)	Side Lock Brake	Overall Height
10"	2-1/2"	Rubber on Cast Iron	1000	SCC-KP92S1025-RSR-SLB-BSL	10-1/2"
		Semi Steel	2000	SCC-KP92S1025-SSR-SLB-BSL	
		Polyurethane/Steel (Green)	2200	SCC-KP92S1025-PUR-GB-SLB-BSL	
		Polyurethane/Steel (Red)		SCC-KP92S1025-PUR-RS-SLB-BSL	
		Phenolic	2500	SCC-KP92S1025-PHR-SLB-BSL	
		EZ Rolling Polyurethane	2400	SCC-KP92S1025-EZPUR-SLB-BSL	
		Ductile Steel	4000	SCC-KP92S1025-DSR-SLB-BSL	
	3"	Rubber on Cast Iron	1100	SCC-KP92S1030-RSR-SLB-BSL	
		High Temp Phenolic	2400	SCC-KP92S1030-PHRHT-SLB-BSL	
		Semi Steel	2500	SCC-KP92S1030-SSR-SLB-BSL	
		Phenolic	2900	SCC-KP92S1030-PHR-SLB-BSL	
		Polyurethane/Steel (Green)	3000	SCC-KP92S1030-PUR-GB-SLB-BSL	
		Polyurethane/Steel (Red)		SCC-KP92S1030-PUR-RS-SLB-BSL	
		Solid Polyurethane		SCC-KP92S1030-SPUR-SLB-BSL	
		Polyurethane on Aluminum		SCC-KP92S1030-PAR-SLB-BSL	
		Polyurethane on Aluminum		SCC-KP92S1030-PAR-SLB-BSL	
		EZ Rolling Polyurethane		SCC-KP92S1030-EZPUR-SLB-BSL	
		Semi Steel V-Groove		3500	
		Heavy Duty Polyurethane	4000	SCC-KP92S1030-EXR-SLB-BSL	
		Ductile V-Groove	6000	SCC-KP92S1030-DVGR-SLB-BSL	
Ductile Steel	SCC-KP92S1030-DSR-SLB-BSL				
Crown Ductile	SCC-KP92S1030-CDSR-SLB-BSL				
12"	2-1/2"	Rubber on Cast Iron	1200	SCC-KP92S1225-RSR-SLB-BSL	15-1/2"
		Semi Steel	2000	SCC-KP92S1225-SSR-SLB-BSL	
		Polyurethane/Steel (Green)	2500	SCC-KP92S1225-PUR-GB-SLB-BSL	
		Polyurethane/Steel (Red)		SCC-KP92S1225-PUR-RS-SLB-BSL	
		EZ Rolling Polyurethane	2700	SCC-KP92S1225-EZPUR-SLB-BSL	
		Phenolic	3000	SCC-KP92S1225-PHR-SLB-BSL	
	3"	Rubber on Cast Iron	1300	SCC-KP92S1230-RSR-SLB-BSL	
		High Temp Phenolic	3500	SCC-KP92S1230-PHRHT-SLB-BSL	
		Polyurethane/Steel (Green)	3500	SCC-KP92S1230-PUR-GB-SLB-BSL	
		Polyurethane/Steel (Red)	3500	SCC-KP92S1230-PUR-RS-SLB-BSL	
		Phenolic	3500	SCC-KP92S1230-PHR-SLB-BSL	
		Solid Polyurethane	3500	SCC-KP92S1230-SPUR-SLB-BSL	
		Semi Steel	2500	SCC-KP92S1230-SSR-SLB-BSL	
		Polyurethane on Aluminum	3500	SCC-KP92S1230-PAR-SLB-BSL	
		EZ Rolling Polyurethane	3500	SCC-KP92S1230-EZPUR-SLB-BSL	
		Heavy Duty Polyurethane	5000	SCC-KP92S1230-EXR-SLB-BSL	
		Crown Ductile	6000	SCC-KP92S1230-CDSR-SLB-BSL	
		Ductile Steel		SCC-KP92S1230-DSR-SLB-BSL	



For Drawing Requests, Please Contact [Customer Service](#)

Pneumatic / Semi-Pneumatic Casters

Series #100 Casters

Pneumatic and semi-pneumatic casters roll quietly and smoothly. Semi-pneumatic wheels are durable, flat-free, and support more weight with less vibration protection. Ideal for all-terrain, indoor, and outdoor use.

Applications

- Warehouse carts
- Dollies
- Shop equipment
- Garden carts
- Medical equipment
- Food service trolleys

Features

- Quiet and smooth rolling
- Durable and flat-free
- Suitable for all-terrain use

Our part numbers adapt to your needs. Use the diagram below as a reference. For help, contact our **customer service** team.

SCC-100S1650-PNT-BSL-FCB-TP4

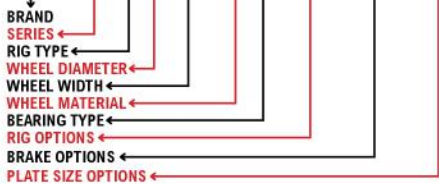

16" Swivel Pneumatic Caster with Swivel Lock & Side Lock Brake with Optional Top Plate



Service Caster Chart Guide

Build Your Caster

Discover more fastening sizes and wheel options if you can't find what you need. And remember, we're always here to **help!**

Series	Mounting	Rig Type	Mounting Size	Bolt Pattern	Wheel Material	Brake	Wheel Size	Bearing Type
100	Top Plate	Swivel (S)	4" x 4-1/2"	2-5/8" x 3-5/8" to 3" x 3"	Pneumatic (PN)	Side Lock (SLB)	6" (150)	Ball Bearing (B)
		Rigid (R)	4-1/2" x 6-1/4" (TP2)	3-3/8" x 5-1/4" to 2-7/16" x 4-15/16"	Semi-Pneumatic (SN)	Face Contact (FCB)	8" (280)	Plain Bore (S)
			5" x 5-1/2" (TP3)	4-1/8" x 4-1/2"	Never Flat (NF)	Bolt-on Swivel Lock (BSL)	10" (3504)	Delrin Bearing (D)
			5" X 7-1/4" (TP4)	3-3/8" X 5-1/4" TO 4-1/8" x 6-1/8"	Foam Filled (PN*-FF)	Weld-on Swivel Lock (WSL)	12" (3506)	Roller Bearing (R)
						Top Lock Brake (TLB)	16" (16)	Precision Bearing (PB)
					Bronze Bearing (BZ)			



SEMI-PNEUMATIC

FOAM FILLED

PNEUMATIC

GRAY PNEUMATIC

NEVER FLAT

ROLL WITH CONFIDENCE

MOVING YOU FORWARD...

Series #100 Casters

Discover the versatile Series #100 Pneumatic Casters, perfect for any need. Choose from various sizes, materials, and load capacities. For personalized help, contact our customer service team.

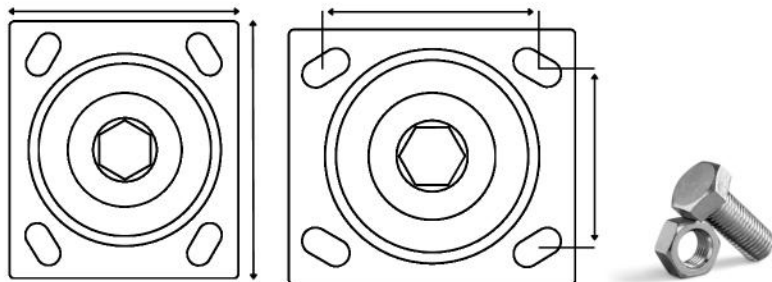

Standard Plate Size	Bolt Pattern	Bolt Diameter
4" x 4-1/2"	2-5/8" x 3-5/8" to 3" x 3"	3/8"
4-1/2" x 6-1/4" (TP2)	3-3/8" x 5-1/4" to 2-7/16" x 4-15/16"	3/8"
5" x 5-1/2" (TP3)	4-1/8" x 4-1/2"	3/8"
5" X 7-1/4" (TP4)	3-3/8" X 5-1/4" TO 4-1/8" x 6-1/8"	1/2"

If you can't find the plate size you need, don't hesitate to reach out to our customer service team. We're here to **help** you find exactly what you're looking for!

Choose Your Movement

- Rigid and Swivel Available



RIGID



SWIVEL



Our **brass** finish casters add style and durability to Bellman carts. For details, contact customer service.

Bearing Type(s)

Roller Bearing

Anti-friction bearing, ideal for manual applications with prevalent shock loading.



Ball Bearing

Ball bearing provides smooth movement and durability.



Tapered Bearing

Tapered bearings ensure smooth, durable performance for heavy-duty caster wheels.



Brake Option(s) & More...

Side Lock Brake (SLB)

The **side lock brake** places a positive locking force against the wheel hub locking the wheel only.



SCC-100S1650-PNT-BSL-FCB-TP4

Bolt-on Swivel Lock (BSL)

The **bolt-on swivel lock** secures swivel casters, preventing unwanted movement. Easy to install, it ensures stability.



SCC-DW100S1650-PNT-BSL-TP4

Face Contact Brake (FCB) & Dual Pneumatic Casters (DW)

The **Face Contact Brake** (FCB) locks wheels with pedal-activated pressure. **Dual Pneumatic Casters** (DW) offer high capacity with rubber tires, ideal for aerospace, construction, and heavy equipment.



SCC-DW100S1650-PNT-BSL-FCB-TP4

Top Lock Brake (TLB)

The **Top lock brake** on casters securely locks the wheel, ensuring stability and safety.



SCC-30CS820-PUR-TLB-RS

All-Terrain Pneumatic Wheels!

Industrial pneumatic wheels cushion cargo on various terrains and indoors. They require air maintenance, hold air well, and have durable hubs. Suitable for hospitals, hotels, studios, labs, and retail stores.

SINGLE WHEEL CASTERS

Wheel Size	Wheel Type	Load Capacity (lbs.)	Overall Height	Swivel Part Number	Rigid Part Number	Color
6" x 2"	Pneumatic	300	7-1/2"	SCC-100S150-PNB	SCC-100R150-PNB	Black
8" x 2.5" (2.80 / 2.50 - 4)	Pneumatic	300	10"	SCC-100S280-PNB	SCC-100R280-PNB	Black
	Pneumatic	300	10"	SCC-100S280-PNB-GRY	SCC-100R280-PNB-GRY	Gray
8" x 2.5"	Semi-Pneumatic	400	10"	SCC-100S825-SNB	SCC-100R825-SNB	Black
10" x 3.5" (4.10 / 3.50 - 4)	Pneumatic	350	12-3/16"	SCC-100S3504-PNB	SCC-100R3504-PNB	Black
10" x 3"	Semi-Pneumatic	650	12-3/16"	SCC-100S1030-SNB	SCC-100R1030-SNB	Black
12" x 3.5" (4.10 / 3.50 - 6)	Pneumatic	450	13-3/4"	SCC-100S3506-PNB	SCC-100R3506-PNB	Black
12" x 3"	Semi-Pneumatic	850	13-3/4"	SCC-100S1230-SNB	SCC-100R1230-SNB	Black
16" x 4.875" (4.80-8)	Pneumatic	1220	19-1/8"	SCC-100S1650-PNT-TP4	SCC-100R1650-PNT-TP4	Black

SINGLE WHEEL CASTERS *with Brakes*

Wheel Size	Wheel Type	Load Capacity (lbs.)	Overall Height	Wheel Brake	Swivel Lock	Wheel Brake Swivel Lock	Color
6" x 2"	Pneumatic	300	7-1/2"	SCC-100S150-PNB-TLB	SCC-100S150-PNB-BSL	SCC-100S150-PNB-TLB-BSL	Black
8" x 2.5" (2.80 / 2.50 - 4)	Pneumatic	300	10"	SCC-100S280-PNB-TLB	SCC-100S280-PNB-BSL	SCC-100S280-PNB-TLB-BSL	Black
	Pneumatic	300	10"	SCC-100S280-PNB-TLB-GRY	SCC-100S280-PNB-BSL-GRY	SCC-100S280-PNB-TLB-BSL-GRY	Gray
8" x 2.5"	Semi-Pneumatic	400	10"	SCC-100S825-SNB-SLB	SCC-100S825-SNB-BSL	SCC-100S825-SNB-SLB-BSL	Black
10" x 3.5" (4.10 / 3.50 - 4)	Pneumatic	350	12-3/16"	SCC-100S3504-PNB-TLB	SCC-100S3504-PNB-BSL	SCC-100S3504-PNB-TLB-BSL	Black
10" x 3"	Semi-Pneumatic	650	12-3/16"	SCC-100S1030-SNB-SLB	SCC-100S1030-SNB-BSL	SCC-100S1030-SNB-SLB-BSL	Black
12" x 3.5" (4.10 / 3.50 - 6)	Pneumatic	450	13-3/4"	SCC-100S3506-PNB-SLB	SCC-100S3506-PNB-BSL	SCC-100S3506-PNB-SLB-BSL	Black
12" x 3"	Semi-Pneumatic	850	13-3/4"	SCC-100S1230-SNB-SLB	SCC-100S1230-SNB-BSL	SCC-100S1230-SNB-SLB-BSL	Black
16" x 4.875" (4.80-8)	Pneumatic	1220	19-1/8"	SCC-100S1650-PNT-FCB-TP4	SCC-100S1650-PNT-TP4-BSL	SCC-100S1650-PNT-BSL-FCB-TP4	Black

ROLL WITH CONFIDENCE EVERYWHERE



Advantages of Dual Wheel Casters!

Dual wheel pneumatic casters offer excellent stability, load capacity, and traction on uneven surfaces, making them ideal for heavy-duty outdoor use. They also provide superior shock absorption and durability.

DUAL WHEEL CASTERS

Wheel Size	Wheel Type	Load Capacity (lbs.)	Overall Height	Swivel Part Number	Rigid Part Number	Color
6" x 2"	Pneumatic	300	7-1/2"	SCC-DW100S150-PNB	SCC-DW100R150-PNB	Black
8" x 2.5" (2.80 / 2.50 - 4)	Pneumatic	300	10"	SCC-DW100S280-PNB	SCC-DW100R280-PNB	Black
	Pneumatic	300	10"	SCC-DW100S280-PNB-GRY	SCC-DW100R280-PNB-GRY	Gray
8" x 2.5"	Semi-Pneumatic	400	10"	SCC-DW100S825-SNB	SCC-DW100R825-SNB	Black
10" x 3.5" (4.10 / 3.50 - 4)	Pneumatic	350	12-3/16"	SCC-DW100S3504-PNB	SCC-DW100R3504-PNB	Black
10" x 3"	Semi-Pneumatic	650	12-3/16"	SCC-DW100S1030-SNB	SCC-DW100R1030-SNB	Black
12" x 3.5" (4.10 / 3.50 - 6)	Pneumatic	450	13-3/4"	SCC-DW100S3506-PNB	SCC-DW100R3506-PNB	Black
12" x 3"	Semi-Pneumatic	850	13-3/4"	SCC-DW100S1230-SNB	SCC-DW100R1230-SNB	Black
16" x 4.875" (4.80-8)	Pneumatic	1220	19-1/8"	SCC-DW100S1650-PNT-TP4	SCC-DW100R1650-PNT-TP4	Black

DUAL WHEEL CASTERS *with Brakes*

Wheel Size	Wheel Type	Load Capacity (lbs.)	Overall Height	Wheel Brake	Swivel Lock	Wheel Brake Swivel Lock	Color
6" x 2"	Pneumatic	300	7-1/2"	SCC-DW100S150-PNB-TLB	SCC-DW100S150-PNB-BSL	SCC-DW100S150-PNB-TLB-BSL	Black
8" x 2.5" (2.80 / 2.50 - 4)	Pneumatic	300	10"	SCC-DW100S280-PNB-TLB	SCC-DW100R280-PNB-BSL	SCC-DW100S280-PNB-TLB-BSL	Black
	Pneumatic	300	10"	SCC-DW100S280-PNB-TLB-GRY	SCC-DW100R280-PNB-BSL-GRY	SCC-DW100S280-PNB-TLB-BSL-GRY	Gray
8" x 2.5"	Semi-Pneumatic	400	10"	SCC-DW100S825-SNB-SLB	SCC-DW100R825-SNB-BSL	SCC-DW100S825-SNB-SLB-BSL	Black
10" x 3.5" (4.10 / 3.50 - 4)	Pneumatic	350	12-3/16"	SCC-DW100S3504-PNB-TLB	SCC-DW100S3504-PNB-BSL	SCC-DW100S3504-PNB-TLB-BSL	Black
10" x 3"	Semi-Pneumatic	650	12-3/16"	SCC-DW100S1030-SNB-SLB	SCC-DW100S1030-SNB-BSL	SCC-DW100S1030-SNB-SLB-BSL	Black
12" x 3.5" (4.10 / 3.50 - 6)	Pneumatic	450	13-3/4"	SCC-DW100S3506-PNB-SLB	SCC-DW100S3506-PNB-BSL	SCC-DW100S3506-PNB-SLB-BSL	Black
12" x 3"	Semi-Pneumatic	850	13-3/4"	SCC-DW100S1230-SNB-SLB	SCC-DW100S1230-SNB-BSL	SCC-DW100S1230-SNB-SLB-BSL	Black
16" x 4.875" (4.80-8)	Pneumatic	1220	19-1/8"	SCC-DW100S1650-PNT-FCB-TP4	SCC-DW100S1650-PNT-TP4-BSL	SCC-DW100S1650-PNT-BSL-FCB-TP4	Black

WHICH CASTER IS RIGHT FOR YOU? SINGLE VS DUAL WHEEL



Choosing the right caster depends on your specific needs. Here's a quick guide to help:

Single Wheel Caster

- **Stability:** Best for lighter loads and smooth surfaces.
- **Maneuverability:** Easier to steer in tight spaces.
- **Applications:** Ideal for bellman & sport carts, and indoor & outdoor use.

Dual Wheel Caster

- **Stability:** Handles heavier loads with greater stability.
- **Maneuverability:** Provides better control on uneven terrain.
- **Applications:** Perfect for heavy-duty equipment, industrial carts, and outdoor use.

Remember, choosing the right caster depends on various factors. Even if you prefer a particular style (single or dual), it's best to consult with our **customer service** team for expert advice and a tailored recommendation before making a purchase.

We offer a range of durable wheels in materials like rubber, polyurethane, and steel. Explore customization options to design wheels that fit your specific needs.

Adaptable Wheels for Every Application

We offer wheels in a range of materials, including durable rubber, quiet polyurethane, heat-resistant steel, and tough nylon, each tailored for specific applications. Our Keyed Drive wheels provide secure performance with quick turnaround times to keep your projects on schedule. Plus, you can customize wheels to meet your exact needs.

RUBBER ON ALUMINUM RA 	SEMI STEEL SS 	NYLON NY 	POLYOLEFIN PO 	GLASS FILLED NYLON GFN / GFN*HT 
POLYURETHANE ON CAST IRON PU 	PHENOLICS PH/ PH*HT 	SOLID POLYURETHANE SPU 	ICEFLOW™ ICE 	RUBBER ON STEEL RS 
MUDDERTUFFER™ TPR 	CAST IRON V-GROOVE DUCTILE V-GROOVE VG / DVG 	THERMO PLASTIC RUBBER (FLAT/DONUT) TPRF / TPRD 	CROWNFORCE™ EZPU 	POLYURETHANE ON POLYOLEFIN PPU 
HARD/SOFT RUBBER HR / SR 	DUCTILE STEEL DS 	PNEUMATIC PN 	SEMI-PNEUMATIC NEVER-FLAT SN / NF 	KEYED DRIVE WHEELS KW 

Looking for **Service Caster** wheels or custom options? We offer many wheels beyond what's listed. Contact our team for personalized solutions!

Mold-on Rubber Wheels

Rubber on Cast Iron Center

These solid cushion rubber tires are permanently bonded to iron wheel centers, delivering exceptional durability and long-lasting performance. Widely utilized on industrial equipment, they ensure reliable operation in demanding environments.

Applications

- Forklifts
- Heavy-duty Carts
- Industrial Tuggers
- Automated Guided Vehicles (AGVs)
- Construction Equipment
- Factory Floor Machinery

Features

- Cushion rubber tread vulcanized to a cast iron center with a lubrication fitting
- Superior protection for floors and loads
- Smooth and effortless rolling
- Shock-absorbing design
- Silent operation

Bearing Type(s)



4" x 2" Mold-On Rubber on Cast Iron Wheels

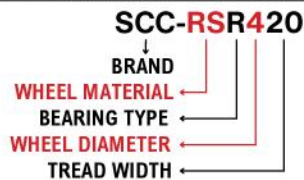

Hardness:

70-80 Shore A Durometer

Temperature Range:
-40°F to 180°F



Dumpster Caster Wheels Built to Last

Mold-on Rubber on Cast Iron

Diameter	Tread Width	Hub Length	Plain Bore Diameters	Load Capacity (lbs.)	Bearing Diameter	Part Number
4"	1-1/2"	1-5/8"	1-3/16"	250	1/2", 5/8", 3/4"	SCC-RSR415
	2"	2-3/16"	3/4"	300		SCC-RSS420
	2"	2-7/16"	1-3/16"	300	1/2", 5/8", 3/4"	SCC-RSR420
5"	1-1/2"	1-5/8"	1-3/16"	350	1/2", 5/8", 3/4"	SCC-RSR515
	2"	2-3/16"	3/4"	450		SCC-RSS520
	2"	2-7/16"	1-3/16"	450	1/2", 5/8", 3/4"	SCC-RSR520
6"	1-1/2"	1-5/8"	1-3/16"	450	1/2", 5/8", 3/4"	SCC-RSR615
	2"	2-3/16"	3/4"	500		SCC-RSS620
	2"	2-7/16"	1-3/16"	500	1/2", 5/8", 3/4"	SCC-RSR620
	2-1/2"	2-3/4"	1-3/16"	600	1/2", 5/8", 3/4"	SCC-RSR625-1-3/16
		2-3/4"	1-15/16"	700	3/4", 1", 1-1/4"	SCC-RSR625
		3-1/4"	1-15/16"	700	3/4", 1", 1-1/4"	SCC-RSR625-3-1/4
3"	3-1/4"	1-15/16"	750	3/4", 1", 1-1/4"	SCC-RSR630	
8"	2"	2-7/16"	1-3/16"	600	1/2", 5/8", 3/4"	SCC-RSR820
	2-1/2"	2-3/4"	1-3/16"	800	1/2", 5/8", 3/4"	SCC-RSR825-1-3/16
		2-3/4"	1-15/16"	850	3/4", 1", 1-1/4"	SCC-RSR825
		3-1/4"	1-15/16"	850	3/4", 1", 1-1/4"	SCC-RSR825-3-1/4
	3"	3-1/4"	1-15/16"	900	3/4", 1", 1-1/4"	SCC-RSR830
10"	2"	2-1/4"	1-3/16", 1-7/16"	700	3/4", 7/8", 1", 1-1/4"	SCC-RSR1020
	2-1/2"	2-3/4"	1-3/16"	900	1/2", 5/8", 3/4"	SCC-RSR1025-1-3/16
		2-3/4"	1-15/16"	950	3/4", 1", 1-1/4"	SCC-RSR1025
		3-1/4"	1/15/16"	950	3/4", 1", 1-1/4"	SCC-RSR1025-3-1/4
	3"	3-1/4"	1-15/16"	1000	3/4", 1", 1-1/4"	SCC-RSR1030
	4"	4-1/4"	1-15/16", 2-7/16"	1400	3/4", 1", 1-1/4", 1-1/2"	SCC-RSR1040

VARIOUS TYPES OF BEARINGS ARE AVAILABLE, INCLUDING BALL BEARINGS, TAPERED BEARINGS, AND DELRIN BEARINGS, OFFERED IN A RANGE OF SIZES.

Unlock a World of Possibilities and Discover More Options with **Service Caster!**

Mold-on Rubber on Cast Iron

Diameter	Tread Width	Hub Length	Plain Bore Diameters	Load Capacity (lbs.)	Bearing Diameter	Part Number
12"	2-1/2"	2-3/4"	1-3/16"	950	1/2", 5/8", 3/4"	SCC-RSR1225-1-3/16
		2-3/4"	1-15/16"	950	3/4", 1", 1-1/4"	SCC-RSR1225
		3-1/4"	1-15/16"	950	3/4", 1", 1-1/4"	SCC-RSR1225-3-1/4
	3"	3-1/4"	1-15/16"	1200	3/4", 1", 1-1/4"	SCC-RSR1230
	3-1/2"	4-1/4"	2-7/16"	1500	3/4", 1", 1-1/4", 1-1/2"	SCC-RSR1235
	4"	4-1/4"	2-7/16"	1600	3/4", 1", 1-1/4", 1-1/2"	SCC-RSR1240
	5"	5-1/4"	2-7/16"	2100	3/4", 1", 1-1/4", 1-1/2"	SCC-RSR1250
14"	2-1/2"	2-3/4"	1-15/16"	1100	3/4", 1", 1-1/4", 1-1/2"	SCC-RSR1425
	3"	3-1/4"	1-15/16"	1300	3/4", 1", 1-1/4", 1-1/2"	SCC-RSR1430
16"	3"	3-1/4"	1-15/16"	1500	3/4", 1", 1-1/4", 1-1/2"	SCC-RSR1630
	4"	4-1/4"	2-7/16"	2000	3/4", 1", 1-1/4", 1-1/2"	SCC-RSR1640
18"	3"	3-1/4"	1-15/16"	1550	3/4", 1", 1-1/4", 1-1/2"	SCC-RSR1830

VARIOUS TYPES OF BEARINGS ARE AVAILABLE, INCLUDING BALL BEARINGS, TAPERED BEARINGS, AND DELRIN BEARINGS, OFFERED IN A RANGE OF SIZES.

MudderTuffer™ Wheels

Solid Thermo Rubber

The MudderTuffer wheel features a rugged thermo rubber tread, resistant to water, oils, and weather. It delivers smooth, non-marking performance with dual-sealed bearings, and operates reliably from -20°F to 180°F.

Applications

- Outdoor Equipment Carts
- Construction Trolleys
- Utility Carts
- Landscaping Equipment
- Warehouse Carts



Hardness:

65 Shore A Durometer



Temperature Range:

-20°F to 180°F



Precision Ball Bearings

Features

- Non-Marking Design makes it ideal for all floor surfaces.
- Dual-Sealed Bearings offer smooth, reliable movement.
- Plastic Core ensures durability and lightweight performance.
- Temperature Range of -20°F to 160°F allows for use in various environments.
- Thermo Rubber Tread provides excellent resistance to water, oils, and weather.

8" x 2" Solid Thermo Rubber Wheels

SCC-TPRB820



Solid Thermo Rubber (MudderTuffer™)

Diameter	Tread Width	Hub Length	Load Capacity (lbs.)	Bearing Diameter	Part Number
4"	2"	2-7/16"	400	1/2", 5/8", 3/4"	SCC-TPRB420
5"	2"	2-7/16"	500	1/2", 5/8", 3/4"	SCC-TPRB520
6"	2"	2-7/16"	600	1/2", 5/8", 3/4"	SCC-TPRB620
8"	2"	2-7/16"	700	1/2", 5/8", 3/4"	SCC-TPRB820

VARIOUS TYPES OF BEARINGS ARE AVAILABLE, INCLUDING BALL BEARINGS, TAPERED BEARINGS, AND DELRIN BEARINGS, OFFERED IN A RANGE OF SIZES.



SERVICE CASTER: RUBBER WHEELS FOR EVERY JOB: BUILT TO LAST AND PERFORM

Mold-on Polyurethane Wheels

Mold-on Polyurethane on Cast Iron Center

The polyurethane wheel, cast to 3/8" and bonded to iron centers, features a non-marking, non-sparking green or red tread that resists ozone, grease, oils, and solvents. *Guaranteed against tread separation for one year in free-wheeling applications.*

Applications

- Industrial Carts
- Manufacturing Equipment
- Hazardous Environments
- Assembly Lines
- Construction Equipment
- Airport Baggage Handling

Features

- Chemically bonded to a sturdy cast iron core
- Non-marking, non-staining, and non-conductive treads
- Protects flooring from damage
- Resists oil, grease, water, and most solvents
- Wheels initiate movement easily and roll smoothly
- Offered in a wide range of colors

Bearing Type(s)



5" x 2" Mold-On Poly on Cast Iron Wheels

SCC-PUB520-RS



Hardness:

95 Shore A Durometer

Temperature Range:

-40°F to 180°F



Mold-on Polyurethane on Cast Iron

Our most popular colors are Green on Black (GB) and Red on Silver (RS).

Diameter	Tread Width	Hub Length	Plain Bore Diameters	Load Capacity (lbs.)	Bearing Diameter	Part Number
3"	1-1/4"	1-1/2"	1-3/16"	800	3/8", 1/2", 5/8", 3/4"	SCC-PUR314
	1-1/2"	1-5/8"	1-3/16"	500	3/8", 1/2", 5/8", 3/4"	SCC-PUR315
3-1/4"	1-1/2"	1-5/8"	1-3/16"	500	3/8", 1/2", 5/8", 3/4"	SCC-PUR3415
	2"	2-3/16"	1-3/16"	600	3/8", 1/2", 5/8", 3/4"	SCC-PUR3420
4"	1-1/2"	1-5/8"	1-3/16"	250	3/8", 1/2", 5/8", 3/4"	SCC-PUR415
	2"	2-3/16"	1-3/16"	700	3/8", 1/2", 5/8", 3/4"	SCC-PUR420
5"	1-1/2"	1-5/8"	1-3/16"	800	3/8", 1/2", 5/8", 3/4"	SCC-PUR515
	2"	2-3/16"	1-3/16"	1100	1/2", 5/8", 3/4"	SCC-PUR520
	3"	3-1/4"	1-15/16"	1600	3/4", 1", 1-1/4"	SCC-PUR530
6"	1-1/2"	1-5/8"	1-3/16"	800	3/8", 1/2", 5/8", 3/4"	SCC-PUR615
	2"	2-3/16"	1-3/16"	1200	1/2", 5/8", 3/4"	SCC-PUR620
	2-1/2"	2-3/4"	1-3/16"	1500	1/2", 5/8", 3/4"	SCC-PUR625-1-3/16
		2-3/4"	1-15/16"	1600	3/4", 1", 1-1/4"	SCC-PUR625
		3-1/4"	1-15/16"	1600	3/4", 1", 1-1/4"	SCC-PUR625-3-1/4
	3"	3-1/4"	1-15/16"	2000	3/4", 1", 1-1/4"	SCC-PUR630
8"	2"	2-7/16"	1-3/16"	1400	1/2", 5/8", 3/4"	SCC-PUR820
	2-1/2"	2-3/4"	1-3/16"	1600	1/2", 5/8", 3/4"	SCC-PUR825-1-3/16
		2-3/4"	1-15/16"	2000	3/4", 1", 1-1/4"	SCC-PUR825
		3-1/4"	1-15/16"	2000	3/4", 1", 1-1/4"	SCC-PUR825-3-1/4
	3"	3-1/4"	1-15/16"	2500	3/4", 1", 1-1/4"	SCC-PUR830
10"	2-1/2"	2-3/4"	1-15/16"	2200	3/4", 1", 1-1/4"	SCC-PUR1025
	2-1/2"	3-1/4"	1-15/16"	2200	3/4", 1", 1-1/4"	SCC-PUR1025-3-1/4
	3"	3-1/4"	1-15/16"	3000	3/4", 1", 1-1/4"	SCC-PUR1030
	4"	4-1/4"	1-15/16", 2-7/16"	5000	3/4", 1", 1-1/4", 1-1/2"	SCC-PUR1040

VARIOUS TYPES OF BEARINGS ARE AVAILABLE, INCLUDING BALL BEARINGS, TAPERED BEARINGS, AND DELRIN BEARINGS, OFFERED IN A RANGE OF SIZES.

For personalized sizes or colors, please reach out to customer service.

Mold-on Polyurethane on Cast Iron

Diameter	Tread Width	Hub Length	Plain Bore Diameters	Load Capacity (lbs.)	Bearing Diameter	Part Number
12"	2-1/2"	2-3/4"	1-3/16"	2500	1/2", 5/8", 3/4"	SCC-PUR1225-1-3/16
		2-3/4"	1-15/16"	2500	3/4", 1", 1-1/4"	SCC-PUR1225
		3-1/4"	1-15/16"	2500	3/4", 1", 1-1/4"	SCC-PUR1225-3-1/4
	3"	3-1/4"	1-15/16"	3500	3/4", 1", 1-1/4"	SCC-PUR1230
	4"	4-1/4"	2-7/16"	5500	3/4", 1", 1-1/4", 1-1/2"	SCC-PUR1240
16"	3"	3-1/4"	1-15/16"	4400	3/4", 1", 1-1/4", 1-1/2"	SCC-PUR1630

VARIOUS TYPES OF BEARINGS ARE AVAILABLE, INCLUDING BALL BEARINGS, TAPERED BEARINGS, AND DELRIN BEARINGS, OFFERED IN A RANGE OF SIZES.

CrownForce™ Wheels

Easy-Roll Heavy-Duty Poly Wheels

Easy-Roll HD Polyurethane Wheels provide smooth movement with a durable cast iron core, offering strength and floor protection. They perform in temperatures from -40°F to +180°F with various bearing options for versatile use.

Applications

- Warehouse Carts
- Material Handling Equipment
- Industrial Dollies
- Heavy Machinery
- Retail Displays

Features

- Crowned Tread for smooth movement.
- Cast Iron Core for maximum durability.
- Shore A 95 for strength and floor protection.
- Temp Range: -40°F to +180°F for versatile use.
- Bearing Options for optimal performance.

10" x 3" Easy-Roll Poly on Cast Iron Wheels

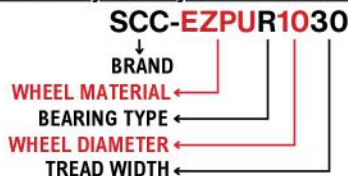

Hardness:

95 Shore A Durometer



Temperature Range:

-40°F to 180°F



**Perfect Wheels for -
Keyed Drive Wheels**



Easy-Roll Heavy-Duty Poly Wheels

Diameter	Tread Width	Hub Length	Plain Bore Diameters	Load Capacity (lbs.)	Bearing Diameter	Part Number
4"	1-1/2"	1-5/8"	1-3/16"	600	3/8", 1/2", 5/8", 3/4"	SCC-EZPUR415
	2"	2-3/16"	1-3/16"	800	1/2", 5/8", 3/4"	SCC-EZPUR420
5"	1-1/2"	1-5/8"	1-3/16"	800	3/8", 1/2", 5/8", 3/4"	SCC-EZPUR515
	2"	2-3/16"	1-3/16"	1300	1/2", 5/8", 3/4"	SCC-EZPUR520
6"	1-1/2"	1-5/8"	1-3/16"	850	3/8", 1/2", 5/8", 3/4"	SCC-EZPUR615
	2"	2-3/16"	1-3/16"	1400	1/2", 5/8", 3/4"	SCC-EZPUR620
	2-1/2"	2-3/4"	1-15/16"	1700	3/4", 1", 1-1/4"	SCC-EZPUR625
	2-1/2"	3-1/4"	1-15/16"	1700	3/4", 1", 1-1/4"	SCC-EZPUR625-3-1/4
	3"	3-1/4"	1-15/16"	2200	3/4", 1", 1-1/4"	SCC-EZPUR630
8"	2"	2-3/16"	1-3/16"	1500	1/2", 5/8", 3/4"	SCC-EZPUR820
	2-1/2"	2-3/4"	1-15/16"	2200	3/4", 1", 1-1/4"	SCC-EZPUR825
	2-1/2"	3-1/4"	1-15/16"	2200	3/4", 1", 1-1/4"	SCC-EZPUR825-3-1/4
	3"	3-1/4"	1-15/16"	2700	3/4", 1", 1-1/4"	SCC-EZPUR830
10"	2-1/2"	2-3/4"	1-15/16"	2400	3/4", 1", 1-1/4"	SCC-EZPUR1025
	2-1/2"	3-1/4"	1-15/16"	2400	3/4", 1", 1-1/4"	SCC-EZPUR1025-3-1/4
	3"	3-1/4"	1-15/16"	3000	3/4", 1", 1-1/4"	SCC-EZPUR1030
12"	2-1/2"	2-3/4"	1-15/16"	2700	3/4", 1", 1-1/4"	SCC-EZPUR1225
	2-1/2"	3-1/4"	1-15/16"	2700	3/4", 1", 1-1/4"	SCC-EZPUR1225-3-1/4
	3"	3-1/4"	1-15/16"	4200	3/4", 1", 1-1/4"	SCC-EZPUR1230

VARIOUS TYPES OF BEARINGS ARE AVAILABLE, INCLUDING BALL BEARINGS, TAPERED BEARINGS, AND DELRIN BEARINGS, OFFERED IN A RANGE OF SIZES.

Semi-Steel Cast Iron Wheels

Semi-Steel Cast Iron Wheels

Semi-Steel (Gray Iron) Wheels are cost-effective, ideal for light to medium-duty on smooth concrete. They shouldn't be used on rough surfaces, with impact, overload, or in automated systems, as they may cause floor damage.

Applications

- Warehouse Carts
- Manufacturing Material Handling
- Equipment Dollies
- Platform Trucks
- Workshop Tool Carts

Features

- Generous Capacity
- Resistant to Abrasion
- Precisely Machined Hub Length and Wheel Face
- Smooth Rolling Even Under Heavy Loads
- Durable and Long-Lasting

Bearing Type(s)



6" x 2" Semi-Steel Cast Iron Wheels

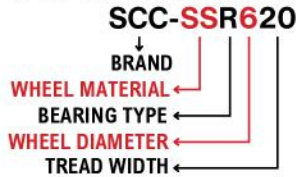

Hardness:

95 Shore A Durometer

Temperature Range:

-45°F to 800°F



THESE WHEELS EXCEL IN HIGH-HEAT ENVIRONMENTS, PERFECT FOR INDUSTRIAL OVENS AND COMMERCIAL KITCHENS.

Semi-Steel Cast Iron Wheels

Diameter	Tread Width	Hub Length	Plain Bore Diameters	Load Capacity (lbs.)	Bearing Diameter	Part Number
2"	1"	1-1/8"	1/4"	250	1/4"	SCC-SS210
2-1/2"	1"	1-1/8"	5/16"	250	5/16"	SCC-SS2510
3"	1-1/4"	1-9/16"	3/8", 1/2"	350	3/8", 1/2"	SCC-SSS314
3-1/2"	1-1/4"	1-9/16"	3/8"	400	3/8"	SCC-SSS3514
3-1/4"	1-1/2"	1-7/8"	1-3/16"	400	3/8", 1/2", 5/8", 3/4"	SCC-SSR3415
	2"	2-3/16"	1-3/16"	700	3/8", 1/2", 5/8", 3/4"	SCC-SSR3420
4"	1-1/2"	1-5/8"	1-3/16"	600	3/8", 1/2", 5/8", 3/4"	SCC-SSR415
	2"	2-3/16"	1-3/16"	700	3/8", 1/2", 5/8", 3/4"	SCC-SSR420
5"	1-1/2"	1-5/8"	1-3/16"	600	3/8", 1/2", 5/8", 3/4"	SCC-SSR515
	2"	2-3/16"	1-3/16"	1000	1/2", 5/8", 3/4"	SCC-SSR520
6"	1-1/2"	1-5/8"	1-3/16"	600	3/8", 1/2", 5/8", 3/4"	SCC-SSR615
	2"	2-3/16"	1-3/16"	1000	1/2", 5/8", 3/4"	SCC-SSR620
	2-1/2"	2-3/4"	1-3/16"	1600	1/2", 5/8", 3/4"	SCC-SSR625-1-3/16
		2-3/4"	1-15/16"	1800	3/4", 1", 1-1/4"	SCC-SSR625
		3-1/4"	1-15/16"	1800	3/4", 1", 1-1/4"	SCC-SSR625-3-1/4
3"	3-1/4"	1-15/16"	2700	3/4", 1", 1-1/4"	SCC-SSR630	
8"	2"	2-3/16"	1-3/16"	1400	1/2", 5/8", 3/4"	SCC-SSR820
	2-1/2"	2-3/4"	1-3/16"	1600	1/2", 5/8", 3/4"	SCC-SSR825-1-3/16
		2-3/4"	1-15/16"	1800	3/4", 1", 1-1/4"	SCC-SSR825
		3-1/4"	1-15/16"	1800	3/4", 1", 1-1/4"	SCC-SSR825-3-1/4
		3"	3-1/4"	1-15/16"	2500	3/4", 1", 1-1/4"
10"	2-1/2"	2-3/4"	1-3/16"	1700	1/2", 5/8", 3/4"	SCC-SSR1025-1-3/16
		2-3/4"	1-15/16"	2000	3/4", 1", 1-1/4"	SCC-SSR1025
		3-1/4"	1-15/16"	2000	3/4", 1", 1-1/4"	SCC-SSR1025-3-1/4
		3"	3-1/4"	1-15/16"	2500	3/4", 1", 1-1/4"

VARIOUS TYPES OF BEARINGS ARE AVAILABLE, INCLUDING BALL BEARINGS, TAPERED BEARINGS, AND DELRIN BEARINGS, OFFERED IN A RANGE OF SIZES.

Semi-Steel Cast Iron Wheels

Diameter	Tread Width	Hub Length	Plain Bore Diameters	Load Capacity (lbs.)	Bearing Diameter	Part Number
12"	2-1/2"	2-3/4"	1-15/16"	2000	3/4", 1", 1-1/4"	SCC-SSR1225
	2-1/2"	3-1/4"	1-15/16"	2000	3/4", 1", 1-1/4"	SCC-SSR1225-3-1/4
	3"	3-1/4"	1-15/16"	2500	3/4", 1", 1-1/4"	SCC-SSR1230

VARIOUS TYPES OF BEARINGS ARE AVAILABLE, INCLUDING **BALL BEARINGS**, **TAPERED BEARINGS**, AND **DELTRIN BEARINGS**, OFFERED IN A RANGE OF SIZES.

Ductile Steel

Flat / Crown Tread Ductile Wheels

Made of ductile iron with a heavy-duty core, these wheels handle temperatures from -45°F to 800°F, offer 45,000 PSI tensile strength, and support up to 10,000 lbs. Various bearing options ensure optimal performance.

Applications

- Industrial Ovens
- High-heat Furnaces
- Heavy-duty Manufacturing Equipment
- Foundry Carts
- Kiln Carts

Features

- High-temperature resistance (-45°F to 800°F)
- 45,000 PSI tensile strength
- Extra-thick, durable core and tread
- Supports up to 10,000 lbs.
- Multiple bearing options for optimized performance

Bearing Type(s)



8" x 2" Semi-Steel Cast Iron Wheels

SCC-DSR830

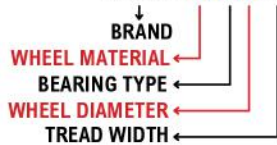

Temperature Range:
-45°F to 800°F



Flat / Crown Tread Ductile Wheels

Diameter	Tread Width	Hub Length	Plain Bore Diameters	Load Capacity (lbs.)	Bearing Diameter	Flat Tread Part Number	Crown Tread Part Number
4"	1-1/2"	2"	1-3/16"	1200	3/8", 1/2", 5/8", 3/4"	SCC-DSR415	**
	2"	2-3/16"	1-3/16"	1500	3/8", 1/2", 5/8", 3/4"	SCC-DSR420	SCC-CDS420
5"	2"	2-3/16"	1-3/16"	1500	1/2", 5/8", 3/4"	SCC-DSR520	SCC-CDSR520
	2-1/2"	2-3/4"	1-15/16"	2000	3/4", 1", 1-1/4"	SCC-DSR525	**
6"	2"	2-3/16"	1-3/16"	2000	1/2", 5/8", 3/4"	SCC-DSR620	SCC-CDSR620
	2-1/2"	2-3/4"	1-15/16"	3500	3/4", 1", 1-1/4"	SCC-DSR625	SCC-CDSR625
	2-1/2"	3-1/4"	1-15/16"	3500	3/4", 1", 1-1/4"	SCC-DSR625-3-1/4	SCC-CDSR625-3-1/4
	3"	3-1/4"	1-15/16"	6000	3/4", 1", 1-1/4"	SCC-DSR630	SCC-CDSR630
8"	2"	2-3/16"	1-3/16"	2300	1/2", 5/8", 3/4"	SCC-DSR820	SCC-CDSR820
	2-1/2"	2-3/4"	1-15/16"	4000	3/4", 1", 1-1/4"	SCC-DSR825	SCC-CDSR825
	2-1/2"	3-1/4"	1-15/16"	4000	3/4", 1", 1-1/4"	SCC-DSR825-3-1/4	SCC-CDSR825-3-1/4
	3"	3-1/4"	1-15/16"	6000	3/4", 1", 1-1/4"	SCC-DSR830	SCC-CDSR830
	4"	4-1/4"	2-7/16"	10000	3/4", 1", 1-1/4", 1-1/2"	SCC-DSR840	**

VARIOUS TYPES OF BEARINGS ARE AVAILABLE, INCLUDING **BALL BEARINGS**, **TAPERED BEARINGS**, AND **DELTRIN BEARINGS**, OFFERED IN A RANGE OF SIZES.

PLEASE NOTE THE PART NUMBERS LISTED ARE FOR WHEELS WITH ROLLER BEARINGS. FOR A DIFFERENT BEARING, CHANGE THE LETTER IN THE PART NUMBER. EXAMPLE: FOR BALL BEARINGS, USE "DSB620" INSTEAD OF "DSR620." FOR AN 8X2 TAPERED BEARING, USE "SCC-DST820."

Flat / Crown Tread Ductile Wheels

Diameter	Tread Width	Hub Length	Plain Bore Diameters	Load Capacity (lbs.)	Bearing Diameter	Flat Tread Part Number	Crown Tread Part Number
10"	2-1/2"	2-3/4"	1-15/16	4500	3/4", 1", 1-1/4"	SCC-DSR1025	**
		3-1/4"	1-15/16"	4500	3/4", 1", 1-1/4"	SCC-DSR1025-3-1/4	
	3"	3-1/4"	1-15/16"	10000	3/4", 1", 1-1/4"	SCC-DSR1030	SCC-CDSR1030
	4"	4-1/4"	2-7/16"	10000	3/4", 1", 1-1/4", 1-1/2"	SCC-DSR1040	
12"	3"	3-1/4"	1-15/16"	6000	3/4", 1", 1-1/4"	SCC-DSR1230	SCC-CDSR1230
	3-1/2"	4-1/4"	1-1/4"	10000	1-1/4"	SCC-DSR1235	**
	4"	4-9/16"	1-1/4"	17000	1-1/4"	SCC-DSR1240	
14	3"	3-1/4"	1-15/16"	6000	3/4", 1", 1-1/4"	SCC-DSR1430	

VARIOUS TYPES OF BEARINGS ARE AVAILABLE, INCLUDING BALL BEARINGS, TAPERED BEARINGS, AND DELRIN BEARINGS, OFFERED IN A RANGE OF SIZES.

Cast Iron V-Groove

Cast Iron V-Groove

The cast iron V-groove wheel is designed for inverted angle tracks but also works on flat surfaces. Its 90° V-groove ensures load balance, making it ideal for industrial applications requiring precise alignment, such as assembly lines, paint lines, and gates.

Applications

- Assembly Lines
- Industrial Gates
- Conveyor Systems
- Sliding Doors

Features

- Precisely machined 90° V-groove with relief for load equalization
- Tensile strength of 30,000 PSI
- Durable cast iron construction
- Usable on both inverted angle tracks and flat surfaces

Bearing Type(s)



Temperature Range:
-45°F to 300°F



4" x 2" Cast Iron V-Groove Wheels

SCC-VGR420

BRAND

WHEEL MATERIAL

BEARING TYPE

WHEEL DIAMETER

TREAD WIDTH

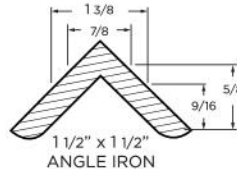
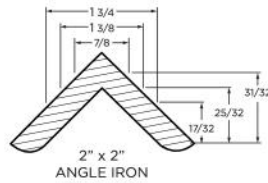

Cast Iron V-Groove

Diameter	Tread Width	Hub Length	Plain Bore Diameters	Load Capacity (lbs.)	Bearing Diameter	Groove Width	Part Number
3"	1-1/4"	1-5/8"	1/2"	350	1/2"	7/8"	SCC-VGS314
	1-1/2"	1-5/8"	1-3/16"	375	1/2", 5/8", 3/4"	7/8"	SCC-VGR315
4"	1-1/2"	1-5/8"	1-3/16"	350	3/8", 1/2", 5/8", 3/4"	7/8"	SCC-VGR415
	2"	2-3/16"	1-3/16"	600	1/2", 5/8", 3/4"	7/8"	SCC-VGR420
5"	2"	2-3/16"	1-3/16"	900	1/2", 5/8", 3/4"	7/8"	SCC-VGR520
6"	2"	2-3/16"	1-3/16"	1000	1/2", 5/8", 3/4"	7/8"	SCC-VGR620
	2-1/2"	2-3/4"	1-15/16"	2500	3/4", 1", 1-1/4"	7/8"	SCC-VGR625
	2-1/2"	3-1/4"	1-15/16"	2500	3/4", 1", 1-1/4"	7/8"	SCC-VGR625-3-1/4
	3"	3-1/4"	1-15/16"	3500	3/4", 1", 1-1/4"	7/8", 1-3/8"	SCC-VGR630
8"	2"	2-3/16"	1-3/16"	1200	1/2", 5/8", 3/4"	7/8"	SCC-VGR820
	2-1/2"	2-3/4"	1-15/16"	2500	3/4", 1", 1-1/4"	7/8"	SCC-VGR825
	2-1/2"	3-1/4"	1-15/16"	2500	3/4", 1", 1-1/4"	7/8"	SCC-VGR825-3-1/4
	3"	3-1/4"	1-15/16"	3500	3/4", 1", 1-1/4"	7/8", 1-3/8"	SCC-VGR830
10"	3"	3-1/4"	1-15/16"	3500	3/4", 1", 1-1/4"	7/8", 1-3/8"	SCC-VGR1030

VARIOUS TYPES OF BEARINGS ARE AVAILABLE, INCLUDING BALL BEARINGS, TAPERED BEARINGS, AND DELRIN BEARINGS, OFFERED IN A RANGE OF SIZES.

Ductile V-Groove

Ductile V-Groove

The Ductile Steel V-Groove Wheel is durable, heavy-duty, and economical. Ideal for inverted angle iron tracks, it can also be used on flat surfaces, offering versatile and long-lasting performance.

Applications

- Sliding Gates
- Industrial Carts
- Conveyor Systems
- Overhead Cranes
- Production Line Equipment

Features

- Extremely solid and well made
- Higher capacity than cast iron v-groove wheels
- More economical than forged steel wheels
- Tensile strength of 30,000 PSI

Temperature Range:

-45°F to 800°F

Bearing Type(s)



6" x 2" Ductile V-Groove Wheels

SCC-DVGR620

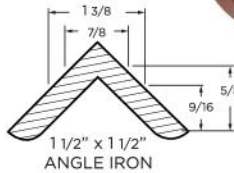
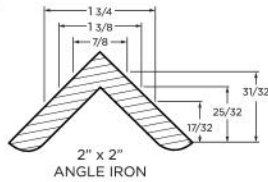
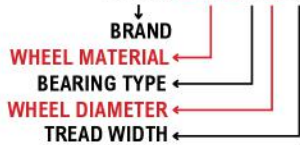

Ductile V-Groove

Diameter	Tread Width	Hub Length	Plain Bore Diameters	Load Capacity (lbs.)	Bearing Diameter	Groove Width	Part Number
4"	1-1/2"	1-5/8"	1-3/16"	1200	3/8", 1/2", 5/8", 3/4"	7/8"	SCC-DVGR415
	2"	2-3/16"	1-3/16"	1500	1/2", 5/8", 3/4"	7/8"	SCC-DVGR420
6"	2"	2-3/16"	1-3/16"	1500	1/2", 5/8", 3/4"	7/8"	SCC-DVGR620
	2-1/2"	2-3/4"	1-15/16"	3500	3/4", 1", 1-1/4"	7/8"	SCC-DVGR625
	2-1/2"	3-1/4"	1-15/16"	3500	3/4", 1", 1-1/4"	7/8"	SCC-DVGR625-3-1/4
	3"	3-1/4"	1-15/16"	5000	3/4", 1", 1-1/4"	7/8", 1-3/8"	SCC-DVGR630
8"	2-1/2"	2-3/4"	1-15/16"	3500	3/4", 1", 1-1/4"	7/8"	SCC-DVGR825
	2-1/2"	3-1/4"	1-15/16"	3500	3/4", 1", 1-1/4"	7/8"	SCC-DVGR825-3-1/4
	3"	3-1/4"	1-15/16"	5000	3/4", 1", 1-1/4"	7/8", 1-3/8"	SCC-DVGR830
10"	3"	3-1/4"	1-15/16"	7000	3/4", 1", 1-1/4"	7/8", 1-3/8"	SCC-DVGR1030

VARIOUS TYPES OF BEARINGS ARE AVAILABLE, INCLUDING BALL BEARINGS, TAPERED BEARINGS, AND DELRIN BEARINGS, OFFERED IN A RANGE OF SIZES.

V-GROOVE Caster Wheels



V-GROOVE CASTER WHEELS GUIDE EQUIPMENT ON ANGLE IRON TRACKS, REDUCING DEBRIS ISSUES AND DISTRIBUTING LOADS EVENLY. THEY ALSO WORK ON FLAT FLOORS. USE TAPERED BEARINGS FOR HEAVY LOADS AND OPT FOR STRONGER WHEELS LIKE DUCTILE OR FORGED STEEL IN TOUGH CONDITIONS.

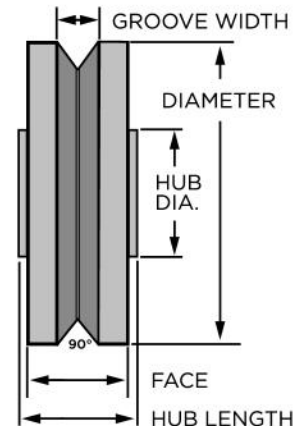
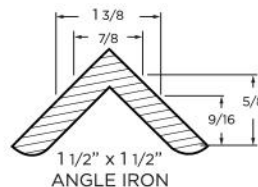
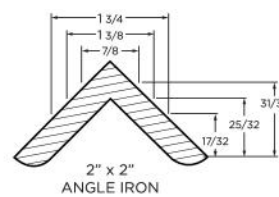

Polyolefin Wheels

Polyolefin Wheels

Polyolefin caster wheels are durable in wet, corrosive environments but have lower capacity and temperature limits than Nylon. They may become brittle in cold and aren't suited for use above 180°F, except for Extra Heavy Duty models

Applications

- Food Processing Facilities
- Pharmaceutical Manufacturing
- Laundry Carts
- Retail Store Displays
- Warehouse Material Handling

Features

- Highly resistant to most liquids and chemicals
- Won't leave marks or scuffs on floors
- Solid one-piece construction, easy to clean
- Operates in temperatures from -20°F to 180°F
- Suitable for wet and corrosive environments

Bearing Type(s)



4" x 2" Polyolefin Wheels

SCC-POR420

BRAND

WHEEL MATERIAL

BEARING TYPE

WHEEL DIAMETER

TREAD WIDTH

Temperature Range:

-20°F to 180°F



Hardness:

65 to 70 Shore D Durometer



Polyolefin Wheels

Diameter	Tread Width	Hub Length	Plain Bore Diameters	Load Capacity (lbs.)	Bearing Diameter	Part Number
2"	13/16"	7/8"	5/16"	80	1/4", 5/16"	SCC-POS210
	1-3/4"	1-13/16"	5/16"	300	5/16"	SCC-POS2134
2-1/2"	15/16"	1-11/32"	5/16"	175	5/16"	SCC-POS2510
	1-1/4"	1-9/16"	5/16"	200	5/16", 3/8", 1/2"	SCC-POS2514
3"	1"	1-1/8"	5/16"	175	5/16"	SCC-POS310
	1-1/4"	1-9/16"	3/8"	300	3/8", 1/2"	SCC-POS314
3-1/2"	1-1/4"	1-9/16"	3/8"	350	3/8", 1/2"	SCC-POS3514
4"	1"	1-1/8"	5/16"	220	5/16"	SCC-POS410
	1-1/4"	1-9/16"	3/8"	370	3/8", 1/2"	SCC-POS414
	1-1/2"	1-5/8"	1-3/16"	400	3/8", 1/2", 5/8", 3/4"	SCC-POR415
	2"	2-3/16"	1-3/16"	500	1/2", 5/8", 3/4"	SCC-POR420
5"	1"	1-1/8"	5/16"	230	5/16"	SCC-POS510
	1-1/4"	1-9/16"	3/8"	400	5/16", 3/8"	SCC-POS514
	1-1/2"	1-5/8"	1-3/16"	450	3/8", 1/2", 5/8", 3/4"	SCC-POR515
	2"	2-3/16"	1-3/16"	650	1/2", 5/8", 3/4"	SCC-POR520
6"	1-1/4"	1-9/16"	3/8"	450	3/8", 1/2"	SCC-POS614
	1-1/2"	1-5/8"	1-3/16"	450	3/8", 1/2", 5/8", 3/4"	SCC-POR615
	2"	2-3/16"	1-3/16"	700	1/2", 5/8", 3/4"	SCC-POR620
8"	2"	2-3/16"	1-3/16"	900	1/2", 5/8", 3/4"	SCC-POR820

VARIOUS TYPES OF BEARINGS ARE AVAILABLE, INCLUDING BALL BEARINGS, TAPERED BEARINGS, AND DELRIN BEARINGS, OFFERED IN A RANGE OF SIZES.

Choose Your Style!



Rubber on Aluminum Wheels

Rubber on Aluminum Wheels

Rubber on aluminum wheels offer a smooth, cushioned ride, protect floors, and resist corrosion. Gray treads are non-marking, while black treads may leave marks. These wheels are a durable, high-grade upgrade with a sleek appearance.

Applications

- Office Furniture & Equipment
- Medical & Laboratory Equipment
- Retail Display Racks
- Food Service Carts
- Aviation & Electronics Manufacturing

Features

- Smooth, Quiet Ride
- Non-Marking Option
- Corrosion & Rust Resistance
- Lightweight, Attractive Finish
- Floor Protection

Bearing Type(s)



8" x 2" Rubber on Aluminum Wheel

SCC-RAR820



Temperature Range:

-40°F to 160°F



Hardness:

65 to 75 Shore A Durometer

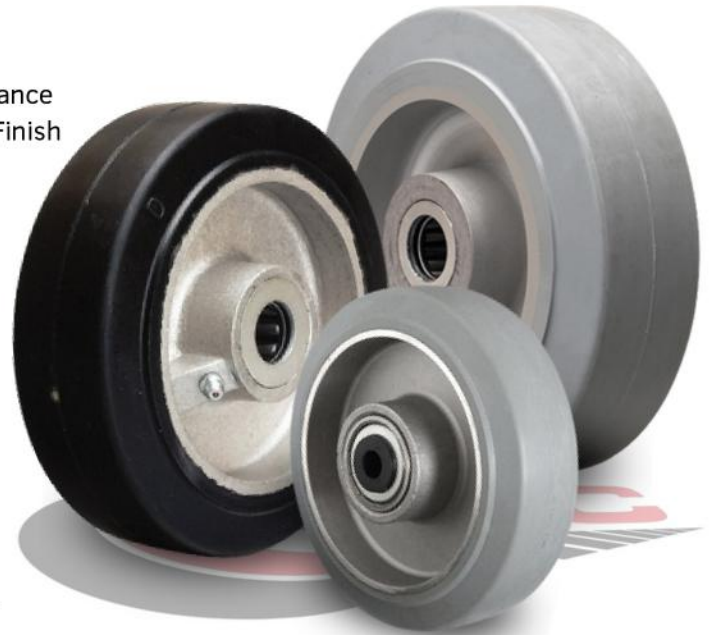

Rubber on Aluminum Wheels

Diameter	Tread Width	Hub Length	Plain Bore Diameters	Load Capacity (lbs.)	Bearing Diameter	Part Number
3-1/2"	1-1/4"	1-9/16"	-	300	3/8"	SCC-RAB3514
4"	1-1/4"	1-9/16"	-	300	3/8"	SCC-RAB414
	2"	2-3/16"	1-3/16"	400	1/2", 5/8", 3/4"	SCC-RAR420
5"	1-1/4"	1-9/16"	-	325	3/8"	SCC-RAB514
	2"	2-3/16"	1-3/16"	500	1/2", 5/8", 3/4"	SCC-RAR520
6"	2"	2-3/16"	1-3/16"	550	1/2", 5/8", 3/4"	SCC-RAR620
8"	1-1/2"	1-11/16"	1-3/8"	500	1/2", 5/8", 3/4"	SCC-RAB815
	1-5/8"	1-13/16"	1-3/8"	500	1/2", 5/8", 3/4"	SCC-RAB8158
	2"	2-3/16"	1-3/16"	600	1/2", 5/8", 3/4"	SCC-RAR820

VARIOUS TYPES OF BEARINGS ARE AVAILABLE, INCLUDING BALL BEARINGS, TAPERED BEARINGS, AND DELRIN BEARINGS, OFFERED IN A RANGE OF SIZES.



Rubber on aluminum caster wheels are often used in **film** and **TV production** studios because their smooth, quiet operation allows crews to move heavy equipment without interrupting audio recording or disturbing sensitive set environments! The non-marking treads also help maintain pristine floors on high-end studio sets.

Polyurethane on Polyolefin

Polyurethane on Polyolefin

These non-marking polyurethane wheels, locked to a polyolefin core, offer various designs, colors, and bearings, with a Shore A 95 durometer and temperature range of -20°F to +180°F.

Applications

- Warehouse Carts
- Medical Equipment
- Food Service
- Retail Displays
- Manufacturing

Features

- Non-Marking Tread
- Chemical & Debris Resistance
- Wide Temperature Range
- Durable Durometer
- Custom Options

Bearing Type(s)



4" x 2" Polyurethane on Polyolefin

SCC-PPUB420

BRAND

WHEEL MATERIAL

BEARING TYPE

WHEEL DIAMETER

TREAD WIDTH

Temperature Range:

-20°F to 180°F



Hardness:

95 Shore A Durometer



CHOOSE YOUR COLOR



Polyurethane on Polyolefin

Diameter	Tread Width	Hub Length	Plain Bore Diameters	Load Capacity (lbs.)	Bearing Diameter	Part Number
2"	1"	1-1/32"	1/4"	100	1/4"	SCC-PPUS210
2-1/2"	1"	1-3/8"	5/16"	100	5/16"	SCC-PPUS2510
	1-1/4"	1-5/8"	1-1/8"	250	5/16", 3/8", 1/2"	SCC-PPUB2514
3"	1"	1-1/8"	5/16"	125	5/16"	SCC-PPUS310
	1-1/4"	1-5/8"	3/8"	300	5/16", 3/8", 1/2"	SCC-PPUB314
3-1/2"	1-1/4"	1-5/8"	3/8"	300	3/8", 1/2"	SCC-PPUB3514
4"	1"	1-1/8"	5/16"	140	5/16"	SCC-PPUS410
	1-1/4"	1-5/8"	3/8"	350	3/8", 1/2"	SCC-PPUB414
	1-1/2"	1-5/8"	1-3/16"	350	3/8", 1/2", 5/8", 3/4"	SCC-PPUR415
	2"	2-3/16"	1-3/16"	500	1/2", 5/8", 3/4"	SCC-PPUR420
5"	1"	1-1/8"	5/16"	140	5/16"	SCC-PPUS510
	1-1/4"	1-5/8"	3/8"	350	3/8", 1/2"	SCC-PPUB514
	1-1/2"	1-5/8"	1-3/16"	450	3/8", 1/2", 5/8", 3/4"	SCC-PPUR515
	2"	2-3/16"	1-3/16"	600	1/2", 5/8", 3/4"	SCC-PPUR520
6"	1-1/4"	1-5/8"	1-1/8"	350	3/8", 1/2"	SCC-PPUB614
	1-1/2"	1-5/8"	1-3/16"	600	3/8", 1/2", 5/8", 3/4"	SCC-PPUR615
	2"	2-3/16"	1-3/16"	900	1/2", 5/8", 3/4"	SCC-PPUR620
8"	1-1/2"	2-1/8"	1-3/8"	600	1/2", 5/8", 3/4"	SCC-PPUB815
	2"	2-3/16"	1-3/16"	1000	1/2", 5/8", 3/4"	SCC-PPUR820
	2-1/2"	2-3/4"	1-15/16"	1100	3/4", 1", 1-1/4"	SCC-PPUR825
	3"	3-1/4"	1-15/16"	1150	3/4", 1", 1-1/4"	SCC-PPUR830
10"	1-1/2"	2-1/8"	1-3/8"	700	1/2", 5/8", 3/4"	SCC-PPUB1015
	2-1/2"	2-3/4"	1-15/16"	1200	3/4", 1", 1-1/4"	SCC-PPUR1025
	3"	3-1/4"	1-15/16"	1250	3/4", 1", 1-1/4"	SCC-PPUR1030
12"	2-1/2"	2-3/4"	1-15/16"	1400	3/4", 1", 1-1/4"	SCC-PPUR1225
	3"	3-1/4"	1-15/16"	1400	3/4", 1", 1-1/4"	SCC-PPUR1230

VARIOUS TYPES OF BEARINGS ARE AVAILABLE, INCLUDING BALL BEARINGS, TAPERED BEARINGS, AND DELRIN BEARINGS, OFFERED IN A RANGE OF SIZES.

Solid Polyurethane Wheels

Solid Polyurethane Wheels

Solid polyurethane wheels for medium-duty loads. These high-performance, steam-cleanable wheels withstand harsh environments and resist blood, brine, salt, grease, oils, and chemicals. Standard hardness: 75-80 Shore D.

Applications

- Food Processing Facilities
- Cleanrooms
- Pharmaceutical Manufacturing
- Chemical Processing Plants
- Medical Equipment

Features

- Chemical Resistance
- Steam Cleanable
- One-Piece Mold Design
- High Impact & Abrasion Resistance
- Temperature Versatility

Bearing Type(s) Use **stainless steel** for better corrosion resistance.



3" x 1-1/4" Solid Polyurethane

SCC-SPUS314

BRAND

WHEEL MATERIAL

BEARING TYPE

WHEEL DIAMETER

TREAD WIDTH



Hardness:

60-65 Shore D Durometer

Temperature Range:

-50°F to 180°F



Solid Polyurethane Wheels

Diameter	Tread Width	Hub Length	Plain Bore Diameters	Load Capacity (lbs.)	Bearing Diameter	Part Number
3"	1-1/4"	1-9/16"	1/2"	300	5/16", 3/8", 1/2"	SCC-SPUS314
3-1/2"	1-1/4"	1-9/16"	1/2"	300	5/16", 3/8", 1/2"	SCC-SPUS3514
4"	1-1/4"	1-9/16"	1/2"	400	5/16", 3/8", 1/2"	SCC-SPUS414
	2"	2-3/16"	1-3/16"	750	1/2", 5/8", 3/4"	SCC-SPUR420
5"	1-1/4"	1-9/16"	1/2"	700	3/8", 1/2"	SCC-SPUS514
	1-1/2"	1-7/8"	1-3/16"	700	3/8", 1/2", 5/8", 3/4"	SCC-SPUR515
	2"	2-3/16"	1-3/16"	800	1/2", 5/8", 3/4"	SCC-SPUR520
6"	1-1/2"	1-5/8"	1-3/16"	600	3/8", 1/2", 5/8", 3/4"	SCC-SPUR615
	2"	2-3/16"	1-3/16"	900	1/2", 5/8", 3/4"	SCC-SPUR620
	3"	3-1/4"	1-15/16"	2000	3/4", 1", 1-1/4"	SCC-SPUR630
8"	2"	2-3/16"	1-3/16"	1000	1/2", 5/8", 3/4"	SCC-SPUR820
	3"	3-1/4"	1-15/16"	2500	3/4", 1", 1-1/4"	SCC-SPUR830
10"	3"	3-1/4"	1-15/16"	3000	3/4", 1", 1-1/4"	SCC-SPUR1030
12"	3"	3-1/4"	1-15/16"	3500	3/4", 1", 1-1/4"	SCC-SPUR1230

VARIOUS TYPES OF BEARINGS ARE AVAILABLE, INCLUDING BALL BEARINGS, TAPERED BEARINGS, AND DELRIN BEARINGS, OFFERED IN A RANGE OF SIZES.

One-Piece Power: Solid Polyurethane Wheels for Ultimate Durability



No Debonding Risk – Solid polyurethane is a one-piece construction, **eliminating** the risk of tread separation found in multi-material wheels. This design ensures longevity, especially in demanding environments.

Easy to Clean & Hygienic – Solid polyurethane wheels are 100% steam cleanable and washable, making them perfect for **cleanrooms**, food processing, and other settings where sanitation is crucial.

ICEFlow™ Wheel

ICEFlow™ Wheel

The ICEFlow™ Wheel features a non-marking polyurethane exterior, securely bonded to a durable polyolefin core. It offers smooth rollability, floor protection, and resistance to chemicals and flat-spotting, making it ideal for all surfaces and heavy loads.

Applications

- Medical Equipment
- Retail Displays
- Food Service Carts
- Industrial Trolleys
- Hospitality Furniture

Features

- Flat-spot resistance maintains performance under prolonged stationary loads.
- Precision ball bearings provide smooth, effortless movement under load.
- Durable polyolefin core prevents separation and ensures longevity.
- Non-marking polyurethane exterior protects floors from damage.
- Chemical resistance ensures durability in tough environments.



Bearing Type(s)



Temperature Range:
-45°F to 180°F



Hardness:

55 Shore D Durometer



2" ICEFlow™ Blue Polyurethane with 1/4" Bearing

SCC-ICE210-14B-BLUE

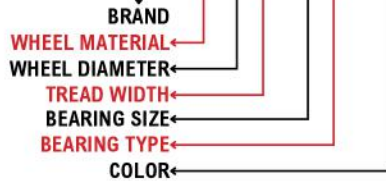

Thermoplastic Rubber Wheels

Diameter	Tread Width	Hub Length	Load Capacity (lbs.)	Bearing Diameter	Part Number	Color / Style
2"	7/8"	1-3/64"	80	1/4"	SCC-ICE210-14B	Clear , Blue , Black , Green , Orange , Purple , Pink , Red
2-5/16"	3/4"	1-3/64"	80	1/4"	SCC-ICE2510-14B	Clear , Blue , Black , Green , Orange , Purple , Pink , Red
3"	15/16"	1-3/64"	100	1/4"	SCC-ICE310-14B	Clear , Blue , Black , Green , Orange , Purple , Pink , Red

Choose Your Style!



Glass Filled Nylon Wheels

Glass Filled Nylon Wheels

Glass Filled Nylon wheels offer non-marking, high-impact performance, resist chemicals and grease, and handle temps from -45°F to 250°F (350°F with high-temp grease). Perfect for tough environments.

Applications

- Manufacturing Plants
- Food Processing
- Pharmaceutical Facilities

Features

- High Impact & Abrasion Resistance
- Non-Marking
- One-Piece Mold Design
- Temperature Versatility

Bearing Type(s)



5" x 2" Glass Filled Nylon with Ball Bearing

SCC-GFNB520



Temperature Range:
-45°F to 250°F

Hardness:

85 Shore D Durometer



High Temp range: -40° to 425°F

Continuous, 475°F to 550°F intermittent

8" x 2" High Temp Glass Filled Nylon

SCC-GFNRHT820

Glass Filled Nylon Wheels

Diameter	Tread Width	Hub Length	Plain Bore Diameters	Load Capacity (lbs.)	Bearing Diameter	Part Number
2"	1-3/4"	1-7/8"	15/16"	300	5/16", 1/2"	SCC-GFNR2134
2-1/2"	1-1/4"	1-9/16"	3/8"	400	3/8"	SCC-GFNS25114
	1-13/16"	2"	3/8", 1-3/16"	800	3/8", 1/2", 3/4"	SCC-GFNR2511316
3"	1-1/4"	1-9/16"	1/2"	400	3/8", 1/2"	SCC-GFNS314
	1-13/16"	2"	3/8", 1/2", 1-3/16"	1200	3/8", 1/2", 3/4"	SCC-GFNR311316
3-1/4"	2"	2-3/16"	1-3/16"	900	1/2", 5/8", 3/4"	SCC-GFNR3420
4"	2"	2-3/16"	1-3/16"	900	1/2", 5/8", 3/4"	SCC-GFNR420
5"	2"	2-3/16"	1-3/16"	1000	1/2", 5/8", 3/4"	SCC-GFNR520
6"	2"	2-3/16"	1-3/16"	1200	1/2", 5/8", 3/4"	SCC-GFNR620
	3"	3-1/4"	1-15/16"	1900	3/4", 1", 1-1/4"	SCC-GFNR830
10"	2"	2-3/16"	1-3/16"	1200	1/2", 5/8", 3/4"	SCC-GFNR1020

High Temp Glass Filled Nylon Wheels

Temperature Range: -40°F to 425°F

Diameter	Tread Width	Hub Length	Plain Bore Diameters	Load Capacity (lbs.)	Bearing Diameter	Part Number
3"	1-1/4"	1-13/32"	3/8", 1/2"	300	3/8", 1/2"	SCC-GFNSHT314
	1-1/2"	1-5/8"	1/2", 3/4"	600	3/8", 1/2", 3/4"	SCC-GFNSHT315
3-1/2"	1-1/4"	1-13/32"	1/2"	600	3/8", 1/2"	SCC-GFNSHT3514
4"	1-1/4"	1-13/32"	1/2"	300	3/8", 1/2"	SCC-GFNSHT414
	1-1/2"	1-5/8"	1/2", 3/4", 1-3/16"	700	3/8", 1/2", 3/4"	SCC-GFNRHT415
	2"	2-3/16"	1-3/16"	800	1/2", 5/8", 3/4"	SCC-GFNRHT420
5"	1-1/4"	1-13/32"	1/2"	700	3/8", 1/2"	SCC-GFNSHT514
	1-1/2"	1-5/8"	1/2", 3/4", 1-3/16"	800	3/8", 1/2", 3/4"	SCC-GFNRHT515
	2"	2-3/16"	1-3/16"	1000	1/2", 5/8", 3/4"	SCC-GFNRHT520
6"	2"	2-3/16"	1-3/16"	1000	1/2", 5/8", 3/4"	SCC-GFNRHT620
8"	2"	2-3/16"	3/4", 1-3/16"	1100	1/2", 5/8", 3/4"	SCC-GFNRHT820
	3"	3-1/4"	1-15/16"	2000	3/4", 1", 1-1/4"	SCC-GFNRHT830

VARIOUS TYPES OF BEARINGS ARE AVAILABLE, INCLUDING BALL BEARINGS, TAPERED BEARINGS, AND DELRIN BEARINGS, OFFERED IN A RANGE OF SIZES.

Phenolic Wheels

Phenolic Wheels

Phenolic wheels provide durability, floor protection, and resist water, oil, and grease. They handle high impact, roll smoothly, are quieter than steel, and sparkproof. Ideal for new or replacement casters with a hardness rating of 90 Shore D.

Applications

- Manufacturing Equipment
- Warehouse Carts
- Heavy-Duty Shelving Units
- Material Handling Trolleys
- Industrial Machinery Platforms

Features

- High-density construction for superior strength
- Hardness rating of 90 Shore D for durability
- Quiet operation compared to steel wheels
- High temperature resistance, up to 475°F
- Excellent floor protection due to non-marking material

Bearing Type(s)



3-1/4" x 2" Phenolic Wheel with Plastic Bearing

SCC-PHD3420



Hardness:

90 Shore D Durometer

Temperature Range:
-65°F to 275°F



High Temp range: -40° to 425°F

Continuous, 475°F to 550°F intermittent



Phenolic Wheels

Diameter	Tread Width	Hub Length	Plain Bore Diameters	Load Capacity (lbs.)	Bearing Diameter	Standard	High Temp	Laminated
3"	1-1/4"	1-3/8"	1/2", 1-1/16"	300	3/8", 1/2"	SCC-PHR314	SCC-PHRHT314	***
	1-1/2"	1-5/8"	1/2", 1-3/16"	600	3/8", 1/2", 3/4"	SCC-PHR315	SCC-PHRHT315	SCC-PHRLM315
3-1/4"	1-1/2"	1-5/8"	1/2", 1-3/16"	600	3/8", 1/2", 3/4"	SCC-PHR3415	SCC-PHRHT3415	SCC-PHRLM3415
	2"	2-3/16"	1-3/16"	900	1/2", 5/8", 3/4"	SCC-PHR3420	SCC-PHRHT3420	SCC-PHRLM3420
3-1/2"	1-1/4"	1-3/8"	1/2", 1-1/16"	350	3/8", 1/2"	SCC-PHR3514	SCC-PHRHT3514	***
4"	1-1/4"	1-3/8"	1/2", 1-1/16"	400	3/8", 1/2"	SCC-PHR414	SCC-PHRHT414	***
	1-1/2"	1-5/8"	1/2", 1-3/16"	600	1/2", 5/8", 3/4"	SCC-PHR415	SCC-PHRHT415	SCC-PHRLM415
	2"	2-3/16"	1-3/16"	900	1/2", 5/8", 3/4"	SCC-PHR420	SCC-PHRHT420	SCC-PHRLM420
5"	1-1/4"	1-3/8"	1/2", 1-1/16"	450	3/8", 1/2"	SCC-PHR514	SCC-PHRHT514	***
	1-1/2"	1-5/8"	1/2", 1-3/16"	600	1/2", 5/8", 3/4"	SCC-PHR515	SCC-PHRHT515	SCC-PHRLM515
	2"	2-3/16"	1-3/16"	1000	1/2", 5/8", 3/4"	SCC-PHR520	SCC-PHRHT520	SCC-PHRLM520
6"	1-1/2"	1-5/8"	1/2", 1-3/16"	800	1/2", 5/8", 3/4"	SCC-PHR615	SCC-PHRHT615	SCC-PHRLM615
	2"	2-3/16"	1-3/16"	1200	1/2", 5/8", 3/4"	SCC-PHR620	SCC-PHRHT620	SCC-PHRLM620
	2-1/2"	2-3/4"	1-3/16"	1400	1/2", 5/8", 3/4"	SCC-PHR625-1-3/16	SCC-PHRHT625-1-3/16	SCC-PHRLM625-1-3/16
		2-3/4"	1-15/16"	1600	3/4", 1", 1-1/4"	SCC-PHR625	SCC-PHRHT625	SCC-PHRLM625
		3-1/4"	1-15/16"	1600	3/4", 1", 1-1/4"	SCC-PHR625-3-1/4	SCC-PHRHT625-3-1/4	SCC-PHRLM625-3-1/4
3"	3-1/4"	1-15/16"	2000	3/4", 1", 1-1/4"	SCC-PHR630	SCC-PHRHT630	SCC-PHRLM630	
7"	3"	3-1/4"	1-15/16"	2200	3/4", 1", 1-1/4"	SCC-PHR730	SCC-PHRHT730	SCC-PHRLM730
8"	2"	2-3/16"	1-3/16"	1400	1/2", 5/8", 3/4"	SCC-PHR820	SCC-PHRHT820	SCC-PHRLM820
	2-1/2"	2-3/4"	1-3/16"	1800	1/2", 5/8", 3/4"	SCC-PHR825-1-3/16	SCC-PHRHT825-1-3/16	SCC-PHRLM825-1-3/16
		2-3/4"	1-15/16"	2000	3/4", 1", 1-1/4"	SCC-PHR825	SCC-PHRHT825	SCC-PHRLM825
		3-1/4"	1-15/16"	2000	3/4", 1", 1-1/4"	SCC-PHR825-3-1/4	SCC-PHRHT825-3-1/4	SCC-PHRLM825-3-1/4
		3"	3-1/4"	1-15/16"	2500	3/4", 1", 1-1/4"	SCC-PHR830	SCC-PHRHT830

VARIOUS TYPES OF BEARINGS ARE AVAILABLE, INCLUDING BALL BEARINGS, TAPERED BEARINGS, AND DELRIN BEARINGS, OFFERED IN A RANGE OF SIZES.

- P - PRECISION
- T - TAPERED BEARING
- HT - HIGH TEMPERATURE
- LM - LAMINATED

Adjust the Code, Transform the Part
Easy Customization!

- X - NO BEARING
- R - ROLLER BEARING
- D - PLASTIC BEARING (DELRIN)
- S - SLEEVE OR PLAIN BEARING

Phenolic Wheels

Diameter	Tread Width	Hub Length	Plain Bore Diameters	Load Capacity (lbs.)	Bearing Diameter	Standard	High Temp	Laminated
10"	2-1/2"	2-3/4"	1-3/16"	2200	1/2", 5/8", 3/4"	SCC-PHR1025-1-3/16	SCC-PHRHT1025-1-3/16	SCC-PHRLM1025-1-3/16
		2-3/4"	1-15/16"	2500	3/4", 1", 1-1/4"	SCC-PHR1025	SCC-PHRHT1025	SCC-PHRLM1025
		3-1/4"	1-15/16"	2500	3/4", 1", 1-1/4"	SCC-PHR1025-3-1/4	SCC-PHRHT1025-3-1/4	SCC-PHRLM1025-3-1/4
	3"	3-1/4"	1-15/16"	2900	3/4", 1", 1-1/4"	SCC-PHR1030	SCC-PHRHT1030	SCC-PHRLM1030
12"	2-1/2"	2-3/4"	1-15/16"	3000	3/4", 1", 1-1/4"	SCC-PHR1225	SCC-PHRHT1225	SCC-PHRLM1225
		3-1/4"	1-15/16"	3000	3/4", 1", 1-1/4"	SCC-PHR1225-3-1/4	SCC-PHRHT1225-3-1/4	SCC-PHRLM1225-3-1/4
	3"	3-1/4"	1-15/16"	3500	3/4", 1", 1-1/4"	SCC-PHR1230	SCC-PHRHT1230	SCC-PHRLM1230
	3-1/2"	4-1/4"	2-7/16"	4000	1", 1-1/4", 1-1/2"	SCC-PHR1235	SCC-PHRHT1235	SCC-PHRLM1235
	4"	4"	2-7/16"	6500	1", 1-1/4", 1-1/2"	SCC-PHR1240	***	***
16"	3"	3-1/4"	2-7/16"	4000	1", 1-1/4", 1-1/2"	SCC-PHR1630	***	SCC-PHRLM1630
	4"	5-1/4"	2-7/16"	8000	1", 1-1/4", 1-1/2"	SCC-PHR1640	***	SCC-PHRLM1640
18"	3"	3-1/4"	1-15/16"	3500	3/4", 1", 1-1/4"	SCC-PHR1830	***	***

VARIOUS TYPES OF BEARINGS ARE AVAILABLE, INCLUDING BALL BEARINGS, TAPERED BEARINGS, AND DELRIN BEARINGS, OFFERED IN A RANGE OF SIZES.

PHENOLIC WHEELS: RELIABLE STRENGTH AND HEAT RESISTANCE FOR DEMANDING ENVIRONMENTS

Standard Black Phenolic Wheels

- **Strength & Durability:** High-density construction with a hardness rating of 90 Shore D.
- **Quiet Operation:** Quieter than steel wheels.
- **Temperature Resistance:** Withstands up to 475°F.
- **Floor Protection:** Non-marking material ensures excellent protection.



Phenolic wheels are made from cotton canvas combined with premium phenolic resin and molded under high pressure for maximum strength. They roll easily, protect floors, and are widely used in manufacturing, warehousing, and bakeries. Economical and durable, these wheels are ideal for high-temperature environments but not recommended for wet conditions.

High-Temperature Phenolic Wheels

- **Heat Resistance:** Designed for continuous use up to 475°F.
- **Brittle Composition:** Made with special high-heat compounds, making them more brittle than standard wheels.
- **Application Warning:** Best suited for smooth surfaces; avoid rough or uneven floors



These high-temp phenolic wheels excel in high-heat applications, maintaining strength under extreme temperatures. However, due to increased brittleness, they should be used cautiously on uneven surfaces to avoid cracking. Ideal for smooth, flat environments, they offer reliable performance in demanding conditions.

Standard Black Phenolic Wheels

- **Durable Build:** Resistant to chipping and fraying, with a sturdy macerated core and canvas tread.
- **High Strength:** 35% more impact strength and 25% higher load capacity than standard wheels.
- **Non-Marking:** Made from phenolic resin, ideal for heavy loads without marking floors.



Laminated wheels provide excellent floor protection and durability, outperforming standard wheels. With 35% more impact strength and 25% higher load capacity, they resist chipping and fraying, making them ideal for heavy-duty applications. Their non-marking design ensures smooth performance without damaging floors, offering long-lasting reliability.

Rubber Wheels

Hard/Soft Rubber Wheels

Hard Rubber Wheels protect floors, are quieter than steel, but can become brittle over time. Soft Rubber Wheels suit lighter loads, protect floors but may leave marks, and wear down on rough surfaces. Larger sizes are more costly, especially with premium materials.

Applications

- Warehousing
- Dollies and Carts
- Indoor Industrial Equipment
- Hospital and Office Furniture

Features

- Hard wheels resist chipping; soft wheels suit light loads
- Less noise than steel wheels
- Prevent surface damage
- Both can become brittle outdoors

Bearing Type(s)



5" x 1-1/4" Hard Rubber Plain Bore

SCC-HRS514



Temperature Range:
-40°F to 160°F



Hardness:

70 Shore D Durometer / Hard
80 Shore A Durometer / Soft



Hard Rubber Wheels

Diameter	Tread Width	Hub Length	Plain Bore Diameters	Load Capacity (lbs.)	Bearing Diameter	Part Number
2"	7/8"	1"	1/4", 5/16"	125	1/4", 5/16"	SCC-HRS210
2-1/2"	7/8"	1"	5/16", 3/8"	200	5/16", 3/8"	SCC-HRS2510
	1-1/4"	1-9/16"	3/8", 1/2"	275	3/8", 1/2"	SCC-HRS2514
3"	1"	1-1/4"	5/16"	125	5/16"	SCC-HRS310
	1-1/4"	1-9/16"	3/8", 1/2"	300	3/8", 1/2"	SCC-HRS314
3-1/2"	1-1/4"	1-9/16"	3/8"	300	3/8"	SCC-HRS3514
4"	1"	1-1/4"	5/16"	140	5/16"	SCC-HRS410
	1-1/4"	1-9/16"	3/8", 1/2"	350	3/8", 1/2"	SCC-HRS414
	1-1/2"	1-5/8"	3/8", 1/2"	400	3/8", 1/2"	SCC-HRS415
5"	1"	1-1/4"	5/16"	145	5/16"	SCC-HRS510
	1-1/4"	1-9/16"	3/8", 1/2"	350	3/8", 1/2"	SCC-HRS514
	1-1/2"	1-5/8"	1/2"	400	3/8", 1/2"	SCC-HRS515

Soft Rubber Wheels

Diameter	Tread Width	Hub Length	Plain Bore Diameters	Load Capacity (lbs.)	Bearing Diameter	Part Number
2"	7/8"	1"	1/4", 5/16"	125	1/4", 5/16"	SCC-SRS210
2-1/2"	1"	1-3/8"	5/16"	150	5/16"	SCC-SRS2510
	1-1/4"	1-9/16"	3/8", 1/2"	275	3/8", 1/2"	SCC-SRS2514
3"	1"	1-1/4"	5/16"	125	5/16"	SCC-SRS310
	1-1/4"	1-9/16"	3/8", 1/2"	300	3/8", 1/2"	SCC-SRS314
3-1/2"	1-1/4"	1-9/16"	3/8"	300	3/8"	SCC-SRS3514
4"	1"	1-1/4"	5/16"	140	5/16"	SCC-SRS410
	1-1/4"	1-9/16"	3/8", 1/2"	350	3/8", 1/2"	SCC-SRS414
	1-1/2"	1-5/8"	3/8", 1/2"	400	3/8", 1/2"	SCC-SRS415
5"	1"	1-1/4"	5/16"	145	5/16"	SCC-SRS510
	1-1/4"	1-9/16"	3/8", 1/2"	350	3/8", 1/2"	SCC-SRS514
	1-1/2"	1-5/8"	1/2"	400	3/8", 1/2"	SCC-SRS515

VARIOUS TYPES OF BEARINGS ARE AVAILABLE, INCLUDING BALL BEARINGS, TAPERED BEARINGS, AND DELRIN BEARINGS, OFFERED IN A RANGE OF SIZES.

Nylon Wheels

Nylon

White Nylon wheels, are ideal for food and pharmaceutical industries. They resist water, chemicals, and abrasion, roll smoothly, and work in temperatures from -40°F to 210°F. Non-marking and steam cleanable.

Applications

- Food Processing Facilities
- Meat and Poultry Packaging Plants
- Pharmaceutical Labs
- Cold Storage and Freezer Environments

Features

- Made from strong Nylon 6 for long-lasting use
- Resistant to water, chemicals, and cleaning solutions
- Quiet operation compared to steel wheels
- Leaves no marks on floors, maintaining cleanliness
- Functions effectively from -40°F to 210°F

Bearing Type(s)



5" x 1-1/4" Nylon Wheel Plain Bore

SCC-NYS514

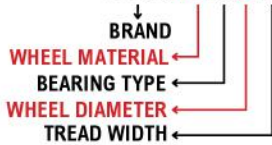

Temperature Range:
-40°F to 210°F



Hardness:
75 Shore D Durometer



Nylon Wheels

Diameter	Tread Width	Hub Length	Plain Bore Diameters	Load Capacity (lbs.)	Bearing Diameter	Part Number
3"	1-1/4"	1-1/8"	1/2", 1-1/8"	300	3/8", 1/2"	SCC-NYS314
3-1/2"	1-1/4"	1-9/16"	1/2"	325	3/8", 1/2"	SCC-NYS3514
4"	1-1/4"	1-9/16"	1/2", 1-1/8"	350	3/8", 1/2"	SCC-NYS414
	2"	2-3/16"	1-3/16"	800	1/2", 5/8", 3/4"	SCC-NYR420
5"	1-1/4"	1-9/16"	1/2", 1-1/8"	500	3/8", 1/2"	SCC-NYS514
	2"	2-3/16"	1-3/16"	900	1/2", 5/8", 3/4"	SCC-NYR520
6"	1-1/4"	1-9/16"	1/2"	525	3/8", 1/2"	SCC-NYS614
	2"	2-3/16"	1-3/16"	1200	1/2", 5/8", 3/4"	SCC-NYR620
8"	2"	2-3/16"	1-3/16"	1300	1/2", 5/8", 3/4"	SCC-NYR820

VARIOUS TYPES OF BEARINGS ARE AVAILABLE, INCLUDING BALL BEARINGS, TAPERED BEARINGS, AND DELRIN BEARINGS, OFFERED IN A RANGE OF SIZES.

Explore More Wheel Options Available



CONDUCTIVE NYLON WHEEL

These non-marking wheels have precision bearings, 85D durometer, and ESD compliance.

85D durometer



RETORT

Heat-stabilized wheels resist oils, solvents, acids, roll easily, and withstand heat.

85D durometer



NYLATRON

These wheels resist oils, solvents, heat, roll smoothly, and support weight.

78-82D durometer



POLYURETHANE ON GLASS FILLED NYLON

Polyurethane bonded nylon wheels, quiet, durable, temperature-resistant, in green/red.

95A durometer

Thermoplastic Rubber Wheels

Thermoplastic Rubber

The Thermoplastic Rubber Wheel combines durability with non-marking floor protection. Made from thermoplastic elastomer on a polypropylene core, it resists chemicals and steam. Available in flat tread for load support and round tread for easier turning.

Applications

- Platform Carts
- Food Service Equipment
- Material Handling Carts
- Drywall Carts
- Assembly Line Dollies

Features

- Durable thermoplastic elastomer bonded to a strong polypropylene core
- Available in flat or round tread for different applications
- Non-marking for floor protection
- Quiet operation, reducing noise during use
- Chemical and steam resistant

Bearing Type(s)



8" x 2" Thermoplastic Rubber Donut Tread

SCC-TPRBD820



Temperature Range:
-20°F to 180°F



Hardness:
75 Shore A Durometer



Thermoplastic Rubber Wheels

Diameter	Tread Width	Hub Length	Plain Bore Diameters	Load Capacity (lbs.)	Bearing Diameter	Part Number	Color / Style
2"	7/8"	1"	1/4", 5/16"	75	1/4", 5/16"	SCC-TPRS210	Gray/Black - Flat
2-1/2"	1-1/4"	1-5/16"	3/8", 1/2", 1-1/8"	250	5/16", 3/8", 1/2"	SCC-TPRB2514	Black, Gray/Gray - Flat
3"	1"	1-1/8"	5/16"	125	5/16"	SCC-TPRS310	Gray/Black - Flat
	1-1/4"	1-9/16"	3/8", 1/2"	250	5/16", 3/8", 1/2"	SCC-TPRB314	Gray/Gray, Gray/Beige - Flat, Donut
3-1/2"	1-1/4"	1-9/16"	3/8", 1/2"	250	3/8", 1/2"	SCC-TPRB3514	Gray/Gray, Gray/Beige - Flat, Donut
	1"	1-1/8"	5/16"	140	5/16"	SCC-TPRS410	Gray/Black, Gray/Gray, Gray/Beige - Flat
4"	1-1/4"	1-9/16"	3/8", 1/2"	250	3/8", 1/2"	SCC-TPRB414	Black/Gray, Gray/Gray, Gray/Beige - Flat, Donut
	1-1/2"	1-5/8"	1-3/16"	280	3/8", 1/2", 5/8", 3/4"	SCC-TPRR415	Gray/Gray - Flat
	2"	2-3/16"	1-3/16"	300	1/2", 5/8", 3/4"	SCC-TPRR420	Gray/Gray, Black/Gray, Gray/Beige - Flat, Donut
	1"	1-1/8"	5/16"	145	5/16"	SCC-TPRS510	Gray/Black, Gray/Gray, Gray/Beige - Flat
5"	1-1/4"	1-9/16"	3/8", 1/2"	300	3/8", 1/2"	SCC-TPRB514	Black/Gray, Gray/Gray, Gray/Beige - Flat, Donut
	1-1/2"	1-5/8"	1-3/16"	300	3/8", 1/2", 5/8", 3/4"	SCC-TPRR515	Gray/Gray - Flat
	2"	2-3/16"	1-3/16"	350	1/2", 5/8", 3/4"	SCC-TPRR520	Black/Gray, Gray/Gray, Gray/Beige - Flat, Donut
6"	1-1/4"	1-9/16"	3/8", 1/2", 1-1/8"	300	3/8", 1/2"	SCC-TPRB614	Gray/Gray, Gray/Beige - Flat, Donut
	1-1/2"	1-5/8"	1-3/16"	375	3/8", 1/2", 5/8", 3/4"	SCC-TPRR615	Gray/Gray - Flat
	2"	2-3/16"	1-3/16"	500	1/2", 5/8", 3/4"	SCC-TPRR620	Black/Gray, Gray/Gray, Gray/Beige - Flat, Donut
8"	1-1/2"	2"	1-3/8"	400	1/2", 5/8", 3/4"	SCC-TPRR815	Gray/Gray, Gray/Beige - Flat
	2"	2-3/16"	1-3/16"	700	1/2", 5/8", 3/4"	SCC-TPRR820	Black/Gray, Gray/Gray, Gray/Beige - Flat, Donut
	2-1/2"	2-3/4"	1-15/16"	800	3/4", 1", 1-1/4"	SCC-TPRR825	Gray/Gray - Flat
10"	2"	2-1/4"	1-3/8"	700	1/2", 5/8", 3/4"	SCC-TPRR1020	Black/Gray - Donut
	2-1/2"	2-3/4"	1-15/16"	850	3/4", 1", 1-1/4"	SCC-TPRR1025	Gray/Gray - Flat
	3"	3-1/4"	1-15/16"	900	3/4", 1", 1-1/4"	SCC-TPRR1030	Gray/Gray - Flat
12"	3"	3-1/4"	1-15/16"	950	3/4", 1", 1-1/4"	SCC-TPRR1230	Gray/Gray - Flat

VARIOUS TYPES OF BEARINGS ARE AVAILABLE, INCLUDING BALL BEARINGS, TAPERED BEARINGS, AND DELRIN BEARINGS, OFFERED IN A RANGE OF SIZES.

Choose Your Style!



Pneumatic Wheels

Pneumatic

Service Caster's Air Pneumatic wheels are ideal for low-speed hand trucks, dollies, and carts. Featuring tube tires, sawtooth tread, and zinc-plated steel centers, they'll keep you moving forward. **Note: Not for highway use! Manual speeds only!**

Applications

- Wheelbarrows
- Hand Trucks and Dollies
- Farm Equipment
- Dock Carts
- Boat Trailers

Features

- Available in Zinc, brass, and color-coated steel rims.
- Longer air retention, minimizing inflation needs.
- Air-filled for smoother rides on rough surfaces.
- Superior traction for all-terrain, low-speed use.
- Centered or offset hubs available.



Pneumatic caster treads include **ribbed** for smooth surfaces, **diamond** for rough terrain, **lug** for heavy-duty grip, and **smooth** for light loads on flat surfaces.

6" x 2" Pneumatic Wheel with 1/2" Ball Bearing

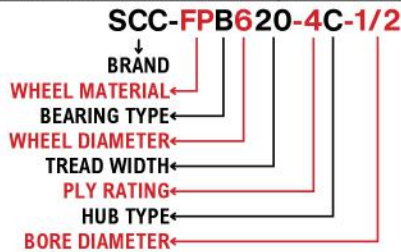

Bearing Type(s)



Pneumatic Wheels

Diameter	Tire Size/Type	Hub Length	Plain Bore Diameters	Load Capacity (lbs.)	Tread Pattern	Hub Design	Bearing Diameter	Part Number	Color / Style
6"	2" (150)	2-1/2"	1-3/8"	200	Sawtooth	Centered	1/2", 5/8", 3/4"	SCC-FPB620-4C	Black/Zinc
	2" (150)	2-1/4"	1-3/8"	200	Sawtooth	Offset	1/2", 5/8", 3/4"	SCC-FPB620-40	Black/Zinc
8"	250-4	2-1/2"	1-3/8"	220	Lug	Centered	1/2", 5/8", 3/4"	SCC-FPB250-4C	Gray/Zinc
	280-4	3-3/16"	1-3/8"	250	Sawtooth	Centered	1/2", 5/8", 3/4"	SCC-FPB280-4C	Black/Zinc, Black/Brass, Gray/Zinc, Gray/Brass
	280-4	2-1/4"	1-3/8"	250	Sawtooth	Offset	1/2", 5/8", 3/4"	SCC-FPB280-40	Black/Zinc, Gray/Zinc
10"	410/350-4	4"	1-3/8"	500	Sawtooth	Centered	1/2", 5/8", 3/4"	SCC-FPB350-4C	Black/Zinc, Gray/Zinc
	410/350-4	2-1/4"	1-3/8"	500	Sawtooth	Offset	1/2", 5/8", 3/4"	SCC-FPB350-40	Black/Zinc, Black/White, Gray/Zinc
12"	410/350-6	4"	1-3/8"	500	Sawtooth	Centered	1/2", 5/8", 3/4"	SCC-FPB350-6C	Black/Zinc
	410/350-6	3-1/4"	1-3/8"	500	Sawtooth	Offset	1/2", 5/8", 3/4"	SCC-FPB350-60	Black/Zinc
13"	13x6.5-6	3-1/4"	-	320	Ribbed	Offset	5/8"	SCC-FPB656-40	Black/White
16"	4.80/3.50-6	3"	1-3/8"	650	Stud	Centered	1/2", 5/8", 3/4"	SCC-FPB480-6C	Black/White
	4.80/3.50-8	3" - 6"	-	300	Ribbed	Centered	1/2", 5/8", 3/4"	SCC-FPB480-8C	Black/White
18"	5.70-8	4-3/4"	-	1800	Sawtooth	Centered	1", 1-1/4"	SCC-FPT1850-8C	Black/Black
25"	6.90-9	4-3/4"	-	3800	Sawtooth	Centered	1-1/4"	SCC-FPT2575-10C	Black/Black

VARIOUS TYPES OF BEARINGS ARE AVAILABLE, INCLUDING BALL BEARINGS, TAPERED BEARINGS, AND DELRIN BEARINGS, OFFERED IN A RANGE OF SIZES.

PNEUMATIC WHEEL ADVANTAGES:

- Shock Absorption** – Smooth ride on uneven terrain.
- Versatile** – Works indoors and outdoors.
- Better Traction** – Strong grip on various surfaces.
- Durable** – Reduces wear and tear on equipment.

OPTIONS AVAILABLE:

- Treads** – Ribbed, smooth, or knobby.
- Mounting** – Swivel, rigid, or locking.
- Sizes** – Multiple load capacities.
- Foam Filling** – Eliminates flats while maintaining cushioning



Semi-Pneumatic Wheels

Semi-Pneumatic Wheels

Semi-pneumatic wheels provide a smooth, quiet ride on all surfaces with durable rubber tread and a tough polymer core. Ideal for carts, they handle various terrains and extreme temperatures effectively.

Applications

- Hotel Bellman Carts
- Food Service Carts
- Luggage Carts
- Garden Equipment
- Medical Transport Carts

Features

- Durable solid rubber tread for long-lasting performance.
- Reliable operation in temperatures from -20°F to +160°F.
- High-impact polymer core resists damage and wear.
- Provides a cushioned, quiet ride on uneven surfaces.
- Wide, soft tread ideal for grass, dirt, and rough terrain.

Bearing Type(s)



Flat Free!



8" x 2.5" Semi-Pneumatic Wheel with Ball Bearing

SCC-SNB825-CPR-2.25HL-34

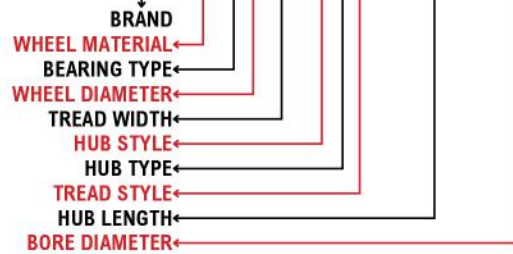

Temperature Range:
-20°F to 160°F



Hardness:
75 Shore A Durometer

Semi-Pneumatic Wheels

Diameter	Tread Width	Hub Length	Plain Bore Diameters	Load Capacity (lbs.)	Hub Design	Bearing Diameter	Part Number
6"	1-1/2"	1-3/8"	1/2"	80	Offset	1/2"	SCC-SNS615-OPD
	1-1/2"	1-3/8"	-	50	Centered	1/2"	SCC-SNB615-CSR
	2"	2-1/2"	1-3/8"	350	Centered	1/2", 5/8", 3/4"	SCC-SNB620-CPR
7"	1-1/2"	1-3/8"	1/2"	55	Offset	1/2"	SCC-SNS715-OPD
	1-1/2"	2"	-	55	Centered	1/2"	SCC-SNB715-CSR
	2"	2-1/4"	1-3/8"	400	Centered	1/2", 5/8", 3/4"	SCC-SNB720-CPR
8"	1-3/4"	1-3/8"	1/2"	60	Offset	1/2"	SCC-SNS8175-OPD
	1-3/4"	2"	-	110	Centered	1/2", 5/8"	SCC-SNB8175-CSR
	2"	2-1/8"	1-3/8"	450	Offset	1/2", 5/8", 3/4"	SCC-SNB820-OPR
	2-1/4"	2-1/4"	1-3/8"	450	Offset	1/2", 5/8", 3/4"	SCC-SNB825-OPR
	2-1/4"	2-1/2"	1-3/8"	450	Centered	1/2", 5/8", 3/4"	SCC-SNB825-CPR
10"	1-3/4"	2-1/16"	1/2"	80	Centered	1/2"	SCC-SNS10175-CPR
	1-3/4"	2-1/16"	-	150	Centered	1/2", 5/8"	SCC-SNB10175-CSR
	1-3/4"	1-1/2"	-	150	Offset	1/2", 5/8"	SCC-SNB10175-OSR
	2"	2-1/4"	1-3/8"	500	Centered	1/2", 5/8", 3/4"	SCC-SNB1020-CPR
	2"	1-5/8"	1-3/8"	500	Offset	1/2", 5/8", 3/4"	SCC-SNB1020-OPR
	2-3/4"	2-1/4"	1-3/8"	650	Offset	1/2", 5/8", 3/4"	SCC-SNB10275-OPR
	2-3/4"	3-1/4"	1-3/8"	650	Centered	1/2", 5/8", 3/4"	SCC-SNB10275-CPR
14"	1-3/4"	2-1/8"	-	150	Centered	5/8", 3/4"	SCC-SNB14175-CSR
12"	3"	2-3/4"	1-3/8"	850	Offset	1/2", 5/8", 3/4"	SCC-SNB1230-OPR
	3"	3-1/4"	1-3/8"	850	Centered	1/2", 5/8", 3/4"	SCC-SNB1230-CPR

VARIOUS TYPES OF BEARINGS ARE AVAILABLE, INCLUDING BALL BEARINGS, TAPERED BEARINGS, AND DELRIN BEARINGS, OFFERED IN A RANGE OF SIZES.

FLAT-FREE. HASSLE-FREE. EVERY TIME.

Never-Flat Wheels

Never-Flat Wheels

Our wheels, made from micro-cellular polyurethane foam, provide a smooth, flat-free ride, easily handling debris and uneven surfaces while remaining non-marking and durable for all floor types.

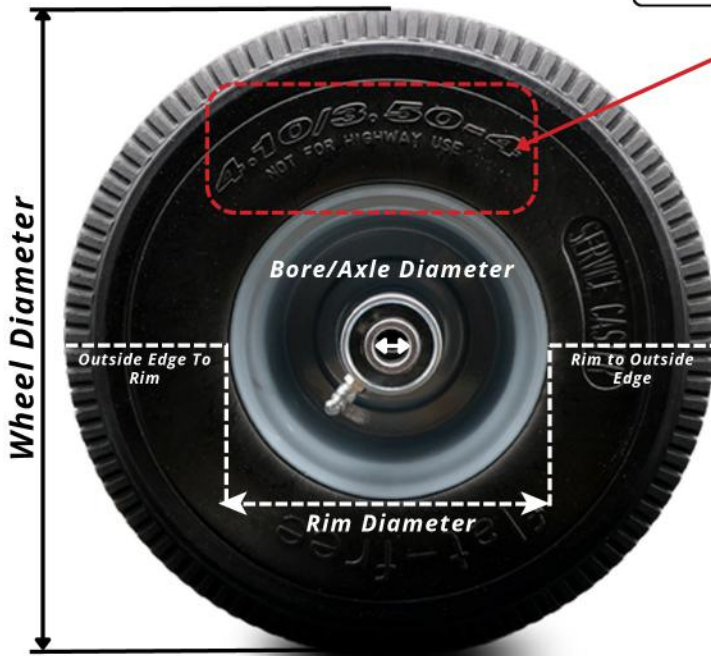

What Do These Numbers Mean?

Tire sizes are typically written in this format:

Example

4.10/3.50-4

- 4.10"** = Tire Width
- 3.50"** = Distance from the outside edge of the tire to the outside edge of the rim
- 4"** = Rim Diameter

Measuring the Overall Wheel Diameter

To calculate the overall diameter of a wheel, add the outside edge to rim, the rim diameter, and the rim to outside edge length.

$3.50" + 4.10" + 3.50" = 11.1"$ Diameter

Note: That tire sizes in the industry are not exact. It is not unusual for tire dimensions to be slightly different than the tire markings.



Never-Flat Wheels

Diameter	Tire Size/Type	Hub Length	Plain Bore Diameters	Load Capacity (lbs.)	Hub Design	Bearing Diameter	Part Number	Color / Style
6"	2"	2-1/4"	-	150	Centered	1/2"	SCC-NFB620-4C	Black/Zinc , Gray/Zinc
	2"	2-3/8"	-	275	Centered	1/2", 5/8", 3/4"	SCC-NFB820-4C	Black/Zinc
8"	2-3/4"	2-1/4"	1-3/8"	250	Offset	1/2", 5/8", 3/4"	SCC-NFB280-40	Black/Gray
	3" (2.50-4)	3-3/16"	1-3/8"	275	Centered	1/2", 5/8", 3/4"	SCC-NFB830-4C	Black/Black
8.9"	2-15/16"	3"	1-3/8"	250	Centered	1/2", 5/8", 3/4"	SCC-NFB930-4C	Black/Zinc , Gray/Zinc
	2-15/16"	2-1/4"	1-3/8"	250	Offset	1/2", 5/8", 3/4"	SCC-NFB930-40	Black/Zinc
10"	3" (4.10/3.50-4)	4"	1-3/8"	280	Centered	1/2", 5/8", 3/4"	SCC-NFB350-4C	Black/Gray , Black/Zinc , Black/White
	3-7/16"	2-1/4"	1-3/8"	280	Offset	1/2", 5/8", 3/4"	SCC-NFB350-40	Black/Zinc
12"	1-3/4" (4.10/3.50-6)	2-3/8"	1-3/8"	150	Centered	1/2", 5/8", 3/4"	SCC-NFB350-6C	Black/Black
16"	3-3/4" (4.80/4.00-8)	3"	1-3/8"	520	Centered	3/4", 1"	SCC-NFB1630-6C	Black/White

VARIOUS TYPES OF BEARINGS ARE AVAILABLE, INCLUDING BALL BEARINGS, TAPERED BEARINGS, AND DELRIN BEARINGS, OFFERED IN A RANGE OF SIZES.

WHEEL MEASURING: LET'S GET ROLLING!

Tire sizes aren't always exact. For instance, a 4.80/4.00-8 tire might be labeled as 16 inches, but actually measures around 15.5 inches. No big deal—it still meets industry standards and works great!

NEED HELP? CALL OUR SERVICE CASTER CUSTOMER SERVICE SQUAD FOR EXPERT ADVICE. WE'VE GOT YOUR WHEELS COVERED!

Here's how to measure like a pro:

1. **Wheel Diameter** – Measure the full diameter, even if it's slightly off from the marking.
2. **Bore/Axle Diameter** – Match the hole size to your axle for a perfect fit.
3. **Wheel Width** – Measure the tread's widest point.
4. **Hub Length** – Get the hub length right for secure attachment.
5. **Hub Type** – Know if you need an **offset** or **centered** hub.

Keyed Drive Wheels

Keyed Drive Wheels

Service Caster's Keyed Drive Wheels feature durable polyurethane or rubber treads for powering equipment. Available in Standard and Metric bores, they include two set screws and can be custom-cut or re-bonded. **Proudly made in the USA.**

Applications

- Conveyor Systems
- Automated Lifts and Elevators
- Robotics and Automated Guided Vehicles (AGVs)
- Assembly Line Equipment
- Printing and Packaging Machinery

Features

- Drive wheel bores available in both Standard and Metric widths.
- Wheels are shipped with 2 set screws: one on the keyway and one 90 degrees from it.
- In-house capabilities for custom cutting any type and size of keyway.
- Re-bonding services to restore old wheels to usable condition.
- **Made in the USA:** All drive wheels are machined, assembled, and packed at our facilities in West Reading, PA.



Metric Sizes Now Available for Custom Drive Wheels!

Rubber Keyed Drive Wheels

Durometer: 70-80 Shore A

Diameter	Tread Width	Hub Length	Load Capacity (lbs.)	Part Number	Bore Diameter (inches)	Bore Diameter (Millimeter)
4"	2"	2-3/16"	290	SCC-RSS420	1/2" , 5/8" , 3/4"	12 , 14 , 16 , 18 , 20
5"	2"	2-3/16"	350	SCC-RSS520	1/2" , 5/8" , 3/4"	12 , 14 , 16 , 18 , 20
6"	2"	2-3/16"	410	SCC-RSS620	1/2" , 5/8" , 3/4"	12 , 14 , 16 , 18 , 20
	3"	3-1/4"	680	SCC-RSS630	3/4" , 1" , 1-1/4" , 1-1/2"	20 , 22 , 24 , 26 , 28 , 30
8"	2"	2-3/16"	500	SCC-RSS820	1/2" , 5/8" , 3/4"	12 , 14 , 16 , 18 , 20
	3"	3-1/4"	850	SCC-RSS830	3/4" , 1" , 1-1/4" , 1-1/2"	20 , 22 , 24 , 26 , 28 , 30
10"	3"	3-1/4"	1000	SCC-RSS1030	3/4" , 1" , 1-1/4" , 1-1/2"	20 , 22 , 24 , 26 , 28 , 30

SET SCREWS ARE AVAILABLE. IF ONE IS SPECIFIED, IT WILL BE PLACED OVER THE KEYWAY; IF TWO, THE SECOND WILL BE POSITIONED 90° FROM THE KEYWAY.

Polyurethane Keyed Drive Wheels

Durometer: 90-95 Shore A

Diameter	Tread Width	Hub Length	Load Capacity (lbs.)	Part Number	Bore Diameter (inches)	Bore Diameter (Millimeter)
4"	1-1/2"	1-5/8"	675	SCC-EZPUS415	1/2" , 5/8" , 3/4"	12 , 14 , 16 , 18 , 20
	2"	2-3/16"	750	SCC-EZPUS420	1/2" , 5/8" , 3/4"	12 , 14 , 16 , 18 , 20
5"	1-1/2"	1-5/8"	700	SCC-EZPUS515	1/2" , 5/8" , 3/4"	12 , 14 , 16 , 18 , 20
	2"	2-3/16"	1050	SCC-EZPUS620	1/2" , 5/8" , 3/4"	12 , 14 , 16 , 18 , 20
6"	1-1/2"	1-5/8"	850	SCC-EZPUS615	1/2" , 5/8" , 3/4"	12 , 14 , 16 , 18 , 20
	2"	2-3/16"	1250	SCC-EZPUS620	1/2" , 5/8" , 3/4"	12 , 14 , 16 , 18 , 20
	3"	3-1/4"	2200	SCC-EZPUS630	3/4" , 1" , 1-1/4" , 1-1/2"	20 , 22 , 24 , 26 , 28 , 30
8"	2"	2-3/16"	1550	SCC-EZPUS820	1/2" , 5/8" , 3/4"	12 , 14 , 16 , 18 , 20
	3"	3-1/4"	2500	SCC-EZPUS830	3/4" , 1" , 1-1/4" , 1-1/2"	20 , 22 , 24 , 26 , 28 , 30
10"	3"	3-1/4"	3000	SCC-EZPUS1030	3/4" , 1" , 1-1/4" , 1-1/2"	20 , 22 , 24 , 26 , 28 , 30

SET SCREWS ARE AVAILABLE. IF ONE IS SPECIFIED, IT WILL BE PLACED OVER THE KEYWAY; IF TWO, THE SECOND WILL BE POSITIONED 90° FROM THE KEYWAY.

We provide all the essential parts and accessories for your caster and wheel needs, including bearings, brakes, mounting options, and much more.

Elevate Your Equipment: Premium Parts & Accessories

Shop our range of caster Parts & Accessories, including [floor locks](#), [wheel bearings](#), [axles](#), [brake kits](#), and more. Each item is designed with the same quality and innovation that define our core products, ensuring optimal performance and reliability. [Stainless steel](#) options are also available, providing enhanced durability and resistance to corrosion.



Roller Bearings



Flanged Ball Bearings



Pedestal Ball Bearings



Precision Ball Bearings



Bronze Bearings



Plastic Bearings



Spanner Bushings



Axle Kit



Retainers & Washers



Caster Pad



Floor Truck Locks

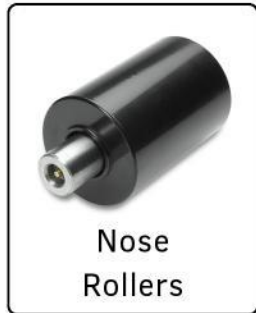

Nose Rollers



Weld & Shim Plate



Thread Guards



Caster Stems



Raceway Seals



Bumpers & Sockets



Expanding Adapters



Swivel Locks



Brake Kits

Looking for caster and wheel parts? Need a custom fit? Contact our [customer service](#) team for personalized solutions. We're here to help!



Roller Bearings

The roller bearing handles heavier loads than a same-size ball bearing. It has a split outer race shell with the roller assembly secured by hardened washers.

Part Number	Inside Diameter	Outside Diameter	Length
SCC-RB1001	1/2"	15/16"	1"
SCC-RB1002	5/8"	1-3/16"	1-3/8"
SCC-RB1003	5/8"	1-3/16"	1-7/8"
SCC-RB1004	3/4"	1-3/16"	1-3/8"
SCC-RB1005	3/4"	1-3/16"	1-7/8"
SCC-RB1006	3/4"	1-3/16"	2-1/2"
SCC-RB1007	3/4"	1-7/16"	2"
SCC-RB1008	7/8"	1-7/16"	2"
SCC-RB1009	1"	1-7/16"	2"
SCC-RB1009-1 9/16	1"	1-9/16"	2-1/2"
SCC-RB10010	1"	1-15/16"	2-1/2"
SCC-RB10011	1"	1-15/16"	3"
SCC-RB10012	1-1/4"	1-15/16"	2-1/2"
SCC-RB10013	1-1/4"	1-15/16"	3"
SCC-RB10014	1-1/4"	2-7/16"	4"
SCC-RB10015	1-1/4"	2-7/16"	5"
SCC-RB10016	1-1/2"	2-7/16"	4"
SCC-RB10017	1-1/2"	2-7/16"	5"



Caged Roller Bearings

Caged drawn cup (1pc) bearings feature a steel cage that securely holds the needle rollers, ensuring maximum strength and long service life.

Part Number	Inside Diameter	Outside Diameter	Length
SCC-RB1004-1PC	3/4"	1-3/16"	1-3/8"
SCC-RB1005-1PC	3/4"	1-3/16"	1-7/8"



Stainless Roller Bearings

The roller bearing split outer raceway sleeve is stainless steel for superior corrosion resistance.

Part Number	Inside Diameter	Outside Diameter	Length
SCC-SSRB1004	3/4"	1-3/16"	1-3/8"
SCC-SSRB1005	3/4"	1-3/16"	1-7/8"
SCC-SSRB10011	1"	1-15/16"	3"

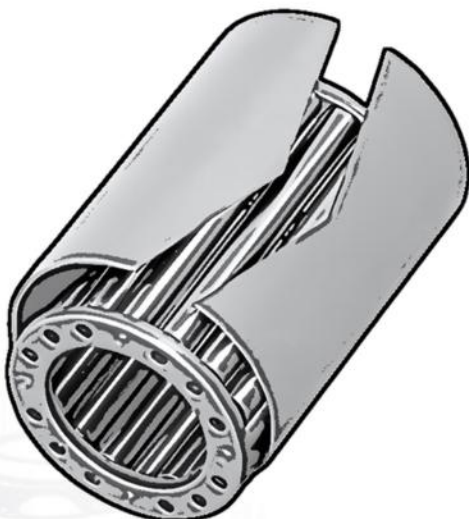

Where Roller Bearing Casters Excel

Roller bearing casters are ideal for applications requiring smooth movement and high load capacity. They're commonly used in material handling carts, industrial equipment, medical devices, dollies, heavy-duty furniture, and commercial laundry or food service carts. Additionally, they perform well in automotive and aircraft industries, mobile warehouse racks, and shipping containers, providing reliable, durable mobility across various surfaces.



Flanged Ball Bearings

Flanged ball bearings support loads, aid alignment, and reduce slippage—ideal for high-vibration applications.

Part Number	Inside Diameter	Outside Diameter
SCC-BB1000	5/16"	1-1/16"
SCC-BB1001	3/8"	1-1/16"
SCC-BB1002	1/2"	1-3/8"
SCC-BB1003	5/8"	1-3/8"
SCC-BB1004	3/4"	1-3/8"



Pedestal Ball Bearings

This bearing ensures smooth, quiet, maintenance-free operation. Easy installation. Available in stainless steel and heat-resistant options!

Part Number	Inside Diameter	Outside Diameter	Wheel Hub
SCC-Q34S-12	1/2"	1-3/16"	1-5/8"
SCC-Q34-12	1/2"	1-3/16"	2-3/16"
SCC-Q34RS-34	3/4"	1-15/16"	2-3/4"
SCC-Q34R-34	3/4"	1-15/16"	3-1/4"



Precision Ball Bearings

The sealed precision ball bearing offers smooth, quiet performance for medium to heavy-duty applications with high speed and radial thrust needs.

Part Number	Inside Diameter	Wheel Bore	Wheel Hub
SCC-PBB38118112	3/8"	1-1/8"	1-1/2"
SCC-PBB121316158	1/2"	1-3/16"	1-5/8"
SCC-PBB123162316	1/2"	1-3/16"	2-3/16"
SCC-PBB5813162316	5/8"	1-3/16"	2-3/16"
SCC-PBB3411516234	3/4"	1-15/16"	2-3/4"
SCC-PBB3411516314	3/4"	1-15/16"	3-1/4"
SCC-PBB11516314	1"	1-15/16"	3-1/4"

NEED METRIC OR STAINLESS? [CUSTOMER SERVICE](#) CAN HELP



Pedestal Ball Bearings

High Temp

Part Number	Inside Diameter	Outside Diameter	Wheel Hub
SCC-Q34-VK	1/2"	1-3/16"	2-3/16"

HIGH TEMP BEARING - 525°F INTERMITTENT



Stainless Steel Pedestal Ball Bearings

Part Number	Inside Diameter	Outside Diameter	Wheel Hub
SCC-SSQ34	1/2"	1-3/16"	2-3/16"

STAINLESS STEEL BEARING - CORRISON RESISTANT



PRECISION Performance

Sealed Precision Ball Bearings ensure smooth, quiet rolling, ideal for carts, machinery, and medical equipment. Available in zinc-plated or stainless steel, they enhance caster performance up to 250°F.



Tapered Roller Bearings

Single-row tapered roller bearings are basic and widely used, with a cone and cup, available in the broadest range of sizes.

Part Number	Inside Diameter	Wheel Width
SCC-TRB34	3/4"	2", 2-1/2", 3"
SCC-TRB1	1"	3", 4"
SCC-TRB114	1-1/4"	4"



Bronze Bearings

Bronze caster bearings, made from a durable bronze alloy, handle temperatures up to 525°F and harsh conditions. They can include a spanner bushing for extra strength and capacity.

Part Number	Inside Diameter	Wheel Bore	Wheel Hub
SCC-BZ34	3/4"	1-3/16"	2-3/16"

Plastic Bearings

These lightweight plastic bearings are durable, comes in one- or two-piece designs, and is suitable for food service and material handling.



Part Number	Inside Diameter	Wheel Bore	Wheel Hub
SCC-DL1000	3/8"	1-1/8"	1-9/16"
SCC-DL1001	1/2"	1-1/8"	1-9/16"
SCC-DL1002	1/2"	1-3/16"	2-3/16"
SCC-DL1003	3/4"	1-3/16"	2-3/16"
SCC-DL1005	1"	1-15/16"	2-3/4", 3-1/4"
SCC-DL1002-1PC-SHORT	1/2"	1-3/16"	1-5/8"
SCC-DL1002-1PC	1/2"	1-3/16"	2-3/16"
SCC-DL1004-1PC	5/8"	1-3/16"	2-3/16"
SCC-DL1003-1PC-SHORT	3/4"	1-3/16"	1-5/8"
SCC-DL1003-1PC	3/4"	1-3/16"	2-3/16"

AVAILABLE IN EITHER ONE-PIECE OR TWO-PIECE BEARINGS.

Plastic Spanner Bushings

This plastic spanner bushing enhances stability and durability, fitting various bearings and wheel setups. It's ideal for applications requiring extra support and is cost-effective.

Part Number	Inside Diameter	Outside Diameter	Length
SCC-DS1000	1/2"	3/4"	1-7/8"
SCC-DS1001	1/2"	3/4"	2-7/16"

NEED A DIFFERENT SIZE? [CUSTOMER SERVICE](#) CAN HELP!

We offer Caster Bearing Kits that include bearings, bushings, and retainer washers, providing everything needed for smooth and reliable caster performance. Each kit is designed for durability and efficiency, ideal for both new installations and replacements to maintain optimal caster function.



Bearing Kit Available



Steel Spanner Bushings

Spanner bushings stabilize casters by evenly distributing weight and reducing axle deflection, ensuring smooth operation and improved load capacity.



Part Number	Inside Diameter	Outside Diameter	Length
SCC-S301SSL	5/16"	3/8"	1.5280"
SCC-S201L	5/16"	7/16"	1.0950"
SCC-S300L	5/16"	1/2"	1.5230"
SCC-S301SL	3/8"	1/2"	1.5156"
SCC-S202SL	3/8"	1/2"	1.516"
SCC-S301L	3/8"	1/2"	1.7030"
SCC-S302XL	3/8"	3/4"	1.7770"
SCC-S301XL	3/8"	3/4"	1.8906"
SCC-S302SL	1/2"	5/8"	1.8906"
SCC-S303SL	1/2"	5/8"	2.4531"
SCC-S304L	1/2"	3/4"	1.7120"
SCC-S302L	1/2"	3/4"	1.8906"
SCC-S303SSL	1/2"	3/4"	2.1600"
SCC-S401L	1/2"	3/4"	2.3270"
SCC-S303L	1/2"	3/4"	2.4531"
SCC-S303XL	1/2"	3/4"	3.0156"
SCC-S402L	1/2"	3/4"	4.0156"
SCC-S30258L	1/2"	3/4"	1.8906"
SCC-S30358L	5/8"	3/4"	2.4531"
SCC-S305L	3/4"	1"	3.0156"
SCC-S306L	3/4"	1"	3.5156"
SCC-S307L	3/4"	1"	3.5780"
SCC-S305XL	1"	1-1/4"	3.0156"
SCC-S306XL	1"	1-1/4"	3.5156"
SCC-S306XXL	1"	1-1/4"	4.5625"
SCC-S403L	1"	1-1/4"	5.5780"
SCC-S501L	1-1/4"	1-1/2"	3.5780"
SCC-S502L	1-1/4"	1-1/2"	4.5780"
SCC-S503L	1-1/4"	1-1/2"	5.5780"

Stainless Steel Spanner Bushings

These stainless steel spanner bushings resist corrosion and wear, ensuring long-lasting performance and reducing the need for frequent replacements.

Part Number	Inside Diameter	Outside Diameter	Length
SCC-SS301SL	3/8"	1/2"	1.5156"
SCC-SS301L	3/8"	1/2"	1.7030"
SCC-SS302XL	3/8"	3/4"	1.707"
SCC-SS301XL	3/8"	3/4"	1.8906"
SCC-SS302L	1/2"	3/4"	1.8906"
SCC-SS303L	1/2"	3/4"	2.4531"
SCC-SS303XL	1/2"	3/4"	3.0156"

Steel Flanged Spanner Bushings

Wheel bearing reducers (top hats) efficiently convert sealed wheel bearings to a smaller diameter.



Part Number	Inside Diameter	Wheel Width	Hub Length
SCC-THS38	3/8"	1-1/4"	1-9/32"
SCC-THS12	1/2"	2"	2-3/16"
SCC-THS34	3/4"	3"	3-1/4"
SCC-THS1	1"	4"	4-1/4"

NEED METRIC OR STAINLESS? [CUSTOMER SERVICE](#) CAN HELP

HOW TO PICK THE BEST WHEELS

- SURFACE COMPATIBILITY
- BEARING TYPE
- ENVIRONMENTAL FACTORS
- BUDGET
- SERVICE CASTER'S EXCEPTIONAL CUSTOMER SERVICE SKILLS.
- PURPOSE AND APPLICATION
- MATERIAL
- LOAD CAPACITY
- WHEEL SIZE AND TYPE

LIKE, SHARE & SUBSCRIBE



Zinc Plated Axle Kits

Axles ensure smooth, even wheel rotation and handle heavy loads. Available in **zinc-plated** or stainless steel for corrosion resistance.



Part Number	Outside Diameter	Length
SCC-AN516218	5/16"	2-1/8"
SCC-ZAN38214	3/8"	2-1/4"
SCC-ZAN38212	3/8"	2-1/2"
SCC-ZAN123	1/2"	3"
SCC-ZAN12312	1/2"	3-1/2"
SCC-ZAN124	1/2"	4"
SCC-ZAN34412	3/4"	4-1/2"
SCC-ZAN345	3/4"	5"
SCC-ZAN34512	3/4"	5-1/2"

Stainless Steel Axle Kits

Stainless steel axle kits ensure smooth rotation, durability, and superior **corrosion resistance** for tough environments.

Part Number	Outside Diameter	Length
SCC-SSZAN38214	3/8"	2-1/4"
SCC-SSZAN38212	3/8"	2-1/2"
SCC-SSZAN12312	1/2"	3-1/2"
SCC-SSZAN124	1/2"	4"
SCC-SSZAN345	3/4"	5"



Pressfit Retaining Washers

Wheel bearing **retainer washers** secure bearings and ensure smooth rotation. Available in plastic, metal, stainless steel, and more.

Part Number	Inside Diameter	Outside Diameter	Type
SCC-RW11	3/4"	1-3/16"	Plastic Combination
SCC-RW11-S	3/4"	1-3/16"	Steel
SCC-RW11-M	3/4"	1-3/16"	Sintered Iron Combination
SCC-RW12	1"	1-7/16"	Steel
SCC-RW12-S	1"	1-9/16"	Steel
SCC-RW13	1"	1-15/16"	Steel
SCC-RW13-M	1"	1-15/16"	Sintered Iron Combination
SCC-RW14	1-1/4"	1-15/16"	Steel
SCC-RW15	1-1/4"	2-7/16"	Steel
SCC-RW16	1-1/2"	2-7/16"	Steel

Neoprene Seal Washers

Washers have a flanged **rubber insert** on a steel base, ensuring a tight seal. Perfect for corrosion resistance.



Part Number	Inside Diameter	Outside Diameter
SCC-NS401	3/4"	1-3/16"
SCC-NS402	1"	1-7/16"
SCC-NS403	1"	1-15/16"
SCC-NS404	1-1/4"	1-15/16"
SCC-NS405	1-1/4"	2-7/16"
SCC-NS406	1-1/2"	2-7/16"

Thrust Washers

Thrust washers secure roller bearings in caster wheels and support axial loads.

Part Number	Inside Diameter	Outside Diameter
SCC-TW501	3/4"	1-5/8"
SCC-TW502	1"	2-3/8"
SCC-TW503	1-1/4"	2-3/4"



"Simply the best :) – Easy to navigate website. Easy ordering process. Fast shipping, high quality parts, excellent prices."

★★★★★ by ERICK ZETINA

Rated 4.9 / 5 | 12,049 reviews



Floor Truck Locks

Our **floor truck locks** ensure secure cart immobilization with a simple step-on pedal for easy loading. The rubber footpad provides stability, increases friction, and protects floors from scratches.

For optimal safety, use only on flat surfaces.

Part Number	Caster Wheel Diameter	Extend Height	Retracted Height	Weight (lbs.)
SCC-FL400KB	4"	5-3/4"	5-1/16"	3.25
SCC-FL500KB	5"	6-5/8"	5-5/8"	3.50
SCC-FL600KB	6"	7-5/8"	6-5/8"	4.50
SCC-FL800KB	8"	9-5/8"	8-5/8"	4.75
SCC-FL400DP	4"	5-7/8"	4-5/8"	3.25
SCC-FL500DP	5"	6-3/4"	5-1/2"	3.50
SCC-FL600DP	6"	7-3/4"	6-1/2"	4.50
SCC-FL800DP	8"	9-3/4"	8-1/2"	4.75

CAN'T FIND YOUR SIZE? [CUSTOMER SERVICE](#) CAN HELP



Standard Plate Size	Bolt Pattern
4" x 4-1/2"	2-5/8" x 3-5/8" to 3" x 3"

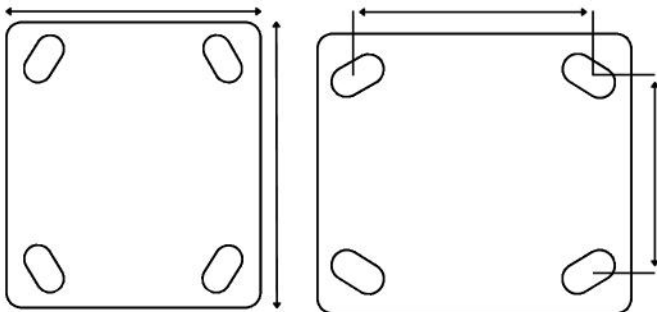

Stainless Steel Floor Truck Locks

Stainless steel, double pedal, floor truck Locks feature durable construction, 304 stainless steel, and rubberized non-slip foot.

Part Number	Caster Wheel Diameter	Extend Height	Retracted Height
SCC-SSFL400DP	4"	5-7/8"	4-5/8"
SCC-SSFL500DP	5"	6-3/4"	5-1/2"
SCC-SSFL600DP	6"	7-3/4"	6-1/2"
SCC-SSFL800DP	8"	9-3/4"	8-1/2"

Nose Rollers

This cast semi-steel **nose roller** features a fully machined, concentric design with a carbon steel axle that is drilled, cross-drilled, and includes a recessed zerk fitting, offering a 20-ton (40,000 lbs.) capacity.



Part Number	Roller Diameter (Inches)	Roller Lengths (Inches)	Axle Diameter (Inches)	Axle Length (Inches)	Capacity (lbs.)	Roller + Axle	WT (lbs.)	Axle	WT (lbs.)
SCC-NR44	4	4	1.5	6.50	40,000	NR4 x 4	16.5	N1.5 X 6.5S	3.25
SCC-NR46	4	6	1.5	8.25	40,000	NR4 x 6	21.25	N1.5 X 8.25S	4.125
SCC-NR80	8	10	1.44	12-1/2	40,000	BR8 X 10	36	B1.44 X 12.5S	5.7



Part Number	Caster Series Number	Top Plate Size
SCC-CP20	#20	2-3/8" x 3-5/8"
SCC-CP30	#30	4" x 4-1/2"
SCC-CP30-U	#30	4" x 4-1/2"
SCC-CP60	#60	4-1/2" x 6-1/4"

Caster Pads

For **quick caster replacement**, use a steel pad welded or bolted under containers with a 3/8" bolt and nylon lock nut. U-bolt hardware is also available.

Weld & Shim Plates

Weld and shim plates are used to **raise the height** of casters and can be attached by welding or bolting.



Part Number	Overall Top Plate Size	Bolt Hole Spacing	Bolt Size	Thickness
SCC-TP20R	2-3/8" x 3-5/8"	1-3/4" x 2-7/8" slotted to 3"	5/16"	1/8"
SCC-TP30R	4" x 4-1/2"	2-5/8" X 3-5/8" Slotted to 3" x 3"	3/8"	1/4"
SCC-TP60R	4-1/2" x 6-1/4"	2-7/16" x 4-15/16" slotted to 3-3/8" x 5-1/4"	1/2"	3/8"
SCC-TP92R	5-1/4" x 7-1/4"	3-3/8" x 5-1/4" slotted to 4-1/8" x 6-1/4"	1/2"	3/8"

Raceway Seals

Rubber; designed for a 4" x 4-1/2" plate.
Operating temperature range: 40°F to 140°F.

Part Number	Caster Series Number
SCC-RW27	#30, #100
SCC-RW27-HT	#30, #100

HIGH-TEMP SEAL: -20°F TO 350°F.



Wheel Thread Guards

The thread guard, available in both metal and plastic, **protects the bearing** from debris.

Part Number	Caster Series Number	Material
SCC-TG114-P	#30, 100	Plastic
SCC-TG114-M	#35, 50	Metal
SCC-TG2-P	#60	Plastic
SCC-TG2-M	#90, 92	Metal



Corner Bumpers

Heavy-duty bumper with extra rounded corners for **added protection** at high-impact areas, featuring tapered and rounded ends.

Part Number	Wheel Diameters
SCC-CB101G	see bumper page for details
SCC-CB100G	
SCC-CB100B	
SCC-CB100G-BC	



Tubing Bumper

Bumpers protect equipment and walls from **impact**, fitting 1" O.D. tubing with a 3-1/2" diameter.

Part Number	Tubing Inside Diameter	Bumper Diameter
SCC-CB200	1"	3-1/2"

Round Bumpers

Gray rubber rolling bumper with steel reinforcement fits 1/2" stem casters, **preventing damage** to walls and equipment.

Part Number	Caster Stem Diameter
SCC-CB50070	1/2"
SCC-CB50093	13/16"
SCC-CB50073	1"
SCC-CB50074	1-1/8"



End Bumpers

Typically used on **cart handle ends**, these bumpers feature a 3-1/4" diameter and a steel insert.

Part Number	Inside Diameter
SCC-CB300	5/16"
SCC-CB301	1/2"

Unlock a World of Possibilities and Discover More Options with Service Caster!

Fastening Options

Service Caster offers a wide range of fastening options, including **threaded**, round, and **expanding** stems, along with various plate options, ensuring a secure and reliable fit for any application. We also provide these in **stainless steel** and have them available in **metric** sizes.

Threaded Stems *Light Duty Caster Series*

Part Number	Threaded Stem Size
SCC-TS05-51648-2MM	5/16"-18 x 4.8" Ladder Stem
SCC-TS05-516112	5/16"-18 x 1-1/2"
SCC-TS05-3810	3/8"-16 x 1"
SCC-TS05-38112	3/8"-16 x 1-1/2"
SCC-TS05-123	1/2"-13 x 1"
SCC-TS05-12112	1/2"-13 x 1-1/2"
SCC-TS05-M8112	M8-1.5 x 38mm
SCC-TS05-M10112	M10-1.25 x 38mm
SCC-TS05-M12112	M12-1.75 x 38mm

STAINLES STEEL AND METRIC STEMS AVAILABLE

Threaded Stems *Medium/Heavy Duty Caster Series*

Part Number	Threaded Stem Size
SCC-TS3810	3/8"-16 x 1"
SCC-TS38112	3/8"-16 x 1-1/2"
SCC-TS121	1/2"-13 x 1"
SCC-TS12112	1/2"-13 x 1-1/2"
SCC-TS58212	5/8"-11 x 2-1/2"
SCC-TS34212	3/4"-10 x 2-1/2"
SCC-TSM10112	M10-1.25 x 38mm
SCC-TSM12112	M12-1.75 x 38mm
SCC-SSTS38112	Stainless Steel 3/8"-16 x 1-1/2"
SCC-SSTS12112	Stainless Steel 1/2"-13 x 1-1/2"
SCC-SSTSM10112	Stainless Steel M10-1.25 x 38mm
SCC-SSTSM12112	Stainless Steel M12-1.75 x 38mm

STAINLES STEEL AND METRIC STEMS AVAILABLE

Threaded Stems *More Option Sizes*

Part Number	Threaded Stem Size
SCC-TS716145	7/16"-14 x 1-1/2"
SCC-TS71614214	7/16"-14 x 2-1/4"
SCC-TS1213234	1/2"-13 x 2-3/4"
SCC-TS1213318	1/2"-13 x 3-1/8"
SCC-TS12134	1/2"-13 x 4"
SCC-TS34101	3/4"-10 x 1"
SCC-TS3410134	3/4"-10 x 1-3/4"
SCC-TS34104	3/4"-10 x 4"
SCC-TS34106	3/4"-10 x 6"
SCC-TS58111	5/8"-11 x 1"
SCC-TS5811134	5/8"-11 x 1-3/4"
SCC-TS58114	5/8"-11 x 4"
SCC-TS5811214	5/8"-11 x 2-1/4"

DON'T SEE YOUR SIZE? LET **CUSTOMER SERVICE** HELP!

Measuring a Threaded Stem

Threaded stems need precise measuring tools to determine the correct diameter and thread pitch. With various sizes and types (metric, standard), using a **thread gauge** is the most reliable method. If you don't have one, hardware stores usually offer assistance.



Pick Your Size



Inch or Metric?

How to Identify Thread Pitch



Measure Up!

Grip Ring Stems

Friction-ring stem casters fit into a hole and use a spring ring to secure themselves, making them easy to install and replace. Ideal for office chairs and tables, they allow smooth 360° movement with minimal tools.

Grip Ring Stems



Single Ring

Part Number	Stem Size
SCC-GR381	3/8" x 1"
SCC-GR71678	7/16" x 7/8"
SCC-GR7161	7/16" x 1"
SCC-GR7161316	7/16" x 1-3/16"
SCC-GR716138	7/16" x 1-3/8"
SCC-GR7161716	7/16" x 1-7/16"
SCC-GR716134	7/16" x 1-3/4"
SCC-GR7162	7/16" x 2"
SCC-GR582316	5/8" x 2-3/16"
SCC-GR805112	.805" x 1-1/2"
SCC-GR8422	.842" x 2"
SCC-GR8452	.845" x 2"
SCC-GR8462316	.846" x 2-3/16"

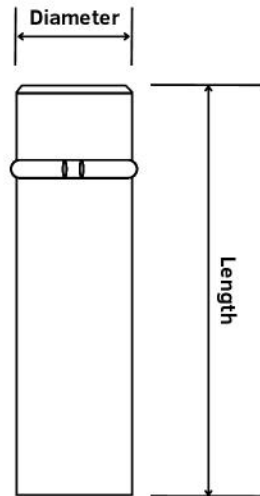

If you still require assistance, feel free to [reach out](#).

Dual Ring

Grip Ring Stems



Part Number	Stem Size
SCC-GR13162316	13/16" x 2-3/16"
SCC-GR865214	.865" x 2-1/4"
SCC-GR12316	1" x 2-3/16"
SCC-GR1182316	1-1/8" x 2-3/16"
SCC-GR1142316	1-1/4" x 2-3/16"
SCC-GR1382316	1-3/8" x 2-3/16"
SCC-GR1122316	1-1/2" x 2-3/16"

DUAL GRIP RING STEMS ENSURE STABILITY.

Measuring with a Wrench

To measure a Grip Ring stem, try fitting both a 7/16" and 3/8" wrench on the stem. The best fit indicates the stem size, though slight wiggle room is normal.

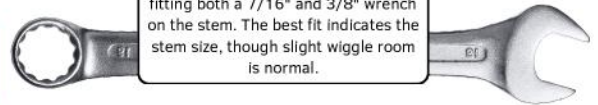

FOR SIZE INQUIRIES, CONTACT [CUSTOMER SERVICE](#).

Square Stems

Bolt-in stem casters fit square or octagonal metal tubing, making them perfect for carts, racks, and similar equipment. They are commonly used in maintenance, construction, and transportation industries.

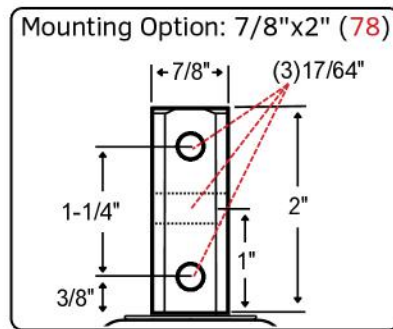
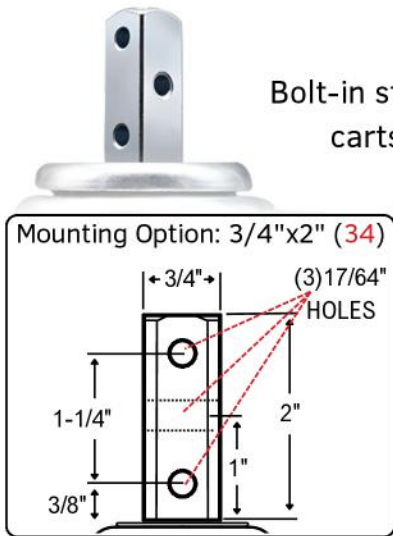

Part Number	Stem Size
SCC-SQ34	3/4" x 2"
SCC-SQ78	7/8" x 2"

3 HOLES ON STEM. SEE DRAWING FOR DETAILS

HOW TO MEASURE STEM



Round Stems

Round stems are typically used in both shopping cart and convertible hand truck casters, designed for smooth, quiet, and durable performance.

Part Number	Stem Size
SCC-RS34212	3/4" x 2-1/2"
SCC-RS78212	7/8" x 2-1/2"
SCC-RS1212	1" x 2-1/2"

EXPANDING STEMS ALSO FIT THIS STEM STYLE.



Expanding Adapter Stems

Designed to fit a variety of square and round tube legs, adapting to the tube's inside diameter. Expanding adapter stem casters are perfect for use on prep tables, work tables, racks, and various shop projects.



Part Number	Expandable Range	Inside Diameter Tubing
SCC-EX34	0.720" - 0.851"	3/4"
SCC-EX78	0.852" - 0.927"	7/8"
SCC-EX1	0.935" - 1.029"	1"
SCC-EX118	1.110" - 1.180"	1-1/8"
SCC-EX114	1.178" - 1.303"	1-1/4"
SCC-EX138	1.360" - 1.425"	1-3/8"
SCC-EX112	1.426" - 1.589"	1-1/2"
SCC-EX158	1.590" - 1.684"	1-5/8"
SCC-EX134	1.685" - 1.80"	1-3/4"
SCC-EX178	1.790" - 1.850"	1-7/8"

Easy to Install Expanding Adapter Stem Casters

Tighten the topmost ring on the expanding caster adapter stem before insertion to compress rubber until it fits snugly into the tube. The expanded stem can be inserted into round or square tubing. It may be necessary to further tighten the nut under the swivel with a wrench until adequately secured.

Expanding Adapter Kits

Expanding sleeve kits for round tubing include a **nylon spacer**, **rubber sleeve**, and **tightening nut**. They secure bolt-hole casters to furniture or equipment by inserting the bolt through the caster, then adding the spacer, sleeve, and nut. The bolt goes into a hole on the furniture or equipment, and the nut is tightened to expand the sleeve, firmly holding the caster in place.



WATCH HOW TO INSTALL EXPANDING STEM CASTERS.

4-Position Bolt-On Swivel Locks

Swivel locks instantly convert swivel casters to rigid ones. Just pull the ring, twist, and release for rigidity; pull and twist again to restore swivel. This feature greatly improves steering, especially for carts used in both tight spaces and long corridors.

Zinc Plated Bolt-on Swivel Locks

Part Number	Caster Series Number
SCC-BSL30	#30, 100
SCC-BSL35	#35, 50
SCC-BSL60	#60
SCC-BSL92	#90, 92



Stainless Steel Bolt-on Swivel Locks

Part Number	Caster Series Number
SCC-SSBSL30	#30, 100
SCC-SSBSL35	#35, 50
SCC-SSBSL60	#60
SCC-SSBSL92	#90, 92

Wheel Brake Kits

Brake kits include parts to install brakes on compatible casters. Engaged brakes stop wheels from rolling, keeping equipment stationary and improving stability. Brakes don't stop swivel casters from swiveling.

Side Lock Brakes

The side lock brake works better on hard-tread wheels. Its cam tightens the axle to stop the wheel, making it lightweight, budget-friendly, and easy to install on most 2" & 3" wide casters.

Part Number	Wheel Diameters	Caster Series Number
SCC-10SLB	2", 2-1/2", 3", 4"	#10
SCC-30SLB-SHORT	3-1/4", 4", 5", 6", 8", 10"	#30, 35, 50, 100
SCC-30SLB	3-1/4", 4", 5", 6", 8", 10"	#30, 35, 50, 100
SCC-SS30SLB	3-1/4", 4", 5", 6", 8", 10"	Stainless Steel
SCC-92SLB	6", 8", 10", 12"	#60, 90, 92



STAINLESS STEEL AVAILABLE. CUSTOM SIZES UPON REQUEST.

Top Lock Brakes

Top lock brakes are foot-friendly and press against the wheel's tread to stop movement. They come in various styles, with the most common being a pedal lever with a rubber pad for optimal friction.



Stainless Steel Top Lock Brakes

Part Number	Wheel Diameters	Caster Series Number
SCC-SSTLB20-3	3"	#20
SCC-SSTLB20-3.5	3.5"	#20
SCC-SSTLB20-4	4"	#20
SCC-SSTLB20-5	5"	#20
SCC-SSTLB20-6	6"	#20
SCC-SSTLB30-4	4"	#30
SCC-SSTLB30-5	5"	#30
SCC-SSTLB30-6	6"	#30
SCC-SSTLB30-8	8"	#30

STAINLESS STEEL AVAILABLE. CUSTOM SIZES UPON REQUEST.



Part Number	Wheel Diameters	Caster Series Number
SCC-TLB20-3	3"	#20
SCC-TLB20-3.5	3.5"	#20
SCC-TLB20-4	4"	#20
SCC-TLB20-5	5"	#20
SCC-TLB20-6	6"	#20
SCC-TLB30-4	4"	#30
SCC-TLB30-5	5"	#30
SCC-TLB30-6	6"	#30
SCC-TLB30-8	8"	#30

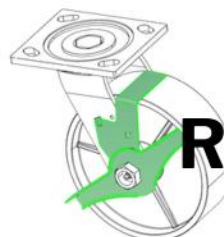

REQUEST DRAWING

Posi-Lock Brakes

The posi lock brake applies a locking force to the wheel tread like a top lock brake, but its pedal is positioned above the wheel instead of on the side.

Part Number	Caster Wheel Diameter	Caster Wheel Width
SCC-20PLB-3	3"	1-1/4"
SCC-20PLB-3.5	3.5"	
SCC-20PLB-4	4"	
SCC-20PLB-5	5"	
SCC-20PLB-6	6"	



Face Contact Brakes

The face contact brake is a stronger option than the universal brake, with a pedal or t-bar handle based on the caster series. It's welded on, so no refunds are offered. With many different styles and sizes.



STAINLESS STEEL AVAILABLE. CUSTOM SIZES UPON REQUEST.



Choose Your Style



Part Number	Wheel Diameters	Wheel Width	Caster Series Number
SCC-FCB30-4	4"	2"	#30
SCC-FCB30-5	5"		
SCC-FCB30-6	6"		
SCC-FCB30-8	8"		
SCC-FCB60-6	6"	2.5"-3"	#60, #90, #92, #100
SCC-FCB60-8	8"		
SCC-FCB60-10	10"		
SCC-FCB60-12	12"		

OEM / Industry Specific

- Albion Industries
- Atosa
- Avantco
- Bassick
- Belshaw
- Cambro
- Case
- Chemtainer
- Choice
- Cosco
- Franke
- Go Mini
- Greenlee
- Haulmaster
- Henny Penny
- Lakeside
- Lavex
- Rubbermaid

Many More...



WE ARE **SERVICE** **CASTER**

- EXPERT CUSTOMER SERVICE
- THOUSANDS OF CASTERS
- SAME DAY SHIPPING FOR
- PHONE, EMAIL, AND ONLINE
- CUSTOM CASTERS AND PRODUCTS

Service Caster Corporation, based in West Reading, Pennsylvania, is the result of the vision of founder Ronald T. Manz, and the dedicated efforts of its employees. We have grown from a small family business into the world's largest caster and wheel manufacturer, providing solutions for everything from light-duty to heavy-duty industrial applications.

While Ronnie's leadership laid the foundation, the dedication of our employees has driven the company's global success across multiple continents. Despite its growth, **Service Caster** remains family-owned and operated. Our team continues to lead the industry with reliable, innovative solutions.



VICE
S IN STOCK
R MOST ORDERS
LINE ORDERING
FABRICATION



Excellent



ng, PA, thrives thanks to the vision of its founder,
team. For over 30 years, the company has grown
cturer, offering solutions from light-duty casters
industrial wheels.



ne **team's** commitment to innovation and quality
s industries like healthcare and manufacturing.
-operated, honoring its roots while continuing to
, innovative mobility solutions.



ECC
CASTER
CORPORATION

See what people are saying about **Service Caster!**

“
Great Experience

I thought I didn't receive my order but found out it was delivered to another part of our building. Once I tracked it down I seen it was sent two days after being placed that's great customer Service in my book!!



David B
Customer

”

“
The company made it super easy to get...

The company made it super easy to get replacement casters for my rolling table. The casters were of very high quality.



michael
Customer

”

“
Service Caster offers quality products...

Service Caster offers quality products and reasonable prices. The stainless steel casters we have purchased several times are high quality.



OS
Customer

”

“
I was impressed

I was impressed. After placing my order with Service Caster my order was filled and delivered in short order it was well packaged. No complaints



GS
Customer

”

“
These people are phenomenal

These people are phenomenal! I ordered the wrong thing - completely my fault/ignorance about the variety of threads, depth, etc. associated with casters. The chairs I was trying to upcycle were European made (metric). Anyway: the Service Caster team offered all the help and guidance to assure my replacement would be what I needed and it WAS! SO happy I found these people. USA-PROUD-Customer.



Valerie T
Customer

”

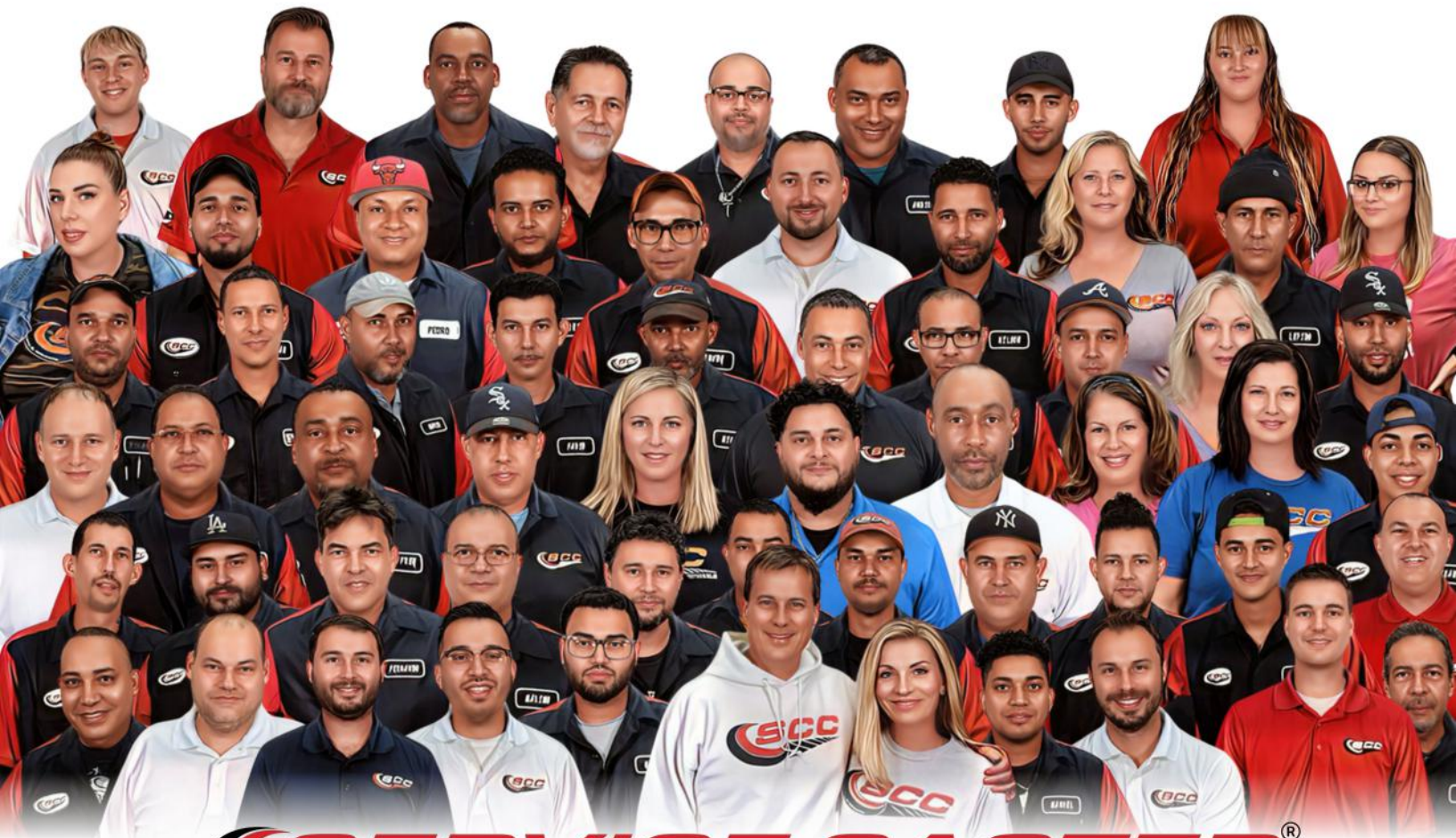

SERVICE CASTER
CORPORATION®

Thank you for choosing us. We're proud to support your projects with Service Caster's trusted **quality, reliability, and excellence.** With our commitment to innovation, we're always **Moving You Forward.**

We wanted to take a moment to express our heartfelt appreciation for the Service Caster team. You're not just a team; you're family. Your hard work, dedication, and commitment don't go unnoticed. As owners, we are grateful for each and every one of you.

In our journey together, we've built more than a business; we've built a community. The support, collaboration, and camaraderie within this team make Service Caster truly special. Your contributions have been the driving force behind our success.

And to our valued customers, we want you to know that you're not just clients – you're a part of our extended family. Your trust means the world to us, and we are committed to providing you with the best service and products.

Thank you for being a crucial part of the Service Caster family. Together, we'll continue to achieve great things.

Cheers to the Service Caster family and our wonderful customers!

Service Caster





Simply scan the QR code to
access our interactive shopping
experience!