

# 48V Magnetic Track System

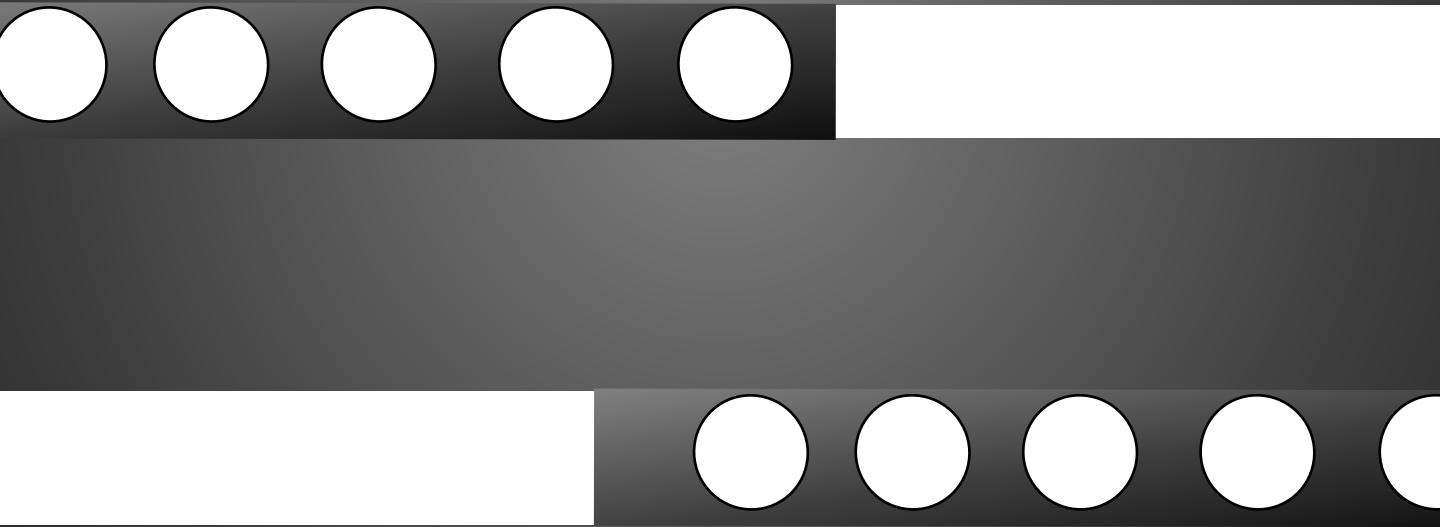



## **Magnets make life simple**

Different light fixtures are held in place by magnetic force along the entire track. No tools are needed to install them. Rotate, Slide into any position, and adjust at any time— all it takes is one hand movement to highlight objects according to requirements



Designed with M20A rail and  
MS900,CFC1045 light



Designed with M20C rail and  
CFC1045 light



Designed with M20C rail and  
MS12 grille light



Designed with M20C rail and  
MS600 Linear light



Designed with M20C rail and  
CFC1045, TS20 spotlight

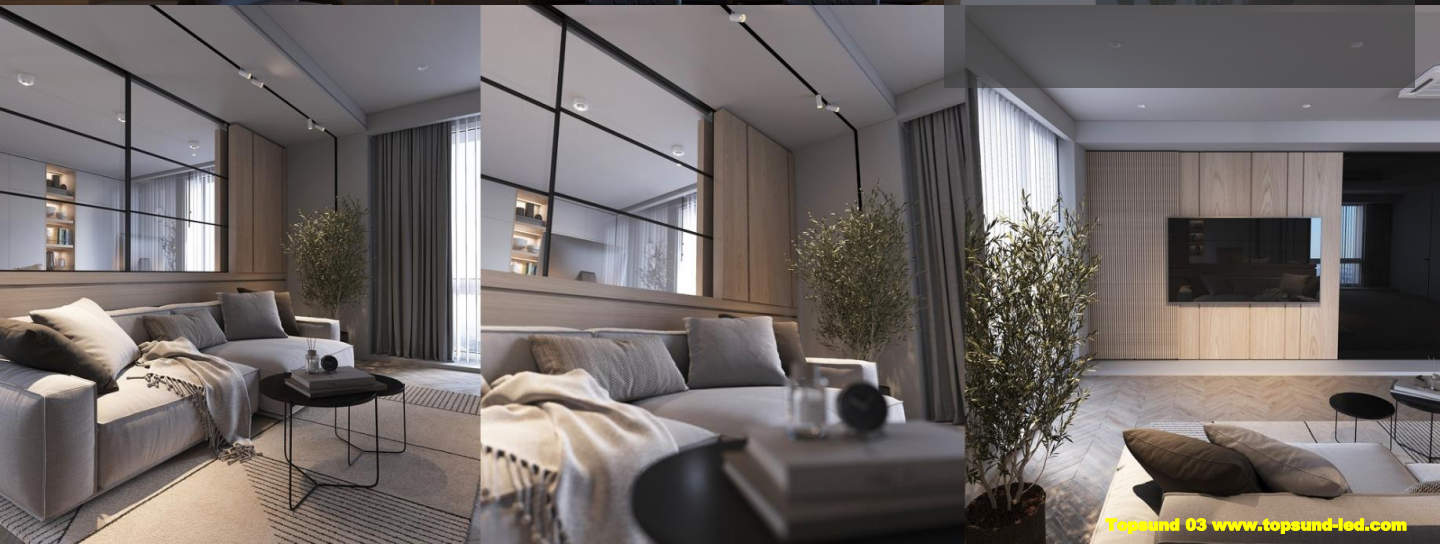



Designed with M20C rail and

CFC40 pendant light





## The effect in space

Magnetic track light system has the flexibility to adapt to every new situation and react to changing requirements in a room- whether you want to evenly light an entire wall or accentuate a particular object. maximum flexibility within the room is ensured since no tools are needed for adjustment, spots are easy to swivel and tilt, and beams can be focused. Light fixtures can be analog-dimmed with no flickering to create the optimal setting.

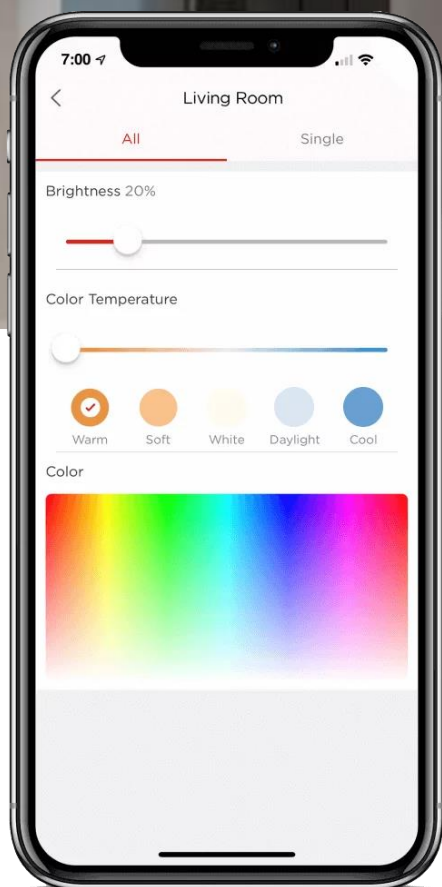

## Wireless control by Philips Hue Bridge

Control your lighting from anywhere, any time by your smartphone or tablet. Not only dim the brightness, but set different scenes as your needs.



## Home Automation

An intelligent solution for networking and controlling intelligent building technology. Due to the targeted linking of devices and functions in accordance with the KNX standard, both living and working have not only become more convenient and secure but also more energy efficient and economical



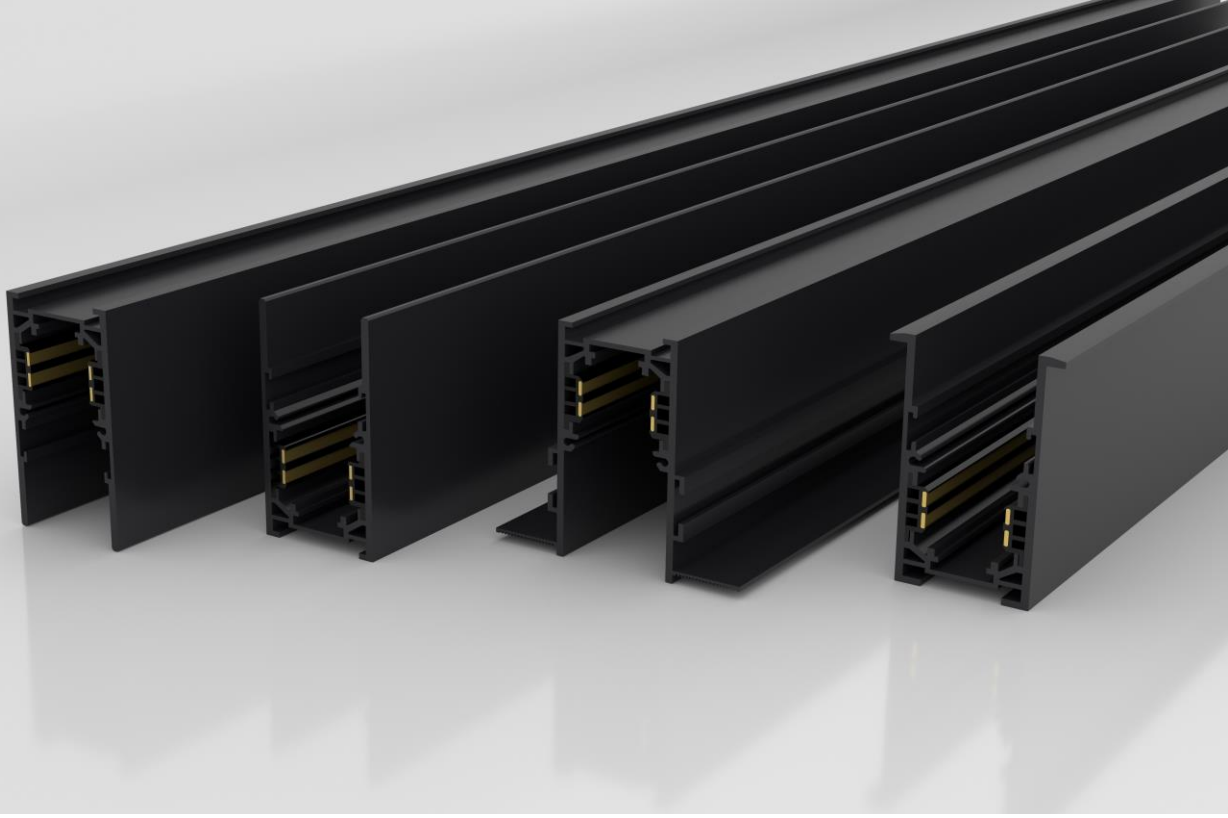

## **Channel Variety**

The magnetic track system is available as a recessed, surface-mounted, and suspended option. The suspended direct/indirect model also enables optional indirect lighting. The power track system use 48V. Each spot can be switched on and off and dimmed individually wirelessly via WIFI, Zigbee or using a DALI signal.

# Track

## M20A

DC 48V	IP 20
-----------	----------

### OPTIONS

Color	RAL9004
Length	1000mm / 2000mm
Installation	Suspended / surface mounted

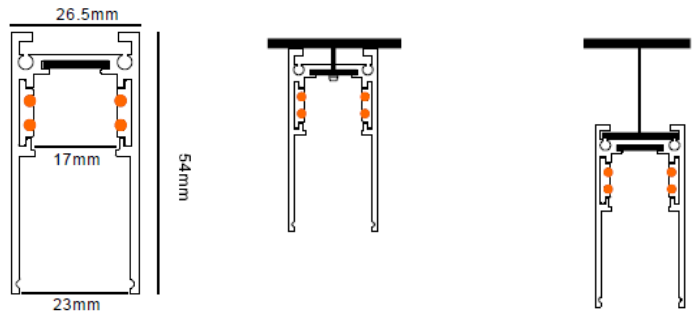

## M20B

DC 48V	IP 20
-----------	----------

### OPTIONS

Color	RAL9004 / RAL9003
Length	1000mm / 2000mm
Installation	Trimless recessed

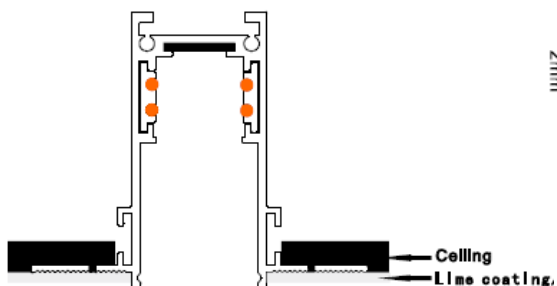
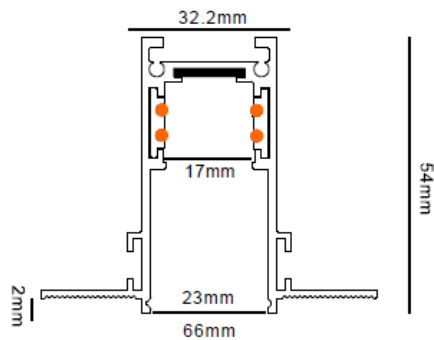

# Track



## M20C

DC  
48V

IP  
20

### OPTIONS

Color RAL9003 / RAL9004

Length 1000mm / 2000mm

Installation Recessed

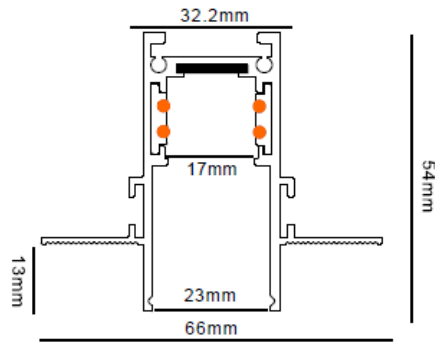
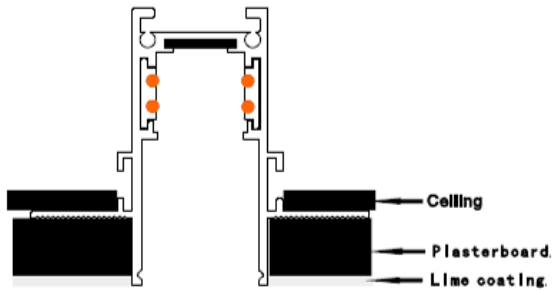

## M20D

DC  
48V

IP  
20

### OPTIONS

Color RAL9003 / RAL9004

Length 1000mm / 2000mm

Installation Recessed

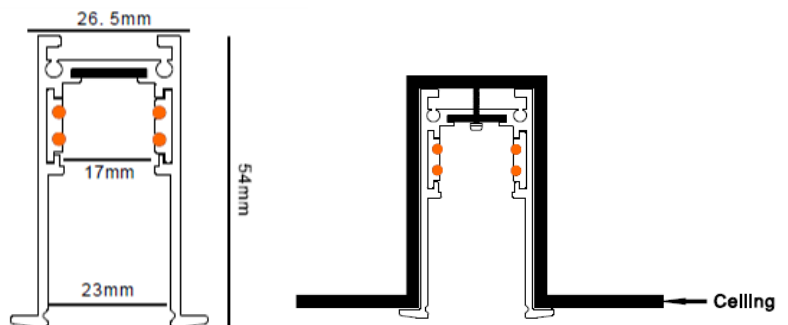

# Round Track



## R32

DC  
48V

IP  
20

### OPTIONS

Color RAL9003 / RAL9004

Length 1000mm / 2000mm

Installation Surface mount / Suspension

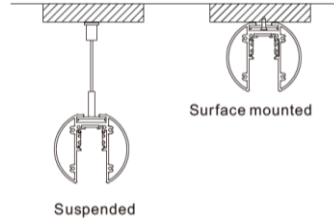
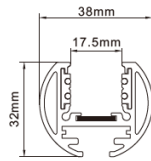

## R55

DC  
48V

IP  
20

### OPTIONS

Color RAL9003 / RAL9004

Length 1000mm / 2000mm

Installation Surface mount / Suspension

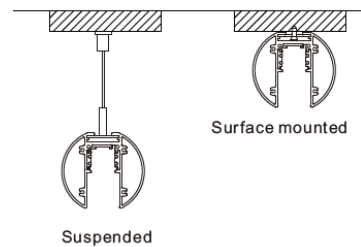
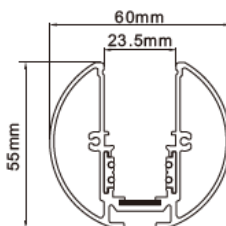



## Spotlight

The popular spotlight series is available in various modifications. The key difference between them lies in the light characteristics and dimensions. Stylish and laconic design combined with technical functionality are perfect for most interiors as a main or additional light source.

A special Pro version of the luminaire allows you to focus light from a narrow angle to a medium one. An exclusive mechanism for changing the angle of light allows you to place accents in the interior.

# Spotlight



## CFC1035

### OPTIONS

Color	RAL9004 / RAL9003
Beam angle	24° / 36°
CCT	2700K / 3000K / 4000K / 5000K
CRI	90Ra
Electrical option	Non Dim / DALI / 1-10V / Zigbee

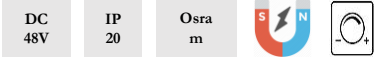

### Dimension (mm)

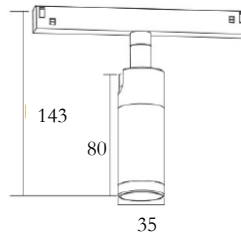

Model	W	LUM	CCT	CRI
CFC1035	5	325	3000K	90

## CFC1045

### OPTIONS

Color	RAL9004 / RAL9003
Beam angle	24° / 36°
CCT	2700K / 3000K / 4000K / 5000K
CRI	90Ra
Electrical option	Non Dim / DALI / 1-10V / Zigbee



### Dimension (mm)

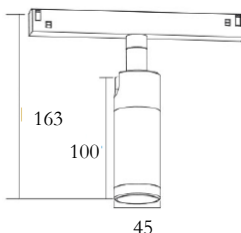

Model	W	LUM	CCT	CRI
CFC1045	10	650	3000K	90

# Spotlight



DC  
48V

IP  
20

Osram



Model	W	LUM	CCT	CRI
TS20	20	1300	3000K	90

## TS20

### OPTIONS

Color	RAL9004 / RAL9003
Beam angle	24° / 36°
CCT	2700K / 3000K / 4000K / 5000K
CRI	90Ra
Electrical option	Non Dim / DALI / 1-10V / Zigbee

### Dimension (mm)

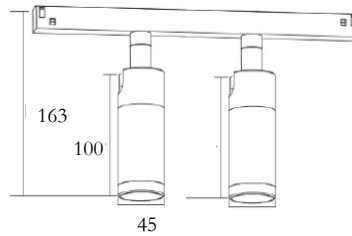

# Zoom



DC  
48V

IP  
20

Osram



Model	W	LUM	CCT	CRI
CFC1043	10	650	3000K	90

## CFC1043

### OPTIONS

Color	RAL9004 / RAL9003
Beam angle	10-55°
CCT	2700K / 3000K / 4000K / 5000K
CRI	90Ra
Electrical option	Non Dim / DALI / 1-10V / Zigbee

### Dimension (mm)

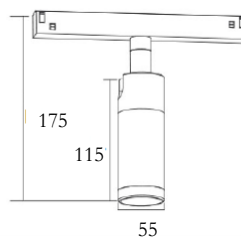



## **Van Gogh**

Van Gogh offers precision light exactly where it is needed. The Framing Projector has four adjustable arms allowing the beam to be framed to the desired size shape (square/rectangle or irregular 4 sided shapes).



# Projector

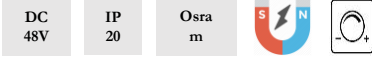

## Z2035

### OPTIONS

Color	RAL9004 / RAL9003
Beam angle	20-35°
CCT	2700K / 3000K / 4000K / 5000K
CRI	90Ra
Electrical option	Non Dim / DALI / 1-10V / Zigbee

### Dimension (mm)

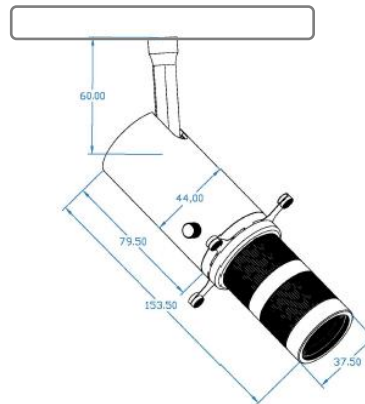

Model	W	LUM	CCT	CRI
Z2035	10	1000	3000K	90



## Linear

Linear makes an impact with their streamlined design and generate base lighting that illuminates objects and rooms especially evenly. The matte diffuser is comfortable for the eyes and eliminates glare. A wide angle of light evenly illuminates even the most distant parts of the room, without creating shadows and glare.

# Linear

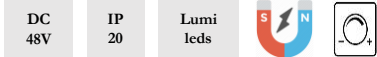

Model	W	LUM	CCT	CRI
MS600	15	900	3000K	90

## MS600

### OPTIONS

Color	RAL9004 / RAL9003
Beam angle	120°
CCT	2700K / 3000K / 4000K / 5000K
CRI	90Ra
Electrical option	Non Dim / DALI / 1-10V / Zigbee

### Dimension (mm)

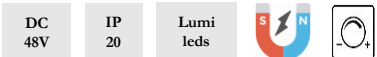
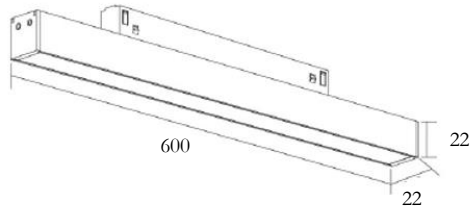

Model	W	LUM	CCT	CRI
MS900	20	1200	3000K	90

## MS900

### OPTIONS

Color	RAL9004 / RAL9003
Beam angle	120°
CCT	2700K / 3000K / 4000K / 5000K
CRI	90Ra
Electrical option	Non Dim / DALI / 1-10V / Zigbee

### Dimension (mm)

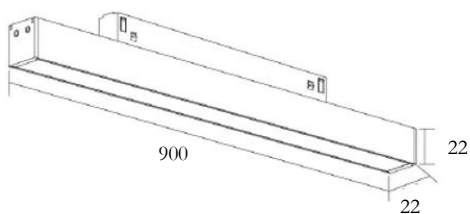



## Dots

The dots series of luminaires is suitable for zoning a room or as a decorative light source. The lamp harmoniously looks in space and creates additional volume in the room.

The special design of the luminaire reflector minimizes glare.

# Dots

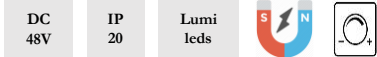

## MS06

### OPTIONS

Color	RAL9004 RAL9003
Beam angle	24° / 36°
CCT	2700K / 3000K / 4000K / 5000K
CRI	90Ra
Electrical option	Non Dim / DALI / 1-10V / Zigbee

### Dimension (mm)

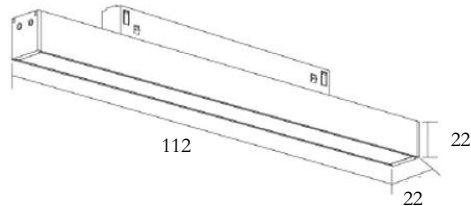

Model	W	LUM	CCT	CRI
MS06	6	360	3000K	90

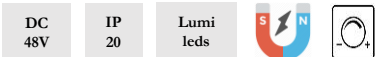

## MS12

### OPTIONS

Color	RAL9004 / RAL9003
Beam angle	24° / 36°
CCT	2700K / 3000K / 4000K / 5000K
CRI	80Ra / 90Ra
Electrical option	Non Dim / DALI / 1-10V / Zigbee

### Dimension (mm)

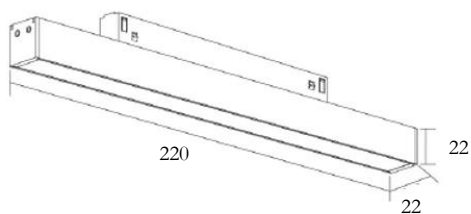

Model	W	LUM	CCT	CRI
MS12	12	720	3000K	90



## WallWasher

The wallwasher series are for creating a cozy atmosphere. Presented in various modifications of diffused or directional light.

The swivel body of the lamp allows you to place accents in the interior.

Bright light, most accurately emphasizes the color and exquisite finish of the surrounding objects.

# Wallwasher



DC  
48V

IP  
20

Lumi  
leds



Model	W	LUM	CCT	CRI
CWW06	6	360	3000K	90

## CWW06

### OPTIONS

Color	RAL9003 / RAL9004
Beam angle	120° / 36°
CCT	2700K / 3000K / 4000K / 5000K
CRI	90Ra
Electrical option	Non Dim / DALI / 1-10V / Zigbee

### Dimension (mm)

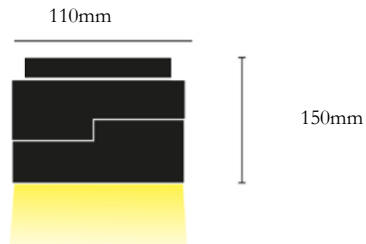

DC  
48V

IP  
20

Lumi  
leds



Model	W	LUM	CCT	CRI
CWW12	12	720	3000K	90

## CWW12

### OPTIONS

Color	RAL9003 / RAL9004
Beam angle	120° / 36°
CCT	2700K / 3000K / 4000K / 5000K
CRI	90Ra
Electrical option	Non Dim / DALI / 1-10V / Zigbee

### Dimension (mm)

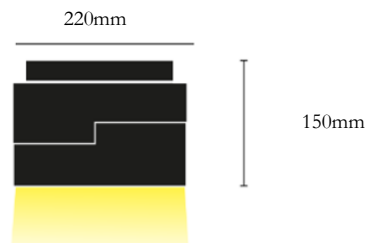



## Pendant

Suspended luminaires, which are integrated directly into the tracks, allow the magnetic track system to do even more - including for living areas, bars, and reception areas. TULA and decorative accents distribution and its remarkably slim design. It also fully protects LEDs from contact and is easy to install.



# Pendant



DC  
48V

IP  
20

Osra  
m



Model	W	LUM	CCT	CRI
CFC40* 300	10	650	3000K	90

## CFC40\*300

### OPTIONS

Color	RAL9004
Beam angle	24° / 36°
CCT	2700K / 3000K / 4000K / 5000K
CRI	90Ra
Electrical option	Non Dim / DALI / 1-10V / Zigbee

### Dimension (mm)

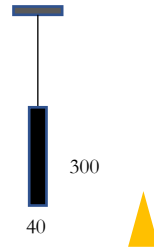

## CFC50\*300

### OPTIONS

Color	RAL9003 / RAL9004
Beam angle	24° / 36°
CCT	2700K / 3000K / 4000K / 5000K
CRI	90Ra
Electrical option	Non Dim / DALI / 1-10V / Zigbee

### Dimension (mm)

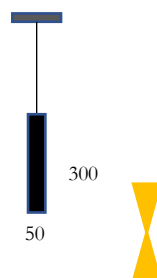

DC  
48V

IP  
20

Lumi  
leds



Model	W	LUM	CCT	CRI
CFC50* 300	10	650	3000K	90

# Pendant



DC  
48V

IP  
20

Osram



Model	W	LUM	CCT	CRI
L130A	10	700	3000K	90

## L130A

### OPTIONS

Color	RAL9004
Beam angle	60°
CCT	2700K / 3000K / 4000K / 5000K
CRI	90Ra
Electrical option	Non Dim / DALI / 1-10V / Zigbee

### Dimension (mm)

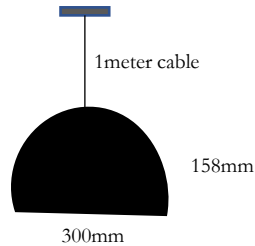

DC  
48V

IP  
20

Lumi  
leds



Model	W	LUM	CCT	CRI
L130B	10	700	3000K	90

## L130B

### OPTIONS

Color	RAL9004
Beam angle	60°
CCT	2700K / 3000K / 4000K / 5000K
CRI	90Ra
Electrical option	Non Dim / DALI / 1-10V / Zigbee

### Dimension (mm)

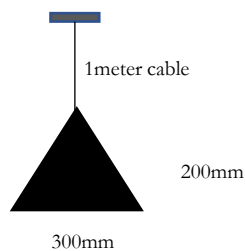



## Universe ball

The Universe ball range is available in different versions for main or local lighting. The frosted diffuser is comfortable for the eye and eliminates a glare effect. The spherical shape of the luminaire illuminates even the most distant parts of the room without casting shadows or glare.

# Universe Ball



DC  
48V

IP  
20

Osram



Model	W	LUM	CCT	CRI
CFC100	10	600	3000K	90

## CFC100

### OPTIONS

Color	RAL9004
Beam angle	180°
CCT	2700K / 3000K / 4000K / 5000K
CRI	90Ra
Electrical option	Non Dim / DALI / 1-10V / Zigbee

### Dimension (mm)

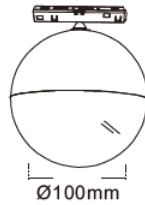

## CFC100S

### OPTIONS

Color	RAL9004
Beam angle	180°
CCT	2700K / 3000K / 4000K / 5000K
CRI	90Ra
Electrical option	Non Dim / DALI / 1-10V / Zigbee

### Dimension (mm)

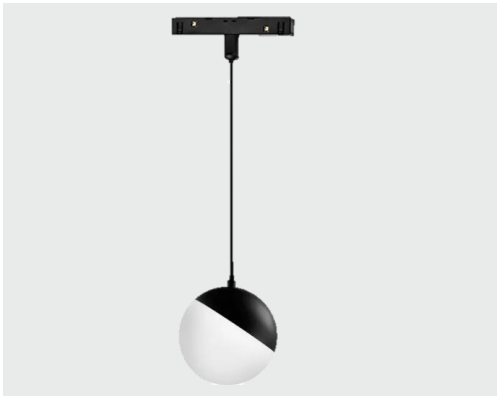
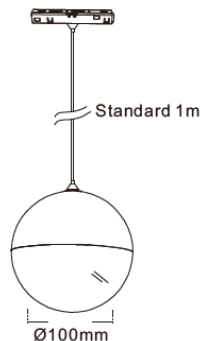

DC  
48V

IP  
20

Lumi  
leds



Model	W	LUM	CCT	CRI
CFC100S	10	600	3000K	90



## Neon Strip

Magnetic Neon strip with 360 degree light beam for the most efficient lighting of your space. It delivers 2700-5000K lighting performance and a CRI >90 color benchmark for flawless color rendering of illuminated objects in space. Neon strip allows you to experiment and perfectly adapt it to your needs. The magnetic rail can give an industrial tone to your space or just a modern note with a combination of lighting fixtures and spotlights.

# Neon Strip

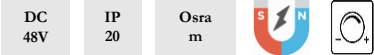

Model	W	LUM	CCT	Length
NS100	15	900	3000K	1000mm

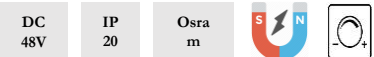

Model	W	LUM	CCT	Length
NS150	20	1200	3000K	1500mm

## NS100

### OPTIONS

Color	RAL9003
Beam angle	360°
CCT	2700K / 3000K / 4000K / 5000K/2700-5000K
CRI	90Ra
Electrical option	Non Dim / DALI / 1-10V / Zigbee

### Dimension (mm)

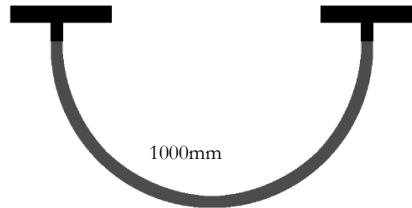

## NS150

### OPTIONS

Color	RAL9003
Beam angle	360°
CCT	2700K / 3000K / 4000K / 5000K/2700-5000K
CRI	90Ra
Electrical option	Non Dim / DALI / 1-10V / Zigbee

### Dimension (mm)

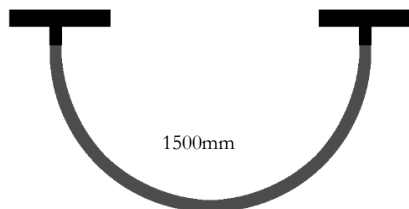



## **Curved Track Rail**

Except straight line track rail, curved or circle track rail is also customized in your project. The shape can be customized according to your request. Let's DIY it.

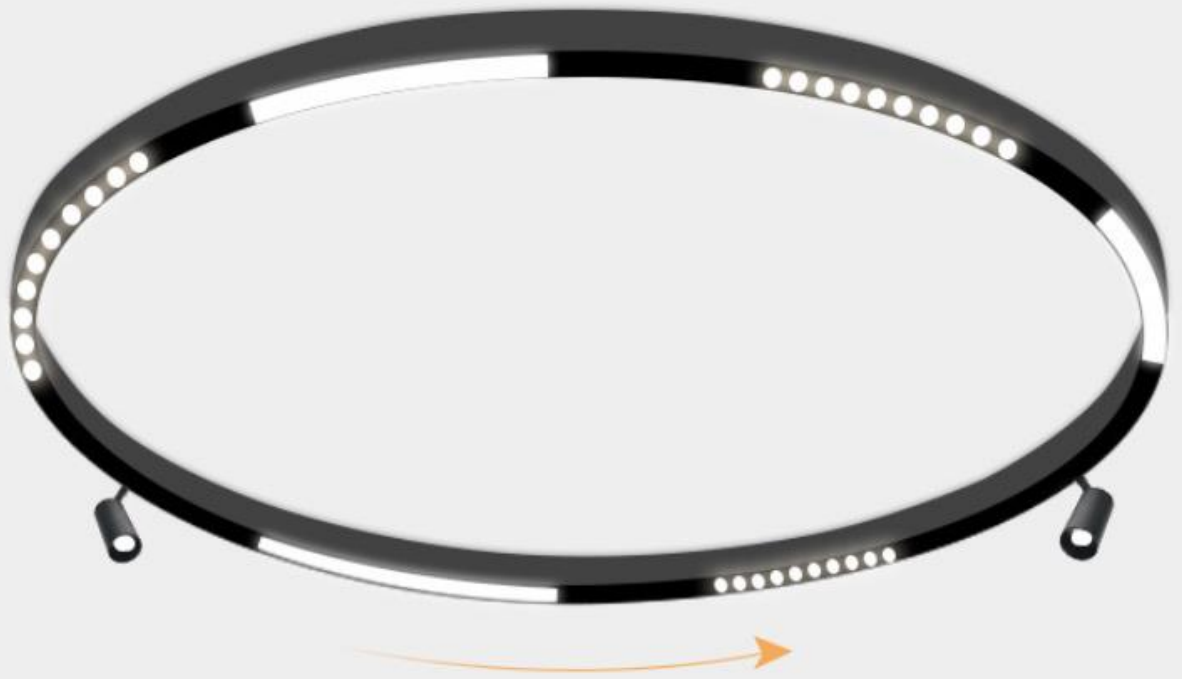

## **Circle Magnetic track rail**

There are 3 installation ways for the circle magnetic track rail: surface mounted, pendant and recessed installation. The standard diameter is 600mm, 900mm, 1200mm.



# Linear



DC  
48V

IP  
20

Osram



## MS180

### OPTIONS

Color RAL9004/RAL9003

Beam angle 120°

CCT 2700K / 3000K / 4000K / 5000K

CRI 90Ra

Electrical option Non Dim

Dimension L180\*W23\*H26mm

Model	W	LUM	CCT	CRI
-------	---	-----	-----	-----

MS180	6	360	3000K	90
-------	---	-----	-------	----

## MS360

### OPTIONS

Color RAL9004/RAL9003

Beam angle 120°

CCT 2700K / 3000K / 4000K / 5000K

CRI 90Ra

Electrical option Non Dim

Dimension L360\*W23\*H26mm

Model	W	LUM	CCT	CRI
-------	---	-----	-----	-----

MS360	12	720	3000K	90
-------	----	-----	-------	----

# Grille



DC  
48V

IP  
20

Osram



## MS06

### OPTIONS

Color	RAL9004/RAL9003
Beam angle	24°
CCT	2700K / 3000K / 4000K / 5000K
CRI	90Ra
Electrical option	Non Dim
Dimension	L180*W23*H26mm

Model	W	LUM	CCT	CRI
MS06	6	390	3000K	90



DC  
48V

IP  
20

Osram



## MS12

### OPTIONS

Color	RAL9004/RAL9003
Beam angle	24°
CCT	2700K / 3000K / 4000K / 5000K
CRI	90Ra
Electrical option	Non Dim
Dimension	L360*W23*H26mm

Model	W	LUM	CCT	CRI
MS12	12	780	3000K	90

# Spotlight



DC  
48V

IP  
20

Osra  
m



## R1045

### OPTIONS

Color	RAL9004/RAL9003
Beam angle	24°
CCT	2700K / 3000K / 4000K / 5000K
CRI	90Ra
Electrical option	Non Dim
Dimension	D45*H103mm

Model	W	LUM	CCT	CRI
R1045	10	650	3000K	90



DC  
48V

IP  
20

Osra  
m



## D03

### OPTIONS

Color	RAL9004/RAL9003
Beam angle	24°
CCT	2700K / 3000K / 4000K / 5000K
CRI	90Ra
Electrical option	Non Dim
Dimension	L35*W22*H45mm

Model	W	LUM	CCT	CRI
D03	3	300	3000K	90



**Topsund Lighting Co.,LTD**

**[www.topsund-led.com](http://www.topsund-led.com)**

**[info@topsund-led.com](mailto:info@topsund-led.com)**

**6Floor,Xinggong Road,Yutang street**

**Guangming District**