

FENCE

Warehouse



www.fencewarehouse.com.au



The Fence Warehouse story.....

We are a proud family owned and operated business with over 20 years experience in the fencing industry, a true one stop shop for all of your fencing needs.

Manufacturers - custom products including fencing, gates and posts. We work on the basis of any style, any height, any width, any colour. Our steel fencing and gates are made with pre galvanised steel, welded with silicon bronze. Quality, affordable and built to last all made in our Sunshine North facility.

Powder Coaters - in house powder coating for fast turn around. We are heavily quality focused and have a 6 tank pre treatment system and offer a large range of Dulux powder colours. We also have a large 9mtr long oven for extra long gates.

Importers & Wholesalers - We pride ourselves on attention to detail in all aspects of sourcing and supplying products. We look domestically and worldwide for factories with the skills and equipment capable of manufacturing the highest quality product at a competitive price. Our quality control team regularly visit our factories to ensure our high standards are always being met.

Project Orders - We can assist to plan and coordinate production of goods for projects. Our diverse supply chain coupled with careful quality control processes enables us to provide the highest quality custom made products delivered on time. From custom fabrication of steel fencing, gates, posts and fittings to supply of various types of glass including toughened clear, tint and acid etch glass, we can do it all.

DIY Specialists - We put together complete DIY kits for self install along with the right advice to get the job done right. Products have been designed with installation considerations in mind to ensure they are as easy to install as possible to save you time on site. Materials can be delivered nationwide. Online orders can be placed on our easy to use website www.fencewarehouse.com.au

Installation - Not up to doing it yourself? We can come to site and provide a quote to supply and install any of our fencing products (Melbourne metro only)

Showroom - feel free to visit our Sunshine North showroom Mon - Fri 8am - 4pm

INDEX

ALUMINIUM POOL FENCING.....	3
POOL FENCING COMPONENTS 4-5.....	4-5
GLASS POOL FENCING.....	6-9
GLASS BALUSTRADE.....	10
STEEL FENCING.....	12
STEEL POSTS.....	13
STEEL FENCING STYLES.....	14-22
STEEL PICKET FENCING.....	23
STEEL SECURITY FENCING.....	24
PREMIUM PERFORATED MESH FENCING.....	25
BLADE ALUMINIUM FENCING.....	26
BLADE POOL FENCING.....	26
VERTICAL BATTEN STEEL FENCING.....	27
VERTI-BLADE FENCING.....	28
SLAT SCREENING.....	30-31
EPIC FENCING.....	32
HAMPTONS FENCING.....	33
FENCING COMPONENTS.....	34-37

FENCE Warehouse

Factory & Showroom: 17 Hawthorn Ave Sunshine North Vic 3020

Ph: 1300 FENCEWARE (1300 336 239)

E: sales@fencewarehouse.com.au

W: www.fencewarehouse.com.au



Pool Fencing
Compliant!
AS 1926.1-2012

SPECIFICATIONS

- Available in Flat top, Picket, Loop and Spear top
- Can be powder coated any standard colour
- Excellent visibility
- Corrosion resistant, low maintenance
- Raked panels also available
- Matching gates available
- 6 Weld points per picket
- Pickets: 16mm diameter x 1.2mm
- Spacings: 72.1 mm gap
- 88.1 mm centres
- Rails: 38mm x 25mm x 1.6mm
- Compliant to AS1926.1-2012
- Mitred top corners on gate

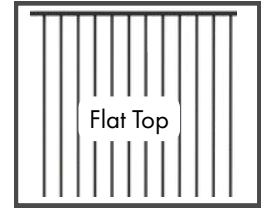

Available in -
Genuine Dulux Powder Coat
Other Colours Available on Request

BLACK

MONUMENT

TECHNICAL INFO

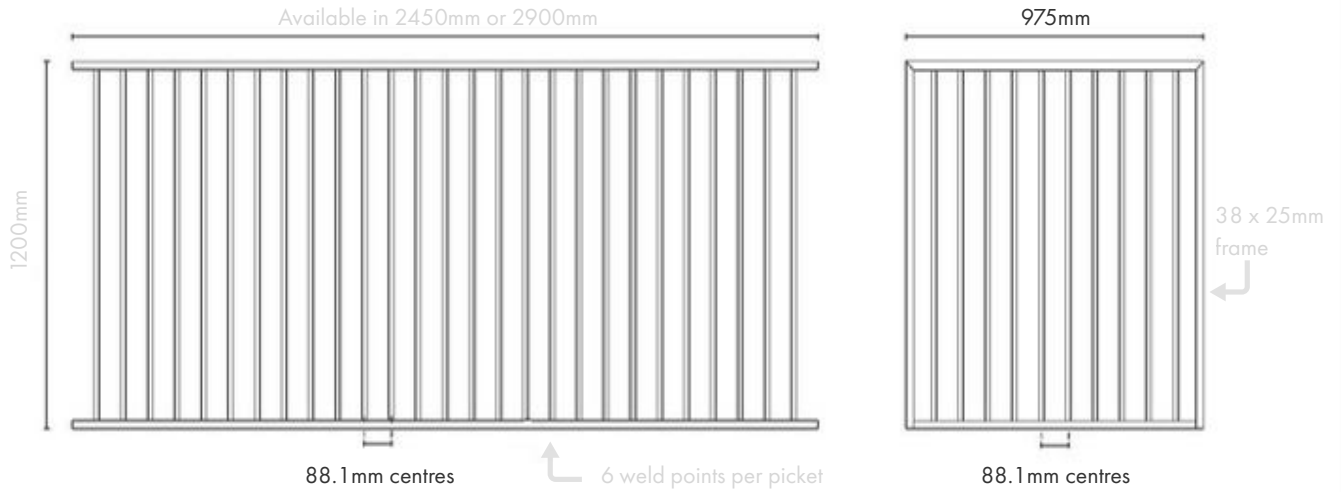

FLAT TOP ALUMINIUM POOL FENCE PANELS

Order Code	Height	Width	Picket Size	Picket Spacing	Centres	Rails
FW-SS-FTP-2450-B/MN	1200mm	2450mm	16mm x 1.2mm	72.1 mm gaps	88.1 mm	38mm x 25mm x 1.6mm
FW-SS-FTP-2900-B/MN	1200mm	2900mm	16mm x 1.2mm	72.1 mm gaps	88.1 mm	38mm x 25mm x 1.6mm

FLAT TOP ALUMINIUM POOL GATE

Order Code	Height	Width	Picket Size	Picket Spacing	Centres	Rails
FW-SS-FTG-0975-B/MN	1200mm	975mm	16mm x 1.2mm	72.1 mm gaps	88.1 mm	38mm x 25mm x 1.6mm

Face Mount Lockable Latch
Order Code: FW-MR-FML-SL



Top Pull Lockable Magna Latch
Order Code: FW-ML-TL



Magna Latch with Kwik Fit Hinge Pair
Order Code: FW-ML-TL-KF-H-FT



Lokk Latch Deluxe
Order Code: FW-LL-DL

- Keyed to Differ

 Order Code: FW-DL-KA

- Keyed Alike



Magna Latch with Tru Close Hinge Pair
Order Code: FW-ML-TL-TC-H-AT



Kwik Fit Fixed Tension Hinges
Order Code: FW-KF-H-FT



Tru Close Gate Hinge (2 Alignment Legs)
Order Code: FW-TC-H-AT-2L-B

- (2 Alignment Legs)



Tru Close Gate Hinge Heavy Duty
Order Code: FW-TC-H-AT-HD-2L-B

- (2 Alignment Legs)



CLICK FOR
TECH SPECS

D Latch and Striker

Order Code: FW-DLS-G

- Zinc

Order Code: FW-DLS-B

- Black



Aluminium Post with Welded Base Plate

Order Code: FW-SS-1300-BP

- 1300mmH

Order Code: FW-SS-1600-BP

- 1600mmH Gate Latch Post

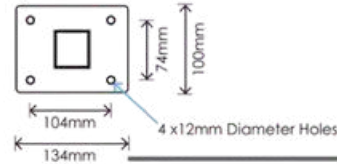

Aluminium Full Post

Order Code: FW-XP-6000-FP

- 50x50mm x 6000mml

Order Code: FW-XP-2400-65FP

- 65x65mm x 2400mml

Order Code: XP-6000-65FP

- 65x65mm x 6000mml

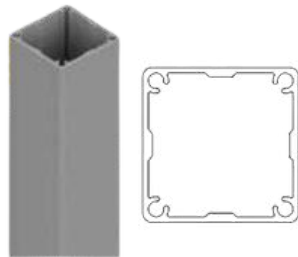

Aluminium In Ground Post

Order Code: FW-SS-1800

- 1800mmH

Order Code: FW-SS-2100

- 2100mmH Gate Latch Post

- 50 x 50mm
- 1.8mm Wall Thickness



Rail Brackets Aluminium Single Lug (Pk 4)

Order Code: FW-SS-BH4-B

- 38 x 25mm



Post Base Plate Set

Order Code: FW-XP-BP-SET

- To Suit 50 x 50mm

Order Code: FW-XP-65BP-SET

- To Suit 65 x 65mm



Rail Brackets Steel Double Lug

Order Code: FW-RBDL-3825B

- Black

Order Code: FW-RBDL-3825G

- Galvanised

- 38 x 25mm



Post Dress Ring

Order Code: FW-XP-DR

- To Suit 50mm Post

Order Code: FW-XP-65DR

- To Suit 65mm Post

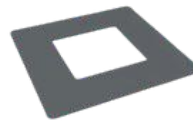

Post Flat Top Plate

Order Code: FW-XP-TP

- To Suit 50mm Post

Order Code: FW-XP-65TP

- To Suit 65mm Post



CLICK FOR
TECH SPECS



GLASS PANELS

- 12mm thick clear toughened
- 5mm radius corners
- Suits friction spigots
- No hole toughened glass
- Superior edge finishing
- Grade 'A' toughened glass
- Australian standards compliant
- AS/NZS2208
- Corner protectors in packing
- Available in widths from 200-2000mm
 - In 50mm increments

FRICION SPIGOT RANGE

Insuluxe spigot

Core drill & base plated



- Durable insulating barrier
 - precisely formed over premium SS2205 stainless steel
- Silver gloss, matt black or matt white finish
- High technology insulated pool fencing
- Tapered, anti-toe-hold top design

Pool Madrid range

SS2205
Core drill



- Duplex stainless steel 2205
- Polish, satin or matt black finish
- Recessed friction plate for ease of installation
- Single friction
- Specifically designed for pool fence load requirements

Lifestyle range

SS2205

Patented DOUBLE FRICTION
Core drill & base plated



- Square spigots available
- Duplex stainless steel 2205
- Polish, satin or matt black finish
- Base plate has multiple fixing points for ease of installation
- Domatic cover included
- Double friction assists glass panel alignment

Versa-tilt

Anodised Aluminium
Deck mount or face mount
Glass tilt adjustable



- Clear anodised internal aluminium channel to guard against corrosion
- Bushed satin, black anodised, or mill finish aluminium covers
- Tilt adjustable glazing channel
- Pre-matched fixing holes in channel
- Deck or face mount options

HINGES

Master Range

A complete range of hinges to suit a large range of applications



Polaris Soft Close Series 155

A complete retro-fit series



Atlantic Soft Close Series 530

Premium soft close hinges with a modern and contemporary look



Polaris Soft Close Series 125

Premium hinges to suit a range of installations



LATCHES

Master Range or Atlantic gate latch ranges



Versatile & interchangeable

- Glass to glass, glass to wall & post or 90 degree corner

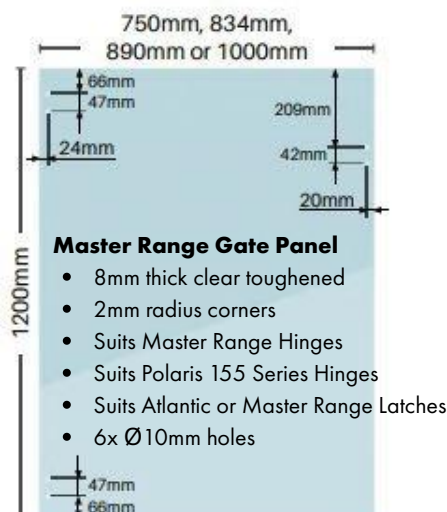

*Hole positions shown to centre of hole

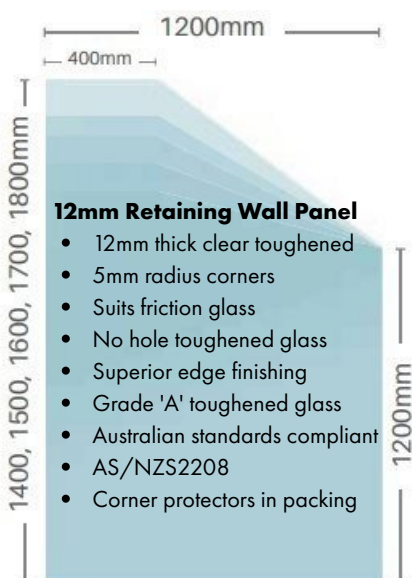
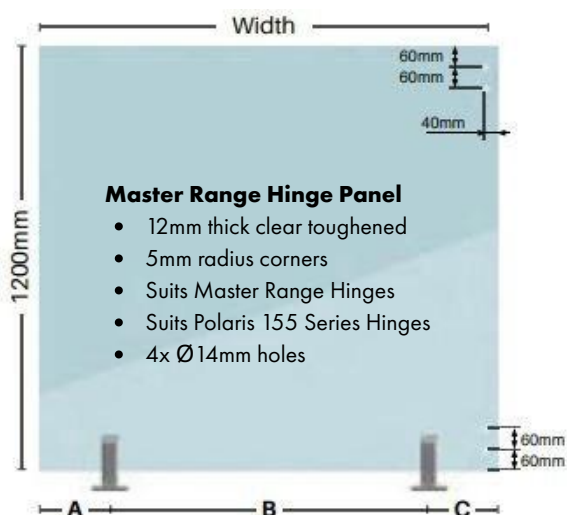

Master Range Gate Panel

Order Code	Width	Height	Sqm	Weight
FW-08SLG-0750	750mm	1200mm	0.90	18kg
FW-08SLG-07834	834mm	1200mm	1.00	20kg
FW-08SLG-0890	890mm	1200mm	1.07	21kg
FW-08SLG-1000	1000mm	1200mm	1.20	24kg

Master Range Hinge Panel

Order Code	Width	Height	Sqm	Weight
FW-12NH-0600	600mm	1200mm	0.72	22kg
FW-12NH-0800	800mm	1200mm	0.96	29kg
FW-12NH-1000	1000mm	1200mm	1.20	36kg
FW-12NH-1100	1100mm	1200mm	1.32	40kg
FW-12NH-1200	1200mm	1200mm	1.44	43kg
FW-12NH-1300	1300mm	1200mm	1.56	47kg
FW-12NH-1400	1400mm	1200mm	1.68	50kg
FW-12NH-01500	1500mm	1200mm	1.80	54kg
FW-12NH-1600	1600mm	1200mm	1.92	58kg
FW-12NH-1700	1700mm	1200mm	2.04	61kg
FW-12NH-1800	1800mm	1200mm	2.16	65kg

12mm Retaining Wall Panel

Order Code	Width	Height	Sqm	Weight
FW-12NRP-1400HT	1200mm	1400mm	1.60	48kg
FW-12NRP-1500HT	1200mm	1500mm	1.68	50kg
FW-12NRP-1600HT	1200mm	1600mm	1.76	53kg
FW-12NRP-1700HT	1200mm	1700mm	1.84	55kg
FW-12NRP-1800HT	1200mm	1800mm	1.92	58kg

To be compliant to pool fencing requirements, raked panels may be needed

- Overcome different levels along fence line
- Overcome landscaping as a toe hold along fence line
- Overcome stepping point issues around fence line

12mm Soft Close Gate Panel

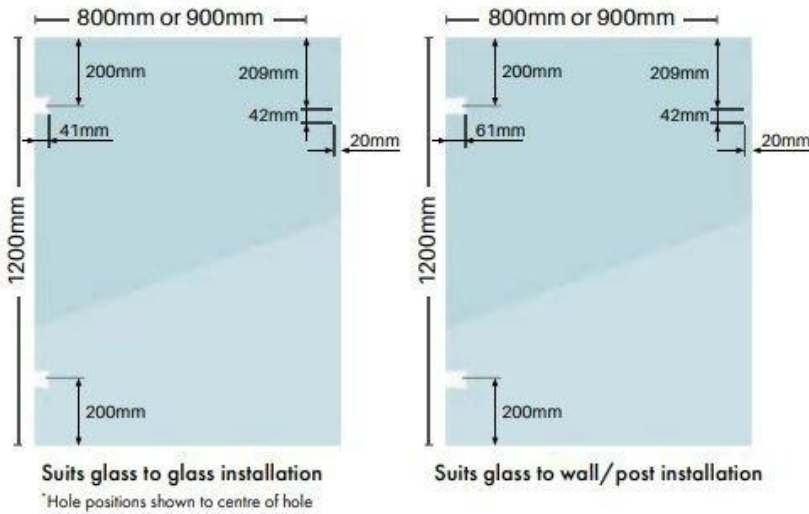

- 12mm thick clear toughened
- 5mm radius corners
- 2x hinge cut outs
- 2 x Ø12mm holes
- Suits Polaris 125 or Atlantic 530 Series hinges

Glass to Glass Application

Order Code	Width	Height	Sqm	Weight
FW-12PGG-0800	800mm	1200mm	0.96	29kg
FW-12PGG-0900	900mm	1200mm	1.08	32kg

Glass to Wall/Post Application

Order Code	Width	Height	Sqm	Weight
FW-12PWG-0800	800mm	1200mm	0.96	29kg
FW-12PWG-0900	900mm	1200mm	1.08	32kg

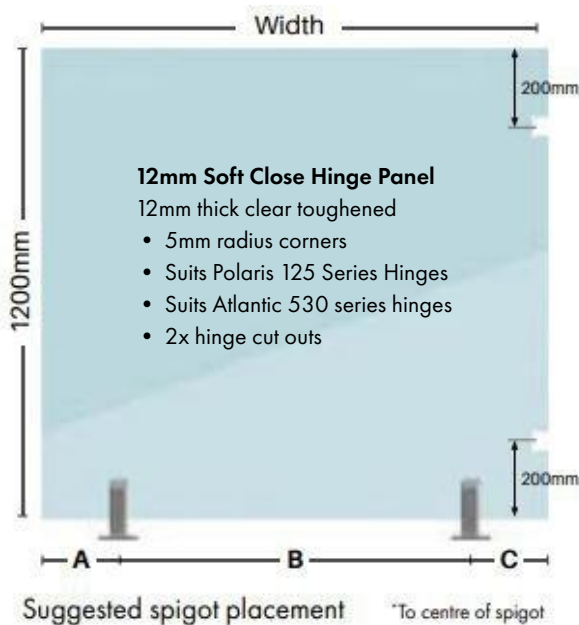

12mm Soft Close Hinge Panel

Order Code	Width	Height	Sqm	Weight
FW-12NPH-0600	600mm	1200mm	0.72	22
FW-12NPH-0800	800mm	1200mm	0.96	29
FW-12NPH-1000	1000mm	1200mm	1.20	36
FW-12NPH-1100	1100mm	1200mm	1.32	40
FW-12NPH-1200	1200mm	1200mm	1.44	43
FW-12NPH-1300	1300mm	1200mm	1.56	47
FW-12NPH-1400	1400mm	1200mm	1.68	50
FW-12NPH-1500	1500mm	1200mm	1.80	54
FW-12NPH-1600	1600mm	1200mm	1.92	58
FW-12NPH-1700	1700mm	1200mm	2.04	61
FW-12NPH-1800	1800mm	1200mm	2.16	65

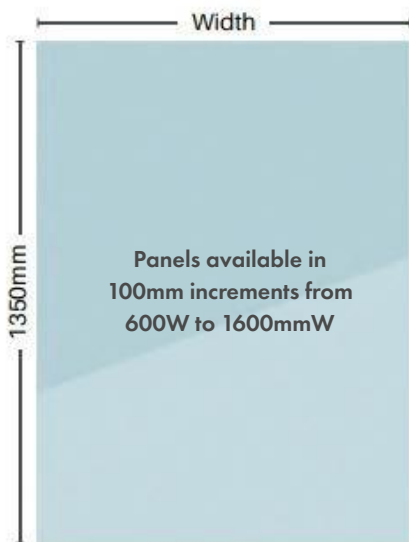

12mm Clearglaze Glass

- Minimalist look
- Glass is grouted directly into the ground
 - Removes the need for spigots
- Available in range of widths from 600 to 1600mm
 - in 100mm increments
- 1350mmH panels

SS316 FRICTION FIT RIGI CLAMPS

Small rigi clamp

Polish, satin or matt black finish



- Suits 12mm glass
- Ideal for panels with 20-50mm gaps

Large rigi clamp

Polish, satin, matt black or matt white finish



- Suits 12mm glass
- Ideal for panels with 20-95mm gaps

90 degree rigi clamp

Polish, satin, matt black or matt white finish



- Suits 12mm glass
- Bracing of glass panels at 90 degrees

Wall rigi clamp

Polish, satin, matt black or matt white finish



- Suits 12mm glass
- Brace glass to walls/posts
- 2x countersunk fixing holes to wall/post

Offset wall rigi clamp

Polish, satin or matt black finish



- Suits 12mm glass
- Brace glass to walls/posts
- Easy install with offset fixing
 - clamp can be added after glass is installed
- Rotate for left or right side fixing
- 1x countersunk hole for fixing to w/p

Swivel rigi clamp

Polish, satin or matt black finish



- Suits 12mm glass
- Multi angle rigi clamp
 - great for variable angle installs

SS205 GLASS CLAMPS

Square front, flat or round back

Polish, satin or matt black finish



D front, flat or round back

Polish, satin or matt black finish



- Gaskets included to suit 8mm, 10mm, or 12mm glass
- Gaskets made from EDPM
- Round back suits Ø50mm round posts

GLASS STANDOFFS



2x Ø5mm holes
M12 centre thread

Ø38mm x 25mm body



Ø38mm x 45mm body



Standoff diameter
Ø38mm

Recommended glass hole size
Ø20mm



2x Ø6.5mm holes
2x 7x12mm slots
M12 centre thread

Ø50mm x 20mm



Ø50mm x 30mm



Ø50mm x 50mm



Standoff diameter
Ø50mm

Recommended glass hole size
Ø20-22mm

15mm Heat Soaked Frameless Balustrade Glass Panels (With No Holes)

- 15mm clear toughened and heat soaked
- 2mm radius corners
- No holes in glass
- Superior flat polish edge finishing
- Grade 'A' toughened glass
- Australian standards AS/NZS2208 compliant

SPECIFICATIONS

- 1000mmH
- Available in 300mmW to 1400mmW in 50mm increments



Order Code	Width	Height	Sqm	Weight
FW-1000FBG-0300	300mm	1000mm	0.30	11kg
FW-1000FBG-0350	350mm	1000mm	0.35	13kg
FW-1000FBG-0400	400mm	1000mm	0.40	15kg
FW-1000FBG-0450	450mm	1000mm	0.45	17kg
FW-1000FBG-0500	500mm	1000mm	0.50	19kg
FW-1000FBG-0550	550mm	1000mm	0.55	21kg
FW-1000FBG-0600	600mm	1000mm	0.60	23kg
FW-1000FBG-0650	650mm	1000mm	0.65	24kg
FW-1000FBG-0700	700mm	1000mm	0.70	26kg
FW-1000FBG-0750	750mm	1000mm	0.75	28kg
FW-1000FBG-0800	800mm	1000mm	0.85	30kg

Order Code	Width	Height	Sqm	Weight
FW-1000FBG-0850	850mm	1000mm	0.85	32kg
FW-1000FBG-0900	900mm	1000mm	0.90	34kg
FW-1000FBG-0950	950mm	1000mm	0.95	36kg
FW-1000FBG-1000	1000mm	1000mm	1.00	38kg
FW-1000FBG-1050	1050mm	1000mm	1.05	39kg
FW-1000FBG-1100	1100mm	1000mm	1.10	41kg
FW-1000FBG-1150	1150mm	1000mm	1.15	43kg
FW-1000FBG-1200	1200mm	1000mm	1.20	45kg
FW-1000FBG-1250	1250mm	1000mm	1.25	47kg
FW-1000FBG-1300	1300mm	1000mm	1.30	49kg
FW-1000FBG-1350	1350mm	1000mm	1.35	51kg
FW-1000FBG-1400	1400mm	1000mm	1.40	53kg

SPIGOTS

Square core drill spigot

Order Code: FW-MADDEL-S
FRICTION FIT



- 60x45mm profile suits balustrade load & deflection requirements
- M10 threaded height adjustment rod
- Specially designed friction plate maximises glass clamping surface area
- Available in: Polish, satin, matt black or matt white
- Suits 15mm to 17.52mm thick glass
- No toe hold contemporary design
- Duplex Stainless steel 2205

Square base plated spigot

Order Code: FW-MADDEL-SBP
FRICTION FIT



- 60x45mm profile suits balustrade load & deflection requirements
- Integrated 100x100mm base plate featuring 4 countersunk fixing holes
- Glass recesses 120mm into spigot throat to maximise clamping area
- Available in: Polish, satin, matt black or matt white
- Suits 15mm to 17.52mm thick glass
- No toe hold contemporary design
- Duplex Stainless steel 2205

Square core drill spigot

Order Code: FW-MADDEL-TF
FRICTION FIT



SS205 M12 fixing nut

- Top fix spigot installed with single central M12 fixing nut
- 60x50mm structure (with 45mm visual face)
- Glass recesses 120mm into spigot area to maximise clamping area
- Available in: Polish, satin, matt black or matt white
- Suits 15mm to 17.52mm thick glass
- No toe hold contemporary design
- Duplex Stainless steel 2205

ACCESSORIES

Dress ring

Order Code: FW-MADDEL-DR

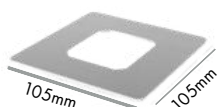

- 105x105mm Outer
- 2mm thick flat dress ring
- Stainless steel marine grade 316

Square slimline domical cover

Order Code: FW-MADDEL-SDC

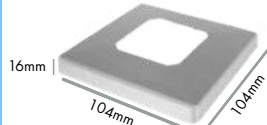

- 104x104x16mm high
- Suits use with countersunk fixings
- Stainless steel marine grade 316

High domical base plate cover

Order Code: FW-MADDEL-HDC

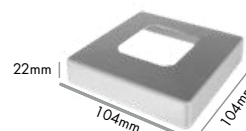

- 104 x 104 x 22mm high
- Suits most M10 or M12 hex nuts
- Stainless steel marine grade 316

Height adjustment packer

Order Code: FW-MADDEL-TFPCR

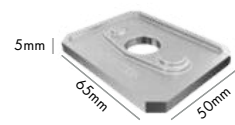

- Sits under top fix spigot
- Packers can be stacked
- Stainless steel SS2205

Deluxe Nanorail

Top glaze deluxe nanorail rectangular handrail

Order Code: FW-STG-R5800-DELUXE

- RHS 30mmW x 21mmH
 - 5800mmL

- Stainless steel 316L railing
- 18mmW x 14mmH glazing slot
- Suits 15mm thick glass
- Silicon glaze glass or use with glazing rubber
- Polish or satin finish

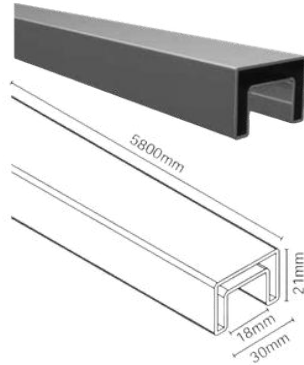

End cap

Order Code:
FW-STG-DELUXE-EC



- Polish or stain finish
- 31mmW x 22mmH
- End cap fits internal of rail leaving vertical surface of end cap visible

Wall plate

Order Code: FW-STG-DELUXE-WP

- Polish or stain finish
- 36mmW x 55mmH x 22.5mmD



Offset wall plate

Order Code: FW-STG-DELUXE-WPEXT

- Polish or stain finish
- 82mmW x 28mmH



Rigid PVC glazing rubber

Order Code: FW-STG-DELUXE-GR



- Black Nylon
- 2900mmL
- Suits 15mm thick glass with Nanorail deluxe
- Glazing rubber fits over glass with rail then pressed on
- 2x lengths required per handrail

Joiner

Order Code: FW-STG-DELUXE-J



- Polish or satin finish
- 104mmW x 22mmH
- Inline joiner
- Fits internal of rails with 4mm visible join on 3 sides (T,L,R)
- 4mm join matches finish of

90 degree joiner

Order Code: FW-STG-DELUXE-90J



- Polish or satin finish
- 85mmW x 85mmL x 22mmH
- 90 degree joiner
- Fits internal of rails with 35x35mm visible corner join

Horizontal adjustable joiner

Order Code: FW-STG-DELUXE-HJA



- Polish or satin finish
- 85mmW x 22mmH
- Horizontal adjustable inline joiner
- Fits internal of rails with exposed swivel section
- Adjusts 45 degrees left and right from inline/180 degree

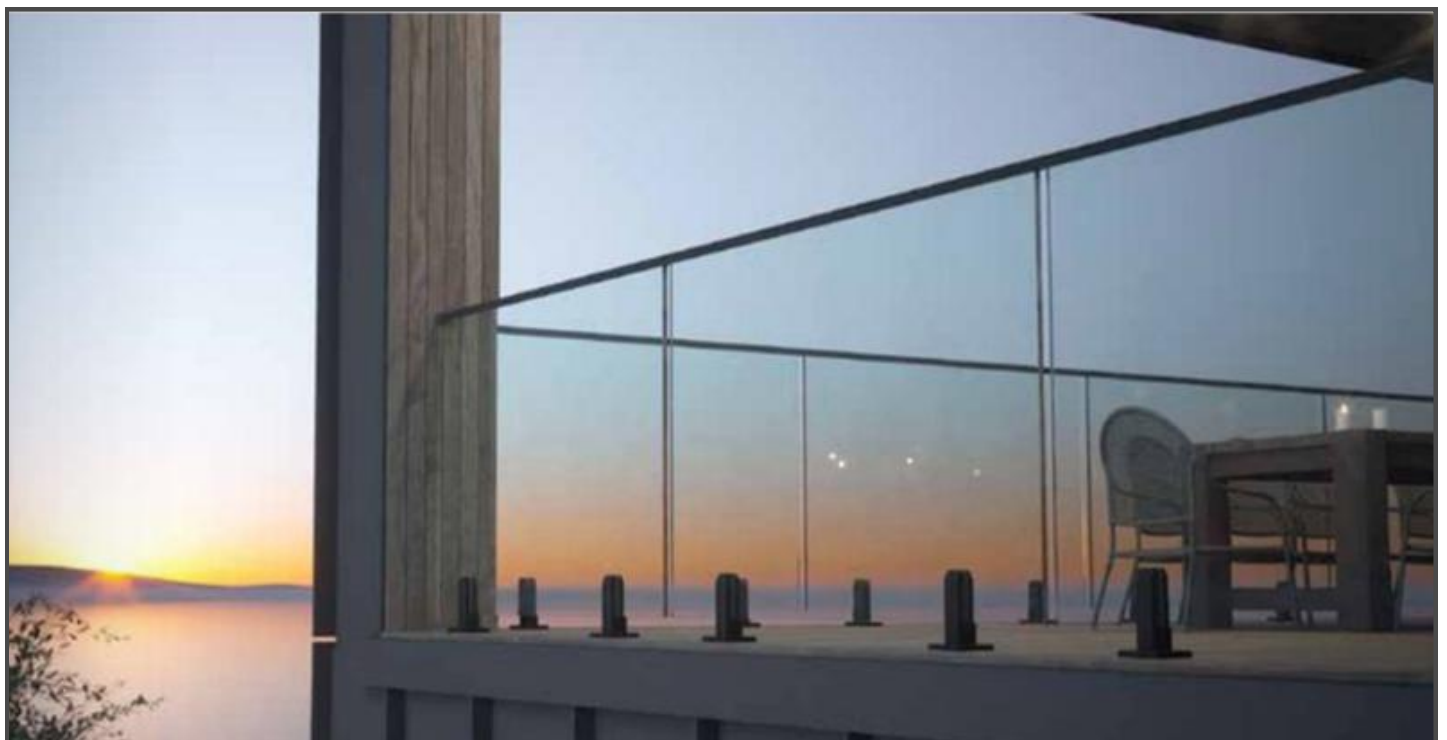

FENCE PANELS AND GATES

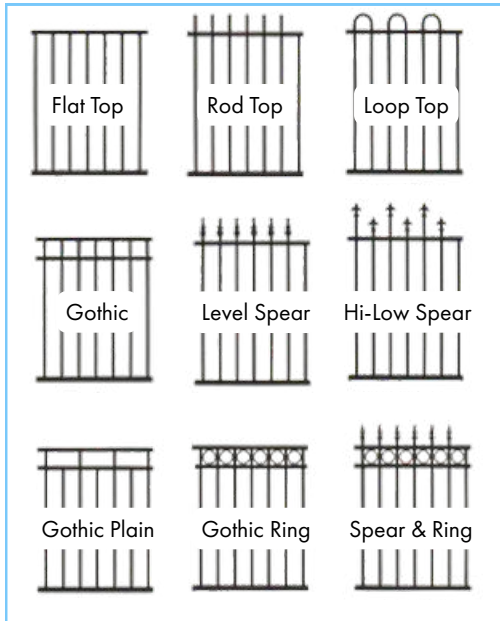

- Fabricated and powder coated in Sunshine North
- Pre Galvanised Tubular Steel
- Welded with Silicon Bronze
- 19mm x 1.2mm round pickets
- 90mm gaps between the pickets (109mm centres)
- 38mm x 25mm x 1.6mm punched rails
- Custom sizes - any height & any length
- Matching swing and sliding gates
- Sliding gates up to 9000mm long
- Custom raked, curved and tapered panels available
- Powder coated any standard stocked colour



Optional Spears

OPTIONAL

- 20mm x 20mm pickets
- 25mm x 25mm pickets
- 40mm x 40mm rails
- 50mm x 50mm rails
- Face welded pickets
- Custom project order specialists

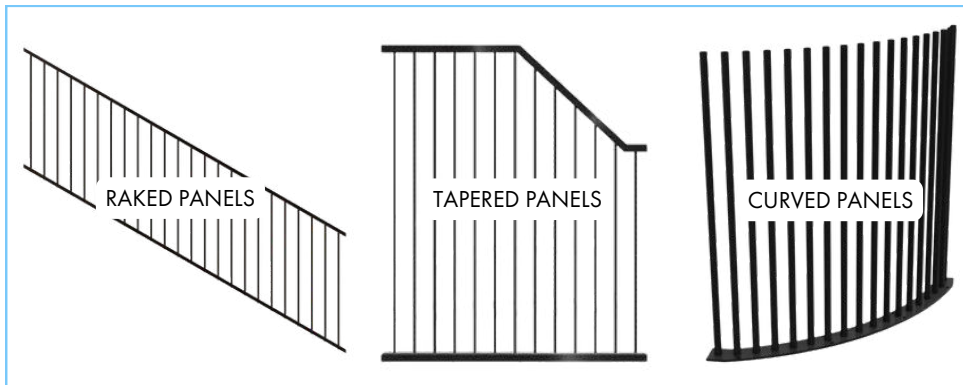

Custom made tubular steel fencing, fabricated and powder coated to your specifications, in house, at our facility in Sunshine North

Key Lock Handle

Order Code: FW-L40-C



- Stylish lever lock set
- Can be keyed alike
- 304 stainless steel
- Suits 40mm x 40mm side frame

Lokk Latch Deluxe

Order Code: FW-L-LLD



- Operates and locks from both sides of gate
- Easy, fast installation
- Fits fence posts 38-150mm deep
- Industrial strength polymer
- Marine grade stainless construction

D Latch & Striker

Order Code: FW-L-DL



- Pad-lockable
- Ideal for boundary, garden & driveway gates

Double Lug Rail Brackets

Order Code: FW-SS-BH-B-1

- Suits 40mm x 40mm rails



Order Code: FW-SS-B3835DL-B

- Suits 38mm x 25mm rails

Letterboxes

Order Code: FW-MB109

- Galvanised steel
- Easy installation
- Key lockable rear flap
- Custom powder coat colours available
- 300mmH x 230mmW x 240mmD



Order Code: FW-MB101

- Stainless steel face with galvanised steel box
- Easy installation
- Key lockable rear flap
- Custom powder coat colours available
- 405mmH x 205mmW x 240mmD



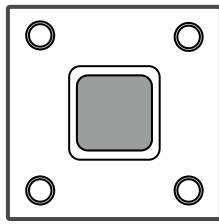
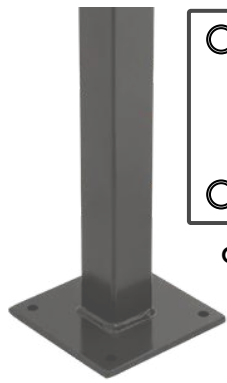

CENTRE WELD

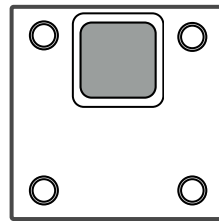

OFFSET WELD

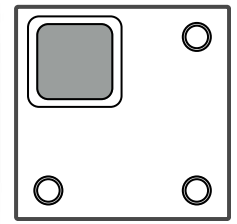
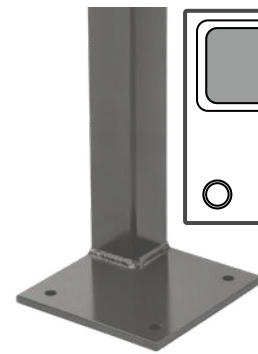

**CORNER
OFFSET WELD**

POST WALL THICKNESS



POST CAPS

STEEL POST SIZE	1.6mm	2mm	2.5mm	3mm	FLAT	BALL	DECOR	VICTORIAN
40mm x 40mm	✓	✓	x	x	✓	x	x	x
50mm x 50mm	✓	✓	✓	x	✓	✓	x	x
65mm x 65mm	✓	✓	✓	x	✓	✓	✓	x
75mm x 75mm	✓	✓	✓	✓	✓	✓	✓	x
90mm x 90mm	x	✓	✓	x	✓	x	x	x
100mm x 100mm	x	✓	✓	✓	✓	✓	x	✓

*Other sizes available on request

STEEL POST PLATE SIZES - ZINC PLATED - 13mm HOLES

Steel Post Plate Size	Product Code
113 x 55 x 5mm	FW-BP113555R
120 x 65 x 5mm	FW-BP120655R
130 x 75 x 5mm	FW-BP130755R
130 x 90 x 5mm	FW-BP130905R
150 x 65 x 5mm	FW-BP150655R
150 x 75 x 5mm	FW-BP150755R
150 x 90 x 5mm	FW-BP15905R
150 x 100 x 5mm	FW-BP1501005R
160 x 80 x 5mm	FW-BP160805R
200 x 100 x 5mm	FW-BP2001005R

2 HOLE PLATES

Steel Post Plate Size	Product Code
100 x 100 x 5mm	FW-BP1001005R
100 x 100 x 8mm	FW-BP1001008R
125 x 125 x 8mm	FW-BP1251258R
130 x 130 x 5mm	FW-BP1301305R
130 x 130 x 8mm	FW-BP1301308SQ
150 x 150 x 8mm	FW-BP1501508SQ
170 x 170 x 8mm	FW-BP1701708SQ
200 x 200 x 8mm	FW-BP2002008R
250 x 250 x 10mm	FW-BP25025010R
300 x 300 x 10mm	FW-BP30030010R

4 HOLE PLATES

R = Round Edge Corners

SQ = Square Edge Corners



- Custom widths and heights available
- Inground and Base plated posts
- Pre galvanised tubular steel
- Compliant to AS1926.1-2012
- Matching gates available
 - Double, swing and sliding gate options



**Pool Fencing
Compliant!
AS 1926.1-2012**

Available in -
Genuine Dulux Powder Coat
Other Colours Available on Request

BLACK

TECHNICAL INFO

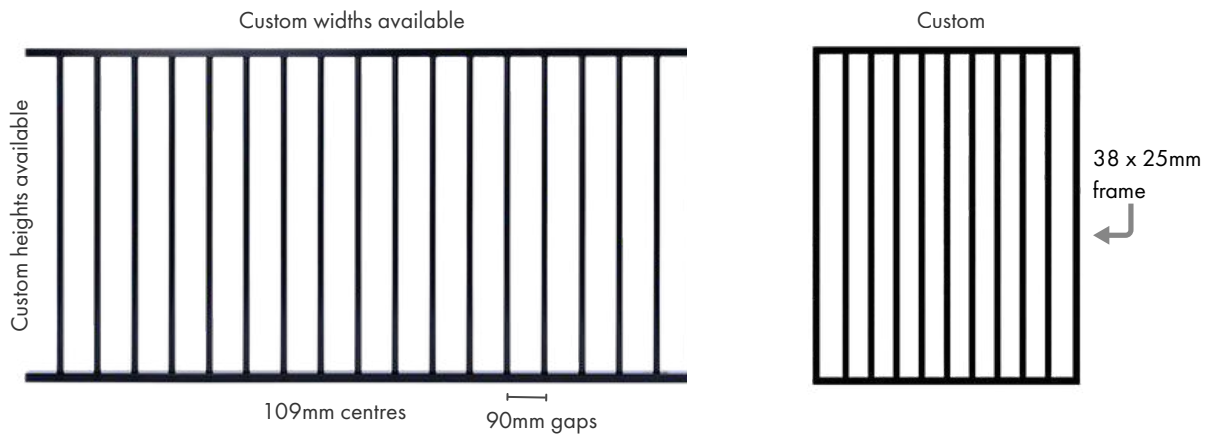

FLAT TOP STEEL FENCE PANELS

Order Code	Height	Width	Picket Size	Picket Spacing	Centres	Rails
FW-SF-FLAT-900	900mm	Any	19mm x 1.2mm	90mm Gaps	109mm	38mm x 25mm x 1.6mm
FW-SF-FLAT-1200	1200mm	Any	19mm x 1.2mm	90mm Gaps	109mm	38mm x 25mm x 1.6mm
FW-SF-FLAT-1500	1500mm	Any	19mm x 1.2mm	90mm Gaps	109mm	38mm x 25mm x 1.6mm
FW-SF-FLAT-1800	1800mm	Any	19mm x 1.2mm	90mm Gaps	109mm	38mm x 25mm x 1.6mm

FLAT TOP STEEL GATES

Order Code	Gate Type	Height	Width	Picket Size	Picket Spacing	Centres	Rails
FW-SFSG-FLAT-HEIGHT	Single	Any	Any	19mm x 1.2mm	90mm Gaps	109mm	38mm x 25mm x 1.6mm
FW-SFDG-FLAT-HEIGHT	Double	Any	Any	19mm x 1.2mm	90mm Gaps	109mm	38mm x 25mm x 1.6mm
FW-SFSG-FT-HEIGHT	Sliding	Any	Any	19mm x 1.2mm	90mm Gaps	109mm	38mm x 25mm x 1.6mm



- Custom heights and widths available
- Inground and base plated post options
- Pre galvanised tubular steel
- Compliant to AS1926.1-2012
- Matching gates available
 - Double, swing and sliding gates



**Pool Fencing
Compliant!
AS 1926.1-2012**

Available in -
Genuine Dulux Powder Coat
Other Colours Available on Request

BLACK

TECHNICAL INFO

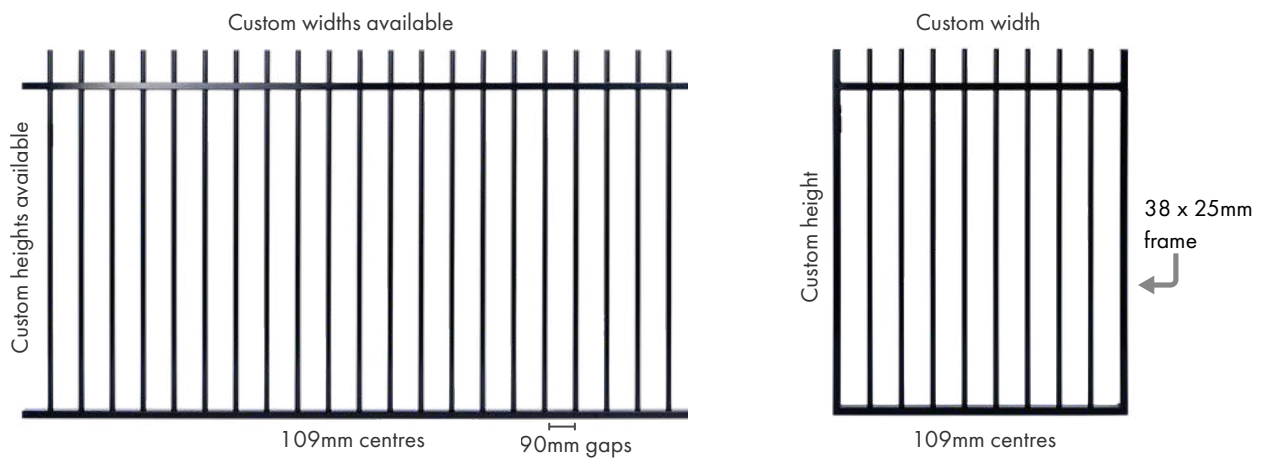

ROD TOP STEEL FENCE PANELS

Order Code	Height	Width	Picket Size	Picket Spacing	Centres	Rails
FW-SF-RODTOP-900	900mm	Any	19mm x 1.2mm	90mm Gaps	109mm	38mm x 25mm x 1.6mm
FW-SF-RODTOP-1200	1200mm	Any	19mm x 1.2mm	90mm Gaps	109mm	38mm x 25mm x 1.6mm
FW-SF-RODTOP-1500	1500mm	Any	19mm x 1.2mm	90mm Gaps	109mm	38mm x 25mm x 1.6mm
FW-SF-RODTOP-1800	1800mm	Any	19mm x 1.2mm	90mm Gaps	109mm	38mm x 25mm x 1.6mm

ROD TOP STEEL GATES

Order Code	Gate Type	Height	Width	Picket Size	Picket Spacing	Centres	Rails
FW-SFSG-RT-HEIGHT	Single	Any	Any	19mm x 1.2mm	90mm Gaps	109mm	38mm x 25mm x 1.6mm
FW-SFDG-RT-HEIGHT	Double	Any	Any	19mm x 1.2mm	90mm Gaps	109mm	38mm x 25mm x 1.6mm
FW-SFSLG-RT-HEIGHT	Sliding	Any	Any	19mm x 1.2mm	90mm Gaps	109mm	38mm x 25mm x 1.6mm



- Custom heights and widths available
- Inground and base plated post options
- Pre galvanised tubular steel
- Compliant to AS1926.1-2012
- Matching gates available
 - Double, swing and sliding gates



**Pool Fencing
Compliant!
AS 1926.1-2012**

Available in -
Genuine Dulux Powder Coat
Other Colours Available on Request

BLACK

TECHNICAL INFO

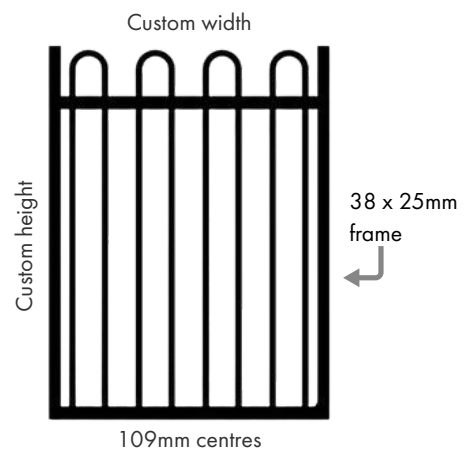

LOOP TOP STEEL FENCE PANELS

Order Code	Height	Width	Picket Size	Picket Spacing	Centres	Rails
FW-SF-LOOP-900	900mm	Any	19mm x 1.2mm	90mm Gaps	109mm	38mm x 25mm x 1.6mm
FW-SF-LOOP-1200	1200mm	Any	19mm x 1.2mm	90mm Gaps	109mm	38mm x 25mm x 1.6mm
FW-SF-LOOP-1500	1500mm	Any	19mm x 1.2mm	90mm Gaps	109mm	38mm x 25mm x 1.6mm
FW-SF-LOOP-1800	1800mm	Any	19mm x 1.2mm	90mm Gaps	109mm	38mm x 25mm x 1.6mm

LOOP TOP STEEL GATES

Order Code	Gate Type	Height	Width	Picket Size	Picket Spacing	Centres	Rails
FW-SFSG-LOOP-HEIGHT	Single	Any	Any	19mm x 1.2mm	90mm Gaps	109mm	38mm x 25mm x 1.6mm
FW-SFDG-LOOP-HEIGHT	Double	Any	Any	19mm x 1.2mm	90mm Gaps	109mm	38mm x 25mm x 1.6mm
FW-SFSG-LT-HEIGHT	Sliding	Any	Any	19mm x 1.2mm	90mm Gaps	109mm	38mm x 25mm x 1.6mm



- Custom heights and widths available
- Inground and base plated post options
- Pre galvanised tubular steel
- Compliant to AS1926.1-2012
- Matching gates available
 - Double, swing and sliding gates



**Pool Fencing
Compliant!
AS 1926.1-2012**

Available in -
Genuine Dulux Powder Coat
Other Colours Available on Request

BLACK

TECHNICAL INFO

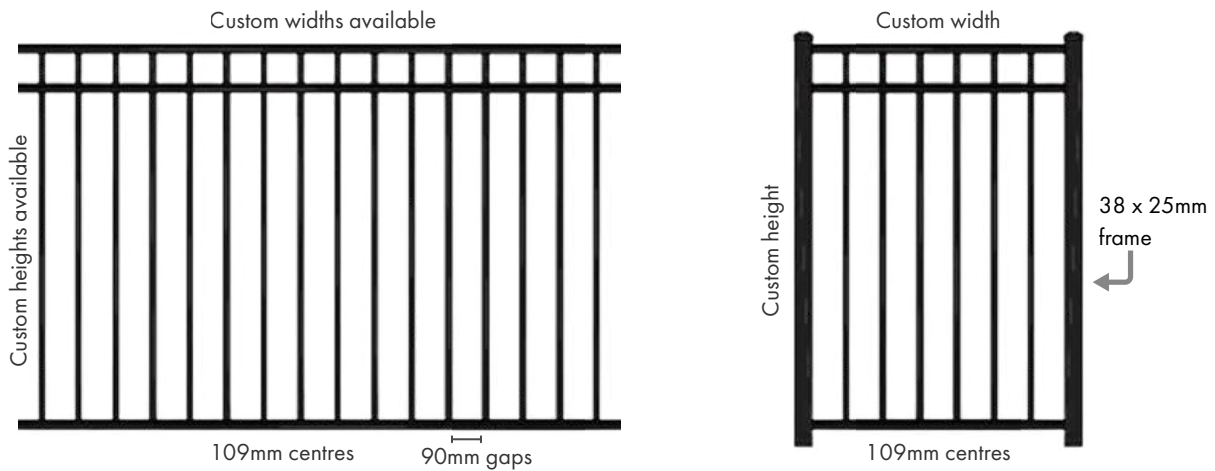

GOTHIC STEEL FENCE PANELS

Order Code	Height	Width	Picket Size	Picket Spacing	Centres	Rails
FW-SF-GOTHIC-900	900mm	Any	19mm x 1.2mm	90mm Gaps	109mm	38mm x 25mm x 1.6mm
FW-SF-GOTHIC-1200	1200mm	Any	19mm x 1.2mm	90mm Gaps	109mm	38mm x 25mm x 1.6mm
FW-SF-GOTHIC-1500	1500mm	Any	19mm x 1.2mm	90mm Gaps	109mm	38mm x 25mm x 1.6mm
FW-SF-GOTHIC-1800	1800mm	Any	19mm x 1.2mm	90mm Gaps	109mm	38mm x 25mm x 1.6mm

GOTHIC STEEL GATES

Order Code	Gate Type	Height	Width	Picket Size	Picket Spacing	Centres	Rails
FW-SFSG-GOTHIC-HEIGHT	Single	Any	Any	19mm x 1.2mm	90mm Gaps	109mm	38mm x 25mm x 1.6mm
FW-SFDG-GOTHIC-HEIGHT	Double	Any	Any	19mm x 1.2mm	90mm Gaps	109mm	38mm x 25mm x 1.6mm
FW-SFSLG-GOTHIC-HEIGHT	Sliding	Any	Any	19mm x 1.2mm	90mm Gaps	109mm	38mm x 25mm x 1.6mm

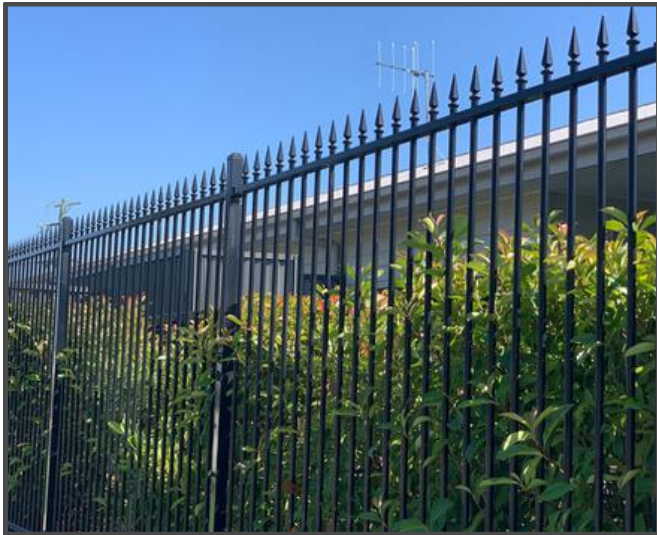

- Custom heights and widths available
- Inground and base plated post options
- Pre galvanised tubular steel
- Compliant to AS1926.1-2012
- Matching gates available
 - Double, swing and sliding gates
- Range of spear options available
- Genuine Dulux Powder coat
 - Custom powder coated any standard colour



**Pool Fencing
Compliant!
AS 1926.1-2012**



Optional Spears

TECHNICAL INFO

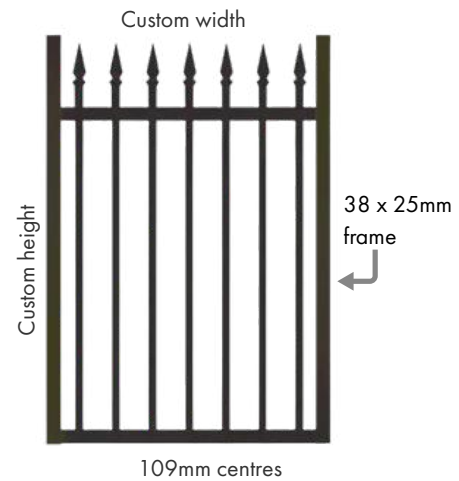

LEVEL SPEAR STEEL FENCE PANELS

Order Code	Height	Width	Picket Size	Picket Spacing	Centres	Rails
FW-SF-LEVEL-900	900mm	Any	19mm x 1.2mm	90mm Gaps	109mm	38mm x 25mm x 1.6mm
FW-SF-LEVEL-1200	1200mm	Any	19mm x 1.2mm	90mm Gaps	109mm	38mm x 25mm x 1.6mm
FW-SF-LEVEL-1500	1500mm	Any	19mm x 1.2mm	90mm Gaps	109mm	38mm x 25mm x 1.6mm
FW-SF-LEVEL-1800	1800mm	Any	19mm x 1.2mm	90mm Gaps	109mm	38mm x 25mm x 1.6mm

LEVEL SPEAR STEEL GATES

Order Code	Gate Type	Height	Width	Picket Size	Picket Spacing	Centres	Rails
FW-SFSG-LEVEL-HEIGHT	Single	Any	Any	19mm x 1.2mm	90mm Gaps	109mm	38mm x 25mm x 1.6mm
FW-SFDG-LEVEL-HEIGHT	Double	Any	Any	19mm x 1.2mm	90mm Gaps	109mm	38mm x 25mm x 1.6mm
FW-SFSG-LS-HEIGHT	Sliding	Any	Any	19mm x 1.2mm	90mm Gaps	109mm	38mm x 25mm x 1.6mm



**Pool Fencing
Compliant!
AS 1926.1-2012**

- Custom heights and widths available
- Inground and base plated post options
- Pre galvanised tubular steel
- Compliant to AS1926.1-2012
- Matching gates available
 - Double, swing and sliding gates
- Range of spear options available
- Genuine Dulux powder coat
 - Custom powder coated any standard colour



Optional Spears

TECHNICAL INFO

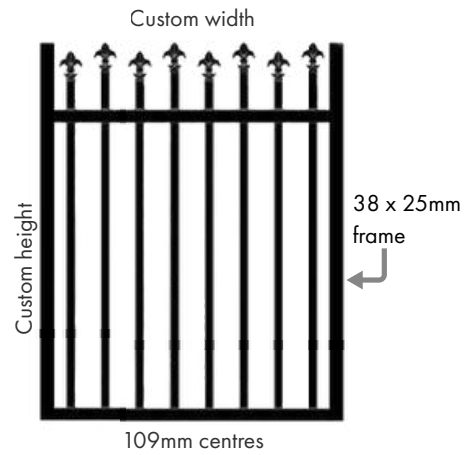
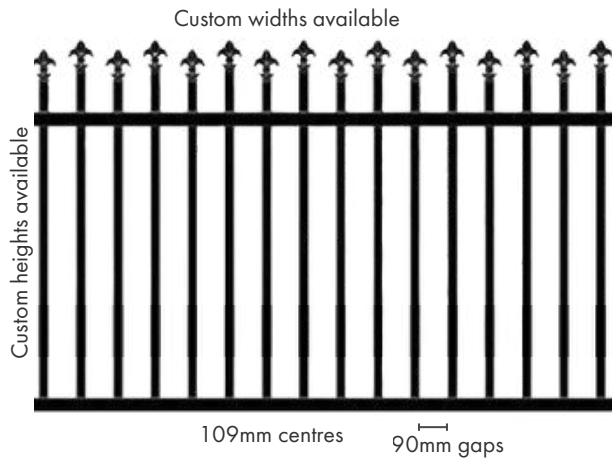

HI-LOW SPEAR STEEL FENCE PANELS

Order Code	Height	Width	Picket Size	Picket Spacing	Centres	Rails
FW-SF-HILO-900	900mm	Any	19mm x 1.2mm	90mm Gaps	109mm	38mm x 25mm x 1.6mm
FW-SF-HILO-1200	1200mm	Any	19mm x 1.2mm	90mm Gaps	109mm	38mm x 25mm x 1.6mm
FW-SF-HILO-1500	1500mm	Any	19mm x 1.2mm	90mm Gaps	109mm	38mm x 25mm x 1.6mm
FW-SF-HILO-1800	1800mm	Any	19mm x 1.2mm	90mm Gaps	109mm	38mm x 25mm x 1.6mm

HI-LOW SPEAR STEEL GATES

Order Code	Gate Type	Height	Width	Picket Size	Picket Spacing	Centres	Rails
FW-SFSG-HLS-HEIGHT	Single	Any	Any	19mm x 1.2mm	90mm Gaps	109mm	38mm x 25mm x 1.6mm
FW-SFDG-HLS-HEIGHT	Double	Any	Any	19mm x 1.2mm	90mm Gaps	109mm	38mm x 25mm x 1.6mm
FW-SFSLG-HLS-HEIGHT	Sliding	Any	Any	19mm x 1.2mm	90mm Gaps	109mm	38mm x 25mm x 1.6mm



- Custom heights and widths available
- Inground and base plated post options
- Pre galvanised tubular steel
- Compliant to AS1926.1-2012
- Matching gates available
 - Double, swing and sliding gates



**Pool Fencing
Compliant!
AS 1926.1-2012**

Available in -
Genuine Dulux Powder Coat
Other Colours Available on Request

BLACK

TECHNICAL INFO

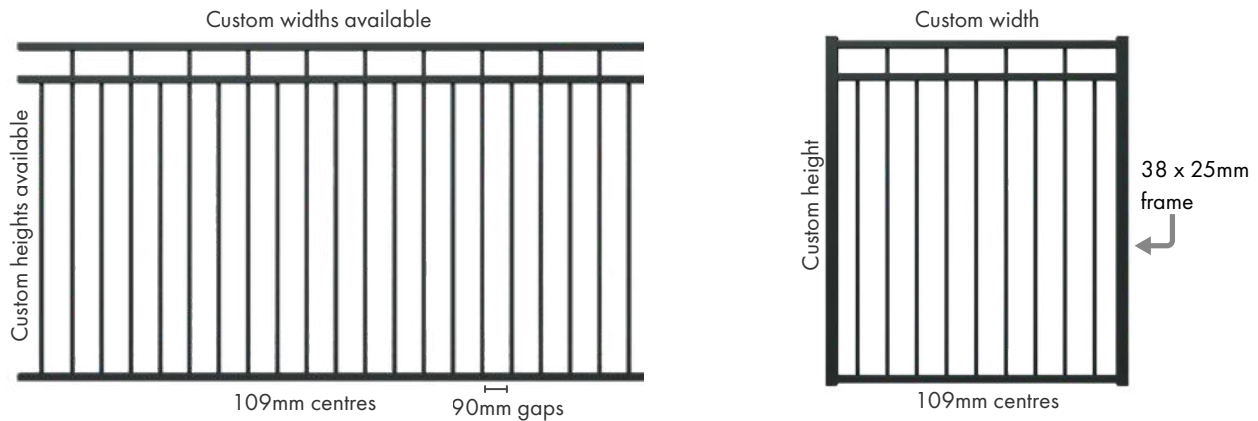

GOTHIC PLAIN STEEL FENCE PANELS

Order Code	Height	Width	Picket Size	Picket Spacing	Centres	Rails
FW-SF-GOTHICPLAIN-900	900mm	Any	19mm x 1.2mm	90mm Gaps	109mm	38mm x 25mm x 1.6mm
FW-SF-GOTHICPLAIN-1200	1200mm	Any	19mm x 1.2mm	90mm Gaps	109mm	38mm x 25mm x 1.6mm
FW-SF-GOTHICPLAIN-1500	1500mm	Any	19mm x 1.2mm	90mm Gaps	109mm	38mm x 25mm x 1.6mm
FW-SF-GOTHICPLAIN-1800	1800mm	Any	19mm x 1.2mm	90mm Gaps	109mm	38mm x 25mm x 1.6mm

GOTHIC PLAIN STEEL GATES

Order Code	Gate Type	Height	Width	Picket Size	Picket Spacing	Centres	Rails
FW-SFSG-GP-HEIGHT	Single	Any	Any	19mm x 1.2mm	90mm Gaps	109mm	38mm x 25mm x 1.6mm
FW-SFDG-GP-HEIGHT	Double	Any	Any	19mm x 1.2mm	90mm Gaps	109mm	38mm x 25mm x 1.6mm
FW-SFSLG-GP-HEIGHT	Sliding	Any	Any	19mm x 1.2mm	90mm Gaps	109mm	38mm x 25mm x 1.6mm



- Custom heights and widths available
- Inground and base plated post options
- Pre galvanised tubular steel
- Compliant to AS1926.1-2012
- Matching gates available
 - Double, swing and sliding gates



**Pool Fencing
Compliant!
AS 1926.1-2012**

Available in -
Genuine Dulux Powder Coat
Other Colours Available on Request

BLACK

TECHNICAL INFO

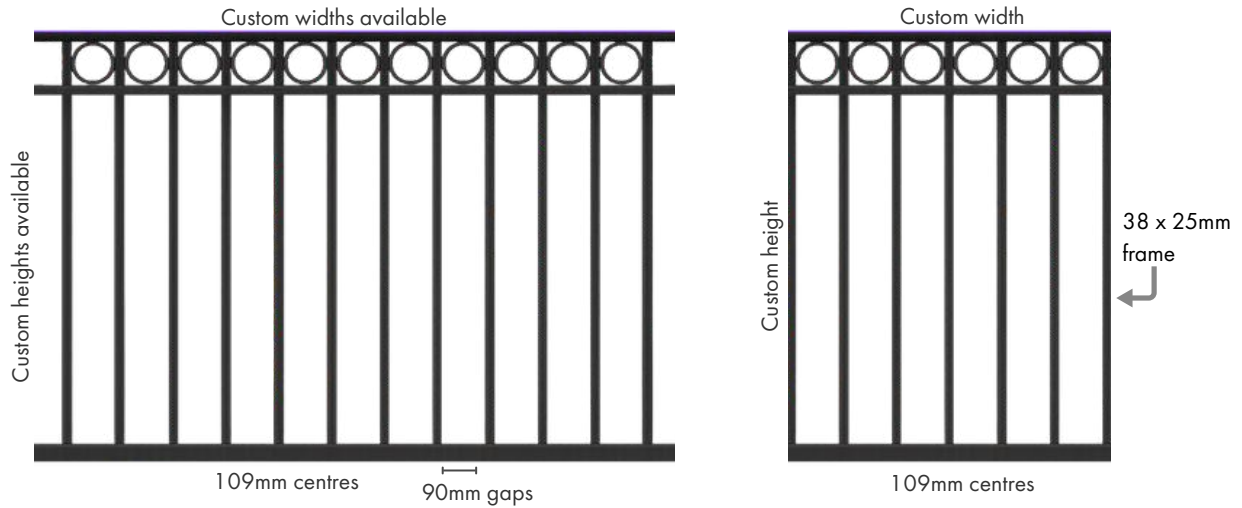

GOTHIC RING STEEL FENCE PANELS

Order Code	Height	Width	Picket Size	Picket Spacing	Centres	Rails
FW-SF-GOTHICRING-900	900mm	Any	19mm x 1.2mm	90mm Gaps	109mm	38mm x 25mm x 1.6mm
FW-SF-GOTHICRING-1200	1200mm	Any	19mm x 1.2mm	90mm Gaps	109mm	38mm x 25mm x 1.6mm
FW-SF-GOTHICRING-1500	1500mm	Any	19mm x 1.2mm	90mm Gaps	109mm	38mm x 25mm x 1.6mm
FW-SF-GOTHICRING-1800	1800mm	Any	19mm x 1.2mm	90mm Gaps	109mm	38mm x 25mm x 1.6mm

GOTHIC RING STEEL GATES

Order Code	Gate Type	Height	Width	Picket Size	Picket Spacing	Centres	Rails
FW-SFSG-GR-HEIGHT	Single	Any	Any	19mm x 1.2mm	90mm Gaps	109mm	38mm x 25mm x 1.6mm
FW-SFDG-GR-HEIGHT	Double	Any	Any	19mm x 1.2mm	90mm Gaps	109mm	38mm x 25mm x 1.6mm
FW-SFSLG-GR-HEIGHT	Sliding	Any	Any	19mm x 1.2mm	90mm Gaps	109mm	38mm x 25mm x 1.6mm



**Pool Fencing
Compliant!
AS 1926.1-2012**

- Custom heights and widths available
- Inground and base plated post options
- Pre galvanised tubular steel
- Compliant to AS1926.1-2012
- Matching gates available
 - Double, swing and sliding gates
- Range of spear options available
- Genuine Dulux powder coat
 - Can be powder coated any standard colour



Optional Spears

TECHNICAL INFO

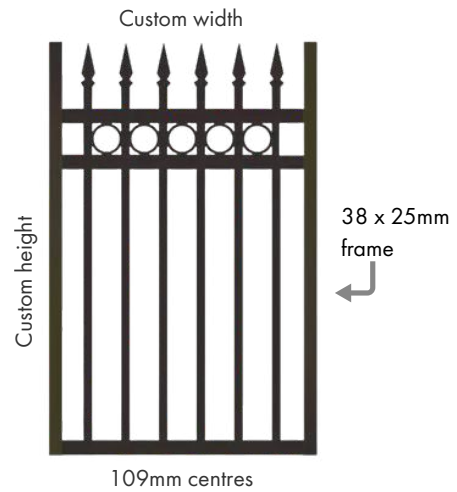
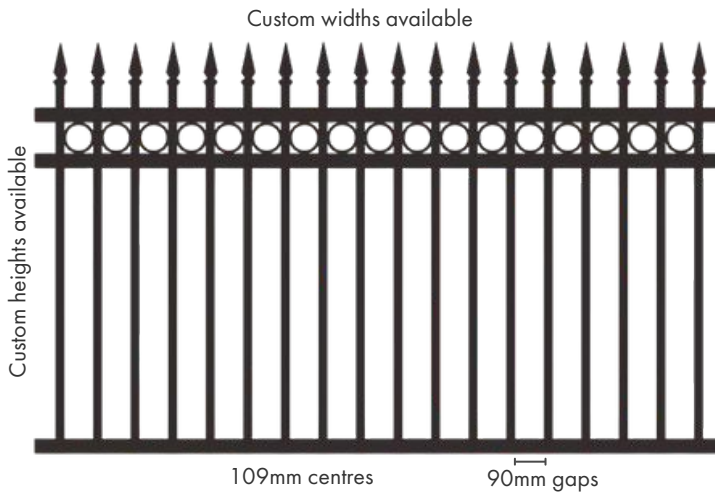

SPEAR & RING STEEL FENCE PANELS

Order Code	Height	Width	Picket Size	Picket Spacing	Centres	Rails
FW-SF-SPEARRING-900	900mm	Any	19mm x 1.2mm	90mm Gaps	109mm	38mm x 25mm x 1.6mm
FW-SF-SPEARRING-1200	1200mm	Any	19mm x 1.2mm	90mm Gaps	109mm	38mm x 25mm x 1.6mm
FW-SF-SPEARRING-1500	1500mm	Any	19mm x 1.2mm	90mm Gaps	109mm	38mm x 25mm x 1.6mm
FW-SF-SPEARRING-1800	1800mm	Any	19mm x 1.2mm	90mm Gaps	109mm	38mm x 25mm x 1.6mm

SPEAR & RING STEEL GATES

Order Code	Gate Type	Height	Width	Picket Size	Picket Spacing	Centres	Rails
FW-SFSG-SPEARRING-HEIGHT	Single	Any	Any	19mm x 1.2mm	90mm Gaps	109mm	38mm x 25mm x 1.6mm
FW-SFDG-SPEARRING-HEIGHT	Double	Any	Any	19mm x 1.2mm	90mm Gaps	109mm	38mm x 25mm x 1.6mm
FW-SFSLG-SR-HEIGHT	Sliding	Any	Any	19mm x 1.2mm	90mm Gaps	109mm	38mm x 25mm x 1.6mm



- Charm of timber, strength of steel
- Fully welded, powder coated and maintenance free
- Can be custom made to any height and any gap size
- Any standard Dulux powder coat colour
- Choice of Letterboxes

Order Code	Picket Size	Gap Size	Panel Height	Plinth	Full Height
FW-SPF1000	65mm x 16mm	25mm	850mm	150mm	1000mm
FW-SPF1200	65mm x 16mm	25mm	1050mm	150mm	1200mm
FW-SPF1500	65mm x 16mm	25mm	1350mm	150mm	1500mm
FW-SPF1800	65mm x 16mm	25mm	1650mm	150mm	1800mm

PICKET CAPITALS



POST CAPITALS



IN GROUND POST

Order Code	Post Width	Height
FW-SP-50	50mm x 50mm	Available in a range of heights from 1800mm to 3200mm
FW-SP-65	65mm x 65mm	
FW-SP-75	75mm x 75mm	
FW-SP-100	100mm x 100mm	

WELDED BASE PLATED POST

Order Code	Post Width	Height	Base Plate Position
FW-SFSP-BP50	50mm x 50mm	Available in a range of heights from 1000mm to 2400mm	Available in Centre Weld, Offset and Corner Offset
FW-SFSP-BP65	65mm x 65mm		
FW-SFSP-BP75	75mm x 75mm		
FW-SFSP-BP100	100mm x 100mm		

STEEL PICKET GATES

- Double or single swing gates and sliding gates available
- Range of heights:
 - 1000mm
 - 1200mm
 - 1500mm
 - 1800mm
- Custom made to any width
- Any standard Dulux powder coat colour



SINGLE GATES

Order Code	Height
FW-SPG-S-1000	1000mm
FW-SPG-S-1200	1200mm
FW-SPG-S-1500	1500mm
FW-SPG-S-1800	1800mm

DOUBLE GATES

Order Code	Height
FW-SPG-D-1000	1000mm
FW-SPG-D-1200	1200mm
FW-SPG-D-1500	1500mm
FW-SPG-D-1800	1800mm

SLIDING GATES

Order Code	Height
FW-SPG-SL-1000	1000mm
FW-SPG-SL-1200	1200mm
FW-SPG-SL-1500	1500mm
FW-SPG-SL-1800	1800mm

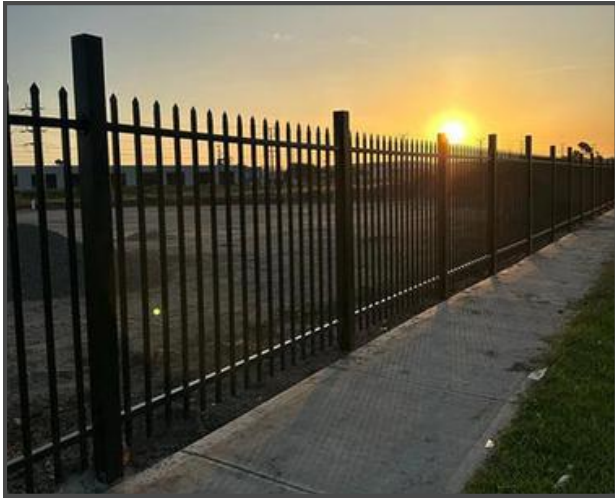

Available in -
Genuine Interpon Powder Coat
Other Colours Available on Request

BLACK

- 1800 or 2400mm Wide
- Pre galvanised tubular steel
- Pressed spear tops
- Matching gates available
 - including custom gate sizes and sliding gates

TECHNICAL INFO

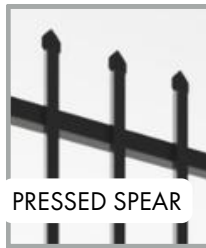
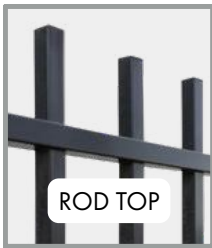
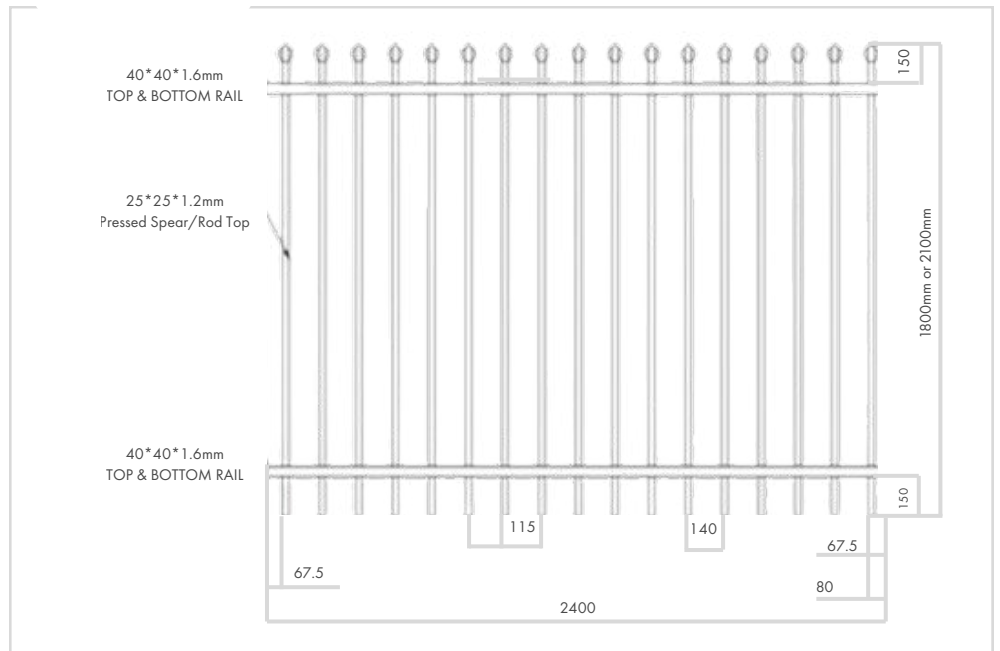

SECURITY STEEL FENCING PANEL

Order Code	Height	Width	Picket Size	Spacing	Centres	Rails
FW-RT/PS-SP-HEIGHT-2400-B	1800 or 2100mm	2400mm	25 x 25 x 1.2mm	115mm	140mm	40 x 40 x 1.6mm

SECURITY STEEL FENCING GATES

Order Code	Gate Type	Height	Width	Picket Size	Spacing	Centres	Rails
FW-RT/PS-SG-HEIGHT-975-B	Single	1800 or 2100mm	975mm	25 x 25 x 1.2mm	115mm	140mm	40 x 40 x 1.6mm
FW-RT/PS-SLG-1800-WIDTH-B	Sliding	1800mm	1000-8500mm Opening	25 x 25 x 1.2mm	115mm	140mm	Top: 40 x 40 x 1.6mm Bottom: 100 x 50mm
FW-RT/PS-SLG-2100-WIDTH-B		2100mm	1000-8500mm Opening	25 x 25 x 1.2mm	115mm	140mm	Top: 40 x 40 x 1.6mm Bottom: 100 x 50mm
FW-RT/PS-DG-HEIGHT-3000-B	Double	1800 or 2100mm	1000-8500mm Opening	25 x 25 x 1.2mm	115mm	140mm	40 x 40 x 1.6mm

Available in FULL PERF or PALM pattern for excellent visibility through punched panel



Pool Fencing
Compliant!
AS 1926.1-2012



Hole punch design ensures pool fencing compliance:

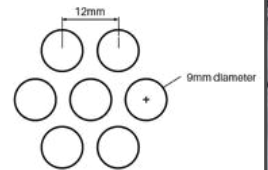

Premium Perf Panel

Order Code: FW-PP-PANEL-B

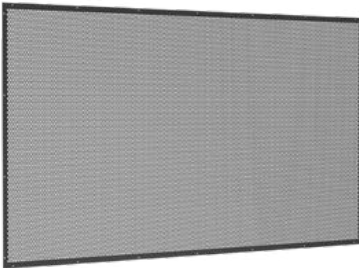

- Premium perf panels are 1988mmW x 1188mmH
 - With framing, panel is 2000mmW x 1200mmH
- Height and width adjustable: simply cut to size
- Akzo Nobel powder coat: matt black textured
- Premium marine grade alloy 5052 H32; 2.5mm thick
- Great alternative to glass
- Minimal cleaning required & shatter proof
- Pool fence compliant: tested to AS1926.1

Premium Perf PALM Panel

Order Code: FW-PP-PP-PANEL-PALM-B

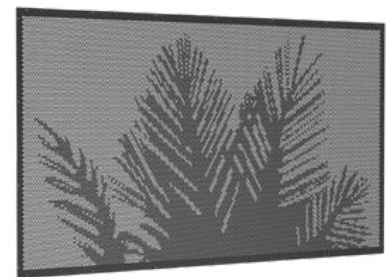

Perf Frame Kit

Order Code: FW-PP-FRAMEKIT-B

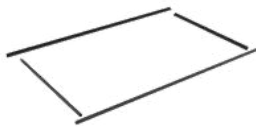

- 38 x 25mm Frame kit
- 2 x 2147mmL horizontal rails with snap in cover
- 2 x 1149mmL vertical rails with snap in cover

Perf U Channel (Pk 2)

Order Code: FW-PP-U-B-2PK



- 42 x 25.4mm
- 1200mmL

INNOVATIVE 2-PART FRAME

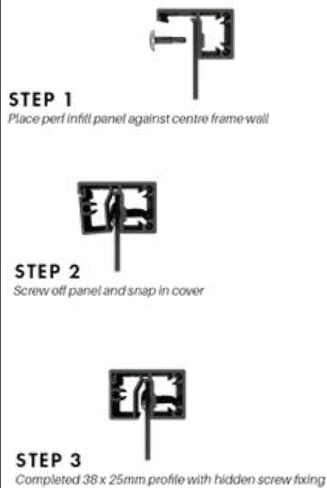

Premium Perf Gate

Order Code: FW-PP-GATE-B



Premium Perf Palm Gate

Order Code: FW-PP-GATE-PALM-B

- Available in Full Perf or Palm style
- Fully assembled gate with 38x25mm framing.
- Framing style matches panel framing
- 975mm wide x 1200mm high gate
- Features strong corner stake construction
- Premium marine grade alloy sheets:
 - 5052 H32; 2.5mm thick
 - Punched 9mm diameter holes
- Akzo Nobel powder coat: matt black textured
- Framing is Satin Black powder coated
- Excellent visibility through punched panel
- Pool fence compliant perf: tested to AS1926.1
- Gate can be installed with side pull or top pull pool fencing latch.

Order Code	Panel Size	Batten Size	Batten Spacing
FW-BLA-A-900-P5010-B	900mm x 2400mm	50mm x 10mm x 1.2mm	50mm
FW-BLA-A-1200-P5010-B	1200mm x 2400mm	50mm x 10mm x 1.2mm	50mm
FW-BLA-A-1500-P5010-B	1500mm x 2400mm	50mm x 10mm x 1.2mm	50mm
FW-BLA-A-1800-P5010-B	1800mm x 1200mm	50mm x 10mm x 1.2mm	50mm

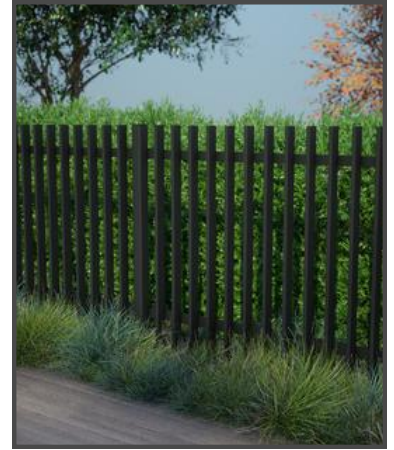

- 2400mm wide
- Pickets welded to 40mm x 40mm x 1.6mm horizontal rails
- 50mm x 10mm x 1.2mm battens
- 50mm gaps

BLACK

Available in -
Genuine Azko Nobel Powder Coat
Other Colours Available on Request

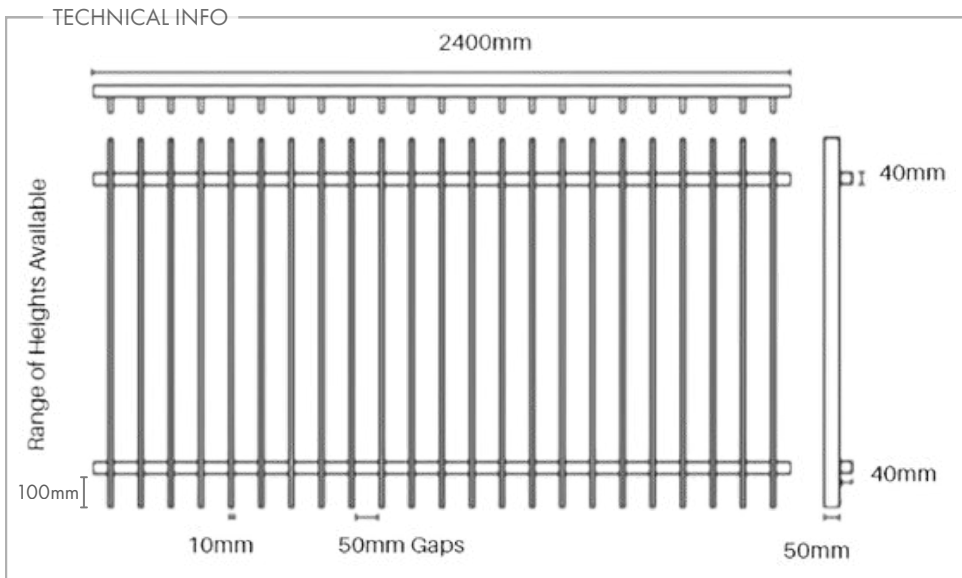

BLADE POOL FENCING

Order Code	Panel Size	Picket Size	Picket Spacing
FW-BLA-PNL-2200-1200-B	900mmH x 2400mmW	50mm x 16mm	79mm
FW-BLA-GATE-0975-1200-B	1200mmH x 975mmW	50mm x 16mm	77mm

- 50mm x 16mm RHS pickets
- Pickets face welded to 40mm x 40mm x 2.4mm horizontal rails
- Aluminium alloy 6061 T6
- Compliant to AS 1926.1-2012
- Can be powder coated any colour

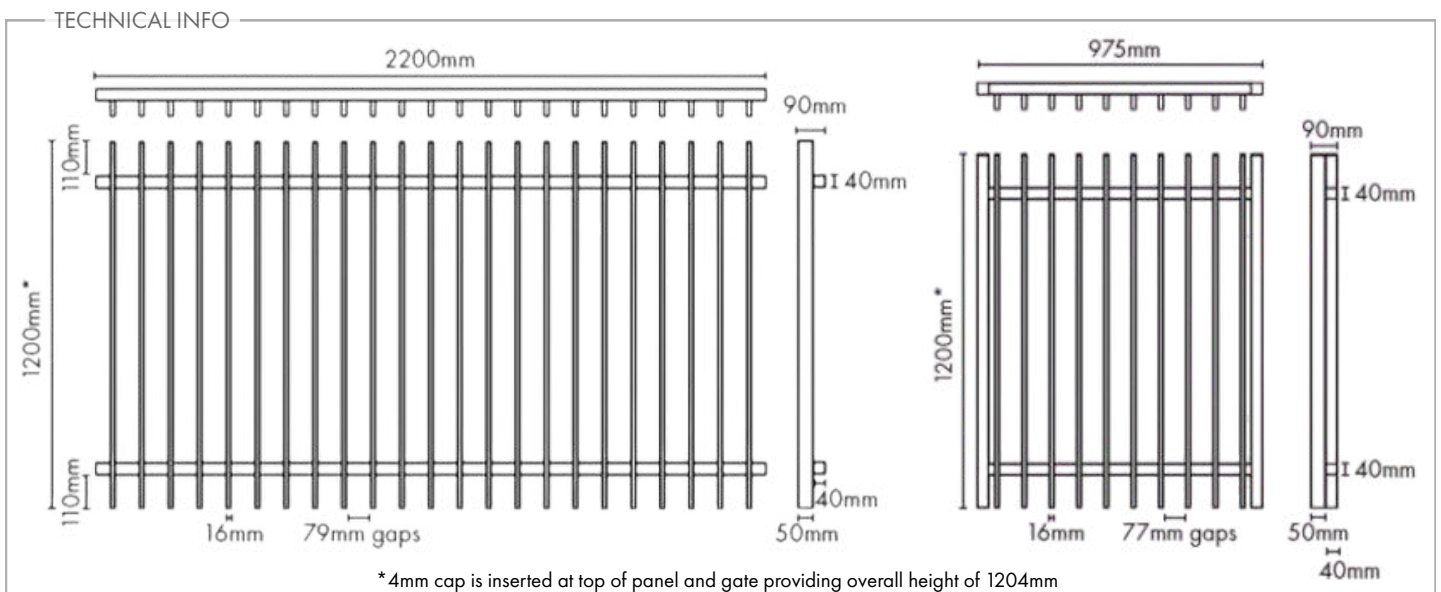

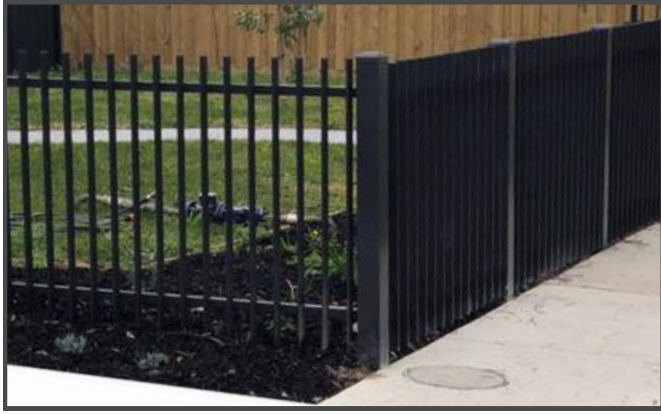

- Custom made vertical batten steel fencing, fabricated and powder coated in house
- Battens face welded to 40mm x 40mm rails
- Custom heights and lengths available
- Choice of gaps between battens
- Can be powder coated any standard colour
- Matching single, double or sliding gates available
- Panels sold by the metre

Available in -
Genuine Azko Nobel Powder Coat
Other Colours Available on Request

**SATIN
BLACK**

TECHNICAL INFO

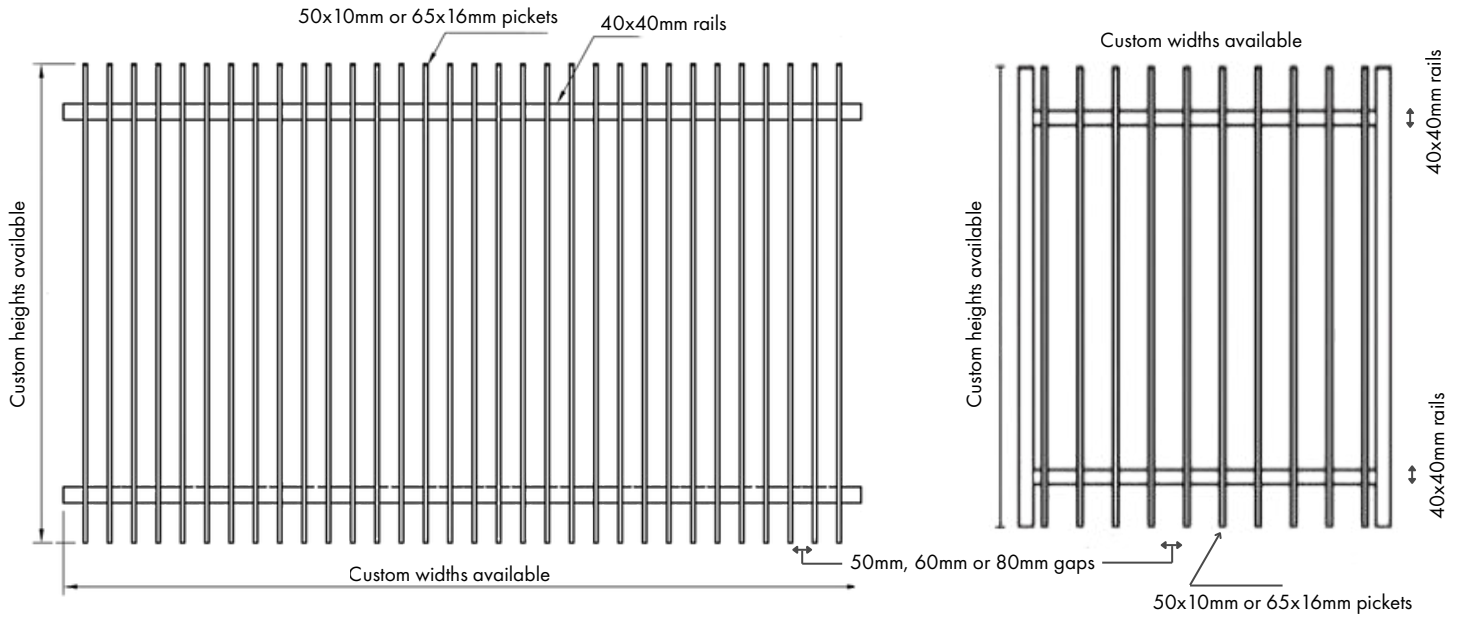

Order Code	Panel Height	Gap Size	Batten Size	Rails
Panels sold by the metre	ANY	50mm	50mm x 10mm	40mm x 40mm
		60mm	65mm x 16mm	40mm x 40mm
		80mm	50mm x 10mm	40mm x 40mm
		80mm	65mm x 16mm	40mm x 40mm

Order Code	Gate Type	Height	Width	Gap Size	Batten Size	Rails
Gates sold by the metre	Single	ANY	ANY	60mm	65mm x 16mm	40mm x 40mm
	Single			80mm	65mm x 16mm	40mm x 40mm
	Double			60mm	65mm x 16mm	40mm x 40mm
	Double			80mm	65mm x 16mm	40mm x 40mm
	Double			50mm	50mm x 10mm	40mm x 40mm
	Double			80mm	50mm x 10mm	40mm x 40mm
	Sliding			60mm	65mm x 16mm	40mm x 40mm
	Sliding			80mm	65mm x 16mm	40mm x 40mm
	Sliding			50mm	50mm x 10mm	40mm x 40mm
	Sliding			80mm	50mm x 10mm	40mm x 40mm



- Unique “floating battens” style
 - 25 x 25mm rails pass through punched holes in the 50 x 25mm pickets
- Panels & gates are welded aluminium
- Unparalleled in strength & style
- Matching pedestrian gates available
- Aluminium alloy 6061-T
- Panels easily cut down in width
- 1000mmH panels are ideal for garden or boundary fencing
- 1200mmH and 1800mmH panels and gates are pool fencing compliant to AS 1926.1
- Gate side stiles are also 50x25mm
- In ground and base plated post options

Available in -
Genuine Azko Nobel Powder Coat
Other Colours Available on Request

SATIN
BLACK

PEARL
WHITE

TECHNICAL INFO

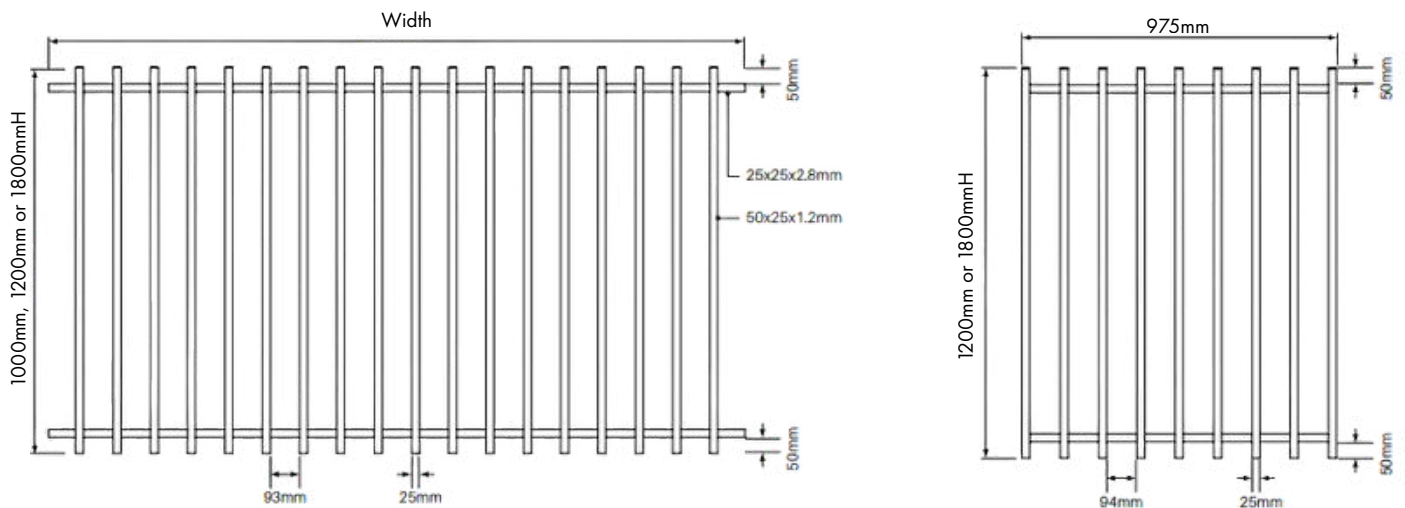

Order Code	Panel Size	Picket Size	Picket Spacing
FW-BR-PANEL-1733-1000-B/W	1000mmH x 1733mmW	50mm x 25mm x 1.2mm	93mm
FW-BR-PANEL-2205-1200-B/W	1200mmH x 2205mmW	50mm x 25mm x 1.2mm	93mm
FW-BR-PANEL-1969-1800-B/W	1800mmH x 1969mmW	50mm x 25mm x 1.2mm	93mm

Order Code	Size	Picket Size	Picket Spacing
FW-BR-GATE-0975-1200-B/W	1200mmH x 975mmW	50mm x 25mm x 1.2mm	94mm
FW-BR-GATE-0975-1800-B/W	1800mmH x 975mmW	50mm x 25mm x 1.2mm	94mm

Base plated post

Order Code: FW-BR-1280-BP-B/W

- 1280mm long
- Satin black or pearl white finish
- 50x25x3mm post with welded 100x75mm base plate
- 10mm thick base plate
- 3mm wall thickness post
- Aluminium alloy 6061-T6
- 50x25mm post profile matches pickets to give a continuous ‘batten’ look.



1800mmH in ground post

Order Code: BR-1800-B/W

2400mmH in ground post

Order Code: FW-BR-1800-B/W

- 50x25x3mm post profile for a continuous ‘batten’ look
- 3mm wall thickness
- Includes 100mm long x 25mm wide anchor at bottom of post for aiding sturdy embedment into concrete
- Aluminium alloy 6061-T6
- Satin black or pearl white finish
- 1800mm or 2400mmL

ALUMINIUM SLATS



65mm x 16.5mm slat with centre web Order Code: FW-XP-6100-S65

- 6100mm long
- 1.2mm wall thickness with centre web
- 3.5mm radius corners
- $I_{xx} = 9.60 \times 10E3 \text{ mmE4}$
- $I_{yy} = 83.09 \times 10E3 \text{ mmE4}$
- PP 157/AP 157
- Alloy 6063-T6

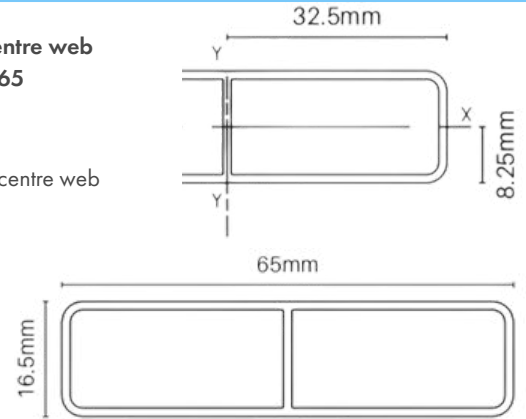

Standard Finishes



Woodlook Finishes



90mm x 16.5mm slat with centre web Order Code: FW-QS-6100-S90

- 6100mm long
- 1.2mm wall thickness with centre web
- 3mm radius corners
- $I_{xx} = 13.28 \times 10E3 \text{ mmE4}$
- $I_{yy} = 202.57 \times 10E3 \text{ mmE4}$
- PP 208/AP 208
- Alloy 6063-T6

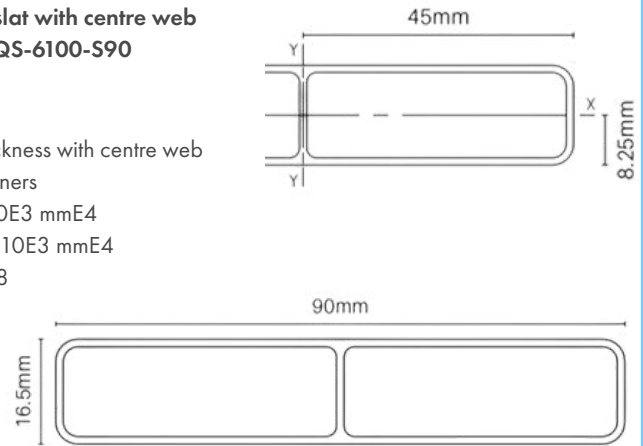

POSTS

50mm x 50mm Full Post Order Code: FW-XP-2400/6000-FP

- 2400 or 6000mm long
- Alloy 6063-T6
- 1.8mm wall thickness with 3mm ribs
- $I_{xx} = 170.44 \times 10E3 \text{ mmE4}$
- $I_{yy} = 170.44 \times 10E3 \text{ mmE4}$

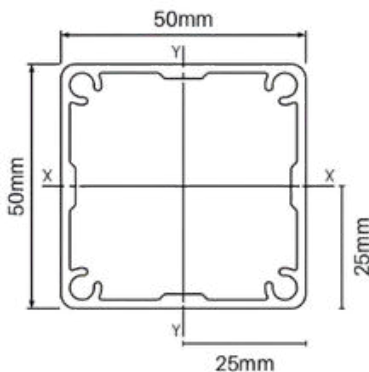

65mm x 65mm Heavy Duty Full Post Order Code: FW-XP-2400/6000-65HD

- 2400 or 6000mm long
- 65mm x 65mm larger profile, heavy duty post
- Alloy 6063-T6
- 3mm wall thickness
- $I_{xx} = 464.62 \times 10E3 \text{ mmE4}$
- $I_{yy} = 464.62 \times 10E3 \text{ mmE4}$

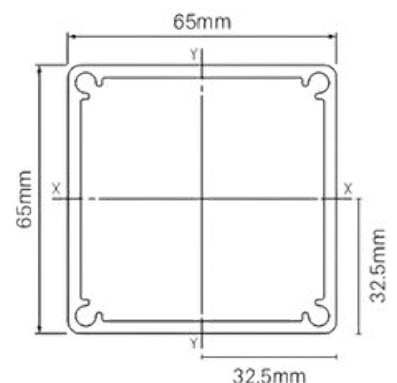

EXPRESS PLUS SLAT ACCESSORIES



Insert - 9mm

Order Code: FW-XPL-2100-INS09

- 2100mm long (65mm slats only)
- Aluminium insert with 9mm spacing



Insert - 20mm

Order Code: FW-XPL-2100-INS20

- 2100mm long (65mm slats only)
- Aluminium insert with 20mm spacing



Side Frame

Order Code: FW-XPL-6000-SF

- 28mm x 32mm x 6000mm
- PP 120 / AP 246
- Alloy 6060-T5
- 2x screw flutes in extrusion used for mechanical fixing of end plates
- Slats are firmly held by patented friction legs - no screwing, riveting or welding required
- $I_{xx} = 21.49 \times 10E3 \text{ mmE4}$
- $I_{yy} = 25.27 \times 10E3 \text{ mmE4}$

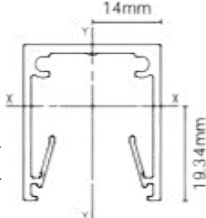
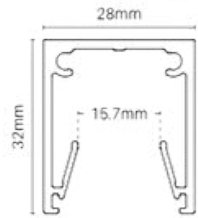

F Section

Order Code: FW-XPL-6000-F

- 6000mm long
- 48 x 32mm
- PP 146 / AP 219
- Alloy 6060-T5

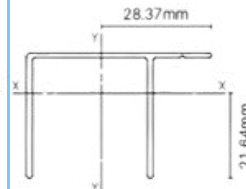
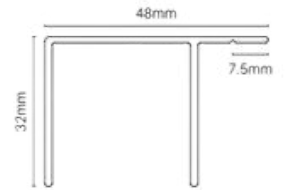

- 1.55mm side wall thickness
- 1.3mm rear wall thickness
- Useful when installing in void situations
- $I_{xx} = 16.97 \times 10E3 \text{ mmE4}$
- $I_{yy} = 36.45 \times 10E3 \text{ mmE4}$



U Channel

Order Code: FW-XPL-6000-U

- 6000mm long
- 33 x 30mm
- PP 181 / AP 181
- Alloy 6063-T5
- 1.55mm side wall thickness
- 1.3mm rear wall thickness
- $I_{xx} = 12.46 \times 10E3 \text{ mmE4}$
- $I_{yy} = 25.09 \times 10E4 \text{ mmE4}$

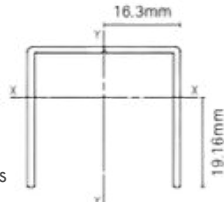

Spacer BLOCK

Order Code: FW-XPL-1000-BLOCK

- 1000mm long
- UV stabilised ASA
- can be cut to required size for use as starting block, slat spacers or if stepped posts, as an infill into the post pocket

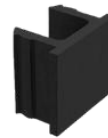

Spacer 20mm

Order Code: FW-XPL-SB-50PK-20MM

- UV stabilised ASA plastic
- 20mm block
- 50 Pack



Centre Support Rail

Order Code: FW-XP-5800-CSR

- 5800mm long
- 40 x 13mm
- Advised for panels over 2000mm wide

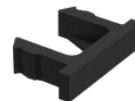

Spacer 5mm

Order Code: FW-XPL-SB-50PK-05MM

- UV stabilised ASA plastic
- 5mm block
- 50 Pack

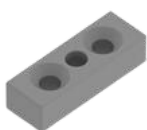

Centre Support Rail Base/ Top Plate

Order Code: FW-XP-BTP

- Includes 2x countersunk screws for fixing to centre support rail



Spacer 9mm

Order Code: FW-XPL-SB-50PK-09MM

- UV stabilised ASA plastic
- 9mm block
- 50 Pack

GATES



- Horizontal and vertical pedestrian and sliding gate options available
- Variable slat spacing including nil spacing
- Cut to size or long length supply
- Installation available



65mm x 16.5mm Gate Slat with 2x Screw flutes and centre web

Order Code: FW-6100-GB65



- 6100mm long
- PP 158 / AP 158
- 1.5mm wall thickness

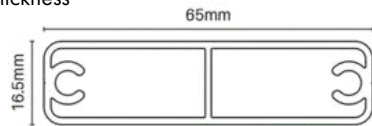

Slotted Gate Side Frame

Order Code: FW-XP-4200-GSF09



- 45mm x 40mm x 4200mm
- Slotted insert to suit 65 x 16.5mm slats with 9mm spacing
- Mates with snap in insert FW-XP-4200-GI
- 3mm wall thickness

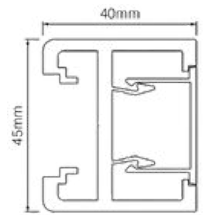

Snap In Gate Insert

Order Code: FW-XP-4200-GI

- 4200mm Long

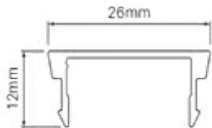

Non Punched Gate Infill

Order Code:

FW-XP-XBAT-4200-INF

- 4200mm long



Slotted Gate Side Frame

Order Code: FW-XP-4200-GSF20



- 45mm x 40mm x 4200mm
- Slotted insert to suit 65 x 16.5mm slats with 20mm spacing
- Mates with snap in insert FW-XP-4200-GI
- 3mm wall thickness

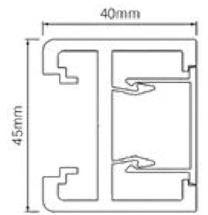

Sliding Gate Bottom Rail

Order Code: FW-XPSG-6100-BR

- 6100mm long

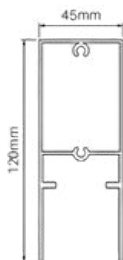

Sliding Gate Top Rail

Order Code: FW-XPSG-6100-TR

- 6100mm long

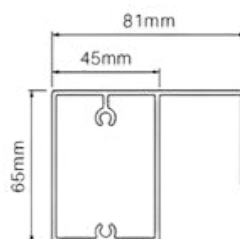

Heavy Duty Pedestrian Gate Top/Bottom Rail

Order Code: FW-XP-6100-HD6545

Order Code: FW-XP-6100-HD6545

- 6100mm long



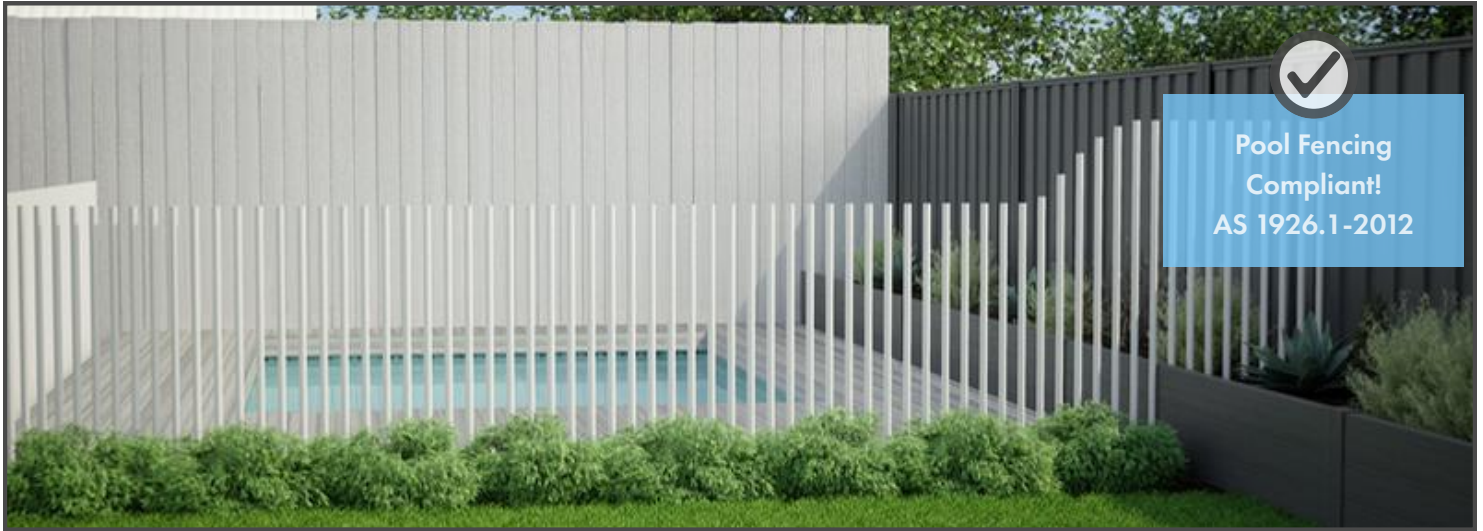

**Pool Fencing
Compliant!
AS 1926.1-2012**

- Vertical, round galvanised steel pickets
- Corrosion resistant and easy to clean (simply wipe/hose down)
- Straight, straight & curve and organic curve configurations
- Bury in grout or bolted to concrete/timber plinth fixing options
- 32mm diameter pickets (3mm wall thickness)
- 80mm centre to centre (48mm gaps)
- Pool fencing compliant to AS1926.1
- Available in Black or White finish

Epic Panel

Order Code: FW-PIK-PNL-1200-1280-B/W

- 1200mmL x 100mmW x 12mm thick plinth
- Panels can be positioned edge to edge to create continuous runs
- Vertical pickets are welded to plinth
- Each panel weighs 52kg

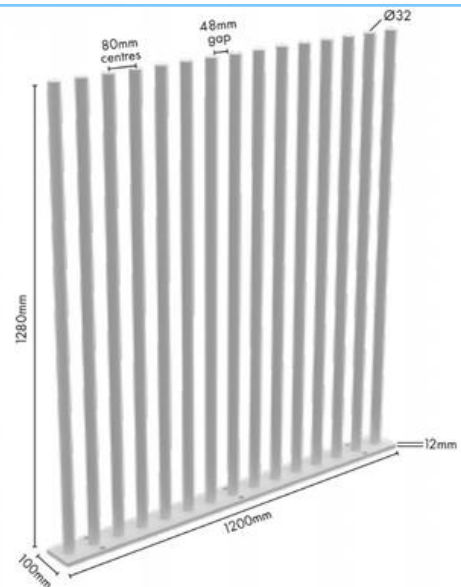
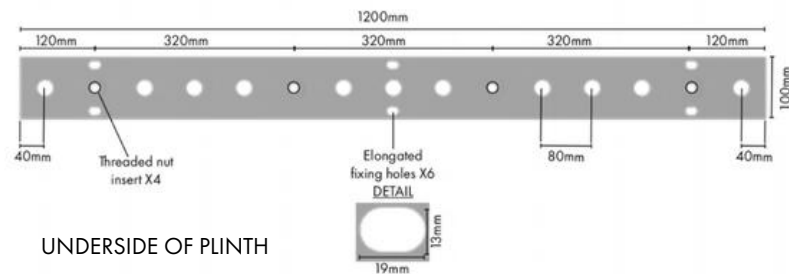

Epic 90 Degree Curved Corner Panel

Order Code: FW-PIK-CURV-1000-1280-B/W

- Innovative 90 degree premade curved panel
- Radius of curve is R1311mm
- Straight panels simply align with curved panel for easy and seamless installation
- Each panel weighs 61kg

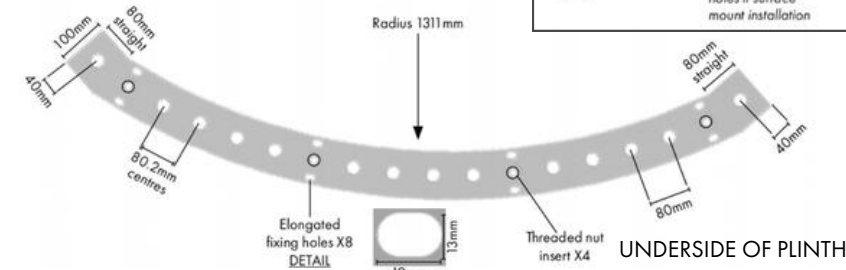
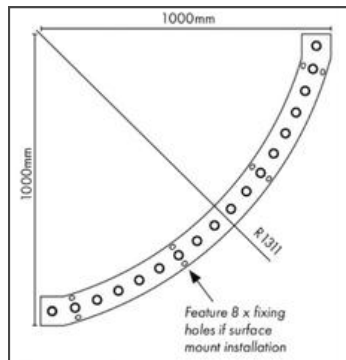

Epic Kit in a Box

Order Code: FW-PIK-KIT-0752-1600-B/W

- KIT Includes
 - 10 x 32mm diameter pickets (1600mml)
 - 10 x top caps
 - 10 x "C" top spacer clips
 - 10 x "C" bottom spacer clips
- Ideal for installations where;
 - high pickets are required (step points or level changes)
 - deeper embedment of pickets is required
 - creating unique shapes (organic curves)
- Clips provide 80mm centre to centre of picket (48mm gap)
 - Spacing compliant to AS1926.1 for pool fencing

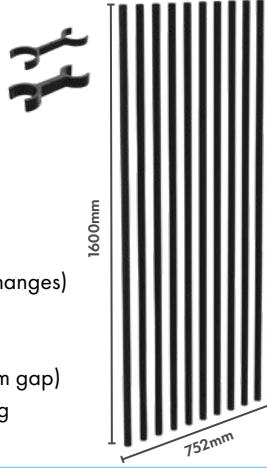

Epic Gate

Order Code: FW-PIK-GATE-0975-1200-B/W

- 975mmW x 1200mmH
- Pedestrian access aluminium gate
- 40x40mm full frame with 32mm round balusters
- 80mm baluster centres (48mm gaps)
- Pool fencing compliant to AS1926.1

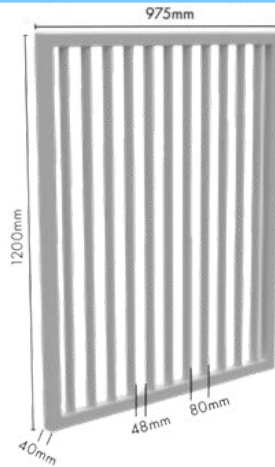

Epic Gate Kit

Order Code: FW-PIK-GATEKIT-B/W

- Includes 2 x 40x40mm powder coated aluminium posts
 - 1257mmL
- 2 x top caps & 2 x domical covers, 6x self tapping screws and 1 x 5mm diameter drill bit included
- Required when installing gate between Epic panels

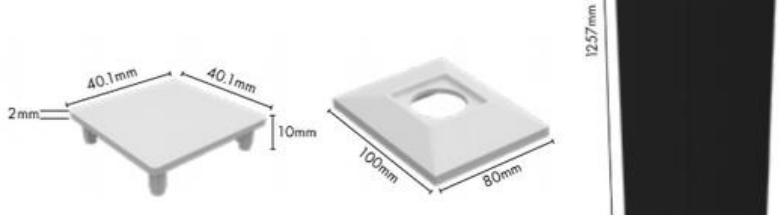

Threaded Rod Kit (Pk 4)

Order Code: FW-PIK-M16ROD-4PK

- M16 threaded rod
- 100mmL



Dress Ring

Order Code: FW-PIK-DR-B/W

- 35mm inner diameter
- 50mm outer diameter
- 2mm thickness



Base Joiner (Pk 5)

Order Code: FW-PIK-BASEJOINER-5PK

- Prevents spreading panel during installation



Base Extender Picket (Pk 4)

Order Code: FW-PIK-EXT-0400-B/W-4PK

- 32mm diameter 400mml
- 20mm thread at top



Plug for Base Plate (Pk 10)

Order Code: FW-PIK-BASEPLUG-B/W

- 18.8 x 12.8mm

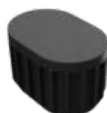

Epic Lever

Order Code: FW-PIK-LEVER

- 400mmL
- Aids alignment of vertical balusters



Round Top Cap

Order Code: FW-PIK-TC-B/W-5PK

- 32mm diameter nylon top cap





FULL PRIVACY
FENCING



SEMI PRIVACY
FENCING



3 RAIL
FENCING



VERTICAL PALING
FENCING



COMBO – FULL PRIVACY
+ SLAT TOPPER



Gate Stopper
Order Code: FW-GS100100

- 100 x 100



Gate Stopper
Order Code: FW-GS10080

- 100 x 80



Retractable Gate Stopper
Order Code: FW-RGS

Weld On/Bolt On Hinges Left Hand
Order Code: FW-WBL



Weld On/Bolt On Hinges Right Hand
Order Code: FW-WBR



Weld On/Weld On Hinges Right Hand
Order Code: FW-WW



Bolt On/Bolt On Hinges Left Hand
Order Code: FW-BBL

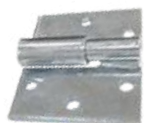

Bolt On/Bolt On Hinges Right Hand
Order Code: FW-BBR



Knock In Bearing Hinge Steel Cap
Order Code: FW-KIBHT



- Suits 50mm Posts
- TOP

Butt Hinge
Order Code: FW-BH-G (Galvanised)



- 75 x 100mm

Butt Hinge
Order Code: FW-BH-B (Black)



- 75 x 100mm

Knock In Bearing Hinge Steel Cap
Order Code: FW-KIBHB



- Suits 50mm Posts
- BOTTOM

Rubber Gate Stopper
Order Code: FW-RGS



Self Closing Hinges (Light Duty)
Order Code: FW-SCL



Adjustable Sliding Gate Catcher Plate

40-80mm	FW-CPA4080-G
80-150mm	FW-CPA80150-G



Sliding Gate Catcher Plate

50mm	FW-CP50-G
75mm	FW-CP75-G
108mm	FW-CP108-G

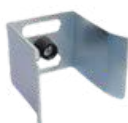

D Latch and Striker



Zinc	FW-DLS-G
Black	FW-DLS-B

Drop Bolts



16 x 300mm	Zinc	FW-DB16300G
16 x 450mm	Zinc	FW-DB16450G
12 x 600mm	Zinc	FW-DB12600G
16 x 600mm	Zinc	FW-DB12600LG
16 x 300mm	Black	FW-DB16300B
16 x 450mm	Black	FW-DB16450B
12 x 600mm	Black	FW-DB12600B

Steel Angle Clips
Order Code: FW-SA7373

- 73 x 73mm



Angle Bracket
Order Code: FW-AB13080

- 130 x 80mm



Angle Bracket
Order Code: FW-AB148100

- 148 x 100mm



Slide Bolts



8 x 87mm	FW-SB887
8 x 144mm	FW-SB8144

Steel Rings (Zinc Plated)
Order Code: FW-SR88X8

- 88 x 8mm



Base Plates (Zinc Plated) Square Corners



100 x 100 x 5	FW-BP1001005SQ
130 x 130 x 5	FW-BP1301305SQ
130 x 130 x 8	FW-BP1301308SQ
150 x 150 x 8	FW-BP1501508SQ
170 x 170 x 8	FW-BP1701708SQ

Base Plates (Zinc Plated) Round Corners



100 x 100 x 4	FW-BP1001004R
125 x 125 x 8	FW-BP1252358R
150 x 150 x 8	FW-BP1501508R
175 x 175 x 8	FW-BP1751758R
200 x 200 x 8	FW-BP2002008R

Post Caps Plastic



40 x 40mm	FW-PCP4040
45 x 45mm	FW-PCP4545
50 x 50mm	FW-PCP5050
65 x 65mm	FW-PCP6565
75 x 75mm	FW-PCP7575
90 x 90mm	FW-PCP9090
100 x 100mm	FW-PCP100100

Post Caps Steel (Galvanised)



40 x 40mm	FW-PCS4040G
50 x 50mm	FW-PCS5050G
65 x 65mm	FW-PCS6565G
75 x 75mm	FW-PCSP7575G
90 x 90mm	FW-PCS9090G
100 x 100mm	FW-PCS100B

Offset Post Base Plate Sleeve



Order Code: FW-BPSO5050

- 47.5mm
- Suits 50mm Posts

Order Code: FW-BPSO6565

- 62.5mm
- Suits 65mm Posts

Centre Post Base Plate Sleeve



Order Code: FW-BPSC5050

- 47.5mm
- Suits 50mm Posts

Order Code: FW-BPSC6565

- 62.5mm
- Suits 65mm Posts

Internal Sliding Gate Wheels Double Bearing



30mm	FW-SGWD-IN60
40mm	FW-SGWD-IN70
50mm	FW-SGWD-IN80
60mm	FW-SGWD-IN90
70mm	FW-SGWD-IN100
80mm	FW-SGWD-IN120
90mm	FW-SGWD-IN140
100mm	FW-SGWD-IN160
200mm	FW-SGWD-IN200

External Sliding Gate Wheels Double Bearing



40mm	FW-SGWD-EX40
50mm	FW-SGWD-EX50
60mm	FW-SGWD-EX60
70mm	FW-SGWD-EX70
80mm	FW-SGWD-EX80
90mm	FW-SGWD-EX90
100mm	FW-SGWD-EX100
120mm	FW-SGWD-EX120
140mm	FW-SGWD-EX140

Post Caps Steel (Black)



50 x 50mm	FW-PCS5050B
65 x 65mm	FW-PCS6565B
75 x 75mm	FW-PCSP7575B
90 x 90mm	FW-PCS9090B
100 x 100mm	FW-PCS100B

Roller Guide with Bracket

Order Code: FW-RGB

- 42 x 150mm



Guide Bracket with White Nylon Roller



30 x 40mm	FW-GBR40
40 x 60mm	FW-GBR60

Sliding Gate Ground Track (U Groove)



FW-SGGT3000

- 3000mm

FW-SGGT5800

- 5800mm

Sliding Gate Plastic Block and C Channel

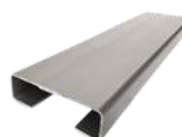

Order Code: FW-SGPB

- 40 x 60mm



Black Nylon Roller



40 x 60mm	FW-BNR60
40 x 100mm	FW-BNR100
40 x 150mm	FW-BNR150
40 x 250mm	FW-BNR250

Ground Track Steel Fixing Pins (100pk)



Order Code: FW-TFP

- 6 x 40mm

Double Side Key Lockable Gate Latch

Order Code: FW-L-LLD



Fully Adjustable Spring Hinges

Order Code: FW-H-TA121

- Pack of 2



SDS 10 x 16 HX C3 - Tek Screws



BASALT	FW-SDS1016BS
BLACK (SATIN)	FW-SDS1016SB
CLASSIC CREAM	FW-SDS1016CC
DUNE	FW-SDS1016D
EVENING HAZE	FW-SDS1016EH
GALVANISED	FW-SDS1016G
IRONSTONE	FW-SDS1016I
MANOR RED	FW-SDS1016MR
MONUMENT	FW-SDS1016MN
PALE EUCALYPT	FW-SDS1016PE
PAPERBARK	FW-SDS1016PB
PEARL WHITE	FW-SDS1016PW
PRIMROSE	FW-SDS1016P
RIVERSAND	FW-SDS1016RS
SURFMIST	FW-SDS1016SM
WILDERNESS	FW-SDS1016W
WOODLAND GREY	FW-SDS1016WG

SDS 12-14 x 20 HX C3 - Tek Screws



BASALT	FW-SDS121420BS
BLACK (SATIN)	FW-SDS121420SB
CLASSIC CREAM	FW-SDS121420CC
DUNE	FW-SDS121420D
EVENING HAZE	FW-SDS121420EH
GALVANISED	FW-SDS121420G
IRONSTONE	FW-SDS121420I
MANOR RED	FW-SDS121420MR
MONUMENT	FW-SDS121420MN
PALE EUCALYPT	FW-SDS121420PE
PAPERBARK	FW-SDS121420PB
PEARL WHITE	FW-SDS121420PW
PRIMROSE	FW-SDS121420P
RIVERSAND	FW-SDS121420RS
SURFMIST	FW-SDS121420SM
WILDERNESS	FW-SDS121420W
WOODLAND GREY	FW-SDS121420WG

Rail Brackets Aluminium Single Lug

Order Code: FW-RBSL-3825B

- 38 x 25mm



Rail Brackets Alum Single Lug (Pk 4)

Order Code: FW-SS-BH4-B

- 38 x 25mm



Rail Brackets Steel Double Lug (Black)

38 x 25mm	FW-RBDL-3825B
30 x 30mm	FW-RBDL-3030B
40 x 40mm	FW-RBDL-4040B
50 x 50mm	FW-RBDL-5050B



Rail Brackets Steel Double Lug (Gal)

38 x 25mm	FW-RBDL-3825G
30 x 30mm	FW-RBDL-3030G
40 x 40mm	FW-RBDL-4040G
50 x 50mm	FW-RBDL-5050G



SDS 12-14 x 25 HX C3 - Tek Screws



BASALT	FW-SDS121425BS
BLACK (SATIN)	FW-SDS121425SB
CLASSIC CREAM	FW-SDS121425CC
DUNE	FW-SDS121425D
EVENING HAZE	FW-SDS121425EH
GALVANISED	FW-SDS121425G
IRONSTONE	FW-SDS121425I
MANOR RED	FW-SDS121425MR
MONUMENT	FW-SDS121425MN
PALE EUCALYPT	FW-SDS121425PE
PAPERBARK	FW-SDS121425PB
PEARL WHITE	FW-SDS121425PW
PRIMROSE	FW-SDS121425P
RIVERSAND	FW-SDS121425RS
SURFMIST	FW-SDS121425SM
WILDERNESS	FW-SDS121425W
WOODLAND GREY	FW-SDS121425WG

Pentaforce Pan Self Driller Class 3 Black

Order Code: FW-PFSD12G-PB

- 12-14 x 25mm



Pentaforce Pan Self Driller Class 3 Gal



12-24 x 32mm	FW-PFSD50012H
12-14 x 25mm	FW-PFSD12G
12-14 x 50mm	FW-PFSD12J

Touch Up Paint (150g)



BLACK	FW-PAINT-B
BASALT	FW-PAINT-BS
DUNE	FW-PAINT-D
WOODLAND GREY	FW-PAINT-WG
MONUMENT	FW-PAINT-MN
PAPER BARK	FW-PAINT-PB
SILVER	FW-PAINT-S
SURFMIST	FW-PAINT-SM
CLASSIC CREAM	FW-PAINT-CC
PEARL WHITE	FW-PAINT-W
SAFETY YELLOW	FW-PAINT-SY

Prolock Pentaforce Driver Bit

Order Code: FW-PFD2-B

- 50mm



AUSTRALIA WIDE DELIVERY OPTIONS

Metro Melbourne delivery available for all products

Local deliveries available for a large range of products to;

- Adelaide
- Brisbane
- Gold Coast
- Newcastle
- Perth
- Sydney

Easy online ordering is now available across our stock range

www.fencewarehouse.com.au

Pick up is available or we can arrange local or palletised freight

Errors and omissions excepted. Measurements and drawings are provided as a guide only and should not be relied upon solely for installation purposes. Product codes, products and prices may change at Fence Warehouse's discretion as systems are constantly reviewed and updated. Please contact Fence Warehouse if you require clarification of product codes, pricing or product stocking. Due to each installation situation being different, it is the installer's responsibility to seek engineering compliance and/or certification should it be required as part of a project, regulatory or statutory requirement. Colours are indicative and should be used as a guide only. All products should adhere to a suitable care and maintenance schedule.

© Copyright 2025. This catalogue is the copyright of Fence Warehouse and cannot be reproduced, copied or replicated without the prior written consent of Fence Warehouse. Such consent applies to images as well as text.

FENCE Warehouse

Location: 17 Hawthorn Ave, Sunshine North Vic 3020

Phone: 1300 FENCEWARE (1300 336 239)

Email: sales@fencewarehouse.com.au

Web: www.fencewarehouse.com.au

