

CATALOGUE

CATALOGUE

CATALOGUE



COLLECTION MARS 2024 - AOÛT 2024



PICTOGRAMMES

PICTOGRAMS



MINIMUM
D'ACHAT
M.O.Q.



RÉSISTANCE
strength



POIDS
weight



DIMENSION
size



MATÉRIAU
material



SUPPLÉMENT
extra



MADE IN
FRANCE



ÂGE
CONSEILLÉ
recommended age



LITRAGE
volume



ÉTANCHE
waterproof



DIAMÈTRE
diameter



RONDELLE
TREKKING
trekking basket



RONDELLE
NEIGE
snow basket



ANTI
CHOC
shockproof



TUBES
TRIANGULAIRES
triangular tubes



OPTIQUE
optics



PUISSANCE
power



BATTERIE
battery



TYPE
D'ÉCLAIRAGE
light type



CHARGE
SOLAIRE
solar charging



PROPRIÉTÉS
D'ÉCLAIRAGE
lighting properties



RÉSISTANCE
CHUTE
drop-proof



NOMBRE
D'UTILISATEURS
number of users



ÉPAISSEUR
thickness



MATIÈRES
RECYCLÉES
recycled material



PERSONNE
GRANDE
tall person



FLOTANT
Floating



NORME
standard



TEMPS
D'UTILISATION
usage time



CHAÎNE
chain



POINTES
spikes



TAILLE
UNIQUE
single size



TACTILE
touch-
sensitive



CUSTOMISABLE
customizable

prix/price

SOMMAIRE

CONTENTS

RANDONNER
HIKE



CAMPER
CAMP



HABILLER
DRESS



ÉQUIPER
EQUIP



GLISSER
SLIDE



CUSTOMISER
CUSTOMIZE



HABILLER
HABILLER
HABILLER

CALDO MEN - PANTALON DE SKI

CALDO MEN - SKI PANT

REF. 901130 S à XXL/S to XXL /NOIR/BLACK

Pantalon de ski paddé, Bretelles et dossard amovibles (fixés avec zipper), Taille ajustable par velcro, Ceinture fermée par boutons pressions et crochet, 2 poches latérales zippées, Guêtres pare-neige avec élastique anti-glisse. Badge rubber logoté sur le devant Sérigraphie réfléchissante sur la jambe arrière gauche

Padded ski pants , Removable straps and bib (fixed by zipper) Velcro adjustable size, Belt closed with snap buttons and hook 2 zipped side pockets, Snow gaiters with anti-slip elastic. Rubber logo badge on the front, Reflective print on left rear leg



À.P.D.
from
10/24



taille /size	assortiment /assortment
S-36	1
M-38	2
L-40	2
XL-42	2
XXL-44	1

EXTERIEUR/
OUTSHELL
100% POLYESTER
ENDUCTION/ COATING
100% POLYURETHANE

MEMBRANE ETANCHE
WATERPROOF
MEMBRANE
3000MM/24H/M²
MEMBRANE
RESPIRANTE
BREATHABLE
MEMBRAN
3000MVP/24H/M²

DOUBLURE/ LINING
100% POLYESTER
OUATE PADDING
100% POLYESTER

COUTURES
SOUDEES
AUX POINTS
STRATEGIQUES
CRITICAL SEAMS
TAPES

MINIMUM
D'ACHAT
M.O.Q.

CALDO LADY - PANTALON DE SKI

CALDO LADY - SKI PANT

REF. 901131 S à XXL/S to XXL /NOIR/BLACK

Pantalon de ski paddé, Bretelles et dossard amovibles (fixés avec zipper), Taille ajustable par velcro, Ceinture fermée par boutons pressions et crochet, 2 poches latérales zippées, Guêtres pare-neige avec élastique anti-glisse. Badge rubber logoté sur le devant Sérigraphie réfléchissante sur la jambe arrière gauche

Padded ski pants , Removable straps and bib (fixed by zipper) Velcro adjustable size, Belt closed with snap buttons and hook 2 zipped side pockets, Snow gaiters with anti-slip elastic. Rubber logo badge on the front, Reflective print on left rear leg



À.P.D.
from
10/24



taille /size	assortiment /assortment
S-36	1
M-38	2
L-40	2
XL-42	2
XXL-44	1

EXTERIEUR/
OUTSHELL
100% POLYESTER
ENDUCTION/ COATING
100% POLYURETHANE

MEMBRANE ETANCHE
WATERPROOF
MEMBRANE
3000MM/24H/M²
MEMBRANE
RESPIRANTE
BREATHABLE
MEMBRAN
3000MVP/24H/M²

DOUBLURE/ LINING
100% POLYESTER
OUATE PADDING
100% POLYESTER

COUTURES
SOUDEES
AUX POINTS
STRATEGIQUES
CRITICAL SEAMS
TAPES

MINIMUM
D'ACHAT
M.O.Q.

CALDO KID - PANTALON DE SKI

CALDO KID - SKI PANT

REF. 901132 6 À 14 ANS /6 to 14 YEARS /NOIR/BLACK

Pantalon de ski paddé, Bretelles et dossard amovibles (fixés avec zipper), Taille ajustable par velcro, Ceinture fermée par boutons pressions et crochet, 2 poches latérales zippées, Guêtres pare-neige avec élastique anti-glisse. Badge rubber logoté sur le devant Sérigraphie réfléchissante sur la jambe arrière gauche

Padded ski pants , Removable straps and bib (fixed by zipper) Velcro adjustable size, Belt closed with snap buttons and hook 2 zipped side pockets, Snow gaiters with anti-slip elastic. Rubber logo badge on the front, Reflective print on left rear leg

new!

À.P.D.
from
10/24



taille /size	assortiment /assortment
6 ans	1
8 ans	2
10 ans	2
12 ans	2
14 ans	1



EXTERIEUR/
OUTSHELL
100% POLYESTER
ENDUCTION/ COATING
100% POLYURETHANE



MEMBRANE ETANCHE
WATERPROOF
MEMBRANE
3000MM/24H/M²
MEMBRANE
RESPIRANTE
BREATHABLE
MEMBRAN
3000MVP/24H/M²



DOUBLURE/ LINING
100% POLYESTER
OUATE PADDING
100% POLYESTER



COUTURES
SOUDEES
AUX POINTS
STRATEGIQUES
CRITICAL SEAMS
TAPES



MINIMUM
D'ACHAT
M.O.Q.

CALOROSO - SALOPETTE DE SKI ENFANT

CALOROSO - KID SKI OVERALL

REF. 901133 2 À 6 ANS /2 to 6 YEARS /NOIR/BLACK

Salopette de ski paddée, Haute de corps en micro polaire avec biais au col et emmanchures, Fermeture par zip avec patte de protection, taille élastiquée, badge rubber logoté en poitrine, Guêtres pare-neige avec élastique anti-glisse

Sérigraphie réfléchissante sur la jambe arrière gauche Padded ski overalls, Upper body in micro fleece with bias at the collar and armholes, Zip closure with protective tab elasticated waist, rubber logo badge on chest, Snow gaiters with anti-slip elastic, Reflective print on left rear leg

new!

À.P.D.
from
10/24



taille /size	assortiment /assortment
2 ans	2
4 ans	2
6 ans	3



EXTERIEUR/
OUTSHELL
100% POLYESTER
ENDUCTION/ COATING
100% POLYURETHANE



MEMBRANE ETANCHE
WATERPROOF
MEMBRANE
3000MM/24H/M²
MEMBRANE
RESPIRANTE
BREATHABLE
MEMBRAN
3000MVP/24H/M²



DOUBLURE/ LINING
100% POLYESTER
OUATE PADDING
100% POLYESTER



COUTURES
SOUDEES
AUX POINTS
STRATEGIQUES
CRITICAL SEAMS
TAPES



MINIMUM
D'ACHAT
M.O.Q.

DENALI SOFTSHELL FEMME

LADY SOFTSHELL

REF. 901047 XS à XXL/XS to XXL/NOIR/BLACK

REF. 901049 XS à XXL/XS to XXL/MARINE/NAVY

REF. 901050 XS à XXL/XS to XXL/ROSE/PINK

Softshell femme / homme à capuche amovible. Empiècement softshell RibStop sur le corps, les manches, et la capuche. Fermeture par zip retourné. Badge rubber avec logo sur la manche droite. Manchons lycra avec passe-pouce. Pattes de resserrage aux poignets. Poche intérieure avec chamoisine. Grandes poches avec zip retournés en poitrine et sur la manche gauche. Bandes réfléchives sur le devant et au dos. Sérigraphie sur la manche gauche et au dos. Lady's and men's softshell jacket with detachable hood. Yokes in softshell Ribstop fabric on body, sleeve and hood. Jacket closed by reversed front zipper. Rubber badge with logo on right sleeve. Lycra handgather with thumbhole. Adjustable tabs at cuff. Inside pocket with glass cleaner in suedine fabric. Large pockets with reversed zipper on the chest and on the left sleeve. Reflective tabs on the front and back. Reflective print on sleeve and back.



taille /size	assortiment /assortiment
S	2
M	2
L	3
XL	2
XXL	1



LOGAN SOFTSHELL HOMME

MEN SOFTHELL

REF. 901042 S à XXXL/S to XXXL/NOIR/BLACK

REF. 901044 S à XXXL/S to XXXL/MARINE/NAVY

REF. 901045 S à XXXL/S to XXXL/ROUGE/RED



taille /size	assortiment /assortiment
S	1
M	2
L	3
XL	2
XXL	1
3XL	1



96%
POLYESTER
4% SPANDEX
SOFTSHELL



TPU
MEMBRANE



WATERPROOF
5000MM/M²
ET RESPIRANT
3000MVP/24H/M²



CONTRE COLLÉE
MICRO POLAIRE
100% POLYESTER



DOUBLURE MESH
100% POLYESTER



MINIMUM
D'ACHAT
m.o.q.

STARTER BLOUSON SOFTSHELL

STARTER - SOFTHELL JACKET FOR MEN

REF. 901072 S à XXXL/S to XXXL/NOIR/BLACK

Blouson Softshell homme à capuche fixe. Lien de resserage à la capuche. Fermeture par zip métal avec tir zip logoté. Poche poitrine avec rabat à bouton pression et zip étanche. Bord côte aux poignets et à la taille. Poches coté fermées par boutons pressions. Intérieur doublé maille filet
 Men Softshell jacket with fixed hood. Hood with drawstring. Closing at front with metallic zip with branded fancy zipper puller. Chest pocket with flap, snap button and waterproof zipper. Rib at cuff and hem. Side pockets closed by snap buttons. Lining in mesh fabric



taille /size	assortiment /assortment
S	1
M	1
L	3
XL	1
XXL	1
3XL	1



96%
POLYESTER
4% SPANDEX
SOFTSHELL



MEMBRANE
EN TPU



WATERPROOF
1000MM/M²
ET RESPIRANT
1000 MVP/24H/M²



CONTRE COLLÉE
MICRO POLAIRE
100% POLYESTER



DOUBLURE MESH
100% POLYESTER



MINIMUM
D'ACHAT
M.O.Q.

SOFTSHELL/SOFTSHELL

HABILLER

OSSAU - DOUDOUNE FEMME

WOMEN LIGHT PADDED JACKET

REF. 901023 S à XXL/S to XXL/NOIR/BLACK**REF. 901025** S À XXL/S TO XXL/MARINE TOUCHE PECHE/NAVY PEACH TOUCH**REF. 901027** S à XXL/S to XXL/VERT CANARD/DUCK GREEN**REF. 901028** S à XXL/S TO XXL/FRAMBOISE/ RASPBERRY**REF. 901029** S à XXL/S TO XXL/RAINBOW/RAINBOW

Doudoune légère à capuche détachable pour femme. Fermeture par zip nylon. Doublure contrastée ou ton sur ton selon les coloris. Badge en rubber sur la manche. Finitions biais à la capuche au poignet et à la taille. Poches cotés fermées par zip invisibles. Poche intérieure. Coupe cintrée.

Light padded jacket with detachable hood for women. Closing by front nylon zipper. Lining in contrasted colour or ton/ton with shell according to the differents combos. Rubber badge on sleeve. EA binding at cuff, hem and hood. Side pockets closed by invisible zipper. Inside pocket. Adjusted fitting.



taille /size	assortiment /assortment
S	2
M	3
L	3
XL	3
XXL	1

POLYESTER
& POLYAMIDEMINIMUM
D'ACHAT
M.O.Q.

OSSAU - DOUDOUNE HOMME

MEN LIGHT PADDED JACKET

REF. 901018 S à XXXL/S to XXXL/NEW FRENCHY/NEW FRENCHY
REF. 901020 S à XXXL/S to XXXL/NOIR/GRIS CHINÉ/BLACK/GREY
REF. 901021 S à XXXL/S to XXXL/CAMO/CAMO
REF. 901022 S à XXXL/S to XXXL/TRICOLOR/TRICOLOR



Doudoune légère à capuche détachable pour homme. Fermeture par zip nylon.
 Doublure contrastée ou ton sur ton selon les coloris. Badge en rubber sur la manche. Finitions biais à la capuche, bas de manches et taille. Cordon de resserage à la capuche. Poches cotés fermées par zip invisibles. Poche intérieure. Coupe ajustée.
 /Light padded jacket with detachable hood for men. Closing by front nylon zipper. Lining in contrasted colour or ton/ton with shell according to the different combos. Rubber badge on sleeve. Drawstring at hood. EA binding at cuff, hem and hood. Side pockets closed by invisible zipper. Inside pocket. Adjusted fitting.



taille /size	assortiment /assortment
S	1
M	3
L	3
XL	3
XXL	1
3XL	1



OSSAU - DOUDOUNE SANS MANCHES FEMME

WOMEN SLEEVELESS LIGHT PADDED JACKET

REF. 901035 S à XXL/S to XXL/NOIR/BLACK**REF. 901037** S À XXL/S to XXL/MARINE TOUCHE PECHE/NAVY**REF. 901039** S à XXL/S to XXL/VERT CANARD/DUCK GREEN**REF. 901040** S À XXL/S to XXL/FRAMBOISE/RASPBERRY**REF. 901041** S À XXL/S to XXL/RAINBOW/RAINBOW

Doudoune légère sans manches femme. Fermeture par zip nylon. Doublure contrastée ou ton sur ton selon les coloris. Badge en rubber en poitrine. Finitions biais aux emmanchures et à la taille. Poches cotés fermées par zip invisibles. Poche intérieure. Coupe cintrée.

/Sleeveless light padded jacket for lady. Closing by front nylon zipper. Lining in contrasted colour or ton/ton with shell according to the different combos. Rubber badge on chest. EA binding at armhole and hem. Side pockets closed by invisible zipper. Inside pocket. Tight fitting. Packable. Storage pouch.

taille /size	assortiment /assortment
S	2
M	3
L	3
XL	3
XXL	1

POLYESTER
& POLYAMIDEMINIMUM
D'ACHAT
m.o.o.

OSSAU - DOUDOUNE SANS MANCHES HOMME

MEN SLEEVELESS LIGHT PADDED JACKET

REF. 901032 S à XXXL/S to XXXL/NOIR GRIS CHINE/BLACK GREY

REF. 901033 S à XXXL/S TO XXXL/CAMO NOIR/BLACK CAMO

REF. 901034 S à XXXL/S TO XXXL/TRICOLOR/TRICOLOR

Doudoune légère sans manches homme. Fermeture par zip nylon. Doublure contrastée ou ton sur ton selon les coloris badge en rubber en poitrine finitions biais aux emmanchures et à la taille. Poches cotés fermées par zip invisibles. Poche intérieure. Coupe ajustée.

/Sleeveless light padded jacket for men. Closing by front nylon zipper. Lining in contrasted colour or ton/ton with shell according to the differents combos. Rubber badge on chest. EA binding at armhole and hem. Side pockets closed by invisible zipper. Inside pocket. Adjusted fitting. Packable. Storage pouch.

taille /size	assortiment /assortment
S	1
M	3
L	3
XL	3
XXL	1
3XL	1



DOUDOUNES SANS MANCHES/SLEEVELESS LIGHT PADDED JACKETS

HABILLER

TEDDY - VESTE POLAIRE FEMME

WOMEN POLAR FLEECE JACKET



POLYESTER

REF. 901055 S à XXL/S to XXL/BLANC/WHITE

REF. 901056 S à XXL/S to XXL/MOCCA/MOCCA

REF. 901058 S à XXL/S to XXL/NOIR/BLACK

REF. 901112 S à XXL/S to XXL/AMARENA/AMARENA

Polaire maille doudou pour femme et/ou enfant à capuche fixe et avec oreilles. Doublure imprimée léopard.

Fermeture par gros zip fantaisie plastique. Badge métallique sur le coté.

Passe-pouce aux manches. Cordons de resserrage à la capuche pour l'adulte

Polar fleece jacket with ears on fixed hood for lady and/or kids.

All over printed lining in coral fleece inside hood. Big fancy plastic zipper at front. Metallic badge on side. Thumbhole at cuff.

Herringbone drawcord at hood for adult.

Taille /size	S	M	L	XL	XXL
Assortiment /assortment	2	2	3	2	1

TEDDY KIDS - VESTE POLAIRE ENFANT

CHILDREN POLAR FLEECE JACKET

REF. 901073 6 À 14 ANS/6 to 14 BLANC/WHITE

REF. 901076 6 À 14 ANS/6 to 14 MOCCA/MOCCA

REF. 901114 6 À 14 ANS/6 to 14/AMARENA/AMARENA

Taille /size	14	12	10	8	6
Assortiment /assortment	2	2	2	2	2



FELICIA - VESTE POLAIRE HYBRIDE FEMME

WOMEN HYBRID POLAR FLEECE JACKET

REF. 901065 S à XXL/S to XXL/ÉCRU/ROSE/OFF WHITE/PINK
REF. 901066 S à XXL/S to XXL/ÉCRU/NOIR/OFF WHITE/BLACK
REF. 901067 S à XXL/S to XXL/NOIR/BLACK

Veste polaire hybride femme/homme à capuche fixe et doublée polaire. Fermeture par zip nylon retourné. Corps et manches en polaire touché nounours. Empiècement doudoune contrasté sur la poitrine et en capuche. Poches cotés zippées. Cordons à la capuche. Élastique de resserrage avec stopper à la taille. Badge rubber sur la manche.

Lady or men Hybrid polar fleece jacket with fixed hood lined with polar fleece. Reversed nylon zipper at front. Body and sleeves in Coral fleece fabric. Yoke in nylon fabric with light padding inside at chest and hood. Side zipped pockets. Herringbone drawcord at hood. Adjustable system at hem with elastic drawcord and stopper. Rubber badge on sleeve. Pockets closed by fancy silver nylon zipper. Adjustable system at hem. Rubber badge and metallic badge on sleeve.



taille /size	assortiment /assortment
S	2
M	2
L	3
XL	2
XXL	1



FURANO - VESTE POLAIRE HYBRIDE HOMME

MEN HYBRID POLAR FLEECE JACKET

REF. 901068 S à XXL/S to XXL/CAMEL/NOIR/CAMEL/BLACK
REF. 901069 S à XXL/S to XXL/ÉCRU/NOIR/OFF WHITE/BLACK
REF. 901070 S à XXL/S to XXL/NOIR/BLACK



taille /size	assortiment /assortment
S	1
M	3
L	3
XL	2
XXL	1

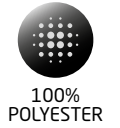

100% POLYESTER



EMPIÈCEMENT/
YOKE
100% NYLON



DOUBLURE/
LINING
100% POLYESTER



QUATINAGE/
PADDING
100% POLYESTER



POLAIRES HYBRIDES/HYBRID POLAR FLEECEES

HABILLER

KIDDY - APRES-SKI À COQUE

HULLED APRES-SKI

REF. 902006 T23 à 28/23 to 28/NOIR/BLACK

REF. 902162 T23 à 28/23 to 28/GRAHIQUE CAMO/CAMO GRAHIC

REF. 902166 T23 à 28/23 to 28/LICORNE/UNICORNE

REF. 902009 T29 à 35/29 to 35/NOIR/BLACK

REF. 902163 T29 à 35/29 to 35/GRAHIQUE CAMO/CAMO GRAHIC

REF. 902167 T29 à 35/29 to 35/LICORNE/UNICORNE

Tige mi-haute synthétique, soufflet sous fermeture par zip, intérieur doublé fausse fourrure, semelle extérieure crantée et coque en TPR.
Synthetic fabric, Mid high upper in synthetic, gusset under closing by zipper, lining in polyester fake fur, notched TPR outsole and outshell.

taille /size	assortiment /assortment
23	2
24	2
25	2
26	2
27	2
28	2

taille /size	assortiment /assortment
29	2
30	2
31	2
32	2
33	2
34	1
35	1

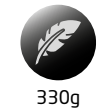

JINNY - APRES SKI A COQUE

ENFANT 29-35

KIDS HULLED SNOW BOOTS

REF. 902171 T29 à 35/29 to 35 / SABLE/SAND

REF. 902172 T29 à 35/29 to 35 / NOIR/BLACK

Tige mi-haute en suedine, Coque en TPR, Languette avec soufflet et badge rubber logoté, Laçage sur le devant, Intérieur et semelle doublés fausse fourrure, Semelle extérieure crantée en TPR

Mid-cut suede upper, TPR shell, Tongue with gusset and rubber logo badge, Lacing on the front, Interior and sole lined with fake fur, Notched TPR outsole



À.P.D.
from
10/24

taille /size	assortiment /assortment
29	2
30	2
31	2
32	2
33	2
34	1
35	1

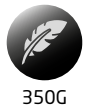

WALSH KID APRES SKI ENFANT KIDS SNOW BOOTS

REF. 902179 T 29 à 35/29 to 35 / BLEU/BLUE

REF. 902180 T 29 à 35/29 to 35 / AMARENA/ AMARENA

Apres-ski hybride enfant

Tige mi-haute en synthétique imprimé effet doudoune

Pied de chaussure en cuir synthétique

Languette avec soufflet et badge rubber logoté

Laçage sur le devant

Intérieur et semelle doublés en fourrure synthétique

Semelle extérieure contrastée et crantée en TPR

Children's hybrid snow boots

All over printed quilted mid-cut upper

Synthetic leather shoe foot

Tongue with gusset and rubber logo badge

Lacing on the front

Interior and sole lined with synthetic fur

Contrasting, notched TPR outsole



À.P.D.
from
10/24

taille /size	assortiment /assortment
29	2
30	2
31	2
32	2
33	2
34	1
35	1



TIGE
UPPER
100%
POLYURETHANE
100%
POLYESTER



SEMELLE/
OUTSOLE
TPR



INTERIEUR /
DOUBLURE
100%
POLYESTER
INSOLE



MEMBRANE
ETANCHE
WATERPROOF
MEMBRANE



335G



x12
MINIMUM
D'ACHAT
M.O.Q.

ALLROAD - APRES-SKI À COQUE HULLED APRES-SKI

REF. 902160 T 36 à 41/36 to 41/KAKI/KHAKI

REF. 902161 T 41 à 46/41 to 46/KAKI/KHAKI

REF. 902004 T 36 à 41/36 to 41/NOIR/BLACK

REF. 902005 T 41 à 46/41 to 46/NOIR/BLACK

Tige mi-haute en synthétique, languette avec soufflet, laçage avant, intérieur doublé polaire, semelle intérieure polaire, semelle extérieure crantée et en TPR, coque en TPR.

/Mid high upper in synthetic, tongue with gusset, lace at front, lining in synthetic fabric polar fleece, insole in polar fleece, notched TPR outsole & outshell.



TIGE /
UPPER
POLYAMIDE



SEMELLE/
OUTSOLE
TPR



DOUBLURE/
LINING
100%
POLYESTER



470g



taille /size	assortiment /assortment
36	1
37	2
38	3
39	3
40	2
41	1

taille /size	assortiment /assortment
41	1
42	3
43	3
44	3
45	1
46	1



x12
MINIMUM
D'ACHAT
M.O.Q.

CHAUSSURES APRES-SKI/SNOW BOOTS

HABILLER

PACOME - APRÈS-SKI À COQUE

HULLED APRÈS-SKI

REF. 902132 T36 à 41/36 to 41/ANTHRACITE/ANTHRACITE

REF. 902133 T36 à 41/36 to 41/BEIGE/BEIGE

Tige mi-haute en feutre avec fausse fourrure, coque en TPR, languette avec soufflet et badge rubber logoté, laçage avant, intérieur doublé fausse fourrure, semelle intérieure doublée fausse fourrure, semelle extérieure crantée en TPR.

/Midhigh upper in felt with fake fur on top, outshell in TPR, tongue with gusset and rubber badge with logo, lace at front, lining in fake fur, insole in fake fur, contrasted and notched TPR outsole.



TIGE / UPPER
100%POLYESTER



SEMELLE/
OUTSOLE
TPR



DOUBLURE/
LINING
100%
POLYESTER



555g



taille /size	assortiment /assortment
36	1
37	2
38	3
39	3
40	2
41	1



MINIMUM
D'ACHAT
M.O.Q.

INUIT - APRES SKI A COQUE

HULLED SNOW BOOTS

REF. 902173 T36 à 41/36 to 41 ECRU/ECRU

REF. 902174 T36 à 41/36 to 41 NOIR/ BLACK

Tige mi-haute en tissu avec empiècement en cuir synthétique et fausse fourrure.

Coque en TPR

Languette avec soufflet et badge rubber logoté.
Laçage bicolore.

Intérieur et semelle doublés fausse fourrure.

Semelle extérieur contrastée et crantée en TPR

Mid-cut upper in polyester fabric with yokes in synthetic leather and fake fur

TPR shell

Tongue with gusset and rubber logo badge.

Two-tone lacing.

Fake fur lined interior and sole.

Contrasting, notched TPR outsole



TIGE / UPPER
100%POLYESTER



EMPIÈCEMENT
YOKE
100%
POLYURETHANE



FAUSSE FOURRURE
FAKE FUR
100% POLYESTER



DOUBLURE/ LINING
100%
POLYESTER



SEMELLE
OUTSOLE
TPR



550G



taille /size	assortiment /assortment
36	1
37	2
38	3
39	3
40	2
41	1



À.P.D.
from
10/24



MINIMUM
D'ACHAT
M.O.Q.

WOOL - APRES SKI A COQUE HULLED SNOW BOOTS

REF. 902176 T36 à 41/36 to 41 GRIS-CAMEL/ GRAY-CAMEL
REF. 902175 T36 à 41/36 to 41 NOIR/ BLACK

Tige mi-haute en cuir synthétique matelassé avec revers.
Empiècement en maille tricot.
Coque en TPR
Languette avec soufflet et badge rubber logoté.
Laçage bicolore.
Intérieur et semelle doublés fausse fourrure.
Semelle extérieur contrastée et crantée en TPR
Mid-cut quilted synthetic leather upper with cuff.
Knitted mesh yoke.
TPR shell
Tongue with gusset and rubber logo badge.
Two-tone lacing.
Fake fur lined interior and sole.
Contrasting and notched TPR outsole



À.P.D.
from
10/24



taille /size	assortiment /assortment
36	1
37	2
38	3
39	3
40	2
41	1

TIGE /UPPER
100%
POLYURETHANE
OU
100% POLYESTER

EMPIECEMENT
YOKE
100% ACRYLIQUE
100% ACRYLIC

FAUSSE FOURRURE
FAKE FUR
100% POLYESTER

DOUBLURE
LINING
100%
POLYESTER

SEMELLE/
OUTSOLE
TPR



560G

x12
MINIMUM
D'ACHAT
M.O.Q.

DOME - APRÈS-SKI BASKET BASKET APRÈS-SKI

REF. 902170 T36 à 41/36 to 41/NOIR/BLACK

Tige mi-haute en cuir synthétique. Intérieur doublé fausse fourrure. Fermeture par lacets avec stopper, languette avec soufflet et badge logoté. Semelle extérieure crantée et contrastée en TPR
/Mid high Upper snowboot for lady .In fake leather. Lining in fake fur. Closing by laces with stopper. Tongue with gusset and branded badge. Contrasted and notched outsole in TPR

TIGE/UPPER
100% POLYURETHANE

SEMELLE/OUTSOLE:
TPR

DOUBLURE/LINING
100% POLYESTER

555g



taille /size	assortiment /assortment
36	1
37	2
38	3
39	3
40	2
41	1

x12
MINIMUM
D'ACHAT
M.O.Q.

GESSI - APRES SKI SNOW BOOTS

REF. 902177 T36 à 41/36 to 41/NOIR/BLACK

REF. 902178 T36 à 41/36 to 41/OR/GOLD

Tige mi-haute en vinyl matelassée.

Pied de chaussure en cuir synthétique brillant

Languette avec soufflet et badge rubber logoté

Laçage sur le devant

Intérieur et semelle doublés en fourrure synthétique

Semelle extérieure contrastée et crantée en TPR

Mid-high padded vinyl upper.

Shiny synthetic leather shoe toe

Tongue with gusset and rubber logo badge

Lacing on the front

Interior and sole lined with synthetic fur

Contrasting and notched TPR outsole



À.P.D.
from
10/24



TIGE / UPPER
100%
POLYURÉTHANE



SEMELLE/
OUTSOLE
TPR



DOUBLURE/
LINING
100%
POLYESTER



600g



MINIMUM
D'ACHAT
M.O.Q.

taille /size	assortiment /assortment
36	1
37	2
38	3
39	3
40	2
41	1

TAOS - APRÈS-SKI APRÈS-SKI

REF. 902077 T36 à 41/36 to 41/BEIGE/BEIGE

Tige mi-haute en cuir synthétique, empiècement tissu imprimé sur le haut, languette avec soufflet et badge logoté, laçage avant, logo serigraphié à l'arrière, intérieur doublé fourrure synthétique, semelle intérieure en fourrure synthétique. Semelle extérieure crantée, contrastée en EVA et TPR.

/Mid-high upper in fake leather, yoke in all over printed fabric at top, tongue with gusset and branded badge, lace at front, printed logo at back, lining in fake fur, insole in fake fur. Contrasted and notched TPR and EVA outsole.



TIGE / UPPER
100%
POLYURÉTHANE



SEMELLE/
OUTSOLE
EVA & TPR



DOUBLURE/
LINING
100%
POLYESTER



600g



MINIMUM
D'ACHAT
M.O.Q.

taille /size	assortiment /assortment
36	1
37	2
38	3
39	3
40	2
41	1



SIERRA LADY- APRES SKI SNOW BOOTS

REF. 902181 T36 à 41/36 to 41/AMARENA
REF. 902182 T36 à 41/36 to 41/INDIGO

Tige mi-haute en cuir synthétique
Empiècement fourrure synthétique sur le haut
Languette avec soufflet et badge rubber logoté
Laçage sur le devant
Intérieur et semelle doublés fausse fourrure.
Semelle extérieure contrastée et crantée
Mid-cut synthetic leather upper
Synthetic fur insert on the top
Tongue with gusset and badge rubber patch
Lacing on the front
Fake fur lined interior and sole.
Contrasting and notched outsole



À.P.D.
from
10/24

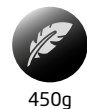

taille /size	assortiment /assortment
36	1
37	2
38	3
39	3
40	2
41	1

WALKYS FEMME - APRÈS-SKI SNOW BOOTS

REF. 902154 T36 à 41/36 to 41/NOIR/BLACK
REF. 902000 T36 à 41/36 to 41/KAKI/KHAKI
REF. 902001 T36 à 41/36 to 41/CAMEL/CAMEL

Tige mi-haute en nubuck synthétique, languette avec soufflet et badge rubber, laçage avant, intérieur doublé fourrure synthétique, semelle intérieure en fourrure synthétique. Semelle extérieure crantée, contrastée et en TPR.
/Mid-high upper in synthetic nubuck, tongue with gusset and rubber badge, lace at front, lining in polyester fake fur, insole in fake fur. Contrasted and notched TPR outsole.

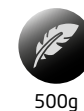
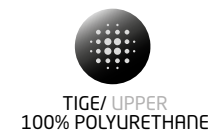

taille /size	assortiment /assortment
36	1
37	2
38	3
39	3
40	2
41	1

KANATA - APRES-SKI A COQUE HULLED SNOW BOOTS

REF. 902183 T 40 à 45/40 to 45/CAMEL/CAMEL
REF. 902184 T 40 à 45/40 to 45/NOIR/BLACK

Tige mi-haute en suedine avec empiècement en cuir synthétique et imprimé carreau.
 Coque en TPR
 Languette avec soufflet et badge rubber logoté.
 Laçage bicolore.
 Intérieur et semelle doublés fausse fourrure.
 Semelle extérieure contrastée et crantée en TPR
 Mid-high suede upper with synthetic leather and all over print yoke.
 TPR shell
 Tongue with gusset and rubber logo badge.
 Two-tone lacing.
 Fake fur lined interior and sole.
 Contrasting and notched TPR outsole



À.P.D.
from
10/24



taille /size	assortiment /assortment
41	1
42	3
43	3
44	3
45	1
46	1



BOLTON - APRES-SKI APRES-SKI

REF. 902108 T 40 à 45/40 to 45/CAMEL/CAMEL
REF. 902109 T 40 à 45/40 to 45/NOIR/BLACK

Tige mi-haute en nubuck synthétique, languette avec soufflet et badge logoté, laçage avant, intérieur doublé fourrure synthétique et mesh, semelle intérieure en fourrure synthétique. Semelle extérieure crantée et contrastée en TPR.
 /Mid-high upper in synthetic nubuck, tongue with gusset and branded badge, lace at front, lining in fake fur and mesh, insole in fake fur. Contrasted and notched TPR outsole.

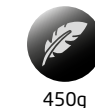

taille /size	assortiment /assortment
40	1
41	2
42	3
43	3
44	2
45	1



WALKYS HOMME - APRÈS-SKI

APRÈS-SKI

REF. 902002 T41 à 46/41 to 46/KAKI/KHAKI

REF. 902003 T41 à 46/41 to 46/CAMEL/CAMEL

Tige mi-haute en nubuck synthétique, languette avec soufflet et badge rubber, laçage avant, intérieur doublé fourrure synthétique, semelle intérieure en fourrure synthétique. Semelle extérieure crantée, contrastée et en TPR.

/Mid-high upper in synthetic nubuck, tongue with gusset and rubber badge, lace at front, lining in polyester fake fur, insole in fake fur. Contrasted and notched TPR outsole.



TIGE/UPPER
100% POLYURETHANE



SEMELLE/OUTSOLE:
TPR



DOUBLURE/LINING
100% POLYESTER



500g



MEMBRANE
ÉTANCHE
WATERPROOF
MEMBRANE



MINIMUM
D'ACHAT
m.o.q.

taille /size	assortiment /assortment
41	1
42	3
43	3
44	3
45	1
46	1

WILLYS MEN - APRÈS-SKI

APRÈS-SKI

REF. 902152 T41 à 46/41 to 46/NOIR/BLACK

Tige mi-haute en nubuck synthétique, languette avec soufflet et badge rubber, laçage avant, intérieur doublé fourrure synthétique, semelle intérieure en fourrure synthétique. Semelle extérieure crantée, contrastée et en TPR.

/Mid-high upper in synthetic nubuck, tongue with gusset and rubber badge, lace at front, lining in fake fur, insole in fake fur. Contrasted and notched TPR outsole.



TIGE/UPPER
100% POLYURETHANE



SEMELLE/OUTSOLE:
TPR



DOUBLURE/LINING
100% POLYESTER



500g



MEMBRANE
ÉTANCHE
WATERPROOF
MEMBRANE



MINIMUM
D'ACHAT
m.o.q.

taille /size	assortiment /assortment
41	1
42	3
43	3
44	3
45	1
46	1



CHAUSSURES APRÈS-SKI/SNOW BOOTS

HABILLER

SIERRA MEN- APRES SKI SNOW BOOTS

REF. 902185 T41 à 46 / 41 to 46 / NOIR/BLACK
REF. 902186 T41 à 46 / 41 to 46 / KAKI/KHAKI

Tige mi-haute en cuir synthétique
 Empiècement feutrine sur le haute
 Languette avec soufflet et badge rubber logoté
 Laçage sur le devant
 Intérieur et semelle doublés fausse fourrure.
 Semelle extérieur contrastée et crantée
 Mid-cut synthetic leather upper
 Felt insert on the top
 Tongue with gusset and branded rubber patch
 Lacing on the front
 Fake fur lined interior and sole.
 Contrasting and notched outsole



À.P.D.
 from
 10/24



taille /size	assortiment /assortment
41	1
42	3
43	3
44	3
45	1
46	1

 TIGE / UPPER
 100%
 POLYURETHANE

 DOUBLURE/
 INSULATE
 100%
 POLYESTER

 SEMELLE/
 OUTSOLE
 TPR



 450g

 **x12**
 minimum
 D'ACHAT
 m.o.o.

HILLS - APRES-SKI SNOW BOOTS

REF. 902099 T40 à 45/40 to 45/MARRON/BROWN
REF. 902101 T40 à 45/40 to 45/NOIR/BLACK

Tige mi-haute en nubuck et cuir synthétique, empiècement tissu chevron sur le haut et sur la languette, languette avec soufflet et badge logoté, laçage avant, intérieur doublé fourrure synthétique, semelle intérieure en fourrure synthétique. Semelle extérieure crantée et contrastée en TPR et MD.
 /Mid-high upper in fake leather and synthetic nubuck, yoke in herringbone fabric at top and tongue, tongue with gusset and branded badge, lace at front, lining in fake fur, insole in fake fur.
 Contrasted and notched TPR and MD outsole.

 TIGE/ UPPER
 100% POLYURETHANE

 SEMELLE/OUTSOLE:
 MD & TPR

 DOUBLURE/LINING
 100% POLYESTER

 470g



taille /size	assortiment /assortment
40	1
41	2
42	3
43	3
44	2
45	1

 **x12**
 minimum
 D'ACHAT
 m.o.o.

NEVADA - APRES SKI SNOW BOOTS

REF. 902187 T41 à 46/41 to 46/MARINE/ NAVY
REF. 902188 T41 à 46/41 to 46/CAMEL/CAMEL

Tige mi-haute en cuir synthétique
 Renfort au talon et sur le devant
 Languette avec soufflet et badge rubber logoté
 Laçage sur le devant
 Intérieur et semelle doublés en tissu
 Semelle extérieur contrastée et crantée
 Mid-high synthetic leather upper
 Reinforcement at heel and front
 Tongue with gusset and branded rubber patch
 Lacing on the front
 Interior and sole lined in mesh fabric
 Contrasting and notched outsole



À.P.D.
 from
 10/24



taille /size	assortiment /assortment
41	1
42	3
43	3
44	3
45	1
46	1



TIGE / UPPER
 100%
 POLYURETHANE



DOUBLURE/
 INSOLE
 100%
 POLYESTER



SEMELLE/
 OUTSOLE
 TPR



MINIMUM
 D'ACHAT
 m.o.q.

PHARES BASKET DE RANDONNÉE

MEN/HIKING SNEAKERS

REF. 905005

T41 à 46/41 to 46/KAKI ORANGE/KHAKI ORANGE

REF. 905007

T41 à 46/41 to 46/NOIR BLEU ROYAL/BLACK ROYAL BLUE

Basket de randonnée en tissu Ribstop avec impression laser. Laçage bicolore. Semelle crantée bicolore. Intérieur de chaussure en tissu. Badge logoté sur la languette. Logo sérigraphié sur le côté

/Hiking Sneakers in Ribstop fabric with laser print. 2 tones lacing. Two tones notched outsole. Lining in mesh fabric. Printed badge on tongue. Printed logo on side

taille /size	assortiment /assortment
41	1
42	3
43	3
44	3
45	1
46	1



TIGE/UPPER :
100% POLYAMIDE +
100% POLYURETHANE



DOUBLURE/LINING
100% POLYESTER



SEMELLE/OUTSOLE:
MD + RUBBER



330g



MINIMUM
D'ACHAT
M.O.Q.

PHARES BASKET DE RANDONNÉE

WOMEN/HIKING SNEAKERS

REF. 905008

T36 à 41/36 to 41/NOIR/BLEU GLACIER

/BLACK/ICE BLUE

Basket de randonnée en tissu Ribstop avec impression laser. Laçage bicolore. Semelle crantée bicolore. Intérieur de chaussure en tissu. Badge logoté sur la languette.

Logo sérigraphié sur le côté
/Hiking Sneakers in Ribstop fabric with laser print. 2 tones lacing. Two tones notched outsole. Lining in mesh fabric. Printed badge on tongue. Printed logo on side

taille /size	assortiment /assortment
36	1
37	2
38	3
39	3
40	2
41	1



TIGE/UPPER :
100% POLYAMIDE +
100% POLYURETHANE



DOUBLURE/LINING
100% POLYESTER



SEMELLE/OUTSOLE:
MD + RUBBER



250g



MINIMUM
D'ACHAT
M.O.Q.

RODNA BASKET DE TRAIL

RODNA MEN/TRAIL BASKET

REF. 905003

T41 à 46/41 to 46/KAKI /KHAKE

Basket de trail en tissu Ribstop avec impression laser. Laçage avec œillet et stopper. Semelle crantée bicolore. Intérieur en tissu. Badge logoté sur la languette
/Hiking Sneakers in Ribstop fabric with laser print lacing with eyelets and stoppers. Two tone notched outsole. Lining in mesh fabric. Printed badge on tongue

taille /size	assortiment /assortment
41	1
42	3
43	3
44	3
45	1
46	1



TIGE/UPPER :
100% POLYAMIDE +
100% POLYURETHANE



DOUBLURE/LINING
100% POLYESTER



SEMELLE/OUTSOLE:
MD+RUBBER+TPU



340g



MINIMUM
D'ACHAT
M.O.Q.

RODNA BASKET DE TRAIL

RODNA WOMEN/TRAIL BASKET

REF. 905004

T36 à 41/36 to 41/AQUA/AQUA

Basket de trail en tissu Ribstop avec impression laser. Laçage avec œillet et stopper. Semelle crantée bicolore. Intérieur en tissu. Badge logoté sur la languette
/Hiking Sneakers in Ribstop fabric with laser print lacing with eyelets and stoppers. Two tone notched outsole. Lining in mesh fabric. Printed badge on tongue

taille /size	assortiment /assortment
36	1
37	2
38	3
39	3
40	2
41	1



TIGE/UPPER :
100% POLYAMIDE +
100% POLYURETHANE



DOUBLURE/LINING
100% POLYESTER



SEMELLE/OUTSOLE:
MD+RUBBER+TPU



285g



MINIMUM
D'ACHAT
M.O.Q.

ZAGORI CHAUSSURES DE RANDONNÉE

MEN/HIKING SHOES

REF. 905013

T 41 à 46/41 to 46/MARINE/ ORANGE/NAVY ORANGE

Chaussures de randonnée tige haute en tissu ripstop et cuir synthétique. Semelle crantée et bicolore. Renfort sur le devant du pied. Laçage bicolore. Intérieur textile. Logo sérigraphié sur le côté, badge logoté sur la languette. Membrane Waterproof /High cut hiking shoes in Ripstop fabric and fake leather. Two tones notched outsole. Yoke in PU at front to reinforce the foot. Two tones laces. Lining in mesh fabric. Printed logo on tongue and on side. WATERPROOF MEMBRANE



taille /size	assortiment /assortment
41	1
42	1
43	1
44	1
45	1
46	1



TIGE/UPPER :
100% POLYESTER
+100% POLYURETHANE



DOUBLURE/LINING
100% POLYESTER



SEMELLE/OUTSOLE:
EVA + RUBBER



MEMBRANE
ETANCHE
WATERPROOF
MEMBRANE



500g



MINIMUM
D'ACHAT
m.o.q.

ZAGORI CHAUSSURES DE RANDONNÉE

WOMEN/HIKING SHOES

REF. 905015 T 36 à 41/36 to 41/AQUA/AQUA

Chaussures de randonnée tige haute en tissu ripstop et cuir synthétique. Semelle crantée bicolore. Renfort sur le devant du pied. Laçage bicolore. Intérieur textile. Logo sérigraphié sur le côté, badge logoté sur la languette. Membrane Waterproof /High cut hiking shoes in Ripstop fabric and fake leather. Two tones notched outsole. Yoke in PU at front to reinforce the foot. Two tones laces. Lining in mesh fabric. Printed logo on tongue and on side. WATERPROOF MEMBRANE



taille /size	assortiment /assortment
36	1
37	1
38	1
39	1
40	1
41	1



TIGE/UPPER :
100% POLYESTER
+100% POLYURETHANE



DOUBLURE/LINING
100% POLYESTER



SEMELLE/OUTSOLE:
EVA + RUBBER



MEMBRANE
ETANCHE
WATERPROOF
MEMBRANE



400g



MINIMUM
D'ACHAT
m.o.q.

TEIFI CHAUSSURES HYBRIDE DE RANDO

HIKING HYBRID SHOES

REF. 905018 T41 à 46/41 to 46/CAMEL/CAMEL

REF. 905019 T36 à 41/36 to 41/CAMEL/CAMEL

REF. 905020 T41 à 46/41 to 46/BEIGE/OFFWHITE

REF. 905021 T36 à 41/36 to 41/BEIGE/OFFWHITE

Chaussure hybride pour randonnée et activités d'eau. Tige en tissu aéré avec empiècement cuir synthétique. Laçage avec stopper. Sangles ajustables sur le côté. Semelle crantée contrastée. Badge logoté sur la languette /Hybrid shoes for hiking and water activities. Airy fabric upper with synthetic leather insert. Lacing with stopper. Adjustable straps on the side. Contrasting notched outsole. Logo badge on the tongue



taille /size	assortiment /assortment
41	1
42	3
43	3
44	3
45	1
46	1

taille /size	assortiment /assortment
36	1
37	2
38	3
39	3
40	2
41	1

TIGE/UPPER :
100% POLYESTER
+100% POLYURETHANE

SEMELLE/OUTSOLE:
TPR

WATERPROOF

360g

MINIMUM
D'ACHAT
m.o.q.

CHAUSSURES/ CHAUSSURES AQUATIQUES

HABILLER

CHAUSSONS D'EAU

/Aquashoes

MARINE/NAVY

- REF. 610870 T25
- REF. 610871 T26
- REF. 610872 T27
- REF. 610873 T28
- REF. 610874 T29
- REF. 610875 T30
- REF. 610876 T31
- REF. 610877 T32
- REF. 610878 T33
- REF. 610879 T34
- REF. 610869 T35
- REF. 610788 T36
- REF. 610789 T37
- REF. 610790 T38
- REF. 610791 T39
- REF. 610792 T40
- REF. 610793 T41
- REF. 610794 T42
- REF. 610795 T43
- REF. 610833 T44
- REF. 610834 T45
- REF. 610868 T46

ROSE/PINK

- REF. 610880 T28
- REF. 610881 T29
- REF. 610882 T30
- REF. 610883 T31
- REF. 610884 T32
- REF. 610885 T33
- REF. 610886 T34
- REF. 610887 T35
- REF. 610888 T36
- REF. 610889 T37
- REF. 610890 T38
- REF. 610891 T39
- REF. 610892 T40



TIGE/UPPER:
100% POLYESTER



SEMELLE/OUTSOLE:
TPR



480g



MINIMUM
D'ACHAT
M.O.Q.

CAMSO MEN CHAUSSONS D'EAU AQUA SHOES

REF. 904010

T41 à 46/41 to 46/NOIR/BLACK

REF. 904012

T41 à 46/41 to 46/BLEU ROYAL/ROYAL BLUE

Chausson aquatique avec semelle sport antidérapante. Fermeture par lacets et stoppers. Semelle ergonomique. Bande élastiquée à l'arrière. Logo sérigraphié sur le côté.
/Aquatic slipper with non-slip sport sole . Closing with laces and stoppers . Ergonomic sole . Elasticated band at the back Screen-printed logo on the side.



TIGE/UPPER :
100% POLYESTER
+100% POLYURETHANE



DOUBLURE/LINING
100% POLYESTER



SEMELLE/OUTSOLE:
EVA + RUBBER



250g

taille /size	assortiment /assortiment
41	1
42	3
43	3
44	3
45	1
46	1



MINIMUM
D'ACHAT
M.O.Q.

CAMSO WOMEN CHAUSSONS D'EAU AQUA SHOES

REF. 904011

T36 à 41/36 to 41/NOIR/BLACK

REF. 904013

T36 à 41/36 to 41/FUSHIA/FUSHIA

Chausson aquatique avec semelle sport antidérapante. Fermeture par lacets et stoppers. Semelle ergonomique. Bande élastiquée à l'arrière. Logo sérigraphié sur le côté.
/Aquatic slipper with non-slip sport sole . Closing with laces and stoppers . Ergonomic sole . Elasticated band at the back Screen-printed logo on the side.



TIGE/UPPER :
100% POLYESTER
+100% POLYURETHANE



DOUBLURE/LINING
100% POLYESTER



SEMELLE/OUTSOLE:
EVA + RUBBER



250g

taille /size	assortiment /assortiment
36	1
37	2
38	3
39	3
40	2
41	1



MINIMUM
D'ACHAT
M.O.Q.

HILLY GANTS SOFTSHELL

SOFTSHELL GLOVES

REF. 903000 S (6)/NOIR/BLACK
REF. 903001 M (7)/NOIR/BLACK
REF. 903002 L (8)/NOIR/BLACK
REF. 903003 XL (9)/NOIR/BLACK
REF. 903004 XXL (10)/NOIR/BLACK

Tissu principale en softshell. Paume en cuir synthétique (100% Polyurethane).

Doublure en polaire.

Poche zippée pour chaufferette.

poignets élastiques et patte de resserage.

Main fabric in softshell. Palm in fake leather (100% Polyurethane).

Lining in polar fleece. Zipped pocket for pocket heat.

Elasticated cuff with adjustable tape.



95% POLYESTER
5% ELASTHANE



QUATINE C40
THINSULATE
PADDING C40
THINSULATE



DÉPERLANT
2000/m²/24H/m²
WATERPROOF
2000mm/24H/m²



MEMBRANE
RESPIRANTE
MEMBRANE
BREATHABLE



DOUBLURE
100% POLYESTER

**DAVOS MOUFLES SOFTSHELL**

SOFTSHELL MITTENS

REF. 903005 S (6)/NOIR/BLACK
REF. 903006 M (7)/NOIR/BLACK
REF. 903007 L (8)/NOIR/BLACK
REF. 903008 XL (9)/NOIR/BLACK
REF. 903009 XXL (10)/NOIR/BLACK

Tissu principale en softshell. Paume en cuir synthétique (100% Polyurethane).

Doublure en polaire.

Poche zippée pour chaufferette.

Poignets élastiques et patte de resserage.

Main fabric in softshell. Palm in fake leather (100% Polyurethane).

Lining in polar fleece. Zipped pocket for pocket heat.

Elasticated cuff with adjustable tape.



95% POLYESTER
5% ELASTHANE



QUATINE C40
THINSULATE
PADDING C40
THINSULATE



DÉPERLANT
2000/m²/24H/m²
WATERPROOF
2000mm/24H/m²



MEMBRANE
RESPIRANTE
MEMBRANE
BREATHABLE



DOUBLURE
100% POLYESTER



TANIA - GANTS SOFTSHELL

SOFTSHELL GLOVES

REF. 903010 4/6 A/NOIR/BLACK

REF. 903011 8/10 A/NOIR/BLACK

REF. 903012 10/12 A/NOIR/BLACK

REF. 903013 14/16 A/NOIR/BLACK

Tissu principale en softshell. Paume en cuir synthétique (100% Polyurethane).

Doublure en polaire.

Poignets élastiques et patte de resserage.

Main fabric in softshell. Palm in fake leather (100% Polyurethane).

Lining in polar fleece.

Elasticated cuff with adjustable tape.



95% POLYESTER
5% ELASTHANE



QUATINE C40
THINSULATE
PADDING C40
THINSULATE



DÉPERLANT
2000/m²/24H/m²
WATERPROOF
2000mm/24H/m²



MEMBRANE
RESPIRANTE
MEMBRANE
BREATHABLE



DOUBLURE
100% POLYESTER



ORELLE - MOUFLES SOFTSHELL

SOFTSHELL MITTENS

REF. 903014 2/4 A/NOIR/BLACK

REF. 903015 4/6 A/NOIR/BLACK

REF. 903016 8/10 A/NOIR/BLACK

REF. 903017 10/12 A/NOIR/BLACK

REF. 903048 14/16 A/NOIR/BLACK

Tissu principale en softshell. Paume en cuir synthétique (100% Polyurethane).

Doublure en polaire.

Poignets élastiques.

Main fabric in softshell. Palm in fake leather (100% Polyurethane). Lining in polar fleece.

Elasticated cuff.



95% POLYESTER
5% ELASTHANE



QUATINE C40
THINSULATE
PADDING C40
THINSULATE



DÉPERLANT
2000/m²/24H/m²
WATERPROOF
2000mm/24H/m²



MEMBRANE
RESPIRANTE
MEMBRANE
BREATHABLE



DOUBLURE
100% POLYESTER



MITTY - GANTS SOFTSHELL POUR SKI DE FOND

MITTY - SOFTSHELL GLOVES FOR
CROSS-COUNTRY SKIING

- REF. 903050** TAILLE S NOIR/BLACK
REF. 903051 TAILLE M NOIR/BLACK
REF. 903052 TAILLE L NOIR/BLACK
REF. 903053 TAILLE XL NOIR/BLACK
REF. 903054 TAILLE XXL NOIR/BLACK

Gants softshell pour ski de fond
 Intérieur de la main en 100% polyurethane
 Poignets élastiqués avec patte de resserrage
 Poche pour chaufferette avec zip étanche
 Dragonne
 Adult softshell gloves for cross country skiing
 Palm in 100% polyurethane
 Elasticated cuffs with tightening tabs
 Warmer pocket with waterproof zip
 Strap

new!

À.P.D.
from
10/24



SOFTSHELL 95%
POLYESTER 5%
ELASTHANE



QUATINE C40
THINSULATE
PADDING C40
THINSULATE



DÉPERLANT
2000 mm/m²/24H
WATERPROOF
2000 mm/m²/24H/m²



MEMBRANE
RESPIRANTE
WATERPROOF
BREATHABLE



DOUBLURE/PADDING
100% POLYESTER

GUANTI - GANTS SOFTSHELL BICOLORE

GUANTI - TWO TONS SOFTSHELL GLOVE

- REF. 903055** TAILLE S CAMEL
REF. 903056 TAILLE M CAMEL
REF. 903057 TAILLE L CAMEL
REF. 903058 TAILLE XL CAMEL
REF. 903059 TAILLE XXL CAMEL
REF. 903060 TAILLE S BLANC/WHITE
REF. 903061 TAILLE M BLANC/WHITE
REF. 903062 TAILLE L BLANC/WHITE
REF. 903063 TAILLE XL BLANC/WHITE
REF. 903064 TAILLE XXL BLANC/WHITE

Gants softshell bicolores
 Intérieur de la main en 100% polyurethane
 Poignets élastiqués avec patte de resserrage
 Poche pour chaufferette avec zip étanche
 Dragonne
 Adult two-tone softshell gloves
 Palm in 100% polyurethane
 Elasticated cuffs with tightening tabs
 Warmer pocket with waterproof zip
 Strap

new!

À.P.D.
from
10/24



SOFTSHELL 95%
POLYESTER 5%
ELASTHANE
Softshell 95%
polyester 5%
Elasthan



QUATINE C40
THINSULATE
PADDING C40
THINSULATE



DÉPERLANT
2000 mvp/m²/24H
WATERPROOF



MEMBRANE
RESPIRANTE
WATERPROOF
BREATHABLE



DOUBLURE/LINING
100% POLYESTER

GLOVY- GANTS SOFTSHELL BICOLORES ENFANTS

GLOVE - TWO TONS KIDS SOFTSHELL GLOVES

- REF. 903065** TAILLE 4/6 A NOIR/BLEU - BLACK/BLUE
REF. 903066 TAILLE 8/10 A NOIR/BLEU - BLACK/BLUE
REF. 903067 TAILLE 12/14 A NOIR/BLEU - BLACK/BLUE
REF. 903068 TAILLE 4/6 A NOIR/AMARENA - BLACK/AMARENA
REF. 903069 TAILLE 8/10 A NOIR/AMARENA - BLACK/AMARENA
REF. 903070 TAILLE 12/14 A NOIR/AMARENA - BLACK/AMARENA

Gants softshell bicolores
 Intérieur de la main en 100% polyuréthane
 Poignets élastiqués avec pattes de resserrage
 Poche pour chauffelette avec zip étanche
 Dragonne
 Two-tone softshell gloves
 Palm in 100% polyurethane
 Elasticated cuffs with tightening tabs
 Warmer pocket with waterproof zip
 Strap



À.P.D.
from
10/24



SOFTSHELL 95%
POLYESTER 5%
ELASTHANNE
Softshell 95%
polyester 5%
Elasthan



QUATINE C40
THINSULATE
PADDING C40
THINSULATE



DEPERLANT
2000 mm/m²/24H
WATERPROOF



MEMBRANE
RESPIRANTE
WATERPROOF
BREATHABLE



DOUBLURE/LINING
100% POLYESTER



SNOWY - MOUFFLES SOFTSHELL ENFANTS

QUANTI - SOFTSHELL KIDS MITTENS

- REF. 903071** TAILLE 2/4 A BLEU / BLUE
REF. 903072 TAILLE 6/8 A BLEU / BLUE
REF. 903073 TAILLE 10/12 A BLEU / BLUE
REF. 903074 TAILLE 2/4 A AMARENA / AMARENA
REF. 903075 TAILLE 6/8 A AMARENA / AMARENA
REF. 903076 TAILLE 10/12 A AMARENA / AMARENA

Mouffles softshell
 Intérieur de la main en 100% polyuréthane
 Poignets élastiqués avec pattes de resserrage
 Poche pour chauffelette avec zip étanche
 Dragonne
 Softshell Mittens
 Palm in 100% polyurethane
 Elasticated cuffs with tightening tabs
 Warmer pocket with waterproof zip
 Strap



À.P.D.
from
10/24



SOFTSHELL 95%
POLYESTER 5%
ELASTHANNE
Softshell 95%
polyester 5%
Elasthan



QUATINE C40
THINSULATE
PADDING C40
THINSULATE



DEPERLANT
2000 mm/m²/24H
WATERPROOF



MEMBRANE
RESPIRANTE
WATERPROOF
BREATHABLE



DOUBLURE/LINING
100% POLYESTER





ÉQUIPER
EQUIPER
ÉQUIPER

ÉQUIPER

Crampons quick fix

Quick fix crampons

REF. 610966 TAILLE S/M
REF. 610967 TAILLE L/XL

Crampons quick fix
Quick fix crampons

new!

A.P.D.
from
10/24



3 POINTES
2mm
3 spikes

Crampons 6 clous

6 spikes crampons

REF. 610004 S (33/36)
REF. 610005 M (37/40)
REF. 610006 L (41/44)
REF. 610007 XL (45/48)

Conforme aux normes
89/686/EEC.
Complies with
89/686/EEC standards.



6 POINTES
2mm
6 spikes

Crampons luxe 10 clous

10 spikes crampons

REF. 610009 M (33/37)
REF. 610010 L (38/42)
REF. 610011 XL (43/47)

Conforme aux normes
89/686/EEC.
Complies with
89/686/EEC standards.



10 POINTES
2mm
10 spikes

INOX
stainless
steel

Crampons EZYFIX 10 clous

10 spikes EZYFIX crampons

REF. 610013 M (37/40)
REF. 610014 L (41/44)
REF. 610015 XL (45/48)

Conforme aux normes
89/686/EEC.
Complies with
89/686/EEC standards.



10 POINTES
2mm
10 spikes

Crampons TRAILER

/TRAIL crampons

- REF. 610771 S (38/40)
- REF. 610772 M (41/43)
- REF. 610773 L (44/46)
- REF. 610774 XL (46+)

Velcro de maintien, conforme aux normes 89/686/EEC.
/Velcro support, complies with 89/686/EEC standards.



TPR & INOX 430 stainless steel

Crampons CHAIN

/CHAIN crampons

- REF. 610026 M (37/40)
- REF. 610027 L (41/44)
- REF. 610028 XL (45/48)

Velcro de maintien, conforme aux normes 89/686/EEC.
/Velcro support, complies with 89/686/EEC standards.



8 POINTES
12mm
8 spikes



TPR & INOX 430 stainless steel



Crampons RUNNING

/RUNNING crampons

- REF. 602723 S (33/36)
- REF. 602724 M (37/40)
- REF. 602725 L (41/44)
- REF. 602726 XL (45/48)

Boîte de protection, conforme aux normes 89/686/EEC.
/Protective case, complies with 89/686/EEC standards.



10 POINTES
5mm
10 spikes



TPR & INOX 430 stainless steel

Crampons PRO antidérapants

/PRO anti-slip crampons

- REF. 610017 S (33/38)
- REF. 610018 M (36/41)
- REF. 610019 L (39/44)
- REF. 610020 XL (43/48)

Usage intensif, conforme aux normes 89/686/EEC.
/Intensive use, complies with 89/686/EEC standards.



11 POINTES
2mm
11 spikes



TUNGSTÈNE
tungsten

Crampons ICE ULTRALIGHT

/ICE ULTRALIGHT crampons

- REF. 602720 S (33/36)
- REF. 602709 M (37/40)
- REF. 602710 L (41/44)
- REF. 602721 XL (45/48)

Boîte de protection, conforme aux normes 89/686/EEC.
/Protective case, complies with 89/686/EEC standards.



8 POINTES
7mm
8 spikes



TPR & INOX 430 stainless steel



Crampons ICE LIGHT

/ICE LIGHT crampons

- REF. 602711 S (33/36)
- REF. 602712 M (37/40)
- REF. 602713 L (41/44)
- REF. 602722 XL (45/48)

Boîte de protection, conforme aux normes 89/686/EEC.
/Protective case, complies with 89/686/EEC standards.



13 POINTES
12mm
13 spikes



TPR & INOX 430 stainless steel



Chaufferette main/pied

/Pocketheat

REF. 610000



8/12h

MINIMUM
D'ACHAT
m.o.q.**Chaufferette pied adhésive**

/Adhesive footheat

REF. 610001



6/8h

MINIMUM
D'ACHAT
m.o.q.**Chaufferette réactivable en bain marie**

/Water bath reactivable magicheat

REF. 610002



45/60min

MINIMUM
D'ACHAT
m.o.q.**Aide au ski Tryski EDGE**

/Tryski EDGE ski assist

REF. 610034

Mâchoires plastiques, convient aux spatules larges et épaisses.
/Plastic jaws, suitable for wide and thick spatulas.

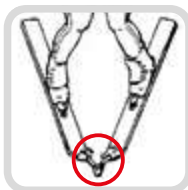
**Aide au ski Tryski GRIFFE**

/Tryski GRIFFE ski assist

REF. 610036

Mâchoires plastiques, modèle résistant pour la location, convient aux spatules larges et épaisses.
/Plastic jaws, resistant for rental, suitable for wide and thick spatulas.

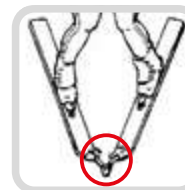
**Aide au ski Tryski SANDOW**

/Tryski SANDOW ski assist

REF. 610035

Mâchoires aluminium, modèle résistant pour la location, convient aux spatules larges et épaisses.
/Aluminium jaws, resistant for rental, suitable for wide and thick spatulas.

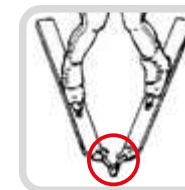

Aide au ski Tryski TUBE

/Tryski TUBE ski assist

REF. 610037

Mâchoires aluminium, convient aux spatules larges et épaisses.
/Aluminium jaws, suitable for wide and thick spatulas.

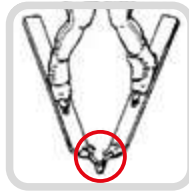

Aide au ski pliable Tryski PRO

/Tryski PRO foldable ski assist

REF. 610039

Mâchoires aluminium, convient aux spatules larges et épaisses.
/Aluminium jaws, suitable for wide and thick spatulas.

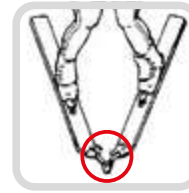

Porte tout botte/ski/roller

/Boot/ski/roller carry all

REF. 610193

Sangle d'épaule, deux attaches velcro, packaging sleeve.
/Shoulder strap, two velcro fasteners, packaging sleeve.



Harnais d'apprentissage

/Learning harness

REF. 610040

Pour apprentissage du ski, pour retenir et guider l'enfant à ski, laisse de 2,5 m.
/For learning to ski, to retain and guide the child to ski, leash of 2,5 m.



3-10 ANS
3-10yo



180g



Harnais d'apprentissage avec poignée

/Learning harness with handle

REF. 610041

Pour apprentissage du ski, pour retenir et guider l'enfant à ski, laisse de 2,5m, poignée de portage.
/For learning to ski, to retain and guide the child to ski, leash of 2,5 m, with handle.



3-10 ANS
3-10yo



Porte ski harnais/sac à dos

/Ski harness/backpack holder

REF. 610195 ADULTE/ADULT
REF. 610796 ENFANT/KID

Confortable avec bretelles ajustables.
/Comfortable with adjustable straps.



Attache velcro ski alpin
/Alpine skiing velcro fastener

REF. 610050 ASSORTIS/ASSORTED
REF. 610711 NOIR/BLACK



2,5x35cm



CUSTOMISABLE
customizable



NOIR



ASSORTIS

Étiquette plastique pour marquage
/Plastic label for marking

REF. 610051 BLANC/WHITE

Étiquette seule, à glisser sur velcro ski alpin (REF. 610050) ou velcro ski de fond (REF. 610062).
/Label alone, to slip on velcro alpine ski (REF. 610050) or cross-country skiing velcro (REF. 610062).



3,5x7cm



MINIMUM
D'ACHAT
m.o.q.

Attache velcro ski de fond
/Cross-country skiing velcro fastener

REF. 610062 ASSORTIS/ASSORTED



2,5x22cm



CUSTOMISABLE
customizable



MINIMUM
D'ACHAT
m.o.q.

Attache velcro carving mousse 50 mm
/50 mm velcro carving foam fastener

REF. 610054 NOIR/BLACK

Mousse de protection noire.
/Black protective foam.



CUSTOMISABLE
customizable



MINIMUM
D'ACHAT
m.o.q.

Attache velcro carving luxe 50 mm
/50 mm velcro carving luxury fastener

REF. 610056 NOIR/BLACK

Injeté blocage carré en T.
/Injected square blocking T.



CUSTOMISABLE
customizable



MINIMUM
D'ACHAT
m.o.q.

Chaussette ski de fond 50 mm
/50 mm cross-country ski socks

REF. 610064 NOIR/BLACK



CUSTOMISABLE
customizable



MINIMUM
D'ACHAT
m.o.q.

Élastique boule pour ski de fond

/Elastic ball for cross-country skiing

REF. 610066

Bracelet élastique attache tout.
/Elastic strap fastens everything.



MADE IN FRANCE



Boucle rapide plastique male/femelle

/Male/female plastic quick loop

REF. 610068 15mm



REF. 610069 20mm



REF. 610070 25mm



REF. 610071 30mm



REF. 610072 40mm



Chaussette réservation ski

/Ski booking sock

REF. 610211

Pochette transparente 21 x 15 cm.
/Transparent pouch 21 x 15 cm.



POLYESTER CORDULA



CUSTOMISABLE customizable



MINIMUM D'ACHAT m.o.q.

Protection semelle botte de ski

/Ski boot sole protection

610030 S/M 37/41

610031 L/XL 42/48



Range ski

/Ski storage

REF. 610134

Range ski à levier automatique à visser avec rail de fixation.
/Ski storage with automatic lever to be screwed with fixing rail.



Porte forfait brassard

/Cuff pass on

REF. 610047 BLANC/WHITE



MADE IN FRANCE



CUSTOMISABLE customizable



MINIMUM D'ACHAT m.o.q.

Leash sangle snowboard 20 mm

Leash snowboard strap 20 mm

REF. 610073 NOIR/BLACKBoucle fermeture plastique.
Plastic buckle closure.

2x70cm

MINIMUM
D'ACHAT
m.o.q.**Leash sangle snowboard 30 mm**

Leash snowboard strap 30 mm

REF. 610074 NOIR/BLACKBoucle fermeture plastique.
Plastic buckle closure.

3x70cm

MINIMUM
D'ACHAT
m.o.q.**Microleash STEP IN sangle/mousqueton**

STEP IN Microleash strap/carabiner

REF. 610077 ASSORTIS/ASSORTEDAttache mousqueton et cordelette.
Carabiner clip and cord.

1,8x20cm

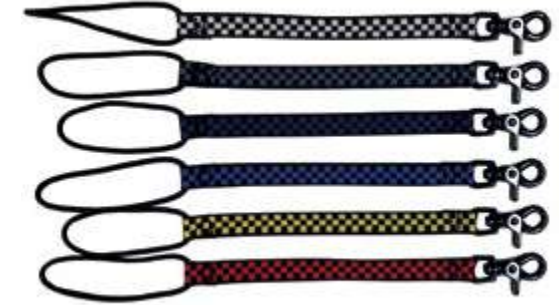
MINIMUM
D'ACHAT
m.o.q.**Microleash STEP IN ressort/mousqueton**

STEP IN Microleash spring/carabiner

REF. 610080 ASSORTIS/ASSORTEDAttache mousqueton et cordelette.
Carabiner clip and cord.MADE IN
FRANCEMINIMUM
D'ACHAT
m.o.q.**Leash**

Leash

REF. 602801 45 à 75 cm/45 to 75 cmBoucle fermeture plastique.
Plastic buckle closure.MADE IN
FRANCEMINIMUM
D'ACHAT
m.o.q.**Leash spécial SNOWSCOOT**

Leash SNOWSCOOT spécial

REF. 610078 NOIR/BLACKAnti vrille inox, jambière velcro,
allongement du ressort de 50 à 200 cm.
Stainless steel twist guard, velcro leg,
extension of the spring from 50 to 200 cm.

0,7cm



Leash TELEMARK avec câble inox

Leash TELEMARK with stainless steel cable

REF. 610081

Fixation pour telemark et ski de randonnée.
Fixing for telemark and ski touring.



Ruban ski poudreuse

Powder ski band

REF. 610083

Ruban de 150cm
fixation par cordelette.
150 cm ribbon
fastening by cord.



Tire luge

Sledge puller

REF. 610085

Poignée plastique et corde.
Plastic handle and rope.



120cm



0,5cm



MADE IN FRANCE



Porte-chaussure poignée

/Shoe holder handle

REF. 610084

Plastique noir, anneau corde.
/Black plastic, rope ring.

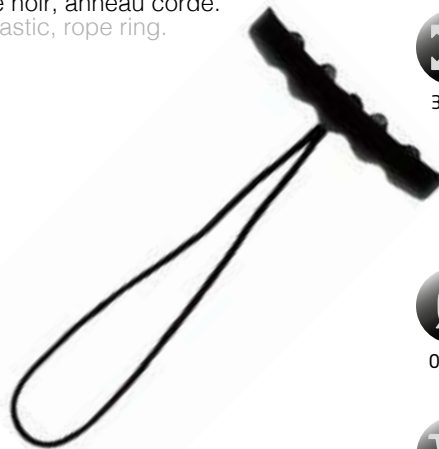

MADE IN FRANCE



30cm



0,5cm



Corde tire luge sans poignée

Sledge puller cord

REF. 610082

Corde pré-découpée livrée en vrac.
Pre-cut rope delivered in bulk.

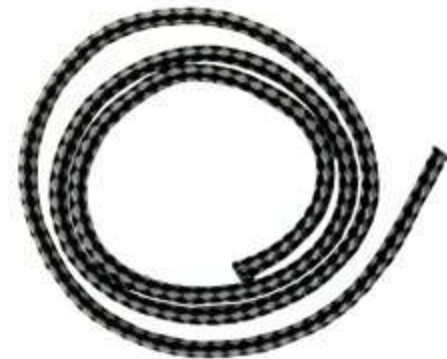

0,5cm



100cm



Pad mousse rond
Round foam pad

REF. 610087

Pad snowboard autocollant en mousse 5 mm striée noire.
Snowboard pad self-adhesive foam 5 mm striated black.



EVA



12cm



MADE IN FRANCE



MINIMUM D'ACHAT m.o.q.

Pad mousse oval
Oval foam pad

REF. 610088

Pad snowboard autocollant en mousse 5 mm striée noire.
Snowboard pad self-adhesive foam 5 mm striated black.



EVA



15cm



MADE IN FRANCE



MINIMUM D'ACHAT m.o.q.

Pad tribal adhésif
Tribal adhesive pad

REF. 610094



8,5x15cm



MADE IN FRANCE



MINIMUM D'ACHAT m.o.q.

Pad vagues adhésif
Waves adhesive pad

REF. 610090

Vendu sous blister
Sold in blister pack.



8,5x14cm



MINIMUM D'ACHAT m.o.q.

Pad rond adhésif
Round adhesive pad

REF. 610091

Vendu sous blister
Sold in blister pack.



10cm



MINIMUM D'ACHAT m.o.q.

Pad burning adhésif
Burning adhesive pad

REF. 610097



15cm



MINIMUM D'ACHAT m.o.q.

Pad star adhésif x 9 pièces

6 pieces star adhesive pad

REF. 610099

Vendu sous blister
Sold in blister pack.



2cm



MINIMUM
D'ACHAT
m.o.o.

Désinfectant chaussures GERMKILLER

GERMKILLER disinfectant footwear

REF. 610120

Senteur menthe,
prêt à l'emploi.

- Norme REACH 1907/2006.
- /Mint scent, ready to use.
- REACH standard 1907/2006.



5L



MADE IN FRANCE

Désinfectant casques GERPOU

GERPOU helmets disinfectant

REF. 610121

Anti-poux et lentes.

- Norme REACH 1907/2006.
- /Anti-lice and nits.
- REACH standard 1907/2006.



1L



MADE IN FRANCE

Désinfectant chaussures GERMKILLER 2.0

GERMKILLER disinfectant footwear

REF. 610803

Prêt à l'emploi.

Bactericide
EN 1276; EN 13727+A2
EN 13697 + A1
EN 16615 / EN 17387 / EN 1500
FONGICIDE
EN 1650/EN13624/EN 13697 + A1
EN 16615 / EN 17387
MYCROBACTERICIDE EN 14348
VIRUCIDE : EN 14476+A2 / EN 16777

Détergent certifié par ECOCERT
Greenlife selon le référentiel ECO-CERT «Ecodétergent» disponible sur <http://detergents.ecocert.com>.
Detergent certified by ECOCERT Greenlife in according to the ECOCERT "Ecodetergent" standard available at <http://detergents.ecocert.com>.



5L



MADE IN FRANCE

Vaporisateur GERVAP

GERVAP vaporizer

REF. 610122

Bec coudé de 18 cm.
Angled nose of 18 cm.



1L



MINIMUM
D'ACHAT
m.o.o.

Sachet de 5 becs coudés

Bag of 5 angled nose

REF. 610123



Activateur pour 401/406/414/480

/Activator for 401/406/414/480

25g**REF. 610107**

Action cinq-minutes, excellente résistance à l'eau.

/Five-minute action, excellent water resistance.

**Frein filet NORMAL**

/NORMAL thread brake

50ml**REF. 610100**

Fixation surf/ski, freinage des filetages, résistance moyenne.

/Surf/ski fastening, thread braking, medium strength.

**Colle cyano tout matériaux**

/All-material cyano glue

20g**REF. 610102**

Adhésion instantanée, faible viscosité, substrats poreux.

/Instant Membership, low viscosity, porous substrates.

MINIMUM D'ACHAT
M.O.Q.**Colle cyano caoutchouc & plastique**

/Cyano rubber/plastic glue

20g**REF. 610103**

Collage de plastiques et d'élastomères, prise très rapide.

/Bonding of plastics and elastomers, very fast setting.

MINIMUM D'ACHAT
M.O.Q.**Colle super cyano semelle ski plastique**

/Glue super cyano ski sole plastic

20g**REF. 610105**

Pour les plastiques : renforcée élastomère, résistance aux chocs, flexibilité. Adhésion instantanée, faible viscosité.

/For plastics: elastomeric reinforced, impact resistant, flexible. Instant adhesion, low viscosity. All substrates.

MINIMUM D'ACHAT
M.O.Q.**Colle super cyano noire**

/Super black cyano glue

20g**REF. 610106**MINIMUM D'ACHAT
M.O.Q.**Rénovateur plastique STOREN**

/STOREN plastic renovator



MADE IN FRANCE

REF. 610124

Tout plastique skis et chaussures.

/All plastic skis and shoes.

5L**Mastic epoxy tube bicomposant**

/Two-component epoxy tube sealant

120g**REF. 610101**

Pâte à malaxer, durcissement rapide.

/Mixing paste, quick curing.



Étiquettes adhésives à transfert thermique

/Thermal transfer adhesive labels

REF. 610111 31x23mm

1 000 pièces. Haute tenue spécial location compatible Zebra/Eltro/Ubi.
/1 000 pieces. High-strength, Zebra/Eltro/Ubi compatible rental.

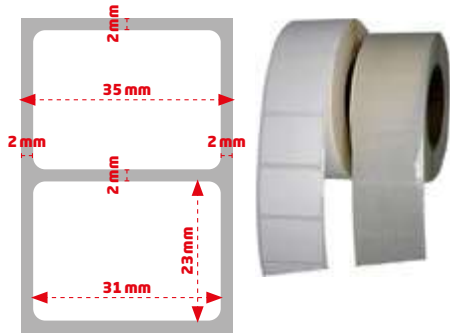

Étiquettes adhésives à transfert thermique deux de front

/Thermal transfer adhesive labels

REF. 610113 31x23mm

1 000 pièces. Haute tenue spécial location compatible Zebra/Eltro/Ubi.
/1 000 pieces. High-strength, Zebra/Eltro/Ubi compatible rental.

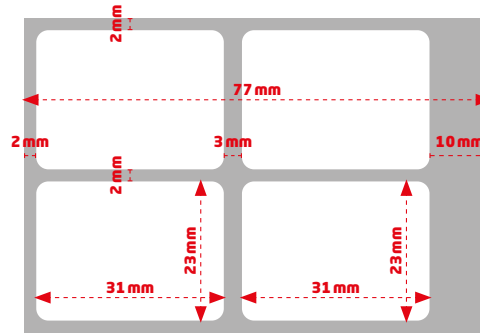

Étiquettes protection transparentes

/Transparent protection labels

REF. 610112 30x22mm

REF. 610768 38x30mm

1 000 pièces.
/1 000 pieces.



Rouleau film d'impression transfert thermique

/Thermal transfer printing film roll

Compatibilité Zebra/Eltro/Ubi. Permet l'impression d'environ 2500 & étiquettes /Zebra/Eltro/Ubi compatible. Printing of approximately 2500 & labels

REF. 610109 55x74mm - 1 de Front



REF. 610110 110x74mm - 2 de Front

Feuille de 50 gommettes rondes adhésives haute tenue

/Sheet of 50 round high-strength adhesive gommettes

- REF. 610691** OR/GOLD
- REF. 610693** ARGENT/SILVER
- REF. 610119** BLANC/WHITE
- REF. 610685** NOIR/BLACK
- REF. 610687** ROUGE/RED
- REF. 610694** ORANGE/ORANGE
- REF. 610690** JAUNE/YELLOW
- REF. 610689** VERT/GREEN
- REF. 610688** BLEU/BLUE



1,8cm



MADE IN FRANCE

Étiquettes adhésives blanches

/White adhesive labels

REF. 610114 51x25mm

REF. 610707 Ø30mm

3000 pièces.
Marquage location journée et semaine.
/3 000 pieces. Day and week rental label.



PVC



Protection spatule de ski universelle

/Universal ski spatula protection

REF. 610136

Vendu par paire.
Vis acier fournies.
/Sold by pairs. Steel screws provided.



Protection spatule de ski medium

/Medium ski spatula protection

REF. 610769

Vendu par paire.
Vis acier fournies.
/Sold by pairs. Steel screws provided.



Protection spatule de ski large freeride

/Freeride large ski spatula protection

REF. 610137

Vendu par paire.
Vis acier fournies.
/Sold by pairs. Steel screws provided.



Protection nez de surf

/Snowboard nose protection

REF. 610135

Vis acier fournies.
/Steel screws provided.



Pack vis & écrou acier tête fendue

/Screw & cracked head steel nut pack

REF. 610138

Compatible 610136, 610769 et 610137.
/Compatible with 610136, 610769 and 610137.



Pack vis & écrou acier tête 6 pans

/Screw & cracked head steel nut pack

REF. 610140

Compatible 610135.
/Compatible with 610135.



Pack fixation snowboard

/Snowboard fastening pack

REF. 610141 16mm

Pack 8 vis INOX 16mm & 8 rondelles.
/Pack of 8 stainless steel screws 16mm & 8 washers.



Crémaillère botte/fix

/Boot/fix rack

REF. 610148 S (165mm)

REF. 610147 M (195mm)

REF. 610146 L (235mm)



Pompe pour crémaillère

/Pump for rack and pinion

REF. 610682



Écrou griffe & vis

/Claw nut & screw

REF. 610754



Pack de 50 vis INOX

/Pack of 50 stainless steel screws

REF. 610142 12mm

REF. 610143 16mm

REF. 610144 19mm



Pack de 50 rondelles

/Pack of 50 washers

REF. 610145



Antivol avec câble rétractable

/Anti-theft locker with retractable cable



7x10cm

REF. 610198Dimension du câble: 135cm/Ø 2,4mm.
/Cable size: 73 cm/Ø 2,4mm.MINIMUM
D'ACHAT
m.o.q.**Mini antivol avec câble rétractable**

/Mini locker with retractable cable



5x7cm

REF. 610197Dimension du câble: 73 cm/Ø 1,6 mm.
/Cable size: 73 cm/Ø 2,4 mm.MINIMUM
D'ACHAT
m.o.q.**Mini tool cinq embouts & clef 8/10mm**

/Five bit mini tool & 8/10mm key

REF. 610199MINIMUM
D'ACHAT
m.o.q.**Affuteur de carre de poche 90° & 88°**

/Pocket edge sharpener 90° & 88°

REF. 610196 NOIR/BLACKLime à 2 faces (gros/fin).
/2-sided file (large/thin).MINIMUM
D'ACHAT
m.o.q.**Fart universel**

/Universal wax

75ml

REF. 610184Application tampon.
Conçu pour une
préparation rapide
et efficace.
/Buffer application.
Designed for quick
and efficient use.MINIMUM
D'ACHAT
m.o.q.**Fart universel en spray**

/Universal spray wax

200ml

REF. 610183Conçu pour une
préparation rapide
et efficace.
/Designed for quick
and efficient use.MINIMUM
D'ACHAT
m.o.q.

Sac chaussures de ski - 1 paire

Ski boots bag - 1 pair

REF. 610202 NOIR/BLACK



POLYESTER



39x25x42cm



280g



CUSTOMISABLE
customizable



MINIMUM
D'ACHAT
M.O.Q.

Sac chaussures de ski - 2 paires

Ski boots bag - 2 pairs

REF. 610201 NOIR/BLACK

Fermeture par zip. Bandoulière ajustable et amovible.
Poignées de portage. Poches latérales en maille filet
/Zip closure. Adjustable and removable shoulder
strap. Carry handles. Pockets mesh side panels



POLYESTER



40x40x30cm



420g



CUSTOMISABLE
customizable



MINIMUM
D'ACHAT
M.O.Q.

Sac chaussures de ski - 4 paires

Ski boots bag - 4 pairs

REF. 610204 NOIR/BLACK



POLYESTER



50x40x60cm



CUSTOMISABLE
customizable



MINIMUM
D'ACHAT
M.O.Q.

Sac location

Rental bag

REF. 610206 NOIR/BLACK

Finition noir vernis.
/Black varnish finish.



POLYPROPYLENE



35x37x55cm



CUSTOMISABLE
customizable



MINIMUM
D'ACHAT
M.O.Q.

Sac chaussures de ski - 1 paire

Ski boots bag - 1 pair

REF. 602805 NOIR/BLACK

Une poche avant et deux sangles d'épaules.
En pré-commande uniquement.
/One front pocket and two shoulder straps.
Pre-order only.



PVC 600D



24x40x42cm



MINIMUM
D'ACHAT
M.O.Q.

Sac de rangement SHOE TO SHOE à deux compartiments - 1 paire

SHOE TO SHOE two-compartment
storage bag - 1 pair

REF. 602812 NOIR/BLACK



POLYESTER



46x14x34cm



MINIMUM
D'ACHAT
M.O.Q.

Housse de casque

Helmet bag

REF. 610208 NOIR/BLACK

Cordon réglable.
/Adjustable cord.



LYCRA



CUSTOMISABLE
customizable



MINIMUM
D'ACHAT
m.o.q.

Housse à snowboard

Snowboard cover

REF. 610220

Zip intégral, bandoulière ajustable
et amovible. Poignées de portage
/Full zip, adjustable and removable
shoulder strap. Carry handles



POLYESTER



162x44cm



790g



MINIMUM
D'ACHAT
m.o.q.

Housse à ski ajustable

Adjustable ski case

REF. 602810 197x33 cm/AJUSTABLE/ADJUSTABLE

Zip au ¼ intégral. Poignées de portage.
Ajustable en longueur par fermeture roll top.
Sangles de compressions ajustables

/Full ¼ zip. Carry handles. Adjustable
in length by roll top closure.
Adjustable compression straps



POLYESTER



780g



197x33cm



MINIMUM
D'ACHAT
m.o.q.

Protège-poignet SNOWBOARD

/SNOWBOARD wrist guard

- REF. 610246 XS
- REF. 610247 S
- REF. 610248 M
- REF. 610249 L
- REF. 610250 XL

Test CRITT N°0501/1244/1620/8100/191A, conforme aux normes ski et snowboard.
/Test CRITT N°0501/1244/1620/8100/191A, compliant with ski and snowboard standards.



NÉOPRÈNE



MINIMUM D'ACHAT m.o.q.

Protège-genoux snowboard, ski, telemark

/Knee protectors snowboard, ski, telemark

- REF. 610252 S
- REF. 610253 M
- REF. 610254 L
- REF. 610255 XL

Test CRITT N°0501/1244/1620/8100/190A, conforme aux normes ski et snowboard.
/Test CRITT N°0501/1244/1620/8100/190A, compliant with ski and snowboard standards.



MINIMUM D'ACHAT m.o.q.

Protection dorsale GRAPH

/GRAPH back protector

- REF. 610221 XS
- REF. 610222 S
- REF. 610223 M
- REF. 610224 L
- REF. 610225 XL

Test CRITT N°0501/1244/1620/8100/191A, conforme aux normes ski et snowboard.
/Test CRITT N°0501/1244/1620/8100/191A, compliant with ski and snowboard standards.



Protège-poignet GRAPH

/GRAPH wrist guard

- REF. 610775 S
- REF. 610776 M
- REF. 610777 L

Test CRITT N°0501/1244/1620/8100/191A, conforme aux normes ski et snowboard.
/Test CRITT N°0501/1244/1620/8100/191A, compliant with ski and snowboard standards.



NÉOPRÈNE



MINIMUM D'ACHAT m.o.q.

Genouillère GRAPH

/GRAPH knee protectors

- REF. 610232 S
- REF. 610233 M
- REF. 610234 L

Test CRITT N°0501/1244/1620/8100/191A, conforme aux normes ski et snowboard.
/Test CRITT N°0501/1244/1620/8100/191A, compliant with ski and snowboard standards.



NÉOPRÈNE



TAILLE UNIQUE
single size



MINIMUM D'ACHAT m.o.q.

Protection fessiers GRAPH

/GRAPH gluteal protection

- REF. 610226 XS
- REF. 610227 S
- REF. 610228 M
- REF. 610229 L
- REF. 610230 XL

Conforme aux normes ski et snowboard.
/Compliant with ski and snowboard standards.



Attaches gants lasso réglable
/Adjustable lasso glove fasteners

REF. 610523 NOIR/BLACK

Vendu en pack de 24 paires.
Sold in packs of 24 pairs.



TAILLE
UNIQUE
single
size



Attaches gants stretch/mousqueton
/Stretch glove/carabiner fasteners

REF. 610524 NOIR/BLACK/ENFANT/KID
REF. 610681 NOIR/BLACK/ADULTE/ADULT

Vendu en pack de 24 paires.
Sold in packs of 24 pairs.



Attache casquette/gants à pince
/Clip cap/glove fastener

REF. 610522
ASSORTIS/ASSORTED

Plastique avec cordon à ressort.
/Plastic with spring cord.



Lot de deux petits mousquetons
/Pack of two carabiners

REF. 701514 NOIR/BLACK



Serre lacet boule
/Lace up ball clamp

REF. 610659



0,2 à 0,6cm



Masque poudreuse néoprène
Neoprene powder mask

REF. 610256 NOIR/BLACK
/ADULTE/ADULT

U
TAILLE
UNIQUE
single
size



x12
MINIMUM
D'ACHAT
m.o.q.

Masque poudreuse néoprène/polaire
Neoprene/polar fleece powder mask

REF. 610257 NOIR/BLACK
/ADULTE/ADULT

U
TAILLE
UNIQUE
single
size

Intérieur polaire.
/Polar fleece interior.



x12
MINIMUM
D'ACHAT
m.o.q.

Masque poudreuse néoprène/cou polaire
Neoprene/polar fleece powder mask

REF. 610258 NOIR/BLACK
/ADULTE/ADULT

U
TAILLE
UNIQUE
single
size

Insert de ventilation, cou/intérieur polaire.
/Ventilation insert, neck/inner polar fleece.



x12
MINIMUM
D'ACHAT
m.o.q.

Masque néoprène DÉMON
DEMON neoprene mask

REF. 610259 ASSORTIS/ASSORTED
/ADULTE/ADULT

U
TAILLE
UNIQUE
single
size



x12
MINIMUM
D'ACHAT
m.o.q.

Masque néoprène ZOMBIE
ZOMBIE neoprene mask

REF. 610260 ASSORTIS/ASSORTED
/ADULTE/ADULT

U
TAILLE
UNIQUE
single
size



x12
MINIMUM
D'ACHAT
m.o.q.

Masque néoprène MASK
MASK neoprene mask

REF. 610261 ASSORTIS/ASSORTED
/ADULTE/ADULT

U
TAILLE
UNIQUE
single
size



x12
MINIMUM
D'ACHAT
m.o.q.

Masque néoprène DÉMON intégral

Full DÉMON neoprene mask

REF. 610267 ASSORTIS/ASSORTED
/ADULTE/ADULT



U
TAILLE
UNIQUE
single
size

x12
MINIMUM
D'ACHAT
m.o.q.

Masque poudreuse néoprène

Neoprene powder mask

REF. 610263 NOIR/BLACK
/ENFANT/KID



U
TAILLE
UNIQUE
single
size

x12
MINIMUM
D'ACHAT
m.o.q.

Masque poudreuse néoprène/polaire

Neoprene/polar fleece powder mask

REF. 610264 NOIR/BLACK
/ENFANT/KID

Intérieur polaire.
/Polar fleece interior.



U
TAILLE
UNIQUE
single
size

x12
MINIMUM
D'ACHAT
m.o.q.

Masque néoprène GRAF

GRAF neoprene mask

REF. 610262 ASSORTIS/ASSORTED
/ADULTE/ADULT



U
TAILLE
UNIQUE
single
size

x12
MINIMUM
D'ACHAT
m.o.q.

Masque néoprène KID

KID neoprene mask

REF. 610265 ASSORTIS/ASSORTED
/ENFANT/KID



U
TAILLE
UNIQUE
single
size

x12
MINIMUM
D'ACHAT
m.o.q.

Masque néoprène KID MONSTER

MONSTER KID neoprene mask

REF. 610266 ASSORTIS/ASSORTED
/ENFANT/KID



U
TAILLE
UNIQUE
single
size

x12
MINIMUM
D'ACHAT
m.o.q.

Gants 100 % soie
/100 % silk under gloves

TAILLES ADULTE/ADULT SIZES

- REF. 610275 T6
- REF. 610276 T6,5
- REF. 610277 T7
- REF. 610278 T7,5
- REF. 610279 T8
- REF. 610280 T8,5
- REF. 610281 T9
- REF. 610282 T9,5
- REF. 610283 T10

TAILLES ENFANT/KID SIZES

- REF. 610289 4 ANS/YO
- REF. 610288 6 ANS/YO
- REF. 610287 8 ANS/YO
- REF. 610286 10 ANS/YO
- REF. 610285 12 ANS/YO
- REF. 610765 14 ANS/YO



SOIE
silk

Chaussettes 100 % soie
/100 % silk socks

- REF. 610290 S (35/37)
- REF. 610291 M (38/40)
- REF. 610292 L (41/43)
- REF. 610293 XL (44/46)



SOIE
silk

Cagoule hublot sous casque 100 % soie
/100 % silk window balaclava under helmet

- REF. 610294 ADULTE/ADULT
- REF. 610295 ENFANT/KID



SOIE
silk



TAILLE
UNIQUE
single
size



MINIMUM
D'ACHAT
m.o.q.

Gants MICROPOLAIRE très fine
/Micro polar fleece very thin gloves

- REF. 610296 S/M
- REF. 610297 L/XL



Gants fins TACTILES extensibles
/Extendable TACTILE under gloves

- REF. 610825 S/M
- REF. 610826 L/XL

Pouce et index tactiles.
/Tactile thumb
and index fingers.



TACTILE
touch-
sensitive

Cagoule MICROPOLAIRE très fine
/Micro polar fleece very thin balaclava

- REF. 610298 ADULTE/ADULT
- REF. 610299 ENFANT/KID



TAILLE
UNIQUE
single
size



MINIMUM
D'ACHAT
m.o.q.

Cagoule 4 en 1 Micropolaire

/4 in 1 balaclava

REF. 610300 ADULTE/ADULT

REF. 610301 ENFANT/KID



TAILLE
UNIQUE
single
size



MINIMUM
D'ACHAT
m.o.q.

Bandanas USA

/USA bandanas

REF. 610271 ASSORTIS/ASSORTED

Motif cachemire,
100 % coton.
/Cashmere pattern,
100 % cotton.



MINIMUM
D'ACHAT
m.o.q.

Bandana triangle doublé polaire

/Polar fleece lined triangle bandana

REF. 610270 NOIR & ROUGE ASSORTIS

/BLACK & RED ASSORTED



MINIMUM
D'ACHAT
m.o.q.

Cagoule DRYTEC

/DRYTEC balaclava

REF. 610302 NOIR/BLACK



POLYESTER



TAILLE
UNIQUE
single
size



MINIMUM
D'ACHAT
m.o.q.

Cagoule épaisse en polaire

/Thick polar fleece balaclava

REF. 610303 NOIR/BLACK



POLYESTER



TAILLE
UNIQUE
single
size



MINIMUM
D'ACHAT
m.o.q.

Cache-oreilles ZOO

/ZOO earmuffs

REF. 610358 ASSORTIS/ASSORTED



TAILLE
UNIQUE
single
size



MINIMUM
D'ACHAT
m.o.q.

Tour de cou TUBTECH

/TUBTECH neckband

REF. 610307 ASSORTIS/ASSORTED

Cordon de réglage.
/Adjustable cord.



TAILLE
UNIQUE
single
size



MINIMUM
D'ACHAT
m.o.q.

TUB'S lycra ou polaire/lycra MASK

/Lycra or polar fleece/lycra TUB'S MASK

REF. 610314 LYCRA/ASSORT./ASSORT.



TAILLE
UNIQUE
single
size



MINIMUM
D'ACHAT
m.o.q.

REF. 610315

POLAIRE/LYCRA/POLAR FLEECE/LYCRA

Tour de cou polaire

/Polar fleece neckband

REF. 610304 NOIR/BLACK

Convertible en bonnet, cordon de réglage.
/Convertible into beanie, adjustable cord.



POLYESTER



TAILLE
UNIQUE
single
size



MINIMUM
D'ACHAT
m.o.q.

Tour de cou polaire COUMIN

/COUMIN polar fleece mini neckband

REF. 610305 NOIR/BLACK

Convertible en bonnet, cordon de réglage.
/Convertible into beanie, adjustable cord.



25x28cm



TAILLE
UNIQUE
single
size



MINIMUM
D'ACHAT
m.o.q.

Tour de cou lycra

/Lycra neckband

REF. 610808 ASSORTIS/ASSORTED



TAILLE
UNIQUE
single
size



MINIMUM
D'ACHAT
m.o.q.

TUB'S lycra N°1
/Lycra TUB'S N°1

REF. 610308 ASSORTIS/ASSORTED



TAILLE
UNIQUE
single
size



MINIMUM
D'ACHAT
m.o.q.

TUB'S lycra N°2
/Lycra TUB'S N°2

REF. 610309 ASSORTIS/ASSORTED



TAILLE
UNIQUE
single
size



MINIMUM
D'ACHAT
m.o.q.

TUB'S lycra GRAF
/Lycra TUB'S GRAF

REF. 610310 ASSORTIS/ASSORTED



TAILLE
UNIQUE
single
size



MINIMUM
D'ACHAT
m.o.q.

TUB'S polaire/lycra N°1
/Polar fleece/lycra TUB'S N°1

REF. 610311 ASSORTIS/ASSORTED



TAILLE
UNIQUE
single
size



MINIMUM
D'ACHAT
m.o.q.

TUB'S polaire/lycra N°2
/Polar fleece/lycra TUB'S N°2

REF. 610312 ASSORTIS/ASSORTED



TAILLE
UNIQUE
single
size



MINIMUM
D'ACHAT
m.o.q.

TUB'S polaire/lycra GRAF
/Polar fleece/lycra TUB'S GRAF

REF. 610313 ASSORTIS/ASSORTED



TAILLE
UNIQUE
single
size



MINIMUM
D'ACHAT
m.o.q.

TUB'S lycra KIDZ
/Lycra TUB'S KIDZ**REF. 610859**
ASSORTIS/ASSORTED

U
TAILLE
UNIQUE
single
size

x12
 **MINIMUM
D'ACHAT
m.o.q.**

Tour de cou polaire ZOO
/Polar fleece neckband ZOO**REF. 610354** ASSORTIS/ASSORTED

U
TAILLE
UNIQUE
single
size

x12
 **MINIMUM
D'ACHAT
m.o.q.**

TUB'S polaire/lycra PAD PATROL
/PAD PATROL Polar fleece/Lycra TUB'S**REF. 610318** BLEU/BLUE

U
TAILLE
UNIQUE
single
size

x12
 **MINIMUM
D'ACHAT
m.o.q.**

TUB'S polaire/lycra KIDZ
/Polar fleece/Lycra TUB'S KIDZ**REF. 610860**
ASSORTIS/ASSORTED

U
TAILLE
UNIQUE
single
size

x12
 **MINIMUM
D'ACHAT
m.o.q.**

TUB'S polaire/lycra STAR WARS
/Polar fleece/Lycra TUB'S STAR WARS**REF. 610320** ASSORTIS/ASSORTED

U
TAILLE
UNIQUE
single
size

x12
 **MINIMUM
D'ACHAT
m.o.q.**

TUB'S fourrure SPIDERMAN
/SPIDERMAN fur TUB'S**REF. 610321** ASSORTIS/ASSORTED

U
TAILLE
UNIQUE
single
size

x12
 **MINIMUM
D'ACHAT
m.o.q.**

TUB'S polaire/lycra REINE DES NEIGES
/FROZEN polar fleece/lycra TUB'S

REF. 610316 ASSORTIS/ASSORTED



TAILLE
UNIQUE
single
size



MINIMUM
D'ACHAT
m.o.q.

TUB'S fourrure REINE DES NEIGES
/FROZEN fur TUB'S

REF. 610763 ASSORTIS/ASSORTED

Intérieur fourrure.
/Fur interior.



TAILLE
UNIQUE
single
size



MINIMUM
D'ACHAT
m.o.q.

TUB'S polaire/lycra LADYBUG
/LADYBUG Polar fleece/lycra TUB'S

REF. 610842
ASSORTIS/ASSORTED



TAILLE
UNIQUE
single
size



MINIMUM
D'ACHAT
m.o.q.

TOURS DE COU/NECKBANDS

ÉQUIPER

Capuche/tour de cou polaire

Polar fleece balaclava/neckband

- REF. 610345 LICORNE BLEU/BLUE UNICORN
- REF. 610346 LICORNE ROSE/PINK UNICORN
- REF. 610347 PANTHÈRE ROSE/PINK PANTHER
- REF. 610348 DINOSAURE/DINOSAUR
- REF. 610349 LOUP/WOLF
- REF. 610350 TIGRE/TIGER
- REF. 610351 DRAGON/DRAGON
- REF. 610840 LICORNE ETOILÉE/STAR UNICORN



Couvre-casque PELUCHE BD

COMICS PLUSH helmet cover

- REF. 610334 LICORNE/UNICORN
- REF. 610336 REQUIN/SHARK
- REF. 610337 CHAT/CAT
- REF. 610338 POULET/CHICKEN
- REF. 610339 PANTHÈRE ROSE/PINK PANTHER
- REF. 610340 LAPIN/RABBIT
- REF. 610341 CARIBOU/CARIBOU



x8
 MINIMUM D'ACHAT m.o.q.

Couvre-casque PELUCHE ANIMAL

ANIMAL PLUSH helmet cover

- REF. 610342 ASSORTIS/ASSORTED



x12
 MINIMUM D'ACHAT m.o.q.

Couvre-casque lycra ANIMAUX

ANIMALS lycra helmet cover

- REF. 610216 ASSORTIS/ASSORTED
- REF. 610814 LICORNE UNIQUEMENT UNICORN ONLY

TAILLE UNIQUE single size



x12
 MINIMUM D'ACHAT m.o.q.

Couvre-casque PELUCHE ZOO

ZOO PLUSH helmet cover

- REF. 610586 T 48 à 58/48 to 58



x12
 MINIMUM D'ACHAT m.o.q.

Bonnet chapka ANIMAL

ANIMAL chapka beanie

REF. 610352 ASSORTIS/ASSORTED



Couvre-casque lycra CARTOON

CARTOON lycra helmet cover

REF. 610333 ASSORTIS/ASSORTED



TAILLE
UNIQUE
single
size



Décoration casque VELCRO

VELCRO helmet decoration



REF. 610331 BIPBIP/ROADRUNNER

REF. 610835 LICORNE/UNICORN



Bonnet chapka ANIMAL & écharpe/moufle intégrée

ANIMAL chapka beanie built-in sling and mitten

REF. 610353 ASSORTIS/ASSORTED



Décoration casque ANIMAL VELCRO

ANIMAL VELCRO helmet decoration

REF. 610323



Décoration casque VELCRO

VELCRO helmet decoration

- REF. 610324 CORNE/HORN
- REF. 610325 MONSTRE/MONSTER
- REF. 610326 YEUX/EYES
- REF. 610327 PUNK/PUNK



Sac à dos peluche

Plush backpack

1L

- REF. 610809 LICORNE/UNICORN
- REF. 610810 CARIBOU/CARIBOU
- REF. 610811 LAPIN/RABBIT
- REF. 610968 MARMOTTE/MARMOT
- REF. 610969 KOALA/KOALA
- REF. 610970 PANDA/PANDA

Poche arrière zippée, poignée de portage, sangles d'épaules réglables.
/Zipped back pocket, carrying handle, adjustable shoulder straps.



FRENDO CONÇOIT
ET FABRIQUE
VOS CEINTURES
ET BRETELLES,
DEPUIS 1986.
FRENDO DESIGNS
AND PRODUCES
BELTS & BRACES,
SINCE 1986.

**Ceinture TRESSÉE STRETCH
boucle métal**

STRETCH BRAIDED belt
metal buckle

REF. 610822 NOIR/BLACK
REF. 610823 MARRON/BROWN

Pack 3x 105 cm & 3x 115 cm.
/3x 105 cm & 3x 115 cm pack.



**Ceinture STRETCH RECYCLÉE 35 mm
boucle plastique**
/STRETCH RECYCLED belt 35 mm
plastic buckle

REF. 610947 ASSORTIS/ASSORTED



118x3,5cm



MADE IN FRANCE



MINIMUM D'ACHAT
m.o.q.

**Ceinture KID STRETCH 25 mm
boucle plastique**
/KID STRETCH belt 25 mm
plastic buckle

REF. 610627 ASSORTIS/ASSORTED



70x2,5cm



MADE IN FRANCE



MINIMUM D'ACHAT
m.o.q.

**Ceinture STRETCH 30 mm
boucle plastique**
/STRETCH belt 30 mm
plastic buckle

REF. 610629 ASSORTIS/ASSORTED
REF. 610628 NOIR/BLACK



118x3cm



MADE IN FRANCE



MINIMUM D'ACHAT
m.o.q.

**Ceinture STRETCH JACQUARD 35 mm
boucle plastique**
/STRETCH JACQUARD belt 35 mm
plastic buckle

REF. 610946 NOIR & MARINE ASSORTIS
/ASSORTED BLACK & NAVY



118x3,5cm



MADE IN FRANCE



MINIMUM D'ACHAT
m.o.q.

**Ceinture STRETCH JEAN 35 mm
boucle plastique**
/STRETCH JEAN belt 35 mm
plastic buckle

REF. 610630 ASSORTIS/ASSORTED



118x3,5cm



MADE IN FRANCE



RÉVERSIBLE



MINIMUM D'ACHAT
m.o.q.

**Ceinture KID STRETCH 25 mm
boucle métal**

/KID STRETCH belt 25 mm
metal buckle



70x2,5cm



MADE IN
FRANCE



**Ceinture STRETCH RECYCLÉE 35 mm
boucle métal**

/STRETCH RECYCLED belt 35 mm
metal buckle



118x3,5cm



MADE IN
FRANCE



**Ceinture STRETCH 40 mm
boucle métal**

/STRETCH belt 40 mm
metal buckle



118x4cm



MADE IN
FRANCE



**Ceinture STRETCH 30 mm
boucle métal**

/STRETCH belt 30 mm
metal buckle



118x3cm



MADE IN
FRANCE



**Ceinture STRETCH JACQUARD 35 mm
boucle métal**

/STRETCH JACQUARD belt 35 mm
metal buckle



118x3,5cm



MADE IN
FRANCE



**Ceinture STRETCH JEAN 35 mm
boucle métal**

/STRETCH JEAN belt 35 mm
metal buckle



118x3,5cm



MADE IN
FRANCE



**Bretelles enfants DESSINS 25 mm
4 pinces en métal**/DRAWINGS kids braces 25 mm
4 metal clampsMADE IN
FRANCE

REF. 610624 ASSORTIS/ASSORTED

MINIMUM
D'ACHAT
m.o.q.**Bretelles UNIES 35 mm
4 pinces en métal**/SOLID braces 35 mm - Boîte ajourée
4 metal clampsMADE IN
FRANCEREF. 610611 NOIR/BLACK
REF. 610612 ASSORTIS/ASSORTEDMINIMUM
D'ACHAT
m.o.q.**Bretelles JEANS OU EDELWEISS 35 mm
4 pinces en métal**/JEANS OR EDELWEISS braces 35 mm
Boîte ajourée- 4 metal clampsMADE IN
FRANCEREF. 610613 JEAN ASSORTIS/ASSORTED
REF. 610618 EDELWEISS ASSORTIS/ASSORTEDMINIMUM
D'ACHAT
m.o.q.**Bretelles enfants NOUNOURS 25 mm
3 pinces en métal**/TEDDY BEAR kids braces 25 mm
3 metal clampsMADE IN
FRANCE

REF. 610625 ASSORTIS/ASSORTED

MINIMUM
D'ACHAT
m.o.q.**Bretelles CADET/BABY 4 pinces en métal**

/CADET/BABY braces 4 metal clamps

MADE IN
FRANCEREF. 610623 CADET 25mmx70cm
ASSORTIS/ASSORTED
REF. 610622 BABY 15mmx55cm
ASSORTIS/ASSORTEDMINIMUM
D'ACHAT
m.o.q.**Bretelles SUBLI 35 mm
4 pinces en métal**/SUBLI braces 35 mm
4 metal clamps Boîte ajouréeMADE IN
FRANCE

REF. 610615 ASSORTIS/ASSORTED

MINIMUM
D'ACHAT
m.o.q.

Bretelles FLUO 35 mm
4 pinces en métal

/FLUO braces 35 mm Boîte ajourée
4 metal clamps



MADE IN FRANCE

REF. 610614 ASSORTIS/ASSORTED



BRETELLES SUBLI CACHEMIRE 35 mm
4 pinces en métal

/SUBLI KASHMIR braces 35 mm
4 metal clamps-Boîte ajourée



MADE IN FRANCE

REF. 610895 ASSORTIS/ASSORTED



Bretelles LARGE 40 mm
4 pinces en plastique

/LARGE braces 40 mm
4 plastic clamps-Boîte ajourée



MADE IN FRANCE

REF. 610619 NOIR/BLACK



Bretelles FLAG 35 mm
4 pinces en métal

/FLAG braces 35 mm
4 metal clamps Boîte ajourée



MADE IN FRANCE

REF. 610621 SUISSE/SWITZERLAND
REF. 610697 ANGLAIS/ENGLISH
REF. 610698 ITALIEN/ITALIAN
REF. 610696 FRANÇAIS/FRENCH



Bretelles JACQUARD 35 mm
4 pinces en métal

/JACQUARD braces 35 mm
4 metal clamps Boîte ajourée



MADE IN FRANCE

REF. 610617 ASSORTIS/ASSORTED



Bretelles FAT 50 mm
3 pinces en métal

/FAT braces 50 mm
3 metal clamps Boîte ajourée



MADE IN FRANCE

REF. 610620 NOIR/BLACK



Poncho junior EVA

/EVA junior poncho

REF. 701372 ROUGE/RED



0,16mm



EVA



ÉTANCHE
waterproof



260g



MINIMUM
D'ACHAT
m.o.q.

Poncho simple PEVA

/PEVA simple poncho

REF. 701382
BLEU/BLEUE

Coupe-vent,
cordon de serrage.
/Windbreaker,
drawstring.



PEVA



ÉTANCHE
waterproof



182g



MINIMUM
D'ACHAT
m.o.q.

Poncho trek EVA

/EVA trek poncho

REF. 701370
BLEU MARINE
/NAVY BLUE

Adapté au portage
de sac à dos.
/Suitable for
carrying
a backpack.



0,16mm



EVA



ÉTANCHE
waterproof



390g



MINIMUM
D'ACHAT
m.o.q.

Poncho light

/Light poncho

REF. 701301 BLEU/BLEUE

Ouverture col zippée
et capuche ajustable.
Housse incluse.
/Zipped collar
opening and
adjustable hood.
Pouch included.



POLYESTER
210T & PU



ÉTANCHE
2000mm
waterproof



250g



MINIMUM
D'ACHAT
m.o.q.

Pélerine respirante

/Breathable pilgrim

REF. 701305
S/M/KAKI/KHAKI
REF. 701306
L/XL/KAKI/KHAKI
REF. 701377
S/M/ROUGE/RED
REF. 701378
L/XL/ROUGE/RED



NYLON
210T
ENDUIT
coated



ÉTANCHE
3000mm
waterproof



S/M 310g
L/XL 340g



MINIMUM
D'ACHAT
m.o.q.

Pélerine imperméable

/Raincoat pilgrim

REF. 610583 S/M
REF. 610584 L/XL

Capuche ajustable avec
cordon élastique, soufflets
latéraux pour confort,
entrejambe fendue, deux
poches intérieures.
/Adjustable hood with
elastic drawstring, side
bellows for comfort,
crotch for buttocks, two
interior pockets.



POLYESTER
ENDUIT PU
PU coated



ÉTANCHE
waterproof



350g



MINIMUM
D'ACHAT
m.o.q.

Poncho imperméable tissu

/Waterproof poncho fabric

REF. 610739 L x 12 pièces adultes/pcs
REF. 610546 L/BLEU/BLEUE
REF. 610547 L/ROUGE/RED



POLYESTER
ENDUIT PU
PU coated



ÉTANCHE
waterproof



L 220g
M 180g
S 150g

M (10-14 ANS/YO)

REF. 610738 x 12 pièces/pcs
REF. 610548 ROUGE/RED
REF. 610549 BLEU/BLEUE



S (6-10 ANS/YO)

REF. 610737 x 12 pièces/pcs
REF. 610550 ROUGE/RED
REF. 610551 BLEU/BLEUE



MINIMUM
D'ACHAT
M.O.Q.

Parapluie grand vent

/Umbrella strong wind

REF. 610715 BLEU CIEL/SKY BLUE
REF. 610717 GRIS/GREY
REF. 610718 MARINE/NAVY
REF. 610719 ROUGE/RED

Haute résistance.
/High strength.



126cm



FIBRE DE VERRE/
CARBONE
fiberglass/carbon



ÉTANCHE
waterproof



MINIMUM
D'ACHAT
M.O.Q.

Parapluie pliant

/Foldable umbrella

REF. 610585 MARINE/NAVY



93cm



ALUMINIUM



ÉTANCHE
waterproof



MINIMUM
D'ACHAT
M.O.Q.

Manteau long protection pluie

/Long protective rain coat

BLEU MARINE/NAVY BLUE

REF. 610579 S (36)
REF. 610580 M (38)
REF. 610581 L (40)
REF. 610582 XL (42)

Capuche à cordon,
ventilation active,
deux poches rabat.
/Drawstring hood,
ventilation, two front
flap pockets.



POLYESTER
ENDUIT PU
PU coated



ÉTANCHE
waterproof



115cm



MINIMUM
D'ACHAT
M.O.Q.

Veste et pantalon de pluie enfant

/Kid rain jacket and pants

VESTE/JACKET

REF. 610575 S (4ANS)
REF. 610576 M (6ANS)
REF. 610577 L (8ANS)
REF. 610578 XL (10ANS)



ÉTANCHE
waterproof



COUTURES
THERMO
SOUDÉES
THERMAL
SEAMS
WELDED

PANTALON/PANT

REF. 610571 S
REF. 610572 M
REF. 610573 L
REF. 610574 XL

Veste et pantalon de pluie adulte

/Adult rain jacket and pants

VESTE/JACKET

REF. 610566 S
REF. 610567 M
REF. 610568 L
REF. 610569 XL
REF. 610570 XXL



ÉTANCHE
waterproof



COUTURES
THERMO
SOUDÉES
THERMAL
SEAMS
WELDED

PANTALON/PANT

REF. 610561 S
REF. 610562 M
REF. 610563 L
REF. 610564 XL
REF. 610565 XXL

BRASSIERE DE BAIN - SUKO

Swimsuit

REF. 610922 S
 REF. 610923 M
 REF. 610924 L
 REF. 610925 XL
 REF. 610926 XXL



REF. 610927 x 12 pièces/pcs
 S/2 - M/3 - L/4 - XL/2 - XXL/1

6.90€ l'unité/unit

**Maillot de bain Femme**

Lady Swimsuit

REF. 610839 S
 REF. 610781 M
 REF. 610782 L
 REF. 610831 XL
 REF. 610832 XXL



REF. 610700 x 12 pièces/pcs
 S/2 - M/3 - L/4 - XL/2 - XXL/1

**CULOTTE DE BAIN AJUSTABLE - POOL**

Swimsuit

REF. 610934 S
 REF. 610935 M
 REF. 610936 L
 REF. 610937 XL
 REF. 610938 XXL



REF. 610939 x 12 pièces/pcs
 S/2 - M/3 - L/4 - XL/2 - XXL/1

**Boxer de bain adulte**

Swim boxer

REF. 610828 S
 REF. 610779 M
 REF. 610780 L
 REF. 610829 XL
 REF. 610830 XXL



REF. 610699 x 12 pièces/pcs
 S/2 - M/3 - L/4 - XL/2 - XXL/1



Boxer de bain adulte - marine

Swim boxer

REF. 610910 S
REF. 610911 M
REF. 610912 L
REF. 610913 XL
REF. 610914 ^{XXL}



REF. 610915 x12 pièces/pcs
S/2 - M/3 - L/4 - XL/2 - XXL/1



Maillot de bain Fille

Girl Swimsuit

REF. 610949 6 ANS
REF. 610950 8 ANS
REF. 610951 10 ANS
REF. 610952 12 ANS
REF. 610953 14 ANS



REF. 610954 x12 pièces/pcs
6/2 - 8/2 - 10/3 - 12/3 - 14/2



Bonnet de bain

Swimming cap

REF. 610837 ENFANT/KID
REF. 610838 ADULTE/ADULT



SILICONE



Boxer de bain garçon-marine

Swim boxer

REF. 610916 6 ANS
REF. 610917 8 ANS
REF. 610918 10 ANS
REF. 610919 12 ANS
REF. 610920 14 ANS



REF. 610921 x12 pièces/pcs
6/2 - 8/2 - 10/3 - 12/3 - 14/2



Brassards de piscine gonflables

Inflatable pool cuffs



TAILLE
UNIQUE
single
size



REF. 610596 ENFANT/KID
3 à 6 ans - 18 à 30 kg



Lunettes de piscine

Swimming goggles

REF. 610545 ADULTE/ADULT
REF. 610867 ENFANT/KID



CROUTCHOUIC
rubber



Lacet rond

Round lace

REF. 610638 90/120/150/180 cm
/ASSORTIS/ASSORTED

Présentoir à pendre.
/Hanging display stand.



REF. 610639 120/150/180/200 cm
/ASSORTIS/ASSORTED

Présentoir à pendre.
/Hanging display stand.



Lacet rond location

Rental round lace

REF. 610641 220cm/NOIR/BLACK

Carton de 25 paires, présentoir à pendre.
/Box of 25 pairs, hanging display.



Lacet rond coloris assortis

Round lace assorted colors

REF. 610653 90cm/ASSORTIS/ASSORTED
REF. 610654 120cm/ASSORTIS/ASSORTED
REF. 610655 150cm/ASSORTIS/ASSORTED



REF. 610656 180cm/ASSORTIS/ASSORTED
REF. 610657 200cm/ASSORTIS/ASSORTED

REF. 610658 220cm
/ASSORTIS



**Semelle FEUTRE rigide de remplacement
botte de location**

Rental boot replacement rigid felt sole

- REF. 610125 T 29/30
- REF. 610126 T 31/32
- REF. 610127 T 33/34
- REF. 610128 T 35/36
- REF. 610129 T 37/38
- REF. 610130 T 39/40
- REF. 610131 T 41/42
- REF. 610132 T 43/44
- REF. 610133 T 45/46



Semelle ALUMINIUM

ALUMINIUM sole



- | | |
|------------------|------------------|
| REF. 610425 T 24 | REF. 610442 T 42 |
| REF. 610426 T 25 | REF. 610443 T 43 |
| REF. 610427 T 26 | REF. 610444 T 44 |
| REF. 610428 T 27 | REF. 610445 T 45 |
| REF. 610429 T 28 | REF. 610446 T 46 |
| REF. 610430 T 29 | |
| REF. 610431 T 30 | |
| REF. 610432 T 31 | |
| REF. 610433 T 32 | |
| REF. 610434 T 33 | |
| REF. 610435 T 34 | |
| REF. 610723 T 35 | |
| REF. 610436 T 36 | |
| REF. 610437 T 37 | |
| REF. 610438 T 38 | |
| REF. 610439 T 39 | |
| REF. 610440 T 40 | |
| REF. 610441 T 41 | |



Semelle ÉTÉ ion argent

SUMMER silver ion sole

- REF. 610493 T 36
- REF. 610494 T 37
- REF. 610495 T 38
- REF. 610496 T 39
- REF. 610497 T 40
- REF. 610498 T 41
- REF. 610499 T 42
- REF. 610500 T 43
- REF. 610501 T 44
- REF. 610502 T 45
- REF. 610503 T 46



Lavable, traitement
antibactérien.
Washable,
antibacterial treatment.

Semelle MÉRINOS

MERINO sole

- REF. 610412 T 36
- REF. 610413 T 37
- REF. 610414 T 38
- REF. 610415 T 39
- REF. 610416 T 40
- REF. 610417 T 41
- REF. 610418 T 42
- REF. 610419 T 43
- REF. 610420 T 44
- REF. 610421 T 45
- REF. 610422 T 46



Semelle CUIR

LEATHER sole



- REF. 610506 T 35
- REF. 610507 T 36
- REF. 610508 T 37
- REF. 610509 T 38
- REF. 610510 T 39
- REF. 610511 T 40
- REF. 610512 T 41
- REF. 610513 T 42
- REF. 610514 T 43
- REF. 610515 T 44
- REF. 610516 T 45
- REF. 610517 T 46



Semelle CHALEUR moulée

MOLDED heat sole

- REF. 610447 T 36
- REF. 610448 T 37
- REF. 610449 T 38
- REF. 610450 T 39
- REF. 610451 T 40
- REF. 610452 T 41
- REF. 610453 T 42
- REF. 610454 T 43
- REF. 610455 T 44
- REF. 610456 T 45
- REF. 610457 T 46



Écran isolant, à mémoire
de forme, micro fourrure
super chaude contre le
froid intense.
/Insulating shield, memory
of shape, micro fur super
hot against intense cold.

Semelle à mémoire de forme FINE

THERMO THIN shopping sole

- REF. 610458** T36
- REF. 610459** T37
- REF. 610460** T38
- REF. 610461** T39
- REF. 610462** T40
- REF. 610463** T41
- REF. 610464** T42
- REF. 610465** T43
- REF. 610466** T44
- REF. 610467** T45
- REF. 610468** T46

Chaud, confortable et extra fine.
/Warm, comfortable and extra thin.



Rérosol imperméabilisant

Waterproofing spray

REF. 610469 200ml

Textiles techniques/cuir.
/Technical textiles/leathers.



Rérosol imperméabilisant

Waterproofing spray

REF. 610424 300ml + 100ml

Textiles techniques/cuir.
/Technical textiles/leathers.



Aerosol spray one shot

Spray one shot

REF. 610504 100ml

Déodorant, désinfectant, rafraichissant. Vaporisation deux buses tête en bas.
/Deodorant, disinfectant, refreshing. Spray two nozzles head down.



Crème cuir coloris neutre

Neutral coloured leather cream

REF. 610470 100ml

Imperméabilise et entretien, coloris neutre, boîte métal.
/Waterproofing and maintenance, neutral color, metal box.



TWIN PACK lessive & imperméabilisant

Detergent & waterproofing TWIN PACK

REF. 610475 225 ml + 225 ml - 4 cycles lavage



Lessive machine pour textile respirant

Breathable textile detergent

REF. 610473 225 ml

Convient pour tous textiles techniques, utilisation dans le bac lessive, non alteration du textile.
/Suitable for all technical textiles, use in the laundry bin, no alteration of the textile.

Imperméabilisant machine pour textile respirant

Waterproofing for breathable textile

REF. 610474 225 ml

Utilisation dans le bac adoucissant, convient pour tous textiles techniques, restaure le déperlant d'origine, maintient la respirabilité.
/Use in the softening tray, suitable for all technical textiles, restores the original water repellent, maintains breathability.



Vaporisateur déodorant de poche

Pocket deodorant spray

REF. 610505 100 ml

Pour chaussures, casques et gants.
/For shoes, helmets and gloves.



Vaporisateur antibuée

Anti-fog spray

REF. 610520 75 ml

Pour lunettes et masque.
/For glasses and helmets.



MINI TWIN PACK lessive & imperméabilisant

Detergent & waterproofing MINI TWIN PACK

REF. 610476 75 + 75 ml 1 cycle lavage



Patch super adhésif réparation tissus imperméables

Repair all outdoor gear

REF. 610519

Résistant & étanche, répare instantanément tous les tissus: nylon, polyester, gore tex, néoprène... La boîte contient 3x patchs adhésif, lingette de nettoyage, fil en nylon de renfort.
/Resistant & waterproof, instantly repairs all fabrics: nylon, polyester, gore tex, neoprene... The box contains 3x adhesive patches, cleaning wipe, reinforcing nylon thread.



Housse de protection smartphone

Smartphone protection house

REF. 610535 BLANC/WHITE



PVC



ÉTANCHE
waterproof



P.191
CUSTOMISABLE
customizable

x10
MINIMUM
D'ACHAT
m.o.q.

Banane running imperméable

Waterproof running belt

REF. 610536 NOIR/BLACK

Passage écouteur et plastique tactile.
/Headphone passage and tactile plastic.



TACTILE
touch-
sensitive



x6
MINIMUM
D'ACHAT
m.o.q.

Mousqueton avec sangle/portable

Carabiner with strap/smartphone

REF. 610525 ASSORTIS/ASSORTED



6cm



ALUMINIUM



x24
MINIMUM
D'ACHAT
m.o.q.

Pochette cendrier écologique

Ecological ashtray pouch

REF. 610948 ARGENT/SILVER



8 x 8 cm



P.191
CUSTOMISABLE
customizable

x50
MINIMUM
D'ACHAT
m.o.q.

Mousqueton avec sangle

Carabiner with strap

REF. 610527 ASSORTIS/ASSORTED



8cm



ALUMINIUM



x24
MINIMUM
D'ACHAT
m.o.q.

Cordon MONTAGNE

MOUNTAIN cord

REF. 610660 ASSORTIS/ASSORTED



MADE IN FRANCE



STRETCH



MINIMUM D'ACHAT m.o.q.

Cordon GRUNGE

GRUNGE cord

REF. 610661 NOIR/BLACK



MADE IN FRANCE



MINIMUM D'ACHAT m.o.q.

Cordon GRUNGE

GRUNGE cord

REF. 610662 ASSORTIS/ASSORTED



MADE IN FRANCE



MINIMUM D'ACHAT m.o.q.

Cordon BUNGEE

BUNGEE cord

REF. 610663 NOIR/BLACK



MADE IN FRANCE



STRETCH



MINIMUM D'ACHAT m.o.q.

Cordon RAINBOW

RAINBOW cord

REF. 610664 ASSORTIS/ASSORTED



MADE IN FRANCE



MINIMUM D'ACHAT m.o.q.

Cordon SPORT

SPORT cord

REF. 610665 NOIR/BLACK



MINIMUM D'ACHAT m.o.q.

Cordon STRETCHY

STRETCHY cord

REF. 610666 NOIR/BLACK



MADE IN FRANCE



x48

MINIMUM D'ACHAT m.o.q.

Cordon TUBE MOUSSE

FOAM TUBE cord

REF. 610668 ASSORTIS/ASSORTED



x48

MINIMUM D'ACHAT m.o.q.

Cordon NAUTIC FLOTTANT BUNGEE

NAUTIC FLOATING BUNGEE cord

REF. 610675 ASSORTIS/ASSORTED



MADE IN FRANCE



x24

MINIMUM D'ACHAT m.o.q.

Cordon NÉOPRÈNE UNI

NEOPRENE UNI cord

REF. 610669 ASSORTIS/ASSORTED



H 40CM

L 2CM



x48

MINIMUM D'ACHAT m.o.q.

Cordon NÉOPRÈNE XL

NEOPRENE XL cord

REF. 610670 NOIR/BLACK

H 40CM

L 3,2CM



x48

MINIMUM D'ACHAT m.o.q.

Cordon NÉOPRÈNE DESSINS

NEOPRENE DRAWINGS cord

REF. 610671 ADULTE/ADULT



H 40CM

L 2,2CM

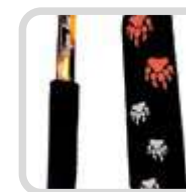

x48

MINIMUM D'ACHAT m.o.q.

Cordon SIMPLE

SIMPLE cord

REF. 610673 ASSORTIS/ASSORTED

REF. 610722 NOIR/BLACK



Cordon FLUO

FLUO cord

REF. 610674 ASSORTIS/ASSORTED



Cordon ENFANT RIGIDE

RIGID KID cord

REF. 610676 ASSORTIS/ASSORTED



Cordon ENFANT PLASTIQUE

PLASTIC KID cord

REF. 610677 ASSORTIS/ASSORTED

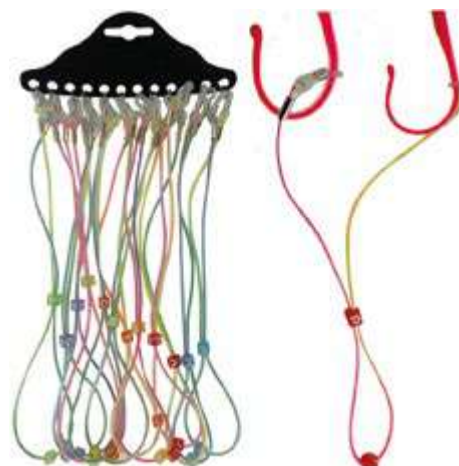



GLISSER
GLISSER
GLISSER

SNOW BOB

REF. 602555 ROUGE/RED
REF. 602556 ORANGE/ORANGE
REF. 602561 BLEU/BLUE
REF. 602682 NOIR/BLACK

Luge pour deux personnes, empilable, livrée avec freins métalliques montés.
 /Stackable sledge for two users, delivered with assembled metal brakes.



MADE IN FRANCE & ITALIE



RÉSISTANCE
 120kg
 strength
 weight 264lb



3800g



66x115x21cm

**SNOW BOB XL**

REF. 602820 ROUGE/RED
REF. 602829 ORANGE/ORANGE
REF. 602884 NOIR/BLACK

Luge pour deux personnes, empilable, longue,
 livrée avec freins métalliques montés.
 /Extra long and stackable sledge for two users,
 delivered with assembled metal brakes.



MADE IN FRANCE & ITALIE



RÉSISTANCE
 130kg
 strength
 weight 286lb



4100g



RALLONGÉE
 À L'INTÉRIEUR
 DE 15cm
 extended
 interior 15cm



66x125x21cm



SNOW BOB RACING

REF. 602827

Luge pour deux personnes, empilable, livrée avec freins métalliques montés.
/Stackable sledge for two users, delivered with assembled metal brakes.



MADE IN FRANCE & ITALIE



RÉSISTANCE
90kg
strength
weight 198lb



3800g



66x115x21cm



SNOW BOB XL RACING

REF. 602828

Luge pour deux personnes, empilable, longue, livrée avec freins métalliques montés.
/Extra long and stackable sledge for two users, delivered with assembled metal brake.



MADE IN FRANCE & ITALIE



RÉSISTANCE
120kg
strength
weight 264lb



4100g



RALLONGÉE
À L'INTÉRIEUR
DE 15cm
extended
interior 15cm



66x125x21cm



BIGG BOB

REF. 602581 ROUGE/RED

Luge deux places côte à côte, livrée avec freins métalliques montés.
/Sledge two seats side by side, delivered with assembled metal brakes.

Cette luge (modèle déposé FREND0) comblera les adeptes et amateurs de glisse. Dimensions généreuses, mais facilement stockable car empilable, elle conviendra aux grands gabarits et pourra aussi être utilisée en solo.
/This sledge (FREND0 registered model) will satisfy fans and lovers of gliding. Large dimensions, but still easily storable because stackable, it will be suitable for tall adults and can also be used solo.



MADE IN FRANCE & ITALIE



RÉSISTANCE
150kg
strength
weight 330lb



7700g



110x122x19cm

SUPER BOB

REF. 602560 ROUGE/RED
 REF. 602739 ORANGE/ORANGE
 REF. 602553 BLEU/BLEUE
 REF. 602683 NOIR/BLACK

Luge empilable, livrée avec
 freins métalliques montés.
 /Stackable sledge, delivered
 with assembled metal brakes.



MADE IN FRANCE & ITALIE



RÉSISTANCE
 90kg
 strength
 weight 198lb



3000g



59x90x12cm

**SÉCURITÉ, CONFORT ET
 SOLIDITÉ, VOUS
 GLISSEZ EN TOUTE
 CONFIANCE AVEC LES
 LUGES SEVEN STYLE
 DEPUIS LES ANNÉES
 1960.**

**SAFETY, COMFORT AND
 DURABILITY, YOU GLIDE
 WITH CONFIDENCE
 WITH THE SEVEN-STYLE
 SLEDGES SINCE THE
 1960s.**

RACK À BOB

REF. 604001

Capacité de vingt luges, pour MINI/SUPER/
SNOW BOB. Quatre roues dont deux avec
freins. Barre antivol et récupérateur d'eau.
/Capacity of twenty sledges, for MINI/SUPER/
SNOW BOB. Four wheels, two of which have
brakes. Anti-theft device and water collector.



161x150x55cm



ACIER
INOXYDABLE
stainless steel



50kg

SIÈGE SNOW BOB

/SNOW BOB SEAT

REF. 2559



**SIÈGE SUPER BOB
& BOB VOLANTE 1**

/SUPER BOB
& VOLANTE 1 SEAT

REF. 2558



FREINS MINI BOB

/MINI BOB BRAKES

REF. 602677



**KIT DE FREINS
BOB VOLANTE 1**

/BOB VOLANTE 1
BRAKES KIT

REF. 602675



**PATIN AVANT BOB
VOLANTE 1 & 2**

/BOB VOLANTE
1 & 2 FRONT SKI

REF. 602674



**SIÈGE JET BOB
& BOB VOLANTE 2**

/JET BOB
& VOLANTE 2 SEAT

REF. 602671



SIÈGE MINI BOB

/MINI BOB SEAT

REF. 602656



SIÈGE BIGG BOB

/BIGG BOB SEAT

REF. 602654



**VOLANT BOB
VOLANTE 1 & 2**

/BOB VOLANTE 1 & 2
STEERING WHEEL

REF. 602673



**KIT DE FREINS
BOB VOLANTE 2**

/BOB VOLANTE 2
BRAKES KIT

REF. 602672



**RIVETS ALU
AVEC RONDELLES**

/ALU RIVETS
WITH NUTS

REF. 602670

Sachet de quatre sets.
/Bag of four sets.



**PLATINES
DE FREINS**

/BRAKES PLATES

REF. 602628



**POIGNÉE
PLASTIQUE**

/PLASTIC HANDLE

REF. 602627



FREINS

/BRAKES

REF. 2119



COQUE

/SHELL

REF. 602629



SANGLES DE PIEDS

/FOOT STRAPS

REF. 602630



**SANGLES DE PIEDS
EXTRA LONGUE**

/EXTRA LONG
FOOT STRAPS

REF. 602676



**ROUE DE RACK À
BOB SANS FREIN**

/SPARE WHEEL
WITHOUT BRAKE

REF. 604002



**ROUE DE RACK À
BOB AVEC FREIN**

/SPARE WHEEL
WITH BRAKE

REF. 604003



SNOWSCOOT

REF. 610149 GRIS/GREY

REF. 610150 NOIR/BLACK

REF. 610770 BLANC/WHITE

Aluminium peint avec patin renforcé "made in EU".

SNOWSCOOT complet avec kit carving/protections/un footstrap.

Painted aluminium with reinforced "made in EU" skates.

SNOWSCOOT completed with carving kit/protections/one footstrap.



ALUMINIUM



RÉSISTANCE
120kg
strength
weight 264lb



88x170x25cm



PAIRE DE POIGNÉES À GLISSER

/PAIR OF SLIDING HANDLES

REF. 610152

PAIRE DE POIGNÉES À BAGUE VISSÉE

/PAIR OF HANDLE WITH SCREWED RING

REF. 610153

JEU DE ROULEMENT

/BEARING CLEARANCE

REF. 610154

MOUSSE TUBE DE GUIDON

/HANDLEBAR TUBE FOAM

REF. 610155

MOUSSE PROTECTION DE POTENCE

/STEM PROTECTION FOAM

REF. 610156

MOUSSE PROTECTION DE CADRE

/FRAME PROTECTION FOAM

REF. 610157

GUIDON/HANDLEBAR

REF. 610159

FOURCHE/FORK

REF. 610160

POTENCE/STEM

REF. 610161

LEASH

/LEASH

REF. 610078



KIT CARVING SILENTBLOC

/SILENTBLOC CARVING KIT

REF. 610680



FOOTSTRAP CORDURA DOUBLE VELCRO

/DOUBLE VELCRO CORDURA FOOTSTRAP

REF. 610686



PATIN AVANT

/FRONT SKATE

REF. 610706 VERT/GREEN
REF. 610852 ROUGE/RED
REF. 610854 BLANC/WHITE
REF. 610856 BLEU/BLUE
REF. 610958 NOIR/BLACK



PATIN ARRIÈRE

/BACK SKATE

REF. 610705 VERT/GREEN
REF. 610853 ROUGE/RED
REF. 610855 BLANC/WHITE
REF. 610857 BLEU/BLUE
REF. 610959 NOIR/BLACK



Patins: Topsheet anti rayure, haut de gamme noyau bois renforcé stringer carbone, noyau bois, inserts renforcés, renfort Carbone, Ptex 7500 tranché.
/Skate: Anti-scratch topsheet, top of the range reinforced wood core stringer carbon, wood core, reinforced inserts, carbon reinforcement, sliced Ptex 7500.

BINGO**REF. 2505**

Pelle à neige classique, Pack coloris assortis.
Classic shovel sledge, assorted colors pack.



170g



RÉSISTANCE
50kg
strength
weight 110lb



33x51x3cm



MINIMUM
D'ACHAT
M.O.Q.

SKIBOARD

REF. 602571 BLEU/BLUE
REF. 602572 ROUGE/RED

Planche de glisse légère, semi-rigide.
Lightweight, semi-rigid gliding board.
Pack à la couleur / color pack



545g



RÉSISTANCE
50kg
strength
weight 110lb



21x69x5cm



MINIMUM
D'ACHAT
M.O.Q.

PAN

REF. 602690 VERT/GREEN
REF. 602693 ROUGE/RED
REF. 602692 BLEU/BLUE

Luge pelle XL à deux poignées.
Two handles XL sledge.
Pack à la couleur



260g



RÉSISTANCE
50kg
strength
weight 110lb



34x54cm



MINIMUM
D'ACHAT
M.O.Q.

PELLE XXL

REF. 2556 VERT/GREEN
REF. 2002 BLEU/BLUE
REF. 2557 ORANGE/ORANGE

Pelle à neige grand format.
Large shovel sledge.
Pack à la couleur
color pack



RÉSISTANCE
50kg
strength
weight 110lb



48x65x2cm



420g



MINIMUM
D'ACHAT
M.O.Q.

SUPERSTAR

REF. 2515

Luge ronde à deux poignées, Pack coloris assortis.

Two handles round sledge, assorted colors pack.



RÉSISTANCE
50kg
strength
weight 110lb



ø60x4cm



550g

NOUVEAU
COLORIS



MINIMUM
D'ACHAT
m.o.ç.

SUPERNOVA 60

REF. 602537 VERT/GREEN

REF. 602538 ROUGE/RED

REF. 602738 BLEU/BLUE

Luge ronde avec sillons directionnels et freins.

/Sledge with directional grooves and brakes.

Pack à la couleur / color pack



700g



RÉSISTANCE
90kg
strength
weight 198lb



ø60x10cm



MINIMUM
D'ACHAT
m.o.ç.

BIG M

REF. 602526 ROUGE/RED

REF. 602528 VERT/GREEN

REF. 602529 BLEU/BLUE

Luge curvée avec sillons directionnels et poignées latérales.

Pack à la couleur / Curved sledge with directional grooves and color pack handles.



1000g



RÉSISTANCE
50kg
strength
weight 110lb



48x73x14cm



MINIMUM
D'ACHAT
m.o.ç.

CLASSIC 1

REF. 602551 BLEU/BLUE
REF. 602552 ROUGE/RED
REF. 602610 VERT/GREEN
REF. 602681 ROSE/PINK

Luge une place avec freins plastiques et tire luge. Livrée freins montés.

One seater sledge with plastic brakes and sledge puller. Delivered brakes assembled.

Pack à la couleur / color pack



1450g



RÉSISTANCE
80kg
strength
weight 176lb



41x77x20cm

**CLASSIC 2**

REF. 602512 ROUGE/RED
REF. 602513 VERT/GREEN
REF. 602608 BLEU/BLUE
REF. 602698 ROSE/PINK

Luge deux places avec freins plastiques et tire luge.

Livree freins montés.
 One seater sledge with plastic brakes and sledge puller.
 Delivered brakes assembled.

Pack à la couleur / color pack



1600g



RÉSISTANCE
80kg
strength
weight 176lb



44x90x22cm

**BABY**

REF. 602550 VERT/GREEN
REF. 2003 ORANGE/ORANGE

Luge bébé avec ceinture de sécurité à cinq points et compartiments latéraux.
 Baby sledge with five anchorages seatbelt and side baskets.

Pack à la couleur / color pack



1800g



RÉSISTANCE
20kg
strength
weight 44lb



50x74x32cm



1-3 ANS
1-3yo



JET STAR

REF. 2547

Luge une place avec freins métalliques et tire luge.
Livrée freins non montés.
One seater sledge with metal brakes and sledge puller. Delivered with unassembled brakes.



2400g



HDPE



RÉSISTANCE
100kg
strength
weight 220lb



40x93x22cm



STRATOS

REF. 602567 GRIS & VERT/GREY & GREEN

REF. 602568 ROUGE/RED

Luge deux places à volant, avec frein central plastique et tire luge rétractable. Volant amovible, permettant d'empiler les luges.

/Two seaters sledge with steering wheel, central plastic brake and retractable puller. Removable steering wheel to stack the sledges.



3950g



RÉSISTANCE
120kg
strength
weight 264lb



56x98x30cm



GALACTUS

REF. 602746 BLEU POLAIRE/POLAR BLUE

Luge deux places à volant avec frein central plastique et tire luge rétractable. Volant amovible, permettant d'empiler les luges

Luge adaptée pour 2 enfants ou 1 adulte et 1 enfant
Vendue dans sa boîte prête à transporter

Two-seater sled with steering wheel with central plastic brake and retractable sled pulls. Removable steering wheel, allowing sleds to be stacked

Sled suitable for 2 children or 1 adult and 1 child
Sold in its box ready to transport



4,75KG



RÉSISTANCE
140kg
strength weight
308lbs



58,8 X 115,5
X 22 CM



À.P.D.
from
10/24

BABY SKI 70

REF. 602504 BLEU/BLUE

REF. 602510 ROSE/PINK

Panoplie skis & bâtons en plastique et aluminium. Fixations par sangles plastique.

Set of skis in plastic and aluminum. plastic straps fastenings.



890g



RÉSISTANCE
50kg
strength
weight 110lb



68cm



À PARTIR
DE 3 ANS
from 3yo

SNOW BABY FUN

REF. 602506

Luge poussette. Siège avec dossier haut, ceinture et sangle entrejambe.

/Stroller sledge with adjustable handle. Seat with high back, belt and crotch strap.



6200g



RÉSISTANCE
50kg
strength
weight 110lb



44x90x63cm



0,6-3 ANS
0.6-3yo



PETITE ENFANCE/EARLY CHILDHOOD

GLISSER

ENVELOPPE POLAIRE

POLAR FLEECE SHELL

REF. 602524

Chancelière confortable et chaude.
Comfortable
and warm sleeping bag.



47x95cm

SIÈGE/SEAT

REF. 602507

Siège une place, livré
avec visserie./One person
seat, delivered with screws.



SANGLE SIÈGE

SEAT SLED STRAP

REF. 602616



FILET + CROCHETS

NET + HOOKS

REF. 602678



ARCEAU DE MANCHE

HANDLE BAR

REF. 602620



BAGUE DE SERRAGE

CLAMPING RING

REF. 602632



PATIN UNIQUE

SILATE

REF. 602585



BARRE LATÉRALES DE SIÈGE

SIDE BARS SEAT

REF. 602906



KIT FREINS LUGE HORNET

HORNET SLEDGE
BRAKES KIT

REF. 602626



KIT FREINS LUGE UFO/

UFO SLEDGE
BRAKES KIT

REF. 2549



KIT FREINS LUGE CLASSIC 1 & 2

CLASSIC 1 & 2
SLEDGE BRAKES KIT

REF. 602618



VOLANT STRATOS ET GALACTUS

STRATOS STEERING
WHEEL

REF. 602631



KIT FREINS + VIS + TIRE LUGE POUR JET STAR/JET STAR BRAKES + SCREW + SLED PULLER KIT

REF. 2116



SANGLE POUR LUGE BABY
BABY SLEDGE SLED STRAP

REF. 602625



POIGNÉE TIRE LUGE CLASSIC 1 & 2 & BABY
CLASSIC 1 & 2
& BABY SLED PULLER

REF. 602634



SANGLE POUR LUGE MINI
MINI SLEDGE SLED STRAPE

REF. 602691



PINCE À BOULE DE NEIGE
SNOW BALL MAKER

REF. 602901 BOULE/BALL

Pack couleurs assorties.
Rivet en métal.
Assorted colors pack
Rivet in metal



9,5x36,5x7,5cm



PINCE A BOULE DE NEIGE PERSONNAGES
SNOWBALL MAKER
CHARACTERS

REF. 602907 BOULE/BALL

Pack couleurs et motifs assortis
Assorted design and colour pack
Rivet en métal.
Rivet in metal



9,5x36,5x7,5cm



À.P.D.
from
10/24



**PELLE À NEIGE
TÉLESCOPIQUE**
TELESCOPIC SHOVEL

REF. 603105

Pelle à neige compacte :
trois éléments télescopiques.
/Compact shovel:
three telescopic sections.



850g



PP6
ALUMINIUM



30x80>95cm
Déplié
Unfolded



30x80>75cm
Plié
Folded



MINIMUM
D'ACHAT
m.o.q.

**PELLE À NEIGE
POLYCARBONATE**
POLYCARBONATE
SHOVEL

REF. 603104

Pelle compacte, légère et très
résistante, démontable rapidement
en trois éléments.
/Compact shovel, light, ultra resistant,
composed of three sections.



800g



PC6
ALUMINIUM



27x75>89cm



MINIMUM
D'ACHAT
m.o.q.

**PELLE À NEIGE
ALUMINIUM**
ALUMINIUM SHOVEL

REF. 603106

Pelle à neige en aluminium,
lame et manche deux brins.
Fonction pioche, lame
incurvée 22x29x4 cm.
Pack couleurs assorties.
/Aluminium shovel, blade
and two sections handle.
Pickaxe function, curved
blade 22x29x4 cm.
/Assorted colors pack.



SIFFLET
DE DÉTRESSE



480g



CORDE DANS
LE MANCHE



ALUMINIUM



22x44>76cm
Plié
Folded



22x44>76cm
Déplié
Unfolded



MINIMUM
D'ACHAT
m.o.q.



CUSTOMISER

CUSTOMISER

CUSTOMISER

Attache velcro ski alpin
/Alpine skiing velcro fastener**REF. 610767** ASSORTIS/ASSORTED
REF. 610836 NOIR/BLACK

2,5x35cm

MINIMUM
D'ACHAT
m.o.q.**Attache velcro carving mousse 50 mm**
/50 mm velcro carving foam fastener**REF. 610055** NOIR/BLACKMINIMUM
D'ACHAT
m.o.q.**Attache velcro carving mousse 40 mm étiquette 3D**
/3D label 40 mm velcro carving foam fastener**REF. 610058** NOIR/BLACKCousues sur deux faces, impression deux faces/
3D thermo, trois couleurs maximum, délai 5 semaines.
/Sewn on two sides, two-sided printing/3D thermo,
three colors maximum, delay 5 weeks.MINIMUM
D'ACHAT
m.o.q.**Attache velcro carving luxe 50 mm**
/50 mm velcro carving luxury fastener**REF. 610057** NOIR/BLACKInjecté blocage carré en T.
/Injected square blocking T.MINIMUM
D'ACHAT
m.o.q.**Chaussette ski de fond 50 mm étiquette 3D**
/3D label 50 mm cross-country ski socks**REF. 610059** NOIR/BLACKCousues sur deux faces, impression deux faces/
3D thermo, trois couleurs maximum, délai 5 semaines.
/Sewn on two sides, two-sided printing/3D thermo,
three colors maximum, delay 5 weeks.MINIMUM
D'ACHAT
m.o.q.

Attache velcro ski de fond
/Cross-country skiing velcro fastener

REF. 610063 ASSORTIS/ASSORTED



2,5 x 22cm



MINIMUM
D'ACHAT
m.o.q.

Porte forfait brassard
/Pass on cuff

REF. 610048 BLANC/WHITE



MADE IN
FRANCE



MINIMUM
D'ACHAT
m.o.q.

Housse de protection smartphone
/Smartphone protective cover

REF. 610861 BLANC/WHITE



PVC



ÉTANCHE
waterproof



MINIMUM
D'ACHAT
m.o.q.

Chaussette ski de fond 50 mm
/50 mm cross-country ski socks

REF. 610065 NOIR/BLACK



MINIMUM
D'ACHAT
m.o.q.

Pochette cendrier écologique
/Ecological ashtray pouch

REF. 610049 ARGENT/SILVER



8 X 8 cm

250 stickers personnalisés offerts (non posés)
pour l'achat de 250 cendriers.
/250 personalized stickers offered (not placed)
for the purchase of 250 ashtray.



MINIMUM
D'ACHAT
m.o.q.

Leash sangle snowboard 30 mm
/Leash snowboard strap 30 mm

REF. 610075 NOIR/BLACK



3x70cm

Boucle fermeture plastique.
/Plastic buckle closure.



PRINT



MINIMUM
D'ACHAT
m.o.q.

Chaussette réservation ski

/Ski booking sock

REF. 610212

Pochette transparente 21 x 15 cm.
/Transparent pouch 21 x 15 cm.



POLYESTER
CORDULA



MINIMUM
D'ACHAT
M.O.Q.

Sac chaussures de ski - 1 paire

/Ski boots bag - 1 pair

REF. 610203 NOIR/BLACK

Impression quadrichromie 1 face minimum.
/Minimum 1-sided quadrichromy printing.



POLYESTER



39x25x42cm



MINIMUM
D'ACHAT
M.O.Q.

Sac location

/Rental bag

REF. 610207 NOIR/BLACK

Finition noir vernis.
/Black varnish finish.



POLYPROPYLENE



35x37x55cm



MINIMUM
D'ACHAT
M.O.Q.

Sac casque

/Helmet bag

REF. 610209 NOIR/BLACK

Cordon réglable.
/Adjustable cord.



LYCRA



MINIMUM
D'ACHAT
M.O.Q.

Sac chaussures de ski - 2 paires

/Ski boots bag - 2 pairs

REF. 610200 NOIR/BLACK

Impression quadrichromie 1 face minimum.
/Minimum 1-sided quadrichromy printing.



POLYESTER



40x38x23cm



MINIMUM
D'ACHAT
M.O.Q.

Sac chaussures de ski - 4 paires

/Ski boots bag - 4 pairs

REF. 610205 NOIR/BLACK

Impression quadrichromie 1 face minimum.
/Minimum 1-sided quadrichromy printing.



POLYESTER



50x40x60cm



MINIMUM
D'ACHAT
M.O.Q.

NOUS PRODUISONS AUSSI
VOS **STICKERS**, AFIN DE BIEN
COMMUNIQUER SUR VOTRE
ENTREPRISE JUSQU'EN HAUT
DES PISTES! **VOIR PAGE SUIVANTE...**

/WE CAN ALSO PRODUCE
YOUR **STICKERS**, IN ORDER
TO COMMUNICATE ON YOUR
COMPANY UP TO THE TOP
OF THE SLOPES! **SEE NEXT PAGE...**

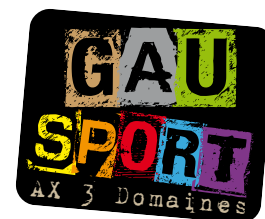



FREND

