



CATÁLOGO DE
PRODUCTOS

2026



Candil
iluminación

Quiénes Somos

En **Candil Iluminación** somos una empresa familiar con más de 60 años de trayectoria en el mercado argentino. A lo largo de estas décadas, construimos una forma de trabajar basada en la seriedad, el compromiso y la cercanía con nuestros clientes, acompañándolos de manera constante y generando relaciones de largo plazo.

Desde hace más de 35 años nos dedicamos al desarrollo, la importación y la distribución mayorista de productos de iluminación, lámparas y accesorios eléctricos, brindando soluciones confiables para proyectos residenciales, comerciales e industriales. Nuestra experiencia nos permite entender las necesidades reales de cada cliente y ofrecer respuestas prácticas, eficientes y sostenibles en el tiempo.

Seleccionamos y desarrollamos productos innovadores y de alta calidad, pensados para una instalación segura, prolija y duradera. Cada artículo de nuestro catálogo está diseñado considerando tanto al profesional que lo instala como al usuario final que lo utiliza a diario, buscando siempre un equilibrio óptimo entre prestaciones, calidad y precio.

Trabajamos en conjunto con estudios de ingeniería y diseño, lo que nos permite interpretar las tendencias del mercado y transformarlas en soluciones funcionales, con excelente rendimiento y una muy buena relación calidad-precio.

En **Candil Iluminación** creemos que los mejores resultados se logran escuchando y acompañando. Por eso abordamos cada vínculo desde una mirada humana, con una atención cercana y personalizada que va más allá de la operación comercial. Cada cliente es una relación que valoramos y cuidamos en el tiempo.

Respaldados por nuestra trayectoria y un equipo comprometido, nos posicionamos como un socio estratégico en iluminación, acompañando a nuestros clientes en cada proyecto con profesionalismo y confianza.

Por qué elegirnos

- Calidad y excelente relación calidad-precio
- Stock permanente y amplia variedad
- Atención personalizada y asesoramiento especializado

Candil Iluminación. Más de 60 años iluminando proyectos y construyendo confianza.



ÍNDICE

1

LÁMPARAS Y LUMINARIAS LED

	12	Lámparas Dicro
GU10	16	Lámparas AR111
	22	Formato profesional
	24	Lámparas E27
E27	30	Lámparas PAR30
	32	Lámparas High Power
G9	34	Lámparas G9
E14	36	Lámparas E14
R7S	38	Lámparas R7S
	40	Filamento E27
Filamento	42	Filamento E14
	44	Filamento Gold
	48	Listones bajo alacena
Listones y Tubos	50	Listones para techo
	52	Tubos LED
Plafones LED	54	Plafones LED Redondos
	56	Plafones LED Cuadrados

2

LUMINARIAS DE EMBUTIR PARA INTERIOR

	62	Selec
	63	Técnico
	64	Orson
	66	Cosme
	68	Walid
Embutidos para Dicro	70	Blas
	72	Fidel
	74	Wilbur
	76	Werner
	78	Afro
	80	Truman
	82	Roque
Cardánicos de Embutir	86	Ecu para Dicro
	88	Ecu para AR111
	90	Zafir
	92	Zac

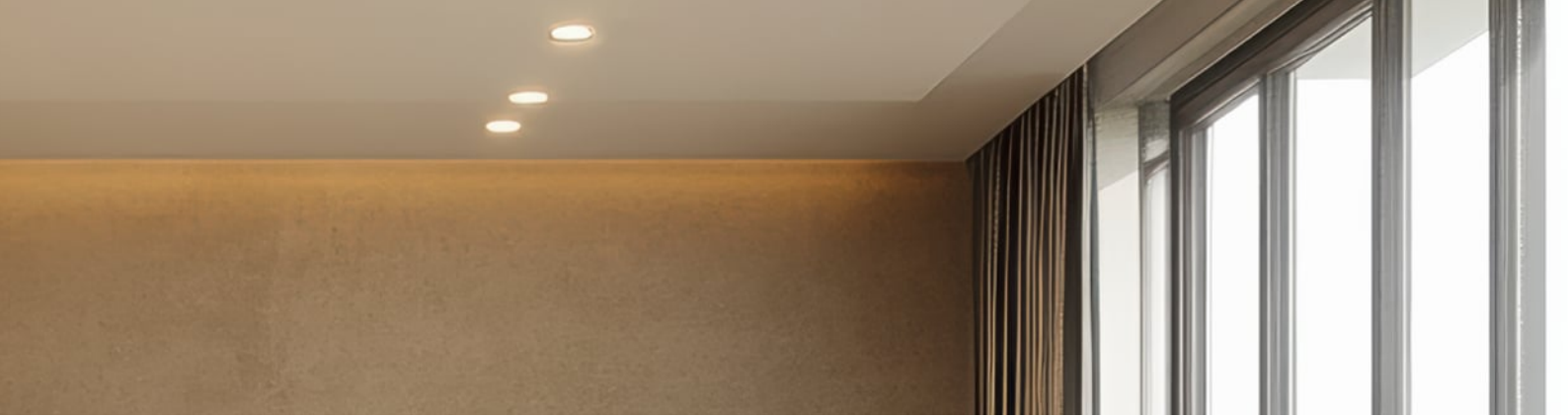

3

LUMINARIAS DE APLICAR PARA INTERIOR

Semiembutidos	96	Balcony I
	97	Balcony II
	98	Gallery I
	99	Gallery II
Cardánicos de Aplicar	100	Plafón Ecuá para Dicro
	102	Plafón Ecuá para AR111
Plafones Monovolúmen	104	Asin
	105	Senku
	106	Tona
Cabezales para Dicro	108	Omega
	109	Bomber
	110	Cala
	111	Runa
	112	Lalo
	113	Fork
	114	Webb
	Cabezales para AR111	116
117		Cinema
118		C700
Accesorios	120	TAPA090
Bases para cabezales	124	Torito
	130	Redonda
	131	Pareto

4

SISTEMAS PARA LÁMPARAS LED

140	Eitu
144	Pola
148	Cachen
150	Memo
152	Ayelen
154	Julita
158	Sheila
162	Sonata
168	Témpano
172	Konus
176	Party
178	Promo
180	Super
182	Vulcano
184	Vistra
186	Lenora
190	Nuria

ÍNDICE

5

APLIQUES DECO PARA G9

- 196 Aplique Fiore
- 200 Aplique Mica
- 202 Aplique Sensei
- 204 Aplique Solo
- 206 Aplique Buda

6

COLGANTES DECO PARA E27

- 210 Concret
- 212 Soviet
- 216 Galeón
- 218 Goleta
- 222 Corbeta
- 224 Micro
- 225 Mega
- 226 Arypa
- 227 Prius
- 228 Faceta
- 230 Jirón
- 232 Piluso
- 234 Chin
- 236 Bebe
- 238 Corona
- 240 Depot

7

COLGANTES Y PLAFONES DECO PARA G9

- 244 Colgantes Ciro
- 246 Plafones Ball

8

COLGANTES, APLIQUES Y PLAFONES HIGH DECO

- 252 Plafón Alec
- 256 Plafón Marc
- 258 Plafón Adonis
- 260 Plafón Basil
- 262 Plafón Titan
- 266 Colgante Titan
- 268 Plafón Corban
- 270 Colgante Corban
- 272 Plafón Moe
- 276 Colgante Leo
- 278 Colgante Kal
- 280 Aplique Magus
- 284 Colgante Calix
- 286 Colgante Nicos
- 290 Aplique Nicos
- 292 Colgante Mateo
- 296 Colgante Dru
- 298 Colgante Bemus
- 300 Plafón Nudo
- 302 Colgante Nudo
- 304 Colgante Lazo
- 306 Plafón Lazo

8

**COLGANTES, APLIQUES Y
PLAFONES**
HIGH DECO

- 310 Plafón Lazo Doble
- 312 Colgante Treck
- 314 Colgante Central
- 316 Plafón Sunshine
- 318 Colgante Sunshine
- 322 Plafón Oval
- 326 Colgante Oval
- 328 Colgante Sonda
- 332 Colgante Sombra
- 334 Colgante Inter
- 336 Aplique Linea
- 338 Plafón Grifo
- 340 Aplique Flash
- 341 Colgante Flash
- 346 Plafón Orbital
- 347 Colgante Orbital
- 348 Aplique Gota
- 349 Colgante Gota
- 350 Colgante Nascar
- 352 Plafón Ghost
- 354 Colgante Curly
- 356 Aplique Paralelo
- 357 Aplique Simple
- 358 Colgante Panal
- 360 Plafón Panal
- 364 Colgante Aruba
- 366 Colgante Vector
- 368 Colgante Pope
- 370 Colgante Lupin
- 372 Colgante Nube
- 374 Plafón Nube
- 376 Colgante Tampa
- 378 Colgante Olimpico
- 380 Colgante Siesta
- 381 Colgante Sarasota
- 382 Colgante Longboat
- 384 Colgante Bahamas
- 386 Plafón Coral
- 388 Plafón Medusa
- 390 Plafón Burako
- 392 Plafón Nemo
- 394 Plafón Mara
- 396 Plafón Siro
- 398 Plafón Naples
- 400 Plafón Venice

ÍNDICE

9

ESCRITORIO CABECERA Y PIE

Lámparas de Escritorio para E27

- 404 Pipo Mesa
- 406 Pipo Pinza
- 408 Tablero

Lineas Madera

- 410 Fiona
- 411 Rufo
- 412 Paulo
- 414 Serena
- 416 Vinicio
- 418 Aplique Fiona

Lámparas de Escritorio LED

- 420 Teen
- 421 Flip
- 422 Bonnie

Apliques de Cabecera

- 424 Aki y Neo
- 426 Aplique Tripo

10

LÁMPARAS DE MESA RECARGABLES

- 432 Softy
- 434 Spicy
- 436 Indu
- 438 Dress

11

LÁMPARAS DE PIE

- 442 Pilo
- 444 Pale
- 446 Rodeo
- 448 Chil
- 450 Trio
- 452 Marcos
- 454 Noven
- 456 Duplex
- 458 Cuna
- 460 Pesca
- 462 Anzuelo
- 464 Rolon
- 466 Rola
- 468 Jama
- 470 Sable
- 472 Rufo
- 473 Goal

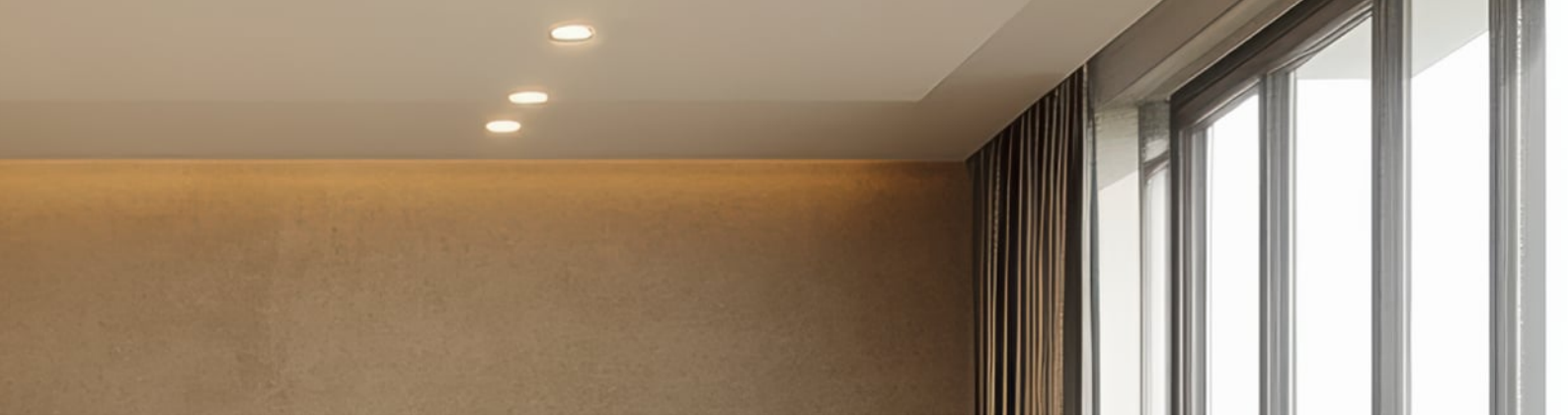

12

LUMINARIAS DE EXTERIOR

De pared	476	Apliques para GU10
	484	Apliques LED
	492	Empotrables LED
Para piso	494	Embutidos de piso
	498	Tero y Jabalina
Para techo	500	Sena y Silo
Proyectores	502	Proyectores Pegasus
	504	Proyectores Alta Potencia
Tortugas	506	Tortugas LED Integrado

13

LUMINARIAS SOLARES DE EXTERIOR

510	Cande
511	Bidus
511	Cirus
512	Crisol
513	Simple
513	Pro
514	Surti Chico
515	Surti Grande
516	Tritón
517	Nusel
518	Poli
519	Camping

14

TIRAS LED Y PERFILES

Tiras LED COB	522	Tiras LED 24V IP20
	525	Tiras LED 24V IP65
	526	Tiras LED 24V RGB
Tiras LED para interior	528	Tiras LED 12V IP33
	530	Tiras LED 24V IP33
Tiras LED para exterior	536	Tiras LED 12V IP66
	538	Tiras LED 24V IP66
Perfiles	540	Perfiles para aplicar
	542	Perfiles para embutir
Fuentes	544	Fuentes IP20
	545	Fuentes IP67





LÁMPARAS Y LUMINARIAS LED

LÁMPARAS LED GU10 :::: DICRO Y AR111



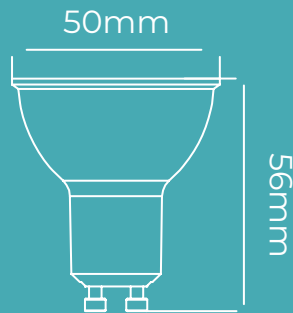

Lámpara LED Dicro 4W Difusa

LGU-1004



4W
275LM

GU10, 4W, 220V 50Hz, Dicro, IP20

3000K, 6500K

275LM

100°

No dimerizable

100 unidades

LINEA BLACK: PROFESIONAL

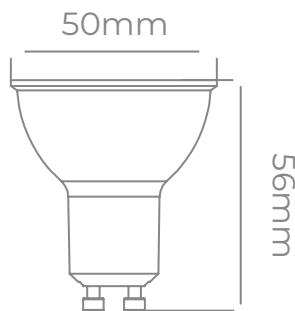

Lámpara LED Dicro 5W Profesional

LGU-4005-DIM



5W
450LM

GU10, 5W, 220V 50Hz, Dicro, IP20

3000K, 6500K

450LM

15°

Dimerizable

100 unidades

LINEA BLACK: PROFESIONAL

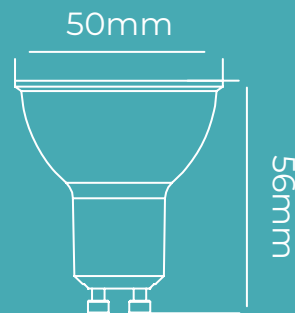

Lámpara LED Dicro 7W Profesional

LGU-4007-DIM



7W
600LM

GU10, 7W, 220V 50Hz, Dicro, IP20

3000K, 6500K

600LM

15°

Dimerizable

100 unidades

Lámpara LED Dicro 4W Puntual

LGU-8004



4W
325LM

GU10, 4W, 220V 50Hz, Dicro, IP20

3000K, 6500K

325LM

35°



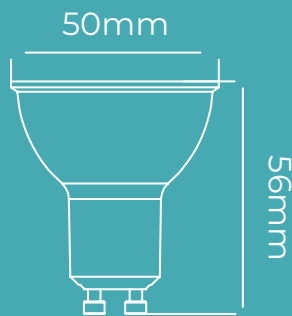

No dimerizable

100 unidades



Dicro LED de Colores

LGU-8004 

-  GU10, 4.5W, 220V 50Hz, Dicro, IP20
-  Amarillo, Rojo, Azul, Verde
-  325LM
-  35°
-  No dimerizable



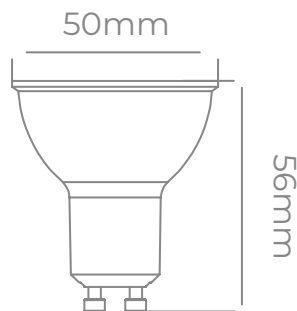

4.5W
325LM

 100 unidades



Dicro LED 7W Difusa

LGU-1807   

-  GU10, 7W, 220V 50Hz, Dicro, IP20
-  3000K, 4000K, 6500K
-  530LM
-  100°
-  No dimerizable

7W
530LM



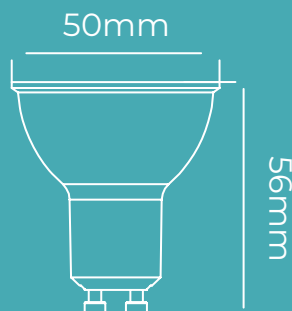

 100 unidades

AHORA EN COLOR NEGRO



Dicro LED 7W Difusa Negra

LGU-1807 BK   

-  GU10, 7W, 220V 50Hz, Dicro, IP20
-  3000K, 4000K, 6500K
-  480LM
-  100°
-  No dimerizable

7W
480LM

 100 unidades

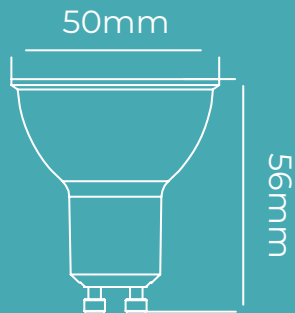

Dicro LED 7W Dífusa Dimerizable

LGU-1807-DIM ● ●

GU10, 7W, 220V 50Hz, Dicro, IP20

3000K, 6500K

480LM

100°

Dimerizable

7W
480LM

100 unidades

AHORA EN COLOR NEGRO

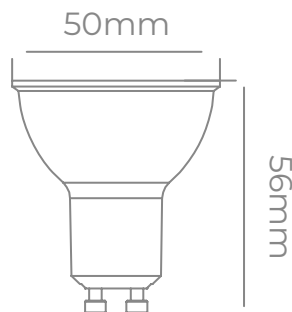

Dicro LED 7W Dífusa Dimerizable Negra

LGU-1807-DIM BK ● ●

GU10, 7W, 220V 50Hz, Dicro, IP20

3000K, 6500K

480LM

100°

Dimerizable

7W
480LM

100 unidades

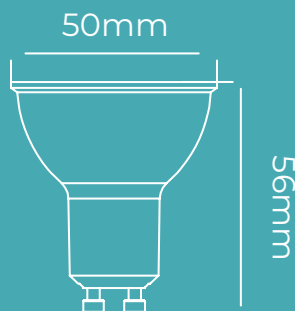

Dicro LED 7W Dífusa Silver

LGU-1807 SV ● ●

GU10, 7W, 220V 50Hz, Dicro, IP20

3000K, 6500K

480LM

100°

No dimerizable

7W
480LM

100 unidades

LÁMPARAS LED GU10 DICRO



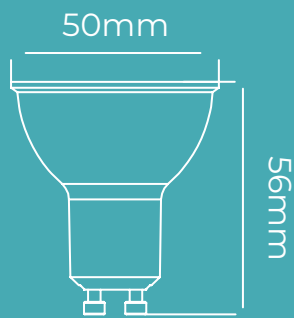

Dicro LED 7W Difusa Dimerizable Silver

LGU-1807-DIM SV ● ●

GU10, 7W, 220V 50Hz, Dicro, IP20

3000K, 6500K

480LM

100°

Dimerizable

7W
480LM

100 unidades

AHORA EN COLOR NEGRO

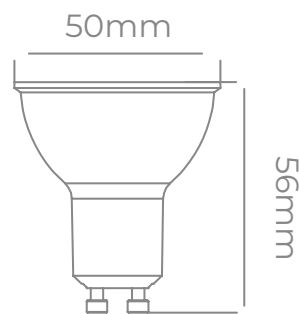

Dicro LED 7W Puntual

LGU-8007 ● ● ●

GU10, 7W, 220V 50Hz, Dicro, IP20

3000K, 4000K, 6500K

520LM

36°

No dimerizable

7W
520LM

100 unidades

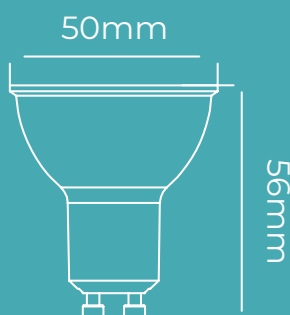

Dicro LED 7W Puntual Dimerizable

LGU-8007-DIM ● ●

GU10, 7W, 220V 50Hz, Dicro, IP20

3000K, 6500K

520LM

36°

Dimerizable

7W
520LM

100 unidades

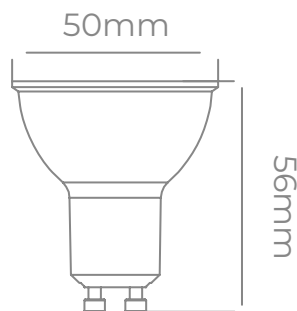

Dicro LED 7W Puntual

LGU-9007 ● ●

GU10, 7W, 220V 50Hz, Dicro, IP20

3000K, 6500K

560LM

35°

No dimerizable

7W
560LM

100 unidades







LINEA BLACK: PROFESIONAL

Lámpara LED Tipo AR111 Profesional

LGU-AR4012 DIM 

12W
1100LM

-  GU10, 12W, 220V 50Hz, AR111, IP20
-  3000K, 6500K
-  1100LM
-  15°
-  Dimerizable





 48 unidades



Lámpara LED Tipo AR111 12W

LGU-1212L   

12W
1055LM

-  GU10, 12W, 220V 50Hz, AR111, IP20
-  3000K, 4000K, 6500K
-  1055LM
-  30°
-  No dimerizable

 48 unidades







AHORA EN COLOR NEGRO

Lámpara LED Tipo AR111 Dimerizable Negra

LGU-1212   

12W
1055LM

-  GU10, 12W, 220V 50Hz, AR111, IP20
-  4000K, 6500K
-  1055LM
-  30°
-  No dimerizable

 48 unidades

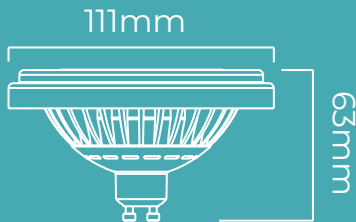

Lámpara LED Tipo AR111 Dimerizable

LGU-1212-DIM ● ●

12W
1055LM

GU10, 12W, 220V 50Hz, AR111, IP20

3000K, 6500K

1055LM

30°

Dimerizable

48 unidades

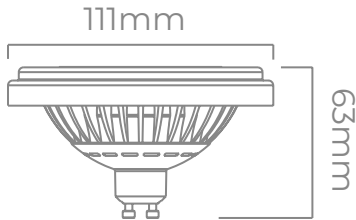

Lámpara LED Tipo AR111 Dimerizable Silver

LGU-1212-DIM SV ●

12W
1055LM

GU10, 12W, 220V 50Hz, AR111, IP20

3000K, 6500K

1055LM

30°

Dimerizable

48 unidades

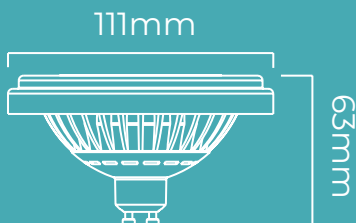

Lámpara LED Tipo AR111 15W

LGU-1215 ● ●

15W
1500LM

GU10, 15W, 220V 50Hz, AR111, IP20

3000K, 6500K

1500LM

30°

No dimerizable

48 unidades

LÁMPARAS LED GU10 TIPO AR111

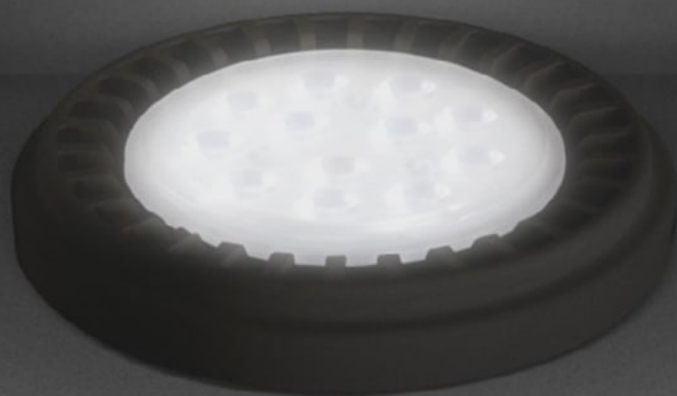

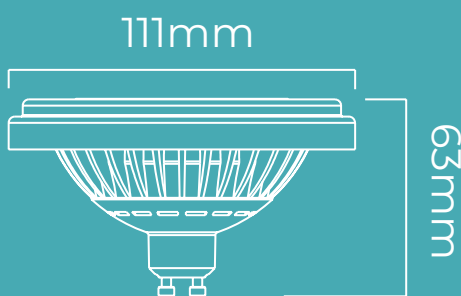

AHORA EN COLOR NEGRO

Lámpara LED Tipo AR111 12W Negra
LGU-1215



GU10, 15W, 220V 50Hz, AR111, IP20

3000K

1055LM

30°

No dimerizable

15W
1500LM

48 unidades

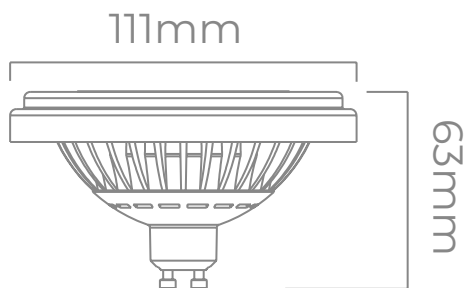

Lámpara LED Tipo AR111 15W Silver

LGU-1215 SV



GU10, 15W, 220V 50Hz, AR111, IP20

3000K, 6500K

1500LM

30°

No dimerizable

15W
1500LM

48 unidades

LÁMPARAS LED FORMATO PROFESIONAL



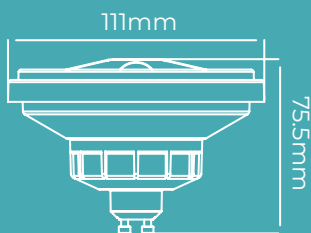

Lámpara LED Profesional tipo Halógena 12W

LGU-ARPRO2412 DIM ● ●

12W
950LM

- GU10, 12W, 220V 50Hz, AR111, IP20
- 3000K, 6500K
- 950LM
- 24°
- Dimerizable

36 unidades

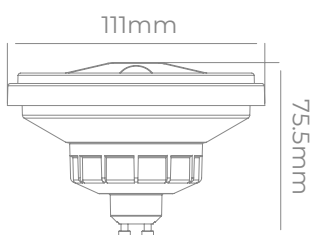

Lámpara LED Profesional tipo Halógena 15W

LGU-ARPRO2415 ● ●

15W
1250LM

- GU10, 15W, 220V 50Hz, AR111, IP20
- 3000K, 6500K
- 1250LM
- 24°
- No dimerizable

36 unidades

AHORA EN COLOR NEGRO

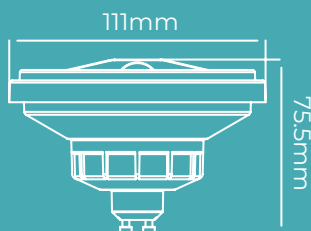

Lámpara LED Profesional tipo Halógena 12W

LGU-ARPRO2412 DIM ●

12W
950LM

- GU10, 12W, 220V 50Hz, AR111, IP20
- 3000K
- 950LM
- 24°
- Dimerizable

36 unidades

AHORA EN COLOR NEGRO

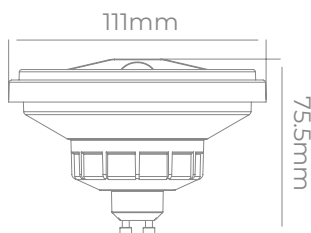

Lámpara LED Profesional tipo Halógena 15W

LGU-ARPRO2415 ● ●

15W
1250LM

- GU10, 15W, 220V 50Hz, AR111, IP20
- 3000K, 6500K
- 1250LM
- 24°
- No dimerizable

36 unidades







LÁMPARAS LED E27



Lámpara LED Fantasia 7W

LE27-VE2007-DIM 



-  E27, 7W, 220V 50Hz, C37, IP20
-  3000K, 6500K
-  720LM
-  200°
-  Dimerizable



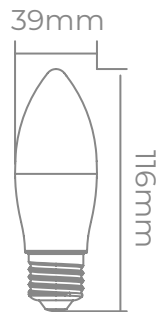

7W
720LM

 100 unidades



Lámpara LED Fantasia 8W

LE27-VE2808  



-  E27, 8W, 220V 50Hz, C37, IP20
-  3000K, 6500K
-  806LM
-  200°
-  No dimerizable



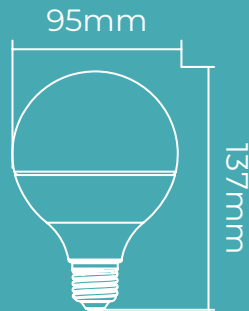

8W
806LM

 100 unidades



Lámpara LED Globo Bocha Chica

LE27-BC3012  



-  E27, 12W, 220V 50Hz, C100, IP20
-  3000K, 6500K
-  1105LM
-  180°
-  No dimerizable



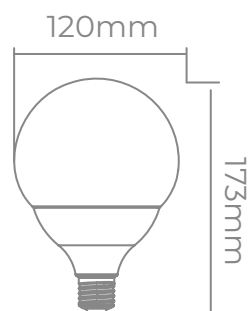

12W
1105LM

 24 unidades



Lámpara LED Globo Bocha Grande

LE27-BG3012  



-  E27, 12W, 220V 50Hz, G120, IP20
-  3000K, 6500K
-  1200LM
-  220°
-  No dimerizable



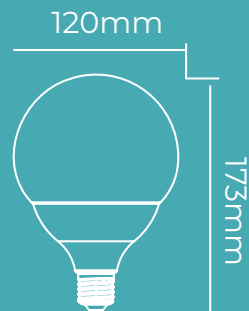

12W
1200LM

 16 unidades



Lámpara LED Globo Bocha Grande

LE27-BG4215  

-  E27, 15W, 220V 50Hz, G120, IP20
-  3000K, 6500K
-  1521LM
-  220°
-  No dimerizable

15W
1521LM

 16 unidades



45mm Ø



78mm

Lámpara LED Gota 4W

LE27-G124 ● ●

E27, 4W, 220V 50Hz, G124, IP20

2700K, 6500K

470LM

150°

No dimerizable

4W
470LM

100 unidades



56,5mm

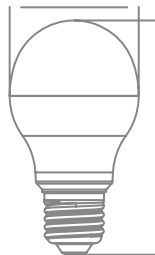

103mm

Lámpara LED Anti Insecto 4W

LE27-A5504-AI ●

E27, 4W, 220V 50Hz, A55, IP20

3000K

55LM

150°

No dimerizable

4W
55LM

100 unidades



60mm Ø



110mm

Lámpara LED Bulbo 6W Dimerizable

LE27-G2406-DIM ● ●

E27, 6W, 220V 50Hz, A60, IP20

3000K, 6500K

510LM

200°

Dimerizable

6W
510LM

100 unidades



60mm

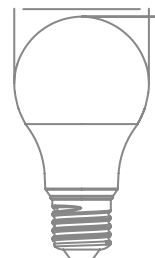

108mm

Lámpara LED A60 7W

LE27-ECA60007 ● ●

E27, 7W, 220V 50Hz, A60, IP20

3000K, 6500K

680LM

180°

No dimerizable

7W
680LM

100 unidades



60mm



108mm

Lámpara LED A60 9W

LE27-ECA60009 ● ●

E27, 9W, 220V 50Hz, A60, IP20

3000K, 6500K

750LM

180°

No dimerizable

9W
750LM

100 unidades

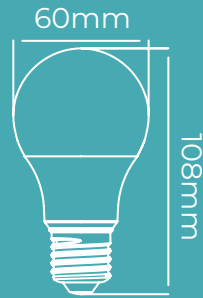

Lámpara LED A60 11W

LE27-ECA60011 ● ●

E27, 11W, 220V 50Hz, A60, IP20

3000K, 6500K

1150LM

180°

No dimerizable

11W
1150LM

100 unidades

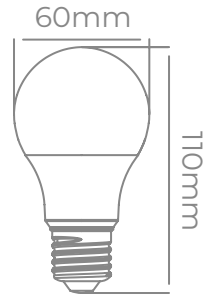

Lámpara LED A60 12W

LE27-ECA60012 ● ●

E27, 12W, 220V 50Hz, A60, IP20

3000K, 6500K

1055LM

180°

No dimerizable

12W
1055LM

100 unidades



Lámpara LED A60 15W

LE27-ECA60015 ● ●

E27, 15W, 220V 50Hz, A60, IP20

3000K, 6500K

1521LM

180°

No dimerizable

15W
1521LM

100 unidades

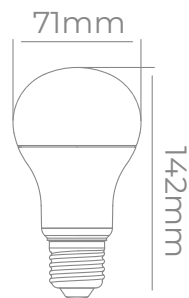

Lámpara LED A70 18W

LE27-ECA70018 ● ●

E27, 18W, 220V 50Hz, A70, IP20

3000K, 6500K

1901LM

180°

No dimerizable

18W
1901LM

200 unidades



Lámpara LED A80 20W

LE27-ECA80020 ● ●

E27, 20W, 220V 50Hz, A80, IP20

3000K, 6500K

2452LM

200°

No dimerizable

20W
2452LM

100 unidades

LÁMPARAS LED E27 ::::



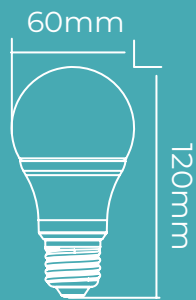





Lámpara LED Bulbo 12W

LE27-G3012



-  E27, 12W, 220V 50Hz, A60, IP20
-  3000K, 6500K
-  1200LM
-  180°
-  No dimerizable



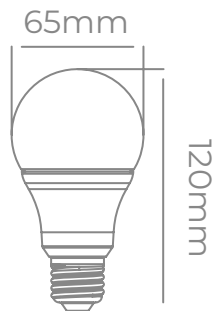

12W
1200LM

 100 unidades

Lámpara LED Bulbo 15W

LE27-A6515



-  E27, 15W, 220V 50Hz, A65, IP20
-  3000K, 6500K
-  1521LM
-  150°
-  No dimerizable



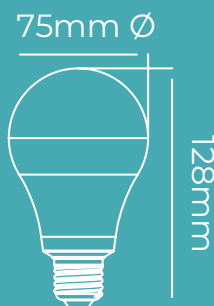

15W
1521LM

 100 unidades

Lámpara LED Bulbo 23W

LE27-A7523



-  E27, 23W, 220V 50Hz, A65, IP20
-  3000K, 6500K
-  2452LM
-  150°
-  No dimerizable

23W
2452LM

 100 unidades

LÁMPARAS LED PAR30



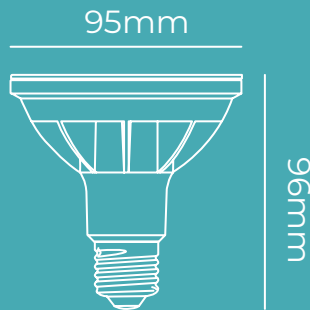

Lámpara LED High Power PAR30

LE27-HPPAR363011 ● ●

E27, 11W, 220V 50Hz, PAR30, IP20

3000K, 6500K

860LM

36°

No dimerizable

11W
860LM

20 unidades

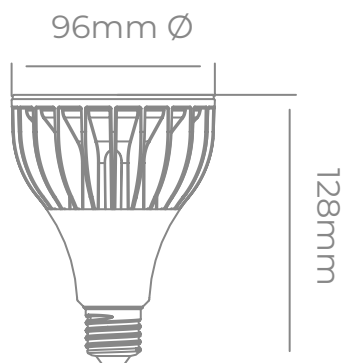

Lámpara LED High Power PAR30

LE27-HPPAR243030 ●

E27, 30W, 220V 50Hz, PAR30, IP20

3000K

2700LM

36°

No dimerizable

30W
2700LM

16 unidades



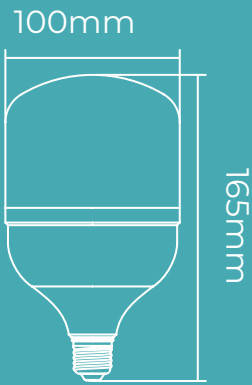

LÁMPARAS LED E27 HIGH POWER ::::





Lámpara LED High Power 30W

LE27-HP360030 ● ●

-  E27, 30W, 220V 50Hz, T120, IP20
-  3000K, 6500K
-  2500LM
-  180°
-  No dimerizable



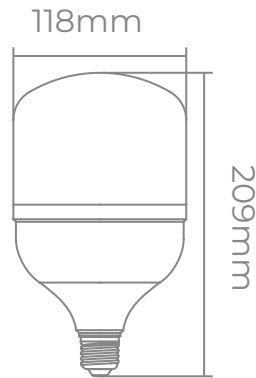

30W
2500LM

 20 unidades



Lámpara LED High Power 40W

LE27-HP360040 ● ●

-  E27, 40W, 220V 50Hz, T140, IP20
-  3000K, 6500K
-  3300LM
-  180°
-  No dimerizable



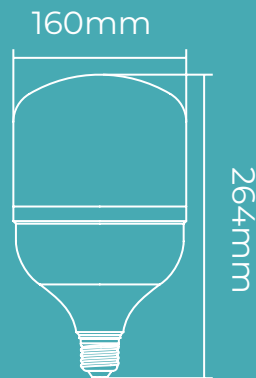

40W
3300LM

 10 unidades



Lámpara LED High Power 60W

LE27-HP360060 ● ●

-  E27, 60W, 220V 50Hz, T160, IP20
-  3000K, 6500K
-  5500LM
-  180°
-  No dimerizable

60W
5500LM

 8 unidades

LÁMPARAS LED G9



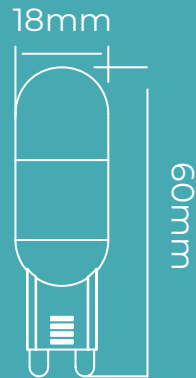





Lámpara LED G9 3W

LG9-5003L



-  G9, 3W, 220V 50Hz, G9, IP20
-  3000K, 6500K
-  300LM
-  270°
-  No dimerizable



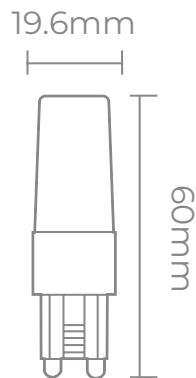

3W
300LM

 480 unidades

Lámpara LED G9 Ultracompacta

LG9-4503



-  G9, 3,5W, 220V 50Hz, G9, IP20
-  3000K, 6500K
-  470LM
-  310°
-  No dimerizable



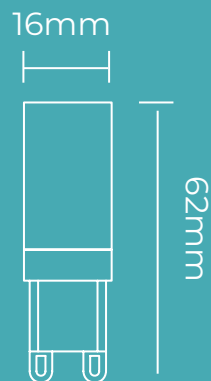

3,5W
470LM

 480 unidades

Lámpara LED G9 5W

LG9-7505L



-  G9, 5W, 220V 50Hz, G9, IP20
-  3000K, 6500K
-  400LM
-  310°
-  No dimerizable



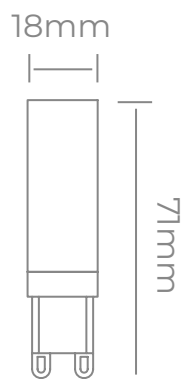

5W
400LM

 480 unidades

Lámpara LED G9 8W

LG9-7008



-  G9, 8W, 220V 50Hz, G9, IP20
-  3000K, 6500K
-  680LM
-  310°
-  No dimerizable

8W
680LM

 480 unidades

LÁMPARAS LED E14 ::::

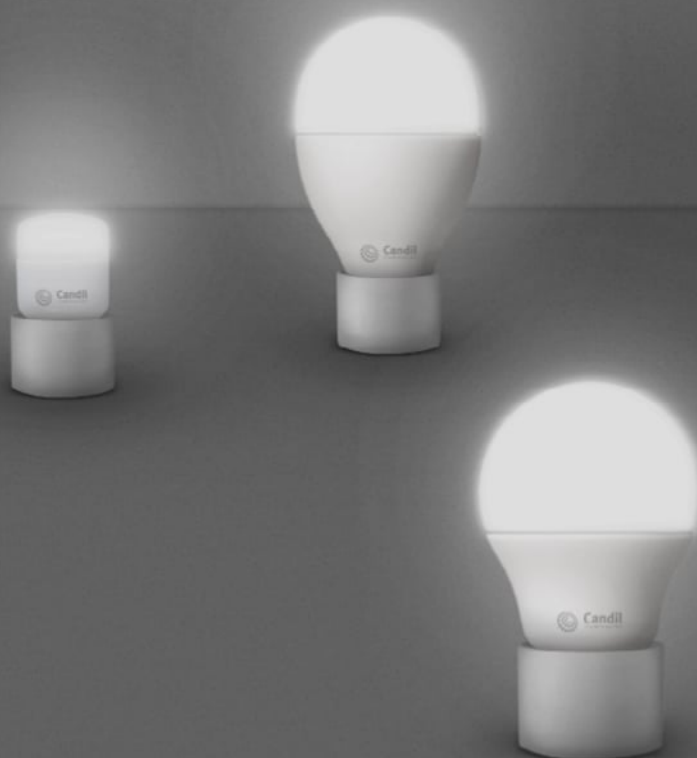



Lámpara LED Perfume

LE14-8001



E14, 5W, 220V 50Hz, T26, IP20

3000K, 6500K

135LM

120°

No dimerizable

1.5W
135LM

200 unidades

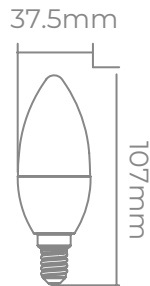

Lámpara LED Velita 5W

LE14-VE1605



E14, 5W, 220V 50Hz, C35, IP20

3000K, 6500K

495LM

200°

No dimerizable

5W
495LM

100 unidades



Lámpara LED Velita 8W

LE14-C3708



E14, 8W, 220V 50Hz, C35, IP20

3000K, 6500K

806LM

200°

No dimerizable

8W
806LM

100 unidades

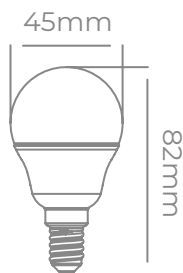

Lámpara LED Gota 5W

LE14-G4505



E14, 5W, 220V 50Hz, G45, IP20

3000K, 6500K

470LM

150°

No dimerizable

5W
470LM

100 unidades

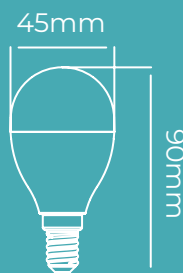

Lámpara LED Gota 8W

LE14-G4508



E14, 8W, 220V 50Hz, G45, IP20

3000K, 6500K

806LM

150°

No dimerizable

8W
806LM

100 unidades

LÁMPARAS LED TIPO CUARZO





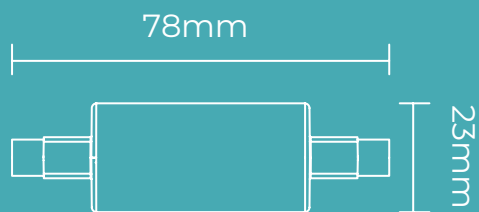

8W
720LM

 100 unidades



Lámpara LED Tipo Cuarzo Corto 8W
R7S-J78008  



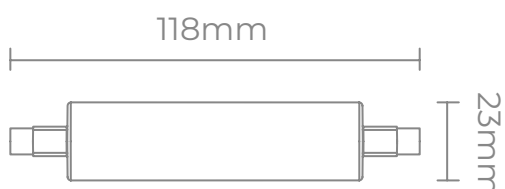

-  R7S, 6W, 220V 50Hz, J78, IP20
-  3000K, 6500K
-  720LM
-  360°
-  No dimerizable

15W
1400LM

 50 unidades



Lámpara LED Tipo Cuarzo Largo 15W
R7S-J11815  

-  R7S, 7W, 220V 50Hz, J118, IP20
-  3000K, 6500K
-  1400LM
-  360°
-  No dimerizable

LÁMPARAS FILAMENTO E27



4W
470LM

100 unidades



60mm

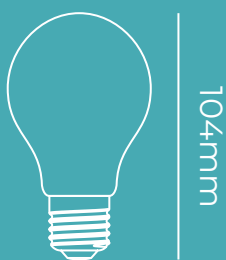

Lámpara LED Filamento 4W

LE27-FILC004



- E27, 4W, 220V 50Hz, A60, IP20
- 3000K
- 470LM
- 360°
- No dimerizable

4W
425LM

100 unidades



45mm

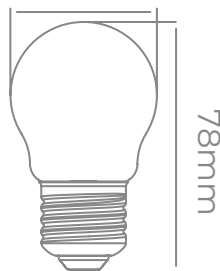

Lámpara LED Filamento Gota 4W

LE27-FILG45004



- E27, 4W, 220V 50Hz, G45, IP20
- 2500K, 2700K
- 425LM
- 360°
- No dimerizable

5W
470LM

100 unidades



58mm

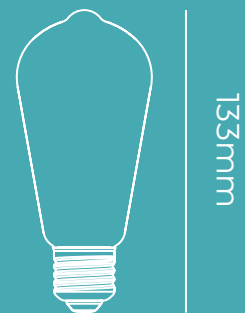

Lámpara LED Filamento Pera 5W

LE27-FILC005



- E27, 5W, 220V 50Hz, ST58, IP20
- 3000K
- 470LM
- 360°
- No dimerizable



6W
806LM

20 unidades

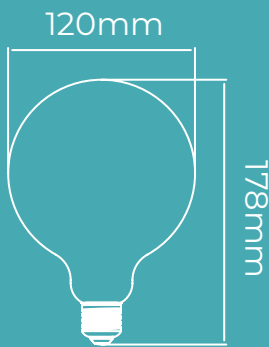

Lámpara LED Filamento Globo 6W
LE27-FILG006

E27, 6W, 220V 50Hz, G125, IP20

3000K

806LM

360°

No dimerizable

7W
806LM

80 unidades

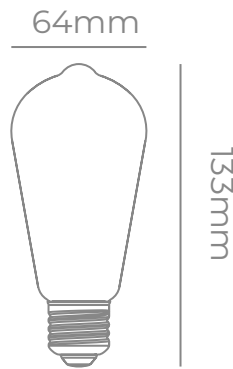

Lámpara LED Filamento Pera 7W
LE27-FILC007

E27, 7W, 220V 50Hz, ST64, IP20

3000K

806LM

360°

No dimerizable

7W
720LM

40 unidades

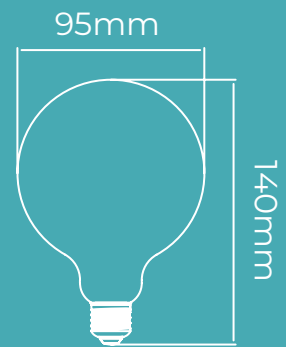

Lámpara LED Filamento Globo 7W
LE27-FILG95007

E27, 7W, 220V 50Hz, G95, IP20

2500K, 2700K

720LM

360°

No dimerizable



LÁMPARAS LED FILAMENTO E14



4W
470LM

 100 unidades



35mm



123mm

Lámpara LED Filamento Vela Deco 4W

LE14-FILVD04



 E14, 4W, 220V 50Hz, CF35, IP20

 3000K

 470LM

 360°

 No dimerizable

4W
420LM

 100 unidades



35mm





97mm

Lámpara LED Filamento Vela 4W

LE14-FILVE04



 E14, 4W, 220V 50Hz, ST35, IP20

 3000K

 420LM

 360°

 No dimerizable

LÁMPARAS FILAMENTO GOLD

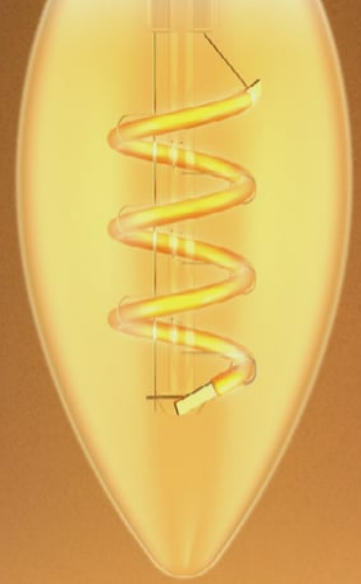

3W
136LM

100 unidades

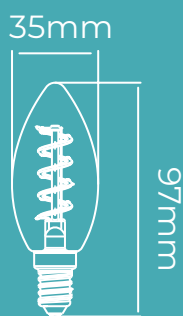

Lámpara LED Filamento Gold 3W
LE14-FVSC3503

- E14, 3W, 220V 50Hz, C35, IP20
- 2000K
- 136LM
- 360°
- No dimerizable

5W
250LM

100 unidades

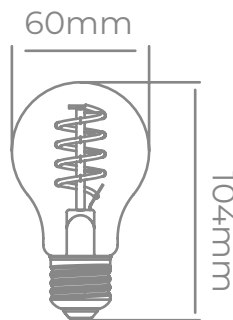

Lámpara LED Filamento Gold 5W
LE27-FVSA6005

- E27, 5W, 220V 50Hz, A60, IP20
- 2000K
- 250LM
- 360°
- No dimerizable

5W
250LM

80 unidades

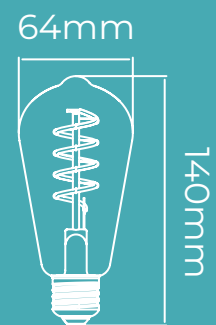

Lámpara LED Filamento Gold 5W
LE27-FVST6405

- E27, 5W, 220V 50Hz, ST64, IP20
- 2000K
- 250LM
- 360°
- No dimerizable

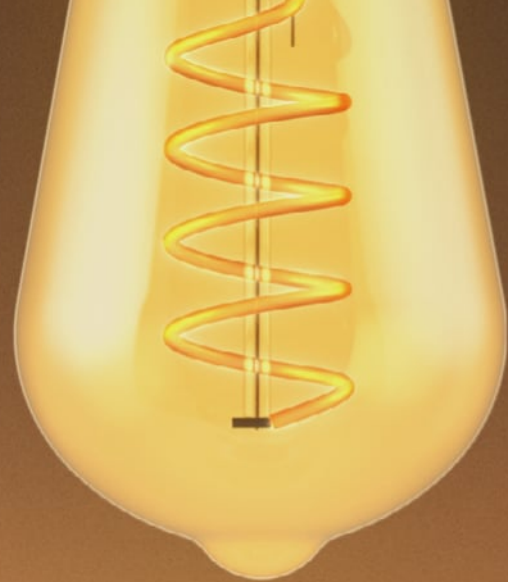



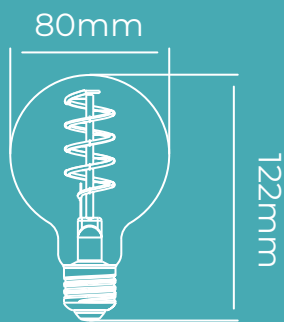

5W
250LM

 80 unidades



Lámpara LED Filamento Gold 5W
LE27-FVSG8005  



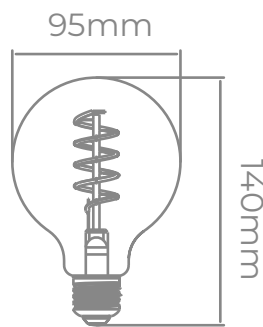

-  E27, 5W, 220V 50Hz, G80, IP20
-  2000K
-  250LM
-  360°
-  No dimerizable

5W
250LM

 20 unidades



Lámpara LED Filamento Gold 5W
LE27-FVSG9505  



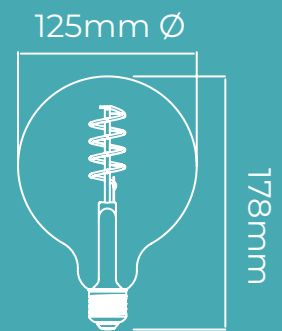

-  E27, 5W, 220V 50Hz, G95, IP20
-  2000K
-  250LM
-  360°
-  No dimerizable

5W
250LM

 20 unidades



Lámpara LED Filamento Gold 5W
LE27-FVSG12505  

-  E27, 5W, 220V 50Hz, G125, IP20
-  2000K
-  250LM
-  360°
-  No dimerizable



LÁMPARAS FILAMENTO GOLD ::::

5W
250LM





6 unidades

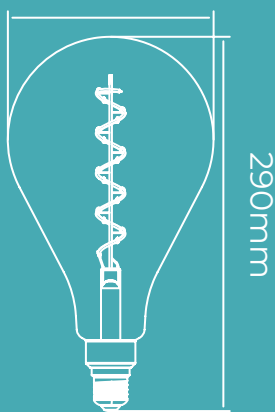

160mm Ø



Lámpara LED Filamento Gold 5W
LE27-FVSPS16005  

 E27, 5W, 220V 50Hz, S160, IP20

 2000K

 250LM

 360°

 No dimerizable

5W
250LM



6 unidades



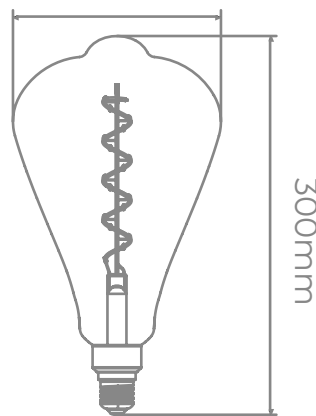

164mm



Lámpara LED Filamento Gold 5W
LE27-FVST16405  

 E27, 5W, 220V 50Hz, T164, IP20

 2000K

 250LM

 360°

 No dimerizable

5W
250LM



8 unidades



65mm

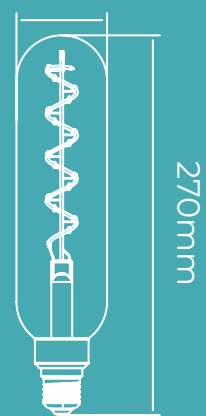

Lámpara LED Filamento Gold 5W
LE27-FVST6505  

 E27, 5W, 220V 50Hz, T65, IP20

 2000K

 250LM

 360°

 No dimerizable

LISTONES LED BAJO ALACENA



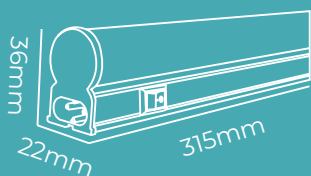

Listón LED Bajo Alacena 5W

BALT8005

LED, 5W, 220V 50Hz, IP20

4000K, 6500K

400LM

200°

No dimerizable

5W
400LM

25 unidades

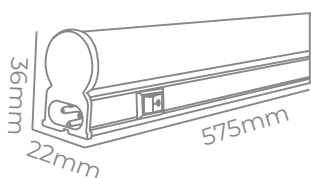

Listón LED Bajo Alacena 9W

BALT8009

LED, 9W, 220V 50Hz, IP20

4000K, 6500K

720LM

200°

No dimerizable

9W
720LM

25 unidades

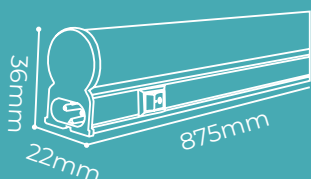

Listón LED Bajo Alacena 12W

BALT8012

LED, 12W, 220V 50Hz, IP20

4000K, 6500K

960LM

200°

No dimerizable

12W
960LM

25 unidades

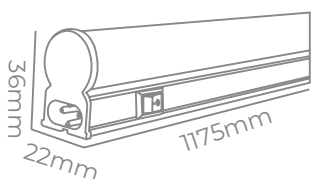

Listón LED Bajo Alacena 18W

BALT8018

LED, 18W, 220V 50Hz, IP20

4000K, 6500K

1440LM

200°

No dimerizable

18W
1440LM

25 unidades

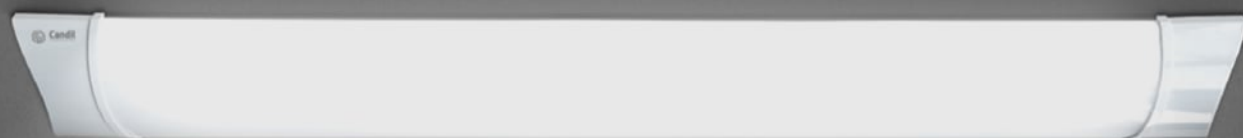

LISTONES LED PARA TECHO



18W
1440LM

 36 unidades

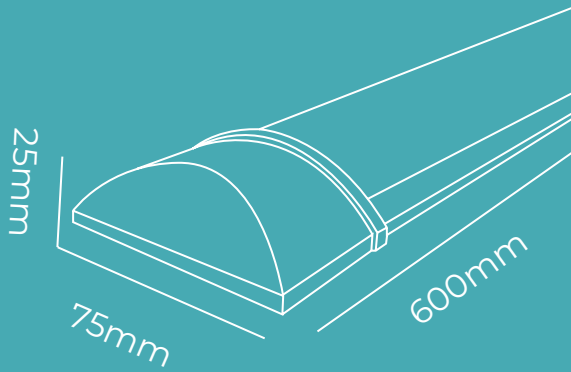

Listón LED para techo 18W

BALT060018  

 LED, 18W, 220V 50Hz, IP20

 3000K, 6500K

 1440LM

 200°

 No dimerizable

36W
2880LM

 24 unidades

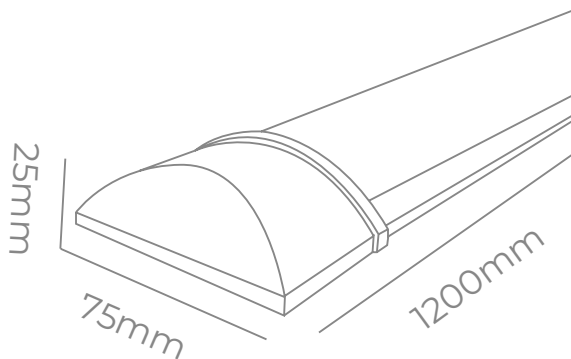

Listón LED para techo 36W

BALT120036  

 LED, 36W, 220V 50Hz, IP20

 3000K, 6500K

 2880LM

 200°

 No dimerizable

TUBOS LED ZÓCALO G13





Tubo LED de Policarbonato 9W

LG13-4806009



9W
800LM

LED, 9W, 220V 50Hz, T8, IP20

4000K

800LM

200°

No dimerizable

25 unidades

Conexión: un solo extremo



Tubo LED de Vidrio 18W

LG13-5012018



18W
1800LM

G13, 18W, 220V 50Hz, T8, IP20

4000K, 6500K

1800LM

200°

No dimerizable

25 unidades

Conexión: un solo extremo





PLAFONES LED REDONDOS



Plafones LED redondos de 6W, 12W, 18W y 28W, contruidos en chapa de acero.

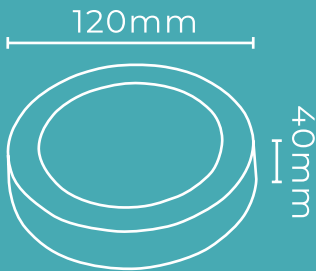

DRIVER DE REPUESTO
DISPONIBLE

- PLRE1206-30 BT
- PLRE1206-30 NM
- PLRE1206-30 NT
- PLRE1206-40 BT
- PLRE1206-40 NT
- PLRE1206-65 BT
- PLRE1206-65 NM
- PLRE1206-65 NT

Plafón LED
Redondo 6W
Art.: PLRE1206



- LED 6W, 220V, 50Hz, IP20
- Blanco texturado, Negro texturado, Niquel mate
- 3000K, 4000K, 6500K
- 280LM
- Chapa de acero
- Clase II

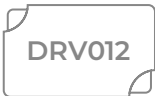
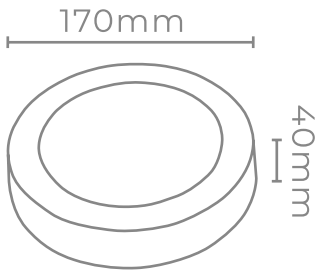

DRIVER DE REPUESTO
DISPONIBLE

- PLRE1712-30 BT
- PLRE1712-30 NM
- PLRE1712-30 NT
- PLRE1712-40 BT
- PLRE1712-40 NT
- PLRE1712-65 BT
- PLRE1712-65 NM
- PLRE1712-65 NT

Plafón LED
Redondo 12W
Art.: PLRE1712

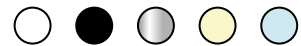

- LED 12W, 220V, 50Hz, IP20
- Blanco texturado, Negro texturado, Niquel mate
- 3000K, 4000K, 6500K
- 820LM
- Chapa de acero
- Clase II

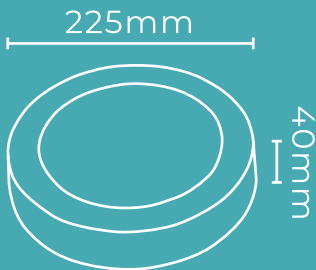

DRIVER DE REPUESTO
DISPONIBLE

- PLRE22218-30 BT
- PLRE22218-30 NM
- PLRE22218-30 NT
- PLRE22218-40 BT
- PLRE22218-40 NT
- PLRE22218-65 BT
- PLRE22218-65 NM
- PLRE22218-65 NT

Plafón LED
Redondo 18W
Art.: PLRE22218



- LED 18W, 220V, 50Hz, IP20
- Blanco texturado, Negro texturado, Niquel mate
- 3000K, 4000K, 6500K
- 1300LM
- Chapa de acero
- Clase II

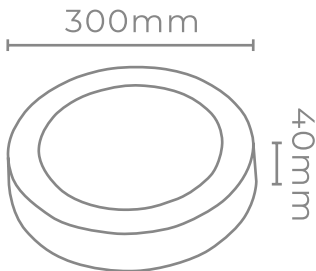

DRIVER DE REPUESTO
DISPONIBLE

- PLRE3028-30 BT
- PLRE3028-30 NM
- PLRE3028-40 BT
- PLRE3028-40 NT
- PLRE3028-65 BT
- PLRE3028-65 NM
- PLRE3028-65 NT

Plafón LED
Redondo 28W
Art.: PLRE3028



- LED 28W, 220V, 50Hz, IP20
- Blanco texturado, Negro texturado, Niquel mate
- 3000K, 4000K, 6500K
- 1800LM
- Chapa de acero
- Clase II



PLAFONES LED CUADRADOS



*Plafones LED cuadrados de
6W, 12W, 18W, 24W y 28W,
construidos en chapa de acero.*

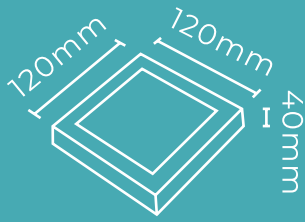

PL121206-30 BT
 PL121206-30 NM
 PL121206-40 BT
 PL121206-40 NT
 PL121206-65 BT
 PL121206-65 NM



DRIVER DE REPUESTO DISPONIBLE

Plafón LED

Cuadrado 6W

Art.: PL121206



LED 6W, 220V, 50Hz, IP20



Blanco texturado, Negro texturado, Niquel mate



3000K, 4000K, 6500K



280LM



Chapa de acero



Clase II

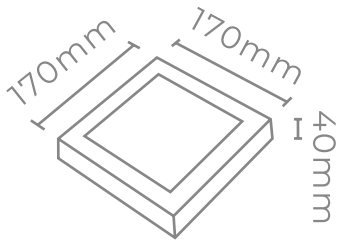

PL1717212-30 BT
 PL1717212-30 NM
 PL1717212-40 BT
 PL1717212-40 NT
 PL1717212-65 BT
 PL1717212-65 NM



DRIVER DE REPUESTO DISPONIBLE

Plafón LED

Cuadrado 12W

Art.: PL1717212

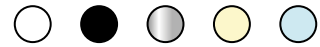

LED 12W, 220V, 50Hz, IP20



Blanco texturado, Negro texturado, Niquel mate



3000K, 4000K, 6500K



820LM



Chapa de acero



Clase II

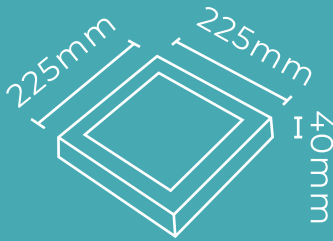

PL222218-30 BT
 PL222218-30 NM
 PL222218-30 NT
 PL222218-40 BT
 PL222218-40 NT
 PL222218-65 BT
 PL222218-65 NM
 PL222218-65 NT



DRIVER DE REPUESTO DISPONIBLE

Plafón LED

Cuadrado 18W

Art.: PL222218



LED 18W, 220V, 50Hz, IP20



Blanco texturado, Negro texturado, Niquel mate



3000K, 4000K, 6500K



1300LM



Chapa de acero



Clase II

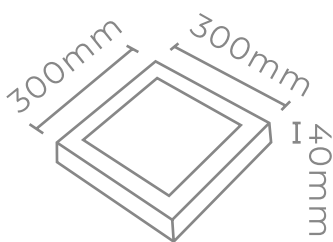

PL303028-30 BT
 PL303028-30 NM
 PL303028-30 NT
 PL303028-40 BT
 PL303028-40 NT
 PL303028-65 BT
 PL303028-65 NM
 PL303028-65 NT



DRIVER DE REPUESTO DISPONIBLE

Plafón LED

Cuadrado 28W

Art.: PL303028



LED 28W, 220V, 50Hz, IP20



Blanco texturado, Negro texturado, Niquel mate



3000K, 4000K, 6500K



1800LM



Chapa de acero



Clase II

PLAFÓN LED 36W



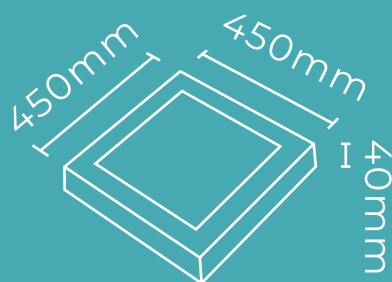
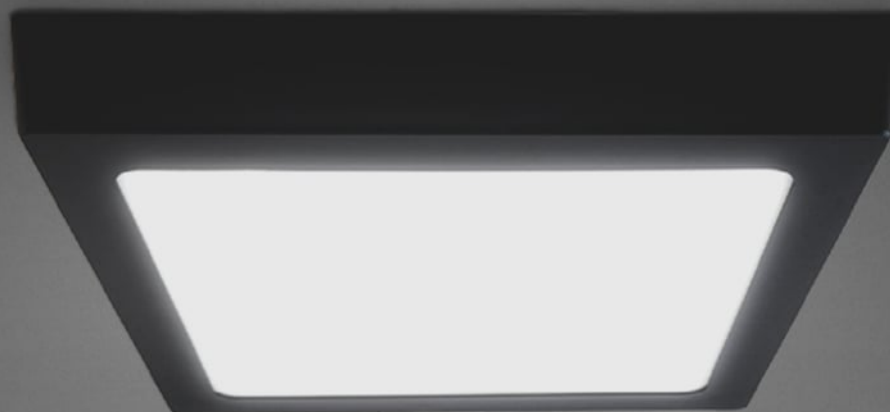



Plafón LED cuadrado 45x45cm, 36W, construido en chapa de acero.



PL454536-30 BT
PL454536-30 NT
PL454536-40 BT
PL454536-40 NT
PL454536-65 BT
PL454536-65 NT

Plafón LED
Cuadrado 36W
Art.: PL454536



-  LED 36W, 220V, 50Hz, IP20
-  Blanco texturado, Negro texturado
-  3000K, 4000K, 65000K
-  2500LM
-  Chapa de acero
-  Clase II



DRIVER DE REPUESTO
DISPONIBLE



PLAFÓN LED 24W





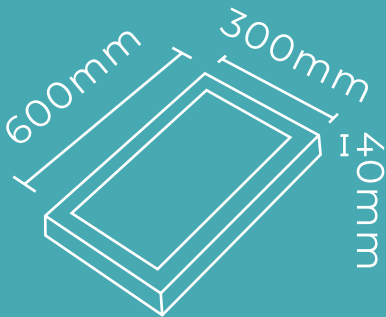



Plafón LED rectangular construido en chapa de acero.



PL603024-30 BT
PL603024-40 BT
PL603024-40 NT
PL603024-65 BT

Plafón LED
Rectangular 24W
Art.: PL603024



-  LED 24W, 220V, 50Hz, IP20
-  Blanco texturado, Negro texturado
-  3000K, 4000K, 6500K
-  1920LM
-  Chapa de acero
-  Clase II





LUMINARIAS DE EMBUTIR PARA INTERIOR

SELEC



Embutido
SELEC
Art.: EGU3715 BT



Embutido
SELEC
Art.: EGU3715 NT



- 1xGU10, Max 15W, 220V, 50Hz, IP20
- Negro texturado, Blanco texturado
- Aluminio
- Fijo
- Antideslumbrante
- Clase II



80mm

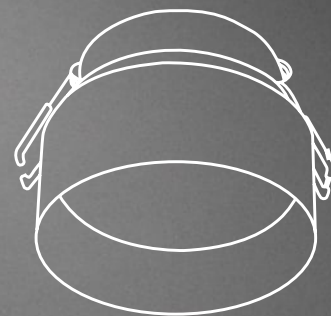

60mm

*Embutido circular fijo para
dicroica GU10 construido
íntegramente en fundición
de aluminio.*

TÉCNICO

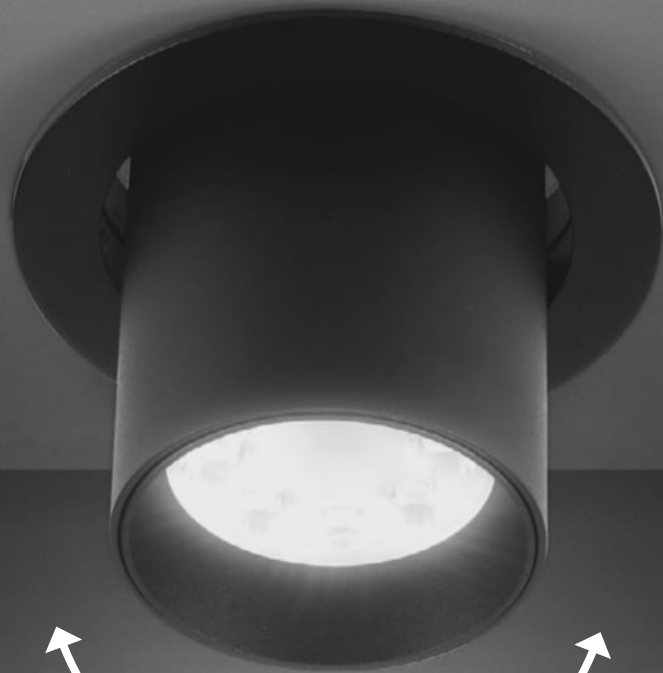

ORIENTABLE



Embutido circular orientable para dicroica GU10 construido íntegramente en fundición de aluminio.



Embutido
TÉCNICO
Art.: EGU3719 BT



Embutido
TÉCNICO
Art.: EGU3719 NT



- 1xGU10, Max 15W, 220V, 50Hz, IP20
- Negro texturado, Blanco texturado
- Aluminio
- Orientable
- Antideslumbrante
- Clase II

ORSON

REDONDO



Embutido
ORSON
Art.: EGU10022A BL

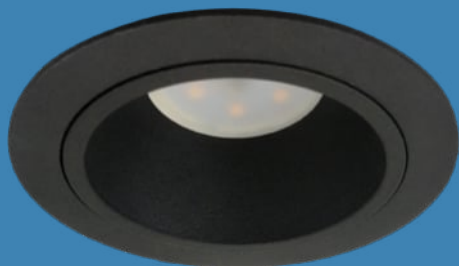

Embutido
ORSON
Art.: EGU10022 NG



- 1xGU10, Max 50W, 220V, 50Hz, IP20
- Blanco texturado, Negro texturado
- Aluminio
- Fijo
- Antideslumbrante
- Clase II

*Embutido circular fijo para
dicroica GU10 construido
íntegramente en fundición
de aluminio.*

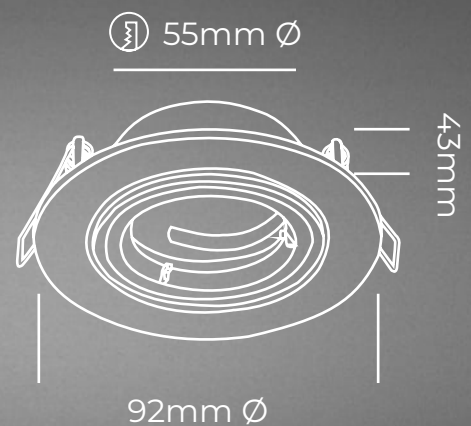

ORSON

CUADRADO

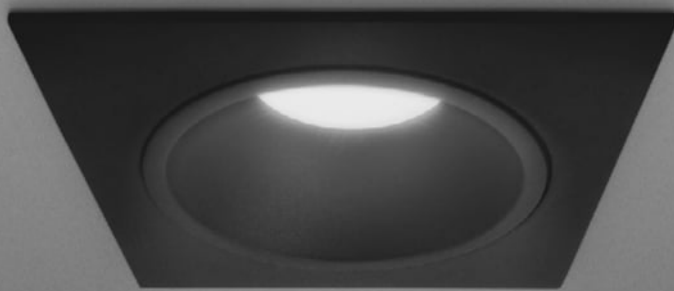





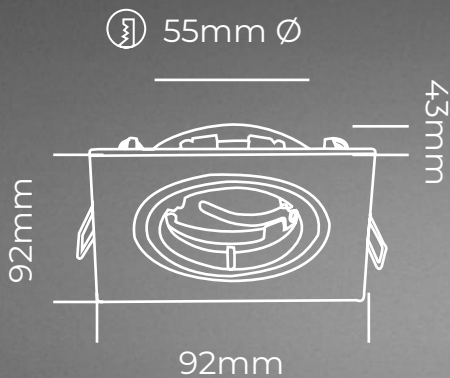

Embutido
ORSON
Art.: EGU10022B BL 



Embutido
ORSON
Art.: EGU10022B NG 



Embutido cuadrado fijo para dicroica GU10 construido íntegramente en fundición de aluminio.

-  1xGU10, Max 50W, 220V, 50Hz, IP20
-  Blanco texturado, Negro texturado
-  Aluminio
-  Fijo
-  Antideslumbrante
-  Clase II



COSME





AHORA EN COLOR NEGRO

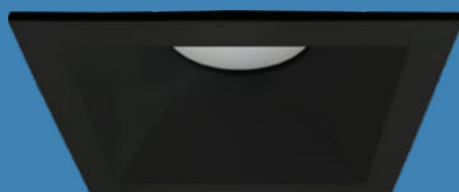

Embutido
COSME
Art.: EGU10051B



AHORA EN COLOR NEGRO

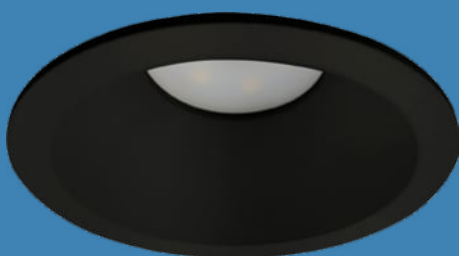





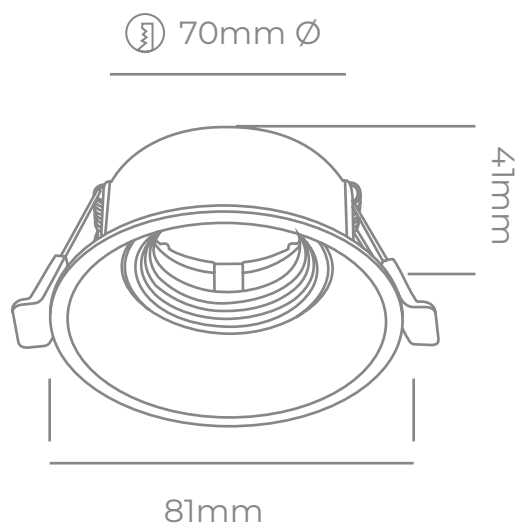
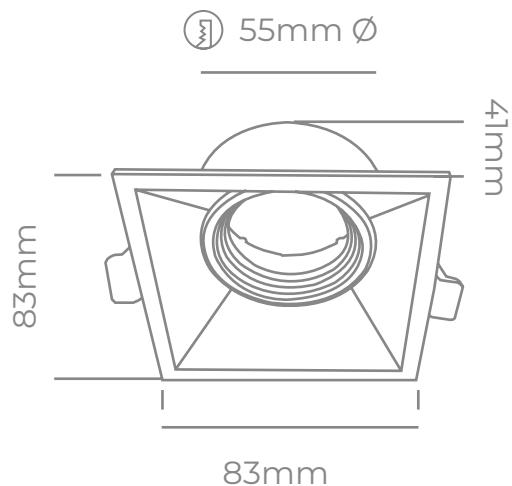

Embutido
COSME
Art.: EGU10051A



Embutido fijo para dicroica GU10,
construido íntegramente en fundición
de aluminio.



-  1xGU10, Max 50W, 220V, 50Hz, IP20
-  Blanco texturado, Negro Texturado
-  Aluminio
-  Fijo
-  Antideslumbrante
-  Clase II

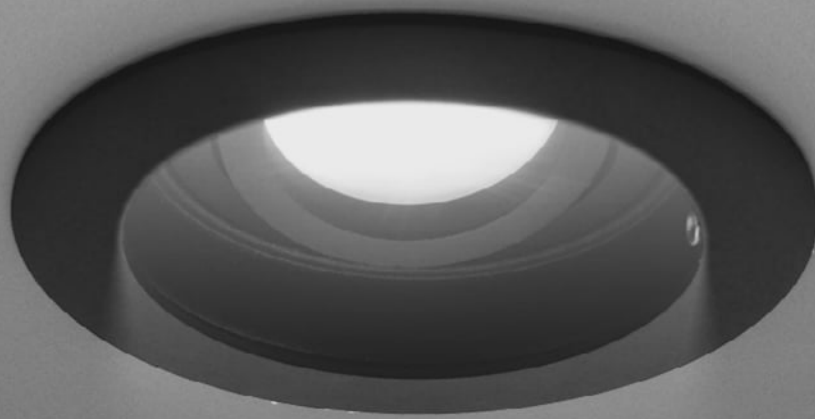

*Embutido redondo orientable
para dicroica GU10, construido
íntegramente en fundición de
aluminio. Antideslumbrante.*

WALID 





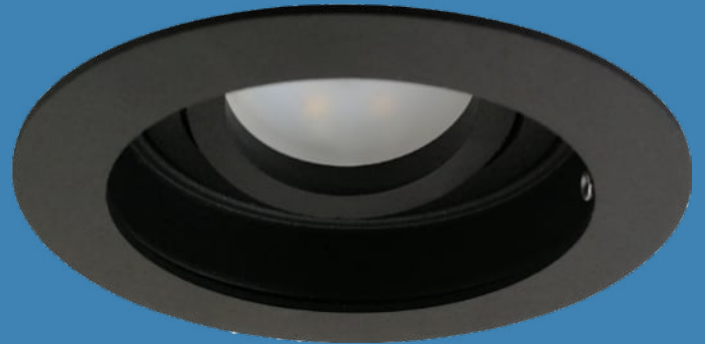

Embutido
WALID
Art.: EGU120015 BL

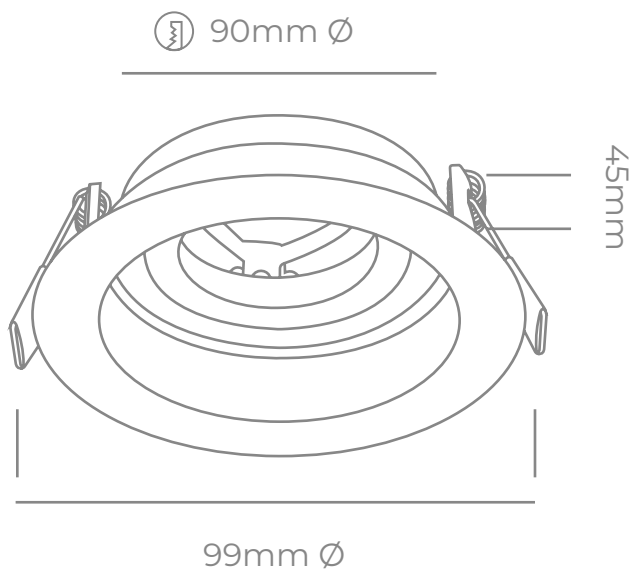

Embutido
WALID
Art.: EGU120015 NG



-  1xGU10, Max 50W, 220V, 50Hz, IP20
-  Blanco texturado, Negro texturado
-  Aluminio
-  Orientable
-  Clase II

BLAS

REDONDO

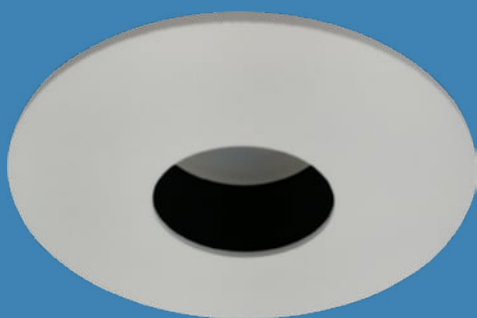

Embutido

BLAS

Art.: EGU10001A BL

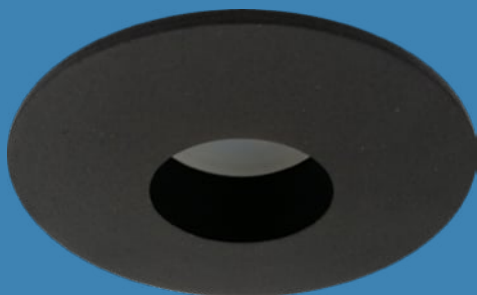

Embutido

BLAS

Art.: EGU10001A NG



- 1xGU10, Max 50W, 220V, 50Hz, IP20
- Blanco texturado, Negro texturado
- Aluminio
- Orientable
- Antideslumbrante
- Clase II



*Embutido circular
Orientable para dicroica
GU10 construido
Íntegramente en fundición
de aluminio.*

70mm Ø

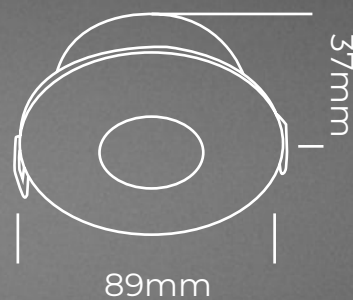

BLAS

CUADRADO

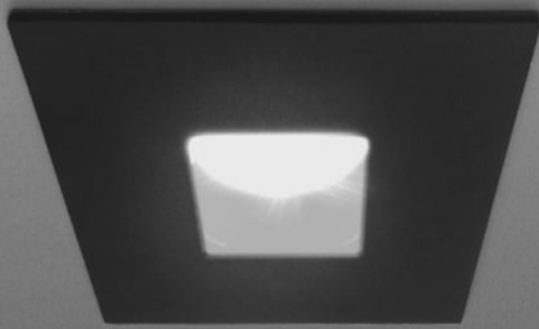





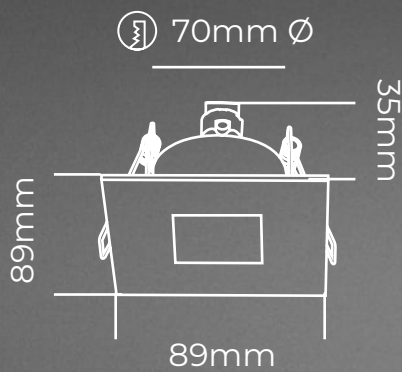

Embutido
BLAS
Art.: EGU10001B BL 



Embutido
BLAS
Art.: EGU10001B NG 



Embutido cuadrado orientable para dicroica GU10 construido íntegramente en fundición de aluminio.

-  1xGU10, Max 50W, 220V, 50Hz, IP20
-  Blanco texturado, Negro texturado
-  Aluminio
-  Orientable
-  Antideslumbrante
-  Clase II



*Embutido orientable para
dicroica GU10, construido
íntegramente en fundición de
aluminio.*

FIDEL 



Embutido
FIDEL
Art.: EGU10020A BL



Embutido
FIDEL
Art.: EGU10020A NG



Embutido
FIDEL
Art.: EGU10020A NM



Embutido
FIDEL
Art.: EGU10020B BL





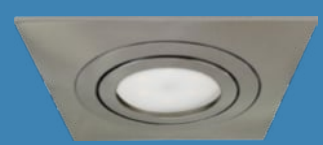

Embutido
FIDEL
Art.: EGU10020B NG

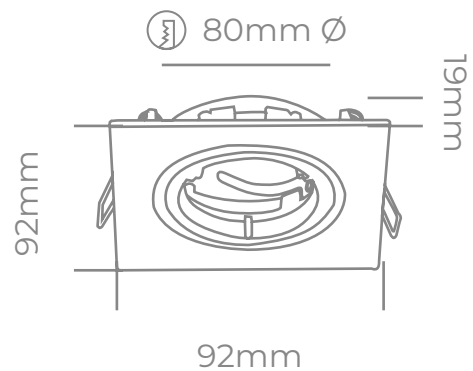
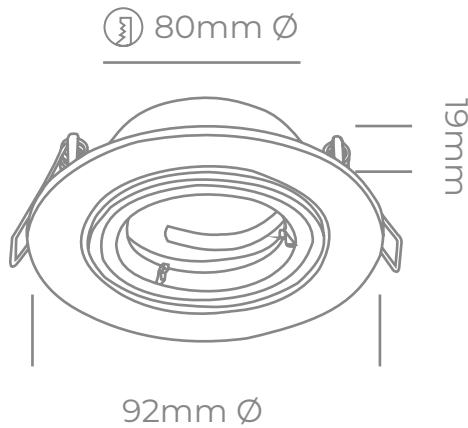

Embutido
FIDEL
Art.: EGU10020B NM



-  1xGU10, Max 50W, 220V, 50Hz, IP20
-  Blanco texturado, Negro texturado, Niquel mate
-  Aluminio
-  Orientable
-  Clase II



*Embutido cuadrado
orientable para dicroica GU10,
construido íntegramente en
chapa.*

WILBUR





Embutido
WILBUR
Art.: EGU120245 BT



Embutido
WILBUR
Art.: EGU120245 NT







Embutido
WILBUR
Art.: EGU120245 OA

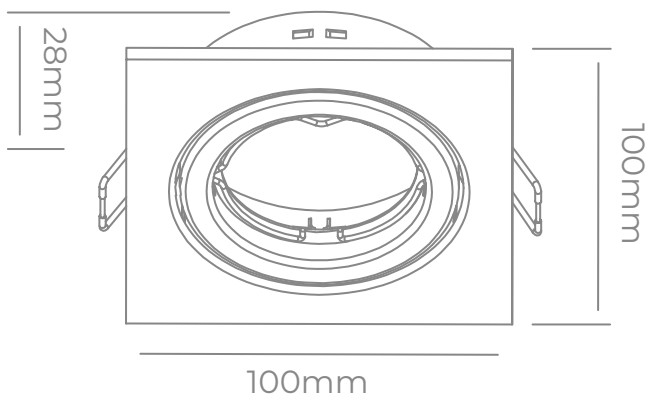

80mm Ø



-  1xGU10, Max 15W, 220V, 50Hz, IP20
-  Blanco texturado, Negro texturado, Oro Antiguo
-  Chapa
-  Orientable
-  Clase II



Embutido
WERNER
Art.: EGU120240 NG



Embutido
WERNER
Art.: EGU120240 BL



Embutido
WERNER
Art.: EGU120240 NM



WERNER



*Embutido circular
orientable para dicroica
GU10 construido en chapa.*





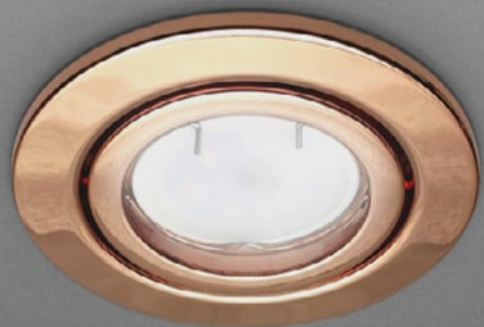

Embutido
WERNER
Art.: EGU120240 OA

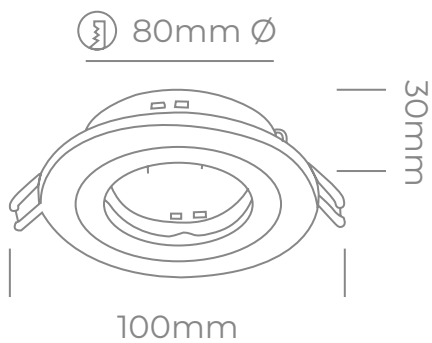

Embutido
WERNER
Art.: EGU120240 CO



-  1xGU10, Max 50W, 220V, 50Hz, IP20
-  Blanco, Negro texturado, Niquel mate, Cobre, Oro Antiguo
-  Chapa
-  Orientable
-  Clase II

AFRO



*Embutido orientable para
dicroica GU10 construido en
chapa. Antideslumbrante.*



Embutido

AFRO 1

Art.: EGU30101 BT



Embutido

AFRO 1

Art.: EGU30101 NT



90mm Ø

38mm

100mm

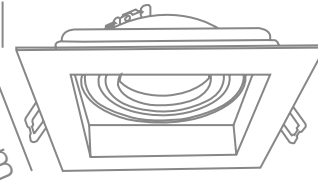

100mm

- 1xGU10, Max 15W, 220V, 50Hz, IP20
- Blanco texturado, Negro Texturado
- Chapa
- Orientable
- Clase II



Embutido
AFRO 1
Art.: EGU30102 BT



Embutido
AFRO 1
Art.: EGU30103 BT



Embutido
AFRO 1
Art.: EGU30102 NT



Embutido
AFRO 1
Art.: EGU30103 NT

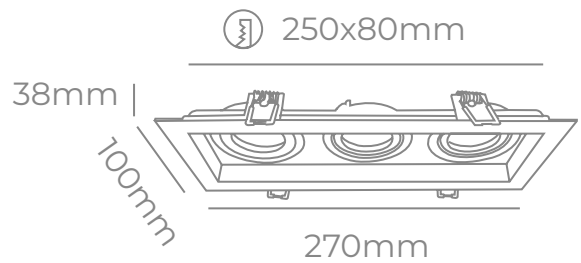
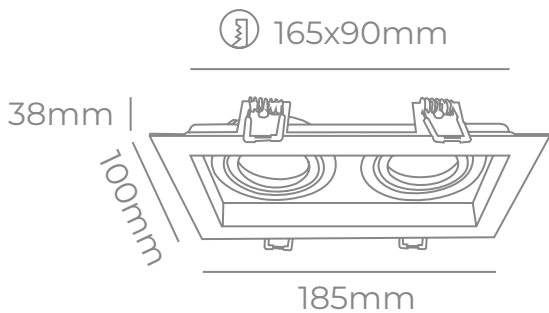

- 2xGU10, Max 15W, 220V, 50Hz, IP20
- Blanco texturado, Negro texturado
- Chapa
- Orientable
- Clase II

- 3xGU10, Max 15W, 220V, 50Hz, IP20
- Blanco texturado, Negro texturado
- Chapa
- Orientable
- Clase II

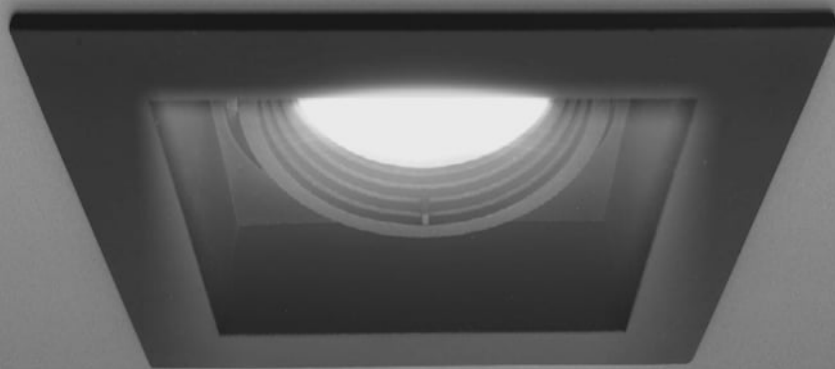

Embutido de 1,2 y 3 luces,
para dicroica GU10,
construido en fundición de
aluminio. Antideslumbrante.

TRUMAN

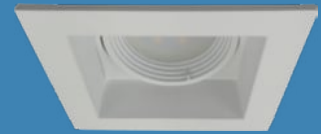





Embutido
TRUMAN 1
Art.: EGU170301 BL

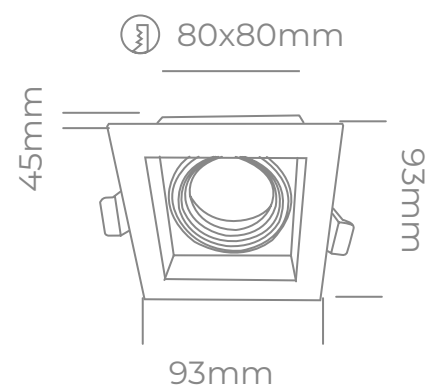

Embutido
TRUMAN 1
Art.: EGU170301 NG



-  1xGU10, Max 50W, 220V, 50Hz, IP20
-  Blanco texturado, Negro texturado
-  Aluminio
-  Orientable
-  Clase II



Embutido
TRUMAN 2
Art.: EGU170302 BL



Embutido
TRUMAN 3
Art.: EGU170303 BL



Embutido
TRUMAN 2
Art.: EGU170302 NG



Embutido
TRUMAN 3
Art.: EGU170303 NG

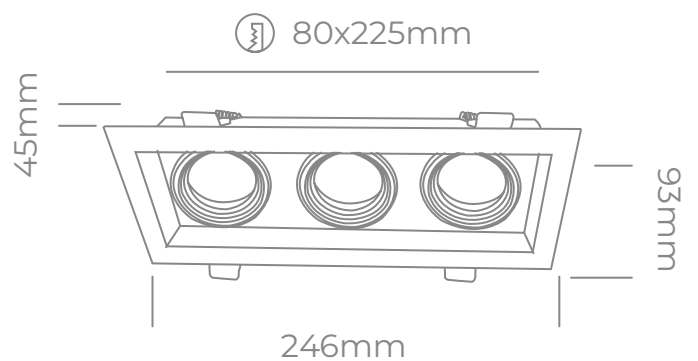
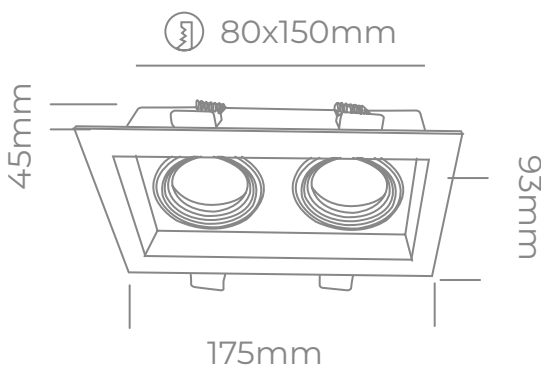

- 2xGU10, Max 50W, 220V, 50Hz, IP20
- Blanco texturado, Negro texturado
- Aluminio
- Orientable
- Clase II

- 3xGU10, Max 50W, 220V, 50Hz, IP20
- Blanco texturado, Negro texturado
- Aluminio
- Orientable
- Clase II

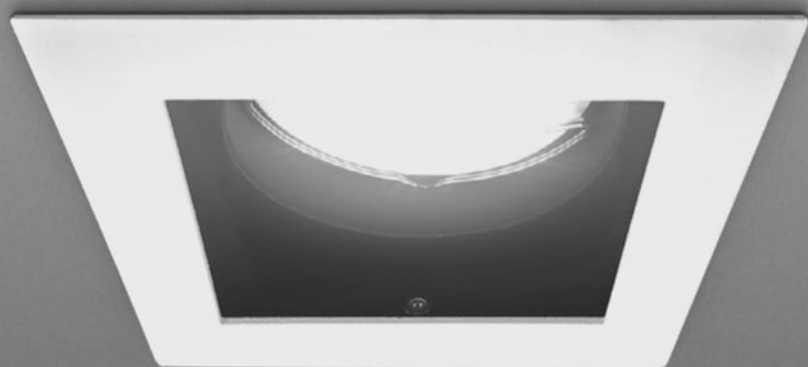

Embutido cuadrado antideslumbrante orientable para dicroica GU10, construido en chapa.

ROQUE



Embutido
ROQUE 1
Art.: EGU150401 BL



Embutido
ROQUE 1
Art.: EGU150401 NG

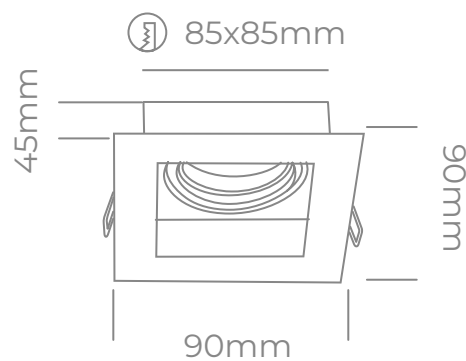

- 1xGU10, Max 50W, 220V, 50Hz, IP20
- Blanco texturado, Negro texturado
- Chapa
- Orientable
- Clase II



Embutido
ROQUE 2
Art.: EGU150402 BL



Embutido
ROQUE 3
Art.: EGU150403 BL



Embutido
ROQUE 2
Art.: EGU150402 NG



Embutido
ROQUE 3
Art.: EGU150403 NG

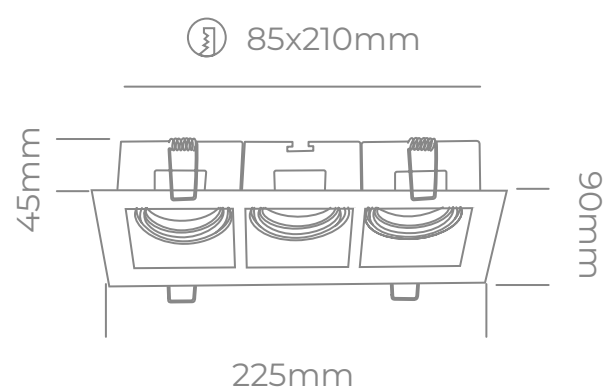
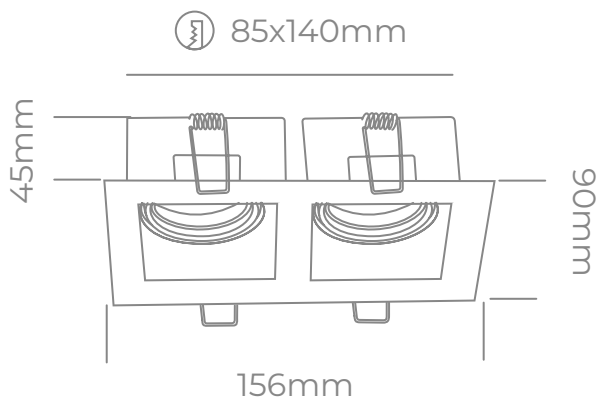

- 2xGU10, Max 50W, 220V, 50Hz, IP20
- Blanco texturado, Negro texturado
- Chapa
- Orientable
- Clase II

- 3xGU10, Max 50W, 220V, 50Hz, IP20
- Blanco texturado, Negro texturado
- Chapa
- Orientable
- Clase II



ROQUE



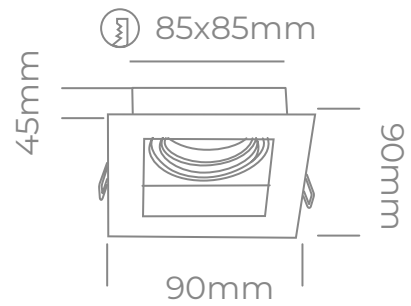
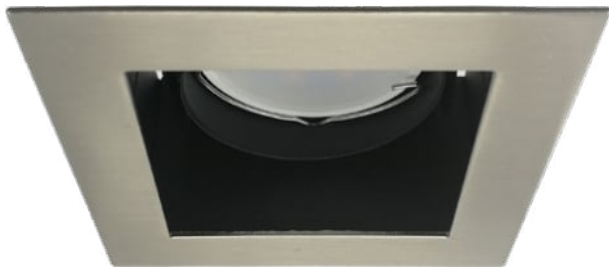

Embutido

ROQUE 1

Art.: EGU150401 NM



- 1xGU10, Max 50W, 220V, 50Hz, IP20
- Niquel mate
- Chapa
- Orientable
- Clase II

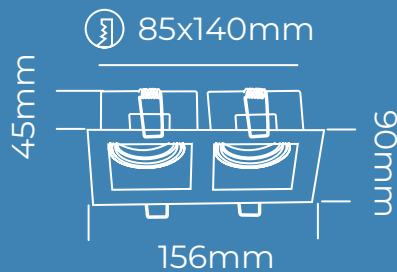

Aplique

ROQUE 2

Art.: EGU150402 NM



- 2xGU10, Max 50W, 220V, 50Hz, IP20
- Niquel mate
- Chapa
- Orientable
- Clase II

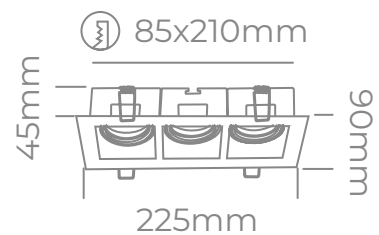

Aplique

ROQUE 3

Art.: EGU150403 NM



- 3xGU10, Max 50W, 220V, 50Hz, IP20
- Niquel mate
- Chapa
- Orientable
- Clase II





Embutido cardánico para
dicroica GU10, construido en
chapa.

ECUA PARA DICRO

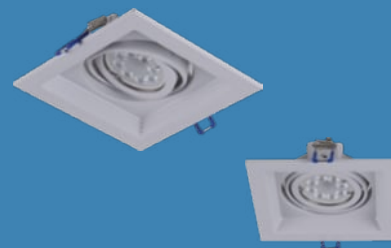

Embutido
ECUA DICRO | 1
Art.: EGU30201 BT



Embutido
ECUA DICRO | 1
Art.: EGU30201 NT



105x105mm

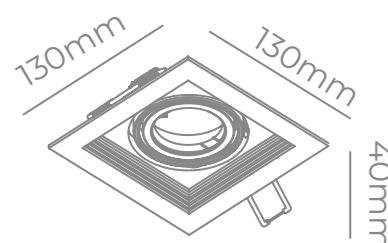

- 1xGU10, Max 15W, 220V, 50Hz, IP20
- Blanco texturado, Negro texturado
- Chapa
- Cardánico
- Clase II



Embutido
ECUA DICRO | 2
Art.: EGU30202 BT

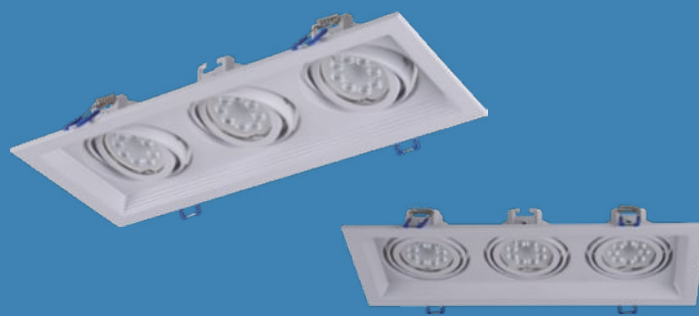

Embutido
ECUA DICRO | 3
Art.: EGU30203 BT



Embutido
ECUA DICRO | 2
Art.: EGU30202 NT



195x105mm

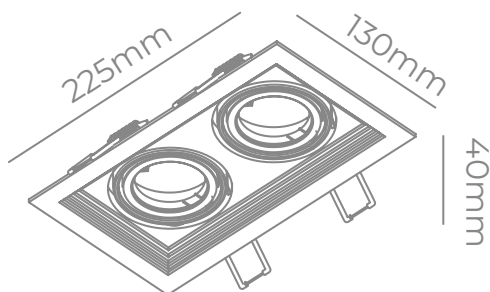







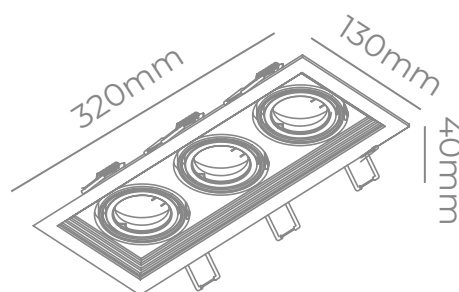



Embutido
ECUA DICRO | 3
Art.: EGU30203 NT



200x105mm



-  2xGU10, Max 15W, 220V, 50Hz, IP20
-  Blanco texturado, Negro texturado
-  Chapa
-  Cardánico
-  Clase II

-  3xGU10, Max 15W, 220V, 50Hz, IP20
-  Blanco texturado, Negro texturado
-  Chapa
-  Cardánico
-  Clase II



*Embutido cardánico
para lámpara tipo AR111,
construido en chapa.*

ECUA PARA AR111



Embutido
ECUA AR111 | 1
Art.: EGU40101 BT







Embutido
ECUA AR111 | 1
Art.: EGU40101 NT

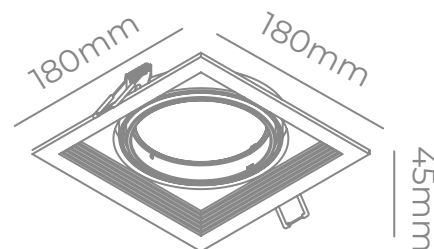

⌀ 160x160mm



-  1xAR111, Max 15W, 220V, 50Hz, IP20
-  Blanco texturado, Negro texturado
-  Chapa
-  Cardánico
-  Clase II



Embutido
ECUA AR111 | 2
Art.: EGU40102 BT



Embutido
ECUA AR111 | 3
Art.: EGU40103 BT



Embutido
ECUA AR111 | 2
Art.: EGU40102 NT



Embutido
ECUA AR111 | 3
Art.: EGU40103 NT





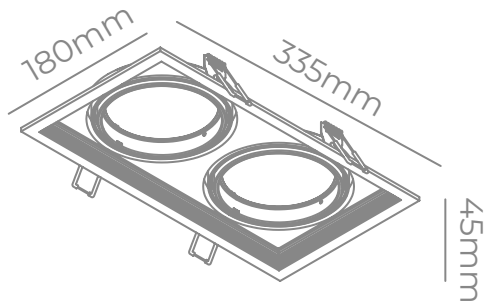



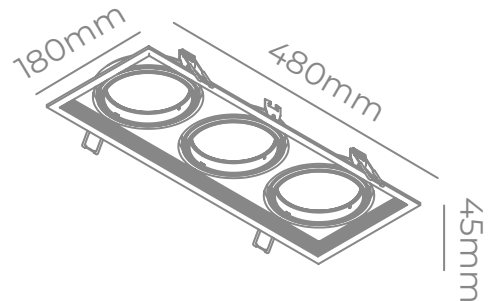



⊗ 305x160mm



⊗ 460x160mm



-  2xAR111, Max 15W, 220V, 50Hz, IP20
-  Blanco texturado, Negro texturado
-  Chapa
-  Cardánico
-  Clase II

-  3xAR111, Max 15W, 220V, 50Hz, IP20
-  Blanco texturado, Negro texturado
-  Chapa
-  Cardánico
-  Clase II



*Embutido cardánico
para lámpara tipo AR11,
construido en chapa.*

ZAFIR



AHORA EN COLOR NEGRO

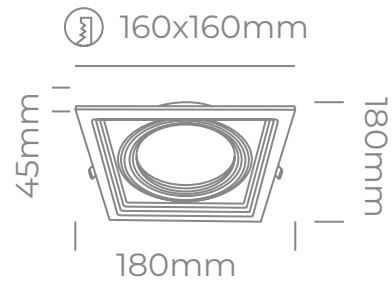





Aplique

ZAFIR 1

Art.: EGU110401



-  1xAR111, Max 50W, 220V, 50Hz, IP20
-  Blanco texturado, Negro Texturado
-  Chapa
-  Cardánico
-  Clase II

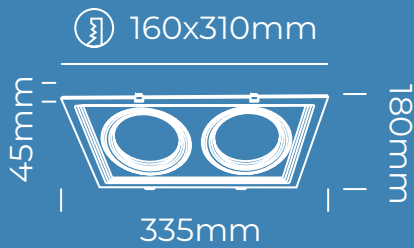





Aplique

ZAFIR 2

Art.: EGU110402



-  2xAR111, Max 50W, 220V, 50Hz, IP20
-  Blanco texturado
-  Chapa
-  Cardánico
-  Clase II

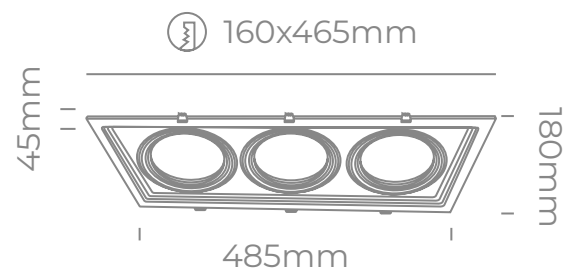





Aplique

ZAFIR 3

Art.: EGU110401



-  3xAR111, Max 50W, 220V, 50Hz, IP20
-  Blanco texturado
-  Chapa
-  Cardánico
-  Clase II





Embutido cuadrado orientable para AR111, construido íntegramente en Chapa.

ZAC 







Embutido
ZAC
Art.: EGU120340 BL

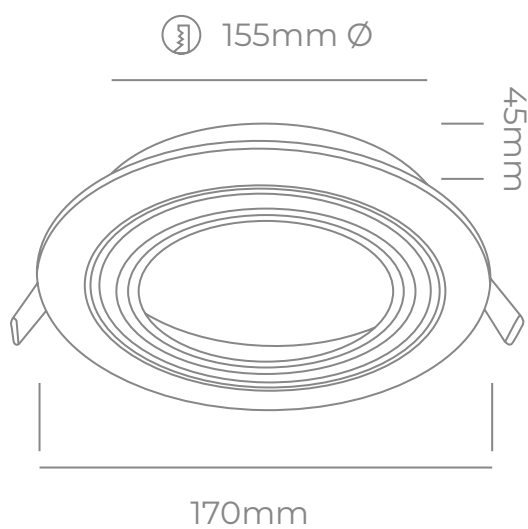

Embutido
ZAC
Art.: EGU120340 NG



-  1xAR111, Max 50W, 220V, 50Hz, IP20
-  Blanco texturado, Negro texturado
-  Chapa
-  Cardánico
-  Clase II





LUMINARIAS DE APLICAR PARA INTERIOR







Luminaria Semi Embutida
BALCONY I
Art.: AGU85001A BT



Luminaria Semi Embutida
BALCONY I
Art.: AGU85001A NT



-  1xGU10, Max 7W, 220V, 50Hz, IP20
-  Blanco texturado, Negro texturado
-  Chapa
-  Orientable
-  Clase I

BALCONY I



Luminaria semi embutida circular orientable para dicroica GU10, construida íntegramente en chapa de acero. Para aplicar sobre caja octogonal chica.

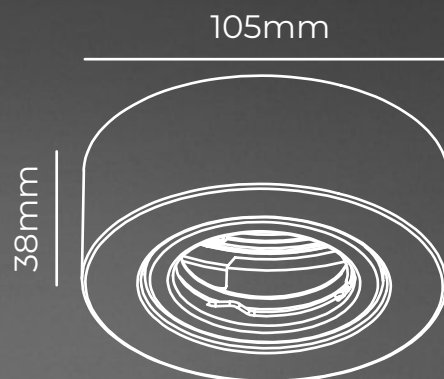

BALCONY II

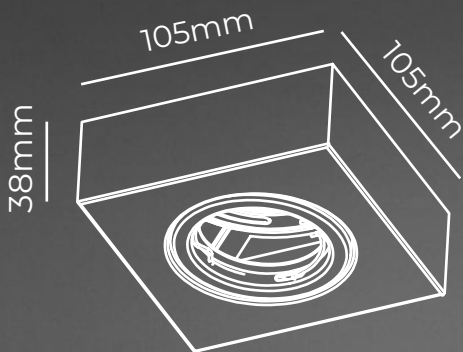





Luminaria semi embutida cuadrada orientable para dicroica GU10, construida íntegramente en chapa de acero. Para aplicar sobre caja octogonal chica.



Luminaria Semi Embutida
BALCONY II
Art.: AGU87001A BT 



Luminaria Semi Embutida
BALCONY II
Art.: AGU87001A NT 

-  1xGU10, Max 7W, 220V, 50Hz, IP20
-  Blanco texturado, Negro texturado
-  Chapa
-  Orientable
-  Clase I



Luminaria Semi Embutida

GALLERY I

Art.: AGU85001B BT

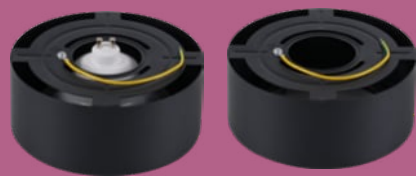

Luminaria Semi Embutida

GALLERY I

Art.: AGU85001B NT



GALLERY I



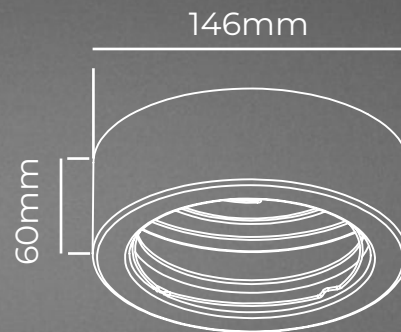

Luminaria semi embutida circular fija para AR111, construida íntegramente en chapa de acero. Para aplicar sobre caja octogonal chica.

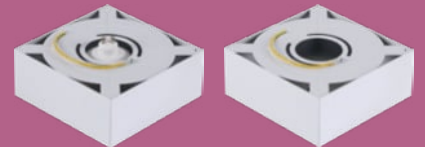

- 1xAR111, Max 7W, 220V, 50Hz, IP20
- Blanco texturado, Negro texturado
- Chapa
- Fijo
- Clase I

GALLERY II





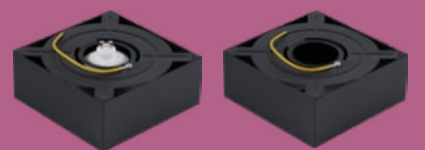

Luminaria Semi Embutida
GALLERY II
Art.: AGU87001B BT 

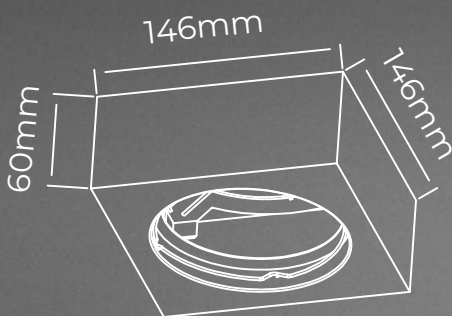

Luminaria Semi Embutida
GALLERY II
Art.: AGU87001B NT 



Luminaria semi embutida cuadrada fija para AR111 construida íntegramente en chapa de acero. Para aplicar sobre caja octogonal chica.

-  1xAR111, Max 7W, 220V, 50Hz, IP20
-  Blanco texturado, Negro texturado
-  Chapa
-  Fijo
-  Clase I

Plafón cardánico para dicroica GU10 construido en chapa.



PLAFÓN ECUA PARA DICRO



Plafón
ECUA DICRO 1
Art.: AGU80001 BT



Plafón
ECUA DICRO 1
Art.: AGU80001 NT

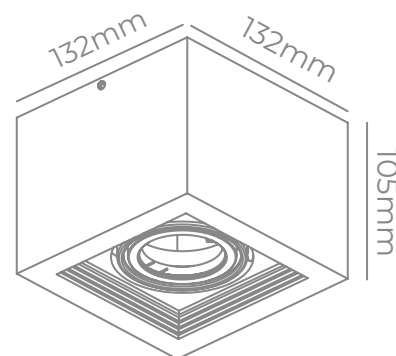

- 1xGU10, Max 7W, 220V, 50Hz, IP20
- Blanco texturado, Negro texturado
- Chapa
- Cardánico
- Clase I



Plafón
ECUA DICRO 2
Art.: AGU80002 BT



Plafón
ECUA DICRO 3
Art.: AGU80003 BT









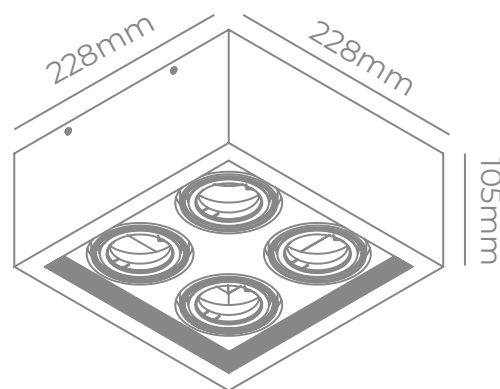
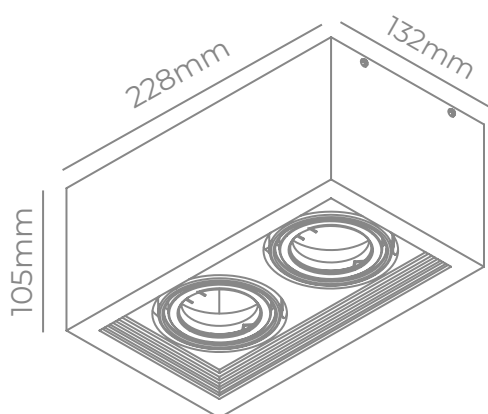



Plafón
ECUA DICRO 2
Art.: AGU80002 NT



Plafón
ECUA DICRO 3
Art.: AGU80003 NT



-  2xGU10, Max 7W, 220V, 50Hz, IP20
-  Blanco texturado, Negro texturado
-  Chapa
-  Cardánico
-  Clase I

-  3xGU10, Max 7W, 220V, 50Hz, IP20
-  Blanco texturado, Negro texturado
-  Chapa
-  Cardánico
-  Clase I

Plafón cardánico para lámpara tipo AR111 construido en chapa.



PLAFÓN ECUA PARA AR111



Plafón
ECUA AR111 | 1
Art.: AGU90001A BT



Plafón
ECUA AR111 | 1
Art.: AGU90001A NT

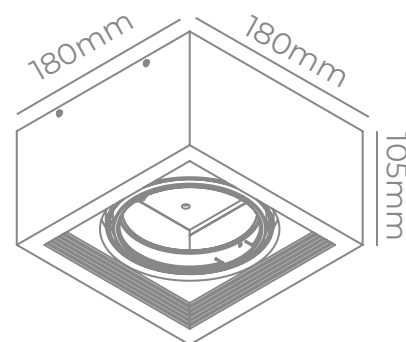

- 1xAR111, 220V, 50Hz, IP20
- Blanco texturado, Negro texturado
- Chapa
- Cardánico
- Clase I



Plafón
ECUA AR111 | 2
Art.: AGU90002A BT



Plafón
ECUA AR111 | 3
Art.: AGU90003A BT









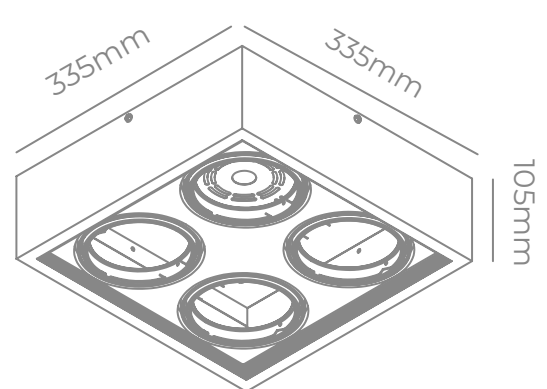
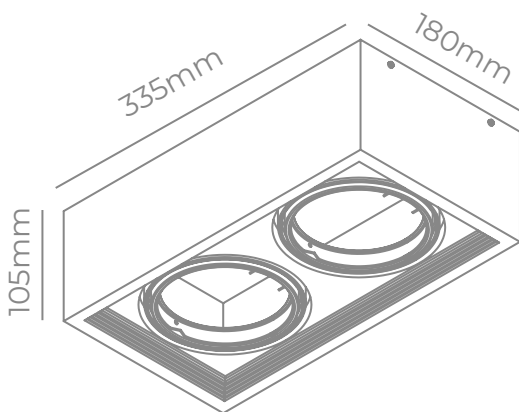



Plafón
ECUA AR111 | 2
Art.: AGU90002A NT



Plafón
ECUA AR111 | 3
Art.: AGU90003A NT



-  2xAR111, 220V, 50Hz, IP20
-  Blanco texturado, Negro texturado
-  Chapa
-  Cardánico
-  Clase I

-  4xAR111, 220V, 50Hz, IP20
-  Blanco texturado, Negro texturado
-  Chapa
-  Cardánico
-  Clase I

ASIN



Plafón
ASIN
Art.: AGU93005 BT



Plafón
ASIN
Art.: AGU93005 NT



- 1xAR111, 220V, 50Hz, IP20
- Blanco texturado, Negro texturado
- Aluminio
- Fijo
- Clase I

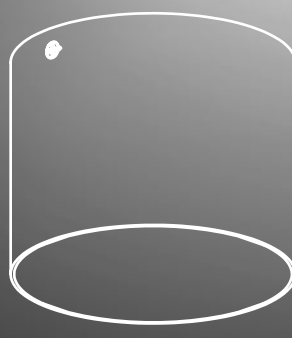

95mm

120mm

Plafón monovolumen
cilíndrico fijo para lámpara
tipo AR111 construido
íntegramente en fundición
de aluminio.

SENKU

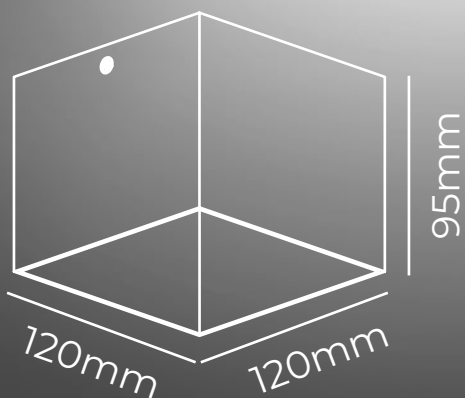

Plafón monovolumen cúbico fijo para lámpara tipo AR111 construido íntegramente en fundición de aluminio.







Plafón
SENKU
Art.: AGU93010 BT



Plafón
SENKU
Art.: AGU93010 NT



-  1xAR111, 220V, 50Hz, IP20
-  Blanco texturado, Negro texturado
-  Aluminio
-  Fijo
-  Clase I

TONA



*Plafón cilíndrico orientable
para lámpara tipo AR111
construido íntegramente en
fundición de aluminio.*





Plafón
TONA
Art.: AGU93015 BT



135mm

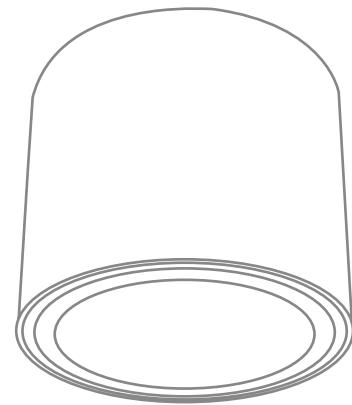





105mm



Plafón
TONA
Art.: AGU93015 NT



-  1xAR111, 220V, 50Hz, IP20
-  Blanco texturado, Negro texturado
-  Aluminio
-  Orientable
-  Clase I

Ω OMEGA



Cabezal
OMEGA
Art.: CGU9001 BT



Cabezal
OMEGA
Art.: CGU9001 NT



- 1xGU10, Max 7W, 220V, 50Hz, IP20
- Blanco texturado, Negro texturado
- Aluminio
- Orientable
- Clase I



Cabezal orientable para lámpara GU10, construido en fundición de aluminio.

BOMBER



Cabezal orientable para lámpara GU10, construido en fundición de aluminio.







Cabezal BOMBER
Art.: CGU9002 BT



Cabezal BOMBER
Art.: CGU9002 NT



-  1xGU10, Max 7W, 220V, 50Hz, IP20
-  Blanco texturado, Negro texturado
-  Aluminio
-  Orientable
-  Clase I

●●●●● CALA







Cabezal
CALA
Art.: CGU6820 BT



Cabezal
CALA
Art.: CGU6820 NT



-  1xGU10, Max 15W, 220V, 50Hz, IP20
-  Blanco texturado, Negro texturado
-  Aluminio
-  Orientable
-  Clase I

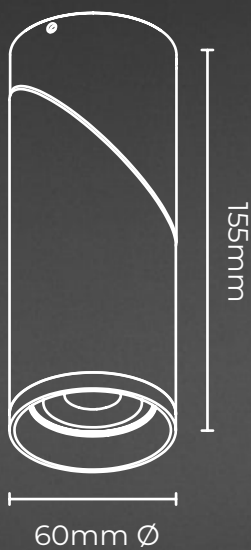

Cabezal orientable para lámpara GU10, construido en fundición de aluminio.

RUNA



120mm

70mm Ø

Cabezal orientable para lámpara GU10, construido en fundición de aluminio.







Cabezal
RUNA
Art.: CGU6715 BT



Cabezal
RUNA
Art.: CGU6715 NT



-  1xGU10, Max 15W, 220V, 50Hz, IP20
-  Blanco texturado, Negro texturado
-  Aluminio
-  Orientable
-  Clase I

 **LALO**







Cabezal
LALO
Art.: CGU6720 BT



Cabezal
LALO
Art.: CGU6720 NT



-  1xGU10, Max 15W, 220V, 50Hz, IP20
-  Negro texturado
-  Aluminio
-  Orientable
-  Clase I

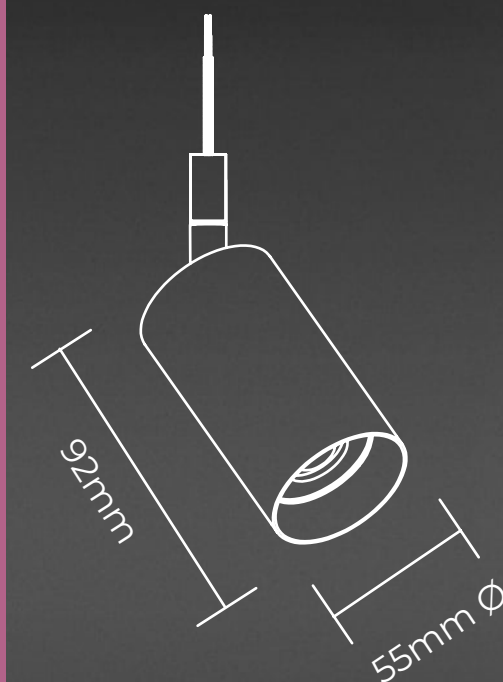

Cabezal orientable para lámpara GU10 construido en fundición de aluminio.

FORK



Cabezal
FORK
Art.: CGU6900 BT



Cabezal
FORK
Art.: CGU6900 NT



Cabezal orientable para lámpara GU10 construido en fundición de aluminio.

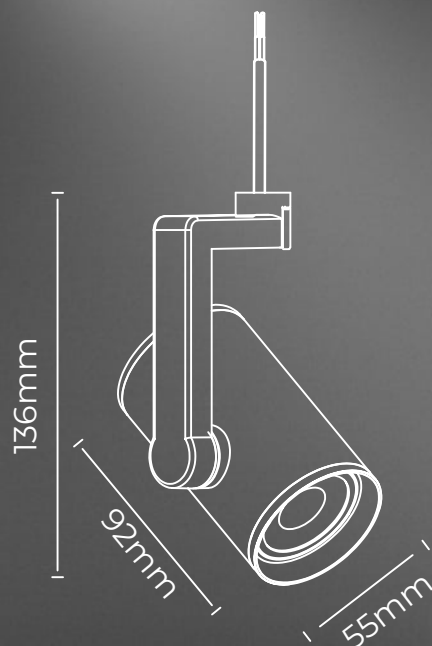

- 1xGU10, Max 15W, 220V, 50Hz, IP20
- Blanco texturado, Negro Texturado
- Aluminio
- Orientable
- Clase I

WEBB



*Cabezal orientable para
lámpara GU10 construido
íntegramente en aluminio.*







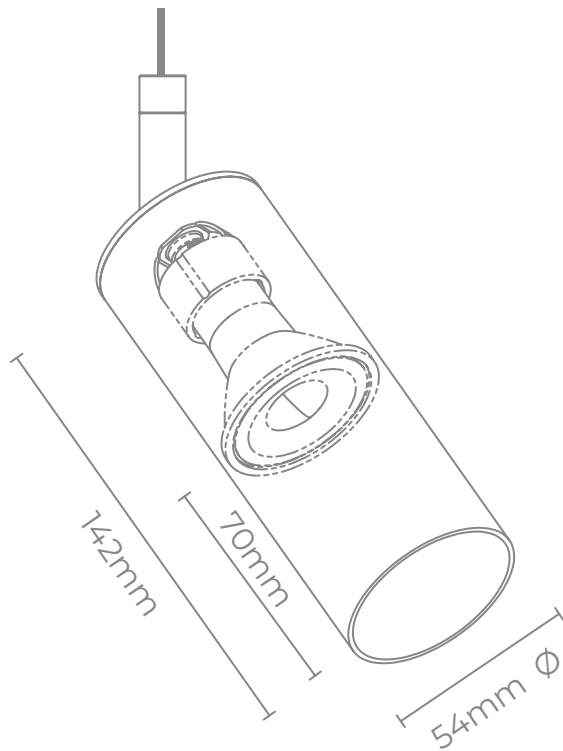

Cabezal
WEBB
Art.: CGU6950 BT



Cabezal
WEBB
Art.: CGU6950 NT



-  1xGU10, Max 15W, 220V, 50Hz, IP20
-  Blanco texturado, Negro Texturado
-  Aluminio
-  Orientable
-  Antideslumbrante
-  Clase I

LUPE



Cabezal
LUPE
Art.: CGU8000 BT



Cabezal
LUPE
Art.: CGU8000 NT



- 1xAR111, Max 15W, 220V, 50Hz, IP20
- Negro texturado
- Aluminio
- Orientable
- Clase I

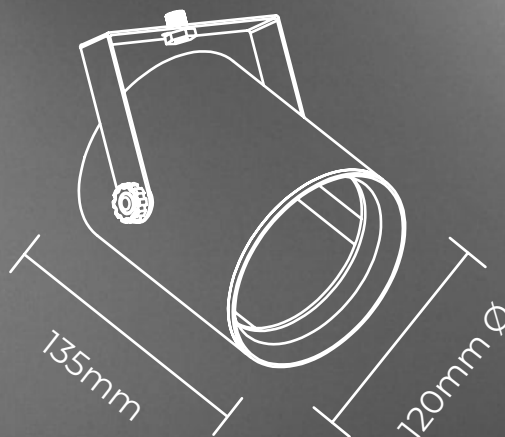

Cabezal orientable para lámpara AR111 construido en fundición de aluminio.

CINEMA

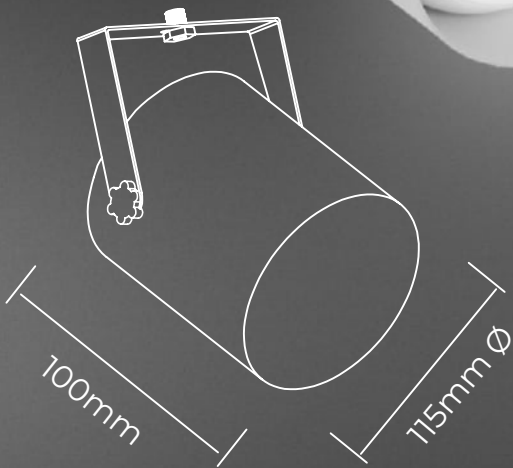

Cabezal orientable para lámpara AR111 construido en chapa de acero.







Cabezal
CINEMA
Art.: CGU8050 BT



Cabezal
CINEMA
Art.: CGU8050 NT



-  1xAR111, Max 15W, 220V, 50Hz, IP20
-  Blanco texturado, Negro texturado
-  Chapa
-  Orientable
-  Clase I

C700



Cabezal orientable para lámpara AR111 construido íntegramente en chapa de acero.



Cabezal
C700
Art.: C700/BT







Cabezal
C700
Art.: C700/NT

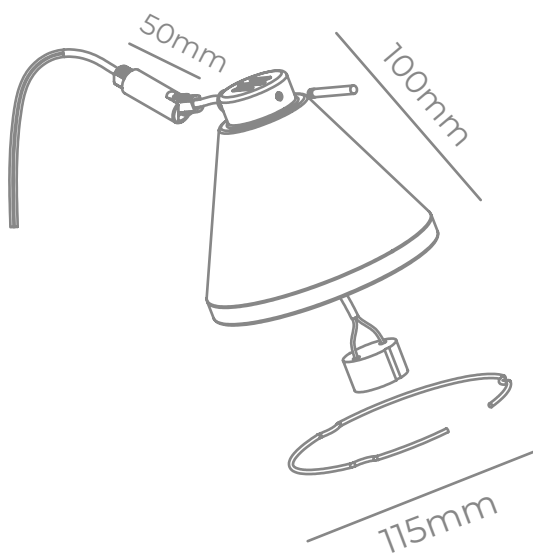

Cabezal
C700
Art.: C700/PL



-  1xAR111, Max 50W, 220V, 50Hz, IP20
-  Blanco texturado, Negro texturado, Platil
-  Chapa
-  Orientable
-  Clase I

TAPA090

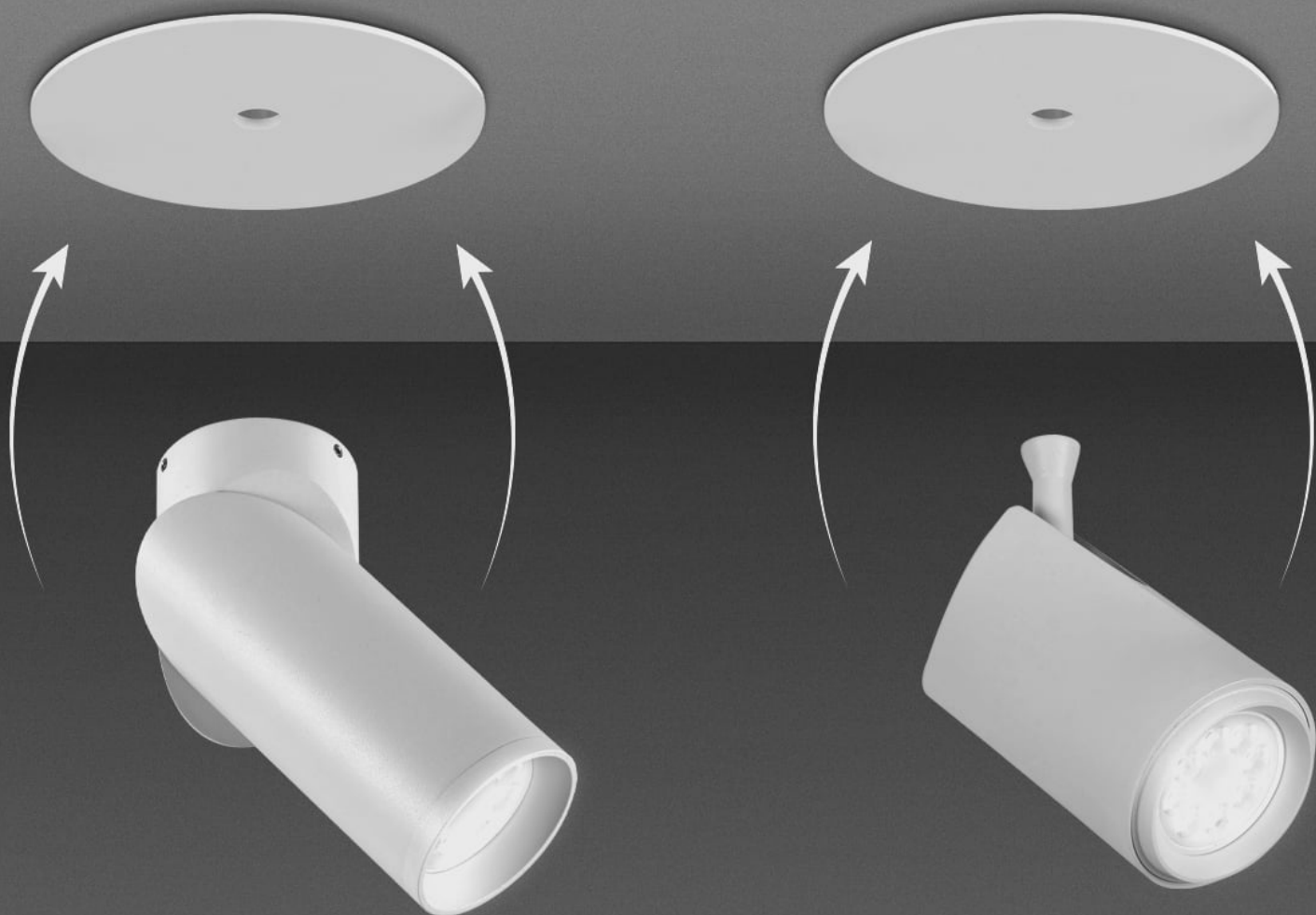

*Tapa ciega con resortes.
Ideal para ser utilizada con
cabezales.*





Tapa ciega
TAPA090
Art.: TAPA090 BT

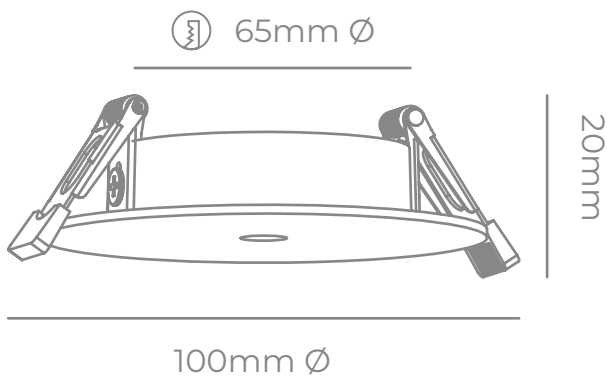

Tapa ciega
TAPA090
Art.: TAPA090 NT



-  Blanco texturado, Negro texturado
-  Chapa

BASES PARA CABEZALES

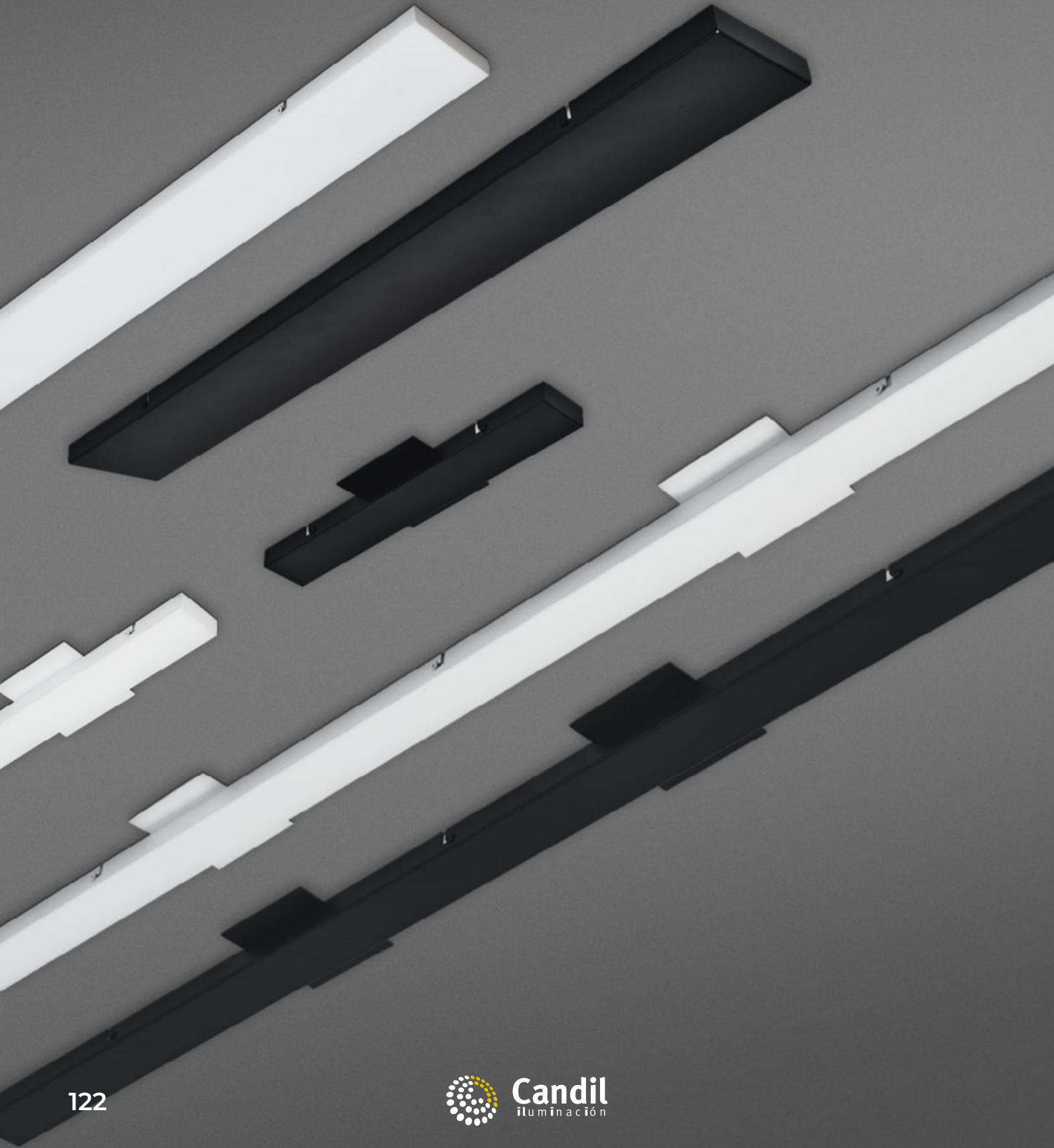

Bases para cabezales de diseño minimalista con acabado texturado en blanco o negro, ideales para configuraciones de iluminación personalizadas.

Cuentan con marcas láser y perforaciones de precisión que facilitan la inserción de los cabezales en la posición deseada.

El modelo Torito incorpora una caja posterior cuadrada para optimizar el montaje, mientras que **el modelo Pareto** destaca por su perfil delgado y discreto. Son una solución técnica robusta y estética, diseñada para adaptarse con versatilidad a cualquier proyecto de iluminación profesional.

TABLA DE MEDIDAS

ARTÍCULO	ANCHO	ALTO	PROFUNDIDAD	MEDIDA DE TAPA
TORITO 355	355mm	50mm	20mm	100x100mm
TORITO 580	580mm	50mm	20mm	100x100mm
TORITO 805	805mm	50mm	20mm	100x100mm
TORITO 1030	1030mm	50mm	20mm	100x100mm
TORITO 1255	1255mm	50mm	20mm	100x100mm
TORITO 1705	1705mm	50mm	20mm	100x100mm
TORITO L	50mm	20mm	90mm	-
REDONDA 100	100mm Ø	100mm Ø	20mm	-
PARETO 100	100mm	100mm	20mm	-
PARETO 355	355mm	100mm	20mm	-
PARETO 580	580mm	100mm	20mm	-
PARETO 805	805mm	100mm	20mm	-
PARETO 1030	1030mm	100mm	20mm	-
PARETO 1255	1255mm	100mm	20mm	-
PARETO 1705	1705mm	100mm	20mm	-

BASE TORITO



Bases para cabezales, construidas en chapa de acero.

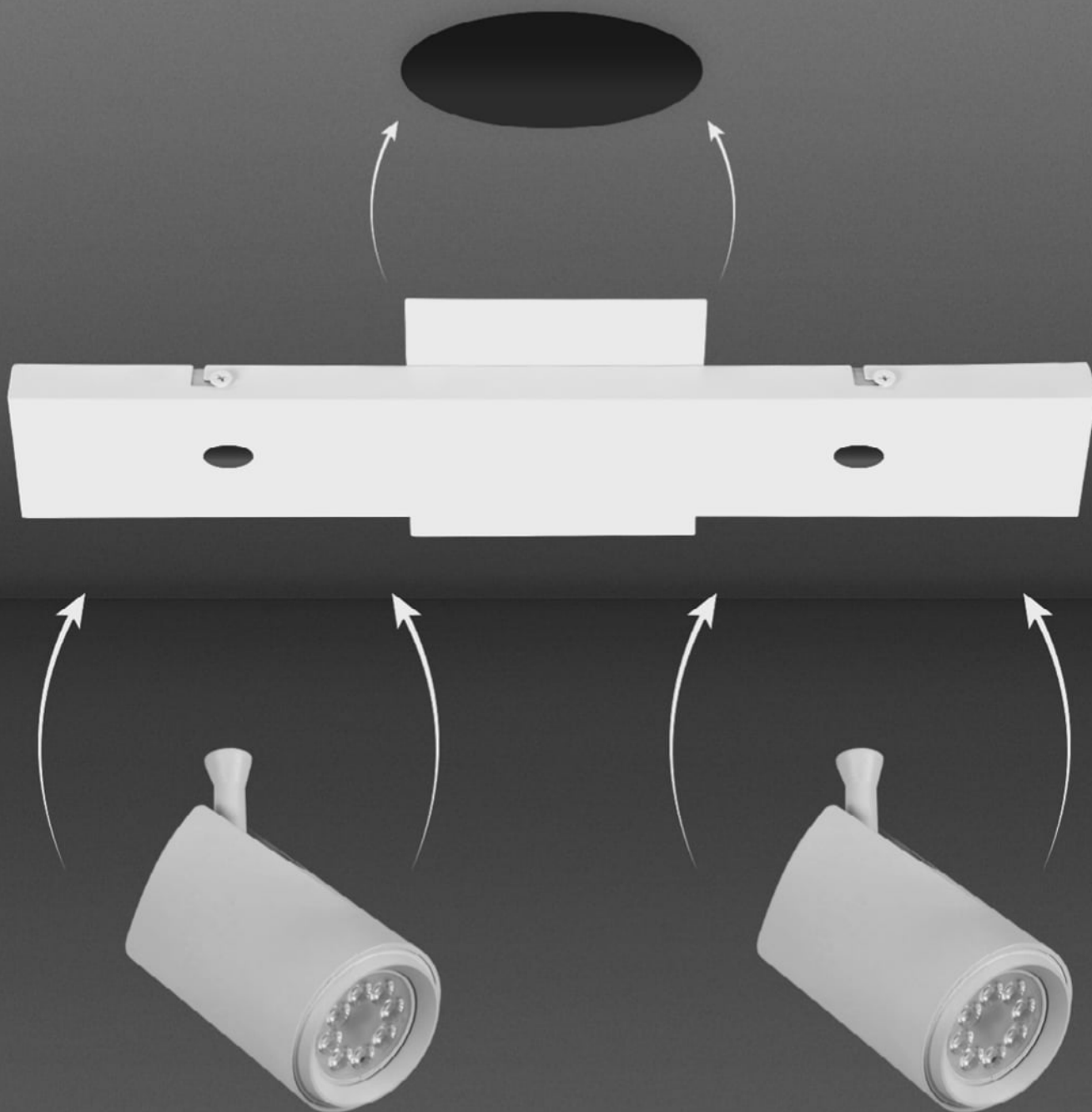

INCLUYEN ORIFICIOS CON **MARCADO LÁSER**;
HABILITE LOS NECESARIOS SEGÚN SU INSTALACIÓN.

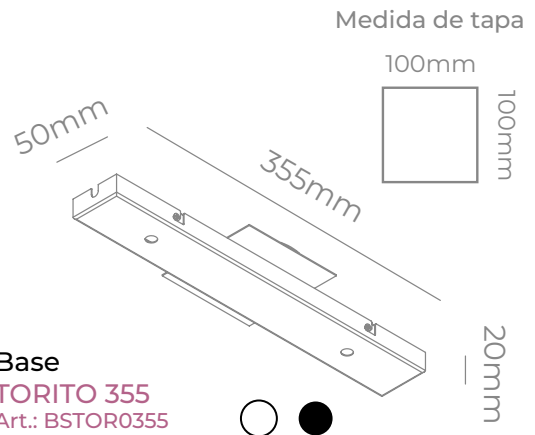

Base
TORITO 355
Art.: BSTOR0355



- Para 2 cabezales
- Blanco texturado, Negro texturado
- Chapa de acero

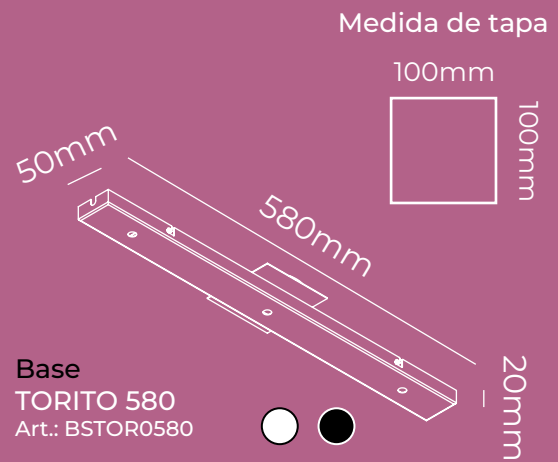

Base
TORITO 580
Art.: BSTOR0580



- Para 3 cabezales
- Blanco texturado, Negro texturado
- Chapa de acero

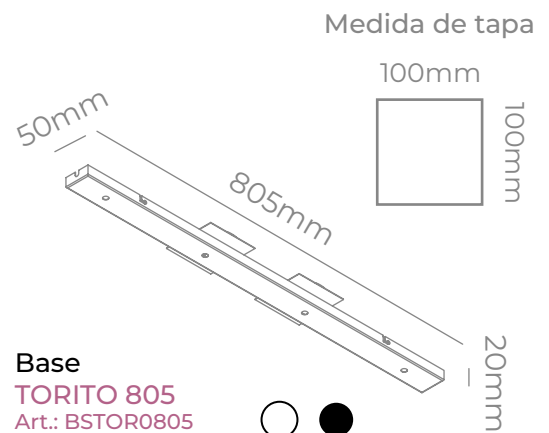
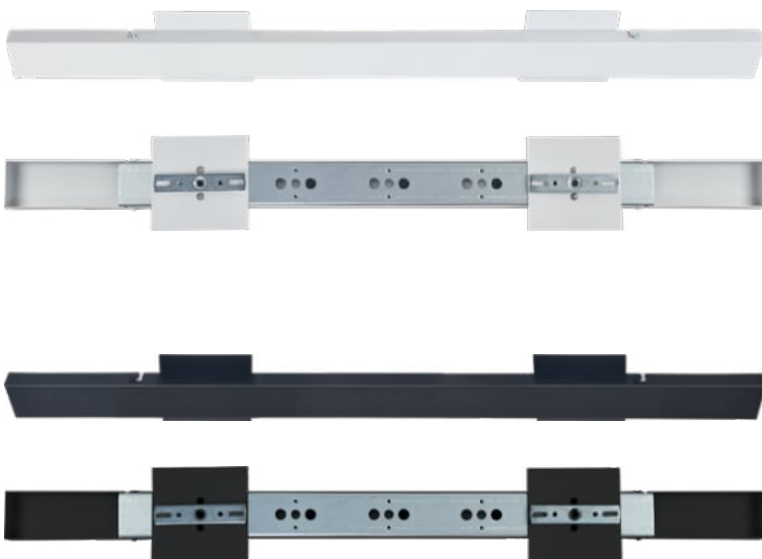

Base
TORITO 805
Art.: BSTOR0805



- Para 4 cabezales
- Blanco texturado, Negro texturado
- Chapa de acero

BASE TORITO



Bases para cabezales construidas en chapa de acero.



INCLUYEN ORIFICIOS CON **MARCADO LÁSER**;
HABILITE LOS NECESARIOS SEGÚN SU INSTALACIÓN.

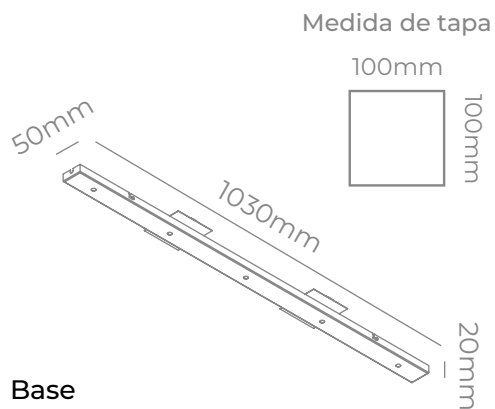
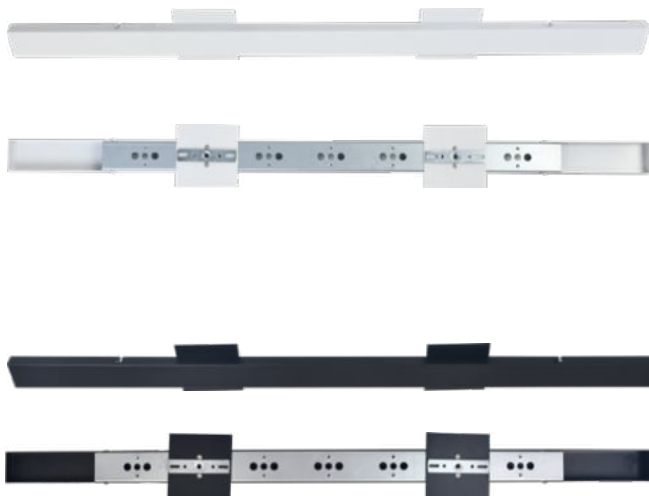

Base
TORITO 1030
 Art.: BSTOR1030



- Para 5 cabezales
- Blanco texturado, Negro texturado
- Chapa de acero

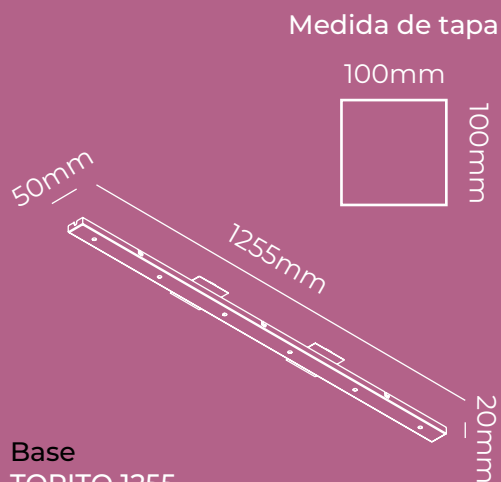
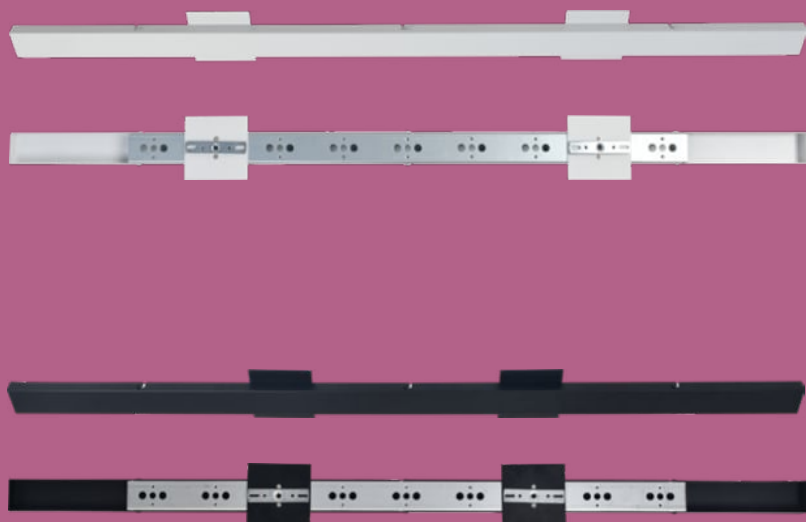

Base
TORITO 1255
 Art.: BSTOR1255



- Para 6 cabezales
- Blanco texturado, Negro texturado
- Chapa de acero

BASE TORITO





Bases para cabezales construidas en chapa de acero.



Base
TORITO 1705
Art.: BSTOR1705



-  Para 8 cabezales
-  Blanco texturado, Negro texturado
-  Chapa de acero

50mm

1705mm

Medida de tapa

100mm



100mm

20mm

INCLUYEN ORIFICIOS CON **MARCADO LÁSER**;
HABILITE LOS NECESARIOS SEGÚN SU INSTALACIÓN.

CONECTOR PARA BASE



TORITO L

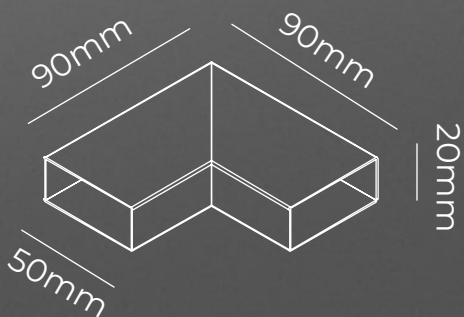
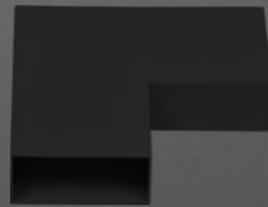
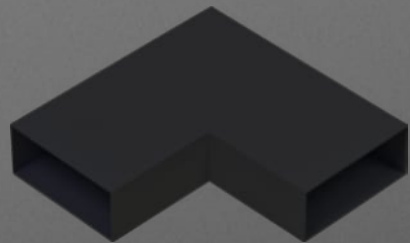
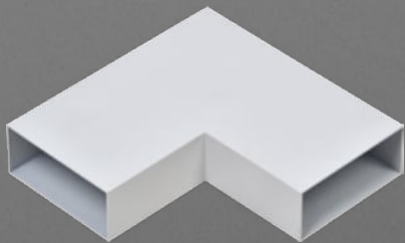
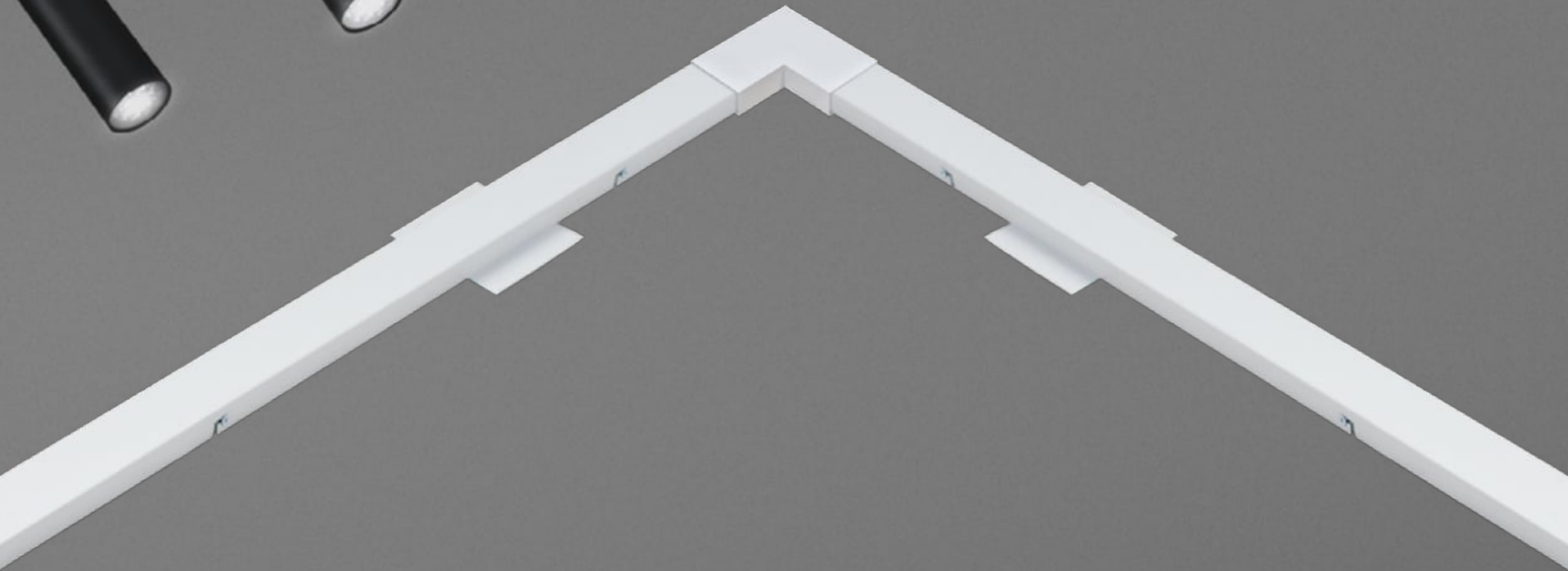

Conector
Torito L
Art.: BSTORCONL



- Blanco texturado, Negro texturado
- Chapa de acero

● Blanco Texturado

● Negro Texturado





Base
REDONDA 100
Art.: BSRED0100 BT



Base
REDONDA 100
Art.: BSRED0100 NT



-  Para 1 cabezal
-  Blanco texturado, Negro texturado
-  Chapa de acero

BASE REDONDA



100mm Ø

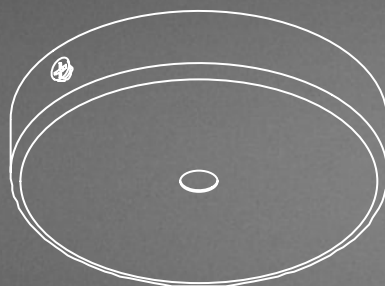

20mm

*Base redonda para
cabezales construida en
chapa de acero.*

BASE PARETO

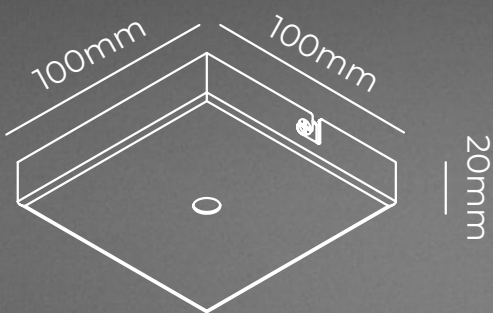
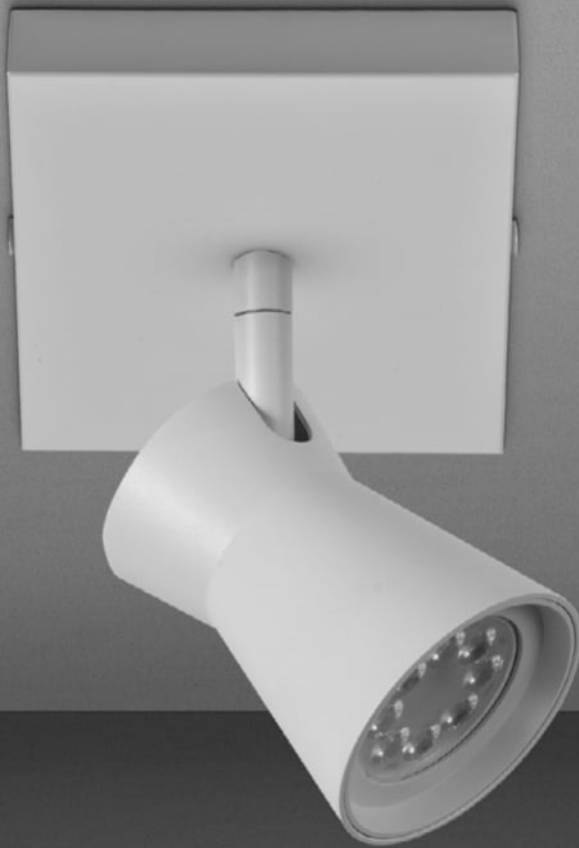

Base cuadrada para cabezales construida en chapa de acero

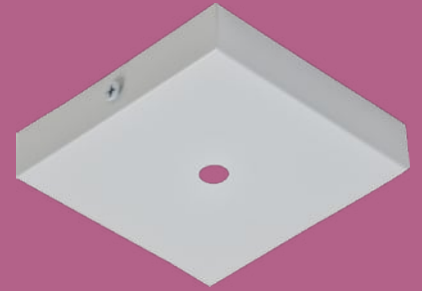



Base
PARETO 100
Art.: BSPAR0100 BT



Base
PARETO 100
Art.: BSPAR0100 NT



-  Para 1 cabezal
-  Blanco texturado, Negro texturado
-  Chapa de acero

BASE PARETO



Bases para cabezales construidas en chapa de acero.



INCLUYEN ORIFICIOS CON **MARCADO LÁSER**;
HABILITE LOS NECESARIOS SEGÚN SU INSTALACIÓN.

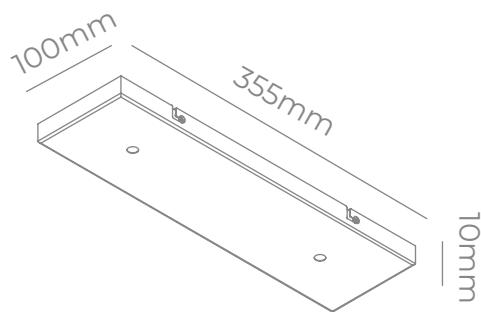

Base
PARETO 355
 Art.: BSPAR0355



- Para 2 cabezales
- Blanco texturado, Negro texturado
- Chapa de acero

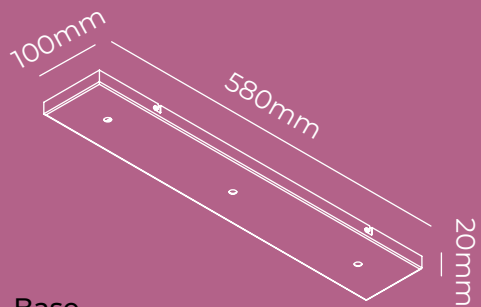

Base
PARETO 580
 Art.: BSPAR0580



- Para 3 cabezales
- Blanco texturado, Negro texturado
- Chapa de acero

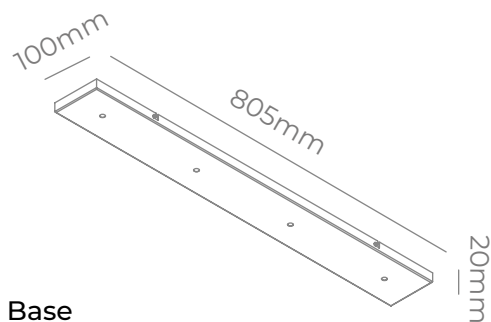

Base
PARETO 805
 Art.: BSPAR0805



- Para 4 cabezales
- Blanco texturado, Negro texturado
- Chapa de acero

BASE PARETO



Bases para cabezales construidas en chapa de acero.



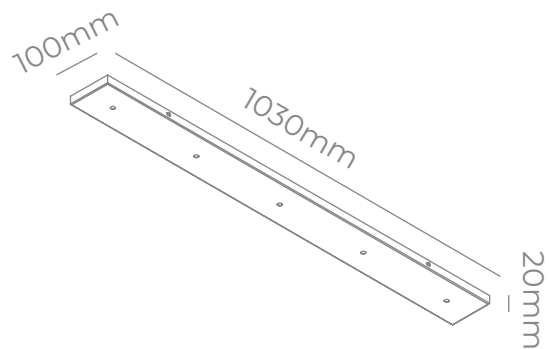

INCLUYEN ORIFICIOS CON **MARCADO LÁSER**;
HABILITE LOS NECESARIOS SEGÚN SU INSTALACIÓN.



Base
PARETO 1030
 Art.: BSPAR1030



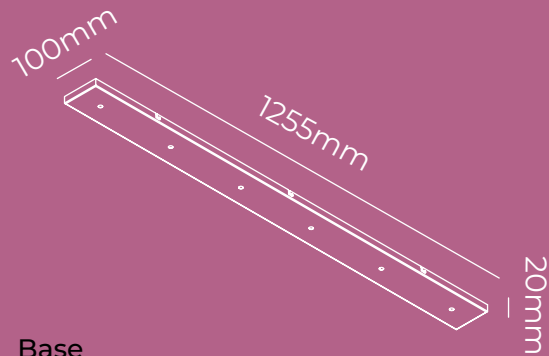
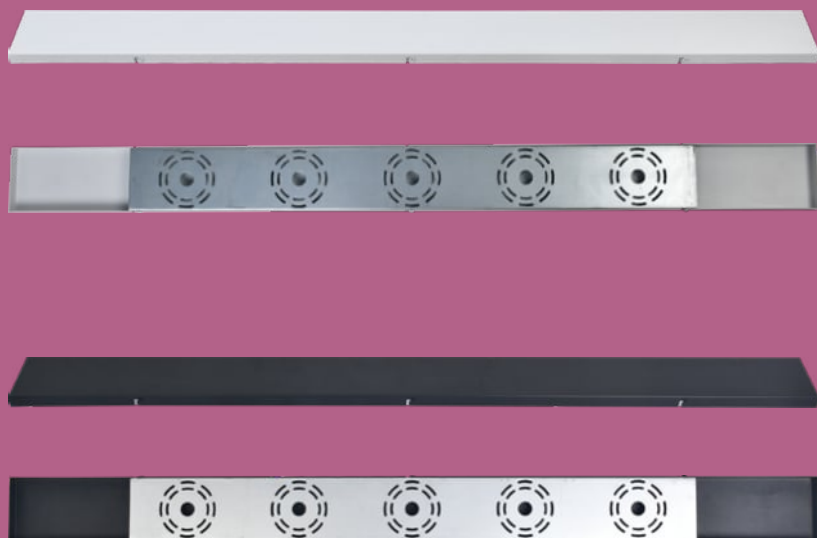

-  Para 5 cabezales
-  Blanco texturado, Negro texturado
-  Chapa de acero



Base
PARETO 1255
 Art.: BSPAR1255



-  Para 6 cabezales
-  Blanco texturado, Negro texturado
-  Chapa de acero

BASE PARETO



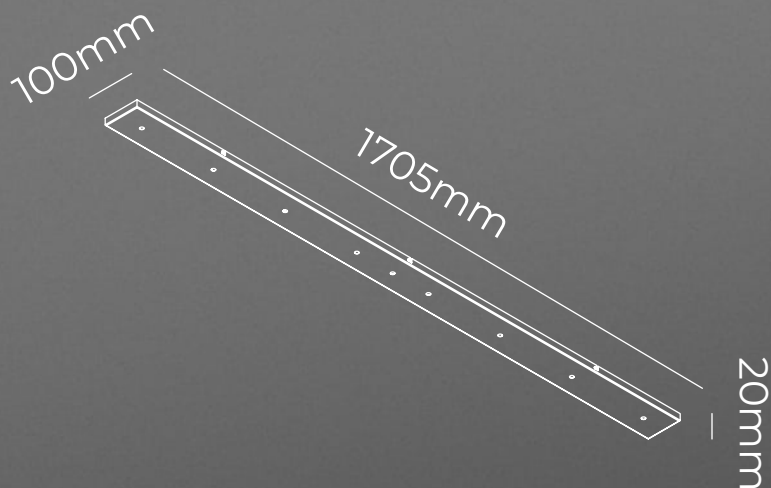

Bases para cabezales construidas en chapa de acero.

INCLUYEN ORIFICIOS CON **MARCADO LÁSER**;
HABILITE LOS NECESARIOS SEGÚN SU INSTALACIÓN.



Base
PARETO 1705
Art.: BSPAR1705



-  Para 8 cabezales
-  Blanco texturado, Negro texturado
-  Chapa de acero



● Blanco Texturado

● Negro Texturado





SISTEMAS PARA LÁMPARAS LED

*Apliques GU10 de 1 a 3 luces.
Bases construidas en chapa de acero,
cabezales de aluminio.*



APLIQUE EITU

 Con interruptor en base

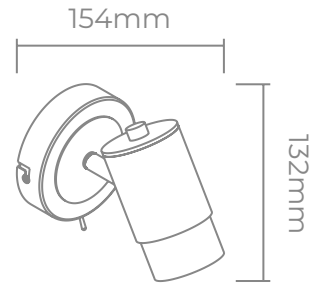





Aplique

EITU 1

Art.: C310/1 NG-OA



-  1xGU10, Max 7W, 220V, 50Hz, IP20
-  Negro mate+Oro Antiguo
-  Chapa de acero
-  Orientable
-  Clase I

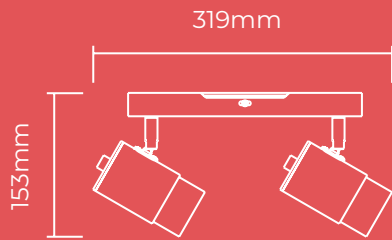





Aplique

EITU 2

Art.: C310/2 NG-OA



-  2xGU10, Max 7W, 220V, 50Hz, IP20
-  Negro mate+Oro Antiguo
-  Chapa de acero
-  Orientable
-  Clase I

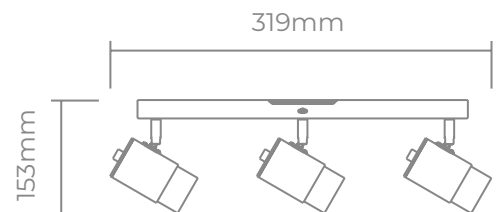





Aplique

EITU 3

Art.: C310/3 NG-OA



-  3xGU10, Max 7W, 220V, 50Hz, IP20
-  Negro mate+Oro Antiguo
-  Chapa de acero
-  Orientable
-  Clase I

Apliques GU10 de 1 a 3 luces
construidos en chapa.



APLIQUE EITU



Aplique
EITU 1
Art.: C310/1 NT







Aplique
EITU 1
Art.: C310/1 BT

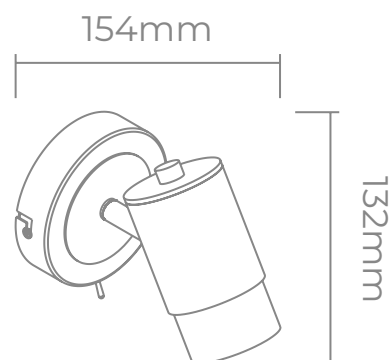

 Con interruptor en base



-  1xGU10, Max 7W, 220V, 50Hz, IP20
-  Blanco texturado
-  Chapa de acero
-  Orientable
-  Clase I



Aplique
EITU 2
Art.: C310/2 NT



Aplique
EITU 3
Art.: C310/3 NT



Aplique
EITU 2
Art.: C310/2 BT



Aplique
EITU 3
Art.: C310/3 BT

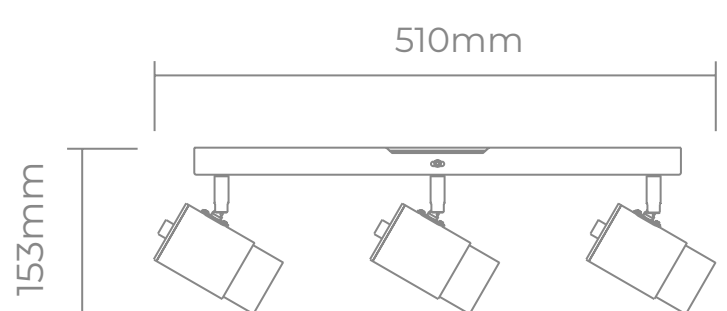
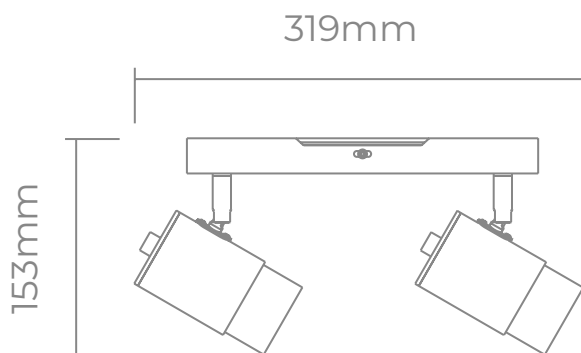

- 2xGU10, Max 7W, 220V, 50Hz, IP20
- Blanco texturado
- Chapa de acero
- Orientable
- Clase I

- 3xGU10, Max 7W, 220V, 50Hz, IP20
- Blanco texturado
- Chapa de acero
- Orientable
- Clase I

*Apliques GU10 de 1 a 3 luces
construidos en chapa.*



APLIQUE POLA

 Con interruptor en base

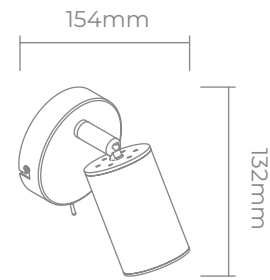





Aplique

POLA 1

Art.: C330/1 NG-OA



-  1xGU10, Max 7W, 220V, 50Hz, IP20
-  Negro texturado, Oro Antiguo
-  Chapa de acero
-  Orientable
-  Clase I

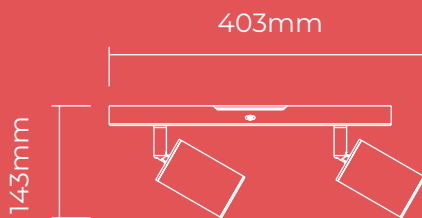





Aplique

POLA 2

Art.: C330/2 NG-OA



-  2xGU10, Max 7W, 220V, 50Hz, IP20
-  Negro texturado, Oro Antiguo
-  Chapa de acero
-  Orientable
-  Clase I

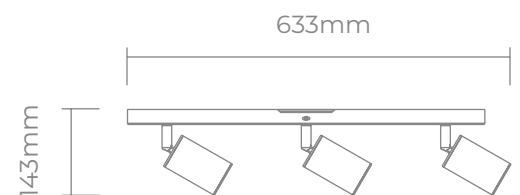





Aplique

POLA 3

Art.: C330/3 NG-OA



-  3xGU10, Max 7W, 220V, 50Hz, IP20
-  Negro texturado, Oro Antiguo
-  Chapa de acero
-  Orientable
-  Clase I



Apliques GU10 de 1 a 3 luces
construidos en chapa.



APLIQUE POLA



Aplique
POLA 1
Art.: C330/1 NT







Aplique
POLA 1
Art.: C330/1 BT

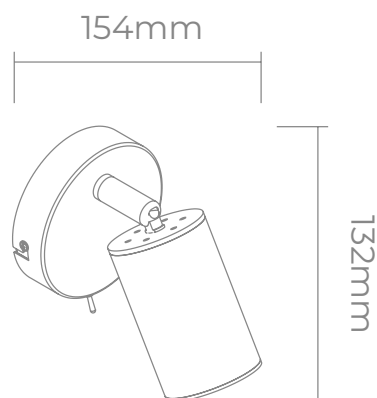

 Con interruptor en base



-  1xGU10, Max 7W, 220V, 50Hz, IP20
-  Negro texturado, Blanco texturado
-  Chapa de acero
-  Orientable
-  Clase I



Aplique
POLA 2
Art.: C330/2 NT



Aplique
POLA 3
Art.:C330/3 NT



Aplique
POLA 2
Art.: C330/2 BT



Aplique
POLA 3
Art.: C330/3 BT

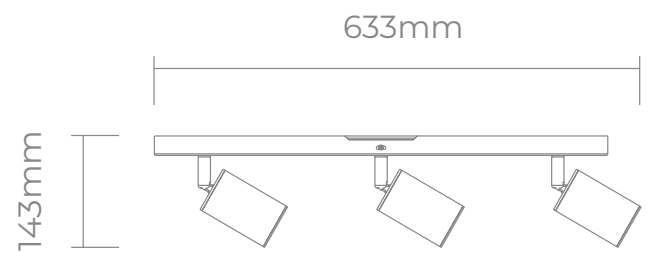
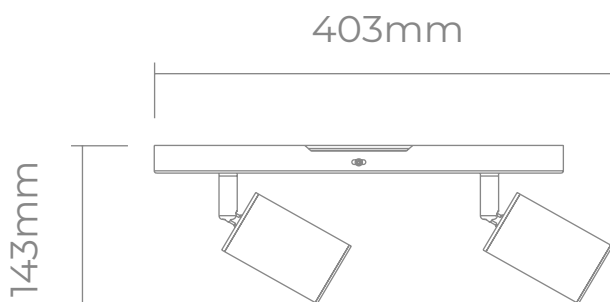

- 2xGU10, Max 7W, 220V, 50Hz, IP20
- Negro texturado, Blanco texturado
- Chapa de acero
- Orientable
- Clase I

- 3xGU10, Max 7W, 220V, 50Hz, IP20
- Negro texturado, Blanco texturado
- Chapa de acero
- Orientable
- Clase I

Apliques GU10 de 1 a 3 luces
construidos en chapa.



APLIQUE CACHEN



Aplique
CACHEN 1
Art.: C320/1 NT



Aplique
CACHEN 1
Art.: C320/1 BT





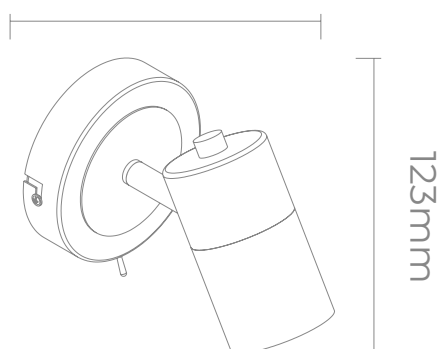

 Con interruptor en base

155mm



123mm

-  1xGU10, Max 7W, 220V, 50Hz, IP20
-  Negro texturado, Blanco texturado
-  Chapa de acero
-  Orientable
-  Clase I



Aplique
CACHEN 2
Art.: C320/2 NT



Aplique
CACHEN 3
Art.: C320/3 NT



Aplique
CACHEN 2
Art.: C320/2 BT



Aplique
CACHEN 3
Art.: C320/3 BT

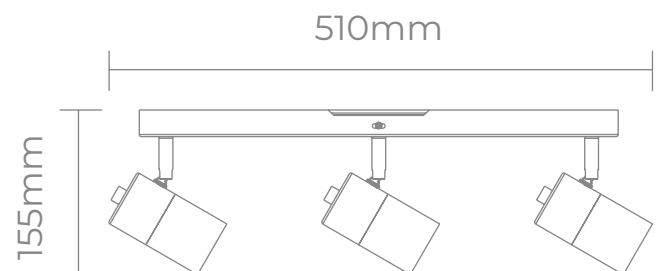
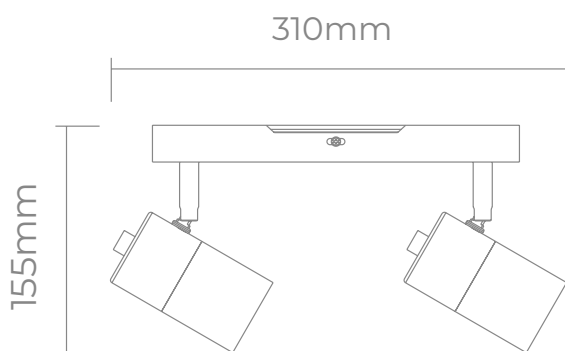

- 2xGU10, Max 7W, 220V, 50Hz, IP20
- Negro texturado, Blanco texturado
- Chapa de acero
- Orientable
- Clase I

- 3xGU10, Max 7W, 220V, 50Hz, IP20
- Negro texturado, Blanco texturado
- Chapa
- Orientable
- Clase I

Apliques GU10 de 1 a 3 luces
construidos en chapa.



APLIQUE MEMO



Aplique
MEMO 1
Art.: C300/1 NT







Aplique
MEMO 1
Art.: C300/1 BT

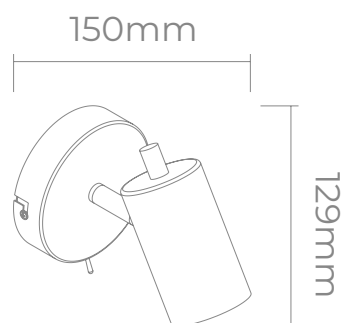

 Con interruptor en base



-  1xGU10, Max 7W, 220V, 50Hz, IP20
-  Negro texturado, Blanco texturado
-  Chapa de acero
-  Orientable
-  Clase I



Aplique
MEMO 2
Art.: C300/2 NT



Aplique
MEMO 3
Art.: C300/3 NT



Aplique
MEMO 2
Art.: C300/2 BT

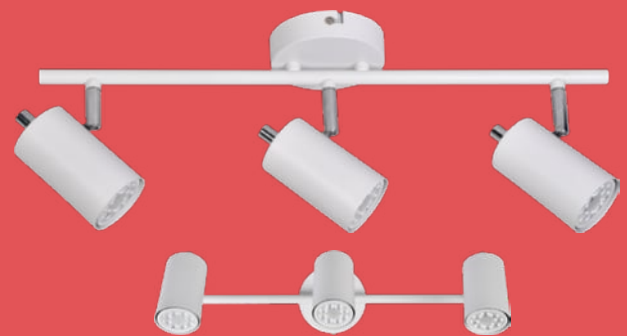

Aplique
MEMO 3
Art.: C300/3 BT

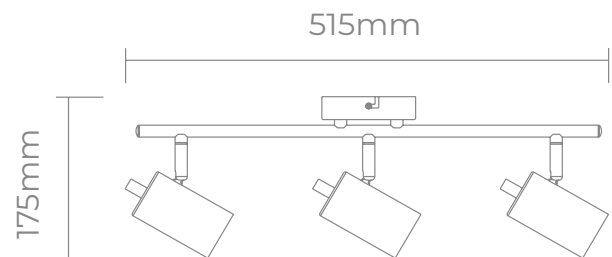
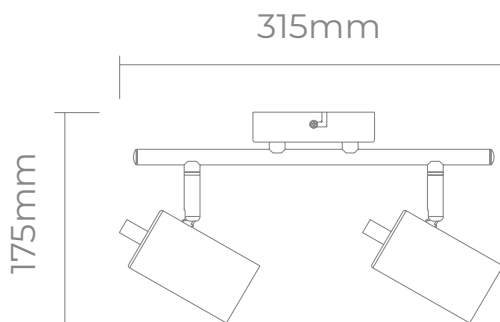

- 2xGU10, Max 7W, 220V, 50Hz, IP20
- Negro texturado, Blanco texturado
- Chapa de acero
- Orientable
- Clase I

- 3xGU10, Max 7W, 220V, 50Hz, IP20
- Negro texturado, Blanco texturado
- Chapa de acero
- Orientable
- Clase I

*Apliques GU10 de 1 a 3 luces
construidos en chapa.*



APLIQUE
AYELEN

 Con interruptor en base

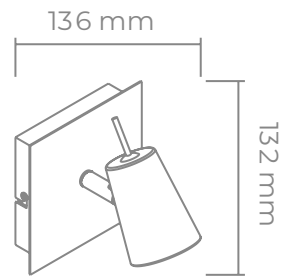





Aplique

AYELEN 1

Art.: C852/1



-  1xGU10, Max 50W, 220V, 50Hz, IP20
-  Blanco mate, Negro mate
-  Chapa de acero
-  Orientable
-  Clase I

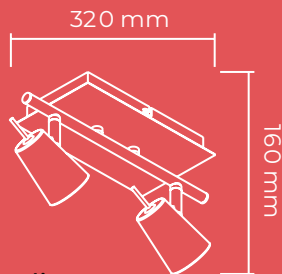





Aplique

AYELEN 2

Art.: C852/2



-  2xGU10, Max 50W, 220V, 50Hz, IP20
-  Blanco mate, Negro mate
-  Chapa de acero
-  Orientable
-  Clase I

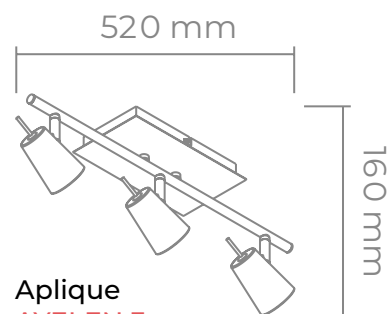





Aplique

AYELEN 3

Art.: C852/3



-  3xGU10, Max 50W, 220V, 50Hz, IP20
-  Blanco mate, Negro mate
-  Chapa de acero
-  Orientable
-  Clase I

Apliques GU10 de 1 a 4 luces
construidos en chapa.



APLIQUE JULITA

 Con interruptor en base

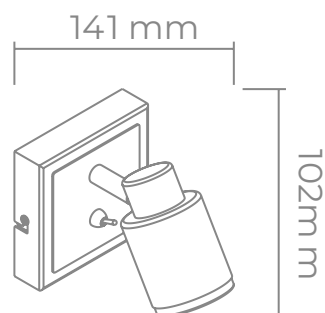





Aplique

JULITA 1

Art.: C791/1 NG



-  1xGU10, Max 50W, 220V, 50Hz, IP20
-  Negro mate
-  Chapa de acero
-  Orientable
-  Clase I

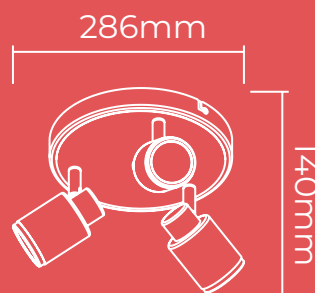





Aplique

JULITA 3 REDONDO

Art.: C791/3R NG



-  3xGU10, Max 50W, 220V, 50Hz, IP20
-  Negro mate
-  Chapa de acero
-  Orientable
-  Clase I

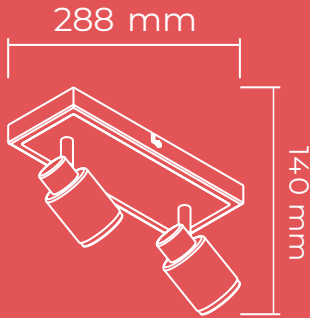

Aplique
JULITA 2
 Art.: C791/2 NG

- 2xGU10, Max 50W, 220V, 50Hz, IP20
- Negro mate
- Chapa de acero
- Orientable
- Clase I

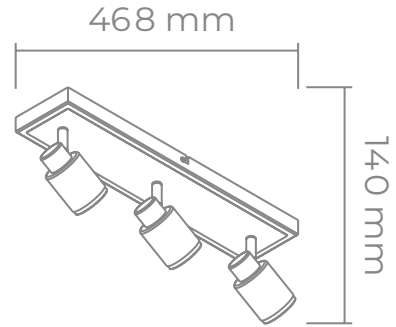

Aplique
JULITA 3
 Art.: C791/3 NG

- 3xGU10, Max 50W, 220V, 50Hz, IP20
- Negro mate
- Chapa de acero
- Orientable
- Clase I

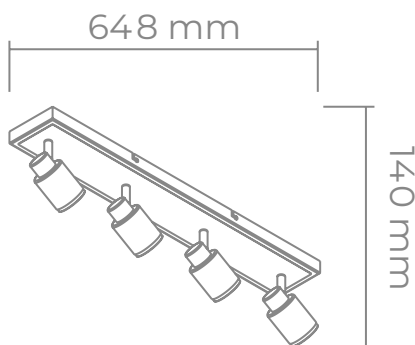

Aplique
JULITA 4 LINEAL
 Art.: C791/4 NG

- 4xGU10, Max 50W, 220V, 50Hz, IP20
- Negro mate
- Chapa de acero
- Orientable
- Clase I

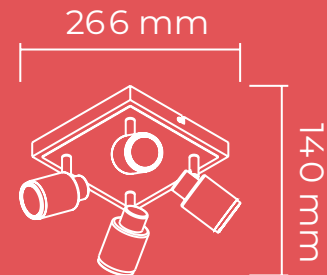

Aplique
JULITA 4 CUADRADO
 Art.: C791/4C NG

- 4xGU10, Max 50W, 220V, 50Hz, IP20
- Negro mate
- Chapa de acero
- Orientable
- Clase I

Apliques GU10 de 1 a 4 luces
construidos en chapa.



APLIQUE JULITA

 Con interruptor en base

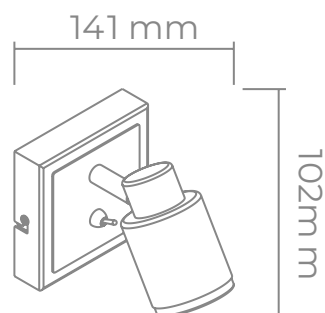





Aplique

JULITA 1

Art.: C791/1 BL



-  1xGU10, Max 50W, 220V, 50Hz, IP20
-  Blanco mate
-  Chapa
-  Orientable
-  Clase I

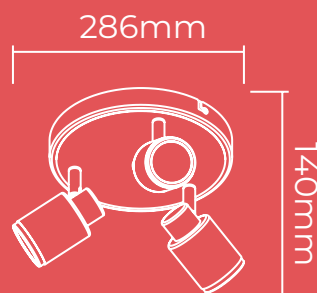





Aplique

JULITA 3 REDONDO





Art.: C791/3R BL

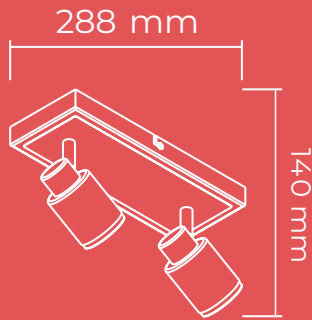

-  3xGU10, Max 50W, 220V, 50Hz, IP20
-  Blanco mate
-  Chapa
-  Orientable
-  Clase I





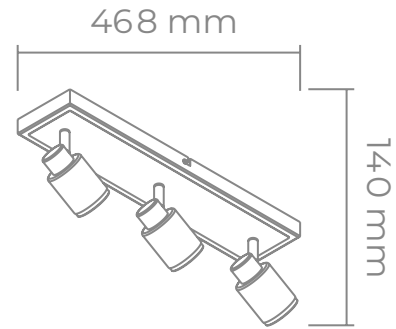

Aplique
JULITA 2
 Art.: C791/2 BL

-  2xGU10, Max 50W, 220V, 50Hz, IP20
-  Blanco mate
-  Chapa
-  Orientable
-  Clase I





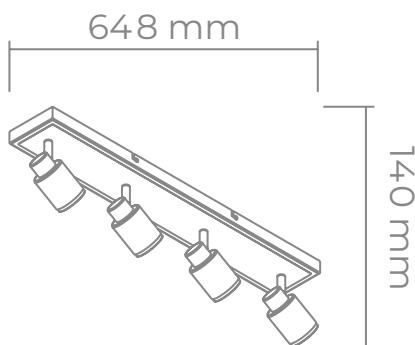

Aplique
JULITA 3
 Art.: C791/3 BL

-  3xGU10, Max 50W, 220V, 50Hz, IP20
-  Blanco mate
-  Chapa
-  Orientable
-  Clase I





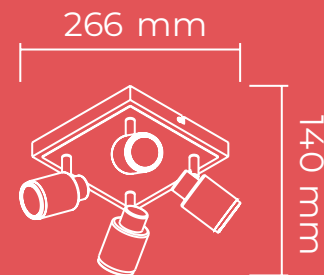

Aplique
JULITA 4 LINEAL
 Art.: C791/4 BL

-  4xGU10, Max 50W, 220V, 50Hz, IP20
-  Blanco mate
-  Chapa
-  Orientable
-  Clase I



Aplique
JULITA 4 CUADRADO
 Art.: C791/4C BL

-  4xGU10, Max 50W, 220V, 50Hz, IP20
-  Blanco mate
-  Chapa
-  Orientable
-  Clase I

*Apliques GU10 de 1 a 3 luces
construidos en chapa.*





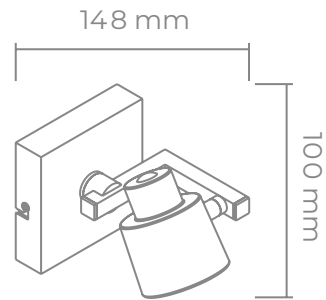

APLIQUE
SHEILA

 Con interruptor en base



Aplique
SHEILA 1
Art.: C684/1 NT





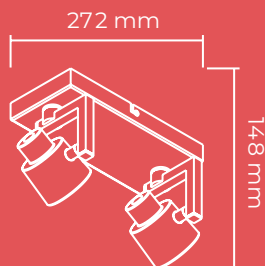

-  1xGU10, Max 50W, 220V, 50Hz, IP20
-  Negro texturado
-  Chapa
-  Orientable
-  Clase I



Aplique
SHEILA 2
Art.: C684/2 NT





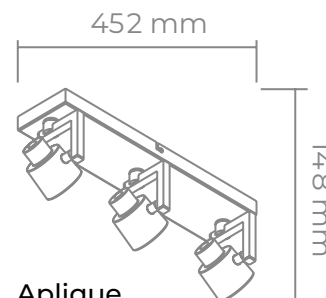

-  2xGU10, Max 50W, 220V, 50Hz, IP20
-  Negro texturado
-  Chapa
-  Orientable
-  Clase I



Aplique
SHEILA 3
Art.: C684/3 NT



-  3xGU10, Max 50W, 220V, 50Hz, IP20
-  Negro texturado
-  Chapa
-  Orientable
-  Clase I

Apliques GU10 de 1 a 3 luces
construidos en Chapa.



APLIQUE SHEILA



Aplique
SHEILA 1
Art.: C684/1 BL



Aplique
SHEILA 1
Art.: C684/1 NM





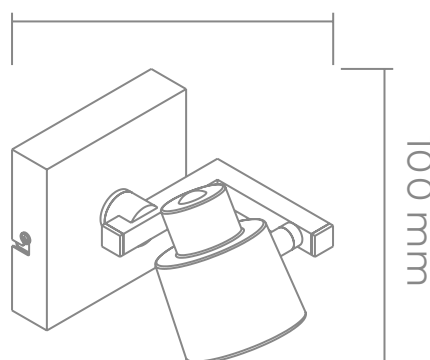

 Con interruptor en base

148 mm



100 mm

-  1xGU10, Max 50W, 220V, 50Hz, IP20
-  Blanco texturado, Niquel mate
-  Chapa
-  Orientable
-  Clase I



Aplique
SHEILA 2
Art.: C684/2 BL



Aplique
SHEILA 3
Art.: C684/3 BL



Aplique
SHEILA 2
Art.: C684/2 NM



Aplique
SHEILA 3
Art.: C684/3 NM

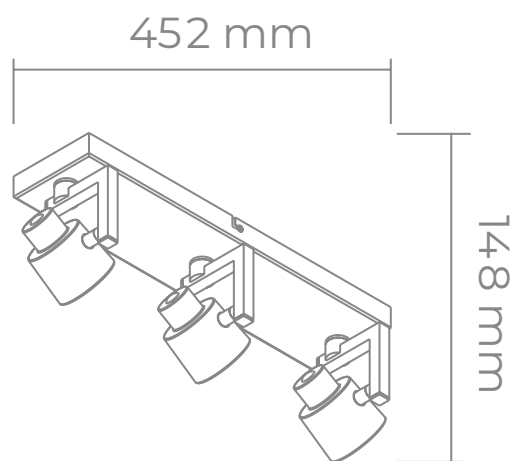
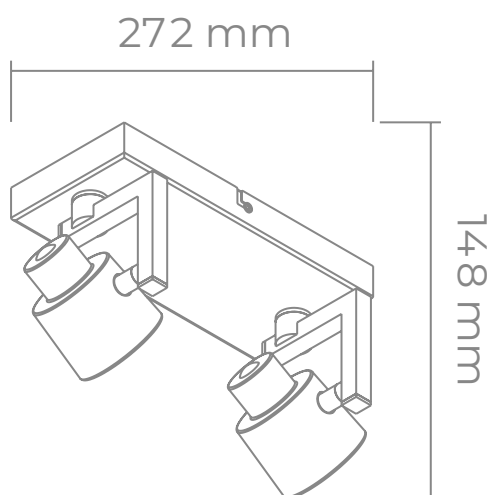

- 2xGU10, Max 50W, 220V, 50Hz, IP20
- Blanco texturado, Niquel mate
- Chapa
- Orientable
- Clase I

- 3xGU10, Max 50W, 220V, 50Hz, IP20
- Blanco texturado, Niquel mate
- Chapa
- Orientable
- Clase I

APLIQUE SONATA







*Apliques GU10 de 1 a 3 luces
construidos en chapa de acero.*





Aplicue
SONATA 1
Art.: C955/1 NM



-  1xGU10, Max 7W, 220V, 50Hz, IP20
-  Niquel mate
-  Chapa
-  Orientable
-  Clase I

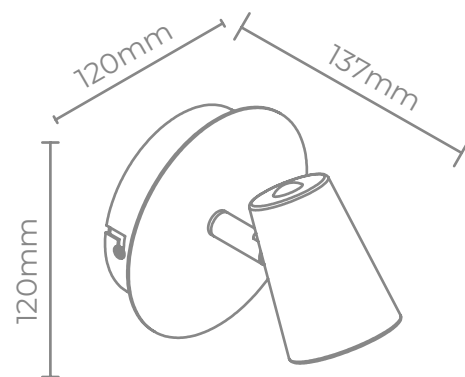





 Con interruptor en base



Aplicue
SONATA 2
Art.: C955/2 NM





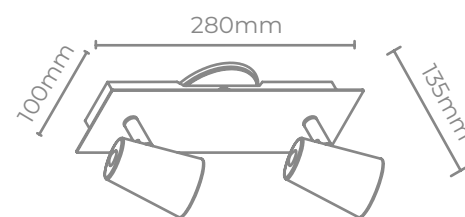

-  2xGU10, Max 7W, 220V, 50Hz, IP20
-  Niquel mate
-  Chapa
-  Orientable
-  Clase I



Aplicue
SONATA 3
Art.: C955/3 NM





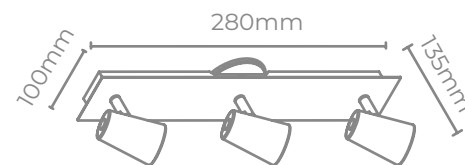

-  3xGU10, Max 7W, 220V, 50Hz, IP20
-  Niquel mate
-  Chapa
-  Orientable
-  Clase I



Aplicue
SONATA 3 REDONDO
Art.: C955/3R NM



-  3xGU10, Max 7W, 220V, 50Hz, IP20
-  Niquel mate
-  Chapa
-  Orientable
-  Clase I

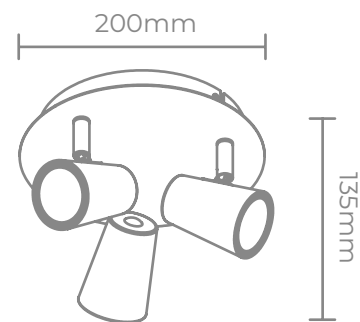



Art.: C955/1 BL

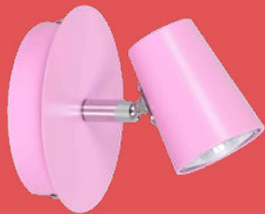

Art.: C955/1 RS

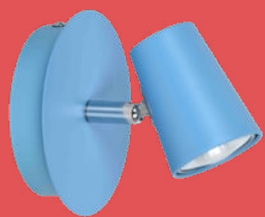

Art.: C955/1 AZ



Art.: C955/2 BL



Art.: C955/2 RS

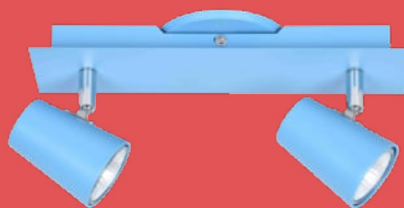





Art.: C955/2 AZ

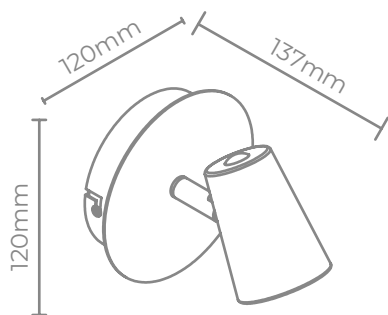

 Con interruptor en base





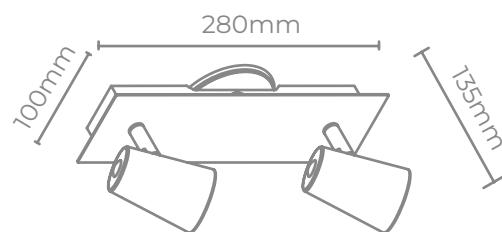

Aplique
SONATA 1

-  1xGU10, Max 40W, 220V, 50Hz, IP20
-  Blanco, Rosa, Celeste
-  Chapa de acero
-  Orientable
-  Clase I



Aplique
SONATA 2

-  2xGU10, Max 40W, 220V, 50Hz, IP20
-  Blanco, Rosa, Celeste
-  Chapa de acero
-  Orientable
-  Clase I



Art.: C955/3 BL



Art.: C955/3 RS



Art.: C955/3 AZ



Art.: C955/3R BL



Art.: C955/3 RS

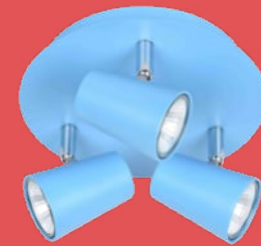

Art.: C955/3R AZ

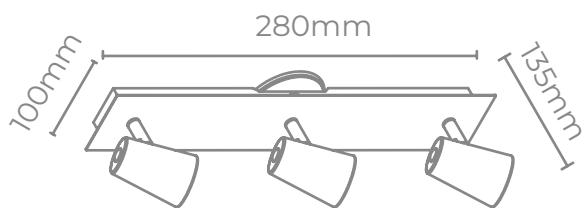

Aplique
SONATA 3 LINEAL

- 3xGU10, Max 40W, 220V, 50Hz, IP20
- Blanco, Rosa, Celeste
- Chapa de acero
- Orientable
- Clase I

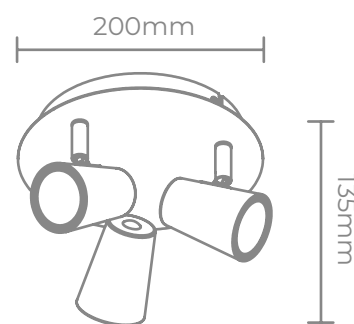

Aplique
SONATA 3 REDONDO

- 3xGU10, Max 40W, 220V, 50Hz, IP20
- Blanco, Rosa, Celeste
- Chapa de acero
- Orientable
- Clase I





APLIQUE SONATA

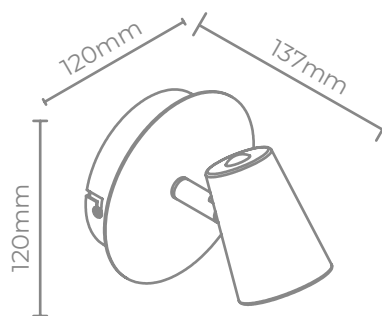

 Con interruptor en base





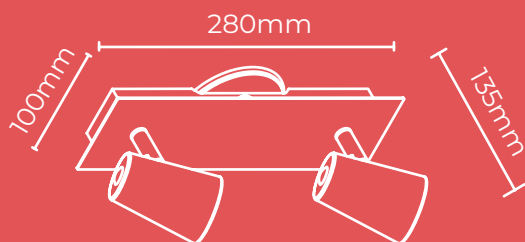

Aplique
SONATA 1
Art.: C955/1 NT

-  1xGU10, Max 50W, 220V, 50Hz, IP20
-  Negro texturado
-  Chapa de acero
-  Orientable
-  Clase I





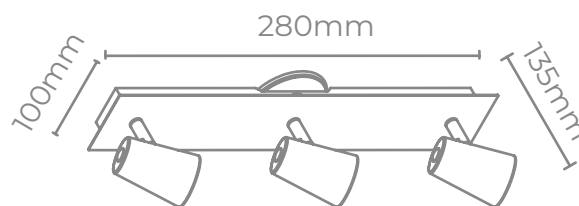

Aplique
SONATA 2
Art.: C955/2 NT

-  2xGU10, Max 50W, 220V, 50Hz, IP20
-  Negro texturado
-  Chapa de acero
-  Orientable
-  Clase I



Aplique
SONATA 3
Art.: C955/3 NT

-  3xGU10, Max 50W, 220V, 50Hz, IP20
-  Negro texturado
-  Chapa de acero
-  Orientable
-  Clase I



*Apliques GU10 de 1 a 4 luces
construidos en chapa de
acero.*

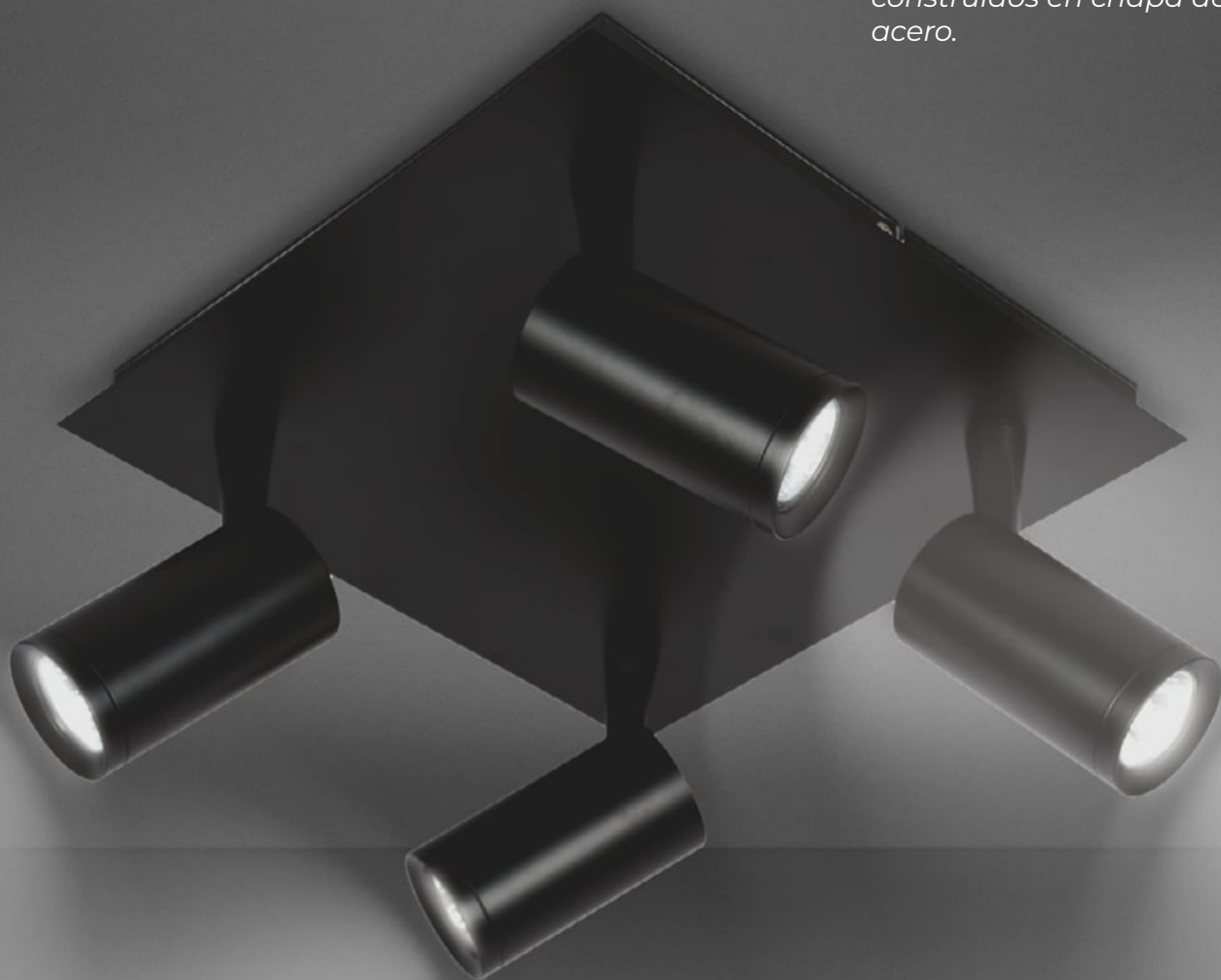





APLIQUE TÉMPANO





Applique
TÉMPANO 1
Art.: C965/1 NT



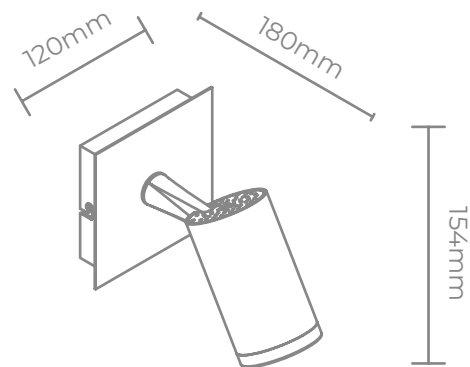

-  1xGU10, Max 50W, 220V, 50Hz, IP20
-  Negro texturado
-  Chapa de acero
-  Orientable
-  Clase I



 Con interruptor en base





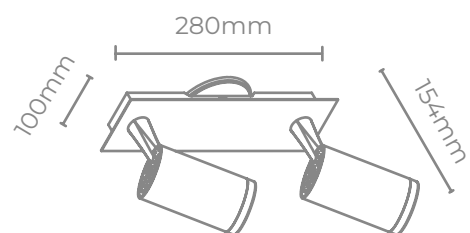

Applique
TÉMPANO 2
Art.: C965/2 NT

-  2xGU10, Max 50W, 220V, 50Hz, IP20
-  Negro texturado
-  Chapa de acero
-  Orientable
-  Clase I





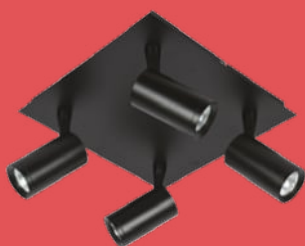
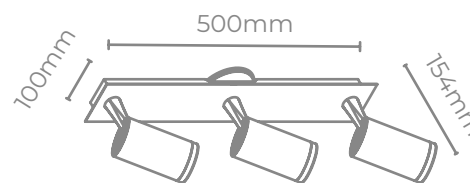

Applique
TÉMPANO 3
Art.: C965/3 NT

-  3xGU10, Max 50W, 220V, 50Hz, IP20
-  Negro texturado
-  Chapa de acero
-  Orientable
-  Clase I



Applique
TÉMPANO 4
Art.: C965/4 NT

-  4xGU10, Max 50W, 220V, 50Hz, IP20
-  Negro texturado
-  Chapa de acero
-  Orientable
-  Clase I

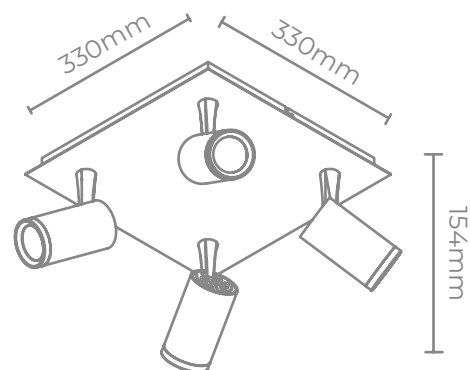



Art.: C965/1 BL



Art.: C965/1 NM



Art.: C965/2 BL







Art.: C965/2 NM

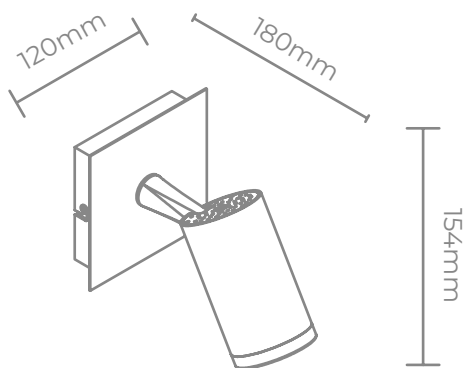

 Con interruptor en base





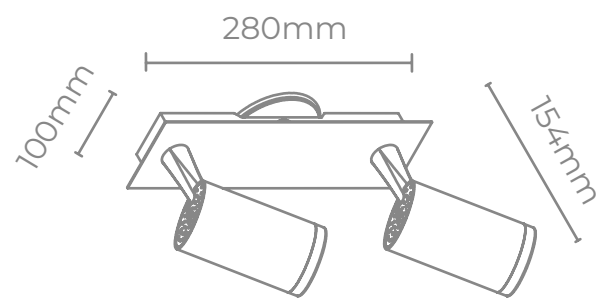

Aplique
TÉMPANO 1

-  1xGU10, Max 50wW, 220V, 50Hz, IP20
-  Blanco, Niquel mate
-  Chapa de acero
-  Orientable
-  Clase I



Aplique
TÉMPANO 2

-  2xGU10, Max 50W, 220V, 50Hz, IP20
-  Blanco, Niquel mate
-  Chapa de acero
-  Orientable
-  Clase I



Art.: C965/3 BL



Art.: C965/3 NM

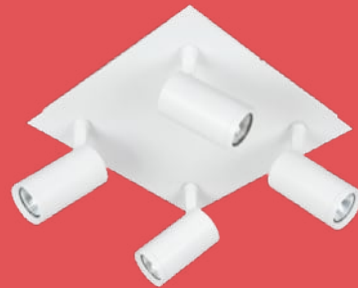

Art.: C965/4 BL



Art.: C965/4 NM

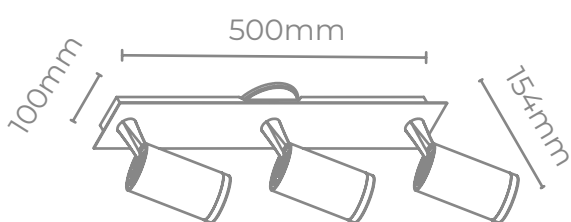

Aplique
TÉMPANO 3

- 3xGU10, Max 50W, 220V, 50Hz, IP20
- Blanco, Niquel mate
- Chapa de acero
- Orientable
- Clase I

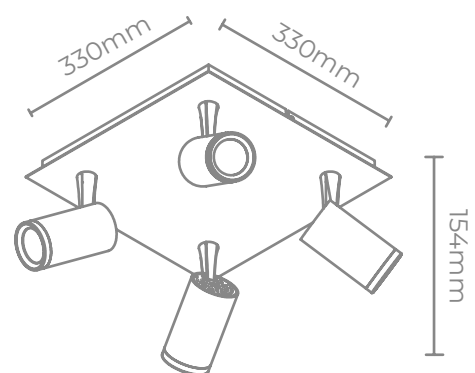

Aplique
TÉMPANO 4

- 4xGU10, Max 50W, 220V, 50Hz, IP20
- Blanco, Niquel mate
- Chapa de acero
- Orientable
- Clase I

*Apliques GU10 de 1 a 3 luces
construidos en chapa de
acero.*



APLIQUE KONUS

 Con interruptor en base

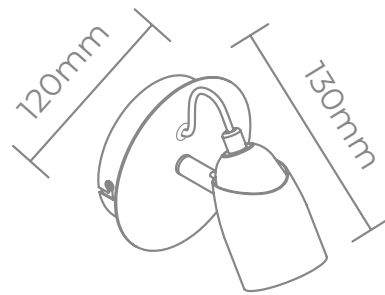

Aplique

KONUS 1

Art.: C100/1 NM



 1xGU10, Max 50W, 220V, 50Hz, IP20

 Níquel mate

 Chapa de acero

 Orientable

 Clase I

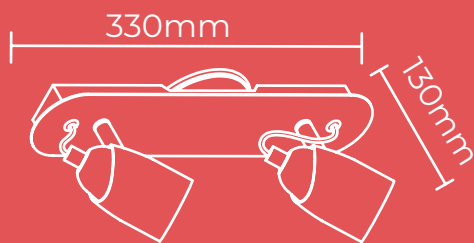

Aplique

KONUS 2

Art.: C100/2 NM



 2xGU10, Max 50W, 220V, 50Hz, IP20

 Níquel mate

 Chapa de acero

 Orientable

 Clase I

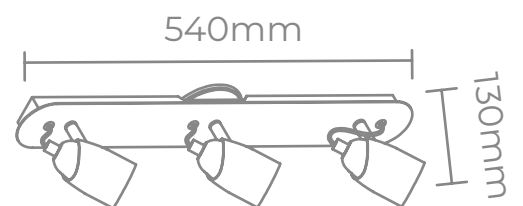

Aplique

KONUS 3

Art.: C100/3 NM



 3xGU10, Max 50W, 220V, 50Hz, IP20

 Níquel mate

 Chapa de acero

 Orientable

 Clase I



APLIQUE KONUS



Applique
KONUS 1
Art.: C100/1 NT







Applique
KONUS 1
Art.: C100/1 BT

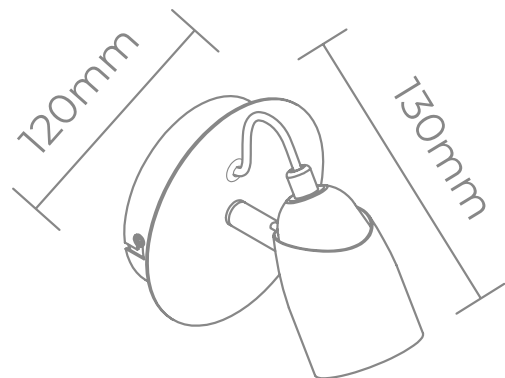

 Con interruptor en base



-  1xGU10, Max 50W, 220V, 50Hz, IP20
-  Negro texturado, Blanco texturado
-  Chapa de acero
-  Orientable
-  Clase I



Aplique
KONUS 2
Art.: C100/2 NT



Aplique
KONUS 3
Art.: C100/3 NT



Aplique
KONUS 2
Art.: C100/2 BT



Aplique
KONUS 3
Art.: C100/3 BT

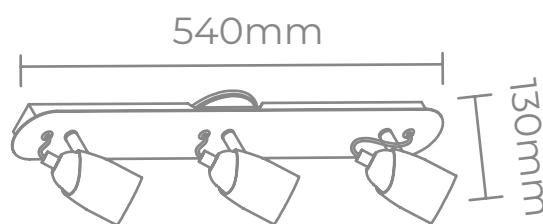
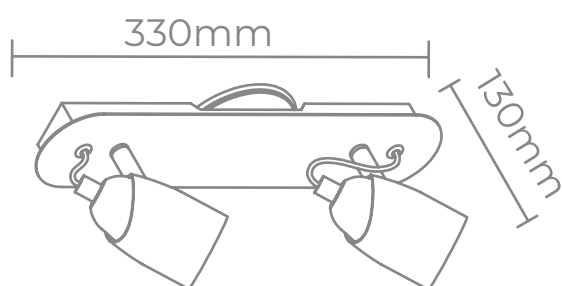

- 2xGU10, Max 50W, 220V, 50Hz, IP20
- Negro texturado, Blanco texturado
- Chapa de acero
- Orientable
- Clase I

- 3xGU10, Max 50W, 220V, 50Hz, IP20
- Negro texturado, Blanco texturado
- Chapa de acero
- Orientable
- Clase I





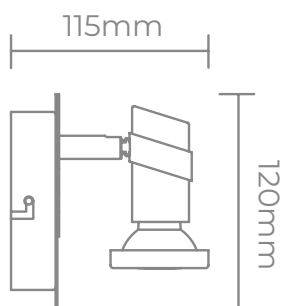

APLIQUE PARTY

 Con interruptor en base



Aplique
PARTY 1
Art.: C090/1





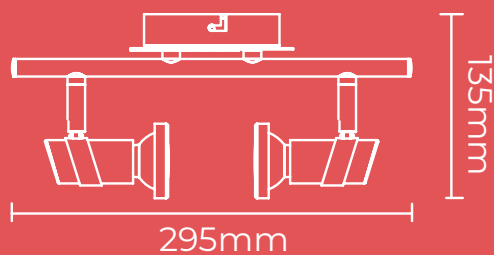

-  1xGU10, Max 50W, 220V, 50Hz, IP20
-  Platil, Negro mate
-  Chapa de acero
-  Orientable
-  Clase I



Aplique
PARTY 2
Art.: C090/2



-  2xGU10, Max 50W, 220V, 50Hz, IP20
-  Platil, Negro mate
-  Chapa de acero
-  Orientable
-  Clase I

Apliques GU10 de 1 a 4 luces
construidos en chapa de acero.

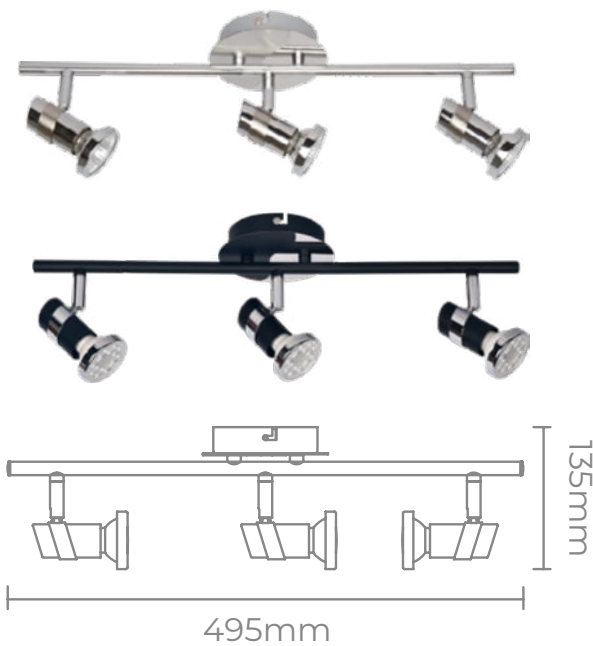

Aplique
PARTY 3
Art.: C090/3



- 3xGU10, Max 50W, 220V, 50Hz, IP20
- Platil, Negro mate
- Chapa de acero
- Orientable
- Clase I

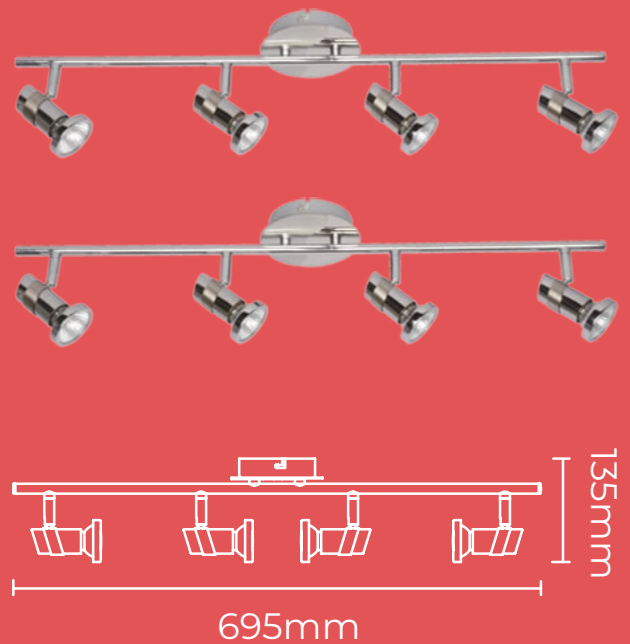

Aplique
PARTY 4
Art.: C090/4



- 4xGU10, Max 50W, 220V, 50Hz, IP20
- Platil
- Chapa de acero
- Orientable
- Clase I

APLIQUE PROMO



 Con interruptor en base







Art.: C208/1 BL

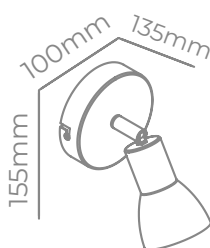

Art.: C208/1 NM



Aplique
PROMO 1

-  1xGU10, Max 50W, 220V, 50Hz, IP20
-  Blanco texturado, Niquel mate
-  Chapa de acero
-  Orientable
-  Clase I



Art.: C208/2 BL



Art.: C208/2 NM







NOVEDAD

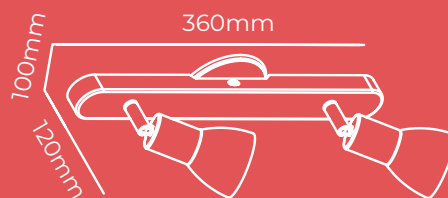

Art.: C208/2 NT



Aplique
PROMO 2

-  2xGU10, Max 50W, 220V, 50Hz, IP20
-  Blanco texturado, Niquel mate, Negro texturado
-  Chapa de acero
-  Orientable
-  Clase I

*Apliques GU10 de 1 a 3 luces
construidos en chapa de acero.*







Art.: C208/3 BL

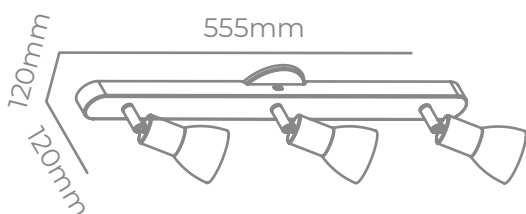

Art.: C208/3 NM



Aplique
PROMO 3 LINEAL

-  3xGU10, Max 50W, 220V, 50Hz, IP20
-  Blanco texturado, Niquel mate
-  Chapa de acero
-  Orientable
-  Clase I







Art.: C208/3R BL

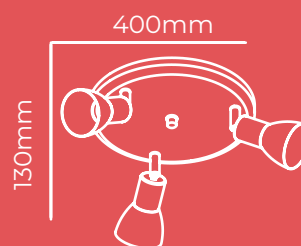

Art.: C208/3R NM



Aplique
PROMO 3 REDONDO

-  3xGU10, Max 50W, 220V, 50Hz, IP20
-  Blanco texturado, Niquel mate
-  Chapa de acero
-  Orientable
-  Clase I

APLIQUE SUPER



 Con interruptor en base







Art.: C900/1 BL

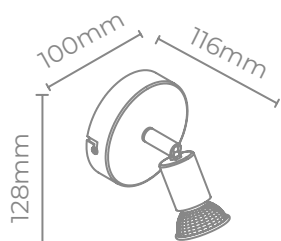

Art.: C900/1 NM



**Aplique
SUPER 1**

-  1xGU10, Max 50W, 220V, 50Hz, IP20
-  Blanco mate, Niquel mate
-  Chapa de acero
-  Orientable
-  Clase I





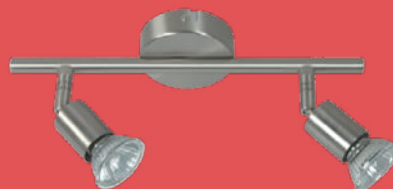

Art.: C900/2 BL

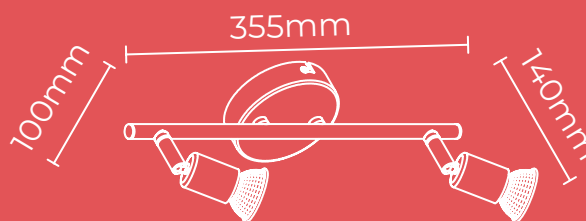

Art.: C900/2 NM



**Aplique
SUPER 2**

-  2xGU10, Max 50W, 220V, 50Hz, IP20
-  Blanco mate, Niquel mate
-  Chapa de acero
-  Orientable
-  Clase I

Apliques GU10 de 1 a 4 luces
construidos en chapa de acero.

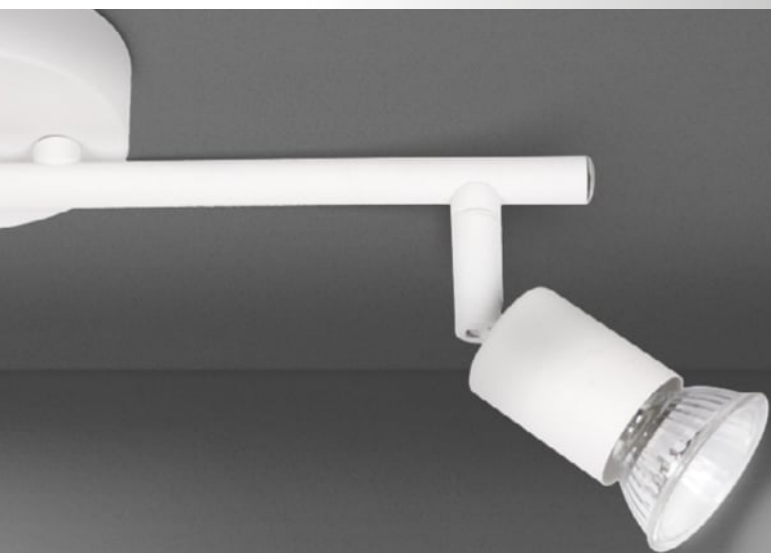

Art.: C900/3 BL



Art.: C900/3 NM



Art.: C900/4 BL



Art.: C9004 NM

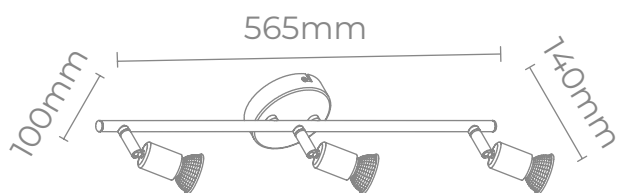

**Aplique
SUPER 3**

- 3xGU10, Max 40W, 220V, 50Hz, IP20
- Blanco mate, Niquel mate
- Chapa de acero
- Orientable
- Clase I

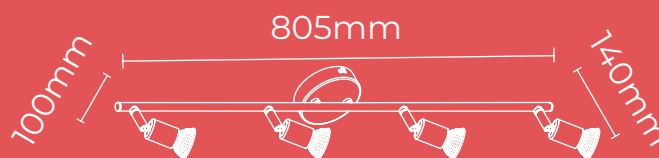

**Aplique
SUPER 4**

- 4xGU10, Max 50W, 220V, 50Hz, IP20
- Blanco mate, Niquel mate
- Chapa de acero
- Orientable
- Clase I

APLIQUE VULCANO



*Apliques GU10 de 1 a 3 luces
construidos en chapa de acero.*





Aplique
VULCANO 1
Art.: C950/1 CR



- 1xGU10, Max 40W, 220V, 50Hz, IP20
- Cromado
- Chapa de acero
- Orientable
- Clase I

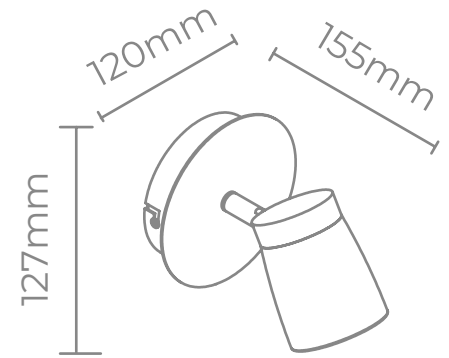

Con interruptor en base



Aplique
VULCANO 2
Art.: C950/2 CR



- 2xGU10, Max 40W, 220V, 50Hz, IP20
- Cromado
- Chapa de acero
- Orientable
- Clase I

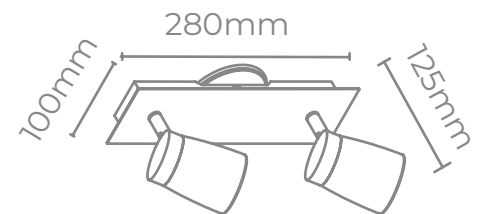

Aplique
VULCANO 3
Art.: C950/3 CR



- 3xGU10, Max 40W, 220V, 50Hz, IP20
- Cromado
- Chapa de acero
- Orientable
- Clase I

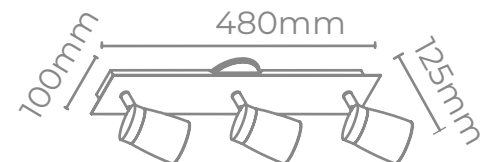

Aplique
VULCANO 3 REDONDO
Art.: C950/3R CR



- 3xGU10, Max 40W, 220V, 50Hz, IP20
- Cromado
- Chapa de acero
- Orientable
- Clase I

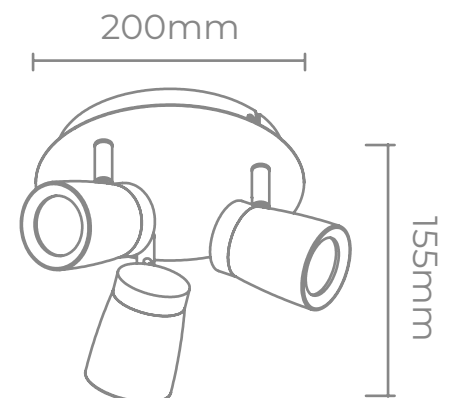

APLIQUE VISTRA





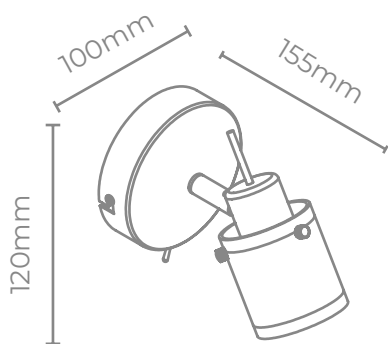

 Con interruptor en base



Aplique
VISTRA 1
Art.: C960/1





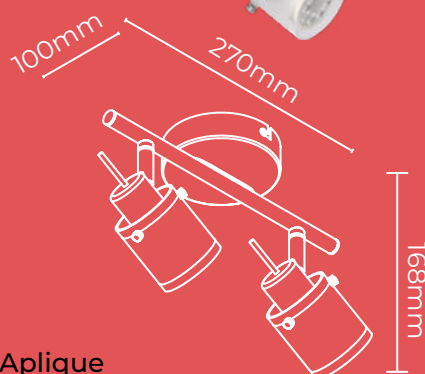

-  1xGU10, Max 50W, 220V, 50Hz, IP20
-  Platil, Negro mate
-  Chapa de acero
-  Orientable
-  Clase I



Aplique
VISTRA 2
Art.: C960/2







-  2xGU10, Max 50W, 220V, 50Hz, IP20
-  Platil, Negro mate
-  Chapa de acero
-  Orientable
-  Clase I

Apliques GU10 de 1 a 3 luces
construidos en chapa.



Aplique
VISTRA 3 LINEAL
Art.: C960/3





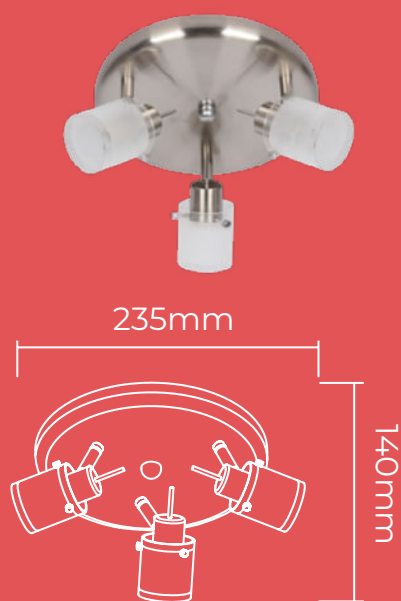

-  3xGU10, Max 50W, 220V, 50Hz, IP20
-  Platil, Negro mate
-  Chapa de acero
-  Orientable
-  Clase I



Aplique
VISTRA 3 REDONDO
Art.: C960/3R



-  3xGU10, Max 50W, 220V, 50Hz, IP20
-  Platil
-  Chapa de acero
-  Orientable
-  Clase I

APLIQUE LENORA



*Apliques E14 de 1 a 4 luces
construidos en chapa de acero.*

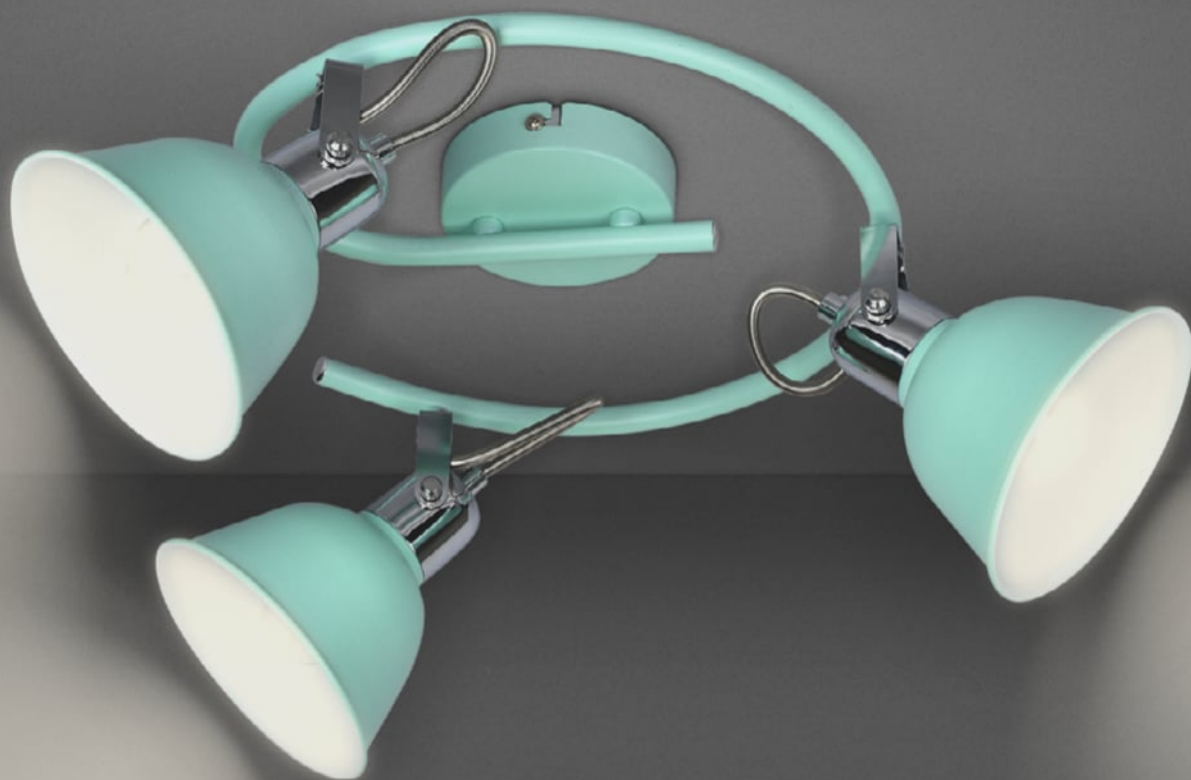







Aplique

LENORA 1

Art.: APE147341 V V



-  1xE14, Max 40W, 220V, 50Hz, IP20
-  Verde vintage
-  Chapa de acero
-  Orientable
-  Clase I

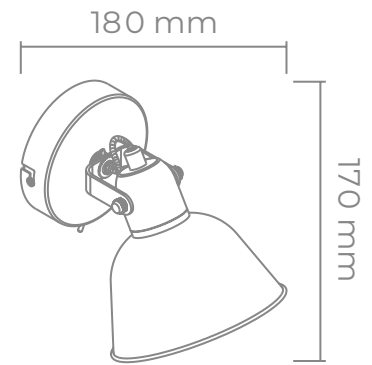





 Con interruptor en base



Aplique

LENORA 2

Art.: APE147342 V V

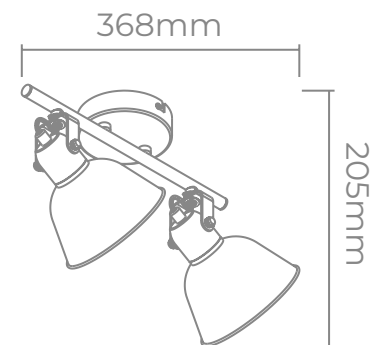

-  2xE14, Max 40W, 220V, 50Hz, IP20
-  Verde vintage
-  Chapa de acero
-  Orientable
-  Clase I







Aplique

LENORA 3

Art.: APE147343 V V



-  3xE14, Max 40W, 220V, 50Hz, IP20
-  Verde vintage
-  Chapa de acero
-  Orientable
-  Clase I

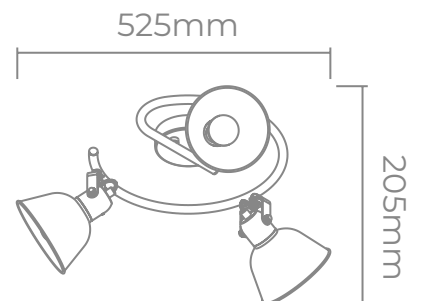





Aplique

LENORA 4

Art.: APE147344 V V



-  4xE14, Max 40W, 220V, 50Hz, IP20
-  Verde vintage
-  Chapa de acero
-  Orientable
-  Clase I

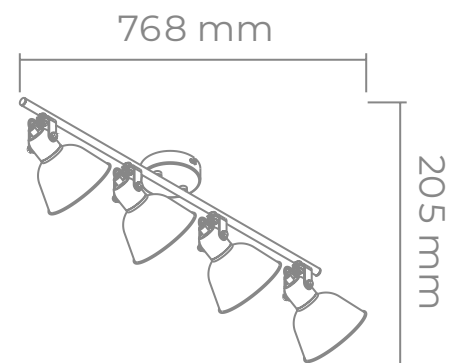



Art.: APE147341 NG ●



Art.: APE147341 BL ○



Art.: APE147342 NG ●





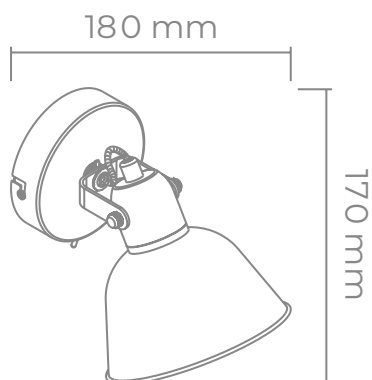

Art.: APE147341 BL ○

 Con interruptor en base





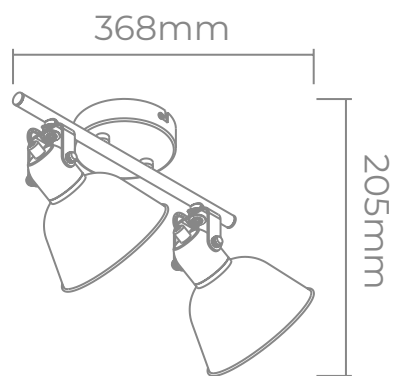

Aplique
LENORA 1

-  1xE14, Max 40W, 220V, 50Hz, IP20
-  Blanco mate, Negro mate
-  Chapa de acero
-  Orientable
-  Clase I



Aplique
LENORA 2

-  2xE14, Max 40W, 220V, 50Hz, IP20
-  Blanco mate, Negro mate
-  Chapa de acero
-  Orientable
-  Clase I



Art.: APE147343 NG



Art.: APE147343 BL



Art.: APE147344 NG



Art.: APE147344 BL

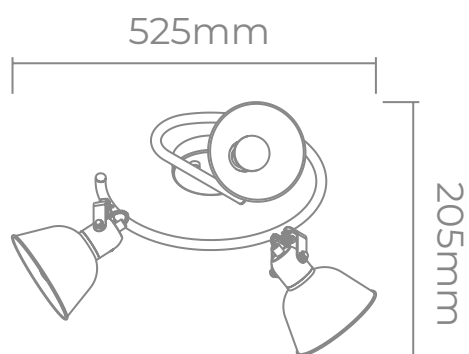

Aplique
LENORA 3

- 3xE14, Max 40W, 220V, 50Hz, IP20
- Blanco mate, Negro mate
- Chapa de acero
- Orientable
- Clase I

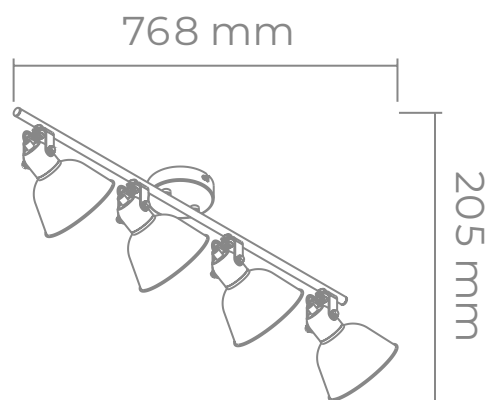

Aplique
LENORA 4

- 4xE14, Max 40W, 220V, 50Hz, IP20
- Blanco mate, Negro mate
- Chapa de acero
- Orientable
- Clase I

*Apliques E14 de 1 a 4 luces
construidos en chapa de acero.*



APLIQUE
NURIA

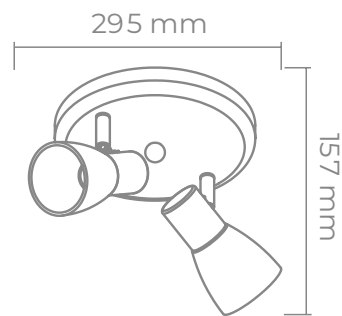

Aplique
NURIA 2 REDONDO
 Art.: APE143582P

- 2xE14, Max 40W, 220V, 50Hz, IP20
- Niquel mate
- Chapa de acero
- Orientable
- Clase I

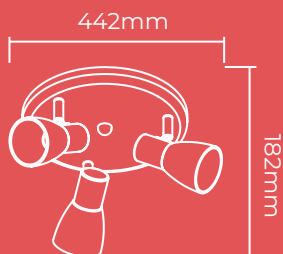

Aplique
NURIA 3 REDONDO
 Art.: APE143583P

- 3xE14, Max 40W, 220V, 50Hz, IP20
- Niquel mate
- Chapa de acero
- Orientable
- Clase I

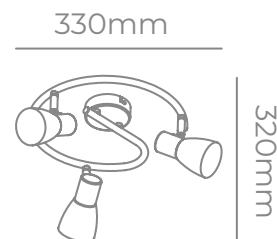

Aplique
NURIA 3 ESPIRAL
 Art.: APE143583E

- 3xE14, Max 40W, 220V, 50Hz, IP20
- Niquel mate
- Chapa de acero
- Orientable
- Clase I

APLIQUE NURIA





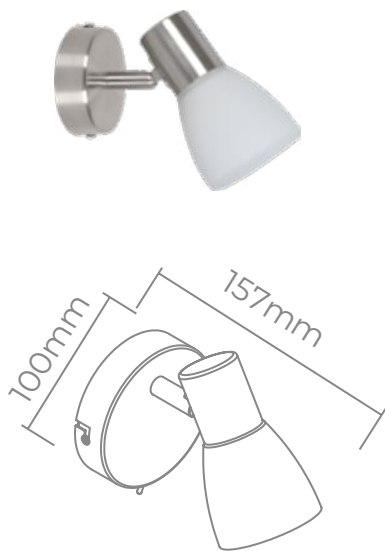

 Con interruptor en base



Aplique
NURIA 1
Art.: APE143581





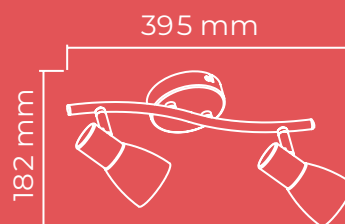

-  1xE14 Max 40W, 220V, 50Hz, IP20
-  Niquel mate
-  Chapa de acero
-  Orientable
-  Clase I



Aplique
NURIA 2 LINEAL
Art.: APE143582



-  2xE14, Max 40W, 220V, 50Hz, IP20
-  Niquel mate, Blanco mate, Negro mate
-  Chapa de acero
-  Orientable
-  Clase I







NOVEDAD

NOVEDAD

Aplique
NURIA 3 LINEAL
 Art.: APE143583







-  3xE14, Max 40W, 220V, 50Hz, IP20
-  Níquel mate, Blanco mate, Negro mate
-  Chapa de acero
-  Orientable
-  Clase I



Aplique
NURIA 4 LINEAL
 Art.: APE143584



-  4xE14, Max 40W, 220V, 50Hz, IP20
-  Níquel mate
-  Chapa de acero
-  Orientable
-  Clase I





APLIQUES DECO PARA G9

APLIQUE FIORE



*Apliques de 1, 2 y 4 luces para lámpara G9.
Base construida en chapa de acero.
Tulipas de vidrio con terminación opal.*



Aplique
FIORE 1
Art.: CG130100/1 BL







Aplique
FIORE 1
Art.: CG130100/1 NG

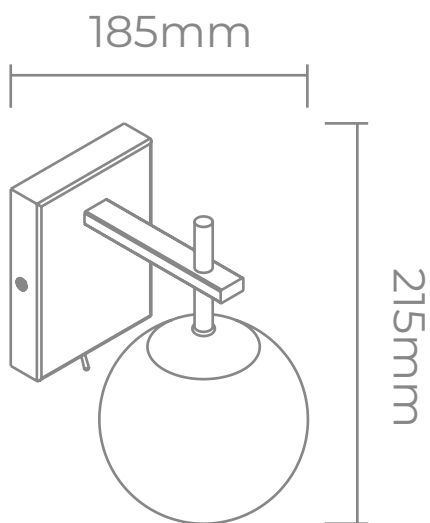

 Con interruptor en base



-  1xG9, Max 8W, 220V, 50Hz, IP20
-  Blanco mate, Negro mate
-  Chapa de acero
-  Fijo
-  Clase I

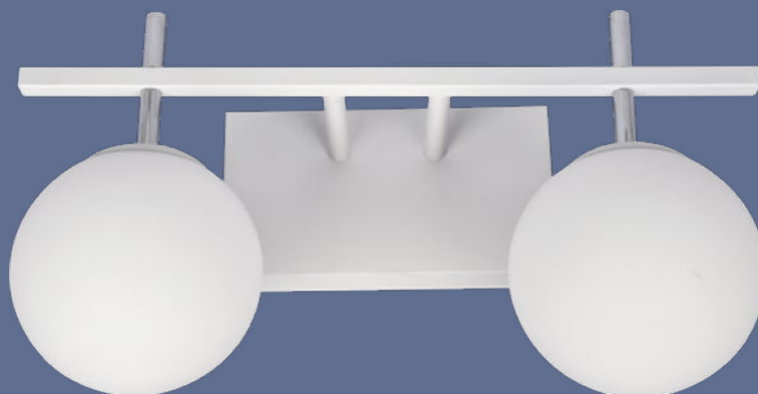





Aplique
FIORE 2
Art.: CG130100/2 BL

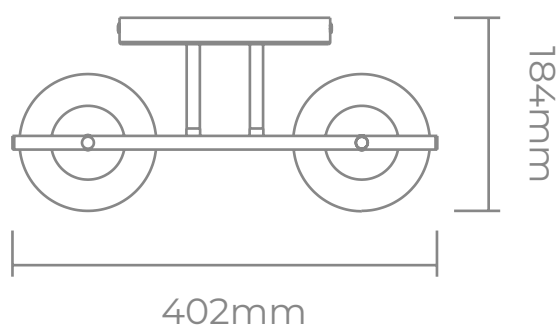

Aplique
FIORE 2
Art.: CG130100/2 NG



-  2xG9, Max 8W, 220V, 50Hz, IP20
-  Blanco mate, Negro mate
-  Chapa de acero
-  Fijo
-  Clase I

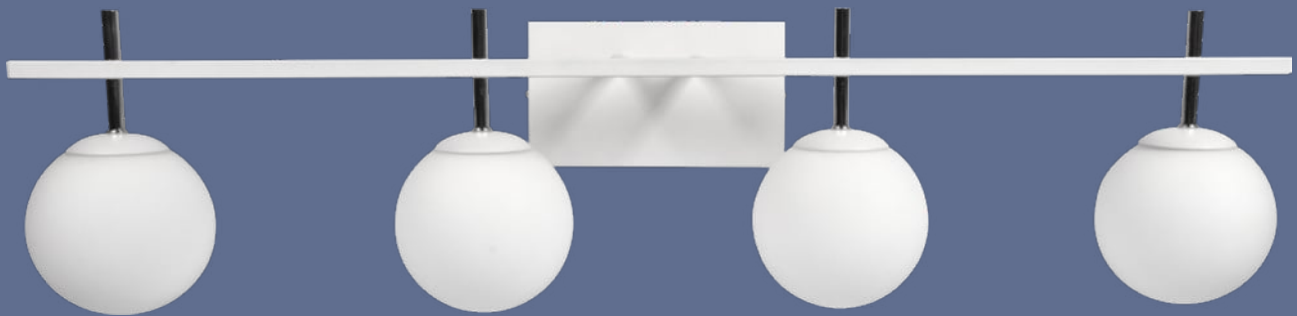

Aplique
FIORE 4
Art.: CG130100/4 BL

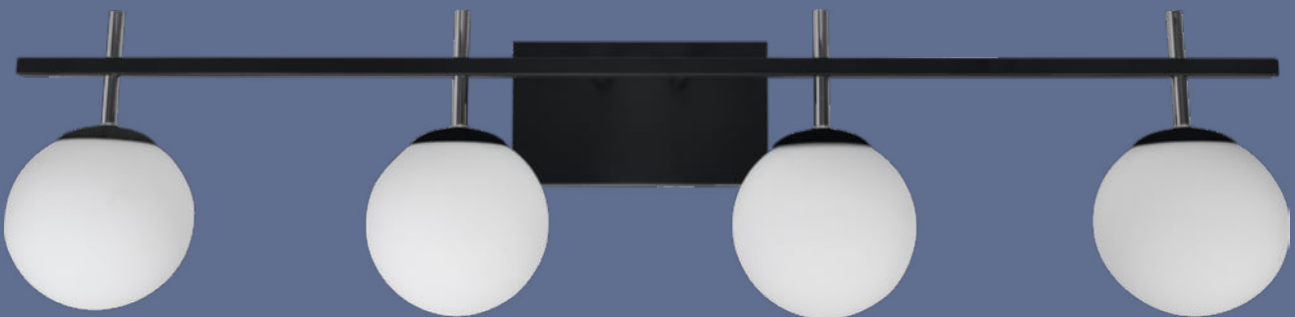



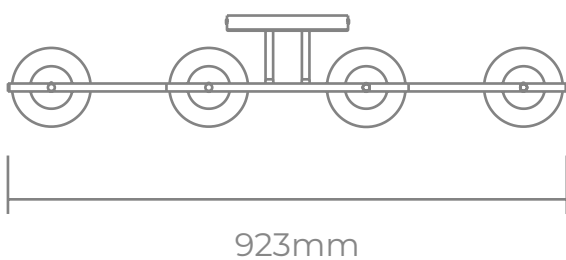

Aplique
FIORE 4
Art.: CG130100/4 NC



184mm

923mm

-  4xG9, Max 8W, 220V, 50Hz, IP20
-  Blanco mate, Negro mate
-  Chapa de acero
-  Fijo
-  Clase I

APLIQUE MICA





Apliques de 2 y 4 luces para lámpara C9, base construida en chapa de acero, tulipas de vidrio con terminación opal.





Aplique
MICA 2
Art.: CG130120/2 NG



 2xG9, Max 8W, 220V, 50Hz, IP20

 Negro mate

 Chapa de acero

 Fijo

 Clase I

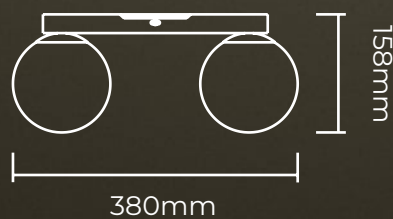

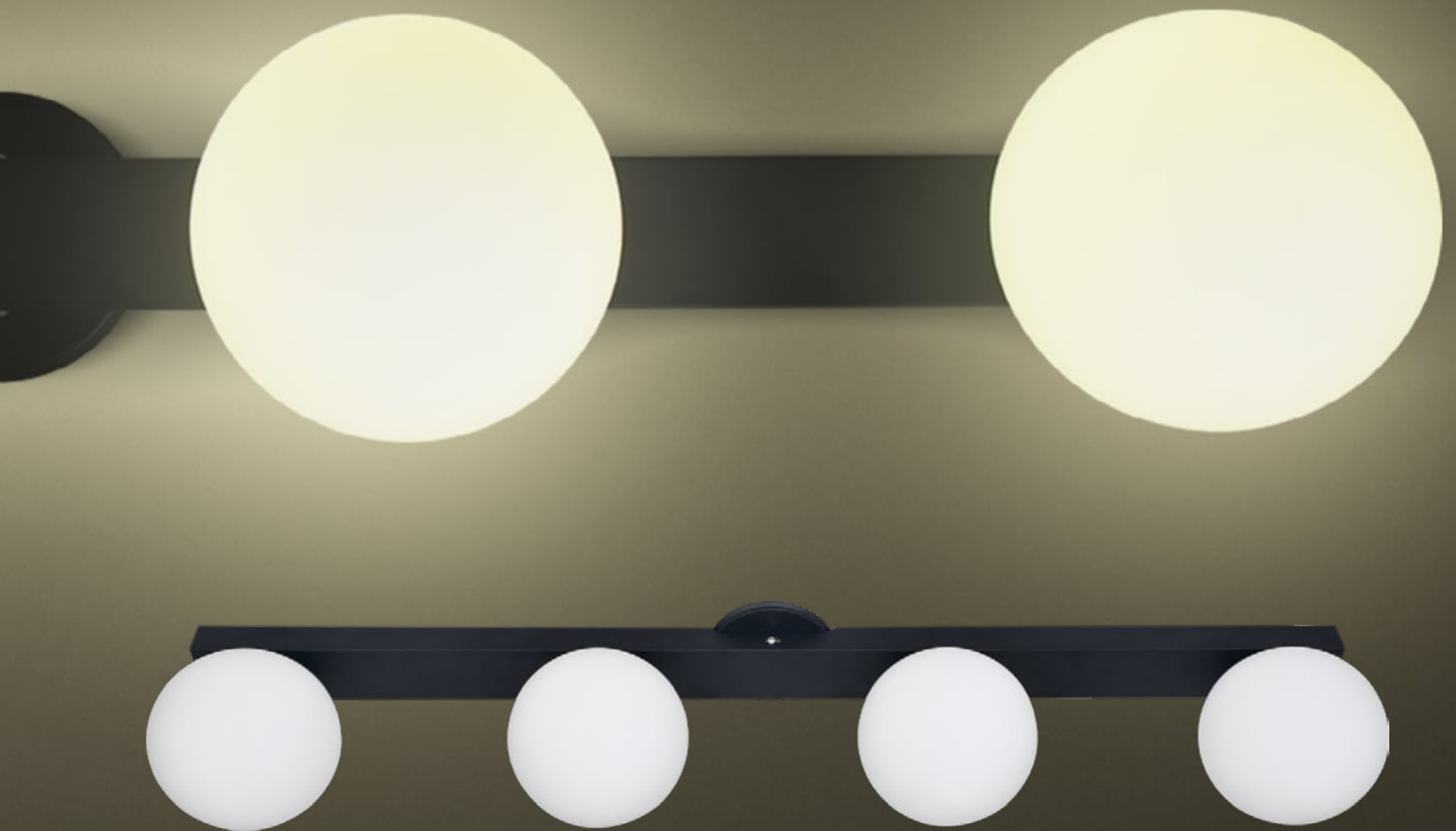



Aplique
MICA 4
Art.: CG130120/4 NG



 4xG9, Max 8W, 220V, 50Hz, IP20

 Negro mate

 Chapa de acero

 Fijo

 Clase I

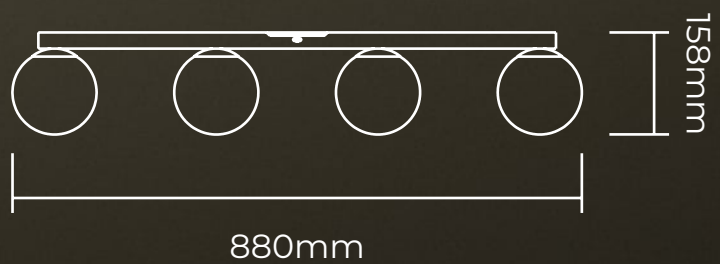

APLIQUE SENSEI

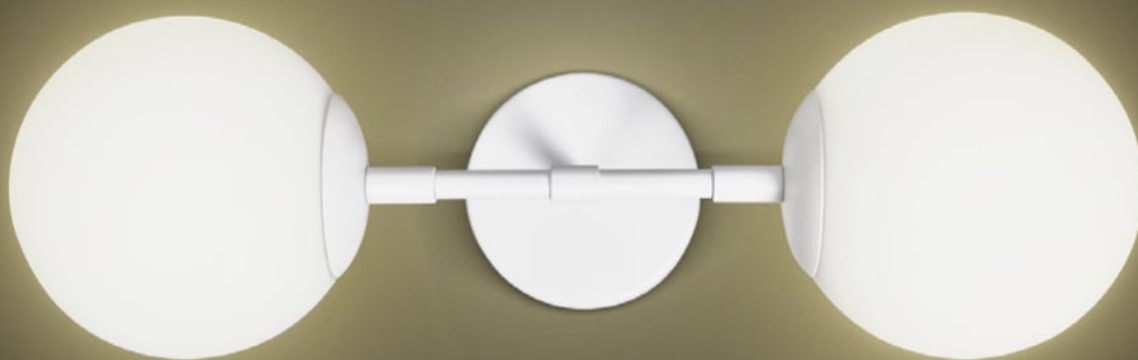

*Aplique para lámpara G9.
Base construida en chapa de acero.
Tulipas de vidrio con terminación opal.*

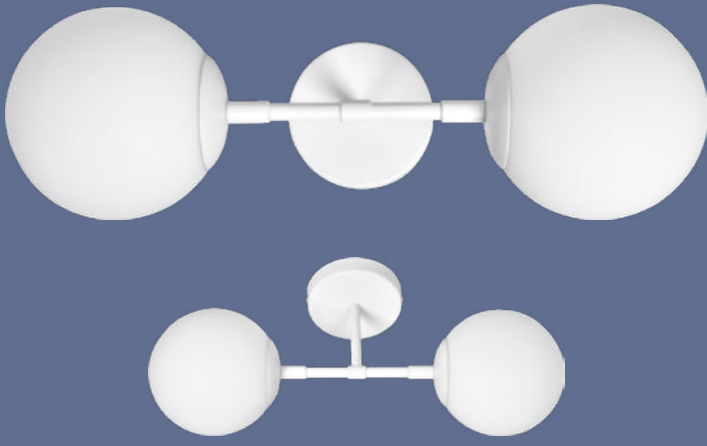



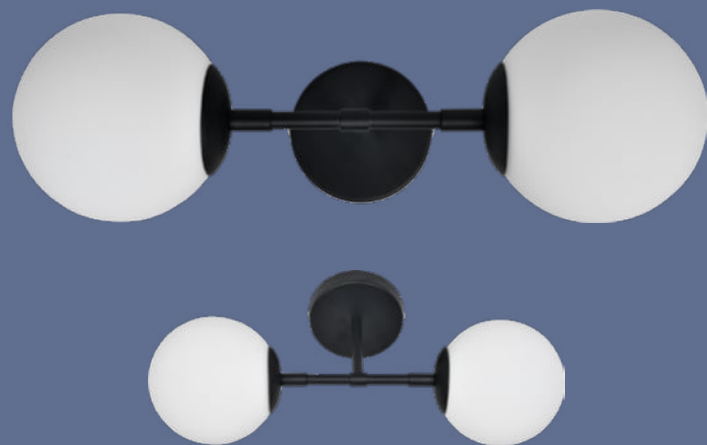

Aplique
SENSEI
Art.: CG130210/2 BL

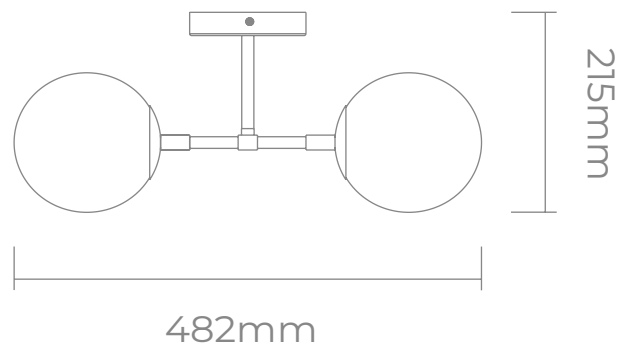

Aplique
SENSEI
Art.: CG130210/2 NG



-  2xG9, Max 8W, 220V, 50Hz, IP20
-  Blanco mate, Negro mate
-  Chapa de acero
-  Fijo
-  Clase I

APLIQUE SOLO



*Aplique para lámpara G9.
Base construida en chapa de acero.
Tulipas de vidrio con terminación opal.*

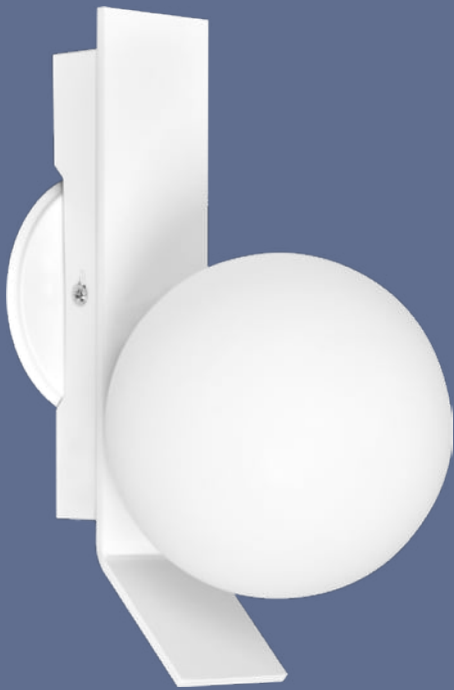





Aplique
SOLO
Art.: CG130300 BL

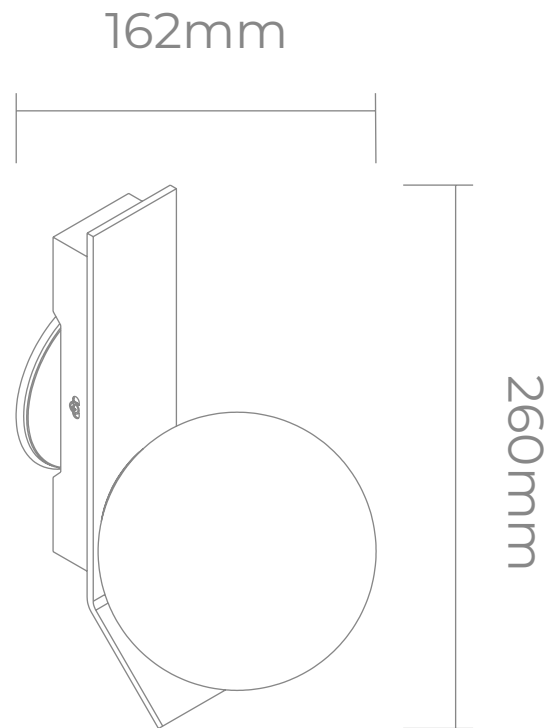

Aplique
SOLO
Art.: CG130300 NG



-  1xG9, Max 8W, 220V, 50Hz, IP20
-  Blanco mate, Negro mate
-  Chapa de acero
-  Fijo
-  Clase I

*Apliques G9 de 1 a 3 luces
construidos en chapa de
acero. Tulipas de vidrio con
terminación opal.*



APLIQUE BUDA

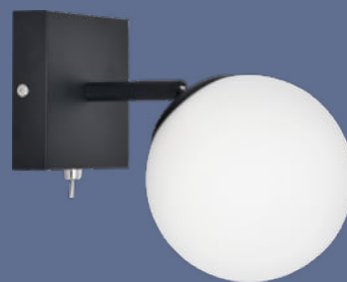

Aplique
BUDA 1
Art.: CG130400/1 NG

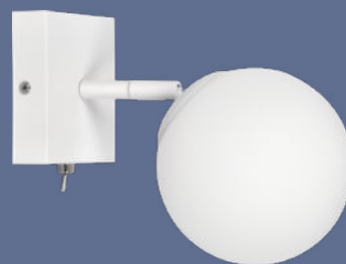







Aplique
BUDA 1
Art.: CG130400/1 BL

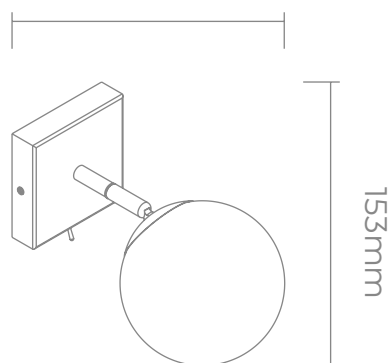

 Con interruptor en base

228mm



-  1xG9, Max 8W, 220V, 50Hz, IP20
-  Negro mate, Blanco mate
-  Chapa de acero
-  Orientable
-  Clase I



Aplique
BUDA 2
Art.: CG130400/2 NG ●



Aplique
BUDA 3
Art.: CG130400/3 NG ●



Aplique
BUDA 2
Art.: CG130400/2 BL ○



Aplique
BUDA 3
Art.: CG130400/3 BL ○

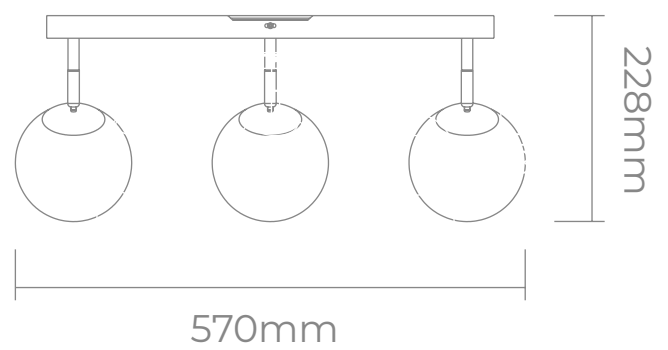
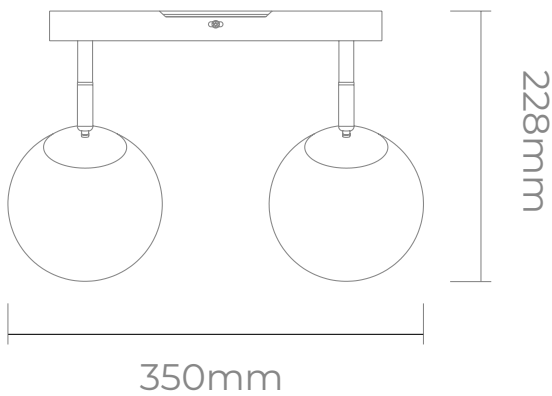

- 2xG9, Max 8W, 220V, 50Hz, IP20
- Negro mate, Blanco mate
- Chapa de acero
- Orientable
- Clase I

- 3xG9, Max 8W, 220V, 50Hz, IP20
- Negro mate, Blanco mate
- Chapa de acero
- Orientable
- Clase I



6



COLGANTES DECO *PARA E27*

COLGANTE CONCRET

Colgantes de 1 y 3 luces para lámpara E27, construido en chapa de acero.





Colgante
CONCRET 1
Art.: CCT70129/1 NG





 1xE27, Max 15W, 220V, 50Hz, IP20



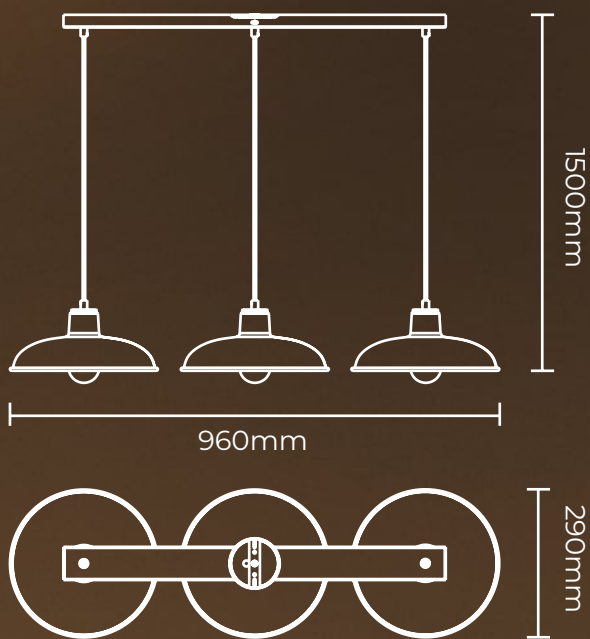

 Negro mate+Oro antiguo



 Chapa de acero

 Clase II



Colgante
CONCRET 3
Art.: CCT70129/3 NG  

-  3xE27, Max 15W, 220V, 50Hz, IP20
-  Negro mate+Oro antiguo
-  Chapa de acero
-  Clase II

  Negro mate + Oro antiguo



COLGANTE SOVIET I



*Colgante para lámpara E27 construido
en chapa de acero.*







Colgante
SOVIET I
Art.: CCT9500A NG

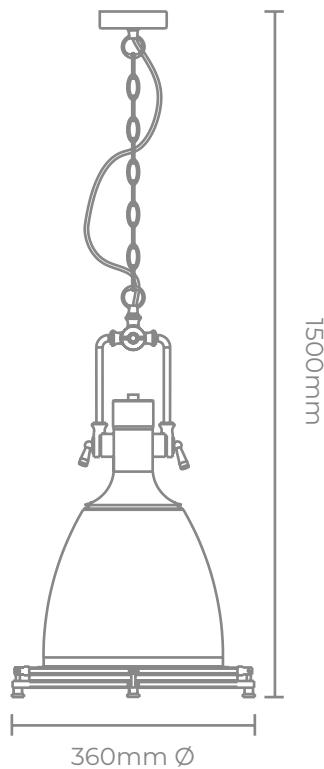

Colgante
SOVIET I
Art.: CCT9500A BL



-  1xE27, Max 15W, 220V, 50Hz, IP20
-  Negro mate, Blanco mate
-  Chapa de acero
-  Clase II

COLGANTE SOVIET II



Colgante para lámpara E27, construido en chapa de acero.









Colgante
SOVIET II
Art.: CCT9500B NG

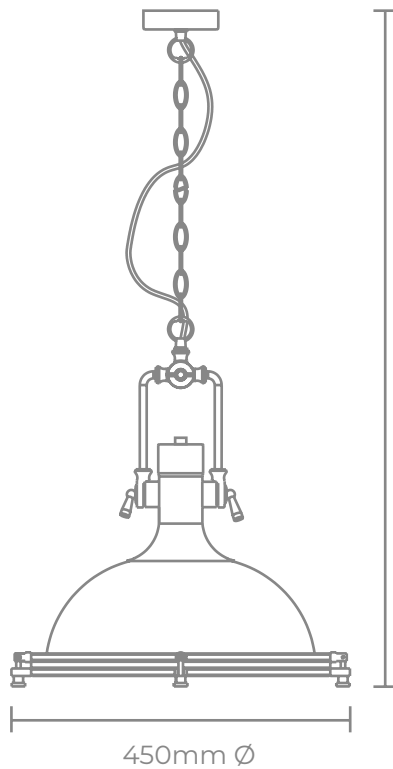

Colgante
SOVIET II
Art.: CCT9500B BL



-  1xE27, Max 15W, 220V, 50Hz, IP20
-  Negro mate, Blanco mate
-  Chapa de acero
-  Clase II

COLGANTE GALEÓN



Colgante para lámpara E27 construido en chapa de acero.

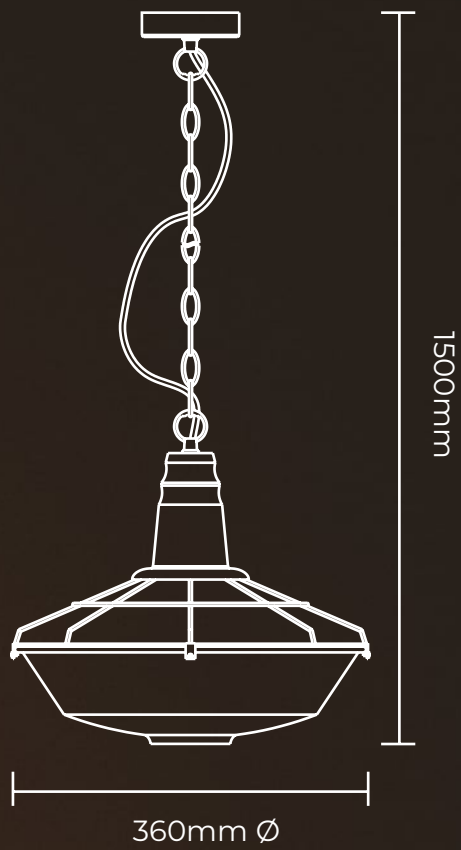

Colgante

GALEÓN

Art.: CCT70535 NG



 1xE27, Max 15W, 220V, 50Hz, IP20

 Negro mate

 Chapa de acero

 Clase II

COLGANTE GOLETA 30



*Colgante para lámpara E27 construido
en chapa de acero.*

CAJA MASTER



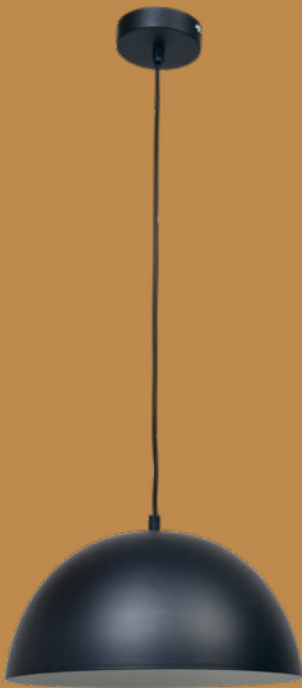

Colgante
GOLETA 30
Art.: CCT71030 NG

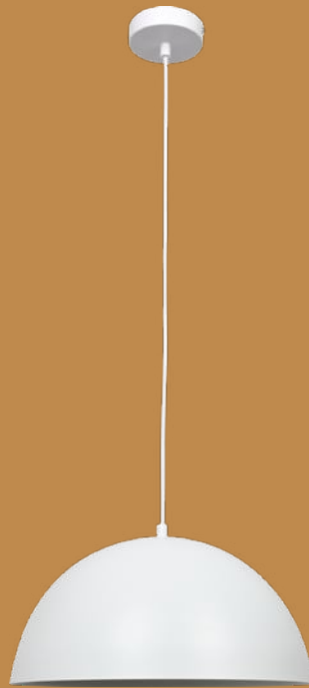



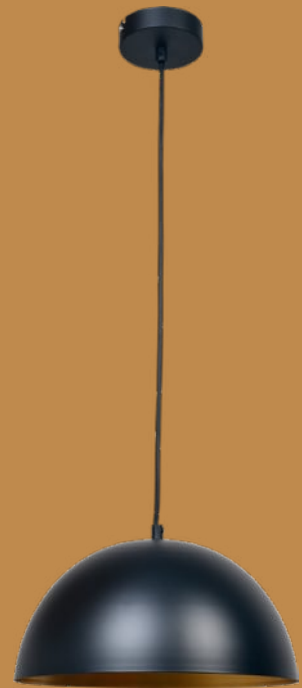

Colgante
GOLETA 30
Art.: CCT71030 BL

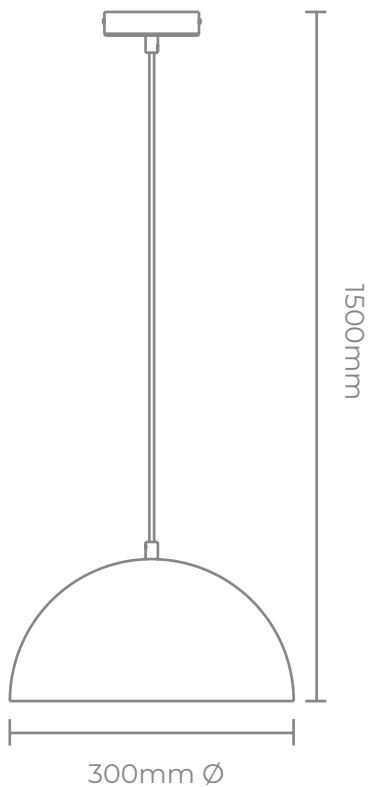

Colgante
GOLETA 30
Art.: CCT71030 NG-OA



-  1xE27, Max 15W, 220V, 50Hz, IP20
-  Negro mate, Blanco mate, Negro mate+Oro Antiguo
-  Chapa de acero
-  Clase II

COLGANTE GOLETA 35



Colgante para lámpara E27 construido en chapa de acero.

CAJA MASTER



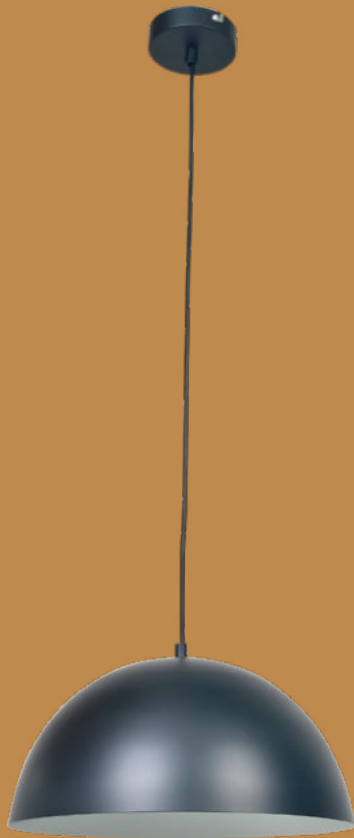



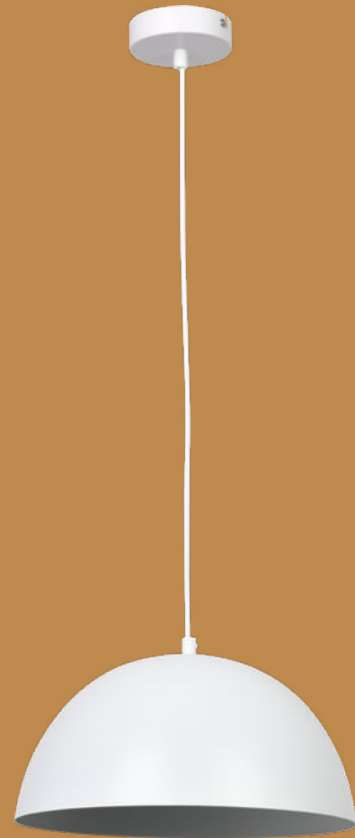

Colgante
COLETA 35
Art.: CCT71035 NG

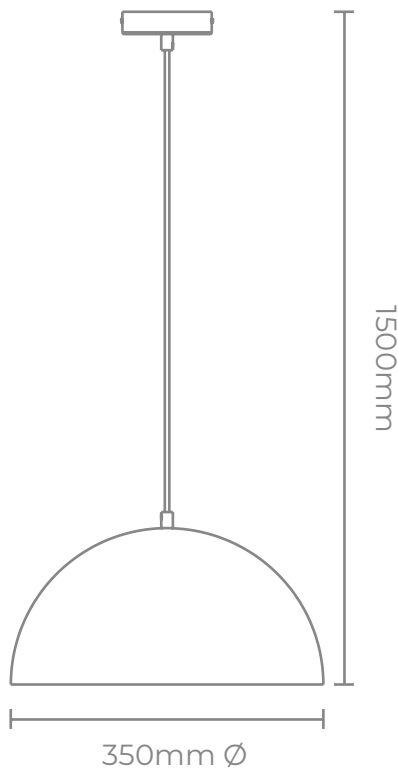

Colgante
COLETA 35
Art.: CCT71035 BL



-  1xE27, Max 15W, 220V, 50Hz, IP20
-  Negro mate, Blanco mate
-  Chapa de acero
-  Clase II



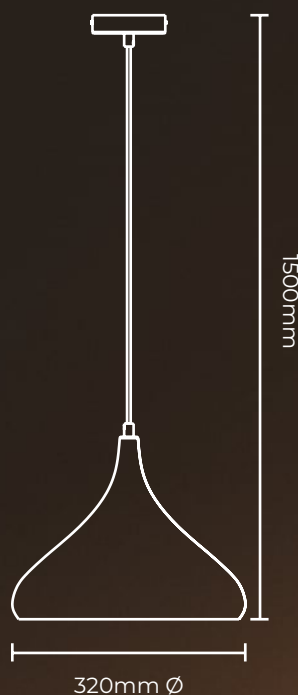

COLGANTE CORBETA 32



Colgante CORBETA 32

Art.: CCT71532 NG-OA



-  1xE27, Max 15W, 220V, 50Hz, IP20
-  Negro mate+Oro antiguo
-  Chapa de acero
-  Clase II

CAJA MASTER



*Colgante para lámpara E27
construido en chapa de
acero.*

COLGANTE CORBETA 42

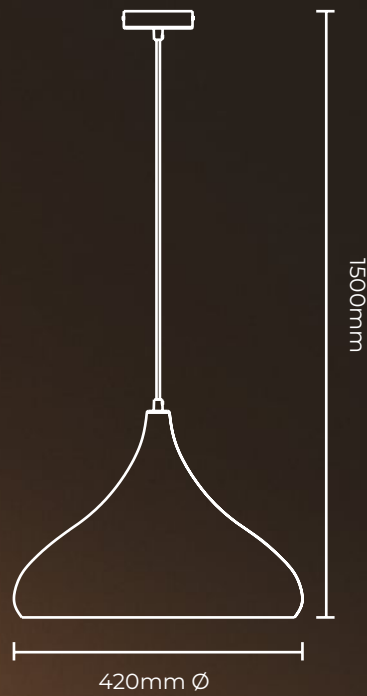

Colgante

CORBETA 42

Art.: CCT71542 NG-OA



1xE27, Max 15W, 220V, 50Hz, IP20

Negro mate+Oro antiguo

Chapa de acero

Clase II

CAJA MASTER





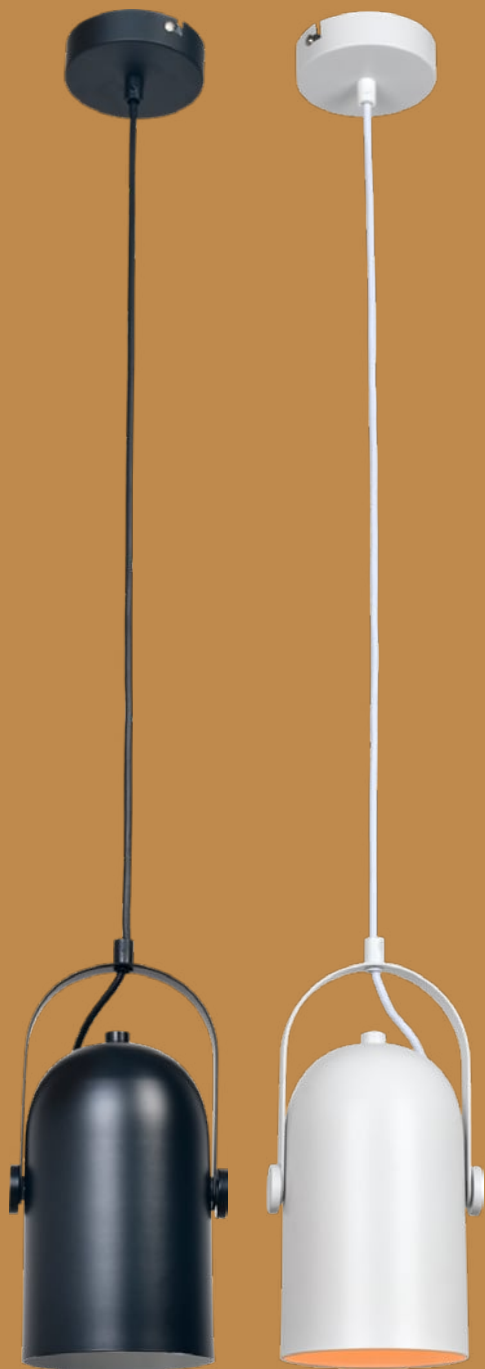

*Colgante para lámpara E27
construido en chapa de
acero.*

COLGANTE MICRO



Colgante
MICRO
Art.: CCT7808



-  1xE27, Max 15W, 220V, 50Hz, IP20
-  Negro mate, Blanco
-  Chapa de acero
-  Clase II

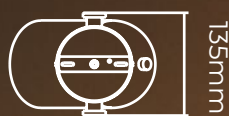
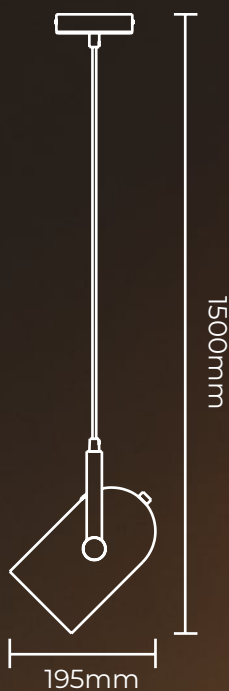

*Colgante para lámpara E27
construido en chapa de acero.*

COLGANTE MEGA



Colgante para lámpara E27
construido en chapa de acero.

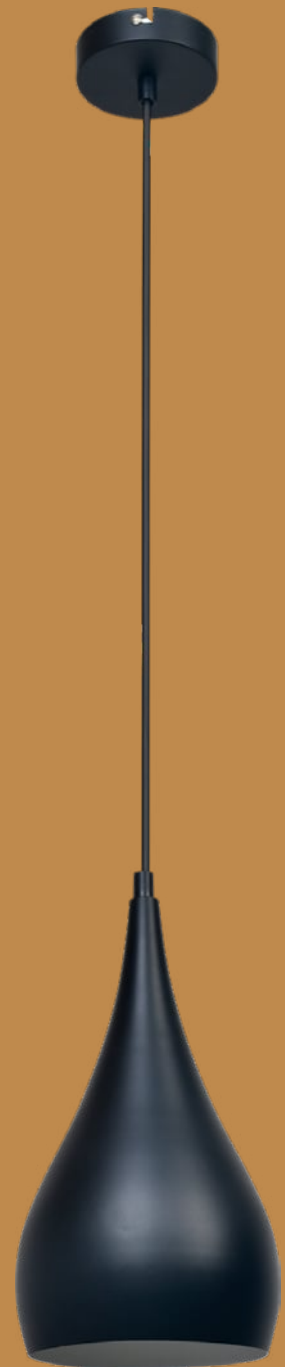
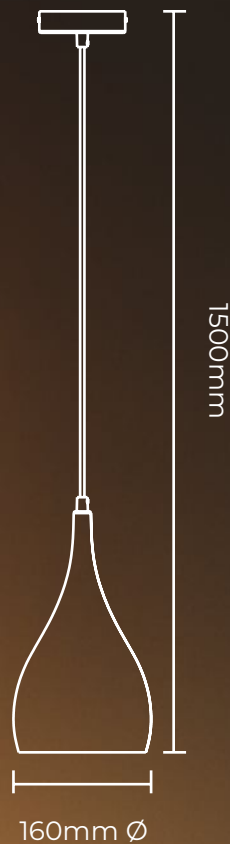





Colgante

MEGA

Art.: CCT72516 NG





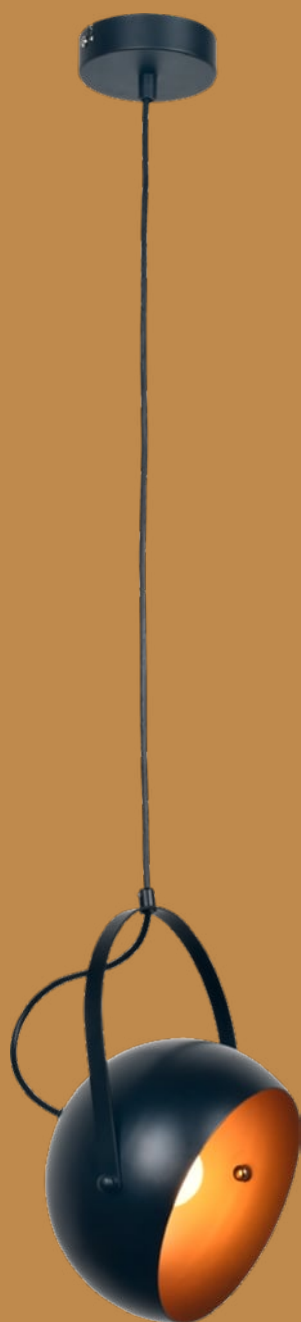

-  1xE27, Max 15W, 220V, 50Hz, IP20
-  Negro mate
-  Chapa de acero
-  Clase II

COLGANTE ARYPA



Colgante
ARYPA
Art.: CCT77018 NG



-  1xE27, Max 15W, 220V, 50Hz, IP20
-  Negro mate
-  Chapa de acero
-  Clase II

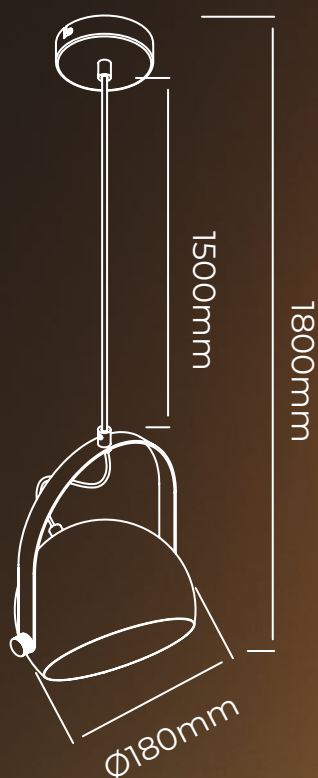

*Colgante para lámpara E27
construido en chapa de acero.*

COLGANTE PRIUS

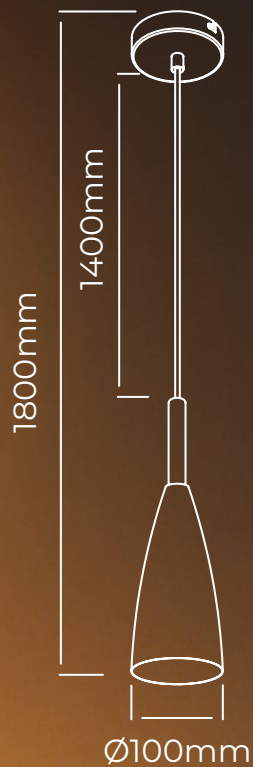



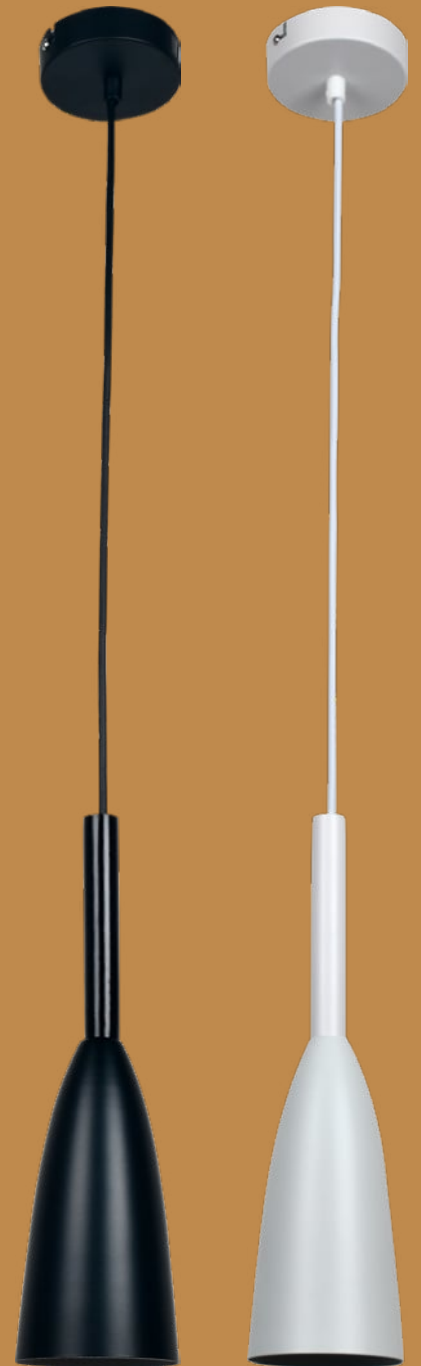

Colgante para lámpara E27
construido en chapa de acero.



Colgante
PRIUS
Art.: CCT72516



-  1xE27, Max 15W, 220V, 50Hz, IP20
-  Negro mate, Blanco
-  Chapa de acero
-  Clase II

COLGANTE FACETA



Colgante facetado para lámpara E27 construido en chapa de acero.

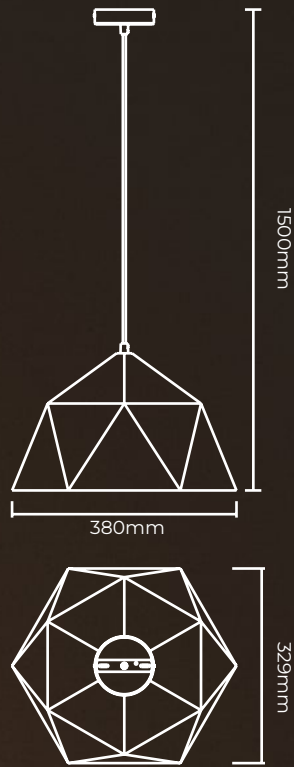

Colgante

FACETA

Art.: CCT73038 NG-OA



- 1xE27, Max 15W, 220V, 50Hz, IP20
- Negro mate+Oro antiguo
- Chapa de acero
- Clase II

CAJA MASTER



COLGANTE JIRÓN



Colgante para lámpara E27 construido en chapa de acero.

CAJA MASTER



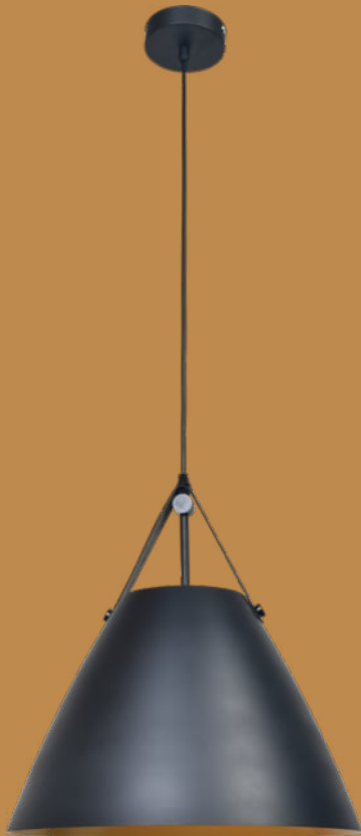



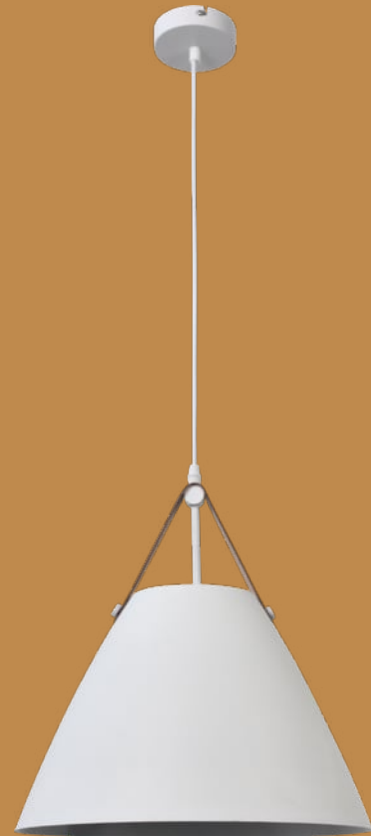

Colgante
JIRÓN
Art.: CCT74035 NG-OA

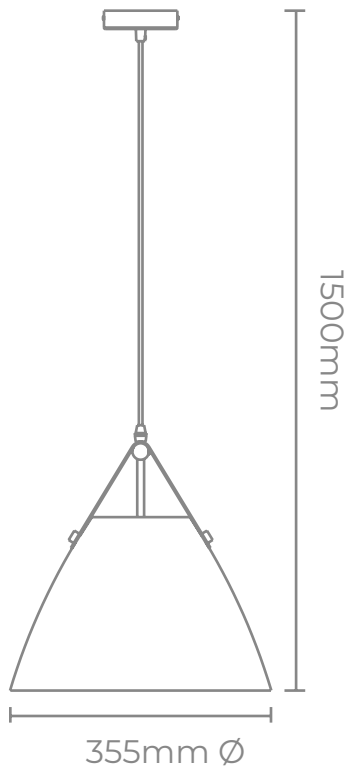

Colgante
JIRÓN
Art.: CCT74035 BL



-  1xE27, Max 15W, 220V, 50Hz, IP20
-  Negro mate+Oro antiguo, Blanco mate+Plata
-  Chapa de acero
-  Clase II

COLGANTE PILUSO



Colgante para lámpara E27 construido en chapa de acero.

CAJA MASTER





Colgante
PILUSO



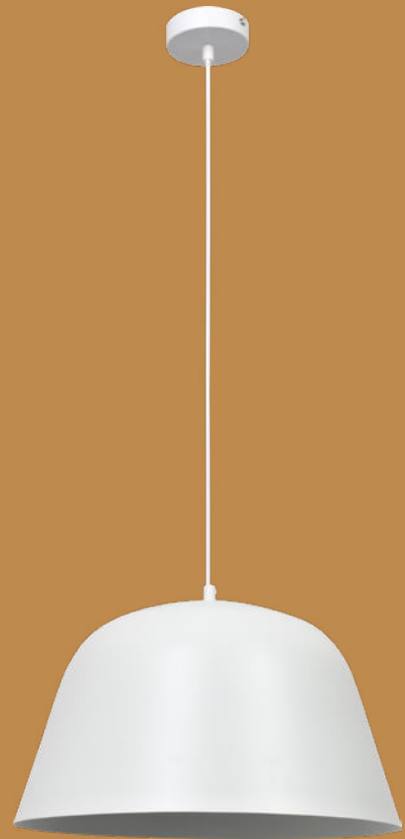

Art.: CCT75040 NG+OA

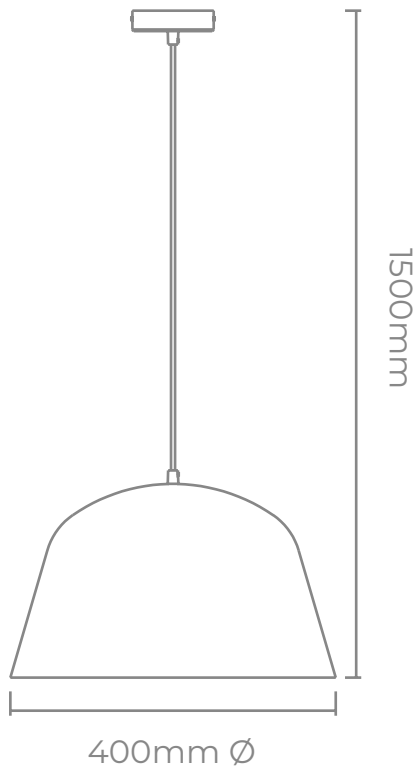

Colgante
PILUSO

Art.: CCT75040 BL



-  1xE27, Max 15W, 220V, 50Hz, IP20
-  Negro mate+Oro antiguo, Blanco mate
-  Chapa de acero
-  Clase II

COLGANTE CHIN



Colgante para lámpara E27 construido en chapa de acero.



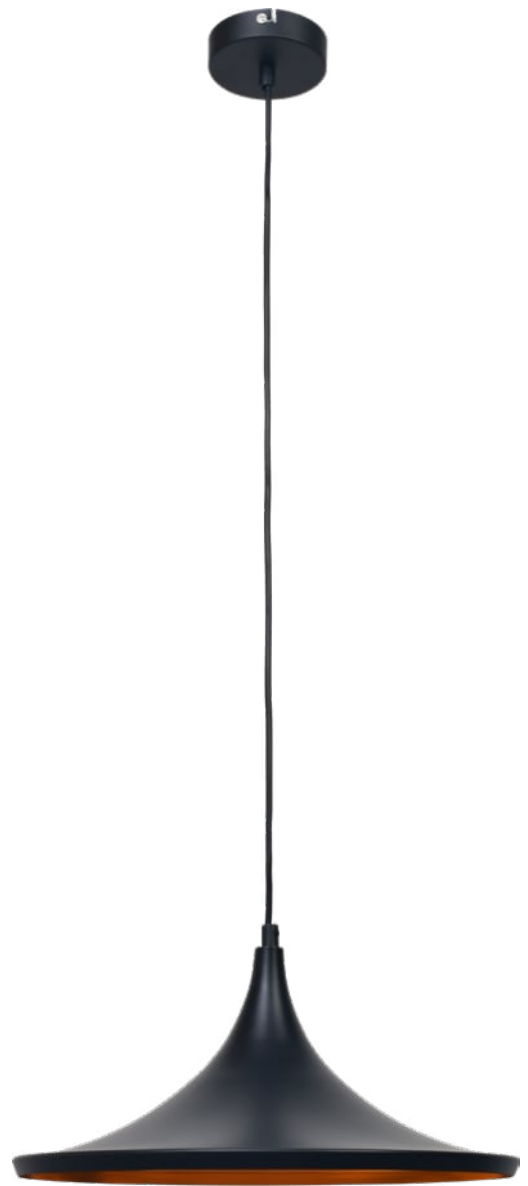
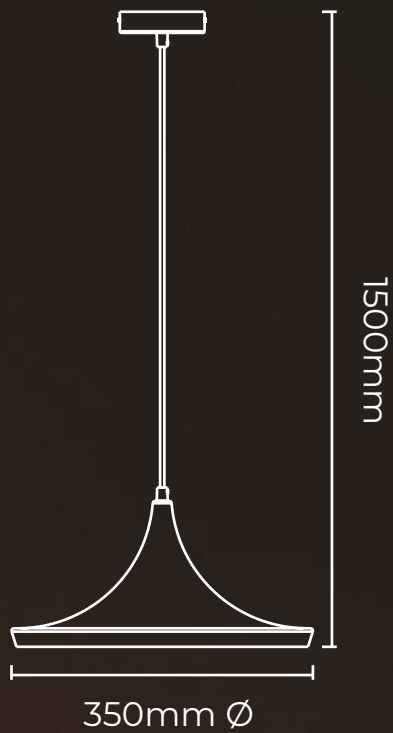



Colgante

CHIN

Art.: CCT76036 NG-OA



 1xE27, Max 15W, 220V, 50Hz, IP20

 Negro mate+Oro antiguo

 Chapa de acero

 Clase II

CAJA MASTER



COLGANTE BEBE

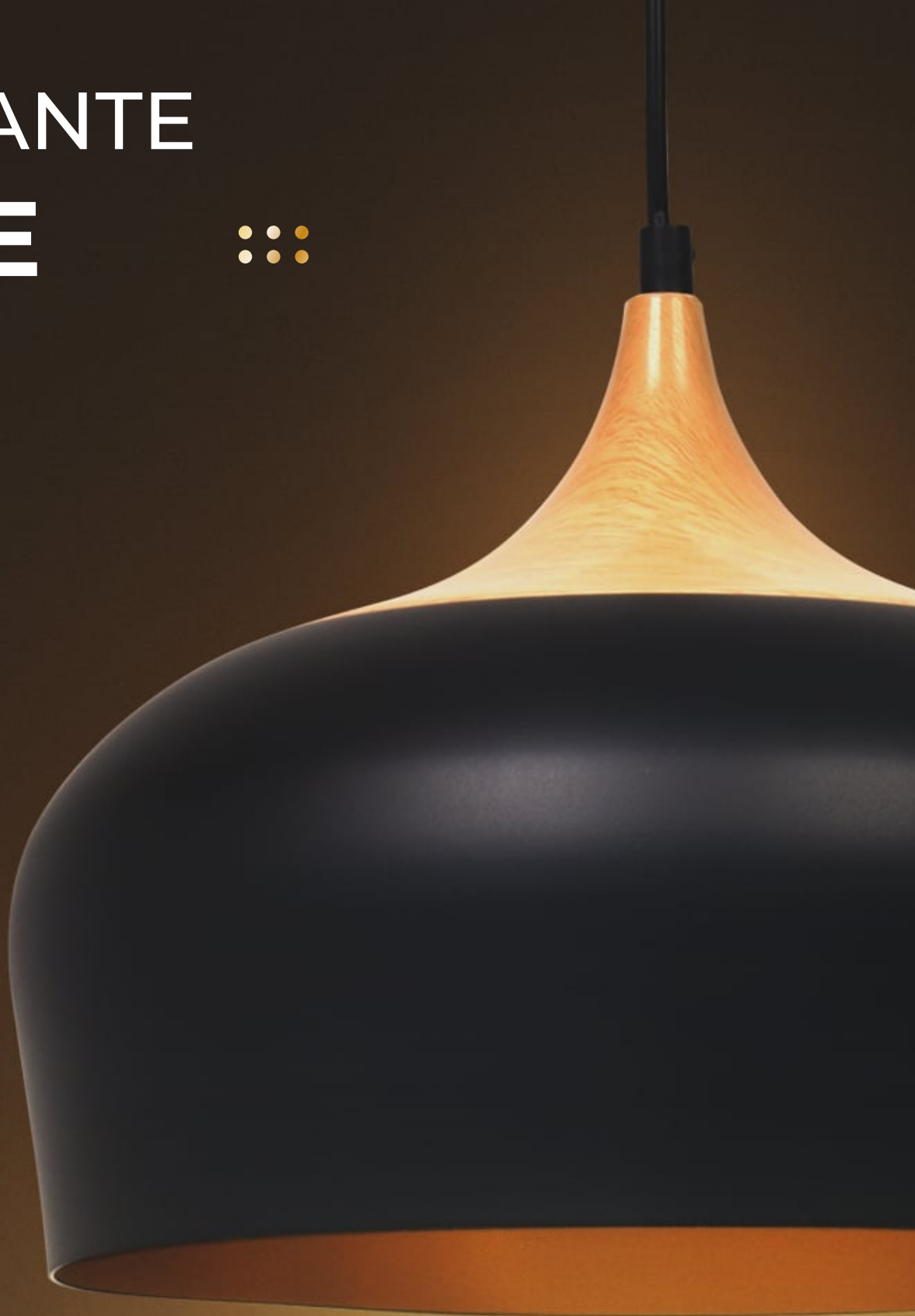

Colgante para lámpara E27 construido en chapa de acero.

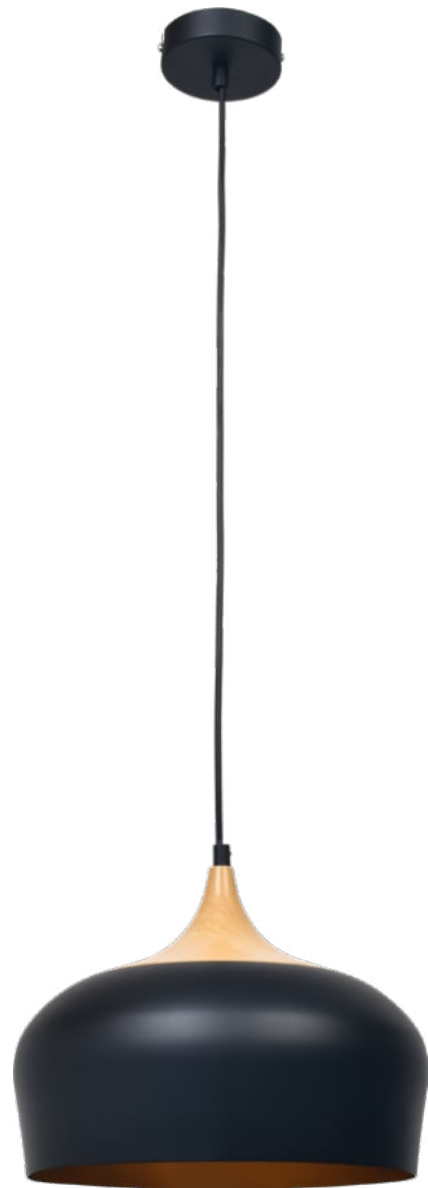
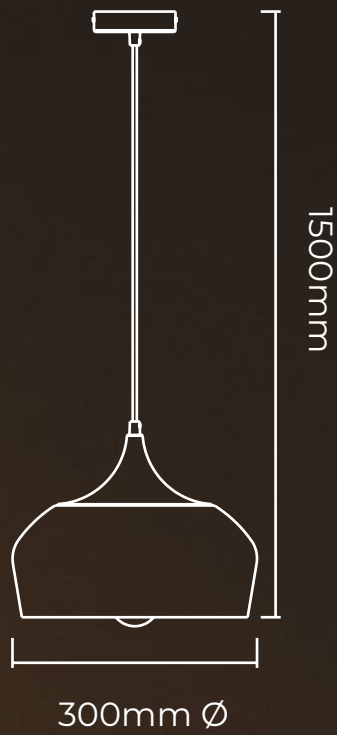

Colgante

BEBE

Art.: CCT76532 NG-OA



1xE27, Max 15W, 220V, 50Hz, IP20



Negro mate+Oro antiguo



Chapa de acero



Clase II



Negro mate + Oro antiguo



COLGANTE CORONA 6 ::::

Colgante de 6 luces para lámpara E27 construido en chapa de acero.

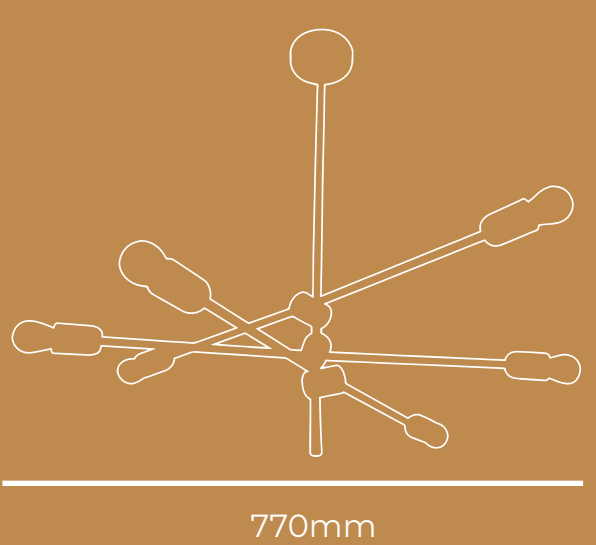





785mm

770mm

Colgante
CORONA 6
Art.: PT894006



-  6xE27, Max 12W, 220V, 50Hz, IP20
-  Negro mate, Bronce mate
-  Chapa de acero
-  Clase I

COLGANTE DEPOT





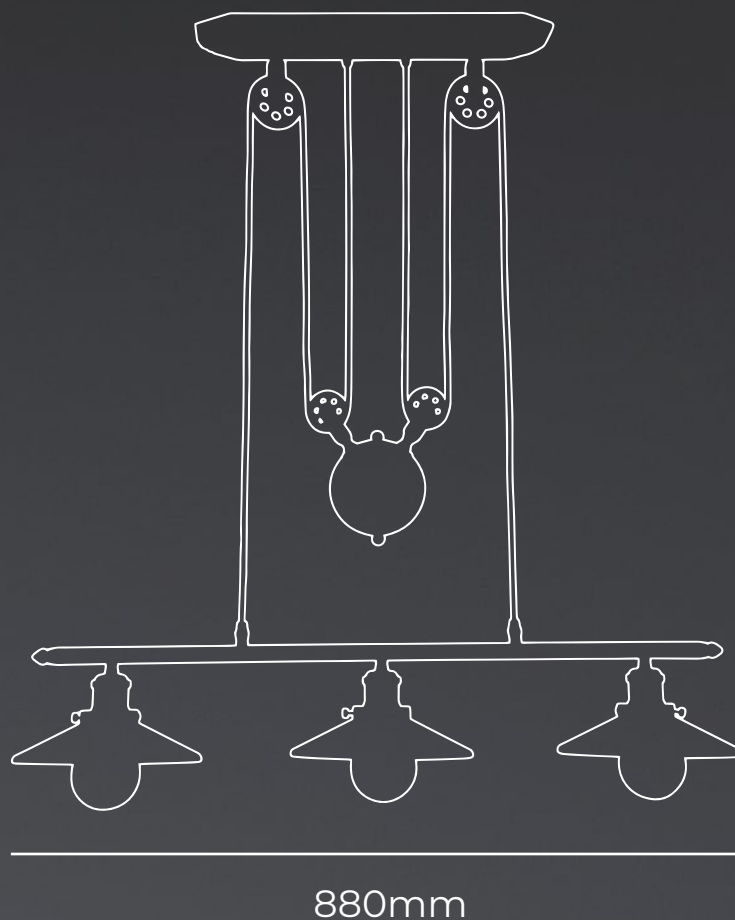
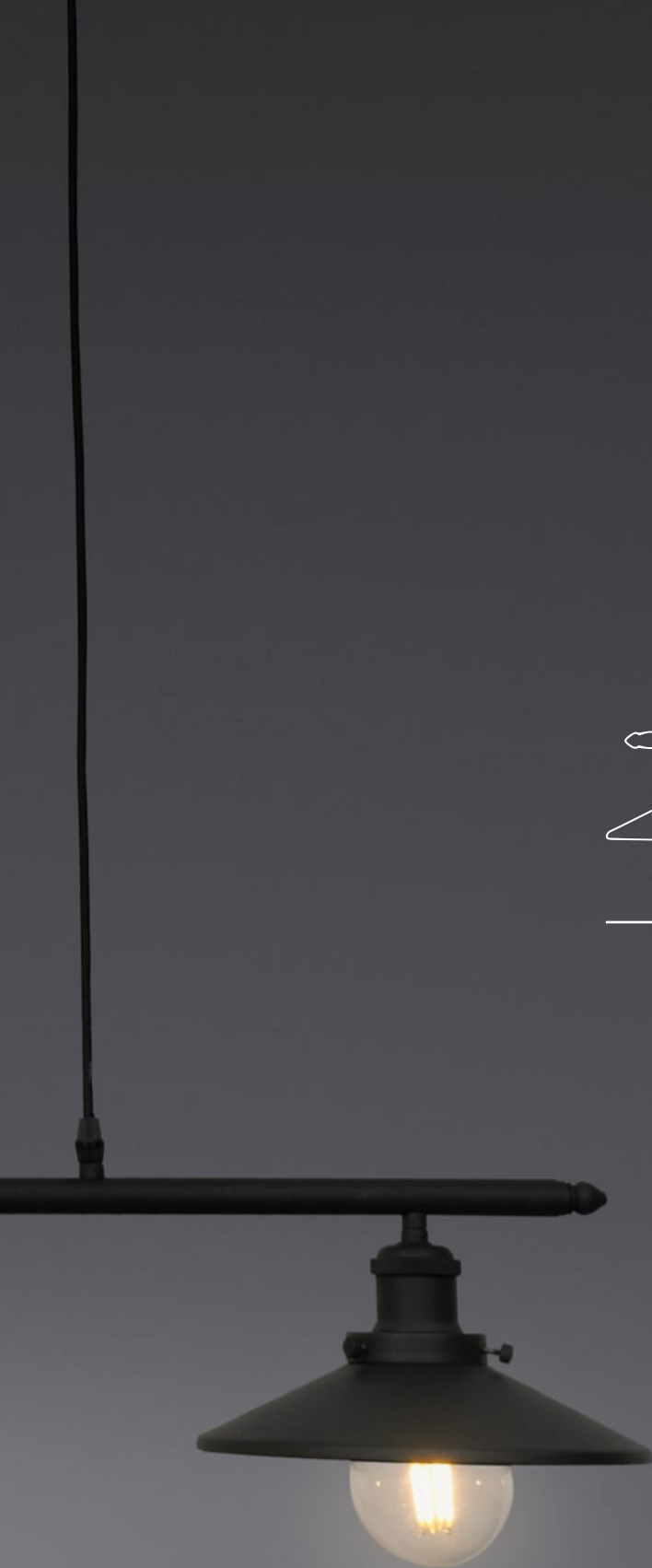

*Colgante de 3 luces para lámpara E27
construido en chapa de acero.*





Colgante
DEPOT
Art.: PT912003



-  3xE27, Max 12W, 220V, 50Hz, IP20
-  Negro mate
-  Chapa de acero
-  Clase I





COLGANTES Y PLAFONES DECO PARA G9

Colgantes G9 de 2 a 4 luces
construidos en chapa de
acero. Tulipas de vidrio con
terminación opal.

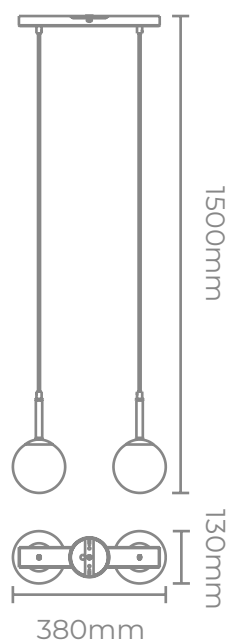
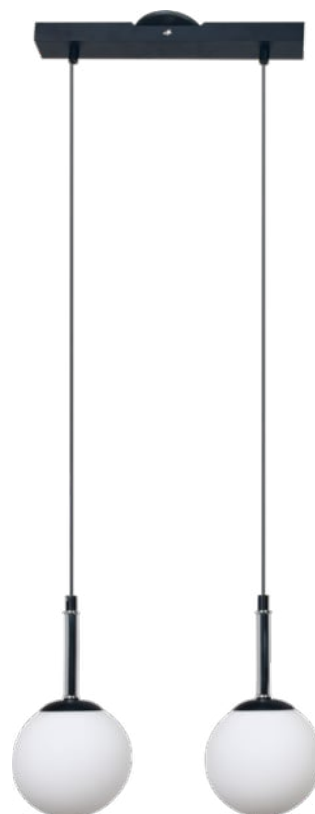

COLGANTE CIRO







Colgante

CIRO 2





Art.: CG130150/2 NG

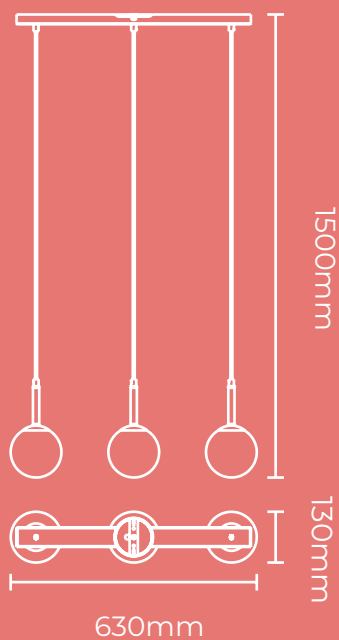
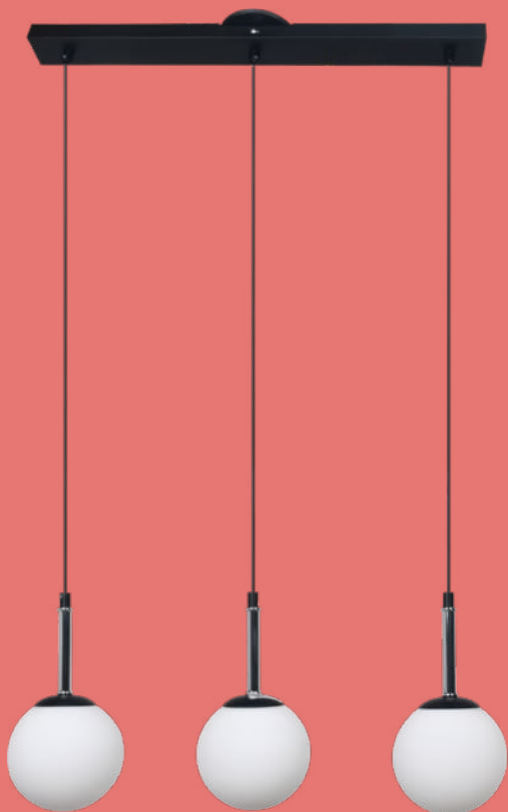

-  2xG9, Max 8W, 220V, 50Hz, IP20
-  Negro mate
-  Chapa de acero
-  Orientable
-  Clase I





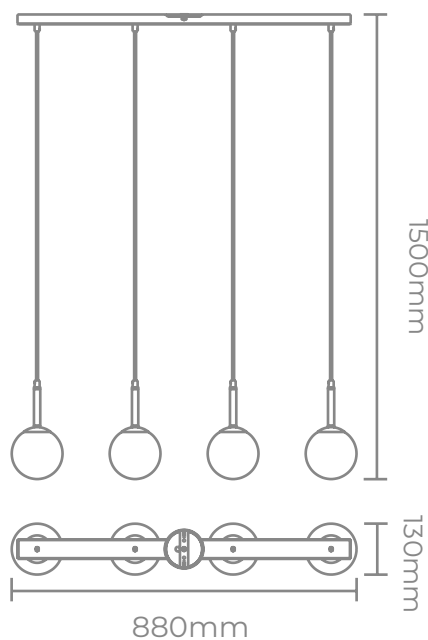

Colgante
CIRO 3
 Art.: CG130150/3 NG

-  3xG9, Max 8W, 220V, 50Hz, IP20
-  Negro mate
-  Chapa de acero
-  Orientable
-  Clase I



Colgante
CIRO 4
 Art.: CG130150/4 NG

-  4xG9, Max 8W, 220V, 50Hz, IP20
-  Negro mate
-  Chapa de acero
-  Orientable
-  Clase I

PLAFÓN BALL 10





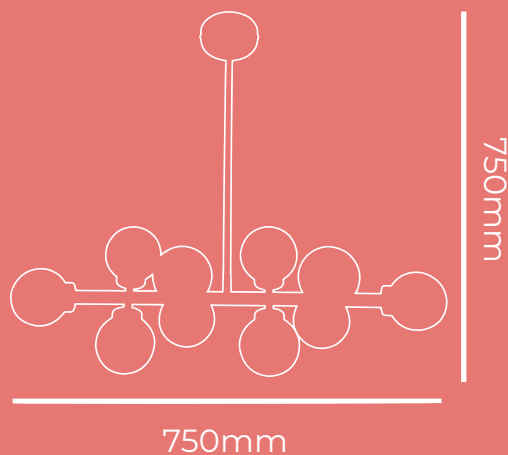

Plafón de 10 luces para lámpara G9 construido en chapa de acero.



Plafón
BALL 10
Art.: PT907010



-  10xG9, Max 12W, 220V, 50Hz, IP20
-  Bronce
-  Chapa de acero
-  Clase I

PLAFÓN BALL 12



Plafón de 12 luces para lámpara G9 construido en chapa de acero.

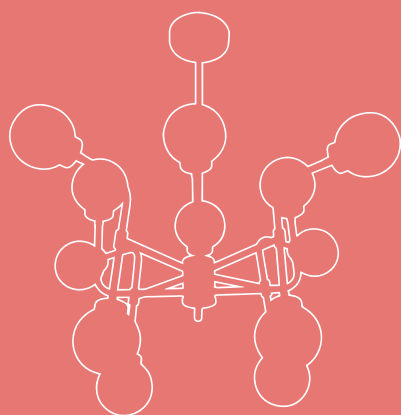





754mm

804mm

Plafón
BALL 12
Art.: PT907012



-  12xG9, Max 12W, 220V, 50Hz, IP20
-  Bronce
-  Chapa de acero
-  Clase I

PLAFÓN BALL COLOR NEGRO



*Plafones de 5, 9 y 10 luces para lámpara G9
construidos en chapa de acero.*

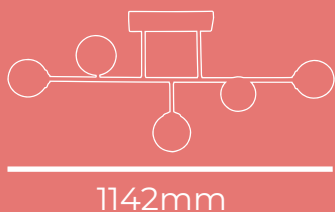

515mm

1142mm

Plafón

BALL 5

Art.: PT907005



 5xG9, Max 12W, 220V, 50Hz, IP20

 Negro texturado

 Chapa de acero

 Clase I

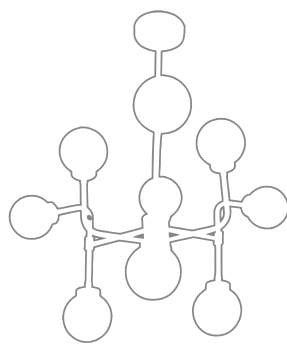

726mm

673mm

Plafón

BALL 9

Art.: PT907009



 9xG9, Max 12W, 220V, 50Hz, IP20

 Negro texturado

 Chapa de acero

 Clase I

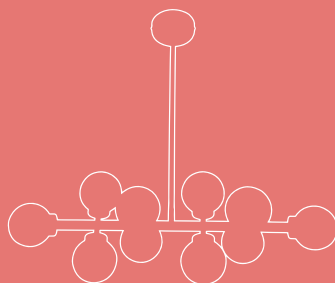
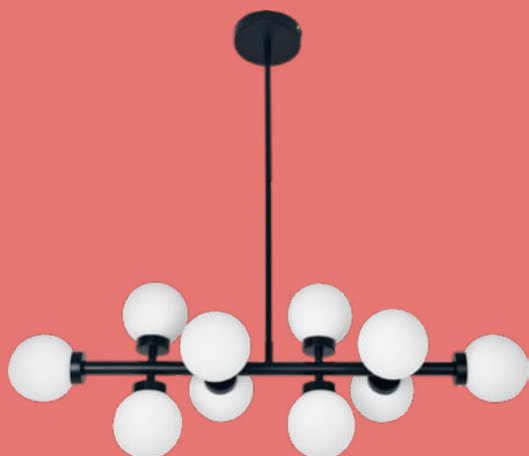

750mm

750mm

Plafón

BALL 10

Art.: PT907010



 10xG9, Max 12W, 220V, 50Hz, IP20

 Negro texturado

 Chapa de acero

 Clase I





COLGANTES Y PLAFONES HIGH DECO LED

PLAFÓN ALEC 40



*Plafón LED de 23W luz cálida,
construido en metal. Difusor de acrílico.*

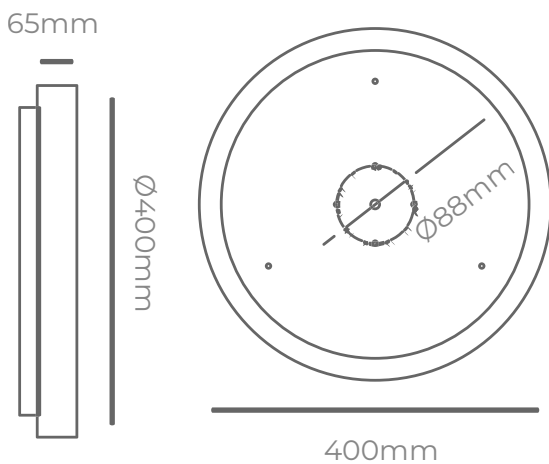
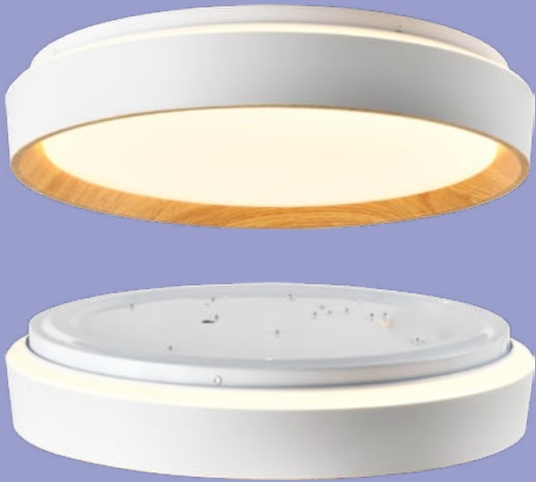

Plafón

ALEC 40

Art.: PTL1230406523



LED 23W, 220V, 50Hz, IP20



Blanco + Madera clara, Negro + Madera oscura



3000K



2070LM



Metal + Acrílico



Clase I



No dimerizable

DRIVER DE REPUESTO
DISPONIBLE

LF-GIR024YS0550H

PLAFÓN ALEC 50



*Plafón LED de 35W luz cálida,
construido en metal. Difusor de acrílico.*

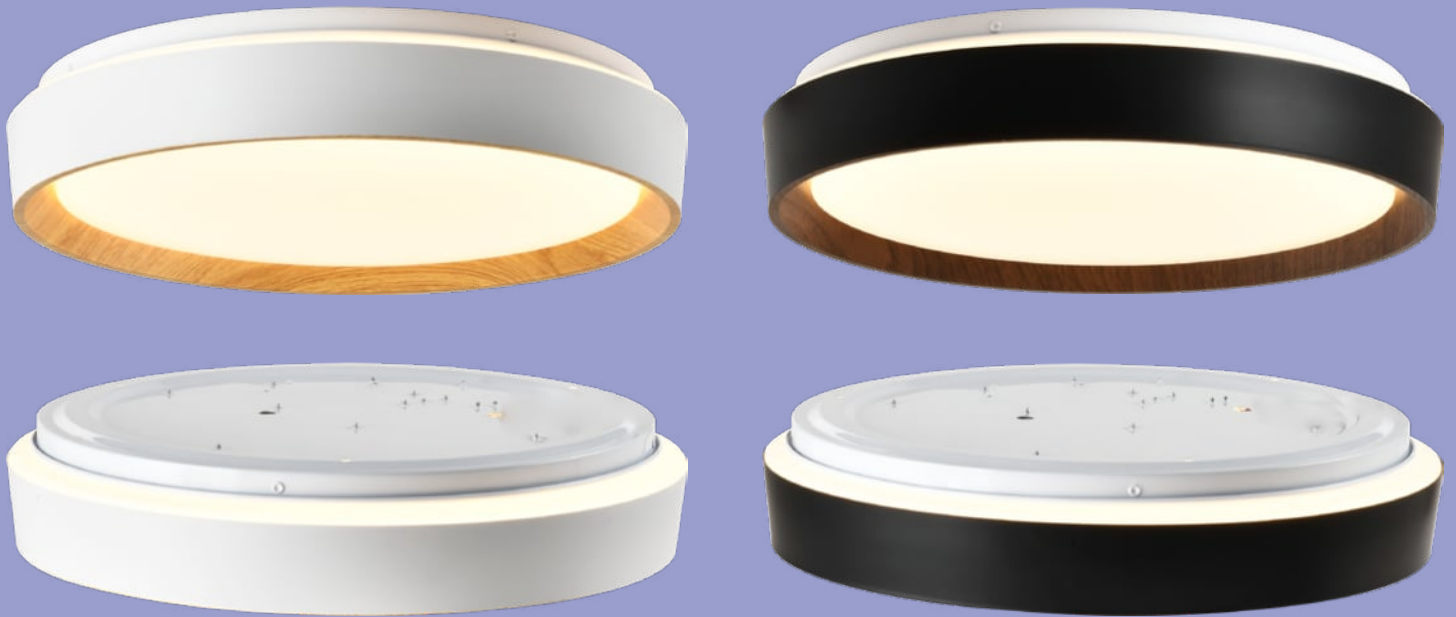

Plafón

ALEC 50

Art.: PTL1240506535

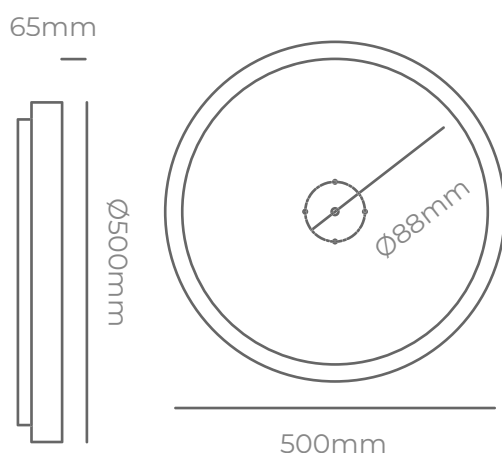

LED 35W, 220V, 50Hz, IP20

Blanco + Madera clara, Negro + Madera oscura

3000K

3150LM

Metal + Acrílico

Clase I

No dimerizable

DRIVER DE REPUESTO
DISPONIBLE

LF-GIF040YS0800H

PLAFÓN MARC ::::

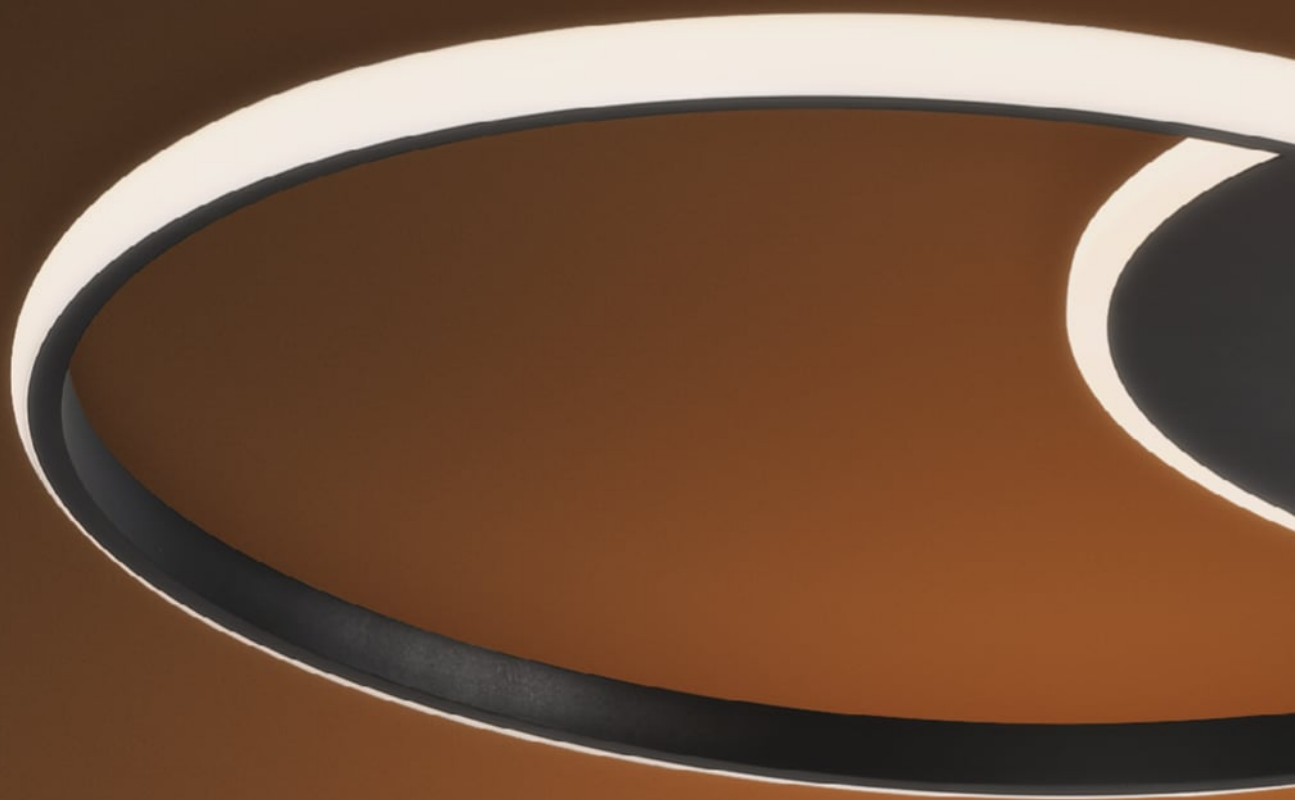



*Plafón LED de 30W luz cálida,
construido en metal y acrílico.*

Plafón
MARC

Art.: PTL1256456030



 LED 30W, 220V, 50Hz, IP20

 Blanco mate, Negro mate

 3000K

 2700LM

 Metal + Acrílico

 Clase I

 No dimerizable

DRIVER DE REPUESTO
DISPONIBLE

LF-GIF030YS0750H

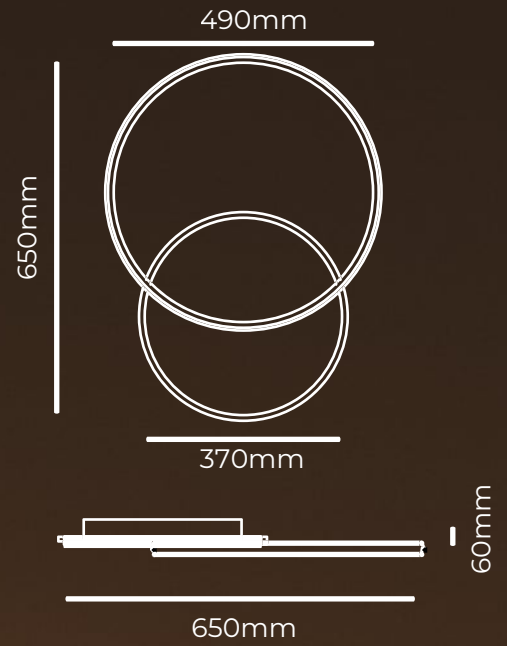

 Blanco mate

 Negro mate

PLAFÓN ADONIS

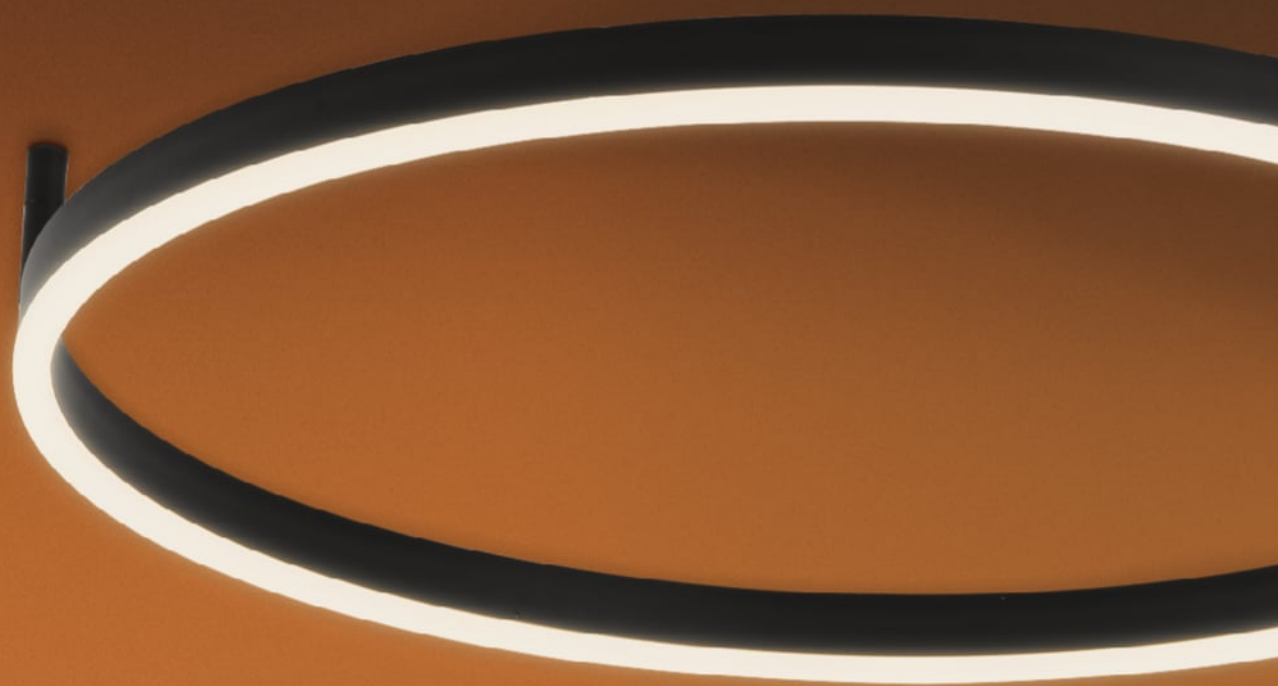

*Plafón LED de 50W luz cálida,
construido en metal y acrílico.*

Plafón
ADONIS
Art.: PTL1268757050



LED 50W, 220V, 50Hz, IP20

Blanco mate, Negro mate

3000K

4500LM

Metal + Acrílico

Clase I

No dimerizable

DRIVER DE REPUESTO
DISPONIBLE

LF-GIF050ES1300H(S)

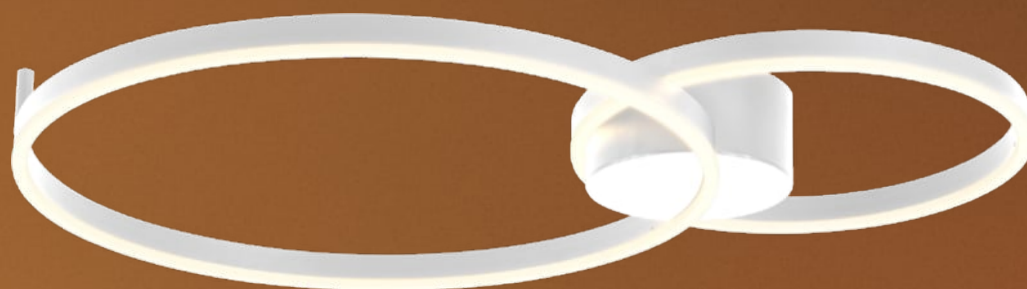
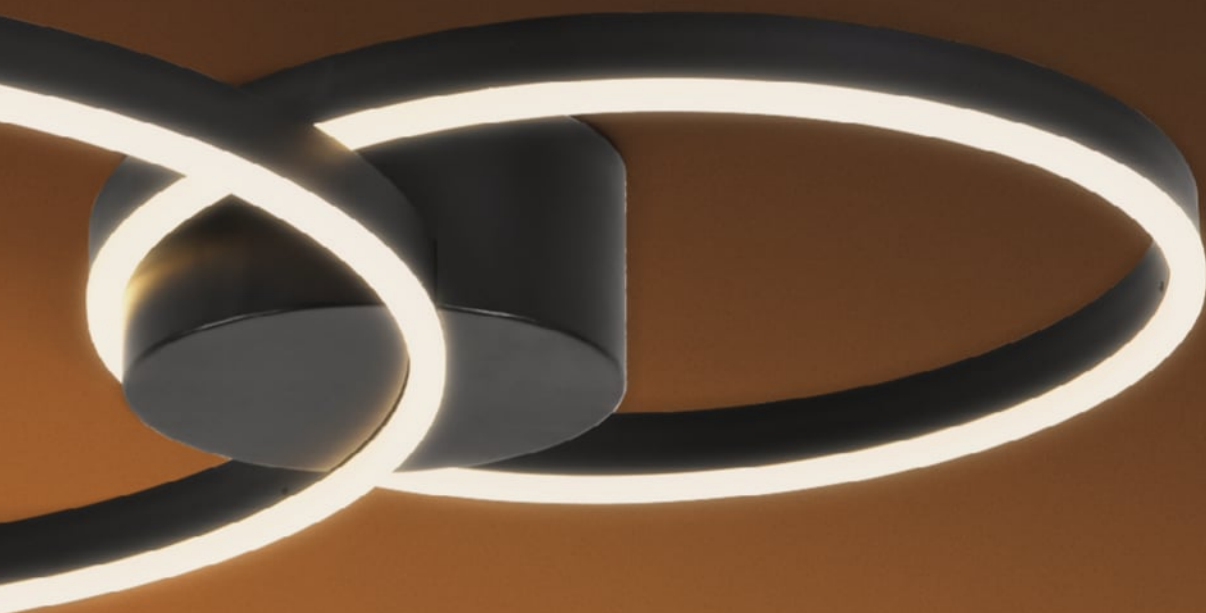
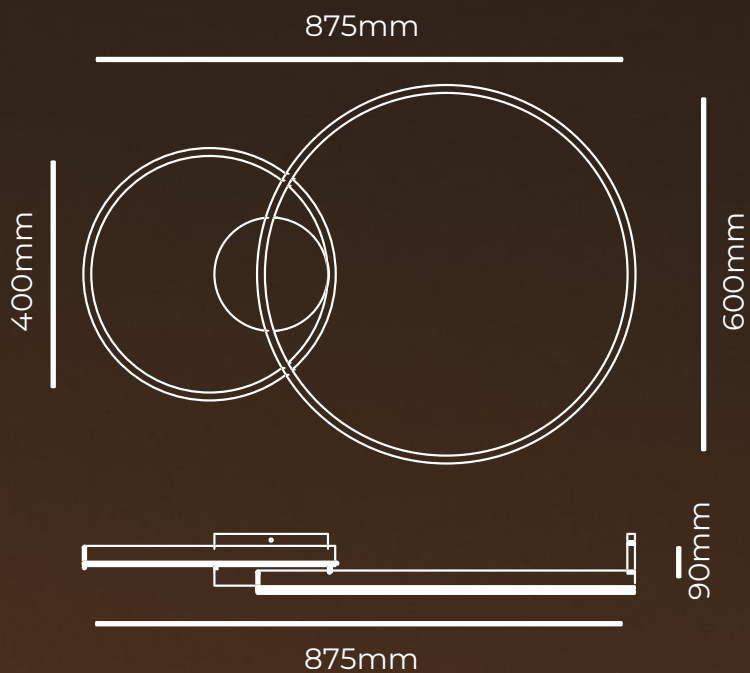

Blanco mate

Negro mate

PLAFÓN BASIL

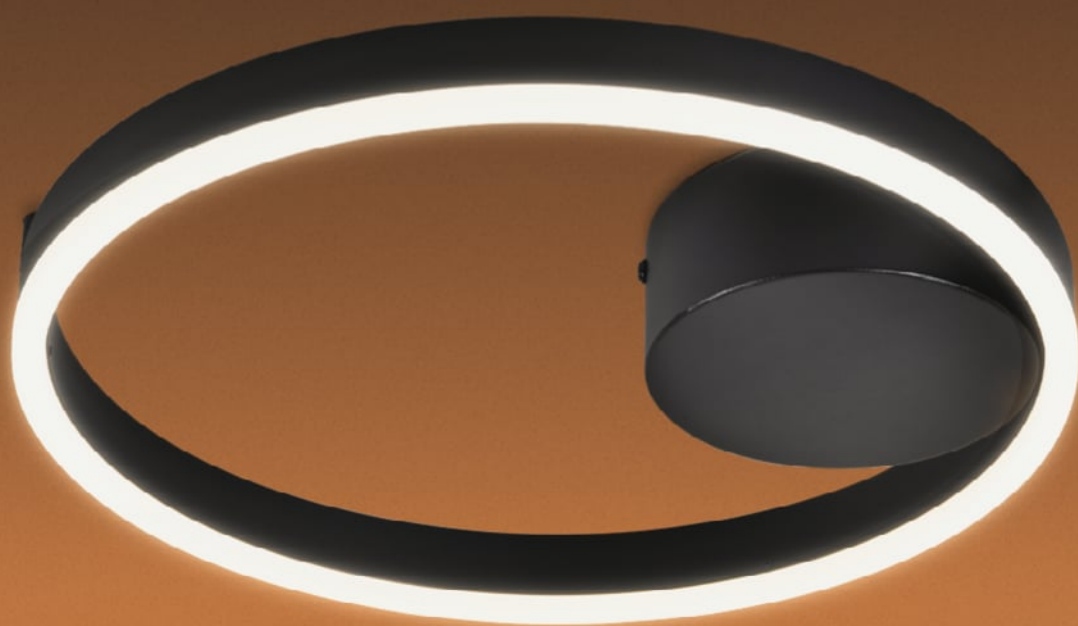

*Plafón LED de 20W luz cálida,
construidos en metal y acrílico.*

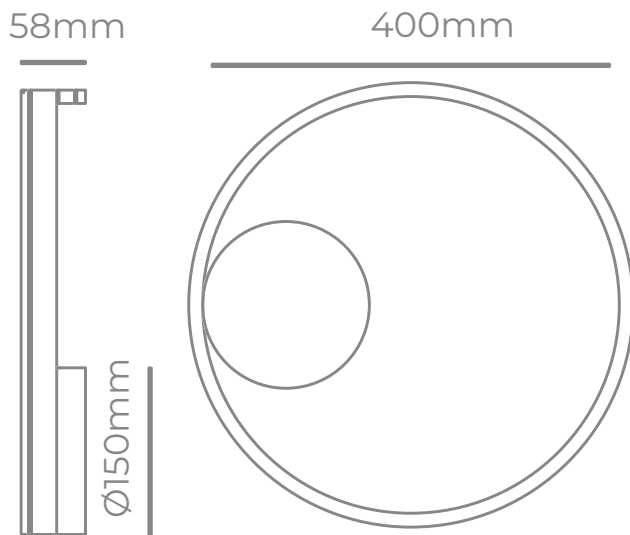
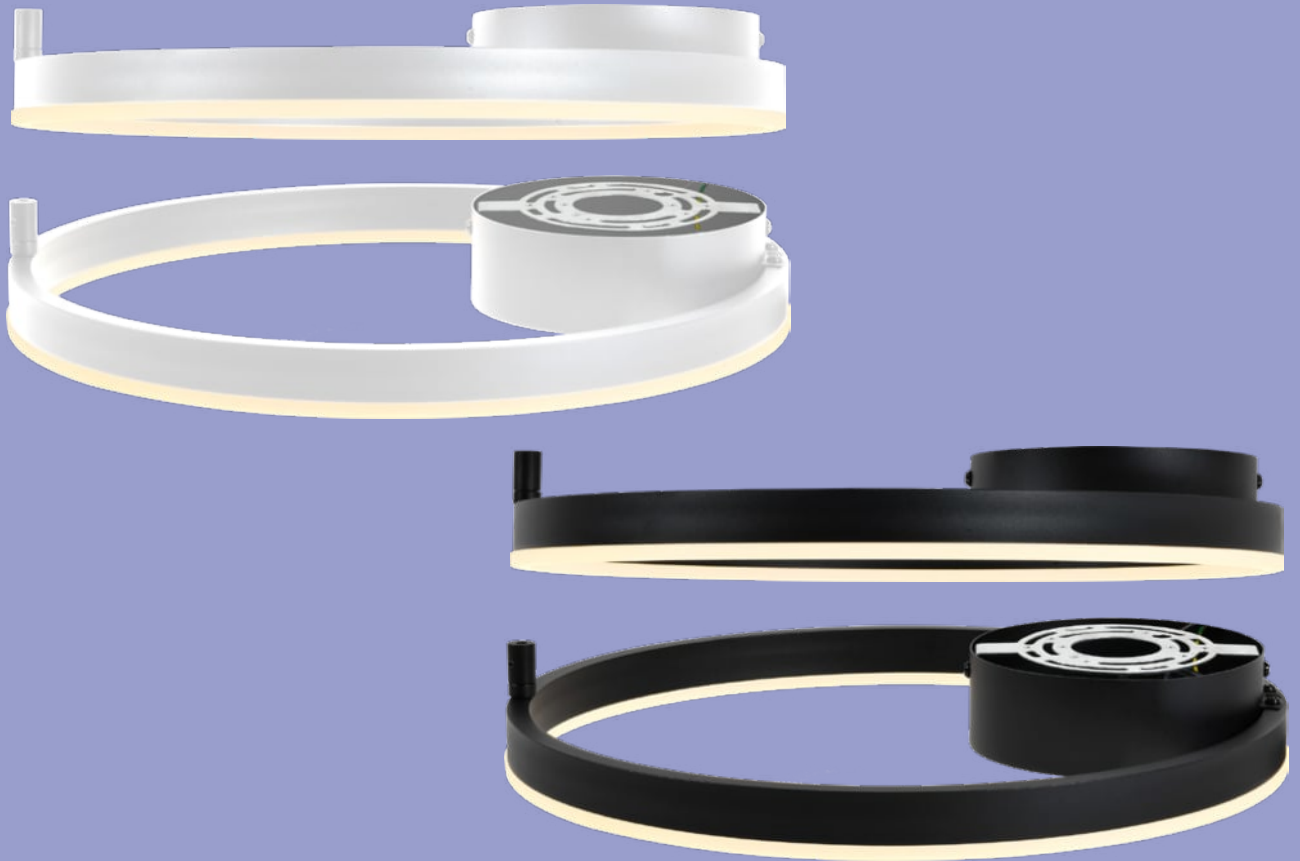

Plafón

BASIL

Art.: PTL1270405020



-  LED 20W, 220V, 50Hz, IP20
-  Blanco mate, Negro mate
-  3000K
-  1800LM
-  Metal + Aluminio + Acrílico
-  Clase I
-  No dimerizable

DRIVER DE REPUESTO
DISPONIBLE

LF-GIR024YS500MA

PLAFÓN TITAN 35



*Plafón LED de 30W luz cálida, dimerizable,
construidos en metal y acrílico.*

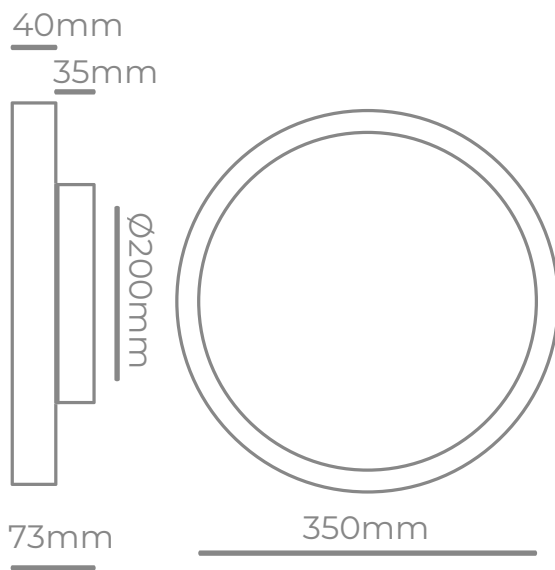

Plafón

TITAN 35

Art.: PTL1283506930



LED 30W, 220V, 50Hz, IP20

Negro, Negro + Oro Antiguo

3000K

2700LM

Metal + Acrílico

Clase I

No dimerizable

DRIVER DE REPUESTO
DISPONIBLE

LF-GIF030YS0750H

PLAFÓN TITÁN 45



Plafón LED de 40W luz cálida, dimerizable, construido en metal y acrílico.

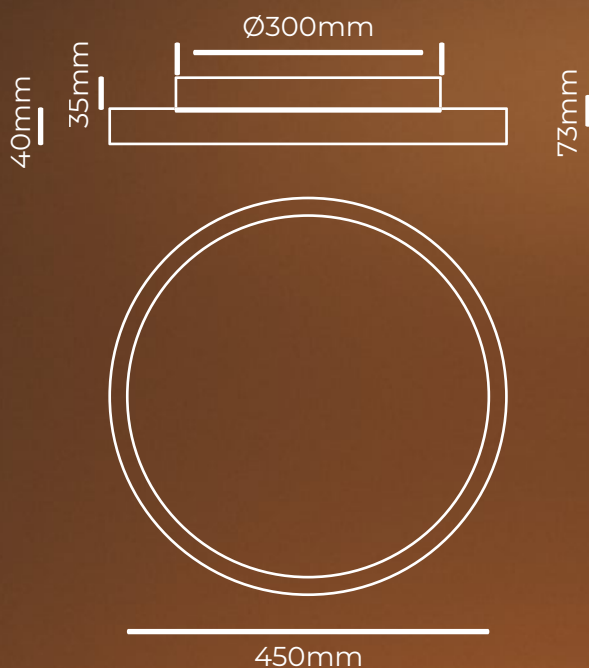

Plafón TITAN 45

Art.: PTL1280456940



- LED 40W, 220V, 50Hz, IP20
- Negro + Oro Antiguo
- 3000K
- 3600LM
- Metal + Acrílico
- Clase I
- Dimerizable

DRIVER DE REPUESTO
DISPONIBLE

LF-ABT040-1050-42

PLAFÓN TITÁN 60



Plafón LED de 50W luz cálida, dimerizable,
construido en metal y acrílico.

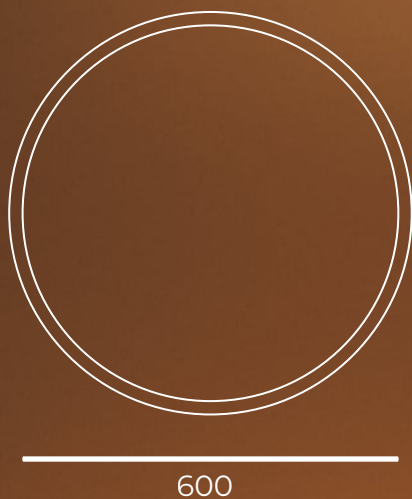
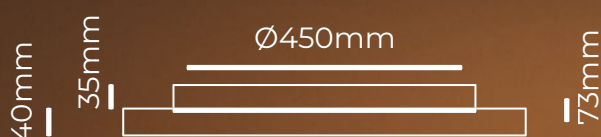

Plafón TITÁN 60

Art.: PTL1280606950



- LED 50W, 220V, 50Hz, IP20
- Negro + Oro Antiguo
- 3000K
- 4500LM
- Metal + Acrílico
- Clase I
- Dimerizable

DRIVER DE REPUESTO
DISPONIBLE

HC-048130LD1

COLGANTE TITÁN 38

Colgante LED de 30W
luz cálida, construido en metal
y acrílico.

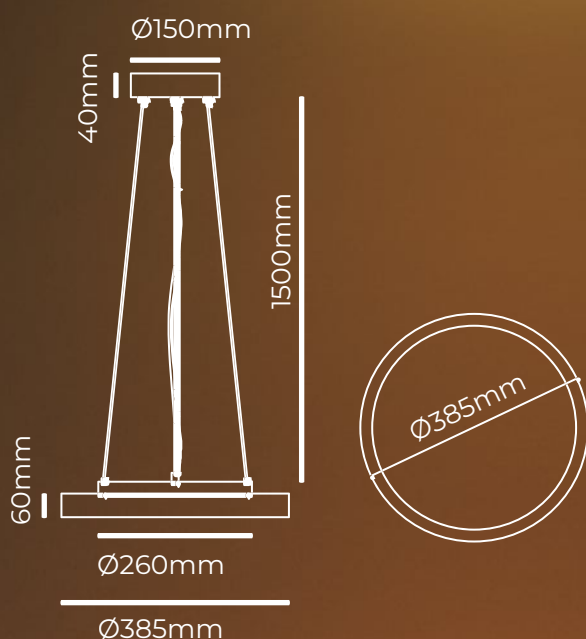

Colgante TITAN 38

Art.: CTL1283853530



- LED 30W, 220V, 50Hz, IP20
- Negro + Oro Antiguo
- 3000K
- 2700LM
- Metal + Acrílico
- Clase I
- No dimerizable

DRIVER DE REPUESTO
DISPONIBLE

LF-GIF030YS0750H

COLGANTE TITÁN 53

Colgante LED de 40W
luz cálida, construido en metal
y acrílico.

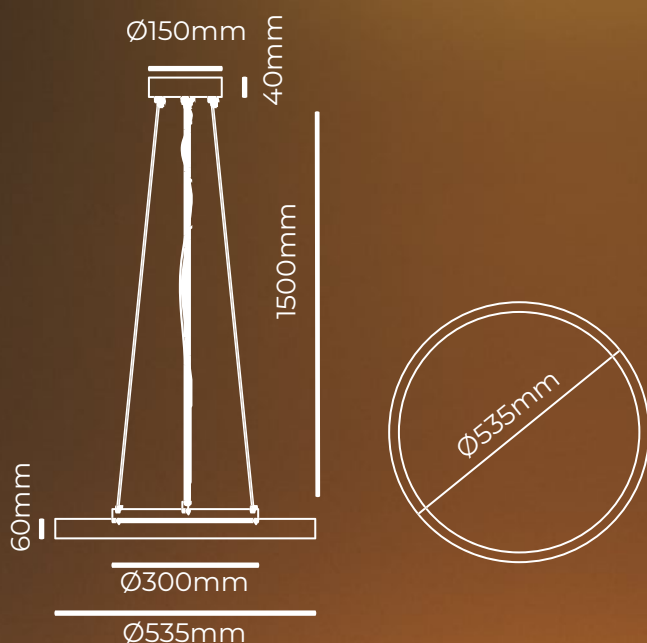

Colgante TITAN 53

Art.: CTL1285353540



- LED 40W, 220V, 50Hz, IP20
- Negro + Oro Antiguo
- 3000K
- 3600LM
- Metal + Acrílico
- Clase I
- No dimerizable

DRIVER DE REPUESTO
DISPONIBLE

LF-GIF040YS1000H

● ● Negro + Oro antiguo

PLAFÓN CORBAN



*Plafón LED 30W luz cálida,
construido en aluminio y acrílico.*

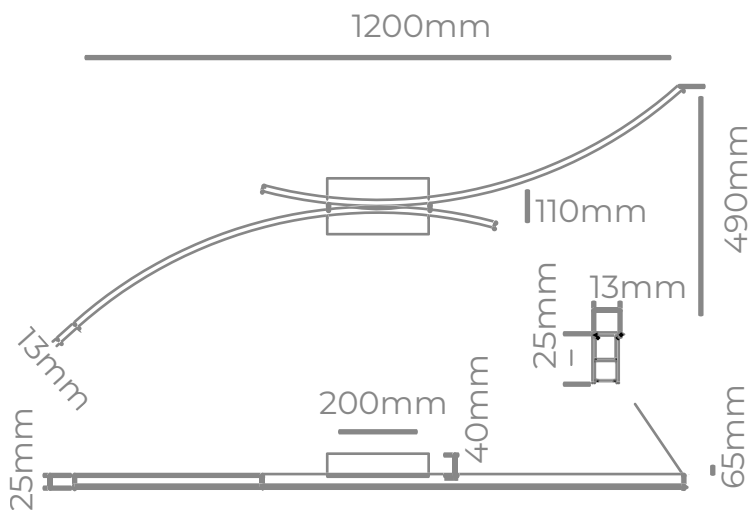
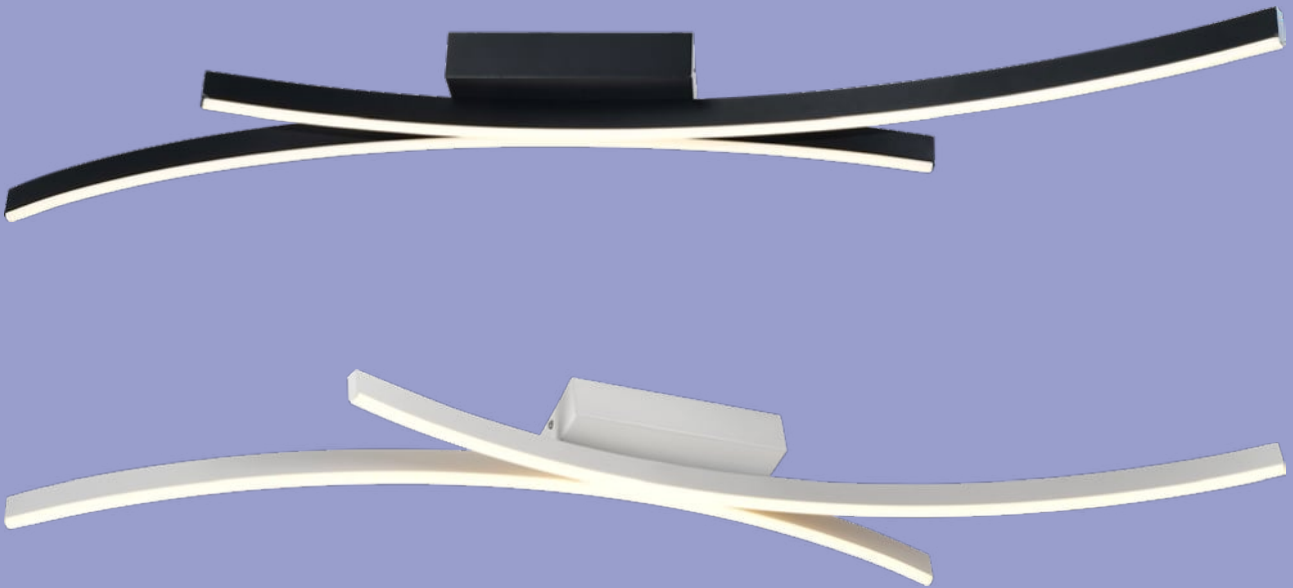

Plafón

CORBAN

Art.: PTL1301206530



-  LED 30W, 220V, 50Hz, IP20
-  Blanco mate, Negro mate
-  3000K
-  2700LM
-  Metal + Acrílico
-  Clase I
-  No dimerizable

DRIVER DE REPUESTO
DISPONIBLE

LF-GIF030YS0750H

COLGANTE CORBAN





*Colgante LED de 30W luz cálida,
construido en aluminio y acrílico.*

Colgante
CORBAN

Art.: CTL1301206530



 LED 30W, 220V, 50Hz, IP20

 Blanco mate, Negro mate

 3000K

 2700LM

 Metal + Acrílico

 Clase I

 No dimerizable

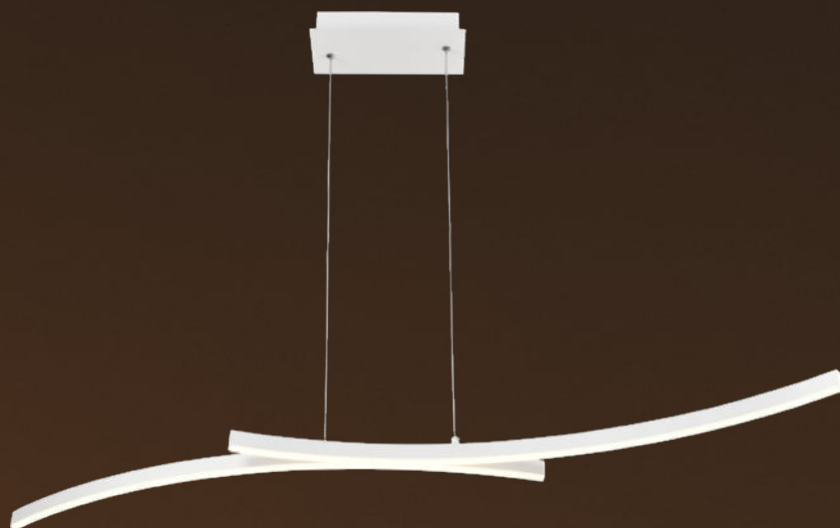

DRIVER DE REPUESTO
DISPONIBLE

LF-GIF030YS0750H

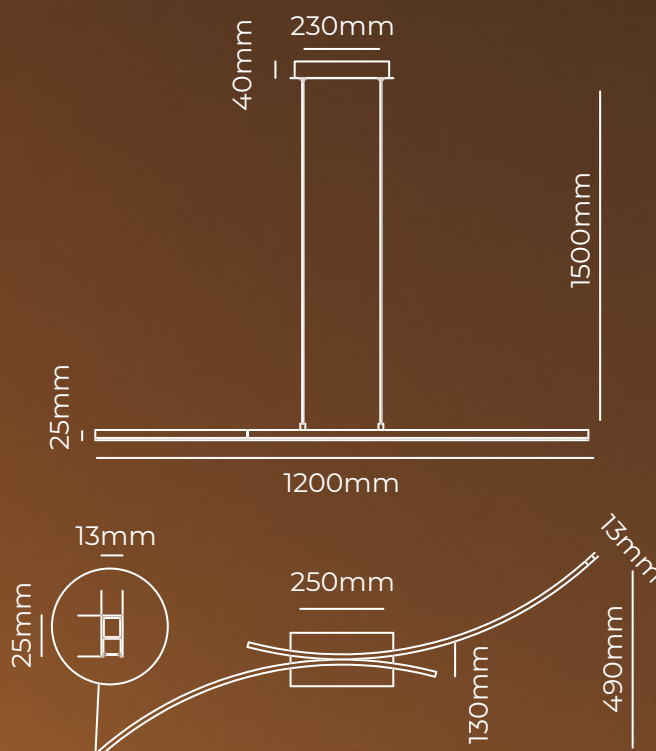

 Negro mate

 Blanco mate

PLAFÓN MOE 80

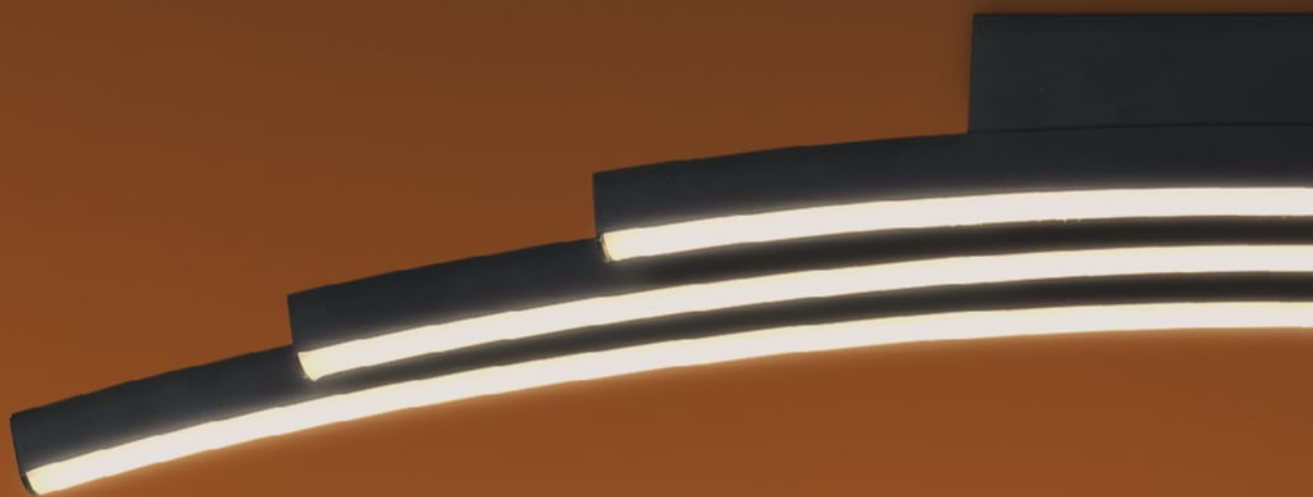

*Colgante LED de 36W luz cálida,
construido en metal y acrílico.*

Plafón
MOE 80
Art.: PTL1318001136



DRIVER DE REPUESTO
DISPONIBLE

LF-GIF040YS0900H

 LED 36W, 220V, 50Hz, IP20

 Blanco mate, Negro mate

 3000K

 3240LM

 Metal + Acrílico

 Clase I

 No dimerizable

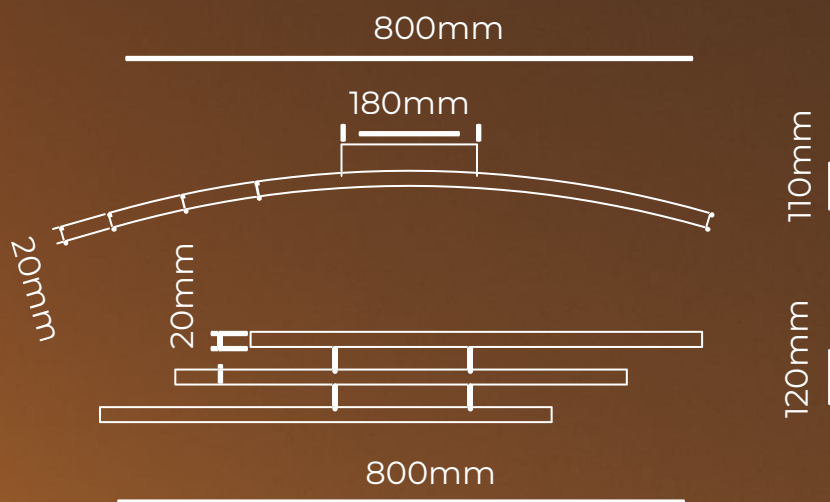
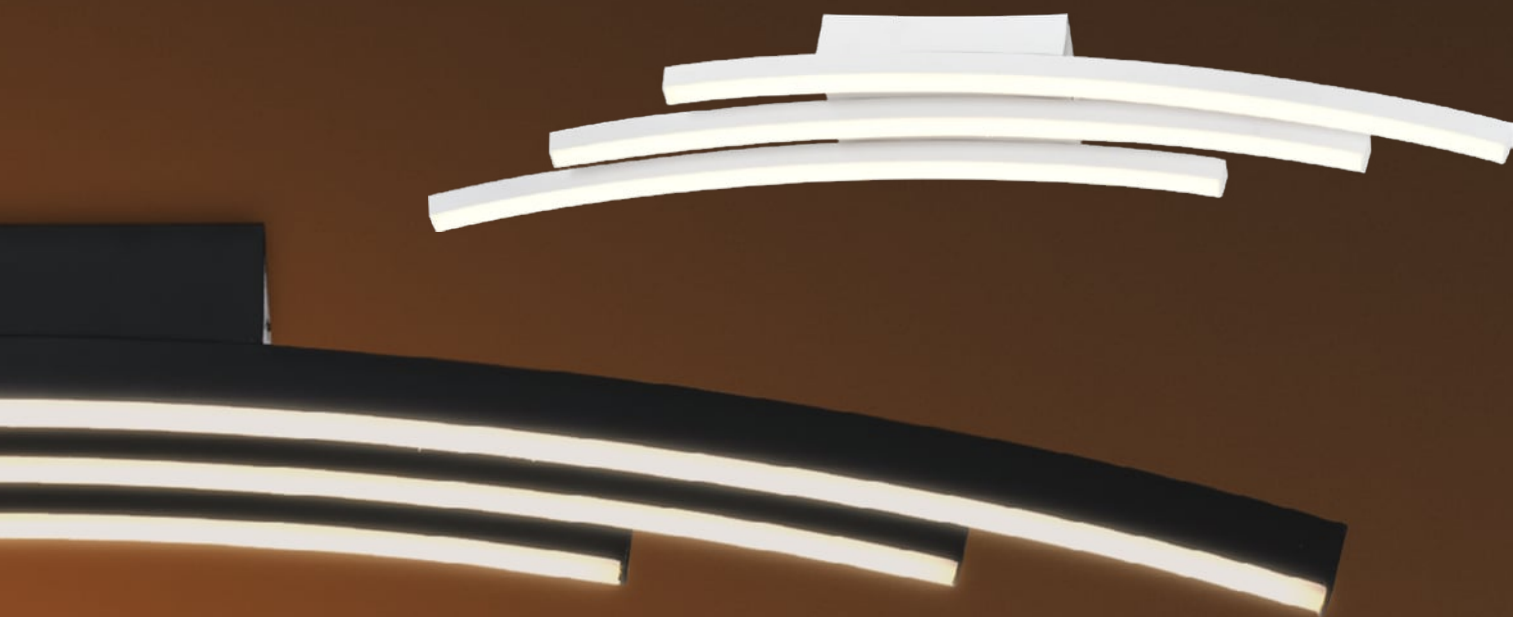

 Negro mate

 Blanco mate

PLAFÓN MOE 120



*Colgante LED de 50W luz cálida,
construido en metal y acrílico.*

Plafón
MOE 120
Art.: PTL1321201650



DRIVER DE REPUESTO
DISPONIBLE

LF-GIF050ES1300H(S)

 LED 50W, 220V, 50Hz, IP20

 Blanco mate, Negro mate

 3000K

 4500LM

 Metal + Acrílico

 Clase I

 No dimerizable

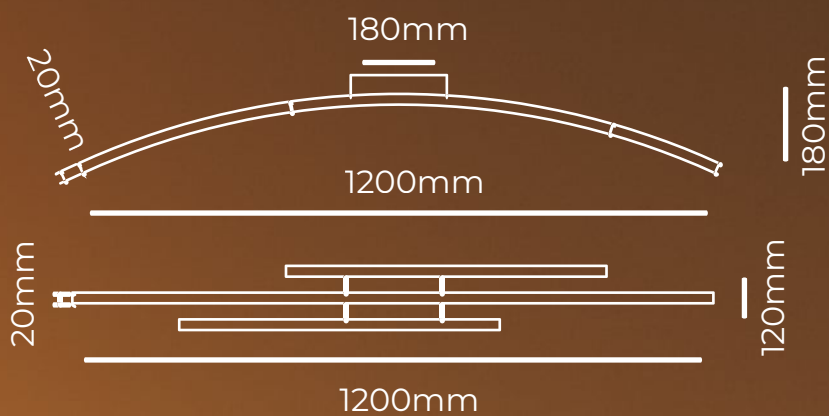
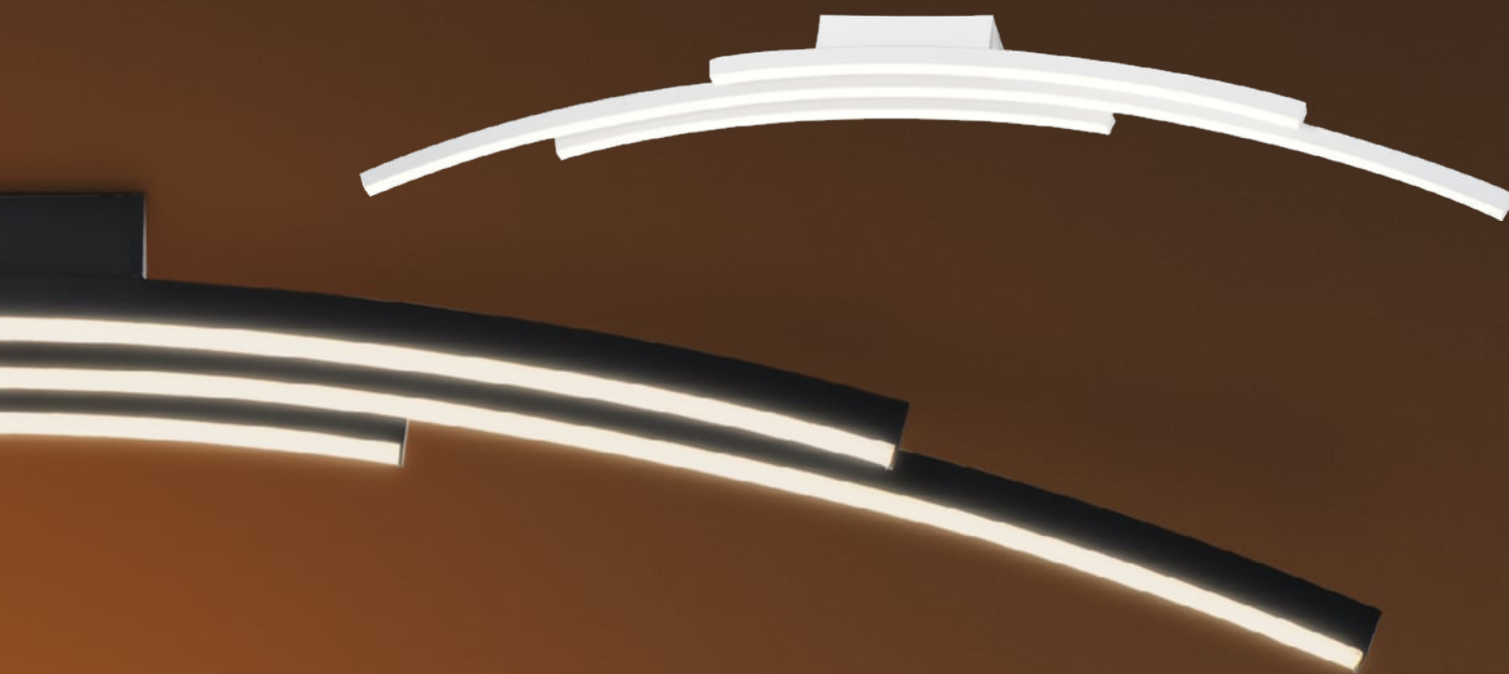

 Negro mate

 Blanco mate

COLGANTE LEO



*Colgante LED de 30W luz cálida,
construido en metal y acrílico.*

Colgante

LEO

Art.: CTLI321451630



 LED 30W, 220V, 50Hz, IP20

 Blanco mate, Negro mate

 3000K

 2700LM

 Metal + Acrílico

 Clase I

 No dimerizable

DRIVER DE REPUESTO
DISPONIBLE

LF-GIF030YS0750H

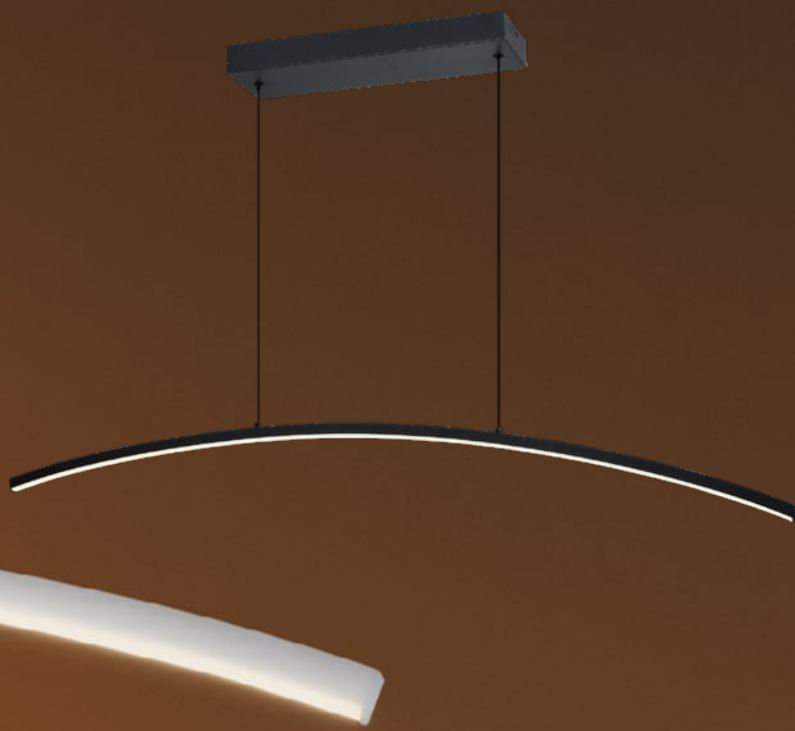
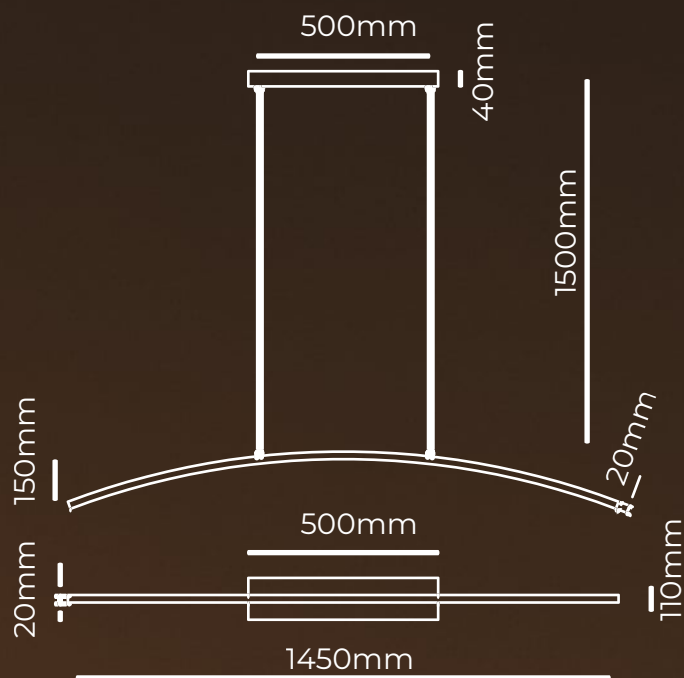

COLGANTE KAL



*Colgante LED de 40W luz cálida,
construido en metal y acrílico.*

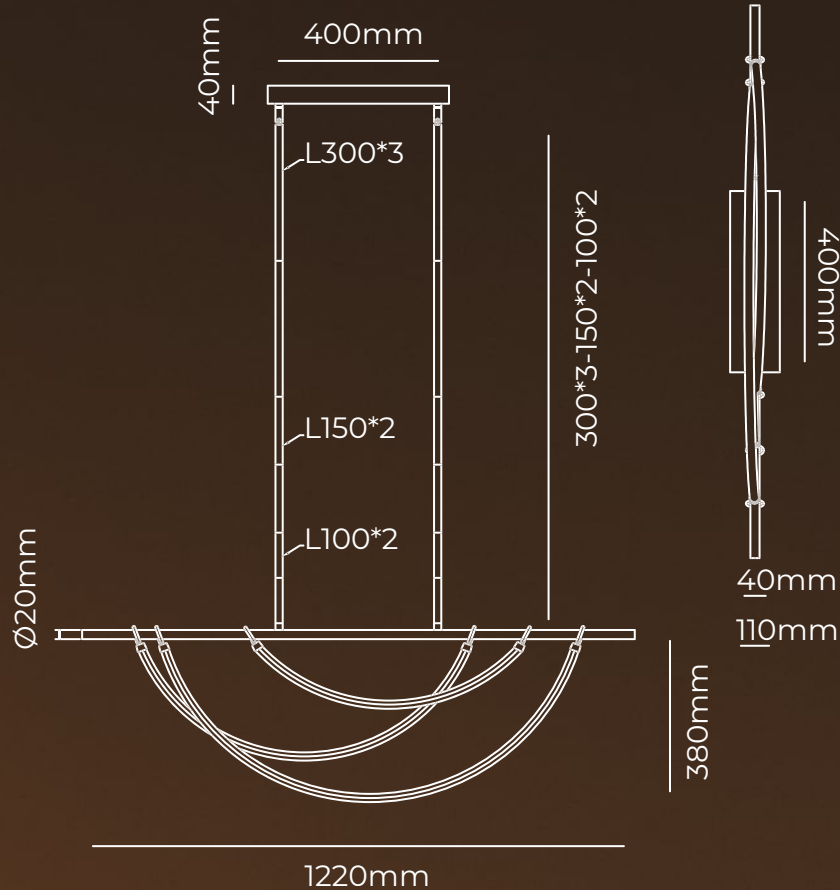

Colgante
KAL
Art.: CTL1332203840





 LED 40W, 220V, 50Hz, IP20

 Negro mate

 3000K

 3600LM

 Metal + Acrílico

 Clase I

 No dimerizable

DRIVER DE REPUESTO
DISPONIBLE

LF-GIF040YS1000H

APLIQUE MAGUS 42



*Aplique LED 12W luz cálida,
construido en metal y acrílico.*



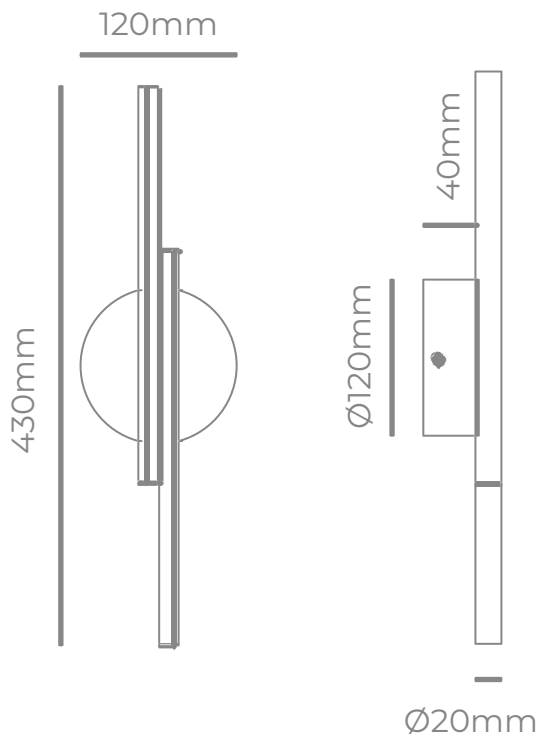

Aplique

MAGUS 42

Art.: APL1314286012



LED 12W, 220V, 50Hz, IP20

Blanco mate, Negro mate

3000K

1080LM

Metal + Aluminio + Silicona

Clase I

No dimerizable

DRIVER DE REPUESTO
DISPONIBLE

LF-GIR013YS0300H

APLIQUE MAGUS 62



*Aplique LED 20W luz cálida,
construido en metal y acrílico.*



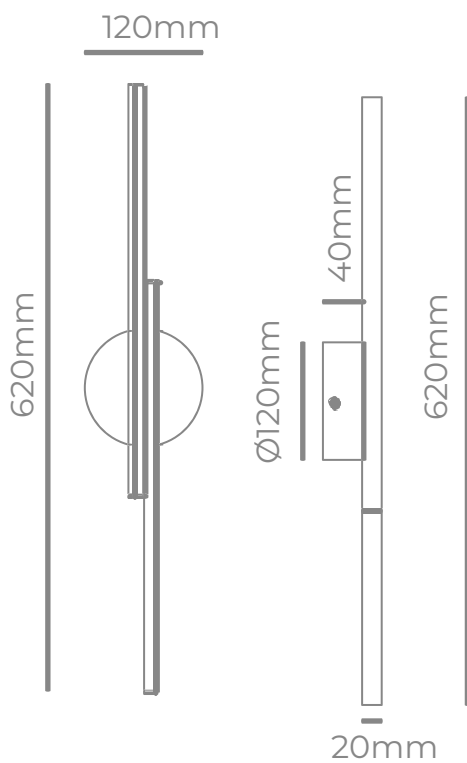

Aplique

MAGUS 62

Art.: APL1316206020



LED 20W, 220V, 50Hz, IP20

Blanco mate, Negro mate

3000K

1800LM

Metal + Aluminio + Silicona

Clase I

No dimerizable

DRIVER DE REPUESTO
DISPONIBLE

LF-GIR024YS500MA

COLGANTE CALIX



*Colgante LED de 6 luces, 36W luz cálida,
construido en metal y acrílico.*

Colgante
CALIX
Art.: CTL1341201336



 LED 36W, 220V, 50Hz, IP20

 Negro mate

 3000K

 3240LM

 Metal + Aluminio

 Clase I

 No dimerizable

DRIVER DE REPUESTO
DISPONIBLE

LF-GIF040YS0900H

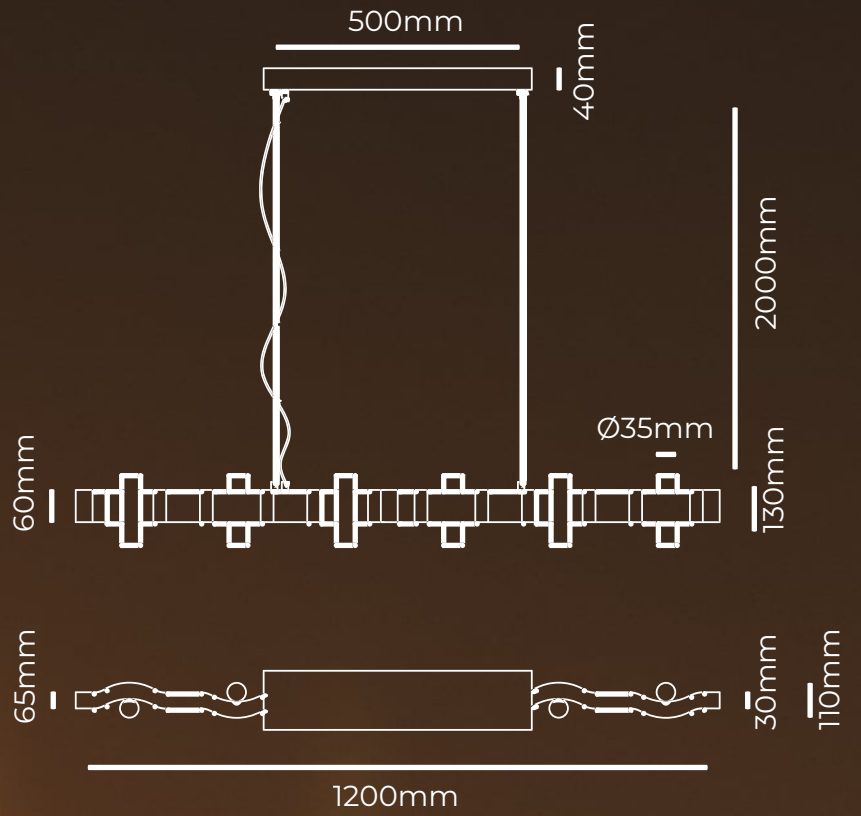

 Negro Mate

COLGANTE NICOS 120

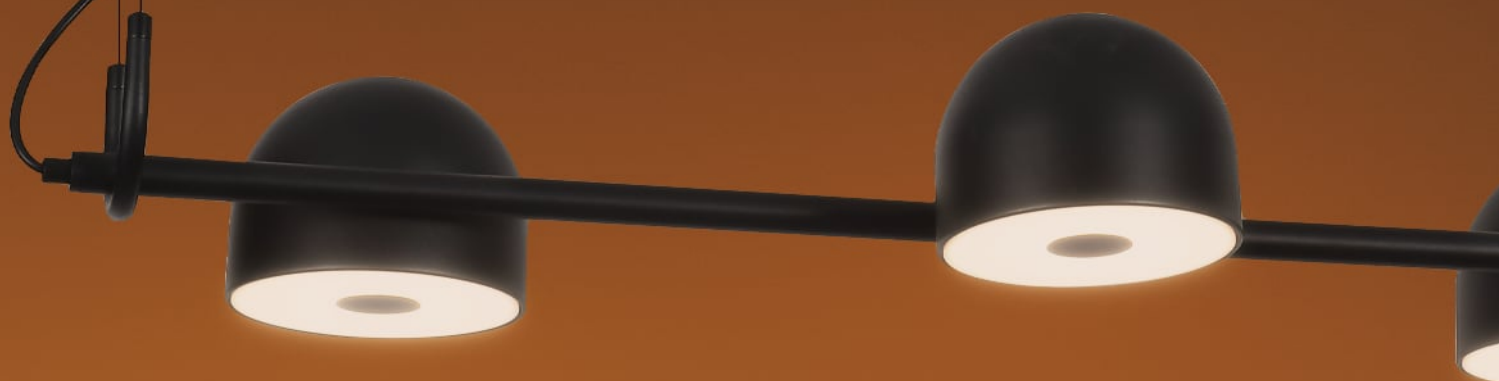

*Colgante LED de 4 luces, 32W luz cálida,
construido en metal y acrílico.*

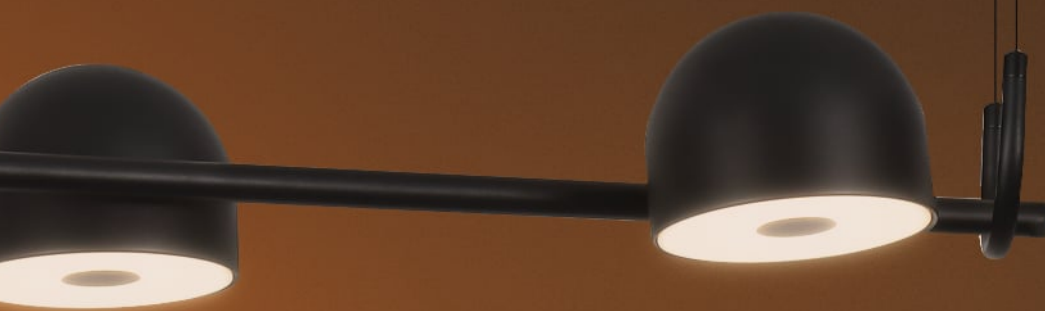
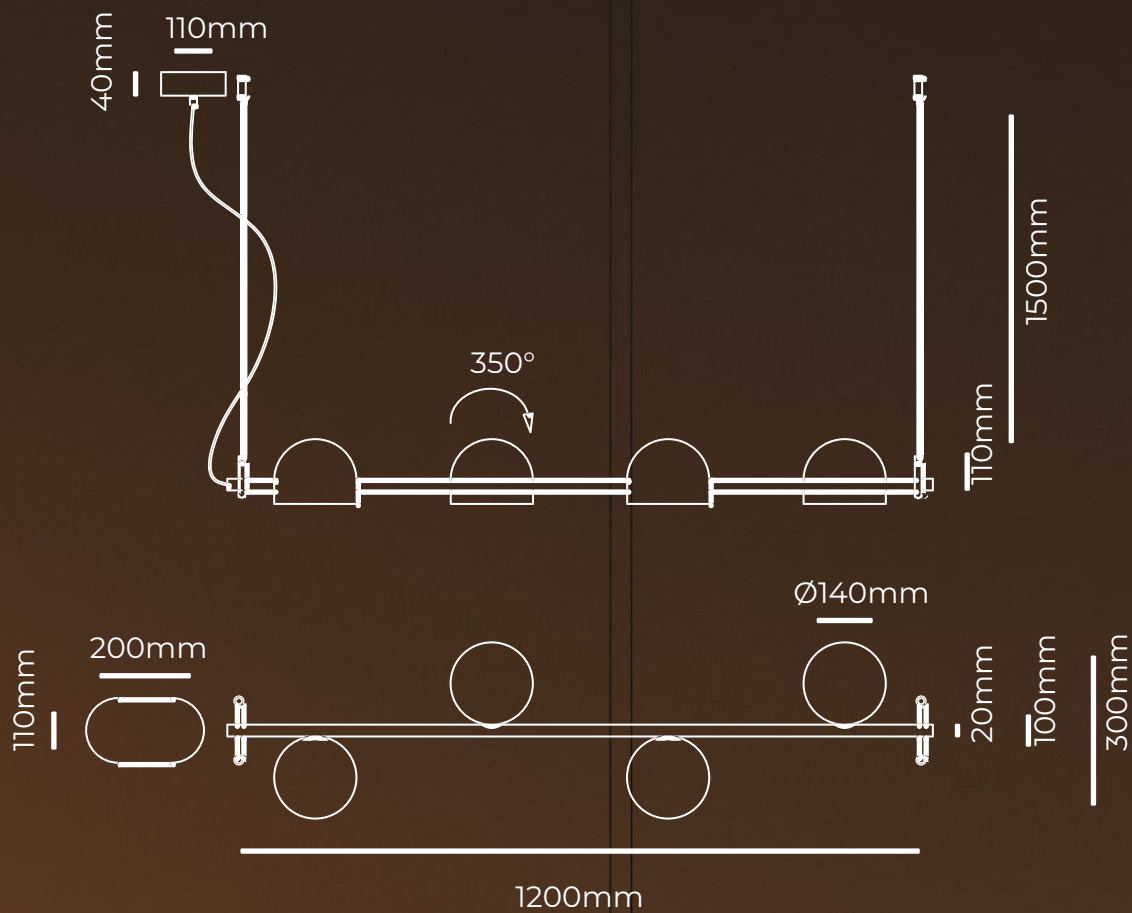

Colgante
NICOS 120
Art.: CTL1351201432



-  LED 32W, 220V, 50Hz, IP20
-  Negro mate
-  3000K
-  2880LM
-  Metal + Acrílico
-  Clase I
-  No dimerizable

DRIVER DE REPUESTO
DISPONIBLE

LF-GIF040YS0800H

COLGANTE NICOS 180



*Colgante LED de 5 luces, 48W luz cálida,
construido en metal y acrílico.*

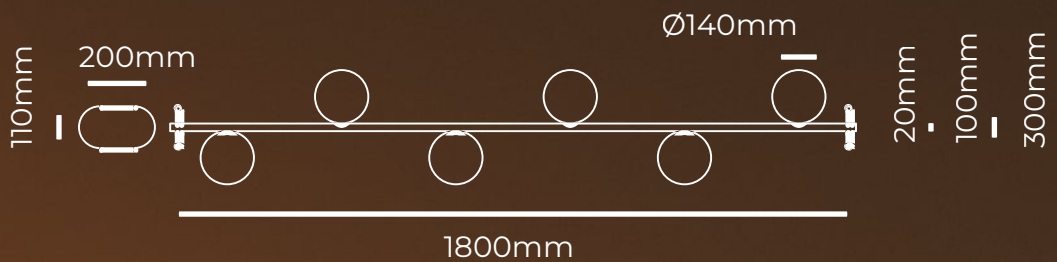
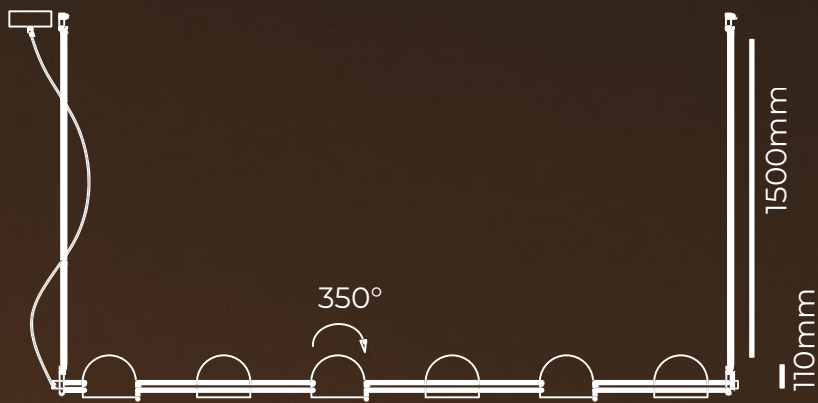

Colgante
NICOS 180
Art.: CTL1351801448



DRIVER DE REPUESTO
DISPONIBLE

LF-GIF050YS1200H

LED 48W, 220V, 50Hz, IP20

Negro mate

3000K

4320LM

Metal + Acrílico

Clase I

No dimerizable

● Negro Mate

APLIQUE NICOS



*Aplicue LED 8W luz cálida,
construido en metal y acrílico.
Cabezal con movimiento. Con interruptor en base.*

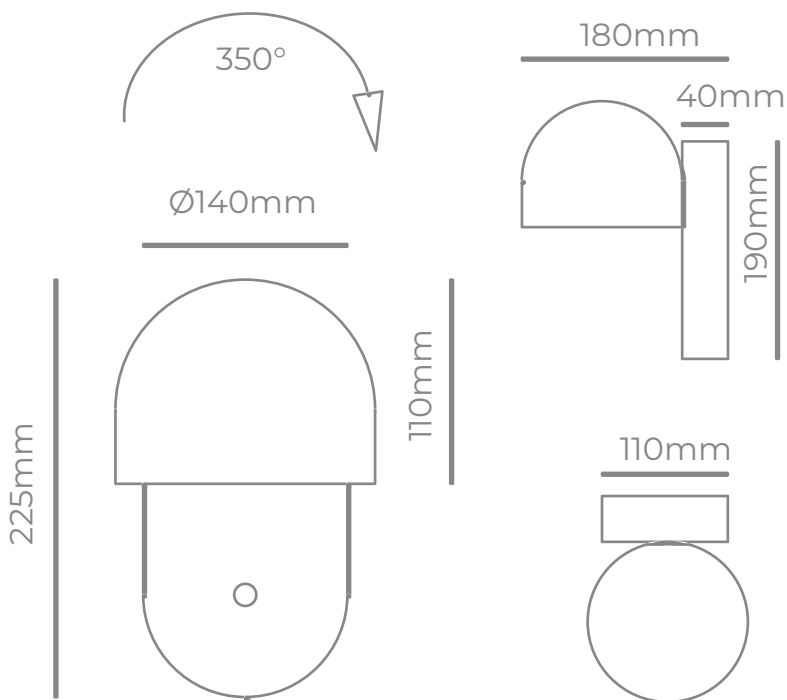

Aplique

NICOS

Art.: APL1351401708



-  LED 8W, 220V, 50Hz, IP20
-  Negro mate
-  3000K
-  720LM
-  Metal + Acrílico
-  Clase I
-  No dimerizable

DRIVER DE REPUESTO
DISPONIBLE

LF-GIR009YS0200H

COLGANTE MATEO I



*Colgante LED 5W luz cálida,
construidos en metal, aluminio y acrílico*

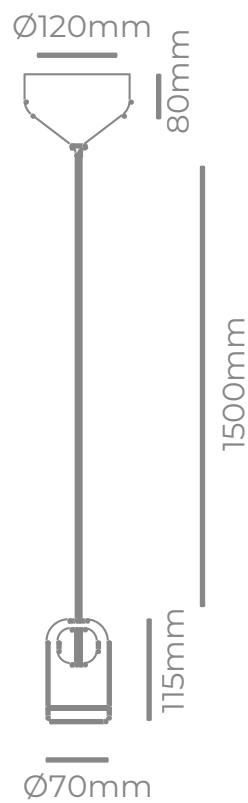
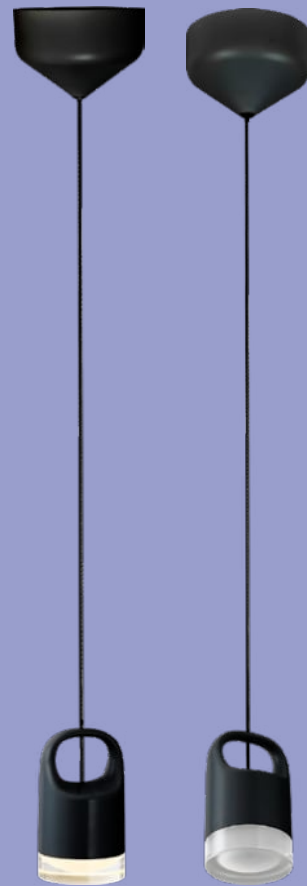
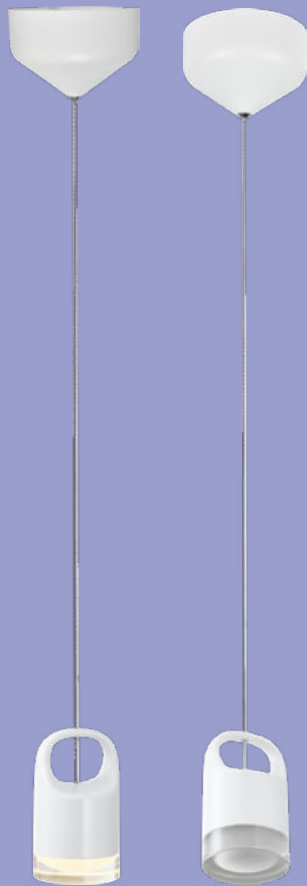

Colgante
MATEO I
 Art.: CTL1360701105



-  LED 5W, 220V, 50Hz, IP20
-  Blanco mate, Negro mate
-  3000K
-  450LM
-  Metal + Aluminio + Acrílico
-  Clase I
-  No dimerizable

DRIVER DE REPUESTO
 DISPONIBLE

LF-GIR009YS0135H

COLGANTE MATEO V



*Colgante LED de 4 luces 20W luz cálida,
construido en metal, aluminio y acrílico.*

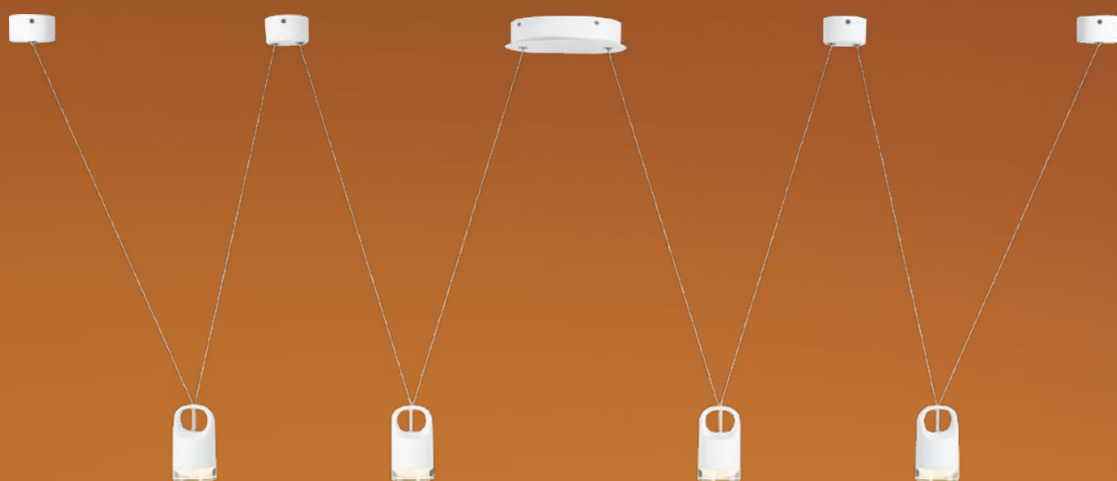



Colgante
MATEO V
Art.: CTLI370701120



- LED 20W, 220V, 50Hz, IP20
- Blanco mate, Negro mate
- 3000K
- 1800LM
- Metal + Aluminio + Acrílico
- Clase I
- No dimerizable

DRIVER DE REPUESTO
DISPONIBLE

LF-GIRO24YS500MA

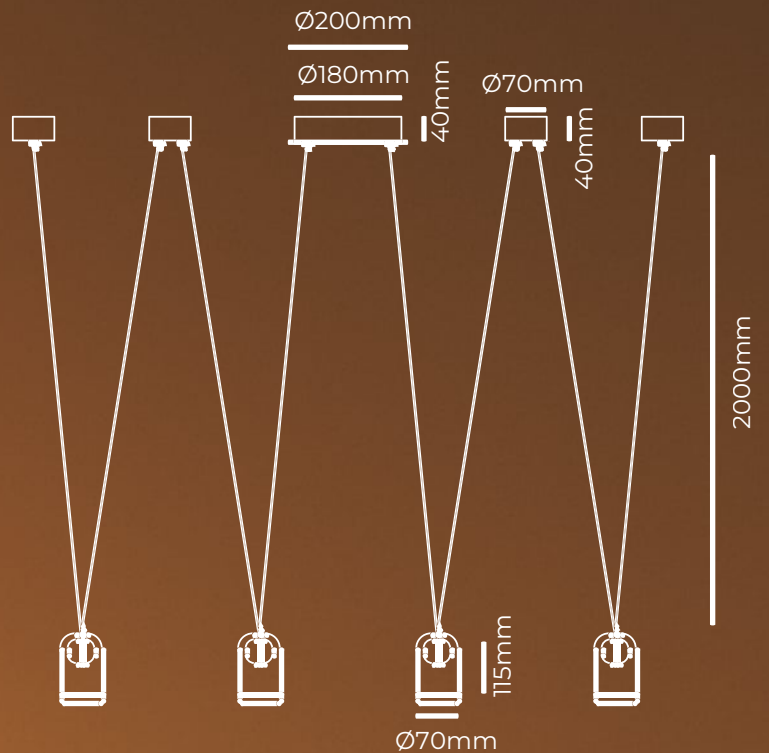

COLGANTE DRU



*Colgante LED 5W luz cálida,
construido en metal, aluminio y acrílico.*



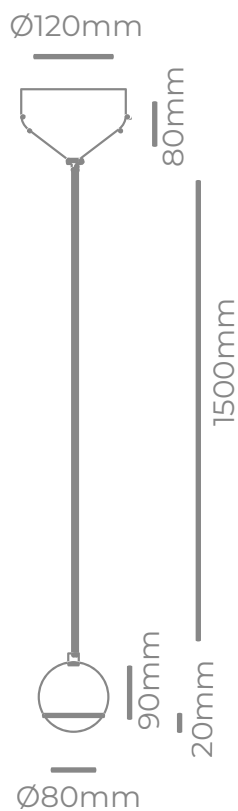
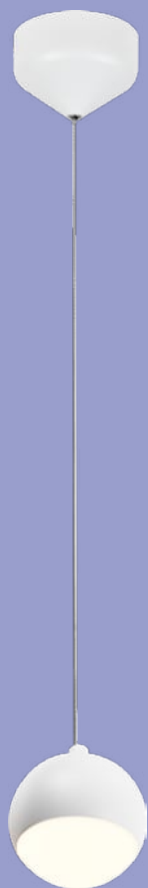

Colgante

DRU

Art.: CTL1380809005



-  LED 5W, 220V, 50Hz, IP20
-  Blanco mate, Negro mate
-  3000K
-  450LM
-  Metal + Aluminio + Acrílico
-  Clase I
-  No dimerizable

DRIVER DE REPUESTO
DISPONIBLE

LF-GIR009YS0135H

COLGANTE BEMUS



*Colgante LED de 5 luces 20W luz cálida,
construido en metal, aluminio y acrílico.*



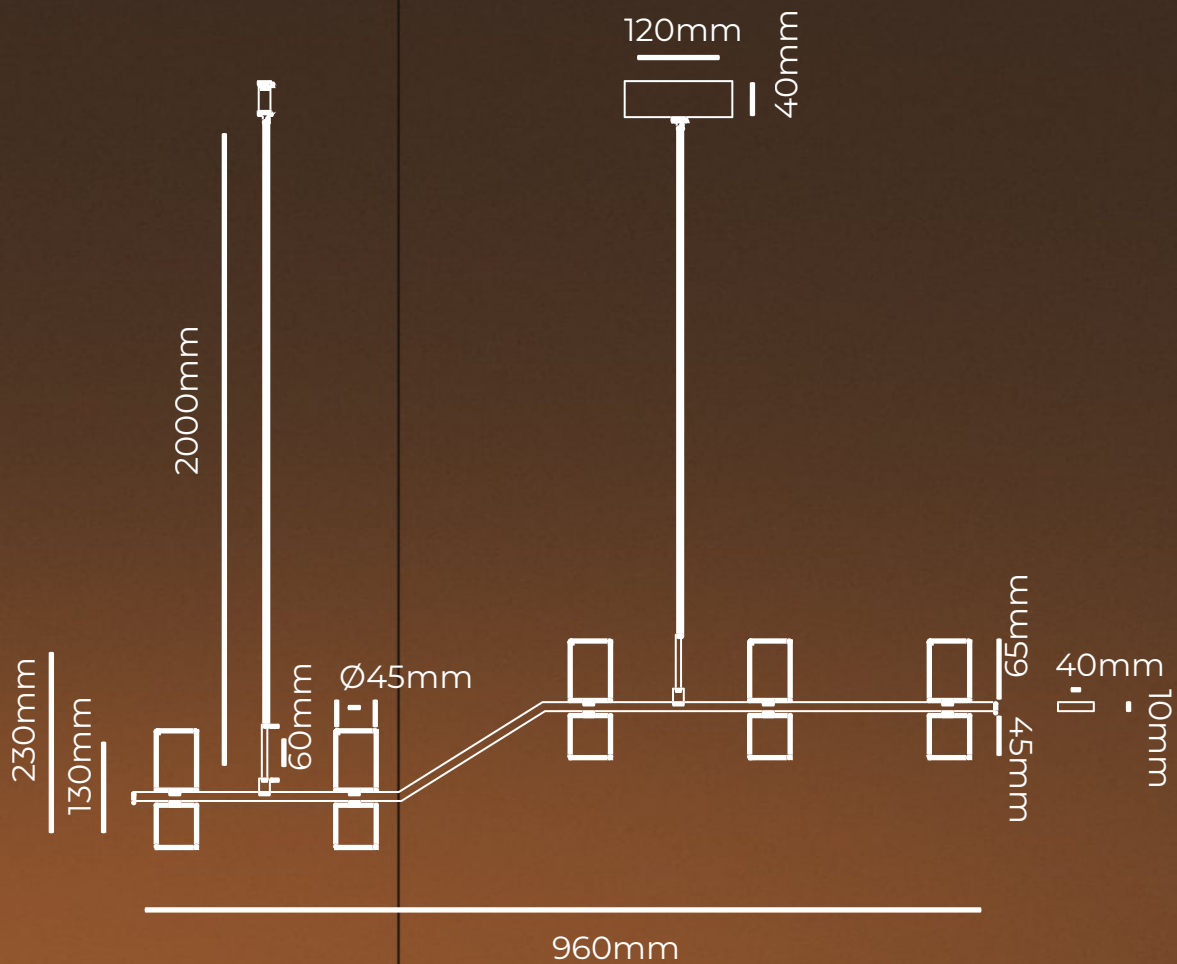

DRIVER DE REPUESTO
DISPONIBLE

LF-GIR024YS500MA

Colgante
BEMUS

Art.: CTL1399602420



-  LED 20W, 220V, 50Hz, IP20
-  Negro mate
-  3000K
-  1800LM
-  Metal + Aluminio + Acrílico
-  Clase I
-  No dimerizable

PLAFÓN NUDO

*Plafón LED de 47W luz cálida, dimerizable,
construido en aluminio, hierro y PVC.*

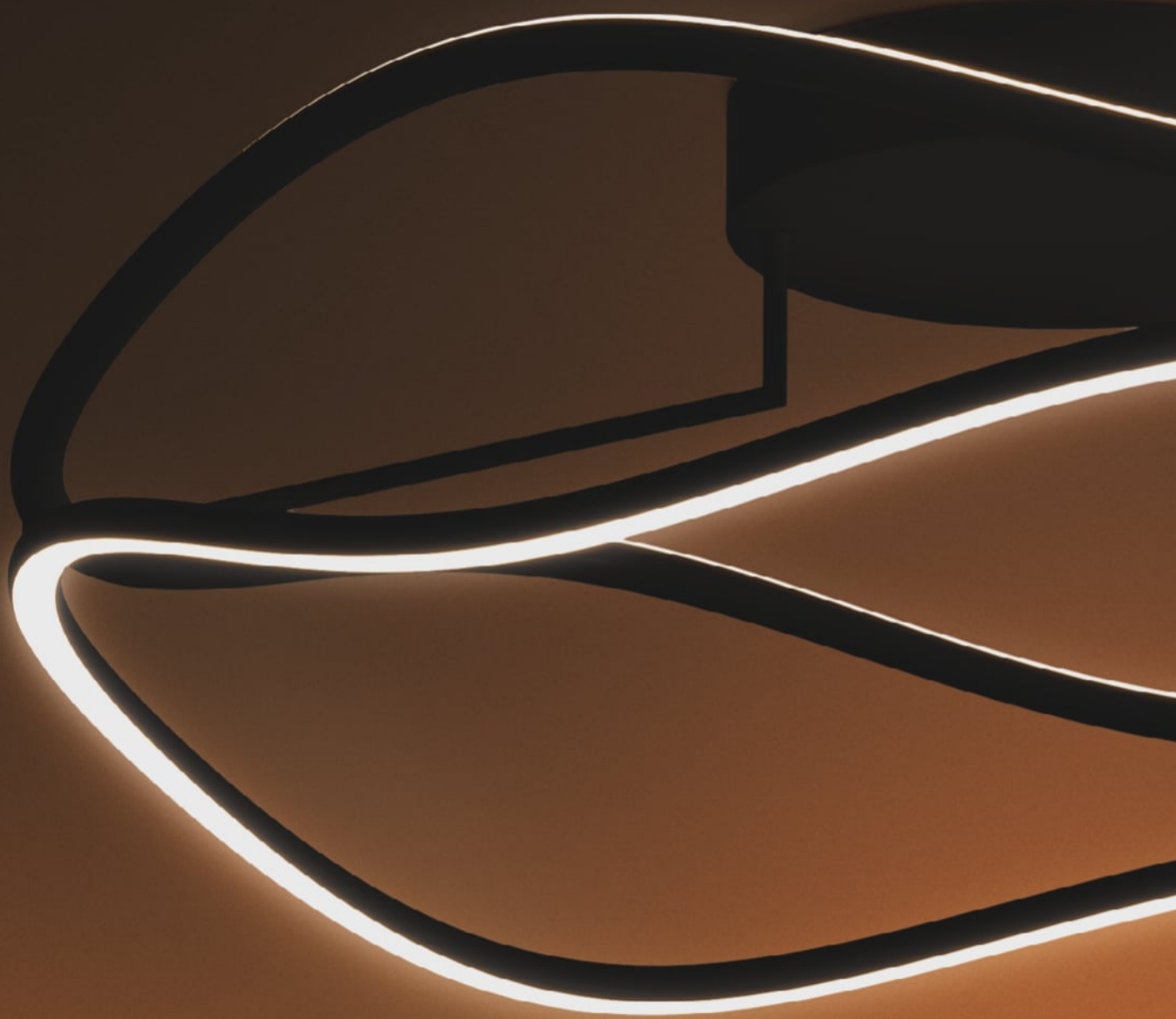

Plafón
NUDO
Art.: PTL890006047



 LED 47W, 220V, 50Hz, IP20

 Negro mate

 3000K

 4230LM

 Hierro + Aluminio + PVC

 Clase I

 Dimerizable

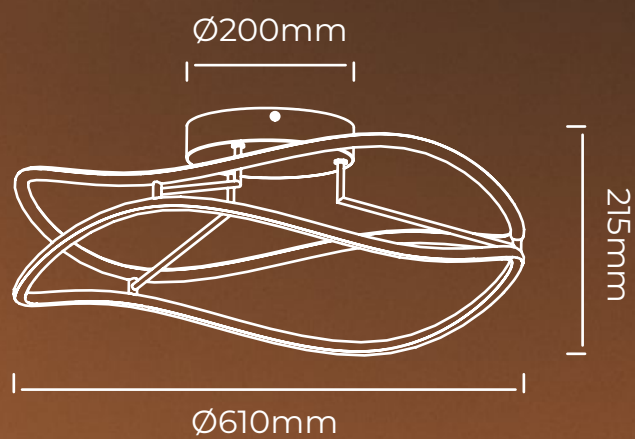

COLGANTE NUDO



*Colgante LED de 47W luz cálida,
dimerizable, construido en aluminio, hierro y PVC.*

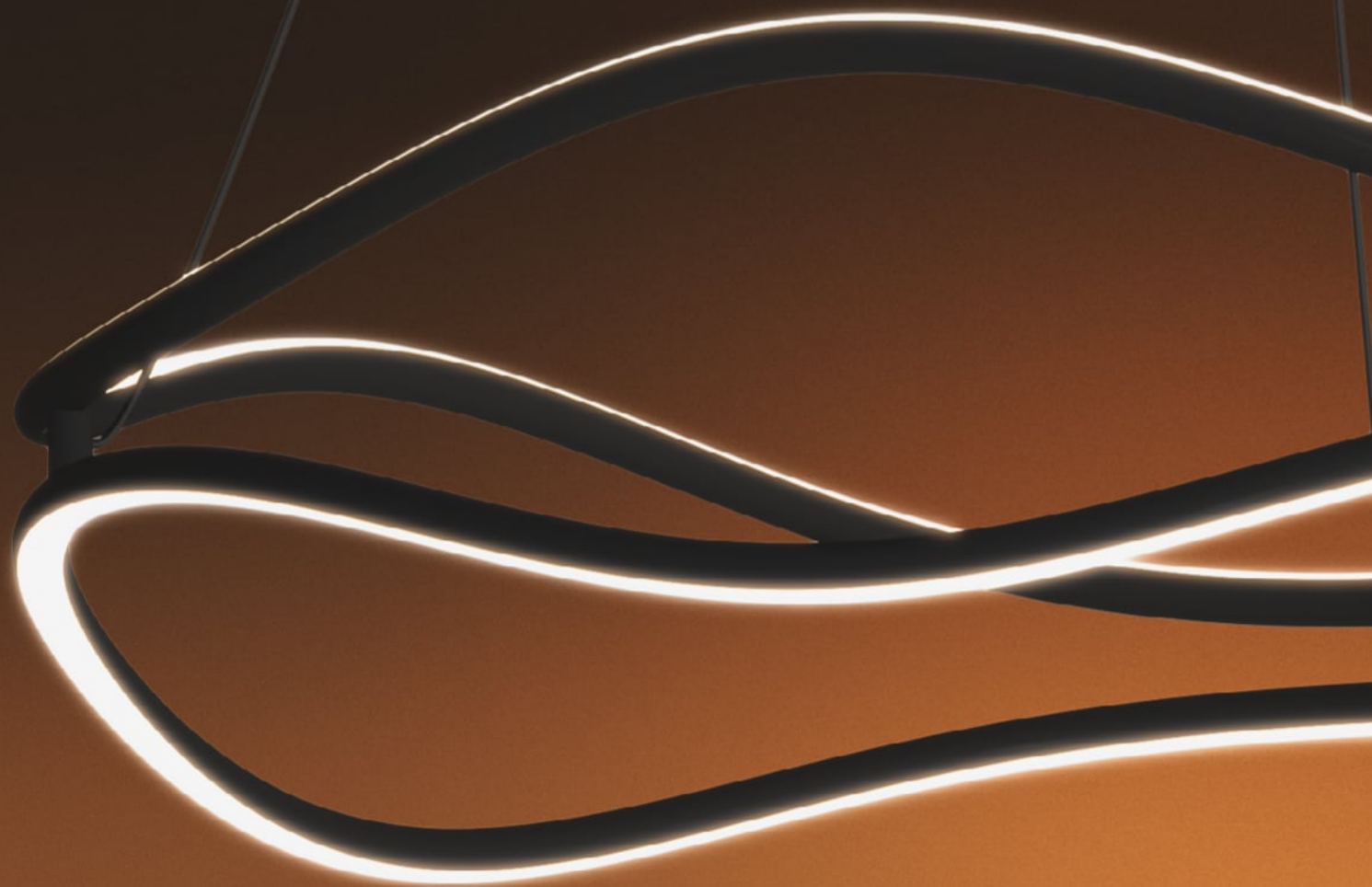

Colgante
NUDO
Art.: CTL890006047



 LED 47W, 220V, 50Hz, IP20

 Negro mate

 3000K

 4230LM

 Hierro + Aluminio + PVC

 Clase I

 Dimerizable

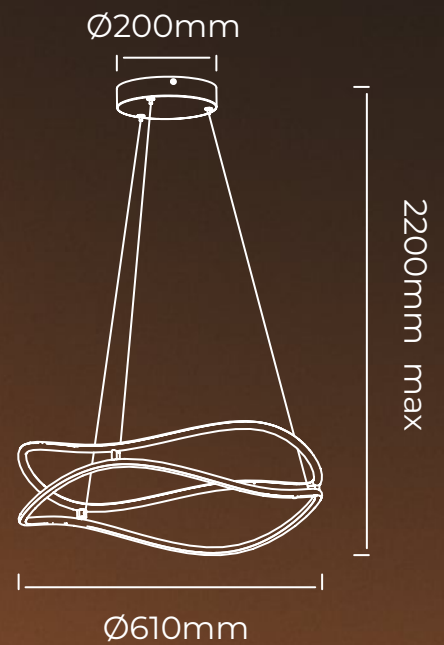
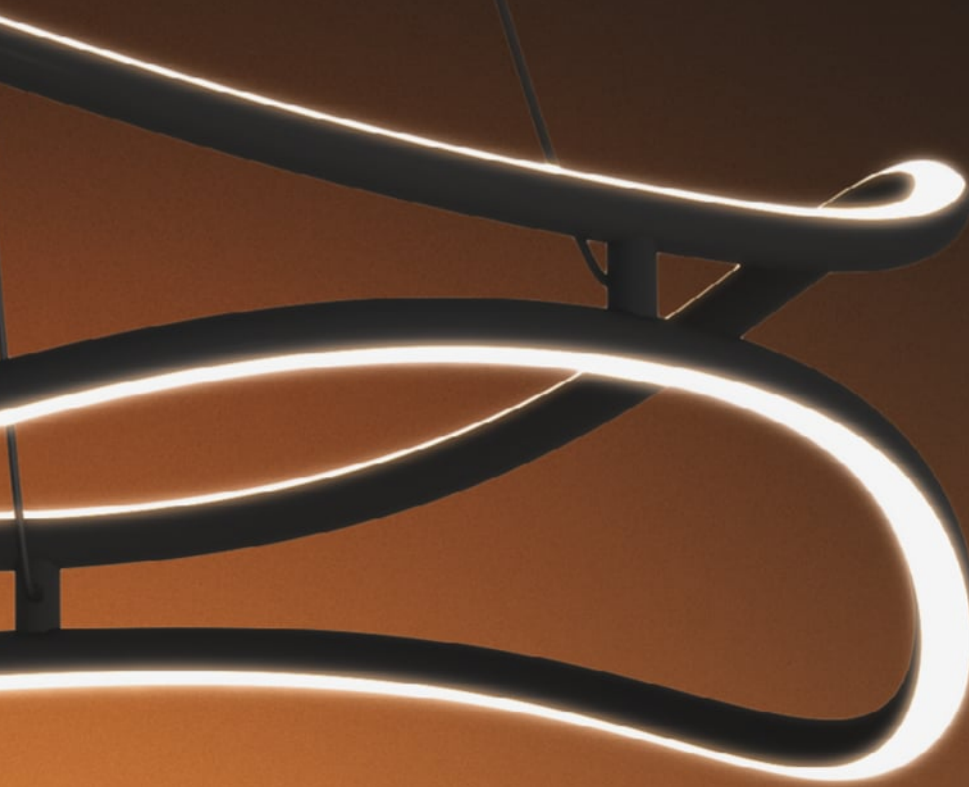

COLGANTE LAZO



*Colgantes LED de 41W y 50W luz cálida, dimerizables,
construidos en aluminio, hierro y PVC.*

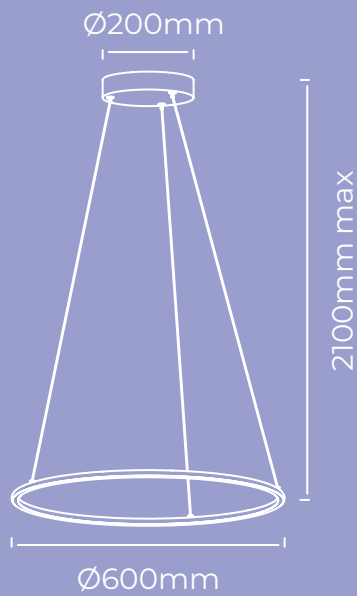

Colgante
LAZO 60
Art.: CTL910006041





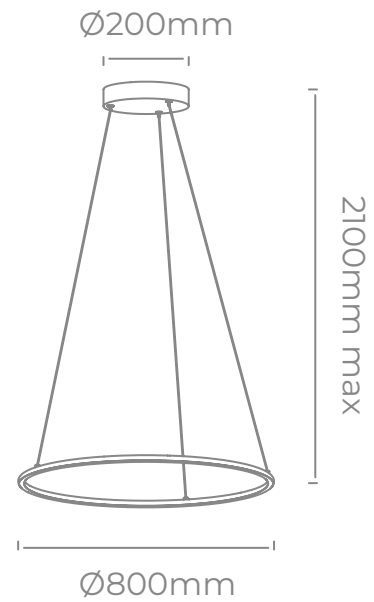



-  LED 41W, 220V, 50Hz, IP20
-  Negro mate
-  3000K
-  3690LM
-  Hierro + Aluminio + PVC
-  Clase I
-  Dimerizable



Colgante
LAZO 80
Art.: CTL910008050



-  LED 50W, 220V, 50Hz, IP20
-  Negro mate
-  3000K
-  4500LM
-  Hierro + Aluminio + PVC
-  Clase I
-  Dimerizable

PLAFÓN LAZO 40

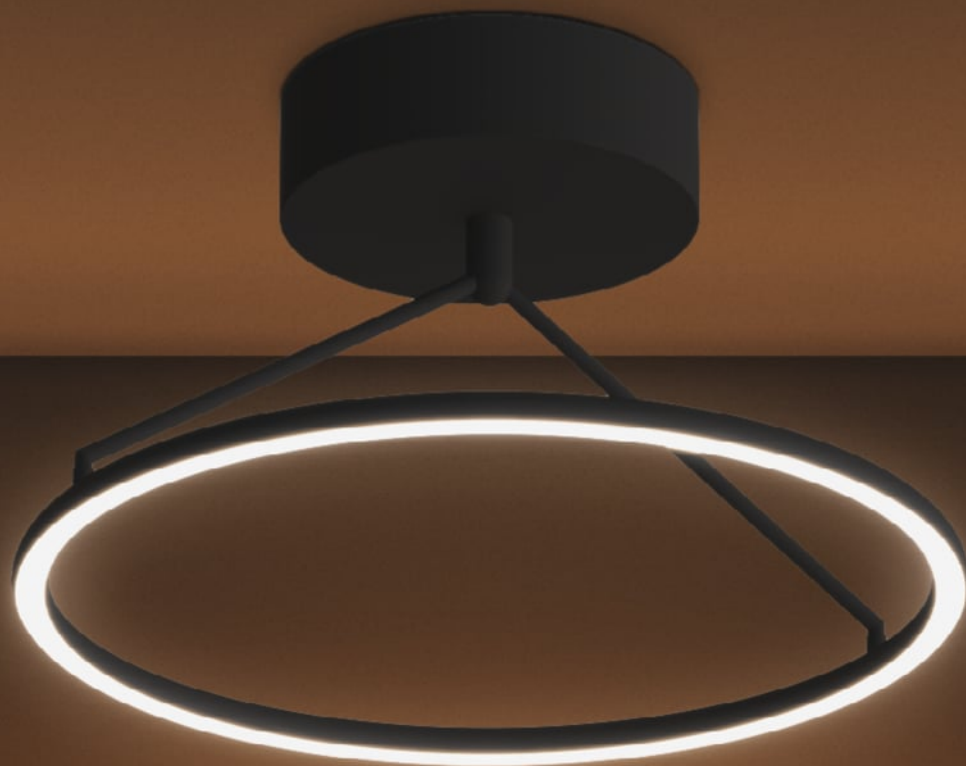

*Plafón LED de 30W luz cálida, dimerizable,
construido en hierro, aluminio y PVC.*

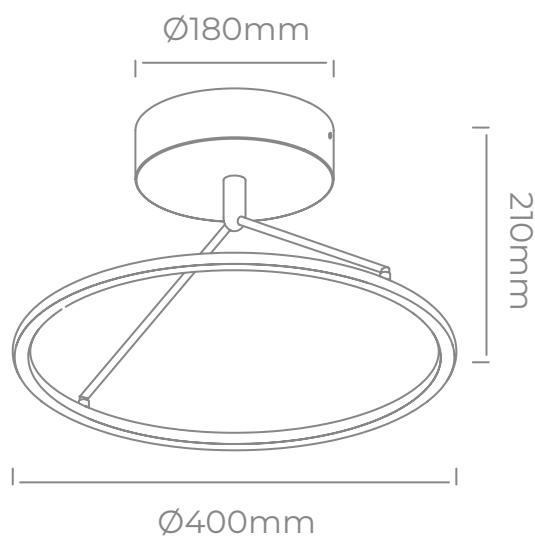
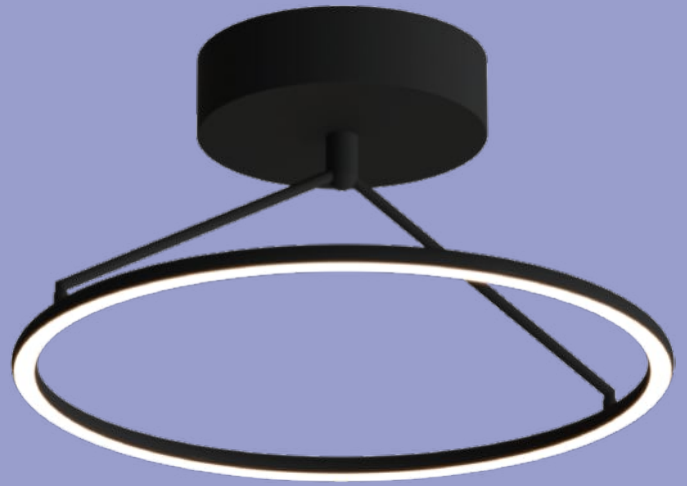
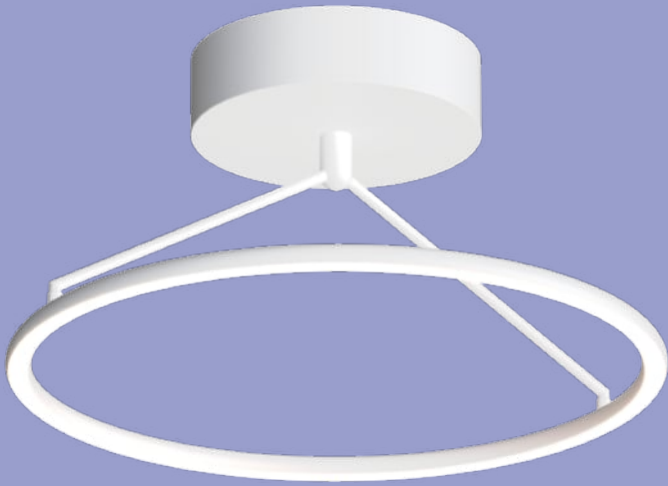







Plafón

LAZO 40

Art.: PTL910402030



-  LED 30W, 220V, 50Hz, IP20
-  Blanco mate, Negro mate
-  3000K
-  3690LM
-  Hierro + Aluminio + PVC
-  Clase I
-  Dimerizable

PLAFÓN LAZO 60



*Plafón LED de 41W luz cálida, dimerizable,
construido en hierro, aluminio y PVC.*



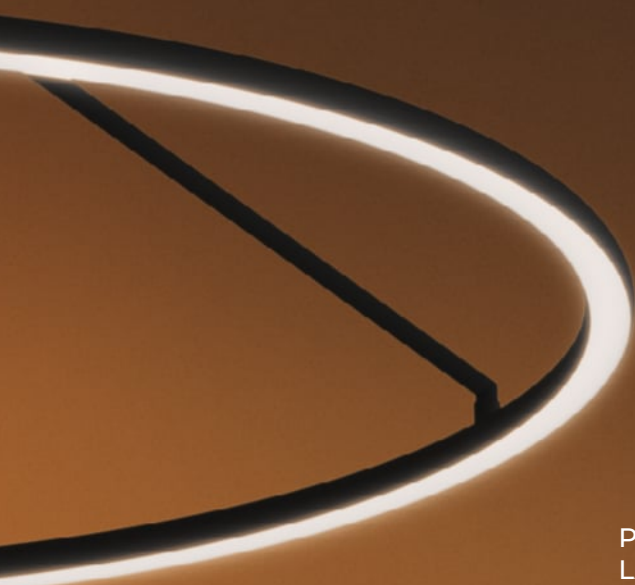
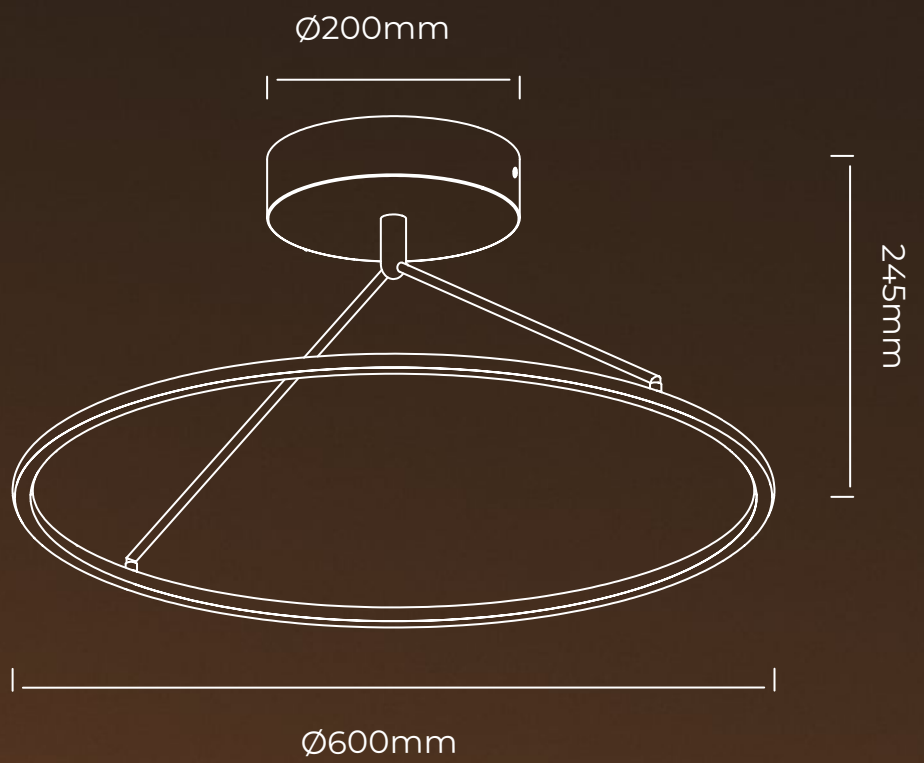

Plafón
LAZO 60
Art.: PTL910602541



 LED 41W, 220V, 50Hz, IP20

 Negro mate

 3000K

 4500LM

 Hierro + Aluminio + PVC

 Clase I

 Dimerizable

PLAFÓN LAZO DOBLE



*Colgante LED de 41W luz cálida, dimerizable,
construido en hierro, aluminio y PVC.*

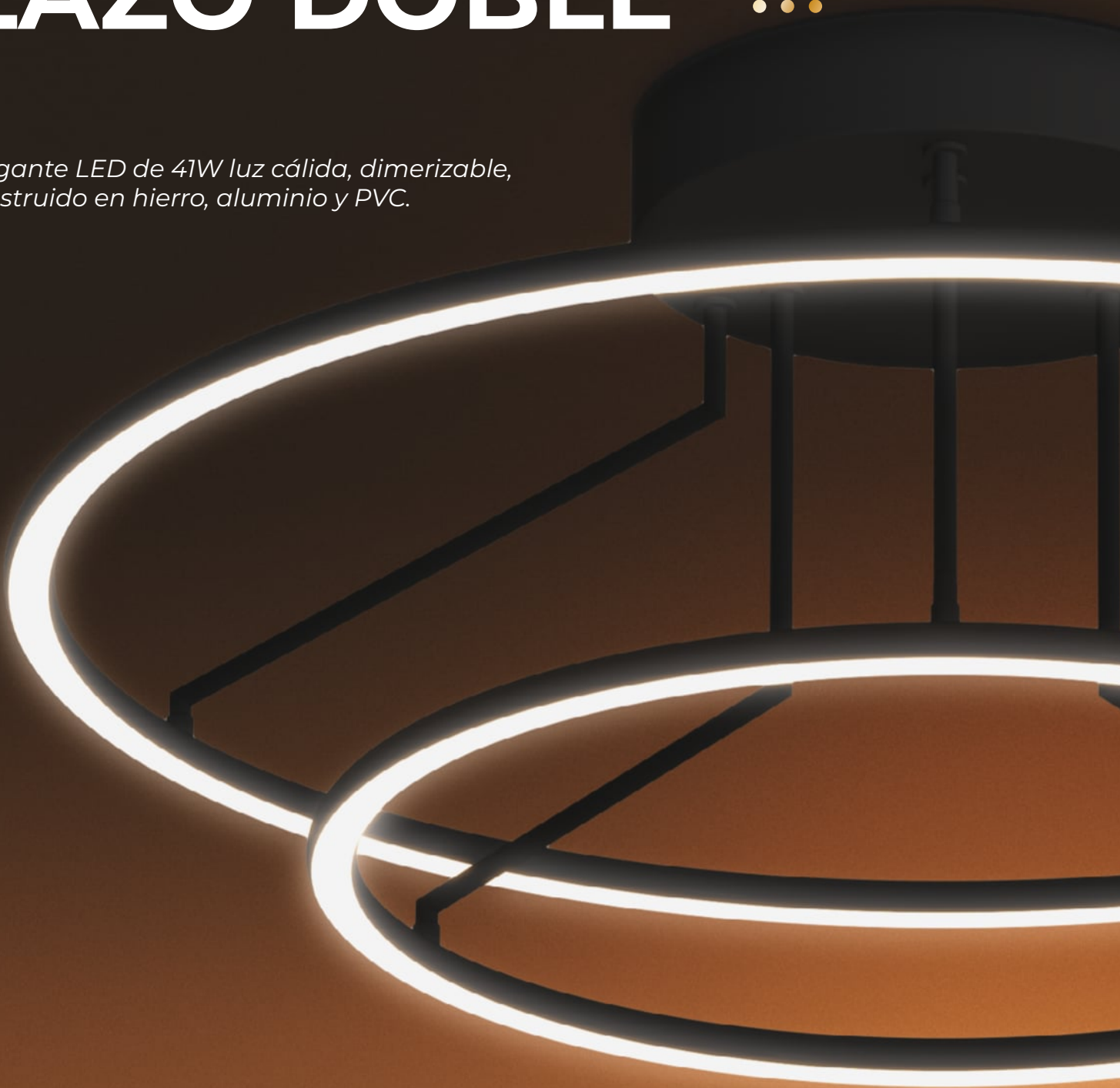



Plafón
LAZO DOBLE
Art.: PTL900622541





 LED 41W, 220V, 50Hz, IP20

 Negro mate

 3000K

 3690LM

 Hierro + Aluminio + PVC

 Clase I

 Dimerizable

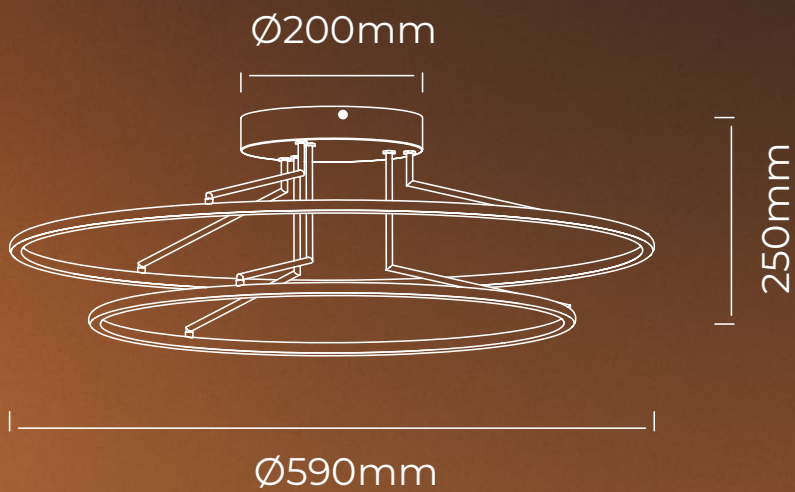

COLGANTE TRECK



*Colgante LED de 65W luz cálida,
dimerizable, construido en aluminio y PVC.*



Colgante
TRECK
Art.: CTL1001558365





 LED 65W, 220V, 50Hz, IP20

 Negro mate

 3000K

 5850LM

 Aluminio + PVC

 Clase I

 Dimerizable

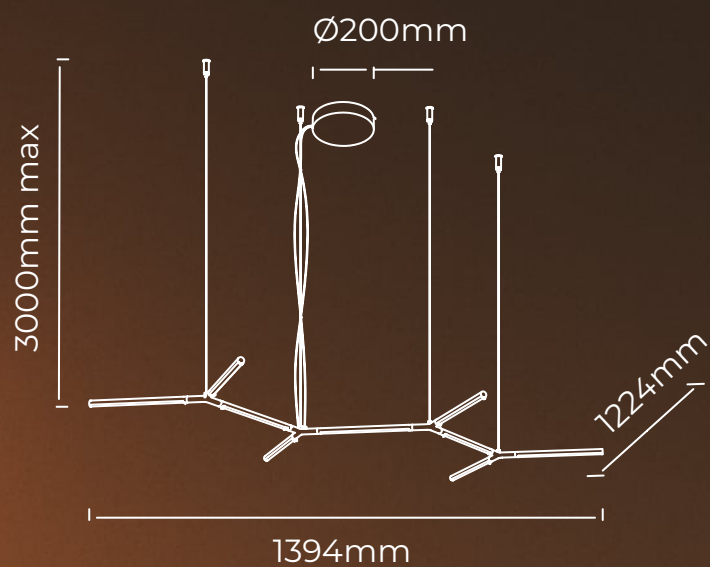
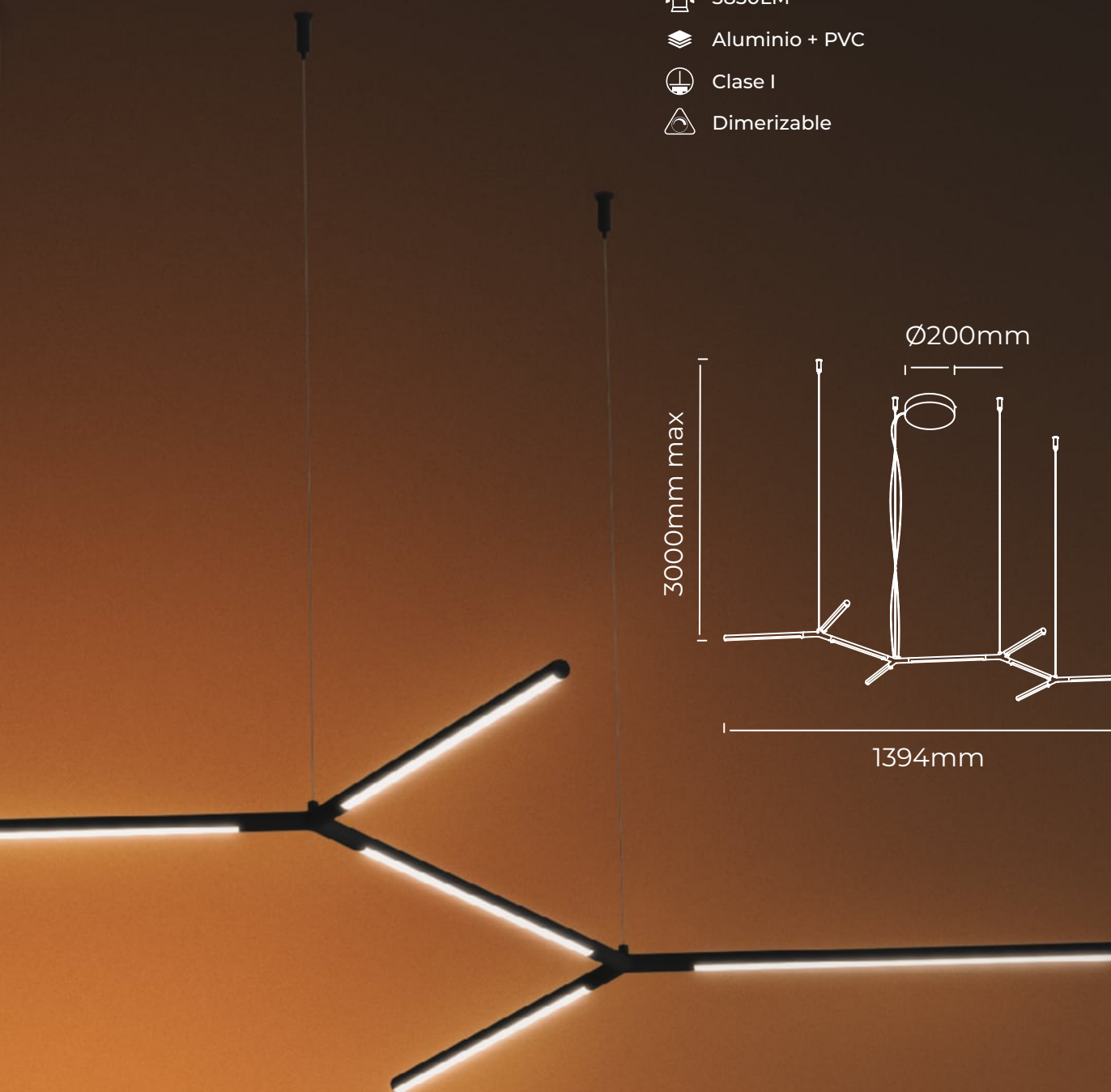

COLGANTE CENTRAL



*Colgante LED de 36W luz cálida,
dimerizable, construido en aluminio y PVC.*



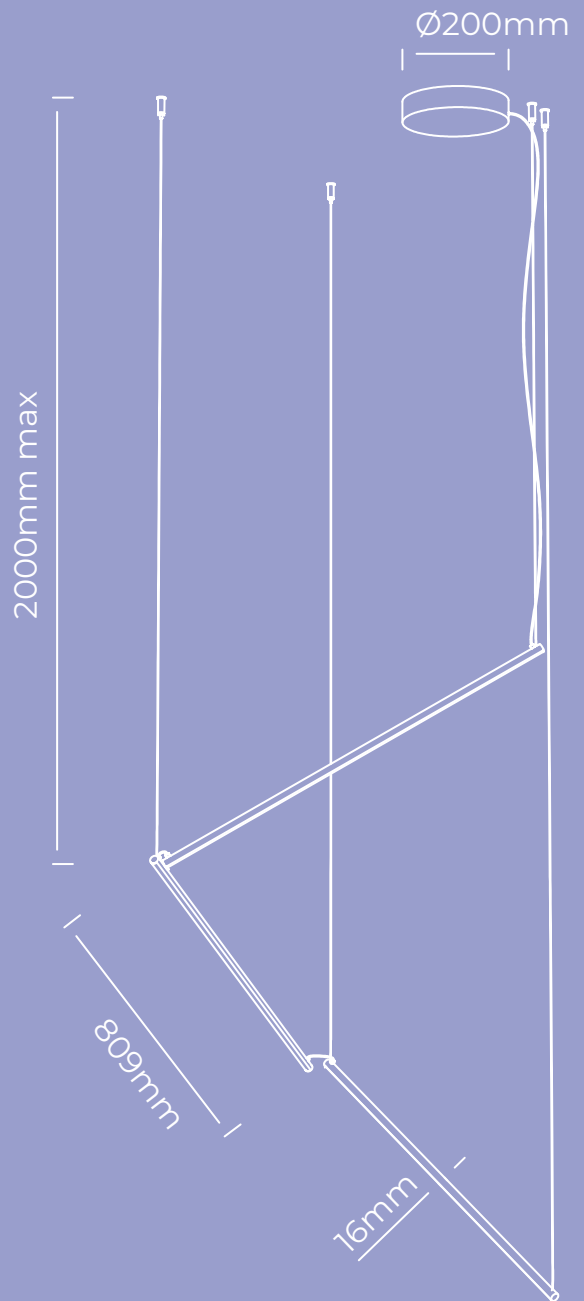

Colgante

CENTRAL

Art.: CTL1000009036



 LED 36W, 220V, 50Hz, IP20

 Negro mate

 3000K

 3240LM

 Aluminio + PVC

 Clase I

 Dimerizable

 Negro mate

PLAFÓN SUNSHINE



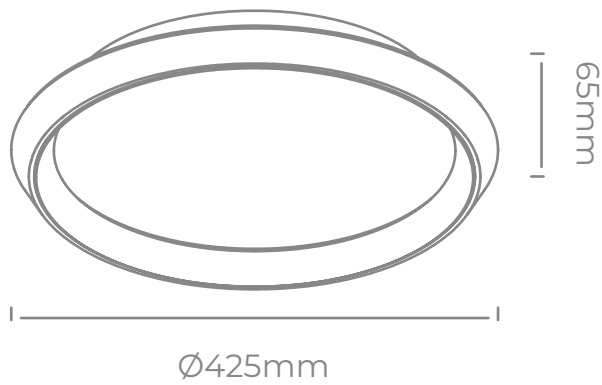
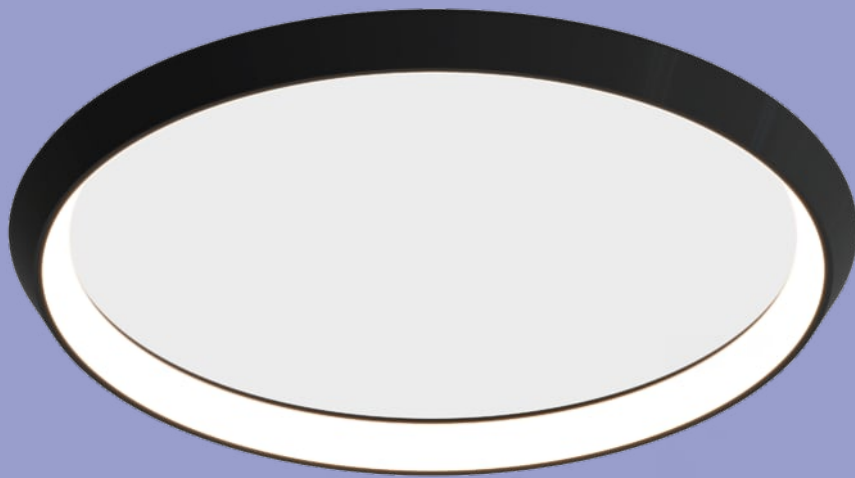
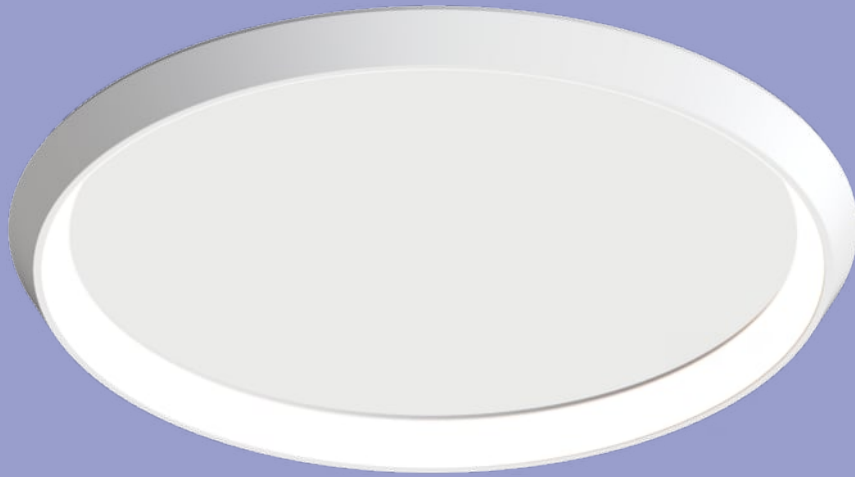

*Plafón LED de 28W luz cálida, dimerizable,
construido en hierro, aluminio y PVC.*





Plafón
SUNSHINE
 Art.: PTL920004228



 LED 28W, 220V, 50Hz, IP20

 Blanco mate, Negro mate

 3000K

 2520LM

 Hierro + Aluminio + PVC

 Clase I

 Dimerizable

COLGANTE SUNSHINE 60



*Colgante LED de 36W luz cálida, dimerizable,
construidos en hierro, aluminio y PVC.*

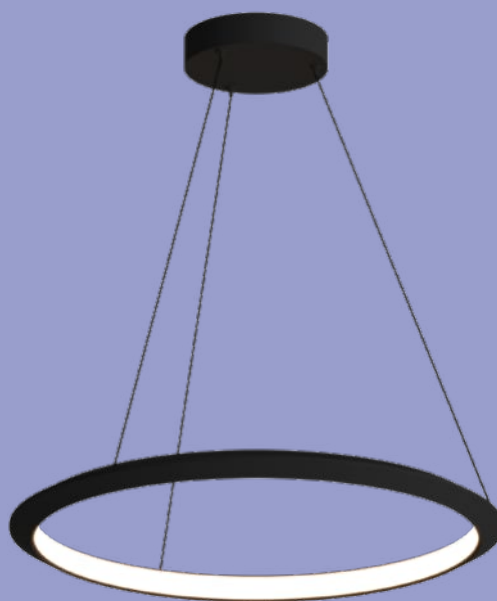

Colgante
SUNSHINE 60
Art.: CTL920006136



-  LED 36W, 220V, 50Hz, IP20
-  Blanco mate, Negro mate
-  3000K
-  3240LM
-  Aluminio + Hierro + PVC
-  Clase I
-  Dimerizable

COLGANTE SUNSHINE 80



*Colgante LED de 49W luz cálida, dimerizable,
construidos en hierro, aluminio y PVC.*





Colgante
SUNSHINE 80
 Art.: CTL920008049



-  LED 49W, 220V, 50Hz, IP20
-  Blanco mate, Negro mate
-  3000K
-  4410LM
-  Hierro + Aluminio + PVC
-  Clase I
-  Dimerizable

PLAFÓN OVAL I



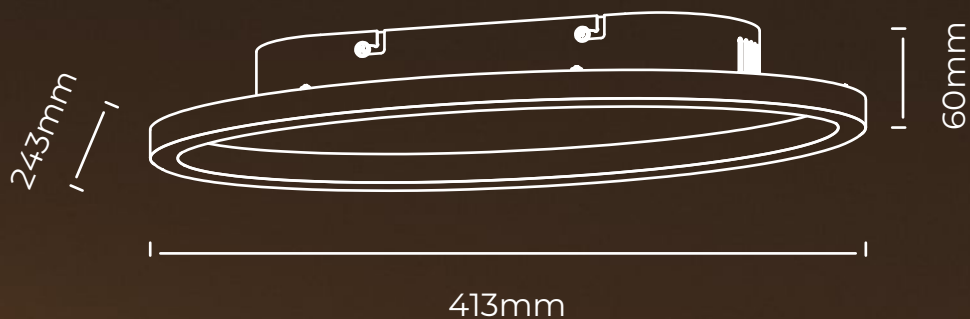

*Plafón LED de 24W luz cálida,
dimerizable, construido en hierro, aluminio y PVC.*



Plafón
OVAL I
Art.: PTL930416024



 LED 24W, 220V, 50Hz, IP20

 Negro mate

 3000K

 2160LM

 Hierro + Aluminio + PVC

 Clase I

 Dimerizable

 Negro mate

PLAFÓN OVAL II



*Plafón LED de 24W luz cálida, dimerizable,
construidos en hierro, aluminio y PVC.*

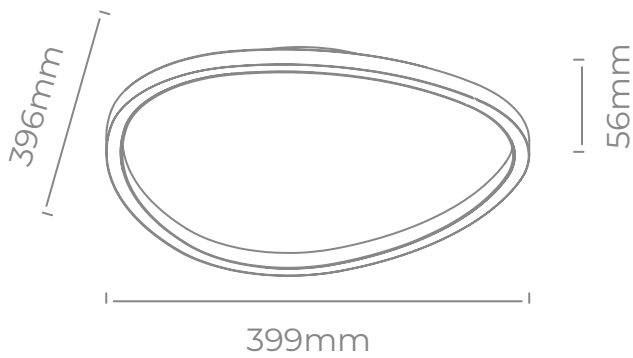



Plafón

OVAL II

Art.: PTL930406024



 LED 24W, 220V, 50Hz, IP20

 Blanco mate, Negro mate

 3000K

 2160LM

 Hierro + Aluminio + PVC

 Clase I

 Dimerizable

COLGANTE OVAL II

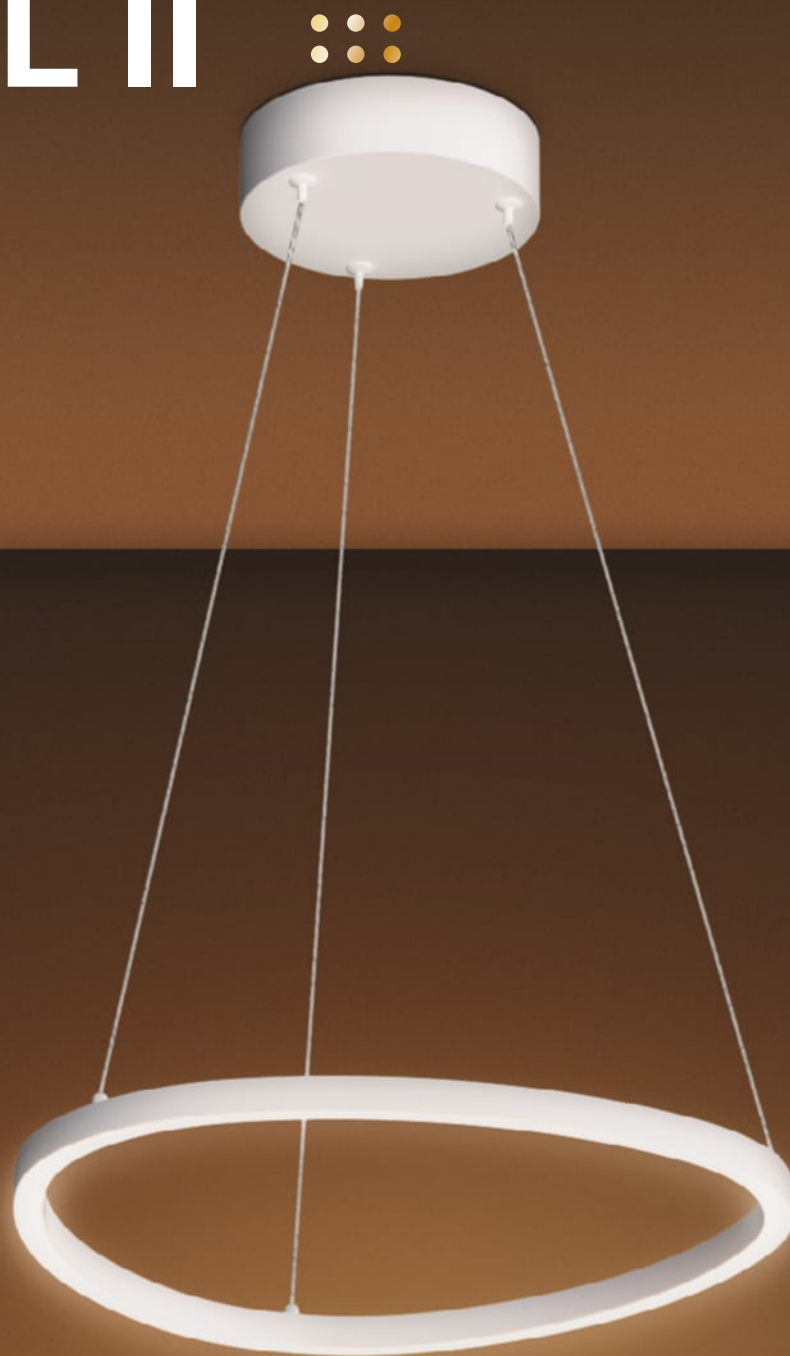

Colgante LED de 24W luz cálida, dimerizable, construido en hierro, aluminio y PVC.

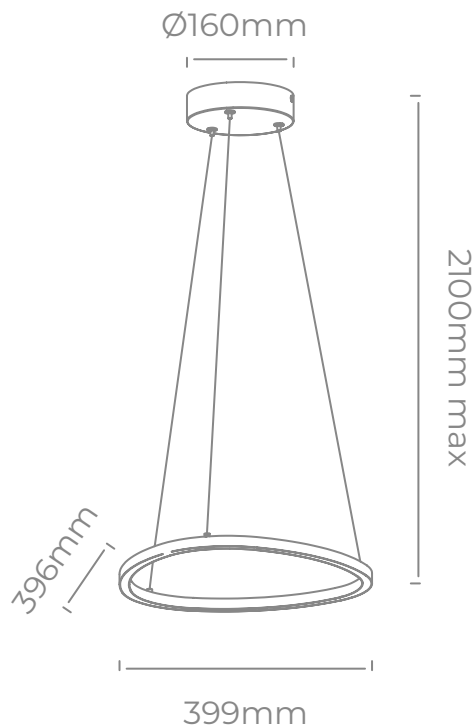

Colgante

OVAL II

Art.: CTL930404024



 LED 24W, 220V, 50Hz, IP20

 Blanco mate, Negro mate

 3000K

 2160LM

 Hierro + Aluminio + PVC

 Clase I

 Dimerizable

COLGANTE SONDA 40

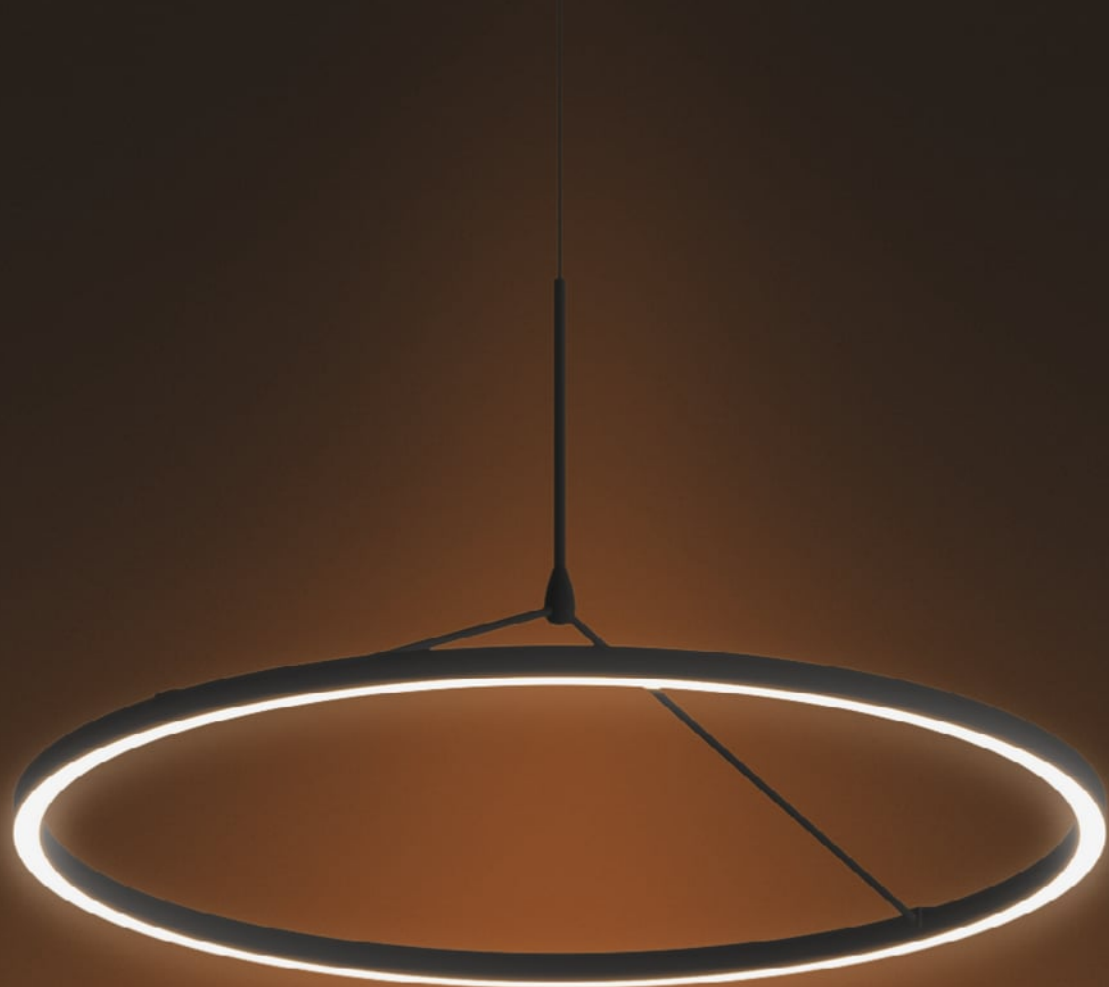

*Colgante LED 27W luz cálida, dimerizable,
construido en hierro, aluminio y PVC.*



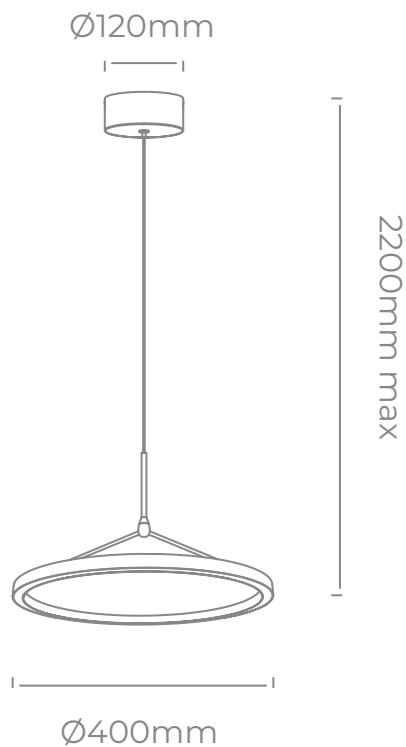







Colgante
SONDA 40

Art.: CTL950004027



-  LED 27W, 220V, 50Hz, IP20
-  Blanco mate, Negro mate
-  3000K
-  2430LM
-  Hierro + Aluminio + PVC
-  Clase I
-  Dimerizable

COLGANTE SONDA 60

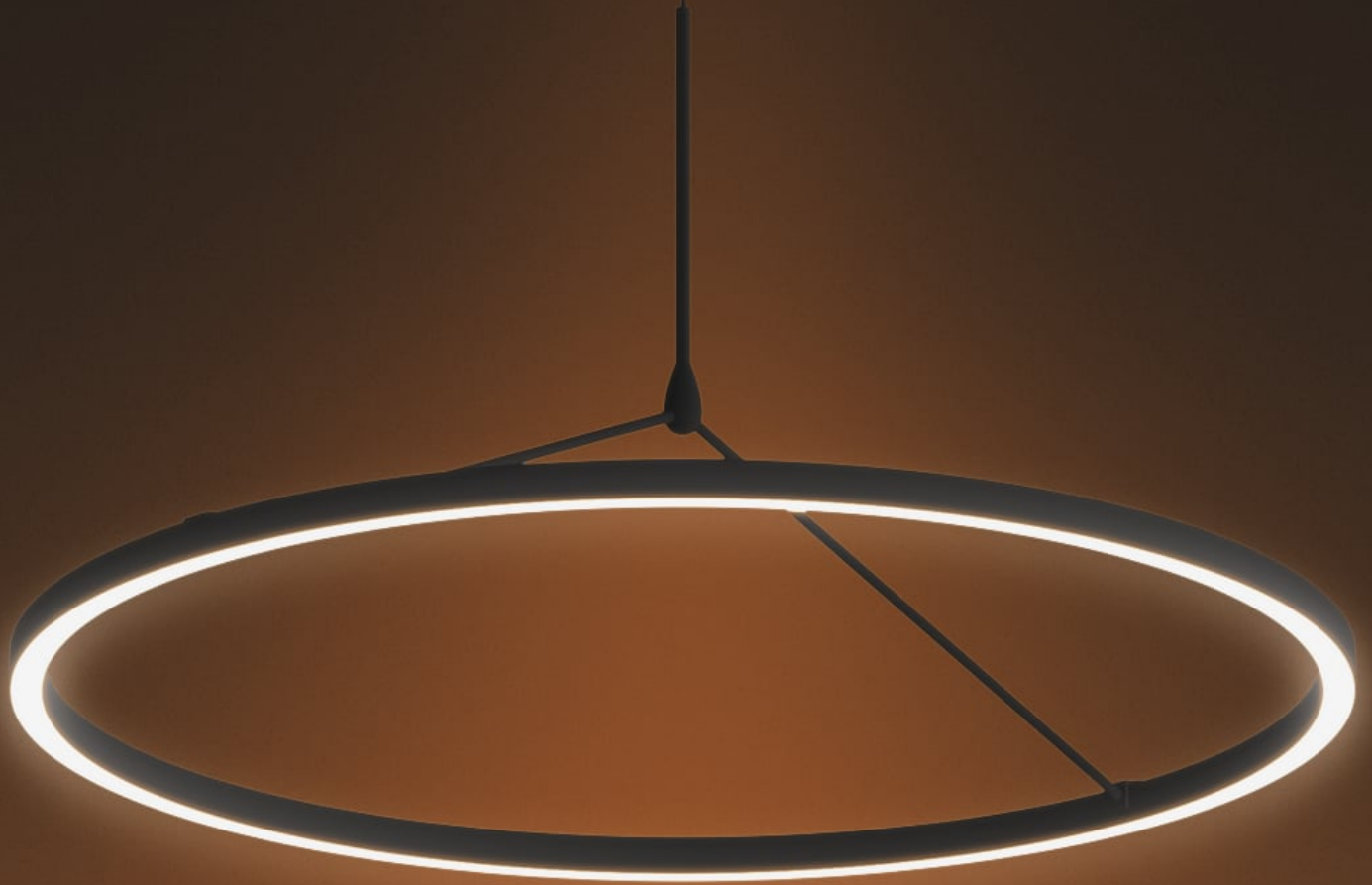

*Colgante LED de 43W luz cálida, dimerizable,
construido en hierro, aluminio y PVC.*



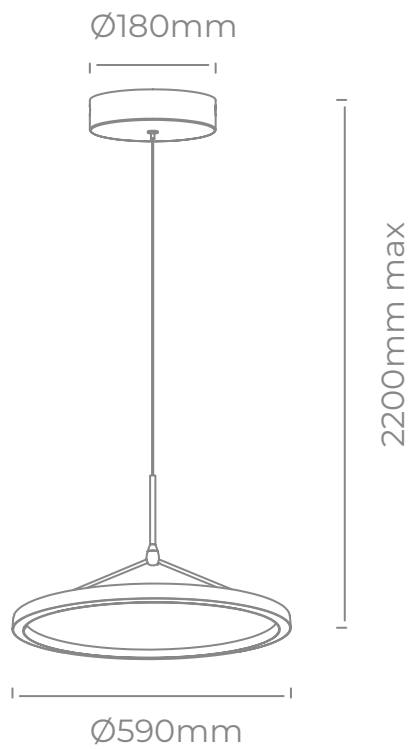
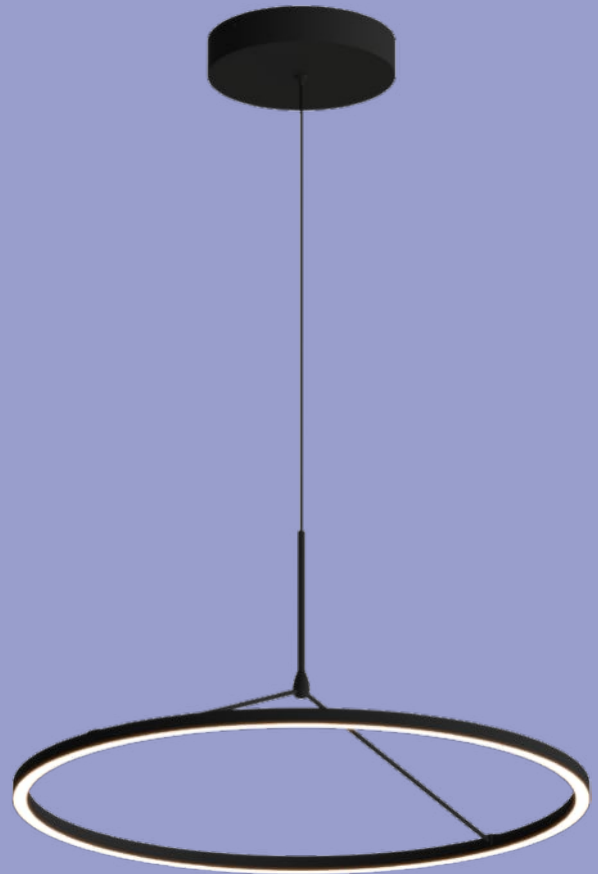
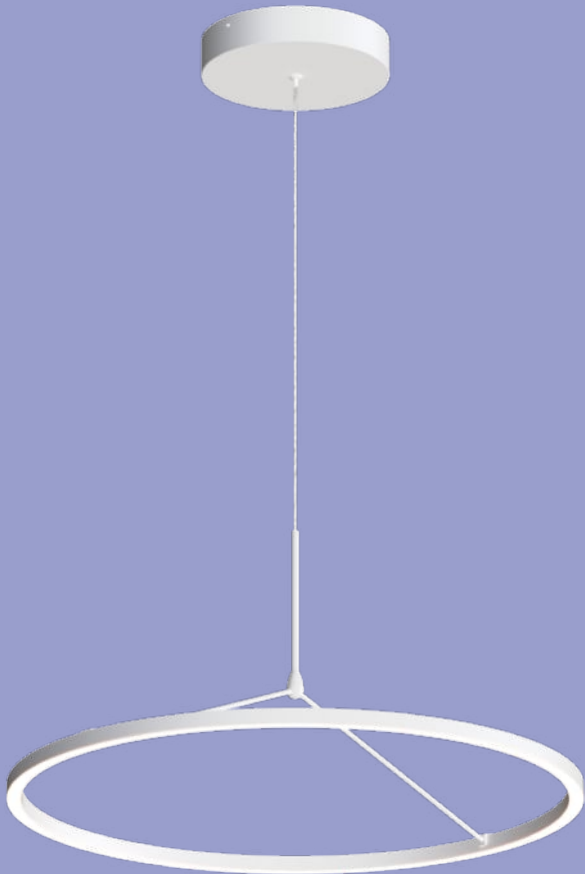



Colgante

SONDA 60

Art.: CTL950005943



 LED 43W, 220V, 50Hz, IP20

 Blanco mate, Negro mate

 3000K

 3870LM

 Hierro + Aluminio + PVC

 Clase I

 Dimerizable

COLGANTE SOMBRA



*Colgante LED de 38W luz cálida,
dimerizable, construido en hierro,
aluminio y PVC.*



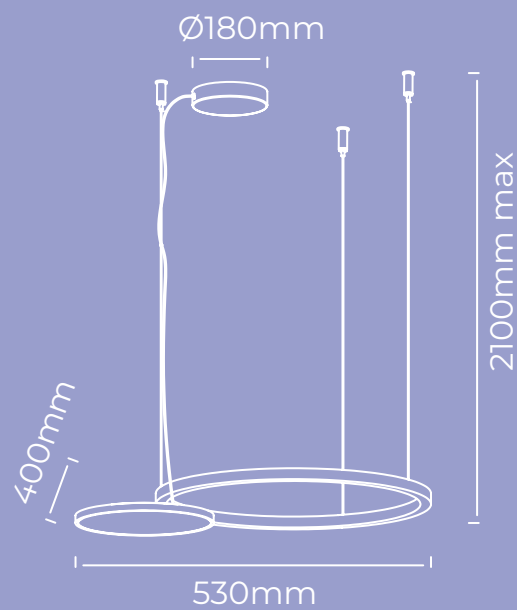

Colgante
SOMBRA
Art.: CTL970534038



- LED 38W, 220V, 50Hz, IP20
- Blanco mate, Negro mate
- 3000K
- 3420LM
- Hierro + Aluminio + PVC
- Clase I
- Dimerizable

● Blanco mate ● Negro mate

COLGANTE INTER



*Colgante LED de 54W luz cálida,
dimerizable, construido en hierro, aluminio y PVC.*



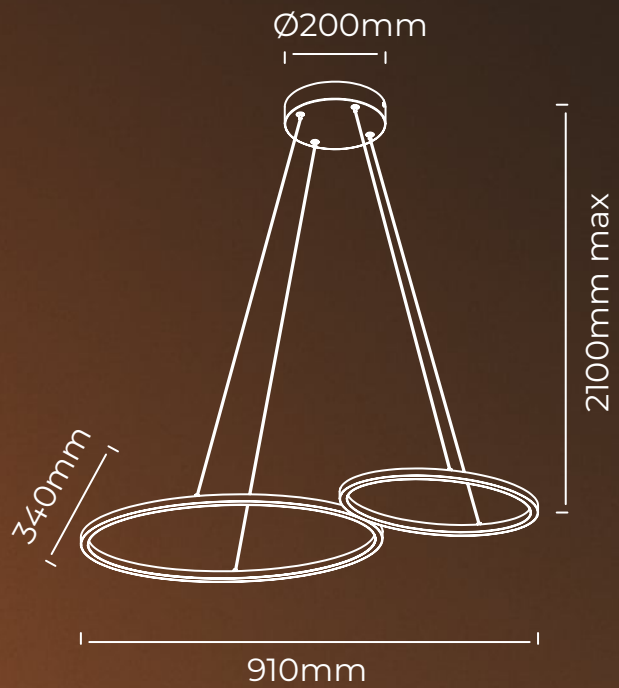

Colgante
INTER
Art.: CTL980913454





 LED 54W, 220V, 50Hz, IP20

 Blanco mate, Negro mate

 3000K

 4860LM

 Hierro + Aluminio + PVC

 Clase I

 Dimerizable

 Blanco mate

 Negro mate

APLIQUE LINEA

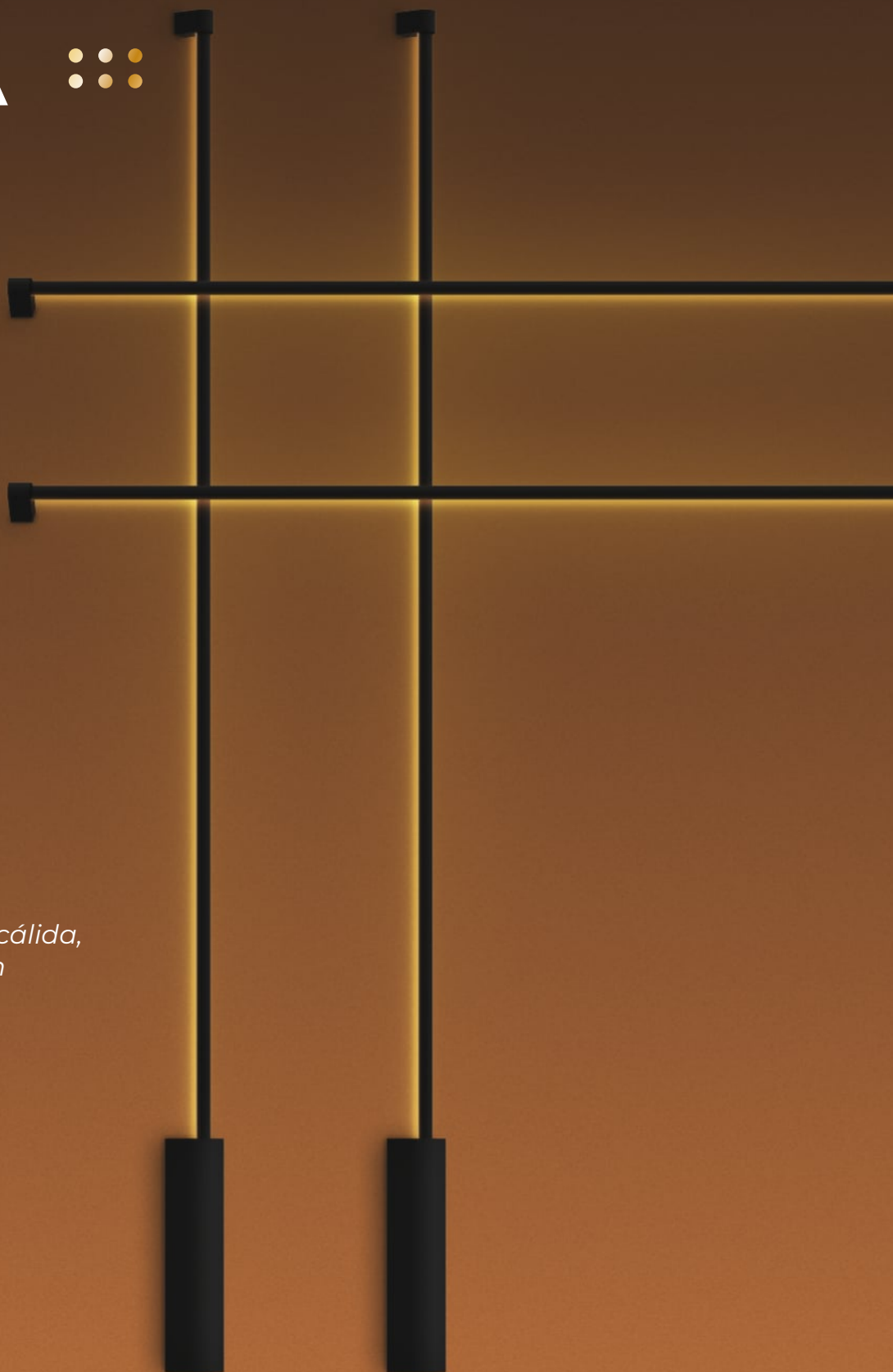

*Colgante LED de 26W luz cálida,
dimerizable, construido en
hierro, aluminio y PVC.*

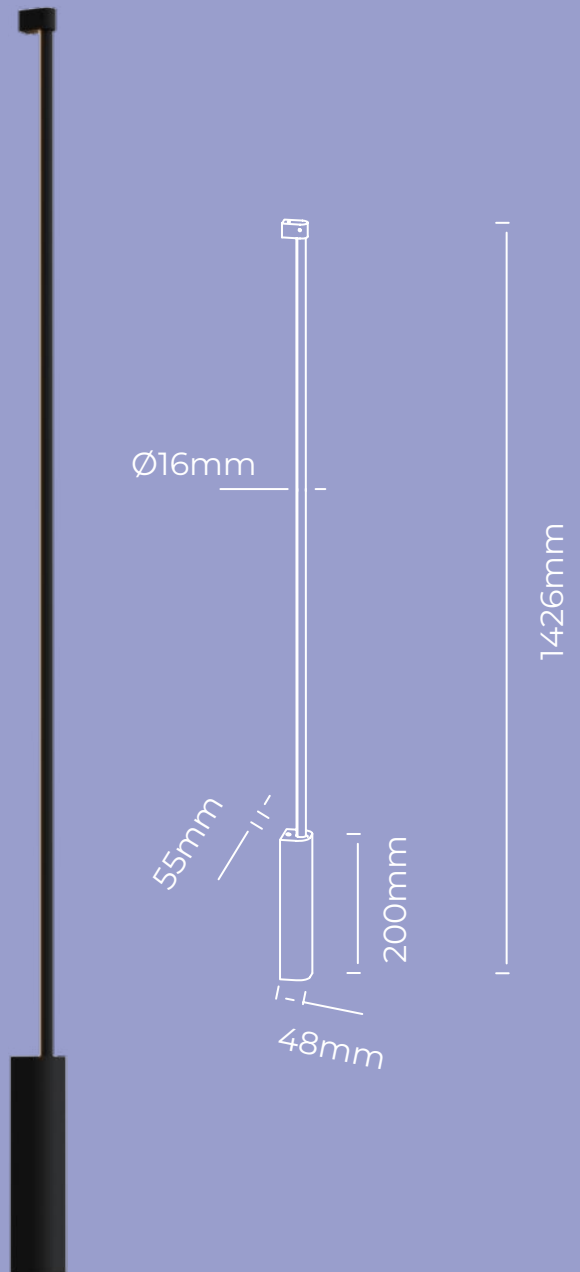
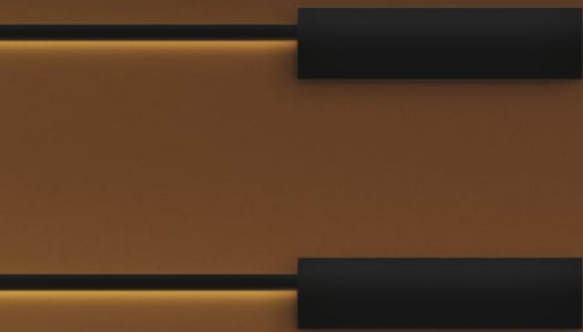

Aplique
LINEA
Art.: APL941405026



-  LED 26W, 220V, 50Hz, IP20
-  Negro mate
-  3000K
-  2340LM
-  Hierro + Aluminio + PVC
-  Clase I
-  Dimerizable

PLAFÓN GRIFO



*Plafone LED de 41W luz cálida, dimerizable,
construidos en hierro, aluminio y PVC.*

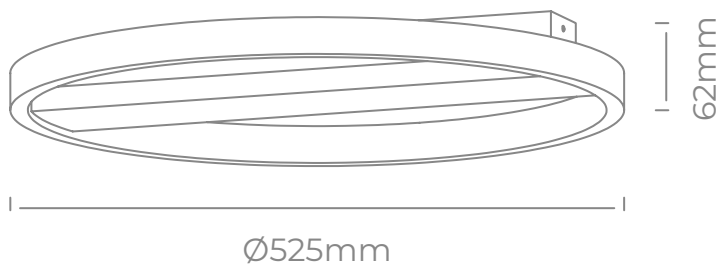
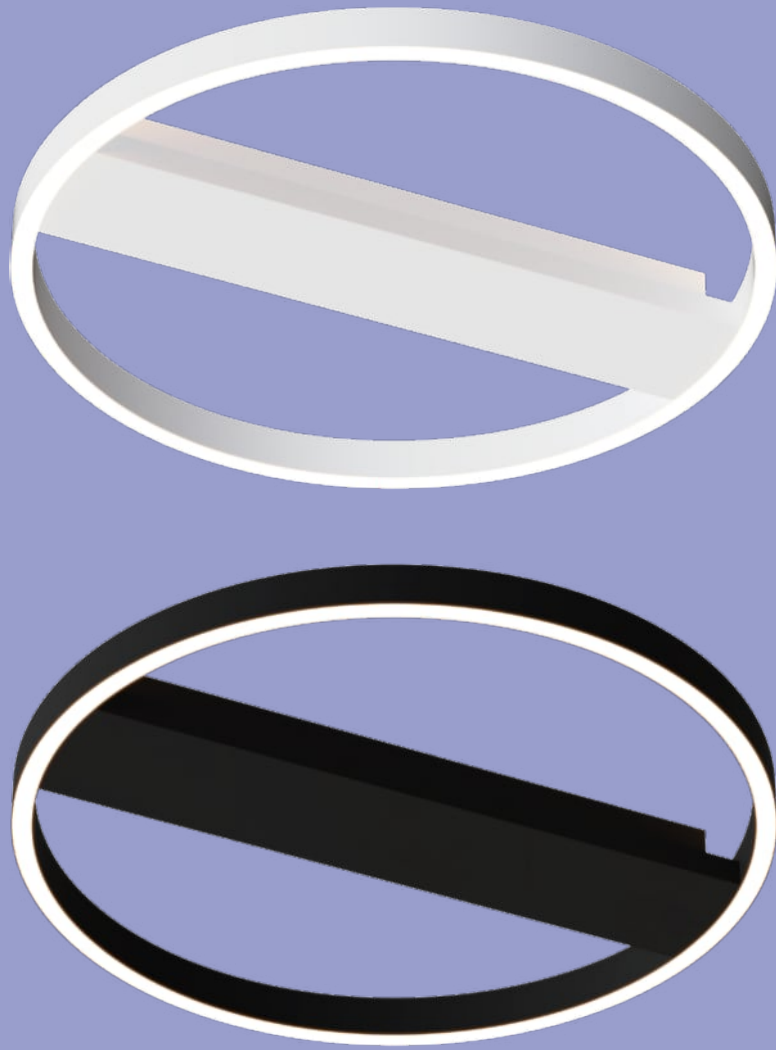



Plafón

GRIFO

Art.: PTL940537041



 LED 41W, 220V, 50Hz, IP20

 Blanco mate, Negro mate

 3000K

 3690LM

 Hierro + Aluminio + PVC

 Clase I

 Dimerizable

APLIQUE FLASH



*Aplique LED de 6W, luz cálida
construido en aluminio y acrílico.*

Colgante
FLASH
Art.: APL101000256



-  LED 6W, 220V, 50Hz, IP20
-  Negro mate
-  3000K
-  540LM
-  Aluminio + Acrílico
-  Clase I
-  No dimerizable

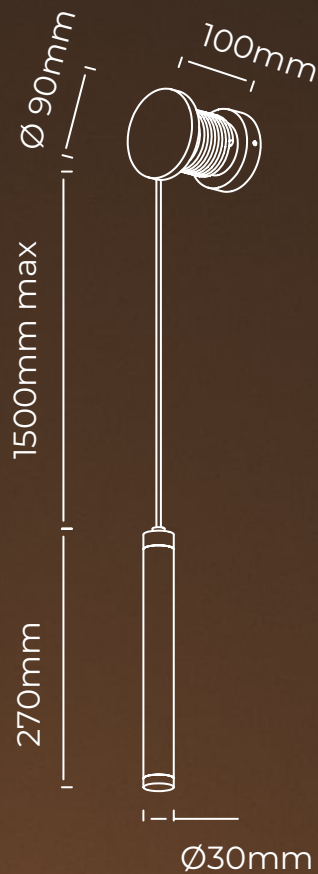







COLGANTE FLASH I

Colgante LED de 8W luz cálida,
dimerizable, construido en hierro,
aluminio y acrílico.



Colgante
FLASH I
Art.: CTLI01000408



-  LED 8W, 220V, 50Hz, IP20
-  Negro mate
-  3000K
-  720LM
-  Hierro + Aluminio + Acrílico
-  Clase I
-  Dimerizable

Ø75mm

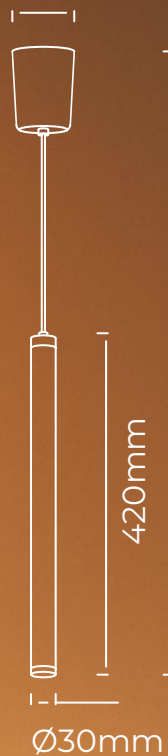

COLGANTE FLASH IV



*Colgante LED de 4 luces luz cálida,
dimerizable, construido en hierro,
aluminio y PVC.*



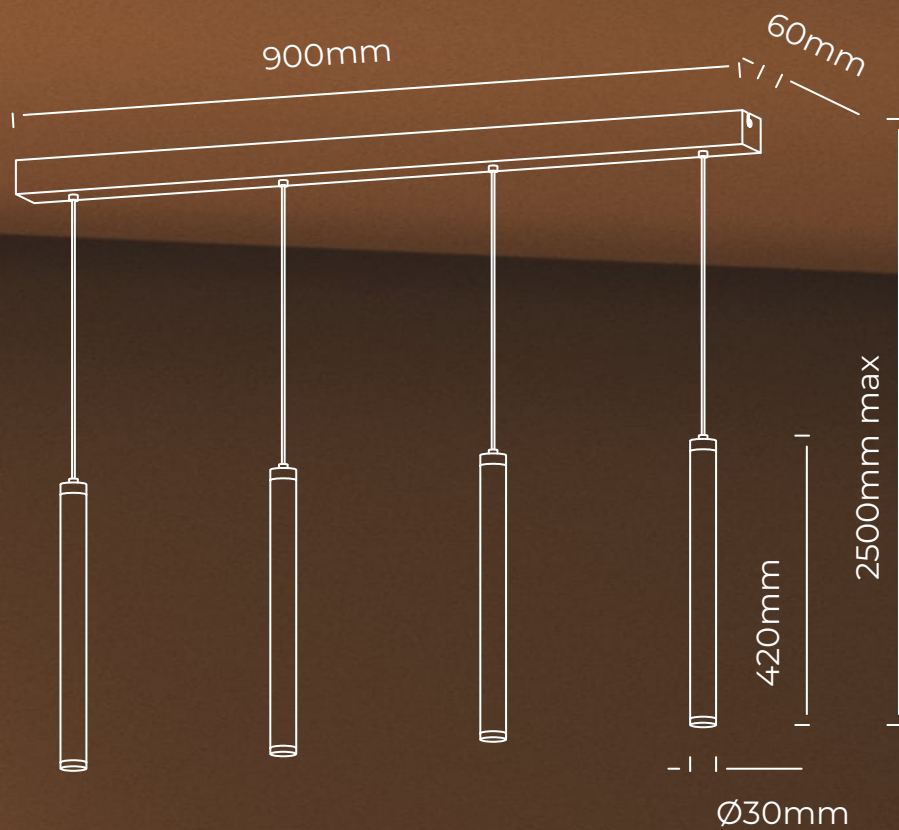

Colgante
FLASH IV
Art.: CTL1040906036



-  LED 36W, 220V, 50Hz, IP20
-  Negro mate
-  3000K
-  3240LM
-  Hierro + Aluminio + Acrílico
-  Clase I
-  Dimerizable

COLGANTE FLASH V



*Colgante LED de 5 luces luz cálida,
construido en hierro, aluminio y PVC.*



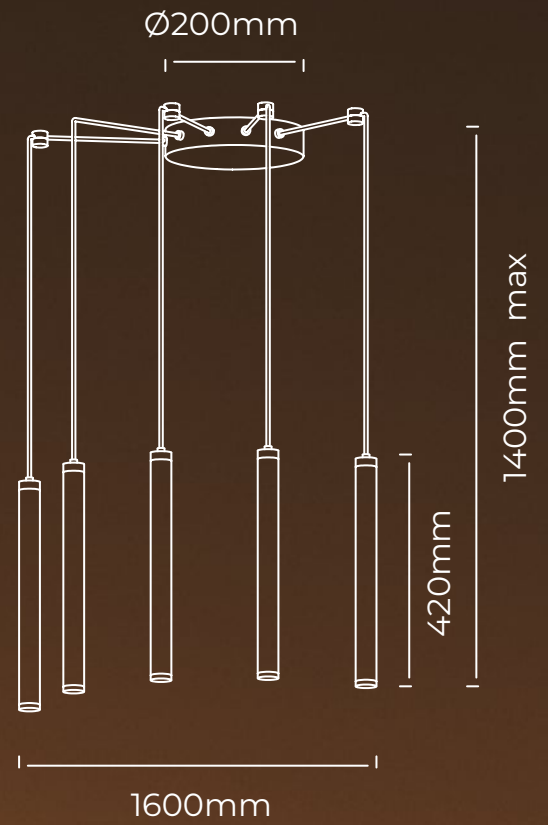



Colgante
FLASH V
Art.: CTLI0516010049



 LED 49W, 220V, 50Hz, IP20

 Negro mate

 3000K

 4410LM

 Hierro + Aluminio + Acrílico

 Clase I

 Dimerizable

PLAFÓN ORBITAL



Plafón LED de 28W luz cálida,
dimerizable, construido en hierro,
aluminio y PVC.

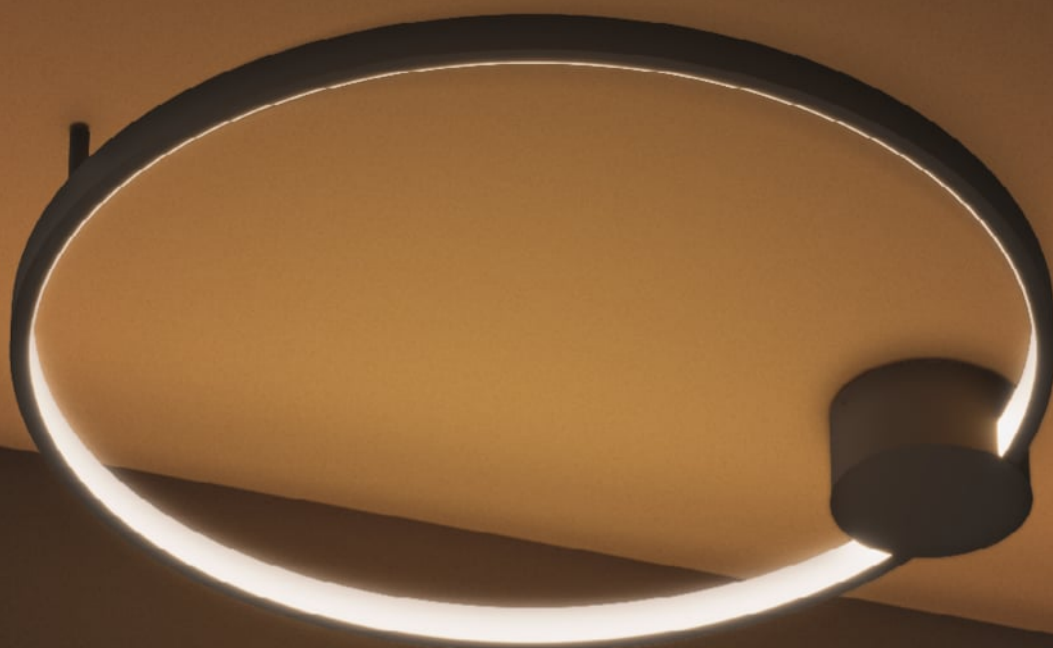



Plafón
ORBITAL
Art.: PTL1210646028





 LED 28W, 220V, 50Hz, IP20

 Negro mate

 3000K

 2520LM

 Hierro + Aluminio + PVC

 Clase I

 Dimerizable

Ø120mm



60mm

Ø610mm



640mm



COLGANTE ORBITAL

Colgante LED de 28W luz cálida,
dimerizable, construido en hierro,
aluminio y PVC

Colgante
ORBITAL
Art.: CTL1210606528





 LED 28W, 220V, 50Hz, IP20

 Negro mate

 3000K

 2520LM

 Hierro + Aluminio + PVC

 Clase I

 Dimerizable

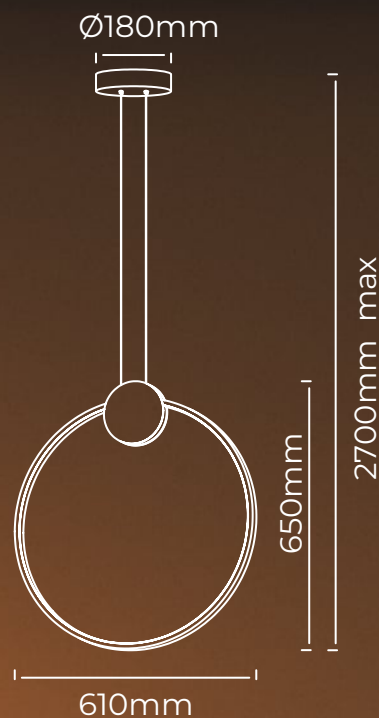

 Negro mate



APLIQUE

●●● GOTA

Aplicado LED de 12W luz cálida, dimerizable, construido en hierro, aluminio y PVC.



Aplicado
GOTA
Art.: APL1200126012



LED 12W, 220V, 50Hz, IP20

Negro mate

3000K

1080LM

Hierro + Aluminio + PVC

Clase I

Dimerizable

COLGANTE

●●● GOTA

Colgante LED de 12W luz cálida, dimerizable construido en hierro, aluminio y PVC.



Ø100mm

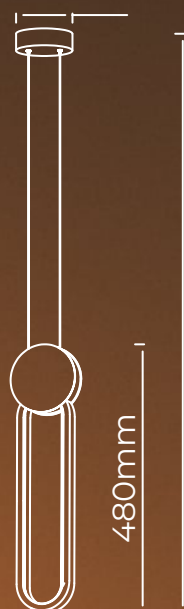

480mm

2500mm max

100mm

Colgante
GOTA
Art.: CTL1200124812



- LED 12W, 220V, 50Hz, IP20
- Negro mate
- 3000K
- 1080LM
- Hierro + Aluminio + PVC
- Clase I
- Dimerizable

COLGANTE NASCAR





*Colgante LED de 41W luz cálida,
dimerizable, construido en hierro, aluminio
y PVC.*



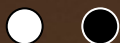

Colgante
NASCAR
Art.: CTL1221203541



 LED 41W, 220V, 50Hz, IP20

 Blanco mate, Negro mate

 3000K

 3690LM

 Hierro + Aluminio + PVC

 Clase I

 Dimerizable

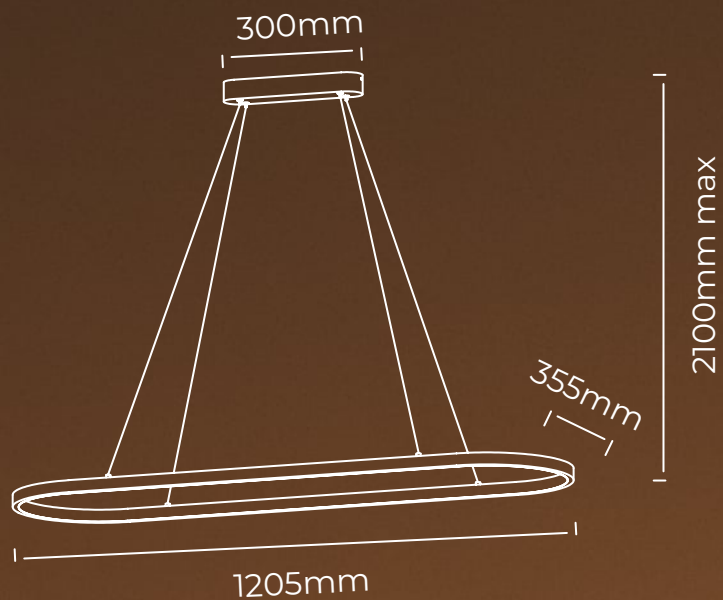

 Blanco mate

 Negro mate

PLAFÓN GHOST



*Plafón LED de 20W luz cálida,
dimerizable, construido en hierro, aluminio y PVC.*



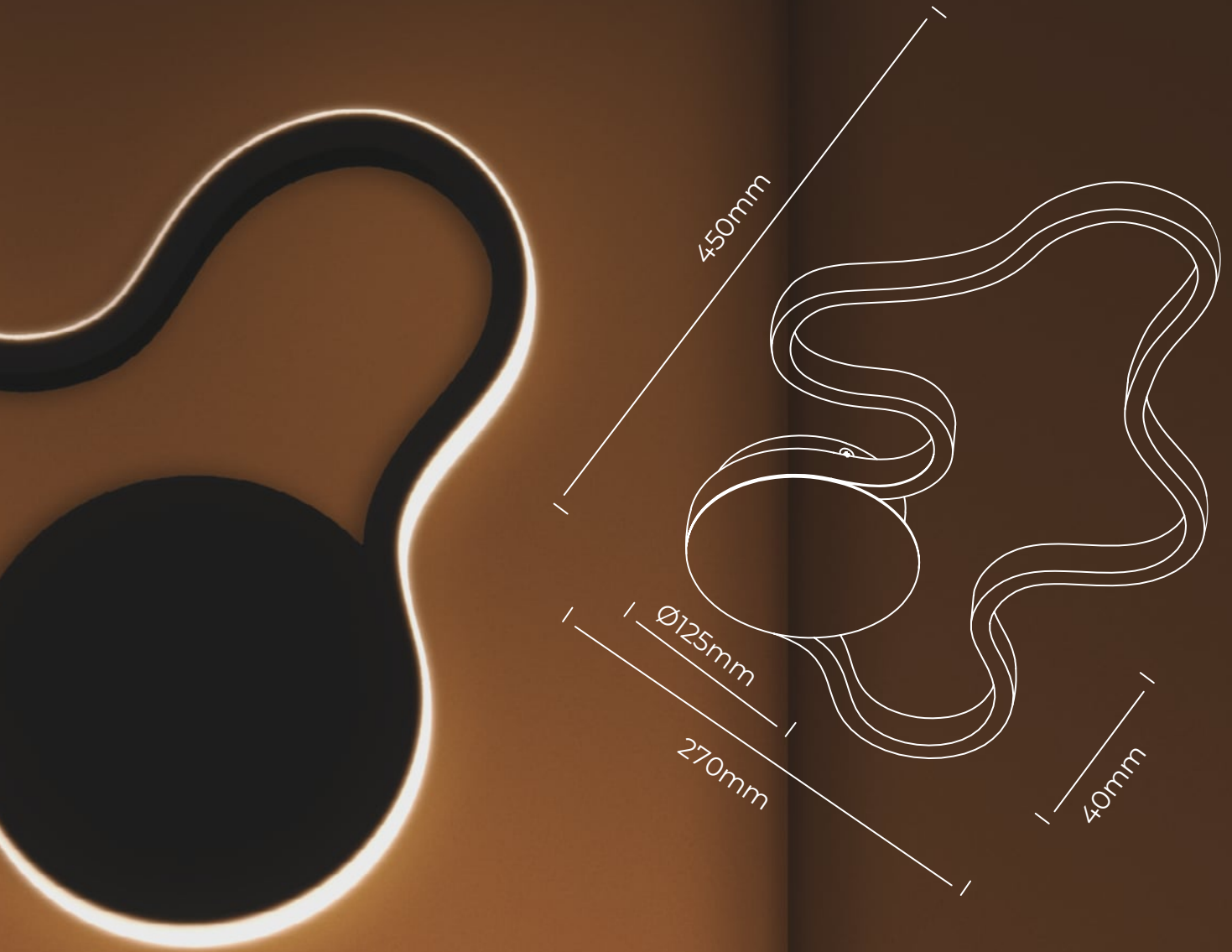

Plafón
GHOST
Art.: PTL960454020



-  LED 20W, 220V, 50Hz, IP20
-  Negro mate
-  3000K
-  1800LM
-  Hierro + Aluminio + PVC
-  Clase I
-  Dimerizable

 Negro mate

COLGANTE CURLY



*Colgante LED de 49W luz cálida,
dimerizable, construido en hierro, aluminio y PVC.*



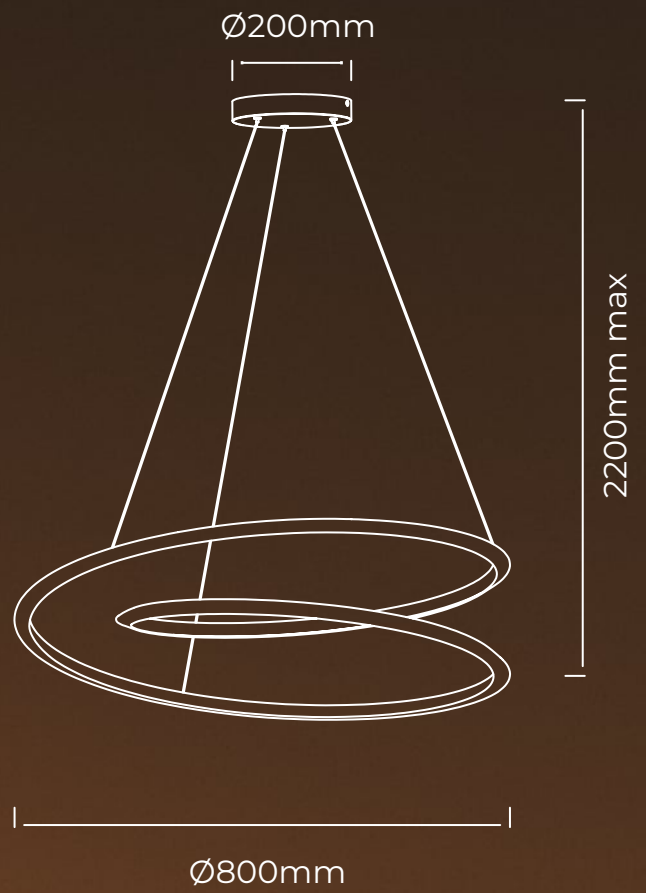



Colgante

CURLY

Art.: CTL9008020049



 LED 49W, 220V, 50Hz, IP20

 Negro mate

 3000K

 4410LM

 Hierro + Aluminio + PVC

 Clase I

 Dimerizable

APLIQUE PARALELO

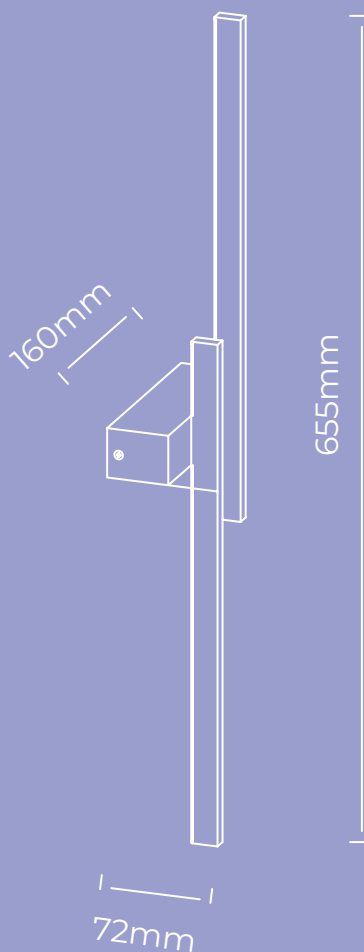

Aplique
PARALELO
Art.: APL1020657212



-  LED 12W, 220V, 50Hz, IP20
-  Negro mate
-  3000K
-  1080LM
-  Hierro + Aluminio + PVC
-  Clase I
-  Dimerizable



*Aplique LED de 12W luz cálida,
dimerizable, construido en hierro,
aluminio y PVC.*

APLIQUE SIMPLE



Aplique LED de 12W luz cálida, dimerizable, construido en hierro, aluminio y PVC.

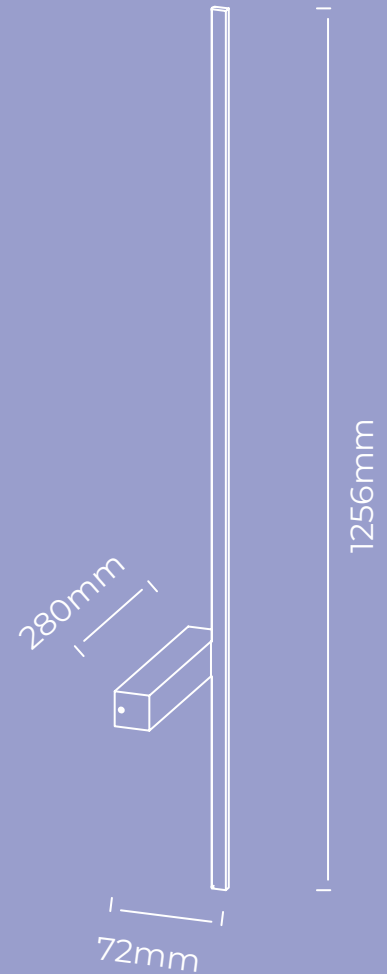

Aplique
SIMPLE
Art.: APL1031267212



-  LED 12W, 220V, 50Hz, IP20
-  Negro mate
-  3000K
-  1080LM
-  Hierro + Aluminio + PVC
-  Clase I
-  Dimerizable

COLGANTE PANAL 6



Colgante LED de 6 luces construido en aluminio.





Colgante

PANAL 6

Art.: CTL8806402833





 LED 36W, 220V, 50Hz, IP20

 Blanco mate, Negro mate

 3000K

 3240LM

 Aluminio

 Clase I

 Dimerizable

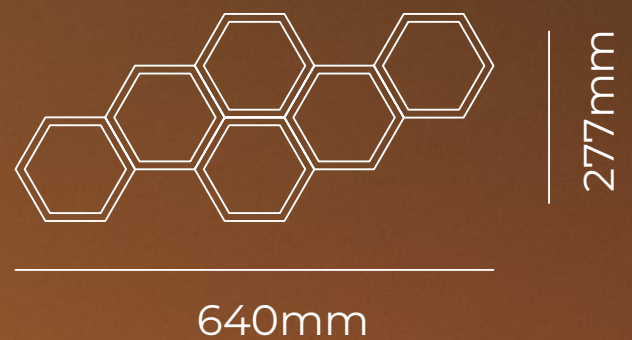
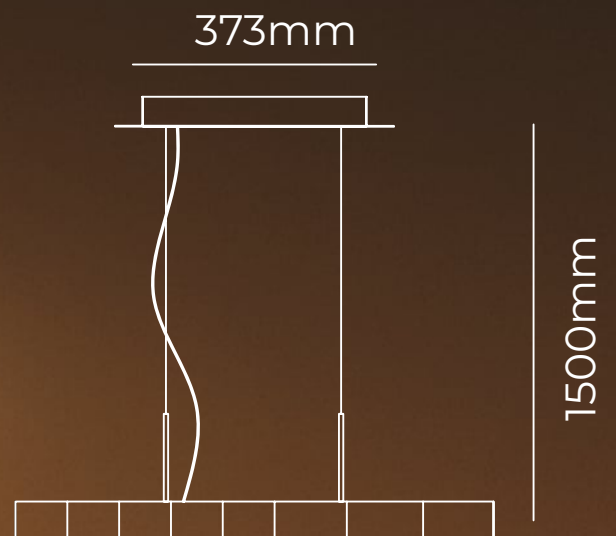

 Negro mate

 Blanco mate

PLAFÓN PANAL



Plafones LED de 4, 5, 6 y 10 luces contruidos en aluminio.



Plafón
PANAL 4
Art.: PTL8804002825

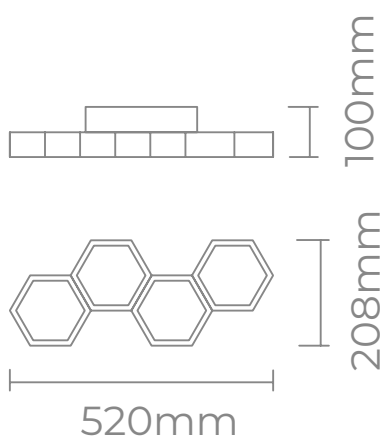

-  LED 25W, 220V, 50Hz, IP20
-  Negro mate, Blanco mate
-  3000K
-  2250LM
-  Aluminio
-  Clase I
-  Dimerizable

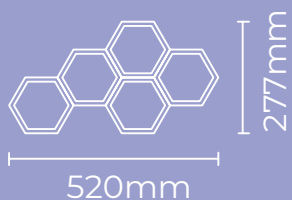
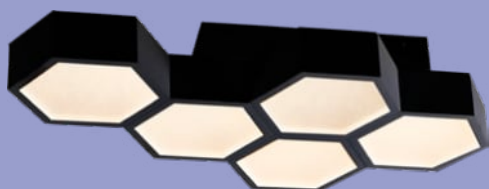

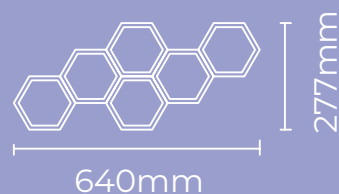
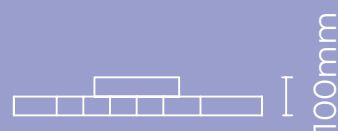
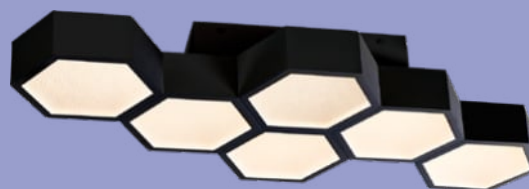

Plafón
PANAL 5
Art.: PTL8806402825





Plafón
PANAL 6
Art.: PTL8806402833



 LED 28W, 220V, 50Hz, IP20

 Negro mate, Blanco mate

 3000K

 2520LM

 Aluminio

 Clase I

 Dimerizable

 LED 36W, 220V, 50Hz, IP20

 Negro mate, Blanco mate

 3000K

 3240LM

 Aluminio





 Clase I

 Dimerizable

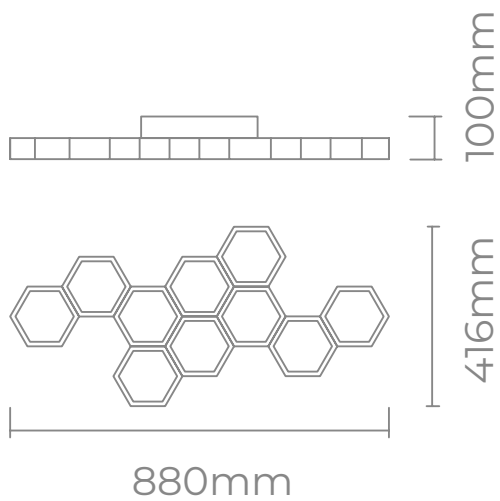

Plafón
PANAL 10
Art.: PTL8808804239



-  LED 54W, 220V, 50Hz, IP20
-  Negro mate, Blanco mate
-  3000K
-  4860LM
-  Aluminio
-  Clase I
-  Dimerizable

COLGANTE ARUBA



Colgantes LED de 1, 3 y 5 luces
construidos en aluminio.

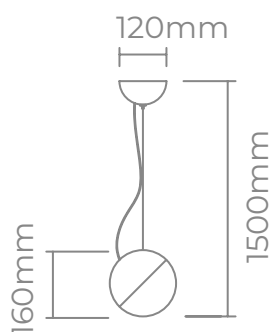

Colgante
ARUBA 1
Art.: CTL77RE01610M



- LED 10W, 220V, 50Hz, IP20
- Negro mate
- 3000K
- 900LM
- Aluminio
- Clase I
- Dimerizable

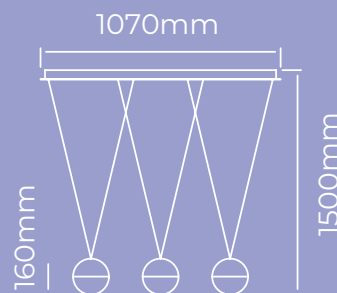
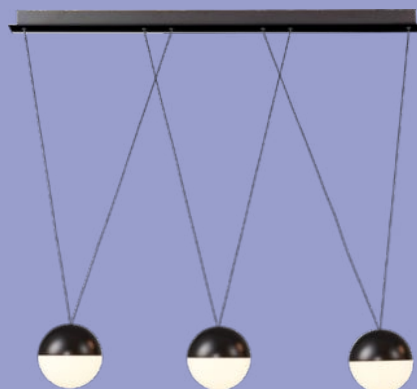

Colgante
ARUBA 3
Art.: CTL7710301632



- LED 32W, 220V, 50Hz, IP20
- Negro mate
- 3000K
- 2880LM
- Aluminio
- Clase I
- Dimerizable

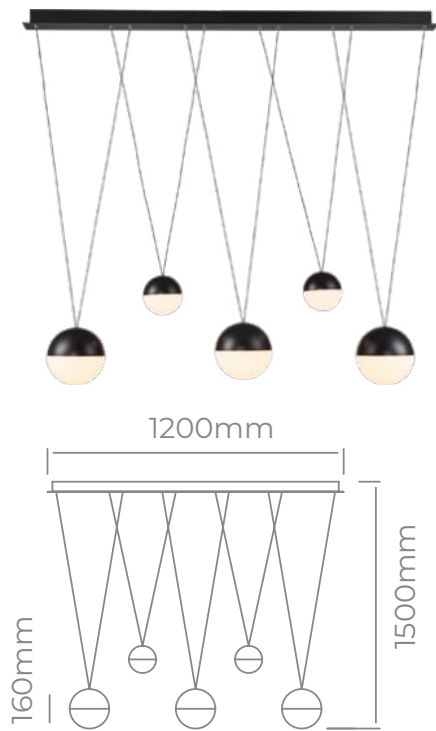
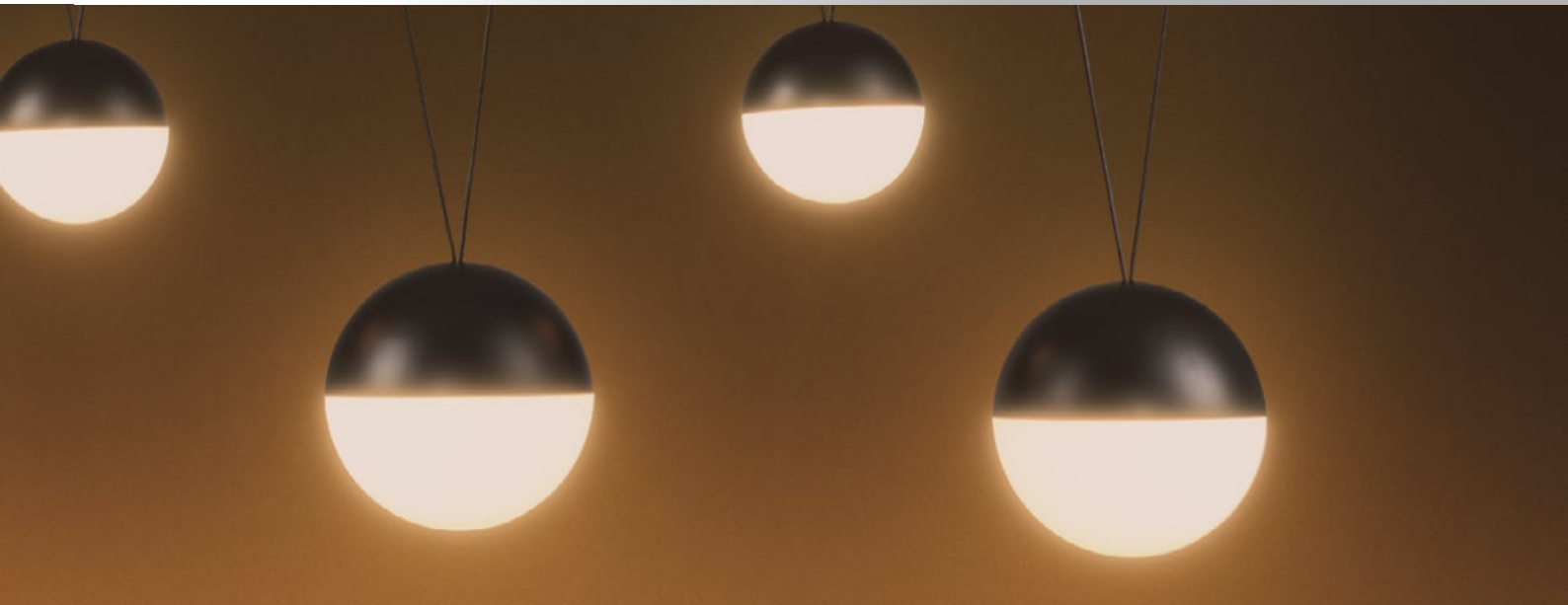

Colgante
ARUBA 5
Art.: CTL7712001636



-  LED 36W, 220V, 50Hz, IP20
-  Negro mate
-  3000K
-  3240LM
-  Aluminio
-  Clase I
-  Dimerizable

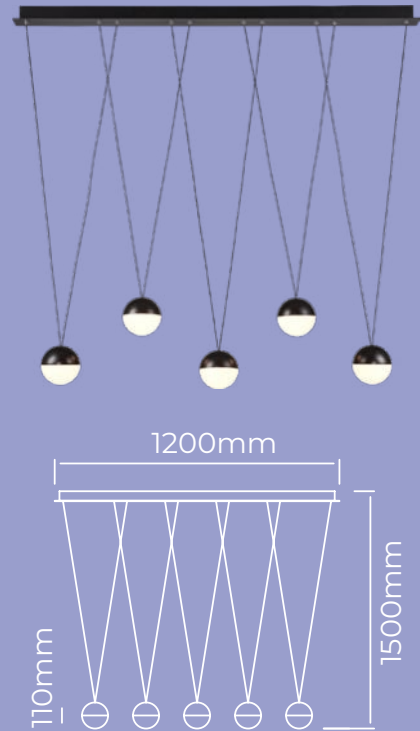

Colgante
ARUBA 5
Art.: CTL7715001643



-  LED 36W, 220V, 50Hz, IP20
-  Negro mate
-  3000K
-  3240LM
-  Aluminio
-  Clase I
-  Dimerizable

COLGANTE VECTOR





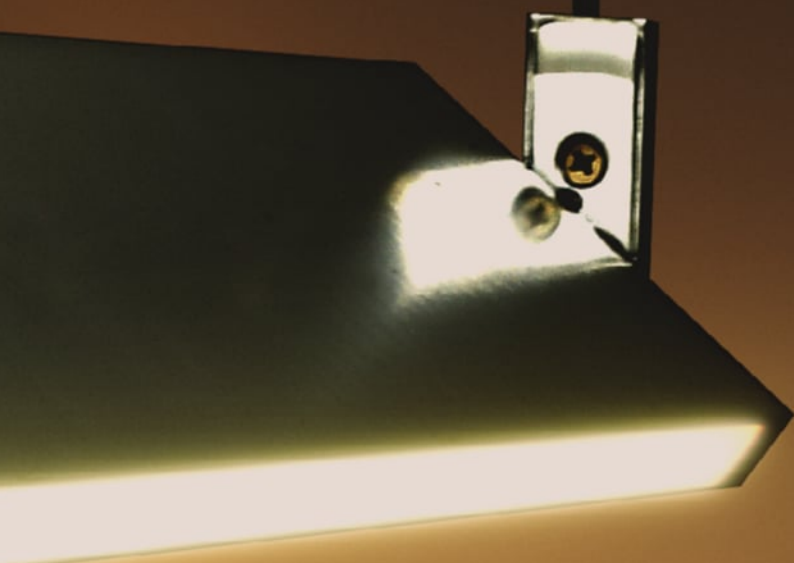
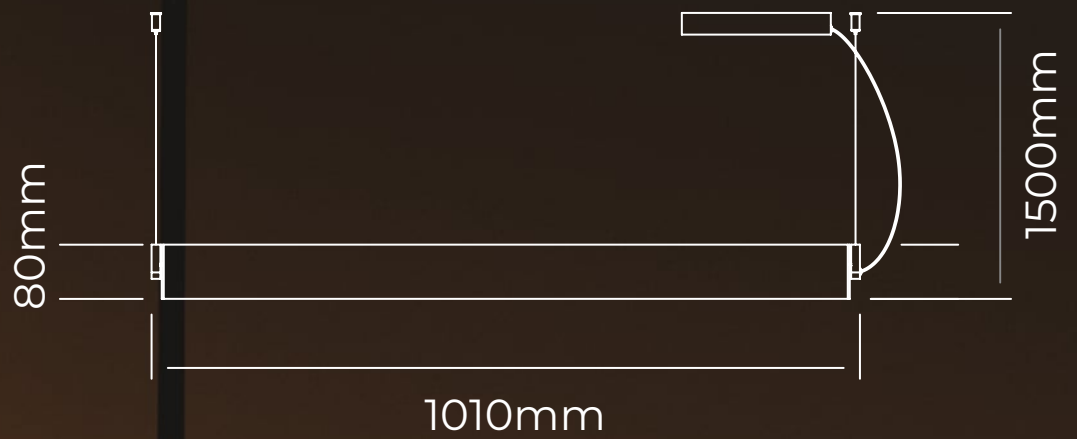



Colgante LED luz cálida, construido en aluminio.



Colgante
VECTOR
Art.: CTL8510408029



-  LED 29W, 220V, 50Hz, IP20
-  Negro mate
-  3000K
-  2610LM
-  Aluminio
-  Clase I
-  Dimerizable



COLGANTE POPE



Colgantes LED de 6 y 8 luces, contruidos en aluminio.

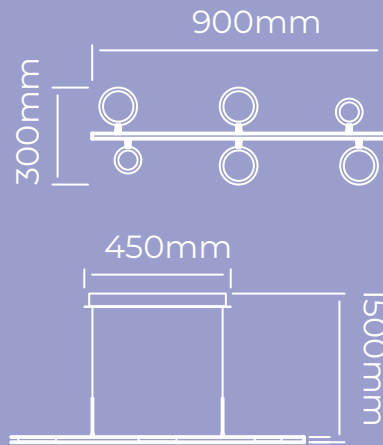
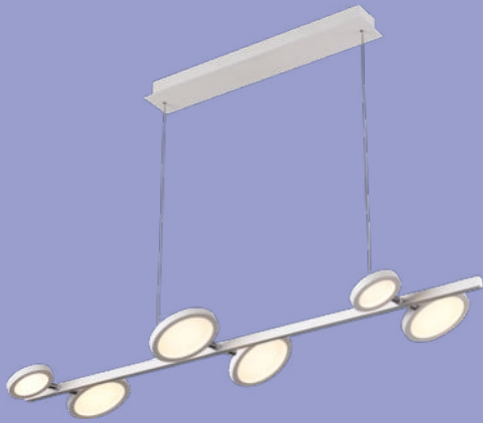

Colgante

POPE 6

Art.: CTL6009003029



-  LED 29W, 220V, 50Hz, IP20
-  Blanco mate
-  3000K
-  2610LM
-  Aluminio
-  Clase I
-  Dimerizable

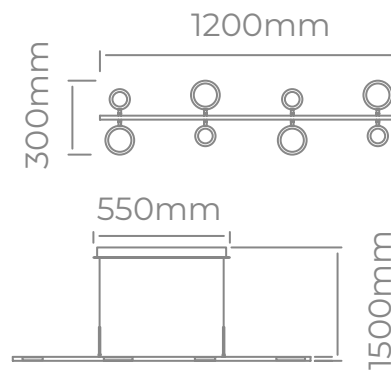

Colgante

POPE 8 LINEAL

Art.: CTL6012003038



-  LED 38W, 220V, 50Hz, IP20
-  Blanco mate
-  3000K
-  3420LM
-  Aluminio
-  Clase I
-  Dimerizable

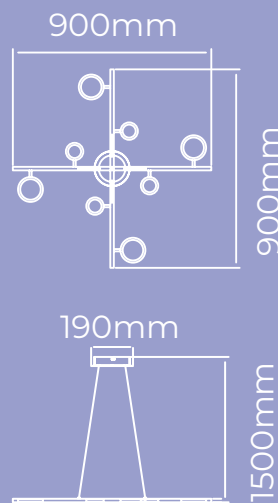
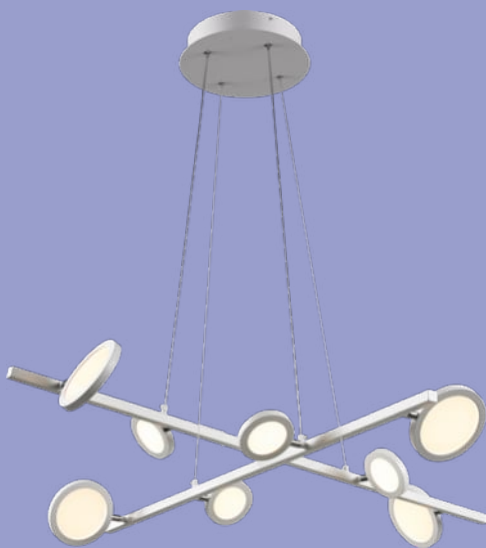

Colgante

POPE 8 BASE REDONDA

Art.: CTL60RE090038



-  LED 38W, 220V, 50Hz, IP20
-  Blanco mate
-  3000K
-  3420LM
-  Aluminio
-  Clase I
-  Dimerizable



Blanco mate

COLGANTE LUPIN



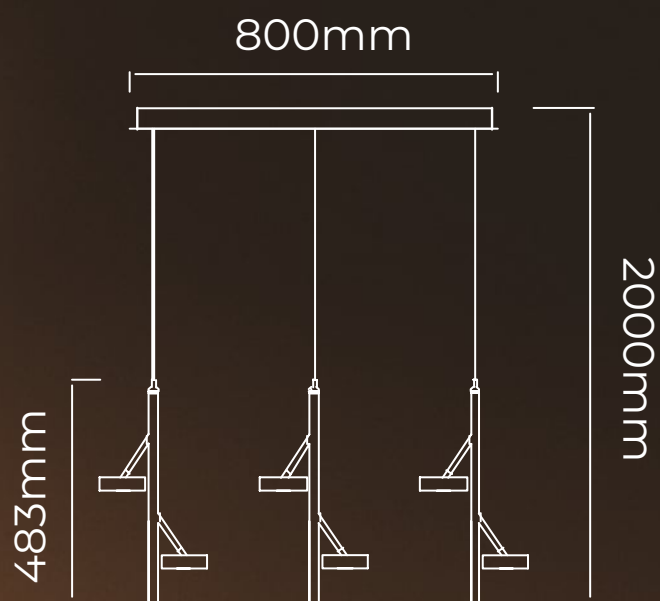
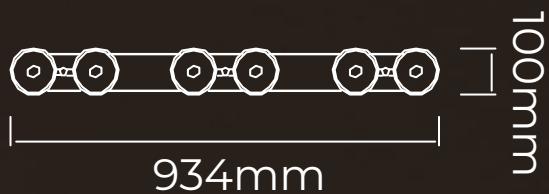

Colgante LED de 6 luces construido en aluminio





Colgante
LUPIN
Art.: CTL37934830



 LED 37W, 220V, 50Hz, IP20

 Blanco mate

 3000K

 2700LM

 Aluminio

 Clase I

 Dimerizable

COLGANTE NUBE



Colgantes LED de 3, 6 y 9 luces contruidos en aluminio

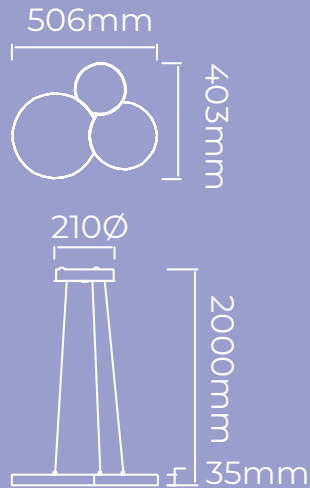

Colgante
NUBE 50

Art.: CTL50X4037A



-  LED 37W, 220V, 50Hz, IP20
-  Blanco mate
-  3000K
-  3330LM
-  Aluminio
-  Clase I
-  Dimerizable

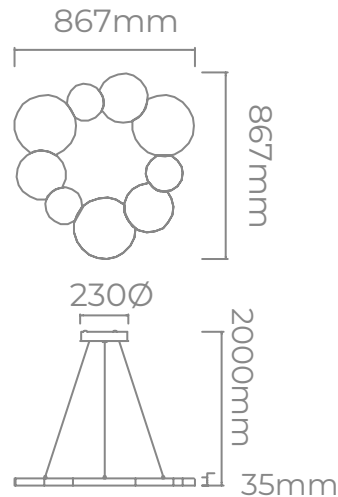

Colgante
NUBE 100

Art.: CTL50X9075A



-  LED 54W, 220V, 50Hz, IP20
-  Blanco mate
-  3000K
-  4860LM
-  Aluminio
-  Clase I
-  Dimerizable

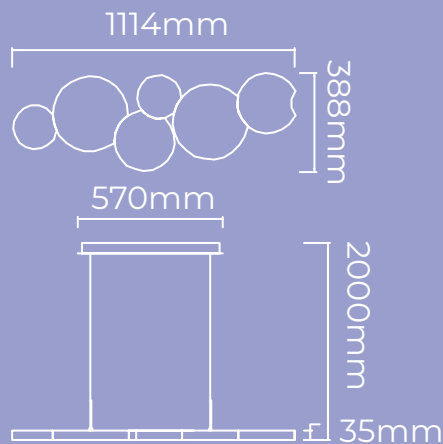
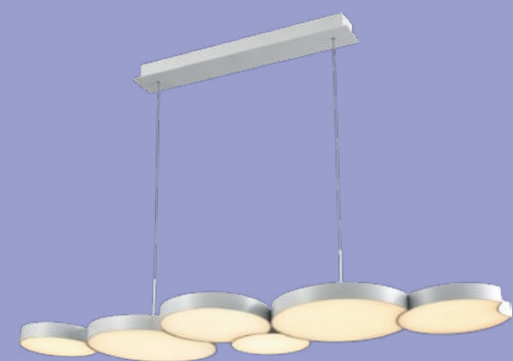

Colgante
NUBE 120

Art.: CTL50X6054C



-  LED 75W, 220V, 50Hz, IP20
-  Blanco mate
-  3000K
-  6750LM
-  Aluminio
-  Clase I
-  Dimerizable



Blanco mate

PLAFÓN NUBE

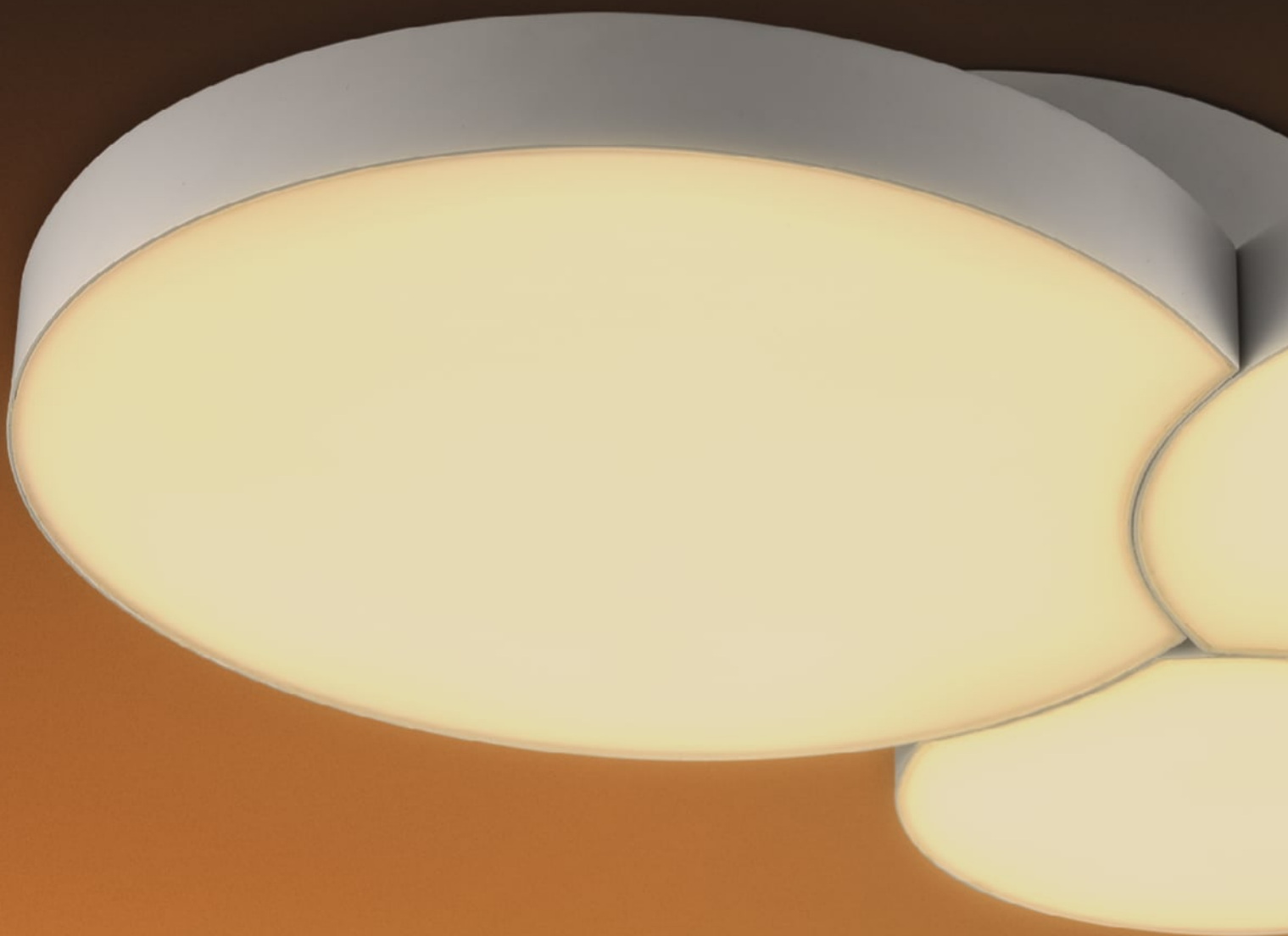

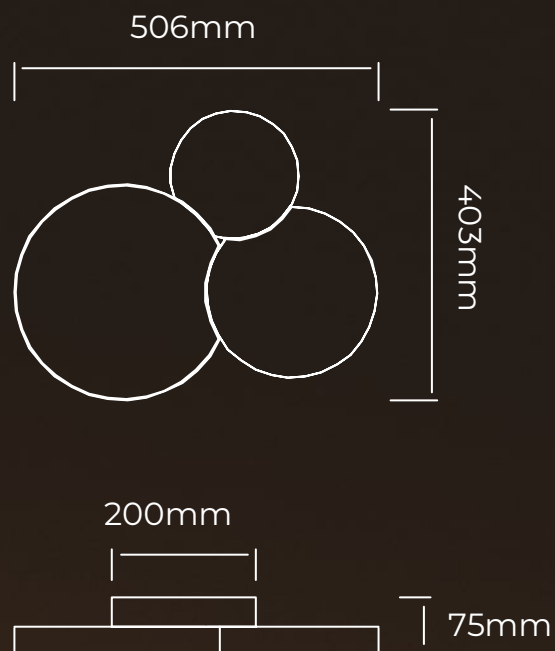

Plafón LED de 3 luces construido en aluminio



Plafón
NUBE 50
Art.: PTL50X3037A





 LED 37W, 220V, 50Hz, IP20

 Blanco mate

 3000K

 3330LM

 Aluminio

 Clase I

 Dimerizable

 Blanco mate

375

COLGANTE TAMPA 60

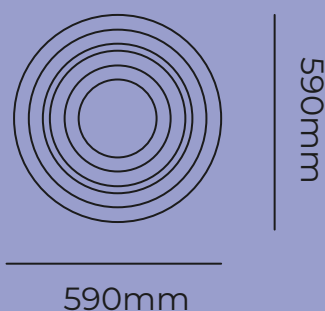
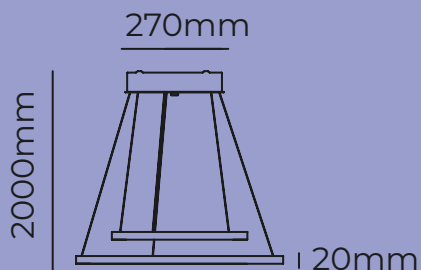

Colgante
TAMPA 60
Art.: CTL22058054



 LED 54W, 220V, 50Hz, IP20

 Blanco mate

 3000K

 4860LM

 Aluminio

 Clase I

 No dimerizable



*Colgante LED de 2 aros, construido
integralmente en aluminio.*

COLGANTE TAMPA 80



Colgante LED de 3 aros, construido
integralmente en aluminio.

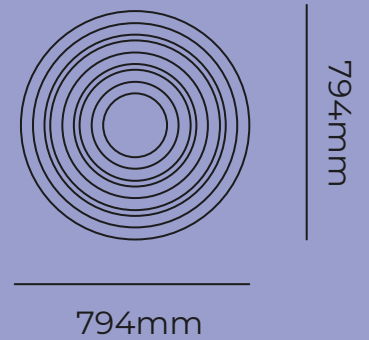
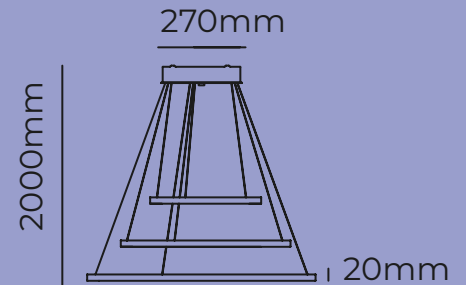

Colgante
TAMPA 80
Art.: CTL22079098



-  LED 98W, 220V, 50Hz, IP20
-  Blanco mate
-  3000K
-  8820LM
-  Aluminio
-  Clase I
-  No dimerizable

COLGANTE OLIMPIC



*Colgantes LED de 3, 6 y 9 aros,
construidos en aluminio.*



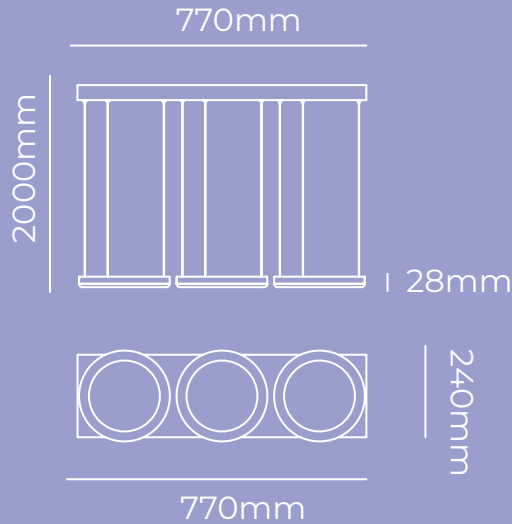

Colgante
OLIMPIC 3
Art.: CTL26772225



-  LED 25W, 220V, 50Hz, IP20
-  Blanco mate
-  3000K
-  2250LM
-  Aluminio
-  Clase I
-  Dimerizable

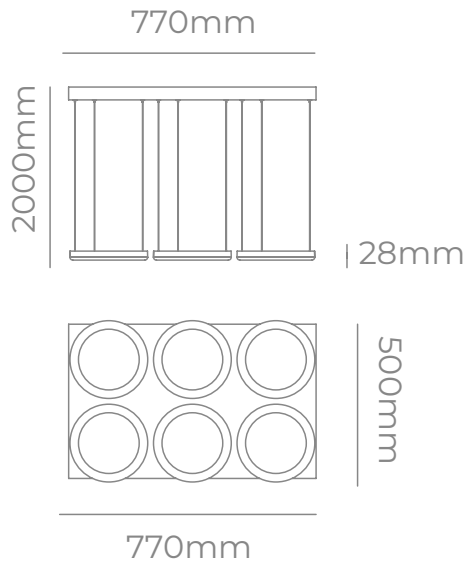

Colgante
OLIMPIC 6
Art.: CTL26774860



-  LED 60W, 220V, 50Hz, IP20
-  Blanco mate
-  3000K
-  5400LM
-  Aluminio
-  Clase I
-  Dimerizable

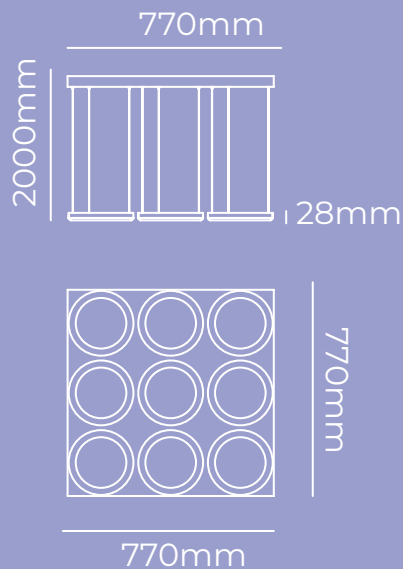
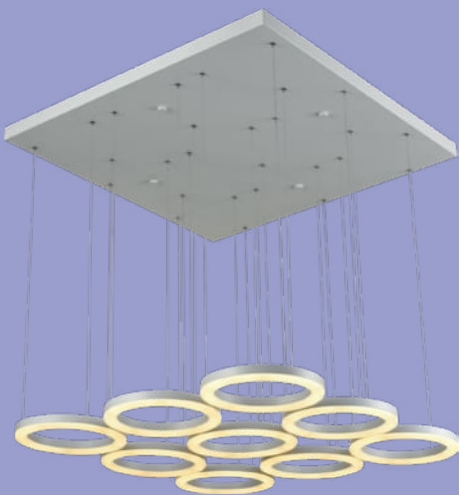

Colgante
OLIMPIC 9
Art.: CTL26777795



-  LED 95W, 220V, 50Hz, IP20
-  Blanco mate
-  3000K
-  8550LM
-  Aluminio
-  Clase I
-  Dimerizable



COLGANTE SIESTA 60

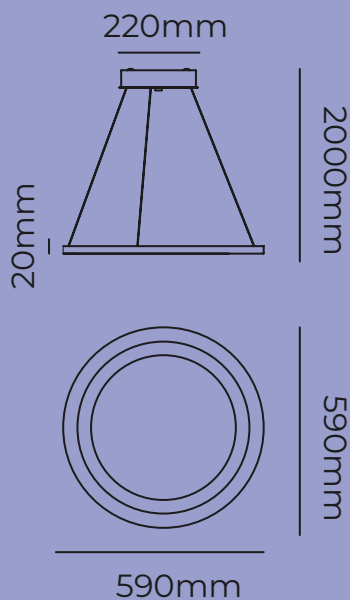

Colgante
SIESTA 60
Art.: CTL21058033



-  LED 33,5W, 220V, 50Hz, IP20
-  Blanco mate
-  3000K
-  3015LM
-  Aluminio
-  Clase I
-  No dimerizable

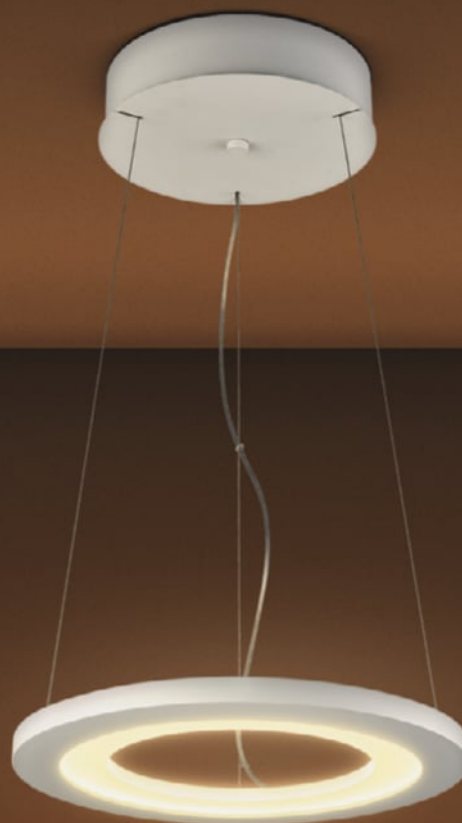

*Colgante LED de un aro
construido en aluminio.*

COLGANTE

●●● SARASOTA 80



Colgante LED de seis aros
construido en aluminio.

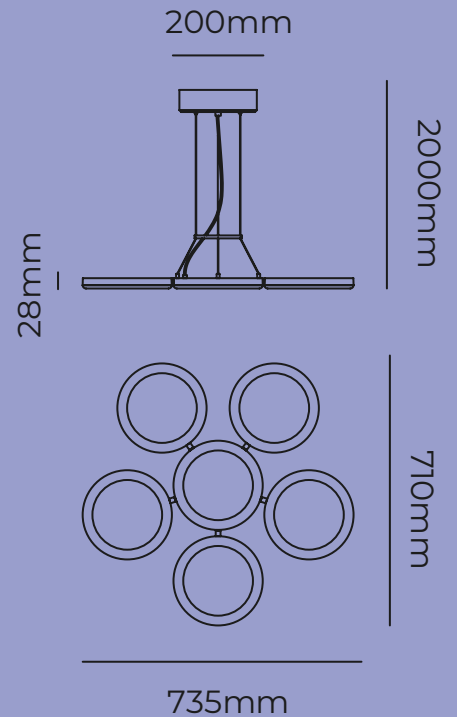

Colgante
SARASOTA 80
Art.: CTL2407660



-  LED 60W, 220V, 50Hz, IP20
-  Blanco mate
-  3000K
-  5400LM
-  Aluminio
-  Clase I
-  Dimerizable

COLGANTE LONGBOAT SINGLE



AHORA EN COLOR NEGRO

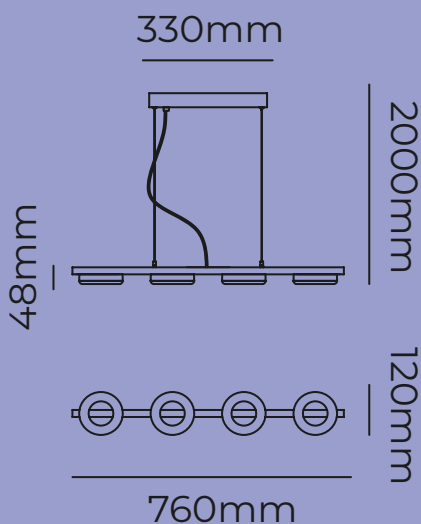



Colgante

LONGBOAT SIMPLE

Art.: CTL24761236



 LED 36W, 220V, 50Hz, IP20

 Blanco mate, Negro mate

 3000K

 3240LM

 Aluminio

 Clase I

 Dimerizable



Colgante LED de cuatro luces, no dimerizable, construido en aluminio.

COLGANTE LONGBOAT DOUBLE



AHORA EN COLOR NEGRO



Colgante LED de seis luces,
dimerizable, construido en aluminio.

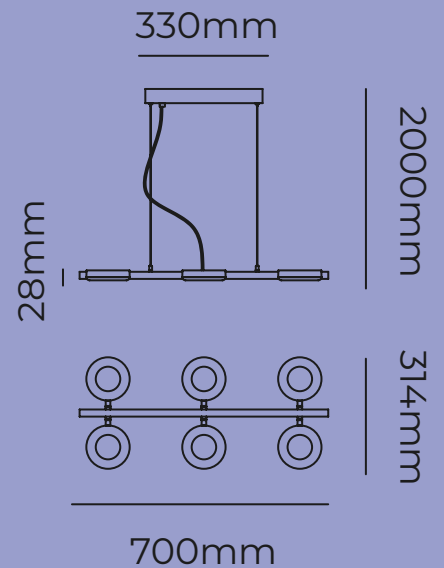

Colgante
LONGBOAT DOUBLE
Art.: CTL24703040



-  LED 40W, 220V, 50Hz, IP20
-  Blanco mate, Negro mate
-  3000K
-  3600LM
-  Aluminio
-  Clase I
-  Dimerizable

COLGANTE BAHAMAS ::::



Colgante LED de 4 luces construido en aluminio.

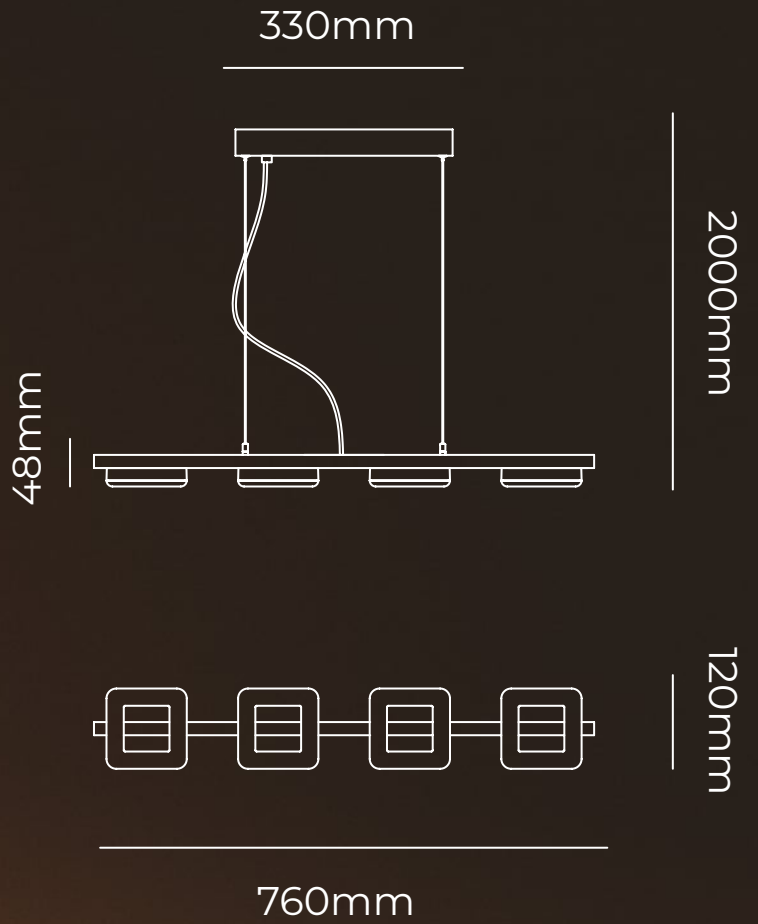
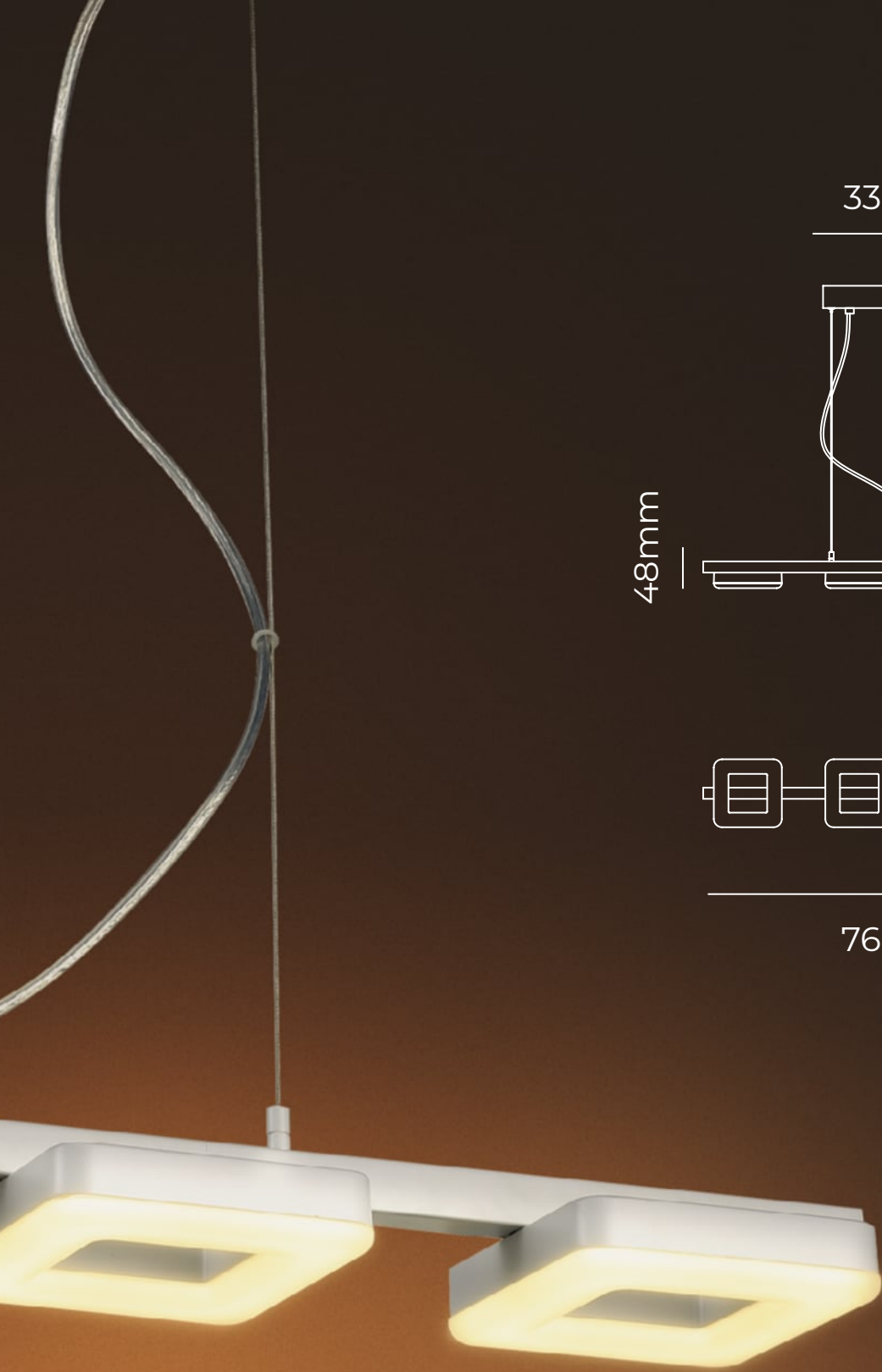

Colgante
BAHAMAS
Art.: CTL25761236



-  LED 36W, 220V, 50Hz, IP20
-  Blanco mate
-  3000K
-  3240LM
-  Aluminio
-  Clase I
-  Dimerizable

PLAFÓN CORAL 60X40



94mm

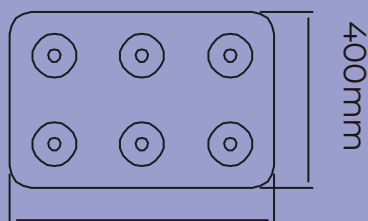

400mm

600mm

Plafón

CORAL 60X40
Art.: PTL33604030



 LED 30W, 220V, 50Hz, IP20

 Blanco mate

 3000K

 2700LM

 Aluminio

 Clase I

 Dimerizable



*Plafón LED de 6 luces,
dimerizable luz cálida,
construido en aluminio.*

PLAFÓN CORAL 60X60



*Plafón LED de 9 luces,
dimerizable luz cálida,
construido en aluminio*

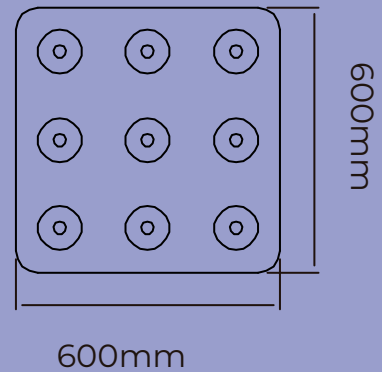

Plafón
CORAL 60X60
Art.: PTL33606044



-  LED 44W, 220V, 50Hz, IP20
-  Blanco mate
-  3000K
-  3960LM
-  Aluminio
-  Clase I
-  Dimerizable

PLAFÓN MEDUSA



*Plafones LED de 6, 10 y 18 luces, dimerizables
luz cálida, contruidos en aluminio.*

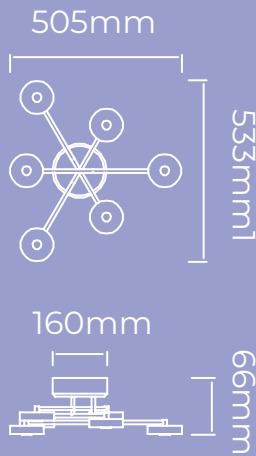
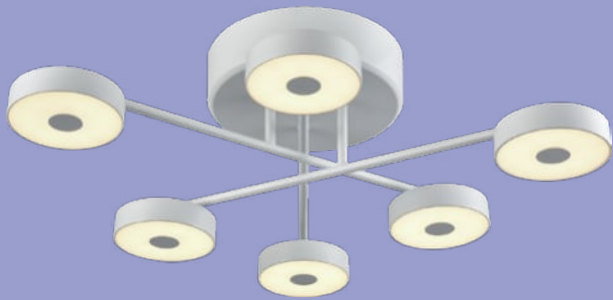

Plafón

MEDUSA 50

Art.: PTL35535330



-  LED 30W, 220V, 50Hz, IP20
-  Blanco mate
-  3000K
-  2700LM
-  Aluminio
-  Clase I
-  Dimerizable

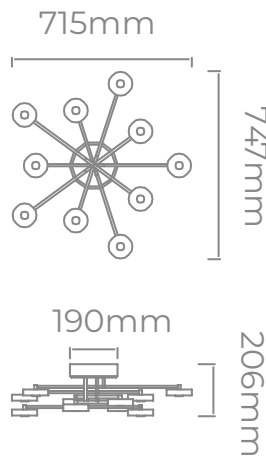

Plafón

MEDUSA 70

Art.: PTL35787853



-  LED 53W, 220V, 50Hz, IP20
-  Blanco mate
-  3000K
-  4770LM
-  Aluminio
-  Clase I
-  Dimerizable

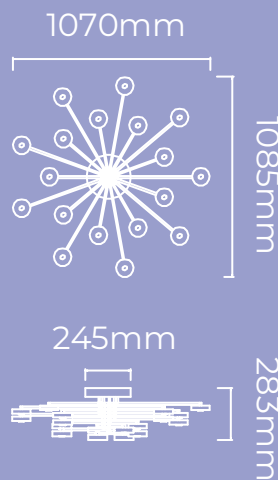
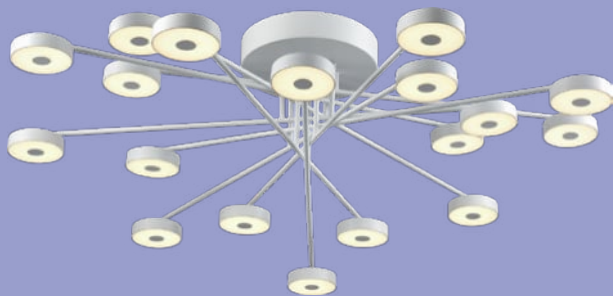

Plafón

MEDUSA 100

Art.: PTL35111186



-  LED 86W, 220V, 50Hz, IP20
-  Blanco mate
-  3000K
-  7740LM
-  Aluminio
-  Clase I
-  Dimerizable



Blanco mate

PLAFÓN BURAKO



AHORA EN COLOR NEGRO



*Plafones LED dimerizables luz cálida,
construidos en aluminio.*



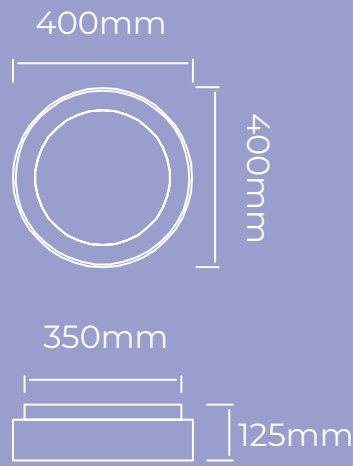

Plafón

BURAKO 40

Art.: PTL31040026



-  LED 26W, 220V, 50Hz, IP20
-  Blanco mate, Negro mate
-  3000K
-  2340LM
-  Aluminio
-  Clase I
-  Dimerizable

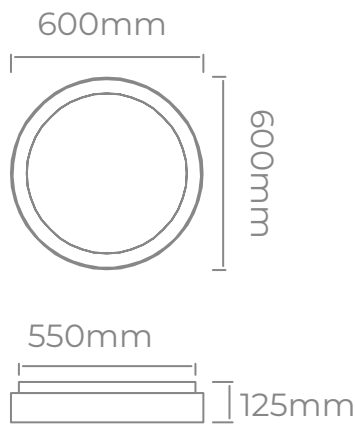

Plafón

BURAKO 60

Art.: PTL31060045



-  LED 45W, 220V, 50Hz, IP20
-  Blanco mate, Negro mate
-  3000K
-  4050LM
-  Aluminio
-  Clase I
-  Dimerizable

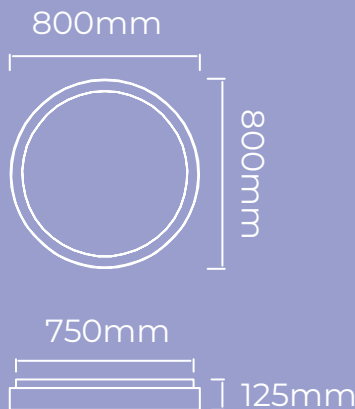

Plafón

BURAKO 80

Art.: PTL31080055



-  LED 55W, 220V, 50Hz, IP20
-  Blanco mate, Negro mate
-  3000K
-  4950LM
-  Aluminio
-  Clase I
-  Dimerizable

PLAFÓN NEMO 60

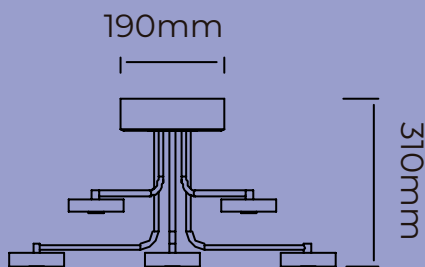
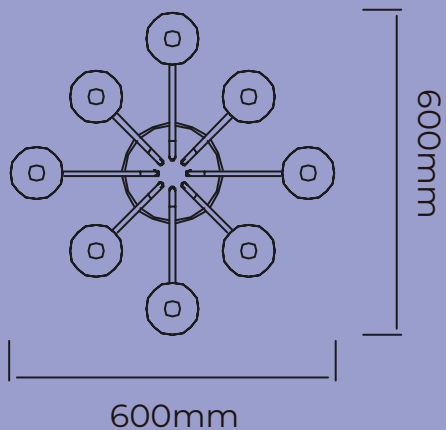

Plafón
NEMO 60
Art.: PTL35454544



 LED 44W, 220V, 50Hz, IP20

 Blanco mate

 3000K

 3960LM

 Aluminio

 Clase I

 Dimerizable



*Plafón LED de 8 luces dimerizable
luz cálida, construido en aluminio.*

PLAFÓN NEMO 70



Plafón LED de 8 luces dimerizable luz cálida, construido en aluminio.

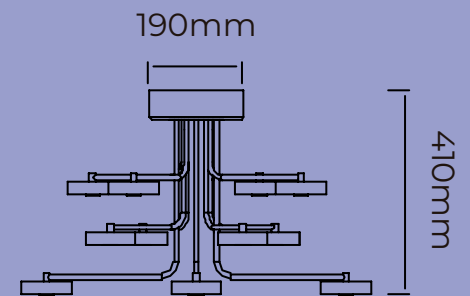
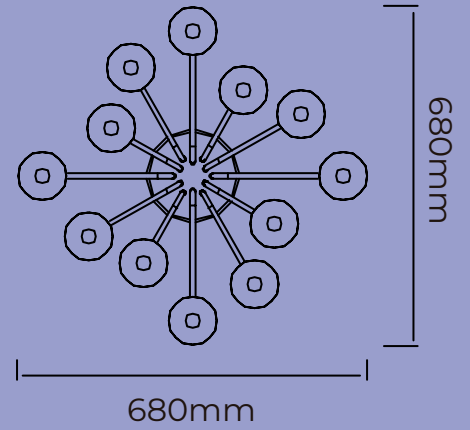

Plafón
NEMO 70
Art.: PTL35525252



-  LED 52W, 220V, 50Hz, IP20
-  Blanco mate
-  3000K
-  4680LM
-  Aluminio
-  Clase I
-  Dimerizable

PLAFÓN MARA



*Plafón LED dimerizable luz cálida,
construido en aluminio.*



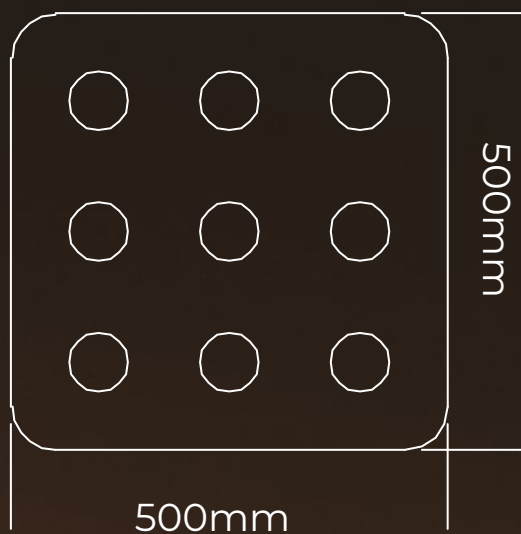

46.5mm



Plafón
MARA
Art.: PTL5205005055





 LED 55W, 220V, 50Hz, IP20

 Blanco mate

 3000K

 4950LM

 Aluminio

 Clase I

 Dimerizable

 Blanco mate

PLAFÓN SIRO 40

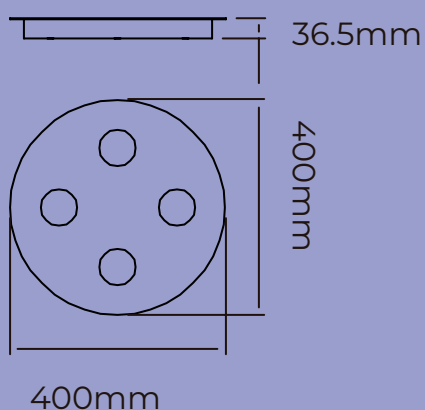

Plafón

SIRO 40

Art.: PTL53040022



 LED 22W, 220V, 50Hz, IP20

 Blanco mate

 3000K

 1980LM

 Aluminio

 Clase I

 Dimerizable

Plafón LED de 4 luces, dimerizable luz cálida, construido en aluminio.

PLAFÓN SIRO 50



Plafón LED de 7 luces dimerizable luz cálida, construido en aluminio.

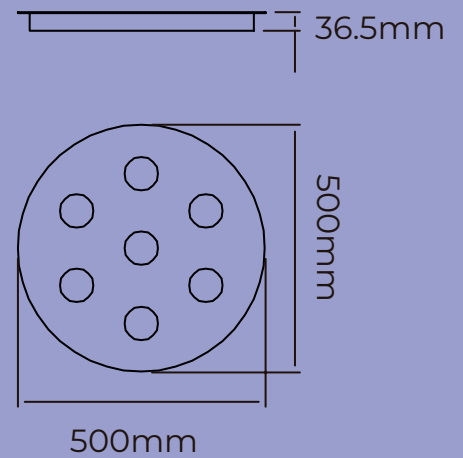

Plafón
SIRO 60
Art.: PTL53056038



-  LED 38W, 220V, 50Hz, IP20
-  Blanco mate
-  3000K
-  3420LM
-  Aluminio
-  Clase I
-  Dimerizable

PLAFÓN NAPLES 40

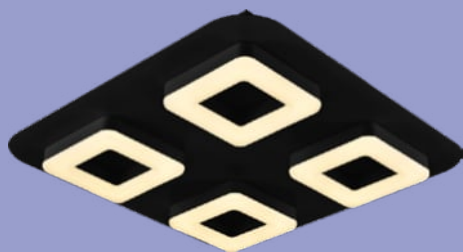

70mm

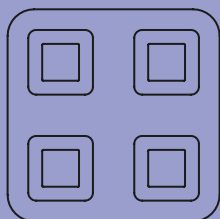

400mm

400mm





Plafón

NAPLES 40

Art.: PTL2504036



 LED 36W, 220V, 50Hz, IP20

 Blanco mate, Negro mate

 3000K

 3240LM

 Aluminio

 Clase I

 Dimerizable

*Plafón LED de 4 luces, dimerizable luz cálida,
construido en aluminio.*

PLAFÓN ::: NAPLES 60



Plafón LED de 9 luces, dimerizable luz cálida, construido en aluminio.



70mm

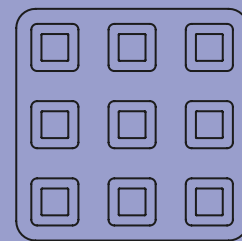



600mm

600mm

Plafón
NAPLES 60
Art.: PTL2506060



 LED 60W, 220V, 50Hz, IP20

 Blanco mate

 3000K

 5400LM

 Aluminio

 Clase I

 Dimerizable

PLAFÓN VENICE 40

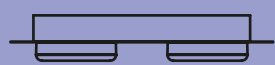
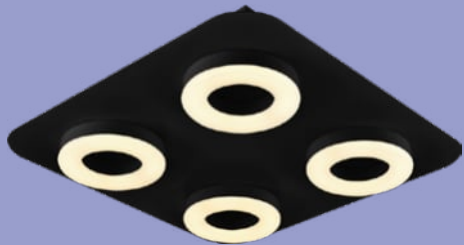

70mm

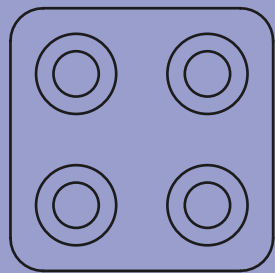

400mm

400mm





Plafón

VENICE 40

Art.: PTL2304036



 LED 36W, 220V, 50Hz, IP20

 Blanco mate, Negro mate

 3000K

 3240LM

 Aluminio

 Clase I

 Dimerizable

*Plafón LED de 4 luces, dimerizable luz cálida,
construido en aluminio.*

PLAFÓN VENICE 60



Plafón LED de 9 luces, dimerizable luz cálida, construido en aluminio.



70mm

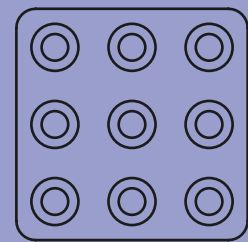

600mm

600mm

Plafón

VENICE 60

Art.: PTL2306060



 LED 60W, 220V, 50Hz, IP20

 Blanco mate

 3000K

 3240LM

 Aluminio

 Clase I

 Dimerizable

 Blanco mate

 Negro mate





ESCRITORIO, CABECERA y PIE

LÁMPARA DE ESCRITORIO PIPO MESA



Lámpara de escritorio con zócalo E27, brazo flexible, construida en chapa de acero.





Art.: 1790



Art.: 1790



Art.: 1790







Art.: 1790

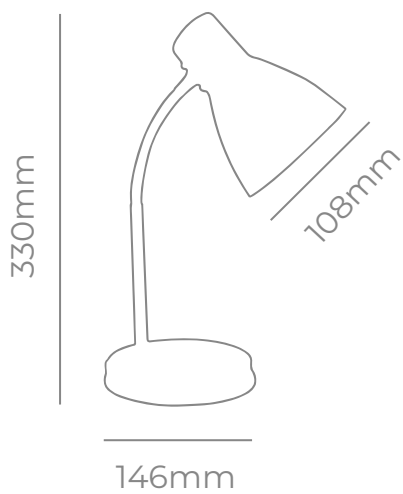

Art.: 1790



Lámpara de escritorio
PIPO MESA

-  1xE27, Max 60W, 220V, 50Hz, IP20
-  Beige, Blanco, Gris, Negro, Verde Vintage
-  Chapa de acero
-  Clase II

LÁMPARA DE ESCRITORIO PIPO PINZA



Lámpara tipo pinza con zócalo E27, brazo flexible, construida en chapa de acero.





Art.: 1791



Art.: 1791



Art.: 1791



Art.: 1791



Art.: 1791



Art.: 1791

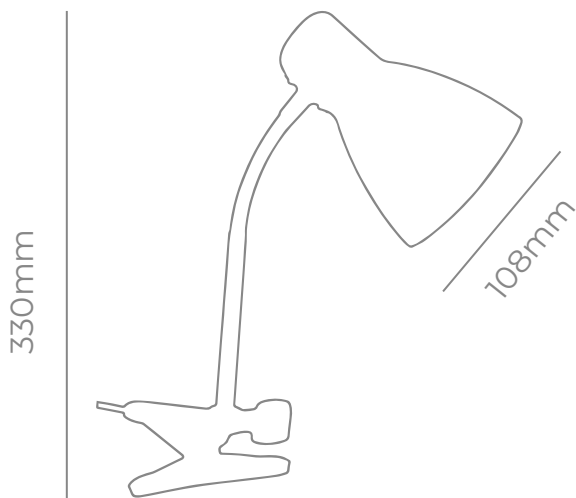

Lámpara de escritorio
PIPO PINZA

- 1xE27, Max 60W, 220V, 50Hz, IP20
- Blanco, Negro, Gris, Rojo, Verde Vintage, Rosa Vintage
- Chapa de acero
- Clase II

LÁMPARA DE ESCRITORIO TABLERO

*Lámpara de escritorio para E27, construida
en chapa de acero.*





Art.: 1794



Art.: 1794



Art.: 1794

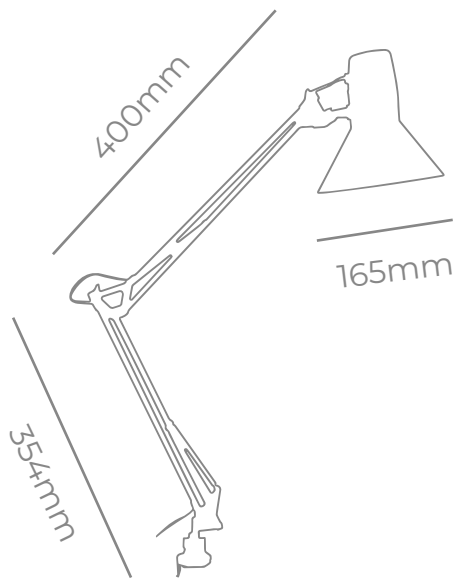

Lámpara de escritorio
TABLERO

 1xE27, Max 60W, 220V, 50Hz, IP20

 Blanco, Gris, Negro

 Chapa de acero

 Clase II



LÁMPARA DE ESCRITORIO **FIONA** ●●●●

Lámpara de escritorio para E27, estructura de madera, cabezal contruido en chapa de acero.

Art.: DL70518 ●

Art.: DL70518 ●

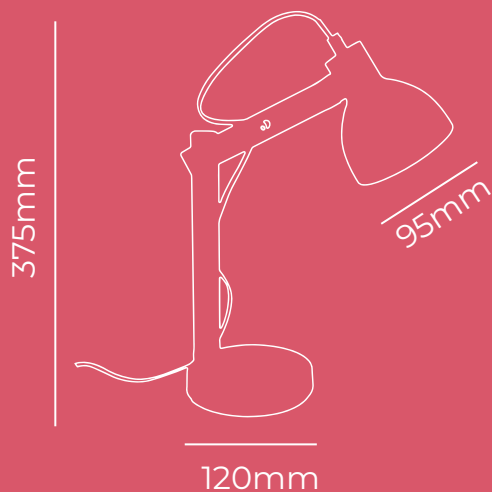

Lámpara de escritorio FIONA

- 💡 1xE14, Max 40W, 220V, 50Hz, IP20
- ♻️ Cobre, Negro
- 🪵 Madera + Chapa de acero
- 📦 Clase II

LÁMPARA DE ESCRITORIO RUFO







Lámpara de escritorio para E27, base de madera, cabezal contruido en chapa de acero.

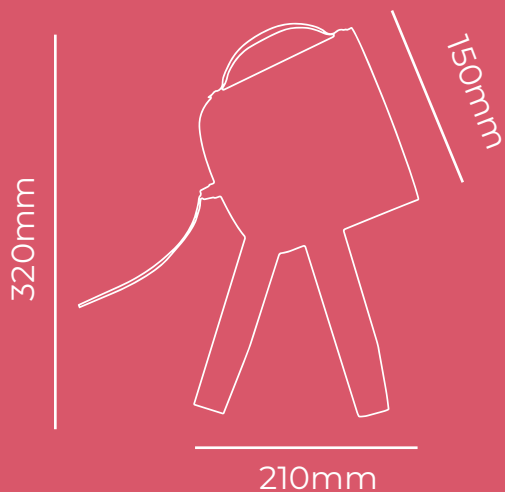

Art.: DL57418



Lámpara de escritorio RUFO

-  1xE27, Max 60W, 220V, 50Hz, IP20
-  Negro
-  Madera + Chapa de acero
-  Clase II

 Cobre

 Negro

LÁMPARA DE ESCRITORIO PAULO



Lámpara de escritorio para E27, estructura de madera, cabezal contruido en chapa de acero.





Art.: DL47329







Art.: DL47329

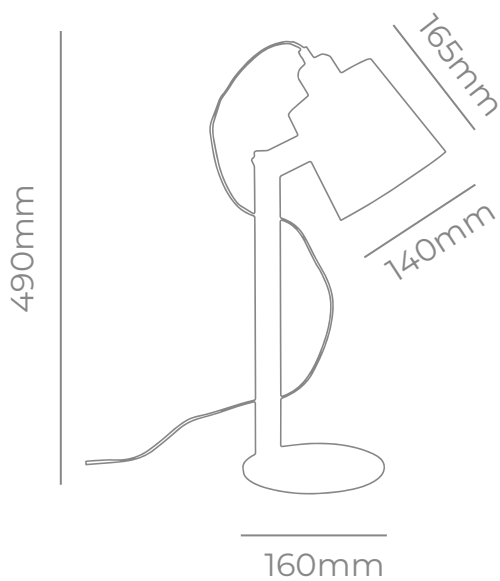

Art.: DL47329



Lámpara de escritorio
PAULO

-  1xE27, Max 60W, 220V, 50Hz, IP20
-  Cobre, Negro, Verde Vintage
-  Madera + Chapa de acero
-  Clase II

LÁMPARA DE ESCRITORIO SERENA



Lámpara de escritorio para E27, estructura de madera, cabezal contruido en chapa de acero.





Art.: DL51725







Art.: DL51725

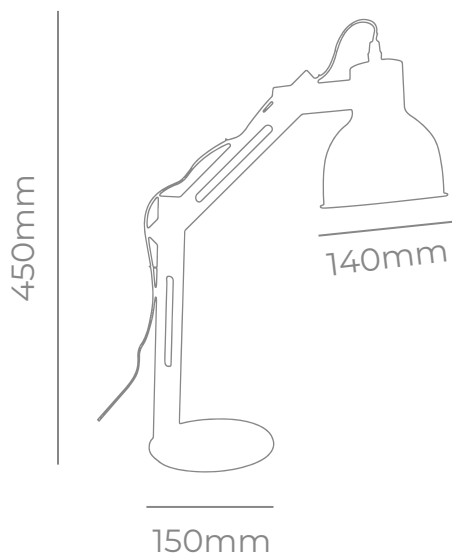

Art.: DL51725



Lámpara de escritorio
SERENA

-  1xE27, Max 60W, 220V, 50Hz, IP20
-  Cobre, Negro, Verde Vintage
-  Madera + Chapa de acero
-  Clase II

LÁMPARA DE ESCRITORIO VINICIO



Lámpara de escritorio para E27, estructura de madera, cabezal contruido en chapa de acero.









Art.: DL49122

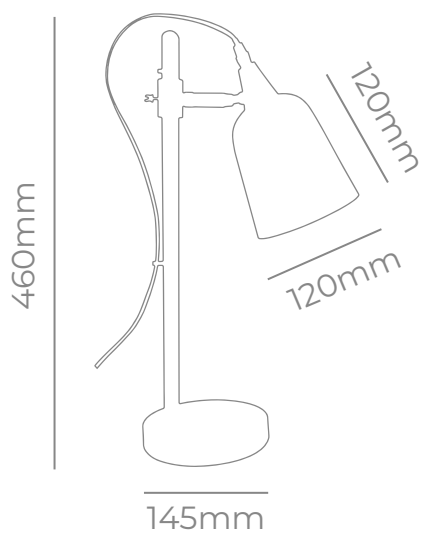

Art.: DL49122



Lámpara de escritorio
VINICIO

-  1xE27, Max 60W, 220V, 50Hz, IP20
-  Cobre, Verde Vintage
-  Madera + Chapa de acero
-  Clase II

APLIQUES DE CABECERA

E14



*Apliques E14 para cabecera,
estructura de madera, cabezal
construido en chapa de acero.*



Art.: APL145501



Art.: APL145501



Art.: APL145501



 Con interruptor en base

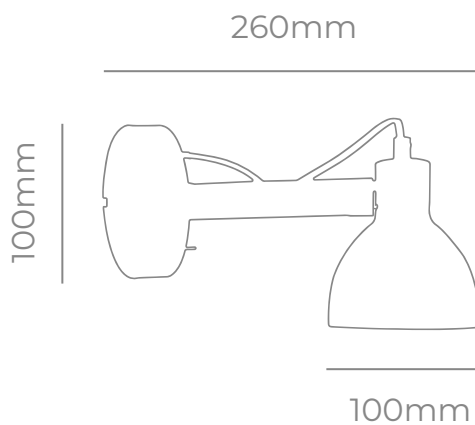

Aplique

FIONA

Art.: APL145501



1xE14, Max 40W, 220V, 50Hz, IP20



Cobre, Negro, Verde Vintage



Madera + Chapa de acero



Clase I

LÁMPARA DE ESCRITORIO

TEEN

Lámpara de escritorio LED con lapicero,
dimerizable.

Lámpara de escritorio

TEEN

Art.: LEP77207



LED 7W, 220V, 50Hz, IP20

Blanco mate

3000K

630LM

Plástico

Clase II

Dimerizable

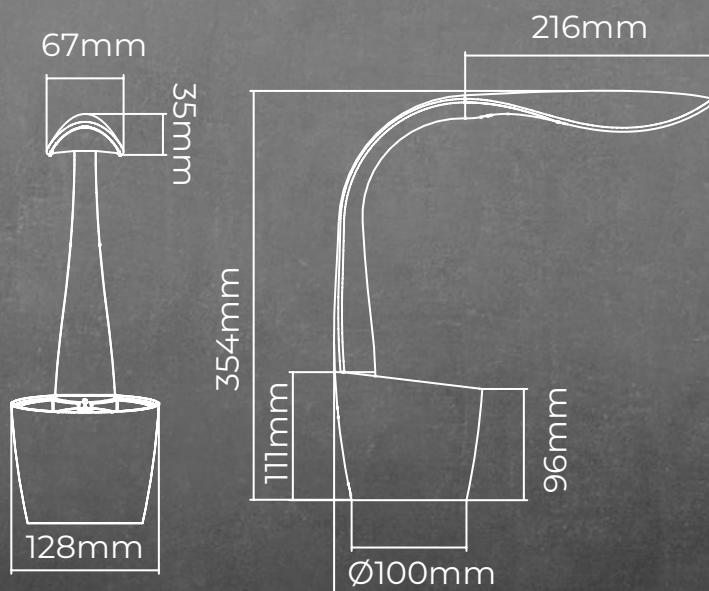
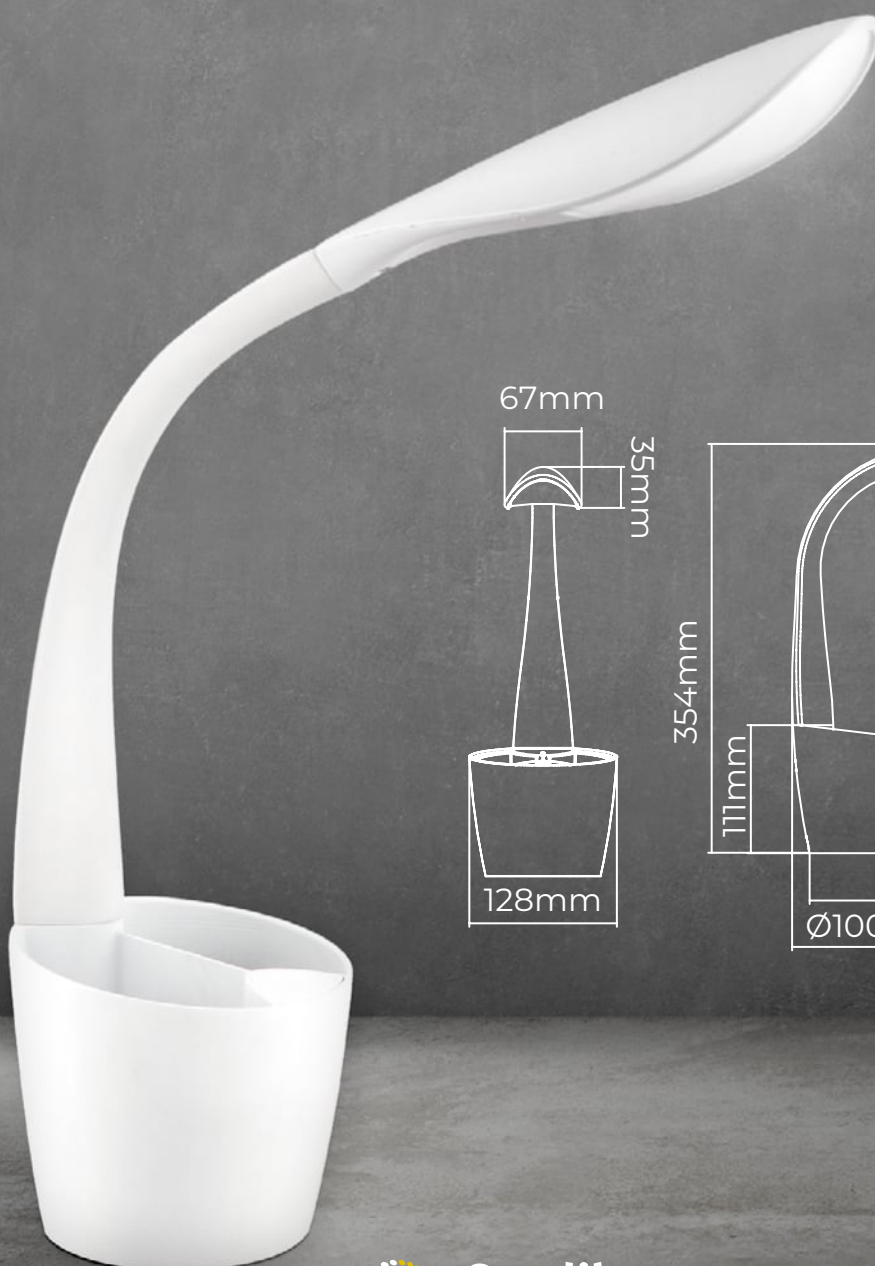

LÁMPARA DE ESCRITORIO

FLIP





Lámpara de escritorio LED, dimerizable.

Lámpara de escritorio

FLIP

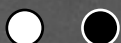
Art.: LEP56107





 LED 7W, 220V, 50Hz, IP20

 Blanco mate, Negro mate

 3000K

 630LM

 Plástico

 Clase II

 Dimerizable



 Blanco mate

 Negro mate

LÁMPARA DE ESCRITORIO **BONNIE**

Lámpara de escritorio LED dimerizable, brazo flexible, construida en plástico.





Art.: LEP49307 



Art.: LEP49307 



Art.: LEP49307 

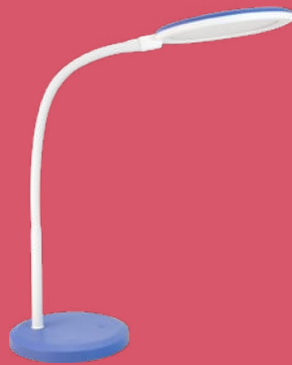

Art.: LEP49307 



Art.: LEP49307 

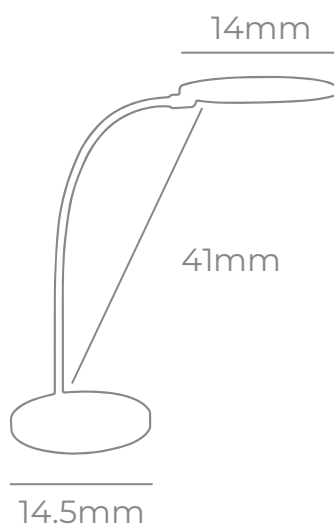

Lámpara de escritorio

BONNIE

-  LED 7.5W, 220V, 50Hz, IP20
-  Blanco, Negro, Rosa, Azul, Rojo
-  3000K
-  675LM
-  Plástico
-  Clase II
-  Dimerizable

APLIQUES DE CABECERA



Apliques LED para cabecera, contruidos íntegramente en fundición de aluminio.



 Con interruptor en base

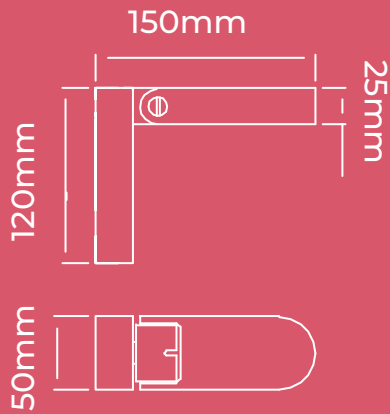

Aplique

AKI

Art.: APL14205



 LED 5W, 220V, 50Hz, IP20

 Blanco texturado, Cromado

 3000K

 450LM

 Aluminio

 Clase I

 Con interruptor en base

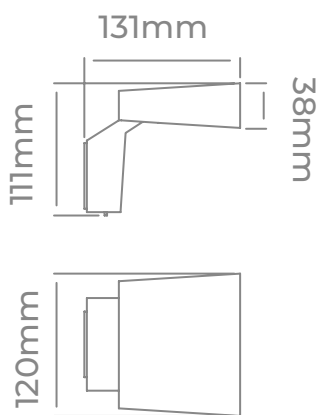

Aplique

NEO

Art.: APL14307



 LED 6.5W, 220V, 50Hz, IP20

 Blanco texturado, Cromado

 3000K

 585LM

 Aluminio

 Clase I

APLIQUE DE PARED

TRIPO



Aplique de pared de estilo industrial con brazo extensible tipo acordeón en acabado negro mate. Su pantalla orientable de interior cobrizo permite ajustar la dirección y el alcance de la luz según la necesidad. Una pieza funcional y con gran personalidad, ideal para cabeceros de cama o espacios de trabajo que buscan un toque vintage y versátil.



Art.: APE141212



💡 1xE14, Max 12W, 220V, 50Hz, IP20

♻️ Negro mate + Oro antiguo

📄 Chapa de acero

☐ Clase II

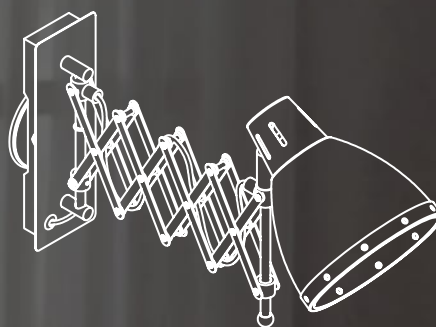
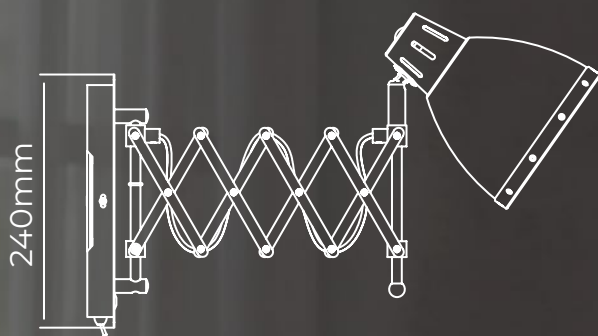
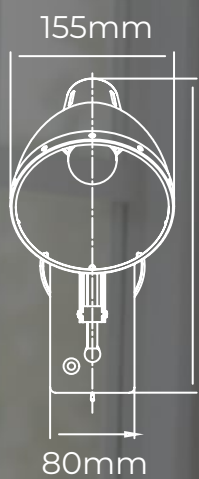

Negro mate + Oro Antiguo

APLIQUES DE CABECERA ::::

Aplique EITU

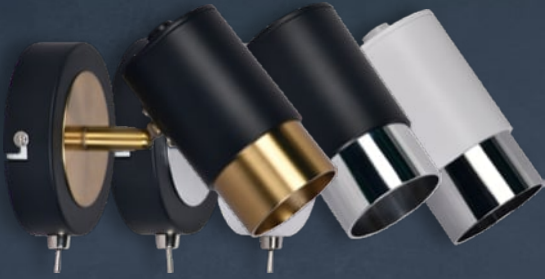

Aplique POLA



Aplique CACHEN



Aplique MEMO



Aplique JULITA



Aplique SHEILA



Aplique TÉMPANO

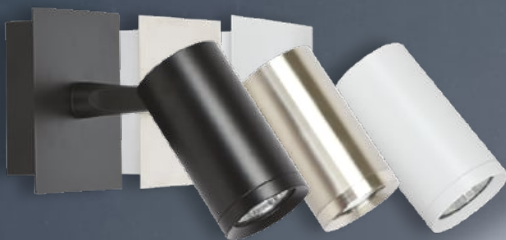

Aplique KONUS



Sistemas de 1 luz con interruptor, disponibles para ser utilizados como apliques de cabecera.

Aplique SONATA



Aplique AYELEN



Aplique PARTY



Aplique SUPER



Aplique PROMO



Aplique MAMBRÚ



Aplique BUDA



Aplique VULCANO



Aplique LENORA



Aplique FIORE







LÁMPARAS DE MESA RECARGABLES

LÁMPARA DE MESA SOFTY



Lámpara de mesa recargable, construida en metal y plástico ABS.





Art.: RCD010



Art.: RCD010



Art.: RCD010



Art.: RCD010

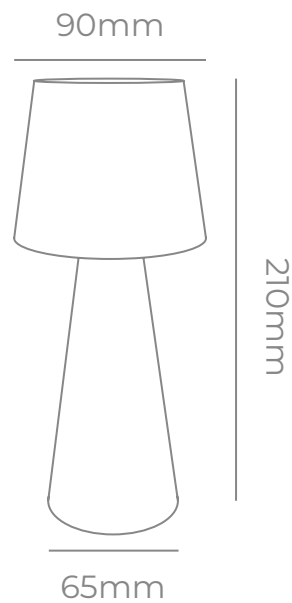

Lámpara de mesa recargable
SOFTY

- Potencia: 5V
- Blanco, Negro, Silver, Oro Antiguo
- 3000K + 4000K + 5000K
- 150LM
- Tiempo de carga: 3 horas
- Autonomía: 6 horas
- Batería de Litio 1200Ah
- Metal + Plástico ABS

LÁMPARA DE MESA SPICY



Lámpara de mesa recargable, construida en metal y plástico ABS.





Art.: RCD020



Art.: RCD020



Art.: RCD020



Art.: RCD020

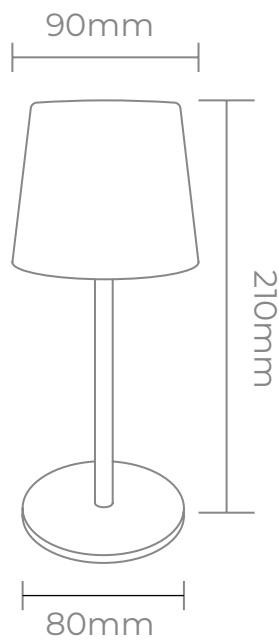

Lámpara de mesa recargable
SPICY

- Potencia: 5V
- Blanco, Negro, Silver, Oro Antiguo
- 3000K + 4000K + 5000K
- 150LM
- Tiempo de carga: 4 horas
- Autonomía: 6 horas
- Batería de Litio 1200Ah
- Metal + Plástico ABS

LÁMPARA DE MESA

INDU

Lámpara de mesa recargable, construida en metal y plástico ABS.



RECARGABLE

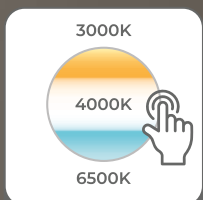

CAMBIO DE
TEMPERATURA

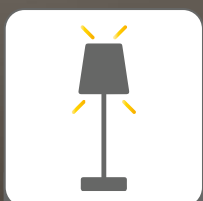

EMISIÓN DE LUZ
SUPERIOR E INFERIOR



AJUSTE DE
BRILLO

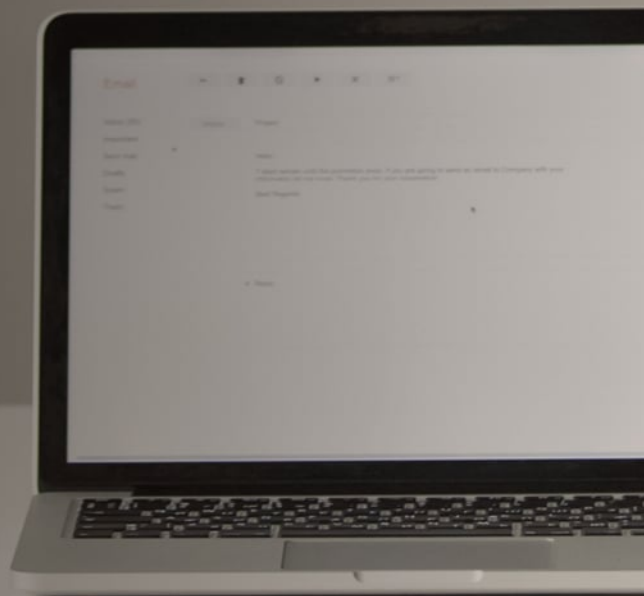

Lámpara de mesa recargable

INDU

Art.: RCD120



- Potencia: 5V
- Negro, Silver, Oro Antiguo
- 3000K + 4000K + 6500K
- 200LM
- Tiempo de carga: 4 horas
- Autonomía: 6 horas
- Batería de Litio 1800Ah
- Metal + Plástico ABS

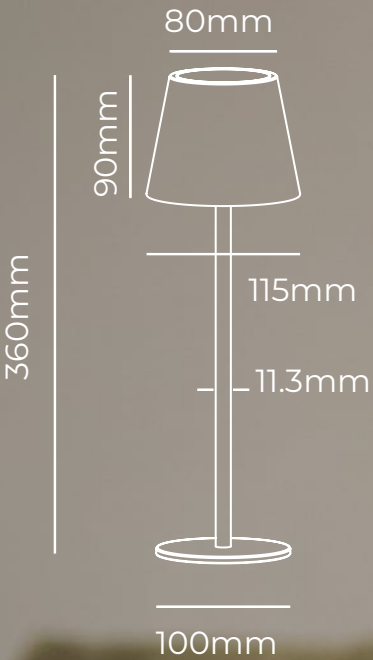

AHORA EN SILVER Y ORO ANTIGUO



Negro Silver Oro Antiguo

LÁMPARA DE MESA DRESS



Lámpara de mesa recargable, construida en metal y plástico ABS.





Art.: RCD145



Art.: RCD145



Art.: RCD145



Art.: RCD145

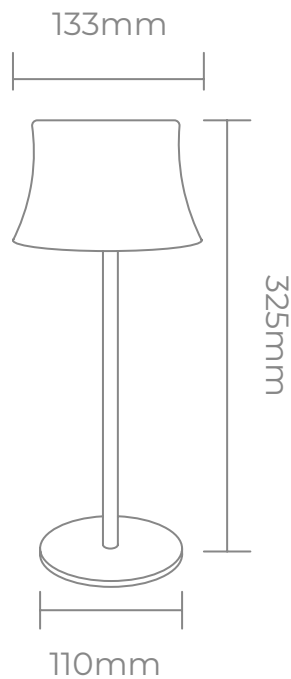

Lámpara de mesa recargable
DRESS

- Potencia: 5V - 3W
- Blanco, Negro, Silver, Oro Antiguo
- 3000K + 4000K + 5000K
- 200LM
- Tiempo de carga: 4 horas
- Autonomía: 6 horas
- Batería de Litio 1800Ah
- Metal + Plástico ABS





LÁMPARAS DE PIE

LÁMPARA DE PIE

PILO



Lámpara de pie de estilo industrial con cuerpo en negro mate y base de mármol de alta calidad. Posee un cabezal cilíndrico orientable de interior cobrizo que brinda una luz cálida y dirigida. Una pieza elegante y funcional, ideal para realzar cualquier rincón con personalidad.

Art.: FLGU101C7S 

 1xGU10, Max 7W, 220V, 50Hz, IP20

 Negro mate

 Chapa de acero + Mármol

 Clase II

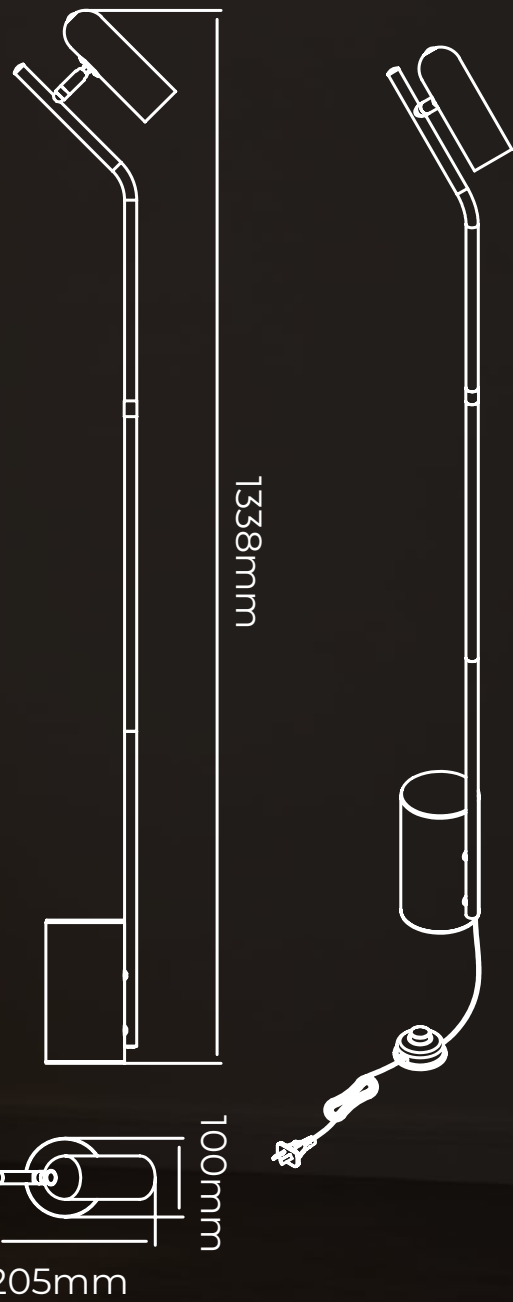

LÁMPARA DE PIE

PALE



Lámpara de pie de estilo industrial con cuerpo en negro mate y base de mármol de alta calidad. Posee un cabezal cilíndrico orientable de interior cobrizo que brinda una luz cálida y dirigida. Una pieza elegante y funcional, ideal para realzar cualquier rincón con personalidad.



Art.: FLGU101C7Q ●

💡 1xGU10, Max 7W, 220V, 50Hz, IP20

♻️ Negro mate

📏 Chapa de acero + Mármol

🔌 Clase II

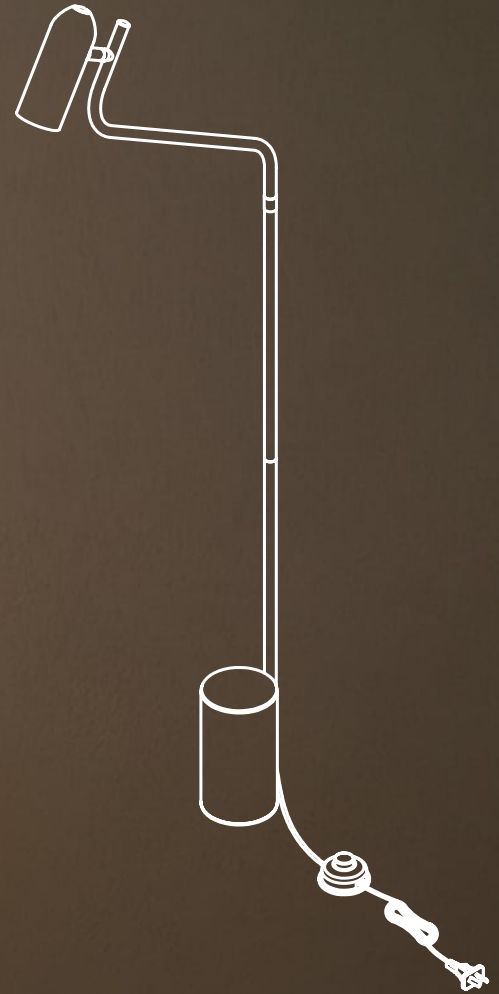

● Negro mate

LÁMPARA DE PIE

RODEO

Lámpara de pie de estilo industrial en negro mate con doble foco fijo y una sólida base de mármol cilíndrica. Sus cabezales de interior cobrizo proporcionan una luz cálida y puntual. Una pieza minimalista y sofisticada, ideal para ambientes modernos.



Art.: FLGU102C7R 

 2xGU10, Max 7W, 220V, 50Hz, IP20

 Negro mate

 Chapa de acero + Mármol

 Clase II

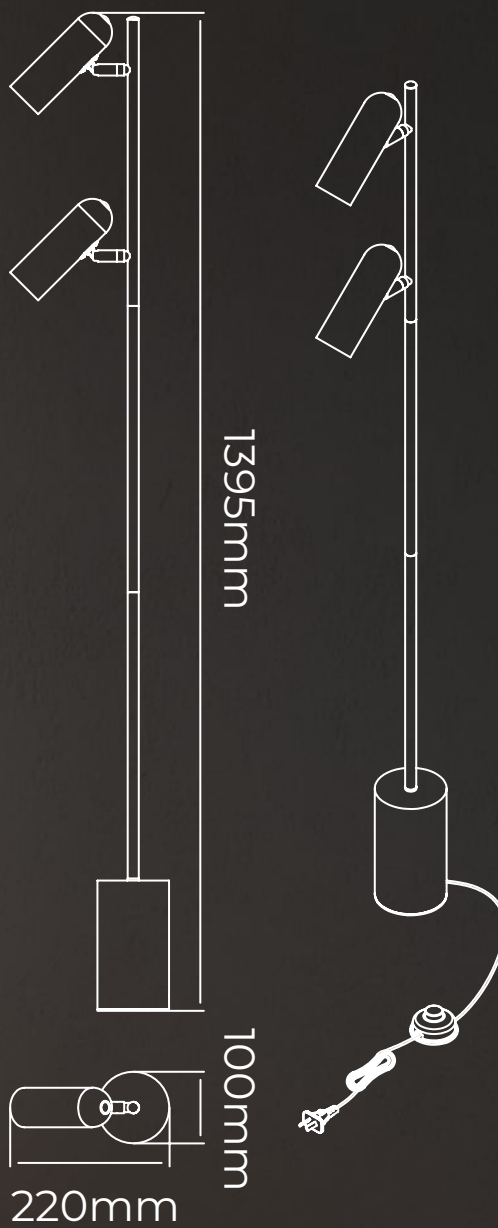
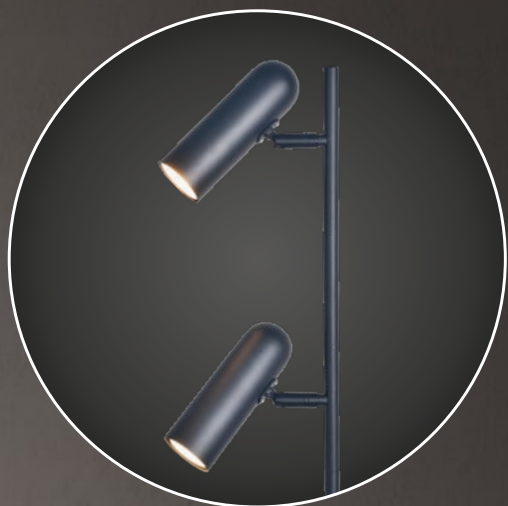

 Negro mate

LÁMPARA DE PIE

CHIL



Lámpara de pie de diseño contemporáneo en negro mate con base rectangular y pantalla cilíndrica de tela. Su interior cobrizo e interruptor de cadena brindan una iluminación cálida y difusa. Una pieza elegante y moderna, ideal para aportar distinción a cualquier ambiente.

Art.: FLE271P12A 

 1xE27, Max 12W, 220V, 50Hz, IP20

 Negro mate

 Chapa de acero

 Clase II



Ø250mm

250mm

1345mm

290mm

 Negro mate

LÁMPARA DE PIE

TRIO





Lámpara de pie en negro mate con triple foco orientable. Sus cabezales cilíndricos de interior cobrizo permiten dirigir la luz de forma independiente, creando una iluminación cálida y dinámica. Una solución moderna y funcional para una distribución de luz personalizada.

Art.: FLE273C12A



 3xE27, Max 12W, 220V, 50Hz, IP20

 Negro mate + Oro Antiguo

 Chapa de acero

 Clase II



1505mm



356mm

325mm



LÁMPARA DE PIE

MARCOS

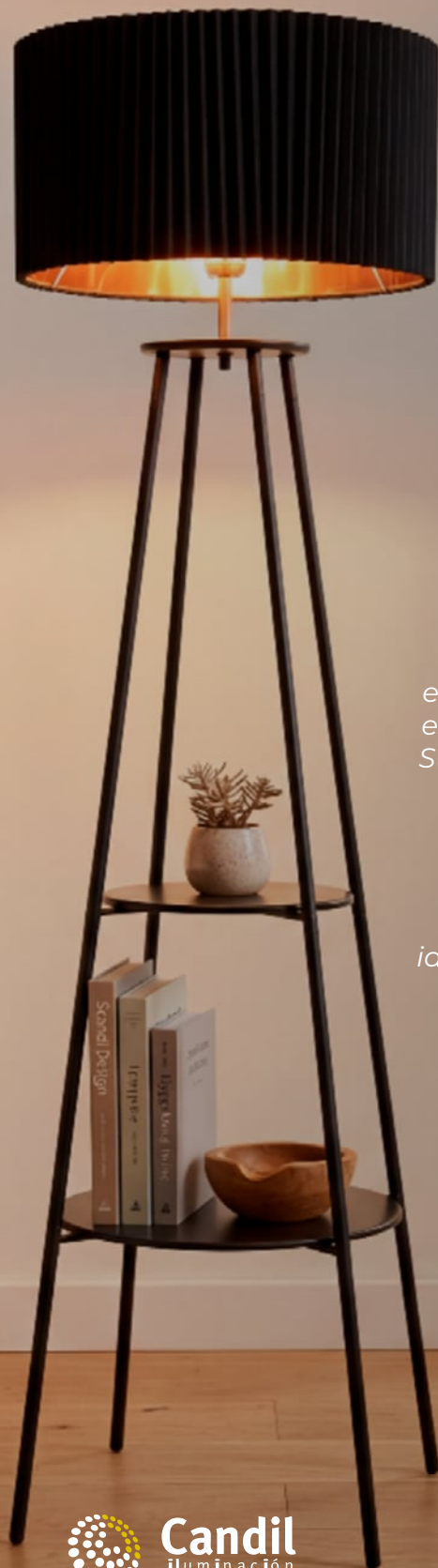



Lámpara de pie tipo trípode en negro mate que integra dos estantes circulares funcionales. Su pantalla plisada con interior cobrizo aporta una textura elegante y una iluminación cálida y sofisticada. Una pieza versátil que combina almacenamiento y diseño, ideal para jerarquizar salones o dormitorios modernos.

Art.: FLE271P12B 

 1xE27, Max 12W, 220V, 50Hz, IP20

 Negro mate

 Chapa de acero

 Clase II

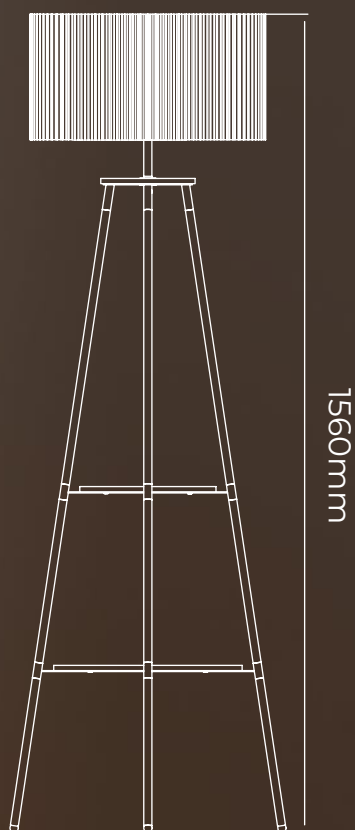

1560mm

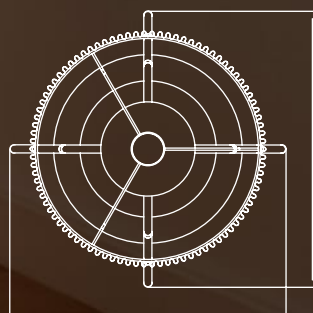

527mm

527mm

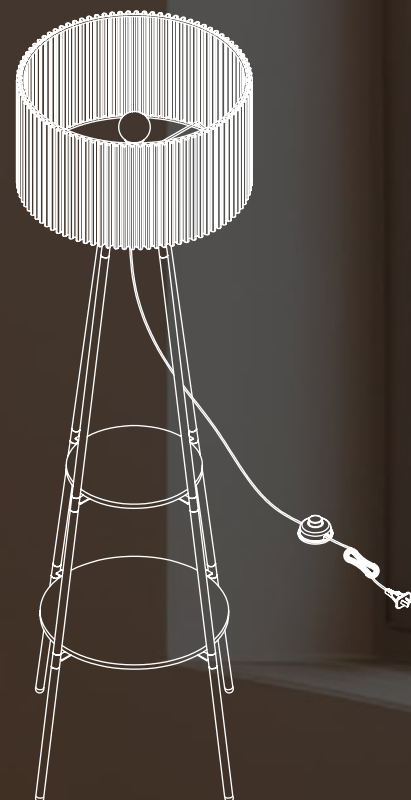



LÁMPARA DE PIE NOVEN





Lámpara de pie de diseño minimalista con estructura metálica en negro mate y cabezal cónico orientable. Su interior en tono cobre suaviza la reflexión, proyectando una luz cálida y puntual ideal para rincones de lectura. Una pieza de estética industrial y moderna que aporta sofisticación y funcionalidad a cualquier ambiente.



Art.: FLE271C12B 

 1xE27, Max 12W, 220V, 50Hz, IP20

 Negro mate

 Chapa de acero

 Clase II



1736mm

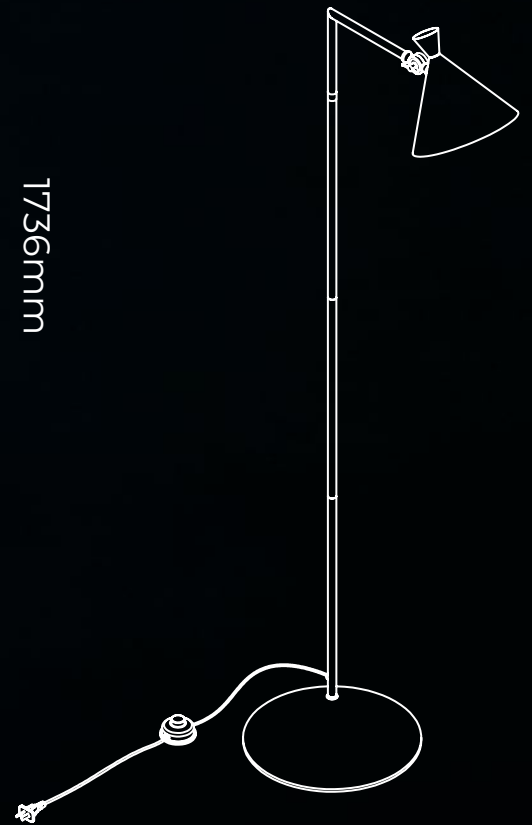
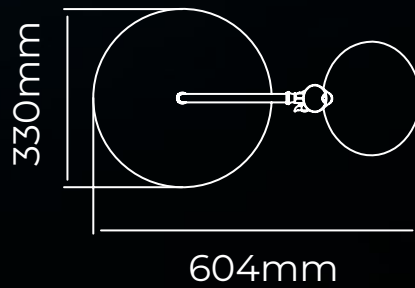

 Negro mate

LÁMPARA DE PIE DUPLEX

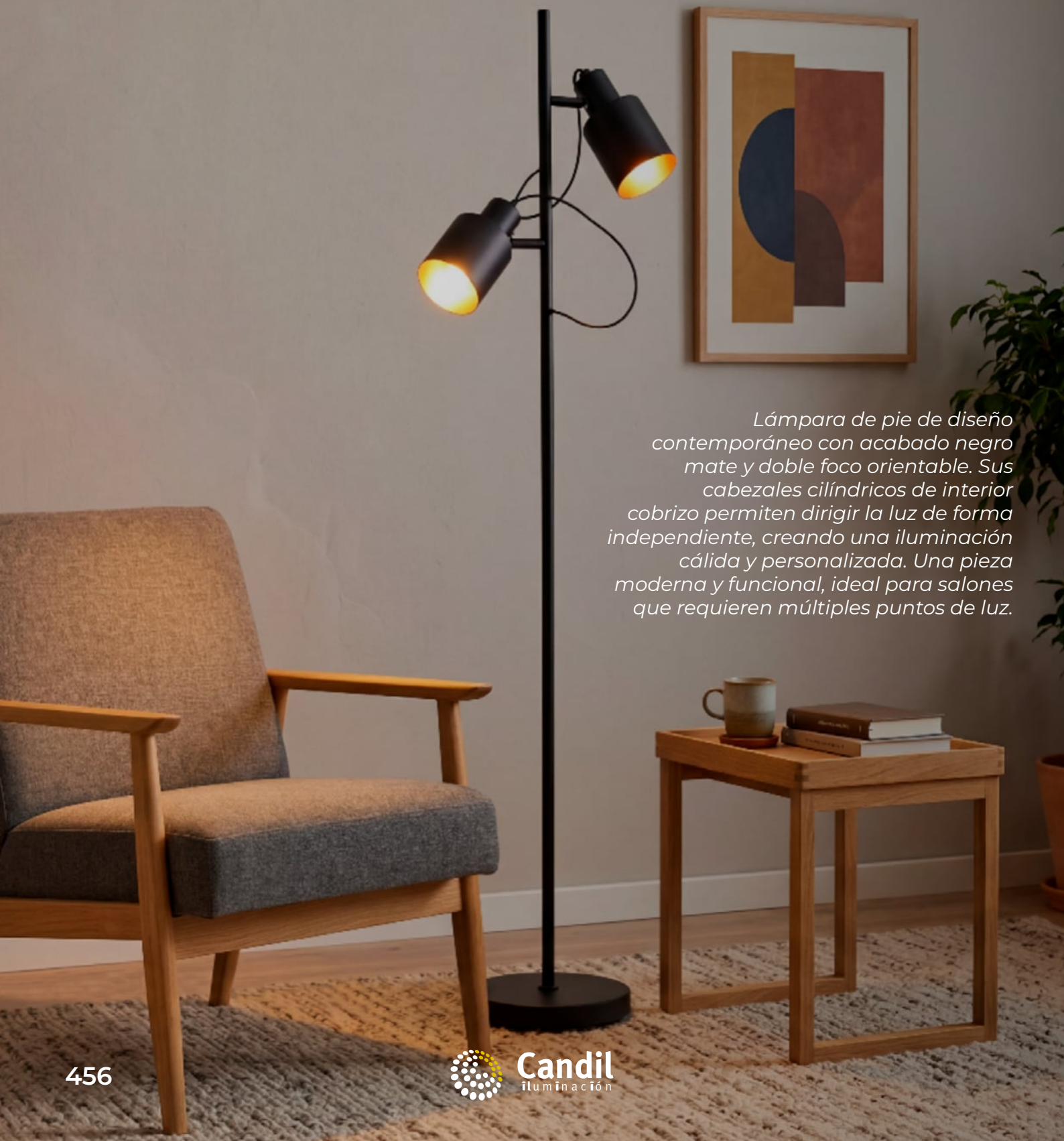

Lámpara de pie de diseño contemporáneo con acabado negro mate y doble foco orientable. Sus cabezales cilíndricos de interior cobrizo permiten dirigir la luz de forma independiente, creando una iluminación cálida y personalizada. Una pieza moderna y funcional, ideal para salones que requieren múltiples puntos de luz.

Art.: FLE272C12C



 1xE27, Max 12W, 220V, 50Hz, IP20

 Negro mate + Oro Antiguo

 Chapa de acero

 Clase II



1385mm

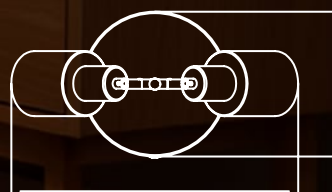

200mm

395mm

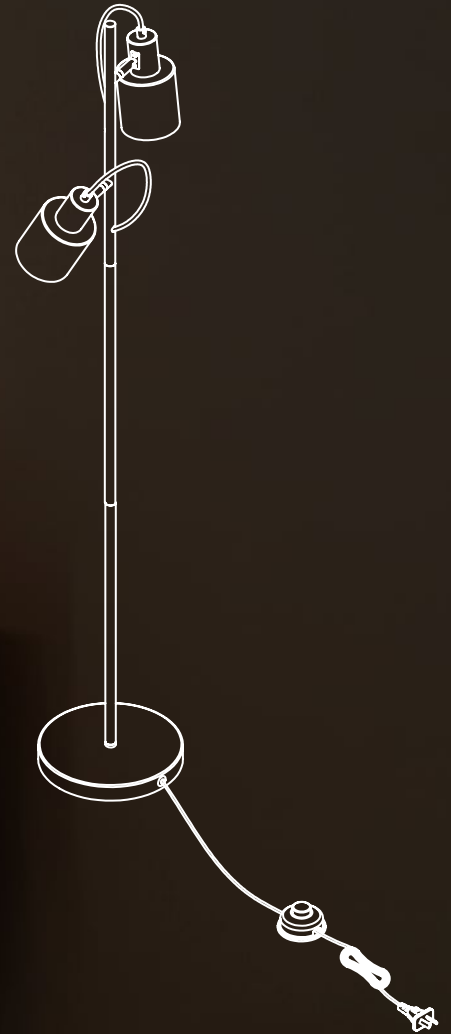

 Negro mate

457

LÁMPARA DE PIE

CUNA

Lámpara de pie de estilo industrial en negro mate con una innovadora base de mármol que **incluye tecnología de carga inalámbrica**. Su cabezal cilíndrico fijo, de interior cobrizo y detalle de rejilla superior, proyecta una iluminación cálida y focalizada. Una pieza robusta, sofisticada y tecnológica, ideal para aportar carácter y distinción a cualquier ambiente contemporáneo.



Art.: FLE271C12D ●

💡 1xE27, Max 12W, 220V, 50Hz, IP20

🌀 Negro mate

📏 Chapa de acero

📦 Clase II

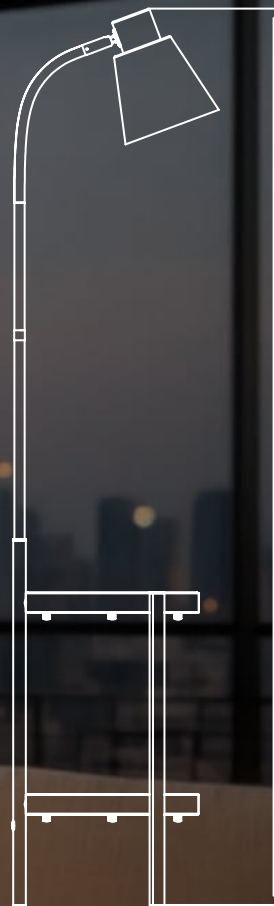

1350mm

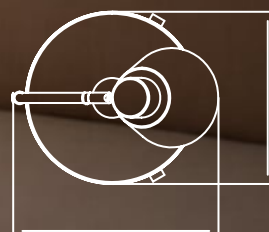

260mm

310mm





LÁMPARA DE PIE PESCA





Lámpara de pie de estilo industrial mecánico con estructura en negro mate y sistema de poleas funcional. Su diseño permite regular la altura de la pantalla cónica, cuyo interior cobrizo emite una luz cálida y dirigida. Una pieza con carácter vintage y gran versatilidad técnica para ambientes modernos.



Art.: FLE271C12E 

 1xE27, Max 12W, 220V, 50Hz, IP20

 Negro mate

 Chapa de acero

 Clase II



1610mm

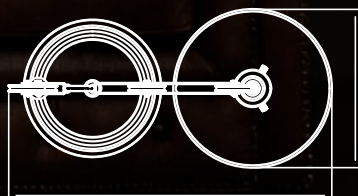

300mm

612mm





 Negro mate

LÁMPARA DE PIE ANZUELO

LLámpara de pie de diseño minimalista con estructura en negro mate y brazo de arco suave. Su pantalla cónica ajustable, con interior cobrizo, ofrece una iluminación cálida y focalizada. Una pieza esbelta y moderna que combina funcionalidad y elegancia en cualquier ambiente.



Art.: FLE271C12F 

 1xE27, Max 12W, 220V, 50Hz, IP20

 Negro mate

 Chapa de acero

 Clase II

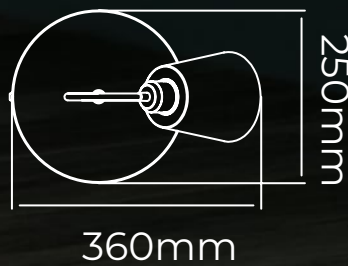
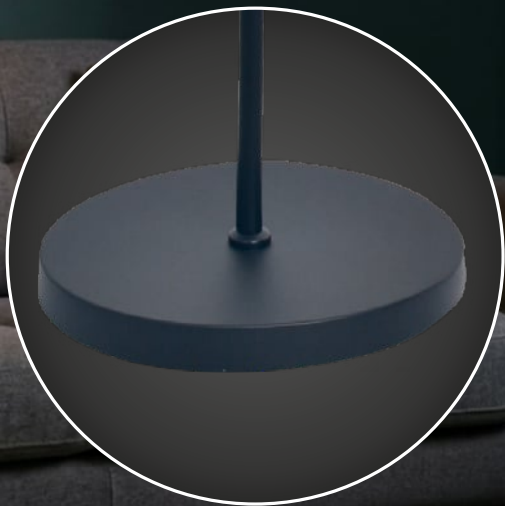



 Negro mate

LÁMPARA DE PIE

ROLON





Lámpara de pie tipo trípode con estética de estudio y acabado negro mate. Su cabezal parabólico orientable con interior cobrizo ofrece una luz indirecta y cálida. Una pieza escenográfica ideal para aportar carácter y diseño a cualquier espacio.

Art.: FLE271C12G  

 1xE27, Max 12W, 220V, 50Hz, IP20

 Negro mate + Oro antiguo

 Chapa de acero

 Clase II



1268mm

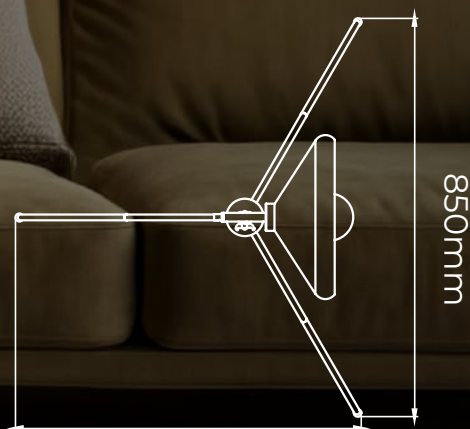

850mm

750mm

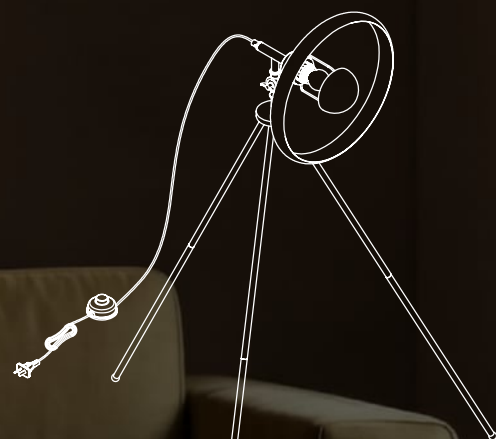

LÁMPARA DE PIE

ROLA





Lámpara de pie tipo trípode con estética industrial y acabado negro mate. Su cabezal esférico orientable presenta un interior cobrizo con difusor central, ofreciendo una iluminación indirecta, cálida y envolvente. Una pieza escenográfica ideal para aportar carácter y diseño a salones o estudios contemporáneos.

Art.: FLE271C12H  

 1xE27, Max 12W, 220V, 50Hz, IP20

 Negro mate + Oro antiguo

 Chapa de acero

 Clase II



1450mm

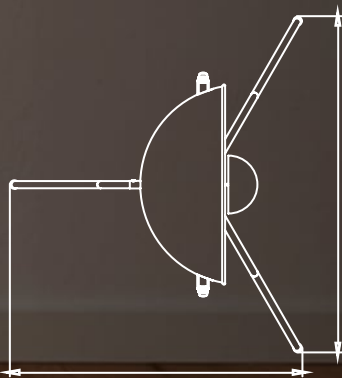

578mm

502mm

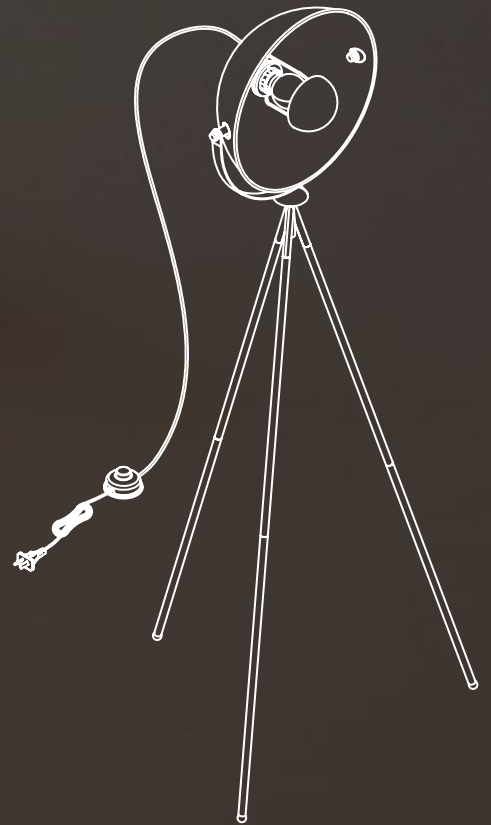

LÁMPARA DE PIE

JAMA

Lámpara de pie de diseño minimalista con estructura en negro mate y brazo de arco sutil. Su pantalla de cúpula con interior cobrizo ofrece una iluminación cálida y focalizada. Una pieza versátil y elegante, ideal para crear climas íntimos en espacios modernos.

Art.: FLE271C12K 

 1xE27, Max 12W, 220V, 50Hz, IP20

 Negro mate

 Chapa de acero

 Clase II

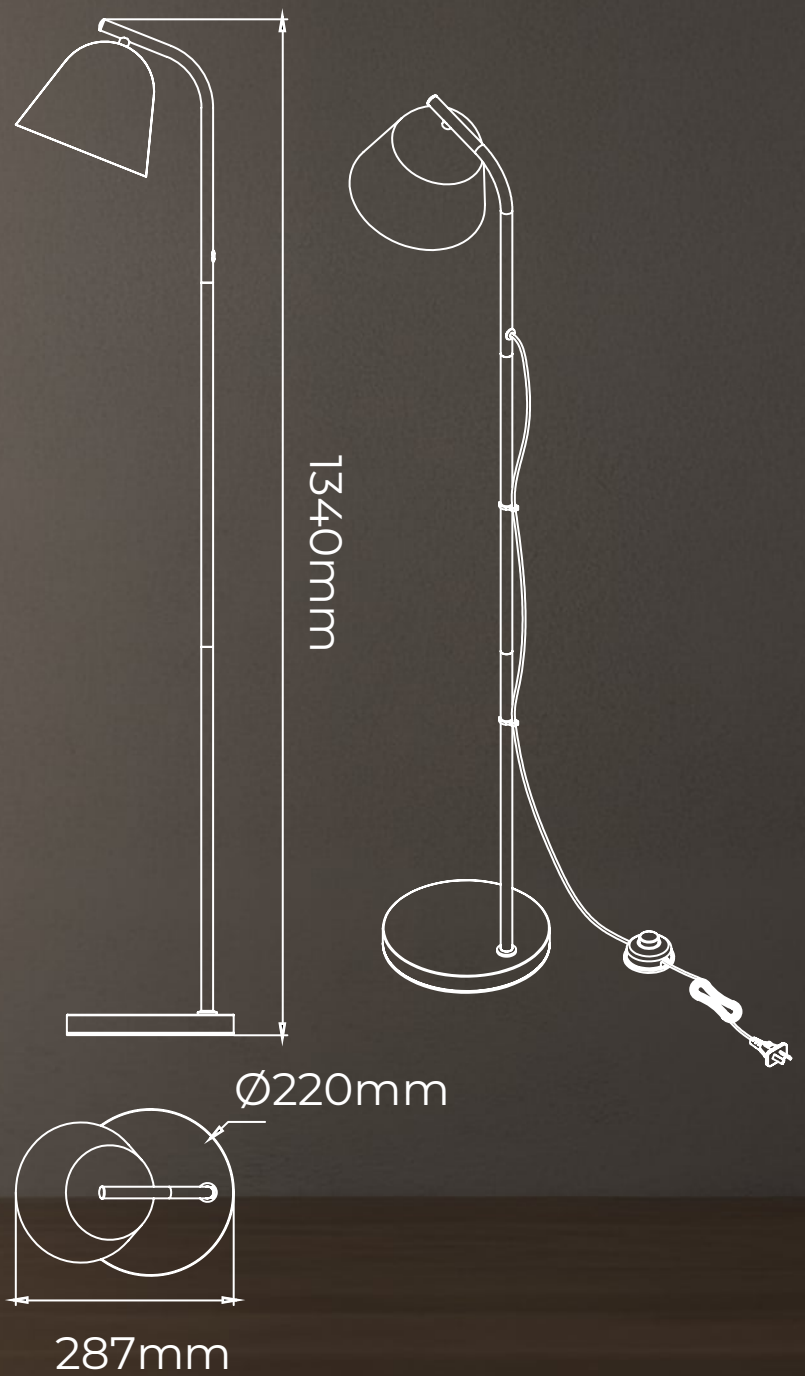

LÁMPARA DE PIE



SABLE

Lámpara de pie tipo boticario en negro mate. Su pantalla rectangular de interior cobrizo e interruptor de cadena aportan un toque vintage y funcional. Una pieza elegante, ideal para despachos o rincones de lectura con personalidad.

Art.: FLE271C12M 

 1xE27, Max 12W, 220V, 50Hz, IP20

 Negro mate

 Chapa de acero

 Clase II

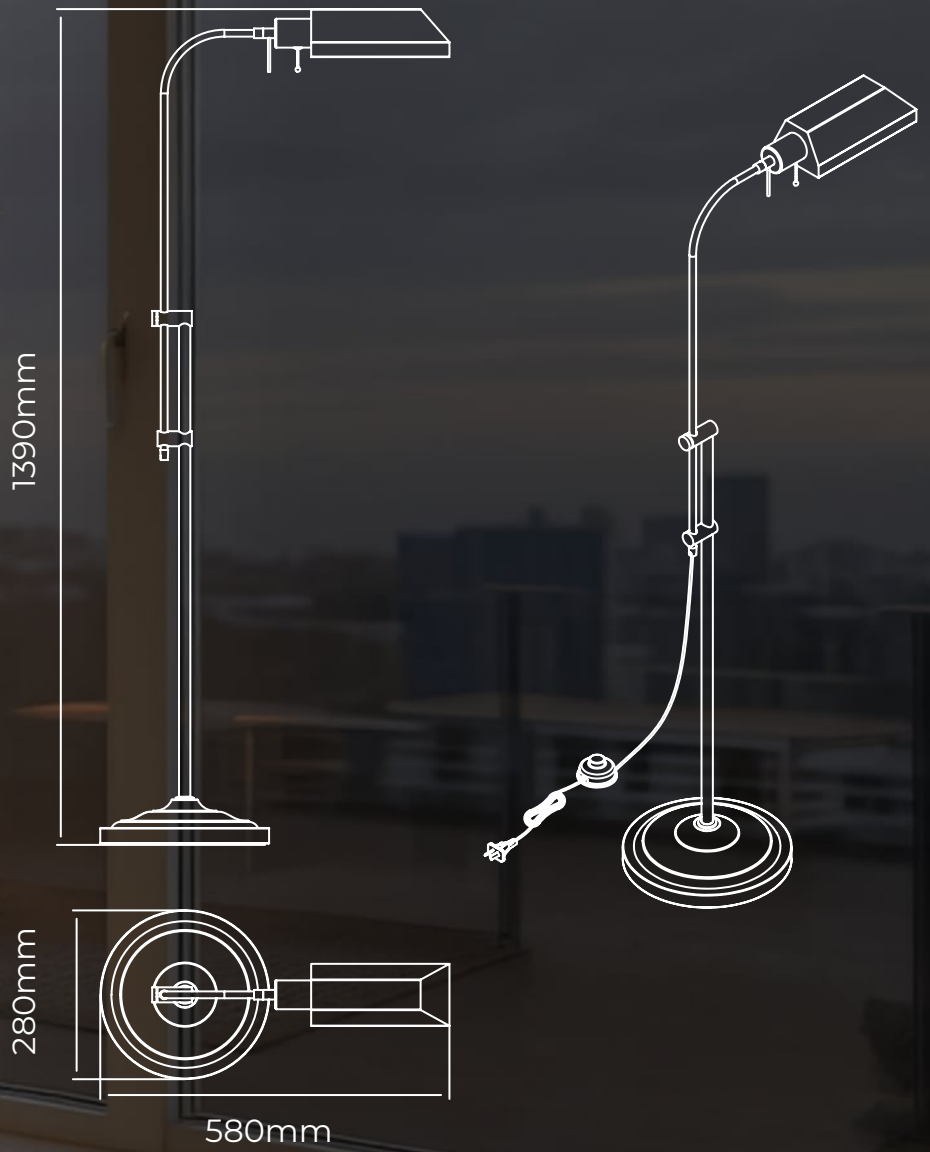
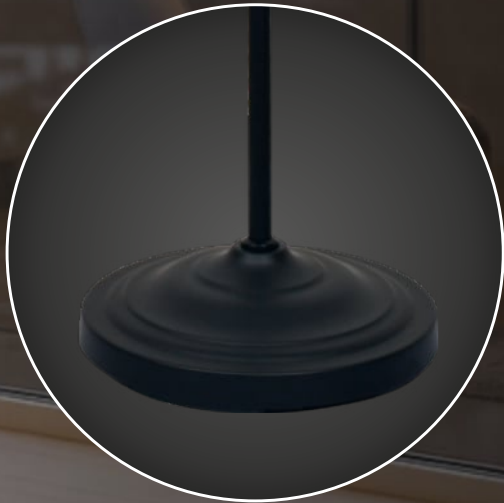
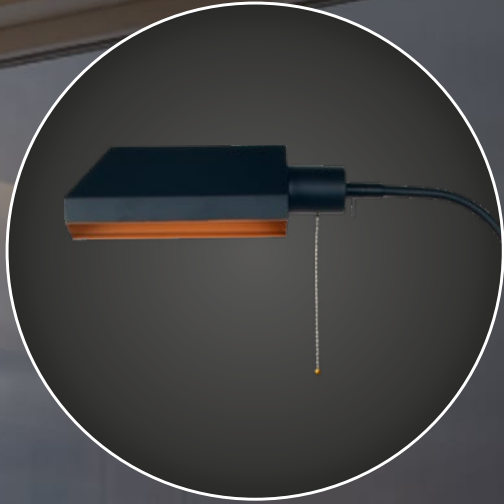

LÁMPARA DE PIE

RUFO

Lámpara de pie tipo proyector para lámpara E27.
Base de madera, cabezal construido en chapa de acero.
Acabado mate.

Art.: FL59541



 1xE27, Max 60W, 220V, 50Hz, IP20

 Gris

 Chapa de acero + Madera

 Clase II



LÁMPARA DE PIE

GOAL

Lámpara de pie para E27 con base de mármol, cuerpo de acero. Altura y largo regulable. Acabado en cromo.

Art.: 1795



 1xE27, Max 100W, 220V, 50Hz, IP20

 Blanco, Negro

 Acero

 Clase II



Disponible también con mármol negro.





LUMINARIAS PARA EXTERIOR

EXTERIOR DE APLICAR GU10





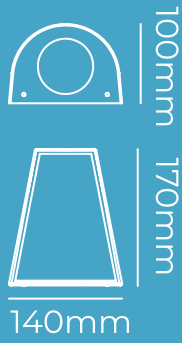
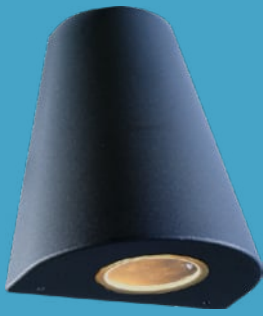

Apliques GU10 para exterior, contruidos íntegramente en fundición de aluminio.





Aplique
ABEL
Art.: B4126







-  1xGU10, Max 35W, 220V, 50Hz, IP54
-  Negro texturado
-  Aluminio
-  Clase I



Aplique
ADRIEL
Art.: B4220







-  1xGU10, Max 35W, 220V, 50Hz, IP44
-  Blanco texturado, Negro texturado, Plata texturado
-  Aluminio
-  Clase I



Aplique
AKIM
Art.: B4221







-  2xGU10, Max 35W, 220V, 50Hz, IP44
-  Blanco texturado, Negro texturado, Plata texturado
-  Aluminio
-  Clase I



Aplique
ALON
Art.: B4230





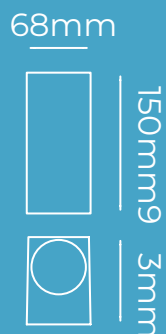

-  1xGU10, Max 35W, 220V, 50Hz, IP44
-  Blanco texturado, Negro texturado, Plata texturado
-  Aluminio
-  Clase I



Aplique
AMIR
Art.: B4231



-  2xGU10, Max 35W, 220V, 50Hz, IP44
-  Blanco texturado, Negro texturado, Plata texturado
-  Aluminio
-  Clase I

APLIQUES GU10 ARLIN, ANTO, ARTI, ARGON



Apliques GU10 para exterior, contruidos en plástico ABS y vidrio.

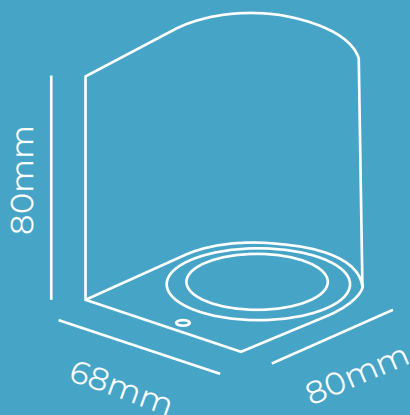

Aplique unidireccional

ARLIN

Art.: B7520



1xGU10, Max 7W, 220V, 50Hz, IP54

Negro texturado

ABS + Vidrio

Clase II

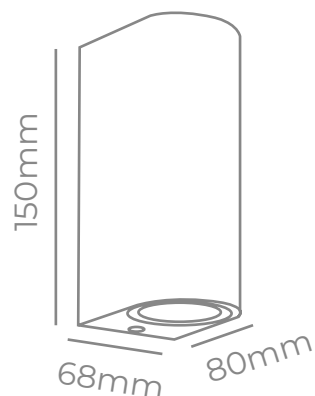

Aplique bidireccional

ANTO

Art.: B7521



2xGU10, Max 7W, 220V, 50Hz, IP54

Negro texturado

ABS + Vidrio

Clase II

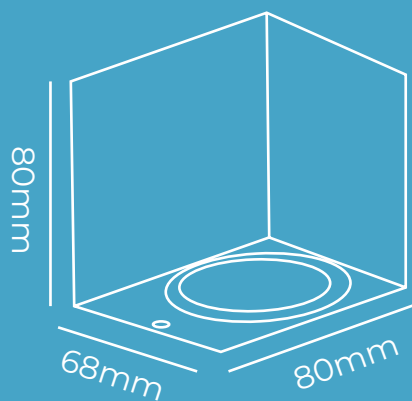

Aplique unidireccional

ARTI

Art.: B7630



1xGU10, Max 7W, 220V, 50Hz, IP54

Negro texturado

ABS + Vidrio

Clase II

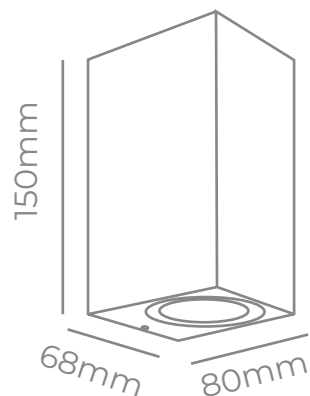

Aplique bidireccional

ARGON

Art.: B7631



2xGU10, Max 7W, 220V, 50Hz, IP54

Negro texturado

ABS + Vidrio

Clase II

APLIQUES GU10 MARO, OTTO

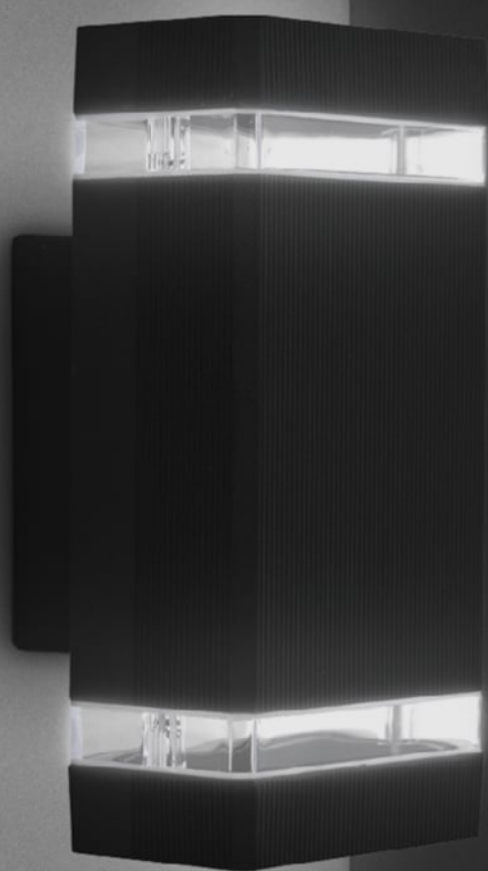

Apliques GU10 para exterior, contruidos íntegramente en fundición de aluminio.



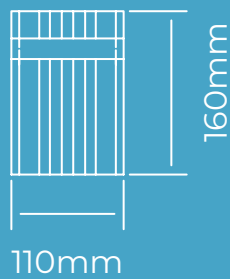
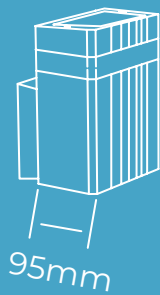

Aplique unidireccional

MARO I

Art.: AP60001



💡 1xGU10, Max 7W, 220V, 50Hz, IP44

♻️ Negro texturado

🏗️ Fundición de aluminio

⚡ Clase I

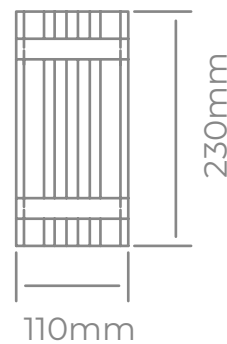
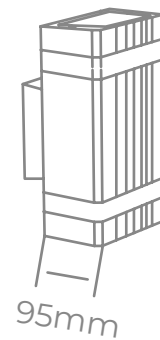

Aplique bidireccional

MARO II

Art.: AP60002



💡 2xGU10, Max 7W, 220V, 50Hz, IP44

♻️ Negro texturado

🏗️ Fundición de aluminio

⚡ Clase I

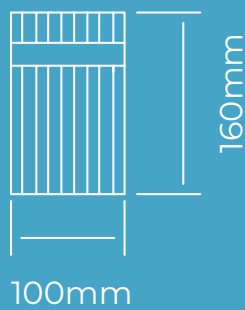

Aplique unidireccional

OTTO I

Art.: AP60003



💡 1xGU10, Max 7W, 220V, 50Hz, IP44

♻️ Negro texturado

🏗️ Fundición de aluminio

⚡ Clase I

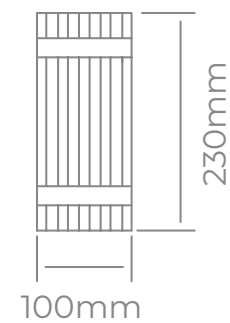

Aplique bidireccional

OTTO II

Art.: AP60004



💡 2xGU10, Max 7W, 220V, 50Hz, IP44

♻️ Negro texturado

🏗️ Fundición de aluminio

⚡ Clase I

APLIQUES ODA Y MAO





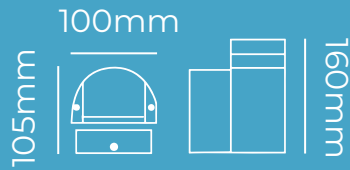

Apliques GU10, unidireccionales y bidireccionales para exterior, contruidos íntegramente en fundición de aluminio.





Aplique
ODA I
Art.: AP50001





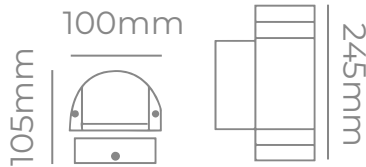

-  1xGU10, Max 50W, 220V, 50Hz, IP54
-  Blanco texturado, Negro texturado, Plata texturado
-  Aluminio
-  Clase I



Aplique
ODA II
Art.: AP50002





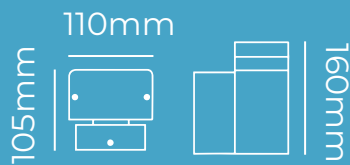

-  2xGU10, Max 50W, 220V, 50Hz, IP54
-  Blanco texturado, Negro texturado, Plata texturado
-  Aluminio
-  Clase I



Aplique
MAO I
Art.: AP50003





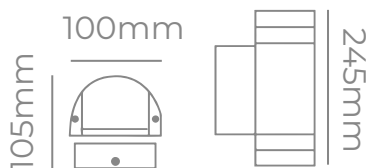

-  1xGU10, Max 50W, 220V, 50Hz, IP54
-  Blanco texturado, Negro texturado, Plata texturado
-  Aluminio
-  Clase I



Aplique
MAO II
Art.: AP50004



-  2xGU10, Max 50W, 220V, 50Hz, IP54
-  Blanco texturado, Negro texturado, Plata texturado
-  Aluminio
-  Clase I

EXTERIOR DE APLICAR LED



Apliques LED para exterior, contruidos en fundición de aluminio.

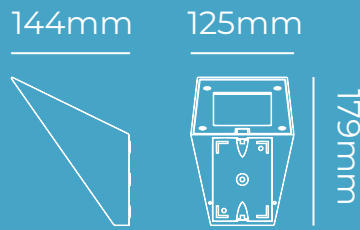

Aplicue

ASHER

Art.: B4400



LED 8.2W, 220V, 50Hz, IP54

Negro Texturado

3000K

738LM

Aluminio

Clase I

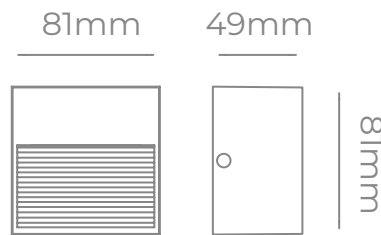

Aplicue

BOXER

Art.: B5250



LED 4.8W, 220V, 50Hz, IP54

Blanco texturado

3000K

432LM

Aluminio

Clase I

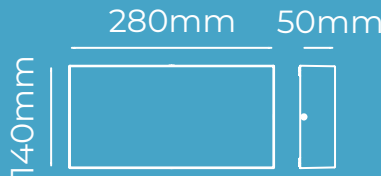
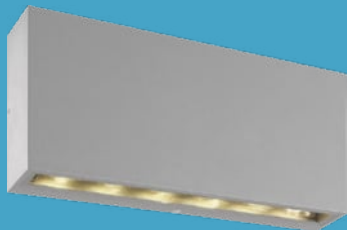

Aplicue

CHAIM 1 GRANDE

Art.: B4470B



LED 8.2W, 220V, 50Hz, IP54

Blanco texturado, Plata texturado

3000K

732LM

Aluminio

Clase I

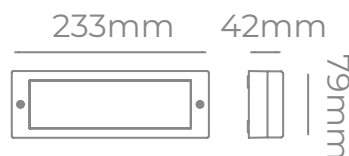

Aplicue

DUDE

Art.: B4615



LED 4.3W, 220V, 50Hz, IP54

Blanco texturado, Negro texturado, Plata texturado

3000K

387LM

Aluminio

Clase I

APLIQUE DONALD



*Aplique LED para exterior, luz cálida,
construido íntegramente en fundición de
aluminio.*

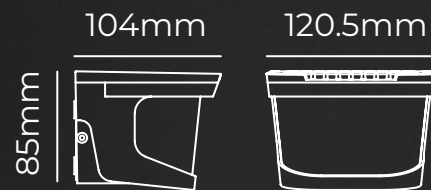

Aplique
DONALD I
Art.: B4490



- LED 4.8W, 220V, 50Hz, IP54
- Negro texturado
- 3000K
- 432LM
- Aluminio
- Clase I

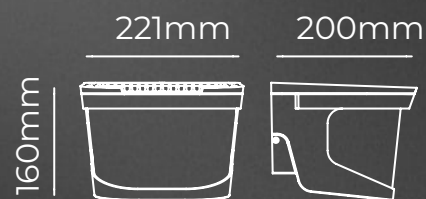

Aplique
DONALD II
Art.: B4491



- LED 11.7W, 220V, 50Hz, IP54
- Negro texturado
- 3000K, 6500K
- 1053LM
- Aluminio
- Clase I

APLIQUE EITAN



*Aplique LED para exterior, luz cálida,
construido íntegramente en fundición de
aluminio.*



140mm5





8mm

140mm

Aplique
EITAN I
Art.: B4720





 LED 4.8W, 220V, 50Hz, IP54

 Negro texturado

 3000K, 6500K

 432LM

 Aluminio

 Clase I

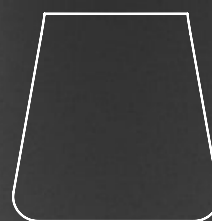

224mm





92mm

225mm

Aplique
EITAN II
Art.: B4721



 LED 8.5W, 220V, 50Hz, IP54

 Negro texturado

 3000K, 6500K

 765LM

 Aluminio

 Clase I

EXTERIOR DE APLICAR LED ::::

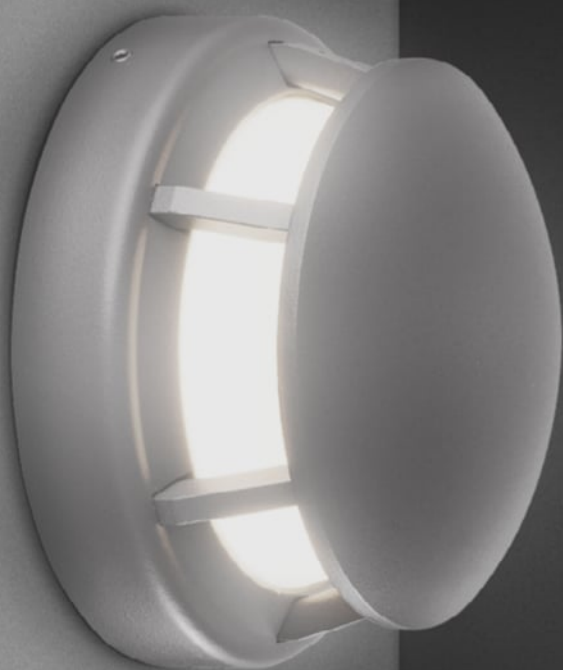

Apliques LED para exterior, contruidos íntegramente en fundición de aluminio.

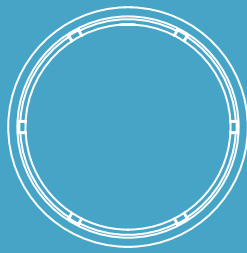
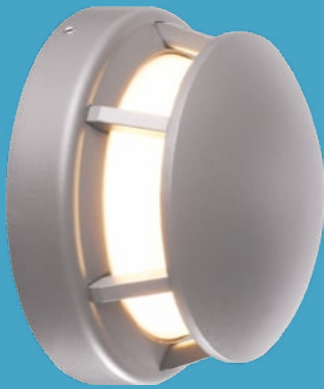







140mm



81mm

Aplique
ÉXITO
Art.: B5810



-  LED 4.4W, 220V, 50Hz, IP54
-  Blanco texturado, Plata texturado
-  3000K
-  396LM
-  Aluminio
-  Clase I



90mm

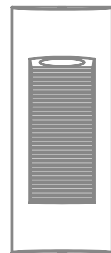







220mm



60mm

Aplique
FALE
Art.: B4725



-  LED 4.8W, 220V, 50Hz, IP54
-  Negro texturado
-  3000K, 6500K
-  432LM
-  Aluminio
-  Clase I

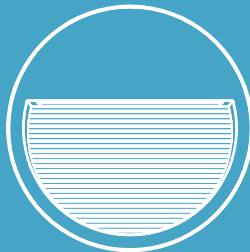







180mm



60mm

Aplique
FISHI
Art.: B5350



-  LED 8.5W, 220V, 50Hz, IP54
-  Negro texturado
-  3000K
-  765LM
-  Aluminio
-  Clase I

EXTERIOR DE APLICAR LED ::::



Apliques LED para exterior, contruidos íntegramente en fundición de aluminio.

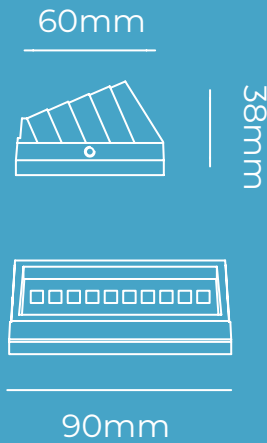

Aplique
RAMPA CHICO
Art.: B6010



- LED 2.1W, 220V, 50Hz, IP54
- Blanco texturado, Negro texturado
- 3000K
- 189LM
- Aluminio
- Clase I

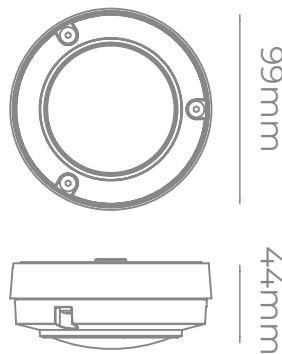

Aplique
SASON
Art.: APL3000



- LED 2.2W, 220V, 50Hz, IP54
- Negro texturado
- 3000K
- 198LM
- Aluminio
- Clase I

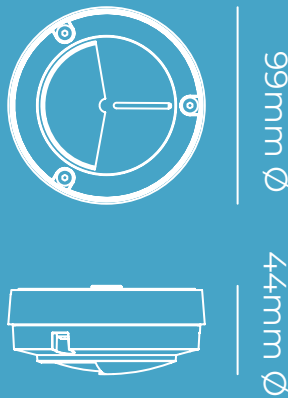

Aplique
SASON CON VICERA
Art.: APL3000V



- LED 2.2W, 220V, 50Hz, IP54
- Negro texturado
- 3000K
- 189LM
- Aluminio
- Clase I

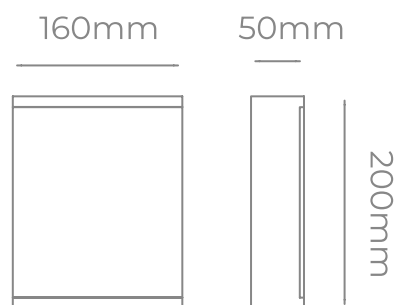

Aplique
SEÑAL
Art.: B5790



- LED 8W, 220V, 50Hz, IP54
- Negro texturado
- 3000K
- 720LM
- Aluminio
- Clase I

EXTERIOR DE EMPOTRAR LED

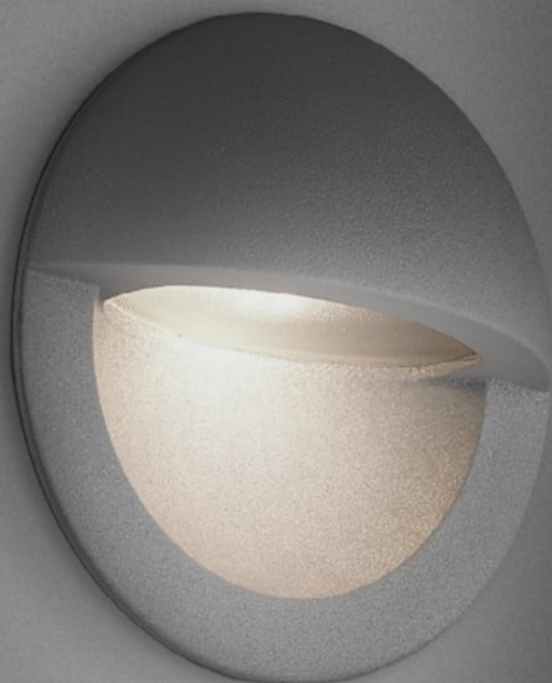

Empotrables LED para exterior, contruidos íntegramente en fundición de aluminio.



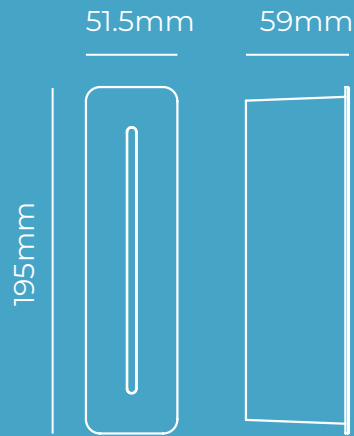







Empotrable

BALTHA

Art.: EP30003



-  LED 3.8W, 220V, 50Hz, IP54
-  Plata texturado
-  6500K
-  342LM
-  Aluminio
-  Clase I

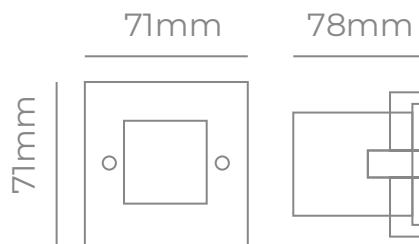

Empotrable

FAN CUADRADO

Art.: EP10007



-  LED 1.8W, 220V, 50Hz, IP54
-  Plata
-  3000K, 6500K
-  162LM
-  Aluminio
-  Clase I

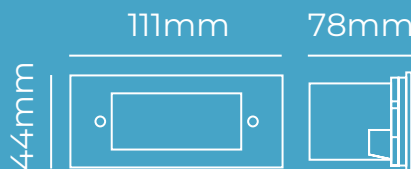

Empotrable

FAN RECTANGULAR

Art.: EP10005



-  LED 1.8W, 220V, 50Hz, IP54
-  Plata
-  3000K, 6500K
-  162LM
-  Aluminio
-  Clase I

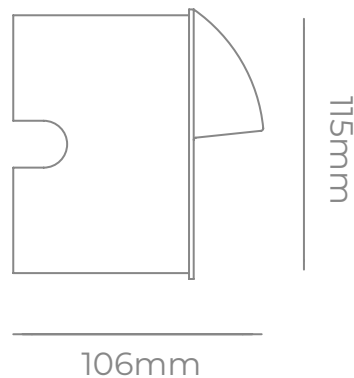
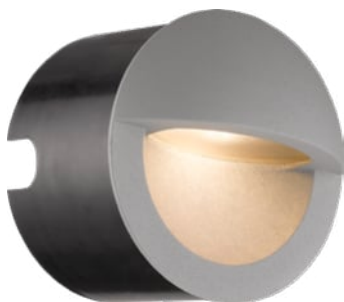







Empotrable

NINO

Art.: EP30004



-  LED 3.8W, 220V, 50Hz, IP54
-  Blanco texturado, Negro texturado, Plata texturado
-  3000K
-  342LM
-  Aluminio
-  Clase I

EMBUTIDOS DE PISO



Embutidos GU10 para exterior contruidos íntegramente en fundición de aluminio.



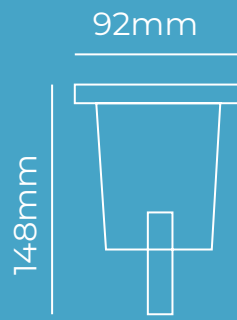

Embutido
E2001



1xGU10, Max 60W, 220V, 50Hz, IP54

Negro texturado

Aluminio

Clase I



FRENTE DE ACERO INOXIDABLE

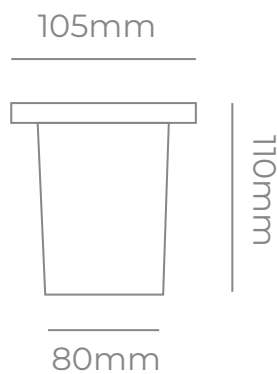

Embutido
E2001P



1xGU10, Max 60W, 220V, 50Hz, IP54

Niquel mate

Aluminio

Clase I



Embutido
E2001C



1xGU10, Max 50W, 220V, 50Hz, IP54

Negro texturado

Aluminio

Clase I

SPOTS URRACA





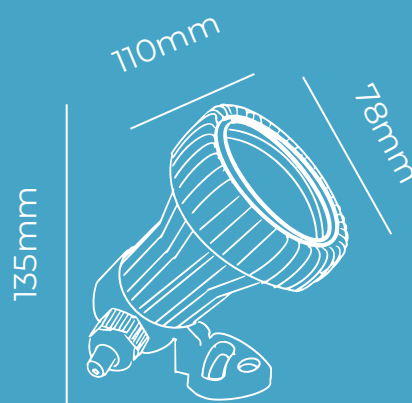

*Spots para lámpara dicro GU10 construido en PVC.
Estaca para embutido E2001 construida en PVC*



Spot GU10
URRACA
Art.: EJ15005





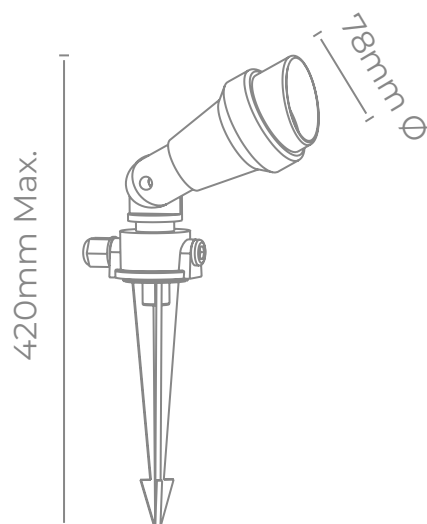

-  1xGU10, Max 7W, 220-240V, 50Hz, IP54
-  Negro texturado
-  PVC
-  Clase II



Spot GU10 con Jabalina
URRACA
Art.: EJ15005V/J



-  1xGU10, Max 7W, 220-240V, 50Hz, IP54
-  Negro texturado
-  PVC
-  Clase II

SPOTS TERO



*Spots para lámpara dicro GU10 construido en PVC.
Estaca para embutido E2001 construida en PVC*



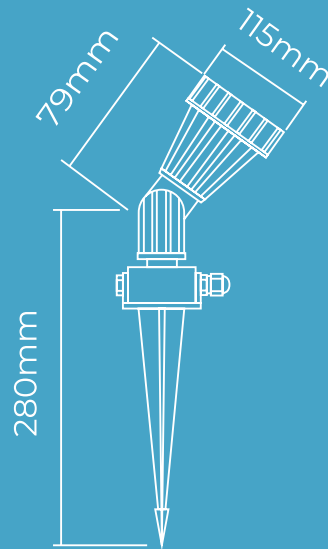

Spot con Jabalina TERO

Art.: EJ15001/J

1xGU10, Max 7W, 220-240V, 50Hz, IP54

Negro texturado

PVC

Clase II

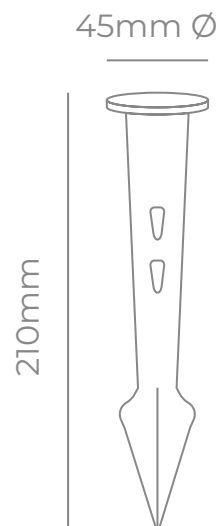

Jabalina

ACCESORIO PARA E2001

Art.: JABALINA

Negro texturado

PVC



EXTERIOR PARA TECHO





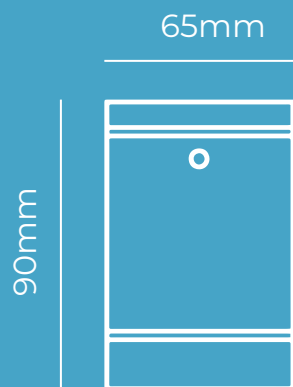

*Apliques para techo contruidos en fundición
de aluminio.*



Aplique
SENA CHICO
Art.: T501





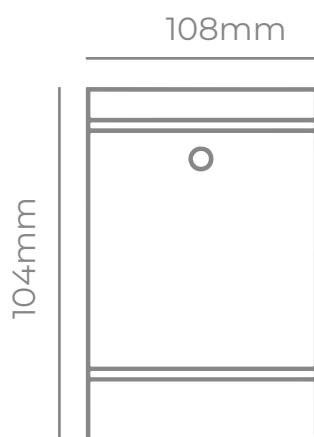

-  1xGU10, Max 50W, 220V, 50Hz, IP54
-  Blanco texturado, Plata texturado
-  Aluminio
-  Clase I



Aplique
SILO GRANDE
Art.: T408





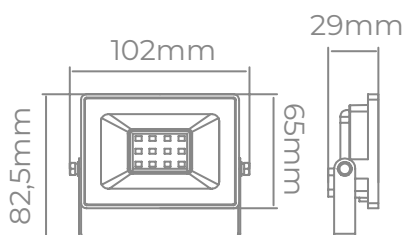

-  1xE27, Max 75W, 220V, 50Hz, IP54
-  Plata texturado
-  Aluminio
-  Clase I

PROYECTORES LED PEGASUS





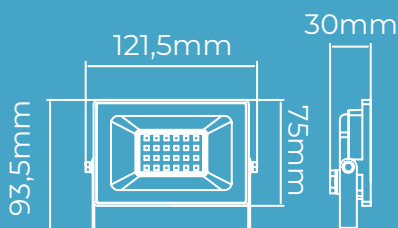

Proyector LED   
PEGASUS 10W
Art.: PL5010

-  LED 10W, 220V, 50Hz, IP65
-  Negro texturado
-  4000K, 6500K
-  Aluminio
-  Clase II





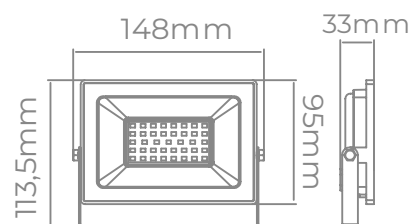

Proyector LED   
PEGASUS 20W
Art.: PL5020

-  LED 20W, 220V, 50Hz, IP65
-  Negro texturado
-  4000K, 6500K
-  Aluminio
-  Clase II



Proyector LED   
PEGASUS 30W
Art.: PL5030

-  LED 30W, 220V, 50Hz, IP65
-  Negro texturado
-  4000K, 6500K
-  Aluminio
-  Clase II

Proyectores LED de 10W, 20W, 30W, 50W y 100W, contruidos íntegramente en fundición de aluminio.



AHORA EN LUZ CÁLIDA

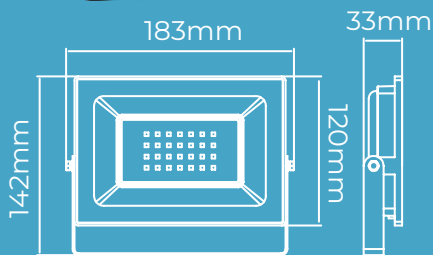

Proyector LED
PEGASUS 50W
Art.: PL5050



- LED 50W, 220V, 50Hz, IP65
- Negro texturado
- 4000K, 6500K
- Aluminio
- Clase II

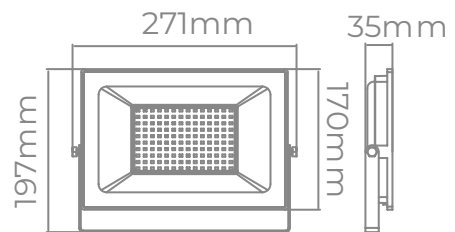

Proyector LED
PEGASUS 100W
Art.: PL5100



- LED 100W, 220V, 50Hz, IP65
- Negro texturado
- 3000K, 6500K
- Aluminio
- Clase II

PROYECTORES LED PEGASUS ALTA POTENCIA



*Proyectores LED de 150W, 200W y 300W
construidos íntegramente en fundición de
aluminio.*





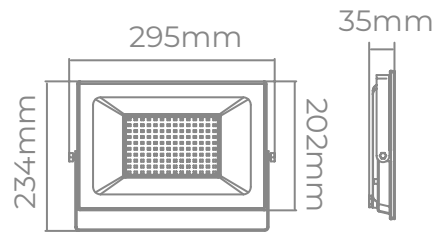

AHORA EN LUZ CÁLIDA



Proyector LED
PEGASUS 150W
Art.: PL5150-60 NT





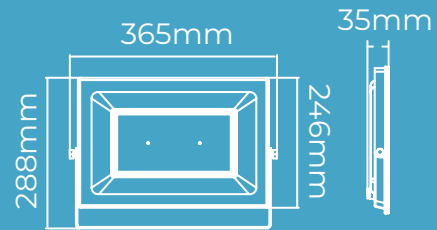

-  LED 150W, 220V, 50Hz, IP65
-  Negro texturado
-  3000K, 6000K
-  Aluminio
-  Clase II



Proyector LED
PEGASUS 200W
Art.: PL5200-60 NT





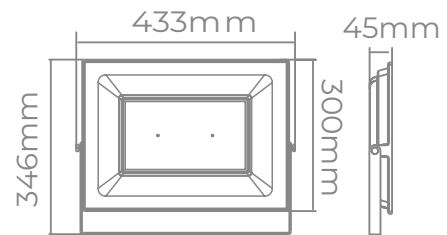

-  LED 200W, 220V, 50Hz, IP65
-  Negro texturado
-  6000K
-  Aluminio
-  Clase II



Proyector LED
PEGASUS 300W
Art.: PL5300-60 NT



-  LED 300W, 220V, 50Hz, IP65
-  Negro texturado
-  6000K
-  Aluminio
-  Clase II

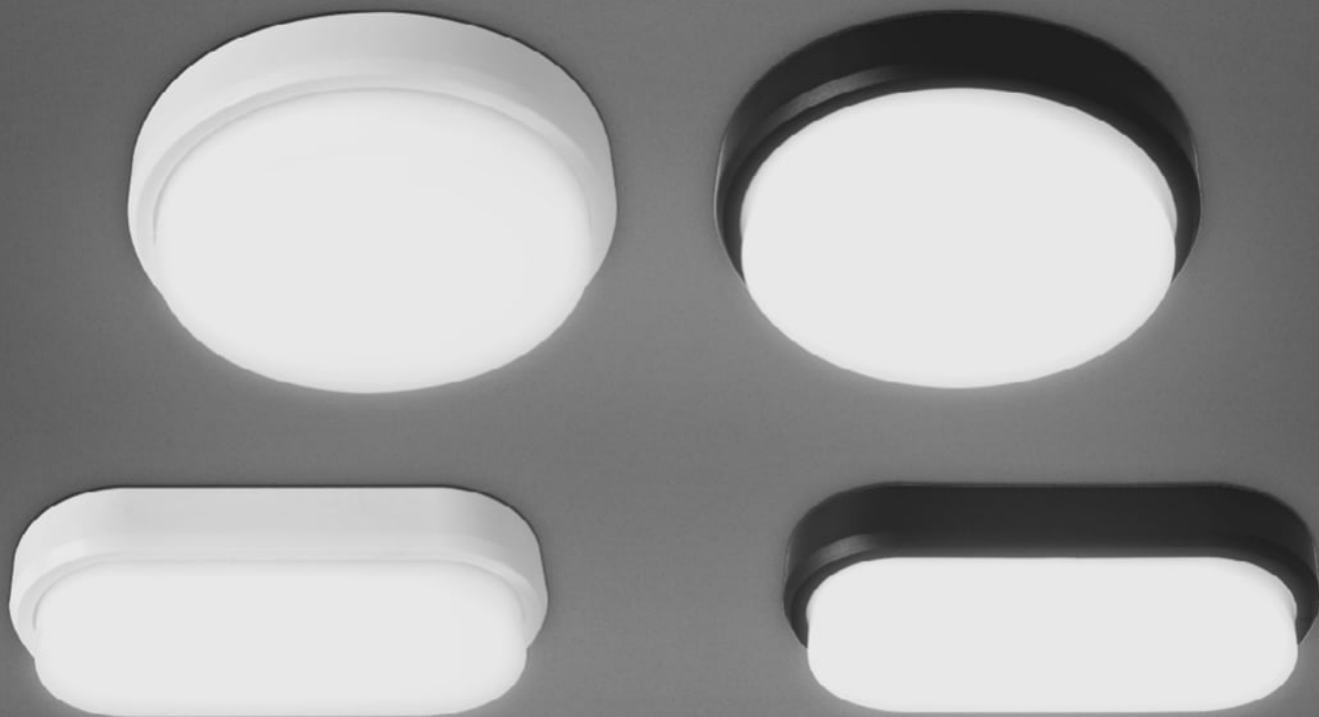

TORTUGAS LED INTEGRADO



*Tortugas LED integrado
construidas íntegramente
en policarbonato.*

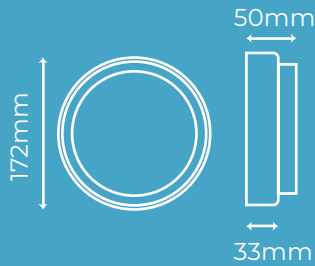

TL1017012-40 BL
TL1017012-40 NG
TL1017012-65 BL
TL1017012-65 NG

Tortuga LED
Redonda 12W
Art.: TL1017012



- LED 12W, 220V, 50Hz, IP54
- Blanco texturado, Negro texturado
- 4000K, 6500K
- Policarbonato
- Clase II

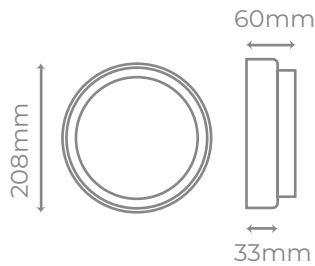

TL1021018-40 BL
TL1021018-40 NG
TL1021018-65 BL
TL1021018-65 NG

Tortuga LED
Redonda 18W
Art.: TL1021018



- LED 18W, 220V, 50Hz, IP54
- Blanco texturado, Negro texturado
- 4000K, 6500K
- Policarbonato
- Clase II

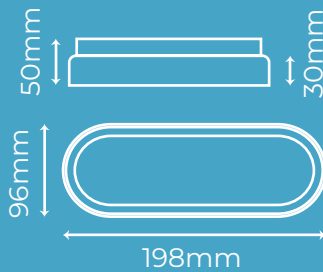

TL2019012-40 BL
TL2019012-40 NG
TL2019012-65 BL
TL2019012-65 NG

Tortuga LED
Ovalada 12W
Art.: TL2019012



- LED 12W, 220V, 50Hz, IP54
- Blanco texturado, Negro texturado
- 4000K, 6500K
- Policarbonato
- Clase II

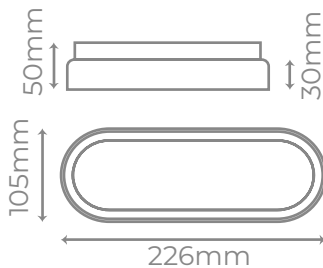

TL2030018-40 BL
TL2030018-40 NG
TL2030018-65 BL
TL2030018-65 NG

Tortuga LED
Ovalada 18W
Art.: TL2030018



- LED 18W, 220V, 50Hz, IP54
- Blanco texturado, Negro texturado
- 4000K, 6500K
- Policarbonato
- Clase II





LUMINARIAS SOLARES DE EXTERIOR

APLIQUE SOLAR CANDE



AHORA TAMBIÉN EN LUZ CÁLIDA

Apliques solar para pared construido en plástico ABS y policarbonato. Con sensor de movimiento.

Aplique Solar
CANDE

Art.: SOL1000



Potencia: 5.5V - 1.5W



Negro mate



3000K, 6500K



200LM



Tiempo de carga: 2-3 días de luz solar continua



Autonomía: 10 horas



Batería de Litio 1200Ah



Plástico ABS + Policarbonato



SOLAR



IP44



3000K

LUZ CÁLIDA

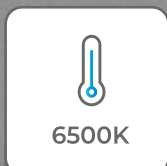

6500K



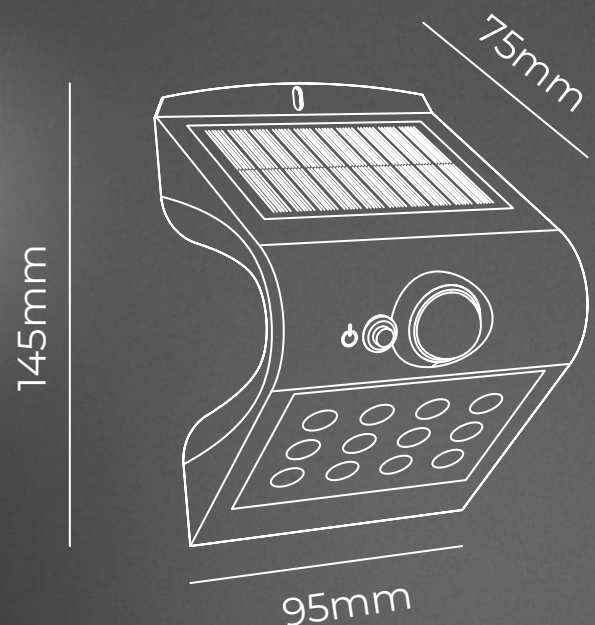

LUZ FRÍA



APLIQUE SOLAR BIDUS

Apliques solar bidireccional para pared construido en plástico ABS.

Aplique Solar Bidireccional
BIDUS
Art.: SOL1005



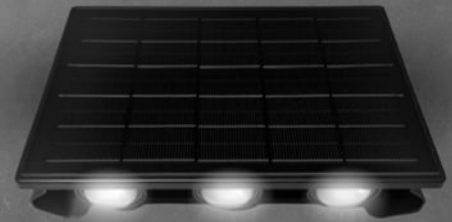





-  Potencia: 3.7V - 2W
-  Negro mate
-  3000K + 4000K + 6500K
-  99LM
-  Tiempo de carga: 6-8 horas
-  Autonomía: 12 horas de luz solar continua
-  Batería de Litio 1800Ah
-  Plástico ABS





APLIQUE SOLAR CIRUS

Apliques solar bidireccional para pared construido en plástico ABS.

Aplique Solar Bidireccional
CIRUS
Art.: SOL1010

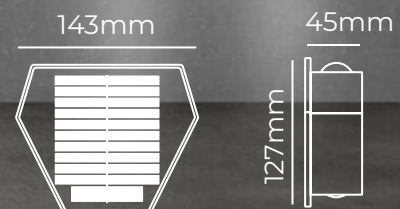
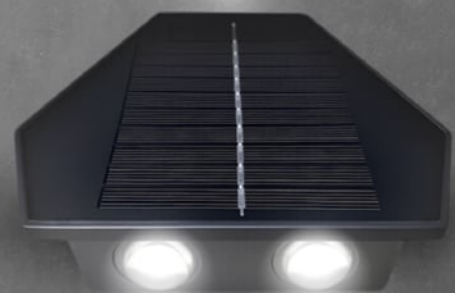
-  Potencia: 6V - 1.2W
-  Negro mate
-  3000K + 4000K + 5000K
-  13LM
-  Tiempo de carga: 5 horas
-  Autonomía: 8-12 horas de luz solar continua
-  Batería de Litio 1200Ah
-  Plástico ABS



 Negro mate

JABALINA SOLAR CRISOL

Jabalina solar de jardín, con función RGB,
construida en plástico ABS y policarbonato.



SOLAR

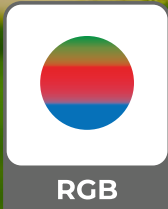

RGB



IP44

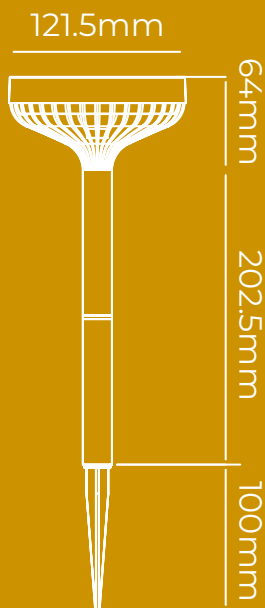

Jabalina Solar RGB
CRISOL
Art.: SOL2000



- Potencia: 2V - 0.4W
- Negro mate
- 3000K + 6500K
- 50LM
- Tiempo de carga: 6-8 horas
- Autonomía: 8 horas
- Batería de Litio 1200mAh / 3.7V
- Plástico ABS + Policarbonato

JABALINA SOLAR SIMPLE

Jabalina solar de jardín,
construida en plástico ABS y policarbonato.

AHORA TAMBIÉN EN LUZ CÁLIDA Y RGB



SOLAR



IP44

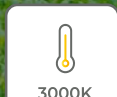

3000K

LUZ CÁLIDA

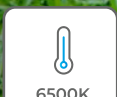

6500K

LUZ FRÍA



RGB



JABALINA SOLAR PRO

Jabalina solar de jardín,
construida en plástico ABS y policarbonato.

AHORA TAMBIÉN EN RGB



SOLAR



IP44

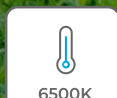

6500K

LUZ FRÍA



RGB

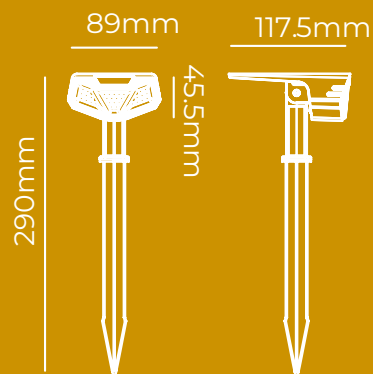

Art. SOL2005 ●

- Potencia: 5V - 0.09W
- Negro mate
- 3000K, 6500K, RGB
- 50LM - 100LM
- Tiempo de carga: 6-8 horas
- Autonomía: 8-10 horas
- Batería de Litio 1500mAh / 3.7V
- Plástico ABS + Policarbonato

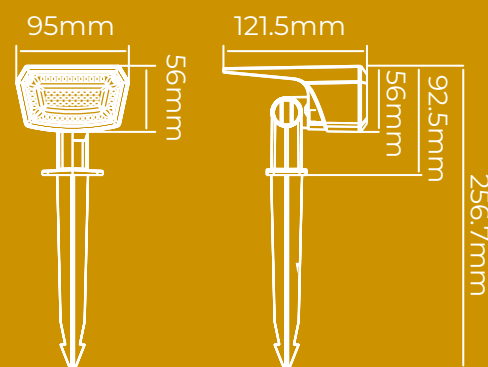

Art. SOL2010 ●

- Potencia: 5V - 0.09W
- Negro mate
- 6500K, RGB
- 50LM - 100LM
- Tiempo de carga: 6-8 horas
- Autonomía: 8-10 horas
- Batería de Litio 1200mAh / 3.7V
- Plástico ABS + Policarbonato

APLIQUE SOLAR SURTI CHICO









AHORA TAMBIÉN EN LUZ CÁLIDA

*Aplique solar para pared construido en plástico ABS y policarbonato.
Con sensor de movimiento.*



Art. SOL2032 

-  Potencia: 5.5V - 0.55W
-  Negro mate
-  3000K, 6500K
-  50LM - 170LM
-  Tiempo de carga: 6-8 horas de luz solar directa
-  Autonomía: 6-10 horas
-  Batería de Litio 1200mAh / 3.7V
-  Plástico ABS + Policarbonato

138mm

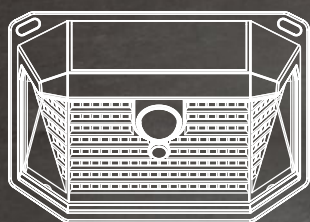

51.5mm



97mm

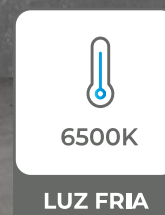
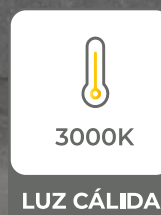









APLIQUE SOLAR SURTI GRANDE

Aplique solar para pared construido en plástico ABS y policarbonato.
Con sensor de movimiento.



Art. SOL2037 

-  Potencia: 5.5V - 1.3W
-  Negro mate
-  6500K
-  400LM
-  Tiempo de carga: 6-8 horas de luz solar directa
-  Autonomía: 6-10 horas
-  Batería de Litio 1200mAh / 3.7V
-  Plástico ABS + Policarbonato

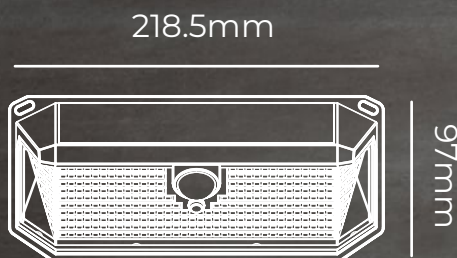

63mm



6500K

LUZ FRIA



SOLAR



SENSOR



IP44

 Negro mate

515

APLIQUE SOLAR TRITÓN



AHORA TAMBIÉN EN LUZ CÁLIDA

Aplique solar para pared construido en plástico ABS y policarbonato.
Con sensor de movimiento.



103mm

50mm

82mm

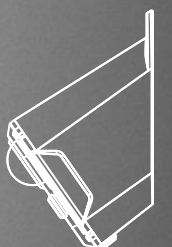

Art. SOL2020



Potencia: 5.5V - 0.44W



Negro mate



3000K, 6500K



50LM - 130LM



Tiempo de carga: 6-8 horas de luz solar directa



Autonomía: 6-10 horas



Batería de Litio 1200Ah / 3.7V



Plástico ABS + Policarbonato



3000K

LUZ CÁLIDA



6500K

LUZ FRÍA



SOLAR



SENSOR



IP44



APLIQUE SOLAR NUSEL



AHORA TAMBIÉN EN LUZ CÁLIDA

Aplique solar para pared construido en plástico ABS y policarbonato.
Con sensor de movimiento.



188mm





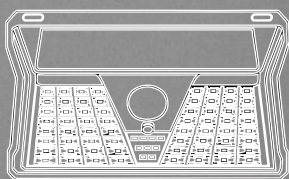



65.5mm

114mm



114mm

Art. SOL2044 

-  Potencia: 5.5V - 0.55W
-  Negro mate
-  3000K, 6500K
-  146LM
-  Tiempo de carga: 6-8 horas de luz solar directa
-  Autonomía: 8-10 horas
-  Batería de Litio 1200Ah
-  Plástico ABS + Policarbonato



3000K

LUZ CÁLIDA



6500K

LUZ FRÍA



SOLAR



SENSOR



IP44

 Negro mate

517

LÁMPARA SOLAR

POLI

Lámpara solar de pared, construida en plástico ABS y policarbonato.

AHORA TAMBIÉN EN LUZ CÁLIDA

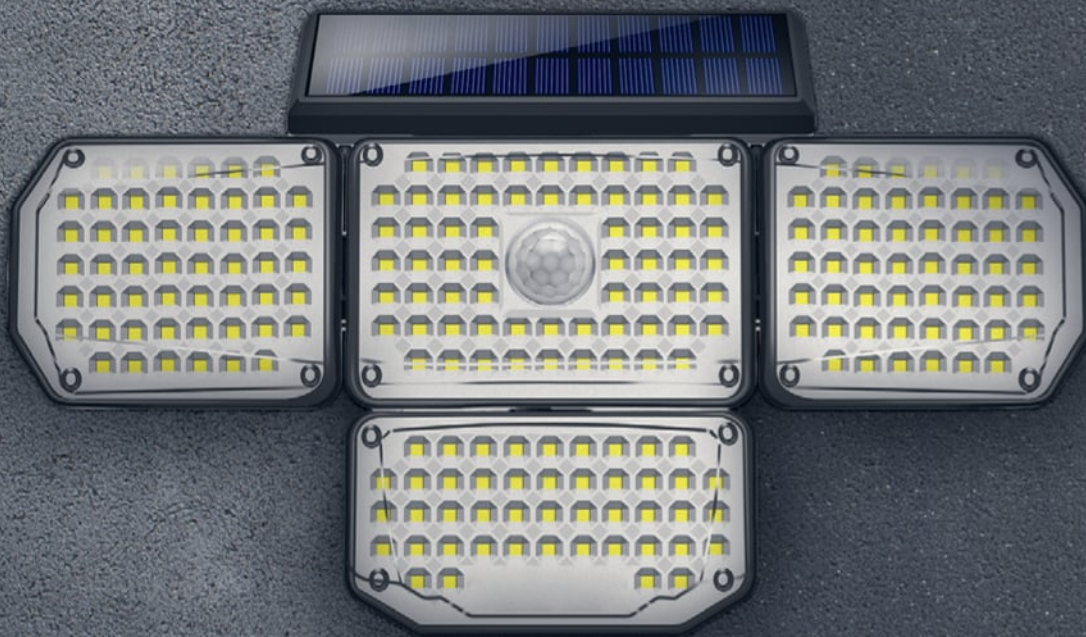

299mm

144.55mm

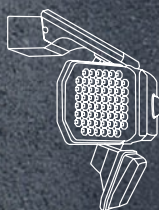
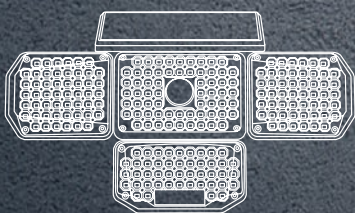

194mm

194mm

Art. SOL2099



- Potencia: 5.5V - 1.5W
- Negro mate
- 3000K, 6500K
- 439LM
- Tiempo de carga: 6-8 horas de luz solar directa
- Autonomía: 8-10 horas
- Batería de Litio 1200Ah
- Plástico ABS + Policarbonato



3000K

LUZ CÁLIDA



6500K

LUZ FRÍA



SOLAR



SENSOR



IP44

LÁMPARA SOLAR CAMPING





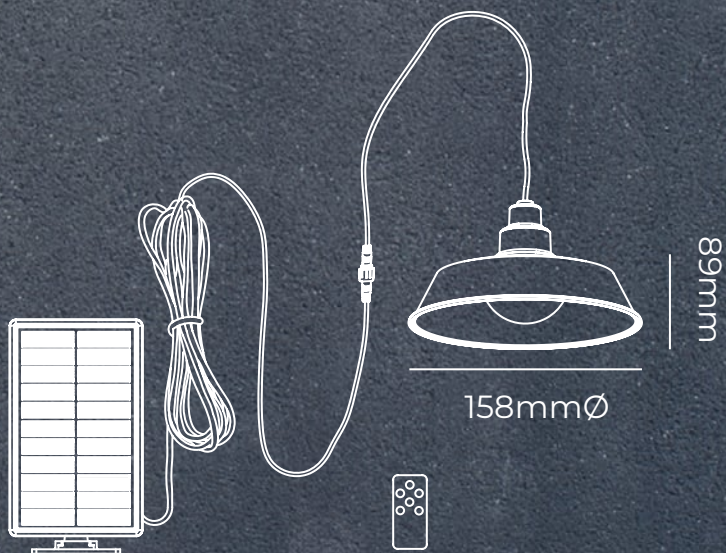



AHORA TAMBIÉN EN LUZ CÁLIDA

Lámpara solar de techo construida en plástico ABS y policarbonato.



Art. SOL3000



-  Potencia: 5.5V - 1.5W
-  Negro mate
-  3000K, 6500K
-  200LM
-  Tiempo de carga: 6-8 horas de luz solar directa
-  Autonomía: 8-10 horas
-  Batería de Litio 1200Ah
-  Plástico ABS + Policarbonato



SOLAR



IP64

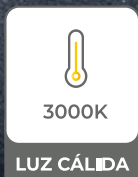

3000K
LUZ CÁLIDA

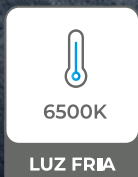

6500K
LUZ FRÍA

 Negro mate







TIRAS LED PERFILES Y FUENTES

Tira LED COB
8W 24V IP20

Artículos:
WCOB2082032018027
WCOB2082032018040
WCOB2082032018065

-  320 LEDS por metro
-  8W por metro, 24V, IP20
-  2700K, 4000K, 6500K
-  800LM por metro
-  5m x 1.8mm x 8mm
-  Clase III
-  Autoadhesivo

 Luz cálida (2700K)



 Luz neutra (4000K)



 Luz fría (6500K)

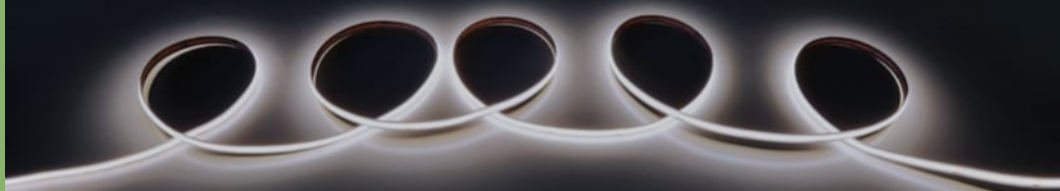

 Luz cálida (2700K)



 Luz neutra (4000K)



 Luz fría (6500K)



Tira LED
10W 24V IP20

Artículos:
WCOB2102048018027
WCOB2102048018040
WCOB2102048018065

-  480 LEDS por metro
-  10W por metro, 24V, IP20
-  2700K, 4000K, 6500K
-  1000LM por metro
-  5m x 1.8mm x 8mm
-  Clase III
-  Autoadhesivo

Tira LED COB
12W 24V IP20

Artículos:
WCOB2122048018027
WCOB2122048018040
WCOB2122048018065

-  480 LEDS por metro
-  12W por metro, 24V, IP20
-  2700K, 4000K, 6500K
-  1200LM por metro
-  5m x 1.8mm x 8mm
-  Clase III
-  Autoadhesivo

 Luz cálida (2700K)



 Luz neutra (4000K)



 Luz fría (6500K)



 Luz cálida (2700K)



 Luz neutra (4000K)



 Luz fría (6500K)









Tira LED
12W 24V IP65

Artículos:
WCOB2126548018027
WCOB2126548018040
WCOB2126548018065

-  480 LEDS por metro
-  12W por metro, 24V, IP65
-  2700K, 4000K, 6500K
-  1200LM por metro
-  5m x 4.5mm x 10.5mm
-  Clase III
-  Autoadhesivo

Tira LED COB
14W 24V IP20







Artículos:
WCOB21420672180RGB

-  672 LEDS por metro
-  14W por metro, 24V, IP20
-  RGB
-  1260LM por metro
-  5m x 1.8mm x 10mm
-  Clase III
-  Autoadhesivo



Tira LED COB
4.5W 24V IP65

Artículos:
WCOB21965784180RGBW

-  784 LEDS por metro
-  19W por metro, 24V, IP65
-  RGBW
-  360LM por metro
-  5m x 4.5mm x 14.5mm
-  Clase III
-  Autoadhesivo











RGB - CCT



Tira LED COB
21W 24V IP20

Artículos:
WCOB22120840180RGBCCT

-  840 LEDs por metro
-  21W por metro, 24V, IP20
-  RGB+CCT
-  360LM por metro
-  5m x 2mm x 12mm
-  Clase III
-  Autoadhesivo

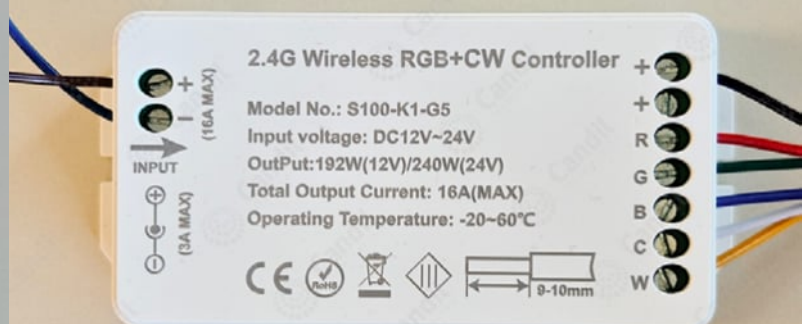

Control + Controladora para Tira LED COB RGB+CCT

Artículo: RGB-CCT-CONTROL

TIRAS LED :: 12V IP33

Tira LED
CHIP 2835 12V IP33

Artículos:
W13308060283527
W13308060283565
W133080602835RJ
W133080602835VD
W133080602835AZ
W133080602835AM
W133080602835RGB

 Chip 2835, 60 LEDS por metro

 9.5W por metro, 12V, IP33

 2700K, 6500K

 800LM por metro

 5m x 8mm

 Clase III

 Autoadhesivo

 Dimerizable

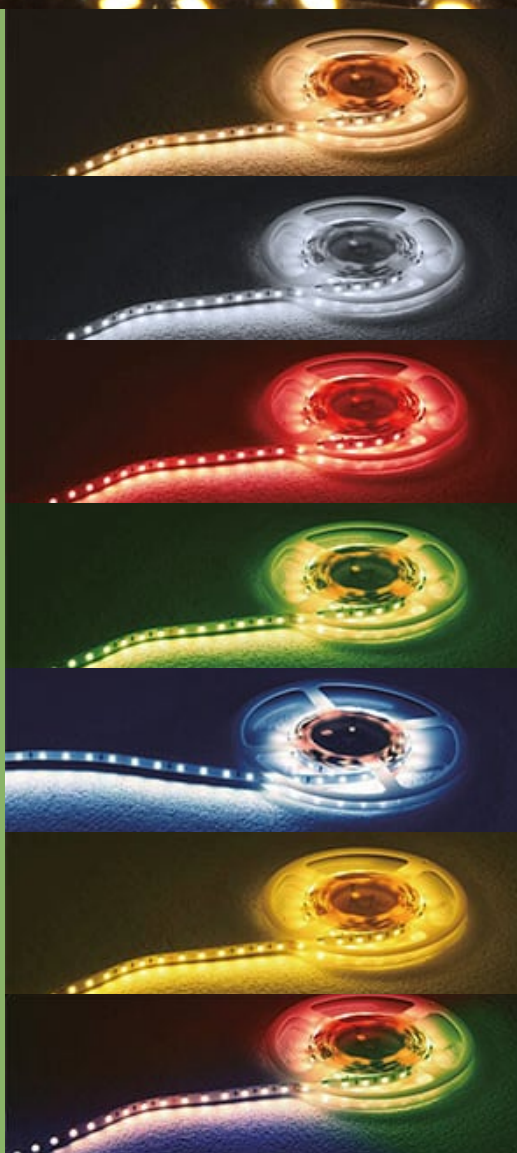

 Luz cálida (2700K)

 Luz fría (6500K)

 Rojo

 Verde

 Azul

 Amarillo

 RGB



Tira LED
CHIP 5050 12V IP33

Artículos:

W13310060505027
W13310060505065
W133100605050RJ
W133100605050VD
W133100605050AZ
W133100605050AM
W133100605050RGB

 Chip 5050, 60 LEDs por metro

 12W por metro, 12V, IP33

 2700K, 6500K

 950LM por metro

 5m x 10mm

 Clase III

 Autoadhesivo

 Dimerizable

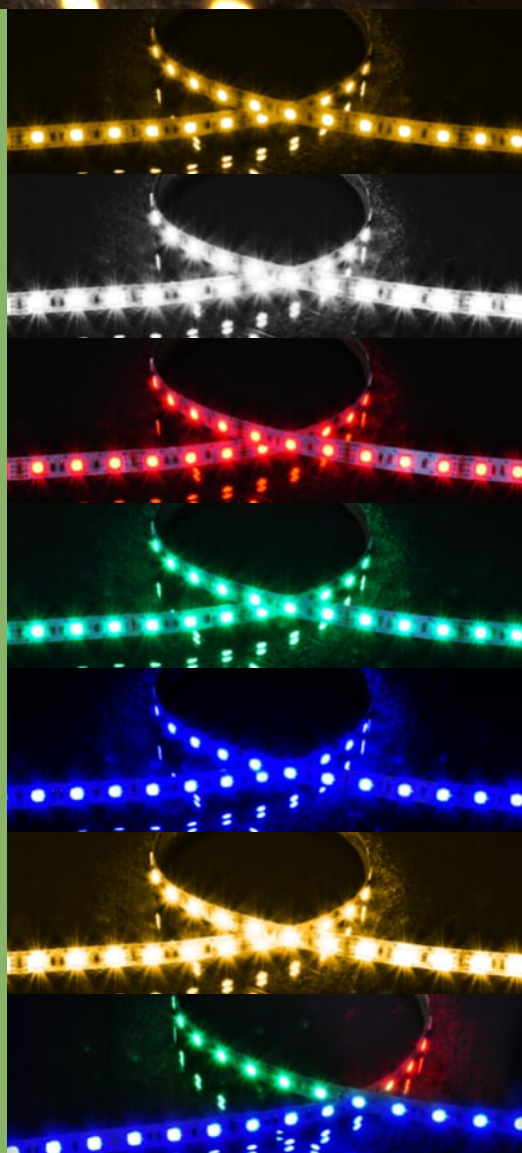

 Luz cálida (2700K)

 Luz fría (6500K)

 Rojo

 Verde

 Azul

 Amarillo

 RGB

TIRAS LED :: 24V IP33



 Luz cálida (2400K)

Tira LED
CHIP 3528 24V IP33

Artículos:
W23308060352824

-  Chip 3528, 60 LEDS por metro
-  4W por metro, 12V, IP33
-  2400K
-  300LM por metro
-  5m x 8mm
-  Clase III
-  Autoadhesivo
-  Dimerizable



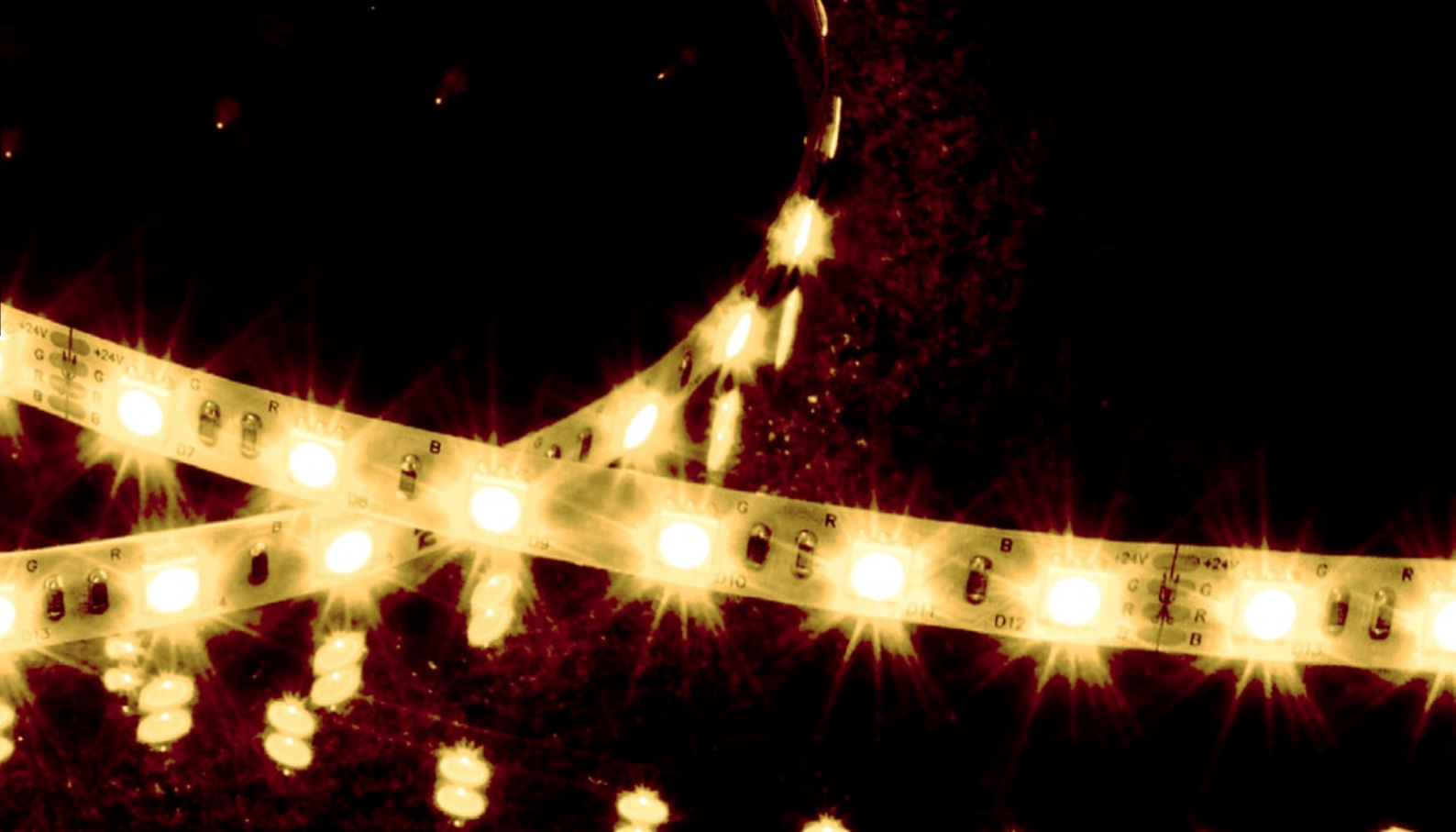

Luz cálida (2400K)

Tira LED
CHIP 2835 24V IP33

Artículos:
W23308098283524

 Chip 2835, 98 LEDS por metro

 12W por metro, 24V, IP33

 2400K

 950LM por metro

 10m x 8mm

 Clase III

 Autoadhesivo

 Dimerizable



 Luz cálida (2700K)



 Luz fría (6000K)



 RGB



Tira LED
CHIP 2835 24V IP33

Artículos:
W23310060505027
W23310060505060
W233100605050RGB

 Chip 5050, 60 LEDs por metro

 12W por metro, 12V, IP66

 2700K, 6000K, RGB

 950LM por metro

 5m x 10mm

 Clase III

 Autoadhesivo

 Dimerizable

 Luz cálida (2700K)



 Luz cálida (3000K)



 Luz neutra (4200K)



Tira LED
CHIP 5730 24V IP33

Artículos:
W23310060573027
W23310060573030
W23310060573042

-  Chip 5730, 60 LEDS por metro
-  12W por metro, 24V, IP33
-  2700K, 3000K, 4200K
-  1000LM por metro
-  5m x 10mm
-  Clase III
-  Autoadhesivo
-  Dimerizable

Tira LED
CHIP 2835 24V IP33

Artículos:
W23334280573027
W23334280573030
W23334280573040

 Chip 2835, 280 LEDS por metro

 17W por metro, 24V, IP33

 2700K, 3000K, 4000K

 1800LM por metro

 2.5m x 34mm

 Clase III

 Dimerizable

 Luz cálida (2700K)



 Luz cálida (3000K)



 Luz neutra (4000K)



Tira LED
CHIP 2835 24V IP33

Artículos:
W23320300573027
W23320300573030
W23320300573042

- Chip 5730, 300 LEDS por metro
- 22W por metro, 24V, IP33
- 2700K, 3000K, 4200K
- 2000LM por metro
- 2.5m x 20mm
- Clase III
- Dimerizable

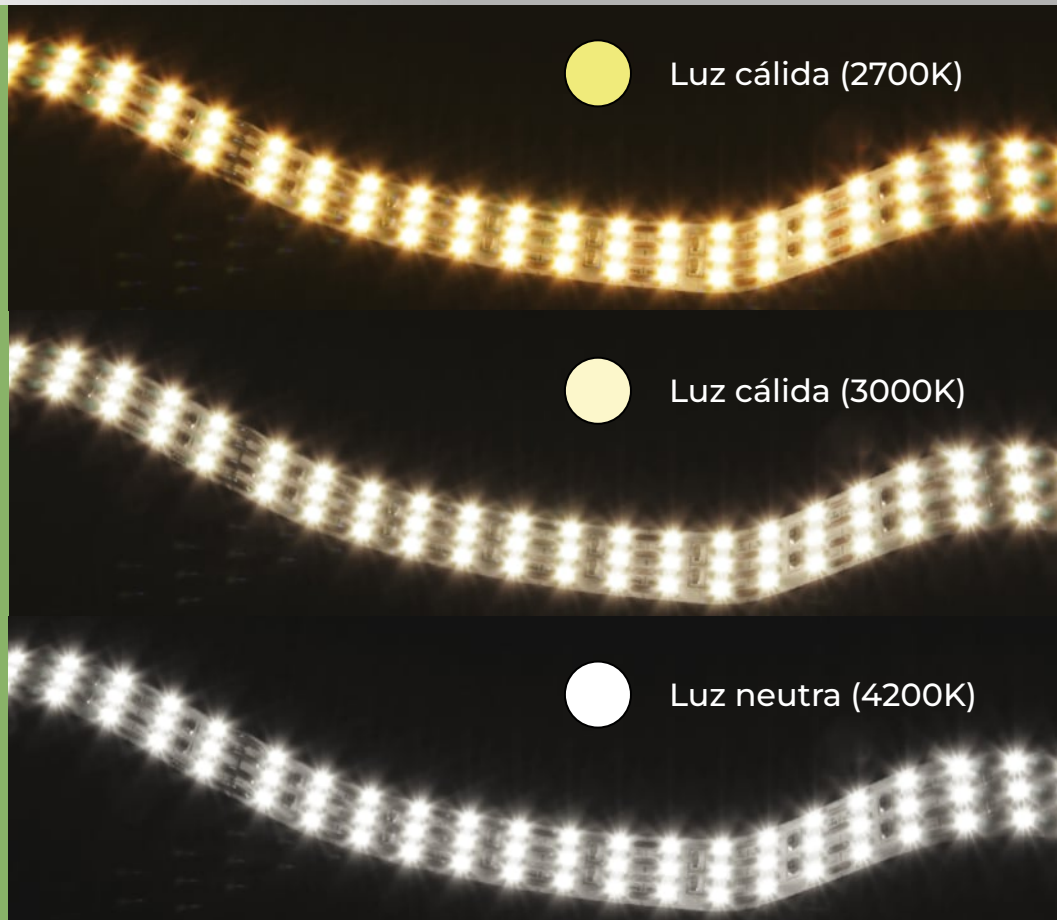

Tira LED
CHIP 2835 24V IP33

Artículos:
W23352420573030
W23352420573042

- Chip 2835, 420 LEDS por metro
- 25W por metro, 24V, IP33
- 3000K, 4200K
- 2500LM por metro
- 2.5m x 52mm
- Clase III
- Dimerizable

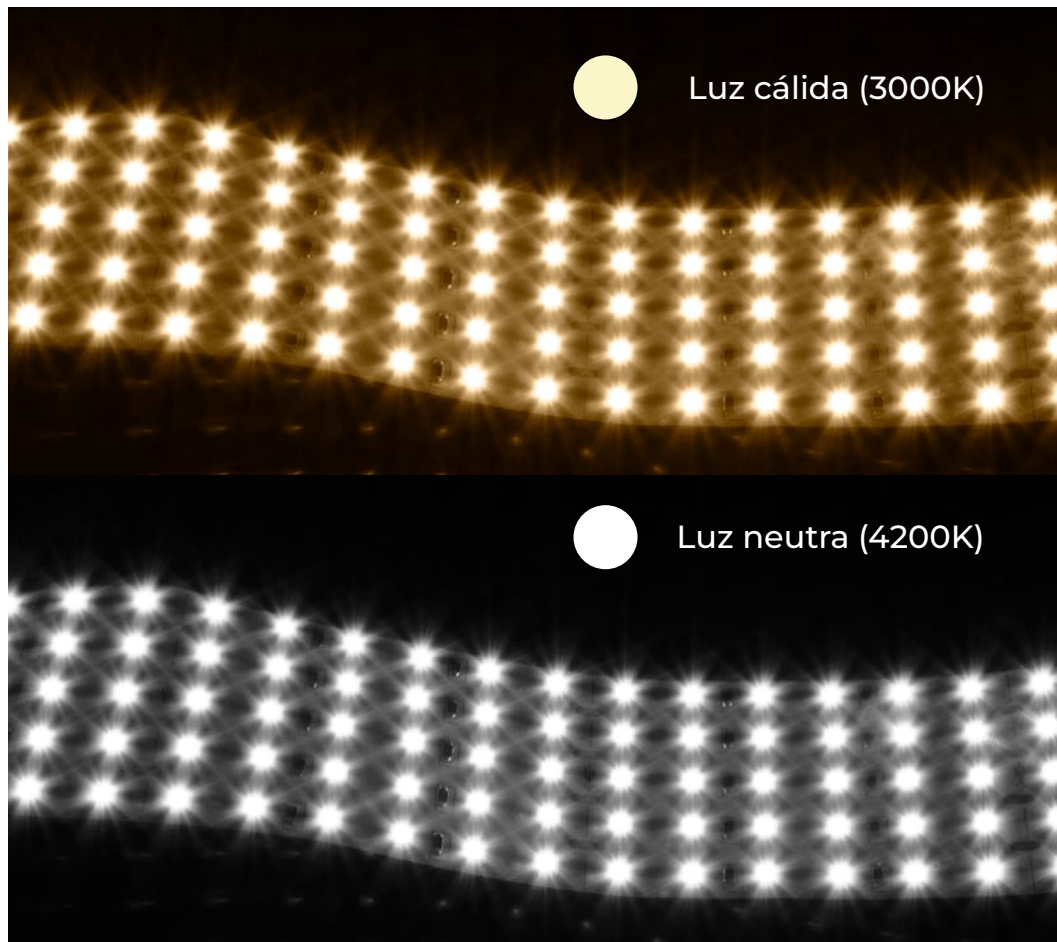



TIRAS LED :: 12V IP66

Tira LED
CHIP 2835 12V IP66

Artículos:

W16608060283527
W16608060283560
W166080602835RJ
W166080602835VD
W166080602835AZ
W166080602835AM
W166080602835RGB

 Chip 2835, 60 LEDS por metro

 9.5W por metro, 12V, IP66

 2700K, 6000K

 800LM por metro

 5m x 8mm

 Clase III

 Dimerizable

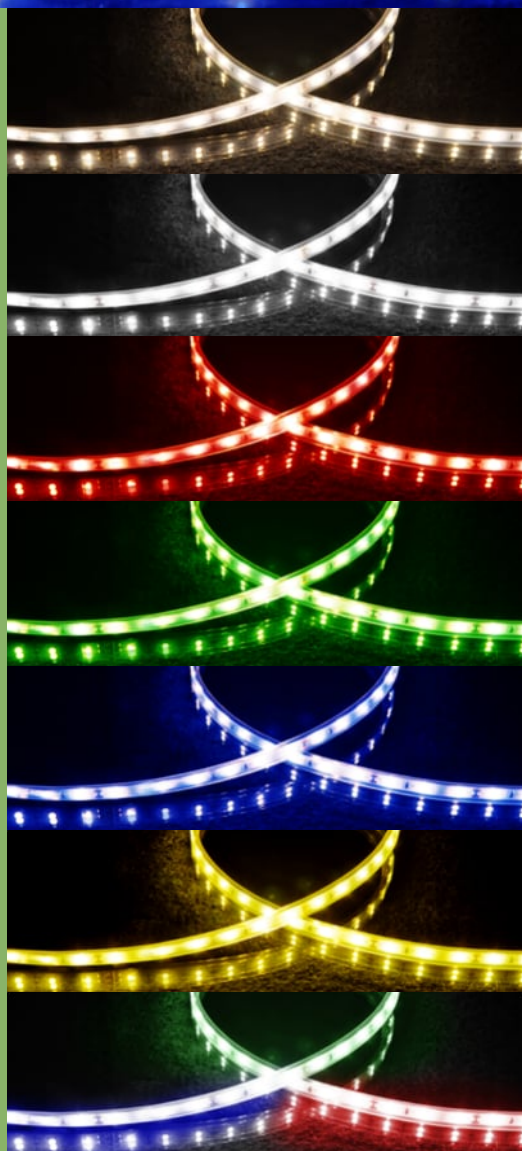

 Luz cálida (2700K)

 Luz fría (6000K)

 Rojo

 Verde

 Azul

 Amarillo

 RGB

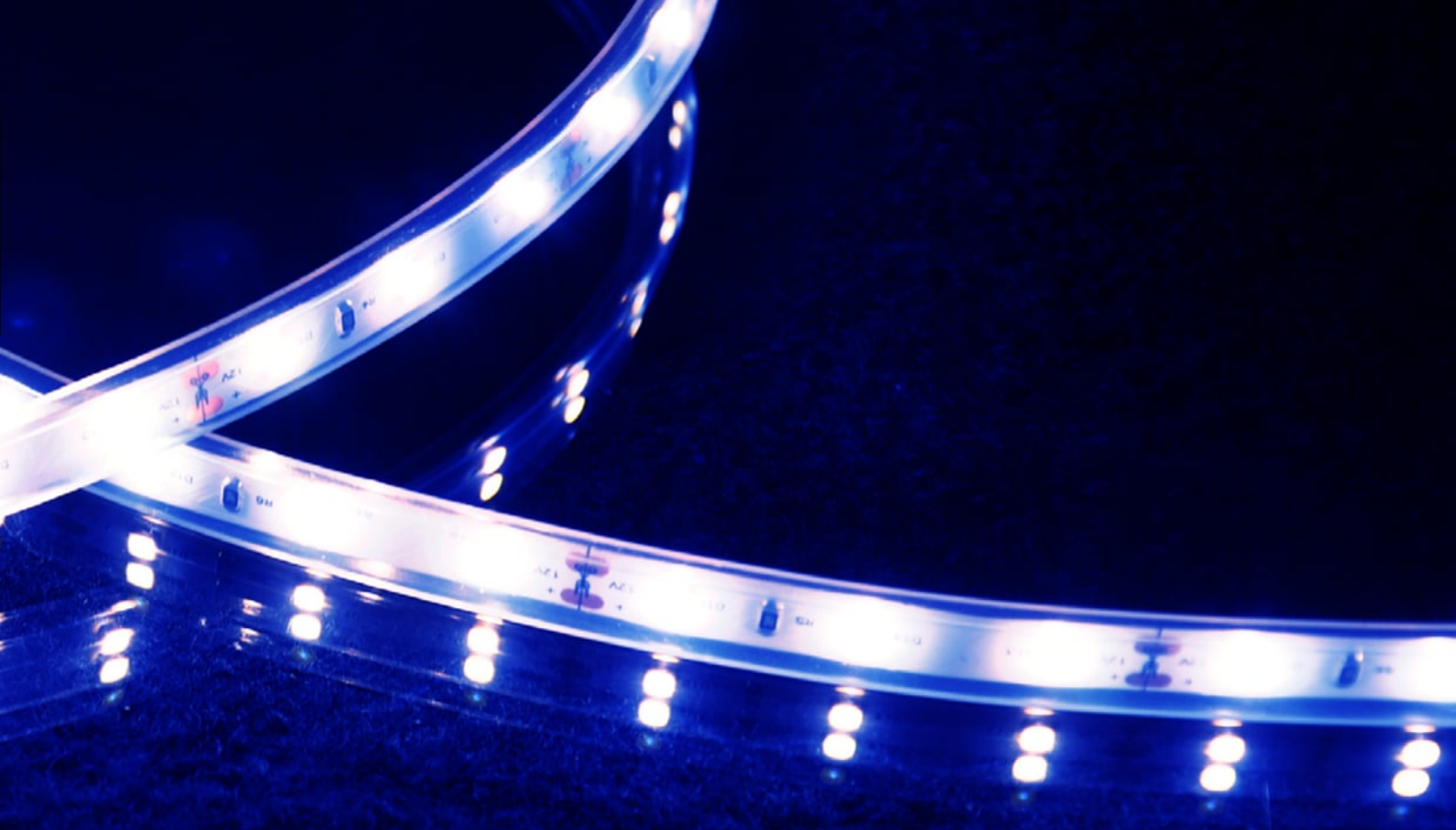

Tira LED
CHIP 5050 12V IP66

Artículos:

W16610060505027
W16610060505060
W166100605050RJ
W166100605050VD
W166100605050AZ
W166100605050AM
W166100605050RGB

 Chip 5050, 60 LEDS por metro

 12W por metro, 12V, IP66

 2700K, 6000K

 950LM por metro

 5m x 10mm

 Clase III

 Dimerizable

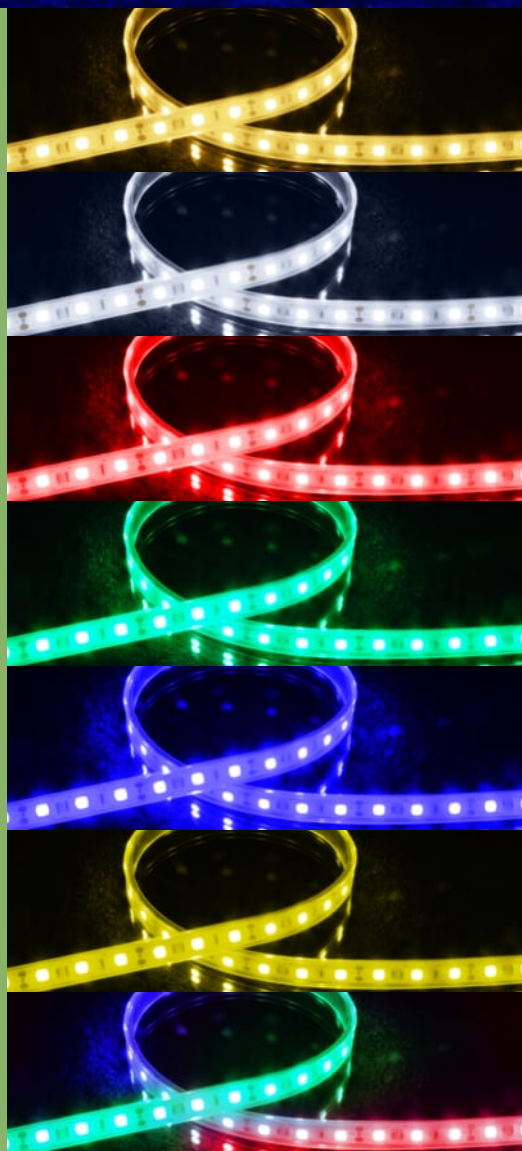

 Luz cálida (2700K)

 Luz fría (6000K)

 Rojo

 Verde

 Azul

 Amarillo

 RGB

TIRAS LED :: 24V IP66

Tira LED
CHIP 3528 24V IP66

Artículos:
W26608060352824

- Chip 2835, 60 LEDS por metro
- 4W por metro, 24V, IP66
- 2400K
- 300LM por metro
- 5m x 8mm
- Clase III
- Dimerizable

Tira LED
CHIP 2835 24V IP66

Artículos:
W26608098283524
W26608098283530

- Chip 2835, 98 LEDS por metro
- 12W por metro, 24V, IP66
- 2700K, 3000K
- 950LM por metro
- 5m x 10mm
- Clase III
- Dimerizable

Luz cálida (2400K)





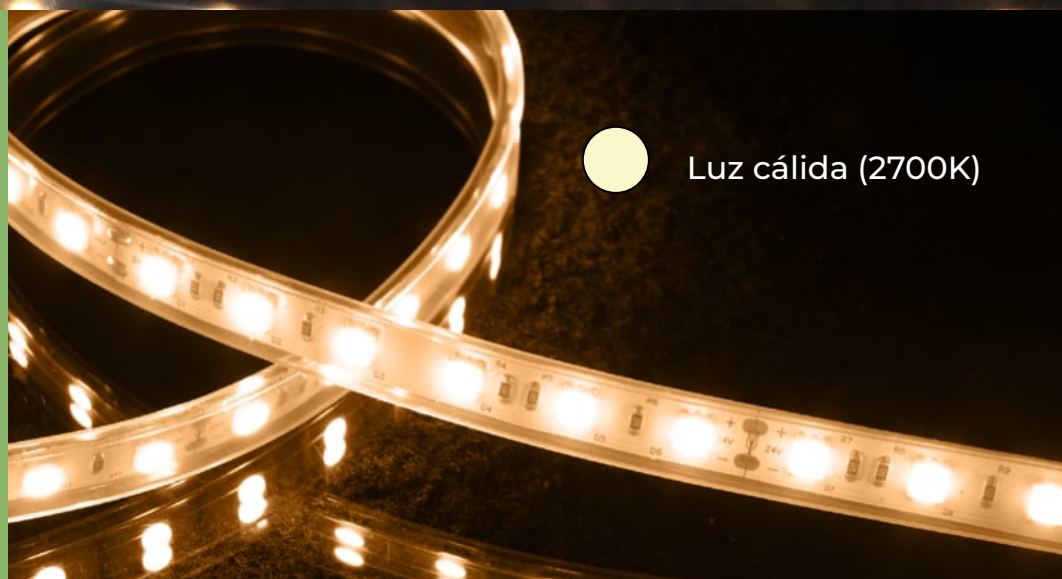

Luz cálida (2400K)

Luz cálida (2700K)



Tira LED
CHIP 2835 24V IP66

Artículos:
W26610060505027
W266100605050RGB

-  Chip 5050, 60 LEDS por metro
-  12W por metro, 24V, IP66
-  2700K, RGB
-  950LM por metro
-  5m x 10mm
-  Clase III
-  Dimerizable



PERFILES DE APLICAR PARA TIRAS LED



Perfiles para tiras LED, contruidos en aluminio. Con difusor de policarbonato.

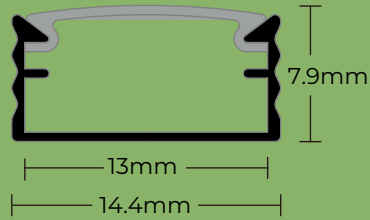

PER-A-1407-1M PL
 PER-A-1407-2M BL
 PER-A-1407-2M PL
 PER-A-1407-2M NG

Perfil de aplicar
 Para tiras de hasta 13mm



1 metro, 2 metros

Blanco, Negro, Plata

Aluminio

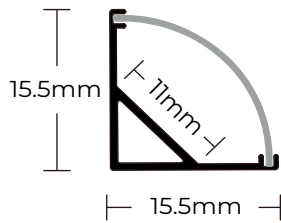

PER-A45-1616-2M PL

Perfil de aplicar a 45°
 Para tiras de hasta 11mm



2 metros

Plata

Aluminio

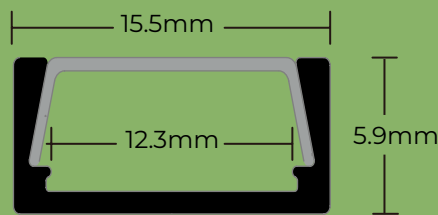

PER-A-1506-1M PL
 PER-A-1506-2M PL
 PER-A-1506-2M BL
 PER-A-1506-2M NG

Perfil de aplicar
 Para tiras de hasta 12mm



1 metro, 2 metros

Blanco, Negro, Plata

Aluminio

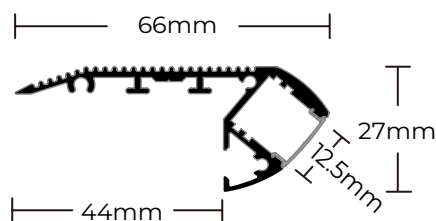

PER-ESC-6627-2M PL

Perfil de aluminio para escaleras
 Para tiras de hasta 12mm



2 metros

Plata

Aluminio

PERFILES DE EMBUTIR PARA TIRAS LED



Perfiles para tiras LED, contruidos en aluminio. Con difusor de policarbonato.

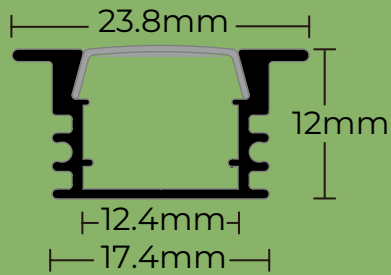

PER-E-2412-2M PL
PER-E-2412-2M BL

Perfil de embutir
Para tiras de hasta 12mm



2 metros

Blanco, Plata

Aluminio

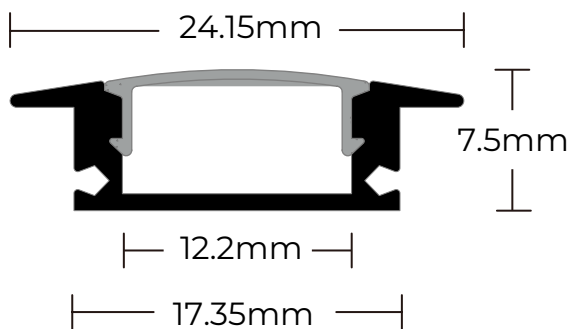

PER-E-1707-2M PL
PER-E-1707-2M BL
PER-E-1707-2M NG

Perfil de embutir
Para tiras de hasta 12mm



2 metros

Blanco, Negro, Plata

Aluminio

Fuente de alimentación para tiras LED IP20 12V.
Con protección de cortocircuito y sobre tensión.

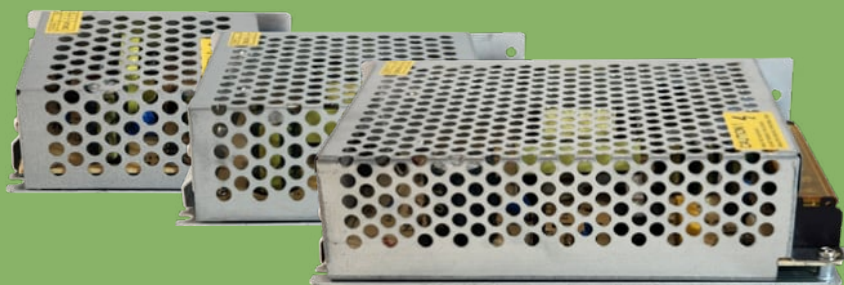

IP20

12V

ARTÍCULO	POTENCIA	MEDIDAS (W:H:D)	ENTRADA	HZ
DRV-12V-IP20-025W	25W-2A	85x59x33mm	176-264V	50/60Hz
DRV-12V-IP20-040W	40W-3.3A	159x98x42mm	176-264V	50/60Hz
DRV-12V-IP20-060W	60W-5A	159x98x42mm	176-264V	50/60Hz
DRV-12V-IP20-100W	100W-8.5A	159x98x42mm	176-264V	50/60Hz
DRV-12V-IP20-120W	120W-10A	159x98x42mm	176-264V	50/60Hz
DRV-12V-IP20-150W	150W-12.5A	198x98x42mm	176-264V	50/60Hz

Fuente de alimentación para tiras LED IP20 24V.
Con protección de cortocircuito y sobre tensión.

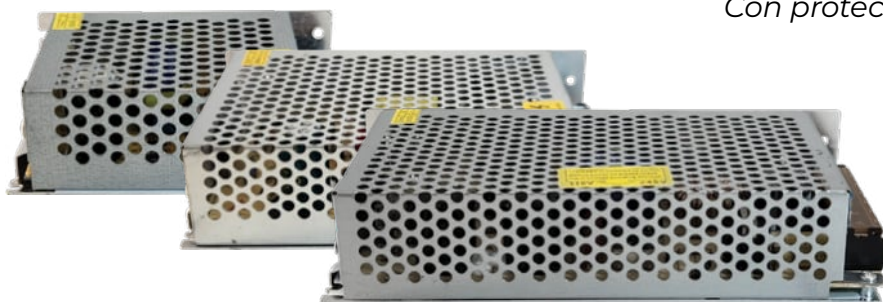

IP20

24V

ARTÍCULO	POTENCIA	MEDIDAS (W:H:D)	ENTRADA	HZ
DRV-24V-IP20-048W	48W-2A	159x98x42mm	176-264V	50/60Hz
DRV-24V-IP20-072W	72W-3A	198x98x42mm	176-264V	50/60Hz
DRV-24V-IP20-120W	120W-5A	198x98x42mm	176-264V	50/60Hz

Fuente de alimentación para tiras LED IP67 12V.
Con protección de cortocircuito y sobre tensión.



IP67 12V

ARTÍCULO	POTENCIA	MEDIDAS (W:H:D)	ENTRADA	HZ
DRV-12V-IP67-030W	30W-2.5A	221x30x20mm	176-264V	50/60Hz
DRV-12V-IP67-060W	60W-5.0A	159x41x21mm	176-264V	50/60Hz
DRV-12V-IP67-100W	100W-10A	188x64x22mm	176-264V	50/60Hz
DRV-12V-IP67-120W	120W-10A	188x64x22mm	176-264V	50/60Hz
DRV-12V-IP67-150W	150W-12.5A	188x64x22mm	176-264V	50/60Hz

Fuente de alimentación para tiras LED IP67 24V.
Con protección de cortocircuito y sobre tensión.



IP67 24V

ARTÍCULO	POTENCIA	MEDIDAS (W:H:D)	ENTRADA	HZ
DRV-24V-IP67-060W	60W-5.0A	85x59x33mm	176-264V	50/60Hz
DRV-24V-IP67-150W	150W-6.25A	159x98x42mm	176-264V	50/60Hz
DRV-24V-IP67-200W	200W-8.5A	250x70x32mm	176-264V	50/60Hz

GLOSARIO



ICONOGRAFÍA

 Colores disponibles

 Material

 Temperatura

 Lúmenes

 Dimerizable

 No dimerizable

 Lámpara tipo E27

 Lámpara tipo Dicroica

 Lámpara tipo AR111

 Lámpara G9

 Lámpara E14

 Lámpara R7S

 Lámpara LED

 Clase I

 Clase II

 Clase III

 Dimensiones de tira LED

 Orientable

 Fijo

 Antideslumbrante

 Tipo de Chip

 Autoadhesivo

 Ángulo

 Unidades por caja

 Largo de perfil

ICONOGRAFÍA

 Potencia (Volts)

 Tiempo de carga

 Autonomía

 Tipo de batería

INDICADORES DE COLOR

 Blanco Texturado/Blanco mate/Blanco

 Negro Texturado/Negro mate/Negro

 Niquel mate

 Cobre

 Bronce

 Plata/Plata texturado/Gris/Silver

 Platil

 Cromado

 Oro Antiguo

 Negro mate+Oro Antiguo

 Blanco mate+Plata

 Rosa/Rosa Vintage

 Celeste/Azul

 Rojo

 Verde Vintage

 2000K

 2500K

 2700K

INDICADORES DE COLOR

 3000K

 4000K

 6500K

 Vidrio Ambar

 Blanco + Madera clara

 Negro + Madera oscura

 RGB

 RGB + Blanco



Candil
iluminación

www.candil.com.ar

ventas@candil.com.ar

(5411) 2150-5398

