

WIRE MESH CABLE TRAY SYSTEM

CATAOG |

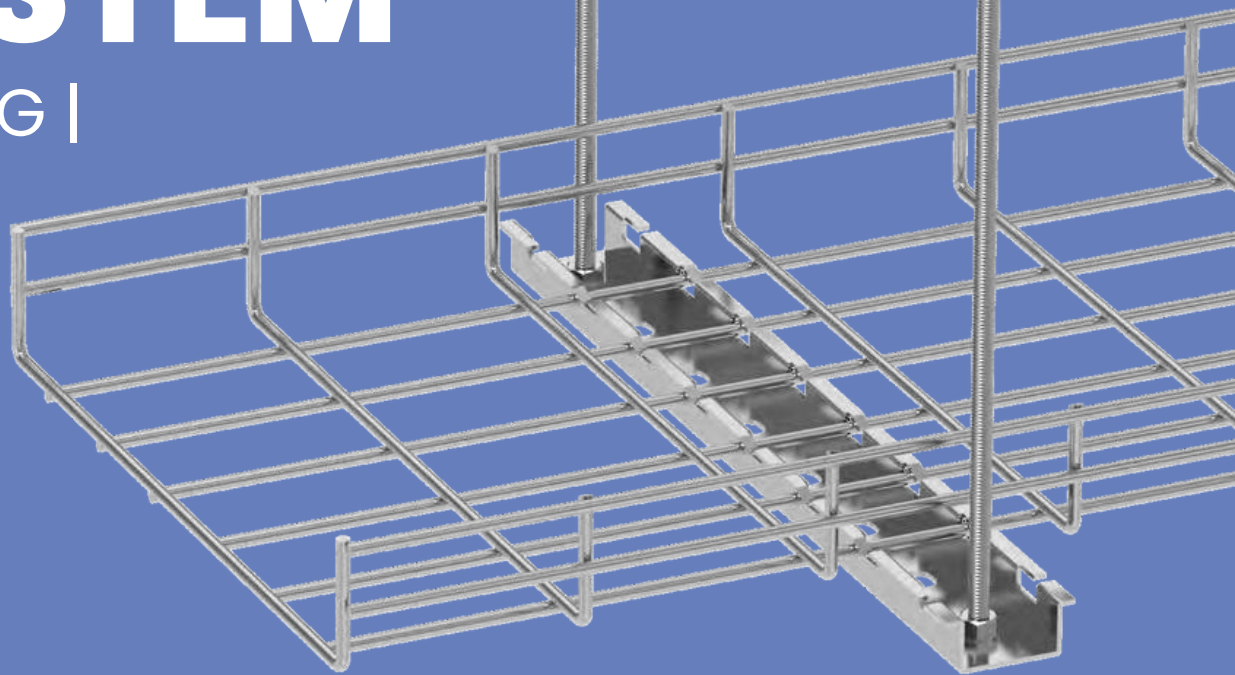

Q360

Wire Mesh Cable Tray System

- The weight of wire mesh cable trays are 1/5 of traditional cable trays, making them easier to install.
- The open design allows continuous airflow, which prevents overheating and the build-up of dust and contaminants.
- All kinds of elbows can be made at the project site flexibly.
- Multiple finishes are available for indoor and outdoor applications.
- Cable visibility allows for more convenient upgrading and maintenance.

Wire Mesh Cable

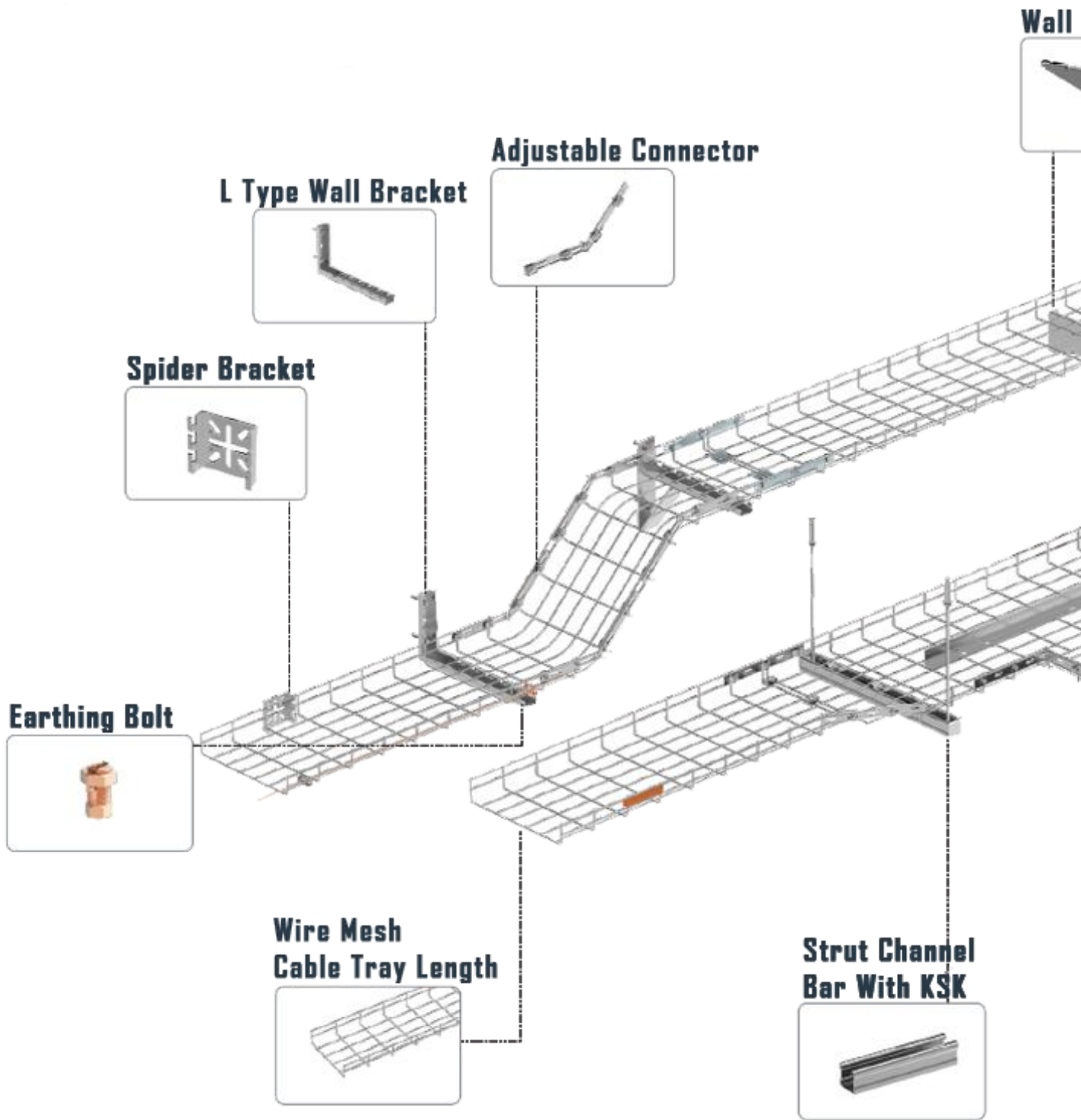

Tray Installation

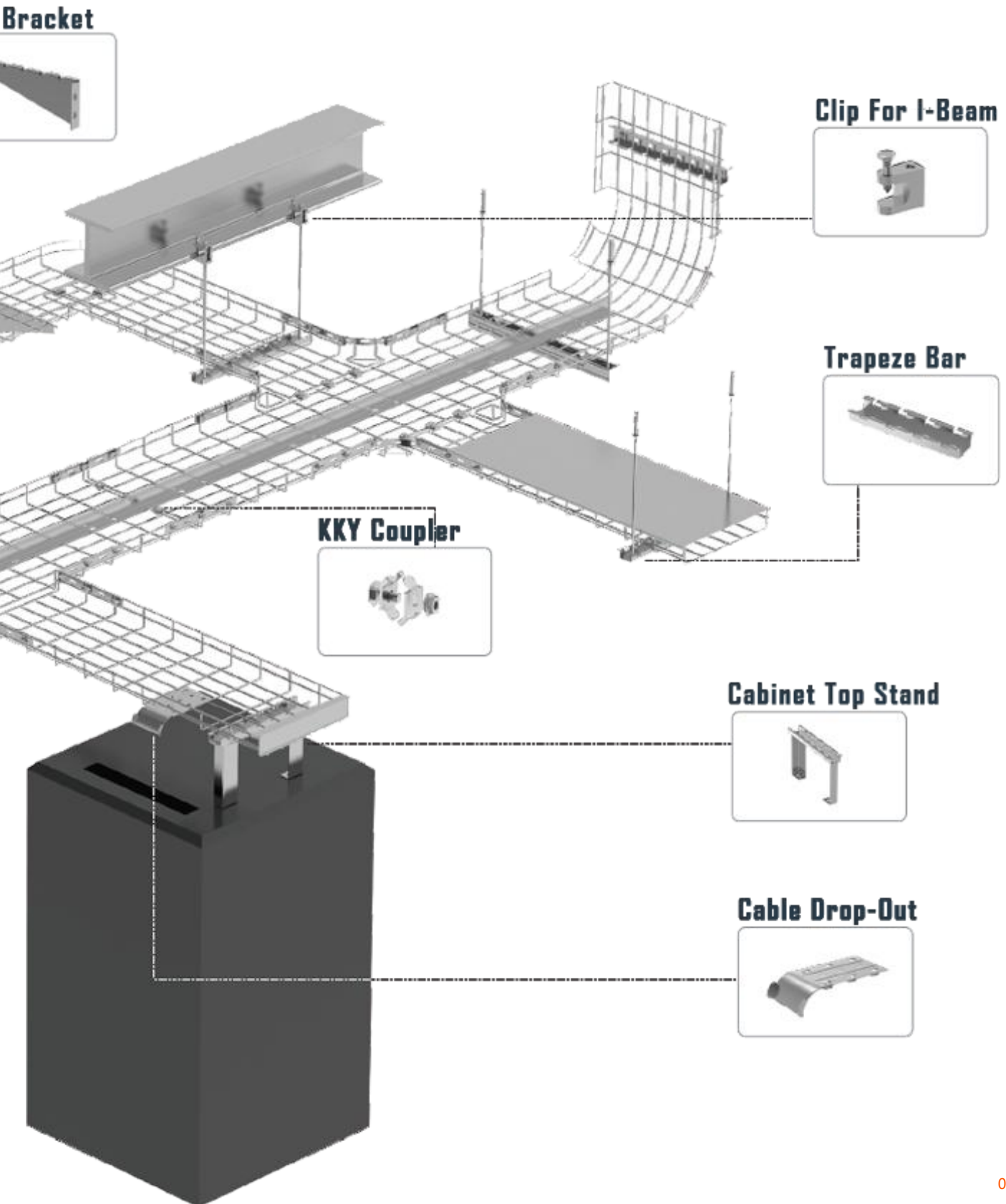

Wire Mesh Cable Tray Contents

Product Description

Part Number

SYSTEM-----07

CM50 Series	CM50
CM100 Series	CM100
CM150 Series	CM150
CM33 Special Series	CM33x33
CMS50 Special Series	CMS50x50
TCM Self-lock Series	TCW-W

ACCESSORIES-----011

Self-Locking Cover	PJ-RCVR
Divider	PJ-DVR
Reinforced Divider	PJ-HJDVR
KKY Coupler	PJ-KKY-SET
KK34 Coupler	PJ-KK34-SET
KK28 Coupler	PJ-KK28-SET
Strengthening Bar	PJ-SBR-SET
Corner Strengthening Bar	PJ-CSB-SET
Radian Connector	PJ-RC90-SET
Adjustable Connector	PJ-AJC-SET
Cable Drop-Out	PJ-CGD
Cap	PJ-CAP
Earthing Bolt	PJ-EHB
Signage	PJ-SGN
Terminator	PJ-TTR
Spider Bracket	PJ-SPB
Wire Cutter	GBJ-CUT
Cover	PJ-CVRC
Fast Lock	PJ-FLK
Fast Fix Splicer	PJ-SPL
Boltless Coupler	PJ-BTC
Industrial Mount Bracket	PJ-LJQD
Tube Outlet	PJ-CDH
Handle	PJ-HDL

CEILING BRACKET -----024

Trapeze Bar	PJ-BR
Strut Channel Bar with KSK	PJ-UHDC
Hold Down Clip Set	PJ-HDC
Fast Channel Clip	PJ-KSK
Threaded Rod	TY-ROD
Drop In Anchor Bolt	TY-PANR
Flange Nut	TY-FNUT
Rod Cap	TY-RODCAP
Strut Channel Terminator	PJ-CCT
M Shaped Bar	PJ-MBR
Hanging Hook	PJ-HKS
50 Tray Holder	PJ-THR
Flag Type Hanging Bracket	PJ-RFB
Clip for I-Beam	PJ-CIB
T-Type Hanging Bracket	PJ-THB

WALL BRACKET -----032

L-Type Wall Bracket	PJ-LWB
Cantilever Wall Bracket	PJ-CWB
Strut Channel Wall Bracket	PJ-TWH
T-Type Wall Bracket	PJ-CRP
T-Type Wall Holder	PJ-TWH
Spider Bracket	PJ-SPB
Concrete Wedge Anchor Bolt	TY-CANR

FLOOR STAND -----036

Cabinet Top Stand	PJ-EFS
Underfloor Bracket	PJ-UFB
Bridge Type Stand	PJ-BTS
50 Side Floor Bracket	PJ-FSDB
Spider Bracket	PJ-SPB
Trapeze Bar	PJ-BR
50 Floor Stand	PJ-50FSD
100 Floor Stand	PJ-100FSD
Flag Type Floor Stand	PJ-FFS

OTHERS -----041

Wall Mount Coupler	PJ-CDKK
Central Hold Down	PJ-CHD
Wire Clip	PJ-DSKK
Mounting Clip	PJ-SHD
Cross Clip	PJ-CCP

CM50 SERIES

Default unit : mm

Part Number	Height	Width	Length	Wire Diameter	Weight
ALL CM50x50	50	50	3000	5.0	3.15kg
ALL CM50x100	50	100	3000	5.0	3.84kg
ALL CM50x150	50	150	3000	5.0	4.56kg
ALL CM50x200	50	200	3000	5.0	5.25kg
ALL CM50x300	50	300	3000	5.0	6.66kg
ALL CM50x400	50	400	3000	5.0	8.07kg
ALL CM50x450	50	450	3000	5.0	8.76kg
ALL CM50x500	50	500	3000	5.0	9.48kg
ALL CM50x600	50	600	3000	5.0	10.89kg

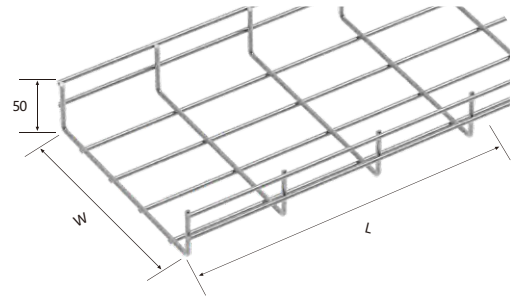

P/N Definition:

- ◆ E.g. CM50x50, CM means wire mesh cable tray, 50x50 means HxW (inner size).
- ◆ Wire diameter range: 3.5mm-6.0mm (common diameter 5.0mm).

Sectional View and Load Chart

Size	Section
50x50	
50x100	
50x150	
50x200	
50x300	
50x400	
50x450	
50x500	
50x600	

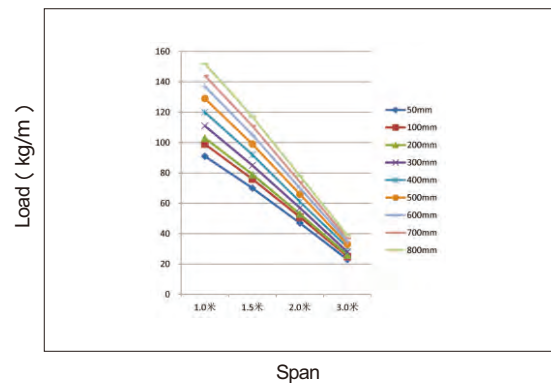

CM100 SERIES

Default unit : mm

Part Number	Height	Width	Length	Wire Diameter	Weight
ALL CM100x100	100	100	3000	5.0	5.25kg
ALL CM100x150	100	150	3000	5.0	5.94kg
ALL CM100x200	100	200	3000	5.0	6.66kg
ALL CM100x300	100	300	3000	5.0	8.07kg
ALL CM100x400	100	400	3000	5.0	9.48kg
ALL CM100x450	100	450	3000	5.0	10.17kg
ALL CM100x500	100	500	3000	5.0	10.89kg
ALL CM100x600	100	600	3000	5.0	12.30kg

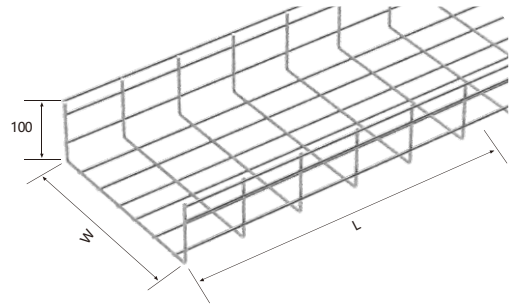

P/N Definition:

- ◆ E.g. CM100x100, CM means wire mesh cable tray, 100x100 means HxW (inner size).
- ◆ Wire diameter range: 3.5mm-6.0mm (common diameter 5.0mm).

Sectional View and Load Chart

Size	Section
100x100	
100x150	
100x200	
100x300	
100x400	
100x450	
100x500	
100x600	

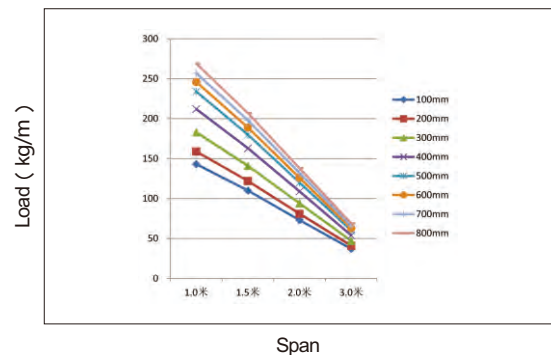

CM150 SERIES

Default unit : mm



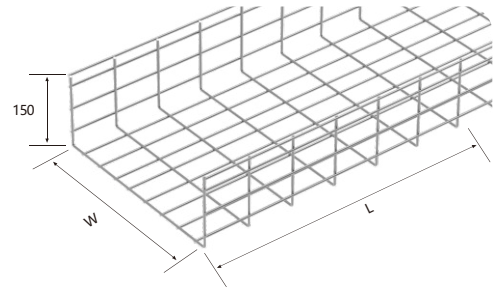



Part Number	Height	Width	Length	Wire Diameter	Weight
ALL CM150x150	150	150	3000	5.0	7.35kg
ALL CM150x200	150	200	3000	5.0	8.07kg
ALL CM150x300	150	300	3000	5.0	9.48kg
ALL CM150x400	150	400	3000	5.0	10.89kg
ALL CM150x450	150	450	3000	5.0	11.58kg
ALL CM150x500	150	500	3000	5.0	12.30kg
ALL CM150x600	150	600	3000	5.0	13.71kg



P/N Definition:

- ◆ E.g. CM150x150, CM means wire mesh cable tray, 150x150 means HxW (inner size).
- ◆ Wire diameter range: 3.5mm-6.0mm (common diameter 5.0mm).

Sectional View and Load Chart

Size	Section
150x150	
150x200	
150x300	
150x400	
150x450	
150x500	
150x600	

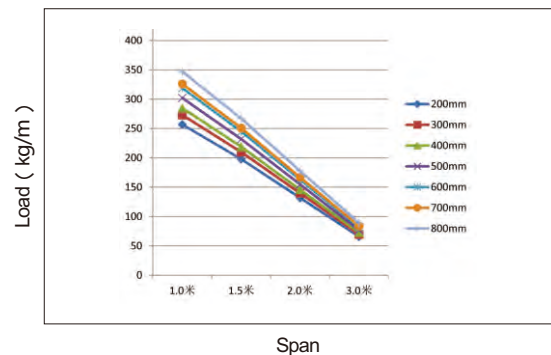

CM33 SPECIAL SERIES

Default unit : mm

Part Number	Height	Width	Length	Wire Diameter	Weight
ALL CM33x33	33	33	3000	5.0	2.43kg

P/N Definition:

- ◆ E.g. CM33x33, CM means wire mesh cable tray, 33x33 means HxW (inner size).
- ◆ Wire diameter range: 3.5mm-6.0mm (common diameter 5.0mm).
- ◆ CM33 series is generally applied to machanical equipment.

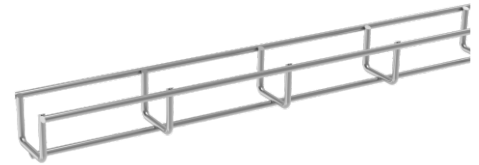
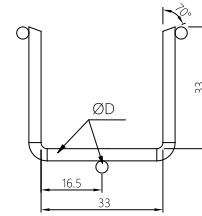

CMS50 SPECIAL SERIES

Default unit : mm

Part Number	Height	Width	Length	Wire Diameter	Weight
ALL CMS50x50	50	50	3000	5.0	3.84kg

P/N Definition:

- ◆ E.g. CMS50x50, CMS means wire mesh cable trays with double metal wires on the bottom along its length, 50x50 means HxW (inner size).
- ◆ Wire diameter range: 3.5mm-6.0mm (common diameter 5.0mm).
- ◆ CMS50 series is generally applied to machanical equipment.

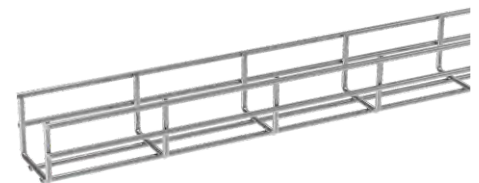
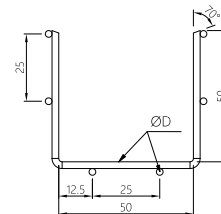

TCM SELF-LOCK SERIES

Default unit : mm

Part Number	Height	Width	Length	Wire Diameter	Weight
ALL TCM40x40	40	40	3000	4.0	1.98kg
ALL TCM40x90	40	90	3000	4.0	2.70kg

P/N Definition:

- ◆ E.g. TCM-W12x12, TCM means self-locking wire mesh cable tray, 12x12 means HxW (inner size).
- ◆ Wire diameter range: 3.5mm-6.0mm (common diameter 4.0mm).
- ◆ CMS50 series is generally applied to machanical equipment.

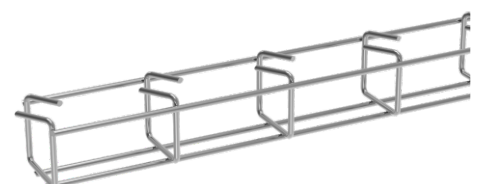
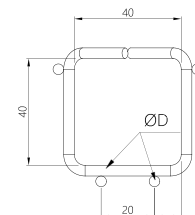

SELF-LOCKING COVER

Default unit : mm

Part Number	Height	Width	Length	Weight
PJ-RCVR100-1000	8.5	100	1m	1.12kg
PJ-RCVR150-1000	8.5	150	1m	1.52kg
PJ-RCVR200-1000	8.5	200	1m	1.91kg
PJ-RCVR300-1000	8.5	300	1m	2.69kg
PJ-RCVR400-1000	8.5	400	1m	3.48kg
PJ-RCVR450-1000	8.5	450	1m	3.87kg
PJ-RCVR500-1000	8.5	500	1m	4.26kg
PJ-RCVR600-1000	8.5	600	1m	5.05kg

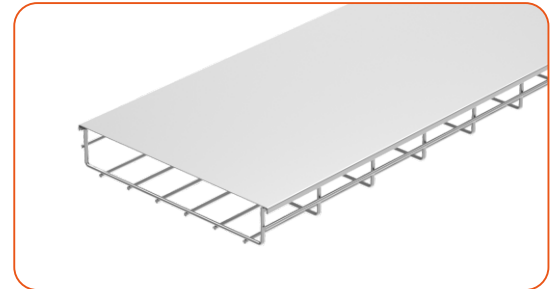
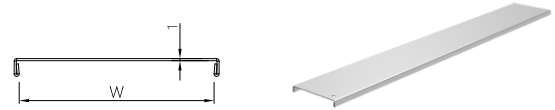

P/N Definition:

- ◆ E.g. PJ-RCVR100-1000, PJ means wire mesh cable tray accessories, RCVR means self-locking cover, 100 means 100mm high, 1000 means 1000mm long.

Instruction Manual :

- ◆ Suitable for: cover for wire mesh cable trays.
- ◆ Fit for: wire diameter from 3.5mm to 6.0mm, covering all sizes of cable trays.

DIVIDER

Default unit : mm

Part Number	Height	Width	Length	Weight
PJ-DVR50-1000	47.5	25.5	1m	0.60kg
PJ-DVR100-1000	75.0	25.5	1m	0.81kg
PJ-DVR150-1000	125.0	25.5	1m	1.27kg
PJ-DVR50-3000	47.5	25.5	3m	1.80kg
PJ-DVR100-3000	75.0	25.5	3m	2.43kg
PJ-DVR150-3000	125.0	25.5	3m	3.81kg

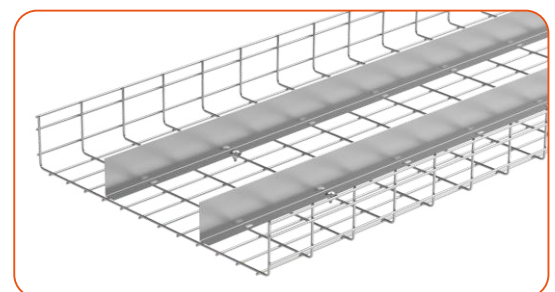

P/N Definition:

- ◆ E.g. PJ-DVR50-1000, PJ means wire mesh cable tray accessories, DVR means divider, 50 means it fits 50mm high wire mesh cable trays, 1000 means 1000mm long per piece.

Instruction Manual :

- ◆ Suitable for: Isolating strong and weak electricity, often used in data center.
- ◆ Fit for: wire diameter from 3.5mm to 6.0mm, covering all sizes of cable trays.
- ◆ Includes: cover ×1, cover clamp ×1, M6×20 carriage bolt ×3.

REINFORCED DIVIDER

Default unit : mm

Part Number	Height	Width	Length	Weight/PCS
ALL PJ-HJDVR50-1000	47.5	24.5	1m	0.60kg
ALL PJ-HJDVR100-1000	75.0	24.5	1m	0.81kg
ALL PJ-HJDVR150-1000	125.0	24.5	1m	1.27kg
ALL PJ-HJDVR50-3000	47.5	24.5	3m	1.80 kg
ALL PJ-HJDVR100-3000	75.0	24.5	3m	2.43 kg
ALL PJ-HJDVR150-3000	125.0	24.5	3m	3.81 kg

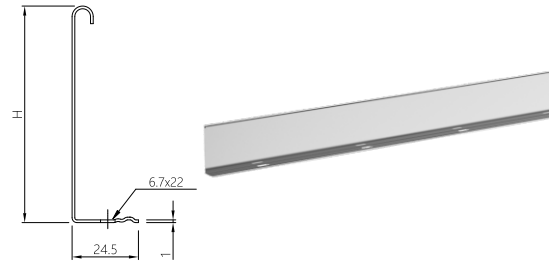

P/N Definition:

- ◆ E.g. PJ-HJDVRB50-1000, PJ means wire mesh cable tray accessories, HJDVRB means reinforced divider; 50 means it fits 50mm high wire mesh cable trays, 1000 means 1000mm long.

Instruction Manual :

- ◆ Suitable for: isolating strong and weak electricity, often used for mechanical equipment.
- ◆ Fit for: wire diameter from 3.5mm to 6.0mm, covering all sizes of cable trays.
- ◆ Includes: cover ×1, cover clamp ×1, M6×20 carriage bolt ×3.

KKY COUPLER

Default unit : mm

Part Number	Height	Width	Pack	Weight
ALL PJ-KKY-SET	19	2.75	20	0.8kg

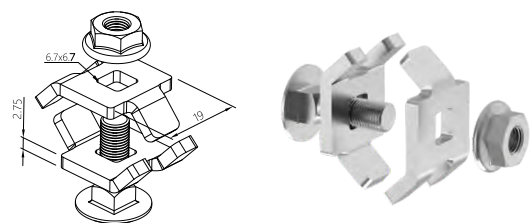

Instruction Manual :

- ◆ Suitable for: connecting wire mesh cable trays.
- ◆ Fit for: diameter of wire from 3.5mm to 6.0mm.
- ◆ Includes: KKY ×2, M6×20 bolt ×1, M6 nut ×1.



KK34 COUPLER

Default unit : mm

Part Number	Height	Width	Pack	Weight
 PJ-KK34-SET	11	34	20	0.80kg

Instruction Manual :

- ◆ Suitable for: connecting wire mesh cable trays.
- ◆ Fit for: diameter of wire from 4.0mm to 6.0mm.
- ◆ Includes: KK34-top ×1, KK34-bottom ×1, M6×20 bolt ×1, M6 nut ×1.

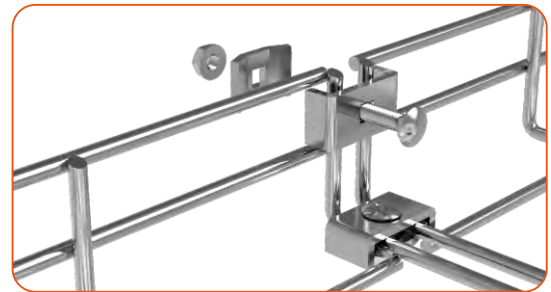
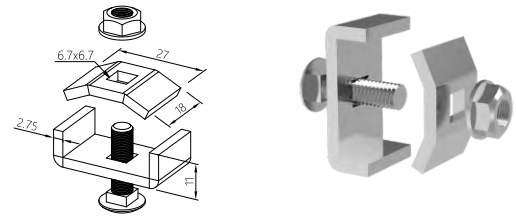

KK28 COUPLER

Default unit : mm

Part Number	Height	Width	Pack	Weight
 PJ-KK28-SET	11	28	20	12.00kg

Instruction Manual :

- ◆ Suitable for: connecting wire mesh cable trays.
- ◆ Fit for: diameter of wire from 3.5mm to 5.0mm.
- ◆ Includes: KK28-top ×1, KK28-bottom ×1, M6×20 bolt ×1, M6 nut ×1.

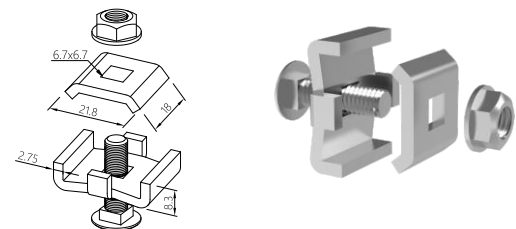

BOLTLESS SIDE COUPLER

Default unit : mm

Part Number	Height	Width	Pack	Weight
ALL PJ-BLC	25	250	100	7.30kg

Instruction Manual :

- ◆ Apply to: Quick connecting wire mesh cable trays.
- ◆ Suit for: Diameter of wire from 3.5mm to 6.0mm.
- ◆ Include: Boltless side coupler x 1.

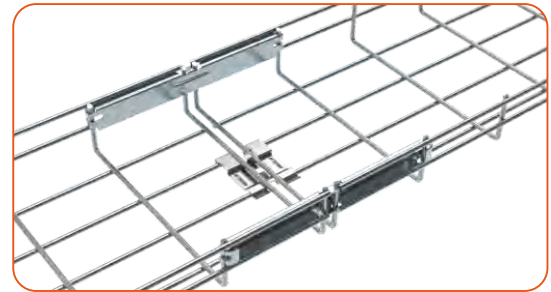
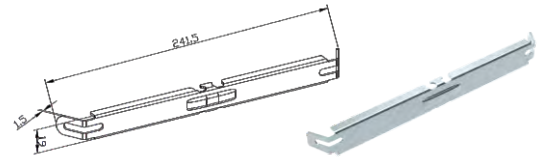

STRENGTHENING BAR

Default unit : mm

Part Number	Height	Width	Pack	Weight
ALL PJ-SBR-SET	19	250	100	15.00kg

Instruction Manual :

- ◆ Suitable for: connecting wire mesh cable trays.
- ◆ Fit for: diameter of wire from 3.5mm to 6.0mm.
- ◆ Includes: bar x1, KK34-top x3, M6x20 bolt x3, M6 nut x3.

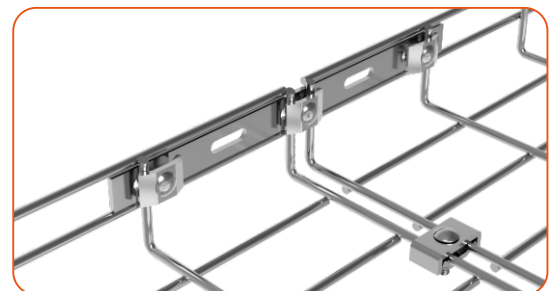
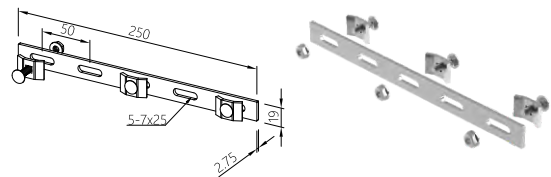

CORNER STRENGTHENING BAR

Default unit : mm

Part Number	Height	Width	Pack	Weight
 PJ-CSB-SET	19	227	100	31.00kg

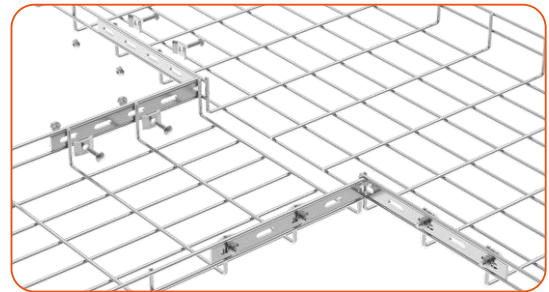
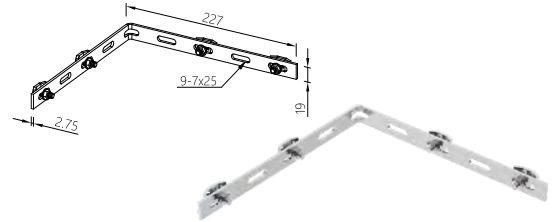

Instruction Manual :

- ◆ Suitable for: connecting elbows, tees, and crosses.
- ◆ Fit for: diameter of wire from 3.5mm to 6.0mm.
- ◆ Includes: bar ×1, KK34-top ×4, M6×20 bolt ×4, M6 nut ×4.



RADIAN CONNECTOR

Default unit : mm

Part Number	Height	Width	Pack	Weight
 PJ-RC90-50-SET	50	304	50	20.00kg
 PJ-RC90-100-SET	100	30	15.00kg	
 PJ-RC90-150-SET	150	304	30	18.00kg

Instruction Manual :

- ◆ Suitable for: connecting elbows, tees, and crosses.
- ◆ Fit for: diameter of wire from 3.5mm to 6.0mm.
- ◆ Includes: bar ×1, KK34-top ×6, M6×20 bolt ×6, M6 nut ×6.

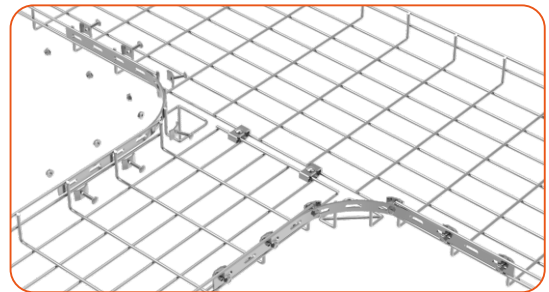
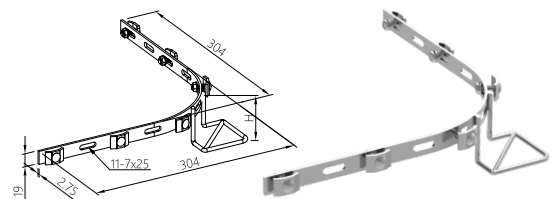

ADJUSTABLE CONNECTOR

Default unit : mm

Part Number	Height	Width	Weight
ALL PJ-AJC-SET	19	192	0.23kg

Instruction Manual :

- ◆ Suitable for: connecting risers.
- ◆ Fit for: diameter of wire from 3.5mm to 6.0mm.
- ◆ Includes: bar ×2, KK34-top ×4, M6×20 bolt ×5, M6 nut ×5.

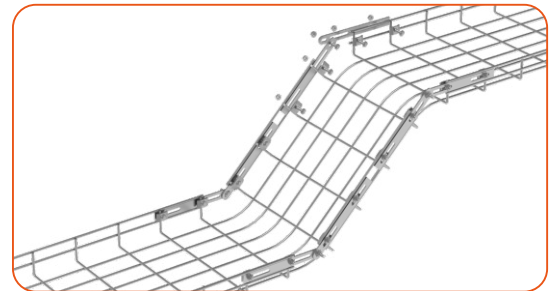
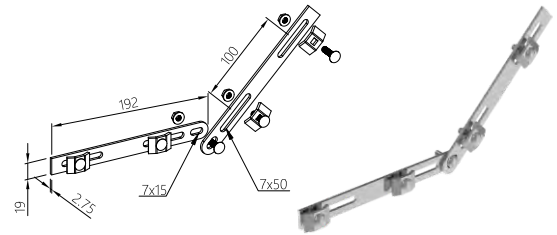

CABLE DROP-OUT

Default unit : mm

Part Number	Height	Width	Pack	Weight
ALL PJ-CGD	192	90	50	9.00kg

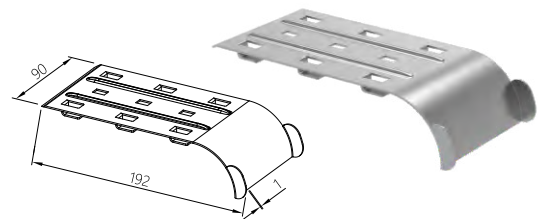

Instruction Manual :

- ◆ Suitable for: cable drop out.
- ◆ Fit for: wire diameter from 3.5mm to 6.0mm, wire mesh cable tray width over 150mm.



CAP

Default unit : mm

Part Number	Height	Pack	Weight
 PJ-CAP-4.0-PT	12	100	0.10kg
 PJ-CAP-5.0-PT	12	100	0.10kg
 PJ-CAP-6.0-PT	12	100	0.10kg



Instruction Manual :

- ◆ Suitable for: covering the shear points of metal wires.
- ◆ Fit for: wire diameter from 4.0mm to 6.0mm.

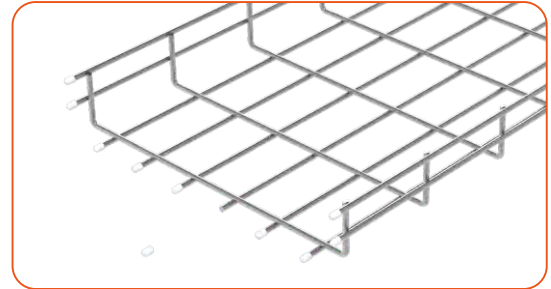

EARTHING BOLT

Default unit : mm

Part Number	Height	Diameter	Weight
 PJ-EHB-5	26	M12	0.03kg
 PJ-EHB-6	27	M14	0.07kg

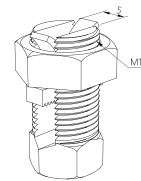

Instruction Manual :

- ◆ Suitable for: ground connection.
- ◆ Fit for: PJ-EHB-5 used for diameter below 5.0mm, PJ-EHB-6 used for diameter from 5.0mm to 7.0mm.

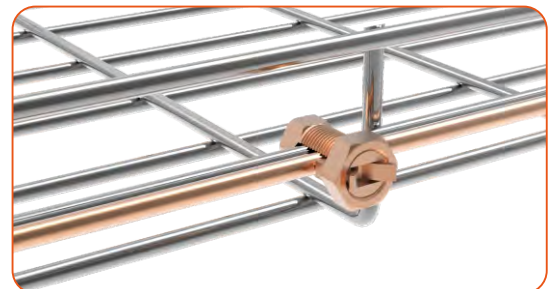

SIGNAGE

Default unit : mm

Part Number	Height	Width	Weight
ALL PJ-SGN-PT	120	17	0.005kg

Instruction Manual :

- ◆ Suitable for: displaying company logo.
- ◆ Fit for: wire diameter from 4.0mm to 6.0mm.

TERMINATOR

Default unit : mm

Part Number	Height	Width	Weight
ALL PJ-TTR50-100	50	100	0.07kg
ALL PJ-TTR50-200	50	200	0.13kg
ALL PJ-TTR50-300	50	300	0.19kg
ALL PJ-TTR100-100	100	100	0.08kg
ALL PJ-TTR100-200	100	200	0.14kg
ALL PJ-TTR100-300	100	300	0.20kg

Instruction Manual :

- ◆ Suitable for: enclosing the ends of wire mesh cable trays.
- ◆ Fit for: wire diameter from 3.5mm to 6.0mm, covering all sizes of cable trays.

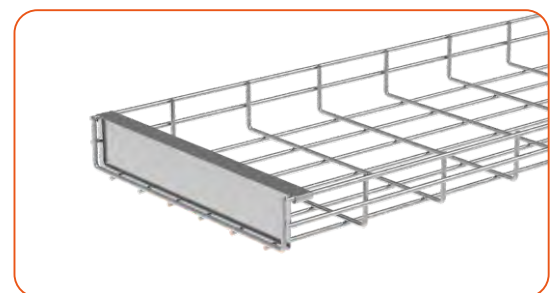
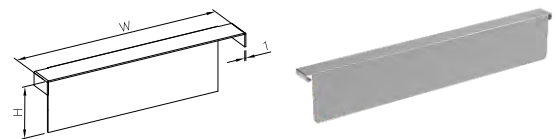

SPIDER BRACKET

Default unit : mm

Part Number	Height	Length	Thickness	Pack	Weight
 PJ-SPB	75	92	2.0	100	0.11kg

Instruction Manual :

- ◆ Suitable for: connection to equipment or junction box.
- ◆ Fit for: wire diameter from 3.5mm to 6.0mm.

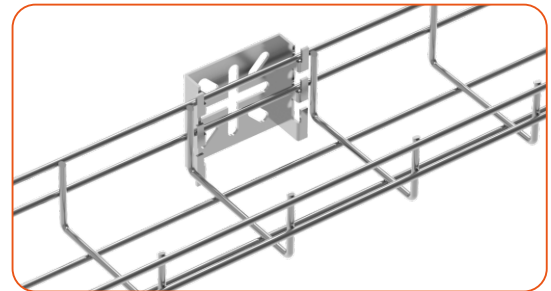
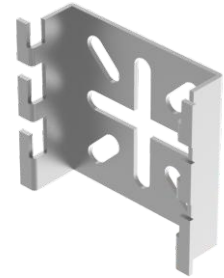
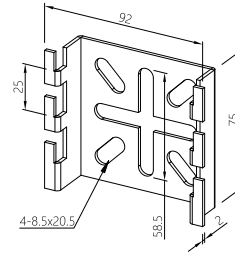

WIRE CUTTER

Default unit : mm

Part Number	Diameter	Length	Weight/PCS
GBJ-CUT	Up to 8mm	24"	1.50kg

Instruction Manual :

- ◆ Suitable for: cutting wire to make elbows on site.
- ◆ Fit for: wire diameter from 3.5mm to 8.0mm.

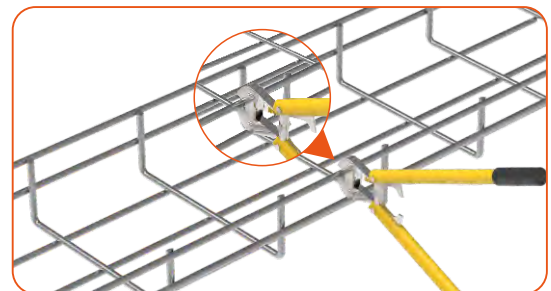

COVER

Default unit : mm

Part Number	Height	Width	Length	Weight
ALL PJ-CVRC100-1000	8.5	100	1m	1.46kg
ALL PJ-CVRC150-1000	8.5	150	1m	1.97kg
ALL PJ-CVRC200-1000	8.5	200	1m	2.48kg
ALL PJ-CVRC300-1000	8.5	300	1m	3.50kg
ALL PJ-CVRC400-1000	8.5	400	1m	4.52kg
ALL PJ-CVRC450-1000	8.5	450	1m	5.03kg
ALL PJ-CVRC500-1000	8.5	500	1m	5.54kg
ALL PJ-CVRC600-1000	8.5	600	1m	6.56kg
ALL PJ-CVRC100-3000	8.5	100	3m	4.38kg
ALL PJ-CVRC150-3000	8.5	150	3m	5.91kg
ALL PJ-CVRC200-3000	8.5	200	3m	7.44kg
ALL PJ-CVRC300-3000	8.5	300	3m	10.50kg
ALL PJ-CVRC400-3000	8.5	400	3m	13.56kg
ALL PJ-CVRC450-3000	8.5	450	3m	15.09kg
ALL PJ-CVRC500-3000	8.5	500	3m	16.62kg
ALL PJ-CVRC600-3000	8.5	600	3m	19.68kg

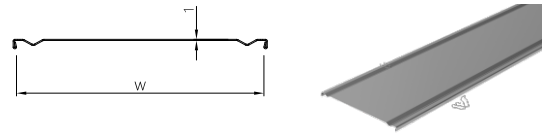

P/N Definition :

- ◆ E.g. PJ-CVRC100-3000, PJ means wire mesh cable tray accessories, CVRC means wire mesh cable tray cover, 100 means 100mm high, 3000 means 3000mm long per piece.

Instruction Manual :

- ◆ Suitable for: cover for wire mesh cable trays.
- ◆ Fit for: wire diameter from 3.5mm to 6.0mm, wire mesh cable tray width over 100mm.
- ◆ Includes: cover ×1, cover clamp ×4.

FAST LOCK

Default unit : mm

Part Number	Height	Length	Pack	Weight
ALL PJ-FLK	19	43	500	7.50kg

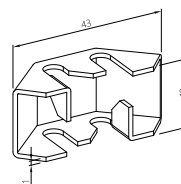

Instruction Manual :

- ◆ Suitable for: making bends.
- ◆ Fit for: diameter of wire from 4.0mm to 6.0mm.



FAST FIX SPLICER

Default unit : mm

Part Number	Height	Length	Pack	Weight
 PJ-SPL	19	255	20	1.40kg

Instruction Manual :

- ◆ Suitable for: boltless connection.
- ◆ Fit for: diameter of wire from 4.5mm to 5.5mm.

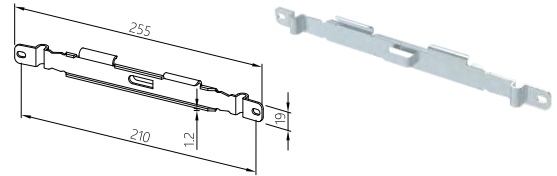

BOLTLESS COUPLER

Default unit : mm

Part Number	Length	Width	Pack	Weight
 PJ-BTC	64.6	50	500	25.00kg

Instruction Manual :

- ◆ Suitable for: boltless connections on the underside of cable trays.
- ◆ Fit for: diameter of wire from 4.5mm to 5.5mm.

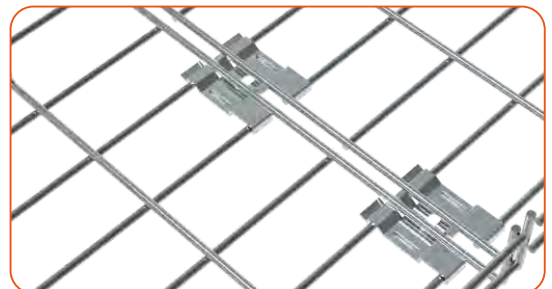
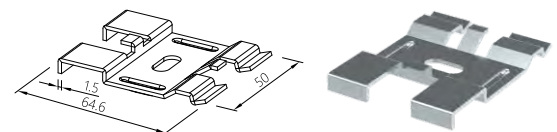

INDUSTRIAL MOUNT BRACKET

Default unit : mm

Part Number	Height	Width	Weight
ALL PJ-LJQD	172	130	0.60kg

Instruction Manual :

- ◆ Suitable for: connection to equipment or junction box.
- ◆ Fit for: wire diameter from 3.5mm to 6.0mm.

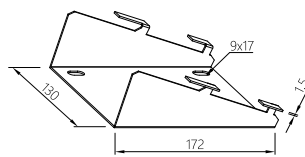

TUBE OUTLET

Default unit : mm

Part Number	Length	Width	Weight
ALL PJ-CDH	109	66	0.12kg

Instruction Manual :

- ◆ Suitable for: connection to tube with diameter 32mm, 25mm & 20mm.
- ◆ Fit for: wire diameter from 3.5mm to 6.0mm.

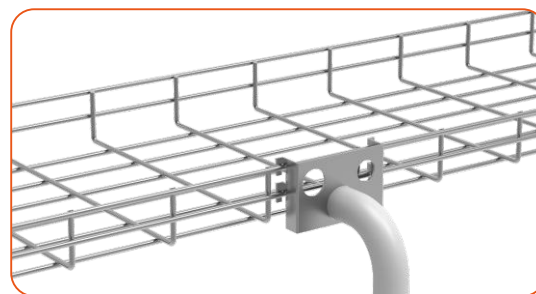
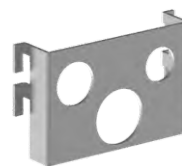
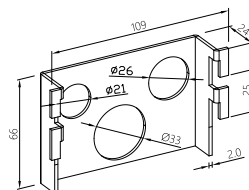

HANDLE

Part Number	Width	Weight
 PJ-HDL	232	0.06kg

Instruction Manual :

- ◆ Suitable for: installation or disassembly of fast fix splicer.

Default unit : mm

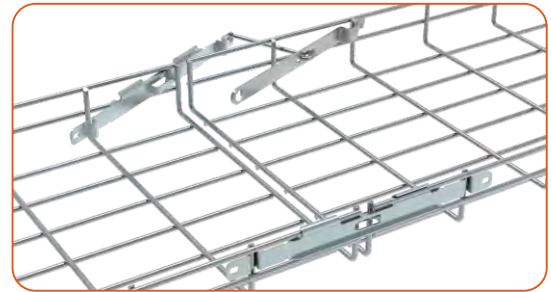
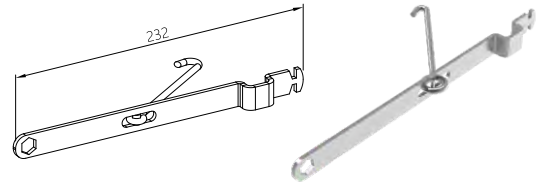

TRAPEZE BAR

Default unit : mm

Part Number	Height	Width	Length	Thickness	Pack	Weight
ALL PJ-BR100	22	53	200	2.0	50	0.23kg
ALL PJ-BR150	22	53	250	2.0	50	0.29kg
ALL PJ-BR200	22	53	300	2.0	30	0.35kg
ALL PJ-BR300	22	53	400	2.0	30	0.46kg
ALL PJ-BR400	22	53	500	2.0	30	0.59kg
ALL PJ-BR450	22	53	550	2.0	20	0.65kg
ALL PJ-BR500	22	53	600	2.0	20	0.70kg
ALL PJ-BR600	22	53	700	2.0	20	0.82kg

Instruction Manual :

- ◆ Suitable for: Hanging trays are often installed with.
- ◆ Fit for: diameter of wire from 3.5mm to 6.0mm
- ◆ Hanging trays are often installed with M10 threaded rod, drop in anchor bolt, and flange nut.

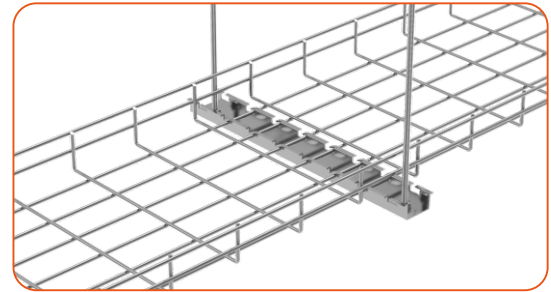
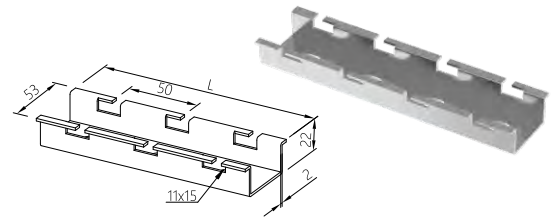

STRUT CHANNEL BAR WITH KSK

Default unit : mm

Part Number	Height	Width	Length	Pack	Weight
ALL PJ-UHDC100	41	41	200	2.0	0.40kg
ALL PJ-UHDC150	41	41	250	2.0	0.68kg
ALL PJ-UHDC200	41	41	300	2.0	0.75kg
ALL PJ-UHDC300	41	41	400	2.0	0.89kg
ALL PJ-UHDC400	41	41	500	2.0	1.10kg
ALL PJ-UHDC450	41	41	550	2.0	1.21kg
ALL PJ-UHDC500	41	41	600	2.0	1.31kg
ALL PJ-UHDC600	41	41	700	2.0	1.52kg

Instruction Manual :

- ◆ Suitable for: hanging trays, also can be used for wall & floor mount.
- ◆ Fit for: diameter of wire from 3.5mm to 6.0mm.
- ◆ Hanging trays are often installed with M12 threaded rod, drop in anchor bolt, and flange nut.

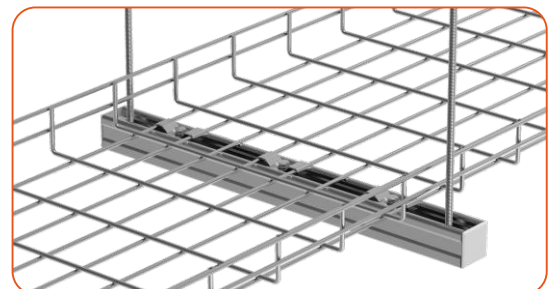
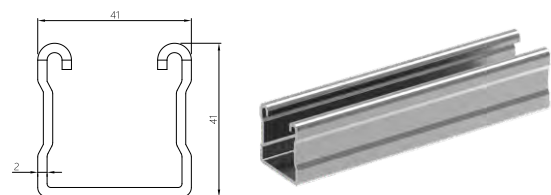

HOLD DOWN CLIP SET

Default unit : mm

Part Number	Width	Thickness	Weight
 PJ-HDC	59	1.5	0.055kg

Instruction Manual :

- ◆ Suitable for: fixing trays on strut channel bar.
- ◆ Fit for: diameter of wire from 3.5mm to 6.0mm.
- ◆ Includes: clip x1, M6 spring nut x1, M6 bolt x1.

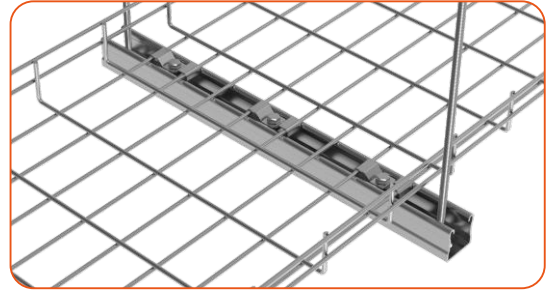
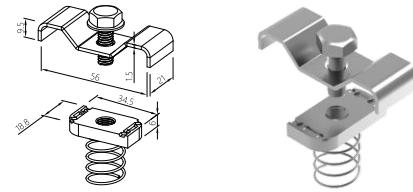

FAST CHANNEL CLIP

Default unit : mm

Part Number	Weight
 PJ-KSK	0.01kg

Instruction Manual :

- ◆ Suitable for: fixing trays on strut channel bar.
- ◆ Fit for: diameter of wire from 3.5mm to 6.0mm.

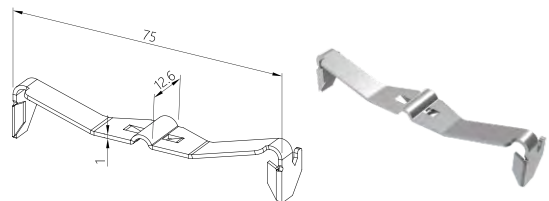

THREADED ROD

Default unit : mm

Part Number	Diameter	Length	Length	Weight
ALL TY-ROD-M8x1000	8	1000	1m	0.26kg
ALL TY-ROD-M8x3000	8	3000	3m	0.78kg
ALL TY-ROD-M10x1000	10	1000	1m	0.40kg
ALL TY-ROD-M10x3000	10	3000	3m	1.20kg
ALL TY-ROD-M12x1000	12	1000	1m	0.64kg
ALL TY-ROD-M12x3000	12	3000	3m	1.89kg
ALL TY-ROD-M14x1000	14	1000	1m	0.85kg
ALL TY-ROD-M14x3000	14 </td <td>3000</td> <td>3m</td> <td>2.50kg</td>	3000	3m	2.50kg

Instruction Manual :

- ◆ Suitable for: fixing the threaded rod to the ceiling.
- ◆ Often used with drop in anchor bolt, flange nut, can be ordered in 3-meter length and cut freely on project site.

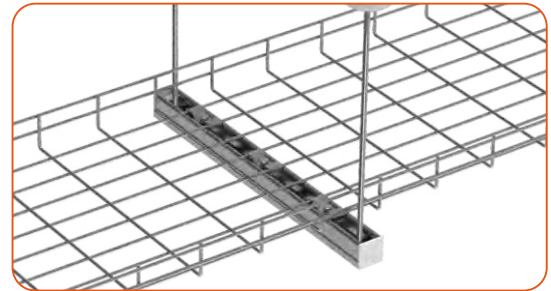

DROP IN ANCHOR BOLT

Default unit : mm

Part Number	Diameter	Length	Weight
ALL TY-PANR-M8x50	8	50	0.01kg
ALL TY-PANR-M10x60	10	60	0.01kg
ALL TY-PANR-M12x70	12	70	0.03kg

Instruction Manual :

- ◆ Suitable for: fixing trapeze or strut channel bars to the ceiling.



FLANGE NUT

Default unit : mm

Part Number	Type	Diameter	Weight
ALL TY-FNUT-M8	flange nut	8	0.010kg
ALL TY-FNUT-M10	flange nut	10	0.011kg
ALL TY-FNUT-M12	flange nut	12	0.012kg
ALL TY-FNUT-M14	flange nut	14	0.014kg
ALL TY-FNUT-M16	flange nut	16	0.015kg
ALL TY-DNUT-M8	dome nut	8	0.010kg
ALL TY-DNUT-M10	dome nut	10	0.011kg
ALL TY-DNUT-M12	dome nut	12	0.012kg
ALL TY-DNUT-M14	dome nut	14	0.014kg

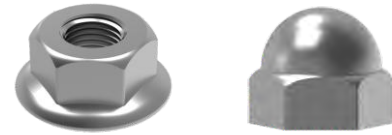

Instruction Manual :

- ◆ Suitable for: flange nut is for fixing threaded rods, dome nut is for threaded rod end decoration.

ROD CAP

Default unit : mm

Part Number	Diameter	Weight
ALL TY-RODCAP-M10	10	0.012kg
ALL TY-RODCAP-M12	12	0.025kg

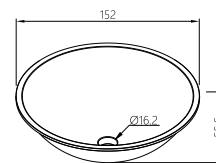

Instruction Manual :

- ◆ Suitable for: threaded rod top decoration.

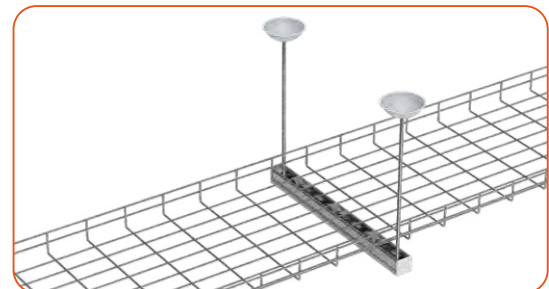

STRUT CHANNEL TERMINATOR

Default unit : mm

Part Number	Height	Width	Weight
ALL PJ-CCT-PT	41	21	0.003kg
ALL PJ-CCT-PT	41	41	0.006kg

Instruction Manual :

- ◆ Suitable for: end cover for strut channel.
- ◆ Fit for: 41mm×41mm, 41mm×21mm strut channel.

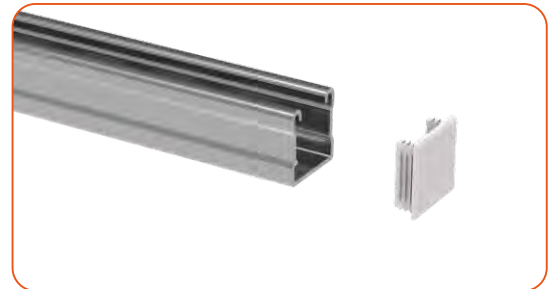

M SHAPED BAR

Default unit : mm

Part Number	Height	Width	Length	Thickness	Pack	Weight
ALL PJ-MBR100	24	63	200	1.5	50	14.40kg
ALL PJ-MBR150	24	63	250	1.5	50	18.00kg
ALL PJ-MBR200	24	63	300	1.5	50	21.60kg
ALL PJ-MBR300	24	63	400	1.5	50	28.80kg
ALL PJ-MBR400	24	63	500	1.5	40	28.80kg
ALL PJ-MBR450	24	63	550	1.5	40	31.70kg
ALL PJ-MBR500	24	63	600	1.5	40	34.40kg
ALL PJ-MBR600	24	63	700	1.5	40	41.60kg

Instruction Manual :

- ◆ Suitable for: hanging trays are often installed with.
- ◆ Fit for: diameter of wire from 3.5mm to 6.0mm.
- ◆ Hanging trays are often installed with M8 threaded rod, drop in anchor bolt, and flange nut.

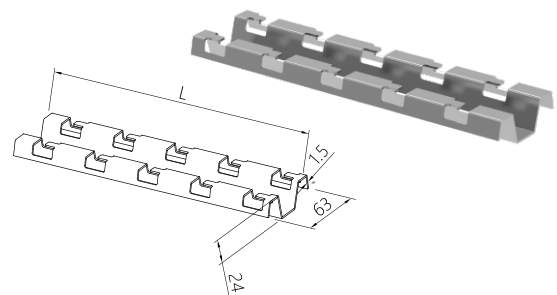

HANGING HOOK

Default unit : mm

Part Number	Height	Width	Length	Thickness	Pack	Weight
 PJ-HKS	42	38.5	35	2.0	500	21.5kg

Instruction Manual :

- ◆ Suitable for: hanging trays are often installed with.
- ◆ Fit for: diameter of wire from 3.5mm to 6.0mm, the width of tray should be ≤ 200 mm.
- ◆ Hanging trays are often installed with M8 threaded rod, drop in anchor bolt, and flange nut.

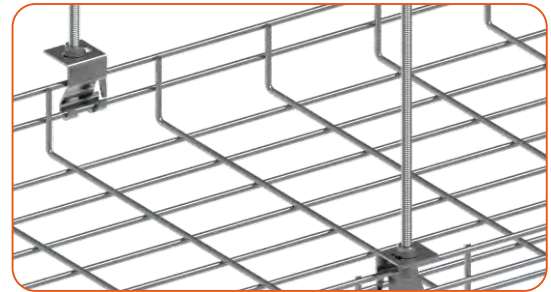
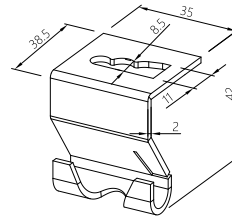

50 TRAY HOLDER

Default unit : mm

Part Number	Height	Width	Length	Thickness	Pack	Weight
 PJ-THR	25	25	72	2.0	500	25.00kg

Instruction Manual :

- ◆ Suitable for: hanging trays are often installed with.
- ◆ Fit for: diameter of wire from 3.5mm to 6.0mm, the width of tray is 50mm
- ◆ Hanging trays are often installed with M10 threaded rod, drop in anchor bolt, and flange nut

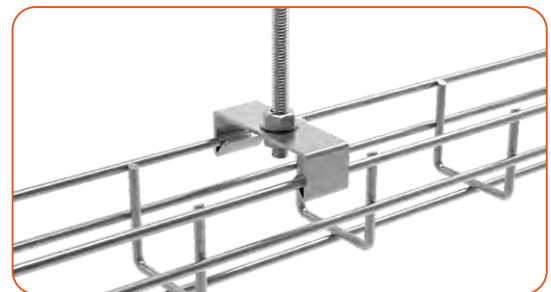
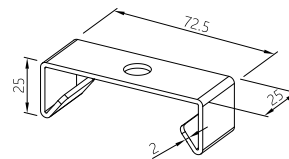

FLAG TYPE HANGING BRACKET

Default unit : mm

Part Number	Height	Weight
EZ PJ-RFB100	500	1.82kg
EZ PJ-RFB150	500	1.88kg
EZ PJ-RFB200	500	1.92kg
EZ PJ-RFB300	500	2.11kg
EZ PJ-RFB400	500	2.40kg
EZ PJ-RFB450	500	2.49kg
EZ PJ-RFB500	500	2.57kg
EZ PJ-RFB600	500	2.72kg

Instruction Manual :

- ◆ Suitable for: hanging trays under ceiling, can support two trays side by side.
- ◆ Fit for: diameter of wire from 3.5mm to 6.0mm.
- ◆ Includes: bracket x1, pole x1.

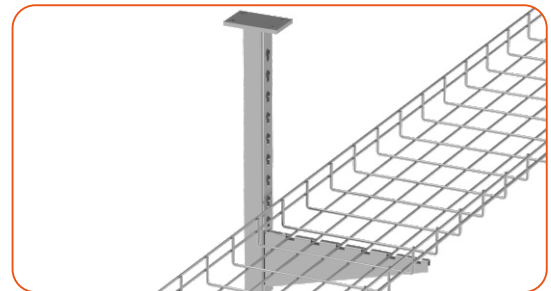
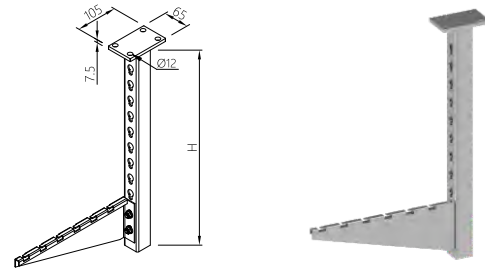

CLIP FOR I-BEAM

Default unit : mm

Part Number	Height	Width	Bore Diameter	Weight
EZ PJ-CIB	46	50	13	0.22kg
PC PJ-CIB	46	50	13	0.22kg
GI PJ-CIB	46	50	13	0.22kg
PC PJ-CIB	46	50	13	0.22kg

Instruction Manual :

- ◆ Suitable for: installation of wire mesh cable tray under I-beam or strut channel.
- ◆ Fit for: diameter of threaded rod from 10mm to 12mm.

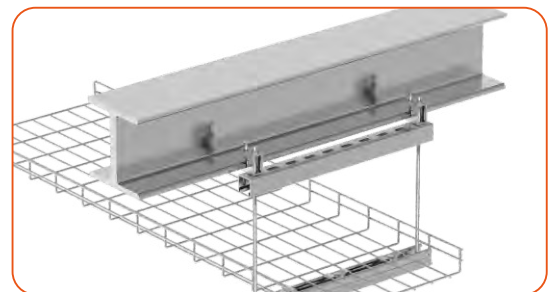
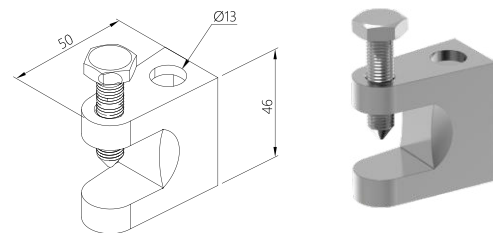

T-TYPE HANGING BRACKET

Default unit : mm

Part Number	Height	Width	Length	Thickness	Weight
 PJ-THB	150	55	80	4.8	0.37kg

Instruction Manual :

- ◆ Suitable for: hanging trays are often installed with.
- ◆ Fit for: diameter of wire from 3.5mm to 6.0mm, width of trays from 100mm to 600mm.
- ◆ Hanging trays are often installed with concrete wedge anchor bolt.

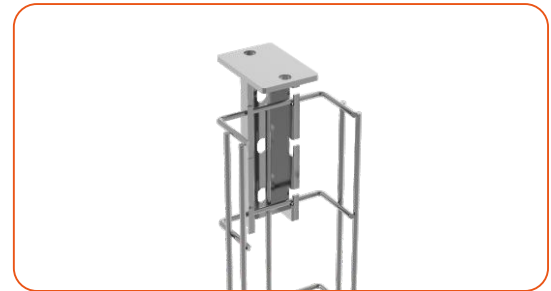
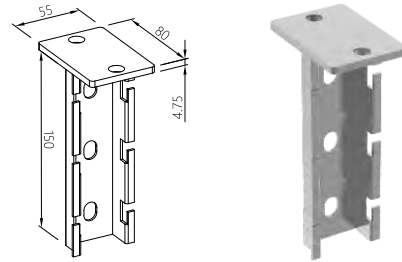

L-TYPE WALL BRACKET

Default unit : mm

Part Number	Height	Length	Thickness	Pack	Weight
ALL PJ-LWB100	168	166	2.0	30	0.42kg
ALL PJ-LWB150	168	216	2.0	30	0.47kg
ALL PJ-LWB200	168	266	2.0	30	0.53kg
ALL PJ-LWB300	168	366	2.0	20	0.62kg

Instruction Manual :

- ◆ Suitable for: supporting trays on wall.
- ◆ Fit for: diameter of wire from 3.5mm to 6.0mm, width from 100mm to 300mm.
- ◆ Includes: bracket x1 (bolt and nut optional).

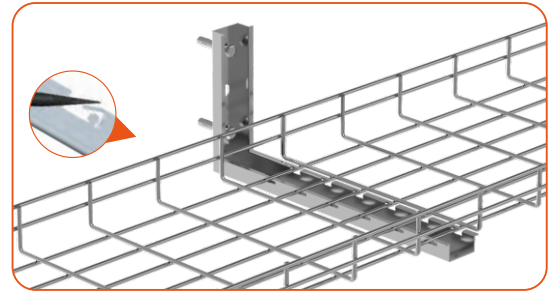
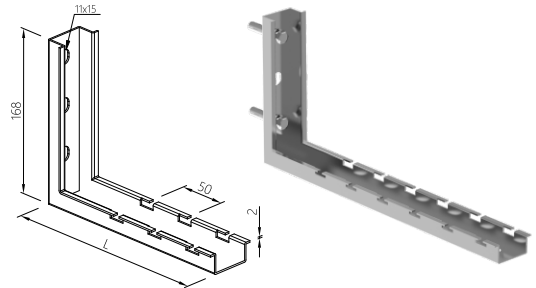

CANTILEVER WALL BRACKET

Default unit : mm

Part Number	Height	Length	Weight
ALL PJ-CWB150	230	200	1.01kg
ALL PJ-CWB200	230	250	1.28kg
ALL PJ-CWB300	230	350	1.19kg
ALL PJ-CWB400	230	450	1.48kg
ALL PJ-CWB450	230	500	1.53kg
ALL PJ-CWB500	230	550	1.59kg
ALL PJ-CWB600	230	650	1.72kg

Instruction Manual :

- ◆ Suitable for: supporting trays on wall.
- ◆ Fit for: diameter of wire from 3.5mm to 6.0mm, width from 150mm to 900mm.
- ◆ Includes: bracket x1 (bolt and nut optional).

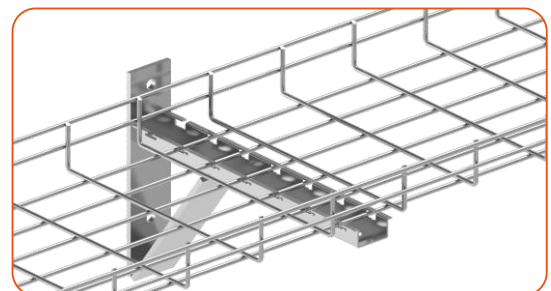
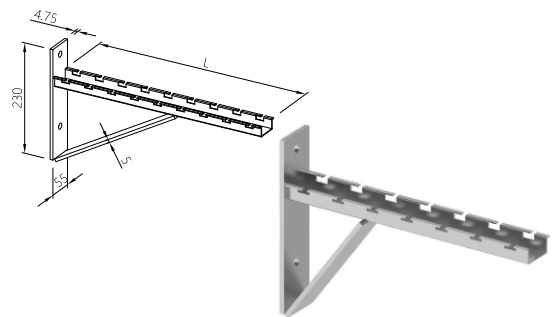

T-TYPE WALL BRACKET

Default unit : mm

Part Number	Height	Length	Weight
ALL PJ-CRP100	84	122	0.32kg
ALL PJ-CRP150	84	172	0.34kg
ALL PJ-CRP200	84	222	0.35kg
ALL PJ-CRP300	84	322	0.38kg

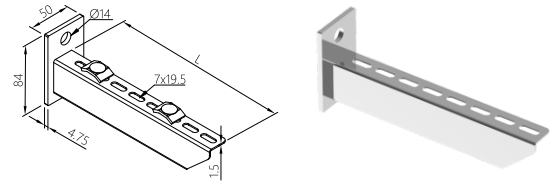

Instruction Manual :

- ◆ Suitable for: supporting trays on wall.
- ◆ Fit for: diameter of wire from 3.5mm to 6.0mm, tray width from 100mm to 300mm.
- ◆ Includes: bracket x1, KK34-top x2, M6x20 bolt x2, M6 nut x2.

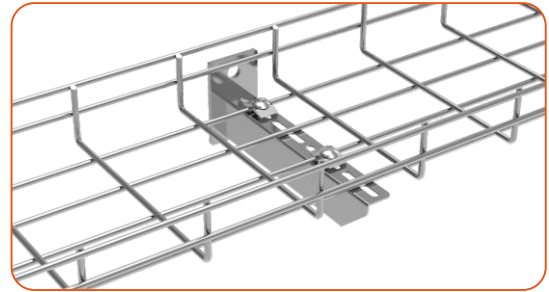

STRUT CHANNEL WALL BRACKET

Default unit : mm

Part Number	Height	Length	Thickness	Weight
ALL PJ-TWH100	139	120	2.0	0.9kg
ALL PJ-TWH150	139	170	2.0	1.02kg
ALL PJ-TWH200	139	220	2.0	1.14kg
ALL PJ-TWH300	139	320	2.0	1.34kg

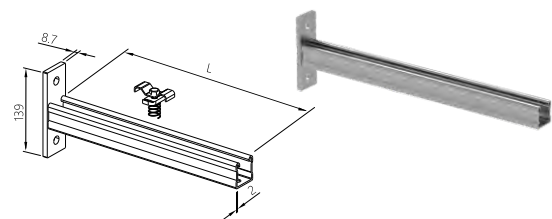

Instruction Manual :

- ◆ Suitable for: supporting trays on wall.
- ◆ Fit for: tray width from 100mm to 300mm.
- ◆ Includes: bracket x1, fast channel clip x1.

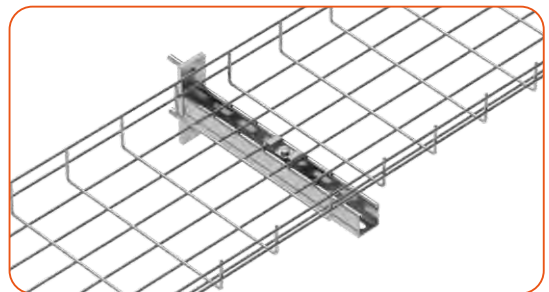

SPIDER BRACKET

Default unit : mm

Part Number	Height	Length	Thickness	Pack	Weight
ALL PJ-SPB	75	92	2.0	100	0.11kg

Instruction Manual :

- ◆ Suitable for: supporting trays on wall.
- ◆ Fit for: diameter of wire from 3.5mm to 6.0mm, Tray width from 50mm to 200mm.
- ◆ Includes: bracket x1 (bolt and nut optional).

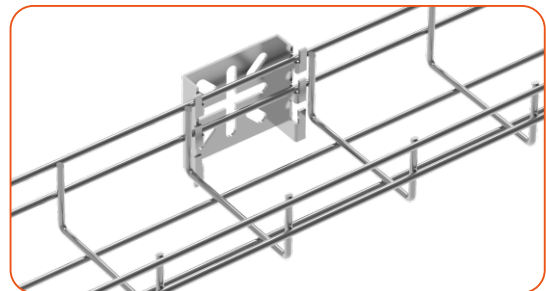
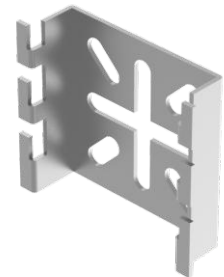
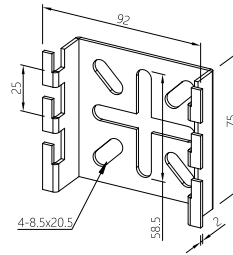

CONCRETE WEDGE ANCHOR BOLT

Default unit : mm

Part Number	Diameter	Length	Weight
ALL TY-CANR-M8x70	8	70	0.010kg
ALL TY-CANR-M8x80	8	80	0.011kg
ALL TY-CANR-M10x70	10	70	0.013kg
ALL TY-CANR-M12x70	12	70	0.016kg
ALL TY-CANR-M14x100	14	100	0.021kg



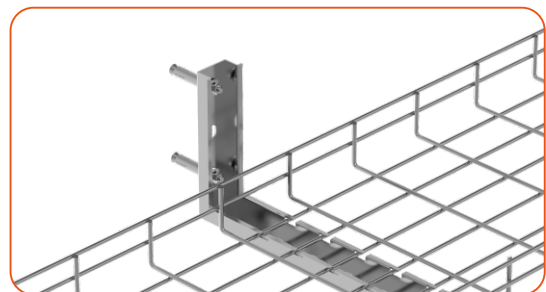

Instruction Manual :

- ◆ Suitable for: fixing brackets on wall or floor.



WALL BRACKET

Default unit : mm

Part Number	Height	Length	Thickness	Pack	Weight
 PJ-WBK100	100	120	2.0	50	0.20kg
 PJ-WBK150	100	170	2.0	50	0.26kg
 PJ-WBK200	100	220	2.0	30	0.30kg
 PJ-WBK300	100	320	2.0	30	0.49kg

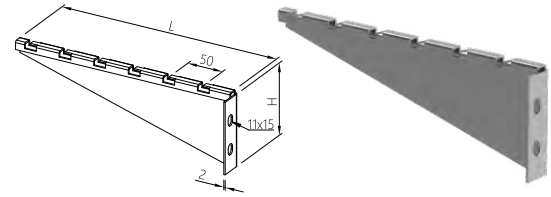



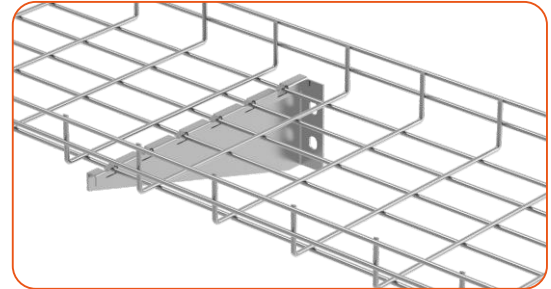

Instruction Manual :

- ◆ Suitable for: supporting trays on walls.
- ◆ Fit for: diameter of wire from 3.5mm to 6.0mm, tray width from 100mm to 600mm.
- ◆ Includes: bracket x1 (bolt and nut optiona).



T-TYPE WALL HOLDER

Default unit : mm

Part Number	Height	Length	Thickness	Weight
 PJ-TWH400	215	420	2.0	2.32kg
 PJ-TWH450	215	470	2.0	2.43kg
 PJ-TWH500	215	520	2.0	2.54kg
 PJ-TWH600	215	620	2.0	2.76kg

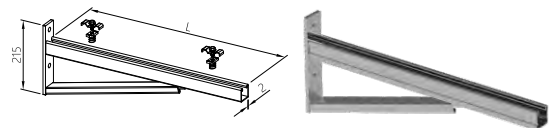

Instruction Manual :

- ◆ Suitable for: supporting trays on walls.
- ◆ Fit for: diameter of wire from 3.5mm to 6.0mm, tray width from 400mm to 900mm.
- ◆ Includes: bracket x1, fast channel clip x3.

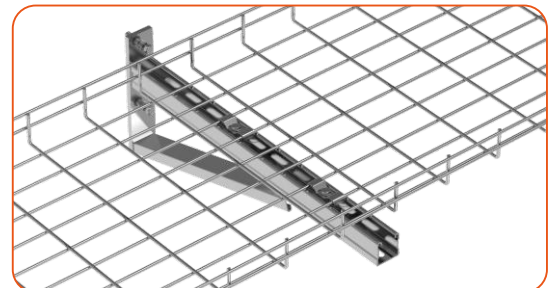

CABINET TOP STAND

Part Number	Height	Length	Thickness	Pack	Weight
ALL PJ-EFS100	120	100	2.0	20	1.31kg
ALL PJ-EFS150	120	150	2.0	20	1.44kg
ALL PJ-EFS200	120	200	2.0	20	1.51kg
ALL PJ-EFS300	120	300	2.0	20	1.67kg
ALL PJ-EFS400	120	400	2.0	20	1.76kg
ALL PJ-EFS450	120	450	2.0	20	1.83kg
ALL PJ-EFS500	120	500	2.0	20	1.91kg
ALL PJ-EFS600	120	600	2.0	20	2.05kg

Instruction Manual :

- ◆ Suitable for: supporting trays on cabinet tops or floors, with 120mm height, other height can be customized.
- ◆ Fit for: tray width from 100mm to 600mm.
- ◆ Includes: trapeze bar x1, foot x2, bolt & nut x1.

Default unit : mm

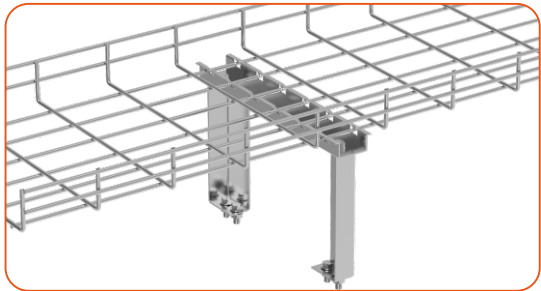
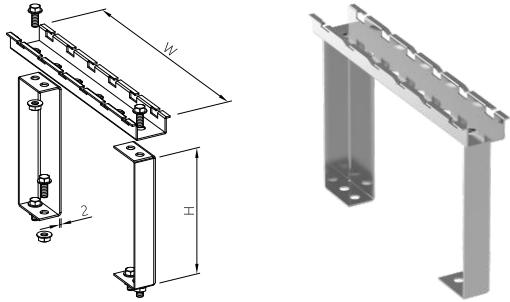

UNDERFLOOR BRACKET

Part Number	Adaptable Tray Width	Thickness	Pack	Weight
ALL PJ-UFB	100 - 500	2.0	14	1.06kg

Instruction Manual :

- ◆ Suitable for: supporting trays under raised floor.
- ◆ Fit for: diameter of wire from 3.5mm to 6.0mm, tray width from 100mm to 500mm.
- ◆ Includes: v clipx 2, trapeze bar x1, necessary bolt and nut.
- ◆ Feature: fix on feet of raised floor, height adjustable.

Default unit : mm

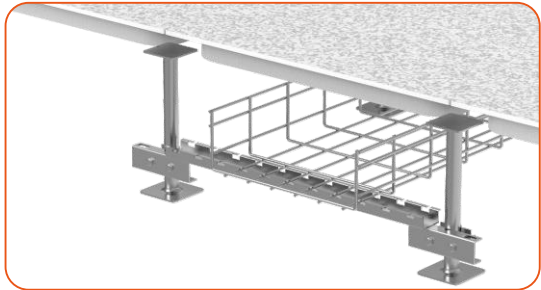
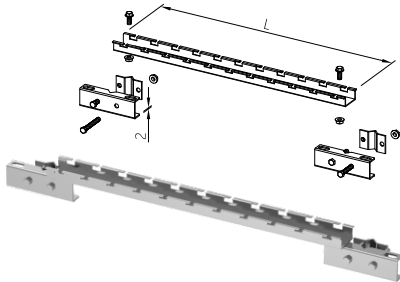

Bridge Type Stand

Part Number	Height	Length
PJ-BTS	300	200-600

Instruction Manual :

- ◆ Fit for: install single or double-layer of trays, height adjustable.
- ◆ Includes: THB x2, DXC x4, PRB x3, L type connector x4.

Default unit : mm

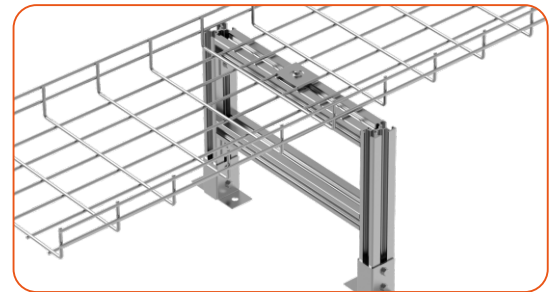
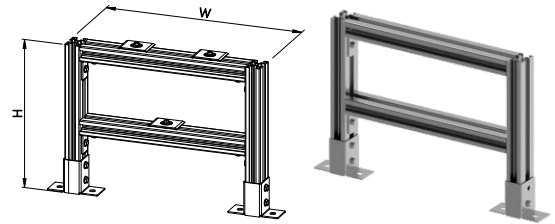

50 SIDE FLOOR BRACKET

Part Number	Height	Width	Length	Weight
PJ-50FSDB	56.5	50	70	0.13kg
PJ-75FSDB	56.5	75	70	0.14kg
PJ-100FSDB	56.5	100	70	0.17kg

Instruction Manual :

- ◆ Suitable for: wall & floor mount, support span 1.4m.
- ◆ Fit for: wire diameter 4.0mm, width 50mm & 75mm & 100mm.

Default unit : mm

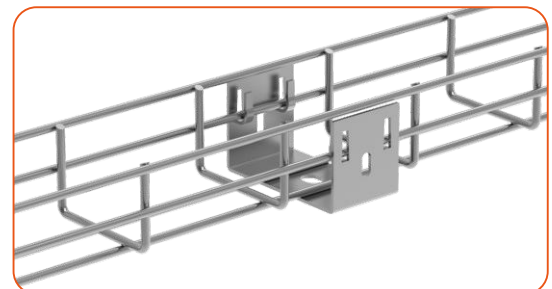
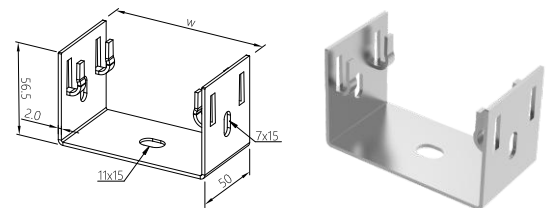

SPIDER BRACKET

Default unit : mm

Part Number	Height	Length	Thickness	Pack	Weight
ALL PJ-SPB	75	92	2.0	100	0.11kg

Instruction Manual :

- ◆ Suitable for: supporting trays on floor.
- ◆ Fit for: wire diameter from 3.5mm to 6.0mm, tray width from 100mm to 600mm.
- ◆ Includes: bracket x1 (bolt and nut optional).

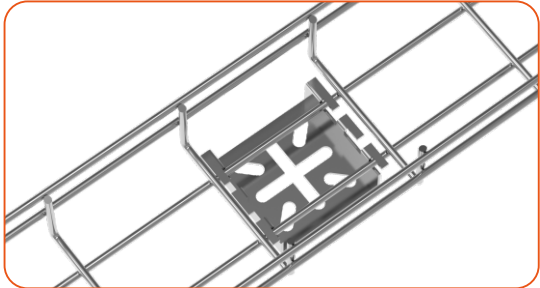
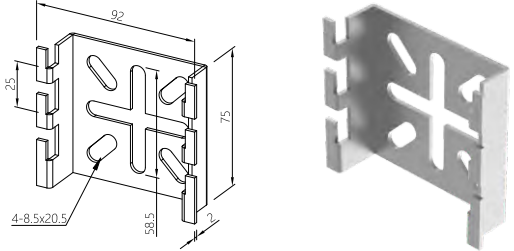

TRAPEZE BAR

Default unit : mm

Part Number	Height	Width	Length	Thickness	Pack	Weight
ALL PJ-BR100	22	53	200	2.0	50	0.23kg
ALL PJ-BR150	22	53	250	2.0	50	0.29kg
ALL PJ-BR200	22	53	300	2.0	30	0.35kg
ALL PJ-BR300	22	53	400	2.0	30	0.46kg
ALL PJ-BR400	22	53	500	2.0	30	0.59kg
ALL PJ-BR450	22	53	550	2.0	20	0.65kg
ALL PJ-BR500	22	53	600	2.0	20	0.70kg
ALL PJ-BR600	22	53	700	2.0	20	0.82kg

Instruction Manual :

- ◆ Suitable for: supporting trays on floor.
- ◆ Fit for: wire diameter from 3.5mm to 6.0mm.

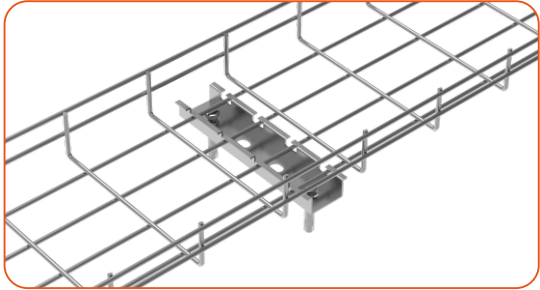
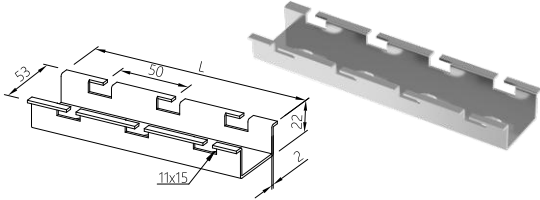

50 FLOOR STAND

Part Number	Height	Width	Length	Thickness	Pack	Weight
 PJ-50FSD	48	35	72	2.0	100	0.07kg

Instruction Manual :

- ◆ Suitable for: supporting 50mm trays on floor or top of cabinet.
- ◆ Fit for: wire diameter from 3.5mm to 6.0mm, width=50mm.

Default unit : mm

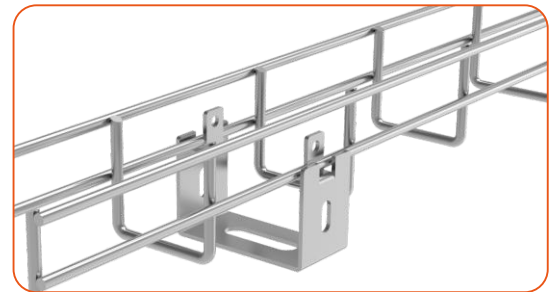
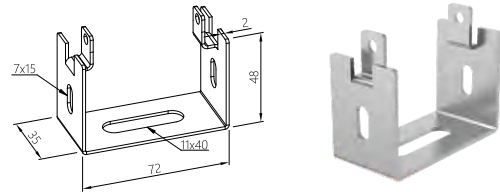

100 FLOOR STAND

Part Number	Height	Width	Length	Thickness	Pack	Weight
 PJ-100FSD	64	64	98	1.0	100	0.14kg

Instruction Manual :

- ◆ Suitable for: supporting 100mm trays on floor or top of cabinet.
- ◆ Fit for: wire diameter from 3.5mm to 6.0mm, width=100mm.
- ◆ Includes: stand x1 (bolt and nut optional).

Default unit : mm

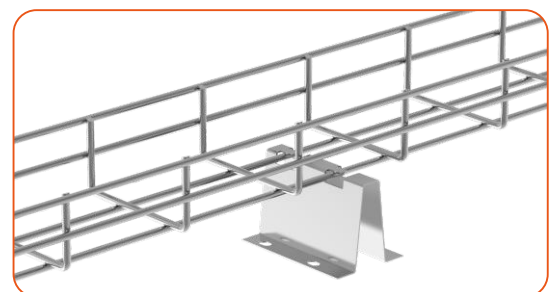
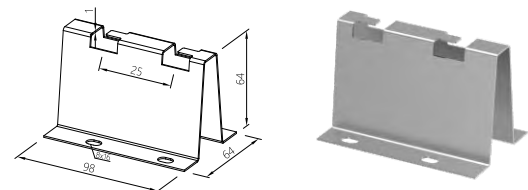

FLAG TYPE FLOOR STAND

Default unit : mm

Part Number	Height	Length	Weight
ALL PJ-FFS100	500	120	1.82kg
ALL PJ-FFS150	500	170	1.88kg
ALL PJ-FFS200	500	220	1.92kg
ALL PJ-FFS300	500	320	2.11kg
ALL PJ-FFS400	500	420	2.40kg
ALL PJ-FFS450	500	470	2.49kg
ALL PJ-FFS500	500	520	2.57kg
ALL PJ-FFS600	500	620	2.72kg

Instruction Manual :

- ◆ Suitable for: supporting 100mm trays on floor, height adjustable
- ◆ Fit for: wire diameter from 3.5mm to 6.0 mm, tray width from 100mm to 600mm.
- ◆ Includes: bracket x1, pole x1 (bolt and nut optional).

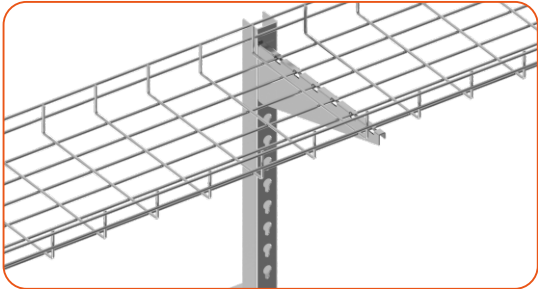
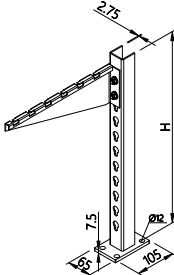

WALL MOUNT COUPLER

Default unit : mm

Part Number	Height	Length	Weight
 PJ-CDKK	43.4	40.6	0.07kg

Instruction Manual :

- ◆ Suitable for: fixing wire mesh cable trays to equipment.
- ◆ Fit for: wire diameter 4mm.

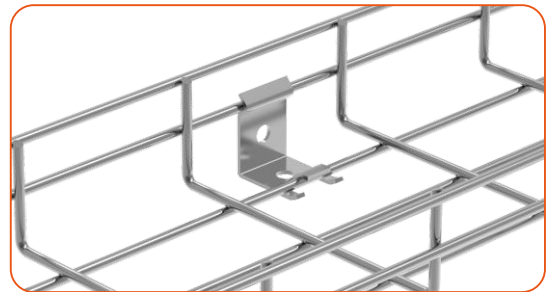
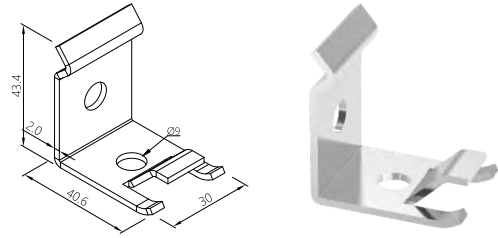

CENTRAL HOLD DOWN

Default unit : mm

Part Number	Height	Length	Thickness	Pack	Weight
 PJ-CHD	43	59	2.0	500	0.11kg

Instruction Manual :

- ◆ Suitable for: fixing trays on machinery or floor.
- ◆ Fit for: wire diameter from 4mm to 6mm.

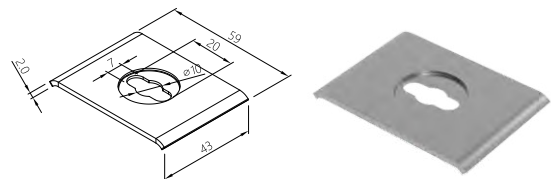

WIRE CLIP

Default unit : mm

Part Number	Width	Length	Thickness	Weight
ALL PJ-DSKK	16	22	2.5	0.03kg

Instruction Manual :

- ◆ Suitable for: mounting dividers or fixing wire mesh cable trays to mechanical equipment.
- ◆ Fit for: wire diameter from 4mm to 6mm.

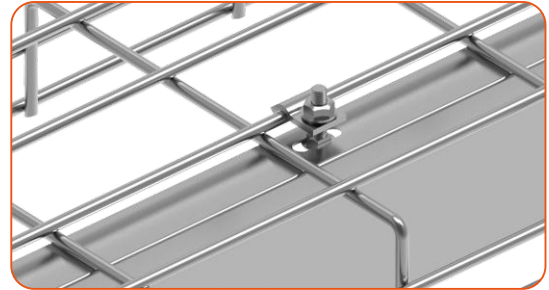
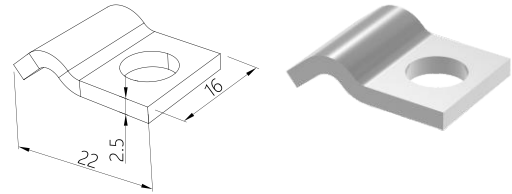

MOUNTING CLIP

Default unit : mm

Part Number	Width	Length	Thickness	Weight
EZ PJ-SHD	39	40	1.5	0.03kg

Instruction Manual :

- ◆ Suitable for: fixing wire mesh cable trays to mechanical equipment or floor directly.
- ◆ Fit for: wire diameter from 4mm to 6mm.

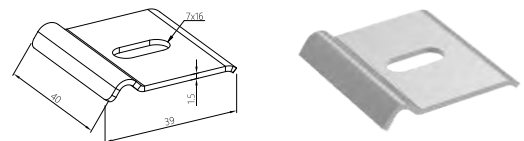

CROSS CLIP

Default unit : mm

Part Number	Width	Length	Weight
 PJ-CCP	37	42	0.02kg

Instruction Manual :

- ◆ Suitable for: fixing wire mesh cable tray to mechanical equipment, wall or floor directly.
- ◆ Fit for: wire diameter from 4mm to 6mm.

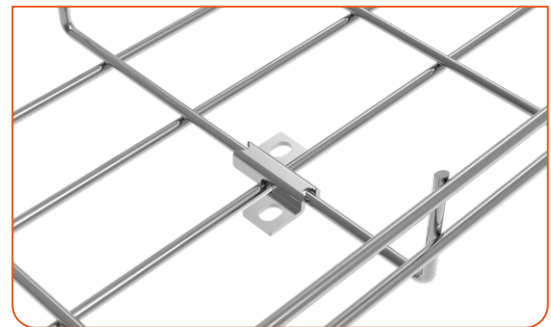
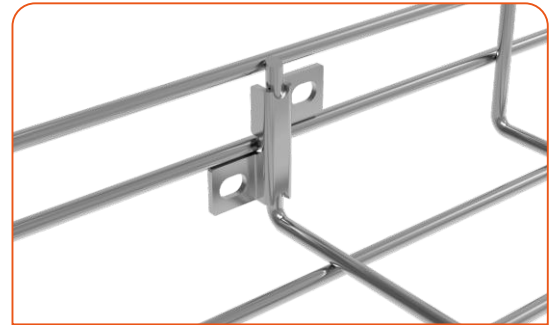
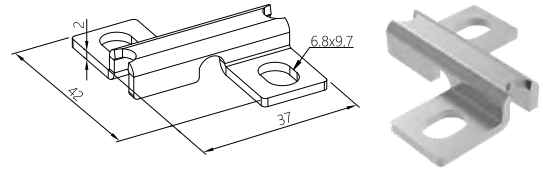

Notes



CONTACT US



**E-Book
Catalog**

Q360