

NAHANCO

2023

EST. 1925

NAHANCO

NAHANCO NAHANCO NAHANCO NAHANCO NAHANCO NAHANCO NAHANCO NAHANCO

NAHANCO

THE RETAIL SOURCE

CO

Contents & Page Guides

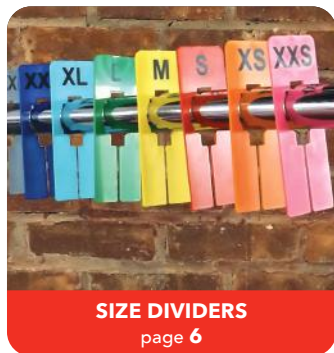

SIZE DIVIDERS
page 6



HANGING SOLUTIONS
page 10



BACKROOM
page 14



PRICING SUPPLIES
page 17



GARMENT BAGS
page 22



RACKS & MERCHANDISERS
page 24

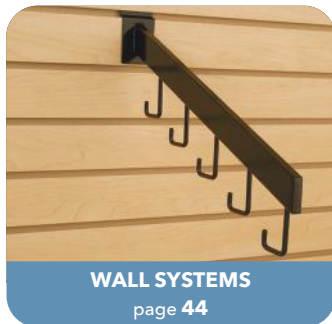

WALL SYSTEMS
page 44



SIGNAGE
page 55

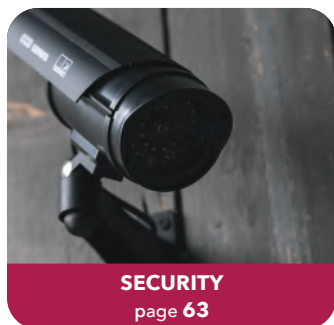

SECURITY
page 63



DRESSING ROOM SUPPLIES
page 66



STORE SUPPLIES
page 70

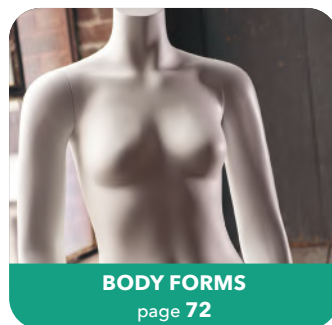

BODY FORMS
page 72

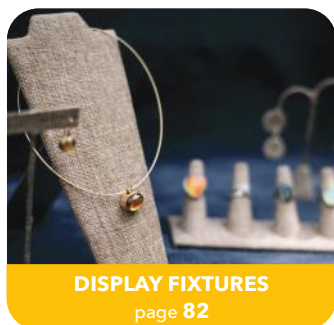

DISPLAY FIXTURES
page 82



SHOE DISPLAYERS
page 85



PACKAGING
page 88



HANGERS
page 92

A GUIDE TO THE SYMBOLS



Our new items



Everyday Value Items
Low prices on items you use every day



Items that can be customized



Products made in the USA



Assembly video available on our website and YouTube channel



Sustainable product



Items that ship via truck



Our economy items



Hangers with concave bodies



California Proposition 65 Warning:
This product contains chemicals known to the State of California to cause cancer, birth defects or other reproductive harm. For more information: www.P65Warnings.ca.gov.

A NOTE ON WEIGHTS

Many of our items now list both the **actual** and the **dimensional** or shipping weight as follows:

actual/dimensional
or
1/3, 3/7, etc.

When multiple cartons are shipped, commas separate the weights as follows:

2, 5 (2 ctns)
or
3, 5/8 (2 ctns), etc.

Sustainability.

Certainly one of the most important and sensitive topics on the planet today – especially as it applies to the business world. **NAHANCO** endeavors to be ever more sustainable with each passing year.

Here’s what we’ve been doing recently:



Recycling / Waste Management

All of the scrap we use in the manufacturing and shipping process, and during our day-to-day operations – plastics, cardboard/paper, and metal – is collected, processed and/or baled and recycled.

Any additional, non-recyclable waste, is compacted and picked up just 3 times per year.



A More Sustainability Facility

-  **Cleaner Fuel** – we’ve converted our entire manufacturing facility from oil to Propane
-  **Better Lighting** – all incandescent lighting has been replaced and florescent fixtures have been fitted with environmentally friendly bulbs
-  **Upgraded Air** – our new compressed air system has resulted in lower operating costs and a reduction in water usage of 100,000 gallons a year

Sustainability and NAHANCO Hangers

WOOD

All of our Wood Hangers are made from sustainable materials – Lotus wood and Bamboo – that are grown in China.



PLASTIC

Plastic Hangers have a useable shelf life of over ten years. And if damaged, the hanger can be recycled. We recycle our own scrap plastic from the manufacturing process. A granulator (and we have a big one!) is used to grind the scrap so we can re-use it. **Zero** plastic goes into the waste stream.



RECYCLED PLASTICS

Our black hangers are made of up to 80% internal and external recycled plastic material. All other hangers we manufacture use up to 20% of internal recycled plastic.



BENEFITS OF WORKING WITH US:

98 years in business

Our US-based industry professionals are available to consult with you on your business needs.



We offer **customizable reporting** on your historical usage and spend.



We have unmatched experience in building and executing **custom programs** designed for your individual business needs.

We leverage our buying power to offer highly **competitive prices** on the items you buy – whether a one-off need or a high-volume, ongoing supply program.



SERVICES WE PROVIDE:



SOURCING

Custom, branded or generic merchandising supplies; domestic or imported, we have you covered.

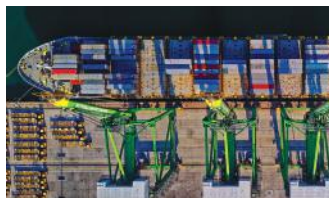

LOGISTICS & DISTRIBUTION

Services are scaled to fit your needs: to your warehouse, direct roll-outs or consolidated shipments.



WAREHOUSING & INVENTORY MGMT

We can maintain inventory of the items you buy from us, so they are ready to ship when you need them.



E COMMERCE ORDERING PLATFORM

Our web-based ordering platform can be customized to your brand-specific catalog.

Custom Creations

NAHANCO offers a robust custom program, that includes something for every customer no matter how big or how small. The program divides into 3 general categories:

1. BUILD A BRAND

Considered our “bespoke” option, for customers looking for something completely unique to their brand. We develop custom plans, executed with full involvement of both your creative teams and ours.

KITH

WE CREATED KITH'S ICONIC BLACK LINE OF HANGERS, WHICH GREW TO INCLUDE A LINE OF KIDS HANGERS.



AN ANNIVERSARY LINE WAS LATER CREATED TO CELEBRATE ALL OF THE COLORS OF KITH



2. INSTA BRAND — custom items ship in DAYS, not months!

A popular option for customers looking to add branded elements to their store supplies. Hangers are the most common choice, we can print custom designs onto size dividers, bags, and other objects. Select products from our extensive inventory and add your logo.



3. CUSTOM CREATOR TOOL

This is our easy-to-use, Do-It-Yourself online customization tool.

A curated selection of our most popular wood hangers are sold in small 24-piece batches, ready for your logo, text, photos... whatever you want to create. Or work with a fun collection of elements available in the tool.

Ideal for smaller boutiques, offices, wedding parties, gifts, and home closets. It can also be employed as a fun way to “test” out logo designs with a small-scale order.



Our Best Selling Hangers

WOOD



NAHANCO Slimline Wood /page 95

SLIM & SLEEK



TRIED & TRUE

NAHANCO Line /page 92
Our most popular wood hanger!



THE MODERN CLASSIC

NORTHSHIRE Line /page 99



THIN, FLAT, NOTCHED

EQUINOX Line /page 97



EXECUTIVE Line /page 98

CONCAVE

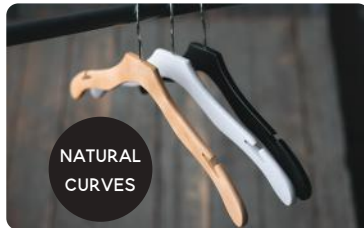

NATURAL CURVES

CONTEMPORARY Line /page 101



FLOWING LINES

SIGNATURE Line /page 100



GREAT ALL-AROUND

TRADITIONAL Line /page 102



RETRO

RETRO Line /page 100



SWIMWEAR Hangers /pg 105
Body-shaped, round, tiered and more



BIKINI

METAL

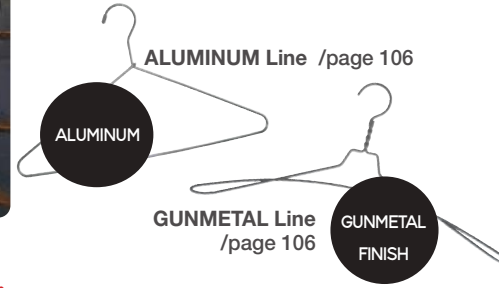

ALUMINUM Line /page 106

ALUMINUM

GUNMETAL Line /page 106

GUNMETAL FINISH

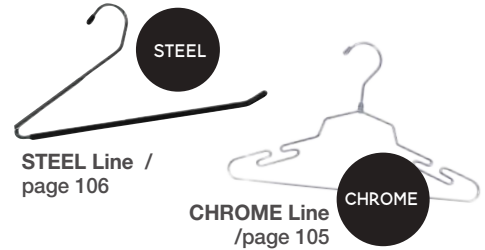

STEEL

STEEL Line /page 106

CHROME Line /page 105

CHROME

PLASTIC



TRADITIONAL STYLES

TRADITIONAL Plastic /page 113
Many styles made by us in the USA



INTIMATE STYLES

INTIMATE Lines /page 110



CHILDREN'S

KIDS' Styles /page 118



SLIM & VERSATILE

VELVET Slimline /page 109



JACKET & SUIT

JACKET Line /page 108



ECONOMY

ECONOMY Lines /page 121



DISPLAY

DISPLAY Lines /page 112

SIZE DIVIDERS



We make most of our sizing products in the USA



Scan to explore more sizing details, or visit nahanco.com

ROUND STANDARD



See nahanco.com for Mon-Sun options

3 1/2" outside diameter; 1 3/8" inside diameter; 1/2 lbs.

Imprinted: .35 each
White w/black: "C"
Black w/gold: "CG"

Imprinted: .35 each
Black w/silver: CBS
Black w/white: CBW

Blank: .17 each
Blank White: CWHT-BLANK
Blank Black: CBLK-BLANK



C2WHITE/
C2BLACK

ROUND LARGE INTERIOR

3 1/2" outside diameter; 1 5/8" inside diameter; 1/2 lbs.

Imprinted: .35 each
White w/black: C2WHITE
Black w/gold: C2BLACK

Blank: .17 each
Blank White: C2WHITE-BLANK
Blank Black: C2BLACK-BLANK

UNIVERSAL

Fits round, square and rectangular hangrails. Choice of sizes or blank. 2"W x 5"H; 1 3/8" inside diameter; 1/2 lbs.

Imprinted: .35 each
White w/black: QSD-W
Black w/gold: QSD-B
Black w/silver: QSDBS
Black w/white: QSDBW

Blank: .17 each
Blank White: QSDWHT-BLANK
Blank Black: QSDBLK-BLANK



QSD

GRAND

Fits round, square and rectangular hangrails. Choice of sizes or blank. 2 5/8"W x 5 3/4"H; 1 3/8" inside diameter; 1/2 lbs.

.56 each - printed
White w/black: GSD-W
Black w/gold: GSD-B

.39 each - blank
Blank White: GSDWHT-BLANK
Blank Black: GSDBLK-BLANK



GSD

CUSTOM colors and/or printing available for most styles. Give us a call!

REGULAR

Fits round, square and rectangular hangrails. Choice of sizes or blank. 2 3/4"W x 6 3/4"H; 1 5/16" inside diameter; 1/2 lbs.

.56 each - printed
White w/black: RSD-W
Black w/gold: RSD-B

.39 each - blank
Blank White: RSD-W/BLANK
Blank Black: RSD-B/BLANK



RSD

EXTRA LARGE

Fits round, square and rectangular hangrails. Choice of sizes or blank. 4"W x 7"H; 1 3/8" inside diameter; 1/2 lbs.

.64 each - printed
White w/black: XLRSDW
Black w/gold: XLRSDB

.39 each - blank
Blank White: XLRSD-W/BLANK
Blank Black: XLRSD-B/BLANK



XLRSD

QUEEN

Fits round hangrails. Choice of sizes or blank. 3 3/4"W x 9 5/16"H; 1 1/2" inside diameter; 5/6 lbs. 50 pieces per pack

Blank:
Blank White: D15 **19.44**
Blank Clear: D05 **19.44**
Blank Black: D25 **19.44**

Imprinted*:
White w/black: D15l **27.86**
Clear w/black: D05l **27.86**
Black w/gold: D25l **27.86**

* Minimum order of 100 pieces (same size) for imprinting



D15

DELUXE

Works with E1 inserts. 3 3/4"W x 10"H; 1 3/4" inside diameter; 8 lbs. 50 pieces per pack/ **36.29**

White: D120W
Black: D220B



D120W

D220B

KING

Slot for inter-changeable sizes. Packed with blank white inserts or specify pre-printed.

3 3/4"W x 10 3/4"H; 1 3/8" inside diameter; 200 pack /21lbs; 100 pack /11lbs.



White:	200	175 "E"	97.90
	100	175E-100	50.54
Clear:	200	75 "E"	97.90
	100	75E-100	50.54
Black:	200	275 "E"	97.90
	100	275E-100	50.54



Extra Inserts (E1)

Fits Deluxe and King size dividers. 3 1/4"W x 2 1.2"H; 1/2 lbs.

100 pieces per pack

White w/black imprint: "E1" **23.33**
Blank White: E1-BLANK **14.26**

PRICE QUOTES ... CUSTOM COLOR ... CUSTOM PRINT ... PRICE QUOTES ... CUSTOM COLOR ... CUSTOM PRINT



PRINTED KITS

5 SIZES / XSMALL - XLARGE

Choose Black, White or Color; Round or Universal
Sizes include: XS, S, M, L, XL

Round and Universal dividers. Choose from black, white, or mixed colors.

8 SIZES / XXSMALL - XXLARGE + BLANK

Choose Black, White or Color; Round or Universal
Sizes include: XXS, XS, S, M, L, XL, XXL, blank



2 PIECES EACH SIZE

BLACK or WHITE 10-Piece Kit; 1 lb; **\$5.05 /kit**

Round / White CWBKIT1
Round /Black CBWKIT1

Universal / White QSDWBKIT1
Universal /Black QSDBWKIT1

MIXED COLORS 10-Piece Kit; 1 lb; **\$10.50 /kit**

Round CCKIT1
Universal QSDCKIT1

5 PIECES EACH SIZE

BLACK or WHITE 25-Piece Kit; 1 lb; **\$8.80 /kit**

Round / White CWBKIT2
Round /Black CBWKIT2

Universal / White QSDWBKIT2
Universal /Black QSDBWKIT2

MIXED COLORS 25-Piece Kit; 1 lb; **\$13.35 /kit**

Round CCKIT2
Universal QSDCKIT2

2 PIECES EACH SIZE

BLACK or WHITE 16-Piece Kit; 1 lb; **\$8.04 /kit**

Round / White CWBKIT3
Round /Black CBWKIT3

Universal / White QSDWBKIT3
Universal /Black QSDBWKIT3

MIXED COLORS 16-Piece Kit; 1 lb; **\$9.20 /kit**

Round CCKIT3
Universal QSDCKIT3

5 PIECES EACH SIZE

BLACK or WHITE 40-Piece Kit; 1 lb; **\$16.72 /kit**

Round / White CWBKIT4
Round /Black CBWKIT4

Universal / White QSDWBKIT4
Universal /Black QSDBWKIT4

MIXED COLORS 40-Piece Kit; 1 lb; **\$19.96 /kit**

Round CCKIT4
Universal QSDCKIT4

10 SIZES / 3 MOS - 4T

Black or White; Round or Universal

Sizes include: 3 Mo, 6 Mo, 9 Mo, 12 Mo, 18 Mo, 24 Mo, 30 Mo, 2T, 3T, 4T



1
PIECE
EACH SIZE

10-Piece Kit; 1 lb; **\$5.05 /kit**

Round / White CWBKIT5
Round /Black CBWKIT5

Universal / White QSDWBKIT5
Universal /Black QSDBWKIT5

5
PIECES
EACH SIZE

50-Piece Kit; 2 lbs; **\$20.87 /kit**

Round / White CWBKIT6
Round /Black CBWKIT6

Universal / White QSDWBKIT6
Universal /Black QSDBWKIT6

SIZE DIVIDERS Size Divider Kits



BLANK KITS

Round and Universal dividers. Choose from black, white, or mixed colors. Blank divider kits are available in a range of quantities.

BLACK & WHITE



SET OF 20 Black or White; Round or Universal; 1 lb; **\$4.67 /kit**

Round / White CWHTBLANK20
Round / Black CBLKBLANK20
Universal / White QSDWBLANK20
Universal / Black QSDBBLANK20



SET OF 50 Black or White; Round or Universal; 2 lbs; **\$9.98 /kit**

Round / White CWHTBLANK50
Round / Black CBLKBLANK50
Universal / White QSDWBLANK50
Universal / Black QSDBBLANK50



SET OF 100 Black or White; Round or Universal; 3 lbs; **\$16.72 /kit**

Round / White CWHTBLANK100
Round / Black CBLKBLANK100
Universal / White QSDWBLANK100
Universal / Black QSDBBLANK100

MIXED COLOR KITS



SET OF 5 COLORS
KITS OF 10
/2 each color; Round or Universal; 1 lb; **\$4.15 /kit**

Round CCKIT5
Universal QSDCKIT5



KITS OF 25
/5 each color; Round or Universal; 1 lb; **\$9.98 /kit**

Round CCKIT6
Universal QSDCKIT6



SET OF 8 COLORS
KITS OF 16
/2 each color; Round or Universal; 1 lb; **\$6.74 /kit**

Round CCKIT7
Universal QSDCKIT7



KITS OF 40
/5 each color; Round or Universal; 2 lb; **\$16.72 /kit**

Round CCKIT8
Universal QSDCKIT8

SALE & CLEARANCE KITS



SALE Red & white; Round or Universal; 1 lb; **\$10.50 /kit**

Round CWRSALE25
Universal QSDWRSALE25



CLEARANCE Red & white; Round or Universal; 1 lb; **\$10.50 /kit**

Round CRWCLEARANCE25
Universal QSDRWCLEARANCE25

BACK ROOM RAIL DIVIDERS

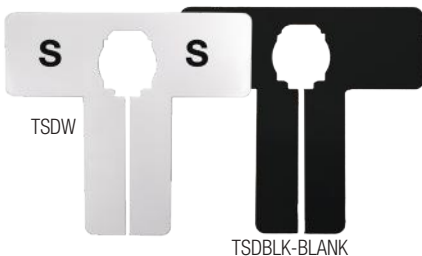

T-SHAPE STOCKROOM DIVIDER
6" high x 6 1/2" wide; 1 1/2" inside dia.; 1/3 lbs.

BLANK \$0.31 /each
TSDBLK-BLANK black
TSDWHT-BLANK white

PRINTED \$0.75 /each
TSDB black
TSDW white



EXTRA-LONG STOCKROOM DIVIDER
Black; 21 1/2" long; 4/7 lbs.
BRDAB **\$20.00 /25 pieces**



Packs OF 25
Choose Black or Yellow; Straight or Curvy body; 19" long; 4/5 lb.

Black Straight Body BRDSB **\$17.82**
Black Curvy Body BRDCB **\$23.65**
Yellow Straight Body BRDSY **\$17.82**
Yellow Curvy Body BRDCY **\$23.65**

White Blank Inserts
each 3.625" x 2.2"; 1 lb.

each BRDSB **\$0.25 each**
pack of 25 pieces BRDCB **\$9.59**

PRICE **QUOTES** ... CUSTOM **COLOR** ... CUSTOM **PRINT** ... PRICE **QUOTES** ... CUSTOM **COLOR** ... CUSTOM **PRINT**

style #	\$	qty	description	size	wgt
SCXS SCS SCM SCL SCXL SC2XL	22.29	1000	White w/ black imprint (works with P12, P13, P14, P16, B14, 2681-10, 2681-12, 1681/8W, 1681/10W, 1681/12W)	1/4"L x 5/8"H x 1/4"W	2
MSM	11.15	100	White/Black	1/2"	1/2
SM25 SMSALE	4.15 13.74	25 100	White/Black Red/White	3/4" 3/4"	1/2 1/2
SM SMB	13.74 13.74	100 100	White/Black Black/White	3/4" 3/4"	1/2 1/2
VHSM25	4.15	25	Black/White	3/4"	1/2
VSM	20.88	500	Black/White Angular VICS markers	3/4"	1
<i>Please visit nahanco.com for a complete list of all of the imprinted sizes available for our SM lines</i>					
VSMTOOL	9.49	1	Metal tool removes size markers from hanger	5 5/8"	1
SMCOLOR	6.87	50	Plain color (Specify)	3/4"	1/2
<p>COLORS: black, white, violet, brown, green, lt green, dk green, orange, yellow, lt yellow, blue, dk blue, pink, neon-orange red, dk red, grey, beige, magenta</p>					
RBKSM	13.74	100	Specify size	3/4"	1/2
<p>SMALL (Red); MEDIUM (Orange); LARGE (Yellow); X-LARGE (Green); XXL (Navy Blue); XXXL (Black)</p>					
TRAY	18.01	1	Clear heavy duty tray w/ locking clasps	Adjusts up to 24 compartments 14 x 8 1/2 x 2	2/6
DSM	5.44	250	Clear with black print on white background	1 1/4" w x 5" h	1/2
DSMBOX	8.40	1	Lt. grey cardboard	8" w x 5" h x 5" d	1/3
LBXS LBS LBM LBL LBXL LBXXL LB1X LB2X LB3X	7.00	1000	Clear with black print: XS S M L XL XXL 1X 2X 3X	1/2" w	1



PLASTIC SIZE MARKERS



Mini Size Markers 1/2"

Black/White Size Markers 3/4"

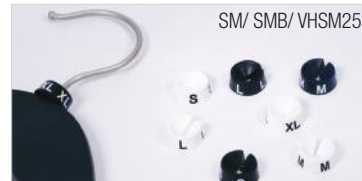

VICS Size Markers 3/4"



Size Marker Remover Tool



Plain Colored Size Markers 3/4"

Actual colors may vary slightly from image

Colored Size Markers 3/4"



Storage Tray for Size Markers

SIZING LABELS



Hem / Inseam Labels
Custom available

Clear Acetate Labels



HANGING SOLUTIONS Non-Slip Attachments



Adhesive Gripper

Black or white adhesive gripper with a raised dotted surface; 3 1/4" long

BNT	1000 /case; 5 lbs.	\$112.90
BNT200	200 /case; 2 lbs.	\$33.31
WNT200	200 /case; 2 lbs.	\$33.31

Adhesive Foam Strips

Adhesive backed foam strips; 3/8"w x 4" l; White or Grey; Choose AP and add this cost to the price of any 100-hanger carton to have the non-slip applied

FP2W	White; 200 /case; 1/2 lbs.	\$9.72
FP7W	White; 1600 /case; 2/8 lbs.	\$41.60
FP2	Grey; 200 /case; 1/2 lbs.	\$8.29
FP-7	Grey; 1600 /case; 2/8 lbs.	\$27.73
AP	Specify color; 100 pairs.	\$27.73



Foam Covers

Stretch foam covers in white (w) and grey (c); 17"w; in packs of 500 and 100

2045W	White; 500 /case; 4/14 lbs.	\$42.12
2045C	Grey; 500 / case; 4/14 lbs.	\$42.12
2041W	White; 100 /case; 2/8 lbs.	\$9.72
2041C	Grey; 100 /case; 2/8lbs.	\$9.17

Rubber Non-slip Hanger Attachments

Grippers that fit over notched, plastic hanger arms without adhesives; 4" long; black or natural; available in packs of 1000 and 200

NS	Natural; 1000 /case; 6 lbs.	\$57.99
NS2	Natural; 200 /case; 2 lbs.	\$16.49
BNS	Black; 1000 /case; 6 lbs.	\$57.99
BNS2	Black; 200 /case; 2 lbs.	\$16.49



Perfect for Slimline Wood Hangers (see page 95-96)



Flexible Non-slip Clear Vinyl Hanger Attachments

Gripper that snap over notched, plastic hanger arms without adhesives; for light to medium weight garments; 4" long, 1/2" wide

NSV2	Clear; 200 /case; 2/3 lbs.	\$40.18
-------------	----------------------------	----------------



Adhesive Foam Non-slip Attachments

Available in Black or White; 3 1/2" long or 2 1/4" long

FG1000B	Black; 1000 /case; 2/3 lbs.	\$31.88
FG1000W	White; 1000 /case; 2/3 lbs.	\$31.88
FGSL1000B	Black; 1000 /case; 2/3 lbs.	\$55.47
FGSL1000W	White; 1000 /case; 2/3 lbs.	\$55.47



Round Rubber Gripper

Available in Natural or Black; gripper stretches over end of most hanger styles and stays put without adhesive; 1" diameter

NSROUND	Natural; 100 /case; 1/2 lb.	\$15.29
BNSROUND	Black; 100 /case; 1/2 lb.	\$15.29



Hanger Grips - Straight w/ Fins

Non-Slip Long Adhesive Grips; these flexible rubber grips are feathered with adhesive backing.; 4" long x 3/8" wide

NSLONG	Natural; 1000 /case; 4 lbs.	\$70.76
NSLONG100	Natural; 100 /case; 1/2 lbs.	\$9.72
BNSLONG	Black; 1000 /case; 4 lbs.	\$70.76
BNSLONG100	Black; 100 /case; 1/2 lbs.	\$9.72

Specialty Items HANGING SOLUTIONS

style #	\$	qty	description	size	wgt
SMALL PACK					
SHKLG	9.72	12 pcs.	Zinc	7"	2
SHKLGRS	13.87		Gunmetal		
SHKLGBC	13.87		Satin Chrome		
SHKLGW	9.72		White		
SHKLG B	9.72		Black		
<i>* Also sold individually</i>					
LARGE PACK					
SHKSM	26.44	50 pcs.	Zinc	4"	3/4
SHKSMRS	31.23		Gunmetal		
SHKSMBC	31.23		Satin Chrome		
SHKSMW	26.44		White		
SHKSM B	26.44		Black		
<i>* Also sold in packs of 12</i>					
SH1	17.99	500	Black	3 1/2"	2
SH1-100	5.99	100		3 1/2"	1/2
SH2	17.44	500	Black	3 7/8"	3
SH2-100	5.99	100		3 7/8"	1/2
25430005	31.88	50	Black w/black hook	11 1/2"	5/9
305078048	23.46	100	Black	7"	2/3
DH	13.99	1000	Black	1 3/4"	2/3
DH500	9.49	500	Black		1/3
DH-WH	14.99	1000	White		2/3
DHWH500	9.49	500	White	1/3	
TC	24.36	500	Black	2 7/8"	6
TC100	6.35	100			2/3
2MINI	49.99	100	Gunmetal with Black coating; hook measures 1 1/4" in dia.	4 3/4" W x 3 3/4" H	6
7MINI	78.41	100		8" W X 4 1/4" H	8
6C1	24.36	500	Black	2 3/4" h, 1" dia. ring	3
6C1-100	9.72	100			1
CIR1M	40.31	1000	Clear	1 1/4" inside dia.	5/6
CIR	22.94	500			3
CIR100	8.04	100			1/2
CIR3100	19.44	100	Clear	2 1/2" inside dia.	4
NHMSH25	20.87	25	Flocked Chrome	3 3/4"H x 3"W 1/4" thick	4
DISPLAYRING	49.25	100	Chrome	2 1/4" dia.	3
061204-01	16.72	100	Natural	6 3/8"H x 4 1/8" dia.	3/7
06120401B	16.72		Black		
1227-04	13.87		Black	3 1/8"H x 3 5/8"W	2/6
1227-05	11.15		Black	3 1/2"H x 1 5/8"W	2
1227-07	8.42		Black	2 3/4"H x 1 3/4" dia.	1/2
BC	41.60	500	Black	open	4
BC100	11.02	100		5"	1
MINI6	72.19	100	Natural with chrome hardware	6"	5
MINI8	90.85			8"	10
MINI6RC	113.79	100	Can be imprinted for an additional charge	6"	9
MINI8RC	123.51			8"	14

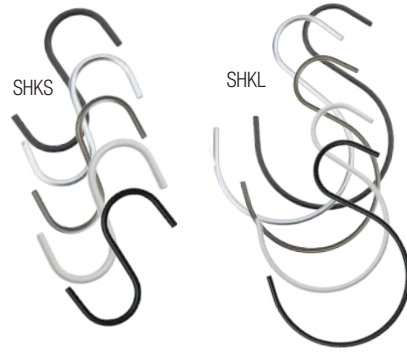

JEAN HOOKS



SOCK HANGERS

LEGGINGS/SCARF HANGERS



Display-It Hook
You'll find hundreds of uses for this inexpensive display method



Tie / Leggings Hanger

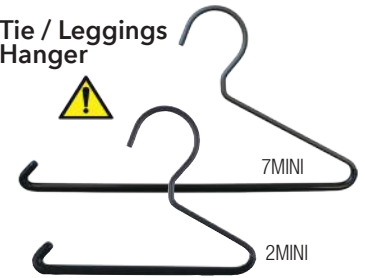

Scarf Hanger



Scarf Rings

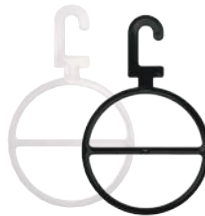

DISPLAYRING

061204-01 06120401B



1227-04



1227-05



1227-07



BELT HANGER

MINI WOODEN HANGERS



HANGING SOLUTIONS Clips

HANG-ALL CLIPS



style #	\$	qty	description	size	wgt
610ECS	83.20		Brushed Chrome		6/7
610EC	54.17		Brushed chrome		6/7
610	32.90	100	Chrome	4 1/2"	6/7
610B	32.90		Black		6/7
610W	32.90		White		6/7
610BBH	37.45		Black w/black hook		6/7
S610	72.84		Brushed chrome		7
610PB	24.36	100	Black	3 1/4"	2/6
HC101	28.51	100	Black	2"	3
HC100	28.51	100	White	2"	3

CLOTHING CLIPS



Hercules Clip

HC101/
HC100



FITTING CLIP



FITTING CLIP BC



GIANT FITTING CLIP

FITTING CLIPS	28.51	100	White	2"	3
FITTING CLIPS 12	8.29	12	White	2"	1
FITTING CLIP BC	71.41	100	Brushed chrome	2 3/8"	4
FITTING CLIP BC-12	10.50	12	Brushed chrome	2 3/8"	1
GIANT FITTING CLIP	34.73	50	White	4"	3

Clever Clips



CC2W



CC2B



CC2C

Ring Clips



RCW

RCB

CC2W	17.90	100	White	2"	1/3
CC2B	17.90	100	Black	2"	1/3
CC2C	21.51	100	Clear	2"	1/3
RCW	59.62	500	White		4/6
RCW100	21.51	100	White	2"	1/2
RCB	34.73	500	Black		4/7
RCB100	8.42	100	Black		1/3

PANTS CLIPS



PC



PCB /
PCB100



PCW /
PCW100

PC	41.47	500	Natural	1 1/2"	3
PC100	13.74	100	Natural	1 1/2"	1/3
PCB	38.75	500	Black - Pant Strut Clip	13/8"Lx3/8"W	2/2
PCB100	12.44	100			2/2
PCW	22.29	500	White - Pant Strut Clip	13/8"Lx3/8"W	2/2
PCW100	7.00	100			2/2

SHIRT CLIPS

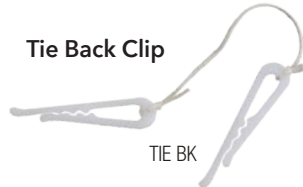

Tie Back Clip

TIE BK

Long Clips



LONG



LONGWHITE

TIE BK	7.00	100	White	1 1/2"/ 2 1/4" elast.	1
LONG	5.57	500	Clear	1 1/2"	1/3
LONGWHITE	8.42	500	White	1 7/16"	2/2
LONGWHITE100	4.15	100	White	1 7/16"	2/2
LJC200	4.15	200	Clear	2"	1/1

Alligator Shirt Clip



LJC200

Triangle Shirt Clip



SHCLIP /
SHCLIP100

SHCLIP	13.22	500	White - Triangle Shape Shirt Clip	1 1/4"L x 5/8"W x 1/4"H	2/2
SHCLIP100	4.92	100			2/2



CLIP100

Tubular Hanger Clip

2 1/4" thick, clip snaps on to any of our tubular hangers; white; 100 pcs/carton:

CLIP100 3 lbs.; **\$24.36**

For tubular hangers, see p. 121

Space Saving Back Room Hooks

Heavy duty black, plastic hook with attached nylon loop strap for hanger management; black;

100 pcs/carton:

GHB100 7"L; 8 lbs.; **\$59.62**

GHB200 5 1/2"L; 7 lbs.; **\$59.62**

12 pcs/carton:

GHB10012 7"L; 1 lb.; **\$11.65**



GHB100

GHB200

BACK ROOM HOOK



SNB

Snap Hanger

Measures 2 1/2"W x 2 1/2"H (when snapped shut); black:

SNB 500 pcs; 5/8 lbs.; **\$61.82**

SNB-100 100 pcs; 2/3 lb.; **\$15.29**

PRESSURE SENSITIVE PACKAGE HANGERS



PS1



PS2



NHH3



NHH1C



NHH4C

Hang Tabs - Hook Style

1 5/8"H x 1"W pre-cut hang tabs with adhesive strip; clear:

PS1 500 pcs; 1 lb; **\$34.73**

PS1100 100 pcs; 1 lb; **\$13.87**

Economy Hang Tabs - Round Style

13/16" x 1 1/2" economy round hole hang tab with adhesive strip; clear:

NHH3 500 pcs; 1 lb;

\$15.29

Economy Hang Tabs - Hook Style

1 1/2" x 1 11/16" economy hook hang tab with adhesive strip; clear:

NHH1C 500 pcs; 1 lb; **\$24.36**

Economy Hang Tabs - Delta Hole Style

1 7/16"H x 1 5/8"W delta hole hang tab, wide with adhesive strip; clear:

NHH4C 500 pcs; 1 lb; **\$22.29**

Hang Tabs - Wide, Delta Hole Style

The delta hole fits almost any style hook; plastic material with a clear adhesive backing; .015" thick; tab measures 1 5/8"W x 1 1/4"H; clear:

PS2 500 pcs; 1 lb; **\$26.44**

PS2100 100 pcs; 1 lb; **\$9.59**

Clip Hanger

Multi-purpose clip for hanging merchandise; 2 1/2" long; black:

CHB 500 pcs; 5/8 lbs; **\$99.79**

CHB-100 100 pcs; 2/3 lb; **\$27.35**



OPEN

CHB



CLOSED

HANGER CONNECTORS



PB / BPB



PB10 / BPB-10

Piggy Back Connectors

Plastic connector strips; natural & black; 10" (4 slots) & 2 1/2" (1 slot) lengths; 100 & 500 piece quantities;

Natural; 2 1/2":

PB 500 pcs; 2 lbs.; **\$34.73**

PB100 100 pcs; 1 lb.; **\$9.72**

Natural; 10":

PB10 500 pcs; 5/8 lbs; **\$99.79**

PB10-100 100 pcs; 2 lbs; **\$27.35**

Black; 10":

BPB-10 500 pcs; 5/8 lbs; **\$99.79**

BPB10-100 100 pcs; 2 lbs; **\$27.35**

PB8 BPB8



BPB1606

PB16 BPB16



Coordinate Strips

Display hanger strips; 50 pieces;

With 5 slots; 7 1/4"L x 1"W:

PB8 Clear; 1 lb.; **\$12.57**

BPB8 Black; 1 lb; **\$12.57**

With 11 slots; 15 3/4"L x 1"W:

PB16 Clear; 2 lbs.; **\$27.09**

BPB16 Black; 2 lbs; **\$19.90**

BPB1606 Black heavy weight; 2 lbs.; **\$22.29**



NHHIPB



HC001

Clear, flexible connectors; 2 5/8" L x 1 5/8" W; 1000 pieces; 3 lbs; **NHHIPB \$61.04**



NHHIPB



HC001B

Plastic connectors; 1 3/4"; 1000 pieces; 3/4 lbs; **HC001** Natural **\$41.60** **HC001B** Black **\$34.73**

BACKROOM Reachers, Boxes & Bins

REACHING HOOKS

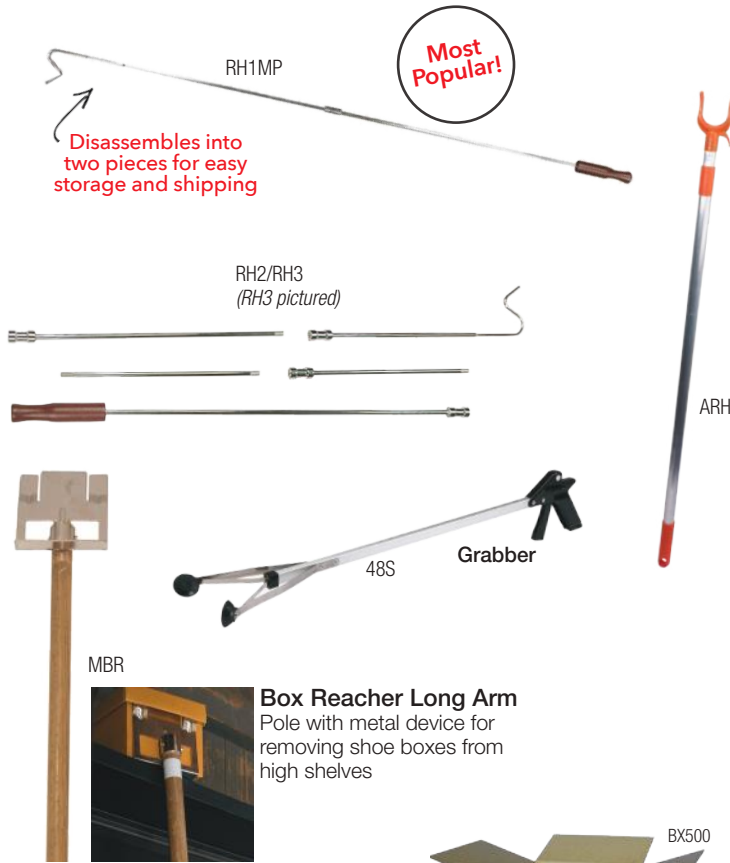

Box Reacher Long Arm
Pole with metal device for removing shoe boxes from high shelves

STORAGE BOXES & BINS

Cardboard Hampers
Hold 50 hangers each



CHH-2/CHH-3



CHH-2/CHH-3 WHITE



Hanger Hamper
Reinforced corners



H H



Black Box Hanger Storage
With reinforced corners and velcro closure. Boxes are foldable and stackable. Each box holds up to 100 hangers.



BB100



NHMB01



NHMB02

Hanger Bins

style #	\$	qty	description	size	wgt
RH1MP	11.90	1	Chrome w/ wood handle 2 pieces, easy assembly	54" L	2/4
RH2	15.49	1	Chrome w/ wood handle 4 pieces, assembly required	70" L	2/3
RH3	18.49	1	Chrome w/ wood handle 5 pieces, assembly required	84" L	2/3
ARH	13.87	1	Aluminum w/ plastic tip -adjustable-	24" - 60" L	1/4
48S	38.75	1	Chrome	47 1/2" L	2/16
MBR	37.45	1	Wood w/ metal end	60" L	3/7
BX500	40.31	25	Cardboard	14x14x17	39/49
CHH-2	62.34	12	Cardboard holds 17" dress hangers	17 1/2 x 5 1/2 x 23	18/21
CHH-3	59.62	12	Cardboard holds 14" skirt/slack hangers	14 1/2 x 3 x 23	14/16
CHH-2 WHITE	68.30	12	White cardboard holds 17" dress hangers	17 1/2 x 5 1/2 x 23	18/21
CHH-3 WHITE	68.30	12	White cardboard holds 14" skirt/slack hangers	14 1/2 x 3 x 23	14/16
H H	83.20	1	Black break resistant plastic	17 1/2 x 6 1/2 x 23	8/22
BB100	69.34	1	Black corrugated plastic w/ removable divider	Assembled: 22 x 21 1/2 x 13 Collapsed: 22 x 21 1/2 x 3	7/23
NHMB01	115.08	1	Large Black Hanger Bin with casters	22" w x 21" d x 23" h (front) / 29" h (back)	13/76
NHMB02	115.08	1	Small Black Hanger Bin with casters Both bins have 2" swivel casters	25 1/2" w x 23" d x 12 1/2" h (front) / 19 1/2" h (back)	9/79

Hanger Racks & Stackers BACKROOM

style # \$ qty description size wgt

MOBILE COLLECTION RACK 24" SYSTEM

(takes IHB2400 bars - see below)

8 bar capacity					
CFR6024M4	287.06	1	bars sold separately	20d x	27/48
CFR6024M4WB	429.88		includes 8 (24") bars	26 3/8w x 66 3/8 h	34/48
6 bar capacity					
CFR5024M4	241.32	1	bars sold separately	18d x	20/42
CFR5024M4WB	352.25		includes 6 (24") bars	26 1/4w x 55 h	25/42

IN STORE TRANSFER RACKS - 21", 24" & 30" SIZES

(bars not included)

ISTR21Z	432.30	1	21" rack /uses IHB2100	20w x 22 3/8 x77h	27
ISTR24Z	447.30	1	24" rack /uses IHB2400	20w x 26 x77h	33
ISTR30Z	475.60	1	30" rack /uses IHB3000	20w x 31 1/4 x77h	37

(Each rack holds 18 hang bars - bars sold separately)

COORDINATING HANGER BARS WITH CLAMPS - 3 SIZES

IHB2100	22.29	1	use with ISTR21Z	21" long	4
IHB2400	22.94	1	use with ISTR24Z & CFR mobile rack system	24" long	1/3
IHB3000	25.01	1	use with ISTR30Z	30" long	6

(24" long hang bar holds approximately 55 hangers)

NH6CR	158.99	1	Metal 6 Bar Rack w/ casters; rack is not adjustable	22 1/2" w x 18" d x 51 1/4" h Bars evenly spaced at 8" apart	19
101	16.90	1	Chrome	33" H; base - 19 1/4" x 7 1/2"	5
101N-WD 101W-WD 101B-WD 101M-WD	34.08	1	Natural White Black Mahogany	33 1/2" high, 19 1/4" x 7 1/8" base	5
S21	77.76	1	Chrome	21" H skirt	5/18
S29	79.06	1	Chrome	29" H skirt	5/23
D21	77.76	1	Chrome	21" H dress	5/18
D29	81.91	1	Chrome	29" H dress	5/23
HCUCRS	122.08	1	Chrome Hanger Caddy Under Cabinet Sliding Rack (frame only)	Fits into 26"H x 20"W x 26" D space	11
<i>Use with S21 & D21 Caddies (sold separately)</i>					
HCSR	143.60	1	Black	Adjusts to hold 21" or 29" hanger caddies	13/25
<i>Use with S21 & D21 Caddies (sold separately)</i>					

HANGER COLLECTION RACKS

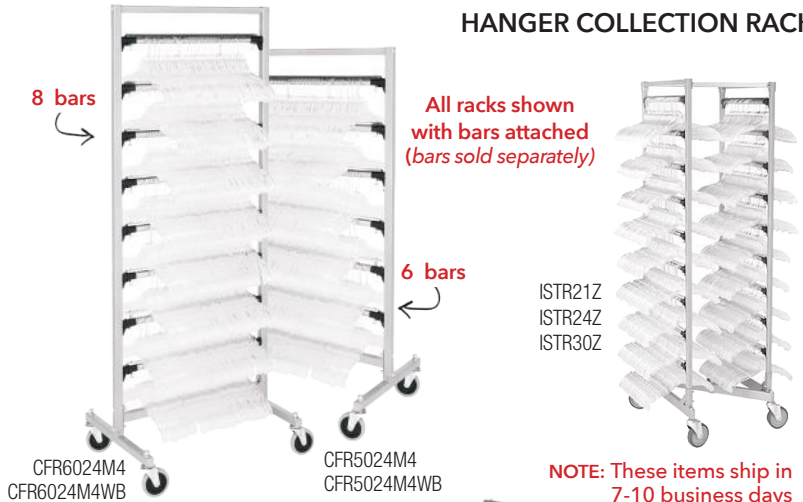

NOTE: These items ship in 7-10 business days

IHB2100 / IHB2400 / IHB3000



NH6CR



101W-WD

101B-WD

101M-WD

101N-WD



Chrome Hanger Stacker
Holds 100 hangers of average size.

101

Most Popular!

HANGER STACKERS

Deluxe Wood Hanger Stacker
Accommodates most of our wood styles.

HANGER CADDIES



- sort /organize hangers by style
- eliminates tangling /breakage
- available in two sizes
- 21" holds approx. 40 hangers
- 29" holds approx. 55 hangers

HCUCRS

Under Cabinet Sliding Rack (frame only)

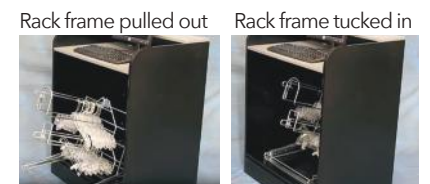

Rack frame pulled out

Rack frame tucked in

Hanger Caddy Spinner



HCSR

BACKROOM Workstations & Folding

MOBILE WORKSTATIONS



style #	\$	qty	description	size	wgt
NH701KD	137.99	1	Small Workstation w/ adjustable 2-3 bin configuration & bottom storage shelf	20" w x 15" d x 36-39" h	52/82
NH702KD	335.99	1	Medium Workstation w/ adjustable 2-3 bin configuration; bottom storage shelf; 2 drop leaves	22" w x 20" d x 39" h; 4 casters (2 locking); expands to 35" x 20" & 48" x 20"	70
NH703KD	426.99	1	Large Workstation w/ adjustable 4-3-2 bin configuration; bottom storage shelf; 2 drop leaves	32" w x 20" d x 39" h; 4 casters (2 locking); expands to 45" x 20" & 58" x 20"	94
			<i>All units: 4" casters w/ locking brakes</i>		
VTL2046	290.56	1	Steel tube folding table w/grey powdercoat finish and laminated work surface. With folding leaves and 2 shelves.	20" w x 18" d x 34 3/4" h without leaves Leaves are 20" x 14" each	7/23
			<i>*Note that this item ships in 7-10 business days</i>		
RUB452500	295.99	1	Grey with 5" non-marking casters	26" W x 40" L x 33" H	49/75

Flat top shelf and lower tray with 3"H sides. Ergonomically designed push handle allows for easy steering. Cart rolls on 2 swivel and 2 rigid casters. Assembles easily.

MOBILE FOLD SYSTEM

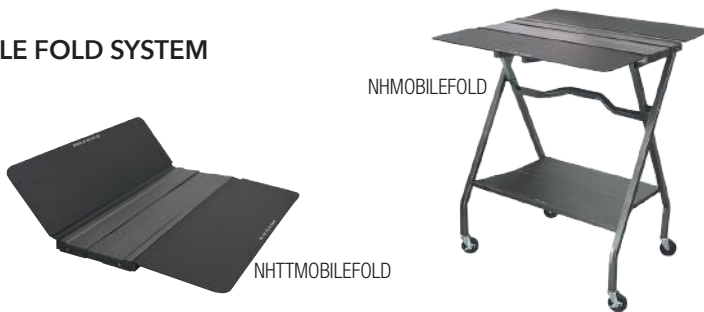

NHMOBILEFOLD	374.99	1	Mobile Fold Station w/ casters	31"L x 12-33"W x 36" h base; center panel adjusts 7-13"; base 21" w	50
NHTTMOBILEFOLD	179.99	1	Table Top Mobile Fold	Portable folding device adjusts to fold 7-13" widths	11

SHIRT FOLDING BOARDS

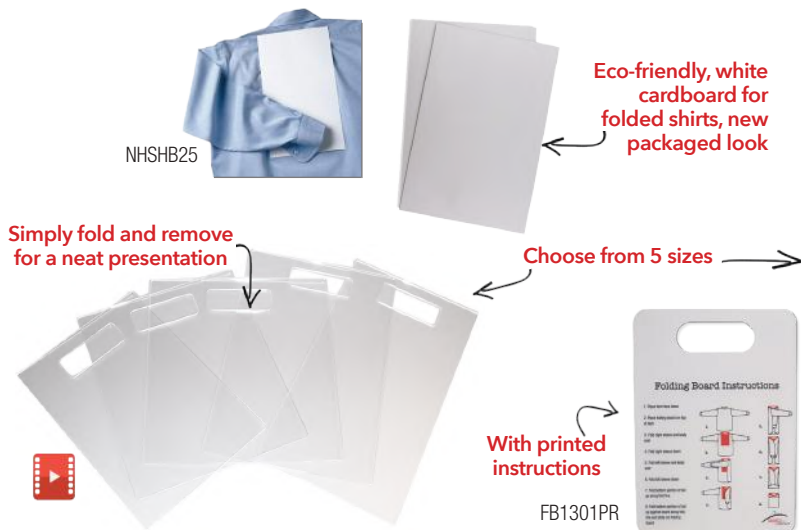

NHSHB25	36.16	1 25LB pack/ 375 pieces	24-point shirt boards; bio-degradable cardboard	8" x 12"	25
FB1301	8.04		1/8" Clear Acrylic	8 1/2" x 12"	1/2
1301SF	9.72			8 1/2" x 15"	
FB1302	9.72	1		10" x 12"	
FB1303	10.50			11" x 12"	
FB1304	10.50			9 1/2" x 14"	
FB1301PR	11.02	1	Acrylic Board with printed folding instructions	8 1/2" x 12"	2

Tagging Accessories PRICING SUPPLIES

style # \$ qty description size wgt

National Standard

J11SKIT	19.99	1	J11S tool, needles & fasteners KIT	KIT	2/6
J11S	7.90	1	National Standard RED Tagging Tool	Standard	1/3
Standard Replacement Needles					
300R	8.29	4 pack	Plastic w/steel needles	Standard	1
Standard Fasteners - Natural					
F1/2	4.15	5000	Natural	1/2"	1/3
F1		5000	Natural	1"	1/3
F2		5000	Natural	2"	1/3
F3		5000	Natural	3"	1/3
F5		5000	Natural	5"	1/3
Standard Fasteners - Colors					
F1-COLORS	11.02	5000	Specify	1"	1/3
F3-COLORS	11.02	5000	Specify	3"	1/3
954718	11.02	5000	Black	1/2"	1/3
C-Hook (Tacking Hook)					
TH	15.29	5000	Natural	1 7/8"	2/7

National Fine

J11F	13.87	1	National Fine RED Tagging Tool	Fine	1/3
Fine Fabric Replacement Needles					
400F	10.90	4 pack	Plastic w/steel needles	Fine	1
Fine Fabric Fasteners - Natural					
FF1	5.57	5000	Natural	1"	1/3
FF2	5.57	5000	Natural	2"	1/3

Dennison Standard

MTGS	27.90	1	TEAL Tagging Tool	Standard	1/3
STGS	33.90	1	BEIGE Tagging Tool	Standard	1/3
760111801	3.87	1	Needle Locks: For MTGS For STGS	Standard	1/3
760034907	3.87	1		Standard	1/3
08941	16.90	4 pack	Replacement needles	Standard	1
06214	9.90	5000	Natural	1"	2/7
06215	9.90	5000	Natural	3"	2/7

National Standard Tagging Tool

NAHANCO tagging tools - Best Value!

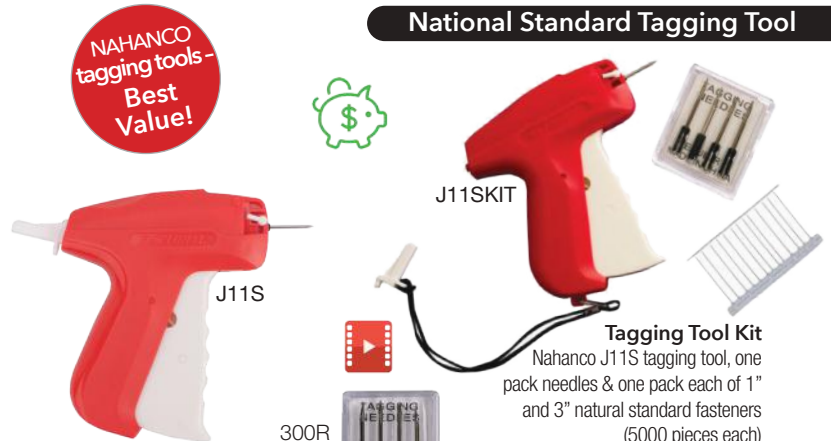

J11S

J11SKIT

Tagging Tool Kit
Nahanco J11S tagging tool, one pack needles & one pack each of 1" and 3" natural standard fasteners (5000 pieces each)

Standard Replacement Needles



300R

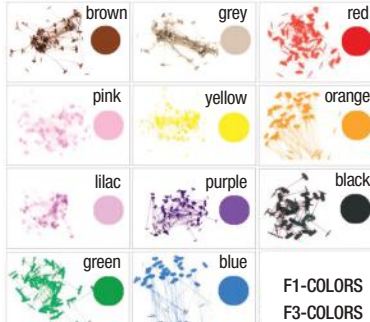

National Standard Tagging Fasteners (F - Natural)

C-Hook Fasteners
Pair and tag with one hook. For use in standard guns.

TH

National Fine Tagging Tool



J11F

Fine Replacement Needles



400F

National Fine Tagging Fasteners
FF1 (1") / FF2 (2")

Dennison Standard Tagging Tool



MTGS

Dennison Needle Locks
760111801 / 760034907



STGS

Dennison Scissor Grip Standard Tagging Tool



08941

Dennison Standard Tagging Fasteners
06214 (1") / 06215 (3")

PRICING SUPPLIES Tagging Accessories

Dennison Mark III® Fine Tagging Tool



MTGF



STGF

Dennison Scissor Grip Fine Tagging Gun

760111801 / 760034907



Dennison Needle Locks



08944

Dennison Fine Replacement Needles



Dennison Fine Tagging Fasteners
08938/08939

style #	\$	qty	description	size	wgt
Dennison Fine					
MTGF	31.90	1	ORANGE Tagging Tool	Fine	1/3
STGF	35.90	1	BLUE Tagging Tool	Fine	1/3
760111801	3.87	1	Needle Locks: For MTGF	Fine	1/3
760034907	3.87	1		Fine	1/3
08944	16.72	4 pack	Replacement needles	Fine	1
08938	14.90	5000	Natural	3/4"	1/3
08939	14.90	5000	Natural	2"	1/3

Dennison System 1000 Tagging Tool



SYS1000

Dennison SYS1000 Needle Locks



760796901



08941

Dennison Standard Replacement Needles



System 1000 Fasteners
(08284/5)

Dennison System 1000					
SYS1000	49.90	1	PURPLE Tagging Tool	Standard	2/7
760796901	2.58	1	Needle Locks: For SYS1000	Standard	1/3
08941	18.10	4 pack	Replacement needles	Standard	1
08284	17.90	5000	Natural	1"	1/2
08285	17.90	5000	Natural	2 1/2"	2/10
DH	13.99	1000	Black	1 3/4"	2/3
DH500	9.49	500	Black		1/3
DH-WH	14.99	1000	White		2/3
DHWH500	9.49	500	White		1/3
SC3	15.90	5000	Natural	3"	1/3
SC5	15.90	5000	Natural	5"	1/3
SC9	17.90	5000	Natural	9"	1/3

NAHANCO fasteners - Best Value!



SC

NAHANCO Super Circles Fasteners - 3", 5", 9" (SC)

Display-It Hook (DH)

You'll find hundreds of uses for this inexpensive display method



Dennison Secure-a-Tach - 5" (08300/2)



Dennison Secure-a-Tie - 5" (08350)
Economy Secure-a-Tie - 5" (08350M)



Dennison Barlock Ladder Ties
(08470, 08471)

08401



08302	34.90	5000	Natural	3"	1/3
08300	29.90	5000	Natural	5"	1/3
08350	69.21	5000	Natural	5"	2/3
08350M	41.47	5000	Natural	5"	2/3
08470	39.90	1000	Natural	7"	2/7
08471	44.90	1000	Natural	11"	2/7
08401	55.90	1000	Black (solid barlock)	8"	2/7

style # \$ qty description size wgt

Monarch Marking Tools

1110-2	91.63	1	Pricing Tool Single Line		2/7
REB111	22.29	17M	Labels: White	3/8x3/4"	
REB135	24.90	17M	Red/Yellow	3/8x3/4"	2/3
REB112	17.90	17M	Red	3/8x3/4"	
3003	6.99	1	Ink roller replacement		2/3
1130	74.26	1	Pricing Tool, Compact Size Single line		1/3
F0122	27.73	25M	Labels: White	.62x.44"	
F0132	34.73	25M	Red	.62x.44"	2/3
F0151	48.60	25M	Green	.62x.44"	
1130-IR	8.42	1	Ink roller replacement		1
3002	12.57	1	SILICONE	1/2 oz.	1
3104-1	2.85	1	PLASTIC	5"	1
1115-4	139.90	1	Pricing Tool Double Line		2/7
FM312	26.44	15M	Labels: White	5/8x3/4"	2/3
3004	6.99	1	Ink roller replacement		1

Monarch Marking Tools



Monarch 1110-2
Prints 1 line, 6 characters



1130 Tools
Prints 1 line, 6 characters



Ink Roller 3003



REB111



REB135



REB112



Ink Roller 1130-IR



Silicone Lubricant 3002



Plastic Label Peeler 3104-1



Labels

white - F0122

red - F0132

green - F0151



Monarch 1115-4
Prints 2 lines, 8 characters



FM312



Ink Roller 3004

Dennison Marking Tools

09225	49.90	1	Pricing Tool Single line		2/7
09140	39.90	15M	Labels: White	1/2x7/8"	
09141	39.90	15M	Red	1/2x7/8"	1/3
09142	39.90	15M	Red/Yellow	1/2x7/8"	
H89891	13.87	5 Pack	Ink rolls - black		1/2
06220	89.90	1	Pricing Tool Double line		2/7
06298	59.90	12.5M	Labels: White	5/8x7/8"	
06302	59.90	12.5M	Red	5/8x7/8"	2/3
H89892	13.87	5 Pack	Ink rolls - black		1/2

Dennison Marking Tools



Dennison 09225 The Mighty One™
Prints 1 line, 8 characters



Ink Roller H89891



09140



09141



09142



Dennison 06220 Model 210 Hand Labeler
Prints 2 lines, 10 characters

Ink Roller H89892

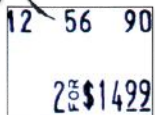

06298



06302



PRICING SUPPLIES Tags & Labels



T1

1 3/8" x 2 3/4"

Coupon Tags Horizontal

T1 /T2 /T3 available in:

- | | |
|---------------|------------------|
| (1) white | (12) lavender |
| (3) grey | (13) buff |
| (4) dark blue | (14) orange |
| (5) pink | (15) light green |
| (9) yellow | (16) dark green |
| (10) red | (19) light blue |

Coupon Tags Vertical



T4 / T5



T2 / T3

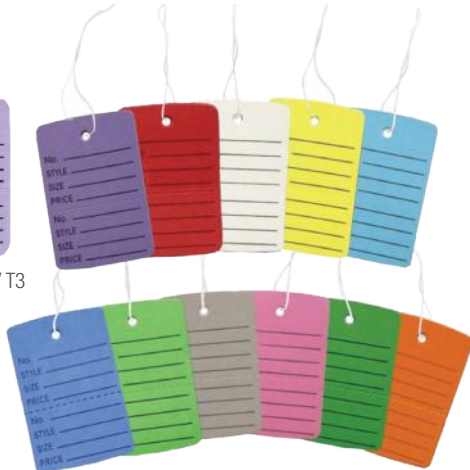

Clearance Tags



641

510



328C



316C

Sale Tags

Special Tags



200

380

320



348



346

Discount Tags

style #	\$	qty	description	size	wgt
Unstrung T1	11.49	1000	Specify	1 3/8x2 3/4"	2
T1-12,13,19	11.49				
Strung T1S	24.36	1000	Specify	1 3/8x2 3/4"	2
Unstrung T2-1	11.49	1000			
T2-3,4,5,9,10,12,14-16	11.49		Specify	1 3/4x2 7/8"	2
T2-13	11.49	1000			
T2-19	11.49				
T3-3	8.99	1000			
T3-1,4,5,9,12,13-15	8.99		Specify	1 1/4x1 7/8"	2
T3-16	8.99	1000			
T3-10,19	8.99				
Strung T2S-5,9	24.49	1000	Specify	1 3/4x2 7/8"	2
T2S-1,3,4,10,12-16,19					
T3S-5	21.51	1000	Specify	1 1/4x1 7/8"	2
T3S-1,19					
T3S-3,4,9,10,12-16					
Unstrung T4	11.49	1000	White	1 3/4x2 7/8"	2
T5	8.99			1 1/4x1 7/8"	2
Strung T4S	16.72	1000	White	1 3/4x2 7/8"	2
T5S	18.79			1 1/4x1 7/8"	2
Unstrung 641	26.44	1000	Red/white	1 7/8x3 1/2"	3
510	18.01			1 3/4x2 7/8"	2
Strung 641S	36.16	1000	Red/white	1 7/8x3 1/2"	3
510S	24.36			1 3/4x2 7/8"	3
Unstrung 328	17.90		Red/white	1 3/4x2 7/8"	2/3
328C	17.90	1000	Red/yellow	1 3/4x2 7/8"	2/3
316	12.57		Red/white	1 1/4x1 7/8"	1/3
316C	12.57		Red/yellow	1 1/4x1 7/8"	1/3
Strung 328S	18.90		Red/white	1 3/4x2 7/8"	3
328CS	18.90	1000	Red/yellow	1 3/4x2 7/8"	2
316S	18.90		Red/white	1 1/4x1 7/8"	2
316CS	18.90		Red/yellow	1 1/4x1 7/8"	2
Unstrung 200	18.01	1000	Red/white	1 3/4x2 7/8"	2
380			Red/yellow	1 3/4x2 7/8"	
320			Red/white	1 3/4x2 7/8"	
Strung 200S	24.36	1000	Red/white	1 3/4x2 7/8"	2
380S			Red/yellow	1 3/4x2 7/8"	
320S			Red/white	1 3/4x2 7/8"	
Unstrung 348	18.01	1000	Red/white	1 3/4x2 7/8"	2/3
346	13.87			1 1/4x1 7/8"	
Strung 348S	24.36	1000	Red/white	1 3/4x2 7/8"	2
346S	21.51			1 1/4x1 7/8"	1

Tags & Labels PRICING SUPPLIES

style #	\$	qty	description	size	wgt
HOLD	16.90		Blue/white	2 3/8x4 3/4"	
SOLD	16.90	1000	Red/white	2 5/8x4 1/4"	5
SALE	27.90		Red/yellow	2 3/8x4 3/4"	
85L	39.90		2 sided, manila Strung	3 1/2x8 1/2"	6
85A	22.94	500	Unstrung, Button hole	3 1/2x6 1/4"	
TL			1 sided, strung manila	3 1/8x6 1/4"	4
TA	35.38	500			
TR					
975				1"	
970	8.42	500	Red/white	1"	1
962				1x1 1/4"	
965				1x1 1/4"	
4473TAG	5.44	250	White	1 3/4x2 7/8"	1
Strung					
4S	18.01			1 x 1 1/2"	1/2
5S	17.37	1000	White	1 1/8x1 13/16"	1/2
6S	18.01			1 5/16x1 15/16"	2/3
7S	22.29			1 1/2x2 1/4"	2/3
8S	23.59			1 3/4x2 11/16"	2/3
Unstrung					
4NS	7.00			1 x 1 1/2"	1
5NS	8.42	1000	White	1 1/8x1 13/16"	1
6NS	8.42			1 5/16x1 15/16"	2/3
7NS	9.07			1 1/2x2 1/4"	2/3
8NS	12.57			1 3/4x2 11/16"	2/3
APT5NKFT	4.92	50	Kraft Shipping Tags, Unstrung: Large	2.375" x 4.75"	1/1
APT2NKFT	4.14	50	Small	1.625" x 3.25"	1/1
8SKFT	5.57	50	Kraft Merchandise Tags, Strung: Large	1.75" x 2.875"	1/1
6SKFT	4.92	50	Small	1.25" x 1.875"	1/1
Strung					
APT1	28.50	1000	Manila	2 3/4x1 3/8"	2
APT2	29.80	1000		3 1/4x1 5/8"	2
APT3	31.09	1000		3 3/4x1 7/8"	3
APT4	37.57	1000		4 1/2x2 1/8"	3
APT5	40.16	1000		4 3/4x2 3/8"	4
APT6	42.76	1000		5 1/4x2 5/8"	5/6
APT7	24.61	500		5 3/4x2 7/8"	3
APT8	27.20	500		6 1/4x3 1/8"	3
Unstrung					
APT1N	15.54	1000	Manila	2 3/4x1 3/8"	2
APT2N	19.43	1000		3 1/4x1 5/8"	3
APT3N	20.72	1000		3 3/4x1 7/8"	3/4
APT4N	22.02	1000		4 1/2x2 1/8"	4
APT5N	27.20	1000		4 3/4x2 3/8"	4/6
APT6N	29.80	1000		5 1/4x2 5/8"	6
APT8N	23.32	500		6 1/4x3 1/8"	3
PIN5	96.94		White	4 5/8x1 3/8"	2/10
PIN7	119.23	500		5 5/8x1 3/4"	



Slit Tags
Slip over
existing tag



Alteration, Layaway and Repair Tags



Deluxe Layaway Alteration



**4473TAG
Blank Tag**



Pressure Sensitive Labels



4S
5S
6S
7S
8S

Merchandise Tags (4S - 8NS)
Available strung or unstrung.



Kraft Tags
Shipping &
Merchandise tags



Manila All-Purpose Tags (APT)
Available strung or unstrung.

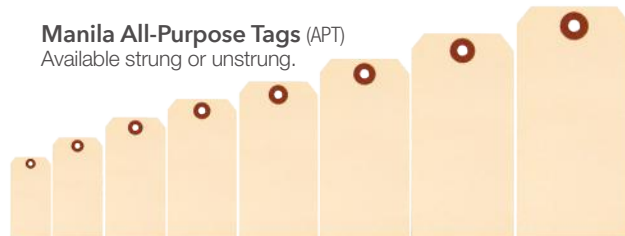

Folding Pin Tickets
With sharp point pins.

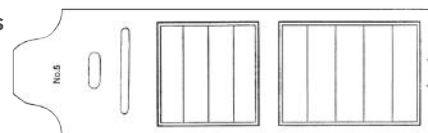

GARMENT BAGS

POLYBAG STANDS



Garment Bag Dispenser /Single Roll Polybags

Base made of 1" square tubing w/ ball bearing mounted platform for ease of turning



K31



3-Roll Bag Dispenser

Base made of 1" square tubing

K30



K32

Bagging Jack

For polybags; with heavy weight base



POLYBAGS



Garment Bags (Polybags) on a Roll

- 1/2 mil Medium Weight Clear Poly Bags (NTP, X)
- 1 mil Super Weight Clear Poly Bags (U)
- 1 mil Super Weight Poly Bags in White (W) or Black (B)



GARMENT BAGS

Transportation Garment Bags

Water-repellent cotton duck w/ full length heavy-duty zippers and 15" hanging bar (with accessory pocket)

Holds up to 25 garments



HL38L
HL48L
HL57L



40" Suit Cover

Polyethylene (taffeta finish), 3 gauge



UV340BB

UV340N

UV340H

style #	\$	qty	description	size	wgt
K30	116.49	1	Chrome Bagjack adjusts 39-68"H	18x31x74H	29
K31	83.49	1	Chrome Bagjack adjusts 39-68"H	13" x 18"	14
K32	83.46	1	Chrome Bagjack adjusts 39-68"H	Base: 12" dia.	14

Large Run Custom Poly Bags

Minimum 50 rolls (can mix sizes same color bag and print).

Customer must supply camera-ready artwork.

Black or white bags - stock ink colors include: red, blue, black, white, orange, yellow, green. One time plate charge of \$75.00

Call us for a low, low price quote!

NTP330		840	Clear	21x4x30"	
NTP338		663	1/2 mil	21x4x38"	
NTP340	55.47	562	opening at top of each bag	21x7x40"	25
NTP354		466		21x4x54"	
NTP372		350		21x4x72"	
X336	75.69	999	Clear	21x3x36"	33
X354	75.69	666	1/2 mil	21x3x54"	
X372	75.69	500		21x3x72"	
U336	75.69	519	Clear	21x3x36"	33
U354	75.69	333	1 mil	21x3x54"	
U372	75.69	249		21x3x72"	
W336	85.28	500	White	21x3x36"	33
W354	85.28	333	1 mil	21x3x54"	
W372	85.28	249		21x3x72"	
B336		500	Black	21x3x36"	33
B354	84.63	333	1 mil	21x3x54"	
B372		249		21x3x72"	
HL38L	78.90		Dark Blue	38"	
HL48L	78.90	1	Dark Blue	48"	3/33
HL57L	78.90		Dark Blue	57"	
UV340BB			Black poly		
UV340N	229.00	100	Brown poly	24 x 40"	29/33
UV340H			Green poly		



style #	\$	qty	description	size	wgt
ETB	368.19	50	Black vinyl luggage	24 x 40"	40
NW40BB	239.89	100	Black w/ID pocket	24 x 40"	22
NW48BBTUX	129.47	50		24 x 48"	24
NW54BB	156.69	50		24 x 54"	27
NW455B	231.60	50	Black w/handles and 4" gusset	24 x 45"	32

Customize "NW" styles with a a minimum order of 100 PIECES

S40	253.11	100	Clear	24 x 40"	34
	246.24		Color - specify		
S54	321.02	100	Clear	24 x 54"	36
	303.00		Color - specify		
	261.40		Brown, Dark Blue		

COLORS: black, red, brown, beige, silver, dark blue, white, grey, clear and burgundy (note: no red or grey for 54" bag)

N8X21	57.54	100	Clear /2 gauge	8 x 21"	6/10
N9X24	53.40		Clear /2 gauge	9 x 24"	
BB72	79.83	12	10" Gusset Imprint available CLEAR	24 x 72"	12
BB66	75.69		CLEAR	24 x 66"	11
BB60	70.11		CLEAR	24 x 60"	10
BB54	65.97		CLEAR	24 x 54"	10
BLK72	61.82	12	Black Vinyl	24" wide at top; 36" at bottom; 72" long	9/10
W72	61.82		White Vinyl		
PNK72	64.54		Pink Vinyl		

Customize "NW" styles with a a minimum order of 100 PIECES

NW7210	255.18	50	Non-woven white cloth 10" gusset	24 x 72"	35
NW72206	162.26	25	Large 7"-20" full side gusset	24 x 68"	25
WGS72	75.69	12	Full 10" Gusset White Vinyl	24 x 72"	11/12
C36	22.94		Clear Vinyl	24 x 36"	4/7
C54	28.51	12	Clear Vinyl	24 x 54"	6/8
C72	39.53		Clear Vinyl	24 x 72"	7/8

Luggage Weight Travel Bag
Taffeta finish with window/ card pocket.
6.8 gauge



ETB



Non-Woven Suit Covers
Cloth-type covers

NW40BB /
NW48BBTUX



NW455B

Non-Woven Fur Covers
Cloth-type covers



Zippered Suit Covers
3 gauge, taffeta finish
S40 / S54

Sewn Shoulder Covers



N9X24

N8X21

Crystal Clear Gusseted Vinyl Bridal Gown and Formal Covers

Reinforced hanger opening and full-length zipper. 4 gauge



Gusset detail



BB54
BB60
BB66
BB72



BLK72

W72

PNK72

Heavy-Duty Embossed Vinyl Bridal Gown Covers

Features a clear vinyl pouch. 3 gauge



White Non-Woven Bridal Cover

Cloth-type material
NW7210/206

Heavy-Duty Full Length Gown Covers

Clear vinyl pouch and reinforced hanger opening. 3 gauge



C54

WGS72

Overlap Clear Covers

Heavy binding, reinforced hanger opening and extra-wide overlap. 2 gauge

C36 / C54 / C72
Can not be imprinted

RACKS & MERCHANDISERS Collapsible Racks

COLLAPSIBLE ROLLING RACKS

Fold flat for easy transportation and storage



Both racks have:



12" extending sides



Clip for storage



Adjustable heights

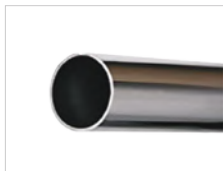

Heavy duty steel frame

RCS-1/RCS2 ACCESSORIES

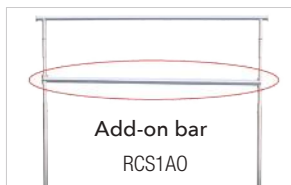

Add-on bar
RCS1A0

Shelf/Display Screen



RCA5

Garment Rack Cover
RCA100



Carrying Bag BRSWF

style #	\$	qty	description	wgt
RCS2	63.90	1	Heavy Gauge Chrome: Lightweight, foldable rolling rack with a weight capacity of 250 lbs. Features include: adjustable height risers - 66" - 71"; Center bar that extends 8" on either side; 4 casters	17
RCS-1	69.99	1	Chrome - 1" round tubing w/4" casters - 22 1/2" wide Adjustable height: 55" - 60" - 65"; 48" hangrail tubing w/12" pullouts; weight capacity of 200 lbs.	16/24



RCS-1 vs RCS2

Collapsible, Rolling Clothing Racks:
A side by side comparison

	RCS-1	RCS2
cost	\$69.99	\$63.90
weights	Actual 16lbs /shipping 24lbs	Actual 17lbs/shipping 17lbs
capacity	Holds up to 400 lbs	Holds up to 300 lbs
measurements	55" - 65"H 48"L x 22.5"W	65.5" - 70"H 48"L x 22.5"W
wheels	NO locking wheels	TWO locking wheels
compact	4.45"H collapsed	3"H collapsed

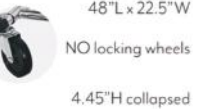

NO locking wheels
4.45"H collapsed



TWO locking wheels
3"H collapsed

RCS1A0	13.90	1	Add on hang bar to create a lower level for hanging (works with both RCS-1 & RCS2)	4/5
RCA5	54.04	1	Chrome: Opened, 45" x 38" /Folded, 45" x 19" Screen only, rack not included (for RCS-1 rack) Includes two connecting brackets, one stabilizing hook, and 3" wheels with 3/8" stems. Fold in half to serve as merchandise shelf.	13/19
BRSWF	63.89	1	Black heavy canvas carrying bag for collapsible rolling rack RCS1 (see RCS-1 pg 24)	4/12
RCA100	98.50	1	60"L x 50"H x 24"W Deluxe zipper garment rack cover. Navy blue nylon	3/10

Utility Racks RACKS & MERCHANDISERS

style #	\$	qty	description	wgt
RCS3	82.80	1	Chrome, 22" wide 1" round chrome tubing Double 48" hangrails with four 12" pull-out rods Height adjustable from 55 to 60 to 65" 4" ball bearing casters	40/45
EL8000	79.90	1	Classic Utility Rack w/ 5 shelves 38" L x 14"W x 60" H (61.5"H w/casters) Zinc-plated industrial-strength steel SHIPS TRUCK	29/29
EL8162	199.90	1	Chrome Utility Rack 6 Shelves 48"W x 18"D x 72"H 2 3/4" dia. casters	98
EL9000	209.90	1	Utility Rack with four casters; holds up to 2500 lbs (250 lbs per shelf); 36"Wx18"Dx72"H; Includes leveling feet and 3" rubber wheels; easy assemble - no tools required	49
K43	90.20	1	60" L, 1 1/4" hangrail Adjusts in height from 54 - 74"; 20" W; 3" casters	27
R504	98.90	1	70"H x 66"L 1 1/4" chrome tubing 4" ball bearing casters Ships Oversize UPS	34
R504AO	24.36	1	Add on hangbar for R504 to create a lower level for hanging	8/8

*The original garment center workhorse.
Base is all-welded construction with heavy steel angle iron.
Large 4" ball casters for easy mobility under heavy loads.*



Heavy Duty
Collapsible Rack



EL8162

Heavy Duty
Utility Rack



EL8000



Classic
Utility
Rack w/5
Wire
Shelves

EL9000

Heavy Duty
Mobile
Shelving Unit
/Utility Rack



K43

Stockroom
Rolling Rack



R504

Add-on
hangbar
R504AO



Heavy Duty Industrial
Rolling Rack

STANDARD Z RACKS

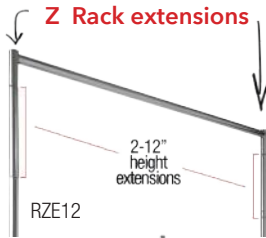

NESTING "Z" RACKS

HEAVY DUTY Z RACKS



Industrial "Z" Rack
Racks nest together to save space



"Z" Rack Cover

Z2464



Universal Rack Cover



style #	\$	qty	description	wgt
Z101	74.90	1	Chrome finish stockroom rolling "Z" clothes rack <ul style="list-style-type: none"> • 73" overall height, 60"L x 69"H x 21"W • Ideal for use in showrooms and warehouses • Will nest together for easy storage when not in use • Heavy Z base is one piece construction • The hangrail is made of 1-1/4" round tubing • Includes 4" industrial rubber casters 	33/70
RZE12	10.50	set of 2	2 - 12" height extensions for Z101	33/20
RZH60	28.51	1	60" add on hangrail for Z101	2
Z201	94.99	1	Chrome finish industrial rolling "Z" clothes rack <ul style="list-style-type: none"> • 63"L x 66"H x 22"W with a blue base • Heavy duty Z base is one piece construction • Will nest together for easy storage when not in use • Features 4" industrial casters • Hangrail made of 1 1/4" square tubing and is 58 1/2" in length • Ideal for showrooms and warehouses • Ships Oversized UPS 	34/39
Z2464	78.41	1 set	Clear Z-rack cover and 2 support bars set for Z101 & Z201; 63.5"W x 69.5"H x 22.5"D	4/4
NHRCPB100	82.99	100 pc/ctn	Rack cover: large, flat polly bag; 58"W x 100"L; 1 mil. thick	43
NHRCPB25	33.99	25 pc/ctn	Rack cover: large, flat polly bag; 58"W x 100"L; 1 mil. thick	10

Floor Racks RACKS & MERCHANDISERS

style #	\$	qty	description	wgt
K40	83.16	1	Chrome: 1" Square tubing 1 1/4" round hangrails 60"L x 22" W Height adjustable every 3" from 48-66"	38
K41	99.90	1	Same as K40 but with center V reinforcing	40

Both K40 and K41 pair with casters
WHEL (see details on page 31)



DOUBLE BAR RACKS

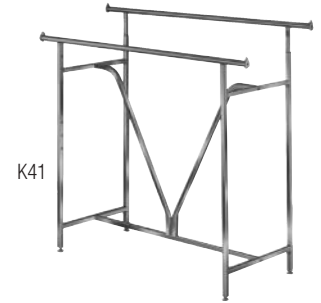

Rack Accessories (for racks K40 /K41)

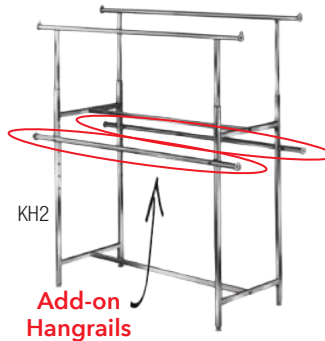

Add-on hangrail



2 per pack



Double-Bar Grid
Clothing Rack Topper 1000034

KH1	29.16	2	Chrome: 60" add-on hangrail for K40 or K41 racks allows you to create 15' of continuous hangrails using only 2 racks	8
KH2	35.38	2	60" add-on hangrail for K40 or K41 racks allows you to create upper and lower hanging	8

1000034	81.99	1	Chrome grid topper 23"x54"x3" <i>Ships oversize UPS</i>	14/32
---------	-------	---	---	-------

FOLDING LINGERIE DISPLAYERS



K35	129.90	1	Chrome: 1" Square tubing 16-twist on 12" tubular arms 61" H	34
K36	129.90	1	1" Square tubing 16-twist on 1/2"x7/8"x12" rectangular arms 61" H	35

K16	129.90	1	Chrome: 1" Square tubing 8- 18" slant arms Total of 40 hooks	33
-----	--------	---	---	----

K16 pairs with a variety of casters -
CTM65, CTM75, TW12 & TW12LK (details on page 31)

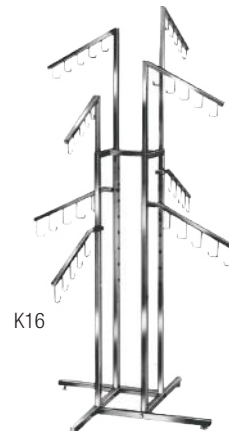

HANDBAG DISPLAYER

RACKS & MERCHANDISERS 4-Way Racks



K85
Chrome



B85
Black

4-WAY GARMENT RACKS with Rectangular Tubing



B86
Black

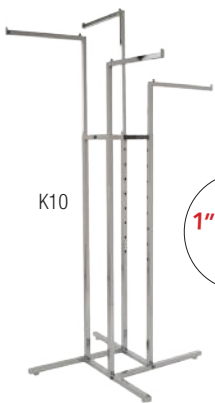

K10



K12

4-ARM SQUARE TUBING RACKS



K15

1" Square
tubing

HIGH CAPACITY FLOOR RACKS



K80
Chrome



B80
Black



K80SC
Satin
Chrome

REPLACEMENT ARM

ARM85

ADD-ON DISPLAY BARS

Twist on
Displays
for Vertical
1/2" x 1 1/2"
Rectangular
Tubing

RV16

RV22



style #	\$	qty	description	wgt
K85	118.32	1	Chrome 4- 16" Straight arms Rectangular Tubing	33/35
B85	118.32	1	Black 4- 16" Straight Arms Rectangular Tubing	36

Racks K85 & B85 pair with two caster styles -
CTM60 & CTM70 (details on page 31)



CTM60



CTM70

B86	118.32	1	Black, 2- 16" Straight arms 2- 18" Slant arms Rectangular Tubing	38
-----	--------	---	--	----

Rack B86 pairs with two caster styles -
CTM60 & CTM70 (details on page 31)



CTM60



CTM70

K10	72.90		1" square tubing 16" straight arm	30
K12	72.90	1	18" slant arm	
K15	72.90		Arms adjust every 3" from 48-72" H	

K10, K12 & K15 pair with casters from kit
TW10KIT516 (see details on page 31)



TW10KIT516

K80	145.02		Chrome, 4- 22" Straight arms Rectangular tubing	34
B80	121.05	1	Black 4- 22" Straight arms Rectangular tubing	36
K80SC	172.63		Satin Chrome 4-22" Straight arms Rectangular tubing	38

The above 3 racks pair with two caster styles -
CTM60 & CTM70 (details on page 31)



CTM60



CTM70

All of the above racks listed on this page
adjust in height every 3" from 48" to 72" high

ARM85	18.01	1	16" Chrome Straight arm for rectangular racks	6
RV16	6.99	1	For Rectangular tubing racks: 16" Chrome Rectangular tubing For vertical 1/2" x 1 1/2"	2/6
RV22	6.99		22" Chrome Rectangular tubing For vertical 1/2" x 1 1/2"	

Floor Racks **RACKS & MERCHANDISERS**

style #	\$	qty	description	wgt
K23	99.99	1	Chrome Rectangular tubing 2-16" straight arms Adjust every 3" from 48-72" H	32
K24	99.90		Chrome Rectangular Tubing 2-18" slant arms adjust every 3" from 48-72" H	34
K21X	106.27	1	Chrome / 2-16" straight arms with X style base and 4 casters; arms adjust every 3" from 48-72" H	27
B90	79.06	1	1/2" W x 1 1/2" H rectangular tubing arms: Straight arm is 16"	7/10
B91			Slant arm is 18" Both racks are independently adjustable every 3", from 52" to 73" H	7
K20	59.90	1	1" square tubing 16" straight arm	18,6,5/8 (3 ctns)
K22	59.90		18" slant arm Arms adjust every 3" from 48-72" H	23/33
K25	59.90	1	Chrome - 45" H x 19 1/2" W Square tubing upright w/2 round tubing arms with disc ends	18,6,6/8 (3 ctns)
K39	49.90			10/13
ARM13	7.39	1	16" Chrome straight arm for square tubing racks	6/8
TV17	7.00		For Square tubing racks: 17" Chrome Rectangular tubing - for vertical 1" tubing /add-on twist-on arms for square tubing racks	
TV12	5.57	1	12" Chrome Square tubing For vertical 1" tubing	1/6
TV16	6.35		16" Chrome Square tubing For vertical 1" tubing	



**CHROME 2-ARM
RECTANGULAR
TUBING RACKS**



**MATTE BLACK
ADJUSTABLE
2-ARM RACKS**

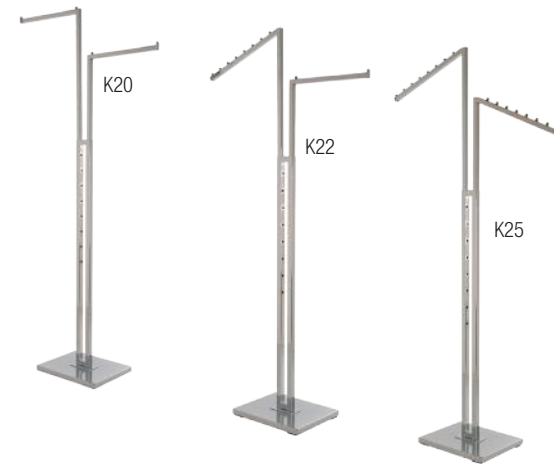

**CHROME
2-ARM SQUARE
TUBING RACKS**



Chrome Bag Rack



Replacement Arm

ARM13



ADD-ON DISPLAY BARS

Twist on
Displayers
for 1"
Square
Tubing

RACKS & MERCHANDISERS Round Racks



ROUND GARMENT RACKS



K53
Cannot be used with casters

ROUND RACK ACCESSORIES

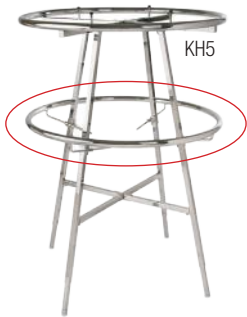

Chrome Grid (1000394)
attached to a K50 rack



GLASS OR MELAMINE ROUND TOPPERS



ROUND RACKS Welded Construction Can be used with casters

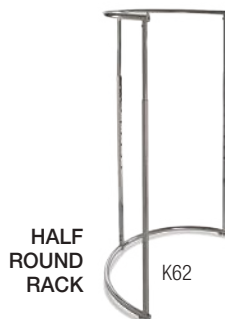

HALF ROUND RACK
K62

style #	\$	qty	description	wgt
K50	99.90	1	36" round chrome rack Ships oversized UPS	8/17 26 (2 ctns)
Works with casters from kit TW10KIT516 (see page 31 for details)				
Racks adjust every 3" from 48" to 66"; uprights are 1" square tubing; round 1 1/4" hangrail; includes shelf supports.				
K53	114.49	1	36" Chrome round revolving rack; Adjusts in height from 48-63"	34/90
KH5	43.68	1	36" add on hangrail for K50/K52WD Ships oversized UPS	8/17 26 (2 ctns)
KH7	27.09	4	Clamps to add a ring	4
1000394	75.49	1	30" Chrome grid topper	9/31
G30	99.90	2	2 pieces per carton 30" glass topper, 3/16" thick for use with 36" round racks	52
G36	50.49	1	1 piece per carton 36" glass topper, 1/4" thick for use with 42" round racks	30
G30/G36 ships UPS oversized - charges will apply				
RTW30 RTB	45.23	1	30" round white topper 30" round black topper for use with 36" round racks	14
SHP1	1.49	1/each	Topper support *4 needed for each rack	1
Racks with Welded Construction (allows for heavy loads)				
K52WD	149.90	1	36" round chrome rack Ships truck	TRUCK 35/90
Works with CTM60 & CTM70 caster styles - (details on page 31)				
K71WDSC	149.90	1	36" Satin chrome; adjusts from 48"-66" H Ships truck	TRUCK 39/90
K73WD	142.99	1	42" round chrome rack Ships truck	TRUCK 38/90
Works with TW10KIT casters - (details on page 31)				
K73WDSC	179.90	1	42" round satin chrome rack Ships truck	TRUCK 38/90
Works with CTM75 casters - (details on page 31)				
KR57MAB	181.90	1	42" Black - same as K73 Ships truck	TRUCK 48/90
Works with CTM75 casters - (details on page 31)				
Racks adjust from 48" to 70" H; uprights are 1" square tubing; square tubing legs taper at bottom to allow casters to fit snugly; hangrail is made of 1" x 1 1/2" rectangular tubing; includes shelf supports				
K62	126.96	1	43" half round rack; Adjusts in height every 3" from 49-73" / 1" sq. tubing / round hangrail	25/34

Accessories RACKS & MERCHANDISERS

style #	\$	qty	description	wgt
CTM60	9.72	1	2" ball caster, 1" stem	1/3
CTM65	9.07		2" ball caster, 5/8" stem	
CTM70	8.42		2 1/2" ball caster, 1" stem	
CTM75	10.50		2 1/2" ball caster, 5/8" stem	
TW12	5.44		2" twin wheel caster, 5/8" stem	
TW12LK	4.15	1 set	2" twin wheel caster, 5/8" stem w/ locking brake	2/2
TW10KIT	8.81		set of (4) 2" wheels, 3/8" stem; (2) w/locking brakes; (2) w/out (works w/ racks K73WD, K87, B87)	
WHRCS	36.81		Replacement casters - 4" for RCS-1, RCS2, RCS3	
WHEL	37.32	4	Heavy duty replacement casters - 2 locking and 2 non-locking; 2 3/4" dia. K40 / K41	5
BBR2T	92.39	1	76" H x 5' L	26
BBR48	52.10		48" H x 5' L	14
BBR54	53.49		54" H x 5' L	16
			Black with chrome hangrails	
K56	99.90	1	60" H Chrome Upper ring 19" diameter w/ 20 - 3" hooks Lower ring 27" D w/ 28- 3" hooks 18" diameter base	11,17,15 (3 ctns)
K58	97.90		52" H Chrome 19" diameter ring w/ 20- 3" hooks 18" diameter base	23, 4/90 (2 ctns)
K29	73.49	1	Chrome Spiral Costumer Spiral w/ 29 balls - 65" H round tubing, 18 1/2" base	26
VM504BR	79.90	2	Notched Costumer Satin Chrome Adjusts every 3" from 49 - 78" high	11, 15 (2 ctns)
VM504MTW	79.90	2	Notched Costumer Matte White Adjusts every 3" from 49 - 78" high	11, 14 (2 ctns)
VM504MAB	79.90	2	Notched Costumer Matte Black Adjusts every 3" from 49 - 78" high	11, 15 (2 ctns)

REPLACEMENT WHEELS



BLACK BEAUTY RACKS

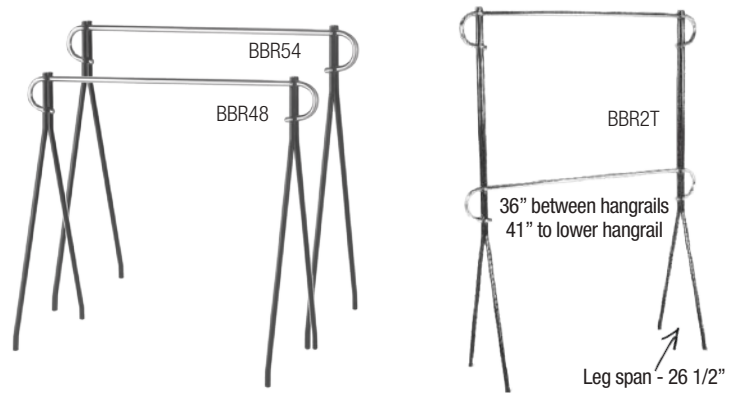

TIE & BELT DISPLAYERS



MANNEQUIN FORM NOTCHED COSTUMERS





Inspired by the Bauhaus arts and design movement, this contemporary collection of store fixtures evoke a sense of clean, sleek lines softened with round tubing arms. Use them as a group to delineate a specialty shop environment within your store.

bauhaus curve series hangrails

Satin Chrome. Uprights and bases constructed of 1" x 3" tubing. Height adjusts from 48" to 72" in 3" increments, Base: 30" x 24"



2-Way Merchandiser
Hangrail measures 48" wide; 1 1/4" diameter; 1 piece/case; 22 lbs
BA48CRVSC \$154.90



Single S-Bar Merchandiser
Hangrail measures 48" wide; 1 1/4" diameter; 1 piece/case; 30 lbs
BA45CURVSC \$182.90



Single C-Bar Merchandiser
Hangrail measures 48" wide; 1 1/4" diameter; 1 piece/case; 30 lbs
BA45HFRSC \$199.90



Adjustable 4-Way Merchandiser
Hangrail measures 20" wide; 1" diameter; 1 piece/case; 46 lbs
BA47CRVSC \$259.90

bauhaus collection in satin chrome



Adjustable 2-Way Rack
Adjusts 46" to 75" H; Arms are 16" L x 1" Dia. with puck ends; Upright is 1" x 3" tubing; Base is 12" x 18". Levelers included; 1 piece; 22 lbs
BA48SC \$129.90



Single Bar Merchandiser
Adjusts 48" to 72" H; Uprights are 1" x 3" tubing; Hangrail is 1 1/4" Dia. x 48" L with puck ends; Base is 24" x 24". Levelers included; 1 piece; 37 lbs
BA45SC \$169.90



Adjustable 4-Way Rack
Adjusts 46" to 75" H; Arms are 16" L x 1" Dia. with puck ends; Uprights are 1" x 3" tubing; Base is 24" x 24". Levelers included; 1 piece; 45 lbs
BA47SC \$219.90



Adjustable Costumer
74" H; Upright is 1" x 3" tubing with holes at 72", 60", 48" and 36" from floor. Includes two 6" x 1" diameter; faceouts with puck ends and levelers; 1 piece; 26 lbs
BA46SC \$169.90



Folding Easel
Frame holds 22" x 28" sign. Easel is 1/2" x 1 1/2" tubing. Overall height is 60"; Legs are each 18" wide. 1 piece/case; 31 lbs
BH80SC \$159.90

PIPELINE GARMENT RACKS

Racks have an anthracite grey or a gloss white finish, where noted. Each garment rack includes 3" casters, 2-locking & 2 non-locking.



Non-adjustable Ballet Bar Rack
64" high; Base: 51"W x 23-3/8"D; 1 piece; 31 lbs.

Anthracite Grey - NHPSSBB
Gloss White - NHPSSBBWTE

\$141.13



Adjustable Ballet Bar Rack

Height adjusts from 48" to 72" high.
Base: 51"W x 23-3/8"D; 1 piece; 35 lbs.

Anthracite Grey - NHPSSBBADJ **\$203.86**
Gloss White - NHPSSBBADJWTE **\$180.14**

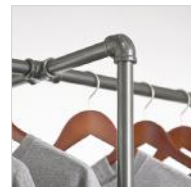

Add-On Hangbar

Only fits the adjustable ballet bar racks
NHPSSBBADJ, NHPSSBBCB1ADJ &
NHPSSBBCB2ADJ; 1 piece; 6 lbs.

Anthracite Grey - NHPSSAOH **\$56.76**
Gloss White - NHPSSAOHWH **\$51.99**



60" Wide Ballet Bar Rack

64" high; Base: 60"W x 23-3/8"D; 1 piece; 31 lbs.

Anthracite Grey - NHPSSBB60

\$160.19



60" Wide Adjustable Ballet Bar Rack

Height adjusts from 48" to 72" high.
Base: 60"W x 23-3/8"D; 1 piece; 38/46 lbs.

Anthracite Grey - NHPSSBB60ADJ
Gloss White - NHPSSBB60ADJWH

\$203.86

Double Tier Ballet Bar Rack

Top Bar height adjusts from 63" - 78" high.
Lower Bar Height adjusts from 45" - 60" high.
Tier step difference measures 18".
Base: 49 5/8"W x 23 1/4"D; 1 piece; 34/40 lbs.

Anthracite Grey - NHPSSBBDTADJ

\$172.99



Adjustable Double Ballet Bar Rack

Each 50" Long hangbar adjusts from 50" to 78" high.
Base: 50"W x 29"D; 1 piece; 61 lbs.

Anthracite Grey - NHPSSBLLADJ **\$295.62**
Gloss White - NHPSSBLLADJWH **\$258.99**

Double Ballet Bar Rack with Top

Frame Only - NHPSSBB2TS
48"W x 24"D x 52"H;
1 piece; 31 lbs.

\$288.99

NHPSSBB2TS - MDF
Optional Top in Darkwood measures 28" x 60" x 1.5";
1 piece; 51 lbs.

\$144.99



More PIPELINE →

Pipeline Garment Racks



Adjustable 4-Way Rack
16" long arms adjust from 48" to 72" h;
base measures 30"; 1 piece; 44 lbs.
Anthracite Grey - NHPSA4; \$204.64
Gloss White - NHPSA4WH; \$177.99



Double Bar Rack
48"L x 22"W; 60" Long Hangbars adjust from
53-1/2" to 80" high; 2 pieces; 2ctns. 52, 10 lbs.
Anthracite Grey - NHPSDBR; \$247.92
Gloss White - NHPSDBRWH; \$225.99



Adjustable 36" Round Rack
Adjusts from 45" to 67" h;
four (4) rubber tipped shelf supports
(takes 30" round toppers - see pg 30);
1 piece; 49/52 lbs.
Anthracite Grey - NHPSR36; \$198.99
Gloss White - NHPSR36WH; \$198.99



Adjustable Ballet Bar Rack
w/one crossbar
41"W x 22"D; 44-72" high;
13" faceouts;
1 piece; 36 lbs.
Anthracite Grey -
NHPS2CBADJ
\$168.99



Adjustable Ballet Bar Rack w/one crossbar
41"W x 22"D; 44-72" high; 13" faceouts; 1 piece; 37 lbs.
Anthracite Grey - NHPSBBCB1ADJ; \$184.99
Gloss White - NHPSBBCB1ADJWH; \$184.99

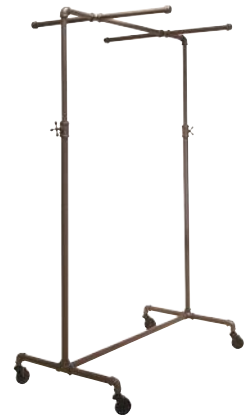

Adjustable Ballet Bar Rack
w/two crossbars
41"W x 22"D; 44-72" high;
13" faceouts; 1 piece; 50 lbs.
Anthracite Grey - NHPSBBCB2ADJ
\$202.99



Adjustable 2-Way Rack
21"W x 21"D; 44-72" high; 13" faceouts;
2 pieces; 4,8 lbs. / 4,17 lbs. (2ctns)
Anthracite Grey - NHPS2WADJ; \$112.99
Gloss White - NHPS2WADJWH; \$112.99



4-Leg Costumer
60"H x 21"W x 21"D w/ 6" faceout;
1 piece; 15 lbs.
Anthracite Grey - NHPSC2; \$95.99
Gloss White - NHPSC2WH; \$95.99



Replacement 2" Casters
Fits pipeline racks & costumers

NON-LOCKING	LOCKING
1 piece; 2/6 lbs	1 piece; 18 lbs
NHCASPS	NHCASPSLK
\$6.99	\$6.99

Pipeline Outrigger and Wall Units

Units and accessories have an antracite grey or a gloss white finish, where noted.



Outrigger Wall Unit

Set of two 96"H slotted uprights (1/2" slots on 1" centers). Can be spaced 24" or 48" on Centers; 1 piece; 30 lbs.

Anthracite Grey - NHPSOR; **\$156.43** Gloss White - NHPSORWH; **\$151.89**



Freestanding Merchandiser

94" high x 20" deep x 48" wide. Slots (1/2" slots on 1" centers) are on each upright; 1 piece; 38, 28, 12 / 90, 90, 12 - 3 ctns.

Anthracite Grey - NHPFS96; **\$374.41**
Gloss White - NHPFS96WH; **\$375.99**

Accessories for Outrigger and Wall Units



Extension Kits for Freestanding Merchandiser

Connect & stabilize two units together.

- Guarantees easy alignment for the 24" or 48" accessories between 2 units.
- Kits include 2 spacers. Can be used on top & bottom or along back.

Anthracite Grey - NHPFSKT24 - 24"w 7 lbs; **\$34.99**

Gloss White - NHPFSKT24WH - 24"w

Anthracite Grey - NHPFSKT48 - 48"w 10 lbs; **\$47.95**

Gloss White - NHPFSKT48WH - 48"w 10 lbs; **\$43.99**



Hangrails

Mounts on rear facing slots of uprights.

2 pieces/carton.

48" wide; 14lbs.

Anthracite Grey - NHPSORHB48 **\$100.57**

Gloss White - NHPSORHB48WH **\$82.99**

24" wide; 10 lbs:

Anthracite Grey - NHPSORHB24 **\$76.98**

Gloss White - NHPSORHB24WH **\$76.49**



Hangrail with 1 Faceout

Works on forward facing slots of uprights of Freestanding Merchandiser only.

24" wide w/12 3/4" faceout;
2 pieces/carton; 11/17 lbs.

Anthracite Grey - NHPSORFO24N **\$95.49**

Gloss White - NHPSORFO24NWH



Hangrail with 2 Faceouts

Works on forward facing slots of uprights of Freestanding Merchandiser only.

48" wide w/12 3/4" faceouts;
2 pieces/carton; 21/31lbs.

Anthracite Grey - NHPSORFO48N **\$162.26**

Gloss White - NHPSORFO48N WH **\$152.99**



Hangrail with 1 Faceout

Mounts on rear facing slots of uprights.

24"W with one 12" long faceout;
2 pieces/carton; 18/20 lbs.

Anthracite Grey - NHPSORFO24 **\$123.99**

Gloss White - NHPSORFO24WH



Hangrail with 2 Faceouts

Mounts on rear facing slots of uprights.

48"W with two 12 3/4" long faceouts;
2 pieces/carton; 29/37 lbs.

Anthracite Grey - NHPSORFO48 **\$161.87**

Gloss White - NHPSORFO48WH **\$152.99**



Add On Arms

3" Long

1 piece; 1 lb

Anthracite Grey - NHPSCLP03 **\$14.99**

Gloss White - NHPSCLP03WH

16" Long

2 pieces; 2 lbs

Anthracite Grey - NHPSF013 **\$52.75**

Gloss White - NHPSF013WH



Large Display Shelves

Bottom of shelf includes a slot for brackets to lock in to and metal support bar to handle heavy loads; 46 3/8"W x 15 3/4"D;
2 pcs/carton; 46 lbs.

Black Melamine - NHPSORSLF48-ML **\$147.74**

White Melamine - NHPSORSLF48MLWH **\$133.23**

Small Display Shelves

Bottom of shelf includes a slot for brackets to lock in to. 22 3/8"W x 15 3/4"D;
2 pcs/carton; 20 lbs.

Black Melamine - NHPSORSLF24-ML

White Melamine - NHPSORSLF24MLWH **\$60.99**



Shelf Brackets

Left & right (set) for use w/ shelves
2 set (4 pcs); 4 lbs.

Anthracite Grey - NHPSORKB **\$27.09**

Gloss White - NHPSORKBWH

CLOTHING RACKS Pipeline Collection

Pipeline Accessories

Acrylic Sign Holders

Sign holder with swedge stem and C style clamp.
Fits pipeline racks & costumers.



5"H x 7"W
includes clamp; 1 piece; 1 lb.
Anthracite Grey - NHPSPJ57P24;
\$17.37
Gloss White - NHPSPJ57P24WH;
\$12.57

7"H x 11"W
includes clamp; 1 piece; 1lb.
Anthracite Grey - NHPSPJ711P24;
\$19.44
Gloss White - NHPSPJ711P24WH
\$14.99

Wall Mount Faceouts



4 1/2" Long
1 piece; 1 lb
Anthracite Grey - NHPSSW04 **\$9.70**
Gloss White - NHPSSW04WH
\$13.40



10" Long
1 piece; 1 lb
Anthracite Grey - NHPSSL10
\$14.70
Gloss White - NHPSSL10WH
\$13.50

Slatwall Faceouts



4 1/2" Long
1 piece; 1 lb
Anthracite Grey - NHPSSW04 **\$9.12**
Gloss White - NHPSSW04WH
\$8.52



10" Long
1 piece; 1 lb
Anthracite Grey - NHPSSW10
\$11.16
Gloss White - NHPSSW10WH
\$10.56

Pipeline Tables & Floor Displayers



Large Nesting Table

Small Nesting Table



Table Topper



Display Table



Tower Table

Large Nesting Table

Frame w/top 62"w x 34"d x 32"h;
1 pc; 18, 42 lbs (2 ctns);
Anthracite Grey - NHPNLTSET;
\$325.49
Gloss White - NHPNLTWHSET;
\$325.49

Small Nesting Table

Frame w/top 48"w x 24"d x 24"h;
1 pc; 39, 41 lbs (2 ctns);
Anthracite Grey - NHPNLTSET;
\$218.99
Gloss White - NHPNLTWHSET;
\$218.99

Table Topper

Frame w/top 54"w x 14"d x 13 1/2"h;
Dark Brown Melamine table top;
1 pc; 6, 29 lbs (2 ctns);
Anthracite Grey - NHPNLTSET
\$109.99

Frame w/top
28"w x 16"d x 18"h;
Dark Brown Melamine table top;
1 pc; 39, 17 lbs (2 ctns);
NHPDTSSET **\$144.99**

Frame w/top
14"w x 14"d x 40"h;
Dark Brown Melamine table
top;
1 pc; 36, 81 lbs (2 ctns);
NHPSTTSET **\$162.99**

Frame only 58"w x 30"d x 30 1/2"h;
1 pc; 22 lbs;

Anthracite Grey - NHPNLT
\$151.99
Gloss White - NHPNLTWH
\$151.99

Frame only 44"w x 20"d x 22 1/2"h;
1 pc; 18 lbs;

Anthracite Grey - NHPNLT
\$122.99
Gloss White - NHPNLTWH
\$122.99

Frame only 50"w x 12"d x 12"h;
1 pc; 6 lbs;

Anthracite Grey - NHPNLT
\$51.99

Frame only
27"w x 15"d x 17"h;
1 pc; 39 lbs;
NHPDTS **\$122.04**

Frame only
13"w x 13"d x 39"h;
1 pc; 39 lbs;
NHPSTT **\$118.99**

Countertop Displays

Pipeline Displayers feature anthracite grey piping
and 3/4" thick bases with a stained cherry finish.

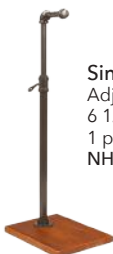

Single Accessory Displayer
Adjusts 16-26"h; 4 1/4" faceout;
6 1/2"w x 8 1/2" d;
1 piece; 4 lbs.
NHPST1 **\$58.99**



Countertop Mirror
10" h x 7 7/8"w; 13 9/16"h;
8" sq. base; 1 piece; 7 lbs.
NHPST1078 **\$66.48**



Triple Accessory Displayer
Adjusts 15 1/2-27"h; 8"w
crossbar; 20"w x 8"d base;
1 piece; 10 lbs.
NHPST3X **\$123.99**



Tiered Accessory Displayers

Small - 8 1/2"h w/ 6 1/2" sq. base; 1 piece; 3 lbs.
NHPSTAMS **\$74.26**

Medium - 11 1/2"h w/ 6 1/2" w x 8 1/2" d base; 1 piece; 3 lbs.
NHPSTAMM **\$60.99**

Large - 17 1/2"h w/ 6 1/2" w x 8 1/2" d base; 1 piece; 4 lbs.
NHPSTAML **\$77.99**

Black Economy Pipe Racks A matte-black pipe rack collection for less

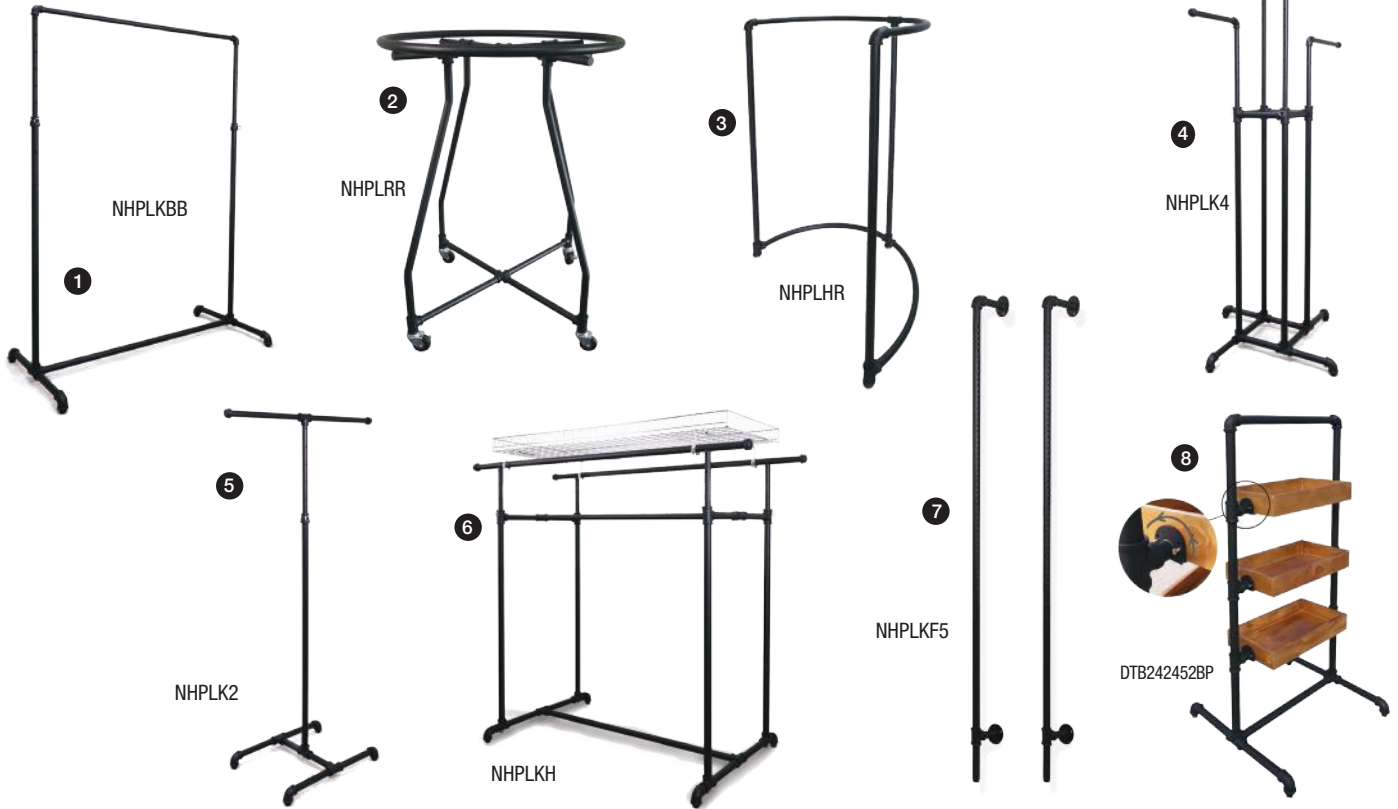

- 1 Ballet Bar Rack - black**
48" w x 23.5" d; 48-72" h adjustable; 1 piece; 34/37 lbs; **NHPLKBB \$132.32**
** Casters available*
- 2 Round rack - black**
Round rail-36" dia; base-42" d; 46" h (not adjustable); includes casters; 1 piece;
20/44, 15 lbs (2 ctns); **NHPLRR \$303.00**
- 3 Half-round rack - black**
35" w / height adjustable from 54"; 1 piece; 20, 8/21 bs (2 ctns);
NHPLHR \$129.60
- 4 4-way pipe rack - black**
30" base; 16" arms; 48-72" h; 1 piece; 40, 19 lbs (2 ctns); **NHPLK4 \$206.97**
** Casters available*
- 5 2-way pipe rack - black**
24.5" w x 18.5" d base; 16" arms; 48-72" h; 1 piece; 18, 4 lbs (2 ctns); **NHPLK2 \$96.81**
** Casters available*
- 6 H rack - black**
48" w x 30" d base; height 48-72"; (*Grid topper sold separately*); 1 piece; 50,
17/21, 7 lbs (3 ctns); **NHPLKH \$209.43**
** Casters available*
- 7 Outrigger pipe rack - black**
90" h; 1/2" slots on 1" center; stands 3.5" from wall; 2 pieces; 19 lbs;
NHPLKF5 \$131.80
- 8 Display rack with 3 wood trays - black**
24"L x 24"W x 52"H; (3) adjustable wood trays measure 17"L x 10"W x 3"h, are
finished in cinnamon melamine & rotate to a 45° or 90° angle; 1 piece; 39/70 lbs;
DTB242452BP \$347.72

Black Economy Pipe Rack Accessories matte black finish



C Hangrail for Outrigger rack - black
24" w; 12" deep; 1 piece; 20/21 lbs;
NHPL12CH \$18.53

3" Casters - black
3" casters, two with brakes and two
without; 4 pieces; 5 lbs;
NHPLCASTER \$46.66



NHPLCASTER



**12" Hangrail bracket for
Outrigger rack - black**
1 piece; 22 lbs; **NHPLCR12
\$7.26**



**3" Hangrail bracket for
Outrigger rack - black**
1 piece; 14 lbs;
NHPLCR3 \$5.18

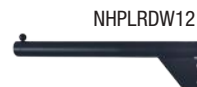

**12" Faceout w/ball end for
Outrigger rack - black**
1 piece; 19 lbs;
NHPLRDW12 \$5.18

BLACK LADDER SYSTEM

The extremely versatile Ladder System allows you to vary your merchandising techniques to suit any retail environment.

The black finish tower ladders measure 73"H and can be accessorized with specialized hangrails, shelves, face-outs and waterfalls (sold separately).

Ships truck.
Some assembly required.



1 A305B



2 A304B

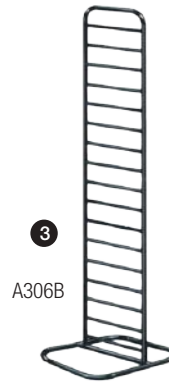

3 A306B



4 A301B



5 AT66B



6 AT77B



7 ARL48B



8 AF12B



9 NHACT4



10 AF7B

- 1 **Double Two-Tier Wall Unit - black**
16"W x 96"L x 88"H; 1 piece; 92 lbs; **must ship truck**; A305B \$286.04
- 2 **Single Two-Tier Wall Unit - black**
16"W x 48"L x 88"H; 1 piece; 58/90 lbs; **must ship truck**; A304B \$185.85
- 3 **Tower Ladder - black**
14"W x 73"H; 18" x 22" base; 1 piece; 23 lbs; A306B \$126.23
- 4 **Double Center Floor Rack - black**
28"W x 48"L x 58"H; 1 piece; 57 lbs; **must ship truck**; A301B \$169.25
- 5 **Top Shelf - black** Fits A301B
Epoxy coated perforated steel; 25" x 48"; 1 piece; 18/26 lbs; AT66B \$101.99
- 6 **Interior Shelf - black** Fits all ladders
Epoxy coated perforated steel; 14" x 45"; 1 piece; 11/15 lbs; AT77B \$50.67
- 7 **Straight Hangrail - black**
With attached 1/4" chrome wire protector; 48"; 1 piece; 4/5 lbs; ARL48B \$15.29
- 8 **12" Faceout - black**
Rectangular tubing; 1 piece; 2 lbs; AF12B \$6.99
- 9 **Caster - black**
4" caster w/ 1"L & 5/16" dia. stem; 150 lb. capacity; 1 piece; 2/2 lbs; NHACT4 \$9.07
- 10 **7-Cube waterfall - black**
16" L; 1/2" x 1 1/2" thick; 1 piece; AF7B \$10.49

Designer 400 RACKS & MERCHANDISERS

DESIGNER 400 SERIES

style # \$ qty description wgt

RV24	13.74	1	Chrome Attaches to rectangular or square tubing 1/2" on 1" center	5/9
------	-------	---	--	-----

RV24 - A bracket made of rectangular tubing that supports DA224 (13" x 24") Duron shelves. The bracket has a clamp that attaches to an upright of a rectangular or square tubing rack. Tightening screws included.

K410B	181.18	1	Black shelves	9/11, 26 lbs 2 ctns
K410AL	171.99		Almond shelves	
K410GY	171.99		Grey shelves	
K410W	164.72		White shelves	

57" H, 1" matte black square tubing frame; (8) 12" shelf brackets; (4) 13" x24" shelves; includes casters and one T-stand

K411B	279.99	1	Black shelves	9/11, 9/11, 41 lbs 3 ctns
K411AL	285.99		Almond shelves	
K411GY	285.99		Grey shelves	
K411W	276.99		White shelves	

54" H, 1" matte black square tubing frame; (16) 12" shelf brackets; (8) 13" x24" shelves; (2) 36" x 1 1/4" round hangrails

K400B	187.50	1	Black shelves	9/11, 32 lbs 2 ctns
K400AL	184.99		Almond shelves	
K400GY	184.99		Grey shelves	
K400W	180.99		White shelves	

57" H, 1" x 2" matte black rectangular tubing frame; (8) 12" shelf brackets; (4) 13" x24" shelves; includes casters; two 16" arms adjust to 70" H

Twist on Shelf Support
Converts any 4 arm rack to display folded and hanging apparel



RV24 for Square or Rectangular Tubing



ECONOMY IMPORT SHOWCASES



FULL VISION SHOWCASES



Assembly required



SC

style #	\$	qty	description	size	wgt
SC4B SC4W SC4M SC6C	224.08	1	Includes 2 glass shelves and shelf brackets: Black White Maple Cherry	38"H x 18"D x 48"L	80/90, 30, 10, 10 lbs; (4 ctns)
SC6B SC6W SC6M SC6C	317.91	1	Black White Maple Cherry	38"H x 18"D x 72"L	100, 30, 30, 20 lbs; (4 ctns)

Standard LPL Finishes



CORNER FILL-IN

Fill-in counters enable you to create various counter configurations and display merchandise.

CFC20

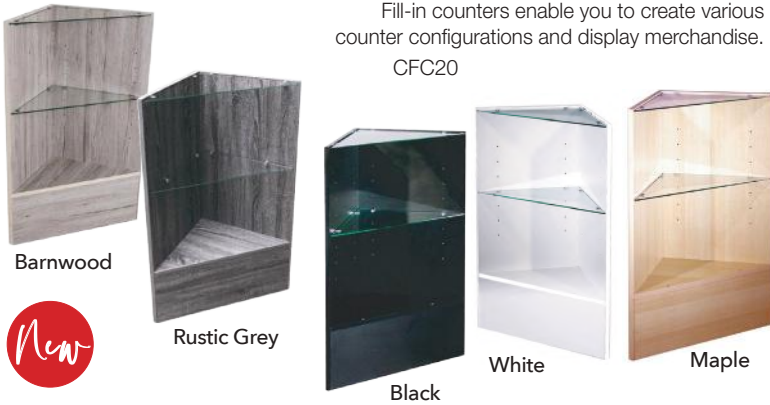

Barnwood

Rustic Grey

Black

White

Maple

CFC20	134.14	1	Corner fill-in - includes 2 glass shelves	38"H x 18"D x 18"L	36/75
-------	--------	---	---	-----------------------	-------

Specify Barnwood, Rustic Grey, Black, White or Maple for CFC20 above and SCPC18 below

PENTAGONAL FILL-IN

SCPC18



SCPC18	138.67	1	Pentagonal fill-in - includes 2 glass shelves	38"H x 18"D x 18"L	30, 18 lbs; (2 ctns)
--------	--------	---	---	-----------------------	----------------------------

REGISTER STAND

Perfect as a stand alone or with a wrap counter and corner fill-in unit.

RS24



RS24BW			Includes 1 (4"H) drawer & 1 wood shelf Well Top (w/6" well): Barnwood		
RS24RG			Rustic Grey		
RS24B	134.52	1	Black	38"H x 18"D x 24"L	81
RS24W			White		
RS24M			Maple		

Shelves RACKS & MERCHANDISERS

style #	\$	qty	description	wgt
W1224	88.99	8	White / 12"x24"	45
B1224			Black / 12"x24"	
M1224			Maple / 12"x24"	
W1248	99.99	4	White / 12"x48"	45
B1248			Black / 12"x48"	
M1248			Maple / 12"x48"	
W1448	110.99	4	White / 14"x48"	50
B1448			Black / 14"x48"	
M1448			Maple / 14"x48"	
Metal shelf signs				
Ledge piece is 6" front to back; sign holder piece is 6 1/2" across				
NHSTCH	9.72	1	Metal	1
NHSTV	7.00		High polished chrome	
Accepts 6 1/2"W x 1 1/2"H paper inserts, (not included)				
SHGL1048	98.49	5	10" x 48"	43
SHGL1224	49.25		12" x 24"	28
SHGL1248	88.20		12" x 48"	53
SHGL1448	99.14		14" x 48"	61
Ships truck				

All sizes packed 4 of one size and color per carton:

13" Shelves - to be used with 12" brackets:

OPEN BOTTOM				
13" x 24"				
DA224B	49.99	4	Black	9/11
DA224G	60.49		Grey	
DA224W	49.25		White	
13" x 48"				
DA248B	90.85	4	Black	29
DA248W	85.99		White	
DA248G	123.99		Grey	

15" Shelves - to be used with 14" brackets:

OPEN BOTTOM				
15" x 24" (almond & grey n/a)				
DA424W	94.35	4		13/16
DA424B	83.98			
15" x 48" (black only)				
DA448B	112.99	4		27/30
DA450B	166.40			
27				

follow style # by /B (for black) /W (for white) /G (for grey) /A (for almond)

How to order special finishes:

STYLE NO. FIN #3 /Surface coverage (woodgrain) on top, bullnose and sides. Add \$10.90 for each shelf.

How to order:

- (1) Choose shelf desired;
- (2) Choose style or surface coverage desired (FIN #2 or FIN#3);
- (3) Choose woodgrain color desired;
- (4) **Min. order 12 shelves per finish;**
- (5) Cost of shelf and cost of woodgrain finish equals total cost. Allow approx. 3-4 weeks.

MELAMINE SQUARE EDGE SHELVES



METAL SHELF OVERLAY RETAIL SIGNS w/framed front

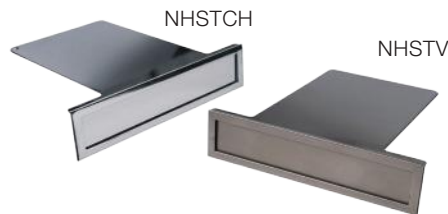

TEMPERED GLASS SHELVES



3/16" thick



DURON BULLNOSE SHELVES

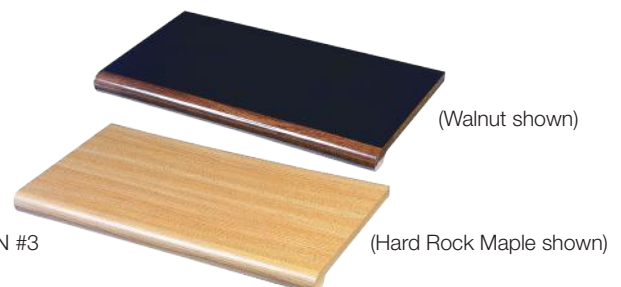
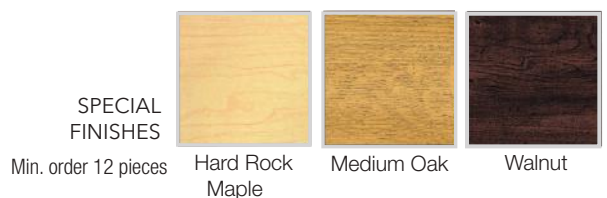
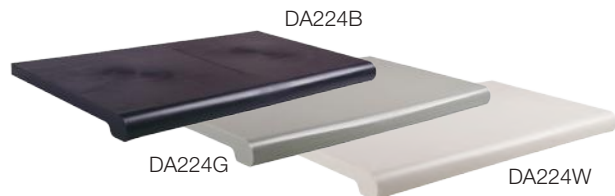

RACKS & MERCHANDISERS Tables & Bins



36" Round Folding Table

WT25



Lightweight Work Table

LWT3072



DT48C

chrome

Folding Dump Table
Includes locking casters



white

black



Table folded for storage

Dump Bin
Adjustable base deck.
Casters optional



white



black



chrome

GTC48C

style #	\$	qty	description	size	wgt
WT25	124.50	1	Table - plywood w/vinyl bullnose edging Constructed from high quality 3/4" 12-ply plywood; coated with UV resistant polyurethane; hardwood runners underneath tabletop; legs fold; folded tables are stackable	36" dia. 30"H	80/100
LWT3072	155.39	1	Lightweight folding work table	30"H x 72"L x 30"W	37/90

ships in 7-10 business days

DT48C	206.76		CHROME	47"L	
DT48W	186.99	1	WHITE	23 1/2"W 31"H	35/74
DT48B	220.90		BLACK	4 5/8"D	

Includes 2 locking and 2 non-locking casters

GTC48B	149.43		BLACK		
GTC48W	149.43	1	WHITE	All styles measure 38" x 38" x 34 3/4"	80 <i>Ships UPS ground</i>
GTC48C	199.90		CHROME		

COLLAPSIBLE ROLLING RACKS

Fold flat for easy transportation and storage



RCS2



RCS-1

RCS2	63.90	1	Heavy Gauge Chrome: Lightweight, foldable rolling rack with a weight capacity of 250 lbs. Features include: adjustable height risers - 66" - 71"; Center bar that extends 8" on either side; 4 casters		17
RCS-1	69.99	1	Chrome - 1" round tubing w/4" casters - 22 1/2" wide Adjustable height: 55" - 60" - 65"; 48" hangrail tubing w/12" pullouts; weight capacity of 200 lbs.		25/45

Displayers RACKS & MERCHANDISERS

style #	\$	qty	description	wgt
DDB242143C	219.80	1	4 Stacking Chrome Baskets: 24"L x 21"W x 43"H; collapsible; w/4 black casters	40/122
BIN2	47.17	1	BLACK 30" x18" x1 8"	11/14
IMPULSE41P	119.49	1	Impulse Tower w/4 Bowls: Clear polycarbonate bowls with metal grey powdercoated base and pole. Acrylic signholder top included; 65 1/2" H; bowls: 12 1/8" dia; 6 1/8" depth base: 16" dia. signholder: 7" x 5 1/2"	22/27
NHSDR	84.94	1	Wire Spinner Rack 4 adjustable spinning tiers with 16 hooks; Black; Heavy duty plastic base and sign holder for signs 8 1/2 x 11" and 1mm thick; Dims: 24" footprint; 66" high; hook length 5"	14/24
DDB4518B DDB4518W	85.54	1	3-Tier Round Impulse Bin: 45"H x 18"W; w/ 3 round baskets each measuring 7"H x 18"W Black White	23/23
DDB1947B	86.70	1	3-Tier Square Bin: Black; 19"W x 47"H; baskets - 6 1/2"H x 16"W each	30/30
DDB1254B	107.44	1	4-Tier Round Display Bin: Black; 54 1/2"H x 12"W; w/ 4 circular baskets measuring 6 1/2"H x 12"W	19/19
IMPULSE4W	115.99	1	Black floor display rack with 4 separate brushed chrome wire rotating baskets. Rack measures 66"H x 22"W; Each individual basket measures 21 3/4"W x 7"D	10/38



4-Tier
Stacking
Chrome
Baskets
w/casters

DDB242143C



Folding
Square
Basket

BIN2

Impulse Posts

Great for small
or end of
season
clearance
items near
register

IMPULSE41P



Holder for
8.5"x11" signs



Wire Spinner Rack

NHSDR



3-TIER BINS



DDB4518B



DDB4518W



DDB1947B



DDB1254B



IMPULSE4W

4-TIER BINS

STANDARD SLATWALL PANELS

Laminated, 3/4" medium density fiber board. Optional inserts must be installed at time of manufacturing for an additional charge (see inserts below).

4' high x 8' long panels. Each panel weighs between 80-100 lbs., and must ship via truck. Crate charge on 1-34 sheets is \$45.00. 

Slatwall Orientation

Horizontal

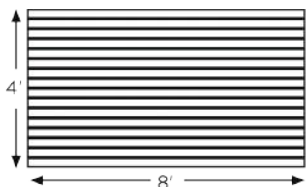

Optional Inserts

Metal inserts add strength, and enhance the appearance.

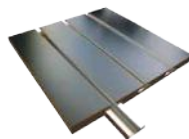

Metal inserts



SOLIDS / MIRROR



WHITE
SW48W \$88.99



BLACK
SW48BK \$93.99



LIGHT GREY
SW48LG \$90.99



DARK GREY
SW48G \$90.99



MIRROR
SW48MIR \$363.99

New Styles

WOOD GRAINS



OAK
SW48O \$91.99



MAHOGANY
SW48M \$96.99



HARDROCK MAPLE
SW48HM \$90.99



WEATHERED BARNWOOD
SW48WB \$97.99



ASH BARNWOOD
SW48AB \$97.99

RUSTICS /textured



ASPEN OAK
SW48AO \$97.99

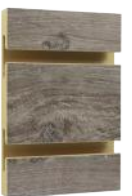

STORMY OAK
SW48SO \$97.99



TIMBERCREEK OAK
SW48TCO \$97.99



RECLAIMED BARNWOOD
SW48RB \$97.99



CAMPFIRE ASH
SW48CA \$97.99



WHITEWASHED FENCE
SW48WWF \$97.99

All prices are per panel with No Insert / NI

INSERT options



Black Aluminum / BAI

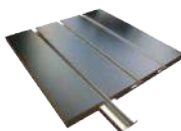

Aluminum / AI

* Note that actual colors may vary slightly from images.

Lead time is 2-3 weeks, with and with out inserts.

CALL or visit online CHAT at nahanco.com for more info. Our friendly Customer Service reps are based in the USA and ready to assist.

Panels made in the USA

Slatwall Accessories WALL SYSTEMS

style #	\$	qty	description	size	wgt
XT4	10.49		Chrome		
XT4B	8.99		Black	4"	2
XT4W	8.99		White		
XT6	10.49		Chrome		
XT6B	8.99		Black	6"	2
XT6W	8.99		White		
XT8	10.50		Chrome		
XT8B	9.07	12	Black	8"	3
XT8W	9.07		White		
XT10	10.50		Chrome		
XT10B	9.07		Black	10"	3
XT10W	9.07		White		
XT12	11.90		Chrome		
XT12B	10.50		Black	12"	4
XT12W	10.50		White		

Mounting plate width: 3/4" (for all hook styles listed above)

Hook widths: Chrome - 3/16" w; Black/White - 1/4" w

XTB	6.35		Black		
XTW	6.35	12	White	1"W x 3	2
XTH	7.91		Chrome	1/4"H	
SWFRC	1.99	1	Chrome	3"	1/2
SW6	6.99		Chrome	6"	1/2
SW12	6.99	1	Chrome	12"	1/2
SW12B	6.99		Black	12"	1/6
SW12W	6.99		White	12"	
HW5H	7.00	1	Chrome	16"	2/6
RWA9	8.42	1	Chrome Rectangular tubing	Adjusts from 9" to 12" to 15" long	2
RW12	5.18		Chrome	12"	1/6
EBLR3	4.67	1	Black	12"	
EWHR3	4.15		White	12"	
RW6	4.15		Chrome	6"	1/2
SW5HB	7.00	1	Black		
SW5H	6.22		Chrome	16"	2/6
SW5HW	7.00		White		
RW5HB	5.96	1	Black	17 1/4"	2/6
RW5H	7.00		Chrome		
SW6BC	4.54	1	Chrome	16 5/8"	2/6
SW6BB	4.15		Black		
SW6BW	4.15		White		
RW7B	15.99	1	Black	16 5/8"	2/6
RW7C			Chrome		
SWED6	2.07	1	CHROME	2 3/4"W x 4 1/2"L	1/5
J2387	33.17	1	CLEAR Holds 36 - 2" cards (not included)	12" W x 12 1/2" H	2/6
SW122	18.79	12	Brushed chrome	3 7/16"H x 2"L	2/5
HG100	50.67	100	White	2" clip	3
HG101	50.67	100	Black	2" clip	3



XT4-12



XTH



SWFRC



SW6/SW12



HW5H

RECTANGULAR TUBING



RWA9

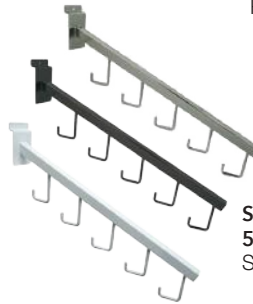

RW12/EBLR3/EWHR3/RW6

Square Tubing
5 Hook Waterfall
SW5H

Rectangular Tubing
5 Hook Waterfall
RW5H



Square Tubing
6 Ball Waterfall
SW6C



Rectangular Tubing
7 Cube Waterfall
RW7C



Slatwall Earring
Card Holder
SWED6

See page 91 for
jewelry cards

Slatwall
Jewelry Card
Displayer
J2387



Slatwall
Clips

SW122



HG100 /
HG101



SW8-14B

Shelf Bracket
Chrome, black or white available

– See page 41 for shelving –



SWAJ

Adjustable Slatwall Bracket
12" - chrome
14" - chrome



3380-76

Slatwall Support Arms
3380-76 for 8" & 10" brackets
3380-77 for 12" & 14" brackets
3380-78 for 12" rectangular tubing



SWFB

SWR2

3" & 12" Rectangular Hangrail Bracket
Chrome, black or white available



SW/RT

Round Hangrail Bracket
– See page 54 for tubing –



SWR81

Rectangular Tubing "U" Hangrail



SW681C

Round Tubing "U" Hangrail



SWT

Scarecrow Displayer



SWML

Millinery Displayer
3" diameter

Tubular Display Form
VM52



Foam Pad
FPMC

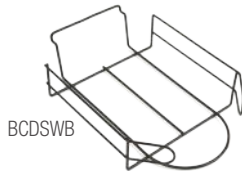

BCDSWB

Slatwall Cap Merchandiser
Holds 12 hats



SW500

Revolving Belt / Tie Display



WWS45W

Slatwall Wire Media Shelf

style #	\$	qty	description	size	wgt
SW8KB	2.99		Chrome		
SW8KBB	2.99		Black	8"	2/7
SW8KBW	2.99		White		
SW10KB	3.29		Chrome		
SW10KBB	3.29		Black	10"	1/6
		1			
SW12KB	3.49		Chrome		
SW12KBB	3.49		Black	12"	1/6
SW12KBW	3.49		White		
SW14KB	3.99		Chrome		
SW14KBB	3.99		Black	14"	1/6
SW14KBW	3.99		White		
SWAJ12	4.15	1	CHROME	12"	1/6
SWAJ14	4.92			14"	1/6
3380-76	6.35			7 3/4"	
3380-77	6.35	1	CHROME	11 1/2"	1/3
3380-78	6.96			11 1/2"	
SWFB	5.57		CHROME	12"	2/7
SWFBB	5.57		BLACK	12"	2/7
		1			
SWR2	4.54		CHROME	3"	1/3
SW/RT	6.74	1	CHROME	12"	1/6
SWR81	20.22		CHROME		
EMABR81	18.01	1	BLACK	22"W x 11" D	5/21
EMTWR81	18.01		WHITE		
SW681C	18.01		CHROME		
SW681B	17.37	1	BLACK	23"W x 12" D	5/21
SW681W	17.37		WHITE		
SWT	20.22		CHROME	Adjusts	
EBLT	14.49	1	BLACK	20 1/2" to	4/21
VM52	24.36	1	CHROME	16" x 24"	3/21
SWML		1	CHROME		
SWMLB	5.44	1	BLACK	4 1/2" H x 8" D	1/3
SWMLW		1	WHITE		
FPMC	9.07	10	GREY	3"	1
BCDSW			CHROME		
BCDSWB	5.44	1	BLACK	8 1/2" x 14" x 2"	2/6
BCDSWW			WHITE		
SW500	27.60	1	CHROME	11" x 17" 12 - 4" hooks	1/6
WWS45W	22.94	1	WHITE	48 x 6 1/2 x 7"	5/13

Slatwall Accessories WALL SYSTEMS

Pipeline Slatwall Fixtures

Coordinates with other pipeline store fixtures (pages 33-37).

Anthracite Grey & Gloss White Fixtures



Matte Black Fixtures



Acrylic Slatwall Fixtures

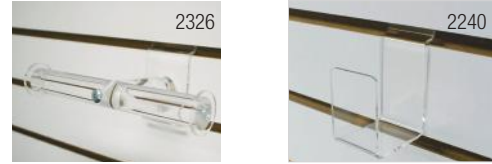

Jewelry Display Bar

Display Hook



Sign Holder

2035



Slatwall Jewelry Card Display

Holds twenty 2" cards

See page 83 for cards

2385



850S

Slatwall Shoe Shelves



2020S

Media Shelves

ACR988
(w/tilt back)



Slatwall Slanted Shoe Display

2086

Slatwall Hanger
Extends 3" from wall



2200S

Slatwall Adjustable Shoe Swivel

Brochure Holders

ACR28SW

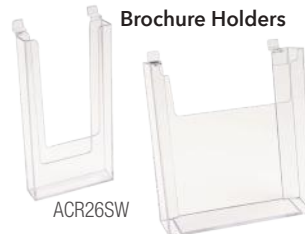

ACR26SW

ACR102

Slatwall Displays
For eyeglasses or sunglasses

1pr/ 2486
6prs/ 2488



2487

Slatwall Mirror

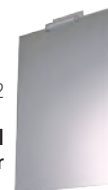

Slatwall Straight Shelf

ACR180

Slatwall Tray

ACR140

style #	\$	qty	description	size	wgt
NHPSSW04	9.07	1	4 1/2" Faceouts: Anthracite Grey	4 1/2" long	1
NHPSSW04WH	8.42	1	Gloss White	4 1/2" long	1
NHPSSW10	11.15	1	10" Faceouts: Anthracite Grey	10" long	1
NHPSSW10WH	10.50	1	Gloss White	10" long	1
SWP12B	11.15	1	Matte black faceout	12" long	2
SWP6NB16	16.85	1	Matte Black Waterfalls: 6-ball	16 1/2" long	4
SWP5H16	18.27	1	5-hook	16 1/2" long	4
2326	29.90	1	1/8" ACRYLIC	8" W x 4" D	1/3
2240	2.99	1	1/8" ACRYLIC	2"	1/3
2035	8.99	1	1/8" ACRYLIC	7w x 11"h	2/7
2385	15.99	1	1/8" ACRYLIC	8" W x 10 1/4" H	2/7
850S	2.49	1	ACRYLIC	4" x 10" w/ 2" tall sign channel at front	2/3
2020S	4.49	1	ACRYLIC	4" x 10"	2/3
ACR988	19.90	1	ACRYLIC	24"L x 2"D x 4"H	3
2086	17.99	1	ACRYLIC	7" X 10"	1/2
2200S	4.49	1	ACRYLIC 45° downslant swivels 180°	2 3/4"W x 9"D	1/3
2476	18.99	1	ACRYLIC	17" W x 7" H x 3 1/2"D	
2486	4.99		1PAIR 3"L		2/6
2487	9.99	1	3/16" ACRYLIC	3 PAIRS 11 3/4"L	1/2
2488	18.49			6 PAIRS 23 3/4"L	5/11
ACR26SW	4.99	1	ACRYLIC	4 x 9"	2/3
ACR28SW	8.99			8 1/2 x 11"	1/3
ACR102	12.99	1	ACRYLIC	8 x 10"	1/7
ACR180	15.49	1	3/16" ACRYLIC	8"D x 12"W	2/7
ACR140	24.99	1	3/16" ACRYLIC	12"L x 9"W x 2"D	2/6

WALL SYSTEMS Grid Wall & Accessories

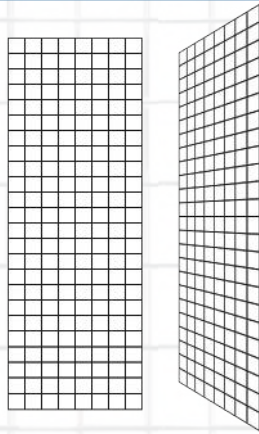

Grid Wall - 1/4" Wire

Uses either grid wall accessories only

Slatgrid Panels

Uses either grid wall or slatwall accessories

**3 Panels
per Carton**



Slatgrid -
Chrome

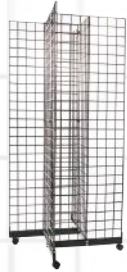

8' length must ship via truck or oversize UPS

Four Way Base

Requires four panels and 12 grid-to-grid connectors. Includes casters



Triangle Base

Requires three panels and nine grid-to-grid connectors. Includes casters



Gondola Base

Requires four panels and nine grid-to-grid connectors

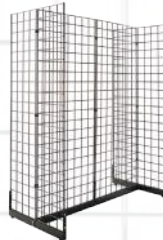

Legs for Grid

CGW7



Grid-to-Grid

For 1/4" wire. Connects grid panels at any required angle



CGW5

Grid to Square Tubing

Connects 1" square tubing to grid panel



WTEWB

Wall Bracket

For mounting grid wall panels to the wall

style #	\$	qty	description	size	wgt
GW26	124.16	3	CHROME		
BLK26	99.14	3	BLACK	2'W x 6'H	55
WTE26	99.14	3	WHITE		
GW28	156.04	3	CHROME		Truck/ UPS
BLK28	131.16	3	BLACK	2'W x 8'H	66/90
WTE28	131.16	3	WHITE		
STGC26	133.47	3	CHROME		
STGB26	111.44	3	BLACK	2'W x 6'H	47
STGW26	111.44	3	WHITE		
STGC28	164.27	3	CHROME		Truck/ UPS
STGB28	145.14	3	BLACK	2'W x 8'H	52/90
STGW28	145.14	3	WHITE		
GW4BA	53.52		CHROME		
BLK4BA	49.90	1	BLACK	36 x 36"	11
WTE4BA	49.90		WHITE		
GW3TB	44.49		CHROME		
BLK3TB	40.56	1	BLACK	24"	10/11
WTE3TB	40.56		WHITE		
GWG48	41.99		CHROME		
BLKG48	38.99	1	BLACK	48 x 24"	12
WTEG48	38.99		WHITE		
GL24C	24.90		CHROME		
GL24B	22.94	1 pair	BLACK	24" H x 24" L	7
GL24W	22.94		WHITE		
CGW7	1.62		CHROME		
CBLK7	1.62	1	BLACK	N/A	1
CWTE7	1.62		WHITE		
CGW5	3.50		CHROME		
CWTE5	4.92	1	WHITE	N/A	1
GWWB	2.49		CHROME		
BLKW B	2.49	1	BLACK	3"	1
WTEWB	2.49		WHITE		

Grid Wall & Accessories WALL SYSTEMS

style #	\$	qty	description	size	wgt
GWH4C	9.07	12	CHROME	4"	1/3
GWH4B	7.65		BLACK		
GWH4W	7.65		WHITE		
GWH6C	10.50		CHROME	6"	1/2
GWH6B	9.07		BLACK		
GWH6W	9.07		WHITE		
GWH8C	11.90		CHROME	8"	1/2
GWH8B	10.49		BLACK		
GWH8W	10.49		WHITE		
GWH10C	11.90		CHROME	10"	1/2
GWH10B	10.50	BLACK			
GWH10W	10.50	WHITE			
GW11	4.85	1	CHROME	12"	3/6
BLK11	3.88		BLACK		
WTE11	3.88		WHITE		
RG12	4.50	1	CHROME	12"	2/7
BLKR3	4.15		BLACK		
WTER3	4.15		WHITE		
GW12	4.92	1	CHROME	12"	2/7
BLK12	3.50		BLACK		
RG7B	7.00	1	CHROME	7 cube	2/6
RG5H	9.07	1	CHROME	5 hook	2/6
GW5H	4.99	1	CHROME	5 hook	2/6
BLK5H	5.31		BLACK		
WTE5H	5.31		WHITE		
GW7B	6.49	1	CHROME	7 ball	2/10
BLK7B	6.49		BLACK		
WTE7B	6.49		WHITE		
GWFRFC	5.44	1	CHROME	3"	1/3
GWFRB	5.44		BLACK		
GWML	4.02	1	CHROME	4 1/2" H	2/7
BLKML	3.76	1	BLACK	8" Deep	
FPMC	9.07	10	GREY	3"	1
KHG684	19.90	1	CHROME	52 1/4"	3/21
KHG681	18.01	1	CHROME	19 1/4 x 11"	3/21
BLHG681	17.37		BLACK		
GW12KB	3.89	1	CHROME	12"	2/7
BLK12KB	3.24		BLACK		
WTE12KB	3.50		WHITE		
GW14KB	4.15	1	CHROME	14"	2/6
BLK14KB	3.50		BLACK		
HML4MAB	5.57	1	BLACK	4"	1/3
GWRT	7.00	1	CHROME	12"	2/7

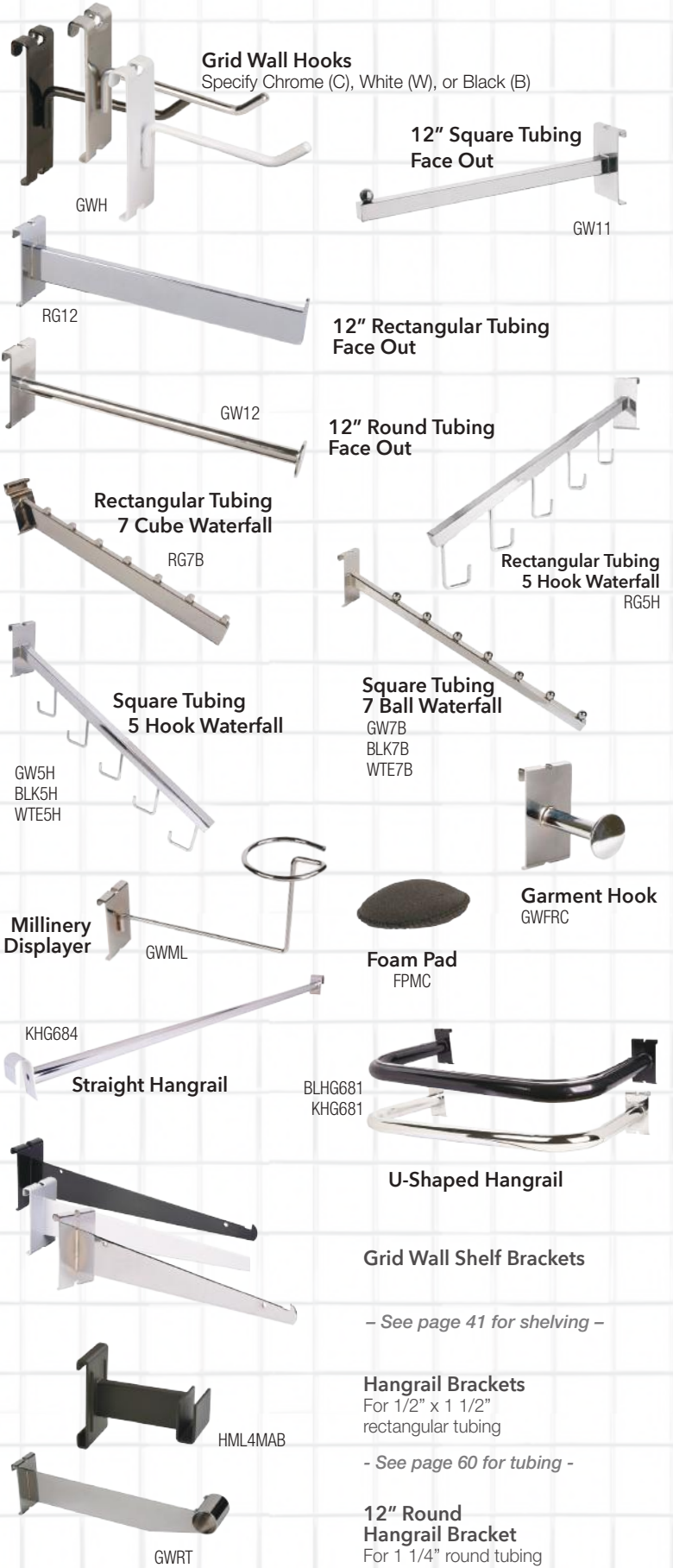

WALL SYSTEMS Grid Wall Accessories

style #	\$	qty	description	size	wgt
BCDGWB					
BCDGW	6.35		CHROME	8 1/2 x 14	
BCDGWB	6.35	1	BLACK	x 2"	1/7
BCDGWW	6.35		WHITE		
GR7	21.38	1	CHROME	24" 7 - 5" hooks	3/12
GW122	25.66	12	BRUSHED CHROME	3 7/16" H	2/3
HS101	34.34	100	BLACK	2"	8
BLKS90	13.22	1	BLACK	24 x 24 x 34 1/2"	6/21
GWS93	24.36		CHROME		
BLKS93	21.51	1	BLACK	15 x 24"	6/21
WTES93	21.51		WHITE		
GWS91	22.29	1	CHROME	15 x 24"	6/21
BLKS91	21.51		BLACK		
JGR410ST	3.88	1	STYRENE	4 x 10"	1/3
HPSG57V	6.09			5 1/2w x 7"h	
HPSG811V	9.59		Vertical	8 1/2w x 11"h	1/2
HPSG114V	17.36			11w x 14"h	
HPSG57H	6.09	1	CLEAR	5 1/2h x 7"w	
HPSG711H	7.78		Horizontal	7h x 11"w	1/2
HPSG811H	11.99			8 1/2h x 11"w	
ACR26GW	4.92	1	ACRYLIC	4 x 9"	1/3
ACR28GW	9.07	1		8 1/2 x 11"	1/7
ACR988GW	25.01	1	ACRYLIC	24"L x 2"D x 4"H	2/4
ACR984GW	17.76	1			
BSK11B	15.99	1	Black	24w x 12d x 4"h shallow	4/12
BSK11C	15.94		Epoxy Chrome		
BSK11W	15.99		White		
BSK12B	18.01	1	Black	24w x 10d x 5"h double slope	4/12
BSK12C	19.44		Epoxy Chrome		
BSK12W	18.01		White		
BSK13B	9.72	1	Black	12w x 12d x 4"h small basket	3/10
BSK13C	9.72		Epoxy Chrome		
BSK13W	9.72		White		
BSK14C	11.79	1	Epoxy Chrome	12w x 12d x 8"h sloped front	3/10
BSK15B	14.64	1	Black	12w x 12d x 8"h deep basket	4/14
BSK15C	15.94		Epoxy Chrome		
BSK15W	14.64		White		



Grid Wall Cap Merchandiser
Holds approximately 12 hats

BCDGWB

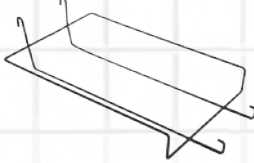

Grid Wall Belt / Tie Display

GR7



GW122



HS101

Triangular Shelf

BLKS90

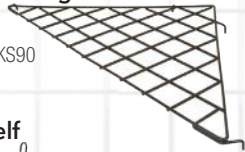

Slant Shelf

BLKS91



Straight Shelf

GWS93

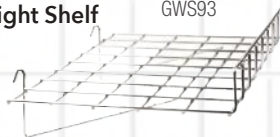

JGR410ST

Injection Molded Shoe Shelf



Acrylic Sign Holder

HPSG

Brochure Holders



ACR26GW

ACR28GW

Media Shelves

ACR988GW
(w/tilt back)



Standard Baskets

Fits Slatwall, Grid Wall and Pegboard

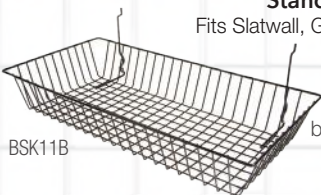

BSK11B

black

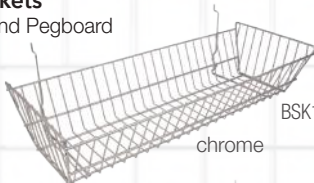

BSK12C

chrome



BSK13B



BSK14B



white

BSK15W

style # \$ qty description size wgt

Satin Zinc:

Universal

SS1048	54.82	10	Single	48"	11
SS1060	64.54		Single	60"	13/19
SS1072	75.69		Single	72"	1/9
SS1084	88.13		Single	84"	19

Heavy Duty

SS1248	63.12	10	Single	48"	15
SS1260	72.84		Single	60"	2/8
SS1272	89.55		Single	72"	3/9
SS1284	102.00		Single	84"	3/11
SS2248	83.98	10	Double	48"	21
SS2272	132.45		Double	72"	4/9
SS2284	154.61		Double	84"	4/11

Extra Heavy Duty

SS3048	100.57	10	Single	48"	29
SS3060	126.88		Single	60"	36
SS3072	149.17		Single	72"	43
SS3084	158.89		Single	84"	5/11

SLOTTED STANDARDS

Universal, Heavy Duty, Extra Heavy Duty

Universal Slotted Standards

Steel thickness: 1/16" (.062")
 Universal: 1/2" slots on 1" centers
 Countersunk mounting
 screw holes 9" apart

Heavy Duty Slotted Standards

Steel thickness: 3/32" (.093") /
 (.062" at the recessed slots)
 Universal: 1/2" slots on 1" centers
 Countersunk mounting
 screw holes 9" apart

Extra Heavy Duty Slotted Standards

Steel thickness: 1/8" (.125")
 1" slots on 2" centers
 Countersunk mounting
 screw holes 12" apart

** Screws not included*

FACEOUT DISPLAYERS

To use on heavy duty slotted standards with 1/2" slots on 1" centers

TS12	4.15	1	CHROME	12"	2/6
TS5H	7.65		CHROME	18"	2/6
RS12	5.96	1	CHROME	12"	3/8
RS14	5.57		CHROME	14"	4/6
TS7B	6.35	1	CHROME	18"	2/6

Straight Arm
Square tubing



TS12

5-Hook
Square tubing

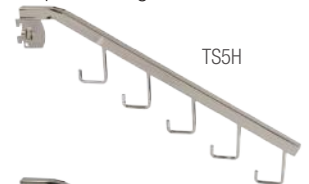

TS5H

Straight Arm
Rectangular tubing



RS12/14



TS7B

7-Ball
Square tubing

FACEOUT DISPLAYERS

To use on extra heavy duty slotted standards with 1" slots on 2" centers

TR7B	2.46	1	CHROME	18"	2/6
RR12	7.52	1	CHROME	12"	2/6
RR14	7.65		CHROME	14"	2/6
RR7B	9.07		CHROME	18"	2/6



TR7B

7-Ball
Square tubing



RR12/14

Straight Arm
Rectangular tubing

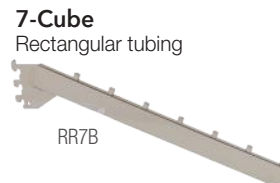

RR7B

7-Cube
Rectangular tubing

WALL SYSTEMS Slotted Standard Brackets

HANGROD BRACKETS - to fit 1 1/4" tubing



12" or 14" Brackets
With nylon stabilizer. For slotted standards with 1/2" slots on 1" centers.

12" Bracket
With locking screw. For slotted standards with 1/2" slots on 1" centers.

12" Double Bracket
For slotted standards with 1/2" slots on 1" centers.

RECTANGULAR TUBING BRACKETS

For use on slotted standards with 1/2" slots on 1" centers

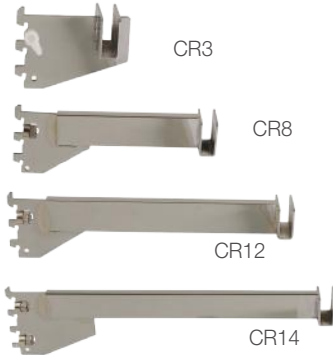

3" Bracket
Flat steel.

8" Bracket
Rectangular tubing.

12" Bracket
Rectangular tubing.

14" Bracket
Rectangular tubing.

RECTANGULAR TUBING BRACKETS

For use on slotted standards with 1" slots on 2" centers



3" Bracket
Flat steel.

8" Bracket
Rectangular tubing.

12" Bracket
Rectangular tubing.

- See page 41 for shelving -



GA

Tap-In Shelf Bracket
Fits universal 1/2" slots on 1" centers. (.080" thick)



GC12

Adjustable Shelf Brackets
Fits universal 1/2" slots on 1" centers. Five positive spring loaded settings.



G12/14

Extra Heavy Duty Shelf Brackets
Fits Extra Heavy Duty Standards. 1" slots on 2" centers. With tightening screw fit "imperial" (.125" thick). Accepts snap-on attachments for use with handrails.



GSBL12/14

Heavy Duty Shelf Brackets with Lip
Fits universal extra heavy duty standards, 1" slots on 2" centers with tightening screw.

style #	\$	qty	description	size	wgt
A212	7.49	1	CHROME	12"	2/6
A214	7.65		CHROME	14"	
ALS212	7.78	1	CHROME	12"	
B212	14.64	1	CHROME	12"	
CR3	4.67	1	CHROME	3"	1/3
CR3B	3.63		BLACK	3"	
CR8	7.65		CHROME	8"	2/6
CR12	5.05	1	CHROME	12"	2/6
CR12B	4.92		BLACK	12"	
CR14	7.12		CHROME	14"	2/6
GR3	4.14	1	CHROME	3"	1/3
GR3MAB	4.28		BLACK	3"	
GR8	7.20		CHROME	8"	2/6
GR12	3.99	1	CHROME	12"	2/6
GR12MAB	6.99		BLACK	12"	
GR14	7.64		CHROME	14"	2/6
GA8	1.81	1	CHROME	8"	2/6
GA10	1.94		CHROME	10"	
GA12	2.00		CHROME	12"	
GA14	2.20		CHROME	14"	
GC12	3.11	1	CHROME	12"	2/6
G12	3.99	1	CHROME	12"	2/6
G14	7.26	1		14"	
GSBL12	7.00	1	CHROME	12"	3/6
GSBL14	6.22	1		14"	

Pegboard & Wall Mount WALL SYSTEMS

style #	\$	qty	description	size	wgt
PHS4	7.00	12	STANDARD 4" long	1/8" D	1/3
PHS6	7.65		6" long		
PHS8	8.42		8" long		
PHH6	9.07	12	HEAVY DUTY 6" long	3/16" D	1/3
PHH8	9.72		8" long		
PHH10	11.15		10" long		
PHH12	7.26		12" long		
PHX6	11.79	12	EXTRA HEAVY DUTY 6" long	1/4"D	1/3
PHX8	12.57		8" long		
PHX10	13.87		10" long		
PHX12	15.29		12" long		
PB1C9	8.42	100	WHITE	ONE SIZE FITS ALL	1
SHP6	18.01	12	7 GAUGE	6"	3/7
SHP8	20.22			8" w/2" tab	
PB6B	4.28	1	CHROME	16 5/8"	1/6
PB5H	4.54	1	CHROME	16"	1/6
PBML	8.42	1	CHROME	8 x 4 1/4"	1/3
ACR26PB	12.83	1	ACRYLIC	4 x 9"	1/7
ACR28PB				8 1/2 x 11"	
ACR984PB	20.74	1	ACRYLIC	24"L x 2"D x 4"H	2/5
TB12	4.41	1	CHROME	12"	2/6
RB12	6.35		CHROME	12"	
TB7B	7.78	1	CHROME	16 5/8" 7 BALL	2/6
TB5H	7.00	1	CHROME	16" 5 HOOK	2/6
FR3	7.00	1	CHROME	3"	1/3
ACR28WM	7.39	1	ACRYLIC	8 1/2 x 11"	1/7
ACR984WM	17.76	1	ACRYLIC	24"L x 2"D x 4"H	2/5
NHPSWL10WH	13.49	1	Gloss White	10" long	14
NHPSWL10	14.64		Anthrocite Grey		

PEGBOARD ACCESSORIES

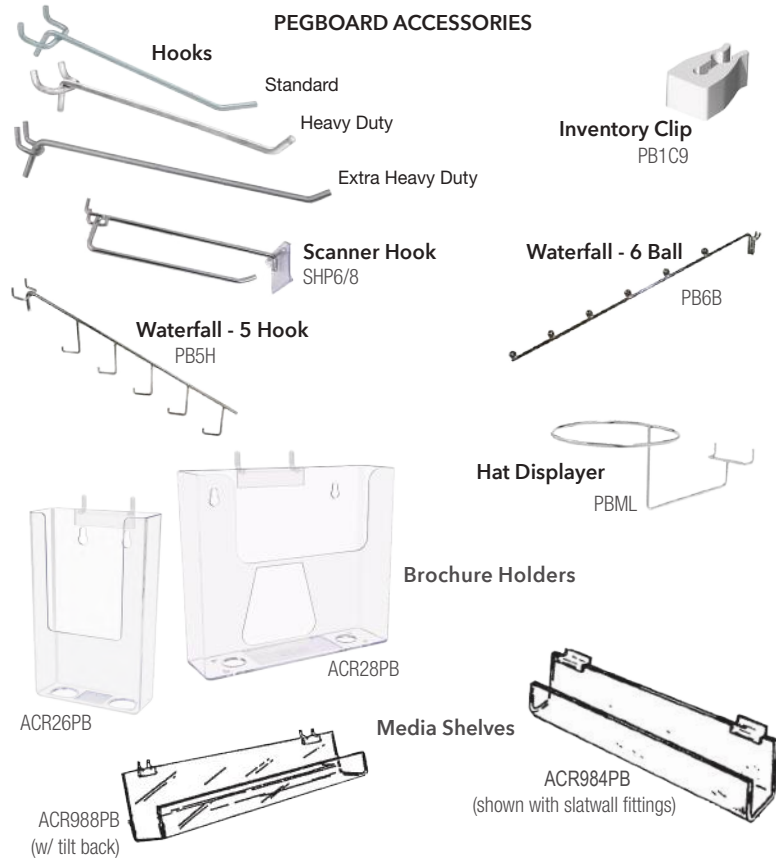

WALLMOUNT ACCESSORIES

* Note that screws are NOT included with wall mount accessories

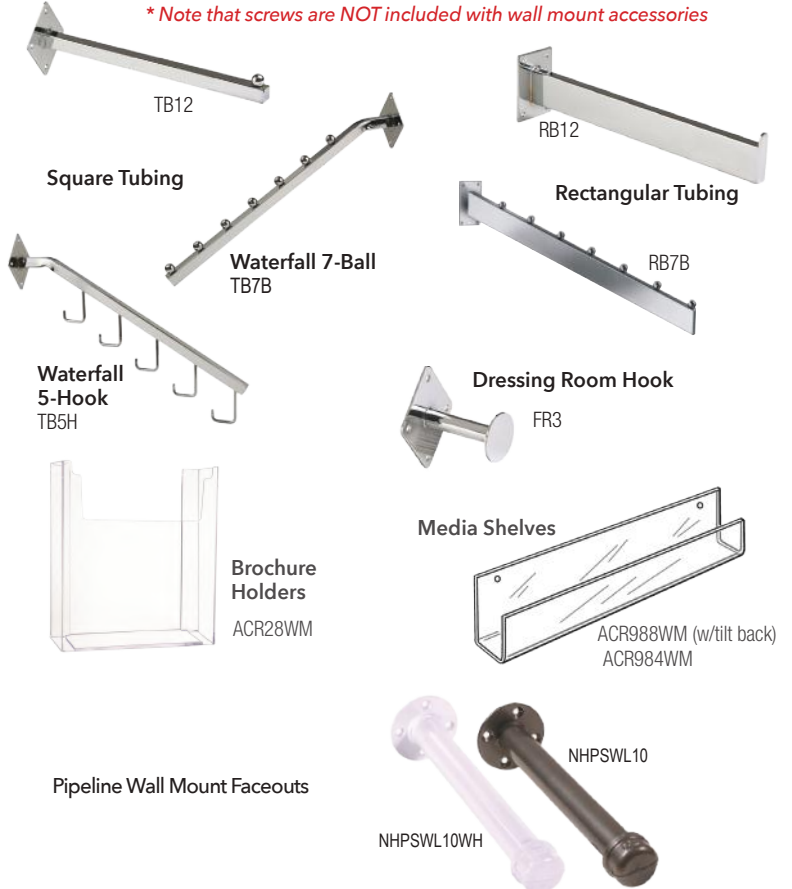

See our selection of coordinating pipeline store fixtures (pages 33-37).

WALL SYSTEMS Tubing & Accessories

ROUND TUBING & ACCESSORIES

Round Tubing
1 1/4" diameter, 14 gauge

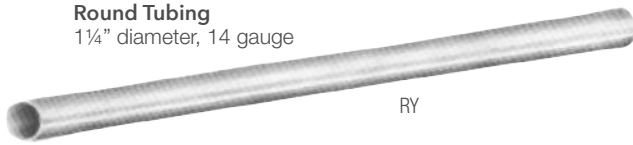

U Flange
For 1 1/4" and
1 5/16" round tubing
UF9



O Flange
For 1 1/4" and
1 5/16" round tubing
OF7

Splicer
For 1 1/4"
round tubing
RYSP



End Cap
For 1 1/4" and
1 5/16" tubing
EC2

RECTANGULAR TUBING & ACCESSORIES



Rectangular Tubing
1/2" x 1 1/2" x 17 gauge



Rectangular Tubing Accessories

End Caps



EC4 chrome plated
EC4MAB matte black

**Extended
End Caps**



EC5 chrome plated
EC5MAB matte black

Splicer



RESP splicer for
rectangular tubing

style #	\$	qty	description	size	wgt		
RY4	13.22	1	CHROME	4'	4/7		
RY5	15.94		CHROME	5'	6		
RY6	21.51		CHROME	6'	6/7		
RY8	23.59		CHROME	8'	8		
RY10	34.08		CHROME	10'	11		
RY12	40.95		CHROME	12'	13		
UF9	3.11		1	CHROME	UFLANGE	1	
OF7	6.35	CHROME		OFLANGE	1		
RYSP	2.01	CHROME		SPLICER	1/3		
EC2	.95	CHROME		END CAP	1		
RH7B	7.39	1	CHROME	14"	2/6		
RH7BMAB	7.00		BLACK	14"			
RH5H	7.65		CHROME	17 3/4"	2		
RH6	4.54		CHROME	6"	1/2		
RH2C	3.89		CHROME	2"	1/3		
RH12	6.35		CHROME	12"	2/6		
RH12MAB	4.28		BLACK	12"			
H4	.78		CHROME	4"	1/3		
H6	1.17		CHROME	6"			
H9	.91		CHROME	9"			
H12	1.68		CHROME	12"			
RE2	3.99		1	All sizes available in chrome except 4' which is also available in black and white	2'	2	
RE3	8.42	3'			3		
RE4	11.79	4'			4/5		
RE5	14.64	5'			5		
RE6	18.79	6'			6/10		
RE8	22.29	8'			6/12		
RE10	34.08	10'			7		
RE12	41.60	12'			9		
REMAB4	11.79	4'			4/5		
EC4	.91	1			CHROME	TUBING	1
EC4MAB	1.08				BLACK	1/2" x 1 1/2"	
EC5	1.44		CHROME	TUBING			
EC5MAB	1.49		BLACK	1/2" x 1 1/2" w/1" extension			
RESP	2.85	CHROME	1/2" x 1 1/2"				



Blue Retro NMSKBLO2

back

front



Open/Closed Sign Kits

Sturdy metal constructed, double-sided signs with two pre-drilled holes. Kits include one (1) black metal chain with two (2) black S hooks for hanging, and two (2) suction cups. Printed in the USA.

All signs are 12" w x 8" h; printed with an "open" message on the front and a "closed" message on the back; 5lbs.

24.36/kit



front

Blue Wash Tones NMSKBLO



back



front

Spanish NMSKABSE

back



front

Hiring - Black NMSKBWH

back



front

Grey w/Dots NMSKGO

back



front

Hiring - Red NMSKRWH

back



front

Red NMSKRO

back



front

Black NMSKBO

back



front

Black Awesome NMSKBOWA

back



front

Red Awesome NMSKROWA

back

SIGNAGE Card Stock Signs

Card Stock signs, available in 3 sizes and 9 designs.

Double sided. Printed on high quality 10 point card stock. Made in the USA.

Don't see the message you're looking for? Give us a call and let us know what you need. We can custom make it for you!



small
5.5" w x 3.5" h
\$1.93 /each
\$9.50 /5 pcs
\$18.90 /10 pcs

medium
7" w x 5.5" h
\$2.19 /each
\$10.75 /5 pcs
\$20.35 /10 pcs

large
11" w x 7" h
\$2.32 /each
\$11.20 /5 pcs
\$21.64 /10 pcs

ship weights:
each - 1 lb
5-pack - 1 lb
10-pack - 1 lb

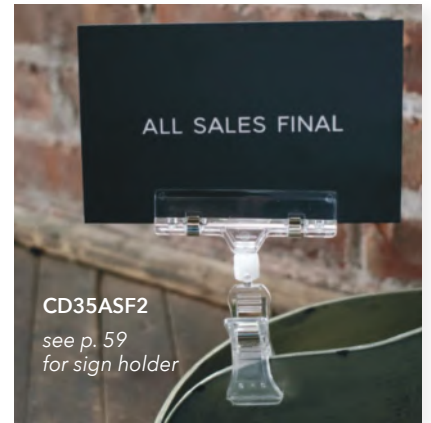

CD35ASF2
see p. 59
for sign holder



CD35ASF2 /small
CD57ASF2 /medium
CD711ASF2 /large



CD35ASF1 /small
CD57ASF1 /medium
CD711ASF1 /large



CD35S1 /small
CD57S1 /medium
CD711S1 /large



CD35S2 /small
CD57S2 /medium
CD711S2 /large



CD35S3 /small
CD57S3 /medium
CD711S3 /large



CD35S4 /small
CD57S4 /medium
CD711S4 /large



CD35S5 /small
CD57S5 /medium
CD711S5 /large



CD35NA2 /small
CD57NA2 /medium
CD711NA2 /large



CD35NA1 /small
CD57NA1 /medium
CD711NA1 /large



CD35SS /small
CD57SS /medium
CD711SS /large



SALEBANNER
Glossy red sale printed vinyl tags slip over the hook of a hanger. 2" w x 4" h; 5/16" dia. hole is 3/16" from top; 100 pcs; 1/3 lb.

27.73



RAH25



RAH007



RAH44

Plastic Display Cards
Red & White plastic card stock, slightly textured on front. Available in 3 styles. 7" w x 11" h; 1 pc; 1 lb. **3.89**

style #	\$	qty	description	wgt
BH28	52.90	1	Chrome, 22x28", 60" H <i>(holds graphics up to 3/16" thick, usable sign area 20 3/4" x 26 3/4")</i>	18
The following signs all hold graphics up to 1/4" thick:				
BH28BAW	116.51	1	Black, All Weather, 22x28", 60" H indoor/outdoor	18
BH22	59.49	1	Chrome, 14x22", 53" H	13
BH28MAB	52.99	1	Matte black, 22x28", 60" H	23
BH23	75.30	1	Chrome, extra heavy base, 14x22", 53" H	13
BH29	105.75	1	Chrome, weighted base, 22x28", 60" H	22
BH24	69.21	1	Chrome, rectangular tubing, 14x22", 56" H	7
BH28SP	43.03	2	Acrylic Sign Protectors (2) crystal clear panels; each 22"w x 28"h x .04" thick <i>(works with BH28 – sold separately)</i>	4
BH28SP2	97.84	1 kit	"Sidewalk Sale" Sign Kit Kit includes (1) BH28 sign, (2) "Sidewalk Sale" poster signs, (2) sign protectors (BH28SP)	24
BH30	79.57	1	Rect. tubing, 22x28", 56" H; Chrome <i>holds graphics up to 3/16" thick</i>	9,8 lbs; (2 ctns)
BH30MAB	62.73	1	Rect. tubing, 22x28", 56" H; Matte Black; <i>holds graphics up to 1/4" thick</i>	9,8 lbs; (2 ctns)
BH55	97.99	1	Double 22" x 28" sign holder; 56" H; Chrome; <i>holds graphics up to 3/16" thick</i>	9,8 lbs; (2 ctns)
BH55MAB	86.70	1	Double 22" x 28" sign holder; 56" H; Matte Black; <i>holds graphics up to 1/4" thick</i>	9,8 lbs; (2 ctns)
BH77	208.49	1	Triple 22" x 28" sign holder; 90" H; Chrome; <i>holds graphics up to 3/16" thick</i>	35/98, 10/25 lbs; (2 ctns)
BH77MAB	169.99	1	Triple 22" x 28" sign holder; 90" H; Matte Black; <i>holds graphics up to 1/4" thick</i>	
MCF711	33.31	6	7x11" card frame w/flat base	7
MCW28V	36.81	1	22x28" frame with wall mount attachment	6/21
NHSTCH	9.72	1	Metal shelf signs Ledge piece is 6" front to back; sign holder piece is 6 1/2" across	1
NHSTV	7.00		High Polished Chrome	
			Metal	
			Accepts 6 1/2"W x 1 1/2"H paper inserts, (not included)	



Bulletin Sign Holders

BH22/BH28
BH28MAB
Chrome or Black
10" x 14"
flat base

BH23/BH29
Chrome
Extra heavy weighted
10" x 14" base



BH24
Chrome
Rectangular tubing frame

BH28BAW
Black
All Weather Sign Holder
10" x 14"
flat base



Acrylic Sign Protectors

BH28SP



"Sidewalk Sale" Sign Kit

BH28SP2



BH30
BH30MAB
Chrome or Black
22" x 28" sign holder.
Rectangular tubing frame base - 15" x 24"



BH55
BH55MAB
Chrome or Black
22" x 28" double sign holder. Rectangular tubing frame base - 15" x 24"



BH77
BH77MAB
Chrome or Black
22" x 28" triple sign holder. Rectangular tubing frame base - 24" x 25"



Countertop Square Corner Card Frame

MCF711



Wall Mount Square Corner Sign Frame

MCW28V



NHSTCH



NHSTV



Metal Shelf Overlay Retail Signs w/framed front

SIGNAGE Sign Holders & Accessories

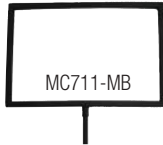

SQUARE CORNER CARD FRAMES



MVER114

MC57, MC711, MC114

MCP57, MCP711



CHROME ROUND CORNER FRAMES

ALLIGATOR CLIP SIGN HOLDERS



WSAC5SN

WSAC6SN

WSAC7SN

CHROME CLAMPS & STEMS



C5



C6



SC22



SC23



SC8



SC11



M3



M6



NS3



NS6

MAGNETIC CLAMPS



SC17



SC20



SC21

style #	\$	qty	description	wgt
MCP711-MB	10.50	1	7x11" Matte black mitre corner card frame w/double 4" stem 3/8"x5" base	7/10
MC711-MB	7.49	1	7x11" Matte black square corner frame w/3" threaded stem attdch.	6/10
SC20-MB	8.90	1	Matte black magnetic clamp threaded	1
SC22-MB	2.48	1	Matte black all purpose clamp threaded	1
MVER114	89.90	6	11x14" chrome sign frame with 5 1/2x11" base	3/12
MC57	27.09	6	5 1/2x7" chrome frame w/ 3/8" fitting	2
MC711	27.90	6	7x11" chrome frame w/ 3/8" fitting	6/10
MC114	42.90	6	11x14" chrome frame w/ 3/8" fitting	6/10
MCP57	8.42	1	chrome, 5 1/2x7 card frame mitred Double 4" stem, 4x7" base	2/6
MCP711	9.72	1	chrome, 7x11" card frame mitred Double 4" stem, 4x7" base	2/6
SB57	10.25	1	10"H shovel base, 5 1/2x7"	2/6
SB711	10.50	1	10" H shovel base, 7x11"	2/6
CF711	8.42	6	7x11" frame w/ 3/8" fitting * while supplies last	6/7
Alligator Clip Sign Holders				
Satin Nickel / down position clip:				
WSAC1SN	18.01	1	12" H	3/6
WSAC2SN	19.44	1	24" H	3/11
WSAC4SN	20.22	1	42" H	4/21
WSAC5SN	3.95	1	Clear, 1"x1" square base; 4"H	0.5/1
WSAC6SN	4.82	1	Black, 1"x1" square base; 4"H	0.5/1
WSAC7SN	4.38	1	"S" design; stainless steel; 3 1/2"H	0.5/1
C5	20.22	6	1" Square w/3" stem - 3/8"	2/3
C6	17.37	6	1/2 x 1 1/2" rect. 2" stem - 3/8"	2/3
SC22	11.65	6	Universal all purpose clamp; Fits round, square & rect. tubing threaded	2/3
SC23	17.37	6	All purpose clamp for 3/8" swedge	2/3
SC8	14.64	6	Spring clamp for 1" sq. tubing w/ threaded 3/8" fitting	2/3
SC11	15.94	6	Spring clamp for rect. tubing w/ threaded 3/8" fitting	2/3
M3	4.92	6	3" threaded stem - 3/8"	2
M6	6.74	6	6" threaded stem - 3/8"	2
NS3	4.92	6	3" swedge stem - 3/8"	2
NS6	7.65	6	6" swedge stem - 3/8"	3
SC17	21.51	6	Magnetic clamp for 1/4 & 3/8" threaded stem	2
SC20	31.23	6	Magnetic clamp for 3/8" threaded stem	2/3
SC21	31.23	6	Magnetic clamp for 3/8" swedge stem	2/3

Sign Holders / Acrylic SIGNAGE

style #	\$	qty	description	wgt
POP1	18.01		Clear: Double clip sign holder 3½" long; clip - 0.75"W x 1.5" H	1/3
POP2	31.23	20	Clip on sign holder w/ spring loaded graphic holder; 4" long; clip - 3.2"W x 1"H	2/7
POP3	41.60		Clip on sign holder w/ spring loaded graphic holder; 6¼"L; clip - 3.2"W x 1"H	2/7
POP4	24.36		Clip on sign holder w/ fixed graphic holder; 3 5/8" long; clip - 2.2"W x 0.88"H	2/7
PK57	11.15		1	5½x7" card holder w/ chrome double stem
PK711	15.03	1	7x11" card holder w/ chrome double stem	3/6
JPC57	52.10	6	5½x7½" frame w/ universal stem	2/3
JPC711	76.98	6	7x11" frame w/ universal stem	3/7
			Horizontal, double-sided, bottom load sign holders:	
PG711	41.60	6	Straight 7x11" card holder	3/7
PJ711	50.67	6	Card holder, chrome channel 7x11" w/ 3/8" fitting	3
PJ57	29.81	6	Card holder chrome channel 5½x7" w/ 3/8" fitting	3/7
PH711	55.75	6	Slanted 7x11" card holder	7/10
PH57	19.31	6	Slanted 5½x7" card holder	3/7
HPCT57H	4.92	1	TOP LOAD HORIZONTAL 5½"H x 7"W	
HPTCT711H	13.87	1	7"H x 11"W	2/3
HPTCT811H	11.15	1	8½"H x 11"W	
HPCT57V	6.35	1	TOP LOAD VERTICAL 7"H x 5½"W	
HPCT711V	11.92	1	11"H x 7"W	2/3
HPCT811V	12.57	1	11"H x 8½"W	
HPCT114V	20.87	1	BOTTOM LOAD VERTICAL 14"H x 11"W	2/3
HPCT57HSB	4.92	1	SLANT BACK HORIZONTAL 5½"H x 7"W	2/3
HPCT711HSB	9.07	1	7"H x 11"W	1/6
HPCT57VSB	5.44	1	SLANT BACK VERTICAL 7"H x 5½"W	1/6
IMCT49	6.35	1	COUNTER BROCHURE HOLDER 4" x 9" clear	1/3
IMCT811	9.59	1	8½" x 11" clear	2/6

CLIP-ON SIGN HOLDERS



ACRYLIC CARD HOLDERS

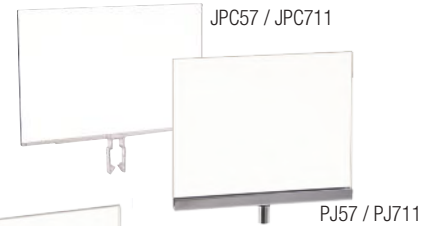

TOP & BOTTOM LOAD SIGN HOLDERS

Crystal clear sign holders

Top Load Styles



Bottom Load Vertical



Slant Back Sign Holders



Brochure Holders



SIGNAGE Sign Hanging Accessories

CEILING ANCHORS



DISC MAGNETS



Spider Anchors

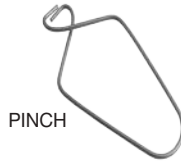

CLEAR LOCKING HOOKS

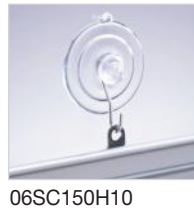
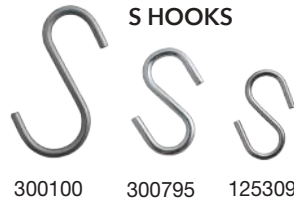
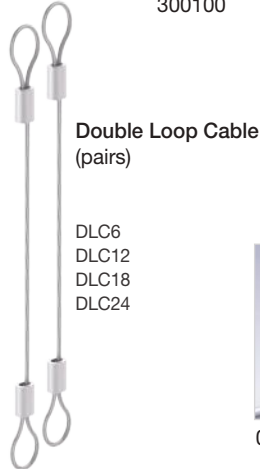

MIRACLE STICKS® ADHESIVE SIGN TABS

NHMS



style #	\$	qty	description	wgt
GCH02	17.37	10	¼" swivel hook slot; rotates 360°; snaps on ceiling grids	5
GCH05	14.64	10	Clear hinged hook ceiling anchor	5
GCH06	13.87	10	7/8" loop ceiling anchor w/ 2" base; twist to connect	5
GCH04	34.08	10	Ceiling anchor w/ steel spring & 15/64" loop	5
RMB18	8.42	1	Plated steel magnet with hook: 1 1/2" dia – holds 18 lbs 2" dia – holds 20 lbs 2 1/2" dia – holds 38 lbs	1
RMB20	13.87			
RMB38	17.37			
MCL1	1.10	1	Plated steel magnet in 2 sizes: 1" – holds 5 lbs 2" – holds 14 lbs	1
MCL2	1.94			
250145	12.96	1	White Gorilla magnet: holds up to 20 lbs	1
250026	75.69	50	White snail adhesive disk	1/3
DISCMAG10	13.87	10	1/2" x 1/8" disc magnet for signage; pull force: 7.36 lb	1/3
DISCMAG30	27.73	30		
RAN1UP	7.52	10	ClearOne-Up™ Spider Anchors use w/ hooks to hold signs perpendicular or parallel	1/3
RAN1UP2	8.29	10		
PINCH	4.15	10	Galvanized steel	1
2501006	32.66	50	Clear, Single locking hooks: 6"	1/3
300100	28.51	100	Galvanized Steel: Long S Hook - 2 5/8"H	2/3
125309	8.42	100	Standard S Hook - 1"H Large S Hook - 1 5/8"H	1
300795	11.15	50		
2500808	13.87	50	Regular Hook 8" Regular Hook 12" Regular Hook 16" Regular Hook 24"	2/3
25008012	15.29	50		2
25008016	20.87	50		2/9
25008024	27.73	50		3/27
DLC6	9.72	2	Double loop cable - sold in pairs; 1/32" uncoated stainless steel w/ ½" long loops; holds up to 50 lbs 6" Cable length 12" Cable length 18" Cable length 24" Cable length	1/2
DLC12	11.15	2		
DLC18	12.57	2		
DLC24	13.87	2		
06SC150H10	10.50	10	Suction cup - Clear with plated steel hook 1 3/4"	1/3
NHMS	22.29	500	Adhesive on both sides. Apply to back of signs to avoid messy taping. 3/8" x 1 5/8"	1



Sign hanging systems & hanging hardware for graphic displays.

Featuring plastic gripper bar sets with snap closures, hanging dowel kits, sign clips that can be used for hanging signs - or simply turn them over to use as countertop displays. We have updated our ceiling anchors too, including magnets, hooks and cables. Easy to assemble and versatile for every season.

Plastic Gripper Bar Sets

Set includes a top and bottom bar, and feature snap grips that close easily. Strong with a rigid torque. Fits signs up to .070" thick. Each set includes two snap grips, two universal hanging clips and is available in three sizes.



GSHR - straight

Straight Sets

Available in 3 sizes and 3 colors (clear / black / silver):

GSH24R - (C/B/S)	24" long	11.79
GSH36R - (C/B/S)	36" long	15.29
GSH48R - (C/B/S)	48" long	19.44



GSHO - oval

Oval Sets

Available in 3 sizes and 2 colors (clear / silver):

GSH24O - (C/S)	24" long	20.87
GSH36O - (C/S)	36" long	24.36
GSH48O - (C/S)	48" long	31.88



Can be used 2 ways

RMB

Round magnetic base w/hook available on page 60



Hanging Dowel Kits

Made for banners with a hem, top and bottom. Each kit includes (2) aluminum 1/2" diameter dowels, end caps and (1) diamond braided cord. Available in 3 sizes.

GDSH24	24" long	11.79
GDSH36	36" long	13.87
GDSH48	48" long	15.29

GDSH



Mini size 1 1/4" w x 2" h

GSHC

2" w x 3" h

Sign Hanging & Countertop Clip Sets

Solid aluminum alloy sign clips coated in a satin finish. Clips feature rubber grips, a binder spring and the ability to grip signs up to 1/2" in thickness.

Satin silver or black. Sold in sets of two, same size/color.

GSHCL	2"W x 3"H	39.53
GSHCLB		
GSHCS	1 1/4"W x 2"H (mini)	27.73
GSHCSB		



FEATHER BANNER SWOOPER FLAG SIGN KITS



SALEFB CLEARANCEFB OPENFB OPENSSEFB

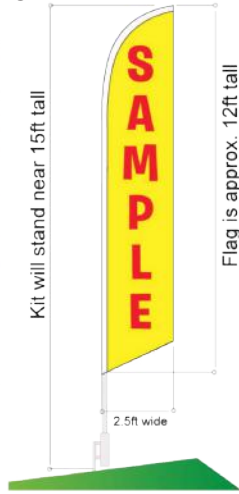

Kit will stand near 15ft tall

Flag is approx. 12ft tall

2.5ft wide

15ft Feather Banner Swooper Flag Sign KIT

Includes 1 flag (12' x 2.5'), 1 4-piece pole kit & 1 stake; stands 15' high when assembled; 1 kit/carton; 7 lbs. **\$97.07 /kit**

- | | |
|--------------------|---------------------------------|
| SALEFB | Sale Sign kit |
| CLEARANCEFB | Clearance Sign kit |
| OPENFB | Open (blue/red) Sign kit |
| OPENSSEFB | Open (stars & stripes) Sign kit |



NHMBB03G

A-Frame Sidewalk Chalkboard

Features a mahogany finish and can be used with chalk and liquid chalk markers (sold separately). It is double-sided and sits on rubber stoppers to prevent scratched floors and added stability. Can be used indoors and/or outdoors.

Closed Dimensions: 20 1/2" (w) x 39 1/2" (h) x 2" (d)
Open Dimensions: 20 1/2" (w) x 37 1/2" (h) x 27" (d)
Writable Area: 17 3/4" x 28 3/4"

1 /carton; 18/24 lbs. **\$116.51**

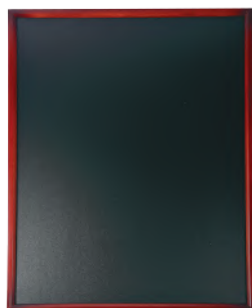

NHMBB10C

Framed Square Chalkboard

Features a mahogany finish and can be used with chalk and liquid chalk markers (sold separately). It can be hung in portrait and landscape with the (2) hooks provided. Indoor use only.

Overall Size: 24" x 30" x 1"
Writable Area: 22 1/2" x 28 1/2"

1 /carton; 9/10 lbs. **\$68.04**



OPENHRB2

LED "OPEN" Sign

LED red and blue open sign with black base for indoor use. Measures 13"H x 21 1/2"W x 1"D. Weight 3lbs. Lifetime of 10,000 hours. Low power consumption. No Flashing. Power supply and chain included; 18 5/8" w x 9 5/8" h. 1 /carton; 3/12 lbs. **\$55.34**



NHMBB03B

A-Frame Sidewalk Marker Board

Features a mahogany finish and black marker board perfect for dry-erase or liquid chalk markers (sold separately). It is double-sided and sits on rubber stoppers to prevent scratched floors and added stability. Indoor use only.

Closed Dimensions: 20 1/2"(w) x 39 1/2" (h) x 2" (d)
Open Dimensions: 20 1/2" (w) x 37 1/2"(h) x 27" (d)
Writing Area: 17 3/4" x 58 3/4"

1 /carton; 18/24 lbs. **\$116.51**

FLAGS



PFL00100



PFL00200

SALE & OPEN Flags

Large 3' x 5' flags. Lightweight and durable outdoor polyester material, double stitched on flying edges for extra durability, and two metal grommets for easy display. 1 /carton; 1 lb.

SALE PFL00100 **\$13.87 each**

OPEN PFL00200 **\$19.43 each**

PENNANTS



PNR100-OMC



PNR100-OPT

Triangle Pennants - (48) 12" x 18" pennants on 100' of nylon rope.

Please specify color: Red/White/Blue(OPT) or Multi-Colored(OMC).

1 /carton; 2/10 lbs.

PNR100-OPT **\$26.49**

PNR100-OMC **\$24.99**



PFL00200KT

OPEN Flag with Pole KIT

Kit consists of one 3' x 5' OPEN flag and a 6' flag pole. The flag pole is white, painted steel and includes a mounting bracket and screws, rotating flag clips, and a gold plastic eagle mounted on the top.

1 kit /carton; 2/5 lbs.

\$42.76

Fluorescent Liquid Chalk Markers

Fluorescent liquid chalk markers. Wipe away easily with a wet cloth.

A set includes 8 markers: Blue, Green, Pink, Purple, Orange, Red, White, and Yellow.

with 1/8" Small Bullet Tip (8)

8 /carton; 1 lb.

\$25.66



NHGEB06



with 5/8" Large Flat Tip (8)

8 /carton; 1/2 lbs.

\$50.67

NHGEB05

style #	\$	qty	description	size	wgt
NHFT	56.99	1	Counterfeit Detector	2 3/4" x 4 1/2"	1
NHFTRBADD	16.99	1	Rechargeable Battery	2 3/4" x 4 1/2"	1
NHFTRB	72.99	1	Detector/Battery kit	both pieces 2 3/4" x 4 1/2"	1
K20020	5.57	1	BLACK	PEN	1
K20020S	16.59	1	Pen set	3 Pens	1
SC3000	25.01	1	Indoor/outdoor simulated cameras w/LEDs Black	7x3 1/2"x5 1/2"	2/3
SC2010	25.01	1	White	5 1/2"x3x2 1/2"	
SCODW	32.01	1	30 LEDs; realistic design; sticker included; uses 2-AA batteries (not included) White wall/ceiling mounted camera dome w/blinking light; uses 2-AA batteries (not included)	9 1/4"x5 1/2"x4 1/2"	2/7
DOME3051	27.48	1	Simulated camera w/ blinking red light; uses 2-AA batteries (not included)	4 1/2" dia.; 3" h	1/3
CA2	62.47	1	Compact, self-contained indoor alarm. Easy installation. Motion detection activates a chime or alarm sound. Uses 9V battery (not included).	3x3x2 1/4" Detects motion at a range of up to 32 feet	1
NH3360	52.99	1	Wireless Entry Alert @ Chime alert w/ Receiver; 10 selectable chimes	All kits feature: up to 500 ft. range; 64-88 dB at 1'; UL/cUL listed, FCC and IC Compliant	1
NH3350	55.99	1	Musical doorbell chime w/ Receiver; 10 selectable sounds		1
NH3300	55.99	1	Doorbell extender w/ Receiver; 2 selectable sounds		1
NH3610	54.49	1	Motion-activated chime w/ Receiver; 10 selectable chimes; weather sealed		1
MG24	77.63	1	CHROME	24 slot arm	2/3
ADAPTERS					
SD75	31.88	1	CHROME	3/4" tube	2
SD100	13.74	1	CHROME	1" sq. tube	1
CABLES					
SD724	5.96	1	CHROME	8'L	1
606	6.87	1	Security chain kit	Standard lock; 46" chain; 8" ring	1/3
LOCKS	3.11	5	Standard Replacement Locks	Standard	1

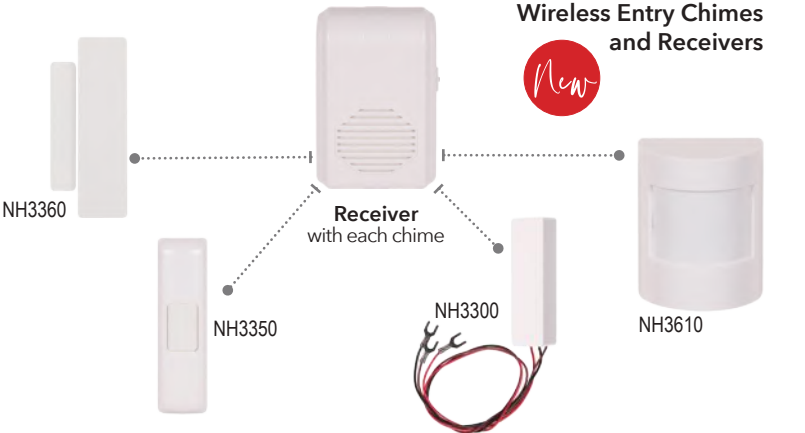

SECURITY Traffic Control



POST & ROPE

Posts available in matte black, polished stainless steel or brass. Red or black velvet ropes in a selection of lengths available (sold separately)

2-post sets for one low price!



POST & TENSION BELTS

Economical posts and belts with slow-retracting brake available in a variety of options



Belt Color Options

Black (BK)	Yellow (YW)
Red (RD)	Maroon (MN)
Blue (BL)	Black/White (BW)
CAUTION - DO NOT ENTER	
Caution (CAU)	

Universal 4-way belt clips integrate with many other manufacturers' units



Tension line replacement cassette...



POST-MOUNTED FRAME KITS & 2-SIDED SIGNS



Frame kit includes 1 frame, 1 black metal adapter and 2 acrylic protectors



* Note that custom signs are also available

style #	\$	qty	description	size	wgt
MLFTMB	109.64		Matte black/ flat top	set = 2 x 40" H / base 14"	
MLUTPS	130.38	2-post set	Polished stainless steel/ urn top	40" H / base 14"	19/25
MLBTPB	137.38		Polished brass/ ball top	40" H / base 14"	
MLRBK48SEPS	88.78			4 ft	
MLRBK72SEPS	80.48	1	Black velvet with stainless steel snap ends and cotton core	6 ft	7/10
MLRBK96SEPS	88.78			8 ft	
MLRRD48SEPS	88.78			4 ft	
MLRRD72SEPS	80.48	1	Red velvet with stainless steel snap ends and cotton core	6 ft	7/10
MLRRD96SEPS	88.78			8 ft	
MLRRD48SEPB	88.78			4 ft	
MLRRD72SEPB	80.48	1	Red velvet with brass snap ends and cotton core	6 ft	7/10
MLRRD96SEPB	88.78			8 ft	
TL700MBBK	114.99		Matte black Post/Belt		
TL700MB	166.41		Black Post/Specify Belt		
TL700PSBK	183.12	2-post set	Polished SS Post/Specify Belt	set = 2 x 40" post 14" base 10" belt	24/27
TL700SSBK	216.43		Satin SS Post/Specify Belt		
TL700YWBK	221.88		Yellow Post -Black Belt		
TL700YW	221.88		Yellow Post/Specify Belt		
TLRE	13.74	1	Wall Mount Receiving End		1
TLWM700MB	83.20	1	Matte Black head/plate - specify belt	10' belt	6
TLWM700PS	91.63	1	Polished SS head/plate - specify belt	10' belt	6
TLRC700MB	60.91		Tension line replacement cassettes - specify belt: Matte black finish		
TLRC700PS	60.91	1	Polished SS finish	10' belt	4
TLRC700SS	60.91		Satin SS finish		
TLRC700YW	60.91		Yellow finish		
TLSK1811MB	36.44	1	Matte Black Frame	8 1/2" x 11" frame kit	3
TLSK1811PC	83.20		Polished Chrome Frame		
TLS811BK03	36.49	1	Exit	8" x 11" 2-sided signs 1/16" thick	1
TLS811BK05	36.49		Please Enter Here		

style #	\$	qty	description	size	wgt		
3181S	148.26	1	POSTS: Satin chrome	34" ht. / base 11.5"	22/59		
3182SA	163.56		Satin brass	34" ht. / base 11.5"			
3101S	173.28	1	Satin chrome	39" ht. / base 11.5"	22/59		
3102S	207.88		Satin brass	39" ht. / base 11.5"			
550541336B 550541336C	168.09 151.50	1	ROPE: Black/ Brass Black/ Chrome	1 1/2" diameter 6 ft	3/6		
550541333BB 550541333BC	125.71 109.12		Black/ Brass Black/ Chrome	3 ft			
550541246B 550541246C	168.09 151.50		Royal blue/ Brass Royal blue/ Chrome	6 ft			
550541333RBB 550541333RBC	125.71 109.12		Royal blue/ Brass Royal blue/ Chrome	3 ft			
550541226B 550541226C	168.09 151.50		Bright Red/ Brass Bright Red/ Chrome	6 ft			
550541223B 550541223C	125.71 109.12		Bright Red/ Brass Bright Red/ Chrome	3 ft			
			<i>See list of available colors pictured right</i>				
890333333	221.75		1	Black Post black tape		40"Hx7"L	22
89033333332	235.61			Black Post black tape/ white stripe		40"Hx7"L	
8901P1P23	221.75			Polished chrome post Blue tape		40"Hx7"L	
8901P333332	221.75	Polished chrome post Black tape/ white stripe		40"Hx7"L			
8902S2S29	249.48	Satin brass clear coated post dark green tape		40"Hx7"L			
66	9.59	1	Rubber floor protector set	13" base	2		
8961P23	138.54		Polished chrome head, blue tape	Wall mount			
8962P28	166.28		Polished brass head, green tape	Wall mount			
896333332	138.54		Black head/black tape/White stripe	Wall mount			
698	20.87		Wall receptacle	N/A			
170133899HD	83.07	1	SuperHold sign adapter - black	3"	3		
S17P32V			Single faced signs: line forms here				
S21P32V	78.93		please wait here please wait here for next available associate	7" w x 11" H 1/8" thick			
S15P33V			this section closed				
S09P32V							

Contemporary Portable Post 318

Clean functional design, lighter weight, lower cost. Available in satin chrome or satin brass.

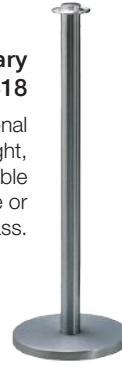

Standard Portable Post 310

Our most popular post for guiding traffic. A proven design. Built for years of dependable service. Available in satin chrome or satin brass.



Velour Rope Colors:



- 54 Antique Gold
- 42 Rust
- 46 Brown
- 22 Bright Red
- 43 Maroon
- 24 Royal Blue
- 71 Ice Blue
- 44 Purple
- 29 Hunter Green
- 48 Beige
- 33 Black

Velour Ropes for the 318 & 310 series

Many other colors and styles of post and ropes available - call Customer Service for more info.

Tensabarrier 890 Series:

Retractable tape system for pedestrian traffic guidance.

- slow retracting tape cassette
- 4-way connecting system
- superhold sign adapter
 - 2 year warranty
 - locking tape end
 - easy installation



Rubber Floor Mat 66



8961P23
8962P28
Wall Mount Tape



Wall Mount Tape 89633332



Wall Receptacle 698



Sign Adapter 170133899HD

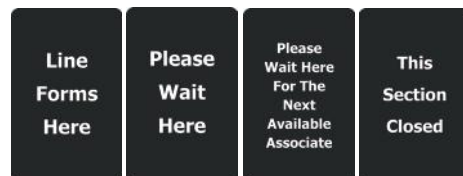

Acrylic Signs

DRESSING ROOM SUPPLIES



NHBLB

Brass Wire Lint Brush



Horse Hair Coat Brush

NHCB



Fabric Comb

NHFC

Lint & Nap Brush

NHNB

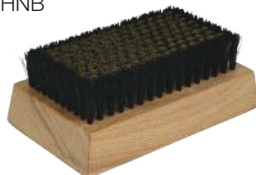

Sweater Comb

NHSC

Janie® Dry Spot Commercial Stick Remover

NHCSR



Grandma's Secret Spot Remover

NHSR

Try-On Panty
Excellent for bathing suits. *Each packed individually.*



TSJ

Hygienic Liner



TCP1

Lint Roller & Replacement Rolls

LL30



LLR



1030A



1061

Ever Blum® Cosmetic Stain Remover

Powder Spot Remover
For fine garments.



Albatross® Electric Spot Cleaning Gun

SG2000



1005

Ever Blum® Spray-A-Spot Cleaning Fluid
Removes a wide variety of stains.

style #	\$	qty	description	size	wgt
NHBLB	24.36	1	Brass wire lint brush	9 1/4" long	2/3
NHCB	20.87	1	Horse hair coat brush, deluxe	14 1/4" long	2/3
NHNB	25.66	1	Lint & Nap brush - Brass wire center with outside row of horse hair bristles - excellent for suedes & sweaters	4 1/2"L x 2 1/2"W	2/3
NHFC	34.73	1	Fabric comb w/steel blade to remove pills from wool garments	6" wide; 7 1/4" long	2/3
NHSC	25.66	1	Sweater comb	6" long, 4 5/8" x 2 1/4" head	2/3
NHCSR	9.72	1	Janie® Dry Spot Commercial Stick Remover	.40 ounces	2/3
NHSR	6.49	1	Grandma's Secret Spot Remover	2 ounces	2/3
TS	54.17	100	White	Misses	2/3
TSJ	44.45		White thong	Junior	2/3
TCP1	77.99	1000	Natural	1 1/2x5"	3
LL30	3.50	1	8" Lint Roller w/ handle	30" roll	1/2
LLR	2.06		4" Refill		
1030A	41.47	1	One can Non-aerosol	8 oz	2
1061	25.66	1	One can Aerosol	12 oz	2
SG2000	180.14	1	Electric spot cleaning gun	Standard	5/6
1005	81.13	1	Spray-A-Spot cleaning fluid	Gallon	10

DRESSING ROOM SUPPLIES

style # \$ qty description size wgt

25 pieces per color per kit:

608 41.47 100/ kit Green, red, yellow, blue 4x4 1/2" 3

608X 54.17 150/ kit Green, red, yellow blue, white, black 4x4 1/2" 4

10 pieces per size per kit:

M319 17.37 30/ kit White: 4,5,6 2x5" 1/2

25 pieces per size per kit:

M320 44.45 100/ kit 1,2,3, Guest 2x5" 3

25 pieces per size per kit:

608-6B 50.03 150 Black w/white print 4x4 1/2" 4

608-6W 50.03 150 White w/black print 4x4 1/2" 4



FITTING ROOM CHECKS

Color coded and notched to indicate number of items. 608 /608X

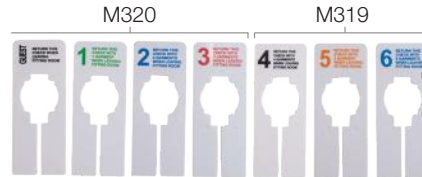

Numbers 1-6 plus 'guest'.



608-6B / 608-6W Numbers 1-6, printed both sides.



Let us create Custom Kits for you today!

3WM	483.99	1	CHROME	center: 20"x60" sides: 18"x60" height: 67 1/4" depth: 30"	80,40 (2 ctns)
TSM	204.99	1	CHROME	20" x 60" panel; legs - 22 1/3"H depth: 30" includes casters	27 10/12 (2 ctns)

Note: the above items ship in two boxes - one for the mirror panels and one for the legs

Allow 5-10 business days to ship

JSB 101.22 12 SPECIFY color 19 1/8 x 13 1/4 x 10" (8 gallons/ 28 liters) 26/43

LSB 83.07 12 SPECIFY color 17 x 11 3/4 x 9" (6 gallons/ 22 liters) 20/29

Colors: Blue (BL), yellow (Y), red (R), black (BLK), grey (GY) and green (G). Note that other colors are available with a 60-90 day lead time.

BSJ 36.16 1 BLACK METAL JUMBO 5/16

BSL 33.31 1 BLACK METAL LARGE 3/14

PGB-BLK 206.71 6 Black 21"L x 15"W x 17"H (36"H W/ handle extended) 35/35
43 liter capacity; max weight 55lbs

MIRRORS



3WM ships truck



TSM ships truck

PLASTIC SHOPPING BASKETS

Choose from two sizes: JSB (Jumbo) and LSB (Large).

Hot stamp printing is available for this item. Ask for details.

All baskets are drop ship only.

Basket stands sold separately (below).



LSB



BSJ

Basket Stand

Black wire metal stand available in two sizes that correspond to shopping baskets above.

PULL & GO BASKETS

- Easy grip pick-up handle and ergonomic, antibacterial, lockable telescopic pull handle
- Smooth panel on the top rim can be used for logo branding
- Washable and 100% recyclable



PGB-BLK

DRESSING ROOM SUPPLIES Tailor Supplies



Measuring Tapes



Thread
NT301C



Lightweight Scissors
Fine quality, sharp steel blades with lightweight plastic handle
NT690



NTTPIN24



Pin Disposal Bank



style #	\$	qty	description	size	wgt
NTEZ	9.59	1	EZ-Off Iron Cleaner	5.25 oz. tube	1/3
ZD100	27.60	1	1- 1 oz. tube of soleplate cleaner 1- application cloth 1- polish/finish cloth 1- set of instructions		1/3
NTHI450F	26.31	1	Replacement Resin Filter - for use w/gravity feed irons		1
NTTIS-NTP5N	41.60	1	Ironing shoe (for use with NTP5N iron)		1
834	6.87	5	White, 60"	60"	1
NTTMC	3.63	1	Crotch tape measure	60"	1/3
NTPCT	2.85	1	Pin cushion tomato	Red/Green	1/3
NTSR6	2.72	1	Large seam ripper		1
NTSR5	1.68	1	Small seam ripper		1
NT4	3.50	3	For all needle types	Gold	1
NTTCA/ NTTCAR	15.16 15.16	48	Tailor's chalk	White Red	1/3
NTZE	6.87	1	Zipper ease		1
NHBSK	18.79	1 kit	Singer® Beginner's Sewing Kit: scissors, needles, pins, thread, measuring tape, thimble, marking pencils, pin cushion, sew/knit gauge, seam ripper included		2/3
NHBT	7.65	1	Basting Tape	1/4" x 11 1/3" yds	2/3
NT301C	12.99	1	Thread clip	4 1/2"	1
NT2025	19.43	1	Scissors	5"	1/3
NT601	13.74	1	Lightweight threadclip	4 3/4"	1/2
NT690	22.16	1	Lightweight dressmaker	9"	1/2
NTTPIN24	15.16	1/2 lb.	T-pin	1 1/2"	1/3
NTX24SD	22.16	1 lb.	Dressmaker pin	1 1/2"	1/7
285	20.74	1 lb.	Straight pin	1"	1/3
NTX3SC	40.31	1440	Safety pin	2" #3	2/3
SBSP	10.63	100	black safety	1 1/2"	1
00	36.03	1440	brass safety	3/4"	1/2
PDB	18.01	1	Pin disposal bank 1000 pin capacity; can be wall mounted		1

Steamers & Irons DRESSING ROOM SUPPLIES

style #	\$	qty	description	size	wgt
J-2	219.90	1	Standard 65" L Hose, 1 gal. water reservoir	1300 watts	18/21
J4	328.67	1	J4000 / Heavy Duty, 65" L Hose 1 gal. water reservoir	1500 watts	25
J1	166.28	1	Hat Steamer 1 gal. water reservoir	1300 watts	14/21
#3	19.31	1	Replacement bottle for J-2	1 gallon	1/6
2A	88.65	1	Hose/Head replacement for J-2 & J4	65" L Hose	3/4
2C	41.47	1	Replacement head/handle for J1 /J-2/ J4		1/1
1030	41.60	1	Rod & nut set for J1 /J-2/ J4		3/3
J6	152.41	1	Plug In 8 oz. water reservoir	600 watts	3/7
0669	36.42	1	Water tank replacement for J6		1/1
0661	2.27	1	Inside O-ring replacement for J6		1/1
0662	2.27	1	Outside O-ring replacement for J6		1/1
0665	22.55	1	Right case half - J6		1/1
0666	22.55	1	Left case half - J6		1/1
0663	32.01	1	Steam cap w/face plate for J6		1
ST500	136.99	1	Grey Steam Butler 1 gallon water reservoir, snap on brush	1350 watts	19
JC100	12.57	1	Liquid Cleaner	10 oz	2/3
NTIRON	64.54	1	Iron has extra power & steam output; auto off; lifetime sole plate	8 ft. cord	4/10
NH2601	34.08	1 pair	Black Heat Gloves: steam /heat resistant; latex free; machine washable	size Large	1/3
NTP5N	211.51	1	Gravity Feed Iron Comes complete w/ water bottle, hoses, iron rest and filter	120 volt 5 lb.	10/13
VR8324U1	298.07	1	Steam Pro Iron	6.5 bar pump pressure w/ 350g/minute steam boost	10

STEAMERS Jiffy Clothes Steamers & Accessories

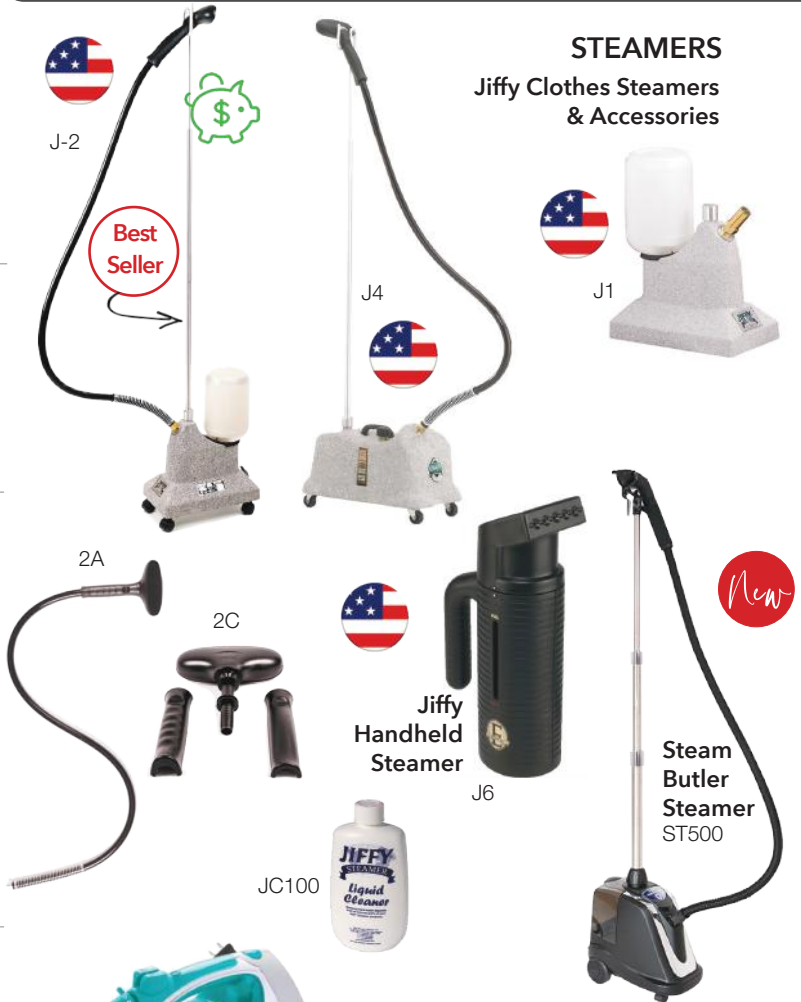

IRONS



STORE SUPPLIES Back Room Supplies

style # \$ qty description size wgt



Folding Platform Truck with Solid Steel Deck

NHFPT



NHFPT	76.33	1	Folding Platform Truck Lightweight, quiet rolling and maneuvers easily on 4" diameter non-marring rubber wheels; folding comfort-grip foam handle; solid steel deck with a non-skid vinyl surface	28"L x 18"W x 33"H (to top of handle) holds up to 400lbs	25/35
-------	-------	---	--	---	-------



SCBL

Commercial Bagless

Sanitaire upright with HEPA filter

Sanitaire Upright
With HEPA filter; uses paper bags
SCPDB

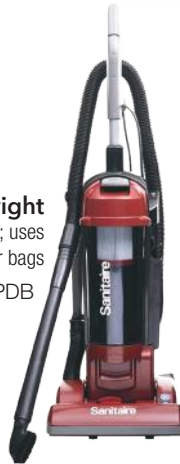

SCBL	396.70	1	Sanitaire bagless: 7-position height adjustment; HEPA filter; w/ furniture guard, dusting brush and crevice tool	13" cleaning path; 10 amps; 3.5 qt; 40 ft. cord; H/ 44", W/ 12-3/4", L/ 13-1/2"	24/43
SCPDB	390.36	1	Sanitaire bagless: 7-position height adjustment; HEPA filter; includes attachments	13" cleaning path; 10 amps; 1 gallon; 40 ft. cord; H/ 44", W/ 12-3/4", L/ 13-1/2"	17/43

2-year warranty on our Sanitaire vacuums above.

VACUUMS

Bona® Hardwood Floor Cleaner and Care Kit

BSB



BMK

BSB	13.74	1	Bona® Hardwood Floor Cleaner – Greenguard certified	32 oz.	1
BMK	73.48	1	Bona® Professional Hardwood Floor Care Kit Includes pole & base; Bona hardwood cleaner; 18" microfiber cleaning pad; 18" microfiber dusting pad	72" pole (telescoping); 32 oz. cleaner; (2) 18" cleaning/dusting pads	1

Bucket & Wringer
WHT202Y



Replacement Mop Head



UNSO2238

Mop Handle



UNSO2342

WHT202Y	62.47	1	Bucket/wringer combo (yellow)	36 qt.	18/29
UNSO2238	7.00	1	Replacement head	16 oz. 5" band	5
UNSO2342	11.79	1	Continental Mop Handle	60"	7

Wet Floor Signs

WHT13W



407WFS27

WHT13W	9.72	1	2-sided Yellow Caution Sign	26" H	3/15
407WFS27	22.29	1	Cone-Shaped Sign	27" H	4/26

Clear Garbage Bags

CTL15931 / 221459



CTL15931	40.31	1000	10 gal.	15x9x31"	25
CTL221459	60.39	100	60 gal.	22x14x59"	28



1 Hand Stretch Wrap for Shipping

Clear, pallet wrap; (65 GA), 1500'L x 18" W;
4 /case; 33 lbs.
WRAP \$68.04

2 Hand Stapler

Stanley light duty hand stapler; 7" wide; 1 /case; 1 lb.
P3 \$29.81

3 Staples

Staples for item P3; 5000 /pack; 1 lb.
P3CH \$8.68

4 Case Cutter

4" case cutter; 12 /case; 1 lb.
HC900 \$8.42

5 Single Edge Blades

Cutting blades for HC900; .009 thick; 100 /pack; 1 lb.
RB900 \$7.65

6 Stanley Tackler

8" light duty stapler; 1 /case; 2 lbs.
T11 \$15.29

7 Staples

Staples for item T11; 1000 /pack; 1 lb.
T11S \$3.56

8 Stanley Tool Kit w/case

Tool kit in a hard-sided case; 10 lbs.
92680 \$62.47

9 Tape Dispenser

Standard packing tape dispenser; 1 /case;
2/3 lbs.
TD \$17.37

10 Packing Tape

2" wide; choose Clear (TAPE6) or Brown (TAPE6T);
6 rolls /pack; 4/6 lbs.
TAPE6 \$20.22

BODY FORMS Jersey Covered Forms

Classic & European Jersey Forms

Classic and European jersey-covered forms. Sold individually, prices are for forms only. All forms available in Cream, Black, Grey or White. Easily pinnable.

MIX & MATCH

Choose a form. Then select a coordinating base & neck block (p 73).

* Note that items may take an additional 3-5 days for shipment

LADIES' CLASSIC FORMS

Pictured left to right in Black (BC):

P22 Classic Dress form

Size 6/7; 32" high; 7/8" flange; 10/47 lbs **\$100.49**

P33 Classic Blouse form

Size 6/7; 21" high; 7/8" flange; 8/47 lbs **\$85.99**

Both style are also available in Cream(CR), Grey(GY) & White(WH).

WORKS WITH

CLASSIC neck blocks & Bases with a 7/8" flange



LADIES' EUROPEAN FORMS

Pictured left to right in Cream(CR):

P26 European Dress form

Size 8; 29" high; 7/8" flange; 10/47 lbs **\$100.49**

P34 European Blouse form

Size 8; 23" high; 7/8" flange; 8/47 lbs **\$92.99**

Both style are also available in Black(BC), Grey(GY) & White(WH).

WORKS WITH

EUROPEAN neck blocks & Bases with a 7/8" flange



CLASSIC style



MEN'S CLASSIC FORMS

Pictured left to right in Grey (GY):

P80 Classic Suit form

Size 40; 29" high; 7/8" flange; 13/47 lbs **\$107.49**

P93 Classic Flat Front Shirt form

Size 40; 24 1/2" high; 7/8" flange; 9/47 lbs **\$85.99**

P91 Classic Shirt/Sweater form

Size 40; 25 1/4" high; 7/8" flange; 9/47 lbs **\$85.99**

All styles are also available in Cream (CR), White (WH) and Black (BC).

WORKS WITH

CLASSIC neck blocks & Bases with a 7/8" flange

EUROPEAN style



MEN'S EUROPEAN FORMS

Pictured left to right in White (WH):

P85 European Coat form

Size 38; 29" high; 7/8" flange; 12/47 lbs **\$100.49**

P97 European Sweater form

Size 38; 22" high; 7/8" flange; 9/47 lbs **\$92.99**

All styles are also available in Cream (CR), Grey (GY) and Black (BC).

WORKS WITH

EUROPEAN neck blocks & Bases with a 7/8" flange

All of our jersey forms are available in the following **Four Color Options:**



Neck Blocks & Bases for Jersey-Covered Forms

Neck blocks and bases, available in both wood and chrome.

Check the information alongside the forms on p.72 to see whether they require **CLASSIC** or **EUROPEAN** accessories

WOODEN NECK BLOCKS



Quincy (NB2)

Fits all **CLASSIC** forms
\$15.49 each; male 2/7 lbs;
 female 2/3 lbs.

Men's	NB232N	Natural
	NB232S	Walnut
	NB232M	Mahogany

Women's	NB231N	Natural
	NB231S	Walnut
	NB231M	Mahogany

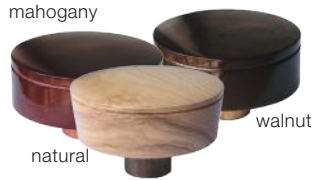

Rookwood (NB5)

Fits all **CLASSIC** forms
\$13.99 each; 3 lbs.

Men's	NB52N	Natural
	NB52S	Walnut
	NB52M	Mahogany

Women's	NB51N	Natural
	NB51S	Walnut
	NB51M	Mahogany



European (NB3)

Fits all **EUROPEAN** forms
\$13.99 each; male 2 lbs;
 female 1/3 lbs.

Men's	NB302N	Natural
	NB302S	Walnut
	NB302M	Mahogany

Women's	NB301N	Natural
	NB301S	Walnut
	NB301M	Mahogany

BRUSHED CHROME EUROPEAN NECK BLOCKS



FSFSCFIN

FSFSC

Fits all **EUROPEAN** forms
 4 1/4" dia.; 1" lip; 1/2 lbs. each

Unisex	FSFSCFIN	\$50.49	UNISEX w/Finial
	FSFSC	\$13.99	UNISEX

WOODEN BASES



Stanford (WB17)

Fits all forms with a **7/8" flange**;
 price per each; 10/35 lbs.

WB172N7/8	Natural - 24"H
WB172S7/8	55.99 Walnut - 24"H
WB172M7/8	Mahogany - 24"H



Marseilles (WB21)

Fits all forms with a **7/8" flange**;
 price per each; 7/21 lbs.

WB212N7/8	Natural - 24"H
WB212S7/8	55.99 Walnut - 24"H
WB212M7/8	Mahogany - 24"H

CHROME BASE



Dressmaker Base
DMB1

DMB1 Dressmaker Chrome Base

36" upright; **7/8" flange**;
 casters included; 36 lbs.
\$116.49

DMU48C Optional Upright

48" optional upright for
 shirt or blouse forms that
 require additional height;
7/8" flange at bottom /
7/8" flange at top; 5 lbs.
\$10.99

**Note that this is an add-on
 piece. The Dressmaker Base
 (DMB1) must be purchased
 along with the Optional
 Upright*

Height: Refers to height of wood only. All wood bases are supplied with a 7/8"x18" chrome pipe to match form flange.

Suggested Base Heights: 24" - Floor stand or low platform (all dress forms)
 16" - Counters, shelves, racks, tables, etc.

BODY FORMS Jersey Forms & Accessories

PIN ON FLEXIBLE ARMS



FXA002R /1R

style #	\$	qty	description	wgt
FXA001R	42.99	2	LADIES - 23 1/4" L	2/12
FXA002R	42.99		MEN - 26"L	3/12

LADIES & MENS PREFERRED 3/4 LENGTH JERSEY-COVERED FORMS



P27



P86

Jersey colors

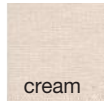

cream

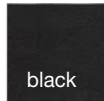

black

Ladies' and Men's Preferred forms are available in two colors - CR (cream) or BC (black).

Each preferred form comes complete with neck block.
Specify: **N** (Natural disk); **W** (Walnut disk); **M** (Mahogany disk); **ND** (Natural Dome); **BC** (Brushed Chrome cap); or **BK** (Black metal cap).



Metal Trimline Bases

Leg only bases for use with 3/4 length forms



* Forms & Bases sold separately



VM504MAB



Forms shown hanging from notched customers
(forms not included)

TFB/58	61.49	1	Bases (leg mount only) - 7/8" x 32" H: Matte Black, 12x12" Base; center pole	4/6 10 (2 ctns)
TFC/58	61.49	1	Brushed Chrome, 12x16" Base; offset pole	4/6 13 (2 ctns)
VM504BR	98.99	2	Satin chrome	11, 15 (2 ctns)
VM504MAB	65.99		Matte Black	
VM504MTW	65.99		Matte White	

Notched costumers /hanging forms - Adjusts every 3" from 49-78"h

Please see p. 31 for full customer images and information

Pinnable Sets & Mannequins **BODY FORMS**

style #	\$	qty	description	wgt
NHZDRFT	147.49	1	Female Dress Form w/ natural wood finial neck block and tripod base; chest-36½"; waist-25½"; hip-36½"; height-30"; height adjusts from 60-75"	13/30
NHZSHMT	130.49	1	Male Shirt Form w/ natural wood finial neck block and tripod base; chest-40"; waist- 34½"; hip-37½"; height-22½"; height adjusts from 58-67"	13/28
NHZMMFBK	223.99	1	Female Dress Form w/ black metal acorn neck block and wheeled base; chest-36½"; waist-25½"; hip-36½"; height-30"; height adjusts from 63-82"	22/50
NHZMMMBK	223.99	1	Male Coat Form w/ black metal acorn neck block and wheeled base; chest-40"; waist-28"; hip-39"; height-29"; height adjusts from 60-79"	23/41
NHZMMFCH	236.49	1	Female Dress Form w/ polished chrome acorn neck block and wheeled base; chest-36½"; waist-25½"; hip-36½"; height-30"; height adjusts from 63-82"	22/50
NHZMMMCH	236.49	1	Male Coat Form w/ polished chrome acorn neck block and wheeled base; chest-40"; waist-28"; hip-39"; height-29"; height adjusts from 60-79"	22/50

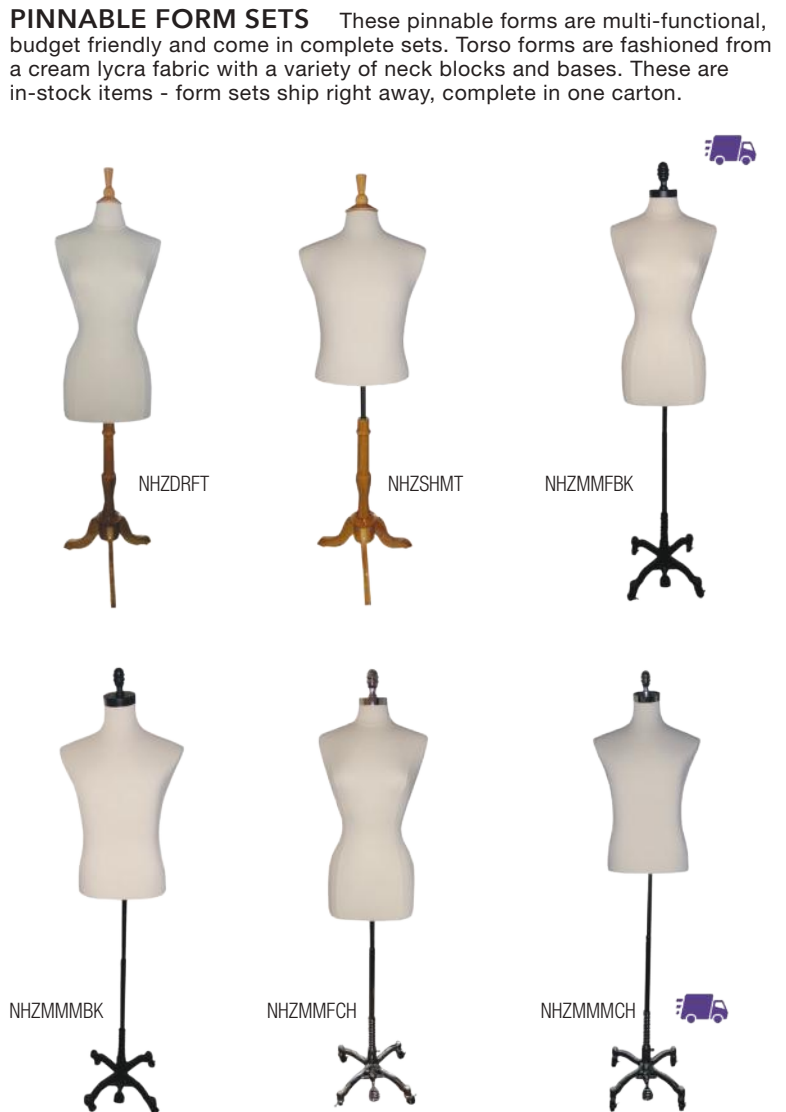

DONNA	252.49	1	African American female form: Shoulder- 18"; Chest- 33"; Waist- 24"; Hip- 35"; Height- 5' 11";	26/57
DARRELL	260.99	1	African American male form: Shoulder- 22"; Chest- 39"; Waist- 31"; Hip- 37"; Height- 6' 2";	26/57

Fiberglass Mannequins



Mannequins come with a base (not pictured)

DONNA

DARRELL

BODY FORMS Mannequins

Gloss
Fiberglass
Mannequins



MICHELLE3W

MICHELLE3B

Michelle3; Gloss;
shoulder 15 3/4",
chest 32 1/2"; waist 23 1/2";
hips 34 1/4"; Height- 5'9".
1 piece; 28/61 lbs.
\$293.99



MICHELLE2B

MICHELLE2W

Michelle2; Gloss;
shoulder 15 3/4",
chest 32 1/2"; waist 23 1/2";
hips 34 1/4"; Height- 5'9".
1 piece; 28/61 lbs.
\$293.99



MICHELLE1W

MICHELLE1B

Michelle1; Gloss;
shoulder 15 3/4",
chest 32 1/2"; waist 23 1/2";
hips 34 1/4"; Height- 5'9".
1 piece; 28/61 lbs.
\$293.99



MIKE1W

MIKE1B

Mike1; Gloss;
shoulder 20 7/8"; chest
37"; waist 31"; hips 37 3/4";
Height- 6'2".
1 piece; 31/84 lbs.
\$299.99



MIKE2W

MIKE2B

Mike2; Gloss;
shoulder 20 7/8"; chest 37";
waist 31"; hips 37 3/4"; Height-
6'2".
1 piece; 31/84 lbs.
\$299.99



MIKE3W

MIKE3B

Mike3; Gloss;
shoulder 20 7/8"; chest
37"; waist 31"; hips 37 3/4";
Height- 6'2".
1 piece; 31/84 lbs.
\$299.99

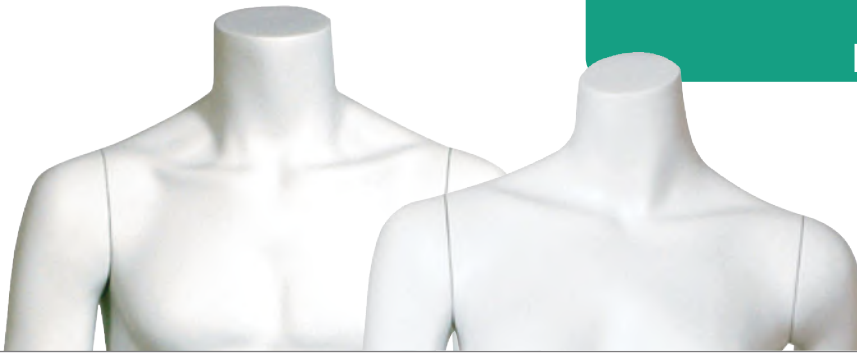

WHITE MANNEQUIN FORMS

Stand included



ERICA1

White; shoulder- 15 3/4";
Chest- 32 1/2";
Waist- 23 1/2";
Hip- 34 1/4"; Height- 5'2".
1 piece; 28/57 lbs.
\$245.49



ERICA2

White; shoulder- 15 3/4";
Chest- 32 1/2";
Waist- 23 1/2";
Hip- 34 1/4"; Height- 5'2".
1 piece; 28/57 lbs.
\$245.49



ERICA3

White; shoulder- 17 3/4";
Chest- 32 1/2";
Waist- 24";
Hip- 34"; Height- 5'2";
1 piece; 28/57 lbs.
\$245.49



ERICA4

White; Shoulder- 16";
Chest- 33";
Waist- 25 1/4";
Hip- 36 1/4"; Height- 5'2";
1 piece; 28/57 lbs.
\$245.99



ERICA5

White; Shoulder- 16";
Chest- 33";
Waist- 25 1/4";
Hip- 36 1/4"; Height- 3'2";
(white seat included);
1 piece; 28/57 lbs.
\$245.49



JANET1W

Janet 1, plus size female
mannequin; White;
shoulder- 21 1/4"; Chest-
32 1/4";
Waist- 34";
Hip- 40 7/8"; Height- 5' 1/4".
1 piece; 30/94 lbs.
\$287.49



JANET2W

Janet 1, plus size female
mannequin; White;
shoulder- 21 1/4";
Chest- 43"; Waist- 34";
Hip- 36"; Height- 6".
1 piece; 30/61 lbs.
\$309.49

Due to their delicate nature and the fragility of mannequins and their components, all mannequin purchases are final. No returns are accepted, except if carton is unopened. Once a carton is opened and product removed, it cannot be re-sold.



ERIC1

White; Shoulder- 20 7/8";
Waist- 31";
Hip- 37 3/4"; Height- 5'8";
1 piece; 31/57 lbs.
\$251.99



ERIC2

White; Shoulder- 20 7/8";
Waist- 31";
Hip- 37 3/4";
Height- 5'8";
1 piece; 31/57 lbs.
\$251.99



ERIC3

White; Shoulder- 20";
Waist- 30 3/4";
Hip- 37 3/4";
Height- 5' 4";
1 piece; 31/57 lbs.
\$251.99

BODY FORMS Polyethylene Forms

POLYETHYLENE FORMS

White, full round, unbreakable, lightweight and affordable. Satin nickel base included (where applicable).

FEMALE Forms

Measurements: bust 34" / waist 24" / hip 35"



NHLP4WH
Female Torso Form;
height 35";
1 piece; 8/46 lbs.
\$56.89



NHLPH4M
Female Torso Form
w/ hanging base measuring
14" x 14"; pole adjusts from
43-74"; form is 35" high;
1 piece; 23/60 lbs.
\$118.58



NHLPF4M
Female Torso Form
w/ standing floor base
measuring 12" x 16" x 42";
form is 35" high;
1 piece; 24/66 lbs.
\$128.30



NHLPB4WH
Female Shirt Form;
height 24";
1 piece; 6/36 lbs.
\$40.95



NHLPHB4M
Female Shirt Form
w/ hanging base measuring
14" x 14"; pole adjusts from
43-74"; form is 24" high;
1 piece; 15/60 lbs.
\$103.42



NHLPFB4M
Female Shirt Form
w/ counter base measuring
10" x 10" x 26";
form is 24" high;
1 piece; 12/47 lbs.
\$95.77

MALE Forms

Measurements: Chest 39"
/ waist 32" / hip 37"



NHMPB5WH
Male Shirt Form;
height 24";
1 piece; 8/36 lbs.
\$84.99



NHMPHB5M
Male Shirt Form
w/ hanging base measuring
14" x 14"; pole adjusts from
43-74"; form is 24" high;
1 piece; 20/60 lbs.
\$110.94



NHMPFB5M
Male Shirt Form
w/ counter base
measuring 10" x 10" x 26";
form is 24" high;
1 piece; 15/47 lbs.
\$103.42



NHMP5WH
Male Torso Form;
height 40";
1 piece; 10/66 lbs.
\$64.54



NHMPH5M
Male Torso Form
w/ hanging base measuring
14" x 14"; pole adjusts from
43-74"; form is 40" high;
1 piece; 27/60 lbs.
\$126.88



NHMPF5M
Male Torso Form
w/ standing floor base
measuring 12" x 16" x 42";
form is 40" high;
1 piece; 24/66 lbs.
\$136.60

Display Forms **BODY FORMS**

style #	\$	qty	description	wgt
LHR15B LHR15W	19.44	1	Ladies waist - 15" across; bust - 19"; hip - 18"; shoulder to shoulder - 16"; height - 31" w/out hook & 36" w/hook; back of from is hollow; matte finish Matte black Matte white	6/71
LHR35B LHR35W	12.99	1	Ladies Upper Torso 19 x 17 x 6" Matte black Matte white	4/22
MHR26B MHR26W	26.31 22.29	1	Mens 35 x 20 x 6" Matte black Matte white	6/71



INJECTION MOLDED half-round forms feature high-quality, lightweight construction. The injection molding process ensures that these forms contain much thicker plastic than comparable vacuum formed forms.

Black (B) Torso Forms
** While Supplies Last*

FF15B FF15W FF15C	22.94 13.87 11.15	1	Girls Sizes 7-14 23 x 13 x 1"	2/21
-------------------------	-------------------------	---	----------------------------------	------



**VALUE
TORSO FORMS**

FF27	13.74	1	Ladies Shirt 21 x 19 1/2 x 4 3/4" <i>(*Black only - while supplies last)</i>	2/21
FF18	20.74		Junior Backside Sizes 5-10, 28x21x5" <i>(*Black only - while supplies last)</i>	2/21
FF24	23.98		Womens Head and Torso 31x21x5" <i>(*Black, Clear or White - while supplies last)</i>	2/24
FF37	13.74		Maternity 30 1/2 x 17 1/2 x 8 1/2" <i>(*Black or White - while supplies last)</i>	5/63



FF20C	15.16	1	Mens Torso Sm. & Up, 32x21x3" <i>(*Clear only - while supplies last)</i>	2/27
FF21	20.22		Mens Shirt Sm. & Up, 14x15x1" <i>(*Black or White - while supplies last)</i>	2/21
FF7C	16.07		Mens Brief Sizes 28-34, 16x17x2" <i>(*Clear only - while supplies last)</i>	2/21



BODY FORMS Display Forms

Apollo & Athena Forms



style #	\$	qty	description	wgt
81/BL 81/S	79.49	1	Male muscular shirt form w/ 5/8" flange ; 24 1/2"H, 39" chest Black Suntan	7/21
30/F 30/BL	64.99	1	Ladies' Blouse Form 23 1/2" H, 34" bust, 24 1/2" waist Pale flesh tone Black <i>Includes 5/8" flange for base or is self standing</i>	4/22
830C	24.36	1	Chrome Base 30" high; 5/8" flange; 8" dia. base	5/21

Female Hip Torso



Male Hip Torso



PEFHIPMW	63.24	1	Female hip torso milky white	6/20
PEMHIPMW	63.76		Male hip torso milky white	6/20

Mens Brief Forms



HB0500	99.92	1	Perfect for displaying mens briefs, brief-boxers, swimwear and other underwear styles. Black	6/22
--------	-------	---	---	------

Glove Hands



Ladies G4L G4R	23.59	1	Beige Left 12" Right 12"	1/7
Mens G7L G7R	31.88 25.66	1	Left 12" Right 12"	1/7

style #	\$	qty	description	wgt
77	9.07		11 1/2" tall / White	1/10
875	60.91		16" Caucasian, Rubber material	4/19
876	66.48	1	16" African American, Rubber material	4/19
804	19.31		20" tall / White	1/12
832	15.68		11 1/2" tall / White	1/10
831	18.79		11 1/2" tall / Suntan	1/10

All mannequin heads above have a hole for mounting on wall

3-D STYRO MANNEQUIN HEAD FORMS



Universal Wall Mount - one bracket fits all

2775	14.64	1	Slatwall/ Pegboard head holder	1/2
------	-------	---	--------------------------------	-----



Women's Hosiery Forms

HW0470	52.62		Beige: Hip high leg, 29 3/4" high	5/27
HW0440	44.32		Thigh high leg, 26 5/8" high	5/20
HW0430	37.32	1	Knee high leg, 18 1/8" high	3/10
HW0410	36.03		Calf high leg, 15 1/4" high	3/10
HW0400	34.60		Anklet, 10 5/8" high	2/3

SELF-STANDING WEIGHTED TOE FORMS



HM0340	44.32		Beige: Knee high leg, 17 3/4" high	3/10
HM0320	33.18	1	Calf high leg, 11 3/4" high	2/7
HM0310	30.46		Low calf high leg, 10" high	2/7

Men's Hosiery Forms



HC0230	34.60		Beige: Knee high leg, 15 1/2" high	
HC0220	34.60	1	Calf high leg, 12 5/8" high	2/16
HC0210	33.18		Crew leg, 8" high	
HC0200	33.18		Anklet leg, 6 1/8" high	2
HC021FL	36.03	1	"Walking" crew leg, 9" high	3/6

Children and Infant Hosiery Forms



DISPLAY FIXTURES Jewelry

BURLAP JEWELRY DISPLAYS

Tightly wrapped burlap for durable, eco-chic displays with a beautiful natural woven linen look



Narrow Necklace Easel Back Stand

Thin easel stand; 4 1/4"W x 8 7/8"H; 1 piece; 1 lb. **\$3.50**

Wide Necklace Easel Back Stand

Displays 1 double-strand or 2 necklaces; 8 1/4"W x 12 1/2"H; 1 piece; 1 lb. **\$4.92**

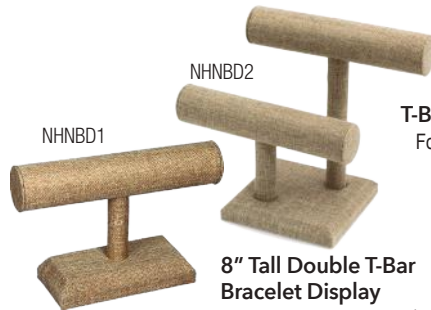

T-Bar Bracelet Display

Holds several bracelets; low profile bar is 1 5/8"D x 7 1/4"W x 5"H; 1 piece; 1 lb. **\$12.57**

8" Tall Double T-Bar Bracelet Display

10"W x 8"H; 1 piece; 1 lb. **\$25.01**



T-Bar Necklace Display

For necklaces and chains; 12"L x 3 1/2"W x 12"H; bar is 2" in diameter; 1 piece; 1 lb. **\$20.22**

Extra Tall T-Bar Necklace Display

T-Bar stand for necklace and chain displays; 14"W x 18"H; 1 piece; 1 lb. **\$19.44**

Displays 1 pair of earrings



T-Bar Earring Displays

T-stand for earring displays; 1 piece; 1 lb; available in 3 sizes:

- Small**
NHNEDS2 4 3/4"H; **\$4.15**
- Medium**
NHNEDTS 5 3/4"H; **\$4.15**
- Tall**
NHNEDS3 6 3/4"H; **\$4.15**



Fixed Finger Ring Displays

Fixed fingers fit and display any ring; 1 piece; 1 lb.

- Single Finger**
NHNRD5 2 1/8"L x 2 1/8"W x 2 3/8"H; **\$3.50**
- Three Finger**
NHNRD3 4 7/8"L x 2 1/4"W x 2"H; **\$7.00**
- Five Finger**
NHNRD5 8"L x 2"W x 2 1/4"H; **\$9.07**



Pillow Jewelry Display

Small burlap pillow for displaying bracelets, small pendants and pins; 3"L x 3"W; 1 piece; 1 lb. **\$3.50**



Earring & Pendant Display Stand

For 1 pair of earrings or a pendant; 2"W x 3"H; 1 piece; 1 lb. **\$2.85**

ECONOMY BLACK VELVET JEWELRY DISPLAYS

A range of displayers finished in a flocked, faux velvet. Attractive & affordable.



Finger Displays

Fixed fingers ring displays; 1 piece; 1 lb.

- Single Finger**
NHBFRD1 2 1/4"L x 2 1/4"W x 2 1/4"H; **\$7.00**
- Five Finger**
NHBFRD5 8"L x 2"W x 2 1/2"H; **\$9.07**



NHBFNE1

Easel Necklace Stand

Single necklace or chain display; 3 3/4"L x 5 1/4"H; 1 piece; 1 lb. **\$4.15**



Pillow Displays

Versatile displayers for bracelets, watches and pins; 1 piece; 1 lb.

- Small** about 3"L x 3"W **\$7.65**
- Medium** about 4"L x 4"W **\$7.65**

Earring & Pendant Display

2"W x 3"H; 1 piece; 1 lb. **\$2.99**



Earring Display Tree

Accommodates 12 pairs of earrings on 3 display bars; 10 1/4"W x 8 1/2"H; 1 piece; 1 lb. **\$20.87**



Earring & Necklace Display Stand

4"W x 5 3/4"H; 1 piece; 1 lb. **\$5.57**



Padded Necklace Display with Easel Stand

6 1/2" x 7 7/8"H; 1 piece; 1 lb. **\$4.15**



Padded Necklace/Earring Combo Display with Easel Stand

Black velvet; 9 3/8"W x 9 1/2"H; 1 piece; 1 lb. **\$5.57**



Single Bracelet / Watch Display Hump

1 3/8"W x 5"L x 2 1/2"H; 1 piece; 1 lb. **\$4.92**

style #	\$	qty	description	size	wgt
NHAND2	10.50	1	Clear acrylic double T	4 1/4" / 8 3/4"	1/3
NHAND1	9.07	1	Clear acrylic single T	18 1/2" H	2/6
NHAED32	16.72	1	4-sided rotating display Holds 32 cards - 2"	5 x 5 x 12"	3/19
NHAED144	29.16	1	Holds 144 cards - 2"	10 1/2 x 10 1/2 x 19 1/2"	18/23
856	20.87	1	3-sided rotating display Clear acrylic w/ black	19 1/2" H	5/10
JCW100	11.79	100	White card	2" x 2"	1/2
JCB100			Black card		
JT1	18.79	1000	White w/ red silk string	1/2 x 7/8"	1/3
JT2	18.01			3/8 x 3/4"	
JT3	13.61		White Adhesive	7/16 x 1 1/2"	
JT4	13.74			9/16 x 1 5/8"	
JPC1	8.68	1	Yellow	7 1/2" L x 5" W	1
A845	8.42	1 Set of three	CLEAR	3x3x3" 4x4x4" 5x5x5"	2/6
J1394	8.68	1	Clear CounterStand	13/4 x 23/4 x 3"	1
J2394	9.72	1	Clear Slatwall	2 1/8"	

JEWELRY DISPLAYERS

Acrylic T Bar Jewelry Displayers



Rotating Jewelry Displayer

Counter Top Revolving Jewelry Display

Holds 108 two-inch cards.

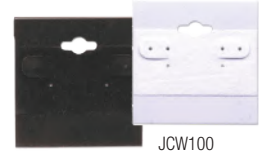
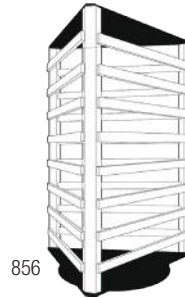

JCB100

JCW100

Jewelry Cards

Cards can also be used on displayers and peg hooks.

Jewelry Tags



JT1

JT2

JT3

JT4

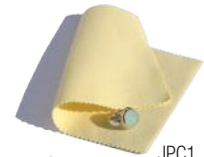

Jewelry Polishing Cloth

Jewelry Risers



A845

J1394

Watch Displayer

For slatwall or counter



DISPLAY FIXTURES Counter Displays

Double Face Mirrors



Reversible Counter Step Display

A859



Sunglass Racks



Countertop or Hanging Cap Display

CAP3

Tower Cap Displayers



CAP8



CAP16

Deluxe Cap/Hat Trees

Revolving or stationary - 20 arms with foam caps



K26

Countertop Handbag Stand

NHCSRHB



Blouse Displayer

Complete w/ base and waist cincher
Q61814



Hook Stand Displayer

Q61810



Scarf Stand

Includes 100 white clips

Q83010



style #	\$	qty	description	size	wgt
Q61014	63.12	1	CHROME oval mirror	10x14x22" 6" base	8/13
NHQ61016	67.26	1	CHROME rectangular mirror	10 x 12" H 3" base	8/13
A859	70.11	1	CLEAR ACRYLIC 2" or 3" D shelves	7"D x 15"W x 10"H	2/10
SUNGLASS36	114.49	1	Sunglass rack w/ 5" mirror - holds 36 pairs	28" H x 14" Dia	8/30
SUNGLASS44	105.99	1	Sunglass rack w/5" mirror - holds 44 pairs	32" H x 14" Dia	9/30
CAP3	51.32	1	BLACK METAL Holds 24 to 30 caps	24H x 9W x 13"D	6/12
CAP8	138.67	1	POWDER COATED wire tubing Silvervein: Holds 64 to 80 caps: 8 pocket tower	65H x 14W x 14"D	16/17
CAP16	202.56	1	Holds 128 to 160 caps 16 pocket, 2 sided	65H x 14W x 24"D	16/17 10/13 (2 ctns)
KREV26	163.04	1	CHROME Revolving	18x61 3/8" 14" sq. base	14 5 14 (4 ctns) 34 lbs
K26	144.99	1	CHROME Stationary	18x61 3/8" 14" sq. base	14 5 14 (3 ctns) 33 lbs
NHCSRHB	37.45	1	CHROME	17" - 31" H; 8" base	6/18
Q61814	42.38	1	CHROME	5/8 x 18"-36"H 6" base 16" hanger	7/19
Q61810	32.66	1	CHROME	5/8 x 18"-36"H 6" base	6/19
Q83010	65.97	1	CHROME	5/8 x 18"-36"H 8" base 14" dia.	8/13

style #	\$	qty	description	wgt
MF0040	4.67	1	Clear Plastic Espadrille Form, size 6-7	1/7
MF0013	4.15	1	Clear Plastic Gladiator Form, size 6-7, 13" tall	1/7
1205	31.88	1 set	Acrylic 3"W x 5"H 3"W x 6 1/2"H 3"W x 8"H 5mm thick bottom measures 5 1/2" deep Set includes all 3 sizes	10/17
S1213	4.92	1	Acrylic 1"W x 2 1/2"H x 2 1/2"D 3/32" thick	1
S1214	6.35		1 3/8"W x 4 1/4"H x 3"D	
1229A	8.42	1	Acrylic 3/16" thick	3
1229B	9.72	1	9 1/4"L x 4"W x 5"H	3
1229C	11.15	1	9 1/4"L x 4"W x 7"H	3/6
1230	22.29	1 set	9 1/4"L x 4"W x 9"H Set includes all 3 sizes	3/6
1413	8.29	1	Acrylic 1/8" thick Single Shoe Rest 4 3/4"H x 3"W x 3 3/4"D	1/2
<i>See page 81 and 86-87 for our selection of foot & hosiery forms</i>				
1210	40.18	1 set	Acrylic 4 mm thick, 7 1/2" D 3"W x 4 1/2"H 3"W x 6 1/2"H 3"W x 9 1/2"H Set includes all 3 sizes	3/10
ZDB109OF1	31.88	12	Natural color in four sizes: 9" high	1/2
ZDB113OF1	34.73		13" high	2/6
ZDB121OF1	52.75		21" high	4
ZDB126OF1	58.32		26" high	4
ZDB1240	7.65	1	7" low top	1/2
ZDB1230	8.42		9" medium height	1/2
ZDB1020	9.72		14" high top tall	2/6
MAR6121PR	8.42	1 pair	14" Black plastic boot form	1/2
MAR6121	69.21	16 prs		11
ZSHOT060	3.50	1	Boot weight	1



Espadrille & Gladiator Forms
Profile of foot, with notched ridges for straps

Heel Rest Shoe Risers **Beveled Edge Slant Shoe Risers**



05010
p. 81

Shoe Rests

G-Bend Shoe Risers

Roll Up Boot Shapers

Inexpensive boot shapers are made out of a smooth natural plastic finish, easy to insert and remove, and they automatically adjust to fill the boot; in four sizes - 9", 13", 21" and 26"



ZDB1210F1

Boot Shapers



ZDB

Smooth plastic finish.
Easy to insert and remove.
Specify (M) Male or (F) Female

Specify **M** for male and **F** for female
Note that male boot shapers are 1" wider than female shapers



MAR6121PR

Boot Weights

Drop into boots for a more stable display



ZSHOT060

SHOE DISPLAYERS

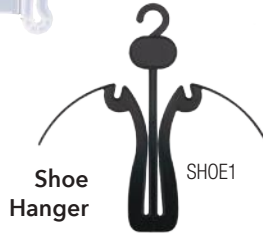

Sport Sandal Forms
Full-round sandal forms specifically designed for open or closed sandals. Also fits thong styles.

Shoe Forms
Fits right or left shoe. Made from lightweight, natural plastic.



Flexi-Form
Made from lightweight, unbreakable plastic.



All forms fit right or left shoe



8-Shelf Shoe Merchandiser
Includes 12" adjustable, tilt shelves.
Ships via truck only

style #	\$	qty	description	wgt
710CH	94.35	100	Chrome w/ black rubber tips; 5" wide	10
JLP156	42.38	500	3 7/8" W x 3 7/8" H	9/12
JLP156100	16.49	100	Natural	3/6
JLP256	42.38	500	Black	9/12
JLP256100	15.49	100		3/6
SH1	17.99	500	Black; 3 1/2" wide	2
SH1-100	5.99	100		1/2
SHOE1	82.56	500	Black; 7 1/4" W x 7 1/4" H	19/21
SHOE1100	18.01	100		4/6
KLGYMR			Men's Gray Sprinkle Right - size 8-9	
KLGYML			Men's Gray Sprinkle Left - size 8-9	
KLGYWR	15.29	1	Women's Gray Sprinkle Right - size 6-7	1/2
KLGYWL			Women's Gray Sprinkle Left - size 6-7	
KLGYR13			Children's Gray Sprinkle Right - size 13	
KLGYL13			Children's Gray Sprinkle Left - size 13	
SHOEFORM10	.36		3 3/8" long, 3" wide	
SHOEFORM13	.71	1	4 1/4" long, 3 1/2" wide	1/2
SHOEFORMMM	.47		4 7/8" long, 3" wide	
SHOEFORMMW	.52		5 7/8" long, 3" wide	
FM7400B			Charcoal Men's, sizes 8-10	
FW7500B	4.15	1	Women's, sizes 4-10	1/2
FC7600B			Children's, sizes 10-13	
FRM DISWB	6.87		Women's Low-cut black Fits sizes 6-9	
FRM DISMB	6.87	1	Men's Low-cut black Fits sizes 8-11	1/2
FRM DISMHB	8.29		Men's High-top Black Fits sizes 8-11	
FRM DISWHB	8.29		Women's High-top Black Fits sizes 6-9	
SSUE	328.49	1	Chrome 56"H x 46"W x 25"D Ships Truck	25 20/25 20/25 (3 ctns)

SHOE DISPLAYERS

style #	\$	qty	description	size	wgt
SDM				Men's	
SDW				Women's	
SDC	88.78	1	CHROME	Children's	2/6
SDA				Athletic	
SD				Adult combo	
SDJ	90.07	1	STURDY PLASTIC	Junior	2/6
24625	20.87	1	Wood; measures men, women and children	17 x 1 1/2"	1/2
T14915	138.54	50	GREY	9"	2/3
T14915-10	31.88	10			1/2
06UPC02	14.64	144	BRONZE	1 1/8"	1/2
TOS1	8.29	144	BEIGE	ONE	1/3
SO1G	16.72	24	BLACK	SIZE FITS	1/3
AS1	23.59	50	WHITE	MOST	2/7
05010	13.87	48	BEIGE KNEE-HI		1/3
NHSDR	110.15	1	Black Metal Rack; 4 spinning tiers w/16 hooks & sign holder; 66"H, 24" footprint, 5" long hooks	66"H, 24" footprint, 5" long hooks	14/24
09059	107.17	144	NICKEL PLATED	3"	7
09059/12	11.15	12		3"	1
SHOEBLA	31.88	144	BLACK	3 1/2"	7
SHOEBLAI	62.34	144	BLACK printed	3 1/2"	7
MBR	37.45	1	Wood box reacher w/ metal end	60" L; 4" square metal plate, L-shaped	4/7

Shoe horns can be printed: Printing area is 2" x 1/2". \$75 plate charge, and a 3 gross minimum (342 pieces) for imprinting. Shoe horns also available in COLORS: 3 gross minimum (342 pieces). Green, Red, Yellow, Blue or White

FOOT MEASURING DEVICES

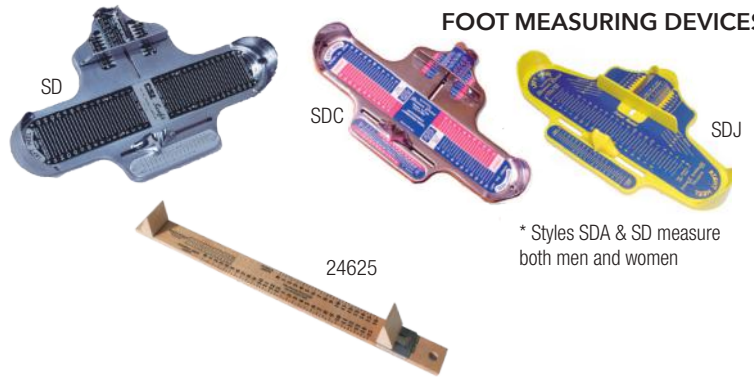

* Styles SDA & SD measure both men and women



Grey Tether with Split Ring/ Adhesive Backing
For securing shoes on display.



Double Polyclip
Clips small signs to back of shoes.

Try On Socks
Foot protectors



Best Seller!

Holder for 8.5"x11" signs

Spinning Sock Displayer

NHSDR



Shoe Horns

Call for color and printing options



SHOEBLA

Box Reacher

Remove shoe boxes from high shelves with our 5-foot long tool.

MBR



PACKAGING Kraft Shopping Bags

KRAFT SHOPPING BAGS

Available in 3 colors - White, Kraft, and Matte Black. These bags are imprintable and a great way to advertise your store. See the following page (89) for more details.



Kraft & White Kraft Shoppers, 100 pack
8x4.75x10.5"; 100 bags/
pack; 17 lbs.
White kraft:
SBCN1-100 \$27.60



CUSTOM PRINTING: Custom printing applies to all style numbers below - see following page 89 for details

style #	\$	qty	color	size	imprint area	wgt
1	81.91	250	White	8x4.75x10.5"	6x5"	24/30
SBCN1-100	27.60	100	White	8x4.75x10.5"	6x5"	24/30
2	101.22	250	White Eco	8x4.75x10.5"	6x5"	24/30
SBCN2E	95.77	250	Kraft Eco	8x4.75x10.5"	6x5"	24/30
3	101.99	250	Kraft Eco	10X5X13.5"	7X8"	24/30
4	111.72	250	White	16x6x13"	10x7"	38/52
5	128.30	250	White Eco	16x6x13"	10x7"	38/52
SBVN2E	105.99	250	Kraft Eco	16x6x13"	10x7"	38/52
6	126.99	200	White	16x6x19.25"	10x11"	43
7	102.64	200	Kraft Eco	16x6x19.25"	10x11"	42
8	108.86	250	Black	8x4.75x10.5"	6x5"	39/54
SBVN4	150.47	250	Black	16x6x13"	10x7"	45
9	81.13	250	White	5.5x3.25x8.375"	3x4"	14
KSB4E	100.57	250	White Eco	5.5x3.25x8.375"	3x4"	15
KSB41	85.28	250	Natural Eco	5.5x3.25x8.375"	3x4"	15
10	96.42	250	White	10x5x13.5"	7x8"	43
KSB6E	110.94	250	White Eco	10x5x13.5"	7x8"	43
KSB7E	95.00	250	Natural Eco	10x5x13.5"	7x8"	43
11	115.86	250	White	13x7x12.5"	9x8"	29
KSB82E	101.22	250	Natural Eco	13x7x12.5"	9x8"	29
12	120.66	250	White	13x7x17.5"	9x9"	44
KSB92E	99.14	250	Natural Eco	13x7x17.5"	9x9"	44

A note about imprint areas and set-up fees:
2 different bag sizes will need 2 different set ups.
• check the imprint area specs on for more info

different size imprint areas
will need different set ups

KSB82E



CUSTOM BAG OPTIONS

for our Natural, White or Black Kraft bags

Create walking billboards for your store



STEP 1

Choose a bag

Choose from any of our Natural, White or Black Kraft bags featured on [page 88](#)



STEP 2

Design it

(Choose from 2 print options below)

A. INK PRINT

A flexible plate is dipped in liquid ink and stamped onto the bag.

ADVANTAGES: Can print small details.

DISADVANTAGES: Ink color appearances may vary.

COST: \$0.24 per side, per bag /\$.48 for both sides



B. HOT STAMP

Foils are pressed and transferred through heat onto the bag.

ADVANTAGES: Produces a true, even color.

DISADVANTAGES: Doesn't allow for small details.

COST: \$0.45 per side, per bag /\$.90 for both sides



STEP 3

Set it up & Place your order

ARTWORK

Vector files are preferred - Illustrator (.ai) files are best. (.docx files will not be accepted)

If artwork quality is not acceptable, art fees may apply.

Please call us (1-800-426-4377) for assistance

SET-UP FEES

Ink Printing and Hot Stamp

Set up fees are per bag size, per order

Please call for set-up fees

ORDERING

Call it in:

1.800.426.4377 and speak with one of our Customer Reps

You can also connect with us via email (mail@nahanco.com)

PACKAGING Shopping Bags

ECO KRAFT EURO SHOPPERS/BAGS



style #	\$	qty	description	size	wgt
Eco Natural Kraft Euro Shoppers/Bags					
NHK19616	219.59	100	XX-Large Shopper	19 x 6 x 16"	48/49
NHK1010	187.19	200	X-Large Shopper	10 1/4 x 10 x 10"	30/31
NHK1048	154.19	250	Large Shopper	10 x 4 x 8"	23/24
NHSN513	83.99	250	Tall Wine/Gift Bag w/Serrated Edge	5 1/4 x 3 1/2 x 13"	19/21

Eco friendly, reusable, recyclable and compostable, these bags are made of 80% recycled fibers and 80% post-consumer content

CARNIVAL GROOVE EUROTOTES (KE)



CARNIVAL GROOVE EUROTOTES					
KE9NH	95.77	200	Kraft w/ natural cotton handles; top & bottom board inserts	9x3 1/2x7"	20
KE13	160.96	200		13x5x10"	33
KE16NH	156.16	100		16x5x13"	23

LUXE GLOSS EUROTOTES (GE)

Gloss laminated bags w/gromets, knotted macrame handle, top and bottom boards

LUXE GLOSS EUROTOTES					
GE6B	50.67	100	BLACK	6x3x8"	9
GE6W	50.67		WHITE		
GE8B	70.76	100	BLACK	8x4x10"	14
GE8W	70.76		WHITE		
GE16B	99.14	100	BLACK	16x6x12"	29
GE16W	99.14		WHITE		

REINFORCED DIE CUT THANK YOU BAGS



THANK YOU DIE CUT BAGS					
NHFO15THA	93.70	500	Medium	15x18x4"	24
NHFO20THA	144.24	500	Large	20x20x5"	35

SUPER GLOSS MERCHANDISING BAGS

In 2 sizes and 2 colors



SUPER GLOSS BAGS					
NHSG9WH	67.26	1000	White - small	9 x 12"	11
NHSG9CLE			Clear - small	1.25 mil.	
NHSG12WH	104.07	1000	White - medium	12 x 15"	16
NHSG12CLE			Clear - medium	1.25 mil.	

PLASTIC MERCHANDISE BAGS

Economy, high density plastic



TSB3-30
Type style and color may vary

BGA
Cannot be imprinted

TSB3-30	27.09	1000	Thank You Type style & color may vary	11 1/2 x 6 1/2 x 21" .75 mil	13
BGA2	70.76	1000	White	12x15"	10

Tissue & Boxes PACKAGING

style #	\$	qty	description	size	wgt
TP1	30.59	1000 sheets	WHITE Tissue Paper	18 x 24"	10/14
TP2	45.75			20 x 30"	15/22
TP3	58.32			24 x 36"	10/22
NH11018	23.99	480 sheets	Solid Recycled KRAFT Tissue Paper	20 x30"	9
TIKNP	61.82	2400 sheets	NEWSPRINT Tissue Paper	20 x30"	50



AB2	74.26	100	WHITE: Shirts	15x9½x2"	29
AB3	56.25	50	Sweaters	17x11x2½"	20/21
AB4	60.39	25	Coats	24x14x4"	21/28
KAB2	70.11	100	KRAFT: Shirts	15x9½x2"	27/29
KAB4	50.67	25	Coats	24x14x4"	23



CORRUGATED BOXES					
NH1293BLA	123.59	24	Black	3" h x 12" l x 9" w	16
NH1293NAT	87.59		Natural		
NH1293WHI	123.59		White		
NH662BLA	131.99	48	Black	2" h x 6" l x 6" w	16
NH662NAT	107.99		Natural		
NH883BLA	160.79	48	Black	3" h x 8" l x 8" w	22
NH883NAT	131.99		Natural		
NH883WHI	160.79		White		
NH994BLA	229.19	48	Black	4" h x 9" l x 9" w	30
NH994NAT	153.59		Natural		
NH994WHI	229.19		White		

CORRUGATED E-COMMERCE BOXES

available in four sizes



WHITE					
JB1	32.66	100	Earring	2½x1½x 7/8"	4/6
JB2	38.88	100	Bracelet	3½x3½x1"	12/14
JB3	55.47	100	Necklace	8x2x 7/8"	10/15
JB4	50.67	100	Large pin	5¼x3¾x 7/8"	10/19
KRAFT					
JB1N	27.09	100	Earring	2½x1½x 7/8"	4/6
JB2N	36.16	100	Bracelet	3½x3½x1"	12/14
JB3N	60.39	100	Necklace	8x2x 7/8"	10/15



HANGERS NAHANCO Line Wood



NAHANCO LINE FLAT SHIRT /DRESS HANGERS

Our most popular wood hanger style - and the style most often chosen for customization. Most styles have inset grippers. Hardware is brushed chrome, bright chrome, gunmetal, black or gold, depending on the finish.

17" wide - 1/2" thick body; 100 pcs /case. SHIRT: 28 lbs. / Dimensional wgt. 34 lbs

19" width - 1/2" thick body; 100 pcs /case. SHIRT: 31/42 lbs;

14" width - 1/2" thick body; 100 pcs /case. SHIRT: 25/25 lbs;

12" width - 1/2" thick body; 100 pcs /case. SHIRT: 18/23 lbs

10" width - 1/2" thick body; 100 pcs /case. SHIRT: 15/16 lbs

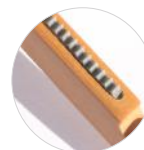

INSET GRIPPERS
Featured on all styles
except black rubber

SHIRT HANGERS

Low gloss natural w/brushed chrome	20019	\$166.41	19"
	20017	\$129.59	17"
	20014	\$128.29	14"
	20012	\$125.70	12"
	20010	\$125.70	10"
Low gloss white w/brushed chrome	20119	\$166.41	19"
	20117	\$129.59	17"
	20114	\$128.29	14"
	20112	\$125.70	12"
	20110	\$125.70	10"
Low gloss black w/brushed chrome	20219	\$166.41	19"
	20217	\$129.59	17"
	20214	\$128.29	14"
	20212	\$125.70	12"
	20210	\$125.70	10"
Low gloss mahogany w/brushed chrome	20319	\$166.41	19"
	20317	\$129.59	17"
	20314	\$128.29	14"
	20312	\$125.70	12"
	20310	\$125.70	10"
High gloss black w/bright chrome	20417	\$127.00	17"
High gloss white w/bright chrome	20517	\$127.00	17"
Low gloss beech w/brushed chrome	20617	\$168.47	17"
Low gloss espresso w/gunmetal	20717	\$127.00	17"
Black rubber w/brushed chrome /no grippers	20817	\$181.43	17"
Low gloss whitewash w/brushed chrome	20917	\$168.47	17"
Raw finish w/gunmetal	21517	\$127.00	17"
Low gloss greywash w/brushed chrome	29917	\$168.47	17"
Low gloss black w/black	20217BH	\$124.40	17"
	20219BH	\$158.10	19"
High gloss black w/gold	20417GH	\$124.40	17"
High gloss white w/gold	20517GH	\$124.40	17"



14" & 12" KIDS' SHIRT HANGERS













10" INFANT SHIRT HANGERS

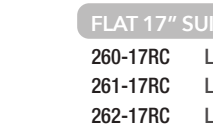

NAHANCO Line Wood **HANGERS**

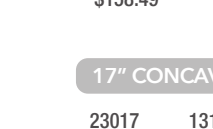
SUIT HANGERS

	Low gloss natural w/brushed chrome	19" 20019WB \$167.17 17" 20017WB \$141.25 14" 20014WB \$141.25
	Low gloss white w/brushed chrome	19" 20119WB \$167.17 17" 20117WB \$141.25 14" 20114WB \$141.25
	Low gloss black w/brushed chrome	19" 20219WB \$167.17 17" 20217WB \$141.25 14" 20214WB \$141.25
	Low gloss mahogany w/brushed chrome	19" 20319WB \$167.17 17" 20317WB \$141.25 14" 20314WB \$156.69
	High gloss black w/ bright chrome	17" 20417WB \$141.25
	High gloss white w/ bright chrome	17" 20517WB \$141.25
	Low gloss beech w/ brushed chrome	17" 20617WB \$165.88
	Low gloss espresso w/gunmetal	17" 20717WB \$143.84
	Black rubber w/brushed chrome /no grippers	17" 20817WB \$178.84 
	Low gloss whitewash w/brushed chrome	17" 20917WB \$194.39
	Raw finish w/gunmetal	17" 21517WB \$147.73
	Low gloss greywash w/brushed chrome	17" 29917WB \$174.95
	Low gloss black w/black	17" 20217WBBH \$141.25 19" 20219WBBH \$174.95
	High gloss black w/gold	17" 20417WBGH \$141.25
	High gloss white w/gold	17" 20517WBGH \$141.25

NAHANCO LINE FLAT SUIT HANGERS with BAR

Our most popular wood style in a suit hanger. Most styles have inset grippers. Hardware is brushed chrome, bright chrome, gunmetal, black or gold, depending on the finish.

17" width – ½" thick body; 100 pcs /case. **SUIT:** 30 lbs. / Dim.wgt. 36 lbs
 19" width – ½" thick body; 100 pcs /case. **SUIT:** 33/35 lbs
 14" width – ½" thick body; 100 pcs /case. **SUIT:** 22/22 lbs

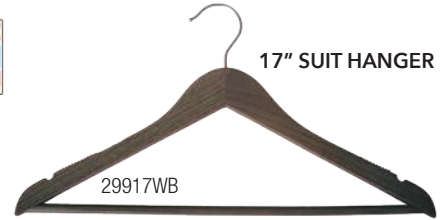

INSET GRIPPERS
Featured on all styles
except black rubber

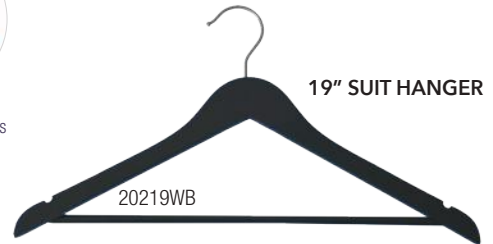

FLAT 17" SUIT HANGER w/ CLIPS

260-17RC	Low gloss natural
261-17RC	Low gloss white
262-17RC	Low gloss black
263-17RC	Low gloss mahogany



INSET GRIPPERS

½" thick; brushed chrome hardware and inset grippers; 1½" drop with brushed chrome clips; 100 /case; 37 lbs; available in four finishes \$158.49



17" CONCAVE JACKET HANGER

23017	131.80	Low gloss natural /brushed chrome hook
23117	131.80	Low gloss white /brushed chrome hook
23217	131.80	Low gloss black /brushed chrome hook
23317	131.80	Low gloss mahogany /brushed chrome hook
23417	131.80	High gloss black /bright chrome hook
23517	131.80	High gloss white /bright chrome hook
23617	156.69	Low gloss beech /brushed chrome hook
23717	131.80	Low gloss espresso /gunmetal hook
23817	75.84	Black rubber /brushed chrome hook 
23917	166.41	Low gloss whitewash /brushed chrome hook



17" wide and ¾" thick; features a 1½" notched flare end; brushed chrome, bright chrome or gunmetal hook depending on the finish; 24 /case; 16/19 lbs; available in ten finishes.

HANGERS NAHANCO Line Wood

NAHANCO LINE FLAT PANT HANGERS



Brushed chrome, bright chrome, black, gold, and gunmetal hardware (depending on the hanger style); 3/8" thick with a 7/8" face; 100 pieces /case; 38 lbs

For a visual reference to all of the NAHANCO Line finishes, see page 92



3/8" thick with a low gloss finish; brushed chrome hardware and locking wooden bar; 100 /case; 27 lbs; available in four finishes \$169.26



with 1 1/2" flare end

17" wide and 3/4" thick with a 14" drop; with a 1 1/2" notched flare end and brushed chrome hardware; 12 /case; 14/27 lbs; available in four finishes \$100.57

FLAT 14" & 12" SKIRT/PANT HANGERS

21014RC	194.39	14"	Low gloss natural
21012RC	194.39	12"	
21114RC	194.39	14"	Low gloss white
21112RC	194.39	12"	
21216BRC	213.83	16"	Low gloss black
21214RC	194.39	14"	
21212RC	194.39	12"	
21314RC	194.39	14"	Low gloss mahogany
21312RC	194.39	12"	
20414RC	194.39	14"	High gloss black w/ bright chrome
20514RC	194.39	14"	High gloss white w/ bright chrome
20614RC	207.35	14"	Low gloss beech
20714RC	194.39	14"	Low gloss espresso w/ gunmetal
20814RC	220.31	14"	Black rubber ⚠️
20914RC	207.35	14"	Low gloss whitewash
21514RC	207.35	14"	Raw finish w/ gunmetal
29914RC	207.35	14"	Low gloss greywash
21214BRC	181.43	14"	Low gloss black w/ black
20414RCGH	194.39	14"	High gloss black w/ gold
20514RCGH	194.39	14"	High gloss white w/ gold

FLAT 14" PANT HANGERS w/ LOCKING BAR

21014PB	Low gloss natural
21114PB	Low gloss white
21214PB	Low gloss black
21314PB	Low gloss mahogany

17" CONCAVE DISPLAY HANGER

24017	Low gloss natural
24117	Low gloss white
24217	Low gloss black
24317	Low gloss mahogany

NAHANCO LINE Hangers a favorite for customizing





Fit TWICE the merchandise on your racks without giving up the luxury of a wood hanger

NAHANCO SLIMLINE WOOD

Behold our slimline wood hanger! Almost as thin as our slimline velvet hangers, and as luxe as our NAHANCO line hangers. Slimline styles enable you to fit twice as many hangers onto your racks, without having to give up the sleek look and feel of wood.

Available in a range of finishes, including natural, black, white, and matte black rubber coated, mahogany, high gloss white, unfinished - all with swivel hooks and various hardware finishes, including brushed chrome, bright chrome, black, and gunmetal hardware.



Great for home closets

suit hanger w/bar



SL70114RC50

pant hanger w/clips

\$79.99 /50



brushed chrome hook

All styles offer a flat face for imprinting, and notches for straps

Low Gloss Black

SL7021750

\$65.49 /50

17" w

Introducing...

SlimLine Jacket Hangers

The SlimLine shape now available in a NEW, heavier jacket style!

Turn the page for details...

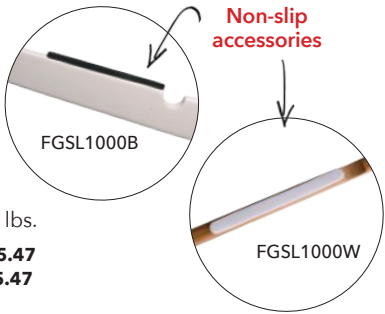

Non-slip accessories

FGSL1000B

FGSL1000W

Adhesive Foam Non-slip Attachments

Available in Black or White; 2 1/4" long; 1000 /case; 2/3 lbs.

FGSL1000B Black \$55.47
FGSL1000W White \$55.47



New

Ends taper to 1/2" thick

Matte Rubber Black

SL23817CH

\$76.49 /25



NON-SLIP
Black Rubber coated finish



SLIM
at only 1/4" thick, you can fit up to 96 hangers in 24" of rack space

HANGERS SLIMLINE Wood

SHIRT/DRESS



JACKET



SKIRT/PANT

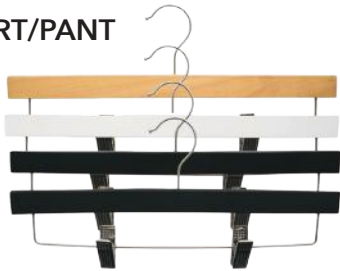

SUIT

w/ bar

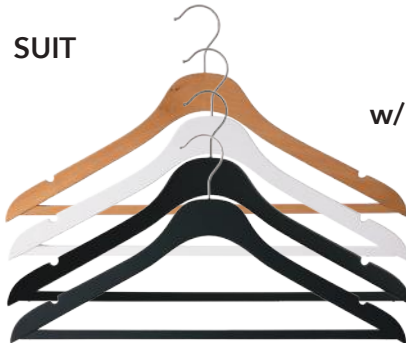

w/ clips

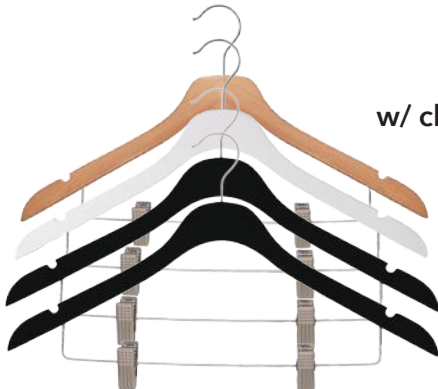

The complete SLIMLINE wood collection:
5 styles, each in 8 finishes

SHIRT HANGERS 50 /case 17" wide, 1/4" thick; 8/13 lbs.

SL7001750	Low gloss Natural	65.49
SL7011750	Low gloss White	65.49
SL7021750	Low gloss Black	65.49
SL7081750	Matte Black Rubber coated	71.99
SL7051750GH	High gloss White w/Gold hook	65.49
SL7021750BH	Low gloss Black w/Black hook	65.49
SL7031750GH	Mahogany w/Gold hook	65.49
SL7151750GM	Raw finish w/Gunmetal hook	65.49

JACKET HANGERS 25 /case 17" wide, 1/2" thick; 27 lbs.

SL23017	Low gloss Natural	71.49
SL23117	Low gloss White	71.49
SL23217	Low gloss Black	71.49
SL23817CH	Matte Black Rubber coated	76.49
SL23517GH	High Gloss White /gold hook	71.49
SL23217BH	Low gloss Black w/black hook	71.99
SL23317GH	Mahogany w/gold hook	71.99
SL23517GM	Raw finish w/gunmetal hook	71.49

SKIRT/PANT HANGERS

50 /case 14" wide, 1/4" thick; 12/12 lbs.

SL70014RC50	Low gloss Natural	79.99
SL70114RC50	Low gloss White	79.99
SL70214RC50	Low gloss Black	79.99
SL70814RC50	Matte Black Rubber coated	85.89
SL70514RC50GH	High gloss White w/Gold hook	79.99
SL70214RC50BH	Low gloss Black w/Black hook	79.99
SL70314RC50GH	Mahogany w/Gold hook	79.99
SL71514RC50GM	Raw finish w/Gunmetal hook	79.99

SUIT HANGERS

50 /case 17" wide, 1/4" thick; 10/14 lbs.

with bar:

SL70017WB50	Low gloss Natural	79.99
SL70117WB50	Low gloss White	79.99
SL70217WB50	Low gloss Black	79.99
SL70817WB50	Matte Black Rubber coated	89.99
SL70517WB50GH	High gloss White w/Gold hook	79.99
SL70217WB50BH	Low gloss Black w/Black hook	79.99
SL70317WB50GH	Mahogany w/Gold hook	79.99
SL71517WB50GM	Raw finish w/Gunmetal hook	79.99

with clips:

50 /case 17" wide, 1/4" thick; 12/19 lbs.

SL70017RC50	Low gloss Natural	97.99
SL70117RC50	Low gloss White	97.99
SL70217RC50	Low gloss Black	97.99
SL70817RC50	Matte Black Rubber coated	99.99
SL70517RC50GH	High gloss White w/Gold hook	97.99
SL70217RC50BH	Low gloss Black w/Black hook	97.99
SL70317RC50GH	Mahogany w/Gold hook	97.99
SL71517RC50GM	Raw finish w/Gunmetal hook	97.99



EQUINOX LINE SHIRT & PANT/SKIRT HANGERS

Thin, flat and sleek with deep, sculpted notches. Perfect for customizing. Everything you could want from a modern hanger.

EQUINOX ACRYLIC HANGERS

High Gloss Black, White & Clear

Shirt hangers:

17"; 5/16" thick; 50 /case; 14 lbs.

w/ brushed chrome hardware:

- 9201750 Black **\$159.54**
- 9101750 White **\$159.54**
- 9001750 Clear **\$159.54**

w/ gold hardware:

- 92017GH50 Black **\$159.54**
- 91017GH50 White **\$159.54**
- 90017GH50 Clear **\$159.54**

w/ black hardware:

- 92017BH50 Black **\$159.54**

w/ shiny chrome hardware:

- 92017CH50 Black **\$159.54**
- 91017CH50 White **\$159.54**
- 90017CH50 Clear **\$159.54**

Pant/skirt hangers:

14"; 5/16" thick; 50 /case; 17 lbs.

w/ brushed chrome hardware:

- 92014RC50 Black **\$179.90**
- 91014RC50 White **\$179.90**
- 90014RC50 Clear **\$179.90**

w/ gold hardware:

- 92014RCG50 Black **\$179.90**
- 91014RCG50 White **\$179.90**
- 90014RCG50 Clear **\$179.90**

w/ black hardware:

- 92014BRC50BH Black **\$179.90**

w/ shiny chrome hardware:

- 92014RCCH50 Black **\$179.90**
- 91014RCCH50 White **\$179.90**
- 90014RCCH50 Clear **\$179.90**

EQUINOX WOOD HANGERS

High Gloss Black & White and Low Gloss Natural w/ brushed chrome hardware; Low Gloss Espresso w/gunmetal hardware



Shirt hangers:

17"; 5/16" thick; 50 /case; 13/15 lbs.

- 29201750 Black **\$124.80**
- 29101750 White **\$124.80**
- 29701750 Espresso **\$124.80**
- 29001750 Natural **\$124.80**

Pant/skirt hangers:

14"; 5/16" thick; 50 /case; 16 lbs.

- 292014RC50 Black **\$137.38**
- 291014RC50 White **\$137.38**
- 297014RC50 Espresso **\$137.38**
- 290014RC50 Natural **\$137.38**



With its thin, flat face, the Equinox is perfect for customizing



New

New

HANGERS Executive Line Wood



EXECUTIVE HANGER LINE

Concave with chrome hardware and a gloss finish



style #	\$	qty	description	size	wgt
2007-14N 2007-14W 2007-14B 2007-14C	62.20	50	Natural White Black Cherry	17 1/2" 1/2" thick	21/22
2007-15N 2007-15W 2007-15B 2007-15C	68.68	50	Natural White Black Cherry	17 1/2" 1/2" thick	16/21
2007-16N 2007-16W 2007-16B 2007-16C	101.08	50	Natural White Black Cherry	17 1/2" 1/2" thick	20/21
2007-17N 2007-17W 2007-17B 2007-17C	62.20	25	Natural White Black Cherry	18" 1/2" thick	13/19
2007-18N 2007-18W 2007-18B 2007-18C	64.79	25	Natural White Black Cherry	18" 1/2" thick	16/22
2007-19N 2007-19W 2007-19B 2007-19C	90.71	25	Natural White Black Cherry	18" 1/2" thick	17/19
200713N 200713W 200713B 200713C	55.47	25	Natural White Black Cherry	14" 1/2" thick	7/9

EXECUTIVE FLARE HANGER LINE

Concave with chrome hardware and a gloss finish

1 7/8" Flare



Executive Pant Hanger

Flat with chrome hardware and a gloss finish

Pairs with our **NAHANCO** Line

NORTHSHIRE LINE JACKET HANGERS

A classic jacket hanger with a 3/8" shoulder, a 1 1/8" flare and a ball end hook. 17" wide; 24 pieces per carton; 9/15 lbs.



Northshire hangers feature notched, flared ends



25217	25117	25517	25717	29517	25317
Low Gloss Black w/ brushed chrome hardware	Low Gloss White w/ brushed chrome hardware	Raw Finish w/ gunmetal hardware	Low Gloss Espresso w/ gunmetal hardware	Low Gloss Greywash w/ brushed chrome hardware	Low Gloss Mahogany w/ brushed chrome hardware
24 pieces/ \$87.35	24 pieces/ \$87.35	24 pieces/ \$87.35	24 pieces/ \$87.35	24 pieces/ \$113.79	24 pieces/ \$87.35

SPECIALTY WOOD HANGERS

BAMBOO HANGERS

Flat with chrome hardware

SLIMLINE BAMBOO

Low gloss finish; 1/2" thick; 50 pieces/case.

Shirt hanger; 17" wide; 13 lbs; **SL21417CH \$ 77.99**

Pant/Skirt hanger; 14" wide w/ 7/8" face; 19 lbs; **SL21414RCCH \$ 106.49**

Suit hanger w/drop bar & clear sleeve; 17" wide; 13 lbs; **SL21417DBSCH \$ 110.99**

Suit hanger w/drop bar and clips; 17" wide; 13 lbs; **SL21417RCCH \$ 124.49**

STANDARD BAMBOO

Low gloss finish; 1/2" thick; 50 pieces/case.

Shirt hanger; 17" wide; 13 lbs; **21417 \$105.49**

Pant/Skirt hanger; 14" wide w/ 7/8" face; 19 lbs; **21414RC \$119.36**

BENTWOOD HANGERS

Flat with chrome hardware

Low gloss natural finish; 1/2" thick; 100 pieces/case.

Shirt hanger; 17" wide; 17 lbs; **664 \$148.39**

Pant/Skirt hanger; 15" wide; 22 lbs; **652 \$206.71**

DARK WOOD HANGERS

Flat with gunmetal hardware

Low gloss dark wood; 1/2" thick; 100 pieces/case.

Shirt hanger; 17" wide; 28/32 lbs; **LVS17TOPDKRS \$138.67**

Pant/Skirt hanger; 14" wide w/ 1 1/8" face; 38 lbs; **LVSPANTDKRS \$187.27**

Display hanger; 12 pieces/case.

17" wide w/ 16" drop; 17/27 lbs; **LVS23317DKRS16 \$165.11**

WALNUT GOLD SERIES HANGERS

Walnut finish with gold hardware

Gloss walnut finish; 1/2" thick; 100 pieces/case.

Flat Shirt hanger; 17" wide; 1/2" thick; 100 pieces/case; 26/29 lbs;

8317GH (no notches) \$117.94

Pant/Skirt hanger; 14" wide; 1/2" thick w/ 7/8" face; flat w/metal clips;

100 pieces/case; 30 lbs; **CLIPGH \$176.13**

Concave Shirt hanger; 17" wide; 1" thick; 40 pieces/case;

24/28 lbs; **2017GH \$138.54**



SL21417RCCH

SL21417DBSCH

SL21417CH

SL21414RCCH

21417

21414RC

664

652

LVS17TOPDKRS

LVS23317DKRS16

LVSPANTDKRS

8317GH (no notches)

CLIPGH

2017GH



HANGERS Signature, Retro & Flat Wood



style #	\$	qty	description	size	wgt
30017	215.01	100	Low gloss natural	16 3/4" 1/2" thick	28
30117	215.01		Low gloss white		
30217	215.01		Low gloss black		
30617	220.58	100	Low gloss beech	16 3/4" 1/2" thick	37/42
30017RC	169.99		Low gloss natural		
30117RC	262.18		Low gloss white		
30217RC	262.18		Low gloss black		
30617RC	214.00		Low gloss beech		

RETRO WOOD HANGERS
Flat with brushed chrome hardware

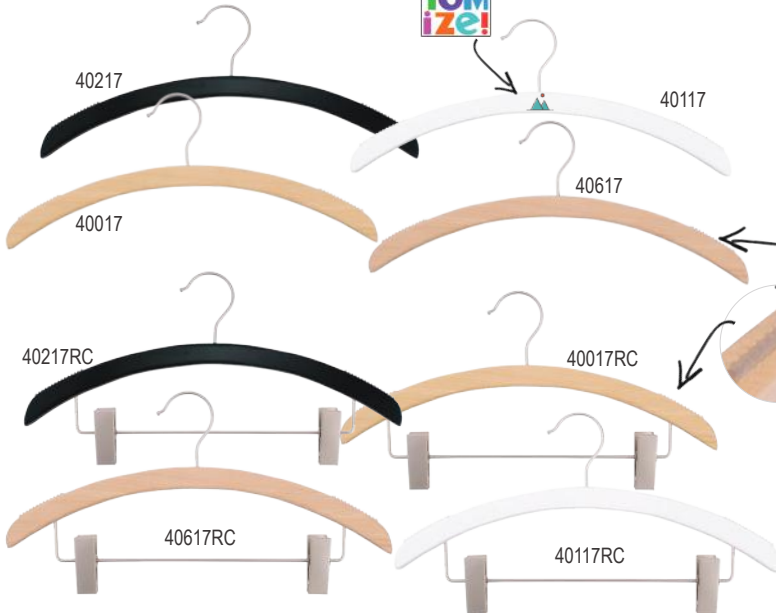

40017	203.86	100	Low gloss natural	16" 1/2" thick	22/28
40117	203.86		Low gloss white		
40217	203.86		Low gloss black		
40617	206.71		Low gloss beech		
40017RC	225.37	100	Low gloss natural	16" 1/2" thick	37
40117RC	232.37		Low gloss white		
40217RC	232.37		Low gloss black		
40617RC	252.46		Low gloss beech		

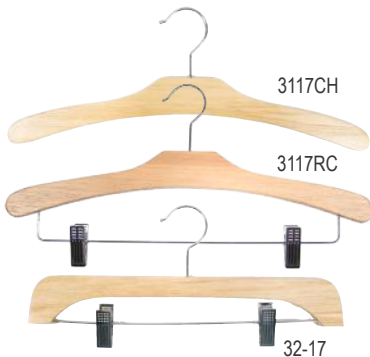

FLAT SHIRT HANGER
Chrome hook

FLAT SUIT HANGER
Chrome hardware

FLAT SKIRT/PANT HANGER
Chrome hardware

3117CH	151.24	100	Natural gloss	16 1/2" 3/8" thick	24/25
3117RC	170.68	100	Natural gloss	16 1/2" 3/8" thick	35
32-17	166.41	100	Natural gloss	14" 3/8" thick 7/8" face	27



CONTEMPORARY HANGER LINE: Flat body with a softer slope, chrome hardware, ball end hook and a gloss finish

CONTEMPORARY SHIRT HANGERS

w/Notches

17" wide; 3/8" thick; 100 /case; 27/29 lbs.

\$186.61

200720NN	Natural
200720WN	White
200720BN	Black



CONTEMPORARY PANT/SKIRT HANGERS

w/Standard Clips

14" wide; 3/8" thick; 100 /case; 30 lbs.

\$165.88

200723N	Natural
200723W	White
200723B	Black

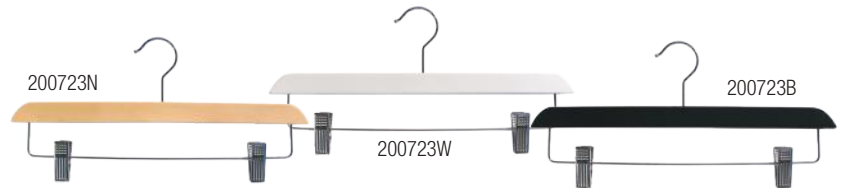

CONTEMPORARY SHIRT HANGERS

No Notches

17" wide; 3/8" thick; 100 /case; 34/35 lbs.

\$172.36

2007-20N	Natural
2007-20W	White
2007-20B	Black
2007-20C	Cherry



CONTEMPORARY SUIT HANGERS

w/Pant Bar

17" wide; 3/8" thick; 100 /case; 37 lbs.

\$194.39

2007-21N	Natural
2007-21W	White
2007-21B	Black
2007-21C	Cherry

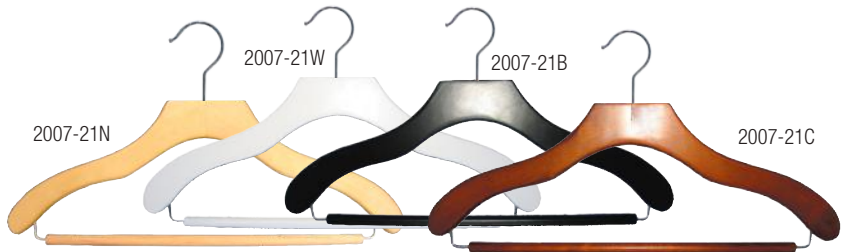

CONTEMPORARY COORDINATE HANGERS

w/Euro Clips

17" wide; 3/8" thick; 100 /case; 47 lbs.

\$200.87

2007-22N	Natural
2007-22W	White
2007-22B	Black
2007-22C	Cherry

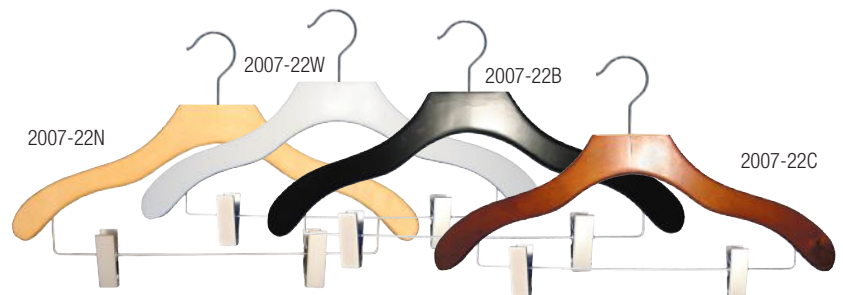

HANGERS Traditional & Concave Wood



FLAT SHIRT HANGER
with Shoulder Notches
Chrome hook



81-17CH 8117WCHNOTCH
8217CHNOBAR



FLAT SHIRT HANGER
without Shoulder Notches
Chrome hook



8117CHNONOTCH 8117WCH



FLAT SUIT HANGER
Stationary pant bar
Chrome hook

80-17 8217CH
8017W

FLAT SUIT HANGER
2" chrome drop
Chrome hook



8017CHRC

SKIRT/PANT HANGERS
Flat with chrome or gold hardware

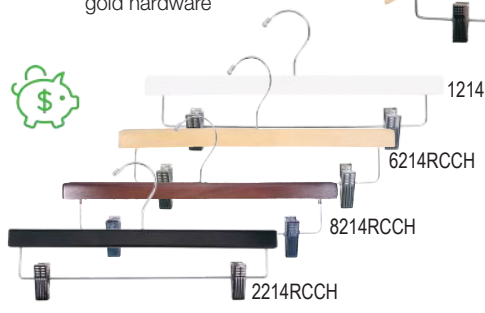

gold hardware

1214RCCH
6214RCCH
8214RCCH
2214RCCH



EXTRA-THICK CONCAVE JACKET HANGER
Chrome hook

2317CH 2017CH 2117CH 2217CH



EXTRA-THICK CONCAVE SUIT HANGER
Chrome hardware and locking trouser bar



2117CHPB 2217CHPB 2317CHPB
2017CHPB

style #	\$	qty	description	size	wgt
---------	----	-----	-------------	------	-----

SHIRT HANGERS - WITH NOTCHES:

81-17CH	79.90		Natural gloss w/ notches		
8217CHNOBAR	79.90	100	Black gloss w/ notches	17" 1/2" thick	28/29
8117WCHNOTCH	79.90		White gloss w/ notches		

SHIRT HANGERS - NO NOTCHES:

8117CHNONOTCH	79.90	100	Natural gloss, no notches	17" 1/2" thick	28/29
8117WCH	79.90		White gloss, no notches		

SUIT HANGERS - WITH PANT/SKIRT BAR:

80-17	79.90		Chrome hook: Natural gloss w/bar		
8017W	79.90	100	White w/bar	17" 1/2" thick	30/31
8217CH	79.90		Black gloss w/bar		

SUIT HANGERS - WITH 2" CHROME DROP:

8017CHRC	109.90	100	Natural w/2" chrome drop	17" 1/2" thick	30/31
----------	--------	-----	--------------------------	-------------------	-------

SUIT HANGERS - WITH 14" CHROME DROP:

1214RCCH	94.90	100	White: Chrome hardware	14" 1/2" thick	31
6214RCCH	94.90	100	Natural: Chrome hardware	14" 1/2" thick	31
6214RCGH	173.40		Gold hardware		
8214RCCH	129.47	100	Walnut: Chrome hardware	14" 1/2" thick	31
8214RCGH	95.77		Gold hardware		
2214RCCH	94.90	100	Black: Chrome hardware	14" 1/2" thick	31
2214RCGH	184.42		Gold hardware		

1" THICK JACKET HANGERS :

2017CH			Walnut gloss		
2117CH	129.99	40	Natural gloss	17" 1" thick	22/32
2217CH			Black gloss		
2317CH			Natural w/waxed finish		

1" THICK SUIT HANGERS :

2017CHPB			Walnut gloss		
2117CHPB	182.35	40	Natural gloss	17" 1" thick	29/39
2217CHPB			Black gloss		
2317CHPB			Natural w/waxed finish		

Traditional Wood HANGERS

style # \$ qty description wgt

SUIT HANGERS - 1/2" THICK:

50-14	203.86		14" Natural w/waxed finish, sq hook	27/35
50-17	198.29		17" Natural w/waxed finish, sq hook	39/40
50-19	203.86		19" Natural w/waxed finish, sq hook	42/48
7017CH	162.26		17" Walnut, chrome hook	38/49
70-19GH	203.86	100	19" Walnut, gold hook	38/44
7117CH	162.26		17" Natural, chrome hook	38/45
71-19GH	203.86		19" Natural, gold hook	41/48
72-17CH	165.11		17" Black, chrome hook	33/48
72-17	165.11		17" Black, gold hook	33/48

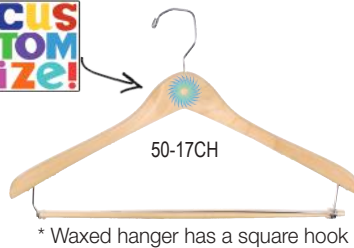

CONCAVE SUIT HANGER
Chrome or gold hardware
with locking trouser bar



Hook finishes
CH = Chrome Hook
GH = Gold Hook

SUIT HANGERS - 1/2" THICK w/ 2" DROP:

70-17RC	171.98	100	17" Walnut, gold hardware	39/45
7117RCCH	171.98		17" Natural, chrome hardware	
7217RCCH	171.98	100	17" Black, chrome hardware	39/48
72-17RC	191.42		17" Black, gold hardware	

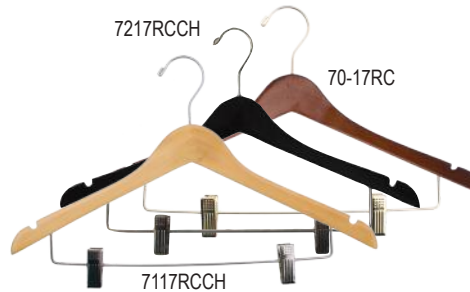

NOTCHED CONCAVE SUIT HANGER
Chrome or gold hardware

DISPLAY HANGERS - 1/2" THICK w/ 10" DROP:

100-17RC	51.32	12	17" Walnut, chrome hardware	7/34
101-17RC			17" Natural, chrome hardware	

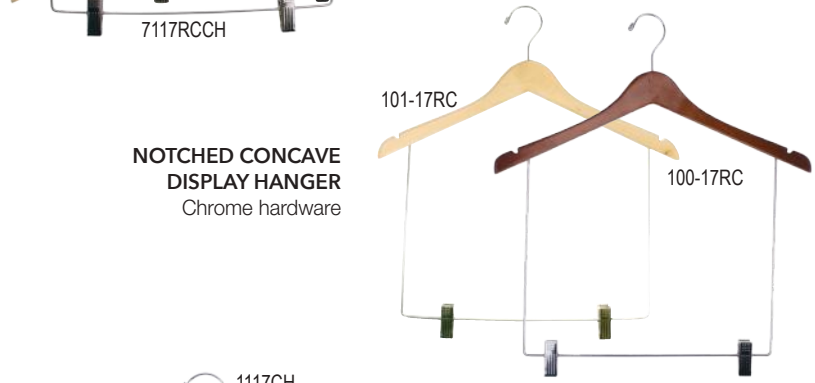

NOTCHED CONCAVE DISPLAY HANGER
Chrome hardware

JACKET HANGERS - 1/2" THICK:

1217CH	127.99		17" Black, chrome hardware	29/31
12-17	127.99		17" Black, gold hardware	29/31
14-17	127.99	100	17" Natural w/waxed finish, chrome	29/31
1017CH	127.99		17" Walnut, chrome hardware	29/33
1017GH	127.99		17" Walnut, gold hardware	29/33
10-19GH	129.99		19" Walnut, gold hardware	33/36
11155CH	127.99		15 1/2" Natural, chrome hardware	22/30
1117CH	127.99		17" Natural, chrome hardware	29/33
11-17GH	127.99		17" Natural, gold hardware	29/33



CONCAVE JACKET HANGER
Chrome or gold hook

SUIT HANGERS - 1" THICK w/ BLACK FLOCKED BAR:

2017CHFB			17" Walnut gloss w/chrome hardware	
2117CHFB	153.99		17" Natural gloss w/chrome hardware	
2217CHFB		40	17" Black gloss w/chrome hardware	29/39
2017GHFB			17" Walnut gloss w/gold hardware	
2117GHFB	156.49		17" Natural gloss w/gold hardware	
2217GHFB			17" Black gloss w/gold hardware	

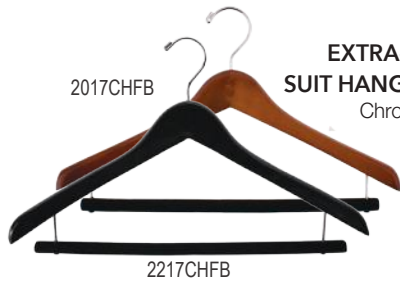

EXTRA-THICK CONCAVE SUIT HANGER w/Flocked Bar
Chrome or Gold hardware



New

8 New styles added!

SUIT HANGERS - 1/2" THICK w/ BLACK FLOCKED BAR:

7017CHFB			17" Walnut gloss w/chrome hardware	
7117CHFB	137.99		17" Natural gloss w/chrome hardware	
7217CHFB		40	17" Black gloss w/chrome hardware	29/39
7017GHFB			17" Walnut gloss w/gold hardware	
7117GHFB	142.49		17" Natural gloss w/gold hardware	
7217GHFB			17" Black gloss w/gold hardware	



NAHANCO HOTEL FLAT WOODEN & CHROME HANGERS

Our Hotel Collection features flat suit ball top wooden hangers, a closed hook chrome hanger and the A-style and B-style security rings used with the ball top hangers. Flat wooden hangers feature a low gloss finish, notched ends, pant bars or clips, and are great for imprinting your company's logo.

FLAT SUIT Ball Top Wood Hanger

w/Metal Sliding Clips

17 1/2" wooden suit hanger features a dropped bar and sliding chrome clips. Notched ends accommodate garments with straps. 100 pieces/case. 33/35 lbs. **\$166.41**



Black
60217BECRC
Mahogany
60317BECRC
Natural
60017BECRC

FLAT SUIT Ball Top Wood Hanger

w/Pant Bar

17 1/2" wooden flat suit hanger features a stationary pant bar. Notched ends accommodate garments with straps. 100 pieces/case. 29/30 lbs. **\$127.66**

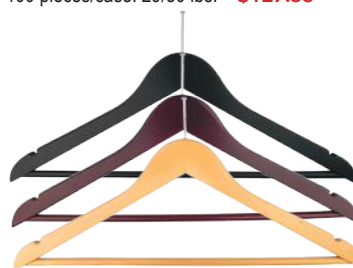

Black
60217BEC
Mahogany
60317BEC
Natural
60017BEC



Most of our wooden hangers can be fitted with a ball post for hotel use. Please call Customer Service for details.



A-RING for Ball Top Hangers

Chrome plated steel hotel-style ring stays put when installed on any standard closet bar; easily detach from the circular hook. 100 pcs/bag. 9 lbs; **HHSRA100 \$30.59**



B-RING for Ball Top Hangers

Chrome finished steel clamping hanger. The B-Style Ring clamps down over the bar. 100 pcs/bag. 5/8 lbs; **HHSRB100 \$34.73**

17" CLOSED HOOK CHROME HANGER

Made with heavy duty 4mm chrome plated wire, this hanger is durable and long lasting. The opening diameter of the hook measures 1 1/2". 100 pieces/case. 25 lbs; **89017 \$130.38**

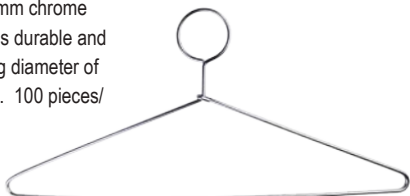

17" MINI HOOK HANGERS

17" wooden suit hangers with a natural gloss finish and a flat 1/2" thick profile, feature notched ends for straps and a mini chrome hook to fit a 5/8" diameter hang bar. 100 pieces/case; w/ 2" drop bar and pinch clips: **8017RCMH \$165.76**
w/ round wood pant bar: **8017NOTCHMH \$126.88**



More HOTEL hanger options include:

- **NAHANCO** LINE - see p 92
- **Executive** LINE - see p 98
- **Contemporary** LINE - see p 101
- **Northshire** LINE - see p 99
- **Equinox** LINE - see p 97
- **Retro** LINE - see p 100
- **Signature** LINE - see p 100
- **Bamboo** styles - see p 99



Chrome-Plated Metal HANGERS

style #	\$	qty	description	size	wgt
Chrome/3.5mm wire gauge:					
SLD12	68.99	100	standard hook	12"	18
SLD-12LH	113.99		loop hook	12"	18
SLD14	78.99		standard hook	14"	20
SLD-14LH	107.99		loop hook	14"	20
SLD16	88.78		standard hook	16"	22
SLD-16LH	85.99		loop hook	16"	22
SLD18	95.99		standard hook	18"	22
SLD-18LH	99.99		loop hook	18"	22
SLD19	99.99		standard hook	19"	24
SLD-19LH	127.49		loop hook	19"	24
SLD-PANT	133.23	100	CHROME 3.5mm wire gauge	14"	22
DSA9	160.96			9" drop	24
DSA16	167.83			16" drop	29
SKT-12	117.94			standard hook	12"
SKT12LH		loop hook	12"	20	
Chrome/3.5mm wire gauge:					
LIN14	119.36	100	standard hook	14"	22
LIN16	105.49		standard hook	16"	24
LIN16LH	151.89		loop hook	16"	24
LIN18	112.36		standard hook	18"	24
DP1410	22.94	10	Chrome diaper pin rod	14"	4
SLC-16	156.69	100	Chrome / 3.5mm wire With Loop Hook	16"	24
SLC16LH				16"	24
BSH12-50	120.66	50	Chrome/3.5mm wire	12"	34/35
BFWC12	81.91	12	Chrome/4.5mm wire Black/4.5mm wire Black rubber /4.5mm wire	All 3 styles - 38" body height 15" shoulders 11" waist/16" hips	10/11
BFWB12	72.84				
BFWBR12	95.77				
BCH14	27.73	12	Chrome /4mm wire Black /4mm wire gauge Black Rubber	14"	5
BBH14	27.73				
BBH14BR	38.23				
SLGLOVE	125.58	100	CHROME	10" wide at bottom, 11 1/2" high	27
SLGLOVE12	33.18	12	3.5mm wire gauge		7
SLHAT	137.38	100	CHROME	9" wide at bottom, 11 1/2" high	27
SLHAT12	33.18	12	3.4mm wire gauge		7
NH4TPH	16.72	3	CHROME 4-tier pant hanger with clips	13" x 15"	3/6
SBD22	66.64	12	CHROME 3mm wire gauge	22"	9
201	41.60		CHROME 6.5mm wire gauge	19"	9
201NOTAIL19	47.17		CHROME 8mm wire gauge	19"	12

CHROME-PLATED HANGERS

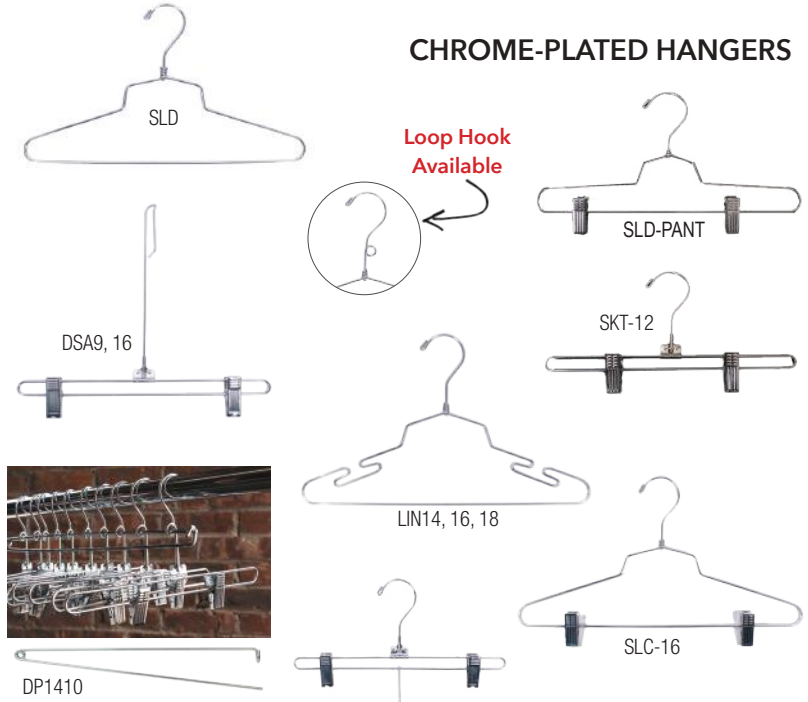

BIKINI & SWIMSUIT HANGERS

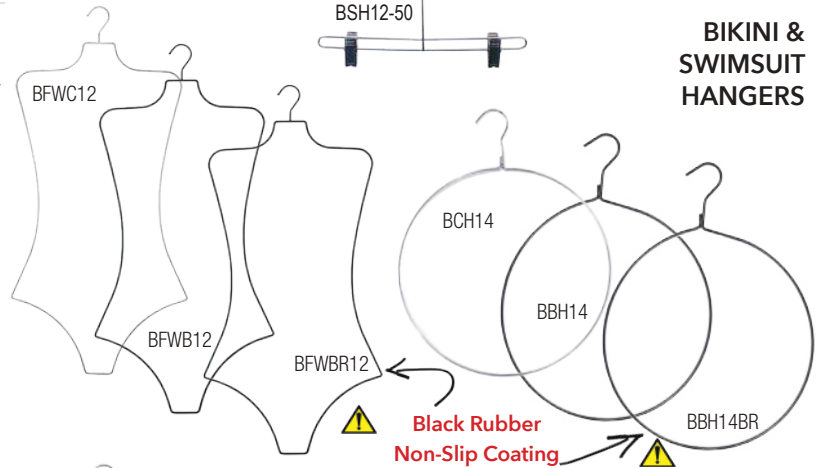

GLOVES & HAT HANGERS



TIERED PANT HANGER



BEDSPREAD, DRAPERY & SLEEPING BAG HANGERS

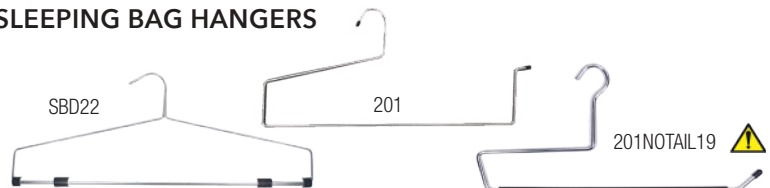

HANGERS Aluminum, Gunmetal & Steel

BRUSHED ALUMINUM

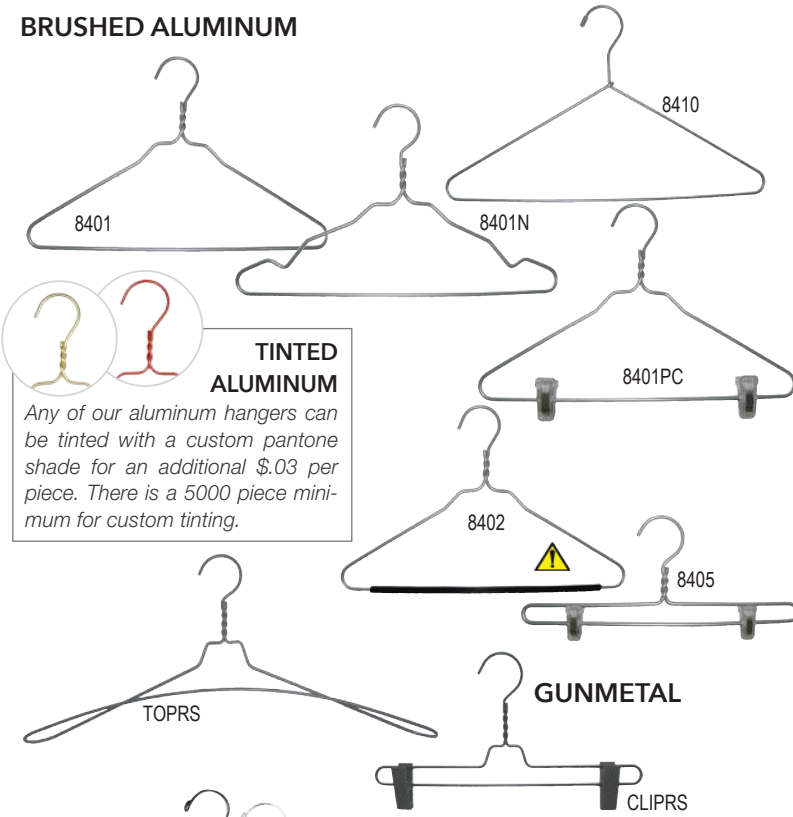

TINTED ALUMINUM
 Any of our aluminum hangers can be tinted with a custom pantone shade for an additional \$.03 per piece. There is a 5000 piece minimum for custom tinting.

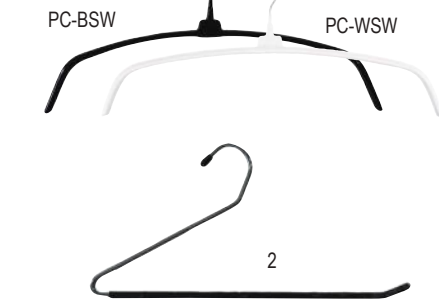

NON-SLIP STEEL HANGER
 A slim, tempered steel shirt hanger coated with a non-slip rubber. Chrome hook does not swivel.

CHROME-PLATED STEEL Skirt/Pant Hanger
 Vinyl-covered, non-slip bar.

New

S-Shape Multilayer Metal Hanger

Lightweight and durable stainless steel



Black Clamp Pant Hanger
 Chrome with rubberized coating

BEDSPREAD, DRAPERY & SLEEPING BAG HANGERS



style #	\$	qty	description	size	wgt
8410	112.49	100	Brushed aluminum standard shirt hanger; 4mm wire gauge	16 1/4"	9/15
BRUSHED ALUMINUM w/twisted neck – 4mm wire gauge:					
8401	149.82		Shirt hanger		11/16
8401N	130.99	100	Notched Shirt hanger	16 1/2"	11/13
8401PC	140.49		Suit hanger w/ clear plastic clips		14/30
8402	116.99	100	Brushed aluminum shirt hanger w/ black rubber sleeve and twisted neck; 4mm wire gauge	16 1/2"	13/18
8405	150.99	100	Brushed aluminum pant hanger w/ clear plastic clips & twisted neck; 4mm wire gauge	15"	11/16
GUNMETAL Finish w/twisted neck – 3.5mm wire gauge:					
TOPRS	166.41	100	Shirt hanger	18", 1 7/8" flare	23
CLIPRS	180.27		Pant hanger w/metal clips	14"	27
3.5mm wire gauge hook w/flat steel body					
PC-BSW	71.49	100	Black	16"	22/24
PC-WSW			White		
2	119.36	100	Chrome with black bar;	12 1/2"	31
2-16	127.66		5.4mm wire gauge	16"	38
NHMLPH	11.79	3	Stainless steel w/clear cap ends	12" W x 15 1/2" H	3/6
CP200	80.48	50	Black	10"	37
Heavy Duty Black Metal Hangers:					
NHTHSFR1	20.87		Sleeping Bag/ Bedspread hanger	25" wide	4
NHTHSFR2	21.51	1	Sleeping Bag/ Bedspread hanger	31" wide	8
NHTHSHM1	22.29		Hooded mummy sleeping bag hanger	23" wide	5

Plastic Jacket & Suit HANGERS

style # \$ qty description size wgt

style #	\$	qty	description	size	wgt
H70	69.34	50	Black	15/8" shoulder:	17/45
H90	72.19			17"	20/48
H110	68.04			19"	23/56

RH = Round Hook			SQ = Square Hook		
-----------------	--	---	------------------	--	---

H17SQ	62.47	100	Black	17"	21/44
H17RH	62.47			19"	22/44
H19RH	83.20				
2593	98.50	50	Black	19" 1 1/2" shoulder	21/46
2563	87.35			18" 1 3/8" shoulder	20/43
2515	97.07	100	Black	15"	26/31
2393	98.50	50	Black w/clear support strap	19"	16/39
2363	87.35			16 1/2"	18/43
8517RH	126.23	100	Tan	17"	29/34
8517SQ	115.86		Tan	17"	
2517RH	103.67		Black	17"	
2518	91.49	100	Black	18"	37/48
8518RH			Tan	18"	36/48
2700PB	59.99	100	Black	17"	22/34
1700PB			White		
700 PB			Clear		
2015PC	96.42	100	Black	15 1/4"	15/24
2690EC	90.85	100	Black	14"	22

CONCAVE EXTRA WIDE-SHOULDERED PLASTIC SUIT HANGER

Textured finish with smooth area for label. Chrome hook



CONCAVE PLASTIC SUIT HANGER

Textured finish with smooth area for label. Chrome hook



CONCAVE WIDE-SHOULDERED SUIT HANGER

Textured finish with smooth area for label & locking trouser bar. Chrome hardware



CONCAVE PLASTIC SUIT HANGER

Textured finish with smooth area for label & locking trouser bar. Chrome hardware



CONCAVE WIDE-SHOULDERED SUIT HANGER

Textured finish with smooth area for label. Chrome hook and clear support strap



CONCAVE STURDY PLASTIC SUIT HANGER

Matte finish with locking trouser bar. Chrome hardware



FLAT PLASTIC SUIT HANGER

Non-slip plastic bar. Chrome hook



PANT HANGER W/ CUSHION GRIP CLIPS

Chrome hook



SUPER STRONG PANT HANGER

For outerwear and jeans



HANGERS Plastic Jacket & Outerwear



CONCAVE STURDY PLASTIC JACKET HANGER

Textured finish with smooth area for label. Chrome hook



CONCAVE JACKET HANGER

With non-slip pads and black hook



FLAT PLASTIC ACTIVE SPORTS HANGER

Smooth finish with area for label application. Chrome hook



CONCAVE WIDE-SHOULDERED PLASTIC JACKET HANGER

Textured finish with smooth area for label. Chrome hook



CONCAVE WIDE-SHOULDERED PLASTIC JACKET HANGER

Textured finish with smooth area for label. Chrome hook



PLASTIC CONCAVE JACKET HANGER

Textured finish with smooth area for label. Chrome hook



PLASTIC CONTOUR JACKET HANGER

Textured finish with smooth area for label. Black hook



FLAT ELEGANT SHIRT HANGER

Chrome hook



FLAT ELEGANT COORDINATE SUIT HANGER

With notches and chrome hardware



FLAT ELEGANT SHIRT/SWEATER HANGER

Chrome hook



FLAT SPORTSMEN'S OUTERWEAR HANGER

With molded grippers

style #	\$	qty	description	size	wgt
2417RH	64.79		Black	17"	20/34
8417RH	76.33	100	Tan	17"	18/28
8417SQ	63.89		Tan	17"	18/28
2418	81.91		Black	18"	22/46
8418RH	81.91		Tan	18"	22/46

RH = Round Hook



SQ = Square Hook

24010550	54.17	50	Black w/ black hook	15"	9/22
H1800RH	77.99	100	Black	18"	20/30
2293	69.34		Black	19"	16/39
2263	66.61	50	Black	16 1/2"	16/38
2493	65.97		Black	19" wide 1 1/2" shoulder	14/39
2463	56.25	50	Black	18" wide 1 3/8" shoulder	14/35
2415	67.91	100	Black	15"	14/26
NHC18	78.93		Black	18"	21/40
NHC17	64.67	100	w/ black hook	17"	20/39
NHC15	63.37		Black	15"	18/28
NH250	60.39	100	Ivory	17"	13/21
BH250			Black		
NH252	138.54		Ivory	17"	29/38
BH252	152.41	100	Black		
NH229	83.98	100	Ivory	18 1/2"	18/31
BH229			Black		
BH350BHM	79.06	100	Black w/ black hook	18 3/4"	21/32

Flocked Velvet HANGERS

style # \$ qty description size wgt

HSL17NB	55.47	100	Black	17 3/8"	12/18
HSL17NG HSL17NP	36.81	50	Moss Grey Pink	17 3/8"	6
HSL17SB	52.75	100	Black (no notches)	17 3/8"	12/18
HSL17PB	58.32	100	Black	17 3/8"	17/19
HSL17PG HSL17PP	43.68	50	Moss Grey Pink	17 3/8"	12/13
HSLCLIPB HSLCLIPG HSLCLIPP	34.08	100	Black Moss Grey Pink	2 3/4" h x 1 1/2" w	4



SLIMLINE HANGERS
A thin velvet flocked hanger with chrome hook, often referred to as "huggables"

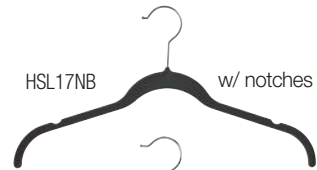

Top Sellers!

SLIMLINE CLIPS



FNHDH4	44.45	12	Black	17" 1" thick	5/9
--------	-------	----	-------	-----------------	-----

FNHDH4



FLOCKED VELVET

FLOCKED THINLINE DISPLAY HANGER
Chrome hook

FLK2508	91.63	100	Black <i>*while supplies last</i>	17"	14/22
---------	-------	-----	--------------------------------------	-----	-------

FLK2508



FLAT FLOCKED SHIRT HANGER
T-shirt weight plastic shirt hanger with velvet finish and chrome hook

FNH250	26.44	12	Black	17"	12/21
--------	-------	----	-------	-----	-------

FNH250



FLAT FLOCKED ELEGANT SHIRT HANGER
Chrome hook

FNH229	29.81	12	Black	18 1/2"	18/31
--------	-------	----	-------	---------	-------

FNH229



FLAT FLOCKED ELEGANT SHIRT/SWEATER HANGER
Chrome hook

F24022222 F24044444	58.32 66.61	25	Black	16" 14"	9/10
------------------------	----------------	----	-------	------------	------

F24022222



FLAT FLOCKED WOOD SHIRT & SKIRT/PANT HANGER
Wood base with chrome hardware

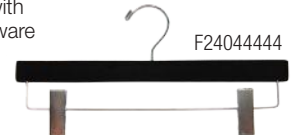

SHIRT/SUIT HANGERS W/ STATIONARY HOOK & EXTENDED DROP
Perfect for Conveyor Systems

NH450 NH452	51.49 10.49	100	Polystyrene Black Shirt/dress Suit w/clips	18 1/4" w; .3" thick; stationary hook w/ 4.75" drop	12/21 23/29
----------------	----------------	-----	--	---	----------------

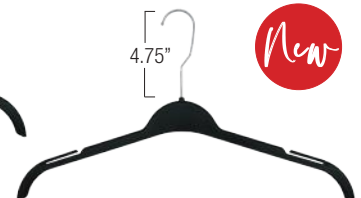

New

HANGERS Intimate Apparel



style #	\$	qty	description	size	wgt
8212	72.84	200	Black plastic with soft padded clips & chrome ball end hook	12"	19/31
NH01	92.92	500	Opaque polystyrene	10"	17
NH01B	79.83		Black	1/8" thick	
NH02	101.35	500	with prongs: Opaque polystyrene	10"	24
NH02B	82.94		Black	1/8" thick	
NH03	109.64	500	Polystyrene		22/33
NH03B	102.64		Clear	12 1/4"	
			Black		
NH04	109.64	250	Polystyrene with plastic clips		17/22
NH04B	102.64		Clear	10 1/2"	
			Black		
<i>Opaque polystyrene with brushed chrome hardware or black with chrome hardware (non-slip applied to shoulders of top hanger)</i>					
NH06	166.28	100	Skirt/Pant hanger	15"	25
NH06B	121.31			1/4" thick	
NH07	87.35	100	Top hanger		15
NH07B	63.89				
<i>Clear - choose from 3 pack sizes:</i>					
NHGS19100	13.74	100		10"	3/6
NHGS19250	40.31	250	Clear		6/10
NHGS19	115.86	1000			21/30
NHGS23100	15.16	100	Clear	10"	7/11
NHGS23250	45.75	250	w/ logo area		10/15
NHGS23	146.32	1000			25/35
<i>Black - 2 pack sizes:</i>					
BNHGS19100	13.74	100	Black	10"	3/6
BNHGS19	115.86	1000			21/30
BNHGS23100	15.16	100	Black	10"	7/11
BNHGS23	146.32	1000	w/ logo area		25/35
KM1	118.99	1000	Clear	10"	27/37
NH08	83.07	100	Grey dip coated metal hanger w/ chrome hook	12"	12/21
NH09	87.35	100	Chrome bottom hanger with clear plastic clips and grey coated tips	11"	13

style # \$ qty description size wgt

Black flat satin padded hangers with & without a drop. Chrome hardware

40840	145.67	100	without drop	15¾"	25
40841	159.54		with drop	15¾", 2" drop	36
4720425	138.67	100	Chrome Hardware: Ivory Satin	15½"	25
4720441	149.82		Ivory Satin	15½", 2" drop	27/35
3395343	153.96	100	Pink Satin	15½", 2" drop	27/37



Satin hangers with coordinating hook and bow detail

806-1	13.87	6	White	15"	3/15
806-2	14.64		Ivory		
806-5	11.79		Pink		
806-25	13.87		Black		
806-99	16.72		Plush Tiger w/gold hook		



Satin hangers w/drop clips & brushed chrome hardware

NH10-S		100	Silver	10 1/2"	15
NH10-W	134.40		White		
NH10-I			Ivory		



Wooden hanger w/chrome hardware and fine, rubber-tipped strap holders

with drop -					
NH11	173.40	100	Unfinished beech	11 7/8"	16/24
NH11B	173.40		Low gloss black		
NH11BR	187.27		Black rubber coated w/brushed chrome		
no drop -					
NH12	138.54	100	Unfinished beech	11 7/8"	16
NH12B	109.12		Low gloss black		
NH12BR	149.30		Black rubber coated w/brushed chrome		
with drop -					
NH13	191.42	100	Unfinished beech	14"	27
NH13B	162.26		Low gloss black		
NH13BR	215.01		Black rubber coated w/brushed chrome		
no drop -					
NH14	151.11	100	Unfinished beech	14"	18
NH14B	122.99		Low gloss black		
NH14BR	161.74		Black rubber coated w/brushed chrome		

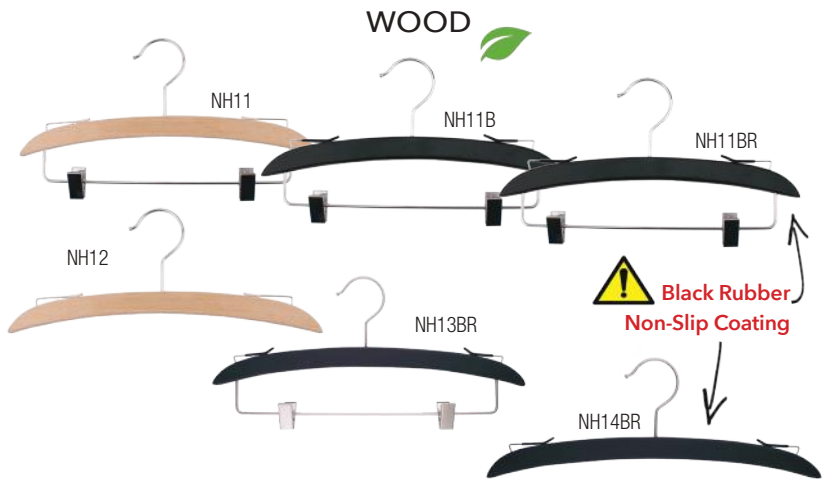

Jumbo weight shirt hanger:					
3405 G	179.63	100	Gold w/gold hook	17"	15/22
4405	167.18		Silver		



Heavy weight Suit Hanger w/metal clips:					
3500RC G	235.74	100	Gold w/gold hardware	17"	24/29
4500RC	192.84		Silver		
3700 G	173.40	100	Heavy weight Gold Coat Hanger w/gold hook	17"	20/23

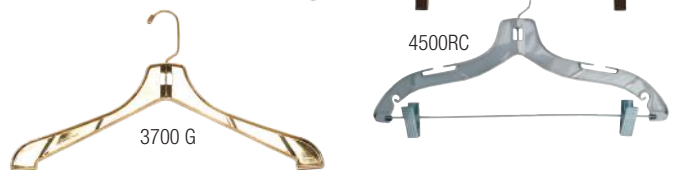

Heavy weight skirt/pant Hanger w/metal clips:					
3600RC G	235.74	100	Gold w/gold hardware	14"	19
4600RCLH	235.74		Silver		



HANGERS Plastic Display

DISPLAY HANGERS



DISPLAY HANGERS
Black w/black hook
White w/white hook



style #	\$	qty	description	size	wgt
DHWS124W	24.36	12	1½" thick: White w/white	4" hook: 12"	4/8
DHBS124B	24.36		Black w/black	12"	
DHWS15WH12	27.73	12	White w/white	15½"	5/12
DHBS15BH12	29.03		Black w/black	15½"	5/18
DHBS17/4B	31.23	12	Black	17¼"	6/15
DHWS15CH12	27.73	12	White w/chrome	15½"	4/8
DHBS15CH12	29.03		Black w/chrome		

DISPLAY HANGERS
Black & White
with chrome hooks



DISPLAY HANGERS w/ DROP
White with 8 or 10" chrome drop
Black with 8 or 12" chrome drop
Pewter with 12" chrome drop

WSK8124W	41.47	12	1½" thick: White	12"-8" drop	6/15
BSK8124B	48.60		Black	12"-8" drop	
WSK10144W	45.75	12	White	15½"-10" drop	8/25
BSK12164B			Black	15½"-12" drop	8/26
BSK12174B	48.60	12	Black	17¼"-12" drop	8/30
PSK10174C			Pewter	17¼"-12" drop	

THINLINE DISPLAY HANGER
Chrome hook



DISPLAY HANGER
Chrome hardware



DH4	20.49	12	Black	17" 1" thick	5/9
DH3	20.49		Black	17" 1½" thick 2" drop	7/19

FROSTED DISPLAY HANGERS

Frosted with brushed chrome hardware and black with chrome hardware

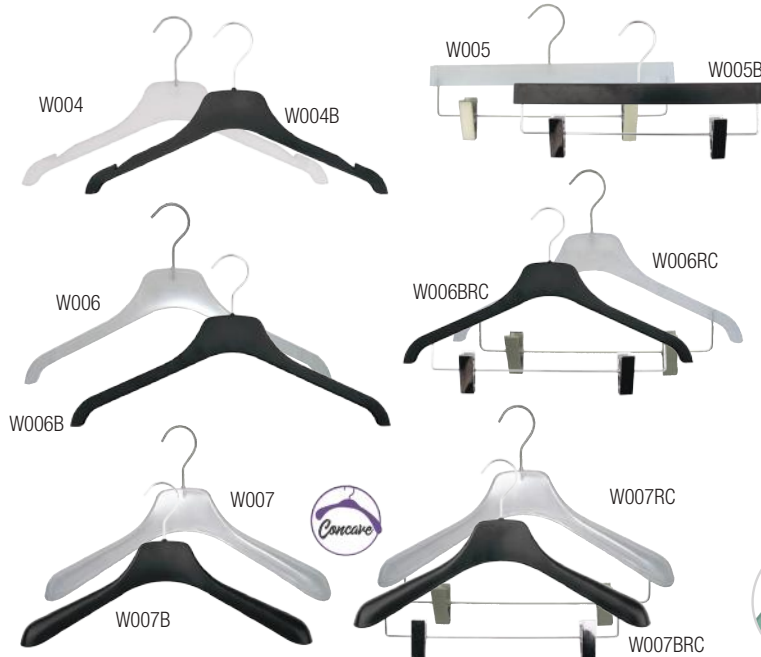

W004	78.07	100	Flat: Clear Frosted	15½"	17/21
W004B	60.04		Black		
W005	279.04	100	Clear Frosted	14"	37
W005B	219.78		Black		
W006	78.07	100	Clear Frosted	17"	18/25
W006B	72.93		Black		
W006RC	284.19	100	Clear Frosted	17"	33/40
W006BRC	194.01		Black		
W007	37.88	24	Concave: Clear Frosted	17"	10/22
W007B	30.46		Black		
W007RC	81.17	24	Clear Frosted	17"	13/28
W007BRC	61.38		Black		



Frosted hangers are available in a range of custom colors, minimum order of 3000 pieces (same color). Call our sales department for more information.

Plastic Traditional Shirt & Dress HANGERS

Department Store style



Heavy Weight Shirt Hangers

17" wide; 100 /case; 15/22 lbs.

500	Clear w/chrome hardware	\$34.99
1500	White hi-impact w/chrome hardware	\$34.99
2500	Black w/ chrome hardware	\$34.99
2500BH	Black w/ black hardware	\$28.09
9500	Clear Break Resistant w/chrome	\$66.49
1500APWW	White hi-impact w/washer & foam strips	\$58.49

weight is 15/26 lbs:

8500	High Gloss Black w/ chrome hook	\$35.99
8500BH	High Gloss Black w/ black hook	\$35.99

Value Hangers



Middle Weight Shirt Hangers

17" wide; 100 /case; 13/26 lbs.

507	Clear w/chrome hardware	\$30.99
1507	White hi-impact w/chrome hardware	\$30.99
2507	Black w/ chrome hardware	\$30.99
2507BH	Black w/ chrome hardware	\$30.09

T-Shirt Hangers



T-Shirt Weight Shirt Hangers

17" wide; 100 /case; 12/18 lbs.

1508	Opaque white w/chrome hardware	\$29.99
2508	Black w/ chrome hardware	\$29.99
2508BH	Black w/ black hardware	\$29.99

Heavy Weight Shirt Hanger

With molded grippers
17" wide; 100 /case; 13/26 lbs

95500	Clear break resistant w/chrome	\$61.49
15500	White w/chrome hardware	\$30.99
25500	Black w/ chrome hardware	\$30.99
25500BH	Black w/ black hardware	\$30.99
25500BHMG	Black w/ black hardware & grippers	\$48.49

With co-ordinate hole

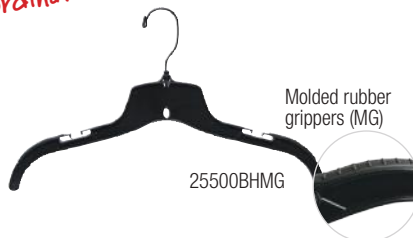

Chain Store favorites



Medium Heavy Weight Shirt Hangers

17" wide; 100 /case; 15/22 lbs.

505	Clear w/chrome hardware	\$31.99
1505	White hi-impact w/chrome hardware	\$31.99
2505	Black w/ chrome hardware	\$31.99
2505BH	Black w/ black hardware	\$31.09



Black plastics

Medium Heavy Weight Shirt Hangers w/molded ridges

17" wide; 100 /case

weight is 14/24 lbs:

505R	Clear w/chrome hardware	\$35.90
1505R	White hi-impact w/chrome hardware	\$35.90
2505R	Black w/ chrome hardware	\$35.90

weight is 15/22 lbs:

2505RBH	Black w/ black hardware	\$35.90
---------	-------------------------	---------



Molded, ridges on shoulders (R)

With molded ridges



With molded rubber grippers

Molded, rubber grippers on shoulders (MG)



Medium Heavy Weight Shirt Hangers w/molded rubber grippers

17" wide; 100 /case

505MG	Clear w/chrome hardware	\$48.48	13/13
2505MG	Black w/ chrome hardware	\$48.48	14/22
2505BHMG	Black w/ black hardware	\$48.48	15/24

With molded ridges & co-ordinate loop

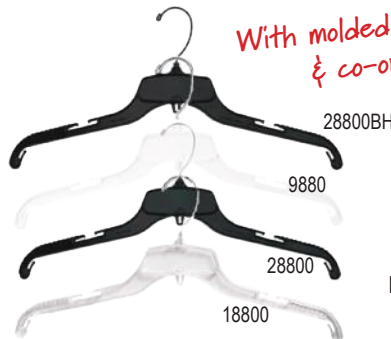

Heavy Weight Shirt Hangers w/ridges & loop

17" wide; 100 /case; 12/26 lbs.

98800	Clear w/chrome hardware	\$53.49
18800	Clear break resistant w/chrome	\$34.99
28800	Black w/ chrome hardware	\$34.99
28800BH	Black w/ black hardware	\$34.99

See more sizes on page 120

HANGERS Traditional Gown & Bridal



Bridal & Formal / Gown



Bridal and Formal Hangers

17" wide; 100 /case; 17/22 lbs.

405	Clear w/chrome hardware	\$44.49
2405	Black w/ chrome hardware	\$44.49
1405	White hi-impact w/chrome hardware	\$44.49
2405BH	Black w/ black hardware	\$44.49

weight is 17/24 lbs:

1405APW	White hi-impact w/chrome & foam strips applied	\$67.49
---------	--	---------



Extra Reinforced Bridal and Gown Hangers

Chrome hook reinforced with a washer
17" wide; 100 /case

405WW	Clear w/washer	\$58.19	16/22
1405WW	White hi-impact w/washer	\$58.19	18/22
1405APWW	White hi-impact w/washer & foam strips	\$74.49	18/24

Department Store

Black plastics



Heavy Weight Hangers

Chrome hook reinforced with a washer
17" wide; 100 /case

500WW	Clear w/washer	\$55.34	18/24
1500WW	White hi-impact w/washer	\$55.34	15/24

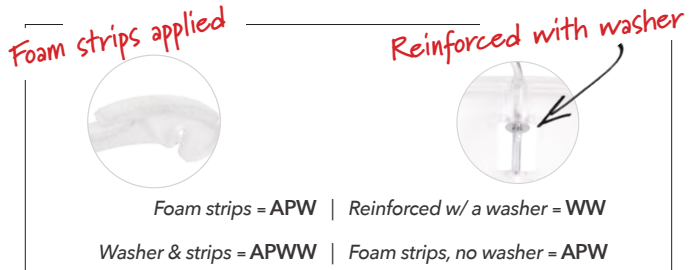

XXX Heavy Weight Hangers

Chrome hook reinforced with a washer
17" wide; 100 /case

300WW	Clear w/washer	\$60.91	20/24
1300WW	White hi-impact w/washer	\$60.91	20/24
2300WW	Black w/washer	\$60.91	19/22



19" Heavy Weight Shirt Hangers

19" wide; 100 /case

900	Clear w/chrome hardware	\$59.99	18/31
1900	White hi-impact w/chrome hardware	\$59.99	18/33
2900	Black w/ chrome hardware	\$59.99	18/33



NO-SNAG © Hangers

17" wide; 100 /case; 19/22 lbs.

905	Clear w/chrome hardware	\$41.99
1905	White hi-impact w/chrome hardware	\$41.99
2905	Black w/ chrome hardware	\$41.99

Traditional Plastic Skirt/Pant HANGERS

 Black plastics

style #	\$	qty	description	size	wgt
600RC	49.90	100	Clear	14"	19
1600RC	49.90		White hi-impact		
2600RC	49.90		Black		
600PC	49.90	100	Clear	14"	19
1600PC	49.90		White hi-impact		
2600PC	49.90		Black		
8600RC	52.90	100	Black Hi-gloss (metal clips)	14"	19
8600RCBH	52.90		Black w/Black Hook		
8600PC	52.90		Black Hi-gloss (plastic clips)		
8600PCBH	52.90		Black w/Black Hook		
600RCLH	49.90	100	Clear	14"	19
1600RCLH	49.90		White hi-impact		
2600RCLH	49.90		Black		
2600RCBH	50.28		Black w/ Black Hook		
600PCLH	49.90	100	Clear	14"	19
1600PCLH	49.90		White hi-impact		
2600PCLH	49.90		Black		
2600PCBH	50.28		Black w/ Black Hook		
602RC	58.68	100	Clear	14"	20
1602RC			White hi-impact		
2602RC			Black		
602PC	58.68	100	Clear	14"	20
1602PC			White hi-impact		
2602PC			Black		
602RCLH	58.68	100	Clear	14"	20
1602RCLH			White hi-impact		
2602RCLH			Black		
602PCLH	58.68	100	Clear	14"	20
1602PCLH			White hi-impact		
2602PCLH			Black		
2602RCBH	50.28	100	Jumbo weight Black Black	14"	20
9602RC	70.99	100	Clear	14"	19
616RC	58.19	100	Clear	16"	21
1616RC			White hi-impact		
2616RC			Black		
614RC	59.90	100	Clear	14"	19
1614RC	59.90		White hi-impact		
2614RC	59.90		Black		
614PC	59.90		Clear		
1614PC	59.90		White hi-impact		
2614PC	59.90		Black		

14" Heavy Weight Skirt/Pant

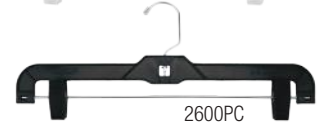
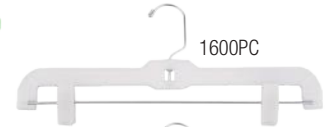

14" Heavy Weight Skirt/Pant w/Long Hook

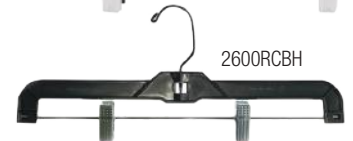
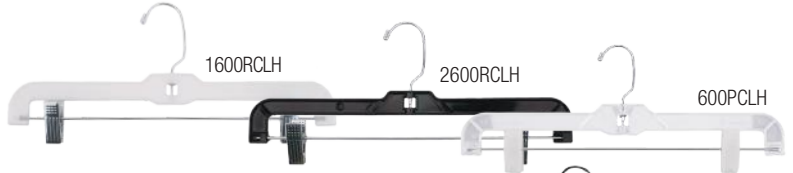

14" Jumbo Weight Skirt/Pant



14" Jumbo Weight Skirt/Pant w/Long Hook



JUMBO WEIGHT SKIRT/PANT HANGER



16" Heavy Weight Skirt/Pant



Coordinate Attachment for Skirts and Pants

4 1/2" drop



HANGERS Traditional Plastic Suit

HEAVY WEIGHT SUIT HANGER

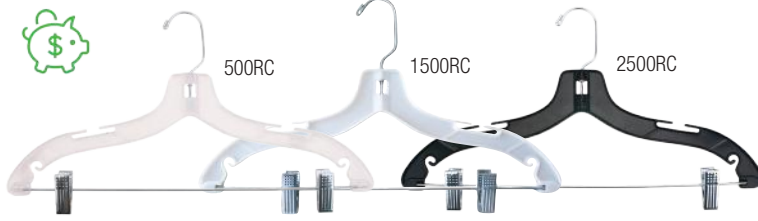

Break Resistant



Glossy Black



style #	\$	qty	description	size	wgt
500RC			Clear		26/27
1500RC			White hi-impact		26/34
2500RC			Black		26/34
2500RCBH	73.48	100	Black w/ black hook	17"	27/34
500PC			Clear		27/34
1500PC			White hi-impact		27/34
2500PC			Black		27/34
2500PCBH			Black w/ black hook		26/27
9500RC	94.99	100	Clear - Break Resistant	17"	27/34
8500RC	74.49		Black Hi-gloss (metal clips)		26/28
8500RCBH	79.19	100	Black w/Black Hook	17"	26/34
8500PC	79.49		Black Hi-gloss (plastic clips)		26/28
8500PCBH	79.19		Black w/Black Hook		26/34

HEAVY WEIGHT COAT HANGERS

Black plastics

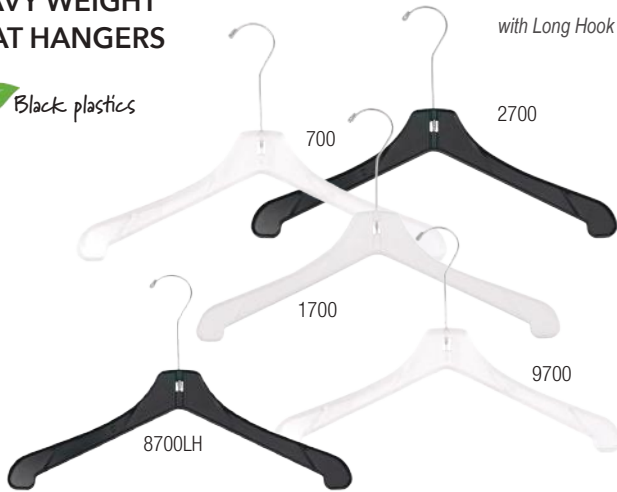

with Long Hook

with Short Hook

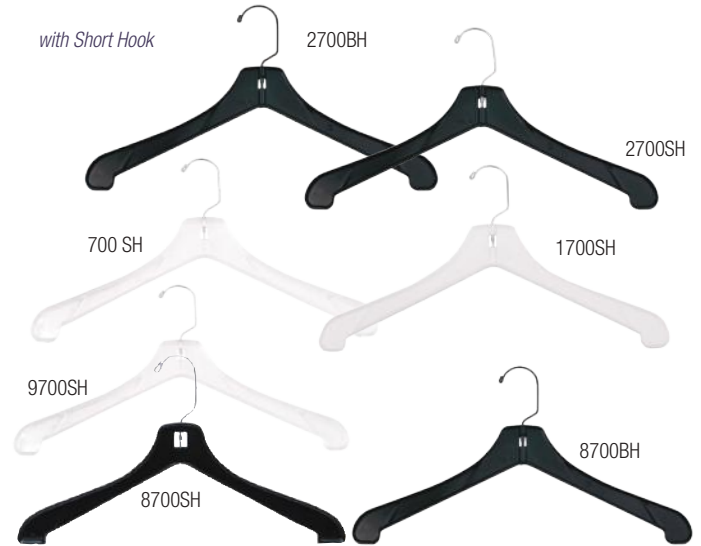

Coat Hangers /Long Hook:

17" wide; 100 /case; 19/26 lbs.

- 700 Clear w/chrome hardware \$43.49
- 2700 Black w/ chrome hardware \$44.49
- 1700 White hi-impact w/chrome hardware \$44.49
- 9700 Clear Break Resistant w/chrome hardware \$85.99

weight is 11/26 lbs:

- 2700 Black Hi-gloss w/ chrome hardware \$44.49

5 13/16" hanger length

Coat Hangers /Short Hook:

17" wide; 100 /case; 18/26 lbs.

- 2700BH Black w/ black hardware \$43.49
- 2700SH Black w/chrome hardware \$43.49
- 700SH Clear w/chrome hardware \$43.49
- 1700SH White hi-impact w/chrome hardware \$43.49
- 9700SH Clear Break Resistant w/chrome hardware \$84.99
- 8700SH Black Break Resistant w/ chrome hardware \$44.99
- 8700BH Black Hi-gloss w/ black hardware \$44.99

3 15/16" hanger length

IMPRINT SERIES



Great for Imprinting!

Skirt/Pant Hanger

Shirt Hanger

RBK1605	95.77		Solid White	14"	21
RBK2605	94.35		Black		
RBK1400	66.99	100	Solid White	17"	19/21
RBK2400	66.99		Black		
9705	73.48	100	Break-resistant CLEAR	17"	23
2705BH	67.26		BLACK w/black hook		17/33
2705CH	67.26		BLACK		17/33

Plastic Skirt/Pant HANGERS

style #	\$	qty	description	size	wgt	
1686-8	65.19	200	White	8"	15	
1686-10	66.61		White	10"	17	
1686/12	74.91		White	12"	18/19	
2686-8	65.19	200	Black	8"	15	
2686-10	66.61		Black	10"	17	
268610BH	66.61		Black w/black hook	10"	17	
2686-12	74.91		Black	12"	18/19	
2681-8	65.19	200	Black	8"	15	
2681-10	68.04		Black	10"	14/19	
2681-12	72.19		Black	12"	18/19	
1681/8W	68.04		White	8"	11/19	
1681/10W	72.19		White	10"	13/18	
1681/12W	77.76		White	12"	15/23	
SCXS SCS SCM SCL SCXL SC2XL	22.29	1000	White w/ black imprint <small>(works with P12, P13, P14, P16, B14, 2681-10, 2681-12, 1681/8W, 1681/10W, 1681/12W)</small>	1/4"L x 5/8"H x 1/4"W	2	
H29B H29W H211B H211W	50.99	100	Black White Black White	9 1/2" 11 1/2"	10/15 10/15 11/19 11/19	
H39B H39W H311B H311W	53.99	100	Black White Black White	9 1/2" 11 1/2"	10/15 10/15 11/18 11/18	
6008 6010 6012 6008B 6010B 6012B 6014B	72.19 74.91 77.76 63.49 58.32 54.90 70.99	200	CLEAR CLEAR CLEAR BLACK BLACK BLACK BLACK	8" 10" 12" 8" 10" 12" 14"	18/20 20/22 23/32 20 16/22 17/26 21/32	
w/ Soft Pad: 6210B 6212B 6214B	70.76 71.99 72.99		BLACK BLACK BLACK	10" 12" 14"	16/22 17/26 21/32	
2650PCBH50	55.47		50	Black w/black hook	14"	10
7500	106.49		200	BLACK	14"	25/34

Snap Grip Swivel Hook Skirt/Pant Hanger



Snap Grip Plastic Hook Skirt/Pant Hanger



Side Size Clips



Pinch Clip Plastic Hook Skirt/Pant Hanger



Pinch Clip Swivel Hook Skirt/Pant Hanger



Pinch Grip Skirt/Pant Hanger



Skirt/Pant Hanger With Black Hook and Clips

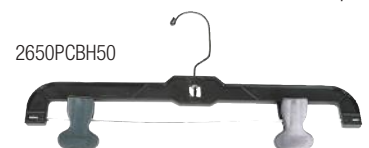

14" Black Plastic Skirt/Pant Hanger With detachable strap and foam bar



HANGERS Junior Plastic Hangers

 Black plastics



Super Heavy Weight Shirt Hanger



style #	\$	qty	description	size	wgt
414			Clear		
1414	28.99	100	White hi-impact	14"	11/15
2414			Black		
2414BH			Black w/Black hook		

Super Heavy Weight Suit Hanger



	Metal clip (RC) w/ vinyl insert		Plastic clip (PC) available in white or black		
414RC			Clear		20/22
1414RC	59.90	100	White hi-impact	14"	20
2414RC			Black		18
2414RCBH	59.90		Black w/Black hook		18/24

Super Heavy Weight Coat Hanger



714			Clear		
1714	44.49	100	White hi-impact	14"	18/22
2714			Black		
2714BH			Black w/Black hook		

Super Heavy Weight Skirt/Pant Hanger



611RC			with metal clips:		
1611RC	59.90	100	Clear	12"	18
2611RC			White hi-impact		
2611RCBH			Black		
			Black w/Black hook		
			with long hook & metal clips:		
611RCLH			Clear		
1611RCLH	59.90	100	White hi-impact	12"	18
2611RCLH			Black		
			with plastic clips:		
611PC	59.90		Clear		
2611PC	59.90	100	White hi-impact	12"	18
1611PC	59.90		Black		
2611PCBH	59.90		Black w/Black hook		

Coordinate Attachment Skirt/Pant Hanger



612RC	59.90		Clear		
1612RC	59.90	100	White hi-impact	12"	19
2612RC	59.90		Black		
			with plastic clips:		
2612PC	59.90	100	Black	12"	19

Children's Plastic HANGERS

 Black plastics

style # \$ qty description size wgt

412			Clear		
1412	26.99	100	White hi-impact	12"	10
2412			Black		
2412BH			Black w/Black hook		
412LH	27.49	100	Clear	12"	10/12
1412LH	26.99		White hi-impact		

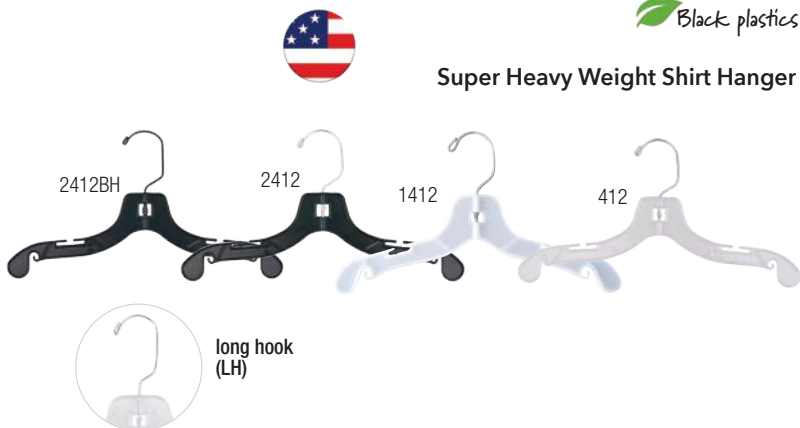

410	44.99	200	Clear		
1410	44.99	200	White hi-impact	10"	13
2410	44.99	200	Black		
2410BH	44.99	200	Black w/Black hook		
CP410	23.99	100	Clear	10"	7

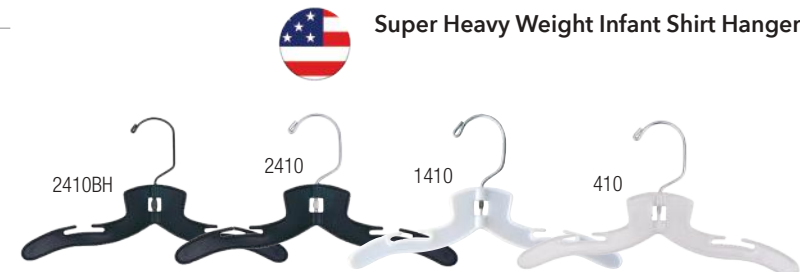

412RC	59.90		Clear		
1412RC	59.90	100	White hi-impact	12"	19/22
2412RC	59.90		Black		
2412RCBH	59.90		Black w/Black hook		
412RCLH	59.90	100	Clear w/Long hook	12"	19/22
1412RCLH	59.90		White w/Long hook		

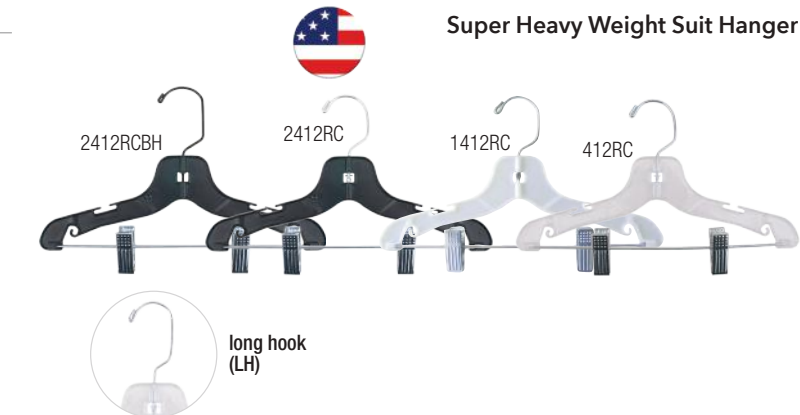

712	37.99		Clear		14/22
1712	37.99	100	White hi-impact	12"	14/22
2712	37.99		Black		14/28
2712BH	37.90		Black w/Black hook		14/28



610RCLH	59.90		Clear		
610PCLH	59.90		Clear		
1610RCLH	59.90	100	White hi-impact	9"	16/23
1610PCLH	59.90		White hi-impact		
2610RCLH	59.90		Black		
2610PCLH	59.90		Black		



HANGERS Vics /Floor-Ready Hangers



NAHANCO works directly with YOUR garment factories. We can supply any of our hanger styles, giving you control over the hangers that you receive.

For more information and images, please visit nahanco.com



484B

Economy Shirt Hanger
With molded non-slip shoulder



28800

Heavy Weight Shirt Hanger
With molded non-slip shoulder



25500

Super Heavy Weight Shirt Hanger



99900

Shirt Hanger
With molded non-slip shoulder



24400

Shirt Hanger
With molded non-slip shoulder



22200

Shirt Hanger
With molded non-slip shoulder



NHPJ41

Shirt Hanger



2358

Shirt Hanger



2705CH

Heavy Weight Coat Hanger



2686-12

Snap Grip Skirt/Pant Hanger



6012B

Pinch Grip Skirt/Pant Hanger

style # \$ qty description size wgt

Size Markers

Angular VICS size markers. Black with white print.
3/4" wide. Sold in packs of 500 pieces /1 lb.
Style # VSM \$20.87



Call or see our website for a complete list of VSM size marker options

Size Marker Remover Tool

5 5/8" metal tool removes size markers from hanger.
Sold as a single piece /1 lb.
Style # VSMT00L \$9.49



485B	52.75		BLACK	15"	18/24
484B	49.90	200	BLACK	17"	15/29
479B	61.49		BLACK	19"	16/36
98800	53.49		Break-resistant CLEAR		
28800	34.99	100	BLACK	17"	13/22
28800BH	34.99		BLACK w/Black hook		
18800	34.99		WHITE		
95500	61.49		Break-resistant CLEAR		
25500	30.99	100	BLACK	17"	14/22
25500BH	30.99		BLACK w/Black hook		
15500	30.99		WHITE		
99900	69.34	100	Break-resistant CLEAR	19"	13/27
94400	48.99		Break-resistant CLEAR		
24400	34.20	100	BLACK	15"	11/15
24400BH	34.99		BLACK w/Black hook		
14400	34.99		WHITE		
92200	47.99		Break-resistant CLEAR		
22200	40.49	100	BLACK	12"	8/15
22200BH	40.49		BLACK w/Black hook		
12200	40.49		WHITE		
NHPJ41	73.48	200	Black	16"	15/36
NHPJ46	92.92		w/black hook	18"	23/38
2358	81.91	200	Black	18 1/2"	25/36
9705	73.48		Break-resistant CLEAR		23
2705BH	67.26	100	BLACK w/black hook	17"	17/33
2705CH	67.26		BLACK		17/33
9686-8	97.07		Break-resistant CLEAR	8"	15
2686-8	83.20		BLACK	8"	15
9686-10	59.49	200	Break-resistant CLEAR	10"	17
2686-10	92.92		BLACK	10"	17
9686-12	105.49		Break-resistant CLEAR	12"	18/22
2686-12	97.07		BLACK	12"	18/22
9686-13	120.66		Break-resistant CLEAR	12 1/2"	18/22
6008	72.19		CLEAR	8"	18/20
6010	74.91		CLEAR	10"	20/22
6012	77.76		CLEAR	12"	23/32
6008B	63.49		BLACK	8"	20
6010B	58.32		BLACK	10"	16/22
6012B	54.90		BLACK	12"	17/26
6014B	70.99		BLACK	14"	21/32
w/ Soft Pad:					
6210B	70.76		BLACK	10"	16/22
6212B	73.48		BLACK	12"	17/26
6214B	72.99		BLACK	14"	21/32

Plastic Budget HANGERS

style #	\$	qty	description	size	wgt
1150	83.20	500	White	10"	15/21
P12	87.35	500	White	12"	16/20
P13	50.67	200	White	13 3/4"	11/20
P14	100.57	500	White	14"	20/31
B14	97.07	500	Black	14"	20/31
SCXS SCS SCM SCL SCXL SC2XL	22.29	1000	White w/ black imprint (works with P12, P13, P14, P16, B14, 2681-10, 2681-12, 1681/8W, 1681/10W, 1681/12W)	1/4"L x 5/8"H x 1/4"W	2
1158	97.07	500	White	18"	29/46
2158			Black		30/42
P18	62.47	200	White	18"	17/37
B18	47.17		Black		
R16WB	124.29	500	White	16"	38/51
SK8	122.86	500	White	8"	23/27
SK11	122.86			11"	34/70
SP8	122.86	500	White	8"	28
SP11	122.86			11"	34/70
FR10	189.00	500	White	9 1/2"	34/70
FR11	92.90	200		11 1/2"	18/37
TBB TBR TBW TBI	44.90	144	Black Red White Ivory	16 3/8"	15/22
CLIP100	24.36	100	White	2 1/4"	3
TBB2 TBR2 TBW2	44.90	144	Black Red White	17"	16/41 16/41 16/44
NT140	74.99	500	14 Gauge White wire	18"	28
NT1305	63.89	500	13 Gauge Goldtone Wire	16"	34
NT145RS	81.91	500	NT145RS w/round, white cardboard		38

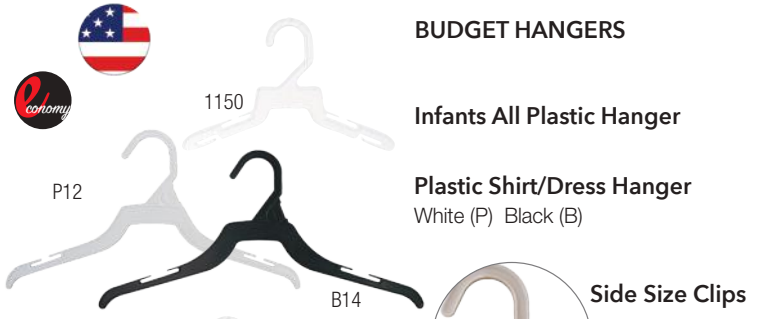

BUDGET HANGERS

Infants All Plastic Hanger

Plastic Shirt/Dress Hanger
White (P) Black (B)



High-Impact Plastic
Shirt Hanger

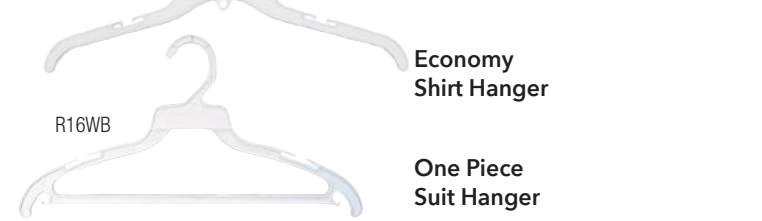

Economy
Shirt Hanger

One Piece
Suit Hanger



Skirt/Pant Hanger

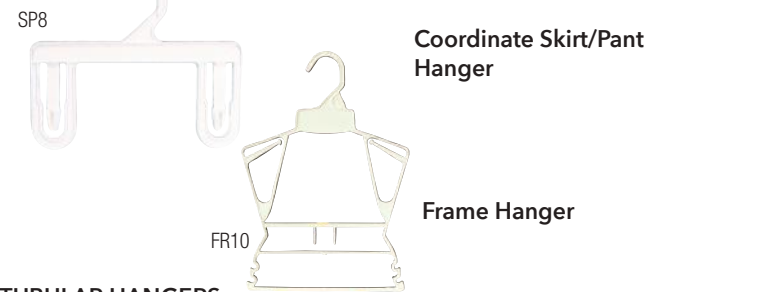

Coordinate Skirt/Pant
Hanger

Frame Hanger

TUBULAR HANGERS

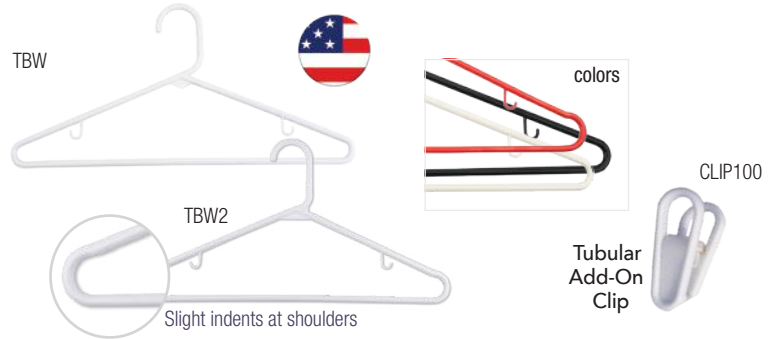

TBW

TBW2

CLIP100

Tubular
Add-On
Clip

Slight indents at shoulders

DRY CLEANING HANGERS



NT140

NT1305

NT145RS

Introducing...

our CUSTOM CREATOR tool



The Custom Creator tool is our most direct-to-consumer offering yet. Navigate to our Custom Creator tool page, choose from a curated selection of wooden hangers; upload your art/logo - or create a design using our online tools; and place your order. Perfect for small-batch custom orders, experimenting with new ideas, offices, personalized gift-giving, and home closets.



- Easy to use online design tool
- No design experience or software needed
- The power of custom at your fingertips
- No calls necessary - unless you need us!
- Your custom hangers ship out in DAYS

Wooden Hanger styles available include:



NAHANCO Line (pages 92-94)



SLIMLine (pages 95-96)



TRADITIONAL Wood Line (pages 102-103)

Ideal for small chain stores and boutiques, as well as Custom Closets!



SCAN to link directly to Custom Creator

Detail Custom Creator in action

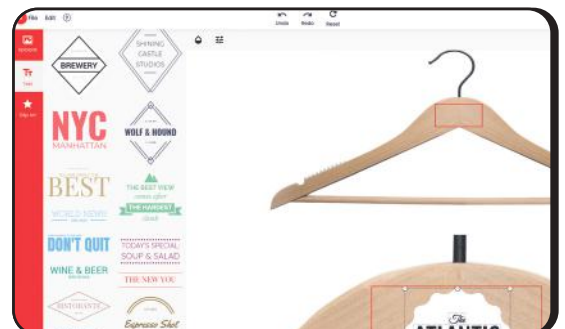

index

Acrylic sign holders36, 50, 59	Foot measuring device87	Mirrors (counter)36, 84	Sign holders57-59, 61
Alteration tags21	Garbage bags70	Mirrors (floor)67	Sign hanging systems 60-61
Bagging Jack22	Garment bags22	Mopping supplies70	Signs 56, 64, 65
Bags 88-90	Glass toppers (round racks)30	Needles (replacement)17, 18	Size dividers & markers6-9
Baskets43, 50, 67	Glove forms80	Non slip attachments10	Slatwall & accessories 36, 44-47
Bedsread hangers106	Glove hangers105	Package hangers13	Slatwall panels 44
Belt hanger11	Grabber 14	Packaging 88-91	Sleeping bag hangers106
Belt racks31, 47	Grid wall & accessories 48-50	Pegboard accessories53	Sock hangers 11
Bikini hangers105	Handbag racks.....27, 29, 31, 84	Pennants 62	Stain Remover 66
Body forms 72-81	Hand truck70	Pipeline Series33-38, 53	Standards & accessories51-52
Boot hanger86	Hang all clips12	Pins68	Staplers71
Boot shapers & weights85	Hanger accessories10, 95	Pin tickets21	Steamers 69
Boxes (gift, apparel, jewelry)91	Hanger collection racks15	Plastic hangers 107-121	Storage tray 7
Boxes (storage)14	Hangers (garment) 92-121	Polybag rolls & dispensers22	Stretch wrap71
Box reacher14, 87	Hanger stackers15	Pricing Supplies17-21	Suction cups 60
Bridal bags23	Hanger storage14	Rack cover25,26	Suit covers23
Bulletin sign holders57	Hanger strips, connectors13	Racks (garment)24-39	Sunglass racks84
Cap Racks84	Hat hangers 105	Reaching hook14	Swimsuit hangers105
Card frames57,58	Head forms81	Register Stands40	Tables36, 42
Cards /stock signs56	Hosiery forms81	Repair tags21	Tacking hooks17
Casters (racks) 24-29, 31, 34, 37, 38	Hotel hangers104	Rolling racks 24-26	Tagging tools17-18
Chalkboards62	Intimate apparel hangers110-11	S Hooks11, 60	Tags20, 21
Circle fasteners18	Irons & Accessories..... 68-69	Safety pins68	Tailor supplies68
Clamps (sign holders)36, 58	Jean hooks11	Sandal forms85-86	Tape 68, 71
Cleaning gun & solvent66	Jersey Forms.....72-74	Sandal hangers86	Tie hanger11
Clips12, 13, 61, 109, 121	Jewelry displays 36, 82-83	Satin hangers111	Tie racks 31
Clothing racks24-39	Jewelry tags & cards83	Scarf racks84	Tissue paper91
Coordinate strips10	Kraft bags88-89	Scarf rings, scarf hangers11	Tool kit71
Counterfeit detector pen63	Kraft tags21	Scissors68	Traffic control 64-65
Counterfeit cash detector kit63	Kraft tissue91	Seam ripper68	Try-on protectors 66, 87
Display bins43	Labels (pricing)19-21	Secure lock system63	Tubing & accessories 54
Display hangers99, 103-105, 112	Labels (sizing)7	Security devices 63-65	Tubular hangers 121
Door alarms63	Ladder systems38	Shelves41	Twist on arms (racks)28, 29
Dressing room supplies66-69	Layaway tags21	Shipping supplies71	Utility Racks/Storage16, 25
Dry cleaning hangers118	LED sign 62	Shoe accessories85-87	Vacuums70
Dump tables & bins42	Leggings hangers11	Shoe forms85-86	VICS hangers 120
Easels32	Lint rollers66	Shoe horns87	Wall mount accessories36, 53
Fasteners17, 18	Literature holders47, 50, 53	Shoe merchandisers47, 85-87	Wooden hangers 92-104, 111
Fitting room checks67	Mannequin forms75-78	Shoe risers85	Workstations16
Fitting clips12	Markers62	Shopping baskets67	Z-racks26
Flags62	Marking tools19	Shopping bags88-90	
Flocked hangers109	Measuring tape 68	Shoulder covers23	
Foam hanger covers10	Message boards62	Showcases40	
Folding boards16	Message boards62	Sidewalk signs62	
Foot/Leg forms81, 87	Metal Hangers105-106	Sign kits55, 61, 62, 64	
	Millinery display46, 49, 53, 84		

More Ways to Pay

Terms: Net 30 days credit. Sorry, no CODs.

Credit Cards:



Prepayment: prepay by ACH or wire payment in advance.

Pricing

Prices are subject to change without notice.

Shipping Information

Shipments are made F.O.B. our warehouse or point of origin. Small orders ship via UPS. Some packages bill as oversized by UPS. When orders exceed UPS limits, we ship via common carrier.

Returns

If you're not satisfied with your purchase, please contact us, explain the problem and we'll take the necessary steps to resolve the problem to your satisfaction. At times there may be a 25% restocking charge for items returned plus freight costs. Customer service will advise you of these charges should they apply to you. Sorry...**No Returns after 30 days.**

Carrier Damage

Our products are inspected prior to shipment and any customer claims for visible or concealed damage must be made with the delivering carrier. Our responsibility ceases when the merchandise is turned over to the carrier.

Backorders

Unfortunately, on occasion we may have to backorder an item. As soon as the item is available, we will ship it - unless otherwise requested not to. If an item is out of stock for more than 30 days, we will notify you.

Please note that we are not responsible for typographical errors.

