

# SECURING SPACES

PHYSICAL SECURITY SOLUTIONS  
MADE IN THE USA



SECURING INFRASTRUCTURE AROUND THE WORLD SINCE 1985



# Redefining Security with Strength, Style, & Innovation

As the premier manufacturer of ready-to-install industrial and commercial gate systems, **TYMETAL**, a Fort Miller Group Company, sets the global standard for advanced perimeter security solutions. For over 40 years, **TYMETAL** has delivered high-quality, fully integrated gate systems to architects, engineers, security consultants, fencing professionals, and facility owners worldwide.

Product line includes:

- Vehicle Gates
- Pedestrian Gates & Portals
- Crash-Rated Barriers

At **TYMETAL**, security is more than a product—it's a commitment to precision, innovation, and trust. Backed by exclusive patents and cutting-edge technology, **TYMETAL** gates are designed to enhance security, deter threats, and stand the test of time. From high-threat environments to custom architectural solutions, every project is tailored to meet the exact specifications.

**TYMETAL** stands out with a team of seasoned professionals dedicated to guiding clients through every step of the process. They ensure that each perimeter solution meets the highest standards of security and design. With a deep-rooted belief that security can be both strong and visually appealing, **TYMETAL's** custom fabrication team combines precision and creativity. They offer powder-coated finishes, intricate laser-cut designs, and integrated branding to create gates that do more than protect—they enhance the property's aesthetic and presence.

**One company, one call.** TYMETAL delivers seamless security with a single source and unmatched reliability, ensuring ultimate peace of mind.



*“**TYMETAL** has been a valuable resource for high quality cantilever gates. Combined with excellent customer service, timely quotes and a willingness to customize gates, **TYMETAL** is an invaluable partner for our business.”*

*- Jeff N. Simmerman, Mills Fence Company*

Right: Georgia State Capitol Pedestrian Entrance. Pg. 23

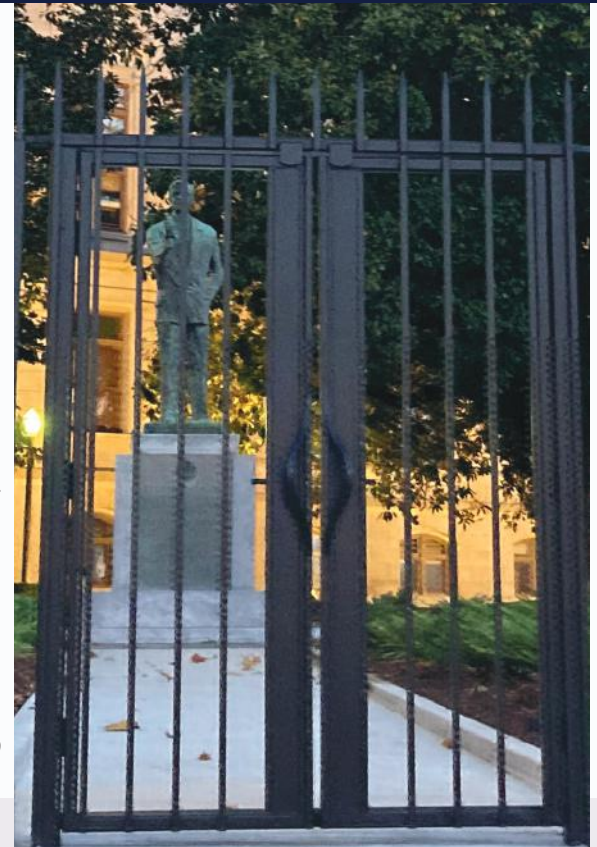

**Right:** Belmont Retail Village, Custom Swing Gate. Pg. 19



**Right:** Crash Test Facility, TCRB Crash Arm. Pg. 29



**Right:** Eversource Sharon Substation, Custom Structural Cantilever Gate. Pg. 14



**Front and Back Cover:** PSE&G Madison Street, Custom Structural Cantilever Gate. Pg. 12

# Market Sectors

- Airports
- Seaports
- Railroads
- Homeland Security
- Energy Facilities
- Financial Institutions
- Chemical Facilities
- Sports Complexes
- Public Spaces
- Distribution Centers
- Educational Institutions
- Transportation Facilities
- Water Treatment Facilities
- Communication & Data Centers
- Justice & Correctional Facilities
- Government & Military Installations

**Far Right:** Structural Cantilever Gate, Ontario Airport, Southern California. Pg. 14

**Right:** NATO Base, Poland TCRB-12. Pg. 29



# Contents

---

Custom Solutions . . . . . 05

Fortress Vehicular Gates. . . . . 13

Pedestrian Gates and Portals. . . . . 23

Crash Rated Barriers . . . . . 25

Specification & Design Support . . . 35

Client List . . . . . 37

About Fort Miller Group . . . . . 38

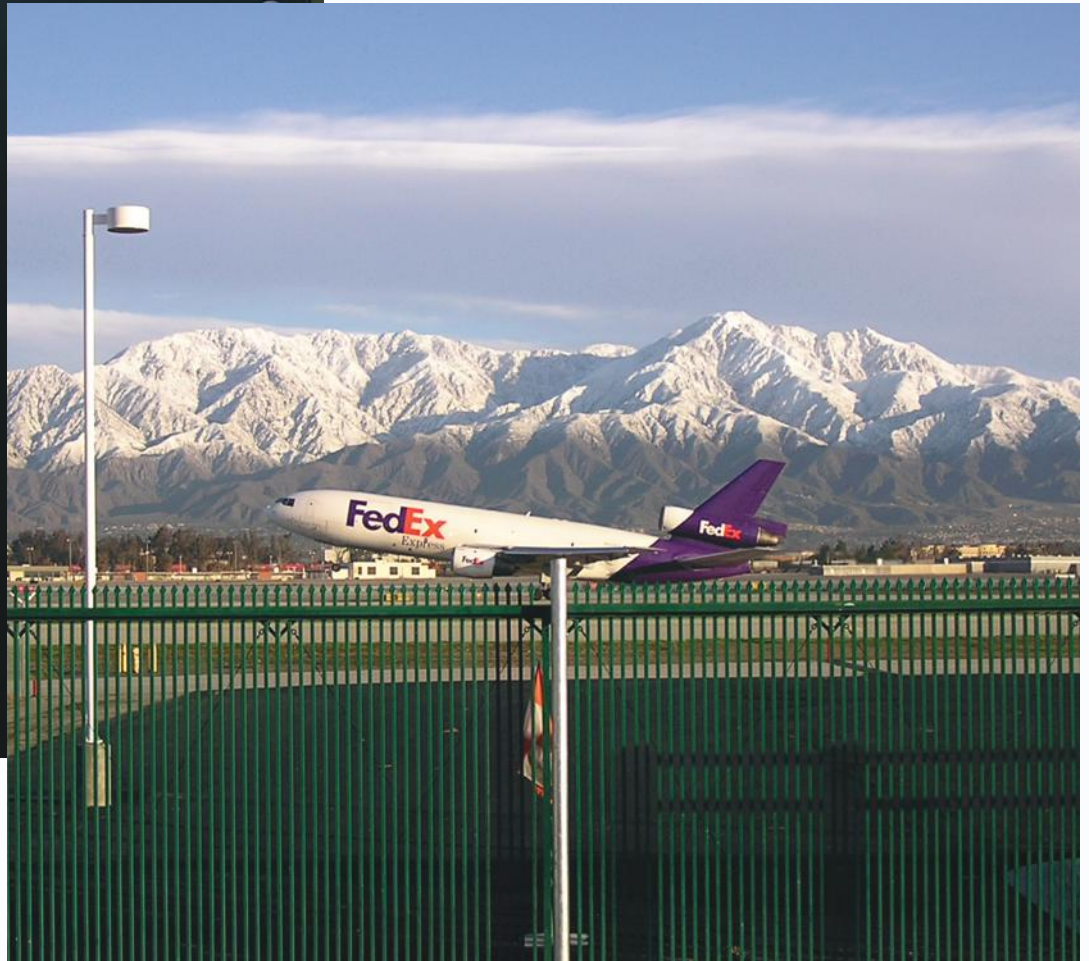

# Georgia State Capitol

Custom Solutions

**Right:** Bi-Parting Box Frame Cantilever Gate with an opening of 61 feet. Pg. 15 for more details.

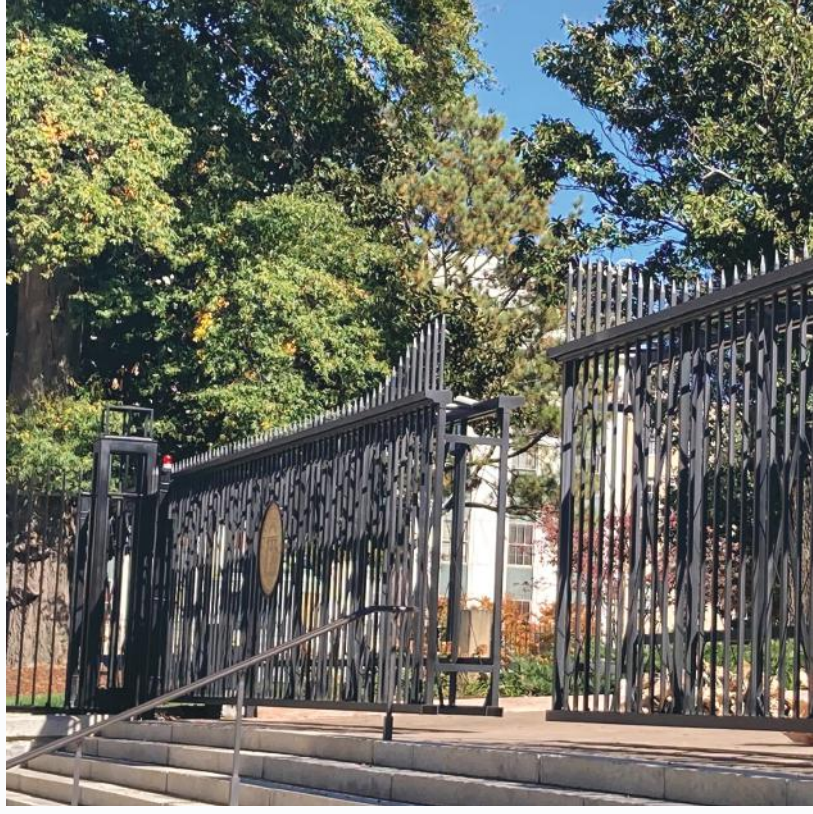

**Right:** Custom Bi-Parting 2150 Pedestrian Gate. Pg. 23





# Perimeter Security

In 2020, **TYMETAL** proudly partnered with **Houser Walker Architecture** to design a state-of-the-art perimeter security system for the **Georgia State Capitol** complex in Atlanta, GA. The mission was clear: to enhance security against potential emergencies while ensuring that the fence and gate components seamlessly complemented the Capitol's Neoclassical architecture.

This project involved a detailed 3D site survey to navigate the unique challenges of the landscape—following the graceful curves of existing granite walls and adapting to the site's vertical topography. From over 1,000 miles away, **TYMETAL** designed and manufactured hundreds of custom components to bring this vision to life. The fencing and gates received a durable electro-static paint finish on-site, ensuring both longevity and visual appeal.

Completed in the Fall of 2021, this project showcases **TYMETAL's** ability to blend security and style flawlessly—demonstrating the team's commitment to precision, craftsmanship, and collaboration.



**Check out this brief video highlighting the Georgia State Capitol project.**

*“The partnership between Houser Walker and TYMETAL was key to the success of this project. Their precision and attention to detail brought our design vision to life, resulting in a secure and architecturally impressive solution.”*

*- Hank Houser, Houser Walker Architecture*

# Javits Center

Custom Solutions

Right: Javits Center, Overhead Slide Gate, Pg. 16

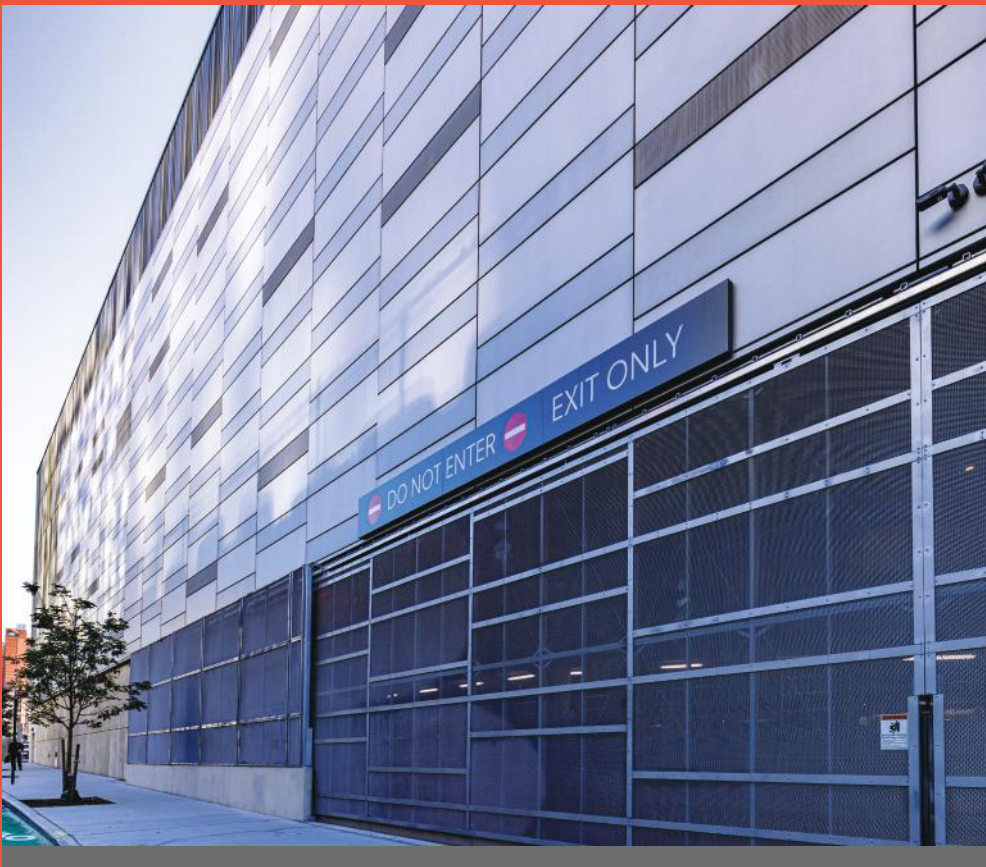

# Custom Gate Design

The **Javits Center** in Manhattan, NY, showcases two impressive automated **Overhead Fortress Slide Gates** with a matching facade, seamlessly blending into the building's design. Spanning opening widths of approximately 42 feet and 74 feet, and standing 18 feet high, these custom versions of the Fortress Overhead Slide Gate are a testament to **TYMETAL's** expertise and innovation. In close collaboration with the Center's Architectural and Engineering teams, **TYMETAL's** engineering team overcame numerous design challenges to bring this vision to life. The successful completion of this project not only highlights the team's ability to work effectively with partners but also demonstrates the full extent of **TYMETAL's** capabilities.



**Right:** Javits Center, Overhead Slide Gate. Pg. 16

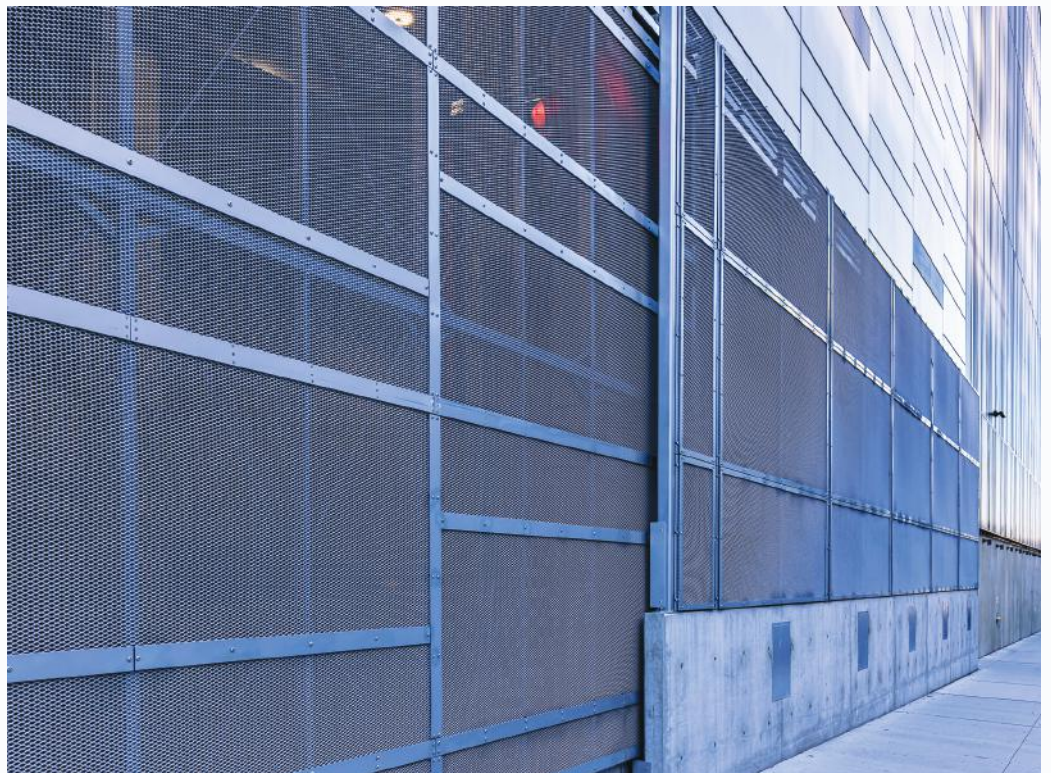

# Philadelphia Museum of Art

Custom Solutions



**Right:** Box Frame Roller Gate, Clear opening width 60 feet 2 inches by 10 feet high, Pg. 18



**Right:** 2150 Pedestrian Portal with perforated Mesh infill. Pg. 23



# Seamless Integration

**TYMETAL** partnered with **Gehry Partners in Los Angeles, CA**, to design a security gate solution for the **Philadelphia Museum of Art**, seamlessly blending protection with the museum's historic architecture. To achieve this, perforated and corrugated 14-gauge bronze metal cladding was used for both sides of the gate frame, creating a visually striking and secure barrier. Spanning an impressive 60 feet 2 inches in width and 10 feet in height, the Box Frame Roller Gate System was equipped with a powerful hydraulic operator, battery backup, and an embedded ground track for reliable performance. Overcoming a unique challenge posed by a slight slope across the opening, we custom-designed the gate frame as a right-angle trapezoid, with each bronze sheet meticulously sized and placed to ensure a flawless fit. This precision was essential, as the high-value bronze cladding required careful coordination due to its cost and long lead time.

To complement the main gate, **TYMETAL** manufactured a **2150 Style Pedestrian Swing Gate** with matching bronze cladding.

This project is a shining example of **TYMETAL's** ability to blend innovative security solutions with architectural elegance, showcasing **TYMETAL's** commitment to both form and function.

**Right:** Box Frame Roller Gate. Clear opening width 60 feet 2 inches by 10 feet high. Pg. 18



# Nashville Metro

## Custom Solutions

TYMETAL.COM



**Right:** Truckstopper 6-30 bollards installed along Broadway, Nashville, TN. Pg. 31

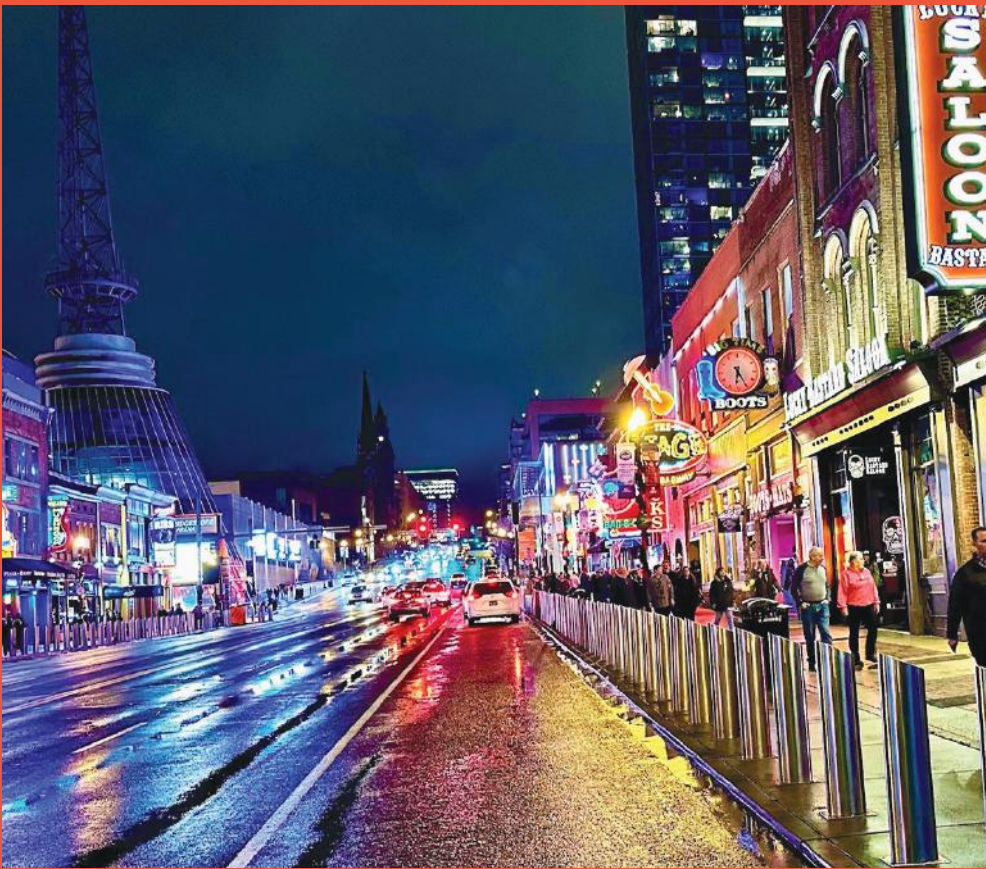

# Custom Bollard Application

To enhance pedestrian safety in busy downtown areas, **Nashville Metro** turned to **TYMETAL** for Removable Truckstopper 6-30 bollards, rated to stop a 16,534-lb truck at 30 mph. Approximately 800 bollards have been installed to date, primarily along Broadway and near public spaces like Bridgestone Arena.

The project required custom hardware and footing designs to fit beneath existing roadways without disrupting infrastructure. Installations also accounted for curved sidewalks and elevation changes, ensuring a secure, visually cohesive street scape.

This ongoing effort balances public safety with urban design, protecting high-foot-traffic zones while maintaining Nashville's downtown character.

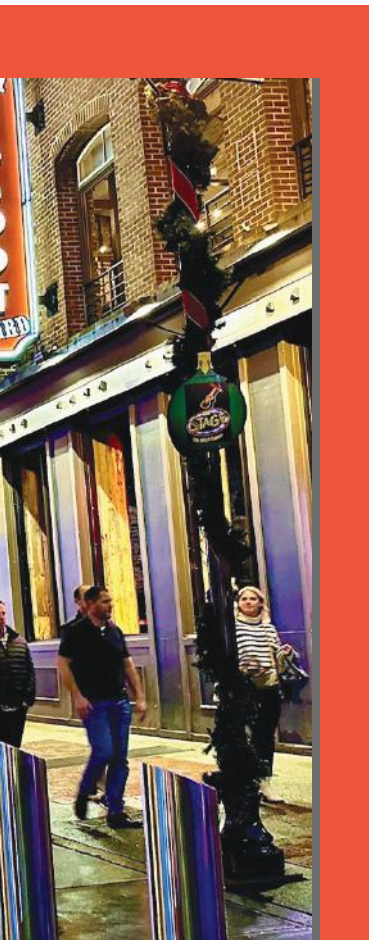
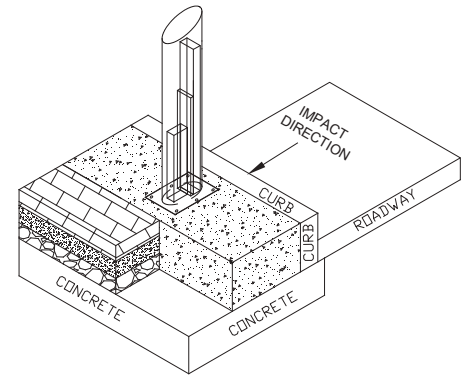

**Right:** Truckstopper 6-30 installed outside of Hard Rock Cafe, Broadway Nashville, TN. Pg. 31



# Fortress Vehicular Gates



**Slide**



**Swing**

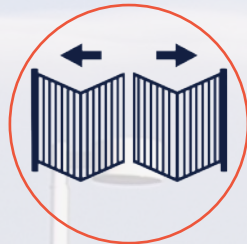

**Fold**

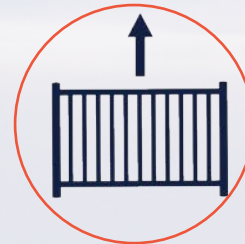

**Lift**

## CANTILEVER SLIDE GATES

Time tested for over 40 years in the field, **TYMETAL's** Cantilever Slide Gates are designed to close clear opening widths up to 120 feet, and available in manual or automated configurations. They are fabricated from heavy wall custom aluminum extrusions, interlocked and welded. Adjustable diagonal steel cables provide additional structural integrity. An enclosed track system with durable ball bearing trolley systems allow the gate to slide effortlessly without the need for a ground track or overhead beam in all weather conditions. Infill alternatives include chain link, ornamental pickets and custom configurations. They are secure, efficient, and often the most cost-effective way to span a vehicular opening.

**Right:** Heavy Duty Cantilever Gate.

**Right:** Naval Operational Support Center, White River Junction, VT Structural Cantilever Gate. Pg. 12



Download specifications and resources here.





## Fortress Heavy Duty Cantilever Slide Gate

(Single Clear Openings up to 30 feet; Bi-parting to 60 feet)

The single track version is supported by two posts at one side of the opening and a single track. As with the entire line of Cantilever Slide Gates the Heavy Duty version includes:

- Enclosed track and ball bearing trolley system.
- Gate panels made of heavy wall aluminum alloy extrusions, providing strength, durability and light weight.
- Welded gate frame that incorporates interlocking components.
- Adjustable diagonal ¼" steel cables that enhance frame structure and provides minimal to zero deflection.

## Fortress Structural Cantilever Slide Gate

(Single Clear Openings up to 40 feet; Bi-parting to 80 feet)

For larger clear openings, the dual track version is supported by four posts at one side of the opening and two tracks (one track to each side of the top horizontal primary gate frame member). In addition to the features highlighted for the Heavy Duty version, the Structural version can:

- Span larger clear opening widths
- Support taller and heavier gate panels.
- Tolerate greater wind loads where challenging site conditions exist.
- Provide an enhanced level of security.

Right: Structural Cantilever Gate.



Right: Structural Cantilever Slide Gate.





**RIGHT:** Ornamental Box Frame Cantilever Gate.

### Fortress Box Frame Cantilever Slide Gate

(Single Clear Openings up to 60 feet; Bi-parting to 120 feet)

The Box Frame version is also supported by four posts at one side of the opening and includes a dual track. It's distinguished by a dual gate frame approximately 2 feet wide that is trussed together, providing the frame structure to span even greater distances. In addition to those features highlighted for the Heavy Duty and Structural version, the Box Frame version can:

- Span even larger clear opening widths.
- Support taller and heavier gate panels.
- Tolerate even greater wind loads where challenging site conditions exist.
- Provide a higher level of security, both functionally and visually.

Download  
specifications and  
resources here.



## Fortress Overhead Slide Gate

(Single or Bi-parting Openings up to 50 feet)

Where space to each side of the opening may be limited or there is a need for elevated security the Overhead Slide Gate is an excellent option. It performs well in high activity environments and tolerant to more extreme weather and wind related site conditions. They are available in manual or automated configurations.

- Suitable for Commercial or Correctional and Justice Facilities.
- Aluminum or steel gate panels.
- Commercial or Correctional grade track and hardware.
- Steel overhead beam or track appropriately sized to span.
- Gate panel infill can be partial or full height.
- Fortress Style Gate Infills or high security infills available.

**Right:** Louvered Overhead Slide Gate.  
**Far Right:** Reinforced Overhead Slide Gate.



**Right:** Overhead Slide Gate.



**Right:** Overhead Slide Gate.



**Below, Right and Far Right:** Powder-coated aluminum picket Telescoping Box Frame Roller Gate.



### Fortress Telescoping Box Frame Roller Gate

(Single Clear Openings up to 83 feet; Bi-parting to 166 feet)

For clear opening widths greater than 120 feet and applications where limited space is available the Telescoping Box Frame Roller Gate system is an excellent option. The system includes a manufactured embedded ground track, roller wheel trolleys and a safety clip feature that can stabilize taller gates in high wind conditions. Its most significant attribute is that the roll-back space needed to store the gate panel when in the open position is approximately 60% to 75% of the clear opening width (the greater the clear opening width the lower the percentage needed for storage).

- Integrated gate, operator and cable system.
- Heights up to 10 feet.
- Available in a manually operated version.
- Fortress Style Gate Infills (except extended pickets) and custom infills are available.

**Download specifications and resources here.**



**Right:** Box Frame Roller Gate.



**Right:** Box Frame Roller Gate with barbed wire.



## Fortress Box Frame Roller Gate

(Single Clear Openings up to 250 feet; Bi-parting to 500 feet)

For clear opening widths up to 500 feet the Box Frame Roller Gate (BFRG) can secure extraordinarily large clear opening widths and, depending on size and application, can be manually operated or automated. Based on gate panel weight the automated version can operate at speeds of 1.0, 2.2 or 3.0 feet per second (larger gates weighing more than 5,000 lb.s are limited to a speed of 1.0 foot per second). For example, a 190 foot clear opening x 8 feet high gate with standard 2" x 2" x 9 gauge steel chain link infill would weigh about 4,550 lb.s and could be matched with an operator that can power it at 3 feet per second. BFRG's are often used to span airfield runways to control aircraft and vehicular traffic and to secure airfield hanger locations. The BFRG utilizes the same track, trolley and stabilizer system as the Telescoping Box Frame Roller Gate and also performs well in higher wind conditions.

- Gate panels made of heavy wall aluminum alloy extrusions, providing strength, durability and light weight.
- Heights up to 12 feet. Contact manufacturer regarding taller applications.
- Fortress Style Gate Infills and custom infills are available.



## SWING GATES

### Fortress Heavy Duty Swing Gate

(Single Clear Openings up to 24 feet; Bi-parting to 48 feet)

The Heavy Duty Swing Gate is ideal for locations where there is not enough room to slide a gate (between buildings, alleys, etc.). Less the track, the Heavy Duty Swing Gate shares the same gate frame design as the Heavy Duty Cantilever Gate series. The aluminum frame is strong, light weight and won't rust. Adjustable diagonal steel cables keep the gate from sagging. The swing gate can be manually operated or automated. There are several operator alternatives, one of which includes battery backup and solar compatibility.

- Gate panels made of heavy wall aluminum alloy extrusions, providing strength, durability and light weight.
- Standard heights up to 8 feet. Contact manufacturer regarding taller applications.
- Fortress Style Gate Infills and custom infills are available.

**Right:** Residential Com lb.. Custom Swing Gate.



**Right:** Port of Los Angeles, CA Heavy Duty Swing Gate.

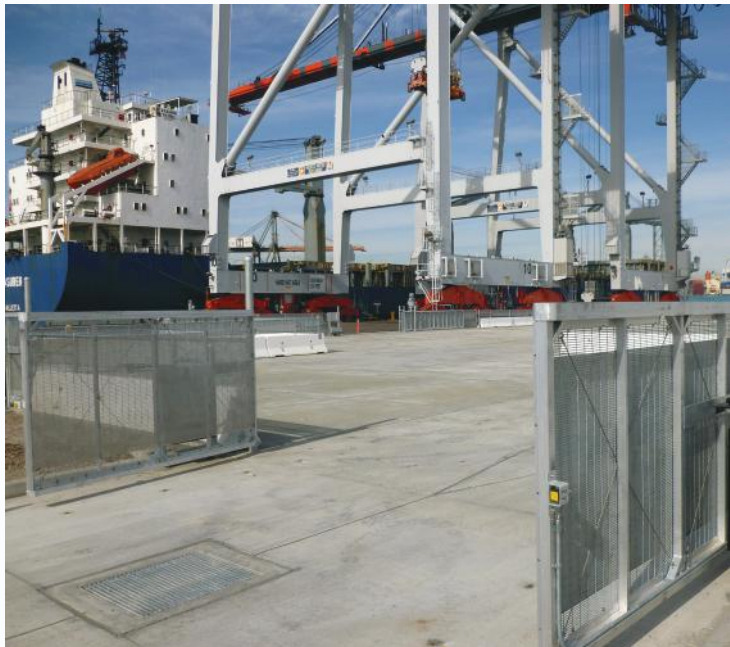

**Right:** Belmont Retail Village, NY Custom Swing Gate System.



**Right:** Houston Police Department, TX Bi-Folding Gate System



## FOLDING GATES

### Securfold Trackless Bi-Folding Gate System

(Bi-parting Clear Openings up to 30 feet)

Trackless Bi-Folding Gate Systems are a good solution for locations with space restrictions to each side of a vehicular opening. Securfold systems also provide the advantages of speed, enhanced security and are capable of meeting those high-performance needs of very active sites. Securfold is available in two configurations, Foldsmart (Standard Duty) and Speedgate (High Performance).

	<b>Securfold Foldsmart</b> (Standard Duty)	<b>Securfold Speedgate</b> (High Performance)
<b>Maximum clear opening width</b>	30 feet	23 feet
<b>Maximum Height</b>	10 feet	10 feet
<b>Opening Speed</b>	8 seconds	7 seconds
<b>Applications</b>	Commercial/Industrial Facilities	Airports, Seaports, Data Centers and Military Installations

#### Features:

- Steel construction.
- Finish: Hot Dip galvanized; optional color/powder coat
- Fully automated. The gate operator is an integral part of the system.
- Listed to UL 325, Class I, II III and IV.
- Custom infills are available.



Download  
specifications and  
resources here.



1-800-328-GATE(4283)



Right: Vertical Lift Gate

## LIFT GATES

### Fortress Vertical Lift Gate

(Single Clear Openings up to 60 feet)

The Vertical Lift Gate incorporates a counter balanced gate panel and an integrated TYM-VSA variable speed gate operator. The gate panel is supported by two W12x53 structural steel lifting columns and slides up to open and down to close. Ideal for larger opening applications where minimal space is available to each side of the opening. By virtue of design, the Vertical Lift Gate is fast and provides a high level of security. The typical clear opening height (distance from grade to bottom of gate panel when in the open position) to allow normal tractor/trailer pass through is 15 feet (clear opening height can be taller). Contact a **TYMETAL** Spec Team Member regarding custom needs beyond those described.

- Gate panels made of heavy wall aluminum alloy extrusions, providing strength, durability and light weight.
- Standard gate panel heights up to 10 feet. Contact manufacturer regarding taller applications.
- Fortress Style Gate Infills and custom infills are available.
- Crank handle drops out of operator enclosure for manual operation if no power.



Right: Green Zone, Iraq, K12 Rated Vertical Lift Gates.

## Fortress Vertical Pivot Gate

(Single Clear Openings up to 26 feet; Bi-parting to 52 feet)

Ideal for applications with limited space to either side of the opening, the Vertical Pivot Gate incorporates an innovative gate rotation system that allows the gate panel to pivot open and close effortlessly. The pivot point is the lower left or right of the gate panel. A heavy-duty compression spring is utilized to counterbalance the weight of the gate panel while an integrated 1-HP continuous duty motor easily powers the system. High maintenance spring sets and drive belts are not needed. The system includes battery backup, allowing for up to 50 cycles in the event of a power outage.

- Gate panels made of heavy wall aluminum alloy extrusions, providing strength, durability and light weight.
- Standard heights up to 8 feet. Contact manufacturer regarding taller applications.
- Fortress Style Gate Infills and custom infills are available.
- Gate operator is solar compatible.

**Right:** FedEx Ground Woodbridge, NJ. Vertical Pivot Gate System

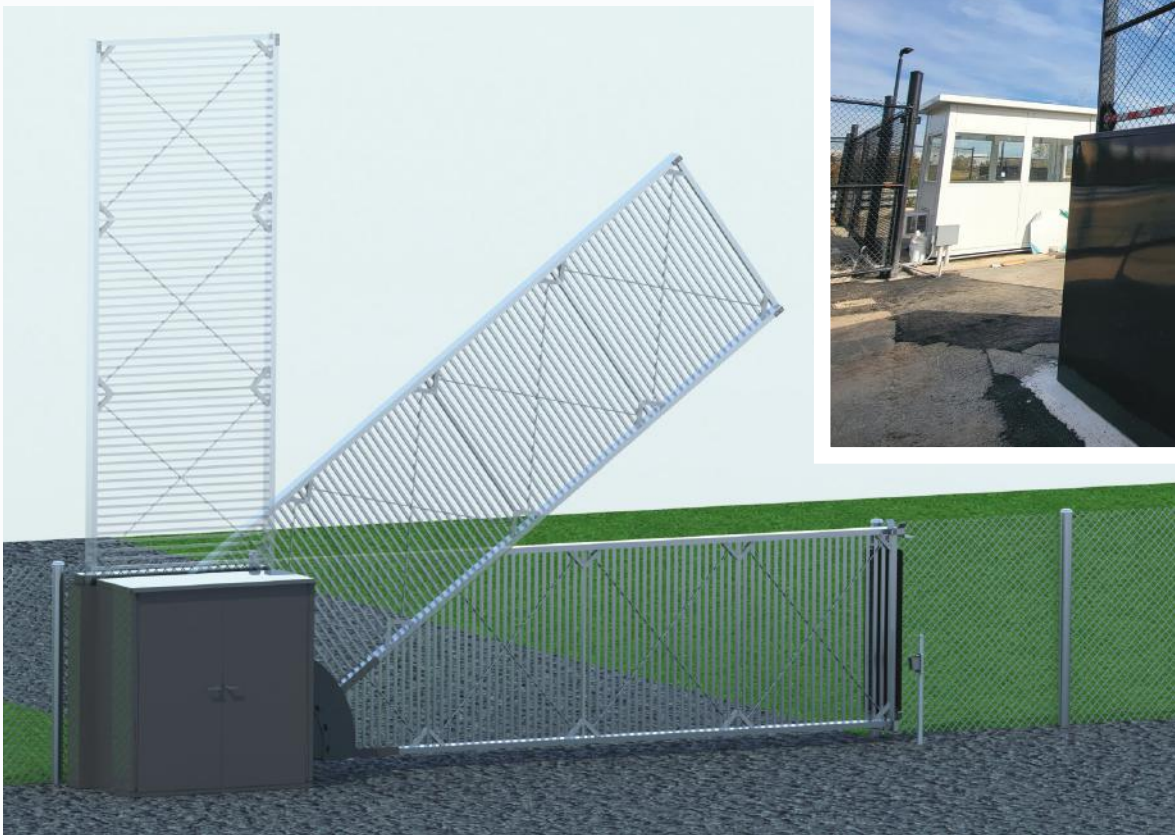

**Download  
specifications and  
resources here.**



# Pedestrian Gates & Portals

## VERSATILE SOLUTIONS FOR SECURE PEDESTRIAN ACCESS

The **2150 Pedestrian Swing Gate**, made of steel, delivers Correctional Grade security with a robust design ideal for perimeter security applications. It features pre-hung construction for easy installation and is available with multiple locking options, including electronic entry and panic bar for Emergency exiting. Standard opening widths to 5 feet x 84 inches high. Double configurations and custom sizes are available. The system is hot-dip galvanized, with optional powder coating for a durable aesthetic finish. An optional outer perimeter grade turnstile can be added; manual or electronic access control features available.

The **2140 Pedestrian Swing Gate**, crafted from aluminum, is designed for perimeter or exterior wall applications where its lighter weight and aesthetics are prioritized. Its aluminum construction complements architectural features and can be powder coated with a durable "automobile-like" finish or left as mill finish. It shares the same pre-hung design, locking alternatives and standard/custom size options as the 2150 gate.

**All Photos:** **TYMETAL** designs pedestrian gates and portals to meet the security requirements and aesthetic vision of each project. The company offers a range of locking options, including electronic configurations, panic bars for emergency exits, and custom pre-installed wiring and locks. Recognizing that every project is unique, **TYMETAL** provides a wide selection of standard infill options as well as fully customizable designs. Examples can be found on this page and the next.

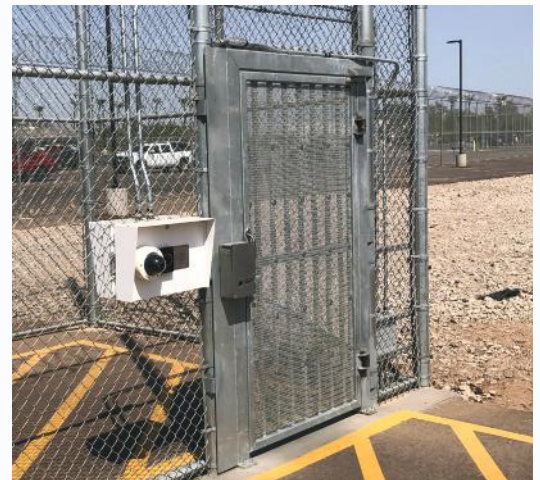



# Hostile Vehicle Mitigation Solutions

## UNDERSTANDING CRASH RATINGS

The first barrier test methods were published in 1985 as Standard SD-STD-02.01 by the Department of Diplomatic Security (DDS), the security arm of the Department of State (DOS). The test vehicle was specified as a Medium-Duty Truck weighing 6800 kg (15,000 lb.s). The payload was securely attached to the frame. Nominal Impact velocities were 50, 65 and 80km/h (30, 40 and 50 mph). Penetration limits (upon impact) were 1, 6 and 15 meters [3 (L3), 20 (L2) and 50 (L1) feet], measured from the attack side of the barrier device to the final resting position of the front of the frame rails of the test vehicle.

**In 2003 the DOS updated** Standard SD-STD-02.01 to **SD-STD-02.01 Revision A**. The revision limited the acceptable penetration distance to the highest level of performance, or 1 meter (3.3 feet). It required a payload of 208-liter (55 gallon) steel drums to be filled with soil, strapped together, and then strapped to the vehicle load platform. In addition, the penetration distance was to be measured from the non-impacted surface of the barrier to the front of the cargo bed, after the vehicle reaches its final position.

**In 2007 Test Method ASTM F2656** was introduced and is the most current US test standard. The Department of Defense (DoD)/US Army Corps of Engineers publishes and maintains a list of tested anti-ram vehicular barriers (DoD Anti-Ram Vehicle Barrier List). ASTM F2656 includes the same test vehicle as that described in 2003 (SD-STD-02.01 Revision A) but added additional test vehicles [Small Passenger Car (SC), Full-Size Sedan (FS), etc.]. The Medium-Duty Truck was re-designated Standard Test Truck (M) and additional penetration ratings were re-established (P1, P2 and P3). The "Most Commonly Used Crash Test Rating" matrix on the next page further describes Test Method ASTM F2656 and details how the previously stated US standards compare to each other, and to the BSI standard.

Right: Crash test facility. TCGR-12 Crash Test



<b>Crash Test Standard</b>	<b>US DoS SD-STD-02.01 (1985)</b>	<b>US DoS SD-STD-02.01 Rev. A (2003)</b>	<b>ASTM F2656-20 (2007 – current)</b>	<b>BSI (British Standards Institution) – PAS 68 &amp; IWA 14</b>
<b>Test Vehicle</b>	15,000 lb. Medium Duty Truck 15,000 lb. Medium Duty Truck	15,000 lb. Medium Duty Truck	15,000 lb. Standard Test Truck (M)	PAS 68: 7,500kg (16,535 lb.s) Cab-Over Engine Medium Duty Truck IWA 14: 7,200 kg (15,873 lb.s) Cab-Over Engine Medium Duty Truck
<b>Test Vehicle Speed</b>	K4 = 30mph K8 = 40mph K12 = 50mph	K4 = 30mph K8 = 40mph K12 = 50mph	M30 = 30mph M40 = 40mph M50 = 50mph	48kph = 30mph 64kph = 40mph 80kph = 50mph
<b>Penetration Ratings</b>	L3 = ≤ 3ft L2 = >3 ft - 20ft L1 = >20 ft - 50ft	Must be ≤ 1 meter	P1 = ≤ 1 meter (3.3 ft) P2 = 1.01m – 7m (3.31 ft – 23 ft) P3 = 7.01 – 30m (23.1 ft -98.4 ft)	Penetration distance of both vehicle and debris field are given in the classification (see interpretation below).
<b>Examples</b>	K12 (L2) - rated to stop a 15,000 lb. truck traveling 50mph with a penetration between 3ft and 20ft.	K4 rated to stop a 15,000 lb. truck traveling at 30mph with a penetration of ≤ 1 m.	M40 (P3) rated to stop a 15,000 lb. truck traveling at 40mph with a penetration between 7.01m and 30m.	How to read PAS 68 Classification Code.

**INTERPRETING THE PAS 68 CLASSIFICATION CODE**

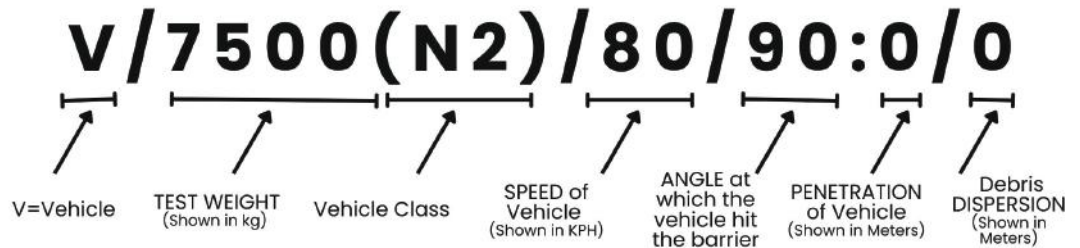

**\*\*IWA 14 does not consider debris dispersion\*\***

*It is important to understand Crash Test Standards before selecting a crash rated vehicular barrier.*

# Crash Rated Barriers



**Gates**

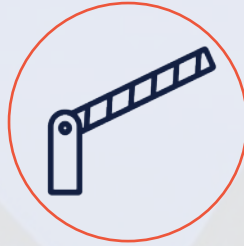

**Beams**

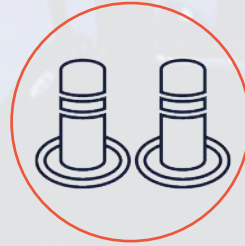

**Bollards**

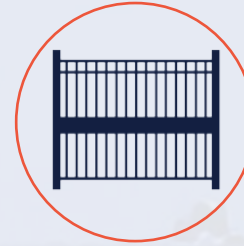

**Fence**

## CRASH RATED VEHICULAR BARRIER TERMINOLOGY

**TYMETAL** provides a broad range of certified anti-ram barriers that are suitable for use in the most demanding perimeter security environments, such as military bases, airports, embassies and high security commercial facilities such as data centers.

**Tested and Certified:** The product has been tested and certified by an independent testing organization. Depending on when the product was tested it could be certified to pass either of the three standards described previously (Pg. 24) (SD-STD-02.01, SD-STD-02.01 Rev. A, ASTM F2656).

**Engineered:** This term means the gate or barrier is designed to pass the most recent crash test standard based on engineering calculations and/or modeling. It may not have undergone an actual test. An engineered stamped certification can be provided to ensure compliance.

**Note:** The term "**Reinforced**" implies stronger and more resistant to impact or damage. Don't be misled by the term. No quantifiable statements can be made unless the product is tested or engineered to perform in a certain way.



**Right:** Marathon Oil, TCG-4 Cantilever System.



**Right:** TCRB-4 Crash Beam.



## CRASH RATED GATES & BEAMS

### M-30 Crash Rated Cantilever Slide Gate Model TCG-4

(Single Clear Openings up to 20 feet)

The TCG-4 features the aluminum Heavy Duty or Structural Cantilever Slide Gate design, with the addition of a crash rated beam and steel stanchions embedded in professionally engineered footings. Available in manual or automated configurations.

- ASTM F2656-07 -M30-P1 crash tested and certified (**will stop a 15,000 lb. vehicle traveling at 30 mph within 1 meter**).
- Standard heights to 8 feet. Contact manufacturer regarding taller applications.
- Fortress Style Gate Infills and custom infills are available.



### M-30 Crash Rated Beam Model TCRB-4

(Single Clear Openings up to 26 feet)

The TCRB-4 pivoting beam incorporates an aluminum crash rated arm and steel stanchions embedded in professionally engineered footings. Available in manual, electromechanical or hydraulically operated configurations.

- ASTM F2656-07 -M30-P1 crash tested and certified (**will stop a 15,000 lb. vehicle traveling at 30 mph within 1 meter**).
- Built in programmable logic controller.
- The aluminum arm is powder coated white and finished with DOT approved reflective tape.



## M-50 Articulating Crash Rated Folding Beam Model ATCRB-12

(Single Clear Openings up to 40 feet)

An M50-P2 tested and rated barrier arm capable of closing clear openings up to 40 feet wide without the need for a center stanchion and has the advantage of lower overhead clearance requirements.

- ASTM F2656-20 -M50-P2 crash tested and certified **(will stop a 15,000 lb. vehicle traveling at 50 mph between 1 and 7 meters).**
- Built in programmable logic controller.
- The aluminum arm is powder coated white and finished with DOT approved reflective tape.

Right: Cherry Point Marine Base, ATCRB-12 Articulating Crash Beam.

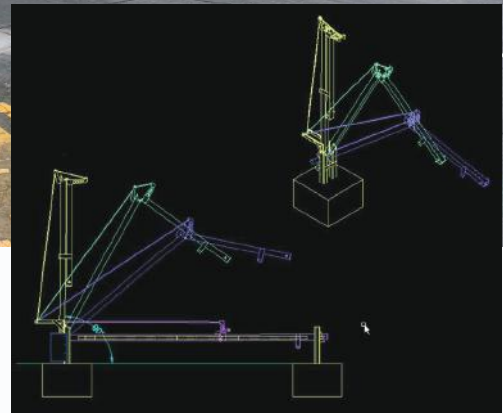

## M-50 Crash Rated Cantilever Slide Gate Model TCGR-12

(Single Clear Openings up to 26 feet)

TCGR-12 features the aluminum Box Frame Cantilever Slide Gate design, with the addition of an M-50 crash rated beam and steel stanchions embedded in professionally engineered footings.

- ASTM F2656-15-M50-P2 crash tested and certified **(will stop a 15,000 lb. vehicle traveling at 50 mph between 1 and 7 meters).**
- Standard heights to 10 feet. Contact manufacturer regarding taller applications.
- Fortress Style Gate Infills and custom infills are available.

Right: PPL Electric Utilities, TCGR-12.



Download  
specifications and  
resources here.



Right: Whiteman Air Force Base, TCRB-12 Crash Beam.



### M-50 Crash Rated Beam Model TCRB-12 (Single Clear Openings up to 24 feet)

The TCRB-12 pivoting beam incorporates an aluminum crash rated arm and steel stanchions embedded in professionally engineered footings. Available in manual, electromechanical or hydraulically operated configurations.

- ASTM F2656-07 -M50-P1 crash tested and certified (will stop a 15,000 lb. vehicle traveling at 50 mph within 1 meter).
- Built in programmable logic controller.
- The aluminum arm is powder coated white and finished with DOT approved reflective tape.

### M-50 Crash Rated Cantilever Slide Gate Model TCG-12

(Single Clear Openings up to 18 feet)

The TCG-12 provides a greater level of security and is suitable for applications with low daily cycle rates. The system incorporates a steel frame and steel crash beam and is most often matched with a hydraulic rail drive gate operator.

- ASTM F2656-07 -M50-P1 crash tested and certified (**will stop a 15,000 lb. vehicle traveling at 50 mph within 1 meter**).
- Standard heights to 8 feet. Contact manufacturer regarding taller applications.
- Fortress Style Gate Infills and custom infills are available.

Right: Federal Justice Tower, Las Vegas, NV TCG-12 Crash Cantilever System.



**Right:** Broadway- Nashville, TN,  
Truckstopper 6 Bollard.

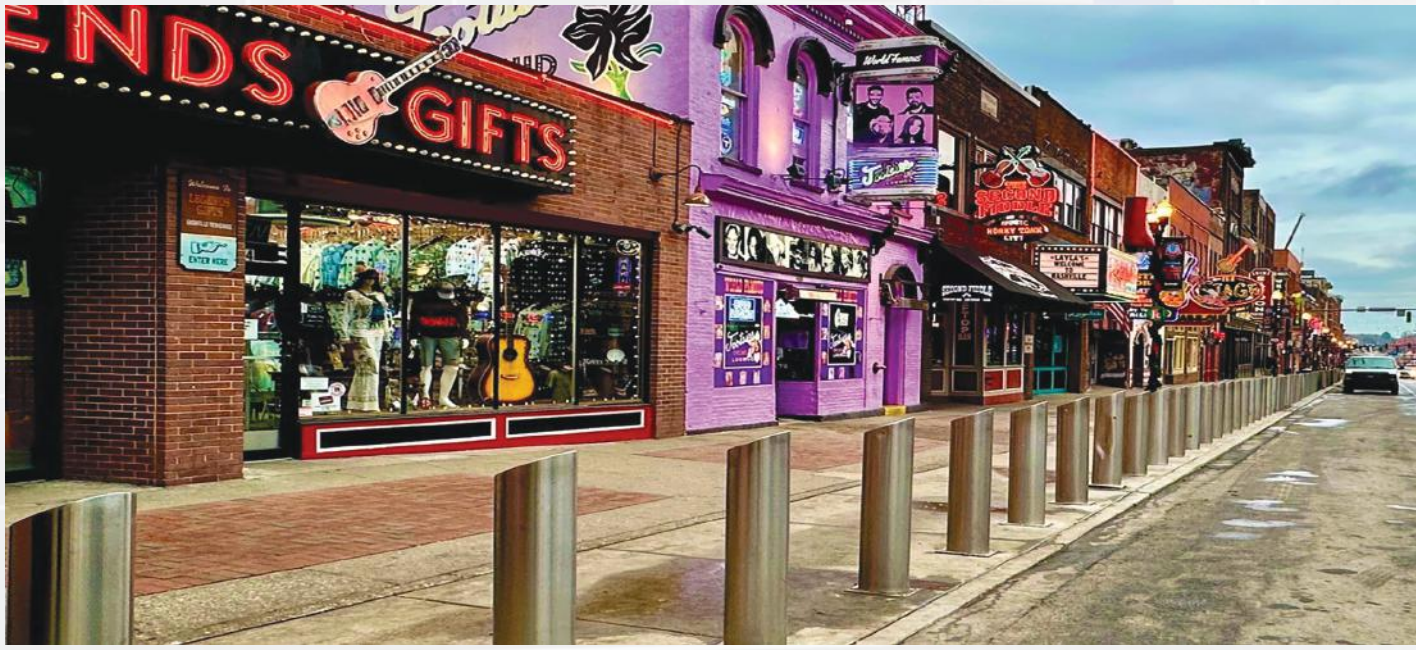

## BOLLARDS

Crash Protection bollard product offerings range from the Car Stopper, designed to stop a 3,306 lb. car traveling at 30 mph to the Truck Stopper series which can stop a 16,534 lb. truck traveling at up to 50 mph. All contain a flexible steel core structure and unique technology for optimal stopping power. If impacted the bollard core flexes subtly, thereby directing much of the vehicle's energy back into the vehicle, allowing for smaller shallow mount foundations. This means that installation is easier and less expensive.

**Right:** Jersey Shore Medical  
Center- Neptune, N.J. Slimline  
Planter 40s



**Right:** Centennial Olympic Park- Atlanta, GA,  
Truckstopper 7 Bollards.



## Truckstopper 5 Removable or Fixed Bollards

(Will stop a 16,534 lb. vehicle traveling at 50 mph.)

For a high degree of crash-tested perimeter security, choose the Truckstopper 5 bollard. This bollard system offers one of the most impressive stopping powers available in the industry — an ideal fit for government facilities and other buildings with demanding security concerns.

- Crash-tested (BSI PAS 68:2010) V/7500/N3/80/90:6.0/18.8
- Installed fixed or removable
- Footing depth is 15-3/4" plus the depth of the sidewalk (4") or pavers (3").

**Right:** Truckstopper 5 with custom covers at Augusta National Golf Course



## Universal Slimline Planter 40

(Will stop a 16,534 lb. vehicle traveling at 40 mph.)

Instead of applying a wall of concrete, many locations can be safeguarded with a crash-rated security planter. The Universal Slimline Planter Bollard 40 is an anti-ram solution engineered to stop a 7.5 metric ton vehicle (16,534 lbs) traveling at 40 mph.

- Crash-tested (BSI PAS 68:2010) V/7500/N2/64/90:2.8/7.2
- Planter is surface mounted with a shallow foundation. Footing depth is 10-1/2" plus the depth of a sidewalk (4") or pavers (3").

**Right:** Slimline Planter 40 at Jersey Shore Medical Center - Neptune, NJ



## Rising Bollard RB001-30

(Will stop a 16,534 lb. vehicle traveling at 30 mph.)

The Truckstopper RB-001-30 Rising Bollard System is a manually operated shallow mount system that is operated by an 18 Volt portable drill. When in the closed position it resides below grade, being shielded by a heavy gauge steel cover. It is perfect for applications where areas or streets require crash protection for periodic events. When the bollards are lowered or not in use, vehicular or pedestrian traffic can simply pass over them.

- Crash-tested (BSI PAS 68:2010) V/7500/N2/48/90:3.2/0.00
- Footing depth is 17-3/4"

**Right:** Rising Bollard RB-001-30



**TO SEE FULL SELECTION OF BOLLARDS PLEASE VISIT OUR WEBSITE TYMETAL.COM**

1-800-328-GATE(4283)

**CRASH RATED FENCE** - A simple and effective way to harden long runs.

## M-50 Crash Rated Fence

**TYMETAL's** Post and Cable Crash Rated Fence is the most practical and cost-effective way to harden longer runs of perimeter security. It can provide both crash rated perimeter security as well as unobstructed aesthetics when installed behind a traditional perimeter fence. Specifiers can choose from a variety of finishes for stand-alone applications, including decorative rail covers for the cables. It can also be incorporated into stonework and architectural precast concrete for urban applications. Due to its design and assembly process significant savings in time and labor expense can be realized during the installation process.

- ASTM F2656-15 -M50-P1 crash tested and certified (**will stop a 15,000 lb. vehicle traveling at 50 mph within 1 meter**).
- Engineered Ratings (\*) available for ASTM F2656-M30-P1, M30-P2, M40-P1, M40-P2 and M50-P2.
- Ideal for military bases, airports, data centers and critical infrastructure sites.

**(\*) Engineered:** This term means the fence or barrier is designed to pass the most recent crash test standard based on engineering calculations and/or modeling. It may not have undergone an actual crash test. A certification can be provided to ensure compliance by a licensed engineer.



Right: TCF Crash Cable Barrier.

## BALLISTIC RATED GATES & FENCE

### Ballistic Protection

**TYMETAL** utilizes UL752 Ballistic rated steel panels to fortify several of our steel gate designs as well as fencing to harden perimeters against a variety of gunshot attacks – ranging from pistol to high power .50 caliber projectiles (UL752 Level 10).

- UL752 ratings up to level 10 available to suit specific threat mitigation requirements.
- Vehicular gate, pedestrian door and fixed fence panel options available for wall heights up to 16' standard.\*
- Integrated ASTM F2656-M30 and M50 crash beam designs available for vehicle gates.
- Ideal for utility substations, data centers and other vulnerable, remote, and/or unmanned infrastructure.

\*Contact **TYMETAL** with site specific dimension requirements.

**Right:** Ballistic protection provide for a Northeast Power Facility.

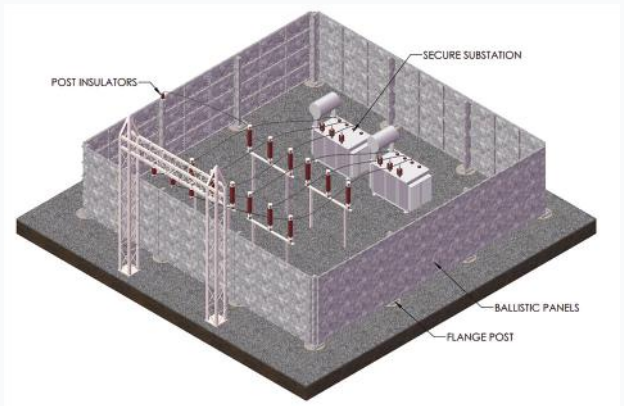

**Right:** Ballistic protection provide for a Northeast Power Facility.



Download  
specifications and  
resources here.



# Specification & Design Support

## One Company. One Contact.

### Why Choose **TYMETAL**?

#### Comprehensive Project Support

**TYMETAL** provide exceptional support throughout the project's life cycle:

**Custom Design Solutions** – For those more difficult requirements, **TYMETAL** provides:

- **Project and Site-Specific Designs:** Custom CAD drawings and detailed specifications.
- **Engineering and Technical Assistance.**
- **Project Management:** An experienced Specification and Design Team member will manage your project through completion.

#### Project Management:

- **Design Phase:** Delivering tailored solutions for unique needs.
- **Design Review:** Ensuring optimal conformance throughout the design process.
- **Installation and Post Installation:** Ensuring a seamless execution and ongoing technical support.
- **Lifetime Support:** **TYMETAL's** commitment continues long after installation. Phone or remote technical assistance is always available.

Download specifications and resources here.



**TYMETAL** serves as a single-source partner for gates, operators, and crash rated barriers, providing comprehensive engineering and technical support at every stage of a project.

## The **TYMETAL** Advantage

**TYMETAL** considers all the factors associated with a project design requirement or purchase, not only the gate or barrier. Factors such as **site conditions, wind load, security, cycle activity and safety** are considered. Taking every possible factor into account and providing a viable solution for the project, in a timely manner, is what distinguishes **TYMETAL** from the competition.

### Horizontal Gate Frame Members (Cantilever Slide Gate Series)

**TYMETAL** uses the sturdiest track and gate frame combination in the industry. Each component is keyed to interlock with each other and then welded to form a one-piece composite structure.

### Vertical Gate Frame Members (Cantilever Slide Gate Series)

**TYMETAL** incorporates 2" x 2" and 1" x 2" vertical members to enhance strength and rigidity. Spacing is no more than 50% of the gate height, compared to competitor's spacing of up to 100% of gate height.

**The Difference:** These design choices significantly improve vertical and lateral stiffness, ensuring superior gate performance.

### The **TYMETAL** Commitment

**TYMETAL** goes beyond industry standards to ensure every gate meets the highest benchmark for quality, security and performance. With a focus on the customer, **TYMETAL's** Technical Sales and Engineering Teams are eager to provide site specific solutions for those more challenging projects – and always, Planning/Design through Post-Construction support.

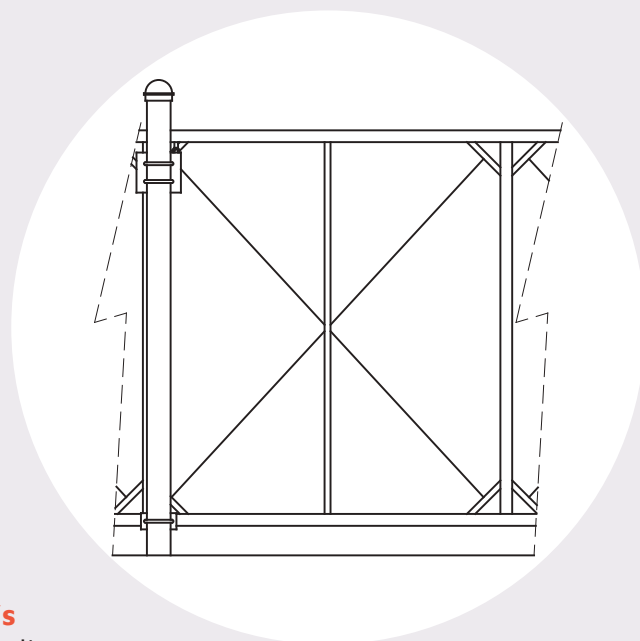
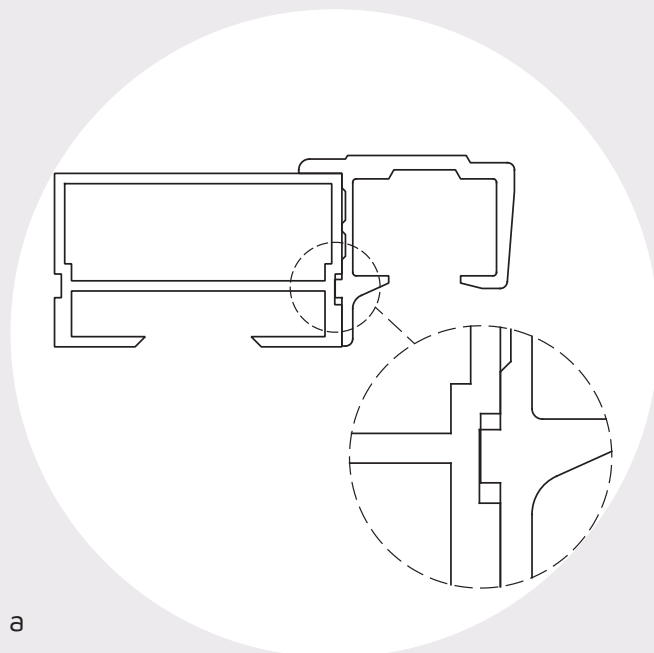

**TYMETAL** Products and Solutions can be found in every State in America as well as many countries around the world.

### Clients we serve include:

#### Aviation

Albany Int'l Airport  
Boeing  
Chicago O'Hare  
Hilo Int'l Airport  
JFK Airport  
Joint Base Andrews  
Los Angeles Int'l Airport  
Lockhead Martin  
Newark Liberty Int'l  
Ontario Int'l Airport  
Philadelphia Int'l Airport  
Pittsburgh Int'l Airport  
Seattle-Tacoma Int'l  
Tampa Int'l Airport

#### Data Centers

Amazon  
Meta [Facebook]  
Google  
J.P. Morgan  
Microsoft  
QTS  
Verizon

#### Distribution

Ace Hardware  
Coca-Cola  
FedEx  
Old Dominion Freight Line  
SAIA LTL Freight  
Target  
USPS  
Walmart

#### Energy

American Transmission  
Ameren  
Arizona Public Service

Atmos Energy  
Berkshire Hathaway  
British Petroleum  
ExxonMobil  
Dominion  
Duke Energy  
Eversource Energy  
Florida Power & Light  
Idaho Power  
National Grid  
Ontario Power  
PSE&G  
Sunoco  
Tennessee Valley

#### Stadiums

Amalie Stadium  
Busch Stadium  
Charles Street Stadium  
Meadowlands Stadium

#### Government & Military

Homeland Security  
NASA  
NATO  
Strategic Petroleum Reserve  
US Air Force  
US Army  
US Coast Guard  
US Dept. of Defense  
US Drug Enforcement Administration [DEA]  
US Dept. of Justice  
US Dept. of State  
US Dept. of Veterans Affairs  
US State of Georgia

#### Justice & Corrections

AL Dept. of Corrections  
AZ Dept. of Corrections  
Bureau of Indian Affairs  
CA Dept. of Corrections  
Core Civic  
Federal Bureau of Prisons  
Fort Lauderdale Police Dept.  
The GEO Group  
NE Correctional Services  
NY State Corrections  
SD Dept. of Corrections  
Orange County Sheriff  
Phoenix Police Dept.  
US ICE  
US Marshals



Veterans Memorial Park, CO

# FORT MILLER GROUP



**TYMETAL** is proud to be part of the Fort Miller Group, a 100% employee-owned organization renowned for its expertise in manufacturing innovative infrastructure solutions.

With a team of over 500 employees nationwide, the Fort Miller Group offers streamlined design, engineering and manufacturing of essential building components, from security solutions, industry-shaping precast concrete structures, to formliner products and custom foam forming solutions.

Headquartered in Upstate New York, the Fort Miller Group's products play a vital role in supporting critical infrastructure and security across all 50 states and around the world.

Fort Miller Group — *Your Vision, Our Expertise.*

[WWW.FMGROUP.COM](http://WWW.FMGROUP.COM)

Notable projects featuring products manufactured by Fort Miller Group include:

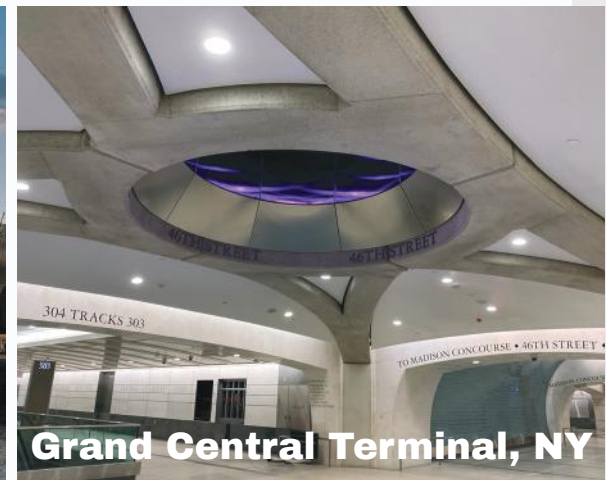

1-800-328-GATE(4283)

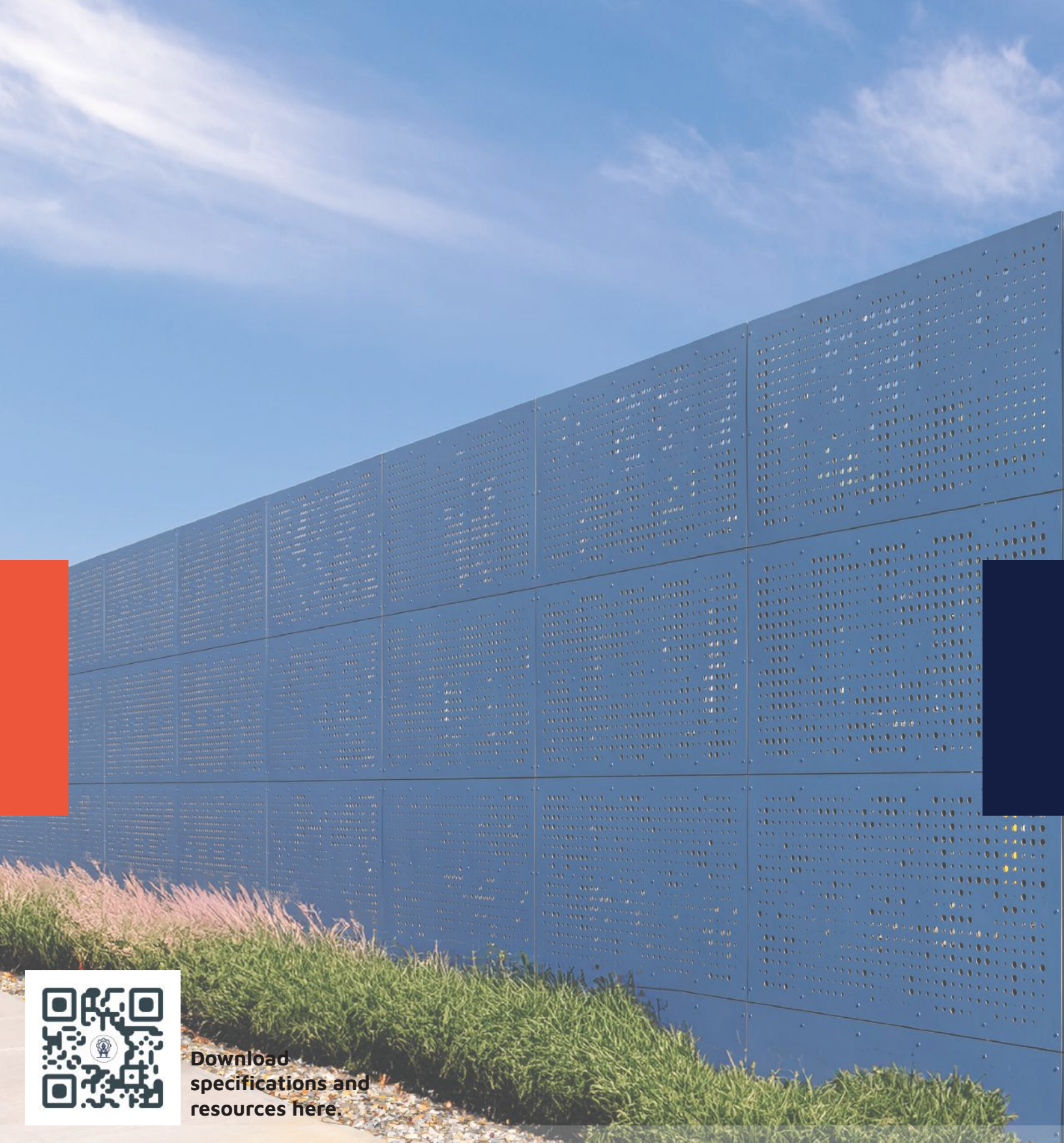

**Download specifications and resources here.**



**20  
25**

Standard and Custom Solutions Manufactured in the USA  
678 Wilbur Avenue Greenwich, NY  
4501 Dixie Farm Road Pearland, TX