

EQUIPMENT
PROFESSIONAL LINE

2025

TCORX
PROFESSIONAL LINE

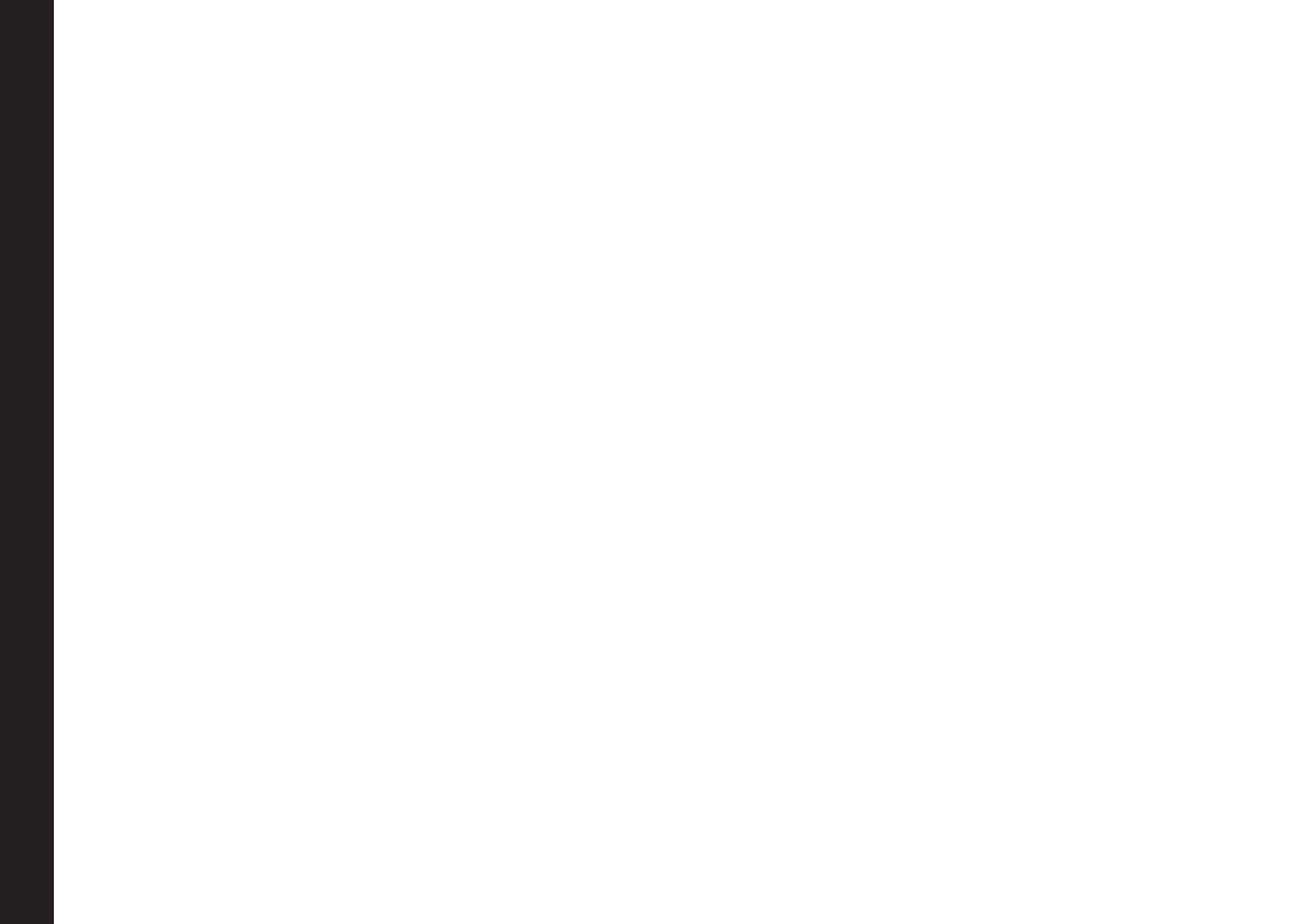

CARDIO 4**TAPIS ROULANT - TREADMILLS**

TRX9000 EVO TFT	5
TRX9000 EVO	6
TRX8500 EVO TFT	7
TRX8500 EVO	8

ELLITTICHE - ELLIPTICALS

ERX9500 TFT	9
ERX9500	10
ERX9000	11

RECUMBENT BIKES

BRXR9500 TFT	12
BRXR9500	13
BRXR9000	14

BIKES

BRX9500 TFT	15
BRX9500	16
BRX9000	17

INDOOR CYCLE

SRX9000	18
SRX8500	19
TX-POWER KEO SYSTEM	20
TX-POWER SPD SYSTEM	21

STAIR CLIMBER

CLX8000 TFT	22
CLX8000	23

CROSSTRAINING & FUNCTIONAL CARDIO

RACE CROSS PRO	24
RACE CROSS	25
BRX AIRMAG 7000	26
RWX AIRMAG 7000	27
SKX AIRMAG 7000	28
BRX AIR 5000	29
RWX AIR 5000	30
SKX AIR 5000	31
BRX AIR CROSS PRO	32
BRX AIR CROSS	33

STRENGTH 34**ABSOLUTE LINE PIN LOADED SINGLE FUNCTION 35-53**

PLX8000 - CONVERGING CHEST PRESS	36
PLX8100 - CONVERGING SHOULDER PRESS	37
PLX8200 - MULTI FLIGHT	38
PLX8300 - LAT MACHINE	39
PLX8350 - DIVERGING LAT PULL DOWN	40
PLX8400 - ASSISTED PULL UP/CHIN UP/DIP	41
PLX8450 - ISOLATERAL SEATED ROW	42
PLX8500 - ADJUSTABLE PULLEY	43
PLX8600 - BICEPS CURL	44
PLX8650 - ABDOMINAL CRUNCH	45
PLX8700 - HORIZONTAL LEG PRESS	46
PLX8800 - LEG EXTENSION	47
PLX8850 - SEATED LEG CURL	48
PLX8900 - PRONE LEG CURL	49
PLX9000 - HIP THRUST	50
PLX9050 - DUAL 45 HYPER EXTENSION	51
PLX9090 - STANDING REAR KICK	52
PLX9100 - MULTI HIP	53

ABSOLUTE LINE PIN LOADED DUAL FUNCTION 54-59

PLX9200 - MULTI PRESS	54
PLX9300 - ISOLATERAL PECTORAL FLY/REAR DELTOIDS	55
PLX9400 - LAT MACHINE/PULLEY	56
PLX9500 - HORIZONTAL LEG PRESS/HACK SQUAT	57
PLX9600 - SEATED LEG CURL/LEG EXTENSION	58
PLX9700 - ABDUCTOR/ADDUCTOR	59

AVANT LINE PIN LOADED SINGLE FUNCTION 60-78

PLX6000 - CONVERGING CHEST PRESS	61
PLX6050 - PECTORAL FLY	62
PLX6100 - CONVERGING SHOULDER PRESS	63
PLX6150 - LATERAL RAISE	64
PLX6200 - MULTI FLIGHT	65
PLX6300 - LAT MACHINE	66
PLX6350 - ASSISTED PULL UP/CHIN UP/DIP	67
PLX6390 - DIVERGING LAT PULL DOWN	68
PLX6400 - PULLEY	69
PLX6500 - LOW ROW	70
PLX6600 - HORIZONTAL LEG PRESS	71
PLX6700 - LEG EXTENSION	72
PLX6800 - PRONE LEG CURL	73
PLX6900 - ABDUCTOR	74
PLX7000 - ABDUCTOR	75
PLX7050 - STANDING REAR KICK	76
PLX7100 - MULTI HIP	77
PLX7200 - SEATED CALF	78

AVANT LINE PIN LOADED DUAL FUNCTION 79-84

PLX7300 - MULTI PRESS	79
PLX7400 - PECTORAL FLY/REAR DELTOIDS	80

PLX7500 - LAT MACHINE/PULLEY	81
PLX7700 - BICEPS/TRICEPS CURL	82
PLX7800 - LEG EXTENSION/PRONE LEG CURL	83
PLX7900 - ADDUCTOR/ABDUCTOR	84

ABSOLUTE LINE PLATE LOADED 85-113

FWX8000 - WIDE CHEST PRESS	86
FWX8050 - PECTORAL FLY	87
FWX8090 - PULLOVER	88
FWX8100 - SHOULDER PRESS	89
FWX8200 - LAT PULLDOWN	90
FWX8300 - UNIVERSAL HIGH ROW	91
FWX8350 - CIRCULAR LAT PULLDOWN	92
FWX8400 - LOW ROW	93
FWX8500 - MID ROW	94
FWX8600 - BICEPS CURL	95
FWX8700 - TRICEPS PRESS	96
FWX8750 - ABDOMINAL CRUNCH	97
FWX8800 - LINEAR LEG PRESS	98
FWX8850 - VERTICAL LEG PRESS	99
FWX8900 - LEG PRESS	100
FWX9000 - PENDULUM SQUAT	101
FWX9050 - BELT SQUAT	102
FWX9100 - HACK SQUAT	103
FWX9150 - V SQUAT	104
FWX9190 - LINEAR HACK SQUAT	105
FWX9200 - SQUAT LUNGE	106
FWX9300 - HIP THRUST	107
FWX9400 - LEG EXTENSION	108
FWX9500 - STANDING LEG CURL	109
FWX9600 - REAR KICK	110
FWX9650 - STANDING ABDUCTOR	111
FWX9700 - SEATED CALF RAISE	112
FWX9750 - STANDING HIP THRUST	113

AVANT LINE PLATE LOADED 114-146

FWX6300 - WIDE CHEST PRESS	115
FWX6350 - INCLINE CHEST PRESS	116
FWX6400 - PECTORAL FLY	117
FWX6450 - SHOULDER PRESS	118
FWX6500 - LATERAL RAISE	119
FWX6550 - STANDING LATERAL RAISE	120
FWX6600 - TOWER SMITH	121
FWX6650 - LAT PULLDOWN	122
FWX6700 - FRONT LAT PULLDOWN	123
FWX6750 - CIRCULAR LAT PULLDOWN	124
FWX6800 - LOW ROW	125
FWX6850 - ROW	126
FWX6900 - LOWER BACK	127
FWX6950 - STANDING T BAR	128
FWX7000 - T BAR	129
FWX7100 - BICEPS CURL	130
FWX7150 - TRICEPS PRESS	131
FWX7200 - ABDOMINAL CRUNCH	132

FWX7250 - LINEAR LEG PRESS	133
FWX7290 - HACK SQUAT	134
FWX7300 - ISOLATERAL LEG PRESS	135
FWX7350 - HACK SQUAT	136
FWX7400 - LEG PRESS / HACK SQUAT	137
FWX7450 - LEG EXTENSION	138
FWX7500 - STANDING LEG CURL	139
FWX7550 - PENDULUM SQUAT	140
FWX7600 - BELT SQUAT	141
FWX7650 - BELT SQUAT	142
FWX7700 - HIP THRUST	143
FWX7750 - STANDING ABDUCTOR	144
FWX7800 - SEATED CALF	145
FWX7850 - STANDING HIP THRUST	146

ALL IN ONE

ASX9000	147
ASX8000	148
ASX7000	149
ASX6000	150

STATIONS

CSX9500	151
CSX9400	152
CSX9300	153
CSX9200	154
CSX9100	155
CSX9000	156
CSX8800	157
CSX8000	158
CSX7000	159
CSX6000	160
CSX4000	161
CSX2000	162
CSX5500	163
CSX5000	164
CSX3500	165
WLX6500	166
WLX6000	167

BENCHES 168

WBX3400	169
WBX3800	170
WBX3600	171
WBX3900	172
WBX3300	173
WBX3200	174
WBX2600	175
WBX2400	176
WBX2200	177
WBX2000	178
WBX2800	179
WBX950	180

WBX700	181
WBX300	182
WBX2450	183
WBX240	184
WBX1800	185
WBX1000	186

CROSSTRAINING & FUNCTIONAL RIGS, RACKS & STORAGE 188

CALISTHENICS 2	189
CALISTHENICS 1	190
ACCESSORI CALISTHENICS	
ACCESSORI CALISTHENICS	191
POWER RACK	192
SQUAT STAND	194
1 CAMPATA AUTOPORTANTE	
1 SPAN STAND ALONE	195
1 CAMPATA A MURO	
1 SPAN WALL MOUNT	196
2 CAMPATE AUTOPORTANTI	
2 SPANS STAND ALONE	197
2 CAMPATE A MURO	
2 SPANS WALL MOUNT	198
3 CAMPATE AUTOPORTANTI	
3 SPANS STAND ALONE	199
3 CAMPATE A MURO	
3 SPANS WALL MOUNT	200
4 CAMPATE AUTOPORTANTI	
4 SPANS STAND ALONE	201
4 CAMPATE A MURO	
4 SPANS WALL MOUNT	202
5 CAMPATE AUTOPORTANTI	
5 SPANS STAND ALONE	203
5 CAMPATE A MURO	
5 SPANS WALL MOUNT	204
5 SPANS WALL MOUNT	205
MASTER HEXAGON	
ELEMENTI STRUTTURALI	
RIGS COMPONENTS	207
ACCESSORI-ACCESSORIES	211
STORAGE PRECOMPOSTI	
PRE-CONFIGURED STORAGES	218
ACCESSORI GABBIE-STORAGE	
RIGS-STORAGES ACCESSORIES	222

OUTDOOR RIGS 224

MASTER HEXAGON OUTDOOR	225
ELEMENTI STRUTTURALI OUTDOOR	
OUTDOOR RIGS COMPONENTS	226
ACCESSORI GABBIE OUTDOOR	
OUTDOOR RIGS ACCESSORIES	230

RACKS

WLX3800	232
WLX3600	233
WLX3400	234

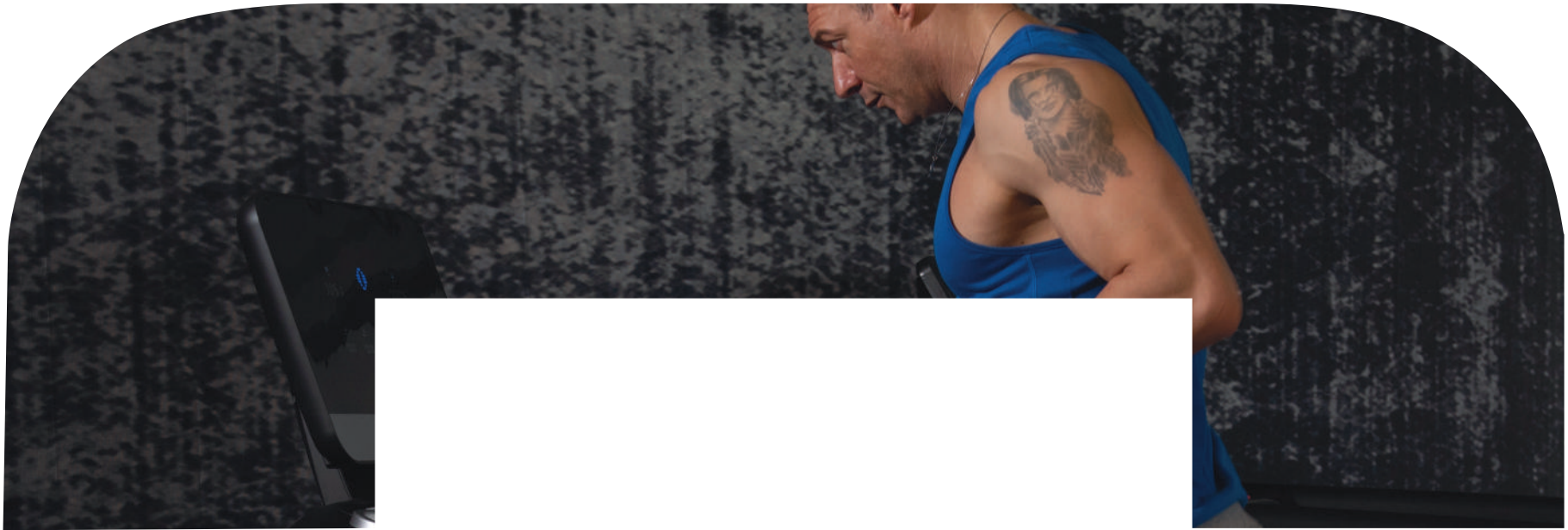

CARDIO



TRX9000 EVO TFT

cod. TRX-9000EVO TFT

App ready 3.0

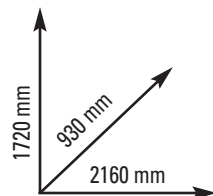
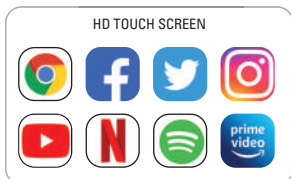

CARDIO - TREADMILLS

MOTORE 6/8 (Peak) HP AC
VELOCITÀ 0,5 - 25,0 Km/h con incremento di 0,1 km/h
PIANO DI CORSA 600 x 1640 mm - nastro autolubrificante spessore 2,5 mm
CONSOLE 21,5" HD touch screen. App pre-installate: Chrome, Facebook, Twitter, Instagram, Youtube, Netflix*, Spotify*, Prime Video*.
* Abbonamento non incluso. Informazioni: velocità-frequenza cardiaca-tempo-inclinazione-consumo calorico-n° passi
PROGRAMMI Quick Start, Real Mode (6), Target Mode(3), Training Mode(6), Race Mode, HRC
CLASSE D'UTILIZZO PROFESSIONALE (EN20957-1 / EN957-6 classe S)

MOTOR 6/8 (Peak) HP AC
SPEED 0,5 - 25,0 Km/h with 0,1 km/h increasing
RUNNING BOARD 600 x 1640 mm - lubry free belt thickness 2,5 mm
CONSOLE 21,5" TFT HD touch screen. App pre-installed: Chrome, Facebook, Twitter, Instagram, Youtube, Netflix*, Spotify*, Prime Video*. * Subscription not included. Functions: speed, pulse, distance, time, incline, calories, pace
PROGRAMS Quick Start, Real Mode (6), Target Mode(3), Training Mode(6), Race Mode, HRC
COMMERCIAL USE (EN20957-1 / EN957-6 class S)

- Inclinazione: elettrica 19% su 20 livelli
- Rilevazione cardio: hand pulse. Ricevitore wireless per fascia cardio integrato
- Peso max utilizzatore: 180 kg
- Dotazioni multimediali: ingresso per lettore MP3 e casse acustiche - wireless station per ricarica smartphone e tablet, se supportato dal dispositivo. APP READY 3.0 Sistema Bluetooth intelligente integrato. Compatibile con Zwift App e Kinomap fitness App (abbonamenti non inclusi).
- Dimensioni prodotto: 2160x930x1720 mm
- Peso: 220 kg

- Incline: 19% with 20-level motor incline
- Heart rate: hand pulse sensors integrated into hand grip. Built-in wireless pulse receiver
- Max userweight: 180 kg
- Multimedia equipment: audio input for MP3 player and loudspeakers. Wireless charging station for smartphone and tablet if supported by your devices. APP READY 3.0 - Built-in Bluetooth intelligent. Compatible with Zwift App and Kinomap fitness App (subscription not included).
- Set up size: 2160x930x1720 mm
- Weight: 220 kg



TRX9000 EVO

cod. TRX-9000EVO

App ready 3.0

COMPATIBILE CON
COMPATIBLE WITH

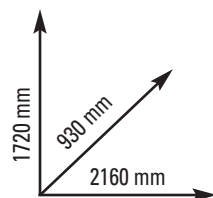

CARDIO - TREADMILLS

MOTORE 6/8 (Peak) HP AC
VELOCITÀ 0,5 - 25,0 Km/h con incremento di 0,1 km/h
PIANO DI CORSA 600 x 1640 mm - nastro autolubrificante spessore 2,5 mm
CONSOLE 7 display LED blue dot + 1 display con diagramma
Informazioni: velocità, pulsazioni, distanza, tempo, inclinazione, calorie, temperatura, step
PROGRAMMI 1 libero, 8 predefiniti, 5 user, HRC
CLASSE D'UTILIZZO PROFESSIONALE (EN20957-1 / EN957-6 classe S)

MOTOR 6/8 (Peak) HP AC
SPEED 0,5 - 25,0 Km/h with 0,1 km/h increasing
RUNNING BOARD 600 x 1640 mm - lubry free belt thickness 2,5 mm
CONSOLE 7 displays LED blue dot + 1 dispaly with diagram.
Functions: speed, incline, time, distance, calories, pulse, temperature, step
PROGRAMS 1 manual, 8 pre-set, 5 user, HRC
COMMERCIAL USE (EN20957-1 / EN957-6 class S)

- Inclinazione: elettrica 19% su 20 livelli
- Rilevazione cardio: hand pulse.
- Ricevitore wireless per fascia cardio integrato
- Peso max utilizzatore: 180 kg
- Dotazioni multimediali: ingresso per lettore MP3 e casse acustiche - ingresso USB. Supporto per smartphone /tablet. APP READY 3.0 - Sistema Bluetooth intelligente integrato. Compatibile con Zwift App e Kinomap fitness App (abbonamenti non inclusi).
- Dimensioni prodotto: 2160x930x1720 mm
- Peso: 220 kg

- Incline: 19% with 20-level motor incline
- Heart rate: Hand pulse sensors integrated into hand grip.
- Built-in wireless pulse receiver
- Max userweight: 180 kg
- Multimedia equipment: audio input for MP3 player and loudspeakers - USB door. Smartphone/tablet holder. APP READY 3.0 - Built-in Bluetooth intelligent. Compatible with Zwift App and Kinomap fitness App (subscription not included).
- Set up size: 2160x930x1720 mm
- Weight: 220 kg



TRX8500 EVO TFT

cod. TRX-8500EVOTFT

App ready 3.0

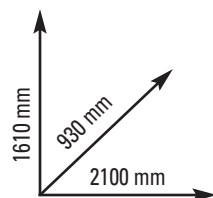
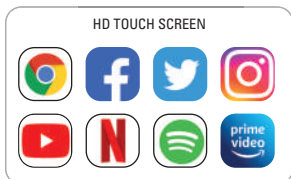

CARDIO - TREADMILLS

MOTORE 5/7 (Peak) HP AC
 VELOCITÀ 0,8-24 km/h-incremento 0.1km/h
 PIANO DI CORSA 600 x 1640 mm - nastro autolubrificante spessore 2 mm
 CONSOLE 15,6" HD touch screen. App pre-installate: Chrome, Facebook, Twitter, Instagram, Youtube, Netflix*, Spotify*, Prime Video*.
 * Abbonamento non incluso. Informazioni: velocità, pulsazioni, distanza, tempo, inclinazione, calorie
 PROGRAMMI Quick start/Real mode (6) /Target mode(3)/Training mode(5)
 CLASSE D'UTILIZZO PROFESSIONALE (EN20957-1 / EN957-6 classe S)

MOTOR 5/7 (Peak) HP AC
 SPEED 0,8-24 km/h with 0,1 km/h increasing
 RUNNING BOARD 600 x 1640 mm - lubry free belt thickness 2 mm
 CONSOLE 15,6" TFT HD touch screen. App pre-installed: Chrome, Facebook, Twitter, Instagram, Youtube, Netflix*, Spotify*, Prime Video*. * Subscription not included. Functions: speed, incline, time, distance, calories, pulse
 PROGRAMS Quick start/Real mode (6) /Target mode(3)/Training mode(5)
 COMMERCIAL USE (EN20957-1 / EN957-6 class S)

- Inclinazione: elettrica 15% su 15 livelli
 - Rilevazione cardio: hand pulse.
 - Ricevitore wireless per fascia cardio integrato.
 - Peso max utilizzatore: 160 kg
 - Dotazioni multimediali: supporto per smartphone/tablet. Ingresso per lettore MP3 e casse acustiche - wireless station per ricarica smartphone e tablet, se supportato dal dispositivo. APP READY 3,0 - Sistema Bluetooth intelligente integrato. Compatibile con Zwift App e Kinomap fitness App (abbonamenti non inclusi)
 - Dimensioni prodotto: 2100x930x1610 mm
 - Peso: 160 kg
-
- Incline: 15% with 15-level incline
 - Heart rate: hand pulse. Built-in wireless pulse receiver.
 - Max userweight: 160 kg
 - Multimedia equipment: smartphone/tablet holder included. Audio input for MP3 player and loudspeakers. Wireless charging station for smartphone and tablet if supported by your devices APP READY 3.0 - Built-in Bluetooth intelligent. Compatible with Zwift App and Kinomap fitness App (subscription not included).
 - Set up size: 2100x930x1610 mm
 - Weight: 160 kg



TRX8500 EVO

cod. TRX-8500EVO

App ready 3.0

COMPATIBILE CON
COMPATIBLE WITH

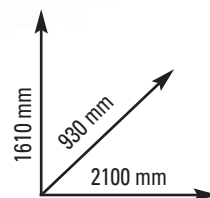

CARDIO - TREADMILLS

MOTORE 5/7 (Peak) HP AC
VELOCITÀ 0,8-24 km/h-incremento 0.1km/h
PIANO DI CORSA 600 x 1640 mm - nastro autolubrificante spessore 2 mm
CONSOLE 7 display LED white dot + 1 display con diagramma.
Informazioni: velocità, pulsazioni, distanza, tempo, inclinazione, calorie, temperatura, step, MET
PROGRAMMI Custom, Manual, Hill, Fat Burn, Target, Cardio, Strength, Fit test, HRC
CLASSE D'UTILIZZO PROFESSIONALE (EN20957-1 / EN957-6 classe S)

MOTOR 5/7 (Peak) HP AC
SPEED 0,8-24 km/h with 0,1 km/h increasing
RUNNING BOARD 600 x 1640 mm - lubry free belt thickness 2 mm
CONSOLE 7 displays LED white dot + 1 dispaly with diagram.
Functions: speed, pulse, distance, time, incline, calories, step, pace, temperature, MET's
PROGRAMS Custom, Manual, Hill, Fat Burn, Target, Cardio, Strength, Fit test, HRC
COMMERCIAL USE (EN20957-1 / EN957-6 class S)

- Inclinazione: elettrica 15% su 15 livelli
 - Rilevazione cardio: hand pulse.
 - Ricevitore wireless per fascia cardio integrato.
 - Peso max utilizzatore: 160 kg
 - Dotazioni multimediali: ingresso per lettore MP3 e casse acustiche - ingresso USB. Supporto per smartphone /tablet. APP READY 3.0 - Sistema Bluetooth intelligente integrato. Compatibile con Zwift App e Kinomap fitness App (abbonamenti non inclusi).
 - Dimensioni prodotto: 2100x930x1610 mm
 - Peso: 160 kg
-
- Incline: 15% with 15-level incline
 - Heart rate: hand pulse. Built-in wireless pulse receiver.
 - Max userweight: 160 kg
 - Multimedia equipment: audio input for MP3 player and loudspeakers - USB door. Smartphone/tablet holder. APP READY 3.0 - Built-in Bluetooth intelligent. Compatible with Zwift App and Kinomap fitness App (subscription not included).
 - Set up size: 2100x930x1610 mm
 - Weight: 160 kg



ERX9500 TFT

cod. ERX-9500-TFT

App ready 3.0

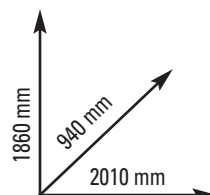
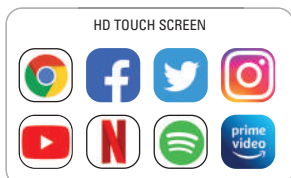

CARDIO - ELLIPTICALS

SISTEMA DI FRENAGGIO Ergometro - magnetico ad induzione e regolazione elettronica dello sforzo su 32 livelli
POGGIAPIEDI extra large per una posizione di allenamento ottimale e confortevole
LUNGHEZZA PASSO 560 mm
CONSOLE 10,1" TFT HD touch screen. App pre-installate: Chrome, Facebook, Twitter, Instagram, Youtube, Netflix*, Spotify*, Prime Video*, Kinomap Fitness App*. * Abbonamento non incluso. Informazioni: velocità, tempo, distanza, calorie, pulse, RPM, Mets, Watt
PROGRAMMI Quick start, Target, 32 predefiniti, 4 User, 3 HRC, Watt, Fitness test
CLASSE D'UTILIZZO PROFESSIONALE (EN20957-1 / EN957-9 classe S)

BRAKING SYSTEM Ergometer with induction magnetic braking system with 32-level electronic resistance adjuster
PLATFORMS extra large for a comfortable training position
STRIDE LENGTH 560 mm
CONSOLE 10,1" TFT HD touch screen. App pre-installed: Chrome, Facebook, Twitter, Instagram, Youtube, Netflix*, Spotify*, Prime Video*, Kinomap Fitness App*. * Subscription not included. Functions: speed, time, distance, calories, pulse, RPM, Mets, Watt
PROGRAMS Quick start, Target, 32 pre-settati, 4 User, 3 HRC, Watt, Fitness test
COMMERCIAL USE (EN20957-1 / EN957-9 class S)

- Rilevazione cardio: hand pulse. Ricevitore wireless per fascia cardio integrato
- Peso max utilizzatore: 180 kg
- Dotazioni multimediali: Ingresso per lettore MP3, casse acustiche, Bluetooth. Ingresso USB per ricarica dispositivi. Supporto per smartphone/tablet. APP READY 3.0 - Sistema Bluetooth intelligente integrato. Compatibile con Zwift App e Kinomap fitness App (abbonamenti non inclusi).
- Dimensioni prodotto: 2010x940x1860 mm
- Peso: 128 kg

- Heart rate: hand pulse. Built-in wireless pulse receiver.
- Max userweight: 180 kg
- Multimedia equipment: Audio input for MP3 player, stereo loudspeakers, Bluetooth. USB door for devices charging. Smartphone/tablet holder. APP READY 3.0 - Built-in Bluetooth intelligent system. Compatible with Zwift App and Kinomap fitness App (subscription not included).
- Set up size: 2010x940x1860 mm
- Weight: 128 kg

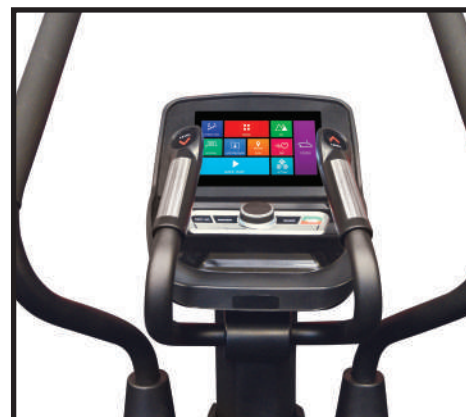

ERX9500

cod. ERX-9500

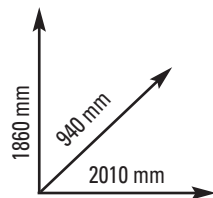

CARDIO - ELLIPTICALS

SISTEMA DI FRENAGGIO Ergometro - magnetico ad induzione e regolazione elettronica dello sforzo su 32 livelli
POGGIAPIEDI extra large per una posizione di allenamento ottimale e confortevole

LUNGHEZZA PASSO 560 mm

CONSOLE 3 display a LED bianco + 1 display con grafico a LED bianco.

Informazioni: tempo, velocità, distanza, calorie, pulsazioni, RPM, Watt

PROGRAMMI 1 libero, 12 predefiniti, 4 user, 1 HRC, Watt, Recovery,

Body fat tester

CLASSE D'UTILIZZO PROFESSIONALE (EN20957-1 / EN957-9 classe S)

BRAKING SYSTEM Ergometer with induction magnetic braking system with 32-level electronic resistance adjuster

PLATFORMS extra large for a comfortable training position

STRIDE LENGTH 560 mm

CONSOLE 3 white LED displays + 1 white LED display with diagram.

Functions: time, speed, distance, calories, pulse, RPM, Watt

PROGRAMMS 1 manual, 12 pre-set, 4 user, 1 HRC, Watt, Recovery,

Body fat tester

COMMERCIAL USE (EN20957-1 / EN957-9 class S)

- Rilevazione cardio: hand pulse. Ricevitore wireless per fascia cardio integrato
- Peso max utilizzatore: 180 kg
- Dimensioni prodotto: 2010x940x1860 mm
- Peso: 115 kg

- Heart rate: hand pulse. Built-in wireless pulse receiver.
- Max userweight: 180 kg
- Set up size: 2010x940x1860 mm
- Weight: 115 kg



ERX9000

cod. ERX-9000

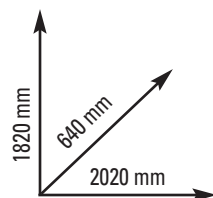

CARDIO - ELLIPTICALS

SISTEMA DI FRENAGGIO Ergometro - magnetico ad induzione e regolazione elettronica dello sforzo su 32 livelli
POGGIAPIEDI extra large per una posizione di allenamento ottimale e confortevole
LUNGHEZZA PASSO 510 mm
CONSOLE 6 display a LED red + 1 display con grafico a LED green.
 Informazioni: tempo, velocità, distanza, calorie, pulsazioni, RPM, Watt
PROGRAMMI 1 libero, 12 predefiniti, 4 user, HRC, Watt
CLASSE D'UTILIZZO PROFESSIONALE (EN20957-1 / EN957-9 classe S)

BRAKING SYSTEM Ergometer with induction magnetic braking system with 32-level electronic resistance adjuster
PLATFORMS extra large for a comfortable training position
STRIDE LENGTH 510 mm
CONSOLE 6 red LED displays + 1 green LED display with diagram.
 Functions: time, speed, distance, calories, pulse, RPM, Watt
PROGRAMS 1 manual, 12 pre-set, 4 user, HRC, Watt
COMMERCIAL USE (EN20957-1 / EN957-9 class S)

- Rilevazione cardio: hand pulse. Ricevitore wireless per fascia cardio integrato
- Peso max utilizzatore: 180 kg
- Dimensioni prodotto: 2020x640x1820 mm
- Peso: 173 kg
- Heart rate: hand pulse. Built-in wireless pulse receiver.
- Max userweight: 180 kg
- Set up size: 2020x640x1820 mm
- Weight: 173 kg



BRXR9500 TFT

cod. BRX-R9500-TFT

App ready 3.0

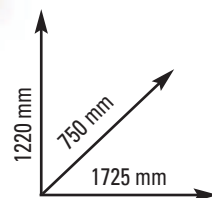
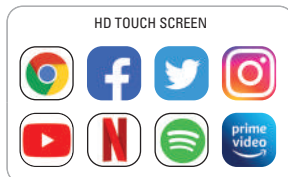

CARDIO - RECUMBENT BIKES

SISTEMA DI FRENAGGIO Ergometro - magnetico ad induzione e regolazione elettronica dello sforzo su 32 livelli
SEDILE regolazione orizzontale. Ampio schienale avvolgente per una posizione di allenamento ottimale e confortevole
PEDALI extra large ed ergonomici per un comfort ottimale
CONSOLE 10,1" TFT HD touch screen. App pre-installate: Chrome, Facebook, Twitter, Instagram, Youtube, Netflix*, Spotify*, Prime Video*, Kinomap Fitness App*. * Abbonamento non incluso. Informazioni: velocità, tempo, distanza, calorie, pulse, RPM, Mets, Watt
PROGRAMMI Quick start, Target, 32 pre-settati, 4 User, 3 HRC, Watt, Fitness test
CLASSE D'UTILIZZO PROFESSIONALE (EN20957-1 / EN957-5 classe S)

BRAKING SYSTEM Ergometer with induction magnetic braking system with 32-level electronic resistance adjuster
SEAT horizontal seat adjustment with ergonomic backrest for a comfortable training position
PEDALS extra large and ergonomic for a great comfort
CONSOLE 10,1" TFT HD touch screen. App pre-installed: Chrome, Facebook, Twitter, Instagram, Youtube, Netflix*, Spotify*, Prime Video*, Kinomap Fitness App*. * Subscription not included. Functions: speed, time, distance, calories, pulse, RPM, Mets, Watt
PROGRAMS Quick start, Target, 32 pre-settati, 4 User, 3 HRC, Watt, Fitness test
COMMERCIAL USE (EN20957-1 / EN957-5 class S)

- Rilevazione cardio: hand pulse. Ricevitore wireless per fascia cardio integrato
- Peso max utilizzatore: 180 kg
- Dotazioni multimediali: accesso facilitato. Ingresso per lettore MP3, casse acustiche, Bluetooth. Ingresso USB per ricarica dispositivi. Supporto per smartphone/tablet. APP READY 3.0 - Sistema Bluetooth intelligente integrato. Compatibile con Zwift App e Kinomap fitness App (abbonamenti non inclusi).
- Dimensioni prodotto: 1725x750x1220 mm
- Peso: 85 kg
- Heart rate: hand pulse. Built-in wireless pulse receiver.
- Max userweight: 180 kg
- Multimedia equipment: easy access. Audio input for MP3 player, stereo loudspeakers, Bluetooth. USB door for devices charging. Smartphone/tablet holder. APP READY 3.0 - Built-in Bluetooth intelligent system. Compatible with Zwift App and Kinomap fitness App (subscription not included)
- Set up size: 1725x750x1220 mm
- Weight: 85 kg



BRXR9500

cod. BRX-R9500

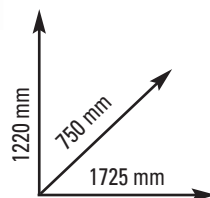

SISTEMA DI FRENAGGIO Ergometro - magnetico ad induzione e regolazione elettronica dello sforzo su 32 livelli
SEDILE regolazione orizzontale. Ampio schienale avvolgente per una posizione di allenamento ottimale e confortevole
PEDALI extra large ed ergonomici per un comfort ottimale
CONSOLE 3 display a LED bianco + 1 display con grafico a LED bianco.
Informazioni: tempo, velocità, distanza, calorie, pulsazioni, RPM, Watt
PROGRAMMI 1 libero, 12 predefiniti, 4 user, 1 HRC, Watt, Recovery, Body fat tester
CLASSE D'UTILIZZO PROFESSIONALE (EN20957-1 / EN957-5 classe S)

BRAKING SYSTEM Ergometer with induction magnetic braking system with 32-level electronic resistance adjuster
SEAT horizontal seat adjustment with ergonomic backrest for a comfortable training position
PEDALS extra large and ergonomic for a great comfort
CONSOLE 3 white LED displays + 1 white LED display with diagram. Functions: time, speed, distance, calories, pulse, RPM, Watt
PROGRAMS 1 manual, 12 pre-set, 4 user, 1 HRC, Watt, Recovery, Body fat tester
COMMERCIAL USE (EN20957-1 / EN957-5 class S)

- Rilevazione cardio: hand pulse. Ricevitore wireless per fascia cardio integrato
- Peso max utilizzatore: 180 kg.
- Dimensioni prodotto: 1725x750x1220 mm
- Peso: 85 kg

- Heart rate: hand pulse. Built-in wireless pulse receiver.
- Max userweight: 180 kg
- Set up size: 1725x750x1220 mm
- Weight: 85 kg



BRXR9000

cod. BRX-R9000

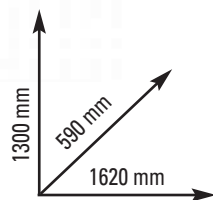

SISTEMA DI FRENAGGIO Ergometro - magnetico ad induzione e regolazione elettronica dello sforzo su 32 livelli
SEDILE regolazione orizzontale. Ampio schienale avvolgente per una posizione di allenamento ottimale e confortevole
PEDALI extra large ed ergonomici per un comfort ottimale
CONSOLE 6 display a LED red + 1 display con grafico a LED green.
Informazioni: tempo, velocità, distanza, calorie, pulsazioni, RPM, Watt
PROGRAMMI 1 libero, 12 predefiniti, 4 user, HRC, Watt
CLASSE D'UTILIZZO PROFESSIONALE (EN20957-1 / EN957-5 classe S)

BRAKING SYSTEM Ergometer with induction magnetic braking system with 32-level electronic resistance adjuster
SEAT horizontal seat adjustment with ergonomic backrest for a comfortable training position
PEDALS extra large and ergonomic for a great comfort
CONSOLE 6 red LED displays + 1 green LED display with diagram.
Functions: time, speed, distance, calories, pulse, RPM, Watt
PROGRAMS 1 manual, 12 pre-set, 4 user, HRC, Watt
COMMERCIAL USE (EN20957-1 / EN957-5 class S)

- Rilevazione cardio: hand pulse. Ricevitore wireless per fascia cardio integrato
- Peso max utilizzatore: 180 kg.
- Dimensioni prodotto: 1620x590x1300 mm
- Peso: 88 kg
- Heart rate: hand pulse. Built-in wireless pulse receiver.
- Max userweight: 180 kg
- Set up size: 1620x590x1300 mm
- Weight: 88 kg

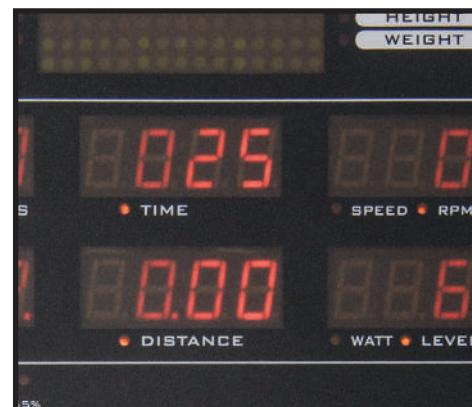

BRX9500 TFT

cod. BRX-9500-TFT

App ready 3.0

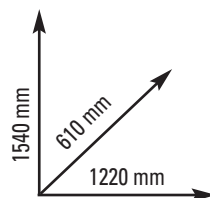
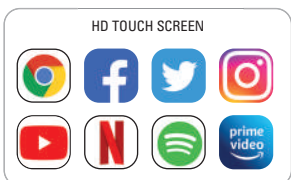

CARDIO - BIKES

SISTEMA DI FRENAGGIO Ergometro - magnetico ad induzione e regolazione elettronica dello sforzo su 32 livelli

PEDALI extra large per una posizione di allenamento ottimale e confortevole
CONSOLE 10,1" TFT HD touch screen. App pre-installate: Chrome, Facebook, Twitter, Instagram, Youtube, Netflix*, Spotify*, Prime Video*, Kinomap Fitness App*. * Abbonamento non incluso. Informazioni: velocità, tempo, distanza, calorie, pulse, RPM, Mets, Watt
PROGRAMMI Quick start, Target, 32 pre-setti, 4 User, 3 HRC, Watt, Fitness test
CLASSE D'UTILIZZO PROFESSIONALE (EN20957-1 / EN957-5 classe S)

BRAKING SYSTEM Ergometer with induction magnetic braking system with 32-level electronic resistance adjuster

PEDALS extra large for a comfortable training position
CONSOLE 10,1" TFT HD touch screen. App pre-installed: Chrome, Facebook, Twitter, Instagram, Youtube, Netflix*, Spotify*, Prime Video*, Kinomap Fitness App*. * Subscription not included. Functions: speed, time, distance, calories, pulse, RPM, Mets, Watt
PROGRAMMS Quick start, Target, 32 pre-set, 4 User, 3 HRC, Watt, Fitness test
COMMERCIAL USE (EN20957-1 / EN957-5 class S)

- Sella EASY FIT SYSTEM sella con regolazione micrometrica orizzontale e verticale. Dotata di dispositivo di sgancio rapido per una regolazione verticale più efficiente e confortevole
- Manubrio multipresa con appoggio ergonomico per avambracci
- Rilevazione cardio: hand pulse. Ricevitore wireless per fascia cardio integrato
- Peso max utilizzatore: 180 kg
- Dotazioni/note: Accesso facilitato. Ingresso per lettore MP3, casse acustiche, Bluetooth. Ingresso USB per ricarica dispositivi. Supporto per smartphone/tablet. APP READY 3.0 - Sistema Bluetooth intelligente integrato. Compatibile con Zwift App e Kinomap fitness App (abbonamenti non inclusi).
- Dimensioni prodotto: 1220x610x1540 mm
- Peso: 68 kg

- Seat EASY FIT SYSTEM seat with horizontal and vertical micrometric adjustment. Equipped with quick release system for a more efficient and comfortable vertical adjustment
- Handlebar multiple handles with ergonomic supports
- Heart rate: hand pulse. Built-in wireless pulse receiver.
- Max userweight: 180 kg
- Equipment/note: Easy access. Audio input for MP3 player, stereo loudspeakers, Bluetooth. USB door for devices charging. Smartphone/tablet holder. APP READY 3.0 - Built-in Bluetooth intelligent system. Compatible with Zwift App and Kinomap fitness App (subscription not included).
- Set up size: 1220x610x1540 mm
- Weight: 68 kg



BRX9500

cod. BRX-9500

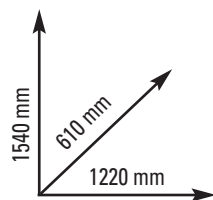

CARDIO - BIKES

SISTEMA DI FRENAGGIO Ergometro - magnetico ad induzione e regolazione elettronica dello sforzo su 32 livelli
PEDALI extra large per una posizione di allenamento ottimale e confortevole
CONSOLE 3 display a LED bianco + 1 display con grafico a LED bianco.
Informazioni: tempo, velocità, distanza, calorie, pulsazioni, RPM, Watt
PROGRAMMI 1 libero, 12 predefiniti, 4 user, 1 HRC, Watt, Recovery, Body fat tester
CLASSE D'UTILIZZO PROFESSIONALE (EN20957-1 / EN957-5 classe S)

BRAKING SYSTEM Ergometer with induction magnetic braking system with 32-level electronic resistance adjuster
PEDALS extra large for a comfortable training position
CONSOLE 3 white LED displays + 1 white LED display with diagram.
Functions: time, speed, distance, calories, pulse, RPM, Watt
PROGRAMS 1 manual, 12 pre-set, 4 user, 1 HRC, Watt, Recovery, Body fat tester
COMMERCIAL USE (EN20957-1 / EN957-5 class S)

- Sella EASY FIT SYSTEM sella con regolazione micrometrica orizzontale e verticale. Dotata di dispositivo di sgancio rapido per una regolazione verticale più efficiente e confortevole
- Manubrio multipresa con appoggio ergonomico per avambracci
- Rilevazione cardio: hand pulse. Ricevitore wireless per fascia cardio integrato
- Peso max utilizzatore: 180 kg
- Dotazioni/note: Accesso facilitato
- Dimensioni prodotto: 1220x610x1540 mm
- Peso: 68 kg
- Seat EASY FIT SYSTEM seat with horizontal and vertical micrometric adjustment. Equipped with quick release system for a more efficient and comfortable vertical adjustment
- Handlebar multiple handles with ergonomic supports
- Heart rate: hand pulse. Built-in wireless pulse receiver.
- Max userweight: 180 kg
- Equipment/note: Easy access
- Set up size: 1220x610x1540 mm
- Weight: 68 kg

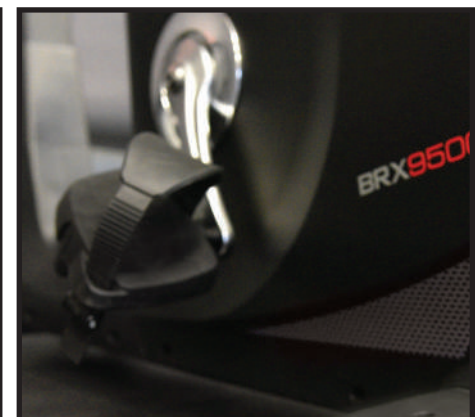

BRX9000

cod. BRX-9000

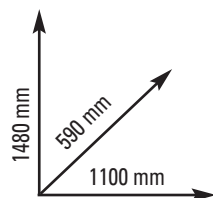

CARDIO - BIKES

SISTEMA DI FRENAGGIO Ergometro - magnetico ad induzione e regolazione elettronica dello sforzo su 32 livelli
SELLA ampia e confortevole con regolazione verticale e orizzontale.
PEDALI extra large ed ergonomici per un comfort ottimale
CONSOLE 6 display a LED red + 1 display con grafico a LED green. Informazioni: tempo, velocità, distanza, calorie, pulsazioni, RPM, Watt
PROGRAMMI 1 libero, 12 predefiniti, 4 user, HRC, Watt
CLASSE D'UTILIZZO PROFESSIONALE (EN20957-1 / EN957-5 classe S)

BRAKING SYSTEM Ergometer with induction magnetic braking system with 32-level electronic resistance adjuster
SEAT vertical and horizontal adjustment for a comfortable training position
PEDALS extra large and ergonomic for a great comfort
CONSOLE 6 red LED displays + 1 green LED display with diagram. Functions: time, speed, distance, calories, pulse, RPM, Watt
PROGRAMS 1 manual, 12 pre-set, 4 user, HRC, Watt
COMMERCIAL USE (EN20957-1 / EN957-5 class S)

- Manubrio multipresa con appoggio ergonomico per avambracci
- Rilevazione cardio: hand pulse. Ricevitore wireless per fascia cardio integrato
- Peso max utilizzatore: 180 kg
- Dimensioni prodotto: 1100x590x1480 mm
- Peso: 70 kg

- Handlebar multiple handles with ergonomic supports
- Heart rate: hand pulse. Built-in wireless pulse receiver.
- Max userweight: 180 kg
- Set up size: 1100x590x1480 mm
- Weight: 70 kg



SRX9000

cod. SRX-9000

COMPUTER E FASCIA CARDIO OPTIONAL
COMPUTER AND CHEST BELT OPTIONAL

COD. CFCSRX-9500



POWER METER PEDALS
KEO SYSTEM OPTIONAL

COD. PMP-KEO



POWER METER PEDALS
SPD SYSTEM OPTIONAL

COD. PMP-SPD

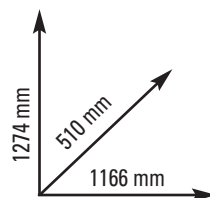

CARDIO - INDOOR CYCLES

SISTEMA DI FRENAGGIO a tampone con feltri in cuoio. Dotato di leva di sicurezza per il bloccaggio rapido del volano.

SISTEMA DI TRASMISSIONE a cinghia

SELLA racing con regolazione verticale e regolazione orizzontale micrometrica

PEDALI a sgancio rapido spd. Pedivella 3 pezzi

CLASSE D'UTILIZZO PROFESSIONALE (EN20957-1 / EN957-5 classe S)

BRAKING SYSTEM long life leather brake pad. Brake button for emergency stop

DRIVE TRAIN belt drive system

SEAT racing saddle with vertical adjustment and micrometrical horizontal adjustment

PEDALS quick cleat retention system spd. Crank: 3 pieces

COMMERCIAL USE (EN20957-1 / EN957-5 class S)

- Manubrio regolazione verticale e regolazione orizzontale micrometrica - con doppio porta borraccia
- Peso max utilizzatore: 150 kg
- Dimensioni prodotto: 1166x510x1274 mm
- Peso: 56 kg

- Handlebar vertical adjustment and micrometrical horizontal adjustment - with double bottle holder
- Max user weight: 150 kg
- Set up size: 1166x510x1274 mm
- Weight: 56 kg

COMPUTER E FASCIA CARDIO **OPTIONAL**
COMPUTER AND CHEST BELT **OPTIONAL**

Informazioni: velocità, distanza, RPM, calorie, pulsazioni, tempo, watt. Dati personali preimpostabili. Fascia cardio con canali di trasmissione BLE, ANT+. Indicatore batteria scarica.

Functions. speed, distance, RPM, calories, pulse, time, watt. Pre-settable data. Chest belt with BLE, ANT+ transmission channel. Low battery indicator



SRX8500

cod. SRX-8500

COMPUTER E FASCIA CARDIO OPTIONAL
COMPUTER AND CHEST BELT OPTIONAL
 COD. CFCSRX-9500



POWER METER PEDALS
KEO SYSTEM OPTIONAL
 COD. PMP-KEO



POWER METER PEDALS
SPD SYSTEM OPTIONAL
 COD. PMP-SPD

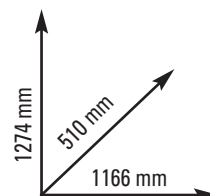

SISTEMA DI FRENAGGIO a tampone con feltri in cuoio. Dotato di leva di sicurezza per il bloccaggio rapido del volano.
 SISTEMA DI TRASMISSIONE a catena
 SELLA racing con regolazione verticale e regolazione orizzontale micrometrica
 PEDALI a sgancio rapido spd. Pedivella 3 pezzi
 CLASSE D'UTILIZZO PROFESSIONALE (EN20957-1 / EN957-5 classe S)
 BRAKING SYSTEM long life leather brake pad. Brake button for emergency stop
 DRIVE TRAIN chain drive system
 SEAT racing saddle with vertical adjustment and micrometrical horizontal adjustment
 PEDALS quick cleat retention system spd. Crank: 3 pieces
 COMMERCIAL USE (EN20957-1 / EN957-5 class S)

- Manubrio regolazione verticale e regolazione orizzontale micrometrica - con doppio porta borraccia
- Peso max utilizzatore: 150 kg
- Dimensioni prodotto: 1166x510x1274 mm
- Peso: 56 kg
- Handlebar vertical adjustment and micrometrical horizontal adjustment - with double bottle holder
- Max user weight: 150 kg
- Set up size: 1166x510x1274 mm
- Weight: 56 kg

COMPUTER E FASCIA CARDIO **OPTIONAL**
 COMPUTER AND CHEST BELT **OPTIONAL**
 Informazioni: velocità, distanza, RPM, calorie, pulsazioni, tempo, watt.
 Dati personali preimpostabili. Fascia cardio con canali di trasmissione BLE, ANT+. Indicatore batteria scarica.

Functions. speed, distance, RPM, calories, pulse, time, watt. Pre-settable data. Chest belt with BLE, ANT+ transmission channel. Low battery indicator



TX-POWER

POWER METER PEDALS KEO SYSTEM

COD. PMP-KEO



CORPO IN ALLUMINIO PRESSOFUSO (Die-Cast), garantisce alta resistenza e longevità

ASSE DEL PEDALE in Cr-Mo (cromo-molibdeno) con lavorazione CNC

CUSCINETTO: con Boccola LSL (Light Self-Lubricating) e Sigillato

ATTACCO (compatibile KEO) in materiale termoplastico, rinforzato con fibra di vetro e tensione regolabile

PROTOCOLLI DI COLLEGAMENTO: ANT+ / BLE 4.0. Consente il collegamento con tutti i devices compatibili con questi protocolli

APPLICAZIONE DI SUPPORTO: Ride for Life, tramite la quale è possibile operare lo "ZERO RESET" del pedale per garantire una perfetta calibrazione

PESO: 218g compreso di batteria

BATTERIA: CR2032, 3V

DURATA BATTERIA: Approssimativamente 100 ore

RESISTENZA ALL'ACQUA: IPX7

MISURA: 97.8mm x 92mm x 42.2mm

DIE-CAST ALUMINIUM BODY, ensuring high strength and longevity

PEDAL AXLE: CNC-machined Cr-Mo (chrome-molybdenum)

BEARING: with LSL bushing (Light Self-Lubricating) and Sealed

KEO CLEATS compatible. Made of thermoplastic material, reinforced with glass fibre and adjustable tension

CONNECTION PROTOCOLS: ANT+ / BLE 4.0. Allows connection with all devices compatible with these protocols

SUPPORTING APPLICATION: Ride for Life, through which you can perform the "ZERO RESET" of the pedal to ensure a perfect calibration

WEIGHT: 218g including battery

BATTERY: CR2032, 3V

BATTERY LIFE: Approx. 100 hours

WATER RESISTANCE: IPX7

DIMENSIONS: 97.8mm x 92mm x 42.2mm

- Misurazione Potenza Totale
- Misurazione media pedale destro e sinistro
- Misurazione indipendente pedale destro e sinistro
- Cadenza (RPM)
- Accuratezza misurazione watt +/- 2.0%
- Compatibilità nativa con ZWIFT
- ANT+ & BLE
- Calibrazione Pre-Attività (Zero Offset)
- Tacchette Keo System comprese
- APP user friendly
- Codice EAN: 8029975809748

- Total Power Measurement
- Average measurement Left and right pedal
- Independent measurement right and left pedal
- Cadence (RPM)
- Watt measurement accuracy +/- 2.0%
- Native compatibility with ZWIFT
- ANT+ & BLE
- Pre-Activity Calibration (Zero Offset)
- Keo System cleats included
- User friendly APP
- EAN code: 8029975809748

SET TX-POWER KEO

COD. PMP-KEO-COMP

Il set comprende una coppia di power meter pedals KEO system e un ciclocomputer d'allenamento per indoor cycling, capace di rilevare tutti i dati emessi dai pedali. Fascia cardio inclusa.

Codice EAN: 8029975810119

The set includes a pair of KEO system power meter pedals and a training computer for indoor cycling, capable of detecting all the data emitted by the pedals. Heart rate monitor included.

EAN code: 8029975810119



TX-POWER

POWER METER PEDALS SPD SYSTEM

COD. PMP-SPD



CORPO IN ALLUMINIO 6061

ASSE DEL PEDALE in Cr-Mo (cromo-molibdeno) con lavorazione CNC

CUSCINETTO: con Boccola LSL (Light Self-Lubricating) e Sigillato

ATTACCO (compatibile SPD) in materiale termoplastico, rinforzato con fibra di vetro e tensione regolabile

PROTOCOLLI DI COLLEGAMENTO: ANT+ / BLE 4.0. Consente il collegamento con tutti i devices compatibili con questi protocolli

APPLICAZIONE DI SUPPORTO: Ride for Life, tramite la quale è possibile operare lo "ZERO RESET" del pedale per garantire una perfetta calibrazione

PESO: 212g compreso di batteria

BATTERIA: CR2032, 3V

DURATA BATTERIA: Approssimativamente 100 ore

RESISTENZA ALL'ACQUA: IPX7

MISURA: 99.15mm x 57.60mm x 40.15mm

ALUMINIUM BODY: 6061

PEDAL AXLE: CNC-machined Cr-Mo (chrome-molybdenum)

BEARING: with LSL (Light Self-Lubricating) bushing and Sealed

LINKAGE (SPD compatible) made of thermoplastic material, reinforced with glass fibre and adjustable tension

CONNECTION PROTOCOLS: ANT+ / BLE 4.0. Allows connection with all devices compatible with these protocols

SUPPORTING APPLICATION: Ride for Life, through which you can perform the "ZERO RESET" of the pedal to ensure a perfect calibration

WEIGHT: 212g including battery

BATTERY: CR2032, 3V

BATTERY LIFE: Approx. 100 hours

WATER RESISTANCE: IPX7

MEASUREMENT: 99.15mm x 57.60mm x 40.15mm

- Misurazione Potenza Totale
- Misurazione media pedale destro e sinistro
- Misurazione indipendente pedale destro e sinistro
- Cadenza (RPM)
- Accuratezza misurazione watt +/- 2.0%
- Compatibilità nativa con ZWIFT
- ANT+ & BLE
- Calibrazione Pre-Attività (Zero Offset)
- Tacchette SPD comprese
- APP user friendly
- Codice EAN: 8029975809755

- Total power measurement
- Average measurement Left and right pedal
- Independent measurement right and left pedal
- Cadence (RPM)
- Watt measurement accuracy +/- 2.0%
- Native compatibility with ZWIFT
- ANT+ & BLE
- Pre-Activity Calibration (Zero Offset) SPD cleats included
- User friendly AP
- EAN code: 8029975809755

SET TX-POWER SPD

COD. PMP-SPD-COMP

Il set comprende una coppia di power meter pedals SPD system e un ciclocomputer d'allenamento per indoor cycling, capace di rilevare tutti i dati emessi dai pedali. Fascia cardio inclusa.

Codice EAN: 8029975810126

The set includes a pair of SPD system power meter pedals and a training computer for indoor cycling, capable of detecting all the data emitted by the pedals. Heart rate monitor included.

EAN code: 8029975810126



STAIR CLIMBER

CLX8000 TFT

cod. CLX-8000-TFT

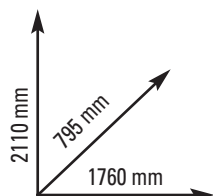
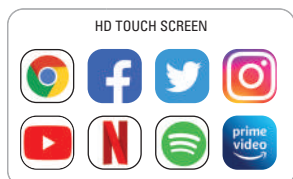

CARDIO - CLIMBER

SISTEMA DI TRASMISSIONE combinato a catene e cinghia sincrona
LIVELLI DI DIFFICOLTÀ 25
VELOCITÀ 22-124 steps/m
CONSOLE 15.6" TFT Touch screen. App pre-installate: Chrome, Facebook, Twitter, Instagram, Youtube, Netflix*, Spotify*, Prime Video*.
* Abbonamento non incluso. Informazioni: pulsazioni, tempo, passi, altezza, calorie, spm, livello di velocità dei passi
PROGRAMMI P1-36 Workout + User | Countdown | Floor Mode
CLASSE D'UTILIZZO PROFESSIONALE (EN20957-1 / EN957-8 classe S)

DRIVE TRAIN synchronized chain and belt drive system
DIFFICULTY LEVELS 25
SPEED 22-124 steps/m
CONSOLE 15.6" TFT Touch screen. App pre-installed: Chrome, Facebook, Twitter, Instagram, Youtube, Netflix*, Spotify*, Prime Video*. * Subscription not included.
Functions: pulse, time, steps, height, calories, spm, step rate level
PROGRAMS P1-36 Workout + User | Countdown | Floor Mode
COMMERCIAL USE (EN20957-1 / EN957-8 class S)

- Manubrio multipresa
- Numero minimo gradini disponibili: 3. Altezza 1° gradino da pedana: 230 mm
Larghezza/ profondità/altezza: 500x245x180 mm
- Rilevazione cardio: hand pulse. Ricevitore wireless per fascia cardio integrato
- Peso max utilizzatore: 180 kg
- Dotazioni/note: tasti e fotocellule d'arresto di emergenza. Ingresso per lettore MP3, casse acustiche, Bluetooth. Ingresso USB. Porta borraccia e smartphone. 2 ruote di trasporto. Design impermeabile al sudore
- Dimensioni prodotto: 1760x795x2110 mm
- Peso: 185 kg

- Handlebar multiple handles
- Minimum numbers of steps available: 3. Height of first step from the platform: 230 mm.
Length/width/height: 500x245x180 mm
- Heart rate: hand pulse. Built-in wireless pulse receiver
- Max user weight: 180 kg
- Equipment/notes: emergency stop button. Audio input for MP3 player, stereo loudspeakers. USB door. Bottle and smartphone holder. 2 moving wheels.
Sweat proof design
- Set up size: 1760x795x2110 mm
- Weight: 185 kg

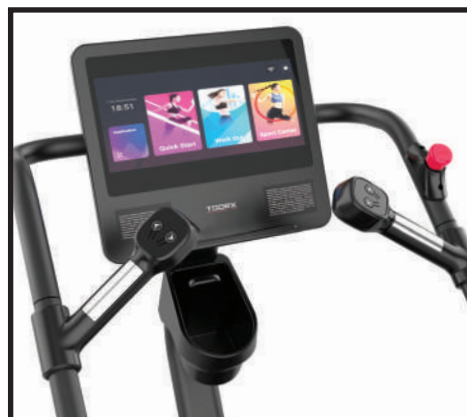

STAIR CLIMBER

CLX8000

cod. CLX-8000

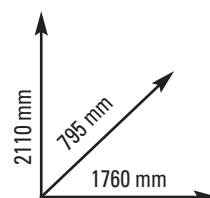

CARDIO - CLIMBER

SISTEMA DI TRASMISSIONE combinato a catene e cinghia sincrona
LIVELLI DI DIFFICOLTÀ 25
VELOCITÀ 22-124 steps/m
CONSOLE 7 display a LED. Informazioni: pulsazioni, tempo, passi, altezza, calorie, spm, livello di velocità dei passi
PROGRAMMI P1-36 +FAT +User |Countdown| Manual-Floor Mode| Cool Down
CLASSE D'UTILIZZO PROFESSIONALE (EN20957-1 / EN957-8 classe S)

DRIVE TRAIN synchronized chain and belt drive system
DIFFICULTY LEVELS 25
SPEED 22-124 steps/m
CONSOLE 7 LED displays. Functions: pulse, time, steps, height, calories, spm, step rate level
PROGRAMS P1-36 +FAT +User |Countdown| Manual-Floor Mode| Cool Down
COMMERCIAL USE (EN20957-1 / EN957-8 class S)

- Manubrio multipresa
- Numero minimo gradini disponibili: 3. Altezza 1° gradino da pedana: 230 mm
Larghezza/ profondità/altezza: 500x245x180 mm
- Rilevazione cardio: hand pulse. Ricevitore wireless per fascia cardio integrato
- Peso max utilizzatore: 180 kg
- Dotazioni/note: tasti e fotocellule d'arresto di emergenza. Ingresso per lettore MP3, casse acustiche, Bluetooth. Ingresso USB. Porta borraccia e smartphone. 2 ruote di trasporto. Design impermeabile al sudore
- Dimensioni prodotto: 1760x795x2110 mm
- Peso: 185 kg

- Handlebar multiple handles
- Minimum numbers of steps available: 3. Height of first step from the platform: 230 mm.
Length/width/height: 500x245x180 mm
- Heart rate: hand pulse. Built-in wireless pulse receiver
- Max user weight: 180 kg
- Equipment/notes: emergency stop button. Audio input for MP3 player, stereo loudspeakers. USB door. Bottle and smartphone holder. 2 moving wheels.
Sweat proof design
- Set up size: 1760x795x2110 mm
- Weight: 185 kg



RACE CROSS PRO

cod. RACE-CROSS-PRO

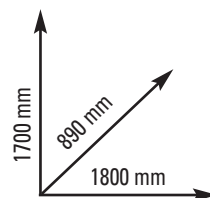

SISTEMA DI FRENAGGIO magnetico su 6 posizioni
PIANO DI CORSA 450 x 1620 mm. Scorrimento su cuscinetti a sfera
CONSOLE 9 display LCD. Informazioni: tempo, distanza, velocità, calorie, pulsazioni, Watt, pace. Inclinazione regolabile
PROGRAMMI interval 20-10, interval 10-20, interval custom, target time, target distance, target calorie, target HR
CLASSE D'UTILIZZO PROFESSIONALE (EN20957-1 / EN957-6 classe S)

BRAKING SYSTEM magnetic with 6-level of resistance adjustment
RUNNING BOARD 450 x 1620 mm. Sliding on ball bearing
CONSOLE LCD 9 LCD displays. Functions: time, distance, speed, calories, pulse, Watt, pace. Adjustable incline
PROGRAMS interval 20-10, interval 10-20, interval custom, target time, target distance, target calorie, target HR
COMMERCIAL USE (EN20957-1 / EN957-6 class S)

- Rilevazione cardio: ricevitore wireless per fascia cardio integrato. Fascia cardio inclusa
- Manubrio multipresa. Maniglie di spinta con inclinazione regolabile
- Peso max utilizzatore: 180 kg
- Dotazioni: porta borraccia
- Dimensioni prodotto: 1800x890x1700 mm
- Peso: 162 kg

- Heart rate: built-in wireless pulse receiver. Chest belt included
- Multiple handles. Push handles with adjustable incline
- Max userweight: 180 kg
- Equipment: bottle holder
- Set up size: 1800x890x1700 mm
- Weight: 162 kg



RACE CROSS

cod. RACE-CROSS

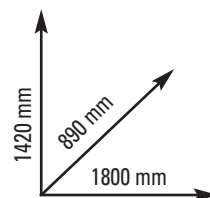

PIANO DI CORSA 450x 1620 mm. Scorrimento su cuscinetti a sfera
CONSOLE 9 display LCD. Informazioni: tempo, distanza, velocità, calorie, pulsazioni, Watt, pace. Inclinazione regolabile
PROGRAMMI interval 20-10, interval 10-20, interval custom, target time, target distance, target calorie, target HR
CLASSE D'UTILIZZO PROFESSIONALE (EN20957-1 / EN957-6 classe S)

RUNNING BOARD 450 x 1620 mm. Sliding on ball bearing
CONSOLE LCD 9 LCD displays. Functions: time, distance, speed, calories, pulse, Watt, pace. Adjustable incline
PROGRAMS interval 20-10, interval 10-20, interval custom, target time, target distance, target calorie, target HR
COMMERCIAL USE (EN20957-1 / EN957-6 class S)

- Rilevazione cardio: ricevitore wireless per fascia cardio integrato. Fascia cardio inclusa
- Peso max utilizzatore: 180 kg
- Dotazioni: porta borraccia
- Dimensioni prodotto: 1800x890x1420 mm
- Peso: 155 kg
- Heart rate: built-in wireless pulse receiver. Chest belt included
- Max userweight: 180 kg
- Equipment: bottle holder
- Set up size: 1800x890x1420 mm
- Weight: 155 kg



BRX AIRMAG 7000

cod. BRX-AIRMAG-7000

App ready



COMPATIBILE CON
COMPATIBLE WITH



wahoo

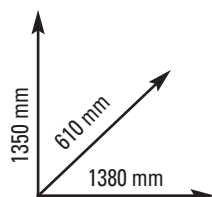

SISTEMA DI FRENAGGIO ad aria e magnetico per un movimento estremamente fluido e scorrevole e un allenamento diversificato
REGOLAZIONE SFORZO ad aria dal livello 1 al livello 10, ad aria+magnetico dal livello 11 al livello 32

SELLA regolazione verticale micrometrica

CONSOLE display LCD - supporto per smartphone e tablet in dotazione.

Informazioni console: RPM, pulsazioni, distanza, distanza/30 min, level, Cycle, velocità, Watts, Watts AVG, tempo, tempo/1km, tempo AVG, data, calorie/hr, memory

PROGRAMMI quick start, time, distance, calories, 3 interval

CLASSE D'UTILIZZO PROFESSIONALE (EN20957-1 / EN957-5 classe S)

BRAKING SYSTEM the air and magnetic resistance system grants a real smooth feeling and a more diverse workout

RESISTANCE ADJUSTMENT air resistance from level 1-10, air+magnetic resistance from level 11-32

SEAT micrometrical vertical adjustment

CONSOLE LCD display - smartphone/ tablet holder included.

Functions: RPM, pulse, distance, distance/30 min, level, cycle, speed, Watts, Watts AVG, time, time/1km, time AVG, date, Calories/hr, memory

PROGRAMS quick start, time, distance, calories, 3 interval

COMMERCIAL USE (EN20957-1 / EN957-5 class S)

- Manubrio: regolazione micrometrica verticale e orizzontale
- Trasmissione a cinghia
- Rilevazione cardio: ricevitore wireless per fascia cardio integrato
- Peso max utilizzatore: 135 kg
- Dotazioni: porta borraccia. Supporto per smartphone e tablet.
- App Ready FTMS: sistema Bluetooth intelligente integrato che consente di usufruire di app specifiche per l'allenamento. Compatibile con Kinomap, Zwift App e tutte le app che utilizzano il protocollo Bluetooth® FTMS (BKool, Rouvy, Wahoo, Fulgaz...). Abbonamenti non inclusi.
- Dimensioni prodotto: 1380x610x1350 mm
- Peso: 42,4 kg

- Handlebar: micrometrical vertical and horizontal adjustment
- Rubber belt
- Heart rate: built-in wireless pulse receiver
- Max userweight: 135 kg
- Equipment: bottle holder. Smartphone/ tablet holder. App Ready FTMS: Built-in Bluetooth intelligent system which enables your machine to fully interact with the most motivating Apps specifically suitable for training. Compatible with Kinomap, Zwift App and all the Apps that use the Bluetooth® FTMS protocol (BKool, Rouvy, Wahoo, Fulgaz...). Subscriptions not included.
- Set up size: 1380x610x1350 mm
- Weight: 42,4 kg



RWX AIRMAG 7000

cod. RWX-AIRMAG-7000

App ready

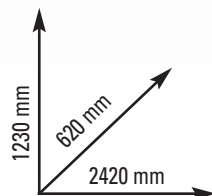

SISTEMA DI FRENAGGIO ad aria e magnetico per un movimento estremamente fluido e scorrevole e un allenamento diversificato
 REGOLAZIONE SFORZO ad aria dal livello 1 al livello 10, ad aria+magnetico dal livello 11 al livello 16
 SEDILE a rulli con cuscinetti a sfera su binario in alluminio
 POGGIAPIEDI ergonomici con lunghezza regolabile
 CONSOLE display LCD - inclinazione regolabile
 Informazioni: numero vogate/min, calorie, tempo, distanza, distanza/30 min, distanza/vogata, level, tempo/500 mt, data, pulsazioni, memory
 PROGRAMMI quick start, time, distance, calories, 3 interval
 CLASSE D'UTILIZZO PROFESSIONALE (EN20957-1 / EN957-7 classe S)
 BRAKING SYSTEM the air and magnetic resistance system grants a real smooth feeling and a more diverse workout
 RESISTANCE ADJUSTMENT air resistance from level 1-10, air+magnetic resistance from level 11-16
 SEAT with roller bearings sliding on aluminum rail
 PEDALS ergonomic with length adjuster
 CONSOLE LCD display - adjustable incline
 Functions: strokes/min, calories, time, distance, distance/30 min, paddle width, level, time/500m, date, pulse, memory
 PROGRAMS quick start, time, distance, calories, 3 interval
 COMMERCIAL USE (EN20957-1 / EN957-7 class S)

- Trasmissione a catena
 - Rilevazione cardio: ricevitore wireless per fascia cardio integrato
 - Peso max utilizzatore: 150 kg
 - Dotazioni: supporto per smartphone e tablet.
- App Ready FTMS: sistema Bluetooth intelligente integrato che consente di usufruire di app specifiche per l'allenamento. Compatibile con Kinomap e tutte le app che utilizzano il protocollo Bluetooth® FTMS (EXR, HOLOFIT...).
- Abbonamenti non inclusi.
- Dimensioni prodotto: 2420x620x1230 mm
 - Peso: 52 kg
-
- Drive train chain
 - Heart rate: built-in wireless pulse receiver
 - Max userweight: 150 kg
 - Equipment: smartphone/tablet holder. App Ready FTMS: Built-in Bluetooth intelligent system which enables your machine to fully interact with the most motivating Apps specifically suitable for training. Compatible with Kinomap and all the Apps that use the Bluetooth® FTMS protocol (EXR, HOLOFIT...).
- Subscriptions not included.
- Set up size 2420x620x1230 mm
 - Weight: 52 kg



SKX AIRMAG 7000

cod. SKX-AIRMAG-7000

App ready



COMPATIBILE CON
COMPATIBLE WITH



Kinomap



cod. SKX-AIRMAG-7000 +
cod. PED-SKX-SKI-CROSS

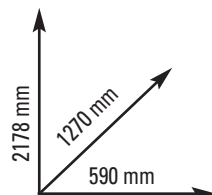

SISTEMA DI FRENAGGIO ad aria e magnetico per un movimento estremamente fluido e scorrevole e un allenamento diversificato
 REGOLAZIONE SFORZO ad aria dal livello 1 al livello 10, ad aria+magnetico dal livello 11 al livello 16
 PEDANA per utilizzo autoportante optional
 CONSOLE display LCD - inclinazione regolabile
 Informazioni: numero vogate/min, calorie, tempo, distanza, distanza/30 min, distanza/vogata, level, tempo/500 mt, data, pulsazioni, memory
 PROGRAMMI quick start, time, distance, calories, 3 interval
 CLASSE D'UTILIZZO PROFESSIONALE (EN20957-1 / EN957-7 classe S)
 BRAKING SYSTEM the air and magnetic resistance system grants a real smooth feeling and a more diverse workout
 RESISTANCE ADJUSTMENT air resistance from level 1-10, air+magnetic resistance from level 11-16
 PLATFORM kit for standalone use - optional
 CONSOLE LCD display - adjustable incline
 Functions: strokes/min, calories, time, distance/30 min, paddle width, level, time/500m, date, pulse, memory
 PROGRAMS quick start, time, distance, calories, 3 interval
 COMMERCIAL USE (EN20957-1 / EN957-7 class S)

- Rilevazione cardio: ricevitore wireless per fascia cardio integrato
- Dotazioni: sistema di cavi in Dyneema con rivestimento ultra resistente. Maniglie ergonomiche con sistema di rotazione di 180°. L'utilizzo dello Ski Trainer richiede il fissaggio a muro o ad una gabbia tramite specifiche staffe. Supporto per smartphone e tablet. App Ready FTMS: sistema Bluetooth intelligente integrato che consente di usufruire di app specifiche per l'allenamento. Compatibile con Kinomap e tutte le app che utilizzano il protocollo Bluetooth® FTMS . Abbonamenti non inclusi.
- Dimensioni prodotto: 590x1270x2178 mm
- Peso: 43,6 kg
- Heart rate: built-in wireless pulse receiver
- Equipment: heavy-duty cables system made in Dyneema with high resistance coating. Ergonomic handles with non-sweat surface and 180° rotating system. Fixing to the wall or to rigs through specific brackets is required. Smartphone/ tablet holder. App Ready FTMS: Built-in Bluetooth intelligent system which enables your machine to fully interact with the most motivating Apps specifically suitable for training. Compatible with Kinomap and all the Apps that use the Bluetooth® FTMS protocol. Subscriptions not included.
- Set up size 590x1270x2178 mm
- Weight: 43,6 kg

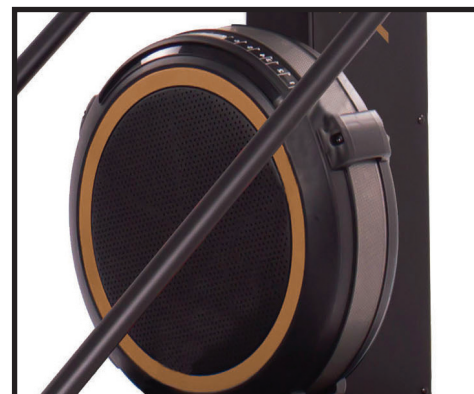

BRX AIR 5000

cod. BRX-AIR-5000

App ready

COMPATIBILE CON
COMPATIBLE WITH

wahoo

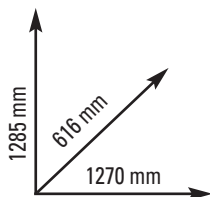

SISTEMA DI FRENAGGIO ad aria per un movimento estremamente fluido e scorrevole

REGOLAZIONE SFORZO su 10 livelli

SELLA regolazione verticale e orizzontale micrometrica

CONSOLE display LCD retro-illuminato blue backlight

Informazioni console: RPM, pulsazioni, distanza, Level, Cycle, velocità, Watts, Watts AVG, tempo, tempo/1km, Calorie/hr

PROGRAMMI game, time, distanza, calorie, 3 interval (serie selezionabili da 1 a 99), user

CLASSE D'UTILIZZO PROFESSIONALE (EN20957-1 / EN957-5 classe S)

BRAKING SYSTEM the air resistance system grants a real smooth feeling

RESISTANCE ADJUSTMENT 10-level

SEAT micrometrical vertical and horizontal adjustment

CONSOLE LCD display blue backlight

Functions: RPM, Pulse, Distance, Level, Cycle, Speed, Watts, Watts AVG, Time, Time/1km, Calories/hr

PROGRAMS game, time, distance, calories, 3 interval (1-99 cycles), user

COMMERCIAL USE (EN20957-1 / EN957-5 class S)

- Trasmissione a cinghia
- Rilevazione cardio: ricevitore wireless per fascia cardio integrato
- Peso max utilizzatore: 150 kg
- Dotazioni: porta borraccia. Supporto per smartphone e tablet. App Ready FTMS: sistema Bluetooth intelligente integrato che consente di usufruire di app specifiche per l'allenamento. Compatibile con Kinomap, Zwift App e tutte le app che utilizzano il protocollo Bluetooth® FTMS (BKool, Rouvy, Wahoo, Fulgaz...). Abbonamenti non inclusi.
- Dimensioni prodotto: 1270x616x1285 mm
- Peso: 45 kg
- Rubber belt
- Heart rate: built-in wireless pulse receiver.
- Max userweight: 150 kg
- Equipment: bottle holder. Smartphone/ tablet holder. App Ready FTMS: Built-in Bluetooth intelligent system which enables your machine to fully interact with the most motivating Apps specifically suitable for training. Compatible with Kinomap, Zwift App and all the Apps that use the Bluetooth® FTMS protocol (BKool, Rouvy, Wahoo, Fulgaz...). Subscriptions not included.
- Set up size: 1270x616x1285 mm
- Weight: 45 kg



RWX AIR 5000

cod. RWX-AIR-5000

App ready

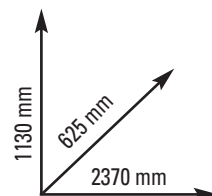

SISTEMA DI FRENAGGIO ad aria per un movimento estremamente fluido e scorrevole
 REGOLAZIONE SFORZO su 10 livelli
 SEDILE a rulli con cuscinetti a sfera su binario in alluminio
 POGGIAPIEDI ergonomici con lunghezza regolabile
 CONSOLE display LCD retro-illuminato blue backlight - inclinazione regolabile. Informazioni: numero vogate/min, calorie, tempo, distanza, distanza/vogata, tempo/500 mt, pulsazioni
 PROGRAMMI game, time, distanza, calorie, 3 interval (serie selezionabili da 1 a 99), user
 CLASSE D'UTILIZZO PROFESSIONALE (EN20957-1 / EN957-7 classe S)
 BRAKING SYSTEM the air resistance system grants a real smooth feeling
 RESISTANCE ADJUSTMENT 10-level
 SEAT with roller bearings sliding on aluminum rail
 PEDALS ergonomic with length adjuster
 CONSOLE LCD display blue backlight - adjustable incline
 Functions: strokes/min, calories, time, distance, paddle width, time/500m, pulse
 PROGRAMS game, time, distance, calories, 3 interval (1-99 cycles), user
 COMMERCIAL USE (EN20957-1 / EN957-7 class S)

- Trasmissione a catena
- Rilevazione cardio: ricevitore wireless per fascia cardio integrato
- Peso max utilizzatore: 150 kg
- Dotazioni: supporto per smartphone e tablet. App Ready FTMS: sistema Bluetooth intelligente integrato che consente di usufruire di app specifiche per l'allenamento. Compatibile con Kinomap e tutte le app che utilizzano il protocollo Bluetooth® FTMS (EXR, HOLOFIT...). Abbonamenti non inclusi.
- Dimensioni prodotto: 2370x625x1130 mm
- Peso: 52 kg
- Drive train chain
- Heart rate: built-in wireless pulse receiver
- Max userweight: 150 kg
- Equipment: smartphone/tablet holder. App Ready FTMS: Built-in Bluetooth intelligent system which enables your machine to fully interact with the most motivating Apps specifically suitable for training. Compatible with Kinomap and all the Apps that use the Bluetooth® FTMS protocol (EXR, HOLOFIT...). Subscriptions not included.
- Set up size 2370x625x1130 mm
- Weight: 52 kg



SKX AIR 5000

SKX-AIR-5000

App ready

COMPATIBILE CON
COMPATIBLE WITH

Kinomap



cod. SKX-AIR-5000 +
cod. PED-SKX-AIR-5000

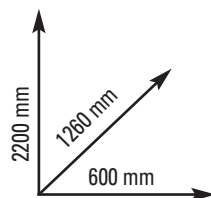

CROSSTRAINING & FUNCTIONAL CARDIO

SISTEMA DI FRENAGGIO ad aria per un movimento estremamente fluido e scorrevole
 REGOLAZIONE SFORZO su 10 livelli
 PEDANA per utilizzo autoportante optional
 CONSOLE display LCD retro-illuminato blu backlight - inclinazione regolabile.
 Informazioni console: media vogate, tempo/500 m, AVG, tempo/500m, pulsazioni, distanza, Watt AVG
 PROGRAMMI quick start, tempo / distanza / calorie (countdown), game, 3 interval (serie selezionabili da 1 a 99)
 CLASSE D'UTILIZZO PROFESSIONALE (EN20957-1 / EN957-7 classe S)
 BRAKING SYSTEM the air resistance system grants a real smooth feeling
 RESISTANCE ADJUSTMENT 10-level
 PLATFORM kit for standalone use - optional
 CONSOLE display blue backlight - adjustable incline.
 Functions: strokes rate, time /500m AVG, time /500m, pulse, distance, Watt AVG
 PROGRAMS quick start, time/ distance / calories (countdown), game, 3 interval (1-99 cycles)
 COMMERCIAL USE (EN20957-1 / EN957-7 class S)

- Rilevazione cardio: ricevitore wireless per fascia cardio integrato
- Dotazioni: sistema di cavi in Dyneema con rivestimento ultra resistente. Maniglie ergonomiche con sistema di rotazione di 180°. L'utilizzo dello Ski Trainer richiede il fissaggio a muro o ad una gabbia tramite specifiche staffe. Supporto per smartphone e tablet. App Ready FTMS: sistema Bluetooth intelligente integrato che consente di usufruire di app specifiche per l'allenamento. Compatibile con Kinomap e tutte le app che utilizzano il protocollo Bluetooth® FTMS. Abbonamenti non inclusi.
- Dimensioni prodotto: 600x1260x2200 mm
- Peso: 40 kg
- Heart rate: built-in wireless pulse receiver
- Equipment: heavy-duty cables system made in Dyneema with high resistance coating. Ergonomic handles with non-sweat surface and 180° rotating system. Fixing to the wall or to rigs through specific brackets is required. Smartphone/ tablet holder. App Ready FTMS: Built-in Bluetooth intelligent system which enables your machine to fully interact with the most motivating Apps specifically suitable for training. Compatible with Kinomap and all the Apps that use the Bluetooth® FTMS protocol. Subscriptions not included.
- Set up size 600x1260x2200 mm
- Weight: 40 kg



BRX AIR CROSS PRO

cod. BRX-AIRCROSS-PRO

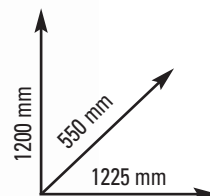

SISTEMA DI FRENAGGIO ad aria con 10 pale radiali
REGOLAZIONE SFORZO dipendente dalla resistenza dell'aria
SELLA regolazione verticale su 5 livelli e regolazione orizzontale su 9 livelli
CONSOLE display LCD retro-illuminato blue backlight - supporto per smartphone e tablet in dotazione.
Informazioni console: RPM, velocità, tempo, distanza, calorie, watt, pulsazioni
PROGRAMMI programma Manuale, programmi Target :tempo, distanza, calorie, pulsazioni. 3 programmi a Intervalli: 10/20, 20/10, Custom
CLASSE D'UTILIZZO PROFESSIONALE (EN20957-1 / EN957-5 classe S)

BRAKING SYSTEM air resistance system with 10 radial blades
RESISTANCE ADJUSTMENT dependent on the air resistance
SEAT vertical adjustment on 5-level and horizontal adjustment on 9-level
CONSOLE LCD display blue backlight - smartphone/ tablet holder included.
Functions: RPM, speed, time, distance, calories, watt, pulse
PROGRAMS Manual, Target programs: time, calories, distance, pulse, 3 Interval programs: 10/20, 20/10, Custom
COMMERCIAL USE (EN20957-1 / EN957-5 class S)

- Trasmissione a cinghia
- Rilevazione cardio: ricevitore wireless per fascia cardio integrato
- Peso max utilizzatore: 150 kg
- Dotazioni: porta borraccia
- Dimensioni prodotto: 1225x550x1200 mm
- Peso: 72 kg

- Drive train belt
- Heart rate: built-in wireless pulse receiver.
- Max userweight: 150 kg
- Equipment: bottle holder
- Set up size: 1225x550x1200 mm
- Weight: 72 kg



BRX AIR CROSS

cod. BRX-AIR-CROSS

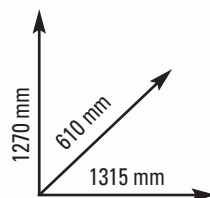

SISTEMA DI FRENAGGIO ad aria con 7 pale radiali
REGOLAZIONE SFORZO dipendente dalla resistenza dell'aria
SELLA regolazione verticale e regolazione orizzontale micrometrica
POGGIPIEDI extra large/3 pezzi
CONSOLE display LCD - supporto per smartphone e tablet in dotazione.
Informazioni console: tempo, distanza, calorie, velocità, RPM, pulsazioni, watt
PROGRAMMI Programma Manuale, Programmi Target: Tempo, Distanza, Calorie, Pulsazioni, 3 Programmi a Intervalli: 10/20, 20/10, Custom
CLASSE D'UTILIZZO PROFESSIONALE (EN20957-1 / EN957-5 classe S)

BRAKING SYSTEM air resistance system with 7 radial blades
RESISTANCE ADJUSTMENT dependent on the air resistance
SEAT vertical adjustment and horizontal micrometric adjustment
PEDALS extra large/3 pieces
CONSOLE LCD display - smartphone/tablet holder included. Functions: time, distance, calories, speed, pulse, RPM, pulsazioni, watt
PROGRAMS Manual, Target programs: Time, Calories, Distance, Pulse, 3 Interval programs: 10/20, 20/10, Custom
COMMERCIAL USE (EN20957-1 / EN957-5 class S)

- Trasmissione a cinghia e a catena
- Rilevazione cardio: ricevitore wireless per fascia cardio integrato
- Peso max utilizzatore: 150 kg
- Dotazioni: porta borraccia
- Dimensioni prodotto: 1315x610x1270 mm
- Peso: 53,5 kg

- Drive train chain and belt
- Heart rate: built-in wireless pulse receiver.
- Max userweight: 150 kg
- Equipment: bottle holder
- Set up size: 1315x610x1270 mm
- Weight: 53,5 kg



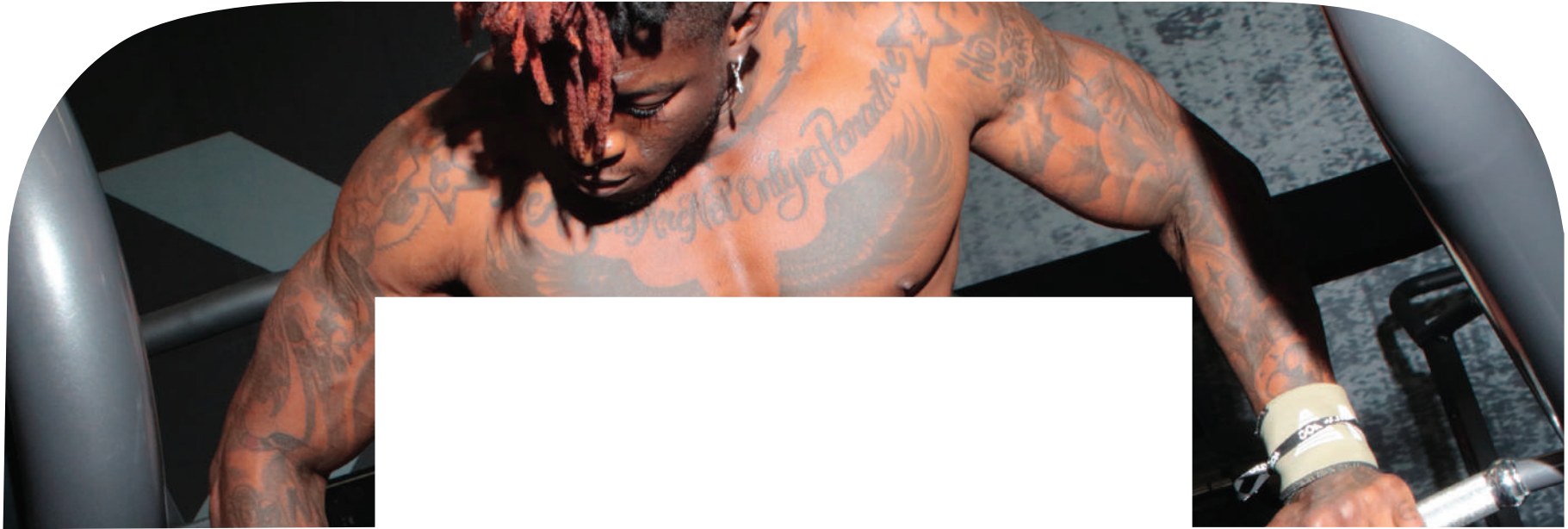

STRENGTH



**PIN LOADED
ABSOLUTE LINE**

PLX8000

cod. PLX-8000

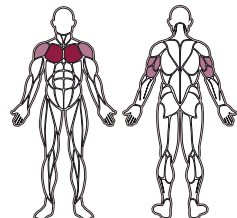

MUSCOLI COINVOLTI MUSCLE GROUPS

- Pettorali - Pectorals
- Tricipiti - Triceps
- Deltoide anteriore - Anterior deltoid

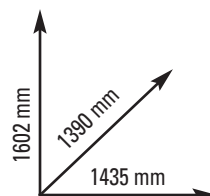

SISTEMA DI SPINTA a leveraggi indipendenti
 PACCO PESI 100 kg in acciaio. Carter di protezione integrale
 REGOLAZIONI: altezza sedile su 18 posizioni
 DIMENSIONI PRODOTTO: 1435x1390x1602 mm
 PESO MAX UTILIZZATORE 120 Kg
 PESO: 226 kg
 CLASSE D'UTILIZZO PROFESSIONALE (EN20957-1 / EN957-2 classe S)

INDEPENDENT PUSH leverage system
 WEIGHT STACK steel 100 kg weight stack with full protection cage
 ADJUSTMENTS: seat height on 18-level
 SET UP SIZE: 1435x1390x1602 mm
 MAX USER WEIGHT 120 Kg
 WEIGHT: 226 kg
 COMMERCIAL USE (EN20957-1 / EN957-2 class S)

- Struttura tubolare in acciaio a sezione ovale 50x100 mm - spessore 3 mm e rotonda ø 60 mm - spessore 3 mm
- Verniciatura doppia a polveri epossidiche, antigraffio. Trattamento dei tubolari con sabbatura e fosfatazione
- Sistema di carrucole/pullegge realizzate in POM, materiale con ottime caratteristiche di scorrimento ed eccellente resistenza all'usura - cuscinetti PREMIUM GRADE
- Sistema di cavi in acciaio ø 5 mm carico massimo 1500 kg.
- Cuscini in schiuma ad alta densità con rivestimento in PU
- Regolazione della seduta a cremagliera assistita da molla a gas
- Pedale di precarico

- Structure oval flat heavy-duty steel tubing oval 50x100 mm - thickness 3 mm and round ø 60 mm - thickness 3 mm.
- Painting double heavy duty powder coating painting, scratch-resistant. Tubing treatment with sandblasting and phosphating process.
- Pulley system made of POM, a very stiff material with low surface friction and good dimensional stability - PREMIUM GRADE bearings
- Cables system steel woven cables ø5 mm, max. loadable weight 1500 kg
- High-density foam cushions with PU upholstery
- Rack seat adjustment system assisted by gas spring
- Preloaded pedal



PLX8100

cod. PLX-8100

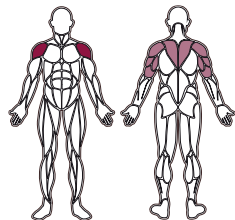

MUSCOLI COINVOLTI MUSCLE GROUPS

- Deltoide anteriore - Anterior deltoid
- Deltoide posteriore - Posterior deltoid
- Tricipiti - Triceps
- Trapezi - Trapezius

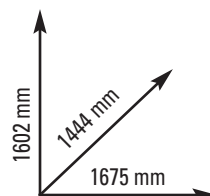

SISTEMA DI SPINTA a leveraggi indipendenti
 PACCO PESI 100 kg in acciaio. Carter di protezione integrale
 REGOLAZIONI: altezza sedile su 18 posizioni, inclinazione schienale su 5 posizioni
 DIMENSIONI PRODOTTO: 1675x1444x1602 mm
 PESO MAX UTILIZZATORE 120 Kg
 PESO: 252 kg
 CLASSE D'UTILIZZO PROFESSIONALE (EN20957-1 / EN957-2 classe S)

INDEPENDENT PUSH leverage system
 WEIGHT STACK steel 100 kg weight stack with full protection cage
 ADJUSTMENTS: seat height on 18-level, backrest incline on 5-level
 SET UP SIZE: 1675x1444x1602 mm
 MAX USER WEIGHT 120 Kg
 WEIGHT: 252 kg
 COMMERCIAL USE (EN20957-1 / EN957-2 class S)

- Struttura tubolare in acciaio a sezione ovale 50x100 mm - spessore 3 mm e rotonda ø 60 mm - spessore 3 mm
- Verniciatura doppia a polveri epossidiche, antigraffio. Trattamento dei tubolari con sabbiatura e fosfatazione
- Sistema di carrucole/pullegge realizzate in POM, materiale con ottime caratteristiche di scorrimento ed eccellente resistenza all'usura - cuscinetti PREMIUM GRADE
- Sistema di cavi in acciaio ø 5 mm carico massimo 1500 kg
- Cuscini in schiuma ad alta densità con rivestimento in PU
- Regolazione della seduta a cremagliera assistita da molla a gas
- Structure oval flat heavy-duty steel tubing oval 50x100 mm - thickness 3 mm and round ø 60 mm - thickness 3 mm.
- Painting double heavy duty powder coating painting, scratch-resistant. Tubing treatment with sandblasting and phosphating process.
- Pulley system made of POM, a very stiff material with low surface friction and good dimensional stability - PREMIUM GRADE bearings
- Cables system steel woven cables ø5 mm, max. loadable weight 1500 kg
- High-density foam cushions with PU upholstery
- Rack seat adjustment system assisted by gas spring

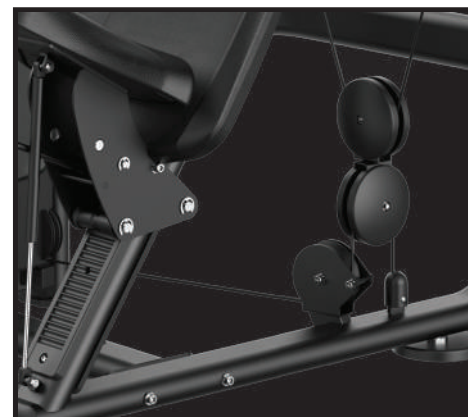

PLX8200

cod. PLX-8200

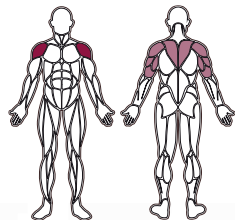

MUSCOLI COINVOLTI MUSCLE GROUPS

- Deltoido anteriore - Anterior deltoid
- Deltoido posteriore - Posterior deltoid
- Tricipiti - Triceps
- Trapezi - Trapezius

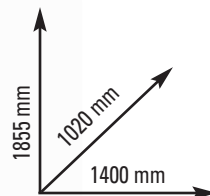

SISTEMA DI TIRO a doppio avvolgimento
 PACCO PESI 90 kg in acciaio. Carter di protezione integrale
 REGOLAZIONI: rotazione bracci di caricamento su 13 posizioni, altezza bracci di caricamento su 14 posizioni
 DIMENSIONI PRODOTTO: 1400x1020x1855 mm
 PESO MAX UTILIZZATORE 120 Kg
 PESO: 261 kg
 CLASSE D'UTILIZZO PROFESSIONALE (EN20957-1 / EN957-2 classe S)

DOUBLE WINDING PULL system
 WEIGHT STACK steel 90 kg weight stack with full protection cage
 ADJUSTMENTS: arms rotation on 13-level, arms height on 14-level
 SET UP SIZE: 1400x1020x1855 mm
 MAX USER WEIGHT 120 Kg
 WEIGHT: 261 kg
 COMMERCIAL USE (EN20957-1 / EN957-2 class S)

- Struttura tubolare in acciaio a sezione ovale 50x100 mm - spessore 3 mm e rotonda ø 60 mm - spessore 3 mm
 - Verniciatura doppia a polveri epossidiche, antigraffio. Trattamento dei tubolari con sabbatura e fosfatazione
 - Sistema di carrucole/pullegge realizzate in POM, materiale con ottime caratteristiche di scorrimento ed eccellente resistenza all'usura - cuscinetti PREMIUM GRADE
 - Sistema di cavi in acciaio ø 5 mm carico massimo 1500 kg
 - Cuscini in schiuma ad alta densità con rivestimento in PU
 - Regolazione della seduta a cremagliera assistita da molla a gas
- Structure oval flat heavy-duty steel tubing oval 50x100 mm - thickness 3 mm and round ø 60 mm - thickness 3 mm.
 - Painting double heavy duty powder coating painting, scratch-resistant. Tubing treatment with sandblasting and phosphating process.
 - Pulley system made of POM, a very stiff material with low surface friction and good dimensional stability - PREMIUM GRADE bearings
 - Cables system steel woven cables ø5 mm, max. loadable weight 1500 kg
 - High-density foam cushions with PU upholstery
 - Rack seat adjustment system assisted by gas spring



PLX8300

cod. PLX-8300

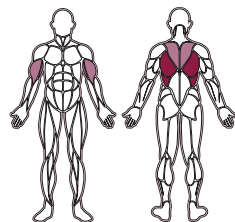
**MUSCOLI COINVOLTI
MUSCLE GROUPS**

- Gran dorsale - Latissimus dorsi
- Bicipiti - Biceps
- Romboidi - Rhomboids
- Trapezio inferiore - Lower trapezius

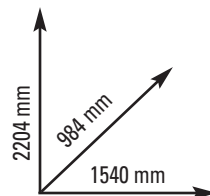

SISTEMA DI TIRO a vettore singolo
 PACCO PESI 100 kg in acciaio. Carter di protezione integrale
 REGOLAZIONI: rulli di bloccaggio gambe su 4 posizioni
 DIMENSIONI PRODOTTO: 1540x984x2204 mm
 PESO MAX UTILIZZATORE 120 Kg
 PESO: 212 kg
 CLASSE D'UTILIZZO PROFESSIONALE (EN20957-1 / EN957-2 classe S)

SINGLE VECTOR PUSH system
 WEIGHT STACK steel 100 kg weight stack with full protection cage
 ADJUSTMENTS: leg press rollers on 4-level
 SET UP SIZE: 1540x984x2204 mm
 MAX USER WEIGHT 120 Kg
 WEIGHT: 212 kg
 COMMERCIAL USE (EN20957-1 / EN957-2 class S)

- Struttura tubolare in acciaio a sezione ovale 50x100 mm - spessore 3 mm e rotonda ø 60 mm - spessore 3 mm
- Verniciatura doppia a polveri epossidiche, antigraffio. Trattamento dei tubolari con sabbatura e fosfatazione
- Sistema di carrucole/pulegge realizzate in POM, materiale con ottime caratteristiche di scorrimento ed eccellente resistenza all'usura - cuscinetti PREMIUM GRADE
- Sistema di cavi in acciaio ø 5 mm carico massimo 1500 kg
- Cuscini in schiuma ad alta densità con rivestimento in PU
- Accessori di serie: barra lat

- Structure oval flat heavy-duty steel tubing oval 50x100 mm - thickness 3 mm and round ø 60 mm - thickness 3 mm.
- Painting double heavy duty powder coating painting, scratch-resistant. Tubing treatment with sandblasting and phosphating process.
- Pulley system made of POM, a very stiff material with low surface friction and good dimensional stability - PREMIUM GRADE bearings
- Cables system steel woven cables ø5 mm, max. loadable weight 1500 kg
- High-density foam cushions with PU upholstery
- Included accessories: lat bar



PLX8350

cod. PLX-8350

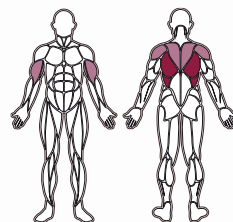

MUSCOLI COINVOLTI MUSCLE GROUPS

- Gran dorsale - Latissimus dorsi
- Bicipiti - Biceps
- Romboidi - Rhomboids
- Trapezio inferiore - Lower trapezius
- Deltoidi posteriori - Posterior deltoids

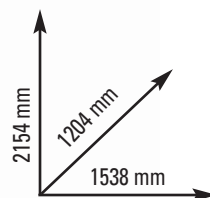

SISTEMA DI SPINTA a leveraggi indipendenti
 PACCO PESI 100 kg in acciaio. Carter di protezione integrale
 REGOLAZIONI: rulli di bloccaggio gambe su 3 posizioni.
 Altezza sedile su 18 posizioni.
 DIMENSIONI PRODOTTO: 1538x1204x2154 mm
 PESO MAX UTILIZZATORE 120 Kg
 PESO: 238 kg
 CLASSE D'UTILIZZO PROFESSIONALE (EN20957-1 / EN957-2 classe S)

INDEPENDENT PUSH leverage system
 WEIGHT STACK steel 100 kg weight stack with full protection cage
 ADJUSTMENTS: leg press rollers on 3-level. Seat height on 18-level
 SET UP SIZE: 1538x1204x2154 mm
 MAX USER WEIGHT 120 Kg
 WEIGHT: 238 kg
 COMMERCIAL USE (EN20957-1 / EN957-2 class S)

- Struttura tubolare in acciaio a sezione ovale 50x100 mm - spessore 3 mm e rotonda ø 60 mm - spessore 3 mm
- Verniciatura doppia a polveri epossidiche, antigraffio.
- Trattamento dei tubolari con sabbatura e fosfatazione
- Sistema di carrucole/pulegge realizzate in POM, materiale con ottime caratteristiche di scorrimento ed eccellente resistenza all'usura - cuscinetti PREMIUM GRADE
- Sistema di cavi in acciaio ø 5 mm carico massimo 1500 kg
- Cuscini in schiuma ad alta densità con rivestimento in PU
- Regolazione della seduta a pantografo assistita da molla a gas

- Structure oval flat heavy-duty steel tubing oval 50x100 mm - thickness 3 mm and round ø 60 mm - thickness 3 mm.
- Painting double heavy duty powder coating painting, scratch-resistant.
- Tubing treatment with sandblasting and phosphating process.
- Pulley system made of POM, a very stiff material with low surface friction and good dimensional stability - PREMIUM GRADE bearings
- Cables system steel woven cables ø5 mm, max. loadable weight 1500 kg
- High-density foam cushions with PU upholstery
- Seat adjustment with pantograph system assisted by gas spring



PLX8400

cod. PLX-8400

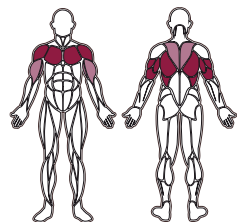

MUSCOLI COINVOLTI MUSCLE GROUPS

- Gran dorsale - Latissimus dorsi
- Pettorali - Pectorals
- Deltoidi anteriori - Anterior deltoids
- Tricipiti - Triceps
- Bicipiti - Biceps
- Romboidi - Rhomboids
- Trapezio inferiore - Lower trapezius

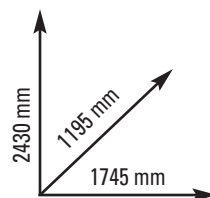

SISTEMA DI AUSILIO a pedana
 PACCO PESI 90 kg in acciaio. Carter di protezione integrale
 REGOLAZIONI: pedana richiudibile
 DIMENSIONI PRODOTTO: 1745x1195x2430 mm
 PESO MAX UTILIZZATORE 120 Kg
 PESO: 221 kg
 CLASSE D'UTILIZZO PROFESSIONALE (EN20957-1 / EN957-2 classe S)

PLATFORM AID system
 WEIGHT STACK steel 90 kg weight stack with full protection cage
 ADJUSTMENTS: foot platform foldable
 SET UP SIZE: 1745x1195x2430 mm
 MAX USER WEIGHT 120 Kg
 WEIGHT: 221 kg
 COMMERCIAL USE (EN20957-1 / EN957-2 class S)

- Struttura tubolare in acciaio a sezione ovale 50x100 mm - spessore 3 mm e rotonda ø 60 mm - spessore 3 mm
- Verniciatura doppia a polveri epossidiche, antigraffio. Trattamento dei tubolari con sabbiatura e fosfatazione
- Sistema di carrucole/pullegge realizzate in POM, materiale con ottime caratteristiche di scorrimento ed eccellente resistenza all'usura - cuscinetti PREMIUM GRADE
- Sistema di cavi in acciaio ø 5 mm carico massimo 1500 kg
- Cuscini in schiuma ad alta densità con rivestimento in PU

- Structure oval flat heavy-duty steel tubing oval 50x100 mm - thickness 3 mm and round ø 60 mm - thickness 3 mm.
- Painting double heavy duty powder coating painting, scratch-resistant Tubing treatment with sandblasting and phosphating process.
- Pulley system made of POM, a very stiff material with low surface friction and good dimensional stability - PREMIUM GRADE bearings
- Cables system steel woven cables ø5 mm, max. loadable weight 1500 kg
- High-density foam cushions with PU upholstery



PLX8450

cod. PLX-8450

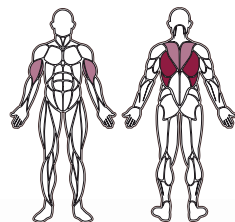
**MUSCOLI COINVOLTI**
MUSCLE GROUPS

- Gran dorsale - Latissimus dorsi
- Bicipiti - Biceps
- Romboidi - Rhomboids
- Trapezio inferiore - Lower trapezius

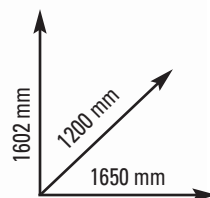

SISTEMA DI SPINTA a leveraggi indipendenti
 PACCO PESI 100 kg in acciaio. Carter di protezione integrale
 REGOLAZIONI: profondità schienale su 5 posizioni, altezza sedile
 su 16 posizioni
 DIMENSIONI PRODOTTO: 1650x1200x1602 mm
 PESO MAX UTILIZZATORE 120 Kg
 PESO: 245 kg
 CLASSE D'UTILIZZO PROFESSIONALE (EN20957-1 / EN957-2 classe S)

INDEPENDENT PUSH leverage system
 WEIGHT STACK steel 100 kg weight stack with full protection cage
 ADJUSTMENTS: backrest forward/backward on 5-level, seat height on
 16-level
 SET UP SIZE: 1650x1200x1602 mm
 MAX USER WEIGHT 120 Kg
 WEIGHT: 245 kg
 COMMERCIAL USE (EN20957-1 / EN957-2 class S)

- Struttura tubolare in acciaio a sezione ovale 50x100 mm - spessore 3 mm e rotonda ø 60 mm - spessore 3 mm
- Verniciatura doppia a polveri epossidiche, antigraffio. Trattamento dei tubolari con sabbiatura e fosfatizzazione
- Sistema di carrucole/pullegge realizzate in POM, materiale con ottime caratteristiche di scorrimento ed eccellente resistenza all'usura - cuscinetti PREMIUM GRADE
- Sistema di cavi in acciaio ø 5 mm carico massimo 1500 kg
- Cuscini in schiuma ad alta densità con rivestimento in PU

- Structure oval flat heavy-duty steel tubing oval 50x100 mm - thickness 3 mm and round ø 60 mm - thickness 3 mm.
- Painting double heavy duty powder coating painting, scratch-resistant. Tubing treatment with sandblasting and phosphating process.
- Pulley system made of POM, a very stiff material with low surface friction and good dimensional stability - PREMIUM GRADE bearings
- Cables system steel woven cables ø5 mm, max. loadable weight 1500 kg
- High-density foam cushions with PU upholstery



PLX8500

cod. PLX-8500

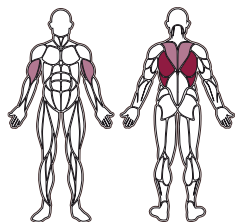

MUSCOLI COINVOLTI MUSCLE GROUPS

- Gran dorsale - Latissimus dorsi
- Bicipiti - Biceps
- Romboidi - Rhomboids
- Trapezio inferiore - Lower trapezius

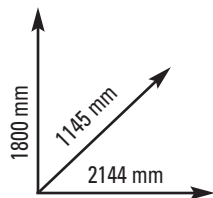

SISTEMA DI TIRO a vettore singolo
 PACCO PESI 100 kg in acciaio. Carter di protezione integrale
 REGOLAZIONI: altezza pulley su 10 posizioni
 DIMENSIONI PRODOTTO: 2144x1145x1800 mm
 PESO MAX UTILIZZATORE 120 Kg
 PESO: 228 kg
 CLASSE D'UTILIZZO PROFESSIONALE (EN20957-1 / EN957-2 classe S)

SINGLE VECTOR PUSH system
 WEIGHT STACK steel 100 kg weight stack with full protection cage
 ADJUSTMENTS: pulley height on 10-level.
 SET UP SIZE: 2144x1145x1800 mm
 MAX USER WEIGHT 120 Kg
 WEIGHT: 228 kg
 COMMERCIAL USE (EN20957-1 / EN957-2 class S)

- Struttura tubolare in acciaio a sezione ovale 50x100 mm - spessore 3 mm e rotonda ø 60 mm - spessore 3 mm
- Verniciatura doppia a polveri epossidiche, antigraffio. Trattamento dei tubolari con sabbiatura e fosfatazione
- Sistema di carrucole/pullegge realizzate in POM, materiale con ottime caratteristiche di scorrimento ed eccellente resistenza all'usura - cuscinetti PREMIUM GRADE
- Sistema di cavi in acciaio ø 5 mm carico massimo 1500 kg
- Cuscini in schiuma ad alta densità con rivestimento in PU

- Structure oval flat heavy-duty steel tubing oval 50x100 mm - thickness 3 mm and round ø 60 mm - thickness 3 mm.
- Painting double heavy duty powder coating painting, scratch-resistant. Tubing treatment with sandblasting and phosphating process.
- Pulley system made of POM, a very stiff material with low surface friction and good dimensional stability - PREMIUM GRADE bearings
- Cables system steel woven cables ø5 mm, max. loadable weight 1500 kg
- High-density foam cushions with PU upholstery



PLX8600

cod. PLX-8600

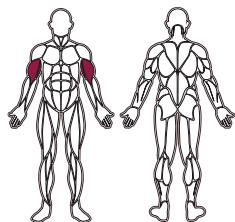
MUSCOLI COINVOLTI
MUSCLE GROUPS

■ Bicipiti - Biceps

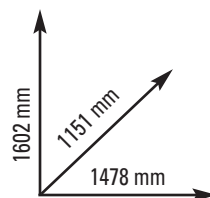

SISTEMA DI TIRO a leveraggio singolo
 PACCO PESI 80 kg in acciaio. Carter di protezione integrale
 REGOLAZIONI: altezza sedile su 18 posizioni
 DIMENSIONI PRODOTTO: 1478x1151x1602 mm
 PESO MAX UTILIZZATORE 120 Kg
 PESO: 205 kg
 CLASSE D'UTILIZZO PROFESSIONALE (EN20957-1 / EN957-2 classe S)

SINGLE PUSH leverage system
 WEIGHT STACK steel 80 kg weight stack with full protection cage
 ADJUSTMENTS: seat height on 18-level
 SET UP SIZE: 1478x1151x1602 mm
 MAX USER WEIGHT 120 Kg
 WEIGHT: 205 kg
 COMMERCIAL USE (EN20957-1 / EN957-2 class S)

- Struttura tubolare in acciaio a sezione ovale 50x100 mm - spessore 3 mm e rotonda ø 60 mm - spessore 3 mm
- Verniciatura doppia a polveri epossidiche, antigraffio. Trattamento dei tubolari con sabbatura e fosfatazione
- Sistema di carrucole/pullegge realizzate in POM, materiale con ottime caratteristiche di scorrimento ed eccellente resistenza all'usura - cuscinetti PREMIUM GRADE
- Sistema di cavi in acciaio ø 5 mm carico massimo 1500 kg
- Cuscini in schiuma ad alta densità con rivestimento in PU
- Regolazione della seduta a cremagliera assistita da molla a gas

- Structure oval flat heavy-duty steel tubing oval 50x100 mm - thickness 3 mm and round ø 60 mm - thickness 3 mm.
- Painting double heavy duty powder coating painting, scratch-resistant. Tubing treatment with sandblasting and phosphating process.
- Pulley system made of POM, a very stiff material with low surface friction and good dimensional stability - PREMIUM GRADE bearings
- Cables system steel woven cables ø5 mm, max. loadable weight 1500 kg
- High-density foam cushions with PU upholstery
- Rack seat adjustment system assisted by gas spring



PLX8650

cod. PLX-8650

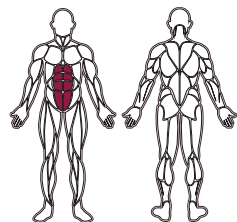

MUSCOLI COINVOLTI MUSCLE GROUPS

■ Addominali - Abdominals

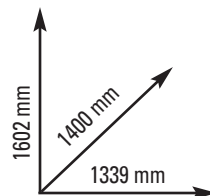

SISTEMA DI SPINTA a telaio flottante
PACCO PESI 80 kg in acciaio. Carter di protezione integrale
REGOLAZIONI: rotazione sedile su 3 posizioni
DIMENSIONI PRODOTTO: 1339x1400x1602 mm
PESO MAX UTILIZZATORE 120 Kg
PESO: 255 kg
CLASSE D'UTILIZZO PROFESSIONALE (EN20957-1 / EN957-2 classe S)

FLOATING PLATFORM PUSH system
WEIGHT STACK steel 80 kg weight stack with full protection cage
ADJUSTMENTS: seat rotation on 3-level
SET UP SIZE: 1339x1400x1602 mm
MAX USER WEIGHT 120 Kg
WEIGHT: 255 kg
COMMERCIAL USE (EN20957-1 / EN957-2 class S)

- Struttura tubolare in acciaio a sezione ovale 50x100 mm - spessore 3 mm e rotonda ø 60 mm - spessore 3 mm
- Verniciatura doppia a polveri epossidiche, antigraffio. Trattamento dei tubolari con sabbatura e fosfatazione
- Sistema di carrucole/pulegge realizzate in POM, materiale con ottime caratteristiche di scorrimento ed eccellente resistenza all'usura - cuscinetti PREMIUM GRADE
- Sistema di cavi in acciaio ø 5 mm carico massimo 1500 kg
- Cuscini in schiuma ad alta densità con rivestimento in PU

- Structure oval flat heavy-duty steel tubing oval 50x100 mm - thickness 3 mm and round ø 60 mm - thickness 3 mm.
- Painting double heavy duty powder coating painting, scratch-resistant. Tubing treatment with sandblasting and phosphating process.
- Pulley system made of POM, a very stiff material with low surface friction and good dimensional stability - PREMIUM GRADE bearings
- Cables system steel woven cables ø5 mm, max. loadable weight 1500 kg
- High-density foam cushions with PU upholstery



PLX8700

cod. PLX-8700

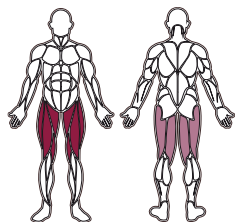
MUSCOLI COINVOLTI
MUSCLE GROUPS

- Quadricipiti - Quadriceps
- Ischiocrurali - Hamstrings

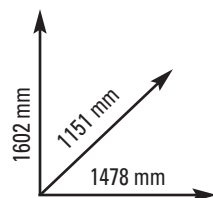

SISTEMA DI SPINTA su pedana fissa
 PACCO PESI 150 kg in acciaio. Carter di protezione integrale
 REGOLAZIONI: profondità sedile su 9 posizioni
 DIMENSIONI PRODOTTO: 1478x1151x1602 mm
 PESO MAX UTILIZZATORE 120 Kg
 PESO: 359 kg
 CLASSE D'UTILIZZO PROFESSIONALE (EN20957-1 / EN957-2 classe S)

FIXED PLATFORM PUSH system
 WEIGHT STACK steel 150 kg weight stack with full protection cage
 ADJUSTMENTS: seat forward/backward on 9-level
 SET UP SIZE: 1478x1151x1602 mm
 MAX USER WEIGHT 120 Kg
 WEIGHT: 359 kg
 COMMERCIAL USE (EN20957-1 / EN957-2 class S)

- Struttura tubolare in acciaio a sezione ovale 50x100 mm - spessore 3 mm e rotonda \varnothing 60 mm - spessore 3 mm
- Verniciatura doppia a polveri epossidiche, antigraffio. Trattamento dei tubolari con sabbatura e fosfatazione
- Sistema di carrucole/pullegge realizzate in POM, materiale con ottime caratteristiche di scorrimento ed eccellente resistenza all'usura - cuscinetti PREMIUM GRADE
- Sistema di cavi in acciaio \varnothing 5 mm carico massimo 1500 kg
- Cuscini in schiuma ad alta densità con rivestimento in PU

- Structure oval flat heavy-duty steel tubing oval 50x100 mm - thickness 3 mm and round \varnothing 60 mm - thickness 3 mm.
- Painting double heavy duty powder coating painting, scratch-resistant. Tubing treatment with sandblasting and phosphating process.
- Pulley system made of POM, a very stiff material with low surface friction and good dimensional stability - PREMIUM GRADE bearings
- Cables system steel woven cables \varnothing 5 mm, max. loadable weight 1500 kg
- High-density foam cushions with PU upholstery

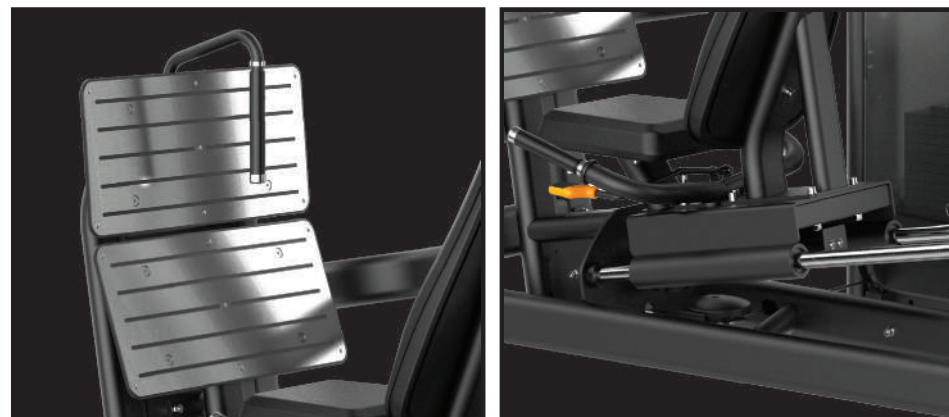

PLX8800

cod. PLX-8800

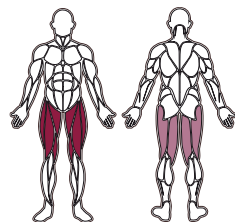
MUSCOLI COINVOLTI
MUSCLE GROUPS

- Quadricipiti - Quadriceps
- Ischiocrurali - Hamstrings

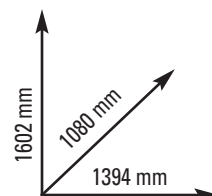

SISTEMA DI SPINTA a leveraggio singolo
 PACCO PESI 90 kg in acciaio. Carter di protezione integrale
 REGOLAZIONI: partenza del leveraggio di spinta su 4 posizioni, roller di appoggio delle caviglie su 7 posizioni, profondità schienale su 8 livelli
 DIMENSIONI PRODOTTO: 1394x1080x1602 mm
 PESO MAX UTILIZZATORE 120 Kg
 PESO: 208 kg
 CLASSE D'UTILIZZO PROFESSIONALE (EN20957-1 / EN957-2 classe S)

SINGLE PUSH leverage system
 WEIGHT STACK steel 90 kg weight stack with full protection cage
 ADJUSTMENTS: Main force leverage on 4-level, small force leverage on 7-level, Backrest forward/backward on 8-level
 SET UP SIZE: 1394x1080x1602 mm
 MAX USER WEIGHT 120 Kg
 WEIGHT: 208 kg
 COMMERCIAL USE (EN20957-1 / EN957-2 class S)

- Struttura tubolare in acciaio a sezione ovale 50x100 mm - spessore 3 mm e rotonda ø 60 mm - spessore 3 mm
- Verniciatura doppia a polveri epossidiche, antigraffio. Trattamento dei tubolari con sabbatura e fosfatazione
- Sistema di carrucole/pullegge realizzate in POM, materiale con ottime caratteristiche di scorrimento ed eccellente resistenza all'usura - cuscinetti PREMIUM GRADE
- Sistema di cavi in acciaio ø 5 mm carico massimo 1500 kg
- Cuscini in schiuma ad alta densità con rivestimento in PU

- Structure oval flat heavy-duty steel tubing oval 50x100 mm - thickness 3 mm and round ø 60 mm - thickness 3 mm.
- Painting double heavy duty powder coating painting, scratch-resistant. Tubing treatment with sandblasting and phosphating process.
- Pulley system made of POM, a very stiff material with low surface friction and good dimensional stability - PREMIUM GRADE bearings
- Cables system steel woven cables ø5 mm, max. loadable weight 1500 kg
- High-density foam cushions with PU upholstery



PLX8850

cod. PLX-8850

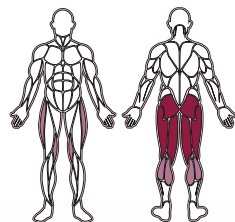
MUSCOLI COINVOLTI
MUSCLE GROUPS

- Femorali - Femorals
- Glutei - Gluteus
- Adduttori - Adductors
- Abduttori - Abductors
- Polpacci - Calves

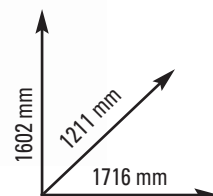

SISTEMA DI SPINTA a leveraggio singolo
 PACCO PESI 90 kg in acciaio. Carter di protezione integrale
 REGOLAZIONI: profondità schienale su 8 posizioni, altezza braccio su 5 posizioni, partenza del leveraggio di spinta su 4 posizioni, roller di appoggio caviglia su 7 posizioni
 DIMENSIONI PRODOTTO: 1716x1211x1602 mm
 PESO MAX UTILIZZATORE 120 Kg
 PESO: 236 kg
 CLASSE D'UTILIZZO PROFESSIONALE (EN20957-1 / EN957-2 classe S)

SINGLE PUSH leverage system
 WEIGHT STACK steel 90 kg weight stack with full protection cage
 ADJUSTMENTS: backrest forward/backward on 8-level, arm height on 5-level, rollers on 4-level, main force leverage on 7-level
 SET UP SIZE: 1716x1211x1602 mm
 MAX USER WEIGHT 120 Kg
 WEIGHT: 236 kg
 COMMERCIAL USE (EN20957-1 / EN957-2 class S)

- Struttura tubolare in acciaio a sezione ovale 50x100 mm - spessore 3 mm e rotonda ø 60 mm - spessore 3 mm
- Verniciatura doppia a polveri epossidiche, antigraffio. Trattamento dei tubolari con sabbiatura e fosfatazione
- Sistema di carrucole/pullegge realizzate in POM, materiale con ottime caratteristiche di scorrimento ed eccellente resistenza all'usura - cuscinetti PREMIUM GRADE
- Sistema di cavi in acciaio ø 5 mm, carico massimo 1500 kg
- Cuscini in schiuma ad alta densità con rivestimento in PU

- Structure oval flat heavy-duty steel tubing oval 50x100 mm - thickness 3 mm and round ø 60 mm - thickness 3 mm.
- Painting double heavy duty powder coating painting, scratch-resistant. Tubing treatment with sandblasting and phosphating process.
- Pulley system made of POM, a very stiff material with low surface friction and good dimensional stability - PREMIUM GRADE bearings
- Cables system steel woven cables ø5 mm, max. loadable weight 1500 kg
- High-density foam cushions with PU upholstery



PLX8900

cod. PLX-8900

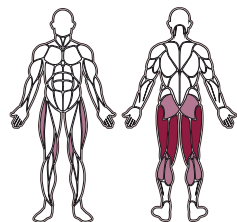

MUSCOLI COINVOLTI MUSCLE GROUPS

- Femorali - Femorals
- Glutei - Gluteus
- Adduttori - Adductors
- Abduttori - Abductors
- Polpacci - Calves



SISTEMA DI SPINTA a leveraggio singolo
 PACCO PESI 90 kg in acciaio. Carter di protezione integrale
 REGOLAZIONI: partenza del leveraggio di spinta su 6 posizioni, roller di appoggio delle caviglie su 7 posizioni
 DIMENSIONI PRODOTTO: 1641x1204x1602 mm
 PESO MAX UTILIZZATORE 120 Kg
 PESO: 221 kg
 CLASSE D'UTILIZZO PROFESSIONALE (EN20957-1 / EN957-2 classe S)

SINGLE PUSH leverage system
 WEIGHT STACK steel 90 kg weight stack with full protection cage
 ADJUSTMENTS: main force leverage on 6-level, small force leverage on 7-level
 SET UP SIZE: 1641x1204x1602 mm
 MAX USER WEIGHT 120 Kg
 WEIGHT: 221 kg
 COMMERCIAL USE (EN20957-1 / EN957-2 class S)

- Struttura tubolare in acciaio a sezione ovale 50x100 mm - spessore 3 mm e rotonda ø 60 mm - spessore 3 mm
- Verniciatura doppia a polveri epossidiche, antigraffio. Trattamento dei tubolari con sabbatura e fosfatazione
- Sistema di carrucole/pulegge realizzate in POM, materiale con ottime caratteristiche di scorrimento ed eccellente resistenza all'usura - cuscinetti PREMIUM GRADE
- Sistema di cavi in acciaio ø 5 mm carico massimo 1500 kg
- Cuscini in schiuma ad alta densità con rivestimento in PU

- Structure oval flat heavy-duty steel tubing oval 50x100 mm - thickness 3 mm and round ø 60 mm - thickness 3 mm.
- Painting double heavy duty powder coating painting, scratch-resistant. Tubing treatment with sandblasting and phosphating process.
- Pulley system made of POM, a very stiff material with low surface friction and good dimensional stability - PREMIUM GRADE bearings
- Cables system steel woven cables ø5 mm, max. loadable weight 1500 kg
- High-density foam cushions with PU upholstery



PLX9000

cod. PLX-9000

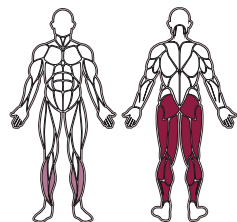
MUSCOLI COINVOLTI
MUSCLE GROUPS

- Femorali - Femorals
- Glutei - Gluteus
- Polpacci - Calves
- Tibiali - Tibialis

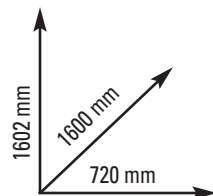

SISTEMA DI SPINTA a leveraggio singolo
 PACCO PESI 100 kg in acciaio. Carter di protezione integrale
 REGOLAZIONI: partenza del leveraggio di spinta su 5 posizioni, rullo di bloccaggio su 5 posizioni, altezza braccio su 2 posizioni
 DIMENSIONI PRODOTTO: 720x1600x1620 mm
 PESO MAX UTILIZZATORE 120 Kg
 PESO: 258,5 kg
 CLASSE D'UTILIZZO PROFESSIONALE (EN20957-1 / EN957-2 classe S)

DOUBLE WINDING PULL system
 WEIGHT STACK steel 100 kg weight stack with full protection cage
 ADJUSTMENTS: main force leverage on 5-level, small force leverage on 5-level, arm height on 2-level.
 SET UP SIZE: 720x1600x1620 mm
 MAX USER WEIGHT 120 Kg
 WEIGHT: 258,5 kg
 COMMERCIAL USE (EN20957-1 / EN957-2 class S)

- Struttura tubolare in acciaio a sezione ovale 50x100 mm - spessore 3 mm e rotonda ø 60 mm - spessore 3 mm
- Verniciatura doppia a polveri epossidiche, antigraffio.
- Trattamento dei tubolari con sabbatura e fosfatazione
- Sistema di carrucole/pullegge realizzate in POM, materiale con ottime caratteristiche di scorrimento ed eccellente resistenza all'usura - cuscinetti PREMIUM GRADE
- Sistema di cavi in acciaio ø 5 mm carico massimo 1500 kg
- Cuscini in schiuma ad alta densità con rivestimento in PU

- Structure oval flat heavy-duty steel tubing oval 50x100 mm - thickness 3 mm and round ø 60 mm - thickness 3 mm.
- Painting double heavy duty powder coating painting, scratch-resistant.
- Tubing treatment with sandblasting and phosphating process.
- Pulley system made of POM, a very stiff material with low surface friction and good dimensional stability - PREMIUM GRADE bearings
- Cables system steel woven cables ø5 mm, max. loadable weight 1500 kg
- High-density foam cushions with PU upholstery



PLX9050

cod. PLX-9050

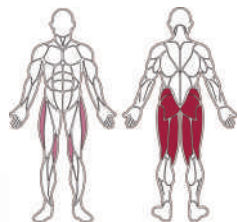

MUSCOLI COINVOLTI MUSCLE GROUPS

- Femorali - Femorals
- Erettori del rachide - Spinal erectors
- Glutei - Gluteus
- Adduttori - Adductors
- Abduttori - Abductors

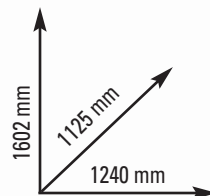

SISTEMA DI TIRO a vettore singolo
 PACCO PESI 80 kg in acciaio. Carter di protezione integrale
 REGOLAZIONI: inclinazione cuscini di appoggio su 9 posizioni,
 rulli di bloccaggio su 5 posizioni, altezza pedana su 6 posizioni
 DIMENSIONI PRODOTTO: 1240x1125x1602 mm
 PESO MAX UTILIZZATORE 120 Kg
 PESO: 220 kg
 CLASSE D'UTILIZZO PROFESSIONALE (EN20957-1 / EN957-2 classe S)

SINGLE VECTOR PUSH system
 WEIGHT STACK steel 80 kg weight stack with full protection cage
 ADJUSTMENTS: cushions incline on 9-level, rollers on 5-level, platform
 height on 6-level
 SET UP SIZE: 1240x1125x1602 mm
 MAX USER WEIGHT 120 Kg
 WEIGHT: 220 kg
 COMMERCIAL USE (EN20957-1 / EN957-2 class S)

- Struttura tubolare in acciaio a sezione ovale 50x100 mm - spessore 3 mm e rotonda ø 60 mm - spessore 3 mm
- Verniciatura doppia a polveri epossidiche, antigraffio. Trattamento dei tubolari con sabbatura e fosfatazione
- Sistema di carrucole/pulegge realizzate in POM, materiale con ottime caratteristiche di scorrimento ed eccellente resistenza all'usura - cuscinetti PREMIUM GRADE
- Sistema di cavi in acciaio ø 5 mm carico massimo 1500 kg
- Cuscini in schiuma ad alta densità con rivestimento in PU

- Structure oval flat heavy-duty steel tubing oval 50x100 mm - thickness 3 mm and round ø 60 mm - thickness 3 mm.
- Painting double heavy duty powder coating painting, scratch-resistant. Tubing treatment with sandblasting and phosphating process.
- Pulley system made of POM, a very stiff material with low surface friction and good dimensional stability - PREMIUM GRADE bearings
- Cables system steel woven cables ø5 mm, max. loadable weight 1500 kg
- High-density foam cushions with PU upholstery



PLX9090

cod. PLX-9090

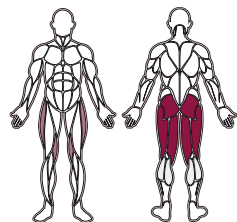
MUSCOLI COINVOLTI
MUSCLE GROUPS

- Femorali - Femorals
- Glutei - Gluteus
- Adduttori - Adductors
- Abduttori - Abductors



SISTEMA DI SPINTA a leveraggio singolo
 PACCO PESI 100 kg in acciaio. Carter di protezione integrale
 DIMENSIONI PRODOTTO: 2255x810x1800 mm
 PESO MAX UTILIZZATORE 120 Kg
 PESO: 261 kg
 CLASSE D'UTILIZZO PROFESSIONALE (EN20957-1 / EN957-2 classe S)

SINGLE PUSH leverage system
 WEIGHT STACK steel 100 kg weight stack with full protection cage
 SET UP SIZE: 2255x810x1800 mm
 MAX USER WEIGHT 120 Kg
 WEIGHT: 261 kg
 COMMERCIAL USE (EN20957-1 / EN957-2 class S)

- Struttura tubolare in acciaio a sezione ovale 50x100 mm - spessore 3 mm e rotonda \varnothing 60 mm - spessore 3 mm
- Verniciatura doppia a polveri epossidiche, antigraffio. Trattamento dei tubolari con sabbatura e fosfatazione
- Sistema di carrucole/pulegge realizzate in POM, materiale con ottime caratteristiche di scorrimento ed eccellente resistenza all'usura - cuscinetti PREMIUM GRADE
- Sistema di cavi in acciaio \varnothing 5 mm carico massimo 1500 kg.
- Cuscini in schiuma ad alta densità con rivestimento in PU

- Structure oval flat heavy-duty steel tubing oval 50x100 mm - thickness 3 mm and round \varnothing 60 mm - thickness 3 mm.
- Painting double heavy duty powder coating painting, scratch-resistant. Tubing treatment with sandblasting and phosphating process.
- Pulley system made of POM, a very stiff material with low surface friction and good dimensional stability - PREMIUM GRADE bearings
- Cables system steel woven cables \varnothing 5 mm, max. loadable weight 1500 kg.
- High-density foam cushions with PU upholstery



PLX9100

cod. PLX-9100

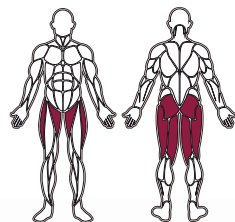

MUSCOLI COINVOLTI MUSCLE GROUPS

- Ischiocrurali - Hamstrings
- Glutei - Gluteus
- Abduttori - Abductors
- Adduttori - Adductors

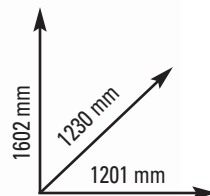

SISTEMA DI TIRO a singolo avvolgimento
 PACCO PESI 90 kg in acciaio. Carter di protezione integrale
 REGOLAZIONI: partenza del leveraggio di spinta su 6 posizioni
 DIMENSIONI PRODOTTO: 1201x1230x1602 mm
 PESO MAX UTILIZZATORE 120 Kg
 PESO: 227 kg
 CLASSE D'UTILIZZO PROFESSIONALE (EN20957-1 / EN957-2 classe S)

SINGLE WINDING PULL system
 WEIGHT STACK steel 90 kg weight stack with full protection cage
 ADJUSTMENTS: force arm rotation on 6-level
 SET UP SIZE: 1201x1230x1602 mm
 MAX USER WEIGHT 120 Kg
 WEIGHT: 227 kg
 COMMERCIAL USE (EN20957-1 / EN957-2 class S)

- Struttura tubolare in acciaio a sezione ovale 50x100 mm - spessore 3 mm e rotonda \varnothing 60 mm - spessore 3 mm
- Verniciatura doppia a polveri epossidiche, antigraffio. Trattamento dei tubolari con sabbatura e fosfatazione
- Sistema di carrucole/pulegge realizzate in POM, materiale con ottime caratteristiche di scorrimento ed eccellente resistenza all'usura - cuscinetti PREMIUM GRADE
- Sistema di cavi in acciaio \varnothing 5 mm carico massimo 1500 kg.
- Cuscini in schiuma ad alta densità con rivestimento in PU

- Structure oval flat heavy-duty steel tubing oval 50x100 mm - thickness 3 mm and round \varnothing 60 mm - thickness 3 mm.
- Painting double heavy duty powder coating painting, scratch-resistant. Tubing treatment with sandblasting and phosphating process.
- Pulley system made of POM, a very stiff material with low surface friction and good dimensional stability - PREMIUM GRADE bearings
- Cables system steel woven cables \varnothing 5 mm, max. loadable weight 1500 kg.
- High-density foam cushions with PU upholstery



PLX9200

cod. PLX-9200

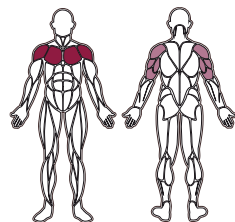

MUSCOLI COINVOLTI MUSCLE GROUPS

- Pettorali - Pectorals
- Deltoide anteriore - Anterior deltoid
- Deltoide posteriore - Posterior deltoid
- Trapezi - Trapezius
- Tricipiti - Triceps

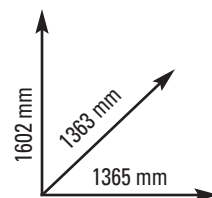

SISTEMA DI SPINTA a leveraggio singolo
 PACCO PESI 100 kg in acciaio. Carter di protezione integrale
 REGOLAZIONI: partenza del leveraggio di spinta su 6 posizioni, altezza sedile su 5 posizioni, profondità schienale su 3 posizioni
 DIMENSIONI PRODOTTO: 1365x1363x1602 mm
 PESO MAX UTILIZZATORE 120 Kg
 PESO: 235 kg
 CLASSE D'UTILIZZO PROFESSIONALE (EN20957-1 / EN957-2 classe S)

SINGLE PUSH leverage system
 WEIGHT STACK steel 100 kg weight stack with full protection cage
 ADJUSTMENTS: main force leverage on 6-level, seat height on 5-level, backrest forward/backward on 3-level
 SET UP SIZE: 1365x1363x1602 mm
 MAX USER WEIGHT 120 Kg
 WEIGHT: 235 kg
 COMMERCIAL USE (EN20957-1 / EN957-2 class S)

- Struttura tubolare in acciaio a sezione ovale 50x100 mm - spessore 3 mm e rotonda ø 60 mm - spessore 3 mm
- Verniciatura doppia a polveri epossidiche, antigraffio. Trattamento dei tubolari con sabbatura e fosfatazione
- Sistema di carrucole/pullegge realizzate in POM, materiale con ottime caratteristiche di scorrimento ed eccellente resistenza all'usura - cuscinetti PREMIUM GRADE
- Sistema di cavi in acciaio ø 5 mm carico massimo 1500 kg
- Cuscini in schiuma ad alta densità con rivestimento in PU
- Regolazione della seduta a pantografo assistita da molla a gas

- Structure oval flat heavy-duty steel tubing oval 50x100 mm - thickness 3 mm and round ø 60 mm - thickness 3 mm.
- Painting double heavy duty powder coating painting, scratch-resistant. Tubing treatment with sandblasting and phosphating process.
- Pulley system made of POM, a very stiff material with low surface friction and good dimensional stability - PREMIUM GRADE bearings
- Cables system steel woven cables ø5 mm, max. loadable weight 1500 kg
- High-density foam cushions with PU upholstery
- Seat adjustment with pantograph system assisted by gas spring



PLX9300

cod. PLX-9300

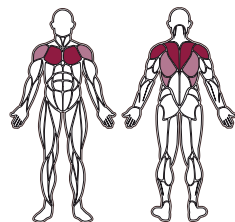

MUSCOLI COINVOLTI MUSCLE GROUPS

- Pettorali - Pectorals
- Deltoidi posteriori - Posterior deltoids
- Trapezi - Trapezius
- Gran dorsale - Latissimus dorsi
- Sottospinato - Infraspinatus

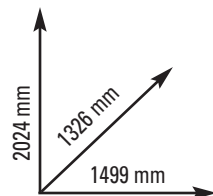

SISTEMA DI SPINTA a leveraggi indipendenti
 PACCO PESI 90 kg in acciaio. Carter di protezione integrale
 REGOLAZIONI: altezza bracci su 6 posizioni, altezza sedile su 18 posizioni,
 profondità schienale su 6 posizioni
 DIMENSIONI PRODOTTO: 1499x1326x2024 mm
 PESO MAX UTILIZZATORE 120 Kg
 PESO: 226 kg
 CLASSE D'UTILIZZO PROFESSIONALE (EN20957-1 / EN957-2 classe S)

INDEPENDENT PUSH leverage system
 WEIGHT STACK steel 90 kg weight stack with full protection cage
 ADJUSTMENTS: arms height on 6-level, seat height on 18-level, backrest
 forward/backward on 6-level
 SET UP SIZE: 1499x1326x2024 mm
 MAX USER WEIGHT 120 Kg
 WEIGHT: 226 kg
 COMMERCIAL USE (EN20957-1 / EN957-2 class S)

- Struttura tubolare in acciaio a sezione ovale 50x100 mm - spessore 3 mm e rotonda ø 60 mm - spessore 3 mm
- Verniciatura doppia a polveri epossidiche, antigraffio. Trattamento dei tubolari con sabbiatura e fosfatazione
- Sistema di carrucole/pullegge realizzate in POM, materiale con ottime caratteristiche di scorrimento ed eccellente resistenza all'usura - cuscinetti PREMIUM GRADE
- Sistema di cavi in acciaio ø 5 mm carico massimo 1500 kg
- Cuscini in schiuma ad alta densità con rivestimento in PU
- Regolazione della seduta a pantografo assistita da molla a gas

- Structure oval flat heavy-duty steel tubing oval 50x100 mm - thickness 3 mm and round ø 60 mm - thickness 3 mm.
- Painting double heavy duty powder coating painting, scratch-resistant. Tubing treatment with sandblasting and phosphating process.
- Pulley system made of POM, a very stiff material with low surface friction and good dimensional stability - PREMIUM GRADE bearings
- Cables system steel woven cables ø5 mm, max. loadable weight 1500 kg
- High-density foam cushions with PU upholstery
- Seat adjustment with pantograph system assisted by gas spring

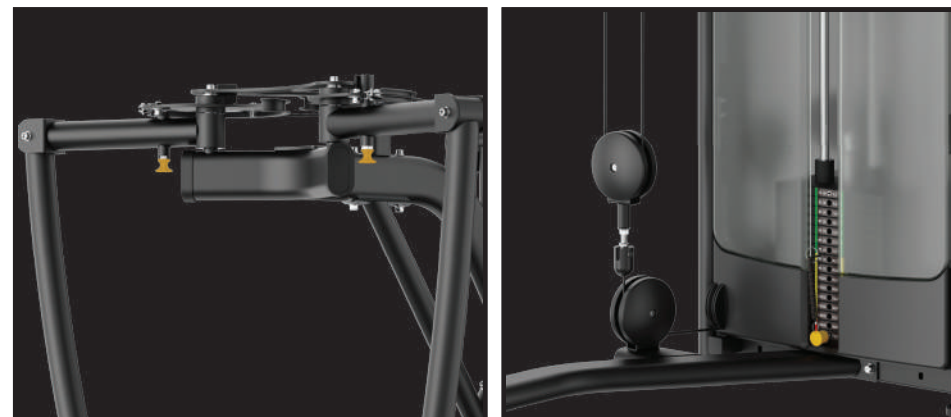

PLX9400

cod. PLX-9400

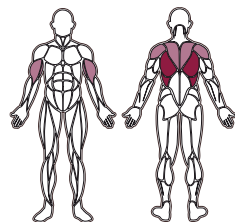
**MUSCOLI COINVOLTI**
MUSCLE GROUPS

- Gran dorsale - Latissimus dorsi
- Bicipiti - Biceps
- Romboidi - Rhomboids
- Trapezio inferiore - Lower trapezius
- Deltoidi posteriori - Posterior deltoids

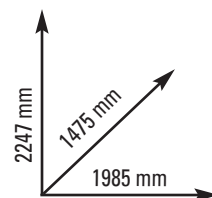

SISTEMA DI TIRO a vettore singolo
 PACCO PESI 100 kg in acciaio. Carter di protezione integrale
 REGOLAZIONI: rulli di bloccaggio gambe su 5 posizioni
 DIMENSIONI PRODOTTO: 1985x1475x2247 mm
 PESO MAX UTILIZZATORE 120 Kg
 PESO: 247 kg
 CLASSE D'UTILIZZO PROFESSIONALE (EN20957-1 / EN957-2 classe S)

SINGLE VECTOR PUSH system
 WEIGHT STACK steel 100 kg weight stack with full protection cage
 ADJUSTMENTS: leg press rollers on 5-level
 SET UP SIZE: 1985x1475x2247 mm
 MAX USER WEIGHT 120 Kg
 WEIGHT: 247 kg
 COMMERCIAL USE (EN20957-1 / EN957-2 class S)

- Struttura tubolare in acciaio a sezione ovale 50x100 mm - spessore 3 mm e rotonda ø 60 mm - spessore 3 mm
- Verniciatura doppia a polveri epossidiche, antigraffio. Trattamento dei tubolari con sabbiatura e fosfatazione
- Sistema di carrucole/pullegge realizzate in POM, materiale con ottime caratteristiche di scorrimento ed eccellente resistenza all'usura - cuscinetti PREMIUM GRADE
- Sistema di cavi in acciaio ø 5 mm carico massimo 1500 kg
- Cuscini in schiuma ad alta densità con rivestimento in PU
- Accessori di serie: barra lat

- Structure oval flat heavy-duty steel tubing oval 50x100 mm - thickness 3 mm and round ø 60 mm - thickness 3 mm.
- Painting double heavy duty powder coating painting, scratch-resistant. Tubing treatment with sandblasting and phosphating process.
- Pulley system made of POM, a very stiff material with low surface friction and good dimensional stability - PREMIUM GRADE bearings
- Cables system steel woven cables ø5 mm, max. loadable weight 1500 kg
- High-density foam cushions with PU upholstery
- Included accessories: lat bar



PLX9500

cod. PLX-9500

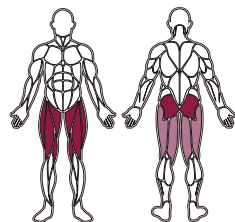
**MUSCOLI COINVOLTI
MUSCLE GROUPS**

- Quadricipiti - Quadriceps
- Glutei - Gluteus
- Ischiocrurali - Hamstrings

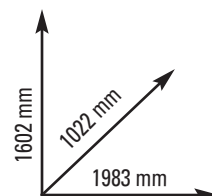

SISTEMA DI SPINTA su pedana fissa
 PACCO PESI 150 kg in acciaio. Carter di protezione integrale
 REGOLAZIONI: altezza sedile su 9 posizioni, profondità schienale su 5 posizioni, cuscini spalle su 9 livelli
 DIMENSIONI PRODOTTO: 1983x1022x1602 mm
 PESO MAX UTILIZZATORE 120 Kg
 PESO: 379 kg
 CLASSE D'UTILIZZO PROFESSIONALE (EN20957-1 / EN957-2 classe S)

FIXED PLATFORM PUSH system
 WEIGHT STACK steel 150 kg weight stack with full protection cage
 ADJUSTMENTS: seat height on 5-level, backrest forward/backward on 5-level, shoulder pads on 9-level
 SET UP SIZE: 1983x1022x1602 mm
 MAX USER WEIGHT 120 Kg
 WEIGHT: 379 kg
 COMMERCIAL USE (EN20957-1 / EN957-2 class S)

- Struttura tubolare in acciaio a sezione ovale 50x100 mm - spessore 3 mm e rotonda ø 60 mm - spessore 3 mm
- Verniciatura doppia a polveri epossidiche, antigraffio. Trattamento dei tubolari con sabbiatura e fosfatazione
- Sistema di carrucole/pullegge realizzate in POM, materiale con ottime caratteristiche di scorrimento ed eccellente resistenza all'usura - cuscinetti PREMIUM GRADE
- Sistema di cavi in acciaio ø 5 mm carico massimo 1500 kg
- Cuscini in schiuma ad alta densità con rivestimento in PU

- Structure oval flat heavy-duty steel tubing oval 50x100 mm - thickness 3 mm and round ø 60 mm - thickness 3 mm.
- Painting double heavy duty powder coating painting, scratch-resistant. Tubing treatment with sandblasting and phosphating process.
- Pulley system made of POM, a very stiff material with low surface friction and good dimensional stability - PREMIUM GRADE bearings
- Cables system steel woven cables ø5 mm, max. loadable weight 1500 kg
- High-density foam cushions with PU upholstery



PLX9600

cod. PLX-9600

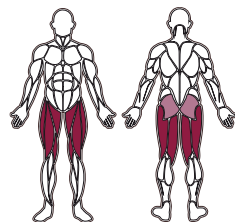
**MUSCOLI COINVOLTI
MUSCLE GROUPS**

- Quadricipiti - Quadriceps
- Femorali - Femorals
- Glutei - Gluteus

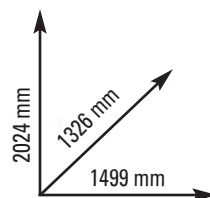

SISTEMA DI SPINTA a leveraggio singolo
 PACCO PESI 90 kg in acciaio. Carter di protezione integrale
 REGOLAZIONI: partenza del leveraggio di spinta su 7 posizioni, altezza braccio su 5 posizioni, roller di appoggio delle caviglie su 7 posizioni, profondità schienale su 8 posizioni
 DIMENSIONI PRODOTTO: 1499x1326x2024 mm
 PESO MAX UTILIZZATORE 120 Kg
 PESO: 252 kg
 CLASSE D'UTILIZZO PROFESSIONALE (EN20957-1 / EN957-2 classe S)

PLATFORM PUSH system
 WEIGHT STACK steel 90 kg weight stack with full protection cage
 ADJUSTMENTS: main force leverage on 7-level, arm height on 5-level, small force leverage on 7-level, Backrest forward/backward on 7-level
 SET UP SIZE: 1499x1326x2024 mm
 MAX USER WEIGHT 120 Kg
 WEIGHT: 252 kg
 COMMERCIAL USE (EN20957-1 / EN957-2 class S)

- Struttura tubolare in acciaio a sezione ovale 50x100 mm - spessore 3 mm e rotonda ø 60 mm - spessore 3 mm
- Verniciatura doppia a polveri epossidiche, antigraffio. Trattamento dei tubolari con sabbiatura e fosfatazione
- Sistema di carrucole/pullegge realizzate in POM, materiale con ottime caratteristiche di scorrimento ed eccellente resistenza all'usura - cuscinetti PREMIUM GRADE
- Sistema di cavi in acciaio ø 5 mm carico massimo 1500 kg
- Cuscini in schiuma ad alta densità con rivestimento in PU

- Structure oval flat heavy-duty steel tubing oval 50x100 mm - thickness 3 mm and round ø 60 mm - thickness 3 mm.
- Painting double heavy duty powder coating painting, scratch-resistant. Tubing treatment with sandblasting and phosphating process.
- Pulley system made of POM, a very stiff material with low surface friction and good dimensional stability - PREMIUM GRADE bearings
- Cables system steel woven cables ø5 mm, max. loadable weight 1500 kg
- High-density foam cushions with PU upholstery

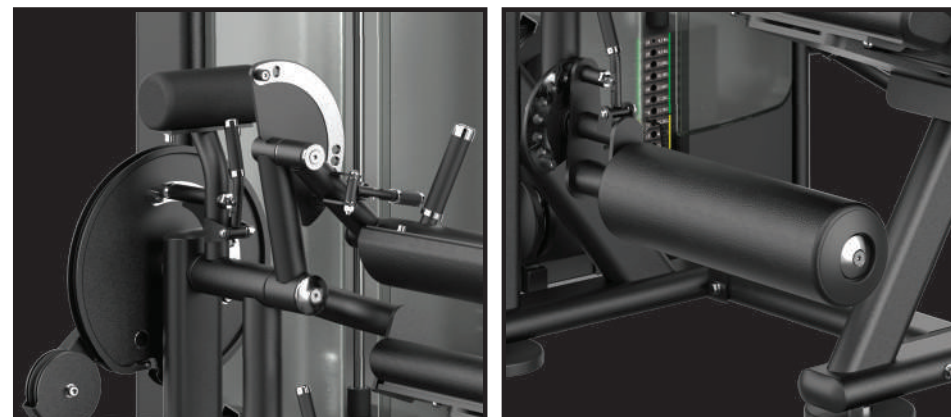

PLX9700

cod. PLX-9700

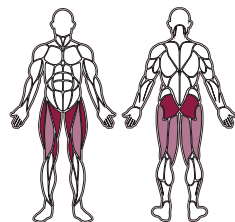

MUSCOLI COINVOLTI MUSCLE GROUPS

- Glutei - Gluteus
- Adduttori - Adductors
- Abduttori - Abductors
- Quadricipiti - Quadriceps
- Femorali - Femorals

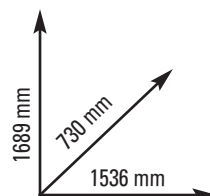

SISTEMA DI SPINTA a leveraggi indipendenti
 PACCO PESI 90 kg in acciaio. Carter di protezione integrale
 REGOLAZIONI: altezza pedana su 6 posizioni
 DIMENSIONI PRODOTTO: 1536x730x1689 mm
 PESO MAX UTILIZZATORE 120 Kg
 PESO: 226 kg
 CLASSE D'UTILIZZO PROFESSIONALE (EN20957-1 / EN957-2 classe S)

INDEPENDENT PUSH leverage system
 WEIGHT STACK steel 90 kg weight stack with full protection cage
 ADJUSTMENTS: foot platform height on 6-level
 SET UP SIZE: 1536x730x1689 mm
 MAX USER WEIGHT 120 Kg
 WEIGHT: 226 kg
 COMMERCIAL USE (EN20957-1 / EN957-2 class S)

- Struttura tubolare in acciaio a sezione ovale 50x100 mm - spessore 3 mm e rotonda ø 60 mm - spessore 3 mm
- Verniciatura doppia a polveri epossidiche, antigraffio. Trattamento dei tubolari con sabbatura e fosfatazione
- Sistema di carrucole/pullegge realizzate in POM, materiale con ottime caratteristiche di scorrimento ed eccellente resistenza all'usura - cuscinetti PREMIUM GRADE
- Sistema di cavi in acciaio ø 5 mm carico massimo 1500 kg
- Cuscini in schiuma ad alta densità con rivestimento in PU

- Structure oval flat heavy-duty steel tubing oval 50x100 mm - thickness 3 mm and round ø 60 mm - thickness 3 mm.
- Painting double heavy duty powder coating painting, scratch-resistant. Tubing treatment with sandblasting and phosphating process.
- Pulley system made of POM, a very stiff material with low surface friction and good dimensional stability - PREMIUM GRADE bearings
- Cables system steel woven cables ø5 mm, max. loadable weight 1500 kg
- High-density foam cushions with PU upholstery





**PIN LOADED
AVANT LINE**

PLX6000

cod. PLX-B6000

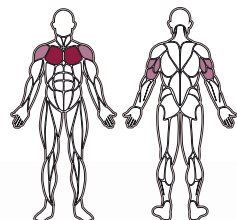

MUSCOLI COINVOLTI MUSCLE GROUPS

- Pettorali - Pectorals
- Tricipiti - Triceps
- Deltoide anteriore - Anterior deltoid



cod. PLX-6000

Disponibile anche con finitura dark silver
Also available with dark silver finishing

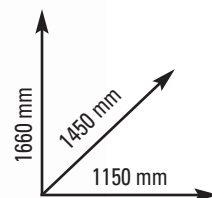

SISTEMA DI SPINTA a leveraggi indipendenti
PACCO PESI 100 kg in acciaio. Carter di protezione integrale
REGOLAZIONI: altezza sedile su 6 posizioni
DIMENSIONI PRODOTTO: 1150x1450x1660 mm
PESO MAX UTILIZZATORE 150 Kg
PESO: 230 kg
CLASSE D'UTILIZZO PROFESSIONALE (EN20957-1 / EN957-2 classe S)

INDEPENDENT PUSH leverage system
WEIGHT STACK steel 100 kg weight stack with full protection cage
ADJUSTMENTS: seat height on 6-level
SET UP SIZE 1150x1450x1660 mm
MAX USER WEIGHT 150 Kg
WEIGHT: 230 kg
COMMERCIAL USE (EN20957-1 / EN957-2 class S)

- Struttura tubolare in acciaio a sezione ovale 75x118 mm e ovale piatta 50x120 mm, 40x80 mm, 50x100 mm - spessore 3 mm.
- Verniciatura doppia a polveri epossidiche, antigraffio. Trattamento dei tubolari con sabbiatura e fosfatazione
- Sistema di carrucole/pulegge realizzate in POM, materiale con ottime caratteristiche di scorrimento ed eccellente resistenza all'usura - cuscinetti PREMIUM GRADE
- Sistema di cavi in acciaio \varnothing 5.8 mm carico massimo 1500 kg.
- Cuscini in schiuma ad alta densità con rivestimento in PU e carter integrali
- Regolazione della seduta a pantografo con bracci in alluminio
- Structure oval flat heavy-duty steel tubing oval 75x118 mm e flat oval 50x120mm, 40x80 mm, 50x100 mm - thickness 3 mm.
- Painting double heavy duty powder coating painting, scratch-resistant. Tubing treatment with sandblasting and phosphating process.
- Pulley system made of POM, a very stiff material with low surface friction and good dimensional stability - PREMIUM GRADE bearings
- Cables system steel woven cables \varnothing 5.8 mm, max. loadable weight 1500 kg.
- High-density foam cushions with PU upholstery and full back cover
- Seat adjustment with pantograph system and aluminium arms



PLX6050

cod. PLX-B6050

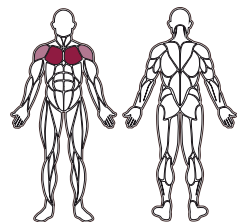
MUSCOLI COINVOLTI
MUSCLE GROUPS

- Pettorali - Pectorals
- Deltoide anteriore - Anterior deltoid

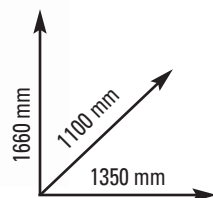

SISTEMA DI SPINTA a leveraggi indipendenti
 PACCO PESI 100 kg in acciaio. Carter di protezione integrale
 REGOLAZIONI: altezza sedile su 6 posizioni
 DIMENSIONI PRODOTTO: 1350x1100x1660 mm
 PESO MAX UTILIZZATORE 150 Kg
 PESO: 210 kg
 CLASSE D'UTILIZZO PROFESSIONALE (EN20957-1 / EN957-2 classe S)

INDEPENDENT PUSH leverage system
 WEIGHT STACK steel 100 kg weight stack with full protection cage
 ADJUSTMENTS: seat height on 6-level
 SET UP SIZE: 1350x1100x1660 mm
 MAX USER WEIGHT 150 Kg
 WEIGHT: 210 kg
 COMMERCIAL USE (EN20957-1 / EN957-2 class S)

- Struttura tubolare in acciaio a sezione ovale 75x118 mm e ovale piatta 50x120 mm, 40x80 mm, 50x100 mm - spessore 3 mm.
- Verniciatura doppia a polveri epossidiche, antigraffio. Trattamento dei tubolari con sabbiatura e fosfatazione
- Sistema di carrucole/pulegge realizzate in POM, materiale con ottime caratteristiche di scorrimento ed eccellente resistenza all'usura - cuscinetti PREMIUM GRADE
- Sistema di cavi in acciaio \varnothing 5.8 mm carico massimo 1500 kg.
- Cuscini in schiuma ad alta densità con rivestimento in PU e carter integrali
- Regolazione della seduta a pantografo con bracci in alluminio

- Structure oval flat heavy-duty steel tubing oval 75x118 mm e flat oval 50x120mm, 40x80 mm, 50x100 mm - thickness 3 mm.
- Painting double heavy duty powder coating painting, scratch-resistant. Tubing treatment with sandblasting and phosphating process.
- Pulley system made of POM, a very stiff material with low surface friction and good dimensional stability - PREMIUM GRADE bearings
- Cables system steel woven cables \varnothing 5.8 mm, max. loadable weight 1500 kg.
- High-density foam cushions with PU upholstery and full back cover
- Seat adjustment with pantograph system and aluminium arms



PLX6100

cod. PLX-B6100

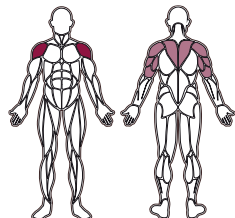

MUSCOLI COINVOLTI MUSCLE GROUPS

- Deltoido anteriore - Anterior deltoid
- Deltoido posteriore - Posterior deltoid
- Tricipiti - Triceps
- Trapezi - Trapezius



cod. PLX-6100

Disponibile anche con finitura dark silver
Also available with dark silver finishing

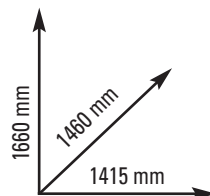

SISTEMA DI SPINTA a leveraggi indipendenti
PACCO PESI 100 kg in acciaio. Carter di protezione integrale
REGOLAZIONI: altezza sedile su 6 posizioni
DIMENSIONI PRODOTTO: 1415x1460x1660 mm
PESO MAX UTILIZZATORE 150 Kg
PESO: 225 kg
CLASSE D'UTILIZZO PROFESSIONALE (EN20957-1 / EN957-2 classe S)

INDEPENDENT PUSH leverage system
WEIGHT STACK steel 100 kg weight stack with full protection cage
ADJUSTMENTS: seat height on 6-level
SET UP SIZE: 1415x1460x1660 mm
MAX USER WEIGHT 150 Kg
WEIGHT: 225 kg
COMMERCIAL USE (EN20957-1 / EN957-2 class S)

- Struttura tubolare in acciaio a sezione ovale 75x118 mm e ovale piatta 50x120 mm, 40x80 mm, 50x100 mm - spessore 3 mm.
- Verniciatura doppia a polveri epossidiche, antigraffio. Trattamento dei tubolari con sabbatura e fosfatazione
- Sistema di carrucole/pulegge realizzate in POM, materiale con ottime caratteristiche di scorrimento ed eccellente resistenza all'usura - cuscinetti PREMIUM GRADE
- Sistema di cavi in acciaio ø 5.8 mm carico massimo 1500 kg.
- Cuscini in schiuma ad alta densità con rivestimento in PU e carter integrali
- Structure oval flat heavy-duty steel tubing oval 75x118 mm e flat oval 50x120mm, 40x80 mm, 50x100 mm - thickness 3 mm.
- Painting double heavy duty powder coating painting, scratch-resistant. Tubing treatment with sandblasting and phosphating process.
- Pulley system made of POM, a very stiff material with low surface friction and good dimensional stability - PREMIUM GRADE bearings
- Cables system steel woven cables ø5.8 mm, max. loadable weight 1500 kg.
- High-density foam cushions with PU upholstery and full back cover

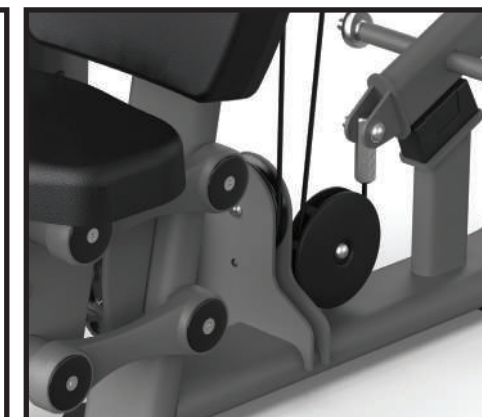
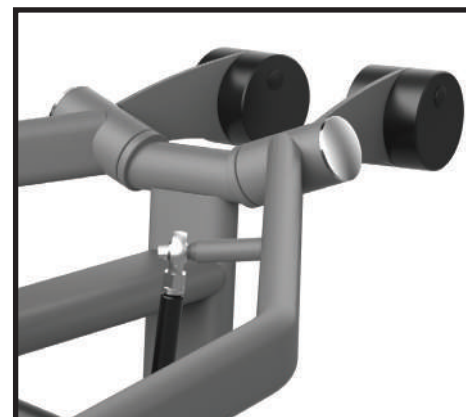

PLX6150

cod. PLX-B6150

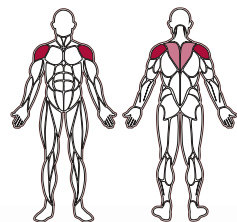

MUSCOLI COINVOLTI MUSCLE GROUPS

- Deltoidi - Deltoids
- Trapezi - Trapezius

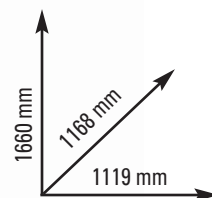

SISTEMA DI SPINTA a leveraggi indipendenti
 PACCO PESI 70 kg in acciaio. Carter di protezione integrale
 REGOLAZIONI: altezza sedile su 6 posizioni
 DIMENSIONI PRODOTTO: 1119x1168x1660 mm
 PESO MAX UTILIZZATORE 150 Kg
 PESO: 185 kg
 CLASSE D'UTILIZZO PROFESSIONALE (EN20957-1 / EN957-2 classe S)

INDEPENDENT PUSH leverage system
 WEIGHT STACK steel 70 kg weight stack with full protection cage
 ADJUSTMENTS: seat height on 6-level
 SET UP SIZE: 1119x1168x1660 mm
 MAX USER WEIGHT 150 Kg
 WEIGHT: 185 kg
 COMMERCIAL USE (EN20957-1 / EN957-2 class S)

- Struttura tubolare in acciaio a sezione ovale 75x118 mm e ovale piatta 50x120 mm, 40x80 mm, 50x100 mm - spessore 3 mm.
- Verniciatura doppia a polveri epossidiche, antigraffio. Trattamento dei tubolari con sabbatura e fosfatazione
- Sistema di carrucole/pullegge realizzate in POM, materiale con ottime caratteristiche di scorrimento ed eccellente resistenza all'usura - cuscinetti PREMIUM GRADE
- Sistema di cavi in acciaio \varnothing 5.8 mm carico massimo 1500 kg.
- Cuscini in schiuma ad alta densità con rivestimento in PU e carter integrali
- Regolazione della seduta a pantografo con bracci in alluminio

- Structure oval flat heavy-duty steel tubing oval 75x118 mm e flat oval 50x120mm, 40x80 mm, 50x100 mm - thickness 3 mm.
- Painting double heavy duty powder coating painting, scratch-resistant. Tubing treatment with sandblasting and phosphating process.
- Pulley system made of POM, a very stiff material with low surface friction and good dimensional stability - PREMIUM GRADE bearings
- Cables system steel woven cables \varnothing 5.8 mm, max. loadable weight 1500 kg.
- High-density foam cushions with PU upholstery and full back cover
- Seat adjustment with pantograph system and aluminium arms



PLX6200

cod. PLX-B6200

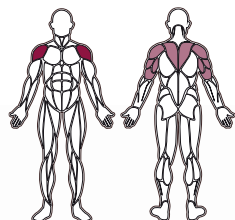

MUSCOLI COINVOLTI MUSCLE GROUPS

- Deltoido anteriore - Anterior deltoid
- Deltoido posteriore - Posterior deltoid
- Tricipiti - Triceps
- Trapezi - Trapezius



cod. PLX-6200

Disponibile anche con finitura dark silver
Also available with dark silver finishing

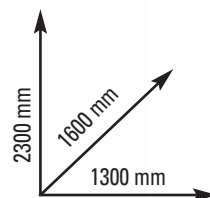

SISTEMA DI SPINTA a doppio avvolgimento
PACCO PESI 80 kg in acciaio. Carter di protezione integrale
REGOLAZIONI: rotazione bracci di caricamento su 9 posizioni
DIMENSIONI PRODOTTO: 1300x1600x2300 mm
PESO MAX UTILIZZATORE 150 Kg
PESO: 205 kg
CLASSE D'UTILIZZO PROFESSIONALE (EN20957-1 / EN957-2 classe S)

DOUBLE WINDING PULL system
WEIGHT STACK steel 80 kg weight stack with full protection cage
ADJUSTMENTS: arm rotation on 9-level
SET UP SIZE: 1300x1600x2300 mm
MAX USER WEIGHT 150 Kg
WEIGHT: 205 kg
COMMERCIAL USE (EN20957-1 / EN957-2 class S)

- Struttura tubolare in acciaio a sezione ovale 75x118 mm e ovale piatta 50x120 mm, 40x80 mm, 50x100 mm - spessore 3 mm.
- Verniciatura doppia a polveri epossidiche, antigraffio.
- Trattamento dei tubolari con sabbatura e fosfatazione
- Sistema di carrucole/pullegge realizzate in POM, materiale con ottime caratteristiche di scorrimento ed eccellente resistenza all'usura - cuscinetti PREMIUM GRADE
- Sistema di cavi in acciaio \varnothing 5.8 mm carico massimo 1500 kg.

- Structure oval flat heavy-duty steel tubing oval 75x118 mm e flat oval 50x120mm, 40x80 mm, 50x100 mm - thickness 3 mm.
- Painting double heavy duty powder coating painting, scratch-resistant.
- Tubing treatment with sandblasting and phosphating process.
- Pulley system made of POM, a very stiff material with low surface friction and good dimensional stability - PREMIUM GRADE bearings
- Cables system steel woven cables \varnothing 5.8 mm, max. loadable weight 1500 kg.



PLX6300

cod. PLX-B6300

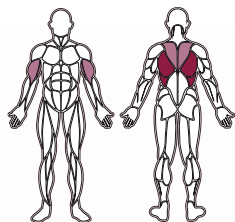

MUSCOLI COINVOLTI MUSCLE GROUPS

- Gran dorsale - Latissimus dorsi
- Bicipiti - Biceps
- Romboidi - Rhomboids
- Trapezio inferiore - Lower trapezius



cod. PLX-6300

Disponibile anche con finitura dark silver
Also available with dark silver finishing

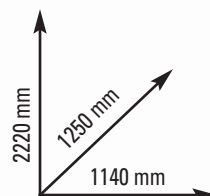

SISTEMA DI TIRO a vettore singolo
PACCO PESI 100 kg in acciaio. Carter di protezione integrale
REGOLAZIONI: rulli di bloccaggio gambe su 5 posizioni
DIMENSIONI PRODOTTO: 1140x1250x2220 mm
PESO MAX UTILIZZATORE 150 Kg
PESO: 195 kg
CLASSE D'UTILIZZO PROFESSIONALE (EN20957-1 / EN957-2 classe S)

SINGLE VECTOR PUSH system
WEIGHT STACK steel 100 kg weight stack with full protection cage
ADJUSTMENTS: leg press rollers on 5-level
SET UP SIZE: 1140x1250x2220 mm
MAX USER WEIGHT 150 Kg
WEIGHT: 195 kg
COMMERCIAL USE (EN20957-1 / EN957-2 class S)

- Struttura tubolare in acciaio a sezione ovale 75x118 mm e ovale piatta 50x120 mm, 40x80 mm, 50x100 mm - spessore 3 mm.
- Verniciatura doppia a polveri epossidiche, antigraffio.
- Trattamento dei tubolari con sabbiatura e fosfatazione
- Sistema di carrucole/pulegge realizzate in POM, materiale con ottime caratteristiche di scorrimento ed eccellente resistenza all'usura - cuscinetti PREMIUM GRADE
- Sistema di cavi in acciaio \varnothing 5.8 mm carico massimo 1500 kg.
- Cuscini in schiuma ad alta densità con rivestimento in PU e carter integrali
- Accessori di serie: barra lat.

- Structure oval flat heavy-duty steel tubing oval 75x118 mm e flat oval 50x120mm, 40x80 mm, 50x100 mm - thickness 3 mm.
- Painting double heavy duty powder coating painting, scratch-resistant.
- Tubing treatment with sandblasting and phosphating process.
- Pulley system made of POM, a very stiff material with low surface friction and good dimensional stability - PREMIUM GRADE bearings
- Cables system steel woven cables \varnothing 5.8 mm, max. loadable weight 1500 kg.
- High-density foam cushions with PU upholstery and full back cover
- Included accessories: lat bar.



PLX6350

cod. PLX-B6350

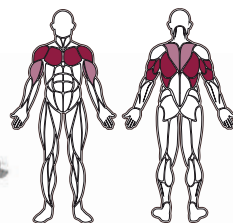

MUSCOLI COINVOLTI MUSCLE GROUPS

- Gran dorsale - Latissimus dorsi
- Pettorali - Pectorals
- Deltoidi anteriori - Anterior deltoids
- Tricipiti - Triceps
- Bicipiti - Biceps
- Romboidi - Rhomboids
- Trapezio inferiore - Lower trapezius



cod. PLX-6350

Disponibile anche con finitura dark silver
Also available with dark silver finishing

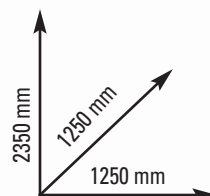

SISTEMA DI AUSILIO a pedana
PACCO PESI 90 kg in acciaio. Carter di protezione integrale
DIMENSIONI PRODOTTO: 1250x1250x2350 mm
PESO MAX UTILIZZATORE 150 Kg
PESO: 250 kg
CLASSE D'UTILIZZO PROFESSIONALE (EN20957-1 / EN957-2 classe S)

PLATFORM AID system
WEIGHT STACK steel 90 kg weight stack with full protection cage
SET UP SIZE: 1250x1250x2350 mm
MAX USER WEIGHT 150 Kg
WEIGHT: 250 kg
COMMERCIAL USE (EN20957-1 / EN957-2 class S)

- Struttura tubolare in acciaio a sezione ovale 75x118 mm e ovale piatta 50x120 mm, 40x80 mm, 50x100 mm - spessore 3 mm.
- Verniciatura doppia a polveri epossidiche, antigraffio.
- Trattamento dei tubolari con sabbatura e fosfatazione
- Sistema di carrucole/pullegge realizzate in POM, materiale con ottime caratteristiche di scorrimento ed eccellente resistenza all'usura - cuscinetti PREMIUM GRADE
- Sistema di cavi in acciaio \varnothing 5.8 mm carico massimo 1500 kg.

- Structure oval flat heavy-duty steel tubing oval 75x118 mm e flat oval 50x120mm, 40x80 mm, 50x100 mm - thickness 3 mm.
- Painting double heavy duty powder coating painting, scratch-resistant.
- Tubing treatment with sandblasting and phosphating process.
- Pulley system made of POM, a very stiff material with low surface friction and good dimensional stability - PREMIUM GRADE bearings
- Cables system steel woven cables \varnothing 5.8 mm, max. loadable weight 1500 kg.



PLX6390

cod. PLX-B6390

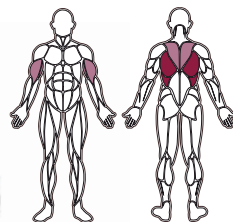
MUSCOLI COINVOLTI
MUSCLE GROUPS

- Gran dorsale - Latissimus dorsi
- Bicipiti - Biceps
- Romboidi - Rhomboids
- Trapezio inferiore - Lower trapezius

SISTEMA DI SPINTA a leveraggi indipendenti
 PACCO PESI 100 kg in acciaio. Carter di protezione integrale
 REGOLAZIONI: altezza sedile su 6 posizioni, roller di appoggio
 delle caviglie su 7 posizioni
 DIMENSIONI PRODOTTO: 1450x1180x2150 mm
 PESO MAX UTILIZZATORE 150 Kg
 PESO: 265 kg
 CLASSE D'UTILIZZO PROFESSIONALE (EN20957-1 / EN957-2 classe S)

INDEPENDENT PUSH leverage system
 WEIGHT STACK steel 100 kg weight stack with full protection cage
 ADJUSTMENTS: seat height on 6-level, small force leverage on 7-level
 SET UP SIZE: 1450x1180x2150 mm
 MAX USER WEIGHT 150 Kg
 WEIGHT: 265 kg
 COMMERCIAL USE (EN20957-1 / EN957-2 class S)

- Struttura tubolare in acciaio a sezione ovale 75x118 mm e ovale piatta 50x120 mm, 40x80 mm, 50x100 mm - spessore 3 mm.
- Verniciatura doppia a polveri epossidiche, antigraffio.
- Trattamento dei tubolari con sabbatura e fosfatazione
- Sistema di carrucole/pullegge realizzate in POM, materiale con ottime caratteristiche di scorrimento ed eccellente resistenza all'usura - cuscinetti PREMIUM GRADE
- Sistema di cavi in acciaio \varnothing 5.8 mm carico massimo 1500 kg.
- Cuscini in schiuma ad alta densità con rivestimento in PU e carter integrali
- Regolazione della seduta a pantografo con bracci in alluminio

- Structure oval flat heavy-duty steel tubing oval 75x118 mm e flat oval 50x120mm, 40x80 mm, 50x100 mm - thickness 3 mm.
- Painting double heavy duty powder coating painting, scratch-resistant.
- Tubing treatment with sandblasting and phosphating process.
- Pulley system made of POM, a very stiff material with low surface friction and good dimensional stability - PREMIUM GRADE bearings
- Cables system steel woven cables \varnothing 5.8 mm, max. loadable weight 1500 kg.
- High-density foam cushions with PU upholstery and full back cover
- Seat adjustment with pantograph system and aluminium arms

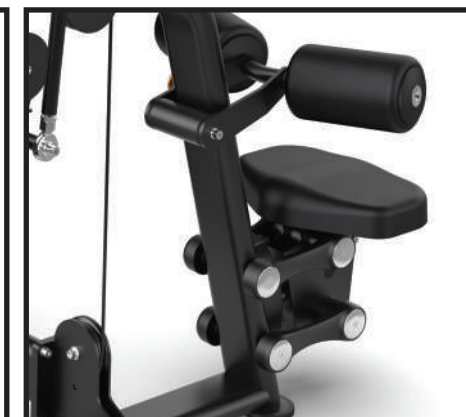
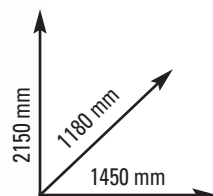

PLX6400

cod. PLX-B6400

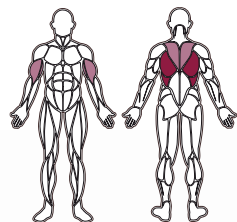

MUSCOLI COINVOLTI MUSCLE GROUPS

- Gran dorsale - Latissimus dorsi
- Bicipiti - Biceps
- Romboidi - Rhomboids
- Trapezio inferiore - Lower trapezius



cod. PLX-6400

Disponibile anche con finitura dark silver
Also available with dark silver finishing

SISTEMA DI TIRO a leveraggio singolo
PACCO PESI 100 kg in acciaio. Carter di protezione integrale
DIMENSIONI PRODOTTO: 746x2046x1660 mm
PESO MAX UTILIZZATORE 150 Kg
PESO: 180 kg
CLASSE D'UTILIZZO PROFESSIONALE (EN20957-1 / EN957-2 classe S)

SINGLE PULL leverage system
WEIGHT STACK steel 100 kg weight stack with full protection cage
SET UP SIZE: 746x2046x1660 mm
MAX USER WEIGHT 150 Kg
WEIGHT: 180 kg
COMMERCIAL USE (EN20957-1 / EN957-2 class S)

- Struttura tubolare in acciaio a sezione ovale 75x118 mm e ovale piatta 50x120 mm, 40x80 mm, 50x100 mm - spessore 3 mm.
- Verniciatura doppia a polveri epossidiche, antigraffio. Trattamento dei tubolari con sabbiatura e fosfatazione
- Sistema di carrucole/pulegge realizzate in POM, materiale con ottime caratteristiche di scorrimento ed eccellente resistenza all'usura - cuscinetti PREMIUM GRADE
- Sistema di cavi in acciaio \varnothing 5.8 mm carico massimo 1500 kg.
- Cuscini in schiuma ad alta densità con rivestimento in PU e carter integrali
- Structure oval flat heavy-duty steel tubing oval 75x118 mm e flat oval 50x120mm, 40x80 mm, 50x100 mm - thickness 3 mm.
- Painting double heavy duty powder coating painting, scratch-resistant. Tubing treatment with sandblasting and phosphating process.
- Pulley system made of POM, a very stiff material with low surface friction and good dimensional stability - PREMIUM GRADE bearings
- Cables system steel woven cables \varnothing 5.8 mm, max. loadable weight 1500 kg.
- High-density foam cushions with PU upholstery and full back cover

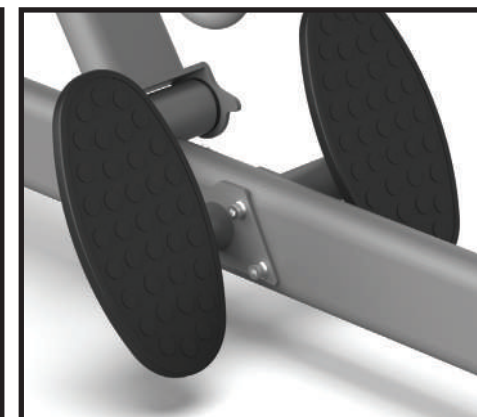

PLX6500

cod. PLX-B6500

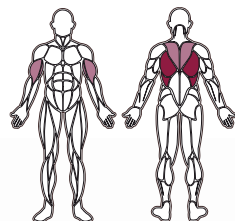

MUSCOLI COINVOLTI MUSCLE GROUPS

- Gran dorsale - Latissimus dorsi
- Bicipiti - Biceps
- Romboidi - Rhomboids
- Trapezio inferiore - Lower trapezius



cod. PLX-6500

Disponibile anche con finitura dark silver
Also available with dark silver finishing

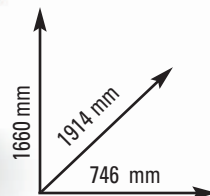

SISTEMA DI TIRO a leveraggio singolo
PACCO PESI 100 kg in acciaio. Carter di protezione integrale
REGOLAZIONI: altezza sedile su 6 posizioni. Rulli chest press su 4 posizioni
DIMENSIONI PRODOTTO: 746x1914x1660 mm
PESO MAX UTILIZZATORE 150 Kg
PESO: 195 kg
CLASSE D'UTILIZZO PROFESSIONALE (EN20957-1 / EN957-2 classe S)

SINGLE PULL leverage system
WEIGHT STACK steel 100 kg weight stack with full protection cage
ADJUSTMENTS: seat height on 6-level. Chest press rollers on 4-level
SET UP SIZE: 746x1914x1660 mm
MAX USER WEIGHT 150 Kg
WEIGHT: 195 kg
COMMERCIAL USE (EN20957-1 / EN957-2 class S)

- Struttura tubolare in acciaio a sezione ovale 75x118 mm e ovale piatta 50x120 mm, 40x80 mm, 50x100 mm - spessore 3 mm.
- Verniciatura doppia a polveri epossidiche, antigraffio. Trattamento dei tubolari con sabbatura e fosfatazione
- Sistema di carrucole/pulegge realizzate in POM, materiale con ottime caratteristiche di scorrimento ed eccellente resistenza all'usura - cuscinetti PREMIUM GRADE
- Sistema di cavi in acciaio \varnothing 5.8 mm carico massimo 1500 kg.
- Cuscini in schiuma ad alta densità con rivestimento in PU e carter integrali
- Structure oval flat heavy-duty steel tubing oval 75x118 mm e flat oval 50x120mm, 40x80 mm, 50x100 mm - thickness 3 mm.
- Painting double heavy duty powder coating painting, scratch-resistant. Tubing treatment with sandblasting and phosphating process.
- Pulley system made of POM, a very stiff material with low surface friction and good dimensional stability - PREMIUM GRADE bearings
- Cables system steel woven cables \varnothing 5.8 mm, max. loadable weight 1500 kg.
- High-density foam cushions with PU upholstery and full back cover

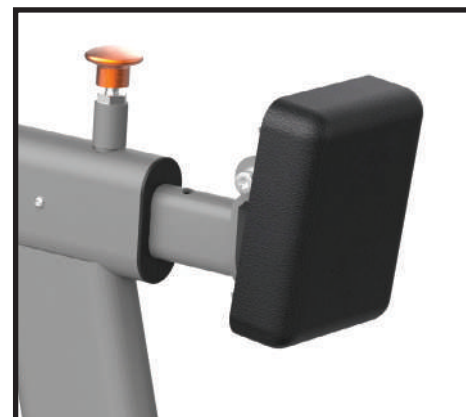

PLX6600

cod. PLX-B6600

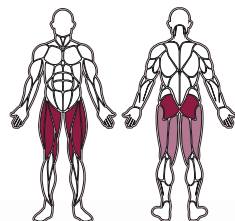

MUSCOLI COINVOLTI MUSCLE GROUPS

- Quadricipiti - Quadriceps
- Ischiocrurali - Hamstrings
- Glutei - Gluteus



cod. PLX-6600

Disponibile anche con finitura dark silver
Also available with dark silver finishing

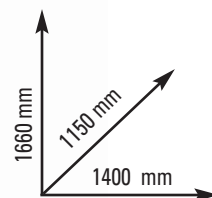

SISTEMA DI SPINTA su pedana fissa
PACCO PESI 150 kg in acciaio. Carter di protezione integrale
REGOLAZIONI: profondità sedile su 16 posizioni
DIMENSIONI PRODOTTO: 1400x1150x1660 mm
PESO MAX UTILIZZATORE 150 Kg
PESO: 330 kg
CLASSE D'UTILIZZO PROFESSIONALE (EN20957-1 / EN957-2 classe S)

FIXED PLATFORM PUSH system
WEIGHT STACK steel 150 kg weight stack with full protection cage
ADJUSTMENTS: backrest forward/backward on 16-level
SET UP SIZE: 1400x1150x1660 mm
MAX USER WEIGHT 150 Kg
WEIGHT: 330 kg
COMMERCIAL USE (EN20957-1 / EN957-2 class S)

- Struttura tubolare in acciaio a sezione ovale 75x118 mm e ovale piatta 50x120 mm, 40x80 mm, 50x100 mm - spessore 3 mm.
- Verniciatura doppia a polveri epossidiche, antigraffio. Trattamento dei tubolari con sabbiatura e fosfatazione
- Sistema di carrucole/pulegge realizzate in POM, materiale con ottime caratteristiche di scorrimento ed eccellente resistenza all'usura - cuscinetti PREMIUM GRADE
- Sistema di cavi in acciaio \varnothing 5.8 mm carico massimo 1500 kg.
- Cuscini in schiuma ad alta densità con rivestimento in PU e carter integrali
- Structure oval flat heavy-duty steel tubing oval 75x118 mm e flat oval 50x120mm, 40x80 mm, 50x100 mm - thickness 3 mm.
- Painting double heavy duty powder coating painting, scratch-resistant. Tubing treatment with sandblasting and phosphating process.
- Pulley system made of POM, a very stiff material with low surface friction and good dimensional stability - PREMIUM GRADE bearings
- Cables system steel woven cables \varnothing 5.8 mm, max. loadable weight 1500 kg.
- High-density foam cushions with PU upholstery and full back cover



PLX6700

cod. PLX-B6700

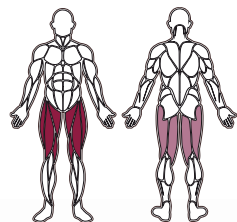

MUSCOLI COINVOLTI MUSCLE GROUPS

- Quadricipiti - Quadriceps
- Ischiocrurali - Hamstrings



cod. PLX-6700

Disponibile anche con finitura dark silver
Also available with dark silver finishing

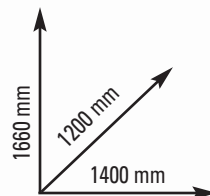

SISTEMA DI SPINTA a leveraggio singolo
PACCO PESI 90 kg in acciaio. Carter di protezione integrale
REGOLAZIONI: partenza del leveraggio di spinta su 4 posizioni, roller di appoggio delle caviglie su 6 posizioni. Inclinazione schienale su 5 posizioni
DIMENSIONI PRODOTTO: 1400x1200x1660 mm
PESO MAX UTILIZZATORE 150 Kg
PESO: 220 kg
CLASSE D'UTILIZZO PROFESSIONALE (EN20957-1 / EN957-2 classe S)

SINGLE PUSH leverage system
WEIGHT STACK steel 90 kg weight stack with full protection cage
ADJUSTMENTS: main force leverage on 4-level, small force leverage on 6-level. Backrest forward/backward on 5-level
SET UP SIZE: 1400x1200x1660 mm
MAX USER WEIGHT 150 Kg
WEIGHT: 220 kg
COMMERCIAL USE (EN20957-1 / EN957-2 class S)

- Struttura tubolare in acciaio a sezione ovale 75x118 mm e ovale piatta 50x120 mm, 40x80 mm, 50x100 mm - spessore 3 mm.
- Verniciatura doppia a polveri epossidiche, antigraffio. Trattamento dei tubolari con sabbatura e fosfatazione
- Sistema di carrucole/pulegge realizzate in POM, materiale con ottime caratteristiche di scorrimento ed eccellente resistenza all'usura - cuscinetti PREMIUM GRADE
- Sistema di cavi in acciaio \varnothing 5.8 mm carico massimo 1500 kg.
- Cuscini in schiuma ad alta densità con rivestimento in PU e carter integrali
- Structure oval flat heavy-duty steel tubing oval 75x118 mm e flat oval 50x120mm, 40x80 mm, 50x100 mm - thickness 3 mm.
- Painting double heavy duty powder coating painting, scratch-resistant. Tubing treatment with sandblasting and phosphating process.
- Pulley system made of POM, a very stiff material with low surface friction and good dimensional stability - PREMIUM GRADE bearings
- Cables system steel woven cables \varnothing 5.8 mm, max. loadable weight 1500 kg.
- High-density foam cushions with PU upholstery and full back cover

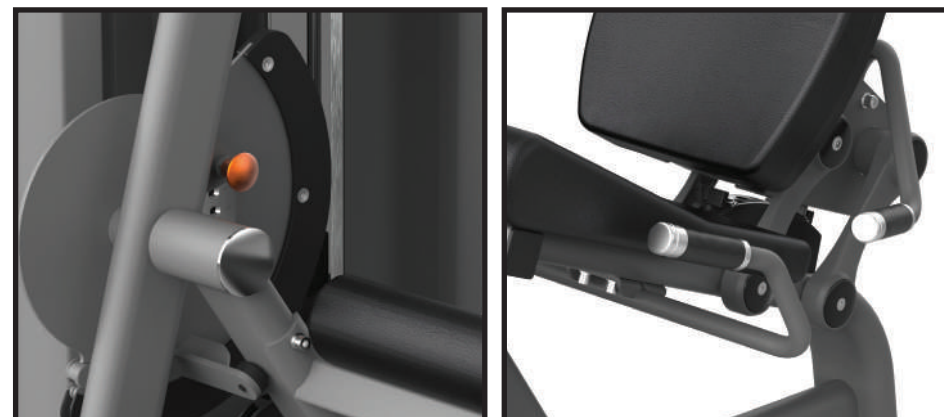

PLX6800

cod. PLX-B6800

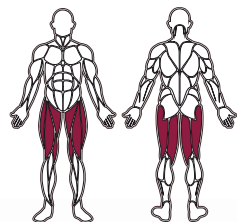

MUSCOLI COINVOLTI MUSCLE GROUPS

- Ischiocrurali - Hamstrings
- Quadricipiti - Quadriceps



cod. PLX-6800

Disponibile anche con finitura dark silver
Also available with dark silver finishing

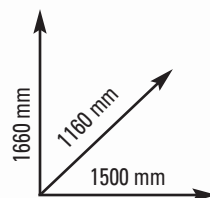

SISTEMA DI SPINTA a leveraggio singolo
PACCO PESI 80 kg in acciaio. Carter di protezione integrale
REGOLAZIONI: partenza del leveraggio di spinta su 4 posizioni, roller di appoggio delle caviglie su 6 posizioni
DIMENSIONI PRODOTTO: 1500x1160x1660 mm
PESO MAX UTILIZZATORE 150 Kg
PESO: 200 kg
CLASSE D'UTILIZZO PROFESSIONALE (EN20957-1 / EN957-2 classe S)

SINGLE PUSH leverage system
WEIGHT STACK steel 80 kg weight stack with full protection cage
ADJUSTMENTS: main force leverage on 4-level, small force leverage on 6-level
SET UP SIZE: 1500x1160x1660 mm
MAX USER WEIGHT 150 Kg
WEIGHT: 200 kg
COMMERCIAL USE (EN20957-1 / EN957-2 class S)

- Struttura tubolare in acciaio a sezione ovale 75x118 mm e ovale piatta 50x120 mm, 40x80 mm, 50x100 mm - spessore 3 mm.
- Verniciatura doppia a polveri epossidiche, antigraffio. Trattamento dei tubolari con sabbatura e fosfatazione
- Sistema di carrucole/pulegge realizzate in POM, materiale con ottime caratteristiche di scorrimento ed eccellente resistenza all'usura - cuscinetti PREMIUM GRADE
- Sistema di cavi in acciaio \varnothing 5.8 mm carico massimo 1500 kg.
- Cuscini in schiuma ad alta densità con rivestimento in PU e carter integrali
- Structure oval flat heavy-duty steel tubing oval 75x118 mm e flat oval 50x120mm, 40x80 mm, 50x100 mm - thickness 3 mm.
- Painting double heavy duty powder coating painting, scratch-resistant. Tubing treatment with sandblasting and phosphating process.
- Pulley system made of POM, a very stiff material with low surface friction and good dimensional stability - PREMIUM GRADE bearings
- Cables system steel woven cables \varnothing 5.8 mm, max. loadable weight 1500 kg.
- High-density foam cushions with PU upholstery and full back cover



PLX6900

cod. PLX-B6900

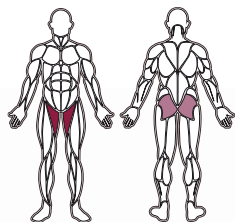

MUSCOLI COINVOLTI MUSCLE GROUPS

- Adduttori - Adductors
- Glutei - Gluteus



cod. PLX-6900

Disponibile anche con finitura dark silver
Also available with dark silver finishing

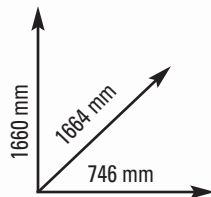

SISTEMA DI SPINTA a leveraggi indipendenti
PACCO PESI 80 kg in acciaio. Carter di protezione integrale
REGOLAZIONI: partenza del leveraggio di spinta su 7 posizioni
DIMENSIONI PRODOTTO: 746x1664x1660 mm
PESO MAX UTILIZZATORE 150 Kg
PESO: 200 kg
CLASSE D'UTILIZZO PROFESSIONALE (EN20957-1 / EN957-2 classe S)

INDEPENDENT PUSH leverage system
WEIGHT STACK steel 80 kg weight stack with full protection cage
ADJUSTMENTS: main force leverage on 7-level
SET UP SIZE: 746x1664x1660 mm
MAX USER WEIGHT 150 Kg
WEIGHT: 200 kg
COMMERCIAL USE (EN20957-1 / EN957-2 class S)

- Struttura tubolare in acciaio a sezione ovale 75x118 mm e ovale piatta 50x120 mm, 40x80 mm, 50x100 mm - spessore 3 mm.
- Verniciatura doppia a polveri epossidiche, antigraffio.
- Trattamento dei tubolari con sabbatura e fosfatazione
- Sistema di carrucole/pulegge realizzate in POM, materiale con ottime caratteristiche di scorrimento ed eccellente resistenza all'usura - cuscinetti PREMIUM GRADE
- Sistema di cavi in acciaio \varnothing 5.8 mm carico massimo 1500 kg.
- Cuscini in schiuma ad alta densità con rivestimento in PU e carter integrali

- Structure oval flat heavy-duty steel tubing oval 75x118 mm e flat oval 50x120mm, 40x80 mm, 50x100 mm - thickness 3 mm.
- Painting double heavy duty powder coating painting, scratch-resistant.
- Tubing treatment with sandblasting and phosphating process.
- Pulley system made of POM, a very stiff material with low surface friction and good dimensional stability - PREMIUM GRADE bearings
- Cables system steel woven cables \varnothing 5.8 mm, max. loadable weight 1500 kg.
- High-density foam cushions with PU upholstery and full back cover

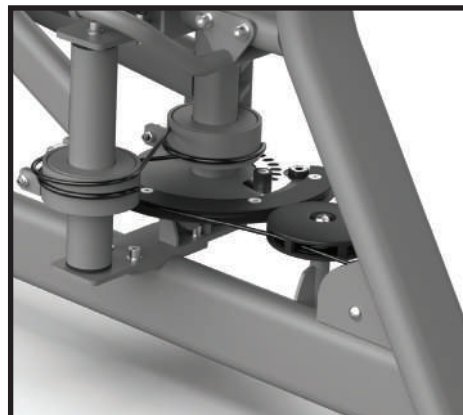

PLX7000

cod. PLX-B7000

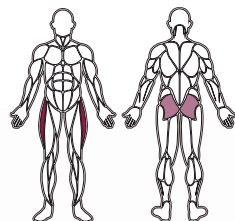

MUSCOLI COINVOLTI MUSCLE GROUPS

- Abductori - Abductors
- Glutei - Gluteus



cod. PLX-7000

Disponibile anche con finitura dark silver
Also available with dark silver finishing

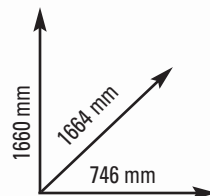

SISTEMA DI SPINTA a leveraggi indipendenti
PACCO PESI 80 kg in acciaio. Carter di protezione integrale
REGOLAZIONI: partenza del leveraggio di spinta su 7 posizioni
DIMENSIONI PRODOTTO: 746x1664x1660 mm
PESO MAX UTILIZZATORE 150 Kg
PESO: 200 kg
CLASSE D'UTILIZZO PROFESSIONALE (EN20957-1 / EN957-2 classe S)

INDEPENDENT PUSH leverage system
WEIGHT STACK steel 80 kg weight stack with full protection cage
ADJUSTMENTS: main force leverage on 7-level
SET UP SIZE: 746x1664x1660 mm
MAX USER WEIGHT 150 Kg
WEIGHT: 200 kg
COMMERCIAL USE (EN20957-1 / EN957-2 class S)

- Struttura tubolare in acciaio a sezione ovale 75x118 mm e ovale piatta 50x120 mm, 40x80 mm, 50x100 mm - spessore 3 mm.
- Verniciatura doppia a polveri epossidiche, antigraffio. Trattamento dei tubolari con sabbatura e fosfatazione
- Sistema di carrucole/pulegge realizzate in POM, materiale con ottime caratteristiche di scorrimento ed eccellente resistenza all'usura - cuscinetti PREMIUM GRADE
- Sistema di cavi in acciaio \varnothing 5.8 mm carico massimo 1500 kg.
- Cuscini in schiuma ad alta densità con rivestimento in PU e carter integrali
- Structure oval flat heavy-duty steel tubing oval 75x118 mm e flat oval 50x120mm, 40x80 mm, 50x100 mm - thickness 3 mm.
- Painting double heavy duty powder coating painting, scratch-resistant. Tubing treatment with sandblasting and phosphating process.
- Pulley system made of POM, a very stiff material with low surface friction and good dimensional stability - PREMIUM GRADE bearings
- Cables system steel woven cables \varnothing 5.8 mm, max. loadable weight 1500 kg.
- High-density foam cushions with PU upholstery and full back cover

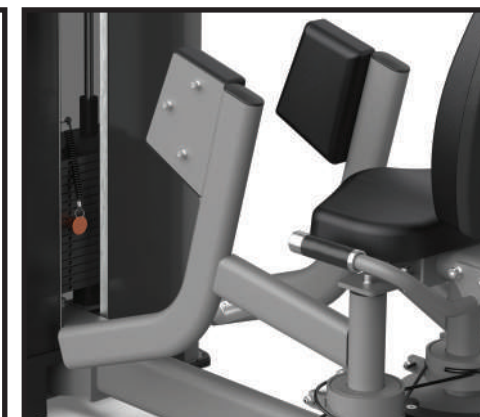
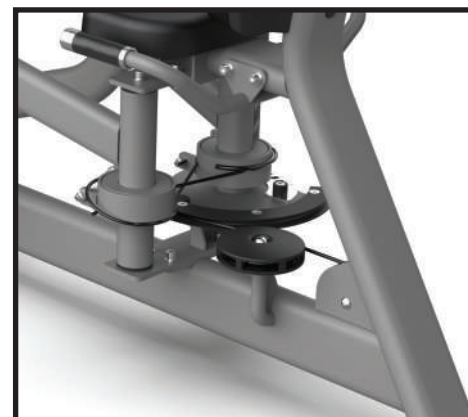

PLX7050

cod. PLX-B7050

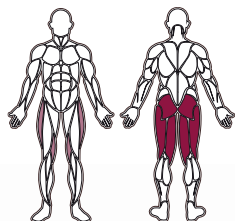

MUSCOLI COINVOLTI MUSCLE GROUPS

- Femorali - Femorals
- Glutei - Gluteus
- Adduttori - Adductors
- Abduttori - Abductors

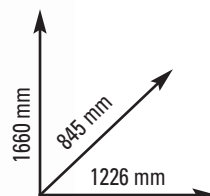

SISTEMA DI SPINTA a leveraggio singolo
 PACCO PESI 80 kg in acciaio. Carter di protezione integrale
 REGOLAZIONI: altezza sedile su 6 posizioni, roller di appoggio
 delle caviglie su 7 posizioni
 DIMENSIONI PRODOTTO: 1226x845x1660 mm
 PESO MAX UTILIZZATORE 150 Kg
 PESO: 185 kg
 CLASSE D'UTILIZZO PROFESSIONALE (EN20957-1 / EN957-2 classe S)

SINGLE PUSH leverage system
 WEIGHT STACK steel 80 kg weight stack with full protection cage
 ADJUSTMENTS: seat height on 6-level, small force leverage on 7-level
 DIMENSIONI PRODOTTO: 1226x845x1660 mm
 MAX USER WEIGHT 150 Kg
 WEIGHT: 185 kg
 COMMERCIAL USE (EN20957-1 / EN957-2 class S)

- Struttura tubolare in acciaio a sezione ovale 75x118 mm e ovale piatta 50x120 mm, 40x80 mm, 50x100 mm - spessore 3 mm.
 - Verniciatura doppia a polveri epossidiche, antigraffio. Trattamento dei tubolari con sabbatura e fosfatazione
 - Sistema di carrucole/pullegge realizzate in POM, materiale con ottime caratteristiche di scorrimento ed eccellente resistenza all'usura - cuscinetti PREMIUM GRADE
 - Sistema di cavi in acciaio \varnothing 5.8 mm carico massimo 1500 kg.
 - Cuscini in schiuma ad alta densità con rivestimento in PU e carter integrali
- Structure oval flat heavy-duty steel tubing oval 75x118 mm e flat oval 50x120mm, 40x80 mm, 50x100 mm - thickness 3 mm.
 - Painting double heavy duty powder coating painting, scratch-resistant. Tubing treatment with sandblasting and phosphating process.
 - Pulley system made of POM, a very stiff material with low surface friction and good dimensional stability - PREMIUM GRADE bearings
 - Cables system steel woven cables \varnothing 5.8 mm, max. loadable weight 1500 kg.
 - High-density foam cushions with PU upholstery and full back cover



PLX7100

cod. PLX-B7100

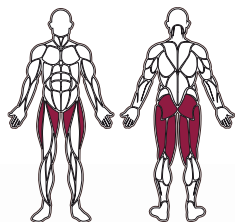

MUSCOLI COINVOLTI MUSCLE GROUPS

- Ischiocrurali - Hamstrings
- Glutei - Gluteus
- Abduttori - Abductors
- Adduttori - Adductors



cod. PLX-7100

Disponibile anche con finitura dark silver
Also available with dark silver finishing

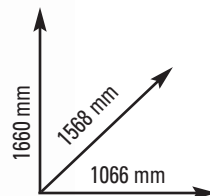

SISTEMA DI SPINTA a singolo avvolgimento
PACCO PESI 80 kg in acciaio. Carter di protezione integrale
REGOLAZIONI: partenza del leveraggio di spinta su 12 posizioni.
Altezza pedana su 4 posizioni
DIMENSIONI PRODOTTO: 1066x1568x1660 mm
PESO MAX UTILIZZATORE 150 Kg
PESO: 235 kg
CLASSE D'UTILIZZO PROFESSIONALE (EN20957-1 / EN957-2 classe S)

SINGLE WINDING PULL system
WEIGHT STACK steel 80 kg weight stack with full protection cage
ADJUSTMENTS: Force arm rotation on 12-level. Pedal height on 4-level
SET UP SIZE: 1066x1568x1660 mm
MAX USER WEIGHT 150 Kg
WEIGHT: 235 kg
COMMERCIAL USE (EN20957-1 / EN957-2 class S)

- Struttura tubolare in acciaio a sezione ovale 75x118 mm e ovale piatta 50x120 mm, 40x80 mm, 50x100 mm - spessore 3 mm.
- Verniciatura doppia a polveri epossidiche, antigraffio. Trattamento dei tubolari con sabbiatura e fosfatazione
- Sistema di carrucole/pulegge realizzate in POM, materiale con ottime caratteristiche di scorrimento ed eccellente resistenza all'usura - cuscinetti PREMIUM GRADE
- Sistema di cavi in acciaio \varnothing 5.8 mm carico massimo 1500 kg.
- Cuscini in schiuma ad alta densità con rivestimento in PU e carter integrali
- Structure oval flat heavy-duty steel tubing oval 75x118 mm e flat oval 50x120mm, 40x80 mm, 50x100 mm - thickness 3 mm.
- Painting double heavy duty powder coating painting, scratch-resistant. Tubing treatment with sandblasting and phosphating process.
- Pulley system made of POM, a very stiff material with low surface friction and good dimensional stability - PREMIUM GRADE bearings
- Cables system steel woven cables \varnothing 5.8 mm, max. loadable weight 1500 kg.
- High-density foam cushions with PU upholstery and full back cover

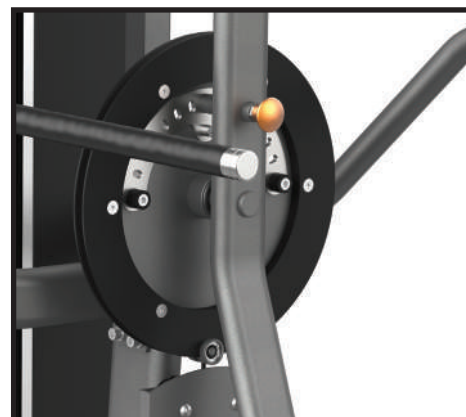

PLX7200

cod. PLX-B7200

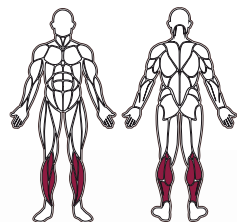

MUSCOLI COINVOLTI MUSCLE GROUPS

- Polpacci - Calves
- Tibiali - Tibials



cod. PLX-7200

Disponibile anche con finitura dark silver
Also available with dark silver finishing

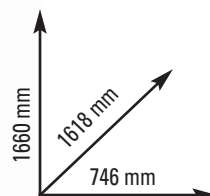

SISTEMA DI SPINTA a leveraggio singolo
PACCO PESI 80 kg in acciaio. Carter di protezione integrale
REGOLAZIONI: rulli di bloccaggio gambe su 6 posizioni
DIMENSIONI PRODOTTO: 746x1618x1660 mm
PESO MAX UTILIZZATORE 150 Kg
PESO: 190 kg
CLASSE D'UTILIZZO PROFESSIONALE (EN20957-1 / EN957-2 classe S)

SINGLE PUSH leverage system
WEIGHT STACK steel 80 kg weight stack with full protection cage
ADJUSTMENTS: leg press rollers on 6-level
SET UP SIZE: 746x1618x1660 mm
MAX USER WEIGHT 150 Kg
WEIGHT: 190 kg
COMMERCIAL USE (EN20957-1 / EN957-2 class S)

- Struttura tubolare in acciaio a sezione ovale 75x118 mm e ovale piatta 50x120 mm, 40x80 mm, 50x100 mm - spessore 3 mm.
- Verniciatura doppia a polveri epossidiche, antigraffio. Trattamento dei tubolari con sabbatura e fosfatazione
- Sistema di carrucole/pulegge realizzate in POM, materiale con ottime caratteristiche di scorrimento ed eccellente resistenza all'usura - cuscinetti PREMIUM GRADE
- Sistema di cavi in acciaio \varnothing 5.8 mm carico massimo 1500 kg.
- Cuscini in schiuma ad alta densità con rivestimento in PU e carter integrali
- Structure oval flat heavy-duty steel tubing oval 75x118 mm e flat oval 50x120mm, 40x80 mm, 50x100 mm - thickness 3 mm.
- Painting double heavy duty powder coating painting, scratch-resistant. Tubing treatment with sandblasting and phosphating process.
- Pulley system made of POM, a very stiff material with low surface friction and good dimensional stability - PREMIUM GRADE bearings
- Cables system steel woven cables \varnothing 5.8 mm, max. loadable weight 1500 kg.
- High-density foam cushions with PU upholstery and full back cover

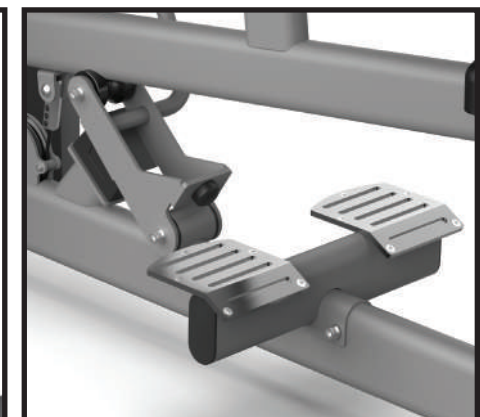

PLX7300

cod. PLX-B7300

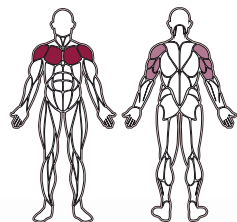
**MUSCOLI COINVOLTI
MUSCLE GROUPS**

- Pettorali - Pectorals
- Deltoide anteriore - Anterior deltoid
- Deltoide posteriore - Posterior deltoid
- Trapezi - Trapezius
- Tricipiti - Triceps

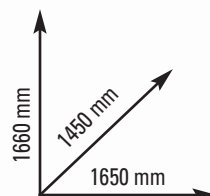

cod. PLX-7300

Disponibile anche con finitura dark silver
Also available with dark silver finishing

SISTEMA DI SPINTA a leveraggio singolo
 PACCO PESI 100 kg in acciaio. Carter di protezione integrale
 REGOLAZIONI: altezza bracci su 7 posizioni
 DIMENSIONI PRODOTTO: 1650x1450x1660 mm
 PESO MAX UTILIZZATORE 150 Kg
 PESO: 230 kg
 CLASSE D'UTILIZZO PROFESSIONALE (EN20957-1 / EN957-2 classe S)

SINGLE PUSH leverage system
 WEIGHT STACK steel 100 kg weight stack with full protection cage
 ADJUSTMENTS: arms height on 7-level
 SET UP SIZE: 1650x1450x1660 mm
 MAX USER WEIGHT 150 Kg
 WEIGHT: 230 kg
 COMMERCIAL USE (EN20957-1 / EN957-2 class S)

- Struttura tubolare in acciaio a sezione ovale 75x118 mm e ovale piatta 50x120 mm, 40x80 mm, 50x100 mm - spessore 3 mm.
 - Verniciatura doppia a polveri epossidiche, antigraffio.
 - Trattamento dei tubolari con sabbiatura e fosfatazione
 - Sistema di carrucole/pulegge realizzate in POM, materiale con ottime caratteristiche di scorrimento ed eccellente resistenza all'usura - cuscinetti PREMIUM GRADE
 - Sistema di cavi in acciaio \varnothing 5.8 mm carico massimo 1500 kg.
 - Cuscini in schiuma ad alta densità con rivestimento in PU e carter integrali
- Structure oval flat heavy-duty steel tubing oval 75x118 mm e flat oval 50x120mm, 40x80 mm, 50x100 mm - thickness 3 mm.
 - Painting double heavy duty powder coating painting, scratch-resistant.
 - Tubing treatment with sandblasting and phosphating process.
 - Pulley system made of POM, a very stiff material with low surface friction and good dimensional stability - PREMIUM GRADE bearings
 - Cables system steel woven cables \varnothing 5.8 mm, max. loadable weight 1500 kg.
 - High-density foam cushions with PU upholstery and full back cover



PLX7400

cod. PLX-B7400

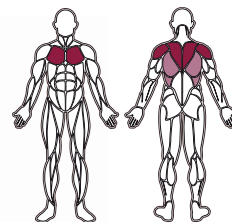

MUSCOLI COINVOLTI MUSCLE GROUPS

- Pettorali - Pectorals
- Deltoidi posteriori - Posterior deltoids
- Trapezi - Trapezius
- Gran dorsale - Latissimus dorsi
- Sottospinato - Infraspinatus



cod. PLX-7400

Disponibile anche con finitura dark silver
Also available with dark silver finishing

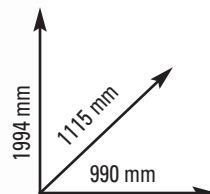

SISTEMA DI SPINTA a leveraggi indipendenti
PACCO PESI 80 kg in acciaio. Carter di protezione integrale
REGOLAZIONI: altezza sedile su 6 posizioni
DIMENSIONI PRODOTTO: 990x1115x1994 mm
PESO MAX UTILIZZATORE 150 Kg
PESO: 235 kg
CLASSE D'UTILIZZO PROFESSIONALE (EN20957-1 / EN957-2 classe S)

INDEPENDENT PUSH leverage system
WEIGHT STACK steel 80 kg weight stack with full protection cage
ADJUSTMENTS: seat height on 6-level
SET UP SIZE: 990x1115x1994 mm
MAX USER WEIGHT 150 Kg
WEIGHT: 235 kg
COMMERCIAL USE (EN20957-1 / EN957-2 class S)

- Struttura tubolare in acciaio a sezione ovale 75x118 mm e ovale piatta 50x120 mm, 40x80 mm, 50x100 mm - spessore 3 mm.
- Verniciatura doppia a polveri epossidiche, antigraffio.
- Trattamento dei tubolari con sabbatura e fosfatazione
- Sistema di carrucole/pulegge realizzate in POM, materiale con ottime caratteristiche di scorrimento ed eccellente resistenza all'usura - cuscinetti PREMIUM GRADE
- Sistema di cavi in acciaio \varnothing 5.8 mm carico massimo 1500 kg.
- Cuscini in schiuma ad alta densità con rivestimento in PU e carter integrali
- Regolazione della seduta a pantografo con bracci in alluminio

- Structure oval flat heavy-duty steel tubing oval 75x118 mm e flat oval 50x120mm, 40x80 mm, 50x100 mm - thickness 3 mm.
- Painting double heavy duty powder coating painting, scratch-resistant.
- Tubing treatment with sandblasting and phosphating process.
- Pulley system made of POM, a very stiff material with low surface friction and good dimensional stability - PREMIUM GRADE bearings
- Cables system steel woven cables \varnothing 5.8 mm, max. loadable weight 1500 kg.
- High-density foam cushions with PU upholstery and full back cover
- Seat adjustment with pantograph system and aluminium arms

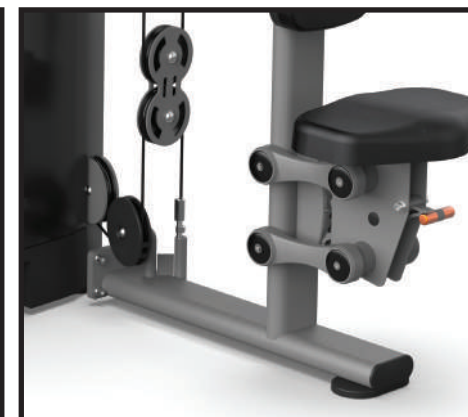

PLX7500

cod. PLX-B7500

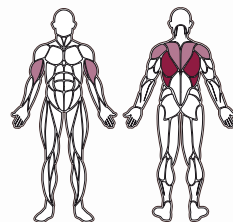

MUSCOLI COINVOLTI MUSCLE GROUPS

- Gran dorsale - Latissimus dorsi
- Bicipiti - Biceps
- Romboidi - Rhomboids
- Trapezio inferiore - Lower trapezius
- Deltoidi posteriori - Posterior deltoids



cod. PLX-7500

Disponibile anche con finitura dark silver
Also available with dark silver finishing

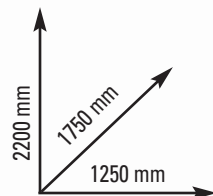

SISTEMA DI TIRO a vettore singolo
PACCO PESI 100 kg in acciaio. Carter di protezione integrale
REGOLAZIONI: rulli di bloccaggio gambe su 5 posizioni
DIMENSIONI PRODOTTO: 1250x1750x2200 mm
PESO MAX UTILIZZATORE 150 Kg
PESO: 220 kg
CLASSE D'UTILIZZO PROFESSIONALE (EN20957-1 / EN957-2 classe S)

SINGLE VECTOR PUSH system
WEIGHT STACK steel 100 kg weight stack with full protection cage
ADJUSTMENTS: leg press rollers on 5-level
SET UP SIZE: 1250x1750x2200 mm
MAX USER WEIGHT 150 Kg
WEIGHT: 220 kg
COMMERCIAL USE (EN20957-1 / EN957-2 class S)

- Struttura tubolare in acciaio a sezione ovale 75x118 mm e ovale piatta 50x120 mm, 40x80 mm, 50x100 mm - spessore 3 mm.
- Verniciatura doppia a polveri epossidiche, antigraffio. Trattamento dei tubolari con sabbatura e fosfatazione
- Sistema di carrucole/pulegge realizzate in POM, materiale con ottime caratteristiche di scorrimento ed eccellente resistenza all'usura - cuscinetti PREMIUM GRADE
- Sistema di cavi in acciaio \varnothing 5.8 mm carico massimo 1500 kg.
- Cuscini in schiuma ad alta densità con rivestimento in PU e carter integrali
- Accessori di serie: barra lat a maniglia doppia

- Structure oval flat heavy-duty steel tubing oval 75x118 mm e flat oval 50x120mm, 40x80 mm, 50x100 mm - thickness 3 mm.
- Painting double heavy duty powder coating painting, scratch-resistant. Tubing treatment with sandblasting and phosphating process.
- Pulley system made of POM, a very stiff material with low surface friction and good dimensional stability - PREMIUM GRADE bearings
- Cables system steel woven cables \varnothing 5.8 mm, max. loadable weight 1500 kg.
- High-density foam cushions with PU upholstery and full back cover
- Included accessories: lat bar and double handle



PLX7700

cod. PLX-B7700

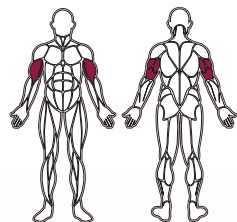

MUSCOLI COINVOLTI MUSCLE GROUPS

- Bicipiti - Biceps
- Tricipiti - Triceps



cod. PLX-7700

Disponibile anche con finitura dark silver
Also available with dark silver finishing

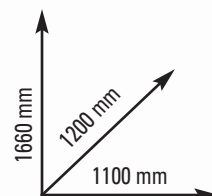

SISTEMA DI SPINTA a leveraggio singolo
PACCO PESI 70 kg in acciaio. Carter di protezione integrale
REGOLAZIONI: altezza sedile su 6 posizioni. Profondità schienale su 6 posizioni
DIMENSIONI PRODOTTO: 1100x1200x1660 mm
PESO MAX UTILIZZATORE 150 Kg
PESO: 205 kg
CLASSE D'UTILIZZO PROFESSIONALE (EN20957-1 / EN957-2 classe S)

SINGLE PUSH leverage system
WEIGHT STACK steel 70 kg weight stack with full protection cage
ADJUSTMENTS: seat height on 6-level. Backrest forward/backward on 6-level
SET UP SIZE: 1100x1200x1660 mm
MAX USER WEIGHT 150 Kg
WEIGHT: 205 kg
COMMERCIAL USE (EN20957-1 / EN957-2 class S)

- Struttura tubolare in acciaio a sezione ovale 75x118 mm e ovale piatta 50x120 mm, 40x80 mm, 50x100 mm - spessore 3 mm.
- Verniciatura doppia a polveri epossidiche, antigraffio. Trattamento dei tubolari con sabbiatura e fosfatazione
- Sistema di carrucole/pulegge realizzate in POM, materiale con ottime caratteristiche di scorrimento ed eccellente resistenza all'usura - cuscinetti PREMIUM GRADE
- Sistema di cavi in acciaio \varnothing 5.8 mm carico massimo 1500 kg.
- Cuscini in schiuma ad alta densità con rivestimento in PU e carter integrali
- Structure oval flat heavy-duty steel tubing oval 75x118 mm e flat oval 50x120mm, 40x80 mm, 50x100 mm - thickness 3 mm.
- Painting double heavy duty powder coating painting, scratch-resistant. Tubing treatment with sandblasting and phosphating process.
- Pulley system made of POM, a very stiff material with low surface friction and good dimensional stability - PREMIUM GRADE bearings
- Cables system steel woven cables \varnothing 5.8 mm, max. loadable weight 1500 kg.
- High-density foam cushions with PU upholstery and full back cover



PLX7800

cod. PLX-B7800

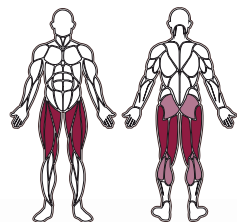

MUSCOLI COINVOLTI MUSCLE GROUPS

- Quadricipiti - Quadriceps
- Femorali - Femorals
- Glutei - Gluteus
- Polpacci - Calves



cod. PLX-7800

Disponibile anche con finitura dark silver
Also available with dark silver finishing

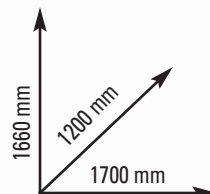

SISTEMA DI SPINTA a leveraggio singolo
PACCO PESI 90 kg in acciaio. Carter di protezione integrale
REGOLAZIONI: rotazione leveraggi di spinta su 5 posizioni
DIMENSIONI PRODOTTO: 1700x1200x1660 mm
PESO MAX UTILIZZATORE 150 Kg
PESO: 220 kg
CLASSE D'UTILIZZO PROFESSIONALE (EN20957-1 / EN957-2 classe S)

SINGLE PUSH leverage system
WEIGHT STACK steel 90 kg weight stack with full protection cage
ADJUSTMENTS: arm rotation on 5-level
SET UP SIZE: 1700x1200x1660 mm
MAX USER WEIGHT 150 Kg
WEIGHT: 220 kg
COMMERCIAL USE (EN20957-1 / EN957-2 class S)

- Struttura tubolare in acciaio a sezione ovale 75x118 mm e ovale piatta 50x120 mm, 40x80 mm, 50x100 mm - spessore 3 mm.
- Verniciatura doppia a polveri epossidiche, antigraffio. Trattamento dei tubolari con sabbatura e fosfatazione
- Sistema di carrucole/pulegge realizzate in POM, materiale con ottime caratteristiche di scorrimento ed eccellente resistenza all'usura - cuscinetti PREMIUM GRADE
- Sistema di cavi in acciaio \varnothing 5.8 mm carico massimo 1500 kg.
- Cuscini in schiuma ad alta densità con rivestimento in PU e carter integrali

- Structure oval flat heavy-duty steel tubing oval 75x118 mm e flat oval 50x120mm, 40x80 mm, 50x100 mm - thickness 3 mm.
- Painting double heavy duty powder coating painting, scratch-resistant. Tubing treatment with sandblasting and phosphating process.
- Pulley system made of POM, a very stiff material with low surface friction and good dimensional stability - PREMIUM GRADE bearings
- Cables system steel woven cables \varnothing 5.8 mm, max. loadable weight 1500 kg.
- High-density foam cushions with PU upholstery and full back cover



PLX7900

cod. PLX-B7900

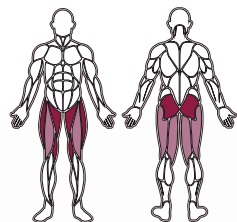

MUSCOLI COINVOLTI MUSCLE GROUPS

- Glutei - Gluteus
- Adduttori - Adductors
- Abduttori - Abductors
- Quadricipiti - Quadriceps
- Femorali - Femorals



cod. PLX-7900

Disponibile anche con finitura dark silver
Also available with dark silver finishing

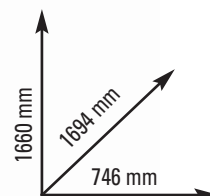

SISTEMA DI SPINTA a leveraggi indipendenti
PACCO PESI 80 kg in acciaio. Carter di protezione integrale
REGOLAZIONI: partenza dei leveraggi di spinta su 8 posizioni
DIMENSIONI PRODOTTO: 746x1694x1660 mm
PESO MAX UTILIZZATORE 150 Kg
PESO: 205 kg
CLASSE D'UTILIZZO PROFESSIONALE (EN20957-1 / EN957-2 classe S)

INDEPENDENT PUSH leverage system
WEIGHT STACK steel 80 kg weight stack with full protection cage
ADJUSTMENTS: force arm forward and backward rotation on 8-level
SET UP SIZE: 746x1694x1660 mm
MAX USER WEIGHT 150 Kg
WEIGHT: 205 kg
COMMERCIAL USE (EN20957-1 / EN957-2 class S)

- Struttura tubolare in acciaio a sezione ovale 75x118 mm e ovale piatta 50x120 mm, 40x80 mm, 50x100 mm - spessore 3 mm.
- Verniciatura doppia a polveri epossidiche, antigraffio.
- Trattamento dei tubolari con sabbatura e fosfatazione
- Sistema di carrucole/pulegge realizzate in POM, materiale con ottime caratteristiche di scorrimento ed eccellente resistenza all'usura - cuscinetti PREMIUM GRADE
- Sistema di cavi in acciaio \varnothing 5.8 mm carico massimo 1500 kg.
- Cuscini in schiuma ad alta densità con rivestimento in PU e carter integrali
- Structure oval flat heavy-duty steel tubing oval 75x118 mm e flat oval 50x120mm, 40x80 mm, 50x100 mm - thickness 3 mm.
- Painting double heavy duty powder coating painting, scratch-resistant.
- Tubing treatment with sandblasting and phosphating process.
- Pulley system made of POM, a very stiff material with low surface friction and good dimensional stability - PREMIUM GRADE bearings
- Cables system steel woven cables \varnothing 5.8 mm, max. loadable weight 1500 kg.
- High-density foam cushions with PU upholstery and full back cover

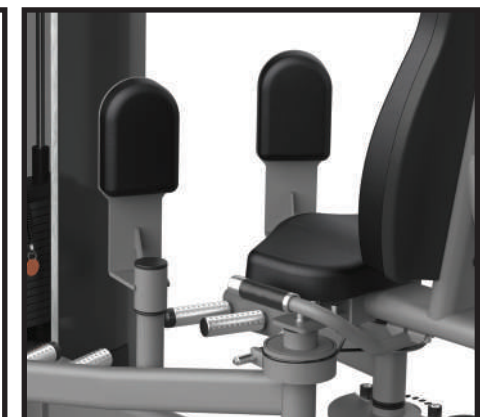

**PLATE LOADED
ABSOLUTE LINE**

FWX8000

cod. FWX-8000

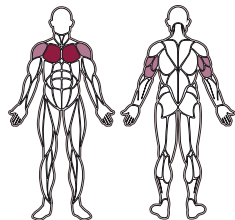
MUSCOLI COINVOLTI
MUSCLE GROUPS

- Pettorali - Pectorals
- Tricipiti - Triceps
- Deltoide anteriore - Anterior deltoid

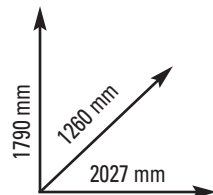

SISTEMA DI SPINTA a leveraggi indipendenti convergenti
 REGOLAZIONI: altezza sedile su 16 posizioni
 DIMENSIONI PRODOTTO: 2027x1260x1790 mm
 PESO MAX UTILIZZATORE 120 Kg
 PESO MAX CARICABILE 300 Kg
 PESO: 150 kg
 CLASSE D'UTILIZZO PROFESSIONALE (EN ISO 20957-1 / EN ISO 20957-2 classe S)

INDEPENDENT COVERGENT PUSH leverage system
 ADJUSTMENTS: seat height on 16-level
 SET UP SIZE: 2027x1260x1790 mm
 MAX USER WEIGHT 120 Kg
 MAX LOADABLE WEIGHT 300 Kg
 WEIGHT: 150 kg
 COMMERCIAL USE (EN ISO 20957-1 / EN ISO 20957-2 class S)

- Struttura tubolare in acciaio a sezione ovale piatta 60x120 mm - spessore 3 mm. Bracci di movimento in acciaio rinforzato a sezione circolare \varnothing 76 mm - spessore 3 mm
- Verniciatura doppia a polveri epossidiche, antigraffio. Trattamento dei tubolari con sabbiatura e fosfatazione
- Sistema di cuscinetti POWER GRADE per garantire uno scorrimento preciso e progressivo
- Cuscini in schiuma ad alta densità con rivestimento in PU
- Regolazione della seduta a cremagliera assistita da molla a gas
- Structure oval flat heavy-duty steel tubing 60x120 mm - thickness 3 mm. Movement arms made of round heavy-duty steel tubing \varnothing 76 mm - thickness 3 mm
- Double heavy duty powder coating painting, scratch-resistant. Tubing treatment with sandblastic and phosphating process
- Pulleys system POWER GRADE bearings for a smooth and precise action
- High-density foam cushions with PU upholstery
- Rack seat adjustment system assisted by gas spring



FWX8050

cod. FWX-8050

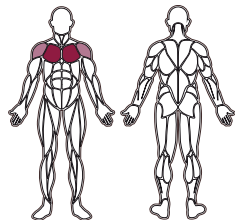
MUSCOLI COINVOLTI
MUSCLE GROUPS

- Pettorali - Pectorals
- Deltoide anteriore - Anterior deltoid

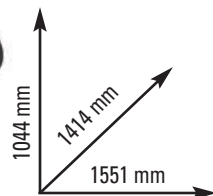

SISTEMA DI SPINTA a leveraggi indipendenti convergenti
 REGOLAZIONI: altezza sedile su 16 posizioni
 DIMENSIONI PRODOTTO: 1551x1414x1044 mm
 PESO MAX UTILIZZATORE 120 Kg
 PESO MAX CARICABILE 200 Kg
 PESO: 100 kg
 CLASSE D'UTILIZZO PROFESSIONALE (EN ISO 20957-1 / EN ISO 20957-2 classe S)

INDEPENDENT COVERGENT PUSH leverage system
 ADJUSTMENTS: seat height on 16-level
 SET UP SIZE: 1551x1414x1044 mm
 MAX USER WEIGHT 120 Kg
 MAX LOADABLE WEIGHT 200 Kg
 WEIGHT: 100 kg
 COMMERCIAL USE (EN ISO 20957-1 / EN ISO 20957-2 class S)

- Struttura tubolare in acciaio a sezione ovale piatta 60x120 mm - spessore 3 mm. Bracci di movimento in acciaio rinforzato a sezione circolare \varnothing 76 mm - spessore 3 mm
- Verniciatura doppia a polveri epossidiche, antigraffio. Trattamento dei tubolari con sabbiatura e fosfatazione
- Sistema di cuscinetti POWER GRADE per garantire uno scorrimento preciso e progressivo
- Cuscini in schiuma ad alta densità con rivestimento in PU
- Regolazione della seduta a cremagliera assistita da molla a gas
- Structure oval flat heavy-duty steel tubing 60x120 mm - thickness 3 mm. Movement arms made of round heavy-duty steel tubing \varnothing 76 mm - thickness 3 mm
- Double heavy duty powder coating painting, scratch-resistant. Tubing treatment with sandblastic and phosphating process
- Pulleys system POWER GRADE bearings for a smooth and precise action
- High-density foam cushions with PU upholstery
- Rack seat adjustment system assisted by gas spring



FWX8090

cod. FWX-8090

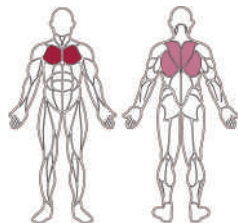
MUSCOLI COINVOLTI
MUSCLE GROUPS

- Pettorali - Pectorals
- Gran dorsale - Latissimus dorsi
- Trapezio inferiore - Lower trapezius

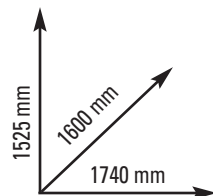

SISTEMA DI SPINTA a telaio flottante
 REGOLAZIONI: altezza sedile su 16 posizioni
 DIMENSIONI PRODOTTO: 1740x1600x1525 mm
 PESO MAX UTILIZZATORE 120 Kg
 PESO MAX CARICABILE 300 Kg
 PESO: 130 kg
 CLASSE D'UTILIZZO PROFESSIONALE (EN ISO 20957-1 / EN ISO 20957-2 classe S)

FLOATING PLATFORM PUSH system
 ADJUSTMENTS: seat height on 16-level
 SET UP SIZE: 1740x1600x1525 mm
 MAX USER WEIGHT 120 Kg
 MAX LOADABLE WEIGHT 300 Kg
 WEIGHT: 130 kg
 COMMERCIAL USE (EN ISO 20957-1 / EN ISO 20957-2 class S)

- Struttura tubolare in acciaio a sezione ovale piatta 60x120 mm - spessore 3 mm. Bracci di movimento in acciaio rinforzato a sezione circolare \varnothing 76 mm - spessore 3 mm
- Verniciatura doppia a polveri epossidiche, antigraffio. Trattamento dei tubolari con sabbiatura e fosfatazione
- Sistema di cuscinetti POWER GRADE per garantire uno scorrimento preciso e progressivo
- Cuscini in schiuma ad alta densità con rivestimento in PU
- Regolazione della seduta a cremagliera assistita da molla a gas
- Structure oval flat heavy-duty steel tubing 60x120 mm - thickness 3 mm. Movement arms made of round heavy-duty steel tubing \varnothing 76 mm - thickness 3 mm
- Double heavy duty powder coating painting, scratch-resistant. Tubing treatment with sandblasting and phosphating process
- Pulleys system POWER GRADE bearings for a smooth and precise action
- High-density foam cushions with PU upholstery
- Rack seat adjustment system assisted by gas spring



FWX8100

cod. FWX-8100

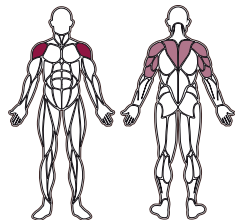
**MUSCOLI COINVOLTI**
MUSCLE GROUPS

- Deltoido anteriore - Anterior deltoid
- Deltoido posteriore - Posterior deltoid
- Tricipiti - Triceps
- Trapezi - Trapezius

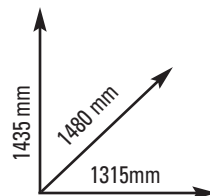

SISTEMA DI SPINTA a leveraggi indipendenti convergenti
 REGOLAZIONI: altezza sedile su 16 posizioni
 DIMENSIONI PRODOTTO: 1315x1480x1435 mm
 PESO MAX UTILIZZATORE 120 Kg
 PESO MAX CARICABILE 300 Kg
 PESO: 130 kg
 CLASSE D'UTILIZZO PROFESSIONALE (EN ISO 20957-1 / EN ISO 20957-2 classe S)

INDEPENDENT COVERGENT PUSH leverage system
 ADJUSTMENTS: seat height on 16-level
 SET UP SIZE: 1315x1480x1435 mm
 MAX USER WEIGHT 120 Kg
 MAX LOADABLE WEIGHT 300 Kg
 WEIGHT: 130 kg
 COMMERCIAL USE (EN ISO 20957-1 / EN ISO 20957-2 class S)

- Struttura tubolare in acciaio a sezione ovale piatta 60x120 mm - spessore 3 mm. Bracci di movimento in acciaio rinforzato a sezione circolare \varnothing 76 mm - spessore 3 mm
- Verniciatura doppia a polveri epossidiche, antigraffio. Trattamento dei tubolari con sabbatura e fosfatazione
- Sistema di cuscinetti POWER GRADE per garantire uno scorrimento preciso e progressivo
- Cuscini in schiuma ad alta densità con rivestimento in PU
- Regolazione della seduta a cremagliera assistita da molla a gas
- Structure oval flat heavy-duty steel tubing 60x120 mm - thickness 3 mm. Movement arms made of round heavy-duty steel tubing \varnothing 76 mm - thickness 3 mm
- Double heavy duty powder coating painting, scratch-resistant. Tubing treatment with sandblastic and phosphating process
- Pulleys system POWER GRADE bearings for a smooth and precise action
- High-density foam cushions with PU upholstery
- Rack seat adjustment system assisted by gas spring



FWX8200

cod. FWX-8200

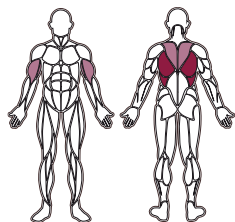
**MUSCOLI COINVOLTI**
MUSCLE GROUPS

- Gran dorsale - Latissimus dorsi
- Bicipiti - Biceps
- Romboidi - Rhomboids
- Trapezio inferiore - Lower trapezius

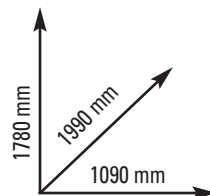

SISTEMA DI TIRO a leveraggi indipendenti divergenti
 REGOLAZIONI: altezza sedile su 16 posizioni
 DIMENSIONI PRODOTTO: 1090x1990x1780 mm
 PESO MAX UTILIZZATORE 120 Kg
 PESO MAX CARICABILE 300 Kg
 PESO: 105 kg
 CLASSE D'UTILIZZO PROFESSIONALE (EN ISO 20957-1 / EN ISO 20957-2 classe S)

INDEPENDENT DIVERGENT PULL leverage system
 ADJUSTMENTS: seat height on 16-level
 SET UP SIZE: 1090x1990x1780 mm
 MAX USER WEIGHT 120 Kg
 MAX LOADABLE WEIGHT 300 Kg
 WEIGHT: 105 kg
 COMMERCIAL USE (EN ISO 20957-1 / EN ISO 20957-2 classe S)

- Struttura tubolare in acciaio a sezione ovale piatta 60x120 mm - spessore 3 mm. Bracci di movimento in acciaio rinforzato a sezione circolare \varnothing 76 mm - spessore 3 mm
- Verniciatura doppia a polveri epossidiche, antigraffio. Trattamento dei tubolari con sabbiatura e fosfatazione
- Sistema di cuscinetti POWER GRADE per garantire uno scorrimento preciso e progressivo
- Cuscini in schiuma ad alta densità con rivestimento in PU
- Regolazione della seduta a cremagliera assistita da molla a gas
- Structure oval flat heavy-duty steel tubing 60x120 mm - thickness 3 mm. Movement arms made of round heavy-duty steel tubing \varnothing 76 mm - thickness 3 mm
- Double heavy duty powder coating painting, scratch-resistant. Tubing treatment with sandblastic and phosphating process
- Pulleys system POWER GRADE bearings for a smooth and precise action
- High-density foam cushions with PU upholstery
- Rack seat adjustment system assisted by gas spring



FWX8300

cod. FWX-8300

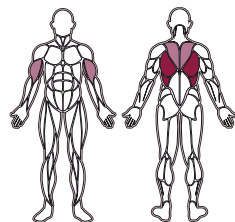
**MUSCOLI COINVOLTI
MUSCLE GROUPS**

- Gran dorsale - Latissimus dorsi
- Bicipiti - Biceps
- Romboidi - Rhomboids
- Trapezio inferiore - Lower trapezius

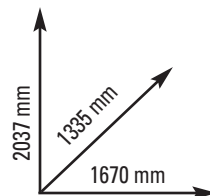

SISTEMA DI TIRO a leveraggi indipendenti
 REGOLAZIONI: altezza sedile su 16 posizioni
 DIMENSIONI PRODOTTO: 1670x1335x2037 mm
 PESO MAX UTILIZZATORE 120 Kg
 PESO MAX CARICABILE 300 Kg
 PESO: 149 kg
 CLASSE D'UTILIZZO PROFESSIONALE (EN ISO 20957-1 / EN ISO 20957-2 classe S)

INDEPENDENT PULL leverage system
 ADJUSTMENTS: seat height on 16-level
 SET UP SIZE: 1670x1335x2037 mm
 MAX USER WEIGHT 120 Kg
 MAX LOADABLE WEIGHT 300 Kg
 WEIGHT: 149 kg
 COMMERCIAL USE (EN ISO 20957-1 / EN ISO 20957-2 class S)

- Struttura tubolare in acciaio a sezione ovale piatta 60x120 mm - spessore 3 mm. Bracci di movimento in acciaio rinforzato a sezione circolare \varnothing 76 mm - spessore 3 mm
- Verniciatura doppia a polveri epossidiche, antigraffio. Trattamento dei tubolari con sabbatura e fosfatazione
- Sistema di cuscinetti POWER GRADE per garantire uno scorrimento preciso e progressivo
- Cuscini in schiuma ad alta densità con rivestimento in PU
- Regolazione della seduta a cremagliera assistita da molla a gas
- Structure oval flat heavy-duty steel tubing 60x120 mm - thickness 3 mm. Movement arms made of round heavy-duty steel tubing \varnothing 76 mm - thickness 3 mm
- Double heavy duty powder coating painting, scratch-resistant. Tubing treatment with sandblastic and phosphating process
- Pulleys system POWER GRADE bearings for a smooth and precise action
- High-density foam cushions with PU upholstery
- Rack seat adjustment system assisted by gas spring



FWX8350

cod. FWX-8350

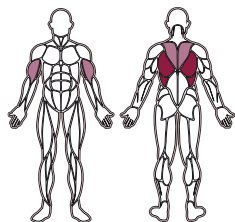
**MUSCOLI COINVOLTI
MUSCLE GROUPS**

- Gran dorsale - Latissimus dorsi
- Bicipiti - Biceps
- Romboidi - Rhomboids
- Trapezio inferiore - Lower trapezius

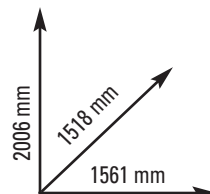

SISTEMA DI SPINTA a leveraggi indipendenti divergenti
 REGOLAZIONI: altezza sedile su 16 posizioni, rulli di bloccaggio su 3 posizioni
 DIMENSIONI PRODOTTO: 1561x1518x2006 mm
 PESO MAX UTILIZZATORE 120 Kg
 PESO MAX CARICABILE 300 Kg
 PESO: 177 kg
 CLASSE D'UTILIZZO PROFESSIONALE (EN ISO 20957-1 / EN ISO 20957-2 classe S)

INDEPENDENT DIVERGENT PUSH leverage system
 ADJUSTMENTS: seat height on 16-level, rollers on 3-level
 SET UP SIZE: 1561x1518x2006 mm
 MAX USER WEIGHT 120 Kg
 MAX LOADABLE WEIGHT 300 Kg
 WEIGHT: 177 kg
 COMMERCIAL USE (EN ISO 20957-1 / EN ISO 20957-2 class S)

- Struttura tubolare in acciaio a sezione ovale piatta 60x120 mm - spessore 3 mm. Bracci di movimento in acciaio rinforzato a sezione circolare \varnothing 76 mm - spessore 3 mm
- Verniciatura doppia a polveri epossidiche, antigraffio. Trattamento dei tubolari con sabbatura e fosfatazione
- Sistema di cuscinetti POWER GRADE per garantire uno scorrimento preciso e progressivo
- Cuscini in schiuma ad alta densità con rivestimento in PU
- Regolazione della seduta a cremagliera assistita da molla a gas
- Structure oval flat heavy-duty steel tubing 60x120 mm - thickness 3 mm. Movement arms made of round heavy-duty steel tubing \varnothing 76 mm - thickness 3 mm
- Double heavy duty powder coating painting, scratch-resistant. Tubing treatment with sandblastic and phosphating process
- Pulleys system POWER GRADE bearings for a smooth and precise action
- High-density foam cushions with PU upholstery
- Rack seat adjustment system assisted by gas spring



FWX8400

cod. FWX-8400

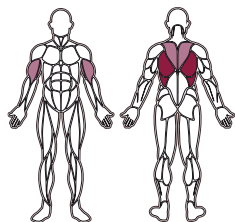
**MUSCOLI COINVOLTI
MUSCLE GROUPS**

- Gran dorsale - Latissimus dorsi
- Bicipiti - Biceps
- Romboidi - Rhomboids
- Trapezio inferiore - Lower trapezius

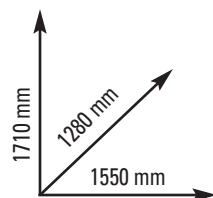

SISTEMA DI TIRO a leveraggi indipendenti divergenti
 REGOLAZIONI: altezza sedile su 16 posizioni
 DIMENSIONI PRODOTTO: 1550x1280x1710 mm
 PESO MAX UTILIZZATORE 120 Kg
 PESO MAX CARICABILE 300 Kg
 PESO: 131 kg
 CLASSE D'UTILIZZO PROFESSIONALE (EN ISO 20957-1 / EN ISO 20957-2 classe S)

INDEPENDENT DIVERGENT PULL leverage system
 ADJUSTMENTS: seat height on 16-level
 SET UP SIZE: 1550x1280x1710 mm
 MAX USER WEIGHT 120 Kg
 MAX LOADABLE WEIGHT 300 Kg
 WEIGHT: 131 kg
 COMMERCIAL USE (EN ISO 20957-1 / EN ISO 20957-2 class S)

- Struttura tubolare in acciaio a sezione ovale piatta 60x120 mm - spessore 3 mm. Bracci di movimento in acciaio rinforzato a sezione circolare \varnothing 76 mm - spessore 3 mm
- Verniciatura doppia a polveri epossidiche, antigraffio. Trattamento dei tubolari con sabbatura e fosfatazione
- Sistema di cuscinetti POWER GRADE per garantire uno scorrimento preciso e progressivo
- Cuscini in schiuma ad alta densità con rivestimento in PU
- Regolazione della seduta a cremagliera assistita da molla a gas
- Structure oval flat heavy-duty steel tubing 60x120 mm - thickness 3 mm. Movement arms made of round heavy-duty steel tubing \varnothing 76 mm - thickness 3 mm
- Double heavy duty powder coating painting, scratch-resistant. Tubing treatment with sandblastic and phosphating process
- Pulleys system POWER GRADE bearings for a smooth and precise action
- High-density foam cushions with PU upholstery
- Rack seat adjustment system assisted by gas spring



FWX8500

cod. FWX-8500

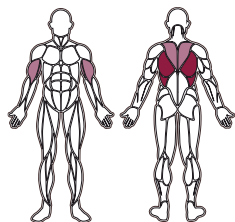
MUSCOLI COINVOLTI
MUSCLE GROUPS

- Gran dorsale - Latissimus dorsi
- Bicipiti - Biceps
- Romboidi - Rhomboids
- Trapezio inferiore - Lower trapezius

SISTEMA DI TIRO a leveraggi indipendenti divergenti
 REGOLAZIONI: altezza sedile su 16 posizioni
 DIMENSIONI PRODOTTO: 1480x1275x1240 mm
 PESO MAX UTILIZZATORE 120 Kg
 PESO MAX CARICABILE 300 Kg
 PESO: 124 kg
 CLASSE D'UTILIZZO PROFESSIONALE (EN ISO 20957-1 / EN ISO 20957-2 classe S)

INDEPENDENT DIVERGENT PULL leverage system
 ADJUSTMENTS: seat height on 16-level
 SET UP SIZE: 1480x1275x1240 mm
 MAX USER WEIGHT 120 Kg
 MAX LOADABLE WEIGHT 300 Kg
 WEIGHT: 124 kg
 COMMERCIAL USE (EN ISO 20957-1 / EN ISO 20957-2 class S)

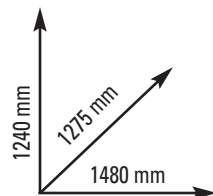

- Struttura tubolare in acciaio a sezione ovale piatta 60x120 mm - spessore 3 mm. Bracci di movimento in acciaio rinforzato a sezione circolare \varnothing 76 mm - spessore 3 mm
- Verniciatura doppia a polveri epossidiche, antigraffio. Trattamento dei tubolari con sabbatura e fosfatazione
- Sistema di cuscinetti POWER GRADE per garantire uno scorrimento preciso e progressivo
- Cuscini in schiuma ad alta densità con rivestimento in PU
- Pedana di spinta: inclinazione 20°
- Regolazione della seduta a cremagliera assistita da molla a gas

- Structure oval flat heavy-duty steel tubing 60x120 mm - thickness 3 mm. Movement arms made of round heavy-duty steel tubing \varnothing 76 mm - thickness 3 mm
- Double heavy duty powder coating painting, scratch-resistant. Tubing treatment with sandblastic and phosphating process
- Pulleys system POWER GRADE bearings for a smooth and precise action
- High-density foam cushions with PU upholstery
- Footplate: 20° incline
- Rack seat adjustment system assisted by gas spring



FWX8600

cod. FWX-8600

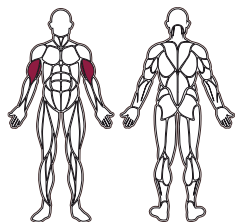
MUSCOLI COINVOLTI
MUSCLE GROUPS

■ Bicipiti - Biceps

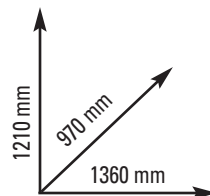

SISTEMA DI TIRO a leveraggio singolo
 TRASMISSIONE DEL CARICO a cinghia
 REGOLAZIONI: altezza sedile su 16 posizioni
 DIMENSIONI PRODOTTO: 1360x970x1210 mm
 PESO MAX UTILIZZATORE 120 Kg
 PESO MAX CARICABILE 200 Kg
 PESO: 95 kg
 CLASSE D'UTILIZZO PROFESSIONALE (EN ISO 20957-1 / EN ISO 20957-2 classe S)

SINGLE PULL leverage system
 BELT LOAD transmission
 ADJUSTMENTS: seat height on 16-level
 SET UP SIZE: 1360x970x1210 mm
 MAX USER WEIGHT 120 Kg
 MAX LOADABLE WEIGHT 200 Kg
 WEIGHT: 95 kg
 COMMERCIAL USE (EN ISO 20957-1 / EN ISO 20957-2 class S)

- Struttura tubolare in acciaio a sezione ovale piatta 60x120 mm - spessore 3 mm. Bracci di movimento in acciaio rinforzato a sezione circolare \varnothing 76 mm - spessore 3 mm
- Verniciatura doppia a polveri epossidiche, antigraffio. Trattamento dei tubolari con sabbatura e fosfatazione
- Sistema di cuscinetti POWER GRADE per garantire uno scorrimento preciso e progressivo
- Cuscini in schiuma ad alta densità con rivestimento in PU
- Regolazione della seduta a cremagliera assistita da molla a gas
- Structure oval flat heavy-duty steel tubing 60x120 mm - thickness 3 mm. Movement arms made of round heavy-duty steel tubing \varnothing 76 mm - thickness 3 mm
- Double heavy duty powder coating painting, scratch-resistant. Tubing treatment with sandblasting and phosphating process
- Pulleys system POWER GRADE bearings for a smooth and precise action
- High-density foam cushions with PU upholstery
- Rack seat adjustment system assisted by gas spring



FWX8700

cod. FWX-8700

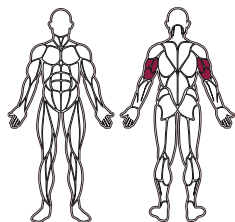
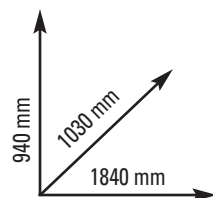

MUSCOLI COINVOLTI
MUSCLE GROUPS
■ Tricipiti - Triceps

SISTEMA DI SPINTA a leveraggio singolo
 REGOLAZIONI: altezza sedile su 16 posizioni
 DIMENSIONI PRODOTTO: 1840x1030x940 mm
 PESO MAX UTILIZZATORE 120 Kg
 PESO MAX CARICABILE 300 Kg
 PESO: 125 kg
 CLASSE D'UTILIZZO PROFESSIONALE (EN ISO 20957-1 / EN ISO 20957-2 classe S)

SINGLE PUSH leverage system
 ADJUSTMENTS: seat height on 16-level
 SET UP SIZE: 1840x1030x940 mm
 MAX USER WEIGHT 120 Kg
 MAX LOADABLE WEIGHT 300 Kg
 WEIGHT: 125 kg
 COMMERCIAL USE (EN ISO 20957-1 / EN ISO 20957-2 class S)

- Struttura tubolare in acciaio a sezione ovale piatta 60x120 mm - spessore 3 mm. Bracci di movimento in acciaio rinforzato a sezione circolare \varnothing 76 mm - spessore 3 mm
- Verniciatura doppia a polveri epossidiche, antigraffio. Trattamento dei tubolari con sabbatura e fosfatazione
- Sistema di cuscinetti POWER GRADE per garantire uno scorrimento preciso e progressivo
- Cuscini in schiuma ad alta densità con rivestimento in PU
- Regolazione della seduta a cremagliera assistita da molla a gas

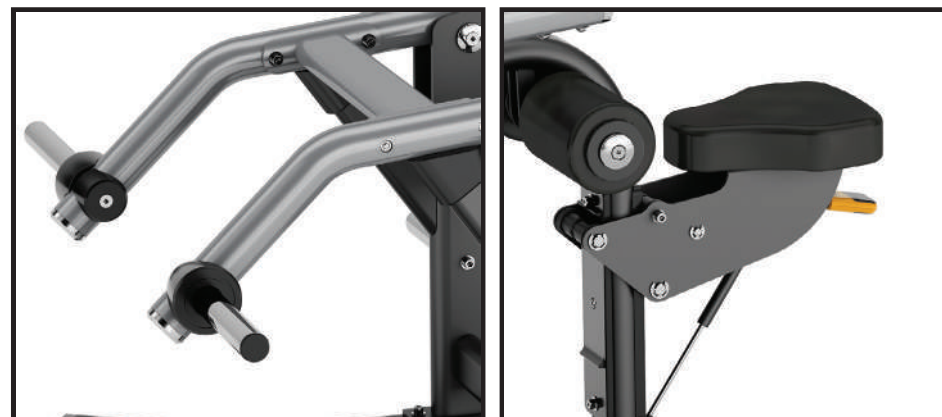
- Structure oval flat heavy-duty steel tubing 60x120 mm - thickness 3 mm. Movement arms made of round heavy-duty steel tubing \varnothing 76 mm - thickness 3 mm
- Double heavy duty powder coating painting, scratch-resistant. Tubing treatment with sandblastic and phosphating process
- Pulleys system POWER GRADE bearings for a smooth and precise action
- High-density foam cushions with PU upholstery
- Rack seat adjustment system assisted by gas spring



FWX8750

cod. FWX-8750

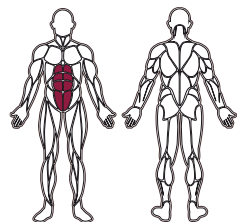

MUSCOLI COINVOLTI MUSCLE GROUPS

■ Addominali - Abdominals

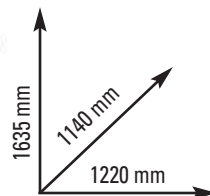

SISTEMA DI SPINTA a telaio flottante
REGOLAZIONI: rotazione sedile su 3 posizioni
DIMENSIONI PRODOTTO: 1220x1140x1635 mm
PESO MAX UTILIZZATORE 120 Kg
PESO MAX CARICABILE 150 Kg
PESO: 128 kg
CLASSE D'UTILIZZO PROFESSIONALE (EN ISO 20957-1 / EN ISO 20957-2 classe S)

FLOATING PLATFORM PUSH system
ADJUSTMENTS: seat rotation on 3-level
SET UP SIZE: 1220x1140x1635 mm
MAX USER WEIGHT 120 Kg
MAX LOADABLE WEIGHT 150 Kg
WEIGHT: 128 kg
COMMERCIAL USE (EN ISO 20957-1 / EN ISO 20957-2 class S)

- Struttura tubolare in acciaio a sezione ovale piatta 60x120 mm - spessore 3 mm. Bracci di movimento in acciaio rinforzato a sezione circolare \varnothing 76 mm - spessore 3 mm
- Verniciatura doppia a polveri epossidiche, antigraffio. Trattamento dei tubolari con sabbiatura e fosfatazione
- Sistema di cuscinetti POWER GRADE per garantire uno scorrimento preciso e progressivo
- Cuscini in schiuma ad alta densità con rivestimento in PU

- Structure oval flat heavy-duty steel tubing 60x120 mm - thickness 3 mm. Movement arms made of round heavy-duty steel tubing \varnothing 76 mm - thickness 3 mm
- Double heavy duty powder coating painting, scratch-resistant. Tubing treatment with sandblastic and phosphating process
- Pulleys system POWER GRADE bearings for a smooth and precise action
- High-density foam cushions with PU upholstery



FWX8800

cod. FWX-8800

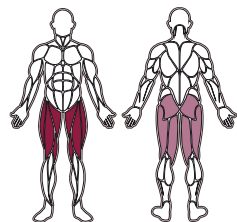

MUSCOLI COINVOLTI MUSCLE GROUPS

- Quadricipiti - Quadriceps
- Ischiocrurali - Hamstrings
- Glutei - Gluteus

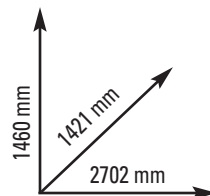

SISTEMA DI SPINTA con pedana montata su carrello
 REGOLAZIONI: inclinazione schienale su 5 posizioni, altezza safety bar su 2 posizioni
 DIMENSIONI PRODOTTO: 2702x1421x1460 mm
 PESO MAX UTILIZZATORE 120 Kg
 PESO MAX CARICABILE 350 Kg
 PESO: 225 kg
 CLASSE D'UTILIZZO PROFESSIONALE (EN ISO 20957-1 / EN ISO 20957-2 classe S)

PLATFORM PUSH system mounted on carriage
 ADJUSTMENTS: backrest incline on 5-level, safety bar height on 2-level
 SET UP SIZE: 2702x1421x1460 mm
 MAX USER WEIGHT 120 Kg
 MAX LOADABLE WEIGHT 350 Kg
 WEIGHT: 225 kg
 COMMERCIAL USE (EN ISO 20957-1 / EN ISO 20957-2 class S)

- Struttura tubolare in acciaio a sezione ovale piatta 60x120 mm - spessore 3 mm.
- Verniciatura doppia a polveri epossidiche, antigraffio.
- Trattamento dei tubolari con sabbatura e fosfatazione
- Sistema di cuscinetti POWER GRADE per garantire uno scorrimento preciso e progressivo
- Cuscini in schiuma ad alta densità con rivestimento in PU
- Pedana di spinta: inclinazione 45°

- Structure oval flat heavy-duty steel tubing 60x120 mm - thickness 3 mm.
- Double heavy duty powder coating painting, scratch-resistant.
- Tubing treatment with sandblasting and phosphating process
- Pulleys system POWER GRADE bearings for a smooth and precise action
- High-density foam cushions with PU upholstery
- Footplate: 45° incline



FWX8850

cod. FWX-8850

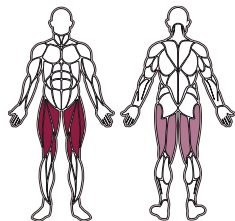
MUSCOLI COINVOLTI
MUSCLE GROUPS

- Quadricipiti - Quadriceps
- Ischiocrurali - Hamstrings

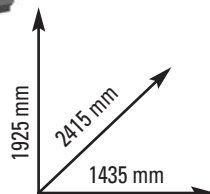

SISTEMA DI SPINTA a pedana su cuscinetti
 REGOLAZIONI: inclinazione schienale su 4 posizioni, inclinazione pedana di spinta su 4 posizioni
 DIMENSIONI PRODOTTO: 1435x2415x1925 mm
 PESO MAX UTILIZZATORE 120 Kg
 PESO MAX CARICABILE 350 Kg
 PESO: 198 kg
 CLASSE D'UTILIZZO PROFESSIONALE (EN ISO 20957-1 / EN ISO 20957-2 classe S)

PLATFORM PUSH system with bearings
 ADJUSTMENTS: backrest incline on 4-level, footplate incine on 4-level
 SET UP SIZE: 1435x2415x1925 mm
 MAX USER WEIGHT 120 Kg
 MAX LOADABLE WEIGHT 350 Kg
 WEIGHT: 198 kg
 COMMERCIAL USE (EN ISO 20957-1 / EN ISO 20957-2 class S)

- Struttura tubolare in acciaio a sezione ovale piatta 60x120 mm - spessore 3 mm.
- Verniciatura doppia a polveri epossidiche, antigraffio. Trattamento dei tubolari con sabbiatura e fosfatazione
- Sistema di cuscinetti POWER GRADE per garantire uno scorrimento preciso e progressivo
- Cuscini in schiuma ad alta densità con rivestimento in PU
- Structure oval flat heavy-duty steel tubing 60x120 mm - thickness 3 mm.
- Double heavy duty powder coating painting, scratch-resistant. Tubing treatment with sandblastic and phosphating process
- Pulleys system POWER GRADE bearings for a smooth and precise action
- High-density foam cushions with PU upholstery



FWX8900

cod. FWX-8900

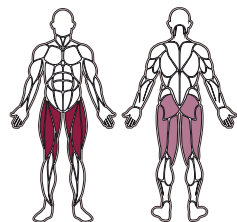
MUSCOLI COINVOLTI
MUSCLE GROUPS

- Quadricipiti - Quadriceps
- Ischiocrurali - Hamstrings
- Glutei - Gluteus

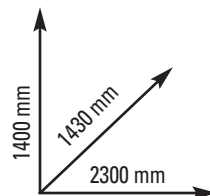

SISTEMA DI SPINTA su pedana a pantografo
 REGOLAZIONI: inclinazione schienale su 4 posizioni
 DIMENSIONI PRODOTTO: 2300x1430x1400 mm
 PESO MAX UTILIZZATORE 120 Kg
 PESO MAX CARICABILE 350 Kg
 PESO: 210 kg
 CLASSE D'UTILIZZO PROFESSIONALE (EN ISO 20957-1 / EN ISO 20957-2 classe S)

PANTOGRAPH PLATFORM PUSH system
 ADJUSTMENTS: backrest incline on 4-level
 SET UP SIZE: 2300x1430x1400 mm
 MAX USER WEIGHT 120 Kg
 MAX LOADABLE WEIGHT 350 Kg
 WEIGHT: 210 kg
 COMMERCIAL USE (EN ISO 20957-1 / EN ISO 20957-2 class S)

- Struttura tubolare in acciaio a sezione ovale piatta 60x120 mm - spessore 3 mm.
- Verniciatura doppia a polveri epossidiche, antigraffio.
- Trattamento dei tubolari con sabbatura e fosfatazione
- Sistema di cuscinetti POWER GRADE per garantire uno scorrimento preciso e progressivo
- Cuscini in schiuma ad alta densità con rivestimento in PU
- Pedana di spinta: inclinazione 45°

- Structure oval flat heavy-duty steel tubing 60x120 mm - thickness 3 mm.
- Double heavy duty powder coating painting, scratch-resistant.
- Tubing treatment with sandblasting and phosphating process
- Pulleys system POWER GRADE bearings for a smooth and precise action
- High-density foam cushions with PU upholstery
- Footplate: 45° incline

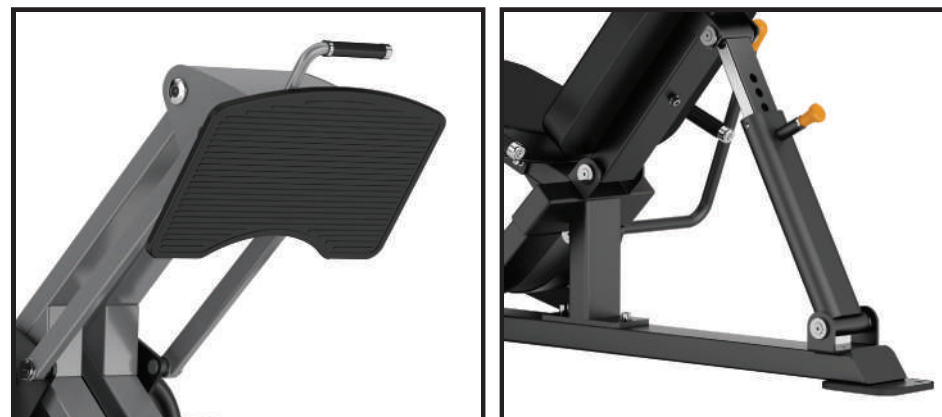

FWX9000

cod. FWX-9000

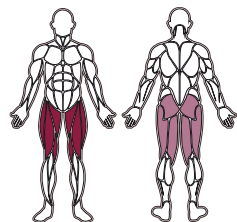

MUSCOLI COINVOLTI MUSCLE GROUPS

- Quadricipiti - Quadriceps
- Ischiocrurali - Hamstrings
- Glutei - Gluteus

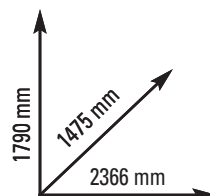

SISTEMA DI SPINTA a telaio flottante
 REGOLAZIONI: altezza safety bar su 12 posizioni, inclinazione pedana di spinta su 5 posizioni
 DIMENSIONI PRODOTTO: 2366x1475x1790 mm
 PESO MAX UTILIZZATORE 120 Kg
 PESO MAX CARICABILE 300 Kg
 PESO: 210 kg
 CLASSE D'UTILIZZO PROFESSIONALE (EN ISO 20957-1 / EN ISO 20957-2 classe S)

FLOATING PLATFORM PUSH system
 ADJUSTMENTS: safety bar height on 12-level, footplate incine on 5-level
 SET UP SIZE: 2366x1475x1790 mm
 MAX USER WEIGHT 120 Kg
 MAX LOADABLE WEIGHT 300 Kg
 WEIGHT: 210 kg
 COMMERCIAL USE (EN ISO 20957-1 / EN ISO 20957-2 class S)

- Struttura tubolare in acciaio a sezione ovale piatta 60x120 mm - spessore 3 mm.
- Verniciatura doppia a polveri epossidiche, antigraffio.
- Trattamento dei tubolari con sabbatura e fosfatazione
- Sistema di cuscinetti POWER GRADE per garantire uno scorrimento preciso e progressivo
- Cuscini in schiuma ad alta densità con rivestimento in PU
- Pedana di appoggio: inclinazione 28.5°~45°
- Structure oval flat heavy-duty steel tubing 60x120 mm - thickness 3 mm.
- Double heavy duty powder coating painting, scratch-resistant.
- Tubing treatment with sandblastic and phosphating process
- Pulleys system POWER GRADE bearings for a smooth and precise action
- High-density foam cushions with PU upholstery
- Footplate: 28.5°~45° incline



FWX9050

cod. FWX-9050

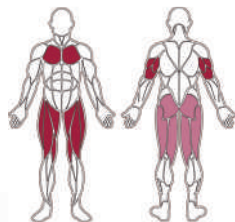
MUSCOLI COINVOLTI
MUSCLE GROUPS

- Pettorali - Pectorals
- Tricipiti - Triceps
- Quadricipiti - Quadriceps
- Ischiocrurali - Hamstrings
- Glutei - Gluteus

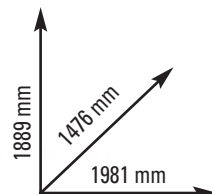

SISTEMA DI SPINTA a leveraggio singolo
 REGOLAZIONI: inclinazione pedana su 4 livelli, aggancio cintura su 3 posizioni per ottenere una differente resistenza
 DIMENSIONI PRODOTTO: 1981x1476x1889 mm
 PESO MAX UTILIZZATORE 120 Kg
 PESO MAX CARICABILE 300 Kg
 PESO: 238 kg
 CLASSE D'UTILIZZO PROFESSIONALE (EN ISO 20957-1 / EN ISO 20957-2 classe S)

SINGLE PUSH leverage system
 ADJUSTMENTS: platform incline on 4-level, hooks for belt connection on 3-position to get different strength ratio
 SET UP SIZE: 1981x1476x1889 mm
 MAX USER WEIGHT 120 Kg
 MAX LOADABLE WEIGHT 300 Kg
 WEIGHT: 238 kg
 COMMERCIAL USE (EN ISO 20957-1 / EN ISO 20957-2 class S)

- Struttura tubolare in acciaio a sezione ovale piatta 60x120 mm - spessore 3 mm. Bracci di movimento in acciaio rinforzato a sezione circolare \varnothing 76 mm - spessore 3 mm
- Verniciatura doppia a polveri epossidiche, antigraffio. Trattamento dei tubolari con sabbiatura e fosfatizzazione
- Sistema di cuscinetti POWER GRADE per garantire uno scorrimento preciso e progressivo
- Dotazioni/note: 4 perni porta dischi \varnothing 50 mm., cintura per sollevamento pesi, pedana antiscivolo
- Structure oval flat heavy-duty steel tubing 60x120 mm - thickness 3 mm. Movement arms made of round heavy-duty steel tubing \varnothing 76 mm - thickness 3 mm
- Double heavy duty powder coating painting, scratch-resistant. Tubing treatment with sandblastic and phosphating process
- Pulleys system POWER GRADE bearings for a smooth and precise action
- Equipment: 4 weight plates holders for \varnothing 50 mm, weightlifting belt, non-slip foot-platform



FWX9100

cod. FWX-9100

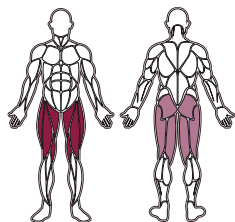
MUSCOLI COINVOLTI
MUSCLE GROUPS

- Quadricipiti - Quadriceps
- Ischiocrurali - Hamstrings
- Glutei - Gluteus

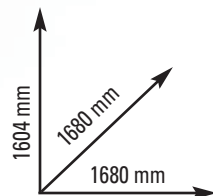

SISTEMA DI SPINTA a telaio flottante
 DIMENSIONI PRODOTTO: 1680x1680x1604 mm
 PESO MAX UTILIZZATORE 120 Kg
 PESO MAX CARICABILE 300 Kg
 PESO: 167 kg
 CLASSE D'UTILIZZO PROFESSIONALE (EN ISO 20957-1 / EN ISO 20957-2 classe S)

FLOATING PLATFORM PUSH system
 SET UP SIZE: 1680x1680x1604 mm
 MAX USER WEIGHT 120 Kg
 MAX LOADABLE WEIGHT 300 Kg
 WEIGHT: 167 kg
 COMMERCIAL USE (EN ISO 20957-1 / EN ISO 20957-2 class S)

- Struttura tubolare in acciaio a sezione ovale piatta 60x120 mm - spessore 3 mm. Bracci di movimento in acciaio rinforzato a sezione circolare \varnothing 76 mm - spessore 3 mm
- Verniciatura doppia a polveri epossidiche, antigraffio. Trattamento dei tubolari con sabbatura e fosfatazione
- Sistema di cuscinetti POWER GRADE per garantire uno scorrimento preciso e progressivo
- Cuscini in schiuma ad alta densità con rivestimento in PU
- Pedana di appoggio: inclinazione 25°

- Structure oval flat heavy-duty steel tubing 60x120 mm - thickness 2,5 mm. Movement arms made of round heavy-duty steel tubing \varnothing 76 mm - thickness 3 mm
- Double heavy duty powder coating painting, scratch-resistant. Tubing treatment with sandblastic and phosphating process
- Pulleys system POWER GRADE bearings for a smooth and precise action
- High-density foam cushions with PU upholstery
- Footplate: 25° incline

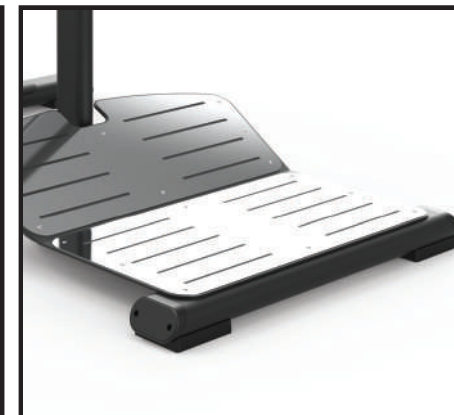

FWX9150

cod. FWX-9150

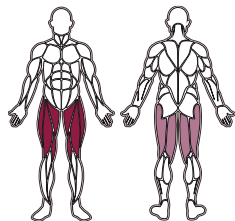
MUSCOLI COINVOLTI
MUSCLE GROUPS

- Quadricipiti - Quadriceps
- Ischiocrurali - Hamstrings

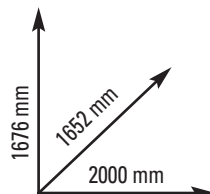

SISTEMA DI SPINTA a telaio flottante
 REGOLAZIONI: altezza safety bar su 3 posizioni, inclinazione pedana di spinta su 6 posizioni
 DIMENSIONI PRODOTTO: 2000x1652x1676 mm
 PESO MAX UTILIZZATORE 120 Kg
 PESO MAX CARICABILE 300 Kg
 PESO: 190 kg
 CLASSE D'UTILIZZO PROFESSIONALE (EN ISO 20957-1 / EN ISO 20957-2 classe S)

FLOATING PLATFORM PUSH system
 ADJUSTMENTS: safety bar height on 3-level, footplate incine on 6-level
 SET UP SIZE: 2000x1652x1676 mm
 MAX USER WEIGHT 120 Kg
 MAX LOADABLE WEIGHT 300 Kg
 WEIGHT: 190 kg
 COMMERCIAL USE (EN ISO 20957-1 / EN ISO 20957-2 class S)

- Struttura tubolare in acciaio a sezione ovale piatta 60x120 mm - spessore 3 mm. Bracci di movimento in acciaio rinforzato a sezione circolare \varnothing 76 mm - spessore 3 mm
- Verniciatura doppia a polveri epossidiche, antigraffio. Trattamento dei tubolari con sabbiatura e fosfatazione
- Sistema di cuscinetti POWER GRADE per garantire uno scorrimento preciso e progressivo
- Cuscini in schiuma ad alta densità con rivestimento in PU
- Structure oval flat heavy-duty steel tubing 60x120 mm - thickness 3 mm. Movement arms made of round heavy-duty steel tubing \varnothing 76 mm - thickness 3 mm
- Double heavy duty powder coating painting, scratch-resistant. Tubing treatment with sandblastic and phosphating process
- Pulleys system POWER GRADE bearings for a smooth and precise action
- High-density foam cushions with PU upholstery

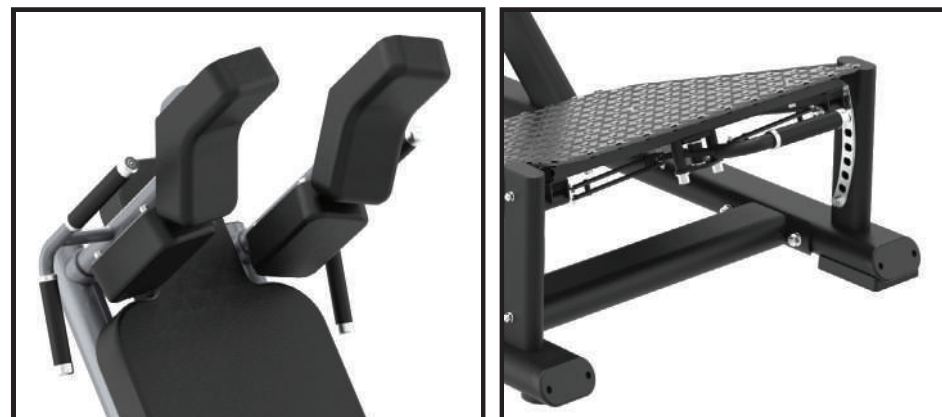

FWX9190

cod. FWX-9190

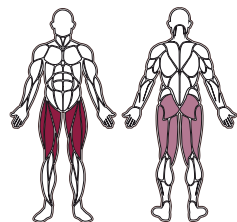

MUSCOLI COINVOLTI MUSCLE GROUPS

- Quadricipiti - Quadriceps
- Ischiocrurali - Hamstrings
- Glutei - Gluteus



SISTEMA DI SPINTA a pedana fissa
 REGOLAZIONI: altezza safety bar su 3 posizioni
 DIMENSIONI PRODOTTO: 2225x1786x1578 mm
 PESO MAX UTILIZZATORE 120 Kg
 PESO MAX CARICABILE 300 Kg
 PESO: 244 kg
 CLASSE D'UTILIZZO PROFESSIONALE (EN ISO 20957-1 / EN ISO 20957-2 classe S)

FIXED PLATFORM PUSH leverage system
 ADJUSTMENTS: safety bar height on 3-level
 SET UP SIZE: 2225x1786x1578 mm
 MAX USER WEIGHT 120 Kg
 MAX LOADABLE WEIGHT 300 Kg
 WEIGHT: 244 kg
 COMMERCIAL USE (EN ISO 20957-1 / EN ISO 20957-2 class S)

- Struttura tubolare in acciaio a sezione ovale piatta 60x120 mm - spessore 3 mm. Bracci di movimento in acciaio rinforzato a sezione circolare \varnothing 76 mm - spessore 3 mm
- Verniciatura doppia a polveri epossidiche, antigraffio. Trattamento dei tubolari con sabbiatura e fosfatazione
- Sistema di cuscinetti POWER GRADE per garantire uno scorrimento preciso e progressivo
- Cuscini in schiuma ad alta densità con rivestimento in PU
- Structure oval flat heavy-duty steel tubing 60x120 mm - thickness 3 mm. Movement arms made of round heavy-duty steel tubing \varnothing 76 mm - thickness 3 mm
- Double heavy duty powder coating painting, scratch-resistant. Tubing treatment with sandblastic and phosphating process
- Pulleys system POWER GRADE bearings for a smooth and precise action
- High-density foam cushions with PU upholstery



FWX9200

cod. FWX-9200

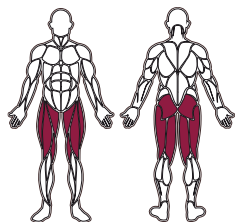
**MUSCOLI COINVOLTI
MUSCLE GROUPS**

- Quadricipiti - Quadriceps
- Ischiocrurali - Hamstrings
- Glutei - Gluteus

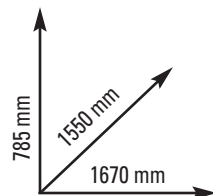

SISTEMA DI SPINTA a telaio flottante
 REGOLAZIONI: altezza rulli di appoggio su 10 posizioni, altezza/inclinazione maniglie su 5 posizioni
 DIMENSIONI PRODOTTO: 1670x1550x785 mm
 PESO MAX UTILIZZATORE 120 Kg
 PESO MAX CARICABILE 300 Kg
 PESO: 101 kg
 CLASSE D'UTILIZZO PROFESSIONALE (EN ISO 20957-1 / EN ISO 20957-2 classe S)

FLOATING PLATFORM PUSH system
 ADJUSTMENTS: backward/forward ankle rollers on 10-level, height/incline handles on 5-level
 SET UP SIZE: 1670x1550x785 mm
 MAX USER WEIGHT 120 Kg
 MAX LOADABLE WEIGHT 300 Kg
 WEIGHT: 101 kg
 COMMERCIAL USE (EN ISO 20957-1 / EN ISO 20957-2 class S)

- Struttura tubolare in acciaio a sezione ovale piatta 60x120 mm - spessore 3 mm. Bracci di movimento in acciaio rinforzato a sezione circolare \varnothing 76 mm - spessore 3 mm
- Verniciatura doppia a polveri epossidiche, antigraffio. Trattamento dei tubolari con sabbatura e fosfatazione
- Sistema di cuscinetti POWER GRADE per garantire uno scorrimento preciso e progressivo

- Structure oval flat heavy-duty steel tubing 60x120 mm - thickness 3 mm. Movement arms made of round heavy-duty steel tubing \varnothing 76 mm - thickness 3 mm
- Double heavy duty powder coating painting, scratch-resistant. Tubing treatment with sandblastic and phosphating process
- Pulleys system POWER GRADE bearings for a smooth and precise action

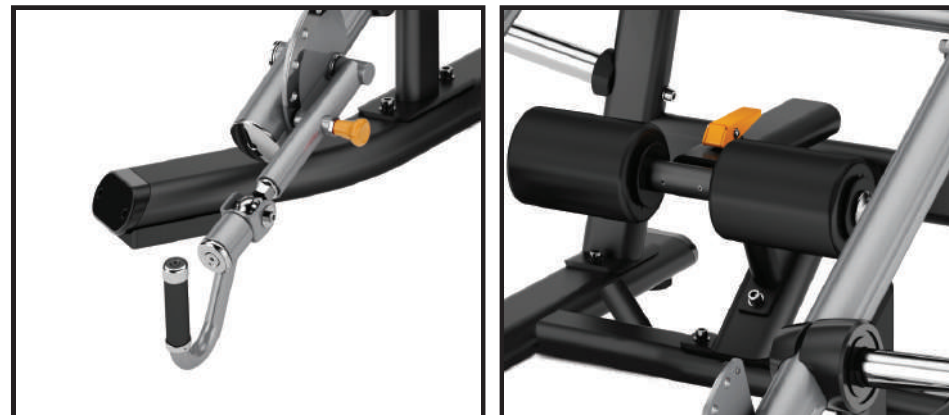

FWX9300

cod. FWX-9300

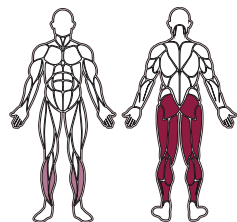
MUSCOLI COINVOLTI
MUSCLE GROUPS

- Femorali - Femorals
- Glutei - Gluteus
- Polpacci - Calves
- Tibiali - Tibialis

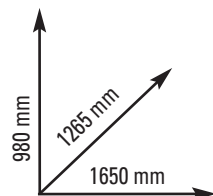

SISTEMA DI SPINTA a leveraggio singolo
 REGOLAZIONI: altezza rullo di spinta su 3 posizioni, rullo pivotante su 10 posizioni per un comodo ingresso alla macchina
 DIMENSIONI PRODOTTO: 1650x1265x980 mm
 PESO MAX UTILIZZATORE 120 Kg
 PESO MAX CARICABILE 200 Kg
 PESO: 108 kg
 CLASSE D'UTILIZZO PROFESSIONALE (EN ISO 20957-1 / EN ISO 20957-2 classe S)

SINGLE PUSH leverage system
 ADJUSTMENTS: push roller height on 3-level, pivot design for easy enter and exit
 SET UP SIZE: 1650x1265x980 mm
 MAX USER WEIGHT 120 Kg
 MAX LOADABLE WEIGHT 200 Kg
 WEIGHT: 108 kg
 COMMERCIAL USE (EN ISO 20957-1 / EN ISO 20957-2 class S)

- Struttura tubolare in acciaio a sezione ovale piatta 60x120 mm - spessore 3 mm. Bracci di movimento in acciaio rinforzato a sezione circolare \varnothing 76 mm - spessore 3 mm
- Verniciatura doppia a polveri epossidiche, antigraffio. Trattamento dei tubolari con sabbiatura e fosfatazione
- Sistema di cuscinetti POWER GRADE per garantire uno scorrimento preciso e progressivo
- Cuscini in schiuma ad alta densità con rivestimento in PU
- Pedana di appoggio: inclinazione 20°
- Structure oval flat heavy-duty steel tubing 60x120 mm - thickness 3 mm. Movement arms made of round heavy-duty steel tubing \varnothing 76 mm - thickness 3 mm
- Double heavy duty powder coating painting, scratch-resistant. Tubing treatment with sandblastic and phosphating process
- Pulleys system POWER GRADE bearings for a smooth and precise action
- High-density foam cushions with PU upholstery
- Footplate: 20° incline



FWX9400

cod. FWX-9400

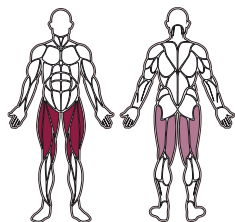
MUSCOLI COINVOLTI
MUSCLE GROUPS

- Quadricipiti - Quadriceps
- Ischiocrurali - Hamstrings

SISTEMA DI SPINTA a leveraggi indipendenti
 REGOLAZIONI: altezza sedile su 16 posizioni
 DIMENSIONI PRODOTTO: 1701x1281x1224 mm
 PESO MAX UTILIZZATORE 120 Kg
 PESO MAX CARICABILE 300 Kg
 PESO: 110 kg
 CLASSE D'UTILIZZO PROFESSIONALE (EN ISO 20957-1 / EN ISO 20957-2 classe S)

INDEPENDENT PUSH leverage system
 ADJUSTMENTS: seat height on 16-level
 SET UP SIZE: 1701x1281x1224 mm
 MAX USER WEIGHT 120 Kg
 MAX LOADABLE WEIGHT 300 Kg
 WEIGHT: 110 kg
 COMMERCIAL USE (EN ISO 20957-1 / EN ISO 20957-2 class S)

- Struttura tubolare in acciaio a sezione ovale piatta 60x120 mm - spessore 3 mm. Bracci di movimento in acciaio rinforzato a sezione circolare \varnothing 76 mm - spessore 3 mm
- Verniciatura doppia a polveri epossidiche, antigraffio. Trattamento dei tubolari con sabbiatura e fosfatazione
- Sistema di cuscinetti POWER GRADE per garantire uno scorrimento preciso e progressivo
- Cuscini in schiuma ad alta densità con rivestimento in PU

- Structure oval flat heavy-duty steel tubing 60x120 mm - thickness 3 mm. Movement arms made of round heavy-duty steel tubing \varnothing 76 mm - thickness 3 mm
- Double heavy duty powder coating painting, scratch-resistant. Tubing treatment with sandblastic and phosphating process
- Pulleys system POWER GRADE bearings for a smooth and precise action
- High-density foam cushions with PU upholstery

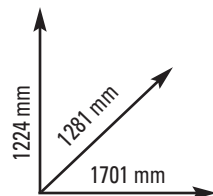

FWX9500

cod. FWX-9500

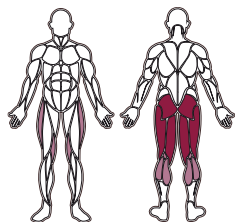
**MUSCOLI COINVOLTI
MUSCLE GROUPS**

- Femorali - Femorals
- Glutei - Gluteus
- Adduttori - Adductors
- Abduttori - Abductors
- Polpacci - Calves

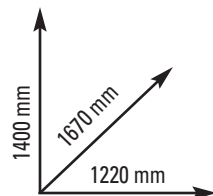

SISTEMA DI SPINTA a leveraggi indipendenti
 DIMENSIONI PRODOTTO: 1220x1670x1400 mm
 PESO MAX UTILIZZATORE 120 Kg
 PESO MAX CARICABILE 300 Kg
 PESO: 125 kg
 CLASSE D'UTILIZZO PROFESSIONALE (EN ISO 20957-1 / EN ISO 20957-2 classe S)

INDIPENDENT PUSH leverage system
 SET UP SIZE: 1220x1670x1400 mm
 MAX USER WEIGHT 120 Kg
 MAX LOADABLE WEIGHT 300 Kg
 WEIGHT: 125 kg
 COMMERCIAL USE (EN ISO 20957-1 / EN ISO 20957-2 class S)

- Struttura tubolare in acciaio a sezione ovale piatta 60x120 mm - spessore 3 mm. Bracci di movimento in acciaio rinforzato a sezione circolare \varnothing 76 mm - spessore 3 mm
- Verniciatura doppia a polveri epossidiche, antigraffio.
- Trattamento dei tubolari con sabbiatura e fosfatazione
- Sistema di cuscinetti POWER GRADE per garantire uno scorrimento preciso e progressivo
- Cuscini in schiuma ad alta densità con rivestimento in PU

- Structure oval flat heavy-duty steel tubing 60x120 mm - thickness 3 mm. Movement arms made of round heavy-duty steel tubing \varnothing 76 mm - thickness 3 mm
- Double heavy duty powder coating painting, scratch-resistant.
- Tubing treatment with sandblastic and phosphating process
- Pulleys system POWER GRADE bearings for a smooth and precise action
- High-density foam cushions with PU upholstery



FWX9600

cod. FWX-9600

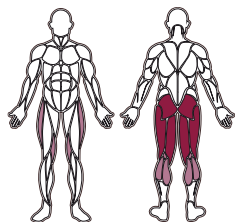

MUSCOLI COINVOLTI MUSCLE GROUPS

- Femorali - Femorals
- Glutei - Gluteus
- Adduttori - Adductors
- Abduttori - Abductors
- Polpacci - Calves

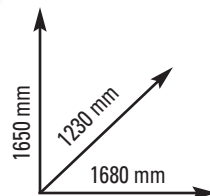

SISTEMA DI SPINTA a pedana mobile
 DIMENSIONI PRODOTTO: 1680x1230x1650 mm
 PESO MAX UTILIZZATORE 120 Kg
 PESO MAX CARICABILE 200 Kg
 PESO: 115 kg
 CLASSE D'UTILIZZO PROFESSIONALE (EN ISO 20957-1 / EN ISO 20957-2 classe S)

MOVING PLATFORM PUSH system
 SET UP SIZE: 1680x1230x1650 mm
 MAX USER WEIGHT 120 Kg
 MAX LOADABLE WEIGHT 200 Kg
 WEIGHT: 115 kg
 COMMERCIAL USE (EN ISO 20957-1 / EN ISO 20957-2 class S)

- Struttura tubolare in acciaio a sezione ovale piatta 60x120 mm - spessore 3 mm. Bracci di movimento in acciaio rinforzato a sezione circolare \varnothing 76 mm - spessore 3 mm
- Verniciatura doppia a polveri epossidiche, antigraffio. Trattamento dei tubolari con sabbatura e fosfatazione
- Sistema di cuscinetti POWER GRADE per garantire uno scorrimento preciso e progressivo
- Cuscini in schiuma ad alta densità con rivestimento in PU
- Pedana di spinta: inclinazione 95°-115°
- Structure oval flat heavy-duty steel tubing 60x120 mm - thickness 3 mm. Movement arms made of round heavy-duty steel tubing \varnothing 76 mm - thickness 3 mm
- Double heavy duty powder coating painting, scratch-resistant. Tubing treatment with sandblastic and phosphating process
- Pulleys system POWER GRADE bearings for a smooth and precise action
- High-density foam cushions with PU upholstery
- Footplate: 95°-115° incline

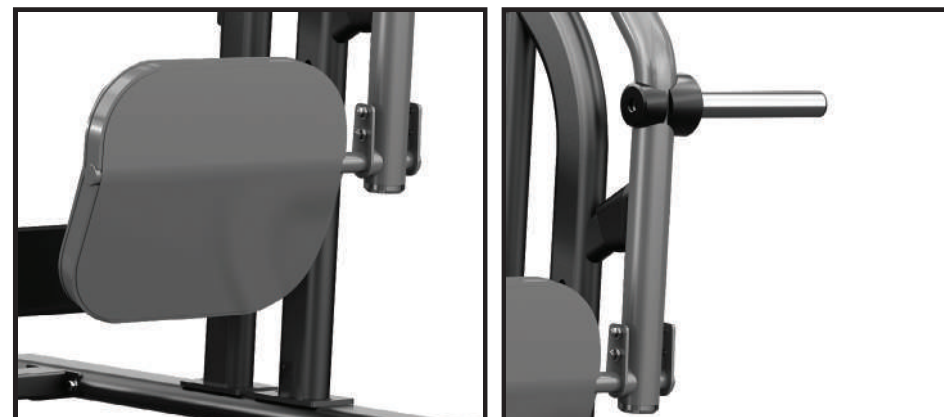

FWX9650

cod. FWX-9650

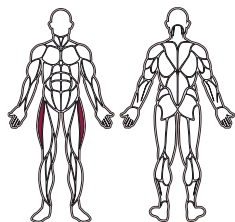
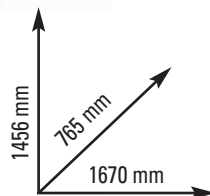
MUSCOLI COINVOLTI
MUSCLE GROUPS
■ Abduttori - Abductors

Bande elastiche non incluse
Elastic bands not included

SISTEMA DI SPINTA a leveraggi indipendenti divergenti
 DIMENSIONI PRODOTTO: 1670x765x1456 mm
 PESO MAX UTILIZZATORE 120 Kg
 PESO MAX CARICABILE 300 Kg
 PESO: 112 kg
 CLASSE D'UTILIZZO PROFESSIONALE (EN ISO 20957-1 / EN ISO 20957-2 classe S)

NDEPENDENT DIVERGENT PUSH leverage system
 SET UP SIZE: 1670x765x1456 mm
 MAX USER WEIGHT 120 Kg
 MAX LOADABLE WEIGHT 300 Kg
 WEIGHT: 112 kg
 COMMERCIAL USE (EN ISO 20957-1 / EN ISO 20957-2 class S)

- Struttura tubolare in acciaio a sezione ovale piatta 50x100 mm - spessore 3 mm.
- Verniciatura doppia a polveri epossidiche, antigraffio. Trattamento dei tubolari con sabbiatura e fosfatazione
- Sistema di cuscinetti POWER GRADE per garantire uno scorrimento preciso e progressivo
- Cuscini in schiuma ad alta densità con rivestimento in PU
- Structure oval flat heavy-duty steel tubing 50x100 mm - thickness 3 mm.
- Double heavy duty powder coating painting, scratch-resistant. Tubing treatment with sandblastic and phosphating process
- Pulleys system POWER GRADE bearings for a smooth and precise action
- High-density foam cushions with PU upholstery



FWX9700

cod. FWX-9700

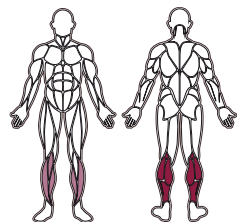
**MUSCOLI COINVOLTI
MUSCLE GROUPS**

- Polpacci - Calves
- Tibiali - Tibialis

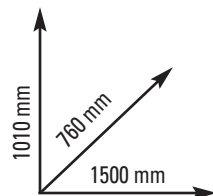

SISTEMA DI SPINTA a telaio flottante
 REGOLAZIONI: altezza cuscini blocca ginocchia su 5 posizioni
 DIMENSIONI PRODOTTO: 1500x760x1010 mm
 PESO MAX UTILIZZATORE 120 Kg
 PESO MAX CARICABILE 200 Kg
 PESO: 60 kg
 CLASSE D'UTILIZZO PROFESSIONALE (EN ISO 20957-1 / EN ISO 20957-2 classe S)

SINGLE PUSH leverage system
 ADJUSTMENTS: knee rollers height on 5-level
 SET UP SIZE: 1500x760x1010 mm
 MAX USER WEIGHT 120 Kg
 MAX LOADABLE WEIGHT 200 Kg
 WEIGHT: 60 kg
 COMMERCIAL USE (EN ISO 20957-1 / EN ISO 20957-2 class S)

- Struttura tubolare in acciaio a sezione ovale piatta 60x120 mm - spessore 3 mm. Bracci di movimento in acciaio rinforzato a sezione circolare \varnothing 76 mm - spessore 3 mm
- Verniciatura doppia a polveri epossidiche, antigraffio. Trattamento dei tubolari con sabbiatura e fosfatizzazione
- Sistema di cuscinetti POWER GRADE per garantire uno scorrimento preciso e progressivo
- Cuscini in schiuma ad alta densità con rivestimento in PU
- Pedana di appoggio: inclinazione 7°
- Structure oval flat heavy-duty steel tubing 60x120 mm - thickness 3 mm. Movement arms made of round heavy-duty steel tubing \varnothing 76 mm - thickness 3 mm
- Double heavy duty powder coating painting, scratch-resistant. Tubing treatment with sandblasting and phosphating process
- Pulleys system POWER GRADE bearings for a smooth and precise action
- High-density foam cushions with PU upholstery
- Footplate: 7° incline



FWX9750

cod. FWX-9750

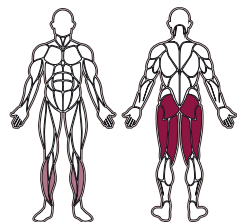
MUSCOLI COINVOLTI
MUSCLE GROUPS

- Femorali - Femorals
- Glutei - Gluteus
- Tibiali - Tibialis



Bande elastiche non incluse
Elastic bands not included

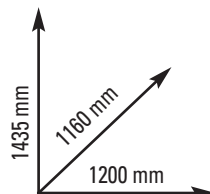

SISTEMA DI SPINTA a leveraggio singolo
REGOLAZIONI: altezza rulli di appoggio su 7 posizioni, profondità rulli di appoggio su 4 posizioni
DIMENSIONI PRODOTTO: 1200x1160x1435 mm
PESO MAX UTILIZZATORE 120 Kg
PESO MAX CARICABILE 150 Kg
PESO: 95 kg
CLASSE D'UTILIZZO PROFESSIONALE (EN ISO 20957-1 / EN ISO 20957-2 classe S)

SINGLE PUSH leverage system
ADJUSTMENTS: height foam roller on 7-level, depth foam roller on 4-level
SET UP SIZE: 1200x1160x1435 mm
MAX USER WEIGHT 120 Kg
MAX LOADABLE WEIGHT 150 Kg
WEIGHT: 95 kg
COMMERCIAL USE (EN ISO 20957-1 / EN ISO 20957-2 class S)

- Struttura tubolare in acciaio a sezione ovale piatta 50x100 mm - spessore 3 mm.
- Verniciatura doppia a polveri epossidiche, antigraffio. Trattamento dei tubolari con sabbiatura e fosfatazione
- Sistema di cuscinetti POWER GRADE per garantire uno scorrimento preciso e progressivo
- Cuscini in schiuma ad alta densità con rivestimento in PU
- Structure oval flat heavy-duty steel tubing 50x100 mm - thickness 3 mm.
- Double heavy duty powder coating painting, scratch-resistant. Tubing treatment with sandblastic and phosphating process
- Pulleys system POWER GRADE bearings for a smooth and precise action
- High-density foam cushions with PU upholstery

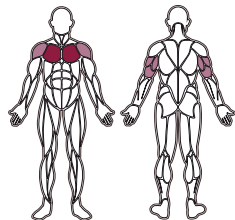



**PLATE LOADED
AVANT LINE**

FWX6300

cod. FWX-6300

**MUSCOLI COINVOLTI
MUSCLE GROUPS**

- Pettorali - Pectorals
- Tricipiti - Triceps
- Deltoide anteriore - Anterior deltoid

SISTEMA DI SPINTA a leveraggi indipendenti convergenti
 REGOLAZIONI: altezza sedile su 13 posizioni
 DIMENSIONI PRODOTTO: 2230x1140x1760 mm
 PESO MAX UTILIZZATORE 150 Kg
 PESO MAX CARICABILE 300 Kg
 PESO: 185 kg
 CLASSE D'UTILIZZO PROFESSIONALE (EN ISO 20957-1 / EN ISO 20957-2 classe S)

INDEPENDENT COVERGENT PUSH leverage system
 ADJUSTMENTS: seat height on 13-level
 SET UP SIZE: 2230x1140x1760 mm
 MAX USER WEIGHT 150 Kg
 MAX LOADABLE WEIGHT 300 Kg
 WEIGHT: 185 kg
 COMMERCIAL USE (EN ISO 20957-1 / EN ISO 20957-2 class S)

- Struttura tubolare in acciaio a sezione rettangolare 50x80 mm - spessore 3 mm
- Verniciatura doppia a polveri epossidiche, antigraffio. Trattamento dei tubolari con sabbatura e fosfatazione
- Sistema di cuscinetti POWER GRADE per garantire uno scorrimento preciso e progressivo
- Cuscini in schiuma ad alta densità con rivestimento in PU
- Structure rectangular heavy-duty steel tubing 50x80 mm - thickness 3 mm
- Double heavy duty powder coating painting, scratch-resistant. Tubing treatment with sandblastic and phosphating process
- Pulleys system POWER GRADE bearings for a smooth and precise action
- High-density foam cushions with PU upholstery

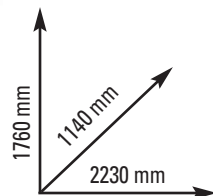

FWX6350

cod. FWX-6350

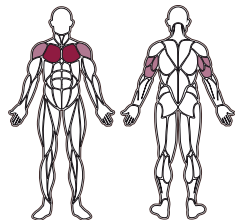
MUSCOLI COINVOLTI
MUSCLE GROUPS

- Pettorali - Pectorals
- Tricipiti - Triceps
- Deltoide anteriore - Anterior deltoid



SISTEMA DI SPINTA a leveraggi indipendenti convergenti
 REGOLAZIONI: altezza sedile su 13 posizioni
 DIMENSIONI PRODOTTO: 1900x1600x1690 mm
 PESO MAX UTILIZZATORE 150 Kg
 PESO MAX CARICABILE 300 Kg
 PESO: 126 kg
 CLASSE D'UTILIZZO PROFESSIONALE (EN ISO 20957-1 / EN ISO 20957-2 classe S)

INDEPENDENT COVERGENT PUSH leverage system
 ADJUSTMENTS: seat height on 13-level
 SET UP SIZE: 1900x1600x1690 mm
 MAX USER WEIGHT 150 Kg
 MAX LOADABLE WEIGHT 300 Kg
 WEIGHT: 126 kg
 COMMERCIAL USE (EN ISO 20957-1 / EN ISO 20957-2 class S)

- Struttura tubolare in acciaio a sezione rettangolare 50x80 mm - spessore 3 mm
- Verniciatura doppia a polveri epossidiche, antigraffio. Trattamento dei tubolari con sabbiatura e fosfatazione
- Sistema di cuscinetti POWER GRADE per garantire uno scorrimento preciso e progressivo
- Cuscini in schiuma ad alta densità con rivestimento in PU
- Structure rectangular heavy-duty steel tubing 50x80 mm - thickness 3 mm
- Double heavy duty powder coating painting, scratch-resistant. Tubing treatment with sandblastic and phosphating process
- Pulleys system POWER GRADE bearings for a smooth and precise action
- High-density foam cushions with PU upholstery



FWX6400

cod. FWX-6400

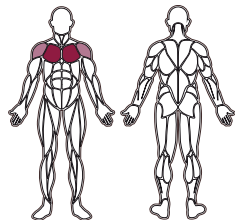
MUSCOLI COINVOLTI
MUSCLE GROUPS

- Pettorali - Pectorals
- Deltoide anteriore - Anterior deltoid

SISTEMA DI SPINTA a leveraggi indipendenti convergenti
 REGOLAZIONI: altezza sedile su 6 posizioni
 DIMENSIONI PRODOTTO: 1750x1600x800 mm
 PESO MAX UTILIZZATORE 150 Kg
 PESO MAX CARICABILE 250 Kg
 PESO: 64 kg
 CLASSE D'UTILIZZO PROFESSIONALE (EN ISO 20957-1 / EN ISO 20957-2 classe S)

INDEPENDENT COVERGENT PUSH leverage system
 ADJUSTMENTS: seat height on 6-level
 SET UP SIZE: 1750x1600x800 mm
 MAX USER WEIGHT 150 Kg
 MAX LOADABLE WEIGHT 250 Kg
 WEIGHT: 64 kg
 COMMERCIAL USE (EN ISO 20957-1 / EN ISO 20957-2 class S)

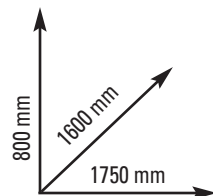

- Struttura tubolare in acciaio a sezione rettangolare 50x80 mm - spessore 3 mm
- Verniciatura doppia a polveri epossidiche, antigraffio. Trattamento dei tubolari con sabbiatura e fosfatazione
- Sistema di cuscinetti POWER GRADE per garantire uno scorrimento preciso e progressivo
- Cuscini in schiuma ad alta densità con rivestimento in PU
- Structure rectangular heavy-duty steel tubing 50x80 mm - thickness 3 mm
- Double heavy duty powder coating painting, scratch-resistant. Tubing treatment with sandblastic and phosphating process
- Pulleys system POWER GRADE bearings for a smooth and precise action
- High-density foam cushions with PU upholstery



FWX6450

cod. FWX-6450

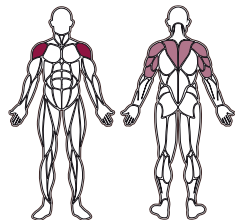
MUSCOLI COINVOLTI
MUSCLE GROUPS

- Deltoido anteriore - Anterior deltoid
- Deltoido posteriore - Posterior deltoid
- Tricipiti - Triceps
- Trapezi - Trapezius

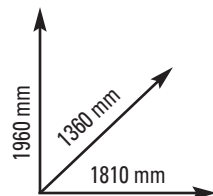

SISTEMA DI SPINTA a leveraggi indipendenti convergenti
 REGOLAZIONI: altezza sedile su 13 posizioni
 DIMENSIONI PRODOTTO: 1810x1360x1960 mm
 PESO MAX UTILIZZATORE 150 Kg
 PESO MAX CARICABILE 300 Kg
 PESO: 136 kg
 CLASSE D'UTILIZZO PROFESSIONALE (EN ISO 20957-1 / EN ISO 20957-2 classe S)

INDEPENDENT COVERGENT PUSH leverage system
 ADJUSTMENTS: seat height on 13-level
 SET UP SIZE: 1810x1360x1960 mm
 MAX USER WEIGHT 150 Kg
 MAX LOADABLE WEIGHT 300 Kg
 WEIGHT: 136 kg
 COMMERCIAL USE (EN ISO 20957-1 / EN ISO 20957-2 class S)

- Struttura tubolare in acciaio a sezione rettangolare 50x80 mm - spessore 3 mm
- Verniciatura doppia a polveri epossidiche, antigraffio. Trattamento dei tubolari con sabbatura e fosfatazione
- Sistema di cuscinetti POWER GRADE per garantire uno scorrimento preciso e progressivo
- Cuscini in schiuma ad alta densità con rivestimento in PU
- Structure rectangular heavy-duty steel tubing 50x80 mm - thickness 3 mm
- Double heavy duty powder coating painting, scratch-resistant. Tubing treatment with sandblastic and phosphating process
- Pulleys system POWER GRADE bearings for a smooth and precise action
- High-density foam cushions with PU upholstery



FWX6500

cod. FWX-6500

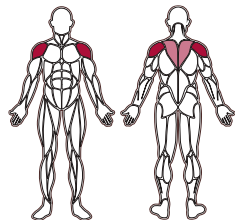
**MUSCOLI COINVOLTI
MUSCLE GROUPS**

- Deltoidi - Deltoids
- Trapezi - Trapezius

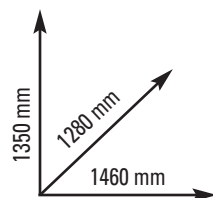

SISTEMA DI SPINTA a leveraggi indipendenti
 REGOLAZIONI: altezza sedile su 13 posizioni
 DIMENSIONI PRODOTTO: 1460x1280x1350 mm
 PESO MAX UTILIZZATORE 150 Kg
 PESO MAX CARICABILE 250 Kg
 PESO: 96 kg
 CLASSE D'UTILIZZO PROFESSIONALE (EN ISO 20957-1 / EN ISO 20957-2 classe S)

INDIPENDENT PUSH leverage system
 ADJUSTMENTS: seat height on 13-level
 SET UP SIZE: 1460x1280x1350 mm
 MAX USER WEIGHT 150 Kg
 MAX LOADABLE WEIGHT 250 Kg
 WEIGHT: 96 kg
 COMMERCIAL USE (EN ISO 20957-1 / EN ISO 20957-2 class S)

- Struttura tubolare in acciaio a sezione rettangolare 50x80 mm - spessore 3 mm
- Verniciatura doppia a polveri epossidiche, antigraffio. Trattamento dei tubolari con sabbatura e fosfatazione
- Sistema di cuscinetti POWER GRADE per garantire uno scorrimento preciso e progressivo
- Cuscini in schiuma ad alta densità con rivestimento in PU
- Structure rectangular heavy-duty steel tubing 50x80 mm - thickness 3 mm
- Double heavy duty powder coating painting, scratch-resistant. Tubing treatment with sandblasting and phosphating process
- Pulleys system POWER GRADE bearings for a smooth and precise action
- High-density foam cushions with PU upholstery



FWX6550

cod. FWX-6550

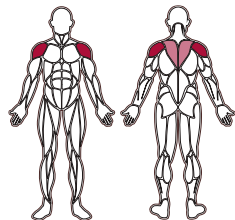
**MUSCOLI COINVOLTI
MUSCLE GROUPS**

- Deltoidi - Deltoids
- Trapezi - Trapezius

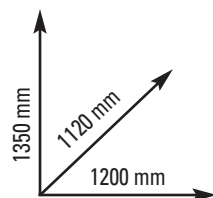

SISTEMA DI SPINTA a leveraggi indipendenti divergenti
 DIMENSIONI PRODOTTO: 1200x1120x1350 mm
 PESO MAX CARICABILE 250 Kg
 PESO: 88 kg
 CLASSE D'UTILIZZO PROFESSIONALE (EN ISO 20957-1 / EN ISO 20957-2 classe S)

INDEPENDENT DIVERGENT PUSH leverage system
 SET UP SIZE: 1200x1120x1350 mm
 MAX LOADABLE WEIGHT 250 Kg
 WEIGHT: 88 kg
 COMMERCIAL USE (EN ISO 20957-1 / EN ISO 20957-2 class S)

- Struttura tubolare in acciaio a sezione rettangolare 50x80 mm - spessore 3 mm
- Verniciatura doppia a polveri epossidiche, antigraffio. Trattamento dei tubolari con sabbatura e fosfatazione
- Sistema di cuscinetti POWER GRADE per garantire uno scorrimento preciso e progressivo
- Cuscini in schiuma ad alta densità con rivestimento in PU
- Structure rectangular heavy-duty steel tubing 50x80 mm - thickness 3 mm
- Double heavy duty powder coating painting, scratch-resistant. Tubing treatment with sandblastic and phosphating process
- Pulleys system POWER GRADE bearings for a smooth and precise action
- High-density foam cushions with PU upholstery



FWX6600

cod. FWX-6600

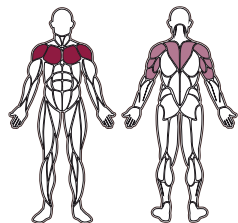
MUSCOLI COINVOLTI
MUSCLE GROUPS

- Pettorali - Pectorals
- Deltoide anteriore - Anterior deltoid
- Deltoidi posteriori - Posterior deltoids
- Trapezi - Trapezius
- Tricipiti - Triceps

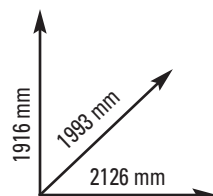
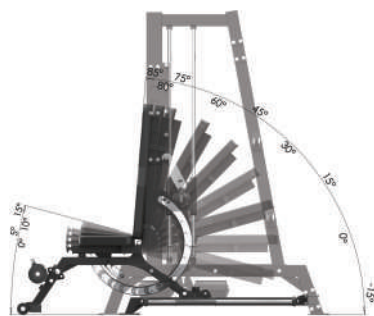

REGOLAZIONI: inclinazione sedile su 4 posizioni, inclinazione schienale su 8 posizioni (da -15° a 85°), profondità sedile su 26 posizioni, altezza ganci di sicurezza bilanciere su 5 posizioni
DIMENSIONI PRODOTTO: 2126x1993x1916 mm
PESO MAX UTILIZZATORE 150 Kg
PESO MAX CARICABILE 400 Kg
PESO: 188 kg
CLASSE D'UTILIZZO PROFESSIONALE (EN ISO 20957-1 / EN ISO 20957-2 classe S)

ADJUSTMENTS: seat height on 4-level, backrest incline on 8-level (from -15° to 85°), seat forward/backward position on 26-level, barbell safety hooks height on 5-level
SET UP SIZE: 2126x1993x1916 mm
MAX USER WEIGHT 150 Kg
MAX LOADABLE WEIGHT 400 Kg
WEIGHT: 188 kg
COMMERCIAL USE (EN ISO 20957-1 / EN ISO 20957-2 class S)

- Struttura tubolare in acciaio rinforzato a sezione rettangolare 100x50 mm, 75x50 mm e 60x40 mm - spessore 3 mm
- Verniciatura doppia a polveri epossidiche, antigraffio. Trattamento dei tubolari con sabbatura e fosfatazione
- Sistema di cuscinetti POWER GRADE per garantire uno scorrimento preciso e progressivo
- Cuscini in schiuma ad alta densità con rivestimento in PU
- Dotazioni/note: 4 perni porta dischi ø50 mm., 3 ganci per fasce elastiche, 2 ruote di trasporto. Rulli gambe superiori rimovibili per un accesso più confortevole. Panca inclinata, piana, declinata.

- Structure rectangular heavyduty steel tubing 100x50 mm, 75x50 mm e 60x40 mm - thickness 3 mm
- Double heavy duty powder coating painting, scratch-resistant. Tubing treatment with sandblastic and phosphating process
- Pulleys system POWER GRADE bearings for a smooth and precise action
- High-density foam cushions with PU upholstery
- Equipment: 4 weight plates holders for ø50 mm, 3 hooks for resistance bands, 2 moving wheels. Upper leg rollers removable for an easy access. Incline, flat, decline bench.



FWX6650

cod. FWX-6650

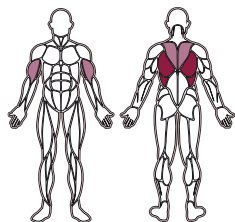
**MUSCOLI COINVOLTI
MUSCLE GROUPS**

- Gran dorsale - Latissimus dorsi
- Bicipiti - Biceps
- Romboidi - Rhomboids
- Trapezio inferiore - Lower trapezius

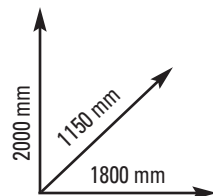

SISTEMA DI TIRO a leveraggi indipendenti convergenti
 REGOLAZIONI: altezza sedile su 13 posizioni
 DIMENSIONI PRODOTTO: 1800x1150x2000 mm
 PESO MAX UTILIZZATORE 150 Kg
 PESO MAX CARICABILE 300 Kg
 PESO: 140 kg
 CLASSE D'UTILIZZO PROFESSIONALE (EN ISO 20957-1 / EN ISO 20957-2 classe S)

INDEPENDENT CONVERGENT PULL leverage system
 ADJUSTMENTS: seat height on 13-level
 SET UP SIZE: 1800x1150x2000 mm
 MAX USER WEIGHT 150 Kg
 MAX LOADABLE WEIGHT 300 Kg
 WEIGHT: 140 kg
 COMMERCIAL USE (EN ISO 20957-1 / EN ISO 20957-2 class S)

- Struttura tubolare in acciaio a sezione rettangolare 50x80 mm - spessore 3 mm
- Verniciatura doppia a polveri epossidiche, antigraffio. Trattamento dei tubolari con sabbatura e fosfatazione
- Sistema di cuscinetti POWER GRADE per garantire uno scorrimento preciso e progressivo
- Cuscini in schiuma ad alta densità con rivestimento in PU
- Structure rectangular heavy-duty steel tubing 50x80 mm - thickness 3 mm
- Double heavy duty powder coating painting, scratch-resistant. Tubing treatment with sandblasting and phosphating process
- Pulleys system POWER GRADE bearings for a smooth and precise action
- High-density foam cushions with PU upholstery



FWX6700

cod. FWX-6700

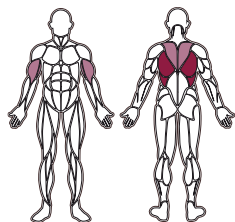
**MUSCOLI COINVOLTI
MUSCLE GROUPS**

- Gran dorsale - Latissimus dorsi
- Bicipiti - Biceps
- Romboidi - Rhomboids
- Trapezio inferiore - Lower trapezius

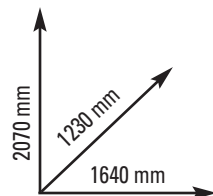

SISTEMA DI TIRO a leveraggi indipendenti divergenti
 REGOLAZIONI: altezza sedile su 13 posizioni
 DIMENSIONI PRODOTTO: 1640x1230x2070 mm
 PESO MAX UTILIZZATORE 150 Kg
 PESO MAX CARICABILE 300 Kg
 PESO: 110 kg
 CLASSE D'UTILIZZO PROFESSIONALE (EN ISO 20957-1 / EN ISO 20957-2 classe S)

INDEPENDENT DIVERGENT PULL leverage system
 ADJUSTMENTS: seat height on 13-level
 SET UP SIZE: 1640x1230x2070 mm
 MAX USER WEIGHT 150 Kg
 MAX LOADABLE WEIGHT 300 Kg
 WEIGHT: 110 kg
 COMMERCIAL USE (EN ISO 20957-1 / EN ISO 20957-2 class S)

- Struttura tubolare in acciaio a sezione rettangolare 50x80 mm - spessore 3 mm
- Verniciatura doppia a polveri epossidiche, antigraffio. Trattamento dei tubolari con sabbatura e fosfatazione
- Sistema di cuscinetti POWER GRADE per garantire uno scorrimento preciso e progressivo
- Cuscini in schiuma ad alta densità con rivestimento in PU
- Structure rectangular heavy-duty steel tubing 50x80 mm - thickness 3 mm
- Double heavy duty powder coating painting, scratch-resistant. Tubing treatment with sandblasting and phosphating process
- Pulleys system POWER GRADE bearings for a smooth and precise action
- High-density foam cushions with PU upholstery



FWX6750

cod. FWX-6750

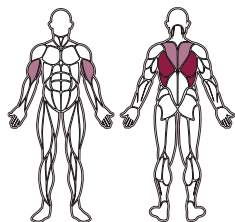
**MUSCOLI COINVOLTI
MUSCLE GROUPS**

- Gran dorsale - Latissimus dorsi
- Bicipiti - Biceps
- Romboidi - Rhomboids
- Trapezio inferiore - Lower trapezius

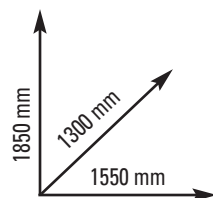

SISTEMA DI TIRO a leveraggi indipendenti divergenti
 REGOLAZIONI: altezza sedile su 13 posizioni
 DIMENSIONI PRODOTTO: 1550x1300x1850 mm
 PESO MAX UTILIZZATORE 150 Kg
 PESO MAX CARICABILE 300 Kg
 PESO: 105 kg
 CLASSE D'UTILIZZO PROFESSIONALE (EN ISO 20957-1 / EN ISO 20957-2 classe S)

INDEPENDENT DIVERGENT PULL leverage system
 ADJUSTMENTS: seat height on 13-level
 SET UP SIZE: 1550x1300x1850 mm
 MAX USER WEIGHT 150 Kg
 MAX LOADABLE WEIGHT 300 Kg
 WEIGHT: 105 kg
 COMMERCIAL USE (EN ISO 20957-1 / EN ISO 20957-2 class S)

- Struttura tubolare in acciaio a sezione rettangolare 50x80 mm - spessore 3 mm
- Verniciatura doppia a polveri epossidiche, antigraffio. Trattamento dei tubolari con sabbatura e fosfatazione
- Sistema di cuscinetti POWER GRADE per garantire uno scorrimento preciso e progressivo
- Cuscini in schiuma ad alta densità con rivestimento in PU
- Structure rectangular heavy-duty steel tubing 50x80 mm - thickness 3 mm
- Double heavy duty powder coating painting, scratch-resistant. Tubing treatment with sandblasting and phosphating process
- Pulleys system POWER GRADE bearings for a smooth and precise action
- High-density foam cushions with PU upholstery



FWX6800

cod. FWX-6800

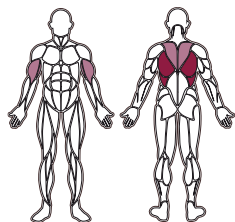
MUSCOLI COINVOLTI
MUSCLE GROUPS

- Gran dorsale - Latissimus dorsi
- Bicipiti - Biceps
- Romboidi - Rhomboids
- Trapezio inferiore - Lower trapezius

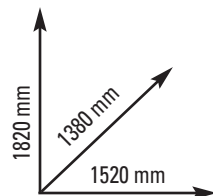

SISTEMA DI TIRO a leveraggi indipendenti divergenti
 REGOLAZIONI: altezza sedile su 13 posizioni
 DIMENSIONI PRODOTTO: 1520x1380x1820 mm
 PESO MAX UTILIZZATORE 150 Kg
 PESO MAX CARICABILE 300 Kg
 PESO: 125 kg
 CLASSE D'UTILIZZO PROFESSIONALE (EN ISO 20957-1 / EN ISO 20957-2 classe S)

INDEPENDENT DIVERGENT PULL leverage system
 ADJUSTMENTS: seat height on 13-level
 SET UP SIZE: 1520x1380x1820 mm
 MAX USER WEIGHT 150 Kg
 MAX LOADABLE WEIGHT 300 Kg
 WEIGHT: 125 kg
 COMMERCIAL USE (EN ISO 20957-1 / EN ISO 20957-2 class S)

- Struttura tubolare in acciaio a sezione rettangolare 50x80 mm - spessore 3 mm
- Verniciatura doppia a polveri epossidiche, antigraffio. Trattamento dei tubolari con sabbatura e fosfatazione
- Sistema di cuscinetti POWER GRADE per garantire uno scorrimento preciso e progressivo
- Cuscini in schiuma ad alta densità con rivestimento in PU
- Structure rectangular heavy-duty steel tubing 50x80 mm - thickness 3 mm
- Double heavy duty powder coating painting, scratch-resistant. Tubing treatment with sandblasting and phosphating process
- Pulleys system POWER GRADE bearings for a smooth and precise action
- High-density foam cushions with PU upholstery



FWX6850

cod. FWX-6850

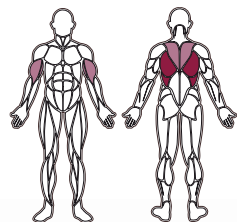

MUSCOLI COINVOLTI MUSCLE GROUPS

- Gran dorsale - Latissimus dorsi
- Bicipiti - Biceps
- Romboidi - Rhomboids
- Trapezio inferiore - Lower trapezius

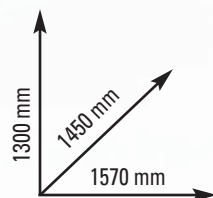

SISTEMA DI TIRO a leveraggi indipendenti divergenti
 REGOLAZIONI: altezza sedile su 13 posizioni
 DIMENSIONI PRODOTTO: 1570x1450x1300 mm
 PESO MAX UTILIZZATORE 150 Kg
 PESO MAX CARICABILE 300 Kg
 PESO: 118 kg
 CLASSE D'UTILIZZO PROFESSIONALE (EN ISO 20957-1 / EN ISO 20957-2 classe S)

INDEPENDENT DIVERGENT PULL leverage system
 ADJUSTMENTS: seat height on 13-level
 SET UP SIZE: 1570x1450x1300 mm
 MAX USER WEIGHT 150 Kg
 MAX LOADABLE WEIGHT 300 Kg
 WEIGHT: 118 kg
 COMMERCIAL USE (EN ISO 20957-1 / EN ISO 20957-2 class S)

- Struttura tubolare in acciaio a sezione rettangolare 50x80 mm - spessore 3 mm
- Verniciatura doppia a polveri epossidiche, antigraffio. Trattamento dei tubolari con sabbatura e fosfatazione
- Sistema di cuscinetti POWER GRADE per garantire uno scorrimento preciso e progressivo
- Cuscini in schiuma ad alta densità con rivestimento in PU
- Structure rectangular heavy-duty steel tubing 50x80 mm - thickness 3 mm
- Double heavy duty powder coating painting, scratch-resistant. Tubing treatment with sandblasting and phosphating process
- Pulleys system POWER GRADE bearings for a smooth and precise action
- High-density foam cushions with PU upholstery

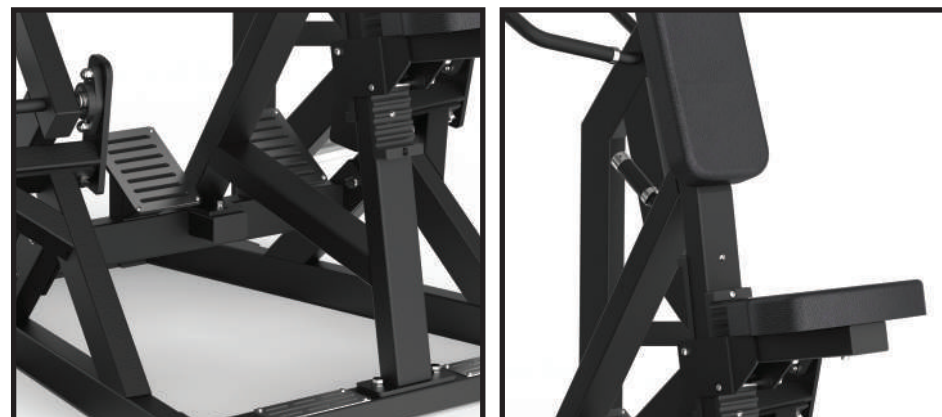

FWX6900

cod. FWX-6900

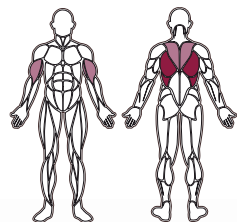
MUSCOLI COINVOLTI
MUSCLE GROUPS

- Gran dorsale - Latissimus dorsi
- Bicipiti - Biceps
- Romboidi - Rhomboids
- Trapezio inferiore - Lower trapezius

SISTEMA DI SPINTA a leveraggi indipendenti
 REGOLAZIONI: altezza sedile su 5 posizioni
 DIMENSIONI PRODOTTO: 2320x1750x1250 mm
 PESO MAX UTILIZZATORE 150 Kg
 PESO MAX CARICABILE 300 Kg
 PESO: 163,5 kg
 CLASSE D'UTILIZZO PROFESSIONALE (EN ISO 20957-1 / EN ISO 20957-2 classe S)

INDEPENDENT PUSH leverage system
 ADJUSTMENTS: seat height on 5-level
 SET UP SIZE: 2320x1750x1250 mm
 MAX USER WEIGHT 150 Kg
 MAX LOADABLE WEIGHT 300 Kg
 WEIGHT: 163,5 kg
 COMMERCIAL USE (EN ISO 20957-1 / EN ISO 20957-2 class S)

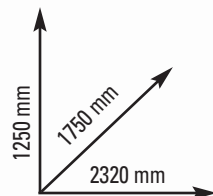

- Struttura tubolare in acciaio a sezione rettangolare 50x80 mm - spessore 3 mm
- Verniciatura doppia a polveri epossidiche, antigraffio. Trattamento dei tubolari con sabbatura e fosfatazione
- Sistema di cuscinetti POWER GRADE per garantire uno scorrimento preciso e progressivo
- Cuscini in schiuma ad alta densità con rivestimento in PU
- Structure rectangular heavy-duty steel tubing 50x80 mm - thickness 3 mm
- Double heavy duty powder coating painting, scratch-resistant. Tubing treatment with sandblasting and phosphating process
- Pulleys system POWER GRADE bearings for a smooth and precise action
- High-density foam cushions with PU upholstery



FWX6950

cod. FWX-6950

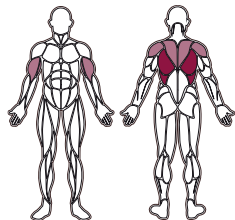

MUSCOLI COINVOLTI MUSCLE GROUPS

- Gran dorsale - Latissimus dorsi
- Bicipiti - Biceps
- Trapezio - Trapezius
- Deltoide posteriore - Posterior deltoid

DIMENSIONI PRODOTTO: 1800x1000x1160 mm
 PESO MAX UTILIZZATORE: 150 Kg
 PESO MAX CARICABILE: 250 kg
 PESO: 60kg
 CLASSE D'UTILIZZO PROFESSIONALE (EN ISO 20957-1 / EN ISO 20957-2 classe S)

SET UP SIZE: 1800x1000x1160 mm
 MAX USER WEIGHT: 150 Kg
 MAX LOADABLE WEIGHT: 250 kg
 WEIGHT: 60 kg
 COMMERCIAL USE (EN ISO 20957-1 / EN ISO 20957-2 class S)

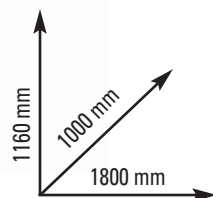

- Struttura tubolare in acciaio rinforzato a sezione rettangolare 50x100x3 mm
- Cuscini in schiuma ad alta densità con rivestimento in cotone riciclato
- Structure tubing section reinforced-steel rectangular tube 50x100x3 mm
- High-density foam cushions with recycled cotton upholstery



FWX7000

cod. FWX-7000

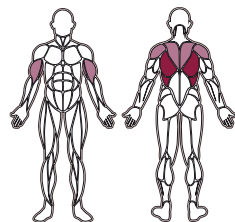

MUSCOLI COINVOLTI MUSCLE GROUPS

- Gran dorsale - Latissimus dorsi
- Bicipiti - Biceps
- Trapezio - Trapezius
- Deltoide posteriore - Posterior deltoid

DIMENSIONI PRODOTTO: 1875x931,5x349 mm
 PESO MAX UTILIZZATORE: 120 Kg
 PESO MAX CARICABILE: 200 kg
 PESO: 38kg
 CLASSE D'UTILIZZO PROFESSIONALE (EN ISO 20957-1 classe S)

SET UP SIZE: 1875x931,5x349 mm
 MAX USER WEIGHT: 120 Kg
 MAX LOADABLE WEIGHT: 200 kg
 WEIGHT: 38 kg
 COMMERCIAL USE (EN ISO 20957-1 class S)

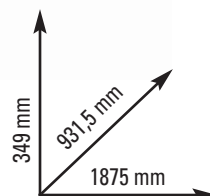

- Struttura tubolare in acciaio rinforzato a sezione quadrata 50x50x2 mm, rettangolare 75x50x2 mm e rotonda ø 50x3 mm
- Verniciatura doppia a polveri epossidiche, antigraffio. Trattamento dei tubolari con sabbatura e fosfatazione

- Structure tubing section reinforced-steel squared tube 50x50x2 mm, rectangular 75x50x2 mm and round ø 50x3 mm
- Double heavy duty powder coating painting, scratch-resistant. Tubing treatment with sandblastic and phosphating process



FWX7100

cod. FWX-7100

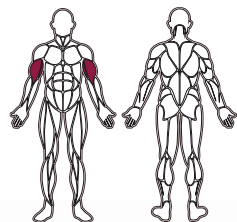
MUSCOLI COINVOLTI
MUSCLE GROUPS

■ Bicipiti - Biceps

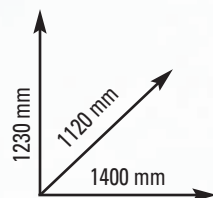

SISTEMA DI TIRO a leveraggio singolo
 REGOLAZIONI: altezza sedile su 13 posizioni
 DIMENSIONI PRODOTTO: 1400x1120x1230 mm
 PESO MAX UTILIZZATORE 150 Kg
 PESO MAX CARICABILE 200 Kg
 PESO: 100 kg
 CLASSE D'UTILIZZO PROFESSIONALE (EN ISO 20957-1 / EN ISO 20957-2 classe S)

SINGLE PULL leverage system
 ADJUSTMENTS: seat height on 13-level
 SET UP SIZE: 1400x1120x1230 mm
 MAX USER WEIGHT 150 Kg
 MAX LOADABLE WEIGHT 200 Kg
 WEIGHT: 100 kg
 COMMERCIAL USE (EN ISO 20957-1 / EN ISO 20957-2 class S)

- Struttura tubolare in acciaio a sezione rettangolare 50x80 mm - spessore 3 mm
- Verniciatura doppia a polveri epossidiche, antigraffio. Trattamento dei tubolari con sabbatura e fosfatazione
- Sistema di cuscinetti POWER GRADE per garantire uno scorrimento preciso e progressivo
- Cuscini in schiuma ad alta densità con rivestimento in PU
- Structure rectangular heavy-duty steel tubing 50x80 mm - thickness 3 mm
- Double heavy duty powder coating painting, scratch-resistant. Tubing treatment with sandblasting and phosphating process
- Pulleys system POWER GRADE bearings for a smooth and precise action
- High-density foam cushions with PU upholstery



FWX7150

cod. FWX-7150

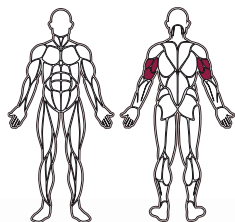
MUSCOLI COINVOLTI
MUSCLE GROUPS
■ Tricipiti - Triceps

SISTEMA DI SPINTA a leveraggio singolo
 REGOLAZIONI: altezza sedile su 13 posizioni
 DIMENSIONI PRODOTTO: 1880x1650x1050 mm
 PESO MAX UTILIZZATORE 150 Kg
 PESO MAX CARICABILE 250 Kg
 PESO: 118 kg
 CLASSE D'UTILIZZO PROFESSIONALE (EN ISO 20957-1 / EN ISO 20957-2 classe S)

SINGLE PUSH leverage system
 ADJUSTMENTS: seat height on 13-level
 SET UP SIZE: 1880x1650x1050 mm
 MAX USER WEIGHT 150 Kg
 MAX LOADABLE WEIGHT 250 Kg
 WEIGHT: 118 kg
 COMMERCIAL USE (EN ISO 20957-1 / EN ISO 20957-2 class S)

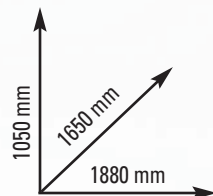

- Struttura tubolare in acciaio a sezione rettangolare 50x80 mm - spessore 3 mm
- Verniciatura doppia a polveri epossidiche, antigraffio. Trattamento dei tubolari con sabbatura e fosfatazione
- Sistema di cuscinetti POWER GRADE per garantire uno scorrimento preciso e progressivo
- Cuscini in schiuma ad alta densità con rivestimento in PU
- Structure rectangular heavy-duty steel tubing 50x80 mm - thickness 3 mm
- Double heavy duty powder coating painting, scratch-resistant. Tubing treatment with sandblasting and phosphating process
- Pulleys system POWER GRADE bearings for a smooth and precise action
- High-density foam cushions with PU upholstery



FWX7200

cod. FWX-7200

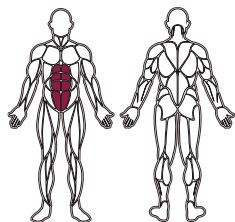

**MUSCOLI COINVOLTI
MUSCLE GROUPS**

■ Addominali - Abdominals

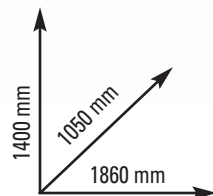

SISTEMA DI SPINTA a leveraggio singolo
REGOLAZIONI: altezza sedile su 13 posizioni
DIMENSIONI PRODOTTO: 1860x1050x1400 mm
PESO MAX UTILIZZATORE 150 Kg
PESO MAX CARICABILE 200 Kg
PESO: 126 kg
CLASSE D'UTILIZZO PROFESSIONALE (EN ISO 20957-1 / EN ISO 20957-2 classe S)

SINGLE PUSH leverage system
ADJUSTMENTS: seat height on 13-level
SET UP SIZE: 1860x1050x1400 mm
MAX USER WEIGHT 150 Kg
MAX LOADABLE WEIGHT 200 Kg
WEIGHT: 126 kg
COMMERCIAL USE (EN ISO 20957-1 / EN ISO 20957-2 class S)

- Struttura tubolare in acciaio a sezione rettangolare 50x80 mm - spessore 3 mm
- Verniciatura doppia a polveri epossidiche, antigraffio. Trattamento dei tubolari con sabbatura e fosfatazione
- Sistema di cuscinetti POWER GRADE per garantire uno scorrimento preciso e progressivo
- Cuscini in schiuma ad alta densità con rivestimento in PU
- Structure rectangular heavy-duty steel tubing 50x80 mm - thickness 3 mm
- Double heavy duty powder coating painting, scratch-resistant. Tubing treatment with sandblastic and phosphating process
- Pulleys system POWER GRADE bearings for a smooth and precise action
- High-density foam cushions with PU upholstery

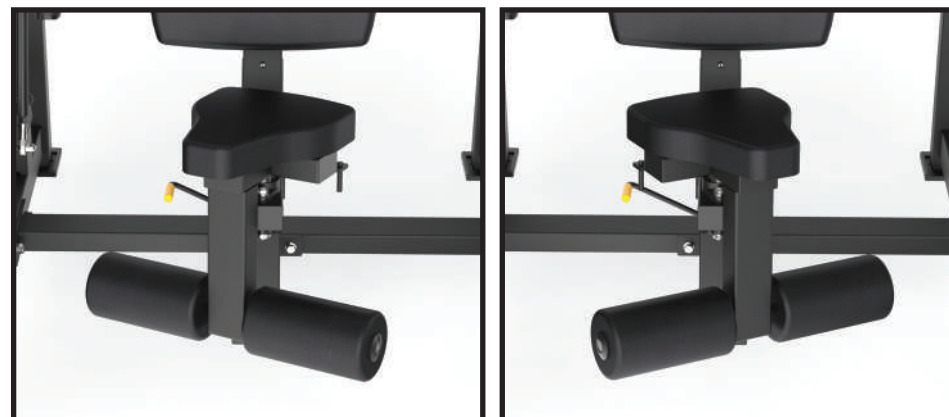

FWX7250

cod. FWX-7250

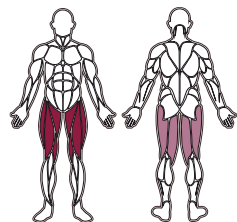
MUSCOLI COINVOLTI
MUSCLE GROUPS

- Quadricipiti - Quadriceps
- Ischiocrurali - Hamstrings



SISTEMA DI SPINTA a pedana su cuscinetti
 REGOLAZIONI: inclinazione schienale su 5 posizioni
 DIMENSIONI PRODOTTO: 2635x1520x1880 mm
 PESO MAX UTILIZZATORE 160 Kg
 PESO MAX CARICABILE 440 Kg
 PESO: 191 kg
 CLASSE D'UTILIZZO PROFESSIONALE (EN ISO 20957-1 / EN ISO 20957-2 classe S)

PLATFORM push system with bearings
 ADJUSTMENTS: backrest incline on 5-position
 SET UP SIZE: 2635x1520x1880 mm
 MAX USER WEIGHT 160 Kg
 MAX LOADABLE WEIGHT 440 Kg
 WEIGHT: 191 kg
 COMMERCIAL USE (EN ISO 20957-1 / EN ISO 20957-2 class S)

- Struttura tubolare in acciaio rinforzato a sezione quadrata 75x75x3 mm, rettangolare 70x50x3 mm e rotonda \varnothing 50x3 mm
- Verniciatura doppia a polveri epossidiche, antigraffio.
- Trattamento dei tubolari con sabbatura e fosfatazione
- Dotazioni/note: Maniglie con funzione fermi di sicurezza, piedini in gomma antiscivolo, sistema di carico dischi \varnothing 50 mm di facile accesso sotto al carrello, 8 ferma dischi a molla \varnothing 49 mm, 4 perni porta dischi \varnothing 50 mm
- Sistema di cuscinetti POWER GRADE per garantire uno scorrimento preciso e progressivo
- Cuscini in schiuma ad alta densità con rivestimento in PU

- Structure reinforced-steel squared tube 75x75x3 mm, rectangular tube 70x50x3 mm and round tube \varnothing 50x3 mm.
- Double heavy duty powder coating painting, scratch-resistant.
- Tubing treatment with sandblastic and phosphating process
- Equipment/notes: Hold down handles, anti-slip rubber feet, easy-access under-carriage plate load system suitable for \varnothing 50 mm weight plates, 8 olympic spring clip \varnothing 49 mm, 4 weight plates storage holders
- Pulleys system POWER GRADE bearings for a smooth and precise action
- High-density foam cushions with PU upholstery

FWX7290

cod. FWX-7290

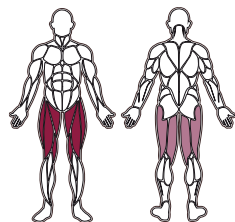
MUSCOLI COINVOLTI
MUSCLE GROUPS

- Quadricipiti - Quadriceps
- Ischiocrurali - Hamstrings

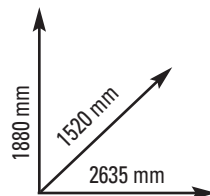

SISTEMA DI SPINTA a pedana su cuscinetti
 REGOLAZIONI: inclinazione schienale su 4 posizioni, inclinazione pedana su 5 posizioni, regolazione punto di partenza Hack Squat su 5 posizioni, regolazione perni di sicurezza su 5 posizioni
 DIMENSIONI PRODOTTO: 2635x1520x1880 mm
 PESO MAX UTILIZZATORE 160 Kg
 PESO MAX CARICABILE 350 Kg
 PESO: 203 kg
 CLASSE D'UTILIZZO PROFESSIONALE (EN ISO 20957-1 / EN ISO 20957-2 classe S)

PLATFORM push system with bearings
 ADJUSTMENTS: backrest incline on 4-position, 3 positions for resistance band, foot plate on 5-position, hack squat heights (Lock Out) on 5-position, safety stopper on 5-position
 SET UP SIZE: 2635x1520x1880 mm
 MAX USER WEIGHT 160 Kg
 MAX LOADABLE WEIGHT 350 Kg
 WEIGHT: 203 kg
 COMMERCIAL USE (EN ISO 20957-1 / EN ISO 20957-2 class S)

- Struttura tubolare in acciaio rinforzato a sezione quadrata 75x75x3 mm e rotonda ø 50x3 mm
- Verniciatura doppia a polveri epossidiche, antigraffio. Trattamento dei tubolari con sabbiatura e fosfatazione
- Dotazioni/notes: Maniglie con funzione fermi di sicurezza, piedini in gomma antiscivolo, sistema di carico dischi ø50 mm di facile accesso sotto al carrello, 8 ferma dischi a molla ø 49 mm, 4 perni porta dischi ø50 mm
- Sistema di cuscinetti POWER GRADE per garantire uno scorrimento preciso e progressivo
- Cuscini in schiuma ad alta densità con rivestimento in PU

- Structure reinforced-steel squared tube 75x75x3 mm and round tube ø 50x3 mm.
- Double heavy duty powder coating painting, scratch-resistant. Tubing treatment with sandblastic and phosphating process
- Equipment/notes: Hold down handles, anti-slip rubber feet, easy-access under-carriage plate load system suitable for ø50 mm weight plates, 8 olympic spring clip ø 49 mm, 4 weight plates storage holders
- Pulleys system POWER GRADE bearings for a smooth and precise action
- High-density foam cushions with PU upholstery



FWX7300

cod. FWX-7300

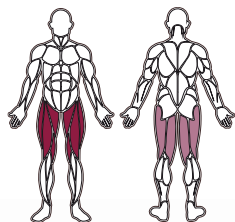
MUSCOLI COINVOLTI
MUSCLE GROUPS

- Quadricipiti - Quadriceps
- Ischiocrurali - Hamstrings

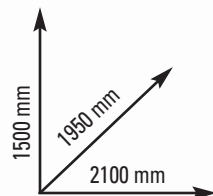

SISTEMA DI SPINTA a pedane indipendenti divergente
 REGOLAZIONI: profondità sedile su 10 posizioni
 DIMENSIONI PRODOTTO: 2100x1950x1500 mm
 PESO MAX UTILIZZATORE 150 Kg
 PESO MAX CARICABILE 400 Kg
 PESO: 195 kg
 CLASSE D'UTILIZZO PROFESSIONALE (EN ISO 20957-1 / EN ISO 20957-2 classe S)

INDEPENDENT DIVERGENT PLATFORMS PUSH system
 ADJUSTMENTS: seat forward - backward on 10-level
 SET UP SIZE: 2100x1950x1500 mm
 MAX USER WEIGHT 150 Kg
 MAX LOADABLE WEIGHT 400 Kg
 WEIGHT: 195 kg
 COMMERCIAL USE (EN ISO 20957-1 / EN ISO 20957-2 class S)

- Struttura tubolare in acciaio a sezione rettangolare 50x80 mm - spessore 3 mm
- Verniciatura doppia a polveri epossidiche, antigraffio. Trattamento dei tubolari con sabbatura e fosfatazione
- Sistema di cuscinetti POWER GRADE per garantire uno scorrimento preciso e progressivo
- Cuscini in schiuma ad alta densità con rivestimento in PU
- Structure rectangular heavy-duty steel tubing 50x80 mm - thickness 3 mm
- Double heavy duty powder coating painting, scratch-resistant. Tubing treatment with sandblasting and phosphating process
- Pulleys system POWER GRADE bearings for a smooth and precise action
- High-density foam cushions with PU upholstery



FWX7350

cod. FWX-7350

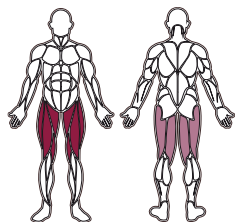
**MUSCOLI COINVOLTI
MUSCLE GROUPS**

- Quadricipiti - Quadriceps
- Ischiocrurali - Hamstrings

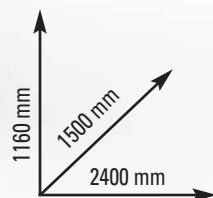

SISTEMA DI SPINTA a pedana fissa
 DIMENSIONI PRODOTTO: 2400x1500x1160 mm
 PESO MAX UTILIZZATORE 150 Kg
 PESO MAX CARICABILE 400 Kg
 PESO: 206 kg
 CLASSE D'UTILIZZO PROFESSIONALE (EN ISO 20957-1 / EN ISO 20957-2 classe S)

FIXED PLATFORM PUSH leverage system
 SET UP SIZE: 2400x1500x1160 mm
 MAX USER WEIGHT 150 Kg
 MAX LOADABLE WEIGHT 400 Kg
 WEIGHT: 206 kg
 COMMERCIAL USE (EN ISO 20957-1 / EN ISO 20957-2 class S)

- Struttura tubolare in acciaio a sezione rettangolare 50x80 mm - spessore 3 mm
- Verniciatura doppia a polveri epossidiche, antigraffio. Trattamento dei tubolari con sabbatura e fosfatazione
- Sistema di cuscinetti POWER GRADE per garantire uno scorrimento preciso e progressivo
- Cuscini in schiuma ad alta densità con rivestimento in PU
- Structure rectangular heavy-duty steel tubing 50x80 mm - thickness 3 mm
- Double heavy duty powder coating painting, scratch-resistant. Tubing treatment with sandblasting and phosphating process
- Pulleys system POWER GRADE bearings for a smooth and precise action
- High-density foam cushions with PU upholstery

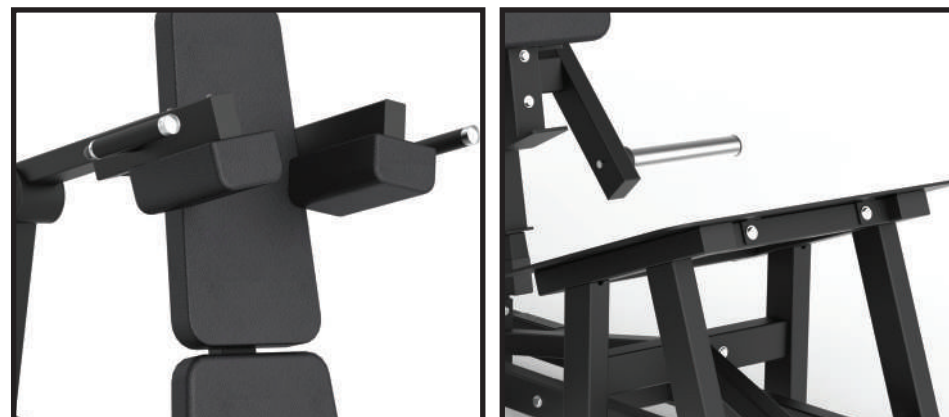

FWX7400

cod. FWX-7400

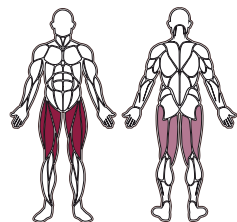
MUSCOLI COINVOLTI
MUSCLE GROUPS

- Quadricipiti - Quadriceps
- Ischiocrurali - Hamstrings

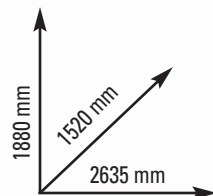

SISTEMA DI SPINTA a pedana
 REGOLAZIONI: inclinazione schienale/pedana su 5 posizioni
 DIMENSIONI PRODOTTO: 2635x1520x1880 mm
 PESO MAX UTILIZZATORE 160 Kg
 PESO MAX CARICABILE 440 Kg
 PESO: 213 kg
 CLASSE D'UTILIZZO PROFESSIONALE (EN ISO 20957-1 / EN ISO 20957-2 classe S)

PLATFORM PUSH system
 ADJUSTMENTS: backrest/platform incline on 5-position
 SET UP SIZE: 2635x1520x1880 mm
 MAX USER WEIGHT 160 Kg
 MAX LOADABLE WEIGHT 440 Kg
 WEIGHT: 213 kg
 COMMERCIAL USE (EN ISO 20957-1 / EN ISO 20957-2 class S)

- Struttura tubolare in acciaio rinforzato a sezione rettangolare 70x50x3 mm e rotonda \varnothing 50x3 mm
- Verniciatura doppia a polveri epossidiche, antigraffio. Trattamento dei tubolari con sabbatura e fosfatazione
- Dotazioni/notes: 2-IN-1 leg press, hack squat. Maniglie con funzione fermi di sicurezza su entrambe le posizioni di allenamento, 3 ganci per fasce elastiche, piedini in gomma anti scivolo, sistema di carico dischi \varnothing 50 mm di facile accesso sotto al carrello, 8 ferma dischi a molla \varnothing 49 mm, 4 perni porta dischi peso
- Sistema di cuscinetti POWER GRADE per garantire uno scorrimento preciso e progressivo
- Cuscini in schiuma ad alta densità con rivestimento in PU

- Structure reinforced-steel rectangular tube 70x50x3 mm and round tube \varnothing 50x3 mm.
- Double heavy duty powder coating painting, scratch-resistant. Tubing treatment with sandblastic and phosphating process
- Equipment/notes: 2-IN-1 leg press, hack squat. Hold down handles on both training positions, 3 pegs for resistance band, anti-slip rubber feet, easy-access under-carriage plate load system suitable for \varnothing 50 mm weight plates, 8 olympic spring clip \varnothing 49 mm, 4 weight plates storage holders
- Pulleys system POWER GRADE bearings for a smooth and precise action
- High-density foam cushions with PU upholstery



FWX7450

cod. FWX-7450

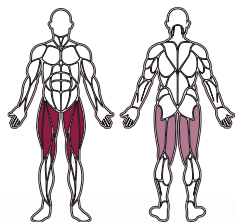
**MUSCOLI COINVOLTI
MUSCLE GROUPS**

- Quadricipiti - Quadriceps
- Ischiocrurali - Hamstrings

SISTEMA DI SPINTA a leveraggi indipendenti
 REGOLAZIONI: altezza sedile su 13 posizioni
 DIMENSIONI PRODOTTO: 1950x1150x1050 mm
 PESO MAX UTILIZZATORE 150 Kg
 PESO MAX CARICABILE 300 Kg
 PESO: 120 kg
 CLASSE D'UTILIZZO PROFESSIONALE (EN ISO 20957-1 / EN ISO 20957-2 classe S)

INDEPENDENT PUSH leverage system
 ADJUSTMENTS: seat height on 13-level
 SET UP SIZE: 1950x1150x1050 mm
 MAX USER WEIGHT 150 Kg
 MAX LOADABLE WEIGHT 300 Kg
 WEIGHT: 120 kg
 COMMERCIAL USE (EN ISO 20957-1 / EN ISO 20957-2 class S)

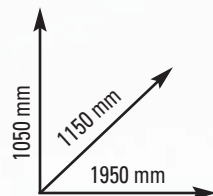

- Struttura tubolare in acciaio a sezione rettangolare 50x80 mm - spessore 3 mm
- Verniciatura doppia a polveri epossidiche, antigraffio. Trattamento dei tubolari con sabbatura e fosfatazione
- Sistema di cuscinetti POWER GRADE per garantire uno scorrimento preciso e progressivo
- Cuscini in schiuma ad alta densità con rivestimento in PU
- Structure rectangular heavy-duty steel tubing 50x80 mm - thickness 3 mm
- Double heavy duty powder coating painting, scratch-resistant. Tubing treatment with sandblasting and phosphating process
- Pulleys system POWER GRADE bearings for a smooth and precise action
- High-density foam cushions with PU upholstery



FWX7500

cod. FWX-7500

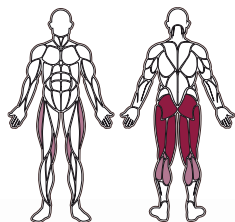
**MUSCOLI COINVOLTI
MUSCLE GROUPS**

- Femorali - Femorals
- Glutei - Gluteus
- Adduttori - Adductors
- Abduttori - Abductors
- Polpacci - Calves

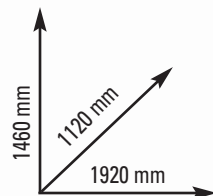

SISTEMA DI SPINTA a leveraggi indipendenti
 DIMENSIONI PRODOTTO: 1920x1120x1460 mm
 PESO MAX UTILIZZATORE 150 Kg
 PESO MAX CARICABILE 300 Kg
 PESO: 108 kg
 CLASSE D'UTILIZZO PROFESSIONALE (EN ISO 20957-1 / EN ISO 20957-2 classe S)

INDEPENDENT PUSH leverage system
 SET UP SIZE: 1920x1120x1460 mm
 MAX USER WEIGHT 150 Kg
 MAX LOADABLE WEIGHT 300 Kg
 WEIGHT: 108 kg
 COMMERCIAL USE (EN ISO 20957-1 / EN ISO 20957-2 class S)

- Struttura tubolare in acciaio a sezione rettangolare 50x80 mm - spessore 3 mm
- Verniciatura doppia a polveri epossidiche, antigraffio. Trattamento dei tubolari con sabbatura e fosfatazione
- Sistema di cuscinetti POWER GRADE per garantire uno scorrimento preciso e progressivo
- Cuscini in schiuma ad alta densità con rivestimento in PU
- Structure rectangular heavy-duty steel tubing 50x80 mm - thickness 3 mm
- Double heavy duty powder coating painting, scratch-resistant. Tubing treatment with sandblasting and phosphating process
- Pulleys system POWER GRADE bearings for a smooth and precise action
- High-density foam cushions with PU upholstery



FWX7550

cod. FWX-7550

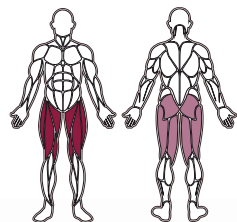

MUSCOLI COINVOLTI MUSCLE GROUPS

- Quadricipiti - Quadriceps
- Ischiocrurali - Hamstrings
- Glutei - Gluteus

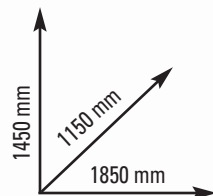

SISTEMA DI SPINTA a telaio flottante
 DIMENSIONI PRODOTTO: 1850x1150x1450 mm
 PESO MAX UTILIZZATORE 150 Kg
 PESO MAX CARICABILE 300 Kg
 PESO: 98 kg
 CLASSE D'UTILIZZO PROFESSIONALE (EN ISO 20957-1 / EN ISO 20957-2 classe S)

FLOATING PLATFORM PUSH system
 SET UP SIZE: 1850x1150x1450 mm
 MAX USER WEIGHT 150 Kg
 MAX LOADABLE WEIGHT 300 Kg
 WEIGHT: 98 kg
 COMMERCIAL USE (EN ISO 20957-1 / EN ISO 20957-2 class S)

- Struttura tubolare in acciaio a sezione rettangolare 50x80 mm - spessore 3 mm
- Verniciatura doppia a polveri epossidiche, antigraffio. Trattamento dei tubolari con sabbiatura e fosfatazione
- Sistema di cuscinetti POWER GRADE per garantire uno scorrimento preciso e progressivo
- Cuscini in schiuma ad alta densità con rivestimento in PU
- Structure rectangular heavy-duty steel tubing 50x80 mm - thickness 3 mm
- Double heavy duty powder coating painting, scratch-resistant. Tubing treatment with sandblasting and phosphating process
- Pulleys system POWER GRADE bearings for a smooth and precise action
- High-density foam cushions with PU upholstery



FWX7600

cod. FWX-7600

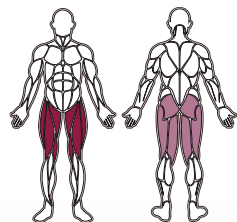
MUSCOLI COINVOLTI
MUSCLE GROUPS

- Quadricipiti - Quadriceps
- Ischiocrurali - Hamstrings
- Glutei - Gluteus

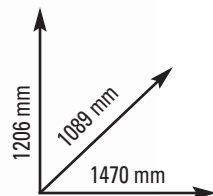

SISTEMA DI SPINTA a leveraggio singolo
 REGOLAZIONI: altezza posizione di partenza su 3 livelli,
 aggancio cintura su 2 posizioni per ottenere una differente resistenza
 DIMENSIONI PRODOTTO: 1470x1089x1206 mm
 PESO MAX UTILIZZATORE 150 Kg
 PESO MAX CARICABILE 400 Kg
 PESO: 73 kg
 CLASSE D'UTILIZZO PROFESSIONALE (EN ISO 20957-1 / EN ISO 20957-2 classe S)

SINGLE PUSH leverage system
 ADJUSTMENTS: start position height on 3-level, hooks for belt connection
 on 2-position to get different strength ratio
 SET UP SIZE: 1470x1089x1206 mm
 MAX USER WEIGHT 150 Kg
 MAX LOADABLE WEIGHT 400 Kg
 WEIGHT: 73 kg
 COMMERCIAL USE (EN ISO 20957-1 / EN ISO 20957-2 class S)

- Struttura tubolare in acciaio a sezione rettangolare 50x70 mm - spessore 3 mm e 40x60 - spessore 3 mm.
- Verniciatura doppia a polveri epossidiche, antigraffio.
Trattamento dei tubolari con sabbatura e fosfatazione
- Sistema di cuscinetti POWER GRADE per garantire uno scorrimento preciso e progressivo
- Dotazioni/note: 4 perni porta dischi ø50 mm., cintura per sollevamento pesi, pedana antiscivolo

- Structure rectangular heavy-duty steel tubing 50x70 mm - thickness 3 mm and 40x60 - spessore 3 mm.
- Double heavy duty powder coating painting, scratch-resistant.
Tubing treatment with sandblastic and phosphating process
- Pulleys system POWER GRADE bearings for a smooth and precise action
- Equipment: 4 weight plates holders for ø50 mm, weightlifting belt, non-slip foot-platform

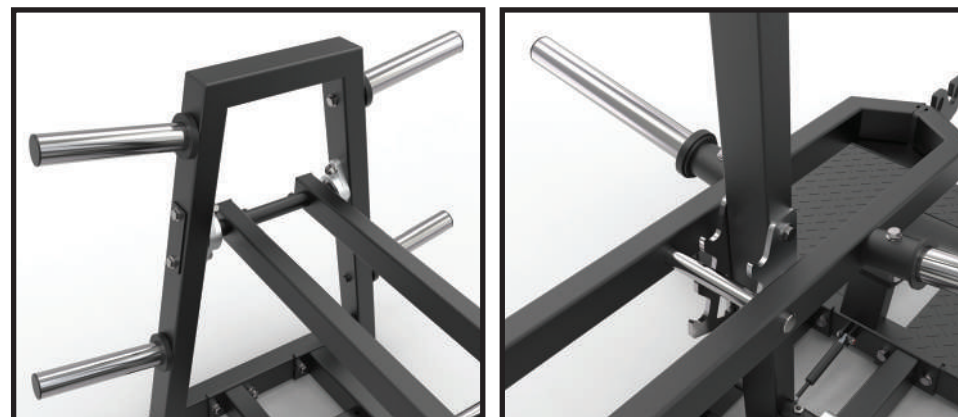

FWX7650

cod. FWX-7650

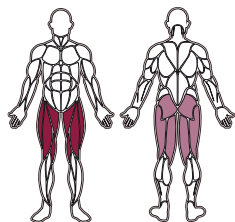
MUSCOLI COINVOLTI
MUSCLE GROUPS

- Quadricipiti - Quadriceps
- Ischiocrurali - Hamstrings
- Glutei - Gluteus

SISTEMA DI SPINTA a leveraggio singolo
 DIMENSIONI PRODOTTO: 2450x1540x1520 mm
 PESO MAX UTILIZZATORE 150 Kg
 PESO MAX CARICABILE 400 Kg
 PESO: 130 kg
 CLASSE D'UTILIZZO PROFESSIONALE (EN ISO 20957-1 / EN ISO 20957-2 classe S)

SINGLE PUSH leverage system
 SET UP SIZE: 2450x1540x1520 mm
 MAX USER WEIGHT 150 Kg
 MAX LOADABLE WEIGHT 400 Kg
 WEIGHT: 130 kg
 COMMERCIAL USE (EN ISO 20957-1 / EN ISO 20957-2 class S)

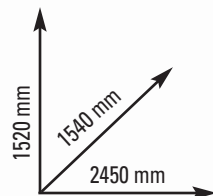

- Struttura tubolare in acciaio a sezione rettangolare 50x80 mm - spessore 3 mm
- Verniciatura doppia a polveri epossidiche, antigraffio. Trattamento dei tubolari con sabbatura e fosfatazione
- Sistema di cuscinetti POWER GRADE per garantire uno scorrimento preciso e progressivo
- Cuscini in schiuma ad alta densità con rivestimento in PU
- Structure rectangular heavy-duty steel tubing 50x80 mm - thickness 3 mm
- Double heavy duty powder coating painting, scratch-resistant. Tubing treatment with sandblasting and phosphating process
- Pulleys system POWER GRADE bearings for a smooth and precise action
- High-density foam cushions with PU upholstery



FWX7700

cod. FWX-7700

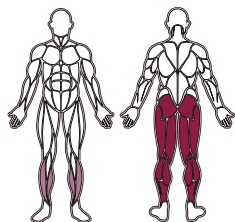
MUSCOLI COINVOLTI
MUSCLE GROUPS

- Femorali - Femorals
- Glutei - Gluteus
- Polpacci - Calves
- Tibiali - Tibialis

SISTEMA DI SPINTA a leveraggio singolo
 REGOLAZIONI: altezza rullo di spinta su 8 posizioni, inclinazione pedana su 4 posizioni
 DIMENSIONI PRODOTTO: 1745x1485x800 mm
 PESO MAX UTILIZZATORE 150 Kg
 PESO MAX CARICABILE 300 Kg
 PESO: 102 kg
 CLASSE D'UTILIZZO PROFESSIONALE (EN ISO 20957-1 / EN ISO 20957-2 classe S)

SINGLE PUSH leverage system
 ADJUSTMENTS: push roller height on 8-level, foot platform incline on 4-level
 SET UP SIZE: 1745x1485x800 mm
 MAX USER WEIGHT 150 Kg
 MAX LOADABLE WEIGHT 300 Kg
 WEIGHT: 102 kg
 COMMERCIAL USE (EN ISO 20957-1 / EN ISO 20957-2 class S)

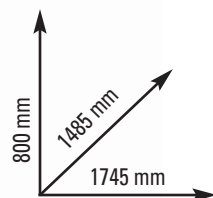

- Struttura tubolare in acciaio rinforzato a sezione rettangolare 100x50x3 mm. Braccio in acciaio rinforzato a sezione ovale 50x80x3 mm.
- Verniciatura doppia a polveri epossidiche, antigraffio. Trattamento dei tubolari con sabbatura e fosfatazione
- Sistema di cuscinetti POWER GRADE per garantire uno scorrimento preciso e progressivo
- Cuscini in schiuma ad alta densità con rivestimento in cotone riciclato
- Structure reinforced-steel rectangular tube 100x50x3 mm. Arm made of oval heavy-duty steel tubing 50x80x3 mm.
- Double heavy duty powder coating painting, scratch-resistant. Tubing treatment with sandblasting and phosphating process
- Pulleys system POWER GRADE bearings for a smooth and precise action
- High-density foam cushions with recycled cotton upholstery



FWX7750

cod. FWX-7750

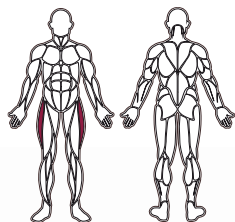
**MUSCOLI COINVOLTI
MUSCLE GROUPS**

■ Abductori - Abductors

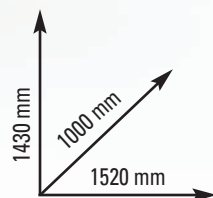

SISTEMA DI SPINTA a leveraggi indipendenti divergenti
 DIMENSIONI PRODOTTO: 1520x1000x1430 mm
 PESO MAX UTILIZZATORE 150 Kg
 PESO MAX CARICABILE 250 Kg
 PESO: 86 kg
 CLASSE D'UTILIZZO PROFESSIONALE (EN ISO 20957-1 / EN ISO 20957-2 classe S)

INDEPENDENT DIVERGENT PUSH leverage system
 SET UP SIZE: 1520x1000x1430 mm
 MAX USER WEIGHT 150 Kg
 MAX LOADABLE WEIGHT 250 Kg
 WEIGHT: 86 kg
 COMMERCIAL USE (EN ISO 20957-1 / EN ISO 20957-2 class S)

- Struttura tubolare in acciaio a sezione rettangolare 50x80 mm - spessore 3 mm
- Verniciatura doppia a polveri epossidiche, antigraffio. Trattamento dei tubolari con sabbatura e fosfatazione
- Sistema di cuscinetti POWER GRADE per garantire uno scorrimento preciso e progressivo
- Cuscini in schiuma ad alta densità con rivestimento in PU
- Structure rectangular heavy-duty steel tubing 50x80 mm - thickness 3 mm
- Double heavy duty powder coating painting, scratch-resistant. Tubing treatment with sandblasting and phosphating process
- Pulleys system POWER GRADE bearings for a smooth and precise action
- High-density foam cushions with PU upholstery



FWX7800

cod. FWX-7800

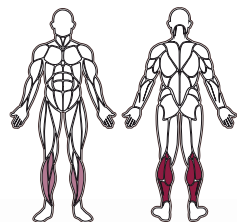
**MUSCOLI COINVOLTI**
MUSCLE GROUPS

- Polpacci - Calves
- Tibiali - Tibialis

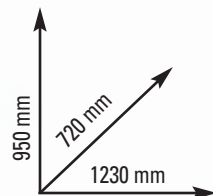

SISTEMA DI SPINTA a leverage singolo
 DIMENSIONI PRODOTTO: 1230x720x950 mm
 PESO MAX UTILIZZATORE 150 Kg
 PESO MAX CARICABILE 200 Kg
 PESO: 53 kg
 CLASSE D'UTILIZZO PROFESSIONALE (EN ISO 20957-1 / EN ISO 20957-2 classe S)

SINGLE PUSH leverage system
 SET UP SIZE: 1230x720x950 mm
 MAX USER WEIGHT 150 Kg
 MAX LOADABLE WEIGHT 200 Kg
 WEIGHT: 53 kg
 COMMERCIAL USE (EN ISO 20957-1 / EN ISO 20957-2 class S)

- Struttura tubolare in acciaio a sezione rettangolare 50x80 mm - spessore 3 mm
- Verniciatura doppia a polveri epossidiche, antigraffio. Trattamento dei tubolari con sabbatura e fosfatazione
- Sistema di cuscinetti POWER GRADE per garantire uno scorrimento preciso e progressivo
- Cuscini in schiuma ad alta densità con rivestimento in PU
- Structure rectangular heavy-duty steel tubing 50x80 mm - thickness 3 mm
- Double heavy duty powder coating painting, scratch-resistant. Tubing treatment with sandblasting and phosphating process
- Pulleys system POWER GRADE bearings for a smooth and precise action
- High-density foam cushions with PU upholstery



FWX7850

cod. FWX-7850

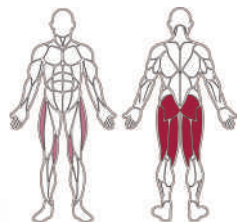
**MUSCOLI COINVOLTI
MUSCLE GROUPS**

- Femorali - Femorals
- Glutei - Gluteus
- Adduttori - Adductors
- Abduuttori - Abductors

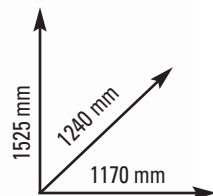

SISTEMA DI SPINTA a leveraggio singolo
 REGOLAZIONI: altezza dei rulli di spinta su 5 livelli, profondità su 4 livelli
 DIMENSIONI PRODOTTO: 1170x1240x1525 mm
 PESO MAX UTILIZZATORE 180 Kg
 PESO MAX CARICABILE 150 Kg
 PESO: 89 kg
 CLASSE D'UTILIZZO PROFESSIONALE (EN ISO 20957-1 / EN ISO 20957-2 classe S)

SINGLE PUSH leverage system
 ADJUSTMENTS: push rollers height on 5-level, width on 4-level
 SET UP SIZE: 1170x1240x1525 mm
 MAX USER WEIGHT 180 Kg
 MAX LOADABLE WEIGHT 150 Kg
 WEIGHT: 89 kg
 COMMERCIAL USE (EN ISO 20957-1 / EN ISO 20957-2 class S)

- Struttura tubolare in acciaio a sezione quadrata 50x50 mm - spessore 3 mm e rettangolare 50x80 mm spessore 3 mm.
- Verniciatura doppia a polveri epossidiche, antigraffio.
- Trattamento dei tubolari con sabbatura e fosfatazione
- Sistema di cuscinetti POWER GRADE per garantire uno scorrimento preciso e progressivo
- Cuscini in schiuma ad alta densità con rivestimento in PU

- Structure squared heavy-duty steel tubing 50x50 mm - thickness 3 mm and rectangular heavy-duty steel tubing 50x80 mm - thickness 3 mm
- Double heavy duty powder coating painting, scratch-resistant.
- Tubing treatment with sandblasting and phosphating process
- Pulleys system POWER GRADE bearings for a smooth and precise action
- High-density foam cushions with PU upholstery

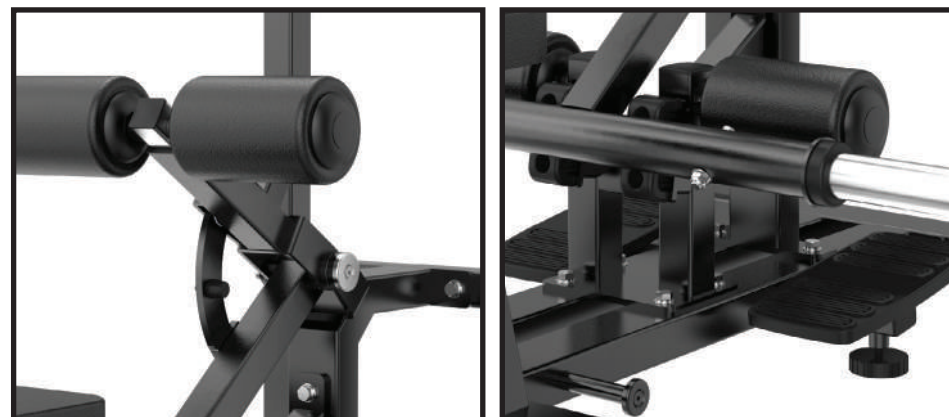

ALL IN ONE

ASX9000

cod. ASX-9000

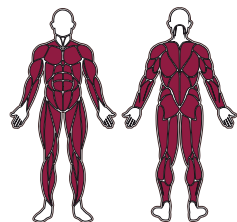

MUSCOLI COINVOLTI MUSCLE GROUPS

■ Full body



TABELLA COMPARATIVA
COMPARATIVE CHART

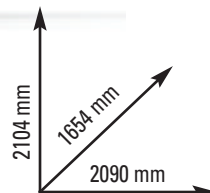

STRENGTH - ALL IN ONE

PULLEY regolabile su 31 livelli (194 mm-1594 mm)
PACCO PESI in acciaio 2x80kg
DIMENSIONI PRODOTTO: 2090x1654x2104 mm
PESO MASSIMO UTILIZZATORE 120 Kg
PESO: 408 Kg (incluso pacco pesi)
CLASSE D'UTILIZZO PROFESSIONALE (EN20957-1 / EN957-2 classe S)

PULLEYS adjustable on 31 levels (194 mm-1594 mm)
WEIGHT STACK steel weight stack 2x80 kg
SET UP SIZE: 2090x1654x2104 mm
MAX USER WEIGHT: 120 KG
WEIGHT: 408 Kg (include weight plates)
COMMERCIAL USE (EN20957-1 / EN957-2 class S)

- Struttura tubolare a sezione quadrata 50x50 mm - spessore 2,5
- Ratio: 1:2 pulley; 1:1 smith bar; 1:2 lat pull down; 1:2 seated rowing
- Bilanciere: 2090mm, scorrimento su cuscinetti a sfera lineari; 2 sicurezze con gancio regolabile, regolabili su 10 posizioni (299mm-1760 mm). Diametro porta dischi da 50 mm.
- DOTAZIONI/NOTE 2-IN-1 dual pulley, 3D smith machine. Lat pulldown/seated rowing/chin-up bar. Attachments: bilanciere, barra tricipiti, barra bicipiti, 2 maniglie trazioni, 2 maniglie trazioni extra long, corda doppia tricipiti, cavigliera

- Structure section square tubing 50x50 mm - thickness 2,5
- Ratio: 1:2 pulley; 1:1 smith bar; 1:2 lat pull down; 1:2 seated rowing
- Barbell: 2090 mm, linear bearing; 2 safety systems with hook to avoid barbell falling, vertically adjustable on 10 levels (299mm-1760 mm). Weight plate holder diameter suitable for ø50 mm weight plates.
- EQUIPMENT/NOTES 2-IN-1 dual pulley, 3D smith machine. Lat pulldown/seated rowing/chin-up bar. Attachments: straight bar, triceps bar, straight short bar, 2 Y-handles, 2 Y-handles extra long, rope, ankle strap



ALL IN ONE

ASX8000

cod. ASX-8000

OPTIONAL



D-HANDLEASX8-WLX38
Parallele
Dip handle



LR-FOOTPLATEASX-8
Pedana per low row
Low row foot plate



LPDASX-8
Lat pull down



LAT-SEATASX8
Lat seat



LMPBASX-8
Seduta lat machine/pulley
Lat machine/pulley seat

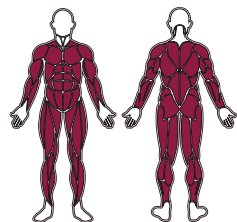

MUSCOLI COINVOLTI MUSCLE GROUPS

■ Full body



TABELLA COMPARATIVA
COMPARATIVE CHART

STRENGTH - ALL IN ONE

PULLEY regolabile 312-1862 mm su 31 livelli interasse 50 mm
PACCO PESI in acciaio 2x90 kg
DIMENSIONI PRODOTTO: 1514x1996x2200 mm
PESO MASSIMO UTILIZZATORE 160 Kg
PESO: 470 kg
CLASSE D'UTILIZZO PROFESSIONALE (EN20957-1 / EN957-2 / EN957-4 classe S)

PULLEYS adjustable on 31 levels (312-1862 mm), distance 50 mm
WEIGHT STACK 2 x 90 kg steel weight stack
SET UP SIZE 1514x1996x2200 mm
MAX USER WEIGHT 160 Kg
WEIGHT: 470 kg
COMMERCIAL USE (EN20957-1 / EN957-2 / EN957-4 class S)

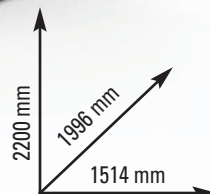
- Struttura tubolare a sezione quadrata 75x75 mm - spessore 3 mm
- Ratio: 1:1 / smith bar - 2:1 / dual pulley - 2:1 / lat pull down
- Bilanciere: 1996 mm, scorrimento su cuscinetto lineare ultra fluido per guida bilanciere Smith, 2 sicurezze con gancio, regolabile verticalmente su 11 livelli (537-1837 mm), passo 130 mm, altezza minima 407 mm da terra (su ganci di sicurezza). Diametro porta dischi da 50 mm.
- DOTAZIONI/NOTE ultra smooth plastic pulley, 2 J-hooks, coppia fermi di sicurezza bilanciere, barra trazioni multi-presa, porta bilanciere, 4 porta dischi ø50 mm, 6 ferma dischi a molla ø49 mm. Attachments: cavigliera, corda doppia tricipiti, catena, 2 maniglie trazioni, maniglia doppia, barra tricipiti, bilanciere e bilanciere CURL, pedana per low row (opzionale)

- Structure section square tube 75x75 mm - thickness 3 mm
- Ratio: 1:1 / smith bar - 2:1 / dual pulley - 2:1 / lat pull down
- Barbell: 1996mm, ultra smooth linear bearing for smith bar guiding, 2 safety systems with hook to avoid barbell falling, vertically adjustable on 11 levels (537-1837mm), distance 130 mm, Lowest height 407 mm from ground up (on safety hooks). Weight plate holder diameter suitable for ø50 mm weight plates.
- EQUIPMENT/NOTES ultra smooth plastic pulley, 2 J-hooks, 2 safety spotter arms, multi-grip chin-up bar, barbell storage, 4 weight plates holders for ø50 mm plates, 6 olympic spring clip ø49 mm. Attachments: ankle strap, tricep rope, chain, 2 Y- handles, V-bar, short straight bar, straight bar and curved bar, non-slip metal footplate(option)

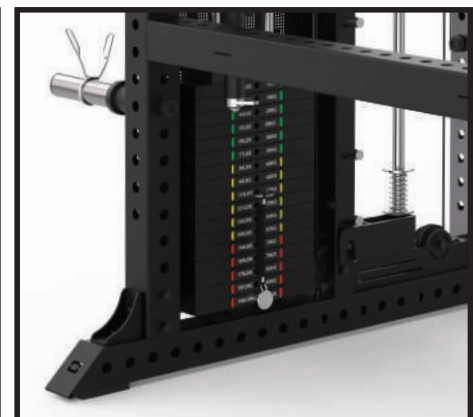

ASX7000

cod. ASX-7000

OPTIONAL



COD. LEG-PRESSASX
Vertical leg press



COD. M-BARASX
Multifunctional bar



COD. MLIFTASX-4.5-6
Monolift



COD. LAT-SEATASX-4.5-6
Lat seat



COD. W-HOLDERASX
Perno porta pesi
Weight plates holder



COD. LPDASX-4.5-6
Lat pull down



COD. J-ARMSASX6000
Jammer arms



COD. SW-HOLDERASX-7
Set 6 perni porta pesi
6 pcs weight plates holders



COD. D-HANDLEASX-7
Parallele
Dip handle



COD. W-HOLDER-SMASX-7
Set 2 perni porta pesi per smith bar
Set of 2 weight plates holders for smith bar



COD. LMASX-7
Landmine



COD. SB-FSASX-7
Supporti bilanciere e fermi di sicurezza
J-cups and safety spotter arms



COD. LR-FOOTPLATEASX-7
Pedana per low row
Low row foot plate

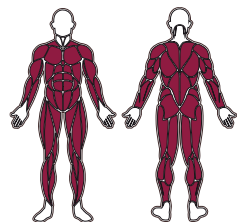

**MUSCOLI COINVOLTI
MUSCLE GROUPS**

■ Full body



TABELLA COMPARATIVA
COMPARATIVE CHART

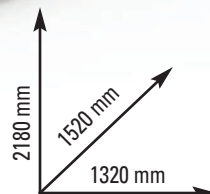

STRENGTH - ALL IN ONE

PULLEY regolabile 300-1875 mm su 50 livelli interasse 25-50 mm
PACCO PESI in acciaio 2x90 kg
DIMENSIONI PRODOTTO: 1320x1520x2180 mm
PESO MASSIMO UTILIZZATORE 160 Kg
PESO: 382.8 kg
CLASSE D'UTILIZZO PROFESSIONALE (EN20957-1 / EN957-2 classe S)

PULLEYS adjustable on 50 levels (300-1875 mm) distance 25-50 mm
WEIGHT STACK steel weight stack 2x90 kg
SET UP SIZE: 1320x1520x2180 mm
PESO MASSIMO UTILIZZATORE 160 Kg
WEIGHT: 382.8 kg
COMMERCIAL USE (EN20957-1 / EN957-2 class S)

- Struttura tubolare a sezione rettangolare 50x70 mm - spessore 2,5 e ovale 50x100 – spessore 2,5 mm
- Ratio: 1:2 / smith bar - 1:2 / fly handle - 1:2 / lat pull down - 1:2 / seated rowing
- Bilanciere: 1282 mm, scorrimento su cuscinetti a sfera lineari, 2 sicurezze con gancio regolabile, regolabili su 11 posizioni (455-1750 mm), passo 130 mm. Diametro porta dischi da 50 mm. Sistema brevettato di aggancio bilanciere guidato ai pacchi peso.
- DOTAZIONI/NOTE 3-IN-1 dual pulley, smith machine, rack. Barra trazioni, 8 ferma dischi a molla ø49 mm. Attachments: cavigliera, corda doppia tricipiti, catena, 2 maniglie trazioni, maniglia doppia, barra tricipiti, bilanciere e bilanciere CURL

- Structure section rectangular tubing 50x70 mm - thickness 2,5 and oval 50x100 – thickness 2,5 mm
- Ratio: 1:2 / smith bar - 1:2 / fly handle - 1:2 / lat pull down - 1:2 / seated rowing
- Barbell: 1282 mm, linear bearings sliding, 2 safety systems with hook to avoid barbell falling, vertically adjustable on 11 levels (455-1750 mm), distance 130 mm. Weight plate holder diameter suitable for ø50 mm weight plates. Patented system to link the barbell to the weight stacks.
- EQUIPMENT/NOTES 3-IN-1 dual pulley, smith machine, rack. Chin-up bar, 8 olympic spring clips ø49 mm. Attachments : ankle strap, rope, chain, 2 D- handles, V-bar, short straight bar, straight bar and curved bar



ALL IN ONE

ASX6000

cod. ASX-6000

OPTIONAL



COD. J-ARMSASX6000
Jammer arms



COD. LAT-SEATASX-4.5-6
Lat seat



COD. LEG-PRESSASX
Leg press



COD. W-HOLDERASX
Perno porta pesi
Weight plates holder



COD. M-BARASX
Multifunctional bar



COD. LPDASX-4.5-6
Lat pull down



COD. MLIFTASX-4.5-6
Monolift



COD. BELT-SQUATASX6000
Belt squat / T bar machine

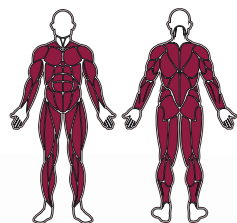

MUSCOLI COINVOLTI MUSCLE GROUPS

■ Full body

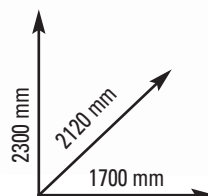

STRENGTH - ALL IN ONE

PULLEY regolabile 372-1947 mm su 22 livelli interasse 75 mm
PACCO PESI in acciaio 2x90kg
J-CUP/SAFETY SPOTTER ARMS Extra strong spessore 5 mm con protezione UHMW (Ultra High Molecular Weight). Regolabile 432-1982 mm su 31 livelli interasse 50 mm
DIMENSIONI PRODOTTO: 1700x2120x2300 mm
PESO MASSIMO UTILIZZATORE 160 Kg
PESO: 415.7 kg
CLASSE D'UTILIZZO PROFESSIONALE (EN20957-1 / EN957-2 classe S)

PULLEYS adjustable on 22 levels (372-1947 mm) distance 75 mm
WEIGHT STACK steel weight stack 2x90 kg
J-CUP/SAFETY SPOTTER ARMS Extra strong - 5 mm thickness with UHMW (Ultra High Molecular Weight) protection pads, adjustable on 31 levels (432-1982 mm) distance 50 mm
SET UP SIZE: 1700x2120x2300 mm
PESO MASSIMO UTILIZZATORE 160 Kg
WEIGHT: 415.7 kg
COMMERCIAL USE (EN20957-1 / EN957-2 class S)

- Struttura tubolare a sezione rettangolare 50x70 mm - spessore 2,5 e 50x100 - spessore 3 mm.
- Ratio: 1:2 / fly handle - 1:2 / lat pull down - 1:2 / seated rowing
- Bilanciere: 1993 mm, scorrimento su cuscinetti a sfera lineari, 2 sicurezze con gancio regolabile, regolabili su 14 posizioni (538-2020 mm), passo 130 mm. Diametro porta dischi da 50 mm
- DOTAZIONI/NOTE 3-IN-1 dual pulley, smith machine, rack, 2 J-hook, copia fermi di sicurezza bilanciere, barra trazioni, parallele, porta bilanciere, 6 porta dischi ø50 mm, 8 ferma dischi a molla ø49 mm. Attachments: cavigliera, corda doppia tricipiti, catena, landmine, 2 maniglie trazioni, pedana per low row, maniglia doppia, barra tricipiti, bilanciere e bilanciere CURL

- Structure section rectangular tubing 50x70 mm - thickness 2,5 and 50x100 - thickness 3 mm
- Ratio: 1:2 / fly handle - 1:2 / lat pull down - 1:2 / seated rowing
- Barbell: 1993 mm, linear bearings sliding, 2 safety systems with hook to avoid barbell falling, vertically adjustable on 14 levels (538-2020mm), distance 130 mm. Weight plate holder diameter suitable for ø50 mm weight plates
- EQUIPMENT/NOTES 3-IN-1 dual pulley, smith machine, rack, 2 J-hooks, 2 safety spotter arms, chin-up bar, dip up bar, barbell storage, 6 weight plates holders for ø50 mm plates, 8 olympic spring clips ø49 mm. Attachments: ankle strap, rope, chain, landmine, non-slip metal footplate, 2 Y- handles, V-bar, short straight bar, straight bar and curved bar

150



TABELLA COMPARATIVA
COMPARATIVE CHART



CSX9500

cod. CSX-9500

cod. CSX-8800 +
cod. CSX-9000 +
cod. CROSS-BARCSX7-9

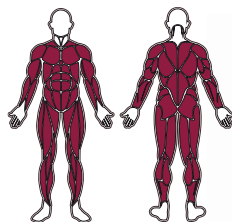

MUSCOLI COINVOLTI
MUSCLE GROUPS

■ Full body

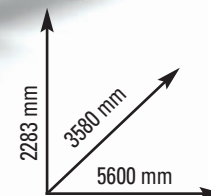

151

PACCO PESI in acciaio: cable crossover 2x70 kg, 2 x triceps machine 60 kg, lat machine 95 kg, pulley rehab 60 kg, pulley 102,5 kg, pull up & push down 102,5 kg
DOTAZIONE: maniglia di trazione, barre lat, 2 corda doppia per tricipiti, barra corta, maniglia pulley, maniglia doppia
DIMENSIONI PRODOTTO: 5600x3580x2283 mm
PESO MAX UTILIZZATORE 150 Kg
PESO: 1130,5 kg
CLASSE D'UTILIZZO PROFESSIONALE (EN20957-1 / EN957-2 classe S)

WEIGHT STACK steel: cable crossover 2x70 kg, 2 x triceps machine 60 kg, lat machine 95 kg, pulley rehab 60 kg, pulley 102,5 kg, pull up & push down 102,5 kg
EQUIPMENT: single strap, lower push bar, lat pull bars, 2 triceps rope, pulley handle, double handle
SET UP SIZE: 5600x3580x2283 mm
MAX USER WEIGHT 150 Kg
WEIGHT: 1130,5 kg
COMMERCIAL USE (EN20957-1 / EN957-2 class S)

- Struttura tubolare in acciaio rinforzato a sezione ovale piatta 50x100 mm - spessore 3 mm.
- Verniciatura doppia a polveri epossidiche, antigraffio
- Sistema di carrucole/pulegge con cuscinetti PREMIUM GRADE in lega d'acciaio per garantire uno scorrimento preciso e progressivo.
- Cavi in acciaio rivestiti in poliuretano

- Structure oval flat heavy-duty steel tubing 50x100 mm - thickness 3 mm.
- Painting double heavy duty powder coating painting, scratch-resistant
- Pulley system PREMIUM GRADE alloy steel bearings for a smooth and precise action.
- Cables system steel woven cables with polyurethane coating



CSX9400

cod. CSX-9400

2x cod. CSX-9000 +
cod. CROSS-BARCSX7-9

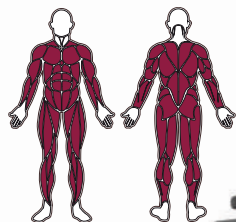

MUSCOLI COINVOLTI
MUSCLE GROUPS

■ Full body

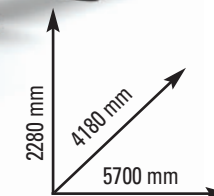

152

PACCO PESI in acciaio: 2 x single pulley 70 kg, 2x lat machine 95 kg, 2x pulley 102,5 kg, 2x triceps 60 kg.
DOTAZIONE: 2 maniglie pulley, 2 lat bar, 2 corde doppie per tricipiti, 2 maniglie doppie
DIMENSIONI PRODOTTO: 5700x4180x2280 mm
PESO MAX UTILIZZATORE 150 Kg
PESO: 1127 kg
CLASSE D'UTILIZZO PROFESSIONALE (EN20957-1 / EN957-2 classe S)

WEIGHT STACK steel: 2x single pulley 70 kg, 2x lat machine 95 kg, 2x pulley 102,5 kg, 2x triceps 60 kg.
EQUIPMENT: 2 pulley handles, 2 lat bars, 2 triceps ropes, 2 double handles
SET UP SIZE: 5700x4180x2280 mm
MAX USER WEIGHT 150 Kg
WEIGHT: 1127 kg
COMMERCIAL USE (EN20957-1 / EN957-2 class S)

- Struttura tubolare in acciaio rinforzato a sezione ovale piatta 50x100 mm - spessore 3 mm.
- Verniciatura doppia a polveri epossidiche, antigraffio
- Sistema di carrucole/pulegge con cuscinetti PREMIUM GRADE in lega d'acciaio per garantire uno scorrimento preciso e progressivo.
- Cavi in acciaio rivestiti in poliuretano

- Structure oval flat heavy-duty steel tubing 50x100 mm - thickness 3 mm.
- Painting double heavy duty powder coating painting, scratch-resistant
- Pulley system PREMIUM GRADE alloy steel bearings for a smooth and precise action.
- Cables system steel woven cables with polyurethane coating



CSX9300

cod. CSX-9300

2x cod. CSX-8800 +
cod. CROSS-BARCSX7-9

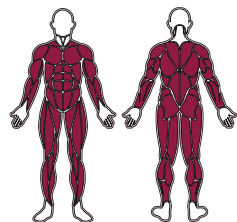

MUSCOLI COINVOLTI MUSCLE GROUPS

■ Full body

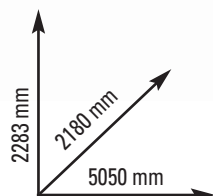

STRENGTH - STATIONS

PACCO PESI in acciaio: cable crossover 2x70 kg, 2 x triceps machine 60 kg, 2 x pulley rehab 60 kg, 2 x pull up & push down 102,5 kg
DOTAZIONE: 2 maniglie di trazione, 4 barre lat, 2 corde doppie per tricipiti, 2 barre corte
DIMENSIONI PRODOTTO: 5050x2180x2283 mm
PESO MAX UTILIZZATORE 150 Kg
PESO: 1029.5 kg
CLASSE D'UTILIZZO PROFESSIONALE (EN20957-1 / EN957-2 classe S)

WEIGHT STACK steel: cable crossover 2x70 kg, 2 x triceps machine 60 kg, 2 x pulley rehab 60 kg, 2 x pull up & push down 102,5 kg
EQUIPMENT: 2 single straps, 2 lower push bars, 4 lat pull bars, 2 triceps rope
SET UP SIZE: 5050x2180x2283 mm
MAX USER WEIGHT 150 Kg
WEIGHT: 1029.5 kg
COMMERCIAL USE (EN20957-1 / EN957-2 class S)

- Struttura tubolare in acciaio rinforzato a sezione ovale piatta 50x100 mm - spessore 3 mm.
- Verniciatura doppia a polveri epossidiche, antigraffio
- Sistema di carrucole/pulegge con cuscinetti PREMIUM GRADE in lega d'acciaio per garantire uno scorrimento preciso e progressivo. Cavi in acciaio rivestiti in poliuretano
- Structure oval flat heavy-duty steel tubing 50x100 mm - thickness 3 mm.
- Painting double heavy duty powder coating painting, scratch-resistant
- Pulley system PREMIUM GRADE alloy steel bearings for a smooth and precise action. Cables system steel woven cables with polyurethane coating



JUNGLE 5 STAZIONI - JUNGLE 5 STATIONS

CSX9200

cod. CSX-9200

cod. SSCSX7-9 +
cod. CSX-9000 +
cod. CROSS-BARCSX7-9

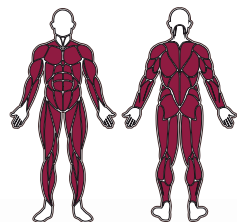

MUSCOLI COINVOLTI MUSCLE GROUPS

■ Full body

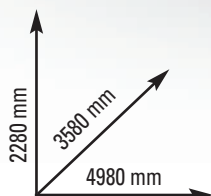

STRENGTH - STATIONS

PACCO PESI in acciaio: cable crossover 2x70 kg, lat machine 95 kg, pulley 102,5 kg, triceps 60 kg.
DOTAZIONE: 2 maniglie pulley, lat bar, corda doppia per tricipiti, maniglia doppia
DIMENSIONI PRODOTTO: 4980x3580x2280 mm
PESO MAX UTILIZZATORE 150 Kg
PESO: 750 kg
CLASSE D'UTILIZZO PROFESSIONALE (EN20957-1 / EN957-2 classe S)

WEIGHT STACK steel: cable crossover 2x70 kg, lat machine 95 kg, pulley 102,5 kg, triceps 60 kg.
EQUIPMENT: 2 pulley handles, lat bar, triceps rope, double handle
SET UP SIZE: 4980x3580x2280 mm
MAX USER WEIGHT 150 Kg
WEIGHT: 750 kg
COMMERCIAL USE (EN20957-1 / EN957-2 class S)

- Struttura tubolare in acciaio rinforzato a sezione ovale piatta 50x100 mm - spessore 3 mm.
- Verniciatura doppia a polveri epossidiche, antigraffio
- Sistema di carrucole/pulegge con cuscinetti PREMIUM GRADE in lega d'acciaio per garantire uno scorrimento preciso e progressivo.
Cavi in acciaio rivestiti in poliuretano
- Structure oval flat heavy-duty steel tubing 50x100 mm - thickness 3 mm.
- Painting double heavy duty powder coating painting, scratch-resistant
- Pulley system PREMIUM GRADE alloy steel bearings for a smooth and precise action. Cables system steel woven cables with polyurethane coating



JUNGLE 5 STAZIONI - JUNGLE 5 STATIONS

CSX9100

cod. CSX-9100

cod. SSCSX7-9 +
cod. CSX-8800 +
cod. CROSS-BARCSX7-9

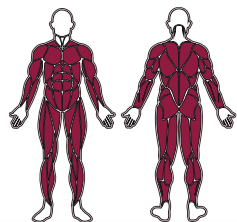

MUSCOLI COINVOLTI MUSCLE GROUPS

■ Full body

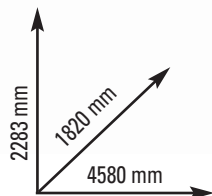

STRENGTH - STATIONS

PACCO PESI in acciaio: cable crossover 2x70 kg, triceps machine 60 kg, pulley rehab 60 kg, pull up & push down 102,5 kg
DOTAZIONE: 2 maniglie di trazione, barre lat, corda doppia per tricipiti, barra corta
DIMENSIONI PRODOTTO: 4580x1820x2283 mm
PESO MAX UTILIZZATORE 150 Kg
PESO: 721.5 kg
CLASSE D'UTILIZZO PROFESSIONALE (EN20957-1 / EN957-2 classe S)

WEIGHT STACK cable crossover 2x70 kg, triceps machine 60 kg, pulley rehab 60 kg, pull up & push down 102,5 kg
EQUIPMENT: 2 single straps, lower push bar, lat pull bars, triceps rope
SET UP SIZE: 4580x1820x2283 mm
MAX USER WEIGHT 150 Kg
WEIGHT: 721.5 kg
COMMERCIAL USE (EN20957-1 / EN957-2 class S)

- Struttura tubolare in acciaio rinforzato a sezione ovale piatta 50x100 mm - spessore 3 mm.
- Verniciatura doppia a polveri epossidiche, antigraffio
- Sistema di carrucole/pulegge con cuscinetti PREMIUM GRADE in lega d'acciaio per garantire uno scorrimento preciso e progressivo. Cavi in acciaio rivestiti in poliuretano
- Structure oval flat heavy-duty steel tubing 50x100 mm - thickness 3 mm.
- Painting double heavy duty powder coating painting, scratch-resistant
- Pulley system PREMIUM GRADE alloy steel bearings for a smooth and precise action. Cables system steel woven cables with polyurethane coating



CSX9000

cod. CSX-9000

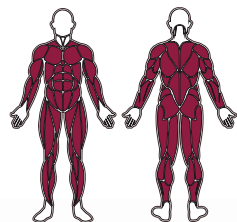

MUSCOLI COINVOLTI MUSCLE GROUPS

■ Full body

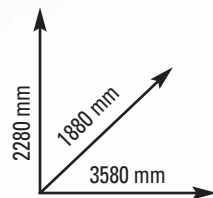

STRENGTH - STATIONS

PACCO PESI in acciaio: single pulley 70 kg, lat machine 95 kg, pulley 102,5 kg, triceps 60 kg.
DOTAZIONE: maniglia pulley, lat bar, corda doppia per tricipiti, maniglia doppia
DIMENSIONI PRODOTTO: 3580x1880x2280 mm
PESO MAX UTILIZZATORE 150 Kg
PESO: 553 kg
CLASSE D'UTILIZZO PROFESSIONALE (EN20957-1 / EN957-2 classe S)

WEIGHT STACK steel: single pulley 70 kg, lat machine 95 kg, pulley 102,5 kg, triceps 60 kg.
EQUIPMENT: pulley handle, lat bar, triceps rope, double handle
SET UP SIZE: 3580x1880x2280 mm
MAX USER WEIGHT 150 Kg
WEIGHT: 553 kg
COMMERCIAL USE (EN20957-1 / EN957-2 class S)

- Struttura tubolare in acciaio rinforzato a sezione ovale piatta 50x100 mm - spessore 3 mm.
- Verniciatura doppia a polveri epossidiche, antigraffio
- Sistema di carrucole/pullegge con cuscinetti PREMIUM GRADE in lega d'acciaio per garantire uno scorrimento preciso e progressivo. Cavi in acciaio rivestiti in poliuretano
- Structure oval flat heavy-duty steel tubing 50x100 mm - thickness 3 mm.
- Painting double heavy duty powder coating painting, scratch-resistant
- Pulley system PREMIUM GRADE alloy steel bearings for a smooth and precise action. Cables system steel woven cables with polyurethane coating

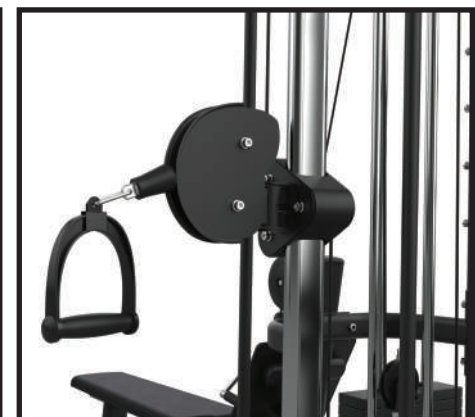

CSX8800

cod. CSX-8800

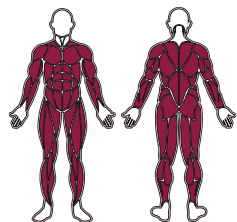

MUSCOLI COINVOLTI MUSCLE GROUPS

■ Full body

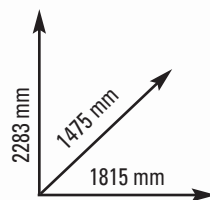

STRENGTH - STATIONS

PACCO PESI in acciaio: push down 70 kg, triceps machine 60 kg, pulley rehab 60 kg, pull up & push down 102,5 kg
 DOTAZIONE: maniglia di trazione, barre lat, corda doppia per tricipiti, barra corta
 DIMENSIONI PRODOTTO: 1815x1475x2283 mm
 PESO MAX UTILIZZATORE 150 Kg
 PESO: 504 kg
 CLASSE D'UTILIZZO PROFESSIONALE (EN20957-1 / EN957-2 classe S)

WEIGHT STACK steel: push down 70 kg, triceps machine 60 kg, pulley rehab 60 kg, pull up & push down 102,5 kg
 EQUIPMENT: single strap, lower push bar, lat pull bars, triceps rope
 SET UP SIZE: 1815x1475x2283 mm
 MAX USER WEIGHT 150 Kg
 WEIGHT: 504 kg
 COMMERCIAL USE (EN20957-1 / EN957-2 class S)

- Struttura tubolare in acciaio rinforzato a sezione ovale piatta 50x100 mm - spessore 3 mm.
- Verniciatura doppia a polveri epossidiche, antigraffio
- Sistema di carrucole/pullegge con cuscinetti PREMIUM GRADE in lega d'acciaio per garantire uno scorrimento preciso e progressivo. Cavi in acciaio rivestiti in poliuretano
- Structure oval flat heavy-duty steel tubing 50x100 mm - thickness 3 mm.
- Painting double heavy duty powder coating painting, scratch-resistant
- Pulley system PREMIUM GRADE alloy steel bearings for a smooth and precise action. Cables system steel woven cables with polyurethane coating



CABLE CROSSOVER

CSX8000

cod. CSX-8000

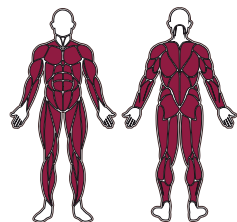

MUSCOLI COINVOLTI MUSCLE GROUPS

■ Full body

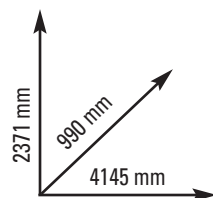

STRENGTH - STATIONS

PACCO PESI 2x100 kg in acciaio. Carter di protezione integrale
DOTAZIONE: coppia maniglie pulley, coppia cavigliere per trazioni, 2 lat bar
DIMENSIONI PRODOTTO: 4145x990x2371 mm
PESO MAX UTILIZZATORE 120 Kg
PESO: 421 kg
CLASSE D'UTILIZZO PROFESSIONALE (EN20957-1 / EN957-2 classe S)

WEIGHT STACK steel 2x100 kg weight stack with full protection cage
EQUIPMENT: 2 pulley handles, 2 pulley ankle cuffs, 2 lat bars
SET UP SIZE: 4145x990x2371 mm
MAX USER WEIGHT 120 Kg
WEIGHT: 421 kg
COMMERCIAL USE (EN20957-1 / EN957-2 class S)

- Struttura tubolare in acciaio rinforzato a sezione ovale piatta 50x100 mm - spessore 3 mm.
- Verniciatura doppia a polveri epossidiche, antigraffio.
- Sistema di carrucole/pulegge con cuscinetti PREMIUM GRADE in lega d'acciaio per garantire uno scorrimento preciso e progressivo. Cavi in acciaio rivestiti in poliuretano

- Structure oval flat heavy-duty steel tubing 50x100 mm - thickness 3 mm.
- Painting double heavy duty powder coating painting, scratch-resistant
- Pulley system PREMIUM GRADE alloy steel bearings for a smooth and precise action. Cables system steel woven cables with polyurethane coating



CABLE CROSSOVER

CSX7000

cod. CSX-7000

2x cod. SSCSX7-9 +
cod. CROSS-BARCSX7-9

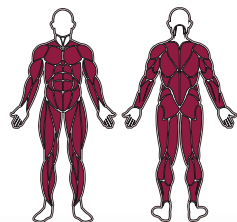

MUSCOLI COINVOLTI MUSCLE GROUPS

■ Full body

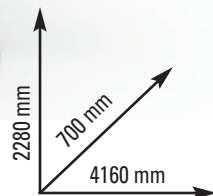

STRENGTH - STATIONS

PACCO PESI 2x70 kg in acciaio.
DOTAZIONE: coppia maniglie pulley
DIMENSIONI PRODOTTO: 4160x700x2280 mm
PESO MAX UTILIZZATORE 150 Kg
PESO: 360 kg
CLASSE D'UTILIZZO PROFESSIONALE (EN20957-1 / EN957-2 classe S)

WEIGHT STACK steel 2x70 kg weight stack
EQUIPMENT: 2 pulley handles
SET UP SIZE: 4160x700x2280 mm
MAX USER WEIGHT 150 Kg
WEIGHT: 360 kg
COMMERCIAL USE (EN20957-1 / EN957-2 class S)

- Struttura tubolare in acciaio rinforzato a sezione ovale piatta 50x100 mm - spessore 3 mm.
- Verniciatura doppia a polveri epossidiche, antigraffio
- Sistema di carrucole/pulegge con cuscinetti PREMIUM GRADE in lega d'acciaio per garantire uno scorrimento preciso e progressivo.
Cavi in acciaio rivestiti in poliuretano
- Structure oval flat heavy-duty steel tubing 50x100 mm - thickness 3 mm.
- Painting double heavy duty powder coating painting, scratch-resistant
- Pulley system PREMIUM GRADE alloy steel bearings for a smooth and precise action. Cables system steel woven cables with polyurethane coating



CABLE CROSSOVER

CSX6000

cod. CSX-6000

2x cod. CSX-2000 +
cod. CROSS-BARCSX2000

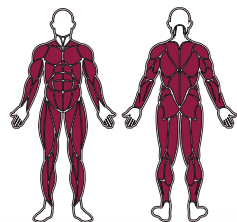

MUSCOLI COINVOLTI MUSCLE GROUPS

■ Full body



STRENGTH - STATIONS

PACCO PESI 2x70 kg in acciaio. Carter di protezione integrale. Pacco pesi 2x30 kg **OPTIONAL** disponibile 2x cod. W-STACKCSX2-6
DOTAZIONE: 2 coppie maniglie pulley, 2 corde doppie per tricipiti, 2 barre tricipiti dritte
DIMENSIONI PRODOTTO: 3800x1000x2260 mm
PESO MAX UTILIZZATORE 150 Kg
PESO: 324 kg
CLASSE D'UTILIZZO PROFESSIONALE (EN20957-1 / EN957-2 classe S)

WEIGHT STACK steel 2x70 kg weight stack with full protection cage. 2x30 kg **OPTIONAL** weight stack available 2x cod. W-STACKCSX2-6
EQUIPMENT: 4 pulley handles, 2 triceps ropes, 2 streight triceps bars
SET UP SIZE: 3800x1000x2260 mm
MAX USER WEIGHT 150 Kg
WEIGHT: 324 kg
COMMERCIAL USE (EN20957-1 / EN957-2 class S)

- Struttura tubolare in acciaio rinforzato a sezione ovale piatta 50x100 mm - spessore 2,5 mm.
- Verniciatura doppia a polveri epossidiche, antigraffio.
- Sistema di carrucole/pulegge con cuscinetti POWER GRADE per garantire uno scorrimento preciso e progressivo. Cavi in acciaio rivestiti in poliuretano

- Structure oval flat heavy-duty steel tubing 50x100 mm - thickness 2,5 mm.
- Painting double heavy duty powder coating painting, scratch-resistant
- Pulley system POWER GRADE bearings for a smooth and precise action. Cables system steel woven cables with polyurethane coating



SINGLE PULLEY

CSX4000

cod. CSX-B4000

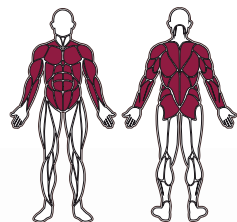

MUSCOLI COINVOLTI MUSCLE GROUPS

- Upper body
- Glutei - Gluteus

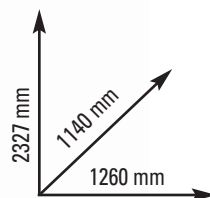

STRENGTH - STATIONS

PACCO PESI 100 kg in acciaio. Carter di protezione integrale
DOTAZIONE: maniglia pulley, cavigliera per trazioni, lat bar
DIMENSIONI PRODOTTO: 1260x1140x2327 mm
PESO MAX UTILIZZATORE 120 Kg
PESO: 228 kg
CLASSE D'UTILIZZO PROFESSIONALE (EN20957-1 / EN957-2 classe S)

WEIGHT STACK steel 100 kg weight stack with full protection cage
EQUIPMENT: 1 pulley handle, 1 pulley ankle cuff, 1 lat bar
SET UP SIZE: 1260x1140x2327 mm
MAX USER WEIGHT 120 Kg
WEIGHT: 228 kg
COMMERCIAL USE (EN20957-1 / EN957-2 class S)

- Struttura tubolare in acciaio rinforzato a sezione ovale piatta 50x100 mm - spessore 3 mm.
- Verniciatura doppia a polveri epossidiche, antigraffio .
- Sistema di carrucole/pulegge con cuscinetti PREMIUM GRADE in lega d'acciaio per garantire uno scorrimento preciso e progressivo.
Cavi in acciaio rivestiti in poliuretano

- Structure oval flat heavy-duty steel tubing 50x100 mm - thickness 3 mm.
- Painting double heavy duty powder coating painting, scratch-resistant
- Pulley system PREMIUM GRADE alloy steel bearings for a smooth and precise action. Cables system steel woven cables with polyurethane coating



SINGLE PULLEY

CSX2000

cod. CSX-2000

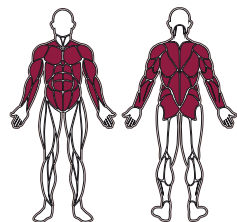

MUSCOLI COINVOLTI MUSCLE GROUPS

- Upper body
- Glutei

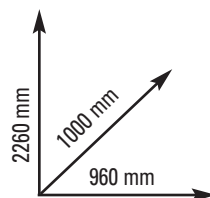

STRENGTH - STATIONS

PACCO PESI 70 kg in acciaio. Carter di protezione integrale. Pacco pesi 30 kg **OPTIONAL** disponibile cod. W-STACKCSX2-6
DOTAZIONE: coppia maniglie pulley, corda doppia per tricipiti, barra tricipiti dritta
DIMENSIONI PRODOTTO: 960x1000x2260 mm
PESO MAX UTILIZZATORE 150 Kg
PESO: 154 kg
CLASSE D'UTILIZZO PROFESSIONALE (EN20957-1 / EN957-2 classe S)

WEIGHT STACK steel 70 kg weight stack with full protection cage. 30 kg **OPTIONAL** weight stack available cod. W-STACKCSX2-6
EQUIPMENT: pulley handles, triceps rope, streight triceps bar
SET UP SIZE: 960x1000x2260 mm
MAX USER WEIGHT 150 Kg
WEIGHT: 154 kg
COMMERCIAL USE (EN20957-1 / EN957-2 class S)

- Struttura tubolare in acciaio rinforzato a sezione ovale piatta 50x100 mm - spessore 2,5 mm.
- Verniciatura doppia a polveri epossidiche, antigraffio.
- Sistema di carrucole/pulegge con cuscinetti POWER GRADE per garantire uno scorrimento preciso e progressivo. Cavi in acciaio rivestiti in poliuretano

- Structure oval flat heavy-duty steel tubing 50x100 mm - thickness 2,5 mm.
- Painting double heavy duty powder coating painting, scratch-resistant
- Pulley system POWER GRADE bearings for a smooth and precise action. Cables system steel woven cables with polyurethane coating



DUAL PULLEY

CSX5500

cod. CSX-5500

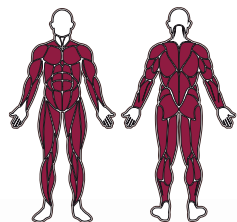

MUSCOLI COINVOLTI MUSCLE GROUPS

■ Full body



STRENGTH - STATIONS

PACCO PESI 2 x 90 kg
DOTAZIONE coppia maniglie pulley, cavigliera, bilanciere, bilanciere curvo, barra tricipiti
DIMENSIONI PRODOTTO: 1314x2945x2147 mm
PESO: 373,5 kg
CLASSE D'UTILIZZO PROFESSIONALE (EN20957-1 / EN957-2 classe S)

WEIGHT STACK 2 x 90 kg
EQUIPMENT: ankle strap 2 x D handles; straight bar, curved bar and triceps bar
SET UP SIZE: 1314x2945x2147 mm
WEIGHT: 373,5 kg
COMMERCIAL USE (EN20957-1 / EN957-2 class S)

- Struttura tubolare in acciaio rinforzato a sezione ovale piatta 50x100 mm - spessore 2,5 mm, a sezione rettangolare 50x100 mm e 75x100 mm - spessore 3 mm
- Verniciatura doppia a polveri epossidiche, antigraffio
- Sistema di carrucole/pulegge con cuscinetti POWER GRADE per garantire uno scorrimento preciso e progressivo. Cavi in acciaio rivestiti in poliuretano

- Structure oval flat heavy-duty steel tubing 50x100 mm - thickness 2,5 mm and rectangular 50x100 mm and 75x100 mm - thickness 3 mm.
- Painting double heavy duty powder coating painting, scratch-resistant
- Pulley system POWER GRADE bearings for a smooth and precise action. Cables system steel woven cables with polyurethane coating

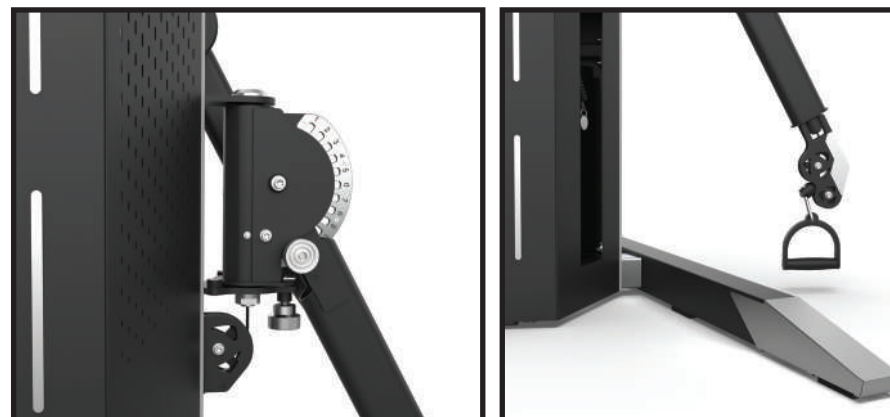

DUAL PULLEY

CSX5000

cod. CSX-B5000

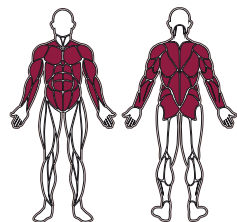

MUSCOLI COINVOLTI MUSCLE GROUPS

- Upper body
- Glutei

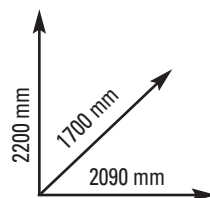

STRENGTH - STATIONS

PACCO PESI in acciaio 2x100kg con carter di protezione integrale
DIMENSIONI PRODOTTO: 2090x1700x2200 mm
PESO MAX UTILIZZATORE 150 Kg
PESO: 360 kg
CLASSE D'UTILIZZO PROFESSIONALE (EN20957-1 / EN957-2 classe S)

STEEL WEIGHT STACK 2x100kg with full protection cage
SET UP SIZE: 2090x1700x2200 mm
MAX USER WEIGHT 150 Kg
WEIGHT: 360 kg
COMMERCIAL USE (EN20957-1 / EN957-2 class S)

- Struttura tubolare in acciaio rinforzato a sezione ovale piatta 100x50 mm - spessore 3 mm
- Verniciatura doppia a polveri epossidiche, antigraffio.
- Sistema di carrucole montate su cuscinetti a sfera radiali DEEP GROOVE PROFESSIONAL. Cavi in acciaio rivestiti in PU ø 5.1 mm
- Dotazione/ note: lat bar, coppia maniglie pulley, barra tricipiti angolata, corda doppia per tricipiti

- Structure flat oval heavy-duty steel tubing 100x50 mm - thickness 3 mm
- Painting double heavy duty powder coating painting, scratch-resistant.
- Pulleys system with DEEP GROOVE PROFESSIONAL radial ball bearings. Woven cables system ø 5.1 mm - PU coated
- Equipment/notes: lat bar, pulley handles, triceps rope, triceps press down bar



DUAL PULLEY

CSX3500

cod. CSX-3500

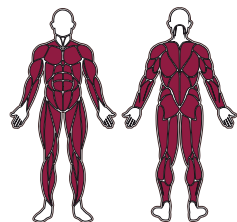

MUSCOLI COINVOLTI MUSCLE GROUPS

■ Full body

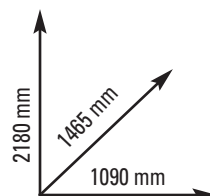

STRENGTH - STATIONS

PACCO PESI 2 x 90 kg
DOTAZIONE coppia maniglie pulley, corda doppia, cavigliera, bilanciere, bilanciere curvo
DIMENSIONI PRODOTTO: 1090x1465x2180 mm
PESO MAX UTILIZZATORE 135 Kg
PESO: 320 kg
CLASSE D'UTILIZZO PROFESSIONALE (EN20957-1 / EN957-2 classe S)

STEEL WEIGHT STACK 2 x 90kg
EQUIPMENT ankle strap, 2 x D handles, straight bar and curved bar, rope
SET UP SIZE 1090x1465x2180 mm
MAX USER WEIGHT 135 Kg
WEIGHT: 320 kg
COMMERCIAL USE (EN20957-1 / EN957-2 class S)

- Struttura tubolare in acciaio rinforzato a sezione ovale piatta 40x80 e 50x100 mm - spessore 2 mm e sezione quadrata 50x50 mm - spessore 2 mm
- Verniciatura doppia a polveri epossidiche, antigraffio.
- Sistema di carrucole montate su cuscinetti HIGH PERFORMANCE. Cavi in acciaio rivestiti in PU ø 4.8 mm

- Structure oval flat heavy-duty steel tubing 40x80 mm and 50x100 mm - thickness 2 mm and squared 50x50 mm - thickness 2 mm
- Painting double heavy duty powder coating painting, scratch-resistant.
- Pulleys system with HIGH PERFORMANCE ball bearings. Woven cables system ø 4.8 mm - PU coated



WLX6500

MULTIPOWER

cod. WLX-B6500

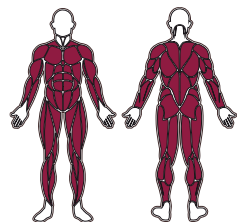

MUSCOLI COINVOLTI MUSCLE GROUPS

■ Full body

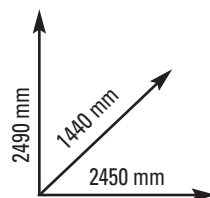

STRENGTH - STATIONS

BILANCIERI bilanciere guidato controbilanciato. Supporti bilanciere montati su cuscinetti a sfera HIGH PERFORMANCE.
Guide scorrimento bilanciere in acciaio pieno ø 30 mm
DIMENSIONI PRODOTTO: 2450x1440x2490 mm
PESO MAX STRUTTURA 200 kg su bilanciere
PESO: 288 kg
CLASSE D'UTILIZZO PROFESSIONALE (EN20957-1 classe S)

BARBELLS counter balanced smith machine.
Barbell holders sliding on HIGH PERFORMANCE ball bearings.
Steel solid barbell sliding guides ø 30 mm
SET UP SIZE: 2450x1440x2490 mm
MAX STRUCTURE WEIGHT 200 kg on barbell
WEIGHT: 288 kg
COMMERCIAL USE (EN20957-1 class S)

- Struttura tubolare in acciaio rinforzato a sezione ovale piatta 100x50 mm - spessore 3 mm
- Verniciatura doppia a polveri epossidiche, antigraffio.
- Structure flat oval heavyduty steel tubing 100x50 mm - thickness 3 mm
- Painting double heavy duty powder coating painting, scratch-resistant.



cod. WLX-6500

Disponibile anche con finitura silver
Also available with silver finishing



WLX6000 MULTIPOWER

cod. WLX-B6000

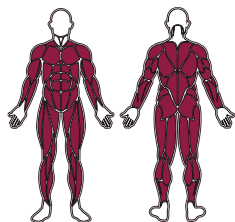

MUSCOLI COINVOLTI MUSCLE GROUPS

■ Full body

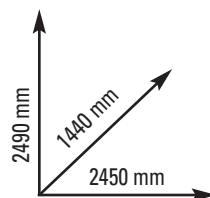

STRENGTH - STATIONS

BILANCIERI supporti bilanciere montati su cuscinetti a sfera HIGH PERFORMANCE. Guide scorrimento bilanciere in acciaio pieno \varnothing 30 mm
DIMENSIONI PRODOTTO: 2450x1440x2490 mm
PESO MAX STRUTTURA 200 kg su bilanciere
PESO: 244 kg
CLASSE D'UTILIZZO PROFESSIONALE (EN20957-1 classe S)

BARBELLS barbell holders sliding on HIGH PERFORMANCE ball bearings.
 Steel solid barbell sliding guides \varnothing 30 mm
SET UP SIZE: 2450x1440x2490 mm
MAX STRUCTURE WEIGHT 200 kg on barbell
WEIGHT: 244 kg
COMMERCIAL USE (EN20957-1 class S)

- Struttura tubolare in acciaio rinforzato a sezione ovale piatta 100x50 mm - spessore 3 mm
- Verniciatura doppia a polveri epossidiche, antigraffio.
- Structure flat oval heavyduty steel tubing 100x50 mm - thickness 3 mm
- Painting double heavy duty powder coating painting, scratch-resistant.



cod. WLX-6000

Disponibile anche con finitura silver
 Also available with silver finishing





BENCHES

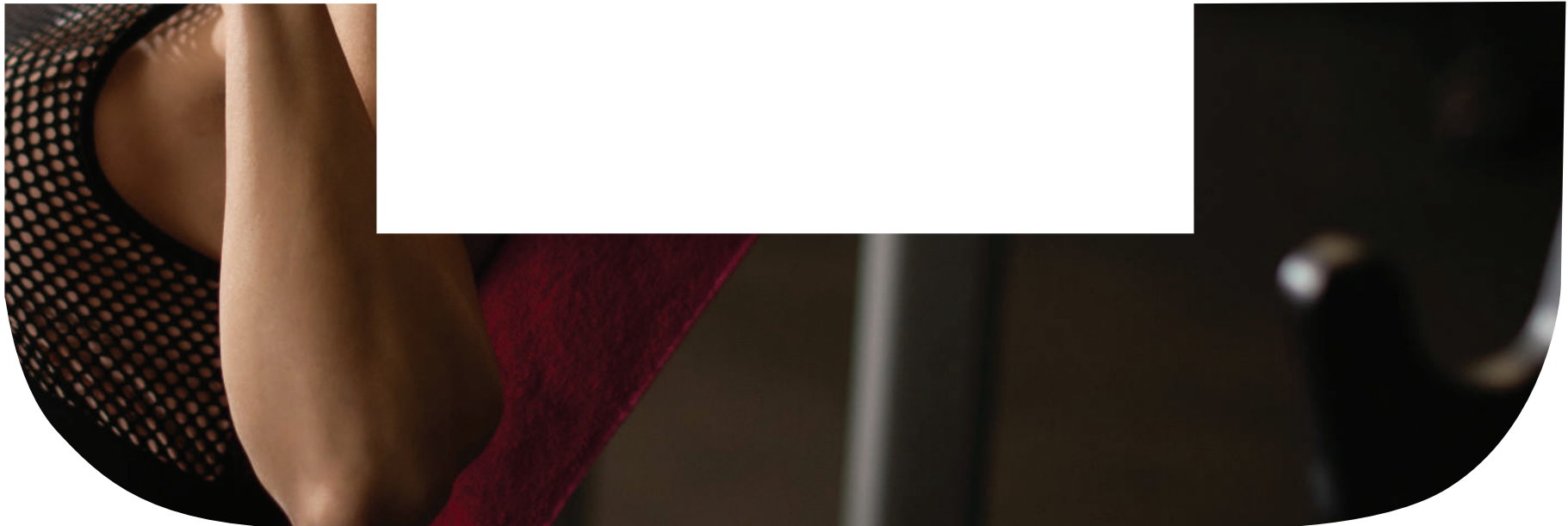

WBX3400

cod. WBX-B3400

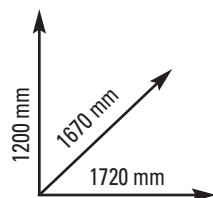

BENCHES

SUPPORTI BILANCIERE con protezione UHMW
CUSCINERIA spessore 65 mm
DIMENSIONI PRODOTTO: 1720x1670x1200 mm
PESO MAX UTILIZZATORE 135 kg
PESO MAX CARICABILE 265 kg
PESO: 68 kg
CLASSE D'UTILIZZO PROFESSIONALE (EN20957-1 classe S)

BARBELLS HOLDERS with UHMW protection pads
CUSHIONS thickness 65 mm
SET UP SIZE: 1720x1670x1200 mm
MAX USER WEIGHT 135 kg
MAX LOADABLE WEIGHT 265 kg
WEIGHT: 68 kg
COMMERCIAL USE (EN20957-1 class S)

- Struttura tubolare in acciaio rinforzato a sezione ovale piatta 100x50 mm - spessore 3 mm
- Verniciatura doppia a polveri epossidiche, antigraffio.
- Structure flat oval heavyduty steel tubing 100x50 mm - thickness 3 mm
- Painting double heavy duty powder coating painting, scratch-resistant.

cod. WBX-3400

Disponibile anche con finitura silver
Also available with silver finishing



WBX3800

cod. WBX-B3800

BENCHES

SUPPORTI BILANCIERE con protezione UHMW
PEDANA ampia e stabile per un'assistenza sicura durante l'esercizio
CUSCINERIA spessore 65 mm
DIMENSIONI PRODOTTO: 2010x1680x1400 mm
PESO MAX UTILIZZATORE 135 kg
PESO MAX CARICABILE 265 kg
PESO: 96 kg
CLASSE D'UTILIZZO PROFESSIONALE (EN20957-1 classe S)

BARBELLS HOLDERS with UHMW protection pads
PLATFORM large and stable platform for a safe assistance during the workout
CUSHIONS thickness 65 mm
SET UP SIZE: 2010x1680x1400 mm
MAX USER WEIGHT 135 kg
MAX LOADABLE WEIGHT 265 kg
WEIGHT: 96 kg
COMMERCIAL USE (EN20957-1 class S)

- Struttura tubolare in acciaio rinforzato a sezione ovale piatta 100x50 mm - spessore 3 mm
- Verniciatura doppia a polveri epossidiche, antigraffio.
- Structure flat oval heavyduty steel tubing 100x50 mm - thickness 3 mm
- Painting double heavy duty powder coating painting, scratch-resistant.



cod. WBX-3800

Disponibile anche con finitura silver
Also available with silver finishing

170

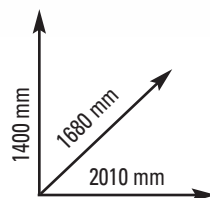

WBX3600

cod. WBX-B3600



BENCHES

SUPPORTI BILANCIERE con protezione UHMW
CUSCINERIA spessore 65 mm
DIMENSIONI PRODOTTO: 2320x1630x1300 mm
PESO MAX UTILIZZATORE 135 kg
PESO MAX CARICABILE 265 kg
PESO: 70 kg
CLASSE D'UTILIZZO PROFESSIONALE (EN20957-1 classe S)

BARBELLS HOLDERS with UHMW protection pads
CUSHIONS thickness 65 mm
SET UP SIZE: 2320x1630x1300 mm
MAX USER WEIGHT 135 kg
MAX LOADABLE WEIGHT 265 kg
WEIGHT: 70 kg
COMMERCIAL USE (EN20957-1 class S)

- Struttura tubolare in acciaio rinforzato a sezione ovale piatta 100x50 mm - spessore 3 mm
- Verniciatura doppia a polveri epossidiche, antigraffio.
- Structure flat oval heavyduty steel tubing 100x50 mm - thickness 3 mm
- Painting double heavy duty powder coating painting, scratch-resistant.

cod. WBX-3600

Disponibile anche con finitura silver
Also available with silver finishing



171

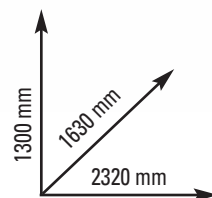

WBX3900

cod. WBX-3900

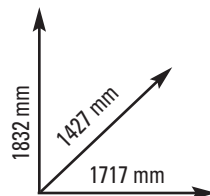
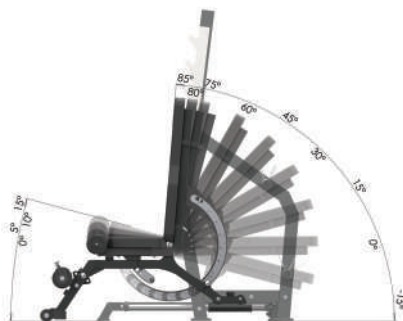

BENCHES

SEDILE inclinazione regolabile su 4 livelli (0-5°-15°-30°). Profondità regolabile su 22 livelli
SCHIENALE inclinazione regolabile su 8 livelli (da -15° a 85°)
DIMENSIONI PRODOTTO: 1717x1427x1832 mm
PESO MAX UTILIZZATORE 150 kg
PESO MAX CARICABILE 350 kg
PESO: 130,5 kg
CLASSE D'UTILIZZO PROFESSIONALE (EN20957-1 / EN957-4 classe S)

SADDLE 4-level adjustment incline (0-5°-15°-30°). Forward/backward position adjustable on 22-level
BACKREST 8-level adjustment incline (from -15° to 85°)
SET UP SIZE: 1717x1427x1832 mm
MAX USER WEIGHT 150 kg
MAX LOADABLE WEIGHT 350 kg
WEIGHT: 130,5 kg
COMMERCIAL USE (EN20957-1 / EN957-4 class S)

- Struttura tubolare in acciaio rinforzato a sezione rettangolare 100x50 mm, 75x50 mm e 60x40 mm - spessore 3 mm
- Cuscineria spessore 60 mm
- Altezza bilanciere regolabile su 7 livelli
- Verniciatura doppia a polveri epossidiche, antigraffio.
- Dotazioni/note: 4 perni porta dischi ø50 mm., 2 ruote di trasporto. Rulli gambe superiori rimovibili per un accesso più confortevole. Panca inclinata, piana, declinata.

- Structure rectangular heavyduty steel tubing 100x50 mm, 75x50 mm e 60x40 mm - thickness 3 mm
- Cushions thickness 60 mm
- Barbell height adjustable on 7-level
- Painting double heavy duty powder coating painting, scratch-resistant.
- Equipment: 4 weight plates holders for ø50 mm, 2 moving wheels. Upper leg rollers removable for an easy access. Incline, flat, decline bench.

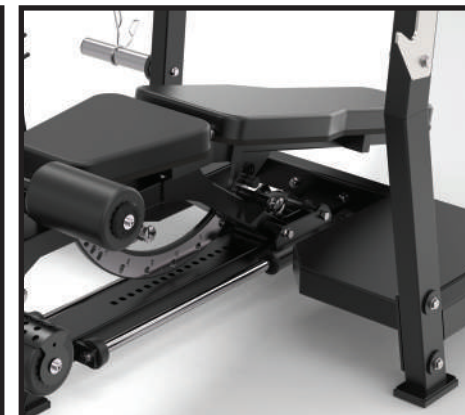
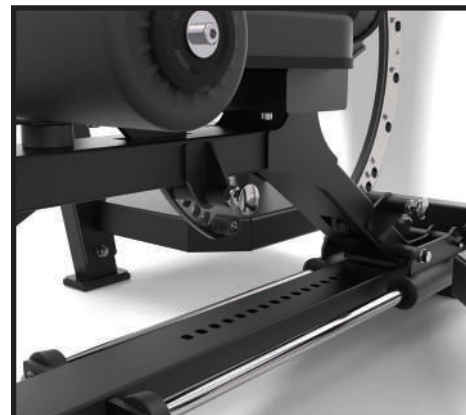

WBX3300

cod. WBX-3300

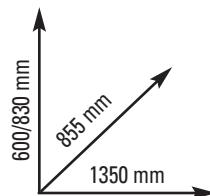

BENCHES

ALTEZZA SCHIENALE regolabile su 10 livelli (min. 600, max. 830 mm)
DIMENSIONI PRODOTTO: 1350x855x600/830 mm
PESO MAX UTILIZZATORE: 120 Kg
PESO MAX CARICABILE: 200 kg
PESO: 41 kg
CLASSE D'UTILIZZO PROFESSIONALE (EN20957-1 / EN957-4 classe S)

BACKREST HEIGHT 10-level adjustment (min. 600, max. 830 mm)
SET UP SIZE: 1350x855x600/830 mm
MAX USER WEIGHT: 120 Kg
MAX LOADABLE WEIGHT: 200 kg
WEIGHT: 41 kg
COMMERCIAL USE (EN20957-1 / EN957-4 class S)

- Struttura tubolare in acciaio rinforzato a sezione quadrata 75x75x3 mm e rettangolare 75x50x3 mm
- Cuscineria spessore 70 mm - con imbottitura sagomata. Ideale per esercizi di tirata orizzontale con bilanciere dritto e offset

- Structure tubing section reinforced-steel squared tube 75x75x3 mm and rectangular 75x50x3 mm
- Saddlery 70 mm thickness - with shaped padding. Ideal for horizontal pull exercises with straight or offset barbell



WBX3200

cod. WBX-B3200

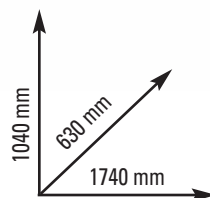

BENCHES

CUSCINERIA spessore 65 mm
DIMENSIONI PRODOTTO: 1740x630x1040 mm
PESO MAX UTILIZZATORE 150 kg
PESO: 49 kg
CLASSE D'UTILIZZO PROFESSIONALE (EN20957-1 classe S)

CUSHIONS thickness 65 mm
SET UP SIZE: 1740x630x1040 mm
MAX USER WEIGHT 150 kg
WEIGHT: 49 kg
COMMERCIAL USE (EN20957-1 class S)

- Struttura tubolare in acciaio rinforzato a sezione ovale piatta 100x50 mm - spessore 3 mm
- Verniciatura doppia a polveri epossidiche, antigraffio.
- Structure flat oval heavyduty steel tubing 100x50 mm - thickness 3 mm
- Painting double heavy duty powder coating painting, scratch-resistant.

cod. WBX-3200

Disponibile anche con finitura silver
Also available with silver finishing



174



WBX2600

cod. WBX-B2600

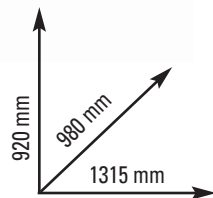

BENCHES

CUSCINERIA spessore 65 mm
DIMENSIONI PRODOTTO: 1315x980x920 mm
PESO MAX UTILIZZATORE 150 kg
PESO: 34 kg
CLASSE D'UTILIZZO PROFESSIONALE (EN20957-1 classe S)

CUSHIONS thickness 65 mm
SET UP SIZE: 1315x980x920 mm
MAX USER WEIGHT 150 kg
WEIGHT: 34 kg
COMMERCIAL USE (EN20957-1 class S)

- Struttura tubolare in acciaio rinforzato a sezione ovale piatta 114x65 mm - spessore 3 mm
- Verniciatura doppia a polveri epossidiche, antigraffio.
- Dotazioni: maniglia e ruote di trasporto
- Structure flat oval heavyduty steel tubing 114x65 mm - thickness 3 mm
- Painting double heavy duty powder coating painting, scratch-resistant.
- Equipment: carry handle and moving wheels

cod. WBX-2600

Disponibile anche con finitura silver
Also available with silver finishing



175

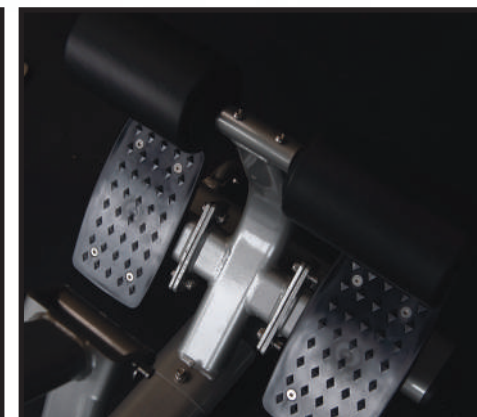

WBX2400

cod. WBX-B2400

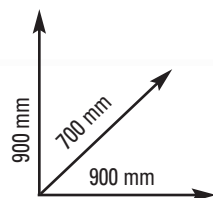

BENCHES

SUPPORTI BILANCIERE con protezione UHMW
CUSCINERIA spessore 65 mm
DIMENSIONI PRODOTTO: 900x700x900 mm
PESO MAX UTILIZZATORE 135 kg
PESO MAX CARICABILE 265 kg
PESO: 41 kg
CLASSE D'UTILIZZO PROFESSIONALE (EN20957-1 classe S)

BARBELLS HOLDERS with UHMW protection pads
CUSHIONS thickness 65 mm
SET UP SIZE: 900x700x900 mm
MAX USER WEIGHT 135 kg
MAX LOADABLE WEIGHT 265 kg
WEIGHT: 41 kg
COMMERCIAL USE (EN20957-1 class S)

- Struttura tubolare in acciaio rinforzato a sezione ovale piatta 100x50 mm - spessore 3 mm
- Verniciatura doppia a polveri epossidiche, antigraffio.
- Structure flat oval heavyduty steel tubing 100x50 mm - thickness 3 mm
- Painting double heavy duty powder coating painting, scratch-resistant.

cod. WBX-2400

Disponibile anche con finitura silver
Also available with silver finishing



WBX2200

cod. WBX-B2200

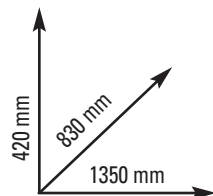

BENCHES

CUSCINERIA spessore 65 mm
DIMENSIONI PRODOTTO: 1350x830x420 mm
PESO MAX UTILIZZATORE 135 kg
PESO MAX CARICABILE 265 kg
PESO: 40 kg
CLASSE D'UTILIZZO PROFESSIONALE (EN20957-1 classe S)

CUSHIONS thickness 65 mm
SET UP SIZE: 1350x830x420 mm
MAX USER WEIGHT 135 kg
MAX LOADABLE WEIGHT 265 kg
WEIGHT: 40 kg
COMMERCIAL USE (EN20957-1 class S)

- Struttura tubolare in acciaio rinforzato a sezione ovale piatta 100x50 mm - spessore 3 mm
- Verniciatura doppia a polveri epossidiche, antigraffio.
- Dotazioni: maniglia e ruote di trasporto
- Structure flat oval heavyduty steel tubing 100x50 mm - thickness 3 mm
- Painting double heavy duty powder coating painting, scratch-resistant.
- Equipment: carry handle and moving wheels

cod. WBX-2200

Disponibile anche con finitura silver
Also available with silver finishing



WBX2000

cod. WBX-B2000

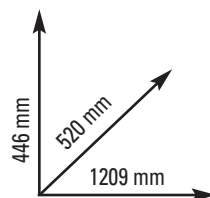

BENCHES

CUSCINERIA spessore 65 mm
DIMENSIONI PRODOTTO: 1209x520x446 mm
PESO MAX UTILIZZATORE 135 kg
PESO MAX CARICABILE 265 kg
PESO: 27 kg
CLASSE D'UTILIZZO PROFESSIONALE (EN20957-1 classe S)

CUSHIONS thickness 65 mm
SET UP SIZE: 1209x520x446 mm
MAX USER WEIGHT 135 kg
MAX LOADABLE WEIGHT 265 kg
WEIGHT: 27 kg
COMMERCIAL USE (EN20957-1 class S)

- Struttura tubolare in acciaio rinforzato a sezione ovale piatta 100x50 mm - spessore 3 mm
- Verniciatura doppia a polveri epossidiche, antigraffio.
- Dotazioni: maniglia e ruote di trasporto
- Structure flat oval heavyduty steel tubing 100x50 mm - thickness 3 mm
- Painting double heavy duty powder coating painting, scratch-resistant.
- Equipment: carry handle and moving wheels

cod. WBX-2000

Disponibile anche con finitura silver
Also available with silver finishing



CHIN/DIP/LEG RAISED

WBX2800

cod. WBX-B2800

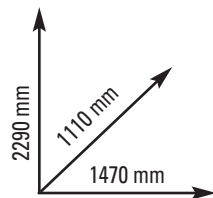

BENCHES

CUSCINERIA spessore 65 mm
DIMENSIONI PRODOTTO: 1470x1110x2290 mm
PESO MAX UTILIZZATORE 150 kg
PESO: 75 kg
CLASSE D'UTILIZZO PROFESSIONALE (EN20957-1 classe S)

CUSHIONS thickness 65 mm
SET UP SIZE: 1470x1110x2290 mm
MAX USER WEIGHT 150 kg
WEIGHT: 75 kg
COMMERCIAL USE (EN20957-1 class S)

- Struttura tubolare in acciaio rinforzato a sezione ovale piatta 80x40 mm - spessore 3 mm
- Verniciatura doppia a polveri epossidiche, antigraffio.
- Structure flat oval heavyduty steel tubing 80x40 mm - thickness 3 mm
- Painting double heavy duty powder coating painting, scratch-resistant.

cod. WBX-2800

Disponibile anche con finitura silver
Also available with silver finishing



WBX950

cod. WBX-950

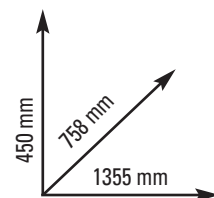

BENCHES

INCLINAZIONE SEDILE regolabile su 3 livelli: 0°, 15°, 30°
INCLINAZIONE SCHIENALE regolabile su 9 livelli: 0°, 20°, 30°, 40°, 50°, 60°, 70°, 80°, 90°
CUSCINERIA spessore 70 mm
DIMENSIONI PRODOTTO: 1355x758x450 mm
PESO MAX UTILIZZATORE 160 kg
PESO MAX CARICABILE 390 kg
PESO: 35,6 kg
CLASSE D'UTILIZZO PROFESSIONALE (EN20957-1 classe S)

SADDLE INCLINE 3-level adjustment (0°, 15°, 30°)
BACKREST INCLINE 9 adjustment (0°, 20°, 30°, 40°, 50°, 60°, 70°, 80°, 90°)
CUSHIONS thickness 70 mm
SET UP SIZE: 1355x758x450 mm
MAX USER WEIGHT 160 kg
MAX LOADABLE WEIGHT 390 kg
WEIGHT: 35,6 kg
COMMERCIAL USE (EN20957-1 class S)

- Struttura in acciaio rinforzato a sezione quadrata 75x75x2,5 mm
- Verniciatura doppia a polveri epossidiche, antigraffio
- Dotazioni: maniglia e ruote di trasporto

- Structure reinforced-steel squared tube 75x75x2,5 mm
- Painting double heavy duty powder coating painting, scratch-resistant
- Equipment: carry handle and moving wheels

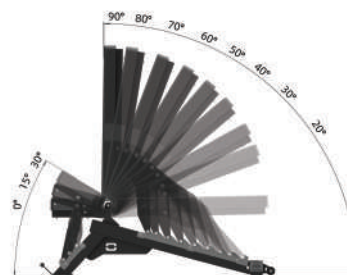

WBX700

cod. WBX-700

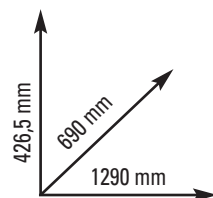

BENCHES

INCLINAZIONE SEDILE regolabile su 2 livelli (0-25°)
INCLINAZIONE SCHIENALE regolabile su 7 livelli (-15 a 85°)
CUSCINERIA spessore 65 mm
DIMENSIONI PRODOTTO: 1290x690x426,5 mm
PESO MAX UTILIZZATORE 160 kg
PESO MAX CARICABILE 320 kg
PESO: 33,6 kg
CLASSE D'UTILIZZO PROFESSIONALE (EN20957-1 classe S)

SADDLE INCLINE 2-level adjustment (0-25°)
BACKREST INCLINE 7-level adjustment (-15 to 85°)
CUSHIONS thickness 65 mm
SET UP SIZE: 1290x690x426,5 mm
MAX USER WEIGHT 160 kg
MAX LOADABLE WEIGHT 320 kg
WEIGHT: 33,6 kg
COMMERCIAL USE (EN20957-1 class S)

- Struttura in acciaio rinforzato a sezione rettangolare 70x50x2,5 mm
- Verniciatura doppia a polveri epossidiche, antigraffio.
- Dotazioni: maniglia e ruote di trasporto
- Structure reinforced-steel rectangular tube 70x50x2,5 mm
- Painting double heavy duty powder coating painting, scratch-resistant.
- Equipment: carry handle and moving wheels

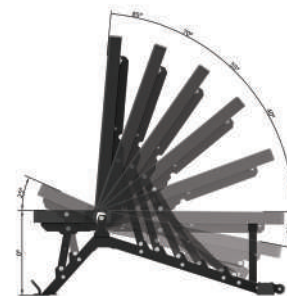

WBX300

cod. WBX-300

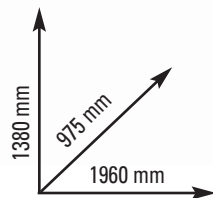

BENCHES

CARRELLO regolazione verticale su 18 livelli, orizzontale su 13 livelli
APPOGGI ADDOMINALI/LOMBARI imbottitura professionale e rivestimento in eco pelle
DIMENSIONI PRODOTTO: 1960x975x1380 mm
PESO MAX UTILIZZATORE 180 kg
PESO: 77 kg
CLASSE D'UTILIZZO PROFESSIONALE (EN20957-1 / EN957-2 classe S)

CARRIAGE vertical adjustment on 18 levels, horizontal adjustment on 13 levels
ABDOMINAL/ LUMBAR SUPPORTS heavy duty padding with ecoleather coating
SET UP SIZE: 1960x975x1380 mm
MAX USER WEIGHT 180 kg
WEIGHT: 77 kg
COMMERCIAL USE (EN20957-1 / EN957-2 class S)

- Dimensione appoggi addominali/lombari: 440x270x260 mm x 2
- Struttura in acciaio rinforzato a sezione rettangolare 75x50x3 mm
- Verniciatura doppia a polveri epossidiche, antigraffio.
- Dotazioni/notes: panca allenamento crosstraining. Sistema multi regolazione. Rulli extra large in foam ad alta densità con rivestimento in PU foam. Rulli/bloccaggio caviglie con distanza regolabile verticalmente
- Abdominal/ lumbar supports size: 440x270x260 mm x 2
- Structure reinforced-steel rectangular tube 75x50x3 mm
- Painting double heavy duty powder coating painting, scratch-resistant.
- Equipment/notes: crosstraining bench. Multi adjustment system. Extra large rollers - high density foam with PU foam coating. Ankle rollers distance adjustment

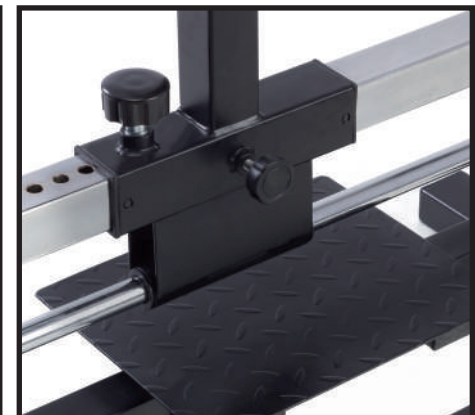

WBX2450

cod.WBX-2450

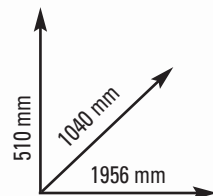
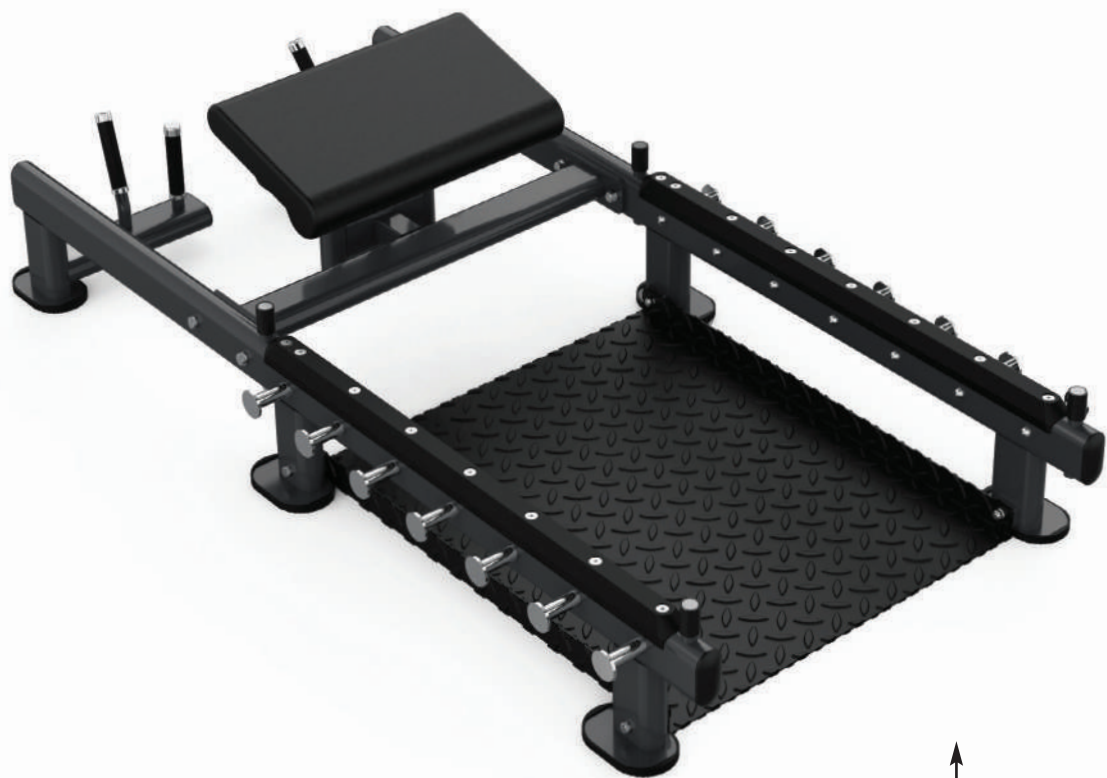

BENCHES

SUPPORTI BILANCIERI con protezione UHMW
CUSCINO con rivestimento in ecopelle.
Regolabile in altezza su 5 livelli e inclinazione su 4 livelli
PEDANA antiscivolo
DIMENSIONI PRODOTTO: 1956x1040x510 mm
PESO MAX UTILIZZATORE 120 kg
PESO: 102 kg
CLASSE D'UTILIZZO PROFESSIONALE (EN20957-1 / EN957-2 classe S)

BARBELL HOLDERS with UHMW protection pads
BACKREST with eco-leather coating. Height adjustment on 5-level.
Incline adjustment on 4-level
PLATFORM non-slip
SET UP SIZE: 1956x1040x510 mm
MAX USER WEIGHT 120 kg
WEIGHT: 102 kg
COMMERCIAL USE (EN20957-1 / EN957-2 class S)

- Strutturain acciaio rinforzato a sezione ovale 100x50x3 mm
- Verniciatura doppia a polveri epossidiche, antigraffio.
- Structure reinforced steel oval tube 100x50x3 mm
- Painting double heavy duty powder coating painting, scratch-resistant.



WBX240

cod. WBX-240

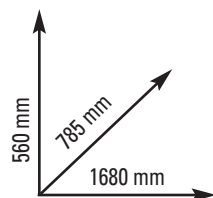

BENCHES

SUPPORTI BILANCIERI con protezione UHMW
CUSCINO 600x310x160 mm con rivestimento in ecopelle.
Regolabile in altezza su 2 livelli
PEDANA antiscivolo
DIMENSIONI PRODOTTO: 1680x785x560 mm
PESO MAX UTILIZZATORE 120 kg
PESO: 56 kg
CLASSE D'UTILIZZO PROFESSIONALE (EN20957-1 / EN957-2 classe S)

BARBELL HOLDERS with UHMW protection pads
BACKREST 600x310x160 mm with eco-leather coating.
Height adjustment on 2-level
PLATFORM non-slip
SET UP SIZE: 1680x785x560 mm
MAX USER WEIGHT 120 kg
WEIGHT: 56 kg
COMMERCIAL USE (EN20957-1 / EN957-2 class S)

- Struttura in acciaio rinforzato a sezione rettangolare 100x50x2 mm
- Verniciatura doppia a polveri epossidiche, antigraffio.
- Dotazioni/notes: 2 maniglie di sollevamento, 2 ruote per il trasporto, 8 ganci per fasce elastiche
- Structure reinforced steel rectangular tube 100x50x 2mm
- Painting double heavy duty powder coating painting, scratch-resistant.
- Equipment/notes: 2 carry handles, 2 moving wheels, 8 hooks for resistance bands

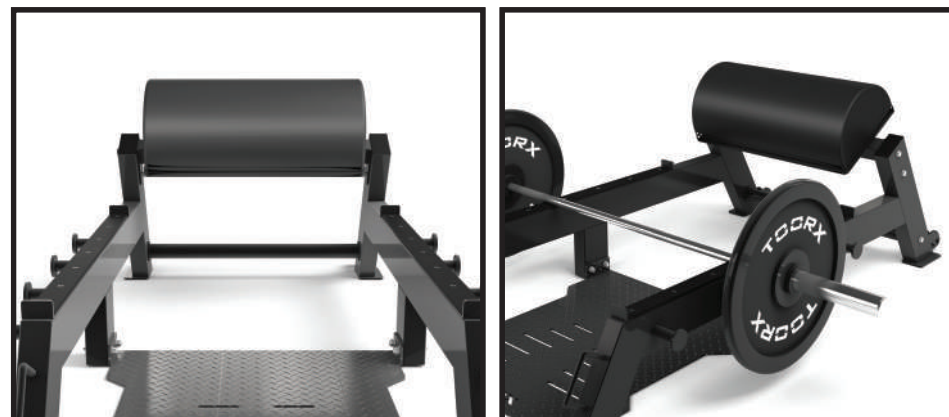

SISSY SQUAT

WBX1800

cod. WBX-1800

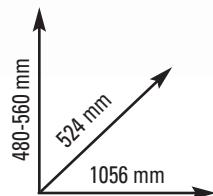

BENCHES

CUSCINERIA spessore 60 mm. Regolazione verticale su 5 posizioni
DIMENSIONI PRODOTTO: 1056x524x480-560 mm
PESO MAX UTILIZZATORE 150 kg
PESO: 27 kg
CLASSE D'UTILIZZO PROFESSIONALE (EN20957-1 / EN957-2 classe S)

CUSHIONS thickness 60 mm. Vertical adjustment on 5-level
SET UP SIZE: 1056x524x480-560 mm
MAX USER WEIGHT 150 kg
WEIGHT: 27 kg
COMMERCIAL USE (EN20957-1 / EN957-2 class S)

- Struttura tubolare in acciaio rinforzato a sezione ovale piatta 100x50 mm - spessore 2 mm
- Verniciatura doppia a polveri epossidiche, antigraffio.
- Dotazioni: maniglia e ruote di trasporto
- Structure flat oval heavyduty steel tubing 100x50 mm - thickness 2 mm
- Painting double heavy duty powder coating painting, scratch-resistant.
- Equipment: carry handle and moving wheelst

WBX1000

cod. WBX-1000

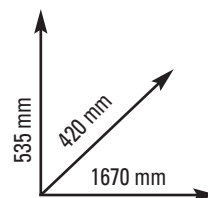

INCLINAZIONE SCHIENALE regolabile su 8 livelli (0-85°)
 DIMENSIONI PRODOTTO: 1670x420x535 mm
 PESO MAX UTILIZZATORE 150 Kg
 PESO MAX CARICABILE: 250 kg
 PESO: 70 kg
 CLASSE D'UTILIZZO PROFESSIONALE (EN20957-1 classe S)

BACKREST INCLINE 8-level adjustment (0-85°)
 SET UP SIZE 1670x420x535mm
 MAX USER WEIGHT 150 Kg
 MAX LOADABLE WEIGHT: 250 kg
 WEIGHT: 70 kg
 COMMERCIAL USE (EN20957-1 class S)

- Cuscineria spessore 55 mm
- Dotazioni: 4 ruote e maniglia di trasporto, 2 ganci per battle rope, 4 ganci per elastici, 2 piedini stabilizzanti retrattili, landmine
- Capacità di stoccaggio: 3 coppie di manubri, 6 kettlebell, 1 palla, piccoli accessori

- Saddlery 55 mm thickness
- Equipment: 4 moving wheels, moving handle, 2 hooks for battle rope, 4 hooks for elastic bands, 2 retractable stabilizing levellers, landmine
- Storage capacity: 3 pairs of dumbbells, 6 kettlebells, 1 ball, small accessories







**RIGS, RACKS
& STORAGE**

CROSSTRaining & FUNCTIONAL

CALISTHENICS 2

cod. G60-C2

STRUTTURE PRECOMPOSTE CALISTHENICS
CALISTHENICS PRE-CONFIGURED RIGS

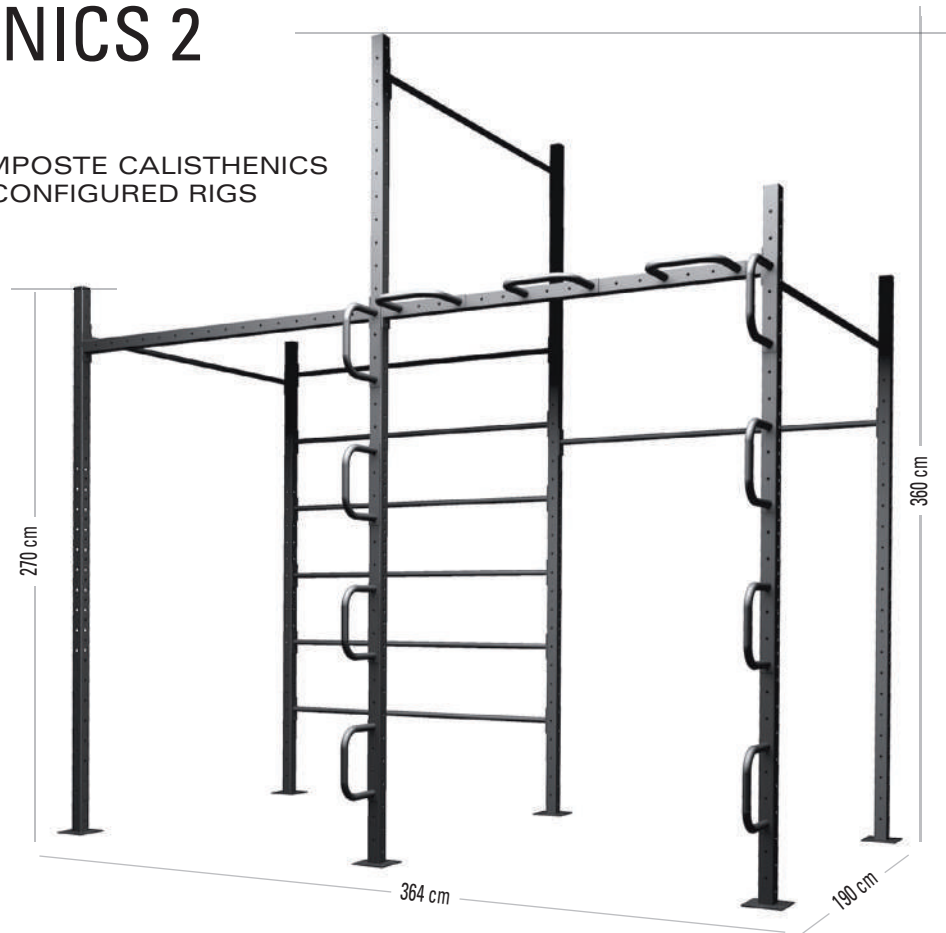

STRUTTURA PRINCIPALE:

- Tubolare sezione quadrata 60x60x3,2 mm
- Stazione progettata per allenamento calistenico
- Struttura dotata di 3 postazioni pull up, 1 spalliera, 2 postazioni verticali ed 1 orizzontale create con maniglie in serie
- Completa la dotazione una postazione anelli/fune da arrampicata, alta 360 cm

MAIN STRUCTURE:

- Square section tubes (60x60x3,2mm)
- Machine designed for calisthenics training.
- Structure equipped with 3 pull up emplacements, 1 gymnastics ladder, 2 vertical and one horizontal emplacements created with handles in a row
- The equipment is completed by an emplacement with rings/climbing rope (360cm height)



CALISTHENICS 1

cod. G60-C1

STRUTTURE PRECOMPOSTE CALISTHENICS
CALISTHENICS PRE-CONFIGURED RIGS



STRUTTURA PRINCIPALE:

- Tubolare sezione quadrata 60x60x3,2 mm
- Stazione progettata per allenamento calistenico
- Le barre pull up, la spalliera, le maniglie in verticale ed orizzontale compongono la dotazione di postazioni indispensabile per un workout completo

MAIN STRUCTURE:

- Square section tubes (60x60x3,2 mm)
- Machine designed for calisthenics training
- The pull up bars, the gymnastics ladder, the handles both in vertical and horizontal position, are the essential equipment for a complete workout



COPPIA PARALLELE A MURO
WALL MOUNT PARALLEL BARS

cod. AGU-PM



- Per serie CHALLENGE e MASTER
- Sezione circolare \varnothing 45 mm
- Spessore 5 mm
- Lunghezza 180 cm
- Altezza 130 cm
- Piastra di base per collegamento a terra 160x160 mm spessore 6 mm
- Ideale per allenamento calisthenics
- 4 set viteria inclusi

- *FOR CHALLENGE and MASTER series*
- *Round tube \varnothing 45 mm*
- *Thickness 5 mm*
- *Length 180 cm*
- *Height 130 cm*
- *Base plate for connecting to the floor 160x160 mm thickness 6 mm*
- *Ideal for calisthenics training*
- *4 sets of screws included*



POWER RACK

cod. G60-PR

RACK CROSTRAINING



STRUTTURA PRINCIPALE:

- Tubolare sezione quadrata 60x60x3,2 mm
- 1 coppia di appoggi bilanciere inclusa

MAIN STRUCTURE:

- Square tube section 60x60x3,2 mm
- 2 j-cups included

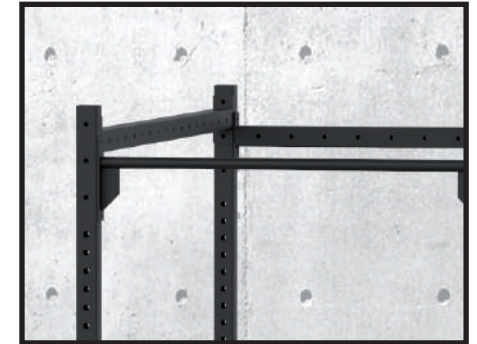

TCORX

PROFESSIONAL LINE

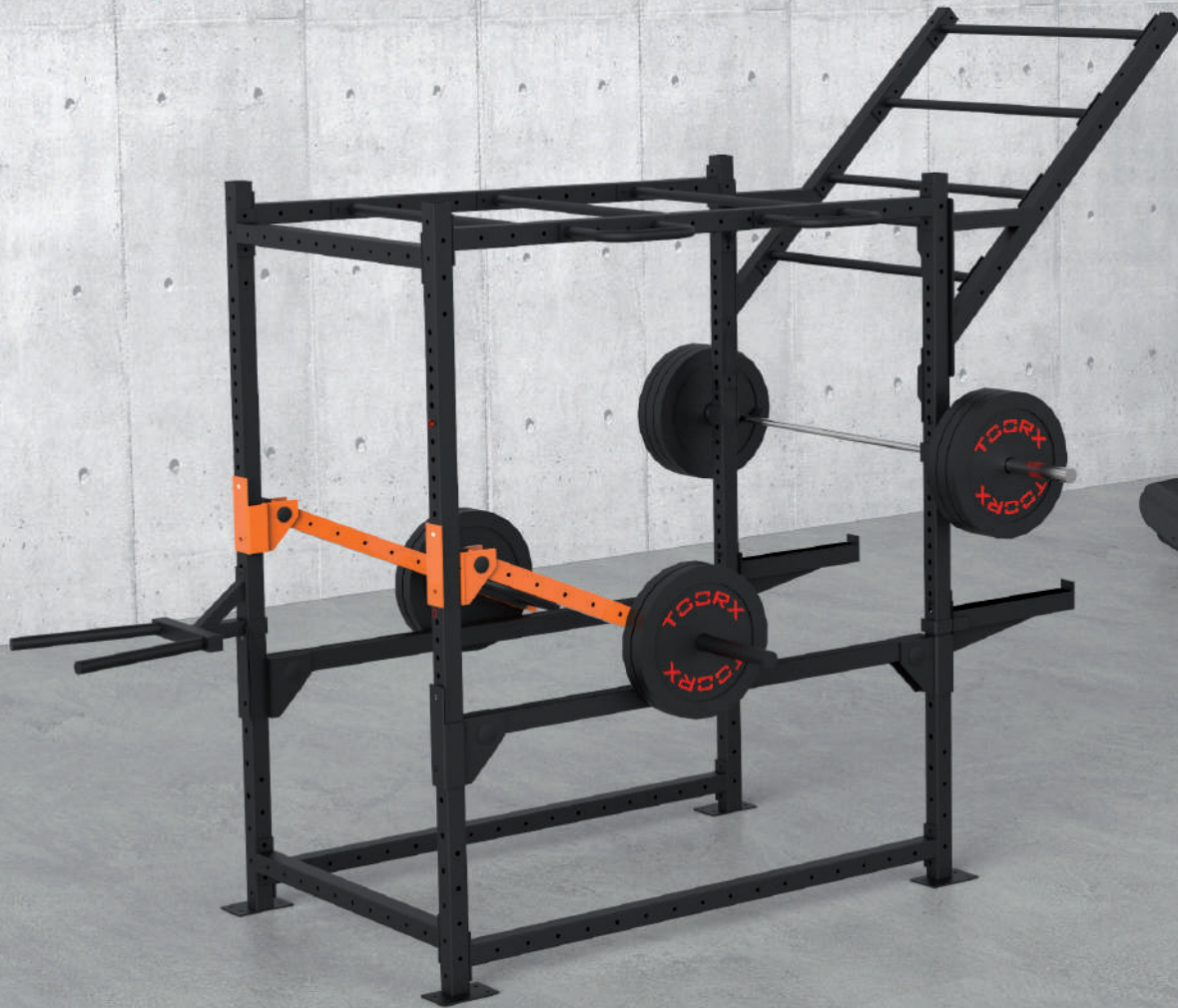

SQUAT STAND

cod. G60-RS

RACK CROSTRAINING



STRUTTURA PRINCIPALE:

- Tubolare sezione quadrata 60x60x3,2 mm
- 1 coppia di appoggi bilanciere inclusa

MAIN STRUCTURE:

- Square tube section 60x60x3,2 mm
- 2 j-cups included

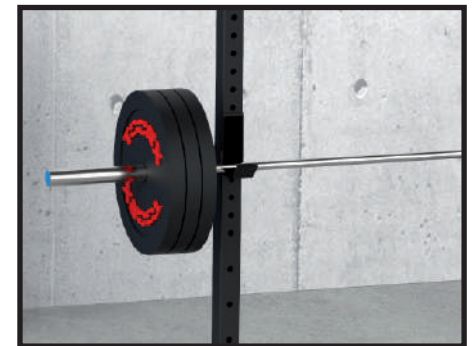

1 CAMPATA AUTOPORTANTE 1 SPAN STAND ALONE

STRUTTURE PRECOMPOSTE CROSSTRaining
CROSSTRaining PRE-CONFIGURED RIGS



COD. G60-1A
COD. G75-1A

COD. G60-1A

Gabbia CHALLENGE 60x60x3,2 mm autoportante 1 campata
1 span CHALLENGE rig 60x60x3,2 mm stand alone

COD. G60-1AMS

Gabbia CHALLENGE 60x60x3,2 mm autoportante 1 campata con monkey station
1 span CHALLENGE rig 60x60x3,2 mm stand alone with monkey station

COD. G75-1A

Gabbia MASTER 75x75x3,2 mm autoportante 1 campata
1 span MASTER rig 75x75x3,2 mm stand alone

COD. G75-1AMS

Gabbia MASTER 75x75x3,2 mm autoportante 1 campata con monkey station
2 coppie di appoggi bilanciere incluse
1 span MASTER rig 75x75x3,2 mm stand alone with monkey station
4 j-cups included



COD. G60-1AMS
COD. G75-1AMS

*: Challenge
**.: Master

RIGS, RACKS & STORAGE

VERSIONE OUTDOOR
OUTDOOR VERSION



COD. G075-1A

COD. G075-1A

Gabbia MASTER OUTDOOR 75x75x3,2 mm autoportante 1 campata
1 span MASTER OUTDOOR rig 75x75x3,2 mm stand alone

COD. G075-1AMS

Gabbia MASTER OUTDOOR 75x75x3,2 mm autoportante
1 campata con monkey station
2 coppie di appoggi bilanciere incluse
1 span MASTER OUTDOOR
rig 75x75x3,2 mm stand alone with monkey station
4 j-cups included



COD. G075-1AMS



1 CAMPATA A MURO 1 SPAN WALL MOUNT

STRUTTURE PRECOMPOSTE CROSSTRaining
CROSSTRaining PRE-CONFIGURED RIGS



COD. G60-1M
COD. G75-1M

COD. G60-1M

Gabbia CHALLENGE 60x60x3,2 mm a muro 1 campata
1 span CHALLENGE rig 60x60x3,2 mm wall mount

COD. G60-1MMS

Gabbia CHALLENGE 60x60x3,2 mm a muro 1 campata con monkey station
1 span CHALLENGE rig 60x60x3,2 mm wall mount with monkey station

COD. G75-1M

Gabbia MASTER 75x75x3,2 mm a muro 1 campata
1 span MASTER rig 75x75x3,2 mm wall mount

COD. G75-1MMS

Gabbia MASTER 75x75x3,2 mm a muro 1 campata con monkey station
1 coppia di appoggi bilanciere inclusa
1 span MASTER rig 75x75x3,2 mm wall mount with monkey station
2 j-cups included



COD. G60-1MMS
COD. G75-1MMS

*: Challenge
**: Master

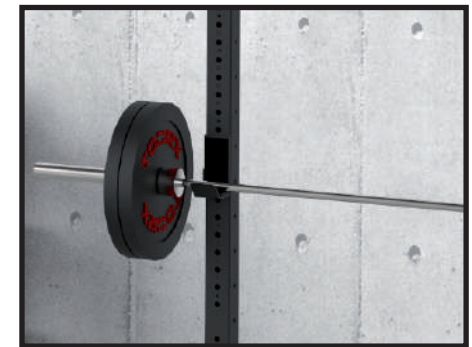
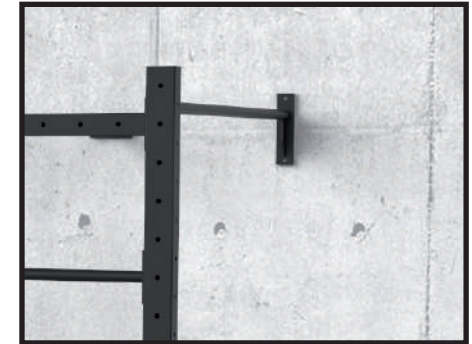

2 CAMPATE AUTOPORTANTI 2 SPANS STAND ALONE

STRUTTURE PRECOMPOSTE CROSSTRaining
CROSSTRaining PRE-CONFIGURED RIGS



COD. G60-2A
COD. G75-2A

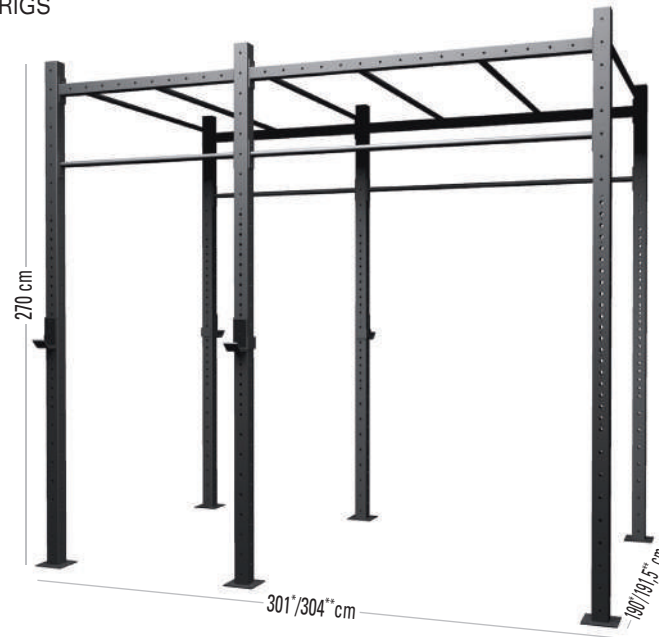

COD. G60-2AMS
COD. G75-2AMS

COD. G60-2A
Gabbia CHALLENGE 60x60x3,2 mm autoportante 2 campate
2 spans CHALLENGE rig 60x60x3,2 mm stand alone

COD. G60-2AMS
Gabbia CHALLENGE 60x60x3,2 mm autoportante 2 campate con monkey station
2 spans CHALLENGE rig 60x60x3,2 mm stand alone with monkey station

COD. G75-2A
Gabbia MASTER 75x75x3,2 mm autoportante 2 campate
2 spans MASTER rig 75x75x3,2 mm stand alone

COD. G75-2AMS
Gabbia MASTER 75x75x3,2 mm autoportante 2 campate con monkey station
2 coppie di appoggi bilanciere incluse
2 spans MASTER rig 75x75x3,2 mm stand alone with monkey station
4 j-cups included

*: Challenge
**.: Master

RIGS, RACKS & STORAGE

VERSIONE OUTDOOR
OUTDOOR VERSION

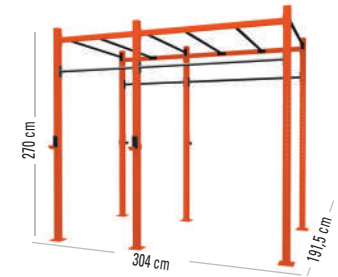

COD. G075-2AMS



COD. G075-2A

COD. G075-2A

Gabbia MASTER OUTDOOR 75x75x3,2 mm autoportante 2 campate
2 spans MASTER OUTDOOR rig 75x75x3,2 mm stand alone

COD. G075-2AMS

Gabbia MASTER OUTDOOR 75x75x3,2 mm autoportante 2 campate con monkey station
2 coppie di appoggi bilanciere incluse
2 spans MASTER OUTDOOR rig 75x75x3,2 mm stand alone with monkey station
4 j-cups included



2 CAMPATE A MURO 2 SPANS WALL MOUNT

STRUTTURE PRECOMPOSTE CROSSTRaining
CROSSTRaining PRE-CONFIGURED RIGS



COD. G60-2M
COD. G75-2M

COD. G60-2M

Gabbia CHALLENGE 60x60x3,2 mm a muro 2 campate
2 spans CHALLENGE rig 60x60x3,2 mm wall mount

COD. G60-2MMS

Gabbia CHALLENGE 60x60x3,2 mm a muro 2 campate con monkey station
2 spans CHALLENGE rig 60x60x3,2 mm wall mount with monkey station

COD. G75-2M

Gabbia MASTER 75x75x3,2 mm a muro 2 campate
2 spans MASTER rig 75x75x3,2 mm wall mount

COD. G75-2MMS

Gabbia MASTER 75x75x3,2 mm a muro 2 campate con monkey station
1 coppia di appoggi bilanciere inclusa
2 spans MASTER rig 75x75x3,2 mm wall mount with monkey station
2 j-cups included

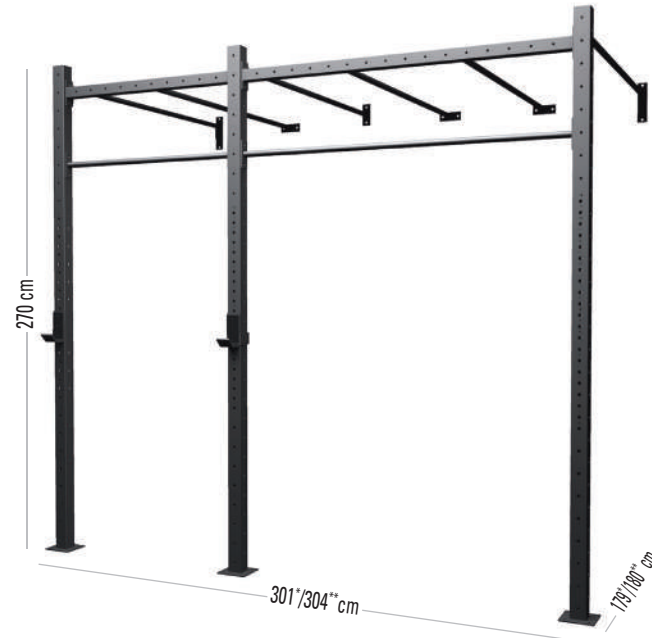

COD. G60-2MMS
COD. G75-2MMS

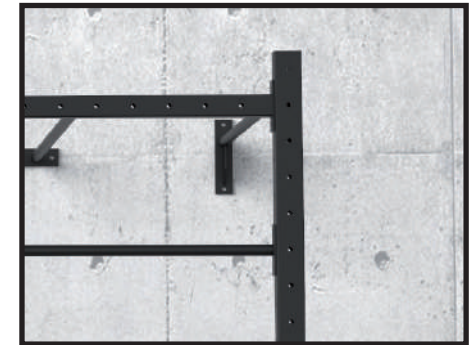
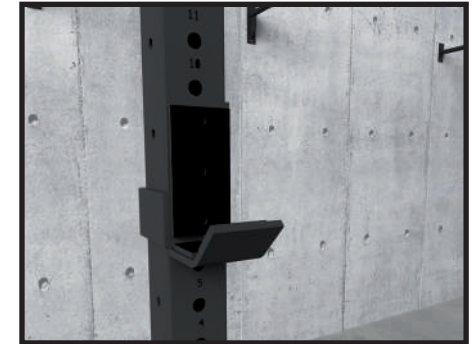

*: Challenge
**: Master

3 CAMPATE AUTOPORTANTI 3 SPANS STAND ALONE

STRUTTURE PRECOMPOSTE CROSSTRaining
CROSSTRaining PRE-CONFIGURED RIGS

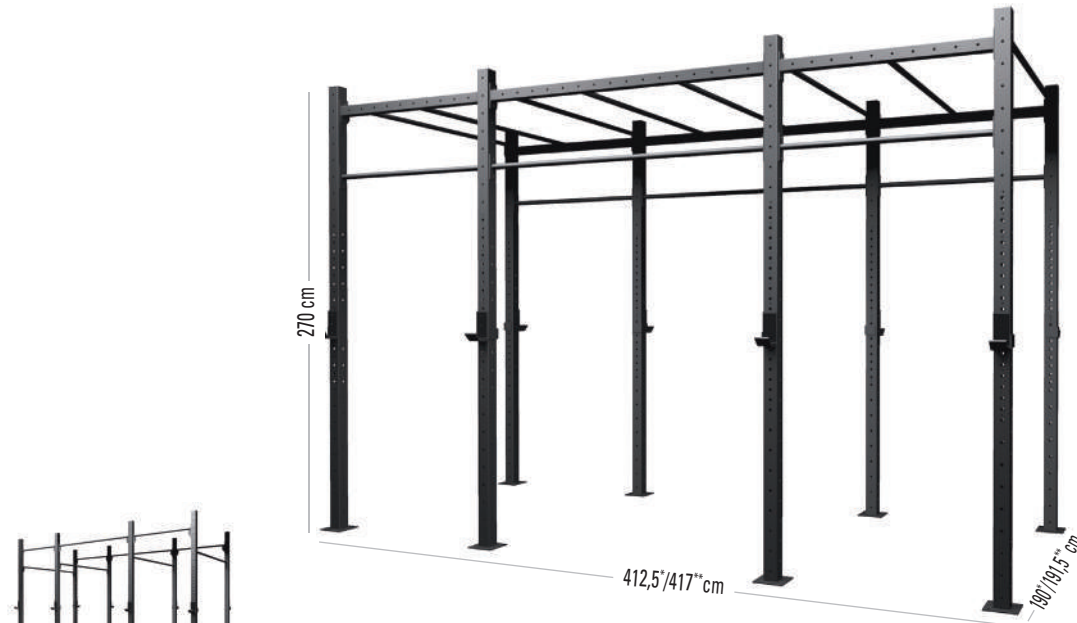

COD. G60-3A
COD. G75-3A

COD. G60-3AMS
COD. G75-3AMS

COD. G60-3A

Gabbia CHALLENGE 60x60x3,2 mm autoportante 3 campate
3 spans CHALLENGE rig 60x60x3,2 mm stand alone

COD. G60-3AMS

Gabbia CHALLENGE 60x60x3,2 mm autoportante 3 campate con monkey station
3 spans CHALLENGE rig 60x60x3,2 mm stand alone with monkey station

COD. G75-3A

Gabbia MASTER 75x75x3,2 mm autoportante 3 campate
3 spans MASTER rig 75x75x3,2 mm stand alone

COD. G75-3AMS

Gabbia MASTER 75x75x3,2 mm autoportante 3 campate con monkey station
4 coppie di appoggi bilanciere incluse
3 spans MASTER rig 75x75x3,2 mm stand alone with monkey station
8 j-cups included

*: Challenge
**: Master

RIGS, RACKS & STORAGE

VERSIONE OUTDOOR
OUTDOOR VERSION

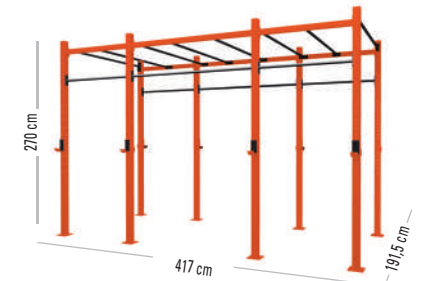

COD. G075-3AMS



COD. G075-3A

COD. G075-3A

Gabbia MASTER OUTDOOR 75x75x3,2 mm autoportante 3 campate
3 spans MASTER OUTDOOR rig 75x75x3,2 mm stand alone

COD. G075-3AMS

Gabbia MASTER OUTDOOR 75x75x3,2 mm autoportante 3 campate con monkey station
4 coppie di appoggi bilanciere incluse
3 spans MASTER OUTDOOR rig 75x75x3,2 mm stand alone with monkey station
8 j-cups included



3 CAMPATE A MURO 3 SPANS WALL MOUNT

STRUTTURE PRECOMPOSTE CROSSTRaining
CROSSTRaining PRE-CONFIGURED RIGS



COD. G60-3M
COD. G75-3M

COD. G60-3M

Gabbia CHALLENGE 60x60x3,2 mm a muro 3 campate
3 spans CHALLENGE rig 60x60x3,2 mm wall mount

COD. G60-3MMS

Gabbia CHALLENGE 60x60x3,2 mm a muro 3 campate con monkey station
3 spans CHALLENGE rig 60x60x3,2 mm wall mount with monkey station

COD. G75-3M

Gabbia MASTER 75x75x3,2 mm a muro 3 campate
3 spans MASTER rig 75x75x3,2 mm wall mount

COD. G75-3MMS

Gabbia MASTER 75x75x3,2 mm a muro 3 campate con monkey station
2 coppie di appoggi bilanciere incluse
3 spans MASTER rig 75x75x3,2 mm wall mount with monkey station
4 j-cups included

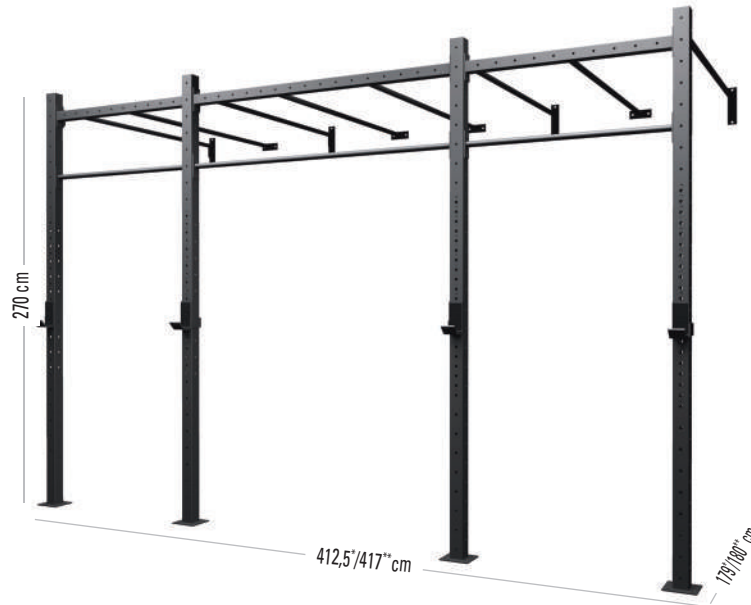

COD. G60-3MMS
COD. G75-3MMS

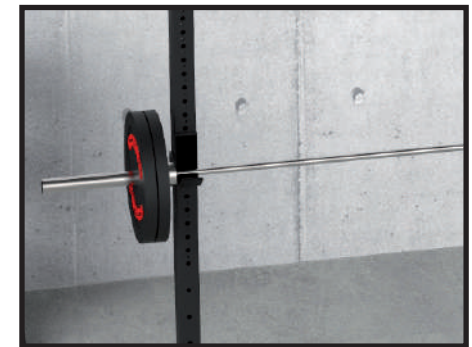

*: Challenge
**: Master

4 CAMPATE AUTOPORTANTI 4 SPANS STAND ALONE

STRUTTURE PRECOMPOSTE CROSSTRAINING
CROSSTRAINING PRE-CONFIGURED RIGS

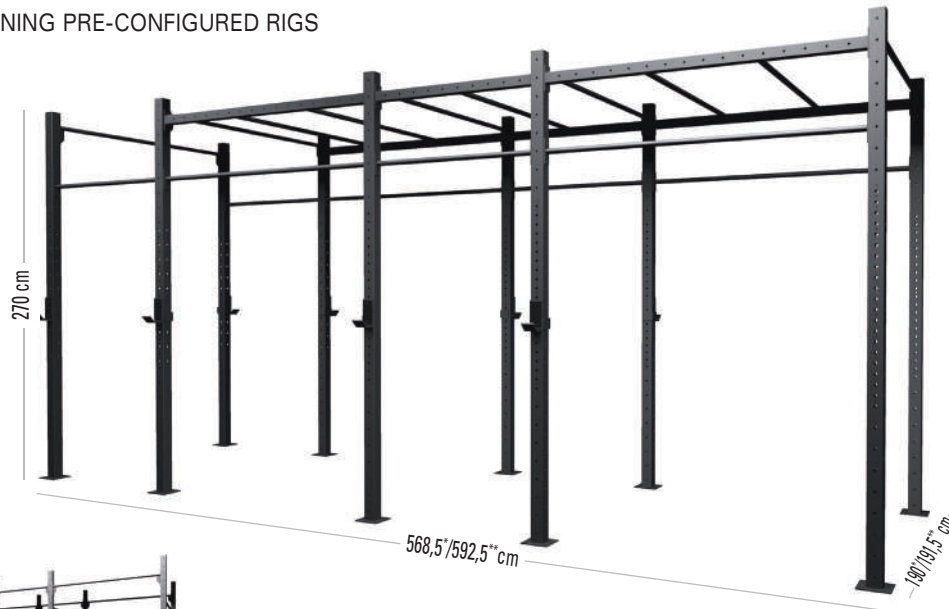

COD. G60-4A
COD. G75-4A

COD. G60-4AMS
COD. G75-4AMS

COD. G60-4A

Gabbia CHALLENGE 60x60x3,2 mm autoportante 4 campate
4 spans CHALLENGE rig 60x60x3,2 mm stand alone

COD. G60-4AMS

Gabbia CHALLENGE 60x60x3,2 mm autoportante 4 campate con monkey station
4 spans CHALLENGE rig 60x60x3,2 mm stand alone with monkey station

COD. G75-4A

Gabbia MASTER 75x75x3,2 mm autoportante 4 campate
4 spans MASTER rig 75x75x3,2 mm stand alone

COD. G75-4AMS

Gabbia MASTER 75x75x3,2 mm autoportante 4 campate con monkey station
4 coppie di appoggi bilanciare incluse
4 spans MASTER rig 75x75x3,2 mm stand alone with monkey station
8 j-cups included

*: Challenge
**: Master

RIGS, RACKS & STORAGE

VERSIONE OUTDOOR
OUTDOOR VERSION



cod. G075-4AMS



cod. G075-4A

COD. G075-4A

Gabbia MASTER OUTDOOR 75x75x3,2 mm autoportante 4 campate
4 spans MASTER OUTDOOR rig 75x75x3,2 mm stand alone

COD. G075-4AMS

Gabbia MASTER OUTDOOR 75x75x3,2 mm autoportante 4 campate con monkey station
4 coppie di appoggi bilanciare incluse
4 spans MASTER OUTDOOR rig 75x75x3,2 mm stand alone with monkey station
8 j-cups included



4 CAMPATE A MURO 4 SPANS WALL MOUNT

STRUTTURE PRECOMPOSTE CROSSTRaining
CROSSTRaining PRE-CONFIGURED RIGS

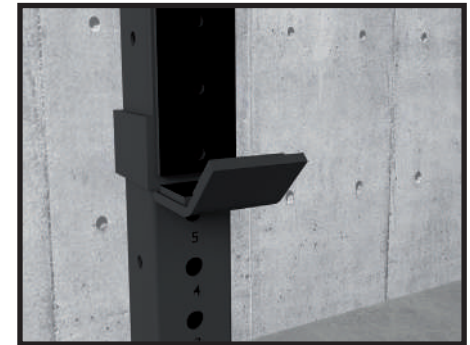
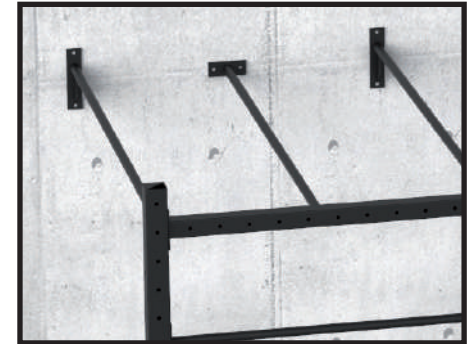
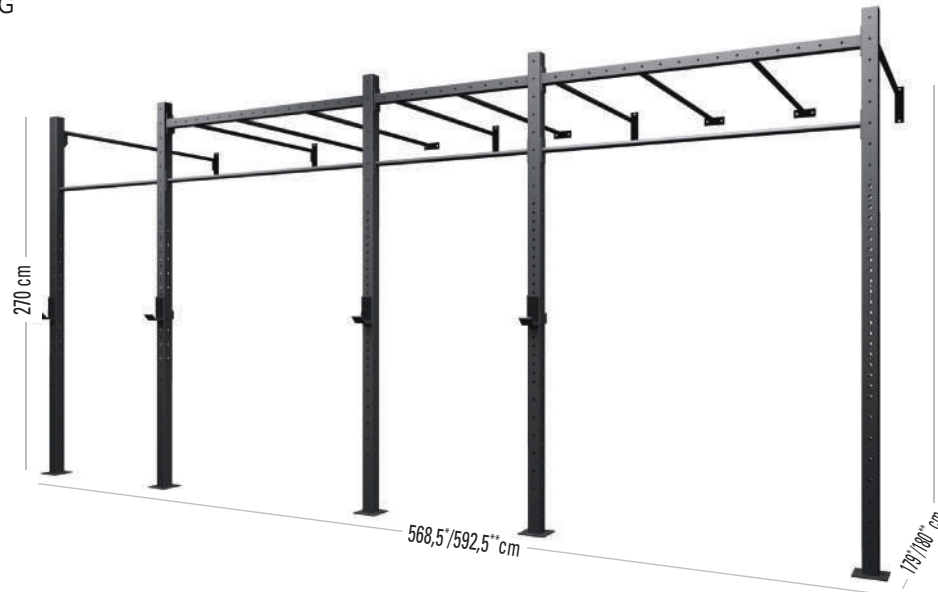

COD. G60-4M
COD. G75-4M

COD. G60-4MMS
COD. G75-4MMS

COD. G60-4M

Gabbia CHALLENGE 60x60x3,2 mm a muro 4 campate
4 spans CHALLENGE rig 60x60x3,2 mm wall mount

COD. 60-4MMS

Gabbia CHALLENGE 60x60x3,2 mm a muro 4 campate con monkey station
4 spans CHALLENGE rig 60x60x3,2 mm wall mount with monkey station

COD. G75-4M

Gabbia MASTER 75x75x3,2 mm a muro 4 campate
4 spans MASTER rig 75x75x3,2 mm wall mount

COD. G75-4MMS

Gabbia MASTER 75x75x3,2 mm a muro 4 campate con monkey station
2 coppie di appoggi bilanciere incluse
4 spans MASTER rig 75x75x3,2 mm wall mount with monkey station
4 j-cups included

*: Challenge
**: Master



5 CAMPATE AUTOPORTANTI 5 SPANS STAND ALONE

STRUTTURE PRECOMPOSTE CROSSTRAINING
CROSSTRAINING PRE-CONFIGURED RIGS

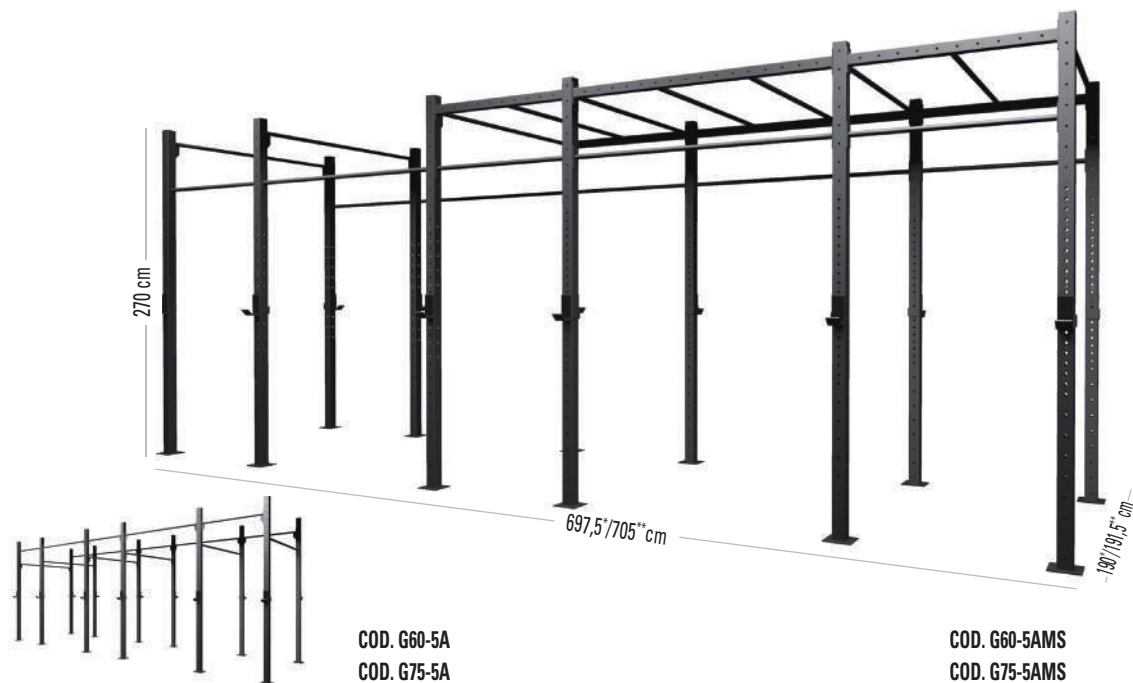

COD. G60-5A
COD. G75-5A

COD. G60-5AMS
COD. G75-5AMS

COD. G60-5A

Gabbia CHALLENGE 60x60x3,2 mm autoportante 5 campate
5 spans CHALLENGE rig 60x60x3,2 mm stand alone

COD. G60-5AMS

Gabbia CHALLENGE 60x60x3,2 mm autoportante 5 campate con monkey station
5 spans CHALLENGE rig 60x60x3,2 mm stand alone with monkey station

COD. G75-5A

Gabbia MASTER 75x75x3,2 mm autoportante 5 campate
5 spans MASTER rig 75x75x3,2 mm stand alone

COD. G75-5AMS

Gabbia MASTER 75x75x3,2 mm autoportante 5 campate con monkey station
6 coppie di appoggi bilanciere incluse
5 spans MASTER rig 75x75x3,2 mm stand alone with monkey station
12 j-cups included

*: Challenge
**: Master

203

RIGS, RACKS & STORAGE

VERSIONE OUTDOOR
OUTDOOR VERSION

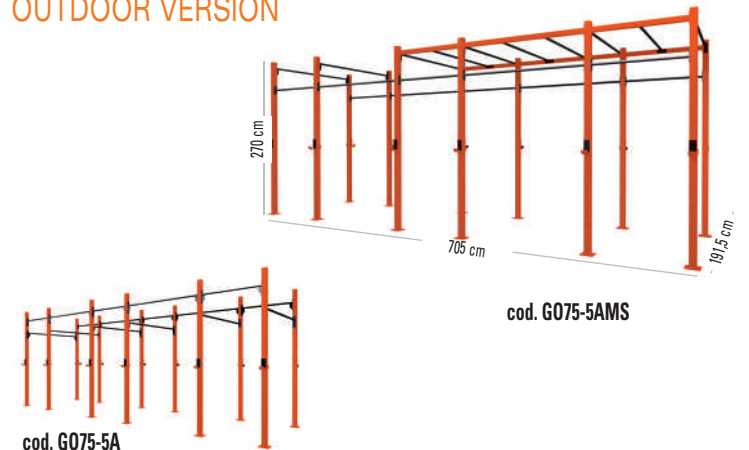

cod. G075-5AMS

cod. G075-5A

COD. G075-5A

Gabbia MASTER OUTDOOR 75x75x3,2 mm autoportante 5 campate
spans MASTER OUTDOOR rig 75x75x3,2 mm stand alone

COD. G075-5AMS

Gabbia MASTER OUTDOOR 75x75x3,2 mm autoportante 5 campate
con monkey station
6 coppie di appoggi bilanciere incluse
5 spans MASTER OUTDOOR rig 75x75x3,2 mm stand alone
with monkey station
12 j-cups included



5 CAMPATE A MURO 5 SPANS WALL MOUNT

STRUTTURE PRECOMPOSTE CROSSTRaining
CROSSTRaining PRE-CONFIGURED RIGS

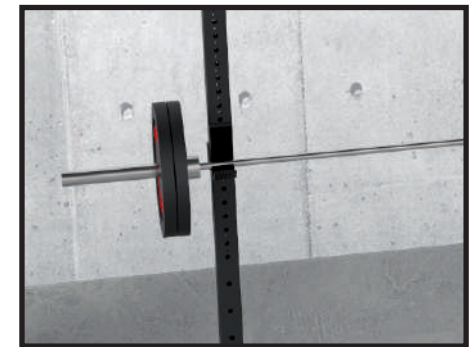
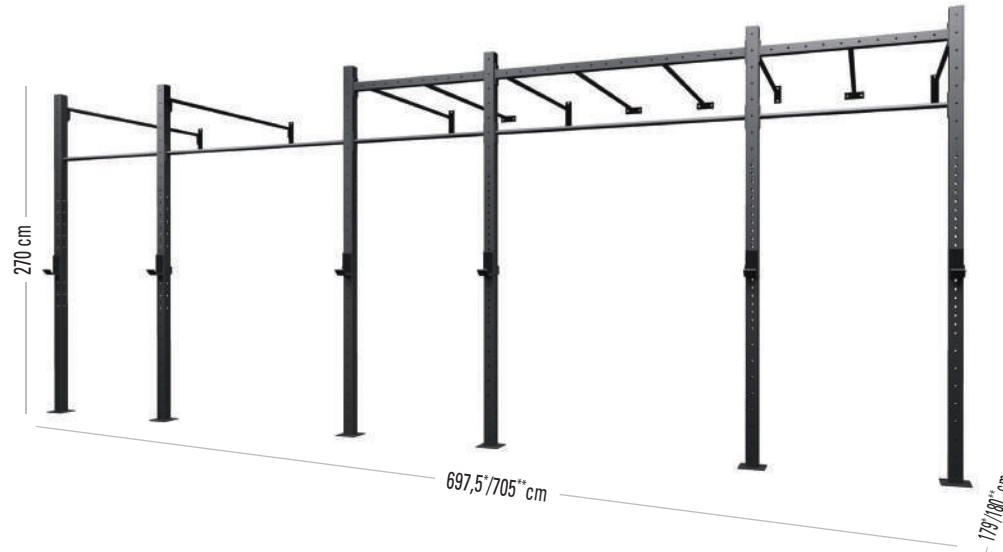

COD. G60-5M
COD. G75-5M

COD. G60-5MMS
COD. G75-5MMS

COD. G60-5M

Gabbia CHALLENGE 60x60x3,2 mm a muro 5 campate
5 spans CHALLENGE rig 60x60x3,2 mm wall mount

COD. 60-5MMS

Gabbia CHALLENGE 60x60x3,2 mm a muro 5 campate con monkey station
5 spans CHALLENGE rig 60x60x3,2 mm wall mount with monkey station

COD. G75-5M

Gabbia MASTER 75x75x3,2 mm a muro 5 campate
5 spans MASTER rig 75x75x3,2 mm wall mount

COD. G75-5MMS

Gabbia MASTER 75x75x3,2 mm a muro 5 campate con monkey station
3 coppie di appoggi bilanciere incluse
5 spans MASTER rig 75x75x3,2 mm wall mount with monkey station
6 j-cups included

*: Challenge
**: Master



MASTER HEXAGON

cod. G75-HEX

Gabbia MASTER HEXAGON 75x75x3,2 mm

HEXAGON MASTER rig 75x75x3,2 mm

STRUTTURE PRECOMPOSTE FUNCTIONAL
FUNCTIONAL PRE-CONFIGURED RIGS



STRUTTURA PRINCIPALE:

- Tubolare sezione quadrata 75x75x3,2 mm
- 1 coppia di appoggi bilanciere inclusa

MAIN STRUCTURE:

- Square tube section 75x75x3,2 mm
- 2 j-cups included

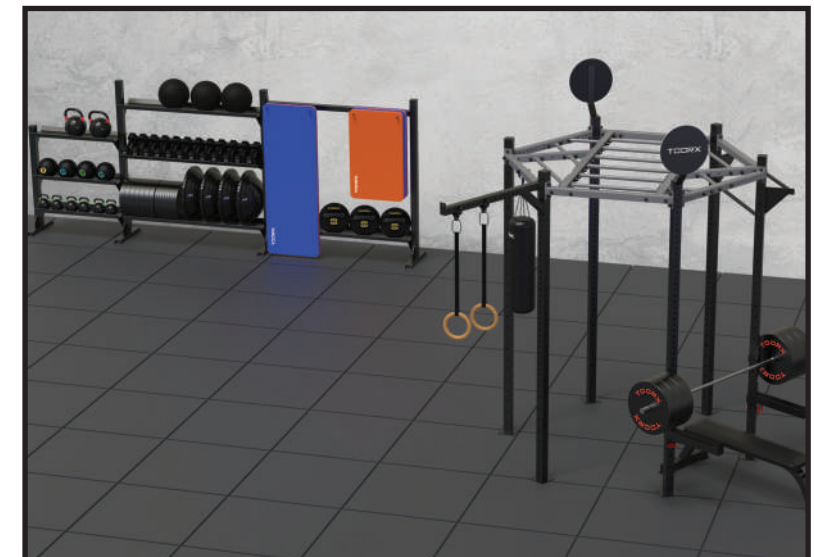
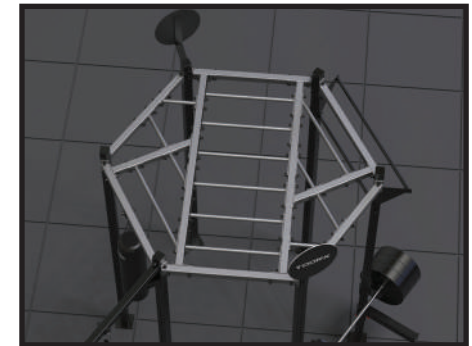

TCORX
PROFESSIONAL LINE

ESEMPIO DI CONFIGURAZIONE GABBIA HEXAGON - EXAMPLE OF HEXAGON RIG

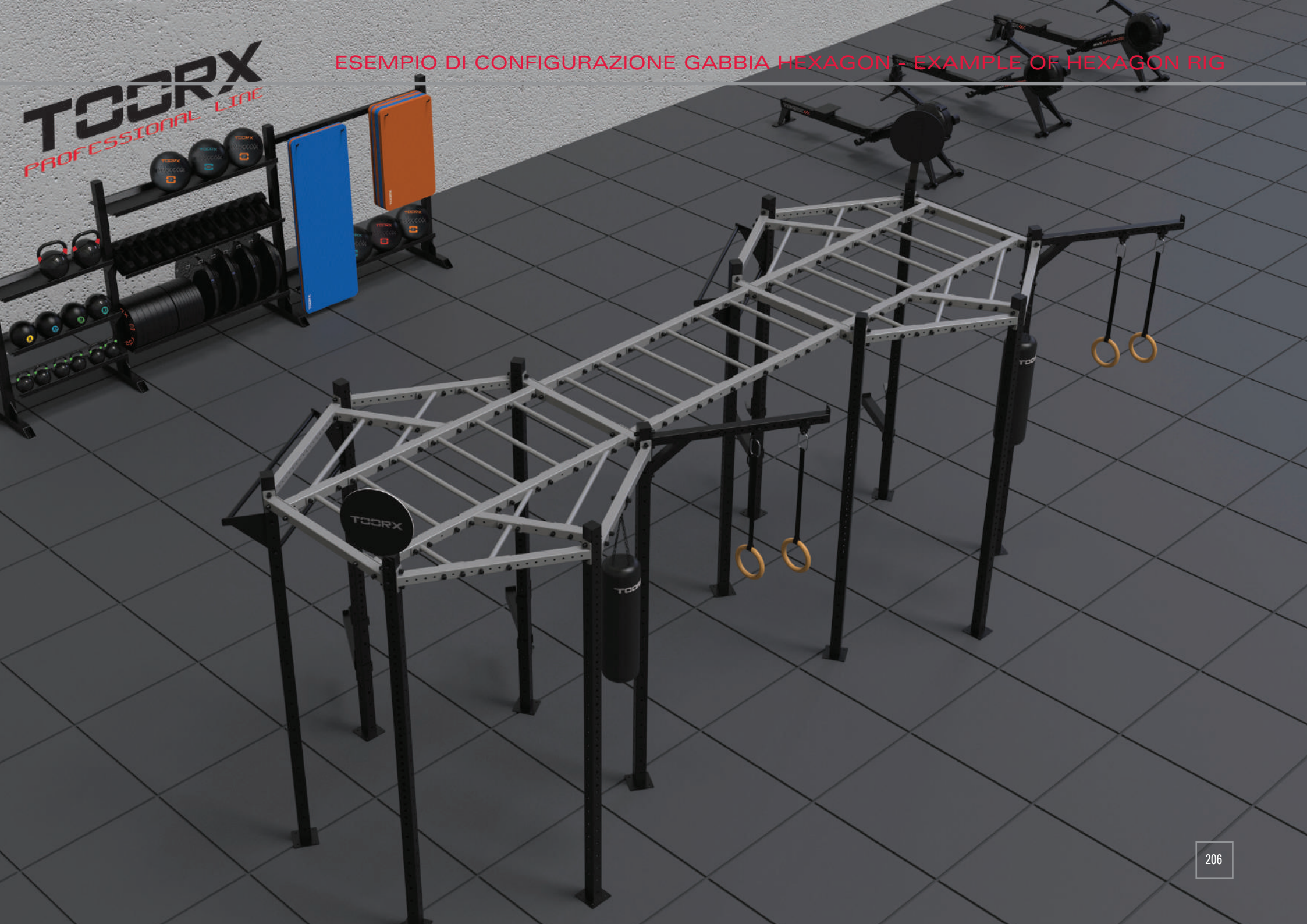

ELEMENTI STRUTTURALI CHALLENGE E MASTER - CHALLENGE AND MASTER RIGS COMPONENTS

MONTANTE 220 CHALLENGE
220 UPRIGHT CHALLENGE

cod. G60-M220

- Altezza 220 cm
- Per serie CHALLENGE - Sezione 60x60x3,2 mm
- Collegamento profili secondari e accessori Foratura ø 13 mm. passo 10 cm.
- Collegamento fermi di sicurezza, supporti bilancieri e parallele Foratura ø 17 mm. passo 5/10 cm.
- Numeri di riferimento (0-20) incisi al laser
- Collegamento a terra
- Piastra di base 160x160 mm. spessore 6 mm

- Height 220cm
- For CHALLENGE series - Section 60x60x3,2mm
- Connection with beams, bars and accessories ø 13mm holes - 10cm step
- Connection with safety spotter arms, J-cups and dip horns ø 17mm holes - 5/10cm step
- Laser-engraved reference numbers (0-20)
- Connection to the ground
- Base plate 160x160 mm. Thickness 6 mm



MONTANTE 270 CHALLENGE
270 UPRIGHT CHALLENGE

cod. G60-M270

- Altezza 270 cm
- Per serie CHALLENGE - Sezione 60x60x3,2 mm
- Collegamento profili secondari e accessori Foratura ø 13 mm. passo 10 cm.
- Collegamento fermi di sicurezza, supporti bilancieri e parallele Foratura ø 17 mm. passo 5/10 cm.
- Collegamento a terra
- Piastra di base 160x160 mm. spessore 6 mm

- Height 270cm
- For CHALLENGE series - Section 60x60x3,2mm
- Connection with beams, bars and accessories ø 13mm holes - 10cm step
- Connection with safety spotter arms, J-cups and dip horns ø 17mm holes - 5/10cm step
- Connection to the ground
- Base plate 160x160 mm. Thickness 6 mm



MONTANTE 270 MASTER
270 UPRIGHT MASTER

cod. G75-M270

- Altezza 270 cm
- Per serie MASTER - Sezione 75x75x3,2 mm
- Collegamento profili secondari e accessori Foratura ø 13 mm. passo 10 cm.
- Collegamento fermi di sicurezza, supporti bilancieri e parallele Foratura ø 17 mm. passo 5/10 cm.
- Numeri di riferimento (0-20) incisi al laser
- Collegamento a terra
- Piastra di base 160x160 mm. spessore 6 mm

- Height 270cm
- For MASTER series - Section 75x75x3,2mm
- Connection with beams, bars and accessories ø 13mm holes - 10cm step
- Connection with safety spotter arms, J-cups and dip horns ø 17mm holes - 5/10cm step
- Laser-engraved reference numbers (0-20)
- Connection to the ground
- Base plate 160x160 mm. Thickness 6 mm



MONTANTE 360 CHALLENGE
360 UPRIGHT CHALLENGE

cod. G60-M360

- Altezza 360 cm
- Per serie CHALLENGE - Sezione 60x60x3,2 mm
- Collegamento profili secondari e accessori Foratura ø 13 mm. passo 10 cm.
- Collegamento fermi di sicurezza, supporti bilancieri e parallele Foratura ø 17 mm. passo 5/10 cm.
- Collegamento a terra
- Piastra di base 160x160 mm. spessore 6 mm

- Height 360cm
- For CHALLENGE series - Section 60x60x3,2mm
- Connection with beams, bars and accessories ø 13mm holes - 10cm step
- Connection with safety spotter arms, J-cups and dip horns ø 17mm holes - 5/10cm step
- Connection to the ground
- Base plate 160x160 mm. Thickness 6 mm



MONTANTE 360 MASTER
360 UPRIGHT MASTER

cod. G75-M360

- Altezza 360 cm
- Per serie MASTER - Sezione 75x75x3,2 mm
- Collegamento profili secondari e accessori Foratura ø 13 mm. passo 10 cm.
- Collegamento fermi di sicurezza, supporti bilancieri e parallele Foratura ø 17 mm. passo 5/10 cm.
- Numeri di riferimento (0-20) incisi al laser
- Collegamento a terra
- Piastra di base 160x160 mm. spessore 6 mm

- Height 360cm
- For MASTER series - Section 75x75x3,2mm
- Connection with beams, bars and accessories ø 13mm holes - 10cm step
- Connection with safety spotter arms, J-cups and dip horns ø 17mm holes - 5/10cm step
- Laser-engraved reference numbers (0-20)
- Connection to the ground
- Base plate 160x160 mm. Thickness 6 mm.



MONTANTE 90 MASTER
90 UPRIGHT MASTER

cod. G75-M90

- Altezza 90 cm
- Per serie MASTER - Sezione 75x75x3,2 mm
- Consente di prolungare il montante G75-M360, aumentandone l'altezza da 360 a 450 cm, e creare una postazione da arrampicata
- Da utilizzare unitamente al profilo di connessione incluso
- Profilo di connessione 68x68x6 mm
- 10 set viteria inclusi

- Height 90 cm
- For MASTER series - Section 75x75x3,2mm
- Allows to extend the upright G75-M360, increasing its height from 360 to 450 cm, and create a climbing station
- To be used together with the included connectors
- Connector section 68x68x6 mm
- 10 sets of screws included



ELEMENTI STRUTTURALI CHALLENGE E MASTER - CHALLENGE AND MASTER RIGS COMPONENTS

PROFILO DI IRRIGIDIMENTO 50 50 BEAM

cod. GU-P50

- Per serie CHALLENGE e MASTER
- Lunghezza 50 cm
- Sezione 60x60x3,2 mm
- Foratura su due lati - ø 13 mm. - passo 10 cm.
- Viteria
- 4 set inclusi



- For CHALLENGE and MASTER series
- Length 50 cm
- Section 60x60x3,2mm
- ø 13mm holes on both side - 10cm step
- Screws
- 4 sets of screws included

PROFILO DI IRRIGIDIMENTO 105 105 BEAM

cod. GU-P105

- Per serie CHALLENGE e MASTER
- Lunghezza 105 cm
- Sezione 60x60x3,2 mm
- Foratura su due lati - ø 13 mm. - passo 10 cm.
- Viteria
- 4 set inclusi



- For CHALLENGE and MASTER series
- Length 105cm
- Section 60x60x3,2mm
- ø 13mm holes on both side - 10cm step
- Screws
- 4 sets of screws included

PROFILO DI IRRIGIDIMENTO 168 168 BEAM

cod. GU-P168

- Per serie CHALLENGE e MASTER
- Lunghezza 168 cm
- Sezione 60x60x3,2 mm
- Foratura su due lati - ø 13 mm. - passo 10 cm.
- Viteria
- 4 set inclusi



- For CHALLENGE and MASTER series
- Length 168cm
- Section 60x60x3,2mm
- ø 13mm holes on both side - 10cm step
- Screws
- 4 sets of screws included

BARRA PULL UP 105 105 PULL UP BAR

cod. GU-B105

- Compatibile con serie CHALLENGE e MASTER
 - Lunghezza 105 cm
 - Sezione circolare ø 32 mm
 - Funzione
- Barra per trazioni utilizzabile singolarmente oppure in serie per comporre Monkey Station in orizzontale o a 45°. Può essere montata a creare una spalliera
- Viteria
 - 4 set inclusi



- Compatible with CHALLENGE and MASTER series
 - Length 105 cm
 - Round tube ø 32 mm
 - Purpose
- Suitable for pulling up, can be used to create an horizontal or 45° Monkey Station. It can be also assembled to create a gymnastic ladder
- Screws
 - 4 sets of screws included

BARRA PULL UP 168 168 PULL UP BAR

cod. GU-B168

- Per serie CHALLENGE e MASTER
 - Lunghezza 168 cm
 - Sezione circolare ø 32 mm
 - Funzione
- Barra per trazioni utilizzabile singolarmente oppure in serie per comporre Monkey Station in orizzontale o a 45°. Può essere montata a creare una spalliera
- Viteria
 - 4 set inclusi



- For CHALLENGE and MASTER series
 - Length 168 cm
 - Round tube ø 32 mm
 - Purpose
- Suitable for pulling up, can be used to create an horizontal or 45° Monkey Station. It can be also assembled to create a gymnastic ladder.
- Screws
 - 4 sets of screws included

DOPPIA BARRA PULL UP 105 105 DOUBLE BAR

cod. GU-DB105

- Per CHALLENGE e MASTER
 - Lunghezza 105 cm
 - Sezione circolare ø 32 mm
 - Funzione
- Barre per trazioni e muscle up
- Viteria
 - 4 set inclusi



- For CHALLENGE and MASTER series
 - Length 105 cm
 - Round tube ø 32mm
 - Purpose
- Suitable for pulling up and muscle up
- Screws
 - 4 sets of screws included

ELEMENTI STRUTTURALI CHALLENGE E MASTER - CHALLENGE AND MASTER RIGS COMPONENTS

DOPPIA BARRA PULL UP 168
168 DOUBLE BAR

cod. **GU-DB168**

- Per serie CHALLENGE e MASTER
 - Lunghezza 168 cm
 - Sezione circolare ø 32 mm
 - Funzione
- Barre per trazioni e muscle up
- Viteria
- 4 set inclusi

- For CHALLENGE and MASTER series
 - Length 168 cm
 - Round tube ø 32mm
 - Purpose
- Suitable for pulling up and muscle up
- Screws
- 4 sets of screws included



BARRA PULL UP 168 RINFORZATA
168 REINFORCED PULL UP BAR

cod. **GU-168R**

- Per serie CHALLENGE e MASTER
- Lunghezza 168 cm
- Sezione circolare ø 32 mm
- Funzione

Barra per trazioni dotata di piastre rinforzate per il collegamento alla struttura principale. La piastra di collegamento permette l'unione di un profilo di irrigidimento nelle campate attigue

- Viteria
- 4 set inclusi

- For CHALLENGE and MASTER series
- Length 168 cm
- Round tube ø 32 mm
- Purpose

Pull up bar equipped with reinforced plates to connect with the main structure. The connection plates allows to connect it with a beam in the nearest spans

- Screws
- 4 sets of screws included

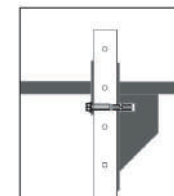

Le barre pull up da 168 cm. rinforzate sono dotate di un'asola ricavata nel rinforzo. Questo dettaglio progettuale rende possibile il collegamento di barre alla stessa quota, nelle campate attigue.

The reinforced 168cm pull up bars include a loop carved in the strengthening part. This detail makes it possible to connect bars at the same height, in the nearest spans.

BARRA PULL UP 105 RINFORZATA
105 REINFORCED PULL UP BAR

cod. **GU-105R**

- Per serie CHALLENGE e MASTER
- Lunghezza 105 cm
- Sezione circolare ø 32 mm
- Funzione

Barra per trazioni dotata di piastre rinforzate per il collegamento alla struttura principale.

- Viteria
- 4 set inclusi

- For CHALLENGE and MASTER series
- Length 105 cm
- Round tube ø 32 mm
- Purpose

Pull up bar equipped with reinforced plates for connection with the main structure.

- Screws
- 4 sets of screws included



PROFILO OBLIQUO
SLANTING FLY ARM

cod. **GU-TO (1pz. / 1pc.)**

- Per serie CHALLENGE e MASTER
- Sezione 60x60x3,2 mm
- Funzione

Profilo a sbalzo utilizzabile singolarmente in abbinamento al gancio per appendere sacco boxe o corda da arrampicata. In coppia costituisce il telaio per comporre Monkey Station a 45°. Se collegato con le staffe dedicate (AG60-SQ e AG75-SQ), consente di unire montanti di altezza diversa (vedere pag. 211-213)

- Viteria
- 2 set inclusi

- For CHALLENGE and MASTER series
- Section 60x60x3,2 mm
- Purpose

Fly arm usable to match the hook to hang a boxing bag or a climbing rope. Two fly arms compose the frame to create a Monkey Station at 45°. If connected with the dedicated brackets (AG60-SQ e AG75-SQ), the fly arm allows to connect different heights uprights (see on page 211-213)

- Screws
- 2 sets of screws included



PROFILO OBLIQUO
SLANTING FLY ARM

cod. **GU-TO2 (2pz. / 2pcs.)**

- Per serie CHALLENGE e MASTER
- Sezione 60x60x3,2 mm
- Funzione

Profilo a sbalzo utilizzabile singolarmente in abbinamento al gancio per appendere sacco boxe o corda da arrampicata. In coppia costituisce il telaio per comporre Monkey Station a 45°. Se collegato con le staffe dedicate (AG60-SQ e AG75-SQ), consente di unire montanti di altezza diversa (vedere pag. 211-213)

- Viteria
- 2 set inclusi

- For CHALLENGE and MASTER series
- Section 60x60x3,2 mm
- Purpose

Fly arm usable to match the hook to hang a boxing bag or a climbing rope. Two fly arms compose the frame to create a Monkey Station at 45°. If connected with the dedicated brackets (AG60-SQ e AG75-SQ), the fly arm allows to connect different heights uprights (see on page 211-213)

- Screws
- 2 sets of screws included



ELEMENTI STRUTTURALI MASTER HEXAGON - MASTER HEXAGON RIGS COMPONENTS

DOPPIA BARRA PULL UP PER GABBIA MASTER HEXAGON DOUBLE PULL UP BAR FOR HEXAGON MASTER RIG

cod. GHEX-DB

- Per serie Master Hexagon
- Lunghezza barra superiore 128 cm
- Lunghezza barra inferiore 100 cm
- Sezione circolare ø 32 mm
- Funzione

Barra per trazioni e muscle up

- Viteria
- 4 set inclusi

- For Hexagon Master series
- Length upper bar 128 cm
- Length lower bar 100 cm
- Round tube ø 32mm
- Purpose
- Suitable for pulling up and muscle up
- Screws
- 4 sets of screws included



PROFILO DI IRRIGIDIMENTO 187 PER GABBIA MASTER HEXAGON 187 BEAM FOR HEXAGON MASTER RIG

cod. GU-P187

- Per serie Master Hexagon
- Lunghezza 187 cm
- Sezione 60x60x3,2 mm
- Foratura su due lati - ø 13 mm. - passo 10 cm.
- Funzione
- Utilizzabili a coppia per unire 2 o più gabbie Master esagonali
- Viteria
- 4 set inclusi

- For Hexagon Master series
- Length 187 cm
- Section 60x60x3,2mm
- ø 13mm holes on both side - 10cm step
- Purpose
- Suitable to connect 2 or more hexagonal rigs
- Screws
- 4 sets of screws included



BARRA PULL UP 74 PER GABBIA MASTER HEXAGON 74 PULL UP BAR FOR HEXAGON MASTER RIG

cod. GU-B74

- Per serie Master Hexagon
- Lunghezza 74 cm
- Sezione circolare ø 32 mm
- Funzione
- Barra per trazioni utilizzabile tra due profili orizzontali GU-P187 per comporre Monkey Station
- Viteria
- 4 set inclusi

- For Hexagon Master series
- Length 74 cm
- Round tube ø 32 mm
- Purpose
- Suitable for pulling up, can be used among two GU-P187 beams to create an horizontal Monkey Station.
- Screws
- 4 sets of screws included



ACCESSORI CHALLENGE - CHALLENGE ACCESSORIES

**COPPIA LEVER ARMS CHALLENGE
LEVER ARMS CHALLENGE**

cod. AG60-LA

- Per serie CHALLENGE - Sezione 60x60x3,2 mm
- Sezione 60x60x3,2 mm
- Foratura su due lati - \varnothing 17 mm passo 10 cm
- Pin di connessione \varnothing 16 mm
- Pin di sicurezza \varnothing 16 mm incluso
- Movimento estremamente fluido grazie al sistema di pin e boccole
- Lunghezza leva 1370 mm
- 1 maniglia e 1 porta dischi inclusi per ogni leva

- For CHALLENGE series - 60x60x3,2 mm tube
- Section 60x60x3,2 mm
- \varnothing 17 mm holes on both the sides . 10 cm step
- \varnothing 16 mm fixing pin
- \varnothing 16 mm safety pin included
- High smooth movement thanks to the pin&bushing system
- Arm length 1370 mm
- 1 handles and 1 weight plates included for each lever



**PARALLELE CHALLENGE
DIP HORNS CHALLENGE**

cod. AG60-P

- Per CHALLENGE - Sezione 60x60x3,2 mm
- Dimensioni 875 x 600 x 358 mm
- Pin di connessione \varnothing 16 mm
- In dotazione pin di sicurezza \varnothing 16 mm

- For CHALLENGE series - 60x60x3,2 mm tube
- Size 875 x 600 x 358 mm
- \varnothing 16 mm fixing pin
- \varnothing 16 mm safety pin included



**COPPIA BARRE DI SICUREZZA CHALLENGE
SAFETY BARS CHALLENGE**

cod. AG60-BS

- Per serie CHALLENGE - Sezione 60x60x3,2 mm
- Sezione 60x60x3,2 mm
- Spessore sgancio rapido 6 mm
- Lunghezza 1680 mm
- 2 pin di connessione \varnothing 16 mm
- Pin di sicurezza \varnothing 16 mm incluso
- Protezioni e pin di sicurezza \varnothing 16 mm incluso

- For CHALLENGE series - 60x60x3,2 mm tube
- Section 60x60x3,2 mm
- Quick release thickness 6 mm
- Length 1680 mm
- 2x \varnothing 16 mm fixing pins
- \varnothing 16 mm safety pin included
- Protection pads and \varnothing 16 mm safety pin included



**COPPIA FERMI DI SICUREZZA BILANCIERE CHALLENGE
SAFETY SPOTTER ARMS CHALLENGE**

cod. AG60-FS

- Per serie CHALLENGE - Sezione 60x60x3,2 mm
- Spessore 8 mm
- Pin di connessione \varnothing 16 mm
- Dotati di protezioni e Pin di sicurezza diam. 16 mm

- For CHALLENGE series - 60x60x3,2 mm tube
- Thickness 8 mm
- \varnothing 16 mm fixing pin
- Protection pads and \varnothing 16 mm safety pin included

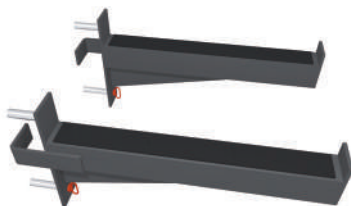

**COPPIA SUPPORTI BILANCIERE CHALLENGE
J-CUPS CHALLENGE**

cod. AG60-SB

- Per serie CHALLENGE - Sezione 60x60x3,2 mm
- Spessore 8 mm
- Pin di connessione \varnothing 16 mm
- Dotati di protezioni.

- For CHALLENGE series - 60x60x3,2 mm tube
- Thickness 8 mm
- \varnothing 16 mm fixing pin
- Protection pads included.



**COPPIA STAFFE DI COLLEGAMENTO MONTANTI 360/270
2 CONNECTING BRACKETS UPRIGHTS 360/270**

cod. AG60-SQ

- Coppia di staffe studiate per connettere tra loro montanti da 270 e 360 cm
- Per serie CHALLENGE
- Da utilizzare in accoppiamento al profilo obliquo GU-TO come da schema a lato
- Spessore 6mm
- Fori \varnothing 13

- 2 brackets designed to connect 270 and 360cm uprights
- For CHALLENGE
- To be used together with the fly arm GU-TO as pictured in the scheme a side
- Thickness: 6mm
- Holes: \varnothing 13

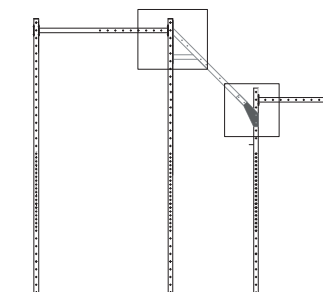
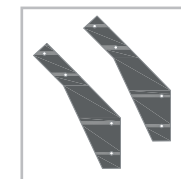

ACCESSORI MASTER - MASTER ACCESSORIES

COPPIA LEVER ARMS MASTER LEVER ARMS MASTER

cod. AG75-LA

- Per serie MASTER - Sezione 75x75x3,2 mm
- Sezione 60x60x3,2 mm
- Foratura su due lati - \varnothing 17 mm passo 10 cm
- Pin di connessione \varnothing 16 mm
- Pin di sicurezza \varnothing 16 mm incluso
- Movimento estremamente fluido grazie al sistema di pin e boccole
- Lunghezza leva 1370 mm
- 1 maniglia e 1 porta dischi inclusi per ogni leva

- For MASTER series - 75x75x3,2 mm tube
- Section 60x60x3,2 mm
- \varnothing 17 mm holes on both the sides. 10 cm step
- \varnothing 16 mm fixing pin
- \varnothing 16 mm safety pin included
- High smooth movement thanks to the pin&bushing system
- Arm length 1370 mm
- 1 handles and 1 weight plates included for each lever



PARALLELE MASTER DIP HORNS MASTER

cod. AG75-P

- Per serie MASTER - Sezione 75x75x3,2 mm
- Dimensioni 887 x 600 x 358 mm
- Pin di connessione \varnothing 16 mm
- In dotazione pin di sicurezza \varnothing 16 mm

- For MASTER series - 75x75x3,2 mm tube
- Size 887 x 600 x 358 mm
- \varnothing 16 mm fixing pin
- \varnothing 16 mm safety pin included



COPPIA BARRE DI SICUREZZA MASTER SAFETY BARS MASTER

cod. AG75-BS

- Per serie MASTER - Sezione 75x75x3,2 mm
- Sezione 60x60x3,2 mm
- Spessore sgancio rapido 6 mm
- Lunghezza 1680 mm
- 2 pin di connessione \varnothing 16 mm
- Pin di sicurezza \varnothing 16 mm incluso
- Protezioni e pin di sicurezza \varnothing 16 mm incluso

- For MASTER series - 75x75x3,2 mm tube
- Section 60x60x3,2 mm
- Quick release thickness 6 mm
- Length 1680 mm
- 2x \varnothing 16 mm fixing pins
- \varnothing 16 mm safety pin included
- Protection pads and \varnothing 16 mm safety pin included



COPPIA FERMI DI SICUREZZA BILANCIERE MASTER SAFETY SPOTTER ARMS MASTER

cod. AG75-FS

- Per serie MASTER - Sezione 75x75x3,2 mm
- Spessore 8 mm
- Pin di connessione \varnothing 16 mm
- Dotati di protezioni e Pin di sicurezza diam. 16 mm

- For MASTER series - 75x75x3,2 mm tube
- Thickness 8 mm
- \varnothing 16 mm fixing pin
- Protection pads and \varnothing 16 mm safety pin included

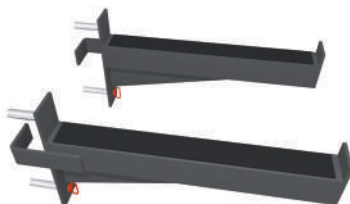

PEDANA STEP UP STEP UP PLATE

cod. AG75-SU

- Per serie MASTER - Sezione 75x75x3,2 mm
- Sezione 75x75x3,2 mm / 75x120x3,2 mm
- Spessore sgancio rapido 6 mm
- Dimensioni pedana 700x450 mm
- Superficie gommata anti scivolo
- Pin di connessione \varnothing 16 mm
- Pin di sicurezza \varnothing 16 mm incluso

- For MASTER series - 75x75x3,2 mm tube
- Section 75x75x3,2 mm / 75x120x3,2 mm
- Quick release thickness 6 mm
- Platform size 700x450 mm
- Non-slip rubber surface
- \varnothing 16 mm fixing pins
- \varnothing 16 mm safety pin included.

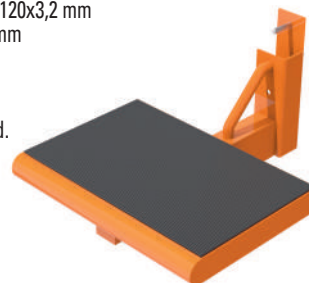

COPPIA SUPPORTI BILANCIERE MASTER J-CUPS MASTER

cod. AG75-SB

- Per serie MASTER - Sezione 75x75x3,2 mm
- Spessore 8 mm
- Pin di connessione \varnothing 16 mm
- Dotati di protezioni.

- For MASTER series - 75x75x3,2 mm tube
- Thickness 8 mm
- \varnothing 16 mm fixing pin
- Protection pads included.



ACCESSORI MASTER - MASTER ACCESSORIES

COPPIA STAFFE DI COLLEGAMENTO MONTANTI 360/270
2 CONNECTING BRACKETS UPRIGHTS 360/270

cod. AG75-SQ

- Coppia di staffe studiate per connettere tra loro montanti da 270 e 360 cm
- Per serie MASTER
- Da utilizzare in accoppiamento al profilo obliquo GU-TO come da schema a lato
- Spessore 6mm
- Fori Ø 13

- 2 brackets designed to connect 270 and 360cm uprights
- For MASTER
- To be used together with the fly arm GU-TO as pictured in the scheme a side
- Thickness: 6mm
- Holes: Ø 13

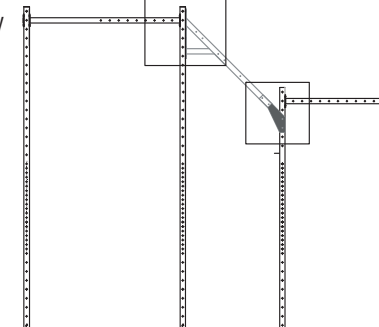
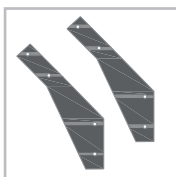

ACCESSORI CHALLENGE-MASTER - CHALLENGE-MASTER ACCESSORIES

MODULO CABLE CROSS
CABLE CROSS ATTACHMENT

cod. AGU-CC

- Per serie CHALLENGE e MASTER
- Pacco pesi in acciaio 90 kg con carter di protezione laterale
- Coppia maniglie pulley incluse
- Sistema di carrucole e pulegge con cuscinetti a sfera HIGH PERFORMANCE
- Sistema di cavi in acciaio intrecciati rivestiti in polivinile
- Struttura tubolare in acciaio rinforzato a sezione quadrata 50x50x2 mm e rettangolare 70x50x2 mm
- Possibilità di utilizzare 2 moduli cable cross in abbinamento alla barra 45° per assemblare una postazione dual pulley
- 8 set viteria inclusi

- For CHALLENGE and MASTER series
- 90kg steel weight stack with lateral protection cage
- 2 pulley handles included
- Pulleys system with HIGH PERFORMANCE ball bearings
- Steel woven cables with polyvinyl coating
- Square and rectangular heavy-duty steel tubing 50x50x2 mm and 70x50x2mm
- 2 attachments together with 1 45° bar allow assembling a dual pulley
- 8 sets of screws included



cod. AGU-CC

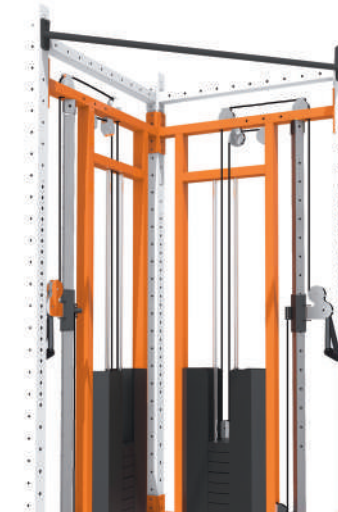

2 x cod. AGU-CC + 1 x cod. AGU-B45



BARRA 45°
45° BAR

cod. AGU-B45

- Per serie CHALLENGE e MASTER
- Barra studiata per connettere tra loro 2 telai a 90°
- Lunghezza 1570 mm
- Sezione circolare ø 32 mm
- Barra utilizzabile in abbinamento a 2 moduli cable cross (AGU-CC) per configurazione dual pulley.
- 4 set viteria inclusi

- For CHALLENGE and MASTER series
- Bar designed to connect 2 frames at 90°
- Length 1570 mm
- Round tube ø 32 mm
- The bar can be used together with 2x cable cross attachments (AGU-CC) for a dual pulley configuration
- 4 sets of screws included

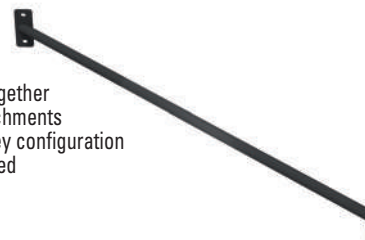

PROFILO ORIZZONTALE
HORIZONTAL FLY ARM

cod. AGU-PO

- Per serie CHALLENGE e MASTER
- Sezione 60x60x3,2 mm
- Lunghezza 110 cm
- Funzione

Utilizzabile in abbinamento al set di fissaggio, come supporto per anelli da ginnastica e corda da arrampicata

- Viteria
- 2 set inclusi

- For CHALLENGE and MASTER series
- Section 60x60x3,2 mm
- Length 110 cm
- Purpose
- Usable together with the fixing set, to hold gym rings and climbing rope
- Screws
- 2 sets of screws included



ACCESSORI CHALLENGE-MASTER - CHALLENGE-MASTER ACCESSORIES

**ACCESSORIO LAT MACHINE
LAT MACHINE ACCESSORY**

cod. AGU-LM

- Cavo d'acciaio rivestito in PVC, con sfera di gravità.
- In dotazione corda di trazione, barra dritta, adattatore per dischi peso con foro ø50mm e moschettone di fissaggio.
- Peso massimo caricabile 100 kg.

- PVC coated steel cable, with gravity ball.
- Supplied with traction rope, straight bar, adapter for weight plates with ø50mm hole and fixing carabiner.
- Maximum loadable weight 100 kg.



**SET DI FISSAGGIO ANELLI DA GINNASTICA/CORDA DA ARRAMPICATA
GYM RINGS/CLIMBING ROPE FIXING SET**

cod. AGU-SFAC (1 pz/1pc)

- Per serie CHALLENGE e MASTER
- Accessorio profilo orizzontale
- Moschettone incluso
- Viteria
- 1 set incluso

- For CHALLENGE and MASTER series
- Horizontal fly arm accessory
- Carabiner included
- Screws
- 1 set of screws included



**PORTA BILANCIERE VERTICALE
VERTICAL BARBELL HOLDER**

cod. AGU-PBV

- Per serie CHALLENGE e MASTER
- Sede per bilancieri ø 50 mm
- Lunghezza 250 mm

- For CHALLENGE and MASTER series
- For ø 50 mm barbells
- Length 250 mm



**LANDMINE DOPPIO
LANDMINE DOUBLE SET**

cod. AGU-LD

- Per serie CHALLENGE e MASTER
- Snodo cardanico con doppia sede per bilancieri ø 50 mm
- Lunghezza 250 mm
- Ideale per allenamento core

- For CHALLENGE and MASTER series
- Cardan joint with dual-slot for ø 50 mm barbells
- Length 250 mm
- Ideal for core training



**BERSAGLIO
TARGET-BOARD**

cod. AGU-B

- Per serie CHALLENGE e MASTER
- Montaggio adattabile alle altezze regolamentari : uomo 300 cm - donna 275 cm
- Disco ø 40 cm - Staffa spessore 8mm
- Viteria
- 2 set inclusi

- For CHALLENGE and MASTER series
- Assembly adjustable to regulation heights : 300cm for men - 275cm for women
- ø 40cm disc - 8mm thick bracket
- Screws
- 2 sets of screws included



ACCESSORI CHALLENGE-MASTER - CHALLENGE-MASTER ACCESSORIES

**BERSAGLIO DOPPIO
DOUBLE TARGET**

cod. AGU-BD

- Per serie CHALLENGE e MASTER
- Due bersagli in 1 per un facile montaggio alle altezze regolamentari 305 cm (uomo) e 275 cm (donna)
- Disco ø 40 cm - Staffa spessore 8 mm
- Viteria
- 2 set inclusi

- For CHALLENGE and MASTER series
- Two Wall Ball Targets in one, for easy setting at regulation 305 cm (Men's) and 275 cm (Women's) target heights
- ø 40cm disc - 8mm thick bracket
- Screws
- 2 sets of screws included



**GANCIO CORDA
ROPE RING**

cod. AGU-GC

- Per serie CHALLENGE e MASTER
- Progettato per battle rope, fune da arrampicata e sacco boxe
- Viteria
- 2 set inclusi

- For CHALLENGE and MASTER series
- Designed for battle rope, climbing rope and boxing bag
- Screws
- 2 sets of screws included



**MANIGLIA
HANDLE**

cod. AGU-M

- Per serie CHALLENGE e MASTER
- Dimensioni impugnatura 236 x 332 mm (ø 32mm)
- Ancorabile a montanti o ad elementi orizzontali per realizzare una composizione di prese
- Fissate a coppie ai profili di irrigidimento creano una postazione pull up
- Viteria
- 2 set inclusi

- For CHALLENGE and MASTER series
- Grip size 236 x 332 mm (ø 32mm)
- To be fixed to uprights or to horizontal components to create a set of handles. Usable for pull up by fixing two handles to a beam
- Screws
- 2 sets of screws included



**PIASTRA DI COLLEGAMENTO PER FISSAGGIO A TERRA
CONNECTION PLATE FOR FLOOR FIXING**

AG60-PC105 per collegamenti da 105 serie Challenge - for 105cm connections Challenge series

AG75-PC105 per collegamenti da 105 serie Master - for 105 cm connections Master series

AG60-PC220 per collegamenti da 105 montanti h 220 serie Challenge - for 105cm connections - upright h 220 Challenge series

AG60-PC168 per collegamenti da 168 serie Challenge - for 168 cm connections Challenge series

AG75-PC168 per collegamenti da 168 serie Master - for 168 cm connections Master series

- Indispensabili per collegare alla base i montanti nei casi in cui non sia possibile fissare la gabbia direttamente a pavimento

• Dimensioni:

AG60-PC105 - 1327 x 217 x 10 mm

AG75-PC105 - 1342 x 217 x 10 mm

AG60-PC220 - 1350x175x10 mm

AG60-PC168 - 1957 x 217 x 10 mm

AG75-PC168 - 1972 x 217 x 10 mm

- Dotate di bulloni ø 12 per l'accoppiamento con le piastre alla base dei montanti

- Suitable to connect the uprights when it is not possible to drill the floor

• Sizes:

AG60-PC105 - 1327 x 217 x 10 mm

AG75-PC105 - 1342 x 217 x 10 mm

AG60-PC220 - 1350x175x10 mm

AG60-PC168 - 1957 x 217 x 10 mm

AG75-PC168 - 1972 x 217 x 10 mm

- Provided with ø 12mm bolts to be matched with the plates at the uprights base



**SISTEMA DI STAFFE A V
V BRACKETS SYSTEM**

cod. AGU-SVM Staffa di collegamento tra 2 profili di irrigidimento paralleli e montante -

Bracket to be connected among 2 parallel beams and 1 upright

cod. AGU-2SV Staffa di collegamento tra 2 profili di irrigidimento paralleli -

Bracket to be connected among 2 parallel beams

cod. AGU-4SV Staffa di collegamento tra 4 profili di irrigidimento paralleli -

Bracket to be connected among 4 parallel beams

- Per serie CHALLENGE e MASTER

- Consente di creare gabbie multi campata senza pali intermedi

- 4 set viteria inclusi

- For CHALLENGE and MASTER series

- Allows to create multi-span rigs structures without intermediate uprights

- 4 sets of screws included

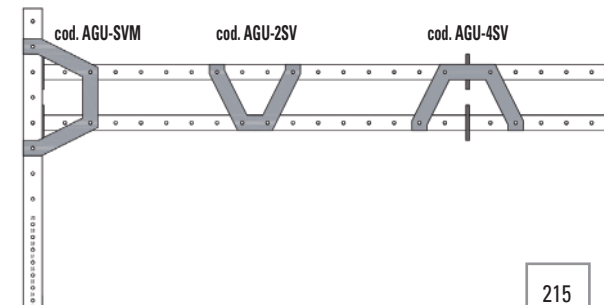

ACCESSORI MASTER HEXAGON - MASTER HEXAGON ACCESSORIES

**COPPIA SUPPORTI BILANCIERE PER GABBIA MASTER HEXAGON
J-CUPS FOR HEXAGON MASTER RIG**

cod. AGHEX-SB

- Per serie Master Hexagon
- Sezione 75x75x3,2 mm
- Spessore 8 mm
- Pin di connessione ø 16 mm
- Dotati di protezioni.

- For Hexagon Master series
- 75x75x3,2 mm tube
- Thickness 8 mm
- ø 16 mm fixing pin
- Protection pads included



**COPPIA FERMI DI SICUREZZA BILANCIERE PER GABBIA MASTER HEXAGON
SAFETY SPOTTER ARMS FOR HEXAGON MASTER RIG**

cod. AGHEX-FS

- Per serie Master Hexagon
- Sezione 75x75x3,2 mm
- Spessore 8 mm
- Pin di connessione ø 16 mm
- Dotati di protezioni e Pin di sicurezza diam. 16 mm

- For Hexagon Master series
- 75x75x3,2 mm tube
- Thickness 8 mm
- ø 16 mm fixing pin
- Protection pads and ø 16 mm safety pin included.



**ACCESSORI COMPATIBILI
COMPATIBLE ACCESSORIES**

cod. GU-TO - PROFILO OBLIQUO

Informazioni dettagliate su questi accessori a pag 209

cod. AG75-P - PARALLELE MASTER

Informazioni dettagliate su questi accessori a pag 212

cod. AGU-PO - PROFILO ORIZZONTALE

Informazioni dettagliate su questi accessori a pag 213

cod. AGU-SFAC - SET DI FISSAGGIO ANELLI DA

GINNASTICA / CORDA DA ARRAMPICATA

Informazioni dettagliate su questi accessori a pag 214

cod. AG75-SU - PEDANA STEP UP MASTER

Informazioni dettagliate su questi accessori pag 212

cod. AGU-B - BERSAGLIO

Informazioni dettagliate su questi accessori a pag 214

cod. AGU-BD - BERSAGLIO DOPPIO

Informazioni dettagliate su questi accessori a pag 215

cod. AGU-GC - GANCIO CORDA

Informazioni dettagliate su questi accessori a pag 215

cod. AGU-LD - LANDMINE DOPPIO

Informazioni dettagliate su questi accessori a pag 214

cod. AGU-M - MANIGLIA

Informazioni dettagliate su questi accessori a pag 215

cod. GU-TO - SLANTING FLY ARM

Detailed info about these accessories at page 209

cod. AG75-P - DIP HORNS MASTER

Detailed info about these accessories at page 212

cod. AGU-PO - HORIZONTAL FLY ARM

Detailed info about these accessories at page 213

cod. AGU-SFAC - GYM RINGS/CLIMBING

ROPE FIXING SET

Detailed info about these accessories at page 214

cod. AG75-SU - STEP UP PLATE MASTER

Detailed info about these accessories at page 212

cod. AGU-B - TARGET

Detailed info about these accessories at page 214

cod. AGU-BD - DOUBLE TARGET

Detailed info about these accessories at page 215

cod. AGU-GC - ROPE RING

Detailed info about these accessories at page 215

cod. AGU-LD - LANDMINE DOUBLE SET

Detailed info about these accessories at page 214

cod. AGU-M - HANDLE

Detailed info about these accessories at page 215



TCORX

PROFESSIONAL LINE



STORAGE AUTOPORTANTE A 3 RIPIANI L 120 H 120 cm

3 SHELVES STAND ALONE STORAGE L 120 H 120 cm

STORAGE PRECOMPOSTI CROSSTRAINING
CROSSTRAINING PRE-CONFIGURED STORAGES

COD. ECB-3R105



COD. RB-3R105

Ampiezza utile di stivaggio 105 cm.
Dimensioni 66 x 120 H.120 cm.
Composto da 2x G75-M120 + 3x AGU-V105

Storage space 105 cm.
Dimensions 66 x 120 H.120 cm.
Made up of 2x G75-M120 +
3x AGU-V105



COD. RB-3R105

COD. ECB-3R105

Campata aggiuntiva per storage RB-3R105
Ampiezza utile di stivaggio 105 cm.
Dimensioni 66 x 112,5 H.120 cm.
Composto da 1x G75-M120 + 3x AGU-V105

Storage space 105 cm.
Dimensions 66 x 112,5 H.120 cm.
Made up of 1x G75-M120 +
3x AGU-V105



STORAGE AUTOPORTANTE A 3 RIPIANI L 183 H 120 cm

3 SHELVES STAND ALONE STORAGE L 183 H 120 cm

STORAGE PRECOMPOSTI CROSSTRAINING
CROSSTRAINING PRE-CONFIGURED STORAGES



COD. ECB-3R168



COD. RB-3R168

COD. RB-3R168

Ampiezza utile di stivaggio 168 cm.
Dimensioni 66 x 183 H.120 cm.
Composto da 2x G75-M120 + 3x AGU-V168

Storage space 168 cm.
Dimensions 66 x 183 H.120 cm.
Made up of 2x G75-M120 +
3x AGU-V168

COD. ECB-3R168

Campata aggiuntiva per storage RB-3R168
Ampiezza utile di stivaggio 168 cm.
Dimensioni 66 x 175,5 H.120 cm.
Composto da 1x G75-M120 + 3x AGU-V168

Storage space 168 cm.
Dimensions 66 x 175,5 H.120 cm.
Made up of 1x G75-M120 +
3x AGU-V168

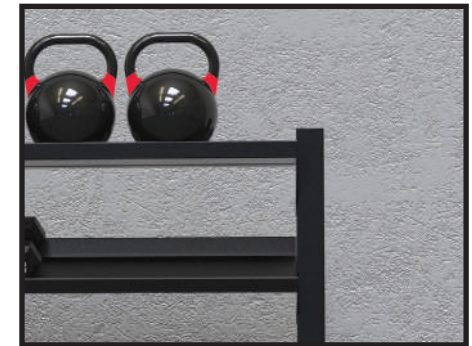

STORAGE AUTOPORTANTE A 4 RIPIANI L 120 H 180 cm

4 SHELVES STAND ALONE STORAGE L 120 H 180 cm

STORAGE PRECOMPOSTI CROSSTRaining
CROSSTRaining PRE-CONFIGURED STORAGES



COD. RA-4R105

COD. ECA-4R105



COD. RA-4R105

Ampiezza utile di stivaggio 105 cm.
Dimensioni 66 x 120 H.180 cm.
Composto da 2x G75-M180 + 4x AGU-V105

Storage space 105 cm.
Dimensions 66 x 120 H.180 cm.
Made up of 2x G75-M180 +
4x AGU-V105

COD. ECA-4R105

Campata aggiuntiva per storage RA-4R105
Ampiezza utile di stivaggio 105 cm.
Dimensioni 66 x 112,5 H.180 cm.
Composto da 1x G75-M180 + 4x AGU-V105

Storage space 105 cm.
Dimensions 66 x 112,5 H.180 cm.
Made up of 1x G75-M180 +
4x AGU-V105

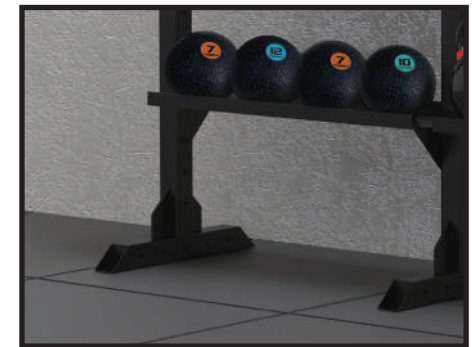

STORAGE AUTOPORTANTE A 4 RIPIANI L 183 H 180 cm

4 SHELVES STAND ALONE STORAGE L 183 H 180 cm

STORAGE PRECOMPOSTI CROSSTRAINING
CROSSTRAINING PRE-CONFIGURED STORAGES



COD. RA-4R168

COD. ECA-4R168



COD. RA-4R168

Ampiezza utile di stivaggio 168 cm.
Dimensioni 66 x 183 H.180 cm.
Composto da 2x G75-M180 + 4x AGU-V168

Storage space 168 cm.
Dimensions 66 x 183 H.180 cm.
Made up of 2x G75-M180 +
4x AGU-V168

COD. ECA-4R168

Campata aggiuntiva per storage RA-4R168
Ampiezza utile di stivaggio 168 cm.
Dimensioni 66 x 175,5 H.180 cm.
Composto da 1x G75-M180 + 4x AGU-V168

Storage space 168 cm.
Dimensions 66 x 175,5 H.180 cm.
Made up of 1x G75-M180 +
4x AGU-V168

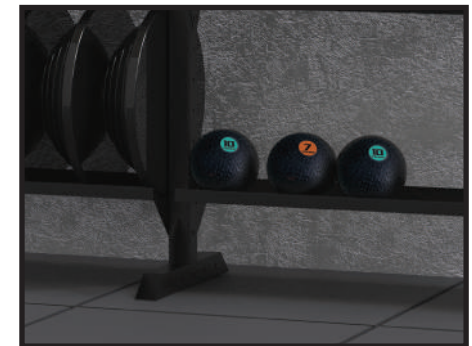

ACCESSORI GABBIE-STORAGE - RIGS-STORAGES ACCESSORIES

**VASSOIO 105
105 SHELF**

cod. AGU-V105

- Per serie CHALLENGE e MASTER
- Lunghezza 1038 mm - Profondità 330 mm - Spessore 2 mm
- 2 staffe di sostegno incluse
- Foratura staffe \varnothing 13 mm - passo 10 cm. La doppia foratura consente di fissare il vassoio in posizione parallela a terra o inclinata, per riporre i manubri
- Completare il montaggio con una barra pull up 105
- 4 set viteria inclusi

- For CHALLENGE and MASTER series
- Length 1038 mm - Width 330 mm - Thickness 2 mm
- 2 brackets included
- Brackets with \varnothing 13 mm holes - 10 cm step. The double holes allow to assemble the shelf in both a straight or inclined position, to stock the dumbbells
- Complete the assembling with a 105 pull up bar
- 4 sets of screws included



**VASSOIO 168
168 SHELF**

cod. AGU-V168

- Per serie CHALLENGE e MASTER
- Lunghezza 1668 mm - Profondità 330 mm - Spessore 2 mm
- 3 staffe di sostegno incluse
- Foratura staffe \varnothing 13 mm - passo 10 cm. La doppia foratura consente di fissare il vassoio in posizione parallela a terra o inclinata, per riporre i manubri
- Completare il montaggio con una barra pull up 168
- 4 set viteria inclusi

- For CHALLENGE and MASTER series
- Length 1668 mm - Width 330 mm - Thickness 2 mm
- 3 brackets included
- Brackets with \varnothing 13 mm holes - 10 cm step. The double holes allow to assemble the shelf in both a straight or inclined position, to stock the dumbbells
- Complete the assembling with a 168 pull up bar
- 4 sets of screws included



**DIVISORE
DIVIDER**

cod. AGU-D

- Accessorio vassoio 105 e 168
- Sezione circolare \varnothing 10 mm
- Profondità 337 mm
- Separatore dischi peso
- 1 set viteria incluso

- 105 and 168 shelves accessory
- Round tube \varnothing 10 mm
- width 337mm
- Weight plates divider
- 1 set of screws included



**GANCIO
HOOK**

cod. AGU-G

- Per serie CHALLENGE e MASTER
- Sezione circolare \varnothing 12 mm
- Lunghezza gancio 300 mm
- Foratura su due lati - \varnothing 13 mm passo 10 cm
- 2 set viteria inclusi

- For CHALLENGE and MASTER series
- Round tube \varnothing 12 mm
- Hook length 300 mm
- \varnothing 13 mm holes on both side - 10 cm step
- 2 sets of screws included



**PORTA DISCHI BODY PUMP
BODY PUMP WEIGHT PLATES HOLDER**

cod. AGU-PDBP

- Per serie CHALLENGE e MASTER
- Sezione circolare \varnothing 29 mm
- Spessore 2 mm
- Lunghezza 250 mm
- Utilizzabili per dischi con foro da \varnothing 30 mm
- 2 set viteria inclusi

- For CHALLENGE and MASTER series
- Round tube \varnothing 29 mm
- Thickness 2 mm
- Length 250 mm
- Suitable for weight plates with \varnothing 30 mm hole
- 2 sets of screws included



**PORTA DISCHI OLIMPIONICI
OLYMPIC WEIGHT PLATES HOLDER**

cod. AGU-PDO

- Per serie CHALLENGE e MASTER
- Sezione circolare \varnothing 49 mm
- Spessore 3 mm
- Lunghezza 400 mm
- Utilizzabili per dischi con foro da \varnothing 50 mm
- 2 set viteria inclusi

- For CHALLENGE and MASTER series
- Round tube \varnothing 49 mm
- Thickness 3 mm
- Length 400 mm
- Suitable for weight plates with \varnothing 50 mm hole
- 2 sets of screws included



ACCESSORI GABBIE-STORAGE - RIG - STORAGE ACCESSORIES

MONTANTE 120

UPRIGHT 120

cod. G75-M120

- Sezione quadrata 75x75x3,2 mm
- Altezza 120 cm
- Foratura su due lati - \varnothing 13 mm passo 10 cm
- Piastra di base per collegamento a terra 660x75x3,2 mm

- Square tube 75x75x3,2 mm
- Height 120 cm
- \varnothing 13 mm holes on both sides - 10 cm step
- Base plate for connecting to the floor 660x75x3,2 mm



MONTANTE 180

UPRIGHT 180

cod. G75-M180

- Sezione quadrata 75x75x3,2 mm
- Altezza 180 cm
- Foratura su due lati - \varnothing 13 mm passo 10 cm
- Piastra di base per collegamento a terra 660x75x3,2 mm

- Square tube 75x75x3,2 mm
- Height 180 cm
- \varnothing 13 mm holes on both sides - 10 cm step
- Base plate for connecting to the floor 660x75x3,2 mm





OUTDOOR RIGS
CROSSTRAINING & FUNCTIONAL



MASTER HEXAGON OUTDOOR

cod. GO75-HEX

Gabbia MASTER HEXAGON

OUTDOOR 75x75x3,2 mm

HEXAGON MASTER OUTDOOR

rig 75x75x3,2 mm

STRUTTURE PRECOMPOSTE FUNCTIONAL
FUNCTIONAL PRE-CONFIGURED RIGS



STRUTTURA PRINCIPALE:

- Trattamento di zincatura elettrolitica e verniciatura a polveri epossidiche color arancio per utilizzo outdoor
- Tubolare sezione quadrata 75x75x3,2 mm
- 1 coppia di appoggi bilanciere inclusa

MAIN STRUCTURE:

- Electrolytic galvanizing treatment and heavy-duty powder coating painting - orange colour - for outdoor use
- Square tube section 75x75x3,2 mm
- 2 j-cups included

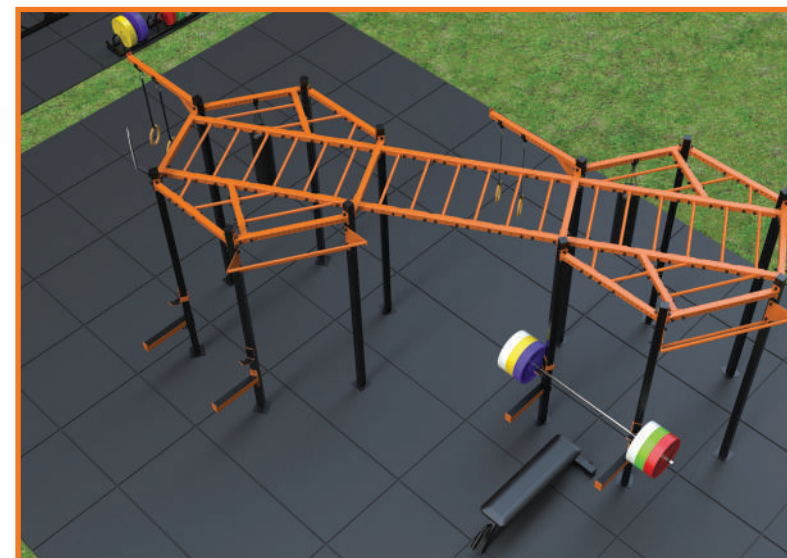

ELEMENTI STRUTTURALI OUTDOOR - OUTDOOR RIGS COMPONENTS

**STRUTTURE PRECOMPOSTE
CROSS TRAINING OUTDOOR
OUTDOOR CROSSTRaining
PRE CONFIGURED RIGS**

cod. G075-1A

Informazioni dettagliate su questa struttura a pag 195
Detailed info about this rig at page 195

cod. G075-1AMS

Informazioni dettagliate su questa struttura a pag 195
Detailed info about this rig at page 195

cod. G075-2A

Informazioni dettagliate su questa struttura a pag 197
Detailed info about this rig at page 197

cod. G075-2AMS

Informazioni dettagliate su questa struttura a pag 197
Detailed info about this rig at page 197

cod. G075-3A

Informazioni dettagliate su questa struttura a pag 199
Detailed info about this rig at page 199

cod. G075-3AMS

Informazioni dettagliate su questa struttura a pag 199
Detailed info about this rig at page 199

cod. G075-4A

Informazioni dettagliate su questa struttura a pag 201
Detailed info about this rig at page 201

cod. G075-4AMS

Informazioni dettagliate su questa struttura a pag 201
Detailed info about this rig at page 201

cod. G075-5A

Informazioni dettagliate su questa struttura a pag 203
Detailed info about this rig at page 203

cod. G075-5AMS

Informazioni dettagliate su questa struttura a pag 203
Detailed info about this rig at page 203

**MONTANTE 90 MASTER
90 UPRIGHT MASTER
cod. G075-M90**

- Trattamento di zincatura elettrolitica e verniciatura a polveri epossidiche color arancio per utilizzo outdoor
- Altezza 90 cm
- Per serie MASTER OUTDOOR - Sezione 75x75x3,2 mm
- Consente di prolungare il montante G075-M360, aumentandone l'altezza da 360 a 450 cm, e creare una postazione da arrampicata
- Da utilizzare unitamente al profilo di connessione incluso
- Profilo di connessione 68x68x6 mm
- 10 set viteria inclusi



- Electrolytic galvanizing treatment and heavy-duty powder coating painting - orange colour - for outdoor use
- Height 90cm
- For MASTER OUTDOOR series - Section 75x75x3,2 mm
- Allows to extend the upright G075-M360, increasing its height from 360 to 450 cm, and create a climbing station
- To be used together with the included connectors
- Connector section 68x68x6 mm
- 10 sets of screws included

**MONTANTE 360 - MASTER OUTDOOR
360 UPRIGHT - MASTER OUTDOOR
cod. G075-M360**

- Trattamento di zincatura elettrolitica e verniciatura a polveri epossidiche color arancio per utilizzo outdoor - Altezza 360 cm
- Per serie MASTER OUTDOOR - Sezione 75x75x3,2 mm
- Collegamento profili secondari e accessori Foratura ø 13 mm. passo 10 cm.
- Collegamento fermi di sicurezza, supporti bilanciari e parallele Foratura ø 17 mm. passo 5/10 cm.
- Numeri di riferimento (0-20) incisi al laser
- Collegamento a terra- Piastra di base 160x160 mm. spessore 6 mm.



- Electrolytic galvanizing treatment and heavy-duty powder coating painting - orange colour - for outdoor use - Height 360cm
- For MASTER OUTDOOR series - Section 75x75x3,2 mm
- Connection with beams, bars and accessories ø 13mm holes - 10cm step
- Connection with safety spotter arms, J-cups and dip horns ø 17mm holes - 5/10cm step
- Laser-engraved reference numbers (0-20)
- Connection to the ground
- Base plate 160x160 mm. Thickness 6 mm.

**MONTANTE 270 - MASTER OUTDOOR
270 UPRIGHT - MASTER OUTDOOR
cod. G075-M270**

- Trattamento di zincatura elettrolitica e verniciatura a polveri epossidiche color arancio per utilizzo outdoor - Altezza 270 cm
- Per serie MASTER OUTDOOR - Sezione 75x75x3,2 mm
- Collegamento profili secondari e accessori Foratura ø 13 mm. passo 10 cm.
- Collegamento fermi di sicurezza, supporti bilanciari e parallele Foratura ø 17 mm. passo 5/10 cm
- Numeri di riferimento (0-20) incisi al laser
- Collegamento a terra
- Piastra di base 160x160 mm. spessore 6 mm



- Electrolytic galvanizing treatment and heavy-duty powder coating painting- orange colour - for outdoor use - Height 270cm
- For MASTER OUTDOOR series - Section 75x75x3,2mm
- Connection with beams, bars and accessories ø 13mm holes - 10cm step
- Connection with safety spotter arms, J-cups and dip horns ø 17mm holes - 5/10cm step
- Laser-engraved reference numbers (0-20)
- Connection to the ground
- Base plate 160x160 mm. Thickness 6 mm

**PROFILO DI IRRIGIDIMENTO 105 - MASTER OUTDOOR
105 BEAM - MASTER OUTDOOR
cod. G075-P105**

- Trattamento di zincatura elettrolitica e verniciatura a polveri epossidiche color arancio per utilizzo outdoor
- Per serie MASTER OUTDOOR
- Lunghezza 105 cm
- Sezione 60x60x3,2 mm
- Foratura su due lati - ø 13 mm. - passo 10 cm.
- Viteria
- 4 set inclusi.



- Electrolytic galvanizing treatment and heavy-duty powder coating painting - orange colour - for outdoor use
- For MASTER OUTDOOR series
- Length 105cm
- Section 60x60x3,2mm
- ø 13mm holes on both side - 10cm step
- Screws
- 4 sets of screws included

ELEMENTI STRUTTURALI OUTDOOR - OUTDOOR RIGS COMPONENTS

PROFILO DI IRRIGIDIMENTO 168 - MASTER OUTDOOR
168 BEAM - MASTER OUTDOOR
cod. G075-P168

- Trattamento di zincatura elettrolitica e verniciatura a polveri epossidi
- Per serie MASTER OUTDOOR
- Lunghezza 168 cm
- Sezione 60x60x3,2 mm
- Foratura su due lati - ø 13 mm. - passo 10 cm. Viteria
- 4 set inclusi

- Electrolytic galvanizing treatment and heavy-duty powder coating painting - orange colour - for outdoor use
- For MASTER OUTDOOR series
- Length 168cm
- Section 60x60x3,2mm
- ø 13mm holes on both side - 10cm step
- Screws
- 4 sets of screws included



PROFILO OBLIQUO SLANTING FLY ARM MASTER OUTDOOR
cod. G075-TO (1pz. / 1pc.)

- Trattamento di zincatura elettrolitica e verniciatura a polveri epossidi
- Sezione 60x60x3,2 mm
- Funzione
- Profilo a sbalzo utilizzabile singolarmente in abbinamento al gancio per appendere sacco boxe o corda da arrampicata. In coppia costituisce il telaio per comporre Monkey Station a 45°. Se collegato con le staffe dedicate (AG60-SQ e AG75-SQ), consente di unire montanti di altezza diversa (vedere pag. 211-213)
- Viteria: 2 set inclusi

- Electrolytic galvanizing treatment and heavy-duty powder coating painting - orange colour - for outdoor use
- Section 60x60x3,2 mm
- Purpose
- Fly arm usable to match the hook to hang a boxing bag or a climbing rope. Two fly arms compose the frame to create a Monkey Station at 45°. If connected with the dedicated brackets (AG60-SQ e AG75-SQ), the fly arm allows to connect different heights uprights (see on page 211-213)
- Screws: 2 sets of screws included



PROFILO OBLIQUO SLANTING FLY ARM MASTER OUTDOOR
cod. G075-T02 (2pz. / 2pcs.)

- Trattamento di zincatura elettrolitica e verniciatura a polveri epossidi
- Sezione 60x60x3,2 mm
- Funzione
- Profilo a sbalzo utilizzabile singolarmente in abbinamento al gancio per appendere sacco boxe o corda da arrampicata. In coppia costituisce il telaio per comporre Monkey Station a 45°. Se collegato con le staffe dedicate (AG60-SQ e AG75-SQ), consente di unire montanti di altezza diversa (vedere pag. 211-213)
- Viteria: 2 set inclusi

- Electrolytic galvanizing treatment and heavy-duty powder coating painting - orange colour - for outdoor use
- Section 60x60x3,2 mm
- Purpose
- Fly arm usable to match the hook to hang a boxing bag or a climbing rope. Two fly arms compose the frame to create a Monkey Station at 45°. If connected with the dedicated brackets (AG60-SQ e AG75-SQ), the fly arm allows to connect different heights uprights (see on page 211-213)
- Screws: 2 sets of screws included





ELEMENTI STRUTTURALI MASTER HEXAGON OUTDOOR - MASTER HEXAGON OUTDOOR RIGS COMPONENTS

**DOPPIA BARRA PULL UP PER GABBIA MASTER HEXAGON OUTDOOR
DOUBLE PULL UP BAR FOR HEXAGON MASTER OUTDOOR RIG
cod. GOHEX-DB**

- Trattamento di zincatura elettrolitica e verniciatura a polveri epossidiche color arancio per utilizzo outdoor
 - Per serie Master Hexagon Outdoor
 - Lunghezza barra superiore 128 cm
 - Lunghezza barra inferiore 100 cm
 - Sezione circolare \varnothing 32 mm
 - Funzione
- Barre per trazioni e muscle up
- Viteria: 4 set inclusi



- Electrolytic galvanizing treatment and heavy-duty powder coating painting - orange colour - for outdoor use
 - For Hexagon Master Outdoor series
 - Length upper bar 128 cm
 - Length lower bar 100 cm
 - Round tube \varnothing 32mm
 - Purpose
- Suitable for pulling up and muscle up
- Screws: 4 sets of screws included

**PROFILO DI IRRIGIDIMENTO 187 PER GABBIA MASTER HEXAGON OUTDOOR
187 BEAM FOR HEXAGON MASTER OUTDOOR RIG
cod. GUO-P187**

- Trattamento di zincatura elettrolitica e verniciatura a polveri epossidiche color arancio per utilizzo outdoor
 - Per serie Master Hexagon Outdoor
 - Lunghezza 187 cm
 - Sezione 60x60x3,2 mm
 - Foratura su due lati - \varnothing 13 mm. - passo 10 cm.
 - Funzione
- Utilizzabili a coppia per unire 2 o più gabbie Master Hexagon Outdoor
- Viteria: 4 set inclusi



- Electrolytic galvanizing treatment and heavy-duty powder coating painting - orange colour - for outdoor use
 - For Hexagon Master Outdoor series
 - Length 187 cm
 - Section 60x60x3,2mm
 - \varnothing 13mm holes on both side - 10cm step
 - Purpose
- Suitable to connect 2 or more Hexagon Master Outdoor rigs
- Screws: 4 sets of screws included



**BARRA PULL UP 74 PER GABBIA MASTER HEXAGON OUTDOOR
74 PULL UP BAR FOR HEXAGON MASTER OUTDOOR RIG
cod. GUO-B74**

- Trattamento di zincatura elettrolitica e verniciatura a polveri epossidiche color arancio per utilizzo outdoor
 - Per serie Master Hexagon Outdoor
 - Lunghezza 74 cm
 - Sezione circolare \varnothing 32 mm
 - Funzione
- Barra per trazioni utilizzabile tra due profili orizzontali GUO-P187 per comporre Monkey Station
- Viteria: 4 set inclusi



- Electrolytic galvanizing treatment and heavy-duty powder coating painting - orange colour - for outdoor use
 - For Hexagon Master Outdoor series
 - Length 74 cm
 - Round tube \varnothing 32 mm
 - Purpose
- Suitable for pulling up, can be used among two GUO-P187 beams to create an horizontal Monkey Station.
- Screws: 4 sets of screws included

ACCESSORI MASTER HEXAGON OUTDOOR - MASTER HEXAGON OUTDOOR ACCESSORIES

COPPIA SUPPORTI BILANCIERE PER GABBIA MASTER HEXAGON OUTDOOR

J-CUPS FOR HEXAGON MASTER OUTDOOR RIG

cod. AGOHEX-SB

- Trattamento di zincatura elettrolitica e verniciatura a polveri epossidiche color arancio per utilizzo outdoor
- Per serie Master Hexagon Outdoor
- Sezione 75x75x3,2 mm
- Spessore 8 mm
- Pin di connessione ø 16 mm
- Dotati di protezioni.

- Electrolytic galvanizing treatment and heavy-duty powder coating painting - orange colour - for outdoor use
- For Hexagon Master Outdoor series
- 75x75x3,2 mm tube
- Thickness 8 mm
- ø 16 mm fixing pin
- Protection pads included



COPPIA FERMI DI SICUREZZA BILANCIERE PER GABBIA MASTER HEXAGON OUTDOOR

SAFETY SPOTTER ARMS FOR HEXAGON MASTER OUTDOOR RIG

cod. AGOHEX-FS

- Trattamento di zincatura elettrolitica e verniciatura a polveri epossidiche color arancio per utilizzo outdoor
- Per serie Master Hexagon Outdoor
- Sezione 75x75x3,2 mm
- Spessore 8 mm
- Pin di connessione ø 16 mm
- Dotati di protezioni e Pin di sicurezza diam. 16 mm

- Electrolytic galvanizing treatment and heavy-duty powder coating painting - orange colour - for outdoor use
- For Hexagon Master Outdoor series
- 75x75x3,2 mm tube
- Thickness 8 mm
- ø 16 mm fixing pin
- Protection pads and ø 16 mm safety pin included.

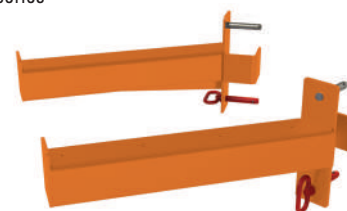

COPPIA SUPPORTI BILANCIERE MASTER OUTDOOR

J-CUPS MASTER OUTDOOR

cod. AGO75-SB

- Trattamento di zincatura elettrolitica e verniciatura a polveri epossidiche color arancio per utilizzo outdoor
- Per serie MASTER OUTDOOR - Sezione 75x75x3,2 mm
- Spessore 8 mm
- Pin di connessione ø 16 mm
- Dotati di protezioni

- Electrolytic galvanizing treatment and heavy-duty powder coating painting - orange colour - for outdoor use
- For MASTER OUTDOOR series - 75x75x3,2 mm tube
- Thickness 8 mm
- ø 16 mm fixing pin
- Protection pads included



TOORX

PROFESSIONAL LINE

ESEMPIO DI CONFIGURAZIONE GABBIA - EXAMPLE OF RIG



POWER RACK

WLX3800

cod. WLX-3800



cod. D-HANDLEASX8-WLX38

PARALLELE
DIP HANDLE
OPTIONAL



cod. KIT-SMTWLX-3800

KIT SMITH MACHINE
SMITH MACHINE KIT
OPTIONAL

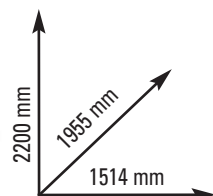

RACKS

BILANCIERI Altezza j-cup regolabile (362-1712 mm) su 26 livelli. Interasse 50 mm J-cup spessore 5 mm con protezione UHMW
DIMENSIONI PRODOTTO: 1514X1955X2200 mm
PESO MAX STRUTTURA 350 Kg
PESO MAX UTILIZZATORE 160 Kg
PESO: 130,6 kg
CLASSE D'UTILIZZO PROFESSIONALE (EN20957-1 / EN957-4 classe S)

BARBELLS J-cup height adjustable (362-1712 mm) su 26 livelli. Distance 50 mm J-cup 5 mm thickness with UHMW protection pads
SET UP SIZE: 1514X1955X2200 mm
MAX STRUCTURE WEIGHT 350 kg
MAX USER WEIGHT 160 kg
WEIGHT: 130,6 kg
COMMERCIAL USE (EN20957-1 / EN957-4 class S)

- Struttura tubolare a sezione quadrata 75x75 mm - spessore 3 mm
- Verniciatura doppia a polveri epossidiche, antigraffio.
- Dotazioni/notes: 2 J-hooks, coppia fermi di sicurezza bilanciere, barra trazioni multi-presa, porta bilanciere, 4 porta dischi ø50 mm, 6 ferma dischi a molla ø49 mm.

- Structure section square tube 75x75 mm - thickness 3 mm
- Painting double heavy duty powder coating painting, scratch-resistant
- Equipment/notes: 2 J-hooks, 2 safety spotter arms, multi-grip chin-up bar, barbell storage, 4 weight plates holders for ø50 mm plates, 6 olympic spring clip ø49 mm.

KIT SMITH MACHINE PER WLX-3800 OPTIONAL

- Peso massimo caricabile 250 Kg.
- Peso 74 kg.
- Bilanciere: 1996 mm, scorrimento su cuscinetto lineare ultra fluido per guida bilanciere Smith, 2 sicurezze con gancio. Diametro porta dischi da 50 mm.
- Peso massimo utilizzatore: 160 Kg
- Dotazioni/notes: smith bar, 2 glide rods, 28 hooks stop

SMITH MACHINE KIT FOR WLX-3800 OPTIONAL

- Max loadable weight 250 Kg.
- Weight 74 kg.
- Barbells: 1996mm, ultra smooth linear bearing for smith bar guliding, 2 safety systems with hook to avoid barbell falling. Weight plate holder diameter suitable for ø50 mm weight plates.
- Max user weight: 160 Kg
- Equipment/notes: smith bar, 2 glide rods, 28 hooks stop

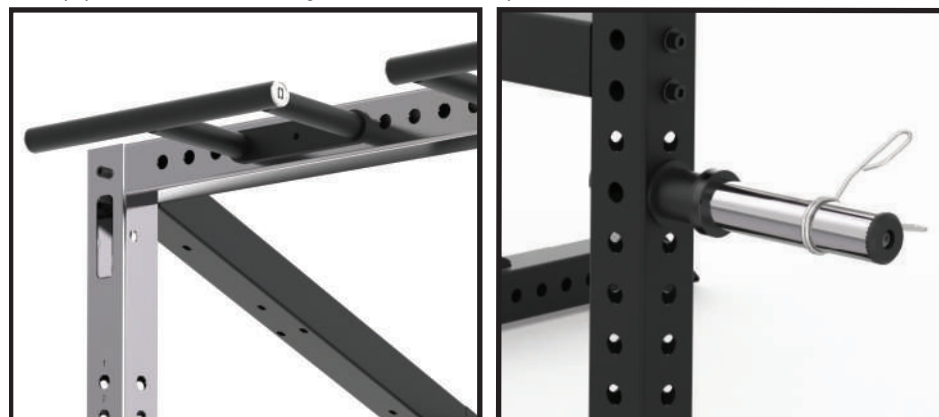

POWER RACK

WLX3600

cod. WLX-3600

TRALICCIO TRAZIONI
MULTIPRESA

TRUSS WITH MULTIPLE HANDLES



cod. LAT-ATTWLX-3600

OPTIONAL
LAT/ PULLDOWN/
SEATED ROW MACHINE

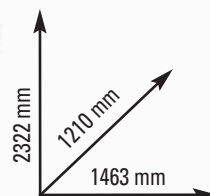

RACKS

BILANCIERI Altezza j-cup regolabile (450-1890 mm) su 25 livelli.
Interasse 60 mm J-cup spessore 6 mm con protezione UHMW
DIMENSIONI PRODOTTO: 1463x1210x2322 mm
PESO MAX STRUTTURA 300 Kg
PESO: 132 kg
CLASSE D'UTILIZZO PROFESSIONALE (EN20957-1 / EN957-4 classe S)

BARBELLS J-cup height adjustable (450-1890 mm) on 25 levels.
Distance 60 mm J-cup 6 mm thickness with UHMW protection pads
SET UP SIZE 1463x1210x2322 mm
MAX STRUCTURE WEIGHT 300 kg
WEIGHT: 132 kg
COMMERCIAL USE (EN20957-1 / EN957-4 class S)

- Struttura tubolare in acciaio rinforzato a sezione 75x75 mm - spessore 3 mm
- Verniciatura doppia a polveri epossidiche, antigraffio .
- Dotazione: 2 j-cups, 2 safety bars, traliccio trazioni

- Structure square heavyduty steel tubing 75x75 mm - thickness 3 mm
- Painting double heavy duty powder coating painting, scratch-resistant
- Equipment: 2 j-cups, 2 safety bars, truss with multiple-handle.

LAT/ PULLDOWN/ SEATED ROW MACHINE **OPTIONAL**.

- Peso max caricabile 160 kg.
- Caricamento a dischi con foro \varnothing 25 mm e \varnothing 50 mm.
- Sistema di carrucole /puleggie con cuscinetti a sfera.
- Dotazioni/note: lat bar, barra tricipiti, poggia piedi per seated row, adattatore per utilizzo dischi in ghisa con foro \varnothing 50 mm inclusi.

- Max loadable weight 160 Kg.
- For weight plates with 25 mm and 50 mm diameter hole.
- Pulleys system with ball bearings.
- Equipment/note: lat bar, triceps bar, foot supports for seated row, adapter for weight plates with 50 mm diameter hole included.



HALF RACK

WLX3400

cod. WLX-3400

TRALICCIO TRAZIONI
MULTIPRESA

TRUSS WITH MULTIPLE HANDLES

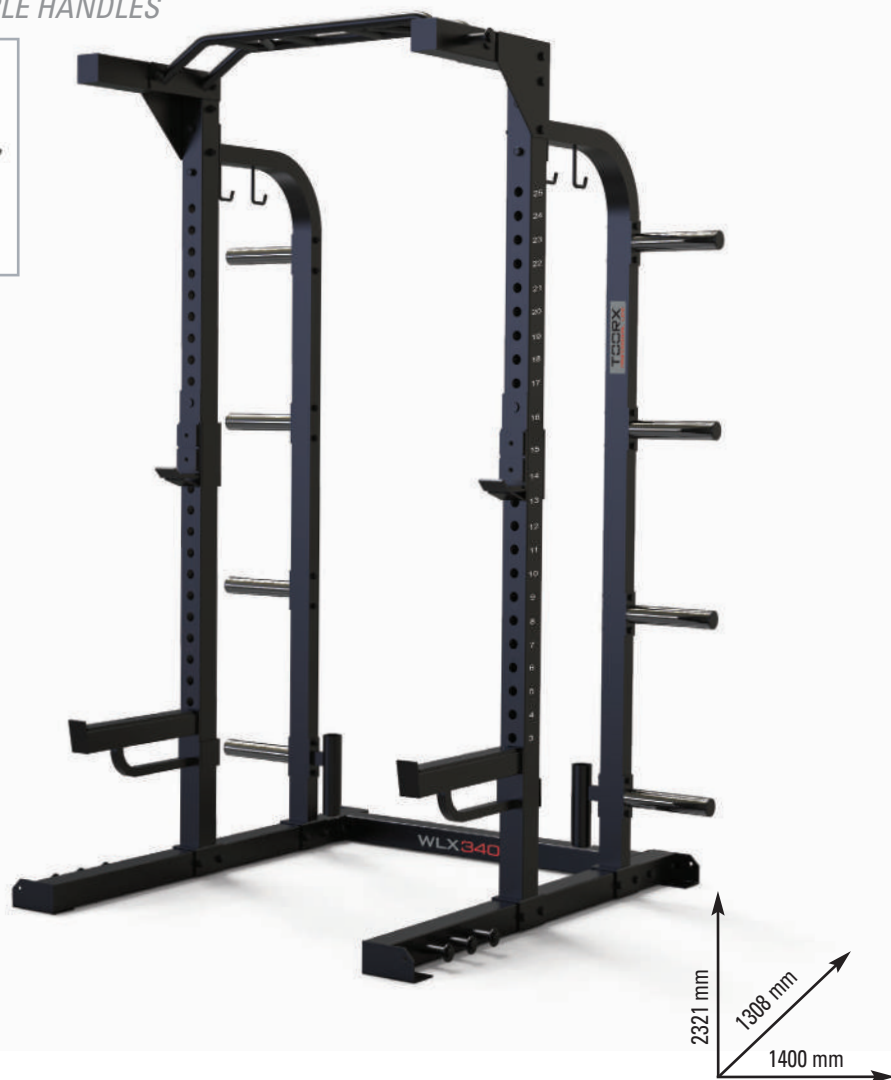

RACKS

BILANCIERI Altezza j-cup/safety spotter arm regolabile (450-1890 mm) su 25 livelli. Interasse 60 mm j-cup/spotter arm spessore 6 mm con protezione UHMW
DIMENSIONI PRODOTTO: 1400x1308x2321 mm
PESO MAX STRUTTURA 300 Kg
PESO: 105 kg
CLASSE D'UTILIZZO PROFESSIONALE (EN20957-1 / EN957-2 classe S)

BARBELLS j-cup/ safety spotter arm height adjustable (450-1890 mm) on 25 levels. Distance 60 mm j-cup/safety spotter arm 6 mm thickness with UHMW protection pads
SET UP SIZE 1400x1308x2321 mm
MAX STRUCTURE WEIGHT 300 kg
WEIGHT: 105 kg
COMMERCIAL USE (EN20957-1 / EN957-2 class S)

- Struttura tubolare in acciaio rinforzato a sezione 75x75 mm - spessore 3 mm
- Verniciatura doppia a polveri epossidiche, antigraffio .
- Dotazione: 2 j-cups, 2 safety spotter arms, 8 barre porta pesi, 2 porta bilancieri, 8 barre in acciaio per fasce elastiche, 4 ganci per elastici, traliccio trazione
- Structure square heavyduty steel tubing 75x75 mm - thickness 3 mm
- Painting double heavy duty powder coating painting, scratch-resistant
- Equipment: 2 j-cups, 2 safety spotter arms, 8 weight plates holders, 2 barbell holders, 8 steel bars for resistance bands, 4 hooks for resistance bands, truss with multiplehandle







contact@toorxprofessional.it

www.toorxprofessional.it

TOORX® è un marchio di proprietà di / *is a brand of*

Garlando S.p.A.

Via Regione Piemonte, 32 - Zona Ind. D1

15068 Pozzolo Formigaro (AL) - Italy

Tel. +39.0143.318500

Fax +39.0143.318585