

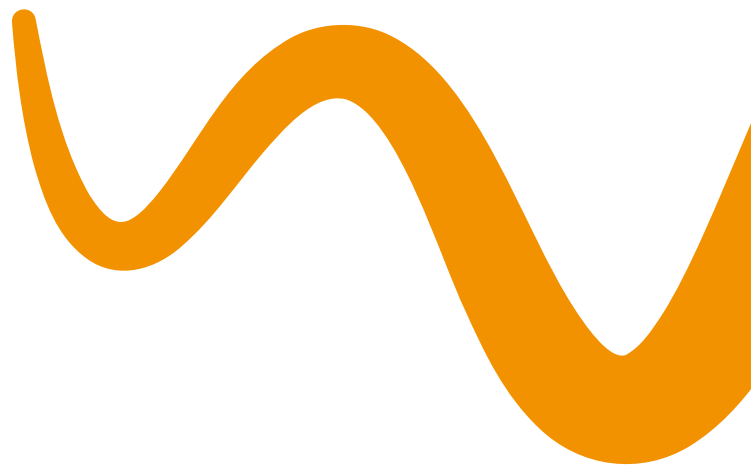

# CLOSE TO YOU

2024 GENERAL CATALOGUE

**Think BIC**



YOU JUST IMAGINE,  
WE MAKE IT REAL.



**THINK BIC**

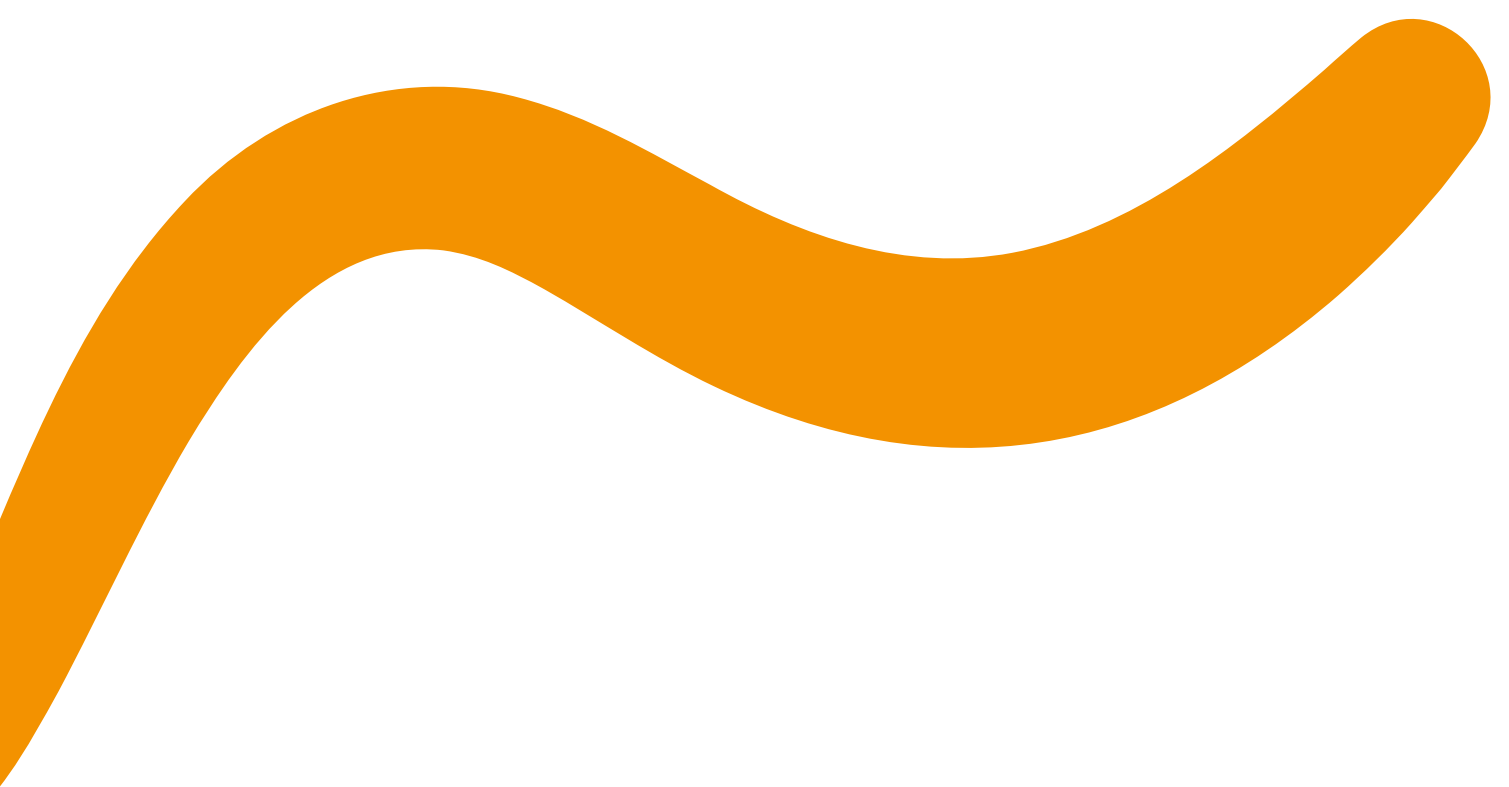

---

# CLOSE TO YOU

---

We were there beside you as you took your first steps in this world. From the moment your doodling became words to the time you lit those special birthday candles, BIC has shared your journey, filling your everyday moments with joy, creativity, and sustainability. As life moves forward, we innovate to remain your trustworthy daily life companion.

Our commitment to innovation leads the way with each step forward in life. We're constantly seeking new ways to simplify your daily routines and add more joy to your journey. Sustainability is our legacy. We're committed to protecting our planet for future generations while considering your values.

This philosophy forms the foundation of everything we do at BIC Graphic. We've forged strong bonds with every person and company we engage with. Our local teams understand your unique needs, crafting high-quality products tailored just for you. We're not just a brand; we're your dedicated partner.

**Close to you** signifies our dedication to delivering quality and sustainability tailored to your needs through our European-made solutions, predominantly sourced from France and Spain. Our local production guarantees both proximity and accessibility, fostering an interconnected network.

Let's continue building this strong partnership where innovation, iconic simplicity and sustainability thrive while reflecting your uniqueness.





## BIC GRAPHIC

6

Our Values	6	Sustainable Actions	24
Our Legacy	8	Sustainable Products	30
Olympic Games	12	Corporate Social Responsibility	34
Your trusted companion	14	Novelties 2024	36
Iconic	16	Printing Techniques	38
Innovative	18	Full Colour britepix™ Digital Range	40
Sustainability	20	Bic® Collection boxes	42

## BIC® WRITING INSTRUMENTS

44

### BALLPENS

BIC® Style	46	BIC® 4 Colours® Flags Collection	136
BIC® Round Stic®	50	BIC® 4 Colours® 3+1 <sup>HB</sup>	138
BIC® M10® Clic	56	<b>METALLIC PENS</b>	
BIC® Media Clic	58	BIC® Metal Pro	140
BIC® Media Clic Grip	63	BIC® Cristal® Re'New™	145
BIC® Media Clic BGuard™ antibacterial	67	<b>ROLLERS AND GELS</b>	
BIC® Media Clic BGuard™ antimicrobial Ecolutions®	70	BIC® Grip Roller	150
BIC® Media Clic Biobased Ecolutions®	72	BIC® XS Finestyle	152
BIC® Media Clic Biobased BGuard™ antibacterial	75	BIC® Intensity® Gel Clic	154
BIC® Media Clic Shine	77	<b>HIGHLIGHTERS AND MARKERS</b>	
BIC® Media Clic Glacé	78	BIC® Brite Liner® Grip	158
BIC® Clic Stic	80	BIC® Velleda® White Board Marker Fine	160
BIC® Clic Stic Stylus	84	BIC® Velleda® White Board Marker Grip	161
BIC® Clic Stic Mini	84	BIC® Mark-It Permanent Marker	162
BIC® Super Clip	88	BIC® Permanent Marker Ecolutions®	163
BIC® Super Clip Advance	94	<b>MECHANICAL PENCILS</b>	
BIC® Super Clip Glacé	98	BIC® Matic®	166
BIC® Super Clip Glacé Advance	98	BIC® Media Clic Mechanical pencil	168
BIC® Super Clip Soft	100	BIC® Media Clic Grip Mechanical pencil	169
BIC® Super Clip Soft Advance	100	<b>PENCILS</b>	
BIC® Super Clip Origin	102	BIC® Evolution® Ecolutions®	174
BIC® Wide Body™	104	Sprout™ Graphite pencil	178
BIC® 4 Colours®	112		
BIC® 4 Colours® Bicolor	114		
BIC® 4 Colours® Gradient	116		
BIC® 4 Colours® Pastel	118		
BIC® 4 Colours® Fashion	120		
BIC® 4 Colours® Sun	122		
BIC® 4 Colours® Fine	124		
BIC® 4 Colours® Fluo	126		
BIC® 4 Colours® Shine	128		
BIC® 4 Colours® Glacé	130		
BIC® 4 Colours® Soft	132		
BIC® 4 Colours® Wood Style	134		

---

## **OTHER WRITING INSTRUMENTS 180**

### **PLASTIC PENS**

Basic Pen	182
Click Pen	184
Striped Grip Pen	186

### **STYLUS PENS**

Sleek Stylus Pen	188
------------------	-----

---

## **NOTEBOOKS 190**

### **ROCKETBOOK®**

Rocketbook® Core Executive A5	194
Rocketbook® Fusion Executive A5	196
Rocketbook® Core Mini A6	198

---

## **BIC®/DJEET® LIGHTERS AND BIC® CASES 200**

### **LIGHTERS**

BIC® J25 Lighter	206
BIC® J23 Lighter	210
BIC® J26 Lighter	214
BIC® J38 Lighter	218

BIC® Clip Case	225
BIC® 3D Case	226

### **OTHER PRODUCTS**

BIC® Pocket Ashtray	228
---------------------	-----

### **LIGHTER CASES**

BIC® Styl'it Luxury Case	222
BIC® Aluminium Flat Case	224

### **DJEET® LIGHTERS**

DJEET® D1 Lighter	236
-------------------	-----

---

## **BIC® PACKAGING 238**

BIC® Packaging Ecolutions®	240
BIC® Packaging	242

---

## **GENERAL INFORMATION 246**

Make it simple!	248
Symbols and abbreviations	250
General information	252

Product index	253
Colour table	254

# OUR VALUES

*An enduring partnership that remains strong thanks to the principles we share.*

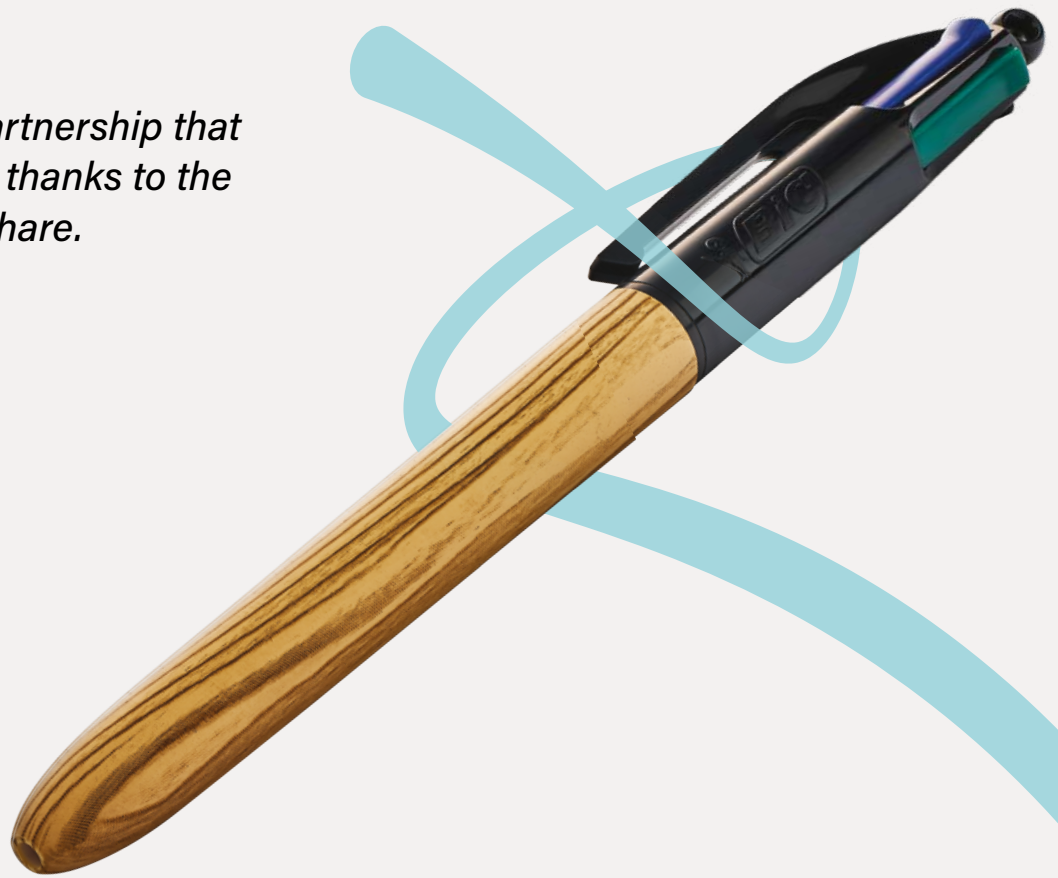

## Certifications



ISO CERTIFIED  
ISO 9001 - ISO 14001



GOLD  
RATING



CO<sub>2</sub> NEUTRAL  
WEBSITE



AUDITED BY  
COCA-COLA



IMPRIM'VERT  
LABEL



MEMBERS OF THE  
UN GLOBAL  
COMPACT



AUDITED BY WCA



AMFORI MEMBERS AND  
AUDITED BY BSCI



SEDEX MEMBERS AND  
AUDITED BY SMETA





# Iconic and innovative

This constant vocation for innovation is manifested in the implementation of new product personalisation techniques, the launch of more sustainable and better quality products, and new special and trend-setting finishes for the most iconic products. A globally recognisable brand and an icon on the cutting edge for its innovative spirit.



## Trusted

The brand is also a benchmark in terms of its compliance with the highest quality and safety standards, not to mention its social, environmental and ethical commitment.



## Close to you

Local production, closer to you, to reduce the carbon footprint. We're close by and anticipate your needs by offering the maximum level of product personalisation, along with digital tools to make personalisation configuration as convenient as possible.

# A JOURNEY WITH YOU



Explore our shared journey over the years, in which our European heritage has shaped a legacy. Discover how tradition and innovation have joined forces to create products that have accompanied you every step of the way.

## 1950s

### 1950

The BIC® brand is born. Launch of BIC® Cristal® in France.



### 1951

First exports to Belgium.

### 1952

First ad campaigns by Raymond Savignac, premiered at Tour de France.

A BIC for every company! BIC® pens adapt to suit all tastes and are used for promotional purposes. Opposite, an ad for the launch of the Promotional Products business in France in the 1970s.

### 1954

BIC® enters Italy, as a licensed manufacturing unit opens in Spain to serve the Iberian Peninsula.

### 1955

First steps in Switzerland, as well as in Dutch, German and Austrian markets.

### 1956

Creation of BIC Lugano, a distribution society for Switzerland, and first steps in the Netherlands and Austria.

### 1957

Acquisition of British group Biro Swan, paving the way to sterling area markets for BIC®.

### 1959

BIC® enters Nordic markets: Sweden, Norway, Finland, and Denmark.

## 1960s

### 1967

BIC® becomes the sponsor of a European cycling team and Spain's Luis Ocaña wins the Tour de France.

## NOUVELLE BILLE



The BIC® Boy, an ad for the New Ballpoint campaign, designed by Raymond Savignac, 1961.

## 1970s

### 1970

The jingle "BIC Naranja y BIC Cristal" makes a huge splash to become part of Spanish pop culture.

### 1972

Société BIC is listed on the Paris Stock Exchange.

### 1976

Launch of the slogan "Si c'est BIC®, c'est bon" for BIC® Lighters in the Belgian market.



**Ce sont des gens de goût...  
...puisque ce sont vos clients!**

Adressez-leur un ambassadeur digne de votre firme, un cadeau de marque connue, dont le renom viendra s'ajouter au vôtre.

Pour une clientèle nombreuse et variée le BIC-Cristal ou le BIC-Opaque.

Pour une clientèle aux goûts classiques le BIC-Poche M.3, ou le BIC-Poche M.4.

Pour une clientèle jeune et dynamique le BIC-Amortisseur ou le BIC-Clic.

Pour ceux qui "ont la signature", le Super-BIC, le plus racé des stylos à bille.

**1978**

"4 francs, 7 BIC razors. The economy counts", says Raymond Poulidor in a humorous commercial for the French market.

**1990s**

**1991**

"La machine à écrire", advertising for Belgian market.

**1995**

Expansion of BIC Graphic's advertising printing business in Europe, centralising all its customisation operations for writing instruments and lighters in Tarragona, Spain. Consolidation of Eastern and Central European market



**1997**

BIC® appears in Formula 1 by sponsoring Alain Prost.

BIC® launches a campaign in Greece with pictures by Oliviero Toscani.

**2010s**

**2011**

Partnership in Europe with Terracycle for collecting used writing instruments.



**2020s**

**2020**

Acquisition of Rocketbook®, a brand of smart reusable notebooks. Acquisition of DJEEP®, a French brand of lighters.



The BIC ballpoint turns and turns, designed by Savignac, 1952.



**BIC**

**BALL POINT PENS**

*GUARANTEED TO WRITE FIRST TIME - EVERY TIME!*

*No Skip*



*No Smear*



*No Clog*



*Less Cost*



**BIC**

**WORLD'S  
LARGEST  
PEN  
MANUFACTURER!**

Form S-463

American advertisement for BIC® products, early 1960s.



We've always been with you during major events, so we're delighted to have been chosen by Paris 2024 to create a range of officially licensed products. Nine exclusive designs of the BIC® 4 Colours® ballpen are now available in stores. We have shared so much, and we have so much left to share.



PRODUIT  
OFFICIEL  
SOUS  
LICENCE



# CLOSE TO WHERE HISTORY OCCURS

---



# ALWAYS BY YOUR SIDE

---

**92 %**

of our products are  
manufactured by the BIC Group

---

**24**

factories on 4 continents

---

**15,898**

Employees worldwide

---

**100 %**

Of our writing instruments  
are printed at BIC Graphic  
Europe, in Tarragona, Spain

---

**29 M.**

BIC® products are chosen every  
day throughout the world



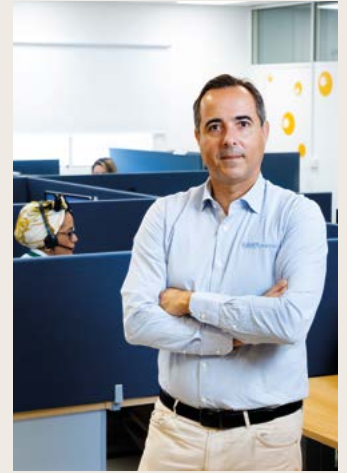
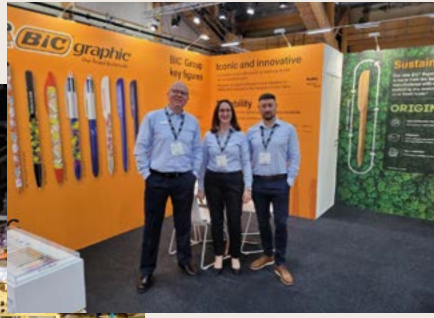

Think of us as your reliable daily companion. Discover how our products instil trust and reliability, supported by our dedicated local customer care and sales team. From capturing your thoughts to igniting your path, we've been there for you at every major moment.



# WE'VE BEEN TOGETHER OUR ENTIRE LIVES

---

In fact, we've been together with you and with so many other people around the world. Our products are known everywhere, and it probably has a certain relationship with our commitment to innovation and with the launch of special products and finishes for our most iconic products. One life together, and we still have a lot left.



## MoMA

2001 - BIC® CRISTAL® IS  
INCLUDED IN THE MUSEUM  
OF MODERN ART (MOMA),  
NEW YORK.

---



## Centre Pompidou

2006 - BIC IS INCLUDED  
IN THE COLLECTION OF  
THE MUSÉE NATIONAL D'ART  
MODERNE, PARIS.

---



1973

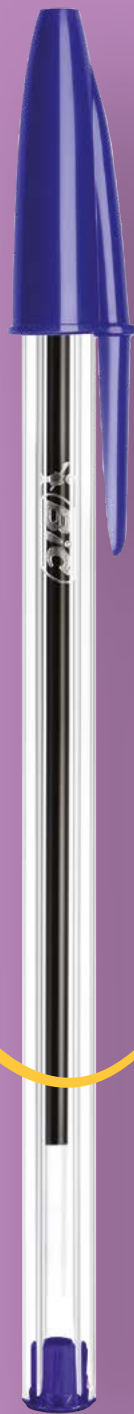

1950

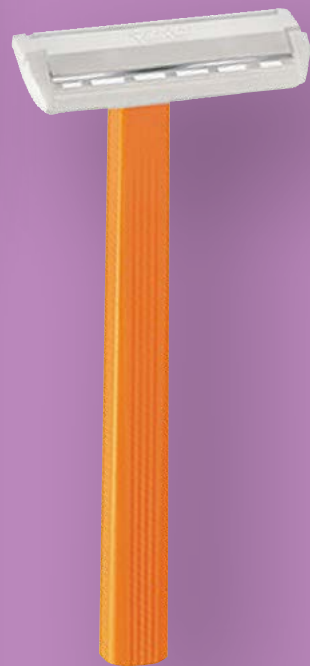

1975

# THE ECO- DESIGN REVOLUTION

---





Welcome to a new era in which eco-design is at the forefront of innovation. Allow us then to show you the development of sustainable production technologies that help to reduce the carbon footprint, solutions for creating long-lasting products and functional features that contribute to design excellence. Are you ready to accompany us?

**A new era lies in your hands**

This is a ballpen, but it is also the symbol of a new era: the BIC® Super Clip Origin biobased ballpen! Our latest BIC® Super Clip is crafted from biobased materials made with natural ingredients, free from petroleum or fossil fuels. \*

\*Refers to barrel and clip.

# PIONEERING SUSTAINABILITY FOR A BETTER FUTURE



Although seemingly an overstatement, we've been working towards a better future for decades now, well before it became a trend. Our efforts include fostering product innovation, like the biobased materials used in our Origin or recycled materials in the Ecolutions® line, acting against climate change and preserving the environment.

So, yes, we can confidently state that we're geared towards sustainability, and this marks the beginning of our pledge for a better future.

**And we can strive towards this goal together.  
Are you with us?**





**ORIGIN**  
**BIOBASED**

BIOBASED

# SUSTAINABILITY BEGINS WITH THE LETTER R



That's right, because BIC's goal of being more sustainable begins with a plan that is based on the letter R. In other words, the 9 Rs of the circular economy. Each R has significant environmental value, and it enhances a product's longevity and creates added value when working in synergy with the others.

# 9Rs



When the phrase “committed to the planet” is more than JUST WORDS.

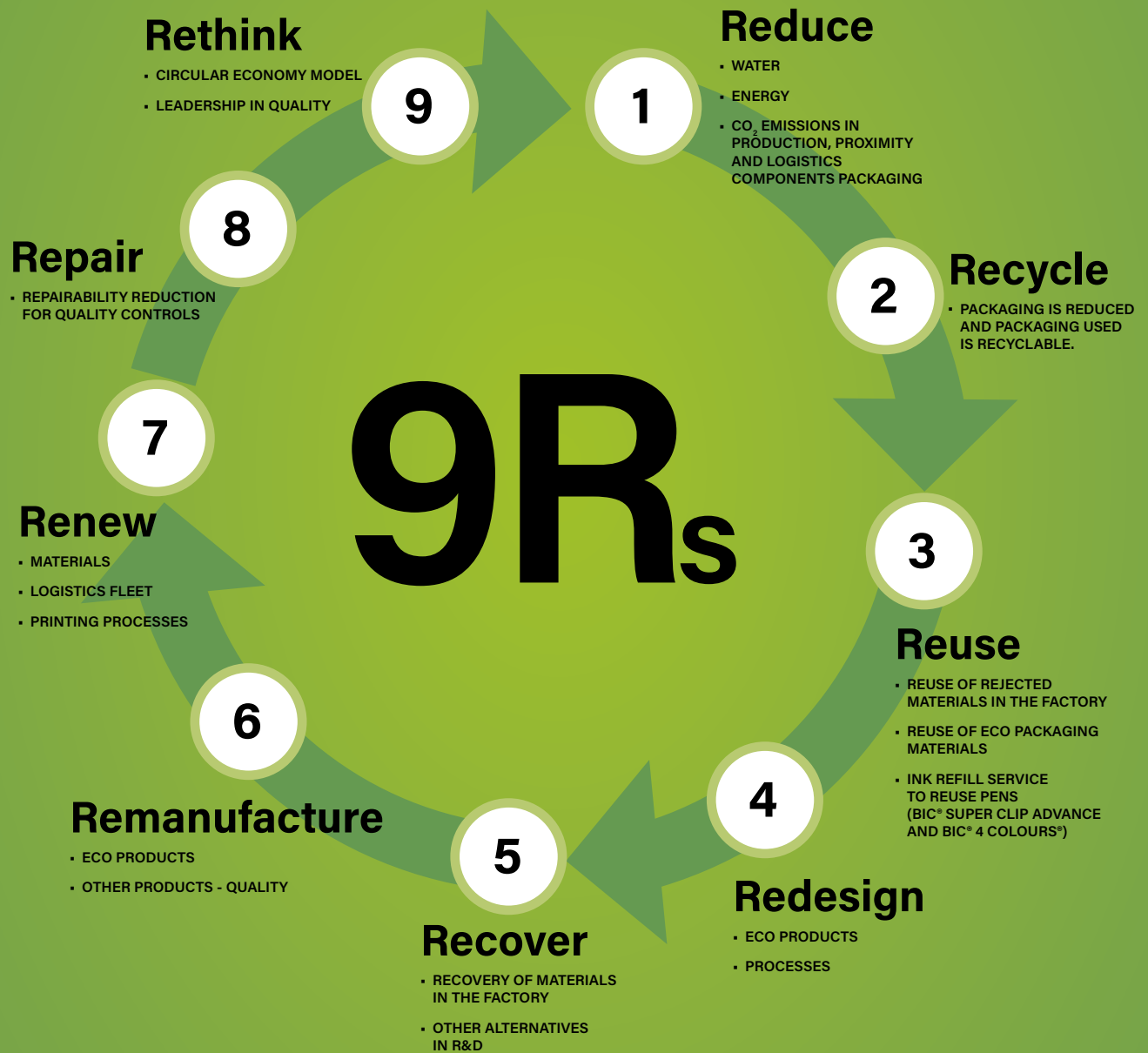

# EMPOWERING CHANGE



It's through action that we achieve real impact. Our sustainable development initiative, «Writing the Future Together,» embodies this commitment. The plan extends until 2025, and we are continuously measuring its goals.

**Want to know more about our plan?  
These are its 5 lines of action:**

## **1 DRIVE SUSTAINABLE INNOVATION**

Our journey is guided by the sustainable development of new products and processes.

---

## **2 TAKE ACTION ON CLIMATE CHANGE**

Electricity from 100 % renewable sources, to reduce greenhouse gas emissions, transforming our use of plastics, adhering to the United Nations Global Compact, renewing our climate commitment, and aligning with the TCFD, the working group created at the request of G20 leaders.

---

## **3 COMMITMENT TO SAFETY AT WORK**

Our commitment to safety extends throughout every facet of our operations, ensuring the well-being of our team members and the communities we serve.

---

## **4 PROACTIVELY ENGAGE SUPPLIERS**

We proactively seek out partnerships and collaborations with suppliers who align with our core principles and values. Our goal is to work hand in hand with providers, collectively advancing towards a more responsible and impactful future.

---

## **5 WORK TOWARDS A BETTER LIFE THROUGH EDUCATION**

More than 187 million children have benefited from direct actions such as donating school supplies, organising school workshops, developing educational tools for teachers, and providing financial support.

---



# CIRCULAR ECONOMY LIGHTER MODEL



After dedicating over seven years to cutting-edge technology development, we've perfected the art of disassembling and recycling every component of a used lighter.

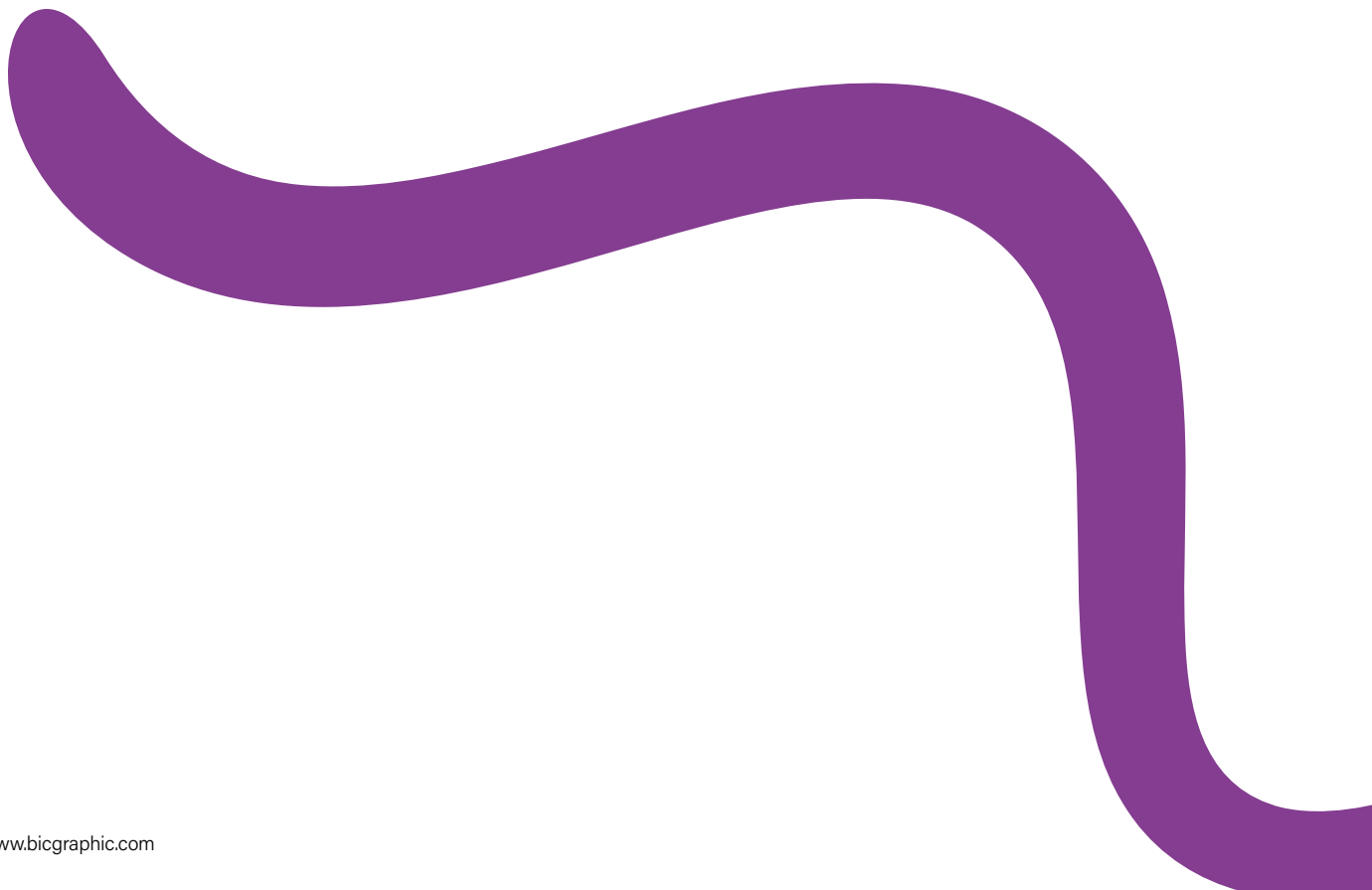

Today, BIC pioneers a circular economy model for the lighter industry

**BIC® LIGHTERS**

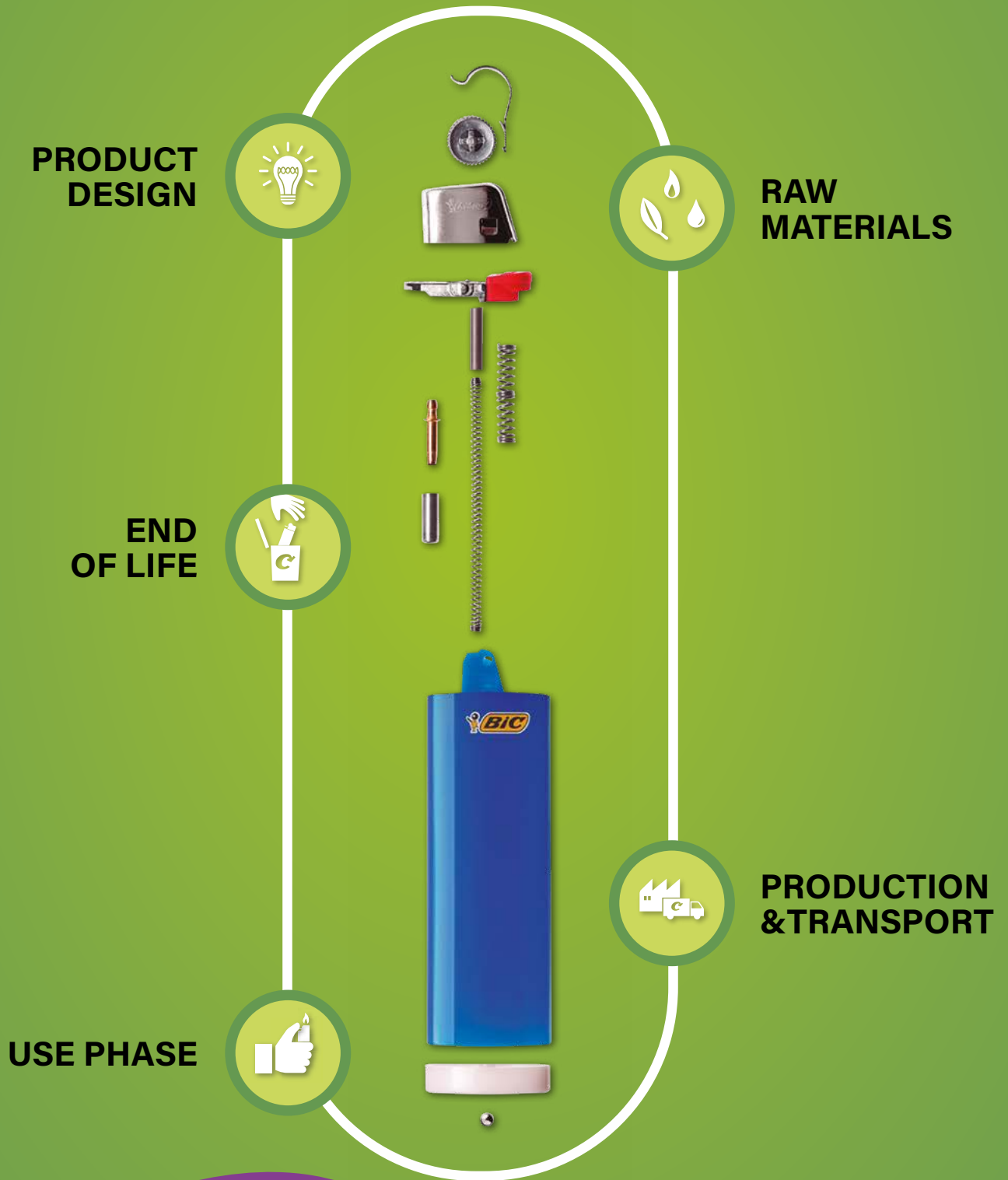



**Refill service on request**



**BIC® SUPER CLIP ADVANCE**



**BIC® 4 COLOURS®**

# REFILL SERVICE FOR YOUR PEN



Think of the pleasant feeling of holding the pen that's just right for you.

You use it so much that it eventually runs out of ink. Now you can extend the life of your BIC® 4 Colours® or even your BIC® Super Clip Advance with our refill service. If you think about it, it's a sustainable solution that's consistent with our way of thinking.

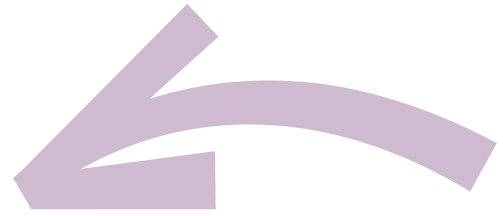

# Let's start from the source

When addressing the challenge of sustainability, one of the most important points to consider is the source of the material used in our products. Some of them may surprise you, but when you're committed to a goal you have to think out of the box when it comes to innovation.

Presenting them below:

- Made from scrap fruit and vegetables trays

- Made from pharmaceutical waste
- Made from scrap plastic car parts

Our Ecolutions® range is made from sustainable materials

- Recycled and recyclable materials
- Biobased materials
- Paper from sustainable forests (FSC)
- Packaging made of recycled paper

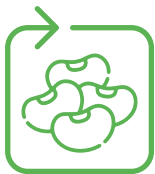

Made from biobased material.

**BIC® SUPER CLIP  
ORIGIN**



Made from scrap fruit and vegetables trays.

**BIC® WIDE BODY™  
ECOLUTIONS®**

**BIC® CLIC STIC  
ECOLUTIONS®**

**BIC® ROUND STIC®  
ECOLUTIONS®**







Made from scrap plastic car parts.

**BIC® MEDIA CLIC  
GRIP ECOLUTIONS®**

**BIC® MEDIA CLIC  
ECOLUTIONS®**

**BIC® SUPER CLIP  
ECOLUTIONS®**



Made from sugar cane.

**BIC® MEDIA CLIC  
BIOBASED  
ECOLUTIONS®**



FSC and recyclable cardboard.

**SPROUT™  
GRAPHITE PENCIL**



Made from recycled fridges and yogurt pots.

**BIC® EVOLUTION®  
ECOLUTIONS®**



Made from pharmaceutical waste.

**BIC® PERMANENT  
MARKER  
ECOLUTIONS®**

**BIC® MATIC®  
ECOLUTIONS®**



 ROCKETBOOK

*Save Your  
Notes.  
Save the  
Planet*



# EMPOWERING CHANGE

In every school, office and home, we help reduce the environmental footprint from start to finish.



The average person will consume 10,000 sheets of paper/year



Equivalent to 1 worker = 1.2 trees per year



Paper is 70% of office waste and 16% of landfill solid waste



4 billion trees are cut down for paper/year



Our manufacturing process reuses 40% of wastewater from the page making process

The re-usable notebook is more eco-sustainable than the traditional notebook, as it presents a dramatically reduced waste of paper, use of water, and environmental footprint.



Rocketbook® is made of recycled PET and HDPE

01



**Corporate  
Foundation**  
*We Give to Create*

02



# DEEDS BEFORE WORDS

---



CSR plays a pivotal role in our sustainable development plan. The BIC Corporate Foundation was therefore set up in 2016 to support educational initiatives throughout the world, primarily through three types of actions: providing grants and product donations, volunteering in our communities and forming global partnerships.

### **And you know what?**

The annual BIC Global Education Week ranks as one of the most significant ventures in recent times. It is there that team members actively labour for a week to improve learning conditions worldwide through specific volunteer activities.

**BIC® 4 Colours® Gradient**  
The most summery vibes



# A pen for every side of you

Presenting the even more versatile BIC® 4 Colours®.  
So that it suits you, and all your sides.



**BIC® 4 Colours® Bicolor**  
A metallic look with an artistic touch



**BIC® 4 Colours® Pastel**  
Vintage colours, dreamy imagery  
*\*Available as of April 2024*

**NEW!**

The new clip and push button on our iconic BIC® 4 Colours® pen enable us to reduce the weight of the product's upper part by **13.1%**, which represents a total of **44 tonnes** less plastic and dyes per year. **Because small changes can make a big difference.**

*New and old clip will co-exist from June 2023 to June 2024. Within one order, the clip will always be the same type.*



**New printing area for all BIC® 4 Colours® white upper parts**

# Our printing techniques

Our product customisation process is regulated by strict quality controls, is in accordance with all EU regulations and passes 5 different quality tests:

- Adhesion test
- Scratch test (ISO 12137:11)
- Abrasion test
- Tumble test
- Exposure to artificial perspiration test

## QUALITY CONTROL TESTS

Every imprinted order passes 4 different quality controls:

- Cosmetic appearance control
- Imprint colour control
- Imprint adherence control
- Resistance to scratching



### Screen printing

Perfect technique for creating high-quality prints and exact colour matches.

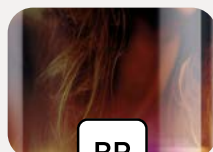

### Brilliant

Choose the brilliant finish for a dazzling final effect.



### Matt

Use the matt finish to add a touch of elegance to your design.



### Metallic

Create great effects! Metallic effects in text, images and backgrounds.

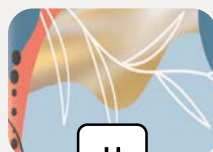

### Holographic

Stand out from the crowd! Play with gold or silver reflections in your design.



### Puffy

Highlighted personalisation that gives a relief effect to your logo.





With more than 50 years of experience as a guarantee!

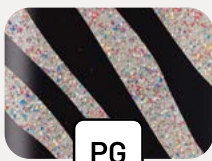

PG

**Puffy Glitter**

Embellish your designs with the shimmering effect of glitter. See and feel its coloured glitter texture.



BP

**BritePix™ Digital**

The solution for full-colour communication. Now on coloured barrels!



LE

**Laser**

Laser engraving brings elegance to your communication. Use it to make a lasting impression.



BP

**BritePix™ Texture**

BritePix™ Texture is a fresh addition to our britePix™ concept: now you don't just see the full colour – you can feel it!



UV

**UV**

Highlight your brand with a high-gloss finish! Combine a matt and gloss finish to highlight contrasts.



BP

**BritePix™ Personalisation**

BritePix™ personalisation. Personalise each unit within the same britePix™ order.

**britepix™**

**BIC GRAPHIC EUROPE  
THE PIONEER IN DIGITAL PRINTING**



BIC® Evolution® Ecolutions®



BIC® Super Clip Advance



BIC® Round Stic®



BIC® Clic Stic Stylus



BIC® Wide Body™



BIC® 4 Colours®



BIC® Media Clic



BIC® XS Finestyle

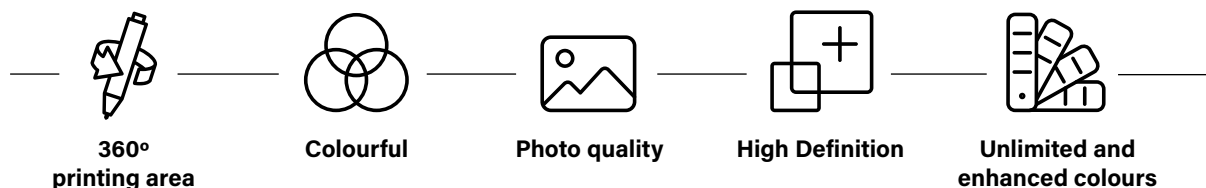

# Your most Colourful solution



## **BritePix™ DIGITAL**

The solution for full colour communication, with photographic excellence, producing a durable imprint that ensures lasting impressions of your logo. Now on coloured barrels!



## **BritePix™ TEXTURE**

BritePix™ Texture is a fresh addition to our britePix™ concept: now you don't just see the full colour – you can feel it!



## **BritePix™ PERSONALISATION**

Personalise each unit within the same britePix™ order.



---

**BIC® COLLECTION**  
**BOX 1 UNIT**  
991212

---

**BIC® COLLECTION**  
**BOX 2 UNITS**  
991213

---

**BIC® COLLECTION**  
**BOX 3 UNITS**  
991214



# A set of BIC® products in customisable boxes

You can go even further in customisation with our FSC cardboard box, customisable on each side. Perfect for combining our iconic BIC® products as a set. In fact, more than just boxes, they are a great way to maximise your sales.

## SPECIAL PACKAGING FOR:

**BIC® 4 COLOURS®**  
**BIC® WIDE BODY™**  
**BIC® SUPER CLIP**  
**BIC® BRITE LINER® GRIP**  
**BIC® GRIP ROLLER**



FSC and recyclable  
cardboard



Made in Europe

# Contents

# 01

---

# BIC®

# WRITING

# INSTRUMENTS

## BALLPENS

BIC® Style	46
BIC® Round Stic®	50
BIC® M10® Clic	56
BIC® Media Clic	58
BIC® Media Clic Grip	63
BIC® Media Clic BGuard™ antibacterial	67
BIC® Media Clic BGuard™ antimicrobial Ecolutions®	70
BIC® Media Clic Biobased Ecolutions®	72
BIC® Media Clic Biobased BGuard™ antibacterial	75
BIC® Media Clic Shine	77
BIC® Media Clic Glacé	78
BIC® Clic Stic	80
BIC® Clic Stic Stylus	84
BIC® Clic Stic Mini	84
BIC® Super Clip	88
BIC® Super Clip Advance	94
BIC® Super Clip Glacé	98
BIC® Super Clip Glacé Advance	98
BIC® Super Clip Soft	100
BIC® Super Clip Soft Advance	100
BIC® Super Clip Origin	102
BIC® Wide Body™	104
BIC® 4 Colours®	112
BIC® 4 Colours® Bicolor	114
BIC® 4 Colours® Gradient	116
BIC® 4 Colours® Pastel	118
BIC® 4 Colours® Fashion	120
BIC® 4 Colours® Sun	122
BIC® 4 Colours® Fine	124
BIC® 4 Colours® Fluo	126
BIC® 4 Colours® Shine	128
BIC® 4 Colours® Glacé	130
BIC® 4 Colours® Soft	132
BIC® 4 Colours® Wood Style	134
BIC® 4 Colours® Flags Collection	136
BIC® 4 Colours® 3+1 <sup>HB</sup>	138

## METALLIC PENS

BIC® Metal Pro	140
BIC® Cristal® Re'New™	145

## ROLLERS AND GELS

BIC® Grip Roller	150
BIC® XS Finestyle	152
BIC® Intensity® Gel Clic	154

## HIGHLIGHTERS AND MARKERS

BIC® Brite Liner® Grip	158
BIC® Velleda® White Board Marker Fine	160
BIC® Velleda® White Board Marker Grip	161
BIC® Mark-It Permanent Marker	162
BIC® Permanent Marker Ecolutions®	163

## MECHANICAL PENCILS

BIC® Matic®	166
BIC® Media Clic Mechanical pencil	168
BIC® Media Clic Grip Mechanical pencil	169

## PENCILS

BIC® Evolution® Ecolutions®	174
Sprout™ Graphite pencil	178

**BIC® STYLE**

**Globally renowned  
BIC® cap design.**

The BIC® Style  
offers excellent  
value for money.





**BIC® STYLE**

1610 Opaque

Colour ink



01/01

01/03

01/04

01/02

02/02

04

10

100%

●  
Only available  
in black ink

●  
Only available  
in blue ink

●  
Only available  
in black ink

MANUFACTURED AND PRINTED IN BIC FACTORIES

REGULATORY COMPLIANCE

ISO certified

IMPRIM'VERT®

UBIQUITY™ PROGRAM  
ALLOWS RECYCLING  
BIC WRITING INSTRUMENTS

100% ELECTRICITY COMING FROM RENEWABLE SOURCES

**WRITING MODES**

BALLPEN M  
0.1 MM

**PRINTING TECHNIQUES**

SP  
SCREEN PRINTING

See page 250 for a detailed explanation of the icons

---

## BIC® STYLE

1610 Clear

Colour ink



92

87

88

89

8H

93

100%

Decoration

**BIC® STYLE**

1610 Opaque  
**A SP:** max. 1 col.

**BIC® STYLE**

1610 Clear  
**B SP:** max. 1 col.

MOQ 500 units

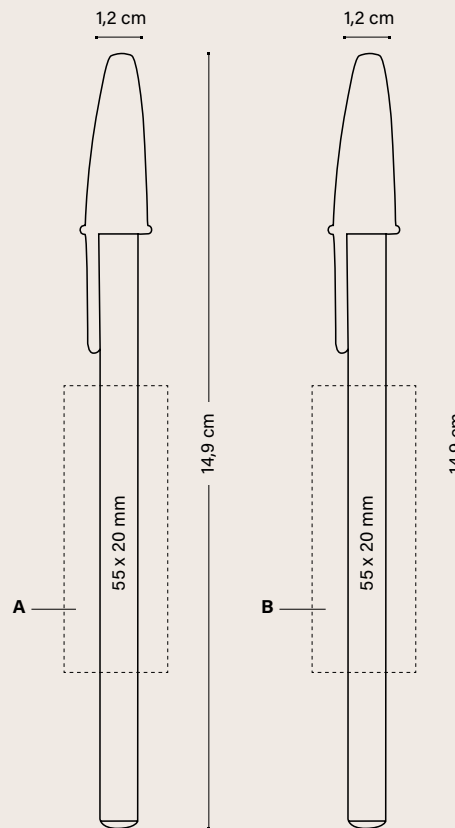

	Price (€)			
<b>BIC® STYLE</b>	500-999	1000-2499	2500-4999	5000
1610				
<b>SP</b>	0,48	0,43	0,41	0,39

**OPTIONAL SPECIAL PACKAGING**



PLASTIC  
 POUCH

+ INFO PAGES 240 TO 245

**EXTERNAL PACKAGING**



500 ± 3,5 KG



**WRITING  
 MODES**



**PRINTING  
 TECHNIQUES**



See page 250 for a detailed explanation of the icons

**BIC® ROUND STIC®**

**The iconic BIC® Round Stic®  
offers a timeless style and high  
quality.**

Its classic design is easy to identify  
and symbolises long-term reliability.





Embossed  
iconic BIC® brand!

**BIC® ROUND STIC®**

1010 Opaque

Colour ink



Red Ink available under request



12



05



07



18



02



03



100%

360°  
Printing

Only available  
on white barrel



MIX &  
MATCH



PERSONALIZED  
COLOURS



MANUFACTURED  
AND PRINTED IN  
BIC FACTORIES



MADE  
IN SPAIN



REGULATORY  
COMPLIANCE



ISO  
certified



IMPRIM'VERT®



UBICITY™ PROGRAM  
ALLOWS RECYCLING  
BIC WRITING INSTRUMENTS



100% ELECTRICITY COMING  
FROM RENEWABLE SOURCES

WRITING  
MODES



BALLPEN M  
Ø 1 MM

PRINTING  
TECHNIQUES



SCREEN PRINTING



DIGITAL

---

**BIC® ROUND STIC®**

1010 Frosted

Colour ink



*Red Ink available under request*



ECO version and standard at the same price!

**ecolutions®**  
MADE FROM 94% RECYCLED MATERIAL\*



**MIX & MATCH**



PERSONALIZED COLOURS



MANUFACTURED AND PRINTED IN BIC FACTORIES



MADE IN SPAIN



REGULATORY COMPLIANCE



ISO certified



IMPRIM'VERT®



ecolutions®



FRUIT AND VEGETABLE TRAYS



LIBICITY™ PROGRAM ALLOWS RECYCLING BIC WRITING INSTRUMENTS



100% ELECTRICITY COMING FROM RENEWABLE SOURCES



WRITING MODES  
BALLPEN M Ø 1 MM



PRINTING TECHNIQUES  
SP  
SCREEN PRINTING



DIGITAL

**BIC® ROUND STIC®**

1E10 Opaque

Colour ink



Red Ink available under request

**BIC® ROUND STIC®**

1E10 Frosted

Colour ink



Red Ink available under request



360° Printing



Only available on white barrel



See page 250 for a detailed explanation of the icons

\*The percentage is calculated based on total weight of the barrel. Due to the recycled content of the raw materials used to make the product, we cannot guarantee that the colours shown in the catalogue or colours customised to order will always have the same colour and appearance.

No extra charge

**BIC® ROUND STIC®**  
 1010 / **ecolutions®** 1E10 Opaque  
 1010 / **ecolutions®** 1E10 Frosted

MOQ 500 units.  
 Standard colours combination

**ecolutions®**



Standard colours combination\*

**Plug**

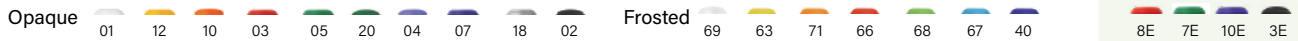
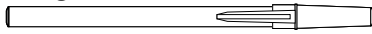

**Cap**

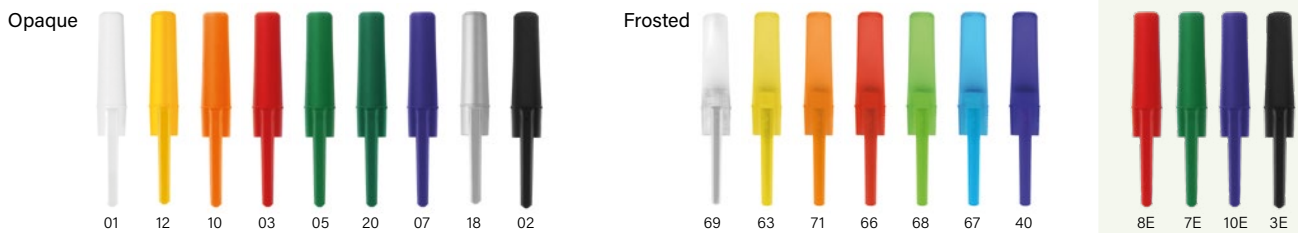
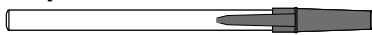

**Section**

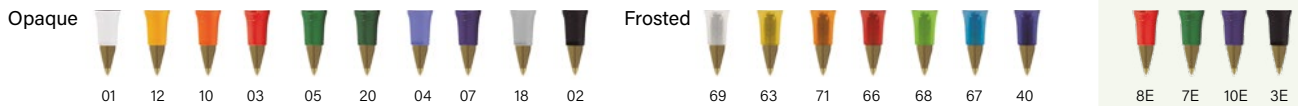
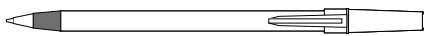

**Barrel**



Exact colour match: ≥ 10.000 units



Add the Möbius loop to your artwork at no additional charge. Please specify it on your order. (Möbius loop imprint defaults to left-hand corner.)

\*Due to the recycled content of the raw materials used to make the product, we cannot guarantee that the colours shown in the catalogue or colours customised to order will always have the same colour and appearance.



Decoration

**BIC® ROUND STIC®**

1010

ecolutions® 1E10

A SP: max. 3 col.

B SP: max. 1 col.

C SP: max. 1 col.

D DG: full-colour

(Only available on white barrel)

MOQ 500 units.

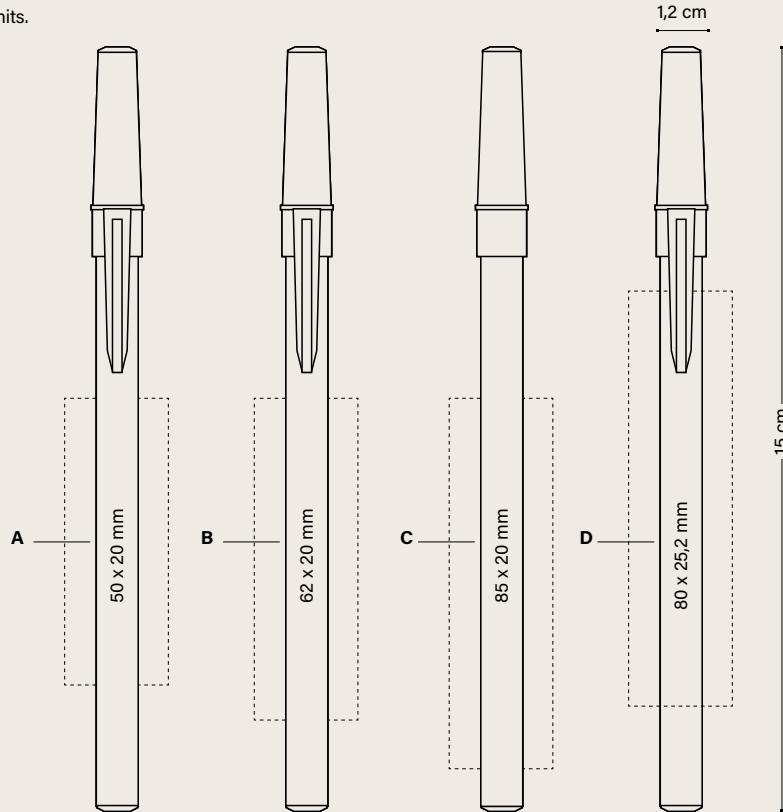

BIC® ROUND STIC®	500-999	1000-2499	2500-4999	Price (€)
1010 / ecolutions® 1E10				5000
SP	0,53	0,51	0,47	0,44
DG	0,77	0,73	0,67	0,63

**Additional imprint charge per colour & position**

SP	0,14	0,14	0,14	0,13
----	------	------	------	------

Prices include one imprint in one position according to specified technique.

**OPTIONAL SPECIAL PACKAGING**



PLASTIC  
POUCH

+ INFO PAGES 240 TO 245

**EXTERNAL PACKAGING**



500 ± 2,5 KG



PERSONALIZED  
COLOURS



MANUFACTURED  
AND PRINTED IN  
BIC FACTORIES



MADE  
IN SPAIN



REGULATORY  
COMPLIANCE



ISO  
certified



IMPRIM'VERT®

ecolutions®



FRUIT AND  
VEGETABLE TRAYS



UBICITY™ PROGRAM  
ALLOWS RECYCLING  
BIC WRITING INSTRUMENTS



100% ELECTRICITY COMING  
FROM RENEWABLE SOURCES

**WRITING  
MODES**



BALLPEN M  
Ø 1 MM

**PRINTING  
TECHNIQUES**



SCREEN PRINTING



DIGITAL

See page 250 for a detailed explanation of the icons



Embossed  
iconic BIC® brand!

## BIC® M10® CLIC

1590

Colour ink



01

8G

10

14

59

04

02

3D

100%

●  
Only available  
in black ink

Decoration

**BIC® M10® CLIC**  
1590

A SP: max. 2 col.

MOQ 500 units

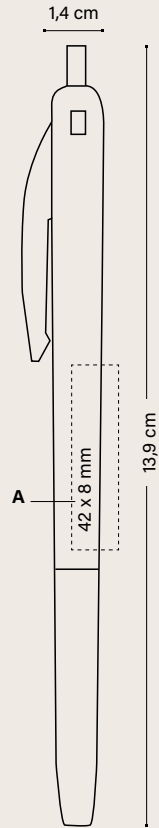

	Price (€)			
<b>BIC® M10® CLIC</b>	500-999	1000-2499	2500-4999	5000
1590				
SP	0,60	0,58	0,54	0,50
<b>Additional imprint charge per colour &amp; position</b>				
SP	0,14	0,14	0,14	0,13

Prices include one colour in screen printing in one position.

**OPTIONAL SPECIAL PACKAGING**



+ INFO PAGES 240 TO 245

**EXTERNAL PACKAGING**

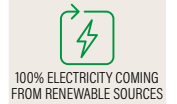

**WRITING MODES**



**PRINTING TECHNIQUES**



SCREEN PRINTING



CHECK OUT THE VIDEO

See page 250 for a detailed explanation of the icons





# BIC<sup>®</sup> MEDIA CLIC

One of the best sellers in the industry, a functional and widely recognized design, our BIC<sup>®</sup> Media Clic is a lasting product available in different materials. Choose between the Standard, Recycled, Biobased, Antibacterial and premium finishes. Be inspired with the wide range of finishes and colours, and match them to enhance your brand.

**ECOLUTIONS<sup>®</sup>**

**GRIP**

**GRIP ECOLUTIONS<sup>®</sup>**

**BGUARD<sup>™</sup> ANTIBACTERIAL**

**BGUARD<sup>™</sup>**

**ANTIMICROBIAL**

**BIOBASED**

**BIOBASED BGUARD<sup>™</sup> ANTIBACTERIAL**

**SHINE**

**GLACÉ**



Embossed  
iconic BIC® brand!



Also in  
Mechanical pencil

## BIC® MEDIA CLIC

1025 Ballpen / 1028 Mechanical pencil (see page 168)

Opaque

Colour ink



Red Ink available under request



ECO version and standard at the same price!

**ecolutions®**

MADE FROM 92% RECYCLED MATERIAL\*

PLASTIC CAR PARTS

**BIC® MEDIA CLIC**

1E25 Ballpen

Opaque

Colour ink



**MIX & MATCH**



PERSONALIZED COLOURS



MANUFACTURED AND PRINTED IN BIC FACTORIES



MADE IN SPAIN



REGULATORY COMPLIANCE



IMPRIM'VERT®

ecolutions®



PLASTIC CAR PARTS



UBICITY™ PROGRAM ALLOWS RECYCLING BIC WRITING INSTRUMENTS



100% ELECTRICITY COMING FROM RENEWABLE SOURCES

**WRITING MODES**



BALLPEN M Ø 1 MM

**PRINTING TECHNIQUES**



SCREEN PRINTING



DIGITAL

See page 250 for a detailed explanation of the icons

\*The percentage is calculated based on total weight of the barrel. Due to the recycled content of the raw materials used to make the product, we cannot guarantee that the colours shown in the catalogue or colours customised to order will always have the same colour and appearance.



*Also in  
Mechanical pencil*

---

## **BIC® MEDIA CLIC**

1025 Ballpen / 1028 Mechanical pencil (see page 168)

Frosted

Colour ink



*Red Ink available under request*





**BIC® MEDIA CLIC**

1025 Ballpen  
Clear  
Colour ink



4D



92



93

100%



Also in  
Mechanical pencil

**BIC® MEDIA CLIC GRIP**

1020 Ballpen  
1021 Mechanical pencil (see page 169)  
Opaque  
Colour ink



360°  
Printing

01/12

100%

Only available  
on white barrel



PERSONALIZED  
COLOURS



MANUFACTURED  
AND PRINTED IN  
BIC FACTORIES



MADE  
IN SPAIN



REGULATORY  
COMPLIANCE



ISO  
certified



IMPRIM'VERT®



UBICITY™ PROGRAM  
ALLOWS RECYCLING  
BIC WRITING INSTRUMENTS



100% ELECTRICITY COMING  
FROM RENEWABLE SOURCES

WRITING  
MODES



BALLPEN M  
Ø 1 MM

PRINTING  
TECHNIQUES



SCREEN PRINTING



DIGITAL

# BIC® MEDIA CLIC / BIC® MEDIA CLIC GRIP

**MIX & MATCH**



PERSONALIZED COLOURS



MANUFACTURED AND PRINTED IN BIC FACTORIES



MADE IN SPAIN



REGULATORY COMPLIANCE



ISO certified



IMPRIM'VERT®

ecolutions®



PLASTIC CAR PARTS



UBICUITY™ PROGRAM ALLOWS RECYCLING BIC WRITING INSTRUMENTS



100% ELECTRICITY COMING FROM RENEWABLE SOURCES

**WRITING MODES**



BALLPEN M 0.1 MM

**PRINTING TECHNIQUES**



SCREEN PRINTING



DIGITAL



Also in Mechanical pencil

## BIC® MEDIA CLIC GRIP

1020 Ballpen

1021 Mechanical pencil (see page 169)

Frosted

Colour ink



01/69

71/69

82/69

40/69

100%



Also in Mechanical pencil

ECO version and standard at the same price!

ecolutions®

MADE FROM 92% RECYCLED MATERIAL\*



PLASTIC CAR PARTS

## BIC® MEDIA CLIC GRIP

1E20 Ballpen

1E21 Mechanical pencil (see page 169)

Opaque

Colour ink



01/03

01/05

01/02

01/07

100%

# BIC® MEDIA CLIC / BIC® MEDIA CLIC GRIP

**BIC® MEDIA CLIC**  
1025 Ballpen / **ecolutions®** 1E25 Ballpen

**BIC® MEDIA CLIC GRIP**  
1020 Ballpen / **ecolutions®** 1E20 Ballpen

MOQ 500 units  
**ecolutions®** Standard colours combination

**MIX & MATCH**  
No extra charge

## Plug



Opaque 01 12 10 03 5C 2D 13 5G 05 3D 04 07 18 02 Frosted 69

## Clip



Opaque 01 12 10 03 5C 2D 13 5G 05 3D 04 07 18 02 Frosted 69

## Barrel



Opaque 01 12 10 03 5C 2D 13 5G 05 3D 04 07 3C 18 02 83 8D 01/12

Frosted 69 63 71 66 68 82 67 40 4B

Clear 4D 92 93

## Barrel & Grip

### Barrel & Grip

01/69 71/69 82/69 40/69

Exact colour match:  $\geq$  10,000 units 1025/1E25  
Exact colour match:  $\geq$  20,000 units 1020/1E20



**ecolutions®**  
PLASTIC CAR PARTS

Standard colours combination\*

Opaque 1E 3E

Barrel & Grip Opaque 01/03 01/05 01/07 01/02

Add the Möbius loop to your artwork at no additional charge. Please specify "Print the Möbius loop" on your order. (Möbius loop imprint defaults to left-hand corner.)

**PERSONALIZED COLOURS** **MANUFACTURED AND PRINTED IN BIC FACTORIES** **MIX & MATCH ecolutions®** **PLASTIC CAR PARTS** **UBICUTY™ PROGRAM ALLOWS RECYCLING BIC WRITING INSTRUMENTS**

**WRITING MODES** BALLPEN M Ø 1 MM

**PRINTING TECHNIQUES** SP SCREEN PRINTING DG DIGITAL

\*Due to the recycled content of the raw materials used to make the product, we cannot guarantee that the colours shown in the catalogue or colours customised to order will always have the same colour and appearance.

See page 250 for a detailed explanation of the icons

# BIC® MEDIA CLIC / BIC® MEDIA CLIC GRIP

## Decoration

### BIC® MEDIA CLIC

1025 Ballpen  
1028 Mechanical pencil (see page 168)  
eColutions® 1E25 Ballpen

A SP: max. 4 col.  
B SP: max. 2 col.  
C DG: full-colour

MOQ 500 units.

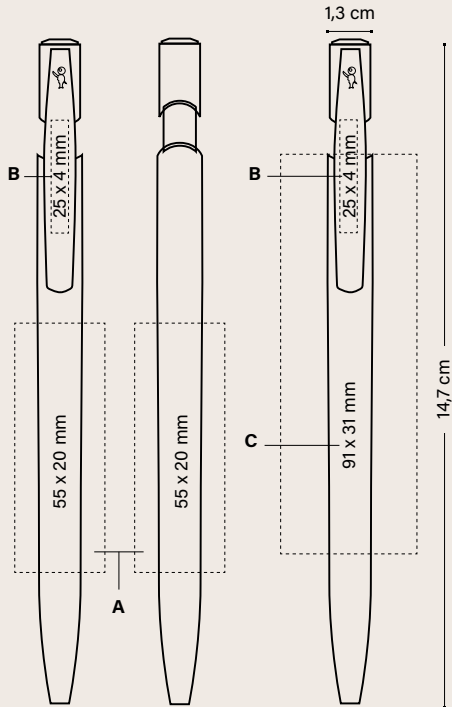

	Price (€)			
BIC® MEDIA CLIC	500-999	1000-2499	2500-4999	5000
1025 / eColutions® 1E25 (Ballpen)				
SP	0,67	0,60	0,54	0,49
DG	0,97	0,87	0,76	0,67

#### Additional imprint charge per colour & position

SP	0,14	0,14	0,14	0,13
----	------	------	------	------

Prices include one imprint in one position according to specified technique.

#### OPTIONAL SPECIAL PACKAGING



ECO SLEEVE

PLASTIC POUCH

WINDOW BOX

+ INFO PAGES 240 TO 245

#### EXTERNAL PACKAGING



500 ± 4.1 KG

## Decoration

### BIC® MEDIA CLIC GRIP

1020 Ballpen  
1021 Mechanical pencil (see page 169)  
eColutions® 1E20 Ballpen  
eColutions® 1E21 Mechanical pencil (see page 169)

D SP: max. 4 col.  
E SP: max. 2 col.  
F DG: full-colour

MOQ 500 units.

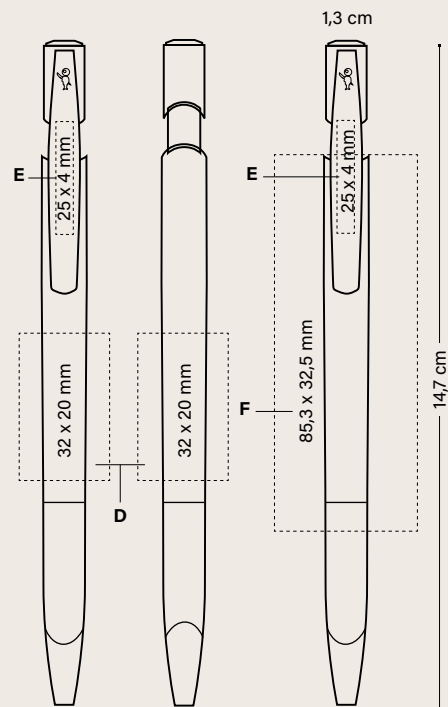

	Price (€)			
BIC® MEDIA CLIC GRIP	500-999	1000-2499	2500-4999	5000
1020 / eColutions® 1E20 (Ballpen)				
SP	0,81	0,70	0,62	0,56
DG	1,04	0,97	0,83	0,74

#### Additional imprint charge per colour & position

SP	0,14	0,14	0,14	0,13
----	------	------	------	------

Prices include one imprint in one position according to specified technique.

#### OPTIONAL SPECIAL PACKAGING



ECO SLEEVE

PLASTIC POUCH

WINDOW BOX

+ INFO PAGES 240 TO 245

#### EXTERNAL PACKAGING



500 ± 4.3 KG



UBIQUITY™ PROGRAM  
ALLOWS RECYCLING  
BIC WRITING INSTRUMENTS

#### WRITING MODES



#### PRINTING TECHNIQUES



## BIC® MEDIA CLIC Antibacterial



Bacteria  
elimination



Entire pen  
protection



Timeless  
protection



Antibacterial  
Test protocol



1E27

1026

# BIC® MEDIA CLIC BGUARD™ ANTIBACTERIAL

BGUARD™



Bacteria elimination



Entire pen protection



Timeless protection



Antibacterial Test protocol

**britePix** DIGITAL THE SOLUTION FOR FULL COLOUR COMMUNICATION!

## BIC® MEDIA CLIC BGUARD™ ANTIBACTERIAL

1026: antibacterial logo

1027: SARS-CoV-2 logo

Opaque

Colour ink



Red Ink available under request



**MIX & MATCH**

No extra charge

## BIC® MEDIA CLIC BGUARD™ ANTIBACTERIAL

1026: antibacterial logo

1027: SARS-CoV-2 logo

Opaque

MOQ 500 units

Standard colours combination

### Plug

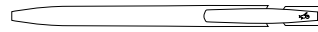

Opaque

1BG 7BG 2BG

### Clip

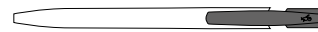

Opaque



1BG 2BG

### Barrel



Opaque



1BG 2BG

Exact colour match: ≥ 10.000 units



Iconic BIC® Boy and Antibacterial logo always visible!

**ANTIBACTERIAL™**

Decoration:

**BIC® MEDIA CLIC BGUARD™  
ANTIBACTERIAL**

1026: antibacterial logo  
1027: SARS-CoV-2 logo

A **SP**: max. 2 col.  
B **SP**: max. 1 col.  
C **DG**: full-colour

MOQ 500 units.

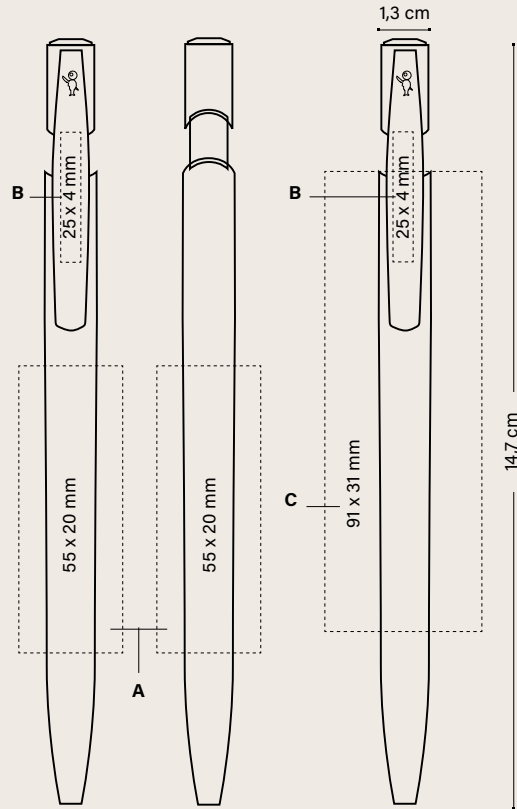

	Price (€)			
<b>BIC® MEDIA CLIC BGUARD™ ANTIBACTERIAL</b>	500-999	1000-2499	2500-4999	5000
1026/1027				
<b>SP</b>	0,74	0,66	0,60	0,55
<b>DG</b>	1,03	0,94	0,82	0,73
<b>Additional imprint charge per colour &amp; position</b>				
<b>SP</b>	0,14	0,14	0,14	0,13

Prices include one imprint in one position according to specified technique.

**OPTIONAL SPECIAL PACKAGING**



ECO SLEEVE



PLASTIC POUCH



WINDOW BOX

+ INFO PAGES 240 TO 245

**EXTERNAL PACKAGING**



500 ± 4,1 KG



**WRITING MODES**



**PRINTING TECHNIQUES**



SCREEN PRINTING



DIGITAL

See page 250 for a detailed explanation of the icons

# BIC® MEDIA CLIC BGUARD™ ANTIMICROBIAL ECOLUTIONS®



ANTIMICROBIAL™\* =



Bacteria elimination  
99% en 24h

+



Viral reduction  
93% in 24 h

+



Fungal inhibition  
for 24 h

BGUARD™ **ecolutions®**

**MIX &  
MATCH**

No extra charge

**ecolutions®**



MADE FROM 86%  
RECYCLED MATERIAL\*\*

PLASTIC  
CAR PARTS



## BIC® MEDIA CLIC BGUARD™ ANTIMICROBIAL ECOLUTIONS®

ecolutions® 1E26: antimicrobial logo

ecolutions® 1E27: SARS-CoV-2 logo

Opaque

Colour ink



Red Ink available under request



**ecolutions®**

PLASTIC  
CAR PARTS



## BIC® MEDIA CLIC BGUARD™ ANTIMICROBIAL ECOLUTIONS®

ecolutions® 1E26 / ecolutions® 1E27



Add the Möbius loop to your artwork at no additional charge. Please specify it on your order. (Möbius loop imprint defaults to left-hand corner.)

MOQ 500 units  
Standard colours combination

### Plug



Opaque 1BG 7BG 2BG

### Clip

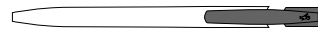

Opaque 1BG 2BG

### Barrel



Opaque 1E 3E

Exact colour match:  $\geq 10.000$  units



You can also choose to print the SARS-CoV-2 reduction logo.  
Ask your Customer Service representative for more information.

\*99.9% of bacteria is eliminated from the surface in 24 hours (and more than 30% in 2 hours).

Tested under ISO 22196 protocol adapted to real usage of the pen.

93% of viruses, Sars-Cov-2 Coronavirus causing Covid-19 disease, are eliminated from the surface in 24 hours, (and around 50% in 2 hours).

Tested under ISO 22196 protocol adapted to real usage of the pen.

Fungi present on the surface is inhibited within 24 hours.

Tested under ISO 22196 protocol adapted to fungi and to real usage of the pen.





Entire pen protection



Timeless protection



Antibacterial Test protocol



Adapted to fungus test protocol



Antiviral test protocol

Decoration

**BIC® MEDIA CLIC Bguard™  
ANTIMICROBIAL ECOLUTIONS®**

ecolutions® 1E26: antimicrobial logo

ecolutions® 1E27: SARS-CoV-2 logo

A SP: max. 2 col.

B SP: max. 2 col.

MOQ 500 units.

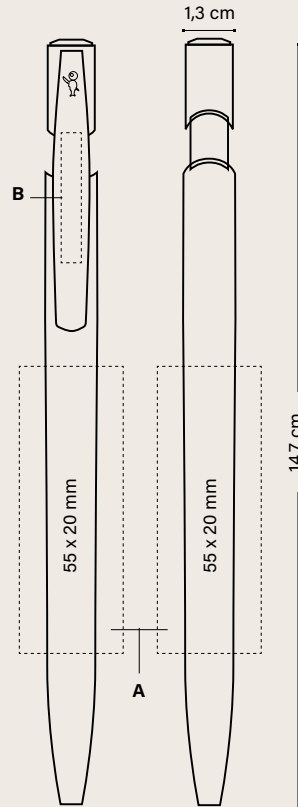

	Price (€)			
<b>BIC® MEDIA CLIC Bguard™ ANTIMICROBIAL</b>	500-999	1000-2499	2500-4999	5000
<b>ecolutions® 1E26 / ecolutions® 1E27</b>				
<b>SP</b>	0,80	0,73	0,67	0,59
<b>Additional imprint charge per colour &amp; position</b>				
<b>SP</b>	0,14	0,14	0,14	0,13

Prices include one colour in screen printing in one position.

OPTIONAL SPECIAL PACKAGING



ECO SLEEVE



PLASTIC POUCH



WINDOW BOX

+ INFO PAGES 240 TO 245

EXTERNAL PACKAGING



500 ± 4,1 KG



PERSONALIZED COLOURS



MANUFACTURED AND PRINTED IN BIC FACTORIES



MADE IN SPAIN



REGULATORY COMPLIANCE



ISO certified



IMPRIM'VERT®



ecolutions®



PLASTIC CAR PARTS



UBICITY™ PROGRAM  
ALLOWS RECYCLING  
BIC WRITING INSTRUMENTS



100% ELECTRICITY COMING  
FROM RENEWABLE SOURCES

WRITING MODES



BALLPEN M  
Ø 1 MM

PRINTING TECHNIQUES



SCREEN PRINTING

Available in selected countries, please ask your customer service representative.

\*\*The percentage is calculated based on total weight of the barrel. Due to the recycled content of the raw materials used to make the product, we cannot guarantee that the colours shown in the catalogue or colours customised to order will always have the same colour and appearance.

BIC® MEDIA CLIC  
BIOBASED ECOLUTIONS®

The top priority  
of the ballpen life cycle  
is sustainability.

ecolutions®

BIOBASED

*Made to last:*

- More than 10,000 clicks
- Increased visibility for your brand
- Break resistant clip



### BIOBASED PEN

There's no more ink in the pen?  
No problem, now you can compost it\*.

The barrel is made of **biobased material**.



### Electricity 100% produced by renewable sources

Produced in our factory and printing  
facilities which are both powered by  
electricity **100% produced using  
renewable sources**.



### Low transport impact:

Production, printing and even  
raw material.



**100%  
Recyclable**  
Ubicuity™

**70%  
Biobased  
MATERIAL\*\***

**100%  
Biobased  
COLORANTS**

BIOBASED **ecolutions**®

**BIOBASED**  
**ecolutions**®

MADE FROM 70% BIO-SOURCED\*  
& 100% INDUSTRIALLY  
COMPOSTABLE MATERIAL



SUGAR CANE

**BIC® MEDIA CLIC BIOBASED ECOLUTIONS®**

1972 Ballpen  
Opaque  
Colour ink  
● ● ●  
Red Ink available under request



Available on  
white barrel



MIX & MATCH



PERSONALIZED COLOURS



MANUFACTURED AND PRINTED IN BIC FACTORIES



MADE IN SPAIN



REGULATORY COMPLIANCE



ISO certified



IMPRIMIT'VERT®  
**ecolutions**®



SUGAR CANE



UBICUITY™ PROGRAM  
ALLOWS RECYCLING  
BIC WRITING INSTRUMENTS



100% ELECTRICITY COMING  
FROM RENEWABLE SOURCES

WRITING MODES



BALLEN M  
Ø 1 MM

PRINTING TECHNIQUES



SP  
SCREEN PRINTING



DG  
DIGITAL

See page 250 for a detailed explanation of the icons

\*The percentage is calculated based on total weight of the barrel. Due to the natural content of the raw materials used to make the product, we cannot guarantee that the colours shown in the catalogue or colours customised to order will always have the same colour and appearance.

# BIC® MEDIA CLIC BIOBASED ECOLUTIONS®



No extra charge

## BIC® MEDIA CLIC BIOBASED ECOLUTIONS®

1972 Ballpen Opaque

MOQ 500 units  
Standard colours combination

### Plug



### Clip

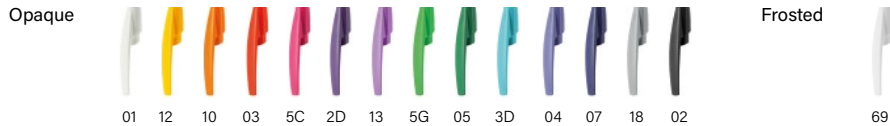

### Barrel

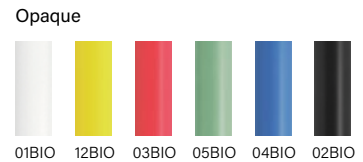

Exact colour match:  
≥ 10.000 units



MANUFACTURED AND PRINTED IN BIC FACTORIES



MADE IN SPAIN



SUGAR CANE



UBICITY™ PROGRAM  
ALLOWS RECYCLING  
BIC WRITING INSTRUMENTS

### WRITING MODES



BALLPEN M  
Ø 1 MM

### PRINTING TECHNIQUES



SCREEN PRINTING



DIGITAL

### Decoration

## BIC® MEDIA CLIC BIOBASED ECOLUTIONS®

1972

**A SP:** max. 2 col.

**B SP:** max. 2 col.

**C DG:** full-colour

MOQ 500 units.

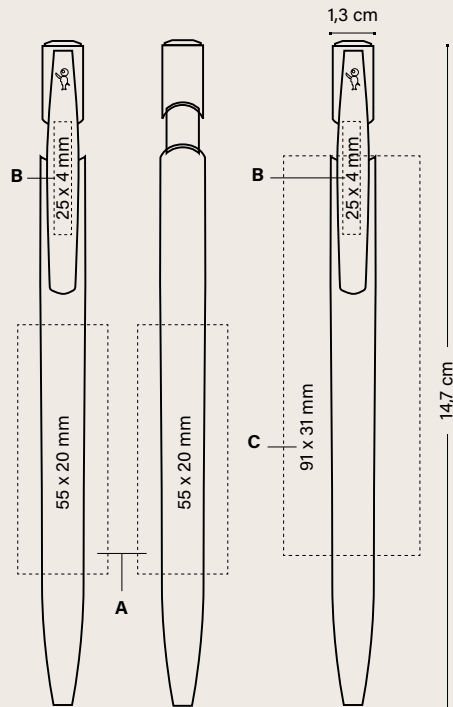

Price (€)

BIC® MEDIA CLIC BIOBASED	500-999	1000-2499	2500-4999	5000
--------------------------	---------	-----------	-----------	------

### ecolutions® 1972

SP	0,80	0,74	0,67	0,62
DG	1,13	1,03	0,90	0,84

### Additional imprint charge per colour & position

SP	0,14	0,14	0,14	0,13
----	------	------	------	------

Prices include one imprint in one position according to specified technique.

### OPTIONAL SPECIAL PACKAGING



ECO SLEEVE



PLASTIC POUCH



WINDOW BOX

+ INFO PAGES 240 TO 245

### EXTERNAL PACKAGING



500 ± 4,3KG

See page 250 for a detailed explanation of the icons

\*Due to the natural content of the raw materials used to make the product, we cannot guarantee that the colours shown in the catalogue or colours customised to order will always have the same colour and appearance.

# BIC® MEDIA CLIC BIOBASED BGUARD™ ANTIBACTERIAL

BGUARD™



Bacteria elimination



Entire pen protection



Timeless protection



Antibacterial Test protocol

## BIOBASED



SUGAR CANE

MADE FROM 70% BIO-SOURCED\*  
& 100% INDUSTRIALLY  
COMPOSTABLE MATERIAL

### BIC® MEDIA CLIC BIOBASED BGUARD™ ANTIBACTERIAL

1973 Ballpen

Opaque

Colour ink



Red Ink available under request



02



360°  
Printing

100%

01

Available on  
white barrel



MIX & MATCH



PERSONALIZED COLOURS



MANUFACTURED AND PRINTED IN BIC FACTORIES



MADE IN SPAIN



REGULATORY COMPLIANCE



ISO certified



IMPRIM'VERT®



SUGAR CANE



UBICITY™ PROGRAM  
ALLOWS RECYCLING  
BIC WRITING INSTRUMENTS



100% ELECTRICITY COMING  
FROM RENEWABLE SOURCES

WRITING  
MODES



BALLPEN M  
Ø 1 MM

PRINTING  
TECHNIQUES



SCREEN PRINTING



DIGITAL

See page 250 for a detailed explanation of the icons

\*The percentage is calculated based on total weight of the barrel. Due to the natural content of the raw materials used to make the product, we cannot guarantee that the colours shown in the catalogue or colours customised to order will always have the same colour and appearance.

# BIC® MEDIA CLIC BIOBASED BGUARD™ ANTIBACTERIAL

BGUARD™

ecolutions®\*



**MIX & MATCH**

No extra charge

## BIC® MEDIA CLIC BIOBASED BGUARD™ ANTIBACTERIAL

1973 Ballpen Opaque

MOQ 500 units. Standard colours combination.

### Plug

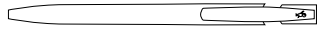

Opaque

01BG 07BG 02BG

### Clip



Opaque

01BG 02BG

### Barrel



Opaque

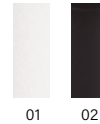

01 02

Exact colour match: ≥ 10.000 units



**MIX & MATCH**



PERSONALIZED COLOURS



MANUFACTURED AND PRINTED IN BIC FACTORIES



MADE IN SPAIN

ecolutions®



SUGAR CANE



UBICITY™ PROGRAM ALLOWS RECYCLING BIC WRITING INSTRUMENTS

WRITING MODES



BALLPEN M Ø 1 MM

PRINTING TECHNIQUES



SCREEN PRINTING



DIGITAL

### Decoration

## BIC® MEDIA CLIC BIOBASED BGUARD™ ANTIBACTERIAL

1973

A SP: max. 2 col.

B SP: max. 2 col.

C DG: full-colour

MOQ 500 units.

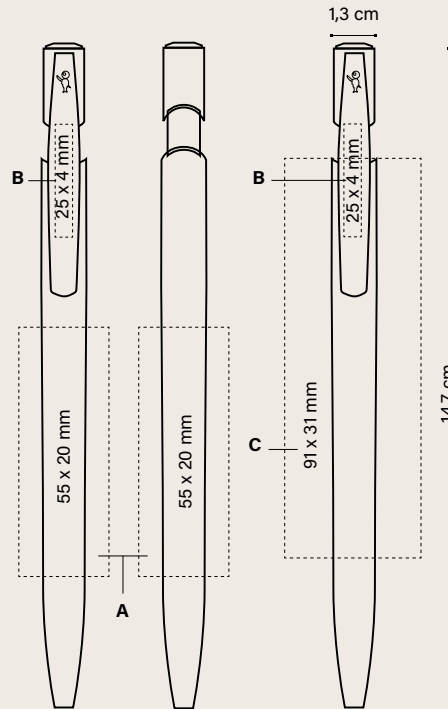

Price (€)

BIC® MEDIA CLIC BIOBASED BGUARD™ ANTIBACTERIAL	500-999	1000-2499	2500-4999	5000
ecolutions® 1973				
SP	0,89	0,83	0,73	0,68
DG	1,34	1,19	1,05	0,94

### Additional imprint charge per colour & position

SP	0,14	0,14	0,14	0,13
----	------	------	------	------

Prices include one imprint in one position according to specified technique.

### OPTIONAL SPECIAL PACKAGING



ECO SLEEVE



PLASTIC POUCH



WINDOW BOX

### EXTERNAL PACKAGING



250 ± 4,3 KG

+ INFO PAGES 240 TO 245

# BIC® MEDIA CLIC SHINE



## BIC® MEDIA CLIC SHINE 1975 Ballpen Opaque

MOQ 500 units. Standard colours combination.

### Plug

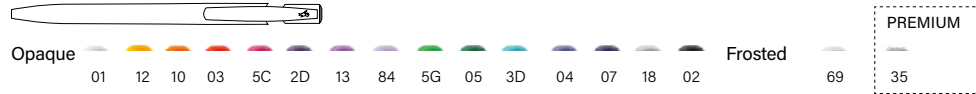

### Clip

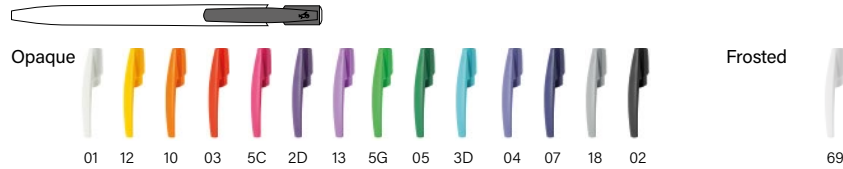

### Barrel

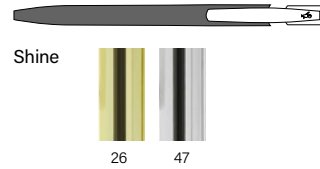

## BIC® MEDIA CLIC SHINE

1975 Ballpen  
Opaque

Colour ink  
● ● ●

Red Ink available under request



47



26

100%

## BIC® MEDIA CLIC SHINE

1975

A SP: max. 2 col.  
B SP: max. 2 col.

MOQ 500 units.

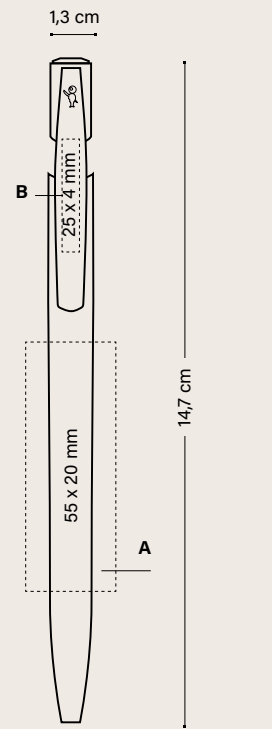

Price (€)

BIC® MEDIA CLIC SHINE	500-999	1000-2499	2500-4999	5000
1975				
SP	1,70	1,47	1,33	1,23
SP (Premium)	1,85	1,62	1,46	1,35

### Additional imprint charge per colour & position

SP	0,14	0,14	0,14	0,13
----	------	------	------	------

Prices include one colour in screen printing in one position.

### OPTIONAL SPECIAL PACKAGING



+ INFO PAGES 240 TO 245

### EXTERNAL PACKAGING



500 ± 4,1 KG



PERSONALIZED COLOURS



MANUFACTURED AND PRINTED IN BIC FACTORIES



MADE IN SPAIN



REGULATORY COMPLIANCE



ISO certified



IMPRIM'VERT®



UBICITY™ PROGRAM  
ALLOWS RECYCLING  
BIC WRITING INSTRUMENTS



100% ELECTRICITY COMING  
FROM RENEWABLE SOURCES

### WRITING MODES



BALLPEN M  
0.1 MM

### PRINTING TECHNIQUES



SCREEN PRINTING

See page 250 for a detailed explanation of the icons

# BIC® MEDIA CLIC GLACÉ

## Our best seller in elegant colours.

---

### BIC® MEDIA CLIC GLACÉ

1030 Opaque

Colour ink



*Red Ink available under request*



47G



76



03G



05G



04G



14G



# BIC® MEDIA CLIC GLACÉ



## BIC® MEDIA CLIC GLACÉ 1030 Ballpen Opaque

MOQ 500 units  
Standard colours combination

### Plug



### Clip

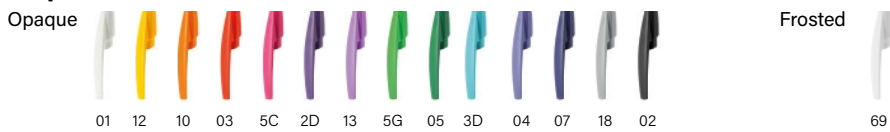

### Barrel

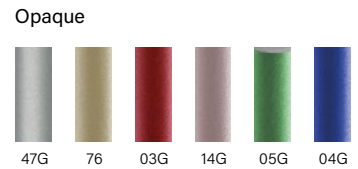

#### Decoration

### BIC® MEDIA CLIC GLACÉ

1030

A SP: max. 2 col.

B SP: max. 2 col.

MOQ 500 units.

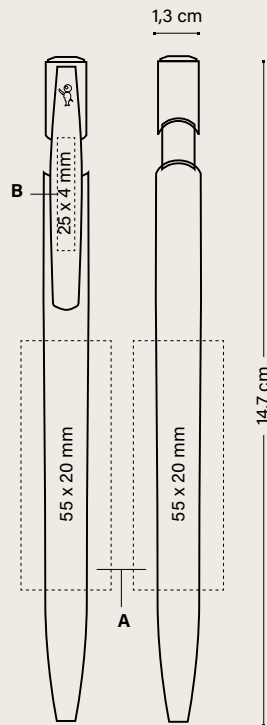

BIC® MEDIA CLIC GLACÉ	500-999	1000-2499	2500-4999	5000
1030				
SP	1,05	0,90	0,78	0,70

#### Additional imprint charge per colour & position

SP	0,14	0,14	0,14	0,13
----	------	------	------	------

Prices include one colour in screen printing in one position.

#### OPTIONAL SPECIAL PACKAGING



#### EXTERNAL PACKAGING



+ INFO PAGES 240 TO 245



MANUFACTURED AND PRINTED IN BIC FACTORIES



MADE IN SPAIN



REGULATORY COMPLIANCE



ISO certified



IMPRIM'VERT®



UBICITY™ PROGRAM  
ALLOWS RECYCLING  
BIC WRITING INSTRUMENTS



100% ELECTRICITY COMING  
FROM RENEWABLE SOURCES



WRITING  
MODES  
BALLPEN M  
Ø 1 MM



PRINTING  
TECHNIQUES  
SP  
SCREEN PRINTING

See page 250 for a detailed explanation of the icons

**BIC® CLIC STIC**

**Modern, flexible,  
reliable. That's how  
BIC® Clic Stic is!**

A large variety of finishes such  
as Digital, Stylus or Softfeel®,  
Mini.

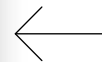

*Thousands of colour  
combinations!*



**BIC® CLIC STIC**

1000 Opaque

Colour ink

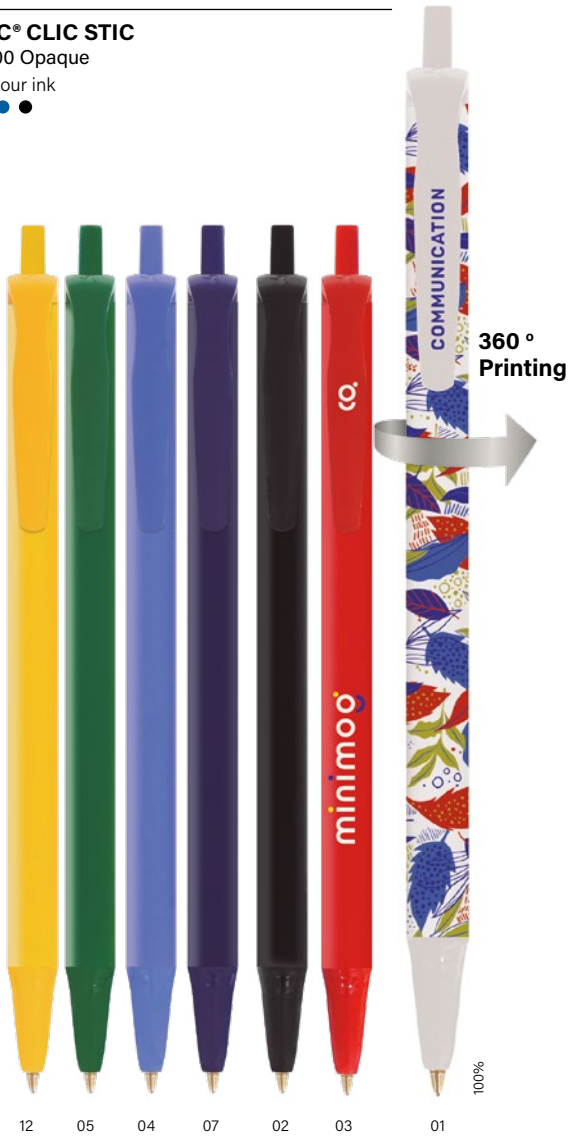

12 05 04 07 02 03 01

Available on white barrel



ECO version and standard at the same price!

ecolutions®

FRUIT AND VEGETABLE TRAYS



MADE FROM 78% RECYCLED MATERIAL\*

**BIC® CLIC STIC**

1E00 Opaque

Colour ink



1E/8E 1E/7E 1E/3E 1E/10E 01

Available on white barrel



MIX & MATCH



PERSONALIZED COLOURS



MANUFACTURED AND PRINTED IN BIC FACTORIES



MADE IN SPAIN



REGULATORY COMPLIANCE



IMPRIM'VERT®



FRUIT AND VEGETABLE TRAYS



UBICITY™ PROGRAM ALLOWS RECYCLING BIC WRITING INSTRUMENTS



100% ELECTRICITY COMING FROM RENEWABLE SOURCES

WRITING MODES



BALLPEN M 0.1 MM

PRINTING TECHNIQUES



SCREEN PRINTING



DIGITAL

\*The percentage is calculated based on total weight of the barrel. Due to the recycled content of the raw materials used to make the product, we cannot guarantee that the colours shown in the catalogue or colours customised to order will always have the same colour and appearance.

*ECO version and standard at the same price!*

**ecolutions®**  
 **MADE FROM 78% RECYCLED MATERIAL\***

 **FRUIT AND VEGETABLE TRAYS**

**BIC® CLIC STIC**  
 1000 Frosted  
 Colour ink  
 ● ● ●  
*Red Ink available under request*



**BIC® CLIC STIC**  
 1E00 Frosted  
 Colour ink  
 ● ● ●  
*Red Ink available under request*



\*The percentage is calculated based on total weight of the barrel. Due to the recycled content of the raw materials used to make the product, we cannot guarantee that the colours shown in the catalogue or colours customised to order will always have the same colour and appearance.

**BIC® CLIC STIC  
SOFTFEEL®**  
1005 Opaque  
Colour ink  
● ● ●  
*Red Ink available  
under request*



**BIC® CLIC STIC  
SOFTFEEL®**  
1005 Frosted  
Colour ink  
● ● ●  
*Red Ink available  
under request*



**MIX &  
MATCH**



PERSONALIZED  
COLOURS



MANUFACTURED  
AND PRINTED IN  
BIC FACTORIES



MADE IN SPAIN



REGULATORY  
COMPLIANCE



**IMPRIM'VERT®**

**ecolutions®**



FRUIT AND  
VEGETABLE TRAYS



UBICITY™ PROGRAM  
ALLOWS RECYCLING  
BIC WRITING INSTRUMENTS



100% ELECTRICITY COMING  
FROM RENEWABLE SOURCES

**WRITING  
MODES**



BALLPEN M  
Ø 1 MM

**PRINTING  
TECHNIQUES**



SCREEN PRINTING



DIGITAL

See page 250 for a detailed explanation of the icons

**MIX & MATCH**



PERSONALIZED COLOURS



MANUFACTURED AND PRINTED IN BIC FACTORIES



MADE IN SPAIN



REGULATORY COMPLIANCE



IMPRIM'VERT®



FRUIT AND VEGETABLE TRAYS



UBICUITY™ PROGRAM ALLOWS RECYCLING BIC WRITING INSTRUMENTS



100% ELECTRICITY COMING FROM RENEWABLE SOURCES

**WRITING MODES**



BALLPEN M 0.1 MM

**PRINTING TECHNIQUES**



SCREEN PRINTING



DIGITAL

*ECO version and standard at the same price!*

**ecolutions®**  
MADE FROM 78% RECYCLED MATERIAL\*



FRUIT AND VEGETABLE TRAYS

## BIC® CLIC STIC STYLUS

1847 Opaque

Colour ink

● ● ●

Red Ink available under request



## BIC® CLIC STIC STYLUS

1846 Opaque

Colour ink

● ● ●

Red Ink available under request



\*The percentage is calculated based on total weight of the barrel. Due to the recycled content of the raw materials used to make the product, we cannot guarantee that the colours shown in the catalogue or colours customised to order will always have the same colour and appearance.

**BIC® CLIC STIC**

1000 Opaque / **ecolutions®** 1E00 Opaque

1000 Frosted / **ecolutions®** 1E00 Frosted

1005 Opaque / Frosted

MOQ 500 units. Standard colours combination

**BIC® CLIC STIC STYLUS**

1846 / 1847 Opaque



**Plug**

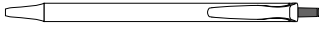

Opaque



Frosted

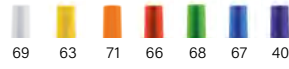

**Clip**

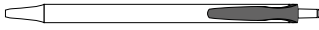

Opaque

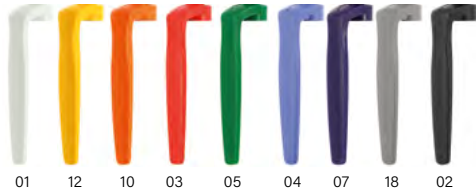

Frosted



**Section**

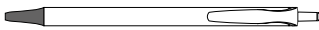

Opaque

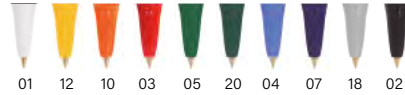

Frosted

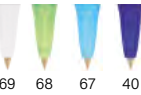

**Stylus**

Opaque



**Barrel**



Opaque

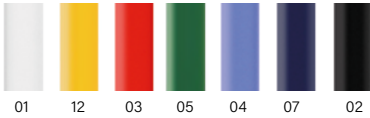

**Stylus**

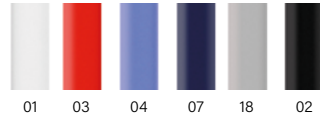

**Softfeel®**

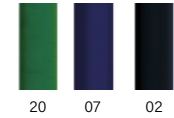

**Mini**



Frosted

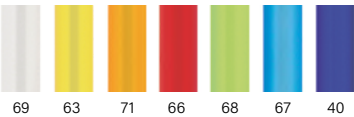

40

Exact colour match: ≥ 10.000 units



MOQ 500 units

**ecolutions®** Standard colours combination\*



Add the Möbius loop to your artwork at no additional charge. Please specify it on your order. (Möbius loop imprint defaults to left-hand corner.)

FRUIT AND VEGETABLE TRAYS



**Plug**

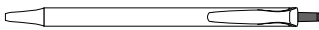

Opaque



**Section**

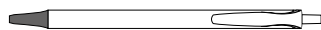

Opaque

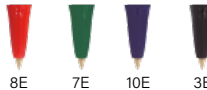

**Stylus**

Opaque



**Clip**



Opaque



**Barrel**



Opaque



Frosted

**Stylus**

Opaque



Exact colour match: ≥ 10.000 units

\*Due to the recycled content of the raw materials used to make the product, we cannot guarantee that the colours shown in the catalogue or colours customised to order will always have the same colour and appearance.



PERSONALIZED COLOURS



MANUFACTURED AND PRINTED IN BIC FACTORIES



MADE IN SPAIN



REGULATORY COMPLIANCE



ISO certified



IMPRIM'VERT®



FRUIT AND VEGETABLE TRAYS



UBICITY™ PROGRAM ALLOWS RECYCLING BIC WRITING INSTRUMENTS



100% ELECTRICITY COMING FROM RENEWABLE SOURCES

WRITING MODES



BALLPEN M Ø 1 MM

PRINTING TECHNIQUES



SCREEN PRINTING



DIGITAL

## Decoration

### BIC® CLIC STIC

1000 / **ecolutions®** 1E00

### BIC® CLIC STIC STYLUS

1847 / **ecolutions®** 1846

**A SP:** max. 3 col.

**B SP:** max. 1 col.

**C SP:** max. 2 col.

**D DG:** full-colour (area for text)  
(Only available on white barrel)

MOQ 500 units.

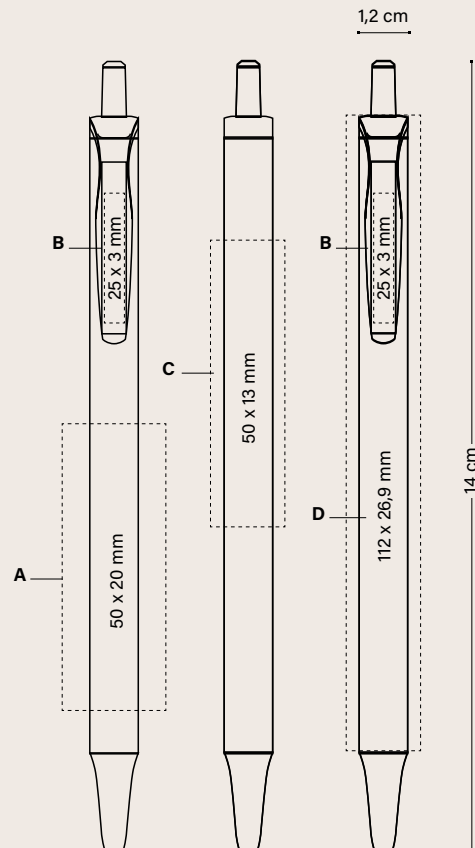

	500-999	1000-2499	2500-4999	Price (€)
<b>BIC® CLIC STIC</b>				5000
1000 / <b>ecolutions®</b> 1E00				
SP	0,85	0,74	0,70	0,66
DG	1,14	1,02	0,96	0,90
1847 / <b>ecolutions®</b> 1846				
SP	1,02	0,91	0,85	0,77
DG	1,31	1,15	1,08	1,02

#### Additional imprint charge per colour & position

SP	0,14	0,14	0,14	0,13
----	------	------	------	------

Prices include one imprint in one position according to specified technique.

#### OPTIONAL SPECIAL PACKAGING



ECO SLEEVE



PLASTIC POUCH

+ INFO PAGES 240 TO 245

#### EXTERNAL PACKAGING



500 ± 2,9 KG



Decoration

**BIC® CLIC STIC SOFTFEEL®**  
1005

A/B SP: max. 1 col.

MOQ 500 units.

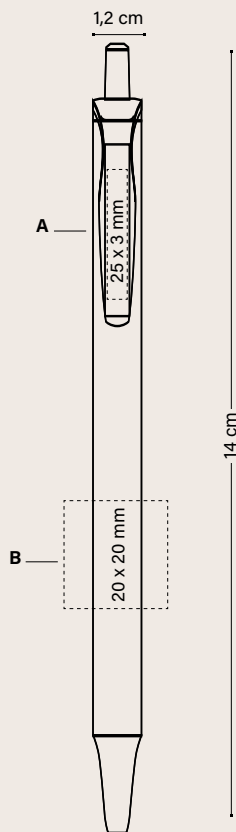

Price (€)

BIC® CLIC STIC SOFTFEEL®	500-999	1000-2499	2500-4999	5000
1005				
SP	1,05	0,94	0,88	0,80

Additional imprint charge per colour & position

SP	0,14	0,14	0,14	0,13
----	------	------	------	------

Prices include one colour in screen printing in one position.

OPTIONAL SPECIAL PACKAGING



+ INFO PAGES 240 TO 245

EXTERNAL PACKAGING



Decoration

**BIC® CLIC STIC MINI**  
1892

A SP: max. 1 col.

B SP: max. 1 col.

C DG: full-colour (area for text)  
(Only available on white barrel)

MOQ 500 units.

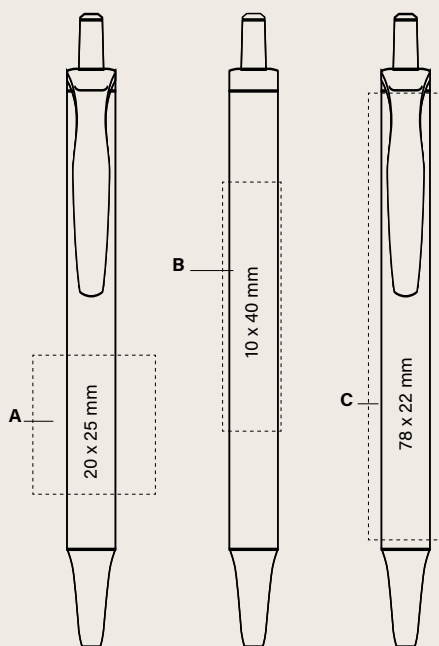

Price (€)

BIC® CLIC STIC MINI	500-999	1000-2499	2500-4999	5000
1892				
SP	0,78	0,64	0,60	0,57
DG	1,06	0,95	0,88	0,82

Prices include one imprint in one position according to specified technique.

OPTIONAL SPECIAL PACKAGING



+ INFO PAGES 240 TO 245

EXTERNAL PACKAGING



MIX & MATCH



PERSONALIZED COLOURS



MANUFACTURED AND PRINTED IN BIC FACTORIES



MADE IN SPAIN



REGULATORY COMPLIANCE



ISO certified



IMPRIM'VERT®



UBICITY™ PROGRAM  
ALLOWS RECYCLING  
BIC WRITING INSTRUMENTS



100% ELECTRICITY COMING  
FROM RENEWABLE SOURCES

WRITING MODES



BALLPEN M  
0.1 MM

PRINTING TECHNIQUES



SCREEN PRINTING



DIGITAL





# BIC<sup>®</sup> SUPER CLIP

Discover the eye-catching clip and its gentle twist mechanism. Large printing areas offer a wide range of personalisation possibilities in the standard and advance versions. Now also available in soft and glacé versions. In addition, the Super Clip Origin, a more innovative and sustainable pen.

Welcome to the future!

**ECOLUTIONS<sup>®</sup>**  
**ADVANCE**  
**GLACÉ**  
**GLACÉ ADVANCE**  
**SOFT**  
**SOFT ADVANCE**  
**ORIGIN**

# BIC® SUPER CLIP

**BIC® SUPER CLIP**  
1039 Opaque  
Colour ink  
● ●



Large  
printing  
areas!



Gentle twist  
mechanism!

360°  
Printing

Available on  
white barrel



ECO version and standard at the same price!

**ecolutions®**  
 **MADE FROM 78% RECYCLED MATERIAL\***  
 **PLASTIC CAR PARTS**

**BIC® SUPER CLIP**  
 1E50 Opaque  
 Colour ink  
 ● ●



**BIC® SUPER CLIP**  
 1039 Clear  
 Colour ink  
 ● ●



**MIX & MATCH**



PERSONALIZED COLOURS



MANUFACTURED AND PRINTED IN BIC FACTORIES



MADE IN SPAIN



REGULATORY COMPLIANCE



ISO certified

**IMPRIM'VERT®**

**ecolutions®**



PLASTIC CAR PARTS



UBICITY™ PROGRAM ALLOWS RECYCLING BIC WRITING INSTRUMENTS



100% ELECTRICITY COMING FROM RENEWABLE SOURCES

**WRITING MODES**



BALLPEN M Ø 1 MM

**PRINTING TECHNIQUES**



SCREEN PRINTING



DIGITAL



BRITEPIX™  
 BRITEPIX™ TEXTURE  
 BRITEPIX™ PERSONALISATION

\*The percentage is calculated based on total weight of the barrel. Due to the recycled content of the raw materials used to make the product, we cannot guarantee that the colours shown in the catalogue or colours customised to order will always have the same colour and appearance.

# BIC® SUPER CLIP

## BIC® SUPER CLIP

1039 Opaque

ecolutions® 1E50 Opaque

1039 Clear

MOQ 250 units

Standard colours combination



No extra charge

### Clip



Opaque

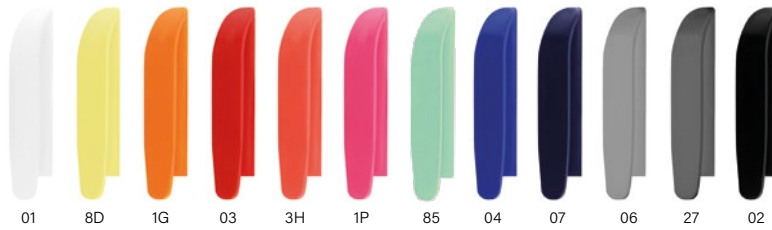

Clear

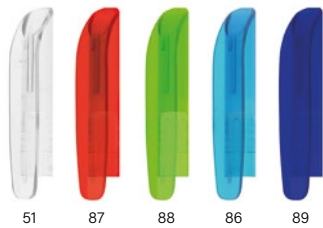

ecolutions®



Standard colours combination\*



1E 1E



Add the Möbius loop to your artwork at no additional charge. Please specify it on your order. (Möbius loop imprint defaults to left-hand hand corner.)

### Barrel



Opaque

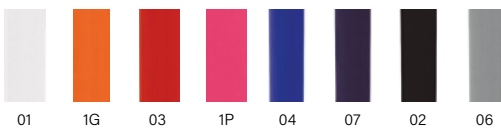

Clear

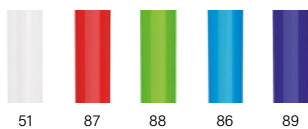

Exact colour match:  $\geq 10.000$  units



\*Due to the recycled content of the raw materials used to make the product, we cannot guarantee that the colours shown in the catalogue or colours customised to order will always have the same colour and appearance.

Decoration

**BIC® SUPER CLIP**

1039

ecolutions® 1E50

**A SP:** max. 2 col.

**B SP:** max. 1 col.

**C DG:** full-colour

**D BP:** full-colour

**BP Texture:** full-colour

MOQ 250 units.

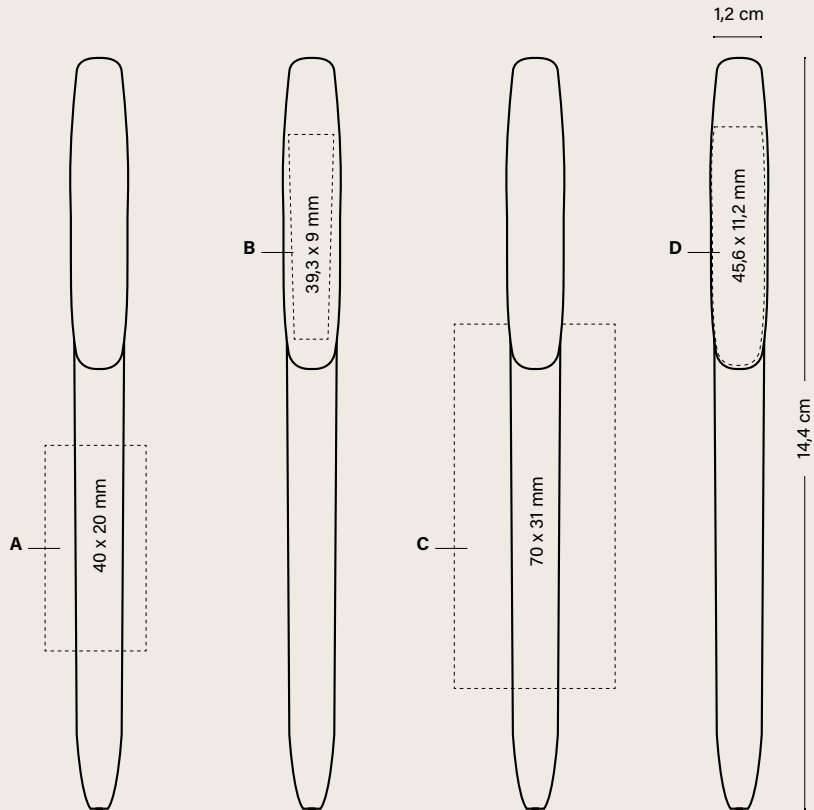

	Price (€)				
<b>BIC® SUPER CLIP</b>	250-499	500-999	1000-2499	2500-4999	5000
1039 / ecolutions® 1E50					
<b>SP</b>	1,13	1,02	0,95	0,88	0,84
<b>DG</b>	1,47	1,32	1,24	1,16	1,04
<b>BP</b>	1,41	1,28	1,19	1,12	0,99

**Additional imprint charge per colour & position**

<b>SP</b>	0,17	0,14	0,14	0,14	0,13
<b>BP</b>	0,24	0,22	0,21	0,20	0,19
<b>BP Texture</b>	0,18	0,16	0,15	0,15	0,14

Prices include one imprint in one position according to specified technique.

**OPTIONAL SPECIAL PACKAGING**



+ INFO PAGES 240 TO 245

**EXTERNAL PACKAGING**



250 ± 2,6 KG

Collection Box  
(1, 2 & 3 units)

**MIX & MATCH**



PERSONALIZED COLOURS



MANUFACTURED AND PRINTED IN BIC FACTORIES



MADE IN SPAIN



REGULATORY COMPLIANCE



ISO certified



IMPRIM'VERT®

ecolutions®



PLASTIC CAR PARTS



UBICITY™ PROGRAM  
ALLOWS RECYCLING  
BIC WRITING INSTRUMENTS



100% ELECTRICITY COMING  
FROM RENEWABLE SOURCES

**WRITING MODES**



BALLPEN M  
0.1 MM

**PRINTING TECHNIQUES**



SCREEN PRINTING



DIGITAL



BRITEPIX™  
BRITEPIX™ TEXTURE  
BRITEPIX™ PERSONALISATION

See page 250 for a detailed explanation of the icons

# BIC® SUPER CLIP ADVANCE

---

## BIC® SUPER CLIP ADVANCE

1073 Opaque

Colour ink







Available on white barrel



MIX & MATCH



PERSONALIZED COLOURS



MANUFACTURED AND PRINTED IN BIC FACTORIES



MADE IN SPAIN



REGULATORY COMPLIANCE



ISO certified



IMPRIM'VERT®



UBICITY™ PROGRAM  
ALLOWS RECYCLING  
BIC WRITING INSTRUMENTS



100% ELECTRICITY COMING FROM RENEWABLE SOURCES

WRITING MODES



BALLPEN M  
Ø 1 MM

PRINTING TECHNIQUES



SCREEN PRINTING



DIGITAL



BRITEPIX™  
BRITEPIX™ TEXTURE  
BRITEPIX™ PERSONALISATION

See page 250 for a detailed explanation of the icons

# BIC® SUPER CLIP ADVANCE

**BIC® SUPER CLIP ADVANCE**  
1073 Opaque

MOQ 250 units  
Standard colours combination

**MIX &  
MATCH**

No extra charge

## Clip

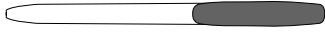

Opaque

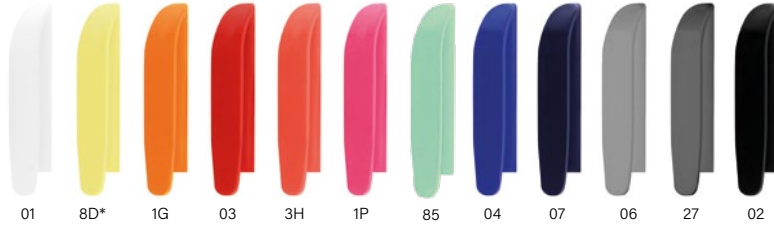

Clear

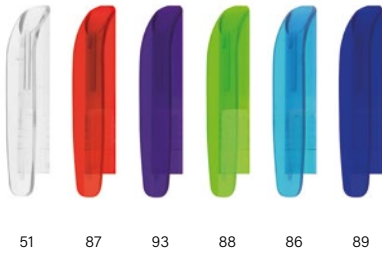

## Barrel



Opaque

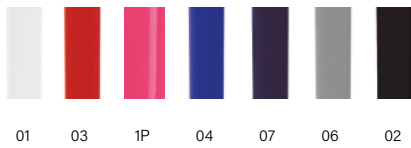

## Section



35

Exact colour match:  $\geq 10.000$  units



Decoration

**BIC® SUPER CLIP ADVANCE**

1073

**A SP:** max. 2 col.

**B SP:** max. 1 col.

**C DG:** full-colour

**D BP:** full-colour

**BP Texture:** full-colour

MOQ 250 units.

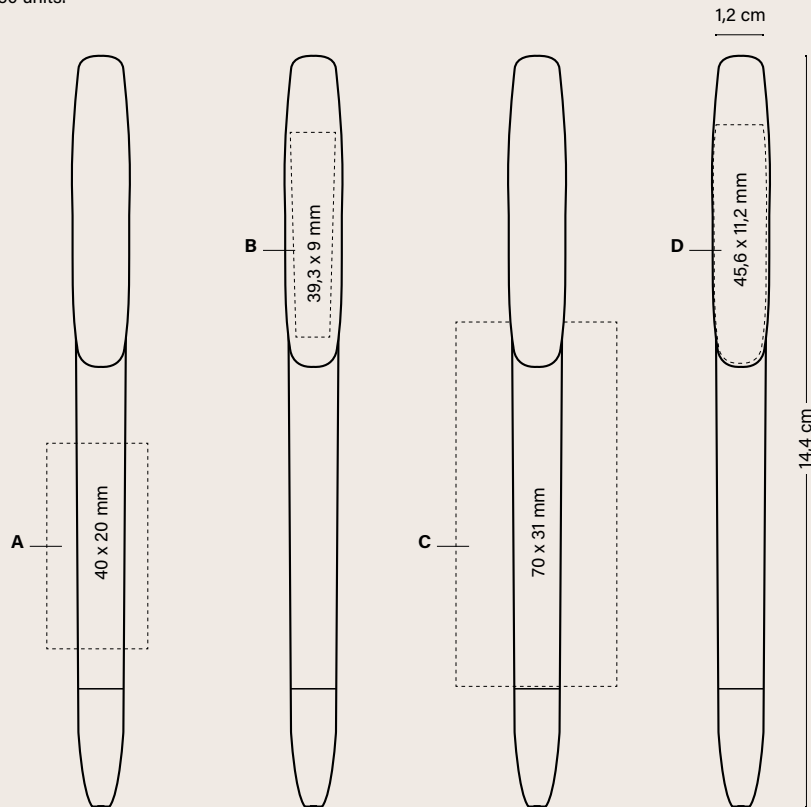

Price (€)

BIC® SUPER CLIP ADVANCE	250-499	500-999	1000-2499	2500-4999	5000
1073					
<b>SP</b>	1,71	1,42	1,33	1,26	1,21
<b>DG</b>	2,09	1,71	1,61	1,51	1,47
<b>BP</b>	1,96	1,62	1,52	1,43	1,39

**Additional imprint charge per colour & position**

<b>SP</b>	0,17	0,14	0,14	0,14	0,13
<b>BP</b>	0,24	0,22	0,21	0,20	0,19
<b>BP Texture</b>	0,18	0,16	0,15	0,15	0,14

Prices include one imprint in one position according to specified technique.

**OPTIONAL SPECIAL PACKAGING**



ECO SLEEVE



PLASTIC POUCH



WINDOW BOX



COLLECTION BOX

Collection Box (1, 2 & 3 units)



250 ± 2,6 KG

+ INFO PAGES 240 TO 245

**EXTERNAL PACKAGING**

**MIX & MATCH**



PERSONALIZED COLOURS



MANUFACTURED AND PRINTED IN BIC FACTORIES



MADE IN SPAIN



REGULATORY COMPLIANCE



ISO certified



IMPRIM'VERT®



UBICITY™ PROGRAM ALLOWS RECYCLING BIC WRITING INSTRUMENTS



100% ELECTRICITY COMING FROM RENEWABLE SOURCES

**WRITING MODES**



BALLPEN M Ø 1 MM

**PRINTING TECHNIQUES**



SCREEN PRINTING



DIGITAL



BRITEPIX™ BRITEPIX™ TEXTURE BRITEPIX™ PERSONALISATION

See page 250 for a detailed explanation of the icons

# BIC® SUPER CLIP GLACÉ & ADVANCE

## Discover the BIC® Super Clip in a new glamorous version.

### BIC® SUPER CLIP GLACÉ

1082

Colour ink



47G

76

014G

03G

04G

05G

100%

### BIC® SUPER CLIP GLACÉ ADVANCE

1084

Colour ink



47G/35

05G/35

014G/35

03G/35

04G/35

76/35

100%



Refill  
service on  
request

# BIC® SUPER CLIP GLACÉ & ADVANCE

## Section

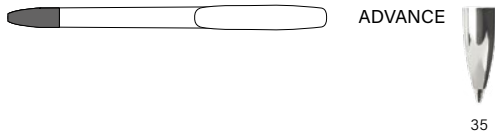

### Decoration

**BIC® SUPER CLIP GLACÉ**  
1082

**BIC® SUPER CLIP GLACÉ  
ADVANCE**  
1084

**A SP:** max. 1 col.  
**B SP:** max. 1 col.

MOQ 250 units  
Standard colours combination

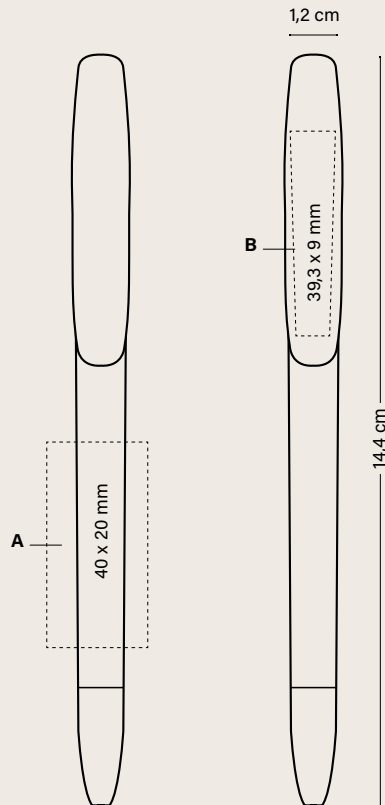

	Price (€)				
BIC® SUPER CLIP GLACÉ	250-499	500-999	1000-2499	2500-4999	5000
1082					
SP	1,89	1,63	1,50	1,42	1,37
1084					
SP	2,31	1,90	1,75	1,65	1,60

### Additional imprint charge per colour & position

SP	0,17	0,14	0,14	0,14	0,13
----	------	------	------	------	------

Prices include one imprint in one position according to specified technique.

### OPTIONAL SPECIAL PACKAGING



+ INFO PAGES 240 TO 245

### EXTERNAL PACKAGING



250 ± 2,6 KG

Collection Box  
(1, 2 & 3 units)



PERSONALIZED  
COLOURS



MANUFACTURED  
AND PRINTED IN  
BIC FACTORIES



MADE IN SPAIN



REGULATORY  
COMPLIANCE



ISO  
certified



IMPRIM'VERT®



UBICITY™ PROGRAM  
ALLOWS RECYCLING  
BIC WRITING INSTRUMENTS



100% ELECTRICITY COMING  
FROM RENEWABLE SOURCES

### WRITING MODES



BALLPEN M  
Ø 1 MM

### PRINTING TECHNIQUES



SCREEN PRINTING



CHECK OUT THE VIDEO

See page 250 for a detailed explanation of the icons

## BIC® SUPER CLIP SOFT & ADVANCE

# Feel the incredible softness of our BIC® Super Clip version with twist mechanism.



### BIC® SUPER CLIP SOFT

1083

Colour ink



02F

03F

07F

100%

### BIC® SUPER CLIP SOFT ADVANCE

1085

Colour ink



02F/35

03F/35

07F/35

100%



Refill  
service on  
request

# BIC® SUPER CLIP SOFT & ADVANCE

## Section

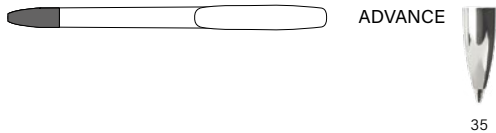

### Decoration

**BIC® SUPER CLIP SOFT**  
1083

**BIC® SUPER CLIP SOFT  
ADVANCE**  
1085

A SP: max. 1 col.

MOQ 250 units  
Standard colours combination

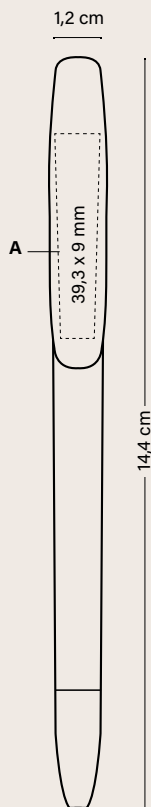

	250-499	500-999	1000-2499	2500-4999	Price (€)
<b>BIC® SUPER CLIP SOFT</b>					5000
1083					
SP	2,33	1,68	1,58	1,49	1,42
1085					
SP	2,89	2,30	2,16	2,08	1,94

### Additional imprint charge per colour & position

SP	0,17	0,14	0,14	0,14	0,13
----	------	------	------	------	------

Prices include one imprint in one position according to specified technique.

### OPTIONAL SPECIAL PACKAGING



ECO SLEEVE



PLASTIC POUCH



WINDOW BOX



COLLECTION BOX

Collection Box  
(1, 2 & 3 units)

+ INFO PAGES 240 TO 245

### EXTERNAL PACKAGING



250 ± 2,6 KG

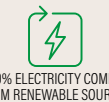

### WRITING MODES



### PRINTING TECHNIQUES



CHECK OUT THE VIDEO

See page 250 for a detailed explanation of the icons

BIC® SUPER CLIP ORIGIN

# Our new BIC® Super Clip is made from natural ingredients\*.

NEW!

**ecolutions®** MADE WITH A BIOBASED MATERIAL

BIC® SUPER CLIP ORIGIN

1038

Colour ink



Gentle twist mechanism!

**ORIGIN**  
BIOBASED

BIC® Super Clip Origin is made from biobased material manufactured with natural polymers excluding any source of petroleum or fossil fuels\*.



Made with castor oil and other ingredients of vegetal origin.\*

*Due to the use of natural materials, our pens feature unique variations in color, highlighting the authentic and distinctive nature of each piece. Embrace the natural charm!*



Manufactured and printed in factories 100% powered by electricity produced using renewable sources.



Barrel and clip are 100% biosourced.



The Ubicuity program, developed by BIC in partnership with Terracycle, enables the recycling of BIC's ballpoint pens.



60

70

6CO



# BIC® SUPER CLIP ORIGIN

## Decoration

### BIC® SUPER CLIP ORIGIN

1038

A SP: max. 1 col.

MOQ 250 units  
Standard colours combination

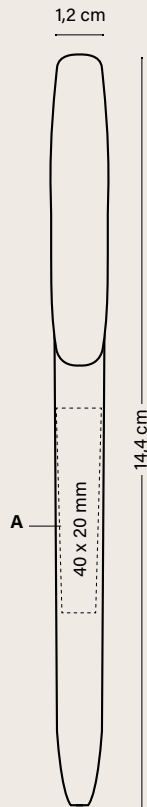

Price (€)

BIC® SUPER CLIP ORIGIN	250-499	500-999	1000-2499	2500-4999	5000
1038					
SP	1,80	1,72	1,46	1,29	1,21

Prices include one colour in screen printing in one position.

## OPTIONAL SPECIAL PACKAGING



ECO SLEEVE



PLASTIC POUCH



WINDOW BOX



COLLECTION BOX

+ INFO PAGES 240 TO 245

Can be used as bookmark

## EXTERNAL PACKAGING



250 ± 2,6 KG

Collection Box (1, 2 & 3 units)



PERSONALIZED COLOURS



MANUFACTURED AND PRINTED IN BIC FACTORIES



MADE IN SPAIN



REGULATORY COMPLIANCE



ISO certified



IMPRIM'VERT®

**ORIGIN BIOBASED**



UBICITY™ PROGRAM ALLOWS RECYCLING BIC WRITING INSTRUMENTS



100% ELECTRICITY COMING FROM RENEWABLE SOURCES

PRINTING TECHNIQUES



SCREEN PRINTING

See page 250 for a detailed explanation of the icons

**BIC® WIDE BODY™**

# **The right size to show the true value of your brand!**

Wide profile and wide variety of  
possibilities to maximise your  
message.





**BIC® WIDE BODY™**  
 1080 Opaque  
 Colour ink  
 ● ● ●  
 Red Ink available under request



01 07 02 18

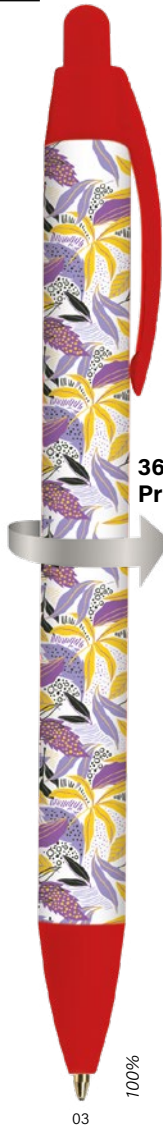

360°  
Printing

100%

Available on white barrel



ECO version and standard at the same price!

**ecolutions®**

MADE FROM 94% RECYCLED MATERIAL\*

FRUIT AND VEGETABLE TRAYS

**BIC® WIDE BODY™**  
**ecolutions® 1E80 Opaque**  
 Colour ink  
 ● ● ●  
 Red Ink available under request



360°  
Printing

100%

Available on white barrel



**MIX & MATCH**



PERSONALIZED COLOURS



MANUFACTURED AND PRINTED IN BIC FACTORIES



MADE IN SPAIN



REGULATORY COMPLIANCE



ISO certified



IMPRIM'VERT®

**ecolutions®**



FRUIT AND VEGETABLE TRAYS



UBICUITY™ PROGRAM ALLOWS RECYCLING BIC WRITING INSTRUMENTS



100% ELECTRICITY COMING FROM RENEWABLE SOURCES

**WRITING MODES**



BALLPEN M Ø 1 MM

**PRINTING TECHNIQUES**



SCREEN PRINTING



DIGITAL

See page 250 for a detailed explanation of the icons

\*The percentage is calculated based on total weight of the barrel. Due to the recycled content of the raw materials used to make the product, we cannot guarantee that the colours shown in the catalogue or colours customised to order will always have the same colour and appearance.

**BIC® WIDE BODY™**

1080 Frosted

Colour ink



40

63

67

68

69

66

71

100%

Large printing areas!



**BIC® WIDE BODY™**

**MINI DIGITAL**

1893 Opaque

1896 Chrome Opaque

Colour ink



01

01

100%

360° Printing

Available on white barrel



**BIC® WIDE BODY™**  
 1080 Opaque  
 ecolutions® 1E80 Opaque  
 1080 Frosted

**BIC® WIDE BODY™ MINI DIGITAL**  
 1893 Opaque  
 1896 Chrome Opaque

MOQ 250 units  
 Standard colours combination

**MIX & MATCH**  
 No extra charge

**Plug**



Opaque



Frosted

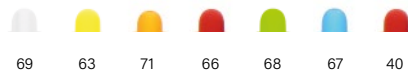

Chrome



**Clip**



Opaque

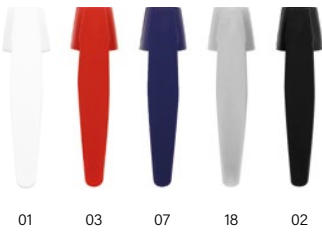

Frosted

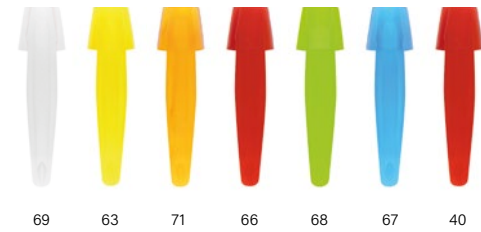

**Barrel**



Opaque



Frosted

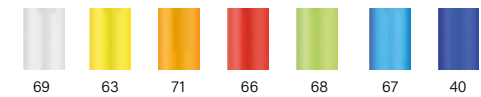

Opaque



**ecolutions® \*\***



Add the Möbius loop to your artwork at no additional charge. Please specify "Print the Möbius loop" on your order. (Möbius loop imprint defaults to left-hand corner.)



FRUIT AND VEGETABLE TRAYS

**Section**

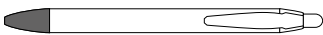

Opaque

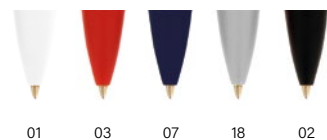

Frosted

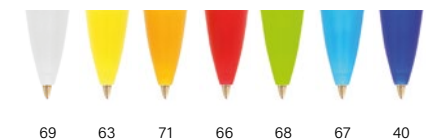

Chrome



Exact colour match: ≥ 10.000 units



**MIX & MATCH**



PERSONALIZED COLOURS



MANUFACTURED AND PRINTED IN BIC FACTORIES



MADE IN SPAIN



REGULATORY COMPLIANCE



ISO certified



IMPRIM'VERT®

ecolutions®



FRUIT AND VEGETABLE TRAYS



UBICITY™ PROGRAM ALLOWS RECYCLING BIC WRITING INSTRUMENTS



100% ELECTRICITY COMING FROM RENEWABLE SOURCES

**WRITING MODES**



BALLPEN M 0.1 MM

**PRINTING TECHNIQUES**



SCREEN PRINTING



DIGITAL

\*While stocks last.

\*\*Due to the recycled content of the raw materials used to make the product, we cannot guarantee that the colours shown in the catalogue or colours customised to order will always have the same colour and appearance.

# BIC® WIDE BODY™

## BIC® WIDE BODY™

1080 Opaque

ecolutions® 1E80

A/C SP: max. 2 col.

B/F SP: max. 1 col.

D DG: full-colour (area for images)

E DG: full-colour (area for text)

MOQ 250 units (SP)

MOQ 500 units (DG)

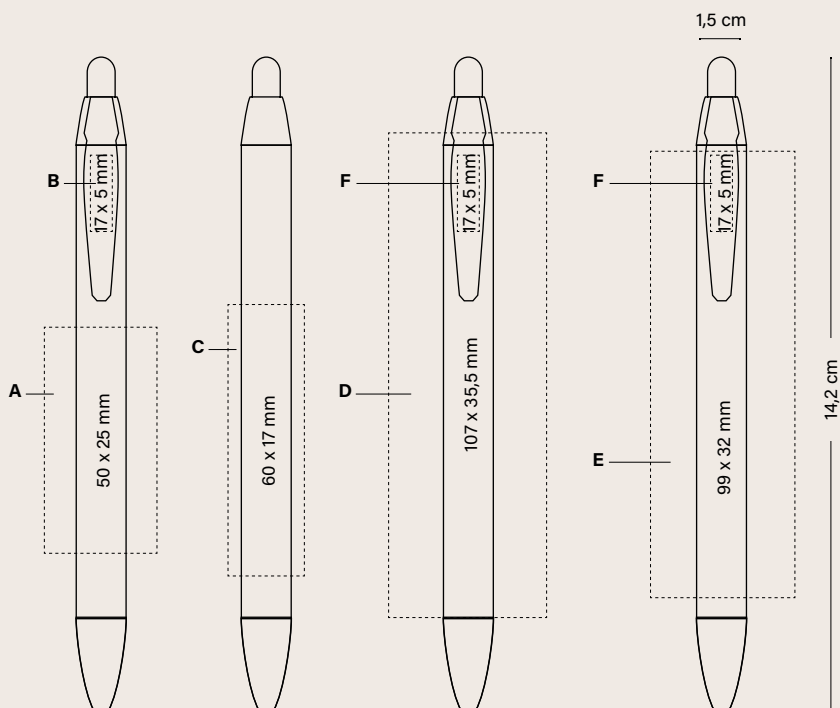

	Price (€)				
BIC® WIDE BODY™	250-499	500-999	1000-2499	2500-4999	5000
1080 / ecolutions® 1E80					
SP	1,38	1,02	0,96	0,90	0,82
DG	-	1,42	1,32	1,23	1,15

### Additional imprint charge per colour & position

SP	0,17	0,14	0,14	0,14	0,13
----	------	------	------	------	------

Prices include one imprint in one position according to specified technique.

### OPTIONAL SPECIAL PACKAGING



+ INFO PAGES 240 TO 245

### EXTERNAL PACKAGING



250 ± 2,6KG

Collection Box  
(1, 2 & 3 units)

**BIC® WIDE BODY™  
MINI DIGITAL**

1893

**BIC® WIDE BODY™  
MINI CHROME DIGITAL**

1896

**A DG:** full-colour (area for images)

**B DG:** full-colour (area for text)

MOQ 500 units (DG)

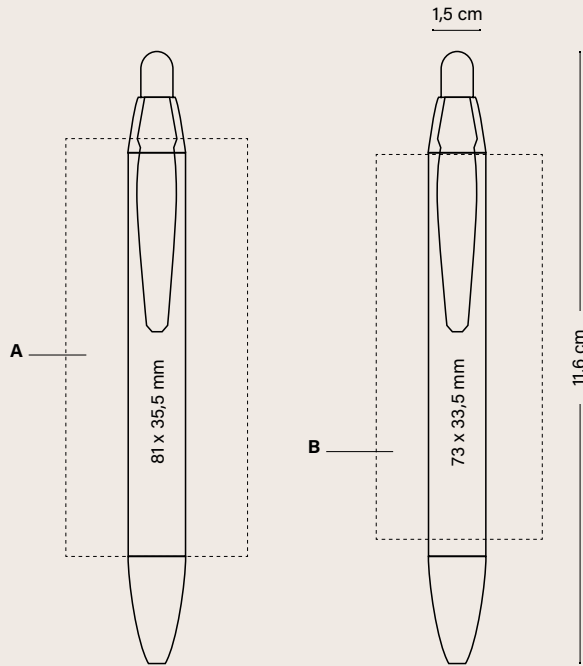

	Price (€)			
BIC® WIDE BODY™ MINI DIGITAL	500-999	1000-2499	2500-4999	5000
1893				
<b>DG</b>	1,25	1,16	1,09	1,03
1896				
<b>DG</b>	2,16	2,02	1,92	1,76

Prices include the digital imprint on the body.

**OPTIONAL SPECIAL PACKAGING**



+ INFO PAGES 240 TO 245

**EXTERNAL PACKAGING**



250 ± 2,6KG

Collection Box  
(1, 2 & 3 units)



PERSONALIZED  
COLOURS



MANUFACTURED  
AND PRINTED IN  
BIC FACTORIES



MADE IN SPAIN



REGULATORY  
COMPLIANCE



ISO  
certified



IMPRIM'VERT®  
eCOlutions®



FRUIT AND  
VEGETABLE TRAYS



UBICITY™ PROGRAM  
ALLOWS RECYCLING  
BIC WRITING INSTRUMENTS



100% ELECTRICITY COMING  
FROM RENEWABLE SOURCES

**WRITING  
MODES**



BALLPEN M  
0.1 MM

**PRINTING  
TECHNIQUES**



SCREEN PRINTING



DIGITAL

See page 250 for a detailed explanation of the icons







## BIC® 4 COLOURS®

The world-renowned BIC® 4 Colours® ballpen gives you the convenience of four different ink colours in one ballpoint pen, making it a great choice to organise notes and record data in different colours. This versatile pen has a 1.0 mm medium point and is filled with long-lasting ink. For added convenience, it has a lanyard hole, so you can take it with you anywhere.

Discover all the versions: Classic, Fashion, Sun, Fine, Shine, Fluo, 3+1<sup>HB</sup> (with mechanical pencil), Glacé, Soft, Wood Style and the latest versions Pastel, Bicolor, Gradient and Flags Collection.

Don't wait...start your collection today!

**BICOLOR  
GRADIENT  
PASTEL  
FASHION  
SUN  
FINE  
FLUO**

**SHINE  
GLACÉ  
SOFT  
WOOD STYLE  
FLAGS COLLECTION  
3+1<sup>HB</sup>**

# BIC® 4 COLOURS®

## Always an icon.



THE SOLUTION FOR FULL COLOUR COMMUNICATION!

Now in coloured barrels

### BIC® 4 COLOURS®

1100 Opaque  
1101 With lanyard  
Colour ink



01/01

02/02

01/03

01/05

01/02

01/12

01/07

**NEW!**

New printing area

360° Printing



Refill service on request

Decoration

**BIC® 4 COLOURS®**

1100/1101

**A SP:** max. 4 col.

**B DG:** Digital print (area for images)

**C BP:** full-colour

**D SP:** 1 col. (only for white upper parts)

MOQ 250 units (SP, DG)

MOQ 100 units (BP)

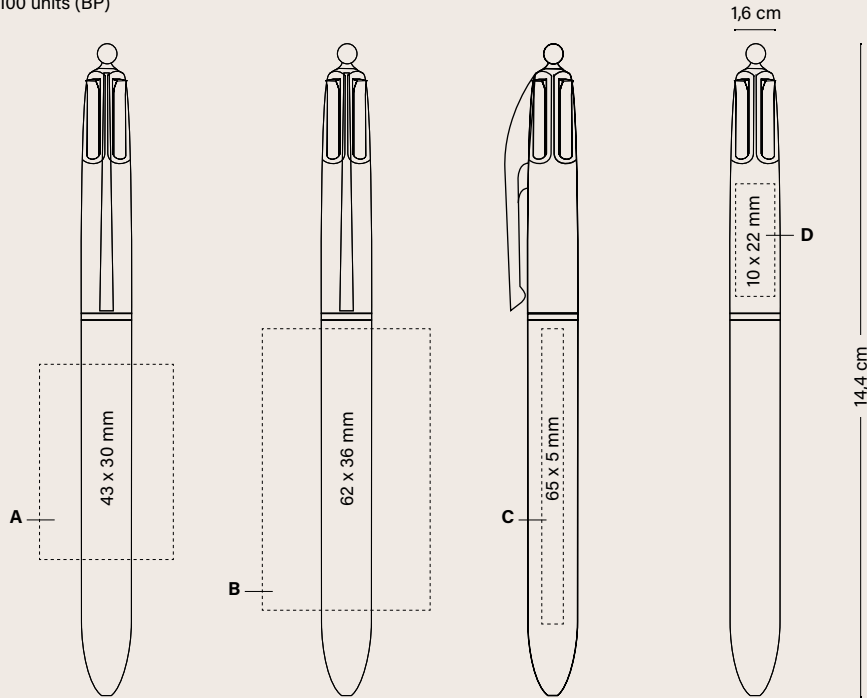

	Price (€)					
BIC® 4 COLOURS®	100-249	250-499	500-999	1000-2499	2500-4999	5000
1100						
SP	-	3,51	3,18	2,94	2,75	2,59
DG	-	4,80	4,35	4,04	3,75	3,54
BP	4,65	3,79	3,43	3,19	2,99	2,81
1101 (lanyard)						
SP	-	3,98	3,61	3,34	3,14	2,94
DG	-	5,26	4,78	4,42	4,12	3,90
BP	5,21	4,26	3,86	3,58	3,37	3,17
<b>Additional imprint charge per colour &amp; position</b>						
SP	-	0,17	0,14	0,14	0,14	0,13
BP	0,26	0,24	0,22	0,21	0,20	0,19
BP Texture	0,20	0,18	0,16	0,15	0,15	0,14
Prices include one imprint in one position according to specified technique.						
Printing on upper part of 4 Colours	-	0,17	0,14	0,14	0,14	0,13

OPTIONAL SPECIAL PACKAGING



+ INFO PAGES 240 TO 245

EXTERNAL PACKAGING



250 ± 3,2KG

Collection Box  
(1, 2 & 3 units)



PERSONALIZED COLOURS



MANUFACTURED AND PRINTED IN BIC FACTORIES



MADE IN FRANCE



REGULATORY COMPLIANCE



ISO certified



IMPRIM'VERT®



UBICITY™ PROGRAM  
ALLOWS RECYCLING  
BIC WRITING INSTRUMENTS



100% ELECTRICITY COMING FROM RENEWABLE SOURCES

WRITING SMODES



BALLPEN M  
Ø 1 MM

PRINTING TECHNIQUES



SCREEN PRINTING



DIGITAL



BRITEPIX™

# BIC® 4 COLOURS® BICOLOR Metallic aesthetics with an artistic touch.

## BIC® 4 COLOURS® BICOLOR

1069 Opaque  
1076 With Lanyard  
Colour ink



01/04G/47



01/05G/47



01/80/47



01/4R/47

**NEW!**

New  
printing area



Refill  
service on  
request

Decoration

**BIC® 4 COLOURS® BICOLOR**

1069/1076

**A SP:** max. 2 col.

**B SP:** max. 1 col.

MOQ 250 units

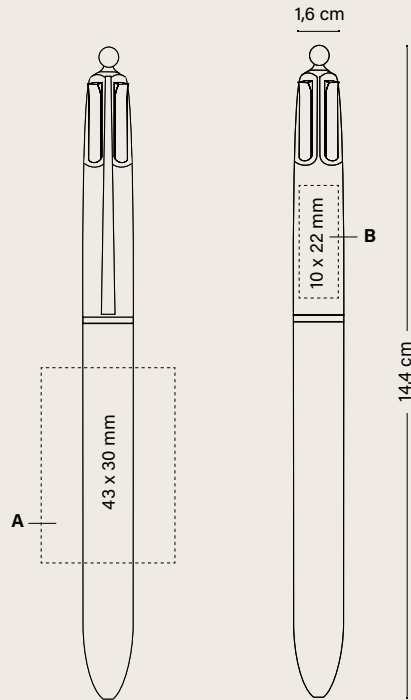

Price (€)

BIC® 4 COLOURS® BICOLOR	100-249	250-499	500-999	1000-2499	2500-4999	5000
1069						
<b>SP</b>	-	4,91	4,46	4,11	3,85	3,62
1076						
<b>SP</b>		5,41	4,91	4,51	4,24	3,99

**Additional imprint charge per colour & position**

<b>SP</b>	-	0,17	0,14	0,14	0,14	0,13
<b>Printing on upper part of 4 Colours</b>	-	0,17	0,14	0,14	0,14	0,13

Prices include one colour in screen printing in one position.

**OPTIONAL SPECIAL PACKAGING**



+ INFO PAGES 240 TO 245

**EXTERNAL PACKAGING**



250 ± 3,2KG

Collection Box  
(1, 2 & 3 units)



PERSONALIZED COLOURS



MANUFACTURED AND PRINTED IN BIC FACTORIES



FABRIQU  EN FRANCE  
MADE IN FRANCE



REGULATORY COMPLIANCE



ISO certified



IMPRIM'VERT®



UBICUITY™ PROGRAM  
ALLOWS RECYCLING  
BIC WRITING INSTRUMENTS



100% ELECTRICITY COMING  
FROM RENEWABLE SOURCES

**WRITING MODES**



BALLPEN M  
Ø 1 MM

**PRINTING TECHNIQUES**



SCREEN PRINTING

# BIC® 4 COLOURS® GRADIENT

## The most summery vibes.

**BIC® 4 COLOURS® GRADIENT**

1074 Opaque  
1075 With Lanyard

Colour ink



**NEW!**

New  
printing area



Refill  
service on  
request

01/3G/8D/4R

Decoration

**BIC® 4 COLOURS® GRADIENT**

1074/1075

**A SP:** max. 2 col.

**B SP:** max. 1 col.

MOQ 250 units

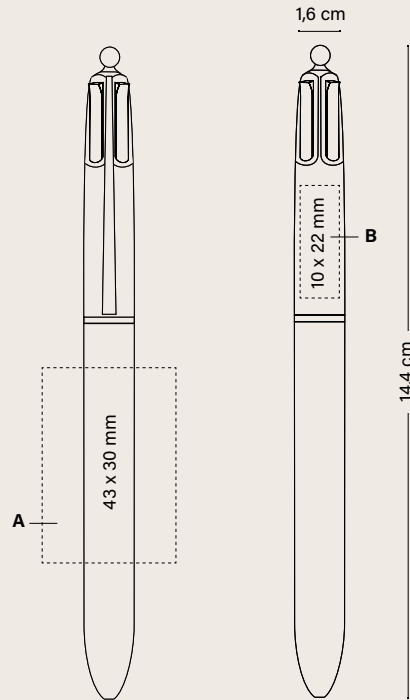

Price (€)

**BIC® 4 COLOURS® GRADIENT** 100-249 250-499 500-999 1000-2499 2500-4999 5000

1074						
SP	-	4,91	4,46	4,11	3,85	3,62
1075						
SP	-	5,41	4,91	4,51	4,24	3,99

**Additional imprint charge per colour & position**

SP	-	0,17	0,14	0,14	0,14	0,13
Printing on upper part of 4 Colours	-	0,17	0,14	0,14	0,14	0,13

Prices include one colour in screen printing in one position.

**OPTIONAL SPECIAL PACKAGING**



+ INFO PAGES 240 TO 245

**EXTERNAL PACKAGING**



PERSONALIZED COLOURS



MANUFACTURED AND PRINTED IN BIC FACTORIES



MADE IN FRANCE



REGULATORY COMPLIANCE



ISO certified



IMPRIM'VERT®



UBICITY™ PROGRAM  
ALLOWS RECYCLING  
BIC WRITING INSTRUMENTS



100% ELECTRICITY COMING  
FROM RENEWABLE SOURCES

WRITING MODES



BALLPEN M  
0.1 MM

PRINTING TECHNIQUES



SCREEN PRINTING

# BIC® 4 COLOURS® PASTEL

## Vintage colours, dreamy imagery.

**NEW!**

**BIC® 4 COLOURS® PASTEL**

1071 Opaque  
1072 With Lanyard

Colour ink  
●●●●



84



8D



83



Refill  
service on  
request



Decoration

**BIC® 4 COLOURS® PASTEL**

1071/1072

A SP: max. 4 col.

MOQ 250 units

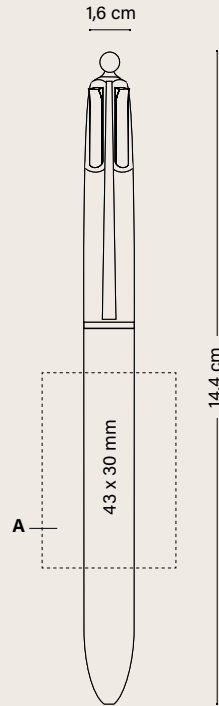

Price (€)

BIC® 4 COLOURS® PASTEL	100-249	250-499	500-999	1000-2499	2500-4999	5000
1071						
SP	-	3,51	3,18	2,94	2,75	2,59
1072						
SP	-	3,98	3,61	3,34	3,14	2,94
<b>Additional imprint charge per colour &amp; position</b>						
SP	-	0,17	0,14	0,14	0,14	0,13

Prices include one colour in screen printing in one position.

**OPTIONAL SPECIAL PACKAGING**



ECO SLEEVE

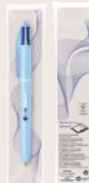

PLASTIC POUCH



WINDOW BOX



COLLECTION BOX



250 ± 3,2KG

Collection Box  
(1, 2 & 3 units)

+ INFO PAGES 240 TO 245

**EXTERNAL PACKAGING**



PERSONALIZED COLOURS



MANUFACTURED AND PRINTED IN BIC FACTORIES



FABRIQUÉ EN FRANCE  
MADE IN FRANCE



REGULATORY COMPLIANCE



ISO certified



IMPRIM'VERT®



UBICITY™ PROGRAM  
ALLOWS RECYCLING  
BIC WRITING INSTRUMENTS



100% ELECTRICITY COMING FROM RENEWABLE SOURCES

**WRITING MODES**



BALLPEN M  
Ø 1 MM

**PRINTING TECHNIQUES**



SCREEN PRINTING



THE SOLUTION  
FOR FULL COLOUR  
COMMUNICATION!

Now on  
coloured barrels

**4 COLOURS® FASHION**

1102 Opaque  
1108 With Lanyard

Colour ink  
●●●●



Decoration

**BIC® 4 COLOURS® FASHION**  
1102/1108

- A SP:** max. 4 col.
- B DG:** Digital print (area for images)
- C BP:** full-colour
- D SP:** max. 1 col.

MOQ 250 units (SP, DG)  
MOQ 100 units (BP)

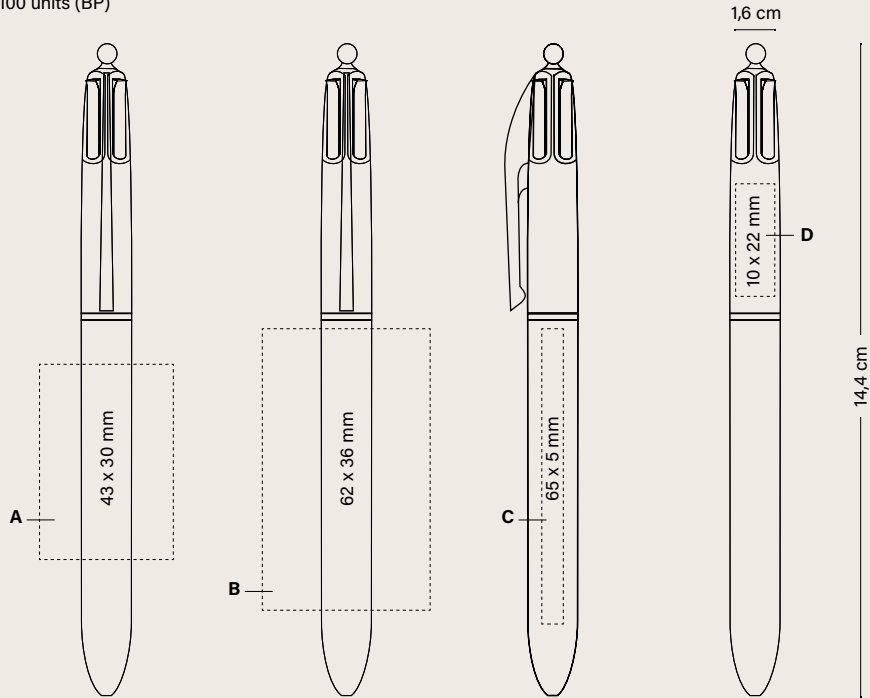

Price (€)

BIC® 4 COLOURS® FASHION	100-249	250-499	500-999	1000-2499	2500-4999	5000
1102						
<b>SP</b>	-	3,51	3,18	2,94	2,75	2,59
<b>DG</b>	-	4,80	4,35	4,04	3,75	3,54
<b>BP</b>	4,65	3,79	3,43	3,19	2,99	2,81
1108 (lanyard)						
<b>SP</b>	-	3,98	3,61	3,34	3,14	2,94
<b>DG</b>	-	5,26	4,78	4,42	4,12	3,90
<b>BP</b>	5,21	4,26	3,86	3,58	3,37	3,17
<b>Additional imprint charge per colour &amp; position</b>						
<b>SP</b>	-	0,17	0,14	0,14	0,14	0,13
<b>BP</b>	0,26	0,24	0,22	0,21	0,20	0,19
<b>BP Texture</b>	0,20	0,18	0,16	0,15	0,15	0,14
Prices include one imprint in one position according to specified technique.						
<b>Printing on upper part of 4 Colours</b>	-	0,17	0,14	0,14	0,14	0,13

OPTIONAL SPECIAL PACKAGING

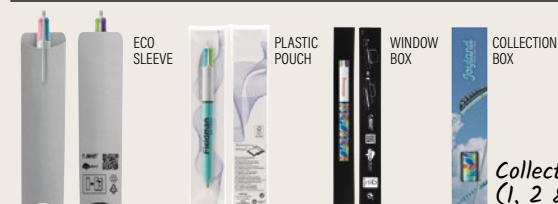

+ INFO PAGES 240 TO 245

EXTERNAL PACKAGING



Collection Box  
(1, 2 & 3 units)

250 ± 3,2KG



PERSONALIZED COLOURS



MANUFACTURED AND PRINTED IN BIC FACTORIES



FABRIQU  EN FRANCE  
MADE IN FRANCE



REGULATORY COMPLIANCE



ISO certified



IMPRIM'VERT®



UBICITY™ PROGRAM  
ALLOWS RECYCLING  
BIC WRITING INSTRUMENTS



100% ELECTRICITY COMING  
FROM RENEWABLE SOURCES

WRITING MODES



BALLPEN M  
0.1 MM

PRINTING TECHNIQUES



SCREEN PRINTING



BRITEPIX™  
BRITEPIX™ TEXTURE  
BRITEPIX™ PERSONALISATION

See page 250 for a detailed explanation of the icons



THE SOLUTION  
FOR FULL COLOUR  
COMMUNICATION!

**BIC® 4 COLOURS® SUN**

- 1097 Opaque
- 1098 With Lanyard
- Colour ink



Decoration

**BIC® 4 COLOURS® SUN**

1097/1098

**A SP:** max. 4 col.

**B DG:** Digital print (area for images)

**C BP:** full-colour

**D SP:** max. 1 col.

MOQ 250 units (SP, DG)

MOQ 100 units (BP)

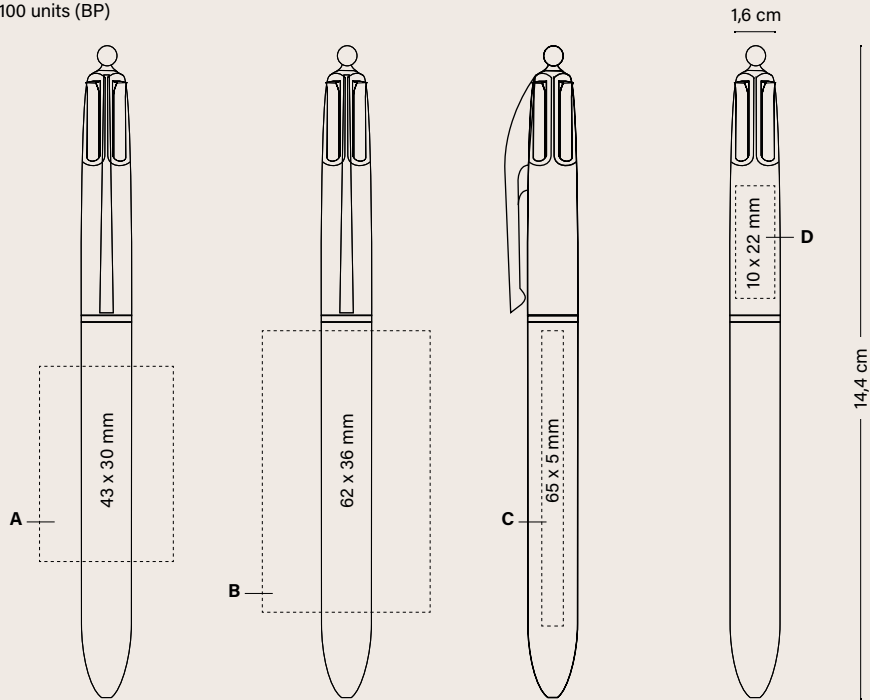

Price (€)

BIC® 4 COLOURS® SUN	100-249	250-499	500-999	1000-2499	2500-4999	5000
1097						
SP	-	3,51	3,18	2,94	2,75	2,59
DG	-	4,80	4,35	4,04	3,75	3,54
BP	4,65	3,79	3,43	3,19	2,99	2,81
1098 (lanyard)						
SP	-	3,98	3,61	3,34	3,14	2,94
DG	-	5,26	4,78	4,42	4,12	3,90
BP	5,21	4,26	3,86	3,58	3,37	3,17
<b>Additional imprint charge per colour &amp; position</b>						
SP	-	0,17	0,14	0,14	0,14	0,13
BP	0,26	0,24	0,22	0,21	0,20	0,19
BP Texture	0,20	0,18	0,16	0,15	0,15	0,14
<b>Prices include one imprint in one position according to specified technique.</b>						
<b>Printing on upper part of 4 Colours</b>	-	0,17	0,14	0,14	0,14	0,13

OPTIONAL SPECIAL PACKAGING

EXTERNAL PACKAGING



+ INFO PAGES 240 TO 245



PERSONALIZED COLOURS



MANUFACTURED AND PRINTED IN BIC FACTORIES



FABRIQU  EN FRANCE

MADE IN FRANCE



REGULATORY COMPLIANCE



ISO certified



IMPRIM'VERT®



UBICUITY™ PROGRAM ALLOWS RECYCLING BIC WRITING INSTRUMENTS



100% ELECTRICITY COMING FROM RENEWABLE SOURCES

WRITING MODES



BALLPEN M 0.1 MM

PRINTING TECHNIQUES



SCREEN PRINTING



DIGITAL



BRITEPIX™

BRITEPIX™ TEXTURE

BRITEPIX™ PERSONALISATION

**britePix**  
DIGITAL

THE SOLUTION  
FOR FULL COLOUR  
COMMUNICATION!

**BIC® 4 COLOURS® FINE**

- 1109 Opaque
  - 1111 With Lanyard
  - Colour ink
- 



01/10

01/10

100%

0.8 mm  
tip!

Decoration

**BIC® 4 COLOURS® FINE**

1109/1111

**A SP:** max. 4 col.

**B DG:** Digital print

**C BP:** full-colour

**D SP:** max. 1 col.

MOQ 250 units (SP, DG)

MOQ 100 units (BP)

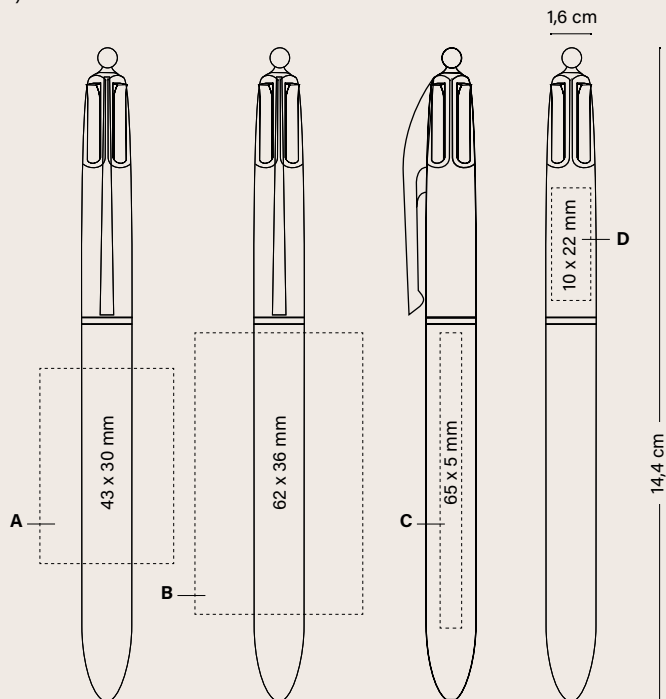

Price (€)

BIC® 4 COLOURS® FINE	100-249	250-499	500-999	1000-2499	2500-4999	5000
1109						
<b>SP</b>	-	3,51	3,18	2,94	2,75	2,59
<b>DG</b>	-	4,80	4,35	4,04	3,75	3,54
<b>BP</b>	4,65	3,79	3,43	3,19	2,99	2,81
1111 (lanyard)						
<b>SP</b>	-	3,98	3,61	3,34	3,14	2,94
<b>DG</b>	-	5,26	4,78	4,42	4,12	3,90
<b>BP</b>	5,21	4,26	3,86	3,58	3,37	3,17

**Additional imprint charge per colour & position**

<b>SP</b>	-	0,17	0,14	0,14	0,14	0,13
<b>BP</b>	0,26	0,24	0,22	0,21	0,20	0,19
<b>BP Texture</b>	0,20	0,18	0,16	0,15	0,15	0,14

Prices include one imprint in one position according to specified technique.

<b>Printing on upper part of 4 Colours</b>	-	0,17	0,14	0,14	0,14	0,13
--	---	------	------	------	------	------

**OPTIONAL SPECIAL PACKAGING**

**EXTERNAL PACKAGING**



+ INFO PAGES 240 TO 245



PERSONALIZED COLOURS



MANUFACTURED AND PRINTED IN BIC FACTORIES



MADE IN FRANCE



REGULATORY COMPLIANCE



IMPRIM'VERT®



UBICITY™ PROGRAM ALLOWS RECYCLING BIC WRITING INSTRUMENTS



100% ELECTRICITY COMING FROM RENEWABLE SOURCES

**WRITING MODES**



BALLPEN M  
Ø 0,8 MM

**PRINTING TECHNIQUES**



SCREEN PRINTING



DIGITAL



BRITEPIX™  
BRITEPIX™ TEXTURE  
BRITEPIX™ PERSONALISATION

**BIC® 4 COLOURS® FLUO**

1114 Opaque  
1116 With Lanyard  
Colour ink  
●●●●





Decoration

**BIC® 4 COLOURS® FLUO**

1114/1116

**A SP:** max. 4 col.

**B BP:** full-colour

**C SP:** max. 1 col.

MOQ 250 units (SP, DG)

MOQ 100 units (BP)

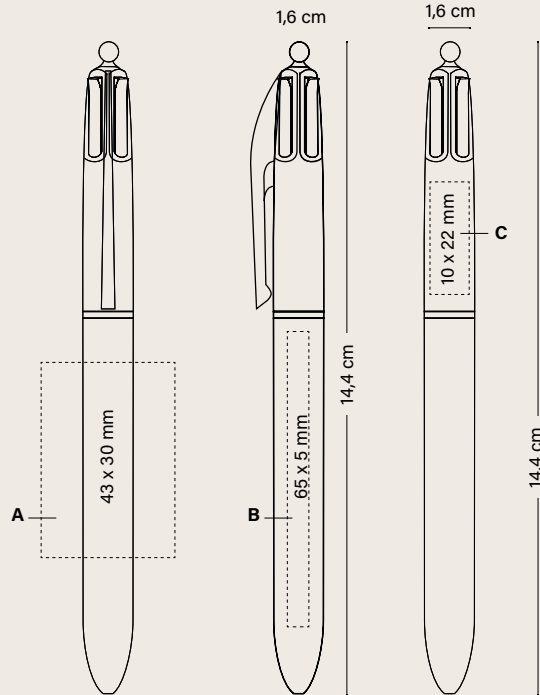

Price (€)

**BIC® 4 COLOURS® FLUO**      100-249   250-499   500-999   1000-2499   2500-4999   5000

1114						
<b>SP</b>	-	3,80	3,43	3,18	2,98	2,81
<b>BP</b>	4,65	4,08	3,69	3,42	3,20	3,03
<b>1116 (lanyard)</b>						
<b>SP</b>	-	4,31	3,89	3,59	3,38	3,19
<b>BP</b>	5,56	4,58	4,14	3,83	3,61	3,41

**Additional imprint charge per colour & position**

<b>SP</b>	-	0,17	0,14	0,14	0,14	0,13
<b>BP</b>	0,26	0,24	0,22	0,21	0,20	0,19
<b>BP Texture</b>	0,20	0,18	0,16	0,15	0,15	0,14

Prices include one imprint in one position according to specified technique.

<b>Printing on upper part of 4 Colours</b>	-	0,17	0,14	0,14	0,14	0,13
--	---	------	------	------	------	------

**OPTIONAL SPECIAL PACKAGING**

**EXTERNAL PACKAGING**



+ INFO PAGES 240 TO 245



PERSONALIZED COLOURS



MANUFACTURED AND PRINTED IN BIC FACTORIES



MADE IN FRANCE



REGULATORY COMPLIANCE



ISO certified



IMPRIM'VERT®



UBICITY™ PROGRAM ALLOWS RECYCLING BIC WRITING INSTRUMENTS



100% ELECTRICITY COMING FROM RENEWABLE SOURCES

**WRITING MODES**



BALLPEN M Ø 1 MM

**PRINTING TECHNIQUES**



SCREEN PRINTING



DIGITAL



BRITEPIX™  
BRITEPIX™ TEXTURE  
BRITEPIX™ PERSONALISATION

**BIC® 4 COLOURS® SHINE**

1106 Opaque

1107 With Lanyard

Colour ink



01/75

01/26

01/7G

01/34

01/97

# BIC® 4 COLOURS® SHINE

## Decoration

### BIC® 4 COLOURS® SHINE

1106/1107

**A SP:** max. 2 col.

**B LE**

**C LE**

**D LE:** 360°

**E SP:** max. 1 col.

MOQ 250 units

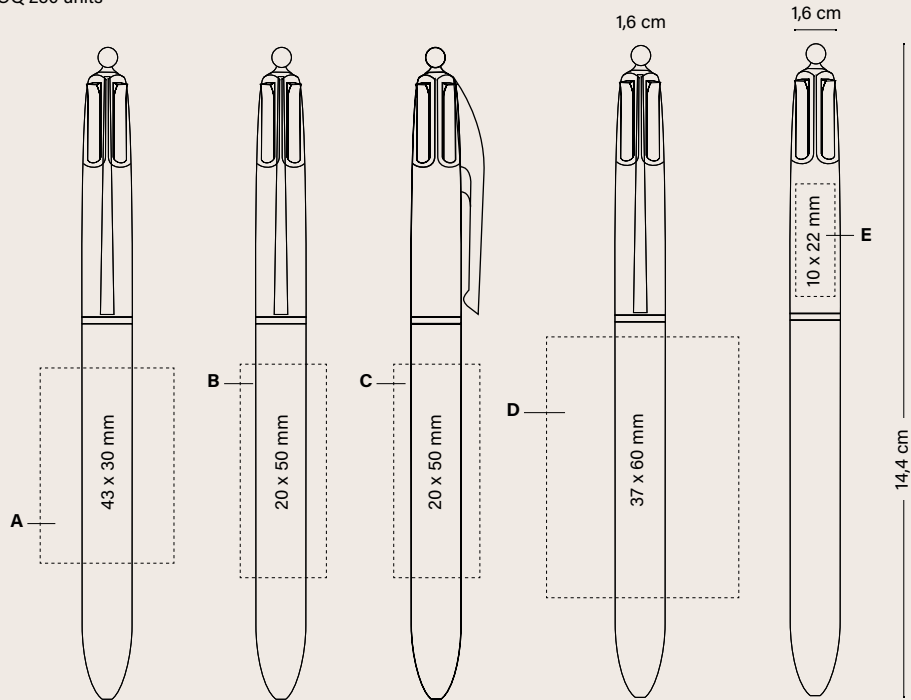

Price (€)

BIC® 4 COLOURS® SHINE	250-499	500-999	1000-2499	2500-4999	5000
1106					
SP	4,02	3,62	3,37	3,15	2,94
LE	4,94	4,44	4,12	3,84	3,63
LE 360°	5,59	5,04	4,69	4,37	4,11
1107 (lanyard)					
SP	4,51	4,07	3,77	3,54	3,31
LE	5,43	4,88	4,54	4,25	4,00
LE 360°	6,10	5,50	5,10	4,78	4,49

#### Additional imprint charge per colour & position

SP	0,17	0,14	0,14	0,14	0,13
----	------	------	------	------	------

Prices include one imprint in one position according to specified technique.

Printing on upper part of 4 Colours	0,17	0,14	0,14	0,14	0,13
-------------------------------------	------	------	------	------	------

#### OPTIONAL SPECIAL PACKAGING



+ INFO PAGES 240 TO 245

#### EXTERNAL PACKAGING



250 ± 3,2KG

Collection Box  
(1, 2 & 3 units)



PERSONALIZED COLOURS



MANUFACTURED AND PRINTED IN BIC FACTORIES



MADE IN FRANCE



REGULATORY COMPLIANCE



ISO certified



IMPRIM'VERT®



UBICITY™ PROGRAM  
ALLOWS RECYCLING  
BIC WRITING INSTRUMENTS



100% ELECTRICITY COMING  
FROM RENEWABLE SOURCES

#### WRITING MODES



BALLPEN M  
Ø 1 MM

#### PRINTING TECHNIQUES



SCREEN PRINTING



LASER

# BIC® 4 COLOURS® GLACÉ

## Our classic pen dressed up.

**BIC® 4 COLOURS® GLACÉ**  
1057 Opaque  
1058 With Lanyard  
Colour ink  
●●●●

**NEW!**



01/76

01/47G

01/03G

01/05G

01/04G

02/47G

02/76

01/14G

New printing area



Refill service on request

# BIC® 4 COLOURS® GLACÉ

## Decoration

### BIC® 4 COLOURS® GLACÉ

1057/1058

**A SP:** max. 2 col.

**B SP:** max. 1 col. (only for white upper parts)

MOQ 250 units

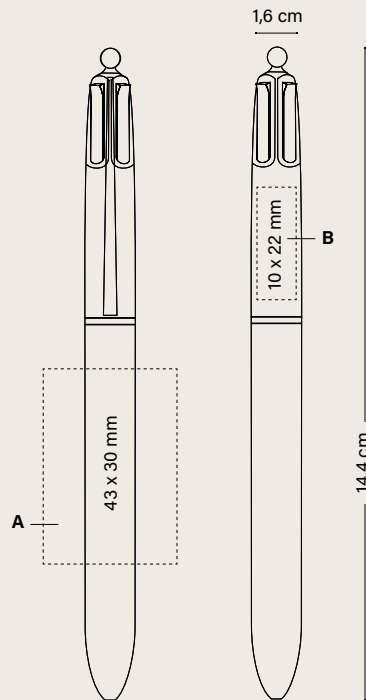

	Price (€)				
BIC® 4 COLOURS® GLACÉ	250-499	500-999	1000-2499	2500-4999	5000
1057					
<b>SP</b>	4,02	3,62	3,37	3,15	2,94
1058 (lanyard)					
<b>SP</b>	4,49	4,05	3,75	3,52	3,29
<b>Additional imprint charge per colour &amp; position</b>					
<b>SP</b>	0,17	0,14	0,14	0,14	0,13
<b>Prices include one colour in screen printing in one position.</b>					
<b>Printing on upper part of 4 Colours</b>	0,17	0,14	0,14	0,14	0,13

## OPTIONAL SPECIAL PACKAGING



+ INFO PAGES 240 TO 245

## EXTERNAL PACKAGING



250 ± 3,2KG



PERSONALIZED COLOURS



MANUFACTURED AND PRINTED IN BIC FACTORIES



MADE IN FRANCE



REGULATORY COMPLIANCE



ISO certified



IMPRIM'VERT®



UBICITY™ PROGRAM ALLOWS RECYCLING BIC WRITING INSTRUMENTS



100% ELECTRICITY COMING FROM RENEWABLE SOURCES

## WRITING MODES



BALLPEN M Ø 1 MM

## PRINTING TECHNIQUES



SCREEN PRINTING

See page 250 for a detailed explanation of the icons

# BIC® 4 COLOURS® SOFT

## A soft touch you won't want to put down!



### BIC® 4 COLOURS® SOFT

- 1060 Opaque
- 1063 With Lanyard
- Colour ink



**NEW!**



01/03F



01/02F



02/02F



01/07F

New printing area

Feel the softness in your hands



Refill service on request

# BIC® 4 COLOURS® SOFT

## Decoration

### BIC® 4 COLOURS® SOFT

1060/1063

**A SP:** max. 1 col.

**B SP:** max. 1 col. (only for white upper parts)

MOQ 250 units

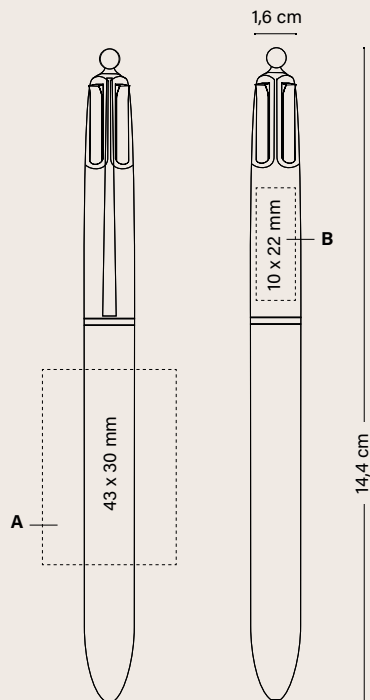

Price (€)

BIC® 4 COLOURS® SOFT	250-499	500-999	1000-2499	2500-4999	5000
1060					
SP	4,18	3,78	3,50	3,28	3,09
1063 (lanyard)					
SP	4,66	4,20	3,89	3,66	3,45
<b>Additional imprint charge per colour &amp; position</b>					
SP	0,17	0,14	0,14	0,14	0,13
<b>Prices include one colour in screen printing in one position.</b>					
<b>Printing on upper part of 4 Colours</b>					
	0,17	0,14	0,14	0,14	0,13

## OPTIONAL SPECIAL PACKAGING



ECO SLEEVE



PLASTIC POUCH



WINDOW BOX



COLLECTION BOX

Collection Box (1, 2 & 3 units)



250 ± 3,2KG

+ INFO PAGES 240 TO 245



PERSONALIZED COLOURS



MANUFACTURED AND PRINTED IN BIC FACTORIES



FABRIQU  EN FRANCE



REGULATORY COMPLIANCE



ISO certified



IMPRIM'VERT®



UBICITY™ PROGRAM ALLOWS RECYCLING BIC WRITING INSTRUMENTS



100% ELECTRICITY COMING FROM RENEWABLE SOURCES

## WRITING MODES



BALLPEN M Ø 1 MM

## PRINTING TECHNIQUES



SCREEN PRINTING

See page 250 for a detailed explanation of the icons

# BIC® 4 COLOURS® WOOD STYLE

## Be impressed with the spectacular wood finish!



### BIC® 4 COLOURS® WOOD STYLE

1061 Opaque  
1064 With Lanyard

Colour ink  
●●●●

**NEW!**



01/6AW

01/05W

01/02W

02/6AW

01/12W

New  
printing area

Bring warmth to your  
brand

  
Refill  
service on  
request



Decoration

**BIC® 4 COLOURS® WOOD STYLE**

1061/1064

**A SP:** max. 2 col.

**B SP:** max. 1 col. (only for white upper parts)

MOQ 250 units

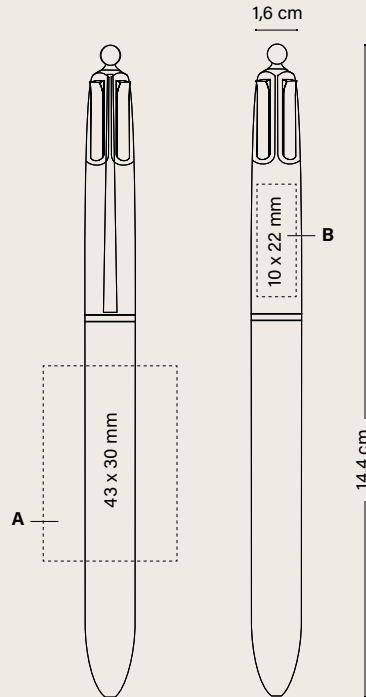

	Price (€)				
<b>BIC® 4 COLOURS® WOOD STYLE</b>	250-499	500-999	1000-2499	2500-4999	5000
1061					
<b>SP</b>	4,18	3,78	3,50	3,28	3,09
1064 (lanyard)					
<b>SP</b>	4,66	4,20	3,89	3,66	3,45
<b>Additional imprint charge per colour &amp; position</b>					
<b>SP</b>	0,17	0,14	0,14	0,14	0,13
<b>Prices include one colour in screen printing in one position.</b>					
<b>Printing on upper part of 4 Colours</b>					
	0,17	0,14	0,14	0,14	0,13

**OPTIONAL SPECIAL PACKAGING**



ECO SLEEVE



PLASTIC POUCH



WINDOW BOX

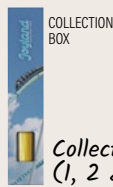

COLLECTION BOX

Collection Box (1, 2 & 3 units)



250 ± 3,2KG

+ INFO PAGES 240 TO 245

**EXTERNAL PACKAGING**



PERSONALIZED COLOURS



MANUFACTURED AND PRINTED IN BIC FACTORIES



MADE IN FRANCE



REGULATORY COMPLIANCE



ISO certified



IMPRIM'VERT®



UBICITY™ PROGRAM ALLOWS RECYCLING BIC WRITING INSTRUMENTS



100% ELECTRICITY COMING FROM RENEWABLE SOURCES

**WRITING MODES**



BALLEN M Ø 1 MM

**PRINTING TECHNIQUES**



SCREEN PRINTING

See page 250 for a detailed explanation of the icons

# BIC® 4 COLOURS® FLAGS COLLECTION

## Celebrate heritage

### BIC® 4 COLOURS® FLAGS COLLECTION

1067  
1068 With Lanyard

Colour ink  
●●●●



01/03/47/05



01/02/03/12



01/03/47/04



01/03/12/03

**NEW!**

New printing area



Refill service on request

# BIC® 4 COLOURS® FLAGS COLLECTION

## Decoration

### BIC® 4 COLOURS® FLAGS COLLECTION

1067/1068

**A SP:** max. 2 col.

**B SP:** max. 1 col.

MOQ 250 units

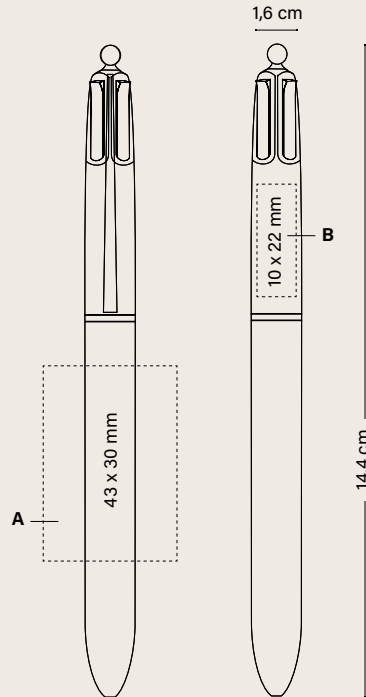

Price (€)

BIC® 4 COLOURS® FLAGS COLLECTION	100-249	250-499	500-999	1000-2499	2500-4999	5000
1067						
<b>SP</b>	-	4,91	4,46	4,11	3,85	3,62
1068						
<b>SP</b>	-	5,41	4,91	4,51	4,24	3,99

#### Additional imprint charge per colour & position

<b>SP</b>	-	0,17	0,14	0,14	0,14	0,13
<b>Printing on upper part of 4 Colours</b>	-	0,17	0,14	0,14	0,14	0,13

Prices include one colour in screen printing in one position.

#### OPTIONAL SPECIAL PACKAGING



+ INFO PAGES 240 TO 245

#### EXTERNAL PACKAGING



Collection Box  
(1, 2 & 3 units)



PERSONALIZED COLOURS



MANUFACTURED AND PRINTED IN BIC FACTORIES



MADE IN FRANCE



REGULATORY COMPLIANCE



ISO certified



IMPRIM'VERT®



UBICITY™ PROGRAM  
ALLOWS RECYCLING  
BIC WRITING INSTRUMENTS



100% ELECTRICITY COMING  
FROM RENEWABLE SOURCES

#### WRITING MODES



BALLPEN M  
Ø 1 MM

#### PRINTING TECHNIQUES



SCREEN PRINTING

**BIC® 4 COLOURS® 3+1<sup>HB</sup>**  
1099 Opaque  
Colour ink  
●●●●

3 ballpens +  
1 mechanical pencil.



  
Refill  
service on  
request



Decoration

**BIC® 4 COLOURS® 3+1<sup>HB</sup>**

1099 Opaque

A/B LE

MOQ 250 units

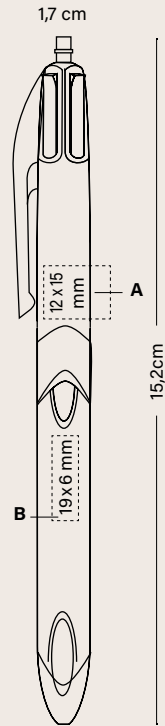

Price (€)

BIC® 4 COLOURS® 3+1 <sup>HB</sup>	250-499	500-999	1000-2499	2500-4999	5000
1099					
LE	5,27	4,77	4,43	4,12	3,90

**Additional imprint charge per colour & position**

LE	1,27	1,14	1,01	1,01	1,01
----	------	------	------	------	------

Prices include one laser engraving in one position.

**OPTIONAL SPECIAL PACKAGING**



PLASTIC  
POUCH



COLLECTION  
BOX

Collection Box  
(1, 2 & 3 units)

+ INFO PAGES 240 TO 245

**EXTERNAL PACKAGING**



250 ± 3,5 KG



PERSONALIZED  
COLOURS



MANUFACTURED  
AND PRINTED IN  
BIC FACTORIES



REGULATORY  
COMPLIANCE



ISO  
certified



IMPRIM'VERT®



UBICITY™ PROGRAM  
ALLOWS RECYCLING  
BIC WRITING INSTRUMENTS



100% ELECTRICITY COMING  
FROM RENEWABLE SOURCES

**WRITING  
MODES**



BALLPEN M  
Ø 1 MM



MECHANICAL PENCIL  
MP Ø 0,7MM

**PRINTING  
TECHNIQUES**



LE  
LASER



CHECK OUT THE  
VIDEO

See page 250 for a detailed explanation of the icons

BIC® METAL PRO

Metal accents, modern design  
with a large selection of  
colours and finishes.

BIC® METAL PRO

1290 Soft  
Colour ink



01F



02F



04F

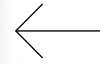

*Maximum writing  
comfort*

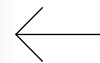

*German ink for  
writing up to 8 km.*

## BIC® METAL PRO

1290 Polished

Colour ink



01E



02E



04E



05E



06P

100%



### WRITING MODES



### PRINTING TECHNIQUES



See page 250 for a detailed explanation of the icons.

**BIC® METAL PRO**

1290 Matt

Colour ink



01D



02D



04D

100%



Decoration

**BIC® METAL PRO**

1290

**A SP:** max. 2 col.  
(Not available in soft finish)

**B LE/SP:** max. 1 col.

**C LE 360°**

MOQ 50 units

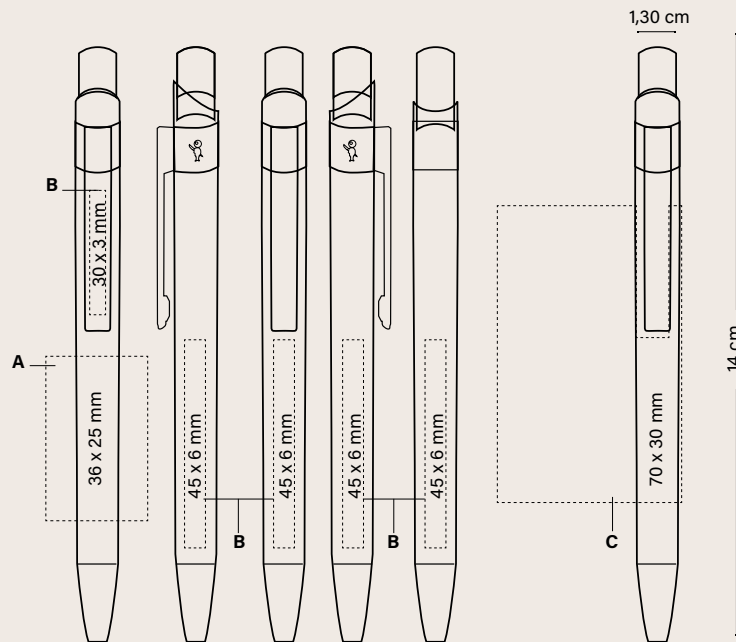

	Price (€)			
<b>BIC® METAL PRO</b>	50-99	100-249	250-499	500-1000
1290				
<b>SP</b>	5,12	4,81	4,59	4,37
<b>LE</b>	7,07	5,90	5,59	5,27
<b>LE 360°</b> (minimum quantity 100 units)	-	8,34	6,70	6,26

**Additional imprint charge per colour & position**

<b>SP</b>	0,45	0,42	0,37	0,32
<b>LE</b>	1,66	1,42	1,29	1,17

Prices include one imprint in one position according to specified technique.

**OPTIONAL SPECIAL PACKAGING**



+ INFO PAGES 240 TO 245

**EXTERNAL PACKAGING**



See page 250 for a detailed explanation of the icons.

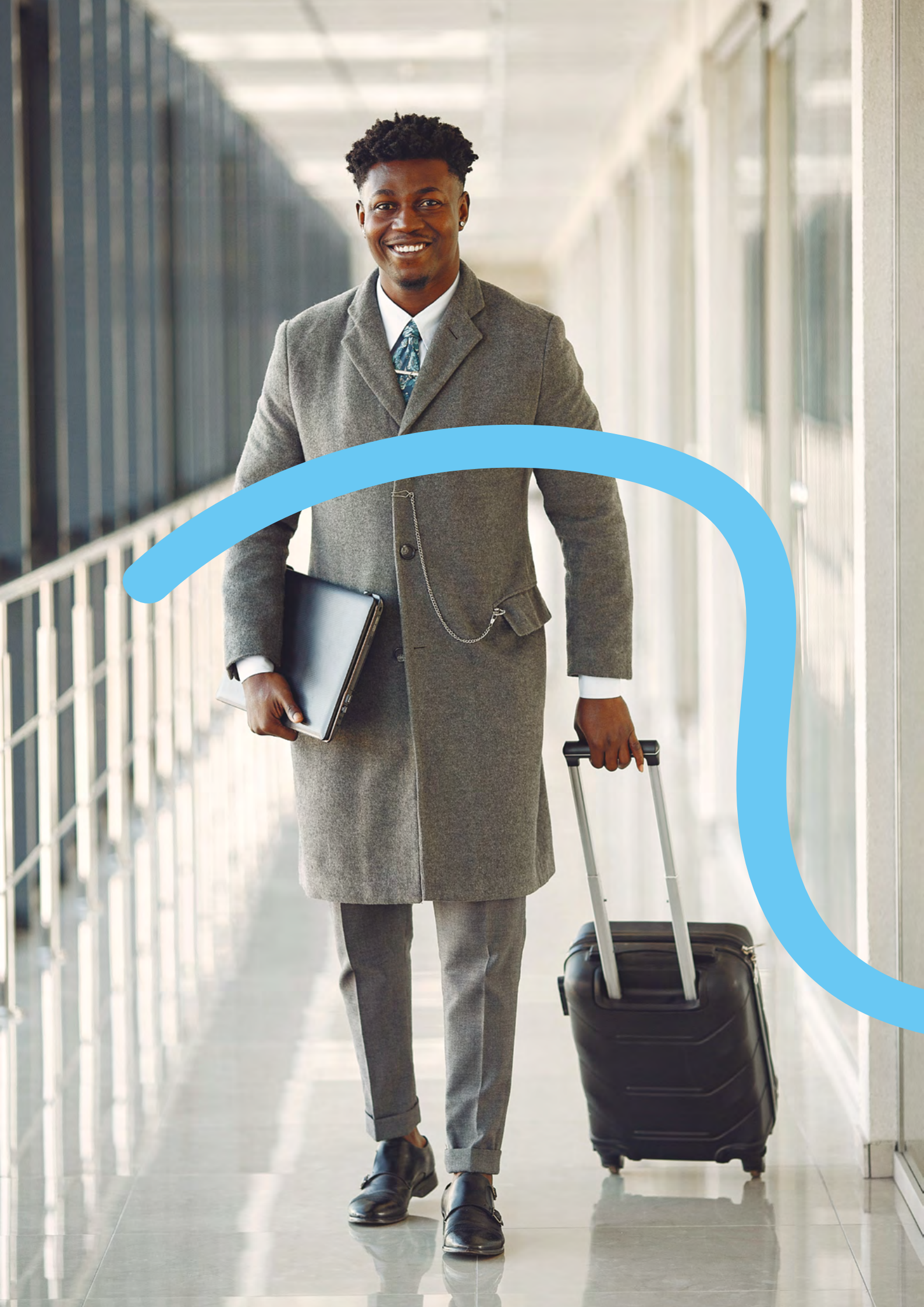

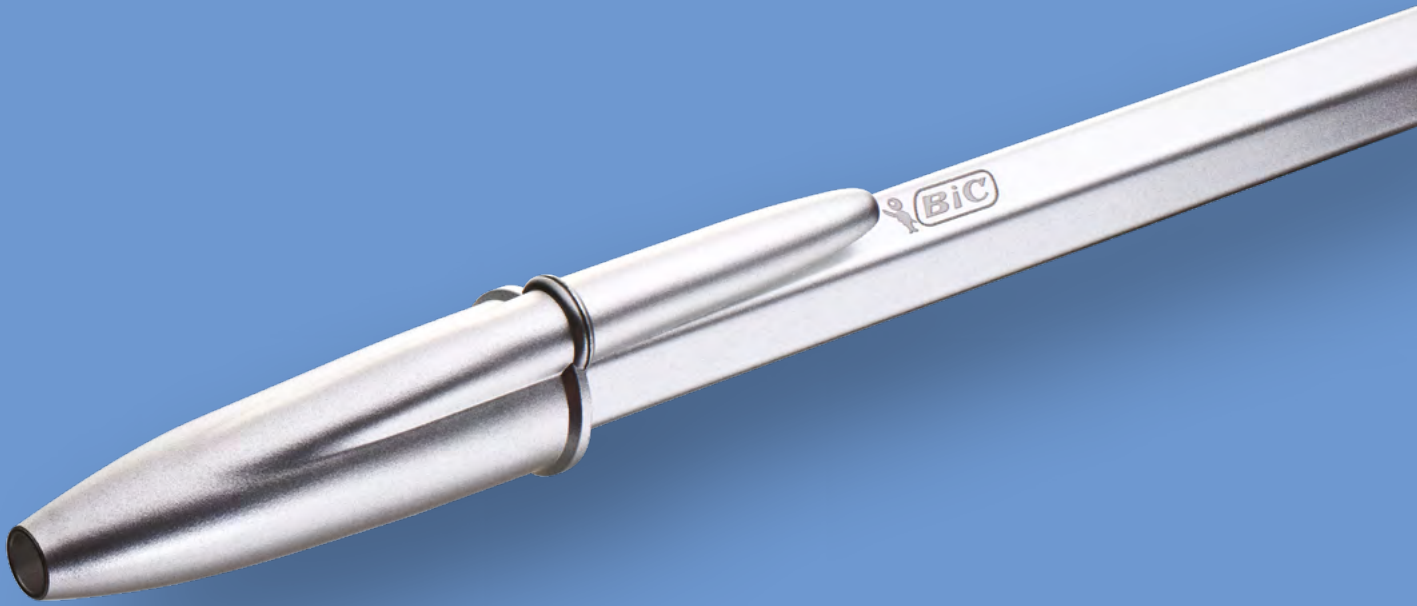

# BIC<sup>®</sup> CRISTAL<sup>®</sup> RE'NEW<sup>™</sup>

---

The iconic BIC<sup>®</sup> Cristal<sup>®</sup> in a metal version. The BIC<sup>®</sup> Cristal<sup>®</sup> Re'New<sup>™</sup> adds to the iconic BIC<sup>®</sup> Cristal<sup>®</sup> original, attaching a sense of modernity to its aluminum matt barrel and the laser engraved BIC<sup>®</sup> logo. The cap has been also redesigned; it's matt grey and manufactured from 96% recycled plastic. Refillable with blue or black inks. Includes 2 cartridges. The same ingenious hexagonal shape as the original BIC<sup>®</sup> Cristal<sup>®</sup> for controlled grip and comfort. Sustainable design, trusted quality, and timeless value. The product comes with BIC<sup>®</sup> Window Box packaging.

BIC® CRISTAL® RE'NEW™

# Elegance dressed in metal

BIC® CRISTAL®  
RE'NEW™

1090

Colour ink



BIC® WINDOW BOX

*1 pen + 2 refills*



*Your Cristal® Re'New™  
comes with this packaging!*

(Included in the price)

Decoration

**BIC® CRISTAL® RE'NEW™**  
1090

A LE: max. 1 col.

MOQ 25 units

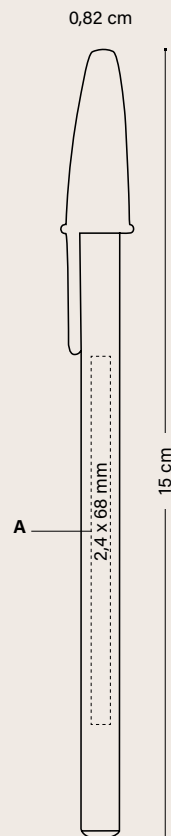

Price (€)

BIC® CRISTAL® RE'NEW™	25-49	50-99	100-249	250-499	500-1000
1090					
LE	7,69	7,16	6,63	6,37	6,10

EXTERNAL PACKAGING



WRITING MODES



PRINTING TECHNIQUES



See page 250 for a detailed explanation of the icons.



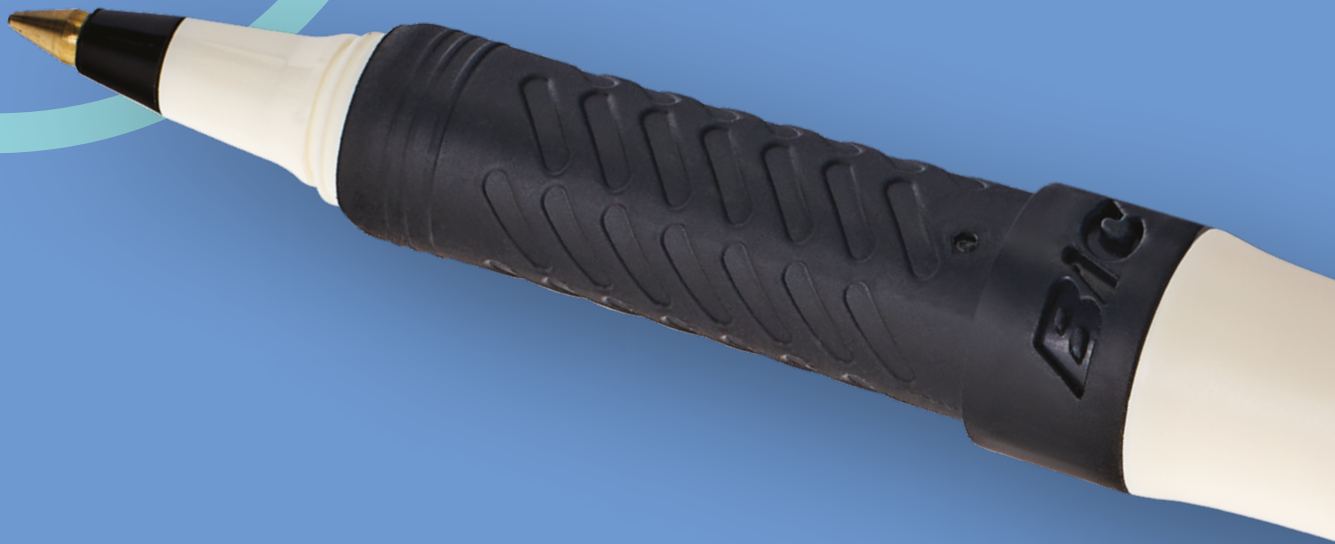

# BIC<sup>®</sup> ROLLERS AND GELS

Enjoy a smooth writing experience. Glide across the paper easily without smudging thanks to the quick-drying ink, ideal for both left and right-handed people.

**BIC<sup>®</sup> GRIP ROLLER**

**BIC<sup>®</sup> XS FINESTYLE**

**BIC<sup>®</sup> INTENSITY<sup>®</sup> GEL CLIC**

# BIC® GRIP ROLLER



MEDIUM WRITING  
Ø 0,7 MM

*High quality medium point liquid ink roller  
pen for smooth and fluid writing*

## BIC® GRIP ROLLER

1187

Colour ink



01/35

12/35

10/35

03/35

59/35

24/35

07/35

06/35

27/35

02/35

14/35

100%

●  
Also available  
in blue ink

●  
Also available  
in blue ink

●  
Also available  
in blue ink



Decoration

**BIC® GRIP ROLLER**

1187

A/B SP: max. 3 col.

MOQ 250 units

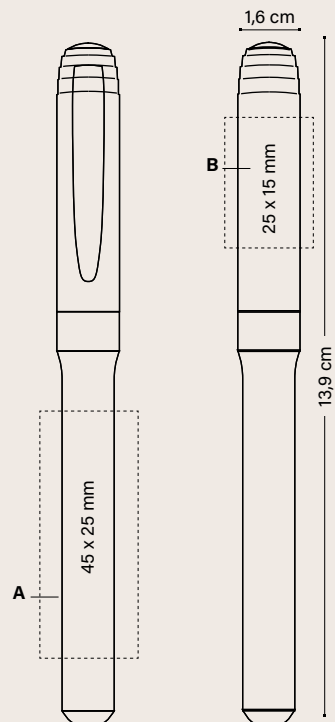

					Price (€)
<b>BIC® GRIP ROLLER</b>	250-499	500-999	1000-2499	2500-4999	5000
1187					
SP	1,86	1,68	1,56	1,46	1,37

**Additional imprint charge per colour & position**

SP	0,17	0,14	0,14	0,14	0,13
----	------	------	------	------	------

Prices include one colour in screen printing in one position.

**OPTIONAL SPECIAL PACKAGING**



ECO SLEEVE

PLASTIC POUCH

WINDOW BOX

MARKING SET

COLLECTION BOX

+ INFO PAGES 240 TO 245

**EXTERNAL PACKAGING**



250 ± 3 KG

Collection Box  
(1, 2 & 3 units)



MANUFACTURED AND PRINTED IN BIC FACTORIES



REGULATORY COMPLIANCE



ISO certified



IMPRIM'VERT®



UBIQUITY™ PROGRAM  
ALLOWS RECYCLING  
BIC WRITING INSTRUMENTS

**WRITING MODES**



ROLLER R  
Ø 0,7 MM

**PRINTING TECHNIQUES**



SCREEN PRINTING

See page 250 for a detailed explanation of the icons.

## BIC® XS FINESTYLE

1851 Opaque

Colour ink



01/03



01/25



01/06

●  
Only available  
in black ink

## BIC® XS FINESTYLE

1851 Clear

Colour ink



89/01

100%

Decoration

**BIC® XS FINESTYLE**

1851

**A PD:** max. 2 col.

**B SP:** max. 2 col.

**C BP:** full-colour

MOQ 250 units

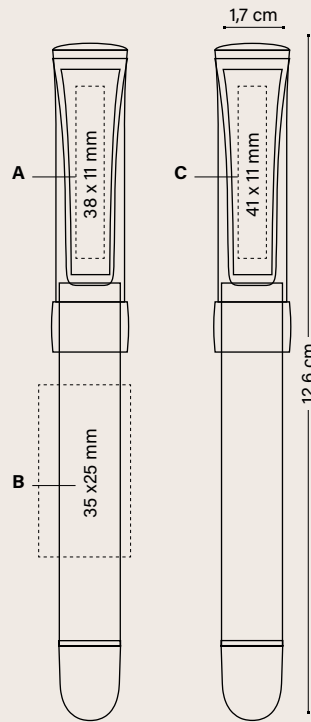

	Price (€)				
BIC® XS FINESTYLE	250-499	500-999	1000-2499	2500-4999	5000
1851					
<b>SP/PD</b>	2,17	1,72	1,61	1,50	1,40
<b>BP</b>	2,24	1,95	1,83	1,71	1,59

**Additional imprint charge per colour & position**

<b>SP/PD</b>	0,17	0,14	0,14	0,14	0,13
<b>BP Texture</b>	0,18	0,16	0,15	0,15	0,14

Prices include one imprint in one position according to specified technique.

**OPTIONAL SPECIAL PACKAGING**



+ INFO PAGES 240 TO 245



**EXTERNAL PACKAGING**

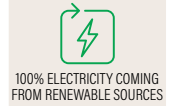

**WRITING MODES**



**PRINTING TECHNIQUES**



See page 250 for a detailed explanation of the icons.

# BIC® INTENSITY® GEL CLIC

---



*Iconic BIC® Boy  
is embossed*

## BIC® INTENSITY® GEL CLIC

1196 Opaque  
Colour ink



01



02

100%

## BIC® INTENSITY® GEL CLIC

1196 Clear  
Colour ink



92



88



86

100%

Decoration

**BIC® INTENSITY® GEL CLIC**

1196

**A SP:** max. 2 col.

**B SP:** max. 4 col.

MOQ 250 units

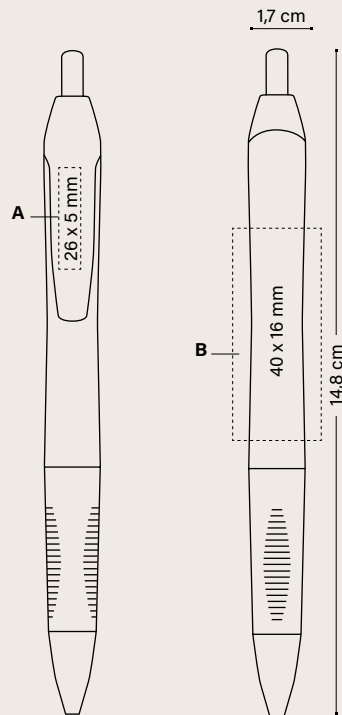

	Price (€)				
<b>BIC® INTENSITY® GEL CLIC</b>	250-499	500-999	1000-2499	2500-4999	5000
1196					
<b>SP</b>	2,91	2,63	2,44	2,27	2,15
<b>Additional imprint charge per colour &amp; position</b>					
<b>SP</b>	0,17	0,14	0,14	0,14	0,13

Prices include one colour in screen printing in one position.

**OPTIONAL SPECIAL PACKAGING**



+ INFO PAGES 240 TO 245

**EXTERNAL PACKAGING**



**WRITING MODES**



**PRINTING TECHNIQUES**



See page 250 for a detailed explanation of the icons.



Ideas



# BIC<sup>®</sup> HIGHLIGHTERS AND MARKERS

---

BIC<sup>®</sup> Markers offer you products specifically designed to write in a highly visible way and mark on surfaces or material that other writing instruments cannot mark on. Make your ideas visible and express yourself whatever the surface with BIC<sup>®</sup> Markers.

**BIC<sup>®</sup> BRITE LINER<sup>®</sup> GRIP**

**BIC<sup>®</sup> VELLEDA<sup>®</sup> WHITE BOARD MARKER FINE**

**BIC<sup>®</sup> VELLEDA<sup>®</sup> WHITE BOARD MARKER GRIP**

**BIC<sup>®</sup> MARK-IT PERMANENT MARKER**

**BIC<sup>®</sup> PERMANENT MARKER ECOLUTIONS<sup>®</sup>**



# BIC® BRITE LINER® GRIP

## BIC® BRITE LINER® GRIP 1192

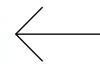

*Textured rubberised grip for more precision and control*

- 12  
●  
Colour ink
- 10  
●  
Colour ink
- 24  
●  
Colour ink
- 59  
●  
Colour ink
- 14  
●  
Colour ink



Decoration

**BIC® BRITE LINER® GRIP**

1192

A/B SP: max. 3 col.

MOQ 250 units

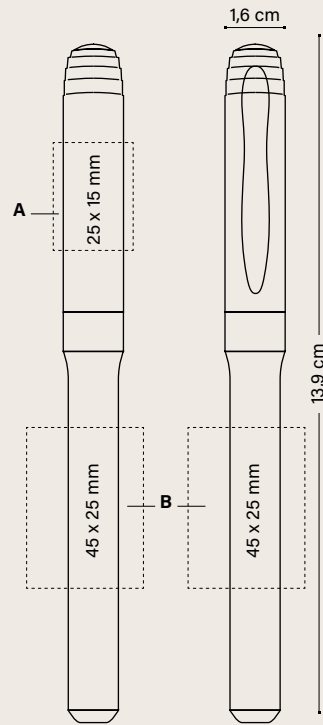

	250-499	500-999	1000-2499	2500-4999	Price (€)
<b>BIC® BRITE LINER® GRIP</b>					5000
1192					

<b>SP</b>	1,67	1,54	1,42	1,31	1,23
-----------	------	------	------	------	------

**Additional imprint charge per colour & position**

<b>SP</b>	0,17	0,14	0,14	0,14	0,13
-----------	------	------	------	------	------

Prices include one colour in screen printing in one position.

**OPTIONAL SPECIAL PACKAGING**



MARKING SET



COLLECTION BOX

Collection Box  
(1, 2 & 3 units)

+ INFO PAGES 240 TO 245

**EXTERNAL PACKAGING**



250 ± 2,8KG



MANUFACTURED AND PRINTED IN BIC FACTORIES



REGULATORY COMPLIANCE



ISO certified



IMPRIM'VERT®



UBICUITY™ PROGRAM  
ALLOWS RECYCLING  
BIC WRITING INSTRUMENTS



WILL NOT DRY OUT IN 24H

**WRITING MODES**



HIGHLIGHTER HL

**PRINTING TECHNIQUES**



SP  
SCREEN PRINTING

**SUITABLE FOR**



FAXES



PHOTOCOPIES



PRINTERS



PAPER

See page 250 for a detailed explanation of the icons

# BIC® VELLEDA® WHITE BOARD MARKER FINE

Velleda®

**BIC® VELLEDA® WHITE BOARD MARKER FINE**  
1651



01/04

Colour ink



01/02

Colour ink

100%

## Decoration

**BIC® VELLEDA® WHITE BOARD MARKER FINE**  
1651

A SP: max. 1 col.

MOQ 500 units

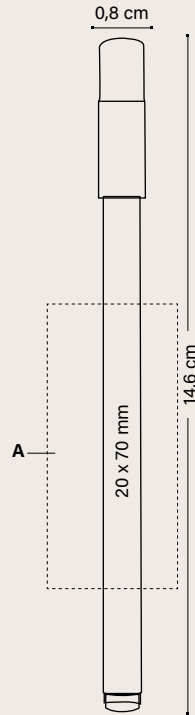

Price (€)

**BIC® VELLEDA® WHITE BOARD MARKER FINE**

1651

SP	500-999	1000-2499	2500-4999	5000
	0,60	0,54	0,51	0,48

Prices include one colour in screen printing in one position.

## OPTIONAL SPECIAL PACKAGING



MARKING SET

Now you can have it as a set!

+ INFO PAGES 240 TO 245

## EXTERNAL PACKAGING



500 ± 3,2KG



MANUFACTURED AND PRINTED IN BIC FACTORIES



MADE IN FRANCE



REGULATORY COMPLIANCE



ISO certified



IMPRIM'VERT®



UBICITY™ PROGRAM ALLOWS RECYCLING BIC WRITING INSTRUMENTS



RESISTANT TIP



MARKER MK

WRITING MODES



SCREEN PRINTING

PRINTING TECHNIQUES

# BIC® VELLEDA® WHITE BOARD MARKER GRIP



## BIC® VELLEDA® WHITE BOARD MARKER GRIP 1213



→  
*Textured rubberised grip for more precision and control*

01/02  
●  
Colour ink

100%

Decoration

### BIC® VELLEDA® WHITE BOARD MARKER GRIP 1213

A/B SP: max. 3 col.

MOQ 250 units

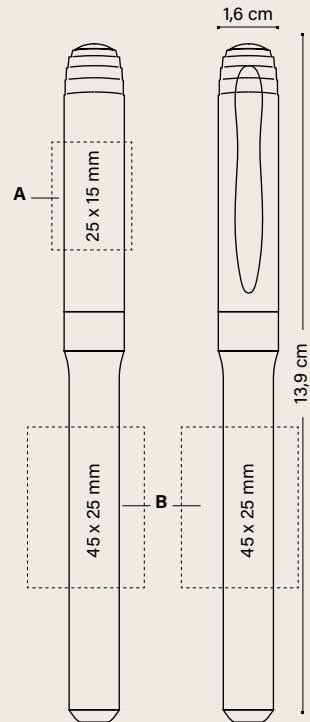

Price (€)

**BIC® VELLEDA® WHITE BOARD MARKER GRIP** 250-499 500-999 1000-2499 2500-4999 5000

1213

SP	1,64	1,48	1,37	1,27	1,19
----	------	------	------	------	------

**Additional imprint charge per colour & position**

SP	0,17	0,14	0,14	0,14	0,13
----	------	------	------	------	------

Prices include one colour in screen printing in one position.

**OPTIONAL SPECIAL PACKAGING**

**EXTERNAL PACKAGING**



MARKING SET



250 ± 2,7KG

*Now you can have it as a set!*

+ INFO PAGES 240 TO 245



MANUFACTURED AND PRINTED IN BIC FACTORIES



REGULATORY COMPLIANCE



ISO certified



IMPRIM'VERT®



UBICITY™ PROGRAM  
ALLOWS RECYCLING  
BIC WRITING INSTRUMENTS



RESISTANT TIP

**WRITING MODES**



MARKER MK

**PRINTING TECHNIQUES**



SCREEN PRINTING

# BIC® MARK-IT PERMANENT MARKER

**BIC® MARK-IT  
PERMANENT  
MARKER**  
1214



01/02  
●  
Colour ink

01/04  
●  
Colour ink

←  
*Textured rubberised  
grip for more  
precision and control*

## Decoration

**BIC® MARK-IT  
PERMANENT MARKER**  
1214

**A/B SP:** max. 3 col.

MOQ 250 units

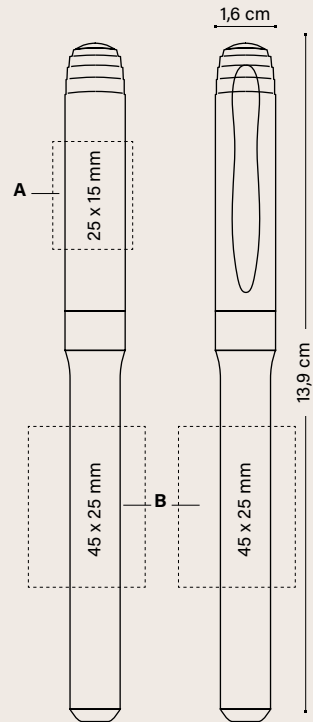

	Price (€)				
<b>BIC® MARK-IT PERMANENT MARKER</b>	250- 499	500- 999	1000- 2499	2500- 4999	5000
1214					
<b>SP</b>	1,61	1,45	1,35	1,25	1,17

### Additional imprint charge per colour & position

<b>SP</b>	0,17	0,14	0,14	0,14	0,13
-----------	------	------	------	------	------

Prices include one colour in screen printing in one position.

### OPTIONAL SPECIAL PACKAGING



MARKING  
SET



250 ± 2,8KG

*You can have  
it as a set!*

+ INFO PAGES 240 TO 245



MANUFACTURED AND  
PRINTED IN BIC FACTORIES



REGULATORY  
COMPLIANCE



ISO  
certified



IMPRIM'VERT®



UBIQUITY™ PROGRAM  
ALLOWS RECYCLING  
BIC WRITING INSTRUMENTS



RESISTANT  
TIP



MARKER  
MK

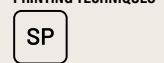

SCREEN PRINTING

# BIC® PERMANENT MARKER ECOLUTIONS®



MADE FROM  
51% RECYCLED MATERIAL\*

Add the Möbius loop to your artwork at no additional charge. Please specify "Print the Möbius loop" on your order. (Möbius loop imprint defaults to left-hand hand corner.)



PHARMACEUTICAL  
WASTE

## BIC® PERMANENT MARKER ecolutions® 1210



02

●  
Colour ink

02

●  
Colour ink

### Decoration

## BIC® PERMANENT MARKER ecolutions® 1210

A SP: max. 1 col.

MOQ 250 units

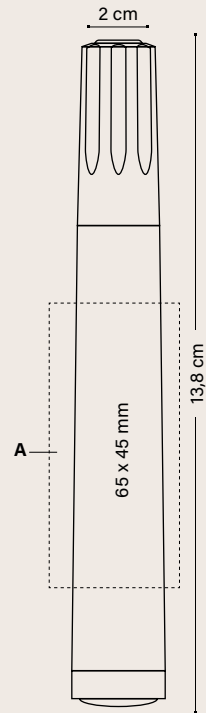

	Price (€)				
BIC® PERMANENT MARKER ecolutions® 1210	250-499	500-999	1000-2499	2500-4999	5000
SP	1,90	1,73	1,60	1,50	1,41

Prices include one colour in screen printing in one position.

### EXTERNAL PACKAGING



MANUFACTURED AND  
PRINTED IN BIC FACTORIES

FABRIQUÉ  
EN FRANCE



MADE IN  
FRANCE



REGULATORY  
COMPLIANCE



PHARMACEUTICAL  
WASTE



RESISTANT  
TIP

### WRITING MODES



MARKER  
MK

### PRINTING TECHNIQUES



SCREEN PRINTING

\* The percentage is calculated on total weight of product excluding ink system. Due to the recycled content of the raw materials used to make the product, we cannot guarantee that the colours shown in the catalogue or colours customised to order will always have the same colour and appearance. See page 250 for a detailed explanation of the icons



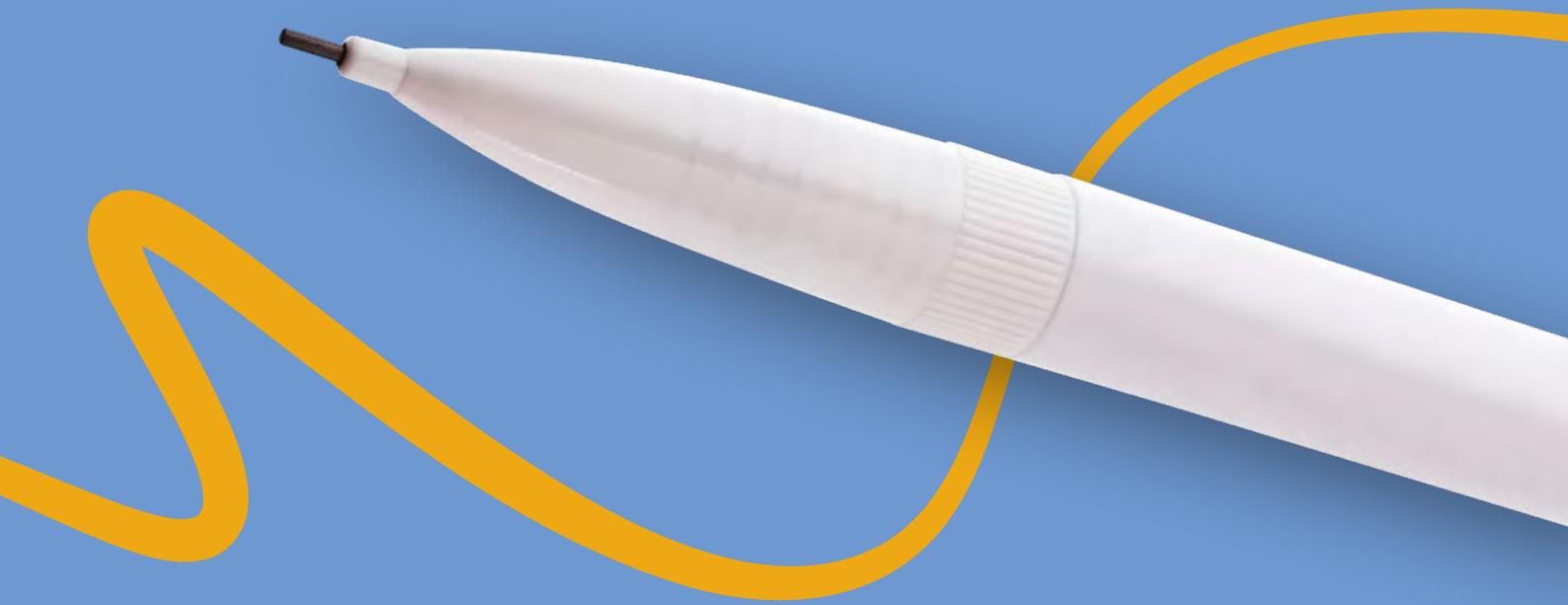

# **BIC<sup>®</sup> MECHANICAL PENCILS**

---

A reference since 1993. Stay sharp with this first-class mechanical pencil!

It is solid and resistant, never needs sharpening and writes smoother and darker than ever!

**BIC<sup>®</sup> MATIC<sup>®</sup>**

**BIC<sup>®</sup> MEDIA CLIC MECHANICAL PENCIL**

**BIC<sup>®</sup> MEDIA CLIC GRIP MECHANICAL PENCIL**

*ECO version and standard at the same price!*

**ecolutions®**



**MADE FROM 65% RECYCLED MATERIAL\***

Add the Möbius loop to your artwork at no additional charge. Please specify it on your order. (Möbius loop imprint defaults to left-hand corner.)



PHARMACEUTICAL WASTE

**BIC® MATIC®**  
1120 Opaque



**BIC® MATIC®**  
**ecolutions®** 1E40 Opaque



\*The percentage is calculated based on total weight of the product. Due to the recycled content of the raw materials used to make the product, we cannot guarantee that the colours shown in the catalogue or colours customised to order will always have the same colour and appearance.



Decoration

**BIC® MATIC®**  
1120  
**ecolutions® 1E40**  
MOQ 500 units

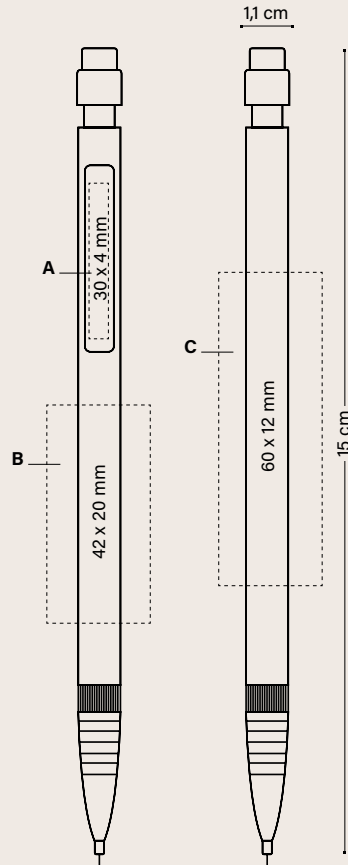

	500-999	1000-2499	2500-4999	Price (€)
<b>BIC® MATIC®</b> 1120/ <b>ecolutions® 1E40</b>				5000
<b>SP</b>	0,82	0,77	0,71	0,67
<b>Additional imprint charge per colour &amp; position</b>				
<b>SP</b>	0,14	0,14	0,14	0,13

Prices include one colour in screen printing in one position.

**OPTIONAL SPECIAL PACKAGING**



PLASTIC POUCH

+ INFO PAGES 240 TO 245

**EXTERNAL PACKAGING**



500 ± 3,1 KG



MANUFACTURED AND PRINTED IN BIC FACTORIES



MADE IN FRANCE



REGULATORY COMPLIANCE



ISO certified

**IMPRIM'VERT®**

**ecolutions®**



PHARMACEUTICAL WASTE



RECYCLABLE



SMOOTHER AND DARKER WRITING



EASY TO USE AND ERASE



2 LEADS 9 CM

**WRITING MODES**



MECHANICAL PENCIL MP Ø 0,7 MM

**PRINTING TECHNIQUES**



SCREEN PRINTING

See page 250 for a detailed explanation of the icons.

# BIC® MEDIA CLIC MECHANICAL PENCIL

---



*Embossed  
iconic BIC® brand!*

---

**BIC® MEDIA CLIC**  
1028 Mechanical pencil  
Opaque



8D

5C

13

83

---

**BIC® MEDIA CLIC**  
1028 Mechanical pencil  
Frosted

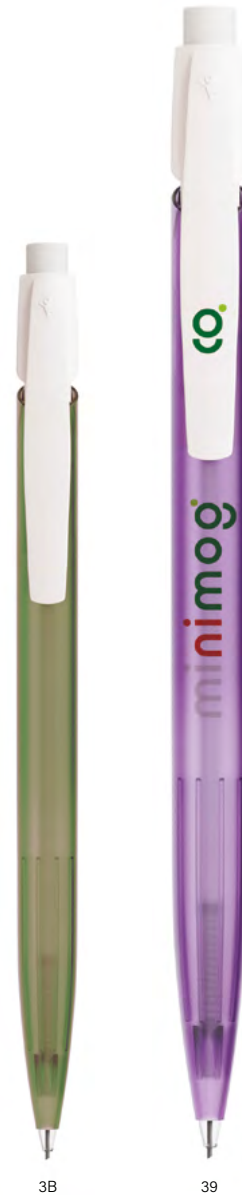

3B

39

# BIC® MEDIA CLIC GRIP MECHANICAL PENCIL

ECO version and standard at the same price!

**ecolutions®**  
 MADE FROM 92%  
 RECYCLED MATERIAL\*



**BIC® MEDIA CLIC GRIP**  
 1021 Mechanical pencil  
 Opaque



01/12

**BIC® MEDIA CLIC GRIP**  
 1021 Mechanical pencil  
 Frosted



69/69

71/69

82/69



40/69

100%

**BIC® MEDIA CLIC GRIP**  
 1E21 Mechanical pencil  
 Opaque



01/03

01/05

01/02

01/07

100%

Only available  
 on white barrel



\*The percentage is calculated based on total weight of the product. Due to the recycled content of the raw materials used to make the product, we cannot guarantee that the colours shown in the catalogue or colours customised to order will always have the same colour and appearance.

# BIC® MEDIA CLIC MECHANICAL PENCIL

**BIC® MEDIA CLIC**  
1028 Mechanical pencil

**BIC® MEDIA CLIC GRIP**  
1021 Mechanical pencil / **ecolutions®** 1E21 Mechanical pencil

MOQ 500 units  
Standard colours combination

**MIX & MATCH**

No extra charge

## Clip

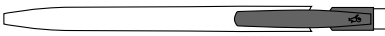

Opaque

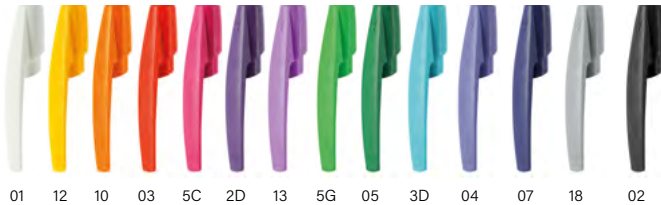

Frosted



01 12 10 03 5C 2D 13 5G 05 3D 04 07 18 02 69

## Barrel



Opaque

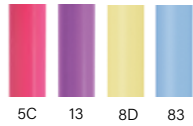

5C 13 8D 83

Frosted



39 3B

## Barrel & Grip



01/12

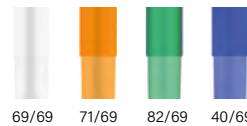

69/69 71/69 82/69 40/69



THE SOLUTION FOR  
**FULL COLOUR  
COMMUNICATION!**

**ecolutions®**



PLASTIC  
CAR PARTS

Standard colours  
combination\*

**Barrel & Grip**

Opaque

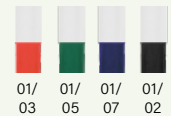

01/  
03 01/  
05 01/  
07 01/  
02



Add the Möbius loop to  
your artwork at no  
additional charge. Please  
specify "Print the Möbius  
loop" on your order.  
(Möbius loop imprint  
defaults to left-hand  
corner.)

All colour range available in Digital britePix™

Exact colour match: ≥ 10.000 units 1028

Exact colour match: ≥ 20.000 units 1021 / 1E21



PERSONALIZED  
COLOURS



MANUFACTURED  
AND PRINTED IN  
BIC FACTORIES

**MIX &  
MATCH**  
**ecolutions®**



PLASTIC  
CAR PARTS



RECYCLABLE

WRITING MODES



MECHANICAL  
PENCIL MP

PRINTING TECHNIQUES



SP  
SCREEN  
PRINTING



DG  
DIGITAL

# BIC® MEDIA CLIC / BIC® MEDIA CLIC GRIP MECHANICAL PENCIL

## BIC® MEDIA CLIC

1028 Mechanical pencil

**A SP:** max. 4 col.

**B SP:** max. 2 col.

**C DG:** full-colour

MOQ 500 units.

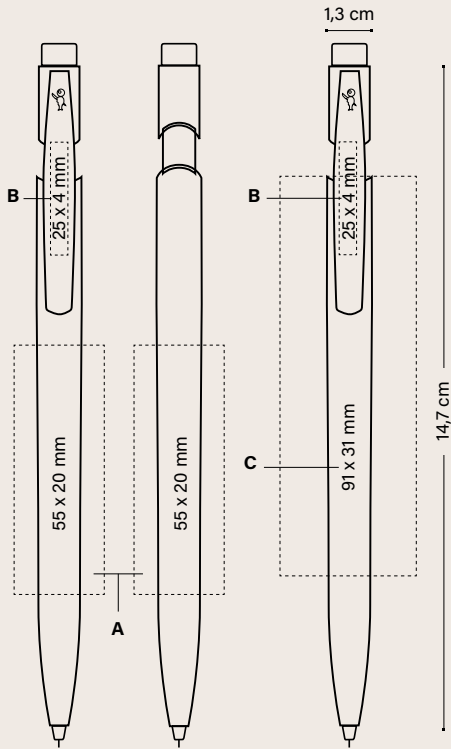

Price (€)

BIC® MEDIA CLIC	500-999	1000-2499	2500-4999	5000
1028 (Mechanical pencil)				
<b>SP</b>	0,87	0,78	0,73	0,67
<b>DG</b>	1,08	0,97	0,87	0,77

### Additional imprint charge per colour & position

<b>SP</b>	0,14	0,14	0,14	0,13
-----------	------	------	------	------

Prices include one imprint in one position according to specified technique.

### OPTIONAL SPECIAL PACKAGING



ECO SLEEVE

PLASTIC POUCH

WINDOW BOX

+ INFO PAGES 240 TO 245

### EXTERNAL PACKAGING



500 ± 4,1 KG

## BIC® MEDIA CLIC GRIP

1021 Mechanical pencil

**ecolutions® 1E21** Mechanical pencil

**D SP:** max. 4 col.

**E SP:** max. 2 col.

**F DG:** full-colour

MOQ 500 units.

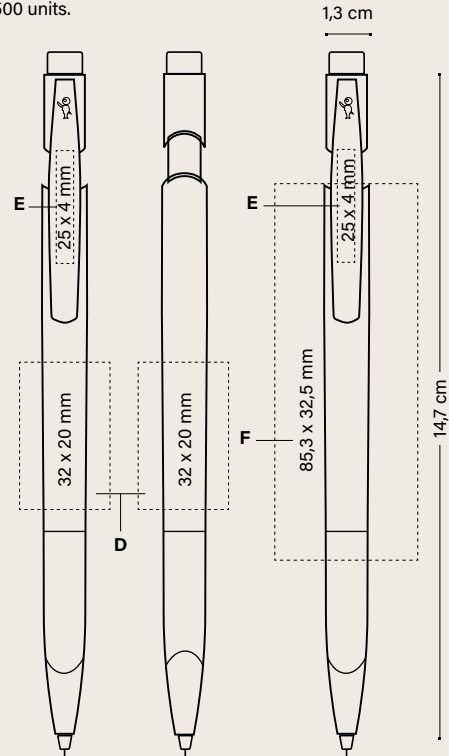

Price (€)

BIC® MEDIA CLIC GRIP	500-999	1000-2499	2500-4999	5000
1021 / <b>ecolutions® 1E21</b> (Mechanical pencil)				
<b>SP</b>	1,08	0,94	0,83	0,76
<b>DG</b>	1,37	1,28	1,09	0,99

### Additional imprint charge per colour & position

<b>SP</b>	0,14	0,14	0,14	0,13
-----------	------	------	------	------

Prices include one imprint in one position according to specified technique.

### OPTIONAL SPECIAL PACKAGING



ECO SLEEVE

PLASTIC POUCH

WINDOW BOX

+ INFO PAGES 240 TO 245

### EXTERNAL PACKAGING



500 ± 4,3 KG



MANUFACTURED AND PRINTED IN BIC FACTORIES



MADE IN SPAIN



PLASTIC CAR PARTS



RECYCLABLE

### WRITING MODES



MECHANICAL PENCIL MP

### PRINTING TECHNIQUES



SP SCREEN PRINTING



DG DIGITAL



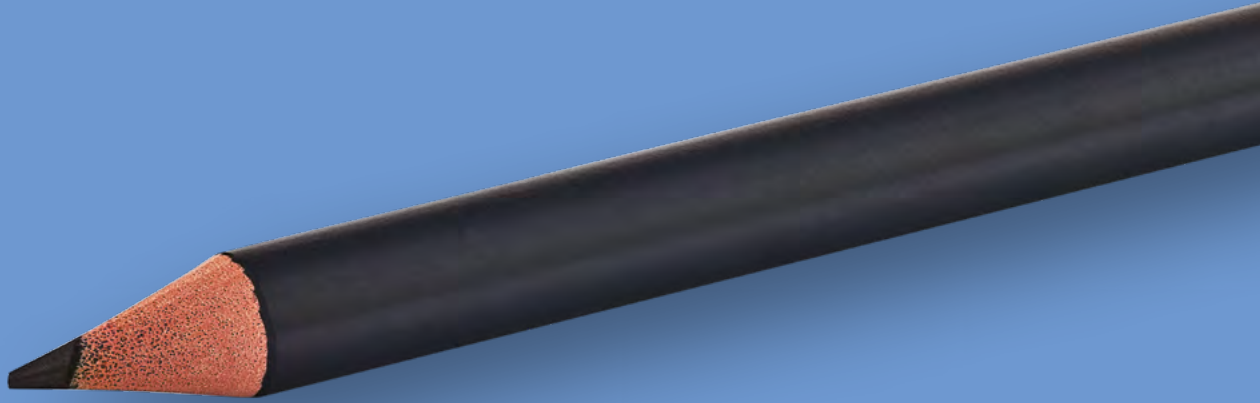

# BIC<sup>®</sup> PENCILS

██████████

A reference since 1993. Wood-free pencil made with recycled synthetic resin material, that will not splinter in the event of breaking. Ultra-resistant HB graphite lead.

**EVOLUTION<sup>®</sup> ECOLUTIONS<sup>®</sup>**



THE SOLUTION FOR FULL COLOUR COMMUNICATION!



THE SOLUTION FOR FULL COLOUR COMMUNICATION!



Embossed iconic BIC® brand!

ecolutions®



MADE FROM 60% RECYCLED MATERIAL\*



FRIGDES AND YOGURT POTS

ecolutions®



MADE FROM 52,7% RECYCLED MATERIAL\*



FRIGDES AND YOGURT POTS

GRAPHITE PENCIL CUT END ecolutions® 1150

GRAPHITE PENCIL WITH ERASER ecolutions® 1151



Protective sheath

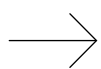

20



02



03



ARROW

100%



100%

360° Printing



20



02



03



COMMUNICATION

01

100%



100%

360° Printing

\*The percentage is calculated based on total weight of the product. Due to the recycled content of the raw materials used to make the product, we cannot guarantee that the colours shown in the catalogue or colours customised to order will always have the same colour and appearance.



**ecolutions®**  
 MADE FROM  
 60% RECYCLED MATERIAL\*



Add the Möbius loop to your artwork at no additional charge. Please specify it on your order. (Möbius loop imprint defaults to left-hand hand corner.)

## GRAPHITE PENCIL

1150/1151

MOQ 500 units  
 Standard colours combination

## Eraser

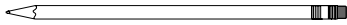

Opaque



## Ferrule

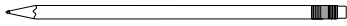

Opaque



## Barrel



Opaque

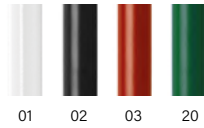

**MIX & MATCH**

No extra charge

**MIX & MATCH**



MANUFACTURED AND PRINTED IN BIC FACTORIES

FABRIQUÉ EN FRANCE

MADE IN FRANCE



REGULATORY COMPLIANCE



IMPRIM'VERT®

ecolutions®



RECYCLABLE



RESISTANT TIP



NO SPLINTER



PROTECTIVE SHEATH



EASY TO USE AND ERASE

**WRITING MODES**



PENCIL PC HB  
 Ø 2,3MM

**PRINTING TECHNIQUES**



SCREEN PRINTING



DIGITAL

See page 250 for a detailed explanation of the icons.



Decoration

**BIC® EVOLUTION® ECOLUTIONS®**  
**ecolutions® 1150** (Pencil cut end)

A SP: max. 1 col.

MOQ 500 units

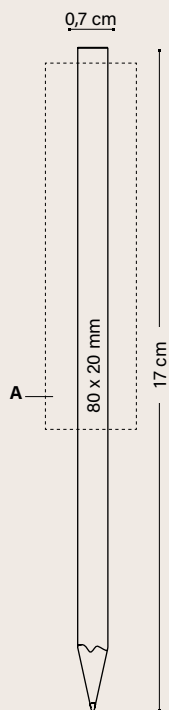

Decoration

**BIC® EVOLUTION® ECOLUTIONS®**  
**ecolutions® 1151** (Pencil with eraser)

MOQ 500 units

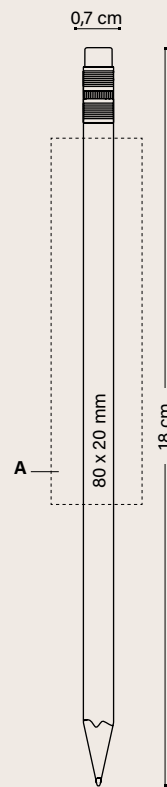

	Price (€)			
BIC® EVOLUTION® ecolutions®	500-999	1000-2499	2500-4999	5000
<b>1150</b>	<hr/>			
<b>SP</b>	0,50	0,47	0,44	0,42
<b>1151</b>	<hr/>			
<b>SP</b>	0,85	0,80	0,75	0,71

Prices include one colour in screen printing in one position.

**OPTIONAL SPECIAL PACKAGING**



PLASTIC  
POUCH  
(x 3 UNITS)

*Now you can  
have it as a set!*

+ INFO PAGES 240 TO 245

**EXTERNAL PACKAGING**



500 ± 3,5 KG

Decoration

**BIC® EVOLUTION® ECOLUTIONS®**  
**ecolutions® 1150** (Pencil cut end Digital)

A DG: full-colour (area for images)

MOQ 500 units

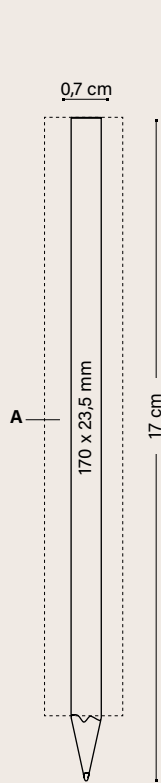

Decoration

**BIC® EVOLUTION® ECOLUTIONS®**  
**ecolutions® 1151** (Pencil with eraser Digital)

MOQ 500 units

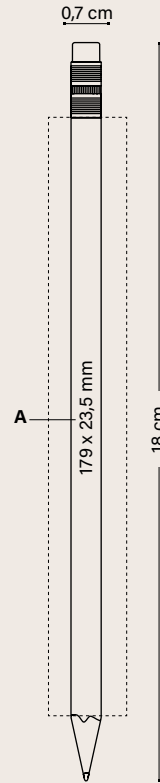

	Price (€)			
<b>BIC® EVOLUTION® ecolutions®</b>	500-999	1000-2499	2500-4999	5000
<b>1150</b>				
<b>DG</b>	0,78	0,75	0,70	0,65
<b>1151</b>				
<b>DG</b>	1,14	1,07	1,00	0,94

Prices include the digital imprint on the body.

**OPTIONAL SPECIAL PACKAGING**



PLASTIC POUCH (X 3 UNITS)

Now you can have it as a set!

+ INFO PAGES 240 TO 245

**EXTERNAL PACKAGING**



500 ± 3,5 KG



MANUFACTURED AND PRINTED IN BIC FACTORIES



MADE IN FRANCE



REGULATORY COMPLIANCE



FRIGIDES AND YOGURT POTS



RECYCLABLE



RESISTANT TIP



NO SPLINTER



PROTECTIVE SHEATH



EASY TO USE AND ERASE

**WRITING MODES**



PENCIL PC HB Ø 2,3MM

**PRINTING TECHNIQUES**



SCREEN PRINTING



DIGITAL

See page 250 for a detailed explanation of the icons.

# SPROUT™ GRAPHITE PENCIL



This pen enables you to convey a meaningful message and sets the foundation for a lasting relationship. The sustainable pencil that you can plant after use and grow into herbs, vegetables or flowers.

SPROUT™ GRAPHITE PENCIL  
53062

With seeds  
→



Standard barrel

Customised barrels

Standard cardboard!



Standard cardboard packaging

Customisable cardboard!

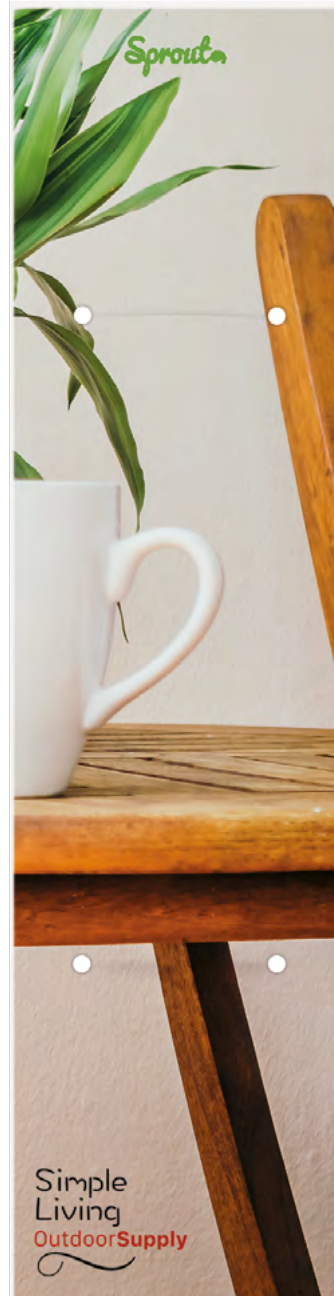

Personalised cardboard packaging



Rear side



Graphite Lead

Once the pencil is too short to write with, plant the stub and watch your message turn into a pot of beautiful herbs, flowers or vegetables.

**Choose between 8 different seeds!**

- |                  |                  |
|------------------|------------------|
| 1. Spruce        | 5. Basil         |
| 2. Sunflower     | 6. Thyme         |
| 3. Daisy         | 7. Sage          |
| 4. Forget me not | 8. Cherry tomato |

Decoration

**SPROUT™ GRAPHITE PENCIL**  
53062

A LE  
B DG

MOQ 100 units

*Pencil sharpening is offered at an extra charge*

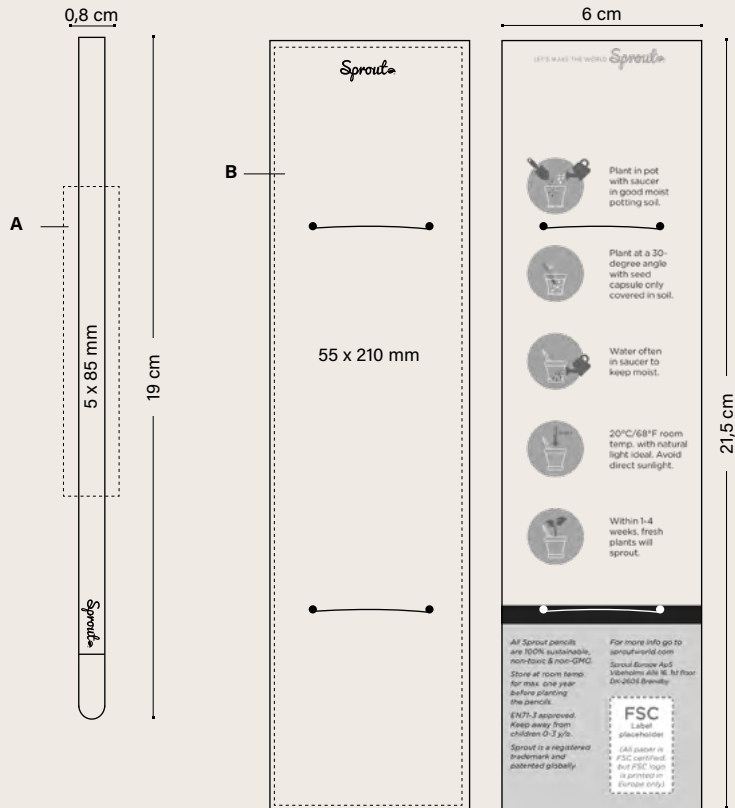

*Planting instructions included on the rear side. For customised cardboard, you can change the font and colours!*

					Price (€)
<b>SPROUT™ CRAYON GRAPHITE</b>	100	250	500	1000	2500
<b>53062</b>					
<b>Pencil with laser engraving</b>	1,86	1,73	1,57	1,47	1,39
<b>Standard Single Cardboard</b>	0,36	0,34	0,33	0,30	0,29
<b>Personalised Single Cardboard</b>	3,02	1,41	1,32	1,25	0,67

**EXTERNAL PACKAGING**



500 ± 2,5 KG (ONLY PENCIL)  
± 5 KG (WITH CARDBOARD PACKAGING)

**PACKAGING**



Sprouta



FSC AND  
RECYCLABLE CARDBOARD



RECYCLABLE

**WRITING MODES**



PENCIL PC HB  
Ø 2,3MM

**PRINTING TECHNIQUES**



LASER



DIGITAL



CHECK OUT THE VIDEO

See page 250 for a detailed explanation of the icons.

# Contents

# 02

---

# OTHER WRITING INSTRUMENTS

---

## PLASTIC PENS

Basic Pen	182
Click Pen	184
Striped Grip Pen	186

## STYLUS PENS

Sleek Stylus Pen	188
------------------	-----

# BASIC PEN

---

## BASIC PEN

12010

Colour ink





Decoration

**BASIC PEN**  
12010

A/B SP: max. 1 col.

MOQ 500 units

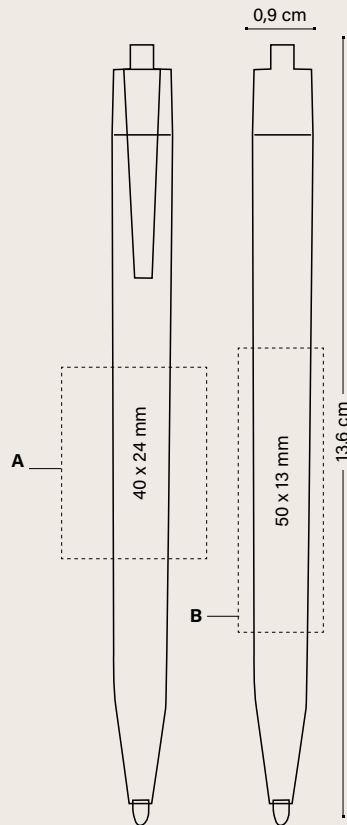

BASIC PEN 12010	Quantity			Price (€)
	500-999	1000-2499	2500-4999	5000
Unimprinted	0,17	0,16	0,16	0,15
SP	0,68	0,54	0,46	0,42

Prices include one colour in screen printing in one position.

**EXTERNAL PACKAGING**



1000 ± 12,5 KG



WRITING  
MODES



PRINTING  
TECHNIQUES



SCREEN PRINTING

See page 250 for a detailed explanation of the icons.

# CLICK PEN

---

## CLICK PEN

11748

Colour ink



Decoration

**CLICK PEN**

11748

**A/B SP:** max. 4 col.

**C/D PD:** max. 4 col.

MOQ 500 units

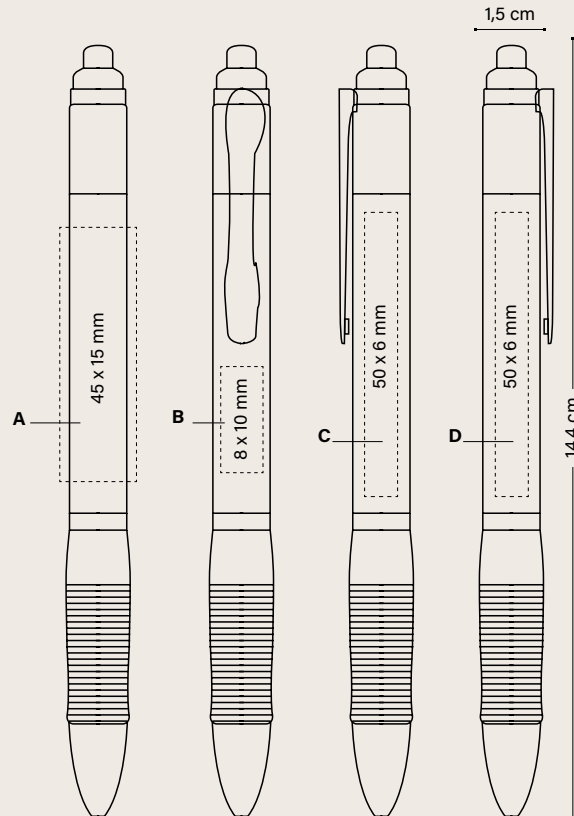

CLICK PEN	500-999	1000-2499	2500-4999	Price (€)
11748				
<b>Unimprinted</b>	0,22	0,21	0,21	0,20
<b>SP</b>	0,66	0,54	0,46	0,43
<b>PD</b>	0,81	0,64	0,55	0,50

**Additional imprint charge per colour & position**

<b>SP</b>	0,14	0,14	0,14	0,13
<b>PD</b>	0,37	0,27	0,20	0,19

Prices include one imprint in one position according to specified technique.

**EXTERNAL PACKAGING**



**WRITING MODES**



**PRINTING TECHNIQUES**



See page 250 for a detailed explanation of the icons.

# STRIPED GRIP PEN

---

---

## STRIPED GRIP PEN

11243

Colour ink



10



03



24



8C



04

100%

Decoration

**STRIPED GRIP PEN**

11243

**A SP:** max. 2 col.

**B PD:** max. 1 col.

MOQ 500 units

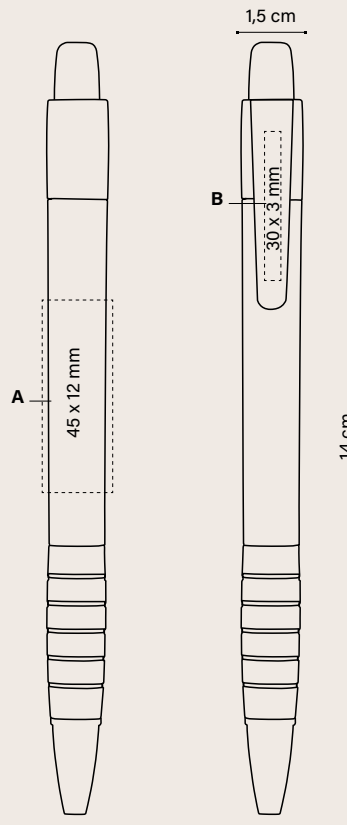

Price (€)

STRIPED GRIP PEN	500-999	1000-2499	2500-4999	5000
11243				
Unimprinted	0,35	0,34	0,34	0,32
SP	0,78	0,65	0,58	0,54
PD	0,85	0,76	0,66	0,61

**Additional imprint charge per colour & position**

SP	0,14	0,14	0,14	0,13
PD	0,37	0,27	0,20	0,19

Prices include one imprint in one position according to specified technique.

**EXTERNAL PACKAGING**



**WRITING MODES**



**PRINTING TECHNIQUES**



# Contents

# 03

---

# NOTEBOOKS

---

**ROCKETBOOK®**

Rocketbook® Core Executive A5	194
Rocketbook® Fusion Executive A5	196
Rocketbook® Core Mini A6	198





# ROCKETBOOK®

Rocketbook® combines the freedom of a traditional pen and paper notebook with its app technology to send handwritten notes quickly and securely to the cloud folder of your choice. It is designed to be the last notebook you'll ever need. Follow the instructions included for a clean page that can be used endlessly. You can choose the Core for taking notes, making graphs and sketching, or go one step further with the Fusion for planning, making lists and setting goals.

**ROCKETBOOK® CORE EXECUTIVE A5**

**ROCKETBOOK® FUSION EXECUTIVE A5**

**ROCKETBOOK® CORE MINI A6**



# ROCKETBOOK® CORE EXECUTIVE A5

**NEW!**

NEW IMPROVED MOQ 25 UNITS!



**ROCKETBOOK® CORE EXECUTIVE A5**  
3728



07  
●  
Navy Blue



01  
○  
White

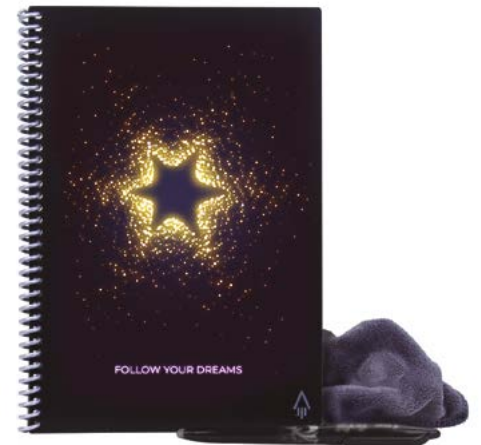

02  
●  
Black

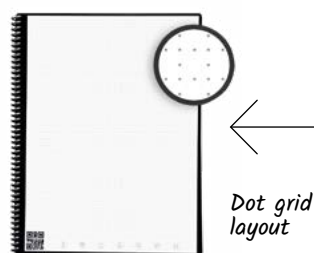
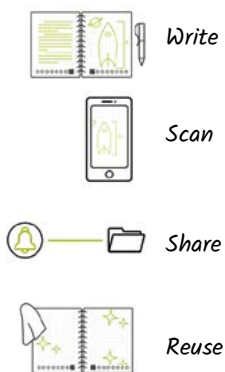

The box always includes:

- Notebook
- Pen
- Cloth
- Instructions

Decoration

**ROCKETBOOK® CORE EXECUTIVE A5**

3728

**A SP:** max. 1 col.

**B BP:** full-colour

**C HS:** max. 1 col.

36 pages

MOQ 25 units

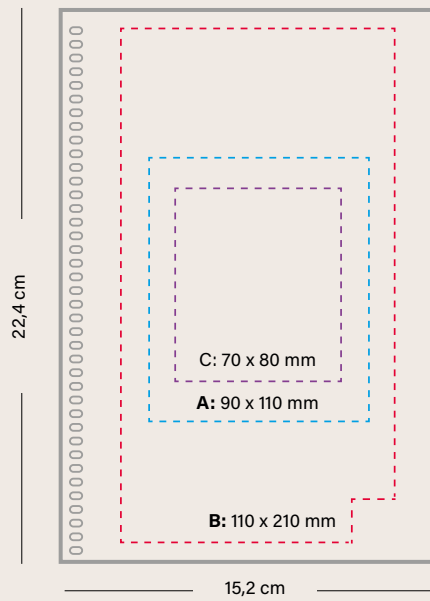

	Price (€)					
ROCKETBOOK® CORE EXECUTIVE A5	25-49	50-99	100-249	250-499	500-999	1000
3728						
<b>SP</b>	38,52	35,02	32,76	29,81	28,08	27,21
<b>HS</b>	39,18	35,62	33,17	30,09	28,32	27,65
<b>BP</b>	44,05	40,05	35,72	32,60	30,68	29,01

Prices include one imprint in one position according to specified technique.

**SPECIAL PACKAGING ALWAYS INCLUDED**



GIFT BOX CORE A5

**EXTERNAL PACKAGING**



50 ± 5,8 KG



ROCKETBOOK® APP AVAILABLE IN:



**PRINTING TECHNIQUES**



SCREEN PRINTING



BRITEPIX™



HOT STAMPING



DOWNLOAD THE APP



HOW IT WORKS

See page 250 for a detailed explanation of the icons.

# ROCKETBOOK® FUSION EXECUTIVE A5

**NEW!**

NEW IMPROVED MOQ 25 UNITS!



**ROCKETBOOK® FUSION EXECUTIVE A5**  
3726



01  
○  
White

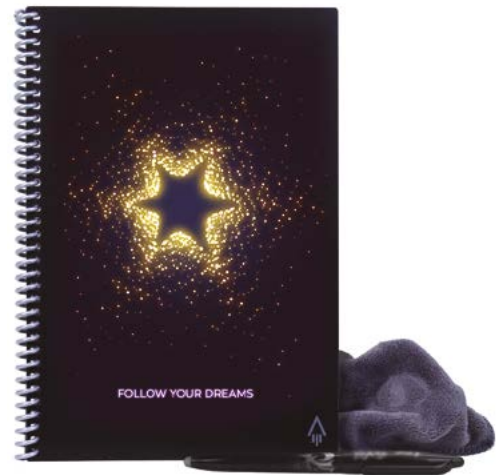

02  
●  
Black

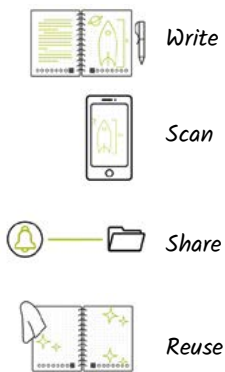

### Seven page styles

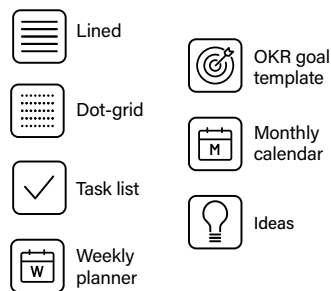

Customisation visible in window cutout



- The box always includes:
- Notebook
  - Pen
  - Cloth
  - Instructions

Decoration

**ROCKETBOOK® FUSION EXECUTIVE A5**

3726

**A SP:** max. 1 col.

**B BP:** full-colour

**C HS:** max. 1 col.

42 pages

MOQ 25 units

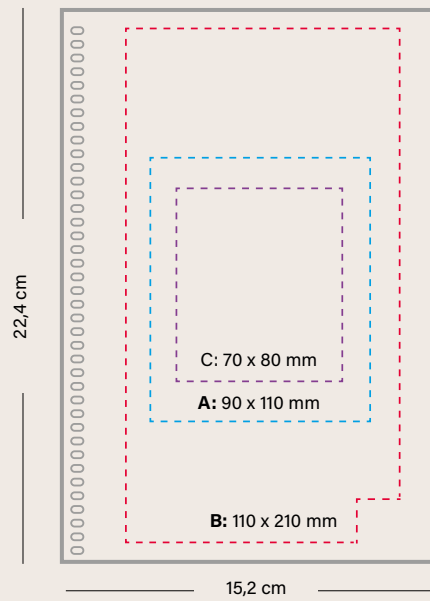

	Price (€)					
ROCKETBOOK® FUSION EXECUTIVE A5	25-49	50-99	100-249	250-499	500-999	1000

3726

SP	41,19	37,44	35,72	33,64	32,00	31,00
HS	41,85	38,05	36,12	33,97	32,21	31,20
BP	47,90	43,52	39,18	36,06	33,95	32,52

Prices include one imprint in one position according to specified technique.

**SPECIAL PACKAGING ALWAYS INCLUDED**

**EXTERNAL PACKAGING**



GIFT BOX FUSION A5



50 ± 5,8 KG



ROCKETBOOK® APP AVAILABLE IN:



**PRINTING TECHNIQUES**



SCREEN PRINTING



BRITEPIX™



HOT STAMPING



DOWNLOAD THE APP



HOW IT WORKS

See page 250 for a detailed explanation of the icons.

# ROCKETBOOK® CORE MINI A6

**NEW!**

NEW IMPROVED MOQ 25 UNITS!





**ROCKETBOOK® CORE MINI A6**  
3727



01  
○  
White

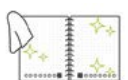

02  
●  
Black

-  Write
-  Scan
-  Share
-  Reuse

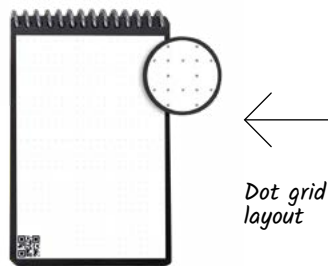

Dot grid layout



Customisation visible in window cutout

- The box always includes:
- Notebook
  - Pen
  - Cloth
  - Instructions

Decoration

**ROCKETBOOK® CORE MINI A6**

3727

**A SP:** max. 1 col.

**B BP:** full-colour

**C HS:** max. 1 col.

48 pages

MOQ 25 units

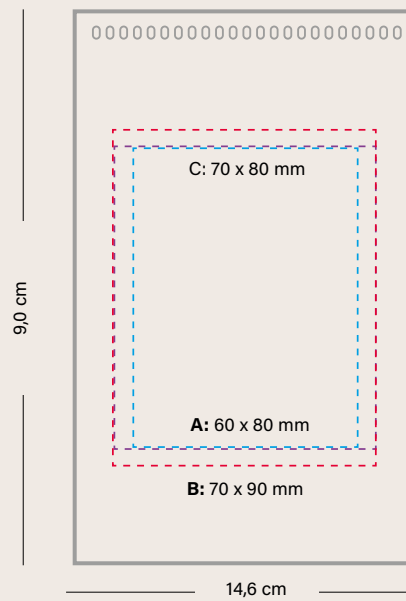

Price (€)

**ROCKETBOOK® CORE MINI A6**      25-49    50-99    100-249    250-499    500-999    1000

3727

	25-49	50-99	100-249	250-499	500-999	1000
<b>SP</b>	21,31	19,37	18,03	16,29	14,93	14,51
<b>HS</b>	21,78	19,80	18,43	16,56	15,61	15,03
<b>BP</b>	26,85	24,41	21,49	18,03	16,55	15,82

Prices include one imprint in one position according to specified technique.

**SPECIAL PACKAGING ALWAYS INCLUDED**

**EXTERNAL PACKAGING**



GIFT BOX CORE A6



50 ± 2,6 KG



**ROCKETBOOK® APP AVAILABLE IN:**



**PRINTING TECHNIQUES**



SCREEN PRINTING



BRITEPIX™



HOT STAMPING



DOWNLOAD THE APP



HOW IT WORKS

See page 250 for a detailed explanation of the icons.

# SLEEK STYLUS PEN

---

## SLEEK STYLUS PEN

11666

Colour ink



01

## SLEEK STYLUS MATT PEN

11747

Colour ink



47



04

## SLEEK STYLUS EXECUTIVE PEN

11976



26

Available in  
blue ink



2N

Available in  
black ink



Decoration

**SLEEK STYLUS PEN**

11666

**SLEEK STYLUS MATT PEN**

11747

**SLEEK STYLUS EXECUTIVE PEN**

11976

**A SP:** max. 1 col.

**B SP:** max. 2 col.

**C LE**

MOQ 500 units (SP)

MOQ 100 units (LE)

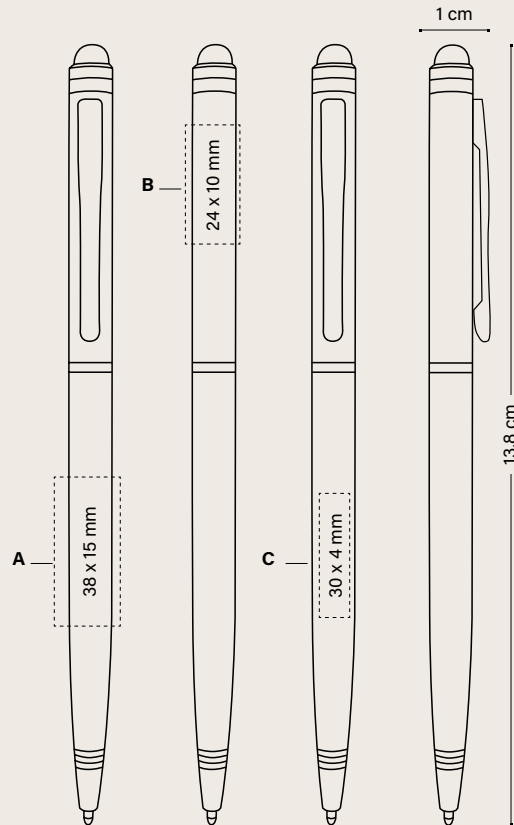

SLEEK STYLUS PEN						Price (€)
	100-249	250-499	500-999	1000-2499	2500-4999	5000
11666						
<b>Unimprinted</b>	1,93	1,85	1,78	1,71	1,66	1,60
<b>SP</b>	-	2,55	2,34	2,15	2,09	1,94
<b>LE</b>	3,85	3,26	3,01	2,83	2,74	2,71

**SLEEK STYLUS MATT PEN / EXECUTIVE PEN**

11747 / 11976

<b>Unimprinted</b>	2,07	1,98	1,90	1,81	1,76	1,71
<b>SP</b>	-	2,68	2,46	2,26	2,19	2,05
<b>LE</b>	3,99	3,40	3,12	2,93	2,85	2,82

**Additional imprint charge per colour & position**

<b>SP</b>	-	0,39	0,34	0,23	0,23	①
<b>LE</b>	1,91	1,41	1,22	1,11	1,08	①

Prices include one imprint in one position according to specified technique.

① Price under request.

**EXTERNAL PACKAGING**



**WRITING MODES**



**PRINTING TECHNIQUES**



See page 250 for a detailed explanation of the icons.

# Contents

04

---

# BIC®/DJEEP® LIGHTERS AND BIC® CASES

---

**BIC® LIGHTERS**

BIC® J25 Lighter	206
BIC® J23 Lighter	210
BIC® J26 Lighter	214
BIC® J38 Lighter	218

**BIC® LIGHTER CASES**

BIC® Styl'it Luxury Case	222
BIC® Aluminium Flat Case	224
BIC® Clip Case	225
BIC® 3D Case	226

**OTHER PRODUCTS**

BIC® Pocket Ashtray	228
---------------------	-----

**DJEEP® LIGHTERS**

DJEEP® D1 Lighter	230
-------------------	-----

# BIC® lighters. Our quality, your safety.

All BIC® pocket lighters meet or exceed international standards and regulations requirements (ISO 9994, EN 13869, ASTM F400, US CPSC).  
Don't risk it, buy BIC®!



BIC® is number one worldwide for branded lighters.



100% of pocket lighters are manufactured by BIC in Europe. All BIC® Pocket Lighters are made in BIC® factories. This is the starting block of the BIC® lighter safety guarantee.

## 50 YEARS

BIC® has acquired 50 years of incredible manufacturing expertise to guarantee the safety and quality of its products.

## 50 CHECKS

Before leaving the factory, every BIC® Lighter undergoes more than 50 automatic quality and security checks.

### CHOOSE WISELY! BIC® Pocket Lighters



BIC® J25 Digital lighter

UP TO 1450



BIC® J23 Digital lighter

UP TO 1800



BIC® J26 Digital lighter

UP TO 3000



BIC® J38 Digital lighter

UP TO 1800

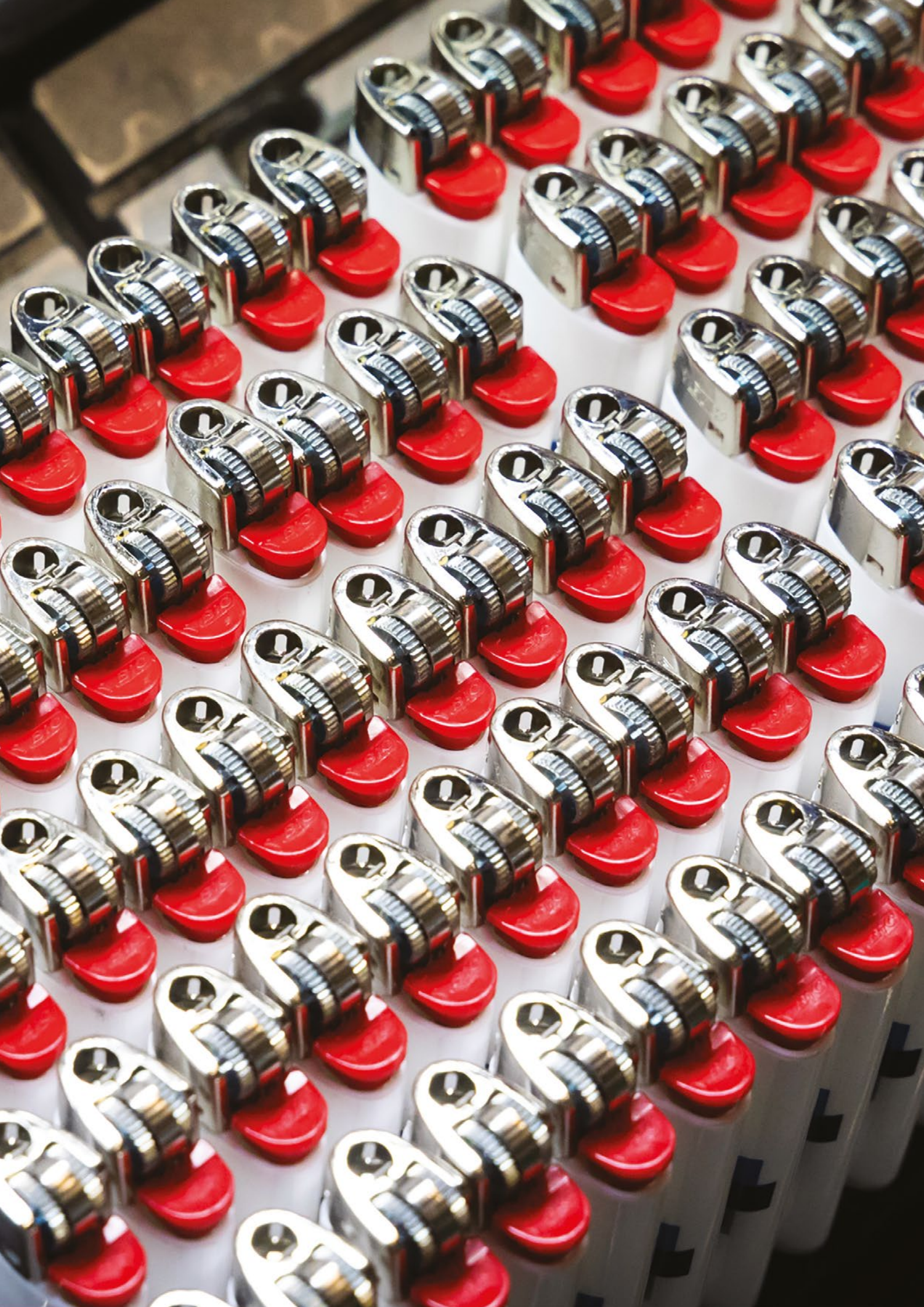



# BIC® LIGHTERS

---

The iconic, well-loved and time-honoured shapes of BIC® pocket lighters remain on trend!  
Four different sizes and a wide range of colour combinations.

**BIC® J25 LIGHTER**

**BIC® J23 LIGHTER**

**BIC® J26 LIGHTER**

**BIC® J38 LIGHTER**

**BIC® STYL'IT LUXURY CASE**

**BIC® ALUMINIUM FLAT CASE**

**BIC® CLIP CASE**

**BIC® 3D CASE**

**BIC® POCKET ASHTRAY**



# BIC® J25 LIGHTER

## Perfect for your pocket!



Iconic BIC® Boy and BIC® logo engraved!

### BIC® J25 LIGHTER

2360

2364 All Black



01

57

57

8G

03

11

59

24

04



25

25

6W

90

02

02

02

02

100%



Decoration



**BIC® J25 LIGHTER**

2360/2364

A/C SP: max. 4 col.

MOQ 300 units

**BIC® J25 LIGHTER BRITEPIX™**

2360 / 2364

A/C BP: full-colour

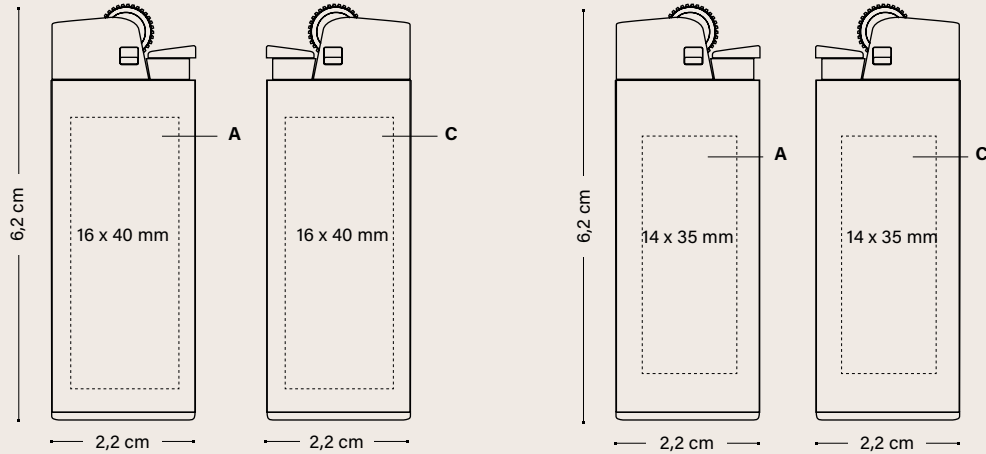

	Price (€)				
<b>BIC® J25 LIGHTER</b>	300-599	600-1199	1200-2999	3000-5099	5100
2360					
SP	1,49	1,31	1,24	1,21	1,18
BP	1,76	1,57	1,49	1,45	1,39
2364					
SP	1,70	1,57	1,48	1,37	1,30
BP	1,99	1,82	1,71	1,60	1,52
<b>Additional imprint charge per colour &amp; position</b>					
SP	0,15	0,14	0,14	0,14	0,11
BP	0,24	0,22	0,21	0,20	0,19

Prices in screen printing include one colour in one position.  
Prices in britePix™ include imprint on the body.

**PACKAGING**



STANDARD PACKAGING:  
IN TRAY OF 50 UNITS

100% recycled!



**EXTERNAL PACKAGING**



600 ± 76 KG



FSC AND  
RECYCLABLE  
CARDBOARD



MANUFACTURED  
AND PRINTED  
IN BIC FACTORIES



MADE IN SPAIN



PASTEL  
MADE IN FRANCE



REGULATORY COMPLIANCE



UP TO 1.450



100% OF ELECTRICITY  
PRODUCED USING  
RENEWABLE SOURCES

**PRINTING  
TECHNIQUES**



SCREEN PRINTING



BRITEPIX™

See page 250 for a detailed explanation of the icons.

## DIGITAL FINISHES



**BR** BRILLIANT



**MT** MATT

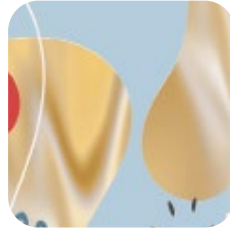

**H** HOLOGRAPHIC



**P** PUFFY



**M** METALLIC



**UV** UV

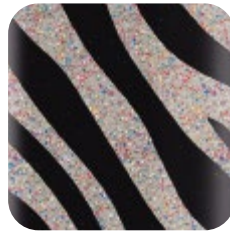

**PG** PUFFY GLITTER

## BIC® J25 DIGITAL LIGHTER 2360



**MT** MATT  
**P** PUFFY

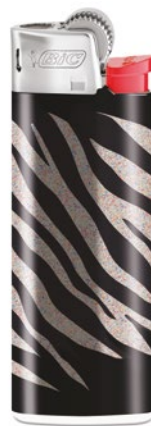

**PG** PUFFY GLITTER



**MT** MATT  
**M** METALLIC

Decoration

**BIC® J25 DIGITAL LIGHTER**

2360

**A DG:** full-colour

MOQ 600 units

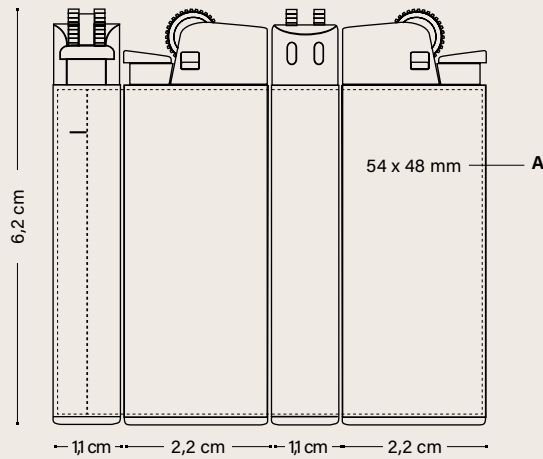

					Price (€)				
<b>BIC® J25 DIGITAL LIGHTER</b>					300-599	600-1199	1200-2999	3000-5099	5100
2360									
<b>DG</b>					-	1,96	1,83	1,73	1,62

							Minimum quantity	
<b>Additional charge for digital finishes</b>								
BR	MT	<b>Brilliant or Matt</b>	Free				600 u.	
	H	<b>Holographic</b>	-	0,27	0,27	0,24	0,19	600 u.
	P	<b>Puffy</b>	-	-	-	0,24	0,19	3.000 u.
	M	<b>Metallic</b>	①				50.000 u.	
	UV	<b>UV</b>	-	-	-	0,24	0,19	3.000 u.
	PG	<b>Puffy Glitter</b>	-	-	-	0,24	0,19	3.000 u.

Prices include the digital imprint on the body.

① Price under request.

**PACKAGING**



STANDARD PACKAGING:  
IN TRAY OF 50 UNITS

100% recycled!



**EXTERNAL PACKAGING**



600 ± 7,6 KG



FSC AND  
RECYCLABLE  
CARDBOARD



MANUFACTURED  
AND PRINTED  
IN BIC FACTORIES



MADE IN SPAIN



FABRIQUÉ  
EN FRANCE  
PASTEL  
MADE IN FRANCE



REGULATORY  
COMPLIANCE



UP TO 1.450



Conform  
ISO 9994



Conform  
EN 13869



100% OF ELECTRICITY  
PRODUCED USING  
RENEWABLE SOURCES

PRINTING  
TECHNIQUES



DG

DIGITAL

See page 250 for a detailed explanation of the icons.

# BIC® J23 LIGHTER



Iconic BIC® Boy  
and BIC® logo  
engraved!

## BIC® J23 LIGHTER 2340



57



12



03



10

*Slim and fits  
everywhere!*



05



04



25



02

Decoration

**BIC® J23 LIGHTER**

2340

A/C SP: max. 4 col.

MOQ 300 units

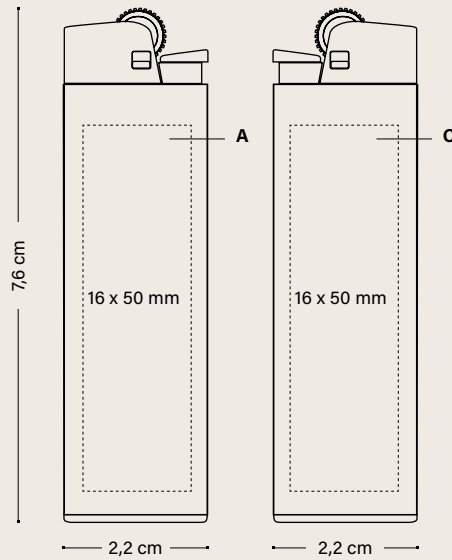

	Price (€)				
<b>BIC® J23 LIGHTER</b>	300-599	600-1199	1200-2999	3000-5099	5100
2340					
<b>SP</b>	1,62	1,49	1,39	1,31	1,27
<b>Additional imprint charge per colour &amp; position</b>					
<b>SP</b>	0,15	0,14	0,14	0,14	0,11

Prices include one colour in screen printing in one position.

**PACKAGING**



STANDARD PACKAGING:  
IN TRAY OF 50 UNITS

100% recycled!



**EXTERNAL PACKAGING**



600 ± 9,5 KG



FSC AND  
RECYCLABLE  
CARDBOARD



MANUFACTURED  
AND PRINTED  
IN BIC FACTORIES



MADE IN FRANCE



REGULATORY  
COMPLIANCE



UP TO 1.800



PRINTING  
TECHNIQUES



SCREEN PRINTING

DIGITAL FINISHES



**BR** BRILLIANT



**MT** MATT

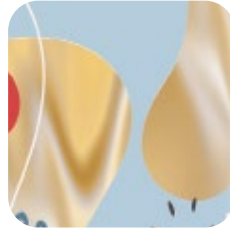

**H** HOLOGRAPHIC



**P** PUFFY



**M** METALLIC



**UV** UV



**PG** PUFFY GLITTER

BIC® J23 DIGITAL LIGHTER  
2340



**MT** MATT



**PG** PUFFY GLITTER



**BR** BRILLIANT

**H** HOLOGRAPHIC GOLD

360°  
Printing

100%

Decoration

**BIC® J23 DIGITAL LIGHTER**

2340

A DG: full-colour

MOQ 600 units

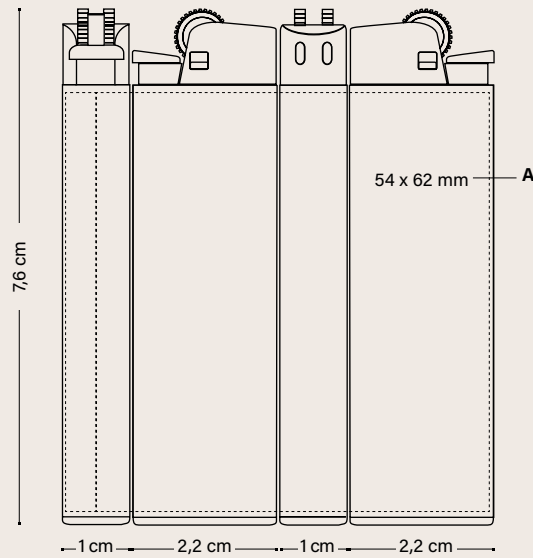

PRINTING TECHNIQUES



BIC® J23 DIGITAL LIGHTER 2340	Price (€)				
	300-599	600-1199	1200-2999	3000-5099	5100
DG	-	2,12	2,01	1,91	1,81

Additional charge for digital finishes						Minimum quantity		
BR	MT	Brilliant or Matt	Free			600 u.		
	H	Holographic	-	0,27	0,27	0,24	0,19	600 u.
	P	Puffy	-	-	-	0,24	0,19	3.000 u.
	M	Metallic	①					50.000 u.
	UV	UV	-	-	-	0,24	0,19	3.000 u.
	PG	Puffy Glitter	-	-	-	0,24	0,19	3.000 u.

Prices include the digital imprint on the body.  
① Price under request.

PACKAGING



STANDARD PACKAGING:  
IN TRAY OF 50 UNITS

100% recycled!



EXTERNAL PACKAGING



600 ± 9,5 KG



FSC AND RECYCLABLE  
CARDBOARD

See page 250 for a detailed explanation of the icons.

# BIC® J26 LIGHTER

## The flame that lasts.



Iconic BIC® Boy  
and BIC® logo  
engraved!

**BIC® J26 LIGHTER**  
2320



01



57



8G



10



6W

Extra long-  
lasting: up to  
3.000 lights!



59



24



25



02



03



Decoration

**BIC® J26 LIGHTER**

2320

A/C SP: max. 4 col.

MOQ 300 units

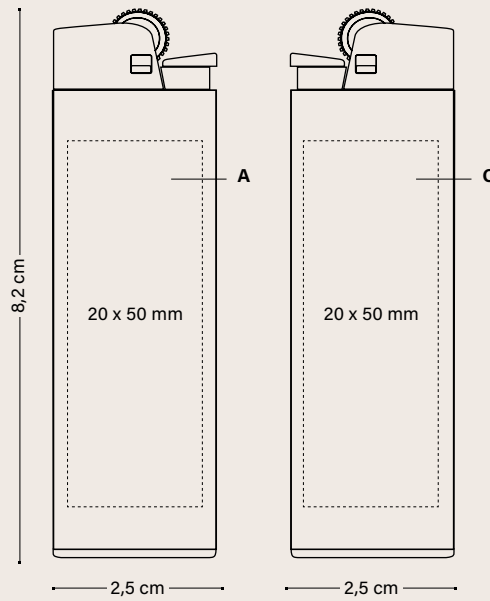

	Price (€)				
<b>BIC® J26 LIGHTER</b>	300-599	600-1199	1200-2999	3000-5099	5100
2320					
<b>SP</b>	1,94	1,70	1,62	1,54	1,47

**Additional imprint charge per colour & position**

<b>SP</b>	0,15	0,14	0,14	0,14	0,11
-----------	------	------	------	------	------

Prices include one colour in screen printing in one position.

**PACKAGING**



STANDARD PACKAGING:  
IN TRAY OF 50 UNITS

100% recycled!



**EXTERNAL PACKAGING**



600 ± 15,1 KG



FSC AND  
RECYCLABLE  
CARDBOARD



MANUFACTURED  
AND PRINTED  
IN BIC FACTORIES



MADE IN SPAIN



REGULATORY  
COMPLIANCE



UP TO 3.000

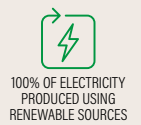

**PRINTING  
TECHNIQUES**



SCREEN PRINTING

## DIGITAL FINISHES



**BR** BRILLIANT



**MT** MATT

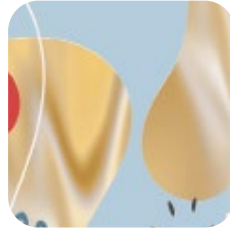

**H** HOLOGRAPHIC



**P** PUFFY



**M** METALLIC



**UV** UV



**PG** PUFFY GLITTER

## BIC® J26 DIGITAL LIGHTER 2320



**MT** MATT



**BR** BRILLIANT



360°  
Printing

**MT** MATT

100%

**H** HOLOGRAPHIC  
SILVER

Decoration

**BIC® J26 DIGITAL LIGHTER**

2320

A DG: full-colour

MOQ 600 units

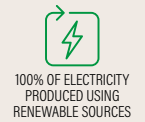
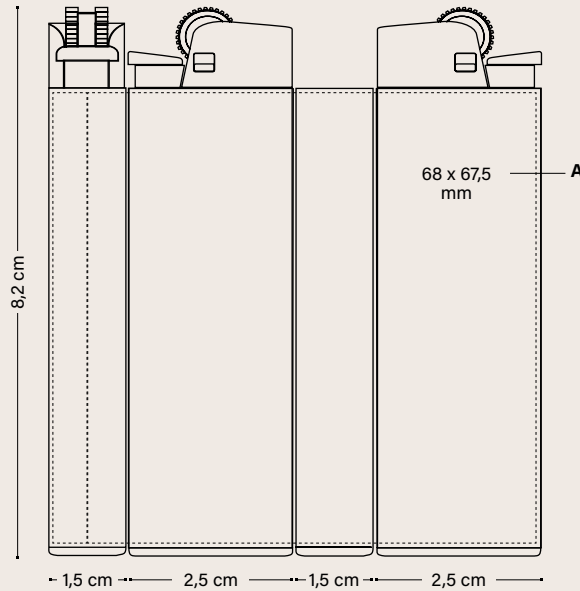

PRINTING TECHNIQUES



		Price (€)				
<b>BIC® J26 DIGITAL LIGHTER</b>		300-599	600-1199	1200-2999	3000-5099	5100
2320						
DG		-	2,50	2,37	2,25	2,08

Additional charge for digital finishes						Minimum quantity		
BR	MT	Brilliant or Matt		Free		600 u.		
	H	Holographic	-	0,27	0,27	0,24	0,19	600 u.
	P	Puffy	-	-	-	0,24	0,19	3.000 u.
	M	Metallic		①				50.000 u.
	UV	UV	-	-	-	0,24	0,19	3.000 u.
	PG	Puffy Glitter	-	-	-	0,24	0,19	3.000 u.

Prices include the digital imprint on the body.

① Price under request.

PACKAGING



STANDARD PACKAGING:  
IN TRAY OF 50 UNITS

100% recycled!



EXTERNAL PACKAGING



600 ± 15,1 KG



FSC AND RECYCLABLE CARDBOARD

See page 250 for a detailed explanation of the icons.

# BIC® J38 LIGHTER

 *Iconic BIC® Boy  
and BIC® logo  
engraved!*

## BIC® J38 LIGHTER 2452



57



25



02



03

100%



*Elegant and  
comfortable  
lighting!*

Decoration

**BIC® J38 LIGHTER**

2452

A/C SP: max. 4 col.

MOQ 300 units

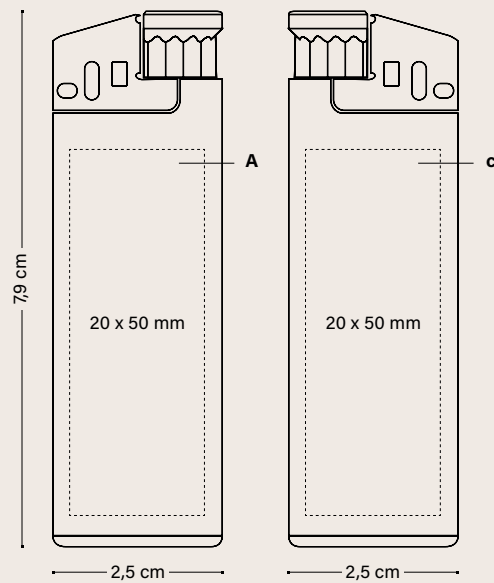

100% OF ELECTRICITY PRODUCED USING RENEWABLE SOURCES

PRINTING TECHNIQUES



	300-599	600-1199	1200-2999	3000-5099	Price (€)
<b>BIC® J38 LIGHTER</b>					5100
2452					
SP	2,07	1,98	1,88	1,80	1,71

Additional imprint charge per colour & position

SP	0,15	0,14	0,14	0,14	0,11
----	------	------	------	------	------

Prices include one colour in screen printing in one position.

PACKAGING



100% recycled!

STANDARD PACKAGING:  
IN TRAY OF 50 UNITS

EXTERNAL PACKAGING



600 ± 13,2 KG



FSC AND RECYCLABLE CARDBOARD

See page 250 for a detailed explanation of the icons.

## FINISHES



**BR** BRILLIANT



**MT** MATT

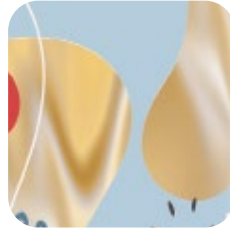

**H** HOLOGRAPHIC



**P** PUFFY



**M** METALLIC



**UV** UV



**PG** PUFFY GLITTER

## BIC® J38 DIGITAL LIGHTER 2452



57

**BR** BRILLIANT



57

**MT** MATT



57

**MT** MATT

**H** HOLOGRAPHIC GOLD

360°  
Printing

100%

Decoration

**BIC® J38 DIGITAL LIGHTER**

2452

**A DG:** full-colour

MOQ 600 units

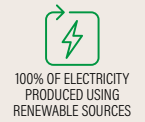
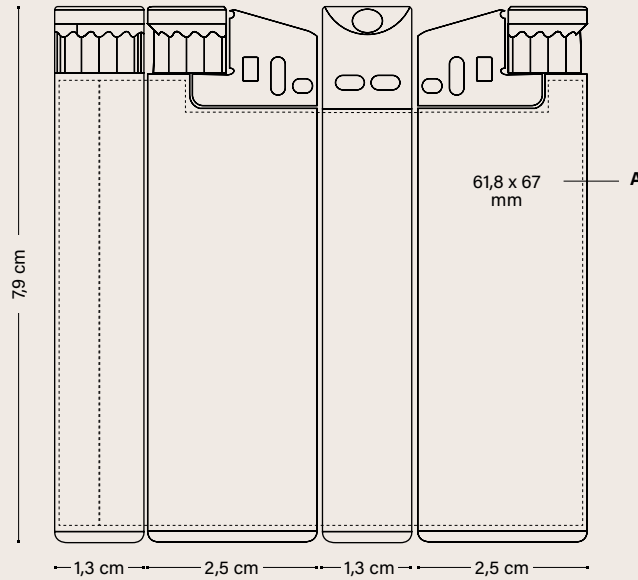

	300-599	600-1199	1200-2999	3000-5099	Price (€)
<b>BIC® J38 DIGITAL LIGHTER</b>					5100
2452					
<b>DG</b>	-	2,27	2,16	2,06	1,96

		Additional charge for digital finishes				Minimum quantity		
BR	MT	Brilliant or Matt				Free	600 u.	
	H	Holographic	-	0,27	0,27	0,24	0,19	600 u.
	P	Puffy	-	-	-	0,24	0,19	3.000 u.
	M	Metallic	①				50.000 u.	
	UV	UV	-	-	-	0,24	0,19	3.000 u.
	PG	Puffy Glitter	-	-	-	0,24	0,19	3.000 u.

Prices include the digital imprint on the body.  
① Price under request.

**PACKAGING**



STANDARD PACKAGING:  
IN TRAY OF 50 UNITS

100% recycled!

**EXTERNAL PACKAGING**



600 ± 13,2 KG



FSC AND  
RECYCLABLE  
CARDBOARD

See page 250 for a detailed explanation of the icons.

# BIC® STYL'IT LUXURY CASE

## BIC® STYL'IT LUXURY CASE 2386 Neon

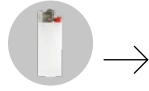

All cases are delivered with a white BIC® 12S lighter!



### Decoration

## BIC® STYL'IT LUXURY CASE 2386

MOQ 100 units  
A/C LE

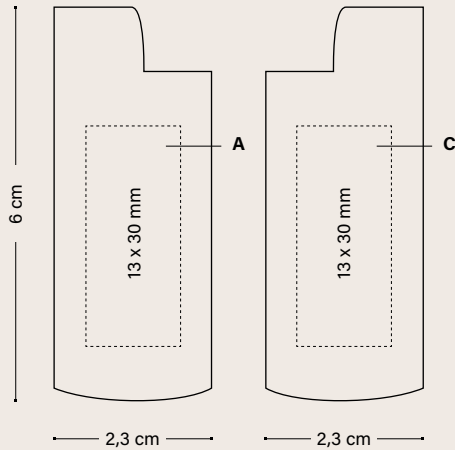

MOQ 100 units  
A/C PD

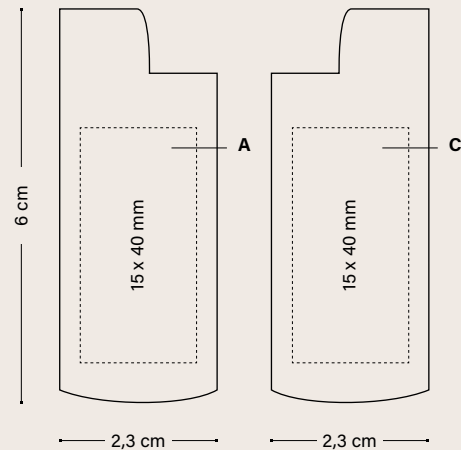

	Price (€)			
BIC® STYL'IT LUXURY CASE NEON	100-299	300-599	600-1199	1200-2999
2386				
PD	3,02	2,66	2,52	2,39
LE	4,31	4,11	3,85	3,72

### Additional imprint charge per colour & position

PD	0,29	0,25	0,18	0,18
LE	1,21	1,09	0,96	0,96

Prices include one imprint in one position according to specified technique.

### PACKAGING



STANDARD PACKAGING:  
BOX FOR 10 UNITS

### EXTERNAL PACKAGING



300 ± 6,1 KG



FSC AND  
RECYCLABLE  
CARDBOARD



PRINTED IN BIC  
FACTORIES



REGULATORY  
COMPLIANCE



### PRINTING TECHNIQUES



PAD PRINTING



LASER



**BIC® STYL'IT LUXURY CASE**  
2153 Soft



All cases are delivered with a white BIC® J25 lighter!



47

**Decoration**

**BIC® STYL'IT LUXURY CASE**

2153

**A/C LE**

MOQ 100 units

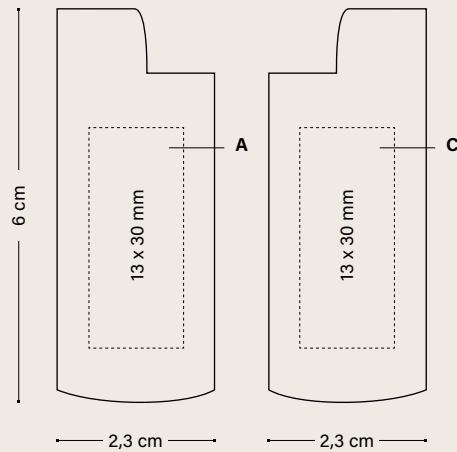

	Price (€)			
<b>BIC® STYL'IT LUXURY CASE SOFT</b>	100-299	300-599	600-1199	1200-2999
2153				
<b>LE</b>	4,52	4,37	4,18	4,02
<b>Additional imprint charge per colour &amp; position</b>				
<b>LE</b>	1,21	1,09	0,96	0,96

Prices include one laser engraving in one position.

**PACKAGING**



STANDARD PACKAGING:  
BOX FOR 10 UNITS

**EXTERNAL PACKAGING**



300 ± 6,1 KG



FSC AND  
RECYCLABLE  
CARDBOARD



PRINTED IN BIC  
FACTORIES



REGULATORY  
COMPLIANCE



**PRINTING TECHNIQUES**



LASER

# BIC® ALUMINIUM FLAT CASE

## BIC® ALUMINIUM FLAT CASE 2156

3 customisable  
sides!

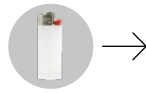

All cases are  
delivered  
with a white  
BIC® J25 lighter!



100%

47

### Decoration

## BIC® ALUMINIUM FLAT CASE 2156

MOQ 100 units  
A/C PD: max. 1 col.

MOQ 100 units  
A/B/C BP: full-colour

MOQ 100 units  
A/B/C LE

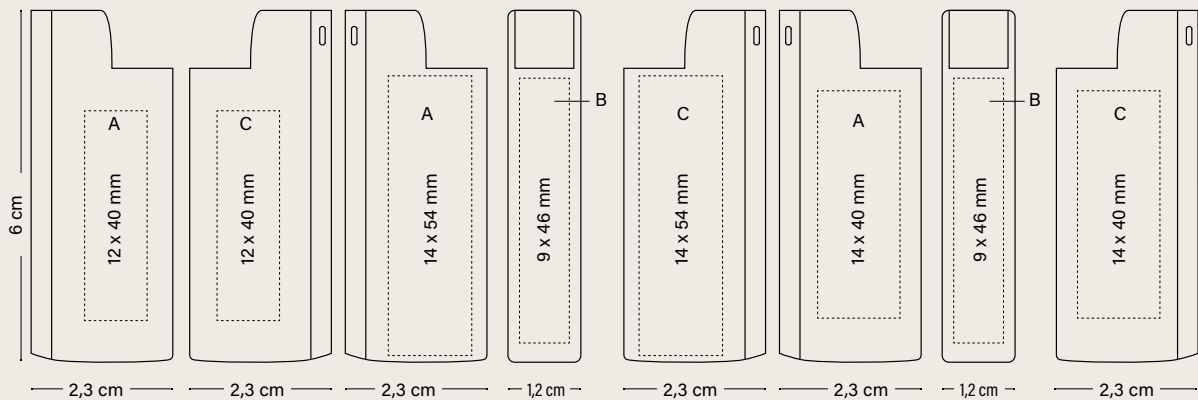

BIC® ALUMINIUM FLAT CASE 2156	Price (€)			
	100-299	300-599	600-1199	1200-2999
PD	1,93	1,85	1,76	1,67
BP	2,14	2,06	1,95	1,86
LE	3,10	2,93	2,71	2,63

### Additional imprint charge per colour & position

PD	0,29	0,25	0,18	0,18
BP	0,25	0,22	0,20	0,19
LE	1,21	1,09	0,96	0,96

Prices include one imprint in one position according to specified technique.

### PACKAGING



STANDARD PACKAGING:  
BOX FOR 50 UNITS

### EXTERNAL PACKAGING



300 ± 6,9 KG



FSC AND  
RECYCLABLE  
CARDBOARD



### PRINTING TECHNIQUES



## BIC® CLIP CASE 2398



All cases are delivered with a white BIC® J25 lighter!



### Decoration

## BIC® CLIP CASE 2398

MOQ 100 units  
A/C PD: max. 1 col.

MOQ 100 units  
A/C BP: full-colour  
BP Texture: full-colour

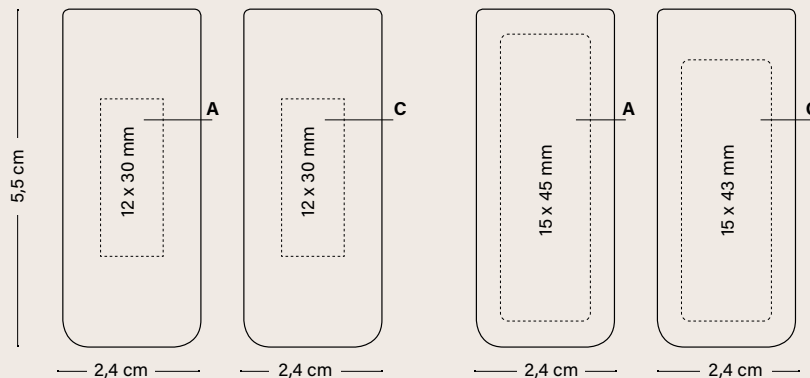

BIC® CLIP CASE 2398	Price (€)			
	100-299	300-599	600-1199	1200-2999
PD	1,55	1,44	1,32	1,29
BP	1,76	1,65	1,52	1,47

#### Additional imprint charge per colour & position

PD	0,29	0,25	0,18	0,18
BP	0,25	0,22	0,20	0,19
BP Texture	0,19	0,17	0,15	0,14

Prices include one imprint in one position according to specified technique.

#### PACKAGING



STANDARD PACKAGING:  
BOX FOR 50 UNITS

#### EXTERNAL PACKAGING



300 ± 7,5 KG



FSC AND  
RECYCLABLE  
CARDBOARD



#### PRINTING TECHNIQUES



PAD PRINTING



BRITPIX™  
BRITPIX™ PERSONALISATION

## BIC® 3D CASE 2395



All cases are delivered with a white BIC® J25 lighter!



Convert your logo into a 3D shape!

Decoration

**BIC® 3D CASE**

2395

A/C 3D: max. 6 col.

MOQ 1.200 units

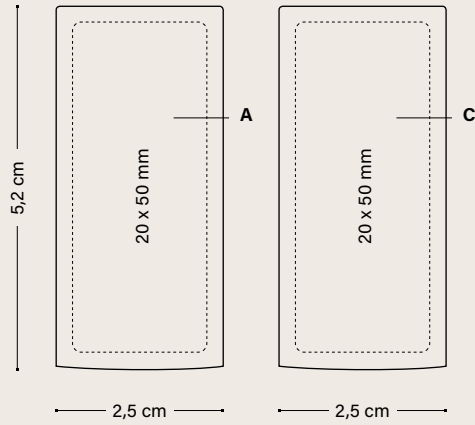

			Price (€)
<b>BIC® 3D CASE</b>	1200-2999	3000-5099	5100
2395			
<b>3D</b>	4,79	4,53	4,31
<b>Additional imprint charge per colour &amp; position</b>			
<b>3D Embossing on side C (1 colour)</b>	0,17	0,15	0,15
<b>Additional embossed colours</b>	0,10	0,09	0,09

Prices include the 3D embossing in one colour in one position.

**PACKAGING**



STANDARD PACKAGING:  
BOX FOR 50 UNITS

**EXTERNAL PACKAGING**



300 ± 7,5 KG



FSC AND  
RECYCLABLE  
CARDBOARD



REGULATORY  
COMPLIANCE

Conform  
ISO 9994

Conform  
EN 13869

85%  
FSC

PRINTING  
TECHNIQUES

3D

EMBOSSING

# BIC® POCKET ASHTRAY

**BIC® POCKET ASHTRAY**  
3850

6 different  
flap shapes  
available!

Reusable and  
hermetic!



## Decoration

**BIC® POCKET ASHTRAY**  
3850

**A SP:** max. 5 col. (max. 2 col.  
for orders under 20.000 pcs.)

MOQ 5.000 units

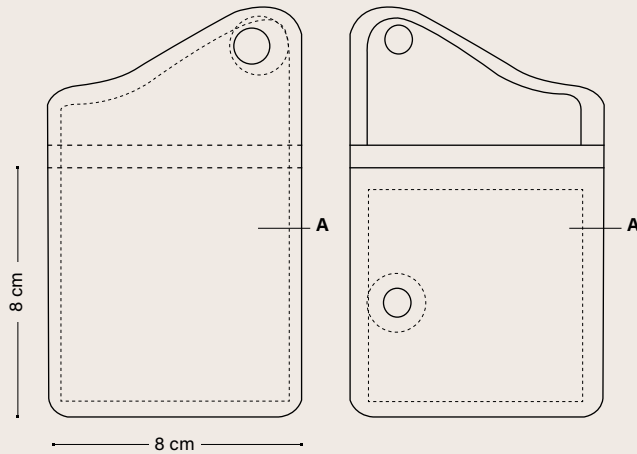

	Price (€)			
<b>BIC® POCKET ASHTRAY</b>	5000-9000	10000-24999	25000-49999	50000
3850				
<b>SP</b>	1,02	0,89	0,74	0,67

### Additional imprint charge per colour & position

<b>SP</b>	0,04	0,03	0,03	0,03
-----------	------	------	------	------

Prices include one colour in screen printing in one position and the legal text.

### PACKAGING



BOX FOR 10 UNITS EACH  
BIC® POCKET ASHTRAY  
COMES IN AN INDIVIDUAL  
CELLOPHANE PACKAGING

### EXTERNAL PACKAGING



500 ± 5,5 KG

## SPECIFICATIONS



REGULATORY  
COMPLIANCE

## PRINTING TECHNIQUES



SCREEN PRINTING

**BIC® POCKET ASHTRAY**  
3851 Kraft

Environmentally friendly image



100%

6F

**Decoration**

**BIC® POCKET ASHTRAY KRAFT**

3851 Kraft

A SP: max. 2 col.

MOQ 10.000 units

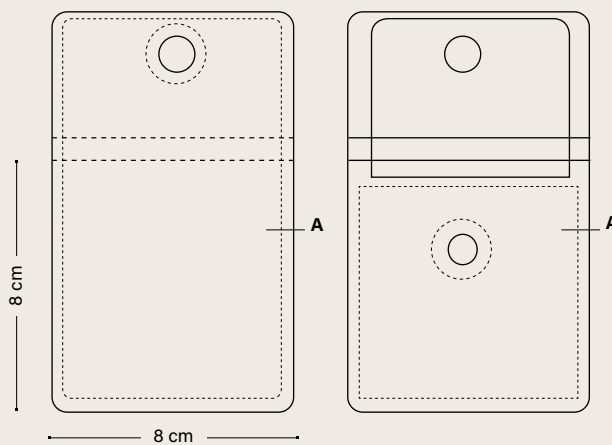

	10000-24999	25000-49999	50000
<b>BIC® POCKET ASHTRAY KRAFT</b>			
3851			
<b>SP</b>	1,09	0,90	0,84

Additional imprint charge per colour & position			
<b>SP</b>	0,03	0,03	0,03

Prices include one colour in screen printing in one position and the legal text.

**PACKAGING**

**EXTERNAL PACKAGING**



BOX FOR 10 UNITS EACH  
BIC® POCKET ASHTRAY  
COMES IN AN INDIVIDUAL  
CELLOPHANE PACKAGING.



500 ± 5,5 KG

**SPECIFICATIONS**



REGULATORY COMPLIANCE

**PRINTING TECHNIQUES**



SCREEN PRINTING





# DJEEP® LIGHTERS

---

Long-lasting and designed with style. DJEEP® is crafted to function perfectly. Each lighter is fully tested to ensure it meets our top-quality criteria.

## DJEEP® D1 LIGHTER



**NEW!**



**Ignite your  
mark.**

A good flame is reliable and flexible. But this flame shines a light on what you stand for. This flame brings colours to life and shows us the way to a brighter tomorrow. This flame is premium, original, creative and engaged.

## ABOUT DJEEP®

We are  
**premium**

We have a taste for the qualitative, the authentic, the iconic. And so, we value long life and quality. That's why we offer up to 3500 flames.

We are  
**singular**

We have our own philosophy and our own vision of the energy of life. We stand firm on our conviction to stand out. That's why we have a unique tank shape.



We are  
**engaged**

We support everyone that moves for the greater good and triggers its energy with positivity and unicity. That's why we pledge to be accessible and inclusive.

We are  
**creative**

Triggering energy to create movement is about being an adventurer, to keep searching for new horizons, to always cast a new light on what is around us. That's why we shape a large collection of distinctive decors with different printing finishes.

# DJEEP® D1 LIGHTER

Long-lasting and designed with style. DJEEP® is crafted to function perfectly. Each lighter is fully tested to ensure it meets our top-quality criteria.



**STABLE FLAME**  
thanks to pure isobutane fuel



**A LONG-LASTING LIGHTER**  
thanks to triple-tank technology



**HIGH RESISTANCE**  
reservoir made of high mechanical resistance resin



**LARGER PUSHER**  
for a better comfort of use



**HIGH-END EFFECTS**  
QUALITY MADE  
compliant with international safety standards  
Made in France



**UNIQUE RECTANGULAR SHAPE**  
to offer comfort in hand and a large surface of expression

**CHILD-RESISTANT SAFETY GUARD**  
compliant with EN 13869 Standard



**NEW!**

# 360° Digital Decoration

DJEEP® offers a wide variety of digital printing effects; select from touch & feel, glossy & matt mix, etched, Holographik®, ... to elevate each lighter.



**01. Base.** Select between:  
 WM WHITE MEDIUM     M METALLIC SILVER     H HOLOGRAPHIC

**03. Finish.** Select between:  
 G GLOSSY     MT MATT     ST DJEEP SOFT TOUCH®

**02. Printing:** We select the best option for you (digital, offset, flexo, silk screen ...) depending on quantity and design options.

**04. Decoration options.** Select up to 2 different decoration options between: GRANITE, FABRIC, DJEEP® SOFT TOUCH®, RESIN CHIP, TOUCH&FEEL, GLOSSY & MATT MIX, BLACK LIGHT, HAMMERED METAL, GLITTERING, FRAGRANT INK, GLOW IN THE DARK, ETCHED, QR CODE, HOLOGRAPHIK®, PEARLESCENT.

## DECORATION POSSIBILITIES



ST

### DJEEP® SOFT TOUCH®

Provide a unique smooth sensation! Deep tones and a soft surface for an exclusive experience.



GT

### GLITTERING

Add a sparkling effect to your design! Make your colours vibrant!



HM

### HAMMERED METAL

A metallic background with a puffy effect pattern. A premium look and feel that stands out!



TF

**TOUCH & FEEL**

Give an embossed effect to your design!



ET

**ETCHED**

Gives an etched or engraved effect to the lighter!  
Create patterns and convert your idea into an elegant design.



GM

**GLOSSY & MATT MIX**

Choose this finish to create distinctions between matt or DJEEP® Soft Touch® and the UV varnish that produces vivid colours.



FI

**FRAGRANT INK**

Rub the label and enjoy the fragrance!  
Available fragrances: Mint, Red Fruits, Mojito, Lime and Pineapple.



QR

**QR CODE**

Redirect your customer to a website, phone number or message. Create interactivity between the lighter and your message!



BL

**BLACK LIGHT**

Under a black light the fluor colours appear.  
You can have light blue, red, green or yellow.



FA

**FABRIC**

Give it the look and feel of fabric with a relief effect and matt finish!



RC

**RESIN CHIP**

Add volume to your design!  
Give the lighter a third dimension!



GR

**GRANITE**

Add a granular feel to the lighter!



GD

**GLOW IN THE DARK**

Expose the DJEEP® lighter to a light bulb or direct sunlight and observe the photoluminescent powder in dark places!



H

**HOLOGRAPHIK®**

A reflective silvery surface to show high quality and innovation!



PE

**PEARLESCENT**

Pearly and subtle shine that transmits elegance and delicacy!

---

**DJEEP® D1 LIGHTER**  
08D1

MOQ 10.000 units  
Standard colours combination



**MIX &  
MATCH**  
No extra charge

---

**Hood**

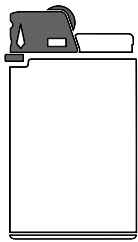

---

**Pusher**

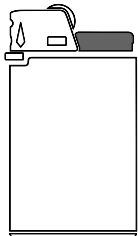

---

**Reservoir**

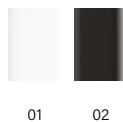
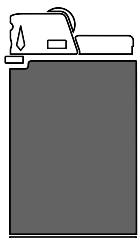

Decoration

**DJEEP® D1 LIGHTER**

08D1

**A DG:** full-colour

MOQ 10000 units

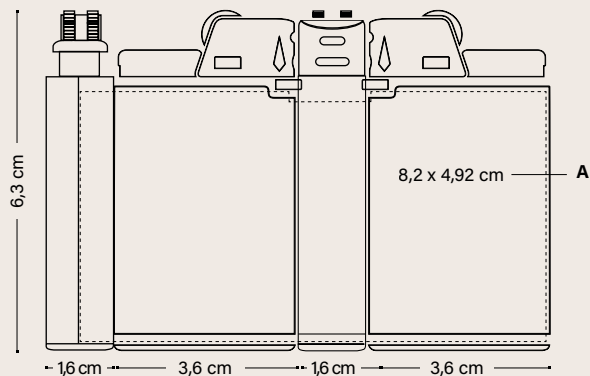

**DJEEP® D1 LIGHTER**

08D1

Price (€)

	10000-24999	25000-49999	50000
<b>DG</b>	2,73	2,59	2,45
<b>Decoration Options</b>	0,26	0,25	0,24
<b>Black, brass, gold hood</b>	0,08	0,08	0,08
<b>Soft touch label finish</b>	0,12	0,12	0,12

**Black/white body, silver hood, white/metallic label base, glossy/mat label finish**

**PACKAGING**



STANDARD PACKAGING:  
IN TRAY OF 10 UNITS

**EXTERNAL PACKAGING**



600 ± 20 KG



FSC AND  
RECYCLABLE  
CARDBOARD



MANUFACTURED AND  
PRINTED IN DJEEP  
FACTORIES



MADE IN FRANCE



REGULATORY  
COMPLIANCE



UP TO 3.500



DJEEP FACTORY POWERED WITH  
100% ELECTRICITY COMING  
FROM RENEWABLE SOURCES

**PRINTING  
TECHNIQUES**



DIGITAL

# Contents

# 05

---



# BIC® PACKAGING

---

BIC® Packaging Ecolutions®	240
BIC® Packaging	242

# BIC® PACKAGING ECOLUTIONS®



## BIC® COLLECTION BOX

FSC cardboard box, customisable on each side and offering large communication surfaces. Ideal for offering our iconic BIC® products as a collection. More than a box, a great way to optimise your sales.

	100-249	250-499	500-999	1000-2499	2500-4999	Price (€) 5000
991212 1 unit	10,16	4,39	2,82	1,86	1,39	1,22
991213 2 units	11,94	5,42	3,93	2,64	1,90	1,84
991214 3 units	12,49	6,24	4,20	3,20	2,65	2,51

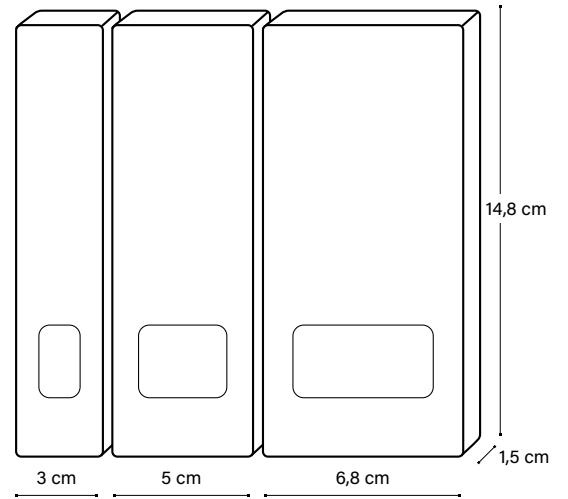

Special packaging for:



- BIC® 4 COLOURS®
- BIC® WIDE BODY™
- BIC® SUPER CLIP
- BIC® BRITE LINER® GRIP
- BIC® GRIP ROLLER



## BIC® ECO SLEEVE

985240

Special recycled sleeve for all BIC® writing instruments except graphite pencils.



Price (€)  
0,25



Special packaging for pens with clip printed:



- BIC® MEDIA CLIC
- BIC® CLIC STIC
- BIC® SUPER CLIP
- BIC® WIDE BODY™
- BIC® INTENSITY® GEL CLIC
- BIC® XS FINE STYLE

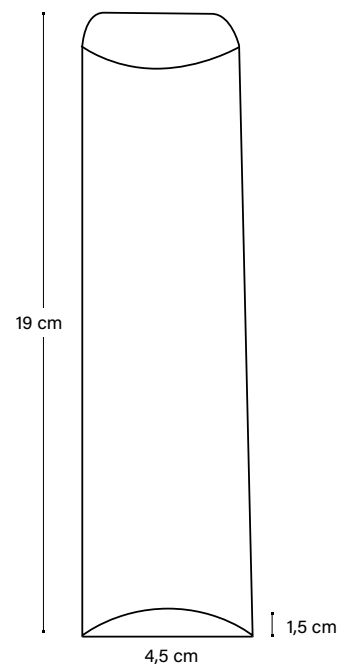

### BIC® WINDOW BOX

985241

Premium design packaging for all BIC® writing instruments except graphite pencils.



FSC AND RECYCLABLE CARDBOARD

Price (€)  
1,48

2,2 cm

2,2 cm

18,7 cm

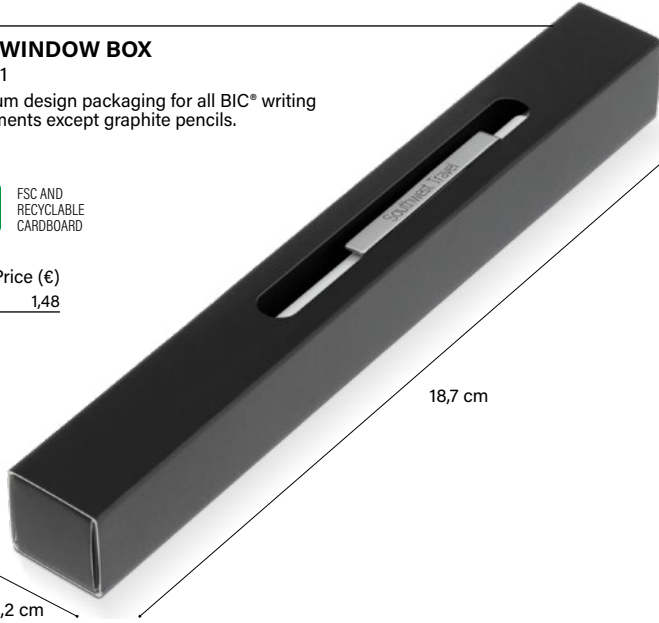

Special packaging for:



BIC® METAL PENS

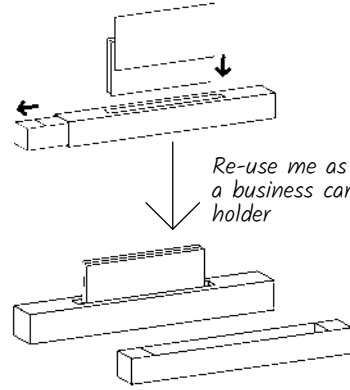

Re-use me as a business card holder

### BIC® PLASTIC POUCH

985242

Special design for this packaging which fits any writing instrument or 3 graphite pencils.

Price (€)  
0,46



FSC AND RECYCLABLE CARDBOARD



RECYCLABLE PLASTIC

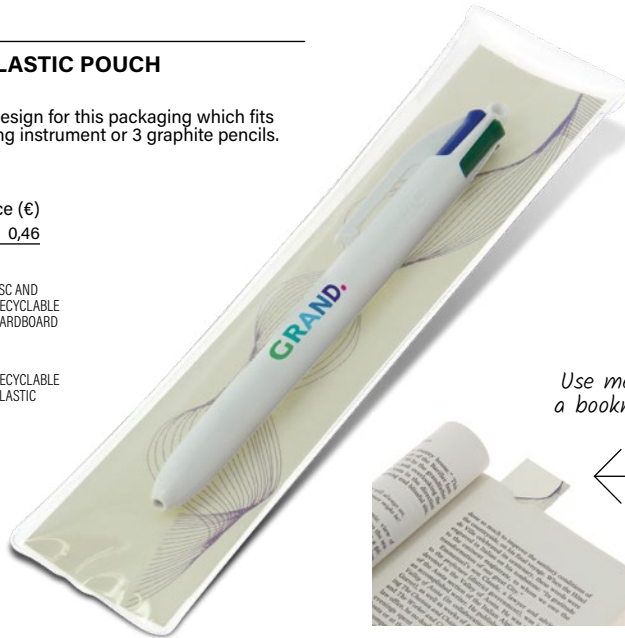

Use me as a bookmark

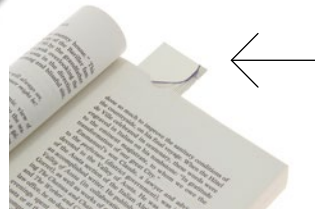

19,6 cm

4,6 cm

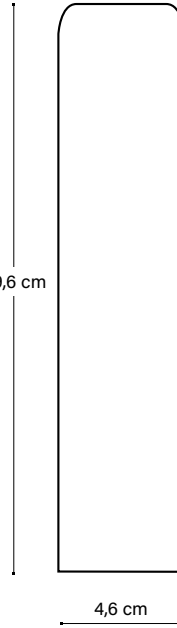

### BIC® MARKING SET

985243

Packaging designed for all types of marker products.

Price (€)  
0,73



FSC AND RECYCLABLE CARDBOARD



RECYCLABLE PLASTIC



16 cm

6,3 cm

Special packaging for:



3 BIC® BRITE LINER® GRIP  
3 BIC® MARK-IT



3 BIC® VELLEDA® GRIP  
3 BIC® VELLEDA® FINE

Use me as a bookmark



MADE IN SPAIN



REGULATORY COMPLIANCE



ISO certified

ecolutions®

## BIC® CELLO WRAP

971634 / 971635 / 971636 / 971637

Packaging to wrap in a tough and transparent plastic material.



Cello wrap 1 unit



Cello wrap 2 units

BIC® CELLO WRAP		Price (€)
1 unit - 971634		0,19
2 units - 971635		0,36
3 units - 971636		0,52
4 units - 971637		0,70

Not available for graphite pencils or metal pens.

## BIC® BLACK VELVET POUCH 1 ITEM

974216

Velvet exclusive packaging for 1 writing instrument.

Especially suitable for metal pens.

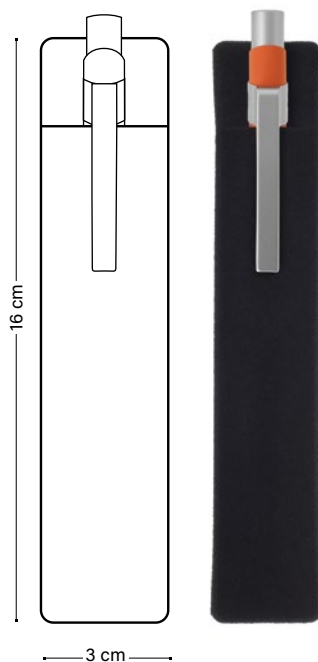

BIC® BLACK VELVET POUCH 1 ITEM		Price (€)
--------------------------------	--	-----------

1 unit		0,53
--------	--	------

Not available for graphite pencils and mechanical pencils.

**BIC® CARTON BLACK&SILVER  
COLOUR GIFT BOX**

974218

Box for all writing instruments, except graphite pencils.

Price (€)

0,36

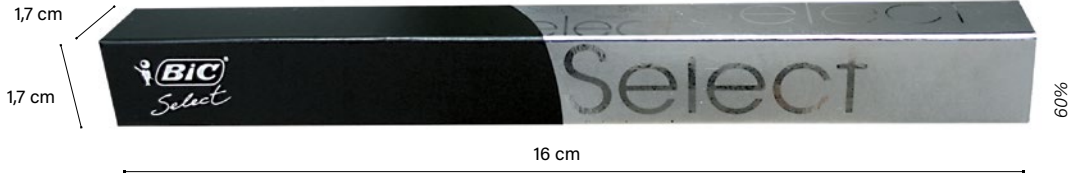

**BIC® FROSTED POUCH (FOR 1 OR 2 ITEMS)**

971640

Transparent packaging for 2 writing instruments.

A SP: max. 1 col.

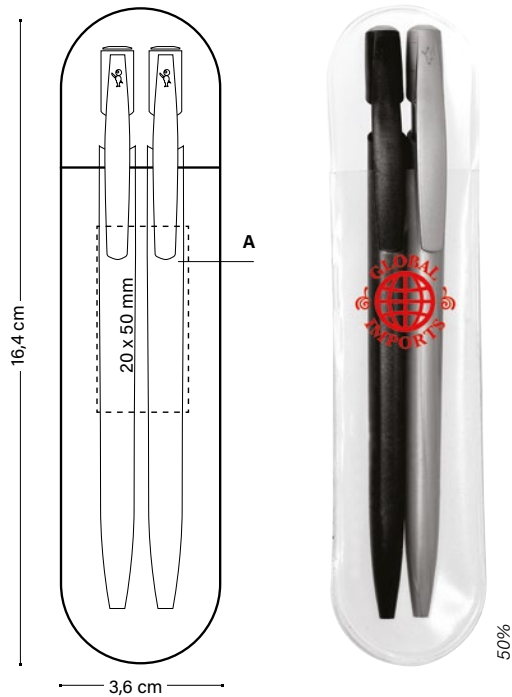

**BIC® FROSTED POUCH**

Price (€)

0,90

**Additional imprint charge per colour & position**

SP 0,48

Available for 1 or 2 slim writing instruments except graphite pencils.

SP SCREEN PRINTING

**BIC® SEE-THROUGH GIFT BOX  
(FOR 1 OR 2 ITEMS)**

974599

Box for all writing instruments, except graphite pencils, with special window.

Price (€)

2,03

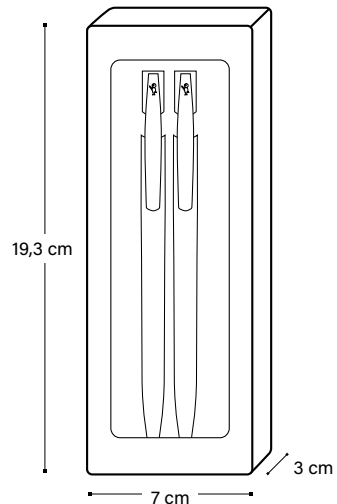

## COUNT BOX

**Small** (for 25 BIC® Clic Stic) - 6 x 6,2 x 14 cm  
971639

**Medium** (for 50 BIC® Media Clic or writing instruments of similar size) - 7,5 x 7,5 x 15,2 cm  
971638

**Large** (only for 100 BIC® Evolution® Ecolutions®) - 7,5 x 7,5 x 19 cm  
971672

	Price (€)
<b>Small</b>	
971639	0,88
<b>Medium</b>	
971638	1,23
<b>Large</b>	
971672	1,69

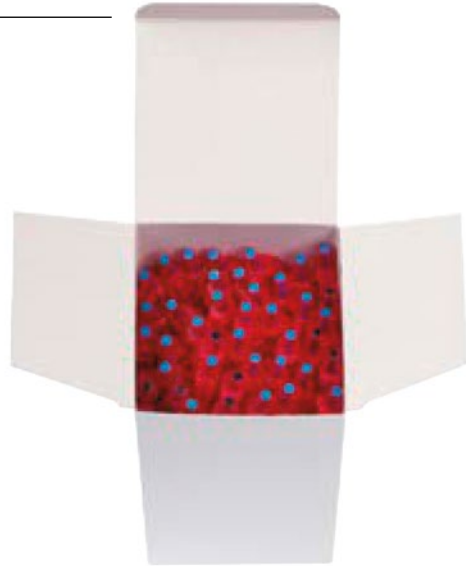

## PLASTIC BAG

**Small** (for 25 BIC® Media Clic or writing instruments of similar size)  
971644 - 12 x 18 cm

**Medium** (for 50 BIC® Media Clic or writing instruments of similar size)  
971643 - 15 x 22 cm

**Large** (for 100 BIC® Media Clic or writing instruments of similar size)  
971642 - 30 x 40 cm

	Price (€)
<b>Small</b>	
971644	0,60
<b>Medium</b>	
971643	1,16
<b>Large</b>	
971642	1,74



## TRAY OF 10 WRITING INSTRUMENTS

974590

Price (€)
1,97

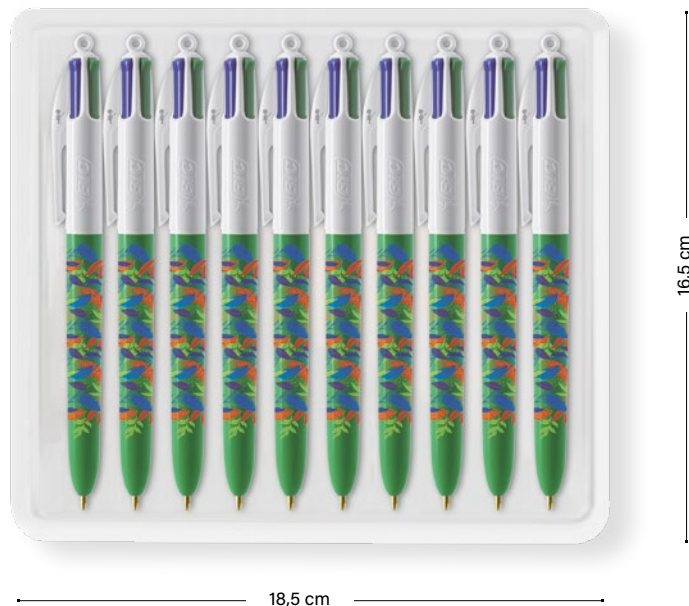

**COUNT BOX 10U. CASES**  
976382



Price (€)  
1,03

Available for BIC® J26,  
BIC® J38, BIC® J23 and BIC® J25.

**COUNT BOX 10U.  
CASES CHILD RESISTANT**  
976403



Price (€)  
1,03

Available for BIC® J26, BIC® J38, BIC® J23 and BIC® Luxury Case Family.

**COUNT BOX 10U.  
J25 CHILD RESISTANT**  
974635



Price (€)  
0,80

Available for BIC® J25.

**BOX OF 50U. METAL STYL'IT CASE**  
977852



Price (€)  
4,61

Available for BIC® Clip Case,  
BIC® 3D Case and BIC® Flat Case.

**TRAY OF 50 BIC® LIGHTERS**



**TRAY OF 10 DJEEP® LIGHTERS**

RECYCLABLE  
CARDBOARD



**BIC® OUTER BOXES**

Special design for all the outer boxes for all writing instruments.



FSC AND  
RECYCLABLE  
CARDBOARD



MADE  
IN SPAIN



FSC AND  
RECYCLABLE  
CARDBOARD



MADE  
IN SPAIN

**DJEEP® OUTER BOXES**

Special design for lighters outer boxes.



FSC AND  
RECYCLABLE  
CARDBOARD



MADE IN FRANCE



# Contents



# GENERAL INFORMATION

---

Make it simple!	248
Symbols and abbreviations	250
General information	252
Product index	253
Colour table	254

# SAVE TIME WHEN CALCULATING YOUR FINAL PRICE

LOOK AT THE QUANTITY COLUMN FOR THE PRICE AND THAT'S IT!

## NO SET UP OR SCREEN CHARGES

## PERSONALISATION INCLUDED

Price includes personalisation in one position.

## CUSTOM MADE COLOURS FOR TRIM

- An "unlimited" choice of barrel and trim colours for orders over 10.000 units.
- A completely personalised pen in any colour you want.
- Available on an extensive range of products.
- A value added service with only a short additional lead time.
- Available for barrel and trims of: BIC® Round Stic®, BIC® Media Clic, BIC® Media Clic Grip\*, BIC® Clic Stic, BIC® Super Clip, BIC® Wide Body™, BIC® XS Finestyle

\*For personalised barrel and grip MOQ is 20.000 units

Set up charge per trim	<b>1.100 €</b>
Set up charge per trim (repeat orders)	<b>660 €</b>
Set up charge per trim from 100.000 units	<b>Free</b>

## OTHER CHARGES

PRE-PRODUCTION ORDER (TRANSPORT NOT INCLUDED) > Available for BIC® Writing Instruments (10 units), BIC® Lighters (10 units)	<b>145 €/order*</b>
> Ink cartridge change when available (handling charge, cartridge not included)	<b>0,18 €/unit</b>
> Cancellations or changes to orders after artwork approval (Subject to BIC GRAPHIC EUROPE, S.A. acceptance). > Fixed cost per change (extra costs such as tooling, components or finished product to be added)	<b>85 €/order</b>
> britePix™ individual personalisation	<b>75 €/order**</b>

## OTHER CHARGES

\*Not available for digital lighters with Puffy, Puffy Glitter, Metallic, Holographic and UV finishes.

\*\*britePix™ individual personalisation allows you to change the texts and images of your artwork, giving you a personalised imprint for each of the products in your order. Both texts and information regarding image changes should be provided in an Excel file. Should you also require changes in the positioning of the texts and images there will be an additional charge.

Terms and conditions of sale apply, please refer to [www.bicgraphic.com](http://www.bicgraphic.com)

## FILE INFORMATION

Please submit your artwork in one of the following formats:

- Electronic file with the graphic design (artwork).
- Separate file for the text. For individual laser engraving please provide texts only in Excel® format (.xls)

## ARTWORKS FEATURES

Please submit your artwork in one of the following formats:

- JPG / 350 dpi not compressed (only for images, no texts)
- PDF / outlined
- Illustrator® CC / outlined
- Photoshop® CC / with layers
- ZIP files

In order to facilitate a fluid order process and obtain an appropriate final result, it is important to provide us the information in one of the above listed formats. Should the customer's design not fit into our imprint area, we will modify it accordingly.

## TYPEFACES:

All the typefaces must be converted to an artwork. Verify the minimum type sizes & line weights. Please, contact Customer Service for further information.

## SPECIAL FOR WRITING PRODUCTS

### SCREEN PRINTING

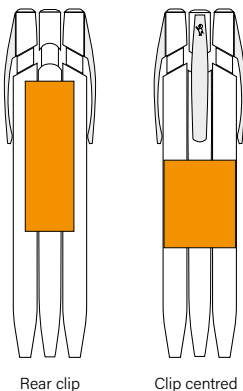

Available imprint area depends on required printing technique.















## SPECIAL FOR DIGITAL LIGHTERS (J25, J23, J26 & J38)























If a direct exact colour is desired a fifth colour may be chosen from the aforementioned Guide for an additional charge. For more information on achieving the closest colour match for imprints on different products within our catalogue please contact our Customer Service Department

# Symbols and abbreviations











## PRINTING TECHNIQUES SYMBOLS

-  **PG Puffy glitter**  
Coloured glitter texture.
-  **P Puffy**  
Highlighted personalisation giving a relief effect to your logo.
-  **BR Brilliant**  
Brilliant finish.
-  **M Metallic**  
Create metallic effects on images and backgrounds.
-  **H Holografic**  
Create attractive gold or silver effects.
-  **MT Matt**  
Matt finish.
-  **UV UV**  
High gloss finish.
-  **HS Hot Stamping**  
Tactile embossing
-  **Print 360° ballpen**
-  **Print 360° lighter**
-  **Digital**  
High-definition 4-colour process. 360° degrees and full length of the barrel/body.
-  **britePix™ Digital**  
The solution for full colour communication. Now on coloured barrels!
-  **britePix™ Texture**  
britePix™ Texture is a fresh addition to our britePix™ concept: now you don't just see the full colour – you can feel it!
-  **britePix™ personalisation**  
Personalise each unit within the same britePix™ order.

-  **SP Screen printing**
-  **LE Laser**
-  **PD Pad printing**
-  **DG Digital**

-  **BP britePix™**
-  **3D Embossing**
-  **TF Touch & feel**
-  **ET Etched**
-  **GM Glossy & matt mix**
-  **FI Fragrant ink**
-  **QR QR code**
-  **BL Black light**
-  **FA Fabric**
-  **RC Resin chip**
-  **GR Granite**
-  **GD Glow in the dark**
-  **H Holographik®**
-  **PE Pearlescent**
-  **ST DjEEP® soft touch®**
-  **GT Glittering**
-  **HM Hammered metal**











































## WRITING MODES

-  **Ballpen** | M Medium 1 mm  
F Fine
-  **Mechanical Pencil MP**
-  **Pencil PC**
-  **Roller Ball R**
-  **Highlighter HL**
-  **Stylus Pen SP**
-  **Finestyle 0,7mm FS**
-  **Gel G**
-  **Marker MK**
-  **Resistant tip**
-  **No splinter**
-  **Easy to use and erase**
-  **Smoother and darker writing**
-  **Smoother, more flowing writing**
-  **Shock resistant**
-  **Will not dry out**
-  **Protective sheath**
-  **2 leads**

## INK COLOURS

- Black
- Light Green
- Light Blue
- Apple Green
- Dark Blue
- Green Dark
- Red
- Fluo
- Orange
- Pink
- Yellow
- Purple

## OTHER SYMBOLS

	<b>New</b>			<b>FSC and recyclable cardboard</b> Certification to promote the appropriate environmental management		<b>Viral reduction 93% in 24 h</b>
	<b>Mix&amp;Match</b> Hundreds of colours of components in stock of writing instruments for full personalisation.			<b>Pharmaceutical waste</b>		<b>Entire pen protection</b>
	<b>Custom colours</b> Choose the exact PMS colour that suits your logo.			<b>Fruit and vegetable trays</b>		<b>Timeless protection</b>
	<b>Manufactured and printed in BIC factories</b>			<b>Fridges and yogurt pots</b>		<b>Bacteria elimination</b>
	<b>Manufactured in BIC factories</b>			<b>Sugar cane</b>		<b>Fungal inhibition for 24 h</b>
	<b>Printed in BIC factories</b>			<b>Ubicuity Program</b> All BIC writing instruments are recyclable through our Ubicuity program, a partnership with Terracycle. For details, visit Terracycle at <a href="https://www.terracycle.com">https://www.terracycle.com</a>		<b>Regulatory compliance</b>
	<b>Assembled and printed in DJEEP factories</b>			<b>100% renewable electricity</b> The BIC Graphic Europe factory is powered by 100% renewable energy. Hence, products are made with 100% renewable electricity.		<b>EN 13869</b> European Child Resistant Regulation for lighters.
	<b>Assembled and printed in BIC factories</b>			<b>Plastic car parts</b>		<b>ISO Certified</b>
	<b>Quality &amp; safety approved</b>					<b>ISO</b> International safety standards
	<b>Country of Origin</b>			<b>IMPRIM'VERT</b>		<b>Number of flames</b>
	<b>Made in France</b>			<b>Möbius Loop</b> Product contains recycled material.		<b>QR code</b> Scan QR code
	<b>Made in Spain</b>			<b>Refill Service</b>		<b>Packaging Information</b>  250 ± 3,5 KG
						<b>DIMENSIONS:</b> Dimensions published of each product correspond to its maximum size, regardless of the drawing position.

# General Information

## TECHNICAL PARAMETERS FOR EACH TYPE OF PRINTING

	DIGITAL / DIGITAL TRANSFER	
Minimum positive text	4 pt (1.4 mm)	<small>4 Point text</small>
Minimum negative text	7 pt (2.4 mm)	<b>7 Point text</b>
Minimum text for half tone	1.5 pt (0.5 mm)	7 Point text
Minimum thickness for positive lines	0.25 pt (0.08 mm)	—————
Minimum thickness for negative lines	0.5 pt (0.17 mm)	—————
Minimum thickness for lines in half tone	0.5 pt (0.17 mm)	—————
Minimum half tone values	C: 8% / M: 8% / Y: 12% / K: 8% 	

	britePix™	
Minimum positive text	6 pt (2.1 mm)	<small>6 Point text</small>
Minimum negative text	7 pt (2.4 mm)	<b>7 Point text</b>
Minimum thickness for positive lines	0.4 pt (0.14 mm)	—————
Minimum thickness for negative lines	0.5 pt (0.17 mm)	—————
Minimum thickness for half tones	1 pt (0.35 mm)	—————
Percentage half tone		

	SCREEN PRINTING/ PAD PRINTING	HOT STAMPING / DEBOSSING	LASER ENGRAVING
Minimum positive text	6 pt (2.1 mm) <small>6 Point text</small>	10 pt (3.5 mm) <b>10 Point text</b>	6 pt (2.1 mm) <small>6 Point text</small>
Minimum negative text	9 pt (3.1 mm) <b>9 Point text</b>	15 pt (5.25 mm) <b>15 Point</b>	NOT RECOMENDED
Minimum thickness for positive lines	0.4 pt (0.14 mm) —————	1.5 pt (0.5 mm) —————	0.3 pt (0.1 mm) —————
Minimum thickness for negative lines	0.5 pt (0.176 mm) —————	2 pt (0.706 mm) —————	0.5 pt (0.17 mm) —————
Minimum thickness for half tones	1.5 pt (0.5 mm) —————	NOT POSSIBLE	NOT POSSIBLE
Percentage half tone	50% —————		

# Product Index

## BIC® WRITING INSTRUMENTS

BIC® Style _____	46
BIC® Round Stic® _____	50
BIC® M10® Clic _____	56
BIC® Media Clic _____	58
BIC® Media Clic Grip _____	63
BIC® Media Clic BGuard™ antibacterial _____	67
BIC® Media Clic BGuard™ antimicrobial Ecolutions® _____	70
BIC® Media Clic Biobased Ecolutions® _____	72
BIC® Media Clic Biobased BGuard™ antibacterial _____	75
BIC® Media Clic Shine _____	77
BIC® Media Clic Glacé _____	78
BIC® Clic Stic _____	80
BIC® Clic Stic Stylus _____	84
BIC® Clic Stic Mini _____	84
BIC® Super Clip _____	88
BIC® Super Clip Advance _____	94
BIC® Super Clip Glacé _____	98
BIC® Super Clip Glacé Advance _____	98
BIC® Super Clip Soft _____	100
BIC® Super Clip Soft Advance _____	100
BIC® Super Clip Origin _____	102
BIC® Wide Body™ _____	104
BIC® 4 Colours® _____	112
BIC® 4 Colours® Bicolor _____	114
BIC® 4 Colours® Gradient _____	116
BIC® 4 Colours® Pastel _____	118
BIC® 4 Colours® Fashion _____	120
BIC® 4 Colours® Sun _____	122
BIC® 4 Colours® Fine _____	124
BIC® 4 Colours® Fluo _____	126
BIC® 4 Colours® Shine _____	128
BIC® 4 Colours® Glacé _____	130
BIC® 4 Colours® Soft _____	132
BIC® 4 Colours® Wood Style _____	134
BIC® 4 Colours® Flags Collection _____	136
BIC® 4 Colours® 3+1 <sup>HB</sup> _____	138
BIC® Metal Pro _____	140
BIC® Cristal® Re'New™ _____	145
BIC® Grip Roller _____	150
BIC® XS Finestyle _____	152
BIC® Intensity® Gel Clic _____	154
BIC® Brite Liner® Grip _____	158
BIC® Velleda® White Board Marker Fine _____	160
BIC® Velleda® White Board Marker Grip _____	161
BIC® Mark-It Permanent Marker _____	162
BIC® Permanent Marker Ecolutions® _____	163
BIC® Matic® _____	166
BIC® Media Clic Mechanical pencil _____	168
BIC® Media Clic Grip Mechanical pencil _____	169
BIC® Evolution® Ecolutions® _____	174
Sprout™ Graphite pencil _____	178

## OTHER WRITING INSTRUMENTS

Basic Pen _____	182
Click Pen _____	184
Striped Grip Pen _____	186
Sleek Stylus Pen _____	188

## NOTEBOOKS

Rocketbook® Core Executive A5 _____	194
Rocketbook® Fusion Executive A5 _____	196
Rocketbook® Core Mini A6 _____	198

## BIC® LIGHTERS AND CASES

BIC® J25 Lighter _____	206
BIC® J23 Lighter _____	210
BIC® J26 Lighter _____	214
BIC® J38 Lighter _____	218
BIC® Styl'it Luxury Case _____	222
BIC® Aluminium Flat Case _____	224
BIC® Clip Case _____	225
BIC® 3D Case _____	226
BIC® Pocket Ashtray _____	228

## DJEEP® LIGHTERS

DJEEP® D1 Lighter _____	230
-------------------------	-----

## BIC® PACKAGING

BIC® Packaging Ecolutions® _____	240
BIC® Packaging _____	242

# Colour table

 <b>01</b> White	 <b>1E</b> White recycled	 <b>57</b> Opaque white	 <b>3C</b> White pearl	 <b>01BIO</b> BIO white	 <b>1T</b> White polished	 <b>51</b> Transparent	 <b>69</b> Frosted white	 <b>2E</b> Frosted white recycled		
 <b>8D</b> Yellow pastel	 <b>8G</b> Light yellow	 <b>12</b> Yellow	 <b>12W</b> Yellow wood	 <b>63</b> Frosted yellow	 <b>6AW</b> Natural wood	 <b>012BIO</b> BIO yellow	 <b>4D</b> Clear yellow	 <b>6F</b> Light brown	 <b>60</b> Natural	
 <b>26</b> Gold	 <b>76</b> Gold glacé	 <b>1G</b> Acid orange	 <b>10</b> Orange	 <b>90</b> Orange pastel	 <b>71</b> Frosted orange	 <b>92</b> Clear orange				
 <b>03</b> Red	 <b>03G</b> Red glacé	 <b>03F</b> Red soft	 <b>8E</b> Red recycled	 <b>87</b> Clear red	 <b>03BIO</b> BIO red	 <b>66</b> Frosted red	 <b>08</b> Burgundy			
 <b>14</b> Pink	 <b>5C</b> Pink fizz	 <b>1P</b> Acid pink	 <b>014G</b> Pink glacé	 <b>07</b> Gold Pink	 <b>11</b> Pink	 <b>80</b> Pink	 <b>97</b> Rose Gold			
 <b>84</b> Purple pastel	 <b>13</b> Violet	 <b>39</b> Frosted Dark Purple	 <b>7G</b> Metallic purple	 <b>2D</b> Purple	 <b>93</b> Clear Purple	 <b>4B</b> Frosted Purple				
 <b>8C</b> Lime	 <b>68</b> Frosted green	 <b>6C</b> Grass green	 <b>88</b> Clear light green	 <b>59</b> Apple green	 <b>82</b> Frosted dark green	 <b>72</b> Clear green	 <b>5G</b> Light green	 <b>05G</b> Green glacé		
 <b>05</b> Green	 <b>05W</b> Green wood	 <b>20</b> Dark green	 <b>7E</b> Dark green recycled	 <b>88</b> Clear dark green	 <b>05BIO</b> BIO green	 <b>3B</b> Frosted jungle				
 <b>83</b> Blue pastel	 <b>3D</b> Caribbean blue	 <b>86</b> Clear blue	 <b>67</b> Frosted blue	 <b>24</b> Light blue	 <b>04BIO</b> BIO blue	 <b>04</b> Blue	 <b>04G</b> Blue glacé	 <b>40</b> Frosted dark blue	 <b>4R</b> Blue turquoise	
 <b>34</b> Metallic Blue	 <b>89</b> Clear dark blue	 <b>25</b> Dark blue	 <b>07</b> Navy blue	 <b>07F</b> Navy blue soft	 <b>10E</b> Navy blue recycled					
 <b>35</b> Chrome	 <b>47</b> Silver	 <b>47G</b> Silver glacé	 <b>75</b> Metallic silver	 <b>18</b> Metal	 <b>06</b> Grey	 <b>27</b> Dark grey	 <b>8H</b> Clear dark grey			
 <b>02BIO</b> BIO black	 <b>02W</b> Black wood	 <b>02F</b> Black soft	 <b>02</b> Black	 <b>3E</b> Black recycled	 <b>2N</b> Black matt					



# CLOSE TO YOU

---





**Interior paper:**  
From sustainable forests with PEFC chain of custody.



[www.bicgraphic.com](http://www.bicgraphic.com)