

ergo **HELIX**
Hardware Solutions

ΚΑΤΑΛΟΓΟΣ ΤΕΧΝΙΚΩΝ ΠΡΟΪΟΝΤΩΝ

▶ **2023**

YATO HAND TOOLS & POWER TOOLS



18V
Li-Ion





Αγαπητοί συνεργάτες

Σε εμπορικό επίπεδο

Σε οργανωτικό και λειτουργικό επίπεδο

Ο χρόνος που αφήνουμε πίσω μας ήταν, αναμφίβολα, μία “δύσκολη” χρονιά που θα την θυμόμαστε για καιρό! Παρά τις αντιξοότητες, για εμάς την Ergohelix ήταν μία χρονιά καθιέρωσης και ανάπτυξης. Ήταν όμως και μία χρονιά που έφερε μεγάλες και ριζικές αλλαγές και στη δική μας αγορά, με την ακόμα μεγαλύτερη επέκταση του ηλεκτρονικού εμπορίου και τη δημιουργία νέων εναλλακτικών καναλιών διάθεσης των προϊόντων.

Οι ολοένα αυξανόμενες ανάγκες της αγοράς μας, τόσο σε προϊόντα όσο και σε εξυπηρέτηση, έκαναν αναγκαία και τη δική μας αναβάθμιση τόσο σε εμπορικό όσο και σε οργανωτικό και λειτουργικό επίπεδο.

- Διευρύνουμε την προϊοντική μας γκάμα και καθιερώσαμε, με τη βοήθειά σας, στην Ελληνική αγορά μια νέα δυναμική μπράντα εργαλείων χειρός, τη **YATO**, σε άκρως ανταγωνιστικές, για την ποιότητά τους, τιμές.
- Καταγράψαμε μεγάλη εμπορική επιτυχία με τις ηλεκτροσυγκολλήσεις **Helix Power** που εκτός από την αδιαμφισβήτητη ποιότητά τους είναι πλέον και **πρώτες σε πωλήσεις**, στην κατηγορία τους, στην Ελληνική αγορά!
- Γίναμε σημαντικός προμηθευτής σε, ποιοτικά, είδη προστασίας εργαζομένων με τα **ToWorkFor & PROTEX**.

Επενδύσαμε σε ανθρώπινο δυναμικό που με τις απαιτούμενες γνώσεις και δεξιότητές τους αναμόρφωσαν πλήρως και αναβάθμισαν σημαντικές πτυχές της λειτουργίας της εταιρείας μας.

- Διευρύνουμε το δίκτυο των συνεργατών μας καλύπτοντας πλέον με έμπειρους πωλητές το σύνολο της επικράτειας.
- Θέσαμε σε λειτουργία το **WMS** δηλαδή την ηλεκτρονική διαχείριση της, 2500 m², αποθήκης μας. Έτσι εκμηδενίσαμε τα ανθρώπινα λάθη και μειώσαμε τους χρόνους εκτέλεσης των παραγγελιών.
- Βελτιώσαμε την τηλεφωνική εξυπηρέτηση, δημιουργώντας μία δυνατή και άψογα εκπαιδευμένη ομάδα back office.
- Ανασχεδιάσαμε το σύστημα διανομής μας αναθέτοντάς το σε εξειδικευμένους παρόχους ώστε οι παραγγελίες σας να φτάνουν στον προορισμό τους -το κατάστημά σας- το συντομότερο δυνατόν.

Αγαπητοί συνεργάτες,

Ο κατάλογος, που έχετε στα χέρια σας, αποτυπώνει στις σελίδες του τη δυναμική της εταιρείας αλλά και τις φιλοδοξίες της για την επόμενη διετία αφού περιλαμβάνει πάνω από 1500 νέους κωδικούς!

Μπαίνουμε δυναμικά στη δύσκολη και ανταγωνιστική αγορά του **ηλεκτρικού εργαλείου** με πρόταση **value for money** (YATO) και των **εξαρτημάτων** του με μία μεγάλη ποικιλία προϊόντων που καλύπτουν σχεδόν κάθε εργασία. Το μεγαλύτερο όμως βάρος θέλουμε να πέσει στη **βελτίωση της εξυπηρέτησής σας**.

Γι' αυτό άμεσα και παράλληλα με τον παρόντα κατάλογο θα λειτουργήσει και το νέο site της εταιρείας με το **B2B**. Εκτός δηλαδή με την όσο το δυνατόν πιο συχνή παρουσία των πωλητών μας στο φυσικό σας κατάστημα **θα έχετε τη δυνατότητα της άμεσης και αδιαμεσολάβητης ηλεκτρονικής καταχώρησης** της παραγγελίας σας ώστε να έχετε άμεση γνώση της **διαθεσιμότητας, των τιμών, του χρόνου παράδοσης και των περιοδικών προσφορών μας**.

Κώστας Γεωργιάδης

B2B www.ergohelix.gr

Business to Business

Το 2021 φέρνει το
B2B website της ErgoHelix
μέσα στον πυρήνα,
των δραστηριοτήτων, της Εταιρείας σας!

Η αποθήκη μας
με ένα **“κλικ”**
στα ράφια σας!

Δίπλα σας όποια στιγμή θέλετε!!!
Από **όπου κι αν βρίσκεστε!!!**

Ενα εργαλείο **με στόχο** την ικανοποίηση
των προτεραιοτήτων
της δικής σας Εταιρείας

Με το B2B η ErgoHelix είναι διαθέσιμη,
για εσάς και τους συνεργάτες σας

24 ώρες το 24ωρο
7 ημέρες την εβδομάδα



Έλεγχος
διαθεσιμότητας
προϊόντων



Ενημέρωση
τιμής αγοράς και
πώλησης



Καταχώρηση
παραγγελίας



Νέα προϊόντα



Προσφορές και
Προτάσεις
“στα μέτρα σας”,
με βάση τις αγοραστικές
σας συνήθειες

**Στο B2B της ErgoHelix το “coreplace” είναι
η δική σας Εταιρεία!!!!**

και φέρνει τα προϊόντα μας πιο γρήγορα στην επιχείρησή σας, στα ράφια σας

Άμεσος στόχος μας είναι οι παραγγελίες που καταχωρούνται στο σύστημα μέχρι τις 11:00 π.μ. να εκτελούνται αυθημερόν!

Αποθήκη και WMS

Επένδυση
σε ανθρώπους
και τεχνολογία



Θεοφάνης Δρέλιας
Logistics Manager

Η καθημερινή, απόλυτη
εξυπηρέτησή σας, σωστά και
άμεσα είναι η πρόκληση που
επιθυμούμε να αριστεύουμε.



Δημήτριος Χατζησάββας
Digital marketing

Δεν θα μπορούσαμε να λείπουμε
από την τεχνολογία. Η σημασία
της γρήγορης, ορθής και έγκυρης
πληροφορίας είναι το κλειδί για
να προχωρήσουμε μπροστά.

Η συνεχώς αυξανόμενη γκάμα προϊόντων/κωδικών και η αύξηση της ταχύτητας κυκλοφορίας των εμπορευμάτων έκανε αναγκαία την καλύτερη οργάνωση της αποθήκης μας (2500m²) τόσο χωροταξικά όσο τεχνολογικά.

Στις αρχές του 2020, η εταιρεία μας απέκτησε έμπειρο **Logistics Manager**, τον Θεοφάνη Δρέλια και υπό τη διοίκηση του εγκαταστάθηκε το σύστημα **WMS (σύστημα διαχείρισης αποθήκης)** της ENTERSOFT.

Με σύγχρονο εξοπλισμό και μηχανήματα, (Barcode, RF) καταφέραμε να εκμηδενίσουμε τα λάθη και τις αστοχίες και να μειώσουμε τον χρόνο παραλαβής και εκτέλεσης των παραγγελιών.

Συγκεκριμένα πραγματοποιείται:

- Αυτόματη αναπλήρωση της περιοχής συλλογής
- Έλεγχος και συσκευασία με χρήση BARCODE
- Επικέτες λίστας συσκευασίας
- Πλήρως αυτοματοποιημένος έλεγχος αποθεμάτων
- Ομαδοποίηση παραγγελιών
- Διαχείριση συλλογών από picking και micro picking
- Διαχείριση cross docking παραγγελιών

Στόχος μας η έγκαιρη παράδοση των σωστών προϊόντων, στον σωστό χρόνο και τόπο.

Η μεταφορά από τις αποθήκες μας ανατέθηκε πλέον σε εξωτερικούς συνεργάτες όπου **με την υποδομή, την τεχνογνωσία, τη συνέπεια και την εμπειρία τους** πετύχαμε πανελλαδική κάλυψη, συντονισμό και ευελιξία σε επείγουσες περιπτώσεις, παράδοση στο σημείο που επιθυμεί ο πελάτης και ελαχιστοποίηση καθυστερήσεων.

Έτσι μόνο πέρσι πετύχαμε 16.000 παραδόσεις, διανομή 37.000 δεμάτων και 1.200 παλετών και είμαστε μόνο στην αρχή!

Customer Service

Εξυπηρέτηση
“ΕΝΤΟΣ ΚΙ ΕΚΤΟΣ”



Χρήστος
Customer Service



Παναγιώτης
Customer Service



Παράλληλα με την ομάδα των έμπειρων πωλητών μας, που καθημερινά επισκέπτονται δεκάδες καταστήματα σε όλη τη χώρα, μία **εσωτερική ομάδα, άμεσης εξυπηρέτησης**, έχει αναλάβει την καθημερινή τηλεφωνική σας υποστήριξη και ενημέρωση.

Με γνώση των προϊόντων και των χρήσεών τους, σας προτείνουν λύσεις, τοποθετούν την παραγγελία σας στο σύστημα, σας πληροφορούν για διαθεσιμότητες, χρόνους παράδοσης και φόρτωσης τής παραγγελίας σας και στέλνουν το παραστατικό τιμολόγησης με τα είδη που θα σας παραδοθούν τη επομένη.

Service Εργαλείων



Δημήτρης
Service Εργαλείων



Για εμάς η εξυπηρέτηση σας δε σταματά με την πώληση των προϊόντων, αλλά δίνουμε αξία στις ανάγκες σας και μετά την αγορά των εμπορευμάτων.

Στις εγκαταστάσεις της εταιρείας μας ήδη λειτουργεί τμήμα service για την υποστήριξη των ηλεκτροκολλήσεων **HelixPower** το οποίο επεκτάθηκε για να μπορέσει να καλύψει τις ανάγκες των **YATO power tools** τα οποία καλύπτονται με **2 χρόνια εγγύηση όπως άλλωστε και οι ηλεκτροκολλήσεις.**

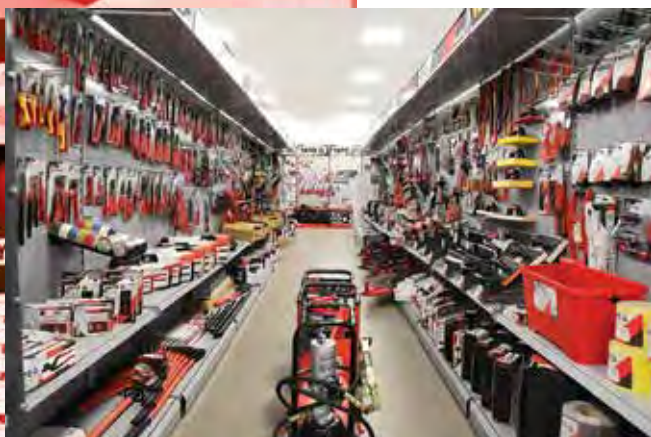

Τμήμα Merchandising

Με το κλειδί στο χέρι!!!

Δεν μας αρκεί να αγοράσετε τα προϊόντα μας, θέλουμε να τα πουλήσετε, το ταχύτερο δυνατόν.

Γι' αυτό έχουμε αναπτύξει προτάσεις για την καλύτερη παρουσία τους μέσα στο κατάστημά σας αλλά και την εκμετάλλευση και αξιοποίηση του ωφέλιμου χώρου σας.

Μπορούμε να αποτυπώσουμε και να επανασχεδιάσουμε τους χώρους σας και να επιλέξουμε τη βέλτιστη προϊοντική γκάμα που αναλογεί στο ύψος του καταστήματός σας.

Το **τμήμα merchandising**, της εταιρείας μας, έχει τη δυνατότητα, σε συνεργασία με εσάς, να αναδιαμορφώσει ή να δημιουργήσει, από την αρχή, τον χώρο του καταστήματος με τον πιο αποτελεσματικό τρόπο για τη σωστή παρουσίαση και προώθηση των προϊόντων.

Μιλήστε με τους πωλητές μας, που σας επισκέπτονται ή επικοινωνήστε μαζί μας για περισσότερες πληροφορίες.

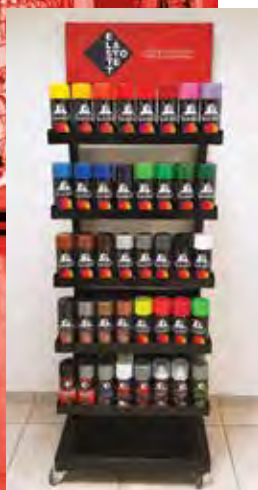

ΛΙΠΑΝΣΗ & ΠΡΟΣΤΑΣΙΑ που "ΔΙΑΡΚΕΙ"



► Τεχνικά σπρέι ΝΕΑΣ ΓΕΝΙΑΣ



ΛΙΠΑΝΤΙΚΟ - ΑΝΤΙΣΚΩΡΙΑΚΟ

**ΒΑΡΥΤΕΡΟ ΑΠΟ ΤΟ ΝΕΡΟ
ΑΠΩΘΕΙ ΤΗΝ ΥΓΡΑΣΙΑ**

- Λιπαίνει
- Συντηρεί
- Ελευθερώνει
- Αδιαβροχοποιεί
- Καθαρίζει
- Προστατεύει

**ΠΡΩΤΟΠΟΡΙΑΚΟ
ΛΙΠΑΝΤΙΚΟ - ΑΝΤΙΣΚΩΡΙΑΚΟ
ΣΠΡΕΪ
ΧΩΡΙΣ ΣΙΛΙΚΟΝΗ**

Παρασκευάζεται στην Ελλάδα | www.n-gr.gr

- **Λιπαίνει, Καθαρίζει και Συντηρεί** μεταλλικούς μηχανισμούς, κλειδαριές, όπλα και σταματάει το τρίξιμο σε μεντεσέδες κ.λπ.
- **Διεισδύει, Ξεσκουριάζει & Απελευθερώνει**, σκουριασμένα και κολλημένα εξαρτήματα όπως βίδες, παξιμάδια, σύρτες και τα επαναφέρει σε λειτουργία
- **Αδιαβροχοποιεί και Προστατεύει**, από την υγρασία και τη διάβρωση, όλα τα ηλεκτρικά κυκλώματα (πίνακες, λάμπες, μοτέρ, συστήματα ανάφλεξης και πόλους μπαταριών). Ιδιαίτερα αποτελεσματικό για ναυτιλιακή χρήση.
- **Καθαρίζει** λεκέδες από πίσσα και γράσα από το χρώμα των αυτοκινήτων



Διαθέσιμο σε συσκευασίες
200ml, 400ml, 500ml και 5Lt



Το **N-GR 21** χάρη στη μοναδική του ιδιότητα να **απωθεί με το βάρος του το νερό και την υγρασία**, διεισδύει αποτελεσματικά, προστατεύει από τη σκουριά, λιπαίνει, απελευθερώνει και **ξεναβάζει σε κίνηση τα πάντα!!!**

New GeneRation spray



8-97

Ηλεκτροσυγκολλήσεις | Ηλεκτρικά Εργαλεία | Εξαρτήματα Ηλεκτρικών Εργαλείων
Τρυπάνια | Δίσκοι | Μύτες



98 - 133

Προστασία | Ασφάλεια & Ένδυση Εργαζομένων



134 - 200

ΕΡΓΑΛΕΙΑ ΧΕΙΡΟΣ
Γενικής Χρήσης | Ηλεκτρολόγων | Υδραυλικών



201 - 269

ΕΡΓΑΛΕΙΑ ΣΥΝΕΡΓΕΙΟΥ - ΕΡΓΑΛΕΙΟΘΗΚΕΣ - ΑΠΟΘΗΚΕΥΣΗ
Αέρας & Εξαρτήματα | Εργαλεία Μηχανικών Αυτοκινήτων | Πριτσινάδοροι | Εργαλειοθήκες | Φακοί

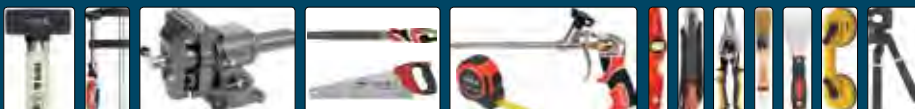

270 - 341

ΕΡΓΑΛΕΙΑ ΚΑΤΑΣΚΕΥΩΝ & ΟΙΚΟΔΟΜΗΣ
Σφυριά | Πριόνια | Μέτρηση | Κοπίδια | Εργαλεία Γυψοσανίδας | Πινέλα | Σπάτουλες



342 - 376

ΣΤΕΡΕΩΤΙΚΑ | ΒΙΔΕΣ



377 - 419

ΚΗΠΟΣ - Κάδοι | Πότισμα
ΑΣΦΑΛΕΙΑ ΣΠΙΤΙΟΥ - Σίτες | Λουκέτα | Κλειδαριές | Εξαρτήματα Αλουμινίου & Ρολών



420 - 484

Τεχνικά Σπρέι | Κόλλες | Ταινίες | Σπρέι Βαφής | Αφροί | Στόκοι | Σιλικόνες





ΗΛΕΚΤΡΟΣΥΓΚΟΛΗΣΕΙΣ

ΗΛΕΚΤΡΙΚΑ ΕΡΓΑΛΕΙΑ & ΕΞΑΡΤΗΜΑΤΑ

HELIX-POWER
power tools WELDING
MACHINE

STHOR

YATO

VOREL

GRINDING

HELIX-POWER
TOOLS

TO WORK
FOR

ΗΛΕΚΤΡΟΣΥΓΚΟΛΗΣΕΙΣ [10 - 18]



MMA | MIG | TIG | PLASMA

Μάσκες | Γυαλιά

Μαγνητικές Γωνίες



ΗΛΕΚΤΡΙΚΑ ΕΡΓΑΛΕΙΑ [19 - 44]

Μπαταρίας και Ρεύματος



ΕΞΑΡΤΗΜΑΤΑ ΗΛΕΚΤΡΙΚΩΝ ΕΡΓΑΛΕΙΩΝ [45 - 97]

Τρυπάνια Μπετού | Μετάλλων | Ξύλου



Λειαντικά | Λάμες | Συρματοβουρτσες

Μύτες | Δίσκοι | Ποτηροτρύπανα



HELIX-POWER

power tools

WELDING MACHINE



your POWER FAMILY

Η δύναμη στις ηλεκτροκολλήσεις

ΕΠΕΞΗΓΗΣΕΙΣ ΧΑΡΑΚΤΗΡΙΣΤΙΚΩΝ

IGBT INVERTER

Η τεχνολογία IGBT (Διπολικό Τρανζίστορ μονωμένης πύλης) είναι εξέλιξη της τεχνολογίας MOSFET και εξασφαλίζει πιο ομαλή απόδοση, χαμηλότερη αντίσταση ρεύματος άρα και θερμοκρασία λειτουργίας

LED DISPLAY

Ψηφιακές ενδείξεις λειτουργιών

ANTI STICK

Διακόπτει την παροχή ρεύματος όταν το ηλεκτρόδιο "κολλήσει" ώστε να απελευθερώνεται εύκολα και να αποφεύγονται τα βραχυκυκλώματα και η υπερθέρμανση του μηχανήματος

ARC FORCE

Ρυθμίζει την παροχή ρεύματος ανάλογα με την απόσταση του ηλεκτροδίου από το μέταλλο, ώστε να διατηρείται σταθερό το τόξο και να διασφαλίζεται ομαλή και ομοιογενής συγκόλληση

HOT START

Ρυθμίζει κατάλληλα την ισχύ του ρεύματος έτσι ώστε να έχουμε γρήγορη και ομαλή εκκίνηση στις συγκολλήσεις

3 PCB

Τρεις ξεχωριστές πλακέτες ελέγχουν τα διαφορετικά μέρη της μηχανής για πιο "ξεκούραστη" λειτουργία και ευκολότερη αλλά και οικονομικότερη επισκευή, σε περίπτωση βλάβης

LIFT TIG FUNCTION

Η μηχανή είναι συμβατή με κιτ Lift Tig

SYNERGY

Εξελιγμένο λογισμικό ρυθμίσεων για ευκολότερη και ακριβέστερη εργασία

CYCLE 45/80/80%

Κύκλος λειτουργίας/απόδοσης του θερμικού διακόπτη, σε λεπτά συνεχόμενης λειτουργίας

PULSE FUNCTION

Λειτουργία παλμών με ρύθμιση συχνότητας για ακριβέστερη εργασία, σε όλα τα μέταλλα

DOUBLE PULSE FUNCTION

Λειτουργία παλμών διπλού εύρους για ακόμη μεγαλύτερη ευελιξία στην εργασία

2T/4T

Λειτουργία συνεχούς ροής τόξου με ένα πάτημα της σκανδάλης της τσιμπίδας

FULL BRIDGE IGBT

Αρχιτεκτονική πλακετών PCB με έμφαση στις υψηλές επιδόσεις και την αντοχή στη σκληρή χρήση

LCD DISPLAY

Ευκρινής οθόνη ενδείξεων LCD για εύκολη χρήση και ρύθμιση

VRD FUNCTION

Κύκλωμα ασφαλείας που μειώνει την τάση στις τσιμπίδες (από 60V σε 12V), όταν η μηχανή είναι σε αναμονή, για την ασφάλεια του χειριστή.

AC DC

Επιλογή λειτουργίας με συνεχές ή εναλλασσόμενο ρεύμα για τέλεια αποτελέσματα σε όλα τα μέταλλα (χάλυβες, αλουμίνιο κ.λπ.).

GAS/NO GAS FUNCTION

Επιλογή λειτουργίας για μηχανές MIG, με ή χωρίς αέριο. Συμβατότητα με συμπαγή ή FLUX σύρματα συγκόλλησης.

** Οι διαστάσεις και το βάρος αφορούν στο μηχάνημα, χωρίς το κουτί και τα εξαρτήματα

SUPERMINI 140FI

2 YEAR WARRANTY

MINI FAMILY

SUPERMINI+ 150

IGBT INVERTER



ARC FORCE



IGBT INVERTER

CYCLE 60%

HOT START

ANTI STICK

LED DISPLAY

ΜΟΛΙΣ 2,3 Kg !!!



"SUPER MINI" ΔΙΑΣΤΑΣΕΙΣ 23 x 9 x 13 cm

ΣΕ ΠΩΛΗΣΕΙΣ No1

ΠΕΡΙΣΣΟΤΕΡΑ ΑΠΟ 20.000 ΤΕΜ.



Μικρές διαστάσεις, χαμηλό βάρος "όλη η δύναμη"!!!!

ΚΩΔΙΚΟΣ 75002140
ΜΟΝΤΕΛΟ S-MINI 140FI
ΑΠΟΔΟΣΕΙΣ 60% 140A - 100% 108A
ΚVA 4,0
ΔΙΑΣΤΑΣΕΙΣ 23x9x13cm**
KG 2,3**
€/ΤΕΜ 72,00 ◀

Κατάλληλη για χρήση με γεννήτρια

2 σε 1



2 σε 1 MMA / LIFT TIG*

IGBT INVERTER

LED DISPLAY

LIFT TIG FUNCTION

VRD FUNCTION

HOT START

ANTI STICK

ARC FORCE

CYCLE 60%

2 σε 1

Μini διαστάσεις "Plus Δυνατότητες"!!!!

ΚΩΔΙΚΟΣ 75002150
ΜΟΝΤΕΛΟ SUPER mini+ PLUS
ΑΠΟΔΟΣΕΙΣ 60% 150A - 100% 116A
ΚVA 4,5
ΔΙΑΣΤΑΣΕΙΣ 23x9x13cm**
KG 2,4**
€/ΤΕΜ 89,00 ◀

Κατάλληλη για χρήση με γεννήτρια

16mm καλώδιο 1,5m
 Περιλαμβάνει τσιμπίδα MMA, σώμα.

NEO

LIFT TIG FUNCTION



*Καλώδια και τσιμπίδα Lift Tig για μετατροπή της MMA σε Lift TIG.

NEO

ΚΩΔΙΚΟΣ 75900160
€/ΤΕΜ 40,00 ◀

S-MINI MAX 160

MAX 60% 160A
2 σε 1 MMA / LIFT TIG*

2 σε 1

MINIum ΔΙΑΣΤΑΣΕΙΣ MAXIum ΔΥΝΑΜΗ!!!

22 x 16 x 13 cm

ΜΟΛΙΣ 2,6 Kg !!!



NEO

ΚΩΔΙΚΟΣ 75002162
ΜΟΝΤΕΛΟ S-MINI MAX
ΑΠΟΔΟΣΕΙΣ 60% 160A
ΚVA 5,35
ΔΙΑΣΤΑΣΕΙΣ 22x16x13cm**
KG 2,6**
€/ΤΕΜ 96,00 ◀

Κατάλληλη για χρήση με γεννήτρια

16mm καλώδιο 3m
 Περιλαμβάνει τσιμπίδα MMA, σώμα.

Ηλεκτροσυγκόλληση MMA και Lift TIG.
 Εξαιρετικός compact σχεδιασμός, χαμηλό βάρος και υψηλές αποδόσεις.



LED DISPLAY

IGBT INVERTER



LIFT TIG FUNCTION

VRD FUNCTION

HOT START

ANTI STICK

ARC FORCE

CYCLE 60%



IGBT INVERTER

MINI FIT 160A - 200A

28,5 x 12 x 18,5 cm
"MINI"
ΔΙΑΣΤΑΣΕΙΣ

ΜΟΛΙΣ 3,6 Kg !!!

LED DISPLAY

IGBT INVERTER

CYCLE 60%

HOT START

ANTI STICK

ARC FORCE

3m

ΜΟΝΤΕΛΟ	160A	200A
ΚΩΔΙΚΟΣ	75002161	75002201
ΑΠΟΔΟΣΕΙΣ	160A (60%) 124A (100%)	200A (60%) 155A (100%)
KVA	5,4	7,1
ΗΛΕΚΤΡΟΔΙΟ	1,5 - 4,0 mm	1,5 - 5,0 mm
ΔΙΑΣΤΑΣΕΙΣ**	28,5x12x18,5cm	
KG**	3,6 Kg (χωρίς τσιμπιδες)	
€/ΤΕΜ	93,00	112,00

Κατάλληλη για χρήση με γεννήτρια

Μεγάλη δύναμη σε μικρό όγκο και βάρος. Ιδανικές για ερασιτεχνική χρήση στο σπίτι και την οικοδομή αλλά και για επαγγελματίες με μέσο όγκο εργασιών.

Έχουν υψηλό κύκλο λειτουργίας, 60%, για ξεκούραστη χρήση και μακροζωία.

Διαθέτουν σταθεροποιητή τάσης για λειτουργία με γεννήτριες.

Παραδίδονται σε χαρτόκουτο και συνοδεύονται από σετ τσιμπιδας και σώματος.



S-MINI MIG 140

MAX 60% 140A
IGBT Inverter Technology
MIG GAS / NO GAS / LIFT TIG* / MMA

NEO

3 σε 1

ΚΩΔΙΚΟΣ 75003140
ΜΟΝΤΕΛΟ S-MINI MIG 140
ΑΠΟΔΟΣΕΙΣ 60% 140A
KVA 4,5
ΔΙΑΣΤΑΣΕΙΣ** 41x18,5x34cm
KG** 7

7 Kg !!!

41x18,5x34cm

€/ΤΕΜ **189,00**

Κατάλληλη για χρήση με γεννήτρια

Ηλεκτροσυγκόλληση MIG/MAG, Lift TIG*, MMA.

Η μικρότερη μηχανή MIG/MAG για σύρμα 0,6 & 0,8mm με αέριο και 0,8 & 1mm χωρίς αέριο FLUX.

Λειτουργία VRD & 2T/4T.

Δέχεται κουλούρες σύρματος 1KG.

Εξαιρετικός compact σχεδιασμός και χαμηλό βάρος, 7,0KG.

Διαθέτει σταθεροποιητή τάσης για λειτουργία με γεννήτρια.

GAS/NO GAS FUNCTION

SYNERGY 1KG WIRE

3m

LIFT TIG FUNCTION

VRD FUNCTION

IGBT INVERTER

CYCLE 60%

LCD DISPLAY

2T/4T

Περιλαμβάνει τσιμπίδα MIG, MMA και σώμα.



NEO
ΣΥΡΜΑ GAS 0,8mm - 1 KG
ΚΩΔΙΚΟΣ 75900082
€/ΤΕΜ **6,65**

NEO
ΣΥΡΜΑ FLUX 0,8mm - 1 KG
ΚΩΔΙΚΟΣ 75900080
€/ΤΕΜ **6,95**

LIFT TIG FUNCTION
NEO

*Καλώδια και τσιμπίδα Lift Tig για μετατροπή της MMA σε Lift TIG.

ΚΩΔΙΚΟΣ 75900160
€/ΤΕΜ **40,00**

4,9-5,4 Kg !!!
32,5x12x19cm

**NONSTOP PROFESSIONAL
MMA 160A - 180A - 200A**
IGBT Inverter Technology

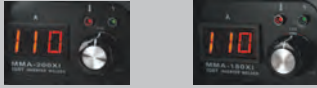

ΜΟΝΤΕΛΟ	160Xi	180Xi	200Xi
ΚΩΔΙΚΟΣ	75000161	75000181	75000201
ΑΠΟΔΟΣΕΙΣ	80% 160A 100% 139A	80% 180A 100% 160A	80% 200A 100% 170A
KVA	6,0	7,0	8,3
ΔΙΑΣΤΑΣΕΙΣ**		32,5x12x19cm	
KG**	4,9	4,9	5,4
€/ΤΕΜ	164,00	174,00	189,00

Κατάλληλες για χρήση με γεννήτρια

MMA



+ ΔΩΡΟ



ΜΑΣΚΑ
ΗΛΕΚΤΡΟΝΙΚΗ HELIX
ΑΞΙΑΣ 28,00 €



INVERTER IGBT

Η σειρά ηλεκτροκολλήσεων Xi NON STOP PROFESSIONAL, είναι κατασκευασμένη για βαριά επαγγελματική χρήση, σε αντίξοες συνθήκες. Ο ασυνήθιστος, μεγάλος, κύκλος λειτουργίας τους (80%) επιτρέπει συνεχή και αδιάλειπτη συγκόλληση NON STOP, ακόμη και σε πολύ παχιά μέταλλα και με χονδρά ηλεκτρόδια χωρίς διακοπές από υπερθέρμανση. Διαθέτει σταθεροποιητή τάσης για λειτουργία με γεννήτριες.

Compact, Flat σχεδιασμός
Ηλεκτρόδιο 1.5mm-5.0mm
16mm καλώδιο 4m
Παραδίδεται σε βαλίτσα
Περιλαμβάνει τσιμπίδα MMA, σώμα, μάσκα, γυαλί, βούρτσα, ματσακόνι

SYNERGY

Xi PROFESSIONAL

SYNERGY PRO 220 Xi

MAX 60% 220A

IGBT Inverter Technology

7,05 Kg !!! 40x16x30,5cm

Ηλεκτροσυγκόλληση MMA και Lift TIG*. Είναι κατασκευασμένη για βαριά και συνεχή, επαγγελματική, χρήση. Διαθέτει λογισμικό synergy για εύκολες και ακριβείς ρυθμίσεις. Περιλαμβάνει καλώδια 25mm/4m και κονέκτορες βαρέως τύπου. Διαθέτει σταθεροποιητή τάσης για λειτουργία με γεννήτρια.



2σε1

MMA / LIFT TIG*

Ηλεκτρόδιο 1.5mm-5.0mm
Υποδοχές 35-50
Περιλαμβάνει τσιμπίδα MMA, σώμα, μάσκα, βούρτσα, ματσακόνι, βαλίτσα



ΚΩΔΙΚΟΣ	75000225
ΜΟΝΤΕΛΟ	SYNERGY PRO 220 Xi
ΑΠΟΔΟΣΕΙΣ	60% 220A
KVA	8
ΔΙΑΣΤΑΣΕΙΣ**	40x16x30,5cm
KG**	7,05
€/ΤΕΜ	210,00

Κατάλληλη για χρήση με γεννήτρια

LIFT TIG FUNCTION

*Καλώδια και τσιμπίδα Lift Tig για μετατροπή της MMA σε Lift TIG.



ΚΩΔΙΚΟΣ 75900250
€/ΤΕΜ 48,00

2 YEAR WARRANTY

HELIX-POWER
power tools **WELDING MACHINE**

MIG 200A PRO - 60%

2σε1

IGBT
INVERTER

CYCLE 60%

4m



NEO

2σε1 MIG/MAG-MMA

Professional
GAS / NO GAS
5 KG wire

ΚΩΔΙΚΟΣ 75002500
ΜΟΝΤΕΛΟ MIG 200A PRO
ΑΠΟΔΟΣΕΙΣ 200A 60%
KVA 11,3
ΔΙΑΣΤΑΣΕΙΣ** 43x22x34cm
KG** 13,5
€/ΤΕΜ **32 9,00** ◀



NEO

ΣΥΡΜΑ FLUX
0,8mm - 5 KG
ΚΩΔΙΚΟΣ 75900081
€ **26,30**

+ ΔΩΡΟ

ΜΑΣΚΑ
ΗΛΕΚΤΡΟΝΙΚΗ HELIX
ΑΞΙΑΣ **28,00 €**



MULTI MIG 200 SYNERGY
MAX 60% 180A

SYNERGY

IGBT
INVERTER

LIFT TIG
FUNCTION

LED
DISPLAY

CYCLE
60%

3σε1 MIG/LIFT TIG/MMA

Ηλεκτροσυγκόλληση 3 σε 1 MIG/MAG, MMA και LIFT TIG με ξεχωριστή υποδοχή για κανονική τιμπίδα TIG.

NEO

ΚΩΔΙΚΟΣ 75031180
ΜΟΝΤΕΛΟ MULTI MIG 200 SYNERGY
ΑΠΟΔΟΣΕΙΣ 60% 180A
KVA
ΔΙΑΣΤΑΣΕΙΣ** 52x23x32cm
KG** 11,60
€/ΤΕΜ **470,00** ◀ **+ ΔΩΡΟ ΜΑΣΚΑ**

Κατάλληλη για χρήση με γεννήτρια

FULL BRIDGE
IGBT

2T/4T

3σε1



Full bridge IGBT Inverter Technology
Τεχνολογία Synergy MIG Welding
2T / 4T Function
Euro Plug MIG Torch
Σύρμα 0.8, 1.0 & FLUX (No Gas)
Κουλούρα 5 KG
Υποδοχές 35-50, 25mm καλώδιο 3m
Περιλαμβάνει τιμπίδα MIG, LIFT TIG, MMA, σώμα, μάσκα, βούρτσα, ματσακόνι
Διαθέτει σταθεροποιητή τάσης για λειτουργία με γεννήτρια.



11,6 Kg
52x23x32cm

**PRO MIG 250A ΤΡΙΦΑΣΙΚΗ
AC/DC DOUBLE PULSE
MIG / LIFT TIG* / MMA**

**40,8 Kg
70x30x58,5cm**



**PULSE
FUNCTION**

**FULL BRIDGE
IGBT**

**DOUBLE PULSE
FUNCTION**

2T/4T



NEO

Επαγγελματική τριφασική μηχανή MIG
Ιδανική για κολλήσεις σε αλουμίνιο, μέγιστη ισχύς **250A**, απόδοση **60%**
FULL BRIDGE IGBT INVERTER TECHNOLOGY,
Τεχνολογία **SYNERGY MIG WELDING**
Λειτουργία **2T / 4T MANUAL / AUTO, DOUBLE PULSE WELDING FUNCTION**
Περιλαμβάνει **τσιμπίδα MIG με TEFLON, ROLLERS U TYPE** για αλουμίνιο 1.2 & 1.6mm
Επιπλέον **LINER** για σύρμα χάλυβα & **FLUX, ROLLERS V TYPE** για χάλυβα 0.8, 1.0 & 1.2mm
Κονέκτορες DINSE βαρέως τύπου 35-50, περιλαμβάνει σετ τσιμπίδων MMA 25mm
Δέχεται **κουλούρες 5 & 15 ΚΙΛΩΝ**, περιλαμβάνει τροχήλατη βάση και θέση φιάλης αερίου

SYNERGY IGBT INVERTER LIFT TIG FUNCTION LED DISPLAY CYCLE 80%

***Καλώδια και τσιμπίδα Lift Tig για μετατροπή της MMA σε Lift TIG.**

LIFT TIG FUNCTION

NEO ΚΩΔΙΚΟΣ 75900250
€ / TEM 48,00 ◀

NEO

ΣΥΡΜΑ FLUX 0,8mm - 5 KG
ΚΩΔΙΚΟΣ 75900081
€ 26,30

ΚΩΔΙΚΟΣ 75003250
ΜΟΝΤΕΛΟ PRO MIG 250
ΑΠΟΔΟΣΕΙΣ 60% 250A
ΔΙΑΣΤΑΣΕΙΣ 70x30x58,5cm ΧΩΡΙΣ ΒΑΣΗ & ΡΟΔΕΣ**
KG 40,8**
€ / TEM 1050,00 ◀

HF PLASMA CUT ΚΟΠΗΣ ΜΕΤΑΛΛΩΝ
MAX 60% 50A
IGBT Inverter Technology

ΚΩΔΙΚΟΣ 75005000
ΜΟΝΤΕΛΟ CUT-50PI
ΑΠΟΔΟΣΕΙΣ 60% 50A
ΚVA 7,0
ΔΙΑΣΤΑΣΕΙΣ 42x19x30cm**
KG 7**
€ / TEM 295,00 ◀

Τσιμπίδα PT-31 4 Μέτρων
Σώμα γείωσης 16mm καλώδιο 3m
Περιλαμβάνει τσιμπίδα CUT, σώμα, ρυθμιστή πίεσης και υδατοπαγίδα



"ΕΞΥΠΝΟ"

NEO **7 Kg**
42x19x30cm

CUT PLASMA ΚΟΠΗΣ ΜΕΤΑΛΛΩΝ
Τεχνολογίας **IGBT INVERTER**.
Εξαιρετικά ισχυρή με **ρεύμα κοπής 20-50A** και κύκλο λειτουργίας 60%. **Μέγιστη δυνατότητα κοπής 18mm** χάλυβα, καθαρό 15mm.

IGBT INVERTER LED DISPLAY CYCLE 60%



2 YEAR
WARRANTY

HELIX-POWER
power tools **WELDING
MACHINE**

SYNERGY PULSE TIG 180
MAX 60% 180A
2 σε 1 TIG & MMA

IGBT Inverter Technology
Τεχνολογία Synergy TIG Welding

ΚΩΔΙΚΟΣ 75010181
ΜΟΝΤΕΛΟ SYNERGY PULSE TIG 180
ΑΠΟΔΟΣΕΙΣ 60% 180A
ΚVA
ΔΙΑΣΤΑΣΕΙΣ** 42x19x30 cm
KG** 6,8
€/ΤΕΜ **279,00** ◀

Κατάλληλη για χρήση με γεννήτρια

Ηλεκτροσυγκόλληση HF TIG με λογισμικό synergy για εύκολες και ακριβείς ρυθμίσεις. Περιλαμβάνει λειτουργία Pulse για ευελιξία και τέλεια αποτελέσματα, σε όλα τα μέταλλα. Διαθέτει σταθεροποιητή τάσης για λειτουργία με γεννήτρια.



6,8 Kg
42x19x30cm

NEO

2σε1

SYNERGY

**IGBT
INVERTER**

**PULSE
FUNCTION**

**LED
DISPLAY**

**CYCLE
60%**

25mm καλώδιο 3m
Περιλαμβάνει τοιμπίδα TIG, MMA,
σώμα, μάσκα, βούρτσα, ματσακόνι

AC/DC TIG/MMA
2 σε 1 TIG & MMA
MAX 60% 200A
IGBT Inverter Technology



16 Kg
50x20x40cm

+ ΔΩΡΟ

ΜΑΣΚΑ
ΗΛΕΚΤΡΟΝΙΚΗ HELIX
ΑΣΙΑΣ **28,00 €**



2σε1



ΚΩΔΙΚΟΣ 75003201
ΜΟΝΤΕΛΟ WSME-200EI
ΑΠΟΔΟΣΕΙΣ 60% 200A
ΚVA 6,2
ΔΙΑΣΤΑΣΕΙΣ** 50x20x40cm
KG** 16
€/ΤΕΜ **579,00** ◀

Κατάλληλη για χρήση με γεννήτρια



Συνοδεύεται από τοιμπίδα ηλεκτροκόλλησης και σετ TIG.

IGBT INVERTER TIG/MMA συνεχούς & εναλλασσόμενου ρεύματος, με λειτουργία παλμών. Ιδανική για συγκόλληση κραμάτων χάλυβα, ανοξείδωτου χάλυβα και χαλκού στο συνεχές DC & κραμάτων αλουμινίου στο εναλλασσόμενο AC. Διαθέτει λειτουργία 2T/4T & σταθεροποιητή τάσης για λειτουργία με γεννήτρια.

2T/4T

**ARC
FORCE**

**LED
DISPLAY**

**PULSE
FUNCTION**

**IGBT
INVERTER**

**AC/DC
MMA/TIG**

**CYCLE
60%**

ΗΛΕΚΤΡΟΝΙΚΗ ΠΛΗΡΩΣ ΑΥΤΟΜΑΤΗ



2 Φωτοκύτταρα

3 Ρυθμίσεις:

- Βαθμού σκίασης DIN
- Ευαισθησίας
- Χρόνου καθυστέρησης

Λειτουργία Τροχίσματος

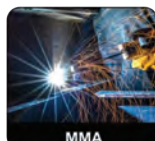

HELIX-POWER
power tools **WELDING MACHINE**

HELIX ΑΥΤΟΜΑΤΗ

ΚΩΔΙΚΟΣ €/ΤΕΜ

7590004 ▶ **28,00**

2 ARC SENSOR	100x50mm VIEWING AREA	1/25000 REACTION TIME	9-13 DARK STATE	DIN 4 LIGHT STATE	weldings MMA/MIG/MAG TIG/PLASMA	SOLAR CELL	CR 2032 3V BATTERY	0,2-0,8s (BRIGHTENING TIME)
--------------	-----------------------	-----------------------	-----------------	-------------------	---------------------------------	------------	--------------------	-----------------------------

Με μπαταρίες που αλλάζουν

ΗΛΕΚΤΡΟΝΙΚΑ ΓΥΑΛΙΑ ΗΛΕΚΤΡΟΣΥΓΚΟΛΛΗΤΩΝ



NEO

SOLAR CELL	DIN 3 LIGHT STATE	DIN 11 DARK STATE	5/10000S REACTION TIME
------------	-------------------	-------------------	------------------------

ΚΩΔΙΚΟΣ €/ΤΕΜ

7590005 ▶ **9,90**

SOLAR CELL	DIN 3 LIGHT STATE	DIN 11 DARK STATE	5/10000S REACTION TIME	UV/IR DIN 16	1x60m Ah LI BATTERY
------------	-------------------	-------------------	------------------------	--------------	---------------------

TX-012

ΚΩΔΙΚΟΣ €/ΤΕΜ

7590006 ▶ **19,00**

NEO

ΓΑΝΤΙΑ ΗΛΕΚΤΡΟΣΥΓΚΟΛΛΗΤΩΝ-ΔΕΡΜΑ



- ▶ MIG/MAG, MMA
- ▶ Μήκος 35cm
- ▶ EN 12477, προδιαγραφή: TYPE A
- ▶ EN 407, προδιαγραφή: 423X4X
- ▶ EN 388, προδιαγραφή: 4244X



NEO

- ▶ Γάντια Ηλεκτροσυγκολλητών μήκους 40 cm
- ▶ Χρώματος καφέ από σιχτό δέρμα μόσχου
- ▶ Ακαυστη ραφή kevlar

4244

ΚΩΔΙΚΟΣ YATO® ΜΕΓΕΘΟΣ ΣΥΣΚ €/ΤΕΜ

21074824 YT-74824 10 12 **6,80**

ΚΩΔΙΚΟΣ ΜΕΓΕΘΟΣ ΣΥΣΚ €/ΤΕΜ

9400061 10 10 **6,25**

ΗΛΕΚΤΡΟΝΙΚΕΣ ΜΑΣΚΕΣ ΗΛΕΚΤΡΟΣΥΓΚΟΛΗΤΩΝ



4 ARC SENSOR
100x50mm VIEWING AREA
1/25000 REACTION TIME

DIN 5-9/9-13 DARK STATE
DIN 4 LIGHT STATE
UV/IR DIN 16
0,1-1,0s BRIGHTENING TIME

SHADE-SENSITIVITY-DELAY
weldings MMA/MIG MAG/TIG
GRINDING CUTTING
2x3V-CR2032 BATTERIES NOT INCLUDED

Από πυρίμαχο πολυπροπυλένιο
4 φωτοκύτταρα
Πλήρως ρυθμιζόμενη

ΕΠΙΛΟΓΗ ΛΕΙΤΟΥΡΓΙΑΣ
1. Συγκόλληση 2. Τρόχισμα 3. Κοπή



Ρύθμιση βαθμού σκίασης DIN
Ρύθμιση ευαισθησίας
Ρύθμιση καθυστέρησης

EN 379 Optical class 1/1/1/2

ΚΩΔΙΚΟΣ	YATO	€/ΤΕΜ
20173925	YT-73925	▶ 57,00



for YT-73925
YT-73926
74484
5 PCS
137x120 mm
1.0mm THICKNESS
PC
CE



ΖΕΛΑΤΙΝΑ ΠΡΟΣΤΑΣΙΑΣ 5 ΤΕΜ

ΚΩΔΙΚΟΣ	YATO	ΣΥΣΚ	€/ΣΕΤ
20073929	YT-73929		7,35

ΓΙΑ YATO 73925, 73926, STHOR 74484 & HELIXPOWER



4 ARC SENSOR
100x60mm VIEWING AREA
1/25000 REACTION TIME
DIN 5-9/9-13 DARK STATE
DIN 4 LIGHT STATE
UV/IR DIN 16

0,1-1,0s BRIGHTENING TIME
SHADE-SENSITIVITY-DELAY
weldings MMA/MIG MAG/TIG
GRINDING CUTTING
2x3V-CR2032 BATTERIES NOT INCLUDED

Ρύθμιση καθυστέρησης

ΕΠΙΛΟΓΗ ΛΕΙΤΟΥΡΓΙΑΣ
1. Συγκόλληση
2. Τρόχισμα
3. Κοπή



Ρύθμιση βαθμού σκίασης DIN

Ρύθμιση ευαισθησίας

EN 379 Optical class 1/1/1/2

ΚΩΔΙΚΟΣ	YATO	€/ΤΕΜ
20173926	YT-73926	▶ 77,00

ΣΕ ΠΩΛΗΣΕΙΣ
No1



ΜΑΓΝΗΤΙΚΗ ΓΩΝΙΑ ΣΥΓΚΟΛΛΗΣΗΣ

ΚΩΔΙΚΟΣ	YATO	(kg)	(mm)	ΣΥΣΚ	€/ΤΕΜ
20000863	YT-0863	11.5	82x120x13	6	2,90
20000864	YT-0864	22.5	102x155x17	6	4,90
20000865	YT-0865	34	122x190x25	6	8,60



ΜΑΓΝΗΤΙΚΗ ΓΩΝΙΑ ΣΥΓΚΟΛΛΗΣΗΣ

ΚΩΔΙΚΟΣ	YATO	(kg)	(mm)	ΣΥΣΚ	€/ΤΕΜ
20000866	YT-0866	11.5	64x95x14	6	3,95
20000867	YT-0867	34.0	111x136x24	6	8,25

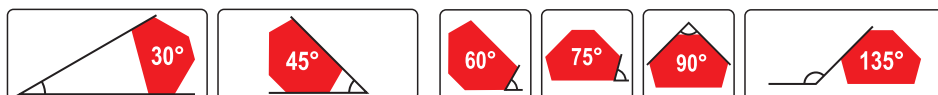

ΣΕΤ 4 ΜΑΓΝΗΤΙΚΩΝ ΓΩΝΙΩΝ

ΚΩΔΙΚΟΣ	YATO	(kg)	(mm)	ΣΥΣΚ	€/ΣΕΤ
20008677	YT-08677	4.5	47x72x12	6	6,90

NEO

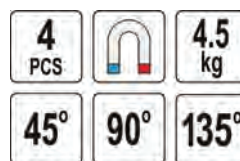
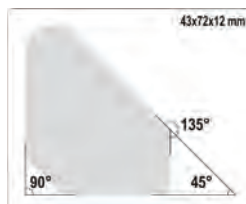

"ΕΞΥΠΝΟ"



NEO

ΜΑΓΝΗΤΙΚΟ ΣΩΜΑ ΓΕΙΩΣΗΣ

ΚΩΔΙΚΟΣ	YATO	ΣΥΣΚ	€/ΤΕΜ
20008625	YT-08625	12	9,70

NEA

2 pcs

ΜΑΓΝΗΤΙΚΕΣ ΓΩΝΙΕΣ - 2 ΤΕΜ



ΚΩΔΙΚΟΣ	YATO	(kg)	ΜΕΓΕΘΟΣ (mm)	ΣΥΣΚ	€/ΤΕΜ
20008721	YT-08721	10	98x113	6	18,00

60° 90° 120°

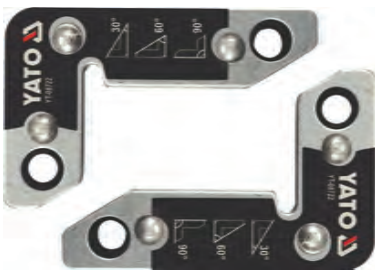

ΚΩΔΙΚΟΣ	YATO	(kg)	ΜΕΓΕΘΟΣ (mm)	ΣΥΣΚ	€/ΤΕΜ
20008722	YT-08722	25	54x84	40	16,00

30° 60° 90°

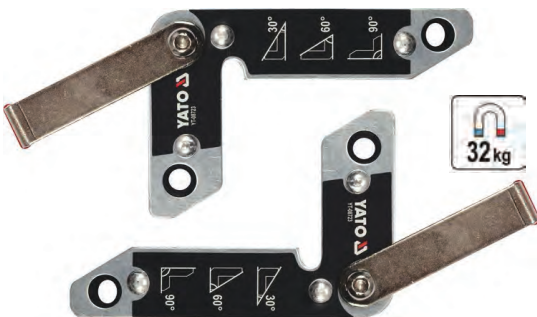

ΚΩΔΙΚΟΣ	YATO	(kg)	ΜΕΓΕΘΟΣ (mm)	ΣΥΣΚ	€/ΤΕΜ
20008723	YT-08723	32	70x110	32	25,00

30° 60° 90°



NEO

NEO



ΜΑΓΝΗΤΙΚΕΣ ΒΑΣΕΙΣ ΤΣΙΜΠΙΔΑΣ

ΚΩΔΙΚΟΣ	YATO		ΣΥΣΚ	€/ΤΕΜ
20008710	YT-08710	MIG		10,90
20008711	YT-08711	TIG		10,90



MIG



TIG





LIFT TIG FUNCTION

NEO

Καλώδια και τσιμπίδα Lift Tig, που μετατρέπουν όλες τις μηχανές MMA σε Lift TIG. Περιλαμβάνουν πλήρη τσιμπίδα TIG καθώς και σωλήνα παροχής αερίου. Διαθέσιμο για κονέκτορες Dinse σε μεγέθη 10-25 και 35-50.

LIFT TIG KIT

ΚΩΔΙΚΟΣ		€/ΤΕΜ
75900160	10-25	▶ 40,00
75900250	35-50	▶ 48,00



ΜΕ 3 ΜΕΤΡΑ ΚΑΛΩΔΙΟ 16mm² ή 4 ΜΕΤΡΑ ΚΑΛΩΔΙΟ 25mm²

ΤΣΙΜΠΙΔΑ & ΣΩΜΑ

ΚΩΔΙΚΟΣ	ΣΥΣΚ	€/ΤΕΜ
ΤΣΙΜΠΙΔΑ		
75900007	3m x 16mm	▶ 9,00
75900017	4m x 25mm	▶ 13,90
ΣΩΜΑ		
75900009	3m x 16mm	▶ 8,00
75900019	4m x 25mm	▶ 12,50

PT-31



PLASMA CUT 50 (PT-31)

ΜΕ ΚΑΛΩΔΙΟ 4 ΜΕΤΡΩΝ ΣΥΜΒΑΤΗ ΜΕ ΟΛΕΣ ΤΙΣ ΜΗΧΑΝΕΣ PLASMA ΠΟΥ ΔΕΧΟΝΤΑΙ ΤΣΙΜΠΙΔΕΣ PT-31

NEO

ΤΣΙΜΠΙΔΑ ΗΛΕΚΤΡΟΚΟΛΛΗΣΗΣ

ΚΩΔΙΚΟΣ	€/ΤΕΜ
75004500-5 HELIX	▶ 32,00



NEO

ΒΑΡΕΩΣ ΤΥΠΟΥ

ΤΣΙΜΠΙΔΕΣ ΣΩΜΑΤΟΣ

ΚΩΔΙΚΟΣ	€/ΤΕΜ
12390008 400A	3,40



ΜΠΟΤΑΚΙ ΑΣΦΑΛΕΙΑΣ MONZA S3 | SRC | HRO

ΗΛΕΚΤΡΟΣΥΓΚΟΛΛΗΤΩΝ

ΚΩΔΙΚΟΣ	ΜΕΓΕΘΟΣ (No)	ΣΥΣΚ	€/ΤΕΜ
40465091xx	39-46	10 ζεύγη ▶	58,00

* Διαθέσιμα μεγέθη 36-38, 47 κατόπιν παραγγελίας



NEO

Άνω Μέρος

- ▶ Τυπωμένο δέρμα υψηλής αντίστασης στο νερό, εύκαμπτο και διαπνέον.
- ▶ Φόδρα Promax Lining που αφαιρεί την υγρασία από το εσωτερικό του παπουτσιού και κατανέμει ομοιόμορφα τη θερμότητα.
- ▶ Πολυανθρακική προστασία δακτύλων Carbonlight Toecap (χωρίς σίδηρο).

Σόλα

- ▶ Δύο υλικών, PU & καουτσούκ. Το μαλακό, PU, απορροφά κραδασμούς και προσδίδει άνεση στην βάδιση. Σε συνδυασμό με τη λαστιχένια σόλα, εξασφαλίζει εξαιρετική πρόσφυση & αντίσταση τριβής.
- ▶ Αντοχή σε θερμοκρασίες έως 300°C.
- ▶ Q-Flex πολυανθρακική προστασία πέλματος (χωρίς σίδηρο).
- ▶ Πλάτος 11cm

ΣΠΡΕΙ ANTI-SPATTER

ΚΩΔΙΚΟΣ	ΠΕΡΙΓΡΑΦΗ	ΣΥΣΚ	€/ΤΕΜ
159230	400ml	6	3,95

NEO



QUANTUM ANTI-SPATTER SPRAY

Το QUANTUM ANTI-SPATTER είναι ένα μη διαβρωτικό προστατευτικό υγρό σε μορφή σπρέι, το οποίο δεν επιτρέπει στα ρινίσματα «πιτσιλιές» που δημιουργούνται κατά τη συγκόλληση να προσκολληθούν στο αντικείμενο. Διαλύεται στο νερό και καθαρίζεται εύκολα. Δεν περιέχει ουσίες σιλκόνης. Χρώμα: διάφανο.



PROFESSIONAL QUALITY POWER TOOLS



2 YEAR WARRANTY

PROFESSIONAL QUALITY POWER TOOLS



18V FAMILY

18V
Li-Ion

ΚΡΟΥΣΤΙΚΟ ΔΡΑΠΑΝΟΚΑΤΣΑΒΙΔΟ YATO YT-82787 / 86



40NM ΡΟΠΗ ΣΤΡΕΦΗΣ
ΔΕΞΙΑ-ΑΡΙΣΤΕΡΗ ΛΕΙΤΟΥΡΓΙΑ
ΡΥΘΜΙΖΟΜΕΝΗ ΤΑΧΥΤΗΤΑ
440-1650RPM
ΤΣΟΚ 13mm



4 Τεμ./Κιβώτιο

ΚΩΔ. 20182787
SOLO
49,00 € ◀

ΚΩΔ. 20182786
1x2Ah
99,00 € ◀



ΚΡΟΥΣΤΙΚΟ ΔΡΑΠΑΝΟΚΑΤΣΑΒΙΔΟ 75Nm YATO YT-82792 / 90 / 91



ΣΕ ΒΑΛΙΤΣΑ



ΚΩΔ. 20182792
SOLO
79,00 € ◀

ΚΩΔ. 20182790
1x3Ah
149,00 € ◀

ΚΩΔ. 20182791
2x3Ah
189,00 € ◀



ΠΑΛΜΙΚΟ ΚΑΤΣΑΒΙΔΙ YATO YT-82801 / 00

YT-82800 ΣΕ ΣΕΤ ΜΕ
ΦΟΡΤΙΣΤΗ ΚΑΙ ΜΠΑΤΑΡΙΑ
LI-ION 2.0Ah
ΜΕΓΙΣΤΗ ΡΟΠΗ 160NM
ΔΕΞΙΑ-ΑΡΙΣΤΕΡΗ ΛΕΙΤΟΥΡΓΙΑ
ΥΠΟΔΟΧΗ ΕΞΑΓΩΝΗ 1/4"
ΤΑΧΥΤΗΤΑ 0-3000RPM
ΚΡΟΥΣΞΕΙΣ 0-3000/MIN



ΚΩΔ. 20182801
SOLO
56,00 € ◀

ΚΩΔ. 20182800
1x2Ah
109,00 € ◀

5 Τεμ./Κιβώτιο

ΓΩΝΙΑΚΟΣ ΤΡΟΧΟΣ 125mm

YATO® YT-82827 / 26 / 28



x2

18V Li-Ion



4 Τεμ./Κιβώτιο



ΑΞΟΝΑΣ M14 ΓΙΑ ΔΙΣΚΟ 125mm
ΔΙΑΚΟΠΤΗΣ ΣΚΑΝΔΑΛΗ
COMPACT ΣΧΕΔΙΑΣΜΟΣ

ΚΩΔ. 20182827
SOLO
50,00 € ◀

ΚΩΔ. 20182826
1x2Ah
99,00 € ◀

ΚΩΔ. 20182828
2x3Ah
174,00 € ◀

ΓΩΝΙΑΚΟΣ ΤΡΟΧΟΣ 125mm ΡΥΘΜΙΖΟΜΕΝΟΣ

YATO® YT-828291



BRUSHLESS MOTOR

SPEED REGULATOR
SOFT START



ΑΞΟΝΑΣ M14 ΓΙΑ ΔΙΣΚΟ 125mm
ΡΥΘΜΙΖΟΜΕΝΗ ΤΑΧΥΤΗΤΑ 2000-9000RPM
ΟΜΑΛΗ ΕΚΚΙΝΗΣΗ & ΦΡΕΝΟ ΑΣΦΑΛΕΙΑΣ

ΚΩΔ. 201828291
SOLO
87,00 € ◀

ΚΩΔ. 20182829
1x3Ah
166,00 € ◀



4 Τεμ./Κιβώτιο

ΠΙΣΤΟΛΕΤΟ SDS PLUS

YATO® YT-82770

ΚΡΟΥΣΗ 2 JOULE



ΚΩΔ. 20182770
1x3Ah
185,00 € ◀



Συνοδεύεται από φορτιστή,
1 μπαταρία 3Ah, 5 εξαρτήματα
& βαλίτσα

3 Τεμ./Κιβώτιο

ΣΠΑΘΟΣΕΓΑ

YATO® YT-82815 - 14

ΜΕ ΦΟΡΤΙΣΤΗ ΚΑΙ ΜΠΑΤΑΡΙΑ 2.0Ah
ΣΥΣΤΗΜΑ ΤΑΧΕΙΑΣ ΑΛΛΑΓΗΣ ΛΑΜΑΣ



ΚΩΔ. 20182815
SOLO
49,00 € ◀

ΚΩΔ. 20182814
1x2Ah
99,00 € ◀

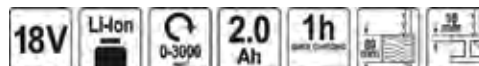

4 Τεμ./Κιβώτιο

2σε1 ΠΑΛΜΙΚΟ ΚΑΤΣΑΒΙΔΙ & ΜΠΟΥΛΟΝΟΚΛΕΙΔΟ 250Nm
YATO  **YT-82802**
BRUSHLESS MOTOR

ΡΥΘΜΙΖΟΜΕΝΗ ΡΟΠΗ 3 ΣΤΑΔΙΩΝ
 150Nm / 200Nm / 250Nm



18V	Li-Ion
250 Nm	0-2600 min ¹
1/2" 12.5mm	T 0-4400 min ¹
3.0 Ah	1.5h
LED	

ΔΕΞΙΑ-ΑΡΙΣΤΕΡΗ ΛΕΙΤΟΥΡΓΙΑ ΣΕ ΠΛΑΣΤΙΚΗ ΒΑΛΙΣΤΑ ΜΕ ΦΟΡΤΙΣΤΗ ΚΑΙ ΜΠΑΤΑΡΙΑ LI-ION 3.0Ah ΥΠΟΔΟΧΗ ΚΑΡΕ 1/2" ΓΙΑ ΚΑΡΥΔΑΚΙ ΑΝΤΑΙΠΤΟΡΑΣ ΑΠΟ ΚΑΡΕ 1/2" ΣΕ ΕΞΑΓΩΝΟ 1/4" ΤΑΧΥΤΗΤΑ 0-2600RPM ΚΡΟΥΣΕΙΣ 0-4400/MIN

ΚΩΔ. 20182802
 1x3Ah
149,00 € 

5 Τεμ./Κιβώτιο

2σε1 ΜΠΟΥΛΟΝΟΚΛΕΙΔΟ & ΠΑΛΜΙΚΟ ΚΑΤΣΑΒΙΔΙ 700Nm
YATO  **YT-828061 YT-82806**

ΜΕΓΙΣΤΗ ΡΟΠΗ 700NM
 3 ΘΕΣΕΙΣ ΡΥΘΜΙΣΗΣ ΡΟΠΗΣ (400/550/700NM)
 ΥΠΟΔΟΧΗ ΚΑΡΕ 1/2"
 ΓΙΑ ΚΑΡΥΔΑΚΙ
 ΑΡΙΣΤΕΡΗ-ΔΕΞΙΑ ΛΕΙΤΟΥΡΓΙΑ
 ΤΑΧΥΤΗΤΑ 0-2600RPM
 ΚΡΟΥΣΕΙΣ 0-5000/MIN
 ΦΡΕΝΟ ΑΣΦΑΛΕΙΑΣ



18V	Li-Ion
1/2" 12.5mm	700 Nm
3.0 Ah	1.5h
LED	
0-2600 min ¹	0-5000 min ¹



BRUSHLESS MOTOR



ΚΩΔ. 201828061
 SOLO
129,00 € 

ΚΩΔ. 20182806
 1x3Ah
199,00 € 

3 Τεμ./Κιβώτιο

ΑΛΟΙΦΑΔΟΡΟΣ 150mm
YATO  **YT-82920**

BRUSHLESS MOTOR



18V	3.0 Ah	1.5h
1500-5000 min ¹	150 g/min	16 mm
		M8

ΚΩΔ. 20182920
179,00 € 

Συνοδεύεται από φορτιστή & 1 μπαταρία 3Ah

ΠΙΣΤΟΛΙ ΘΕΡΜΟΚΟΛΛΑΣ
YATO  **YT-82854**

ΚΟΛΛΑ 11mm

18V	2.0 Ah	1h
11 mm	≥ 60 min	25 g/min



ΚΩΔ. 20182854
 1x2Ah
84,00 € 

10 Τεμ./Κιβώτιο

Συνοδεύεται από φορτιστή & 1 μπαταρία 2Ah

ΠΙΣΤΟΛΙ ΒΑΦΗΣ ΚΑΤΩ ΔΟΧΕΙΟΥ
YATO  **YT-82765**

ΜΠΕΚ 2.2mm
 ΔΟΧΕΙΟ 1 ΛΙΤΡΟΥ
 ΜΕ ΦΟΡΤΙΣΤΗ ΚΑΙ
 ΜΠΑΤΑΡΙΑ 4.0Ah



18V	4.0 Ah	2h
2.2 mm	1.0 V/min	1000 ml



ΚΩΔ. 20182765
 1x4Ah
125,00 € 

4 Τεμ./Κιβώτιο

Συνοδεύεται από φορτιστή & 1 μπαταρία 4Ah



2x3Ah



ΣΕΤ 4 **BRUSHLESS**
ΚΡΟΥΣΤΙΚΟ ΔΡΑΠΑΝΟΚΑΤΣΑΒΙΔΟ 75NM
ΠΑΛΜΙΚΟ ΜΠΟΥΛΟΝΟΚΛΕΙΔΟ 2 ΣΕ 1 - 250NM
YATO  **YT-SET004**

NEO 



ΠΕΡΙΛΑΜΒΑΝΕΙ:

- ΚΡΟΥΣΤΙΚΟ ΔΡΑΠΑΝΟΚΑΤΣΑΒΙΔΟ 75Nm
- ΠΑΛΜΙΚΟ / ΜΠΟΥΛΟΝΟΚΛΕΙΔΟ 2 ΣΕ 1 - 250Nm
- ΦΟΡΤΙΣΤΗ ΚΑΙ 2 ΜΠΑΤΑΡΙΕΣ 3.0Ah
- 2 ΠΛΑΣΤΙΚΕΣ ΒΑΛΙΤΣΕΣ ΜΕΤΑΦΟΡΑΣ

ΚΩΔ. 201004004
279,00 € 

ΣΕΤ 5 **BRUSHLESS**
ΚΡΟΥΣΤΙΚΟ ΔΡΑΠΑΝΟΚΑΤΣΑΒΙΔΟ 75NM
ΠΑΛΜΙΚΟ ΜΠΟΥΛΟΝΟΚΛΕΙΔΟ 2 ΣΕ 1 - 250NM
ΓΩΝΙΑΚΟ ΤΡΟΧΟ 125MM ΡΥΘΜΙΖΟΜΕΝΟ
YATO  **YT-SET005**

NEO 



2x3Ah



ΠΕΡΙΛΑΜΒΑΝΕΙ:

- ΚΡΟΥΣΤΙΚΟ ΔΡΑΠΑΝΟΚΑΤΣΑΒΙΔΟ 75Nm
- ΠΑΛΜΙΚΟ / ΜΠΟΥΛΟΝΟΚΛΕΙΔΟ 2 ΣΕ 1 - 250Nm
- ΓΩΝΙΑΚΟ ΤΡΟΧΟ 125mm ΡΥΘΜΙΖΟΜΕΝΟ
- ΦΟΡΤΙΣΤΗ ΚΑΙ 2 ΜΠΑΤΑΡΙΕΣ 3.0Ah
- 2 ΠΛΑΣΤΙΚΕΣ ΒΑΛΙΤΣΕΣ ΜΕΤΑΦΟΡΑΣ ΚΑΙ ΥΦΑΣΜΑΤΙΝΗ ΤΣΑΝΤΑ

ΚΩΔ. 201005005
389,00 € 



ΣΕΤ 1
ΚΡΟΥΣΤΙΚΟ ΔΡΑΠΑΝΟΚΑΤΣΑΒΙΔΟ
ΠΑΛΜΙΚΟ ΚΑΤΣΑΒΙΔΙ
YATO  YT-SET001



YATO  YT-7433

ΠΕΡΙΛΑΜΒΑΝΕΙ:

- YT-82789** Κρουστικό δραπανοκατσάβιδο 40Nm
- YT-82801** Παλμικό κατσαβίδι 160 Nm
- YT-82842** 2 μπαταρίες 2Ah
- YT-82848** Ταχυφορτιστής
- YT-7433** Υφασμάτινη τσάντα μεταφοράς

2x2Ah

Το σετ περιλαμβάνει 2 μπαταρίες και 1 φορτιστή για χρήση σε όλα τα εργαλεία του

ΚΩΔ. 201001001
199,00 € ◀



ΣΕΤ 2
ΚΡΟΥΣΤΙΚΟ ΔΡΑΠΑΝΟΚΑΤΣΑΒΙΔΟ
ΠΙΣΤΟΛΕΤΟ SDS PLUS
ΓΩΝΙΑΚΟΣ ΤΡΟΧΟΣ 125MM
YATO  YT-SET002



2x3Ah

Το σετ περιλαμβάνει 2 μπαταρίες και 1 φορτιστή για χρήση σε όλα τα εργαλεία του

ΠΕΡΙΛΑΜΒΑΝΕΙ:

- YT-82789** Κρουστικό δραπανοκατσάβιδο 40Nm
- YT-82770** Πιστολέτο SDS PLUS 2,0J 3 λειτουργιών
- YT-82827** Γωνιακός τροχός 125mm
- YT-82843** 2 μπαταρίες 3Ah
- YT-82848** Ταχυφορτιστής
- YT-7430** Υφασμάτινη τσάντα μεταφοράς & πλαστική βαλίτσα



Υφασμάτινη τσάντα μεταφοράς **YATO  YT-7430** & πλαστική βαλίτσα

ΚΩΔ. 201002002
335,00 € ◀



ΣΕΤ 3
ΚΡΟΥΣΤΙΚΟ ΔΡΑΠΑΝΟΚΑΤΣΑΒΙΔΟ
ΠΑΛΜΙΚΟ ΚΑΤΣΑΒΙΔΙ
ΓΩΝΙΑΚΟΣ ΤΡΟΧΟΣ 125MM
YATO  YT-SET003



2x3Ah

Το σετ περιλαμβάνει 2 μπαταρίες και 1 φορτιστή για χρήση σε όλα τα εργαλεία του

ΠΕΡΙΛΑΜΒΑΝΕΙ:

- YT-82789** Κρουστικό δραπανοκατσάβιδο 40Nm
- YT-82801** Παλμικό κατσαβίδι 160 Nm
- YT-82828** Γωνιακός τροχός 125mm
- YT-82843** 2 μπαταρίες 3Ah
- YT-82848** Ταχυφορτιστής
- YT-7430** Υφασμάτινη τσάντα μεταφοράς



YATO  YT-7430

ΚΩΔ. 201003003
379,00 € ◀

**ΚΡΟΥΣΤΙΚΟ
ΔΡΑΠΑΝΟΚΑΤΣΑΒΙΔΟ
YATO  YT-82789**



**MOTOR
MABUCHI*
CIUVE**



ΚΩΔ. 20182789
63,50 € 

*MABUCHI MOTOR CO LTD JAPAN
5 Τεμ./Κιβώτιο

**ΜΠΟΥΛΟΝΟΚΛΕΙΔΟ
YATO  YT-82805**

ΜΕΓΙΣΤΗ ΡΟΠΗ 300NM
ΥΠΟΔΟΧΗ 1/2" ΚΑΡΕ ΓΙΑ
ΚΑΡΥΔΑΚΙΑ
ΑΡΙΣΤΕΡΗ-ΔΕΞΙΑ ΛΕΙΤΟΥΡΓΙΑ
ΤΑΧΥΤΗΤΑ 0-2200RPM
ΚΡΟΥΣΕΙΣ 0-2700/MIN



ΚΩΔ. 20182805
73,00 € 



5 Τεμ./Κιβώτιο

**ΠΙΣΤΟΛΙ ΘΕΡΜΟΥ ΑΕΡΑ
YATO  YT-82285**



550 °C **100 l/min**

ΚΩΔ. 20182285
49,00 € 

**ΠΙΣΤΟΛΕΤΟ SDS+
18V 24MM
YATO  YT-82772**



4 Τεμ./Κιβώτιο



ΚΩΔ. 20182772
110,00 € 

**ΜΠΑΤΑΡΙΑ 2Ah
YATO  YT-82842**

18V 



ΚΩΔ. 20182842
34,00 € 

**ΜΠΑΤΑΡΙΑ 4Ah
YATO  YT-82844**



ΚΩΔ. 20182844
56,00 € 

**ΦΟΡΤΙΣΤΗΣ
YATO  YT-82848**



ΚΩΔ. 20182848
20,00 € 

220-240V~
50/60Hz



**ΣΕΓΑ
YATO  YT-82823**



ΚΩΔ. 20182823
49,00 € 

5 Τεμ./Κιβώτιο



**ΔΙΣΚΟΠΡΙΟΝΟ
YATO  YT-82811**



ΚΩΔ. 20182811
60,00 € 

2 Τεμ./Κιβώτιο



**ΠΟΛΥΕΡΓΑΛΕΙΟ
YATO  YT-82819**

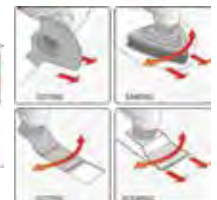

ΚΩΔ. 20182819
49,00 € 

4 Τεμ./Κιβώτιο

18V FAMILY

ΧΩΡΙΣ ΜΠΑΤΑΡΙΑ ΚΑΙ ΦΟΡΤΙΣΤΗ

ΦΟΡΗΤΟΣ ΣΥΜΠΙΕΣΤΗΣ ΑΕΡΑ 18V SOLO YATO YT-82895



1.0 MPa
14 l/min
50 cm



ΠΙΕΣΗ 1MPa
ΔΕΝ ΠΕΡΙΛΑΜΒΑΝΕΙ
ΜΠΑΤΑΡΙΑ Ή ΦΟΡΤΙΣΤΗ

ΚΩΔ. 20182895
38,00 € ◀

5 Τεμ./Κιβώτιο

ΠΡΟΒΟΛΕΑΣ LED YATO YT-82961



1600 lm
2 lighting modes
180 °C
METAL FRAME
TRANSPORT HANDLE

ΚΩΔ. 20182961
39,00 € ◀

ΠΑΛΜΙΚΟ ΤΡΙΒΕΙΟ SOLO YATO YT-82751



18V Li-Ion
13000 rpm
2.0 mm
90x187 mm



ΚΩΔ. 20182751
49,00 € ◀

1 h CHARGING 2.0 Ah
1.5 h CHARGING 3.0 Ah
2 h CHARGING 4.0 Ah
3 h CHARGING 6.0 Ah

ΜΠΑΤΑΡΙΑ 3Ah YATO YT-82843



ΚΩΔ. 20182843
50,00 € ◀

ΦΟΡΤΙΣΤΗΣ ΔΙΠΛΟΣ YATO YT-82849



ΚΩΔ. 20182849
35,00 € ◀

230V~50Hz



ΜΠΑΤΑΡΙΑ 6Ah YATO YT-82845



ΚΩΔ. 20182845
78,00 € ◀

ΕΚΚΕΝΤΡΟ ΤΡΙΒΕΙΟ SOLO YATO YT-82753



18V Li-Ion
0-12000 rpm
2.0 mm
125 mm



ΚΩΔ. 20182753
52,00 € ◀

ΑΝΑΔΕΥΤΗΡΑΣ SOLO YATO YT-82881



M14

ΥΠΟΔΟΧΗ M14
ΡΥΘΜΙΖΟΜΕΝΗ ΤΑΧΥΤΗΤΑ 0-650RPM
ΠΕΡΙΛΑΜΒΑΝΕΙ ΕΞΑΡΤΗΜΑ ΑΝΑΔΕΥΤΗΡΑ

ΚΩΔ. 20182881
83,00 € ◀

ΠΙΣΤΟΛΙ ΣΙΛΙΚΟΝΗΣ ΣΤΟΚΑΔΟΡΟΣ YATO YT-82889



2000 N
0.5-8 mm/s
225 mm

5 Τεμ./Κιβώτιο



ΚΩΔ. 20182889
75,00 € ◀

ΚΑΤΑΛΛΗΛΟ ΓΙΑ ΦΥΣΙΓΓΙΟ
ΜΗΚΟΣ ΦΥΣΙΓΓΙΟΥ 225mm
ΡΥΘΜΙΖΟΜΕΝΗ ΤΑΧΥΤΗΤΑ
ΕΜΒΟΛΟΥ 0,5-8mm/S
ΠΙΕΣΗ ΕΜΒΟΛΟΥ 2000N

ΑΛΟΙΦΑΔΟΡΟΣ YATO YT-82922



18V Li-Ion
2500 rpm
254 Ø mm

ΚΩΔ. 20182922
58,00 € ◀



18V FAMILY

ΧΩΡΙΣ ΜΠΑΤΑΡΙΑ ΚΑΙ ΦΟΡΤΙΣΤΗ



1h CHARGING
2.0 Ah

1.5h CHARGING
3.0 Ah

2h CHARGING
4.0 Ah

3h CHARGING
6.0 Ah

ΕΠΙΛΕΞΤΕ: 1 ΜΠΑΤΑΡΙΑ & 1 ΦΟΡΤΙΣΤΗ για όλα τα εργαλεία 18V FAMILY

ΧΟΡΤΟΚΟΠΤΙΚΟ YATO YT-85010



BRUSHLESS MOTOR

2 x 18 = 36V

ΚΩΔ. 20185010
139,00 € 



ΑΛΥΣΟΠΡΙΟΝΟ **SOLO** YATO YT-82813



2 x 18 = 36V

ΚΩΔ. 20182813
135,00 € 



ΜΠΟΡΝΤΟΥΡΩΦΑΛΙΔΟ YATO YT-82833



ΚΩΔ. 20182833
75,00 € 

18V



ΦΥΣΗΤΗΡΑΣ ΚΗΠΟΥ YATO YT-85175



2 x 18 = 36V

ΚΩΔ. 20185175
89,00 € 



ΠΛΥΣΤΙΚΟ/ΠΙΕΣΤΙΚΟ 18V 23BAR YATO YT-85930



6 Τεμ./Κιβώτιο

18V

ΚΩΔ. 20185930
99,00 € 



Χάρη στη **ΛΕΙΤΟΥΡΓΙΑ ΑΝΑΡΡΟΦΗΣΗΣ** μπορεί να λειτουργεί ακόμα και με νερό από κουβά!!!



ΚΟΝΤΑΡΟΠΡΙΟΝΟ YATO YT-82837

18V



ΚΩΔ. 20182837
95,00 € 

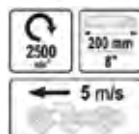

ΨΕΚΑΣΤΙΚΟ YATO YT-86211

18V



ΚΩΔ. 20186211
89,00 € 



**ΑΛΥΣΟΠΡΙΟΝΟ
18V COMPACT
YATO  YT-828135**

18V



ΠΕΡΙΛΑΜΒΑΝΕΙ ΜΠΑΤΑΡΙΑ 2.0Ah ΚΑΙ ΦΟΡΤΙΣΤΗ

Μικρό, εύχρηστο πριόνι μπαταρίας 18 V σχεδιασμένο για κοπή ξύλου σε εργασίες κηπουρικής και ελαφρών κατασκευών. Είναι τέλειο για γρήγορο κλάδεμα κλαδιών δέντρων, θάμνων, κορμών ξύλου και για πολλές άλλες εργασίες κοπής ξύλου.



NEO 



Χαρακτηριστικά:

Λάμα και αλυσίδα: 4" (μήκος 100mm)
Βήμα αλυσίδας: 7,62 mm, Πλάτος αλυσίδας 1,1 mm
Ταχύτητα αλυσίδας: 4,8 m/s, Ταχύτητα περιστροφής: 3200 rpm
Προστασία από τυχαία εκκίνηση, ένδειξη φόρτισης μπαταρίας
Μαλακή και άνετη λαβή, χαμηλό βάρος: 1,1 kg
Το σετ περιλαμβάνει: αλυσίδα πριονιού, κάλυμμα λάμας

ΚΩΔ. 201828135
107,00 € 

**ΚΛΑΔΕΥΤΗΡΙ ΜΠΑΤΑΡΙΑΣ 18V
YATO  YT-828377**

18V



NEO 

ΠΕΡΙΛΑΜΒΑΝΕΙ ΜΠΑΤΑΡΙΑ 2.0Ah ΚΑΙ ΦΟΡΤΙΣΤΗ

ΚΩΔ. 201828377
169,00 € 



**ΧΟΡΤΟΚΟΠΤΙΚΟ SOLO 18V
YATO  YT-82831**

18V

NEO 



ΚΩΔ. 20182831
65,00 € 

**ΓΕΝΝΗΤΡΙΑ INVERTER 42.7CC
YATO  YT-85481**

ΙΣΧΥΣ 800 W
ΣΤΑΘΜΗ ΘΟΡΥΒΟΥ 65 dB
ΚΑΤΑΝΑΛΩΣΗ 0,75 L/h



NEO 

ΚΩΔ. 20185481
249,00 € 

**ΕΠΑΝΑΦΟΡΤΙΖΟΜΕΝΟ
ΚΑΤΣΑΒΙΔΙ ΗΛΕΚΤΡΟΝΙΚΩΝ**

**ΣΕΤ
YATO YT-27930**



ΚΩΔ. 20127930
38,00 €

ΣΕ ΜΕΤΑΛΛΙΚΗ ΚΑΣΕΤΙΝΑ
ΠΕΡΙΛΑΜΒΑΝΕΙ
39 ΕΞΑΡΤΗΜΑΤΑ ΚΑΙ ΜΥΤΕΣ
ΦΟΡΤΙΣΗ USB

3,6V



- 2.5, 3.0, 3.5, 4.0, 4.5 mm; CrV;
- 1.2, 1.6, 2.0, 2.4, 3.0 mm (L=28 mm); CrV;
- PH000, PH00, PH0, PH1 x2 (L=28 mm); CrV
- PZ0 x2, PZ1 x2 (L=28 mm); CrV;
- T4, T5, T6, T7, T8, T9, T10 (L=28 mm); CrV;
- 1.5, 2.0, 2.5, 3.0, 4.0 mm (L=28 mm); CrV;
- S0, S1, S2, S3 (L=28 mm); CrV;
- 60 mm; CrV;
- 120 mm; CrV;



**ΕΠΑΝΑΦΟΡΤΙΖΟΜΕΝΟ
ΚΑΤΣΑΒΙΔΙ 3.6V**

YATO YT-82760



ΚΩΔ. 20182760
16,00 €



ΡΟΠΗ 2NM
ΕΝΣΩΜΑΤΩΜΕΝΗ ΜΠΑΤΑΡΙΑ LI-ION



**ΕΥΘΥΣ
ΛΕΙΑΝΤΗΡΑΣ 750W
ΡΥΘΜΙΖΟΜΕΝΟΣ**

YATO YT-82080



ΚΩΔ. 20182080
79,00 €

8 Τεμ./Κιβώτιο



**ΠΡΙΟΝΟΚΟΡΔΕΛΑ
ΦΟΡΗΤΗ
YATO  YT-82185**



ΣΕ ΠΩΛΗΣΕΙΣ
No 1

ΣΥΜΠΑΓΗΣ ΠΡΙΟΝΟΚΟΡΔΕΛΑ YATO
Για σταθερή ή φορητή χρήση
Γρήγορη κοπή χωρίς σπινθήρες



ΒΑΡΟΣ
6,5 Kg
χωρίς τη βάση

- ▶ Βάση με σφιγκτήρα που κλειδώνει το κομμένο υλικό, αυξάνει την ασφάλεια της εργασίας
- ▶ Λυχνία LED που φωτίζει το σημείο κοπής
- ▶ Ισχύς 1100 W - Ρυθμιζόμενη ταχύτητα της λεπίδας από 0,7-2,4 m / sec.
- ▶ Διάσταση πριονοκορδέλας (περιλαμβάνεται): 14 TPI, 1140 x 12,7 x 0,6 mm
- ▶ Ελαστικό καλώδιο 3 m

ΚΩΔ. 20182185
253,00 € ◀

ΔΙΑΣΤΑΣΕΙΣ ΚΟΠΗΣ	
90°	45°
120x75	50x30
90x90	38x38
Ø 110	Ø 40

1100 W	230-240V-50Hz	1140 x 12,7 x 0,6 mm	127x127 mm
0,7-2,4 m/s	14 TPI	3m	

ΑΝΤΑΛΛΑΚΤΙΚΗ ΠΡΙΟΝΟΚΟΡΔΕΛΑ

ΚΩΔ. 130641014
22,00 €

BI METAL M42 10-14 TPI

1140 x 12,7 x 0,6 mm

**ΤΑΧΥΠΡΙΟΝΟ 355mm
YATO  YT-82181**



2450 W		4000 RPM
230V-50Hz	0-45° CUTTABLE	200°C TEMPERATURE PROOF WINDING
LONG LIFE MOTOR	SOFT START	



ΚΩΔ. 20182181
189,00 € ◀

**ΔΙΣΚΟΙ ΚΟΠΗΣ ΜΕΤΑΛΛΟΥ Ø 355mm
YATO  YT-61132**



NEO 

ΚΩΔ. 20061132
3,95 €

25 Τεμ./Κιβώτιο

**ΣΠΑΘΟΣΕΓΑ
YATO  YT-82281**



1050 W	230-240V-50Hz	3m
0-2500 min ⁻¹	28 mm	

ΚΩΔ. 20182281
75,00 € ◀

4 Τεμ./Κιβώτιο



**ΠΟΛΥΕΡΓΑΛΕΙΟ
YATO  YT-82220**



300W



ΚΩΔ. 20182220
72,00 € ◀

4 Τεμ./Κιβώτιο



RADIAL

ΔΙΣΚΟΠΡΙΟΝΟ RADIAL 255mm
1800W ΞΥΛΟΥ / ΜΕΤΑΛΛΟΥ
YATO  YT-82174

ΔΥΟ ΤΑΧΥΤΗΤΕΣ 2500 - 3800RPM
 ΔΥΝΑΤΟΤΗΤΑ ΚΟΠΗΣ ΩΣ 5mm ΣΕ ΜΕΤΑΛΛΟ
 ΕΥΡΟΣ ΚΟΠΗΣ 70X305mm ΣΕ 90 ΜΟΙΡΕΣ
 ΕΥΡΟΣ ΚΟΠΗΣ 40X210mm ΣΕ 45 ΜΟΙΡΕΣ
 ΔΕΣΜΗ ΛΕΙΖΕΡ ΓΙΑ ΑΚΡΙΒΕΙΑ ΣΤΗΝ ΚΟΠΗ
 ΔΙΣΚΟΣ MULTI 255 X 25.4 X 1.4mm 36T



1800 W	230-240V- 50Hz	25 [mm] 235x25.4x1.4
36T		
METAL	2500 RPM	90°/75 mm 45°/75 mm CUTTING CAPACITY
	3800 RPM	90°/205 mm 45°/210 mm CUTTING CAPACITY



ΚΩΔ. 20182174
279,00 € ◀

ΔΙΣΚΟΠΡΙΟΝΟ RADIAL 305mm
YATO  YT-82175



NEO 

1800 W	230-240V- 50Hz	5000 RPM	25 [mm] 235x305x1.4
90°/125 mm 45°/130 mm CUTTING CAPACITY	90°/340 mm 45°/225 mm CUTTING CAPACITY	40T	



ΚΩΔ. 20182175
376,00 € ◀

ΓΩΝΙΑΚΟΙ ΤΡΟΧΟΙ

ΠΥΘΜΙΖΟΜΕΝΟΣ
YATO  **YT-82101**



ΚΩΔ. 20182101
58,00 € ◀

8 Τεμ./Κιβώτιο

ΠΥΘΜΙΖΟΜΕΝΟΣ
YATO  **YT-82098**



ΚΩΔ. 20182098
65,00 € ◀

YATO  **YT-82097**



SLIM Body



ΚΩΔ. 20182097
42,00 € ◀

6 Τεμ./Κιβώτιο

YATO  **YT-82105**



ΚΩΔ. 20182105
105,00 € ◀

ΚΟΦΤΗΣ ΠΛΑΚΙΔΙΩΝ 125mm

YATO  **YT-82159**



ΚΩΔ. 20182159
96,00 € ◀

ΣΕΓΑ

YATO  **YT-82274**

LOW VIBRATION



ΚΩΔ. 20182274
48,00 € ◀



ΜΕΧΡΙ ΕΞΑΝΤΛΗΣΕΩΣ
ΤΟΥ ΑΠΟΘΕΜΑΤΟΣ



8 Τεμ./Κιβώτιο

ΔΙΣΚΟΠΡΙΟΝΟ

YATO  **YT-82152**



ΚΩΔ. 20182152
79,00 € ◀

2 Τεμ./Κιβώτιο



ΡΟΥΤΕΡ

YATO  **YT-82380**



ΚΩΔ. 20182380
129,00 € ◀

2 Τεμ./Κιβώτιο



ΠΛΑΝΗ

YATO  **YT-82141**



ΚΩΔ. 20182141
58,00 € ◀

6 Τεμ./Κιβώτιο



ΤΑΙΝΙΟΛΕΙΑΝΤΗΡΑΣ

YATO  **YT-82240**



4 Τεμ./Κιβώτιο

ΚΩΔ. 20182240
85,00 € ◀



ΚΡΟΥΣΤΙΚΑ ΔΡΑΠΑΝΑ

YATO  **YT-82034 710W**



710 W
220-240 V-50 Hz
0-2800
T
0-48000 min⁻¹

5 Τεμ./Κιβώτιο

ΚΩΔ. 20182034
47,00 € ◀

ΤΣΟΚ 13mm
ΔΙΑΤΡΗΣΗ ΣΕ ΞΥΛΟ 25mm
& ΜΕΤΑΛΛΟ 13mm
ΔΕΞΙΑ ΚΑΙ ΑΡΙΣΤΕΡΗ ΛΕΙΤΟΥΡΓΙΑ



YATO  **YT-82044 1050W**

2 ΤΑΧΥΤΗΤΩΝ



1050 W
220-240 V-50 Hz
0-1500
0-2800
T
0-48000 min⁻¹

ΚΩΔ. 20182044
84,00 € ◀

ΤΣΟΚ 13mm
ΔΙΑΤΡΗΣΗ ΣΕ ΞΥΛΟ 30mm
& ΜΕΤΑΛΛΟ 13mm
ΔΕΞΙΑ ΚΑΙ ΑΡΙΣΤΕΡΗ
ΛΕΙΤΟΥΡΓΙΑ
5 Τεμ./Κιβώτιο

ΚΑΤΣΑΒΙΔΙΕΡΑ ΓΥΦΟΣΑΝΙΔΑΣ
YATO  **YT-82071**



550 W
230-240V-50Hz
25-55 x3.5 mm
0-5500
mini¹
6.35 mm



ΚΩΔ. 20182071
99,00 € ◀

ΔΡΑΠΑΝΟΚΑΤΣΑΒΙΔΟ
YATO  **YT-82060**



300 W
230V-50Hz
40 Nm
0-400
0-1400
13 mm
4m



ΚΩΔ. 20182060
55,00 € ◀

6 Τεμ./Κιβώτιο

SDS PLUS

YATO  **YT-82122**
850W



ΚΡΟΥΣΗ 3.3 JOULE
ΔΙΑΤΡΗΣΗ ΣΕ: ΜΠΕΤΟ 32mm
ΜΕΤΑΛΛΟ 13mm / ΞΥΛΟ 30mm
ΤΑΧΥΤΗΤΑ 0-1300RPM
ΚΡΟΥΣΕΙΣ 0-5100/MIN
ΠΕΡΙΛΑΜΒΑΝΕΙ ΤΑΧΥΤΣΟΚ 13mm
ΣΕ ΠΛΑΣΤΙΚΗ ΒΑΛΙΤΣΑ

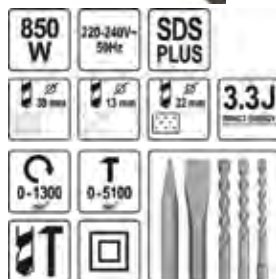

ΜΕ 5 ΕΞΑΡΤΗΜΑΤΑ

ΚΩΔ. 20182122
109,00 € ◀

3 Τεμ./Κιβώτιο

YATO  **YT-82123 1100W**



ΚΡΟΥΣΗ 5 JOULE
ΤΑΧΥΤΗΤΑ 0-850RPM
ΚΡΟΥΣΕΙΣ 0-5000/MIN
ΣΥΣΤΗΜΑ ΕΛΑΙΟΨΥΞΗΣ ΕΜΒΟΛΟΥ
2 ΛΕΙΤΟΥΡΓΙΕΣ
(ΔΙΑΤΡΗΣΗ ΜΕ ΚΡΟΥΣΗ/ΚΑΛΕΜΙΣΜΑ)
ΣΕ ΠΛΑΣΤΙΚΗ ΒΑΛΙΤΣΑ

2 Τεμ./Κιβώτιο

ΚΩΔ. 20182123
106,00 € ◀

SDS MAX 1300W
YATO  **YT-82131**



ΚΡΟΥΣΗ 20 JOULE
ΤΑΧΥΤΗΤΑ 300-540RPM
ΚΡΟΥΣΕΙΣ 0-2900/MIN
3 ΛΕΙΤΟΥΡΓΙΕΣ
(ΔΙΑΤΡΗΣΗ/ΔΙΑΤΡΗΣΗ
ΜΕ ΚΡΟΥΣΗ/ΚΑΛΕΜΙΣΜΑ)
ΣΕ ΠΛΑΣΤΙΚΗ ΒΑΛΙΤΣΑ
ΔΥΝΑΤΟΤΗΤΑ ΔΙΑΤΡΗΣΗΣ ΣΕ ΜΠΕΤΟ
50mm ΜΕ ΑΡΙΔΑ & ΣΕ ΜΠΕΤΟ ΜΕ
ΠΟΤΗΡΟΚΟΡΩΝΑ 150mm



ΚΩΔ. 20182131
219,00 € ◀

ΚΑΤΕΔΑΦΙΣΤΙΚΟ ΠΝΕΥΜΑΤΙΚΟ ΠΙΣΤΟΛΕΤΟ 1600W
YATO  **YT-82001**



ΚΡΟΥΣΗ 65 JOULE
ΥΠΟΔΟΧΗ ΕΞΑΡΤΗΜΑΤΩΝ HEX (ΕΞΑΓΩΝΟ)
ΚΡΟΥΣΕΙΣ 0-1900/MIN
ΣΥΣΤΗΜΑ ΕΛΑΙΟΨΥΞΗΣ ΕΜΒΟΛΟΥ
ΠΕΡΙΛΑΜΒΑΝΕΙ ΒΕΛΟΝΙ ΚΑΙ ΚΑΛΕΜΙ

ΚΩΔ. 20182001
259,00 € ◀

ΦΥΣΗΤΗΡΑΣ
YATO  **YT-85170**



ΚΩΔ. 20185170
35,00 € ◀

4 Τεμ./Κιβώτιο

ΤΡΙΒΕΙΑ

YATO  YT-82230

260 W



ΚΩΔ. 20182230
47,00 € ◀

4 Τεμ./Κιβώτιο



YATO  YT-82234

300 W



ΚΩΔ. 20182234
75,00 € ◀

4 Τεμ./Κιβώτιο



ΕΚΚΕΝΤΡΟ ΠΕΡΙΣΤΡΟΦΙΚΟ ΤΡΙΒΕΙΟ
YATO  YT-82207



ΚΩΔ. 20182207
67,00 € ◀

ΑΛΟΙΦΑΔΟΡΟΣ
YATO  YT-82196

1400 W



ΚΩΔ. 20182196
120,00 € ◀

2 Τεμ./Κιβώτιο

ΑΛΟΙΦΑΔΟΡΟΣ
720W 150mm
YATO  YT-82200

NEO 



ADDITIONAL PADS / DODATKOWE KRĄŻKI



ΚΩΔ. 20182200
114,00 € ◀

4 Τεμ./Κιβώτιο

ΤΡΙΒΕΙΑ

ΤΡΙΒΕΙΟ ΤΟΙΧΟΥ
YATO **YT-82340**



ΚΩΔ. 20182340
119,00 € ◀

1220 W	230V~50Hz	1500-2300	GRIT 60, 80, 100 120, 180, 240
∅ 210 mm	∅ 215 mm	∅ 225 mm	

2 Τεμ./Κιβώτιο

ΤΡΙΒΕΙΟ ΤΟΙΧΟΥ - ΜΠΕΤΟΥ
YATO **YT-82341**



ΚΩΔ. 20182341
165,00 € ◀

1300 W	230-240V~50Hz	600-1750
	M14	
∅ 180 mm		

2 Τεμ./Κιβώτιο

x3 **ΑΝΤΑΛΛΑΚΤΙΚΑ ΤΡΙΒΕΙΩΝ**

	SOFT	HARD	DELTA	28 cm	PERFORATION
P					
60	YT-84570 4,80 €	YT-84580 4,80 €	YT-84610 5,00 €	YT-84600 7,70 €	YT-84600 7,70 €
80	YT-84571 4,80 €	YT-84581 5,25 €	YT-84611 5,00 €	YT-84601 7,70 €	YT-84601 7,70 €
120	YT-84573 5,60 €	YT-84583 4,80 €	YT-84613 5,75 €	YT-84602 7,70 €	YT-84602 7,70 €
180	YT-84575 5,60 €	YT-84585 4,85 €	YT-84615 5,75 €	YT-84605 7,70 €	YT-84605 7,70 €

ΛΕΙΑΝΤΗΣ ΜΠΕΤΟΝ
YATO **YT-60323**
∅ 180mm - 6600rpm



ΚΩΔ. 20060323
24,25 €

10 Τεμ./Κιβώτιο

ΤΡΙΒΕΙΟ ΚΑΜΗΛΟΠΑΡΔΑΛΗ
ΤΟΙΧΟΥ/ΓΥΦΟΣΑΝΙΔΑΣ

YATO **YT-82350**



ΚΩΔ. 20182350
215,00 € ◀

710 W	230-240V~50Hz	600-1500 min⁻¹ 3000-6000 min⁻¹	225 mm	M6
∅ 225 mm	∅ 215 mm	∅ 210 mm	GRIT 60, 80, 100 120, 180, 240	

YATO **YT-82355**
820 W



ΚΩΔ. 20182355
249,00 € ◀

230-240V~50/60Hz	820 W	600-1900 min⁻¹	max 165 cm
∅ 215 mm	∅ 210 215 225 mm	M6	LED LIGHTING

2 Τεμ./Κιβώτιο

**ΑΝΑΔΕΥΤΗΡΑΣ
YATO  YT-82607**



1600 W 220-240V-50/60Hz 180-400-500-750mm³ M14 160 mm 140L

ΚΩΔ. 20182607
119,00 € ◀

**ΠΙΣΤΟΛΙ ΒΑΦΗΣ
YATO  YT-82553**



ΚΩΔ. 20182553
62,00 € ◀

600 W 220-240V-50Hz 2.6 mm 1.0 l/min 1000 ml

6 Τεμ./Κιβώτιο

**ΚΑΡΟΤΙΕΡΑ 2200W
YATO  YT-81980**



2200 W 230V-50Hz 1 1/4" 32 mm 1200 14" 6.3 mm

NEO 



ΚΩΔ. 20181980
289,00 € ◀

ΔΟΝΗΤΗΣ ΜΠΕΤΟΝ

**ΔΟΝΗΤΗΣ ΜΠΕΤΟΝ
YATO  YT-82600**



ΠΕΡΙΛΑΜΒΑΝΕΙ ΑΚΡΟ
3.5m / 35mm

1200 W 230V-50Hz 5000 35 mm 3.5m

ΚΩΔ. 20182600
106,00 € ◀

ΑΝΤΑΛΛΑΚΤΙΚΟ
ΜΑΡΚΟΥΤΣΙ
ΚΩΔ. ΖΥ 82600-29
49,00 €

**ΔΟΝΗΤΗΣ ΜΠΕΤΟΝ 2300W
YATO  YT-82601**



NEO 

2300 W 230V-50Hz 4000 35 mm 4m

ΚΩΔ. 20182601
209,00 € ◀



**ΚΟΦΤΗΣ ΜΠΕΤΟΥ
YATO  YT-84820**



4 kW 4700 1/2" 12.5 mm 93.6 cm³ 15 40 : 1 1.0

ΚΩΔ. 20184820
879,00 € ◀



YATO  YT-60004
ΔΙΑΜΑΝΤΟΔΙΣΚΟΣ
ΒΕΝΖΙΝΟΚΙΝΗΤΟΥ
ΚΟΦΤΗ ΜΠΕΤΟΝ 400MM
ΓΙΑ ΥΓΡΗ ΚΑΙ ΞΗΡΑ ΚΟΠΗ
Ø d 25,4mm / D 3,6mm / H 10mm

3350mm³ max 400 80 mm
ΚΩΔ. 20060004
69,00 €

**ΑΝΤΛΙΑ ΑΚΑΘΑΡΤΩΝ ΥΔΑΤΩΝ
YATO  YT-85343**

1100 W 230V-50Hz Q max 17800 l/h

INOX

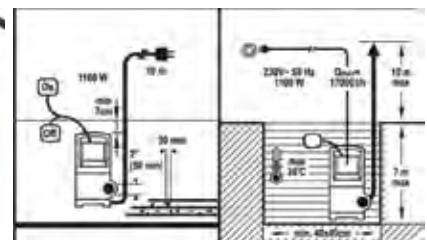

Q [m]	Q [l/h]
0	17000
1	16000
2	14000
3	12000
4	10000
5	8000
6	6000
7	4000
8	2000
9	1000
10	500
11	200
12	100
13	50
14	20
15	10
16	5
17	0

3 Τεμ./Κιβώτιο



ΚΩΔ. 20185343
89,00 € ◀

ΣΚΟΥΠΕΣ

YATO  YT-85701



1400 W
220-240 V-50/60 Hz
30 l
18 kPa
2000 W
WET AND DRY
POWER SOCKET
IPX4

ΚΩΔ. 20185701
119,00 € ◀

YATO  YT-85715



220-240 V-50/60 Hz
30 l
BLOW FUNCTION
POWER SOCKET
WET AND DRY
2000 W (max)
18 kPa
IPX4
1600 W

ΚΩΔ. 20185715
279,00 € ◀

YATO  YT-85710



220-240 V-50/60 Hz
70 l
WET AND DRY ADJUSTABLE POWER
18 kPa
IPX4

2400 W

ΚΩΔ. 20185710
229,00 € ◀

ΠΛΑΣΤΙΚΟ/ΠΙΕΣΤΙΚΟ
1400W 105 BAR
YATO  YT-85910



1400 W
230-240V-50Hz
10.5 MPa (max)
7 MPa
5 l/min
IPX5

ΚΩΔ. 20185910
99,00 € ◀

NEO 

ΠΛΑΣΤΙΚΟ/ΠΙΕΣΤΙΚΟ
2000W 150 BAR
YATO  YT-85915



2000 W

NEO 

ΚΩΔ. 20185915
179,00 € ◀

220-240V-50Hz
15 MPa (max)
10 MPa
6 l/min
IPX5

ΣΑΚΟΥΛΕΣ

x3

YATO  ΣΑΚΟΥΛΑ ΓΙΑ ΣΚΟΥΠΑ €
YT-85730 YT-85710 11,70
YT-85731 YT-85701 10,70

ΦΙΛΤΡΑ

YATO  ΦΙΛΤΡΑ ΓΙΑ ΣΚΟΥΠΑ €
YT-85738 YT-85701 16,20
YT-85739 YT-85710 18,30

ΠΙΣΤΟΛΙΑ ΘΕΡΜΟΚΟΛΛΑΣ

YATO  YT-82401 **35W**

ΚΟΛΛΑ 11mm
ΡΥΘΜΙΣΗ ΘΕΡΜΟΚΡΑΣΙΑΣ
150-200°C

NEO 



ΚΩΔ. 20182401
15,00 € ◀

230V~50Hz
35(400) W
150-200 °C
3-6 min
15 g/min
2x
11 mm

YATO  YT-82403 **30W**

ΚΟΛΛΑ 11mm
ΤΑΧΕΙΑ ΘΕΡΜΑΝΣΗ ΚΟΛΛΑΣ
ΡΟΗ ΚΟΛΛΑΣ 20GR/MIN



NEO 

ΚΩΔ. 20182403
24,00 € ◀

230-240V-50Hz
30(450) W
100-200 °C
3-5 min
20 g/min
11 mm
1.5 m

ΠΙΣΤΟΛΙΑ ΘΕΡΜΟΥ ΑΕΡΑ

YATO  YT-82294



2000 W	220-240V- 50Hz	450/600 °C
250-500 l/min		

ΚΩΔ. 20182294
26,00 € 

YATO  YT-82295



3 ΤΑΧΥΤΗΤΩΝ

2000 W	220-240V- 50/60Hz	50-600 °C
250-500 l/min	TEMPERATURE REGULATION	

ΚΩΔ. 20182295
48,00 € 

YATO  YT-82296



1600 W	220-240V- 50/60Hz	50-650 °C
250-500 l/min	LCD DISPLAY	

ΚΩΔ. 20182296
66,00 € 

ΜΑΧΑΙΡΙ ΠΟΛΥΣΤΕΡΙΝΗΣ ΘΕΡΜΙΚΟ
YATO  YT-82190



230V- 50Hz	220 W	70-450 °C				LED
---------------	----------	--------------	---	---	---	-----

ΚΩΔ. 20182190
45,00 € 

ΚΟΛΛΗΤΗΡΙ

YATO  YT-82451

230V- 50Hz	200 W
	



ΚΩΔ. 20182451
30,00 € 

ΚΟΛΛΗΤΗΡΙΑ

YATO  YT-8272 - 60W

YATO  YT-8273 - 80W



80W	230V- 50Hz
520°C	TIP 2.5x3x6mm

60 W

ΚΩΔ. 20108272
10,00 € 

80 W

ΚΩΔ. 20108273
11,00 € 

ΣΤΑΘΜΟΣ ΣΥΓΚΟΛΛΗΣΗΣ

YATO  YT-82458

75W
ΠΑΡΟΧΗ ΘΕΡΜΟΥ ΑΕΡΑ
750W

220-240V- 50Hz	900M	120 l/min
750 W	100-480 °C	+/-2 °C
75 W	200-480 °C	+/-1 °C
LED DISPLAY	ESD SAFE	



ΚΩΔ. 20182458
85,00 € 

ΣΤΑΘΜΟΣ ΣΥΓΚΟΛΛΗΣΗΣ

YATO  YT-82459

70W

ΚΩΔ. 20182459
47,00 € 

70 W	220-240V- 50Hz	200-480 °C
+/-1 °C	900M	ESD SAFE
LED DISPLAY		





ΨΗΦΙΑΚΟΣ ΑΝΙΧΝΕΥΤΗΣ

ΚΩΔΙΚΟΣ	YATO	ΣΥΣΚ	€/ΤΕΜ
20173131	YT-73131	40	▶ 43,00



NEO

4in1
4w1
9V
6F22
6h

ΥΓΡΑΣΙΟΜΕΤΡΟ 4ΣΕ1

ΑΝΙΧΝΕΥΤΗΣ ΤΟΙΧΟΥ/ΤΑΣΗΣ

ΚΩΔΙΚΟΣ	YATO	ΣΥΣΚ	€/ΤΕΜ
20173138	YT-73138		▶ 66,00



0.2-2.9% WALL/WOODRY
6-60% WOOD
AUTO POWER OFF
10 mm MAX DEPTH
LCD DISPLAY
CE

NEO

0,2-60%



ΜΕΤΡΟ LASER

ΚΩΔΙΚΟΣ	YATO	ΣΥΣΚ	€/ΤΕΜ
20173127	YT-73127	20	▶ 69,00

ΥΓΡΑΣΙΟΜΕΤΡΟ ΗΛΕΚΤΡΟΝΙΚΟ

ΚΩΔΙΚΟΣ	YATO	ΣΥΣΚ	€/ΤΕΜ
20173141	YT-73141	20	▶ 26,00



NEO

ΘΕΡΜΟΜΕΤΡΟ ΗΛΕΚΤΡΟΝΙΚΟ

ΚΩΔΙΚΟΣ	YATO	ΣΥΣΚ	€/ΤΕΜ
20173201	YT-73201		▶ 34,00



Laser - 40 m



ΜΕΤΡΟ LASER ΣΤΑΥΡΟΣ LASER ΜΕΤΡΟΤΑΙΝΙΑ

LASER 3 ΣΕ 1

ΚΩΔΙΚΟΣ	YATO	ΣΥΣΚ	€/ΤΕΜ
20173122	YT-73122		▶ 48,00

ΨΗΦΙΑΚΑ ΑΛΦΑΔΙΑ



ΑΛΟΥΜΙΝΙΟΥ ΜΑΓΝΗΤΙΚΟ 400mm

ΚΩΔΙΚΟΣ **YATO** ΣΥΣΚ **€/ΤΕΜ**
 20130397 YT-30397 ▶ **31,00**

610 mm
2 PRECISION WALLS
 ALUMINUM HIGH QUALITY PRECIS 2
 ACCURACY
 0.027" ± 0.5 mm/m
 LASER ACCURACY
 ± 0.3 mm / 10 m
 WORK TEMPERATURE
 0°C-60°C



LASER L-610mm

ΚΩΔΙΚΟΣ **YATO** ΣΥΣΚ **€/ΤΕΜ**
 20130400 YT-30400 ▶ **49,00**



ΜΕ ΟΘΟΝΗ LED 150mm

ΚΩΔΙΚΟΣ **YATO** ΣΥΣΚ **€/ΤΕΜ**
 20130395 YT-30395 ▶ **38,00**

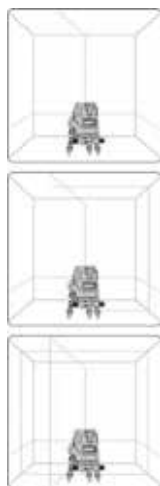

5 ΓΡΑΜΜΩΝ



± 2mm / 10m
 0°C-40°C
 ± 3°
 25m RANGE
 CLASS II
 515Nm LASER ENERGY
 3.7V 1800mAh
IP54

LASER ΠΡΑΣΙΝΗΣ ΔΕΣΜΗΣ

ΚΩΔΙΚΟΣ **YATO** ΣΥΣΚ **€/ΤΕΜ**
 20130432 YT-30432 8 ▶ **172,00**



LASER ΠΛΑΚΑΔΩΝ

ΚΩΔΙΚΟΣ **YATO** ΣΥΣΚ **€/ΤΕΜ**
 20130410 YT-30410 ▶ **47,00**

ΦΟΡΤΙΣΤΕΣ / ΣΥΝΤΗΡΗΤΕΣ ΜΠΑΤΑΡΙΑΣ ΑΥΤΟΚΙΝΗΤΟΥ

YATO  **YT-83033**

NEO 



ΑΥΤΟΜΑΤΗ ΛΕΙΤΟΥΡΓΙΑ ΦΟΡΤΙΣΗΣ / ΣΥΝΤΗΡΗΣΗΣ
ΣΥΜΒΑΤΟΣ ΜΕ 6V-12V
4A MAX
ΚΑΤΑΛΛΗΛΟΣ ΓΙΑ ΜΠΑΤΑΡΙΕΣ
WET/GEL/AGM
120Ah MAX

ΚΩΔ. 20183033
39,00 € ◀ 20 Τεμ./Κιβώτιο



4A MAX
YATO  **YT-83000**

2A
4A



ΚΩΔ. 20183000
28,00 € ◀



ΑΥΤΟΜΑΤΗ ΛΕΙΤΟΥΡΓΙΑ
ΦΟΡΤΙΣΗΣ / ΣΥΝΤΗΡΗΣΗΣ
ΣΥΜΒΑΤΟΙ ΜΕ 6V-12V
ΚΑΤΑΛΛΗΛΟΙ ΓΙΑ ΜΠΑΤΑΡΙΕΣ
WET/GEL/AGM
200Ah MAX

8A MAX
YATO  **YT-83001**

2A
8A



ΚΩΔ. 20183001
45,00 € ◀

YATO  **YT-8301**



8 Τεμ./Κιβώτιο

ΚΩΔ. 20108301
56,00 € ◀

YATO  **YT-83003**



ΑΥΤΟΜΑΤΗ ΛΕΙΤΟΥΡΓΙΑ ΦΟΡΤΙΣΗΣ / ΣΥΝΤΗΡΗΣΗΣ
ΣΥΜΒΑΤΟΣ ΜΕ 12V
15A MAX
ΚΑΤΑΛΛΗΛΟΣ ΓΙΑ ΜΠΑΤΑΡΙΕΣ WET/GEL/AGM
200Ah MAX

ΚΩΔ. 20183003
79,00 € ◀

NEO 



YATO  **YT-8302**



8 Τεμ./Κιβώτιο

ΚΩΔ. 20108302
86,20 € ◀

ΦΟΡΤΙΣΤΗΣ & BOOSTER

YATO  **YT-83051**

NEO 



2 Τεμ./Κιβώτιο

ΚΩΔ. 20183051
129,00 € ◀

ΜΠΑΤΑΡΙΑΣ ΜΕΓΙΣΤΗ
ΧΩΡΗΤΙΚΟΤΗΤΑ
ΜΠΑΤΑΡΙΑΣ 300Ah
ΙΣΧΥΣ 15A
12 / 24V



**POWER BANK
& STARTER
9000 mAh
YATO  YT-83081**



ΚΩΔ. 20183081
75,00 € ◀



**POWER BANK
& STARTER
12.000 mAh
YATO  YT-83082**



ΚΩΔ. 20183082
82,00 € ◀

10 Τεμ./Κιβώτιο

**ΑΕΡΟΣΥΜΠΙΕΣΤΗΣ
ΑΥΤΟΚΙΝΗΤΟΥ 12V
YATO  YT-73462**



ΠΑΡΟΧΗ 60LT/MIN
ΠΙΕΣΗ 1MPa



ΚΩΔ. 20173462
41,00 € ◀

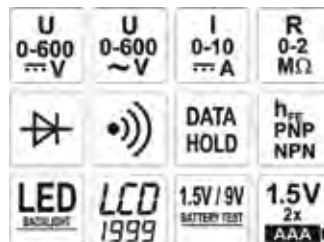

NEO 

ΨΗΦΙΑΚΟ ΠΟΛΥΜΕΤΡΟ

ΚΩΔΙΚΟΣ **YATO ** ΣΥΣΚ **€/ΤΕΜ**
20173081 YT-73081 ▶ **11,00**

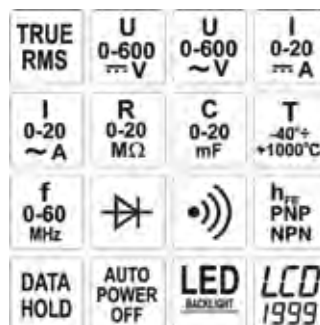

NEO 

ΨΗΦΙΑΚΟ ΠΟΛΥΜΕΤΡΟ

ΚΩΔΙΚΟΣ **YATO ** ΣΥΣΚ **€/ΤΕΜ**
20173083 YT-73083 ▶ **33,00**



TRUE RMS	U 0-600 ~V	U 0-600 ~V	I 0-10 ~A
I 0-10 ~A	R 0-60 MΩ	C 0-60 mF	0.1%+99%
f 0-60 MHz	T -40°+ +1370°C		
AUTO RANGE	AUTO POWER OFF	DATA HOLD	h _{FE} PNP NPN
MAX & MIN VALUE DISPLAY	LED BACKLIGHT	LCD 5999	
FOR YT-73085	9V 6F22		



NEO

ΨΗΦΙΑΚΟ ΠΟΛΥΜΕΤΡΟ

ΚΩΔΙΚΟΣ **YATO** ΣΥΣΚ **€/TEM**
20173085 YT-73085 ▶ **38,00**



AUTO POWER OFF	
NEO	

ΜΕ ΜΕΤΡΗΣΗ ΘΕΡΜΟΚΡΑΣΙΑΣ

L1 L2 L3	U 0-600 ~V	U 0-600 ~V	I 0-10 ~A	I 0-10 ~A	R 0-40 MΩ
C 0-100 μF	f 100 kHz	5%+95%	T -20°+ +1000°C		AUTO RANGE

ΠΟΛΥΜΕΤΡΟ & ΦΑΣΗΜΕΤΡΟ

ΚΩΔΙΚΟΣ **YATO** ΣΥΣΚ **€/TEM**
20173086 YT-73086 ▶ **71,95**

5 in 1	U 0-600 ~V	U 0-600 ~V	I 0-10 ~A	I 0-10 ~A	R 0-40 MΩ
5 w 1	C 0-100 μF	f 200 kHz	1%+99%	T -20°+ +1000°C	%RH 30%+ 90%
		AUTO RANGE	AUTO POWER OFF		



NEO



ΛΟΥΞΟΜΕΤΡΟ & ΥΓΡΟΜΕΤΡΟ

ΚΩΔΙΚΟΣ **YATO** ΣΥΣΚ **€/TEM**
20173087 YT-73087 ▶ **97,00**



- ΜΕΤΡΗΣΗ:**
- ▶ ΗΛΕΚΤΡΙΚΩΝ ΤΙΜΩΝ AC/DC
 - ▶ ΘΕΡΜΟΚΡΑΣΙΑΣ
 - ▶ ΥΓΡΑΣΙΑΣ
 - ▶ ΦΩΤΕΙΝΟΤΗΤΑΣ
 - ▶ ΕΝΤΑΣΗΣ ΗΧΟΥ

NEO

	3V 2x AAA	U A.C. 0-600V	U D.C. 0-600V	I A.C. 0-600A	R 0-60 MΩ	V A.C. VFC	LOW IMPEDANCE MODE	LED BACKLIGHT
TRUE RMS	DATA HOLD		CONTINUITY TEST	LCD 5999			AUTO POWER OFF	AUTO RANGE

ΑΜΠΕΡΟΤΣΙΜΠΙΔΑ

ΚΩΔΙΚΟΣ **YATO** ΣΥΣΚ **€/TEM**
20173092 YT-73092 ▶ **30,00**



TRUE RMS	LCD 6000	0-600V A.C.
0-600V D.C.	0-600A A.C.	0-600A D.C.
0-60 MΩ	0-60 mF	0-10 MHz
°C -30 +1000		
NCV		AUTO RANGE
DATA HOLD	PEAK HOLD	
LED BACKLIGHT	AUTO POWER OFF	2x AAA

0-600V AC/DC
0-600A AC/DC

NEO

ΑΜΠΕΡΟΤΣΙΜΠΙΔΑ

ΚΩΔΙΚΟΣ **YATO** ΣΥΣΚ **€/TEM**
20173093 YT-73093 ▶ **49,00**

ΚΡΟΥΣΤΙΚΟ ΔΡΑΠΑΝΟΚΑΤΣΑΒΙΔΟ

STHOR 78974

18V



ΚΩΔ. 22078974

55,00 €

με μπαταρία & φορτιστή

ΒΑΡΟΣ 1,9 Kg

ΠΙΣΤΟΛΙ ΘΕΡΜΟΚΟΛΛΑΣ

STHOR 78154

7,2V



ΚΩΔ. 22078154

27,00 €

ΒΑΡΟΣ 1 Kg

ΚΡΟΥΣΤΙΚΟ ΔΡΑΠΑΝΟ

STHOR 78992

600 W



ΚΩΔ. 22078992

32,00 €

ΒΑΡΟΣ 1,85 Kg

ΚΡΟΥΣΤΙΚΟ ΔΡΑΠΑΝΟ

STHOR 78995

710 W



ΚΩΔ. 22078995

36,00 €

ΒΑΡΟΣ 2,05 Kg

ΕΚΚΕΝΤΡΟ ΤΡΙΒΕΙΟ

STHOR 79309

430 W



ΚΩΔ. 22079309

49,00 €

ΒΑΡΟΣ 2,2 Kg

ΠΑΛΜΙΚΟ ΤΡΙΒΕΙΟ

STHOR 79491

135 W



ΚΩΔ. 22079491

19,00 €

ΒΑΡΟΣ 1,2 Kg

ΔΙΣΚΟΠΡΙΟΝΟ

STHOR 79257

1400 W



ΚΩΔ. 22079257

70,85 €

ΒΑΡΟΣ 4,4 Kg



ΠΛΑΝΗ

STHOR 79416

600 W



ΚΩΔ. 22079416

46,00 €

ΒΑΡΟΣ 2,55 Kg



ΑΝΤΛΙΑ ΑΚΑΘΑΡΤΩΝ ΥΔΑΤΩΝ

500 W

STHOR 79782

600 W

STHOR 79783

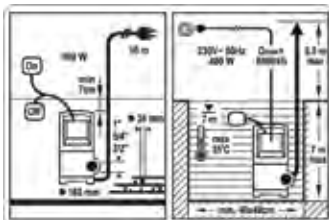

IPX8 Protection grade

500 W 10000 l/h max H 6.5m
600 W 11500 l/h max H 7.0m



ΚΩΔ. 22079782
500 W

51,00€

ΚΩΔ. 22079783
600 W

52,00 €



ΠΙΣΤΟΛΙ ΘΕΡΜΟΥ ΑΕΡΑ
STHOR 79320

230V



ΚΩΔ. 22079320
16,90 €

ΦΥΣΗΤΗΡΑΣ
STHOR 79662

400 W

ΣΕ ΠΩΛΗΣΕΙΣ
No1



ΚΩΔ. 22079662
22,00 €

ΒΑΡΟΣ 1,73 Kg

ΠΙΣΤΟΛΙ ΘΕΡΜΟΚΟΛΛΑΣ
STHOR 73052

230V



ΚΩΔ. 22073052
7,50 €

ΚΟΛΛΗΤΗΡΙ ΠΛΑΣΤΙΚΩΝ & PVC ΣΩΛΗΝΩΝ
STHOR 78912

300°C 750W & 1500W



ΚΩΔ. 22078912
51,00 €

ΑΚΟΝΙΣΤΗΡΙ
STHOR 73473

150 W



ΚΩΔ. 22073473
54,00 €
ΒΑΡΟΣ 1,76 Kg

ΠΟΛΥΕΡΓΑΛΕΙΟ ΤΥΠΟΥ DREMEL
LUND 79314

LUND 79314



40 ΕΞΑΡΤΗΜΑΤΑ

ΚΩΔ. 28079314
29,00 €



ΑΝΤΑΛΛΑΚΤΙΚΕΣ ΠΕΤΡΕΣ
ΓΙΑ ΤΟ ΑΚΟΝΙΣΤΗΡΙ 73473
STHOR 73473-1

ΣΕΤ 3 ΤΕΜΑΧΙΩΝ

ΚΩΔ. 22073473-1
9,00 €

ΣΚΟΥΠΑΚΙΑ



STHOR 82954

ΚΩΔ. 22082954

24,00 €



STHOR 82952

ΚΩΔ. 22082952

16,30 €



STHOR 82953

ΚΩΔ. 22082953

35,00 €

COMPRESSOR

STHOR 82107



STHOR 82105

ΚΩΔ. 22082105

15,00 €



ΚΩΔ. 22082107

21,00 €



FOR 115 mm FOR 125 mm

NEO

ΒΑΣΗ ΤΡΟΧΟΥ

ΚΩΔΙΚΟΣ **VOREL** ΣΥΣΚ €/ΤΕΜ
21179641 79641 4 **33,50**



NEO



ΒΑΣΗ ΔΡΑΠΑΝΟΥ

ΚΩΔΙΚΟΣ **VOREL** h(mm) ΣΥΣΚ €/ΤΕΜ
21179640 79640 400 10 **27,00**



ΕΞΑΡΤΗΜΑΤΑ ΗΛΕΚΤΡΙΚΩΝ ΕΡΓΑΛΕΙΩΝ



ΕΞΑΡΤΗΜΑΤΑ

ΗΛΕΚΤΡΙΚΩΝ ΕΡΓΑΛΕΙΩΝ [45 - 97]

Τρυπάνια Μπετού | Μετάλλων | Ξύλου

Λειαντικά | Λάμες | Συρματόβουρτσες

Μύτες | Δίσκοι | Ποτηροτρύπανα

ΔΙΑΜΑΝΤΟΤΡΥΠΑΝΑ ΜΠΕΤΟΥ YG-8C

Για μπετό και δομικά υλικά
Μύτη από καρβίδιο, προδιαγραφής YG-8C
Στέλεχος σκληρότητας 40CR - HRC47



7
pcs

ΣΕΤ 7 ΤΜΧ.

ΚΩΔΙΚΟΣ	YATO 	ø(mm)	ΣΥΣΚ	€/ΤΕΜ
20004390	YT-4390	4,5,6,8,9,10,12	10	7,45

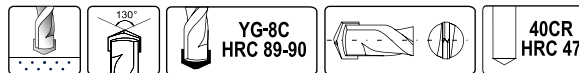

ΚΩΔΙΚΟΣ **YATO**  ø x L(mm) ΣΥΣΚ €/ΤΕΜ

ΚΟΝΤΑ				
20004361	YT-4361	4x70	100	0,63
20004362	YT-4362	5x90	100	0,70
20004363	YT-4363	6x100	100	0,80
20004367	YT-4367	7x100	75	0,89
20004369	YT-4369	8x120	75	0,95
20004375	YT-4375	10x120	75	1,22
20004379	YT-4379	12x150	50	1,60
20004383	YT-4383	14x180	25	2,00
20004385	YT-4385	16x180	25	2,80
ΜΑΚΡΙΑ				
20004364	YT-4364	6x150	100	0,89
20004370	YT-4370	8x200	50	1,20
20004376	YT-4376	10x200	50	1,43
20004380	YT-4380	12x200	50	1,90

ΤΡΥΠΑΝΙΑ UNIVERSAL

Για όλα τα υλικά και για γρανίτη
Μύτη από καρβίδιο, προδιαγραφής YG-8
Στέλεχος σκληρότητας HRC90-92



**ΕΝΑ ΤΡΥΠΑΝΙ
ΓΙΑ ΟΛΑ ΤΑ ΥΛΙΚΑ**

& ΓΙΑ ΓΡΑΝΙΤΗ

NEO



ΚΩΔΙΚΟΣ **YATO**  ø x L(mm) €/ΤΕΜ

ΚΟΝΤΑ				
20043941	YT-43941	4x75		0,84
20043942	YT-43942	5x85		0,86
20043943	YT-43943	6x100		1,05
20043945	YT-43945	8x120		1,35
20043946	YT-43946	10x150		1,75
20043947	YT-43947	12x150		2,05
ΜΑΚΡΙΑ				
20043960	YT-43960	6x400		2,55
20043962	YT-43962	8x400		3,30
20043963	YT-43963	10x400		3,75
20043964	YT-43964	12x400		4,05
20043965	YT-43965	14x400		4,30
20043966	YT-43966	16x400		6,05
20043967	YT-43967	18x400		6,20
20043968	YT-43968	20x400		6,80

YG8
TIP

HRC
90-92



ΤΡΥΠΑΝΙΑ UNIVERSAL HEX

Για όλα τα υλικά
Μύτη από καρβίδιο, προδιαγραφής YG-8C
Στέλεχος σκληρότητας HRC89-91

NEO



ΚΩΔΙΚΟΣ **YATO**  ø x L(mm) €/ΤΕΜ

20044780	YT-44780	3x85		1,25
20044781	YT-44781	4x85		1,35
20044782	YT-44782	5x85		1,45
20044783	YT-44783	6x85		1,50
20044784	YT-44784	7x85		1,60
20044785	YT-44785	8x100		1,75
20044786	YT-44786	10x120		2,20
20044787	YT-44787	12x120		2,70

NEO

5
pcs

ΣΕΤ 5 ΤΜΧ. HEX

ΚΩΔΙΚΟΣ	YATO 	ø(mm)	ΣΥΣΚ	€/ΤΕΜ
20044789	YT-44789	4-10		6,80



ΔΙΑΜΑΝΤΟΤΡΥΠΑΝΑ SDS PLUS



3 POINT TIP



SDS PLUS

3 POINT TIP DK-30

DOUBLE SPIRAL



ΚΩΔΙΚΟΣ	YATO 	ø x L(mm)	€/ΤΕΜ
20004161	YT-4161	5x110	1,27
20004162	YT-4162	6x110	1,39
20004163	YT-4163	6x160	1,60
20004164	YT-4164	6x210	1,75
20041641	YT-41641	6.5x200	2,45
20041642	YT-41642	6.5x260	2,75
20004165	YT-4165	8x110	1,60
20004166	YT-4166	8x160	1,70
20004167	YT-4167	8x210	2,10
20004168	YT-4168	8x460	3,90
20004169	YT-4169	8x600	4,60
20004170	YT-4170	10x160	1,75
20004171	YT-4171	10x210	2,05
20004172	YT-4172	10x300	2,80
20004173	YT-4173	10x460	3,75
20004174	YT-4174	10x600	4,00
20004175	YT-4175	12x160	2,15
20004176	YT-4176	12x260	2,60
20004177	YT-4177	12x460	4,05
20004178	YT-4178	12x600	4,95
20004179	YT-4179	14x260	3,20
20004180	YT-4180	14x460	5,20
20004181	YT-4181	16x200	3,85
20004182	YT-4182	16x300	4,65
20004183	YT-4183	16x460	6,10
20004184	YT-4184	16x600	7,45
20004185	YT-4185	18x460	7,40
20004186	YT-4186	18x600	9,60
20004187	YT-4187	20x460	9,30
20004188	YT-4188	20x600	11,55
20004189	YT-4189	22x460	13,00
20004190	YT-4190	22x600	13,35
20004191	YT-4191	25x460	13,15
20004192	YT-4192	25x600	16,85



ΤΕΤΡΑΚΟΠΟ Χ-TIP

Για σπλισμένο σκυρόδεμα



SDS PLUS

X-TIP OD CARBIDE



ΚΩΔΙΚΟΣ	YATO 	ø x L(mm)	€/ΤΕΜ
20041930	YT-41930	5x110	2,05
20041935	YT-41935	5x160	2,55
20041931	YT-41931	6x110	2,30
20041936	YT-41936	6x160	2,70
20041942	YT-41942	6x210	3,20
20041951	YT-41951	6x460	6,55
20041938	YT-41938	8x160	3,50
20041943	YT-41943	8x210	4,00
20041952	YT-41952	8x460	7,15
20041940	YT-41940	10x160	4,35
20041945	YT-41945	10x210	4,80
20041953	YT-41953	10x460	7,70
20041962	YT-41962	10x600	10,75
20041941	YT-41941	12x160	5,65
20041946	YT-41946	12x210	6,50
20041954	YT-41954	12x460	9,65
20041963	YT-41963	12x600	12,65
20041947	YT-41947	14x210	9,05
20041955	YT-41955	14x460	12,80
20041964	YT-41964	14x600	16,00
20041970	YT-41970	14x1000	24,50
20041948	YT-41948	16x210	10,55
20041956	YT-41956	16x460	14,60
20041965	YT-41965	16x600	17,45
20041971	YT-41971	16x1000	29,45
20041949	YT-41949	18x210	12,25
20041957	YT-41957	18x460	18,80
20041950	YT-41950	22x210	19,55
20041958	YT-41958	22x460	30,60
20041967	YT-41967	22x600	31,25
20041973	YT-41973	22x1000	45,45



20 x 14
x 250
mm



40 x 14
x 250
mm

ΚΑΛΕΜΙ SDS

ΚΩΔΙΚΟΣ	YATO 	L(mm)	ΣΥΣΚ	€/ΤΕΜ
20004721	YT-4721	250	6	10,05

ΚΑΛΕΜΙ ΦΑΡΔΥ SDS

ΚΩΔΙΚΟΣ	YATO 	L(mm)	ΣΥΣΚ	€/ΤΕΜ
20004723	YT-4723	250	6	11,45



CHISEL
WIDTH:
80 mm

CrMo

NEO 



4 x 14
x 250
mm

ΚΑΛΕΜΙ ΦΑΡΔΥ 80mm

ΚΩΔΙΚΟΣ	YATO 	L(mm)	ΣΥΣΚ	€/ΤΕΜ
20047212	YT-47212	250	6	12,05

ΒΕΛΟΝΙ SDS

ΚΩΔΙΚΟΣ	YATO 	L(mm)	ΣΥΣΚ	€/ΤΕΜ
20004720	YT-4720	250	6	11,80



22 x 18
x 250
mm

ΚΑΛΕΜΙ ΚΑΝΑΛΙΩΝ SDS

ΚΩΔΙΚΟΣ	YATO 	L(mm)	ΣΥΣΚ	€/ΤΕΜ
20004722	YT-4722	250	6	14,90

SDS PLUS



ΔΙΑΜΑΝΤΟΤΡΥΠΑΝΑ

5 ΤΕΜ

Ø 5,6,8,10,12x160 mm

22023988 | **STHOR** 23988

6,40 €



ΚΑΛΕΜΙ 20mm

Ø 20x14 mm - L250 mm

22023591 | **STHOR** 23591

2,45 €



SDS MAX



ΒΕΛΟΝΟΚΑΛΕΜΑ

Ø 25x18 mm - L400 mm

22023604 | **STHOR** 23604

4,75 €



ΚΑΛΕΜΙ 40mm

Ø 40x14 mm - L250 mm

22023592 | **STHOR** 23592

3,25 €



ΚΑΛΕΜΙ 60mm

CrV

Ø 60 mm - L250 mm

22023594 | **STHOR** 23594

7,80 €



ΒΕΛΟΝΟΚΑΛΕΜΑ

Ø 50x18 mm - L400 mm

22023606 | **STHOR** 23606

5,75 €



ΒΕΛΟΝΙ

Ø 14 mm - L250 mm

22023590 | **STHOR** 23590

2,45 €



ΚΑΛΕΜΙ ΚΑΝΑΛΙΩΝ

Ø 22x14 mm - L250 mm

22023593 | **STHOR** 23593

3,15 €



ΒΕΛΟΝΟΚΑΛΕΜΑ

Ø 18 mm - L400 mm

22023602 | **STHOR** 23602

4,75 €



YG-6X
90
HRA

ΤΡΥΠΑΝΙΑ ΚΕΡΑΜΙΚΩΝ - ΤΖΑΜΙΩΝ

ΚΩΔΙΚΟΣ	YATO	∅(mm)	ΣΥΣΚ	€/ΤΕΜ
20003725	YT-3725	4	100	2,70
20003726	YT-3726	6	100	3,35
20003727	YT-3727	8	100	3,85
20003728	YT-3728	10	50	4,05

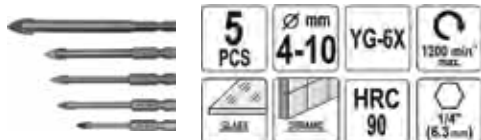

5
PCS
∅ mm
4-10
YG-6X
1200 min¹
max.
HRC
90
1/4"
(6.3mm)

ΣΕΤ 5 ΤΕΜΑΧΙΩΝ

22021709 | **STOR** 21709

9,95 €

4-10 mm



TCT
YG-11C
Cr50
50mm
M16

ΔΙΑΜΑΝΤΟΚΟΡΩΝΑ SDS

ΚΩΔΙΚΟΣ	YATO	∅(mm)	TCT	ΣΥΣΚ	€/ΤΕΜ
20004402	YT-4402	65	6	24	10,50
20004403	YT-4403	80	8	20	12,00



V max.
80 m/s
12 200 min¹
max.
∅ 22.2mm
M14

ΛΕΙΑΝΤΗΣ ΜΠΕΤΟΝ

ΚΩΔΙΚΟΣ	YATO	∅(mm)	rpm	ΣΥΣΚ	€/ΤΕΜ
20060322	YT-60322	125	12200	30	11,90
20060323	YT-60323	180	6600	10	24,25



4
PCS

ΠΟΤΗΡΟΤΡΥΠΑΝΑ ΠΛΑΚΙΔΙΩΝ

ΚΩΔΙΚΟΣ	VOREL	∅(mm)	€/ΤΕΜ
21103301	03301	33, 53, 67, 83	20,90

ΠΟΤΗΡΟΤΡΥΠΑΝΑ

ΓΙΑ ΔΡΑΠΑΝΟ - ΚΕΡΑΜΙΚΩΝ & ΠΛΑΚΙΔΙΩΝ



ΚΩΔΙΚΟΣ	YATO 	(mm)	rpm	€/ΤΕΜ
20060422	YT-60422	6	600	3,25
20060423	YT-60423	8	600	3,60
20060424	YT-60424	10	600	4,20
20060425	YT-60425	12	600	4,95
20060427	YT-60427	16	600	6,35
20060428	YT-60428	20	500	7,80
20060429	YT-60429	25	500	9,65
20060430	YT-60430	30	500	11,40
20060431	YT-60431	40	500	14,95
20060432	YT-60432	50	400	18,65
20060433	YT-60433	68	400	34,80
20060434	YT-60434	80	400	39,35
20060435	YT-60435	105	400	50,25
20060436	YT-60436	125	400	59,65

ΓΙΑ ΓΩΝΙΑΚΟ ΤΡΟΧΟ - ΚΕΡΑΜΙΚΩΝ & ΓΡΑΝΙΤΗ



ΚΩΔΙΚΟΣ	YATO 	(mm)	€/ΤΕΜ
20060441	YT-60441	6	14,15
20060442	YT-60442	8	15,65
20060443	YT-60443	10	16,80
20060444	YT-60444	20	18,65
20060445	YT-60445	30	26,05
20060446	YT-60446	51	36,85
20060447	YT-60447	68	49,20



ΥΓΡΗΣ/ΞΗΡΑΣ ΚΟΠΗΣ



ΔΙΑΜΑΝΤΟΚΟΡΩΝΕΣ

ΚΩΔΙΚΟΣ	YATO 	ø(mm)	ΣΥΣΚ € /ΤΕΜ
20060401	YT-60401	6	8,85
20060402	YT-60402	8	9,15
20060403	YT-60403	10	9,40

ΣΕΤ 3 ΤΕΜ.

20060409	YT-60409	6, 8, 10	22,95
----------	----------	----------	--------------

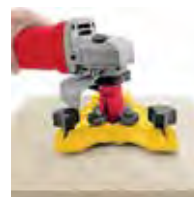

4-84 mm



**ΡΥΘΜΙΖΟΜΕΝΟΣ
ΜΕ ΒΕΝΤΟΥΖΑ**



ΟΔΗΓΟΣ ΠΟΤΗΡΟΤΡΥΠΑΝΩΝ

ΚΩΔΙΚΟΣ	VOREL 	€/ΤΕΜ
21103960	03960	12,50

V max.
80
m/s

ΝΕΑ ΣΕΙΡΑ ΔΙΑΜΑΝΤΟΔΙΣΚΩΝ ΓΙΑ ΚΑΘΕ ΧΡΗΣΗ

NEA 

Για χρήση σε δομικά υλικά όπως:
Τσιμέντο, τούβλο, κεραμίδι, τοιχοποιία, πέτρα, ασβεστόλιθος

ΚΩΔΙΚΟΣ	YATO 	φA(mm)	φD(mm)	RPM max	€/TEM
20059961	YT-59961	115	1,8	12000	7,45
20059962	YT-59962	125	2,0	12000	8,95
20059965	YT-59965	230	2,2	6500	25,30



Για χρήση σε πλακάκια, κεραμικά

ΚΩΔΙΚΟΣ	YATO 	φA(mm)	φD(mm)	RPM max	€/TEM
20059951	YT-59951	115	1,6	12000	7,30
20059952	YT-59952	125	1,6	12000	8,90
20059955	YT-59955	230	2,2	6500	22,35



Για χρήση σε δομικά υλικά όπως:
Τσιμέντο, μπετόν, τούβλο, κεραμίδι, τοιχοποιία, πέτρα, ασβεστόλιθος

ΚΩΔΙΚΟΣ	YATO 	φA(mm)	φD(mm)	RPM max	€/TEM
20059981	YT-59981	115	1,3	12000	10,40
20059982	YT-59982	125	1,3	12000	11,50
20059985	YT-59985	230	2,0	6500	29,50



Για χρήση σε υλικά όπως:
Κεραμικά, τούβλο, κεραμίδι, πορσελάνη, γυαλί, πλακάκια

ΚΩΔΙΚΟΣ	YATO 	φA(mm)	φD(mm)	RPM max	€/TEM
20059971	YT-59971	115	1,6	12000	11,15
20059972	YT-59972	125	1,6	12000	12,25
20059975	YT-59975	230	2,0	6500	27,60





NEO 

ΔΙΣΚΟΙ ΚΟΠΗΣ ΙΝΟΧ CD

ΚΩΔΙΚΟΣ	YATO 	Ø A(mm)	D (mm)	RPMmax	ΣΥΣΚ	€/ΤΕΜ
20006101	YT-6101	115	1.2	13200	25	0,58
20061025	YT-61025	125	1.0	12200	50	0,59
20006105	YT-6105	180	1.5	8600	25	1,20
20006107	YT-6107	230	2.0	6500	25	1,75



NEO 

ΔΙΣΚΟΙ ΚΟΠΗΣ ΜΕΤΑΛΛΟΥ Ø 355mm

ΚΩΔΙΚΟΣ	YATO 	Ø A(mm)	D (mm)	RPMmax	ΣΥΣΚ	€/ΤΕΜ
20061132	YT-61132	355	3.2	4400	25	3,95



NEO 

ΔΙΣΚΟΙ ΛΕΙΑΝΣΗΣ

ΚΩΔΙΚΟΣ	YATO 	Ø A(mm)	D (mm)	RPMmax	ΣΥΣΚ	€/ΤΕΜ
20006121	YT-6121	115	6.0	13200	25	1,05
20006124	YT-6124	125	6.0	12200	30	1,15
20006125	YT-6125	230	6.0	6500	5	3,50



NEO 

ΔΙΣΚΟΙ ΚΟΠΗΣ ΠΕΤΡΑΣ

ΚΩΔΙΚΟΣ	YATO 	Ø A(mm)	D (mm)	RPMmax	ΣΥΣΚ	€/ΤΕΜ
20005930	YT-5930	115	1.2	13200	25	0,56
20005932	YT-5932	125	1.2	12200	25	0,65
20005935	YT-5935	230	3.2	6500	25	2,35



ΔΙΣΚΟΙ ΚΟΠΗΣ

ΚΩΔΙΚΟΣ	VOREL 	Ø (mm)	min-1	ΣΥΣΚ	€/ΤΕΜ
21108630	08630	115x1.0x22	12000	25	0,48
21108631	08631	125x1.0x22	11000	25	0,61
21108639	08639	230x1.6x22	6600	25	1,80



ΔΙΣΚΟΙ ΛΕΙΑΝΣΗΣ

ΚΩΔΙΚΟΣ	VOREL 	Ø (mm)	min-1	ΣΥΣΚ	€/ΤΕΜ
21108663	08663	115x6.0x22	13300	25	0,94
21108665	08665	125x6.8x22	11000	25	1,15



ΔΙΣΚΟΙ ΦΤΕΡΟΥ

ΚΩΔΙΚΟΣ	VOREL 	ΤΥΠΟΣ	Ø (mm)	min-1	ΣΥΣΚ	€/ΤΕΜ
21107984	07984	P40	125	12300	50	1,25
21107985	07985	P60	125	12300	50	1,25
21107986	07986	P80	125	12300	50	1,25
21107988	07988	P120	125	12300	50	1,25



Για επαγγελματική χρήση σε:
σίδηρο
inox
αλουμίνιο
ξύλο
πλαστικά

ΠΟΤΗΡΟΤΡΥΠΑΝΑ

ΚΩΔΙΚΟΣ	YATO 	ø(mm)	ΣΥΣΚ	€/ΤΕΜ
20003303	YT-3303	19	25	2,30
20003304	YT-3304	20	25	2,45
20003306	YT-3306	22	25	2,70
20003308	YT-3308	25	25	3,00
20003311	YT-3311	29	25	3,50
20003313	YT-3313	32	25	3,85
20003315	YT-3315	35	25	4,10
20003317	YT-3317	38	25	4,65
20003318	YT-3318	40	25	4,85
20003321	YT-3321	44	25	5,30
20003322	YT-3322	46	25	5,65
20003323	YT-3323	48	25	5,80
20003324	YT-3324	51	25	6,15
20003327	YT-3327	57	25	6,90
20003329	YT-3329	60	25	7,25
20003330	YT-3330	64	25	7,70
20003332	YT-3332	67	25	8,05
20003333	YT-3333	68	25	8,20
20003334	YT-3334	70	25	8,45
20003336	YT-3336	76	25	9,15
20003338	YT-3338	83	25	9,95
20003343	YT-3343	95	25	11,90
20003345	YT-3345	102	10	12,30
20003346	YT-3346	105	10	12,60
20003349	YT-3349	114	10	13,70
20003350	YT-3350	121	10	14,50
20003351	YT-3351	127	10	15,25
20003353	YT-3353	140	10	17,00



ΦΟΡΕΙΣ ΠΟΤΗΡΟΤΡΥΠΑΝΩΝ

ΚΩΔΙΚΟΣ	YATO 	ø(mm)	ΣΥΣΚ	€/ΤΕΜ
20003370	YT-3370	14-30	25	3,25



ΦΟΡΕΙΣ ΠΟΤΗΡΟΤΡΥΠΑΝΩΝ

ΚΩΔΙΚΟΣ	YATO 	ø(mm)	ΣΥΣΚ	€/ΤΕΜ
20003372	YT-3372	32-140	25	5,70



ΦΟΡΕΙΣ ΠΟΤΗΡΟΤΡΥΠΑΝΩΝ

ΚΩΔΙΚΟΣ	YATO 	ø(mm)	ΣΥΣΚ	€/ΤΕΜ
20003374	YT-3374		25	7,90



HSS

ΑΝΤΑΛΛΑΚΤΙΚΟ ΦΟΡΕΑ

ΚΩΔΙΚΟΣ	YATO 	ø(mm)	H(mm)	ΣΥΣΚ	€/ΤΕΜ
20003376	YT-3376	6.0	75	25	1,48



8
PCS



ΣΕ ΠΩΛΗΣΕΙΣ
No1

ΣΕΤ ΠΟΤΗΡΟΤΡΥΠΑΝΩΝ

ΚΩΔΙΚΟΣ	YATO 	ø(mm)	ΣΥΣΚ	€/ΤΕΜ
20003380	YT-3380	22-73	10	40,00

DIN 338 **HSS 6542**



NEO



Για Βιομηχανική και Επαγγελματική χρήση

Χρήση σε:

- μέταλλα, σιδηρούχα και μη
- κράματα μετάλλων
- πλαστικά



ΚΩΔΙΚΟΣ	YATO	ø(mm)	RPM max	ΣΥΣΚ	€/ΣΥΣΚ
20004430	YT-4430	1.0	3800	10	1,44
20004431	YT-4431	1.5	3800	10	1,70
20004432	YT-4432	2.0	4000	10	2,00
20004433	YT-4433	2.5	3200	10	2,35
20004435	YT-4435	3.0	2600	10	2,55
20004436	YT-4436	3.2	2500	10	2,60
20004437	YT-4437	3.5	2300	10	3,30
20004438	YT-4438	4.0	2000	10	4,10
20004439	YT-4439	4.2	1900	10	4,45
20004440	YT-4440	4.5	1800	10	5,20
20004442	YT-4442	5.0	1600	10	6,40
20004443	YT-4443	5.2	1500	10	6,75
20004444	YT-4444	5.5	1500	10	7,60
20004445	YT-4445	6.0	1300	10	8,80
20004446	YT-4446	6.5	1200	10	10,25
20004447	YT-4447	7.0	1100	10	12,35
20004448	YT-4448	7.5	1100	10	14,40
20004449	YT-4449	8.0	1000	10	17,65
20004450	YT-4450	8.5	900	5	9,85
20004451	YT-4451	9.0	900	5	11,50
20004452	YT-4452	9.5	800	5	12,60
20004453	YT-4453	10.0	800	5	14,45
20004454	YT-4454	10.5	800	3	9,30
20004455	YT-4455	11.0	700	3	10,45
20004456	YT-4456	12.0	700	3	13,10
20004457	YT-4457	12.5	600	3	14,05
20004458	YT-4458	13.0	600	3	15,00



6 pcs

ΚΩΔΙΚΟΣ	YATO	ø(mm)	ΣΥΣΚ	€/ΤΕΜ
20004460	YT-4460	2,3,4,5,6,8	15	4,60



10 pcs

ΚΩΔΙΚΟΣ	YATO	ø(mm)	ΣΥΣΚ	€/ΤΕΜ
20004461	YT-4461	1,2,3,4,5,6,7,8,9,10	20	11,70



19 pcs

ΚΩΔΙΚΟΣ	YATO	ø(mm)	ΣΥΣΚ	€/ΤΕΜ
20004462	YT-4462	1.0,1.5,2.0,2.5,3.0,3.5, 4.0,4.5,5.0, 5.5,6.0,6.5, 7.0,7.5,8.0,8.5,9.0,9.5,10.0	15	21,50

Co-HSS ΚΟΒΑΛΤΙΟΥ

DIN 338

Co-HSS

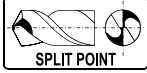

SPLIT POINT



135°

Rm
>900 N/mm²

HSS-E Co HS6-5-2-5
(PN-EN ISO 4957:2002(u))



ΚΩΔΙΚΟΣ	YATO 	ø(mm)	ΤΕΜ/ΣΥΣΚ	€/ΣΥΣΚ
20004020	YT-4020	2.0	2	0,68
20004025	YT-4025	2.5	2	0,81
20004030	YT-4030	3.0	2	1,04
20004032	YT-4032	3.2	1	0,87
20004035	YT-4035	3.5	1	0,87
20004040	YT-4040	4.0	1	1,07
20004042	YT-4042	4.2	1	1,33
20004045	YT-4045	4.5	1	1,33
20004050	YT-4050	5.0	1	1,60
20004052	YT-4052	5.2	1	1,60
20004055	YT-4055	5.5	1	1,70
20004060	YT-4060	6.0	1	1,90
20004065	YT-4065	6.5	1	2,35
20004070	YT-4070	7.0	1	2,80
20004075	YT-4075	7.5	1	3,10
20004080	YT-4080	8.0	1	3,65
20004085	YT-4085	8.5	1	4,00
20004090	YT-4090	9.0	1	4,75
20004100	YT-4100	10.0	1	6,00
20004110	YT-4110	11.0	1	7,30
20004120	YT-4120	12.0	1	8,90



Co-HSS

6 pcs

ΚΩΔΙΚΟΣ	YATO 	ø(mm)	ΣΥΣΚ	€/ΤΕΜ
20041602	YT-41602	2,3,4,5,6,8	15	8,60



Co-HSS

10 pcs

ΚΩΔΙΚΟΣ	YATO 	ø(mm)	ΣΥΣΚ	€/ΤΕΜ
20041603	YT-41603	1,2,3,4,5,6,7,8,9,10	20	20,00



Co-HSS

19 pcs



ΚΩΔΙΚΟΣ	YATO 	ø(mm)	ΣΥΣΚ	€/ΤΕΜ
20041604	YT-41604	1-10 (ανά 0.5)		38,15

ΤΡΥΠΑΝΙΑ ΤΙΤΑΝΙΟΥ HEX 1/4"



ΚΩΔΙΚΟΣ	YATO 	Ø(mm)	€/ΤΕΜ
20044752	YT-44752	2.5	0,68
20044754	YT-44754	3.0	0,64
20044756	YT-44756	3.5	0,68
20044757	YT-44757	4.0	0,76
20044758	YT-44758	4.2	0,80
20044759	YT-44759	4.5	0,80
20044761	YT-44761	5.0	0,86
20044764	YT-44764	6.0	1,03
20044766	YT-44766	7.0	1,19
20044768	YT-44768	8.0	1,42
20044772	YT-44772	10	1,95



5 pcs

ΚΩΔΙΚΟΣ	YATO 	Ø(mm)	ΣΥΣΚ	€/ΤΕΜ
20044700	YT-44700	4,5,6,8,10	30	4,50

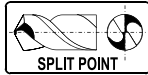

6 pcs

ΚΩΔΙΚΟΣ	YATO 	Ø(mm)	ΣΥΣΚ	€/ΤΕΜ
20044673	YT-44673	2,3,4,5,6,8	50	5,10



10 pcs

ΚΩΔΙΚΟΣ	YATO 	Ø(mm)	ΣΥΣΚ	€/ΤΕΜ
20044674	YT-44674	1,2,3,4,5,6,7,8,9,10	25	11,00



19 pcs

ΚΩΔΙΚΟΣ	YATO 	Ø(mm)	ΣΥΣΚ	€/ΤΕΜ
20044675	YT-44675	1-10 (ανά 0.5)		23,80



25 pcs

ΚΩΔΙΚΟΣ	YATO 	Ø(mm)	ΣΥΣΚ	€/ΤΕΜ
20044676	YT-44676	1-13 (ανά 0.5)		59,90

ΤΡΥΠΑΝΙΑ ΚΩΝΙΚΑ ΜΕ ΔΙΑΒΑΘΜΙΣΗ



ΚΩΔΙΚΟΣ	YATO 	φ(mm)	ΣΥΣΚ	€/ΤΕΜ
20044741	YT-44741	4-22	25	6,00

TITANIUM COATED
HSS 4241

ΣΕ ΠΩΛΗΣΕΙΣ
No1



ΚΩΔΙΚΟΣ	YATO 	φ(mm)	ΣΥΣΚ	€/ΤΕΜ
20044739	YT-44739	6-35		14,75



ΚΩΔΙΚΟΣ	YATO 	φ(mm)	ΣΥΣΚ	€/ΤΕΜ
20044740	YT-44740	6-38	10	15,00



ΚΩΔΙΚΟΣ	YATO 	φ(mm)	ΣΥΣΚ	€/ΤΕΜ
20044731	YT-44731	3-20		12,45

ΤΡΥΠΑΝΙΑ ΚΩΝΙΚΑ ΜΕ ΔΙΑΒΑΘΜΙΣΗ - ΤΙΤΑΝ 

STEEL
TITANIUM COATED
HSS

ΣΕ ΠΩΛΗΣΕΙΣ
No1



ΚΩΔΙΚΟΣ	STHOR	φ(mm)	GRADES	€/ΤΕΜ
22022611	22611	4-20	9	4,95
22022612	22612	4-32	15	9,50
22022613	22613	4-39	13	14,60



3
pcs



ΣΕΤ 3 ΤΕΜ
Ø 4.0 - 32.0 mm
ΚΩΔ. 22022616
STHOR 22616
14,95 €



4
pcs

ΣΕΤ 4 ΤΕΜ
Ø 4.0 - 39.0 mm
ΚΩΔ. 22022617
STHOR 22617
29,00 €

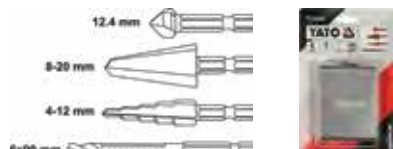

ΣΕΤ ΚΑΤΕΡΓΑΣΙΑΣ ΜΕΤΑΛΛΩΝ

ΚΩΔΙΚΟΣ	YATO 	ΣΥΣΚ	€/ΤΕΜ
20044705	YT-44705	12	15,50

4 PCS
1/4" (6.3mm)
HSS 4241



ΤΡΥΠΑΝΙΑ ΣΙΔΗΡΟΥ HSS - 13 ΤΕΜ

ΚΩΔΙΚΟΣ	STHOR	ΤΕΜ	ΣΥΣΚ	€/ΤΕΜ
22022180	22180	13	25	3,95

Ø 2.0; 2.5; 3.0; 3.5; 4.0; 4.5; 5.0; 5.5; 6.0; 6.5; 7.0; 7.5; 8.0 mm



ΤΡΥΠΑΝΙΑ ΣΙΔΗΡΟΥ HSS - 19 ΤΕΜ

ΚΩΔΙΚΟΣ	STHOR	ΤΕΜ	ΣΥΣΚ	€/ΤΕΜ
22022190	22190	19	30	9,30

Ø 1.0; 1.5; 2.0; 2.5; 3.0; 3.5; 4.0; 4.5; 5.0; 5.5; 6.0; 6.5; 7.0; 7.5; 8.0; 8.5; 9.0; 9.5; 10.0; 10.5; 11.0; 11.5; 12.0; 12.5; 13.0 mm



ΤΡΥΠΑΝΙΑ ΣΙΔΗΡΟΥ HSS-G - 13 ΤΕΜ

ΚΩΔΙΚΟΣ	STHOR	ΤΕΜ	ΣΥΣΚ	€/ΤΕΜ
22021998	21998	13	10	4,45

Ø 2.0; 2.5; 3.0; 3.5; 4.0; 4.5; 5.0; 5.5; 6.0; 6.5; 7.0; 7.5; 8.0 mm



ΤΡΥΠΑΝΙΑ ΣΙΔΗΡΟΥ HSS-G - 19 ΤΕΜ

ΚΩΔΙΚΟΣ	STHOR	ΤΕΜ	ΣΥΣΚ	€/ΤΕΜ
22021999	21999	19	5	9,30

Ø 1.0; 1.5; 2.0; 2.5; 3.0; 3.5; 4.0; 4.5; 5.0; 5.5; 6.0; 6.5; 7.0; 7.5; 8.0; 8.5; 9.0; 9.5; 10.0 mm

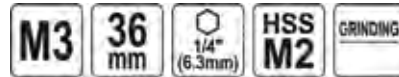

NEO 



ΤΡΥΠΑΝΙ - ΚΟΛΑΟΥΖΟ

ΚΩΔΙΚΟΣ	YATO 	ΜΕΓΕΘΟΣ	L(mm)	€/ΤΕΜ
20044840	YT-44840	M3	36	5,75
20044841	YT-44841	M4	39	6,05
20044842	YT-44842	M5	41	6,30
20044843	YT-44843	M6	44	6,55
20044845	YT-44845	M8	51	6,95
20044847	YT-44847	M10	59	7,85

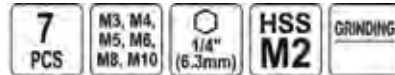

NEO 

ΤΡΥΠΑΝΙ - ΚΟΛΑΟΥΖΟ ΣΕΤ 7 ΤΜΧ

ΚΩΔΙΚΟΣ	YATO 	ΜΕΓΕΘΟΣ	€/ΤΕΜ
20044849	YT-44849	M3,M4,M5,M6,M8,M10	39,00



NEO 



ΦΡΕΖΑ ΜΕΤΑΛΛΩΝ

ΚΩΔΙΚΟΣ	YATO 	Ø (mm)	L(mm)	€/ΤΕΜ
20044721	YT-44721	6.3	40	2,50
20044722	YT-44722	8.3	40	3,10
20044723	YT-44723	10.4	40	3,95
20044724	YT-44724	12.4	40	4,95
20044725	YT-44725	16.5	45	8,30
20044726	YT-44726	20.5	45	11,80

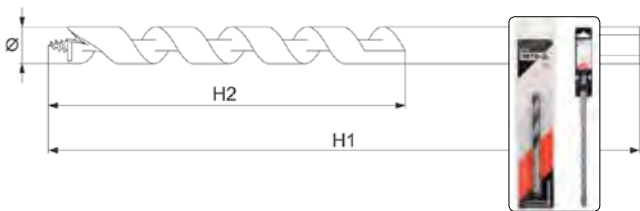

ΑΚΙΔΟΣ

ΚΩΔΙΚΟΣ	YATO	ø(mm)	H1(mm)	H2(mm)	ΣΥΣΚ	€/ΤΕΜ
20004350	YT-4350	3	60	35	30	0,57
20004351	YT-4351	4	75	44	30	0,60
20004352	YT-4352	5	85	52	30	0,68
20004353	YT-4353	6	90	57	30	0,72
20004354	YT-4354	7	100	67	30	0,80
20004355	YT-4355	8	110	75	30	0,92
20004356	YT-4356	10	120	77	30	1,17
20004357	YT-4357	12	150	97	15	1,70
20004358	YT-4358	13	150	97	15	2,00
20004359	YT-4359	16	180	120	15	3,15

ΤΡΥΠΑΝΙΑ ΞΥΛΟΥ ΣΕΤ ΑΚΙΔΟΣ

ΚΩΔΙΚΟΣ	STOR	ΤΕΜ	ΣΥΣΚ	€/ΤΕΜ
22022381	22381	8	10	2,30

Ø 3; 4; 5; 6; 7; 8; 9; 10 mm



ΦΤΕΡΟΥ

ΚΩΔΙΚΟΣ	YATO	ø(mm)	H(mm)	ΣΥΣΚ	€/ΤΕΜ
20003238	YT-3238	10	152	30	1,44
20003239	YT-3239	12	152	50	1,44
20003241	YT-3241	14	152	50	1,60
20003242	YT-3242	16	152	50	1,62
20003243	YT-3243	18	152	50	1,64
20003244	YT-3244	20	152	50	1,66
20003245	YT-3245	22	152	50	1,74
20003246	YT-3246	24	152	50	1,79
20003247	YT-3247	25	152	50	1,93
20003248	YT-3248	26	152	50	2,05
20003249	YT-3249	28	152	50	2,15
20003250	YT-3250	30	152	50	2,35
20003251	YT-3251	32	152	50	2,45
20003252	YT-3252	34	152	50	2,65
20003253	YT-3253	35	152	50	2,80
20003254	YT-3254	38	152	50	2,90
20003255	YT-3255	40	152	50	2,95

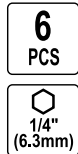

ΣΕΤ ΦΤΕΡΟΥ 6ΤΜΧ.

ΚΩΔΙΚΟΣ	YATO	ø(mm)	H(mm)	ΣΥΣΚ	€/ΤΕΜ
20003258	YT-3258	10-25	152	25	7,20

ΣΕΤ ΦΤΕΡΟΥ 8ΤΜΧ.

ΚΩΔΙΚΟΣ	YATO	ø(mm)	H(mm)	ΣΥΣΚ	€/ΤΕΜ
20003259	YT-3259	12-32	152	5	17,70

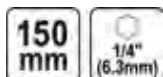

ΠΡΟΕΚΤΑΣΗ ΦΤΕΡΟΥ

ΚΩΔΙΚΟΣ	YATO	H(mm)	ΣΥΣΚ	€/ΤΕΜ
20003256	YT-3256	150	60	3,45
20003257	YT-3257	300	30	5,05

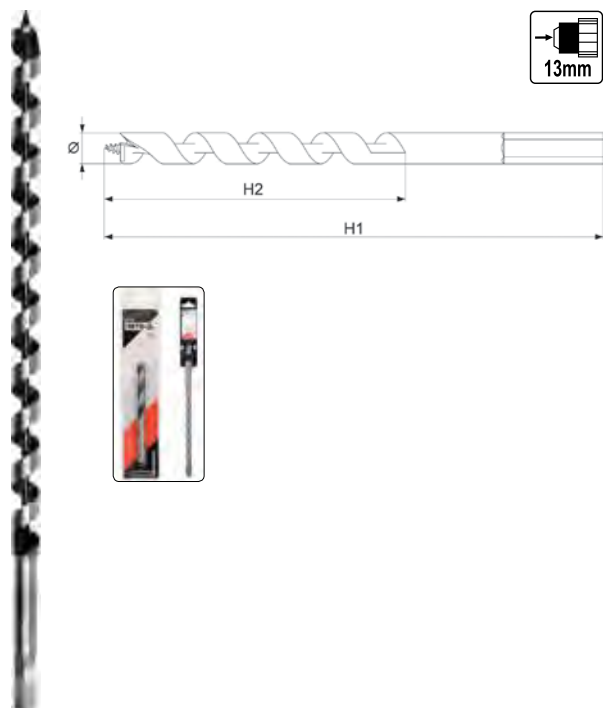

ΚΩΔΙΚΟΣ	YATO 	ø(mm) x L(mm)	ΣΥΣΚ	€/ΤΕΜ
20003261	YT-3261	6x191	60	2,15
20003262	YT-3262	8x191	70	2,30
20003263	YT-3263	8x400	60	3,95
20003264	YT-3264	10x191	50	2,50
20003265	YT-3265	10x400	50	4,05
20003266	YT-3266	12x191	50	3,00
20003267	YT-3267	12x400	20	4,95
20003270	YT-3270	14x191	50	3,20
20003271	YT-3271	14x400	20	5,75
20003272	YT-3272	16x191	50	3,70
20003273	YT-3273	16x400	20	6,30
20003274	YT-3274	18x215	40	4,55
20003275	YT-3275	18x400	20	7,00
20003276	YT-3276	20x215	20	5,50
20003277	YT-3277	20x400	20	9,10
20003278	YT-3278	22x215	20	6,40
20003279	YT-3279	22x400	10	9,80
20003281	YT-3281	24x400	6	11,00
20003282	YT-3282	25x215	20	7,60
20003283	YT-3283	25x400	5	11,85



ΚΩΔΙΚΟΣ	YATO 	ø(mm)	H(mm)	ΣΥΣΚ	€/ΤΕΜ
20003298	YT-3298	10,12,14, 16,18,20	230	15	22,00



ΠΕΡΙΛΑΜΒΑΝΕΙ ΠΡΟΕΚΤΑΣΗ 300mm
ΥΠΟΔΟΧΗ HEX



ΞΥΛΟΥ ΤΕΤΡΑΚΟΠΑ ΣΕΤ 7 ΤΕΜ.

ΚΩΔΙΚΟΣ	YATO 	ΔΙΑΣΤΑΣΕΙΣ ø (mm)	€/ΤΕΜ
20044693	YT-44693	16-25	24,00

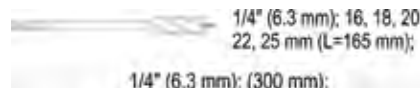

ΞΥΛΟΥ 4-ΦΤΕΡΟ

ΚΩΔΙΚΟΣ	YATO 	ø (mm)	€/ΤΕΜ
20044680	YT-44680	10x165	2,85
20044681	YT-44681	12x165	3,20
20044682	YT-44682	14x165	3,60
20044683	YT-44683	16x165	4,00
20044684	YT-44684	18x165	4,40
20044685	YT-44685	20x165	4,95
20044686	YT-44686	22x165	5,55
20044687	YT-44687	25x165	6,10
20044688	YT-44688	28x165	6,85
20044689	YT-44689	30x165	7,20
20044690	YT-44690	32x165	7,80

ΣΕΤ ΤΡΥΠΑΝΙΑ - ΚΑΒΙΛΙΕΣ

ΚΩΔΙΚΟΣ	YATO	Ø(mm)	ΣΥΣΚ	€/ΤΕΜ
20044112	YT-44112	6	4	3,50
20044111	YT-44111	8	4	4,25
20044113	YT-44113	10	4	4,30

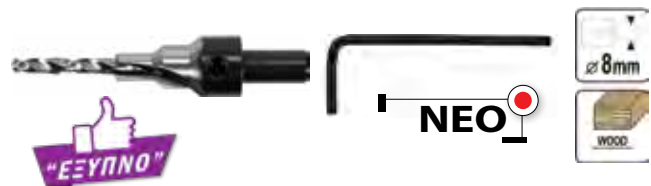
ΦΡΕΖΟΤΡΥΠΑΝΟ ΞΥΛΟΥ

ΚΩΔΙΚΟΣ	YATO	Ø min	Ø max	ΣΥΣΚ	€/ΤΕΜ
20033021	YT-33021	4mm	6mm		2,60
20033022	YT-33022	5mm	7mm		2,85
20033023	YT-33023	7mm	10mm		3,30

ΣΕΤ ΡΥΘΜΙΣΤΕΣ ΒΑΘΟΥΣ

ΚΩΔΙΚΟΣ	YATO	ΓΙΑ ΤΡΥΠΑΝΙΑ	ΣΥΣΚ	€/ΤΕΜ
20044100	YT-44100	6, 8, 10mm		1,65

ΤΡΥΠΑΝΙΑ ΞΥΛΟΥ ΜΕΝΤΕΣΕ

ΚΩΔΙΚΟΣ	YATO	Ø (mm)	ΣΥΣΚ	€/ΤΕΜ
20033010	YT-33010	26		4,40
20033011	YT-33011	35		6,15

ΣΕΤ 5 ΤΕΜ.

ΚΩΔΙΚΟΣ	YATO	Ø (mm)	ΣΥΣΚ	€/ΤΕΜ
20033015	YT-33015	15-35		20,50

ΚΟΠΤΙΚΑ ΞΥΛΟΥ ΣΕΤ

ΚΩΔΙΚΟΣ	VOREL	L(mm)	ΤΕΜ	ΣΥΣΚ	€/ΤΕΜ
21122551	22551	15,20,25,30,35	5	5	12,55

ΚΟΠΤΙΚΑ ΞΥΛΟΥ ΣΕΤ

ΚΩΔΙΚΟΣ	VOREL	Ø (mm)	ΤΕΜ	ΣΥΣΚ	€/ΤΕΜ
21122550	22550	8	12	5	23,20

ΠΟΤΗΡΟΤΡΥΠΑΝΑ ΞΥΛΟΥ

ΚΩΔΙΚΟΣ	VOREL	Ø (mm)	ΤΕΜ	ΣΥΣΚ	€/ΤΕΜ
21122565	22565	51,76,89	4	12	5,80

ΠΟΤΗΡΟΤΡΥΠΑΝΑ ΞΥΛΟΥ

ΚΩΔΙΚΟΣ	VOREL	Ø (mm)	ΤΕΜ	ΣΥΣΚ	€/ΤΕΜ
21122572	22572	38-127	9	6	7,60

ΛΕΙΑΝΤΙΚΑ ΜΕΤΑΛΛΩΝ

NEA 
 13 mm

ΚΩΔΙΚΟΣ	YATO 	∅ (mm)	ΣΥΣΚ	€/ΤΕΜ
20061714	YT-61714	13		3,10



 13 mm

ΚΩΔΙΚΟΣ	YATO 	∅ (mm)	ΣΥΣΚ	€/ΤΕΜ
20061715	YT-61715	13		3,10



 13 mm

ΚΩΔΙΚΟΣ	YATO 	∅ (mm)	ΣΥΣΚ	€/ΤΕΜ
20061716	YT-61716	13		3,10



 13 mm

ΚΩΔΙΚΟΣ	YATO 	∅ (mm)	ΣΥΣΚ	€/ΤΕΜ
20061718	YT-61718	13		3,10

 6.0 mm

ΚΩΔΙΚΟΣ	YATO 	∅ (mm)	ΣΥΣΚ	€/ΤΕΜ
20061719	YT-61719	6		2,60

ΛΕΙΑΝΤΙΚΑ ΜΕΤΑΛΛΩΝ - ΣΕΤ

NEO 
 6 PCS  6.0mm  HSS

ΚΩΔΙΚΟΣ	YATO 	∅ (mm)	ΣΥΣΚ	€/ΤΕΜ
20061711	YT-61711	6	12	16,00

ΡΑΣΠΕΣ ΜΕΤΑΛΛΩΝ



NEA 

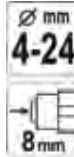

ΚΩΔΙΚΟΣ	YATO 	Ø (mm)	ΣΥΣΚ	€/ΤΕΜ
20061700	YT-61700	4-24	10	5,30

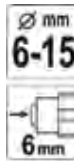

ΚΩΔΙΚΟΣ	YATO 	Ø (mm)	ΣΥΣΚ	€/ΤΕΜ
20061701	YT-61701	6-15	10	2,00

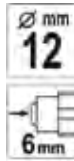

ΚΩΔΙΚΟΣ	YATO 	Ø (mm)	ΣΥΣΚ	€/ΤΕΜ
20061702	YT-61702	12	10	2,00

ΛΕΙΑΝΤΙΚΑ - ΣΕΤ

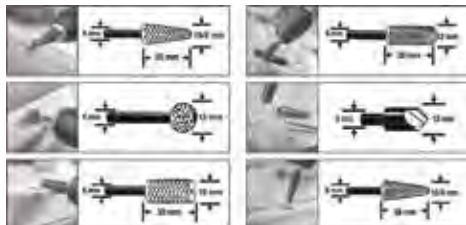

ΜΕΤΑΛΛΟΥ & ΞΥΛΟΥ

ΚΩΔΙΚΟΣ	YATO 	Ø (mm)	ΣΥΣΚ	€/ΤΕΜ
20061712	YT-61712	6-12	10	10,50

ΡΑΣΠΕΣ ΞΥΛΟΥ



NEA 

Ømm
6-15



ΚΩΔΙΚΟΣ	YATO 	Ø (mm)	ΣΥΣΚ	€/ΤΕΜ
20061703	YT-61703	6-15	10	2,00

Ømm
13



ΚΩΔΙΚΟΣ	YATO 	Ø (mm)	ΣΥΣΚ	€/ΤΕΜ
20061704	YT-61704	13	10	2,10

Ømm
15



ΚΩΔΙΚΟΣ	YATO 	Ø (mm)	ΣΥΣΚ	€/ΤΕΜ
20061705	YT-61705	15	10	2,25

Ømm
20



ΚΩΔΙΚΟΣ	YATO 	Ø (mm)	ΣΥΣΚ	€/ΤΕΜ
20061706	YT-61706	20	10	4,30

Ømm
25

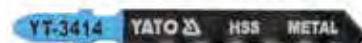

ΚΩΔΙΚΟΣ	YATO 	Ø (mm)	ΣΥΣΚ	€/ΤΕΜ
20061707	YT-61707	25	10	4,85

5
pcs

ΞΥΛΟΥ

ΚΩΔΙΚΟΣ	YATO	ΜΗΚΟΣ ΟΛΙΚΟ(mm)	ΜΗΚΟΣ ΚΟΠΗΣ(mm)	ΠΑΧΟΣ (mm)	ΤΡΙ	ΣΥΣΚ	€/ΣΕΤ
20003407	YT-3407	75	50	1.0	13	50	1,90
20003402	YT-3402	100	75	1.2	8	50	1,70
20003401	YT-3401	100	75	1.3	10	50	3,55
20003410	YT-3410	100	75	1.4	6	50	2,80
20003404	YT-3404	100	75	1.3	10	50	3,15
20003408	YT-3408	115	90	1.3	13~8	50	6,45
20003409	YT-3409	115	90	1.3	8	50	4,15

ΣΕΤ

























ΚΩΔΙΚΟΣ	YATO	ΜΗΚΟΣ ΟΛΙΚΟ(mm)	ΜΗΚΟΣ ΚΟΠΗΣ(mm)	ΠΑΧΟΣ (mm)	ΤΡΙ	ΣΥΣΚ	€/ΣΕΤ
20003445	YT-3445	100	75	1.3	10	25	4,40
		100	75	1.3	6		
		75	50	1.0	32		
		75	57	1.0	12		



5
pcs









ΜΕΤΑΛΛΟΥ

ΚΩΔΙΚΟΣ	YATO 	ΜΗΚΟΣ ΟΛΙΚΟ(mm)	ΜΗΚΟΣ ΚΟΠΗΣ(mm)	ΠΑΧΟΣ (mm)	ΤΡΙ	ΣΥΣΚ	€/ΣΕΤ
20003413	YT-3413	75	50	1.0	12	25	4,30
							
20003412	YT-3412	75	50	1.0	21	25	4,40
							
20003411	YT-3411	100	75	1.0	8	25	4,90
							
20003415	YT-3415	100	75	1.0	24~10	25	4,70
							
20003416	YT-3416	130	106	1.0	21	25	6,55
							

5
pcs



BI-METAL

ΚΩΔΙΚΟΣ	YATO 	ΜΗΚΟΣ ΟΛΙΚΟ(mm)	ΜΗΚΟΣ ΚΟΠΗΣ(mm)	ΠΑΧΟΣ (mm)	ΤΡΙ	ΣΥΣΚ	€/ΣΕΤ
20003400	YT-3400	100	75	1.27	6	50	5,90
							
20003417	YT-3417	130	106	1.27	10~5	25	5,65
							

5
pcs



ΚΕΡΑΜΙΚΩΝ

ΚΩΔΙΚΟΣ	YATO 	ΜΗΚΟΣ ΟΛΙΚΟ(mm)	ΜΗΚΟΣ ΚΟΠΗΣ(mm)	ΠΑΧΟΣ (mm)	ΤΡΙ	ΣΥΣΚ	€/ΣΕΤ
20003421	YT-3421	75	50	1.2	-	25	6,30
							

2
PCS

ΣΠΑΘΟΣΕΓΑΣ

HCS



BIM



ΚΩΔΙΚΟΣ	YATO	ΜΗΚΟΣ (mm)	ΠΑΧΟΣ	TPI	€/ΣΕΤ
---------	------	------------	-------	-----	-------

ΞΥΛΟ

20033921	YT-33921	150	1.2	4	2,30
20033922	YT-33922	150	1.0	6	2,30
20033923	YT-33923	150	1.0	8	2,30



20033920	YT-33920	300	1.45	5	6,65
----------	----------	-----	------	---	------



ΞΥΛΟ - ΜΕΤΑΛΛΟ

20033930	YT-33930	150	1.0	10	4,30
20033931	YT-33931	150	1.0	18	4,30
20033932	YT-33932	150	1.0	24	4,30



20033933	YT-33933	225	1.0	10	6,10
20033934	YT-33934	225	1.0	24	6,10

20033935	YT-33935	300	1.25	6	8,05
----------	----------	-----	------	---	------



ΔΟΜΙΚΑ ΥΛΙΚΑ

20033950	YT-33950	455	1.5	1.5	27,95
----------	----------	-----	-----	-----	-------



ΔΟΜΙΚΑ ΥΛΙΚΑ - 1 τεμ.

20033960	YT-33960	215	2	2	13,00
20033961	YT-33961	462	2	1	21,65



ΛΑΜΕΣ ΣΕΤ



ΚΩΔΙΚΟΣ	STOR	ΜΗΚΟΣ (mm)	ΧΡΗΣΗ	TPI	ΣΥΣΚ	€/ΣΕΤ
22027850	27850	92	ΞΥΛΟ	14		6,30
		150	ΞΥΛΟ	8		
		150	ΞΥΛΟ	6		
		150	ΞΥΛΟ	4		
		150	ΞΥΛΟ/ΜΕΤΑΛΛΟ	24		
		150	ΞΥΛΟ/ΜΕΤΑΛΛΟ	18		
		150	ΞΥΛΟ/ΜΕΤΑΛΛΟ	10		

ΣΜΥΡΙΔΟΠΑΝΟ - ΑΞΟΝΑΚΙ Ø40-Ø80

ΚΩΔΙΚΟΣ	YATO	No	ΔΙΑΣΤΑΣΕΙΣ(mm)	ΣΥΣΚ	€/ΤΕΜ
Ø40					
20083352	YT-83352	60	40x20x6	10	0,82
20083353	YT-83353	80	40x20x6	10	0,82
20083355	YT-83355	120	40x20x6	10	0,82
20083356	YT-83356	150	40x20x6	10	0,82
Ø60					
20083362	YT-83362	60	60x30x6	10	1,55
20083363	YT-83363	80	60x30x6	10	1,55
20083365	YT-83365	120	60x30x6	10	1,55
20083366	YT-83366	150	60x30x6	10	1,55
Ø80					
20083372	YT-83372	60	80x30x6	10	2,05
20083373	YT-83373	80	80x30x6	10	2,05
20083375	YT-83375	120	80x30x6	10	2,05
20083376	YT-83376	150	80x30x6	10	2,05

ΚΕΤΣΕΣ - ΣΜΥΡΙΔΟΠΑΝΟ - ΑΞΟΝΑΚΙ Ø50

ΚΩΔΙΚΟΣ	YATO	No	ΔΙΑΣΤΑΣΕΙΣ(mm)	ΣΥΣΚ	€/ΤΕΜ
20083390	YT-83390	60	50x30x6	10	1,85
20083391	YT-83391	100	50x30x6	10	1,85
20083392	YT-83392	150	50x30x6	10	1,85
20083393	YT-83393	200	50x30x6	10	1,85

ΚΕΤΣΕΣ - ΣΜΥΡΙΔΟΠΑΝΟ - ΑΞΟΝΑΚΙ Ø80

ΚΩΔΙΚΟΣ	YATO	No	ΔΙΑΣΤΑΣΕΙΣ(mm)	ΣΥΣΚ	€/ΤΕΜ
20083398	YT-83398	60	80x50x6	10	4,80
20083399	YT-83399	100	80x50x6	10	4,80
20083400	YT-83400	150	80x50x6	10	4,80
20083401	YT-83401	200	80x50x6	10	4,80

NEO

ΓΙΑ ΜΕΤΑΛΛΟ & ΞΥΛΟ

ΑΥΤΟΚΟΛΛΗΤΟ ΓΥΑΛΟΧΑΡΤΟ

ΚΩΔΙΚΟΣ	YATO	GRIT	Ø (mm)	ΣΥΣΚ	€/ΤΕΜ
20083451	YT-83451	40	125	50	0,82
20083452	YT-83452	60	125	50	0,82
20083453	YT-83453	80	125	50	0,82
20083454	YT-83454	100	125	50	0,82
20083455	YT-83455	120	125	50	0,82
20083456	YT-83456	150	125	50	0,82
20083457	YT-83457	180	125	50	0,82
20083458	YT-83458	220	125	50	0,82

ΠΕΤΡΕΣ ΔΙΔΥΜΩΝ ΤΡΟΧΩΝ

ΚΩΔΙΚΟΣ	VOREL	Ø (mm)	min-1	ΚΟΚΚΟΣ	ΣΥΣΚ	€/ΤΕΜ
21108860	08860	125x12.7x16	5850	A36P	10	2,10
21108861	08861	125x12.7x16	5850	A60P	10	2,15
21108864	08864	150x12.7x16	5350	A36P	10	2,90
21108865	08865	150x12.7x16	5350	A60P	10	2,90

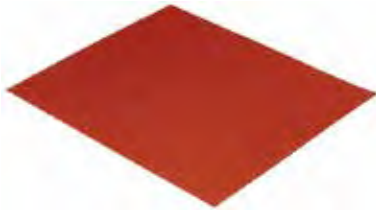

ALUMINIUM
OXIDE

ΓΥΑΛΟΧΑΡΤΟ

ΚΩΔΙΚΟΣ	YATO	No	ΔΙΑΣΤΑΣΕΙΣ(mm)	ΣΥΣΚ	€/ΤΕΜ
20008350	YT-8350	40	230x280	50	0,18
20008351	YT-8351	60	230x280	50	0,18
20008352	YT-8352	80	230x280	50	0,18
20008353	YT-8353	100	230x280	50	0,18
20008354	YT-8354	120	230x280	50	0,18
20008355	YT-8355	150	230x280	50	0,18
20008356	YT-8356	180	230x280	50	0,18
20008357	YT-8357	220	230x280	50	0,18
20008358	YT-8358	240	230x280	50	0,18



SILICON
CARBIDE

WATERPROOF

ΓΥΑΛΟΧΑΡΤΟ ΑΔΙΑΒΡΟΧΟ

ΚΩΔΙΚΟΣ	YATO	No	ΔΙΑΣΤΑΣΕΙΣ(mm)	ΣΥΣΚ	€/ΤΕΜ
20008400	YT-8400	60	230x280	50	0,26
20008401	YT-8401	80	230x280	50	0,26
20008402	YT-8402	100	230x280	50	0,26
20008403	YT-8403	120	230x280	50	0,26
20008404	YT-8404	150	230x280	50	0,26
20008405	YT-8405	180	230x280	50	0,26
20008407	YT-8407	240	230x280	50	0,26
20008409	YT-8409	320	230x280	50	0,26
20008411	YT-8411	400	230x280	50	0,26
20008413	YT-8413	600	230x280	50	0,26
20008415	YT-8415	1000	230x280	50	0,26



ALUMINIUM
OXIDE

ΣΜΥΡΙΔΟΠΑΝΟ

ΚΩΔΙΚΟΣ	YATO	No	ΔΙΑΣΤΑΣΕΙΣ(mm)	ΣΥΣΚ	€/ΤΕΜ
20083161	YT-83161	40	230x280	50	0,40
20083162	YT-83162	60	230x280	50	0,40
20083163	YT-83163	80	230x280	50	0,40
20083164	YT-83164	100	230x280	50	0,40
20083165	YT-83165	120	230x280	50	0,40
20083166	YT-83166	150	230x280	50	0,40
20083167	YT-83167	180	230x280	50	0,40
20083168	YT-83168	220	230x280	50	0,40



ΒΑΣΗ ΛΑΣΤΙΧΟ ΤΡΟΧΟΥ & ΔΡΑΠΑΝΟΥ VELCRO

ΚΩΔΙΚΟΣ	VOREL	Ø (mm)	min-1	ΣΥΣΚ	€/ΤΕΜ
21108316	08316	125	12200	30	2,85



ΒΑΣΗ ΤΡΟΧΟΥ VELCRO ΛΑΣΤΙΧΟ

ΚΩΔΙΚΟΣ	VOREL	Ø (mm)	min-1	ΣΥΣΚ	€/ΤΕΜ
21108318	08318	125	12500	25	2,50

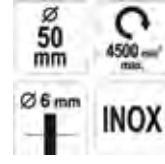

ΚΩΔΙΚΟΣ	YATO 	∅ (mm)	RPMmax	ΣΥΣΚ	€/ΤΕΜ
20047565	YT-47565	50	4500	20	1,90
20047568	YT-47568	75	4500	12	2,55
20004758	YT-4758	100	4500	12	2,90

ΚΩΔΙΚΟΣ	YATO 	∅ (mm)	RPMmax	ΣΥΣΚ	€/ΤΕΜ
20047497	YT-47497	50	4500	12	2,90
20004751	YT-4751	75	4500	12	3,20



ΚΩΔΙΚΟΣ	YATO 	∅ (mm)	RPMmax	ΣΥΣΚ	€/ΤΕΜ
20047496	YT-47496	25	4500	20	2,85

ΚΩΔΙΚΟΣ	YATO 	∅ (mm)	RPMmax	ΣΥΣΚ	€/ΤΕΜ
20004752	YT-4752	75	6000	12	4,55



ΚΩΔΙΚΟΣ	YATO 	∅ (mm)	RPMmax	ΣΥΣΚ	€/ΤΕΜ
20004759	YT-4759	75	20000	10	4,30



ΚΩΔΙΚΟΣ	YATO 	∅ (mm)	RPMmax	ΣΥΣΚ	€/ΤΕΜ
20047593	YT-47593	37,50,62,75	4500	6	8,90



M14

ΚΩΔΙΚΟΣ	YATO 	∅ (mm)	RPMmax	ΣΥΣΚ	€/ΤΕΜ
20004764	YT-4764	125	10000	8	11,50



ΚΩΔΙΚΟΣ	YATO 	∅ (mm)	RPMmax	ΣΥΣΚ	€/ΤΕΜ
20047612	YT-47612	125	12500	10	6,80



INOX

NEO 



ΔΙΔΥΜΩΝ ΤΡΟΧΩΝ

ΚΩΔΙΚΟΣ	YATO 	Ø (mm)	RPMmax	ΣΥΣΚ	€/ΤΕΜ
20047554	YT-47554	150x32	6000	5	11,90
20047555	YT-47555	200x32	4500	5	16,40





M14



Ø 65 mm
12500 RPM max
M14 INOX



ΚΩΔΙΚΟΣ	YATO 	Ø (mm)	RPMmax	ΣΥΣΚ	€/ΤΕΜ
20004766	YT-4766	100	8500	4	5,95

ΚΩΔΙΚΟΣ	YATO 	Ø (mm)	RPMmax	ΣΥΣΚ	€/ΤΕΜ
20047658	YT-47658	65	12500	10	4,50

ΠΛΑΣΤΙΚΟΒΟΥΡΤΣΕΣ

NEA 



Ø 75 mm
4500 RPM max
Ø 6 mm
NYLON



ΚΩΔΙΚΟΣ	YATO 	Ø (mm)	RPMmax	ΣΥΣΚ	€/ΤΕΜ
20047780	YT-47780	25	4500	20	3,30

ΚΩΔΙΚΟΣ	YATO 	Ø (mm)	RPMmax	ΣΥΣΚ	€/ΤΕΜ
20047782	YT-47782	75	4500	10	4,95





Ø 75 mm
4500 RPM max
Ø 6 mm
NYLON



Ø 65 mm
12200 RPM max
M14 NYLON



ΚΩΔΙΚΟΣ	YATO 	Ø (mm)	RPMmax	ΣΥΣΚ	€/ΤΕΜ
20047791	YT-47791	75	4500	10	4,75
20047792	YT-47792	100	4500	10	6,40

ΚΩΔΙΚΟΣ	YATO 	Ø (mm)	RPMmax	ΣΥΣΚ	€/ΤΕΜ
20047785	YT-47785	65	12200	10	9,80
20047787	YT-47787	125	6500	6	18,20



M14



ΚΑΜΠΑΝΑ

ΚΩΔΙΚΟΣ	VOREL	Ø (mm)	min-1	ΣΥΣΚ	€/ΤΕΜ
21106970	06970	75	12500	12	2,65
21106971	06971	100	8500	6	4,00



M14



ΚΑΜΠΑΝΑ ΚΟΤΣΙΔΑ

ΚΩΔΙΚΟΣ	VOREL	Ø (mm)	min-1	ΣΥΣΚ	€/ΤΕΜ
21106974	06974	65	12500	12	5,75
21106975	06975	80	8500	12	6,55
21106976	06976	100	8500	6	9,25



M14



ΤΡΟΧΟΥ

ΚΩΔΙΚΟΣ	VOREL	Ø (mm)	min-1	ΣΥΣΚ	€/ΤΕΜ
21106973	06973	115	12500	12	3,00



ΚΑΜΠΑΝΑ ΔΡΑΠΑΝΟΥ

ΚΩΔΙΚΟΣ	VOREL	Ø (mm)	min-1	ΣΥΣΚ	€/ΤΕΜ
21106987	06987	50	4500	10	1,35
21106988	06988	75	4500	12	1,85



ΔΡΑΠΑΝΟΥ

ΚΩΔΙΚΟΣ	VOREL	Ø (mm)	min-1	ΣΥΣΚ	€/ΤΕΜ
21106985	06985	75	4500	10	1,46
21106986	06986	100	4500	12	1,80



ΔΡΑΠΑΝΟΥ ΠΙΝΕΛΟ

ΚΩΔΙΚΟΣ	VOREL	Ø (mm)	min-1	ΣΥΣΚ	€/ΤΕΜ
21106992	06992	24	4500	24	1,11

3
pcs

ΣΕΤ

ΚΩΔΙΚΟΣ	VOREL	Ø (mm)	min-1	ΣΥΣΚ	€/ΤΕΜ
21106989	06989	25; 50; 50	4500	12	2,85



ΔΙΔΥΜΩΝ ΤΡΟΧΩΝ

ΚΩΔΙΚΟΣ	VOREL	Ø (mm)	min-1	ΣΥΣΚ	€/ΤΕΜ
21106978	06978	125	6000	12	3,70
21106979	06979	150	6000	12	6,45
21106980	06980	200	4500	12	9,40



NEO

ΔΡΑΠΑΝΟΥ ΠΙΝΕΛΟ ΚΟΤΣΙΔΑ

ΚΩΔΙΚΟΣ	VOREL	Ø (mm)	min-1	ΣΥΣΚ	€/ΤΕΜ
21106995	06995	22		24	2,35



10 mm



BIM

ΚΩΔ. 20034683
YATO  YT-34683
10x40 mm / ΣΥΣΚ 5
4,45 €/ΤΕΜ

20 mm



ΚΩΔ. 20034686
YATO  YT-34686
20x40 mm / ΣΥΣΚ 5
4,55 €/ΤΕΜ

28.5 mm

3 pcs



ΚΩΔ. 20034684
YATO  YT-34684
28,5x40 mm / ΣΥΣΚ 5
11,00 €/ΤΕΜ

88 mm

HSS



Για μέταλλο, ξύλο και γυψοσανίδα
ΚΩΔ. 20034680
YATO  YT-34680
88 mm / ΣΥΣΚ 5
7,40 €/ΤΕΜ



Για ξύλο και πλαστικό
ΚΩΔ. 20034685
YATO  YT-34685
34x40 mm / ΣΥΣΚ 5
5,70 €/ΤΕΜ

HCS

34 mm

3 pcs



ΣΠΑΤΟΥΛΑ
ΚΩΔ. 20034688
YATO  YT-34688
52 mm / ΣΥΣΚ 5
3,00 €/ΤΕΜ

HCS

52 mm



HSS

BIM

HCS



ΚΩΔ. 20034691
YATO  YT-34691
mm 88 / 34x40 / 34x40
ΣΥΣΚ 5
12,50 €/ΤΕΜ

3 pcs



HM

70 mm



ΚΩΔ. 20034682
YATO  YT-34682
70 mm / ΣΥΣΚ 10
7,10 €/ΤΕΜ



Για τσιμέντο,
κεραμικά πλακάκια,
Fiberglass



HM

80 mm



ΡΑΣΠΑ ΚΑΡΒΙΔΙΟΥ
Για τσιμέντο,
κεραμικά πλακάκια



ΒΑΣΗ ΓΙΑ ΓΥΑΛΟΧΑΡΤΟ

90 mm

EVA



ΚΩΔ. 20034689
YATO  YT-34689
90 mm / ΣΥΣΚ 5
3,50 €/ΤΕΜ



ΓΥΑΛΟΧΑΡΤΟ
ΑΝΤΑΛΛΑΚΤΙΚΟ



90 mm

10 pcs

Για μέταλλο, ξύλο,
γυψοσανίδα

ΚΩΔ. 20034690
YATO  YT-34690
90 mm / ΣΥΣΚ 5
2,50 €/ΤΕΜ





ΥΠΕΡ ΔΙΑΦΑΝΗ



ΘΕΡΜΟΚΟΛΛΑ ΚΙΛΟΥ - ΥΠΕΡ ΔΙΑΦΑΝΗ

ΚΩΔΙΚΟΣ	Ø(mm)	L(mm)	ΣΥΣΚ	€/Kg
2040050	11	300	25	8,30



WORKING
TEMPERATURE
TEMPERATURA
PRACY
170~200°C

SOFTENING POINT
TEMPERATURA
MIĘKNIENIA
85+/-2°C

OPEN TIME
CZAS OTWARTY
20~30 s

Ø
7.2mm

Ø
11.2mm

ΘΕΡΜΟΚΟΛΛΕΣ



ΚΩΔΙΚΟΣ	YATO	Ø(mm)	L(mm)	TEM	ΣΥΣΚ	€/TEM
ΔΙΑΦΑΝΗ						
20082440	YT-82440	7.2	200	10	50	1,70
ΜΑΥΡΗ						
20082441	YT-82441	7.2	100	12	50	1,30
20082433	YT-82433	11.2	200	5	40	2,10
ΚΟΚΚΙΝΗ						
20082442	YT-82442	7.2	100	12	50	1,30
20082434	YT-82434	11.2	200	5	40	2,10
ΜΠΛΕ						
20082443	YT-82443	7.2	100	12	50	1,30
20082435	YT-82435	11.2	200	5	40	2,10
ΠΡΑΣΙΝΗ						
20082444	YT-82444	7.2	100	12	50	1,30
20082436	YT-82436	11.2	200	5	40	2,10
ΚΙΤΡΙΝΗ						
20082445	YT-82445	7.2	100	12	50	1,30
20082437	YT-82437	11.2	200	5	40	2,10
ΛΕΥΚΗ						
20082446	YT-82446	7.2	100	12	50	1,30
20082438	YT-82438	11.2	200	5	40	2,10
ΚΑΦΕ						
20082447	YT-82447	7.2	100	12	50	1,30
20082439	YT-82439	11.2	200	5	40	2,10



13
PCS



ΣΕΤ ΑΞΕΣΟΥΑΡ ΜΙΚΡΟΕΡΓΑΛΕΙΩΝ - 13 ΤΕΜ.

ΚΩΔΙΚΟΣ	VOREL	ΤΕΜ	ΣΥΣΚ	€/ΤΕΜ
21125410	25410	13	10	6,05



17
PCS



ΣΕΤ ΑΞΕΣΟΥΑΡ ΜΙΚΡΟΕΡΓΑΛΕΙΩΝ - 17 ΤΕΜ.

ΚΩΔΙΚΟΣ	VOREL	ΤΕΜ	ΣΥΣΚ	€/ΤΕΜ
21125411	25411	17	10	7,20



22
PCS



ΣΕΤ ΑΞΕΣΟΥΑΡ ΜΙΚΡΟΕΡΓΑΛΕΙΩΝ - 22 ΤΕΜ.

ΚΩΔΙΚΟΣ	VOREL	ΤΕΜ	ΣΥΣΚ	€/ΤΕΜ
21125412	25412	22	10	6,40



ΤΣΟΚ ΔΡΑΠΑΝΩΝ ΜΕ ΚΛΕΙΔΙ

ΚΩΔΙΚΟΣ	VOREL	Ø (mm)	ΜΕΓΕΘΟΣ	ΣΥΣΚ	€/ΤΕΜ
21179630	79630	1.5-13	1/2"	5	5,80



ΤΣΟΚ ΔΡΑΠΑΝΩΝ ΑΥΤΟΜΑΤΑ

ΚΩΔΙΚΟΣ	VOREL	Ø (mm)	ΜΕΓΕΘΟΣ	ΣΥΣΚ	€/ΤΕΜ
21179570	79570	1-10	3/8"	10	4,90
21179580	79580	2-13	1/2"	5	6,40



ΜΥΘΗ ΒΙΔΑΣ ΓΥΨΟΣΑΝΙΔΑΣ

ΚΩΔΙΚΟΣ	YATO	Ø(mm)	ΜΗΚΟΣ(mm)	ΣΥΣΚ	€/ΤΕΜ
20007980	YT-7980	6,3	25	20	16,60



ΓΙΑ ΜΑΚΡΙΕΣ ΒΙΔΕΣ

ΦΟΡΕΑΣ ΜΑΓΝΗΤΙΚΟΣ

ΚΩΔΙΚΟΣ	YATO	Ø(mm)	ΜΗΚΟΣ(mm)	ΣΥΣΚ	€/ΤΕΜ
20000467	YT-0467	6.3	80	20	3,30



ΦΟΡΕΑΣ ΓΙΑ ΕΞΑΓΩΝΕΣ ΜΥΤΕΣ 1/4"

ΚΩΔΙΚΟΣ	YATO	ΜΗΚΟΣ(mm)	ΣΥΣΚ	€/ΤΕΜ
20004671	YT-04671	120	20	3,70

ΓΙΑ ΜΑΚΡΙΕΣ ΒΙΔΕΣ



HEX 1/4" (6.3 mm) / SDS PLUS
L = 60 mm

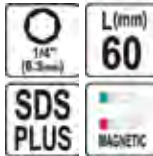

ΦΟΡΕΑΣ ΜΥΤΗΣ SDS

ΚΩΔΙΚΟΣ	YATO	ΜΗΚΟΣ(mm)	ΣΥΣΚ	€/ΤΕΜ
20004690	YT-04690	60	50	1,70



ΕΙΔΙΚΕΣ ΜΥΤΕΣ

ΚΩΔΙΚΟΣ	YATO	Ø(mm)	L(mm)	ΣΥΣΚ	€/ΤΕΜ
20000493	YT-0493	#0 1/4"	100	25	2,30
20000496	YT-0496	#1 1/4"	100	25	2,30
20000497	YT-0497	#2 1/4"	100	25	2,30
		#3 1/4"	100	25	2,30
		#4 1/4"	100	25	2,30



ΕΙΔΙΚΕΣ ΜΥΤΕΣ

ΚΩΔΙΚΟΣ	YATO	Ø(mm)	L(mm)	ΣΥΣΚ	€/ΤΕΜ
20000498	YT-0498	#4 1/4"	100	25	2,30
		#8 1/4"	100	25	2,30
20000499	YT-0499	#6 1/4"	100	25	2,30
		#10 1/4"	100	25	2,30



ΤΣΟΚ 1/4" - ΑΥΤΟΜΑΤΟ

ΚΩΔΙΚΟΣ	YATO	Ø(mm)	ΣΥΣΚ	€/ΤΕΜ
20004644	YT-04644	1/4"	50	6,85



ΦΟΡΕΑΣ ΜΥΤΗΣ ΜΑΚΡΥΣ

ΚΩΔΙΚΟΣ	YATO 	Ø(mm)	ΜΗΚΟΣ(mm)	ΣΥΣΚ	€/ΤΕΜ
20004681	YT-04681	6.3	150	50	3,25
20004682	YT-04682	6.3	200	50	3,85
20004684	YT-04684	6.3	300	50	4,75



ΕΥΚΑΜΠΤΗ ΠΡΟΕΚΤΑΣΗ ΓΙΑ ΜΥΤΕΣ

ΚΩΔΙΚΟΣ	YATO 	Ø	ΜΗΚΟΣ(mm)	ΣΥΣΚ	€/ΤΕΜ
20014001	YT-14001	1/4"	300	100	4,40



ΑΝΤΑΠΤΟΡΑΣ ΓΩΝΙΑΚΟΣ ΔΡΑΠΑΝΟΥ

ΚΩΔΙΚΟΣ	YATO 	Ø(mm)	ΜΗΚΟΣ(mm)	ΣΥΣΚ	€/ΤΕΜ
21004632	YT-04632	1/4"	37	100	5,75

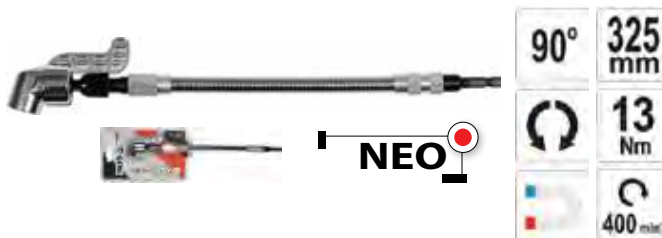

ΑΝΤΑΠΤΟΡΑΣ ΓΩΝΙΑΚΟΣ ΜΕ ΠΡΟΕΚΤΑΣΗ

ΚΩΔΙΚΟΣ	YATO 	Ø(mm)	ΜΗΚΟΣ(mm)	ΣΥΣΚ	€/ΤΕΜ
20004636	YT-04636	1/4"	325	10	18,00



ΓΩΝΙΑΚΟΣ ΦΟΡΕΑΣ ΓΙΑ ΜΥΤΕΣ

ΚΩΔΙΚΟΣ	YATO 	Ø(mm)	ΜΗΚΟΣ(mm)	ΣΥΣΚ	€/ΤΕΜ
21004630	YT-04630	1/4"	105	60	2,70



ΑΝΤΑΠΤΟΡΑΣ ΓΩΝΙΑΚΟΣ ΔΡΑΠΑΝΟΥ

ΚΩΔΙΚΟΣ	YATO 	Ø(mm)	ΜΗΚΟΣ(mm)	ΣΥΣΚ	€/ΤΕΜ
21004631	YT-04631	1/4"	155	50	13,00



1/4" (6.3mm)	1/4" 6.3mm
3/8" 10mm	1/2" 12.5mm



1/4" (6.3 mm), L = 65 mm
3/8" (9.5 mm), L = 65 mm
1/2" (12.7 mm), L = 70 mm

ΑΝΤΑΠΤΟΡΕΣ ΓΙΑ ΚΑΡΥΔΑΚΙΑ-ΣΕΤ 3 ΤΕΜ

ΚΩΔΙΚΟΣ	YATO	ΣΥΣΚ	€/ΤΕΜ
20004685	YT-04685	HEX	20 3,25
20004686	YT-04686	SDS	20 6,00





NEO 

CrV

ΑΝΤΑΠΤΟΡΑΣ ΓΙΑ ΚΑΡΥΔΑΚΙΑ

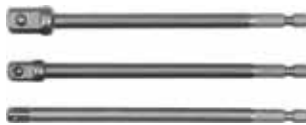
ΚΩΔΙΚΟΣ	YATO	Ø(mm)	ΜΗΚΟΣ(mm)	ΣΥΣΚ	€/ΤΕΜ
20004625	YT-04625	1/4"	65	40	1,30
20004627	YT-04627	1/2"	70	40	1,50



NEO 

1/4" 6.3mm	1/4" 6.3mm	3/8" 10mm
1/2" 12.5mm	150mm	CrV

ΑΝΤΑΠΤΟΡΕΣ ΠΡΟΕΚΤΑΣΗ ΓΙΑ ΚΑΡΥΔΑΚΙΑ

ΚΩΔΙΚΟΣ	YATO	Ø(mm)	ΜΗΚΟΣ(mm)	ΣΥΣΚ	€/ΤΕΜ
20004628	YT-04628	1/4,1/2,3/8"	150	24	5,95



NEO 

50mm
1/4" 6.3mm
1/2" 12.5mm

ΑΝΤΑΠΤΟΡΑΣ ΜΥΤΗΣ ΜΠΟΥΛΟΝΟΚΛΕΙΔΩΝ

ΚΩΔΙΚΟΣ	YATO	ΣΥΣΚ	€/ΤΕΜ
20004691	YT-04691	1/4" ΓΙΑ ΜΠΟΥΛΟΝΟΚΛΕΙΔΟ 1/2"	10 4,30



NEO 

YATO  NON-SLIP SYSTEM

	COLD FORGED
	AISI S2
	HRC 58-62
21.8mm max.	

ΜΥΤΗ ΣΤΑΥΡΟΚΑΤΣΑΒΙΔΟΥ

ΚΩΔΙΚΟΣ	YATO	Ø	+	+	L(mm)	ΣΥΣΚ	€/ΤΕΜ
20000486	YT-0486	-	PH2	-	150	25	2,10
20000487	YT-0487	-	PH2	-	200	25	2,85

ΣΕΤ ΜΥΤΕΣ 1/4" - 10 ΤΕΜ

**10
pcs**

ΚΩΔΙΚΟΣ	YATO	⊖	⊕	⊕	L(mm)	ΣΥΣΚ	€/ΤΕΜ
20000470	YT-0470	-	-	PZ1	25	25	3,55
20000471	YT-0471	-	-	PZ2	25	25	3,55
20000472	YT-0472	-	-	PZ3	25	25	3,55

**10
pcs**

ΚΩΔΙΚΟΣ	YATO	⊖	⊕	⊕	L(mm)	ΣΥΣΚ	€/ΤΕΜ
20000477	YT-0477	-	PH1	-	50	25	6,05
20000478	YT-0478	-	PH2	-	50	25	6,05
20000480	YT-0480	-	PH2	-	75	25	9,05

**10
pcs**

ΚΩΔΙΚΟΣ	YATO	⊖	⊕	⊕	L(mm)	ΣΥΣΚ	€/ΤΕΜ
20000474	YT-0474	-	PH1	-	25	25	3,55
20000475	YT-0475	-	PH2	-	25	25	3,55
20000476	YT-0476	-	PH3	-	25	25	3,55

**10
pcs**

ΚΩΔΙΚΟΣ	YATO	⊖	⊕	⊕	L(mm)	ΣΥΣΚ	€/ΤΕΜ
20000482	YT-0482	5mm	2xPH1	2xPZ1	25	25	3,55
		6mm	2xPH2	2xPZ2	25		

**10
pcs**

ΚΩΔΙΚΟΣ	YATO	⊖	⊕	⊕	L(mm)	ΣΥΣΚ	€/ΤΕΜ
20000483	YT-0483	5mm	2xPH1	2xPZ1	50	25	5,95
		6mm	2xPH2	2xPZ2	50		



ΜΥΤΕΣ ΣΕΤ 1/4" - 34 ΤΕΜ

ΚΩΔΙΚΟΣ	YATO 	€/ΤΕΜ
20004623	YT-04623	14,00



1/4" (6.3 mm): 5, 6, 7, 8, 9, 10, 11, 12 mm (L=25 mm); 1/4" (6.3 mm): PH1, 2 x PH2, 2 x PH3 (L=25 mm); S2; 1/4" (6.3 mm): 3, 4, 2 x 5.5, 2 x 6.5 mm (L=25 mm); S2; 1/4" (6.3 mm): 2 x PH1, 2 x PH2, 2 x PH3 (L=25 mm); S2; 1/4" (6.3 mm): 2 x PZ1, 2 x PZ2, 2 x PZ3 (L=25 mm); S2; 1/4" (6.3 mm): T10, T15, T20, T25, T27, T30, (L=25 mm); S2; 1/4" (6.3 mm), (L=60 mm); CrV



ΜΥΤΕΣ ΣΕΤ 1/4" - 23 ΤΕΜ IMPACT

ΚΩΔΙΚΟΣ	YATO 	€/ΤΕΜ
20004621	YT-04621	13,50



1/4" (6.3 mm): PH0, 2 x PH2, PH3 (L=25 mm); S2; 1/4" (6.3 mm): PZ0, 2 x PZ2, PZ3 (L=25 mm); S2; 1/4" (6.3 mm): 2 x T20, 2 x T25, 2 x T30, T40 (L=25 mm); S2; 1/4" (6.3 mm): 4, 5, 6 mm (L=25 mm); S2; 1/4" (6.3 mm): PH2 (L=50 mm); S2; 1/4" (6.3 mm): PZ2 (L=50 mm); S2; 1/4" (6.3 mm): T20, T30 (L=50 mm); S2; 1/4" (6.3 mm), (L=60 mm); CrV



ΜΥΤΕΣ ΣΕΤ 1/4" - 32 ΤΕΜ

ΚΩΔΙΚΟΣ	YATO 	€/ΤΕΜ
21004622	YT-04622	15,00



1/4" (6.3 mm): 3, 4, 5, 6 mm (L=25 mm); S2; 1/4" (6.3 mm): PH1, 2 x PH2, PH3 (L=25 mm); S2; 1/4" (6.3 mm): PZ1, 2 x PZ2, PZ3 (L=25 mm); S2; 1/4" (6.3 mm): T10, T15, T20, T25, T27, T30, T40 (L=25 mm); S2; 1/4" (6.3 mm): T10, T15, T20, T25, T27, T30, T40 (L=25 mm); S2; 1/4" (6.3 mm): 3, 4, 5, 6 mm (L=25 mm); S2; 1/4" (6.3 mm), (L=70 mm); CrV; 1/4" (6.3 mm), (L=25 mm); S2



ΜΥΤΕΣ ΣΕΤ 1/4" - 59 ΤΕΜ

ΚΩΔΙΚΟΣ	YATO 	€/ΤΕΜ
20004624	YT-04624	21,00

1/4" (6.3 mm): 2, 4, 6.5 mm (L=25 mm); S2; 1/4" (6.3 mm): PH0, 2 x PH1, 2 x PH2, PH3 (L=25 mm); S2; 1/4" (6.3 mm): 2 x PZ1, 2 x PZ2, PZ3 (L=25 mm); S2; 1/4" (6.3 mm): T10, T15, T20, T25, T30, T40 (L=25 mm); S2; 1/4" (6.3 mm): T8, T9, T10, T15, T20, T25, T27, T30, T40 (L=25 mm); S2; 1/4" (6.3 mm): 2, 2.5, 3, 4, 5, 6, 8 mm (L=25 mm); S2; 1/4" (6.3 mm): S0, S1, S2, S3 (L=25 mm); S2; 1/4" (6.3 mm): 1, 2, 3, 4 mm (L=25 mm); S2; 1/4" (6.3 mm): 6, 8, 10 mm (L=25 mm); S2; 1/4" (6.3 mm): 4, 6, 8, 10 mm (L=25 mm); S2; 1/4" (6.3 mm): M5, M6, M8 (L=25 mm); S2; 1/4" (6.3 mm): C1, C2, C3 (L=25 mm); S2; 1/4" (6.3 mm), (L=70 mm); CrV; 1/4" (6.3 mm), CrV





ΜΥΤΕΣ ΣΕΤ 56 ΤΕΜ

ΚΩΔΙΚΟΣ	STHOR	ΣΥΣΚ	€/ΤΕΜ
22066310	66310	8	10,00

- 1/4" (6.3 mm): 3, 4, 5, 5.5, 6, 7 mm (L=25 mm); 4, 6 mm (L=50 mm); CrV;
- 1/4" (6.3 mm): PH0, PH1 x2, PH2 x5, PH3 (L=25 mm); PH1, PH2, PH3 (L=50 mm); CrV;
- 1/4" (6.3 mm): PZ0, PZ1 x2, PZ2 x5, PZ3 (L=25 mm); PZ1, PZ2, PZ3 (L=50 mm); CrV;
- 1/4" (6.3 mm): T10, T15, T20, T25, T27, T30, T40 (L=25 mm); T15, T20, T25 (L=50 mm); CrV
- 1/4" (6.3 mm): 2, 2.5, 3, 4, 5, 5.5, 6 mm (L=25 mm); 4, 5, 6 mm (L=50 mm); CrV;
- 1/4" (6.3 mm): S0, S1, S2, S3 (L=25 mm); CrV



ΜΥΤΕΣ ΣΕΤ 41 ΤΕΜ

ΚΩΔΙΚΟΣ	STHOR	ΣΥΣΚ	€/ΤΕΜ
22066301	66301	10	7,40

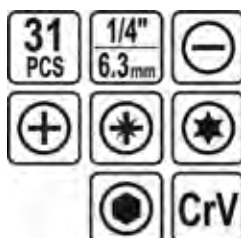

ΜΥΤΕΣ ΣΕΤ 31 ΤΕΜ

ΚΩΔΙΚΟΣ	STHOR	ΣΥΣΚ	€/ΤΕΜ
22066302	66302	10	7,60



- 1/4" (6.3 mm): 3, 4, 5, 5.5, 6, 7 mm (L=25 mm); CrV;
- 1/4" (6.3 mm): PH0, PH1 x2, PH2 x2, PH3 (L=25 mm); CrV;
- 1/4" (6.3 mm): PZ0, PZ1 x2, PZ2 x2, PZ3 (L=25 mm); CrV;
- 1/4" (6.3 mm): T10, T15, T20, T25, T27, T30 (L=25 mm); CrV
- 1/4" (6.3 mm): 2, 3, 4, 5, 5.5, 6 mm (L=25 mm); CrV;
- 1/4" (6.3 mm): (L=60 mm); CrV



ΜΥΤΕΣ ΣΕΤ 10 ΤΕΜ

ΚΩΔΙΚΟΣ	STHOR	ΣΥΣΚ	€/ΤΕΜ
22065705	65705	5	4,80



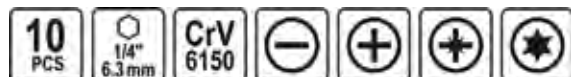

- 1/4" (6.3 mm): 5, 6 mm (L=25 mm); CrV;
- 1/4" (6.3 mm): PH0, PH1, PH2 (L=25 mm); CrV;
- 1/4" (6.3 mm): PZ1, PZ2 (L=25 mm); CrV
- 1/4" (6.3 mm): T15, T20 (L=25 mm); CrV;
- 1/4" (6.3 mm): (L=60 mm); CrV





Μύτες Impact HELIX color

- Από ειδικό κράμα ατσάλιου SK2 για να αντέχουν τις τεράστιες ροπές των σύγχρονων παλμικών (impact) δραπανοκατσάβιδων.
- Με ζώνη περιστροφής (torsion) απορρόφησης των κραδασμών για την αποφυγή της θραύσης.
-  Χρωματιστός δακτύλιος αναγνώρισης για εύκολη ανεύρεση της κατάλληλης μύτες.
-  Συμβατές με το **μαγνητικό δακτυλίδι συγκράτησης** της βίδας που μετατρέπει την ίδια τη μύτη σε ολοκληρωμένο σύστημα σταθερού βιδώματος.
- **Μήκος μικρής μύτες 30mm** (αντί 25mm του ανταγωνισμού) για να μην χάνεται η μύτη στις στάνταρ υποδοχές των παλμικών κατσαβιδιών.



ΜΥΤΕΣ PH



ΚΩΔΙΚΟΣ	ΔΙΑΣΤΑΣΗ	ΣΥΣΚ	€/τεμ.
122001300	PH1x30mm	20	0,42
122002300	PH2x30mm	20	0,42
122003300	PH3x30mm	20	0,42

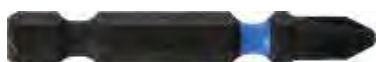

ΚΩΔΙΚΟΣ	ΔΙΑΣΤΑΣΗ	ΣΥΣΚ	€/τεμ.
122001500	PH1x50mm	10	0,55
122002500	PH2x50mm	10	0,55
122003500	PH3x50mm	10	0,55



ΚΩΔΙΚΟΣ	ΔΙΑΣΤΑΣΗ	ΣΥΣΚ	€/τεμ.
122001750	PH1x75mm	10	0,75
122002750	PH2x75mm	10	0,75
122003750	PH3x75mm	10	0,75



ΚΩΔΙΚΟΣ	ΔΙΑΣΤΑΣΗ	ΣΥΣΚ	€/τεμ.
122002100	PH2x100mm	10	0,90



ΜΥΤΕΣ PZ



ΚΩΔΙΚΟΣ	ΔΙΑΣΤΑΣΗ	ΣΥΣΚ	€/τεμ.
122201300	PZ1x30mm	20	0,42
122202300	PZ2x30mm	20	0,42
122203300	PZ3x30mm	20	0,42



ΚΩΔΙΚΟΣ	ΔΙΑΣΤΑΣΗ	ΣΥΣΚ	€/τεμ.
122201500	PZ1x50mm	10	0,55
122202500	PZ2x50mm	10	0,55
122203500	PZ3x50mm	10	0,55



ΚΩΔΙΚΟΣ	ΔΙΑΣΤΑΣΗ	ΣΥΣΚ	€/τεμ.
122201750	PZ1x75mm	10	0,75
122202750	PZ2x75mm	10	0,75
122203750	PZ3x75mm	10	0,75



ΚΩΔΙΚΟΣ	ΔΙΑΣΤΑΣΗ	ΣΥΣΚ	€/τεμ.
122202100	PZ2x100mm	10	0,90



ΜΥΤΕΣ R



ΚΩΔΙΚΟΣ	ΔΙΑΣΤΑΣΗ	ΣΥΣΚ	€/τεμ.
122102300	R2x30mm	20	0,42
122103300	R3x30mm	20	0,42

ΚΩΔΙΚΟΣ	ΔΙΑΣΤΑΣΗ	ΣΥΣΚ	€/τεμ.
122102500	R2x50mm	10	0,55
122103500	R3x50mm	10	0,55

ΚΩΔΙΚΟΣ	ΔΙΑΣΤΑΣΗ	ΣΥΣΚ	€/τεμ.
122102750	R2x75mm	10	0,75
122103750	R3x75mm	10	0,75

ΚΩΔΙΚΟΣ	ΔΙΑΣΤΑΣΗ	ΣΥΣΚ	€/τεμ.
122102100	R2x100mm	10	0,90
122103100	R3x100mm	10	0,90



ΜΥΤΕΣ TORX



ΚΩΔΙΚΟΣ	ΔΙΑΣΤΑΣΗ	ΣΥΣΚ	€/τεμ.
122301030	T10x30mm	20	0,42
122301530	T15x30mm	20	0,42
122302030	T20x30mm	20	0,42
122302530	T25x30mm	20	0,42
122302730	T27x30mm	20	0,42
122303030	T30x30mm	20	0,42
122304030	T40x30mm	20	0,42

ΚΩΔΙΚΟΣ	ΔΙΑΣΤΑΣΗ	ΣΥΣΚ	€/τεμ.
122301050	T10x50mm	10	0,55
122301550	T15x50mm	10	0,55
122302050	T20x50mm	10	0,55
122302550	T25x50mm	10	0,55
122302750	T27x50mm	10	0,55
122303050	T30x50mm	10	0,55
122304050	T40x50mm	10	0,55

122303075	T30x75mm	10	0,75
-----------	----------	----	------

DARKO
Impact**ΜΥΤΕΣ ΑΛΛΕΝ**

ΚΩΔΙΚΟΣ	ΔΙΑΣΤΑΣΗ	ΣΥΣΚ	€/τεμ.
122703030	3.0x30mm	20	0,42
122704030	4.0x30mm	20	0,42
122705030	5.0x30mm	20	0,42
122706030	6.0x30mm	20	0,42

DARKO
Impact**ΜΥΤΕΣ ΙΣΙΕΣ**

ΚΩΔΙΚΟΣ	ΔΙΑΣΤΑΣΗ	ΣΥΣΚ	€/τεμ.
122404030	4.0x30mm	20	0,42
122404530	4.5x30mm	20	0,42
122405530	5.5x30mm	20	0,42
122406030	6x30mm	20	0,42

ΜΥΤΕΣ IMPACT TORSION ΣΕΤ 4 ΤΕΜ**NEO****DARKO**
Impact**ΜΥΤΕΣ PH - PZ / ΣΕΤ 4 ΤΕΜ**

ΚΩΔΙΚΟΣ	ΠΕΡΙΧΕΙ	ΣΥΣΚ	€/ΣΕΤ
122000001	PH2x30mm PH2x50mm PZ2x30mm PZ2x50mm		2,80

**ΜΥΤΕΣ PH / ΣΕΤ 4 ΤΕΜ**

ΚΩΔΙΚΟΣ	ΠΕΡΙΧΕΙ	ΣΥΣΚ	€/ΣΕΤ
122000002	2 x PH2x30mm 2 x PH2x50mm		2,80

**ΜΥΤΕΣ PZ / ΣΕΤ 4 ΤΕΜ**

ΚΩΔΙΚΟΣ	ΠΕΡΙΧΕΙ	ΣΥΣΚ	€/ΣΕΤ
122000003	PZ1x30mm PZ2x30mm PZ2x50mm PZ3x50mm		2,80

**ΜΥΤΕΣ PZ / ΣΕΤ 4 ΤΕΜ**

ΚΩΔΙΚΟΣ	ΠΕΡΙΧΕΙ	ΣΥΣΚ	€/ΣΕΤ
122000004	2 x PZ2x30mm 2 x PZ2x50mm		2,80

**ΜΥΤΕΣ PH / ΣΕΤ 4 ΤΕΜ**

ΚΩΔΙΚΟΣ	ΠΕΡΙΧΕΙ	ΣΥΣΚ	€/ΣΕΤ
122000005	PH1x30mm PH2x30mm PH2x50mm PH3x50mm		2,80



ΜΑΓΝΗΤΙΚΟ ΔΑΧΤΥΛΙΔΙ ΣΥΓΚΡΑΤΗΣΗΣ



ΚΩΔΙΚΟΣ	ΔΙΑΣΤΑΣΗ	ΣΥΣΚ	€/τεμ.
122600230	23mm	2	2,60

HALF INOX

ΜΑΓΝΗΤΙΚΟΣ ΦΟΡΕΑΣ



1/4"



ΚΩΔΙΚΟΣ	ΔΙΑΣΤΑΣΗ	ΣΥΣΚ	€/τεμ.
122600360	1/4"x60mm	2	1,95

ΤΑΧΕΙΑΣ ΑΠΕΛΕΥΘΕΡΩΣΗΣ

ΜΑΓΝΗΤΙΚΟΣ ΦΟΡΕΑΣ ΣΥΓΚΡΑΤΗΣΗΣ



1/4"



ΚΩΔΙΚΟΣ	ΔΙΑΣΤΑΣΗ	ΣΥΣΚ	€/τεμ.
122600160	1/4"x60mm	2	3,10
122600100	1/4"x100mm	2	4,65

2 ΣΕ 1 - 1/4" & 3/8"

ΜΑΓΝΗΤΙΚΟΣ ΦΟΡΕΑΣ ΣΥΓΚΡΑΤΗΣΗΣ



ΚΩΔΙΚΟΣ	ΔΙΑΣΤΑΣΗ	ΣΥΣΚ	€/τεμ.
122096365	1/4" & 3/8" x 65mm		3,90



1/4"

3/8" Dr.

NEO



ΓΙΑ ΜΥΤΗ & ΚΑΡΥΔΑΚΙ !!!

DARKO
Impact



ΜΑΓΝΗΤΙΚΟΣ ΦΟΡΕΑΣ

ΚΩΔΙΚΟΣ	ΔΙΑΣΤΑΣΗ	ΣΥΣΚ	€/τεμ.
122600261	1/4 X 60 mm	1	3,95



DARKO
Impact



ΜΑΓΝΗΤΙΚΟΣ ΦΟΡΕΑΣ & ΜΑΓΝΗΤΙΚΟ ΔΑΚΤΥΛΙΔΙ

ΚΩΔΙΚΟΣ	ΔΙΑΣΤΑΣΗ	ΣΥΣΚ	€/τεμ.
122600262	1/4 X 60 mm	1	7,15



DARKO
Impact



ΜΑΓΝΗΤΙΚΑ ΚΑΡΥΔΑΚΙΑ

ΚΩΔΙΚΟΣ	ΔΙΑΣΤΑΣΗ	ΣΥΣΚ	€/τεμ.
122506650	6mmx65mm	2	1,85
122508650	8mmx65mm	2	1,90
122510650	10mmx65mm	2	2,40
122513650	13mmx65mm	2	2,90
122517650	17mmx65mm	2	4,75

DARKO
Impact



ΣΕΤ ΚΑΡΥΔΑΚΙΑ ΜΑΓΝΗΤΙΚΑ 3 ΤΕΜ

ΚΩΔΙΚΟΣ	ΔΙΑΣΤΑΣΗ	ΤΕΜ/ΣΕΤ	ΣΥΣΚ	€/σετ
122503000	8-10-13mm	3	1	7,65





ΦΟΡΕΑΣ ΓΙΑ ΚΑΡΥΔΑΚΙ 1/2" - 15 ΜΟΙΡΩΝ



ΚΩΔΙΚΟΣ	ΔΙΑΣΤΑΣΗ	ΣΥΣΚ	€/τεμ.
122500455	1/4 X 55 mm	1	4,60



ΣΕΤ ΜΥΤΕΣ ΓΥΨΟΣΑΝΙΔΑΣ PH2 - 10 ΤΕΜ.

ΚΩΔΙΚΟΣ	ΔΙΑΣΤΑΣΗ	ΣΥΣΚ	€/σετ
122000265	PH2 X65 mm	100	8,30

Contents:
10 x Impact Double Ended
Bit(65mm):
PH2- PH2(Drywall)



ΣΕΤ ΜΥΤΕΣ - 20 ΤΕΜ.

ΚΩΔΙΚΟΣ	ΤΕΜ/ΣΕΤ	ΣΥΣΚ	€/σετ
122002006	20	100	14,95

Contents:
60mm Impact Bit Holder
1/4" Dr. x 50mm Socket Adaptor
2 x Magnetic Nut Setter(45mm): 1/4", 10mm
16 x Impact Insert Bit(25mm):
PH: 1, 2, 3
PZ: 1, 2, 3
SL: 3, 4.5, 5.5, 6.5mm
TX: T10, T15, T20, T25, T30
RO: RO2



ΣΕΤ ΜΥΤΕΣ - 6 ΤΕΜ.

ΚΩΔΙΚΟΣ	ΤΕΜ/ΣΕΤ	ΣΥΣΚ	€/σετ
122000641	6	200	5,95

Contents:
Mag Booster
5 x Impact Power Bit(50mm):
PH: 2
PZ: 2
RO: RO2
TX: T20, T25

**ΣΕΤ ΜΥΤΕΣ - 10 ΤΕΜ.**

ΚΩΔΙΚΟΣ	ΤΕΜ/ΣΕΤ	ΣΥΣΚ	€/σετ
122001046	10	100	6,95

Contents:
 10 x Impact Power Bit(50mm):
 PH:1, 2
 PZ: 1, 2
 TX: T10, T15, T20, T25, T30, T40

**ΦΟΡΕΑΣ 1/4" ΓΙΑ ΤΣΟΚ 3/8"**

ΚΩΔΙΚΟΣ	ΔΙΑΣΤΑΣΗ	ΣΥΣΚ	€/τεμ.
122003246	1/4"	1	3,25

**ΑΝΤΑΠΤΟΡΑΣ SDS ΓΙΑ ΤΣΟΚ 1/2"**

ΚΩΔΙΚΟΣ	ΔΙΑΣΤΑΣΗ	ΣΥΣΚ	€/τεμ.
12009400	1/2"	1	5,15

**ΤΣΟΚ 1/4" ΑΥΤΟΜΑΤΟ**

ΚΩΔΙΚΟΣ	ΔΙΑΣΤΑΣΗ	ΣΥΣΚ	€/τεμ.
122009400	6mm	1	5,10

drills **TIGER**

HELIX TIGER MULTIPURPOSE DRILLS

Κατάλληλο για **μπετό, πέτρα, μάρμαρο, πλακάκια, γρανίτη** και **λεπτά μέταλλα**.
Επαγγελματικό διαμαντοτρύπανο πολλαπλών χρήσεων για δομικά υλικά και μέταλλα.
Ιδανικό για δράπανα μπαταρίας καθώς **δουλεύει και χωρίς κρούση**.

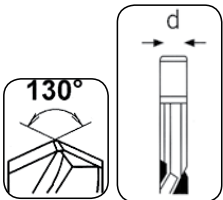

ΠΟΛΛΑΠΛΩΝ ΕΦΑΡΜΟΓΩΝ "TIGER" & ΓΡΑΝΙΤΗ



ΚΩΔΙΚΟΣ	Ø mm	ΜΗΚΟΣ mm	ΣΥΣΚ	€/ΤΕΜ
42330004	4,0	75	1	0,96
42330005	5,0	85	1	1,12
42330006	6	100	1	1,20
42330007	7,0	100	1	1,49
42330008	8,0	120	1	1,89
42330100	10,0	120	1	2,60
42330120	12,0	150	1	3,65
42330620	6,0 LONG	200	1	2,68
42330820	8,0 LONG	200	1	3,05
42331020	10,0 LONG	200	1	3,60
42331220	12,0 LONG	200	1	4,40

ΣΕΤ ΤΡΥΠΑΝΙΑ TIGER HELIX



ΚΩΔΙΚΟΣ	Ø mm	ΣΥΣΚ	€/ΤΕΜ
42331005	5 τεμ (4-5-6-8-10)	1	7,75
42331008	8 τεμ (3-4-5-6-7-8-9-10)	1	11,85



ΤΡΥΠΑΝΙ ΓΡΑΝΙΤΗ ΠΟΡΣΕΛΑΝΗΣ & ΣΚΛΗΡΩΝ ΥΛΙΚΩΝ



ΚΩΔΙΚΟΣ	Ø mm	ΜΗΚΟΣ mm	ΣΥΣΚ	€/ΤΕΜ
42600004	4	75	1	3,20
42600005	5	85	1	3,45
42600006	6	100	1	3,60
42600008	8	120	1	5,55
42600010	10	120	1	7,10
42600012	12	150	1	10,40

drills HSS-G

Din 338, 340, 1889

STRAIGHT SHANK FULLY GROUND TWIST DRILLS
BRIGHT FINISH - POINT ANGLE 135° - SPLIT POINTΙδανικό για χρήση σε: **μαλακά** και **σκληρά μέταλλα, κράματα μετάλλων** με δυνατότητα για χρήση ακόμη και σε **ανοξειδωτά**.

Επαγγελματικό τρυπάνι από υψηλής ποιότητας ατσάλι με ασημένιο φινιρίσμα (bright) κατασκευασμένο με τη μέθοδο της αφαίρεσης υλικού (Grounded). Έχει διπλό τρύχισμα (Split point) στη μύτη 118°/135° για καλύτερο κεντράρισμα, ακρίβεια στη διάτρηση και καλύτερη εξαγωγή των ρινισμάτων από βαθιές τρύπες.

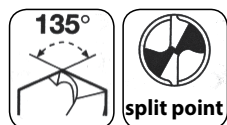
338
DIN**R_s ≤ 700 N/mm²****ΤΡΥΠΑΝΙ ΣΙΔΗΡΟΥ HSS-G DIN 338**

ΚΩΔΙΚΟΣ	Ø mm	ΜΗΚΟΣ mm	ΣΥΣΚ	€/ΤΕΜ
03380010	1,0	34	10	0,27
03380015	1,5	40	10	0,29
03380020	2,0	49	10	0,30
03380025	2,5	57	10	0,34
03380030	3,0	61	10	0,38
03380032	3,2	65	10	0,44
03380035	3,5	70	10	0,44
03380040	4,0	75	10	0,48
03380042	4,2	75	10	0,55
03380045	4,5	80	10	0,55
03380050	5,0	86	10	0,61
03380052	5,2	86	10	0,70
03380055	5,5	93	10	0,70
03380060	6,0	93	10	0,80
03380065	6,5	101	10	0,95
03380070	7,0	109	5	1,13
03380075	7,5	109	5	1,23
03380080	8,0	117	5	1,47
03380085	8,5	117	5	1,63
03380090	9,0	125	5	1,90
03380095	9,5	125	5	2,10
03380100	10,0	133	5	2,40
03380105	10,5	133	5	2,65
03380110	11,0	142	5	3,10
03380115	11,5	142	5	3,35
03380120	12,0	151	5	3,78
03380125	12,5	151	5	4,08
03380130	13,0	151	5	4,45

1897
DIN**R_s ≤ 1200 N/mm²****ΞΕΠΟΝΤΑΡΙΣΤΕΣ HSS-E Co**

ΚΩΔΙΚΟΣ	Ø mm	ΣΥΣΚ	€/ΤΕΜ
180130600	6	10	6,20
180130800	8	10	8,90
180131000	10	10	10,40

**340
DIN**



R≤700 N/mm²



ΤΡΥΠΑΝΙ ΣΙΔΗΡΟΥ HSS-G DIN 340, ΜΑΚΡΥ

ΚΩΔΙΚΟΣ	Ø mm	ΜΗΚΟΣ mm	ΣΥΣΚ	€/ΤΕΜ
03400020	2,0	85	10	0,50
03400025	2,5	95	10	0,60
03400030	3,0	100	10	0,60
03400032	3,2	106	10	0,60
03400035	3,5	112	10	0,72
03400040	4,0	119	10	0,83
03400042	4,2	119	10	0,87
03400045	4,5	126	10	0,87
03400050	5,0	132	10	1,15
03400055	5,5	139	10	1,25
03400060	6,0	139	10	1,35
03400065	6,5	148	10	1,60
03400070	7,0	156	5	1,90
03400075	7,5	156	5	2,05
03400080	8,0	165	5	2,30
03400085	8,5	165	5	3,00
03400090	9,0	175	5	3,05
03400095	9,5	175	5	3,40
03400100	10,0	184	5	3,90

**1869
DIN**



R≤800 N/mm²



ΤΡΥΠΑΝΙ ΣΙΔΗΡΟΥ HSS-G DIN 1869 ΠΟΛΥ ΜΑΚΡΥ

ΚΩΔΙΚΟΣ	Ø mm	ΜΗΚΟΣ mm	ΣΥΣΚ	€/ΤΕΜ
186930150	3,0	150	10	3,62
186935165	3,5	165	10	5,40
186940175	4,0	175	10	6,15
186945185	4,5	185	10	6,55
186950195	5,0	195	10	7,55
186960205	6,0	205	10	9,45
186980240	8,0	240	10	14,20

drills **HSS**
Din 338

**338
DIN**
R≤650 N/mm²

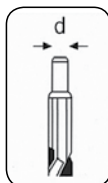

ΤΡΥΠΑΝΙ ΣΙΔΗΡΟΥ HSS DIN 338 ΤΟΡΝΙΡΙΣΜΕΝΟ 13mm

ΚΩΔΙΚΟΣ	Ø mm	d	ΜΗΚΟΣ mm	ΣΥΣΚ	€/ΤΕΜ
03382135	13,5	10	160	5	4,47
03382140	14,0	10	160	5	4,47
03382145	14,5	10	169	5	5,04
03382150	15,0	10	169	5	5,90
03382155	15,5	10	178	5	6,75
03382160	16,0	10	178	5	7,10
03382165	16,5	13	184	5	7,75
03382170	17,0	13	184	5	7,80
03382175	17,5	13	191	5	8,00
03382180	18,0	13	191	5	8,45
03382185	18,5	13	198	5	9,35
03382190	19,0	13	198	5	9,65
03382195	19,5	13	205	5	10,70
03382200	20,0	13	205	5	11,00

drills HSS-E Co

Din 338, 340

COBALT TWIST DRILLS GROUND FROM THE SOLID POINT ANGLE 130° – COPPER FINISH

Ιδανικό για χρήση σε: **ανοξειδωτα** και **βαμμένα ατσάλια** καθώς και σε **σκληρά κράματα**.

Επαγγελματικό κοβαλιούχο τρυπάνι από υψηλής ποιότητας ατσάλι, με κίτρινο φινιρίσμα κατασκευασμένο με τη μέθοδο της αφαίρεσης υλικού (Grounded). Έχει διπλό τρόχισμα (Split point) στη μύτη 118°/130° για καλύτερο κεντράρισμα και ακρίβεια στη διάτρηση καθώς και καλύτερη εξαγωγή των ρινομάτων από βαθιές τρύπες.

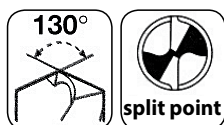
**338
DIN****COBALT****R_s ≤ 1100 N/mm²****ΤΡΥΠΑΝΙ ΣΙΔΗΡΟΥ HSS-COBALT DIN 338**

ΚΩΔΙΚΟΣ Ø mm ΜΗΚΟΣ mm ΣΥΣΚ €/ΤΕΜ

03381010	1,0	34	10	0,39
03381015	1,5	40	10	0,41
03381020	2,0	49	10	0,48
03381025	2,5	57	10	0,57
03381030	3,0	61	10	0,62
03381032	3,2	65	10	0,74
03381035	3,5	70	10	0,75
03381040	4,0	75	10	0,86
03381042	4,2	75	10	1,00
03381045	4,5	80	10	1,06
03381050	5,0	86	10	1,26
03381052	5,2	86	10	1,59
03381055	5,5	93	10	1,59
03381060	6,0	93	10	1,70
03381065	6,5	101	10	2,15
03381070	7,0	109	5	2,49
03381075	7,5	109	5	2,72
03381080	8,0	117	5	3,50
03381085	8,5	117	5	3,73
03381090	9,0	125	5	5,05
03381095	9,5	125	5	5,33
03381100	10,0	133	5	5,53
03381110	11,0	142	5	7,15
03381120	12,0	151	5	8,20
03381130	13,0	151	5	9,58

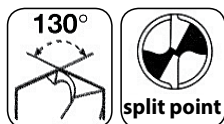
**340
DIN****COBALT****R_s ≤ 1200 N/mm²****ΤΡΥΠΑΝΙ ΣΙΔΗΡΟΥ HSS-CO 5% DIN 340, ΜΑΚΡΥ**

ΚΩΔΙΚΟΣ Ø mm ΜΗΚΟΣ mm ΣΥΣΚ €/ΤΕΜ

03401030	3,0	100	10	1,15
03401032	3,2	106	10	1,45
03401035	3,5	112	10	1,45
03401040	4,0	119	10	1,65
03401042	4,2	119	10	2,00
03401045	4,5	126	10	2,00
03401050	5,0	132	10	2,25
03401060	6,0	139	10	3,20



drills ΠΟΤΗΡΟΤΡΥΠΑΝΑ

HSS-G HOLE SAWS

Ποτηροτρύπανα με HSS-G.

Ιδανικό για χρήση σε: **μαλακά και σκληρά μέταλλα.**

**HSS-G
DMO 5**

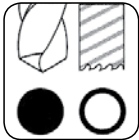

ΠΟΤΗΡΟΤΡΥΠΑΝΟ HSS-G DMO 5

ΚΩΔΙΚΟΣ	Ø mm	ΣΥΣΚ	€/ΤΕΜ
45501300	13	1	8,35
45501400	14	1	8,80
45501500	15	1	9,00
45501600	16	1	9,00
45501700	17	1	9,00
45501800	18	1	9,00
45501900	19	1	9,30
45502000	20	1	9,85
45502100	21	1	10,30
45502200	22	1	10,80
45502300	23	1	11,60
45502400	24	1	11,80
45502500	25	1	12,20
45502600	26	1	13,00
45502700	27	1	13,20
45502800	28	1	13,75
45502900	29	1	14,25
45503000	30	1	14,50
45503100	31	1	15,10
45503200	32	1	15,55
45503300	33	1	16,10
45503400	34	1	16,60
45503500	35	1	17,00
45503600	36	1	17,80
45503700	37	1	18,00
45503800	38	1	18,50
45503900	39	1	20,10
45504000	40	1	20,10
45504200	42	1	20,75
45504500	45	1	23,15
45504800	48	1	24,70
45505000	50	1	25,15
45505200	52	1	30,40
45505600	56	1	34,15
45506000	60	1	36,60
45506500	65	1	45,80
45507000	70	1	50,10
45507500	75	1	53,20

ΣΥΝΙΣΤΩΜΕΝΗ ΤΑΧΥΤΗΤΑ ΚΟΠΗΣ / r.p.m.

Ø mm	ΠΛΑΣΤΙΚΟ	ΑΛΟΥΜΙΝΙΟ	ΜΑΛΑΚΑ ΜΕΤΑΛΛΑ	ΧΥΤΟΣΙΔΗΡΟΣ
10+17	500	800	400	360
18+24	370	530	350	270
25+32	290	380	280	230
33+38	250	290	230	180
39+45	210	250	200	170
46+52	190	200	180	150
53+58	170	185	150	120
59+65	130	170	120	90
68+70	110	130	100	80
75+85	100	100	80	70
90+100	90	90	70	60
105+120	70	70	60	50

ΦΡΕΖΑ HSS-E Co 5% DIN 335 FORM C 90°

ΚΑΤΑΛΛΗΛΕΣ ΓΙΑ ΙΝΟΧ



R≤1200 N/mm²

ΚΩΔΙΚΟΣ	Ø mm	ΣΥΣΚ	€/ΤΕΜ
754000001	6,3	1	7,15
754000002	8,3	1	8,95
754000003	10,4	1	10,60
754000004	12,4	1	13,30
754000005	16,5	1	17,45
754000006	20,5	1	21,50
754000007	25,0	1	30,05
754000008	31,0	1	39,40

drills **ΠΟΤΗΡΟΤΡΥΠΑΝΑ**

TCT HOLE SAWS

Ποτηροτρύπανα με βίντι. Ιδανικό για χρήση σε: **σκληρούς χάλυβες, κράματα μετάλλων, σκληρά μέταλλα και ανοξείδωτο ατσάλι.**

for
INOX

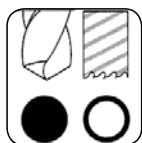

ΠΟΤΗΡΟΤΡΥΠΑΝΟ ΚΑΡΒΙΔΙΟΥ ΓΙΑ ΚΟΠΗ ΙΝΟΧ

ΚΩΔΙΚΟΣ	Ø mm	ΣΥΣΚ	€/ΤΕΜ
45301600	16	1	10,70
45301700	17	1	11,40
45301800	18	1	12,15
45301900	19	1	12,80
45302000	20	1	13,45
45302200	22	1	14,80
45302400	24	1	16,15
45302500	25	1	16,85
45302600	26	1	17,55
45302700	27	1	18,20
45302800	28	1	18,85
45303000	30	1	20,20
45303200	32	1	21,55
45303300	33	1	22,25
45303400	34	1	22,85
45303500	35	1	23,60
45303600	36	1	24,25
45303800	38	1	25,60
45304000	40	1	27,00
45304200	42	1	28,30
45304500	45	1	30,30
45304800	48	1	32,35
45305000	50	1	33,70
45305200	52	1	35,10
45305400	54	1	36,45
45306000	60	1	40,45
45306500	65	1	47,00

ΣΥΝΙΣΤΩΜΕΝΗ ΤΑΧΥΤΗΤΑ ΚΟΠΗΣ / r.p.m.

Ø mm	ΑΝΟΞΕΙΔΩΤΟ ΑΤΣΑΛΙ	ΚΡΑΜΑ ΑΤΣΑΛΙΟΥ	ΧΥΤΟΣΙΔΗΡΟΣ
15+20	520	800	670
21+30	400	550	450
31+40	280	450	320
41+50	250	380	270
51+60	200	300	230
65+80	180	280	190
85+100	150	200	150
105+130	80	130	100

ΚΑΤΑΛΛΗΛΑ ΓΙΑ ΙΝΟΧ & ΣΚΛΗΡΑ ΚΡΑΜΑΤΑ

**ΦΡΕΖΑΚΙΑ ΚΑΡΒΙΔΙΟΥ
diamond cut**



SB

ΚΩΔΙΚΟΣ	Ø mm	ΣΥΣΚ	€/ΤΕΜ
75320616	6,0	1	10,80
75320820	8,0	1	12,90
75321020	10,0	1	15,05
75321225	12,0	1	17,05



SC

75330616	6,0	1	10,80
75330820	8,0	1	12,90
75331020	10,0	1	15,05
75331225	12,0	1	17,05



SF

75360820	8,0	1	12,90
75361020	10,0	1	15,05
75361225	12,0	1	17,05



SM

75400820	8,0	1	12,90
75401020	10,0	1	15,05

ΣΥΝΙΣΤΩΜΕΝΗ
ΤΑΧΥΤΗΤΑ ΚΟΠΗΣ
27000-35000



ΔΙΣΚΟΣ ΚΟΠΗΣ INOX CD LINEA

ΚΩΔΙΚΟΣ	ΔΙΑΣΤΑΣΗ	ΠΡΟΔΙΑΓΡΑΦΗ	ΣΥΣΚ	€/τεμ.
5500011510	115X1,0	A60S	25	0,95
5500012510	125X1,0	A60S	25	1,00
5500023019	230X1,9	A46S	25	2,35

Linea
INDUSTRIALE



ΓΙΑ ΕΠΑΓΓΕΛΜΑΤΙΚΗ ΧΡΗΣΗ

PLATINUM

Ιδανικό για τροχούς με υψηλή ιπποδύναμη



ΔΙΣΚΟΙ ΚΟΠΗΣ INOX PLATINUM

ΚΩΔΙΚΟΣ	ΔΙΑΣΤΑΣΗ	ΠΡΟΔΙΑΓΡΑΦΗ	ΣΥΣΚ	€/τεμ.
5500311510	115X1,0	A46V	50	1,20
5500312510	125X1,0	A46V	50	1,25
5500323019	230X1,9	A46V	25	3,15

PLATINUM



ΓΙΑ ΒΙΟΜΗΧΑΝΙΚΗ ΧΡΗΣΗ

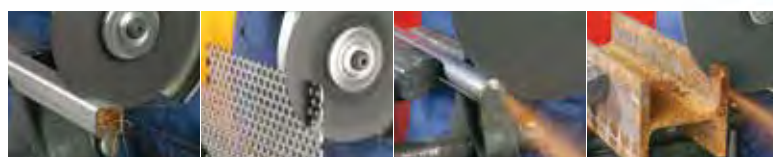

Κόκκοι οξειδίου αργιλίου υψηλής απόδοσης.
Νέο μείγμα με πάχος 3.4 mm χωρίς σίδηρο, χωρίς θείο και χωρίς χλώριο.



Ένας δίσκος για όλα τα υλικά!!!

Jolly



ΔΙΣΚΟΙ ΚΟΠΗΣ MULTI JOLLY

ΚΩΔΙΚΟΣ	ΔΙΑΣΤΑΣΗ	ΠΡΟΔΙΑΓΡΑΦΗ	ΣΥΣΚ	€/τεμ.
5500411510	115X1,0	C60T	50	1,10
5500412510	125X1,0	C60T	50	1,16
5500423016	230X1,9	C46T	25	3,05

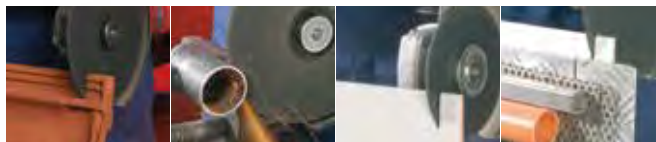

▷ INOX ▷ Σίδηρο ▷ Αλουμίνιο ▷ Πέτρα ▷ PVC ▷ Πλακάκι

JOLLY UNIVERSAL FLAT CUT-OFF WHEEL

Ένας δίσκος για όλα τα υλικά χωρίς να χρειάζεται αλλαγή τροχού.

Εφαρμογή: σίδηρο, ανοξείδωτο ατσάλι, αλουμίνιο, πέτρα, πλακάκια, PVC.

Λειαντικοί κόκκοι πυριτίου-άνθρακα χωρίς σίδηρο (< 0,1%).

Ακριβής, ασφαλής και άνετη κοπή σε όλα τα υλικά χωρίς υπολείμματα σε σίδηρο και ανοξείδωτο.



ΔΙΣΚΟΣ ΚΟΠΗΣ ΣΙΔΗΡΟΥ LINEA

ΚΩΔΙΚΟΣ	ΔΙΑΣΤΑΣΗ	ΠΡΟΔΙΑΓΡΑΦΗ	ΣΥΣΚ	€/τεμ.
5500111525	115X2,5	A30S	25	1,20
5500112525	125X2,5	A30S	25	1,25
5500123025	230X2,5	A30S	25	2,30
5500135030	350X3,0	A30S	10	6,95

Linea
INDUSTRIALE



ΔΙΣΚΟΣ ΛΕΙΑΝΣΗΣ ΣΙΔΗΡΟΥ-INOX LINEA

ΚΩΔΙΚΟΣ	ΔΙΑΣΤΑΣΗ	ΠΡΟΔΙΑΓΡΑΦΗ	ΣΥΣΚ	€/τεμ.
5500211564	115X6,4	A30S	25	1,70
5500212564	125X6,4	A30S	25	2,00
5500223064	230X6,4	A30S	25	4,50

Linea
INDUSTRIALE



GRINDING

BEST WORKING PERFORMANCE

MAXI
ΔΙΑΡΚΕΙΑ - ΑΠΟΔΟΣΗ!!!

ΔΙΣΚΟΣ ΦΤΕΡΟΥ ΖΙΡΚΟΝΙΟΥ MAXI



ΚΩΔΙΚΟΣ	ΔΙΑΜΕΤΡΟΣ	ΚΟΚΚΟΣ	ΣΥΣΚ	€/τεμ.
5500911540	115	40	10	2,40
5500911560	115	60	10	2,40
5500911580	115	80	10	2,40
5500911512	115	120	10	2,40
5500912540	125	40	10	2,55
5500912560	125	60	10	2,55
5500912580	125	80	10	2,55
5500912512	125	120	10	2,55



Κόκκοι ζιρκονίου υψηλής ποιότητας επάνω σε βαμβακερό πανί ενισχυμένο με ίνες. Η μεγάλη πυκνότητα (MAXI) πτερυγίων και η υψηλότερη ποσότητα λιπαντικού υλικού παρέχουν μεγαλύτερη διάρκεια ζωής σε σύγκριση με τους παραδοσιακούς δίσκους.

Εφαρμογή: ανοξείδωτος χάλυβας, χάλυβας υψηλής αντοχής, μη σιδηρούχα μέταλλα, αλουμίνιο, χυτοσίδηρος.

ΔΙΣΚΟΣ ΦΤΕΡΟΥ ΚΕΡΑΜΙΚΟΣ & ZIRCON

PLATINUM



ΚΩΔΙΚΟΣ	ΔΙΑΣΤΑΣΗ	ΣΥΣΚ	€/τεμ.
5500711540	115/40	10	3,50
5500711560	115/60	10	3,50
5500711580	115/80	10	3,50
5500712540	125/40	10	4,50
5500712560	125/60	10	4,50
5500712580	125/80	10	4,50



Ο συνδυασμός κόκκων **SG Κεραμικών & Ζιρκονίου** το καθιστά ιδανικό για τη λείανση ακόμα και σε σκληρότερα υλικά χωρίς να τα υπερθερμαίνουν. Καθαρότερο, τελικό, αποτέλεσμα χωρίς "καψίματα" και μεγαλύτερη διάρκεια ζωής του προϊόντος.

Εφαρμογή: ανοξείδωτος χάλυβας, χάλυβας υψηλού εφελκυσμού, χάλυβας υψηλού κράματος, χρώμιο, τιτάνιο, πολύ σκληρά υλικά ή σκληρές επιφάνειες με υψηλό βαθμό δυσκολίας στην εργασία.

ΔΙΣΚΟΣ ΓΥΑΛΙΣΜΑΤΟΣ INOX



PLATINUM
FINISH



ΚΩΔΙΚΟΣ	ΔΙΑΣΤΑΣΗ	ΣΥΣΚ	€/τεμ.
5500811500	115	5	13,20

Μη υφασμάτινος δίσκος για άριστα φινιρίσματα σε χάλυβα και ανοξείδωτο ατσάλι. Επιθετικοί κόκκοι οξειδίου του αργιλίου για σατινέ φινιρίσμα και κόκκοι καρβιδίου πυριτίου για γυαλιστερό φινιρίσμα σε χαμηλή ταχύτητα. Μειωμένη ταχύτητα στις επιφάνειες.



Η εξέλιξη του παραδοσιακού δίσκου Stripper!!!

PLATINUM STRIPPER



ΚΩΔΙΚΟΣ	ΔΙΑΣΤΑΣΗ	ΣΥΣΚ	€/τεμ.
5500911500	115	5	7,70
5500912500	125	5	7,95

Για αφαίρεση και γυάλισμα.
ΧΡΗΣΗ Αφαίρεση οξειδώσεων - σκουριάς, χρωμάτων από μέταλλα - ξύλα και τσιμέντο.

Ανοιχτή νάιλον δομή με λειαντικά καρβιδίου του πυριτίου σε υψηλότερη πυκνότητα σε σύγκριση με τον παραδοσιακό δίσκο **STRIPPER** για υψηλότερες επιδόσεις και μεγαλύτερη διάρκεια ζωής σε βερνίκια και εργασίες αφαίρεσης σκουριάς χωρίς γρατζουνιές.

Εφαρμογή: μέταλλα, καουτσούκ, πλαστικά, λάκα, ξύλο και σκυρόδεμα.

- Οφέλη:
- Καλό φινίρισμα σε όλα τα υλικά
 - Συμμορφώνεται εύκολα σε περίγραμμα και σχήματα επιφάνειας
 - Μακροζωία



ΔΙΣΚΟΣ FIBER

ΚΩΔΙΚΟΣ	ΔΙΑΜΕΤΡΟΣ	ΚΟΚΚΟΣ	ΣΥΣΚ	€/τεμ.
5500611516	115x22,23	16	25	0,62
5500611524	115x22,23	24	25	0,62
5500611536	115x22,23	36	25	0,52
5500611550	115x22,23	50	25	0,46
5500611560	115x22,23	60	25	0,42
5500611580	115x22,23	80	25	0,42
5500611510	115x22,23	100	25	0,41
5500611512	115x22,23	120	25	0,41
5500612516	125x22,23	16	25	0,73
5500612524	125x22,23	24	25	0,70
5500612580	125x22,23	80	25	0,48
5500612510	125x22,23	100	25	0,47
5500612512	125x22,23	120	25	0,46
5500618016	180x22,23	16	25	1,36
5500618024	180x22,23	24	25	1,30
5500618036	180x22,23	36	25	1,15
5500618050	180x22,23	50	25	1,00
5500618060	180x22,23	60	25	0,92
5500618080	180x22,23	80	25	0,90
5500618010	180x22,23	100	25	0,88
5500618012	180x22,23	120	25	0,86



ΔΙΑΜΑΝΤΟΔΙΣΚΟΣ ΚΟΠΗΣ



NEO



ΧΡΗΣΗ

Κοπή: σίδηρο, ασάλι, μέταλλα.

ΚΩΔΙΚΟΣ	ΔΙΑΣΤΑΣΗ	ΣΥΣΚ	€/τεμ.
66011500	115		10,50
66012500	125		14,95

- **Ικανότητα κοπής:** περισσότερα από 1000 κοψίματα ανά δίσκο
- **Ζωή Δίσκου:** 30 φορές μεγαλύτερη από τους κοινούς δίσκους
- **Η διάμετρος δεν μειώνεται με τη χρήση,** όπως συμβαίνει με όλους τους δίσκους
- **Δεν παράγει δυσάρεστες οσμές** όπως οι κοινοί δίσκοι



ΔΙΑΜΑΝΤΟΔΙΣΚΟΣ ΚΟΠΗΣ MULTI



NEO



ΧΡΗΣΗ

Κοπή: δομικά υλικά, μέταλλα.

ΚΩΔΙΚΟΣ	ΔΙΑΣΤΑΣΗ	ΣΥΣΚ	€/τεμ.
88011500	115		10,50
88012500	125		14,95

- **Ικανότητα κοπής:** περισσότερα από 1000 κοψίματα ανά δίσκο
- **Ζωή Δίσκου:** 30 φορές μεγαλύτερη από τους κοινούς δίσκους
- **Η διάμετρος δεν μειώνεται με τη χρήση,** όπως συμβαίνει με όλους τους δίσκους
- **Δεν παράγει δυσάρεστες οσμές** όπως οι κοινοί δίσκοι
- **Κατάλληλος για υγρή και ξηρή κοπή.**
Η χρήση νερού αυξάνει τη διάρκεια ζωής.

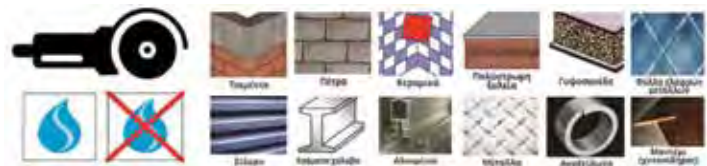

ΔΙΑΜΑΝΤΟΔΙΣΚΟΣ ΚΟΠΗΣ MULTI



NEO

ΧΡΗΣΗ

Κοπή: κεραμικά, μάρμαρο, πάγκους κουζίνας, corian, δομικά υλικά.

ΚΩΔΙΚΟΣ	ΔΙΑΣΤΑΣΗ	ΣΥΣΚ	€/τεμ.
77012500	125		15,25

- **Ικανότητα κοπής:** περισσότερα από 1000 κοψίματα ανά δίσκο
- **Ζωή Δίσκου:** 30 φορές μεγαλύτερη από τους κοινούς δίσκους
- **Η διάμετρος δεν μειώνεται με τη χρήση,** όπως συμβαίνει με όλους τους δίσκους
- **Δεν παράγει δυσάρεστες οσμές** όπως οι κοινοί δίσκοι
- **Σε συσκευασία Blister**



ΗΛΕΚΤΡΟΔΙΟ Fincord - M



ΚΩΔΙΚΟΣ	ΔΙΑΣΤΑΣΗ	ΣΥΣΚ	€/kg
61000200	Ø 2,0	6 X 3,5kg	7,10
61000250	Ø 2,5	6 X 4kg	4,60
61000320	Ø 3,2	6 X 4kg	4,45
61000400	Ø 4,0	6 X 4kg	4,50

Τεχνικά Χαρακτηριστικά

Ηλεκτρόδιο μέσης επένδυσης τύπου ρουτιλίου, ιδιαίτερα κατάλληλο για κολλήσεις λεπτών ελασμάτων.

Για συνεχείς ραφές το Fincord-M μπορεί να κρατιέται σε επαφή με το αντικείμενο χωρίς κίνδυνο κυρτότητας του κορδονιού.

Αυτόματη έναυση και επανέναυση.

Ελάχιστο πιτσίλισμα.

Στρωτή εμφάνιση ραφής.

ΗΛΕΚΤΡΟΔΙΟ Belinox



ΚΩΔΙΚΟΣ	ΔΙΑΣΤΑΣΗ	ΣΥΣΚ	€/kg
61010200	Ø 2,0	6 X 3kg	21,10
61010250	Ø 2,5	6 X 3kg	16,50
61010320	Ø 3,2	6 X 3kg	16,50

Τεχνικά Χαρακτηριστικά

Ηλεκτρόδιο ρουτιλίου υψηλά κεκραμένο με πολύ χαμηλή περιεκτικότητα άνθρακα για σταθεροποιημένους ή μη χρωμιονικελιούχους χάλυβες του τύπου 18 Cr/8 Ni ανθεκτικούς στην ατμοσφαιρική διάβρωση. Ανθεκτικό σε καταθρυμματισμό των κόκκων όταν δουλεύεται σε θερμοκρασίες μέχρι 350°C. Ομαλή συγκόλληση.

Καλή έναυση κι επανέναυση. Καλή εμφάνιση, λεπτός κυματισμός, λείες συνδέσεις.

Εύκολη απομάκρυνση της κρούστας.

ΗΛΕΚΤΡΟΔΙΟ Overcord -S



ΚΩΔΙΚΟΣ	ΔΙΑΣΤΑΣΗ	ΣΥΣΚ	€/kg
61020250	Ø 2,5	6 X 3,5kg	5,20
61020320	Ø 3,2	6 X 4,5kg	4,90

Τεχνικά Χαρακτηριστικά

Ηλεκτρόδιο παχιάς επένδυσης τύπου ρουτιλίου για γενικές εργασίες σιδηρών κατασκευών λεπτών ελασμάτων σιδήρου και χάλυβα, εργασίες καροσσερί αυτοκινήτων, κατασκευές λεβήτων, εργασίες λαμαρινοκατασκευών κ.λπ..

Καλή εμφάνιση ραφών χωρίς πιτσίλισμα, με αυτόματη έναυση κι επανέναυση.

Εύκολη απομάκρυνση κρούστας.

ΗΛΕΚΤΡΟΔΙΟ Supercito ΒΑΣΙΚΟ



ΚΩΔΙΚΟΣ	ΔΙΑΣΤΑΣΗ	ΣΥΣΚ	€/kg
61030250	Ø 2,5	6 X 3kg	4,50
61030320	Ø 3,2	6 X 4,5kg	4,15
61030400	Ø 4	6 X 4,5kg	4,15
61030500	Ø 5	6 X 4,5kg	4,35

Τεχνικά Χαρακτηριστικά

Ηλεκτρόδιο βασικού τύπου με απόδοση 115%.

Κατάλληλο για συνεκτικές συνδέσεις μεγάλης αντοχής σε ρηγματώσεις, ακόμα και χαλύβων με άνθρακα μέχρι 0,4 %. Καλά χαρακτηριστικά συγκόλλησης σε όλες τις θέσεις, εύκολη απομάκρυνση κρούστας.

**ΣΥΡΜΑ ΗΛΕΚΤΡΟΣΥΓΚΟΛΛΗΣΗΣ
MIG / MAG / FLUX**

ΚΑΤΑΛΛΗΛΑ ΓΙΑ ΣΥΓΚΟΛΛΗΣΕΙΣ ΣΕ ΧΑΛΥΒΑ
ΧΩΡΙΣ ΑΕΡΙΟ (ΤΑ ΣΥΡΜΑΤΑ FLUX)
ΚΑΙ ΜΕ ΧΡΗΣΗ CORGON (ΤΟ ΣΥΡΜΑ GAS).
ΤΑ ΣΥΡΜΑΤΑ 1KG ΕΙΝΑΙ ΣΥΜΒΑΤΑ ΜΕ ΤΗ
HELIXPOWER SMINI MIG 140 (75003140)



ΚΩΔΙΚΟΣ 75900081
ΠΕΡΙΓΡΑΦΗ FLUX 0,8mm
KG 5

€ **26,30**



ΚΩΔΙΚΟΣ 75900080
ΠΕΡΙΓΡΑΦΗ FLUX 0,8mm
KG 1

€ **6,95**



ΚΩΔΙΚΟΣ 75900083
ΠΕΡΙΓΡΑΦΗ GAS 0,8mm
KG 5

€ **18,90**



ΚΩΔΙΚΟΣ 75900082
ΠΕΡΙΓΡΑΦΗ GAS 0,8mm
KG 1

€ **6,65**



ΠΡΟΣΤΑΣΙΑ | ΑΣΦΑΛΕΙΑ & ΕΝΔΥΣΗ ΕΡΓΑΖΟΜΕΝΩΝ



ΠΑΠΟΥΤΣΙΑ ΕΡΓΑΣΙΑΣ [98 - 117]



ToWorkFor Παπούτσια Ασφάλειας

PROTEX Παπούτσια Ασφάλειας & Εργασίας

Κάλτσες | Επιγονατίδες



ΓΕΝΙΚΑ ΕΙΔΗ ΠΡΟΣΤΑΣΙΑΣ [118 - 129]



Ωτοασπίδες | Κράνη | Γυαλιά

Μάσκες | Γάντια | Ζώνες



ΕΝΔΥΣΗ ΕΡΓΑΣΙΑΣ [130 - 133]





MADE IN EU

SAFETY SHOES FOR THE WORKINGCLASS HERO

SAFETY SHOES FOR THE

WORKING CLASS HERO



ΜΠΟΤΑΚΙ ΑΣΦΑΛΕΙΑΣ TIGER S3 SRC-HRO

ΚΩΔΙΚΟΣ	ΜΟΝΤΕΛΟ	ΜΕΓΕΘΟΣ (No)	ΣΥΣΚ	€/ΤΕΜ
40486726xx	TIGER	39-46	10 ζεύγη ▶	88,00

* Διαθέσιμα μεγέθη 35-38, 47-51 κατόπιν παραγγελίας

Άνω Μέρος

- ▶ Ενισχυμένο Καφέ Nubuck δέρμα υψηλής αντίστασης στο νερό.
- ▶ Φόδρα Mesh Space 3D Bonding, τεχνολογία συγκόλλησης, χωρίς ραφές, που αποτρέπει ερεθισμούς & δημιουργεί έναν τρισδιάστατο σκελετό στεγανό & σταθερό.
- ▶ Πολυανθρακική προστασία δακτύλων Carbon light Toecap (χωρίς σίδηρο).
- ▶ Αντιστατικό με υψηλή άνεση.

Σόλα

- ▶ Νιτριλίου δύο στρωμάτων με έντονες αυλακώσεις για εξαιρετική πρόσφυση σε βρεγμένες ή ανώμαλες επιφάνειες & αντίσταση τριβής.
- ▶ Q-Flex πολυανθρακική προστασία πέλματος (χωρίς σίδηρο).
- ▶ Αντοχή σε θερμοκρασίες ως 300°C.
- ▶ Πλάτος 11cm.



Αντιστατική προστασία



Προστασία δακτύλων, από αλουμίνιο



Q Flex, προστασία με ανθρακονήματα



Υδροαπωθητικό



Αντοχή σε θερμοκρασία έως 300°C



Μεταλλική προστασία δακτύλων



100% συνθετική προστασία (χωρίς μέταλλο)



Αδιάβροχη μεμβράνη



Προστασία δακτύλων, Carbon Light

ΕΠΙΛΕΞΤΕ ΤΟ ΝΟΥΜΕΡΟ ΣΑΣ

NITRILE RUBBER Σόλα Καουτσούκ-Νιτριλίου

Μήκος πέλματος cm	22.25	22.29	23.55	24.20	24.85	25.55	26.15	26.80	27.45	28.10	28.75	29.40	30.05	30.70	31.35
Νούμερο Παπουτσιού	35	36	37	38	39	40	41	42	43	44	45	46	47	48	49

**ΗΛΕΚΤΡΟΛΟΓΩΝ
18.000V !!!**

ΜΠΟΤΑΚΙ ΑΣΦ. WATT WR SRC WRU HRO SB

ΚΩΔΙΚΟΣ	ΜΕΓΕΘΟΣ (No)	ΣΥΣΚ	€/ΤΕΜ
40461521xx	39-46	10 ζεύγη	99,00

* Διαθέσιμα μεγέθη 37-38, 47-48 κατόπιν παραγγελίας



NEO



NITRILE RUBBER

RESISTANT UP TO 300°C



ΕΙΔΙΚΑ ΣΧΕΔΙΑΣΜΕΝΟ ΓΙΑ ΗΛΕΚΤΡΟΛΟΓΟΥΣ
ΑΝΤΟΧΗ ΣΕ 18000V
ΥΨΗΛΗΣ ΠΟΙΟΤΗΤΑΣ ΔΕΡΜΑ NUBUCK
ΠΟΛΥΑΝΘΡΑΚΙΚΗ ΠΡΟΣΤΑΣΙΑ ΔΑΚΤΥΛΩΝ
ΠΡΟΣΤΑΣΙΑ ΠΕΛΜΑΤΟΣ ΑΠΟ ΑΝΘΡΑΚΟΝΗΜΑΤΑ
ΘΕΡΜΙΚΗ ΑΝΤΟΧΗ ΣΟΛΑΣ ΕΩΣ 300°C



NEO

ΠΑΠΟΥΤΣΙ ΑΣΦΑΛΕΙΑΣ X-303 S3-SRC-ESD

ΚΩΔΙΚΟΣ	ΜΕΓΕΘΟΣ (No)	ΣΥΣΚ	€/ΤΕΜ
40462160xx	39-46	10 ζεύγη	89,00

* Διαθέσιμα μεγέθη 35-38, 47-48 κατόπιν παραγγελίας

HYPERCLEAN



Άνω Μέρος

- Μαλακή επένδυση για βελτιωμένη εφαρμογή και άνεση
- Αντιβακτηριδιακή επένδυση μικροϊνών. Πρωτοποριακό υλικό από ίνες πολυεστέρα. Αδιάβροχο, ανθεκτικό και διαπνέον
- Προστασία δακτύλων από Aluminium Toesap (50% ελαφρύτερο από το σίδηρο 200 J σύμφωνα με το DIN EN 12568). Ελαφρύ, ανθεκτικό έως 200Joule. Με επιστροφή από λάστιχο για επιπλέον προστασία

Σόλα

- FLOAT, Αντιδιατρητική εσωτερική σόλα, εξαιρετικά εύκαμπτη και ελαφριά.
- CARBON PRO, υψηλής ποιότητας αφρώδης πάτος, υψηλών επιδόσεων
- Εξωτερική σόλα PU, ενισχυμένη στα σημεία υψηλότερης καταπόνησης
- Σόλα PU διπλής πυκνότητας. Μαλακή ενδιάμεση σόλα, που εξασφαλίζει άνεση και απορρόφηση κραδασμών. Ενισχυμένη εξωτερική σόλα για καλύτερη πρόσφυση και υψηλή αντοχή
- Τάπες ανοιχτού τύπου, ειδικά σχεδιασμένες, ώστε να αυτοκαθαρίζονται και να διώχνουν τα νερά



Γλωσσάριο Υποδημάτων Ασφαλείας

- S1:** ➤ Αντιστατικές Ιδιότητες ➤ Απορρόφηση ενέργειας από το τακούνι ➤ Αντίσταση σόλας στους υδρογονάνθρακες
- S3:** ➤ Αντιστατικές Ιδιότητες ➤ Απορρόφηση ενέργειας από το τακούνι ➤ Αντίσταση σόλας στους υδατάνθρακες ➤ Αδιάβροχο στο νερό ➤ Αντιδιατρητική σόλα
- WR:** ➤ Αντίσταση ολόκληρου του υποδήματος στη διείσδυση του νερού
- SRB-SRC:** ➤ Αντοχή στην ολίσθηση ➤ Όλοι οι τύποι σκληρών δαπέδων πολλαπλών χρήσεων εσωτερικού ή εξωτερικού χώρου
- ESD:** ➤ Ηλεκτροστατική εκφόρτιση
- HRO:** ➤ Αντοχή σε θερμοκρασία έως 300°C
- O2:** ➤ Σχεδιασμός κλειστού τύπου ➤ Τακούνι με απορρόφηση κραδασμών ➤ Αντιστατικές Ιδιότητες

WORKOUT

EVA SAFETY

TRIPLE SPEED

ΠΑΠΟΥΤΣΙ ΑΣΦΑΛΕΙΑΣ WARM UP S3-SRC-ESD

ΚΩΔΙΚΟΣ	ΜΟΝΤΕΛΟ	ΜΕΓΕΘΟΣ (No)	ΣΥΣΚ	€/ΤΕΜ
40482466xx	WARM UP GREY	39-46	10 ζεύγη ▶	85,00

* Διαθέσιμα μεγέθη 35-38, 47-48 κατόπιν παραγγελίας



NEO



Άνω Μέρος

- Υφασμα, μαύρο MICROSUEDE
- Μαλακό υλικό και πολύ ανθεκτικό στην τριβή και το σκίσιμο. Δεν λεικιάζει
- Προστασία δακτύλων από Aluminum Toecap (50% ελαφρύτερο από το σίδερο 200 J σύμφωνα με το DIN EN 12568)

Σόλα

- Σόλα τεχνολογίας TRIPLE SPEED με συνδυασμό EVA Safety και Rubber ελαφριά, αντιστατική, αντικραδασμική & αντιολισθητική
- Μη μεταλλική μεσαία σόλα διάτρησης FLOAT, εξαιρετικά ελαφριά και ευέλικτη
- Τακούι τεχνολογίας ACTIVE FOAM που βοηθά στην αποτροπή της μυϊκής κόπωσης, ενώ ταυτόχρονα ανακουφίζει την πίεση της φτέρνας



Άνω Μέρος

- Microfiber & Cordura με εξαιρετική αντοχή και διάρκεια.
- Φόδρα Promax Lining που αφαιρεί την υγρασία από το εσωτερικό του παπουτσιού και κατανέμει ομοιόμορφα τη θερμότητα.
- Προστασία δακτύλων από Aluminum Toesap (50% ελαφρύτερο από το σίδηρο).
- Εσωτερικός πάτος, Biorelax, πλενόμενος, αντιβακτηριδιακός, αντιστατικός & 100% αναπνευστότητα.

Σόλα

- Αερόσολα Nitrile Rubber, δύο στρωμάτων, τεχνολογίας AIR TUBELESS
- Φόδρα Promax Lining που αφαιρεί την υγρασία από το εσωτερικό του παπουτσιού και κατανέμει ομοιόμορφα τη θερμότητα.
- Q-Flex πολυανθρακική προστασία πέλματος (χωρίς σίδηρο).

SAFETY RUNNERS™
AIR TUBELESS TECHNOLOGY



ΠΑΠΟΥΤΣΙ ΑΣΦΑΛΕΙΑΣ STRIDE S3 SRC-ESD

ΚΩΔΙΚΟΣ	ΜΕΓΕΘΟΣ (No)	ΣΥΣΚ	€/ΤΕΜ
40488613xx	39-46	10 ζεύγη	▶ 86,00

* Διαθέσιμα μεγέθη 37-38, 47-48 κατόπιν παραγγελίας



ΠΑΠΟΥΤΣΙ ΑΣΦΑΛΕΙΑΣ POWER S3 SRC-ESD

ΚΩΔΙΚΟΣ	ΜΕΓΕΘΟΣ (No)	ΣΥΣΚ	€/ΤΕΜ
40488600xx	39-46	10 ζεύγη	▶ 89,00

* Διαθέσιμα μεγέθη 36-38, 47 κατόπιν παραγγελίας



ΝΕΟΣ

ΣΧΕΔΙΑΣΜΟΣ ΣΟΛΑΣ
ΚΑΛΥΤΕΡΗ ΠΡΟΣΦΥΣΗ
ΣΕ ΟΛΕΣ ΤΙΣ ΕΠΙΦΑΝΕΙΕΣ

PATENTED MIDSOLE SYSTEM.
TESTED AND CERTIFIED
BY INESCOPE*

Reduction in lower back muscle activity prevents low back pain

Up to 52% increased thermal insulation providing warmer feet

OPTIMAL PERFORMANCE
EXTREME COMFORT

AIR TUBELESS

Smoother foot-to-ground contact reduces forces up to 55%

AIR TUBELESS TECHNOLOGY

MADE IN EU**TOWORKFOR®**
BOLDLY SAFE**FULL GRIP™**

POWERED BY MICHELIN® TECHNICAL SOLES

1o
ΣΕ ΔΗΜΟΤΙΚΟΤΗΤΑ**ΜΠΟΤΑΚΙ ΑΣΦΑΛΕΙΑΣ WHEELS S3 SRC-HRO**

ΚΩΔΙΚΟΣ	ΜΕΓΕΘΟΣ (No)	ΣΥΣΚ	€/ΤΕΜ
40480620xx	39-47	10 ζεύγη	▶ 89,00

**ΣΕ ΠΩΛΗΣΕΙΣ**
No 1**NEO****ΜΠΟΤΑΚΙ ΑΣΦΑΛΕΙΑΣ GEAR S3 SRC-HRO**

ΚΩΔΙΚΟΣ	ΜΕΓΕΘΟΣ (No)	ΣΥΣΚ	€/ΤΕΜ
40460312xx	39-47	10 ζεύγη	▶ 89,00

Άνω Μέρος

- ▶ Ενισχυμένο δέρμα Nubuck με εξαιρετική αντοχή σε νερό, βενζίνη και λάδια.
- ▶ Φόδρα Promax Lining που αφαιρεί την υγρασία από το εσωτερικό του παπουτσιού και κατανέμει ομοιόμορφα τη θερμότητα.
- ▶ Άνετος, εσωτερικός, πάτος που πλένεται και αντικαθίσταται.
- ▶ Ενισχυμένη προστασία αστραγάλων RubXpro.
- ▶ Πολυανθρακική προστασία Δαχτύλων Carbon Light toecap (χωρίς σίδηρο).
- ▶ Αντιστατικό, ευέλικτο με υψηλή άνεση.

Σόλα

- ▶ Ενιαία σόλα από ελαστικό νιτρίλιο, Nitrile Rubber, με επιστρωση μαλακού PU για μεγαλύτερη άνεση και απορρόφηση κραδασμών. Σχεδιασμένη από τη **MICHELIN**.
- ▶ Μεγάλη αντίσταση στην τριβή, εξαιρετικά αντιστατικά χαρακτηριστικά και με βέλτιστη αντοχή σε λάδια.
- ▶ Πολυλειτουργικός σχεδιασμός για όλες τις απαιτητικές, υπαίθριες, εργασίες.
- ▶ Q-Flex πολυανθρακική προστασία πέλματος (χωρίς σίδηρο).
- ▶ Αντοχή σε θερμοκρασίες έως και 300°C.



ΜΠΟΤΑΚΙ ΑΣΦΑΛΕΙΑΣ ΜΑΙΑ S3 SRC

ΚΩΔΙΚΟΣ	ΜΟΝΤΕΛΟ	ΜΕΓΕΘΟΣ (No)	ΣΥΣΚ	€/ΤΕΜ
40464930xx	ΜΑΙΑ	38-47	10 ζεύγη	▶ 42,00

* Διαθέσιμα μεγέθη 36-37 κατόπιν παραγγελίας



Άνω Μέρος

- ▶ Τυπωμένο δέρμα υψηλής αντίστασης στο νερό. Εύκαμπτο & διαπνέον.
- ▶ Φόδρα Mesh Space 3D Bonding, τεχνολογία συγκόλλησης χωρίς ραφές που αποτρέπει ερεθισμούς & δημιουργεί έναν τρισδιάστατο σκελετό στεγανό & σταθερό.
- ▶ Μεταλλική προστασία δακτύλων Steel Toecap.

Σόλα

- ▶ Δύο στρωμάτων PU διαφορετικής πυκνότητας, το πρώτο, πιο μαλακό απορροφά κραδασμούς και προσδίδει άμεσα στην βάδιση, το δεύτερο, σκληρότερο για εξαιρετική πρόσφυση & αντίσταση τριβής.
- ▶ Συνθετική προστασία πέλματος.
- ▶ Πλάτος 10,5cm.



ΜΠΟΤΑΚΙ ΑΣΦΑΛΕΙΑΣ ΒΕΙΑ S3 SRC

ΚΩΔΙΚΟΣ	ΜΟΝΤΕΛΟ	ΜΕΓΕΘΟΣ (No)	ΣΥΣΚ	€/ΤΕΜ
40465190xx	ΒΕΙΑ	38-47	10 ζεύγη	▶ 55,00
40465191xx	FAFE	38-47	10 ζεύγη	▶ 51,00

* Διαθέσιμα μεγέθη 36-37 κατόπιν παραγγελίας

Άνω Μέρος

- ▶ Πλήρως αποψιλωμένο δέρμα, υψηλής αντίστασης στο νερό & τα λάδια, εύκαμπτο & διαπνέον.
- ▶ Φόδρα Mesh Space 3D Bonding, τεχνολογία συγκόλλησης χωρίς ραφές που αποτρέπει ερεθισμούς & δημιουργεί έναν τρισδιάστατο σκελετό, στεγανό & σταθερό.
- ▶ Πολυανθρακική προστασία δακτύλων, Carbonlight Toecap (χωρίς σίδηρο).
- ▶ Αντιστατικό με υψηλή άνεση.

Σόλα

- ▶ Δύο στρωμάτων PU διαφορετικής πυκνότητας, το πρώτο, πιο μαλακό απορροφά κραδασμούς και προσδίδει άμεσα στην βάδιση, το δεύτερο, σκληρότερο για εξαιρετική πρόσφυση & αντίσταση τριβής.
- ▶ Q-Flex πολυανθρακική προστασία πέλματος (χωρίς σίδηρο)
- ▶ Πλάτος 10,5cm



ΠΑΠΟΥΤΣΙ ΑΣΦΑΛΕΙΑΣ FAFE S3 SRC



ΜΠΟΤΑΚΙ ΑΣΦ. NURBURGRING S3 SRC-HRO



ΚΩΔΙΚΟΣ	ΜΕΓΕΘΟΣ (No)	ΣΥΣΚ	€/ΤΕΜ
40465195xx	39-46	10 ζεύγη	▶ 65,00

* Διαθέσιμα μεγέθη 36-38, 47 κατόπιν παραγγελίας



NITRILE RUBBER



ΚΟΥΡΦΑΙΑΣ ΠΟΙΟΤΗΤΑΣ ΔΕΡΜΑ NUBUCK ANILINE
ΠΟΛΥΑΝΘΡΑΚΙΚΗ ΠΡΟΣΤΑΣΙΑ ΔΑΚΤΥΛΩΝ
ΠΡΟΣΤΑΣΙΑ ΠΕΛΜΑΤΟΣ ΑΠΟ ΑΝΘΡΑΚΟΝΗΜΑΤΑ



ΜΠΟΤΑΚΙ ΑΣΦΑΛΕΙΑΣ TRAIL S3 SRC

ΚΩΔΙΚΟΣ	ΜΕΓΕΘΟΣ (No)	ΣΥΣΚ	€/ΤΕΜ
40464520xx	39-46	10 ζεύγη	▶ 64,00

* Διαθέσιμα μεγέθη 36-38, 47 κατόπιν παραγγελίας



Άνω Μέρος

- Ενισχυμένο εύκαμπτο Nubuck δέρμα υψηλής αντίστασης στο νερό & τα λάδια.
- Φόδρα Mesh Space 3D Bonding, τεχνολογία συγκόλλησης χωρίς ραφές που αποτρέπει ερεθισμούς & δημιουργεί έναν τρισδιάστατο σκελετό στεγανό & σταθερό.
- Πολυανθρακική προστασία δακτύλων Carbon light Toecap (χωρίς σίδηρο).
- Αντιστατικό με υψηλή άνεση.

Σόλα

- Δύο στρωμάτων PU διαφορετικής πυκνότητας, το πρώτο, πιο μαλακό απορροφά κραδασμούς και προσδίδει άμεσα στην βάδιση, το δεύτερο, σκληρότερο για εξαιρετική πρόσφυση & αντίσταση τριβής.
- Q-Flex πολυανθρακική προστασία πέλματος (χωρίς σίδηρο)
- Πλάτος 11cm



ΜΠΟΤΑΚΙ ΑΣΦΑΛΕΙΑΣ MONZA S3 | SRC | HRO

ΚΩΔΙΚΟΣ	ΜΕΓΕΘΟΣ (No)	ΣΥΣΚ	€/ΤΕΜ
40465091xx	39-46	10 ζεύγη	▶ 58,00

* Διαθέσιμα μεγέθη 36-38, 47 κατόπιν παραγγελίας



ΗΛΕΚΤΡΟΣΥΓΚΟΛΛΗΤΩΝ



Άνω Μέρος

- Τυπωμένο δέρμα υψηλής αντίστασης στο νερό, εύκαμπτο και διαπνέον.
- Φόδρα Promax Lining που αφαιρεί την υγρασία από το εσωτερικό του παπουτσιού και κατανέμει ομοιόμορφα τη θερμότητα.
- Πολυανθρακική προστασία δακτύλων Carbonlight Toecap (χωρίς σίδηρο).

Σόλα

- Δύο υλικών, PU & καουτσούκ. Το μαλακό, PU, απορροφά κραδασμούς και προσδίδει άνεση στην βάδιση. Σε συνδυασμό με τη λαστιχένια σόλα, εξασφαλίζει εξαιρετική πρόσφυση & αντίσταση τριβής.
- Αντοχή σε θερμοκρασίες έως 300°C.
- Q-Flex πολυανθρακική προστασία πέλματος (χωρίς σίδηρο).
- Πλάτος 11cm



ΑΔΙΑΒΡΟΧΟ**ΧΩΡΙΣ ΣΙΔΕΡΟ****RESISTANT UP TO 300°C****NITRILE RUBBER****ΜΠΟΤΑΚΙ ΑΣΦ. SNIPER O2 SRC HRO WR**

ΚΩΔΙΚΟΣ	ΜΕΓΕΘΟΣ (No)	ΣΥΣΚ	€/ΤΕΜ
40461120xx	39-47	10 ζεύγη	79,00

Άνω Μέρος

- Premium δέρμα Aniline. Υλικά υψηλής ποιότητας, αδιάβροχα, ανθεκτικά σε καύσιμα και λάδια. Εξαιρετική αντοχή, ελαστικότητα και διαπνοή.
- Υφασμα αδιάβροχο και διαπνέον.
- Υφασμάτινο πλέγμα 3D. Εξαιρετική διαπνοή, εφαρμογή και άνεση, χωρίς οσμές.
- Σύστημα κορδονιών για γρήγορη και άψογη εφαρμογή. Ανθεκτικό PVC.

Σόλα

- Εσωτερικός πάτος Biorelax. Άριστη απορρόφηση κραδασμών. Με ενεργό άνθρακα για εξουδετέρωση οσμών.
- Ενδιάμεση σόλα μαλακό PU με εξαιρετική απορρόφηση κραδασμών.
- Σόλα Nitrile Rubber. Αποκλειστικός σχεδιασμός που εγγυάται ευκαμψία, άνεση και ελαστικότητα.
- Τάπες ανοιχτού τύπου, ειδικά σχεδιασμένες ώστε να απομακρύνουν το νερό και να βελτιώνουν την πρόσφυση, σε όλες τις επιφάνειες.
- Ασφάλεια στη σκάλα. Ειδική διαμόρφωση στην καμάρα του πέλματος για καλύτερη πρόσφυση σε σκαλοπάτια και ράγες.



NEO

ΚΑΛΤΣΕΣ PRO ENERGY TWF - ΣΕΤ 3ΤΕΜ

ΚΩΔΙΚΟΣ	ΜΕΓΕΘΟΣ (No)	ΣΥΣΚ	€/ΤΕΜ
4192203538	35-38	3 ζεύγη	5,60
4192203942	39-42	3 ζεύγη	5,60
4192204346	43-46	3 ζεύγη	5,60
4192204750	47-50	3 ζεύγη	5,60

Χαρακτηριστικά:

- Οικολογικό ανακυκλωμένο βαμβάκι με Πολυαμίδιο
- Σχεδιασμός **flex fit** για τέλεια εφαρμογή και άνεση
- Εξαιρετική ανθεκτικότητα και διάρκεια ζωής
- Ταχυστέγνωτο ύφασμα, απομακρύνει τον ιδρώτα
- Ενισχυμένες ζώνες στη φτέρνα και τα δάχτυλα

Σύνθεση :

- 60% Ανακυκλωμένο βαμβάκι ➤ 35% Πολυαμίδιο ➤ 5% Elastane



ΕΣΩΤΕΡΙΚΗ ΣΟΛΑ ΠΑΠΟΥΤΣΙΩΝ COMFORT

ΚΩΔΙΚΟΣ	ΜΕΓΕΘΟΣ (No)	ΣΥΣΚ	€/ΤΕΜ
4009048xx	39-46	10 ζεύγη	7,50
9900000408	ΕΚΘΕΤΗΡΙΟ ΓΙΑ ΣΟΛΕΣ ΠΑΠΟΥΤΣΙΩΝ		

Οι πάτοι TOWORKFOR COMFORT βοηθούν στη σωστή προσαρμογή και σταθεροποίηση του ποδιού στο παπούτσι. Είναι φτιαγμένοι από πολύ πυκνή πολυουρεθάνη για απορρόφηση των κραδασμών ενώ το λεπτό και ανατομικό σχήμα τους ελαττώνει την πίεση στο πόδι, τον αστράγαλο και τη φτέρνα, κατά τη διάρκεια απαιτητικών εργασιών και βαδίσματος μεγάλων αποστάσεων ενώ ταυτόχρονα υποστηρίζει το πέλμα παρέχοντας μεγάλη άνεση. Είναι αντιστατικοί και μπορούν να πλυθούν.

Κύρια Πλεονεκτήματα

- Υπέρ απαλή πολυουρεθάνη
- Σημεία απορρόφησης κραδασμών
- Ανατομικό σχήμα
- Βαθιά φτέρνα
- Κατασκευασμένο στην Ε.Ε.

ΚΟΡΔΟΝΙΑ ΠΑΠΟΥΤΣΙΩΝ

ΚΩΔΙΚΟΣ	ΠΕΡΙΓΡΑΦΗ	ΧΡΩΜΑ	ΜΗΚΟΣ	ΣΥΣΚ	€/ΤΕΜ
400900101	ΠΛΑΚΕ	ΓΚΡΙ	130cm	1	3,50
400900099	ΠΛΑΚΕ	ΜΑΥΡΑ	130cm	1	3,50
400900103	ΣΤΡΟΓΓΥΛΑ	ΓΚΡΙ	130cm	1	3,50
400900089	ΣΤΡΟΓΓΥΛΑ	ΚΑΦΕ	130cm	1	3,50
400900052	ΣΤΡΟΓΓΥΛΑ	ΜΑΥΡΑ	130cm	1	3,50
9900000408	ΕΚΘΕΤΗΡΙΟ ΓΙΑ ΚΟΡΔΟΝΙΑ ΠΑΠΟΥΤΣΙΩΝ				

- Τεχνικά Κορδόνια παπουτσιών
- Αντίσταση σχισίματος
- Υπέρ Ελαφριά
- Με αδιάβροχη επικάλυψη
- Πλακέ ή Στρογγυλά



PUBS

ΔΙΑΠΝΕΟΝ ΑΝΩ ΜΕΡΟΣ ΓΙΑ ΑΝΕΣΗ



ΠΡΟΣΤΑΣΙΑ ΔΑΚΤΥΛΩΝ ΑΠΟ ΑΤΣΑΛΙ

ΑΝΤΙΟΛΙΣΘΗΤΙΚΗ ΣΟΛΑ ΑΠΟ ΚΑΟΥΤΣΟΥΚ



- Τα παπούτσια εργασίας, με спор εμφάνιση, από τη σειρά **PUBS SB P** είναι σχεδιασμένα για τη μέγιστη άνεση πολλών ωρών εργασίας σε ξηρές συνθήκες.
- Το διαπνέον επάνω μέρος με επένδυση από σφουγγάρι, στο εσωτερικό, εξασφαλίζει κυκλοφορία του αέρα και ευχάριστη εφαρμογή, στο πάνω μέρος του ποδιού.
- Ένας ειδικός πάτος με άνετο αφρό, πάχους έως και **10 mm**, υποστηρίζει τέλεια τα δάχτυλα, το μέσο του ποδιού και τη φτέρνα.
- Η **λαστιχένια** σόλα καθώς και η ενδιάμεση, **αντιδιατρητική**, σόλα από **Kevlar** είναι εύκαμπτες και δεν περιορίζουν τις κάμψεις του μεταταρσίου, σε αντίθεση με τα παπούτσια με παραδοσιακή σόλα από PU και χαλύβδινο ένθετο.
- Η προστασία του ποδιού, και πιο συγκεκριμένα των δακτύλων, συμπληρώνεται από ένα **ατσάλινο** καπάκι δακτύλων ανθεκτικό στην κρούση.

NEO

ΜΠΟΤΑΚΙ ΑΣΦΑΛΕΙΑΣ PUBS SB P

ΔΙΑΠΝΕΟΝ ΥΦΑΣΜΑ

ΠΡΟΣΤΑΣΙΑ ΔΑΚΤΥΛΩΝ ΑΠΟ ΑΤΣΑΛΙ



ΑΝΕΤΟΣ ΚΑΙ ΑΝΘΕΚΤΙΚΟΣ ΑΦΡΩΔΗΣ ΠΑΤΟΣ

ΑΝΤΙΔΙΑΤΡΗΤΙΚΗ ΕΝΔΙΑΜΕΣΗ ΣΟΛΑ ΑΠΟ ΕΥΚΑΜΠΤΟ ΚΕVΛΑR ΓΙΑ ΑΝΕΣΗ ΚΑΙ ΠΡΟΣΤΑΣΙΑ

ΑΝΘΕΚΤΙΚΗ, ΕΥΚΑΜΠΤΗ ΚΑΙ ΑΝΤΙΟΛΙΣΘΗΤΙΚΗ ΣΟΛΑ ΑΠΟ ΚΑΟΥΤΣΟΥΚ



ΚΩΔΙΚΟΣ	YATO 	ΜΕΓΕΘΟΣ (No)	ΣΥΣΚ	€/ΤΕΜ
21080620	YT-80620	39	▶	49,95
21080621	YT-80621	40	▶	49,95
21080622	YT-80622	41	▶	49,95
21080623	YT-80623	42	▶	49,95
21080624	YT-80624	43	▶	49,95
21080625	YT-80625	44	▶	49,95
21080626	YT-80626	45	▶	49,95
21080627	YT-80627	46	▶	49,95
21080628	YT-80628	47	▶	49,95

PACS

ΠΑΠΟΥΤΣΙ ΑΣΦΑΛΕΙΑΣ PACS SB P



ΚΩΔΙΚΟΣ	YATO 	ΜΕΓΕΘΟΣ (No)	ΣΥΣΚ	€/ΤΕΜ
21080632	YT-80632	39	▶	59,95
21080633	YT-80633	40	▶	59,95
21080634	YT-80634	41	▶	59,95
21080635	YT-80635	42	▶	59,95
21080636	YT-80636	43	▶	59,95
21080637	YT-80637	44	▶	59,95
21080638	YT-80638	45	▶	59,95
21080639	YT-80639	46	▶	59,95
21080640	YT-80640	47	▶	59,95

- Ελαφρύ και άνετο
- Διαπνέον ύφασμα
- Προστασία SBP
- Αντιολισθητικό SRA
- Προστασία δακτύλων Χάλυβας 200J/15kN
- Προστασία πέλματος 1100N Composite Flex
- Ενισχυμένη σόλα Πρότυπο EN 20345

ΑΕΡΟΣΟΛΑ



Τα παπούτσια εργασίας της σειράς **PACS SB P** είναι σχεδιασμένα για μέγιστη άνεση κατά τη διάρκεια πολλών ωρών εργασίας. Προστατεύουν τα δάχτυλα και το κάτω μέρος του ποδιού από σοβαρούς τραυματισμούς. Το επάνω μέρος, εξασφαλίζει κυκλοφορία αέρα και ευχάριστη εφαρμογή. Η **σόλα από PU**, με θάλαμο αέρα, **απορροφά τους κραδασμούς**. **Αντιδιατρητική προστασία** πέλματος πάχους 4 mm από το υλικό που χρησιμοποιείται για την παραγωγή αλεξίσφαιρων γιλέκων. Προστασία δακτύλων από χάλυβα.

SAFETY SHOES PROTEX

safety products



SAFE RUNNER - ΑΘΛΗΤΙΚΟ ΑΣΦΑΛΕΙΑΣ S1P

ΚΩΔΙΚΟΣ	ΜΕΓΕΘΟΣ (No)	ΣΥΣΚ	€/ΤΕΜ
40400300xx	38-47	10	▶ 33,00

**NEO****560gr. !!!**

- ▶ Δέρμα Σουέτ (Καστόρι) με διαπνέον ύφασμα, υψηλής αντοχής, Air Mesh
- ▶ Φόδρα, Mesh, αντιβακτηριδιακή, υψηλής διαπνοής
- ▶ Σόλα, δίχρωμη, δύο υλικών MD (EVA + RUBBER)
- ▶ Συνθετική προστασία πέλματος (kevlar)
- ▶ Χαλύβδινη προστασία δακτύλων

**BASIC - ΜΠΟΤΑΚΙ ΑΣΦΑΛΕΙΑΣ S1P**

ΚΩΔΙΚΟΣ	ΜΕΓΕΘΟΣ (No)	ΣΥΣΚ	€/ΤΕΜ
40400999xx	38-47	10	▶ 18,00

**NEO****450gr. !!!**

- ▶ Ανάγλυφο αδιάβροχο δέρμα, αγελάδας, 1,6mm
- ▶ Εσωτερική φόδρα, Mesh, 120gsm
- ▶ Αντιβακτηριδιακή, υψηλής διαπνοής
- ▶ Εσωτερικός, ανατομικός και αναπνευστικός, πάτος από υλικό EVA
- ▶ Χαλύβδινη προστασία δακτύλων και πέλματος
- ▶ Σόλα PU/PU, δύο στρωμάτων, διαφορετικής πυκνότητας
- ▶ Το πρώτο, πιο μαλακό, απορροφά κραδασμούς και προσδίδει άνεση στη βάρδια. Το δεύτερο, σκληρότερο, για εξαιρετική πρόσφυση & αντίσταση τριβής
- ▶ >>Oil resistant - Ανθεκτική στα λάδια
- ▶ >>Slip resistant - Αντιολισθητική
- ▶ >>Acid resistant - Ανθεκτική στα οξέα
- ▶ >>Shock absorber - Τακούνι απορρόφησης κραδασμών





650gr. !!!

- ▶ Ανάγλυφο αδιάβροχο δέρμα, αγελάδας, 1,6mm
- ▶ Εσωτερική φόδρα, Mesh, 120gsm
Αντιβακτηριδιακή, υψηλής διαπνοής
- ▶ Εσωτερικός, ανατομικός και αναπαυτικός, πάτος από υλικό EVA
- ▶ Χαλύβδινη προστασία δακτύλων και πέλματος
- ▶ Σόλα PU/PU, δύο στρωμάτων, διαφορετικής πυκνότητας
Το πρώτο, πιο μαλακό, απορροφά κραδασμούς και προσδίδει άνεση στη βάδιση. Το δεύτερο, σκληρότερο, για εξαιρετική πρόσφυση & αντίσταση τριβής
»Oil resistant - Ανθεκτική στα λάδια
»Slip resistant - Αντιολισθητική
»Acid resistant - Ανθεκτική στα οξέα
»Shock absorber - Τακούνι απορρόφησης κραδασμών

PROTEX ONE - ΜΠΟΤΑΚΙ ΑΣΦΑΛΕΙΑΣ S3

ΚΩΔΙΚΟΣ	ΜΕΓΕΘΟΣ (No)	ΣΥΣΚ	€/ΤΕΜ
40400100xx	38-47	10	▶ 20,00



PROTEX PLUS - ΜΠΟΤΑΚΙ ΑΣΦΑΛΕΙΑΣ S3

ΚΩΔΙΚΟΣ	ΜΕΓΕΘΟΣ (No)	ΣΥΣΚ	€/ΤΕΜ
40400500xx	38-47	10	▶ 29,00



560gr. !!!

- ▶ Μαλακό και ανθεκτικό, αδιάβροχο, δέρμα αγελάδας 1,8mm
- ▶ Εσωτερική φόδρα, Mesh, 120gsm
Αντιβακτηριδιακή υψηλής διαπνοής
- ▶ Εσωτερικός, ανατομικός & αναπαυτικός, πάτος από υλικό EVA
- ▶ Χαλύβδινη προστασία δακτύλων και πέλματος
- ▶ Σόλα PU/PU, δύο στρωμάτων, διαφορετικής πυκνότητας
Το πρώτο, πιο μαλακό, απορροφά κραδασμούς και προσδίδει άνεση στη βάδιση. Το δεύτερο, σκληρότερο, για εξαιρετική πρόσφυση & αντίσταση τριβής
»Oil resistant - Ανθεκτική στα λάδια
»Slip resistant - Αντιολισθητική
»Acid resistant - Ανθεκτική στα οξέα
»Shock absorber - Τακούνι απορρόφησης κραδασμών



**RUN - ΑΘΛΗΤΙΚΟ ΠΑΠΟΥΤΣΙ ΕΡΓΑΣΙΑΣ**

ΚΩΔΙΚΟΣ	ΜΕΓΕΘΟΣ (No)	ΣΥΣΚ	€/ΤΕΜ
40400900xx	38-47	10	▶ 25,50

**270gr. !!!**

- ▶ Συνθετικό δέρμα PU & ύφασμα, air mesh fabric
- ▶ Ανθεκτική φόδρα, Mesh, αντιβακτηριδιακή, αναπνεύσιμη
- ▶ Σόλα EVA, τρίχρωμη, ανατομική και ελαστική
- ▶ Πάτος PU

RUN PLUS - ΑΘΛΗΤΙΚΟ ΠΑΠΟΥΤΣΙ ΕΡΓΑΣΙΑΣ

ΚΩΔΙΚΟΣ	ΜΕΓΕΘΟΣ (No)	ΣΥΣΚ	€/ΤΕΜ
40400200xx	38-47	10	▶ 29,00

520gr. !!!

- ▶ Συνθετικό δέρμα TPU & ύφασμα, air mesh fabric
- ▶ Ανθεκτική φόδρα, Mesh, αντιβακτηριδιακή, αναπνεύσιμη που απορροφά και απελευθερώνει την υγρασία
- ▶ Σόλα, Rubber:
 - >> αντιολισθητική
 - >> ανατομική
 - >> αντιστατική
 - >> εύκαμπτη

NEO

SHORT 01 - ΣΚΑΡΠΙΝΙ ΕΡΓΑΣΙΑΣ

ΚΩΔΙΚΟΣ	ΜΕΓΕΘΟΣ (No)	ΣΥΣΚ	€/ΤΕΜ
40400400xx	38-47	10	▶ 18,00



NEO

350gr. !!!

- ▶ Ανάγλυφο, αδιάβροχο δέρμα αγελάδας 1,6mm
- ▶ Εσωτερική φόδρα, Mesh, 120gsm
Αντιβακτηριδιακή υψηλής διαπνοής
- ▶ Εσωτερικός, ανατομικός & αναπαυτικός, πάτος από υλικό EVA
- ▶ Σόλα PU/PU, δύο στρωμάτων, διαφορετικής πυκνότητας
Το πρώτο, πιο μαλακό, απορροφά κραδασμούς και προσδίδει άνεση στη βάδιση. Το δεύτερο, σκληρότερο, για εξαιρετική πρόσφυση & αντίσταση τριβής
 »Oil resistant - Ανθεκτική στα λάδια
 »Slip resistant - Αντιολισθητική
 »Acid resistant - Ανθεκτική στα οξέα
 »Shock absorber - Τακούνι απορρόφησης κραδασμών



OLIVE - ΜΠΟΤΑΚΙ ΕΡΓΑΣΙΑΣ

ΚΩΔΙΚΟΣ	ΜΕΓΕΘΟΣ (No)	ΣΥΣΚ	€/ΤΕΜ
40400000xx	38-47	10	▶ 18,00



380gr. !!!

- ▶ Ανάγλυφο, αδιάβροχο δέρμα αγελάδας 1,6mm
- ▶ Εσωτερική φόδρα, Mesh, 120gsm
Αντιβακτηριδιακή υψηλής διαπνοής
- ▶ Εσωτερικός, ανατομικός & αναπαυτικός, πάτος από υλικό EVA
- ▶ Σόλα PU/PU, δύο στρωμάτων, διαφορετικής πυκνότητας
Το πρώτο, πιο μαλακό, απορροφά κραδασμούς και προσδίδει άνεση στη βάδιση. Το δεύτερο, σκληρότερο, για εξαιρετική πρόσφυση & αντίσταση τριβής
 »Oil resistant - Ανθεκτική στα λάδια
 »Slip resistant - Αντιολισθητική
 »Acid resistant - Ανθεκτική στα οξέα
 »Shock absorber - Τακούνι απορρόφησης κραδασμών





ΕΛΛΗΝΙΚΗΣ ΚΑΤΑΣΚΕΥΗΣ

NEO

75% ΒΑΜΒΑΚΙ - 25% ΠΟΛΥΕΣΤΕΡ

**PROTEX 100 - ΣΕΤ 3 ΤΕΜ**

ΚΩΔΙΚΟΣ	ΜΕΓΕΘΟΣ (No)	ΧΡΩΜΑ	ΣΥΣΚ	€/ΣΕΤ
4941003741	37-41	ΜΑΥΡΟ	6	▶ 3,70
4941004246	42-46	ΜΑΥΡΟ	6	▶ 3,70
4941013741	37-41	ΛΑΔΙ	6	▶ 3,70
4941014246	42-46	ΛΑΔΙ	6	▶ 3,70

ΣΟΣΟΝΙ PROTEX 280 - ΣΕΤ 3 ΤΕΜ

50% ΒΑΜΒΑΚΙ - 47% ΠΟΛΥΕΣΤΕΡ - 3% ΕΛΑΣΤΑΝ

ΚΩΔΙΚΟΣ	ΜΕΓΕΘΟΣ (No)	ΧΡΩΜΑ	ΣΥΣΚ	€/ΣΕΤ
4942803741	37-41	ΜΑΥΡΟ	6	▶ 3,30
4942804246	42-46	ΜΑΥΡΟ	6	▶ 3,30
4942813741	37-41	ΓΚΡΙ	6	▶ 3,30
4942814246	42-46	ΓΚΡΙ	6	▶ 3,30



80% ΒΑΜΒΑΚΙ - 20% ΠΟΛΥΑΜΙΔΙΟ

**ΔΙΧΡΩΜΗ PROTEX 310**

ΚΩΔΙΚΟΣ	ΜΕΓΕΘΟΣ (No)	ΧΡΩΜΑ	ΣΥΣΚ	€/ΤΕΜ
4943103741	37-41	ΓΚΡΙ / ΚΙΤΡΙΝΟ	6	▶ 2,40
4943104246	42-46	ΓΚΡΙ / ΚΙΤΡΙΝΟ	6	▶ 2,40

50% ΜΑΛΛΙ - 30% ΑΚΡΥΛΙΚΟ
17% ΠΟΛΥΑΜΙΔΙΟ - 3% ΕΛΑΣΤΑΝ**ΙΣΟΘΕΡΜΙΚΗ PROTEX 780**

ΚΩΔΙΚΟΣ	ΜΕΓΕΘΟΣ (No)	ΧΡΩΜΑ	ΣΥΣΚ	€/ΤΕΜ
4947803741	37-41	ΜΑΥΡΟ	6	▶ 3,95
4947804246	42-46	ΜΑΥΡΟ	6	▶ 3,95



GEL
SUPPORT



ΕΠΙΓΟΝΑΤΙΔΕΣ

ΚΩΔΙΚΟΣ	ΥΑΤΟ	ΣΥΣΚ	€/ΤΕΜ
21007461	ΥΤ-7461	12	16,00



ΕΠΙΓΟΝΑΤΙΔΕΣ

ΚΩΔΙΚΟΣ	VOREL	ΣΥΣΚ	€/ΤΕΜ
21174601	74601	24	7,95



NEO

ΕΠΙΓΟΝΑΤΙΔΕΣ

ΚΩΔΙΚΟΣ	VOREL	ΣΥΣΚ	€/ΤΕΜ
21174602	74602	36	10,95



NEO

ΕΠΙΓΟΝΑΤΙΔΕΣ

ΚΩΔΙΚΟΣ	VOREL	ΣΥΣΚ	€/ΤΕΜ
21174595	74595	60	5,00



ΩΤΟΑΣΠΙΔΕΣ



SNR
22 dB

5
PAIRS
PAR

ΚΩΔΙΚΟΣ	YATO	ΜΕΓΕΘΟΣ	ΣΥΣΚ	ΠΑΚΕΤΟ	€/ΣΥΣΚ
21007455	YT-7455	8-12	5	25	2,90



NEO

50
PAIRS

8-12
mm

SNR
28 dB

ΚΩΔΙΚΟΣ	YATO	ΜΕΓΕΘΟΣ	ΣΥΣΚ	ΠΑΚΕΤΟ	€/ΣΥΣΚ
21007456	YT-7456	8-12	50	20	29,95



SNR
34 dB

200
PAIRS
PAR

ΚΩΔΙΚΟΣ	YATO	ΜΕΓΕΘΟΣ	ΣΥΣΚ	ΠΑΚΕΤΟ	€/ΣΥΣΚ
21074510	YT-74510	7-12	200	20	40,25

ΑΚΟΥΣΤΙΚΑ ΠΡΟΣΤΑΣΙΑΣ



ΚΩΔΙΚΟΣ	YATO	ΣΥΣΚ	€/ΤΕΜ
21074621	YT-74621	60	6,80

SNR
27 dB



NEO

ΚΩΔΙΚΟΣ	YATO	ΣΥΣΚ	€/ΤΕΜ
21074633	YT-74633	24	13,00

SNR
32 dB

CE

ΕΠΑΝΑΦΟΡΤΙΖΟΜΕΝΕΣ ΕΝΕΡΓΕΣ ΩΤΟΑΣΠΙΔΕΣ



Με μικρόφωνο υψηλής ευαισθησίας, σε κάθε αυτί. Απομονώνει τους θορύβους και αναπαράγει μόνο την ομιλία και τους ασφαλείς ήχους.

Είναι επαναφορτιζόμενες, μπορούν να συνδεθούν με καλώδιο σε smartphone (και με Bluetooth για το μοντέλο YT-74626).

SNR
29dB

3.7 V
700mAh

3.5h

30h

BUILT-IN MICROPHONE
COMFORTABLE SLIDING LOW BATTERY ALARM

WIRELESS REMOVED AUTO POWER OFF

AUX
(ø3.5 mm)

USB

Bluetooth

SNR
28dB

3.7 V
700mAh

3.5h

30h

BUILT-IN MICROPHONE
COMFORTABLE SLIDING LOW BATTERY ALARM

WIRELESS REMOVED AUTO POWER OFF

AUX
(ø3.5 mm)

USB



ΚΩΔΙΚΟΣ	YATO	ΣΥΣΚ	€/ΣΥΣΚ
21074626	YT-74626	200	58,00

ΚΩΔΙΚΟΣ	YATO	ΣΥΣΚ	€/ΣΥΣΚ
21074625	YT-74625	200	50,00



HDPE



ΚΡΑΝΟΣ ΠΡΟΣΤΑΣΙΑΣ

ΚΩΔΙΚΟΣ	VOREL	ΧΡΩΜΑ	ΣΥΣΚ	€/ΤΕΜ
21174171	74171	ΠΟΡΤΟΚΑΛΙ	40	5,80
21174172	74172	ΚΙΤΡΙΝΟ	40	5,80
21174173	74173	ΛΕΥΚΟ	40	5,80
21174174	74174	ΚΟΚΚΙΝΟ	40	5,80



ΑΚΟΥΣΤΙΚΑ ΠΡΟΣΤΑΣΙΑΣ

ΚΩΔΙΚΟΣ	VOREL	ΣΥΣΚ	€/ΤΕΜ
21174581	74581	10	5,90



ΠΡΟΣΩΠΙΔΑ

ΚΩΔΙΚΟΣ	VOREL	ΣΥΣΚ	€/ΤΕΜ
21174471	74471		11,20



ΠΡΟΣΩΠΙΔΑ ΣΥΡΜΑΤΙΝΗ & ΑΚΟΥΣΤΙΚΑ

ΚΩΔΙΚΟΣ	VOREL	ΣΥΣΚ	€/ΤΕΜ
21174462	74462	40	22,10

MESH
395x200
mm



ΚΩΔΙΚΟΣ	YATO 	ΣΥΣΚ €/ΤΕΜ
21007363	YT-7363	12 3,60
TYPE 91977 EN166:2001F		

ΚΩΔΙΚΟΣ	YATO 	ΣΥΣΚ €/ΤΕΜ
21073602	YT-73602	12 3,95
TYPE 92281 EN166:2001F		



ΚΩΔΙΚΟΣ	YATO 	ΣΥΣΚ €/ΤΕΜ
21073700	YT-73700	12 8,20
TYPE 92218SR EN166:2001F		

ΚΩΔΙΚΟΣ	YATO 	ΣΥΣΚ €/ΤΕΜ
21007364	YT-7364	12 3,60
TYPE 91977 EN166:2001F		



ΚΩΔΙΚΟΣ	YATO 	ΣΥΣΚ €/ΤΕΜ
21073603	YT-73603	12 3,95
TYPE 92281 EN166:2001F		

ΚΩΔΙΚΟΣ	YATO 	ΣΥΣΚ €/ΤΕΜ
21007362	YT-7362	12 2,20
TYPE 9844 EN166:2001F		



ΠΡΕΣΒΥΩΠΙΑΣ

ΚΩΔΙΚΟΣ	YATO 	ΒΑΘΜΟΙ	ΣΥΣΚ €/ΤΕΜ
21073612	YT-73612	+1.5 D	12 3,95
21073613	YT-73613	+2.0 D	12 3,95
21073614	YT-73614	+2.5 D	12 3,95
21073615	YT-73615	+3.0 D	12 3,95
TYPE 9844BI EN166:2001F			





NEO 

ΓΙΑ LASER

ΚΩΔΙΚΟΣ	YATO 	ΣΥΣΚ €/ΤΕΜ
21030460 YT-30460		100 4,90



ΤΡΟΧΟΥ

ΚΩΔΙΚΟΣ	YATO 	ΣΥΣΚ €/ΤΕΜ
21007380 YT-7380 TYPE 2769 EN166:2001F		20 2,85



NEO 



ΚΩΔΙΚΟΣ	YATO 	ΣΥΣΚ €/ΤΕΜ
21073766 YT-73766 TYPE 92275 EN 166:2001 F		12 8,75



ΚΩΔΙΚΟΣ	YATO 	ΣΥΣΚ €/ΤΕΜ
21007377 YT-7377 TYPE 2876 EN166:2001F		12 10,40



ΚΩΔΙΚΟΣ	YATO 	ΣΥΣΚ €/ΤΕΜ
21007382 YT-7382 TYPE SG60 EN166:2001B		10 7,70



NEO 



10x 15x 20x 25x **2 LED** **ABS** **4.5V**
3xLR1130



ΚΩΔΙΚΟΣ	YATO 	ΣΥΣΚ €/ΤΕΜ
21073840 YT-73840		60 12,90



3
PCS

FFP1 NR

3ΤΜΧ

ΚΩΔΙΚΟΣ	YATO 	ΣΥΣΚ	€/ΤΕΜ
21074870	YT-74870	FFP1	50 2,70



3
PCS

FFP1 NR

3ΤΜΧ

ΚΩΔΙΚΟΣ	YATO 	ΣΥΣΚ	€/ΤΕΜ
21007485	YT-7485	FFP1	25 2,50



3
PCS

FFP1 NR

ΜΕ ΒΑΛΒΙΔΑ 3ΤΜΧ

ΚΩΔΙΚΟΣ	YATO 	ΣΥΣΚ	€/ΤΕΜ
21007486	YT-7486	FFP1	25 2,95



3
PCS

FFP2 NR

ΜΕ ΒΑΛΒΙΔΑ 3ΤΜΧ

ΚΩΔΙΚΟΣ	YATO 	ΣΥΣΚ	€/ΤΕΜ
21007492	YT-7492	FFP2	15 3,75



3
PCS

FFP2 NR

ΜΕ ΒΑΛΒΙΔΑ 3ΤΜΧ

ΚΩΔΙΚΟΣ	YATO 	ΣΥΣΚ	€/ΤΕΜ
21074917	YT-74917	FFP2	50 3,60

FFP1: ΑΡΓΙΛΙΟ / ΑΝΘΡΑΚΙΚΟ ΑΣΒΕΣΤΙΟ / ΑΛΕΥΡΙ / ΟΡΥΚΤΕΛΑΙΑ / ΓΥΡΗ ΛΟΥΛΟΥΔΙΩΝ / ΣΚΟΥΡΙΑ
FFP2: ΤΣΙΜΕΝΤΟ / ΚΑΡΒΙΔΙΟ / ΚΙΜΩΛΙΑ / ΓΡΑΦΙΤΗΣ / ΓΥΦΟΣ / ΜΑΓΓΑΝΙΟ / ΣΚΟΝΗ ΧΡΩΜΑΤΩΝ
FFP3: ΑΜΙΑΝΤΟ / ΧΡΩΜΙΟ / ΜΕΤΑΛΛΙΚΑ ΑΕΡΙΑ / ΦΥΤΟΦΑΡΜΑΚΑ / ΧΑΛΚΟΣ



PE
PU

12
PAIRS / PAR



ΓΑΝΤΙΑ ΕΡΓΑΣΙΑΣ PE/PU

ΚΩΔΙΚΟΣ	VOREL	ΖΕΥΓΗ	ΜΕΓΕΘΟΣ	ΣΥΣΚ	€/ΤΕΜ
21174077	74077	12	9	12	0,85
21174078	74078	12	10	12	0,85



PE
PU



ΓΑΝΤΙΑ ΕΡΓΑΣΙΑΣ PE/PU

ΚΩΔΙΚΟΣ	VOREL	ΜΕΓΕΘΟΣ	ΣΥΣΚ	€/ΤΕΜ
21174079	74079	9	12	1,05
21174080	74080	10	12	1,05



LATEX
POLYESTER
LATEKS
POLIESTER

10
SIZE / ROZMAR



ΓΑΝΤΙΑ ΠΡΟΣΤΑΣΙΑΣ LATEX/POLYESTER

ΚΩΔΙΚΟΣ	VOREL	ΜΕΓΕΘΟΣ	ΣΥΣΚ	€/ΤΕΜ
21174146	74146	10	12	1,25



10
SIZE



LATEX
ACRYLIC



ΓΑΝΤΙΑ LATEX - POLYESTER

ΚΩΔΙΚΟΣ	VOREL	ΣΥΣΚ	€/ΤΕΜ
21174149	74149	12	1,75



ΓΑΝΤΙΑ ΠΡΟΣΤΑΣΙΑΣ ΧΗΜΙΚΩΝ

ΚΩΔΙΚΟΣ	VOREL	ΣΥΣΚ	€/ΤΕΜ
21174151	74151	12	3,25

**ΓΑΝΤΙΑ ΔΕΡΜΑΤΙΝΑ ΤΥΠΟΥ ΤΖΙΝ 2143**

ΚΩΔΙΚΟΣ	ΜΕΓΕΘΟΣ	ΣΥΣΚ	€/ΤΕΜ
9400041	10	12	2,40

- Γάντια εργασίας τύπου τζιν από δέρμα μόσχου σχιστό
- Φοδραρισμένο εσωτερικά
- Μανσέτα ασφαλείας

**ΓΑΝΤΙΑ ΔΕΡΜΑΤΙΝΑ ΕΝΙΣΧΥΜΕΝΑ 4233**

ΚΩΔΙΚΟΣ	ΜΕΓΕΘΟΣ	ΣΥΣΚ	€/ΤΕΜ
9400031	10	12	2,95

- Γάντια, δερματοπάνια, εργασίας από σχιστό δέρμα μόσχου (κρούτα)
- Με ενίσχυση σε παλάμη, δείκτη και αντίχειρα
- Βαμβακερή επένδυση
- Μανσέτα ασφαλείας

**ΓΑΝΤΙΑ ΔΕΡΜΑΤΙΝΑ ΟΔΗΓΟΥ 3123**

ΚΩΔΙΚΟΣ	ΜΕΓΕΘΟΣ	€/ΤΕΜ
9400021	10	5,00

- Γάντια Χειριστών-Μονταδόρων από φυσικό δέρμα μόσχου σε λευκή απόχρωση
- Πολύ καλή αίσθηση αφής
- Κατάλληλα για χειριστές μηχανημάτων, οδηγούς και εργασίες γενικής φύσεως

**ΓΑΝΤΙΑ ΗΛΕΚΤΡΟΣΥΓΚΟΛΛΗΤΩΝ-ΔΕΡΜΑ 4244**

ΚΩΔΙΚΟΣ	ΜΕΓΕΘΟΣ	ΣΥΣΚ	€/ΤΕΜ
9400061	10	10	6,25



- Γάντια Ηλεκτροσυγκολλητών μήκους 40 cm
- Χρώματος καφέ από σχιστό δέρμα μόσχου
- Άκαυστη ραφή kevlar



ΑΝΤΙΚΟΠΤΙΚΑ ΓΑΝΤΙΑ ΝΙΤΡΙΛΙΟΥ IMPALA 4543

ΚΩΔΙΚΟΣ	ΜΕΓΕΘΟΣ	ΣΥΣΚ	€/ΤΕΜ
9400051	9	12	4,90
9400052	10	12	4,90
9400053	11	12	4,90

- Αντικοπτικά γάντια από πλέξη DYNEMA εμποτισμένα με nitrile για υψηλές αντοχές
- Η ευκαμπτότητα και η άνεσή τους διευκολύνουν την ασφαλή χρήση αιχμηρών αντικειμένων



ΓΑΝΤΙΑ LATEX - ΝΕΟΠΡΕΝΕ ΔΙΧΡΩΜΑ

ΚΩΔΙΚΟΣ	ΜΕΓΕΘΟΣ	€/ΤΕΜ
9400070	M	1,50
9400071	L	1,50
9400072	XL	1,50

- Γάντια από latex/neoprene
- Χρώματος μπλε/κίτρινο
- Κατάλληλα για βιομηχανική χρήση



ΓΑΝΤΙΑ ΝΙΤΡΙΛΙΟΥ ΜΑΥΡΑ ΜΙΑΣ ΧΡΗΣΗΣ



ΚΩΔΙΚΟΣ	ΜΕΓΕΘΟΣ	€/100 ΤΕΜ
9400011	8	6,50
9400012	9	6,50
9400013	10	6,50

- Γάντια από nitrile χωρίς πούδρα
- Χρώματος μαύρου
- Εξαιρετική εφαρμογή και αφή



ΓΑΝΤΙΑ ΝΙΤΡΙΛΙΟΥ ΣΥΝΕΡΓΕΙΟΥ ΜΙΑΣ ΧΡΗΣΗΣ

ΚΩΔΙΚΟΣ	ΜΕΓΕΘΟΣ	€/50 ΤΕΜ
9400014	M	9,95
9400015	L	9,95
9400016	XL	9,95



- Γάντια από nitrile χωρίς πούδρα
- Χρώματος πορτοκαλί, μέσο πάχος 0,20mm
- Ανατομικό σχήμα και ανάγλυφη παλάμη για εξαιρετικό κράτημα



ΓΑΝΤΙΑ ΗΛΕΚΤΡΟΣΥΓΚΟΛΛΗΤΩΝ-ΔΕΡΜΑ

ΚΩΔΙΚΟΣ	ΥΑΤΟ	ΜΕΓΕΘΟΣ	ΣΥΣΚ	€/ΤΕΜ
21074824	ΥΤ-74824	10	12	6,80

NEO

- MIG/MAG, MMA
- Μήκος 35cm
- EN 12477, προδιαγραφή: TYPE A
- EN 407, προδιαγραφή: 423X4X
- EN 388, προδιαγραφή: 4244X





“NYLON PU”

ΚΩΔΙΚΟΣ	YATO 	ΜΕΓΕΘΟΣ	ΣΥΣΚ	€/ΤΕΜ
21007472	YT-7472	10	50	1,60



“NYLON /ΝΙΤΡΙΛΙΟΥ”

ΚΩΔΙΚΟΣ	YATO 	ΜΕΓΕΘΟΣ	ΣΥΣΚ	€/ΤΕΜ
21074739	YT-74739	9	50	1,60
21007474	YT-7474	10	50	1,60



“PE/ΝΙΤΡΙΛΙΟΥ”

ΚΩΔΙΚΟΣ	YATO 	ΜΕΓΕΘΟΣ	ΣΥΣΚ	€/ΤΕΜ
21007480	YT-7480	9	12	1,70
21007481	YT-7481	10	12	1,70



COTTON / LATEX

ΚΩΔΙΚΟΣ	YATO 	ΜΕΓΕΘΟΣ	ΣΥΣΚ	€/ΤΕΜ
21007471	YT-7471	10	12	1,80



NEO 



“ΔΕΡΜΑ/ΒΑΜΒΑΚΙ”

ΚΩΔΙΚΟΣ	YATO 	ΜΕΓΕΘΟΣ	ΣΥΣΚ	€/ΤΕΜ
21074642	YT-74642	10	10	4,20



NEO 



“ΔΕΡΜΑ”

ΚΩΔΙΚΟΣ	YATO 	ΜΕΓΕΘΟΣ	ΣΥΣΚ	€/ΤΕΜ
21074647	YT-74647	10	10	4,95



NEO 



“ΣΥΝΘΕΤΙΚΟ ΔΕΡΜΑ”

ΚΩΔΙΚΟΣ	YATO 	ΜΕΓΕΘΟΣ	ΣΥΣΚ	€/ΤΕΜ
21074666	YT-74666	10	12	10,55



NEO 



ΓΑΝΤΙΑ ΑΝΤΙΚΟΠΤΙΚΑ

ΚΩΔΙΚΟΣ	YATO 	ΜΕΓΕΘΟΣ	ΣΥΣΚ	€/ΤΕΜ
21074771	ΥΤ-74771	9	12	4,60
21074772	ΥΤ-74772	10	12	4,60

- ΠΟΛΥΑΙΘΥΛΕΝΙΟ / ΠΟΛΥΟΥΡΕΘΑΝΗ
- Αντοχή στην τριβή: επίπεδο 4/4
- Αντοχή σε σκίσιμο: επίπεδο 4/4
- Αντοχή σε τρύπημα: επίπεδο 3/4
- Προστασία κοπής σύμφωνα με ISO 13977 (N)
Επίπεδο προστασίας: B
EN 420 & EN 388: 2016



ΓΑΝΤΙΑ ΑΜΜΟΒΟΛΗΣ

ΚΩΔΙΚΟΣ	YATO 	ΜΕΓΕΘΟΣ	ΣΥΣΚ	€/ΤΕΜ
21055846	ΥΤ-55846			21,00

NEO 



ΜΕ ΚΟΥΚΚΙΔΕΣ ΝΙΤΡΙΛΙΟΥ ΑΝΤΙΟΛΙΣΘΗΤΙΚΑ

ΚΩΔΙΚΟΣ	YATO 	ΜΕΓΕΘΟΣ	ΣΥΣΚ	€/ΤΕΜ
21074757	ΥΤ-74757	8	12	2,95
21074758	ΥΤ-74758	9	12	2,95
21074759	ΥΤ-74759	10	12	2,95

NEO 

- SPANDEX / ΝΙΤΡΙΛΙΟ
- Αντοχή στην τριβή: επίπεδο 4/4
- Αντοχή σε σκίσιμο: επίπεδο 3/4
- Αντοχή σε κοπή & τρύπημα: επίπεδο 1/4
- Σύμφωνα με τις προδιαγραφές
EN 420 & EN 388: 2016



NEO 

ΓΑΝΤΙΑ ΝΙΤΡΙΛΙΟΥ ΓΙΑ ΘΘΟΝΕΣ ΑΦΗΣ

ΚΩΔΙΚΟΣ	YATO 	ΜΕΓΕΘΟΣ	ΣΥΣΚ	€/ΤΕΜ
21074754	ΥΤ-74754	8	12	2,50
21074755	ΥΤ-74755	9	12	2,50
21074756	ΥΤ-74756	10	12	2,50

- Αντοχή στην τριβή: επίπεδο 3/4
- Αντοχή σε σκίσιμο: επίπεδο 2/4
- Αντοχή σε κοπή & τρύπημα: επίπεδο 1/4
- Σύμφωνα με τις προδιαγραφές
EN 420 & EN 388: 2016





NEO 

100%
POLYESTER



ΙΜΑΝΤΕΣ ΠΡΟΣΤΑΣΙΑΣ

ΚΩΔΙΚΟΣ	YATO 	ΣΥΣΚ	€/ΤΕΜ
21074221	YT-74221	20	23,00



NEO 

100%
POLYESTER



ΙΜΑΝΤΕΣ ΠΡΟΣΤΑΣΙΑΣ

ΚΩΔΙΚΟΣ	YATO 	ΣΥΣΚ	€/ΤΕΜ
21074220	YT-74220	10	42,00



100%
POLYESTER

NEO 

ΙΜΑΝΤΑΣ ΑΠΟΡΡΟΦΗΣΗΣ ΚΡΑΔΑΣΜΩΝ

ΚΩΔΙΚΟΣ	YATO 	ΣΥΣΚ	€/ΤΕΜ
21074227	YT-74227	15	21,00



NEO 

MANUAL
LOCKING
SELF
CLOSING

16 mm

ΚΡΙΚΟΣ ΑΣΦΑΛΕΙΑΣ

ΚΩΔΙΚΟΣ	YATO 	ΣΥΣΚ	€/ΤΕΜ
21074229	YT-74229	20	6,05



ΕΛΑΣΤΙΚΗ ΖΩΝΗ ΠΡΟΣΤΑΣΙΑΣ ΜΕΣΗΣ

ΚΩΔΙΚΟΣ	YATO	ΜΕΓΕΘΟΣ	ΣΥΣΚ	€/ΤΕΜ
21074242	YT-74242	XL	50	9,45
21074241	YT-74241	2XL	50	9,45

➤ Με ανάκλαση

Μέχρι εξαντλήσεως του αποθέματος

- Ζώνες προστασίας της οσφεικής χώρας από τραυματισμούς κατά την εκτέλεση βαρέων εργασιών
- Μειώνουν την ένταση των οπισθίων μυών, μεταφέροντας το βάρος στον κορμό. Σταθεροποιούν τη σπονδυλική στήλη.
- Από ιδιαίτερα ενισχυμένο αλλά εύκαμπτο και αδιάβροχο ύφασμα
- Ρυθμιζόμενο πιάσιμο με velcro
- Τιράντες, εύκολα, ρυθμιζόμενες



➤ 65% POLYESTER, 35% COTTON
➤ 240gr



65% POLYESTER
35% COTTON
65% POLIESTER
35% ΒΑΒΕΛΙΝΑ



ΦΟΡΜΑ ΕΡΓΑΣΙΑΣ ΜΕ ΤΙΡΑΝΤΕΣ "DAN"

ΚΩΔΙΚΟΣ	YATO 	ΜΕΓΕΘΟΣ	ΣΥΣΚ	€/ΤΕΜ
21080290	YT-80290	S	10	▶ 32,00
21080291	YT-80291	M	10	▶ 32,00
21080292	YT-80292	L	10	▶ 32,00
21080293	YT-80293	XL	10	▶ 32,00
21080294	YT-80294	XXL	10	▶ 32,00



➤ 65% POLYESTER, 35% COTTON
➤ 240gr

65% POLYESTER
35% COTTON
65% POLIESTER
35% ΒΑΒΕΛΙΝΑ



ΜΠΟΥΦΑΝ ΕΡΓΑΣΙΑΣ "DAN"

ΚΩΔΙΚΟΣ	YATO 	ΜΕΓΕΘΟΣ	ΣΥΣΚ	€/ΤΕΜ
21080280	YT-80280	S	10	▶ 27,90
21080281	YT-80281	M	10	▶ 27,90
21080282	YT-80282	L	10	▶ 27,90
21080283	YT-80283	XL	10	▶ 27,90
21080284	YT-80284	XXL	10	▶ 27,90



➤ 65% POLYESTER, 35% COTTON
➤ 240gr



65% POLYESTER
35% COTTON
65% POLIESTER
35% ΒΑΒΕΛΙΝΑ



ΠΑΝΤΕΛΟΝΙ ΕΡΓΑΣΙΑΣ "DAN"

ΚΩΔΙΚΟΣ	YATO 	ΜΕΓΕΘΟΣ	ΣΥΣΚ	€/ΤΕΜ
21080285	YT-80285	S	10	▶ 26,90
21080286	YT-80286	M	10	▶ 26,90
21080287	YT-80287	L	10	▶ 26,90
21080288	YT-80288	XL	10	▶ 26,90
21080289	YT-80289	XXL	10	▶ 26,90

ΠΙΝΑΚΑΣ ΕΠΙΛΟΓΗΣ ΜΕΓΕΘΟΥΣ

No YATO	ΠΕΡΙΦ. ΜΕΣΗΣ cm	ΠΕΡΙΦ. ΣΤΗΘΟΥΣ cm	ΥΨΟΣ cm
S	74-82	86-94	164-172
M	82-90	94-102	172-180
L	90-98	102-110	180-188
XL	98-106	110-118	180-188
XXL	98-106	110-118	188-196
XXXL	106-117	118-129	196-204

65% POLYESTER
35% COTTON

ΦΟΡΜΑ ΕΡΓΑΣΙΑΣ ΜΕ ΤΙΡΑΝΤΕΣ

ΚΩΔΙΚΟΣ	YATO	ΜΕΓΕΘΟΣ	€/ΤΕΜ
21080188	YT-80188	S	32,00
21080189	YT-80189	M	32,00
21080190	YT-80190	L	32,00
21080191	YT-80191	L/XL	32,00
21080192	YT-80192	XL	32,00
21080193	YT-80193	XXL	32,00

- 65% POLYESTER, 35% COTTON
- 267gr

70% POLYESTER
30% COTTON

ΜΠΟΥΦΑΝ ΕΡΓΑΣΙΑΣ

ΚΩΔΙΚΟΣ	YATO	ΜΕΓΕΘΟΣ	€/ΤΕΜ
21080176	YT-80176	S	27,50
21080177	YT-80177	M	27,50
21080178	YT-80178	L	27,50
21080179	YT-80179	L/XL	27,50
21080180	YT-80180	XL	27,50
21080181	YT-80181	XXL	27,50

- 65% POLYESTER, 35% COTTON
- 267gr

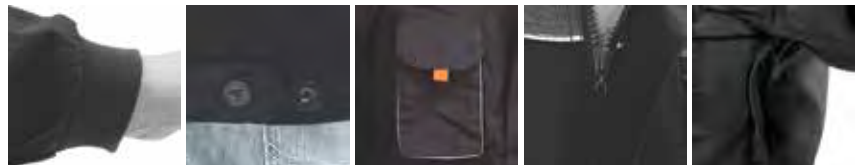
65% POLYESTER
35% COTTON

ΠΑΝΤΕΛΟΝΙ ΕΡΓΑΣΙΑΣ

ΚΩΔΙΚΟΣ	YATO	ΜΕΓΕΘΟΣ	€/ΤΕΜ
21080182	YT-80182	S	26,50
21080183	YT-80183	M	26,50
21080184	YT-80184	L	26,50
21080185	YT-80185	L/XL	26,50
21080186	YT-80186	XL	26,50
21080187	YT-80187	XXL	26,50

- 65% POLYESTER, 35% COTTON
- 267gr





NEO 



ΦΟΡΜΑ ΕΡΓΑΣΙΑΣ

ΚΩΔΙΚΟΣ	YATO 	ΜΕΓΕΘΟΣ	€/ΤΕΜ
21080407	YT-80407	S	27,00
21080408	YT-80408	M	27,00
21080409	YT-80409	L	27,00
21080410	YT-80410	L/XL	27,00
21080411	YT-80411	XL	27,00
21080412	YT-80412	XXL	27,00

➤ 65% POLYESTER, 35% COTTON



NEO 



ΠΑΝΤΕΛΟΝΙ ΕΡΓΑΣΙΑΣ

ΚΩΔΙΚΟΣ	YATO 	ΜΕΓΕΘΟΣ	€/ΤΕΜ
21080401	YT-80401	S	22,50
21080402	YT-80402	M	22,50
21080403	YT-80403	L	22,50
21080404	YT-80404	L/XL	22,50
21080405	YT-80405	XL	22,50
21080406	YT-80406	XXL	22,50

➤ 65% POLYESTER, 35% COTTON

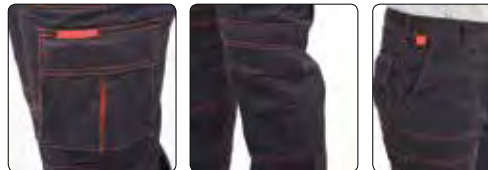

100%
POLYESTER

ΓΙΛΕΚΟ ΑΝΑΚΛΑΣΤΙΚΟ ΠΟΡΤΟΚΑΛΙ

ΚΩΔΙΚΟΣ	VOREL 	ΜΕΓΕΘΟΣ	ΣΥΣΚ	€/ΤΕΜ
21174660	74660	L	100	2,95
21174661	74661	XL	100	2,95
21174662	74662	XXL	100	2,95

NEO 

ΜΠΟΥΦΑΝ ΕΡΓΑΣΙΑΣ

ΚΩΔΙΚΟΣ	YATO 	ΜΕΓΕΘΟΣ	€/ΤΕΜ
21079530	YT-79530	S	33,00
21079531	YT-79531	M	33,00
21079532	YT-79532	L	33,00
21079533	YT-79533	XL	33,00
21079534	YT-79534	XXL	33,00
21079535	YT-79535	XXXL	33,00

CE

- 96% POLYESTER, 4% SPANDEX
- 320gr/m²

SOFT SHELL

ΑΔΙΑΒΡΟΧΟ - ΔΙΑΠΝΕΟΝ

NEO 

ΜΠΟΥΦΑΝ ΕΡΓΑΣΙΑΣ

ΚΩΔΙΚΟΣ	YATO 	ΜΕΓΕΘΟΣ	€/ΤΕΜ
21079550	YT-79550	S	38,00
21079551	YT-79551	M	38,00
21079552	YT-79552	L	38,00
21079553	YT-79553	XL	38,00
21079554	YT-79554	XXL	38,00
21079555	YT-79555	XXXL	38,00

CE

- 96% POLYESTER, 4% SPANDEX
- 320gr/m²

SOFT SHELL

ΑΔΙΑΒΡΟΧΟ - ΔΙΑΠΝΕΟΝ

100%
POLYESTER

ΓΙΛΕΚΟ ΑΝΑΚΛΑΣΤΙΚΟ ΚΙΤΡΙΝΟ

ΚΩΔΙΚΟΣ	VOREL 	ΜΕΓΕΘΟΣ	ΣΥΣΚ	€/ΤΕΜ
21174664	74664	L	100	2,95
21174665	74665	XL	100	2,95
21174666	74666	XXL	100	2,95



ΕΡΓΑΛΕΙΑ ΧΕΙΡΟΣ



ΓΕΝΙΚΗΣ ΧΡΗΣΗΣ [134 - 174]

Κλειδιά | Καρυδάκια

Πένσες | Κατσαβίδια



ΕΡΓΑΛΕΙΑ ΗΛΕΚΤΡΟΛΟΓΩΝ [175 - 188]

Πένσες VDE | Κατσαβίδια VDE

Πρέσες | Κόφτες | Γδάρτες

Δοκιμαστικά Κατσαβίδια VDE

Πολύμετρα | Μπαλαντέζες



ΕΡΓΑΛΕΙΑ ΥΔΡΑΥΛΙΚΩΝ [189 - 200]

Τσιμπίδες STILSON

Σωληνοκόφτες | Κουκουνάρες

Αποφρακτικά | Φλόγιστρα





DIN
3113

AS-DRIVE

CrV

ΓΕΡΜΑΝΟΠΟΥΛΥΓΩΝΑ

ΚΩΔΙΚΟΣ	YATO 	Ø (mm)	ΜΗΚΟΣ(mm)	ΣΥΣΚ	€/ΤΕΜ
20000335	YT-0335	6	110	10	1,70
20000336	YT-0336	7	120	10	1,70
20000337	YT-0337	8	130	10	1,80
20000338	YT-0338	9	140	10	2,05
20000339	YT-0339	10	150	10	2,20
20000340	YT-0340	11	160	10	2,30
20000341	YT-0341	12	170	10	2,45
20000342	YT-0342	13	180	10	2,65
20000343	YT-0343	14	190	10	2,70
20000344	YT-0344	15	200	10	3,00
20000345	YT-0345	16	210	10	3,35
20000346	YT-0346	17	220	10	3,50
20000347	YT-0347	18	230	10	3,90
20000348	YT-0348	19	235	10	4,00
20000349	YT-0349	20	250	10	4,60
20000350	YT-0350	21	260	10	4,80
20000351	YT-0351	22	270	5	5,35
20000352	YT-0352	23	280	5	6,75
20000353	YT-0353	24	290	5	6,80
20000354	YT-0354	25	300	5	9,10
20000355	YT-0355	26	310	5	8,80
20000356	YT-0356	27	320	5	9,45
20000357	YT-0357	28	330	5	9,50
20000358	YT-0358	29	340	5	10,70
20000359	YT-0359	30	350	5	11,15
20000360	YT-0360	32	370	5	12,55
20000760	YT-00760	34	425	5	11,55
20000761	YT-00761	36	460	5	15,50
20000762	YT-00762	38	460	5	16,15
20000763	YT-00763	41	500	5	19,15
20000764	YT-00764	46	540	5	25,10



ΣΕΤ

ΚΩΔΙΚΟΣ	YATO 	ΣΥΣΚ	€/ΤΕΜ
20000362	YT-0362	6	39,00

12
PCS

8, 9, 10, 11, 12, 13, 14,
15, 17, 19, 22, 24 mm

ΓΕΡΜΑΝΙΚΑ ΚΛΕΙΔΙΑ



DIN
3110

CrV

ΚΩΔΙΚΟΣ	YATO 	Ø (mm)	ΜΗΚΟΣ(mm)	ΣΥΣΚ	€/ΤΕΜ
20000367	YT-0367	6x7	120	10	1,70
20000368	YT-0368	8x9	140	10	1,90
20000369	YT-0369	10x11	155	10	2,05
20000370	YT-0370	12x13	170	10	2,20
20000371	YT-0371	14x15	180	10	2,90
20000372	YT-0372	16x17	200	10	3,25
20000373	YT-0373	18x19	220	10	3,55
20000374	YT-0374	20x22	230	10	4,40
20000375	YT-0375	21x23	245	10	5,25
20000376	YT-0376	24x27	260	5	7,30
20000377	YT-0377	25x28	270	5	8,65
20000378	YT-0378	30x32	295	5	10,55



ΣΕΤ

ΚΩΔΙΚΟΣ	YATO 	ΣΥΣΚ	€/ΤΕΜ
20000380	YT-0380	6	35,00

10
PCS

6x7, 8x9, 10x11, 12x13, 14x15,
16x17, 18x19, 20x22, 21x23,
24x27 mm



ΣΕ ΠΩΛΗΣΕΙΣ
No 1



72T

CrV
6140

AS-DRIVE

**ΣΕΤ**

ΚΩΔΙΚΟΣ YATO® ΣΥΣΚ €/ΤΕΜ
20000208 YT-0208 10 **36,00**

7
pcs10, 12, 13, 14,
15, 17, 19 mm**ΓΕΡΜΑΝΟΠΟΛΥΓΩΝΑ ΚΑΣΤΑΝΙΑΣ**

ΚΩΔΙΚΟΣ	YATO®	Ø (mm)	ΜΗΚΟΣ(mm)	ΣΥΣΚ	€/ΤΕΜ
20001907	YT-01907	7	130	10	4,45
20001908	YT-01908	8	141	10	4,50
20001909	YT-01909	9	151	10	4,70
20000191	YT-0191	10	160	10	4,55
20000192	YT-0192	11	165	10	5,00
20000193	YT-0193	12	170	10	5,20
20000194	YT-0194	13	180	10	5,55
20000195	YT-0195	14	190	10	6,35
20000196	YT-0196	15	200	10	6,60
20000197	YT-0197	16	210	10	7,70
20000198	YT-0198	17	225	10	7,75
20000200	YT-0200	19	245	10	8,35
20000189	YT-0189	21	290	6	9,95
20000201	YT-0201	22	290	6	11,80



NEO

👍
"ΕΞΥΠΝΟ"



72T

CrV
50BV30**ΓΕΡΜΑΝΟΠΟΛΥΓΩΝΑ ΚΥΡΤΑ ΚΑΣΤΑΝΙΑΣ**

ΚΩΔΙΚΟΣ	YATO®	Ø (mm)	ΜΗΚΟΣ(mm)	ΣΥΣΚ	€/ΤΕΜ
20001872	YT-01872	10	167	25	4,10
20001873	YT-01873	11	172	25	4,10
20001874	YT-01874	12	177	25	4,90
20001875	YT-01875	13	182	25	4,90
20001876	YT-01876	14	192	25	5,40
20001879	YT-01879	17	228	20	6,10
20001881	YT-01881	19	239	20	6,55

Μέχρι εξαντλήσεως
του αποθέματος

10
mm13
mm17
mm19
mm

72T

CrV

ΠΟΛΥΓΩΝΑ ΚΑΣΤΑΝΙΑΣ 4 ΣΕ 1

ΚΩΔΙΚΟΣ	YATO®	Ø (mm)	ΜΗΚΟΣ(mm)	ΣΥΣΚ	€/ΤΕΜ
20004945	YT-4945	10x13x17x19	200	5	19,00

DIN
838

CrV

AS-DRIVE

ΣΕΤ

ΚΩΔΙΚΟΣ YATO® ΣΥΣΚ €/ΤΕΜ
20000396 YT-0396 6 **29,90**

8
PCS6x7, 8x9, 10x11, 12x13, 14x15,
16x17, 18x19, 20x22 mm**ΠΟΛΥΓΩΝΑ**

ΚΩΔΙΚΟΣ	YATO®	Ø (mm)	ΜΗΚΟΣ(mm)	ΣΥΣΚ	€/ΤΕΜ
20000383	YT-0383	6x7	165	10	1,90
20000384	YT-0384	8x9	185	10	2,10
20000385	YT-0385	10x11	200	10	2,40
20000386	YT-0386	12x13	220	10	2,70
20000387	YT-0387	14x15	230	10	3,60
20000388	YT-0388	16x17	255	10	4,10
20000389	YT-0389	18x19	270	5	4,45
20000390	YT-0390	20x22	290	5	5,95
20000391	YT-0391	21x23	310	5	7,10
20000392	YT-0392	24x27	330	5	9,25
20000394	YT-0394	30x32	390	3	14,10





150 mm 200 mm 250 mm
300 mm DIN 3117 CrV



ΓΑΛΛΙΚΑ ΚΛΕΙΔΙΑ

ΚΩΔΙΚΟΣ	YATO 	ΜΗΚΟΣ(mm)	ΣΥΣΚ	€/ΤΕΜ
20002170	YT-2170	150	6	8,00
20002171	YT-2171	200	6	10,00
20002172	YT-2172	250	6	13,90
20002173	YT-2173	300	6	19,00

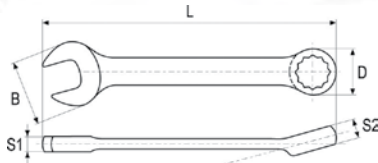

CrV AS-DRIVE

ΓΕΡΜΑΝΟΠΟΛΥΓΩΝΑ ΚΟΝΤΑ

ΚΩΔΙΚΟΣ	YATO 	Ø (mm)	ΜΗΚΟΣ(mm)	ΣΥΣΚ	€/ΤΕΜ
20004904	YT-4904	11	100	10	1,95



CrV 6140

ΡΑΚΟΡΟΚΛΕΙΔΑ

ΚΩΔΙΚΟΣ	YATO 	Ø (mm)	ΜΗΚΟΣ(mm)	ΣΥΣΚ	€/ΤΕΜ
20000135	YT-0135	8x10	140	10	2,25
20000136	YT-0136	11x12	160	10	2,80
20000137	YT-0137	13x14	175	10	3,45
20000138	YT-0138	15x17	190	10	4,10
20001385	YT-01385	17x19	195	10	4,20
20000139	YT-0139	19x21	230	10	4,80
20000140	YT-0140	22x24	250	10	6,50

ΣΕΤ

ΚΩΔΙΚΟΣ	YATO 	ΣΥΣΚ	€/ΤΕΜ
20000143	YT-0143	25	14,00

4 pcs 8x10, 11x12, 13x14, 15x17 mm



ΠΙΠΟΚΛΕΙΔΑ

ΚΩΔΙΚΟΣ	YATO 	Ø (mm)	ΜΗΚΟΣ(mm)	ΣΥΣΚ	€/ΤΕΜ
20001628	YT-1628	8	117	12	4,65
20001630	YT-1630	10	131	12	5,00
20001631	YT-1631	11	138	12	5,70
20001632	YT-1632	12	147	12	5,65
20001633	YT-1633	13	154	12	6,45
20001634	YT-1634	14	162	12	6,70



CrV 6140

ΓΕΡΜΑΝΟΠΟΛΥΓΩΝΑ CrV

ΚΩΔΙΚΟΣ	VOREL	mm	ΣΥΣΚ	€/ΤΕΜ
21151671	51671	6	20	1,15
21151672	51672	7	20	1,19
21151673	51673	8	20	1,23
21151674	51674	9	20	1,25
21151675	51675	10	20	1,25
21151676	51676	11	20	1,30
21151677	51677	12	20	1,50
21151678	51678	13	20	1,65
21151679	51679	14	20	1,70
21151680	51680	15	20	1,90
21151681	51681	16	20	1,95
21151682	51682	17	20	2,10
21151683	51683	18	20	2,65
21151684	51684	19	20	2,85
21151685	51685	20	20	3,85
21151686	51686	21	20	4,05
21151687	51687	22	20	4,15
21151688	51688	23	10	4,60
21151689	51689	24	10	5,10
21151690	51690	25	10	6,70
21151691	51691	26	10	7,10
21151692	51692	27	10	7,60
21151693	51693	28	10	9,00
21151694	51694	29	10	11,50
21151695	51695	30	10	11,55
21151696	51696	32	10	12,20

ΓΕΡΜΑΝΟΠΟΛΥΓΩΝΑ CrV

ΚΩΔΙΚΟΣ	VOREL	mm	ΣΥΣΚ	€/ΤΕΜ
21151720	51720	8; 10; 12; 13; 14; 17	4	8,75
21151721	51721	6; 8; 10; 12; 13; 14; 17; 19	4	9,90

6 pcs

8 pcs

ΓΕΡΜΑΝΟΠΟΛΥΓΩΝΑ ΚΑΣΤΑΝΙΑΣ

ΚΩΔΙΚΟΣ	VOREL	mm	ΣΥΣΚ	€/ΤΕΜ
21152652	52652	10	10	3,70
21152653	52653	11	10	3,95
21152654	52654	12	10	4,35
21152655	52655	13	10	4,45
21152656	52656	14	10	4,85
21152657	52657	15	10	4,95
21152658	52658	17	10	5,90
21152659	52659	19	10	6,30

ΣΕΤ ΓΕΡΜΑΝΟΠΟΛΥΓΩΝΑ ΚΑΣΤΑΝΙΑΣ

ΚΩΔΙΚΟΣ	VOREL	mm	ΣΥΣΚ	€/ΤΕΜ
21152661	52661	10; 13; 17; 19	4	18,00



ΣΕΤ ΓΕΡΜΑΝΙΚΑ

ΚΩΔΙΚΟΣ	VOREL	mm	ΣΥΣΚ	€/ΤΕΜ
21151740	51740	6x7; 8x9; 10x11; 12x13; 14x15; 16x17	6	9,55
21151741	51741	6x7; 8x9; 10x11; 12x13; 14x15; 16x17; 18x19; 20x22	8	16,00

ΣΕΤ ΓΑΝΤΖΟΚΛΕΙΔΑ

ΚΩΔΙΚΟΣ	VOREL	mm	ΣΥΣΚ	€/ΤΕΜ
21154000	54000	9-32	2	9,40

ΓΑΛΛΙΚΟ ΚΛΕΙΔΙ

ΚΩΔΙΚΟΣ	VOREL	ΜΗΚΟΣ (mm)	ΣΥΣΚ	€/ΤΕΜ
21154070	54070	150	6	4,45
21154071	54071	200	6	5,90
21154072	54072	250	6	8,25
21154073	54073	300	6	9,90

ΚΑΡΥΔΑΚΙ ΜΕΤΑΒΛΗΤΟ

ΚΩΔΙΚΟΣ	VOREL	ΜΕΓΕΘΟΣ INCH"	ΣΥΣΚ	€/ΤΕΜ
21153002	53002	7-19 3/8	8	9,90
21153003	53003	11-32 1/2	6	19,75



7-19 mm

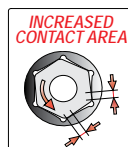

1/4"	DIN 3121
6.3mm	
CrV 50BV30	AS-DRIVE

ΚΑΡΥΔΑΚΙΑ ΕΞΑΓΩΝΑ 1/4"

ΚΩΔΙΚΟΣ	YATO 	ØA(mm)	ΣΥΣΚ	€/ΤΕΜ
20001401	YT-1401	4.0	24	0,50
20001403	YT-1403	5.0	24	0,50
20001404	YT-1404	5.5	24	0,50
20001405	YT-1405	6.0	24	0,50
20001406	YT-1406	7.0	24	0,50
20001407	YT-1407	8.0	24	0,50
20001408	YT-1408	9.0	24	0,55
20001409	YT-1409	10.0	24	0,60
20001410	YT-1410	11.0	24	0,65
20001411	YT-1411	12.0	24	0,68
20001412	YT-1412	13.0	24	0,79



DIN 3121
CrV 50BV30
AS-DRIVE

ΚΑΡΥΔΑΚΙΑ 1/4" ΜΑΚΡΙΑ

ΚΩΔΙΚΟΣ	YATO 	ØA(mm)	ΣΥΣΚ	€/ΤΕΜ
20001418	YT-1418	7.0	24	0,80
20001419	YT-1419	8.0	24	0,80
20001420	YT-1420	9.0	24	0,84
20001421	YT-1421	10.0	24	1,05
20001422	YT-1422	11.0	24	1,15
20001423	YT-1423	12.0	24	1,22
20001424	YT-1424	13.0	24	1,36

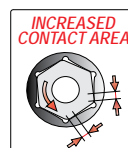

3/8"	DIN 3121
10mm	
CrV 50BV30	AS-DRIVE

ΚΑΡΥΔΑΚΙΑ 3/8"

ΚΩΔΙΚΟΣ	YATO 	ØA(mm)	ΣΥΣΚ	€/ΤΕΜ
20003801	YT-3801	6	24	0,75
20003802	YT-3802	7	24	0,75
20003803	YT-3803	8	24	0,75
20003804	YT-3804	9	24	0,75
20003805	YT-3805	10	24	0,75
20003806	YT-3806	11	24	0,75
20003807	YT-3807	12	24	0,85
20003808	YT-3808	13	24	0,85
20003809	YT-3809	14	24	0,90
20003810	YT-3810	15	24	1,00
20003811	YT-3811	16	24	1,00
20003812	YT-3812	17	12	1,25
20003813	YT-3813	18	12	1,35
20003814	YT-3814	19	12	1,45

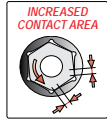

1/2"
12.5mm

DIN
3121

CrV
50BV30

AS-DRIVE

ΚΑΡΥΔΑΚΙΑ ΕΞΑΓΩΝΑ 1/2"

ΚΩΔΙΚΟΣ	YATO 	ΟΑ(mm)	ΣΥΣΚ	€/ΤΕΜ
20001201	YT-1201	8	12	1,30
20001202	YT-1202	9	12	1,30
20001203	YT-1203	10	12	1,30
20001204	YT-1204	11	12	1,30
20001205	YT-1205	12	12	1,30
20001206	YT-1206	13	12	1,30
20001207	YT-1207	14	12	1,30
20001208	YT-1208	15	12	1,30
20001209	YT-1209	16	12	1,30
20001210	YT-1210	17	12	1,46
20001211	YT-1211	18	12	1,56
20001212	YT-1212	19	12	1,56
20001213	YT-1213	20	12	1,80
20001214	YT-1214	21	12	1,80
20001215	YT-1215	22	12	2,10
20001216	YT-1216	23	12	2,35
20001217	YT-1217	24	12	2,35
20001218	YT-1218	27	12	3,30
20001219	YT-1219	30	6	4,55
20001220	YT-1220	32	6	4,65



1/2"
12.5mm

DIN
3121

CrV
50BV30

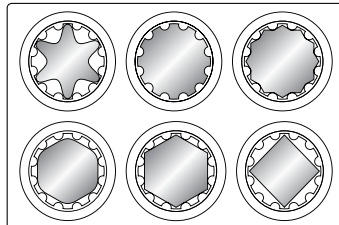

6 ΣΕ 1

ΚΑΡΥΔΑΚΙΑ ΠΟΛΥΓΩΝΑ 1/2"

ΚΩΔΙΚΟΣ	YATO 	ΟΑ(mm)	ΣΥΣΚ	€/ΤΕΜ
20001462	YT-1462	10	10	1,34
20001463	YT-1463	11	10	1,34
20001464	YT-1464	12	10	1,34
20001465	YT-1465	13	12	1,34
20001466	YT-1466	14	12	1,34
20001467	YT-1467	15	12	1,36
20001468	YT-1468	16	12	1,36
20001469	YT-1469	17	10	1,75
20001470	YT-1470	18	12	1,80
20001471	YT-1471	19	12	1,95
20001472	YT-1472	20	12	2,00
20001473	YT-1473	21	10	2,10
20001474	YT-1474	22	12	2,25
20001475	YT-1475	23	12	2,50
20001476	YT-1476	24	12	2,80
20001478	YT-1478	27	12	3,65
20001480	YT-1480	30	6	4,25
20001481	YT-1481	32	6	4,60



1/2"
12.5mm

DIN
3121

CrV
50BV30

AS-DRIVE



ΚΑΡΥΔΑΚΙΑ ΜΑΚΡΙΑ 1/2"

ΚΩΔΙΚΟΣ	YATO 	Ο(mm)	ΜΗΚΟΣ(mm)	ΣΥΣΚ	€/ΤΕΜ
20001221	YT-1221	8	76	10	2,50
20001223	YT-1223	10	76	10	2,50
20001226	YT-1226	13	76	10	2,55
20001229	YT-1229	16	76	10	2,60
20001230	YT-1230	17	76	10	2,70
20001232	YT-1232	19	76	10	3,10
20001234	YT-1234	21	76	10	3,55



3/4"
19mm

DIN
3121

CrV
50BV30

AS-DRIVE



ΚΑΡΥΔΑΚΙΑ 3/4"

ΚΩΔΙΚΟΣ	YATO	ØA(mm)	ΣΥΣΚ	€/ΤΕΜ
20001308	YT-1308	27	12	5,60
20001311	YT-1311	30	8	6,75
20001312	YT-1312	32	8	8,95
20001314	YT-1314	34	8	9,75
20001316	YT-1316	36	6	10,30
20001317	YT-1317	38	6	10,90
20001318	YT-1318	41	4	12,10
20001322	YT-1322	46	4	13,90
20001324	YT-1324	50	4	15,10
20001328	YT-1328	55	4	18,75
20001330	YT-1330	60	4	21,75

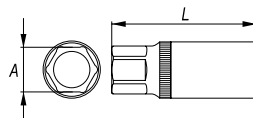

DIN
3121

CrV
50BV30

AS-DRIVE



1/2"
12.5mm

3/8"
10mm

ΚΑΡΥΔΑΚΙΑ ΓΙΑ ΜΠΟΥΖΙ

ΚΩΔΙΚΟΣ	YATO	Ø	A	Lmm	ΣΥΣΚ	€/ΤΕΜ
20001253	YT-1253	1/2"	16	64	10	1,75
20001254	YT-1254	1/2"	21	64	10	2,40
20003851	YT-3851	3/8"	16	64	10	1,75
20003841	YT-3841	3/8"	18	63	25	2,30



NEO



ΓΙΑ ΑΛΥΣΟΠΡΙΟΝΟ

ΚΑΡΥΔΑΚΙΑ ΓΙΑ ΜΠΟΥΖΙ ΚΥΡΤΟ

ΚΩΔΙΚΟΣ	YATO	Ø	A	Lmm	ΣΥΣΚ	€/ΤΕΜ
20038512	YT-38512	3/8"	14	88	25	5,85



DIN
3121

CrV
50BV30

ΠΟΛΥΣΠΑΣΤΑ

ΚΩΔΙΚΟΣ	YATO	Ø	ΣΥΣΚ	€/ΤΕΜ
20001437	YT-1437	1/4"	20	2,05
20003850	YT-3850	3/8"	10	2,65
20001252	YT-1252	1/2"	5	4,70
20001352	YT-1352	3/4"	12	13,20



T20	50 L(mm)	1/2" 12.5mm	max. 12.7 Nm
DIN 3120	HRC 58-62	AISI S2 CRV6150	TORX

ΚΑΡΥΔΑΚΙΑ TORX 1/2"

ΚΩΔΙΚΟΣ	YATO®	⊘	ΜΗΚΟΣ(mm)	ΣΥΣΚ	€/ΤΕΜ
20004310	YT-04310	T20	55	40	2,15
20004311	YT-04311	T25	55	40	2,15
20004312	YT-04312	T27	55	40	2,15
20004313	YT-04313	T30	55	40	2,15
20004314	YT-04314	T40	55	40	2,15
20004315	YT-04315	T45	55	40	2,15
20004316	YT-04316	T50	55	40	2,15
20004317	YT-04317	T55	55	40	2,15



50 L(mm)	1/2" 12.5mm	max. 30.0 Nm
DIN 3120	HRC 58-62	AISI S2 CRV6150
		HEX

ΚΑΡΥΔΑΚΙΑ ΑΛΛΕΝ 1/2"

ΚΩΔΙΚΟΣ	YATO®	⊘	ΜΗΚΟΣ(mm)	ΣΥΣΚ	€/ΤΕΜ
20004381	YT-04381	5	55	40	2,15
20004382	YT-04382	6	55	40	2,15
21004383	YT-04383	7	55	40	2,15
20004384	YT-04384	8	55	40	2,15
21004385	YT-04385	10	55	40	2,20
21004386	YT-04386	12	55	40	2,35



100 L(mm)	1/2" 12.5mm	max. 16.0 Nm
DIN 3120	HRC 58-62	AISI S2 CRV6150
		HEX

ΚΑΡΥΔΑΚΙΑ ΑΛΛΕΝ ΜΑΚΡΙΑ 1/2"

ΚΩΔΙΚΟΣ	YATO®	⊘	ΜΗΚΟΣ(mm)	ΣΥΣΚ	€/ΤΕΜ
21004390	YT-04390	4	100	20	2,75
20004391	YT-04391	5	100	20	2,75
20004392	YT-04392	6	100	20	2,75
20004393	YT-04393	7	100	20	2,75
20004394	YT-04394	8	100	20	2,75
20004395	YT-04395	10	100	20	2,75
20004396	YT-04396	12	100	20	3,10



50 L(mm)	1/2" 12.5mm	max. 30.0 Nm
DIN 3120	HRC 58-62	AISI S2 CRV6150
		SPLINE

ΚΑΡΥΔΑΚΙΑ ΠΟΛΥΣΦΗΝΑ 1/2"

ΚΩΔΙΚΟΣ	YATO®	⊘	ΜΗΚΟΣ(mm)	ΣΥΣΚ	€/ΤΕΜ
20004341	YT-04341	M6	55	40	2,15
20004342	YT-04342	M8	55	40	2,15
20004343	YT-04343	M10	55	40	2,15
20004344	YT-04344	M12	55	40	2,30



CrV
6140

ΚΑΡΥΔΑΚΙ 1/4" - 1/2" ΓΙΑ ΜΥΤΕΣ

ΚΩΔΙΚΟΣ	YATO	Ø	ΓΙΑ ΜΥΤΗ	ΣΥΣΚ	€/ΤΕΜ
20001297	YT-1297	1/4"	1/4"	10	0,82
20001295	YT-1295	1/2"	5/16"	10	2,02

DIN
3121

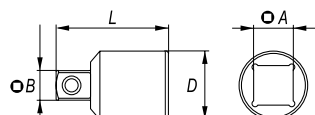
CrV
50BV30

ΑΝΤΑΠΤΟΡΕΣ

ΚΩΔΙΚΟΣ	YATO	ØA	ØB	ΣΥΣΚ	€/ΤΕΜ
20001438	YT-1438	1/4"	3/8"	10	0,70
20003853	YT-3853	3/8"	1/4"	10	0,66
20003854	YT-3854	3/8"	1/2"	10	1,11
20001255	YT-1255	1/2"	3/8"	10	1,33
20001258	YT-1258	1/2"	3/4"	10	3,05
20001259	YT-1259	3/4"	1/2"	5	5,25



DIN
3121

CrV
50BV30

ΠΡΟΕΚΤΑΣΕΙΣ

ΚΩΔΙΚΟΣ	YATO	Ø	M(mm)	ΣΥΣΚ	€/ΤΕΜ
20001430	YT-1430	1/4"	75	30	0,86
20001431	YT-1431	1/4"	100	20	0,98
20003843	YT-3843	3/8"	75	10	1,48
20003844	YT-3844	3/8"	150	10	2,45
20001246	YT-1246	1/2"	75	15	2,00
20001247	YT-1247	1/2"	125	5	3,25
20001248	YT-1248	1/2"	250	5	5,65
20001341	YT-1341	3/4"	200	5	13,85

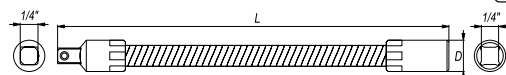
1/4"
6.3mm
CrV
6140

ΠΡΟΕΚΤΑΣΗ ΕΥΚΑΜΠΤΗ

ΚΩΔΙΚΟΣ	YATO	Ø	M(mm)	ΣΥΣΚ	€/ΤΕΜ
20001400	YT-1400	1/4"	150	25	1,85

1/4"
6.3mm
CrV
50BV30

ΚΑΤΣΑΒΙΔΙ 1/4"

ΚΩΔΙΚΟΣ	YATO	Ø	M(mm)	ΣΥΣΚ	€/ΤΕΜ
20001427	YT-1427	1/4"	150	12	3,85



QUICK
RELEASE

72T

CrV
6140

ΜΑΝΕΛΑ ΚΑΣΤΑΝΙΑΣ

ΚΩΔΙΚΟΣ	YATO 	Ø	T	M(mm)	ΣΥΣΚ	€/ΤΕΜ
20000730	YT-0730	1/4"	72	155	12	9,90
20000731	YT-0731	3/8"	72	200	6	12,90
20000732	YT-0732	1/2"	72	255	6	16,90



1/4"
6.3mm

CrV

72T

ΜΑΝΕΛΑ

ΚΩΔΙΚΟΣ	VOREL 	size	L(mm)	ΣΥΣΚ	€/ΤΕΜ
21153575	53575	1/4"	155	12	7,80
21153576	53576	3/8"	200	6	9,60
21153577	53577	1/2"	250	6	13,80



3/4"
19mm

DIN
3122

QUICK
RELEASE

24T

CrV
6140

ΜΑΝΕΛΑ 3/4"

ΚΩΔΙΚΟΣ	YATO 	Ø	T	M(mm)	ΣΥΣΚ	€/ΤΕΜ
20001360	YT-1360	3/4"	24	625	10	59,00



DIN
3121

CrV
50BV30

ΜΑΝΕΛΑ ΤΑΦ

ΚΩΔΙΚΟΣ	YATO 	Ø	ΣΥΣΚ	€/ΤΕΜ
20001426	YT-1426	1/4"	10	1,90
20003840	YT-3840	3/8"	10	4,70
20001243	YT-1243	1/2"	4	6,45
20001350	YT-1350	3/4"	5	23,50



1/4x1/4"
6.3x6.3 mm



72T

CrV
6140



3D



ΔΟΡΥΦΟΡΙΚΗ ΜΑΝΕΛΑ

ΚΩΔΙΚΟΣ	YATO 	Ø	T	M(mm)	ΣΥΣΚ	€/ΤΕΜ
21003311	YT-03311	1/4"x1/4"	72	115	10	28,75



NEO 



HRC 40 **CrV 50BV30** **72T**

ΜΑΝΕΛΑ ΚΑΣΤΑΝΙΑΣ 8-19

ΚΩΔΙΚΟΣ	YATO 	Ø	L(mm)	ΣΥΣΚ	€/ΤΕΜ
20002400	YT-02400	8-19	225	5	17,50



ΜΕ ΥΠΟΔΟΧΗ ΓΙΑ ΜΥΤΗ

ΜΑΝΕΛΑ 1/4"

ΚΩΔΙΚΟΣ	YATO 	Ø	T	M(mm)	ΣΥΣΚ	€/ΤΕΜ
20000331	YT-0331	1/4"	72	136	12	17,20



1/4"
6.3mm

DIN 3122 **QUICK RELEASE**

72T **CrV 6140**



ΚΑΣΤΑΝΙΑ 1/4"

ΚΩΔΙΚΟΣ	YATO 	Ø(mm)	ΣΥΣΚ	€/ΤΕΜ
20014390	YT-14390	1/4"		9,95

11 PCS  **1/4"** **(6.3mm)** **S2**    **72T** **CrV 6150**



1/4" 180x450 CrV
6.3mm mm 50BV30

ΤΑΦ ΣΠΑΣΤΑ

ΚΩΔΙΚΟΣ	YATO 	Ø"(mm)	ΜΗΚΟΣ(mm)	ΣΥΣΚ	€/ΤΕΜ
20015291	YT-15291	1/4"	450	10	10,95
20015293	YT-15293	1/2"	450	10	11,15



CrV
6140



ΤΑΦ ΚΑΡΥΔΑΚΙΑ

ΚΩΔΙΚΟΣ	YATO 	Ø (mm)	ΜΗΚΟΣ(mm)	ΣΥΣΚ	€/ΤΕΜ
20001552	YT-1552	8	310	10	5,35
20001554	YT-1554	10	310	10	5,35
20001556	YT-1556	12	310	10	5,35
20001557	YT-1557	13	310	10	5,35



CrV
6140



ΤΑΦ ΙΣΙΑ

ΚΩΔΙΚΟΣ	YATO 	Ø"(mm)	ΜΗΚΟΣ(mm)	ΣΥΣΚ	€/ΤΕΜ
20001565	YT-1565	1/4" (6.3)	310	10	5,75
20001566	YT-1566	3/8" (9.5)	310	10	5,90
20001567	YT-1567	1/2" (12.7)	310	10	6,05



YATO  1/4" (6.3mm) 6.3mm
3/8" 10mm 1/2" 12.5mm

1/4" (6.3 mm), L = 65 mm
3/8" (9.5 mm), L = 65 mm
1/2" (12.7 mm), L = 70 mm

ΑΝΤΑΠΤΟΡΕΣ ΓΙΑ ΚΑΡΥΔΑΚΙΑ

ΚΩΔΙΚΟΣ	YATO 	ΣΥΣΚ	€/ΤΕΜ
20004685	YT-04685	HEX	20 3,25
20004686	YT-04686	SDS	20 6,00



1/2"
12.5mm CrMo
SCM-440 AS-DRIVE



ΚΑΡΥΔΑΚΙΑ ΑΕΡΟΣ ΜΑΚΡΙΑ 1/2"

ΚΩΔΙΚΟΣ	YATO	Ø"(mm)	ΜΗΚΟΣ(mm)	ΣΥΣΚ	€/ΤΕΜ
20001030	YT-1030	10	78	30	4,40
20001032	YT-1032	12	78	30	4,40
20001033	YT-1033	13	78	30	4,40
20001034	YT-1034	14	78	30	4,40
20001036	YT-1036	16	78	30	5,25
20001037	YT-1037	17	78	25	5,25
20001039	YT-1039	19	78	24	5,25
20001041	YT-1041	21	78	20	5,25
20001042	YT-1042	22	78	18	5,25
20001044	YT-1044	24	78	15	6,15
20001047	YT-1047	27	78	12	9,65
20001050	YT-1050	30	78	10	10,50
20001052	YT-1052	32	78	10	10,95



1/2"
12.5mm CrMo
SCM-440

ΠΡΟΕΚΤΑΣΗ ΑΕΡΟΣ 1/2"

ΚΩΔΙΚΟΣ	YATO	Ø"(mm)	ΜΗΚΟΣ(mm)	ΣΥΣΚ	€/ΤΕΜ
20001061	YT-1061	12.7	125	28	7,45
20001062	YT-1062	12.7	250	30	16,05



1/2"
12.5mm CrMo
SCM-440

ΣΥΣΤΟΛΗ ΑΕΡΟΣ 1/2" - 3/4"

ΚΩΔΙΚΟΣ	YATO	Ø"(mm)	ΜΗΚΟΣ(mm)	ΣΥΣΚ	€/ΤΕΜ
20001067	YT-1067	12.7 - 19	48	40	7,05

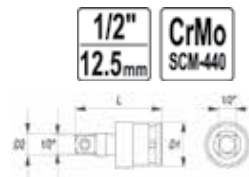

1/2"
12.5mm CrMo
SCM-440

ΠΟΛΥΣΠΑΣΤΟ ΑΕΡΟΣ 1/2"

ΚΩΔΙΚΟΣ	YATO	Ø"(mm)	ΜΗΚΟΣ(mm)	ΣΥΣΚ	€/ΤΕΜ
20001064	YT-1064	12.7	63	25	13,80



8 pcs
1/4"
6.3mm
CrV 50BV30
AS-DRIVE

ΣΕΤ ΚΑΡΥΔΑΚΙ ΜΑΚΡΥ 1/4"

ΚΩΔΙΚΟΣ	YATO 	Ø	ΣΥΣΚ	€/ΤΕΜ
20014431	YT-14431	1/4"	10	6,95

□ 1/4" (6.3 mm): 5.5, 6, 7, 8, 9, 10, 12, 13 mm
(L=50 mm); CrV 50BV30



10 PCS
1/2"
12.5mm
CrV 50BV30
AS-DRIVE

ΣΕΤ ΚΑΡΥΔΑΚΙ ΜΑΚΡΥ 1/2"

ΚΩΔΙΚΟΣ	YATO 	Ø	ΣΥΣΚ	€/ΤΕΜ
20038861	YT-38861	1/2"	10	22,00

□ 1/2" (12.7 mm): 10, 12, 13, 14, 15, 17, 19, 21, 22, 24 mm
(L=76 mm); CrV 50BV30



9 pcs
CrV 50BV30

ΣΕΤ ΚΑΡΥΔΑΚΙΑ TORX 1/4"

ΚΩΔΙΚΟΣ	YATO 	Ø	ΣΥΣΚ	€/ΤΕΜ
20000520	YT-0520	1/4"	10	7,90

□ 1/4" (6.3 mm): E5, E6, E7, E8, 3/8" (9.5 mm): E10, E12, E14, E16;
□ 1/4" (6.3 mm) (M) x 3/8" (9.5 mm) (F)



9 pcs
1/2"
12.5mm
TORX
CrV 50BV30

ΣΕΤ ΚΑΡΥΔΑΚΙΑ TORX 1/2"

ΚΩΔΙΚΟΣ	YATO 	Ø	ΣΥΣΚ	€/ΤΕΜ
20000521	YT-0521	1/2"	20	20,90

1/2" (12.7 mm): E10, E11, E12, E14, E16, E18, E20, E22, E24



AISI S2
CrV 6150
TORX

12 PCS
HRC 58-62
DIN 3120
AISI S2

ΣΕΤ ΚΑΡΥΔΑΚΙΑ TORX 1/4" & 3/8"

ΚΩΔΙΚΟΣ	YATO 	Ø	ΣΥΣΚ	€/ΤΕΜ
20004332	YT-04332	1/4", 3/8"	10	12,00

1/4" (6.3 mm): L=37 mm; T8, T10, T15, T20, T25, T27, T30
3/8" (9.5 mm): L=48 mm; T40, T45, T47, T50, T55



HEX

9 PCS
HRC 58-62
DIN 3120
AISI S2

ΣΕΤ ΚΑΡΥΔΑΚΙΑ ΑΛΛΕΝ 1/4" & 3/8"

ΚΩΔΙΚΟΣ	YATO 	Ø	ΣΥΣΚ	€/ΤΕΜ
20004401	YT-04401	1/4", 3/8"	6	8,95

1/4" (6.3 mm): L=37 mm; 2, 3, 4, 5, 6 mm
3/8" (9.5 mm): L=48 mm; 7, 8, 10, 12 mm





7
PCS
TORX

218Nm
max.

AISI
S2

HRC
58-62

⊕ x6: L=30 mm: T25, T30,
T40, T45, T50, T55; AISI S2;
⊕ 1/2" (12.7 mm):
10 mm; CrV 6150

ΣΕΤ TORX

ΚΩΔΙΚΟΣ	YATO	Ø	ΣΥΣΚ	€/ΤΕΜ
20000410	YT-0410	1/2"	24	4,20



7
PCS
HEX

218Nm
max.

AISI
S2

HRC
58-62

⊕ x6: L=30 mm: H4, H5,
H6, H8, H10, H12 mm; AISI S2;
⊕ 1/2" (12.7 mm):
10 mm; CrV 6150

ΣΕΤ ΑΛΛΕΝ

ΚΩΔΙΚΟΣ	YATO	Ø	ΣΥΣΚ	€/ΤΕΜ
20000412	YT-0412	1/2"	24	4,20



6
PCS
SPLINE

218Nm
max.

AISI
S2

HRC
58-62

⊕ x5: L=30 mm: M5, M6,
M8, M10, M12; AISI S2;
⊕ 1/2" (12.7 mm):
10 mm; CrV 6150

ΣΕΤ SPLINE

ΚΩΔΙΚΟΣ	YATO	Ø	ΣΥΣΚ	€/ΤΕΜ
20000414	YT-0414	1/2"	24	4,20



8
PCS
RIBBE

218Nm
max.

AISI
S2

HRC
58-62

⊕ x7: L=30 mm: M5, M6,
M7, M8, M10, M12, M14; AISI S2;
⊕ 1/2" (12.7 mm):
10 mm; CrV 6150

ΣΕΤ RIBBE

ΚΩΔΙΚΟΣ	YATO	Ø	ΣΥΣΚ	€/ΤΕΜ
20000418	YT-0418	1/2"	24	6,05



40
PCS
TORX

218Nm
max.

AISI
S2

HRC
58-62

⊕ x14: L=30 mm: H4, H5, H6, H7, H8, H10, H12;
L=75 mm: H4, H5, H6, H7, H8, H10, H12; AISI S2;
⊕ x10: L=30 mm: M5, M6, M8, M10, M12;
L=75 mm: M5, M6, M8, M10, M12; AISI S2;
⊕ x14: L=30 mm: T20, T25, T30, T40, T45, T50, T55;
L=75 mm: T20, T25, T30, T40, T45, T50, T55; AISI S2;
⊕ x2: 1/2" (12.7 mm): 10 mm, 3/8" (9.5 mm); 10 mm; CrV 6150

ΣΕΤ 40 TMX

ΚΩΔΙΚΟΣ	YATO	Ø	ΣΥΣΚ	€/ΤΕΜ
20000400	YT-0400	3/8" & 1/2"	10	28,10



12
PCS

1/2"
12.5mm

72T



CrMo
440

CrV
50BV30

AS-DRIVE

ΣΕΤ 1/2" - 12 ΤΜΧ.

ΚΩΔΙΚΟΣ	YATO 	Ø	ΣΥΣΚ	€/ΤΕΜ
20038821	YT-38821	1/2"	5	29,00

 1/2" (12.7 mm): 10, 11, 12, 13, 14, 15, 17, 19, 21, 24 mm (L=38 mm); CrV 50BV30;
 1/2" (12.7 mm); (127 mm); CrV 50BV30;
 1/2" (12.7 mm); (255 mm); 72T; CrMo 440









25
pcs



ΚΑΣΕΤΙΝΑ 1/2" - 25 ΤΜΧ.

ΚΩΔΙΚΟΣ	YATO 	Ø	ΣΥΣΚ	€/ΤΕΜ
20038741	YT-38741	1/2"	2	60,40

 1/2" (12.7 mm): 10, 11, 12, 13, 14, 15, 16, 17, 18, 19, 20, 21, 22, 23, 24 mm (L=38 mm); 27, 30, 32 mm (L=42 mm);
 1/2" (12.7 mm); (127 mm); CrV 50BV30;
 1/2" (12.7 mm): 16, 21 mm; CrV 50BV30;
 1/2" (12.7 mm); (255 mm); CrV 50BV30;
 1/2" (12.7 mm); (255 mm);
 1/2" (12.7 mm); (317 mm); CrV 50BV30;
 1/2" (12.7 mm) (F) x 3/8" (9.5 mm) (M); CrV 50BV30

1/2"
12.5mm

CrV
50BV30

CrV
6140

72T

AS-DRIVE



















94
pcs



ΚΑΣΕΤΙΝΑ 1/4" & 1/2" - 94 ΤΜΧ.

ΚΩΔΙΚΟΣ	YATO 	Ø	ΣΥΣΚ	€/ΤΕΜ
20012681	YT-12681	1/2" & 1/4"	2	99,00

 1/2" (12.7 mm): 10, 11, 12, 13, 14, 15, 16, 17, 18, 19, 20, 21, 22, 23, 24 mm (L=38 mm); 27, 30, 32 mm (L=42 mm); 1/4" (6.3 mm): 4, 4.5, 5, 5.5, 6, 7, 8, 9, 10, 11, 12, 13, 14 mm (L=25 mm); CrV 50BV30;  1/2" (12.7 mm): 14, 15, 17, 19 mm (L=76 mm); 1/4" (6.3 mm): 6, 7, 8, 9, 10, 11, 12, 13 mm (L=50 mm); CrV 50BV30;  1/2" (12.7 mm); (127, 254 mm); 1/4" (6.3 mm); (50.8, 101.6 mm); CrV 50BV30;  3/8" (9.5 mm) (F) x 1/2" (12.7 mm) (M); CrV 50BV30;  1/4" (6.3 mm); (150 mm); CrV 50BV30;  1/2" (12.7 mm), 1/4" (6.3 mm); CrV 50BV30;  1/2" (12.7 mm): 16, 21 mm; CrV 50BV30;  1/4" (6.3 mm); (152.4 mm); CrV 40;  1/2" (12.7 mm); (255 mm); 1/4" (6.3 mm); (155 mm); 72T; CrMo 440;  1/4" (6.3 mm); (150 mm); CrV 50BV30;  1/2" (12.7 mm) x 5/16" (7.9 mm); CrV 50BV30;  1/4" (6.3 mm) x 1/4" (6.3 mm); CrV 50BV30;  5/16" (7.9 mm): 8, 10, 12 mm (L=30 mm); AISI S2;  5/16" (7.9 mm): PH3, PH4 (L=30 mm); AISI S2;  5/16" (7.9 mm): PZ3, PZ4 (L=30 mm); AISI S2;  5/16" (7.9 mm): T40, T45, T50, T55 (L=30 mm); AISI S2;  5/16" (7.9 mm): 8, 10, 12, 14 mm (L=30 mm); AISI S2; 1/4" (6.3 mm): 4, 5.5, 7 mm (L=37 mm); AISI S2 / CrV 6150; 1/4" (6.3 mm): PH1, PH2 (L=37 mm); AISI S2 / CrV 6150; 1/4" (6.3 mm): PZ1, PZ2 (L=37 mm); AISI S2 / CrV 6150; 1/4" (6.3 mm): T8, T10, T15, T20, T25, T30 (L=37 mm); AISI S2 / CrV 6150; 1/4" (6.3 mm): 3, 4, 5, 6 mm (L=37 mm); AISI S2 / CrV 6150; 1.5, 2, 2.5 mm; CrV 6150

CrV
50BV30

CrMo
440

S2

72T

AS-DRIVE

1/2"
12.5mm

1/4"
6.3mm

CrV
40

CrV
6150

38
pcs

1/4" 6.3mm	CrV 50BV30	CrV 6150	CrV 40
CrMo 440	S2	72T	AS-DRIVE

ΚΑΣΕΤΙΝΑ 1/4" - 38 ΤΜΧ.

ΚΩΔΙΚΟΣ	YATO	Ø	ΣΥΣΚ	€/ΤΕΜ
20014471	YT-14471	1/4"	10	▶ 28,00

- 1/4" (6.3 mm): 3.5, 4, 4.5, 5, 5.5, 6, 7, 8, 9, 10, 11, 12, 13, 14 mm (L=25 mm); CrV 50BV30;
- 1/4" (6.3 mm); (50.8, 101.6 mm); CrV 50BV30;
- 1/4" (6.3 mm); CrV 50BV30;
- 1/4" (6.3 mm); (152.4 mm); CrV 40;
- 1/4" (6.3 mm); (155 mm); 72T; CrMo 440;
- 1/4" (6.3 mm); (150 mm); CrV 50BV30;
- 1/4" (6.3 mm): 4, 5.5, 6.5 mm (L=37 mm); AISI S2 / CrV 6150;
- 1/4" (6.3 mm): PH1, PH2 (L=37 mm); AISI S2 / CrV 6150;
- 1/4" (6.3 mm): PZ1, PZ2 (L=37 mm); AISI S2 / CrV 6150;
- 1/4" (6.3 mm): T10, T15, T20, T25, T30, T40 (L=37 mm); AISI S2 / CrV 6150;
- 1/4" (6.3 mm): 3, 4, 5, 6, 8 mm (L=37 mm); AISI S2 / CrV 6150

ΣΕ ΠΩΛΗΣΕΙΣ
No 1

56
pcs

1/4" 6.3mm	CrV 50BV30	CrV 6150	CrV 40
CrMo 440	S2	72T	AS-DRIVE

ΚΑΣΕΤΙΝΑ 1/4" - 56 ΤΜΧ.

ΚΩΔΙΚΟΣ	YATO	Ø	ΣΥΣΚ	€/ΤΕΜ
20014501	YT-14501	1/4"	10	▶ 35,00

- 1/4" (6.3 mm): 4, 4.5, 5, 5.5, 6, 7, 8, 9, 10, 11, 12, 13 mm (L=25 mm); CrV 50BV30;
- 1/4" (6.3 mm): 6, 7, 8, 9, 10, 11, 12, 13 mm (L=50 mm); CrV 50BV30;
- 1/4" (6.3 mm): E4, E5, E6, E7, E8, E10; CrV 6150;
- 1/4" (6.3 mm); (76, 152.4 mm); CrV 50BV30;
- 1/4" (6.3 mm); (150 mm); CrV 50BV30;
- 1/4" (6.3 mm); CrV 50BV30;
- 1/4" (6.3 mm); (152.4 mm); CrV 40;
- 1/4" (6.3 mm); (155 mm); 72T; CrMo 440;
- 1/4" (6.3 mm); (150 mm); CrV 50BV30;
- 1/4" (6.3 mm) (F) x 3/8" (9.5 mm) (M); CrV 50BV30;
- 1/4" (6.3 mm): 4, 5.5, 6.5 mm (L=37 mm); AISI S2 / CrV 6150;
- 1/4" (6.3 mm): PH1, PH2, PH3 (L=37 mm); AISI S2 / CrV 6150;
- 1/4" (6.3 mm): PZ1, PZ2, PZ3 (L=37 mm); AISI S2 / CrV 6150;
- 1/4" (6.3 mm): T8, T10, T15, T20, T25, T30, T40 (L=37 mm); AISI S2 / CrV 6150;
- 1/4" (6.3 mm): 3, 4, 5, 6, 7, 8 mm (L=37 mm); AISI S2 / CrV 6150

22
pcs

3/8" 10mm	CrV 50BV30	CrV 40
CrMo 440	72T	AS-DRIVE

ΚΑΣΕΤΙΝΑ 3/8" - 22 ΤΜΧ.

ΚΩΔΙΚΟΣ	YATO	Ø	ΣΥΣΚ	€/ΤΕΜ
20038561	YT-38561	3/8"	10	▶ 30,70

- 3/8" (9.5 mm): 6, 7, 8, 9, 10, 11, 12, 13, 14, 15, 16 mm (L=28 mm); 17, 18, 19, 20, 21, 22 mm (L=30 mm); CrV 50BV30;
- 3/8" (9.5 mm); (76, 152.4 mm); CrV 50BV30;
- 3/8" (9.5 mm); CrV 50BV30;
- 3/8" (9.5 mm); (198 mm); CrV 40;
- 3/8" (9.5 mm); (200 mm); 72T; CrMo 440



122
pcs











ΚΑΣΕΤΙΝΑ 1/4" & 1/2" - 100 ΤΜΧ.

ΚΩΔΙΚΟΣ	YATO	Ø	ΣΥΣΚ	€/ΤΕΜ
20038901	YT-38901	1/2" & 1/4"	2	162,65

NEO 

1/2" 12.5mm	1/4" 6.3mm	CrV 6150	CrV 50BV30	CrMo 440	S2	72T	AS-DRIVE
----------------	---------------	-------------	---------------	-------------	----	-----	----------



-  1/4" (6.3 mm): T8, T10, T15, T20, T25 (L=37 mm); AISI S2 / CrV 6150;
-  1/4" (6.3 mm): T10, T15, T20, T25, T40 (L=37 mm); AISI S2 / CrV 6150;
-  1/4" (6.3 mm): 3, 4, 5, 6 mm (L=37 mm); AISI S2 / CrV 6150;
-  8, 9, 10, 11, 12, 13, 14, 15, 16, 17, 18, 19 mm; CrV;
-  4x100, 6x150, PH2x100, PH3x150 mm; S2;
-  180 mm;  160 mm;
-  160 mm;  250 mm; CrV;
-  300 g;  2, 2.5, 3, 4, 5, 6, 7, 8, 10 mm; CrV 6150

-  1/2" (12.7 mm): 12, 13, 14, 15, 16, 17, 18, 19, 20, 21, 22, 24 mm (L=38 mm); 27, 30, 32 mm (L=42 mm);
-  1/4" (6.3 mm): 4, 4.5, 5, 5.5, 6, 7, 8, 9, 10, 11, 12, 13, 14 mm (L=25 mm); CrV 50BV30;
-  1/2" (12.7 mm): 10, 12, 13, 14, 17, 19 mm (L=76 mm);
-  1/4" (6.3 mm): 4, 5, 6, 7, 8, 9 mm (L=50 mm); CrV 50BV30;
-  1/2" (12.7 mm): E10, E12, E14, E16, E18, E20, E22, E24; CrV 6150;
-  1/2" (12.7 mm): (254 mm), 1/4" (6.3 mm): (152.4 mm); CrV 50BV30;
-  3/8" (9.5 mm) (F) x 1/2" (12.7 mm) (M), 3/8" (9.5 mm) (F) x 1/4" (6.3 mm) (M); CrV 50BV30;
-  1/2" (12.7 mm), 1/4" (6.3 mm); CrV 50BV30;  1/2" (12.7 mm): 16, 21 mm; CrV 50BV30;
-  1/2" (12.7 mm); (255 mm), 1/4" (6.3 mm); (155 mm); 72T; CrMo 440;
-  1/4" (6.3 mm); (150 mm); CrV 50BV30;
-  1/4" (6.3 mm) x 1/4" (6.3 mm); CrV 50BV30;
-  1/4" (6.3 mm): 3, 4, 5, 6 mm (L=25 mm); AISI S2;
-  1/4" (6.3 mm): PH0, PH1, PH2 (L=25 mm); AISI S2;
-  1/4" (6.3 mm): P20, P21, P22 (L=25 mm); AISI S2;
-  1/4" (6.3 mm): 4.0, 5.5, 6.5 mm (L=37 mm); AISI S2 / CrV 6150;
-  1/4" (6.3 mm): PH1, PH2, PH3 (L=37 mm); AISI S2 / CrV 6150;
-  1/4" (6.3 mm): P22, P23 (L=37 mm); AISI S2 / CrV 6150;

























82
pcs

ΚΑΣΕΤΙΝΑ 1/4" & 1/2" - 82 ΤΜΧ.

ΚΩΔΙΚΟΣ	YATO	Ø	ΣΥΣΚ	€/ΤΕΜ
20012691	YT-12691	1/2" & 1/4"	2	99,15



-  1/2" (12.7 mm): 14, 15, 16, 17, 18, 19, 20, 22, 24 mm (L=38 mm); 27, 30, 32 mm (L=42 mm);
-  1/4" (6.3 mm): 4, 4.5, 5, 5.5, 6, 7, 8, 9, 10, 11, 12, 13, 14 mm (L=25 mm); CrV 50BV30;
-  1/2" (12.7 mm): (127, 254 mm), 1/4" (6.3 mm): (50.8, 101.6 mm); CrV 50BV30;
-  3/8" (9.5 mm) (F) x 1/2" (12.7 mm) (M); CrV 50BV30;
-  1/4" (6.3 mm): (150 mm); CrV 50BV30;
-  1/2" (12.7 mm), 1/4" (6.3 mm); CrV 50BV30;
-  1/2" (12.7 mm): 16, 21 mm; CrV 50BV30;
-  1/4" (6.3 mm): (152.4 mm); CrV 40;
-  1/2" (12.7 mm): (255 mm), 1/4" (6.3 mm): (155 mm); 72T; CrMo 440;
-  1/4" (6.3 mm): (150 mm); CrV 50BV30;
-  1/2" (12.7 mm) x 5/16" (7.9 mm); CrV 50BV30;
-  1/4" (6.3 mm) x 1/4" (6.3 mm); CrV 50BV30;
-  5/16" (7.9 mm): 8, 10, 12 mm (L=30 mm); AISI S2;
-  5/16" (7.9 mm): PH3, PH4 (L=30 mm); AISI S2;
-  5/16" (7.9 mm): P23, P24 (L=30 mm); AISI S2;
-  5/16" (7.9 mm): T40, T45, T50, T55 (L=30 mm); AISI S2;
-  5/16" (7.9 mm): 8, 10, 12, 14 mm (L=30 mm); AISI S2;
-  1/4" (6.3 mm): 4, 5.5, 7 mm (L=37 mm); AISI S2 / CrV 6150;
-  1/4" (6.3 mm): PH1, PH2 (L=37 mm); AISI S2 / CrV 6150;
-  1/4" (6.3 mm): P21, P22 (L=37 mm); AISI S2 / CrV 6150;
-  1/4" (6.3 mm): T8, T10, T15, T20, T25, T30 (L=37 mm); AISI S2 / CrV 6150;
-  1/4" (6.3 mm): 3, 4, 5, 6 mm (L=37 mm); AISI S2 / CrV 6150;
-  8, 10, 11, 12, 13, 14, 17, 19, 22 mm; CrV

82 pcs	1/2" 12.5mm	1/4" 6.3mm	CrV 40	CrV 6150
	CrV 50BV30	CrMo 440	S2	72T
			AS-DRIVE	



12 pcs
1/2" 12.5mm
45T AS-DRIVE

ΣΕΤ ΚΑΡΥΔΑΚΙΑ 1/2"

ΚΩΔΙΚΟΣ	STHOR	ΣΥΣΚ	€/ΤΕΜ
22058633	58633	5	19,00

- 1/2" (12.7 mm): 10, 11, 12, 13, 14, 15, 17, 19, 21, 24 mm;
- 1/2" (12.7 mm);
- 1/2" (12.7 mm)



ΣΕ ΠΩΛΗΣΕΙΣ
No 1



ΣΕΤ ΚΑΡΥΔΑΚΙΑ 1/4"

ΚΩΔΙΚΟΣ	STHOR	ΣΥΣΚ	€/ΤΕΜ
22058640	58640	10	18,00

38 pcs
1/4" 6.3mm
45T AS-DRIVE

- 1/4" (6.3 mm): 3.5, 4, 4.5, 5, 5.5, 6, 7, 8, 9, 10, 11, 12, 13, 14 mm (L=25 mm);
- 1/4" (6.3 mm): (50.8, 101.6 mm);
- 1/4" (6.3 mm);
- 1/4" (6.3 mm); (108 mm);
- 1/4" (6.3 mm); (155 mm); 45T;
- 1/4" (6.3 mm); (150 mm);
- 1/4" (6.3 mm); (150 mm);
- 1/4" (6.3 mm): 4, 5.5, 6.5 mm (L=37 mm);
- 1/4" (6.3 mm): PH1, PH2 (L=37 mm);
- 1/4" (6.3 mm): PZ1, PZ2 (L=37 mm);
- 1/4" (6.3 mm): T10, T15, T20, T25, T30, T40 (L=37 mm);
- 1/4" (6.3 mm): 3, 4, 5, 6, 8 mm (L=37 mm)



"ΕΞΥΠΝΟ"

ΣΕΤ ΚΑΡΥΔΑΚΙΑ 1/4"

ΚΩΔΙΚΟΣ	STHOR	ΣΥΣΚ	€/ΤΕΜ
22058643	58643	10	24,00

56 pcs
1/4" 6.3mm
CrV 50BV30
45T AS-DRIVE

- 1/4" (6.3 mm): 4, 4.5, 5, 5.5, 6, 7, 8, 9, 10, 11, 12, 13 mm (L=25 mm);
- 1/4" (6.3 mm): 6, 7, 8, 9, 10, 11, 12, 13 mm (L=50 mm);
- 1/4" (6.3 mm): E4, E5, E6, E7, E8, E10; CrV 50BV30;
- 1/4" (6.3 mm): (76, 152.4 mm);
- 1/4" (6.3 mm); (150 mm);
- 1/4" (6.3 mm);
- 1/4" (6.3 mm); (108 mm);
- 1/4" (6.3 mm); (155 mm); 45T;
- 1/4" (6.3 mm); (150 mm);
- 1/4" (6.3 mm) (F) x 3/8" (9.5 mm) (M);
- 1/4" (6.3 mm): 4, 5.5, 6.5 mm (L=37 mm);
- 1/4" (6.3 mm): PH1, PH2, PH3 (L=37 mm);
- 1/4" (6.3 mm): PZ1, PZ2, PZ3 (L=37 mm);
- 1/4" (6.3 mm): T8, T10, T15, T20, T25, T30, T40 (L=37 mm);
- 1/4" (6.3 mm): 3, 4, 5, 6, 7, 8 mm (L=37 mm)

ΣΕΤ ΚΑΡΥΔΑΚΙΑ 3/8"

ΚΩΔΙΚΟΣ	STHOR	ΣΥΣΚ	€/ΤΕΜ
22058661	58661	10	▶ 23,55



- 3/8" (9.5 mm): 6, 7, 8, 9, 10, 11, 12, 13, 14, 15, 16 mm (L=28 mm); 3/8" (9.5 mm); 3/8" (9.5 mm); (200 mm); 45T
 17, 18, 19, 20, 21, 22 mm (L=30 mm); 3/8" (9.5 mm); (198 mm);
 3/8" (9.5 mm); (76, 152.4 mm);

ΣΕΤ ΚΑΡΥΔΑΚΙΑ 1/2" & 1/4"

ΚΩΔΙΚΟΣ	STHOR	ΣΥΣΚ	€/ΤΕΜ
22058687	58687	3	▶ 67,00

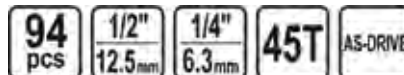

- 1/2" (12.7 mm): 10, 11, 12, 13, 14, 15, 16, 17, 18, 19, 20, 21, 22, 23, 24 mm (L=38 mm); 1/4" (6.3 mm): (150 mm); 1/4" (6.3 mm): 4, 5.5, 7 mm (L=37 mm);
 27, 30, 32 mm (L=42 mm); 1/4" (6.3 mm): 4, 4.5, 5, 5.5, 6, 7, 8, 9, 10, 11, 12, 13, 14 mm (L=25 mm); 1/4" (6.3 mm): PH1, PH2 (L=37 mm);
 1/2" (12.7 mm): 14, 15, 17, 19 mm (L=76 mm); 1/4" (6.3 mm): PZ1, PZ2 (L=37 mm);
 1/4" (6.3 mm): 6, 7, 8, 9, 10, 11, 12, 13 mm (L=50 mm); 1/4" (6.3 mm): T8, T10, T15, T20, T25, T30 (L=37 mm);
 1/2" (12.7 mm) (127, 254 mm), 1/4" (6.3 mm) (50.8, 101.6 mm); 1/4" (6.3 mm): 3, 4, 5, 6 mm (L=37 mm);
 3/8" (9.5 mm) (F) x 1/2" (12.7 mm) (M); 1/4" (6.3 mm): (150 mm); 1.5, 2.0, 2.5 mm
 1/2" (12.7 mm), 1/4" (6.3 mm); 1/2" (12.7 mm): 16, 21 mm;
 1/4" (6.3 mm): (108 mm); 5/16" (7.9 mm): PH3, PH4 (L=30 mm);
 1/2" (12.7 mm): (255 mm), 1/4" (6.3 mm): (155 mm); 45T; 5/16" (7.9 mm): P23, P24 (L=30 mm);
 1/4" (6.3 mm) x 5/16" (7.9 mm); 5/16" (7.9 mm): T40, T45, T50, T55 (L=30 mm);
 1/4" (6.3 mm) x 1/4" (6.3 mm) (L=25 mm); 5/16" (7.9 mm): 8, 10, 12, 14 mm (L=30 mm);
 5/16" (7.9 mm): 8, 10, 12 mm (L=30 mm);

Σειρά πένσοειδών από υλικά υψηλών προδιαγραφών - **DIN 5746** -
για βιομηχανική χρήση

με εξαιρετική σχέση Ποιότητας - Τιμής!!!

Κυρίως σώμα κατασκευασμένο από χάλυβα σκληρότητας **HRC 44-50** (spring steel)

Κοπτικές άκρες από χάλυβα, σκληρότητας **HRC 58-62** (knife steel)

Τρίχρωμη, ανατομική, λαβή διαφορετικής σκληρότητας
για άνετο, σταθερό και ακριβή χειρισμό



ΠΕΝΣΕΣ CrV55 ΓΕΝΙΚΗΣ ΧΡΗΣΗΣ

ΚΩΔΙΚΟΣ	YATO	ΜΗΚΟΣ(mm)	ΣΥΣΚ	€/ΤΕΜ
20001940	YT-1940	160	6	7,80
20001941	YT-1941	180	6	8,95
20001942	YT-1942	200	6	10,50



ΠΛΑΓΙΟΚΟΦΤΕΣ CrV55

ΚΩΔΙΚΟΣ	YATO	ΜΗΚΟΣ(mm)	ΣΥΣΚ	€/ΤΕΜ
20001947	YT-1947	160	6	7,50
20001948	YT-1948	190	6	9,70



ΜΥΤΟΣΙΜΠΙΔΑ CrV55 ΙΣΙΟ

ΚΩΔΙΚΟΣ	YATO	ΜΗΚΟΣ(mm)	ΣΥΣΚ	€/ΤΕΜ
20001943	YT-1943	160	6	7,20
20001944	YT-1944	200	6	8,35



ΜΥΤΟΣΙΜΠΙΔΑ CrV55 ΚΥΡΤΟ

ΚΩΔΙΚΟΣ	YATO	ΜΗΚΟΣ(mm)	ΣΥΣΚ	€/ΤΕΜ
20001945	YT-1945	160	6	7,35
20001946	YT-1946	200	6	8,65



160 mm **HRC 55-62**
CrV

ΠΕΝΣΕΣ CrV ΓΕΝΙΚΗΣ ΧΡΗΣΗΣ

ΚΩΔΙΚΟΣ	YATO 	ΜΗΚΟΣ(mm)	ΣΥΣΚ	€/ΤΕΜ
20006600	YT-6600	160	6	5,95
20006601	YT-6601	180	6	6,95
20006602	YT-6602	200	6	7,80



160 mm **HRC 55-62**
CrV



ΠΛΑΓΙΟΚΟΦΤΕΣ CrV

ΚΩΔΙΚΟΣ	YATO 	ΜΗΚΟΣ(mm)	ΣΥΣΚ	€/ΤΕΜ
20006610	YT-6610	160	6	5,75
20006611	YT-6611	180	6	6,65



160 mm **200 mm**
DIN 5746 **NICKEL IRON FINISH**



ΜΥΤΟΤΣΙΜΠΙΔΑ ΙΣΙΟ

ΚΩΔΙΚΟΣ	YATO 	ΜΗΚΟΣ(mm)	ΣΥΣΚ	€/ΤΕΜ
20002016	YT-2016	160	6	5,75
20002018	YT-2018	200	6	6,55



160 mm **200 mm**
DIN 5746 **NICKEL IRON FINISH**



ΜΥΤΟΤΣΙΜΠΙΔΑ ΚΥΡΤΑ

ΚΩΔΙΚΟΣ	YATO 	ΜΗΚΟΣ(mm)	ΣΥΣΚ	€/ΤΕΜ
20002026	YT-2026	160	6	5,85
20002028	YT-2028	200	6	6,90



NEO 

HRC 50 **CrV**



ΜΥΤΟΤΣΙΜΠΙΔΟ ΜΑΚΡΥ 340mm

ΚΩΔΙΚΟΣ	YATO 	ΜΗΚΟΣ(mm)	ΣΥΣΚ	€/ΤΕΜ
20020400	YT-20400	340	5	14,20



NEO 

45° **HRC 50** **CrV**



ΜΥΤΟΤΣΙΜΠΙΔΟ ΜΑΚΡΥ 330mm

ΚΩΔΙΚΟΣ	YATO 	ΜΗΚΟΣ(mm)	ΣΥΣΚ	€/ΤΕΜ
20020401	YT-20401	330	5	14,20

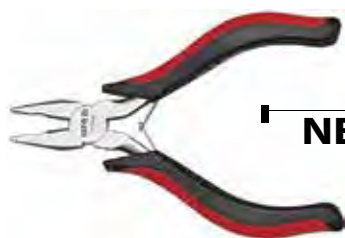
NEO 115
mmNICKEL
IRON
FINISH

ΜΙΝΙ ΠΕΝΣΑ 115 mm

ΚΩΔΙΚΟΣ	YATO 	ΜΗΚΟΣ(mm)	ΣΥΣΚ	€/ΤΕΜ
20002080	YT-2080	115	6	3,90

NEO 115
mmNICKEL
IRON
FINISH

ΜΙΝΙ ΠΛΑΓΙΟΚΟΦΤΗΣ 115 mm

ΚΩΔΙΚΟΣ	YATO 	ΜΗΚΟΣ(mm)	ΣΥΣΚ	€/ΤΕΜ
20002081	YT-2081	115	6	3,90

115
mmNICKEL
IRON
FINISH

ΜΙΝΙ ΜΥΤΟΣΙΜΠΙΔΟ ΙΣΙΟ 115 mm

ΚΩΔΙΚΟΣ	YATO 	ΜΗΚΟΣ(mm)	ΣΥΣΚ	€/ΤΕΜ
20002083	YT-2083	115	6	3,90

115
mmNICKEL
IRON
FINISH

ΜΙΝΙ ΜΥΤΟΣΙΜΠΙΔΟ ΚΥΡΤΟ 115 mm

ΚΩΔΙΚΟΣ	YATO 	ΜΗΚΟΣ(mm)	ΣΥΣΚ	€/ΤΕΜ
20002084	YT-2084	115	6	3,90

115
mmNICKEL
IRON
FINISH

ΜΙΝΙ ΠΛΑΤΥΣΙΜΠΙΔΟ 115 mm

ΚΩΔΙΚΟΣ	YATO 	ΜΗΚΟΣ(mm)	ΣΥΣΚ	€/ΤΕΜ
20002085	YT-2085	115	6	3,90

115
mmNICKEL
IRON
FINISH

ΜΙΝΙ ΜΥΤΟΣΙΜΠΙΔΟ ΣΤΡΟΓΓΥΛΟ 115 mm

ΚΩΔΙΚΟΣ	YATO 	ΜΗΚΟΣ(mm)	ΣΥΣΚ	€/ΤΕΜ
20002086	YT-2086	115	6	3,90

115
mmNICKEL
IRON
FINISH

ΜΙΝΙ ΜΠΡΟΣΤΟΚΟΦΤΗΣ 115 mm

ΚΩΔΙΚΟΣ	YATO 	ΜΗΚΟΣ(mm)	ΣΥΣΚ	€/ΤΕΜ
20002082	YT-2082	115	6	3,90



175 mm **200 mm**
CrV 50 **HRC**
DROP FORGED STEEL 55-60
STAL KUTA NA ZIMNO HEAD GLOWICA

ΤΑΝΑΛΙΕΣ

ΚΩΔΙΚΟΣ	YATO 	ΜΗΚΟΣ(mm)	ΣΥΣΚ	€/ΤΕΜ
20002051	YT-2051	175	6	6,70
20002052	YT-2052	200	6	7,45



175 mm **200 mm**
CrV 50 **HRC**
DROP FORGED STEEL 55-60
STAL KUTA NA ZIMNO HEAD GLOWICA

ΜΠΡΟΣΤΟΚΟΦΤΕΣ

ΚΩΔΙΚΟΣ	YATO 	ΜΗΚΟΣ(mm)	ΣΥΣΚ	€/ΤΕΜ
20002063	YT-2063	175	6	7,95
20002064	YT-2064	200	6	8,95

ΑΣΦΑΛΕΙΟΤΣΙΜΠΙΔΑ ΕΛΑΤΗΡΙΟΥ



CrV **NICKEL IRON FINISH**



ΕΞΩΤΕΡΙΚΗΣ ΑΣΦΑΛΕΙΑΣ ΙΣΙΟ

ΚΩΔΙΚΟΣ	YATO 	ΜΗΚΟΣ(mm)	ΣΥΣΚ	€/ΤΕΜ
20002140	YT-2140	150	6	5,35
20002144	YT-2144	200	6	6,50



CrV **NICKEL IRON FINISH**



ΕΞΩΤΕΡΙΚΗΣ ΑΣΦΑΛΕΙΑΣ ΚΥΡΤΟ

ΚΩΔΙΚΟΣ	YATO 	ΜΗΚΟΣ(mm)	ΣΥΣΚ	€/ΤΕΜ
20002141	YT-2141	150	6	5,35
20002145	YT-2145	200	6	6,50



CrV **NICKEL IRON FINISH**



ΕΣΩΤΕΡΙΚΗΣ ΑΣΦΑΛΕΙΑΣ ΙΣΙΟ

ΚΩΔΙΚΟΣ	YATO 	ΜΗΚΟΣ(mm)	ΣΥΣΚ	€/ΤΕΜ
20002142	YT-2142	150	6	5,35
20002146	YT-2146	200	6	6,50



CrV **NICKEL IRON FINISH**

ΕΣΩΤΕΡΙΚΗΣ ΑΣΦΑΛΕΙΑΣ ΚΥΡΤΟ

ΚΩΔΙΚΟΣ	YATO 	ΜΗΚΟΣ(mm)	ΣΥΣΚ	€/ΤΕΜ
20002143	YT-2143	150	6	5,35
20002147	YT-2147	200	6	6,50



5
PCS

160
mm

∅ mm
10-50

ΣΕΤ ΑΣΦΑΛΕΙΟΤΣΙΜΠΙΔΑ

ΚΩΔΙΚΟΣ	YATO	ΜΗΚΟΣ(mm)	ΣΥΣΚ	€/ΤΕΜ
20002130	YT-2130	160	20	12,50



CrMo

180
mm

250
mm

ΓΚΡΙΠ

ΚΩΔΙΚΟΣ	YATO	ΜΗΚΟΣ(mm)	ΣΥΣΚ	€/ΤΕΜ
20002450	YT-2450	180	6	8,70
20002451	YT-2451	250	6	11,00



225
mm

CrMo

ΓΚΡΙΠ ΜΥΤΕΡΟ

ΚΩΔΙΚΟΣ	YATO	ΜΗΚΟΣ(mm)	ΣΥΣΚ	€/ΤΕΜ
20002460	YT-2460	225	6	9,20



225
mm

TYPE
U

ΓΚΡΙΠ ΗΛΕΚΤΡΟΣΥΓΚΟΛΛΗΤΩΝ

ΚΩΔΙΚΟΣ	YATO	ΜΗΚΟΣ(mm)	ΣΥΣΚ	€/ΤΕΜ
20002461	YT-2461	225	6	15,40



0-12.7
mm

78 mm

ΓΚΡΙΠ ΠΛΑΤΥ

ΚΩΔΙΚΟΣ	YATO	ΜΗΚΟΣ(mm)	ΣΥΣΚ	€/ΤΕΜ
20002463	YT-2463	200	6	12,15



280
mm

0-100
mm

TYPE
C

ΓΚΡΙΠ ΤΥΠΟΥ "C"

ΚΩΔΙΚΟΣ	YATO	ΜΗΚΟΣ(mm)	ΣΥΣΚ	€/ΤΕΜ
20002466	YT-2466	280	6	16,45



9
PCS

Al

STAINLESS
STEEL
STAL
NIEODZEWNA

BLISTER

- ▶ Λαβή Αλουμινίου
- ▶ Ανοξειδωτες λάμες

ΠΟΛΥΕΡΓΑΛΕΙΟ "9 ΧΡΗΣΕΩΝ"

ΚΩΔΙΚΟΣ	YATO 	ΣΥΣΚ	€/ΤΕΜ
20076040	YT-76040	10	7,50



9
PCS

STAINLESS
STEEL
STAL
NIEODZEWNA

BLISTER

ΠΟΛΥΕΡΓΑΛΕΙΟ "9 ΧΡΗΣΕΩΝ" ΙΝΟΧ

ΚΩΔΙΚΟΣ	YATO 	ΣΥΣΚ	€/ΤΕΜ
20076043	YT-76043	6	12,80

ΠΕΝΣΑ

ΚΩΔΙΚΟΣ	VOREL	ΜΗΚΟΣ(mm)	ΣΥΣΚ	€/ΤΕΜ
21140042	40042	180	6	4,00

ΠΛΑΓΙΟΚΟΦΤΗΣ

ΚΩΔΙΚΟΣ	VOREL	ΜΗΚΟΣ(mm)	ΣΥΣΚ	€/ΤΕΜ
21140047	40047	160	6	3,60

ΜΥΤΟΣΙΜΠΙΔΟ ΙΣΙΟ

ΚΩΔΙΚΟΣ	VOREL	ΜΗΚΟΣ(mm)	ΣΥΣΚ	€/ΤΕΜ
21140045	40045	180	6	4,00

ΜΥΤΟΣΙΜΠΙΔΟ ΚΥΡΤΟ

ΚΩΔΙΚΟΣ	VOREL	ΜΗΚΟΣ(mm)	ΣΥΣΚ	€/ΤΕΜ
21140051	40051	180	6	3,95

**180
mm**

ΜΠΡΟΣΤΟΚΟΦΤΗΣ

ΚΩΔΙΚΟΣ	VOREL	ΜΗΚΟΣ(mm)	ΣΥΣΚ	€/ΤΕΜ
21141121	41121	180	6	3,25

ΣΕΤ ΜΙΝΙ

ΚΩΔΙΚΟΣ	VOREL	ΣΥΣΚ	€/ΤΕΜ
21142308	42308	4	8,80

**4
pcs**



S2
**HRC
58**
ΚΑΤΣΑΒΙΔΙΑ ⊖ ΙΣΙΑ

ΚΩΔΙΚΟΣ	YATO	⊖	ΜΗΚΟΣ(mm)	ΣΥΣΚ	€/ΤΕΜ
20025900	YT-25900	2	75	12	2,00
20025901	YT-25901	3	75	12	2,00
20025903	YT-25903	3	150	12	2,15
20025904	YT-25904	4	100	12	2,25
20025905	YT-25905	4	150	12	2,50
20025909	YT-25909	5	150	12	2,95
20025912	YT-25912	6	150	12	3,65
20025914	YT-25914	8	150	6	5,05

S2
**HRC
58**
ΚΑΤΣΑΒΙΔΙΑ ⊕ ΡΗ

ΚΩΔΙΚΟΣ	YATO	⊕	ΜΗΚΟΣ(mm)	ΣΥΣΚ	€/ΤΕΜ
20025924	YT-25924	PH1	100	12	2,70
20025925	YT-25925	PH1	150	12	2,95
20025926	YT-25926	PH1	200	12	3,25
20025929	YT-25929	PH2	100	12	3,30
20025930	YT-25930	PH2	150	12	3,65
20025931	YT-25931	PH2	200	12	4,00
20025933	YT-25933	PH3	150	6	4,95

ΚΑΤΣΑΒΙΔΙΑ ΝΑΝΟΙ ⊖ ⊕ ΙΣΙΑ & ΡΗ

ΚΩΔΙΚΟΣ	YATO	⊖	⊕	ΜΗΚΟΣ(mm)	ΣΥΣΚ	€/ΤΕΜ
20025910	YT-25910	6		38	12	2,25
20025922	YT-25922		PH1	38	12	2,15
20025928	YT-25928		PH2	38	12	2,25

S2
**HRC
58**
ΚΑΤΣΑΒΙΔΙΑ ⊕ ΡΖ

ΚΩΔΙΚΟΣ	YATO	⊕	ΜΗΚΟΣ(mm)	ΣΥΣΚ	€/ΤΕΜ
20025941	YT-25941	PZ1	100	12	2,70
20025942	YT-25942	PZ2	100	12	3,25
20025943	YT-25943	PZ2	150	12	3,50

S2
**HRC
58**
ΚΑΤΣΑΒΙΔΙΑ TORX

ΚΩΔΙΚΟΣ	YATO	TORX	ΜΗΚΟΣ(mm)	ΣΥΣΚ	€/ΤΕΜ
20025952	YT-25952	T7	75	12	2,00
20025953	YT-25953	T8	75	12	2,00
20025954	YT-25954	T9	75	12	2,05
20025955	YT-25955	T10	100	12	2,70
20025956	YT-25956	T15	100	12	2,75
20025957	YT-25957	T20	100	12	2,80
20025958	YT-25958	T25	100	12	3,30
20025959	YT-25959	T27	100	12	3,35
20025960	YT-25960	T30	100	12	3,40
20025961	YT-25961	T40	100	6	4,45



ΚΑΤΣΑΒΙΔΙΑ ΠΕΡΑΣΤΟ

ΚΩΔΙΚΟΣ	YATO®	⊖	⊕	ΜΗΚ(μm)	ΣΥΣΚ	€/ΤΕΜ
20025987	YT-25987	6		200	6	4,60
20025991	YT-25991	8		250	6	6,30
20025994	YT-25994		PH2	150	6	4,30



ΣΟΥΒΛΙ

ΚΩΔΙΚΟΣ	YATO®	L (mm)	ΣΥΣΚ	€/ΤΕΜ
20001374	YT-1374	120	12	6,50



ΣΟΥΒΛΙ ΚΥΡΤΟ

ΚΩΔΙΚΟΣ	YATO®	L (mm)	ΣΥΣΚ	€/ΤΕΜ
20001375	YT-1375	125	12	7,40

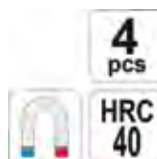

ΣΟΥΒΛΙΑ ΣΕΤ 4 ΤΜΧ

ΚΩΔΙΚΟΣ	YATO®	ΣΥΣΚ	€/ΤΕΜ
20000843	YT-0843	12	4,60



6
PCS

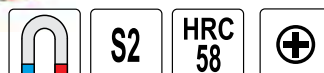

ΣΕΤ ΚΑΤΣΑΒΙΔΙΑ 6 ΤΕΜ.

ΚΩΔΙΚΟΣ	YATO®	ΜΗΚΟΣ(μm)	ΣΥΣΚ	€/ΤΕΜ
20025965	YT-25965	75	6	14,00

⊕ PH1-100mm / PH2-100mm / PH0-75mm
⊖ 3.0-75mm / 5.0-100mm / 6.0-100mm



S2 HRC 57-61

ΚΑΤΣΑΒΙΔΙΑ ΗΛΕΚΤΡΟΝΙΚΩΝ ⊖

ΚΩΔΙΚΟΣ	YATO 	⊖	ΜΗΚΟΣ(mm)	ΣΥΣΚ	€/ΤΕΜ
20025802	YT-25802	1.4	50	50	1,40
20025803	YT-25803	1.6	50	50	1,40
20025804	YT-25804	1.8	50	50	1,40
20025806	YT-25806	2.0	75	50	1,50
20025808	YT-25808	2.4	75	50	1,50



S2 HRC 57-61



ΚΑΤΣΑΒΙΔΙΑ ΗΛΕΚΤΡΟΝΙΚΩΝ ⊕

ΚΩΔΙΚΟΣ	YATO 	⊕	ΜΗΚΟΣ(mm)	ΣΥΣΚ	€/ΤΕΜ
20025832	YT-25832	PH000	75	50	1,50
20025834	YT-25834	PH00	75	50	1,50
20025836	YT-25836	PH0	75	50	1,45



S2 HRC 57-61

ΚΑΤΣΑΒΙΔΙΑ ΗΛΕΚΤΡΟΝΙΚΩΝ

ΚΩΔΙΚΟΣ	YATO 		ΜΗΚΟΣ(mm)	ΣΥΣΚ	€/ΤΕΜ
20025852	YT-25852	T5	50	50	1,50
20025853	YT-25853	T6	50	50	1,50
20025854	YT-25854	T7	50	50	1,50
20025855	YT-25855	T8	50	50	1,50
20025856	YT-25856	T9	50	50	1,50
20025857	YT-25857	T10	50	50	1,50



6 PCS ⊖ 1.4 / 2.0 / 2.4
⊕ PH00 / PH0 / PH1
S2 HRC 57-61

ΣΕΤ ΚΑΤΣΑΒΙΔΙΑ ΗΛΕΚΤΡΟΝΙΚΩΝ

ΚΩΔΙΚΟΣ	YATO 	ΜΗΚΟΣ(mm)	ΣΥΣΚ	€/ΤΕΜ
20025861	YT-25861	50	6	12,60



6 PCS  T5 / T6 / T7 / T8 / T9 / T10
S2 HRC 57-61

ΣΕΤ ΚΑΤΣΑΒΙΔΙΑ ΗΛΕΚΤΡΟΝΙΚΩΝ

ΚΩΔΙΚΟΣ	YATO 	ΜΗΚΟΣ(mm)	ΣΥΣΚ	€/ΤΕΜ
20025862	YT-25862	50	6	12,90

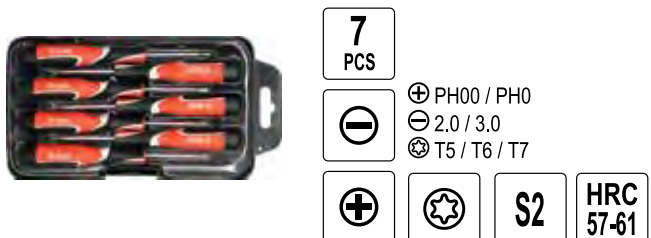

7 PCS
⊕ PH00 / PH0
⊖ 2.0 / 3.0
 T5 / T6 / T7
S2 HRC 57-61

ΣΕΤ ΚΑΤΣΑΒΙΔΙΑ ΗΛΕΚΤΡΟΝΙΚΩΝ

ΚΩΔΙΚΟΣ	YATO 	ΜΗΚΟΣ(mm)	ΣΥΣΚ	€/ΤΕΜ
20025863	YT-25863	50	6	13,90



ΚΑΤΣΑΒΙΔΙ ΕΥΚΑΜΠΤΟ 1/4"



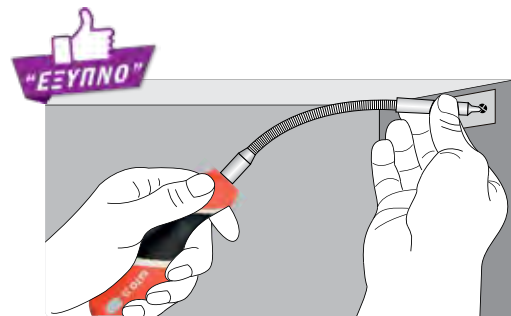



ΚΩΔΙΚΟΣ	YATO 	ΜΕΓΕΘΟΣ(mm)	ΣΥΣΚ	€/ΤΕΜ
20001382	YT-1382	380	6	12,50

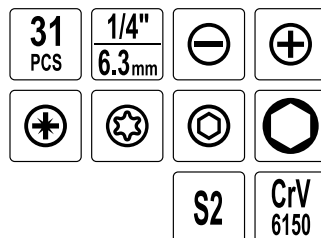

ΚΑΤΣΑΒΙΔΙ ΕΥΚΑΜΠΤΟ 1/4" - ΣΕΤ

ΚΩΔΙΚΟΣ	YATO 	ΣΥΣΚ	€/ΤΕΜ
20025972	YT-25972	6	14,60

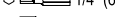

-  215 mm;
-  1/4" (6.3 mm): 3.0, 3.5, 4.0, 5.5, 6.5 mm (L=25 mm);
-  1/4" (6.3 mm): PH0, PH1, PH2, PH3 (L=25 mm);
-  1/4" (6.3 mm): PZ0, PZ1, PZ2, PZ3 (L=25 mm);
-  1/4" (6.3 mm): T10, T15 (L=25 mm);
-  1/4" (6.3 mm): 2.0, 3.0, 4.0, 5.0, 6.0 mm (L=25 mm);
-  1/4" (6.3 mm): 5.0, 6.0, 7.0, 8.0(x2), 9.0, 10.0, 11.0, 12.0, 13.0 mm



ΚΑΤΣΑΒΙΔΙ 6 ΣΕ 1

ΚΩΔΙΚΟΣ	YATO 	ΣΥΣΚ	€/ΤΕΜ
20025971	YT-25971	12	6,20

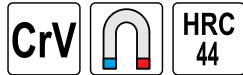

ΚΑΤΣΑΒΙΔΙΑ ΚΑΡΥΔΑΚΙ

ΚΩΔΙΚΟΣ	YATO 	Ø(mm)	ΜΗΚΟΣ(mm)	ΣΥΣΚ	€/ΤΕΜ
20001543	YT-1543	7	125	6	7,60
20001544	YT-1544	8	125	6	7,90
20001546	YT-1546	10	125	6	8,15
20001549	YT-1549	13	125	6	8,90

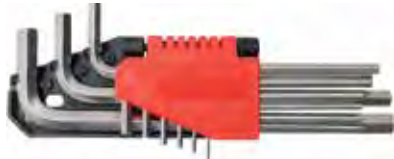

ΣΕΤ ΑΛΛΕΝ 9 ΤΕΜ. - LONG

ΚΩΔΙΚΟΣ	YATO 	Ø(mm)	ΣΥΣΚ	€/ΤΕΜ
20000502	YT-0502	2.0-10.0	6	6,50



ΣΕΤ ΑΛΛΕΝ 9 ΤΕΜ. ΜΠΙΛΙΑΣ - LONG

ΚΩΔΙΚΟΣ	YATO 	Ø(mm)	ΣΥΣΚ	€/ΤΕΜ
20000507	YT-0507	2.0-10.0	6	6,50



ΣΕΤ TORX 9 ΤΕΜ. - LONG

ΚΩΔΙΚΟΣ	YATO 	Ø(mm)	ΣΥΣΚ	€/ΤΕΜ
20000511	YT-0511	T10-T50	6	5,70



ΣΕΤ TORX ΜΠΙΛΙΑΣ

ΚΩΔΙΚΟΣ	YATO 	Ø(mm)	ΣΥΣΚ	€/ΤΕΜ
20005123	YT-05123	T9-T40	10	9,60

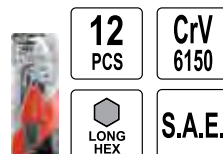

ΣΕΤ ΑΛΛΕΝ 12 ΤΕΜ. ΙΝΤΣΑΣ - LONG

ΚΩΔΙΚΟΣ	YATO 	Ø(mm)	ΣΥΣΚ	€/ΤΕΜ
20005835	YT-5835	1/16" - 3/8"	6	7,75

ΣΕΤ ΚΛΕΙΔΙΩΝ ΑΛΛΕΝ 10 ΤΕΜ.

ΚΩΔΙΚΟΣ	YATO®	Ø(mm)	ΣΥΣΚ	€/ΤΕΜ
20000504	YT-0504	1.50-10.00	12	4,00

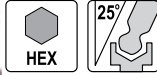
10
PCS

S2
ΣΕΤ ΑΛΛΕΝ ΜΠΙΛΙΑΣ 10 ΤΕΜ

ΚΩΔΙΚΟΣ	YATO®	Ø(mm)	ΣΥΣΚ	€/ΤΕΜ
LONG				
20000560	YT-0560	1.27-10.0	12	12,90
EXTRA LONG				
20000561	YT-0561	1.27-10.0	12	15,90

S2
7
PCS

9
PCS

ΣΕΤ TORX

ΚΩΔΙΚΟΣ	YATO®	Ø(mm)	ΣΥΣΚ	€/ΤΕΜ
LONG				
20000562	YT-0562	T9-T30	12	8,15
EXTRA LONG				
20000563	YT-0563	T10-T50	12	17,75

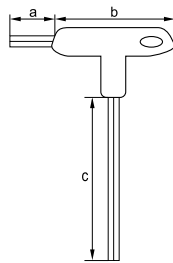
S2

ΤΑΦ ΑΛΛΕΝ

ΚΩΔΙΚΟΣ	YATO®	Ø(mm)	c(mm)	ΣΥΣΚ	€/ΤΕΜ
20005571	YT-05571	2.5	100	12	1,85
20005572	YT-05572	3.0	100	12	2,05
20005574	YT-05574	4.0	140	12	2,35
20005576	YT-05576	5.0	140	12	2,90
20005577	YT-05577	6.0	170	12	3,85
20005578	YT-05578	7.0	170	12	4,30
20005579	YT-05579	8.0	200	12	5,70
20005581	YT-05581	10.0	200	12	7,50

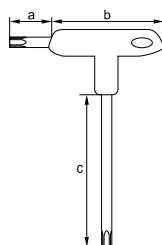
S2

ΤΑΦ TORX

ΚΩΔΙΚΟΣ	YATO®	Ø(mm)	c(mm)	ΣΥΣΚ	€/ΤΕΜ
20005601	YT-05601	T8	100	12	2,25
20005602	YT-05602	T9	100	12	2,30
20005603	YT-05603	T10	100	12	2,30
20005604	YT-05604	T15	100	12	2,30
20005605	YT-05605	T20	130	12	2,40
20005606	YT-05606	T25	130	12	2,90
20005607	YT-05607	T27	140	12	3,40
20005608	YT-05608	T30	170	12	3,60
20005609	YT-05609	T40	170	12	4,50
20005610	YT-05610	T45	200	12	5,60
20005611	YT-05611	T50	200	12	6,45

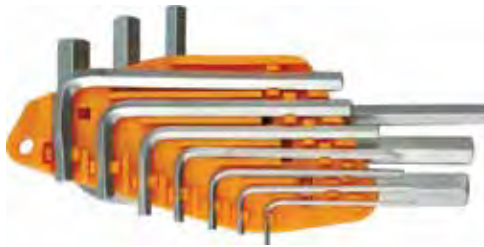

NEO

ΣΕΤ ΑΛΛΕΝ 10 ΤΕΜ.

ΚΩΔΙΚΟΣ	VOREL	mm	ΣΥΣΚ	€/ΤΕΜ
21156393	56393	1,5; 2; 2,5; 3; 4; 5; 5,5; 6; 8; 10	10	3,30



NEO

ΣΕΤ ΑΛΛΕΝ 10 ΤΕΜ.

ΚΩΔΙΚΟΣ	VOREL	mm	ΣΥΣΚ	€/ΤΕΜ
21156391	56391	1,5-10	20	2,50

ΣΕΤ ΑΛΛΕΝ ΜΠΙΛΙΑΣ

ΚΩΔΙΚΟΣ	VOREL	mm	ΣΥΣΚ	€/ΤΕΜ
21156477	56477	2; 2,5; 3; 4; 5; 5,5; 6; 8; 10		4,90

ΣΕΤ ΑΛΛΕΝ TORX

ΚΩΔΙΚΟΣ	VOREL	mm	ΣΥΣΚ	€/ΤΕΜ
21156478	56478	T10; T15; T20; T25; T27; T30; T40; T45; T50	20	5,10

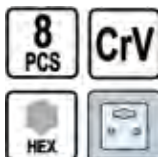
ΣΕΤ ΑΛΛΕΝ

ΚΩΔΙΚΟΣ	VOREL	mm	ΣΥΣΚ	€/ΤΕΜ
21156506	56506	1,5; 2; 2,5; 3; 4; 5; 6; 8	25	4,70

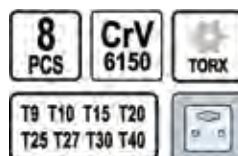
ΣΕΤ TORX

ΚΩΔΙΚΟΣ	VOREL	ΣΥΣΚ	€/ΤΕΜ
21156507	56507	25	4,30

ΚΑΤΣΑΒΙΔΙΑ
**CrV
6150**

ΚΩΔΙΚΟΣ	VOREL	mm	ΣΥΣΚ	€/ΤΕΜ
21160950	60950	3x75	12	1,22
21160952	60952	4x100	12	1,30
21160957	60957	6x150	12	2,45
21160959	60959	8x150	6	3,30

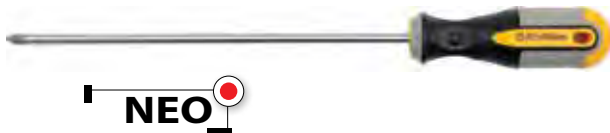

ΚΩΔΙΚΟΣ	VOREL	mm	ΣΥΣΚ	€/ΤΕΜ
21160939	60939	PZ3x150	6	3,15



ΚΩΔΙΚΟΣ	VOREL	mm	ΣΥΣΚ	€/ΤΕΜ
21160969	60969	PH3x150	6	3,15

ΚΑΤΣΑΒΙΔΙ ΚΑΣΤΑΝΙΑ ΜΥΤΕΣ

ΚΩΔΙΚΟΣ	VOREL	ΣΥΣΚ	€/ΤΕΜ
21164655	64655	6	9,60

**31
PCS**
**CrV
6150**
**HRC
50-54**

φ 14x90,3 mm: 3, 3.5, 4, 5, 5.5, 6 mm (L=25 mm)
 φ 14x90,3 mm: PH0, PH1, PH2, PH3 (L=25 mm)
 φ 14x90,3 mm: T10, T15, T20, T25, T30 (L=25 mm)
 φ 14x90,3 mm: PZ0, PZ1, PZ2, PZ3 (L=25 mm)
 φ 14x90,3 mm: 2, 2.5, 3, 4, 5, 6 mm
 φ 14x90,3 mm: S0, S10 (L=25 mm)
 2.6 x 50 mm: PH0 x 50 mm



NEO

ΚΑΤΣΑΒΙΔΙΑ - ΣΕΤ

ΣΕΤ 6 ΤΕΜ.

ΚΩΔΙΚΟΣ	VOREL	ΣΥΣΚ	€/ΤΕΜ
21160783	60783	10	8,65



Ίσια: 6.5x38, 5.5x75, 6.5x100 mm
 Σταυρός: PH2x38, PH1x75, PH2x100 mm

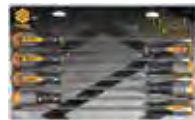

ΣΕΤ 8 ΤΕΜ.

ΚΩΔΙΚΟΣ	VOREL	ΣΥΣΚ	€/ΤΕΜ
21160990	60990	10	22,85



Ίσια: 5.5x325, 6.5x325, 8.0x325 mm
 Phillips: PH0x325, PH1x325, PH2x325 mm
 TORX: T25x325, T30x325 mm



ΣΕΤ 12 ΤΜΧ - 165mm

ΚΩΔΙΚΟΣ	VOREL	ΣΥΣΚ	€/ΤΕΜ
21164555	64555	10	11,30



2.5 mm, 3.5 mm
 PH00, PH0
 T6, T7, T8, T10
 45°, 90°, 135°, 180°



ΣΕΤ ΚΑΤΣΑΒΙΔΙ ΚΑΣΤΑΝΙΑΣ & ΜΥΤΕΣ 41 ΤΕΜ

ΚΩΔΙΚΟΣ	VOREL	ΣΥΣΚ	€/ΤΕΜ
21164385	64385	6	16,00



1/4" (6.3 mm) 6, 6, 7, 8, 9, 10 mm (1-10 mm) DV
 1/4" (6.3 mm) 11, 12, 13, 14, 15, 16, 17, 18, 19, 20, 21, 22, 23, 24, 25, 26, 27, 28, 29, 30, 31, 32, 33, 34, 35, 36, 37, 38, 39, 40, 41 mm (1-41 mm) DV
 1/4" (6.3 mm) 42, 43, 44, 45, 46, 47, 48, 49, 50, 51, 52, 53, 54, 55, 56, 57, 58, 59, 60, 61, 62, 63, 64, 65, 66, 67, 68, 69, 70, 71, 72, 73, 74, 75, 76, 77, 78, 79, 80, 81, 82, 83, 84, 85, 86, 87, 88, 89, 90, 91, 92, 93, 94, 95, 96, 97, 98, 99, 100 mm (1-100 mm) DV
 1/4" (6.3 mm) 101, 102, 103, 104, 105, 106, 107, 108, 109, 110, 111, 112, 113, 114, 115, 116, 117, 118, 119, 120, 121, 122, 123, 124, 125, 126, 127, 128, 129, 130, 131, 132, 133, 134, 135, 136, 137, 138, 139, 140, 141, 142, 143, 144, 145, 146, 147, 148, 149, 150, 151, 152, 153, 154, 155, 156, 157, 158, 159, 160, 161, 162, 163, 164, 165, 166, 167, 168, 169, 170, 171, 172, 173, 174, 175, 176, 177, 178, 179, 180, 181, 182, 183, 184, 185, 186, 187, 188, 189, 190, 191, 192, 193, 194, 195, 196, 197, 198, 199, 200 mm (1-200 mm) DV
 1/4" (6.3 mm) 201, 202, 203, 204, 205, 206, 207, 208, 209, 210, 211, 212, 213, 214, 215, 216, 217, 218, 219, 220, 221, 222, 223, 224, 225, 226, 227, 228, 229, 230, 231, 232, 233, 234, 235, 236, 237, 238, 239, 240, 241, 242, 243, 244, 245, 246, 247, 248, 249, 250 mm (1-250 mm) DV
 1/4" (6.3 mm) 251, 252, 253, 254, 255, 256, 257, 258, 259, 260, 261, 262, 263, 264, 265, 266, 267, 268, 269, 270, 271, 272, 273, 274, 275, 276, 277, 278, 279, 280, 281, 282, 283, 284, 285, 286, 287, 288, 289, 290, 291, 292, 293, 294, 295, 296, 297, 298, 299, 300 mm (1-300 mm) DV
 1/4" (6.3 mm) 301, 302, 303, 304, 305, 306, 307, 308, 309, 310, 311, 312, 313, 314, 315, 316, 317, 318, 319, 320, 321, 322, 323, 324, 325, 326, 327, 328, 329, 330, 331, 332, 333, 334, 335, 336, 337, 338, 339, 340, 341, 342, 343, 344, 345, 346, 347, 348, 349, 350 mm (1-350 mm) DV
 1/4" (6.3 mm) 351, 352, 353, 354, 355, 356, 357, 358, 359, 360, 361, 362, 363, 364, 365, 366, 367, 368, 369, 370, 371, 372, 373, 374, 375, 376, 377, 378, 379, 380, 381, 382, 383, 384, 385, 386, 387, 388, 389, 390, 391, 392, 393, 394, 395, 396, 397, 398, 399, 400 mm (1-400 mm) DV
 1/4" (6.3 mm) 401, 402, 403, 404, 405, 406, 407, 408, 409, 410, 411, 412, 413, 414, 415, 416, 417, 418, 419, 420, 421, 422, 423, 424, 425, 426, 427, 428, 429, 430, 431, 432, 433, 434, 435, 436, 437, 438, 439, 440, 441, 442, 443, 444, 445, 446, 447, 448, 449, 450 mm (1-450 mm) DV
 1/4" (6.3 mm) 451, 452, 453, 454, 455, 456, 457, 458, 459, 460, 461, 462, 463, 464, 465, 466, 467, 468, 469, 470, 471, 472, 473, 474, 475, 476, 477, 478, 479, 480, 481, 482, 483, 484, 485, 486, 487, 488, 489, 490, 491, 492, 493, 494, 495, 496, 497, 498, 499, 500 mm (1-500 mm) DV
 1/4" (6.3 mm) 501, 502, 503, 504, 505, 506, 507, 508, 509, 510, 511, 512, 513, 514, 515, 516, 517, 518, 519, 520, 521, 522, 523, 524, 525, 526, 527, 528, 529, 530, 531, 532, 533, 534, 535, 536, 537, 538, 539, 540, 541, 542, 543, 544, 545, 546, 547, 548, 549, 550 mm (1-550 mm) DV
 1/4" (6.3 mm) 551, 552, 553, 554, 555, 556, 557, 558, 559, 560, 561, 562, 563, 564, 565, 566, 567, 568, 569, 570, 571, 572, 573, 574, 575, 576, 577, 578, 579, 580, 581, 582, 583, 584, 585, 586, 587, 588, 589, 590, 591, 592, 593, 594, 595, 596, 597, 598, 599, 600 mm (1-600 mm) DV
 1/4" (6.3 mm) 601, 602, 603, 604, 605, 606, 607, 608, 609, 610, 611, 612, 613, 614, 615, 616, 617, 618, 619, 620, 621, 622, 623, 624, 625, 626, 627, 628, 629, 630, 631, 632, 633, 634, 635, 636, 637, 638, 639, 640, 641, 642, 643, 644, 645, 646, 647, 648, 649, 650 mm (1-650 mm) DV
 1/4" (6.3 mm) 651, 652, 653, 654, 655, 656, 657, 658, 659, 660, 661, 662, 663, 664, 665, 666, 667, 668, 669, 670, 671, 672, 673, 674, 675, 676, 677, 678, 679, 680, 681, 682, 683, 684, 685, 686, 687, 688, 689, 690, 691, 692, 693, 694, 695, 696, 697, 698, 699, 700 mm (1-700 mm) DV
 1/4" (6.3 mm) 701, 702, 703, 704, 705, 706, 707, 708, 709, 710, 711, 712, 713, 714, 715, 716, 717, 718, 719, 720, 721, 722, 723, 724, 725, 726, 727, 728, 729, 730, 731, 732, 733, 734, 735, 736, 737, 738, 739, 740, 741, 742, 743, 744, 745, 746, 747, 748, 749, 750 mm (1-750 mm) DV
 1/4" (6.3 mm) 751, 752, 753, 754, 755, 756, 757, 758, 759, 760, 761, 762, 763, 764, 765, 766, 767, 768, 769, 770, 771, 772, 773, 774, 775, 776, 777, 778, 779, 780, 781, 782, 783, 784, 785, 786, 787, 788, 789, 790, 791, 792, 793, 794, 795, 796, 797, 798, 799, 800 mm (1-800 mm) DV
 1/4" (6.3 mm) 801, 802, 803, 804, 805, 806, 807, 808, 809, 810, 811, 812, 813, 814, 815, 816, 817, 818, 819, 820, 821, 822, 823, 824, 825, 826, 827, 828, 829, 830, 831, 832, 833, 834, 835, 836, 837, 838, 839, 840, 841, 842, 843, 844, 845, 846, 847, 848, 849, 850 mm (1-850 mm) DV
 1/4" (6.3 mm) 851, 852, 853, 854, 855, 856, 857, 858, 859, 860, 861, 862, 863, 864, 865, 866, 867, 868, 869, 870, 871, 872, 873, 874, 875, 876, 877, 878, 879, 880, 881, 882, 883, 884, 885, 886, 887, 888, 889, 890, 891, 892, 893, 894, 895, 896, 897, 898, 899, 900 mm (1-900 mm) DV
 1/4" (6.3 mm) 901, 902, 903, 904, 905, 906, 907, 908, 909, 910, 911, 912, 913, 914, 915, 916, 917, 918, 919, 920, 921, 922, 923, 924, 925, 926, 927, 928, 929, 930, 931, 932, 933, 934, 935, 936, 937, 938, 939, 940, 941, 942, 943, 944, 945, 946, 947, 948, 949, 950 mm (1-950 mm) DV
 1/4" (6.3 mm) 951, 952, 953, 954, 955, 956, 957, 958, 959, 960, 961, 962, 963, 964, 965, 966, 967, 968, 969, 970, 971, 972, 973, 974, 975, 976, 977, 978, 979, 980, 981, 982, 983, 984, 985, 986, 987, 988, 989, 990, 991, 992, 993, 994, 995, 996, 997, 998, 999, 1000 mm (1-1000 mm) DV
 1/4" (6.3 mm) 1001, 1002, 1003, 1004, 1005, 1006, 1007, 1008, 1009, 1010, 1011, 1012, 1013, 1014, 1015, 1016, 1017, 1018, 1019, 1020, 1021, 1022, 1023, 1024, 1025, 1026, 1027, 1028, 1029, 1030, 1031, 1032, 1033, 1034, 1035, 1036, 1037, 1038, 1039, 1040, 1041, 1042, 1043, 1044, 1045, 1046, 1047, 1048, 1049, 1050 mm (1-1050 mm) DV
 1/4" (6.3 mm) 1051, 1052, 1053, 1054, 1055, 1056, 1057, 1058, 1059, 1060, 1061, 1062, 1063, 1064, 1065, 1066, 1067, 1068, 1069, 1070, 1071, 1072, 1073, 1074, 1075, 1076, 1077, 1078, 1079, 1080, 1081, 1082, 1083, 1084, 1085, 1086, 1087, 1088, 1089, 1090, 1091, 1092, 1093, 1094, 1095, 1096, 1097, 1098, 1099, 1100 mm (1-1100 mm) DV
 1/4" (6.3 mm) 1101, 1102, 1103, 1104, 1105, 1106, 1107, 1108, 1109, 1110, 1111, 1112, 1113, 1114, 1115, 1116, 1117, 1118, 1119, 1120, 1121, 1122, 1123, 1124, 1125, 1126, 1127, 1128, 1129, 1130, 1131, 1132, 1133, 1134, 1135, 1136, 1137, 1138, 1139, 1140, 1141, 1142, 1143, 1144, 1145, 1146, 1147, 1148, 1149, 1150 mm (1-1150 mm) DV
 1/4" (6.3 mm) 1151, 1152, 1153, 1154, 1155, 1156, 1157, 1158, 1159, 1160, 1161, 1162, 1163, 1164, 1165, 1166, 1167, 1168, 1169, 1170, 1171, 1172, 1173, 1174, 1175, 1176, 1177, 1178, 1179, 1180, 1181, 1182, 1183, 1184, 1185, 1186, 1187, 1188, 1189, 1190, 1191, 1192, 1193, 1194, 1195, 1196, 1197, 1198, 1199, 1200 mm (1-1200 mm) DV
 1/4" (6.3 mm) 1201, 1202, 1203, 1204, 1205, 1206, 1207, 1208, 1209, 1210, 1211, 1212, 1213, 1214, 1215, 1216, 1217, 1218, 1219, 1220, 1221, 1222, 1223, 1224, 1225, 1226, 1227, 1228, 1229, 1230, 1231, 1232, 1233, 1234, 1235, 1236, 1237, 1238, 1239, 1240, 1241, 1242, 1243, 1244, 1245, 1246, 1247, 1248, 1249, 1250 mm (1-1250 mm) DV
 1/4" (6.3 mm) 1251, 1252, 1253, 1254, 1255, 1256, 1257, 1258, 1259, 1260, 1261, 1262, 1263, 1264, 1265, 1266, 1267, 1268, 1269, 1270, 1271, 1272, 1273, 1274, 1275, 1276, 1277, 1278, 1279, 1280, 1281, 1282, 1283, 1284, 1285, 1286, 1287, 1288, 1289, 1290, 1291, 1292, 1293, 1294, 1295, 1296, 1297, 1298, 1299, 1300 mm (1-1300 mm) DV
 1/4" (6.3 mm) 1301, 1302, 1303, 1304, 1305, 1306, 1307, 1308, 1309, 1310, 1311, 1312, 1313, 1314, 1315, 1316, 1317, 1318, 1319, 1320, 1321, 1322, 1323, 1324, 1325, 1326, 1327, 1328, 1329, 1330, 1331, 1332, 1333, 1334, 1335, 1336, 1337, 1338, 1339, 1340, 1341, 1342, 1343, 1344, 1345, 1346, 1347, 1348, 1349, 1350 mm (1-1350 mm) DV
 1/4" (6.3 mm) 1351, 1352, 1353, 1354, 1355, 1356, 1357, 1358, 1359, 1360, 1361, 1362, 1363, 1364, 1365, 1366, 1367, 1368, 1369, 1370, 1371, 1372, 1373, 1374, 1375, 1376, 1377, 1378, 1379, 1380, 1381, 1382, 1383, 1384, 1385, 1386, 1387, 1388, 1389, 1390, 1391, 1392, 1393, 1394, 1395, 1396, 1397, 1398, 1399, 1400 mm (1-1400 mm) DV
 1/4" (6.3 mm) 1401, 1402, 1403, 1404, 1405, 1406, 1407, 1408, 1409, 1410, 1411, 1412, 1413, 1414, 1415, 1416, 1417, 1418, 1419, 1420, 1421, 1422, 1423, 1424, 1425, 1426, 1427, 1428, 1429, 1430, 1431, 1432, 1433, 1434, 1435, 1436, 1437, 1438, 1439, 1440, 1441, 1442, 1443, 1444, 1445, 1446, 1447, 1448, 1449, 1450 mm (1-1450 mm) DV
 1/4" (6.3 mm) 1451, 1452, 1453, 1454, 1455, 1456, 1457, 1458, 1459, 1460, 1461, 1462, 1463, 1464, 1465, 1466, 1467, 1468, 1469, 1470, 1471, 1472, 1473, 1474, 1475, 1476, 1477, 1478, 1479, 1480, 1481, 1482, 1483, 1484, 1485, 1486, 1487, 1488, 1489, 1490, 1491, 1492, 1493, 1494, 1495, 1496, 1497, 1498, 1499, 1500 mm (1-1500 mm) DV
 1/4" (6.3 mm) 1501, 1502, 1503, 1504, 1505, 1506, 1507, 1508, 1509, 1510, 1511, 1512, 1513, 1514, 1515, 1516, 1517, 1518, 1519, 1520, 1521, 1522, 1523, 1524, 1525, 1526, 1527, 1528, 1529, 1530, 1531, 1532, 1533, 1534, 1535, 1536, 1537, 1538, 1539, 1540, 1541, 1542, 1543, 1544, 1545, 1546, 1547, 1548, 1549, 1550 mm (1-1550 mm) DV
 1/4" (6.3 mm) 1551, 1552, 1553, 1554, 1555, 1556, 1557, 1558, 1559, 1560, 1561, 1562, 1563, 1564, 1565, 1566, 1567, 1568, 1569, 1570, 1571, 1572, 1573, 1574, 1575, 1576, 1577, 1578, 1579, 1580, 1581, 1582, 1583, 1584, 1585, 1586, 1587, 1588, 1589, 1590, 1591, 1592, 1593, 1594, 1595, 1596, 1597, 1598, 1599, 1600 mm (1-1600 mm) DV
 1/4" (6.3 mm) 1601, 1602, 1603, 1604, 1605, 1606, 1607, 1608, 1609, 1610, 1611, 1612, 1613, 1614, 1615, 1616, 1617, 1618, 1619, 1620, 1621, 1622, 1623, 1624, 1625, 1626, 1627, 1628, 1629, 1630, 1631, 1632, 1633, 1634, 1635, 1636, 1637, 1638, 1639, 1640, 1641, 1642, 1643, 1644, 1645, 1646, 1647, 1648, 1649, 1650 mm (1-1650 mm) DV
 1/4" (6.3 mm) 1651, 1652, 1653, 1654, 1655, 1656, 1657, 1658, 1659, 1660, 1661, 1662, 1663, 1664, 1665, 1666, 1667, 1668, 1669, 1670, 1671, 1672, 1673, 1674, 1675, 1676, 1677, 1678, 1679, 1680, 1681, 1682, 1683, 1684, 1685, 1686, 1687, 1688, 1689, 1690, 1691, 1692, 1693, 1694, 1695, 1696, 1697, 1698, 1699, 1700 mm (1-1700 mm) DV
 1/4" (6.3 mm) 1701, 1702, 1703, 1704, 1705, 1706, 1707, 1708, 1709, 1710, 1711, 1712, 1713, 1714, 1715, 1716, 1717, 1718, 1719, 1720, 1721, 1722, 1723, 1724, 1725, 1726, 1727, 1728, 1729, 1730, 1731, 1732, 1733, 1734, 1735, 1736, 1737, 1738, 1739, 1740, 1741, 1742, 1743, 1744, 1745, 1746, 1747, 1748, 1749, 1750 mm (1-1750 mm) DV
 1/4" (6.3 mm) 1751, 1752, 1753, 1754, 1755, 1756, 1757, 1758, 1759, 1760, 1761, 1762, 1763, 1764, 1765, 1766, 1767, 1768, 1769, 1770, 1771, 1772, 1773, 1774, 1775, 1776, 1777, 1778, 1779, 1780, 1781, 1782, 1783, 1784, 1785, 1786, 1787, 1788, 1789, 1790, 1791, 1792, 1793, 1794, 1795, 1796, 1797, 1798, 1799, 1800 mm (1-1800 mm) DV
 1/4" (6.3 mm) 1801, 1802, 1803, 1804, 1805, 1806, 1807, 1808, 1809, 1810, 1811, 1812, 1813, 1814, 1815, 1816, 1817, 1818, 1819, 1820, 1821, 1822, 1823, 1824, 1825, 1826, 1827, 1828, 1829, 1830, 1831, 1832, 1833, 1834, 1835, 1836, 1837, 1838, 1839, 1840, 1841, 1842, 184



ΣΕΤ ΚΑΤΣΑΒΙΔΙΑ ΜΙΝΙ

ΚΩΔΙΚΟΣ	VOREL	ΣΥΣΚ	€/ΤΕΜ
21164553	64553	PH00; PH0; PH1; 1.4; 2.4; 3.0	10 5,10
21164554	64554	T5; T6; T7; T8; T9; T10	10 4,85



ΚΑΤΣΑΒΙΔΙ ΜΕ ΜΥΤΕΣ

ΚΩΔΙΚΟΣ	VOREL	ΣΥΣΚ	€/ΤΕΜ
21164396	64396		10 7,00

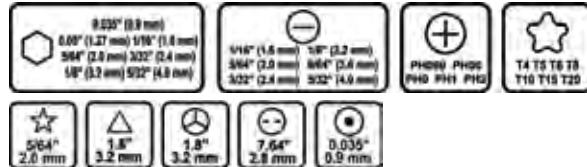

ΣΕΤ ΜΥΤΕΣ ΚΙΝΗΤΩΝ

ΚΩΔΙΚΟΣ	VOREL	ΣΥΣΚ	€/ΤΕΜ
21164384	64384		6 14,90



- 1 10,25 mm ØV
- 2 PH00, PH0, PH1, PH1, ØV
- 3 T2, T3, T4, T5, T6, T8, T10, ØV
- 4 T1, ØV
- 5 15,25 mm ØV
- 6 8,8, 12, 15 mm ØV
- 7 Y00, Y00, Y0, ØV
- 8 30 mm ØV
- 9 4/16 mm ØV



ΤΑΦ ΚΑΣΤΑΝΙΑ ΚΑΙ ΜΥΤΕΣ

ΚΩΔΙΚΟΣ	VOREL	ΣΥΣΚ	€/ΤΕΜ
21165105	65105		6 9,30



- 1 1/4" (6.3 mm) 4, 5, 6, 7, 8, 9, 10, 11, 12 mm
- 2 1/4" (6.3 mm) (L=180 mm); CV 6150;
- 3 1/4" (6.3 mm) (L=25 mm); CV 6150;
- 4 1/4" (6.3 mm) 4, 5, 6 mm (L=25 mm); CV 6150;
- 5 1/4" (6.3 mm) PH0, PH1, PH2, PH3 (L=25 mm); CV 6150;
- 6 1/4" (6.3 mm) P20, P21, P22, P23 (L=25 mm); CV 6150;
- 7 1/4" (6.3 mm) T10, T15, T20 (L=25 mm); CV 6150

ΕΡΓΑΛΕΙΑ ΗΛΕΚΤΡΟΛΟΓΩΝ



ΕΡΓΑΛΕΙΑ ΗΛΕΚΤΡΟΛΟΓΩΝ [175 - 188]

Πένσες VDE | Κατσαβίδια VDE

Πρέσες | Κόφτες | Γδάρτες

Δοκιμαστικά Κατσαβίδια VDE

Πολύμετρα | Μπαλαντζές







160 mm 180 mm 200 mm
CrV 1000 V 

1000V VDE CERTIFICATE
EN 60900:2012

ΠΕΝΣΕΣ ΗΛΕΚΤΡΟΛΟΓΩΝ

ΚΩΔΙΚΟΣ	YATO 	ΜΗΚΟΣ(mm)	ΣΥΣΚ	€/ΤΕΜ
20021152	YT-21152	180	6	13,70
20021153	YT-21153	200	6	15,00



160 mm 180 mm
1000 V 
CrV

1000V VDE CERTIFICATE
EN 60900:2012

ΠΛΑΓΙΟΚΟΦΤΕΣ ΗΛΕΚΤΡΟΛΟΓΩΝ

ΚΩΔΙΚΟΣ	YATO 	ΜΗΚΟΣ(mm)	ΣΥΣΚ	€/ΤΕΜ
20021158	YT-21158	160	6	12,30
20021159	YT-21159	180	6	13,30



160 mm 200 mm
1000 V 
CrV

1000V VDE CERTIFICATE
EN 60900:2012

ΜΥΤΟΣΙΜΠΙΔΑ ΗΛΕΚΤΡΟΛΟΓΩΝ

ΚΩΔΙΚΟΣ	YATO 	ΜΗΚΟΣ(mm)	ΣΥΣΚ	€/ΤΕΜ
20021154	YT-21154	160	6	12,00
20021155	YT-21155	200	6	13,70



NEO 

ΓΑΛΛΙΚΟ ΚΛΕΙΔΙ VDE

ΚΩΔΙΚΟΣ	YATO 	ΜΗΚΟΣ(mm)	ΣΥΣΚ	€/ΤΕΜ
20020941	YT-20941	250	6	32,65

CrV 1000 V  250 mm



NEO 

ΓΚΑΖΟΤΑΝΑΛΙΑ VDE

ΚΩΔΙΚΟΣ	YATO 	ΜΗΚΟΣ(mm)	ΣΥΣΚ	€/ΤΕΜ
20021161	YT-21161	250	6	15,65

CrV 1000 V  250 mm



NEO 

ΣΥΝΘΕΤΙΚΗ ΠΕΝΣΑ VDE

ΚΩΔΙΚΟΣ	YATO 	ΜΗΚΟΣ(mm)	ΣΥΣΚ	€/ΤΕΜ
20021191	YT-21191	200	6	13,95





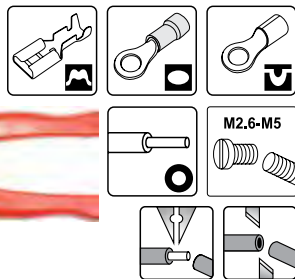

ΚΟΦΤΗΣ - ΑΠΟΓΥΜΝΩΤΗΣ ΚΑΛΩΔΙΩΝ

ΚΩΔΙΚΟΣ	YATO 	ΜΗΚΟΣ(mm)	ΣΥΣΚ	€/ΤΕΜ
20019691	YT-19691	170	6	9,30



ΑΠΟΓΥΜΝΩΤΗΣ - ΠΡΕΣΑ ΚΑΛΩΔΙΩΝ

ΚΩΔΙΚΟΣ	YATO 	ΣΥΣΚ	€/ΤΕΜ
20002254	YT-2254	12	8,80

							
mm ²	AWG	mm ²	AWG	mm ²	AWG	mm ²	AWG
0.5-5.0	20-10	0.5-5.0	20-10	0.5-5.5	20-10	0.5-5.0	20-10



ΠΡΕΣΑ - ΑΠΟΓΥΜΝΩΤΗΣ ΚΑΛΩΔΙΩΝ

ΚΩΔΙΚΟΣ	YATO 	ΣΥΣΚ	€/ΤΕΜ
20002256	YT-2256	10	13,95



ΓΔΑΡΤΗΣ ΚΑΛΩΔΙΩΝ

ΚΩΔΙΚΟΣ	YATO 	ΣΥΣΚ	€/ΤΕΜ
20002268	YT-2268	10	7,50



195 mm
20-10 mm²
0.5-6.0 mm² (20AWG-12AWG)
SK5

NEO 



ΓΔΑΡΤΗΣ			
ΚΩΔΙΚΟΣ	YATO 	ΣΥΣΚ	€/ΤΕΜ
20002275	YT-2275	10	23,50



NEO 



ΓΔΑΡΤΗΣ			
ΚΩΔΙΚΟΣ	YATO 	ΣΥΣΚ	€/ΤΕΜ
20002274	YT-2274	15	15,50
<p>125 mm 20-10 mm² (0.5-6.0 mm²) 6-13 mm² RG6 RG59 SK5</p>			



SK5



ΑΠΟΓΥΜΝΩΤΗΣ ΚΑΛΩΔΙΩΝ				
ΚΩΔΙΚΟΣ	YATO 	mm²	ΣΥΣΚ	€/ΤΕΜ
20002316	YT-2316	1.0-3.2	8	13,00



Ømm
8-28

NEO 

ΓΔΑΡΤΗΣ				
ΚΩΔΙΚΟΣ	YATO 	Ø (mm)	ΣΥΣΚ	€/ΤΕΜ
20002280	YT-2280	8-28	10	13,95



NEO 

15.3 m 3x1.5 mm
STEEL BRAKE ABS

ΑΤΣΑΛΙΝΑ ΚΑΛΩΔΙΩΝ 15,3 ΜΕΤΡΑ				
ΚΩΔΙΚΟΣ	YATO 	L (m)	ΣΥΣΚ	€/ΤΕΜ
20025010	YT-25010	15,3	6	16,15



NEO 

ΨΑΛΙΔΙ ΗΛΕΚΤΡΟΛΟΓΩΝ VDE

ΚΩΔΙΚΟΣ	YATO 	ΜΗΚΟΣ(mm)	ΣΥΣΚ €/ΤΕΜ
20021200	YT-21200	160	6 23,85



140 mm
STAINLESS STEEL STAL NIEROZEWNA
HRC 52-56



ΨΑΛΙΔΙ ΗΛΕΚΤΡΟΛΟΓΩΝ "140mm"

ΚΩΔΙΚΟΣ	YATO 	ΜΗΚΟΣ(mm)	ΣΥΣΚ €/ΤΕΜ
20001974	YT-1974	140	12 5,70



NEO 

ΜΑΧΑΙΡΙ ΚΑΛΩΔΙΩΝ VDE

ΚΩΔΙΚΟΣ	YATO 	ΜΗΚΟΣ(mm)	ΣΥΣΚ €/ΤΕΜ
20021210	YT-21210	180	6 13,50

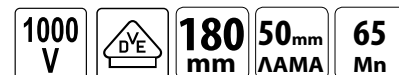

NEO 

ΑΠΟΓΥΜΝΩΤΗΣ ΟΜΟΑΞΟΝΙΚΩΝ ΚΑΛΩΔΙΩΝ VDE

ΚΩΔΙΚΟΣ	YATO 	ΜΗΚΟΣ(mm)	ΣΥΣΚ €/ΤΕΜ
20021211	YT-21211	155	6 23,85

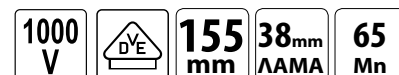

85 mm
200 mm
3CR13
HRC 42-48

ΜΑΧΑΙΡΙ ΗΛΕΚΤΡΟΛΟΓΟΥ ΙΣΙΟ

ΚΩΔΙΚΟΣ	YATO 	ΣΥΣΚ €/ΤΕΜ
20007600	YT-7600	6 5,25



75 mm
190 mm
3CR13
HRC 42-48

ΜΑΧΑΙΡΙ ΗΛΕΚΤΡΟΛΟΓΟΥ ΚΥΡΤΟ

ΚΩΔΙΚΟΣ	YATO 	ΣΥΣΚ €/ΤΕΜ
20007601	YT-7601	6 5,00



ΚΟΦΤΗΣ ΚΑΛΩΔΙΩΝ

ΚΩΔΙΚΟΣ	YATO 	L (mm)	ΣΥΣΚ	€/ΤΕΜ
20002260	YT-2260	125	15	5,70



ΚΟΦΤΗΣ ΚΑΛΩΔΙΩΝ

ΚΩΔΙΚΟΣ	YATO 	L (mm)	ΣΥΣΚ	€/ΤΕΜ
20002262	YT-2262	125	20	15,70



ΚΟΦΤΗΣ ΚΑΛΩΔΙΩΝ

ΚΩΔΙΚΟΣ	YATO 	L (mm)	Max θ (mm)	ΣΥΣΚ	€/ΤΕΜ
20001966	YT-1966	160	6	6	5,40

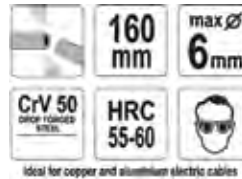

ideal for copper and aluminum electric cables



ΚΟΦΤΗΣ ΚΑΛΩΔΙΩΝ

ΚΩΔΙΚΟΣ	YATO 	L (mm)	Max θ (mm)	ΣΥΣΚ	€/ΤΕΜ
20018602	YT-18602	380	22*	10	127,00



*MAX ΚΟΠΗ ΣΕ ΓΥΜΝΟ ΚΑΛΩΔΙΟ \varnothing 22mm/380mm² ή \varnothing 52mm ΣΕ ΚΑΛΩΔΙΟ ΜΕ ΜΟΝΩΣΗ



ΚΟΦΤΗΣ ΚΑΛΩΔΙΩΝ

ΚΩΔΙΚΟΣ	YATO 	L (mm)	Max θ (mm)	ΣΥΣΚ	€/ΤΕΜ
20018612	YT-18612	770	25	5	46,00

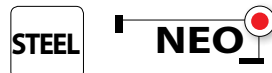



ΑΠΟΓΥΜΝΩΤΗΣ - ΠΡΕΣΑ ΚΑΛΩΔΙΩΝ

ΚΩΔΙΚΟΣ	YATO 	mm ²	ΣΥΣΚ	€/ΤΕΜ
20002313	YT-2313	0.5-6.0	5	12,00

205 mm	HRC 52-57							7-8 mm
---------------	------------------	---	---	---	---	---	---	---------------



ΠΡΕΣΑ ΚΑΛΩΔΙΩΝ

ΚΩΔΙΚΟΣ	YATO 	mm ²	ΣΥΣΚ	€/ΤΕΜ
20002300	YT-2300	0.5-6.0	5	14,70

230 mm			
---------------	---	---	---



ΠΡΕΣΑ ΑΚΡΟΔΕΚΤΩΝ

ΚΩΔΙΚΟΣ	YATO 	mm ²	ΣΥΣΚ	€/ΤΕΜ
20002240	YT-2240	0.2-6.0	6	44,00

180 mm		HRC 44-47
---------------	---	------------------



ΠΡΕΣΑ ΚΑΛΩΔΙΩΝ

ΚΩΔΙΚΟΣ	YATO 	mm ²	ΣΥΣΚ	€/ΤΕΜ
20002299	YT-2299	0.5-4.0	5	14,40



ΠΡΕΣΑ ΚΑΛΩΔΙΩΝ ΚΑΣΤΑΝΙΑΣ - 6 ΤΕΜ

ΚΩΔΙΚΟΣ	YATO 	mm ²	ΣΥΣΚ	€/ΤΕΜ
20002245	YT-2245	0.5-6 / 1.5-10 / 0.5-4	10	105,00



6 pcs 260 mm RG 6 RG 58 RG 59 RG 62

20-10 (AWG) 0.5-6 mm ² (DIN)	22-10 (AWG) 0.5-6 mm ² (DIN)	20-8 (AWG) 1.5-10 mm ² (DIN)	22-12 (AWG) 0.5-4 mm ² (DIN)
---	---	---	---



ΠΡΕΣΑ ΑΚΡΟΔΕΚΤΩΝ ΥΔΡΑΥΛΙΚΗ

ΚΩΔΙΚΟΣ	YATO 	L (mm)	ΣΥΣΚ	€/ΤΕΜ
20022862	YT-22862	470	3	75,00



ΠΕΝΣΑ ΔΙΚΤΥΩΝ

ΚΩΔΙΚΟΣ	VOREL 	ΣΥΣΚ	€/ΤΕΜ
21145503	45503	RJ45, RJ11	10 12,80



ΑΠΟΓΥΜΝΩΤΗΣ ΚΑΛΩΔΙΩΝ - ΠΡΕΣΑ ΑΚΡΟΔΕΚΤΩΝ

ΚΩΔΙΚΟΣ	VOREL 	ΤΕΜ	ΣΥΣΚ	€/ΤΕΜ
21145050	45050	100	25	6,85



• application: industry
• VDE certificate

⊖

1000 V

S2

HRC 56-60



ΚΑΤΣΑΒΙΔΙΑ ΗΛΕΚΤΡΟΛΟΓΩΝ VDE

ΚΩΔΙΚΟΣ	YATO 	⊖	ΜΗΚΟΣ(mm)	ΣΥΣΚ	€/ΤΕΜ
20028150	YT-28150	2.5	75	12	2,10
20028153	YT-28153	3.0	100	12	2,20
20028174	YT-28174	3.5	100	12	2,55
20002817	YT-2817	4.0	100	12	2,85
20002818	YT-2818	5.5	125	12	3,15
20002819	YT-2819	6.5	150	12	4,10
20002820	YT-2820	8.0	175	12	5,30



• application: industry
• VDE certificate

⊕

1000 V

S2

HRC 56-60



ΚΑΤΣΑΒΙΔΙΑ ΗΛΕΚΤΡΟΛΟΓΩΝ VDE

ΚΩΔΙΚΟΣ	YATO 	⊕	ΜΗΚΟΣ(mm)	ΣΥΣΚ	€/ΤΕΜ
20002821	YT-2821	PH0	60	12	2,20
20002822	YT-2822	PH1	80	12	2,90
20002823	YT-2823	PH2	100	12	3,75
20002824	YT-2824	PH3	150	12	5,15



• application: industry
• VDE certificate

⊕

1000 V

S2

HRC 56-60



ΚΑΤΣΑΒΙΔΙΑ ΗΛΕΚΤΡΟΛΟΓΩΝ VDE

ΚΩΔΙΚΟΣ	YATO 	⊕	ΜΗΚΟΣ(mm)	ΣΥΣΚ	€/ΤΕΜ
20028245	YT-28245	PZ0	60	12	2,20
20002825	YT-2825	PZ1	80	12	2,95
20002826	YT-2826	PZ2	100	12	3,80
20028263	YT-28263	PZ3	150	12	5,00



• application: industry
• VDE certificate

1000 V

S2

HRC 56-60



5 pcs



NEO  7 pcs

ΣΕΤ ΚΑΤΣΑΒΙΔΙΑ ΗΛΕΚΤΡΟΛΟΓΩΝ VDE

ΚΩΔΙΚΟΣ	YATO 	⊖	⊕	⊕	L(mm)	ΣΥΣΚ	€/ΤΕΜ
ΣΕΤ 5 ΤΕΜ							
20002827	YT-2827	5.5	PH1 PH2		75	20	15,00
					100		
					125		
					80		
					100		

ΣΕΤ 7 ΤΕΜ							
20002828	YT-2828	PH1 PH2		PH1 PH2	100	10	21,00
					100		
					125		
					80		
					100		
					80		
					100		

ΣΕΤ ΚΑΤΣΑΒΙΔΙΑ ΗΛΕΚΤΡΟΛΟΓΩΝ VDE

ΚΩΔΙΚΟΣ	YATO 	⊖	⊕	250V	L(mm)	ΣΥΣΚ	€/ΤΕΜ
20028290	YT-28290			4	100	24	39,00
					100		
					100		
					100		
					100		
					100		
					100		
					100		
					100		
					100		
					100		
					150		



1000 V

HRC 54-61

S2



NEO  12 pcs



ΣΕ ΠΩΛΗΣΕΙΣ
No1

70-250
V

70-600
V

POWER
ZASILANIE
2x1.5 V
LR41
BATTERY*
* BATTERY
NOT INCLUDED
* BATERII
NIE DOLĄCZONO

1.5-9 V

50-500
Hz

CONTINUITY
TEST
TEST
CIĄGŁOŚCI



ΔΟΚΙΜΑΣΤΙΚΟ ΚΑΤΣΑΒΙΔΙ LED

ΚΩΔΙΚΟΣ	YATO 	ΣΥΣΚ €/ΤΕΜ
20002864	YT-2864	6 2,60



90-1000
V

CONTINUITY
TEST

LED
ILLUMINATION

ON / OFF
AUTO
POWER
OFF

1.5V
2x
AAA
SL 4.5 mm



ΔΟΚΙΜΑΣΤΙΚΟ ΚΑΤΣΑΒΙΔΙ LED

ΚΩΔΙΚΟΣ	YATO 	⊖	ΣΥΣΚ €/ΤΕΜ
20028310	YT-28310	4.5	6 11,00



70-250
V

70-1000
V

POWER
ZASILANIE
2x1.5 V
LR44
BATTERY*
* BATTERY
NOT INCLUDED
* BATERII
NIE DOLĄCZONO

1.5-9 V

50-500
Hz

CONTINUITY
TEST
TEST
CIĄGŁOŚCI



ΨΗΦΙΑΚΟ ΔΟΚΙΜΑΣΤΙΚΟ ΚΑΤΣΑΒΙΔΙ

ΚΩΔΙΚΟΣ	YATO 	ΣΥΣΚ €/ΤΕΜ
20028631	YT-28631	6 4,50



190
mm

125-250
V~

ΔΟΚΙΜΑΣΤΙΚΟ ΚΑΤΣΑΒΙΔΙ

ΚΩΔΙΚΟΣ	YATO 	⊖	ΜΗΚΟΣ(mm)	ΣΥΣΚ €/ΤΕΜ
20028300	YT-28300	3.0	190	12 1,40

In accordance with polish standard PN-E 08509:1988



NEO 

ΨΗΦΙΑΚΟΣ ΑΝΙΧΝΕΥΤΗΣ

ΚΩΔΙΚΟΣ	YATO 	ΣΥΣΚ	€/ΤΕΜ
20173131	YT-73131	40	▶ 43,00

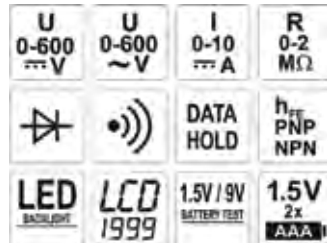

NEO 

ΨΗΦΙΑΚΟ ΠΟΛΥΜΕΤΡΟ

ΚΩΔΙΚΟΣ	YATO 	ΣΥΣΚ	€/ΤΕΜ
20173081	YT-73081		▶ 11,00

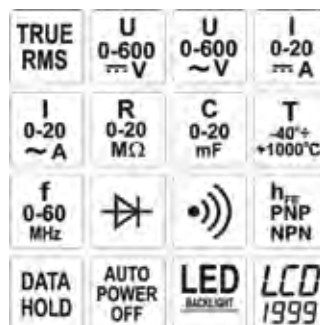

NEO 

ΨΗΦΙΑΚΟ ΠΟΛΥΜΕΤΡΟ

ΚΩΔΙΚΟΣ	YATO 	ΣΥΣΚ	€/ΤΕΜ
20173083	YT-73083		▶ 33,00



TRUE RMS	U 0-600 ~V	U 0-600 ~V	I 0-10 ~A
I 0-10 ~A	R 0-60 MΩ	C 0-60 mF	0.1%+99%
f 0-60 MHz	T -40+ +1370°C	Diode symbol	Bluetooth icon
AUTO RANGE	AUTO POWER OFF	DATA HOLD	hFE PNP NPN
RADIOIC BUTTON-HOOK	MAX & MIN VALUE DISPLAY	LED BACKLIGHT	LCD 5999
FOR YT-7309	9V	5F22	



AUTO POWER OFF	Bluetooth icon
NEO 	

ΜΕ ΜΕΤΡΗΣΗ ΘΕΡΜΟΚΡΑΣΙΑΣ



NEO 



L1 L2 L3	U 0-600 ~V	U 0-600 ~V	I 0-10 ~A	I 0-10 ~A	R 0-40 MΩ
C 0-100 μF	f 100 kHz	5%+95%	T -20+ +1000°C	Diode symbol	AUTO RANGE

ΨΗΦΙΑΚΟ ΠΟΛΥΜΕΤΡΟ

ΚΩΔΙΚΟΣ **YATO**  ΣΥΣΚ **€/TEM**
20173085 YT-73085 ▶ **38,00**

ΠΟΛΥΜΕΤΡΟ & ΦΑΣΗΜΕΤΡΟ

ΚΩΔΙΚΟΣ **YATO**  ΣΥΣΚ **€/TEM**
20173086 YT-73086 ▶ **71,95**



NEO 



- ΜΕΤΡΗΣΗ:**
- ▶ ΗΛΕΚΤΡΙΚΩΝ ΤΙΜΩΝ AC/DC
 - ▶ ΘΕΡΜΟΚΡΑΣΙΑΣ
 - ▶ ΥΓΡΑΣΙΑΣ
 - ▶ ΦΩΤΕΙΝΟΤΗΤΑΣ
 - ▶ ΕΝΤΑΣΗΣ ΗΧΟΥ

NEO 

5 in 1	U 0-600 ~V	U 0-600 ~V	I 0-10 ~A	I 0-10 ~A	R 0-40 MΩ
5 w 1	C 0-100 μF	f 200 kHz	1%+99%	T -20+ +1000°C	%RH 30%+ 90%
3.5-100dB	40000 lx	AUTO RANGE	AUTO POWER OFF	Bluetooth icon	

LED BACKLIGHT	3V 2x AAA	U A.C. 0-600V	U D.C. 0-600V	I A.C. 0-600A	R 0-60 MΩ	V A.C. VFC	LOW IMPEDANCE MODE	LED
TRUE RMS	DATA HOLD	CONTINUITY TEST	LCD 5999	Diode symbol	Bluetooth icon	AUTO POWER OFF	AUTO RANGE	

ΛΟΥΞΟΜΕΤΡΟ & ΥΓΡΟΜΕΤΡΟ

ΚΩΔΙΚΟΣ **YATO**  ΣΥΣΚ **€/TEM**
20173087 YT-73087 ▶ **97,00**

ΑΜΠΕΡΟΤΣΙΜΠΙΔΑ

ΚΩΔΙΚΟΣ **YATO**  ΣΥΣΚ **€/TEM**
20173092 YT-73092 ▶ **30,00**

ΠΟΛΥΜΠΡΙΖΑ



**3G X 1 1,4M ΚΑΛΩΔΙΟ
H05W-F
10/16 A 250V~3500W**



ΜΕ ΔΙΑΚΟΠΤΗ

ΚΩΔΙΚΟΣ	ΘΕΣΕΙΣ	ΣΥΣΚ	€/ΤΕΜ
44801600	3	10	▶ 7,30
44806605	4	10	▶ 7,80
44811609	6	10	▶ 9,40



**3G X 1,5 1,5M ΚΑΛΩΔΙΟ
H05W-F
16A 250V~3500W**



ΜΕ ΔΙΑΚΟΠΤΗ ΚΑΙ ΠΡΟΣΤΑΣΙΑ

ΚΩΔΙΚΟΣ	ΘΕΣΕΙΣ	ΣΥΣΚ	€/ΤΕΜ
44816604	6	6	▶ 22,40



**3G X 1,5 1,4M ΚΑΛΩΔΙΟ
H05VV-F
16A 250V~3680W**

ΜΕ ΔΙΑΚΟΠΤΗ 3 + 2 USB

ΚΩΔΙΚΟΣ	ΘΕΣΕΙΣ	ΣΥΣΚ	€/ΤΕΜ
44823602	3+2	10	▶ 15,45



**3G X 1,5 3M ΚΑΛΩΔΙΟ
H05VV-F
16A 250V ~3680W**

ΠΡΟΕΚΤΑΣΗ 3Μ

ΚΩΔΙΚΟΣ	ΣΥΣΚ	€/ΤΕΜ
44571008	10	▶ 10,00



**3G X 1,5
H05VV-F
16A 250V ~3680W**

ΠΡΟΕΚΤΑΣΗ 10,15 25 Μ

ΚΩΔΙΚΟΣ	ΜΗΚΟΣ m	ΣΥΣΚ	€/ΤΕΜ
44575006	10	6	▶ 19,50
44576003	15	6	▶ 28,00
44577000	25	6	▶ 47,00

ΜΠΑΛΑΝΤΕΖΕΣ ΚΑΡΟΥΛΙΑ



**H05VV-F
ΜΕ ΘΕΡΜΟΣΤΑΤΗ**



**H05VV-F
ΜΕ ΘΕΡΜΟΣΤΑΤΗ**



**IP-20
PROTECTION**

**250V - 16A
4000W**



**IP-20
PROTECTION**

**230V - 14A
3200W**

3X1,5

ΚΛΕΙΣΤΟΥ ΤΥΠΟΥ - 4 (2P+T)

ΚΩΔΙΚΟΣ	ΔΙΑΣΤΑΣΗ	ΣΥΣΚ	€/ΤΕΜ
44749605	15 M	1	▶ 41,00
44772603	25 M	2	▶ 58,00
44777608	50 M	1	▶ 97,00

ΚΩΔΙΚΟΣ	ΔΙΑΣΤΑΣΗ	ΣΥΣΚ	€/ΤΕΜ
44729607	10 M	10	▶ 31,00
44734601	15 M	6	▶ 37,10



**IP-20
3.500 W**



**H05VV-F
ΜΕ ΘΕΡΜΟΣΤΑΤΗ**



**IP-55
4.000 W**



**H05VV-F 3G2,5
ΜΕ ΘΕΡΜΟΣΤΑΤΗ**

3X1,5 - ΜΕΤΑΛΛΙΚΗ

3X2,5 - ΜΕΤΑΛΛΙΚΗ

ΚΩΔΙΚΟΣ	ΔΙΑΣΤΑΣΗ	ΣΥΣΚ	€/ΤΕΜ
44770500	3X1,5X25M	1	▶ 112,00
44775505	3X1,5X50M	1	▶ 155,00

ΚΩΔΙΚΟΣ	ΔΙΑΣΤΑΣΗ	ΣΥΣΚ	€/ΤΕΜ
44785511	3X2,5X25M	1	▶ 157,00
44786518	3X2,5X50M	1	▶ 239,00



NEO

ΜΠΑΛΑΝΤΕΖΑ ΣΕ ΜΙΚΡΟ ΠΛΑΣΤΙΚΟ ΚΑΡΟΥΛΙ

ΚΩΔΙΚΟΣ	ΚΑΛΩΔΙΟ	ΣΥΣΚ	€/τεμ.
12321220	3G1,5 mm ² 20m		▶ 41,00



NEO

ΜΠΑΛΑΝΤΕΖΑ ΣΕ ΜΕΓΑΛΟ ΠΛΑΣΤΙΚΟ ΚΑΡΟΥΛΙ

ΚΩΔΙΚΟΣ	ΚΑΛΩΔΙΟ	ΣΥΣΚ	€/τεμ.
12322225	3G1,5 mm ² 25m		▶ 59,00
12322250	3G1,5 mm ² 50m		▶ 97,00
12322325	3G2,5 mm ² 25m		▶ 80,00
12322350	3G2,5 mm ² 20m		▶ 139,00



NEO

ΜΠΑΛΑΝΤΕΖΑ ΣΕ ΜΙΚΡΟ ΜΕΤΑΛΛΙΚΟ ΚΑΡΟΥΛΙ

ΚΩΔΙΚΟΣ	ΚΑΛΩΔΙΟ	ΣΥΣΚ	€/τεμ.
12323330	3G2,5 mm ² 30m		▶ 99,00



NEO

ΜΠΑΛΑΝΤΕΖΑ ΣΕ ΜΕΓΑΛΟ ΜΕΤΑΛΛΙΚΟ ΚΑΡΟΥΛΙ

ΚΩΔΙΚΟΣ	ΚΑΛΩΔΙΟ	ΣΥΣΚ	€/τεμ.
12324350	3G2,5 mm ² 50m		▶ 149,00



NEO

ΜΠΑΛΑΝΤΕΖΑ ΣΕ ΚΑΡΟΥΛΙ ΚΛΕΙΣΤΟΥ ΤΥΠΟΥ

ΚΩΔΙΚΟΣ	ΚΑΛΩΔΙΟ	ΣΥΣΚ	€/τεμ.
12325215	3G1,5 mm ² 15m		▶ 36,00



ΠΡΟΕΚΤΑΣΗ ΚΑΛΩΔΙΟ ΜΕ ΓΩΝΙΑΚΟ ΦΙΣ



ΚΩΔΙΚΟΣ	ΚΑΛΩΔΙΟ	ΣΥΣΚ	€/τεμ.
12341503	3G1,5 mm ² 3m		▶ 7,55
12341505	3G1,5 mm ² 5m		▶ 10,75
12341510	3G1,5 mm ² 10m		▶ 18,10



ΤΣΙΜΠΙΔΕΣ ΚΑΛΩΔΙΩΝ / ΣΩΜΑΤΟΣ



ΚΩΔΙΚΟΣ	ΠΕΡΙΓΡΑΦΗ	ΣΥΣΚ	€/τεμ.
12390001	11cm ΚΟΚΚΙΝΗ		1,35
12390003	14cm ΚΟΚΚΙΝΗ		1,50
12390005	18cm ΚΟΚΚΙΝΗ		1,85



ΤΣΙΜΠΙΔΕΣ ΣΩΜΑΤΟΣ ΒΑΡΕΩΣ ΤΥΠΟΥ



ΚΩΔΙΚΟΣ	ΠΕΡΙΓΡΑΦΗ	ΣΥΣΚ	€/τεμ.
12390008	400A		3,40



ΠΡΟΣΤΑΤΕΥΤΙΚΟ ΚΑΛΥΜΜΑ ΠΡΙΖΑΣ ΣΕΤ 10 ΤΕΜ

ΚΩΔΙΚΟΣ	ΣΥΣΚ	€/τεμ.
12363302		▶ 1,35



ΣΤΑΥΡΟΣ ΣΟΥΚΟ ΛΕΥΚΟΣ

ΚΩΔΙΚΟΣ	ΠΕΡΙΓΡΑΦΗ	ΣΥΣΚ	€/τεμ.
12350014	3 ΘΕΣΕΩΝ		▶ 3,40



ΚΑΡΑΒΟΧΕΛΩΝΑ ΜΕ ΠΛΕΓΜΑ



ΚΩΔΙΚΟΣ	ΠΕΡΙΓΡΑΦΗ	ΣΥΣΚ	€/τεμ.
12312010	ΛΕΥΚΟ		▶ 5,15
12312011	ΜΑΥΡΟ		▶ 5,15



ΠΟΛΥΠΡΙΖΟ ΜΕ ΔΙΑΚΟΠΤΗ / ΠΡΟΕΚΤΑΣΗ



ΚΩΔΙΚΟΣ	ΠΕΡΙΓΡΑΦΗ	ΣΥΣΚ	€/τεμ.
12334211	4 ΘΕΣΕΩΝ 3x1x1,5m		▶ 7,35
12334225	4 ΘΕΣΕΩΝ 3x1,5x5m		▶ 14,45
12335212	5 ΘΕΣΕΩΝ 3x1x1,8m		▶ 8,55
12335225	5 ΘΕΣΕΩΝ 3x1,5x5m		▶ 15,20

ΕΡΓΑΛΕΙΑ ΥΔΡΑΥΛΙΚΩΝ



ΕΡΓΑΛΕΙΑ ΥΔΡΑΥΛΙΚΩΝ [189 - 200]

Τσιμπίδες STILSON

Σωληνοκόφτες | Κουκουνάρες

Αποφρακτικά | Φλόγιστρα



 250
mm

 300
mm

CrV

ΓΚΑΖΟΤΑΝΑΛΙΕΣ

ΚΩΔΙΚΟΣ	YATO	ΜΗΚΟΣ(mm)	ΣΥΣΚ	€/ΤΕΜ
20002090	YT-2090	250	6	10,70
20002091	YT-2091	300	6	13,30



90°

 DIN
5234

 CrV
6140

ΤΣΙΜΠΙΔΕΣ ΥΔΡΑΥΛΙΚΩΝ 90°

ΚΩΔΙΚΟΣ	YATO	ΜΑΧ Ø	ΜΗΚΟΣ(mm)	ΣΥΣΚ	€/ΤΕΜ
20002210	YT-2210	1"	320	24	16,00
20002211	YT-2211	1.5"	420	18	26,70
20002212	YT-2212	2"	560	12	42,00



45°

 DIN
5234

 CrV
6140

ΤΣΙΜΠΙΔΕΣ ΥΔΡΑΥΛΙΚΩΝ 45°

ΚΩΔΙΚΟΣ	YATO	ΜΑΧ Ø	ΜΗΚΟΣ(mm)	ΣΥΣΚ	€/ΤΕΜ
20002213	YT-2213	1"	330	24	18,70
20002214	YT-2214	1.5"	415	18	28,30
20002215	YT-2215	2"	530	12	42,95

 7"
175mm

45mm

20mm

 HRC
47-53

 HARDENED
JAWS

ΓΕΡΜΑΝΙΚΟΥ ΤΥΠΟΥ ΤΣΙΜΠΙΔΑ

ΚΩΔΙΚΟΣ	YATO	L(mm)	---(mm)	ΣΥΣΚ	€/ΤΕΜ
20022000	YT-22000	175	45	6	6,50
20022001	YT-22001	225	45	6	8,45
20022002	YT-22002	275	45	6	11,40



16-38mm

5/8"-1 1/2"

 QUICK
RELEASE

 300
mm

 HARDENED
JAWS
HRC 46-52

 SELF-
ADJUSTING

ΡΥΘΜΙΖΟΜΕΝΗ ΤΣΙΜΠΙΔΑ 16-38mm

ΚΩΔΙΚΟΣ	YATO	L(mm)	ΣΥΣΚ	€/ΤΕΜ
20022005	YT-22005	300	6	16,00



CrMo

HRC
55-60

ΣΤΙΛΣΟΝ

ΚΩΔΙΚΟΣ	YATO®	ΜΕΓ.	ΣΥΣΚ	€/ΤΕΜ
20002488	YT-2488	10"/250mm	6	9,70
20002489	YT-2489	12"/300mm	6	13,80
20002490	YT-2490	14"/350mm	2	17,50
20002491	YT-2491	18"/450mm	3	24,00
20002492	YT-2492	24"/600mm	2	37,00

16" 18"
20" 22" 400-550
mmHRC
55-60 CrMo

ΣΤΙΛΣΟΝ ΠΤΥΣΣΟΜΕΝΟ 400-550mm

ΚΩΔΙΚΟΣ	YATO®	ΜΕΓ.	ΣΥΣΚ	€/ΤΕΜ
20022257	YT-22257	16-22"		36,75



ΨΑΛΙΔΙ ΣΩΛΗΝΟΣ

ΚΩΔΙΚΟΣ	YATO®	ø(mm)	ΣΥΣΚ	€/ΤΕΜ
20002231	YT-2231	42	6	12,05



ΨΑΛΙΔΙ ΣΩΛΗΝΟΣ PVC

ΚΩΔΙΚΟΣ	YATO®	ΜΕΓ.	ΣΥΣΚ	€/ΤΕΜ
20022271	YT-22271	0-42mm		14,00
20022273	YT-22273	0-63mm		19,90



ΚΟΥΡΜΠΑΔΟΡΟΣ

ΚΩΔΙΚΟΣ	YATO®	ø(mm)	ΣΥΣΚ	€/ΤΕΜ
20021840	YT-21840	6.3 / 8 / 10	20	11,20



 250
mm

ΓΚΑΖΟΤΑΝΑΛΙΑ

ΚΩΔΙΚΟΣ	VOREL	ΜΗΚΟΣ(mm)	ΣΥΣΚ	€/ΤΕΜ
21140057	40057	250	6	7,05

ΣΩΛΗΝΟΚΑΒΟΥΡΑΣ

ΚΩΔΙΚΟΣ	VOREL	ΜΗΚΟΣ(mm)	ΣΥΣΚ	€/ΤΕΜ
21155625	55625	245	6	7,40
21155635	55635	310	6	10,80
21155645	55645	395	4	14,00



45°

ΤΣΙΜΠΙΔΑ ΥΔΡΑΥΛΙΚΩΝ

ΚΩΔΙΚΟΣ	VOREL	ΜΕΓΕΘΟΣ	ΣΥΣΚ	€/ΤΕΜ
21155210	55210	1.0"/25 mm	24	9,15
21155211	55211	1.5"/38 mm	16	12,60
21155212	55212	2.0"/50 mm	8	19,05



90°

ΤΣΙΜΠΙΔΑ ΥΔΡΑΥΛΙΚΩΝ

ΚΩΔΙΚΟΣ	VOREL	ΜΕΓΕΘΟΣ	ΣΥΣΚ	€/ΤΕΜ
21155215	55215	1.0"/25 mm	24	8,20
21155216	55216	1.5"/38 mm	16	11,85
21155217	55217	2.0"/50 mm	8	17,85

ΠΡΕΣΑ ΠΟΛΥΣΤΡΩΜΑΤΙΚΩΝ ΣΩΛΗΝΩΝ

ΚΩΔΙΚΟΣ	YATO	ΣΥΣΚ	€/ΤΕΜ
20021735	YT-21735	AL-PEX	2 168,00

NEO

PE-RT AL PE-RT	PEX AL PEX	U 16mm	U 20mm	U 25mm	U 32mm
9 PCS	6t =60kN	TH 16mm	TH 20mm	TH 26mm	TH 32mm





∅ 1/10" - 7/8"
∅ 3-22 mm

PLASTIC
Al, Cu

BEARING STEEL

ΣΩΛΗΝΟΚΟΦΤΗΣ ∅ 3-22mm

ΚΩΔΙΚΟΣ	YATO 	∅(mm)	ΣΥΣΚ	€/ΤΕΜ
20022318	YT-22318	3-22	100	4,85



ΣΩΛΗΝΟΚΟΦΤΗΣ ∅ 3-32mm

ΚΩΔΙΚΟΣ	YATO 	∅(mm)	ΣΥΣΚ	€/ΤΕΜ
20022338	YT-22338	3-32	50	12,00

PLASTIC
Al, Cu

∅ 1/10" - 5/4"
∅ 3-32 mm

QUICK-ADJUSTMENT
WITH DEBURRER

BEARING STEEL

PIPE LIFTING WHEEL



ΣΩΛΗΝΟΚΟΦΤΗΣ ∅ 10-40mm

ΚΩΔΙΚΟΣ	YATO 	∅(mm)	ΣΥΣΚ	€/ΤΕΜ
20002232	YT-22322	10-40	20	25,85

STEEL

Cu

Al

PLASTIC

∅ 3/8" - 1-5/8"
∅ 10-40 mm

BEARING STEEL



ΣΩΛΗΝΟΚΟΦΤΗΣ ∅ 6-45mm

ΚΩΔΙΚΟΣ	YATO 	∅(mm)	ΣΥΣΚ	€/ΤΕΜ
20002233	YT-22333	6-45	25	27,25

∅ 1/4" - 7/4"
∅ 6-45 mm

PLASTIC
Al, Cu

WITH DEBURRER

PIPE LIFTING WHEEL

BEARING STEEL



2
pcs

BEARING STEEL



ΑΝΤΑΛΛΑΚΤΙΚΑ ΣΩΛΗΝΟΚΟΦΤΗ 2 ΤΕΜ

ΚΩΔΙΚΟΣ	YATO 	a(mm)	ΓΙΑ ΤΟ	ΣΥΣΚ	€/ΤΕΜ
20022314	YT-22314	26	YT-2232	6	4,50



2
pcs



ΕΚΧΕΙΛΩΤΙΚΟ

ΚΩΔΙΚΟΣ	YATO 	ø(mm)	ΣΥΣΚ	€/ΤΕΜ
20002182	YT-2182	22, 25, 28	20	22,00



7
pcs



ΕΚΧΕΙΛΩΤΙΚΟ ø 22,25,28mm

ΚΩΔΙΚΟΣ	YATO 	ø(mm)	ΣΥΣΚ	€/ΤΕΜ
20002180	YT-2180	3/5/6/8/10/12/14/15/16/19	10	29,00

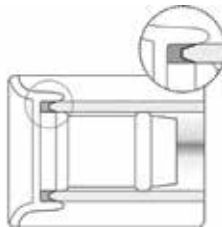

ΕΚΧΕΙΛΩΤΙΚΟ

ΚΩΔΙΚΟΣ	YATO 	ø(mm)	ΣΥΣΚ	€/ΤΕΜ
20022373	YT-22373	16/20/25	200	5,90
20022374	YT-22374	16/20/26	200	5,90



S55C

ΣΩΛΗΝΟΜΕΓΕΝΗ

ΚΩΔΙΚΟΣ	YATO 	ø(mm)	ΣΥΣΚ	€/ΤΕΜ
20006510	YT-6510	60	4	41,00
20006511	YT-6511	76	2	58,00



10
PCS

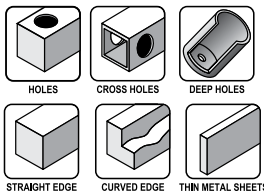

BODY
KORPUS
ø12 mm

HSS
M2

EXCHANGEABLE
ROTATING
BLADE
WYMIENNE
OBRACANE
OSTRZE

ΑΠΟΓΡΕΖΩΤΗΣ

ΚΩΔΙΚΟΣ	YATO 	ΠΕΡΙΓΡΑΦΗ	ΣΥΣΚ	€/ΤΕΜ
20022360	YT-22360	ΕΡΓΑΛΕΙΟ	50	9,95
20022361	YT-22361	ΑΝΤΑΛΛΑΚΤΙΚΑ 10ΤΕΜ	12	13,50



ΣΩΛΗΝΟΚΑΒΟΥΡΑΣ

ΚΩΔΙΚΟΣ	YATO	L(mm)	ΣΥΣΚ	€/ΤΕΜ
20022255	YT-22255	300	5	20,80

ΑΝΤΑΛΛΑΚΤΙΚΟ ΛΟΥΡΙ

20022256	YT-22256		50	6,60
----------	----------	--	----	------



ΣΩΛΗΝΟΚΑΒΟΥΡΑΣ ΑΛΥΣΙΔΑΣ

ΚΩΔΙΚΟΣ	YATO	L(mm)	ΣΥΣΚ	€/ΤΕΜ
20022260	YT-22260	300	6	22,00



ΚΑΣΤΑΝΙΑ ΥΔΡΑΥΛΙΚΩΝ

ΚΩΔΙΚΟΣ	YATO	∅	ΣΥΣΚ	€/ΤΕΜ
21003315	YT-03315	1/2"	6	15,00



ΕΞΑΡΤΗΜΑ ΚΑΣΤΑΝΙΑΣ ΥΔΡΑΥΛΙΚΩΝ

ΚΩΔΙΚΟΣ	YATO	∅	ΣΥΣΚ	€/ΤΕΜ
20003316	YT-03316	1/2" ΑΡΣΕΝΙΚΟ	1	8,70
29903317	YT-03317	1/2" ΘΗΛΥΚΟ	1	10,40



9Cr2

ΚΟΥΚΟΥΝΑΡΑ ΥΔΡΑΥΛΙΚΩΝ

ΚΩΔΙΚΟΣ	YATO	ΜΕΓΕΘΟΣ(")	ΣΥΣΚ	€/ΤΕΜ
20002918	YT-2918	1/2	10	9,45
20002919	YT-2919	3/4	10	9,45
20002920	YT-2920	1	10	10,85
20002921	YT-2921	5/4	10	11,50



4 pcs

9Cr2

ΑΝΤΑΛΛΑΚΤΙΚΑ ΜΑΧΑΙΡΙΑ ΚΟΥΚΟΥΝΑΡΑΣ

ΚΩΔΙΚΟΣ	YATO	ΜΕΓΕΘΟΣ(")	ΣΥΣΚ	€/ΤΕΜ
20002912	YT-2912	1/2	4	3,65
20002913	YT-2913	3/4	4	3,65
20002914	YT-2914	1	4	3,65



ΣΕΤ ΚΟΥΚΟΥΝΑΡΑΣ 5 ΤΜΧ.

ΚΩΔΙΚΟΣ	YATO	ΜΕΓΕΘΟΣ(mm)	ΣΥΣΚ	€/ΤΕΜ
20029001	YT-29001	10/12.5/19/25	4	57,00

3/8" 1/2" 3/4" 1"

10 mm 12.5 mm 19 mm 25 mm



STAINLESS
STEEL
WIRE

ΣΥΡΜΑΤΟΒΟΥΡΤΣΑ ΣΩΛΗΝΟΣ

ΚΩΔΙΚΟΣ	YATO 	ø(mm)	ΣΥΣΚ	€/ΤΕΜ
20063705	YT-63705	15/22	50	3,90



10
PCS

FOR PIPES
Cu

75x130
mm

METAL
FREE

DRY WORK

WET WORK



ΣΦΟΥΓΓΑΡΙ ΚΑΘΑΡΙΣΜΟΥ

ΚΩΔΙΚΟΣ	YATO 	ΔΙΑΣΤΑΣΕΙΣ(mm)	ΣΥΣΚ	€/ΤΕΜ
20063740	YT-63740	75x130	50	4,40



NEO 

ΑΤΣΑΛΙΝΑ ΑΠΟΦΡΑΞΗΣ

ΚΩΔΙΚΟΣ	YATO 	ø (mm)	L (m)	ΣΥΣΚ	€/ΤΕΜ
20025002	YT-25002	6x1.3	3	40	4,45
20025003	YT-25003	6x1.3	5	20	5,95
20025005	YT-25005	9x1.7	10	6	18,00



NEO 

150
cm

ø
9.0
mm

73cm
MINI-LENGTH

ΑΠΟΦΡΑΚΤΗΣ

ΚΩΔΙΚΟΣ	YATO 	ø (mm)	L (cm)	ΣΥΣΚ	€/ΤΕΜ
20024983	YT-24983	9	150	6	10,50



ø
6.0
mm

7.6
m



ΑΠΟΦΡΑΚΤΗΣ ΔΡΑΠΑΝΟΥ

ΚΩΔΙΚΟΣ	YATO 	ø (mm)	L (cm)	ΣΥΣΚ	€/ΤΕΜ
20024991	YT-24991	6	760		23,60

NEO 



ΑΤΣΑΛΙΝΑ ΑΠΟΦΡΑΞΗΣ

ΚΩΔΙΚΟΣ	VOREL	Ø (mm)	L (mm)	ΣΥΣΚ €/ΤΕΜ
21155542	55542	6	3	18 3,65



ΑΤΣΑΛΙΝΑ ΑΠΟΦΡΑΞΗΣ

ΚΩΔΙΚΟΣ	VOREL	Ø (mm)	L (mm)	ΣΥΣΚ €/ΤΕΜ
21155544	55544	9	5	5 9,90



ΑΠΟΦΡΑΚΤΙΚΟ ΝΙΠΤΗΡΑ

ΚΩΔΙΚΟΣ	VOREL	Ø (mm)	ΣΥΣΚ €/ΤΕΜ
21155505	55505	65; 155	24 8,50



ΑΠΟΦΡΑΚΤΙΚΟ ΝΙΠΤΗΡΑ

ΚΩΔΙΚΟΣ	VOREL	Ø (mm)	ΣΥΣΚ €/ΤΕΜ
21155500	55500	135	10 15,00





"ΕΞΥΠΝΟ"

PIEZO	2800°C	2.0 kW
142 g/h	2.59 MPa	G1" F
PROPAN	 GAS	AUTO START STOP
LOCK	CONTINUOUS RUN LOCK	TURBO NOZZLE



Ιδανικό για συγκόλληση χαλκοσωλήνων με διάμετρο μέχρι 32 mm και μαλακή συγκόλληση σωλήνων διαμέτρου μέχρι 100 mm

- Το ακροφύσιο, τεχνολογίας «turbo», αυξάνει τη ροή του αερίου και επιτυγχάνει υψηλές θερμοκρασίες έως 2800 βαθμούς
- Αυτόματος διακόπτης on/off
- Ανάφλεξη τεχνολογίας ριεζο που επιτρέπει την άμεση απενεργοποίηση της συσκευής
- Δυνατότητα εργασίας από οποιαδήποτε γωνία
- Ορειχάλκινο σώμα
- Έλεγχος ροής αερίου
- Κλειδίωμα σκανδάλης για συνεχή λειτουργία.



ADAPTER



G1" M x G7/16" F



EURO TYPE EN417

ΕΠΑΓΓΕΛΜΑΤΙΚΟ ΦΛΟΓΙΣΤΡΟ "TURBO"

ΚΩΔΙΚΟΣ	YATO 	ΣΥΣΚ	€/ΤΕΜ
20036715	YT-36715		56,00





NEO 



ΦΛΟΓΙΣΤΡΟ ΒΟΥΤΑΝΙΟΥ

ΚΩΔΙΚΟΣ	YATO 	ΣΥΣΚ	€/ΤΕΜ
20036700	YT-36700	10	32,00



PIEZO ELECTRIC	30 ml	60-90 min
GAS	BUTANE lighter gas	CHILD PROTECTION LOCK



NEO 



 GAS LEVEL INSPECTION WINDOW	 SOLDERING IRON 450°C	 HOT AIR GUN 600°C
 7 PCS		 TORCH 1300°C

ΚΟΛΛΗΤΗΡΙ ΒΟΥΤΑΝΙΟΥ

ΚΩΔΙΚΟΣ	YATO 	W	ΣΥΣΚ	€/ΤΕΜ
20036706	YT-36706	30-125	6	58,50

7 PCS	PIEZO ELECTRIC	30 ml	75 min	
30-125 W	GAS	BUTANE lighter gas PROPANE-BUTANE lighter gas	CHILD PROTECTION LOCK	



ΦΛΟΓΙΣΤΡΟ ΒΟΥΤΑΝΙΟΥ

ΚΩΔΙΚΟΣ	VOREL	kW	ΣΥΣΚ €/ΤΕΜ
21173420	73420	0.22	10 13,60

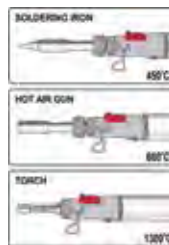

ΚΟΛΛΗΤΗΡΙ ΒΟΥΤΑΝΙΟΥ

ΚΩΔΙΚΟΣ	VOREL	W	ΣΥΣΚ €/ΤΕΜ
21173410	73410	25 ~ 80	12 20,65



ΦΛΟΓΙΣΤΡΟ ΠΙΣΣΑΣ

ΚΩΔΙΚΟΣ	VOREL	MPa(max)	kW	L (mm)	ΣΥΣΚ €/ΤΕΜ
21173340	73340	1.2	19.5	360	10 31,20

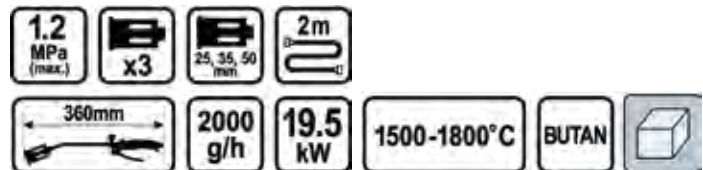

ΦΛΟΓΙΣΤΡΟ ΠΙΣΣΑΣ

ΚΩΔΙΚΟΣ	VOREL	MPa(max)	kW	L (mm)	ΣΥΣΚ €/ΤΕΜ
21173341	73341	1.2	28	745	20 29,85



ΕΡΓΑΛΕΙΑ ΣΥΝΕΡΓΕΙΟΥ

ΕΡΓΑΛΕΙΟΘΗΚΕΣ | ΑΠΟΘΗΚΕΥΣΗ

YATO

VOREL

HELIX-POWER
TOOLS

Tayg

QBRICK
SYSTEM

PATROL
GROUP

ΕΡΓΑΛΕΙΑ ΣΥΝΕΡΓΕΙΟΥ [201 - 239]



Αέρας | Δυναμόμετρα | Φιλτρόκλειδα

Γρασαδόροι | Εξολκείς | Πριτσιναδόροι

ΕΡΓΑΛΕΙΟΘΗΚΕΣ - ΑΠΟΘΗΚΕΥΣΗ [240 - 263]



Εργαλειοθήκες | Συστήματα Αποθήκευσης

Εργαλειοφορείς



ΦΑΚΟΙ - ΛΑΜΠΕΣ ΣΥΝΕΡΓΕΙΟΥ [264 - 269]



NEO 

0.63 MPa	141 l/min	20000 min ⁻¹	Ø (max) 10mm
360° SWAY	SPEED REGULATOR	0.66kg ULTRA LIGHT	STANDARD

ΑΕΡΟΤΡΟΧΟΣ

ΚΩΔΙΚΟΣ	YATO 	€/ΤΕΜ
20009695	YT-09695	26,00



NEO 

0.63 MPa	113 l/min	0.9kg ULTRA LIGHT	max Ø 10mm
1800 min ⁻¹	STANDARD	COMPOSITE BODY	



ΑΕΡΟΔΡΑΠΑΝΟ

ΚΩΔΙΚΟΣ	YATO 	€/ΤΕΜ
20009703	YT-09703	39,00



ULTRA LIGHT 



NEO 

0.63 MPa	T 4500 min ⁻¹	113 l/min	0.95kg ULTRA LIGHT
	COMPOSITE BODY	STANDARD	

ΑΕΡΟΚΟΠΙΔΟ

ΚΩΔΙΚΟΣ	YATO 	€/ΤΕΜ
20009904	YT-09904	27,00



NEO 

0.63 MPa	80 Nm	160 min ⁻¹	142 l/min
360° SWAY	SPEED REGULATOR	1.4kg ULTRA LIGHT	1/2" 12.5mm STANDARD

ULTRA LIGHT 

ΚΑΣΤΑΝΙΑ 1/2"

ΚΩΔΙΚΟΣ	YATO 	€/ΤΕΜ
20009803	YT-09803	44,00





"ΕΞΥΠΝΟ"

NEO 

75mm Ø 3/8" Inlet	0.8 MPa	18000 min ⁻¹	170 l/min
360° ROTARY SWITCH	SPEED REGULATOR	0.7 kg ULTRA LIGHT	STANDARD

ΑΕΡΟΚΟΦΤΗΣ

ΚΩΔΙΚΟΣ	YATO 	€/ΤΕΜ
20009717	YT-09717	28,00



NEO 

0.63 MPa	113 l/min	25000 min ⁻¹	6mm Ø
360° ROTARY SWITCH	SPEED REGULATOR	0.33kg ULTRA LIGHT	STANDARD

ΕΥΘΥΣ ΛΕΙΑΝΤΗΡΑΣ

ΚΩΔΙΚΟΣ	YATO 	€/ΤΕΜ
20009633	YT-09633	23,50



ULTRA LIGHT 

NEO 

0.63 MPa	113 l/min	20000 min ⁻¹	6mm Ø
360° ROTARY SWITCH	SPEED REGULATOR	0.48kg ULTRA LIGHT	STANDARD

ΓΩΝΙΑΚΟΣ ΛΕΙΑΝΤΗΡΑΣ

ΚΩΔΙΚΟΣ	YATO 	€/ΤΕΜ
20009676	YT-09676	42,00



NEO 

ΣΕΤ
5 pcs

75
mm

ΔΙΣΚΟΣ ΚΟΠΗΣ ΜΕΤΑΛΛΟΥ

ΚΩΔΙΚΟΣ	YATO 	ΣΥΣΚ	€/ΤΕΜ
20000994	YT-0994	12	3,90



SHORT BODY

ΚΟΝΤΟ ΣΩΜΑ
1200 Nm
142 LT/Min

COMPACT

NEO 



ΚΩΔΙΚΟΣ	YATO 	Nm	ΣΥΣΚ	€/ΤΕΜ
20009515	YT-09515	1200		98,00

1/2" 12.7mm	SINGLE HAMMER TYPE	0.63 MPa	142 l/min	1200 Nm	10000 min ⁻¹	COMPOSITE BODY	STANDARD
----------------	--------------------------	-------------	--------------	------------	----------------------------	-------------------	----------



1/2" 12.5mm	1/4" 6.3mm	680 Nm	10000 min ⁻¹	0.63 MPa	165 l/min
----------------	---------------	-----------	----------------------------	-------------	--------------

ΚΩΔΙΚΟΣ	YATO 	Nm	ΣΥΣΚ	€/ΤΕΜ
20109513	YT-09513	680	10	147,00

ΚΟΝΤΟ

TWIN HAMMER™ - Mechanism ensuring resilience to damage and overload



NEO 



1/2" 12.5mm	1/4" 6.3mm	550 Nm	7500 min ⁻¹	0.63 MPa	119 l/min
----------------	---------------	-----------	---------------------------	-------------	--------------



ΚΩΔΙΚΟΣ	YATO 	Nm	ΣΥΣΚ	€/ΤΕΜ
20009511	YT-09511	550	8	78,00

ΑΛΟΥΜΙΝΙΟΥ 1/2"

TWIN HAMMER™ - Mechanism ensuring resilience to damage and overload

NEO 



1/2" 12.5mm	STANDARD	1000 Nm	6000 min ⁻¹	0.63 MPa	120 l/min
----------------	----------	------------	---------------------------	-------------	--------------



ΚΩΔΙΚΟΣ	YATO 	Nm	ΣΥΣΚ	€/ΤΕΜ
20009528	YT-09528	1000	6	99,00

TWIN HAMMER™ - Mechanism ensuring resilience to damage and overload

NEO 



0.63 MPa	12000 min ⁻¹	84 l/min	2.5 mm	150 mm	360° SWITCH ANGLE	STANDARD
-------------	----------------------------	-------------	-----------	-----------	-------------------------	----------

ΤΡΙΒΕΙΟ ΑΕΡΟΣ				
ΚΩΔΙΚΟΣ	YATO 	ΣΥΣΚ	€/ΤΕΜ	
20009739	YT-09739	10	58,00	

NEO 



ΤΑΙΝΙΟΛΕΙΑΝΤΗΡΑΣ

ΚΩΔΙΚΟΣ	YATO	mm	ΣΥΣΚ	€/ΤΕΜ
20009741	YT-09741	10x330	10	49,00

ΤΑΙΝΙΑ ΛΕΙΑΝΣΗΣ ΞΥΛΟΥ-ΜΕΤΑΛΛΟΥ

ΚΩΔΙΚΟΣ	YATO	GRIT	mm	ΣΥΣΚ	€/ΤΕΜ
20009743	YT-09743	60	10x330	10	3,70
20009744	YT-09744	80	10x330	10	3,70
20009745	YT-09745	100	10x330	10	3,70
20009746	YT-09746	120	10x330	10	3,70

ΓΩΝΙΑΚΟΣ ΤΡΟΧΟΣ

ΚΩΔΙΚΟΣ	YATO	ΣΥΣΚ	€/ΤΕΜ
20009675	YT-09675	8	62,00

ΚΑΡΦΩΤΙΚΑ

ΚΩΔΙΚΟΣ	YATO	mm	ΣΥΣΚ	€/ΤΕΜ
20009201	YT-09201	6-16		33,00
20009202	YT-09202	25-40		45,00

ΤΑΠΕΤΣΑΡΙΑΣ

ΚΩΔΙΚΟΣ	YATO	mm	€/ΤΕΜ
20009203	YT-09203	25-40 & 10-50	47,00





NEO 

230-240V-50Hz	0.82 MPa	90L CAPACITY	585x490 x490 mm	STANDARD
---------------	----------	--------------	-----------------	----------

ΚΑΜΠΙΝΑ ΑΜΜΟΒΟΛΗΣ

ΚΩΔΙΚΟΣ	YATO 	ΣΥΣΚ	€/ΤΕΜ
20055840	YT-55840		198,00



NEO 

ΓΑΝΤΙΑ ΑΜΜΟΒΟΛΗΣ

ΚΩΔΙΚΟΣ	YATO 	ΣΥΣΚ	€/ΤΕΜ
21055846	YT-55846		21,00



0.8 MPa (max)	6.3 mm	1m HOSE
1/4" 6.3 mm	160 l/min	AI



ΣΕΤ ΑΜΜΟΒΟΛΗΣ

ΚΩΔΙΚΟΣ	YATO 	ΣΥΣΚ	€/ΤΕΜ
20002375	YT-2375	10	21,00



1.0 l	AI
0.8 MPa (max)	160 l/min



ΠΙΣΤΟΛΙ ΑΜΜΟΒΟΛΗΣ

ΚΩΔΙΚΟΣ	YATO 	ΣΥΣΚ	€/ΤΕΜ
20002376	YT-2376	20	22,00



4
PCS

4,5,6,7
mm

NEO 

ΜΥΤΕΣ ΚΑΜΠΙΝΑΣ ΑΜΜΟΒΟΛΗΣ

ΚΩΔΙΚΟΣ	YATO 	ΣΥΣΚ	€/ΤΕΜ
20055844	YT-55844		4,60



NEO 

4
PCS

410x300
mm

ΠΡΟΣΤΑΤΕΥΤΙΚΟ ΦΙΛΜ

ΚΩΔΙΚΟΣ	YATO 	ΣΥΣΚ	€/ΤΕΜ
20055845	YT-55845		7,10



0.6 l

1.5 mm

0.3 MPa (max)

410 l/min

NEO 

ΠΙΣΤΟΛΙ ΒΑΦΗΣ

ΚΩΔΙΚΟΣ	YATO 	ΣΥΣΚ	€/ΤΕΜ
20002341	YT-2341	20	37,10



NEO 

1.0 l

1.8 mm

0.4 MPa (max)

380 l/min

ΠΙΣΤΟΛΙ ΒΑΦΗΣ

ΚΩΔΙΚΟΣ	YATO 	ΣΥΣΚ	€/ΤΕΜ
20002346	YT-2346	10	38,00



0.8 MPa (max)

0.85 l

130 l/min

AI

NEO 

ΠΕΤΡΕΛΙΕΡΑ

ΚΩΔΙΚΟΣ	YATO 	ΣΥΣΚ	€/ΤΕΜ
20002374	YT-2374	2	14,80



NEO 

0.62 MPa (max)

113 l/min

220 mm

1.0 l

AI

STANDARD

ΠΙΣΤΟΛΙ ΑΦΡΟΥ

ΚΩΔΙΚΟΣ	YATO 	ΣΥΣΚ	€/ΤΕΜ
20023640	YT-23640	10	34,00

ΠΙΣΤΟΛΙΑ ΑΕΡΟΣ



ΚΩΔΙΚΟΣ	YATO 	ΣΥΣΚ	€/ΤΕΜ
20023731	YT-23731	20	6,60



NEO 

ΚΩΔΙΚΟΣ	YATO 	ΣΥΣΚ	€/ΤΕΜ
20002373	YT-2373	20	5,80



NEO 

ΚΩΔΙΚΟΣ	YATO 	ΣΥΣΚ	€/ΤΕΜ
20023723	YT-23723	25	8,20

ΑΕΡΟΜΕΤΡΑ



NEO 

ΚΩΔΙΚΟΣ	YATO 	ΣΥΣΚ	€/ΤΕΜ
20002370	YT-2370		13,00



ΚΩΔΙΚΟΣ	YATO 	ΣΥΣΚ	€/ΤΕΜ
20023701	YT-23701	20	15,90



NEO 

ΚΩΔΙΚΟΣ	YATO 	mm	€/ΤΕΜ
20023702	YT-23702	440	24,00

ΜΕΤΡΗΤΗΣ ΠΙΕΣΗΣ ΕΛΑΣΤΙΚΩΝ 15 BAR

ΚΩΔΙΚΟΣ	ΥΑΤΟ	ΣΥΣΚ	€/ΤΕΜ
20024301	YT-24301	25	7,90

ΠΙΣΤΟΛΙ ΑΕΡΟΣ

ΚΩΔΙΚΟΣ	VOREL	ΣΥΣΚ	€/ΤΕΜ
21181643	81643	20	4,40

ΠΙΣΤΟΛΙ ΑΕΡΟΣ ΜΑΚΡΥ

ΚΩΔΙΚΟΣ	VOREL	ΣΥΣΚ	€/ΤΕΜ
21181644	81644	20	5,25

ΑΕΡΟΜΕΤΡΟ

ΚΩΔΙΚΟΣ	VOREL	ΣΥΣΚ	€/ΤΕΜ
21181651	81651	10	11,85

ΒΑΛΒΙΔΑ ΑΕΡΟΜΕΤΡΟΥ

ΚΩΔΙΚΟΣ	VOREL	(mm)	ΣΥΣΚ	€/ΤΕΜ
21181661	81661	6	50	1,75
21181653	81653	8	50	1,75

ΣΕΤ ΑΕΡΟΣ

ΚΩΔΙΚΟΣ	VOREL	ΣΥΣΚ	€/ΤΕΜ
21181634	81634	20	14,50





1/2" 12.5mm	0.63 MPa _{max}	113 l/min
160 min ⁻¹	69 Nm	1/4" 6.3mm

ΑΕΡΟΚΑΣΤΑΝΙΑ

ΚΩΔΙΚΟΣ	VOREL	(mm)	l/min	min-1	ΣΥΣΚ	€/ΤΕΜ
21181119	81119	12.5	113	160	10	40,70



1/4" 6.3mm	0.63 MPa _{max}
T 4500 min ⁻¹	113 l/min

ΑΕΡΟΚΟΠΙΔΟ

ΚΩΔΙΚΟΣ	VOREL	(mm)	l/min	ΣΥΣΚ	€/ΤΕΜ
21181133	81133	6.3	113	8	20,60



0.4 MPa	1.0 l
1.5mm	450 l/min
STANDARD	

ΠΙΣΤΟΛΙ ΒΑΦΗΣ ΑΕΡΟΣ ΚΑΤΩ

ΚΩΔΙΚΟΣ	VOREL	∅ (mm)	ΣΥΣΚ	€/ΤΕΜ
21181617	81617	1.5	20	19,00



0.4 MPa	0.68 l
1.5mm	450 l/min

ΠΙΣΤΟΛΙ ΒΑΦΗΣ ΑΕΡΟΣ ΠΑΝΩ

ΚΩΔΙΚΟΣ	VOREL	∅ (mm)	ΣΥΣΚ	€/ΤΕΜ
21181618	81618	1.5	20	15,00



1/2" **12.5 mm** **0-7000 rpm** **340 Nm**
0.63 MPa_{max} **226 l/min** **STANDARD**

ΑΕΡΟΚΛΕΙΔΟ

ΚΩΔΙΚΟΣ	VOREL	(mm)	l/min	Nm	ΣΥΣΚ	€/ΤΕΜ
21181100	81100	12.5	226	340	10	35,00



ΛΕΙΑΝΤΗΡΑΣ ΑΕΡΟΣ

ΚΩΔΙΚΟΣ	VOREL	(mm)	l/min	min-1	ΣΥΣΚ	€/ΤΕΜ
21181107	81107	6.3	100	25000	20	17,75

0.63 MPa_{max} **100 l/min** **25000 rpm** **∅6mm** **1/4"**
6.3mm



ΛΕΙΑΝΤΗΡΑΣ ΑΕΡΟΣ & ΣΕΤ ΕΞΑΡΤΗΜΑΤΩΝ

ΚΩΔΙΚΟΣ	VOREL	(mm)	l/min	min-1	ΣΥΣΚ	€/ΤΕΜ
21181109	81109	6.3	127	22000	8	22,90

15 PCS **0-22000 rpm** **STANDARD** **0.63 MPa_{max}** **∅3,6mm** **127 l/min**



STANDARD **0.63 MPa_{max}** **113 l/min** **0-10000 rpm** **∅150mm**

ΤΡΙΒΕΙΟ ΑΕΡΑ

ΚΩΔΙΚΟΣ	VOREL	(mm)	∅ (mm)	MPa	ΣΥΣΚ	€/ΤΕΜ
21181114	81114	6.3	150	0.63	10	34,00



∅ [mm] **150** **10500 rpm^{max}** **M8** **dia / for: 81114**

ΑΝΤΑΛΛΑΚΤΙΚΟ ΤΡΙΒΕΙΟΥ

ΚΩΔΙΚΟΣ	VOREL	∅ (mm)	min-1	ΣΥΣΚ	€/ΤΕΜ
21181115	81115	150	0-10000	10	5,30



ΚΩΔΙΚΟΣ	YATO	SIZE	ΣΥΣΚ	€/ΤΕΜ
20002390	YT-2390	1/4"	50	3,35
20002391	YT-2391	3/8"	50	3,55
20002392	YT-2392	1/2"	50	3,75



ΚΩΔΙΚΟΣ	YATO	SIZE	ΣΥΣΚ	€/ΤΕΜ
20002393	YT-2393	1/4"	50	3,45
20002394	YT-2394	3/8"	50	3,45
20002395	YT-2395	1/2"	50	3,95



ΚΩΔΙΚΟΣ	YATO	SIZE	ΣΥΣΚ	€/ΤΕΜ
20002396	YT-2396	1/4"	50	3,60
20002397	YT-2397	3/8"	50	3,65
20002398	YT-2398	1/2"	50	3,80



ΚΩΔΙΚΟΣ	YATO	SIZE	ΣΥΣΚ	€/ΤΕΜ
20002399	YT-2399	1/4"	50	0,93
20002401	YT-2401	3/8"	50	1,15
20002402	YT-2402	1/2"	50	1,55



ΚΩΔΙΚΟΣ	YATO	SIZE	ΣΥΣΚ	€/ΤΕΜ
20002403	YT-2403	1/4"	50	0,78
20002404	YT-2404	3/8"	50	1,15



ΚΩΔΙΚΟΣ	YATO	SIZE	ΣΥΣΚ	€/ΤΕΜ
20002405	YT-2405	1/4"	50	1,22
20002406	YT-2406	3/8"	50	1,31
20002407	YT-2407	1/2"	50	1,35

ΤΑΧΥΣΥΝΔΕΣΜΟΙ ΜΠΡΟΥΤΖΙΝΟΙ



ΚΩΔΙΚΟΣ	YATO	Μ	ΣΥΣΚ	€/ΤΕΜ
20024091	YT-24091	3/8"	25	19,35



ΚΩΔΙΚΟΣ	YATO	Μ	ΣΥΣΚ	€/ΤΕΜ
20024092	YT-24092	1/4"	50	6,75
20024093	YT-24093	3/8"	50	6,45
20024094	YT-24094	1/4"	50	6,10
20024095	YT-24095	3/8"	50	6,35



NEO 



ΜΠΑΛΑΝΤΕΖΑ ΑΕΡΑ

ΚΩΔΙΚΟΣ	YATO 	M	€/ΤΕΜ
20024243	YT-24243	14	62,00



EASILY MOUNTS TO WORKBENCH OR WALL
INCLUDES 4 ANCHORS



NEO 

ΜΠΑΛΑΝΤΕΖΑ ΑΕΡΑ

ΚΩΔΙΚΟΣ	YATO 	SIZE	€/ΤΕΜ
20024240	YT-24240	10mm x 15m	78,20



NEO 



ΣΠΙΡΑΛ ΑΕΡΟΣ

ΚΩΔΙΚΟΣ	YATO 	θ (mm)	ΜΗΚΟΣ(m)	ΣΥΣΚ	€/ΤΕΜ
20024202	YT-24202	5.5x8	10	25	17,85
20024203	YT-24203	5.5x8	15	25	24,25
20024205	YT-24205	6.5x10	10	25	25,50
20024206	YT-24206	6.5x10	15	25	37,05
20024208	YT-24208	8x12	10	25	31,90
20024209	YT-24209	8x12	15	20	45,30



ΣΩΛΗΝΑ ΑΕΡΟΣ

ΚΩΔΙΚΟΣ	YATO 	θ (mm)	ΜΗΚΟΣ(m)	ΣΥΣΚ	€/ΤΕΜ
20024221	YT-24221	8	20	8	32,00
20024225	YT-24225	10	20	8	33,00

ΜΑΝΟΜΕΤΡΟ

ΚΩΔΙΚΟΣ	VOREL	MPa	bar	ΣΥΣΚ	€/ΤΕΜ
21182611	82611	0.05-0.3	0.5-3.0	10	11,85

PE

ΣΠΙΡΑΛ ΑΕΡΟΣ

ΚΩΔΙΚΟΣ	VOREL	(mm)	L (m)	ΣΥΣΚ	€/ΤΕΜ
21181490	81490	5x8	5	50	5,85
21181491	81491	5x8	10	25	8,40
21181492	81492	5x8	15	25	10,25

ΤΡΟΜΠΑ ΠΟΔΗΛΑΤΟΥ - ΧΕΙΡΟΣ

ΚΩΔΙΚΟΣ	VOREL	ΣΥΣΚ	€/ΤΕΜ
21182031	82031		7,20

ΔΙΠΛΗ ΤΡΟΜΠΑ ΠΟΔΙΟΥ

ΚΩΔΙΚΟΣ	VOREL	MPa	ΣΥΣΚ	€/ΤΕΜ
21182015	82015	0-0.7	6	18,65

ΤΡΟΜΠΑ

ΚΩΔΙΚΟΣ	VOREL	MPa	ΣΥΣΚ	€/ΤΕΜ
21182022	82022	0.1-1	10	16,30



**ΠΡΩΤΟΠΟΡΙΑΚΟ
ΛΙΠΑΝΤΙΚΟ – ΑΝΤΙΣΚΩΡΙΑΚΟ ΣΠΡΕΪ
ΧΩΡΙΣ ΣΙΛΙΚΟΝΗ**

ΛΙΠΑΝΣΗ και ΠΡΟΣΤΑΣΙΑ ΠΟΥ “ΔΙΑΡΚΕΙ”

**ΒΑΡΥΤΕΡΟ ΑΠΟ ΤΟ ΝΕΡΟ
ΑΠΩΘΕΙ ΤΗΝ ΥΓΡΑΣΙΑ**

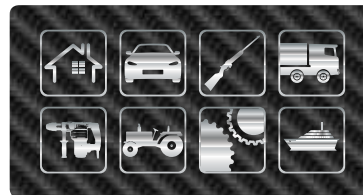

Το **N-GR 21** χάρη στη μοναδική του ιδιότητα να απωθεί με το βάρος του το νερό και την υγρασία, διεισδύει αποτελεσματικά, προστατεύει από τη σκουριά, λιπαίνει, απελευθερώνει και **ξαναβάζει σε κίνηση τα πάντα!!!**



- ▶ Λιπαίνει
- ▶ Συντηρεί
- ▶ Ελευθερώνει
- ▶ Αδιαβροχοποιεί
- ▶ Καθαρίζει
- ▶ Προστατεύει

ΚΩΔΙΚΟΣ	ΠΕΡΙΓΡΑΦΗ	ΣΥΣΚ	€/ΤΕΜ
520102	200ml	24	3,95
520104	400ml	15	5,90
520105	450+50ml	15	6,95
520110	5 Lt	1	55,00



ΚΑΘΑΡΙΣΤΙΚΟ ΦΡΕΝΩΝ

- ▶ Ισχυρό Καθαριστικό
- ▶ Ταχυστέγνωτο
- ▶ Μη Διαβρωτικό
- ▶ Μη Αγώγιμο



Καθαρίζει δίσκους, δαγκάνες, ταμπόρα & τακάκια από σκόνη, γράσα και καπνιά

ΚΩΔΙΚΟΣ	ΠΕΡΙΓΡΑΦΗ	ΣΥΣΚ	€/ΤΕΜ
520119	500ml	15	3,60



ΓΡΑΣΟ ΛΙΘΙΟΥ

ΕΝΙΣΧΥΜΕΝΟ ΜΕ ΤΕΦΛΟΝ



- ▶ Λιπαντικό
- ▶ Αντιτριβικό

ΛΙΠΑΝΣΗ ΠΟΥ “ΔΙΑΡΚΕΙ”

ΚΩΔΙΚΟΣ	ΠΕΡΙΓΡΑΦΗ	ΣΥΣΚ	€/ΤΕΜ
520300	500ml	15	5,90



Πανάκια Wonder Wipes Multi-Use



• Καλύτερο προϊόν DIY 2014!

Τα ματηλάκια **WONDER WIPES Multi-Use** είναι σχεδιασμένα ειδικά για τους εργαζόμενους στον οικοδομικό και κατασκευαστικό τομέα και προσφέρουν τη δυνατότητα απομάκρυνσης νωπών και μερικών ώριμων βαφών, σφραγιστικών, συγκολλητικών, ασφαλτικών, πολυουρεθάνης, διογκούμενων αφρών, πολυεστέρα και εποξειδικών από χέρια, εξοπλισμό και επιφάνειες. Εξοντώνουν τα βακτήρια της MRSA, σαλμονέλα, λιστέρια και E-Coli. Επίσης απομακρύνουν με ευκολία λάδια, γράσο, πετρέλαιο και μελάνι ενώ το ισχυρό καθαριστικό τους είναι ταυτόχρονα φιλικό για τα χέρια.

ΚΩΔΙΚΟΣ	ΠΡΟΪΟΝ	ΣΥΣΚΕΥΑΣΙΑ	ΤΜΧ /ΚΙΒ	ΚΙΒ/ ΠΛΤ	ΤΙΜΗ/ ΤΜΧ(€)
467442	WONDER WIPES MULTI-USE	100 ΠΑΝΑΚΙΑ	6	52	10.15

2t

ΤΡΙΠΟΔΑ ΣΤΗΡΙΞΗΣ - 2 ΤΕΜΑΧΙΑ

ΚΩΔΙΚΟΣ	VOREL	t	mm	ΣΥΣΚ	€/ΤΕΜ
21180312	80312	2	280-370	5	27,10

ΤΕΤΡΑΠΟΔΑ ΣΤΗΡΙΞΗΣ - 2 ΤΕΜΑΧΙΑ

ΚΩΔΙΚΟΣ	VOREL	t	mm	ΣΥΣΚ	€/ΤΕΜ
21180307	80307	2	265-415	1	38,00
21180308	80308	3	280-420	1	43,00

2t

ΚΑΡΟΤΣΟΓΡΥΛΟΙ

ΚΩΔΙΚΟΣ	VOREL	max t	mm	ΣΥΣΚ	€/ΤΕΜ
21180111	80111	2	135-325	1	59,00

ΓΡΥΛΟΣ ΥΔΡΑΥΛΙΚΟΣ

ΚΩΔΙΚΟΣ	VOREL	max t	mm	ΣΥΣΚ	€/ΤΕΜ
21180012	80012	2	148-276	6	20,00
21180022	80022	3	180-350	6	24,00
21180032	80032	5	185-355	4	29,00
21180052	80052	10	195-375	4	41,00

3m

ΠΑΛΑΓΚΟ

ΚΩΔΙΚΟΣ	VOREL	ΚΙΛΑ	ΑΛΥΣΙΔΑm	ΣΥΣΚ	€/ΤΕΜ
21180751	80751	1000	3	1	60,00
21180752	80752	2000	3	1	78,00
21180753	80753	3000	3	1	115,00

NEO

ΚΡΙΚΟΠΑΛΑΓΚΟ 1000 DAN

ΚΩΔΙΚΟΣ	YATO	ΣΥΣΚ	€/ΤΕΜ
20005911	YT-5911	6	36,00



Ø mm
150

ΠΙΑΤΟ ΜΑΓΝΗΤΙΚΟ

ΚΩΔΙΚΟΣ	YATO 	ΣΥΣΚ	€/ΤΕΜ
20000830	YT-0830	12	4,95

NEO 



2
PCS

Ø 150mm

Ø 108mm

0-10
T
(TESLA)



ΣΕΤ ΠΙΑΤΑ ΜΑΓΝΗΤΙΚΑ - 2ΤΕΜ.

ΚΩΔΙΚΟΣ	YATO 	ΣΥΣΚ	€/ΤΕΜ
20008302	YT-08302	6	6,90



 max.
13 Kg

NEO 

ΜΑΓΝΗΤΙΚΗ ΒΑΣΗ ΕΡΓΑΛΕΙΩΝ

ΚΩΔΙΚΟΣ	YATO 	mm	ΣΥΣΚ	€/ΤΕΜ
20000835	YT-0835	500	4	8,00



15 kg
max.

NEO 

ΜΑΓΝΗΤΙΚΗ ΒΑΣΗ ΑΕΡΟΚΛΕΙΔΩΝ

ΚΩΔΙΚΟΣ	YATO 	ΣΥΣΚ	€/ΤΕΜ
20008707	YT-08707	5	24,90



ΜΕ ΓΑΝΤΖΟ, ΜΑΓΝΗΤΗ & LED

585 mm

3in1
3w1

FLEXIBLE HANDLE

LED
VIBR

3x
LR1120

NEO 

ΕΥΚΑΜΠΤΟΣ ΣΥΛΛΕΚΤΗΣ

ΚΩΔΙΚΟΣ	YATO 	mm	ΣΥΣΚ	€/ΤΕΜ
20006613	YT-06613	585	10	11,30



 22.5 kg

 82mm

TELESCOPIC HANDLE
59~99 cm

ΜΑΓΝΗΤΙΚΟΣ

NEO 

ΤΗΛΕΣΚΟΠΙΚΟΣ ΣΥΛΛΕΚΤΗΣ

ΚΩΔΙΚΟΣ	YATO 	mm	ΣΥΣΚ	€/ΤΕΜ
20000860	YT-0860	59-99	6	14,90



190x120
x34
mm



PVC

ΜΑΓΝΗΤΙΚΗ ΤΑΜΠΑΚΕΡΑ - 15 ΘΕΣΕΙΣ

ΚΩΔΙΚΟΣ	YATO 	mm	ΣΥΣΚ	€/ΤΕΜ
20008320	YT-08320	190x120x34		8,30

NEO 



NEO 

1/2"	0-300	3/4"	0-500	CrV
12.5mm	Nm	19.0mm	Nm	6140

ΔΥΝΑΜΟΚΛΕΙΔΑ

ΚΩΔΙΚΟΣ	YATO 	Ø	Nm	ΣΥΣΚ	€/ΤΕΜ
20007641	YT-07641	1/2"	0-300	16	13,80
20007642	YT-07642	3/4"	0-500	9	18,00



NEO 

CrV
6140

ΔΥΝΑΜΟΚΛΕΙΔΑ

ΚΩΔΙΚΟΣ	YATO 	Ø	Nm	Lmm	ΣΥΣΚ	€/ΤΕΜ
20000750	YT-0750	3/8"	20-110	342-360	20	74,00
21000760	YT-0760	1/2"	42-210	445-465	12	78,00



NEO 

1/2" 12.5 mm 360° CrV

ΔΥΝΑΜΟΚΛΕΙΔΑ 360 ΜΟΙΡΩΝ 1/2"

ΚΩΔΙΚΟΣ	YATO 	Ø	Nm	mm	ΣΥΣΚ	€/ΤΕΜ
20000593	YT-0593	1/2"		12,5	12	6,90



ΔΥΝΑΜΟΚΛΕΙΔΑ

ΚΩΔΙΚΟΣ	VOREL 	ΜΕΓΕΘΟΣ (mm)	ΣΥΣΚ	€/ΤΕΜ
21157450	57450	12.7	6	13,40

1/2"	0-200 Nm	
12.5mm	0-20 mkp	



ΔΥΝΑΜΟΚΛΕΙΔΑ

ΚΩΔΙΚΟΣ	VOREL 	ΜΕΓΕΘΟΣ L(mm)	Nm	ΣΥΣΚ	€/ΤΕΜ
21157300	57300	9.5mm	270	13.6-108	20 40,00
21157350	57350	12.7mm	465	28.0-2	10 35,00



ΣΦΥΡΟΚΑΤΣΑΒΙΔΑ 15 ΤΜΧ.

ΚΩΔΙΚΟΣ	YATO 	ΣΥΣΚ	€/ΤΕΜ
20028015	YT-28015	16	18,00



15	160	CrV	S2	
PCS	mm	6150		MAGNETIC
5/16"	1/2"	+	-	
8mm	12.5mm			



CrV
6150

ΜΥΤΕΣ ΣΦΥΡΟΚΑΤΣΑΒΙΔΩΝ 5/16"

ΚΩΔΙΚΟΣ	YATO 	⊖	⊕	ΜΗΚ(μm)	ΣΥΣΚ	€/ΤΕΜ
20002810	YT-2810		PH2	36	5	2,45
20002811	YT-2811		PH3	36	5	4,20
20002812	YT-2812	8+10	PH2+3	36	4	2,85

6
pcs

ΣΕΤ ΕΞΟΛΚΕΙΣ ΒΙΔΩΝ

ΚΩΔΙΚΟΣ	YATO®	Ø (mm)	ΜΗΚΟΣ(mm)	ΣΥΣΚ	€/ΤΕΜ
20000590	YT-0590	3-6	52	12	4,90
		6-8	58		
		8-11	66		
		11-14	75		
		14-18	80		
		18-25	88		

NEO

5
PCS

1/4"
(6.3mm)

STEEL

HSS
4241

ΕΞΟΛΚΕΙΣ ΒΙΔΩΝ

ΚΩΔΙΚΟΣ	YATO®	Ø (mm)	ΣΥΣΚ	€/ΤΕΜ
20006035	YT-06035	0-6, 1-8, 2-10, 3-12, 4-14	40	8,50

ΔΟΚΙΜΑΣΤΙΚΟ ΜΠΑΤΑΡΙΑΣ LED

ΚΩΔΙΚΟΣ	YATO®	ΣΥΣΚ	€/ΤΕΜ
20002865	YT-2865	25	1,95

6-24 V
CABLE
90 cm

NEO

6-12 V
CABLE
90 cm

NEO
ΔΟΚΙΜΑΣΤΙΚΟ ΜΠΑΤΑΡΙΑΣ

ΚΩΔΙΚΟΣ	YATO®	ΣΥΣΚ	€/ΤΕΜ
20002866	YT-2866	10	4,60

ΤΑΙΝΙΑ ΥΦΑΣΜΑΤΙΝΗ

ΚΩΔΙΚΟΣ	YATO®	ΜΕΓΕΘΟΣ (mm)	ΣΥΣΚ	€/ΤΕΜ
20081500	YT-81500	19x15x0.3	10	2,00
20081501	YT-81501	19x25x0.3	10	3,00

15m
19x0.3mm
HOT MELT GLUE
NON-WOVEN FABRIC
-40°C
+105°C

NEO



ΦΙΛΤΡΟΚΛΕΙΔΟ

ΚΩΔΙΚΟΣ	VOREL 	Ø mm	ΣΥΣΚ	€/ΤΕΜ
21157610	57610	55-110	10	5,60



ΦΙΛΤΡΟΚΛΕΙΔΟ

ΚΩΔΙΚΟΣ	YATO 	Ø (mm)	ΣΥΣΚ	€/ΤΕΜ
20000824	YT-0824	80-160	6	14,90
20000825	YT-0825	100-200	5	25,60



ΦΙΛΤΡΟΚΛΕΙΔΟ ΑΛΥΣΙΔΑΣ

ΚΩΔΙΚΟΣ	YATO 	Ø (mm)	ΣΥΣΚ	€/ΤΕΜ
20008253	YT-08253	60-115	5	13,40
20008254	YT-08254	75-170	5	15,00

NEO 

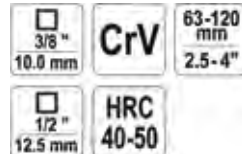

ΦΙΛΤΡΟΚΛΕΙΔΟ 63-120mm

ΚΩΔΙΚΟΣ	YATO 	Ø (mm)	ΣΥΣΚ	€/ΤΕΜ
20000826	YT-0826	63-120	12	10,00



NEO 



ΤΑΠΟΚΛΕΙΔΟ 8, 10mm

ΚΩΔΙΚΟΣ	YATO 	ΣΥΣΚ	€/ΤΕΜ
20005995	YT-05995	6	4,45



NEO 



ΤΑΠΟΚΛΕΙΔΑ - ΣΕΤ 6 ΤΕΜ

ΚΩΔΙΚΟΣ	YATO 	Ø	ΣΥΣΚ	€/ΤΕΜ
20005997	YT-05997	3/8" (9,5mm)	10	14,50



PVC

ΣΕ ΠΩΛΗΣΕΙΣ
No1



ΜΕΤΑΛΛΙΚΑ

IMPACT
RESISTANT



ΛΑΔΙΚΑ

ΚΩΔΙΚΟΣ	YATO	cm ³	ΣΥΣΚ	€/ΤΕΜ
ΛΑΔΙΚΑ PVC				
20000690	YT-0690	220	10	3,30
20000691	YT-0691	270	10	3,50

ΛΑΔΙΚΑ ΜΕΤΑΛΛΙΚΑ

20006912	YT-06912	200	10	3,50
20006913	YT-06913	300	10	5,80
20006914	YT-06914	500	10	6,80



NEO

600 cm³
P (MPa)
27-41
AI



ΓΡΑΣΑΔΟΡΟΣ

ΚΩΔΙΚΟΣ	YATO	ΣΥΣΚ	€/ΤΕΜ
20007042	YT-07042	6	25,00



69 MPa (max.)
44 cm
G26

NEO

ΜΑΡΚΟΥΤΣΙ ΚΑΙ ΚΕΦΑΛΗ

ΚΩΔΙΚΟΣ	YATO	mm	ΣΥΣΚ	€/ΤΕΜ
20007101	YT-07101	440		6,95



15 mm
G26

NEO

ΚΕΦΑΛΗ ΓΡΑΣΑΔΟΡΟΥ

ΚΩΔΙΚΟΣ	YATO	θ(mm)	ΣΥΣΚ	€/ΤΕΜ
20007102	YT-07102	15		2,75



NEO

PP
150 mm

ΧΩΝΙ

ΚΩΔΙΚΟΣ	YATO	θ(mm)	ΣΥΣΚ	€/ΤΕΜ
20000692	YT-0692	150	30	1,70

ΛΑΔΙΚΑ

ΚΩΔΙΚΟΣ	VOREL	ml	ΣΥΣΚ	€/ΤΕΜ
21178303	78303	300	10	4,15

ΤΡΟΜΠΑ ΛΑΔΙΟΥ

ΚΩΔΙΚΟΣ	VOREL	cm ³	ΣΥΣΚ	€/ΤΕΜ
21178044	78044	500	10	10,65

ΓΡΑΣΑΔΟΡΟΣ

ΚΩΔΙΚΟΣ	VOREL	cm ³	ΣΥΣΚ	€/ΤΕΜ
21178047	78047	500	10	14,40

ΓΡΑΣΑΔΟΡΟΣ

ΚΩΔΙΚΟΣ	VOREL	cm ³	ΣΥΣΚ	€/ΤΕΜ
21178043	78043	600	6	18,60

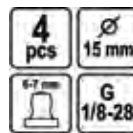
ΚΕΦΑΛΕΣ ΓΡΑΣΑΔΟΡΩΝ

ΚΩΔΙΚΟΣ	VOREL	Ø mm	ΤΕΜ	ΣΥΣΚ	€/ΤΕΜ
21178061	78061	15	4	20	3,15

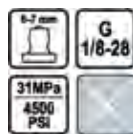
ΜΑΡΚΟΥΤΣΙΑ ΓΡΑΣΑΔΟΡΩΝ

ΚΩΔΙΚΟΣ	VOREL	ΜΗΚΟΣ mm	MPa	ΣΥΣΚ	€/ΤΕΜ
21178067	78067	300	31	50	1,60
21178068	78068	500	31	50	2,05



ΕΞΩΛΚΕΙΣ 2 ΠΟΔΩΝ

ΚΩΔΙΚΟΣ **YATO** max θ (mm) max force(t) ΣΥΣΚ €/ΤΕΜ

ΕΞΩΛΚΕΑΣ 3" / 75mm

20002515 YT-2515 75 1.1 6 **11,50**

ΕΞΩΛΚΕΑΣ 4" / 100mm

20002516 YT-2516 100 1.4 12 **14,00**

ΕΞΩΛΚΕΑΣ 6" / 150mm

20002517 YT-2517 120 6 10 **22,00**



ΕΞΩΛΚΕΙΣ 3 ΠΟΔΩΝ

ΚΩΔΙΚΟΣ **YATO** θ (mm) ΣΥΣΚ €/ΤΕΜ

ΕΞΩΛΚΕΑΣ 3" / 75mm

20002511 YT-2511 50-150 20 **16,50**

ΕΞΩΛΚΕΑΣ 4" / 100mm

20002512 YT-2512 60-200 20 **23,00**

ΕΞΩΛΚΕΑΣ 6" / 150mm

20002513 YT-2513 80-300 10 **42,00**



ΕΞΩΛΚΕΑΣ 2 ΠΟΔΩΝ

ΚΩΔΙΚΟΣ **YATO** θ (mm) ΣΥΣΚ €/ΤΕΜ

20008462 YT-08462 10-40 6 **10,70**



ΕΞΩΛΚΕΑΣ 2 ΠΟΔΩΝ

ΚΩΔΙΚΟΣ **YATO** θ (mm) ΣΥΣΚ €/ΤΕΜ

20025145 YT-25145 5-30 **11,50**



ΕΞΩΛΚΕΑΣ ΒΡΑΧΙΟΝΑ ΥΑΛΟΚΑΘΑΡΙΣΤΗΡΩΝ

ΚΩΔΙΚΟΣ **YATO** ΣΥΣΚ €/ΤΕΜ

20000846 YT-0846 20 **6,35**



ΕΞΟΛΚΕΑΣ ΑΚΡΟΜΠΑΡΟΥ

ΚΩΔΙΚΟΣ	YATO 	ΣΥΣΚ	€/ΤΕΜ
20006122	YT-06122	20	17,75



ΕΞΟΛΚΕΑΣ ΑΚΡΟΜΠΑΡΟΥ ΜΕΓΑΛΟΣ

ΚΩΔΙΚΟΣ	YATO 	ΣΥΣΚ	€/ΤΕΜ
20006123	YT-06123	10	28,80

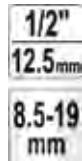

ΕΞΟΛΚΕΑΣ ΒΙΔΩΝ/ΠΑΞΙΜΑΔΙΩΝ

ΚΩΔΙΚΟΣ	YATO 	ΣΥΣΚ	€/ΤΕΜ
21006251	YT-06251	10	10,90

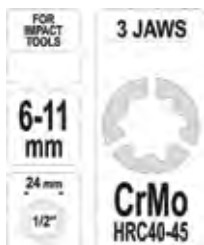

ΓΙΑ ΠΑΛΜΙΚΟ

ΕΞΟΛΚΕΑΣ ΒΙΔΩΝ/ΠΑΞΙΜΑΔΙΩΝ

ΚΩΔΙΚΟΣ	YATO 	ΣΥΣΚ	€/ΤΕΜ
29906256	YT-06256	6	15,00



300 mm CrV
ΛΕΒΙΕΣ

ΚΩΔΙΚΟΣ	YATO®	ΜΕΓΕΘΟΣ(mm)	ΣΥΣΚ	€/ΤΕΜ
20000808	YT-0808	400	20	12,70
20000809	YT-0809	500	5	16,25
20000810	YT-0810	600	5	21,60

17 GAUGES
TAPER
ΦΙΛΕΡ

ΚΩΔΙΚΟΣ	YATO®	ΜΗΚΟΣ(mm)	ΠΛΑΤΟΣ	ΣΥΣΚ	€/ΤΕΜ
20007220	YT-7220	100	10	10	3,50

ΜΕΓΕΘΟΣ

 0.02; 0.03; 0.04; 0.05; 0.06; 0.07; 0.08; 0.09; 0.10;
0.15; 0.20; 0.25; 0.30; 0.40; 0.50; 0.75; 1.00

17 GAUGES
PARALLEL

20007221	YT-7221	200	12.8	10	7,90
----------	---------	-----	------	----	-------------

ΜΕΓΕΘΟΣ

 0.02; 0.03; 0.04; 0.05; 0.06; 0.07; 0.08; 0.09; 0.10;
0.15; 0.20; 0.25; 0.30; 0.40; 0.50; 0.75; 1.00

NEO

ΠΕΝΣΑ-ΠΝΙΚΤΗΣ ΣΕΤ

ΚΩΔΙΚΟΣ	YATO®	ΣΥΣΚ	€/ΤΕΜ
21008403	YT-08403	5	11,45

3 PCS
BENT
NON-CONDUCTIVE

WILL NOT CUT HOSES

NEO
ΜΠΟΥΛΟΝΟΚΛΕΙΔΟ ΣΤΑΥΡΟΣ

ΚΩΔΙΚΟΣ	YATO®	ΣΥΣΚ	€/ΤΕΜ
20000801	YT-0801	17x19x21x1/2"	10 14,00

7 pcs
DROP FORGED
GENUINE HICKORY
NEO
ΣΕΤ ΦΑΝΟΠΟΙΩΝ

ΚΩΔΙΚΟΣ	YATO®	m (g)	ΣΥΣΚ	€/ΤΕΜ
20004590	YT-4590	4900	4	66,00



ΔΙΑΧΩΡΙΣΤΙΚΟ ΔΙΣΚΟΦΡΕΝΩΝ

ΚΩΔΙΚΟΣ	YATO 	ΣΥΣΚ	€/ΤΕΜ
20000610	YT-0610	12	13,20

NEO 



TELESCOPIC HANDLE
250x750mm  LED

ΠΤΥΣΣΟΜΕΝΟΣ ΜΑΓΝΗΤΗΣ ΜΕ LED

ΚΩΔΙΚΟΣ	YATO 	ΣΥΣΚ	€/ΤΕΜ
21006611	YT-06611	12	6,00



 TELESCOPIC HANDLE
250x750mm **2 kg**

NEO 

ΠΤΥΣΣΟΜΕΝΟΣ ΜΑΓΝΗΤΗΣ 2kg

ΚΩΔΙΚΟΣ	YATO 	ΣΥΣΚ	€/ΤΕΜ
20000661	YT-0661	12	7,95

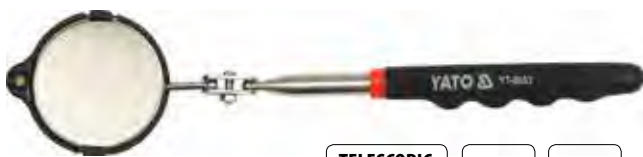

TELESCOPIC HANDLE
265x920mm **LED** **STAINLESS STEEL**

ΠΤΥΣΣΟΜΕΝΟΣ ΚΑΘΡΕΠΤΗΣ ΜΕ LED

ΚΩΔΙΚΟΣ	YATO 	ΣΥΣΚ	€/ΤΕΜ
20000663	YT-0663	10	10,10

NEO 



4 pcs
250 - 930 mm, Ø 57 mm
TELESCOPIC HANDLE 
150 - 620 mm
TELESCOPIC HANDLE 

ΣΕΤ ΜΗΧΑΝΙΚΟΥ

ΚΩΔΙΚΟΣ	YATO 	ΣΥΣΚ	€/ΤΕΜ
20000662	YT-0662	10	15,40



2.5m

ΚΑΛΩΔΙΑ ΕΚΚΙΝΗΣΗΣ

ΚΩΔΙΚΟΣ	YATO 	rated load(A)	ΣΥΣΚ	€/ΤΕΜ
20083151	YT-83151	200	12	12,25
20083152	YT-83152	400	12	15,60



ΣΕ ΠΩΛΗΣΕΙΣ
No1

NEO 

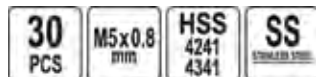

ΣΕΤ ΕΠΙΔΙΟΡΘΩΣΗΣ ΣΠΕΙΡΩΜΑΤΩΝ

ΚΩΔΙΚΟΣ	YATO 	ΜΕΓΕΘΟΣ(mm)	ΣΥΣΚ	€/ΤΕΜ
20017631	YT-17631	M5x0.8	30	9,00
20017632	YT-17632	M6x1.0	30	11,00
20017633	YT-17633	M8x1.25	30	13,70
20017634	YT-17634	M10x1.5	30	16,00
20017635	YT-17635	M12x1.75	20	19,00



NEO 



ΣΕΤ ΕΠΙΔΙΟΡΘΩΣΗΣ ΣΠΕΙΡΩΜΑΤΩΝ

ΚΩΔΙΚΟΣ	YATO 	ΜΕΓΕΘΟΣ(mm)	ΣΥΣΚ	€/ΤΕΜ
20001769	YT-1769	M6x1.0x10.8 M8x1.25x10.8 M10x1.5x13.5	5	49,00



NEO 

STAINLESS
STEEL

ΕΛΑΤΗΡΙΑ ΕΠΙΣΚΕΥΗΣ ΣΠΕΙΡΩΜΑΤΩΝ

ΚΩΔΙΚΟΣ	YATO 	ΜΕΓΕΘΟΣ(mm)	ΣΥΣΚ	€/ΣΥΣΚ
20001764	YT-1764	M5x0.8x6.7	20	4,45
20001765	YT-1765	M6x1.0x10.8	20	4,95
20001766	YT-1766	M8x1.25x10.8	20	6,15
20001767	YT-1767	M10x1.5x13.5	15	5,65
20001768	YT-1768	M12x1.75x16.3	10	4,55



NEO 



ΔΟΚΙΜΑΣΤΙΚΟ ΥΓΡΩΝ ΦΡΕΝΩΝ

ΚΩΔΙΚΟΣ	YATO 	ΣΥΣΚ	€/ΤΕΜ
20072981	YT-72981	28	57,00



ΚΟΛΑΟΥΖΑ**ΚΟΛΑΟΥΖΑ ΜΕΤΡΙΚΑ ΣΕΤ 3 ΤΕΜ CARBON**

ΚΩΔΙΚΟΣ	ΔΙΑΣΤΑΣΗ	ΣΥΣΚ	€/ΤΕΜ
0700703050	M3X0,5	1	2,70
0700704070	M4X0,7	1	2,70
0700705080	M5X0,8	1	2,85
0700706100	M6X1,0	1	2,85
0700707100	M7X1,0	1	3,85
0700708125	M8X1,25	1	3,85
0700709125	M9X1,25	1	5,10
0700710150	M10X1,5	1	4,95
0700712175	M12X1,75	1	6,15
0700714200	M14X2,0	1	7,80
0700716200	M16X2,0	1	9,40
0700718250	M18X2,5	1	12,30
0700720250	M20X2,5	1	13,65
0700722250	M22X2,5	1	16,60
0700724300	M24X3,0	1	19,05

**ΚΟΛΑΟΥΖΑ ΜΕΤΡΙΚΑ ΣΕΤ 2 ΤΕΜ CARBON**

ΚΩΔΙΚΟΣ	ΔΙΑΣΤΑΣΗ	ΣΥΣΚ	€/ΤΕΜ
0800808100	M8X1,0	1	2,83
0800810100	M10X1,0	1	3,57
0800810125	M10X1,25	1	3,57
0800812100	M12x1,0	1	4,38
0800812125	M12X1,25	1	4,38
0800812150	M12X1,5	1	4,38
0800814125	M14x1,25	1	5,85
0800814150	M14X1,5	1	5,85
0800816150	M16X1,5	1	6,80
0800818150	M18x1,5	1	9,10
0800820150	M20x1,5	1	10,40

**ΚΟΛΑΟΥΖΑ ΜΕΤΡΙΚΑ ΣΕΤ 3 ΤΕΜ HSS-G**

ΚΩΔΙΚΟΣ	ΔΙΑΣΤΑΣΗ	ΣΥΣΚ	€/ΤΕΜ
0100103050	M3X0,5	1	6,80
0100104070	M4X0,7	1	6,90
0100105080	M5X0,8	1	7,00
0100106100	M6X1,0	1	7,90
0100107100	M7X1,0	1	9,25
0100108125	M8X1,25	1	9,25
0100110150	M10X1,5	1	12,70
0100112175	M12X1,75	1	16,15
0100114200	M14X2,0	1	21,35
0100116200	M16X2,0	1	25,30
0100118250	M18X2,5	1	34,85
0100120250	M20X2,5	1	41,30

ΚΟΛΑΟΥΖΟ ΜΗΧΑΝΗΣ HSS-G DIN 371/C



ΚΩΔΙΚΟΣ	ΔΙΑΣΤΑΣΗ	ΣΥΣΚ	€/ΤΕΜ
03715203050	M3x50	1	4,60
03715204070	M4x70	1	4,60
03715205080	M5x80	1	4,90
03715206100	M6x100	1	5,15
03715208125	M8x125	1	6,45
03715210150	M10x150	1	8,00



Din
1814

ΜΑΝΕΛΕΣ ΚΟΛΑΟΥΖΩΝ

ΚΩΔΙΚΟΣ	YATO	ΜΕΓΕΘΟΣ	L (mm)	ΣΥΣΚ	€/ΤΕΜ
20002995	YT-2995	M1-M8	125	50	5,35
20002996	YT-2996	M3-M10	180	25	6,25
20002993	YT-2993	M4-M12	280	25	11,10
20002994	YT-2994	M5-M20	375	20	18,35



Din
225

ΜΑΝΕΛΕΣ ΦΙΛΙΕΡΑΣ

ΚΩΔΙΚΟΣ	YATO	ΜΕΓΕΘΟΣ	ø(mm)	L(mm)	ΣΥΣΚ	€/ΤΕΜ
20002981	YT-2981	M4.5-M6	20x7	200	25	4,80
20002982	YT-2982	M7-M9	25x9	224	25	5,60
20002984	YT-2984	M12-M14	38x14	315	15	10,95



ΚΑΣΤΑΝΙΕΣ ΚΟΛΑΟΥΖΩΝ

ΚΩΔΙΚΟΣ	YATO	ΜΕΓΕΘΟΣ	L (mm)	ΣΥΣΚ	€/ΤΕΜ
20002989	YT-2989	M3-M10	85	20	9,80
20002990	YT-2990	M5-M12	100	20	12,90



ΠΡΙΤΣΙΝΑΔΟΡΟΣ 253mm

ΚΩΔΙΚΟΣ	YATO 	ø(mm)	L(mm)	ΣΥΣΚ	€/ΤΕΜ
20036011	YT-36011	2.4; 3.2; 4.0; 4.8	253	12	13,70



ΠΡΙΤΣΙΝΑΔΟΡΟΣ 280mm

ΚΩΔΙΚΟΣ	YATO 	ø(mm)	L(mm)	ΣΥΣΚ	€/ΤΕΜ
20003600	YT-3600	2,4/3,2/4,0/4,8	280	6	19,60



ΠΡΙΤΣΙΝΑΔΟΡΟΣ COMPACT 200mm

ΚΩΔΙΚΟΣ	YATO 	ø(mm)	L(mm)	ΣΥΣΚ	€/ΤΕΜ
20036012	YT-36012	2.4; 3.2; 4.0; 4.8	200	30	18,90



ΠΡΙΤΣΙΝΑΔΟΡΟΣ

ΚΩΔΙΚΟΣ	VOREL 	L (mm)	θ (mm)	ΣΥΣΚ	€/ΤΕΜ
21170023	70023	250	2.4; 3.2; 4.0; 4.8	12	5,90



ΠΡΙΤΣΙΝΑΔΟΡΟΣ 380mm

ΚΩΔΙΚΟΣ	YATO 	ø(mm)	L(mm)	ΣΥΣΚ	€/ΤΕΜ
20036095	YT-36095	2,4;3,2;4,0;4,8;6,4	380	12	36,00



ΠΡΙΤΣΙΝΑΔΟΡΟΣ

ΚΩΔΙΚΟΣ	YATO 	ø(mm)	L(mm)	ΣΥΣΚ	€/ΤΕΜ
20036070	YT-36070	2,4;3,2;4,0;4,8	190-270		14,90

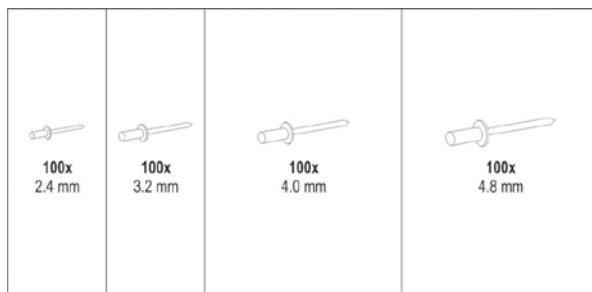

ΠΡΙΤΣΙΝΙΑ ΣΕΤ 400 ΤΜΧ

ΚΩΔΙΚΟΣ	YATO 	mm	ΣΥΣΚ	€/ΤΕΜ
20036420	YT-36420	2,4,3,2,4,0,4,8	5	8,85



400
PCS

MIX
SIZE

AI



50
pcs

AI

NEO

ΠΡΙΤΣΙΝΙΑ ΣΕΤ 50 ΤΜΧ

ΚΩΔΙΚΟΣ	VOREL 	mm	ΣΥΣΚ	€/ΤΕΜ
21170330	70330	3.2x9.6	25	0,66
21170340	70340	3.2x12.7	25	0,72
21170400	70400	4x6.4	25	0,90
21170410	70410	4x9.6	25	0,96
21170420	70420	4x12.7	25	1,09
21170430	70430	4x19	25	1,31
21170490	70490	4.8x9.6	25	1,38
21170500	70500	4.8x12.7	25	1,48
21170510	70510	4.8x19	25	1,65



ΠΡΙΤΣΙΝΑΔΟΡΟΣ ΣΠΕΙΡΩΜΑΤΩΝ 200mm

ΚΩΔΙΚΟΣ	YATO 	ΜΕΓΕΘΟΣ	L(mm)	ΣΥΣΚ	€/ΤΕΜ
20036140	YT-36140	M3;M4;M5;M6	200	20	36,00



200 mm



STAINLESS STEEL, STEEL, ALUMINIUM



300 mm

ΠΡΙΤΣΙΝΑΔΟΡΟΣ ΣΠΕΙΡΩΜΑΤΩΝ 300mm

ΚΩΔΙΚΟΣ	YATO 	ΜΕΓΕΘΟΣ	L(mm)	ΣΥΣΚ	€/ΤΕΜ
20036112	YT-36112	M3,M4,M5,M6,M8,	300	20	42,00

NEO 

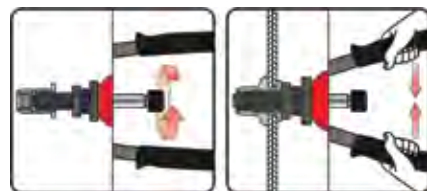

ΠΡΙΤΣΙΝΑΔΟΡΟΣ ΣΠΕΙΡΩΜΑΤΩΝ 338mm

ΚΩΔΙΚΟΣ	YATO 	ΜΕΓΕΘΟΣ	L(mm)	ΣΥΣΚ	€/ΤΕΜ
20036119	YT-36119	M5;M6;M8;M10;M12	338	6	52,50

338 mm



STAINLESS STEEL, STEEL, ALUMINIUM



NEO 

260 mm



ΠΡΙΤΣΙΝΑΔΟΡΟΣ 3 ΣΕ 1

ΚΩΔΙΚΟΣ	YATO 	ΜΕΓΕΘΟΣ	L(mm)	ΣΥΣΚ	€/ΤΕΜ
20036091	YT-36091	M3,M4,M5,M6,M8,M10 2,4,3,2,4,4,8,6,4mm	260	6	77,00

ΨΑΛΙΔΙ ΛΑΜΑΡΙΝΑΣ με 2 κεφαλές κοπής
ΠΡΙΤΣΙΝΑΔΟΡΟΣ
ΠΡΙΤΣΙΝΑΔΟΡΟΣ ΣΠΕΙΡΩΜΑΤΟΣ

Ø 24 32 40 46 64 mm M3, M4, M5, M6, M8, M10





ΠΡΙΤΣΙΝΑΔΟΡΟΣ ΣΠΕΙΡΩΜΑΤΩΝ 360mm

ΚΩΔΙΚΟΣ	YATO	ΜΕΓΕΘΟΣ	L(mm)	ΣΥΣΚ	€/ΤΕΜ
20036128	YT-36128	M3,M4,M5,M6,M8,M10,M12	360	12	76,00



ΠΡΙΤΣΙΝΙΑ ΣΠΕΙΡΩΜΑΤΟΣ ΑΛΟΥΜ ΣΕΤ 20 ΤΜΧ

ΚΩΔΙΚΟΣ	YATO	ΜΕΓΕΘΟΣ	ΣΥΣΚ	€/ΤΕΜ
20036451	YT-36451	M3	125	1,50
20036452	YT-36452	M4	100	1,78
20036453	YT-36453	M5	75	1,90
20036454	YT-36454	M6	50	2,00



ΠΡΙΤΣΙΝΙΑ ΣΠΕΙΡΩΜΑΤΟΣ ΣΕΤ 20 ΤΜΧ

ΚΩΔΙΚΟΣ	YATO	ΜΕΓΕΘΟΣ	ΣΥΣΚ	€/ΤΕΜ
20036470	YT-36470	M3	125	1,35
20036471	YT-36471	M4	100	1,40
20036472	YT-36472	M5	75	1,50
20036473	YT-36473	M6	50	1,85
20036474	YT-36474	M8	40	2,50
20036475	YT-36475	M10	25	3,45
20036476	YT-36476	M12	15	5,40



ΠΡΙΤΣΙΝΙΑ ΣΠΕΙΡΩΜΑΤΟΣ ΑΛΟΥΜ ΣΕΤ 150 ΤΜΧ

ΚΩΔΙΚΟΣ	YATO	ΣΥΣΚ	€/ΤΕΜ
20036460	YT-36460	1	12,75

M3-M10



ΠΡΙΤΣΙΝΙΑ ΣΠΕΙΡΩΜΑΤΟΣ ΣΕΤ 150 ΤΜΧ

ΚΩΔΙΚΟΣ	YATO	ΣΥΣΚ	€/ΤΕΜ
20036481	YT-36481	1	11,10

M3-M11

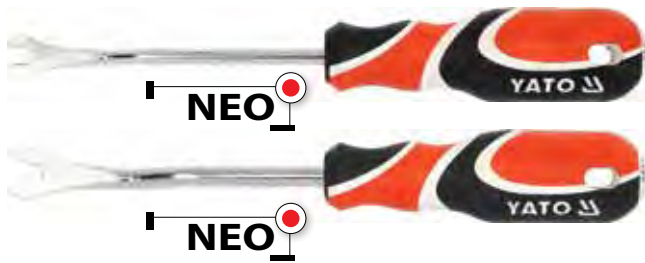
ΕΡΓΑΛΕΙΑ ΑΦΑΙΡΕΣΗΣ ΤΑΠΕΤΣΑΡΙΑΣ

ΚΩΔΙΚΟΣ	YATO	ΜΕΓΕΘΟΣ(mm)	ΣΥΣΚ	€/ΤΕΜ
20001371	YT-1371	6.2x115	12	5,90
20001372	YT-1372	10x115	12	6,50

SVCМ

ΕΡΓΑΛΕΙΑ ΑΦΑΙΡΕΣΗΣ ΤΑΠΕΤΣΑΡΙΑΣ

ΚΩΔΙΚΟΣ	YATO	ΣΥΣΚ	€/ΤΕΜ
20000837	YT-0837	6	9,50

6 pcs



ΛΕΒΙΕΔΕΣ ΑΦΑΙΡΕΣΗΣ ΤΑΠΕΤΣΑΡΙΑΣ

ΚΩΔΙΚΟΣ	YATO	ΣΥΣΚ	€/ΤΕΜ
20000847	YT-0847		11,80

4 pcs

ΣΕΤ ΚΛΙΠΣ ΑΥΤΟΚΙΝΗΤΩΝ

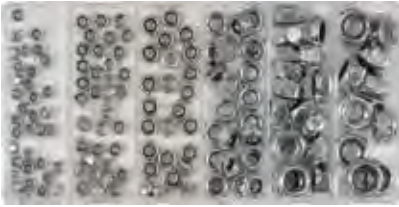
ΚΩΔΙΚΟΣ	YATO	ΑΥΤΟΚΙΝΗΤΟ	ΤΕΜ/ΣΕΤ	ΕΙΔΗ/ΣΕΤ	ΣΥΣΚ	€/ΤΕΜ
20006650	YT-06650	TOYOTA/LEXUS	360	18	25	20,95
20006651	YT-06651	RENAULT	300	6	25	20,65
20006652	YT-06652	OPEL	300	6	25	21,05
20006653	YT-06653	PEUGEOT	345	12	25	21,40
20006654	YT-06654	FIAT	308	12	25	19,10
20006655	YT-06655	VOLVO	350	12	25	18,15
20006656	YT-06656	HONDA	418	18	25	22,95
20006657	YT-06657	NISSAN	408	18	25	19,10
20006658	YT-06658	MAZDA	475	18	25	23,70
20006659	YT-06659	MITSUBISHI	370	12	25	19,90
20006660	YT-06660	FORD	415	18	25	19,25
20006661	YT-06661	BMW	290	6	25	20,65
20006662	YT-06662	MERCEDES	270	12	25	20,65
20006663	YT-06663	VOLKSWAGEN	255	12	25	19,10
20006664	YT-06664	AUDI	160	12	25	19,90



146
PCS

MIX
SIZE

INSERT
LOCK



ΠΑΞΙΜΑΔΙΑ ΑΣΦΑΛΕΙΑΣ ΣΕΤ 146 ΤΜΧ

ΚΩΔΙΚΟΣ	YATO	ΣΥΣΚ	€/ΤΕΜ
20006774	YT-06774	5/20	7,05

M4, M5, M6, M8, M10, M12



300
PCS

MIX
SIZE



ΠΑΞΙΜΑΔΙΑ ΣΕΤ 300 ΤΜΧ

ΚΩΔΙΚΟΣ	YATO	ΣΥΣΚ	€/ΤΕΜ
20006772	YT-06772	5/20	6,35

M3, M4, M5, M6, M8, M10

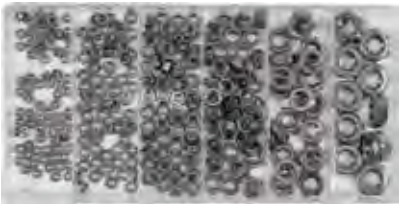

300
PCS

MIX
SIZE

RODBARROW

STAINLESS
STEEL



ΠΑΞΙΜΑΔΙΑ ΣΕΤ ΙΝΟΧ 300 ΤΜΧ

ΚΩΔΙΚΟΣ	YATO	ΣΥΣΚ	€/ΤΕΜ
20006773	YT-06773	5/20	9,85

M3, M4, M5, M6, M8, M10



150
PCS

MIX
SIZE



ΠΑΞΙΜΑΔΙΑ ΤΥΦΛΑ ΣΕΤ 150 ΤΜΧ

ΚΩΔΙΚΟΣ	YATO	ΣΥΣΚ	€/ΤΕΜ
20006775	YT-06775	5/20	6,80

M3, M4, M5, M6, M8, M10

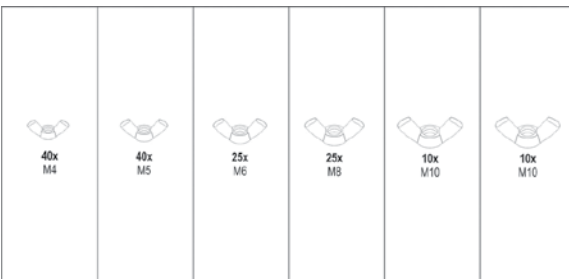

M4, M5, M6, M8, M10

ΠΕΤΑΛΟΥΔΕΣ ΣΕΤ 150 ΤΜΧ

ΚΩΔΙΚΟΣ	YATO	ΣΥΣΚ	€/ΤΕΜ
20006776	YT-06776	5/25	9,95



150
PCS

METRIC

MIX
SIZE























ΡΟΔΕΛΕΣ ΑΛΟΥΜΙΝΙΟΥ ΣΕΤ 150 ΤΜΧ

ΚΩΔΙΚΟΣ	YATO 	ΣΥΣΚ	€/ΤΕΜ
20006865	YT-06865	5/20	19,90



300 PCS MIX SIZE METRIC AI

5x9x1.0 mm, 8x14x1.5 mm, 12x16x1.0 mm, 14x20x1.5 mm, 18x24x1.5 mm, 22x29x1.5 mm, 6x10x1.0 mm, 9x14x1.0 mm, 12x16x1.5 mm, 14x20x2.0 mm, 20x24.5x1.5 mm, 24x29x1.5 mm, 6x12x1.0 mm, 10x14x1.0 mm, 12x18x1.5 mm, 16x20x1.5 mm, 20x24.5x0.8 mm, 24x32x2.0 mm, 8x12x1.0 mm, 10x14x1.5 mm, 13x18x1.0 mm, 16x22x1.5 mm, 19x26x2.0 mm, 26x34x2.0 mm, 8x14x1.0 mm, 10x16x1.0 mm, 14x18x1.5 mm, 18x22x1.5 mm, 22x27x1.0 mm, 28x36x2.0 mm

5x10x1 mm  10 pcs	8x11x1 mm  10 pcs	11x17x1.5 mm  10 pcs	12.5x20x1.5 mm  10 pcs	15x20x2 mm  10 pcs	16.5x24x2 mm  10 pcs
6x10x1 mm  10 pcs	10x16x1 mm  10 pcs	14x18x1 mm  10 pcs	14x20x1.5 mm  10 pcs	16x22x2 mm  10 pcs	17.5x24x2 mm  10 pcs
7x10x1 mm  10 pcs	10.5x17x1.5 mm  10 pcs	12x20x1.5 mm  10 pcs	10x10x1.0 mm  10 pcs	10x16x1.0 mm  10 pcs	10.5x17x1.5 mm  10 pcs

5x10x1.0 mm, 6x10x1.0 mm, 7x10x1.0 mm, 8x11x1.0 mm, 10x16x1.0 mm, 10.5x17x1.5 mm, 11x17x1.5 mm, 14x18x1.0 mm, 12x20x1.5 mm, 12.5x20x1.5 mm, 14x20x1.5 mm, 15x20x2.0 mm, 16x22x2.0 mm, 16.5x24x2.0 mm, 17.5x24x2.0 mm

ΡΟΔΕΛΕΣ ΧΑΛΚΟΥ ΣΕΤ 150 ΤΜΧ

ΚΩΔΙΚΟΣ	YATO 	ΣΥΣΚ	€/ΤΕΜ
20006871	YT-06871	5/20	22,45



150 PCS Cu

6 mm, 8 mm, 10 mm, 12 mm, 13 mm, 14 mm, 15 mm, 16 mm, 18 mm, 20 mm; M8x1.0, M10x1.0, M12x1.5, M14x1.5, M16x1.5, M18x1.5, M20x1.5; G1/4

ΒΙΔΕΣ ΛΑΣΤΙΚΑ ΛΑΔΙΟΥ ΣΕΤ 534 ΤΜΧ









ΚΩΔΙΚΟΣ	YATO 	ΣΥΣΚ	€/ΤΕΜ
20006864	YT-06864	5/10	54,30



534 PCS MIX SIZE Cu

6-20mm



M3, M4, M5, M6; M3x8 mm, M4x16 mm, M5x12 mm, M6x20 mm









ΒΙΔΕΣ - ΚΛΙΠΣ ΑΥΤ/ΤΟΥ ΣΕΤ 170 ΤΜΧ

ΚΩΔΙΚΟΣ	YATO 	ΣΥΣΚ	€/ΤΕΜ
20006780	YT-06780	5/20	7,40







170 PCS MIX SIZE



M6X1  5 pcs	M8X1  10 pcs	M8X1 90°  5 pcs	M10X1 90°  5 pcs	M10X1  10 pcs
M6X1 90°  5 pcs	M8X1 45°  5 pcs	M10X1 45°  5 pcs		

M6x1, M6x1 45°, M6x1 90°, M8x1, M8x1 45°, M8x1 90°, M10x1, M10x1 45°, M10x1 90°

 100x 2.4 mm	 100x 3.2 mm	 100x 4.0 mm	 100x 4.8 mm
---	---	---	---

2.4, 3.2, 4.0, 4.8 mm



150 PCS MIX SIZE AI



150 PCS MIX SIZE



ΓΡΑΣΑΔΟΡΟΙ ΣΕΤ 110 ΤΜΧ

ΚΩΔΙΚΟΣ	YATO	ΣΥΣΚ	€/ΤΕΜ
20006888	YT-06888	5/20	11,60



110 PCS METRIC

ΠΡΙΤΣΙΝΙΑ ΣΕΤ 400 ΤΜΧ

ΚΩΔΙΚΟΣ	YATO	ΣΥΣΚ	€/ΤΕΜ
20036420	YT-36420	5/20	8,85



400 PCS MIX SIZE AI



ΠΡΙΤΣΙΝΙΑ ΣΠΕΙΡΩΜΑΤΟΣ ΑΛΟΥΜ ΣΕΤ 150 ΤΜΧ

ΚΩΔΙΚΟΣ	YATO	ΣΥΣΚ	€/ΤΕΜ
20036460	YT-36460	1	12,75

M3-M10

ΠΡΙΤΣΙΝΙΑ ΣΠΕΙΡΩΜΑΤΟΣ ΣΕΤ 150 ΤΜΧ

ΚΩΔΙΚΟΣ	YATO	ΣΥΣΚ	€/ΤΕΜ
20036481	YT-36481	1	11,10

M3-M11

10 pcs 7,0 x 12,5 mm 5,0 x 20,5 mm	6 pcs 9,5 x 16,0 mm 8 pcs 8,0 x 28,5 mm	12 pcs 8,5 x 47,0 mm 8,0 x 44,5 mm	8 pcs 4,5 x 44,5 mm 9,0 x 35,0 mm	10 pcs 5,5 x 38,0 mm
10 pcs 6,5 x 10,0 mm 5,5 x 25,5 mm	12 pcs 9,5 x 19,0 mm	12 pcs 7,0 x 51,0 mm 4,0 x 79,5 mm	10 pcs 7,0 x 38,0 mm	10 pcs 8,5 x 36,5 mm 7,0 x 19,0 mm
10 pcs 5,5 x 17,5 mm 6,5 x 22,0 mm	10 pcs 8,0 x 31,5 mm			

ΣΕΤ 200ΤΜΧ ΕΛΑΤΗΡΙΑ

ΚΩΔΙΚΟΣ	YATO 	ΣΥΣΚ	€/ΤΕΜ
20006875	ΥΤ-06875	5/20	6,70



200
PCS

MIX
SIZE



555
PCS

MIX
SIZE

ΚΟΠΙΛΙΕΣ ΣΕΤ 555 ΤΜΧ

ΚΩΔΙΚΟΣ	YATO 	ΣΥΣΚ	€/ΤΕΜ
20006873	ΥΤ-06873	5/10	7,60

1.6x25 mm, 2.4x25 mm, 2.4x38 mm,
3.2x32 mm, 3.2x50 mm, 4.0x64 mm



300
PCS

1.5-22
mm

E-RING ΣΕΤ 300 ΤΜΧ

ΚΩΔΙΚΟΣ	YATO 	ΣΥΣΚ	€/ΤΕΜ
20006884	ΥΤ-06884	5/25	8,60

1.5 mm, 3 mm, 5 mm, 6 mm, 10 mm,
12 mm, 15 mm, 19 mm, 22 mm



26
PCS

MIX
SIZE

16-40
mm



ΣΦΙΚΤΗΡΕΣ ΛΑΣΤΙΧΟΥ 26 ΤΜΧ

ΚΩΔΙΚΟΣ	YATO 	ΣΥΣΚ	€/ΤΕΜ
20006782	ΥΤ-06782	5/20	7,15

16, 22, 25, 28, 35, 40 mm



300
PCS

EXTERNAL



ΕΞΩΤΕΡΙΚΕΣ ΑΣΦΑΛΕΙΕΣ ΣΕΤ 300ΤΜΧ

ΚΩΔΙΚΟΣ	YATO 	ΣΥΣΚ	€/ΤΕΜ
20006880	ΥΤ-06880	5/20	8,10

Ø 3, 4, 5, 6, 8, 9, 11, 12, 13, 14, 15, 19, 20, 22, 25, 26, 28, 32 mm



ΕΣΩΤΕΡΙΚΕΣ ΑΣΦΑΛΕΙΕΣ ΣΕΤ 300 ΤΜΧ











ΚΩΔΙΚΟΣ	YATO 	ΣΥΣΚ	€/ΤΕΜ
20006881	YT-06881	5/20	8,05

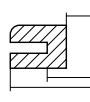

300
PCS

INTERNAL

Ø 3, 4, 5, 6, 8, 9, 11, 12, 13, 14, 15, 19, 20, 22, 25, 26, 28, 32 mm

5 PCS  D= 22.0 mm ID= 15.0 mm OD= 26.0 mm	40 PCS  D= 9.5 mm ID= 6.0 mm OD= 13.0 mm	5 PCS  D= 15.8 mm ID= 12.0 mm OD= 19.0 mm	40 PCS  D= 7.9 mm ID= 5.0 mm OD= 10.0 mm	25 PCS 	5 PCS  D= 25.4 mm ID= 17.0 mm OD= 32.0 mm
	40 PCS  D= 6.3 mm ID= 3.0 mm OD= 8.0 mm	20 PCS  D= 12.7 mm ID= 11.0 mm OD= 15.0 mm	5 PCS  D= 11.0 mm ID= 9.0 mm OD= 15.0 mm		

6.3; 7.9; 9.5; 11.0; 12.7; 15.8; 22.0; 25.4

ΕΛΑΣΤΙΚΕΣ ΡΟΔΕΛΕΣ ΣΕΤ 180 ΤΜΧ

ΚΩΔΙΚΟΣ	YATO 	ΣΥΣΚ	€/ΤΕΜ
20006878	YT-06878	5/20	5,70



180
PCS

MIX
SIZE

3x1 mm 20 pcs 13x3 mm 5 pcs 6x3 mm 20 pcs	4x1 mm 20 pcs 14x2.5 mm 5 pcs 7x2 mm 20 pcs	4.5x2 mm 20 pcs 17x2.5 mm 5 pcs 8x2 mm 20 pcs	5x2 mm 20 pcs 18x4 mm 5 pcs 9x2 mm 5 pcs	6x2 mm 20 pcs 20x2 mm 5 pcs 10x2 mm 5 pcs	6x2.5 mm 20 pcs 22x2 mm 5 pcs 12x3 mm 5 pcs
--	--	--	---	--	--

O-RING ΣΕΤ 225 ΤΜΧ

ΚΩΔΙΚΟΣ	YATO 	ΣΥΣΚ	€/ΤΕΜ
20006877	YT-06877	5/20	5,10



O -RINGS ΨΥΚΤΙΚΩΝ ΣΕΤ 270 ΤΜΧ

ΚΩΔΙΚΟΣ	YATO 	ΣΥΣΚ	€/ΤΕΜ
20006879	YT-06879	6/24	20,15



270
PCS

MIX
SIZE

HNBR
MATERIAL



Ø 5.29 x 1.78 mm, 6.07 x 1.78 mm, 6.8 x 1.9 mm, 7.65 x 1.78 mm, 7.8 x 1.9 mm, 8 x 2 mm, 8.8 x 1.9 mm, 10.82 x 1.78 mm, 10.77 x 2.62 mm, 11 x 2 mm, 12 x 2 mm, 13.9 x 1.8 mm, 13.95 x 2.62 mm, 10 x 2 mm, 15 x 2 mm, 17 x 2 mm, 17.17 x 1.78 mm, 17.04 x 3.53 mm



419
PCS

MIX
SIZE

NBR
MATERIAL



O-RINGS ΣΕΤ 419 ΤΜΧ

ΚΩΔΙΚΟΣ	YATO 	ΣΥΣΚ	€/ΤΕΜ
20006876	YT-06876	24	13,80

3x1.5 mm, 4.4x2 mm, 5x2 mm, 7x1.5 mm, 10x1.5 mm,
10x2.5 mm, 11x2.5 mm, 13x1.5 mm, 13x2.5 mm, 14x2.5 mm,
16x2.5 mm, 18x2.5 mm, 19x2.5 mm, 21x2.5 mm, 22x2.5 mm,
18x3.5 mm, 20x3.5 mm, 22x3.5 mm, 23.5x3.5 mm, 25x3.5 mm,
26.5x3.5 mm, 28x3.5 mm, 30x3.5 mm, 31x3.5 mm, 33x3.5 mm,
34.5x3.5 mm, 36x3.5 mm, 38x3.5 mm, 41x3.5 mm, 44x3.5 mm,
47x3.5 mm, 50x3.5 mm



ΘΕΡΜΟΣΥΣΤΕΛΛΟΜΕΝΑ ΣΕΤ 127 ΤΜΧ

ΚΩΔΙΚΟΣ	YATO 	ΣΥΣΚ	€/ΤΕΜ
20006866	YT-06866	5/20	5,00



127
PCS

MIX
SIZE

125°C
max.

600 V
max.

Ø 2.0 x 40, 2.5 x 40, 3.5 x 40, 5.0 x 40, 7.0 x 80, 10.0 x 80, 13.0 x 85 mm



ΚΛΕΜΕΣ ΣΕΤ 50 ΤΜΧ

ΚΩΔΙΚΟΣ	YATO 	ΣΥΣΚ	€/ΤΕΜ
20006868	YT-06868	5	6,60



50
PCS

MIX
SIZE

0.5 - 1.5; 1.5 - 2.5



ΑΚΡΟΔΕΚΤΕΣ ΣΕΤ 28 ΤΜΧ

ΚΩΔΙΚΟΣ	YATO 	ΣΥΣΚ	€/ΤΕΜ
20006870	YT-06870	5	5,90



28
PCS

MIX
SIZE

ΜΕΓΕΘΗ 50/55/60/65/70/80 mm
10 pcs / clip without insulation - 6 pcs / clip insulation
4 pcs / Big charging clip insulation - 6 pcs / Mini alligator - clip
2 pcs / Small charging clip insulation

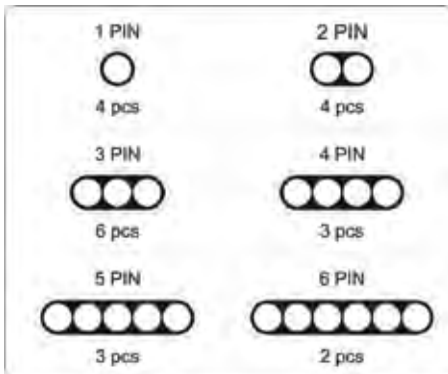

424
PCS

1-6
PIN

NEO



ΚΟΝΒΕΚΤΟΡΕΣ ΚΑΛΩΔΙΩΝ 424 ΤΜΧ

ΚΩΔΙΚΟΣ	YATO	ΣΥΣΚ	€/ΤΕΜ
20006869	YT-06869	6	26,60



ΑΣΦΑΛΕΙΕΣ ΑΥΤΟΚΙΝΗΤΩΝ 24 ΤΜΧ

ΚΩΔΙΚΟΣ	YATO	ΣΥΣΚ	€/ΤΕΜ
20083140	YT-83140	24	10,00

(20A, 30A, 40A, 50A, 60A, 70A, 80A, 100A) X 3 PCS

NEO

24
PCS

MAXI



ΑΣΦΑΛΕΙΕΣ ΑΥΤΟΚΙΝΗΤΩΝ 97 ΤΜΧ

ΚΩΔΙΚΟΣ	YATO	ΣΥΣΚ	€/ΤΕΜ
20083141	YT-83141	24	7,90

(3A, 5A, 7.5A, 10A, 15A, 20A, 25A, 30A) X 12 PCS

NEO

97
PCS

STANDARD

FUSE
PULLER



ΚΟΝΕΚΤΟΡΕΣ ΚΑΛΩΔΙΩΝ 160ΤΜΧ

ΚΩΔΙΚΟΣ	YATO	ΣΥΣΚ	€/ΤΕΜ
20006891	YT-06891		9,05

12 x (0.25mm-1.5mm²), 18 x (1.5mm-2.5mm²), 12 x (4mm-6mm²), 10 x (1.5mm-2.5mm²), 5 x (4mm-6mm²), 10 x (1.5mm-2.5mm²), 5 x (4mm-6mm²), 4 x (0.25mm-1.5mm²), 4 x (1.5mm-2.5mm²), 10 x (1.5mm-2.5mm²), 10 x (1.5mm-2.5mm²), 4 x 5mm², 4 x 8mm², 4 x 10mm², 10 x 4mm², 10 x 5mm², 10 x 6mm², 10 x 4mm², 8 x 4mm²

NEO

160
PCS

MIX



171
PCS

MIX

max °C
125

NEO 

ΘΕΡΜΟΣΥΣΤΕΛΛΟΜΕΝΑ ΣΕΤ 171 ΤΜΧ

ΚΩΔΙΚΟΣ	YATO 	ΣΥΣΚ	€/ΤΕΜ
20006867	YT-06867		7,80
2.0x30, 4.0x60, 4.5x60, 5.0x60, 6.0x60, 8.0x90, 9.0x90, 12.0x90, 18.0x90, 10.0x1000			

ΘΕΡΜΟΣΥΣΤΕΛΛΟΜΕΝΑ ΜΕ ΚΟΛΛΑ

NEA 



30
PCS

0,25x0,34
mm²

105
°C

0,25-0,34mm² 30ΤΜΧ

ΚΩΔΙΚΟΣ	YATO 	ΣΥΣΚ	€/ΤΕΜ
20081440	YT-81440		5,00

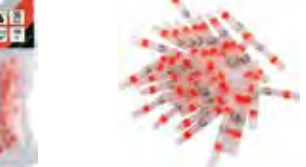

30
PCS

0,5x1,5
mm²

105
°C

0,5-1,5mm² 30ΤΜΧ

ΚΩΔΙΚΟΣ	YATO 	ΣΥΣΚ	€/ΤΕΜ
20081441	YT-81441		5,50



30
PCS

1,5x2,5
mm²

105
°C

1,5-2,5mm² 30ΤΜΧ

ΚΩΔΙΚΟΣ	YATO 	ΣΥΣΚ	€/ΤΕΜ
20081442	YT-81442		6,00



20
PCS

4,0x6,0
mm²

105
°C

4-6mm² 20ΤΜΧ

ΚΩΔΙΚΟΣ	YATO 	ΣΥΣΚ	€/ΤΕΜ
20081443	YT-81443		4,90



100
PCS

0,25x6,0
mm²

105
°C



ΣΕΤ 0,25-6mm² 100ΤΜΧ

ΚΩΔΙΚΟΣ	YATO 	ΣΥΣΚ	€/ΤΕΜ
20081450	YT-81450		19,90



NEO 



ΕΡΓΑΛΕΙΟΘΗΚΗ

ΚΩΔΙΚΟΣ	YATO 	ΣΥΡΤΑΡΙΑ	ΣΥΣΚ	€/ΤΕΜ
20008873	YT-08873	3	1	▶ 76,00



NEO 



ΤΡΟΛΕΪ ΕΡΓΑΣΙΑΣ

ΚΩΔΙΚΟΣ	YATO 	ΔΙΣΚΟΙ	ΣΥΣΚ	€/ΤΕΜ
20055210	YT-55210	3	1	▶ 99,00



NEO 

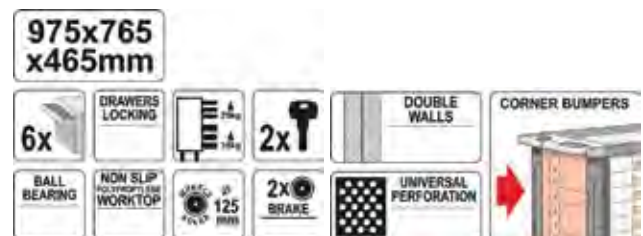

ΕΡΓΑΛΕΙΟΘΗΚΗ ΤΡΟΧΗΛΑΤΗ

ΚΩΔΙΚΟΣ	YATO 	ΣΥΡΤΑΡΙΑ	ΣΥΣΚ	€/ΤΕΜ
20055299	YT-55299	6	2	▶ 473,50



NEO 



ΑΝΘΕΚΤΙΚΗ ΚΑΤΑΣΚΕΥΗ ΑΠΟ ΧΑΛΥΒΑ
ΔΙΑΘΕΤΕΙ 7 ΣΥΡΤΑΡΙΑ ΜΕ ΚΛΕΙΔΑΡΙΑ
ΔΙΑΣΤΑΣΕΙΣ 665 x 453 x 932 mm
ΠΛΕΥΡΙΚΗ ΔΙΑΤΡΗΤΗ ΕΠΙΦΑΝΕΙΑ

ΕΡΓΑΛΕΙΟΘΗΚΗ ΤΡΟΧΗΛΑΤΗ

ΚΩΔΙΚΟΣ	YATO 	ΣΥΡΤΑΡΙΑ	ΣΥΣΚ	€/ΤΕΜ
20009000	YT-09000	7	1	▶ 390,00



NEO 

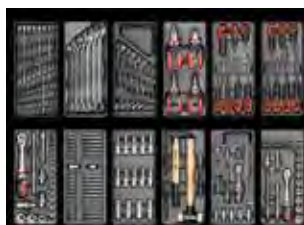

ΜΕ ΕΡΓΑΛΕΙΑ - 177 ΤΕΜ.



ΑΝΘΕΚΤΙΚΗ ΚΑΤΑΣΚΕΥΗ ΑΠΟ ΧΑΛΥΒΑ
ΔΙΑΘΕΤΕΙ 6 ΣΥΡΤΑΡΙΑ ΜΕ ΚΛΕΙΔΑΡΙΑ
ΠΕΡΙΛΑΜΒΑΝΕΙ 177 ΤΕΜ. ΕΡΓΑΛΕΙΩΝ
ΔΙΑΣΤΑΣΕΙΣ 975 x 765 x 465 mm

ΠΛΕΥΡΙΚΗ ΔΙΑΤΡΗΤΗ ΕΠΙΦΑΝΕΙΑ
ΑΝΤΙΟΛΙΣΘΗΤΙΚΟΣ ΠΑΓΚΟΣ ΕΡΓΑΣΙΑΣ
4 ΤΡΟΧΟΙ, ΟΙ 2 ΜΕ ΦΡΕΝΟ

ΕΡΓΑΛΕΙΟΘΗΚΗ ΤΡΟΧΗΛΑΤΗ ΜΕ ΕΡΓΑΛΕΙΑ

ΚΩΔΙΚΟΣ	YATO 	ΣΥΡΤΑΡΙΑ	ΣΥΣΚ	€/ΤΕΜ
20055300	YT-55300	6	1	▶ 769,00



ΑΝΘΕΚΤΙΚΗ ΜΕΤΑΛΛΙΚΗ ΚΑΤΑΣΚΕΥΗ
ΑΝΕΤΑ ΚΑΙ ΑΝΘΕΚΤΙΚΑ ΜΑΞΙΛΑΡΙΑ
ΜΕΤΑΤΡΕΠΕΤΑΙ ΜΕ ΜΙΑ ΚΙΝΗΣΗ
6 ΠΕΡΙΣΤΡΕΦΟΜΕΝΟΙ ΤΡΟΧΟΙ



2 ΣΕ 1

NEO 

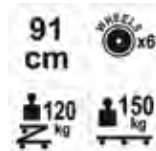

ΣΚΑΜΠΟ & ΞΑΠΛΩΣΤΡΑ ΣΥΝΕΡΓΕΙΟΥ

ΚΩΔΙΚΟΣ	YATO 	ΣΥΣΚ	€/ΤΕΜ
20008802	YT-08802	1	▶ 49,00



ΕΡΓΑΛΕΙΟΘΗΚΗ

ΚΩΔΙΚΟΣ	YATO 	ΣΥΣΚ	€/ΤΕΜ
20009102	YT-09102	1	▶ 169,00

ΣΕ ΠΩΛΗΣΕΙΣ
No1



ΕΡΓΑΛΕΙΟΘΗΚΗ

ΚΩΔΙΚΟΣ	YATO 	ΣΥΣΚ	€/ΤΕΜ
20009101	YT-09101	1	▶ 179,00



ΣΕ ΠΩΛΗΣΕΙΣ
No1



ΕΡΓΑΛΕΙΟΘΗΚΗ

ΚΩΔΙΚΟΣ	YATO 	ΣΥΡΤΑΡΙΑ	ΣΥΣΚ	€/ΤΕΜ
20009108	YT-09108	1	2	▶ 58,20



ΕΡΓΑΛΕΙΟΘΗΚΗ

ΚΩΔΙΚΟΣ	YATO 	ΣΥΡΤΑΡΙΑ	ΣΥΣΚ	€/ΤΕΜ
20009107	YT-09107	2	2	▶ 68,30



600D
POLYESTER

16
POCKETS

ΥΦΑΣΜΑΤΙΝΗ ΕΡΓΑΛΕΙΟΘΗΚΗ

ΚΩΔΙΚΟΣ	YATO 	ΜΕΓΕΘΟΣ	ΣΥΣΚ	€/ΤΕΜ
20074370	YT-74370	31X19X21 / 12"	6	▶ 22,85



17
POCKETS

600D
POLYESTER

ΥΦΑΣΜΑΤΙΝΗ ΕΡΓΑΛΕΙΟΘΗΚΗ

ΚΩΔΙΚΟΣ	YATO 	ΜΕΓΕΘΟΣ	ΣΥΣΚ	€/ΤΕΜ
20074372	YT-74372	33X21X34 / 13"	6	▶ 27,55



11
POCKETS

600D
POLYESTER

ΥΦΑΣΜΑΤΙΝΗ ΕΡΓΑΛΕΙΟΘΗΚΗ

ΚΩΔΙΚΟΣ	YATO 	ΜΕΓΕΘΟΣ	ΣΥΣΚ	€/ΤΕΜ
20074373	YT-74373	52X23X33 / 22"	6	▶ 33,00

16
POCKETS

HEAVY
DUTY
NYLON
ΥΦΑΣΜΑΤΙΝΗ ΕΡΓΑΛΕΙΟΘΗΚΗ

ΚΩΔΙΚΟΣ	YATO	ΜΕΓΕΘΟΣ	ΣΥΣΚ	€/ΤΕΜ
20007433	YT-7433	40X23X21 / 16"	12	▶ 14,90

ΥΦΑΣΜΑΤΙΝΗ ΕΡΓΑΛΕΙΟΘΗΚΗ

ΚΩΔΙΚΟΣ	YATO	ΜΕΓΕΘΟΣ	ΣΥΣΚ	€/ΤΕΜ
20007430	YT-7430	49X26X34 / 19"	12	▶ 21,60

YATO
STEEL
EDGES
FRAMES

50
POCKETS

HEAVY
DUTY
NYLON
STEEL
EDGES
FRAMES

17
POCKETS

600D
POLYESTER

RUBBER
BOTTOM
ΥΦΑΣΜΑΤΙΝΗ ΕΡΓΑΛΕΙΟΘΗΚΗ

ΚΩΔΙΚΟΣ	YATO	ΜΕΓΕΘΟΣ	ΣΥΣΚ	€/ΤΕΜ
20074360	YT-74360	32X18X31 / 15"	8	▶ 22,60

ΥΦΑΣΜΑΤΙΝΗ ΕΡΓΑΛΕΙΟΘΗΚΗ

ΚΩΔΙΚΟΣ	YATO	ΜΕΓΕΘΟΣ	ΣΥΣΚ	€/ΤΕΜ
20074361	YT-74361	41X21X33 / 16"	6	▶ 25,50

15
POCKETS

600D
POLYESTER

RUBBER
BOTTOM

41
POCKETS

600D
POLYESTER

ΥΦΑΣΜΑΤΙΝΗ ΕΡΓΑΛΕΙΟΘΗΚΗ

ΚΩΔΙΚΟΣ	YATO	ΜΕΓΕΘΟΣ	ΣΥΣΚ	€/ΤΕΜ
20074351	YT-74351	46X25X33 / 18"	4	▶ 36,00



HEAVY DUTY
NYLON



ΘΗΚΗ ΖΩΝΗΣ ΔΡΑΠΑΝΟΚΑΤΣΑΒΙΔΟΥ

ΚΩΔΙΚΟΣ	YATO 	ΣΥΣΚ	€/ΤΕΜ
20007414	YT-7414	48	▶ 3,85



HEAVY DUTY
NYLON



ΘΗΚΗ ΣΦΥΡΙΟΥ & ΠΡΟΚΩΝ, ΖΩΝΗΣ

ΚΩΔΙΚΟΣ	YATO 	ΣΥΣΚ	€/ΤΕΜ
20007419	YT-7419	40	▶ 3,20



HEAVY DUTY
NYLON

ΘΗΚΗ ΕΡΓΑΛΕΙΩΝ ΖΩΝΗΣ

ΚΩΔΙΚΟΣ	YATO 	ΣΥΣΚ	€/ΤΕΜ
20007416	YT-7416	20	▶ 5,40



HEAVY DUTY
NYLON

ΘΗΚΗ ΖΩΝΗΣ ΔΡΑΠΑΝΟΚΑΤΣΑΒΙΔΟΥ

ΚΩΔΙΚΟΣ	YATO 	ΣΥΣΚ	€/ΤΕΜ
20007413	YT-7413	10	▶ 5,75

ΘΗΚΗ ΕΡΓΑΛΕΙΩΝ ΖΩΝΗΣ

ΚΩΔΙΚΟΣ	YATO	ΣΥΣΚ	€/ΤΕΜ
20007417	YT-7417	39	▶ 3,15

ΘΗΚΗ ΕΡΓΑΛΕΙΩΝ ΖΩΝΗΣ - 8 ΤΣΕΠΕΣ

ΚΩΔΙΚΟΣ	YATO	ΣΥΣΚ	€/ΤΕΜ
20007410	YT-7410	20	▶ 9,05

8
POCKETS

HEAVY DUTY
NYLON



NEO



6
POCKETS

ΠΟΔΙΑ ΜΕ 6 ΘΗΚΕΣ ΕΡΓΑΛΕΙΩΝ

ΚΩΔΙΚΟΣ	YATO	ΣΥΣΚ	€/ΤΕΜ
20074060	YT-74060	60	▶ 9,85



HEAVY DUTY
NYLON

90-120
cm

ΖΩΝΗ ΓΙΑ ΘΗΚΕΣ ΕΡΓΑΛΕΙΩΝ

ΚΩΔΙΚΟΣ	YATO	ΣΥΣΚ	€/ΤΕΜ
20007409	YT-7409	50	▶ 3,05



ΕΡΓΑΛΕΙΟΘΗΚΗ

ΚΩΔΙΚΟΣ	YATO 	ΜΕΓΕΘΟΣ (mm)	ΣΥΣΚ	€/ΤΕΜ
20000882	YT-0882	360x150x115	4	▶ 16,50



ΕΡΓΑΛΕΙΟΘΗΚΗ

ΚΩΔΙΚΟΣ	YATO 	ΜΕΓΕΘΟΣ (mm)	ΣΥΣΚ	€/ΤΕΜ
20000883	YT-0883	428x180x180	1	▶ 32,00



ΕΡΓΑΛΕΙΟΘΗΚΗ

ΚΩΔΙΚΟΣ	YATO 	ΜΕΓΕΘΟΣ (mm)	ΣΥΣΚ	€/ΤΕΜ
20000886	YT-0886	510x220x240	1	▶ 46,00



ΕΡΓΑΛΕΙΟΘΗΚΗ

ΚΩΔΙΚΟΣ	YATO 	ΜΕΓΕΘΟΣ (mm)	ΣΥΣΚ	€/ΤΕΜ
20000885	YT-0885	460x200x225	1	▶ 36,00

ΣΕ ΠΩΛΗΣΕΙΣ
No 1

ΕΡΓΑΛΕΙΟΘΗΚΗ 4 ΚΟΥΜΠΩΜΑΤΩΝ

ΚΩΔΙΚΟΣ	ΜΟΝΤΕΛΟ	ΔΙΑΣΤΑΣΗ	ΣΥΣΚ	€/ΤΕΜ.
44131004	No 31	17" 445x3235x230mm	6	▶ 17,95
44133008	No 33	19" 480x258x255mm	3	▶ 21,70
44135002	No 35	23" 580x285x290mm	3	▶ 32,00
44149009		ΙΜΑΝΤΑΣ ΕΡΓ/ΚΗΣ		▶ 2,95



ΤΑΜΠΑΚΙΕΡΑ & ΕΤΑΖΕΡΑ



No 31-33

No 35

ΕΡΓΑΛΕΙΟΘΗΚΗ ΜΕ ΕΤΑΖΕΡΑ

ΚΩΔΙΚΟΣ	ΜΟΝΤΕΛΟ	ΔΙΑΣΤΑΣΗ	ΣΥΣΚ	€/ΤΕΜ.
44172007	650B	650x300x295mm	2	▶ 37,00

ΜΕΤΑΛΛΙΚΑ ΚΟΥΜΠΩΜΑΤΑ



ΕΡΓΑΛΕΙΟΘΗΚΗ 4 ΚΟΥΜΠΩΜΑΤΩΝ

ΚΩΔΙΚΟΣ	ΜΟΝΤΕΛΟ	ΔΙΑΣΤΑΣΗ	ΣΥΣΚ	€/ΤΕΜ.
44162008	No 400	16" 400x225x190mm	6	▶ 14,40
44163005	No 450	18" 450x285x250mm	3	▶ 25,50



ΜΕ ΤΑΜΠΑΚΙΕΡΑ & ΕΤΑΖΕΡΑ



No 400



No 450

ΕΡΓΑΛΕΙΟΘΗΚΗ 4 ΚΟΥΜΠ & ΛΑΒΗ ΑΛΟΥΜΙΝΙΟΥ

ΚΩΔΙΚΟΣ	ΜΟΝΤΕΛΟ	ΔΙΑΣΤΑΣΗ	ΣΥΣΚ	€/ΤΕΜ.
44166006	No 500E	20" 500x295x270mm	3	▶ 35,00
44168000	No 600E	23" 600x305x295mm	3	▶ 42,00



**No 500E
No 600E**

ΕΡΓΑΛΕΙΟΘΗΚΗ ΜΕ ΤΑΜΠΑΚΙΕΡΕΣ & ΕΤΑΖΕΡΑ

ΚΩΔΙΚΟΣ	ΜΟΝΤΕΛΟ	ΔΙΑΣΤΑΣΗ	ΣΥΣΚ	€/ΤΕΜ.
44111006	No 11	14" 356x192x150mm	6	▶ 8,40
44112003	No 12	16" 400x217x166mm	6	▶ 10,25



ΕΡΓΑΛΕΙΟΘΗΚΗ ΜΕ ΤΑΜΠΑΚΙΕΡΕΣ & ΕΤΑΖΕΡΑ

ΚΩΔΙΚΟΣ	ΜΟΝΤΕΛΟ	ΔΙΑΣΤΑΣΗ	ΣΥΣΚ	€/ΤΕΜ.
44121005	21	310x160x130mm	6	▶ 5,30
44123009	23	356x184x163mm	6	▶ 9,80
44125003	25	400x206x188mm	6	▶ 11,95

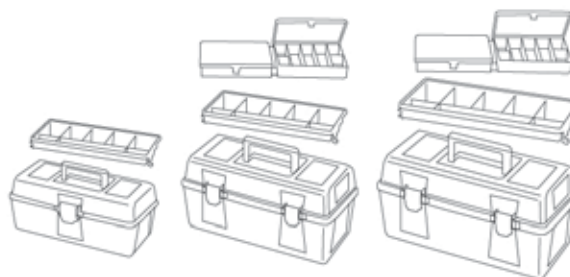

No 21

No 23

No 25

ΤΡΟΧΗΛΑΤΕΣ ΔΙΑΙΡΟΥΜΕΝΕΣ TRAIL BOX

ΚΩΔΙΚΟΣ	ΜΟΝΤΕΛΟ	ΔΙΑΣΤΑΣΗ	ΣΥΣΚ	€/ΤΕΜ.
44157004	No 57	470x290x630mm	1	▶ 45,00

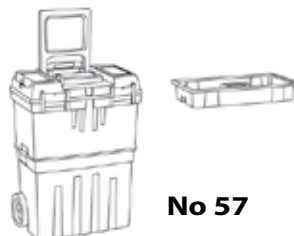

ΕΡΓΑΛΕΙΟΘΗΚΗ ΤΡΟΧΗΛΑΤΗ ΜΕ ΤΑΜΠΑΚΙΕΡΕΣ

ΚΩΔΙΚΟΣ	ΜΟΝΤΕΛΟ	ΔΙΑΣΤΑΣΗ	ΣΥΣΚ	€/ΤΕΜ.
44150005	No 50	675x472x416mm	1	▶ 71,25



ΥΦΑΣΜΑΤΙΝΕΣ ΕΡΓΑΛΕΙΟΘΗΚΕΣ

ΚΩΔΙΚΟΣ	ΜΟΝΤΕΛΟ	ΔΙΑΣΤΑΣΗ	ΣΥΣΚ	€/ΤΕΜ.
44080005	13" BN-1	345x220x225mm	6	▶ 19,80
44082009	18" BN-3	455x250x265mm	6	▶ 42,50

ΚΛΕΙΣΤΟΥ ΤΥΠΟΥ





ΖΩΝΗ ΕΡΓΑΛΕΙΩΝ - ΜΟΝΗ 89 / ΔΙΠΛΗ 90

ΚΩΔΙΚΟΣ	ΠΕΡΙΓΡΑΦΗ	ΥΛΙΚΟ	ΣΥΣΚ	€/ΤΕΜ.
44089602	1 θήκη	Polyester 600D	10	▶ 10,40
44090608	2 θήκες	Polyester 600D	6	▶ 16,90



ΖΩΝΗ ΕΡΓΑΛΕΙΩΝ ΕΠΑΓΓΕΛΜΑΤΙΚΗ - ΜΟΝΗ 91 / ΔΙΠΛΗ 92

ΚΩΔΙΚΟΣ	ΠΕΡΙΓΡΑΦΗ	ΥΛΙΚΟ	ΣΥΣΚ	€/ΤΕΜ.
44091605	1 θήκη	Polyester 900D	10	▶ 16,40
44092602	2 θήκες	Polyester 900D	6	▶ 37,00



PROFESSIONAL

ΣΑΚΙΔΙΟ ΕΡΓΑΛΕΙΩΝ BP20

ΚΩΔΙΚΟΣ	ΜΟΝΤΕΛΟ	ΔΙΑΣΤΑΣΗ	ΣΥΣΚ	€/ΤΕΜ.
44097614	BP20 / 30ltrs	490x390x190mm	2	▶ 78,50



POLYESTER 600d ΜΕ ΕΛΑΣΤΙΚΟ ΠΑΤΟ



ΣΕ ΠΩΛΗΣΕΙΣ
No1**ΤΑΜΠΑΚΙΕΡΕΣ ΜΕ ΣΤΑΘΕΡΑ & ΚΙΝΗΤΑ ΧΩΡΙΣΜΑΤΑ**

ΚΩΔΙΚΟΣ	ΜΟΝΤΕΛΟ	ΔΙΑΣΤΑΣΗ	ΣΥΣΚ	€/ΤΕΜ.
44020001	20-9	190x150x42mm	12	▶ 2,45
44021008	21-10	256x192x42mm	12	▶ 3,25
44022005	22-26	312x238x51mm	6	▶ 7,10
44023002	23-26	388x290x61mm	6	▶ 9,75
44024009	24-26	460x350x81mm	5	▶ 13,90

ΤΑΜΠΑΚΙΕΡΕΣ ΜΕ ΑΦΑΙΡΟΥΜΕΝΑ ΚΟΥΤΑΚΙΑ

ΚΩΔΙΚΟΣ	ΜΟΝΤΕΛΟ	ΔΙΑΣΤΑΣΗ	ΣΥΣΚ	€/ΤΕΜ.
44035005	330-16	330x247x54mm	6	▶ 10,60
44034008	330-32	330x247x54mm	6	▶ 12,10

**ΘΗΚΗ ΔΡΑΠΑΝΟΥ ΜΕ ΤΑΜΠΑΚΙΕΡΑ**

ΚΩΔΙΚΟΣ	ΜΟΝΤΕΛΟ	ΔΙΑΣΤΑΣΗ	ΣΥΣΚ	€/ΤΕΜ.
44141003	No 41	385x330x130mm	7	▶ 14,50





ΣΤΙΒΑΖΟΜΕΝΑ ΣΚΑΦΑΚΙΑ ΑΠΟΘΗΚΕΥΣΗΣ



ΚΩΔΙΚΟΣ	44304002	44306006	44309007	44312007
ΕΞΩΤ. ΔΙΑΣΤΑΣΗ mm	360x170x190	360x170x190	360x170x190	360x170x190
ΔΙΑΣΤΑΣΗ ΣΥΡΤΑΡΙΩΝ	160x170x80	100x170x80	100x170x50	80x170x50
ΣΥΡΤΑΡΙΑ	4	6	9	12
ΣΥΣΚ	4	4	4	4
€/ΤΕΜ.	▶ 16,00	▶ 16,00	▶ 16,00	▶ 16,00



ΣΚΑΦΑΚΙΑ

ΚΩΔΙΚΟΣ	ΜΟΝΤΕΛΟ	ΔΙΑΣΤΑΣΗ	ΣΥΣΚ	€/ΤΕΜ.
ΚΟΚΚΙΝΟ				
44251108	N2	170x100x80mm	24	▶ 1,05
44252105	N3	236x160x130mm	15	▶ 2,60
44254109	N4	336x216x155mm	12	▶ 4,85
44258107	N5	500x303x200mm	12	▶ 12,90
ΜΠΛΕ				
44251023	N2	170x100x80mm	24	▶ 1,05
44252020	N3	236x160x130mm	15	▶ 2,60
44254024	N4	336x216x155mm	12	▶ 4,85
44258022	N5	500x303x200mm	12	▶ 12,90



ΣΚΑΦΑΚΙΑ ΑΝΑΔΙΠΛΟΥΜΕΝΟ ΜΠΛΕ

ΚΩΔΙΚΟΣ	ΠΕΡΙΓΡΑΦΗ	ΔΙΑΣΤΑΣΗ	ΣΥΣΚ	€/ΤΕΜ.
44204029	ΣΚΑΦΑΚΙ 54	336x216x175	11	▶ 5,10
44206023	ΣΚΑΦΑΚΙ 56	420x270x200	11	▶ 8,30
44209024	ΣΚΑΦΑΚΙ 59	500x303x275	8	▶ 16,00
44210020	ΣΚΑΦΑΚΙ 60	600x400x325	6	▶ 23,40



ΡΑΦΙΕΡΕΣ

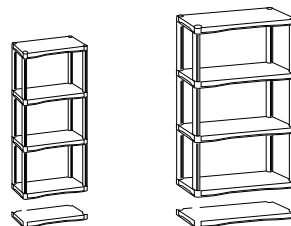

ΜΟΝΤΕΛΟ	635	945
ΚΩΔΙΚΟΣ	44227004	44220005
ΔΙΑΣΤΑΣΗ mm	600x300x1800	900x400x1800
ΥΛΙΚΟ	Πολυπροπυλένιο	Πολυπροπυλένιο
ΣΥΣΚ	1	1
€/ΤΕΜ.	► 29,00	► 54,00



ΣΥΡΤΑΡΙΑ ΡΑΦΙΩΝ

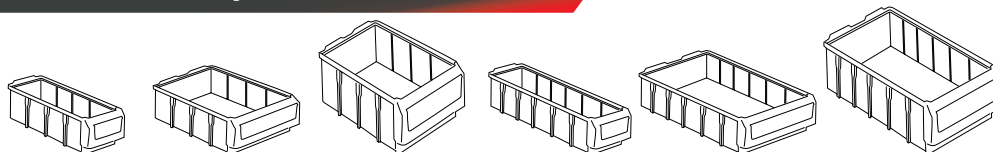

ΜΟΝΤΕΛΟ	301	302	303	401	402	403
ΚΩΔΙΚΟΣ	44355004	44356001	44357008	44360008	44361005	44362002
ΔΙΑΣΤΑΣΗ mm	291x116x90	291x232x90	291x232x140	391x116x90	391x232x90	391x232x140
ΧΩΡΗΤΙΚΟΤΗΤΑ	2 L.	4,4 L.	7 L.	2,7 L.	6,1 L.	9,7 L.
ΥΛΙΚΟ	Πολυπροπυλένιο	Πολυπροπυλένιο	Πολυπροπυλένιο	Πολυπροπυλένιο	Πολυπροπυλένιο	Πολυπροπυλένιο
ΣΥΣΚ	20	10	8	20	10	8
€/ΤΕΜ.	► 2,85	► 4,05	► 6,05	► 3,75	► 5,40	► 8,10



ΔΙΑΧΩΡΙΣΤΙΚΑ ΣΥΡΤΑΡΙΩΝ



ΜΟΝΤΕΛΟ	01	02	03
ΚΩΔΙΚΟΣ	44390005	44391002	44392009
ΔΙΑΣΤΑΣΗ mm	103x79	219x79	219x129
ΥΛΙΚΟ	Πολυπροπυλένιο	Πολυπροπυλένιο	Πολυπροπυλένιο
ΣΥΣΚ	20	10	10
€/ΤΕΜ.	► 5,85	► 5,80	► 8,00

ΚΙΤ ΜΕΤΑΛΛΙΚΟ

ΜΟΝΤΕΛΟ	ΚΩΔΙΚΟΣ	ΠΕΡΙΕΧΟΜΕΝΑ	€/ΤΕΜ.
301	44398308	1 ΡΑΦΙΕΡΑ ΜΕΤΑΛ (1030X337X2000mm) 16 ΡΑΦΙΑ 120 ΣΥΡΤΑΡΙΑ 301 (291x116x90mm) 360 ΔΙΑΧΩΡΙΣΤΙΚΑ ΣΥΡΤΑΡΙΩΝ 01(103x79mm)	▶ 877,00
401	44399305	1 ΡΑΦΙΕΡΑ ΜΕΤΑΛ (1030X437X2000mm) 16 ΡΑΦΙΑ 120 ΣΥΡΤΑΡΙΑ 401 (391x116x90mm) 600 ΔΙΑΧΩΡΙΣΤΙΚΑ ΣΥΡΤΑΡΙΩΝ 01(103x79mm)	▶ 1135,00
302	44398315	1 ΡΑΦΙΕΡΑ ΜΕΤΑΛ (1030X337X2000mm) 16 ΡΑΦΙΑ 60 ΣΥΡΤΑΡΙΑ 302 (291x232x90mm) 180 ΔΙΑΧΩΡΙΣΤΙΚΑ ΣΥΡΤΑΡΙΩΝ 02(219x79mm)	▶ 813,00
402	44399312	1 ΡΑΦΙΕΡΑ ΜΕΤΑΛ (1030X437X2000mm) 16 ΡΑΦΙΑ 60 ΣΥΡΤΑΡΙΑ 402 (391x232x90mm) 300 ΔΙΑΧΩΡΙΣΤΙΚΑ ΣΥΡΤΑΡΙΩΝ 02(219x79mm)	▶ 1000,00
303	44398322	1 ΡΑΦΙΕΡΑ ΜΕΤΑΛ (1030X337X2000mm) 12 ΡΑΦΙΑ 48 ΣΥΡΤΑΡΙΑ 303 (291x232x140mm) 130 ΔΙΑΧΩΡΙΣΤΙΚΑ ΣΥΡΤΑΡΙΩΝ 03(219x129mm)	▶ 866,00
403	44399329	1 ΡΑΦΙΕΡΑ ΜΕΤΑΛ (1030X437X2000mm) 12 ΡΑΦΙΑ 48 ΣΥΡΤΑΡΙΑ 403 (391x232x140mm) 150 ΔΙΑΧΩΡΙΣΤΙΚΑ ΣΥΡΤΑΡΙΩΝ 03(219x129mm)	▶ 993,00
310	44398339	1 ΡΑΦΙΕΡΑ ΜΕΤΑΛ (1030X337X2000mm) 15 ΡΑΦΙΑ 40 ΣΥΡΤΑΡΙΑ 301 (291x116x90mm) 20 ΣΥΡΤΑΡΙΑ 302 (291x232x90mm) 16 ΣΥΡΤΑΡΙΑ 303 (291x232x140mm) 120 ΔΙΑΧΩΡΙΣΤΙΚΑ ΣΥΡΤΑΡΙΩΝ 01(103x79mm) 60 ΔΙΑΧΩΡΙΣΤΙΚΑ ΣΥΡΤΑΡΙΩΝ 02(219x79mm) 40 ΔΙΑΧΩΡΙΣΤΙΚΑ ΣΥΡΤΑΡΙΩΝ 03(219x129mm)	▶ 838,00
410	44399336	1 ΡΑΦΙΕΡΑ ΜΕΤΑΛ (1030X437X2000mm) 15 ΡΑΦΙΑ 40 ΣΥΡΤΑΡΙΑ 401 (391x116x90mm) 20 ΣΥΡΤΑΡΙΑ 402 (391x232x90mm) 16 ΣΥΡΤΑΡΙΑ 403 (391x232x140mm) 200 ΔΙΑΧΩΡΙΣΤΙΚΑ ΣΥΡΤΑΡΙΩΝ 01(103x79mm) 100 ΔΙΑΧΩΡΙΣΤΙΚΑ ΣΥΡΤΑΡΙΩΝ 02(219x79mm) 80 ΔΙΑΧΩΡΙΣΤΙΚΑ ΣΥΡΤΑΡΙΩΝ 03(219x129mm)	▶ 1110,00

302 - 30cm
402 - 40cm



60 ΣΥΡΤΑΡΙΑ

301 - 30cm
401 - 40cm



120 ΣΥΡΤΑΡΙΑ

303 - 30cm
403 - 40cm



48 ΣΥΡΤΑΡΙΑ

310 - 30cm
410 - 40cm



76 ΣΥΡΤΑΡΙΑ

ΛΙΠΑΝΣΗ & ΠΡΟΣΤΑΣΙΑ που "ΔΙΑΡΚΕΙ"



► Τεχνικά σπρέι ΝΕΑΣ ΓΕΝΙΑΣ



ΛΙΠΑΝΤΙΚΟ - ΑΝΤΙΣΚΩΡΙΑΚΟ

**ΒΑΡΥΤΕΡΟ ΑΠΟ ΤΟ ΝΕΡΟ
ΑΠΩΘΕΙ ΤΗΝ ΥΓΡΑΣΙΑ**

- Λιπαίνει
- Συντηρεί
- Ελευθερώνει
- Αδιαβροχοποιεί
- Καθαρίζει
- Προστατεύει

**ΠΡΩΤΟΠΟΡΙΑΚΟ
ΛΙΠΑΝΤΙΚΟ - ΑΝΤΙΣΚΩΡΙΑΚΟ
ΣΠΡΕΪ
ΧΩΡΙΣ ΣΙΛΙΚΟΝΗ**

Παρασκευάζεται στην Ελλάδα | www.n-gr.gr

- **Λιπαίνει, Καθαρίζει και Συντηρεί** μεταλλικούς μηχανισμούς, κλειδαριές, όπλα και σταματάει το τρίξιμο σε μεντεσέδες κ.λπ.
- **Διεισδύει, Ξεσκουριάζει & Απελευθερώνει**, σκουριασμένα και κολλημένα εξαρτήματα όπως βίδες, παξιμάδια, σύρτες και τα επαναφέρει σε λειτουργία
- **Αδιαβροχοποιεί και Προστατεύει**, από την υγρασία και τη διάβρωση, όλα τα ηλεκτρικά κυκλώματα (πίνακες, λάμπες, μοτέρ, συστήματα ανάφλεξης και πόλους μπαταριών). Ιδιαίτερα αποτελεσματικό για ναυτιλιακή χρήση.
- **Καθαρίζει** λεκέδες από πίσσα και γράσα από το χρώμα των αυτοκινήτων



Διαθέσιμο σε συσκευασίες
200ml, 400ml, 500ml και 5Lt



Το **N-GR 21** χάρη στη μοναδική του ιδιότητα να **απωθεί με το βάρος του το νερό και την υγρασία**, διεισδύει αποτελεσματικά, προστατεύει από τη σκουριά, λιπαίνει, απελευθερώνει και **ξεναβάζει σε κίνηση τα πάντα!!!**

New GeneRation spray



ΣΥΣΤΗΜΑ ΑΠΟΘΗΚΕΥΣΗΣ ΚΑΙ ΠΡΟΒΟΛΗΣ



ΒΑΣΕΙΣ ΣΤΗΡΙΞΗΣ

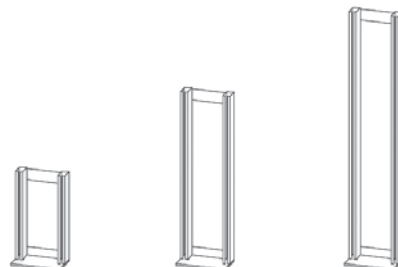

ΚΩΔΙΚΟΣ
ΔΙΑΣΤΑΣΗ cm
ΣΥΣΚ
€/ΤΕΜ.

44340000	44341007	44342004
60	121	177
1	1	1
▶ 75,00	▶ 87,00	▶ 137,00



ΚΩΔΙΚΟΣ
ΣΥΣΚ
€/ΤΕΜ.

44343001
1
▶ 5,50

ΔΙΑΦΑΝΗ ΑΝΑΚΛΙΝΟΜΕΝΑ ΣΚΑΦΑΚΙΑ ΑΠΟΘΗΚΕΥΣΗΣ



ΚΩΔΙΚΟΣ
ΔΙΑΣΤΑΣΗ mm
ΣΚΑΦΑΚΙΑ
ΣΥΣΚ
€/ΤΕΜ.

44333064	44334061	44335068	44336065	44339066
600x196x241	600x168x206	600x133x165	600x92x114	600x63x81
3	4	5	6	9
4	6	6	12	12
▶ 60,00	▶ 47,00	▶ 39,00	▶ 24,00	▶ 21,15

**ΣΕΙΡΑ
PRO**



**ΣΕΙΡΑ
PRIME**

**ΣΕΙΡΑ
ONE**



➤ ΑΔΙΑΒΡΟΧΟΙ ➤ ΠΡΟΣΤΑΣΙΑ ΑΠΟ ΣΚΟΝΗ ➤ ΑΝΘΕΚΤΙΚΟΙ ➤ ΣΥΜΒΑΤΟΙ ΜΕ ΟΛΕΣ ΤΙΣ ΣΕΙΡΕΣ QBRICK

QBRICK SYSTEM -PRO 2.0

ORGANIZER 200

ΚΩΔ. 29554409
45.2x35.8x7.9/6L

24,00 €



NEA



ORGANIZER 300

ΚΩΔ. 29554416
45.2x35.8x11/9L

27,00 €



ORGANIZER MULTI

ΚΩΔ. 29555659
25.7x18.2x6.5/1.7L

7,00 €

BOX 130 2.0

ΚΩΔ. 29555642
45x31x13/9L

13,00 €



TECHNICIAN CASE 2.0

ΚΩΔ. 29555499
45x33.2x17.1/12L

32,00 €



QBRICK SYSTEM PRO 2.0

450
mm

331
mm

500 BASIC

ΚΩΔ. 29551378
45x26x22.4/14L

21,75 €



TOOLBOX 2.0

ΚΩΔ. 29554249
45x33.4x24/19L

31,00 €



CART 2.0

ΚΩΔ. 29554256
45x39x69/28L

80,00 €

DRAWER 2 TOOLBOX 2.0 BASIC

ΚΩΔ. 29557479
45x31x24.4/4.5, 9.5L

58,00 €



CART 2.0 PLUS

ΚΩΔ. 29558858
49x40x66

87,00 €



DRAWER 3 TOOLBOX 2.0 BASIC

ΚΩΔ. 29557455
45x31x24.4/3x4.5L

69,00 €



TRANSPORTPLATFORM

ΚΩΔ. 29556908
50.6x32.5x14

41,00 €

➤ ΑΔΙΑΒΡΟΧΟΙ ➤ ΠΡΟΣΤΑΣΙΑ ΑΠΟ ΣΚΟΝΗ ➤ ΑΝΘΕΚΤΙΚΟΙ ➤ ΣΥΜΒΑΤΟΙ ΜΕ ΟΛΕΣ ΤΙΣ ΣΕΙΡΕΣ QBRICK

QBRICK SYSTEM - PRO 2.0



SET 6
ΚΩΔ. 29557967

88,00 €

QBRICK SYSTEM - PRO

➤ ΑΔΙΑΒΡΟΧΟΙ ➤ ΠΡΟΣΤΑΣΙΑ ΑΠΟ ΣΚΟΝΗ ➤ ΑΝΘΕΚΤΙΚΟΙ ➤ ΣΥΜΒΑΤΟΙ ΜΕ ΟΛΕΣ ΤΙΣ ΣΕΙΡΕΣ QBRICK
ΕΙΔΙΚΗ ΔΙΑΜΟΡΦΩΣΗ ΕΣΩΤΕΡΙΚΟΥ ΜΕ ΑΦΡΟ ΓΙΑ ΑΣΦΑΛΗ ΜΕΤΑΦΟΡΑ ΕΡΓΑΛΕΙΩΝ ΚΑΘΕ ΕΙΔΟΥΣ



ΣΕΤ 4
ΚΩΔ. 29555710
4 ΤΕΜΑΧΙΩΝ

125,00 €



ΘΗΚΗ ΕΡΓΑΛΕΙΩΝ
ΚΩΔ. 29554232

19,00 €



PRO 600
ΚΩΔ. 295450029
54.5X27X24.6

35,00 €

➤ ΜΕΓΑΛΗ ΑΝΤΟΧΗ ➤ ΠΛΗΡΗΣ ΠΡΟΣΑΡΜΟΓΗ ΣΤΙΣ ΑΝΑΓΚΕΣ ΤΟΥ ΧΡΗΣΤΗ

QBRICK SYSTEM PRIME

NEA

TOOLBOX 150 PROFI

ΚΩΔ. 29556724
53.5x32.7x14.1/13.5L

43,00 €



PRO ORGANIZER MULTI

ΚΩΔ. 29555659
25.7x18.2x6.5/1.7L

7,00 €



TOOLBOX 250 EXPERT

ΚΩΔ. 29557301
53.5x32.7x27.7/26L

52,00 €



TOOLBOX 250 VARIO

ΚΩΔ. 29556731
53.5x32.7x27.1/26L

42,00 €



CART

ΚΩΔ. 29556915
59x42.5x66/37L

99,00 €

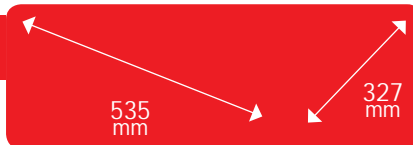

NEO

SET 1

ΚΩΔ. 29557998
59x42.5x78

190,00 €



QBRICK SYSTEM TWO

PROMO SET I

ΚΩΔ. 29552597
6 ΣΕ 1

158,00 €



ΕΠΑΓΓΕΛΜΑΤΙΚΑ ΣΥΣΤΗΜΑΤΑ ΑΠΟΘΗΚΕΥΣΗΣ ΚΑΙ ΜΕΤΑΦΟΡΑΣ ΕΡΓΑΛΕΙΩΝ

QBRICK SYSTEM**LONGER BASIC**ΚΩΔ. 29546251
79.3x38.5x32.2/50L**79,00 €****ΚΑΒΑΛΕΤΟ - 2 ΤΕΜ**

ΚΩΔ. 29557257

35,00 €

Καβαλέτα Υψηλής Αντοχής και Ποιότητας με Αντιολισθητικά Πέλματα και Πρακτικό Ράφι, στο κάτω μέρος

Ειδική διαμόρφωση που επιτρέπει τη στήριξη επιφάνειας εργασίας, με σφιγκτήρες και την εύκολη επεξεργασία υλικών

**R BOX**ΚΩΔ. 29553907
33.3x18.7x14.7/13"**6,00 €**ΚΩΔ. 29553914
38.5x23x20.4/16"**9,00 €**ΚΩΔ. 29553921
48.5x28.4x26.5/19"**14,00 €**

ΕΠΑΓΓΕΛΜΑΤΙΚΑ ΣΥΣΤΗΜΑΤΑ ΑΠΟΘΗΚΕΥΣΗΣ ΚΑΙ ΜΕΤΑΦΟΡΑΣ ΕΡΓΑΛΕΙΩΝ

QBRICK SYSTEM ONE

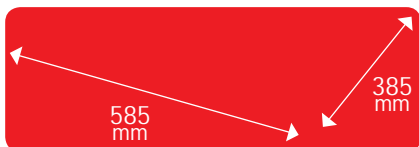

ORGANIZER M

ΚΩΔ. 29551286
27.5x37.5x95

18,00 €



ORGANIZER XL

ΚΩΔ. 29551262
58.2x38.7x13.1

55,00 €



200 2.0 VARIO

ΚΩΔ. 29554454
58.5x38.5x17.1/15,4L

44,00 €



200 PROFI

ΚΩΔ. 29545926
58.5x38.5x19/15,5L

58,00 €

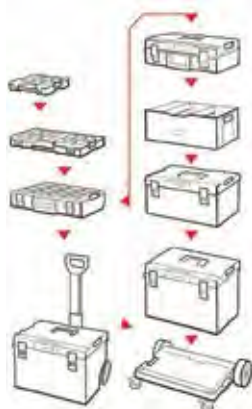

350 PROFI 2.0

ΚΩΔ. 29545933
58.5x38.5x32/38L

59,00 €



DRAWER 2 TOOLBOX 2

ΚΩΔ. 29559770

107,00 €



350 BASIC

ΚΩΔ. 29545896
58.5x38.5x32/38L

53,00 €



450 BASIC

ΚΩΔ. 29545902
58.5x38.5x42/52L

59,00 €

ΦΤΙΑΞΕ ΤΟ ΔΙΚΟ ΣΟΥ ΣΥΣΤΗΜΑ



BOX PLUS

ΚΩΔ. 29548385
57.6x35.9x23.7

27,00 €



ONE CART

ΚΩΔ. 29551132
58.5x46x76.5

93,00 €



TRANSPORT PLATFORM 2

ΚΩΔ. 29559947

65,00 €

CART 2.0.

ΚΩΔ. 29557202
64.1x48.5x66/52L

122,00 €



➤ ΑΔΙΑΒΡΟΧΟΙ ➤ ΠΡΟΣΤΑΣΙΑ ΑΠΟ ΣΚΟΝΗ ➤ ΑΝΘΕΚΤΙΚΟΙ ➤ ΣΥΜΒΑΤΟΙ ΜΕ ΟΛΕΣ ΤΙΣ ΣΕΙΡΕΣ QBRICK

QBRICK SYSTEM ONE - ΣΕΤ ΕΡΓΑΛΕΙΟΦΟΡΩΝ



ΣΕΤ 1
ΚΩΔ. 29510010
2 TEM
132,00 €

◀ PRO 600

◀ ONE CART

ΣΕΤ 2
ΚΩΔ. 29510011
3 TEM
205,00 €



200 PROFI ▶

350 BASIC ▶

ONE CART ▶

CART VARIO
SET 2.0 NR 1
ΚΩΔ. 29558018
TEM
207,00 €



NEO



ΕΡΓΑΛΕΙΟΘΗΚΗ SEMI PROFI CARBO

ΚΩΔΙΚΟΣ	ΔΙΑΣΤΑΣΗ	ΣΥΣΚ	€/ΣΕΤ
29548873	12"+16"	1	▶ 15,00
29548989	12"+20"	1	▶ 25,00



ΕΡΓΑΛΕΙΟΘΗΚΗ FORMULA CARBO

**ΚΛΙΠΣ
ΑΛΟΥΜΙΝΙΟΥ**

ΚΩΔΙΚΟΣ	ΜΟΝΤΕΛΟ	ΔΙΑΣΤΑΣΗ	ΣΥΣΚ	€/ΤΕΜ
29550364	S500	462x256x242	1	▶ 21,30
29550371	S600	547x271x278	1	▶ 26,70
29552092	S700	595x289x328	1	▶ 31,60



ΘΗΚΗ ΕΡΓΑΛΕΙΩΝ HD 600mm

ΚΩΔΙΚΟΣ	ΔΙΑΣΤΑΣΗ	ΣΥΣΚ	€/ΤΕΜ
29517916	600x240x380	1	▶ 32,00



**ΚΛΙΠΣ ΑΠΟ
TECHNICAL POLYAMIDE**



ΕΡΓΑΛΕΙΟΘΗΚΗ ΤΡΟΧΗΛΑΤΗ COMPACT HD

ΚΩΔΙΚΟΣ	ΔΙΑΣΤΑΣΗ	ΣΥΣΚ	€/ΤΕΜ
29549474	450x350x645	1	▶ 46,00

**ΚΛΙΠΣ ΑΠΟ
TECHNICAL
POLYAMIDE**



Functional organism



Supporting slot



Covers covers impact resistant



Lock handle



Measure



ΘΗΚΗ ΕΡΓΑΛΕΙΩΝ PREMIUM 400mm

ΚΩΔΙΚΟΣ	ΔΙΑΣΤΑΣΗ	ΣΥΣΚ	€/ΤΕΜ
29501178	400x320x180	1	▶ 9,75



ΤΑΜΠΑΚΕΡΑ ΤWIN

ΚΩΔΙΚΟΣ	ΜΟΝΤΕΛΟ	ΔΙΑΣΤΑΣΗ	ΣΥΣΚ	€/ΤΕΜ
29509973	B300/284MM	284x192x100	1	▶ 8,00
29509980	B400/385MM	385x283x100	1	▶ 14,00



ΤΑΜΠΑΚΕΡΑ ΣΕΤ DOMINO 19"/25"/36"

ΚΩΔΙΚΟΣ	ΔΙΑΣΤΑΣΗ	ΣΥΣΚ	€/ΤΕΜ
29585761	364x268x110	1	▶ 12,40

ORGANIZER ΕΡΓΑΛΕΙΩΝ ΤΟΙΧΟΥ MEDIUM

ΚΩΔΙΚΟΣ	ΔΙΑΣΤΑΣΗ	ΣΥΣΚ	€/ΤΕΜ
29550081	600x400x145	1	▶ 25,00





UV
LED

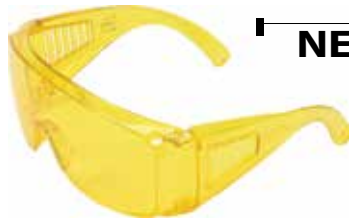

NEO 

ΦΑΚΟΣ UV + ΓΥΑΛΙΑ

ΚΩΔΙΚΟΣ	YATO 	LED	ΣΥΣΚ	€/ΤΕΜ
20008581	YT-08581	51		15,00



51 LED	UV	395 nm	3x1.5V (AAA) NOT INCLUDED
-----------	----	-----------	---------------------------------



5W	400 lm
4500K	CRI 95
CHARGING TIME 4 h	WORK TIME 4 h
3.7V 2600mAh Li-Ion	IP65
IK07	x2
	HOOK

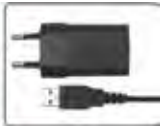

COB
LED

NEO 

ΚΩΔΙΚΟΣ	YATO 	ΣΥΣΚ	€/ΤΕΜ
20008509	YT-08509	12	77,85



7+3 W	60-600 lm 120 lm
6500 K	3.7V 2600mAh Li-Ion
1.5-16.5h WORK TIME	4.5h CHARGING TIME
USB BATTERY CHARGER	MAGNETIC
BRIGHT LIGHTING	POLYCARBONATE DIFFUSER
LED CHARGE INDICATOR	HOOK



COB
LED

NEO 

ΚΩΔΙΚΟΣ	YATO 	ΣΥΣΚ	€/ΤΕΜ
20008519	YT-08519	20	58,00



COB
LED

10W	800 lm	3.7V 4400mAh Li-Ion	4400mAh
6000 K	Micro USB	WORK TIME 2.5 h	CHARGING TIME 5.5 h



NEO 

ΚΩΔΙΚΟΣ	YATO 	ΣΥΣΚ	€/ΤΕΜ
20081820	YT-81820	6	43,00



30+7 LED	140 lm
FRONT LIGHTING	3.7V 2000mAh Li-Ion
WORK TIME	CHARGING TIME
4 h	4 h
USB BATTERY CHARGER	x3
x2 HOOK	POLYCARBONATE DIFFUSER



NEO 

ΚΩΔΙΚΟΣ	YATO 	ΣΥΣΚ	€/ΤΕΜ
20008507	YT-08507	12	36,00



FRONT LIGHTING	1+7 LED	250 lm	3.7V 1800mAh Li-Ion
USB BATTERY CHARGER	12V BATTERY CHARGER	CHARGING TIME	WORK TIME
		4 h	4 h
	x2	x2 HOOK	

NEO 

COB LED

ΚΩΔΙΚΟΣ	YATO 	ΣΥΣΚ	€/ΤΕΜ
20008504	YT-08504	10	33,00



POWER LED

6W	XPG3	500 lm
200 m	3 LIGHTING MODES ZOOM
3.7V 2200mAh Li-Ion	IPX7	USB BATTERY CHARGER



XP-G3 ME CREE LED 6W USB 

ΚΩΔΙΚΟΣ	YATO 	ΣΥΣΚ	€/ΤΕΜ
20008568	YT-08568	6	25,00



NEO 

5W	XTE	350 lm
150 m	4 LIGHTING MODES ZOOM
3.7 V 550 mAh Li-Ion	USB CHARGING	IPX4

POWER LED



XT-E ME LED CREE 5W USB - 94x27mm

ΚΩΔΙΚΟΣ	YATO 	ΣΥΣΚ	€/ΤΕΜ
20008569	YT-08569	12	18,30



ΦΑΚΟΣ ΚΕΦΑΛΗΣ 100 lm

ΚΩΔΙΚΟΣ	YATO 	lm	ΣΥΣΚ €/ΤΕΜ
20008590	YT-08590	100	25 11,50

3W

ZOOM

WATER PROOF

100 lm

1.5V 3x AAA



ΦΑΚΟΣ ΚΕΦΑΛΗΣ 450 lm

ΚΩΔΙΚΟΣ	YATO 	lm	ΣΥΣΚ €/ΤΕΜ
20008591	YT-08591	450	6 20,00

10W **XM-L2**

450 lm **ZOOM**

3 LIGHTING MODES

6V 4x AA



ΚΩΔΙΚΟΣ	YATO 	lm	ΣΥΣΚ €/ΤΕΜ
20081821	YT-81821	680	8 17,20



10W **680 lm**

6V 4x AA **3 LIGHTING MODES**

PA6 POLYCARBONATE **MAGNETIC**



NEO 



ΚΩΔΙΚΟΣ	YATO 	ΣΥΣΚ	€/ΤΕΜ
20008514	YT-08514	12	7,60

ΚΩΔΙΚΟΣ	YATO 	ΣΥΣΚ	€/ΤΕΜ
20008513	YT-08513	50	10,00

ΜΕΓΑΛΗΣ ΕΜΒΕΛΕΙΑΣ



ΚΩΔΙΚΟΣ	YATO 	ΣΥΣΚ	€/ΤΕΜ
20008567	YT-08567	8	26,00



ΦΑΚΟΣ LED

ΚΩΔΙΚΟΣ	VOREL 	ΜΠΑΤΑΡΙΑ	ΣΥΣΚ	€/ΤΕΜ
21182724	82724	3xAAA	12	6,50



ΦΑΚΟΣ LED

ΚΩΔΙΚΟΣ	VOREL 	ΜΠΑΤΑΡΙΑ	ΣΥΣΚ	€/ΤΕΜ
21188555	88555	3xAAA	12	9,40

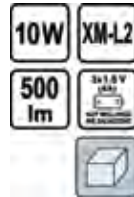

ΦΑΚΟΣ LED

ΚΩΔΙΚΟΣ	VOREL	ΜΠΑΤΑΡΙΑ	ΣΥΣΚ	€/ΤΕΜ
21188560	88560	3xAA	12	21,40



ΕΥΚΑΜΠΤΟΣ ΜΑΓΝΗΤΗΣ ΜΕ LED

ΚΩΔΙΚΟΣ	VOREL	LED	ΜΠΑΤΑΡΙΑ	ΣΥΣΚ	€/ΤΕΜ
21178405	78405	3	4xLR44	12	6,40



ΦΑΚΟΣ LED

ΚΩΔΙΚΟΣ	VOREL	ΜΠΑΤΑΡΙΑ	ΣΥΣΚ	€/ΤΕΜ
21182726	82726	3xAA	12	5,35



ΦΑΚΟΣ LED

ΚΩΔΙΚΟΣ	VOREL	LED	ΜΠΑΤΑΡΙΑ	ΣΥΣΚ	€/ΤΕΜ
21182730	82730	20+3	3xAAA	12	5,15





ΛΑΜΠΑ ΣΥΝΕΡΓΕΙΟΥ

ΚΩΔΙΚΟΣ	VOREL	W	ΤΥΠΟΣ	ΣΥΣΚ	€/ΤΕΜ
21182715	82715	60	ΠΛΑΣΤΙΚΗ	10	17,95



ΛΑΜΠΑ ΣΥΝΕΡΓΕΙΟΥ ΛΑΣΤΙΚΟ

ΚΩΔΙΚΟΣ	VOREL	W	ΤΥΠΟΣ	ΣΥΣΚ	€/ΤΕΜ
21182717	82717	100	ΛΑΣΤΙΚΟ	10	31,80



ΛΑΜΠΑ ΣΥΝΕΡΓΕΙΟΥ LED

ΚΩΔΙΚΟΣ	VOREL	W	LED	ΣΥΣΚ	€/ΤΕΜ
21182706	82706	4.5	24	10	14,90





ΕΡΓΑΛΕΙΑ ΚΑΤΑΣΚΕΥΩΝ ΟΙΚΟΔΟΜΙΚΑ ΕΡΓΑΛΕΙΑ



ΕΡΓΑΛΕΙΑ ΚΑΤΑΣΚΕΥΩΝ [270 - 293]



Σφυριά | Σκαρπέλα

Σφιγκτήρες | Μέγγενες

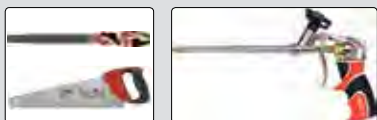

Λίμες | Πριόνια | Ψαλίδια

Πιστόλια Αφρού και Σιλικόνης

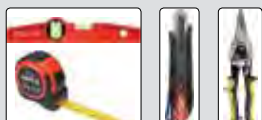

ΜΕΤΡΗΣΗ - ΚΟΠΗ [294 - 309]

Μέτρα | Αλφάδια | Κοπίδια



ΟΙΚΟΔΟΜΙΚΑ ΕΡΓΑΛΕΙΑ [310 - 341]

Πινέλα | Σπάτουλες | Τριβίδια

Εργαλεία Γυψοσανίδας





DIN
1041

- Μεταλλικό δακτυλίδι συγκράτησης.
- Υψηλής ποιότητας ξύλινη λαβή.
- Forged carbon steel.

ΣΦΥΡΙ ΜΗΧΑΝΙΚΩΝ ΠΕΝΑΣ

ΚΩΔΙΚΟΣ	YATO 	ΒΑΡΟΣ (g)	ΣΥΣΚ	€/ΤΕΜ
20004501	YT-4501	100	12	3,30
20004502	YT-4502	200	6	3,95
20004503	YT-4503	300	6	4,95
20004504	YT-4504	400	6	5,60
20004505	YT-4505	500	6	6,00
20004506	YT-4506	600	6	7,15



DIN
6475

- Μεταλλικό δακτυλίδι συγκράτησης.
- Υψηλής ποιότητας ξύλινη λαβή.
- Forged carbon steel.

ΒΑΡΙΟΠΟΥΛΑ

ΚΩΔΙΚΟΣ	YATO 	ΒΑΡΟΣ (g)	ΣΥΣΚ	€/ΤΕΜ
20004550	YT-4550	1000	6	8,70
20004551	YT-4551	1250	6	10,15
20004552	YT-4552	1500	6	11,70
20004553	YT-4553	2000	6	14,45



- Λαβή Fiberglass

ΛΑΣΤΙΧΕΝΙΑ ΜΑΤΣΟΛΑ

ΚΩΔΙΚΟΣ	YATO 	ΒΑΡ.(g)	ΜΗΚ(mm)	Ø(mm)	ΣΥΣΚ	€/ΤΕΜ
20004594	YT-4594	440	340	50	6	5,55



- Λαβή ξύλινη

ΛΑΣΤΙΧΕΝΙΑ ΜΑΤΣΟΛΑ

ΚΩΔΙΚΟΣ	YATO 	ΒΑΡ.(g)	ΜΗΚ(mm)	Ø(mm)	ΣΥΣΚ	€/ΤΕΜ
20004601	YT-4601	340	291	49	12	4,70
20004602	YT-4602	370		50	6	5,55
20004603	YT-4603	580	341	58	6	6,45
20004604	YT-4604	780	341	63	6	8,15



PU

ΜΑΤΣΟΛΑ ΜΗ ΑΝΑΠΗΔΗΣΗΣ

ΚΩΔΙΚΟΣ	YATO	ΒΑΡ.(g)	ΜΗΚ.(mm)	Ø(mm)	ΣΥΣΚ	€/ΤΕΜ
20004620	YT-4620	740	300	44.5	4	8,40
20004622	YT-4622	900	336	53.5	4	10,40



NYLON
PU

➤ Λαβή ξύλινη

ΜΑΤΣΟΛΑ NYLON / PU

ΚΩΔΙΚΟΣ	YATO	ΒΑΡ.(g)	ΜΗΚ.(mm)	Ø(mm)	ΣΥΣΚ	€/ΤΕΜ
20004631	YT-4631	250	280	28	6	13,85
20004632	YT-4632	340	315	35	6	18,05
20004633	YT-4633	660	350	45	6	27,75



DIN
5131
7294

GENUINE
HICKORY

ΤΣΕΚΟΥΡΙ

ΚΩΔΙΚΟΣ	YATO	ΒΑΡ.(g)	ΜΗΚ.(mm)	Ø(mm)	ΣΥΣΚ	€/ΤΕΜ
20008002	YT-8002	800	380	5131	20	12,85
20008003	YT-8003	1000	430	5131	12	14,15
20008004	YT-8004	1250	710	7294	12	22,00



ΣΦΥΡΙ

ΚΩΔΙΚΟΣ	VOREL	g	ΣΥΣΚ	€/ΤΕΜ
21130310	30310	100	6	3,20
21130320	30320	200	6	3,95
21130330	30330	300	6	4,75
21130340	30340	400	6	5,35



CrV
60 **HRC**
56-62

ΣΚΑΡΠΕΛΑ

ΚΩΔΙΚΟΣ	YATO 	ΔΙΑΣΤΑΣΕΙΣ (mm)	ΣΥΣΚ	€/ΤΕΜ
20006241	YT-6241	8	10	4,55
20006242	YT-6242	10	10	4,65
20006243	YT-6243	12	10	4,70
20006244	YT-6244	14	10	4,75
20006245	YT-6245	15	10	4,85
20006246	YT-6246	16	10	4,95
20006247	YT-6247	18	10	5,10
20006248	YT-6248	20	10	5,20
20006249	YT-6249	22	10	5,35
20006251	YT-6251	25	10	5,50
20006253	YT-6253	28	10	5,65
20006256	YT-6256	35	10	6,05



ΣΚΑΡΠΕΛΑ ΣΕΤ 4 ΤΜΧ.

ΚΩΔΙΚΟΣ	YATO 	ΣΥΣΚ	€/ΤΕΜ
20006260	YT-6260	5	17,50

4 pcs **10,16** **20,25** mm **60** CrV **HRC** 58-60



6 pcs



ΣΕΤ ΞΥΛΟΓΛΥΠΤΙΚΗΣ

ΚΩΔΙΚΟΣ	VOREL 	ΣΥΣΚ	€/ΤΕΜ
21125700	25700	6	4,55



DROP FORGED

ΛΟΣΤΟΣ

ΚΩΔΙΚΟΣ	YATO 	ΔΙΑΣΤΑΣΕΙΣ (mm)	ΣΥΣΚ	€/ΤΕΜ
20046801	YT-46801	450x18	6	6,40
20046802	YT-46802	600x18	6	8,85
20046803	YT-46803	750x18	6	10,05
20046804	YT-46804	900x18	5	11,75



ΜΕΓΙΣΤΟ ΜΗΚΟΣ 300mm
ΠΛΑΤΟΣ 6-32mm

ΤΥΠΟΥ ΧΕΛΙΔΟΝΟΟΥΡΑΣ



ΜΗΤΡΑ ΔΙΑΜΟΡΦΩΣΗΣ ΣΥΝΔΕΣΜΩΝ

ΚΩΔΙΚΟΣ	YATO 	ΣΥΣΚ	€/ΤΕΜ
20044085	YT-44085		110,00



ΚΟΠΙΔΙΑ

ΚΩΔΙΚΟΣ	YATO	ΜΗΚ(μm)	ΦΑΡΔΟΣ	ΣΥΣΚ	€/ΤΕΜ
20047147	YT-47147	142	10.0	20	2,20
20047148	YT-47148	152	12.5	20	2,35
20047149	YT-47149	172	16.0	20	3,05

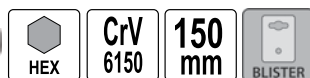

ΖΟΥΜΠΑΔΕΣ

ΚΩΔΙΚΟΣ	YATO	ΜΗΚ(μm)	Ø ΜΥΤΗΣ	ΣΥΣΚ	€/ΤΕΜ
20047141	YT-47141	150	1.5	20	1,60
20047142	YT-47142	150	3.0	20	1,95
20047143	YT-47143	150	4.0	20	1,95
20047144	YT-47144	150	5.0	20	1,95
20047145	YT-47145	150	6.0	20	2,10
20047146	YT-47146	150	8.0	20	2,10

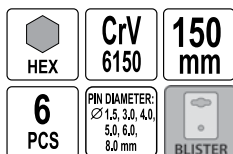

ΖΟΥΜΠΑΔΕΣ ΣΕΤ 6 ΤΕΜΑΧΙΩΝ

ΚΩΔΙΚΟΣ	YATO	ΜΗΚΟΣ(μm)	ΣΥΣΚ	€/ΤΕΜ
20047121	YT-47121	150	6/24	10,05

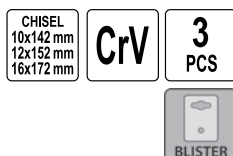

ΚΟΠΙΔΙΑ ΣΕΤ 3 ΤΕΜΑΧΙΩΝ

ΚΩΔΙΚΟΣ	YATO	ΣΥΣΚ	€/ΤΕΜ
20004711	YT-4711	6	12,50

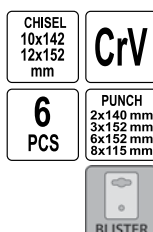

ΠΟΝΤΕΣ & ΚΟΠΙΔΙΑ ΣΕΤ 6 ΤΕΜΑΧΙΩΝ

ΚΩΔΙΚΟΣ	YATO	ΣΥΣΚ	€/ΤΕΜ
20004712	YT-4712	6	16,00

 CrV
6150

ΠΟΝΤΕΣ

ΚΩΔΙΚΟΣ	YATO®	ΜΗΚ(μm)	(mm)	ΣΥΣΚ	€/ΤΕΜ
20047150	YT-47150	100	6.0	20	1,90
20047151	YT-47151	112	8.0	20	2,10

NEO

 125
mm

ΠΟΝΤΑ ΡΥΘΜΙΖΟΜΕΝΗ

ΚΩΔΙΚΟΣ	YATO®	ΜΗΚ(μm)	ΣΥΣΚ	€/ΤΕΜ
20047161	YT-47161	125	12	6,00

 125
mm

ΑΥΤΟΜΑΤΗ ΠΟΝΤΑ

ΚΩΔΙΚΟΣ	YATO®	L(mm)	ΣΥΣΚ	€/ΤΕΜ
20047160	YT-47160	125	12	5,40

 140
mm

YG6X

ΧΑΡΑΚΤΗΣ - ΣΗΜΑΔΕΥΤΗΡΙ

ΚΩΔΙΚΟΣ	YATO®	L(mm)	ΣΥΣΚ	€/ΤΕΜ
20003740	YT-3740	140	6	2,30

 4
pcs

ΣΕΤ ΣΓΡΟΜΠΙΣ

ΚΩΔΙΚΟΣ	YATO®	ø(mm)	ΣΥΣΚ	€/ΤΕΜ
20035880	YT-35880	2; 3; 4; 5	20	2,10
20035881	YT-35881	6; 8; 10	20	3,25



ΣΓΡΟΜΠΙΑ

ΚΩΔΙΚΟΣ	YATO®	ø(mm)	ΣΥΣΚ	€/ΤΕΜ
20035858	YT-35858	10	20	1,60
20035860	YT-35860	12	20	1,90
20035863	YT-35863	15	20	2,70
20035864	YT-35864	16	20	3,05
20035866	YT-35866	18	20	3,85
20035868	YT-35868	20	20	4,55
20035870	YT-35870	22	20	5,35
20035873	YT-35873	25	20	7,75



ΣΕ ΠΩΛΗΣΕΙΣ
No1

ΜΑΝΤΑΛΑΚΙ

ΚΩΔΙΚΟΣ	YATO 	L(mm)	ΜΕΓ.ΑΝΟΙΓ.	ΜΕΓ.ΒΑΘ.	ΣΥΣΚ	€/ΤΕΜ
20064270	YT-64270	100	42	44	24	1,60
20064271	YT-64271	150	55	68	12	2,70
20064272	YT-64272	200	79	91	10	3,30



NEO 

ΜΑΝΤΑΛΑΚΙ

ΚΩΔΙΚΟΣ	YATO 	L(mm)	ΜΕΓ.ΑΝΟΙΓ.	ΜΕΓ.ΒΑΘ.	ΣΥΣΚ	€/ΤΕΜ
20064275	YT-64275	55	20	20	500	0,47
20064276	YT-64276	100	25	25	48	1,62
20064277	YT-64277	150	50	50	24	2,80
20064278	YT-64278	230	90	90	8	5,40



1"
25mm

ΣΦΙΓΚΤΗΡΑΣ ΤΥΠΟΥ C

ΚΩΔΙΚΟΣ	YATO 	ΜΕΓΕΘΟΣ(mm)	ΠΙΕΣΗ(kg)	ΣΥΣΚ	€/ΤΕΜ
20064251	YT-64251	50	200	50	2,60
20064252	YT-64252	75	280	30	5,00
20064253	YT-64253	100	350	30	6,10
20064254	YT-64254	125	390	18	8,80
20064255	YT-64255	150	450	12	10,30

**ΣΦΙΓΚΤΗΡΑΣ ΜΑΡΑΓΚΩΝ**

ΚΩΔΙΚΟΣ	YATO 	ΜΕΓΕΘΟΣ(mm)	ΣΥΣΚ	€/ΤΕΜ
20006440	YT-6440	50x100	12	4,80
20006441	YT-6441	50x150	12	4,90
20006442	YT-6442	50x200	12	5,00
20006443	YT-6443	50x250	12	5,40
20006444	YT-6444	50x300	12	5,70
20006445	YT-6445	80x200	10	7,10
20006446	YT-6446	80x250	10	7,60
20006447	YT-6447	80x300	10	7,90
20006448	YT-6448	80x500	10	8,95
20006449	YT-6449	120x300	10	13,50
20006450	YT-6450	120x500	10	15,00
20006451	YT-6451	120x800	6	18,50
20006452	YT-6452	120x1000	6	20,00
20006453	YT-6453	120x1200	6	24,50
20006454	YT-6454	120x1500	6	28,90

ΓΩΝΙΑΚΗ ΜΕΓΓΕΝΗ

ΚΩΔΙΚΟΣ	VOREL	mm	ΣΥΣΚ	€/ΤΕΜ
21138751	38751	65	6	24,00

ΣΦΙΓΚΤΗΡΑΣ ΣΩΛΗΝΑ 3/4"

ΚΩΔΙΚΟΣ	VOREL	ΣΥΣΚ	€/ΤΕΜ
21138620	38620	12	14,60

ΣΦΙΓΚΤΗΡΑΣ ΙΜΑΝΤΑ

ΚΩΔΙΚΟΣ	VOREL	m	ΣΥΣΚ	€/ΤΕΜ
21138531	38531	4	20	11,00

ΝΤΑΒΙΝΤΙΑ

ΚΩΔΙΚΟΣ	VOREL	mm	ΣΥΣΚ	€/ΤΕΜ
21137100	37100	50x100	12	3,60
21137101	37101	50x150	12	4,15
21137102	37102	50x200	12	4,30
21137106	37106	80x200	10	6,50
21137108	37108	80x300	10	7,25
21137110	37110	120x300	10	13,50
21137112	37112	120x800	10	18,20
21137114	37114	120x1200	6	25,25
21137115	37115	120x1500	6	30,25



➤ Αμόνι και μάγουλα από ατσάλι

ΜΕΓΓΕΝΕΣ ΠΕΡΙΣΤΡΕΦΟΜΕΝΕΣ



7
kg

ΚΩΔΙΚΟΣ	YATO	ΒΑΡΟΣ (kg)	ΣΥΣΚ	€/ΤΕΜ
20006501	YT-6501	7	2	80,00



10
kg

ΚΩΔΙΚΟΣ	YATO	ΒΑΡΟΣ (kg)	ΣΥΣΚ	€/ΤΕΜ
20006502	YT-6502	10	2	99,00



15
kg

ΚΩΔΙΚΟΣ	YATO	ΒΑΡΟΣ (kg)	ΣΥΣΚ	€/ΤΕΜ
20006503	YT-6503	15	1	129,00



21
kg

ΚΩΔΙΚΟΣ	YATO	ΒΑΡΟΣ (kg)	ΣΥΣΚ	€/ΤΕΜ
20006504	YT-6504	21	1	179,00

ΜΕΓΓΕΝΕΣ ΔΙΠΛΗΣ ΠΕΡΙΣΤΡΟΦΗΣ



10
kg



ΣΕ ΠΩΛΗΣΕΙΣ
No1

ΚΩΔΙΚΟΣ	YATO	ΒΑΡΟΣ (kg)	ΣΥΣΚ	€/ΤΕΜ
20006505	YT-6505	10	1	109,00



20
kg

ΚΩΔΙΚΟΣ	YATO	ΒΑΡΟΣ (kg)	ΣΥΣΚ	€/ΤΕΜ
20006506	YT-6506	20	1	185,00

➤ Αμόνι και μάγουλα από ατσάλι

ΜΕΓΓΕΝΕΣ ΔΡΑΠΑΝΟΥ

ΚΩΔΙΚΟΣ	YATO	ΑΝΟΙΓΜΑ(mm)	ΣΥΣΚ	€/ΤΕΜ
20065071	YT-65071	50	10	17,00
20065072	YT-65072	100	6	27,00
20065073	YT-65073	150	2	49,00



ΣΦΙΓΚΤΗΡΕΣ ΣΚΑΝΔΑΛΗΣ

NEO¹**Μεταλλική Μπάρα 6x16mm**

μεγάλης αντοχής για ακαμψία και αυξημένη δύναμη συγκράτησης 50-60 Kg.

QUICK
LOCK

ΚΩΔΙΚΟΣ	YATO®	ΜΗΚΟΣ (mm)	ΣΥΣΚ	€/ΤΕΜ
20064312	YT-64312	200		5,50
20064313	YT-64313	300		6,00
20064314	YT-64314	450		7,50
20064315	YT-64315	600		8,50
20064316	YT-64316	750		9,60



Δυνατότητα αναστροφής και χρήσης ως αποστάτη/ανυψωτή

Σκανδάλη και σιαγόνες από ενισχυμένο νάilon για αντοχή και χαμηλό βάρος

Αντιολισθητικά μάγουλα σιαγόνων για σταθερό κράτημα, χωρίς να τραυματίζονται τα συγκρατούμενα κομμάτια



ΜΑΓΝΗΤΙΚΗ ΓΩΝΙΑ ΣΥΓΚΟΛΛΗΣΗΣ

ΚΩΔΙΚΟΣ	YATO®	(kg)	(mm)	ΣΥΣΚ	€/ΤΕΜ
20000863	YT-0863	11.5	82x120x13	6	2,90
20000864	YT-0864	22.5	102x155x17	6	4,90
20000865	YT-0865	34	122x190x25	6	8,60

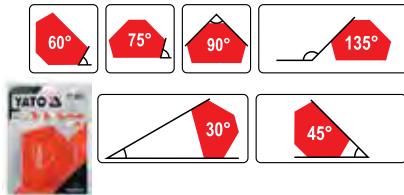

ΜΑΓΝΗΤΙΚΗ ΓΩΝΙΑ ΣΥΓΚΟΛΛΗΣΗΣ

ΚΩΔΙΚΟΣ	YATO®	(kg)	(mm)	ΣΥΣΚ	€/ΤΕΜ
20000866	YT-0866	11.5	64x95x14	6	3,95
20000867	YT-0867	34.0	111x136x24	6	8,25

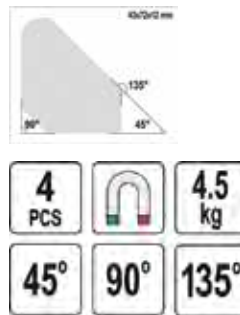

ΣΕΤ 4 ΜΑΓΝΗΤΙΚΩΝ ΓΩΝΙΩΝ

ΚΩΔΙΚΟΣ	YATO®	(kg)	(mm)	ΣΥΣΚ	€/ΣΕΤ
20008677	YT-08677	4.5	47x72x12	6	6,90



NEO

NEA 2 pcs

ΜΑΓΝΗΤΙΚΕΣ ΓΩΝΙΕΣ - 2 ΤΕΜ



ΚΩΔΙΚΟΣ	YATO®	(kg)	ΜΕΓΕΘΟΣ (mm)	ΣΥΣΚ	€/ΤΕΜ
20008721	YT-08721	10	98x113	6	18,00

60° 90° 120°



ΚΩΔΙΚΟΣ	YATO®	(kg)	ΜΕΓΕΘΟΣ (mm)	ΣΥΣΚ	€/ΤΕΜ
20008722	YT-08722	25	54x84	40	16,00

30° 60° 90°



ΚΩΔΙΚΟΣ	YATO®	(kg)	ΜΕΓΕΘΟΣ (mm)	ΣΥΣΚ	€/ΤΕΜ
20008723	YT-08723	32	70x110	32	25,00

30° 60° 90°

ΛΙΜΕΣ ΓΙΑ ΑΛΥΣΟΠΡΙΟΝΑ 3 ΤΜΧ

ΚΩΔΙΚΟΣ	YATO	Ø (mm)	FOR	ΣΥΣΚ	€/ΤΕΜ
20085025	YT-85025	4.0	3/8"	4	3,15
20085027	YT-85027	4.8	0,325"	4	3,15

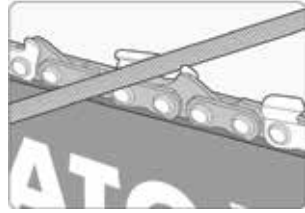
ΛΙΜΕΣ ΓΙΑ ΑΛΥΣΟΠΡΙΟΝΑ ΜΕ ΟΔΗΓΟ

ΚΩΔΙΚΟΣ	YATO	Ø (mm)	FOR	ΣΥΣΚ	€/ΤΕΜ
20085030	YT-85030	4.0	3/8"	4	3,75
20085032	YT-85032	4.8	0,325"	4	3,75

ΔΙΑΜΑΝΤΟΛΙΜΑ ΑΚΟΝΙΣΜΑΤΟΣ

ΚΩΔΙΚΟΣ	YATO	GRIT	L (mm)	ΣΥΣΚ	€/ΤΕΜ
20076080	YT-76080	240/400	250	12	8,60

240/400
GRIT250
mm
ΔΙΑΜΑΝΤΟΠΛΑΚΑ ΑΚΟΝΙΣΜΑΤΟΣ

ΚΩΔΙΚΟΣ	YATO	GRIT	(mm)	ΣΥΣΚ	€/ΤΕΜ
20076086	YT-76086	400	4x150	10	7,50
20076087	YT-76087	600	4x150	10	7,50

150x50
mmSTEEL
BASE

ΛΙΜΑ ΠΛΑΚΕ

ΚΩΔΙΚΟΣ	YATO	#	ΜΗΚΟΣ(mm)	ΣΥΣΚ	€/ΤΕΜ
20062229	YT-62229	1	200	20	4,30
20006223	YT-6223	1	250	20	5,85
20006180	YT-6180	2	150	20	3,75
20006185	YT-6185	2	200	20	4,40
20006228	YT-6228	2	250	20	6,05
20006190	YT-6190	2	300	10	7,45
20062329	YT-62329	3	200	20	4,70
20006233	YT-6233	3	250	20	6,55

ΛΙΜΑ ΗΜΙΣΤΡΟΓΓΥΛΗ

ΚΩΔΙΚΟΣ	YATO	#	ΜΗΚΟΣ(mm)	ΣΥΣΚ	€/ΤΕΜ
20062259	YT-62259	1	200	20	5,00
20006226	YT-6226	1	250	20	6,50
20006183	YT-6183	2	150	20	4,15
20006188	YT-6188	2	200	20	5,05
20006231	YT-6231	2	250	20	6,55
20006193	YT-6193	2	300	10	8,25
20062349	YT-62349	3	200	20	5,50
20006235	YT-6235	3	250	20	7,00

ΛΙΜΑ ΣΤΡΟΓΓΥΛΗ

ΚΩΔΙΚΟΣ	YATO	#	ΜΗΚΟΣ(mm)	ΣΥΣΚ	€/ΤΕΜ
20006184	YT-6184	2	150	20	3,30
20006189	YT-6189	2	200	20	3,65
20006232	YT-6232	2	250	20	4,60

ΛΙΜΑ ΤΡΙΓΩΝΗ

ΚΩΔΙΚΟΣ	YATO	#	ΜΗΚΟΣ(mm)	ΣΥΣΚ	€/ΤΕΜ
20006182	YT-6182	2	150	20	3,55
20006187	YT-6187	2	200	20	4,15
20006230	YT-6230	2	250	20	5,40

ΛΙΜΑ ΤΕΤΡΑΓΩΝΗ

ΚΩΔΙΚΟΣ	YATO	#	ΜΗΚΟΣ(mm)	ΣΥΣΚ	€/ΤΕΜ
20006181	YT-6181	2	150	20	3,55
20006186	YT-6186	2	200	20	3,95
20006229	YT-6229	2	250	20	5,15

ΣΕΤ ΛΙΜΕΣ 3 ΤΜΧ

ΚΩΔΙΚΟΣ	YATO	mm	ΣΥΣΚ	€/ΤΕΜ
20006237	YT-6237	250	10	17,00



6
pcs
ΣΕΤ ΛΙΜΕΣ 6 ΤΜΧ

ΚΩΔΙΚΟΣ	YATO	L (mm)	mm	ΣΥΣΚ	€/ΤΕΜ
20006160	YT-6160	65	3x140	50	4,00

6
pcs
ΣΕΤ ΛΙΜΕΣ 6 ΤΜΧ

ΚΩΔΙΚΟΣ	YATO	L (mm)	mm	ΣΥΣΚ	€/ΤΕΜ
20006161	YT-6161	75	4x160	25	5,00
20006162	YT-6162	85	5x180	25	7,00

5
pcs
ΣΕΤ ΔΙΑΜΑΝΤΟΛΙΜΕΣ 5 ΤΜΧ

ΚΩΔΙΚΟΣ	YATO	L (mm)	mm	ΣΥΣΚ	€/ΤΕΜ	
20006156	YT-6156	150	70	5x180	10	7,50

ΡΑΣΠΕΣ ΞΥΛΟΥ
250
mm #45
STEEL
ΡΑΣΠΑ ΠΛΑΚΕ

ΚΩΔΙΚΟΣ	YATO	#	ΣΥΣΚ	€/ΤΕΜ
20006219	YT-6219	45	12	5,70

250
mm #45
STEEL
ΡΑΣΠΑ ΗΜΙΣΤΡΟΓΓΥΛΗ

ΚΩΔΙΚΟΣ	YATO	#	ΣΥΣΚ	€/ΤΕΜ
20006220	YT-6220	45	12	6,20

250
mm #45
STEEL
ΡΑΣΠΑ ΣΤΡΟΓΓΥΛΗ

ΚΩΔΙΚΟΣ	YATO	#	ΣΥΣΚ	€/ΤΕΜ
20006221	YT-6221	45	12	4,60



ΡΑΣΠΕΣ ΣΕΤ 3 ΤΜΧ

ΚΩΔΙΚΟΣ	YATO	#	ΣΥΣΚ	€/ΤΕΜ
20006222	YT-6222	45	5	15,00

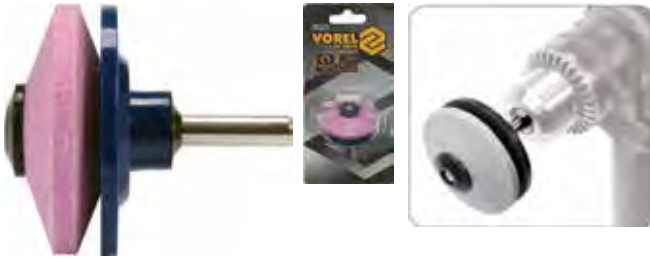

ΑΚΟΝΙΣΤΗΡΙ ΜΑΧΑΙΡΙΩΝ

ΚΩΔΙΚΟΣ	VOREL	L (mm)	ΣΥΣΚ €/ΤΕΜ
21126200	26200	200	25 1,15

ΑΚΟΝΙΣΤΗΡΙ ΔΡΑΠΑΝΩΝ

ΚΩΔΙΚΟΣ	VOREL	ΣΥΣΚ €/ΤΕΜ
21126225	26225	80 3,00



Add water / Dolać wody

ΑΚΟΝΙΣΤΗΡΙ 3 ΣΤΑΔΙΩΝ

ΚΩΔΙΚΟΣ	VOREL	ΣΥΣΚ €/ΤΕΜ
21126220	26220	12 5,70

3 SHARPEN LEVELS

ΣΥΡΜΑΤΟΒΟΥΡΤΣΑ ΤΣΑΡΟΥΧΙ

ΚΩΔΙΚΟΣ	VOREL	ΣΥΣΚ €/ΤΕΜ
21106965	06965	25 0,99

ΣΥΡΜΑΤΟΒΟΥΡΤΣΑ ΞΥΛΙΝΗ ΛΑΒΗ

ΚΩΔΙΚΟΣ	VOREL	ΣΕΙΡΕΣ	ΣΥΣΚ €/ΤΕΜ
21106930	06930	3	12 0,77
21106940	06940	4	12 0,86
21106950	06950	5	12 0,95



340 mm
3 ROWS
STAINLESS
STEEL



ΚΩΔΙΚΟΣ	YATO 	ΣΕΙΡΕΣ	L (mm)	ΣΥΣΚ €/ΤΕΜ
20006336	YT-6336	3	340	12 3,45

NEO  **INOX**



290 mm
4 ROWS
STAINLESS
STEEL



ΚΩΔΙΚΟΣ	YATO 	ΣΕΙΡΕΣ	L (mm)	ΣΥΣΚ €/ΤΕΜ
20006339	YT-6339	4	290	12 3,90

NEO  **INOX**



290 mm
4 ROWS
BRASS



ΚΩΔΙΚΟΣ	YATO 	ΣΕΙΡΕΣ	L (mm)	ΣΥΣΚ €/ΤΕΜ
20006345	YT-6345	4	290	12 4,35

NEO 



260 mm
4 ROWS
BRASS



ΚΩΔΙΚΟΣ	YATO 	ΣΕΙΡΕΣ	L (mm)	ΣΥΣΚ €/ΤΕΜ
20006344	YT-6344	4	260	12 3,85

NEO 



ΚΩΔΙΚΟΣ	YATO 	ΣΕΙΡΕΣ	L (mm)	ΣΥΣΚ €/ΤΕΜ
20006351	YT-6351	3	180	24 3,05



NEO 
3 pcs 180 mm
STAINLESS STEEL BRASS 3 ROWS NYLON

**2
PCS**
**100
pcs
Ø 5 mm**
**220
mm**
**150
mm**
**Ø (mm)
2,5, 3, 3,5
4, 4,5, 5**
ΣΕΤ ΜΥΛΟΣ ΤΣΑΓΚΑΡΗΔΩΝ-ΜΠΟΥΝΤΟΥΖΙΕΡΑ

ΚΩΔΙΚΟΣ	VOREL	ΣΥΣΚ	€/ΤΕΜ
21143603	43603	5	12,60

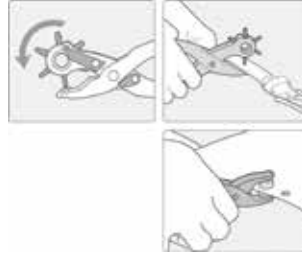
ΣΙΔΗΡΟΠΡΙΟΝΟ

ΚΩΔΙΚΟΣ	VOREL	(mm)	ΣΥΣΚ	€/ΤΕΜ
21127322	27322	300	6	9,80

ΠΡΙΟΝΙ 150mm

ΚΩΔΙΚΟΣ	VOREL	(mm)	ΣΥΣΚ	€/ΤΕΜ
21127600	27600	150	30	1,25

ΛΑΜΕΣ ΠΡΙΟΝΙΟΥ 150mm

ΚΩΔΙΚΟΣ	VOREL	(mm)	ΣΥΣΚ	€/ΤΕΜ
21127800	27800	150	10	1,25

ΛΑΜΑ ΔΙΠΛΗ

ΚΩΔΙΚΟΣ	VOREL	ΤΥΠΟΣ	Lmm	Wmm	ΣΥΣΚ	€/ΤΕΜ
21127513	27513	RAMD	300	25	3	2,30





24
TPI
FOR
METAL
300
mm
BI-
METAL

ΣΙΔΗΡΟΠΡΙΟΝΟ

ΚΩΔΙΚΟΣ	YATO	ΜΗΚΟΣ(mm)	ΣΥΣΚ	€/ΤΕΜ
20003161	YT-3161	300	6	12,30



300
mm
12
mm
24
TPI

ΛΑΜΕΣ ΣΙΔΗΡΟΠΡΙΟΝΟΥ

ΚΩΔΙΚΟΣ	YATO	ΜΗΚΟΣ(mm)	ΣΥΣΚ	€/ΣΕΤ
20003460	YT-3460	300	5	2,20

BI-METAL
M2+Co8%

20003462	YT-3462	300	2	3,15
----------	---------	-----	---	------



245
mm
SS
STAINLESS STEEL
Al
22.5°
± 45°
90°



ΓΩΝΙΑΚΟ ΨΑΛΙΔΙ ΓΙΑ ΛΑΣΤΙΧΑ

ΚΩΔΙΚΟΣ	YATO	ΜΗΚΟΣ(mm)	ΣΥΣΚ	€/ΤΕΜ
20018960	YT-18960	245	4	18,50



5 ΣΕ 1 ΨΑΛΙΔΙ ΓΙΑ ΛΑΣΤΙΧΑ & ΣΩΛΗΝΕΣ PVC

ΚΩΔΙΚΟΣ	VOREL	(mm)	ΣΥΣΚ	€/ΤΕΜ
21148350	48350	220	6	17,80



5 in 1
5w1
17, 20, 27
mm
90°
± 45-120°
Al



ΣΕΤ ΨΑΛΙΔΙΑ 5 ΤΕΜ

ΚΩΔΙΚΟΣ	VOREL	(mm)	ΣΥΣΚ	€/ΤΕΜ
21176314	76314	140; 170; 190; 220; 250	12	7,60



ΠΡΙΟΝΙ ΞΥΛΟΥ

ΚΩΔΙΚΟΣ	YATO 	ΜΗΚΟΣ(mm)	ΣΥΣΚ	€/ΤΕΜ
20003101	YT-3101	400	12	6,75
20003102	YT-3102	450	10	7,40
20003103	YT-3103	500	10	8,00



ΠΡΙΟΝΙ ΓΥΦΟΣΑΝΙΔΑΣ ΤΡΙΠΛΗΣ ΚΟΠΗΣ

ΚΩΔΙΚΟΣ	YATO 	ΣΥΣΚ	€/ΤΕΜ
20031343	YT-31343	12	6,60



ΠΡΙΟΝΙ ΞΥΛΟΥ

ΚΩΔΙΚΟΣ	YATO 	ΜΗΚΟΣ(mm)	ΣΥΣΚ	€/ΤΕΜ
20003133	YT-3133	300	12	5,25



ΠΡΙΟΝΙ

ΚΩΔΙΚΟΣ	YATO 	ΜΗΚΟΣ(mm)	ΣΥΣΚ	€/ΤΕΜ
20031310	YT-31310	660	10	11,70



ΤΟΞΟΠΡΙΟΝΟ

ΚΩΔΙΚΟΣ	YATO 	ΜΗΚΟΣ(mm)	ΣΥΣΚ	€/ΤΕΜ
20003201	YT-3201	450	12	8,70
20003202	YT-3202	530	12	9,50



ΛΑΜΑ ΤΟΞΟΠΡΙΟΝΟΥ ΓΙΑ ΞΥΛΟ

ΚΩΔΙΚΟΣ	YATO 	ΜΗΚΟΣ(mm)	ΣΥΣΚ	€/ΤΕΜ
20003221	YT-3221	450	50	1,50
20003222	YT-3222	530	50	1,60



ΠΡΙΟΝΙ ΓΙΑ ΦΑΛΤΣΟΚΟΥΤΙ

ΚΩΔΙΚΟΣ	YATO	ΜΗΚΟΣ(mm)	ΣΥΣΚ	€/ΤΕΜ
20003130	YT-3130	300	12	7,35



ΠΡΙΟΝΙ

ΚΩΔΙΚΟΣ	YATO	ΜΗΚΟΣ(mm)	ΣΥΣΚ	€/ΤΕΜ
20003150	YT-3150	350	10	16,40



ΠΡΙΟΝΙ ΓΙΑ PVC

ΚΩΔΙΚΟΣ	YATO	ΜΗΚΟΣ(mm)	ΣΥΣΚ	€/ΤΕΜ
20031303	YT-31303	350	12	6,60

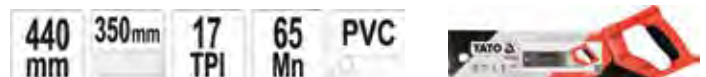

ΠΡΙΟΝΙ ΞΥΛΟΥ ΜΕ ΡΥΘΜΙΖΟΜΕΝΗ ΛΑΒΗ

ΚΩΔΙΚΟΣ	YATO	ΜΗΚΟΣ(mm)	ΣΥΣΚ	€/ΤΕΜ
20031290	YT-31290	250	6	7,40

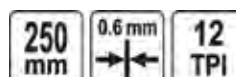



ΠΛΑΝΗ ΞΥΛΟΥ

ΚΩΔΙΚΟΣ	VOREL	ΣΥΣΚ	€/ΤΕΜ
21125881	25881	90x26	10 4,00



ΠΛΑΝΗ ΞΥΛΟΥ

ΚΩΔΙΚΟΣ	VOREL	ΣΥΣΚ	€/ΤΕΜ
21125886	25886	200x42	6 8,30



ΠΛΑΝΗ ΞΥΛΟΥ

ΚΩΔΙΚΟΣ	VOREL	ΣΥΣΚ	€/ΤΕΜ
21125887	25887	235x44	5 9,70



ΟΔΗΓΟΣ ΤΡΥΠΗΜΑΤΟΣ

ΚΩΔΙΚΟΣ	YATO	Ø (mm)	ΣΥΣΚ	€/ΤΕΜ
20044120	YT-44120	6, 8, 10	10 55,00	

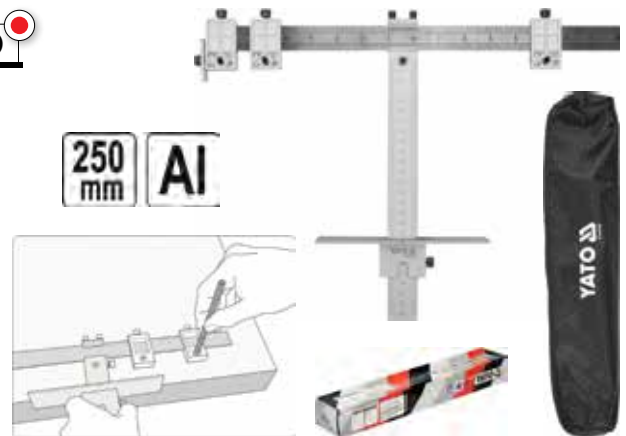

ΟΔΗΓΟΣ ΤΡΥΠΗΜΑΤΟΣ

ΚΩΔΙΚΟΣ	YATO	ΣΥΣΚ	€/ΤΕΜ
20044130	YT-44130	20	25,00



ΦΑΛΤΣΟΚΟΥΤΙ

ΚΩΔΙΚΟΣ	VOREL	ΚΟΥΤΙ(mm)	ΣΥΣΚ	€/ΤΕΜ
21129311	29311	250x45	70	2,35
21129312	29312	285x60	50	2,55

PTFE
COATED

ΠΙΣΤΟΛΙ ΑΦΡΟΥ

ΚΩΔΙΚΟΣ	YATO	ΣΥΣΚ €/ΤΕΜ
20006741	YT-6741	10 16,60



NEO

QUICK FLOW
ADJUSTMENT

AI

PTFE

ΠΙΣΤΟΛΙ ΑΦΡΟΥ

ΚΩΔΙΚΟΣ	YATO	ΣΥΣΚ €/ΤΕΜ
20067421	YT-67421	20 24,35

PTFE
COATED

ΠΙΣΤΟΛΙ ΑΦΡΟΥ

ΚΩΔΙΚΟΣ	YATO	ΣΥΣΚ €/ΤΕΜ
20006745	YT-6745	20 26,00



NEO

500
mm AI PTFE

ΠΙΣΤΟΛΙ ΑΦΡΟΥ ΜΑΚΡΥ 500mm

ΚΩΔΙΚΟΣ	YATO	ΣΥΣΚ €/ΤΕΜ
20067460	YT-67460	20 19,00



300 ml 225 mm

ΠΙΣΤΟΛΙ ΣΙΛΙΚΟΝΗΣ

ΚΩΔΙΚΟΣ	YATO	ΜΗΚΟΣ (mm)	ΣΥΣΚ €/ΤΕΜ
20006750	YT-6750	225	20 4,95



300 ml 225 mm

ΠΙΣΤΟΛΙ ΣΙΛΙΚΟΝΗΣ

ΚΩΔΙΚΟΣ	YATO 	ΜΗΚΟΣ (mm)	ΣΥΣΚ €/ΤΕΜ
20006751	YT-6751	225	10 8,95



ΥΠΕΡ-ΒΑΡΕΩΣ ΤΥΠΟΥ

ΠΙΣΤΟΛΙ ΣΙΛΙΚΟΝΗΣ & ΧΗΜΙΚΗΣ ΡΗΤΙΝΗΣ

ΚΩΔΙΚΟΣ	YATO 	ΜΗΚΟΣ (mm)	ΣΥΣΚ €/ΤΕΜ
20006753	YT-6753	225	6 14,95

300 ml 225 mm



1L CAPACITY AI
ΣΕ ΠΩΛΗΣΕΙΣ No1

ΣΤΟΚΑΔΟΡΟΣ ΓΙΑ ΣΑΛΑΜΙ 600ml

ΚΩΔΙΚΟΣ	YATO 	ΣΥΣΚ €/ΤΕΜ
20067583	YT-67583	12 23,00



NEO 

4 pcs TPR



NEO 



4 pcs TPR

ΣΠΑΤΟΥΛΕΣ ΣΙΛΙΚΟΝΗΣ

ΚΩΔΙΚΟΣ	YATO 	ΣΥΣΚ	€/ΤΕΜ
20005261	YT-5261	20	2,00

ΣΠΑΤΟΥΛΕΣ ΣΙΛΙΚΟΝΗΣ ΣΕΤ 4 ΤΕΜ

ΚΩΔΙΚΟΣ	YATO 	ΣΥΣΚ	€/ΤΕΜ
20052621	YT-52621	12	4,35

 230
mm

ΠΙΣΤΟΛΙ ΣΙΛΙΚΟΝΗΣ

ΚΩΔΙΚΟΣ	VOREL	(mm)	ΣΥΣΚ	€/ΤΕΜ
21109150	09150	230	20	2,75

 230
mm

ΠΙΣΤΟΛΙ ΣΙΛΙΚΟΝΗΣ

ΚΩΔΙΚΟΣ	VOREL	(mm)	ΣΥΣΚ	€/ΤΕΜ
21109130	09130	230	10	6,75

ΠΙΣΤΟΛΙ ΑΦΡΟΥ

ΚΩΔΙΚΟΣ	VOREL	ΣΥΣΚ	€/ΤΕΜ
21109173	09173	10	9,95

ΠΙΣΤΟΛΙ ΣΙΛΙΚΟΝΗΣ Τ. ΑΓΓΛΙΑΣ HelixTools

ΚΩΔΙΚΟΣ	ΠΕΡΙΓΡΑΦΗ	ΣΥΣΚ	€/τεμ.
75000005	300ml	24	3,90

- ▶ ▶ ▶ Πιστόλι σιλικόνης με **σύστημα "dripless"** για να μην στάζει το υλικό κατά την εφαρμογή. Από ανθεκτικό σκελετό, με εξάγωνη ράβδο, ενισχυμένο μηχανισμό εξαγωγής και γάντζο.

ΠΙΣΤΟΛΙ ΣΙΛΙΚΟΝΗΣ ΒΑΡΕΩΣ ΤΥΠΟΥ HelixTools

ΚΩΔΙΚΟΣ	ΠΕΡΙΓΡΑΦΗ	ΣΥΣΚ	€/τεμ.
75000006	300ml	12	7,90

- ▶ ▶ ▶ **Επαγγελματικό, βαρέως τύπου.** Πιστόλι σιλικόνης με **σύστημα "dripless"** για να μην στάζει το υλικό κατά την εφαρμογή. Για σιλικόνες και σφραγιστικά σε φυσίγγιο.



ΚΩΔΙΚΟΣ	YATO	ΔΙΑΣΤΑΣΗ(m)	ΣΥΣΚ	€/ΤΕΜ
20071070	YT-71070	3x0,16	12	2,75
20071071	YT-71071	5x0,19	12	4,00
20071072	YT-71072	5x0,25	12	5,10
20071073	YT-71073	8x0,25	6	7,25



ΚΩΔΙΚΟΣ	YATO	ΔΙΑΣΤΑΣΗ(m)	ΣΥΣΚ	€/ΤΕΜ
20071150	YT-71150	2x0,16	12	1,95
20071151	YT-71151	3x0,16	12	2,05
20071153	YT-71153	5x0,19	12	2,90
20071155	YT-71155	7,5x0,25	12	5,50
20071156	YT-71156	10x0,25	6	6,95



ΚΩΔΙΚΟΣ	YATO	ΜΗΚ(m)	ΜΕΓΕΘ.(mm)	ΣΥΣΚ	€/ΤΕΜ
20071570	YT-71570	20	15	40	9,30
20071571	YT-71571	30	15	40	12,50
20071572	YT-71572	50	15	20	18,40



NEO 

ΜΕΓΑΛΩΝ ΑΠΟΣΤΑΣΕΩΝ

ΤΡΟΧΟΣ ΜΕΤΡΗΣΗΣ

ΚΩΔΙΚΟΣ	YATO	ΜΕΤΡΗΣΗ(ΧΛΜ)	ΣΥΣΚ	€/ΤΕΜ
20071655	YT-71655	10		56,00

RANGE 0,1-99999,9 m	+/- 0,5%	m/ft	160 mm	REPLAC LCD	AI	ABS
---------------------------	-------------	------	-----------	---------------	----	-----

**SHOCK
PROOF**
**ΣΕ ΠΩΛΗΣΕΙΣ
No 1**

ΜΑΓΝΗΤΙΚΟ SHOCK PROOF - 2 ΜΑΤΙΑ

ΚΩΔΙΚΟΣ	YATO	ΜΗΚΟΣ (mm)	ΣΥΣΚ	€/ΤΕΜ
20030370	YT-30370	250	60	8,90

SHOCK PROOF / ΜΑΓΝΗΤΙΚΟ - 2 ΜΑΤΙΑ

ΚΩΔΙΚΟΣ	YATO	ΜΗΚΟΣ (mm)	ΣΥΣΚ	€/ΤΕΜ
20030060	YT-30060	400	10	7,60
20030061	YT-30061	600	10	8,80
20030062	YT-30062	800	10	9,95
20030063	YT-30063	1000	10	11,90
20030064	YT-30064	1200	10	13,90

3 ΜΑΤΙΑ

ΚΩΔΙΚΟΣ	YATO	ΜΗΚΟΣ (mm)	ΣΥΣΚ	€/ΤΕΜ
20003001	YT-3001	400	20	6,50
20003002	YT-3002	600	20	8,40
20003003	YT-3003	800	20	9,75
20003004	YT-3004	1000	20	12,55
20003005	YT-3005	1200	20	15,05

3 ΜΑΤΙΑ

ΚΩΔΙΚΟΣ	YATO	ΜΗΚΟΣ (mm)	ΣΥΣΚ	€/ΤΕΜ
20003022	YT-3022	600	20	11,30
20003023	YT-3023	800	20	13,95
20003024	YT-3024	1000	30	17,05
20003025	YT-3025	1200	30	18,70
20003026	YT-3026	1500	30	25,60

ΑΛΦΑΔΙ ΜΙΝΙ ΜΑΓΝΗΤΙΚΟ

ΚΩΔΙΚΟΣ	VOREL	ΜΗΚ(μm)	ΜΑΤΙΑ	ΣΥΣΚ	€/ΤΕΜ
21116300	16300	230	3	100	2,35

ΑΛΦΑΔΙ ΜΙΝΙ ΜΑΓΝΗΤΙΚΟ

ΚΩΔΙΚΟΣ	VOREL	ΜΗΚ(μm)	ΜΑΤΙΑ	ΣΥΣΚ	€/ΤΕΜ
21116301	16301	230	3	100	4,10

ΑΛΦΑΔΙ ΤΡΑΠΕΖΟΕΙΔΕΣ

ΚΩΔΙΚΟΣ	VOREL	ΜΗΚ(μm)	ΜΑΤΙΑ	ΣΥΣΚ	€/ΤΕΜ
21116280	16280	500	2	50	6,65

ΑΛΦΑΔΙ ΑΛΟΥΜΙΝΙΟΥ

ΚΩΔΙΚΟΣ	VOREL	ΜΗΚ(μm)	ΜΑΤΙΑ	ΣΥΣΚ	€/ΤΕΜ
21117606	17606	600	3	20	7,85
21117608	17608	800	3	20	9,60
21117610	17610	1000	3	20	11,50
21117612	17612	1200	3	15	12,95
21117615	17615	1500	3	15	15,05

ΑΛΦΑΔΙ ΓΩΝΙΑΣ

ΚΩΔΙΚΟΣ	VOREL	ΜΑΤΙΑ	ΣΥΣΚ	€/ΤΕΜ
21116012	16012	3	25	4,00



ΓΩΝΙΑ ΜΟΙΡΟΓΝΩΜΟΝΙΟ

ΚΩΔΙΚΟΣ	VOREL	mm	ΣΥΣΚ	€/ΤΕΜ
21118797	18797	350	10	24,75
21118798	18798	500	10	25,65



ΠΑΡΑΛΛΗΛΟΓΡΑΦΟΣ

ΚΩΔΙΚΟΣ	VOREL	ΣΥΣΚ	€/ΤΕΜ
21118470	18470	20	3,00



ΜΟΙΡΟΓΝΩΜΟΝΙΟ

ΚΩΔΙΚΟΣ	VOREL	ΜΗΚ(mm)	ΜΑΤΙΑ	ΣΥΣΚ	€/ΤΕΜ
21118473	18473	250	1	10	7,60



ΧΑΡΑΚΑΣ ΑΛΟΥΜΙΝΙΟΥ

ΚΩΔΙΚΟΣ	VOREL	ΜΗΚ(mm)	ΜΑΤΙΑ	ΣΥΣΚ	€/ΤΕΜ
21119770	19770	600	2	12	8,25



ΜΑΓΝΗΤΙΚΟ ΖΥΓΙ

ΚΩΔΙΚΟΣ	VOREL	ΜΗΚ(mm)	ΣΥΣΚ	€/ΤΕΜ
21117310	17310	6	6	9,95



ΠΑΧΥΜΕΤΡΟ ΒΙΔΑΣ

ΚΩΔΙΚΟΣ	VOREL	ΕΜΒΕΛΕΙΑ (mm)	ΣΥΣΚ	€/ΤΕΜ
21115110	15110	0.02-150	10	9,95

ΣΕ ΠΩΛΗΣΕΙΣ
No 1

ΠΑΝΤΟΓΡΑΦΟΙ

NEO 



125 mm
44 mm
1.5 mm
MAGNETIC



260 mm
1.5 mm
MAGNETIC



535 mm
100 mm
MAGNETIC



ΚΩΔΙΚΟΣ	YATO 	ΜΗΚΟΣ (mm)	ΣΥΣΚ	€/ΤΕΜ
20003735	YT-3735	125	24	5,80
20003736	YT-3736	260	10	10,00
20037364	YT-37364	535	10	27,00



"ΕΞΥΠΝΟ"

ΓΩΝΙΕΣ ΜΑΡΑΓΚΩΝ - ΑΛΟΥΜΙΝΙΟΥ



NEO 
170 mm
METRIC
Al

ΜΕ ΜΟΙΡΟΓΝΩΜΟΝΙΟ

ΚΩΔΙΚΟΣ	YATO 	ΜΕΓΕΘΟΣ (mm)	ΣΥΣΚ	€/ΤΕΜ
20070782	YT-70782	170		16,00



180 mm
Al

ΚΩΔΙΚΟΣ	YATO 	ΜΕΓΕΘΟΣ (mm)	ΣΥΣΚ	€/ΤΕΜ
20070786	YT-70786	180	8	13,00

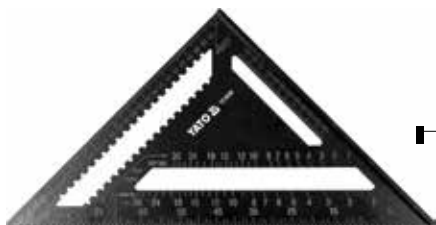

NEO 
300 mm
Al

ΚΩΔΙΚΟΣ	YATO 	ΜΕΓΕΘΟΣ (mm)	ΣΥΣΚ	€/ΤΕΜ
20070787	YT-70787	300	6	26,00

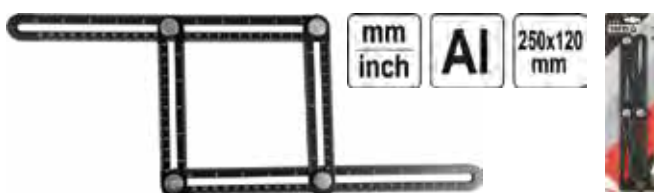

mm
inch
Al
250x120 mm

ΠΑΡΑΛΛΗΛΟΓΡΑΦΟΣ

ΚΩΔΙΚΟΣ	YATO 	ΜΕΓΕΘΟΣ (mm)	ΣΥΣΚ	€/ΤΕΜ
20070880	YT-70880	250 x 120	10	13,50

NEO 

ΓΩΝΙΕΣ

NEO 

ΚΩΔΙΚΟΣ	YATO 	ΜΗΚΟΣ (mm)	ΣΥΣΚ	€/ΤΕΜ
20070771	YT-70771	300		7,40

NEO 

ΚΩΔΙΚΟΣ	YATO 	ΜΗΚΟΣ (mm)	ΣΥΣΚ	€/ΤΕΜ
20070772	YT-70772	300		17,80



AI

ΧΑΡΑΚΑΣ

ΚΩΔΙΚΟΣ	YATO 	ΜΗΚΟΣ (mm)	ΣΥΣΚ	€/ΤΕΜ
20007070	YT-7070	300	25	4,35
20007071	YT-7071	600	10	7,30

ΣΕ ΠΩΛΗΣΕΙΣ
No1

45° 90° AI

ΓΩΝΙΑ

ΚΩΔΙΚΟΣ	YATO 	ΜΗΚΟΣ (mm)	ΣΥΣΚ	€/ΤΕΜ
20007080	YT-7080	250	6	6,20
20007081	YT-7081	300	6	6,65
20007082	YT-7082	350	6	6,90

STAINLESS
STEEL
STAL
METALURGIA

ΓΩΝΙΑ

ΚΩΔΙΚΟΣ	YATO 	ΜΕΓΕΘΟΣ (mm)	ΣΥΣΚ	€/ΤΕΜ
20007083	YT-7083	150 x 300	25	8,20
20007084	YT-7084	250 x 500	10	11,60

II INOX
STAINLESS STEELNEO 

ΡΙΓΑ INOX

ΚΩΔΙΚΟΣ	YATO 	L (mm)	ΣΥΣΚ	€/ΤΕΜ
20070720	YT-70720	150	10	0,93
20070721	YT-70721	300	12	2,10
20070723	YT-70723	600	20	3,90
20070724	YT-70724	1000	20	8,45



ΡΙΓΑ

ΚΩΔΙΚΟΣ	YATO 	(mm)	ΣΥΣΚ	€/ΤΕΜ
20070713	YT-70713	500x59x2	8	6,90
20070715	YT-70715	1000x59x2	8	11,00

500 mm mm inch
x2 AINEO 



ΜΟΙΡΟΓΝΩΜΟΝΙΟ

ΚΩΔΙΚΟΣ	YATO 	ΜΕΓΕΘΟΣ (mm)	ΣΥΣΚ €/ΤΕΜ
20072140	YT-72140	120 x 150	10 21,00

120x150
mm +/-
0.1
mm



ΔΙΑΒΗΤΗΣ

ΚΩΔΙΚΟΣ	YATO 	ΜΕΓΕΘΟΣ (mm)	ΣΥΣΚ €/ΤΕΜ
20072101	YT-72101	200	20 10,00

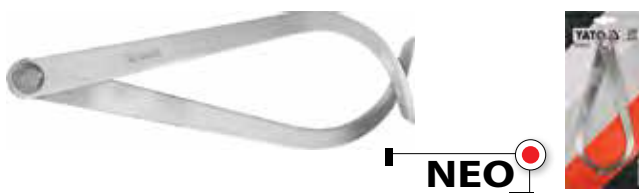

ΚΟΥΜΠΑΣΟ ΕΞΩΤΕΡΙΚΟ

ΚΩΔΙΚΟΣ	YATO 	ΜΗΚΟΣ (mm)	ΣΥΣΚ €/ΤΕΜ
20072115	YT-72115	200	20 7,05

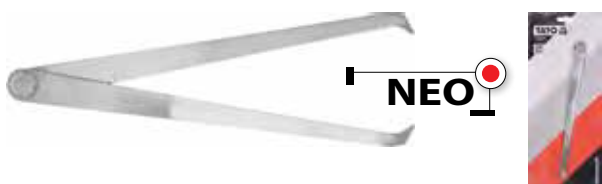

ΚΟΥΜΠΑΣΟ ΕΣΩΤΕΡΙΚΟ

ΚΩΔΙΚΟΣ	YATO 	ΜΗΚΟΣ (mm)	ΣΥΣΚ €/ΤΕΜ
20072131	YT-72131	250	10 7,90



ΠΑΧΥΜΕΤΡΟ ΙΝΟΧ

ΚΩΔΙΚΟΣ	YATO	ΕΜΒΕΛΕΙΑ (mm)	ΣΥΣΚ	€/ΤΕΜ
20007200	YT-7200	0-150	10	31,80



ΨΗΦΙΑΚΟ ΠΑΧΥΜΕΤΡΟ

ΚΩΔΙΚΟΣ	YATO	ΕΜΒΕΛΕΙΑ (mm)	ΣΥΣΚ	€/ΤΕΜ
20007201	YT-7201	0-150	10	29,90

+/- 0.03 mm	SCALE SKALA mm inch	BATTERY SR44 1.55V
-------------------	------------------------------	--------------------------



RANGE 0-25 mm	+/- 0.01 mm
---------------------	-------------------



ΜΙΚΡΟΜΕΤΡΟ

ΚΩΔΙΚΟΣ	YATO	ΜΕΤΡΗΣΗ (mm)	ΣΥΣΚ	€/ΤΕΜ
20072300	YT-72300	0-25	30	28,00



ΜΙΚΡΟΜΕΤΡΟ ΜΕ ΨΗΦΙΑΚΗ ΕΝΔΕΙΞΗ

ΚΩΔΙΚΟΣ	YATO	ΜΕΤΡΗΣΗ (mm)	ΣΥΣΚ	€/ΤΕΜ
20072305	YT-72305	0-25	20	73,00

SCALE mm inch	LCD DISPLAY	RANGE 0-25 mm	+/- 0.002 mm
---------------------	----------------	---------------------	--------------------

ULTRA SHARP



9 mm SK2H AUTO LOCK METAL SLIDING BAR ABS

ΚΩΔΙΚΟΣ	YATO	ΛΕΠΙΔΑ (mm)	ΣΥΣΚ	€/ΤΕΜ
20075003	YT-75003	9x0.4	10	1,85

NEO **ULTRA SHARP**



ULTRA SHARP

ΚΩΔΙΚΟΣ	YATO	ΛΕΠΙΔΑ (mm)	ΣΥΣΚ	€/ΤΕΜ
20075123	YT-75123	18x0.5	10	2,60

18 mm SK2H AUTO LOCK METAL SLIDING BAR ABS **NEO**



ULTRA SHARP

ΚΩΔΙΚΟΣ	YATO	ΛΕΠΙΔΑ (mm)	ΣΥΣΚ	€/ΤΕΜ
20075124	YT-75124	18x0.5	10	3,00

18 mm SK2H AUTO LOCK METAL SLIDING BAR ABS **NEO**



ULTRA SHARP

NEO

10 pcs SK2H

SK2H 10 ΤΕΜ. ΑΝΤΑΛΛΑΚΤΙΚΕΣ ΛΑΜΕΣ

ΚΩΔΙΚΟΣ	YATO	ΛΕΠΙΔΑ (mm)	ΣΥΣΚ	€/ΤΕΜ
20075260	YT-75260	9x0.4	10	2,00
20075261	YT-75261	18x0.5	10	2,60

ΑΝΤΑΛΛΑΚΤΙΚΕΣ ΛΑΜΕΣ



BLISTER SK5 10 PCS

SK5 10 ΤΕΜ.

ΚΩΔΙΚΟΣ	YATO	ΛΕΠΙΔΑ (mm)	ΣΥΣΚ	€/ΤΕΜ
20007528	YT-7528	9x0.4	24	1,25
20007529	YT-7529	18x0.5	24	1,90
20007530	YT-7530	25x0.7	6	4,40



BLISTER SK5 10 PCS

ΤΡΑΠΕΖΟΕΙΔΗΣ SK5

ΚΩΔΙΚΟΣ	YATO	ΛΕΠΙΔΑ (mm)	ΣΥΣΚ	€/ΤΕΜ
20007531	YT-7531	61x33x0.5	24	2,05



SK2

ABS



ΚΟΦΤΗΣ ΠΛΑΣΤΙΚΟΣ

ΚΩΔΙΚΟΣ	YATO	ΛΕΠΙΔΑ (mm)	ΣΥΣΚ	€/ΤΕΜ
20007504	YT-7504	9x0.4	24	0,95
20007505	YT-7505	18x0.5	24	1,40

- ABS
- Λάμα SK2



LOCK

ABS
TPR

SK2

ΚΟΦΤΗΣ

ΚΩΔΙΚΟΣ	YATO	ΛΕΠΙΔΑ (mm)	ΣΥΣΚ	€/ΤΕΜ
20007506	YT-7506	9x0.4	24	1,90
20007507	YT-7507	18x0.5	12	2,90

ABS
TPRmax. 20 kg
BLADE PULL FORCEAUTO
LOCKMETAL
SLIDING BAR

SK5



ΚΟΦΤΗΣ

ΚΩΔΙΚΟΣ	YATO	ΛΕΠΙΔΑ (mm)	ΣΥΣΚ	€/ΤΕΜ
20075072	YT-75072	18x0.5	12	1,90
20075101	YT-75101	25x0.7	12	2,90

Zn
TPRmax. 20 kg
BLADE PULL FORCEAUTO
LOCKMETAL
SLIDING BAR

SK5



ΚΟΦΤΗΣ

ΚΩΔΙΚΟΣ	YATO	ΛΕΠΙΔΑ (mm)	ΣΥΣΚ	€/ΤΕΜ
20075122	YT-75122	18x0.5	12	2,80

Zn
TPR
ABSmax. 20 kg
BLADE PULL FORCEAUTO
LOCKMETAL
SLIDING BAR

SK5

ΣΕ ΠΩΛΗΣΕΙΣ
No1

ΚΟΦΤΗΣ

ΚΩΔΙΚΟΣ	YATO	ΛΕΠΙΔΑ (mm)	ΣΥΣΚ	€/ΤΕΜ
20075121	YT-75121	18x0.5	12	3,60





Zn
TPR
ABS
61x33x0.5
mm
AUTO
RETRACTABLE
1+3
MULTI-STOP
STRAP
SIDE CUTTER
SK5

ΚΟΦΤΗΣ

ΚΩΔΙΚΟΣ	YATO 	ΛΕΠΙΔΑ (mm)	ΣΥΣΚ	€/ΤΕΜ
20075201	YT-75201	61x33x0.5	12	7,90



NEO 

ΞΥΣΤΡΑ ΤΗΛΕΣΚΟΠΙΚΗ

ΚΩΔΙΚΟΣ	YATO 	ΜΗΚΟΣ (mm)	ΣΥΣΚ	€/ΤΕΜ
20007551	YT-7551	390-600	10	9,60



ΣΕΤ ΚΟΠΙΔΙΑ

ΚΩΔΙΚΟΣ	YATO 	ΛΕΠΙΔΑ (mm)	ΣΥΣΚ	€/ΤΕΜ
20075140	YT-75140		6	8,60

14
PCS
Al
HANDLE
T10
STEEL
SOFT GRIP
HRC
60



178
mm
TUNGSTEN
CARBIDE
YD05
HRA
92.5-93

ΤΖΑΜΟΚΟΦΤΗΣ OIL

ΚΩΔΙΚΟΣ	YATO 	ΜΗΚΟΣ (mm)	ΣΥΣΚ	€/ΤΕΜ
20007561	YT-7561	178	6	7,50

18
mm

ΚΟΠΙΔΙ

ΚΩΔΙΚΟΣ	VOREL	ΛΑΜΑ (mm)	ΣΥΣΚ €/ΤΕΜ
21176182	76182	18	24 1,75

18
mm

ΚΟΠΙΔΙ

ΚΩΔΙΚΟΣ	VOREL	ΛΑΜΑ (mm)	ΣΥΣΚ €/ΤΕΜ
21176183	76183	18	24 1,85

9
mm

ΚΟΠΙΔΙ

ΚΩΔΙΚΟΣ	VOREL	ΛΑΜΑ (mm)	ΣΥΣΚ €/ΤΕΜ
21176160	76160	9	24 2,10

18
mm

ΚΟΠΙΔΙ

ΚΩΔΙΚΟΣ	VOREL	ΛΑΜΑ (mm)	ΣΥΣΚ €/ΤΕΜ
21176184	76184	18	12 2,80

3
 pcs

ΣΕΤ ΚΟΠΙΔΙΑ 3 ΤΕΜ.

ΚΩΔΙΚΟΣ	VOREL	ΣΕΤ/ΤΕΜ	ΣΥΣΚ	€/ΤΕΜ
21176230	76230	3	50	1,02

5
 pcs

ΣΕΤ ΚΟΠΙΔΙΑ 5 ΤΕΜ.

ΚΩΔΙΚΟΣ	VOREL	ΣΕΤ/ΤΕΜ	ΣΥΣΚ	€/ΤΕΜ
21176250	76250	5	30	1,95

60
 mm

ΞΥΣΤΡΑ ΤΖΑΜΙΩΝ

ΚΩΔΙΚΟΣ	VOREL	ΛΑΜΑ (mm)	ΣΥΣΚ	€/ΤΕΜ
21106820	06820	60	50	0,60

HRC
60-62DIN
6438

CrMo

ΣΕ ΠΩΛΗΣΕΙΣ
No1

ΨΑΛΙΔΙ ΛΑΜΑΡΙΝΑΣ

ΚΩΔΙΚΟΣ	YATO 	ΠΕΡΙΓΡΑΦΗ	ΜΗΚΟΣ	ΣΥΣΚ	€/ΤΕΜ
20001922	YT-1922	ΙΣΙΟ	290mm	6	22,00

ΙΣΙΟ
YATO  YT-1962ΑΡΙΣΤΕΡΟ
YATO  YT-1960ΔΕΞΙ
YATO  YT-1961HRC
56-62

CrMo

ΣΕ ΠΩΛΗΣΕΙΣ
No1

ΨΑΛΙΔΙΑ ΛΑΜΑΡΙΝΑΣ

ΚΩΔΙΚΟΣ	YATO 	ΠΕΡΙΓΡΑΦΗ	ΜΗΚΟΣ	ΣΥΣΚ	€/ΤΕΜ
20001962	YT-1962	ΙΣΙΟ	250mm	6	9,95
20001960	YT-1960	ΑΡΙΣΤΕΡΟ	250mm	6	9,95
20001961	YT-1961	ΔΕΞΙ	250mm	6	9,95



CrMo

ΚΟΦΤΗΣ ΜΠΕΤΟΥ

ΚΩΔΙΚΟΣ	YATO 	ΜΕΓ.	ΜΑΧ ϕ	ΣΥΣΚ	€/ΤΕΜ
20001851	YT-1851	14"/350mm	6	6	15,70
20001852	YT-1852	18"/450mm	7	6	20,00
20001853	YT-1853	24"/600mm	10	2	26,55
20001854	YT-1854	30"/750mm	12	6	39,90
20001855	YT-1855	36"/900mm	14	4	52,90



ΚΑΡΦΩΤΙΚΟ

ΚΩΔΙΚΟΣ	YATO 	ΣΥΣΚ €/ΤΕΜ
20070020	YT-70020	6 11,80

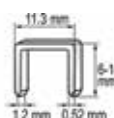

ΚΑΡΦΩΤΙΚΟ

ΚΩΔΙΚΟΣ	YATO 	ΣΥΣΚ €/ΤΕΜ
20070021	YT-70021	6 19,95



ΣΥΝΔΕΤΗΡΕΣ

ΚΩΔΙΚΟΣ	YATO 	L(mm)	ΤΕΜ.	ΣΥΣΚ €/ΤΕΜ
20007022	YT-7022	6	1000	50 0,91
20007023	YT-7023	8	1000	50 1,20
20007024	YT-7024	10	1000	50 1,35
20007025	YT-7025	12	1000	50 1,50
20007026	YT-7026	14	1000	50 1,55



ΣΠΑΣΤΟ ΜΑΧΑΙΡΙ ΜΕ ΜΑΥΡΗ ΛΑΜΑ

ΚΩΔΙΚΟΣ	YATO 	ΣΥΣΚ €/ΤΕΜ
20076051	YT-76051	12 11,05

- STAINLESS STEEL
- HRC 58



ΣΠΑΣΤΟ ΜΑΧΑΙΡΙ ΜΕ ΔΟΝΤΙΑ

ΚΩΔΙΚΟΣ	YATO 	ΣΥΣΚ €/ΤΕΜ
20076052	YT-76052	6 14,15

- STAINLESS STEEL
- HRC 58



ΚΟΦΤΗΣ ΠΛΑΚΙΔΙΩΝ ΤΥΠΟΥ SIGMA

ΚΩΔΙΚΟΣ	YATO	(mm)	ΣΥΣΚ	€/ΤΕΜ
20003703	YT-3703	630	1	149,00

ΡΟΔΑΚΙ ΓΙΑ ΚΟΦΤΗ ΠΛΑΚΙΔΙΩΝ

20003713	YT-3713	12,6X3X3	50	2,60
----------	---------	----------	----	------



ΚΟΦΤΗΣ ΠΛΑΚΙΔΙΩΝ ΜΕ ΠΑΓΚΟ

ΚΩΔΙΚΟΣ	YATO	(mm)	ΣΥΣΚ	€/ΤΕΜ
20037040	YT-37040	600x650	1	189,00

ΚΟΠΗ 600mm
ΥΨΟΣ ΠΑΓΚΟΥ 650mm
ΑΝΘΕΚΤΙΚΗ ΜΕΤΑΛΛΙΚΗ ΚΑΤΑΣΚΕΥΗ



ΨΑΛΙΔΙ ΓΕΝΙΚΗΣ ΧΡΗΣΗΣ

ΚΩΔΙΚΟΣ	YATO	ΜΗΚΟΣ(mm)	ΣΥΣΚ	€/ΤΕΜ
20019764	YT-19764	190	12	2,15
20019765	YT-19765	215	12	2,40
20019766	YT-19766	245	12	3,30

STAINLESS
STEEL BLADE
OSTRZE
ZE STALI
NIERZĘDZEWYJ



ΨΑΛΙΔΙ ΓΕΝΙΚΗΣ ΧΡΗΣΗΣ

ΚΩΔΙΚΟΣ	YATO	ΜΗΚΟΣ(mm)	ΣΥΣΚ	€/ΤΕΜ
20001976	YT-1976	65	12	6,05

65 mm HRC 50-54 3Cr13 STAINLESS STEEL





ΜΑΧΑΙΡΙ ΠΟΛΥΣΤΕΡΙΝΗΣ

ΚΩΔΙΚΟΣ	YATO 	ΜΗΚΟΣ(mm)	ΣΥΣΚ	€/ΤΕΜ
20007623	YT-7623	500	10	9,00



ΜΑΧΑΙΡΙ ΠΕΤΡΟΒΑΜΒΑΚΑ

ΚΩΔΙΚΟΣ	YATO 	ΜΗΚΟΣ(mm)	ΣΥΣΚ	€/ΤΕΜ
20007624	YT-7624	480	10	14,70



ΘΕΡΜΙΚΟ ΜΑΧΑΙΡΙ ΠΟΛΥΣΤΕΡΙΝΗΣ

ΚΩΔΙΚΟΣ	YATO 	W	L(mm)	ΣΥΣΚ	€/ΤΕΜ
20182190	YT-82190	220	220	10	45,00



ΓΑΝΤΖΟΣ

ΚΩΔΙΚΟΣ	YATO 	ΜΗΚΟΣ(mm)	ΣΥΣΚ	€/ΤΕΜ
20054233	YT-54233	300	10	10,05



YATO  YT-6926

HB

144
PCS**ΜΟΛΥΒΙ ΜΑΡΑΓΚΟΥ**

ΚΩΔΙΚΟΣ	YATO 	L(mm)	W(mm)	TEM.	ΣΥΣΚ	€/TEM
20006926	YT-6926	245	12	144	8	71,00

YATO  YT-6927

HB

144
PCS

HB

ΜΟΛΥΒΙ ΚΤΙΣΤΗ

ΚΩΔΙΚΟΣ	YATO 	L(mm)	W(mm)	TEM.	ΣΥΣΚ	€/TEM
20006927	YT-6927	245	12	144	8	72,40

1+5
LEADS

HB

ΜΟΛΥΒΙ ΜΗΧΑΝΙΚΟ ΚΑΙ ΜΥΤΕΣ

ΚΩΔΙΚΟΣ	YATO 	ΣΥΣΚ	€/TEM
20069281	YT-69281	144	3,24

YATO  YT-69940YATO  YT-69940YATO  YT-69940YATO  YT-69940YATO  YT-69940**ΜΟΛΥΒΙΑ ΔΙΧΡΩΜΑ ΣΕΤ 12 ΤΕΜ**

ΚΩΔΙΚΟΣ	YATO 	ΣΥΣΚ	€/TEM
20069940	YT-69940	120	2,90

12
PCS175
mm

4x2mm

12
PCS6
COLORS120x12
mm

METAL

CONCRETE

GLASS

WOOD

STONE

RUBBER

ΚΕΡΟΜΠΟΓΙΕΣ (ΚΡΑΓΙΟΝ) ΣΕΤ 12 ΤΕΜ

ΚΩΔΙΚΟΣ	YATO 	ΧΡΩΜΑ	ΣΥΣΚ	€/TEM
20069930	YT-69930		50	5,00



OIL
PAINT
EMULSION
PAINT

 LATEX
PAINT
CERAMIC
PAINT

 IMPREGNATING
PAINT

VARNISHE

ΠΙΝΕΛΑ ΜΕ ΞΥΛΙΝΗ ΛΑΒΗ

ΛΕΥΚΗ ΦΥΣΙΚΗ ΤΡΙΧΑ ΜΕ ΣΥΝΘΕΤΙΚΕΣ ΙΝΕΣ 50-50

ΚΩΔΙΚΟΣ	YATO	ΜΕΓΕΘΟΣ	ΣΥΣΚ	€/ΤΕΜ
20054500	YT-54500	1"/25mm	12	1,95
20054501	YT-54501	1,5"/38mm	12	2,45
20054502	YT-54502	2"/50mm	12	3,45
20054503	YT-54503	2,5"/63mm	12	4,35
20054504	YT-54504	3"/75mm	12	5,60
20054505	YT-54505	4"/100mm	12	7,75

ΜΑΥΡΗ ΦΥΣΙΚΗ ΤΡΙΧΑ ΜΕ ΣΥΝΘΕΤΙΚΕΣ ΙΝΕΣ 50-50

ΚΩΔΙΚΟΣ	YATO	ΜΕΓΕΘΟΣ	ΣΥΣΚ	€/ΤΕΜ
20054520	YT-54520	1"/25mm	12	2,15
20054521	YT-54521	1,5"/38mm	12	2,70
20054522	YT-54522	2"/50mm	12	3,70
20054523	YT-54523	2,5"/63mm	12	4,80
20054524	YT-54524	3"/75mm	12	6,10

ΠΙΝΕΛΑ ΜΕ ΠΛΑΣΤΙΚΗ ΛΑΒΗ ΤΥΠΟΥ ΑΓΓΛΙΑΣ

ΛΕΥΚΗ ΦΥΣΙΚΗ ΤΡΙΧΑ ΜΕ ΣΥΝΘΕΤΙΚΕΣ ΙΝΕΣ 50-50

ΚΩΔΙΚΟΣ	YATO	ΜΕΓΕΘΟΣ	ΣΥΣΚ	€/ΤΕΜ
20054540	YT-54540	1"/25mm	12	1,85
20054541	YT-54541	1,5"/38mm	12	2,30
20054542	YT-54542	2"/50mm	12	3,05
20054543	YT-54543	2,5"/63mm	12	4,00
20054544	YT-54544	3"/75mm	12	4,95

ΜΑΥΡΗ ΦΥΣΙΚΗ ΤΡΙΧΑ ΜΕ ΣΥΝΘΕΤΙΚΕΣ ΙΝΕΣ 50-50

ΚΩΔΙΚΟΣ	YATO	ΜΕΓΕΘΟΣ	ΣΥΣΚ	€/ΤΕΜ
20054550	YT-54550	1"/25mm	12	2,15
20054551	YT-54551	1,5"/38mm	12	2,65
20054552	YT-54552	2"/50mm	12	3,50
20054553	YT-54553	2,5"/63mm	12	4,60
20054554	YT-54554	3"/75mm	12	5,65

ΣΥΝΘΕΤΙΚΗ ΤΡΙΧΑ

ΚΩΔΙΚΟΣ	YATO	ΜΕΓΕΘΟΣ	ΣΥΣΚ	€/ΤΕΜ
20054563	YT-54563	2,5"/63mm	12	4,40
20054564	YT-54564	3"/75mm	12	5,40

OIL
PAINT
EMULSION
PAINTLATEX
PAINT
CERAMIC
PAINTIMPREGNATING
PAINT

VARNISHE



ΠΙΝΕΛΑ ΣΤΡΟΓΓΥΛΑ



ΜΕ ΞΥΛΙΝΗ ΛΑΒΗ ΛΕΥΚΗ ΦΥΣΙΚΗ ΤΡΙΧΑ ΜΕ ΣΥΝΘΕΤΙΚΕΣ ΙΝΕΣ 50-50

ΚΩΔΙΚΟΣ	YATO®	ΜΕΓΕΘΟΣ Ø	ΣΥΣΚ	€/ΤΕΜ
20054580	YT-54580	35mm	12	3,65
20054581	YT-54581	40mm	12	4,20
20054582	YT-54582	50mm	12	6,35
20054583	YT-54583	60mm	12	9,60



ΜΕ ΠΛΑΣΤΙΚΗ ΛΑΒΗ

ΜΑΥΡΗ ΦΥΣΙΚΗ ΤΡΙΧΑ ΜΕ ΣΥΝΘΕΤΙΚΕΣ ΙΝΕΣ 50-50

ΚΩΔΙΚΟΣ	YATO®	ΜΕΓΕΘΟΣ Ø	ΣΥΣΚ	€/ΤΕΜ
20054590	YT-54590	16mm	12	2,40
20054591	YT-54591	23mm	12	3,35
20054592	YT-54592	29mm	12	4,90
20054593	YT-54593	33mm	12	5,80



ΜΕ ΞΥΛΙΝΗ ΛΑΒΗ ΓΙΑ ΚΑΛΟΡΙΦΕΡ

ΛΕΥΚΗ ΦΥΣΙΚΗ ΤΡΙΧΑ ΜΕ ΣΥΝΘΕΤΙΚΕΣ ΙΝΕΣ 50-50

ΚΩΔΙΚΟΣ	YATO®	ΜΕΓΕΘΟΣ Ø	ΣΥΣΚ	€/ΤΕΜ
20054620	YT-54620	1,5"/38mm	12	2,60
20054621	YT-54621	2"/50mm	12	3,55
20054622	YT-54622	2,5"/63mm	12	5,25

ΒΟΥΡΤΣΕΣ



ΤΑΠΕΤΣΑΡΙΑΣ ΜΕ ΞΥΛΙΝΗ ΛΑΒΗ

ΣΥΝΘΕΤΙΚΗ ΤΡΙΧΑ FIBER

ΚΩΔΙΚΟΣ	YATO®	ΜΕΓΕΘΟΣ Ø	ΣΥΣΚ	€/ΤΕΜ
20054640	YT-54640	30x110mm	2	5,10
20054641	YT-54641	40x140mm	2	7,95
20054642	YT-54642	50x150mm	2	10,50



ΧΡΩΜΑΤΟΣ ΜΕ ΞΥΛΙΝΗ ΛΑΒΗ

ΣΥΝΘΕΤΙΚΗ ΤΡΙΧΑ FIBER

ΚΩΔΙΚΟΣ	YATO®	ΜΕΓΕΘΟΣ Ø	ΣΥΣΚ	€/ΤΕΜ
20054650	YT-54650	70x170mm	2	12,80
20054651	YT-54651	80x180mm	2	16,65
20054652	YT-54652	90x190mm	2	21,80

ΡΟΛΟ ΒΑΦΗΣ - ΑΝΤΑΛΛΑΚΤΙΚΑ 2 ΤΕΜ

ΚΩΔΙΚΟΣ	VOREL	W(mm)	AØ(mm)	BØ(mm)	ΣΥΣΚ	€/2ΤΕΜ
20609375	09375	50	35	6	200	0,83
20609377	09377	100	35	6	90	1,12
20609378	09378	150	50	6	45	2,55

ΣΚΑΦΑΚΙ

ΚΩΔΙΚΟΣ	VOREL	(mm)	ΣΥΣΚ	€/ΤΕΜ
20609406	09406	150x245	150	0,63
20609408	09408	330x350	60	1,85

ΣΕΤ ΣΚΑΦΑΚΙ - ΡΟΛΟ

ΚΩΔΙΚΟΣ	VOREL	(mm)	ΛΑΒΗ Ø(mm)	ΣΥΣΚ	€/ΤΕΜ
20609390	09390	180	6	12	3,60

ΣΕΤ ΣΚΑΦΑΚΙ - ΡΟΛΟ

ΚΩΔΙΚΟΣ	VOREL	(mm)	ΛΑΒΗ Ø(mm)	ΣΥΣΚ	€/ΤΕΜ
20609395	09395	50	6	60	0,93

ΠΙΝΕΛΟ

ΚΩΔΙΚΟΣ	VOREL	W ΒΟΥΡΤΣΑΣ	L ΒΟΥΡΤΣΑΣ	ΣΥΣΚ	€/ΤΕΜ
20609521	09521	25mm	44/39mm	50	0,68
20609522	09522	36mm	51/46mm	50	0,83
20609523	09523	50mm	51/46mm	50	1,15
20609524	09524	63mm	51/46mm	50	1,42
20609525	09525	76mm	51/46mm	50	1,70



ΠΙΝΕΛΟ ΚΥΡΤΟ

ΚΩΔΙΚΟΣ	VOREL	W ΒΟΥΡΤΣΑΣ	L ΒΟΥΡΤΣΑΣ	ΣΥΣΚ	€/ΤΕΜ
20609560	09560	25mm	44/39mm	50	0,74
20609561	09561	36mm	51/46mm	50	0,88
20609562	09562	50mm	51/46mm	50	1,20



ΒΟΥΡΤΣΑ

ΚΩΔΙΚΟΣ	VOREL	W ΒΟΥΡΤΣΑΣ	L ΒΟΥΡΤΣΑΣ	ΣΥΣΚ	€/ΤΕΜ
20609636	09636	110x30mm	51/46mm	30	3,20
20609638	09638	130x30mm	51/46mm	30	3,75
20609640	09640	140x40mm	57/52mm	30	5,15
20609642	09642	150x50mm	64/59mm	30	6,35



ΣΗΜΑΔΕΥΤΗΡΙ ΚΙΜΩΛΙΑΣ / ΠΟΥΔΡΑ

ΚΩΔΙΚΟΣ	VOREL	L(m)	ΒΑΡΟΣ(g)	ΣΥΣΚ	€/ΤΕΜ
ΣΗΜΑΔΕΥΤΗΡΙ ΚΙΜΩΛΙΑΣ					
20617505	17505	15	115	10	2,80
ΠΟΥΔΡΑ ΜΠΛΕ 115 gr					
20617507	17507		115	20	1,40



ΑΝΑΜΙΚΤΗΡΑΣ ΧΡΩΜΑΤΩΝ

ΚΩΔΙΚΟΣ	YATO	ΣΥΣΚ	€/ΤΕΜ
20054670	YT-54670	50	0,62



ΜΑΓΝΗΤΙΚΗ ΣΥΓΚΡΑΤΗΣΗ ΠΙΝΕΛΩΝ

ΚΩΔΙΚΟΣ	VOREL	ΣΥΣΚ	€/ΤΕΜ
20609590	09590		2,15



ΜΟΥΣΑΜΑΣ - 90 gr

ΚΩΔΙΚΟΣ	VOREL	ΔΙΑΣΤΑΣΕΙΣ (m)	ΣΥΣΚ	€/ΤΕΜ
21985030	85030	3X5	18	9,40
21985040	85040	4X5	9	12,55
21985060	85060	5X8	5	25,05

ΠΤΟΥΚΟΣΠΑΤΟΥΛΕΣ ΠΛΑΣΤΙΚΕΣ ΣΕΤ 4 ΤΕΜ

ΚΩΔΙΚΟΣ	VOREL	ΔΙΑΣΤΑΣΕΙΣ ΣΕΤ(mm)	ΣΥΣΚ	€/ΤΕΜ
20605950	05950	50, 73, 98, 118	10	0,80

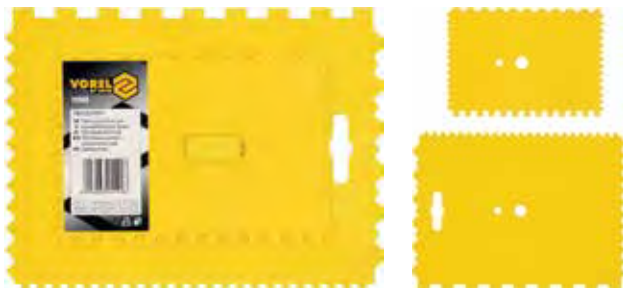
ΠΛΑΣΤΙΚΗ ΣΠΑΤΟΥΛΑ ΠΛΑΚΑΔΩΝ ΣΕΤ 2 ΤΕΜ

ΚΩΔΙΚΟΣ	VOREL	ΔΙΑΣΤΑΣΕΙΣ ΣΕΤ(cm)	ΣΥΣΚ	€/ΤΕΜ
20605960	05960	18X13, 13x9	10	1,35

ΠΛΑΣΤΙΚΕΣ ΣΠΑΤΟΥΛΕΣ ΣΕΤ 4 ΤΜΧ

ΚΩΔΙΚΟΣ	VOREL	ΔΙΑΣΤΑΣΕΙΣ ΣΕΤ(cm)	ΣΥΣΚ	€/ΤΕΜ
20605980	05980	4, 6, 8, 10	30	1,80

ΑΝΑΔΕΥΤΗΡΕΣ ΕΞΑΓΩΝΟΙ

ΚΩΔΙΚΟΣ	VOREL	mm	◻	ΣΥΣΚ	€/ΤΕΜ
20609060	09060	60x400	HEX	40	2,35
20609080	09080	85x400	HEX	40	2,70
20609090	09090	100x600	HEX	30	4,20

ΑΝΑΔΕΥΤΗΡΑΣ - M14

ΚΩΔΙΚΟΣ	VOREL	mm	◻	ΣΥΣΚ	€/ΤΕΜ
20609063	09063	115x580	M14	10	19,30

ΤΡΙΒΕΙΟ ΤΟΙΧΟΥ ΛΑΣΤΙΧ. ΛΑΒΗ

ΚΩΔΙΚΟΣ	VOREL	L(mm)	ΠΑΧΟΣ ΛΑΣΤ.(mm)	ΣΥΣΚ	€/ΤΕΜ
20606537	06537	270x130	9	20	4,60
20606538	06538	270x130	18	20	7,40

270x130
mm
ΤΡΙΒΙΔΙ ΣΟΒΑ ΜΕ ΣΠΟΓΓΩΔΕΣ ΕΛΑΣΤΙΚΟ

ΚΩΔΙΚΟΣ	VOREL	(mm)	ΣΥΣΚ	€/ΤΕΜ
20606540	06540	270x130	20	3,10

STAINLESS
STEEL
ΣΠΑΤΟΥΛΑΔΟΡΟΣ ΙΝΟΧ ΛΑΒΗ

ΚΩΔΙΚΟΣ	VOREL	(mm)	ΣΥΣΚ	€/ΤΕΜ
20606700	06700	270x125	24	3,55

STAINLESS
STEEL
ΣΠΑΤΟΥΛΑ ΚΟΛΛΑΣ ΜΕ ΔΟΝΤΙ

ΚΩΔΙΚΟΣ	VOREL	(mm)	ΔΟΝΤΙ(mm)	ΣΥΣΚ	€/ΤΕΜ
20606740	06740	270x125	4x4	24	3,60
20606760	06760	270x125	6x6	24	3,60
20606780	06780	270x125	8x8	24	3,60
20606781	06781	270x125	10x10	24	3,60

ΑΛΦΑΔΟΛΑΣΤΙΧΟ 15m

ΚΩΔΙΚΟΣ	VOREL	L(m)	ΜΕΓΕΘΟΣ(mm)	ΣΥΣΚ	€/ΤΕΜ
20616000	16000	15	10	15	9,60



PU

ΣΦΟΥΓΓΑΡΙ

ΚΩΔΙΚΟΣ	VOREL	(mm)	ΣΥΣΚ	€/ΤΕΜ
20604544	04544	165x100x80	18	2,45

ΣΤΑΥΡΟΙ ΠΛΑΚΙΔΙΩΝ

ΚΩΔΙΚΟΣ	VOREL	L(mm)	ΤΕΜ	ΣΥΣΚ	€/ΤΕΜ
20604600	04600	1.5	200	100	0,49
20604610	04610	2.0	200	100	0,49
20604620	04620	2.5	200	100	0,49
20604630	04630	3.0	150	100	0,49
20604640	04640	4.0	100	100	0,49
20604650	04650	5.0	100	100	0,49
20604660	04660	6.0	75	100	0,49
20604668	04668	8.0	30	100	0,49
20604670	04670	10.0	30	100	0,49

ΡΟΛΟ ΒΑΦΗΣ

ΚΩΔΙΚΟΣ	VOREL	W(mm)	A(mm)	Ø(mm)	ΣΥΣΚ	€/ΤΕΜ
20609334	09334	100	9	6	40	1,28
20609336	09336	180	18	6	60	3,75

ΡΟΛΟ ΒΑΦΗΣ

ΚΩΔΙΚΟΣ	VOREL	W(mm)	A(mm)	Ø(mm)	ΣΥΣΚ	€/ΤΕΜ
20609307	09307	180	20	6	55	3,50
20609308	09308	250	20	6	50	4,40

ΡΟΛΟ ΒΑΦΗΣ

ΚΩΔΙΚΟΣ	VOREL	W(mm)	AØ(mm)	BØ(mm)	ΣΥΣΚ	€/ΤΕΜ
20609359	09359	150	50	6	50	3,70

ΡΟΛΟ ΒΑΦΗΣ

ΚΩΔΙΚΟΣ	VOREL	W(mm)	AØ(mm)	BØ(mm)	ΣΥΣΚ	€/ΤΕΜ
20609371	09371	70	35	6	80	1,05
20609372	09372	100	35	6	70	1,21
20609373	09373	150	50	6	50	2,25

ΡΟΛΟ ΒΑΦΗΣ - ΑΝΤΑΛΛΑΚΤΙΚΟ

ΚΩΔΙΚΟΣ	VOREL	W(mm)	A(mm)	Ø(mm)	ΣΥΣΚ	€/ΤΕΜ
20609310	09310	180	20	6	10	2,55
20609311	09311	250	20	6	40	3,45

ΡΟΛΟ ΒΑΦΗΣ - ΑΝΤΑΛΛΑΚΤΙΚΟ

ΚΩΔΙΚΟΣ	VOREL	W(mm)	A(mm)	Ø(mm)	ΣΥΣΚ	€/ΤΕΜ
20609331	09331	180	6	6	10	3,00
20609332	09332	250	6	8	10	3,55

ΡΟΛΟ ΒΑΦΗΣ - ΑΝΤΑΛΛΑΚΤΙΚΑ 2 ΤΕΜ

ΚΩΔΙΚΟΣ	VOREL	W(mm)	A(mm)	Ø(mm)	ΣΥΣΚ	€/2ΤΕΜ
20609338	09338	100	9	6	150	1,28

**2
pcs**



STAINLESS
STEEL

ΣΠΑΤΟΥΛΑΔΟΡΟΣ ΙΝΟΧ ΠΛΑΣΤΙΚΗ ΛΑΒΗ

ΚΩΔΙΚΟΣ	YATO 	(mm)	ΣΥΣΚ	€/ΤΕΜ
20005200	YT-5200	270x130	30	7,20



STAINLESS
STEEL

ΣΠΑΤΟΥΛΑΔΟΡΟΣ ΠΛΑΚΑΔΩΝ ΜΕ ΔΟΝΤΙ

ΚΩΔΙΚΟΣ	YATO 	ΔΟΝΤΙ	(mm)	ΣΥΣΚ	€/ΤΕΜ
20005202	YT-5202	6x6	275x130	30	7,50
20005203	YT-5203	8x8	270x130	30	7,50
20005204	YT-5204	10x10	260x130	30	7,50



STAINLESS
STEEL

ΣΠΑΤΟΥΛΑΔΟΡΟΣ ΙΝΟΧ ΣΤΡΟΓΓΥΛΑ ΑΚΡΑ

ΚΩΔΙΚΟΣ	YATO 	(mm)	ΣΥΣΚ	€/ΤΕΜ
20005214	YT-5214	200x80	20	13,60



ΣΠΑΤΟΥΛΑΔΟΡΟΣ ΓΥΨΟΣΑΝΙΔΑΣ

ΚΩΔΙΚΟΣ	YATO 	(mm)	ΣΥΣΚ	€/ΤΕΜ
20005218	YT-5218	165x370	20	7,95



STAINLESS
STEEL

ΣΠΑΤΟΥΛΑ ΚΟΛΛΑΣ

ΚΩΔΙΚΟΣ	YATO 	(mm)	ΣΥΣΚ	€/ΤΕΜ
20005226	YT-5226	250	20	10,85
20005228	YT-5228	350	20	12,45
20005230	YT-5230	500	20	14,75

AI

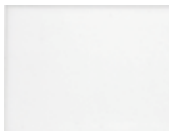

ΤΡΙΒΙΔΙ ΣΟΒΑ ΜΕ ΛΑΣΤΙΧΟ

ΚΩΔΙΚΟΣ	YATO 	(mm)	ΣΥΣΚ	€/ΤΕΜ
20051901	YT-51901	270x130	10	4,50



ΤΡΙΒΙΔΙ ΣΟΒΑ

ΚΩΔΙΚΟΣ	YATO 	(mm)	ΣΥΣΚ	€/ΤΕΜ
20051904	YT-51904	270x130	10	4,55



ΤΡΙΒΙΔΙ ΤΟΙΧΟΥ ΜΕ ΣΦΟΥΓΓΑΡΙ

ΚΩΔΙΚΟΣ	YATO 	(mm)	ΣΥΣΚ	€/ΤΕΜ
20051906	YT-51906	270x130	10	4,55

ΤΡΙΒΙΔΙ ΤΟΙΧΟΥ ΜΕ ΣΦΟΥΓΓΑΡΙ

ΚΩΔΙΚΟΣ	YATO 	(mm)	ΣΥΣΚ	€/ΤΕΜ
20051908	YT-51908	270x130	10	4,65

ΤΡΙΒΙΔΙ ΤΟΙΧΟΥ

ΚΩΔΙΚΟΣ	YATO 	(mm)	ΣΥΣΚ	€/ΤΕΜ
20051911	YT-51911	270x130	20	2,65

ΤΡΙΒΙΔΙ ΠΟΛΥΟΥΡΕΘΑΝΗΣ ΣΟΒΑ

ΚΩΔΙΚΟΣ	VOREL	(mm)	ΣΥΣΚ	€/ΤΕΜ
20606400	06400	130x270	10	1,75
20606410	06410	140x500	10	3,35
20606440	06440	170x320	10	2,60

ΤΡΙΒΙΔΙ ΣΟΒΑ

ΚΩΔΙΚΟΣ	VOREL	(mm)	ΣΥΣΚ	€/ΤΕΜ
20606470	06470	270x130	20	3,95
20606472	06472	350x160	15	6,50

ΤΡΙΒΙΔΙ ΣΟΒΑ 270x130

ΚΩΔΙΚΟΣ	VOREL	(mm)	ΣΥΣΚ	€/ΤΕΜ
20606500	06500	270x130	24	1,50

 270x130
mm

ΤΡΙΒΙΔΙ ΣΟΒΑ ΜΕ ΦΕΛΟ

ΚΩΔΙΚΟΣ	VOREL	(mm)	ΣΥΣΚ	€/ΤΕΜ
20606510	06510	270x130	20	3,65

 270x130
mm

ΤΡΙΒΙΔΙ ΣΟΒΑ ΜΕ ΛΑΣΤΙΧΟ

ΚΩΔΙΚΟΣ	VOREL	(mm)	ΣΥΣΚ	€/ΤΕΜ
20606520	06520	270x130	30	2,55

 270x130
mm

ΤΡΙΒΕΙΟ ΤΟΙΧΟΥ ΑΦΡ. ΠΛΑΣΤ ΛΑΒΗ

ΚΩΔΙΚΟΣ	VOREL	L(mm)	ΠΑΧΟΣ ΣΦΟΥΓΓ.(mm)	ΣΥΣΚ	€/ΤΕΜ
20606532	06532	270x130	30	20	3,25

STAINLESS
STEEL**ΜΥΣΤΡΙ ΣΟΒΑΤΖΗ - ΠΛΑΣΤΙΚΗ ΛΑΒΗ**

ΚΩΔΙΚΟΣ	YATO 	(mm)	ΣΥΣΚ	€/ΤΕΜ
20005234	YT-5234	200x190	10	9,65

STAINLESS
STEEL**ΜΥΣΤΡΙ ΤΡΑΠΕΖΟΕΙΔΕΣ ΙΝΟΧ - ΠΛΑΣΤΙΚΗ ΛΑΒΗ**

ΚΩΔΙΚΟΣ	YATO 	(mm)	ΣΥΣΚ	€/ΤΕΜ
20005237	YT-5237	120x180x80	10	7,15

STAINLESS
STEEL**ΜΥΣΤΡΙ ΗΛΕΚΤΡΟΛΟΓΟΥ - ΠΛΑΣΤΙΚΗ ΛΑΒΗ**

ΚΩΔΙΚΟΣ	YATO 	(mm)	ΣΥΣΚ	€/ΤΕΜ
20005245	YT-5245	135x80	20	5,70



4 PCS	SS STAINLESS STEEL	50 mm
75 mm	100 mm	150 mm

**ΣΕΤ ΣΠΑΤΟΥΛΕΣ - 4 ΤΕΜ.**

ΚΩΔΙΚΟΣ	YATO 	(mm)	ΣΥΣΚ	€/ΤΕΜ
20052790	YT-52790	50, 75, 100, 150	10	9,00

NEO NEO **ΣΠΑΤΟΥΛΑΔΟΡΟΣ ΦΙΝΙΡΙΣΜΑΤΟΣ**

ΚΩΔΙΚΟΣ	YATO 	(mm)	ΣΥΣΚ	€/ΤΕΜ
20005212	YT-5212	500	20	12,10

ΣΠΑΤΟΥΛΕΣ ΞΥΛΙΝΗ ΛΑΒΗ ΣΕΤ 3 ΤΕΜ

ΚΩΔΙΚΟΣ	VOREL	(mm)	ΤΕΜ	ΣΥΣΚ	€/ΤΕΜ
20606130	06130	30-50-80	3	25	1,55

3
pcs

30
mm

50
mm

80
mm

 STAINLESS
STEEL

ΣΠΑΤΟΥΛΑΔΟΡΟΣ ΜΕ ΠΛΑΣΤΙΚΗ ΛΑΒΗ

ΚΩΔΙΚΟΣ	VOREL	(mm)	ΣΥΣΚ	€/ΤΕΜ
20606294	06294	40	100	0,58
20606295	06295	60	80	0,73
20606296	06296	80	60	0,89
20606297	06297	100	50	0,99
20606298	06298	150	80	1,20
20606301	06301	200	60	1,47
20606304	06304	250	50	1,75
20606307	06307	350	25	2,45
20606308	06308	450	25	3,00
20606309	06309	600	10	4,40

ΜΥΣΤΡΙ ΤΡΙΓΩΝΙΚΟ

ΚΩΔΙΚΟΣ	VOREL	(mm)	ΣΥΣΚ	€/ΤΕΜ
20606340	06340	180	50	2,30
20606350	06350	200	50	2,50
20606360	06360	220	50	2,65

 STAINLESS
STEEL

ΜΥΣΤΡΙ ΤΡΑΠΕΖΟΕΙΔΕΣ ΑΝΟΞΕΙΔΩΤΟ

ΚΩΔΙΚΟΣ	VOREL	(mm)	ΣΥΣΚ	€/ΤΕΜ
20606370	06370	130	50	2,95

ΣΠΑΤΟΥΛΕΣ

ΚΩΔΙΚΟΣ	VOREL	(mm)	ΣΥΣΚ	€/ΤΕΜ
20606030	06030	30	12	0,44
20606040	06040	40	12	0,49
20606050	06050	50	12	0,53
20606060	06060	60	12	0,60
20606080	06080	80	12	0,67
20606100	06100	100	12	0,72

STAINLESS
STEEL

ΣΠΑΤΟΥΛΕΣ ΙΝΟΧ

ΚΩΔΙΚΟΣ	VOREL	(mm)	ΣΥΣΚ	€/ΤΕΜ
20605901	05901	30	6	1,75
20605902	05902	40	6	1,80
20605903	05903	50	6	2,00
20605904	05904	60	6	2,00
20605905	05905	80	6	2,05
20605906	05906	100	6	2,05

STAINLESS
STEEL

ΣΠΑΤΟΥΛΕΣ ΙΝΟΧ

ΚΩΔΙΚΟΣ	VOREL	(mm)	ΣΥΣΚ	€/ΤΕΜ
20605911	05911	30	6	1,35
20605912	05912	40	6	1,45
20605913	05913	50	6	1,55
20605914	05914	60	6	1,65
20605915	05915	80	6	1,75
20605916	05916	100	6	1,85



ΚΟΥΒΑΣ ΠΛΑΣΤΙΚΟΣ

ΚΩΔΙΚΟΣ	VOREL	ΛΙΤΡΑ	ΣΥΣΚ	€/ΤΕΜ
20606390	06390	12	680	2,15
20606392	06392	20	390	3,50



ΚΟΥΒΑΣ ΠΛΑΣΤΙΚΟΣ ΜΕ ΣΤΟΜΙΟ

ΚΩΔΙΚΟΣ	VOREL	ΛΙΤΡΑ	ΣΥΣΚ	€/ΤΕΜ
20606391	06391	12	720	2,20



ΣΚΑΦΗ ΛΑΣΠΗΣ

ΚΩΔΙΚΟΣ	VOREL	ΛΙΤΡΑ	ΣΥΣΚ	€/ΤΕΜ
20606394	06394	40	210	7,70
20606395	06395	60	210	8,75

**ΖΕΜΠΙΛΙΑ ΤΑΥΓ**

Υψηλής ποιότητας και αντοχής

Από ανακυκλωμένο, μη τοξικό, πολυαιθυλένιο που δίνει την αίσθηση του λάστιχου

**26 ΛΙΤΡΩΝ**

ΚΩΔΙΚΟΣ	ΔΙΑΜΕΤΡΟΣ	ΜΕΓΕΘΟΣ - Lt	ΣΥΣΚ	€/ΤΕΜ.
44919114	35 cm	26	12	▶ 4,50

**30 ΛΙΤΡΩΝ**

ΚΩΔΙΚΟΣ	ΔΙΑΜΕΤΡΟΣ	ΜΕΓΕΘΟΣ - Lt	ΣΥΣΚ	€/ΤΕΜ.
44919145	42 cm	30	12	▶ 4,95

**42 ΛΙΤΡΩΝ**

ΚΩΔΙΚΟΣ	ΔΙΑΜΕΤΡΟΣ	ΜΕΓΕΘΟΣ - Lt	ΣΥΣΚ	€/ΤΕΜ.
44919152	45 cm	42	12	▶ 6,15

**65 ΛΙΤΡΩΝ**

ΚΩΔΙΚΟΣ	ΔΙΑΜΕΤΡΟΣ	ΜΕΓΕΘΟΣ - Lt	ΣΥΣΚ	€/ΤΕΜ.
44919121	55 cm	65	6	▶ 9,90



ΠΡΙΟΝΙ ΑΦΡΟΜΠΕΤΟΝ ΜΕ ΒΙΝΤΙ

ΚΩΔΙΚΟΣ	VOREL	mm	ΔΟΝΤΙ	ΣΥΣΚ	€/ΤΕΜ
21128012	28012	660	34	6	23,45



GALVANIZED
STEEL

ΤΡΥΠΑΝΙ ΑΦΡΟΜΠΕΤΟΝ

ΚΩΔΙΚΟΣ	VOREL	(mm)	ΣΥΣΚ	€/ΤΕΜ
21105821	05821	60	20	3,90
21105822	05822	80	20	4,40
21105823	05823	120	20	5,65



ALOXITE
COATING

ΣΦΟΥΓΓΑΡΙ ΛΕΙΑΝΣΗΣ

ΚΩΔΙΚΟΣ	VOREL	ΤΥΠΟΣ	(mm)	ΣΥΣΚ	€/ΤΕΜ
21108302	08302	P80	125x90x65x25	100	1,65
21108304	08304	P120	125x90x65x25	100	1,65
21108307	08307	P180	125x90x65x25	100	1,65



ALOXITE
COATING

ΣΦΟΥΓΓΑΡΙ ΛΕΙΑΝΣΗΣ

ΚΩΔΙΚΟΣ	VOREL	ΤΥΠΟΣ	(mm)	ΣΥΣΚ	€/ΤΕΜ
21107910	07910	P46	124x98x12	100	1,00
21107912	07912	P80	124x98x12	100	1,00
21107914	07914	P120	124x98x12	100	1,00
21107916	07916	P180	124x98x12	100	1,00

ΣΠΑΓΓΟΣ ΚΙΤΡΙΝΟΣ 50m

ΚΩΔΙΚΟΣ	VOREL	L(m)	ΣΥΣΚ	€/ΤΕΜ
20617488	17488	50	60	2,10

ΚΑΛΕΜΙ ΠΛΑΚΕ ΜΕ ΠΛΑΣΤΙΚΗ ΛΑΒΗ

ΚΩΔΙΚΟΣ	VOREL	L(mm)	ΣΥΣΚ	€/ΤΕΜ
20635250	35250	250	12	1,80
20635300	35300	300	12	2,15



**12mm ΠΑΧΟΣ
23mm ΠΛΑΤΟΣ**

ΚΑΛΕΜΙ ΠΛΑΚΕ

ΚΩΔΙΚΟΣ	VOREL	L(mm)	ΒΑΡΟΣ(Kg)	ΣΥΣΚ	€/ΤΕΜ
20635373	35373	250	0.46	10	7,95
20635374	35374	300	0.53	10	8,75



**300
mm**

ΒΕΛΟΝΙ ΜΕ ΠΛΑΣΤΙΚΗ ΛΑΒΗ

ΚΩΔΙΚΟΣ	VOREL	L(mm)	ΣΥΣΚ	€/ΤΕΜ
20635430	35430	300	12	2,05



PU

ΣΦΟΥΓΓΑΡΙ

ΚΩΔΙΚΟΣ	VOREL	(mm)	ΣΥΣΚ	€/ΤΕΜ
20604540	04540	165x100x60	74	1,33



ΧΗΜΙΚΗ ΕΠΟΞΙΚΗ ΡΗΤΙΝΗ

2 ΣΥΣΤΑΤΙΚΩΝ, 300ml

ΚΩΔΙΚΟΣ	ΠΕΡΙΓΡΑΦΗ	ΣΥΣΚ	€/ΤΕΜ
2040020	300ml	12	7,95

ΜΕ 2 ΑΚΡΟΦΥΣΙΑ



2040011 ΑΝΤΑΛΛΑΚΤΙΚΟ ΑΚΡΟΦΥΣΙΟ 12 **0,35**

HELIX-CHEM
drills-screws
& fasteners

ΘΕΡΜΟΚΡΑΣΙΑ	ΧΡΟΝΟΣ ΣΤΕΡΕΩΣΗΣ	ΧΡΟΝΟΣ ΕΦΑΡΜΟΓΗΣ ΣΕ ΣΤΕΓΝΗ ΤΡΥΠΑ	ΧΡΟΝΟΣ ΕΦΑΡΜΟΓΗΣ ΣΕ ΒΡΕΓΜΕΝΟ ΜΠΕΤΟ
5° C	25 min	120 min	240 min
10° C	15 min	80 min	160 min
20° C	6 min	45 min	60 min
30° C	4 min	25 min	50 min
35° C	2 min	20 min	40 min



BUILDING TRUST



2 ΣΥΣΤΑΤΙΚΩΝ - ΧΩΡΙΣ ΣΤΥΡΕΝΙΟ

ΧΗΜΙΚΗ ΡΗΤΙΝΗ - SIKA ANCHORFIX®-1 N

ΚΩΔΙΚΟΣ	ΠΕΡΙΓΡΑΦΗ	ΣΥΣΚ	€/ΤΕΜ
617866	300ml	12	9,50



201
PCS



ΣΕΤ ΤΟΠΟΘΕΤΗΣΗΣ & ΕΠΙΠΕΔΩΣΗΣ ΠΛΑΚΙΔΙΩΝ

ΚΩΔΙΚΟΣ	VOREL	ΣΥΣΚ	€/ΤΕΜ
21104680	04680	200 +1 ΤΕΜ	6 37,30

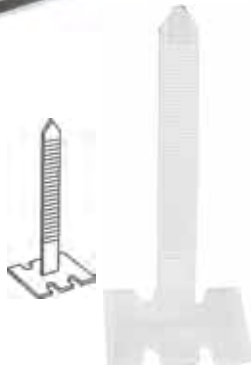

100 ΤΕΜ

ΚΩΔΙΚΟΣ	VOREL	ΣΥΣΚ	€/ΤΕΜ
21104681	04681	18	5,25

100 ΤΕΜ

ΚΩΔΙΚΟΣ	VOREL	ΣΥΣΚ	€/ΤΕΜ
21104682	04682	30	8,65

ΣΕΤ ΤΟΠΟΘΕΤΗΣΗΣ & ΕΠΙΠΕΔΩΣΗΣ ΠΛΑΚΙΔΙΩΝ

ΚΩΔΙΚΟΣ	VOREL	ΣΥΣΚ	€/ΤΕΜ
21104692	04692	300+100ΤΕΜ	1 25,50



100 ΤΕΜ

ΚΩΔΙΚΟΣ	VOREL	ΣΥΣΚ	€/ΤΕΜ
21104690	04690		6,65

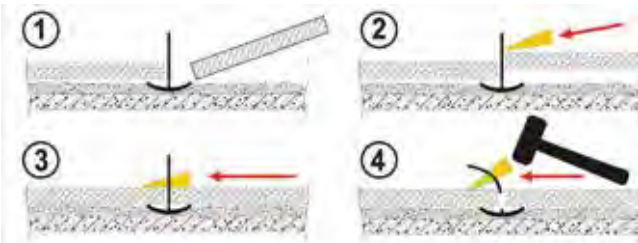

20-70
mm

ΕΡΓΑΛΕΙΟ ΤΟΠΟΘΕΤΗΣΗΣ

ΚΩΔΙΚΟΣ	VOREL	ΣΥΣΚ	€/ΤΕΜ
21104699	04699	5	11,70

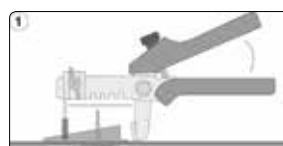

Ανά m²

30x30	33x33	40x40	45x45	50x50	60x60	80x80	60x30	100x50	120x60
42	36	20	28	24	10	10	22	16	10



ΣΤΑΥΡΟΙ ΠΛΑΚΙΔΙΩΝ

ΚΩΔΙΚΟΣ	(mm)	ΠΟΣΟΤΗΤΑ	ΣΥΣΚ	€/500τεμ
44910005	1	500 τεμ	6	▶ 4,50
44910012	1,5	500 τεμ	6	▶ 4,50
44910029	2	500 τεμ	6	▶ 4,50
44910036	3	500 τεμ	6	▶ 4,50
44910050	5	300 τεμ	6	▶ 3,45



ΑΠΟΣΤΑΤΗΣ ΑΛΦΑΔΟΠΟΙΗΣΗΣ

ΚΩΔΙΚΟΣ	(mm)	ΠΟΣΟΤΗΤΑ	ΣΥΣΚ	€/250τεμ
44913228	1	250 τεμ	6	▶ 22,15
44913259	1,5	250 τεμ	6	▶ 22,15
44913280	2	250 τεμ	6	▶ 22,15
44913310	3	250 τεμ	6	▶ 22,15

ΠΑΞΙΜΑΔΙ ΑΛΦΑΔΟΠΟΙΗΣΗΣ

ΚΩΔΙΚΟΣ	(mm)	ΠΟΣΟΤΗΤΑ	ΣΥΣΚ	€/50τεμ
44913495		50 τεμ	6	▶ 9,10



ΑΠΟΣΤΑΤΗΣ ΑΛΦΑΔΟΠΟΙΗΣΗΣ ΠΕΤΡΑΣ

ΚΩΔΙΚΟΣ	(mm)	ΠΟΣΟΤΗΤΑ	ΣΥΣΚ	€/250τεμ
44913341	1	250 τεμ	6	▶ 25,70
44913372	2	250 τεμ	6	▶ 25,70



ΠΕΝΣΑ ΑΛΦΑΔΟΠΟΙΗΣΗΣ ΠΛΑΚΙΔΙΩΝ

ΚΩΔΙΚΟΣ	(mm)	ΠΟΣΟΤΗΤΑ	ΣΥΣΚ	€/ΤΕΜ
44913488		1	6	▶ 16,99

ΣΦΗΝΑ ΚΩΔΙΚΟΣ	(mm)	ΠΟΣΟΤΗΤΑ	ΣΥΣΚ	€/250τεμ
44913433	22	250 τεμ	6	▶ 23,70



SIKA Masking Tape 60C

ΤΑΙΝΙΑ ΜΑΣΚΑΡΙΣΜΑΤΟΣ ΓΙΑ ΓΕΝΙΚΕΣ ΕΦΑΡΜΟΓΕΣ ΣΤΗΝ ΚΑΤΑΣΚΕΥΗ

ΚΩΔΙΚΟΣ	ΠΡΟΪΟΝ	ΣΥΣΚ	ΤΙΜΗ/ΤΜΧ(€)
552213-1	19MM X 45M	48	0.94
552214-1	25MM X 45M	36	1.24
552215-1	30MM X 45M	30	1.52
552216-1	38MM X 45M	24	1.88
552217-1	50MM X 45M	18	2.48

Περιγραφή

Επαγγελματική ταινία μασκαρίσματος γενικής χρήσης με δυνατό άρπαγμα και αντοχή σε θερμοκρασία 60°C για 30 λεπτά.

Ιδανική για ελαιοχρωματισμούς με βαφές νερού & διαλύτη. Αποτελείται από κορεσμένο ημι-κρεπ χαρτί επικαλυμμένο με συγκολλητικό τύπου SNR και συνεργάζεται άριστα με τα οικοδομικά σφραγιστικά της Sika καθώς η κόλλα της ταινίας δεν επηρεάζει τον πολυμερισμό τους.



SIKA Washi Tape

ΡΥΖΟΧΑΡΤΟ

ΚΩΔΙΚΟΣ	ΠΡΟΪΟΝ	ΣΥΣΚ	ΤΙΜΗ/ΤΜΧ(€)
552090	25MM X 50M	36	3.45
552091	50MM X 50M	18	7.25

Περιγραφή

Επαγγελματικής χρήσης ταινία μασκαρίσματος, βάσης ακρυλικού συγκολλητικού από λεπτό, ανάγλυφο χαρτί washi (ριζόχαρτο). Ιδανική επιλογή για λεπτές και ακριβείς γραμμές σε εφαρμογές ναυτιλίας, αυτοκινητοβιομηχανίας και για επαγγελματικές εφαρμογές στην κατασκευή.

Το ιδιαίτερα μικρό πάχος του χαρτιού της επιτρέπει την απομάκρυνσή της ενόσω η βαφή είναι νωπή – ακόμη και 30 λεπτά μετά (ανάλογα με το πάχος βαφής).



SIKA Blue Masking Tape UV

ΑΔΙΑΒΡΟΧΗ ΤΑΙΝΙΑ ΜΑΣΚΑΡΙΣΜΑΤΟΣ, ΑΝΘΕΚΤΙΚΗ ΣΕ ΥΠΕΡΙΩΔΗ ΑΚΤΙΝΟΒΟΛΙΑ ΓΙΑ ΕΞΩΤΕΡΙΚΕΣ ΝΑΥΤΙΛΙΑΚΕΣ ΕΦΑΡΜΟΓΕΣ

ΚΩΔΙΚΟΣ	ΠΡΟΪΟΝ	ΣΥΣΚ	ΤΙΜΗ/ΤΜΧ(€)
551998	25MM X 50M	36	3.70
551999	50MM X 50M	18	7.40

Περιγραφή

Ειδικά σχεδιασμένη ταινία, ναυτιλιακών εφαρμογών, για εξωτερική χρήση.

Κατάλληλη για μόνιμη εφαρμογή 15 ημερών σε εξωτερικό περιβάλλον, εκτεθειμένη σε υπεριώδη ακτινοβολία.

Το ειδικό ανθεκτικό, σε νερό, χαρτί της σε συνδυασμό με το συγκολλητικό της επιτρέπει την εύκολη, χωρίς υπολείμματα, στεγνή απομάκρυνσή της, μετά την εφαρμογή.



ΑΚΡΥΛΙΚΗΣ ΚΟΛΛΑΣ ΕΛΑΣΤΙΚΟΤΗΤΑ ΕΩΣ 10%

UV PROTECTION

25 m 50 m

25 m 50 m

ΧΑΡΤΟΤΑΙΝΙΑ ΓΕΝΙΚΗΣ ΧΡΗΣΗΣ

ΚΩΔΙΚΟΣ	VOREL	ΦΑΡΔΟΣ mm	ΜΗΚΟΣ m	ΣΥΣΚ	€/ΤΕΜ
21175270	75270	19	25	12	0,54
21175271	75271	25	25	36	0,71
21175272	75272	30	25	10	0,87
21175273	75273	38	25	6	1,09
21175274	75274	48	25	6	1,36
21175285	75285	25	50	9	1,36
21175286	75286	30	50	10	1,65
21175287	75287	38	50	6	2,05
21175288	75288	48	50	6	2,50

ΧΑΡΤΟΤΑΙΝΙΑ 60°C ΠΡΟΣΤΑΣΙΑ UV 14 ΗΜΕΡΩΝ

ΚΩΔΙΚΟΣ	VOREL	ΦΑΡΔΟΣ mm	ΜΗΚΟΣ m	ΣΥΣΚ	€/ΤΕΜ
21175120	75120	30	25	40	1,44
21175121	75121	38	25	24	1,80
21175122	75122	48	25	24	2,30
21175123	75123	30	50	40	2,90
21175124	75124	38	50	24	3,65
21175125	75125	48	50	24	4,60

Πανίσχυρη ταινία διπλής όψεως Powerful Grip



Η **Powerful Grip Tape** αποτελεί έναν νέο τύπο ταινίας διπλής όψεως που διαθέτει απίστευτα ισχυρή και άμεση συγκόλληση.

- Προσφύεται σχεδόν σε οποιοδήποτε υλικό, σε εσωτερικές ή εξωτερικές εφαρμογές, συμπεριλαμβάνοντας κεραμικά, τουβλοποιία, ξύλο, μέταλλα, πλαστικά και pvc.
- Είναι ανθεκτική σε υγρασία
- Δεν υποβαθμίζεται με την επίδραση της υπεριώδους ακτινοβολίας.
- Είναι ιδανική για οικιακή, βιομηχανική, κατασκευαστική χρήση
- Μπορεί να εφαρμοστεί και ως αντικατάστατο τρυπήματος και βιδώματος.



Η ΤΑΙΝΙΑ ΠΟΥ ΝΟΜΙΖΕΙ ΠΩΣ ΕΙΝΑΙ ΚΟΛΛΑ!

ΚΩΔΙΚΟΣ	ΧΡΩΜΑ	ΣΥΣΚ	ΤΜΧ /ΚΙΒ	ΚΙΒ/ ΠΛΤ	ΤΙΜΗ/ ΤΜΧ(€)
484678	ΔΙΑΦΑΝΟ	12MM X 2.5M	48	105	2.80
484679	ΔΙΑΦΑΝΟ	25MM X 2.5M	24	105	4.90
484680	ΔΙΑΦΑΝΟ	50MM X 2.5M	12	105	8.78



2 PCS
19mm x 5m
19mm x 2.25m

ΑΦΡΩΔΕΙΣ ΤΑΙΝΙΕΣ ΔΙΠΛΗΣ ΟΨΗΣ

ΚΩΔΙΚΟΣ	VOREL	ΦΑΡΔΟΣ mm	ΜΗΚΟΣ m	ΣΥΣΚ	€/ΤΕΜ
20675100	75100	19	2.25 & 5	12	2,40



ΤΑΙΝΙΕΣ ΔΙΠΛΗΣ ΟΨΗΣ - ΜΟΚΕΤΑΣ

ΚΩΔΙΚΟΣ	VOREL	ΦΑΡΔΟΣ mm	ΜΗΚΟΣ m	ΣΥΣΚ	€/ΤΕΜ
20675261	75261	50	10	36	2,65
20675262	75262	50	25	24	6,15



ΤΑΙΝΙΕΣ ΔΙΠΛΗΣ ΟΨΗΣ PP

ΚΩΔΙΚΟΣ	VOREL	ΦΑΡΔΟΣ mm	ΜΗΚΟΣ m	ΣΥΣΚ	€/ΤΕΜ
20675246	75246	50	10	72	1,38
20675247	75247	50	25	36	3,20



ΤΑΙΝΙΑ ΔΙΠΛΗΣ ΟΨΗΣ - GEL 3m x 3cm x 2mm

**ΣΥΓΚΡΑΤΗΣΗ 8,5 Kg
ΜΕ 1 ΜΕΤΡΟ ΤΑΙΝΙΑΣ**

ΥΠΕΡΔΙΑΦΑΝΗ

**ΜΕ ΣΩΜΑΤΙΔΙΑ
ΝΑΝΟΤΕΧΝΟΛΟΓΙΑΣ**



**ΑΔΙΑΒΡΟΧΗ
ΠΛΥΝΕΤΕ & ΞΑΝΑ ΚΟΛΛΗΣΤΕ**

ΝΑΝΟ ΤΑΡΕ / ΔΙΑΦΑΝΗ ΤΑΙΝΙΑ - HELIX CHEM

ΚΩΔΙΚΟΣ	ΧΡΩΜΑ	ΦΑΡΔΟΣ mm	ΜΗΚΟΣ m	ΣΥΣΚ	€/ΤΕΜ
901302030	ΥΠΕΡΔΙΑΦΑΝΗ	30	3	8	3,90

ΒΕΝΤΟΥΖΕΣ ΤΖΑΜΙΩΝ ΑΛΟΥΜΙΝΙΟΥ



∅
125
mm

max
60 kg

Al

 **NEO¹**



ΜΟΝΗ

ΚΩΔΙΚΟΣ	YATO 	∅(mm)	Kg	ΣΥΣΚ	€/ΤΕΜ
20037235	YT-37235	125	60		15,00



∅
125
mm

max
120 kg

Al

ΔΙΠΛΗ

ΚΩΔΙΚΟΣ	YATO 	∅(mm)	Kg	ΣΥΣΚ	€/ΤΕΜ
20037236	YT-37236	125	120		26,00

 **NEO¹**



 **NEO¹**

ΤΡΙΠΛΗ

ΚΩΔΙΚΟΣ	YATO 	∅(mm)	Kg	ΣΥΣΚ	€/ΤΕΜ
20037237	YT-37237	125	190		34,00

∅
125
mm

max
190 kg

Al

BΕΝΤΟΥΖΕΣ ΤΖΑΜΙΩΝ ΜΕ ΑΝΤΛΙΑ ΚΕΝΟΥ

Εξαιρετικά μεγάλη δύναμη συγκράτησης,
χάρη στην ενσωματωμένη αντλία κενού



NEO¹



204mm

ΚΩΔΙΚΟΣ	YATO®	∅(mm)	Kg	ΣΥΣΚ	€/ΤΕΜ
20037220	YT-37220	204	58		68,70

Κατάλληλη για χρήση σε όλες τις λείες επιφάνειες (γυαλί,
πλακάκι, γρανίτη, μέταλλα)
Ανθεκτική κατασκευή, από ABS και μέταλλο
Εργονομική λαβή



NEO¹



150mm

ΚΩΔΙΚΟΣ	YATO®	∅(mm)	Kg	ΣΥΣΚ	€/ΤΕΜ
20037223	YT-37223	150	32		61,00

Κατάλληλη για χρήση σε όλες τις λείες επιφάνειες (γυαλί,
πλακάκι, γρανίτη, μέταλλα)
Ανθεκτική κατασκευή, από PVC
Εργονομική λαβή



ΣΕ ΠΩΛΗΣΕΙΣ
No 1

115
Ømm



ΒΕΝΤΟΥΖΑ ΤΖΑΜΙΩΝ ΠΛΑΣΤΙΚΗ

	ΚΩΔΙΚΟΣ	VOREL	Ø(mm)	Kg	ΣΥΣΚ	€/ΤΕΜ
40 kg	ΜΟΝΗ					
	21105300	05300	115	40	48	4,90
70 kg	ΔΙΠΛΗ					
	21105301	05301	115	70	24	9,60
100 kg	ΤΡΙΠΛΗ					
	21105302	05302	115	100	12	14,90



ΒΕΝΤΟΥΖΑ ΤΖΑΜΙΩΝ ΑΛΟΥΜΙΝΙΟΥ

	ΚΩΔΙΚΟΣ	VOREL	Ø(mm)	Kg	ΣΥΣΚ	€/ΤΕΜ
40 kg	ΜΟΝΗ					
	21105311	05311	115	40	50	9,90
70 kg	ΔΙΠΛΗ					
	21105312	05312	115	70	10	19,70

115
Ømm

Al



5
PCS

300kg



NEO

ΣΕΤ ΜΕΤΑΦΟΡΑΣ ΕΠΙΠΛΩΝ

	ΚΩΔΙΚΟΣ	ΥΑΤΟ	ΣΥΣΚ	€/ΤΕΜ
	20037490	ΥΤ-37490	6	26,00



ΣΑΚΟΥΛΕΣ ΑΠΟΡΡΙΜΜΑΤΩΝ

ΚΩΔΙΚΟΣ	VOREL	L	TEM	(μm)	ΜΗΚΟΣ(cm)	ΣΥΣΚ	€/TEM
21109489	09489	60	20	13	72	45	1,95
21109474	09474	80	20	20	85	25	2,50
21109465	09465	120	10	30	110	25	2,80



ΣΑΚΟΥΛΕΣ ΑΠΟΡΡΙΜΜΑΤΩΝ ΕΝΙΣΧΥΜΕΝΕΣ

ΚΩΔΙΚΟΣ	VOREL	L	TEM	(μm)	ΜΗΚΟΣ(cm)	ΣΥΣΚ	€/TEM
21109490	09490	60	10	30	60	25	2,15
21110015	10015	120	10	40	110	25	3,15



ΣΑΚΟΥΛΕΣ ΟΙΚΟΔΟΜΙΚΩΝ ΑΠΟΡΡΙΜΜΑΤΩΝ

ΚΩΔΙΚΟΣ	VOREL	L	TEM	(μm)	ΜΗΚΟΣ(cm)	ΣΥΣΚ	€/TEM
21109470	09470	80	10	40	85	30	2,20
21109471	09471	120	15	60		10	8,45



ΣΑΚΟΥΛΕΣ ΓΙΑ ΜΠΑΖΑ ΟΙΚΟΔΟΜΗΣ

ΚΩΔΙΚΟΣ	VOREL	L	TEM	(μm)	ΜΗΚΟΣ(cm)	ΣΥΣΚ	€/TEM
21109475	09475	80	10	142	85	10	8,00



ΣΑΚΟΥΛΕΣ ΑΠΟΡΡΙΜΜΑΤΩΝ ΚΗΠΟΥ

ΚΩΔΙΚΟΣ	FLO	L	TEM	(μm)	ΜΗΚΟΣ(cm)	ΣΥΣΚ	€/TEM
21109480	09480	60	10	60	72	12	4,35
21109482	09482	120	10	60	110	15	6,75



ΑΝΑΔΕΥΤΗΡΕΣ

HEX

HEX

ΚΩΔΙΚΟΣ	YATO 	Ømm	Lmm	Kg	ΣΥΣΚ	€/ΤΕΜ
20005497	YT-5497	70	400	5-10	20	6,05
20005499	YT-5499	100	600	10-20	16	9,85

M14

 **NEO**

M14

ΚΩΔΙΚΟΣ	YATO 	Ømm	Lmm	Kg	ΣΥΣΚ	€/ΤΕΜ
20005503	YT-5503	120	600	15-25	14	16,50
20005504	YT-5504	160	600	20-30	8	20,10

SDS

 **NEO**

SDS PLUS

ΚΩΔΙΚΟΣ	YATO 	Ømm	Lmm	Kg	ΣΥΣΚ	€/ΤΕΜ
20005501	YT-5501	100	600	10-20	16	15,25
20005502	YT-5502	120	600	15-25	14	16,00



0.4-0.8 MPa	400 l/min	4.75l	max. 50m ² /1h	STANDARD
-------------	-----------	-------	---------------------------	----------



 **NEO**

ΠΙΣΤΟΛΙ ΣΟΒΑΝΤΙΣΜΑΤΟΣ ΑΕΡΟΣ

ΚΩΔΙΚΟΣ	YATO 	ΣΥΣΚ	€/ΤΕΜ
20154400	YT-54400	4	97,00

140x40
mm

ΡΑΣΠΑ ΓΥΨΟΣΑΝΙΔΑΣ

ΚΩΔΙΚΟΣ	YATO®	ΜΕΓΕΘΟΣ	ΣΥΣΚ	€/ΤΕΜ
20061678	YT-61678	140x40	15	6,50

140x40
mm

ΑΝΤΑΛΛΑΚΤΙΚΟ ΡΑΣΠΑΣ ΓΥΨΟΣΑΝΙΔΑΣ

ΚΩΔΙΚΟΣ	YATO®	ΜΕΓΕΘΟΣ	ΣΥΣΚ	€/ΤΕΜ
20061679	YT-61679	140x40	10	2,75

ΑΝΤΑΛΛΑΚΤΙΚΗ ΛΑΜΑ ΓΙΑ ΤΗ ΡΑΣΠΑ YT-61678

250x40
mm

ΡΑΣΠΑΣ ΓΥΨΟΣΑΝΙΔΑΣ

ΚΩΔΙΚΟΣ	YATO®	ΜΕΓΕΘΟΣ	ΣΥΣΚ	€/ΤΕΜ
20061680	YT-61680	250x40	15	12,30

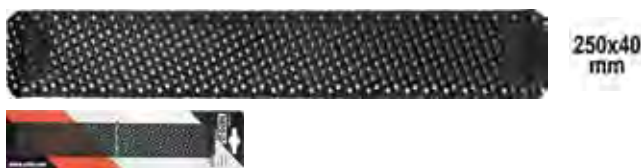
250x40
mm

ΑΝΤΑΛΛΑΚΤΙΚΟ ΡΑΣΠΑΣ ΓΥΨΟΣΑΝΙΔΑΣ

ΚΩΔΙΚΟΣ	YATO®	ΜΕΓΕΘΟΣ	ΣΥΣΚ	€/ΤΕΜ
20061681	YT-61681	250x40	30	2,75

ΑΝΤΑΛΛΑΚΤΙΚΗ ΛΑΜΑ ΓΙΑ ΤΗ ΡΑΣΠΑ YT-61680

9.5-15
mm2
BLADES

ΠΛΑΝΗ ΓΥΨΟΣΑΝΙΔΑΣ

ΚΩΔΙΚΟΣ	YATO®	ΣΥΣΚ	€/ΤΕΜ
20076260	YT-76260	10	10,00



ΤΗΛΕΣΚΟΠΙΚΗ ΜΠΑΡΑ ΣΤΗΡΙΞΗΣ

ΚΩΔΙΚΟΣ	YATO 	ΜΕΓΕΘΟΣ (cm)	ΣΥΣΚ	€/ΤΕΜ
20064552	YT-64552	125-290	6	35,20



2
pcs

ΛΑΒΕΣ ΜΕΤΑΦΟΡΑΣ ΓΥΨΟΣΑΝΙΔΑΣ

ΚΩΔΙΚΟΣ	YATO 	ΣΥΣΚ	€/ΤΕΜ
20037440	YT-37440	2	16,00



ΛΑΒΗ ΜΕΤΑΦΟΡΑΣ ΠΑΝΕΛ

ΚΩΔΙΚΟΣ	YATO 	max Kg	ΣΥΣΚ	€/ΤΕΜ
20037444	YT-37444	80	12	10,85



55mm
LIFTING CAPACITY
Al

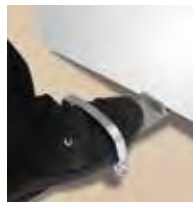

ΕΡΓΑΛΕΙΟ ΜΕΤΑΦΟΡΑΣ ΓΥΨΟΣΑΝΙΔΑΣ

ΚΩΔΙΚΟΣ	YATO 	ΣΥΣΚ	€/ΤΕΜ
20037450	YT-37450	10	15,10





NEO 

275 mm
SECTION THICKNESS
0.5-0.8 mm
GR15
BEARING STEEL (PUNCH)
A380
Al-Ti
ALLOY HEAD

ΠΕΝΣΕΣ ΔΙΑΤΡΗΣΗΣ ΠΡΟΦΙΛ

ΚΩΔΙΚΟΣ	YATO 	L (mm)	ΣΥΣΚ	€/ΤΕΜ
20005130	YT-5130	275	6	18,00



345 mm
SECTION THICKNESS
0.5-0.8 mm
65Mn
MATERIAL OF PUNCH

ΚΩΔΙΚΟΣ	YATO 	L (mm)	ΣΥΣΚ	€/ΤΕΜ
20005131	YT-5131	345	6	23,00

NEO 



260 mm
SECTION THICKNESS
0.5-0.8 mm
65Mn
MATERIAL OF PUNCH
ST12

ΚΩΔΙΚΟΣ	YATO 	L (mm)	ΣΥΣΚ	€/ΤΕΜ
20051312	YT-51312	260	6	24,00

NEO 



300 mm
SECTION THICKNESS
0.5-0.8 mm

ΠΕΝΣΑ ΔΙΑΤΡΗΣΗΣ ΠΡΟΦΙΛ

ΚΩΔΙΚΟΣ	VOREL 	(mm)	ΣΥΣΚ	€/ΤΕΜ
21104301	04301	300	6	12,90



ΣΕ ΠΩΛΗΣΕΙΣ
No 1

ΠΕΝΣΕΣ ΔΙΑΜΟΡΦΩΣΗΣ ΠΡΟΦΙΛ

ΣΤΡΑΝΤΖΑ ΧΕΙΡΟΣ



ΚΩΔΙΚΟΣ	YATO 	L (mm)	ΣΥΣΚ	€/ΤΕΜ
20005140	YT-5140	210	2	21,00

210 mm

80x35 mm

NEO 



ΚΩΔΙΚΟΣ	YATO 	L (mm)	ΣΥΣΚ	€/ΤΕΜ
20005142	YT-5142	210	2	23,50

210 mm

150x35 mm

NEO 



ΠΡΙΟΝΙ ΓΥΨΟΣΑΝΙΔΑΣ ΤΡΙΠΛΗΣ ΚΟΠΗΣ

ΚΩΔΙΚΟΣ	YATO 	ΣΥΣΚ	€/ΤΕΜ
20031343	YT-31343	12	6,60



ΚΟΦΤΕΣ ΓΥΨΟΣΑΝΙΔΑΣ



NEO 

ΚΩΔΙΚΟΣ	YATO 	ΣΥΣΚ	€/ΤΕΜ
20076266	YT-76266	6	20,00



NEO 

ΚΩΔΙΚΟΣ	YATO 	ΣΥΣΚ	€/ΤΕΜ
20076270	YT-76270	1	87,00



10 pcs

ΠΙΣΤΟΛΙ ΕΦΑΡΜΟΓΗΣ ΓΥΨΟΣΑΝΙΔΩΝ

ΚΩΔΙΚΟΣ	YATO 	ΣΥΣΚ	€/ΤΕΜ
20051450	YT-51450	6	17,75





30-400
Ømm



ΚΟΦΤΗΣ ΓΥΨΟΣΑΝΙΔΑΣ

ΚΩΔΙΚΟΣ	VOREL 	Ø (mm)	ΣΥΣΚ	€/ΤΕΜ
21103990	03990	30-400	12	6,75



20-94
Ømm



ΠΟΤΗΡΟΤΡΥΠΑΝΟ ΓΥΨΟΣΑΝΙΔΑΣ

ΚΩΔΙΚΟΣ	VOREL 	Ø (mm)	ΣΥΣΚ	€/ΤΕΜ
21103940	03940	20-94	24	9,35



NEO 



ΚΟΦΤΗΣ ΠΛΑΚΙΔΙΩΝ

ΚΩΔΙΚΟΣ	YATO 	L (mm)	ΣΥΣΚ	€/ΤΕΜ
20037160	YT-37160	200	6	11,75

200
mm



100
mm



NEO 

ΑΝΥΨΩΤΗΣ

ΚΩΔΙΚΟΣ	YATO 	ΣΥΣΚ	€/ΤΕΜ
20037200	YT-37200	15	7,35



TPU

NEO 



ΑΝΥΨΩΤΕΣ ΑΕΡΑ

ΚΩΔΙΚΟΣ	YATO 	ΔΙΑΣΤΑΣΗ	ΣΥΣΚ	€/ΤΕΜ
20067380	YT-67380	150X150	24	8,50
20067383	YT-67383	270X130	48	9,00



135kg
max.



YT-67380

0-50
mm



YT-67383

50
mm



ΣΤΕΡΕΩΤΙΚΑ ΒΙΔΕΣ



ΣΤΕΡΕΩΤΙΚΑ [342 - 356]



Βύσματα Πλαστικά & Μεταλλικά

Χημικές Ρητίνες

Δεματικά



ΒΙΔΕΣ [357 - 376]

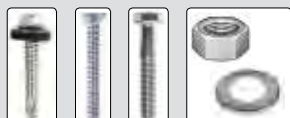

Στριφόνια | Νοβοπανόβιδες

Τρυπανόβιδες

Ροδέλες | Παξιμάδια

Ντίζες | Πριτσίνια





Νέο βασικό επαγγελματικό βύσμα γενικής χρήσης, με νέα σχεδίαση για άριστη πρόσφυση σε συμπαγή και λιγότερο συμπαγή υλικά και με καλή συμπεριφορά ακόμη και σε τούβλο και αφρομετόν.

ΒΥΣΜΑ NYLON

ΟΙΚΟΝΟΜΙΚΗ ΣΥΣΚΕΥΑΣΙΑ

ΚΩΔΙΚΟΣ	ΔΙΑΣΤΑΣΗ	ΣΥΣΚ	€/100
25105025	5X25	16x800	1,15
25106030	6X30	8x600	1,15
25108040	8x40	8x300	2,46
25110050	10x50	8x150	4,70
25112060	12x60	8x100	7,70
25111470	14x70	8x50	14,20

ΜΙΚΡΗ ΣΥΣΚΕΥΑΣΙΑ

ΚΩΔΙΚΟΣ	ΔΙΑΣΤΑΣΗ	ΣΥΣΚ	€/100
25005025	5x25	60x200	1,43
25006030	6x30	60x100	1,60
25007030	7x30	24x100	2,60
25008040	8x40	24x100	2,80
25010050	10x50	24x50	5,15
25012060	12x60	36x25	10,25



ΒΥΣΜΑ NYLON BLISTER

ΚΩΔΙΚΟΣ	ΔΙΑΣΤΑΣΗ	ΤΕΜ ΣΕΤ	ΣΥΣΚ	€/ΣΕΤ
259106030	6x30	20	10	0,95
259108040	8x40	12	10	1,05
259110050	10x50	6	10	1,05
259120060	12x60	4	10	1,05



ΒΥΣΜΑ UNIVERSAL ΧΥΠ



ΚΩΔΙΚΟΣ	ΔΙΑΣΤΑΣΗ	ΣΥΣΚ	€/100
25706030	6X30	24x200	1,90
25708040	8X40	16x200	3,95
25710050	10X50	12x100	7,60
25712060	12X60	16x50	13,80
25714070	14X70	16x25	22,50

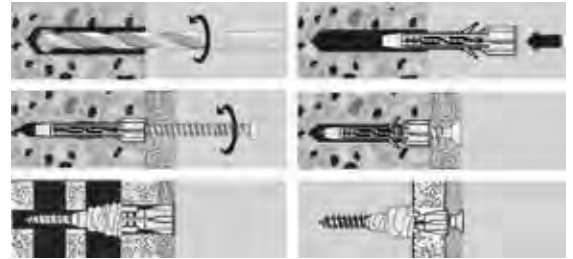

ΜΕ ΒΙΔΑ



ΒΥΣΜΑ Universal ΧΥΠ BLISTER

ΚΩΔΙΚΟΣ	ΔΙΑΣΤΑΣΗ	ΤΕΜ ΣΕΤ	ΣΥΣΚ	€/ΣΕΤ
259706035	6x35	20	10	1,55
259708050	8x50	10	10	1,55
259710060	10x60	6	10	1,45

ΒΥΣΜΑ NYLON MULTI - ΜΑΚΡΥ



ΚΩΔΙΚΟΣ	ΔΙΑΣΤΑΣΗ	ΣΥΣΚ	€/100
25206050	6X50	36x100	3,40
25208060	8X60	24x100	5,75
25210070	10X70	16x50	9,90



ΒΥΣΜΑ NYLON Multi - ΜΑΚΡΥ BLISTER

ΚΩΔΙΚΟΣ	ΔΙΑΣΤΑΣΗ	ΤΕΜ ΣΕΤ	ΣΥΣΚ	€/ΣΕΤ
259206050	6x50	10	10	1,45
259208060	8x60	8	10	1,10
259210070	10x70	5	10	1,10



MULTI πολυχρηστικό βύσμα για κάθε υλικό





ΒΥΣΜΑ ΝΥΛΟΝ ΚΑΡΦΩΤΟ

ΚΩΔΙΚΟΣ	ΔΙΑΣΤΑΣΗ	ΣΥΣΚ	€/100
25506040	6X40	12x200	4,60
25506050	6X50	8x200	6,00
25506060	6X60	6x200	6,50
25506080	6X80	6x200	8,65
25508060	8X60	6x100	10,60
25508080	8X80	6x100	13,50
25508100	8X100	6x100	15,50
25508120	8X120	6x100	20,00
25508140	8X140	6x100	22,00



ΒΥΣΜΑ ΝΥΛΟΝ ΚΑΡΦΩΤΟ ΒΛΙΣΤΕΡ

ΚΩΔΙΚΟΣ	ΔΙΑΣΤΑΣΗ	ΤΕΜ ΣΕΤ	ΣΥΣΚ	€/ΣΕΤ
259526040	6x40	10	10	1,40
259526060	6x60	10	10	1,60
259526080	6x80	10	10	2,00
259528060	8x60	7	10	1,65
259528080	8x80	7	10	1,80
259528100	8x100	7	10	2,00
259528120	8x120	5	10	1,85



ΦΑΡΔΥ ΚΕΦΑΛΙ

ΚΩΔΙΚΟΣ	ΔΙΑΣΤΑΣΗ	ΣΥΣΚ	€/100
25516040	6X40	6x200	4,90
25516060	6X60	6x200	7,90



ΝΥΛΟΝ ΚΑΡΦΩΤΟ ΦΑΡΔΥ ΚΕΦΑΛΙ ΒΛΙΣΤΕΡ

ΚΩΔΙΚΟΣ	ΔΙΑΣΤΑΣΗ	ΤΕΜ ΣΕΤ	ΣΥΣΚ	€/ΣΕΤ
259516040	6x40	7	10	1,25
259516060	6x60	7	10	1,60



ΒΥΣΜΑ NYLON ΜΑΚΡΥ

ΧΩΡΙΣ ΒΙΔΑ



ΚΩΔΙΚΟΣ	ΔΙΑΣΤΑΣΗ	ΣΥΣΚ	€/100
25608080	8X80	10x100	8,10
25608100	8X100	10x100	9,35
25608120	8X120	10x100	10,50
25610080	10X80	10x100	10,60
25610100	10X100	10x100	11,40
25610120	10X120	10x100	12,40



ΜΕ ΒΙΔΑ



ΚΩΔΙΚΟΣ	ΔΙΑΣΤΑΣΗ	ΒΙΔΑ	ΣΥΣΚ	€/100
25408080	8X80	PZ	10x100	17,90
25408100	8X100	PZ	10x100	21,60
25408120	8X120	PZ	10x100	25,00
25410080	10X80	PZ	12x50	37,50
25410100	10X100	PZ	6x60	46,35
25410120	10X120	PZ	6x50	53,00
25412100	12X100	HEX	16x25	44,70
25412120	12X120	HEX	16x26	53,30
25412140	12X140	HEX	16x25	56,00



ΜΕ ΒΙΔΑ HEX TORX



ΒΥΣΜΑ NYLON ΜΑΚΡΥ BLISTER

ΚΩΔΙΚΟΣ	ΔΙΑΣΤΑΣΗ	ΤΕΜ ΣΕΤ	ΣΥΣΚ	€/ΣΕΤ
259410080	10x80	4	10	2,45
259410100	10x100	4	10	2,70
259410120	10x120	4	10	3,00

ΒΥΣΜΑ ΓΥΦΟΣΑΝΙΔΑΣ ΝΥΛΟΝ



ΚΩΔΙΚΟΣ	ΔΙΑΣΤΑΣΗ	ΣΥΣΚ	€/100
25308040	M80X40	6x200	6,40



ΧΩΡΙΣ ΒΙΔΑ



ΒΥΣΜΑ ΓΥΦΟΣΑΝΙΔΑΣ ΝΥΛΟΝ BLISTER



ΚΩΔΙΚΟΣ	ΔΙΑΣΤΑΣΗ	ΤΕΜ ΣΕΤ	ΣΥΣΚ	€/ΣΕΤ
259308040	M80x40	5	10	1,30



ΒΥΣΜΑ ΚΟΧΛΙΩΤΟ SMART DRIVE



ΝΥΛΟΝ



ΚΩΔΙΚΟΣ	ΣΥΣΚ	€/100
21301003	24x100	5,10



ΒΥΣΜΑ ΚΟΧΛΙΩΤΟ ΝΥΛΟΝ BLISTER

ΚΩΔΙΚΟΣ	ΔΙΑΣΤΑΣΗ	ΤΕΜ ΣΕΤ	ΣΥΣΚ	€/ΣΕΤ
259301003	13-32	10	10	1,05

ΜΕΤΑΛΛΙΚΟ



ΚΩΔΙΚΟΣ	ΣΥΣΚ	€/100
21301004	24x100	16,80



ΒΥΣΜΑ ΚΟΧΛΙΩΤΟ ΜΕΤΑΛΛΙΚΟ BLISTER

ΚΩΔΙΚΟΣ	ΔΙΑΣΤΑΣΗ	ΤΕΜ ΣΕΤ	ΣΥΣΚ	€/ΣΕΤ
259401529	15-29	10	10	2,60

ΒΥΣΜΑ ΜΕΤΑΛΛΙΚΟ ΓΥΨΟΣΑΝΙΔΑΣ ΜΟΝΗΣ & ΔΙΠΛΗΣ

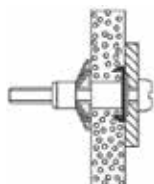

ΚΩΔΙΚΟΣ	ΔΙΑΣΤΑΣΗ	Ø	ΠΑΧΟΣ mm	ΣΥΣΚ	€/100
2030438	M4X38	8	Μονή 8-16	24x100	14,95
2030446	M4X46	8	Διπλή 16-24	24x100	17,80
2030552	M5X52	10	Μονή 8-16	12x100	25,20
2030565	M5X65	10	Διπλή 16-32	8x100	28,90
2030652	M6X52	12	Μονή 8-16	8x100	29,90
2030665	M6X65	12	Διπλή 16-32	8x100	35,70



NEO¹



ΒΥΣΜΑ ΜΕΤΑΛΛΙΚΟ BLISTER

ΚΩΔΙΚΟΣ	ΔΙΑΣΤΑΣΗ	ΤΕΜ ΣΕΤ	ΣΥΣΚ	€/ΣΕΤ	
Μονή 8-15	259304038	4x38	10	10	2,65
Διπλή 16-21	259304046	4x46	10	10	2,95
Μονή 5-16	259305052	5x52	5	10	2,30
Διπλή 16-32	259305065	5x65	5	10	2,50



ΜΕ ΓΑΝΤΖΟ

ΚΩΔΙΚΟΣ	ΔΙΑΣΤΑΣΗ	Ø	ΠΑΧΟΣ mm	ΣΥΣΚ	€/100
2031438	M4X38	8	Μονή 8-16	16x100	26,50



ΜΕ ΓΩΝΙΑ

ΚΩΔΙΚΟΣ	ΔΙΑΣΤΑΣΗ	Ø	ΠΑΧΟΣ mm	ΣΥΣΚ	€/100
2032438	M4X38	8	Μονή 8-16	16x100	22,80





ΕΡΓΑΛΕΙΑ ΕΦΑΡΜΟΓΗΣ ΒΥΣΜΑΤΩΝ ΓΥΨΟΣΑΝΙΔΑΣ

ΚΩΔΙΚΟΣ	ΣΥΣΚ	€/ΤΕΜ
2030100	15x1	5,40



ΚΩΔΙΚΟΣ	ΣΥΣΚ	€/ΤΕΜ
25010000	20x1	16,20



10 pcs



ΚΩΔΙΚΟΣ	YATO	ΣΥΣΚ	€/ΤΕΜ
20051450	YT-51450	6	17,75



ΚΩΔΙΚΟΣ	YATO	ΣΥΣΚ	€/ΤΕΜ
20051452	YT-51452		12,00



ΒΥΣΜΑ ΘΕΡΜΟΠΡΟΣΟΦΕΩΝ S-IPH10/P

ΚΩΔΙΚΟΣ	ΔΙΑΣΤΑΣΗ	ΘΡΟΔΕΛΑΣ	ΣΥΣΚ	€/100
23910070	10X70	60	200	11,10
23910090	10X90	60	200	11,90
23910120	10X120	60	200	15,15
23910140	10X140	60	200	16,75
23910160	10X160	60	200	18,15

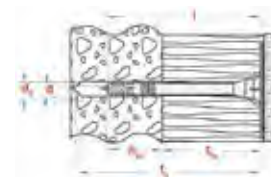

ΕΡΓΑΛΕΙΟ ΤΟΠΟΘΕΤΗΣΗΣ ΒΥΣΜΑΤΩΝ ΘΕΡΜΟΠΡΟΣΟΦΗΣ

ΚΩΔΙΚΟΣ	mm	ΣΥΣΚ	€/100
23910102	67	1	5,50



ΤΑΠΑ ΠΟΛΥΕΣΤΕΡΙΝΗΣ ΒΥΣΜΑΤΩΝ ΘΕΡΜΟΠΡΟΣΟΦΗΣ

ΚΩΔΙΚΟΣ	mm	ΣΥΣΚ	€/100
23910101	67X16	100	4,90

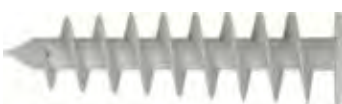

ΒΥΣΜΑ-ΒΙΔΑ ΘΕΡΜΟΠΡΟΣΟΦΕΩΝ



ΚΩΔΙΚΟΣ	ΔΙΑΣΤΑΣΗ	ΒΙΔΑ(mm)	ΣΥΣΚ	€/100
23932550	25X50	4,5-5	16x25	29,10
23932585	25x85	4,5-5	16x25	49,15

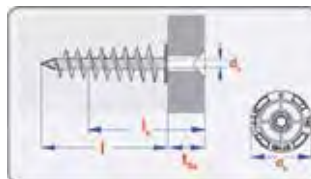

ΕΞΤΡΑ ΡΟΔΕΛΑ Ø 90mm

ΚΩΔΙΚΟΣ	Ø	ΣΥΣΚ	€/100
23900090	90	100	16,50



ΒΥΣΜΑ ΑΦΡΟΜΠΕΤΟΝ-ΝΥΛΟΝ



ΚΩΔΙΚΟΣ	ΔΙΑΣΤΑΣΗ	ΣΥΣΚ	€/100
23310650	6X50	24x25	29,50
23310860	8X60	24x20	33,60
23311080	10X70	24x15	43,00

ΒΥΣΜΑ ΑΦΡΟΜΠΕΤΟΝ-ΞΥΛΟΥ



ΚΩΔΙΚΟΣ	ΔΙΑΣΤΑΣΗ	ΣΥΣΚ	€/100
23300632	6X32	24x200	9,10
23300838	8X38	24x100	12,60
23300860	8X60	12x100	14,60
23301060	10X60	8x100	16,90



ΒΥΣΜΑ ΟΡΕΙΧΑΛΚΙΝΟ



ΚΩΔΙΚΟΣ	ΔΙΑΣΤΑΣΗ	ΣΥΣΚ	€/100
25206000	M6	24x200	28,45
25208000	M8	24x100	49,40
25201000	M10	10x150	73,25



ΒΥΣΜΑ ΝΤΙΖΑΣ ΚΤΥΠΗΤΟ, ΚΩΝΟΥ



ΚΩΔΙΚΟΣ	ΔΙΑΣΤΑΣΗ	ΣΥΣΚ	€/100
22200630	6X25	10x100	13,25
22200830	8X30	10x100	18,95
22201040	10X40	10x50	31,15
22201250	12X50	8x50	52,50





ΧΗΜΙΚΗ ΕΠΟΞΙΚΗ ΡΗΤΙΝΗ

2 ΣΥΣΤΑΤΙΚΩΝ, 300ml

ΚΩΔΙΚΟΣ	ΠΕΡΙΓΡΑΦΗ	ΣΥΣΚ	€/ΤΕΜ
2040020	300ml	12	7,95

ΜΕ 2 ΑΚΡΟΦΥΣΙΑ



2040011 ΑΝΤΑΛΛΑΚΤΙΚΟ ΑΚΡΟΦΥΣΙΟ 12 **0,35**

HELIX-CHEM
drills - screws
& fasteners

ΘΕΡΜΟΚΡΑΣΙΑ	ΧΡΟΝΟΣ ΣΤΕΡΕΩΣΗΣ	ΧΡΟΝΟΣ ΕΦΑΡΜΟΓΗΣ ΣΕ ΣΤΕΓΝΗ ΤΡΥΠΑ	ΧΡΟΝΟΣ ΕΦΑΡΜΟΓΗΣ ΣΕ ΒΡΕΓΜΕΝΟ ΜΠΕΤΟ
5° C	25 min	120 min	240 min
10° C	15 min	80 min	160 min
20° C	6 min	45 min	60 min
30° C	4 min	25 min	50 min
35° C	2 min	20 min	40 min



ΧΗΜΙΚΗ ΡΗΤΙΝΗ - SIKA ANCHORFIX[®]-1 N

ΚΩΔΙΚΟΣ	ΠΕΡΙΓΡΑΦΗ	ΣΥΣΚ	€/ΤΕΜ
617866	300ml	12	9,50

2 ΣΥΣΤΑΤΙΚΩΝ - ΧΩΡΙΣ ΣΤΥΡΕΝΙΟ



ΔΙΑΤΡΗΤΟ ΒΥΣΜΑ ΧΗΜΙΚΗΣ ΡΗΤΙΝΗΣ

ΚΩΔΙΚΟΣ	ΔΙΑΣΤΑΣΗ (mm)	ΣΥΣΚ	€/100
24401280	12X80	M6 20	16,65
24401685	16X85	M8-10 20	17,20
24416130	16X130	M8-10 20	23,65
24420085	20X85	M12 20	21,55



ΝΤΙΖΑ ΧΗΜΙΚΗΣ ΡΗΤΙΝΗΣ ΓΑΛΒΑΝΙΣΜΕΝΗ

ΚΩΔΙΚΟΣ	ΔΙΑΣΤΑΣΗ	ΣΥΣΚ	€/ΤΕΜ
22408110	8X110	10	0,53
22401013	10X130	10	0,86
22401216	12X160	10	1,60
22401619	16X190	10	3,35
22402026	20X260	6	5,20



ΛΕΥΚΟ

ΔΕΜΑΤΙΚΑ ΚΑΛΩΔΙΩΝ ΠΟΛΥΑΜΙΔΙΟ

(NYLON 6,6)



ΚΩΔΙΚΟΣ	ΠΛΑΤΟΣ W mm	ΜΗΚΟΣ L mm	ΣΥΣΚ	€/100
15225100	2,5	100	100	0,55
15225200	2,5	200	100	1,10
15236140	3,6	140	100	1,15
15236200	3,6	200	100	1,50
15236302	3,6	302	100	2,60
15248250	4,8	250	100	2,80
15248302	4,8	302	100	3,15
15248430	4,8	430	100	5,50
15276370	7,6	370	100	7,90
15276540	7,6	540	100	11,80

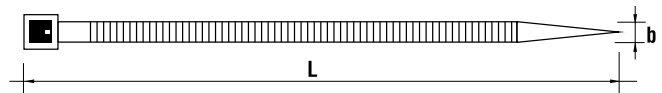

ΜΑΥΡΟ

ΔΕΜΑΤΙΚΑ ΚΑΛΩΔΙΩΝ ΠΟΛΥΑΜΙΔΙΟ

(NYLON 6,6)



ΚΩΔΙΚΟΣ	ΠΛΑΤΟΣ W mm	ΜΗΚΟΣ L mm	ΣΥΣΚ	€/100
15325100	2,5	100	100	0,55
15325200	2,5	200	100	1,10
15336140	3,6	140	100	1,15
15336200	3,6	200	100	1,50
15336302	3,6	302	100	2,60
15348250	4,8	250	100	2,80
15348302	4,8	302	100	3,15
15348430	4,8	430	100	5,50
15376370	7,6	370	100	7,90
15376540	7,6	540	100	11,80
15390710	9,0	710	100	24,70

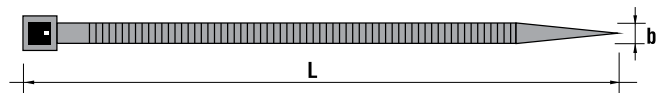

ΥΛΙΚΟ:

Πολυαμίδιο (Nylon 6,6). Αγνή πρώτη ύλη, χωρίς προσμίξεις ανακυκλωμένου πλαστικού

ΠΡΟΣΤΑΣΙΑ ΥΠΕΡ. ΑΚΤΙΝ.:

UV. Η σειρά του μαύρου δεματικού είναι κατάλληλη για εξωτερική χρήση

ΑΝΤΟΧΗ ΣΤΗ ΦΩΤΙΑ:

UL 94, το πρότυπο για την ασφάλεια της ευφλεκτότητας των πλαστικών υλικών V-2.

ΘΕΡΜΟΚΡΑΣΙΑ ΕΡΓΑΣΙΑΣ:

-20°C / +85°C



ΕΛΛΗΝΙΚΟ ΠΡΟΪΟΝ



ΤΣΕΡΚΙ ΜΕΤΑΛΛΙΚΟ

ΚΩΔΙΚΟΣ	ΔΙΑΣΤΑΣΗ	ΣΥΣΚ	€/ΤΕΜ
24501200	12x0,7 / 10m	50	3,95
24501800	18x0,8 / 10m	25	6,10
24501500	15 ΜΕ ΜΟΝΩΣΗ	25	7,50



NEO 

100
PCS

SS201
STAINLESS STEEL



ΑΝΟΞΕΙΔΩΤΑ

ΚΩΔΙΚΟΣ	YATO 	mm	ΤΕΜ. ΣΕΤ	ΣΥΣΚ	€/ΤΕΜ
20070561	YT-70561	4,6x200	100	1	10,75
20070563	YT-70563	4,6x300	100	1	12,35
20070565	YT-70565	4,6x400	100	1	14,95
20070568	YT-70568	4,6x550	100	1	18,10
20070571	YT-70571	4,6x700	100	1	20,40
20070581	YT-70581	8,0x250	50	1	9,30
20070583	YT-70583	8,0x350	50	1	10,95
20070586	YT-70586	8,0x500	50	1	13,05
20070588	YT-70588	8,0x600	50	1	15,50



10
PCS
NYLON
PU

NEO 

VELCRO ΛΕΥΚΟ

ΚΩΔΙΚΟΣ	VOREL 	mm	ΤΕΜ. ΣΕΤ	ΣΥΣΚ	€/ΤΕΜ
21173840	73840	150x25	10		2,00
21173843	73843	300x25	10		2,60
21173845	73845	450x25	10		3,35



10
PCS
NYLON
PU

NEO 

VELCRO ΜΑΥΡΟ

ΚΩΔΙΚΟΣ	VOREL 	mm	ΤΕΜ. ΣΕΤ	ΣΥΣΚ	€/ΤΕΜ
21173850	73850	150x25	10		2,00
21173853	73853	300x25	10		2,60
21173855	73855	450x25	10		3,35

ΒΥΣΜΑ EXPRESS ΑΠΟ ΧΑΛΥΒΑ 6.8

ZINC



ΣΕ ΠΩΛΗΣΕΙΣ
No1

ΚΩΔΙΚΟΣ	ΔΙΑΣΤΑΣΗ	ΣΥΣΚ	€/100
20200660	6X60	16x100	12,50
20200680	6X80	16x100	13,80
20200880	8X80	4x120	17,25
20200890	8X90	4x120	19,40
20208100	8X100	4x100	21,00
20208115	8X115	4x100	22,90
20210090	10X90	4x80	28,20
20210100	10X100	4x50	29,30
20210120	10X120	4x60	33,60
20210140	10X140	4x60	38,00
20212100	12X100	4x40	39,70
20212120	12X120	4x50	46,60
20212140	12X140	4x40	53,50
20212160	12X160	4x30	59,50
20212180	12X180	4x25	67,30
20214120	14X120	4x25	76,80
20214145	14X145	4x25	86,30
20214170	14X170	4x25	98,30
20216125	16X125	4x25	94,00
20216145	16X145	4x25	99,80
20216175	16X175	4x20	110,00
20216220	16X220	4x15	146,60
20220170	20X170	4x8	182,50
20220200	20X200	4x8	226,50
20220220	20X220	4x8	246,50



ΒΥΣΜΑ ΧΑΛΥΒΔΙΝΟ 4 ΦΥΛΛΩΝ ΜΕ ΒΙΔΑ



ΚΩΔΙΚΟΣ	ΔΙΑΣΤΑΣΗ	ΣΥΣΚ	€/100
22200655	M6	8x100	16,70
22200865	M8	8x50	26,45
22201075	M10	8x40	42,55
22201295	M12	8x25	80,50

ΒΥΣΜΑ ΧΑΛΥΒΔΙΝΟ 4 ΦΥΛΛΩΝ ΧΩΡΙΣ ΒΙΔΑ



ΚΩΔΙΚΟΣ	ΔΙΑΣΤΑΣΗ	ΣΥΣΚ	€/100
23200600	M6	8x200	9,20
23200800	M8	8x100	15,55
23201000	M10	8x60	23,00
23201200	M12	8x45	44,85



**ΒΥΣΜΑ ΝΤΙΖΑΣ ΚΤΥΠΗΤΟ, ΚΩΝΟΥ**

ΚΩΔΙΚΟΣ	ΔΙΑΣΤΑΣΗ	ΣΥΣΚ	€/100
24200630	6X30	40x100	5,25
24200830	8X30	20x100	6,30
24201040	10X40	20x50	10,70
24201250	12X50	10x50	25,20
24201665	16X65	12x25	55,20

**ΓΙΑ ΜΠΕΤΟΝ ΚΑΙ ΤΟΥΒΛΟ****ΒΥΣΜΑ ΚΕΛΥΦΟΥΣ**

ΚΩΔΙΚΟΣ	ΔΙΑΣΤΑΣΗ	Ø	ΣΥΣΚ	€/100
80116045	6x45	8	6x200	15,05
80116060	6x60	8	4x200	16,50
80118060	8x60	10	8x100	25,20
80118080	8x80	10	6x100	29,60
80110100	10x100	12	8x50	51,70

ΒΥΣΜΑ ΚΕΛΥΦΟΥΣ ΜΕ ΚΡΙΚΟ

ΚΩΔΙΚΟΣ	ΔΙΑΣΤΑΣΗ	ΣΥΣΚ	€/100
80206045	6x45	8x100	20,90
80208060	8x60	6x80	35,75
80210070	10x70	6x50	60,50

ΒΥΣΜΑ ΚΕΛΥΦΟΥΣ ΜΕ ΓΑΝΤΖΟ

ΚΩΔΙΚΟΣ	ΔΙΑΣΤΑΣΗ	ΣΥΣΚ	€/100
80106045	6x45	8x100	20,90
80108060	8x60	6x80	35,75
80110070	10x70	6x50	60,50



ΣΤΡΙΦΟΝΙ ΓΑΛΒΑΝΙΖΕ DIN 571



ΚΩΔΙΚΟΣ	ΔΙΑΣΤΑΣΗ	ΣΥΣΚ	€/100
057106040	6x40	12x200	2,70
057106050	6x50	10x200	3,00
057106060	6x60	8x200	3,40
057106070	6x70	7x200	4,20
057106080	6x80	12x100	4,60
057106090	6x90	12x100	4,90
057106100	6x100	12x100	5,70
057106120	6x120	10x100	6,90
057108040	8x40	16x100	5,00
057108050	8x50	12x100	5,40
057108060	8x60	10x100	6,50
057108070	8x70	8x100	7,05
057108080	8x80	8x100	7,95
057108090	8x90	16x50	8,80
057108100	8x100	16x50	9,60
057108120	8x120	12x50	11,20
057108140	8x140	10x50	12,90
057108160	8x160	8x50	16,80
057110050	10x50	12x50	10,60
057110060	10x60	12x50	13,00
057110070	10x70	12x50	13,30
057110080	10x80	10x50	15,40
057110090	10x90	10x50	16,00
057110100	10x100	8x50	16,30
057110120	10x120	14x25	21,00
057110140	10x140	12x25	23,00
057110160	10x160	12x25	24,80
057110180	10x180	12x25	30,00
057110200	10x200	12x25	39,00

ΜΠΟΥΖΟΣΤΡΙΦΟΝΟ DIN 88149



ΚΩΔΙΚΟΣ	ΔΙΑΣΤΑΣΗ	ΣΥΣΚ	€/100
881490660	6x60	10x100	6,40
881490680	6x80	10x100	8,60
881490860	8x60	10x100	9,50
881490880	8x80	10x100	12,30
881490810	8x100	10x100	16,00
881491010	10x100	5x100	22,80
881491012	10x120	5x100	28,80

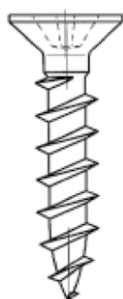

PVC WINDOW



ΚΩΔΙΚΟΣ	ΔΙΑΣΤΑΣΗ	ΣΥΣΚ	€/1000
350004025	4,0x25	13x1000	8,95
350004035	4,0x35	6x1000	11,50
350004040	4,0x40	12x1000	12,80
350004045	4,0x45	10x500	14,40
350004055	4,0x55	10x500	17,20
350004065	4,0x65	6x500	20,00

**ΤΣΙΜΕΝΟΒΙΔΑ
ΙΡΙΔΙΟ**

ΚΩΔΙΚΟΣ	ΔΙΑΣΤΑΣΗ	ΣΥΣΚ	€/1000
36007572	7,5x72	10x100	77,00
36007592	7,5x92	10x100	100,00
36075112	7,5x112	10x100	120,00
36075132	7,5x132	8x100	143,00
36075152	7,5x152	8x100	168,00
36075182	7,5x182	6x100	202,00
36075202	7,5x202	6x100	225,00

**ΤΣΙΜΕΝΟΒΙΔΑ
ΓΑΛΒΑΝΙΖΕ ΑΣΗΜΙ**

ΚΩΔΙΚΟΣ	ΔΙΑΣΤΑΣΗ	ΣΥΣΚ	€/1000
36107572	7,5X072	10x100	77,00
36107592	7,5X092	10x100	100,00
36175112	7,5X112	10x100	120,00
36175132	7,5X132	8x100	143,00
36175152	7,5X152	8x100	168,00
36175182	7,5X182	6x100	202,00
36175202	7,5x202	6x100	225,00

**ΤΣΙΜΕΝΟΒΙΔΑ
ΑΚΕΦΑΛΗ ΙΡΙΔΙΟ**

ΚΩΔΙΚΟΣ	ΔΙΑΣΤΑΣΗ	ΣΥΣΚ	€/1000
36207592	7,5X092	10x100	106,00
36275112	7,5X112	10x100	126,00
36275132	7,5X132	10x100	150,00
36275152	7,5X152	8x100	177,00

**ΤΑΠΕΣ
ΓΙΑ ΤΣΙΜΕΝΟΒΙΔΑ**

ΚΩΔΙΚΟΣ	ΧΡΩΜΑ	ΣΥΣΚ	€/1000
360000109	Λευκή	100	18,00
360000110	Καφέ	100	18,00
360000111	Μαύρη	100	18,00

7505
**PZ
HEAD**

**ΝΟΒΟΠΑΝΟΒΙΔΑ PZ
ΓΑΛΒΑΝΙΖΕ**

ΚΩΔΙΚΟΣ	ΔΙΑΣΤΑΣΗ	ΣΥΣΚ	€/1000
750500312	3x12	6x1500	4,50
750500316	3x16	16x1500	5,65
750500320	3x20	16x1500	6,45
750500325	3x25	16x1500	6,90
750500330	3x30	12x1000	7,55
750503512	3,5x12		5,10
750503516	3,5x16	16x1500	5,50
750503518	3,5x18		5,90
750503520	3,5x20	16x1500	6,30
750503525	3,5x25	12x1000	7,40
750503530	3,5x30	12x1000	8,50
750503535	3,5x35	6x1000	8,80
750503540	3,5x40	6x1000	10,00
750503545	3,5x45	6x1000	11,30
750503550	3,5x50	4x1000	12,40
750500416	4x16	16x1000	6,25
750500418	4x18	16x1000	7,15
750500420	4x20	16x1000	7,65
750500425	4x25	12x1000	9,10
750500430	4x30	6x1000	10,80
750500435	4x35	6x1000	11,30
750500440	4x40	6x1000	12,50
750500445	4x45	4x1000	13,80
750500450	4x50	4x1000	14,80
750500460	4x60	6x500	17,50
750500470	4x70	6x500	21,10
750504530	4,5x30	12x500	13,50
750504535	4,5x35	12x500	15,00
750504540	4,5x40	6x1000	16,50
750504550	4,5x50	4x1000	19,50
750500520	5x20	12x1000	11,00
750500525	5x25	6x1000	13,60
750500530	5x30	6x1000	15,40
750500535	5x35	12x450	17,90
750500540	5x40	4x1000	19,00
750500545	5x45	6x500	21,85
750500550	5x50	6x500	25,00
750500560	5x60	4x500	29,00
750500570	5x70	4x500	31,50
750500580	5x80	4x500	36,00
750500590	5x90	12x150	39,50
750500510	5x100	4x500	45,00
750500630	6x30	4x1000	22,50
750500640	6x40	4x700	29,60
750500650	6x50	4x500	33,50
750500660	6x60	4x500	39,50
750500670	6x70	4x500	50,00
750500680	6x80	6x200	56,00
750500690	6x90	6x200	63,30
750500610	6x100	6x100	67,00
750500612	6x120	6x100	83,60
750500614	6x140	6x100	97,30
750500616	6x160	6x100	114,00

**ΒΙΔΑ ΓΥΦΟΣΑΝΙΔΑΣ
ΜΑΥΡΗ DIN 18182****ΜΥΤΕΡΗ**

ΚΩΔΙΚΟΣ	ΔΙΑΣΤΑΣΗ	ΣΥΣΚ	€/1000
181823525	3,5x25	16x1000	6,95
181823535	3,5x35	13x1000	9,00
181823545	3,5x45	6x1000	11,40

**ΜΕ ΤΡΥΠΑΝΙ**

ΚΩΔΙΚΟΣ	ΔΙΑΣΤΑΣΗ	ΣΥΣΚ	€/1000
181833525	3,5x25	13x1000	8,95
181833535	3,5x35	10x1000	11,60
181833545	3,5x45	6x1000	14,50

**ΛΑΜΑΡΙΝΟΒΙΔΑ TRUSS HELIX**

ΚΩΔΙΚΟΣ	ΔΙΑΣΤΑΣΗ	ΣΥΣΚ	€/100
7907004213	4.2X13	16x1000	8,00
7907004216	4.2X16	13x1000	8,70
7907004219	4.2X19	10x1000	9,65

**ΒΥΣΜΑ ΓΥΦΟΣΑΝΙΔΑΣ ΚΟΧΛΙΩΤΟ ΜΕΤΑΛΛΙΚΟ**

ΚΩΔΙΚΟΣ	ΔΙΑΣΤΑΣΗ	ΣΥΣΚ	€/100
21301001	13x32	10x200	9,20

ΜΕ ΒΙΔΑ**ΒΥΣΜΑ ΓΥΦΟΣΑΝΙΔΑΣ ΚΟΧΛΙΩΤΟ ΠΛΑΣΤΙΚΟ**

ΚΩΔΙΚΟΣ	ΣΥΣΚ	€/100
22301002	20x100	4,25



**ΤΡΥΠΑΝΟΒΙΔΑ TRUSS
DIN 7504**



ΚΩΔΙΚΟΣ	ΔΙΑΣΤΑΣΗ	ΣΥΣΚ	€/1000
7507004213	4,2x13	8x1500	8,85
7507004216	4,2x16	8x1200	9,85
7507004219	4,2x19	8x1000	10,65
7507004225	4,2x25	8x1000	12,90
7507004232	4,2x32	8x1000	16,00
7507004238	4,2x38	6x1000	17,60

7504

**SELF
DRILLING**

**HEX
HEAD**

**ΤΡΥΠΑΝΟΒΙΔΑ ΜΕ ΕΞΑΓΩΝΟ ΚΕΦΑΛΙ & ΡΟΔΕΛΑ
ΣΤΕΓΑΝΩΣΗΣ DIN 7504 / ΤΡΥΠΑΝΙ ΚΟΝΤΟ #3**



ΚΩΔΙΚΟΣ	ΔΙΑΣΤΑΣΗ	ΣΥΣΚ	€/1000
7506106319	6,3x19	6x300	48,00
7506106325	6,3x25	6x250	54,00
7506106332	6,3x32	6x200	60,00
7506106338	6,3x38	12x250	66,00
7506106350	6,3x50	6x120	77,00
97506106360	6,3x60	6x180	90,00
7506106360	6,3x60	8x200	90,00
7506106375	6,3x75	6x100	100,00
7506106310	6,3x100	8x100	129,00
7506106312	6,3x125	6x50	152,00



**ΤΡΥΠΑΝΟΒΙΔΑ ΜΕ ΕΞΑΓΩΝΟ ΚΕΦΑΛΙ & ΡΟΔΕΛΑ
ΣΤΕΓΑΝΩΣΗΣ DIN 7504 / ΤΡΥΠΑΝΙ ΜΑΚΡΥ#4**

ΚΩΔΙΚΟΣ	ΔΙΑΣΤΑΣΗ	ΣΥΣΚ	€/1000
7506116325	6,3x25	12x200	58,30
7506116332	6,3x32		64,00
7506116338	6,3x38	6x200	73,00
97506116350	6,3x50	6x200	83,00
97506116310	6,3x100	6x100	140,00
7506116310	6,3x100		140,00
97506116312	6,3x125	6x100	175,00
7506116312	6,3x125		175,00

DIN **7504**

**ΤΡΥΠΑΝΟΒΙΔΑ ΜΕ ΕΞΑΓΩΝΟ ΚΕΦΑΛΙ
 DIN 7504 ΤΡΥΠΑΝΙ ΚΟΝΤΟ #3**
**SELF
 DRILLING**
**HEX
 HEAD**

ΚΩΔΙΚΟΣ	ΔΙΑΣΤΑΣΗ	ΣΥΣΚ	€/1000
7506005519	5,5x19	6x700	23,30
7506005525	5,5x25	6x300	27,40
7506005532	5,5x32	6x400	31,65
7506005538	5,5x38	6x400	34,70
97506005538	5,5x38	6x400	34,70
7506006325	6,3x25	6x250	39,95
7506006332	6,3x32	6x300	51,50
7506006338	6,3x38	6x240	57,20
97506006338	6,3x38	6x240	57,20
97506006350	6,3x50	6x250	68,00
7506006350	6,3x50	6x350	68,00

**ΤΡΥΠΑΝΟΒΙΔΑ ΜΕ ΕΞΑΓΩΝΟ ΚΕΦΑΛΙ & ΡΟΔΕΛΑ
 ΣΤΕΓΑΝΩΣΗΣ DIN 7504 / ΤΡΥΠΑΝΙ ΚΟΝΤΟ #3**
ΚΟΚΚΙΝΗ RAL 3013

ΚΩΔΙΚΟΣ	ΔΙΑΣΤΑΣΗ	ΣΥΣΚ	€/1000
97506206375	6,3x75	6x120	120,00

**ΡΟΔΕΛΑ
 ΣΤΕΓΑΝΩΣΗΣ**

ΚΩΔΙΚΟΣ	ΔΙΑΣΤΑΣΗ	ΣΥΣΚ	€/1000
32001600	16mm	6x1000	13,90
32001900	19mm	6x1000	19,10

7504

SELF DRILLING

FLAT HEAD



**ΤΡΥΠΑΝΟΒΙΔΑ ΦΡΕΖΑΤΗ PHILIPS
DIN 7504**



ΚΩΔΙΚΟΣ	ΔΙΑΣΤΑΣΗ	ΣΥΣΚ	€/1000
97503003513	3,5x13	16x1000	8,00
7503003513	3,5x13		8,00
7503003516	3,5x16	16x1000	9,00
7503003519	3,5x19	24x1000	9,70
97503003916	3,9x16	24x600	10,00
7503003916	3,9x16	24x600	10,00
7503003925	3,9x25	24x600	14,65
97503003932	3,9x32	24x500	18,00
7503003932	3,9x32		18,00
7503003938	3,9x38	12x1000	23,00
97503004216	4,2x16	24x1000	10,10
7503004216	4,2x16	12x1000	10,10
7503004219	4,2x19	12x1000	12,50
97503004225	4,2x25	24x600	16,00
7503004225	4,2x25	12x1000	16,00
7503004232	4,2x32	12x1000	19,65
97503004238	4,2x38	24x300	24,00
7503004238	4,2x38	8x1000	24,00
7503004250	4,2x50	12x500	29,70
7503004260	4,2x60	6x500	36,00
97503004263	4,2x63	24x100	36,00
97503004819	4,8x19	24x500	21,00
7503004819	4,8x19	12x1000	21,00
7503004825	4,8x25	12x1000	23,00
7503004832	4,8x32	12x1000	25,00
7503004838	4,8x38	12x500	27,60
7503004850	4,8x50	12x500	38,00
97503004863	4,8x63	24x100	48,00

**ΤΡΥΠΑΝΟΒΙΔΑ ΦΡΕΖΑΤΗ ΤΕΤΡΑΓΩΝΟ
ΚΕΦΑΛΙ DIN 7504, ΓΑΛΒΑΝΙΖΕ**



ΚΩΔΙΚΟΣ	ΔΙΑΣΤΑΣΗ	ΣΥΣΚ	€/1000
7503104219	4,2x19	12x1000	13,50
7503104225	4,2x25	12x1000	17,00
97503104232	4,2x32	16x300	21,00
7503104232	4,2x32		21,00
97503104238	4,2x38	16x300	26,00
7503104238	4,2x38		26,00



**ΤΡΥΠΑΝΟΒΙΔΑ ΦΡΕΖΑΤΗ ΤΕΤΡΑΓΩΝΟ
ΛΕΥΚΟ ΚΕΦΑΛΙ DIN 7504**



ΚΩΔΙΚΟΣ	ΔΙΑΣΤΑΣΗ	ΣΥΣΚ	€/1000
97503114219	4,2x19	24x800	23,00
7503114219	4,2x19	16x1000	23,00
97503114225	4,2x25	24x400	28,00
7503114225	4,2x25		28,00

**ΤΡΥΠΑΝΟΒΙΔΑ ΦΡΕΖΑΤΗ ΤΕΤΡΑΓΩΝΟ
ΜΑΥΡΟ ΚΕΦΑΛΙ DIN 7504**



ΚΩΔΙΚΟΣ	ΔΙΑΣΤΑΣΗ	ΣΥΣΚ	€/1000
97503124219	4,2x19	24x600	23,00
7503124219	4,2x19	16x1000	23,00
97503124225	4,2x25	24x600	28,00
7503124225	4,2x25		28,00

7504

**SELF
DRILLING**

**PAN
HEAD**



**ΤΡΥΠΑΝΟΒΙΔΑ ΨΩΜΑΚΙ PHILIPS
DIN 7504**



ΚΩΔΙΚΟΣ	ΔΙΑΣΤΑΣΗ	ΣΥΣΚ	€/1000
7504003510	3,5x10	36x1000	10,00
97504003519	3,5x19	16x1000	16,00
7504003519	3,5x19	16x1000	16,00
97504004213	4,2x13	24x800	15,00
7504004213	4,2x13	16x1000	15,00
97504004216	4,2x16	24x800	16,50
7504004216	4,2x16	16x1000	16,50
97504004219	4,2x19	24x700	18,00
7504004219	4,2x19		18,00
97504004225	4,2x25	24x500	21,60
7504004225	4,2x25	16x1000	21,60
97504004232	4,2x32	24x300	25,60
7504004232	4,2x32		25,60
7504004238	4,2x38	16x500	28,60
97504004250	4,2x50	24x100	33,00
7504004250	4,2x50	24x100	33,00
97504004819	4,8x19	12x1000	25,00
7504004819	4,8x19		25,00
97504004825	4,8x25	16x500	28,00
7504004825	4,8x25		28,00
7504004832	4,8x32	16x500	33,00
97504004838	4,8x38	24x700	39,00
7504004838	4,8x38	12x500	39,00
7504004850	4,8x50	12x500	48,00

**ΤΡΥΠΑΝΟΒΙΔΑ ΨΩΜΑΚΙ ΤΕΤΡΑΓΩΝΟ
ΚΕΦΑΛΙ DIN 7504 / ΓΑΛΒΑΝΙΖΕ**



ΚΩΔΙΚΟΣ	ΔΙΑΣΤΑΣΗ	ΣΥΣΚ	€/1000
97504104213	4,2x13	24x900	16,00
7504104213	4,2x13		16,00
7504104216	4,2x16	16x1000	17,80
7504104219	4,2x19	12x1000	19,30
97504104225	4,2x25	24x450	22,00
7504104225	4,2x25	12x1000	22,00
7504104232	4,2x32	12x500	27,00
97504104238	4,2x38	24x200	30,00
7504104238	4,2x38		30,00
97504104250	4,2x50	24x200	35,00
7504104250	4,2x50		35,00



**ΤΡΥΠΑΝΟΒΙΔΑ ΨΩΜΑΚΙ ΤΕΤΡΑΓΩΝΟ
ΛΕΥΚΟ ΚΕΦΑΛΙ DIN 7504**



ΚΩΔΙΚΟΣ	ΔΙΑΣΤΑΣΗ	ΣΥΣΚ	€/1000
97504114219	4,2x19	24x700	29,00
7504114219	4,2x19		29,00
7504114225	4,2x25	12x1000	33,00

**ΤΡΥΠΑΝΟΒΙΔΑ ΨΩΜΑΚΙ ΤΕΤΡΑΓΩΝΟ
ΜΑΥΡΟ ΚΕΦΑΛΙ DIN 7504**



ΚΩΔΙΚΟΣ	ΔΙΑΣΤΑΣΗ	ΣΥΣΚ	€/1000
97504124219	4,2x19	24x700	29,00
7504124219	4,2x19		29,00
97504124225	4,2x25	12x1000	33,00
7504124225	4,2x25		33,00

7981

**PAN
HEAD**

**ΛΑΜΑΡΙΝΟΒΙΔΑ PHILIPS
DIN 7981 / ΓΑΛΒΑΝΙΖΕ**



ΚΩΔΙΚΟΣ	ΔΙΑΣΤΑΣΗ 1	ΔΙΑΣΤΑΣΗ 2	ΣΥΣΚ	€/1000
7981002910	4x3/8	2,9x10	36x1000	5,85
7981002913	4x1/2	2,9x13	36x1000	6,50
7981002916	4x5/8	2,9x16	36x1000	7,10
7981002919	4x3/4	2,9x19	36x1000	9,25
7981002925	4x1	2,9x25	16x1000	10,45
7981003506	6x1/4	3,5x6	36x1000	6,85
7981003510	6x3/8	3,5x10	16x1000	7,30
7981003513	6x1/2	3,5x13	16x1000	8,05
7981003516	6x5/8	3,5x16	16x1000	9,10
7981003519	6x3/4	3,5x19	36x1000	10,20
7981003525	6x1	3,5x25	16x1000	11,00
7981004296	8x3/8	4,2x10	16x1000	10,10
7981004213	8x1/2	4,2x13	16x1000	9,60
7981004216	8x5/8	4,2x16	12x1000	11,90
7981004219	8x3/4	4,2x19	12x1000	13,10
7981004225	8x1	4,2x25	12x1000	15,10
7981004232	8x1 1 1/4	4,2x32	16x500	18,05
7981004238	8x1 1/2	4,2x38	16x500	20,70
7981004250	8x2	4,2x50	12x500	26,40
7981004819	10x3/4	4,8x19	12x1000	17,05
7981004825	10x1	4,8x25	16x500	19,60
7981004832	10x1 1/4	4,8x32	12x500	24,35
7981004838	10x1 1/2	4,8x38	12x500	27,30
7981004850	10x2	4,8x50	12x500	34,45
7981005525	12x1	5,5x25	12x500	29,05
7981005532	12x1 1/4	5,5x32	16x250	35,35
7981005538	12x1 1/2	5,5x38	16x250	39,05
7981005550	12x2	5,5x50	12x250	45,55
7981005575	12x3	5,5x75	12x250	57,20



**ΛΑΜΑΡΙΝΟΒΙΔΑ ΤΕΤΡΑΓΩΝΟ ΚΕΦΑΛΙ
DIN 7981 / ΓΑΛΒΑΝΙΖΕ**



ΚΩΔΙΚΟΣ	ΔΙΑΣΤΑΣΗ 1	ΔΙΑΣΤΑΣΗ 2	ΣΥΣΚ	€/1000
7981104213	8x1/2	4,2x13	16x1000	12,65
7981104219	8x3/4	4,2x19	12x1000	15,20
7981104225	8x1	4,2x25	12x1000	16,75
7981104232	8x1 1 1/4	4,2x32	16x500	19,70
7981104238	8x1 1/2	4,2x38	16x500	22,55
7981104250	8x2	4,2x50	12x500	30,25
7981104838	10x1 1/2	4,8x38	12x500	31,25
7981104850	10x2	4,8x50	12x500	39,60
7981105525	12x1	5,5x25	12x500	24,65
7981105538	12x1 1/2	5,5x38	12x500	45,10
7981105550	12x2	5,5x50	12x250	51,70
7981105575	12x3	5,5x75	12x250	66,00

DIN **7981****PAN
HEAD****ΛΑΜΑΡΙΝΟΒΙΔΑ ΤΕΤΡΑΓΩΝΟ ΛΕΥΚΟ
ΚΕΦΑΛΙ DIN 7981**

ΚΩΔΙΚΟΣ	ΔΙΑΣΤΑΣΗ 1	ΔΙΑΣΤΑΣΗ 2	ΣΥΣΚ	€/1000
7981114213	8x1/2	4,2x13	16x1000	17,60
7981114216	8x5/8	4,2x16	16x1000	19,25
7981114219	8x3/4	4,2x19	12x1000	22,00
7981114225	8x1	4,2x25	12x1000	23,45
7981114238	8x1 1/2	4,2x38	16x500	30,80
7981114250	8x2	4,2x50	12x500	35,75
7981114838	10x1 1/2	4,8x38	12x500	41,25
7981114850	10x2	4,8x50	16x250	47,30
7981115538	12x1 1/2	5,5x38	16x250	58,30
7981115550	12x2	5,5x50	12x250	63,80

**ΛΑΜΑΡΙΝΟΒΙΔΑ ΤΕΤΡΑΓΩΝΟ ΜΑΥΡΟ
ΚΕΦΑΛΙ DIN 7981**

ΚΩΔΙΚΟΣ	ΔΙΑΣΤΑΣΗ 1	ΔΙΑΣΤΑΣΗ 2	ΣΥΣΚ	€/1000
7981124213	8x1/2	4,2x13	16x1000	17,60
7981124219	8x3/4	4,2x19	12x1000	22,00
7981124225	8x1	4,2x25	12x1000	23,45
7981124238	8x1 1/2	4,2x38	16x500	30,80
7981124250	8x2	4,2x50	12x500	35,75
7981124838	10x1 1/2	4,8x38	12x500	41,25
7981124850	10x2	4,8x50	16x250	47,30

7982

**FLAT
HEAD**



**ΛΑΜΑΡΙΝΟΒΙΔΑ PHILIPS
DIN 7982 / ΓΑΛΒΑΝΙΖΕ**



ΚΩΔΙΚΟΣ	ΔΙΑΣΤΑΣΗ 1	ΔΙΑΣΤΑΣΗ 2	ΣΥΣΚ	€/1000
7982002913	4x1/2	2,9x13	36x1000	5,85
7982003510	6x3/8	3,5x10	36x1000	6,60
7982003513	6x1/2	3,5x13	36x1000	7,05
7982003516	6x5/8	3,5x16	36x1000	7,70
7982003519	6x3/4	3,5x19	16x1000	8,70
7982003525	6x1	3,5x25	16x1000	10,25
7982004213	8x1/2	4,2x13	16x1000	9,25
7982004216	8x5/8	4,2x16	16x1000	9,60
7982004219	8x3/4	4,2x19	16x1000	10,70
7982004225	8x1	4,2x25	12x1000	13,20
7982004232	8x1 1/4	4,2x32	12x1000	16,40
7982004238	8x1 1/2	4,2x38	16x500	18,70
7982004250	8x2	4,2x50	16x500	23,80
7982004819	10x3/4	4,8x19	12x1000	14,00
7982004825	10x1	4,8x25	12x1000	17,05
7982004832	10x1 1/4	4,8x32	16x1000	20,90
7982004838	10x1 1/2	4,8x38	12x500	24,00
7982004850	10x2	4,8x50	12x500	30,05

**ΛΑΜΑΡΙΝΟΒΙΔΑ ΤΕΤΡΑΓΩΝΟ ΚΕΦΑΛΙ
DIN 7982 / ΓΑΛΒΑΝΙΖΕ**



ΚΩΔΙΚΟΣ	ΔΙΑΣΤΑΣΗ 1	ΔΙΑΣΤΑΣΗ 2	ΣΥΣΚ	€/1000
7982104219	8x3/4	4,2x19	16x1000	13,20
7982104225	8x1	4,2x25	12x1000	14,65

**ΛΑΜΑΡΙΝΟΒΙΔΑ ΤΕΤΡΑΓΩΝΟ ΛΕΥΚΟ
ΚΕΦΑΛΙ DIN 7982**



ΚΩΔΙΚΟΣ	ΔΙΑΣΤΑΣΗ 1	ΔΙΑΣΤΑΣΗ 2	ΣΥΣΚ	€/1000
7982114213	8x1/2	4,2x13	16x1000	16,50
7982114219	8x3/4	4,2x19	16x1000	20,90
7982114225	8x1	4,2x25		22,00
7982114238	8x1 1/2	4,2x38	12x1000	28,60
7982114250	8x2	4,2x50	12x500	33,00
7982114825	10 x 1	4,8x25	12x500	26,40
7982114838	10x1 1/2	4,8x38	16x1000	38,50
7982114850	10x2	4,8x50	12x500	44,00

**ΛΑΜΑΡΙΝΟΒΙΔΑ ΤΕΤΡΑΓΩΝΟ ΜΑΥΡΟ
ΚΕΦΑΛΙ DIN 7982**



ΚΩΔΙΚΟΣ	ΔΙΑΣΤΑΣΗ 1	ΔΙΑΣΤΑΣΗ 2	ΣΥΣΚ	€/1000
7982124213	8x1/2	4,2x13	16x1000	16,50
7982124219	8x3/4	4,2x19	16x1000	20,90
7982124225	8x1	4,2x25	12x1000	22,00
7982124238	8x1 1/2	4,2x38	12x1000	28,60
7982124250	8x2	4,2x50	12x500	33,00
7982124838	10x1 1/2	4,8x38	16x1000	38,50
7982124850	10x2	4,8x50	12x500	44,00

di933



**ΑΤΣΑΛΟΒΙΔΑ ΕΞΑΓΩΝΗ
DIN933 8,8 ΓΑΛΒΑΝΙΖΕ**

ΚΩΔΙΚΟΣ	ΔΙΑΣΤΑΣΗ	ΣΥΣΚ	€/1000
0933006016	6X16	18x200	30,80
0933006020	6X20	18x200	31,45
0933006025	6X25	12x200	33,80
0933006030	6X30	12x200	36,15
0933006040	6X40	10x200	44,60
0933006050	6X50	8x200	53,50
0933006060	6X60	6x200	72,15
0933008016	8X16	10x200	58,10
0933008020	8X20	10x200	58,50
0933008025	8X25	8x200	66,50
0933008030	8X30	8x200	73,70
0933008040	8X40	6x200	89,00
0933008050	8X50	5x200	103,00
0933008060	8X60	4x200	119,00
0933008070	8X70	4x200	142,60
0933008080	8X80	4x200	161,90
0933010016	10X16	x200	125,00
0933010020	10X20	6x200	107,00
0933010025	10X25	5x200	115,00
0933010030	10X30	4x200	125,00
0933010040	10X40	6x100	151,70
0933010050	10X50	6x100	176,00
0933010060	10X60	5x100	200,85
0933010070	10X70	4x100	225,15
0933010080	10X80	4x100	254,40
0933012020	12X20	4x200	172,50
0933012025	12X25	6x100	169,00
0933012030	12X30	6x100	183,00
0933012035	12X35	x100	200,85
0933012040	12X40	5x100	218,15
0933012050	12X50	4x100	252,90
0933012060	12X60	4x100	283,00
0933012070	12X70	6x50	323,00



ΚΡΙΚΟΣ

ΚΩΔΙΚΟΣ	ΔΙΑΣΤΑΣΗ	ΣΥΣΚ	€/100
22406055	M6X55 C11mm	200	9,00
22408070	M8X70 C13mm	100	29,00
22410080	M10X80 C11mm	70	39,00
22412010	M12X100 C19mm	40	76,00



ΓΑΝΤΖΟΣ

ΚΩΔΙΚΟΣ	ΔΙΑΣΤΑΣΗ	ΣΥΣΚ	€/100
22506055	M6X55 C11mm	200	8,40
22508070	M8X70 C13mm	100	22,00
22510080	M10X80 C14mm	70	38,00
22512010	M12X100 C19mm	40	70,00

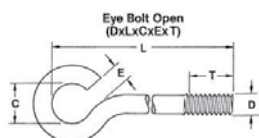

din **931**



**ΑΤΣΑΛΟΒΙΔΑ ΕΞΑΓΩΝΗ
DIN931 8,8 ΓΑΛΒΑΝΙΖΕ**

ΚΩΔΙΚΟΣ	ΔΙΑΣΤΑΣΗ	ΣΥΣΚ	€/1000
0931006070	6X70	6x200	80,20
0931006080	6X80	6x200	95,50
0931006090	6X90	10x100	119,05
0931006100	6X100	10x100	143,00
0931008070	8X70	4x200	154,60
0931008080	8X80	4x200	177,00
0931008090	8X90	6x100	200,00
0931008100	8X100	6x100	233,00
0931008120	8X120	5x100	305,00
0931008140	8X140	5x100	403,00
0931010080	10X80	4x100	310,00
0931010090	10X90	6x50	340,00
0931010100	10X100	6x50	387,00
0931010120	10X120	6x50	456,00
0931010140	10X140	6x50	551,00
0931010160	10X160	4x50	802,00
0931012080	12X80	6x50	415,00
0931012090	12X90	5x50	459,00
0931012100	12X100	4x50	500,00
0931012120	12X120	4x50	597,00
0931012140	12X140	4x50	762,00
0931012160	12X160	4x50	998,00

din **603**



**ΚΑΡΟΒΙΔΑ ΜΕ ΠΑΞΙΜΑΔΙ 4,8 ΓΑΛΒΑΝΙΖΕ
DIN 603**

ΚΩΔΙΚΟΣ	ΔΙΑΣΤΑΣΗ	ΣΥΣΚ	€/1000
1603006030	6x30	10x200	80,00
1603006035	6x35	10x200	82,50
1603006040	6x40	6x200	90,15
1603006050	6x50	6x200	101,25
1603006060	6x60	6x200	120,65
1603006070	6x70	4x200	132,10
1603006080	6x80	4x200	137,35
1603006090	6x90	6x100	168,95
1603006100	6x100	6x100	183,00
1603008040	8x40	4x200	166,35
1603008050	8x50	4x200	176,55
1603008060	8x60	4x200	210,80
1603008070	8x70	4x100	229,85
1603008080	8x80	4x100	252,75
1603008090	8x90	4x100	284,50
1603008100	8x100	4x100	297,10
1603008120	8x120	6x50	337,30
1603001060	10x60	4x100	377,20
1603001070	10x70	4x100	386,10
1603001080	10x80	4x100	439,40
1603010100	10x100	6x50	511,80
1603010120	10x120	4x50	572,75



**ΝΤΙΖΑ ΓΑΛΒΑΝΙΖΕ 4,8
DIN 975**

ΚΩΔΙΚΟΣ	ΔΙΑΣΤΑΣΗ	ΣΥΣΚ	€/ΤΕΜ
097500510	M5 / 1M	50	0,38
097500610	M6 / 1M	50	0,45
097500810	M8 / 1M	50	0,70
097501010	M10 / 1M	25	1,10
097501210	M12 / 1M	20	1,60
097501410	M14 / 1M	20	2,30
097501610	M16 / 1M	10	3,00
097501810	M18 / 1M	10	3,80
097502010	M20 / 1M	5	4,75
097502210	M22 / 1M	5	5,85
097502410	M24 / 1M	5	6,85
097500620	M6 / 2M		0,90
097500820	M8 / 2M	25	1,40
097501020	M10 / 2M	25	2,20
097501220	M12 / 2M	20	3,20



ΑΠΟΓΡΕΖΩΤΗΣ ΑΚΡΩΝ ΝΤΙΖΑΣ 3-19mm

ΚΩΔΙΚΟΣ	YATO	ΣΥΣΚ	€/ΤΕΜ
20022357	YT-22357		11,40



**ΠΑΞΙΜΑΔΙ ΓΑΛΒΑΝΙΖΕ
DIN 934**

ΚΩΔΙΚΟΣ	ΔΙΑΣΤΑΣΗ	ΣΥΣΚ	€/1000
093400300	M3	36x1500	2,90
093400400	M4	36x1000	4,25
093400500	M5	16x1000	5,85
093400600	M6	16x1000	7,50
093400800	M8	8x550	14,20
093401000	M10	8x250	29,50
093401200	M12	8x160	47,00
093401400	M14	8x110	70,00
093401600	M16	8x80	96,00
093401800	M18	8x50	158,00
093402000	M20	8x20	182,00
093402200	M22	8x20	270,00
093402400	M24	8x20	340,00



300 PCS MIX SIZE

ΓΑΛΒΑΝΙΖΕ

ΠΑΞΙΜΑΔΙΑ ΣΕΤ 300 ΤΜΧ

ΚΩΔΙΚΟΣ	YATO	ΣΥΣΚ	€/ΤΕΜ
20006772	YT-06772	5/20	6,35

M3, M4, M5, M6, M8, M10

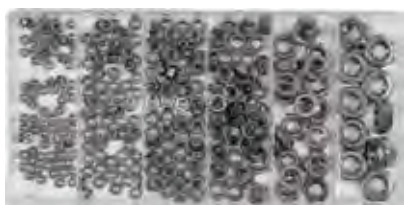

300 PCS MIX SIZE ROZMIAROW STAINLESS STEEL



INOX

ΠΑΞΙΜΑΔΙΑ ΣΕΤ INOX 300 ΤΜΧ

ΚΩΔΙΚΟΣ	YATO	ΣΥΣΚ	€/ΤΕΜ
20006773	YT-06773	5/20	9,85

M3, M4, M5, M6, M8, M10



ΠΑΞΙΜΑΔΙΑ ΑΣΦΑΛΕΙΑΣ DIN 985

ΚΩΔΙΚΟΣ	ΔΙΑΣΤΑΣΗ	ΣΥΣΚ	€/1000
098500300	M3	4x12500	6,20
098500400	M4	4x6500	6,35
098500500	M5	10x2000	6,75
098500600	M6	10x1000	9,35
098500800	M8	8x550	18,15
098501000	M10	8x250	43,25
098501200	M12	8x150	62,00

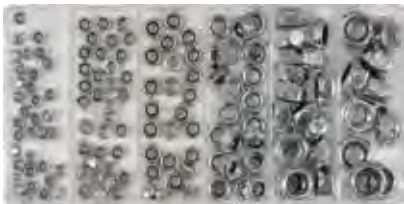

146
PCS

MIX
SIZE

INSERT
LOCK



ΠΑΞΙΜΑΔΙΑ ΑΣΦΑΛΕΙΑΣ ΣΕΤ 146 ΤΜΧ

ΚΩΔΙΚΟΣ	YATO	ΣΥΣΚ	€/ΤΕΜ
20006774	YT-06774	5/20	7,05

M4, M5, M6, M8, M10, M12



ΠΕΤΑΛΟΥΔΑ ΓΑΛΒΑΝΙΖΕ DIN 315

ΚΩΔΙΚΟΣ	ΔΙΑΣΤΑΣΗ	ΣΥΣΚ	€/1000
031500400	M4	500	48,00
031500500	M5	200	57,00
031500600	M6	200	66,00
031500800	M8	200	79,00
031501000	M10	100	170,00

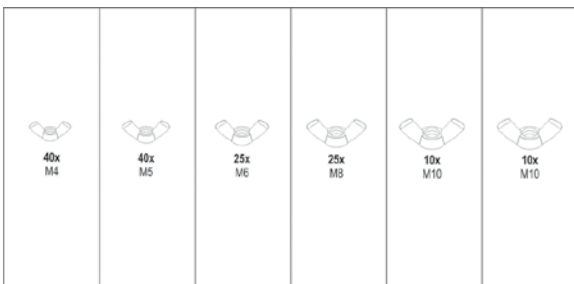

M4, M5, M6, M8, M10

ΠΕΤΑΛΟΥΔΕΣ ΣΕΤ 150 ΤΜΧ

ΚΩΔΙΚΟΣ	YATO	ΣΥΣΚ	€/ΤΕΜ
20006776	YT-06776	5/25	9,95



150
PCS

METRIC

MIX
SIZE



**ΤΥΦΛΟ ΠΑΞΙΜΑΔΙ ΓΑΛΒΑΝΙΖΕ
DIN 1587**

ΚΩΔΙΚΟΣ	ΔΙΑΣΤΑΣΗ	ΣΥΣΚ	€/1000
158700400	M4	1000	33,00
158700500	M5	1000	34,00
158700600	M6	1000	38,00
158700800	M8	500	74,30
158701000	M10	500	148,00
158701200	M12	200	223,00

150
PCSMIX
SIZE**ΠΑΞΙΜΑΔΙΑ ΤΥΦΛΑ ΣΕΤ 150 ΤΜΧ**

ΚΩΔΙΚΟΣ	ΥΑΤΟ	ΣΥΣΚ	€/ΤΕΜ
20006775	YT-06775	5/20	6,80

M3, M4, M5, M6, M8, M10

**ΠΑΞΙΜΑΔΙ ΦΛΑΝΤΖΑΣ ΓΑΛΒΑΝΙΖΕ
DIN 6923**

ΚΩΔΙΚΟΣ	ΔΙΑΣΤΑΣΗ	ΣΥΣΚ	€/1000
692300600	M6	1000	10,60
692300800	M8	1000	21,90
692301000	M10	500	36,00
692301200	M12	250	69,00

**ΠΑΞΙΜΑΔΙΑ ΝΤΙΖΑΣ (ΜΟΥΦΑ)
DIN 6334**

ΚΩΔΙΚΟΣ	ΔΙΑΣΤΑΣΗ	ΣΥΣΚ	€/1000
633400620	M6x20	4x700	37,00
633400825	M8x25	4x450	77,00
633401030	M10x30	4x250	169,00
633401236	M12x36	4x125	245,00

**ΡΟΔΕΛΑ ΓΑΛΒΑΝΙΖΕ
ΓΚΡΟΒΕΡ DIN127**

ΚΩΔΙΚΟΣ	ΔΙΑΜΕΤΡΟΣ	ΣΥΣΚ	€/1000
012700500	Ø5	4x10000	2,70
012700600	Ø6	18x1000	4,70
012700800	Ø8	18x500	8,00
012701000	Ø10	24x250	12,70
012701200	Ø12	4x2000	19,10



ΡΟΔΕΛΑ ΓΑΛΒΑΝΙΖΕ x2 DIN 125

ΚΩΔΙΚΟΣ	ΔΙΑΜΕΤΡΟΣ	ΣΥΣΚ	€/1000
Εσωτερική x Εξωτερική			
012500300	Ø 3x6	36x2000	2,55
012500400	Ø 4x8	40x1500	2,90
012500500	Ø 5x10	50x1000	3,35
012500600	Ø 6x12	20x1000	5,35
012500800	Ø 8x16	16x1000	9,20
012501000	Ø 10x20	12x500	18,40
012501200	Ø 12x24	14x250	31,80
012501400	Ø 14x28	16x250	43,80
012501600	Ø 16x32	6x250	52,80
012501800	Ø 18x36	10x100	83,40
012502000	Ø 20x40	10x100	95,90



ΡΟΔΕΛΑ ΓΑΛΒΑΝΙΖΕ x3 DIN 9021

ΚΩΔΙΚΟΣ	ΔΙΑΜΕΤΡΟΣ	ΣΥΣΚ	€/1000
Εσωτερική x Εξωτερική			
902100300	Ø 3x9	60x1000	4,40
902100400	Ø 4x12	30x1000	4,50
902100500	Ø 5x15	16x1000	8,00
902100600	Ø 6x18	8x1000	13,80
902100800	Ø 8x24	4x1000	29,90
902101000	Ø 10x30	12x200	56,00
902101200	Ø 12x36	10x100	100,00
902101400	Ø 14x42	16x50	175,00
902101600	Ø 16x48	12x50	186,00
902101800	Ø 18x54	16x25	365,00
902102000	Ø 20x60	16x25	375,00



ΡΟΔΕΛΑ ΓΑΛΒΑΝΙΖΕ DIN 440

ΚΩΔΙΚΟΣ	ΔΙΑΜΕΤΡΟΣ	ΣΥΣΚ	€/1000
Εσωτερική x Εξωτερική			
044001000	Ø 10x35	6x200	74,00
044001200	Ø 12x44	6x100	135,00



ΡΟΔΕΛΑ ΓΑΛΒΑΝΙΖΕ x4 4xD

ΚΩΔΙΚΟΣ	ΔΙΑΜΕΤΡΟΣ	ΣΥΣΚ	€/1000
Εσωτερική x Εξωτερική			
044100400	Ø 4x16	16x500	14,10
044100500	Ø 5x20	12x500	18,95
044100600	Ø 6x24	12x250	25,70
044100800	Ø 8x32	8x200	60,95
044101000	Ø 10x40	10x100	116,00
044101200	Ø 12x48	12x50	200,00



555
PCS

MIX
SIZE

ΚΟΠΙΛΙΕΣ ΣΕΤ 555 ΤΜΧ

ΚΩΔΙΚΟΣ	ΥΑΤΟ 	ΣΥΣΚ	€/ΤΕΜ
20006873	ΥΤ-06873	5/10	9,85

1.6x25 mm, 2.4x25 mm, 2.4x38 mm,
3.2x32 mm, 3.2x50 mm, 4.0x64 mm



300
PCS

∅ 1.5-22
mm

E-RING ΣΕΤ 300 ΤΜΧ

ΚΩΔΙΚΟΣ	ΥΑΤΟ 	ΣΥΣΚ	€/ΤΕΜ
20006884	ΥΤ-06884	5/25	8,60

1.5 mm, 3 mm, 5 mm, 6 mm, 10 mm,
12 mm, 15 mm, 19 mm, 22 mm



300
PCS

EXTERNAL

ΕΞΩΤΕΡΙΚΕΣ ΑΣΦΑΛΕΙΕΣ ΣΕΤ 300ΤΜΧ

ΚΩΔΙΚΟΣ	ΥΑΤΟ 	ΣΥΣΚ	€/ΤΕΜ
20006880	ΥΤ-06880	5/20	8,10

∅ 3, 4, 5, 6, 8, 9, 11, 12, 13, 14, 15, 19, 20, 22, 25, 26, 28, 32 mm



ΕΣΩΤΕΡΙΚΕΣ ΑΣΦΑΛΕΙΕΣ ΣΕΤ 300 ΤΜΧ

ΚΩΔΙΚΟΣ	ΥΑΤΟ 	ΣΥΣΚ	€/ΤΕΜ
20006881	ΥΤ-06881	5/20	8,05



300
PCS

INTERNAL

∅ 3, 4, 5, 6, 8, 9, 11, 12, 13, 14, 15, 19, 20, 22, 25, 26, 28, 32 mm



ΠΡΙΤΣΙΝΙ ΑΛΟΥΜΙΝΙΟΥ

ΚΩΔΙΚΟΣ	ΔΙΑΣΤΑΣΗ	ΣΥΣΚ	€/1000
ΓΑΛΒΑΝΙΖΕ			
733700360	3x6	20x1000	9,30
733700380	3x8	20x1000	9,70
733700310	3x10	20x1000	8,90
733700312	3x12	20x1000	10,75
733700315	3x15	10x1000	11,85
733700460	4x6	10x1000	12,75
733700480	4x8	10x1000	13,35
733700410	4x10	10x1000	14,20
733700412	4x12	10x1000	15,80
733700415	4x15	10x500	18,60
733700418	4x18	10x500	20,00
733700420	4x20	10x500	20,30
733700425	4x25	5x500	23,70
733700430	4x30	5x250	31,10
733700580	4,8x8	10x500	19,00
733700510	4,8x10	10x500	19,50
733700512	4,8x12	10x500	21,20
733700515	4,8x15	5x500	23,70
733700518	4,8x18	5x500	28,80
733700520	4,8x20	5x500	31,60
733700525	4,8x25	5x250	36,00
ΛΕΥΚΟ			
733701480	4x8	10x1000	23,70
733701410	4x10	10x1000	24,00
733701412	4x12	10x1000	25,50
733701418	4x18	10x500	34,50
733701420	4x20	10x500	34,95
733701430	4x30	5x250	52,50
ΜΑΥΡΟ			
733702480	4x8	10x1000	23,70
733702410	4x10	10x1000	24,00
733702412	4x12	10x1000	25,50



ΠΡΙΤΣΙΝΑΔΟΡΟΙ ΔΡΑΠΑΝΟΥ

ΚΩΔΙΚΟΣ	ΠΕΡΙΓΡΑΦΗ	ΣΥΣΚ	€/τεμ.
122000048	ΓΙΑ ΑΠΛΑ ΠΡΙΤΣΙΝΙΑ	1	45,00
122000006	ΓΙΑ ΠΡΙΤΣΙΝΙΑ ΣΠΕΙΡΩΜΑΤΟΣ	1	45,00





20 PCS M3 Al

NEO 

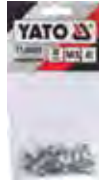

ΠΡΙΤΣΙΝΙΑ ΣΠΕΙΡΩΜΑΤΟΣ ΑΛΟΥΜ ΣΕΤ 20 ΤΜΧ

ΚΩΔΙΚΟΣ	YATO 	ΜΕΓΕΘΟΣ	ΣΥΣΚ	€/ΤΕΜ
20036451	YT-36451	M3	125	1,50
20036452	YT-36452	M4	100	1,78
20036453	YT-36453	M5	75	1,90
20036454	YT-36454	M6	50	2,00



20 PCS M3

NEO 



ΠΡΙΤΣΙΝΙΑ ΣΠΕΙΡΩΜΑΤΟΣ ΣΕΤ 20 ΤΜΧ

ΚΩΔΙΚΟΣ	YATO 	ΜΕΓΕΘΟΣ	ΣΥΣΚ	€/ΤΕΜ
20036470	YT-36470	M3	125	1,35
20036471	YT-36471	M4	100	1,40
20036472	YT-36472	M5	75	1,50
20036473	YT-36473	M6	50	1,85
20036474	YT-36474	M8	40	2,50
20036475	YT-36475	M10	25	3,45
20036476	YT-36476	M12	15	5,40



150 PCS MIX SIZE Al



ΠΡΙΤΣΙΝΙΑ ΣΠΕΙΡΩΜΑΤΟΣ ΑΛΟΥΜ ΣΕΤ 150 ΤΜΧ

ΚΩΔΙΚΟΣ	YATO 	ΣΥΣΚ	€/ΤΕΜ
20036460	YT-36460	1	12,75

M3-M10



150 PCS MIX SIZE



ΠΡΙΤΣΙΝΙΑ ΣΠΕΙΡΩΜΑΤΟΣ ΣΕΤ 150 ΤΜΧ

ΚΩΔΙΚΟΣ	YATO 	ΣΥΣΚ	€/ΤΕΜ
20036481	YT-36481	1	11,10

M3-M11



400 PCS MIX SIZE Al



ΠΡΙΤΣΙΝΙΑ ΣΕΤ 400 ΤΜΧ

ΚΩΔΙΚΟΣ	YATO 	mm	ΣΥΣΚ	€/ΤΕΜ
20036420	YT-36420	2,4,3,2,4,0,4,8	5	8,85



50 pcs Al

NEO 

ΠΡΙΤΣΙΝΙΑ ΣΕΤ 50 ΤΜΧ

ΚΩΔΙΚΟΣ	VOREL 	mm	ΣΥΣΚ	€/ΤΕΜ
21170330	70330	3.2x9.6	25	0,66
21170340	70340	3.2x12.7	25	0,72
21170400	70400	4x6.4	25	0,90
21170410	70410	4x9.6	25	0,96
21170420	70420	4x12.7	25	1,09
21170430	70430	4x19	25	1,31
21170490	70490	4.8x9.6	25	1,38
21170500	70500	4.8x12.7	25	1,48
21170510	70510	4.8x19	25	1,65

ΚΑΔΟΙ ΚΗΠΟΣ ΣΙΤΕΣ | ΚΛΕΙΔΑΡΙΕΣ



ΚΑΔΟΙ - ΚΗΠΟΣ [377 - 392]



ΣΙΤΕΣ - ΛΟΥΚΕΤΑ - ΙΜΑΝΤΕΣ [393 - 402]



ΚΛΕΙΔΑΡΙΕΣ [403 - 419]

Αφαλοί | Σύρτες

Εξαρτήματα Αλουμινίου & Ρολών



ECO SET 25 & 35 ΛΙΤΡΩΝ

Για εύκολο διαχωρισμό & διαχείριση των ανακυκλώσιμων υλικών

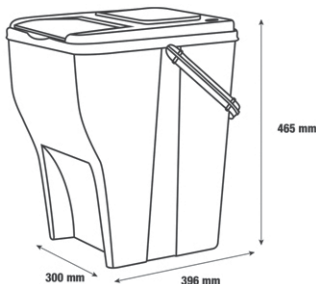
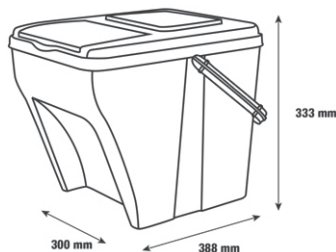

ΣΥΝΤΟΜΑ ΔΙΑΘΕΣΙΜΑ



3 x 25 ΛΙΤΡΑ
ΚΩΔ. 29534342
400x300x458 mm
30,00 €

4 x 25 ΛΙΤΡΑ
ΚΩΔ. 29534423
400x300x516 mm
39,00 €

3 x 35 ΛΙΤΡΑ
ΚΩΔ. 29534234
400x300x590 mm
€

4 x 35 ΛΙΤΡΑ
ΚΩΔ. 29534343
400x300x648 mm
€

2 x 25 + 2 x 35 ΛΙΤΡΑ
ΚΩΔ. 29534434
400x300x648 mm
€

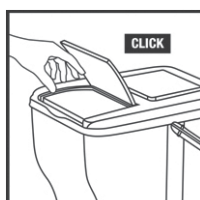

ΕΥΚΟΛΟ ΑΝΟΙΓΜΑ

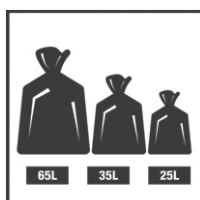

ΓΙΑ ΠΟΛΛΑ ΜΕΓΕΘΗ ΣΑΚΟΥΛΑΣ

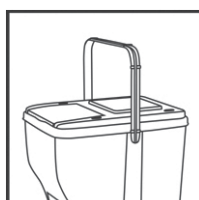

ΜΕ ΕΡΓΟΝΟΜΙΚΗ ΧΕΙΡΟΛΑΒΗ

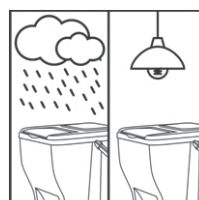

ΑΝΘΕΚΤΙΚΗ ΣΤΟ ΝΕΡΟ ΓΙΑ ΕΣΩΤΕΡΙΚΗ & ΕΞΩΤΕΡΙΚΗ ΧΡΗΣΗ

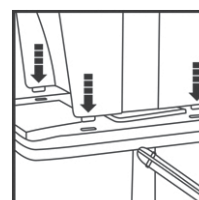

ΕΥΚΟΛΟ ΚΑΙ ΣΤΑΘΕΡΟ ΣΤΟΙΒΑΓΜΑ



ΚΑΔΟΣ 100 ΛΙΤΡΩΝ ECO ΜΕ ΡΟΔΕΣ & ΠΕΝΤΑΛ

ΚΩΔΙΚΟΣ	ΧΡΩΜΑ	ΔΙΑΣΤΑΣΗ	ΣΥΣΚ	€/ΤΕΜ.
44421020	ΜΠΛΕ	600x568x770mm	3	▶ 47,00
44421105	ΚΟΚΚΙΝΟ	600x568x770mm	3	▶ 47,00
44421037	ΠΡΑΣΙΝΟ	600x568x770mm	3	▶ 47,00
44421013	ΚΙΤΡΙΝΟ	600x568x770mm	3	▶ 47,00
44421235	ΚΑΦΕ	600x568x770mm	3	▶ 47,00
44421006	ΓΚΡΙ	600x568x770mm	3	▶ 47,00



ΚΑΔΟΣ 120 ΛΙΤΡΩΝ ECO ΜΕ ΡΟΔΕΣ & ΠΕΝΤΑΛ

ΚΩΔΙΚΟΣ	ΧΡΩΜΑ	ΔΙΑΣΤΑΣΗ	ΣΥΣΚ	€/ΤΕΜ.
44423024	ΜΠΛΕ	600x568x886mm	3	▶ 51,50
44423239	ΚΑΦΕ	600x568x886mm	3	▶ 51,50
44423031	ΠΡΑΣΙΝΟ	600x568x886mm	3	▶ 51,50



ΚΑΔΟΣ 120 ΛΙΤΡΩΝ ECO ΜΕ ΡΟΔΕΣ & ΠΕΝΤΑΛ

ΚΩΔΙΚΟΣ	ΧΡΩΜΑ	ΔΙΑΣΤΑΣΗ	ΣΥΣΚ	€/ΤΕΜ.
44443008	ΓΚΡΙ	600x568x886mm	3	▶ 66,00
44443015	ΚΙΤΡΙΝΟ	600x568x886mm	3	▶ 66,00
44443022	ΜΠΛΕ	600x568x886mm	3	▶ 66,00





ΚΑΔΟΣ 50 ΛΙΤΡΩΝ ECO

ΚΩΔΙΚΟΣ	ΧΡΩΜΑ	ΔΙΑΣΤΑΣΗ	ΣΥΣΚ	€/ΤΕΜ.
44412103	ΚΟΚΚΙΝΟ	410x400x510mm	4	▶ 16,50



ΚΑΔΟΣ 50 ΛΙΤΡΩΝ ECO ΜΕ ΠΕΝΤΑΛ

ΚΩΔΙΚΟΣ	ΧΡΩΜΑ	ΔΙΑΣΤΑΣΗ	ΣΥΣΚ	€/ΤΕΜ.
44430008	ΓΚΡΙ	399x428x509mm	3	▶ 19,00
44430015	ΚΙΤΡΙΝΟ	399x428x509mm	3	▶ 19,00
44430022	ΜΠΛΕ	399x428x509mm	3	▶ 19,00
44430039	ΠΡΑΣΙΝΟ	399x428x509mm	3	▶ 19,00



ΚΑΔΟΣ 60 ΛΙΤΡΩΝ ECO ΜΕ ΠΕΝΤΑΛ

ΚΩΔΙΚΟΣ	ΧΡΩΜΑ	ΔΙΑΣΤΑΣΗ	ΣΥΣΚ	€/ΤΕΜ.
44431005	ΓΚΡΙ	399x428x645mm	3	▶ 22,40
44431012	ΚΙΤΡΙΝΟ	399x428x645mm	3	▶ 22,40
44431029	ΜΠΛΕ	399x428x645mm	3	▶ 22,40
44431036	ΠΡΑΣΙΝΟ	399x428x645mm	3	▶ 22,40



ΚΑΔΟΣ 80 ΛΙΤΡΩΝ ECO ΜΕ ΡΟΔΕΣ & ΠΕΝΤΑΛ

ΚΩΔΙΚΟΣ	ΧΡΩΜΑ	ΔΙΑΣΤΑΣΗ	ΣΥΣΚ	€/ΤΕΜ.
44433009	ΓΚΡΙ	400x550x785mm	3	▶ 35,00
44433016	ΚΙΤΡΙΝΟ	400x550x785mm	3	▶ 35,00
44433023	ΜΠΛΕ	400x550x785mm	3	▶ 35,00
44433030	ΠΡΑΣΙΝΟ	400x550x785mm	3	▶ 35,00





ΚΑΔΟΣ 120 ΛΙΤΡΩΝ ΚΗΠΟΥ ΜΕ ΡΟΔΕΣ

ΚΩΔΙΚΟΣ	ΔΙΑΣΤΑΣΗ	ΣΥΣΚ	€/ΤΕΜ.
44424007	600x568x886mm	3	62,00



ΚΑΔΟΣ 120 ΛΙΤΡΩΝ ΚΗΠΟΥ ΜΕ ΡΟΔΕΣ & ΠΕΝΤΑΛ

ΚΩΔΙΚΟΣ	ΜΟΝΤΕΛΟ	ΔΙΑΣΤΑΣΗ	ΣΥΣΚ	€/ΤΕΜ.
44426001		600x568x886mm	3	67,00



ΣΑΚΟΥΛΕΣ ΑΠΟΡΡΙΜΜΑΤΩΝ

ΚΩΔΙΚΟΣ	ΠΕΡΙΓΡΑΦΗ	ΤΕΜ	ΣΥΣΚ	€/ΤΕΜ.
21109490	60Ltr 30mm - ΜΑΥΡΗ	10	25	2,15
21109470	80Ltr 40mm - ΜΑΥΡΗ	10	30	2,20
21110015	120Ltr 40mm - ΜΑΥΡΗ	10	25	3,15
21109489	60Ltr 13mm - ΜΠΛΕ	20	45	1,95
21109465	120Ltr 30mm - ΜΠΛΕ	10	25	2,80





1/2"
12.5mm
ABS



ΣΥΝΔΕΣΜΟΣ ΛΑΣΤΙΧΟΥ

ΚΩΔΙΚΟΣ	YATO 	ΣΥΣΚ	€/ΤΕΜ
20008976	YT-8976	1/2" 24	0,54



1/2"
12.5mm
ABS



➤ 3 ΔΡΟΜΩΝ

ΣΥΝΔΕΣΜΟΣ ΛΑΣΤΙΧΟΥ

ΚΩΔΙΚΟΣ	YATO 	ΣΥΣΚ	€/ΤΕΜ
20008977	YT-8977	1/2" 24	0,76



1/2"
12.5mm
ABS



ΣΥΝΔΕΣΜΟΣ 2 ΕΞΟΔΩΝ

ΚΩΔΙΚΟΣ	YATO 	ΣΥΣΚ	€/ΤΕΜ
20008978	YT-8978	1/2" 24	2,05



ABS



ΡΑΚΟΡ ΒΡΥΣΗΣ

ΚΩΔΙΚΟΣ	YATO 	ΣΥΣΚ	€/ΤΕΜ
20008973	YT-8973	1/2"-3/4" 12	0,65
20008974	YT-8974	3/4"-1 12	0,72



1/2" 12.5mm
3/4" 19mm
ABS
FLOW REGULATION
SOFT COATED
(3/4" (19 mm))



ΣΕΤ ΕΚΤΟΞΕΥΤΗ ΝΕΡΟΥ

ΚΩΔΙΚΟΣ	YATO 	ΣΥΣΚ	€/ΤΕΜ
20099831	YT-99831	1/2"-3/4" 48	4,35



1/2"
12.5mm
3/4"
19mm
ABS

ΣΥΝΔΕΣΜΟΣ ΛΑΣΤΙΧΟΥ 1/2" - 3/4"

ΚΩΔΙΚΟΣ	FLO	ΠΕΡΙΓΡΑΦΗ	ΣΥΣΚ	€/ΤΕΜ
21389011	89011	1/2-3/4"	30	1,12

➤ Πλαστικό



1/2"
12.5mm
3/4"
19mm
ABS

ΡΑΚΟΡ ΒΡΥΣΗΣ 1/2" - 3/4"

ΚΩΔΙΚΟΣ	FLO	ΠΕΡΙΓΡΑΦΗ	ΣΥΣΚ	€/ΤΕΜ
21389017	89017	1/2-3/4"	30	0,54

➤ Πλαστικό



ΣΥΝΔΕΣΜΟΣ ΛΑΣΤΙΧΟΥ "Υ" 1/2"

ΚΩΔΙΚΟΣ	FLO	ΠΕΡΙΓΡΑΦΗ	ΣΥΣΚ	€/ΤΕΜ
21389243	89243	1/2" - 3 δρόμων	125	0,59

➤ Πλαστικό
➤ 3 Δρόμων

ΤΑΧΥΣΥΝΔΕΣΜΟΙ ΛΑΣΤΙΧΟΥ ΒΡΥΣΗΣ



ABS

NEO



NEO

ABS

STOP

ΚΩΔΙΚΟΣ	YATO	ΣΥΣΚ	€/ΤΕΜ
20099801	YT-99801 1/2"	12	1,20
20099802	YT-99802 3/4"	12	1,33

ΚΩΔΙΚΟΣ	YATO	ΣΥΣΚ	€/ΤΕΜ
20099803	YT-99803 1/2"	12	1,30
20099804	YT-99804 3/4"	12	1,46



1/2"

12.5mm

ABS

NEO



1/2"

12.5mm

FLOW REGULATION

ABS

NEO

ΣΥΝΔΕΣΜΟΣ ΛΑΣΤΙΧΟΥ

ΚΩΔΙΚΟΣ	YATO	ΣΥΣΚ	€/ΤΕΜ
20099810	YT-99810 1/2"	12	1,00
20099811	YT-99811 3/4"	12	1,33

ΣΥΝΔΕΣΜΟΣ 1/2" - 3/4"

ΚΩΔΙΚΟΣ	YATO	ΣΥΣΚ	€/ΤΕΜ
20008979	YT-8979 1/2"-3/4"	24	1,31



NEO

ABS

ΕΚΤΟΞΕΥΤΗΣ ΝΕΡΟΥ

ΚΩΔΙΚΟΣ	YATO	ΣΥΣΚ	€/ΤΕΜ
20099830	YT-99830	12	1,37

ΤΑΧΥΣΥΝΔΕΣΜΟΙ ΛΑΣΤΙΧΟΥ ΒΡΥΣΗΣ

ΚΩΔΙΚΟΣ	FLO	ΠΕΡΙΓΡΑΦΗ	ΣΥΣΚ	€/ΤΕΜ
21389001	89001	1/2"	30	0,67
21389002	89002	3/4"	30	0,92

➤ Πλαστικό

ΤΑΧΥΣΥΝΔΕΣΜΟΙ ΛΑΣΤΙΧΟΥ ΒΡΥΣΗΣ

ΚΩΔΙΚΟΣ	FLO	ΠΕΡΙΓΡΑΦΗ	ΣΥΣΚ	€/ΤΕΜ
21389003	89003	1/2"	30	0,74
21389004	89004	3/4"	30	0,97

➤ Πλαστικό

➤ Με Υδατοφράχτη (STOP)

ΣΥΝΔΕΣΜΟΣ ΛΑΣΤΙΧΟΥ

ΚΩΔΙΚΟΣ	FLO	ΠΕΡΙΓΡΑΦΗ	ΣΥΣΚ	€/ΤΕΜ
21389007	89007	1/2"	30	0,61
21389008	89008	3/4"	30	0,74

➤ Πλαστικό



1/2"

12.5mm

ABS



1/2"

12.5mm

STOP

ABS



1/2"

12.5mm

ABS

ΠΙΣΤΟΛΙΑ ΝΕΡΟΥ



ΚΩΔΙΚΟΣ **YATO**  ΣΥΣΚ €/TEM
20008963 YT-8963 12 **9,90**



ΚΩΔΙΚΟΣ **YATO**  ΣΥΣΚ €/TEM
20099841 YT-99841 12 **12,20**



ΚΩΔΙΚΟΣ **YATO**  ΣΥΣΚ €/TEM
20008956 YT-8956 12 **9,20**



ΚΩΔΙΚΟΣ **YATO**  ΣΥΣΚ €/TEM
20008967 YT-8967 12 **21,00**



ΡΥΘΜΙΖΟΜΕΝΟ

ΚΩΔΙΚΟΣ **YATO**  ΣΥΣΚ €/TEM
20008966 YT-8966 12 **11,20**



ΡΥΘΜΙΖΟΜΕΝΟ ΜΕ ΡΟΟΣΤΑΤΗ

ΚΩΔΙΚΟΣ **YATO**  ΣΥΣΚ €/TEM
20008957 YT-8957 12 **13,30**



NEO



ΠΟΤΙΣΤΙΚΟ ΓΚΑΖΟΝ

ΚΩΔΙΚΟΣ	ΥΑΤΟ	ΣΥΣΚ	€/ΤΕΜ
20008985	YT-8985	48	6,70



NEO



ΚΑΡΟΥΛΙ ΓΙΑ ΛΑΣΤΙΚΟ ΚΗΠΟΥ

ΚΩΔΙΚΟΣ	ΥΑΤΟ	ΣΥΣΚ	€/ΤΕΜ
20099852	YT-99852	3/4"-45m 1/2"-50m	73,80



ΛΑΣΤΙΚΟ ΚΗΠΟΥ "PRACTIC"

ΚΩΔΙΚΟΣ	FLO	ΠΕΡΙΓΡΑΦΗ	ΣΥΣΚ	€/ΤΕΜ
21389314	89314	20m - 3/4"	1	25,90
21389315	89315	50m - 3/4"	1	38,80

- Σωλήνας κήπου από εύκαμπτο πλαστικό 3 στρωμάτων
- Μεγάλης αντοχής στη γήρανση και την προστασία ακτινοβολίας UV
- Εύρος λειτουργίας σε συνθήκες θερμοκρασίας από -20 έως +60 °C
- Ανώτατο όριο 25 Bar

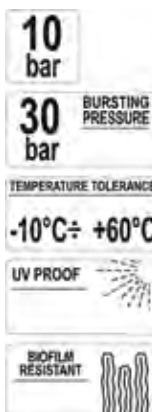

ΛΑΣΤΙΚΟ ΚΗΠΟΥ "STRONG LINE"

ΚΩΔΙΚΟΣ	FLO	ΠΕΡΙΓΡΑΦΗ	ΣΥΣΚ	€/ΤΕΜ
21389295	89295	50m - 3/4"	1	107,25

- Σωλήνας κήπου, ενισχυμένης κατασκευής
- Αυξημένη αντοχή σε σχίσιμο και στρίψιμο, διατηρώντας παράλληλα υψηλή ευκαμψία
- Τριών στρωμάτων:
εσωτερική στρώση από μαλακό PVC
ενισχυτική στρώση κατασκευασμένη από πυκνή υφασματίνη πλεξούδα
εξωτερικό στρώμα, ανθεκτικό στις καιρικές συνθήκες
- Πίεση λειτουργίας: 10 Bar / ➤ Ανώτατο όριο: 30 Bar
- Εύρος λειτουργίας σε συνθήκες θερμοκρασίας από -10 έως +60 °C
- Προστασία ακτινοβολίας UV



ΣΕΛΑ ΓΙΑ ΛΑΣΤΙΚΟ ΚΗΠΟΥ

ΚΩΔΙΚΟΣ	FLO	ΠΕΡΙΓΡΑΦΗ	ΣΥΣΚ	€/ΤΕΜ
21389345	89345	ABS	1	3,10

- Από ανθεκτικό ABS
- Για λάστιχο 1/2", 3/4", 5/8", 1"

ΚΛΑΔΕΥΤΗΡΙΑ



ΚΩΔΙΚΟΣ **YATO** Lmm ΣΥΣΚ €/ΤΕΜ
20008815 YT-8815 180 12 **5,50**

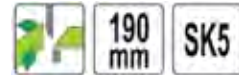

ΚΩΔΙΚΟΣ **YATO** Lmm ΣΥΣΚ €/ΤΕΜ
20008816 YT-8816 190 12 **5,40**

- Λεπίδες από ανθρακούχο χάλυβα – SK5
- Τα ψαλίδια συλλογής και τρύγου είναι εφοδιασμένα με δύο λεπτές λεπίδες που διασφαλίζουν εύκολη πρόσβαση σε αμπέλια που χρειάζονται “ξεκαθάρισμα” και σε φρούτα που πρέπει να συλλεχθούν, για παράδειγμα τσαμπιά από σταφύλια ή πορτοκάλια.



ΚΩΔΙΚΟΣ **YATO** Lmm ΣΥΣΚ €/ΤΕΜ
20008800 YT-8800 205 12 **7,15**



ΚΩΔΙΚΟΣ **YATO** Lmm ΣΥΣΚ €/ΤΕΜ
20008843 YT-8843 180 12 **8,45**



ΚΩΔΙΚΟΣ **YATO** Lmm ΣΥΣΚ €/ΤΕΜ
20008807 YT-8807 200 12 **8,30**



ΚΩΔΙΚΟΣ **YATO** Lmm ΣΥΣΚ €/ΤΕΜ
20008808 YT-8808 200 12 **8,45**



ΕΡΓΑΛΕΙΟ ΜΠΟΛΙΑΣΜΑΤΟΣ

ΚΩΔΙΚΟΣ **YATO** ΣΥΣΚ €/ΤΕΜ
20088505 YT-88505 **19,90**

NEO CARBON
STEEL 350
mm**ΦΥΤΕΥΤΗΣ/ΦΤΥΑΡΑΚΙ ΚΗΠΟΥ**

ΚΩΔΙΚΟΣ	YATO 	Lmm	ΣΥΣΚ	€/ΤΕΜ
20008865	YT-8865	350	10	3,55

NEO CARBON
STEEL 325
mm**ΤΣΟΥΓΚΡΑΝΑΚΙ ΚΗΠΟΥ**

ΚΩΔΙΚΟΣ	YATO 	Lmm	ΣΥΣΚ	€/ΤΕΜ
20008866	YT-8866	325	10	4,80

NEO CARBON
STEEL 310
mm**ΣΚΑΛΙΣΤΗΡΙ ΚΗΠΟΥ**

ΚΩΔΙΚΟΣ	YATO 	Lmm	ΣΥΣΚ	€/ΤΕΜ
20008867	YT-8867	310	10	5,55

NEO CARBON
STEEL 420
mm**ΣΚΑΛΙΣΤΗΡΙ ΚΗΠΟΥ**

ΚΩΔΙΚΟΣ	YATO 	Lmm	ΣΥΣΚ	€/ΤΕΜ
20008868	YT-8868	420	10	4,05

NEO CARBON
STEEL 400
mm**ΤΣΟΥΓΚΡΑΝΑΚΙ ΦΥΛΛΩΝ**

ΚΩΔΙΚΟΣ	YATO 	Lmm	ΣΥΣΚ	€/ΤΕΜ
20008869	YT-8869	400	10	4,90

NEO CARBON
STEEL 360
mm**ΦΤΥΑΡΑΚΙ ΚΗΠΟΥ ΦΑΡΔΥ**

ΚΩΔΙΚΟΣ	YATO 	Lmm	ΣΥΣΚ	€/ΤΕΜ
20008870	YT-8870	360	10	4,85

NEO 1050Mn
STEEL 120
cm HRC
40-48**ΦΤΥΑΡΙ**

ΚΩΔΙΚΟΣ	YATO 	Lcm	ΣΥΣΚ	€/ΤΕΜ
20086804	YT-86804	120	6	19,80



NEO 



ΨΑΛΙΔΙ

ΚΩΔΙΚΟΣ	YATO 	Lmm	ΣΥΣΚ	€/ΤΕΜ
20008852	YT-8852	310	6	10,50



NEO 



ΤΟΞΟΠΡΙΟΝΟ

ΚΩΔΙΚΟΣ	YATO 	Lmm	ΣΥΣΚ	€/ΤΕΜ
20003200	YT-3200	300	12	8,75

ΨΑΛΙΔΕΣ ΜΕ ΚΥΜΑΤΙΣΤΗ ΛΑΜΑ



NEO 



ΚΩΔΙΚΟΣ	YATO 	Lmm	ΣΥΣΚ	€/ΤΕΜ
20008822	YT-8822	550	12	17,60



NEO 

ΤΗΛΕΣΚΟΠΙΚΗ

ΚΩΔΙΚΟΣ	YATO 	Lmm	ΣΥΣΚ	€/ΤΕΜ
20008824	YT-8824	690-890		26,85

ΨΑΛΙΔΕΣ ΚΛΑΔΕΜΑΤΟΣ



NEO 

BY PASS

ΚΩΔΙΚΟΣ	YATO 	Lmm	ΣΥΣΚ	€/ΤΕΜ
20008835	YT-8835	780	12	22,50



NEO 

ΜΕ ΑΜΟΝΙ

ΚΩΔΙΚΟΣ	YATO 	Lmm	ΣΥΣΚ	€/ΤΕΜ
20008836	YT-8836	770		25,70

**ΠΡΙΟΝΙ ΚΗΠΟΥ ΑΝΑΔΙΠΛΟΥΜΕΝΟ**

ΚΩΔΙΚΟΣ	FLO	ΠΕΡΙΓΡΑΦΗ	ΣΥΣΚ	€/ΤΕΜ
21328641	28641	180mm	20	4,60

- 3 πλευρών, ακονισμένο δόντι
- 180mm

**ΠΡΙΟΝΙ ΚΛΑΔΕΜΑΤΟΣ**

ΚΩΔΙΚΟΣ	FLO	ΠΕΡΙΓΡΑΦΗ	ΣΥΣΚ	€/ΤΕΜ
21328642	28642	290mm		5,70

NEO**ΤΣΟΥΓΚΡΑΝΑ ΚΗΠΟΥ**

ΚΩΔΙΚΟΣ	FLO	ΠΕΡΙΓΡΑΦΗ	ΣΥΣΚ	€/ΤΕΜ
21399401	99401	425mm	1	3,10

- 22 δόντια
- 425mm

**ΣΤΕΙΛΙΑΡΙ ΞΥΛΙΝΟ 130cm**

ΚΩΔΙΚΟΣ	FLO	ΠΕΡΙΓΡΑΦΗ	ΣΥΣΚ	€/ΤΕΜ
21399415	99415	130cm	1	2,65

- 130cm

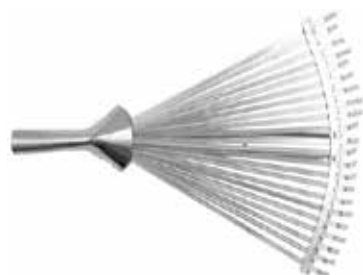
**ΤΣΟΥΓΚΡΑΝΑ ΚΗΠΟΥ, ΡΥΘΜΙΖΟΜΕΝΗ**

ΚΩΔΙΚΟΣ	FLO	ΠΕΡΙΓΡΑΦΗ	ΣΥΣΚ	€/ΤΕΜ
21399391	99391	460mm	1	5,65

- 22 δόντια
- 460mm

ΦΥΤΕΥΤΗΣ ΑΥΤΟΜΑΤΟΣ

ΚΩΔΙΚΟΣ	FLO	ΠΕΡΙΓΡΑΦΗ	ΣΥΣΚ	€/ΤΕΜ
21399033	99033		10	4,10

ΣΥΛΛΕΚΤΗΣ ΚΑΡΠΩΝ

ΚΩΔΙΚΟΣ	FLO	ΠΕΡΙΓΡΑΦΗ	ΣΥΣΚ	€/ΤΕΜ
21389880	89880		12	4,35

ΨΕΚΑΣΤΗΡΑΣ ΠΡΟΠΙΣΣΕΩΣ 1Lt

ΚΩΔΙΚΟΣ	FLO	ΠΕΡΙΓΡΑΦΗ	ΣΥΣΚ	€/ΤΕΜ
21389507	89507	1Lt	1	5,50

- Ιδανικό για εργασία στον κήπο και το σπίτι
- Ιδανικό για ψεκασμό φυτών
- Ακροφύσιο Brass με δυνατότητα αλλαγής της ροής νερού, από συνεχή σε "βεντάλια"
- Η λειτουργία μόνιμης εργασίας επιτρέπει τον ελεύθερο και άνετο ψεκασμό
- Η συσκευή διαθέτει αποσυμπιεστή που ενεργοποιείται αυτόματα μόλις ξεπεράσει τα 0,2 MPa



0.2 MPa



5.0l

ΨΕΚΑΣΤΗΡΑΣ ΠΡΟΠΙΣΣΕΩΣ ΠΛΑΤΗΣ 5Ltr

ΚΩΔΙΚΟΣ	FLO	ΠΕΡΙΓΡΑΦΗ	ΣΥΣΚ	€/ΤΕΜ
21389515	89515	5Lt	1	20,00

- Ψεκαστήρας χωρητικότητας 5 λίτρων
- Κατασκευασμένος από πλαστικό υψηλής ποιότητας
- Εξοπλισμένο με ρυθμιζόμενο ακροφύσιο ψεκασμού, μηχανισμό άντλησης, ελαφριά και εύχρηστη λόγχη, βαλβίδα εκτόνωσης πίεσης καθώς και ιμάντα που διευκολύνει τη μεταφορά δεξαμενής
- Μεγάλο στόμιο, σχήματος χοάνης, ώστε η πλήρωση να είναι γρήγορη και εύκολη
- Ιδανικό για τις περισσότερες εφαρμογές
- Κατάλληλο για φροντίδα δέντρων, θάμνων, ανθισμένων φυτών ή λαχανικών



ΠΕΡΙΦΡΑΞΗ ΚΗΠΟΥ

ΚΩΔΙΚΟΣ	FLO	Hmm	Lm	ΣΥΣΚ	€/ΤΕΜ
21388701	88701	150	9	36	8,15
21388702	88702	200	9	24	10,90

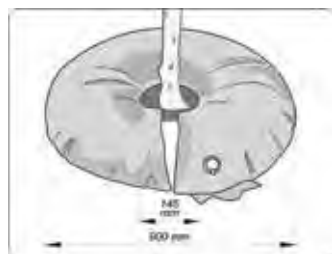

ΑΡΓΟ ΠΟΤΙΣΜΑ ΔΕΝΔΡΩΝ

ΚΩΔΙΚΟΣ	FLO	ΠΕΡΙΓΡΑΦΗ	ΣΥΣΚ	€/ΤΕΜ
21389720	89720	55Lt	20	16,15



ΠΤΥΣΣΟΜΕΝΟ ΒΑΡΕΛΙ ΣΥΛΛΟΓΗΣ ΝΕΡΟΥ

ΚΩΔΙΚΟΣ	FLO	ΠΕΡΙΓΡΑΦΗ	ΣΥΣΚ	€/ΤΕΜ
21389700	89700	100Lt	6	44,35
21389702	89702	250Lt	6	60,00

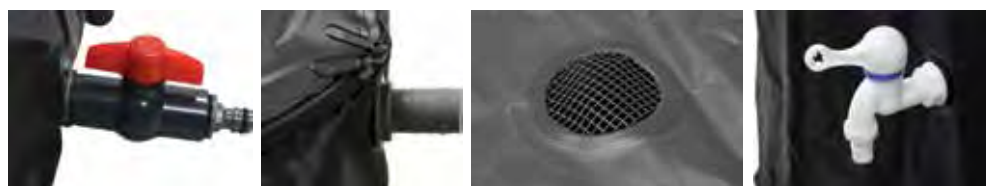

ΕΠΙΛΕΞΤΕ: 1 ΜΠΑΤΑΡΙΑ & 1 ΦΟΡΤΙΣΤΗ για όλα τα εργαλεία 18V FAMILY

ΧΟΡΤΟΚΟΠΤΙΚΟ
YATO  YT-85010

36V  2x 18V 
5800 
245x25.4 
340 
1.6 
3m 

BRUSHLESS MOTOR

2 x 18 = 36V

ΚΩΔ. 20185010
139,00 € 



ΑΛΥΣΟΠΡΙΟΝΟ SOLO
YATO  YT-82813



2 x 18 = 36V

ΚΩΔ. 20182813
135,00 € 



36V  2x 18V 
4500 
1h 
ACQUATIC TOOL
ELECTRIC CHAIN
SAW
EQUIPPED
WITH
0.17 L 
14" 
35 cm 
0.375" 
9.525 mm 
0.050" 
1.27 mm 

ΜΠΟΡΝΤΟΥΡΩΦΑΛΙΔΟ
YATO  YT-82833

18V  
1h 
22" 
560 mm 
1650 

ΚΩΔ. 20182833
75,00 € 

18V



ΦΥΣΗΤΗΡΑΣ ΚΗΠΟΥ
YATO  YT-85175

ΚΩΔ. 20185175
89,00 € 

2 x 18 = 36V

36V  2x 18V 
8000-12500 
8 
m/min 
2in1 
2w1 
45L 



ΠΛΥΣΤΙΚΟ/ΠΙΕΣΤΙΚΟ
18V 23BAR
YATO  YT-85930

ΚΩΔ. 20185930
99,00 € 

18V



18V 
6m 
2.3 
MPa 

ΨΕΚΑΣΤΙΚΟ
YATO  YT-86211

18V

18V 
2in1 
2w1 
12L 
7m 
≤1.5 
l/min 

ΚΩΔ. 20186211
89,00 € 







ΚΟΝΤΑΡΟΠΡΙΟΝΟ
YATO  YT-82837

18V

ΚΩΔ. 20182837
95,00 € 



2500 
200mm 
8" 
5 m/s 

**ΑΛΥΣΟΠΡΙΟΝΟ
18V COMPACT
YATO  YT-828135**

18V



ΠΕΡΙΛΑΜΒΑΝΕΙ ΜΠΑΤΑΡΙΑ 2.0Ah ΚΑΙ ΦΟΡΤΙΣΤΗ

Μικρό, εύχρηστο πριόνι μπαταρίας 18 V σχεδιασμένο για κοπή ξύλου σε εργασίες κηπουρικής και ελαφρών κατασκευών. Είναι τέλειο για γρήγορο κλάδεμα κλαδιών δέντρων, θάμνων, κορμών ξύλου και για πολλές άλλες εργασίες κοπής ξύλου.



NEO 



Χαρακτηριστικά:

Λάμα και αλυσίδα: 4" (μήκος 100mm)
Βήμα αλυσίδας: 7,62 mm, Πλάτος αλυσίδας 1,1 mm
Ταχύτητα αλυσίδας: 4,8 m/s, Ταχύτητα περιστροφής: 3200 rpm
Προστασία από τυχαία εκκίνηση, ένδειξη φόρτισης μπαταρίας
Μαλακή και άνετη λαβή, χαμηλό βάρος: 1,1 kg
Το σετ περιλαμβάνει: αλυσίδα πριονιού, κάλυμμα λάμας

ΚΩΔ. 201828135
107,00 € 

**ΚΛΑΔΕΥΤΗΡΙ ΜΠΑΤΑΡΙΑΣ 18V
YATO  YT-828377**

18V

NEO 



ΠΕΡΙΛΑΜΒΑΝΕΙ ΜΠΑΤΑΡΙΑ 2.0Ah ΚΑΙ ΦΟΡΤΙΣΤΗ

ΚΩΔ. 201828377
169,00 € 



**ΧΟΡΤΟΚΟΠΤΙΚΟ SOLO 18V
YATO  YT-82831**

18V

NEO 



ΚΩΔ. 20182831
65,00 € 

**ΓΕΝΝΗΤΡΙΑ INVERTER 42.7CC
YATO  YT-85481**

ΙΣΧΥΣ 800 W
ΣΤΑΘΜΗ ΘΟΡΥΒΟΥ 65 dB
ΚΑΤΑΝΑΛΩΣΗ 0,75 L/h



NEO 

ΚΩΔ. 20185481
249,00 € 

ΣΙΤΕΣ ΑΝΤΙΚΟΥΝΟΥΠΙΚΕΣ - ΕΡΓΑΛΕΙΑ ΤΟΠΟΘΕΤΗΣΗΣ



FIBERGLASS

ΚΩΔΙΚΟΣ	ΔΙΑΣΤΑΣΗ	ΣΥΣΚ/ΡΟΛΟ	€/m ²
0900080	80 cm X 30m	6	1,45
0900100	100 cm X 30m	6	1,45
0900120	120 cm X 30m	6	1,45
0900140	140 cm X 30m	6	1,45
0900160	160 cm X 30m	6	1,45
0900180	180 cm X 30m	6	1,45
0900200	200 cm X 30m	3	1,45
0900220	220 cm X 30m	3	1,45
0900240	240 cm X 30m	3	1,45

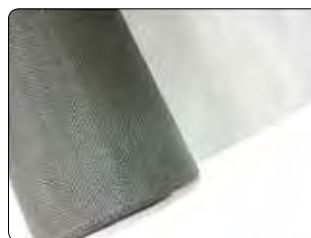
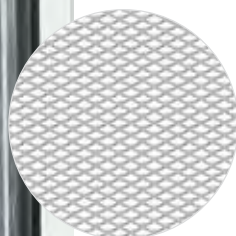

ΑΛΟΥΜΙΝΙΟΥ

ΚΩΔΙΚΟΣ	ΔΙΑΣΤΑΣΗ	ΣΥΣΚ/ΡΟΛΟ	€/m ²
09010080	80 cm X 30m	2	3,20
09010100	100 cm X 30m	2	3,20
09010120	120 cm X 30m	2	3,20
09010150	150 cm X 30m	2	3,20
09010180	180 cm X 30m	2	3,20



ΛΑΣΤΙΧΟ ΣΙΤΑΣ

ΚΩΔΙΚΟΣ	ΠΕΡΙΓΡΑΦΗ	ΣΥΣΚ/ΡΟΛΟ	€/Kg
360001-013	ΛΕΥΚΟ Νο6	1	4,70
360001-023	ΜΑΥΡΟ Νο6	1	4,70



ΡΟΔΑΚΙ ΤΟΠΟΘΕΤΗΣΗΣ ΛΑΣΤΙΧΟΥ ΣΙΤΑΣ

ΚΩΔΙΚΟΣ	ΠΕΡΙΓΡΑΦΗ	ΣΥΣΚ	€/ΤΕΜ
360002	ΡΟΔΑΚΙ ΣΙΤΑΣ ΜΕΛΛΙΟΣ	1	11,60
550000	ΡΟΔΑΚΙ ΣΙΤΑΣ ΤΕΧΝΕΞΑΛ	1	11,30
901320000	ΡΟΔΑΚΙ ΣΙΤΑΣ HELIX	1	4,90

HELIX-CHEM



NEO

ΑΥΤΟΚΟΛΛΗΤΑ ΕΠΙΣΚΕΥΗΣ ΣΙΤΑΣ - 15 ΤΕΜ.

ΚΩΔΙΚΟΣ	€/ΤΕΜ
901350500	2,00

περιέχει:

10 τεμ. 5x5 cm
5 τεμ. 10x5 cm

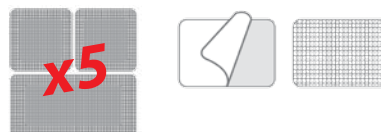

NEO

ΣΙΤΑ ΠΑΡΑΘΥΡΟΥ - ΑΥΤΟΚΟΛΛΗΤΗ

ΚΩΔΙΚΟΣ	ΠΕΡΙΓΡΑΦΗ	€/ΤΕΜ
901315020	150 x 200cm ΓΚΡΙ	3,90

ΚΙΤ ΣΤΑΘΕΡΗΣ ΣΙΤΑΣ
ΜΕ ΑΥΤΟΚΟΛΛΗΤΟ VELCRO 700x0,6 cm

ΕΥΚΟΛΙΑ ΣΤΗΝ ΕΦΑΡΜΟΓΗ & ΤΗΝ ΤΟΠΟΘΕΤΗΣΗ
ΚΑΘΑΡΙΖΕΤΑΙ & ΑΦΑΙΡΕΙΤΑΙ ΕΥΚΟΛΑ



NEO

ΤΑΙΝΙΑ ΕΠΙΣΚΕΥΗΣ ΣΙΤΑΣ - ΑΥΤΟΚΟΛΛΗΤΗ

ΚΩΔΙΚΟΣ	ΠΕΡΙΓΡΑΦΗ	€/ΤΕΜ
901350200	2m x 5cm ΓΚΡΙ	3,60



ΤΑΚΟΣ ΒΛ70 ΟΡΕΙΧ/ΝΟΣ

ΚΩΔΙΚΟΣ	ΜΕΓΕΘΟΣ	Ø ΛΑΙΜΟΥ	ΔΕΙΚΤΗΣ ΑΣΦΑΛΕΙΑΣ	Νο PINS	ΑΝΤΙΣΚΩΡΙΑΚΟΣ ΔΕΙΚΤΗΣ	ΣΥΣΚ	€/ΤΕΜ
90602070	60mm	7,8	8	4	2	6	9,60
90602080	75mm	11,8	9	5	4	6	11,60
90602090	90mm	11,8	10	5	4	6	16,90



3 ΚΛΕΙΔΙΑ

- Συμπαγές ορειχάλκινο σώμα.
- Ισχυρός ορειχάλκινος κύλινδρος, υψηλής ακριβείας, με μεγάλη ανθεκτικότητα στη σκουριά.
- 3, ορειχάλκινα, επινικελωμένα κλειδιά.
- Επισκληρυμένοι ατσάλινοι λαιμός για μεγαλύτερη αντοχή στο κόψιμο και ελατήριο από ανοξείδωτο ατσάλι μεγάλης ανθεκτικότητας. Μηχανισμός Μπίλιας.
- Κατάλληλο για εξωτερικούς χώρους και βιομηχανική χρήση.

ΒΣ 16 ΟΡΕΙΧΑΛΚΙΝΑ ΕΛΑΦΡΙΟΥ ΤΥΠΟΥ

ΚΩΔΙΚΟΣ	ΜΕΓΕΘΟΣ	Ø ΛΑΙΜΟΥ	ΔΕΙΚΤΗΣ ΑΣΦΑΛΕΙΑΣ	Νο PINS	ΑΝΤΙΣΚΩΡΙΑΚΟΣ ΔΕΙΚΤΗΣ	ΣΥΣΚ	€/ΤΕΜ
ΛΝΕΟ 90611035		5	4	4	4	6	2,90
90611045		6,3	4	5	4	6	4,30
90611055		7	5	5	4	6	6,10



3 ΣΙΔΕΡΕΝΙΑ ΚΛΕΙΔΙΑ

- Ορειχάλκινο σώμα.
- Ορειχάλκινος κύλινδρος, ακριβείας, ανθεκτικός στη σκουριά.
- 3, σιδερένια, επινικελωμένα κλειδιά.
- Επισκληρυμένος ατσάλινος λαιμός.

ΛΟΥΚΕΤΑ BC90 ΟΡΕΙΧ/ΝΑ

- Συμπαγές ορειχάλκινο σώμα.
- Ισχυρός ορειχάλκινος κύλινδρος, υψηλής ακριβείας, με μεγάλη ανθεκτικότητα στη σκουριά.
- 3, ορειχάλκινα, επιπικελωμένα κλειδιά.
- Στα μεγέθη άνω των 30mm επισκληρυμένος ατσάλινος λαιμός για μεγαλύτερη αντοχή στο κόψιμο και ελατήριο από ανοξείδωτο ατσάλι μεγάλης ανθεκτικότητας.
- Ορειχάλκινη γλώσσα μεγάλης αντοχής και στα μεγέθη άνω των 30mm διπλή ορειχάλκινη γλώσσα.
- Ορειχάλκινοι πύροι μεγάλης ακριβείας.
- Κατάλληλο για εξωτερικούς χώρους.

3 ΚΛΕΙΔΙΑ ΟΡΕΙΧ/ΝΑ
ΛΟΥΚΕΤΟ BC90 ΟΡΕΙΧ/ΝΟ

ΚΩΔΙΚΟΣ	ΜΕΓΕΘΟΣ	Ø ΛΑΙΜΟΥ	ΔΕΙΚΤΗΣ ΑΣΦΑΛΕΙΑΣ	Νο PINS	ΑΝΤΙΣΚΩΡΙΑΚΟΣ ΔΕΙΚΤΗΣ	ΣΥΣΚ	€/ΤΕΜ
90600020	20mm	3,3	2	4	2	6	2,00
90600025	25mm	4,3	3	4	2	6	2,40
90600030	30mm	5	4	4	4	6	3,20
90600040	40mm	6,3	6	5	4	6	4,40
90600050	50mm	8	7	6	5	6	6,35
90600060	60mm	10	9	6	6	6	9,75

ΒΑΡΕΩΣ ΤΥΠΟΥ
BC90 ΜΑΚΡΥΛΑΙΜΟ

ΚΩΔΙΚΟΣ	ΜΕΓΕΘΟΣ	Ø ΛΑΙΜΟΥ	ΔΕΙΚΤΗΣ ΑΣΦΑΛΕΙΑΣ	Νο PINS	ΑΝΤΙΣΚΩΡΙΑΚΟΣ ΔΕΙΚΤΗΣ	ΣΥΣΚ	€/ΤΕΜ
90600130	30mm	5,0	4	4	4	6	3,40
90600140	40mm	6,3	6	5	5	6	4,70
90600150	50mm	8	7	6	6	6	7,85

ΒΑΡΕΩΣ ΤΥΠΟΥ
BC90 ΣΕΤ 4ΤΕΜ

ΚΩΔΙΚΟΣ	ΜΕΓΕΘΟΣ	Ø ΛΑΙΜΟΥ	ΔΕΙΚΤΗΣ ΑΣΦΑΛΕΙΑΣ	Νο PINS	ΑΝΤΙΣΚΩΡΙΑΚΟΣ ΔΕΙΚΤΗΣ	ΣΥΣΚ	€/ΤΕΜ
90600225	25mm	4,3	3	4	2	6	9,40
90600230	30mm	5	4	4	4	6	12,50
90600240	40mm	6,3	6	5	4	6	17,40

- **Ενιαίο κλειδί (Universal Key)**

ΒΑΡΕΩΣ ΤΥΠΟΥ

ΥΨΗΛΟΣ ΔΕΙΚΤΗΣ ΑΣΦΑΛΕΙΑΣ 6-9**ΛΟΥΚΕΤΟ ΝΙΚΕΛ LS21**

ΚΩΔΙΚΟΣ	ΜΕΓΕΘΟΣ	Ø ΛΑΙΜΟΥ	ΔΕΙΚΤΗΣ ΑΣΦΑΛΕΙΑΣ	Νο DISC	ΑΝΤΙΣΚΩΡΙΑΚΟΣ ΔΕΙΚΤΗΣ	ΣΥΣΚ	€/ΤΕΜ
90606040	40mm	7	6	6	4	6	3,00
90606050	50mm	9	8	7	4	6	4,00
90606060	60mm	11	9	7	4	6	5,00

**3 ΚΛΕΙΔΙΑ ΑΣΦΑΛΕΙΑΣ**

- Σώμα από επιχρωμιωμένο ατσάλι.
- Ορειχάλκινος κύλινδρος μεγάλης αντοχής και διάρκειας.
- Μηχανισμός 3 δίσκων με χαλύβδινο κλειδί.
- Ατσάλινος λαιμός.
- Μηχανισμός μπίλιας διπλού κλειδώματος.
- Ορειχάλκινος κύλινδρος μεγάλης αντοχής και ακριβείας.

ΑΝΤΙΣΤΑΣΗ ΣΤΗ ΣΚΟΥΡΙΑ**ΛΟΥΚΕΤΟ ΑΣΦΑΛΕΙΑΣ LS05**

ΚΩΔΙΚΟΣ	ΜΕΓΕΘΟΣ	Ø ΛΑΙΜΟΥ	ΔΕΙΚΤΗΣ ΑΣΦΑΛΕΙΑΣ	Νο PINS	ΑΝΤΙΣΚΩΡΙΑΚΟΣ ΔΕΙΚΤΗΣ	ΣΥΣΚ	€/ΤΕΜ
90605050	50mm	8,8	7	8	5	6	9,75
90605060	60mm	10,8	8	8	5	6	12,30

**3 ΚΛΕΙΔΙΑ ΑΣΦΑΛΕΙΑΣ**

- Ατσάλινο σώμα με μαύρη πλαστική αδιάβροχη επικάλυψη.
- Ορειχάλκινος κύλινδρος, υψηλής ακριβείας, αντισκωρικός με μεγάλη ανθεκτικότητα.
- 4 αδιάβροχα κλειδιά με πλαστική επικάλυψη στο κεφάλι.
- Επισκληρυμένοι ατσάλινο λαιμός, υψηλής αντοχής στο κόψιμο και το πριόνισμα, ελατήριο από ανοξείδωτο ατσάλι μεγάλης ανθεκτικότητας.
- Διπλή μπίλια ασφαλείας.
- Κατάλληλο για εξωτερικούς χώρους.

ΥΨΗΛΟΣ ΔΕΙΚΤΗΣ ΑΣΦΑΛΕΙΑΣ 9-10**ΒΛ 63 ΤΑΚΟΣ ΜΕ ΑΤΣΑΛΙΝΗ ΕΠΕΝΔΥΣΗ**

ΚΩΔΙΚΟΣ	ΜΕΓΕΘΟΣ	Ø ΛΑΙΜΟΥ	ΔΕΙΚΤΗΣ ΑΣΦΑΛΕΙΑΣ	Νο PINS	ΑΝΤΙΣΚΩΡΙΑΚΟΣ ΔΕΙΚΤΗΣ	ΣΥΣΚ	€/ΤΕΜ
90603070	70mm	11,8	9	5	3	6	8,50
90603080	80mm	11,8	10	5	3	6	10,50



- Ανθεκτικό, χαλύβδινο, σώμα.
- Πρόσθετο, ατσάλινο εξωτερικό περίβλημα.
- Επισκληρυμένοι, ατσάλινο λαιμός.
- Διπλή μπίλια ασφαλείας.
- Πίροι ασφαλείας.
- Υψηλή ασφάλεια για όλες τις χρήσεις.

ΒΑΡΕΩΣ ΤΥΠΟΥ
BC 13 ΣΙΔΕΡΕΝΙΑ ΛΟΥΚΕΤΑ - ΣΦΥΡΗΛΑΤΑ

ΚΩΔΙΚΟΣ	ΜΕΓΕΘΟΣ mm	Ø ΛΑΙΜΟΥ	ΔΕΙΚΤΗΣ ΑΣΦΑΛΕΙΑΣ	Νο PINS	ΑΝΤΙΣΚΩΡΙΑΚΟΣ ΔΕΙΚΤΗΣ	ΣΥΣΚ	€/ΤΕΜ
90610025	25	4,3	1	4	1	6	1,05
90610032	32	5,3	3	5	2	6	1,50
90610038	38	6,3	5	5	3	6	1,65
90610050	50	9	7	6	3	6	2,85
90610063	63	10,5	9	6	3	6	3,55



- ▶ Συμπαγές, χαλύβδινο, σώμα.
- ▶ Ορειχάλκινος κύλινδρος, μεγάλης ακριβείας και αντοχής στη σκουριά.
- ▶ Επισκληρυμένοι, ατσάλινοι λαιμοί.
- ▶ 3 σιδερένια, επιπικελωμένα, κλειδιά.
- ▶ Λαστιχένια δακτυλίδια, λαιμού για προστασία από την υγρασία.

ΥΨΗΛΟΣ ΔΕΙΚΤΗΣ ΑΣΦΑΛΕΙΑΣ 9-10
BL 73 ΤΑΚΟΣ ΣΙΔΕΡΕΝΙΟΣ

ΚΩΔΙΚΟΣ	ΜΕΓΕΘΟΣ	Ø ΛΑΙΜΟΥ	ΔΕΙΚΤΗΣ ΑΣΦΑΛΕΙΑΣ	Νο PINS	ΑΝΤΙΣΚΩΡΙΑΚΟΣ ΔΕΙΚΤΗΣ	ΣΥΣΚ	€/ΤΕΜ
90607375	75mm	11,8	9	5	3	6	6,50
90607390	90mm	11,8	10	5	3	6	8,40



- ▶ Συμπαγές, χαλύβδινο, σώμα.
- ▶ Ορειχάλκινος κύλινδρος, μεγάλης ακριβείας και αντοχής στη σκουριά.
- ▶ Επισκληρυμένοι, ατσάλινοι λαιμοί.
- ▶ 3 σιδερένια, επιπικελωμένα, κλειδιά.

ΛΟΥΚΕΤΟ ΠΛΑΣΤ ΕΠΕΝΔ ΒΧ01

ΚΩΔΙΚΟΣ	ΜΕΓΕΘΟΣ	Ø ΛΑΙΜΟΥ	ΔΕΙΚΤΗΣ ΑΣΦΑΛΕΙΑΣ	Νο PINS	ΑΝΤΙΣΚΩΡΙΑΚΟΣ ΔΕΙΚΤΗΣ	ΣΥΣΚ	€/ΤΕΜ
---------	---------	-------------	----------------------	------------	--------------------------	------	-------

ΜΠΛΕ

90608030	30mm	5,3	3	5	6	6	2,40
90608040	40mm	6,3	5	5	6	6	2,80

ΚΟΚΚΙΝΟ

90608130	30mm	5,3	3	5	6	6	2,40
90608140	40mm	6,3	5	5	6	6	2,80



- ▶ Σιδερένιο σώμα, επιχρωμιωμένο, με έγχρωμο πλαστικό αδιάβροχο κάλυμμα.
- ▶ Ισχυρός ορειχάλκινος κύλινδρος, υψηλής ακριβείας, αντισκωρικός με μεγάλη ανθεκτικότητα.
- ▶ 3 Ατσάλινα κλειδιά.
- ▶ Επισκληρυμένος ατσάλινος λαιμός με δύο στρώματα αδιαβροχοποίησης.
- ▶ Ορειχάλκινη γλώσσα, μεγάλης αντοχής. Στα μεγέθη άνω των 38mm διπλή ορειχάλκινη γλώσσα.
- ▶ Ορειχάλκινοι πύροι μεγάλης ακριβείας.
- ▶ Μοναδικό σχέδιο.

ΛΟΥΚΕΤΟ INOX BC92



ΚΩΔΙΚΟΣ	ΜΕΓΕΘΟΣ	Ø ΛΑΙΜΟΥ	ΔΕΙΚΤΗΣ ΑΣΦΑΛΕΙΑΣ	Νο PINS	ΑΝΤΙΣΚΩΡΙΑΚΟΣ ΔΕΙΚΤΗΣ	ΣΥΣΚ	€/ΤΕΜ
90607032	32mm	5	4	4	6	6	10,90
90607038	38mm	6,3	6	5	6	6	12,90
90607050	50mm	8	7	5	6	6	15,40
90607063	63mm	10	8	6	6	6	19,30
ΜΑΚΡΥΛΑΙΜΟ							
90607132	32mm	5	4	4	6	6	11,50
90607138	38mm	6,3	6	5	6	6	13,60

- Ανοξείδωτο ατσάλινο σώμα.
- Ορειχάλκινος κύλινδρος μεγάλης αντοχής και ακριβείας.
- 3 επινικελωμένα ορειχάλκινα κλειδιά.
- Ανοξείδωτος ατσάλινος κύλινδρος και ανοξείδωτο ελατήριο.
- Διπλή ορειχάλκινη γλώσσα, μεγάλης αντοχής, διπλού κλειδώματος.
- Ορειχάλκινοι πύροι μεγάλης ακριβείας.
- Κατάλληλο για εξωτερικούς χώρους.



ΔΑΚΤΥΛΙΚΟΥ ΑΠΟΤΥΠΩΜΑΤΟΣ

ZW02 TSA FINGER PRINT

ΚΩΔΙΚΟΣ	ΜΕΓΕΘΟΣ	ΣΥΣΚ	€/ΤΕΜ
90612030	30mm		39,00



ΕΞΥΠΝΟ ΒΙΟΜΕΤΡΙΚΟ ΛΟΥΚΕΤΟ ZW02 TSA

Δακτυλικό αποτύπωμα και κωδικός pin!!!



- **ΛΟΥΚΕΤΟ ΑΦΗΣ** διπλής λειτουργίας.
- Ξεκλειδώνει με δακτυλικό αποτύπωμα, ενεργοποιείται με την αφή ή και με αριθμητικό κωδικό 3-6 ψηφίων.
- Αισθητήρας 360°, για εύκολη και άμεση αναγνώριση σε 0,5 δευτερόλεπτα.
- Αποθηκεύστε μέχρι 5, διαφορετικά, δακτυλικά αποτυπώματα (1 Admin).
- Συμβατό με master keys τελωνείων (TSA) που επιτρέπει έλεγχο χωρίς καταστροφή του λουκέτου.
- Ενσωματωμένη μπαταρία 3.7 Volt, χωρητικότητας 60 mAh.
- Χαμηλή κατανάλωση ενέργειας, ένδειξη χαμηλής μπαταρίας.
- Αυτόματη απενεργοποίηση μετά από 10" αδράνειας.
- Φόρτιση μέσω θύρας micro USB.



ΛΟΥΚΕΤΟ ΣΥΝΔ ΑΛΟΥΜ AL 11			ΜΕΤΑΒΛΗΤΟΥ ΣΥΝΔΥΑΣΜΟΥ		
ΚΩΔΙΚΟΣ	ΜΕΓΕΘΟΣ	Ø ΛΑΙΜΟΥ	ΑΝΤΙΣΚΩΡΙΑΚΟΣ ΔΕΙΚΤΗΣ	ΣΥΣΚ	€/ΤΕΜ
ΜΑΥΡΟ					
90609120	20mm*3	3,2	1	6	3,30
90609130	30mm*4	5	2	6	5,00
ΚΟΚΚΙΝΟ					
90609020	20mm*3	3,2	1	6	3,30
90609030	30mm*4	5	2	6	5,00



- Χαλύβδινος κρίκος.
- Σώμα αλουμινίου.



ΛΟΥΚΕΤΟ ΣΥΝΔ NL 11 ΟΡΕΙΧ/ΝΟ				ΜΕΤΑΒΛΗΤΟΥ ΣΥΝΔΥΑΣΜΟΥ		
ΚΩΔΙΚΟΣ	ΜΕΓΕΘΟΣ	Ø ΛΑΙΜΟΥ	ΔΕΙΚΤΗΣ ΑΣΦΑΛΕΙΑΣ	ΑΝΤΙΣΚΩΡΙΑΚΟΣ ΔΕΙΚΤΗΣ	ΣΥΣΚ	€/ΤΕΜ
90609220	20mm*3	3	2	2	6	3,00
90609228	28mm*3	5	2	4	6	4,85
90609238	38mm*4	6,3	5	4	6	7,75

- Ορειχάλκινο Σώμα.
- Ατσάλινος Λαίμος.
- Με συνδυασμούς 3 ή 4 ψηφίων.
- Κατάλληλο για βαλίτσες, ντουλάπες, αποδυτήρια κλπ.



ΛΟΥΚΕΤΟ ΣΥΝΔ ΒΑΛΙΤΣΑΣ NL21					
ΚΩΔΙΚΟΣ	ΜΕΓΕΘΟΣ	Ø ΛΑΙΜΟΥ	ΑΝΤΙΣΚΩΡΙΑΚΟΣ ΔΕΙΚΤΗΣ	ΣΥΣΚ	€/ΤΕΜ
90609320	20mm	3	4	6	1,40

- Σώμα αλουμινίου.
- Πλήκτρα συνδυασμού από αλουμίνιο.
- Κατάλληλο για βαλίτσες.



HELIX

ΚΛΕΙΔΟΘΗΚΗ ΤΟΙΧΟΥ ΜΕ ΣΥΝΔΥΑΣΜΟ

ΚΩΔΙΚΟΣ	€/ΤΕΜ
90700001	12,90



▶ ΧΡΩΜΑΤΑ:
ΜΑΥΡΟ
ΜΠΛΕ
ΚΟΚΚΙΝΟ

ΑΛΥΣΙΔΑ ΚΛΕΙΔΩΜΑΤΟΣ 65cm

ΚΩΔΙΚΟΣ	VOREL	ΜΗΚΟΣ(cm)	Ø(mm)	ΣΥΣΚ	€/ΤΕΜ
21977830	77830	65	8	12	4,50



▶ ΧΡΩΜΑΤΑ:
ΜΑΥΡΟ
ΜΠΛΕ
ΚΟΚΚΙΝΟ

ΑΛΥΣΙΔΑ ΚΛΕΙΔΩΜΑΤΟΣ 65cm

ΚΩΔΙΚΟΣ	VOREL	ΜΗΚΟΣ(cm)	Ø(mm)	ΣΥΣΚ	€/ΤΕΜ
21977831	77831	65	8	12	3,40



▶ ΧΡΩΜΑΤΑ:
ΜΑΥΡΟ
ΜΠΛΕ
ΚΟΚΚΙΝΟ

ΑΛΥΣΙΔΑ ΚΛΕΙΔΩΜΑΤΟΣ 120cm

ΚΩΔΙΚΟΣ	VOREL	ΜΗΚΟΣ(cm)	Ø(mm)	ΣΥΣΚ	€/ΤΕΜ
21977833	77833	120	8	10	5,10



▶ ΧΡΩΜΑΤΑ:
ΜΑΥΡΟ
ΜΠΛΕ
ΚΟΚΚΙΝΟ

ΑΛΥΣΙΔΑ ΚΛΕΙΔΩΜΑΤΟΣ 180cm

ΚΩΔΙΚΟΣ	VOREL	ΜΗΚΟΣ(cm)	Ø(mm)	ΣΥΣΚ	€/ΤΕΜ
21977840	77840	180	12	10	8,10

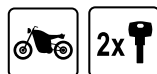

ΑΛΥΣΙΔΑ ΚΛΕΙΔΩΜΑΤΟΣ 120cm

ΚΩΔΙΚΟΣ	VOREL	ΜΗΚΟΣ(cm)	Ø(mm)	ΣΥΣΚ	€/ΤΕΜ
21977881	77881	120	7	12	18,30



ΔΙΧΤΥ ΣΥΓΚΡΑΤΗΣΗΣ

ΚΩΔΙΚΟΣ	VOREL	ΜΕΓΕΘΟΣ ΣΥΣΚ	€/ΤΕΜ
21182261	82261	90x90	5,75



ΧΤΑΠΟΔΙ - ΣΕΤ 2 ΤΕΜ

ΚΩΔΙΚΟΣ	VOREL	ΜΕΓΕΘΟΣ ΣΥΣΚ	€/ΤΕΜ
21182322	82322	100cm	4,90



ΔΙΧΤΥ ΑΠΟΣΚΕΥΩΝ

Θήκες από δίχτυ με γάντζους για τοποθέτηση στα πίσω καθίσματα ή το πορτ μπαγκάζ, του αυτοκινήτου. Ιδανικές για τακτοποίηση και συγκράτηση αντικειμένων.

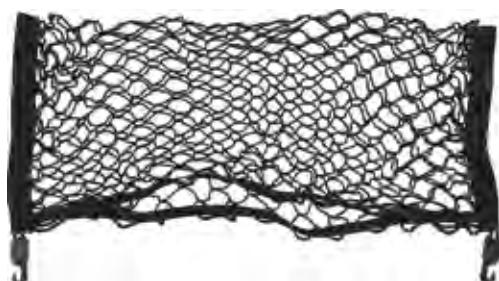

ΚΩΔΙΚΟΣ	VOREL	ΜΕΓΕΘΟΣ ΣΥΣΚ	€/ΤΕΜ
21182260	82260	70x30cm	8,10

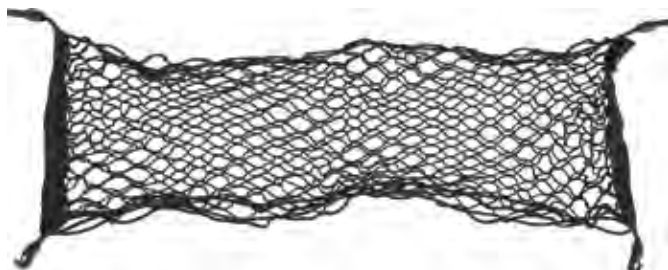

ΚΩΔΙΚΟΣ	VOREL	ΜΕΓΕΘΟΣ ΣΥΣΚ	€/ΤΕΜ
21182262	82262	90x30cm	7,65

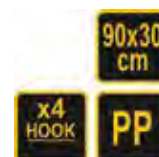

ΧΤΑΠΟΔΙ - 8 ΓΑΝΤΖΟΙ

ΚΩΔΙΚΟΣ	VOREL	ΜΗΚΟΣ(cm)	ΓΑΝΤΖΟΙ	ΣΥΣΚ	€/ΤΕΜ
21982300	82300	80	8	25	2,27

ΧΤΑΠΟΔΙ

ΚΩΔΙΚΟΣ	VOREL	ΜΗΚΟΣ(cm)	ΤΕΜ	ΣΥΣΚ	€/ΤΕΜ
21982360	82360	80	2	25	3,15
21982370	82370	100	2	25	3,55

ΙΜΑΝΤΑΣ ΠΡΟΣΔΕΣΗΣ

ΚΩΔΙΚΟΣ	VOREL	ΜΗΚΟΣ(cm)	ΠΛΑΤ. mm	ΣΥΣΚ	€/ΤΕΜ
21982331	82331	250	25	2	4,75

ΙΜΑΝΤΑΣ ΠΡΟΣΔΕΣΗΣ

ΚΩΔΙΚΟΣ	VOREL	ΜΗΚΟΣ(cm)	ΠΛΑΤ. mm	ΣΥΣΚ	€/ΤΕΜ
21982400	82400	500	25	2	10,30

ΙΜΑΝΤΑΣ ΠΡΟΣΔΕΣΗΣ

ΚΩΔΙΚΟΣ	VOREL	ΜΗΚΟΣ(cm)	ΠΛΑΤ. mm	ΣΥΣΚ	€/ΤΕΜ
21982380	82380	800	35	10	17,30

1000 daN

ΙΜΑΝΤΑΣ ΠΡΟΣΔΕΣΗΣ

ΚΩΔΙΚΟΣ	VOREL	ΜΗΚΟΣ(cm)	ΠΛΑΤ. mm	ΣΥΣΚ	€/ΤΕΜ
21982373	82373	600	50	7	21,55
21982374	82374	800	50	6	24,15

1600 daN

21982395	82395	1200	50	5	36,00
----------	-------	------	----	---	--------------

2500 daN



Made in Japan

ΣΟΥΣΤΕΣ ΑΕΡΟΣ 8803 N3

Μηχανισμός σούστα μπράτσο πόρτας **RYOBI S-8803**
Επώνυμος Ιαπωνικός μηχανισμός σούστα επαναφοράς πόρτας **Ryobi** κορυφαίας ποιότητας κατασκευής και λειτουργίας.

Είναι κατάλληλος για πόρτες έως 70 Kg και μέγιστο πλάτος φύλλου 105cm.

Δυνατότητα ρύθμισης της ταχύτητας κλεισίματος της πόρτας και του φρεναρίσμάτος της, πριν το κλείσιμο.

Είναι εύκολος στην τοποθέτηση και ρύθμιση του.

Ο μηχανισμός έχει προδιαγραφές για να λειτουργήσει χωρίς κανένα πρόβλημα για 500.000 κύκλους εργασίας.

ΚΩΔΙΚΟΣ	ΧΡΩΜΑ	€/ΤΕΜ
760003	ΛΕΥΚΗ	38,00
760003-2	ΜΑΥΡΗ	38,00
760003-3	ΑΣΗΜΙ	38,00



ΣΟΥΣΤΕΣ VOREL 40-65Kg

ΚΩΔΙΚΟΣ	VOREL	ΧΡΩΜΑ	ΣΥΣΚ	€/ΤΕΜ
21178465	78465	ΚΑΦΕ		26,25



ΣΟΥΣΤΕΣ VOREL 25-85Kg

ΚΩΔΙΚΟΣ	VOREL	ΧΡΩΜΑ	ΣΥΣΚ	€/ΤΕΜ
21178470	78470	ΑΣΗΜΙ		48,55
21178471	78471	ΚΑΦΕ		48,55
21178472	78472	ΛΕΥΚΟ		48,55



ΚΥΛΙΝΔΡΟΣ ΑΣΦΑΛΕΙΑΣ PREMIUM

ΚΩΔΙΚΟΣ	ΠΕΡΙΓΡΑΦΗ	ΚΟΥΤΙ/ΚΙΒ.	€/ΤΕΜ
4050061	62mm (31-31) Ορειχάλκινο	12/72	13,00
4050062	62mm (31-31) Νίκελ	12/72	13,60
4050076	76mm (31-45) Νίκελ	12/72	15,20
4050086	86mm (31-55) Νίκελ	1/60	16,50
4050092	90mm (45-45) Νίκελ Συμμετρικός	1/60	17,60
4050091	91mm (31-60) Νίκελ	1/60	17,60
4050101	101mm (31-70) Νίκελ	1/60	21,50
4051000	ΚΛΕΙΔΙ ΑΚΟΠΟ Νίκελ	1/60	0,80

ΧΑΡΑΓΜΕΝΟΣ - ΑΤΣΑΛΙΝΟ ΛΑΜΑΚΙ - 5 ΚΛΕΙΔΙΑ



ΚΥΛΙΝΔΡΟΣ ΥΠΕΡΑΣΦΑΛΕΙΑΣ SCORPION X18U

ΚΩΔΙΚΟΣ	ΠΕΡΙΓΡΑΦΗ	€/ΤΕΜ
4060060	60mm (30-30)	25,00
4060075	75mm (30-45)	27,00

18 ΑΤΣΑΛΙΝΑ ΛΑΜΑΚΙΑ & ΜΠΑΡΑ ΑΣΦΑΛΕΙΑΣ

- **ΑΠΑΡΑΒΙΑΣΤΟΣ**
ΑΝΟΙΓΕΙ ΜΟΝΟ ΜΕ ΤΑ ΑΥΘΕΝΤΙΚΑ ΚΛΕΙΔΙΑ ΤΟΥ.
- Αστρονομικοί συνδυασμοί **περισσότεροι από 60 εκατομμύρια.**
- Με **ατσάλινες λάμες** για να μην σπάει.
5 ΚΛΕΙΔΙΑ



ΚΛΕΙΔΑΡΙΑ ΑΣΦΑΛΕΙΑΣ ΑΝΟΙΓΟΜΕΝΩΝ ΠΟΡΤΩΝ

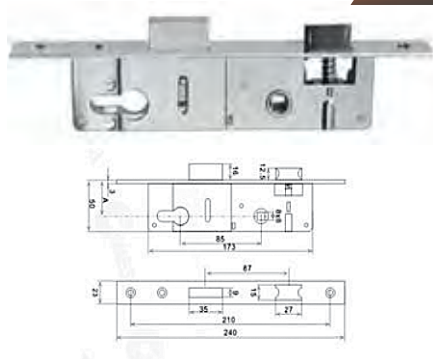

ΚΩΔΙΚΟΣ	ΠΕΡΙΓΡΑΦΗ	ΤΕΜ./ΚΙΒ.	€/ΤΕΜ
400020	20/Με Κύλινδρο 54 mm	30	11,30
401532	20 Χωρίς Κύλινδρο	30	5,50
401530	30 Χωρίς Κύλινδρο	30	7,50
401535	35 Χωρίς Κύλινδρο	30	7,50

ΑΛΟΥΜΙΝΙΟΥ ΚΑΙ ΣΙΔΗΡΟΥ

ΚΛΕΙΔΑΡΙΑ ΚΥΡΙΑΣ ΕΙΣΟΔΟΥ



ΚΩΔΙΚΟΣ	ΠΕΡΙΓΡΑΦΗ	€/ΤΕΜ
401531	45 Χωρίς Κύλινδρο	7,85

ΚΥΛΙΝΔΡΟΣ SCORPION



ΚΩΔΙΚΟΣ	ΠΕΡΙΓΡΑΦΗ	€/ΤΕΜ
400053	54mm απλός	6,00
400060	60mm απλός	6,65
400075	75mm απλός	8,00
400083	83mm απλός	8,60

ΚΛΕΙΔΑΡΙΑ ΜΕΣΟΠΟΡΤΑΣ



ΚΩΔΙΚΟΣ	ΠΕΡΙΓΡΑΦΗ	€/ΤΕΜ
400166	ΜΕΣΟΠΟΡΤΑΣ	

ΚΛΕΙΔΑΡΙΑ ΤΕΤΡΑΓΩΝΗ



ΚΩΔΙΚΟΣ	ΠΕΡΙΓΡΑΦΗ	€/ΤΕΜ
401050	Με αντίκρισμα Δεξιά	
401051	Με αντίκρισμα Αριστερή	

3 ΚΛΕΙΔΙΑ & ΚΡΙΚΟ ΑΣΦΑΛΕΙΑΣ

**ΠΟΜΟΛΑ 110/20**

ΚΩΔΙΚΟΣ	ΠΕΡΙΓΡΑΦΗ	ΧΡΩΜΑ	ΣΥΣΚ	€/ΤΕΜ
221101	110/20	Λευκό	20	4,30
221102	110/20	Μαύρο	20	4,30
221103	110/20	Καφέ	20	4,30
221104	110/20	Ασημί	20	4,30

**ΠΟΜΟΛΟ ΠΛΑΣΤΙΚΟ ΣΙΔΕΡΟΠΟΡΤΑΣ ΠΛΑΚΕ (803)**

ΚΩΔΙΚΟΣ	ΧΡΩΜΑ	ΣΥΣΚ	€/ΤΕΜ
251101	Λευκό	20	2,30
251102	Μαύρο	20	2,30
251103	Καφέ	20	2,30
251104	Γκρι	20	2,30

**ΠΟΜΟΛΟ ΜΕΣΟΠΟΡΤΑΣ (902)**

ΚΩΔΙΚΟΣ	ΧΡΩΜΑ	ΣΥΣΚ	€/ΤΕΜ
251201	Λευκό	20	3,50
251202	Μαύρο	20	3,50
251203	Καφέ	20	3,50
251204	Γκρι	20	3,50

**ΠΟΜΟΛΟ ΠΛΑΣΤΙΚΟ ΣΙΔΕΡΟΠΟΡΤΑΣ ΙΣΙΟ (120)**

ΚΩΔΙΚΟΣ	ΧΡΩΜΑ	ΣΥΣΚ	€/ΤΕΜ
251301	Λευκό	20	3,50
251302	Μαύρο	20	3,50
251303	Καφέ	20	3,50
251304	Γκρι	20	3,50

**ΠΟΜΟΛΟ ΠΛΑΣΤΙΚΟ ΣΙΔΕΡΟΠΟΡΤΑΣ ΚΥΡΤΟ (130)**

ΚΩΔΙΚΟΣ	ΧΡΩΜΑ	ΣΥΣΚ	€/ΤΕΜ
251401	Λευκό	20	3,50
251402	Μαύρο	20	3,50
251403	Καφέ	20	3,50
251404	Γκρι	20	3,50

ΣΥΡΤΕΣ ΑΛΟΥΜΙΝΙΟΥ ΒΑΡΕΩΣ ΤΥΠΟΥ / BLISTER



Ø
12

ΚΩΔΙΚΟΣ	ΠΕΡΙΓΡΑΦΗ	ΧΡΩΜΑ	ΣΥΣΚ	€/ΤΕΜ
229001	No 100 Ø12	Λευκό	12	3,60
229002	No 100 Ø12	Μαύρο	12	3,60
229003	No 100 Ø12	Καφέ	12	3,60
229004	No 100 Ø12	Ασημί	12	3,60
229005	No 100 Ø12	Χρυσό	12	3,60
229201	No 120 Ø12	Λευκό	12	3,90
229202	No 120 Ø12	Μαύρο	12	3,90
229203	No 120 Ø12	Καφέ	12	3,90
229204	No 120 Ø12	Ασημί	12	3,90
229205	No 120 Ø12	Χρυσό	12	3,90
229501	No 150 Ø12	Λευκό	12	5,00
229502	No 150 Ø12	Μαύρο	12	5,00
229503	No 150 Ø12	Καφέ	12	5,00
229504	No 150 Ø12	Ασημί	12	5,00
229505	No 150 Ø12	Χρυσό	12	5,00
229701	No 200 Ø12	Λευκό	10	6,55
229702	No 200 Ø12	Μαύρο	10	6,55
229703	No 200 Ø12	Καφέ	10	6,55
229704	No 200 Ø12	Ασημί	10	6,55
229705	No 200 Ø12	Χρυσό	10	6,55

ΣΥΡΤΕΣ ΑΛΟΥΜΙΝΙΟΥ ΕΛΑΦΡΟΥ ΤΥΠΟΥ / BLISTER



Ø
8

ΚΩΔΙΚΟΣ	ΠΕΡΙΓΡΑΦΗ	ΧΡΩΜΑ	ΣΥΣΚ	€/ΤΕΜ
228401	No 40 Ø8	Λευκό	30	2,30
228402	No 40 Ø8	Μαύρο	30	2,30
228403	No 40 Ø8	Καφέ	30	2,30
228404	No 40 Ø8	Ασημί	30	2,30
228405	No 40 Ø8	Χρυσό	30	2,30
228601	No 60 Ø8	Λευκό	25	2,55
228602	No 60 Ø8	Μαύρο	25	2,55
228603	No 60 Ø8	Καφέ	25	2,55
228604	No 60 Ø8	Ασημί	25	2,55
228605	No 60 Ø8	Χρυσό	25	2,55
228801	No 80 Ø8	Λευκό	20	2,95
228802	No 80 Ø8	Μαύρο	20	2,95
228803	No 80 Ø8	Καφέ	20	2,95
228804	No 80 Ø8	Ασημί	20	2,95
228805	No 80 Ø8	Χρυσό	20	2,95
228901	No 100 Ø8	Λευκό	20	3,25
228902	No 100 Ø8	Μαύρο	20	3,25
228903	No 100 Ø8	Καφέ	20	3,25
228904	No 100 Ø8	Ασημί	20	3,25
228905	No 100 Ø8	Χρυσό	20	3,25

ΣΥΡΤΗΣ ΛΟΥΚΕΤΟΥ



ΚΩΔΙΚΟΣ	ΠΕΡΙΓΡΑΦΗ	€/ΤΕΜ
220015	N15	2,35
220020	N20	4,00
220025	N25	4,50
220030	N30	5,30

**ΧΕΙΡΟΛΑΒΗ Χ-820**

ΚΩΔΙΚΟΣ	ΠΕΡΙΓΡΑΦΗ	ΧΡΩΜΑ	€/ΤΕΜ
010820	ΣΤΑΘΕΡΗ ΑΠΛΗ	Λευκό	3,35
010820-2	ΣΤΑΘΕΡΗ ΑΠΛΗ	Μαύρο	3,35
010820-3	ΣΤΑΘΕΡΗ ΑΠΛΗ	Καφέ	3,35
010820-4	ΣΤΑΘΕΡΗ ΑΠΛΗ	Ασημί	3,35

**ΣΠΑΝΙΟΛΕΤΑ XS-500**

ΚΩΔΙΚΟΣ	ΠΕΡΙΓΡΑΦΗ	ΧΡΩΜΑ	€/ΤΕΜ
010500	ΑΝΟΙΓΟΜΕΝΟΥ	Λευκό	12,10
010500-2	ΑΝΟΙΓΟΜΕΝΟΥ	Μαύρο	12,10

**ΧΕΙΡΟΛΑΒΗ Χ-505**

ΚΩΔΙΚΟΣ	ΠΕΡΙΓΡΑΦΗ	ΧΡΩΜΑ	€/ΤΕΜ
010505	ΜΙΚΡΩΝ ΠΑΡΑΘΥΡΩΝ	Λευκό	8,60
010505-2	ΜΙΚΡΩΝ ΠΑΡΑΘΥΡΩΝ	Μαύρο	8,60

**ΧΕΙΡΟΛΑΒΗ ΔΙΠΛΗ Χ-502**

ΚΩΔΙΚΟΣ	ΠΕΡΙΓΡΑΦΗ	ΧΡΩΜΑ	€/ΤΕΜ
010502	ΜΕ ΡΟΖΕΤΑ & ΕΛΑΤΗΡΙΟ ΕΠΑΝΑΦΟΡΑΣ	Λευκό	16,65
010502-2	ΜΕ ΡΟΖΕΤΑ & ΕΛΑΤΗΡΙΟ ΕΠΑΝΑΦΟΡΑΣ	Μαύρο	16,65

**ΧΕΙΡΟΛΑΒΗ ΔΙΠΛΗ Χ-508**

ΚΩΔΙΚΟΣ	ΠΕΡΙΓΡΑΦΗ	ΧΡΩΜΑ	€/ΤΕΜ
010508	ΔΙΠΛΗ ΜΕ ΠΛΑΚΑ	Λευκό	17,35
010508-2	ΔΙΠΛΗ ΜΕ ΠΛΑΚΑ	Μαύρο	17,35

ΚΛΕΙΔΑΡΙΑ ΓΑΝΤΖΟΥ ΣΥΡΟΜΕΝΩΝ ΓΙΑ ΣΕΙΡΕΣ 150-700



ΚΩΔΙΚΟΣ	ΠΕΡΙΓΡΑΦΗ	ΧΡΩΜΑ	€/ΤΕΜ
051012	Κλειδαριά	Λευκή	9,00
051012-1	Κλειδαριά	Μαύρη	9,00
051012-2	Κλειδαριά	Καφέ	9,00
051012-3	Κλειδαριά	Ασημί	9,00
051013	Χούφτα	Λευκή	3,60
051013-1	Χούφτα	Μαύρη	3,60
051013-2	Χούφτα	Καφέ	3,60
051013-3	Χούφτα	Ασημί	3,60
051014	Λαβή	Λευκή	3,20
051014-1	Λαβή	Μαύρη	3,20
051014-2	Λαβή	Καφέ	3,20
051014-3	Λαβή	Ασημί	3,20



ΡΑΟΥΛΑ ΣΥΡΟΜΕΝΩΝ ΜΕ ΡΟΥΛΕΜΑΝ

ΚΩΔΙΚΟΣ	ΠΕΡΙΓΡΑΦΗ	€/ΤΕΜ
550002	Ορειχάλκινο Διπλό	6,65
550001	Ορειχάλκινο Μονό	3,50
550004	Τεφλόν Διπλό	4,08
550003	Τεφλόν Μονό	2,17

ΣΤΟΠ ΑΛΟΥΜΙΝΙΟΥ



ΚΩΔΙΚΟΣ	ΠΕΡΙΓΡΑΦΗ	ΧΡΩΜΑ	€/ΤΕΜ
220111	ΤΑΦ	Λευκό	0,90
220111-2	ΤΑΦ	Μαύρο	0,90
220111-3	ΤΑΦ	Καφέ	0,90
220111-4	ΤΑΦ	Ασημί	0,90
220110	ΠΙ	Λευκό	0,60
220110-2	ΠΙ	Μαύρο	0,60
220110-3	ΠΙ	Καφέ	0,60
220110-4	ΠΙ	Ασημί	0,60
220102	ΣΧΙΣΤΟ	Λευκό	1,00
220102-2	ΣΧΙΣΤΟ	Μαύρο	1,00
220102-3	ΣΧΙΣΤΟ	Καφέ	1,00
220102-4	ΣΧΙΣΤΟ	Ασημί	1,00



ΓΑΝΤΖΟΣ ΑΝΟΞΕΙΔΩΤΟΣ

ΚΩΔΙΚΟΣ	ΠΕΡΙΓΡΑΦΗ	ΣΥΣΚ	€/ΤΕΜ
5603060	No.60	25	3,35
5603080	No.80	20	3,80
5603100	No.100	20	4,10
5603120	No.120	20	4,45
5603140	No.140	20	4,90
5603160	No.160	20	5,85
5603180	No.180	20	6,25
5603200	No.200	20	7,10

**ΣΤΟΠ ΠΟΡΤΑΣ**

ΚΩΔΙΚΟΣ	ΧΡΩΜΑ	€/ΤΕΜ
112000-1	ΛΕΥΚΟ	4,25
112000-2	ΜΑΥΡΟ	4,25
112000-3	ΚΑΦΕ	4,25

ΑΣΦΑΛΕΙΑ DOUBLEX S ΑΝΟΙΓΟΜΕΝΩΝ

ΚΩΔΙΚΟΣ	ΧΡΩΜΑ	ΣΥΣΚ	€/ΤΕΜ
110018-1	Λευκό	20	10,55
110018-2	Μαύρο	20	10,55
110018-3	Καφέ	20	10,55
110018-4	Ασημί	20	10,55

ΚΛΕΙΔΑΡΙΑ ΣΥΡΟΜΕΝΩΝ DOUBLEX CLASSIC

ΚΩΔΙΚΟΣ	ΧΡΩΜΑ	ΣΥΣΚ	€/ΤΕΜ
110001-1	Λευκό	50	6,75
110001-2	Μαύρο	50	6,75
110001-3	Καφέ	50	6,75
110001-4	Ασημί	50	6,75

ΧΟΥΦΤΑ ΣΥΡΟΜΕΝΩΝ DOUBLEX CLASSIC

ΚΩΔΙΚΟΣ	ΧΡΩΜΑ	ΣΥΣΚ	€/ΤΕΜ
110002-1	Λευκό	50	3,50
110002-2	Μαύρο	50	3,50
110002-3	Καφέ	50	3,50
110002-4	Ασημί	50	3,50

ΛΑΒΗ ΣΥΡΟΜΕΝΩΝ DOUBLEX CLASSIC

ΚΩΔΙΚΟΣ	ΧΡΩΜΑ	ΣΥΣΚ	€/ΤΕΜ
110003-1	Λευκό	50	3,50
110003-2	Μαύρο	50	3,50
110003-3	Καφέ	50	3,50
110003-4	Ασημί	50	3,50

ΚΛΕΙΔΑΡΙΑ ΣΥΡΟΜΕΝΩΝ DOUBLEX OVAL



ΚΩΔΙΚΟΣ	ΧΡΩΜΑ	ΣΥΣΚ	€/ΤΕΜ
110013-1	Λευκό	50	5,15
110013-2	Μαύρο	50	5,15
110013-3	Καφέ	50	5,15
110013-4	Ασημί	50	5,15

ΧΟΥΦΤΑ ΣΥΡΟΜΕΝΩΝ DOUBLEX OVAL



ΚΩΔΙΚΟΣ	ΧΡΩΜΑ	ΣΥΣΚ	€/ΤΕΜ
110014-1	Λευκό	50	3,25
110014-2	Μαύρο	50	3,25

ΚΛΕΙΔΑΡΙΑ ΣΥΡ DOUBLEX CLASSIC ΜΕ ΚΛΕΙΔΙ



ΚΩΔΙΚΟΣ	ΧΡΩΜΑ	ΣΥΣΚ	€/ΤΕΜ
110110-1	Λευκό	30	6,75
110110-2	Μαύρο	30	6,75
110110-3	Καφέ	30	6,75
110110-4	Ασημί	30	6,75

ΧΟΥΦΤΑ ΣΥΡ DOUBLEX CLASSIC ΜΕ ΚΛΕΙΔΙ



ΚΩΔΙΚΟΣ	ΜΕΓΕΘΟΣ	ΣΥΣΚ	€/ΤΕΜ
110201	N 1	30	3,80
110202	N 2	30	4,45
110203	N 3	30	4,75

ΛΑΒΗ DOUBLEX CLASSIC ΜΕ ΚΛΕΙΔΙ



ΚΩΔΙΚΟΣ	ΧΡΩΜΑ	ΣΥΣΚ	€/ΤΕΜ
110029-1	Λευκό	50	3,50
110029-2	Μαύρο	50	3,50
110029-3	Καφέ	50	3,50
110029-4	Ασημί	50	3,50



ΚΛΕΙΔΑΡΙΑ ΣΥΡΟΜΕΝΩΝ DOUBLEX ΟΒΑΛ ΛΑΒΗ

ΚΩΔΙΚΟΣ	ΧΡΩΜΑ	ΣΥΣΚ	€/ΤΕΜ
110012-1	Λευκό	50	6,55
110012-2	Μαύρο	50	6,55



ΧΟΥΦΤΑ ΣΥΡΟΜΕΝΩΝ DOUBLEX ΟΒΑΛ ΛΑΒΗ

ΚΩΔΙΚΟΣ	ΧΡΩΜΑ	ΣΥΣΚ	€/ΤΕΜ
110015-1	Λευκό	50	4,95
110015-2	Μαύρο	50	4,95



COBRA ΣΥΡΤΗΣ ΑΣΦΑΛΕΙΑΣ ΑΝΟΙΓΟΜΕΝΩΝ

ΚΩΔΙΚΟΣ	ΧΡΩΜΑ	ΣΥΣΚ	€/ΤΕΜ
110030-1	Λευκό	30	10,90
110030-2	Μαύρο	30	10,90
110030-3	Καφέ	30	10,90





ΑΝΕΜΟΣΤΗΡΙΓΜΑ ΚΥΚΝΟΣ

ΚΩΔΙΚΟΣ	ΧΡΩΜΑ	ΣΥΣΚ	€/ΤΕΜ
110016-2	Μαύρο	50	1,95



ΑΣΦΑΛΕΙΑ DOUBLEX ΣΥΡΟΜΕΝΩΝ ΔΑΓΚΑΝΑ

ΚΩΔΙΚΟΣ	ΧΡΩΜΑ	ΣΥΣΚ	€/ΤΕΜ
110005-1	Λευκό	50	3,30
110005-2	Μαύρο	50	3,30
110005-3	Καφέ	50	3,30
110005-4	Ασημί	50	3,30



ΞΙΦΙΑΣ ΑΣΦΑΛΕΙΑ ΡΟΛΩΝ

ΚΩΔΙΚΟΣ	ΧΡΩΜΑ	ΣΥΣΚ	€/ΤΕΜ
115000-1	Λευκό	50	15,85
115000-2	Μαύρο	50	15,85



ΑΝΤΙΚΛΕΠΤΙΚΟ CAL CAMERA

ΚΩΔΙΚΟΣ	ΧΡΩΜΑ	ΣΥΣΚ	€/ΣΕΤ
110019-1	Λευκό	50	2,70
110019-2	Μαύρο	50	2,70



ΑΝΤΙΚΛΕΠΤΙΚΟ CAL EYΡΟΡΑ

ΚΩΔΙΚΟΣ	ΧΡΩΜΑ	ΣΥΣΚ	€/ΤΕΜ
110080-1	Λευκό	50	3,25
110080-2	Μαύρο	50	3,25



ΑΝΤΙΚΛΕΠΤΙΚΟ CROCODILE

ΚΩΔΙΚΟΣ	ΣΥΣΚ	€/ΤΕΜ
110258	16 ΣΕΤ	4,50

**ΤΣΕΡΚΙ ΡΟΛΩΝ**

ΚΩΔΙΚΟΣ	mm	ΧΡΩΜΑ	€/ΤΕΜ
24049047	130	ΛΕΥΚΟ	0,80
24049057	170	ΛΕΥΚΟ	0,86
24049056	190	ΛΕΥΚΟ	1,20

**ΤΑΜΠΑΚΕΡΑ ΙΜΑΝΤΑ 6 ΜΕΤΡΩΝ**

ΚΩΔΙΚΟΣ	ΧΡΩΜΑ	€/ΤΕΜ
24049040-0	ΛΕΥΚΟ	5,00
24049040-1	ΜΑΥΡΟ	5,00
24049040-2	ΚΑΦΕ	5,00

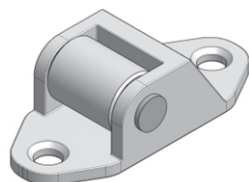
**ΟΔΗΓΟΣ ΙΜΑΝΤΑ**

ΚΩΔΙΚΟΣ	ΧΡΩΜΑ	€/ΤΕΜ
24049037-0	ΛΕΥΚΟ	0,57
24049037-1	ΜΑΥΡΟ	0,57

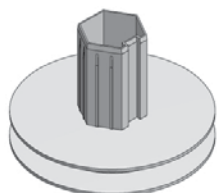
**ΔΙΣΚΟΣ ΜΕ ΚΟΥΠΑ**

ΚΩΔΙΚΟΣ	ΔΙΑΜΕΤΡΟΣ ΔΙΣΚΟΥ	ΔΙΑΣΤΑΣΗ ΚΟΥΠΑΣ	€/ΤΕΜ
20031439	115mm	40mm	0,80
24039044	145mm	40mm	0,90
20031451	150mm	60mm	1,75

**ΡΟΥΛΕΜΑΝ ΒΑΡΕΩΣ ΤΥΠΟΥ 028**

ΚΩΔΙΚΟΣ	ΔΙΑΣΤΑΣΗ (mm)	€/ΤΕΜ
20031264	28x12	0,65



ΚΟΥΠΕΣ ΠΛΑΣΤΙΚΕΣ

ΚΩΔΙΚΟΣ	ΔΙΑΣΤΑΣΗ ΚΟΥΠΑΣ	€/ΤΕΜ
24049043	40mm	0,45
24049112	60mm	0,95

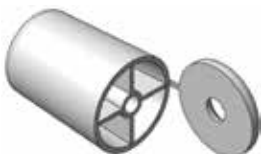

ΣΤΟΠΕΡ ΕΞΩΤΕΡΙΚΟ 30mm

ΚΩΔΙΚΟΣ	ΧΡΩΜΑ	€/ΤΕΜ
24049045-0	ΛΕΥΚΟ	0,10
24049045-1	ΜΑΥΡΟ	0,10

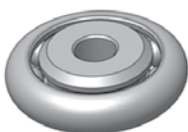

ΡΟΥΛΕΜΑΝ 042x12

ΚΩΔΙΚΟΣ	ΔΙΑΣΤΑΣΗ (mm)	€/ΤΕΜ
24049111	42x12	1,05



ΒΑΣΗ ΡΟΥΛΕΜΑΝ

ΚΩΔΙΚΟΣ	ΔΙΑΣΤΑΣΗ (mm)	€/ΤΕΜ
24049109	42	0,80



ΣΥΝΔΕΣΜΟΣ 90 ΝΙΚΕΛ ΓΙΑ ΜΗΧΑΝΙΣΜΟ ΜΑΝΙΒΕΛΑΣ

ΚΩΔΙΚΟΣ	ΠΕΡΙΓΡΑΦΗ	€/ΤΕΜ
24049122	8mm / ΤΕΤΡΑΓΩΝΟ	24,00

**ΜΠΟΥΤΟΝ ΕΠΑΛΛΗΛΩΝ**

ΚΩΔΙΚΟΣ	ΠΕΡΙΓΡΑΦΗ	ΧΡΩΜΑ	€/ΤΕΜ
051870	ΜΠΟΥΤΟΝ	Λευκό	5,80
051870-2	ΜΠΟΥΤΟΝ	Μαύρο	5,80

**ΣΤΟΠ ΠΑΤΖΟΥΡΙΟΥ ΣΤΡΙΦΤΑ**

ΚΩΔΙΚΟΣ	ΠΕΡΙΓΡΑΦΗ	ΧΡΩΜΑ	€/ΤΕΜ
620001	ΑΝΕΜΟΣΤΗΡΙΓΜΑ ΤΑΦ ΜΕ ΑΜΟΡΤΙΣΕΡ	Μαύρο	1,40
620001-2	ΑΝΕΜΟΣΤΗΡΙΓΜΑ ΤΑΦ ΜΕ ΑΜΟΡΤΙΣΕΡ	Λευκό	1,40

**ΣΤΟΠ ΠΑΤΖΟΥΡΙΟΥ ΑΥΤΟΜΑΤΑ ΔΙΦΥΛΛΑ**

ΚΩΔΙΚΟΣ	ΠΕΡΙΓΡΑΦΗ	ΧΡΩΜΑ	€/ΤΕΜ
250003	ΣΤΟΠ ΠΑΤΖΟΥΡΙΟΥ ΑΥΤΟΜΑΤΑ	Λευκό	1,76
250002	ΣΤΟΠ ΠΑΤΖΟΥΡΙΟΥ ΑΥΤΟΜΑΤΑ	Μαύρο	1,76

**ΓΩΝΙΑ ΛΟΥΚΕΤΟΥ**

ΚΩΔΙΚΟΣ	€/ΤΕΜ
224204	2,90

**ΠΙΡΟΣ ΑΛΥΣΙΔΑΚΙ**

ΚΩΔΙΚΟΣ	ΠΕΡΙΓΡΑΦΗ	€/ΤΕΜ
141000	100mm	0,82
141500	150mm	0,98

**ΑΣΦΑΛΕΙΑ ΜΑΝΤΑΛΟ ΕΧΜΕΤΑΛ**

ΚΩΔΙΚΟΣ	ΧΡΩΜΑ	€/ΤΕΜ
061000	Λευκό	11,00
061000-1	Μαύρο	11,00
061000-2	Καφέ	11,00
061000-3	Ασημί	11,00



ΣΕ ΠΩΛΗΣΕΙΣ
No 1

115
Ømm



ΒΕΝΤΟΥΖΑ ΤΖΑΜΙΩΝ ΠΛΑΣΤΙΚΗ

	ΚΩΔΙΚΟΣ	VOREL	Ø(mm)	Kg	ΣΥΣΚ	€/ΤΕΜ
40 kg	ΜΟΝΗ					
	21105300	05300	115	40	48	4,90
70 kg	ΔΙΠΛΗ					
	21105301	05301	115	70	24	9,60
100 kg	ΤΡΙΠΛΗ					
	21105302	05302	115	100	12	14,90



ΒΕΝΤΟΥΖΑ ΤΖΑΜΙΩΝ ΑΛΟΥΜΙΝΙΟΥ

	ΚΩΔΙΚΟΣ	VOREL	Ø(mm)	Kg	ΣΥΣΚ	€/ΤΕΜ
40 kg	ΜΟΝΗ					
	21105311	05311	115	40	50	9,90
70 kg	ΔΙΠΛΗ					
	21105312	05312	115	70	10	19,70

115
Ømm

Al



5
PCS

300kg



NEO

ΣΕΤ ΜΕΤΑΦΟΡΑΣ ΕΠΙΠΛΩΝ

	ΚΩΔΙΚΟΣ	ΥΑΤΟ	ΣΥΣΚ	€/ΤΕΜ
	20037490	YT-37490	6	26,00

ΒΕΝΤΟΥΖΕΣ ΤΖΑΜΙΩΝ ΑΛΟΥΜΙΝΙΟΥ



∅
125
mm

max
60
kg

Al

 **NEO¹**



ΜΟΝΗ

ΚΩΔΙΚΟΣ	YATO 	∅(mm)	Kg	ΣΥΣΚ	€/ΤΕΜ
20037235	YT-37235	125	60		15,00



∅
125
mm

max
120
kg

Al

ΔΙΠΛΗ

ΚΩΔΙΚΟΣ	YATO 	∅(mm)	Kg	ΣΥΣΚ	€/ΤΕΜ
20037236	YT-37236	125	120		26,00

 **NEO¹**



 **NEO¹**

ΤΡΙΠΛΗ

ΚΩΔΙΚΟΣ	YATO 	∅(mm)	Kg	ΣΥΣΚ	€/ΤΕΜ
20037237	YT-37237	125	190		34,00

∅
125
mm

max
190
kg

Al

BΕΝΤΟΥΖΕΣ ΤΖΑΜΙΩΝ ΜΕ ΑΝΤΛΙΑ ΚΕΝΟΥ

Εξαιρετικά μεγάλη δύναμη συγκράτησης,
χάρη στην ενσωματωμένη αντλία κενού



NEO¹



204mm

ΚΩΔΙΚΟΣ	YATO®	∅(mm)	Kg	ΣΥΣΚ	€/ΤΕΜ
20037220	YT-37220	204	58		68,70

Κατάλληλη για χρήση σε όλες τις λείες επιφάνειες (γυαλί,
πλακάκι, γρανίτη, μέταλλα)
Ανθεκτική κατασκευή, από ABS και μέταλλο
Εργονομική λαβή



NEO¹



150mm

ΚΩΔΙΚΟΣ	YATO®	∅(mm)	Kg	ΣΥΣΚ	€/ΤΕΜ
20037223	YT-37223	150	32		61,00

Κατάλληλη για χρήση σε όλες τις λείες επιφάνειες (γυαλί,
πλακάκι, γρανίτη, μέταλλα)
Ανθεκτική κατασκευή, από PVC
Εργονομική λαβή



ΑΕΡΟΣΤΟΠ ΤΥΠΟΥ D

ΚΩΔΙΚΟΣ	VOREL	ΔΙΑΣΤ(μm)	ΜΗΚΟΣ(cm)	ΧΡΩΜΑ	ΣΥΣΚ	€/ΤΕΜ
21976752	76752	9x7.4	6	ΑΣΠΡΟ	24	4,20
21976762	76762	9x7.4	6	ΚΑΦΕ	24	4,20



ΑΕΡΟΣΤΟΠ ΤΥΠΟΥ E

ΚΩΔΙΚΟΣ	VOREL	ΔΙΑΣΤ(μm)	ΜΗΚΟΣ(cm)	ΧΡΩΜΑ	ΣΥΣΚ	€/ΤΕΜ
21976750	76750	9x4	6	ΑΣΠΡΟ	24	3,10
21976760	76760	9x4	6	ΚΑΦΕ	24	3,10

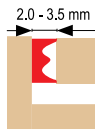

ΑΕΡΟΣΤΟΠ ΤΥΠΟΥ P

ΚΩΔΙΚΟΣ	VOREL	ΔΙΑΣΤ(μm)	ΜΗΚΟΣ(cm)	ΧΡΩΜΑ	ΣΥΣΚ	€/ΤΕΜ
21976751	76751	9x5.5	6	ΑΣΠΡΟ	24	3,35
21976761	76761	9x5.5	6	ΚΑΦΕ	24	3,35

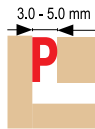

ΑΕΡΟΣΤΟΠ ΤΥΠΟΥ R

ΚΩΔΙΚΟΣ	VOREL	ΔΙΑΣΤ(μm)	ΜΗΚΟΣ(cm)	ΧΡΩΜΑ	ΣΥΣΚ	€/ΤΕΜ
21976756	76756	9x5.5	100	ΑΣΠΡΟ	6	40,65
21976766	76766	9x5.5	100	ΚΑΦΕ	6	40,65





NON-SLIP
ANTY-POŚLIZGOWY



ΑΥΤΟΚΟΛΛΗΤΑ ΤΣΟΧΑΚΙΑ ΕΠΙΠΛΩΝ

ΚΩΔΙΚΟΣ	VOREL	ø(mm)	ΤΕΜ	ΣΥΣΚ	€/ΤΕΜ
21974882	74882	25	18	24	0,93
ΚΑΦΕ					
21974885	74885	18	32	24	0,96
21974886	74886	25	18	24	1,00
21974887	74887	38	8	24	0,96



NONWOVEN
WŁÓKNINA



ΑΥΤΟΚΟΛΛΗΤΑ ΤΣΟΧΑΚΙΑ ΕΠΙΠΛΩΝ

ΚΩΔΙΚΟΣ	VOREL	(mm)	ΤΕΜ	ΣΥΣΚ	€/ΤΕΜ
ΛΕΥΚΟ					
21974849	74849	100x120	1	60	0,61
ΚΑΦΕ					
21974869	74869	100x120	1	60	0,61



4
PCS

SOFT
PLASTIC
ΜΕΚΚΙΕ
TWORZYWO

DOUBLE
SIDE TAPE
TASMA
DWUSTRONNA



ΓΩΝΙΑΚΗ ΠΡΟΣΤΑΣΙΑ ΕΠΙΠΛΩΝ

ΚΩΔΙΚΟΣ	VOREL	ΤΕΜ	ΣΥΣΚ	€/ΤΕΜ
21974771	74771	4	16	2,10
21974772	74772	4	16	2,95



SILICONE
SILIKON



ΑΥΤΟΚΟΛΛΗΤΑ ΣΙΛΙΚΟΝΗΣ ΕΠΙΠΛΩΝ

ΚΩΔΙΚΟΣ	VOREL	ø(mm)	ΤΕΜ	ΣΥΣΚ	€/ΤΕΜ
21974910	74910	8	25	32	0,96
21974911	74911	10	20	32	1,00
21974912	74912	13	12	32	0,98



3
PCS

FOAM TAPE
TASMA
MONTAZOWA

ABS



ΑΥΤΟΚΟΛΛΗΤΟΙ ΓΑΝΤΖΟΙ

ΚΩΔΙΚΟΣ	VOREL	MAX(kg)	ΤΕΜ	ΣΥΣΚ	€/ΤΕΜ
21974730	74730	1.0	3	12	1,37



ANTI - SLIP
ANTYPOŚLIZGOWY



ΠΛΑΣΤΙΚΟ ΣΚΑΜΠΟ

ΚΩΔΙΚΟΣ	VOREL	ΜΕΓΕΘΟΣ(cm)	ΣΥΣΚ	€/ΤΕΜ
21975915	75915	30x20x21	10	6,00



ΣΠΡΕΪ | ΚΟΛΛΕΣ | ΤΑΙΝΙΕΣ | ΒΑΦΕΣ ΣΥΓΚΟΛΛΗΤΙΚΑ ΣΦΡΑΓΙΣΤΙΚΑ



ΣΠΡΕΪ - ΚΟΛΛΕΣ [420 - 438]



Τεχνικά Σπρέι

Κόλλες | Θερμόκολλες



ΤΑΙΝΙΕΣ - ΒΑΦΕΣ [439 - 446]



Ταινίες | Χαρτοταινίες | Διπλής Όψεως

Σπρέι Βαφής | Βαφές



ΣΥΓΚΟΛΛΗΤΙΚΑ - ΣΦΡΑΓΙΣΤΙΚΑ [447 - 484]



Συγκολλητικά | Στεγανωτικά

Στόκοι | Σιλικόνες | Αφροί

Πιστόλια Αφρού και Σιλικόνης



ΛΙΠΑΝΣΗ & ΠΡΟΣΤΑΣΙΑ που "ΔΙΑΡΚΕΙ"

N-GR

New GeneRation spray

► Τεχνικά σπρέι ΝΕΑΣ ΓΕΝΙΑΣ



N-GR BC

BRAKE CLEANER

ΚΑΘΑΡΙΣΤΙΚΟ ΦΡΕΝΩΝ

- Ισχυρό Καθαριστικό
- Ταχυστέγνωτο
- Μη Διαβρωτικό
- Μη Αγώγιμο

N-GR New GeneRation spray
Τεχνικά σπρέι ΝΕΑΣ ΓΕΝΙΑΣ



ΚΑΘΑΡΙΖΕΙ:
ΔΙΣΚΟΥΣ, ΔΑΚΤΥΛΙΑΣ, ΤΑΜΠΟΥΡΑ & ΘΡΑΚΑ
ΑΠΟ ΣΙΔΗΡΗ, ΓΡΑΣΑ ΚΑΙ ΡΑΠΑ

ΚΑΘΑΡΙΣΤΙΚΟ ΦΡΕΝΩΝ



N-GR 61

SILICON SPRAY

100% ΚΑΘΑΡΗ ΣΙΛΙΚΟΝΗ

ΥΠΕΡ ΣΥΜΠΥΚΝΩΜΕΝΟ ΣΠΡΕΙ

- Προστατεύει
- Αδιαβροχοποιεί
- Λιπαίνει
- Αναζωογονεί
- Γυαλίζει

ΛΙΠΑΝΣΗ και ΠΡΟΣΤΑΣΙΑ που "ΔΙΑΡΚΕΙ"



100% ΚΑΘΑΡΗ ΣΙΛΙΚΟΝΗ



N-GR 21

HIQ20 LUBRICANT FORMULA

ΛΙΠΑΝΤΙΚΟ - ΑΝΤΙΣΚΩΡΙΑΚΟ

LUBRICATES - PENETRATES

- Λιπαίνει
- Συντηρεί
- Ελευθερώνει
- Αδιαβροχοποιεί
- Καθαρίζει
- Προστατεύει

ΛΙΠΑΝΣΗ και ΠΡΟΣΤΑΣΙΑ που "ΔΙΑΡΚΕΙ"



ΛΙΠΑΝΤΙΚΟ - ΑΝΤΙΣΚΩΡΙΑΚΟ



N-GR CC

CONTACT CLEANER

ΚΑΘΑΡΙΣΤΙΚΟ ΗΛΕΚΤΡΙΚΩΝ ΕΠΑΦΩΝ

& ΟΛΟΚΛΗΡΩΜΕΝΩΝ ΚΥΚΛΩΜΑΤΩΝ



Καθαριστικό
Μη αγώγιμο
Υψηλής διεισδυτικότητας
Δεν διαβρώνει
Δεν αφήνει κατάλοιπα

ΚΑΘΑΡΙΣΤΙΚΟ ΗΛΕΚΤΡΙΚΩΝ ΕΠΑΦΩΝ

& ΟΛΟΚΛΗΡΩΜΕΝΩΝ ΚΥΚΛΩΜΑΤΩΝ



N-GR GL

GREASE LITHIUM

ΓΡΑΣΟ ΛΙΘΙΟΥ

ΕΝΙΣΧΥΜΕΝΟ ΜΕ ΤΕΦΛΟΝ

- Λιπαντικό
- Αντιφριβικό

N-GR New GeneRation spray
Τεχνικά σπρέι ΝΕΑΣ ΓΕΝΙΑΣ



ΙΔΑΝΙΚΟ ΓΙΑ ΧΡΗΣΗ ΣΕ
ΓΡΑΝΑΖΙΑ, ΑΝΤΙΣΤΡΕΦ. ΡΟΛΟΙΩΝ
ΓΡΑΜΜΕΣ, ΒΑΛΒΙΔΕΣ, ΝΤΙΖΕΣ, ΡΟΛΟΤΙ
ΜΗΤΑΛΩΝ, ΓΚΑΡΑΖΟΠΟΡΤΕΣ ΚΑΠ.

ΓΡΑΣΟ ΛΙΘΙΟΥ

ΕΝΙΣΧΥΜΕΝΟ ΜΕ ΤΕΦΛΟΝ

New GeneRation spray



N-GR ▶ New GeneRation spray ▶ Τεχνικά σπρέι ΝΕΑΣ ΓΕΝΙΑΣ

www.n-gr.gr



- ▶ Λιπαίνει
- ▶ Συντηρεί
- ▶ Ελευθερώνει
- ▶ Αδιαβροχοποιεί
- ▶ Καθαρίζει
- ▶ Προστατεύει

ΛΙΠΑΝΤΙΚΟ - ΑΝΤΙΣΚΩΡΙΑΚΟ

**SUPER
MULTI-PURPOSE
LUBRICANT**

**ΒΑΡΥΤΕΡΟ ΑΠΟ ΤΟ ΝΕΡΟ
ΑΠΩΘΕΙ ΤΗΝ ΥΓΡΑΣΙΑ**

ΠΡΩΤΟΠΟΡΙΑΚΟ ΛΙΠΑΝΤΙΚΟ – ΑΝΤΙΣΚΩΡΙΑΚΟ ΣΠΡΕΪ ΧΩΡΙΣ ΣΙΛΙΚΟΝΗ

ΛΙΠΑΝΣΗ και ΠΡΟΣΤΑΣΙΑ που “ΔΙΑΡΚΕΙ”

- ▶ **Λιπαίνει, Καθαρίζει και Συντηρεί** μεταλλικούς μηχανισμούς, κλειδαριές, όπλα και σταματάει το τρίξιμο σε μεντεσέδες κ.λπ.
- ▶ **Διεισδύει, Ξεσκουριάζει & Απελευθερώνει**, σκουριασμένα και κολλημένα εξαρτήματα όπως βίδες, παξιμάδια, σύρτες και τα επαναφέρει σε λειτουργία
- ▶ **Αδιαβροχοποιεί και Προστατεύει**, από την υγρασία και τη διάβρωση, όλα τα ηλεκτρικά κυκλώματα (πίνακες, λάμπες, μοτέρ, συστήματα ανάφλεξης και πόλους μπαταριών). Ιδιαίτερα αποτελεσματικό για ναυτιλιακή χρήση.
- ▶ **Καθαρίζει** λεκέδες από πίσσα και γράσα από το χρώμα των αυτοκινήτων



**Το Λιπαντικό- Αντισκωρικό σπρέι που
ΔΕΝ ΦΟΒΑΤΑΙ ΤΟ ΝΕΡΟ!!!**

Με τη νέα εξελιγμένη φόρμουλα, **HiQ20**

Η **HiQ20** διατηρεί όλες τις τεχνικές ιδιότητες που έκαναν το Q20 μοναδικό κάνοντάς το, ταυτόχρονα, φιλικότερο στο χρήστη & το περιβάλλον



από το Q20 στο **NGR21**

Η ΕΞΕΛΙΞΗ ΤΩΝ ΕΙΔΩΝ!!!

ΚΩΔΙΚΟΣ	ΠΕΡΙΓΡΑΦΗ	ΣΥΣΚ	€/ΤΕΜ
520102	200ml	24	3,95
520104	400ml	15	5,90
520105	450+50ml	15	6,95
520110	5 Lt	1	55,00



Το **N-GR 21** χάρη στη μοναδική του ιδιότητα να απωθεί με το βάρος του το νερό και την υγρασία, διεισδύει αποτελεσματικά, προστατεύει από τη σκουριά, λιπαίνει, απελευθερώνει και ξαναβάζει σε κίνηση τα πάντα!!!

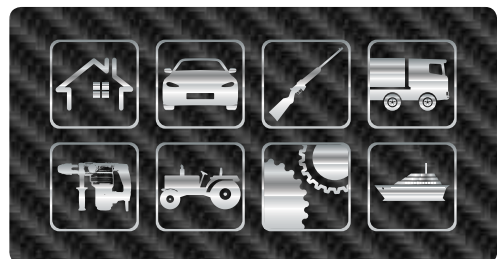

N-GR ▶ New GeneRation spray ▶ Τεχνικά σπρέι ΝΕΑΣ ΓΕΝΙΑΣ



- ▶ Προστατεύει
- ▶ Αδιαβροχοποιεί
- ▶ Λιπαίνει
- ▶ Αναζωογονεί
- ▶ Γυαλίζει

100% ΚΑΘΑΡΗ ΣΙΛΙΚΟΝΗ

ΚΩΔΙΚΟΣ	ΠΕΡΙΓΡΑΦΗ	ΣΥΣΚ	€/ΤΕΜ
520111	400ml	15	6,95

Το **N-GR 61** έχει **εξαιρετική λιπαντική ικανότητα**, λόγω της μεγάλης περιεκτικότητάς του σε σιλίκονη. Τα ιδιαίτερα χαρακτηριστικά του βοηθούν ώστε να γίνεται αργή απορρόφηση επιτυγχάνοντας έτσι **μεγαλύτερη διάρκεια**.

Παρασκευάζεται στην Ελλάδα | www.n-gr.gr

ΛΙΠΑΝΣΗ και ΠΡΟΣΤΑΣΙΑ που "ΔΙΑΡΚΕΙ"
ΥΠΕΡ ΣΥΜΠΥΚΝΩΜΕΝΟ ΣΠΡΕΪ
100% ΚΑΘΑΡΗΣ ΣΙΛΙΚΟΝΗΣ

- ▶ Για χρήση σε πλαστικά και λαστιχένια αντικείμενα και εξαρτήματα αλλά και σε μεταλλικούς μηχανισμούς όπου η χρήση ορυκτών λιπαντικών δεν είναι κατάλληλη.
- ▶ **Διατηρεί** μαλακά και ελαστικά λαστιχένια παρεμβύσματα (πόρτες αυτοκινήτων, ψυγείων, παραθύρων κ.λπ.).
- ▶ **Συντηρεί και Αναζωογονεί** πλαστικά και βινύλ σε ταμπλό και επενδύσεις, στο εσωτερικό και το εξωτερικό, των αυτοκινήτων ενώ προστατεύει και χαρίζει όψη καινούριου στα ελαστικά τους.
- ▶ **Λιπαίνει** διαδρόμους και όργανα γυμναστικής.
- ▶ **Προστατεύει** από τον ήλιο και το θαλασσινό νερό και διατηρεί ελαστικά τα μπαλόνια σε φουσκωτά σκάφη.
- ▶ **Αναζωογονεί, Γυαλίζει και Αδιαβροχοποιεί** τέντες, σκηνές, καλύμματα, μαξιλάρια, σέλες, στρώματα θαλάσσης, πέδιλα σκι κ.λπ..
- ▶ **Διατηρεί** την ελαστικότητα και τη διαφάνεια σε φέριγκκ μοτοσικλετών και σκαφών (plexiglass).
- ▶ **Ιδανικό σε** μηχανισμούς ανάκλησης παραθύρων και πορτών αλουμινίου, σε σίτες καθώς και για τα ροδάκια των συρόμενων. Επίσης σε πλαστικές, ελαστικές επιφάνειες, πλαστικά κουφώματα, σίτες και πλαστικά ράουλα.
- ▶ **Μονώνει και διατηρεί** όλες τις ηλεκτρικές συνδέσεις και **αποτρέπει** τη συσσώρευση σκόνης.



ΚΑΘΑΡΙΣΤΙΚΟ ΗΛΕΚΤΡΙΚΩΝ ΕΠΑΦΩΝ
& ΟΛΟΚΛΗΡΩΜΕΝΩΝ ΚΥΚΛΩΜΑΤΩΝ

- ▶ Καθαριστικό
- ▶ Μη αγώγιμο
- ▶ Υψηλής διεισδυτικότητας
- ▶ Δεν διαβρώνει
- ▶ Δεν αφήνει κατάλοιπα

ΚΑΘΑΡΙΣΤΙΚΟ ΗΛΕΚΤΡΙΚΩΝ ΕΠΑΦΩΝ
& ΟΛΟΚΛΗΡΩΜΕΝΩΝ ΚΥΚΛΩΜΑΤΩΝ



- ▶ **Μη αγώγιμο, Υψηλής Διεισδυτικότητας και Καθαριστικής Δύναμης** σπρέι, για ηλεκτρικές επαφές, διακόπτες, πρίζες, πόλους μπαταριών, ηλεκτρικούς πίνακες κ.λπ..
- ▶ **Καθαρίζει Χωρίς να Διαβρώνει και Απομακρύνει** άμεσα σκόνης, γράσα, υγρασία, **Αποκαθιστά** την ομαλή ροή του ρεύματος και **Αποτρέπει** τα βραχυκυκλώματα.
- ▶ Εξατμίζεται γρήγορα **χωρίς να αφήνει κατάλοιπα**.

ΚΩΔΙΚΟΣ	ΠΕΡΙΓΡΑΦΗ	ΣΥΣΚ	€/ΤΕΜ
520205	400ml	15	4,65

Παρασκευάζεται στην Ελλάδα | www.n-gr.gr



N-GR ▶ New GeneRation spray ▶ Τεχνικά σπρέι ΝΕΑΣ ΓΕΝΙΑΣ



ΚΑΘΑΡΙΣΤΙΚΟ ΦΡΕΝΩΝ

- ▶ Ισχυρό Καθαριστικό
- ▶ Ταχυστέγνωτο
- ▶ Μη Διαβρωτικό
- ▶ Μη Αγώγιμο

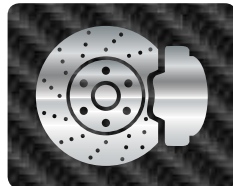

- ▶ Το **N-GR BRAKE CLEANER** είναι ένα ισχυρό, ταχυστέγνωτο, μη διαβρωτικό και μη αγώγιμο καθαριστικό φρένων.
- ▶ **Διαλύει** τα υπολείμματα των υγρών φρένων, απομακρύνει την κάπνα και τη σκόνη από όλα τα συστήματα της πέδησης όπως δίσκους, ταμπούρα, δαγκάνες, σιαγόνες και τακάκια.
- ▶ **Εξατμίζεται** γρήγορα χωρίς να αφήνει κατάλοιπα.

Καθαρίζει δίσκους, δαγκάνες, ταμπούρα & τακάκια από σκόνη, γράσα και κάπνα

ΚΩΔΙΚΟΣ	ΠΕΡΙΓΡΑΦΗ	ΣΥΣΚ	€/ΤΕΜ
520119	500ml	15	3,60

Παρασκευάζεται στην Ελλάδα | www.n-gr.gr



ΓΡΑΣΟ ΛΙΘΙΟΥ

ΕΝΙΣΧΥΜΕΝΟ ΜΕ ΤΕΦΛΟΝ

- ▶ Λιπαντικό
- ▶ Αντιτριβικό



- ▶ Το γράσο λιθίου **N-GR Lithium Grease** είναι ενισχυμένο με τεφλόν, υλικό γνωστό για τις **αντιτριβικές του ιδιότητες**.
- ▶ Είναι **εξαιρετικά διεισδυτικό**, με αντοχή έως τους 120 βαθμούς Κελσίου.
- ▶ Το ψεκαζόμενο προϊόν είναι σε υγρή μορφή ώστε να μπορεί να **διεισδύει** ακόμα και σε δύσκολα σημεία και έπειτα αποκτά την παστώδη υφή του γράσου.
- ▶ Παραμένει μαλακό **χωρίς όμως να τρέχει ή να λιώνει** επιτυγχάνοντας έτσι **μακροχρόνια λίπανση** τόσο σε υψηλές όσο και σε χαμηλές θερμοκρασίες.
- ▶ **ΙΔΑΝΙΚΟ** για χρήση σε γρανάζια, αλυσίδες, ρουλεμάν, τροχαλίες, ελατήρια, ντίζες, πόλους μπαταριών, γκαραζόπορτες κ.λπ..

ΛΙΠΑΝΣΗ ΠΟΥ "ΔΙΑΡΚΕΙ"

ΚΩΔΙΚΟΣ	ΠΕΡΙΓΡΑΦΗ	ΣΥΣΚ	€/ΤΕΜ
520300	500ml	15	5,90

Παρασκευάζεται στην Ελλάδα | www.n-gr.gr



ΣΠΡΕΙ ΑΝΤΙΣΚΩΡΙΑΚΟ LBS 3500

ΤΟΜΕΙΣ ΕΦΑΡΜΟΓΩΝ

Ξεμπλοκάρει παξιμάδια, βίδες και μηχανικά εξαρτήματα τα οποία έχουν μπλοκαριστεί από την σκουριά. Λιπαίνει κινούμενους μηχανισμούς, ηλεκτρονικά εξαρτήματα, εξαρτήματα αυτοκινήτων, ποδηλάτων, ραπτικών μηχανών, εργαλείων, κ.ά. Προσφέρει αντι-οξειδωτική λειτουργία για ηλεκτρικές και ηλεκτρονικές επαφές. Απομακρύνει το νερό ή την υγρασία από τις επιφάνειες. Προστατεύει από το πάγωμα μηχανικά μέρη των αυτοκινήτων και εξαρτήματα κινητήρων. Καθαρίζει και αφαιρεί γράσσα, λάδια, κόλλες, κλπ. Είναι κατάλληλο για ναυτιλιακές εφαρμογές σε σκάφη, εξοπλισμό ψαρέματος, και εξαρτήματα μηχανών τα οποία βρίσκονται σε επαφή με το θαλασσινό νερό.

ΚΩΔΙΚΟΣ	ΠΕΡΙΓΡΑΦΗ	ΣΥΣΚ	€/ΤΕΜ
153600	200ml	12	2,40
153500	400ml	12	3,65
153501	400ml ΜΕ ΕΙΔΙΚΗ ΒΑΛΒΙΔΑ	12	4,10

NEO

QUANTUM PENETRATING OIL

Διεισδυτικό λιπαντικό πολλαπλών χρήσεων σε μορφή σπρέι για καθαρισμό, λίπανση, προστασία και ξεμπλοκάρισμα μηχανικών εξαρτημάτων.

Δεν περιέχει προωθητικά που βλάπτουν το όζον (φθοριομένους υδρογονάνθρακες).

 **ΜΕ ΕΙΔΙΚΗ ΒΑΛΒΙΔΑ**
NEO

ΣΠΡΕΙ SILICONE

ΤΟΜΕΙΣ ΕΦΑΡΜΟΓΩΝ

Λιπαίνει και προστατεύει διαφόρων ειδών εξαρτήματα (μεταλλικά, πλαστικά, ελαστικά) από τη φθορά και το τρίξιμο. Εφαρμόζεται σε πόρτες, κλειδαριές, μεντεσέδες, ράουλα, κ.α. Εμποδίζει το πάγωμα και τη σκλήρυνση των ελαστικών. Είναι κατάλληλο για αδιαβροχοποίηση επιφανειών όπως υφάσματα, ξύλα, τέντες, ομπρέλες, κ.ά.. Είναι επίσης κατάλληλο σαν αντικολλητικό για εφαρμογές καλοπιών.

ΚΩΔΙΚΟΣ	ΠΕΡΙΓΡΑΦΗ	ΣΥΣΚ	€/ΤΕΜ
159226	400ml ΣΙΛΙΚΟΝΗΣ	6	3,95

QUANTUM SILICONE SPRAY

Σπρέι σιλικόνης για λίπανση, προστασία και αδιαβροχοποίηση μεταλλικών, πλαστικών και ελαστικών εξαρτημάτων. Δημιουργεί ένα διάφανο και αντικολλητικό φιλμ.

Παρουσιάζει εξαιρετική αντοχή στην ηλιακή ακτινοβολία καθώς και στις υψηλές και χαμηλές θερμοκρασίες (θερμοκρασιακή αντοχή από -50 °C έως +200 °C).



ΣΠΡΕΙ GREASE

ΤΟΜΕΙΣ ΕΦΑΡΜΟΓΩΝ

Το Quantum Spray Grease έχει ευρεία χρήση σε αγροτικά μηχανήματα, οχήματα, μηχανοκίνητα δίκυκλα, βιομηχανικά εξαρτήματα, κ.ά.. Είναι ιδιαίτερα κατάλληλο για αλυσίδες ή μάντες μετάδοσης κίνησης που υπόκεινται σε υψηλά φορτία και αναπτύσσονται υψηλές θερμοκρασίες.

ΚΩΔΙΚΟΣ	ΠΕΡΙΓΡΑΦΗ	ΣΥΣΚ	€/ΤΕΜ
159225	400ml ΛΙΠΑΝΤΙΚΟ	6	4,60

QUANTUM GREASE SPRAY

Είναι γράσσο λιθίου σε μορφή σπρέι υψηλών απαιτήσεων, κατάλληλο για τη λίπανση αλυσίδων, ρουλεμάν ή άλλων κινούμενων μηχανικών εξαρτημάτων. Παρουσιάζει υψηλή μηχανική και θερμική αντοχή. Εμποδίζει τη φθορά και το κόλλημα των μηχανικών μερών. Προστατεύει από τη διάβρωση και από τις καιρικές συνθήκες. Είναι ανθεκτικό σε ήπια οξέα και βάσεις. Παρουσιάζει υδατο-απωθητικές ιδιότητες. Είναι εύκολο στη χρήση με στοχευμένο ψεκάσμο. Δεν στάζει όταν εφαρμόζεται ακόμα και σε κάθετες επιφάνειες. Δεν περιέχει προωθητικά που βλάπτουν το όζον (φθοριομένους υδρογονάνθρακες).

ΣΠΡΕΪ CONTACT CLEANER



ΤΟΜΕΙΣ ΕΦΑΡΜΟΓΩΝ

Είναι κατάλληλο για καθαρισμό ηλεκτρικών επαφών, διακοπών, μπαταριών, μπριζών, ηλεκτρονικών κυκλωμάτων, ηλεκτρικών πινάκων, κ.ά..

ΚΩΔΙΚΟΣ	ΠΕΡΙΓΡΑΦΗ	ΣΥΣΚ	€/ΤΕΜ
159227	400ml ΚΑΘΑΡΙΣΤΙΚΟ ΕΠΑΦΩΝ	6	3,95

QUANTUM CONTACT CLEANER SPRAY

Σπρέι για τον καθαρισμό των ηλεκτρικών επαφών, με υψηλή διεισδυτική ικανότητα. Είναι μη αγώγιμο, δεν αφήνει υπολείμματα και δεν διαβρώνει τις μεταλλικές επιφάνειες. Απομακρύνει άμεσα σκόνη, ρύπους και υγρασία.

ΣΠΡΕΪ BRAKE CLEANER



ΤΟΜΕΙΣ ΕΦΑΡΜΟΓΩΝ

Κατάλληλο για τον καθαρισμό των δισκώφρενων, των ταμπουρών, των δαγκάνων, των τακακιών, κ.ά...

ΚΩΔΙΚΟΣ	ΠΕΡΙΓΡΑΦΗ	ΣΥΣΚ	€/ΤΕΜ
159220	400ml ΚΑΘΑΡΙΣΤΙΚΟ ΦΡΕΝΩΝ	6	3,50

QUANTUM BRAKE CLEANER

Ισχυρό καθαριστικό για τα φρένα οχημάτων. Καθαρίζει από τα υπολείμματα λαδιών, κάπνας, σκόνης, κ.ά.. Παρουσιάζει ισχυρή καθαριστική ικανότητα, χωρίς να αφήνει υπολείμματα. Δεν είναι αγώγιμο και δεν είναι διαβρωτικό. Παρουσιάζει ταχύτατο στέγνωμα.

ΣΠΡΕΪ BUMPER



ΤΟΜΕΙΣ ΕΦΑΡΜΟΓΩΝ

Είναι κατάλληλο για βαφή φθαρμένων πλαστικών προφυλακτήρων. Δημιουργεί ένα σατινέ φινιρίσμα με μεγάλη αντοχή στις μηχανικές καταπονήσεις. Παρουσιάζει εξαιρετική πρόσφυση σε μεγάλη ποικιλία υποστρωμάτων όπως μέταλλα, αλουμίνιο, διαφόρων ειδών πλαστικά, ξύλο, γυαλί, πέτρες, σκυρόδεμα, κ.ά..

ΚΩΔΙΚΟΣ	ΠΕΡΙΓΡΑΦΗ	ΣΥΣΚ	€/ΤΕΜ
159224	400ml ΒΑΦΗ ΠΡΟΦΥΛΑΚΤΗΡΑ	6	3,85

QUANTUM BUMPER SPRAY

Το BUMPER SPRAY είναι ταχυστέγνωτο χρώμα σε μορφή σπρέι ακρυλικής βάσεως, κατάλληλο για βαφή προφυλακτήρων. Στεγνώνει γρήγορα και δεν κρεμάει ακόμα και όταν εφαρμόζεται σε κάθετες επιφάνειες. Έχει εξαιρετική αντοχή στη UV ακτινοβολία και μεγάλη αντοχή στα χτυπήματα και τις γρατζουνιές. Διαθέτει εξαιρετική πρόσφυση σε επιφάνειες από σκληρά πλαστικά, με εξαίρεση το πολυαιθυλένιο, το πολυπροπυλένιο και το τεφλόν. Παρουσιάζει μεγάλη καλυπτική ικανότητα. Δεν περιέχει προωθητικά που βλάπτουν το όζον.

UNDERBODY COATING SPRAY



ΤΟΜΕΙΣ ΕΦΑΡΜΟΓΩΝ

Εφαρμόζεται για την προστασία του κάτω μέρους των αμαξωμάτων.

ΚΩΔΙΚΟΣ	ΠΕΡΙΓΡΑΦΗ	ΣΥΣΚ	€/ΤΕΜ
159219	400ml UNDERBODY COATING	6	4,20

QUANTUM UNDERBODY COATING SPRAY

Προστατευτικό από ελαστικό καουτσούκ για την προστασία των αφανών επιφανειών των αμαξωμάτων. Είναι εξαιρετικά ελαστικό με άριστη πρόσφυση στις εφαρμοζόμενες επιφάνειες και με ηχο-απορροφητικές ιδιότητες. Προστατεύει το αμάξιμα από τη διάβρωση, την υγρασία, τις πέτρες ή τα χαλίκια του οδοστρώματος, κ.ά.. Μπορεί να βαφτεί με υδατοδιαλυτά χρώματα και με τα συνήθη χρώματα αυτοκινήτου.

**ΤΟΜΕΙΣ ΕΦΑΡΜΟΓΩΝ**

Κατάλληλο για την προστασία και το γυάλισμα των ταμπλό και των υπόλοιπων πλαστικών επιφανειών του αυτοκινήτου.

ΣΠΡΕΙ COCKPIT

ΚΩΔΙΚΟΣ	ΠΕΡΙΓΡΑΦΗ	ΣΥΣΚ	€/ΤΕΜ
159221	400ml ΓΥΑΛΙΣΤΙΚΟ ΤΑΜΠΛΟ	6	3,50

QUANTUM COCKPIT SPRAY

Γυαλιστικό ταμπλό με βάση τη σιλικόνη. Προσφέρει μακρόχρονη γυαλάδα και προστασία ενώ ταυτόχρονα αρωματίζει ευχάριστα το εσωτερικό του οχήματος. Εμποδίζει την επικάλυψη της σκόνης. Είναι αντιστατικό. Δεν ξεραίνεται ούτε εξατμίζεται από την έκθεση του στην ηλιακή ακτινοβολία.

**ΤΟΜΕΙΣ ΕΦΑΡΜΟΓΩΝ**

Κατάλληλο για τον καθαρισμό των καθισμάτων, των πατακιών, των μοκετών και των υφασμάτων των επιφανειών στο εσωτερικό των οχημάτων.

ΣΠΡΕΙ FOAM CLEANER

ΚΩΔΙΚΟΣ	ΠΕΡΙΓΡΑΦΗ	ΣΥΣΚ	€/ΤΕΜ
159222	400ml ΚΑΘΑΡΙΣΤΙΚΟ ΑΦΡΟΥ	6	4,15

QUANTUM FOAM CLEANER SPRAY

Υψηλής ποιότητας καθαριστικός αφρός ταπετσαρίας και υφασμάτων. Καθαρίζει γρήγορα και αποτελεσματικά τα υφάσματα από λίπη, λάδια, βρωμιά, ενώ ταυτόχρονα αρωματίζει ευχάριστα το σαλόνι του αυτοκινήτου. Στεγνώνει γρήγορα χωρίς να αφήνει κατάλοιπα.

**ΣΠΡΕΙ ANTI-SPATTER**

ΚΩΔΙΚΟΣ	ΠΕΡΙΓΡΑΦΗ	ΣΥΣΚ	€/ΤΕΜ
159230	400ml	6	3,95

QUANTUM ANTI-SPATTER SPRAY

Το QUANTUM ANTI-SPATTER είναι ένα μη διαβρωτικό προστατευτικό υγρό σε μορφή σπρέι, το οποίο δεν επιτρέπει στα ρινίσματα «πιτσιλιές» που δημιουργούνται κατά τη συγκόλληση να προσκολληθούν στο αντικείμενο. Διαλύεται στο νερό και καθαρίζεται εύκολα. Δεν περιέχει ουσίες σιλικόνης. Χρώμα: διάφανο.



ΥΠΕΡ ΔΙΑΦΑΝΗ



ΘΕΡΜΟΚΟΛΛΑ ΚΙΛΟΥ - ΥΠΕΡ ΔΙΑΦΑΝΗ

ΚΩΔΙΚΟΣ	Ø(mm)	L(mm)	ΣΥΣΚ	€/Kg
2040050	11	300	25	8,30



WORKING TEMPERATURE
TEMPERATURA PRACY
170~200°C

SOFTENING POINT
TEMPERATURA MIĘKNIENIA
85+/-2°C

OPEN TIME
CZAS OTWARTY
20~30 s

Ø
7.2mm

Ø
11.2mm

ΘΕΡΜΟΚΟΛΛΕΣ



ΚΩΔΙΚΟΣ	YATO	Ø(mm)	L(mm)	TEM	ΣΥΣΚ	€/TEM
ΔΙΑΦΑΝΗ						
20082440	YT-82440	7.2	200	10	50	1,70
ΜΑΥΡΗ						
20082441	YT-82441	7.2	100	12	50	1,30
20082433	YT-82433	11.2	200	5	40	2,10
ΚΟΚΚΙΝΗ						
20082442	YT-82442	7.2	100	12	50	1,30
20082434	YT-82434	11.2	200	5	40	2,10
ΜΠΛΕ						
20082443	YT-82443	7.2	100	12	50	1,30
20082435	YT-82435	11.2	200	5	40	2,10
ΠΡΑΣΙΝΗ						
20082444	YT-82444	7.2	100	12	50	1,30
20082436	YT-82436	11.2	200	5	40	2,10
ΚΙΤΡΙΝΗ						
20082445	YT-82445	7.2	100	12	50	1,30
20082437	YT-82437	11.2	200	5	40	2,10
ΛΕΥΚΗ						
20082446	YT-82446	7.2	100	12	50	1,30
20082438	YT-82438	11.2	200	5	40	2,10
ΚΑΦΕ						
20082447	YT-82447	7.2	100	12	50	1,30
20082439	YT-82439	11.2	200	5	40	2,10

**ΤΟΜΕΙΣ ΕΦΑΡΜΟΓΩΝ**

Είναι κατάλληλη για βιομηχανικές εφαρμογές, για οικιακή χρήση, για μοντελισμό, κ.ά..

Παρουσιάζει ισχυρή πρόσφυση σε γυαλιά, μέταλλα, ξύλα, πλαστικά, κεραμικά, ελαστικά, δέρματα, κ.ά..

Είναι ιδιαίτερα κατάλληλη για κολλήσεις και ενώσεις των ελαστικών παρεμβυσμάτων στα κουφώματα αλουμινίου.

QUICK GRAB

ΚΩΔΙΚΟΣ	ΠΕΡΙΓΡΑΦΗ	ΣΥΣΚ	€/ΤΕΜ
151710	20gr ΔΙΑΦΑΝΟ	20	3,70

QUICK GRAB

Η QUICK GRAB είναι κόλλα στιγμής κυανοακρυλικής βάσης για ευρεία γκάμα εφαρμογών. Κολλάει άμεσα και δυνατά με μία μόνο σταγόνα.

**ΤΟΜΕΙΣ ΕΦΑΡΜΟΓΩΝ**

Είναι κατάλληλο για συγκολλήσεις μεγάλης ποικιλίας υλικών όπως κεραμικά, γυαλί, ξύλο, δέρμα, κάποια είδη πλαστικών, μέταλο, μάρμαρο, πορσελάνη, κ.ά..

Δεν είναι κατάλληλο για εφαρμογή σε πολυαιθυλένιο, πολυπροπυλένιο, τεφλόν και σιλικόνη. Είναι ιδιαίτερα κατάλληλο για συγκολλήσεις μεγάλων επιφανειών λόγω του μεγάλου ανοιχτού χρόνου εφαρμογής.

EPOXY UNIVERSAL

ΚΩΔΙΚΟΣ	ΠΕΡΙΓΡΑΦΗ	ΣΥΣΚ	€/ΤΕΜ
151810	28ml	12	4,15

EPOXY UNIVERSAL

Το ELASTOTET EPOXY UNIVERSAL είναι ένα ισχυρό εποξειδικό συγκολλητικό, δύο συστατικών με μεγάλο χρόνο εφαρμογής (30 λεπτά). Διατίθεται σε εύχρηστη συσκευασία διπλής σύριγγας η οποία αδειάζει ίση ποσότητα από το κάθε συστατικό. Είναι ανθεκτικό στο νερό, στα αλκάλια και στα διαλύματα οξέων. Δεν αλλοιώνεται χρωματικά, δεν σπάει ούτε συρρικνώνεται τόσο κατά τη διάρκεια όσο και μετά την σκλήρυνσή του. Μπορεί να βαφεί, να γυαλοχαρτιστεί και να τρυπηθεί.

**ΤΟΜΕΙΣ ΕΦΑΡΜΟΓΩΝ**

Είναι κατάλληλο για συγκολλήσεις μεγάλης ποικιλίας υλικών όπως ασάλι, ανοξείδωτο ασάλι, αλουμίνιο, μπρούτζο, γαλβανισμένη λαμαρίνα, χαλκό, ξύλο, πέτρα, κάποια είδη πλαστικών, κ.ά.. Δεν είναι κατάλληλο για εφαρμογή σε πολυαιθυλένιο, πολυπροπυλένιο, τεφλόν και σιλικόνη. Είναι ιδιαίτερα κατάλληλο για εφαρμογή σε υλικά τα οποία υπόκεινται σε ακραίες συνθήκες, όπως υψηλές θερμοκρασίες, έντονες δονήσεις, θαλασινό νερό, κ.ά..

EPOXY METAL

ΚΩΔΙΚΟΣ	ΠΕΡΙΓΡΑΦΗ	ΣΥΣΚ	€/ΤΕΜ
151811	28ml	12	4,65

EPOXY METAL

Το ELASTOTET EPOXY METAL είναι ένα ισχυρό εποξειδικό συγκολλητικό, δύο συστατικών, γεμισμένο με ρινίσματα ανοξείδωτου μετάλλου. Διατίθεται σε εύχρηστη συσκευασία διπλής σύριγγας η οποία αδειάζει ίση ποσότητα από το κάθε συστατικό. Είναι ανθεκτικό στο νερό, στα αλκάλια και στα διαλύματα οξέων. Δεν αλλοιώνεται χρωματικά, δεν σπάει και ούτε συρρικνώνεται τόσο κατά τη διάρκεια όσο και μετά την σκλήρυνσή του. Μπορεί να βαφεί, να γυαλοχαρτιστεί και να τρυπηθεί.

**ΤΟΜΕΙΣ ΕΦΑΡΜΟΓΩΝ**

Είναι κατάλληλο για συγκολλήσεις μεγάλης ποικιλίας υλικών όπως κεραμικά, γυαλί, ξύλο, δέρμα, κάποια είδη πλαστικών, μέταλο, μάρμαρο, πορσελάνη, κ.ά..

Δεν είναι κατάλληλο για εφαρμογή σε πολυαιθυλένιο, πολυπροπυλένιο, τεφλόν και σιλικόνη.

EPOXY FAST

ΚΩΔΙΚΟΣ	ΠΕΡΙΓΡΑΦΗ	ΣΥΣΚ	€/ΤΕΜ
151812	28ml	12	4,65

EPOXY FAST

Το ELASTOTET EPOXY FAST είναι ένα ισχυρό εποξειδικό συγκολλητικό, δύο συστατικών, γρήγορης σκλήρυνσης. Διατίθεται σε εύχρηστη συσκευασία διπλής σύριγγας η οποία αδειάζει ίση ποσότητα από το κάθε συστατικό. Είναι ανθεκτικό στο νερό, στα αλκάλια και στα διαλύματα οξέων. Δεν αλλοιώνεται χρωματικά, δεν σπάει και ούτε συρρικνώνεται τόσο κατά τη διάρκεια όσο και μετά την σκλήρυνσή του. Μπορεί να βαφεί, να γυαλοχαρτιστεί και να τρυπηθεί.



ΤΟΜΕΙΣ ΕΦΑΡΜΟΓΩΝ

Είναι κατάλληλο για συγκολλήσεις μεγάλης ποικιλίας υλικών όπως ασφάλι, αλουμίνιο, ξύλο, πέτρα, πλακάκια, μπετόν, κεραμικά, κ.α. Είναι ιδιαίτερα κατάλληλο για τα περισσότερα σκληρά πλαστικά, όπως PVC, fiberglass, plexiglass, πολυκαρβονικά και πολλά άλλα. Δεν είναι κατάλληλο για εφαρμογή σε πολυαιθυλένιο, πολυπροπυλένιο, τεφλόν και σιλικόνη.

EPOXY PLASTIC

ΚΩΔΙΚΟΣ	ΠΕΡΙΓΡΑΦΗ	ΣΥΣΚ	€/ΤΕΜ
151813	28ml	12	6,05

EPOXY PLASTIC

Το ELASTOTET EPOXY PLASTIC είναι ένα ισχυρό συγκολλητικό, δύο συστατικών, με βάση το methylmethacrylate. Είναι ιδιαίτερα κατάλληλο για έκθεση σε ακραίες καιρικές συνθήκες, (ακτινοβολία UV, νερό, ιδιαίτερα χαμηλές και υψηλές θερμοκρασίες). Διατίθεται σε εύχρηστη συσκευασία διπλής σύριγγας η οποία αδειάζει ίση ποσότητα από το κάθε συστατικό. Είναι ανθεκτικό στο νερό, στα αλκάλια και στα διαλύματα οξέων. Δεν αλλοιώνεται χρωματικά, δεν σπάει και ούτε συρρικνώνεται τόσο κατά τη διάρκεια όσο και μετά την σκλήρυνσή του. Μπορεί να βαφεί, να γυαλοχαρτιστεί και να τρυπηθεί.



ΤΟΜΕΙΣ ΕΦΑΡΜΟΓΩΝ

Ο ELASTOTET EPOXY REPAIR KIT είναι κατάλληλος για γεμίσματα σε ρωγμές και τρύπες σε δεξαμενές, βαρέλια, δοχεία, αντικείμενα οικιακής χρήσης, εργαλεία, αυτοκίνητα, σκάφη αναψυχής, κ.ά..

EPOXY REPAIR KIT

ΚΩΔΙΚΟΣ	ΠΕΡΙΓΡΑΦΗ	ΣΥΣΚ	€/ΤΕΜ
151814	57gr	12	4,65

EPOXY REPAIR KIT

Ο ELASTOTET EPOXY REPAIR KIT είναι ένας ισχυρός εποξειδικός στόκος, κατάλληλος για γεμίσματα σε ρωγμές και τρύπες. Παρουσιάζει εξαιρετική πρόσφυση σε μεγάλη ποικιλία υποστρωμάτων, όπως μπετόν, μέταλα, πέτρα, ξύλο, κάποια είδη πλαστικών, κ.ά.. Δεν είναι κατάλληλος για εφαρμογή σε πολυαιθυλένιο, πολυπροπυλένιο, τεφλόν. Παρουσιάζει αντοχή σε υψηλές θερμοκρασίες (έως +120°C). Είναι αδιάβροχος (κατάλληλος και για εφαρμογές κάτω από το νερό) και κατάλληλος τόσο για εσωτερική όσο και για εξωτερική χρήση. Μπορεί να βαφεί, να γυαλοχαρτιστεί και να τρυπηθεί.



ΤΟΜΕΙΣ ΕΦΑΡΜΟΓΩΝ

Είναι κατάλληλο για οικιακή χρήση, για συγκολλητικές εφαρμογές στην επιπλοποιία, για συγκόλληση μοκετών, συνθετικών πατωμάτων, κ.ά..

GLUE SPRAY

ΚΩΔΙΚΟΣ	ΠΕΡΙΓΡΑΦΗ	ΣΥΣΚ	€/ΤΕΜ
159229	400ml	6	4,50

GLUE SPRAY

Το GLUE SPRAY είναι ταχυστέγνωτη κόλλα σε μορφή σπρέι γενικής χρήσης. Στεγνώνει γρήγορα και δεν κρεμάει ακόμα και όταν εφαρμόζεται σε κάθετες επιφάνειες. Διαθέτει εξαιρετική πρόσφυση σε μεγάλη ποικιλία υποστρωμάτων όπως γυαλιά, ξύλα, μέταλλα, πλαστικά, δέρματα, υφάσματα, χαρτόνια, ελαστικά, κ.ά.. Είναι κατάλληλο για συγκολλήσεις μεγάλων επιφανειών. Δεν περιέχει προωθητικά που βλάπτουν το όζον.



PU MARINE ADHESIVE 105

ΤΟΜΕΙΣ ΕΦΑΡΜΟΓΩΝ

Το PU MARINE ADHESIVE 105 είναι ιδιαίτερα κατάλληλο για ισχυρές συγκολλήσεις ανάμεσα σε ξύλο και άλλα ετεροειδή υλικά, σε πληθώρα βιομηχανικών και ναυτιλιακών εφαρμογών. Κολλά σε όλα τα υλικά όπως ξύλο, αλουμίνιο, σκυρόδεμα, πλακάκια κ.ά.. Μετά τον πολυμερισμό του, το προϊόν παραμένει εντελώς αδιάβροχο.

ΚΩΔΙΚΟΣ	ΠΕΡΙΓΡΑΦΗ	ΣΥΣΚ	€/ΤΕΜ
151511	200gr ΜΕΛΙ	1	4,25
151510	750gr ΜΕΛΙ	1	9,70

PU MARINE ADHESIVE 105

Το PU MARINE ADHESIVE 105 είναι ένα ισχυρό συγκολλητικό ενός συστατικού με βάση ρητίνες πολυουρεθάνης, το οποίο αναπτύσσει τις μηχανικές και συγκολλητικές του ιδιότητες σε επαφή με την ατμοσφαιρική υγρασία. Είναι λεπτόρευστο με υψηλή διεισδυτικότητα. Έχει ιδιαίτερα υψηλή χημική αντοχή. Παρουσιάζει ήπια διόγκωση κατά τον πολυμερισμό του. Δεν περιέχει διαλύτες. Επιδέχεται βαφή μετά το στέγνωμά του.



PVC ADHESIVE 630

ΤΟΜΕΙΣ ΕΦΑΡΜΟΓΩΝ

Κατάλληλη για πλαστικές σωληνώσεις PVC ύδρευσης και αποχέτευσης. Είναι ιδιαίτερα κατάλληλη για σωληνώσεις σε πσίνες διαμέτρου έως 350 mm.

ΚΩΔΙΚΟΣ	ΠΕΡΙΓΡΑΦΗ	ΣΥΣΚ	€/ΤΕΜ
151613	80ml ΔΙΑΦΑΝΟ	1	3,00
151611	250ml ΔΙΑΦΑΝΟ	1	5,25
151611-1	250ml ΓΚΡΙ	1	5,25
151612	500ml ΔΙΑΦΑΝΟ	1	9,25
151612-1	500ml ΓΚΡΙ	1	9,25

PVC ADHESIVE 630

Η PVC ADHESIVE 630 είναι κόλλα με βάση τον διαλύτη για συγκολλήσεις σκληρού PVC. Είναι ιδανική για μόνιμες συγκολλήσεις σε υδραυλικές σωληνώσεις από PVC. Διαθέτει εξαιρετική δύναμη συγκόλλησης και μεγάλη ταχύτητα σκληρυνσης. Παρουσιάζει υψηλή αντοχή στο νερό, στα ανόργανα οξέα, στις θερμοκρασιακές μεταβολές και στους κραδασμούς. Κολλάει και ταυτόχρονα γεμίζει τα διάκενα των σωληνώσεων.

502 Συγκολλητικό Ξύλου Γενικής Χρήσης



ΜΕ ΚΑΠΑΚΙ
ΠΟΛΛΑΠΛΗ
ΧΡΗΣΕΩΝ



Το **502 Wood Adhesive** είναι υψηλής ποιότητας συγκολλητικό ξύλου βάσεως ρητινών, για εργασίες συγκόλλησης ξυλείας όλων των τύπων. Μπορεί να χρησιμοποιηθεί σε εσωτερικές και εξωτερικές εφαρμογές. Διαθέτει ισχυρή δύναμη συγκόλλησης, είναι ανθεκτικό σε κρούσεις και συνήθως ισχυρότερο από το ίδιο το σώμα του ξύλου. Είναι ιδανικό για όλες τις γενικές εργασίες ξυλουργικής, για συναρμολόγηση ξυλείας και οικιακές εφαρμογές. Είναι ταχείας ωρίμανσης και πήζει εντός 10 λεπτών. Όταν σκληραίνει γίνεται διαφανές.

Πληροί τις απαιτήσεις του προτύπου **EN 204 (D3)** και **BS EN 14256** για αντίσταση σε ερπυσμό.

ΚΩΔΙΚΟΣ	ΠΡΟΪΟΝ	ΧΡΩΜΑ	ΣΥΣΚ	ΤΜΧ /Κιβ	Κιβ/ ΠΛΤ	ΤΙΜΗ/ ΤΜΧ(€)
483366	502ΜΠΟΥΚΑΛΙ	-	125ml	12	135	3.26
482248	502 ΜΠΟΥΚΑΛΙ	-	250ml	12	120	4.21
482247	502 ΔΟΧΕΙΟ	-	500ml	20	40	6.83

Συγκολλητικό Σπρέυ για μοκέτες και χαλιά



Το **Spray Adhesive** είναι έτοιμο για χρήση, μαγνητικό συγκολλητικό δαπέδων βάσης διαλύτη. Σταθεροποιεί τις άκρες από τις μοκέτες, και χρησιμεύει ιδιαίτερα στην ενίσχυση των δύσκολων σημείων, όπως στις ακμές σκαλοπατιών, πλαστικών και ξύλινων σοβατεπιών. Προσφύεται στις περισσότερες κοινές επιφάνειες, συμπεριλαμβανοντας ξύλο, μοκέτα, μέταλλο, πέτρα, σκυρόδεμα, PVCu και πολλές άλλες.

ΚΩΔΙΚΟΣ	ΠΡΟΪΟΝ	ΧΡΩΜΑ	ΣΥΣΚ	ΤΜΧ /Κιβ	Κιβ/ ΠΛΤ	ΤΙΜΗ/ ΤΜΧ(€)
483334	SPRAY ADHESIVE	-	500ml	12	114	6.85

Κόλλα Στιγμής Βιομηχανικών Χρήσεων



PVCu
Πλαστικά
Γυαλί
Μέταλλα



Το **Industrial Superglue GP** είναι μεσαίου ιξώδους συγκολλητικό για ανοχές έως και 0,1mm.

Κατάλληλο για εφαρμογές μικρού πάχους με απαίτηση για ταχεία πήξη. Συγκολλά τις περισσότερες μη πορώδεις επιφάνειες, όπως π.χ. πλαστικά, μέταλλα, γυαλί, PVCu, καουτσούκ και EPDM.

Ιξώδες στους 25°C-100 cps.

Πήζει σε 5-15 δευτερόλεπτα.

Παρέχεται σε ειδική συσκευασία ραφίου.

ΚΩΔΙΚΟΣ	ΠΡΟΪΟΝ	ΧΡΩΜΑ	ΣΥΣΚ	ΤΜΧ /ΚΙΒ	ΚΙΒ/ ΠΛΤ	ΤΙΜΗ/ ΤΜΧ(€)
484651	IND SUPERGLUE GP	ΔΙΑΦΑΝΟ	20GR	25	16	6.25

Βενζινόκολλα

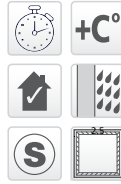

Laminates
Ξύλο
Φελλός
Μέταλλα



Το **Stick2 Contact Adhesive** είναι εξαιρετικής απόδοσης συγκολλητικό ταχείας ωρίμανσης, κατάλληλο για εσωτερική και εξωτερική χρήση, για υποστρώματα όπως laminate, ξύλο, σκληρό PVC, ABS, δέρμα, φελλό και μέταλλα.

Άμεση συγκόλληση σε 1 λεπτό.

ΚΩΔΙΚΟΣ	ΠΡΟΪΟΝ	ΧΡΩΜΑ	ΣΥΣΚ	ΤΜΧ /ΚΙΒ	ΚΙΒ/ ΠΛΤ	ΤΙΜΗ/ ΤΜΧ(€)
489420	S2 CONTACT ADH	ΜΠΕΖ	30ml	10	24	6.00

Διάφανο Συγκολλητικό Σκληρών Πλαστικών



Πλαστικά
Ακρυλικά
ABS
Σκληρό PVC



Το **Stick2 Hard Plastic Adhesive** είναι ισχυρό, διάφανο συγκολλητικό με γρήγορο στέγνωμα, κατάλληλο για συγκόλληση των περισσότερων τύπων πλαστικών, όπως σκληρό PVC, ακρυλικά, πολυκαρβονικά και ABS.

Ιδανικό για σωληνώσεις που δεν βρίσκονται υπό πίεση, εξαρτήματα αυτοκινήτων και για πολλές οικιακές εφαρμογές.

ΚΩΔΙΚΟΣ	ΠΡΟΪΟΝ	ΧΡΩΜΑ	ΣΥΣΚ	ΤΜΧ /ΚΙΒ	ΚΙΒ/ ΠΛΤ	ΤΙΜΗ/ ΤΜΧ(€)
482347	S2 H.PLASTIC ADH	ΔΙΑΦΑΝΟ	30ml	10	24	6.20

Εποξειδικό Συγκολλητικό Στιγμής 2 Συστ. σε σύριγγα



Μέταλλα
Γυαλί
Ξύλο
Κεραμικά



Το **Stick2 Rapid Epoxy Adhesive -Syringe** είναι ισχυρό, δύο συστατικών, διαφανές συγκολλητικό που σκληραίνει εντός μόλις 4 λεπτών. Προσφύεται στα περισσότερα υλικά και αφού ωριμάσει μπορεί να τρυπηθεί, να τριφτεί και να βαφτεί. Κατάλληλο για βιομηχανική και οικιακή χρήση.

ΚΩΔΙΚΟΣ	ΠΡΟΪΟΝ	ΧΡΩΜΑ	ΣΥΣΚ	ΤΜΧ /ΚΙΒ	ΚΙΒ/ ΠΛΤ	ΤΙΜΗ/ ΤΜΧ(€)
483851	S2 RAPID-EPOXY SYRINGE	ΔΙΑΦΑΝΟ	24ml	12	12	11.87

Κόλλα Στιγμής Γενικής Χρήσης σε σωληνάριο



PVCu
Πλαστικά
Γυαλί
Μέταλλα

1 + 1 ΔΩΡΟ!



Το **Stick2 All Purpose Superglue Tube** είναι κυανοακρυλική κόλλα κατάλληλη για ανοχές έως και 0,1mm. Συγκολλά μη πορώδεις επιφάνειες, όπως πλαστικά, μέταλλα, PVCu, καουτσούκ, κεραμικά και πολλά άλλα. Άμεση συγκόλληση σε 1 λεπτό.

ΚΩΔΙΚΟΣ	ΠΡΟΪΟΝ	ΧΡΩΜΑ	ΣΥΣΚ	ΤΜΧ /ΚΙΒ	ΚΙΒ/ ΠΛΤ	ΤΙΜΗ/ ΤΜΧ(€)
483372	S2 AP SUPERGLUE TUBE	ΔΙΑΦΑΝΟ	3GR	12	30	3.30

Θιξοτροπική Κόλλα Στιγμής



PVCu
Πλαστικά
Γυαλί
Μέταλλα



Το **Stick2 Superglue Gel** μια κυανοακρυλική κόλλα στιγμής σε μορφή gel με πρόσφυση στα περισσότερα κοινά υποστρώματα.

Η υψηλού ιξώδους φόρμουλά του το καθιστά ιδανικό για κατακόρυφες εφαρμογές.

Δεν τρέχει και λειτουργεί ως πληρωτικό σε μικρά κενά και πορώδη υποστρώματα.

ΚΩΔΙΚΟΣ	ΠΡΟΪΟΝ	ΧΡΩΜΑ	ΣΥΣΚ	ΤΜΧ /ΚΙΒ	ΚΙΒ/ ΠΛΤ	ΤΙΜΗ/ ΤΜΧ(€)
482348	S2 SUPERGLUE GEL	ΔΙΑΦΑΝΟ	3GR	12	20	3.90



BORO
Κυανοακρυλική
κόλλα στιγμής

ΚΩΔΙΚΟΣ	ΠΡΟΪΟΝ	ΣΥΣΚ	€ ΤΕΜ
80100106	6 GR	12	2.45

Κυανοακρυλική κόλλα στιγμής, σε μπουκαλάκι που τη διατηρεί και μετά το άνοιγμα της, χωρίς να στεγνώνει. Κολλάει μία πολύ μεγάλη ποικιλία υλικών όπως: μέταλλα, πλαστικά ή ελαστομερή, αλλά και άλλες πιο δύσκολες, προς συγκόλληση, επιφάνειες όπως: χαρτί, χαρτόνι, φελλό, ξύλο, δέρμα, ύφασμα, κεραμικά κ.λπ..



BORO ΚΟΛΛΗΤΗΣ
Βενζινόκολλα
γενικής χρήσης

ΚΩΔΙΚΟΣ	ΠΡΟΪΟΝ	ΣΥΣΚ	€ ΤΕΜ
80100107	-	12	2.05

Βενζινόκολλα γενικής χρήσης ισχυρή, ταχείας πήξεως, η οποία χρησιμοποιείται για τη συγκόλληση δέρματος, πέτρας, χαρτιού, πλαστικών, ταπετσαρίας-οικιακής και αυτοκινήτου- και πολλές άλλες εφαρμογές που εσείς θα δημιουργήσετε.



BORO F-35
Υπερ-διάφανη
εποξειδική κόλλα.
Γενικής χρήσης

ΚΩΔΙΚΟΣ	ΠΡΟΪΟΝ	ΣΥΣΚ	€ ΤΕΜ
80100103	28 GR	12	7.30

Υπερ-διάφανη εποξειδική κόλλα δύο συστατικών. Γενικής χρήσης, τελείως διαφανής. Προσφύεται σε γυαλί, πορσελάνη, ξύλο, φάμππεργκλάς, κεραμικά κ.λπ.. Χρόνος πήξης 5 λεπτά.

**BORO WELD**

Εποξειδική κόλλα μετάλλων
2 συστατικών 180°C

ΚΩΔΙΚΟΣ	ΠΡΟΪΟΝ	ΣΥΣΚ	€ ΤΕΜ
80100102	6 GR	12	8.00

Αντοχή σε θερμοκρασία έως 180 °C.

Ταχεία πήξη σε 5 λεπτά.

Προσφύεται σε όλα τα υλικά.

Χρώμα ανθρακί.

Εφαρμόζεται σε όλα τα μέταλλα, τσιμέντο, πλακάκια, σκληρό πλαστικό.

Μηχανική αντοχή 25 N/mm² (3600 PSI).

**BORO METAL**

Εποξειδική κόλλα
2 συστατικών 260°C

ΚΩΔΙΚΟΣ	ΠΡΟΪΟΝ	ΣΥΣΚ	€ ΤΕΜ
80100101	28 GR	12	9.30

Περιέχει ειδική ρητίνη μετάλλου που διεγείρεται από τον μαγνήτη έλξη.

Στεγνώνει σε 3 λεπτά.

Αντέχει έως 260°C (500 °F).

Γεμίζει και κολλάει χαλκό, αλουμίνιο, μπρούτζο, αστάλι, χρυσό, ασήμι, τσιμέντο, πέτρα, σκληρά πλαστικά κ.λπ..Επιδέχεται τρύπημα και διάνοιξη σπειρώματος.

Αντέχει σε νερό, πετρέλαιο, βενζίνη, λάδια και άλλα.

Χρησιμοποιείται στο σπίτι, στο αυτοκίνητο, στα αγροτικά μηχανήματα και όποια άλλη εφαρμογή γνωρίσετε μαζί του.

Μηχανική αντοχή 35 N/mm² (4300 PSI).

**BORO PLAST**

Υγρό, σκληρό πλαστικό στιγμής.
Βάφεται, τρίβεται,
διαμορφώνεται.

ΚΩΔΙΚΟΣ	ΠΡΟΪΟΝ	ΣΥΣΚ	€ ΤΕΜ
80100104	-	12	9.70

Κολλάει, γεμίζει κενά, ρήγματα, λιμάρεται και βάφεται, τρυπιέται και διαμορφώνεται σε 1 λεπτό.

Χρησιμοποιείται σε σπασμένους προφυλακτήρες αυτοκινήτων και φέρινγκ μοτοσυκλετών, σε πλαστικά μέρη σκαφών αναψυχής, για την επιδιόρθωση όλων των πλαστικών καλυμμάτων, από hi-fi ή μηχανές γραφείου και 1001 ακόμα εφαρμογές που εσείς θα βρείτε μαζί του.



METAL FILLER 200°C

Ειδική κόλλα για γέμισμα και συμπλήρωμα σε μέταλλο, ξύλο, τσιμέντο

ΚΩΔΙΚΟΣ	ΠΡΟΪΟΝ	ΣΥΣΚ	€ ΤΕΜ
80100105	-	12	10.00

Η METAL FILLER είναι ειδική κόλλα για όλα τα μέταλλα που μπορεί να χρησιμοποιηθεί και σε ξύλο, πέτρα και τσιμέντο. Περιέχει ρινίσματα σιδήρου που μαγνητίζονται.

Αντέχει έως τους 200°C (392 °F).

Στιγμιαίο αποτέλεσμα χωρίς ανακάτεμα.

Τη METAL FILLER μπορείτε να τη χρησιμοποιήσετε ως συμπλήρωμα μετάλλου σε Κάρτερ, κορμούς και μεταλλικά ψυγεία μηχανών εσωτερικής καύσης.

Αντικαθιστά τις κολλήσεις με καλάι στις πλακέτες από τα ολοκληρωμένα κυκλώματα.

Υποβοηθά την αγωγιμότητα της πλακέτας.

Αποκαθιστά το μέταλλο στην ψωρίαση, σε μηχανουργικές εφαρμογές.

Γεμίζει οπές από λάθος υπολογισμούς κατασκευών.

Χρήση σε μοτοσυκλέτες, σκάφη επαγγελματικά και αναψυχής, σε όλα τα είδη των οχημάτων, σε όλες τις αλουμινοκατασκευές, στη βιομηχανία, αγροτικά εργαλεία και σωληνώσεις άρδευσης, όπως επίσης και σε στρατιωτικές εφαρμογές, σε συμπλήρωμα μετάλλου σε οπτικά συστήματα και λουιές εφαρμογές που εσείς θα γνωρίσετε μαζί της, που αφορούν στη δημιουργία και το γέμισμα όλων των μετάλλων.



BORO STICK STEEL 90MM

ΕΠΟΞΙΔΙΚΗ ΚΟΛΛΑ 2 ΣΥΣΤΑΤΙΚΩΝ

ΚΩΔΙΚΟΣ	ΠΡΟΪΟΝ	ΣΥΣΚ	€ ΤΕΜ
80100108	57 ΓΡ	12	7.85

BORO STICK STEEL 90mm

Ειδική εποξειδική κόλλα πλαστελίνης, η οποία δημιουργεί μέταλλο, σε 5 λεπτά. Αντέχει στους 260°C. Κολλάει και επισκευάζει οποιαδήποτε μορφής σπασμένα ή ραγισμένα μεταλλικά εξαρτήματα. Χρησιμοποιείται σε σίδηρο, ατσάλι, αλουμίνιο, χαλκό, μπρούτζο, ξύλο, τσιμέντο, μπετόν, τούβλο και ορισμένα σκληρά πλαστικά.

Μπορεί να τρυπηθεί, να τριφτεί, να το βιάψετε, να του ανοίξετε πάσο, μετά από 1 ώρα. Χρώμα ανθρακί μετάλλου.



BORO 245

ΚΟΛΛΕΣ ΣΠΕΙΡΩΜΑΤΩΝ

ΚΩΔΙΚΟΣ	ΠΡΟΪΟΝ	ΣΥΣΚ	€ ΤΕΜ
80110245	10 ML	12	8.20
80150245	50 ML	12	15.50

BORO 245 Μεσαίου βαθμού ασφάλισης

Είναι ένα προϊόν γενικής χρήσης, μεσαίου βαθμού ασφάλισης, για οποιοδήποτε σπείρωμα.

Είναι αποτελεσματικό σε όλα τα μέταλλα, συμπεριλαμβανομένων και των ενεργών μετάλλων, όπως το ανοξείδωτο ατσάλι, επιμεταλλωμένα, χρωμιωμένα, κάθε τύπου μπουλόνια και βίδες. Ασφαλίζει κατά των κραδασμών και αποσυναρμολογείται με τα συνήθη εργαλεία.

Χρησιμοποιείται σε κινούμενα εξαρτήματα, όπως συμπιεστές, ατέρμονες, σκαπτικά και γεωργικά μηχανήματα, συρόμενα φορτηγά κ.λπ..

Τεχνικά χαρακτηριστικά

Γέμισμα διάκενων: 0,005" (0,1 mm)

Ρευστότητα: 5000 cps

Εύρος θερμοκρασίας: -55 έως 150 °C

Χρόνος ελέγχου: 15 min



BORO 275

Ασφαλιστικό σπειρωμάτων

ΚΩΔΙΚΟΣ	ΠΡΟΪΟΝ	ΣΥΣΚ	€ ΤΕΜ
80110275	10 ML	12	8.20
80150275	50 ML	12	15.50

BORO 275 Υψηλού βαθμού ασφάλισης

Ασφαλίζει σπειρώματα τα οποία δεν χρειάζονται αποσυναρμολόγηση, προσφέροντας υψηλού βαθμού ασφάλιση.

Επιτρέπει σε φθαρμένα μπουλόνια να ξαναχρησιμοποιηθούν. Δεν επηρεάζεται από τα βιομηχανικά υγρά και αέρια και είναι ιδανικό για την ασφάλιση σπειρωμάτων, αντλίες, καλούπια από πρέσες, συνδέσμους αυτοκινήτων, τρένων, τρακτέρ και πολλές άλλες εφαρμογές.

Τεχνικά χαρακτηριστικά

Γέμισμα διάκενων: 0,007" (0,15 mm)

Ρευστότητα: 550 cps

Εύρος θερμοκρασίας: -55 έως 150 °C

Χρόνος ελέγχου: 15 min

Πλήρης σκλήρυνση: 24h



BORO 761

Κόλλα ρουλεμάν

ΚΩΔΙΚΟΣ	ΠΡΟΪΟΝ	ΣΥΣΚ	€ ΤΕΜ
80110761	10 ML	12	8.20
80150761	50 ML	12	15.50

Κόλλα ρουλεμάν Μεσαίου βαθμού ασφάλισης

Χρησιμοποιείται για το γέμισμα του κενού μεταξύ φωλιάς και ρουλεμάν. Αποσυναρμολογείται με συνήθη εργαλεία. Συνιστάται για τη συγκράτηση ρουλεμάν σε άξονες και φθαρμένες φωλιές.

Τεχνικά χαρακτηριστικά

Γέμισμα διάκενων: 0,006" (0,15 mm)

Ρευστότητα: 550 cps

Εύρος θερμοκρασίας: -55 έως 150 °C

Χρόνος ελέγχου: 30 min

Πλήρης σκλήρυνση: 24 h

Στρεπτική αντοχή: 1500 psi (10 N/mm)



BORO 768

Κόλλα για άξονες

ΚΩΔΙΚΟΣ	ΠΡΟΪΟΝ	ΣΥΣΚ	€ ΤΕΜ
80110768	10 ML	12	8.20
80150768	50 ML	12	15.50

Κόλλα για άξονες Υψηλού βαθμού ασφάλισης

και γέμισμα διάκενων εξαρτήματα που δεν χρειάζονται συχνή αποσυναρμολόγηση.

Επιτρέπει την κατασκευή εξαρτημάτων με μεγαλύτερες αντοχές, στεγανοποιεί και σταματά τη σκουριά.

Τεχνικά χαρακτηριστικά

Γέμισμα διάκενων: 0,01" (0,25 mm)

Ρευστότητα: 2000 cps

Στρεπτική αντοχή: 4000 psi (28 N/mm)

Χρόνος ελέγχου: 30 min

Πλήρης σκλήρυνση: 24h



SIKA Masking Tape 60C

ΤΑΙΝΙΑ ΜΑΣΚΑΡΙΣΜΑΤΟΣ ΓΙΑ ΓΕΝΙΚΕΣ ΕΦΑΡΜΟΓΕΣ ΣΤΗΝ ΚΑΤΑΣΚΕΥΗ

ΚΩΔΙΚΟΣ	ΠΡΟΪΟΝ	ΣΥΣΚ	ΤΙΜΗ/ΤΜΧ(€)
552213-1	19MM X 45M	48	0.94
552214-1	25MM X 45M	36	1.24
552215-1	30MM X 45M	30	1.52
552216-1	38MM X 45M	24	1.88
552217-1	50MM X 45M	18	2.48

Περιγραφή

Επαγγελματική ταινία μασκαρίσματος γενικής χρήσης με δυνατό άρπαγμα και αντοχή σε θερμοκρασία 60°C για 30 λεπτά.

Ιδανική για ελαιοχρωματισμούς με βαφές νερού & διαλύτη. Αποτελείται από κορεσμένο ημι-κρεπ χαρτί επικαλυμμένο με συγκολλητικό τύπου SNR και συνεντάσσεται άριστα με τα οικοδομικά σφραγιστικά της Sika καθώς η κόλλα της ταινίας δεν επηρεάζει τον πολυμερισμό τους.



SIKA Washi Tape

ΡΥΖΟΧΑΡΤΟ

ΚΩΔΙΚΟΣ	ΠΡΟΪΟΝ	ΣΥΣΚ	ΤΙΜΗ/ΤΜΧ(€)
552090	25MM X 50M	36	3.45
552091	50MM X 50M	18	7.25

Περιγραφή

Επαγγελματικής χρήσης ταινία μασκαρίσματος, βάσης ακρυλικού συγκολλητικού από λεπτό, ανάγλυφο χαρτί washi (ριζόχαρτο). Ιδανική επιλογή για λεπτές και ακριβείς γραμμές σε εφαρμογές ναυτιλίας, αυτοκινητοβιομηχανίας και για επαγγελματικές εφαρμογές στην κατασκευή.

Το ιδιαίτερα μικρό πάχος του χαρτιού της επιτρέπει την απομάκρυνσή της ενόσω η βαφή είναι νωπή – ακόμη και 30 λεπτά μετά (ανάλογα με το πάχος βαφής).



SIKA Blue Masking Tape UV

ΑΔΙΑΒΡΟΧΗ ΤΑΙΝΙΑ ΜΑΣΚΑΡΙΣΜΑΤΟΣ, ΑΝΘΕΚΤΙΚΗ ΣΕ ΥΠΕΡΙΩΔΗ ΑΚΤΙΝΟΒΟΛΙΑ ΓΙΑ ΕΞΩΤΕΡΙΚΕΣ ΝΑΥΤΙΛΙΑΚΕΣ ΕΦΑΡΜΟΓΕΣ

ΚΩΔΙΚΟΣ	ΠΡΟΪΟΝ	ΣΥΣΚ	ΤΙΜΗ/ΤΜΧ(€)
551998	25MM X 50M	36	3.70
551999	50MM X 50M	18	7.40

Περιγραφή

Ειδικά σχεδιασμένη ταινία, ναυτιλιακών εφαρμογών, για εξωτερική χρήση.

Κατάλληλη για μόνιμη εφαρμογή 15 ημερών σε εξωτερικό περιβάλλον, εκτεθειμένη σε υπεριώδη ακτινοβολία.

Το ειδικό ανθεκτικό, σε νερό, χαρτί της σε συνδυασμό με το συγκολλητικό της επιτρέπει την εύκολη, χωρίς υπολείμματα, στεγνή απομάκρυνσή της, μετά την εφαρμογή.



ΧΑΡΤΟΤΑΙΝΙΑ ΓΕΝΙΚΗΣ ΧΡΗΣΗΣ

ΚΩΔΙΚΟΣ		ΦΑΡΔΟΣ mm	ΜΗΚΟΣ m	ΣΥΣΚ	€/ΤΕΜ
21175270	75270	19	25	12	0,54
21175271	75271	25	25	36	0,71
21175272	75272	30	25	10	0,87
21175273	75273	38	25	6	1,09
21175274	75274	48	25	6	1,36
21175285	75285	25	50	9	1,36
21175286	75286	30	50	10	1,65
21175287	75287	38	50	6	2,05
21175288	75288	48	50	6	2,50



ΧΑΡΤΟΤΑΙΝΙΑ 60°C ΠΡΟΣΤΑΣΙΑ UV 14 ΗΜΕΡΩΝ

ΚΩΔΙΚΟΣ		ΦΑΡΔΟΣ mm	ΜΗΚΟΣ m	ΣΥΣΚ	€/ΤΕΜ
21175120	75120	30	25	40	1,44
21175121	75121	38	25	24	1,80
21175122	75122	48	25	24	2,30
21175123	75123	30	50	40	2,90
21175124	75124	38	50	24	3,65
21175125	75125	48	50	24	4,60

Πανίσχυρη ταινία διπλής όψεως Powerful Grip

Η **Powerful Grip Tape** αποτελεί έναν νέο τύπο ταινίας διπλής όψεως που διαθέτει απίστευτα ισχυρή και άμεση συγκόλληση.

- Προσφύεται σχεδόν σε οποιοδήποτε υλικό, σε εσωτερικές ή εξωτερικές εφαρμογές, συμπεριλαμβάνοντας κεραμικά, τουβλοποιία, ξύλο, μέταλλα, πλαστικά και pvc.
- Είναι ανθεκτική σε υγρασία
- Δεν υποβαθμίζεται με την επίδραση της υπερύθρου ακτινοβολίας.
- Είναι ιδανική για οικιακή, βιομηχανική, κατασκευαστική χρήση
- Μπορεί να εφαρμοστεί και ως αντικατάστατο τρυπήματος και βιδώματος.



Η ΤΑΙΝΙΑ ΠΟΥ ΝΟΜΙΖΕΙ ΠΩΣ ΕΙΝΑΙ ΚΟΛΛΑ!

ΚΩΔΙΚΟΣ	ΧΡΩΜΑ	ΣΥΣΚ	ΤΜΧ /ΚΙΒ	ΚΙΒ/ ΠΛΤ	ΤΙΜΗ/ ΤΜΧ(€)
484678	ΔΙΑΦΑΝΟ	12MM X 2.5M	48	105	2.80
484679	ΔΙΑΦΑΝΟ	25MM X 2.5M	24	105	4.90
484680	ΔΙΑΦΑΝΟ	50MM X 2.5M	12	105	8.78



2
PCS

19mm x 5m
19mm x 2.25m



ΑΦΡΩΔΕΙΣ ΤΑΙΝΙΕΣ ΔΙΠΛΗΣ ΟΨΗΣ

ΚΩΔΙΚΟΣ	VOREL	ΦΑΡΔΟΣ mm	ΜΗΚΟΣ m	ΣΥΣΚ	€/ΤΕΜ
20675100	75100	19	2.25 & 5	12	2,40

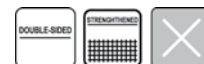

ΤΑΙΝΙΕΣ ΔΙΠΛΗΣ ΟΨΗΣ - ΜΟΚΕΤΑΣ

ΚΩΔΙΚΟΣ	VOREL	ΦΑΡΔΟΣ mm	ΜΗΚΟΣ m	ΣΥΣΚ	€/ΤΕΜ
20675261	75261	50	10	36	2,65
20675262	75262	50	25	24	6,15



ΤΑΙΝΙΕΣ ΔΙΠΛΗΣ ΟΨΗΣ PP

ΚΩΔΙΚΟΣ	VOREL	ΦΑΡΔΟΣ mm	ΜΗΚΟΣ m	ΣΥΣΚ	€/ΤΕΜ
20675246	75246	50	10	72	1,38
20675247	75247	50	25	36	3,20



ΤΑΙΝΙΑ ΔΙΠΛΗΣ ΟΨΗΣ - GEL 3m x 3cm x 2mm

**ΣΥΓΚΡΑΤΗΣΗ 8,5 Kg
ΜΕ 1 ΜΕΤΡΟ ΤΑΙΝΙΑΣ**

ΥΠΕΡΔΙΑΦΑΝΗ

**ΜΕ ΣΩΜΑΤΙΔΙΑ
ΝΑΝΟΤΕΧΝΟΛΟΓΙΑΣ**



**ΑΔΙΑΒΡΟΧΗ
ΠΛΥΝΕΤΕ & ΞΑΝΑ ΚΟΛΛΗΣΤΕ**

ΝΑΝΟ ΤΑΡΕ / ΔΙΑΦΑΝΗ ΤΑΙΝΙΑ - HELIX CHEM

ΚΩΔΙΚΟΣ	ΧΡΩΜΑ	ΦΑΡΔΟΣ mm	ΜΗΚΟΣ m	ΣΥΣΚ	€/ΤΕΜ
901302030	ΥΠΕΡΔΙΑΦΑΝΗ	30	3	8	3,90

ΤΑΙΝΙΑ ΣΥΣΚΕΥΑΣΙΑΣ ΔΙΑΦΑΝΗ

ΑΘΟΥΡΥΒΗ



ΚΩΔΙΚΟΣ	ΔΙΑΣΤΑΣΕΙΣ	ΣΥΣΚ	€/ΤΕΜ
9010003860	38mm x 60m	48	1,60
9010004860	48mm x 60m	36	2,00

- Διάφανη ταινία πολυπροπυλενίου
- **Αθόρυβη (no noise)**
- Πάχος 28 mic

28mic - 60 Μέτρων

ΤΑΙΝΙΑ ΣΥΣΚΕΥΑΣΙΑΣ ΚΑΦΕ

ΑΘΟΥΡΥΒΗ



ΚΩΔΙΚΟΣ	ΔΙΑΣΤΑΣΕΙΣ	ΣΥΣΚ	€/ΤΕΜ
9010013860	38mm x 60m	48	1,60
9010014860	48mm x 60m	36	2,00

- Καφέ ταινία πολυπροπυλενίου
- **Αθόρυβη (no noise)**
- Πάχος 28 mic

28mic - 60 Μέτρων



ΥΦΑΣΜΑΤΙΝΕΣ ΤΑΙΝΙΕΣ "DUCT"

ΚΩΔΙΚΟΣ	VOREL	ΦΑΡΔΟΣmm	ΜΗΚΟΣm	ΣΥΣΚ	€/ΤΕΜ
20675238	75238	48	10	36	1,26
20675239	75239	38	50	32	4,10
20675240	75240	48	50	24	5,20

- Ταινία πολυαιθυλενίου, ενισχυμένο με πολυεστερικές ίνες και κόλλα Hot Mest



ΑΛΟΥΜΙΝΟΤΑΙΝΙΕΣ

ΚΩΔΙΚΟΣ	VOREL	ΦΑΡΔΟΣmm	ΜΗΚΟΣm	ΣΥΣΚ	€/ΤΕΜ
20675140	75140	48	10	36	1,40
20675141	75141	48	50	24	6,65





Αυτοβουλκανιζόμενη Επισκευαστική Ταινία Σιλικόνης Silweld Tape

Σε έκτακτη ανάγκη ή για επισκευή, η **Silweld** είναι μια πραγματικά απίστευτη ταινία σιλικόνης που παρέχει υδατοστεγή και αεροστεγή σφράγιση σε δευτερόλεπτα.

- Δεν κολλάει.
- Απόλυτα αδιάβροχη.
- Μονώνει έως και 8.000Volts.
- Αντέχει σε ακραίες θερμοκρασίες -65 έως +260°C.
- Ανθεκτική σε λάδια, πετρέλαιο, οξέα, θαλασσινό νερό, διαλύτες, UV ακτινοβολία.
- Αντέχει σε πίεση 700psi.

- Λειτουργεί ακόμη και κάτω από το νερό.
- Η Silweld έχει τόσες εφαρμογές, που μπορεί να χρησιμοποιηθεί σε μόνιμες ή προσωρινές επισκευές παντού!
- Σε όλους τους εύκαμπτους ή μη σωλήνες.
- Σε ηλεκτρικές μονώσεις και σφραγίσεις ηλεκτρικών καλωδίων και συνδέσεων.
- Για αντιδιαβρωτική προστασία.
- Και πολλές, πολλές άλλες χρήσεις!

ΚΩΔΙΚΟΣ	ΠΡΟΪΟΝ	ΧΡΩΜΑ	ΣΥΣΚ	ΤΜΧ /ΚΙΒ	ΚΙΒ/ ΠΛΤ	ΤΙΜΗ/ ΤΜΧ(€)
484806	SILWELD REPAIR	ΜΑΥΡΟ	3Μ	6	265	15.40



ΤΑΙΝΙΕΣ ΤΕΦΛΟΝ

ΚΩΔΙΚΟΣ	VOREL	ΦΑΡΔΟΣ	ΠΑΧΟΣ	ΜΗΚΟΣ	ΣΥΣΚ	€/ΤΕΜ
20675201	75201	12	0.1	12 250	0,51	
20675202	75202	19	0.2	15 200	1,70	



ΤΑΙΝΙΑ ΥΦΑΣΜΑΤΙΝΗ

ΚΩΔΙΚΟΣ	YATO	ΜΕΓΕΘΟΣ (mm)	ΣΥΣΚ	€/ΤΕΜ
20081500	YT-81500	19x15x0.3	10	2,00
20081501	YT-81501	19x25x0.3	10	3,00



ΝΗΜΑ ΣΤΕΓΑΝΩΣΗΣ ΤΕΦΛΟΝ 50Μ

ΚΩΔΙΚΟΣ	YATO	ΣΥΣΚ	€/ΤΕΜ
20029220	YT-29220	25	4,90

ΣΠΡΕΙ ΑΚΡΥΛΙΚΟ ΧΡΩΜΑ - 400ml



ΤΟΜΕΙΣ ΕΦΑΡΜΟΓΩΝ

Είναι κατάλληλο για βαφή ή για σήμανση διαφόρων αντικειμένων και επιφανειών σε βιομηχανικές εφαρμογές, στον κλάδο αυτοκινήτου, σε οικοδομικές εφαρμογές καθώς και για οικιακή χρήση. Παρουσιάζει εξαιρετική πρόσφυση σε μεγάλη ποικιλία υποστρωμάτων όπως μέταλλα, αλουμίνιο, πλαστικά διαφόρων ειδών, ξύλο, γυαλί, πέτρες, σκυρόδεμα, κ.ά..

ΚΩΔΙΚΟΣ	ΧΡΩΜΑ	ΠΕΡΙΓΡΑΦΗ	ΣΥΣΚ	€/ΤΕΜ
159128		9010 PURE WHITE	6	3,45
159129		9016 GLOSS WHITE	6	3,45
159130		9016 MATT WHITE	6	3,45
159125		9001 CREAM	6	3,45
159146		1015 LIGHT IVORY	6	3,45
159137		3015 LIGHT PINK	6	3,45
159138		4003 HEATHER VIOLET	6	3,45
159131		4005 BLUE LILAC	6	3,45
159110		1023 TRAFFIC YELLOW	6	3,45
159147		1007 DAF YELLOW	6	3,45
159132		2004 PURE ORANGE	6	3,45
159136		2002 VERMILION	6	3,45
159114		3020 TRAFFIC	6	3,45
159111		3000 FLAME RED	6	3,45
159112		3003 RUBY RED	6	3,45
159113		3005 WINE RED	6	3,45
159123		8003 CLAY BROWN	6	3,45
159135		8007 FAWN BRAWN	6	3,45
159124		8017 CHOCOLATE BROWN	6	3,45
159145		8014 SEPIA BROWN	6	3,45
159119		6018 YELLOW GREEN	6	3,45
159120		6024 TRAFFIC GREEN	6	3,45
159142		6002 LEAF GREEN	6	3,45
159118		6010 GRASS GREEN	6	3,45
159133		6005 MOSS GREEN	6	3,45
159141		5018 TURQUOISE BLUE	6	3,45
159117		5015 SKY BLUE	6	3,45
159140		5017 TRAFFIC BLUE	6	3,45
159116		5010 GENTIAL BLUE	6	3,45
159115		5002 ULTRAMARINE BLUE	6	3,45
159139		5003 SAPPHIRE BLUE	6	3,45
159122		7035 LIGHT GREY	6	3,45
159134		7001 SILVER GREY	6	3,45
159143		7004 SINGAL GREY	6	3,45
159144		7023 CONCRETE GREY	6	3,45
159121		7005 MOUSSE GREY	6	3,45
159126		9005 BLACK GLOSS	6	3,45
159127		9005 MATT BLACK	6	3,45

QUANTUM COLOR SPRAY

Είναι ταχυστέγνωτο χρώμα σε μορφή σπρέι ακρυλικής βάσεως, κατάλληλο για εσωτερική και για εξωτερική χρήση. Στεγνώνει γρήγορα και δεν κρεμίζει ακόμα και όταν εφαρμόζεται σε κάθετες επιφάνειες. Έχει εξαιρετική αντοχή στη UV ακτινοβολία και μεγάλη αντοχή στην τριβή. Παρουσιάζει μεγάλη καλυπτική ικανότητα. Δεν περιέχει προωθητικά που βλάπτουν το όζον.

ΣΠΡΕΙ PAINT REMOVER



ΤΟΜΕΙΣ ΕΦΑΡΜΟΓΩΝ

Κατάλληλο για τον καθαρισμό των επιφανειών από χρώματα, βερνίκια ή άλλες συνθετικές ουσίες. Είναι κατάλληλο για εφαρμογή σε μεταλλικές ή ξύλινες επιφάνειες, σε τοίχους από μπετόν ή σοβά, σε πλακάκια, σε τζάμια, κ.ά.. Προτείνεται δοκιμή πριν από χρήση σε ευαίσθητες επιφάνειες.

ΚΩΔΙΚΟΣ	ΠΕΡΙΓΡΑΦΗ	ΣΥΣΚ	€/ΤΕΜ
159228	400ml ΚΑΘΑΡΙΣΤΙΚΟ ΜΠΟΓΙΑΣ	6	5,25

QUANTUM PAINT REMOVER SPRAY

Ισχυρό διαβρωτικό και αφαιρετικό χρωμάτων σε μορφή σπρέυ. Αφαιρεί γρήγορα και αποτελεσματικά παλαιά χρώματα, βερνίκια ή κόλλες από τις επιφάνειες στις οποίες εφαρμόζεται. Είναι κατάλληλο για τους περισσότερους τύπους χρωμάτων όπως οικοδομικά, βερνικοχρώματα, βαφές πολυουρεθάνης, κ.ά..



ΣΠΡΕΙ ΜΕΤΑΛΛΙΚΟ

ΤΟΜΕΙΣ ΕΦΑΡΜΟΓΩΝ

Είναι κατάλληλο για βαφή ή σήμανση διαφόρων αντικειμένων και επιφανειών σε βιομηχανικές εφαρμογές, στον κλάδο αυτοκινήτου, σε οικοδομικές εφαρμογές καθώς και για διακοσμητικές εφαρμογές ή οικιακή χρήση. Παρουσιάζει εξαιρετική πρόσφυση σε μεγάλη ποικιλία υποστρωμάτων όπως μέταλλα, αλουμίνιο, ξύλο, γυαλί, πέτρες, σκυρόδεμα, πλαστικά διαφόρων ειδών, κ.ά..

ΚΩΔΙΚΟΣ	ΧΡΩΜΑ	ΠΕΡΙΓΡΑΦΗ	ΣΥΣΚ	€/ΤΕΜ
159312		400ml LIGHT GOLD	6	3,80
159311		400ml COPPER GOLD	6	3,80
159218		400ml RICH GOLD	6	5,55
159310		400ml RED	6	5,30
159316		400ml SILVER LIGTH	6	3,80
159317		400ml NIKEL	6	5,55
159315		400ml BLUE	6	5,30
159314		400ml BLACK	6	5,30

QUANTUM COLOR SPRAY METALLIC

Το COLOR SPRAY METALLIC σε μεταλλικές αποχρώσεις, είναι ταχυστέγνωτο χρώμα σε μορφή σπρέι, κατάλληλο για εσωτερική και εξωτερική χρήση. Στεγνώνει γρήγορα και δεν κρεμιάει ακόμα και όταν εφαρμόζεται σε κάθετες επιφάνειες. Έχει εξαιρετική αντοχή στην ακτινοβολία UV και μεγάλη αντοχή στην τριβή. Παρουσιάζει μεγάλη καλυπτική ικανότητα. Δεν περιέχει προωθητικά που βλάπτουν το όζον.



ΣΠΡΕΙ ΥΨΗΛΩΝ ΘΕΡΜ/ΣΙΩΝ

ΤΟΜΕΙΣ ΕΦΑΡΜΟΓΩΝ

Είναι κατάλληλο για εφαρμογή σε σωληνώσεις θέρμανσης, εξατμίσεις αυτοκινήτων, συστήματα κεντρικής θέρμανσης κτιρίων, καμινάδες, φούρνους, σε μαγειρικές εστίες, σχάρες μπάρμπεκιου, τζάκια, κ.ά.. Παρουσιάζει εξαιρετική πρόσφυση σε μεγάλη ποικιλία υποστρωμάτων όπως μέταλλα, αλουμίνιο, ξύλο, γυαλί, πέτρες, σκυρόδεμα, κ.ά..

ΚΩΔΙΚΟΣ	ΧΡΩΜΑ	ΠΕΡΙΓΡΑΦΗ	ΣΥΣΚ	€/ΤΕΜ
159414		400ml WHITE	6	5,60
159412		400ml SILVER	6	5,60
159411		400ml RED	6	5,60
159410		400ml BROWN	6	5,60
159413		400ml BLACK	6	5,60

QUANTUM COLOR SPRAY HIGH TEMPERATURE

Είναι ταχυστέγνωτο χρώμα σε μορφή σπρέι με αντόχη σε υψηλές θερμοκρασίες (έως +350 °C) Στεγνώνει γρήγορα και δεν κρεμιάει ακόμα και όταν εφαρμόζεται σε κάθετες επιφάνειες. Έχει εξαιρετική αντοχή στη UV ακτινοβολία και μεγάλη αντοχή στην τριβή. Παρουσιάζει μεγάλη καλυπτική ικανότητα. Δεν περιέχει προωθητικά που βλάπτουν το όζον.



NEO

ΦΘΟΡΙΖΟΝΤΑ ΣΠΡΕΙ

ΤΟΜΕΙΣ ΕΦΑΡΜΟΓΩΝ

Είναι κατάλληλο για βαφή ή για σήμανση διαφόρων αντικειμένων και επιφανειών σε βιομηχανικές εφαρμογές, στον κλάδο αυτοκινήτου, σε οικοδομικές εφαρμογές καθώς και για οικιακή χρήση. Παρουσιάζει εξαιρετική πρόσφυση σε μεγάλη ποικιλία υποστρωμάτων όπως μέταλλα, αλουμίνιο, πλαστικά διαφόρων ειδών, ξύλο, γυαλί, πέτρες, σκυρόδεμα, κ.ά..

ΚΩΔΙΚΟΣ	ΧΡΩΜΑ	ΠΕΡΙΓΡΑΦΗ	ΣΥΣΚ	€/ΤΕΜ
159511		400ml F12 YELLOW	6	5,50
159512		400ml F14 ORANGE	6	5,50
159513		400ml F11 RED	6	5,50
159510		400ml F10 GREEN	6	5,50

ΦΘΟΡΙΖΟΝΤΑ ΣΠΡΕΙ

Το φθορίζον, Quantum, Color Spray είναι ταχυστέγνωτο χρώμα σε μορφή σπρέι. Ακρυλικής βάσεως, κατάλληλο για εσωτερική και εξωτερική χρήση. Στεγνώνει γρήγορα και δεν κρεμιάει ακόμα και όταν εφαρμόζεται σε κάθετες επιφάνειες. Έχει εξαιρετική αντοχή στη UV ακτινοβολία και μεγάλη αντοχή στην τριβή. Παρουσιάζει μεγάλη καλυπτική ικανότητα. Δεν περιέχει προωθητικά που βλάπτουν το όζον.



ΣΠΡΕΙ VARNISH

ΤΟΜΕΙΣ ΕΦΑΡΜΟΓΩΝ

Είναι κατάλληλο για εφαρμογή σε ξύλα, μέταλλα, πέτρες, πλαστικά, κ.α. Χρησιμοποιείται για την προστασία και το γυάλισμα διαφόρων επιφανειών στην βιομηχανία, στην επιπλοποιία, στο αυτοκίνητο ή στο σπίτι.

ΚΩΔΙΚΟΣ	ΠΕΡΙΓΡΑΦΗ	ΣΥΣΚ	€/ΤΕΜ
159211	400ml GLOSS	6	4,10
159811	400ml MATT	6	4,10

QUANTUM VARNISH

Το QUANTUM VARNISH είναι διαφανές ακρυλικό βερνίκι σε μορφή σπρέι, κατάλληλο για την προστασία διαφόρων επιφανειών. Είναι κατάλληλο για εσωτερική και εξωτερική χρήση. Είναι ιδιαίτερα ανθεκτικό στην ακτινοβολία UV. Δεν κίτρινίζει. Γυαλίζει και προστατεύει από τις φθορές. Δεν περιέχει προωθητικά που βλάπτουν το όζον.



ΣΠΡΕΙ GALVANIZE

ΤΟΜΕΙΣ ΕΦΑΡΜΟΓΩΝ

Είναι ιδιαίτερα κατάλληλο για σημειακές επαναβαφές σε πολυκαιρισμένες γαλβανισμένες επιφάνειες ή επιφάνειες που έχουν αλλοιωθεί από τις συγκολλήσεις.

ΨΥΧΡΟ ΓΑΛΒΑΝΙΣΜΑ

99%

ΠΕΡΙΕΚΤΙΚΟΤΗΤΑ ΨΕΥΔΑΡΓΥΡΟΥ

ΚΩΔΙΚΟΣ	ΠΕΡΙΓΡΑΦΗ	ΣΥΣΚ	€/ΤΕΜ
159210	400ml ΓΑΛΒΑΝΙΖΕ	6	4,60

QUANTUM GALVANIZE SPRAY

Είναι προστατευτικό επίχρισμα σε μορφή σπρέι, πλούσιο σε περιεκτικότητα φυλλιδίων ψευδαργύρου (περιεκτικότητα 99%). Προσφέρει μακρόχρονη αντισκωριακή καθοδική προστασία σε όλες τις σιδηρές κατασκευές. Προσφέρεται ηλεκτροχημικά στις επιφάνειες του σιδήρου ή του χάλυβα δημιουργώντας ένα επιφανειακό φιλμ το οποίο προσφέρει εξίσου αποτελεσματική καθοδική προστασία (όσον αφορά στην αντοχή στο χρόνο του φιλμ και στην προστασία από διάβρωση από άλατα) με την εμβάπτιση του θερμού γαλβανισμού. Μπορεί να χρησιμοποιηθεί και ως αστάρι για τις συνήθεις βαφές. Παρουσιάζει καλή ηλεκτρική αγωγιμότητα. Παρουσιάζει επίσης μεγάλη καλυπτική ικανότητα: μπορεί να δημιουργήσει φιλμ πάχους 30 μικρών σε ένα χέρι. Στεγνώνει γρήγορα και δεν κρεμάει ακόμα και όταν εφαρμόζεται σε κάθετες επιφάνειες. Δεν περιέχει προωθητικά που βλάπτουν το όζον.



ΣΠΡΕΙ PRIMER

ΤΟΜΕΙΣ ΕΦΑΡΜΟΓΩΝ

Εφαρμόζεται σε μεταλλικές επιφάνειες πριν από την τελική βαφή, προσφέροντας υψηλή αντισκωριακή προστασία.

ΚΩΔΙΚΟΣ	ΠΕΡΙΓΡΑΦΗ	ΣΥΣΚ	€/ΤΕΜ
159212	400ml ΓΚΡΙ	6	4,40
159214	400ml ΚΟΚΚΙΝΟ	6	4,40
159217	400ml ΛΕΥΚΟ	6	4,40

QUANTUM PRIMER

Το QUANTUM PRIMER είναι αστάρι μετάλλων σε μορφή σπρέι, κατάλληλο για την προστασία μεταλλικών επιφανειών. Βελτιώνει την πρόσφυση των τελικών βαφών. Στεγνώνει γρήγορα και είναι συμβατό με όλα τα συνήθη χρώματα διαλύτου (ακρυλικά, αλκυδικά, νιτροκυταρίνης). Δεν περιέχει προωθητικά που βλάπτουν το όζον.



ΣΠΡΕΙ WHEEL RIM

ΤΟΜΕΙΣ ΕΦΑΡΜΟΓΩΝ

Είναι κατάλληλο για βάφη όλων των τύπων των μεταλλικών ζαντών.

ΚΩΔΙΚΟΣ	ΠΕΡΙΓΡΑΦΗ	ΣΥΣΚ	€/ΤΕΜ
159216	400ml ΖΑΝΤΑΣ - ΑΣΗΜΙ	6	5,45

QUANTUM WHEEL RIM

Το QUANTUM WHEEL RIM είναι ταχυστέγνωτο μεταλλικό χρώμα σε μορφή σπρέι κατάλληλο για βαφή σε ζάντες. Στεγνώνει γρήγορα και δεν κρεμάει ακόμα και όταν εφαρμόζεται σε κάθετες επιφάνειες. Έχει εξαιρετική αντοχή στη UV ακτινοβολία, στην τριβή και στους ρύπους. Προστατεύει από τη σκουριά. Παρουσιάζει μεγάλη καλυπτική ικανότητα. Δεν περιέχει προωθητικά που βλάπτουν το όζον.



ΣΠΡΕΙ SMALTO

ΤΟΜΕΙΣ ΕΦΑΡΜΟΓΩΝ

Είναι κατάλληλο για βαφή διαφόρων λευκών ηλεκτρικών οικιακών συσκευών, όπως πλυντήρια, ψυγεία, κ.ά.. Είναι επίσης κατάλληλο για την σημειακή βαφή και επιδιόρθωση των λευκών ειδών υγιεινής όπως νιπτήρες, μπανιέρες, λεκάνες, κ.λπ..

ΚΩΔΙΚΟΣ	ΠΕΡΙΓΡΑΦΗ	ΣΥΣΚ	€/ΤΕΜ
159215	400ml ΣΜΑΛΤΟ	6	4,40

QUANTUM SMALTO

Το QUANTUM SMALTO είναι ταχυστέγνωτο χρώμα σε μορφή σπρέι ακρυλικής βάσεως, κατάλληλο για βαφή λευκών οικιακών συσκευών και ειδών υγιεινής. Στεγνώνει γρήγορα και δεν κρεμάει ακόμα και όταν εφαρμόζεται σε κάθετες επιφάνειες. Έχει εξαιρετική αντοχή στη UV ακτινοβολία. Είναι επίσης ιδιαίτερα ανθεκτικό στις γρατζουνιές. Προστατεύει από τη σκουριά. Παρουσιάζει άριστη καλυπτική ικανότητα με ένα πέρασμα. Δεν περιέχει προωθητικά που βλάπτουν το όζον.

Προστατευτική Βαφή Ξύλου Επαγγελματικής Χρήσης Wood Stain



Το **Wood Stain** είναι επαγγελματικής χρήσης βαφή ξύλου με χαμηλό περιεχόμενο σε διαλύτες.

Ενισχύει τις φυσικές ιδιότητες του ξύλου και προσφέρει μακροπρόθεσμη προστασία και ανθεκτικότητα στις καιρικές επιδράσεις.

Η βαφή έχει ανθεκτικό τελείωμα που δεν ρηγματώνει, ούτε αποφλοιώνεται, καθώς επίσης και εξαιρετική αντίσταση στην υπεριώδη ακτινοβολία.

Είναι ιδανική για χρήση σε λεία, πλανισμένη ξυλεία σε εσωτερικούς και εξωτερικούς χώρους, όπως σε πόρτες, κουφώματα, ξυλεία αρχιτεκτονικών εφαρμογών, επενδύσεις, έπιπλα κήπου, κ.τ.λ.

Υπό συνθήκες καιρικές συνθήκες, παρέχει προστασία έως και 5 χρόνια. Η διαφανής απόχρωση (Maintenance Clear Coat) ενεργεί ως επιστροφή συντήρησης που προστατεύει και ενισχύει το ξύλο, χωρίς να το αποχρωματίζει ή να το σκουραίνει.

ΚΩΔΙΚΟΣ	ΠΡΟΪΟΝ	ΧΡΩΜΑ	ΣΥΣΚ	ΤΜΧ /ΚΙΒ	ΚΙΒ/ ΠΛΤ	ΤΙΜΗ/ ΤΜΧ(€)
483221	WS SATIN	ΠΕΥΚΟ	750ml	6	112	20.85
483222	WS SATIN	ΠΕΥΚΟ	2.5L	2	105	51.20
483208	WS SATIN	ΔΡΥΣ ΣΚΟΥΡΟ	750ml	6	112	20.85
483209	WS SATIN	ΔΡΥΣ ΣΚΟΥΡΟ	2.5L	2	105	51.20
483212	WS SATIN	ΜΑΟΝΙ	750ml	6	112	20.85
483214	WS SATIN	ΜΑΟΝΙ	2.5L	2	105	51.20
483216	WS SATIN	ΔΡΥΣ ΑΝΟΙΧΤΟ	750ml	6	112	20.85
483217	WS SATIN	ΔΡΥΣ ΑΝΟΙΧΤΟ	2.5L	2	105	51.20
483224	WS SATIN	ΤΡΙΑΝΤΑΦΥΛΛΙΑ	750ml	6	112	20.85
483225	WS SATIN	ΤΡΙΑΝΤΑΦΥΛΛΙΑ	2.5L	2	105	51.20
483227	WS SATIN	ΤΙΚ	750ml	6	112	20.85
483228	WS SATIN	ΤΙΚ	2.5L	2	105	51.20
483230	WS SATIN	ΚΑΡΥΔΙΑ	750ml	6	112	20.85
483231	WS SATIN	ΚΑΡΥΔΙΑ	2.5L	2	105	51.20

Αν και καταβλήθηκε κάθε δυνατή προσπάθεια για πιστή χρωματική αναπαραγωγή, τα χρώματα της εκτύπωσης δε θα ταυρίζουν απόλυτα με αυτά του υλικού. Εφαρμοσμένα δείγματα είναι διαθέσιμα κατόπιν ζήτησης.

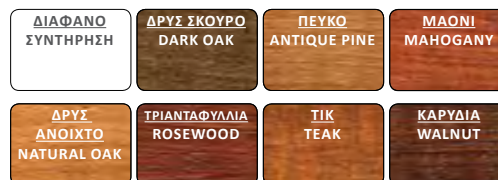

Ξυλόστοκος Πολλαπλών Χρήσεων



Ξύλο
Σκυρόδεμα
Τούβλο
Σοβάς
Πέτρα



Το **Multi Purpose Premium Joiners Grade Wood Filler** είναι πολλαπλών εφαρμογών στόκος ξύλων που γεμίζει οπές, ρωγμές, κενά και μικρές ατέλειες σε ξύλινες επιφάνειες.

Είναι εύκολος στο τρίψιμο και μπορεί να βαφτεί επιφανειακά και με έμποτισμό, καθώς και να βερνικωθεί. Δεν περιέχει διαλύτες.

ΚΩΔΙΚΟΣ	ΠΡΟΪΟΝ	ΧΡΩΜΑ	ΣΥΣΚ	ΤΜΧ /ΚΙΒ	ΚΙΒ/ ΠΛΤ	ΤΙΜΗ/ ΤΜΧ(€)
480465	MP W. FILLER	ΔΡΥΣ ΑΝΟΙΧΤΟ	250ml	6	160	4.68
480461	MP W. FILLER	ΚΙΤΡΙΝΟ	250ml	6	160	4.68
480464	MP W. FILLER	ΜΑΟΝΙ	250ml	6	160	4.68
480462	MP W. FILLER	ΚΑΣΤΑΝΟ	250ml	6	160	4.68
480463	MP W. FILLER	ΠΕΥΚΟ	250ml	6	160	4.68
480466	MP W. FILLER	ΔΡΥΣ ΣΚΟΥΡΟ	250ml	6	160	4.68
480467	MP W. FILLER	ΛΕΥΚΟ	250ml	6	160	4.68

Λάδι Teak



Το **Teak Oil** είναι παραδοσιακού τύπου προϊόν επιφανειακής επεξεργασίας που χρησιμοποιείται για αποκατάσταση των φυσικών ελαίων και της φυσικής απόχρωσης του ξύλου από υποβάθμιση λόγω παλαιότητας ή καιρικών επιδράσεων.

Κατάλληλο για εσωτερική ή εξωτερική χρήση σε ξύλα χωρίς επιστρώσεις.

ΚΩΔΙΚΟΣ	ΠΡΟΪΟΝ	ΧΡΩΜΑ	ΣΥΣΚ	ΤΜΧ /ΚΙΒ	ΚΙΒ/ ΠΛΤ	ΤΙΜΗ/ ΤΜΧ(€)
484805	TEAK OIL	-	500ML	12	80	9.20



BUILDING TRUST



SIKAFLEX® -11 FC+

All in one



ΚΩΔΙΚΟΣ	ΠΡΟΪΟΝ	ΧΡΩΜΑ	ΣΥΣΚ	ΤΙΜΗ/ΤΜΧ(€)
410997	300ML	ΛΕΥΚΟ	12	11.25
411084	300ML	ΚΑΦΕ	12	11.25
418476	300ML	ΓΚΡΙ	12	11.25
411055	300ML	ΜΑΥΡΟ	12	11.25
418477	300ML	ΜΠΕΖ	12	11.25
410176	600ML	ΓΚΡΙ	20	13.20
410269	600ML	ΛΕΥΚΟ	20	13.20

Περιγραφή

Το Sikaflex -11 FC+ είναι ενός συστατικού πολυουρεθανικό, ελαστικό σφραγιστικό και συγκολλητικό πολλαπλών χρήσεων. Κατάλληλο για εσωτερικές και εξωτερικές εφαρμογές.

ΕΦΑΡΜΟΓΕΣ

Ως σφραγιστικό χρησιμοποιείται σε οριζόντιους και κατακόρυφους αρμούς, για ηχομόνωση σωληνώσεων μεταξύ σκυροδέματος και προστατευτικών περιβλημάτων. Χρησιμοποιείται επίσης μεταξύ χωρισμάτων, για σφράγιση ραφών, σε μεταλλικές και ξύλινες κατασκευές, για κατασκευές εξαερισμού και πολλά άλλα.

Ως συγκολλητικό είναι κατάλληλο για εσωτερικές και εξωτερικές εφαρμογές σε περβάζια παραθύρων, σκαλοπάτια, κατώφλια, σοβατεπιά, προκατασκευασμένα στοιχεία και πολλά άλλα.

ΧΑΡΑΚΤΗΡΙΣΤΙΚΑ / ΠΛΕΟΝΕΚΤΗΜΑΤΑ

Το Sikaflex-11 FC+ είναι έτοιμο για χρήση. Εύκαμπτο και ελαστικό. Ωριμάζει χωρίς δημιουργία φυσαλίδων. Έχει πολύ καλή πρόσφυση στα περισσότερα κατασκευαστικά υλικά. Έχει καλές μηχανικές αντοχές, ανθεκτικότητα σε γήρανση και περιβαλλοντικές επιδράσεις. Προσφέρει συγκόλληση χωρίς σταθεροποίηση των συγκολλούμενων τμημάτων. Απορροφητικό δονήσεων και κρούσεων.

SIKAFLEX® CONSTRUCTION+ PU

Σφραγιστικό για προσόψεις
σκυροδέματος και τοιχοποιίες



NEO



ΚΩΔΙΚΟΣ	ΠΡΟΪΟΝ	ΧΡΩΜΑ	ΣΥΣΚ	ΤΙΜΗ/ ΤΜΧ(€)
443755	300ML	ΛΕΥΚΟ	12	7.90
443751	300ML	ΓΚΡΙ	12	7.90
437308	600ML	ΛΕΥΚΟ	20	9.80
438640	600ML	ΓΚΡΙ	20	9.80

ΕΦΑΡΜΟΓΕΣ

Για κατασκευαστικούς αρμούς και αρμούς σύνδεσης σε προσόψεις σκυροδέματος

ΧΑΡΑΚΤΗΡΙΣΤΙΚΑ

- Πολύ καλή αντοχή σε γήρανση και περιβαλλοντικές επιδράσεις
- Κινητικότητα αρμού ±35% (ASTM C719)
- Ωρίμανση χωρίς δημιουργία φυσαλίδων
- Πολύ καλή εργασιμότητα
- Καλή πρόσφυση σε πολλά υποστρώματα
- Χωρίς διαλύτες
- Πολύ χαμηλών εκπομπών πτητικών

ΚΑΤΑΝΑΛΩΣΗ

1 σωληνάριο ανά 6 τρέχοντα μέτρα αρμού (10 mm x 10 mm)

SIKAFLEX® UNIVERSAL

Γενικής Χρήσης PU



ΚΩΔΙΚΟΣ	ΠΡΟΪΟΝ	ΧΡΩΜΑ	ΣΥΣΚ	ΤΙΜΗ/ ΤΜΧ(€)
562685	300ML	ΛΕΥΚΟ	12	7.65
562686	300ML	ΓΚΡΙ	12	7.65

Περιγραφή

Το Sikaflex® Universal είναι 1-συστατικού PU πολυουρεθανικό ελαστικό σφραγιστικό που ωριμάζει με την ατμοσφαιρική υγρασία.

Πλεονεκτήματα Προϊόντος

- Κινητικότητα ±25% (ASTM C-719)
- Καλή πρόσφυση σε πορώδη υποστρώματα
- Καλές ιδιότητες εφαρμογής
- Κατάλληλο για εσωτερική και εξωτερική χρήση

Τομείς Εφαρμογής

Το Sikaflex® Universal είναι σχεδιασμένο για σφράγιση οικοδομικών αρμών (διαστολικών και κατασκευαστικών).

Κατανάλωση

1 φύσιγγα ανά 2,8 τρέχοντα μέτρα αρμού (10 mm x 10 mm)

SIKAFLEX® 111 STICK & SEALΕύκαμπτο, **υβριδικό**
σφραγιστικό & συγκολλητικό

ΚΩΔΙΚΟΣ	ΠΡΟΪΟΝ	ΧΡΩΜΑ	ΣΥΣΚ	ΤΙΜΗ/ ΤΜΧ(€)
449600	290ML	ΛΕΥΚΟ	12	8.90
449601	290ML	ΜΑΥΡΟ	12	8.80
586645	290ML	ΓΚΡΙ	12	8.80

ΕΦΑΡΜΟΓΕΣ

- Ως σφραγιστικό για σφράγιση οριζόντιων και κατακόρυφων αρμών
- Ως συγκολλητικό για συγκόλληση επί των περισσότερων κοινών υλικών στην κατασκευή:
- Σκυρόδεμα
- Τοιχοποιία
- Πλειονότητα πετρωμάτων
- Κεραμικά
- Ξύλο
- Μέταλλα
- Γυαλί
- Πλαστικά όπως PVC, PA, PET και EPS/XPS

ΧΑΡΑΚΤΗΡΙΣΤΙΚΑ

- Προσφύεται καλά σε πλειάδα υποστρωμάτων χωρίς την ανάγκη προηγούμενης εφαρμογής ασαριού
- Προσφύεται σε νωπό σκυρόδεμα
- Συμβατό με τα περισσότερα υποστρώματα, EPS/XPS, ανθρακούφασματα και ασφαλτικά
- Καλές μηχανικές αντοχές και αντοχή σε καιρικές επιδράσεις

ΚΑΤΑΝΑΛΩΣΗ

- 1 φύσιγγα 290 ml αποδίδει:
- 100 σημειακές εφαρμογές διαμέτρου = 30mm & πάχους = 4mm
 - 15 m κορδόνι με διάμετρο ακροφυσίου = 5 mm (~20 ml ανά τρέχον μέτρο)

**SIKAFLEX® 112 CRYSTAL CLEAR**Υπερδιάφανο, **υβριδικό**
σφραγιστικό & συγκολλητικό

ΚΩΔΙΚΟΣ	ΠΡΟΪΟΝ	ΧΡΩΜΑ	ΣΥΣΚ	ΤΙΜΗ/ ΤΜΧ(€)
449602	290ML	ΔΙΑΦΑΝΟ	12	11.70

ΕΦΑΡΜΟΓΕΣ

Ως συγκολλητικό, είναι κατάλληλο για συγκόλληση των περισσότερων κοινών υλικών της κατασκευής, όπως:

- Σκυρόδεμα
- Τοιχοποιία
- Πλειονότητα πετρωμάτων
- Κεραμικά
- Ξύλο
- Μέταλλα
- Γυαλί
- PVC
- Ως σφραγιστικό χρησιμοποιείται για περιμετρική σφράγιση γύρω από συγκολλημένα στοιχεία.

ΧΑΡΑΚΤΗΡΙΣΤΙΚΑ

- 100 % διαφανές
- Καλό αρχικό άρπαγμα
- Συγκολλητικό-σφραγιστικό με σήμανση CE
- Ιδιαίτερα χαμηλών εκπομπών

ΚΑΤΑΝΑΛΩΣΗ

- 1 φύσιγγα 290 ml αποδίδει:
- 100 σημειακές εφαρμογές διαμέτρου = 30 mm & πάχους = 4 mm
 - 15 m κορδόνι με διάμετρο ακροφυσίου = 5 mm (~20 ml ανά τρέχον μέτρο)



Μέταλλα
Γυαλί
Τούβλο
Ευλεία
PVCU

- ΓΙΑ ΕΦΑΡΜΟΓΗ ΜΕ ΤΟ ΧΕΡΙ!



ΣΥΓΚΟΛΛΗΤΙΚΟ & ΣΦΡΑΓΙΣΤΙΚΟ STIXALL σε σωληνάριο Easi-Squeeze

ΚΩΔΙΚΟΣ	ΠΡΟΪΟΝ	ΧΡΩΜΑ	ΣΥΣΚ	ΤΜΧ/ ΚΙΒ	ΚΙΒ/ ΠΛΤ	ΤΙΜΗ/ ΤΜΧ(€)
483124	EASI SQ STIXALL	ΥΠΕΡ-ΔΙΑΦΑΝΟ	80ml	12	210	7.05
483111	EASI SQ STIXALL	ΛΕΥΚΟ	80ml	12	210	5.76

SIKAFLEX 118 EXTREME GRAB

Συγκολλητικό με ιδιαίτερα ισχυρό αρχικό άρπαγμα



ΕΦΑΡΜΟΓΕΣ

- Για εξωτερική και εσωτερική συγκόλληση:
- Για εσωτερικές και εξωτερικές εφαρμογές συγκόλλησης διαφόρων αντικειμένων, όπως πέτρα, τούβλα, παράθυρα, περβάζια παραθύρων και πορτών, καθρέφτες, ξύλινα δοκάρια και βαριά αντικείμενα εν γένει
 - Πιστοποιημένο και για σφράγιση εσωτερικών και εξωτερικών προσόψεων
 - Σχεδιασμένο για συγκόλληση σε επιφάνειες σκυροδέματος, κονιαμάτων, φυσικών πετρωμάτων, ινοπλισμένου τσιμέντου, κεραμικών, ξύλου και μετάλλων

ΧΑΡΑΚΤΗΡΙΣΤΙΚΑ

- Ιδιαίτερα ισχυρό αρχικό άρπαγμα
- Συγκόλληση βαριών αντικειμένων χωρίς προσωρινή υποστήριξη
- Καλή εργασιμότητα
- Ιδιαίτερα χαμηλών εκπομπών
- Ισχυρή και ελαστική συγκόλληση
- Πολύ χαμηλών εκπομπών

ΚΑΤΑΝΑΛΩΣΗ

1 φύσιγγα 290 ml αποδίδει:

~100 σημειακές εφαρμογές διαμέτρου 30 mm & πάχους 4 mm

~15 m τριγωνικό κορδόνι (~20 ml ανά τρέχον μέτρο)



ΚΩΔΙΚΟΣ	ΠΡΟΪΟΝ	ΧΡΩΜΑ	ΣΥΣΚ	ΤΙΜΗ/ΤΜΧ(€)
564091	290ML	ΛΕΥΚΟ	12	9.90

Sika MaxTack® &

Sika MaxTack® Invisible

Μονταζόκολλες νερού ταχείας ωρίμανσης



ΕΦΑΡΜΟΓΕΣ

- Για εσωτερικές και στεγασμένες εξωτερικές εφαρμογές συγκόλλησης κατασκευαστικών υλικών, όπως:
- σοβατεπιών
 - ξύλινων επενδύσεων
 - πάνελ
 - πηλινων πλακιδίων
 - ανοδιωμένου αλουμινίου
 - προφίλ σκληρού PVC
 - διογκωμένης και εξηλασμένης πολυστερίνης
 - ξύλινων διακοσμητικών στοιχείων

ΧΑΡΑΚΤΗΡΙΣΤΙΚΑ

- Ισχυρή αρχική πρόσφυση (πρώιμη αντοχή)
- Εξαλείφει την ανάγκη για καρφιά και βίδες
- Καλή πρόσφυση σε πολλά υποστρώματα
- Καλή εργασιμότητα
- Υδατικής βάσης
- Μπορεί να βαφτεί με υδατικής βάσης βαφές
- Για εσωτερική χρήση σε τοίχους και ταβάνια
- Για προστατευμένες εξωτερικές εφαρμογές σε τοίχους (εξώστες, μπαλκόνια)
- Έκδοση Invisible που ωριμάζοντας γίνεται διάφανη

ΚΑΤΑΝΑΛΩΣΗ

Χρησιμοποιώντας μύτη διαμέτρου 5 mm, αποδίδονται ~14m μήκους συγκολλητικού (για φύσιγγα των 280ml) (~20 ml ανά τρεχούμενο μέτρο)

ΚΩΔΙΚΟΣ	ΠΡΟΪΟΝ	ΧΡΩΜΑ	ΣΥΣΚ	ΤΙΜΗ/ΤΜΧ(€)
421240	280ML	ΛΕΥΚΟ	12	5.80
639794	290ML	ΔΙΑΦΑΝΟ*	12	5.80

* ΛΕΥΚΟ (ΔΙΑΦΑΝΕΣ ΜΕΤΑ ΤΗΝ ΩΡΙΜΑΝΣΗ ΤΟΥ)

NEO

SIKA ANCHORFIX®-1 N

Συγκολλητικό υλικό αγκυρώσεων ταχείας ωρίμανσης



ΚΩΔΙΚΟΣ	ΠΡΟΪΟΝ	ΧΡΩΜΑ	ΣΥΣΚ	ΤΙΜΗ/ΤΜΧ(€)
617866	300ML	ΛΕΥΚΟ	12	10.00

Περιγραφή

Αγκυρωτικό υλικό 2-συστατικών, ελεύθερο στυρενίου και διαλύτη, πολυεστερικής βάσης.

Πλεονεκτήματα Προϊόντος

- Ταχείας ωρίμανσης
- Εφαρμόζεται με κανονικό πιστόλι χειρός για φύσιγγες
- Χρησιμοποιείται σε χαμηλές θερμοκρασίες
- Υψηλή ικανότητα ανάληψης φορτίων
- Έγκριση ETA σύμφωνα με ETAG 029 για αγκυρώσεις σε τοιχοποιία
- Δεν παρουσιάζει ολίσθηση ακόμα και σε εφαρμογές οροφής
- Χωρίς στυρένιο
- Ελαφριάς οσμής
- Μειωμένη απώλεια υλικού

ΔΙΑΦΕΣΙΜΟ ΜΕΧΡΙ ΕΞΑΝΤΛΗΣΕΩΣ ΤΟΥ ΑΠΟΘΕΜΑΤΟΣ

Τομείς Εφαρμογής

Το Sika AnchorFix®-1 N μπορεί να χρησιμοποιηθεί μόνο από έμπειρους επαγγελματίες. Ταχείας ωρίμανσης συγκολλητικό υλικό αγκυρώσεων για στερεώσεις σε:

- Ράβδους / οπλισμούς
- Κοχλίες αγκύρωσης με σπείρωμα (ντιζες)
- Βίδες και ειδικά συστήματα στερεώσεων
- Σκυροδεμα
- Τοιχοποιία με συμπαγή και διάτρητα τούβλα
- Σκληρό φυσικό πέτρωμα*
- Συμπαγή βράχο*

* Τα υποστρώματα αυτά ενδέχεται να ποικίλουν σημαντικά, κυρίως σε ό,τι αφορά στην αντοχή τους, στη σύνθεση και στο πορώδες. Συνεπώς, σε κάθε εφαρμογή σε αυτά τα υποστρώματα πρέπει προηγουμένως να επιβεβαιωθεί η καταλληλότητα του Sika AnchorFix®-1 N με εφαρμογή του σε μία δοκιμαστική περιοχή. Ελέγξτε κυρίως την αντοχή πρόσφυσης, το λείκισμα της επιφάνειας και την πιθανότητα αποχρωματισμού.

SIKACRYL® UNIVERSAL PRO

Ακρυλικός στόκος γενικής χρήσης

310ml

ΟΙΚΟΝΟΜΙΚΟ

Περιγραφή

Το Sikacryl® Universal Pro είναι 1-συστατικού, γενικής χρήσης, ακρυλικό σφραγιστικό. Κατάλληλο για πλήρωση ρωγμών και αρμών, τόσο σε εσωτερικούς όσο και σε εξωτερικούς χώρους (προστατευμένη εφαρμογή). Αποτελεί πλαστο-ελαστικό, κοστολογικά αποδοτικό σφραγιστικό, ιδιαίτερος κατάλληλο για μη-κινητικούς (στατικούς) αρμούς.

Πλεονεκτήματα Προϊόντος

- Βαφόμενο. Μπορεί να χρησιμοποιηθεί σε όλα τα πορώδη υποστρώματα, όπως τούβλο, σκυρόδεμα, ξύλο, κ.λπ.
- Ιδιαίτερα εύκολο στην εφαρμογή και τον καθαρισμό
- Υδατοστεγανό μετά την ωρίμανσή του
- Άοσμο
- Καλές ιδιότητες εφαρμογής
- Καλή πρόσφυση σε διάφορα υποστρώματα
- Καλή αντοχή σε υπεριώδη ακτινοβολία
- Ανθεκτικό σε βροχή



Τομείς Εφαρμογής

Σφράγιση αρμών, περιορισμένης κινητικότητας, μεταξύ διάφορων κατασκευαστικών υλικών (ξύλο, σκυρόδεμα, τούβλα, κ.λπ.).
Πλήρωση ρωγμών σε τοίχους και ταβάνια.
Σφράγιση κατασκευαστικών αρμών, μεταξύ παραθύρων, πορτών, τοίχων κ.λπ..

Κατανάλωση

1 φύσιγγα ανά 3,1 τρέχοντα μέτρα αρμού 10x10mm

ΚΩΔΙΚΟΣ	ΠΡΟΪΟΝ	ΧΡΩΜΑ	ΣΥΣΚ	ΤΙΜΗ/ΤΜΧ(€)
449500	310ML	ΛΕΥΚΟ	12	1.46
750097	600ML	ΛΕΥΚΟ	20	2.60



Sikasil®-400 Heat Sealant

Σφραγιστικό σιλικόνης υψηλών θερμοκρασιών

NEO

ΕΦΑΡΜΟΓΕΣ

Για σφράγιση κατασκευαστικών στοιχείων και υλικών εκτεθειμένων στη θερμότητα, όπως:

- Υψηλής απόδοσης φλάντζες
- Πόρτες φούρνων βιομηχανικής και οικιακής χρήσης
- Μεταλλικές καμινάδες
- Συστήματα καλωδιώσεων
- Θερμαντικές συσκευές

SIKACRYL® 200

Ελαστικό, ακρυλικό, σφραγιστικό

300ml

ΟΙΚΟΝΟΜΙΚΟ

Περιγραφή

Το Sikacryl®-200 είναι 1-συστατικού ακρυλικό σφραγιστικό που δεν κρεμίζει, με κινητικότητα ± 12,5% και υψηλή αντίσταση σε βροχή.

Πλεονεκτήματα Προϊόντος

- Χωρίς διαλύτες
- Καλές ιδιότητες εφαρμογής
- Βαφόμενο
- Καλή πρόσφυση σε διάφορα υποστρώματα
- Μεταφερόμενο σε θερμοκρασίες έως και -10°C (για 24 ώρες μέγιστα)
- Για εσωτερική και εξωτερική χρήση
- Καλή αντοχή σε υπεριώδη ακτινοβολία
- Ανθεκτικό σε βροχή

Τομείς Εφαρμογής

Το Sikacryl®-200 είναι σχεδιασμένο για σφράγιση αρμών σύνδεσης μεσαίας κινητικότητας σε υποστρώματα όπως σκυρόδεμα, ελαφροσκυρόδεμα, σοβά, ινοπλισμένο τσιμέντο, γυψοσανίδες, αλουμίνιο, PVC και ξύλο.

Το Sikacryl®-200 είναι σχεδιασμένο για αρμούς σύνδεσης γύρω από παράθυρα, περβάζια παραθύρων, πόρτες, σωλήνες PVC, σε τοίχους και οροφές ξηράς δόμησης.

Το Sikacryl®-200 είναι σχεδιασμένο για πλήρωση ρωγμών σε εσωτερικούς και εξωτερικούς χώρους (χωρίς μόνιμη εμβάπτιση σε νερό).

Κατανάλωση

1 φύσιγγα ανά 3 τρέχοντα μέτρα αρμού 10x10mm

ΚΩΔΙΚΟΣ	ΠΡΟΪΟΝ	ΧΡΩΜΑ	ΣΥΣΚ	ΤΙΜΗ/ΤΜΧ(€)
494120	300ML	ΛΕΥΚΟ	12	3.50
639585	300ML	ΓΚΡΙ	12	3.50



ΚΩΔΙΚΟΣ	ΠΡΟΪΟΝ	ΧΡΩΜΑ	ΣΥΣΚ	ΤΙΜΗ/ΤΜΧ(€)
639267	300ML	-	12	8.60

ΧΑΡΑΚΤΗΡΙΣΤΙΚΑ

- Ανθεκτικό έως τους 270 °C μακροπρόθεσμα και έως τους 300 °C βραχυπρόθεσμα
- Ταχείας ωρίμανσης
- Υψηλή ευκαμψία από τους -40 °C έως τους +230 °C
- Σε κόκκινη απόχρωση για εύκολο εντοπισμό της εφαρμογής

Κατανάλωση

1 φύσιγγα ανά 2,9 τρέχοντα μέτρα αρμού 10 x 10 mm

SIKASIL UNIVERSAL

Σιλικόνη γενικής χρήσης



Περιγραφή

Το Sikasil® Universal είναι μια στεγανοποιητική σιλικόνη χωρίς διαλύτες για εσωτερικές και εξωτερικές εφαρμογές.

Πλεονεκτήματα Προϊόντος

- Υψηλή ελαστικότητα και ευελιξία
- Πολύ καλή αντοχή σε συρρίκνωση, ρωγμές και αποχρωματισμούς
- Πολύ καλή πρόσφυση σε μια ποικιλία από μη πορώδη υποστρώματα

Τομείς Εφαρμογής

Το Sikasil® Universal είναι μια σιλικόνη πολλαπλών χρήσεων και ιδιαίτερα σε υαλοπίνακες και εφαρμογές αδιαβροχοποίησης σε μη πορώδη υποστρώματα όπως γυαλί ή κεραμικά πλακίδια.

Κατανάλωση

1 φύσιγγα ανά 2,8 τρέχοντα μέτρα αρμού 10x10mm

ΚΩΔΙΚΟΣ	ΠΡΟΪΟΝ	ΧΡΩΜΑ	ΣΥΣΚ	ΤΙΜΗ/ΤΜΧ(€)
449300	280ML	ΛΕΥΚΟ	12	2.65
449301	280ML	ΔΙΑΦΑΝΟ	12	2.65
449302	280ML	ΚΑΦΕ	12	2.65
449303	280ML	ΓΚΡΙ	12	2.65
449304	280ML	ΜΠΕΖ	12	2.65
438769	280ML	ΜΑΥΡΟ	12	2.65

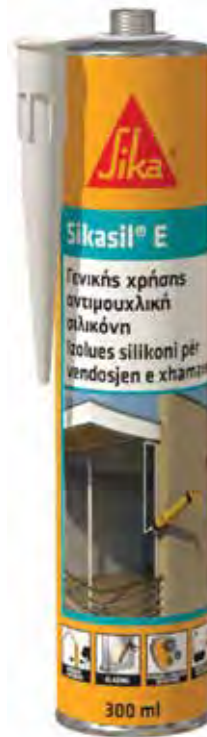

SIKASIL E

Σφραγιστικό σιλικόνης για υαλοστάσια

ΑΝΤΙΜΟΥΧΛΙΚΗ ΑΝΤΙΜΥΚΗΤΙΑΚΗ

Περιγραφή

Το Sikasil® E είναι ελαστικό σφραγιστικό 1-συστατικού για σφράγιση υαλοστασίων.

Πλεονεκτήματα Προϊόντος

- Μακροπρόθεσμη αντοχή σε μύκητες και άλγη
- Καλή αντοχή σε υπεριώδη ακτινοβολία και καιρικές επιδράσεις
- Πολύ καλή πρόσφυση στα περισσότερα μη πορώδη υποστρώματα
- Κινητικότητα ±20 %
- Χωρίς διαλύτες (σύμφωνα με TRGS 610)
- Υψηλή ελαστικότητα και ευκαμψία

Τομείς Εφαρμογής

- Για εφαρμογές αρμολογήσης και σφράγισης σε μη πορώδη υποστρώματα όπως είναι το γυαλί
- Για εσωτερική και εξωτερική χρήση

Κατανάλωση*

Πλάτος x Βάθος αρμού [mm]	Μήκος αρμού [m] ανά 300 ml
10 x 10	3,0
15 x 10	2,0
20 x 10	1,5

*Η κατανάλωση εξαρτάται από την τραχύτητα και την απορροφητικότητα του υποστρώματος. Οι ανωτέρω τιμές είναι θεωρητικές και δε συμπεριλαμβάνουν επιπλέον υλικό λόγω πορώδους επιφάνειας, προφίλ επιφάνειας, διακυμάνσεων επιπεδότητας, φύρας, κ.λπ..

ΚΩΔΙΚΟΣ	ΠΡΟΪΟΝ	ΧΡΩΜΑ	ΣΥΣΚ	ΤΙΜΗ/ΤΜΧ(€)
706600	300ML	ΔΙΑΦΑΝΟ	12	3.85
707850	300ML	ΛΕΥΚΟ	12	3.85

SIKASIL-C

Σφραγιστικό σιλικόνης ουδέτερης ωρίμανσης για οικοδομικές εφαρμογές και είδη υγιεινής



Περιγραφή

Το Sikasil®-C είναι σφραγιστικό σιλικόνης ενός συστατικού, ουδέτερης ωρίμανσης κατάλληλο για εσωτερικές και εξωτερικές εφαρμογές.

Πλεονεκτήματα Προϊόντος

- Παρέχει πρόσφυση σε μία ευρεία ποικιλία υποστρωμάτων χωρίς αστάρωμα
- Μακροπρόθεσμη ανθεκτικότητα στην ανάπτυξη μούχλας
- Έχει εξαιρετική αντοχή στην υπεριώδη ακτινοβολία και στις καιρικές συνθήκες



ΚΩΔΙΚΟΣ	ΠΡΟΪΟΝ	ΧΡΩΜΑ	ΣΥΣΚ	ΤΙΜΗ/ΤΜΧ(€)
73984	300ML	ΔΙΑΦΑΝΟ	12	4.10
73985	300ML	ΛΕΥΚΟ	12	4.10



- Αδύνατη οσμή
- Μη διαβρωτική
- Έχει μεγάλη ελαστικότητα και ευκαμψία

Τομείς Εφαρμογής

Το Sikasil®-C είναι κατάλληλο για υαλοστάσια και στεγανές εφαρμογές σε τζάμια, μέταλλα, βαμμένες επιφάνειες, ξύλο, ακρυλικά, πολυκαρβονικά, κεραμικά πλακίδια, καθώς και για εφαρμογές σε είδη υγιεινής.

Κατανάλωση

1 φύσιγγα ανά 3 τρέχοντα μέτρα αρμού 10x10mm

SIKA BOOM®-521 FOAMFIX

Πολυουρεθανικός αφρός



Συγκολλητικός Πολυουρεθανικός Αφρός
Ιδανικός για Γυψοσανίδες & Θερμοπροσόψεις

ΕΦΑΡΜΟΓΕΣ

Κατάλληλος για επικόλληση των ακόλουθων υλικών:

- Γυψοσανίδες
- Πλάκες εξήλασμένης πολυστερίνης (XPS)
- Stygofaam – Πλάκες διογκωμένης πολυστερίνης (EPS)
- Ξύλινες ινοσανίδες
- Πλάκες φελλού
- Σανίδες πολυουρεθάνης/πολυισοκυανουρίας (PUR/PIR)

Επίσης χρησιμοποιείται για:

- Τοποθέτηση θερμομονωτικών πάνελ και πλήρωση δημιουργούμενων κενών κατά την εφαρμογή της κόλλας
- Συγκόλληση ξύλινων δομικών υλικών σε σκυρόδεμα, μέταλλα, κ.λπ..
- Όλους τους τύπους εφαρμογών που απαιτούν πολυουρεθανικό αφρό με περιορισμένη διόγκωση
- Τοποθέτηση και απομόνωση πλαισίων παραθύρων και θυρών

ΚΩΔΙΚΟΣ	ΠΡΟΪΟΝ	ΧΡΩΜΑ	ΣΥΣΚ	ΤΙΜΗ/ΤΜΧ(€)
592039	800ML	-	12	7.60

ΧΑΡΑΚΤΗΡΙΣΤΙΚΑ

- Καλή πρόσφυση σε σκυρόδεμα, ξύλο, τουβλοδομές, σοβά, μέταλλα και PVC
- Ταχείας ωρίμανσης
- Ιδιαίτερα χαμηλής διόγκωσης
- Ιδιαίτερα οικονομικός
- Καλή εφελκυστική αντοχή
- Δυνατότητα χρήσης σε εσωτερικές και εξωτερικές εφαρμογές, σε οριζόντιες και κατακόρυφες επιφάνειες
- Άμεση πρόσφυση και δυνατότητα χρήσης των πανέλων εντός 2 ωρών από την προσαρμογή τους
- Ελάχιστη δευτερογενής διόγκωση κατά την περίοδο ωρίμανσης
- Ελαφρύ υλικό σε σύγκριση με σοβά και άλλα εναλλακτικά υλικά που χρησιμοποιούνται σε συστήματα θερμομόνωσης

ΚΑΤΑΝΑΛΩΣΗ

- ~ 14 m² για προσαρμογή θερμομονωτικών πλακών EPS/XPS
- ~ 40 m για εφαρμογή σε κορδόνι σε επιφάνεια 30x30m

**SIKA BOOM®-420 FIRE**

Πυράντοχος, διογκούμενος πολυουρεθανικός αφρός



ΚΩΔΙΚΟΣ	ΠΡΟΪΟΝ	ΧΡΩΜΑ	ΣΥΣΚ	ΤΙΜΗ/ΤΜΧ(€)
622196	750ML	-	12	20.60

ΕΦΑΡΜΟΓΕΣ

- Αποκαθιστά την πυραντίσταση δαπέδου ή τοίχου που διατρέχονται από γραμμικές σφραγίσεις
- Κατάλληλος μόνο για εσωτερική εφαρμογή

ΧΑΡΑΚΤΗΡΙΣΤΙΚΑ

- Πυραντίσταση έως και 180 λεπτά σύμφωνα με EN 1366-4
- Δυνατότητα εφαρμογής είτε με πιστόλι, είτε με ακροφύσιο
- 1-συστατικού, έτοιμος για χρήση
- Με βαλβίδα ασφαλείας για παρατεταμένη διάρκεια ζωής
- Ο ώριμος αφρός μπορεί να κοπεί και να τριφτεί

ΚΑΤΑΝΑΛΩΣΗ

- Ένα δοχείο 750 ml αποδίδει μέχρι ~44 lt με πιστόλι ή ~30 lt με ακροφύσιο

**SIKA BOOM® P**

Διογκούμενος πολυουρεθανικός αφρός ταχείας ωρίμανσης



ΚΩΔΙΚΟΣ	ΠΡΟΪΟΝ	ΧΡΩΜΑ	ΣΥΣΚ	ΤΙΜΗ/ΤΜΧ(€)
750491	300ML	-	12	3.90
595869	750ML	-	12	5.40

420gr**ΕΦΑΡΜΟΓΕΣ**

- Στερέωση και μόνωση πλαισίων θυρών και παραθύρων
- Πλήρωση και σφράγιση κενών, αρμών και κοιλοτήτων
- Πλήρωση διεισδύσεων σε τοίχους
- Μόνωση περιμετρικά ηλεκτρικών πριζών και σωλήνων νερού

ΧΑΡΑΚΤΗΡΙΣΤΙΚΑ

- Εξαιρετική πρόσφυση & ικανότητα πλήρωσης
- Υψηλές θερμομονωτικές και ηχοαπορροφητικές ιδιότητες
- Προσφύεται σχεδόν σε όλα τα κατασκευαστικά υλικά, εκτός από πολυαιθυλένιο, τεφλόν, σιλικόνη και επιφάνειες με λάδια, γράσα, αποκαλυπτικά μέσα κ.λπ..
- Ανθεκτικός σε μύκητες, υδατοστεγανός, βαφόμενος
- Ο ώριμος αφρός είναι άκαμπος και μπορεί να κοπεί, να διαμορφωθεί και να τριφτεί

ΚΑΤΑΝΑΛΩΣΗ

Ένα δοχείο 750 ml αποδίδει μέχρι 45 lt

Sika Boom® Low Expansion Αφροί πιστολιού και χειρός, χαμηλής διόγκωσης**Sika Boom®-120 Χειρός**

ΚΩΔΙΚΟΣ	ΠΡΟΪΟΝ	ΧΡΩΜΑ	ΣΥΣΚ	ΤΙΜΗ/ΤΜΧ(€)
620395	750ML	-	12	6.30

ΚΑΤΑΝΑΛΩΣΗ

Ένα δοχείο 750 ml αποδίδει μέχρι 45 lt

**Sika Boom®-520 Πιστολιού**

ΚΩΔΙΚΟΣ	ΠΡΟΪΟΝ	ΧΡΩΜΑ	ΣΥΣΚ	ΤΙΜΗ/ΤΜΧ(€)
592042	750ML	-	12	5.60

ΚΑΤΑΝΑΛΩΣΗ

Η κατανάλωση μπορεί να ρυθμιστεί από την πίεση που θα ασκηθεί στο άκρο της βαλβίδας / του προσαρμογέα του πιστολιού Sika® Dispenser.

ΕΦΑΡΜΟΓΕΣ

- Τοποθέτηση και μόνωση πλαισίων πορτών, παραθύρων, σκαλοπατιών
- Στερέωση και στεγανοποίηση κενών, αρμών, κοιλοτήτων, συνδέσεων
- Γεμίματα διεισδύσεων σε τοίχους, γύρω από αεραγωγούς κλιματισμού
- Μόνωση ηλεκτρικών εξόδων και σωληνώσεων νερού

ΧΑΡΑΚΤΗΡΙΣΤΙΚΑ

- Ακριβής δοσομέτρηση, χαμηλή κατανάλωση
- Ιδιαίτερως κατάλληλος για αρμούς μικρού πλάτους
- Διατηρεί την ελαστικότητά του
- Ταχείας ωρίμανσης
- Ιδιαίτερα περιορισμένης δευτερογενούς διόγκωσης
- Προσφύεται σε όλα τα κατασκευαστικά υλικά, όπως ξύλο, σκυρόδεμα, μέταλλα, αλουμίνιο, αεριοσκυρόδεμα, τούβλα
- Εξαιρετική θερμομόνωση
- Ιδιαίτερα αποτελεσματική ηχοαπόσβεση
- Δεν προσβάλλεται από μούχλα, είναι στεγανός και βαφόμενος

SIKAFILL 90 MP

Ακρυλικής βάσης, ελαστική μεμβράνη στεγανοποίησης δωμάτων



ΚΩΔΙΚΟΣ	ΠΡΟΪΟΝ	ΧΡΩΜΑ	ΣΥΣΚ	ΤΙΜΗ/ΤΜΧ(€)
771389	12KG	ΛΕΥΚΟ	1	50.50

Πλεονεκτήματα Προϊόντος

- Αδιαπέραστο από τη βροχή
- Ανθεκτικό στις καιρικές επιδράσεις
- Γεφυρώνει μικρορηγματώσεις του υποστρώματος
- Υψηλής ελαστικότητας
- Καλή πρόσφυση σε διάφορα υποστρώματα
- Καλή δυνατότητα διείσδυσης
- Εύκολο στην εφαρμογή
- Οικονομικό προϊόν
- Υδατικής βάσης
- Μη τοξικό
- Αφλεκτο

Τομείς Εφαρμογής

- Στεγανοποίηση δωμάτων με βατότητα, εφαρμοσμένο πάνω σε διάφορα υποστρώματα όπως κεραμικά πλακίδια, ινοπλισμένα κονιάματα, τσίγκο, αλουμίνιο, ξύλο, πλακίδια, τούβλα, κονιάματα, σκυρόδεμα, ασφαλτόπανα με τελική επένδυση φύλλου αλουμινίου
- Για την προστασία στηθαίων και διαχωριστικών τοίχων από υγρασία και πιθανές διεισδύσεις νερού

ΚΑΤΑΝΑΛΩΣΗ

1-2 kg/m² σε 2 ή περισσότερες στρώσεις

*Σημαντική υπενθύμιση όσον αφορά στο υλικό, δεν απαιτείται χρήση ειδικού ασταριού, καθώς ως αστάρι το πρώτο χέρι του SikaFill-90 MP αραιώνεται 20% με νερό και η επόμενη ή οι επόμενες στρώσεις ακολουθούν χωρίς αραιώση.

**Το υλικό στην ετικέτα του αναγράφει την ημερομηνία παραγωγής και έχει χρόνο ζωής σε κλειστή συσκευασία 24 μήνες.

SIKACEM EXTRABOND 100

Βελτιωτικό γαλάκτωμα τσιμεντοκονιαμάτων



ΚΩΔΙΚΟΣ	ΠΡΟΪΟΝ	ΧΡΩΜΑ	ΣΥΣΚ	ΤΙΜΗ/ΤΜΧ(€)
532186	1 KG	ΛΕΥΚΟ	10	5.10
532187	5 KG	ΛΕΥΚΟ	1	20.70

Περιγραφή

Το SikaCem® ExtraBond-100 είναι ένα γαλακτώδες υγρό πρόσμικτο κονιαμάτων για επιχρίσματα, επισκευαστικά, στεγανά κονιάματα και τσιμεντοκονίες δαπέδων.

Πλεονεκτήματα Προϊόντος

- Πολύ καλή πρόσφυση
- Μεγαλύτερη ευκαμψία
- Μικρότερη υδατοπερατότητα
- Μεγαλύτερη αντοχή σε τριβή

Τομείς Εφαρμογής

- Παντός είδους κονιάματα στην κατασκευή
- Παραγωγή σοβά, κονιαμάτων επικάλυψης

ΚΑΤΑΝΑΛΩΣΗ

Εν γίνεται 5-10% κ.β. τσιμέντου ανάλογα με την εφαρμογή

SIKA PRIMER 3N

Αστάρι βάσεως διαλύτη για πορώδη υποστρώματα και μεταλλικές επιφάνειες



ΚΩΔΙΚΟΣ	ΠΡΟΪΟΝ	ΧΡΩΜΑ	ΣΥΣΚ	ΤΙΜΗ/ΤΜΧ(€)
114665	250ML	ΔΙΑΦΑΝΕΣ	6	22.00

Περιγραφή

Το Sika® Primer-3 N είναι ένα αστάρι βάσεως διαλύτη για τα προϊόντα των σειρών SikaFlex®, SikaHyFlex®, SikaBond® και Sikasil® που εφαρμόζονται επί πορώδων υποστρωμάτων (π.χ. σκυρόδεμα) και μεταλλικών επιφανειών.

Πλεονεκτήματα Προϊόντος

- Εύκολο στην εφαρμογή
- Απωθητικό νερού
- Σύντομος χρόνος ξήρανσης

ΚΑΤΑΝΑΛΩΣΗ

Σε πορώδη υποστρώματα (ανά lt):-5m² /-250 τρέχοντα μέτρα και σε μη πορώδη:-8m² /-400

Sika MonoTop®-112 MultiUse Repair

Επισκευαστικό κονίαμα
σκυροδέματος

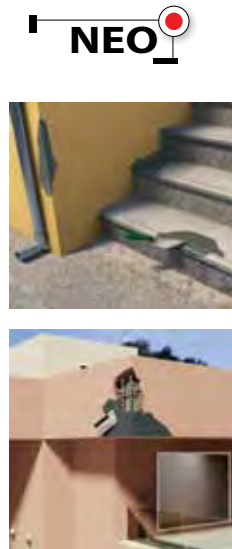

ΚΩΔΙΚΟΣ	ΠΡΟΪΟΝ	ΧΡΩΜΑ	ΣΥΣΚ	ΤΙΜΗ/ ΤΜΧ(€)
533449	4Χ5 ΚG	ΓΚΡΙ		9.80

Περιγραφή

Το Sika MonoTop®-112 MultiUse Repair είναι ενός συστατικού, έτοιμο προς χρήση κονίαμα, που περιέχει τσιμεντοειδούς βάσης συνδετικό υλικό, επιλεγμένα αδρανή, συνθετικές ίνες και ειδικά πρόσμικτα.

Χρήσεις

- Αποκατάσταση και επισκευή στοιχείων σκυροδέματος (κολώνες, δοκοί, πλάκες, άκρες μπαλκονιών)
- Εξομάλυνση κατεστραμμένων περιοχών σε κατακόρυφες και οριζόντιες επιφάνειες
- Πλήρωση κενών, φωλιών, πόρων και μικρών ατελειών σε γωνίες και ακμές

Πλεονεκτήματα

- Εύκολο στην εφαρμογή, ακόμη και σε εφαρμογές οροφής
- Εύκολο στην ανάμειξη, απλά προστίθεται νερό
- Καλές μηχανικές αντοχές. Καλή πρόσφυση στα περισσότερα κοινά κατασκευαστικά υλικά, όπως σκυρόδεμα, πέτρα, τούβλα, χάλυβα

Συσκευασία

Κιβώτιο των 4 πλαστικών συσκευασιών με επένδυση αλουμινίου, των 5 kg έκαστη

Sika MonoTop®-110 QuickFix

Ταχύπηκτο κονίαμα
στερεώσεων



ΚΩΔΙΚΟΣ	ΠΡΟΪΟΝ	ΧΡΩΜΑ	ΣΥΣΚ	ΤΙΜΗ/ ΤΜΧ(€)
533446	4Χ5 ΚG	ΓΚΡΙ		10.05

Περιγραφή

Το Sika MonoTop®-110 QuickFix είναι ενός συστατικού, έτοιμο προς χρήση, ταχύπηκτο κονίαμα βάσης τσιμεντοειδούς συνδετικού υλικού και επιλεγμένων αδρανών, που χαρακτηρίζεται από ταχεία ανάληψη μηχανικών αντοχών και προορίζεται για κονίαμα στερεώσεων.

Χρήσεις

- Το Sika MonoTop®-110 QuickFix είναι ειδικά σχεδιασμένο για εφαρμογές που απαιτείται κονίαμα ταχείας πήξης, όπως:
- Στερέωση αγκυρώσεων, βλήτρων, στηριγμάτων σωληνώσεων, στερέωση κουφωμάτων
 - Αγκυρώσεις σε πασσάλους, πέργκολες, στύλους, φράχτες

Πλεονεκτήματα

- Πήξη μέσα σε λίγα λεπτά
- Πρακτική συσκευασία, κατάλληλο και για μικρές εφαρμογές
- Εξαιρετική πήξη ακόμη και παρουσία υγρασίας
- Μπορεί να βαφτεί μετά την ωρίμανσή του
- Καλή πρόσφυση σε μέταλλο

Συσκευασία

5 kg σάκι με επένδυση αλουμινίου, συσκευασμένοι σε κιβώτιο που περιέχει 4 σάκους

Sika MonoTop®-100 Fire Resistant

Πυρίμαχο κονίαμα



ΚΩΔΙΚΟΣ	ΠΡΟΪΟΝ	ΧΡΩΜΑ	ΣΥΣΚ	ΤΙΜΗ/ ΤΜΧ(€)
530113	4Χ5 KG	ΓΚΡΙ		11.60

Περιγραφή

Το Sika MonoTop®-100 Fire Resistant είναι ενός συστατικού, ταχείας πήξης πυρίμαχο κονίαμα για τοποθέτηση πυρίμαχων πλίνθων, καθώς και για την κατασκευή και επισκευή στοιχείων ανθεκτικών στη θερμότητα.

Χρήσεις

Κατασκευή και επισκευή στοιχείων που υποβάλλονται σε συνθήκες έντονης θερμότητας, όπως ψησταριές, τζάκια, φούρνοι, κ.ά.

Ειδικά σχεδιασμένο τόσο για τοποθέτηση και αρμολόγηση μεταξύ πυρίμαχων κεραμικών, τσιμεντένιων μπλοκ, πλακιδίων terracota που λειτουργούν σε συνθήκες υψηλής θερμοκρασίας.

Ως κονίαμα φινιρίσματος σε περιβάλλον που αναπτύσσονται υψηλές θερμοκρασίες λειτουργίας.

Πλεονεκτήματα

- Υψηλή θερμική αντοχή, έως τους 750 °C
- Ταχεία ανάληψη αντοχών
- Εύκολο στην ανάμειξη
- Εύκολο στην εφαρμογή

Συσκευασία

5 kg πλαστικοί σάκοι

Sika MonoTop®-111

AntiCorrosion
Αντιδιαβρωτικό



ΚΩΔΙΚΟΣ	ΠΡΟΪΟΝ	ΧΡΩΜΑ	ΣΥΣΚ	ΤΙΜΗ/ ΤΜΧ(€)
533445	10Χ2 KG			10.85

Περιγραφή

Μείγμα ενός συστατικού τσιμεντοειδούς βάσης, τροποποιημένο με πολυμερή και πυριτική παυτάλη για χρήση ως αντιδιαβρωτική προστασία χαλύβδινου σπλισμού και γέφυρα πρόσφυσης.

Εφαρμογές

- Αντιδιαβρωτική προστασία πριν από εργασίες επισκευών
- Γέφυρα πρόσφυσης σε επιφάνειες σκυροδέματος και κονιαμάτων

Χαρακτηριστικά / Πλεονεκτήματα

- Ανάμειξη μόνο με νερό
- Εύκολος τρόπος εφαρμογής
- Εξαιρετική πρόσφυση σε σκυρόδεμα, κονιάματα και χάλυβα
- Υψηλή προστασία έναντι διείσδυσης νερού και χλωριδίων
- Υψηλής μηχανικής αντοχής
- Εφαρμόσιμο με βούρτσα ή ψεκασμό

Συσκευασία

2 kg πλαστικοί σάκοι

Sika MonoTop®-109 WaterProofing

Τσιμεντοειδές κονίαμα στεγανοποίησης



NEO

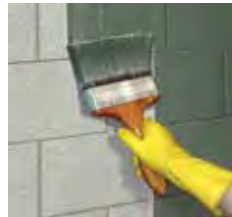

ΚΩΔΙΚΟΣ	ΠΡΟΪΟΝ	ΧΡΩΜΑ	ΣΥΣΚ	ΤΙΜΗ/ΤΜΧ(€)
533581	4Χ5 ΚG	ΓΚΡΙ		12.30

Περιγραφή

Το Sika MonoTop®-109 WaterProofing είναι ενός συστατικού, έτοιμο προς χρήση κονίαμα στεγανοποίησης, κατάλληλα διαμορφωμένης συνεκτικότητας για εφαρμογή με βούρτσα.

Χρήσεις

Το Sika MonoTop®-109 WaterProofing είναι ειδικά σχεδιασμένο για τη στεγανοποίηση και προστασία θεμελίων, τοιχίων υπογείων ή κατασκευών πριν την επίχωση, φρεατίων ανελκυστήρων, δεξαμενών νερού, κ.λπ.

Πλεονεκτήματα

- Ενόσ συστατικού, απλά προσθέστε νερό
- Καλή πρόσφυση σε πολλά υποστρώματα
- Εφαρμόσιμο απευθείας σε τούβλο, σκυρόδεμα και θεμελιώσεις από πέτρα

Συσκευασία

Σακουλάκια με επένδυση αλουμινίου των 5 kg (χαρτοκιβώτιο με 4 σακουλάκια)

Sika MonoTop®-108 WaterPlug

Υπερ-ταχύπηκτο σφραγιστικό διαρροών



NEO



ΚΩΔΙΚΟΣ	ΠΡΟΪΟΝ	ΧΡΩΜΑ	ΣΥΣΚ	ΤΙΜΗ/ΤΜΧ(€)
533495	4Χ5 ΚG	ΓΚΡΙ		16.00

Περιγραφή

Το Sika MonoTop®-108 WaterPlug είναι ένα υπερ-ταχείας πήξης τσιμεντοειδές κονίαμα ενός συστατικού για σφράγιση διαρροών σε τοίχους από σκυρόδεμα και τοιχοποιίες γενικότερα.

Σκληύρυνση εντός ~60-80 δευτερολέπτων (στους +20°C)

Χρήσεις

Άμεση σφράγιση-αντιμετώπιση αρνητικών πιέσεων νερού-διεισδύσεων νερού διαμέσου ρηγματώσεων, εσοχών χαλικοδεμάτων και κατασκευαστικών αρμών
Άμεση σφράγιση, αντιμετώπιση διεισδύσεων νερού αποστράγγισης πριν το τελικό στάδιο κύριας στρώσης στεγανοποίησης

Πλεονεκτήματα

Ταχεία πήξη, χωρίς το υλικό να “εκπλένεται” λόγω παρουσίας νερού υπό πίεση ή τρεχούμενου νερού

Συσκευασία

5 kg σάκοι αλουμινίου συσκευασμένοι σε χαρτοκιβώτιο που περιέχει 4 συσκευασίες

➤ Δεν «τρέχει» (ακόμη & σε εφαρμογή στο ταβάνι) ➤ Δε συρρικνώνεται ➤ Δε ρηγματώνει ➤ Δε χρειάζεται πολλές στρώσεις



Τούβλο
Πέτρα
Σκυρόδεμα
Σοβάς



Αφρόστοκος One Strike

ΚΩΔΙΚΟΣ	ΠΡΟΪΟΝ	ΧΡΩΜΑ	ΣΥΣΚ	ΤΜΧ /ΚΙΒ	ΚΙΒ/ ΠΛΤ	ΤΙΜΗ/ ΤΜΧ(€)
461918	ONE STRIKE	-	250ml	18		4.65
461917	ONE STRIKE	-	450ml	12	64	5.89
461916	ONE STRIKE	-	1L	6	54	9.06

Το **One Strike** είναι ένας νέος, επαναστατικός στόκος που περιέχει στη σύνθεσή του ελαφριά πολυμερή, τα οποία νερμίζουν οπές και κενά ακόμη και μεγάλου βάθους. Κατάλληλος για χρήση σε σοβά, ξύλο, τούβλο, πέτρα και επιχρίσματα. Ιδανικός για εφαρμογές οροφής, δεν κρεμάει και δεν τρέχει. Το One Strike δίνει ένα λείο τελείωμα που απαιτεί ελάχιστο ή και καθόλου τρίψιμο και είναι έτοιμο για βαφή ή για να δεχθεί ταπετσαρία σε μόλις 30 λεπτά.

➤ Δε χρειάζεται τρίψιμο ➤ Δεν αργεί να στεγνώσει (30') ➤ Δεν κοστίζει



SIKAFLEX 291i

Ναυτιλιακό σφραγιτικό συγκολλητικό πολλαπλών χρήσεων



ΚΩΔΙΚΟΣ	ΠΡΟΪΟΝ	ΧΡΩΜΑ	ΣΥΣΚ	ΤΙΜΗ/ΤΜΧ(€)
929101	300ML	ΛΕΥΚΟ	12	13.55
929102	300ML	ΜΑΥΡΟ	12	13.55
929103	300ML	ΓΚΡΙ	12	13.55
929104	300ML	ΚΑΦΕ	12	13.55
929111	600ML	ΛΕΥΚΟ	20	21.75
929122	70ML	ΜΑΥΡΟ	24	9.95
929123	70ML	ΛΕΥΚΟ	24	9.95

Περιγραφή

Το Sikaflex®-291i είναι ένα θιξοτροπικό σφραγιτικό υλικό πολυουρεθάνης ενός συστατικού ειδικά αναπτυγμένο για την ναυτιλία, που ωριμάζει με την ατμοσφαιρική υγρασία σχηματίζοντας ένα ανθεκτικό ελαστομερές. Το Sikaflex®-291i πληρεί επιπλέον τα κριτήρια αργής μετάδοσης πυρκαγιάς του International Maritime Organisation (IMO).

Πλεονεκτήματα Προϊόντος

- Πιστοποίηση IMO
- Σύνθεση ενός συστατικού
- Ελαστικό
- Ελαφριάς οσμής
- Μη διαβρωτικό
- Μπορεί να βαφτεί
- Έχει πολύ καλή πρόσφυση σε μεγάλο εύρος υποστρωμάτων
- Δεν απελευθερώνει VOC και αέριους ρύπους

Τομείς Εφαρμογής

Το Sikaflex®-291i είναι ένα προϊόν πολλαπλών χρήσεων για χρήση σε ναυτιλιακές εφαρμογές. Είναι κατάλληλο για τον σχηματισμό ελαστικών αρμών ανθεκτικών σε δονήσεις και μπορεί να χρησιμοποιηθεί επίσης σε ποικιλία εσωτερικών και εξωτερικών εφαρμογών σφράγισης. Το Sikaflex®-291i έχει εξαιρετική πρόσφυση σε συνήθη υλικά που χρησιμοποιούνται σε ναυτιλιακές κατασκευές όπως ξύλο, μέταλλα, αστάρια μετάλλων και βαφές (2 συστατικών), κεραμικά υλικά και πλαστικά (GRP, κλπ.). Το Sikaflex®-291i δεν πρέπει να χρησιμοποιείται για την σφράγιση πλαστικών που είναι επιρρεπή σε ρωγμάτωση υπό περιβαλλοντική καταπόνηση (π.χ. Plexiglas, πολυκαρβονικά κλπ.).

SIKAFLEX 292i

Δομικό ναυτιλιακό συγκολλητικό



ΚΩΔΙΚΟΣ	ΠΡΟΪΟΝ	ΧΡΩΜΑ	ΣΥΣΚ	ΤΙΜΗ/ΤΜΧ(€)
929201	300ML	ΛΕΥΚΟ	12	26.35

Περιγραφή

Το Sikaflex®-292i είναι ένα θιξοτροπικό συγκολλητικό υλικό πολυουρεθάνης, ενός συστατικού, με μορφή πάστας που δεν κρεμεί και ωριμάζει με την ατμοσφαιρική υγρασία ώστε να σχηματισθεί ένα ανθεκτικό ελαστομερές. Το Sikaflex®-292i εμφανίζει εξαιρετικές ιδιότητες συγκόλλησης και υψηλό βαθμό μηχανικής αντοχής. Επιπλέον πληρεί τα κριτήρια αργής μετάδοσης πυρκαγιάς του International Maritime Organisation (IMO).

Πλεονεκτήματα Προϊόντος

- Με πιστοποίηση IMO
- Σύνθεση ενός συστατικού
- Ελαστικό
- Μπορεί να βαφτεί
- Έχει καλές ιδιότητες πλήρωσης διακένων
- Αντοχή σε υψηλές, δυναμικές καταπονήσεις
- Αποσβένει δονήσεις
- Μη διαβρωτικό
- Μη αγώγιμο ηλεκτρικά
- Έχει πολύ καλή πρόσφυση σε μεγάλο εύρος υποστρωμάτων
- Χωρίς διαλύτες και εκπομπές VOC

Τομείς Εφαρμογής

Το Sikaflex®-292i χρησιμοποιείται σε δομικές συναρμογές ναυτιλιακών κατασκευών που υπόκεινται σε μεγάλες μηχανικές καταπονήσεις. Είναι κατάλληλο για μέταλλα, ειδικότερα αλουμίνιο (συμπεριλαμβανομένων ανοδιωμένων επικαλύψεων), μεταλλικών ασταριών και βαφών (2 συστατικών), ή κεραμικά υλικά, πλαστικά όπως το GRP (ακόρεστη πολυεστερική ρητίνη), ABS, κλπ. Διάφανα πλαστικά και ορυκτό γυαλί υπό UV δεν πρέπει να συγκολλούνται με Sikaflex®-292i. Το προϊόν αυτό θα πρέπει να χρησιμοποιείται μόνο από έμπειρους επαγγελματίες. Θα πρέπει να πραγματοποιούνται πειραματικές δοκιμές υπό κανονικές συνθήκες και με τα πραγματικά υποστρώματα ώστε να επαληθεύεται η παρεχόμενη πρόσφυση και η συμβατότητα του προϊόντος.

SIKAFLEX 295UV

Ναυτιλιακό συγκολλητικό για οργανικά κρύσταλλα



APPLICATION RULES AND GUIDELINES

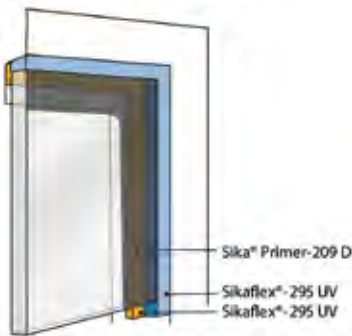

ΚΩΔΙΚΟΣ	ΠΡΟΪΟΝ	ΧΡΩΜΑ	ΣΥΣΚ	ΤΙΜΗ/ΤΜΧ(€)
929501	300ML	ΛΕΥΚΟ	12	18.20
929502	300ML	ΜΑΥΡΟ	12	18.20

SIKAFLEX 290 DC PRO

Επαγγελματικό σφραγιστικό στεγανοποίησης καταστρώματος



ΚΩΔΙΚΟΣ	ΠΡΟΪΟΝ	ΧΡΩΜΑ	ΣΥΣΚ	ΤΙΜΗ/ΤΜΧ(€)
929002	300ML	ΜΑΥΡΟ	12	17.20
929012	600ML	ΜΑΥΡΟ	20	25.35

Περιγραφή

Το Sikaflex®-295 UV είναι ένα συγκολλητικό-σφραγιστικό, με προσαρτία από UV, υλικό πολυουρεθάνης, ενός συστατικού, με μορφή πάστας που ωριμάζει με την ατμοσφαιρική υγρασία ώστε να σχηματισθεί ένα ανθεκτικό ελαστομερές. Το Sikaflex® - 295 UV πληρεί τις απαιτήσεις του Διεθνούς Όργανισμού Ναυτιλίας (International Maritime Organisation).

Πλεονεκτήματα Προϊόντος

- Σύνθεση ενός συστατικού
- Ταχεία ωρίμανση
- Κοντό κορδόνι αποκοπής
- Εγκεκριμένο για την ναυτιλιακή αγορά κατασκευαστών (OEM)
- Ανθεκτικό στην γήρανση και τις καιρικές συνθήκες
- Κατάλληλο για οργανικά τζάμια

Τομείς Εφαρμογής

Το Sikaflex® - 295 UV έχει αναπτυχθεί ειδικά για την ναυτιλιακή βιομηχανία, όπου χρησιμοποιείται για να συγκολλήσει και να σφραγίσει πλαστικά υλικά υαλοπινάκων σε σκάφη και πλοία. Λόγω της εξαιρετικής αντοχής του στην υπεριώδη ακτινοβολία αυτό το προϊόν μπορεί να χρησιμοποιηθεί επίσης στην σφράγιση αρμών με σοβαρή έκθεση. Ζητήστε από την Τεχνική μας Υπηρεσία οδηγίες πριν χρησιμοποιήσετε το Sikaflex® - 295 UV σε θερμικά διαμορφωμένα πλαστικά.

Τα κατάλληλα υποστρώματα περιλαμβάνουν:

- Αλουμίνιο (γυαλιστερό ή ανοδιωμένο)
- GRP (πολυεστερική ρητίνη)
- Ανοξείδωτο χάλυβα
- Ξύλο
- Βαφές 2 συστατικών
- Πλαστικά υλικά υαλοπινάκων (PC, PMMA)

Περιγραφή

Το Sikaflex®-290 DC PRO είναι ένα σφραγιστικό υλικό ενός συστατικού, βάσεως πολυουρεθάνης, ανθεκτικό στην υπεριώδη ακτινοβολία που έχει συντεθεί ειδικά για την στεγανοποίηση αρμών σε παραδοσιακά ξύλινα καταστρώματα πλοίων. Παρουσιάζει εξαιρετική αντοχή στις καιρικές συνθήκες και συνεπώς είναι κατάλληλο για ιδιαίτερα εκτεθειμένους ανοικτούς αρμούς στο θαλάσσιο περιβάλλον. Το σφραγιστικό υλικό ωριμάζει ώστε να σχηματισθεί ένα εύκαμπτο ελαστομερές που μπορεί να τριφτεί με γυαλόχαρτο. Το Sikaflex®-290 DC PRO πληρεί τις απαιτήσεις του Διεθνούς Όργανισμού Ναυτιλίας (International Maritime Organisation).

Πλεονεκτήματα Προϊόντος

- Εξαιρετική αντοχή στις καιρικές συνθήκες
- Σύνθεση ενός συστατικού
- Μη διαβρωτικό
- Εύκολη και γρήγορη τριβή
- Ανθεκτικό στο θαλασσινό και γλυκό νερό.
- Εύκολη εφαρμογή
- Ιδανική ροή εφαρμογής

Τομείς Εφαρμογής

Το Sikaflex®-290 DC PRO χρησιμοποιείται αποκλειστικά για την στεγανοποίηση αρμών σε παραδοσιακά ξύλινα καταστρώματα στην κατασκευή λέμβων και πλοίων. Το προϊόν θα πρέπει να χρησιμοποιείται μόνο από επαγγελματίες χρήστες. Θα πρέπει να διεξάγονται πειράματα στα πραγματικά υποστρώματα και υπό πραγματικές συνθήκες ώστε να επαληθευτεί η παρεχόμενη πρόσφυση και η συμβατότητα του προϊόντος.

ΚΑΤΑΝΑΛΩΣΗ

1 σωληνάριο 600 ml ανά 6 τρέχοντα μέτρα αρμού (10x10 mm)

SIKAFLEX 298

Αυτοεπιπεδούμενο
συγκολλητικό ναυτιλιακών
επιστρώσεων



ΚΩΔΙΚΟΣ	ΠΡΟΪΟΝ	ΧΡΩΜΑ	ΣΥΣΚ	ΤΙΜΗ/ ΤΜΧ(€)
929812	600ML	ΜΑΥΡΟ	20	18.75

Περιγραφή

Το SikaFlex®-298 είναι ένα ελαφρώς θιξοτροπικό, πολυουρεθανικής βάσης συγκολλητικό υλικό, ενός συστατικού που ωριμάζει με την ατμοσφαιρική υγρασία ώστε να σχηματιστεί ένα ανθεκτικό ελαστομερές. Το SikaFlex®-298 πληρεί τις απαιτήσεις του Διεθνούς Όργανισμού Ναυτιλίας (International Maritime Organisation).

Πλεονεκτήματα Προϊόντος

- Σύνθεση ενός συστατικού
- Ελαφρώς θιξοτροπικό
- Ελαστικό
- Ηχομονωτικό
- Μεγάλου χρόνου εργασιμότητας

Τομείς Εφαρμογής

Το SikaFlex®-298 είναι κατάλληλο για τη συγκόλληση επενδύσεων καταστρωμάτων από σύνθετα υλικά και ρητίνες (εκτός πολυαιθυλενίου, πολυπροπυλενίου) και για τη τοποθέτηση και σφράγιση σανίδων ξύλου όπως teak πάνω στην επιφάνεια του καταστρώματος. Στα κατάλληλα υποστρώματα περιλαμβάνονται GRP, κόντρα πλακέ θαλάσσης, αλουμίνιο με αντιδιαβρωτική επικάλυψη (εποξειδικής ή πολυουρεθανικής-ακρυλικής βάσης) και ανοξείδωτο αστάλι.

SIKA MULTI PRIMER MARINE

Ναυτιλιακό αστάρι επιφανειών
πολυουρεθανικής συγκόλλησης
για γενική χρήση



ΚΩΔΙΚΟΣ	ΠΡΟΪΟΝ	ΧΡΩΜΑ	ΣΥΣΚ	ΤΙΜΗ/ ΤΜΧ(€)
920015	30ML	ΔΙΑΦΑΝΟ	1	11.40
920025	250ML	ΔΙΑΦΑΝΟ	1	37.95
920035	1000ML	ΔΙΑΦΑΝΟ	1	94.55

Περιγραφή

Το Sika® MultiPrimer Marine είναι ένα λεπτόρευστο αστάρι για την προετοιμασία επιφανειών πριν την συγκόλληση - σφράγιση με πολυουρεθανικά προϊόντα της Sika σε ευρεία γκάμα υποστρωμάτων.

Πλεονεκτήματα Προϊόντος

- Εξαιρετική πρόσφυση σε πολλά υποστρώματα
- Εύκολη εφαρμογή
- Εξαιρετική αντοχή
- Μεγάλος ανοιχτός χρόνος εφαρμογής

Τομείς Εφαρμογής

Το Sika® MultiPrimer Marine βελτιώνει την πρόσφυση σε υποστρώματα όπως ξύλο (teak, mahogany, oregon και φελλό), μέταλλα όπως αλουμίνιο και γαλβανισμένο αστάλι, πλαστικά και βαμμένες/ασταρωμένες επιφάνειες. Το προϊόν θα πρέπει να χρησιμοποιείται μόνο από επαγγελματίες χρήστες. Θα πρέπει να διεξάγονται πειράματα στα πραγματικά υποστρώματα και υπό πραγματικές συνθήκες ώστε να επαληθεύεται η παρεχόμενη πρόσφυση και η συμβατότητα του προϊόντος.

Σφραγιστικό Σιλικόνης Forever White



Το **Forever White** είναι εξαιρετικής απόδοσης σφραγιστικό σιλικόνης που παραμένει μόνιμα στεγανό και εύκαμπτο. Με εξαιρετική αντοχή στην ανάπτυξη μούχλας σε περιοχές με αυξημένη παρουσία υγρασίας.



ANTI-ΒΑΚΤΗΡΙΑΔΙΑΚΗ ΤΕΧΝΟΛΟΓΙΑ

Τα προϊόντα Forever White περιέχουν ένα αντιμικροβιακό συστατικό, ειδικά σχεδιασμένο για να αναστέλλει την ανάπτυξη επιβλαβών οργανισμών όπως βακτήρια, μούχλα και άλγη, ενώ ταυτόχρονα προσφέρει ασφάλεια ακόμη και στις πιο ευαίσθητες εφαρμογές.



ΠΕΡΙΟΧΕΣ ΕΦΑΡΜΟΓΗΣ

- Γύρω από ντουζιέρες, μπανιέρες, νεροχύτες & λοιπά είδη υγιεινής
- Για γενική χρήση σε χώρους με αυξημένα επίπεδα υγρασίας
- Για κουζίνες και λουπούς βοηθητικούς χώρους
- Για περιμετρική σφράγιση παραθύρων και πορτών.

ΚΩΔΙΚΟΣ	ΠΡΟΪΟΝ	ΧΡΩΜΑ	ΣΥΣΚ	ΤΜΧ /ΚΙΒ	ΚΙΒ/ ΠΛΤ	ΤΙΜΗ/ ΤΜΧ(€)
461971	FOREVER WHITE SILICONE	ΛΕΥΚΟ	C3	12	120	10.47
461972	FOREVER CLEAR SILICONE	ΔΙΑΦΑΝΟ	C3	12	120	10.47

Πολυουρεθανική Βαφή Δαπέδων Μηχανικής Καταπόνησης/Τροχήλατης Κυκλοφορίας



ΓΚΡΙ
PANTONE
425 C

Το **Floor Paint** είναι χαμηλού ιξώδους και υψηλών αντοχών βαφή, πολυουρεθανικής φόρμουλας. Παρέχει διαφανή, σκληρή τελική επιφάνεια σε δάπεδα από σκυρόδεμα, πέτρα και ξύλο που υπόκειται σε ελαφριά μηχανική καταπόνηση λόγω κίνησης τροχήλατων ανυψωτικών οχημάτων. Είναι ιδανική για χρήση σε δάπεδα γκαράζ, εργαστηρίων, αποθηκών, διαδρόμων, κ.τ.λ. Προσδίδει αυξημένη ανθεκτικότητα, αντοχή σε απότριψη και καλή αντίσταση σε αραιωμένα οξέα, αλκάλια και λάδια.

ΚΩΔΙΚΟΣ	ΠΡΟΪΟΝ	ΧΡΩΜΑ	ΣΥΣΚ	ΤΜΧ /ΚΙΒ	ΚΙΒ/ ΠΛΤ	ΤΙΜΗ/ ΤΜΧ(€)
538684	FLOOR PAINT GREY	MAT ΓΚΡΙ	5L	4	24	107.54

Πανάκια Wonder Wipes Multi-Use



- Καλύτερο προϊόν DIY 2014!



Τα μαντηλάκια **WONDER WIPES Multi-Use** είναι σχεδιασμένα ειδικά για τους εργαζόμενους στον οικοδομικό και κατασκευαστικό τομέα και προσφέρουν τη δυνατότητα απομάκρυνσης νωπών και μερικών ώριμων βαφών, σφραγιστικών, συγκολλητικών, ασφαλτικών, πολυουρεθάνης, διογκούμενων αφρών, πολυεστέρα και εποξειδικών από χέρια, εξοπλισμό και επιφάνειες. Εξοντώνουν τα βακτήρια της MRSA, σαλμονέλα, λιστέρια και E-Coli. Επίσης απομακρύνουν με ευκολία λάδια, γράσο, πετρέλαιο και μελάνι ενώ το ισχυρό καθαριστικό τους είναι ταυτόχρονα φιλικό για τα χέρια.

ΚΩΔΙΚΟΣ	ΠΡΟΪΟΝ	ΣΥΣΚΕΥΑΣΙΑ	ΤΜΧ /ΚΙΒ	ΚΙΒ/ ΠΛΤ	ΤΙΜΗ/ ΤΜΧ(€)
467442	WONDER WIPES MULTI-USE	100 ΠΑΝΑΚΙΑ	6	52	10.15



PTFE
COATED



ΠΙΣΤΟΛΙ ΑΦΡΟΥ

ΚΩΔΙΚΟΣ	YATO 	ΣΥΣΚ €/ΤΕΜ
20006741	YT-6741	10 16,60



NEO 

QUICK FLOW
ADJUSTMENT

AI

PTFE

ΠΙΣΤΟΛΙ ΑΦΡΟΥ

ΚΩΔΙΚΟΣ	YATO 	ΣΥΣΚ €/ΤΕΜ
20067421	YT-67421	20 24,35



PTFE
COATED



"ΕΞΥΠΝΟ"

ΠΙΣΤΟΛΙ ΑΦΡΟΥ

ΚΩΔΙΚΟΣ	YATO 	ΣΥΣΚ €/ΤΕΜ
20006745	YT-6745	20 26,00



NEO 

500
mm AI PTFE



ΠΙΣΤΟΛΙ ΑΦΡΟΥ ΜΑΚΡΥ 500mm

ΚΩΔΙΚΟΣ	YATO 	ΣΥΣΚ €/ΤΕΜ
20067460	YT-67460	20 19,00



300 ml 225 mm

ΠΙΣΤΟΛΙ ΣΙΛΙΚΟΝΗΣ

ΚΩΔΙΚΟΣ	YATO 	ΜΗΚΟΣ (mm)	ΣΥΣΚ €/ΤΕΜ
20006750	YT-6750	225	20 4,95



300 ml 225 mm

ΠΙΣΤΟΛΙ ΣΙΛΙΚΟΝΗΣ

ΚΩΔΙΚΟΣ	YATO 	ΜΗΚΟΣ (mm)	ΣΥΣΚ €/ΤΕΜ
20006751	YT-6751	225	10 8,95



ΥΠΕΡ-ΒΑΡΕΩΣ ΤΥΠΟΥ

ΠΙΣΤΟΛΙ ΣΙΛΙΚΟΝΗΣ & ΧΗΜΙΚΗΣ ΡΗΤΙΝΗΣ

ΚΩΔΙΚΟΣ	YATO 	ΜΗΚΟΣ (mm)	ΣΥΣΚ €/ΤΕΜ
20006753	YT-6753	225	6 14,95

300 ml 225 mm



1L CAPACITY AI
ΣΕ ΠΩΛΗΣΕΙΣ No1

ΣΤΟΚΑΔΟΡΟΣ ΓΙΑ ΣΑΛΑΜΙ 600ml

ΚΩΔΙΚΟΣ	YATO 	ΣΥΣΚ €/ΤΕΜ
20067583	YT-67583	12 23,00

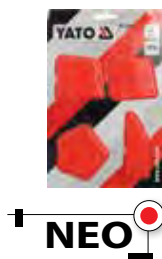

4 pcs TPR



NEO



4 pcs TPR

ΣΠΑΤΟΥΛΕΣ ΣΙΛΙΚΟΝΗΣ

ΚΩΔΙΚΟΣ	YATO 	ΣΥΣΚ	€/ΤΕΜ
20005261	YT-5261	20	2,00

ΣΠΑΤΟΥΛΕΣ ΣΙΛΙΚΟΝΗΣ ΣΕΤ 4 ΤΕΜ

ΚΩΔΙΚΟΣ	YATO 	ΣΥΣΚ	€/ΤΕΜ
20052621	YT-52621	12	4,35



230 mm

ΠΙΣΤΟΛΙ ΣΙΛΙΚΟΝΗΣ

ΚΩΔΙΚΟΣ	VOREL	(mm)	ΣΥΣΚ	€/ΤΕΜ
21109150	09150	230	20	2,75



230 mm

ΠΙΣΤΟΛΙ ΣΙΛΙΚΟΝΗΣ

ΚΩΔΙΚΟΣ	VOREL	(mm)	ΣΥΣΚ	€/ΤΕΜ
21109130	09130	230	10	6,75

ΠΙΣΤΟΛΙ ΑΦΡΟΥ

ΚΩΔΙΚΟΣ	VOREL	ΣΥΣΚ	€/ΤΕΜ
21109173	09173	10	9,95

ΠΙΣΤΟΛΙ ΣΙΛΙΚΟΝΗΣ Τ. ΑΓΓΛΙΑΣ HelixTools

ΚΩΔΙΚΟΣ	ΠΕΡΙΓΡΑΦΗ	ΣΥΣΚ	€/τεμ.
75000005	300ml	24	3,90

- ▶ ▶ ▶ Πιστόλι σιλικόνης με σύστημα "dripless" για να μην στάζει το υλικό κατά την εφαρμογή. Από ανθεκτικό σκελετό, με εξάγωνη ράβδο, ενισχυμένο μηχανισμό εξαγωγής και γάντζο.

ΠΙΣΤΟΛΙ ΣΙΛΙΚΟΝΗΣ ΒΑΡΕΩΣ ΤΥΠΟΥ HelixTools

ΚΩΔΙΚΟΣ	ΠΕΡΙΓΡΑΦΗ	ΣΥΣΚ	€/τεμ.
75000006	300ml	12	7,90

- ▶ ▶ ▶ **Επαγγελματικό, βαρέως τύπου.** Πιστόλι σιλικόνης με σύστημα "dripless" για να μην στάζει το υλικό κατά την εφαρμογή. Για σιλικόνες και σφραγιστικά σε φυσίγγιο.



ELASTO T

ELASTO T
SILICONE

S100

SILICONE SEALANT FOR HEAVY DUTY APPLICATIONS AS SOLAR HEATERS, GLASS CONSTRUCTIONS, SCOTLIES, BOATS, AQUARIA

ELASTO T
SILICONE

S400

ANTIFUNGAL GENERAL PURPOSE SILICONE SEALANT FOR ALUMINIUM, STAINLESS STEEL, GLASS

ELASTO T
ACRYLIC

SEALAC

SILICONE BASED ACRYLIC SEALANT FOR INTERNAL & EXTERNAL USE

ELASTO T
SILICONE

S100

SILICONE SEALANT FOR HEAVY DUTY APPLICATIONS AS SOLAR HEATERS, GLASS CONSTRUCTIONS, SCOTLIES, BOATS, AQUARIA

ELASTO T
SILICONE

S200

ELASTO T

ΣΦΡΑΓΙΣΤΙΚΑ ΣΥΓΚΟΛΛΗΤΙΚΑ ΣΤΕΓΑΝΩΤΙΚΑ ΣΠΡΕΥ

S900

NEUTRAL SILICONE

ARQUET FLOORING CRYSEAL

LAMINATE FLOORING CRYSEAL



ISOFIX ACRYLIC

ΚΩΔΙΚΟΣ	ΠΕΡΙΓΡΑΦΗ	ΣΥΣΚ	€/ΤΕΜ
150007	ΛΕΥΚΟ 260ml	25	1,47

ΤΟΜΕΙΣ ΕΦΑΡΜΟΓΩΝ

Το σφραγιστικό ISOFIX ACRYLIC είναι κατάλληλο για σφράγιση αρμών γύρω από κουφώματα αλουμινίου, PVC ή ξύλινα καθώς και για σφραγίσεις αρμών και συναρμογών σε τοίχους και ταβάνια.

ISOFIX ACRYLIC

Σφραγιστικό με βάση ακρυλικές ρητίνες σε υδατική διασπορά. Στεγνώνει με την εξάτμιση του νερού που περιέχει και μετατρέπεται σε μία πλαστο-ελαστική μάζα με ικανοποιητική αντοχή στις καιρικές συνθήκες.



ISOFIX SILICONE N5

ΑΝΤΙΜΟΥΧΛΙΚΗ

ΚΩΔΙΚΟΣ	ΠΕΡΙΓΡΑΦΗ	ΣΥΣΚ	€/ΤΕΜ
152000	ΔΙΑΦΑΝΗ 260ml	25	2,70
152001	ΛΕΥΚΗ 260ml	25	2,70

ΤΟΜΕΙΣ ΕΦΑΡΜΟΓΩΝ

Η ISOFIX SILICONE είναι κατάλληλη για σφράγιση συναρμογών σε μη πορώδη υλικά, όπως γυαλί, αλουμίνιο, πορσελάνινα πλακάκια, κεραμικά, κ.ά.. Έχει ευρεία εφαρμογή σε συναρμογές γύρω από κουφώματα αλουμινίου, ειδών υγιεινής και πάγκων κουζίνας.

ISOFIX SILICONE

Η ISOFIX SILICONE είναι οικονομική αντιμυκητιακή ακετοξική σιλικόνη γενικής χρήσης με πολύ καλή πρόσφυση, χωρίς αστάρι, σε πληθώρα υποστρωμάτων. Παρουσιάζει υψηλή ελαστικότητα καθώς και υψηλή αντοχή στις καιρικές συνθήκες.



ISOFIX NEUTRAL

ΑΝΘΕΚΤΙΚΗ ΣΤΗ ΜΟΥΧΛΑ

ΚΩΔΙΚΟΣ	ΠΕΡΙΓΡΑΦΗ	ΣΥΣΚ	€/ΤΕΜ
152006	ΛΕΥΚΗ 280ml	12	3,85
152007	ΔΙΑΦΑΝΗ 280ml	12	4,10

ΤΟΜΕΙΣ ΕΦΑΡΜΟΓΩΝ

Η σιλικόνη ISOFIX NEUTRAL είναι κατάλληλη για σφράγιση αρμών σε είδη υγιεινής και κουζίνες. Εμποδίζει την ανάπτυξη μυκητών (μαύρες κηλίδες) στην επιφάνεια της, οι οποίοι είναι δυνατόν να δημιουργηθούν σε κλειστούς χώρους και σε συνθήκες υψηλής υγρασίας. Είναι ιδιαίτερα κατάλληλη για εφαρμογή σε πλαστικές μπανιέρες και ντουζιέρες όπου οι συνθήκες σιλικόνες αποτυγχάνουν. Είναι επίσης κατάλληλη για σφραγίσεις αρμών σε υαλοκατασκευές, κουφώματα παντός είδους, υδραυλικές σωληνώσεις, μεταλλικές κατασκευές κ.ά..

ISOFIX NEUTRAL

Σιλικόνη ουδέτερου τύπου, ανθεκτική στην ανάπτυξη μούχλας, με εξαιρετική αντοχή στην ακτινοβολία UV και στις καιρικές συνθήκες. Στεγνώνει με την υγρασία του ατμοσφαιρικού αέρα και μετατρέπεται σε μία μόνιμη ελαστική μάζα.



ISOFIX HYBRID

ΤΟΜΕΙΣ ΕΦΑΡΜΟΓΩΝ

Το ISOFIX HYBRID είναι ιδανικό για κόλληση, στερέωση και σφράγιση σχεδόν σε όλα τα οικοδομικά υλικά. Είναι κατάλληλο για σφράγιση αρμών και συναρμογών σε κουφώματα παντός είδους, σε οροφές και ταράτσες, υδραυλικές σωληνώσεις, πάγκους, δάπεδα, ηλεκτρολογικές εγκαταστάσεις, κανάλια κλιματισμού/εξαερισμού κ.ά.. Η υψηλή μηχανική αντοχή του σε συνδυασμό με τη μόνιμη ελαστικότητά του, το καθιστούν ως ιδανική λύση για συγκολλήσεις μεταξύ ετεροειδών υλικών όπου αναπτύσσονται δυναμικά φορτία. Ενδεικτικά προτείνεται για συγκολλήσεις καθρεπτών, πλακιδίων, αξεσουάρ μπάνιων, περβαζιών, νεροχυτών, γυψοσανίδων, μονωτικών φύλλων, διακοσμητικών πλαισίων, μεταλλικών πλαισίων κ.ά..

ΚΩΔΙΚΟΣ	ΠΕΡΙΓΡΑΦΗ	ΣΥΣΚ	€/ΤΕΜ
152025	ΛΕΥΚΗ 280ml	12	4,60

ISOFIX HYBRID

Ισχυρό συγκολλητικό και σφραγιστικό υλικό με βάση ρητίνες τροποποιημένου σιλανίου (SMP-Silyl Modified Polymers). Στεγνώνει με την υγρασία του ατμοσφαιρικού αέρα (ή του υποστρώματος) και μετατρέπεται σε μία ισχυρή ελαστική μάζα, η οποία κολλά και σφραγίζει.



ISOFIX HYBRID CLEAR

ΤΟΜΕΙΣ ΕΦΑΡΜΟΓΩΝ

Το ISOFIX HYBRID CLEAR είναι ιδανικό για κόλληση, στερέωση και σφράγιση σε μεγάλη ποικιλία υποστρωμάτων. Λόγω της πολύ μεγάλης διαφανεσίας του είναι ιδιαίτερα κατάλληλο για εφαρμογή σε υαλοκατασκευές, όπως γυάλινα χωρίσματα, ντουζιέρες, βιτρίνες, κουφώματα κ.ά..

ΚΩΔΙΚΟΣ	ΠΕΡΙΓΡΑΦΗ	ΣΥΣΚ	€/ΤΕΜ
152026	ΥΠΕΡΔΙΑΦΑΝΟ 280ml	12	8,60

ISOFIX HYBRID CLEAR

Ισχυρό συγκολλητικό και σφραγιστικό υλικό με βάση ρητίνες τροποποιημένου σιλανίου (SMP-Silyl Modified Polymers). Στεγνώνει με την υγρασία του ατμοσφαιρικού αέρα (ή του υποστρώματος) και μετατρέπεται σε μία ισχυρή ελαστική μάζα, η οποία κολλά και σφραγίζει.



ΑΦΡΟΣ ΠΟΛΥΟΥΡΕΘΑΝΗΣ

ΤΟΜΕΙΣ ΕΦΑΡΜΟΓΩΝ

Είναι κατάλληλος για γεμίσματα οπών μεταξύ τοιχείων και σωληνώσεων και κενών ανάμεσα σε κουφώματα και τοιχοποιία. Ενδείκνυται για την τοποθέτηση και στερέωση κουφωμάτων και κασών για πόρτες. Χρησιμοποιείται επίσης και για μόνωση σε στέγες από κεραμίδια.

ΚΩΔΙΚΟΣ	ΠΕΡΙΓΡΑΦΗ	ΣΥΣΚ	€/ΤΕΜ
154000	300ml ΧΕΙΡΟΣ	12	3,70
154010	700ml ΧΕΙΡΟΣ	12	4,90

ISOFIX Αφρός πολυουρεθάνης χειρός ή πιστολιού για πλήρωση κενών, ρωγμών και οπών. Έχει εξαιρετική πρόσφυση σε όλα τα υποστρώματα εκτός από πολυαιθυλένιο, πολυπροπυλένιο και τεφλόν. Είναι ανθεκτικός στο νερό και τη γήρανση αλλά ευαίσθητος στην ακτινοβολία UV. Προσφέρει εξαιρετική μόνωση. Μετά την σκλήρυνση δεν συρρικνώνεται.



ΑΦΡΟΣ ΠΟΛΥΟΥΡΕΘΑΝΗΣ

ΤΟΜΕΙΣ ΕΦΑΡΜΟΓΩΝ

Είναι κατάλληλος για γεμίματα οπών μεταξύ τοιχείων και σωληνώσεων και κενών ανάμεσα σε κουφώματα και τοιχοποιία. Ενδείκνυται για την τοποθέτηση και στερέωση κουφωμάτων και κασών για πόρτες. Χρησιμοποιείται επίσης και για μόνωση σε στέγες από κεραμίδια.

ΚΩΔΙΚΟΣ	ΠΕΡΙΓΡΑΦΗ	ΣΥΣΚ	€/ΤΕΜ
154001	750ml ΧΕΙΡΟΣ	12	5,20
154002	750ml ΠΙΣΤΟΛΙΟΥ	12	5,50

LASTOFOAM Αφρός πολυουρεθάνης χειρός ή πιστολιού για πλήρωση κενών, ρωγμών και οπών. Έχει εξαιρετική πρόσφυση σε όλα τα υποστρώματα εκτός από πολυαιθυλένιο, πολυπροπυλένιο και τεφλόν. Είναι ανθεκτικός στο νερό και τη γήρανση αλλά ευαίσθητος στην ακτινοβολία UV. Προσφέρει εξαιρετική μόνωση. Ελεύθερη διόγκωση μέχρι 40 λίτρα ανά φιάλη. Μετά την σκλήρυνση δεν συρρικνώνεται.



ΑΦΡΟΣ ΧΑΜΗΛΗΣ ΔΙΟΓΚΩΣΗΣ

ΤΟΜΕΙΣ ΕΦΑΡΜΟΓΩΝ

Είναι κατάλληλος για τοποθέτηση παραθύρων και πόρτων, για τοποθέτηση ξύλινων σκαλών και περβαζιών, για γέμισμα τρυπών, ρωγμών, αρμών και ανοιγμάτων. Είναι επίσης κατάλληλος για σφράγισμα ανοιγμάτων σε σκεπές και μονωτικά υλικά, για γέμισμα τρυπών γύρω από σωλήνες, κ.ά..

ΚΩΔΙΚΟΣ	ΠΕΡΙΓΡΑΦΗ	ΣΥΣΚ	€/ΤΕΜ
154101	750ml ΧΕΙΡΟΣ	12	6,00
154102	750ml ΠΙΣΤΟΛΙΟΥ	12	6,00

LASTOFOAM Χαμηλής Διόγκωσης

Αφρός πολυουρεθάνης για πλήρωση κενών, ρωγμών και οπών. Παρουσιάζει χαμηλή δευτερογενή διόγκωση, επιτρέποντας την εύκολη τοποθέτηση πορτών και παραθύρων χωρίς να προκαλεί παραμόρφωση της κάσας. Έχει εξαιρετική πρόσφυση σε όλα τα υποστρώματα εκτός από πολυαιθυλένιο, πολυπροπυλένιο και τεφλόν. Είναι ανθεκτικός στο νερό και τη γήρανση αλλά ευαίσθητος στην ακτινοβολία UV. Προσφέρει εξαιρετική μόνωση. Ελεύθερη διόγκωση μέχρι 45 λίτρα ανά φιάλη. Μετά την σκλήρυνση δεν συρρικνώνεται.



ΑΦΡΟΣ ΧΑΜΗΛΗΣ ΔΙΟΓΚΩΣΗΣ

**2 ΣΕ 1
ΠΙΣΤΟΛΙΟΥ & ΧΕΙΡΟΣ**

ΤΟΜΕΙΣ ΕΦΑΡΜΟΓΩΝ

Είναι κατάλληλος για γεμίματα οπών μεταξύ τοιχείων και σωληνώσεων και κενών ανάμεσα σε κουφώματα και τοιχοποιία. Ενδείκνυται για την τοποθέτηση και στερέωση κουφωμάτων και κασών για πόρτες. Χρησιμοποιείται επίσης και για μόνωση σε στέγες από κεραμίδια.

ΚΩΔΙΚΟΣ	ΠΕΡΙΓΡΑΦΗ	ΣΥΣΚ	€/ΤΕΜ
154103	750ml ΠΙΣΤΟΛΙΟΥ & ΧΕΙΡΟΣ	12	6,60

LASTOFOAM 2in1

Αφρός πολυουρεθάνης για χρήση με τον ειδικό ανάπτορα (χειρός) αλλά και με το ειδικό πιστόλι εφαρμογής. Προσφέρει ευκολία και οικονομία, καθώς έχει καλύτερη ακρίβεια στη χρήση λόγω της ελεγχόμενης διόγκωσης. Είναι κατάλληλος για πλήρωση κενών, ρωγμών και οπών. Έχει εξαιρετική πρόσφυση σε όλα τα υποστρώματα εκτός από πολυαιθυλένιο, πολυπροπυλένιο και τεφλόν. Είναι ανθεκτικός στο νερό και τη γήρανση αλλά ευαίσθητος στην ακτινοβολία UV. Προσφέρει εξαιρετική μόνωση. Ελεύθερη διόγκωση μέχρι 40 λίτρα ανά φιάλη. Μετά την σκλήρυνση δεν συρρικνώνεται.

ΧΡΟΝΟΣ ΕΝΑΠΟΘΗΚΕΥΣΗΣ

ΚΛΕΙΣΤΗΣ ΣΥΣΚΕΥΑΣΙΑΣ (SHELF LIFE): Τουλάχιστον 12 μήνες σε χώρους με κανονική θερ/σία και υγρασία.



LASTOFOAM STYRENE ADHESIVE

**ΙΔΑΝΙΚΟ ΓΙΑ
ΘΕΡΜΟΠΡΟΣΩΨΕΙΣ**

ΤΟΜΕΙΣ ΕΦΑΡΜΟΓΩΝ

Η κόλλα LASTOFOAM STYRENE ADHESIVE χρησιμοποιείται για την κόλληση πλακών, από εξηλασμένη ή διογκωμένη πολυστερίνη, με την επιφάνεια εφαρμογής τού συστήματος. Ενδείκνυται τόσο για εξωτερική όσο και για εσωτερική χρήση.

Έχει εξαιρετική πρόσφυση σε σοβάδες, τούβλα, κονιάματα, ασφαλτό, ξύλο, hardboard, γύψο, χαρτόνι και μέταλλα.

ΧΡΟΝΟΣ ΕΝΑΠΟΘΗΚΕΥΣΗΣ ΚΛΕΙΣΤΗΣ

ΣΥΣΚΕΥΑΣΙΑΣ (SHELF LIFE): Τουλάχιστον 12 μήνες σε χώρους με κανονική θερ/σία και υγρασία.

ΚΩΔΙΚΟΣ	ΠΕΡΙΓΡΑΦΗ	ΣΥΣΚ	€/ΤΕΜ
154203	750ml πιστολιού	12	6,30

LASTOFOAM STYRENE ADHESIVE

Συγκολλητικός αφρός πολυουρεθάνης, χωρίς διαλύτες.

Χρησιμοποιείται για συγκόλληση μονωτικών πλακών από πολυστερίνη. Εμφανίζει χαμηλή διόγκωση και είναι εύκολη στη χρήση και την εφαρμογή. Η επιφάνεια εφαρμογής μπορεί να είναι υγρή αλλά όχι καλυμμένη με πάγο. Έχει εξαιρετική πρόσφυση σε όλα τα υποστρώματα εκτός από πολυαιθυλένιο, πολυπροπυλένιο και τεφλόν. Είναι ανθεκτικός στο νερό και τη γήρανση αλλά ευαίσθητος στην ακτινοβολία UV. Το στέγνωμα της κόλλας επιτυγχάνεται με την έκθεση της στην υγρασία τού ατμοσφαιρικού αέρα.





ΑΦΡΟΣ ΧΑΜΗΛΩΝ ΘΕΡΜΟΚΡΑΣΙΩΝ - WINTER

ΤΟΜΕΙΣ ΕΦΑΡΜΟΓΩΝ

Είναι ιδιαίτερα κατάλληλος για εφαρμογή τους χειμερινούς μήνες και σε περιοχές όπου επικρατούν χαμηλές θερμοκρασίες. Είναι κατάλληλος για γεμίματα οπών μεταξύ τοιχίων και σωληνώσεων και κενών ανάμεσα σε κουφώματα και τοιχοποιία. Ενδείκνυται για την τοποθέτηση και στερέωση κουφωμάτων και κασών για πόρτες. Χρησιμοποιείται επίσης και για μόνωση σε στέγες από κεραμίδια.

ΚΩΔΙΚΟΣ	ΠΕΡΙΓΡΑΦΗ	ΣΥΣΚ	€/ΤΕΜ
154201	750ml ΧΕΙΡΟΣ	12	7,15

LASTOFOAM WINTER

Αφρός πολυουρεθάνης χειρός με δυνατότητα εφαρμογής σε χαμηλές θερμοκρασίες (θερμοκρασία περιβάλλοντος μέχρι -10 °C). Έχει εξαιρετική πρόσφυση σε όλα τα υποστρώματα εκτός από πολυαιθυλένιο, πολυπροπυλένιο και τεφλόν. Είναι ανθεκτικός στο νερό και τη γήρανση αλλά ευαίσθητος στην ακτινοβολία UV. Προσφέρει εξαιρετική μόνωση. Ελεύθερη διόγκωση μέχρι 40 λίτρα ανά φιάλη. Μετά την σκλήρυνση δεν συρρικνώνεται.



ΑΦΡΟΣ 65 ΛΙΤΡΑ

ΤΟΜΕΙΣ ΕΦΑΡΜΟΓΩΝ

Είναι κατάλληλος για γεμίματα οπών μεταξύ τοιχίων και σωληνώσεων και κενών ανάμεσα σε κουφώματα και τοιχοποιία. Χρησιμοποιείται επίσης και για μόνωση σε στέγες από κεραμίδια.

ΚΩΔΙΚΟΣ	ΠΕΡΙΓΡΑΦΗ	ΣΥΣΚ	€/ΤΕΜ
154301	830ml ΠΙΣΤΟΛΙΟΥ	12	6,40

LASTOFOAM 65 LT

Αφρός πολυουρεθάνης πιστολιού πολύ υψηλής απόδοσης. Σε ελεύθερη διόγκωση αποδίδει μέχρι 65 λίτρα ανά φιάλη. Είναι κατάλληλος για πλήρωση κενών, ρωγμών και οπών. Έχει εξαιρετική πρόσφυση σε όλα τα υποστρώματα εκτός από πολυαιθυλένιο, πολυπροπυλένιο και τεφλόν. Είναι ανθεκτικός στο νερό και τη γήρανση αλλά ευαίσθητος στην ακτινοβολία UV. Μετά την σκλήρυνση δεν συρρικνώνεται.



ΑΦΡΟΣ ΒΡΑΔΥΚΑΥΣΤΟΣ CLASS B1 & B2

ΤΟΜΕΙΣ ΕΦΑΡΜΟΓΩΝ

Είναι κατάλληλοι για τοποθέτηση πορτών και κουφωμάτων πυρασφάλειας. Είναι επίσης κατάλληλοι για γεμίματα και στερεώσεις όπου υπάρχει απαίτηση για χρήση υλικών με βραδύκαυστες ιδιότητες.

ΚΩΔΙΚΟΣ	ΠΕΡΙΓΡΑΦΗ	ΣΥΣΚ	€/ΤΕΜ
154501	B1 - 750ml ΠΙΣΤΟΛΙΟΥ	12	8,75
154401	B2 - 750ml ΠΙΣΤΟΛΙΟΥ	12	7,15

LASTOFOAM B1 & B2 ΒΡΑΔΥΚΑΥΣΤΟΣ ΑΦΡΟΣ ΠΟΛΥΟΥΡΕΘΑΝΗΣ ΠΙΣΤΟΛΙΟΥ

Αφρός πολυουρεθάνης βραδύκαυστος κλάση B1 & κλάση B2 (με βάση την DIN 4102) για πλήρωση κενών, ρωγμών και οπών. Παρουσιάζουν υψηλή αντοχή στη φωτιά εμποδίζοντας τη διάδοσή της σε περιπτώσεις πυρκαγιάς. Έχουν εξαιρετική πρόσφυση σε όλα τα υποστρώματα εκτός από πολυαιθυλένιο, πολυπροπυλένιο και τεφλόν. Είναι ανθεκτικοί στο νερό και τη γήρανση αλλά είναι ευαίσθητος στην ακτινοβολία UV. Προσφέρουν εξαιρετική μόνωση. Ελεύθερη διόγκωση μέχρι 45 λίτρα ανά φιάλη. Μετά την σκλήρυνση δεν συρρικνώνεται.



LASTOFOAM GUN SPRAY CLEANER

ΚΩΔΙΚΟΣ	ΠΕΡΙΓΡΑΦΗ	ΣΥΣΚ	€/ΤΕΜ
154610	500ml	12	4,30

LASTOFOAM Gun Spray Cleaner

Διαλυτικό σε μορφή σπρέι για τον καθαρισμό των πιστολιών αφρού πολυουρεθάνης, καθώς και για την απομάκρυνση φρέσκου αφρού (που δεν έχει ακόμη σκληρύνει) από επιφάνειες ή εργαλεία. Απαραίτητο για τη χρήση αφρού πολυουρεθάνης πιστολιού.

**ΤΟΜΕΙΣ ΕΦΑΡΜΟΓΩΝ**

Είναι ιδιαίτερα κατάλληλο για αρμούς υλικών με πορώδη επιφάνεια σε εσωτερικούς και εξωτερικούς χώρους, όπως ανάμεσα σε παράθυρα και περβάζια, κουφώματα (πόρτες & παράθυρα) και τοίχους, ρωγμές σε τοίχους, κ.λπ.. Είναι κατάλληλο για αρμούς χωρίς ιδιαίτερη διαστασιακή μεταβολή (**έως 7%**). Δεν είναι κατάλληλο για σφράγιση αρμών μόνιμα εμβαπτισμένων στο νερό (π.χ δεξαμενές).

ACRYLIC

ΚΩΔΙΚΟΣ	ΠΕΡΙΓΡΑΦΗ	ΣΥΣΚ	€/ΤΕΜ
150001	280ml ΛΕΥΚΟ	25	1,57
150002	280ml ΜΑΥΡΟ	25	1,78
150005	280ml ΚΑΦΕ	25	1,78
150006	280ml ΓΚΡΙ	25	1,78
150400	400ml ΛΟΥΚΑΝΙΚΟ ΛΕΥΚΟ	30	1,78
150600	600ml ΛΟΥΚΑΝΙΚΟ ΛΕΥΚΟ	15	2,48

ACRYLIC**Ακρυλικός στόκος, γενικής χρήσης.**

Σφραγιστικό ακρυλικό ενός συστατικού με βάση ακρυλικές ρητίνες, για εσωτερική και εξωτερική χρήση. Έχει καλή πρόσφυση στα περισσότερα υποστρώματα. Μπορεί να εφαρμοστεί ακόμα και σε υγρές επιφάνειες χωρίς τη χρήση ασαριού.

Βάφεται μετά τη σκλήρυνσή του με τα συνήθη οικοδομικά χρώματα.

**ΑΚΡΟΦΥΣΙΟ ΓΙΑ ΛΟΥΚΑΝΙΚΟ**

ΚΩΔΙΚΟΣ	ΠΕΡΙΓΡΑΦΗ	ΣΥΣΚ	€/ΤΕΜ
150011			0,10

**ΤΟΜΕΙΣ ΕΦΑΡΜΟΓΩΝ**

Είναι κατάλληλο για αρμούς σε όλα τα δομικά υλικά, σε εσωτερικούς και εξωτερικούς χώρους, όπως ανάμεσα σε παράθυρα και περβάζια, κουφώματα (πόρτες & παράθυρα) και τοίχους, ρωγμές σε τοίχους, κ.λπ.. Είναι κατάλληλο για αρμούς με διαστασιακή μεταβολή έως 12%. Δεν είναι κατάλληλο για σφράγιση αρμών μόνιμα εμβαπτισμένων στο νερό (π.χ. δεξαμενές).

ACRYLIC PRO 6000**2 ΦΟΡΕΣ ΠΙΟ ΕΛΑΣΤΙΚΟ**

ΚΩΔΙΚΟΣ	ΠΕΡΙΓΡΑΦΗ	ΣΥΣΚ	€/ΤΕΜ
150800	280ml ΛΕΥΚΟ	25	1,74
150460	400ml ΛΕΥΚΟ	30	2,00
150860	600ml ΛΕΥΚΟ	15	2,79

ACRYLIC PRO 6000 - ΑΚΡΥΛΙΚΟ ΣΦΡΑΓΙΣΤΙΚΟ ΜΕ ΕΛΑΣΤΙΚΟΤΗΤΑ ΕΩΣ 12% ΜΕΓΑΛΗ ΕΛΑΣΤΙΚΟΤΗΤΑ & ΑΝΤΟΧΗ ΣΕ ΕΞΩΤΕΡΙΚΕΣ ΣΥΝΘΗΚΕΣ (UV)

Είναι ιδιαίτερα ανθεκτικό στη βροχή ακόμα και σε πολύ σύντομο χρόνο (μερικές ώρες) από την εφαρμογή του.

Στην επαφή του με τον αέρα μετατρέπεται σε πλαστοελαστική μάζα με πρόσφυση τόσο σε πορώδη δομικά υλικά (μπετόν, σοβά, αμιαντοτσιμέντο, ξύλο, τούβλο, κ.λπ.), όσο και σε μη πορώδη υλικά, όπως αλουμίνιο, PVC, λαμαρίνα κ.ά..

Βάφεται μετά τη σκλήρυνσή του με τα συνήθη οικοδομικά χρώματα, χωρίς να δημιουργεί γυαλάδες ή κρακελάρισμα της βαφής.

**ΤΟΜΕΙΣ ΕΦΑΡΜΟΓΩΝ**

Είναι κατάλληλο για αρμούς σε όλα τα δομικά υλικά σε εσωτερικούς και εξωτερικούς χώρους, όπως ανάμεσα σε παράθυρα και περβάζια, κουφώματα (πόρτες & παράθυρα) και τοίχους, ρωγμές σε τοίχους, κ.λπ.. Είναι κατάλληλο για αρμούς με διαστασιακή μεταβολή **έως 12%**. Δεν είναι κατάλληλο για σφράγιση αρμών μόνιμα εμβαπτισμένων στο νερό (π.χ δεξαμενές).

SEALAC**ΣΙΛΙΚΟΝΟΥΧΟ ΑΚΡΥΛΙΚΟ**

ΚΩΔΙΚΟΣ	ΠΕΡΙΓΡΑΦΗ	ΣΥΣΚ	€/ΤΕΜ
150701	280ml ΛΕΥΚΟ	25	2,20
150702	5kg ΛΕΥΚΟ	1	20,00

SEALAC**Ελαστικότητα έως 12%.**

Σφραγιστικό υλικό ενός συστατικού με βάση ελαστομερείς ακρυλικές ρητίνες σε υδατική διασπορά. Στην επαφή του με τον αέρα μετατρέπεται σε πλαστοελαστική μάζα με πρόσφυση τόσο σε πορώδη δομικά υλικά (μπετόν, σοβά, αμιαντοτσιμέντο, ξύλο, τούβλο, κ.τ.λ), όσο και σε μη πορώδη υλικά, όπως αλουμίνιο, PVC, λαμαρίνα, κ.ά..

Βάφεται μετά τη σκλήρυνσή του με τα συνήθη οικοδομικά χρώματα.



FIRE ACRYLIC

ΤΟΜΕΙΣ ΕΦΑΡΜΟΓΩΝ

Συνιστάται για σφράγιση αρμών ανάμεσα σε κουφώματα και τοιχοποιία σε κτιριακές εγκαταστάσεις με προδιαγραφές πυρασφάλειας και γενικά όπου υπάρχει απαίτηση καθυστέρησης διαδόσεως της φωτιάς. Δεν είναι κατάλληλο για σφράγιση αρμών μόνιμα εμβαπτισμένων στο νερό (π.χ. δεξαμενές).

ΚΩΔΙΚΟΣ	ΠΕΡΙΓΡΑΦΗ	ΣΥΣΚ	€/ΤΕΜ
150010	280ml ΛΕΥΚΟ	25	3,48

FIRE ACRYLIC

ΑΚΡΥΛΙΚΟΣ ΣΤΟΚΟΣ ΑΝΘΕΚΤΙΚΟΣ ΣΤΗ ΦΩΤΙΑ

Ελαστομερές Σφραγιστικό Υλικό, με βάση ειδικές ακρυλικές ρητίνες και ανόργανα πληρωτικά, ανθεκτικά στη φωτιά.

Χαρακτηριστικά :

Σε περιπτώσεις πυρκαγιάς έχει την ιδιότητα να διογκώνεται και η ανόργανη κρούστα που δημιουργείται επιβραδύνει τη διάδοση της φωτιάς.

Δεν περιέχει διαλύτες.

Μετά την τοποθέτησή του, σε επαφή με τον ατμοσφαιρικό αέρα, μετατρέπεται σε συνεκτική πλαστοελαστική μάζα, η οποία προσφύεται στα χείλη των αρμών.

Είναι κατάλληλο για εσωτερική και εξωτερική χρήση.

Έχει καλή πρόσφυση στα περισσότερα υποστρώματα.

Μπορεί να εφαρμοστεί ακόμα και σε υγρές επιφάνειες χωρίς τη χρήση ασαριού.

Βάφεται μετά τη σκλήρυνσή του με τα συνήθη οικοδομικά χρώματα.

Είναι κατάλληλο για αρμούς χωρίς μεγάλη λειτουργική μεταβολή πλάτους (μέχρι 8%).

Καλύπτει τις απαιτήσεις της προδιαγραφής BS 476 part 20: 1987.



LASTOSPAT

ΤΟΜΕΙΣ ΕΦΑΡΜΟΓΩΝ

Χρησιμοποιείται για το σπατουλάρισμα επιφανειών (τοιχών, ξύλου, κ.λπ.) και το στοκάρισμα πριν από το βάψιμο.

ΚΩΔΙΚΟΣ	ΠΕΡΙΓΡΑΦΗ	ΣΥΣΚ	€/ΤΕΜ
150900	400gr ΛΕΥΚΟ	48	1,40
150910	800gr ΛΕΥΚΟ	24	2,10
150920	5kgr ΛΕΥΚΟ	1	10,80

LASTOSPAT

Ακρυλικός στόκος οικοδομών για το στοκάρισμα και το σπατουλάρισμα σε όλα τα υποστρώματα, πριν από το βάψιμο. Παράγεται υπό κενό (δεν περιέχει φυσαλίδες). Δουλεύεται εύκολα, γεμίζει και στρώνει θαυμάσια. Στεγνώνει γρήγορα χωρίς να σκάει και τρίβεται εύκολα προσφέροντας μία λεία και ανθεκτική επιφάνεια χωρίς ατέλειες. Δημιουργεί ένα μη απορροφητικό, υπερλευκό υπόστρωμα, ιδανικό για βάψιμο.



LASTOSPAT LIGHTWEIGHT

ΤΟΜΕΙΣ ΕΦΑΡΜΟΓΩΝ

Χρησιμοποιείται για το στοκάρισμα επιφανειών (τοιχών, ξύλου, κ.λπ.) πριν από το βάψιμο.

ΚΩΔΙΚΟΣ	ΠΕΡΙΓΡΑΦΗ	ΣΥΣΚ	€/ΤΕΜ
150930	250ml ΛΕΥΚΟ	48	2,30
150940	1LT ΛΕΥΚΟ	9	7,30
150941	3LT ΛΕΥΚΟ	1	20,80

LASTOSPAT LIGHTWEIGHT

Ελαφρύς ακρυλικός στόκος για το στοκάρισμα σε όλα τα υποστρώματα, πριν από το βάψιμο. Γεμίζει κενά και σπές με ένα πέρασμα χωρίς να συρρικνώνεται κατά το στέγνωμα και χωρίς να απαιτεί επαναστοκάρισμα. Δεν κρεμίζει και στρώνει θαυμάσια. Στεγνώνει γρήγορα χωρίς να σκάει. Δημιουργεί ένα μη απορροφητικό, υπερλευκό υπόστρωμα, ιδανικό για βάψιμο.

**ΣΙΛΙΚΟΝΗ S-400****ΑΝΘΕΚΤΙΚΗ
ΣΤΗ ΜΟΥΧΛΑ****ΤΟΜΕΙΣ ΕΦΑΡΜΟΓΩΝ**

Η S-400 είναι κατάλληλη για σφράγιση συναρμογών σε μη πορώδη υλικά, όπως γυαλί, αλουμίνιο, πορσελάνινα πλακάκια, κεραμικά, κ.ά.. Έχει ευρεία εφαρμογή σε συναρμογές γύρω από κουφώματα αλουμινίου, ειδών υγιεινής και πάγκων κουζίνας.

ΚΩΔΙΚΟΣ	ΠΕΡΙΓΡΑΦΗ	ΣΥΣΚ	€/ΤΕΜ
152400	80cc ΔΙΑΦΑΝΟ	50	1,60
152401	80cc ΛΕΥΚΟ	50	1,60
152402	80cc ΜΑΥΡΟ	50	1,60
152440	280ml ΔΙΑΦΑΝΟ	25	2,98
152441	280ml ΛΕΥΚΟ	25	2,98
152442	280ml ΜΑΥΡΟ	25	2,98
152445	280ml ΚΑΦΕ	25	2,98
152446	280ml ΓΚΡΙ	25	2,98

S-400**Γενικής χρήσης**

Η S-400 είναι **ανθεκτική** στην εμφάνιση **μούχλας** ακετοξική σιλικόνη για γενική χρήση. Έχει πολύ καλή πρόσφυση, χωρίς αστάρι, σε πληθώρα υποστρωμάτων. Παρουσιάζει υψηλή ελαστικότητα καθώς και υψηλή αντοχή στις καιρικές συνθήκες.

**ΣΙΛΙΚΟΝΗ S-200****ΑΝΤΙΜΟΥΧΛΙΚΗ****ΤΟΜΕΙΣ ΕΦΑΡΜΟΓΩΝ**

Είναι ιδιαίτερα κατάλληλη για μπάνια και κουζίνες (μπανιέρες, νιπτήρες, νεροχύτες, πλακάκια, κ.ά.), νοσοκομεία, εργαστήρια. Το μυκητοκτόνο που περιέχει εμποδίζει την εμφάνιση μυκήτων στην επιφάνεια του σφραγιστικού. Δεν συνιστάται η εφαρμογή της σε ενυδρεία.

ΚΩΔΙΚΟΣ	ΠΕΡΙΓΡΑΦΗ	ΣΥΣΚ	€/ΤΕΜ
152200	280ml ΔΙΑΦΑΝΟ	25	3,15
152201	280ml ΛΕΥΚΟ	25	3,15
152240	400ml ΛΟΥΚ ΔΙΑΦΑΝΟ	30	4,05
152241	400ml ΛΟΥΚ ΛΕΥΚΟ	30	4,05
152260	600ml ΛΟΥΚ ΔΙΑΦΑΝΟ	15	5,80
152261	600ml ΛΟΥΚ ΛΕΥΚΟ	15	5,80

S-200

Η S-200 είναι ανθεκτική στην εμφάνιση μούχλας ακετοξική σιλικόνη για σφράγιση αρμών μεταξύ γυαλιού, αλουμινίου, πορσελάνης, κεραμικών. Είναι ιδιαίτερα ανθεκτική στο νερό, την υγρασία και τα απορρυπαντικά. Παρουσιάζει περιορισμένη συρρίκνωση μετά τον πολυμερισμό της.

**ΣΙΛΙΚΟΝΗ s-100****& ΓΙΑ ΕΝΥΔΡΕΙΑ****ΤΟΜΕΙΣ ΕΦΑΡΜΟΓΩΝ**

Συνιστάται σε εφαρμογές υψηλών απαιτήσεων (βιομηχανικές ή τεχνολογικές), όπως **ενυδρεία, ηλιακούς θερμοσίφωνες**, βτιρίνες καταστημάτων, υαλοκατασκευές, σκάφη αναψυχής, κ.ά..

ΚΩΔΙΚΟΣ	ΠΕΡΙΓΡΑΦΗ	ΣΥΣΚ	€/ΤΕΜ
152100	280ml ΔΙΑΦΑΝΟ	25	4,30

S - 100

Η S-100 είναι ακετοξική σιλικόνη υψηλής μηχανικής αντοχής και εξαιρετικής συγκολλητικότητας σε μη πορώδη υποστρώματα. Επιδεικνύει εξαιρετική αντοχή στη γήρανση εφόσον διατηρεί τις ιδιότητες της για πάνω από 15 έτη ακόμη και σε δύσκολες εξωτερικές συνθήκες όπως έκθεση σε ηλιακή ακτινοβολία, βροχή και παγετό.

**10 ΧΡΟΝΙΑ
ΕΓΓΥΗΣΗ**

ΣΙΛΙΚΟΝΗ SUPER WHITE 10

ΑΝΤΙΒΑΚΤΗΡΙΔΙΑΚΟ



ΤΟΜΕΙΣ ΕΦΑΡΜΟΓΩΝ

Η SUPER WHITE 10 είναι κατάλληλη για σφράγιση αρμών σε κατασκευές από γυαλί, αλουμίνιο, πορσελάνη (πλακίδια, είδη υγιεινής) και μη πορώδη (εφραλωμένα) κεραμικά. Είναι ιδιαίτερα κατάλληλη για εφαρμογές σε μπάνια και κουζίνες (μπανιέρες, νιπτήρες, νεροχύτες, πλακίδια, κ.λ.π), νοσοκομεία, εργαστήρια και γενικά σε οποιοδήποτε χώρο υπάρχει αυξημένη ανάγκη τήρησης κανόνων υγιεινής. Δεν συνιστάται η εφαρμογή της σε ενυδρεία.

ΚΩΔΙΚΟΣ	ΠΕΡΙΓΡΑΦΗ	ΣΥΣΚ	€/ΤΕΜ
152500	280ml ΔΙΑΦΑΝΟ	12	5,00
152501	280ml ΛΕΥΚΟ	12	5,00
NEO 152510	80ml ΔΙΑΦΑΝΟ	12	2,90
NEO 152511	80ml ΛΕΥΚΟ	12	2,90

SUPER WHITE 10

Η SUPER WHITE 10 είναι όξινη σιλικόνη υψηλής ποιότητας με ενσωματωμένη τεχνολογία αντιβακτηριδιακής προστασίας Fungiban®. Η αντιβακτηριδιακή προστασία Fungiban® προσφέρει ενεργή πρόληψη κατά της ανάπτυξης μυκήτων, που λεκιάζουν την επιφάνεια της σιλικόνης, σε περιοχές εκτεθειμένες σε υγρασία.



S - 900 ΣΙΛΙΚΟΝΗ ΟΥΔΕΤΕΡΗ

ΤΟΜΕΙΣ ΕΦΑΡΜΟΓΩΝ

Η σιλικόνη S 900 είναι κατάλληλη για σφράγιση και συγκόλληση κατασκευών από γυαλί, πλακίδια, κεραμικά, υαλότουβλα, πλαστικά (PVC, εποξειδικά, πολυεστέρες, πολυακρυλικά, πολυκαρβονικά και φορμικά), βαμμένο ή περασμένο με βερνίκι ξύλο, κ.ά.. Η S 900 παρουσιάζει άριστη πρόσφυση σε μεταλλικές επιφάνειες χωρίς να τις διαβρώνει ή να τις οξειδώνει όπως γαλβανιζέ λαμαρίνες, ανοξείδωτα μέταλλα, ψευδάργυρο, χαλκό, αλουμίνια βαμμένα με ηλεκτροστατική βαφή ή άβαφα, κ.ά.. Η S-900 είναι ιδιαίτερα κατάλληλη για σφράγιση στην εξωτερική πλευρά των κουφωμάτων (αλουμινίου ή PVC) ανάμεσα στο προφίλ και το μάρμαρο ή τον τοίχο.

ΚΩΔΙΚΟΣ	ΠΕΡΙΓΡΑΦΗ	ΕΛΑΧΙΣΤΗ ΠΑΡΑΓΓ. ΣΥΣΚ	€/ΤΕΜ
153000	280ml ΔΙΑΦΑΝΟ	25	4,05
153001	280ml ΛΕΥΚΟ	25	3,65
153002	280ml ΜΑΥΡΟ 9005	12	3,75
153005	280ml ΚΑΦΕ 8014	12	3,75
153006	280ml ΓΚΡΙ 7045	12	3,75
153121	280ml ΜΠΕΖ 1015	12	5,45
153127	280ml ΓΚΡΙ 7035	12	5,45
153128	280ml ΓΚΡΙ 7005	12	5,45
153129	280ml ΑΣΗΜΙ 9006	12	5,45
153130	280ml ΔΡΥΙΝΟ	12	5,45
153131	280ml ΔΡΥΙΝΟ ΣΚΟΥΡΟ	12	5,45
153200	600ml ΛΟΥΚ ΔΙΑΦΑΝΟ	15	7,45
153201	600ml ΛΟΥΚ ΛΕΥΚΟ	15	6,95
153205	600ml ΛΟΥΚ ΚΑΦΕ	30 KIB.	15 6,95

S - 900

Η S-900 είναι ουδέτερη σιλικόνη με άριστη πρόσφυση σε όλα τα υποστρώματα, πορώδη και μη πορώδη. Παρουσιάζει εξαιρετική αντοχή στις καιρικές συνθήκες (ακτινοβολία UV, βροχή, παγετός). Δεν συρρικνώνεται.

SILICON REMOVER SR 52

ΤΟΜΕΙΣ ΕΦΑΡΜΟΓΩΝ

Χρησιμοποιείται για την αφαίρεση της στεγνωμένης σιλικόνης από επιφάνειες, γυαλιού, μετάλλου, πλαστικών, ξύλου, κ.ά.. Δεν προτείνεται η εφαρμογή του σε ευαίσθητες επιφάνειες.

ΚΩΔΙΚΟΣ	ΠΕΡΙΓΡΑΦΗ	ΣΥΣΚ	€/ΤΕΜ
158280	80cc SR 52 ΣΩΛ	12	2,70

SILICONE REMOVER SR 52

Καθαριστικό ζελέ υπολειμμάτων στεγνωμένης σιλικόνης. Διατίθεται σε παστώδη υφή σε κόκκινη απόχρωση. Διαλύει την στερεοποιημένη σιλικόνη χωρίς να αφήνει υπολείμματα. Είναι κατάλληλο για χρήση σε οριζόντιες και κάθετες επιφάνειες. Μπορεί να χρησιμοποιηθεί σε όλες τις επιφάνειες (γυαλί, μέταλλα, κεραμικά, πορσελάνη) αφού προηγηθεί δοκιμή. Ξεπλένεται με νερό.



**ΣΙΛΙΚΟΝΗ S-MIRROR****ΚΑΘΡΕΠΤΗ****ΤΟΜΕΙΣ ΕΦΑΡΜΟΓΩΝ**

Η S-mirror είναι ιδανική για στερέωση καθρεπτών. Προσφέρει εξασφαλισμένη συγκόλληση ενώ παράλληλα δεν καταστρέφει την επαργύρωση του καθρέπτη.

ΚΩΔΙΚΟΣ	ΠΕΡΙΓΡΑΦΗ	ΣΥΣΚ	€/ΤΕΜ
157601	280ml ΛΕΥΚΟ	25	5,60

S - mirror

Η S-mirror είναι καθρεπτόκολλα ενός συστατικού, με εξαιρετικές συγκολλητικές ικανότητες σε όλα τα υποστρώματα, όπως ξύλο, νοβοπάν, μπετόν, σοβά, τοίχους βαμμένους με πλαστικά χρώματα ή ριπολίνη. Είναι άοσμη και δεν ενοχλεί καθόλου το δέρμα και τα μάτια.

**ΣΙΛΙΚΟΝΗ S - HI TEMP****+300 °C****ΤΟΜΕΙΣ ΕΦΑΡΜΟΓΩΝ**

Είναι ιδανική σαν υγρή φλάντζα σε μηχανές αυτοκινήτων, αντλιών, καυστήρων, καπάκια βαλβίδων, σωλήνες εξάτμισης ή εξαρτισμού.

ΚΩΔΙΚΟΣ	ΠΕΡΙΓΡΑΦΗ	ΣΥΣΚ	€/ΤΕΜ
152600	80ml ΣΩΛ ΚΟΚΚΙΝΟ	12	3,30
152601	80ml ΣΩΛ ΜΑΥΡΟ	12	3,30
152620	280ml ΚΟΚΚΙΝΟ	25	6,15
152630	280ml ΜΑΥΡΟ	25	6,15

S - HiTemp

Η S-HiTemp είναι επαγγελματική σιλικόνη υψηλών θερμοκρασιών από -40° C έως +260° C, ενώ για περιορισμένο χρονικό διάστημα αντέχει έως και τους +300° C. Δεν σκάει και δεν συρρικνώνεται. Αντέχει σε λάδια, γράσο, νερό, αντιψυκτικό και βαλβολίνες. Μετά τον πολυμερισμό παραμένει ελαστική.

**FIRESEAL W****+1200 °C****ΤΟΜΕΙΣ ΕΦΑΡΜΟΓΩΝ**

Είναι ιδιαίτερα κατάλληλο για σφραγίσεις σε τζάκια, φούρνους, λέβητες, εστίες, καμινάδες και σωληνώσεις ατμού. Παρουσιάζει άριστη πρόσφυση σε μεγάλη ποικιλία υποστρωμάτων όπως πυρότουβλα, μπετόν, μεταλλικές επιφάνειες, φυσικές πέτρες, κ.ά.. Το FIRESEAL W παρουσιάζει περιορισμένη αντοχή στο νερό.

ΚΩΔΙΚΟΣ	ΠΕΡΙΓΡΑΦΗ	ΣΥΣΚ	€/ΤΕΜ
155502	280ml ΜΑΥΡΟ	25	3,50

FIRESEAL W

Το FIRESEAL W είναι σφραγιστικό ενός συστατικού κατάλληλο για αρμούς που βρίσκονται εκτεθειμένοι σε πολύ υψηλές θερμοκρασίες (μέχρι 1200 OC). Το προϊόν στεγνώνει με φυσική εξάτμιση.

**PARQUET FLOORING ACRYSEAL****ΞΥΛΙΝΑ ΠΑΤΩΜΑΤΑ****ΤΟΜΕΙΣ ΕΦΑΡΜΟΓΩΝ**

Είναι κατάλληλο για σφράγιση αρμών σε δάπεδα από ξύλο, laminate και μοριοσανίδα. Είναι ιδιαίτερα κατάλληλο για τους αρμούς στα τελειώματα του παρκέ, στις ενώσεις του με μάρμαρα ή πλακάκια, στα σοβατεπί, στις συναρμογές με τις σωληνώσεις του καλοριφέρ, κ.ά.. Είναι επίσης κατάλληλο για σφραγίσεις αρμών σε πόρτες και παράθυρα από ξύλο, αλουμίνιο ή PVC. Γενικά είναι κατάλληλο για αρμούς μέτριας κινητικότητας (μέχρι 8%). Δεν είναι κατάλληλο για αρμούς με μόνιμη εμβάπτιση στο νερό.

ΚΩΔΙΚΟΣ	ΠΕΡΙΓΡΑΦΗ	ΣΥΣΚ	€/ΤΕΜ
155701	280ml ΔΡΥΙΝΟ	12	2,88
155702	280ml ΚΑΡΥΔΙΑ	12	2,88
155703	280ml ΚΕΡΑΣΙΑ	12	2,88
155704	280ml ΜΑΟΝΙ	12	2,88
155705	280ml ΟΞΙΑ	12	2,88
155706	280ml ΣΦΕΝΔΑΜΟΣ	12	2,88

PARQUET FLOORING ACRYSEAL

Το PARQUET FLOORING ACRYSEAL είναι ελαστομερές σφραγιστικό ενός συστατικού, με βάση ειδικές ακρυλικές ρητίνες, σε αποχρώσεις ξύλου, κατάλληλο για σφράγιση αρμών σε παρκέ, κουφώματα και έπιπλα.





ΑΡΜΟΚΟΛΛΑ S-800

ΤΟΜΕΙΣ ΕΦΑΡΜΟΓΩΝ

Η S-800 είναι ιδανική για τη σφράγιση των τριχοειδών αρμών που δημιουργούνται στα φάλτσα των κουφωμάτων αλουμινίου.

ΚΩΔΙΚΟΣ	ΠΕΡΙΓΡΑΦΗ	ΣΥΣΚ	€/ΤΕΜ
155011	280ml ΛΕΥΚΟ	25	6,75
155012	280ml ΜΑΥΡΟ	25	6,75

S-800

Αρμόκολλα υψηλής σκληρότητας με βάση ειδικό τύπο σιλικόνης. Έχει καλή πρόσφυση σε βαμμένο αλουμίνιο. Δεν λεκιάζει και δεν κτρινίζει. Μπορεί να χρησιμοποιηθεί μετά από αρκετό καιρό ακόμη και εάν η συσκευασία έχει ανοιχθεί, χωρίς να χάσει τις αρχικές της ιδιότητες.



ΑΡΜΟΚΟΛΛΑ ELASTOTAN

ΤΟΜΕΙΣ ΕΦΑΡΜΟΓΩΝ

Το ELASTOTAN μπορεί να χρησιμοποιηθεί για σφράγιση επιφανειών από γυαλί, μέταλλο, απλό και βαμμένο ξύλο, PVC, πολυκαρβονικό, πολυμεθακρυλικό, τσιμέντο, γρανίτη, μάρμαρο κ.ά.. Είναι ιδιαίτερα κατάλληλο για σφραγίσεις σε πληθώρα κατασκευαστικών εφαρμογών όπως αρμοί διαστολής σκυροδέματος, αρμοί σε υαλοπετάσματα, αρμοί κουφωμάτων παραθύρων και πορτών, αρμοί σε υαλοκατασκευές, αρμοί σε οροφές και καμινάδες, αρμοί υδρορροών και αεραγωγών, κ.ά..

ΚΩΔΙΚΟΣ	ΠΕΡΙΓΡΑΦΗ	ΕΛΑΧΙΣΤΗ ΠΑΡΑΓΓ. ΣΥΣΚ	€/ΤΕΜ
155111	280ml ΛΕΥΚΟ	25	4,40
155116	280ml ΓΚΡΙ	25	4,40
155161	600ml ΛΟΥΚΑΝ ΛΕΥΚΟ	15	7,75
155162	600ml ΛΟΥΚΑΝ ΜΑΥΡΟ 30 ΚΙΒ.	15	7,75
155166	600ml ΛΟΥΚΑΝ ΓΚΡΙ	15	7,75

ELASTOTAN

Ελαστομερές σφραγιστικό υλικό, με εξαιρετική πρόσφυση σε μεγάλη ποικιλία υποστρωμάτων. Οι μηχανικές ιδιότητες και η πρόσφυση του προϊόντος δεν επηρεάζονται από την έκθεση στον ήλιο, τη βροχή, το χιόνι και το όζον. Παρουσιάζει υψηλή ελαστικότητα σε μεγάλο θερμοκρασιακό εύρος και είναι κατάλληλο για αρμούς μεγάλης κινητικότητας.



ΑΡΜΟΚΟΛΛΑ ELASTOTAN S

ΤΟΜΕΙΣ ΕΦΑΡΜΟΓΩΝ

Είναι ιδιαίτερα κατάλληλο σε προσόψεις κτιρίων από φυσικές πέτρες όπως μάρμαρο, γρανίτη, κ.ά.. Επίσης μπορεί να χρησιμοποιηθεί για σφράγιση αρμών μεταξύ ομοειδών και ετεροειδών υλικών όπως αρμούς σκυροδέματος (συστολής - διαστολής, διακοπή), υποστρώματα από σοβά, γυαλί, αλουμίνιο, ξύλο, πολυκαρβονικό, πέτρα, πλαστικό, αμιαντοτσιμέντο, τοποθέτηση σωλήνων από μέταλλο ή PVC, τοποθέτηση μεμβρανών από PVC σε μόνωση ταρατσών, συναρμογές κουφωμάτων, κ.ά..

ΚΩΔΙΚΟΣ	ΠΕΡΙΓΡΑΦΗ	ΣΥΣΚ	€/ΤΕΜ
155211	280ml ΛΕΥΚΟ	25	5,40
155213	600ml ΛΟΥΚ ΛΕΥΚΟ	15	10,20

ELASTOTAN - S

Το ELASTOTAN-S είναι ελαστομερές σφραγιστικό αρμών ενός συστατικού που πολυμερίζεται με την ατμοσφαιρική υγρασία. Δεν εμφανίζει εξίδρωση πλαστικοποιητή (λαδιού), με συνέπεια να μην λαδώνει τις φυσικές πέτρες και το σκυρόδεμα. Δεν ευνοεί την επικάλυψη της σκόνης. Έχει άριστη πρόσφυση σε πληθώρα υποστρωμάτων χωρίς τη χρήση primer. Οι μηχανικές ιδιότητες και η πρόσφυση του προϊόντος δεν επηρεάζονται από την έκθεση στον ήλιο, τη βροχή, το χιόνι και το όζον.



LASTOSTICK

ΤΟΜΕΙΣ ΕΦΑΡΜΟΓΩΝ

Είναι ιδιαίτερα κατάλληλο για τις εσωτερικές συγκολλήσεις προφίλ αλουμινίου (κόλλα για γωνιάστρα), για όλες τις ξυλοκατασκευές, για υποκατάσταση βυσμάτων, για στερέωση μεταλλικών ράβδων και οπλισμού σε σκυρόδεμα και σε ένα πλήθος εφαρμογών. Η μάζα του δεν συρρικνώνεται, αντίθετα διογκώνεται ελαφρά και έτσι μπορεί να χρησιμοποιηθεί για την πλήρωση κενών και οπών σε σκυρόδεμα. ΣΗΜ. Ο ψεκασμός των επιφανειών με νερό επιταχύνει τη συγκόλληση.

ΚΩΔΙΚΟΣ	ΠΕΡΙΓΡΑΦΗ	ΣΥΣΚ	€/ΤΕΜ
151111	280ml ΛΕΥΚΟ	25	6,00
151121	600ml ΛΟΥΚ ΛΕΥΚΟ	15	10,35
151131	1LT ΛΕΥΚΟ	9	20,85

LASTOSTICK

Το Lastostick είναι ισχυρό συγκολλητικό 1 συστατικού που αναπτύσσει τις συγκολλητικές και μηχανικές του ιδιότητες σε επαφή με την υγρασία του ατμοσφαιρικού αέρα. Συγκολλά όλα τα είδη των υλικών, αλουμίνιο, ξύλο, σκυρόδεμα, σίδηρο, κ.ά.. Δεν περιέχει διαλύτες. Δεν επηρεάζεται από το νερό και την υγρασία.

**ELASTOBOND****ELASTOBOND**

Το Elastobond είναι ελαστομερές σφραγιστικό και συγκολλητικό υλικό με βάση υβριδικές ρητίνες. Προσφέρει ταχύτατη συγκόλληση. Έχει υψηλή μηχανική αντοχή και εξαιρετική αντοχή σε ακτινοβολία UV. Βάφεται με τα συνήθη οικοδομικά χρώματα. Δεν λαδώνει τις απορροφητικές επιφάνειες και δεν επιτρέπει την ανάπτυξη μυκήτων. Δεν περιέχει διαλύτες και ισοκυανικά.

ΤΟΜΕΙΣ ΕΦΑΡΜΟΓΩΝ

Είναι κατάλληλο για σφραγίσεις και ελαστικές συγκολλήσεις σε όλα τα υποστρώματα όπως μεταλλικές επιφάνειες, σκυρόδεμα, πλαστικά, βαμμένο αλουμίνιο, γυαλί, μάρμαρο. Ενδείκνυται για συγκόλληση καθρέπτων (δεν καταστρέφει την επαργύρωση του καθρέπτη) καθώς και για συγκολλήσεις στη διαδικασία παραγωγής πάνελ, πορτών ασφαλείας, κλπ.

ΚΩΔΙΚΟΣ	ΠΕΡΙΓΡΑΦΗ	ΣΥΣΚ	€/ΤΕΜ
157020	280ml ΔΙΑΦΑΝΟ	12	8,70
157021	280ml ΛΕΥΚΟ	12	7,00
157022	280ml ΜΑΥΡΟ	12	7,00
157026	280ml ΓΚΡΙ	12	7,00
157061	600ml ΛΟΥΚΑΝ ΛΕΥΚΟ	15	11,75
157066	600ml ΛΟΥΚΑΝ ΓΚΡΙ	15	11,75
157080	80ml ΣΩΛ ΛΕΥΚΟ	50	2,75
157086	80ml ΣΩΛ ΔΙΑΦΑΝΟ	50	3,80

ΜΟΝΤΑΖΟΚΟΛΛΕΣ ELASTOTET**MONTAGE STICK****ΤΟΜΕΙΣ ΕΦΑΡΜΟΓΩΝ**

Είναι ιδιαίτερα κατάλληλο για στερέωση και συγκόλληση διαφόρων διακοσμητικών αντικειμένων από γύψο, πλαστικών καναλιών, πάνελ, σε επενδύσεις φύλλων από αφρώδη πολυουρεθάνη, φελιζόλ και PVC.

ΚΩΔΙΚΟΣ	ΠΕΡΙΓΡΑΦΗ	ΣΥΣΚ	€/ΤΕΜ
151211	280ml ΛΕΥΚΟ	25	2,50

MONTAGE STICK - Χωρίς διαλύτη

Το Montage Stick είναι κόλλα μοντάζ ακρυλικής βάσης (νερού), χωρίς διαλύτες. Κολλά άριστα σε όλα τα υποστρώματα όπως ξύλο, πλαστικά, μάρμαρο, πλακάκια, γύψο, σοβά. Είναι ιδανική για κάθετες επιφάνειες. Προσφέρει ελαστική συγκόλληση καταργώντας τη μηχανική στερέωση. Βάφεται.

**NEO****HIGH TACK MS****ΑΜΕΣΟ ΑΡΠΑΓΜΑ****ΤΟΜΕΙΣ ΕΦΑΡΜΟΓΩΝ**

Ιδανικό για συγκολλήσεις σε οικοδομικές, βιομηχανικές και ναυπηγικές κατασκευές. Λόγω της μόνιμης ελαστικότητάς του είναι για συγκολλήσεις ετεροειδών επιφανειών και όπου υπάρχουν δυναμικά φορτία (αυτοκίνητα, σκάφη αναψυχής, μηχανήματα κ.λπ.) καθώς τού επιτρέπει να απορροφά τους κραδασμούς, χωρίς να σπάει, προσφέροντας ταυτόχρονα ηχομόνωση. Παρουσιάζει εξαιρετική πρόσφυση σε υλικά όπως γυαλί, ξύλο, μέταλλο, αλουμίνιο βαμμένο ή άβαφο, καθρέπτες, μπετόν, ρνκ, πολυκαρβονικά, ABS κ.ά.. Ταυτόχρονα σφραγίζει και στεγανοποιεί κενά, ρωγμές ή αρμούς. Χρόνος εναποθήκευσης: 12 μήνες περίπου.

ΚΩΔΙΚΟΣ	ΠΕΡΙΓΡΑΦΗ	ΣΥΣΚ	€/ΤΕΜ
156100	290ml ΛΕΥΚΟ	12	6,70

ELASTOBOND MS HIGH TACK**Πανίσχυρο υβριδικό συγκολλητικό ενός συστατικού**

Καταργεί βίδες και καρφιά, άμεσο άρπαγμα, χωρίς καμία προσωρινή στήριξη. **ΦΥΣΙΚΑ ΧΑΡΑΚΤΗΡΙΣΤΙΚΑ:** Εξαιρετική πρόσφυση σε μεγάλη ποικιλία υποστρωμάτων, στεγνώνει με την υγρασία του ατμοσφαιρικού αέρα και βάφεται. Μόνιμα ελαστικό, απορροφά τους κραδασμούς. Εξαιρετικά υψηλή μηχανική αντοχή σε εφελκυσμό. Καλή αντοχή στη γήρανση και την UV ακτινοβολία. Εξαιρετική πρόσφυση ακόμα και σε υγρές επιφάνειες. Αντοχή σε υγρά περιβάλλοντα και το θαλασσινό νερό. Αντοχή σε θερμοκρασιακές μεταβολές: -40° ως +100°C. Δεν διαβρώνει τα μέταλλα και τους καθρέπτες.

**MONTAGE-S****ΤΟΜΕΙΣ ΕΦΑΡΜΟΓΩΝ**

Είναι κατάλληλο για ισχυρές συγκολλήσεις σε πληθώρα εφαρμογών όπως: κολλήσεις διακοσμητικών στοιχείων, πάνελ, γυψοσανίδες, κανάλια καλωδίων, κλπ., μαρμάρων σε περβάζια παραθύρων, κολλήσεις σε ξύλινα πλαίσια, κολλήσεις σε πάνελ, συγκολλήσεις νεροχυτών και νιπτήρων, συγκολλήσεις κεραμικών πλακιδίων και μαρμάρων, συγκολλήσεις μπριζοδιακοπών σε τοίχους, κ.ά.. Παρουσιάζει άριστη πρόσφυση τόσο πορώδη όσο και μη-πορώδη, χωρίς primer. Είναι κατάλληλο για τα συνήθη οικοδομικά υλικά, όπως αλουμίνιο, γυαλί, PVC, ξύλο, σκυρόδεμα, πλακάκια, μάρμαρο, τούβλο, κ.ά..

ΚΩΔΙΚΟΣ	ΠΕΡΙΓΡΑΦΗ	ΣΥΣΚ	€/ΤΕΜ
151300	80ml ΣΩΛ ΔΙΑΦΑΝΟ	50	2,70
151306	80ml ΣΩΛ ΜΠΕΖ	50	2,70
151310	280ml ΔΙΑΦΑΝΟ	25	4,75
151316	280ml ΜΠΕΖ	25	4,75

MONTAGE-S

Το Montage-S είναι κόλλα μονταρίσματος ενός συστατικού με βάση το συνθετικό καουτσούκ σε διασπορά διαλύτου.



ELASTOSEAL PU 25 LM

ΤΟΜΕΙΣ ΕΦΑΡΜΟΓΩΝ

Συνιστάται για σφραγίσεις και συγκολλήσεις μεταξύ ομοειδών και ετεροειδών υλικών σε κλασικά κτιριακά και τεχνικά έργα, προκατασκευασμένα, βιομηχανικές εφαρμογές, εσωτερική διακόσμηση κ.λπ.. Έχει πρόσφυση στα περισσότερα υποστρώματα των κτιριακών κατασκευών: κεραμικά, τσιμέντο, γυαλί, ξύλο, γαλβανιζέ λαμαρίνα κ.λπ..

ΚΩΔΙΚΟΣ	ΠΕΡΙΓΡΑΦΗ	ΣΥΣΚ	€/ΤΕΜ
157131	300ml ΛΕΥΚΟ	25	4,60
157136	300ml ΓΚΡΙ	25	4,60
157161	600ml ΛΟΥΚ ΛΕΥΚΟ	15	5,80
157166	600ml ΛΟΥΚ ΓΚΡΙ	15	5,80

ELASTOSEAL PU 25 LM

Ελαστομερές σφραγιστικό υλικό πολυουρεθανικής βάσης, με εξαιρετική πρόσφυση σε μεγάλη ποικιλία υποστρωμάτων. Παρουσιάζει υψηλή ελαστικότητα σε μεγάλο θερμοκρασιακό εύρος και είναι κατάλληλο για αρμούς μεγάλης κινητικότητας. Βάφεται με τα συνήθη οικοδομικά χρώματα.



ELASTOSEAL PU 50 FC

ΤΟΜΕΙΣ ΕΦΑΡΜΟΓΩΝ

Συνιστάται για σφραγίσεις και συγκολλήσεις μεταξύ ομοειδών και ετεροειδών υλικών σε κτιριακές εφαρμογές, σε βιομηχανικές εφαρμογές, στην κατασκευή κουφωμάτων αλουμινίου, σε ανελκυστήρες, κ.ά.. Είναι ιδιαίτερα κατάλληλο και για εφαρμογές στην φανοποιία και σε σκάφη αναψυχής. Έχει πρόσφυση σε μεγάλη ποικιλία υποστρωμάτων όπως μπετόν, γυαλί, ξύλο, γαλβανιζέ λαμαρίνα, αλουμίνιο, κ.ά..

ΚΩΔΙΚΟΣ	ΠΕΡΙΓΡΑΦΗ	ΣΥΣΚ	€/ΤΕΜ
157231	300ml ΛΕΥΚΟ	25	4,80
157232	300ml ΜΑΥΡΟ	25	4,80
157236	300ml ΓΚΡΙ	25	4,80
157261	600ml ΛΟΥΚ ΛΕΥΚΟ	15	6,10
157262	600ml ΛΟΥΚ ΜΑΥΡΟ	15	6,10
157266	600ml ΛΟΥΚ ΓΚΡΙ	15	6,10

ELASTOSEAL PU 50 FC

Ελαστομερές σφραγιστικό και συγκολλητικό υλικό πολυουρεθανικής βάσης, με υψηλή μηχανική αντοχή και μεγάλη ταχύτητα πολυμερισμού. Είναι κατάλληλο για ελαστικές συγκολλήσεις και για αρμούς μικρής - μέτριας κινητικότητας. Βάφεται με τα συνήθη οικοδομικά χρώματα.



WINDSHIELD PU 230 ΠΑΡΜΠΡΙΖΟΚΟΛΛΑ

ΤΟΜΕΙΣ ΕΦΑΡΜΟΓΩΝ

Συνιστάται για ελαστικές συγκολλήσεις μεταξύ ομοειδών και ετεροειδών υλικών σε βιομηχανικές και ναυπηγικές εφαρμογές. Είναι ιδιαίτερα κατάλληλο για συγκολλήσεις παρμπρίζ σε επιβατικά οχήματα. Γενικώς συνιστάται για όλες τις εφαρμογές όπου απαιτείται μία ισχυρή ελαστική - δομική συγκόλληση μεταξύ ετεροειδών στοιχείων όπως μεταλλικά φύλλα, fiber-glass, κ.ά., τα οποία υφίστανται υψηλό μηχανικό και θερμικό στρες.

ΚΩΔΙΚΟΣ	ΠΕΡΙΓΡΑΦΗ	ΣΥΣΚ	€/ΤΕΜ
157861	310ml ΜΑΥΡΟ	25	7,50

WINDSHIELD PU 230

Ισχυρό συγκολλητικό ενός συστατικού με βάση την πολυουρεθάνη κατάλληλο για συγκολλήσεις παρμπρίζ.



WINDSHIELD BLACK PRIMER

ΤΟΜΕΙΣ ΕΦΑΡΜΟΓΩΝ

Το WINDSHIELD BLACK PRIMER είναι αστάρι κατάλληλο για χρήση πριν από την τοποθέτηση της παρμπρίζκολλας πολυουρεθάνης σε όλες τις εφαρμογές τοποθέτησης κολλητών παρμπρίζ.

ΚΩΔΙΚΟΣ	ΠΕΡΙΓΡΑΦΗ	ΣΥΣΚ	€/ΤΕΜ
158260	50ml ΜΑΥΡΟ	6	6,60
158261	500ml ΜΑΥΡΟ	6	17,50

WINDSHIELD BLACK PRIMER

Το WINDSHIELD BLACK PRIMER είναι αστάρι σε μαύρη απόχρωση με βάση ρητίνες αλειφατικής πολυουρεθάνης. Στεγνώνει γρήγορα και είναι απόλυτα συμβατό με παρμπρίζκολλες πολυουρεθάνης. Συνδυαζόμενο με το ELASTOTET PRIMER DM δημιουργεί ένα ισχυρό υπόστρωμα για τη βελτίωση της πρόσφυσης της κόλλας στην επιφάνεια του γυαλιού. Εύκολη εφαρμογή με πινέλο.

CALF



ΤΟΜΕΙΣ ΕΦΑΡΜΟΓΩΝ

Είναι ιδιαίτερα κατάλληλο για ναυπηγικές κατασκευές και για τη σφράγιση αρμών σε ξύλινα καταστρώματα πλοίων από ξύλο (teak decks).

ΚΩΔΙΚΟΣ	ΠΕΡΙΓΡΑΦΗ	ΣΥΣΚ	€/ΤΕΜ
155432	600ml ΛΟΥΚΑΝ ΜΑΥΡΟ	15	10,95

CALF

Ελαστομερές σφραγιστικό υλικό με βάση συνθετικές ρητίνες. Είναι ιδιαίτερα ανθεκτικό τόσο σε χαμηλές, όσο και σε υψηλές θερμοκρασίες (από -40 °C έως +150 °C), στην ηλιακή ακτινοβολία και στο θαλασσινό νερό. Παραμένει σταθερό και συνεκτικό καθ' όλη τη διάρκεια της εφαρμογής του χωρίς να συρρικνώνεται και χωρίς να ξεβάφει. Δεν περιέχει διαλύτες.

ΚΟΛΛΑ DECK

ΚΟΛΛΑ ΤΖΑΜΙΩΝ IG-1K



ΤΟΜΕΙΣ ΕΦΑΡΜΟΓΩΝ

Είναι ιδιαίτερα κατάλληλο για τη σφράγιση διπλών τζαμιών, θερμοκηπίων και ηλιακών συλλεκτών.

ΚΩΔΙΚΟΣ	ΠΕΡΙΓΡΑΦΗ	ΕΛΑΧΙΣΤΗ ΠΑΡΑΓΓ.	ΣΥΣΚ	€/ΤΕΜ
157661	600ml ΜΑΥΡΟ		15	7,96
157662	25kgr ΜΑΥΡΟ	20 ΤΕΜ.	1	330,40
157663	250kgr ΜΑΥΡΟ	4 ΤΕΜ.	1	2689,00

IG - 1K

Σφραγιστικό διπλών τζαμιών 1 συστατικού. Στην επαφή του με τον αέρα μετατρέπεται σε μια ελαστική και συνεκτική μάζα. Έχει εξαιρετική πρόσφυση σε όλα τα υποστρώματα (ειδικά στο γυαλί και το αλουμίνιο), υψηλές μηχανικές ιδιότητες και αντοχή στη γήρανση, ακτινοβολία UV, έκθεση στο νερό ή την υγρασία.

SG-1K



ΤΟΜΕΙΣ ΕΦΑΡΜΟΓΩΝ

Είναι ιδιαίτερα κατάλληλο για εφαρμογή σε υαλοπετάσματα, για τη συγκόλληση των διπλών τζαμιών στον αλουμινένιο σκελετό.

ΚΩΔΙΚΟΣ	ΠΕΡΙΓΡΑΦΗ	ΕΛΑΧΙΣΤΗ ΠΑΡΑΓΓ.	ΣΥΣΚ	€/ΤΕΜ
157761	600ml ΛΟΥΚ ΜΑΥΡΟ	30 ΚΙΒ.	15	8,50
157762	27kgr ΚΑΔΟΣ ΜΑΥΡΟ	20 ΤΕΜ.	1	384,85
157763	270kgr ΒΑΡΕΛΙ ΜΑΥΡΟ	4 ΤΕΜ.	1	3010,80

SG - 1K

Ισχυρό συγκολλητικό ενός συστατικού με βάση ειδικές ελαστομερείς ρητίνες σιλικόνης. Στην επαφή του με τον αέρα μετατρέπεται σε μια ελαστική και συνεκτική μάζα. Έχει εξαιρετική πρόσφυση σε όλα τα υποστρώματα (ειδικά στο γυαλί και το αλουμίνιο). Παρουσιάζει υψηλές μηχανικές ιδιότητες και αντοχή στη γήρανση, στην ακτινοβολία UV, στην έκθεση στο νερό ή την υγρασία.

ΣΥΓΚΟΛΛΗΤΙΚΟ



ΤΟΜΕΙΣ ΕΦΑΡΜΟΓΩΝ

Προτείνεται για γενική χρήση σε στεγανοποιήσεις επιφανειών. Λόγω της υψηλής αντοχής στο νερό της σχηματιζόμενης μεμβράνης, είναι κατάλληλο για επιφάνειες με λιμνάζοντα νερά, για ταράτσες, υπόγεια, δεξαμενές, μπαλκόνια, ταρατσόκηπους, ζαρντινιέρες, τούνελ (μέθοδος cut & cover), αρδευτικά κανάλια, γέφυρες, πάρκινγκ, κουζίνες και μπάνια (κάτω από τα πλακίδια), ταράτσες με μόνωση αφρού πολυουρεθάνης, κ.ά..

ΚΑΤΑΝΑΛΩΣΗ 1,5-1,8 Kg/m²

LASTOFLEX PU

ΚΩΔΙΚΟΣ	ΠΕΡΙΓΡΑΦΗ	ΣΥΣΚ	€/ΤΕΜ
156310	1kgr ΛΕΥΚΟ	1	9,10
156311	6kgr ΛΕΥΚΟ	1	45,95
156312	25kgr ΛΕΥΚΟ	1	145,00

ΔΙΑΛΥΤΗΣ PU για LASTOFLEX PU

156335	1kgr	1	5,00
156336	4kgr	1	20,00
156337	16kgr	1	80,00

LASTOFLEX PU Ελαστομερές επαλειπτικό ενός συστατικού με βάση την πολυουρεθάνη, κατάλληλο για μόνιμη στεγανοποίηση επιφανειών. Αντιδρώντας με την υγρασία του αέρα, μετατρέπεται σε μία ισχυρή και ελαστική μεμβράνη, αδιαπέραστη στο νερό. Εφαρμόζεται εύκολα με πινέλο, ρολό ή σπρέι (airless). Προσφέρει μακροχρόνια στεγανοποίηση και προστασία, υψηλή αντοχή σε λιμνάζοντα νερά χωρίς να ξεφλουδίζει. Δημιουργεί μία μονολιθική μεμβράνη χωρίς αρμούς η οποία είναι 100% κολλητή στο υπόστρωμα. Διαθέτει εξαιρετική αντοχή στις καιρικές συνθήκες (βροχή, παγετό, ηλιακή ακτινοβολία). Παρουσιάζει εξαιρετική ικανότητα γεφύρωσης αρμών. Είναι κατάλληλο για κυκλοφορία πεζών. Παρουσιάζει υψηλή ανακλαστικότητα της ηλιακής ακτινοβολίας (για το προϊόν σε λευκή απόχρωση) και σημαντική μείωση της θερμοκρασίας.



ΤΟΜΕΙΣ ΕΦΑΡΜΟΓΩΝ

Είναι κατάλληλο για μόνωση σε κάθετες και οριζόντιες επιφάνειες. Λόγω της εξαιρετικής αντοχής στην ηλιακή ακτινοβολία και της εξαιρετικής υδροφοβίας του, είναι κατάλληλο για υγραμόνωση δωματίων σαν προϊόν τελικής στρώσης. Είναι ιδιαίτερα κατάλληλο για προστασία και στεγανοποίηση ταρατσών με μόνωση από αφρώδη πολυουρεθάνη.

ΚΑΤΑΝΑΛΩΣΗ 1,2-1,8 Kg/m²

LASTOFLEX ST

**25 ΧΡΟΝΙΑ +
ΠΡΟΣΔΟΚΙΜΟ ΖΩΗΣ**

ΚΩΔΙΚΟΣ	ΠΕΡΙΓΡΑΦΗ	ΣΥΣΚ	€/ΤΕΜ
156410	700ml ΛΕΥΚΟ	1	8,15
156411	3,6LT ΛΕΥΚΟ	1	38,40
156412	18LT ΛΕΥΚΟ	1	138,35

ΔΙΑΛΥΤΗΣ D60 για LASTOFLEX ST

156339	3,6kgr	1	22,00
156338	16kgr	1	96,00

LASTOFLEX ST. Υγρό, μονωτικό, επαλειπτικό, ενός συστατικού, τελευταίας γενιάς, με βάση σιλανικές ρητίνες. Διαθέτει μόνιμη ελαστικότητα σε μεγάλο θερμοκρασιακό εύρος και εξαιρετική αντοχή στη γήρανση (ακτινοβολία UV, νερό). Στεγνώνει γρήγορα (μπορεί να πατηθεί σε 3-4 ώρες μετά την εφαρμογή του). Απλώνεται εύκολα χωρίς να σχηματίζει φυσαλίδες. Έχει μεγάλη περατότητα στους υδρατμούς.



NEO

ΤΟΜΕΙΣ ΕΦΑΡΜΟΓΩΝ

Το LASTOFLEX-AR συνιστάται για χρήση ως τελική στρώση, επάνω από το LASTOFLEX-PU ή για την επικάλυψη μονώσεων από αφρό πολυουρεθάνης, προσφέροντας μακροχρόνια προστασία από την ηλιακή ακτινοβολία UV. Το LASTOFLEX-AR προσφέρει μια γυαλιστερή και χρωματικά σταθερή επιφάνεια με εξαιρετική αντοχή στην τριβή, η οποία είναι κατάλληλη για κυκλοφορία πεζών και οχημάτων. Είναι ιδιαίτερα κατάλληλο για στεγανοποίηση δωματίων, μπαλκονιών, διαδρόμων κυκλοφορίας, εκτεθειμένων πάρκινγκ αυτοκινήτων, σταδίων κ.ά..

ΚΑΤΑΝΑΛΩΣΗ 0,15-0,35 Kg/m²

LASTOFLEX AR

UV ΠΡΟΣΤΑΣΙΑ

ΚΩΔΙΚΟΣ	ΠΕΡΙΓΡΑΦΗ	ΣΥΣΚ	€/ΤΕΜ
156610	19 Kg ΛΕΥΚΟ		318,00

LASTOFLEX AR

Υγρομονωτικό ενός συστατικού, υψηλής μηχανικής αντοχής, με βάση αλειφατική πολυουρεθάνη το οποίο πολυμερίζεται σε ελαστική και συνεκτική μάζα όταν έρθει σε επαφή με το περιβάλλον. Εύκολη εφαρμογή με πινέλο, ρολό ή σπρέι (airless). Προσφέρει μακροχρόνια στεγανοποίηση και προστασία, υψηλή αντοχή σε λιμνάζοντα νερά, χωρίς να ξεφλουδίζει. Διαθέτει εξαιρετική μηχανική αντοχή και είναι κατάλληλο ακόμα και για κυκλοφορία οχημάτων. Παρουσιάζει χρωματική σταθερότητα, χωρίς κιμωλίαση, ακόμα και κατόπιν μακροχρόνιας έκθεσης σε UV. Διαθέτει εξαιρετική αντοχή στις καιρικές συνθήκες (βροχή, παγετό, ηλιακή ακτινοβολία) και διατηρεί την ελαστικότητά του ακόμα και σε πολύ χαμηλές θερμοκρασίες (-40°C). Έχει άριστη συμβατότητα με τα επαλειφόμενα πολυουρεθάνικά μονωτικά ταρατσών.



NEO

ΤΟΜΕΙΣ ΕΦΑΡΜΟΓΩΝ

Το LASTOFLEX PB 1K χρησιμοποιείται για την υγραμόνωση θεμελίων, υπογείων, σε οροφές, μπαλκόνια και μπάνια, κάτω από πλακάκια, roof garden, δεξαμενές, τούνελ (cut & cover) κ.ά.. Χρόνος εναποθήκευσης: Τουλάχιστον 12 μήνες σε χώρους με κανονική θερμότητα και υγρασία.

ΚΑΤΑΝΑΛΩΣΗ 1,3-2 Kg/m²

LASTOFLEX PB 1K

ΚΩΔΙΚΟΣ	ΠΕΡΙΓΡΑΦΗ	ΣΥΣΚ	€/ΤΕΜ
156915	23 Kg ΜΑΥΡΟ	1	106,50

LASTOFLEX PB 1K. Επαλειπτικό μονωτικό ενός συστατικού με βάση πολυουρεθάνικές και ασφαλτικές ρητίνες.

Δημιουργεί μια μονολιθική μεμβράνη, χωρίς αρμούς, 100% κολλημένη στο υπόστρωμα. Έχει εξαιρετική ελαστικότητα και ικανότητα γεφύρωσης ακόμη και σε πολύ χαμηλές θερμοκρασίες (-40°C). Έχει εξαιρετική πρόσφυση σε πορώδεις επιφάνειες και πολύ καλή αντοχή στο νερό και τα χημικά. Πολυμερίζεται σε μικρό χρόνο.



NEO

LASTOFLEX MS

ΤΟΜΕΙΣ ΕΦΑΡΜΟΓΩΝ

Χρησιμοποιείται για στεγανοποίηση επιφανειών. Λόγω της εξαιρετικής υδροφοβίας, της σχηματιζόμενης μεμβράνης, είναι κατάλληλο για λιμνάζοντα νερά, ταράτσες, ζαρντινιέρες, οροφές με μόνωση από αφρό πολυουρεθάνης κ.ά.. Λόγω της εξαιρετικής αντοχής στην ηλιακή ακτινοβολία μπορεί να περαστεί σαν τελική στρώση. Χρόνος εναποθήκευσης: Τουλάχιστον 12 μήνες σε χώρους με κανονική θερ/σία και υγρασία.

ΚΑΤΑΝΑΛΩΣΗ 1,5-1,8 Kg/m²

ΚΩΔΙΚΟΣ	ΠΕΡΙΓΡΑΦΗ	ΣΥΣΚ	€/ΤΕΜ
156210	6kgr ΛΕΥΚΟ	1	69,80
156212	25kgr ΛΕΥΚΟ	1	232,15

LASTOFLEX MS

ΕΠΑΛΕΙΠΤΙΚΟ ΕΝΟΣ ΣΥΣΤΑΤΙΚΟΥ ΓΙΑ ΜΟΝΙΜΗ ΥΓΡΟΜΟΝΩΣΗ ΜΕ ΒΑΣΗ MSP ΡΗΤΙΝΕΣ. Μετατρέπεται σε μια ισχυρή, ελαστική, μεμβράνη αδιαπέραστη από το νερό.

Εφαρμόζεται εύκολα με πινέλο, ρολό ή σπρέι ακόμη και σε μία παχιά στρώση χωρίς να αφήνει φυσαλίδες ή ρωγμές. 100% αντοχή στην ηλιακή ακτινοβολία. Στα λιμνάζοντα νερά δεν ξεφλουδίζει. Δημιουργεί μια μονολιθική μεμβράνη, χωρίς αρμούς, 100% κολλημένη στο υπόστρωμα. Σε περίπτωση φθοράς επιδιορθώνεται, τοπικά, χωρίς το νερό να διαχέεται στο υπόστρωμα. Παραμένει ελαστικό και σε πολύ χαμηλές θερμοκρασίες και έχει εξαιρετικές ικανότητες γεφύρωσης. Εφαρμόζεται απευθείας ακόμη και σε υγρά υποστρώματα.



NEO

LASTOFLEX TC

2 ΣΥΣΤΑΤΙΚΩΝ

ΤΟΜΕΙΣ ΕΦΑΡΜΟΓΩΝ

Είναι κατάλληλο για στεγανοποίηση και προστασία δεξαμενών νερού, τεγνητών λιμνών και ταμιευτήρων από σκουρόδεμα. Είναι επίσης κατάλληλο για στεγανοποίηση εσωτερικών χώρων, όπως μπάνια (κάτω από τα πλακάκια), καθ' όσον διαθέτει ήπια οσμή και είναι ελεύθερο διαλυτών. Είναι ιδιαίτερα ανθεκτικό στο νερό, στην υδρόλυση και στα χημικά. Χρόνος εναποθήκευσης: Τουλάχιστον 12 μήνες σε χώρους με κανονική θερ/σία και υγρασία.

ΚΩΔΙΚΟΣ	ΠΕΡΙΓΡΑΦΗ	ΣΥΣΚ	€/ΤΕΜ
156810	7kgr ΜΠΕΖ	1	66,35

LASTOFLEX TC. Κατάλληλο & για στεγανοποίηση δεξαμενών με πόσιμο νερό

Ελαστομερές επαλειπτικό, δύο συστατικών, με βάση την πολυουρεθάνη, κατάλληλο για μόνιμη στεγανοποίηση επιφανειών. Δημιουργεί μία μονολιθική μεμβράνη, χωρίς αρμούς, η οποία είναι 100% κολλητή στο υπόστρωμα. Διατηρεί την ελαστικότητά του ακόμα και σε πολύ χαμηλές θερμοκρασίες (-40°C). Δεν περιέχει διαλύτες και είναι κατάλληλο για εφαρμογή σε κλειστούς χώρους. Προσφέρει ταχύτατο πολυμερισμό και μπορεί να εφαρμοστεί και σε ένα χέρι. Είναι κατάλληλο για μόνιμη εμβάπτιση σε νερό.



LASTOFLEX-W

ΤΟΜΕΙΣ ΕΦΑΡΜΟΓΩΝ

Χρησιμοποιείται για μόνωση ταρασών. Εφαρμόζεται σε όλα τα υποστρώματα (σκουρόδεμα, πλάκες, αμιαντοσιμέντο, κ.ά.). Δεν είναι κατάλληλο για επιφάνειες μόνιμα εμβαπτισμένες σε νερό.

ΚΩΔΙΚΟΣ	ΠΕΡΙΓΡΑΦΗ	ΣΥΣΚ	€/ΤΕΜ
156940	5kgr ΛΕΥΚΟ	1	23,90
156941	15kgr ΛΕΥΚΟ	1	75,15

LASTOFLEX - W

Επαλειπτικό, υγρομονωτικό ενός συστατικού, υβριδικής βάσεως, για στεγάνωση και προστασία δομικών κατασκευών. Η πρωτοποριακή σύνθεσή του με συνδυασμό αλειφατικών πολυουρεθανικών και ακρυλικών πολυμερών, παρουσιάζει εξαιρετική αντοχή στις καιρικές συνθήκες, υψηλή μηχανική αντοχή και μεγάλη ευκολία τοποθέτησης, καθ' όσον πρόκειται για σύστημα νερού. Παρουσιάζει μικρή προσρόφηση νερού και υψηλή αντοχή σε ακτινοβολία UV και υγρασία. Μπορεί να εφαρμοστεί ακόμα και σε υγρά υποστρώματα.



SILIPROOF

ΤΟΜΕΙΣ ΕΦΑΡΜΟΓΩΝ

Προστατεύει τις επιφάνειες από βροχή. Είναι ατμοπερατό και επιτρέπει την αναπνοή των δομικών στοιχείων. Είναι διαφανές και δεν αλλοιώνει τη χρωματική όψη των επιφανειών. Προστατεύει τις επιφάνειες από την εξίδρωση αλάτων (ιδιαίτερα των αλκαλικών υποστρωμάτων). Αδιαβροχοποιεί τους αρμούς πλακιδίων, προστατεύοντας από τη βρωμιά που συσσωρεύεται. Εφαρμόζεται εύκολα και γρήγορα.

ΚΩΔΙΚΟΣ	ΠΕΡΙΓΡΑΦΗ	ΣΥΣΚ	€/ΤΕΜ
156950	800ml	1	9,30
156951	4LT	1	38,50
156952	17LT	1	160,00

SILIPROOF

Αδιαβροχοποιητικό επαλειπτικό επιφανειών, ιδιαίτερα κατάλληλο για εφαρμογή σε ανόργανα, πορώδη υποστρώματα, όπως σοβάς, φυσικές πέτρες, σκουρόδεμα, πλακίδια με πόρους (μη εφραλωμένα), διακοσμητικά τούβλα, κ.ά.. Χάρη στη μικρομοριακή σύνθεσή του εισχωρεί εύκολα στο υπόστρωμα και δημιουργεί μια υδρόφοβη επιφάνεια εξαιρετικής αντοχής και διάρκειας στο χρόνο.



LASTOCRYL-R

ΤΟΜΕΙΣ ΕΦΑΡΜΟΓΩΝ

Χρησιμοποιείται για μόνωση ταρασών. Εφαρμόζεται σε όλα τα υποστρώματα (σκουρόδεμα, πλάκες, αμιαντοσιμέντο, κ.ά.). Δεν είναι κατάλληλο για επιφάνειες μόνιμα εμβαπτισμένες σε νερό.

ΚΩΔΙΚΟΣ	ΠΕΡΙΓΡΑΦΗ	ΣΥΣΚ	€/ΤΕΜ
156920	1kgr ΛΕΥΚΟ	1	4,80
156921	5kgr ΛΕΥΚΟ	1	18,20
156922	15kgr ΛΕΥΚΟ	1	49,70

LASTOCRYL - R

Υγρό μονωτικό επαλειπτικό με βάση ακρυλικές ρητίνες και ειδικά πρόσθετα. Παρουσιάζει μικρή προσρόφηση νερού και υψηλή αντοχή σε ακτινοβολία UV και υγρασία. Είναι ιδιαίτερα φιλικό προς τον χρήστη, καθ' όσον δεν περιέχει διαλύτες ή άλλες τοξικές ουσίες. Μπορεί να εφαρμοστεί ακόμα και σε υγρά υποστρώματα.



NEO

ELASTOTET-F EPOXY

2 ΣΥΣΤΑΤΙΚΩΝ

ΤΟΜΕΙΣ ΕΦΑΡΜΟΓΩΝ

Είναι κατάλληλο για εφαρμογές σε βιομηχανικά δάπεδα με υψηλές μηχανικές καταπονήσεις. Είναι κατάλληλο για δάπεδα σε αποθήκες, βιομηχανίες, εσωτερικά πάρκινγκ αυτοκινήτων, πολυκαταστήματα, κ.ά.
Χρόνος εναποθήκευσης: Τουλάχιστον 12 μήνες σε χώρους με κανονική θερ/σία και υγρασία.

ΚΩΔΙΚΟΣ	ΠΕΡΙΓΡΑΦΗ	ΣΥΣΚ	€/ΤΕΜ
158150	15,75 kgr ΓΚΡΙ	1	266,60
158151	15,75 kgr ΜΠΕΖ	1	266,60

ELASTOTET-F EPOXY

Αυτοεπιπεδούμενο υλικό δαπέδων σε συσκευασία 2 συστατικών με βάση εποξειδικές ρητίνες. Παρουσιάζει ιδιαίτερα υψηλή χημική αντοχή σε οργανικά και ανόργανα οξέα, σε πετρελαιοειδή, αλκάλια, απορρυπαντικά και αρκετούς διαλύτες. Εφαρμόζεται ως επαλειφόμενο επίχρισμα ή ως αυτοεπιπεδούμενο εποξειδικό δάπεδο μαζί με χαλαζιακή άμμο. Δεν περιέχει διαλύτες.



NEO

ELASTOTET EPOXY PAINT

2 ΣΥΣΤΑΤΙΚΩΝ

ΤΟΜΕΙΣ ΕΦΑΡΜΟΓΩΝ

Συνιστάται για μακροχρόνιες εφαρμογές επάλειψης επιφανειών σκυροδέματος και μεταλλικών επιφανειών σε βιομηχανικούς χώρους και τεχνικά έργα.
Χρόνος εναποθήκευσης: Τουλάχιστον 12 μήνες σε χώρους με κανονική θερ/σία και υγρασία.

ΚΩΔΙΚΟΣ	ΠΕΡΙΓΡΑΦΗ	ΣΥΣΚ	€/ΤΕΜ
158080	15,75 kgr ΓΚΡΙ	1	206,00

ELASTOTET EPOXY PAINT

Εγχρωμη βαφή, 2 συστατικών, με βάση εποξειδικές ρητίνες. Παρουσιάζει εξαιρετική αντοχή σε υγρό περιβάλλον ακόμη και σε θαλάσσιο. Είναι ανθεκτικό σε συνήθεις οργανικούς διαλύτες όπως βενζίνη, πετρέλαιο, ξυλόλη κ.ά.



NEO

ELASTOTET VL COLOR

ΤΟΜΕΙΣ ΕΦΑΡΜΟΓΩΝ

Κατάλληλο για εφαρμογές σε βιομηχανικά δάπεδα ως προϊόν τελικής επικάλυψης. Εφαρμόζεται είτε απ' ευθείας σε βιομηχανικά δάπεδα από μπετόν, είτε ως προϊόν επικάλυψης στο αυτοεπιπεδούμενο πολυουρεθανικό δάπεδο ELASTOTET-F. Είναι κατάλληλο για εφαρμογή σε δάπεδα όπου απαιτείται υψηλή μηχανική αντοχή όπως αποθήκες, χώροι παραγωγής εργοστασίων, ψυκτικοί θάλαμοι, κλειστά πάρκινγκ και συνεργεία αυτοκινήτων. Δεν είναι κατάλληλο για χρήση σε εξωτερικούς χώρους.
Χρόνος εναποθήκευσης: Τουλάχιστον 12 μήνες σε χώρους με κανονική θερ/σία και υγρασία.

ΚΩΔΙΚΟΣ	ΠΕΡΙΓΡΑΦΗ	ΣΥΣΚ	€/ΤΕΜ
158055	1 kgr ΓΚΡΙ	1	12,35
158056	5 kgr ΓΚΡΙ	1	59,00
158057	20 kgr ΓΚΡΙ	1	213,00
158058	1 kgr ΜΠΕΖ	1	12,35
158059	5 kgr ΜΠΕΖ	1	59,00
158060	20 kgr ΜΠΕΖ	1	213,00

ELASTOTET VL COLOR

Εγχρωμο, επαλειφόμενο, επίχρισμα δαπέδων, ενός συστατικού, με βάση την πολυουρεθάνη. Έχει ικανότητα πρόσφυσης σε πολλές πορώδεις επιφάνειες, ακόμα και χωρίς τη χρήση ασταριού. Παρουσιάζει εξαιρετική αντοχή στην τριβή και τις μηχανικές καταπονήσεις. Έχει αντοχή στην υδρόλυση, τα οξέα, τα καύσιμα και τα απορρυπαντικά.



NEO

ELASTOTET ANTI-G ST

ANTI-GRAFFITI

ΤΟΜΕΙΣ ΕΦΑΡΜΟΓΩΝ

Το ELASTOTET ANTI-G ST συνιστάται για επάλειψη υποστρωμάτων από εμφανή μεττά, μεταλλικών επιφανειών και σοβάδων σε κτιριακά έργα κ.ά.. Παρουσιάζει εξαιρετική πρόσφυση σε μεγάλη ποικιλία υποστρωμάτων χωρίς PRIMER (μετόν, τούβλα, πλακάκια, σοβά, μέταλλα, πλαστικά).
Χρόνος εναποθήκευσης: Τουλάχιστον 12 μήνες σε χώρους με κανονική θερ/σία και υγρασία.

ΚΩΔΙΚΟΣ	ΠΕΡΙΓΡΑΦΗ	ΣΥΣΚ	€/ΤΕΜ
158070	20 kgr ΓΚΡΙ		322,00
158071	20 kgr ΛΕΥΚΟ		322,00

ELASTOTET ANTI-G ST. ANTI-GRAFFITI

Αντιρρυπαντική και αντικολλητική βαφή, ενός συστατικού. Πολυμερίζεται με την ατμοσφαιρική υγρασία. Δημιουργεί αντικολλητική επιφάνεια που προστατεύει τις επιφάνειες από ρύπανση με χρώματα σπρέι (Graffiti), καθώς και από αφισοκολλησεις, επιτρέποντας τον εύκολο καθαρισμό τους.
Προσφέρει μόνιμη προστασία ακόμα και μετά από αλληπάλληλους καθαρισμούς. Εξαιρετική αντοχή στη γήρανση και τις δυσμενείς καιρικές συνθήκες καθώς και στην έκθεση στον ήλιο. Είναι ελαστικό, δεν σκάει, δεν ξεφλουδίζει. Επισκευάζεται τοπικά, χωρίς προεργασία.



NEO

ELASTOTET ANTI-G PU

ANTI-GRAFFITI

ΤΟΜΕΙΣ ΕΦΑΡΜΟΓΩΝ

Συνιστάται για επάλειψη υποστρωμάτων από εμφανή μεττά, μεταλλικών επιφανειών και σοβάδων σε κτιριακά και τεχνικά έργα. Είναι ιδιαίτερα κατάλληλο για βαφές τοιχίων και σφράγγων στην οδοποιία, για χρήση σε ναυτιλιακές ή βιομηχανικές εφαρμογές, μεταλλικές κατασκευές, δεξαμενές, κ.ά..
Χρόνος εναποθήκευσης: Τουλάχιστον 12 μήνες σε χώρους με κανονική θερ/σία και υγρασία.

ΚΩΔΙΚΟΣ	ΠΕΡΙΓΡΑΦΗ	ΣΥΣΚ	€/ΤΕΜ
158075	20 kgr ΓΚΡΙ		285,00

ELASTOTET ANTI-G PU. ANTI-GRAFFITI

2 ΣΥΣΤΑΤΙΚΩΝ

Επίχρισμα, 2 συστατικών, με βάση ειδική κατηγορία αλειφατικής πολυουρεθάνης (PU) που επιτρέπει την εύκολη απομάκρυνση βαφών σπρέι (Graffiti). Προσφέρει μόνιμη αντιρρυπαντική προστασία, επιτρέποντας τον επαναλαμβανόμενο καθαρισμό (με κατάλληλα αφαιρετικά -removers-). Παρουσιάζει εξαιρετική αντοχή στη γήρανση, τις δυσμενείς καιρικές συνθήκες, το υγρό περιβάλλον ακόμη και το θαλάσσιο, τους συνήθεις οργανικούς διαλύτες όπως βενζίνη, πετρέλαιο, ξυλόλη κ.ά.. Δεν αλλοιώνεται χρωματικά και δεν κτρινίζει από την έκθεση στον ήλιο.



NEO

ELASTOTET PU POOL

2 ΣΥΣΤΑΤΙΚΩΝ

ΤΟΜΕΙΣ ΕΦΑΡΜΟΓΩΝ

Το ELASTOTET PU POOL συνιστάται για μακροχρόνιες εφαρμογές επάλειψης επιφανειών σκυροδέματος σε πισίνες.

ΚΩΔΙΚΟΣ	ΠΕΡΙΓΡΑΦΗ	ΣΥΣΚ	€/ΤΕΜ
158090	20kgr ΓΑΛΑΖΙΟ	1	280,00
158095	20kgr ΜΠΕΖ	1	280,00

ELASTOTET PU POOL

Εγχρωμη βαφή, 2 συστατικών, με βάση ειδικές ρητίνες αλειφατικής πολυουρεθάνης, για χρήση σε πισίνες. Παρουσιάζει εξαιρετική αντοχή στη γήρανση, την ηλιακή ακτινοβολία, το υγρό περιβάλλον ακόμη και το θαλάσσιο. Δεν αλλοιώνεται χρωματικά και δεν κίτρινίζει από την έκθεση στον ήλιο. Παρουσιάζει μακροχρόνια αντοχή και δεν ξεβαφεί όπως οι συνήθεις εποξειδικές βαφές πισίνας.



NEO

ELASTOTET PRIMER EP-W

ΤΟΜΕΙΣ ΕΦΑΡΜΟΓΩΝ

Το Primer EP-W χρησιμοποιείται κυρίως ως αστάρι για επαλειφόμενα στεγανοποιητικά ταρτασών σε πορώδεις επιφάνειες (μπετόν), ακόμα και νωπές. Βελτιώνει επίσης την πρόσφυση των πολυουρεθανικών επαλειφόμενων στεγανοποιητικών όπως το LASTOFLEX PU ή το LASTOFLEX ST ακόμα και σε λείες επιφάνειες (μέταλλα, πλακάκια).

ΚΩΔΙΚΟΣ	ΠΕΡΙΓΡΑΦΗ	ΣΥΣΚ	€/ΤΕΜ
158210	4kgr		48,75
158215	20kgr		220,00

ELASTOTET PRIMER EP-W Εποξειδικό αστάρι νερού, δύο συστατικών.

Χαρακτηριστικά :

Παρουσιάζει υψηλή μηχανική αντοχή και αντοχή σε τριβή. Διαθέτει άριστη πρόσφυση σε πορώδεις επιφάνειες (μπετόν, ξύλο), ακόμα και νωπές και σε μέταλλα. Ισχυροποιεί την επιφάνεια του υποστρώματος. Δημιουργεί φράγμα υδρατμών προστατεύοντας το στεγανοποιητικό από τις αρνητικές πιέσεις. Είναι συμβατό με τα περισσότερα πολυμερή στεγανοποιητικά. Διαθέτει εύκολη εφαρμογή με πινέλο ή ρολό.



NEO

ELASTOTET PRIMER DM

ΤΟΜΕΙΣ ΕΦΑΡΜΟΓΩΝ

Το ELASTOTET PRIMER DM βελτιώνει την πρόσφυση των ελαστομερών συγκολλητικών με βάση την πολυουρεθάνη (ELASTOSEAL-PU 50 FC, WINDSHIELD PU 230, PU PARQUET 430) ή αλειφατικών επιχρισμάτων (LASTOFLEX-TR, WINDSHIELD BLACK PRIMER) σε λείες επιφάνειες από γυαλί ή μέταλλο.

ΚΩΔΙΚΟΣ	ΠΕΡΙΓΡΑΦΗ	ΣΥΣΚ	€/ΤΕΜ
158250	0,5 Lt		6,00
158251	1 Lt		11,00
158252	4 Lt		38,00

ELASTOTET PRIMER DM

Είναι σιλανικό αστάρι για τη βελτίωση της προσφύσεως πολυουρεθανικών υλικών μόνωσης σε λείες επιφάνειες όπως πλακάκι γυαλί πορσελάνη. Στεγνώνει γρήγορα χωρίς να αλλοιώνει την όψη του υποστρώματος. Παρουσιάζει εξαιρετική πρόσφυση σε επιφάνειες από γυαλί, κεραμικά πλακάκια, βαμμένες μεταλλικές επιφάνειες, βαμμένες επιφάνειες αλουμινίου με ηλεκτροστατική βαφή, κ.ά.. Είναι συμβατό με μεγάλη ποικιλία προϊόντων πολυουρεθάνης. Εύκολη εφαρμογή με πινέλο ή πανί.



ELASTOTET PRIMER VL

ΤΟΜΕΙΣ ΕΦΑΡΜΟΓΩΝ

Το ELASTOTET PRIMER VL εφαρμόζεται ως αστάρι πριν από την εφαρμογή μονωτικών ταρτασών (LASTOFLEX-ST, LASTOFLEX-PU) και σφραγιστικών αρμών (ELASTOSEAL-PU, ELASTOTAN) σε υποστρώματα από μπετόν. Είναι επίσης κατάλληλο για χρήση ως αστάρι σε ξύλινα παρκέ πριν από την εφαρμογή παρκετόκολλας πολυουρεθάνης ή κόλλας με βάση πολυμερή τερματισμένα με σιλάνια.

ΚΩΔΙΚΟΣ	ΠΕΡΙΓΡΑΦΗ	ΣΥΣΚ	€/ΤΕΜ
158230	1kgr	1	12,10
158231	4kgr	1	40,90
158232	17kgr	1	167,00

ELASTOTET PRIMER VL

Το ELASTOTET PRIMER VL είναι πολυουρεθανικό αστάρι για την βελτίωση της πρόσφυσης σε πορώδεις επιφάνειες, πολυμερικών ελαστομερών σφραγιστικών, στεγανοποιητικών ή συγκολλητικών υλικών. Παρουσιάζει υψηλή διεισδυτική ικανότητα. Ισχυροποιεί το υπόστρωμα. Διαθέτει εύκολη εφαρμογή με πινέλο ή ρολό.

ELASTOTET PRIMER W40

ΤΟΜΕΙΣ ΕΦΑΡΜΟΓΩΝ

Είναι κατάλληλο για χρήση τόσο σε εσωτερικές (σοβάς, γυψοσανίδα), όσο και σε εξωτερικές επιφάνειες (μπετόν, τιμεντόπλακες, κ.α.). Προστατεύει και ενισχύει τα ακρυλικά επαλειπτικά μονωτικά ταρτασών και καθέτων επιφανειών, καθώς και τα οικοδομικά χρώματα από το ξεφλούδισμα.

ΚΩΔΙΚΟΣ	ΠΕΡΙΓΡΑΦΗ	ΣΥΣΚ	€/ΤΕΜ
158200	1kgr	1	12,80

ELASTOTET PRIMER W40

Αστάρι ειδικά σχεδιασμένο για τη βελτίωση της πρόσφυσης της τελικής στρώσης καθώς και για την αύξηση της υδροφοβίας των πορωδών-αλκαλικών υποστρωμάτων. Διεισδύει απόλυτα στις πορώδεις επιφάνειες, ενώ ταυτόχρονα επιτρέπει την περατότητα των υδρατμών από μέσα προς τα έξω. Προσφέρει εξαιρετική διεισδυση σε πορώδεις επιφάνειες, βελτιώνει την πρόσφυση της τελικής στρώσης και μειώνει την απορροφητικότητα των πορωδών επιφανειών, επιτρέποντας ταυτόχρονα την αναπνοή των επιφανειών. Παρουσιάζει εξαιρετική αντοχή σε αλκαλικά υποστρώματα.

ΛΙΠΑΝΣΗ & ΠΡΟΣΤΑΣΙΑ που "ΔΙΑΡΚΕΙ"

N-GR

New GeneRation spray

► Τεχνικά σπρέι ΝΕΑΣ ΓΕΝΙΑΣ

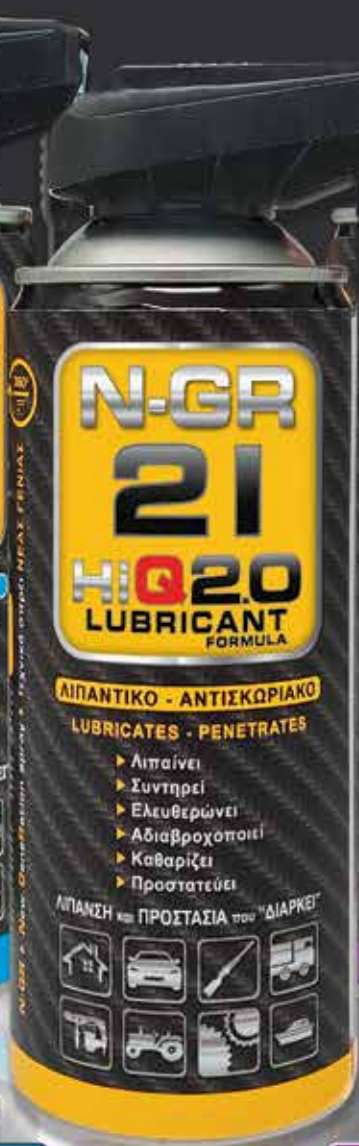

ΚΑΘΑΡΙΣΤΙΚΟ ΦΡΕΝΩΝ

100% ΚΑΘΑΡΗ ΣΙΛΙΚΟΝΗ

ΚΑΘΑΡΙΣΤΙΚΟ ΗΛΕΚΤΡΙΚΩΝ ΕΠΑΦΩΝ
& ΟΛΟΚΛΗΡΩΜΕΝΩΝ ΚΥΚΛΩΜΑΤΩΝ

ΓΡΑΣΟ ΛΙΘΙΟΥ
ΕΝΙΣΧΥΜΕΝΟ ΜΕ ΤΕΦΛΟΝ

ΛΙΠΑΝΤΙΚΟ - ΑΝΤΙΣΚΩΡΙΑΚΟ

New GeneRation spray

ergoHELIX
Hardware Solutions



ergoHELIX | Α. ΚΑΡΑΒΑΣ Α.Ε.

Θηβών 210, Αγ. Ιωάννης Ρέντης 18233
τ. 211 8000 610 | φ. 211 8000 296
info@ergohelix.gr | www.ergohelix.gr