

# WINDOW BLINDS





Every once in a while, a new technology, an old problem, and a big idea turn into an innovation.



*Dean Kamen*



# CONTENTS

---

## 07 INTERIOR BLINDS

### 09 MANUAL

Rolle®

19 Day & Night Blinds

22 Duo Blinds

24 Sansheer Blinds

26 Roman Blinds

28 Venetian Blinds

32 Vertical Blinds

### 35 MOTORISED

Motor System

39 Roller Blinds

43 Day & Night Blinds

46 Duo Blinds

48 Sansheer Blinds

50 Roman Blinds

52 Venetian Blinds

## 55 EXTERIOR BLINDS

### 57 MANUAL

Roller Blinds

### 61 MOTORISED

Roller Blinds

65 Roman Blinds

### 67 SKYLIGHT & AWNING

Skylight Tension & Vellum

71 Retractable Awning

### 76 FABRICS

Interior Fabric

Exterior Fabric

### 78 ACCESSORIES MOTORISED

### 80 CURTAIN TRACK

### 82 OUR PRODUCT LINE

# INTERIOR BLINDS

Supported by high quality components and extensive selections of fabric from all over the world, Sandei's Interior Blinds is committed to ensure superior comfort for customers.

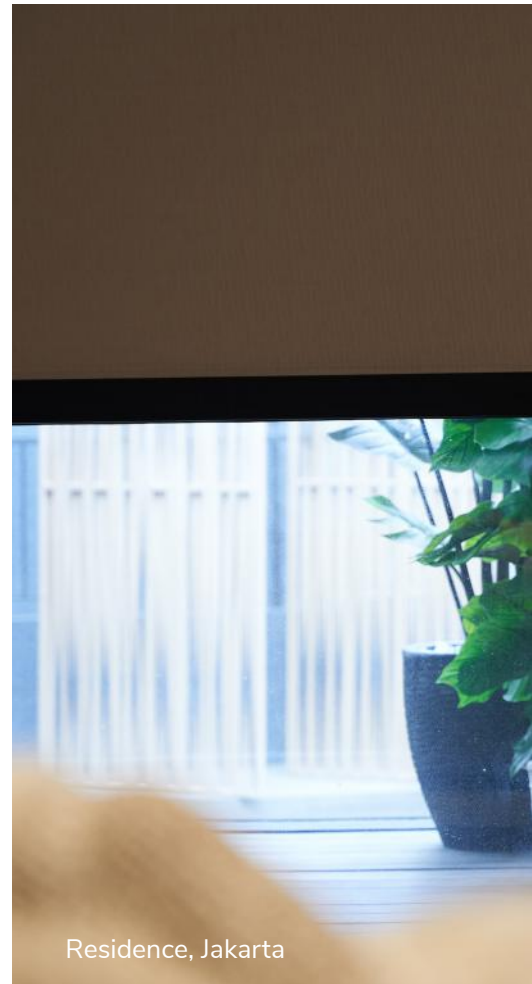

Residence, Jakarta

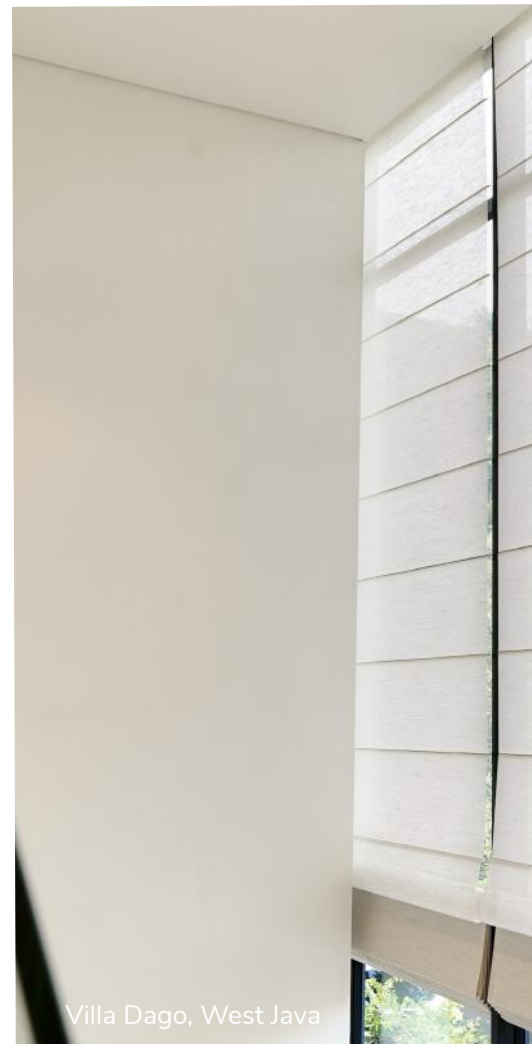

Villa Dago, West Java



# MANUAL



# Rolle®



Rolle is a manual Sandei Roller Blinds which is specifically designed with materials and technology from Germany, can be applied to an opening with a height **up to 6 meters**.



German  
Technology



Heavy Duty



Small, Medium,  
Large



DIN EN ISO 9001 : 2015  
Certificate  
(European Standard Quality)



12 years warranty for component

# Manual Roller Blinds

### HEAD

The standard will come side bracket only. Yet, Rolle® has many other options that could be chosen for the head such as extra head rail or cover box with various color options



Cover Box

Head Rail

Side Bracket

**High quality**  
Operation unit durability  
**10.000 cycle = 12y**



### High quality components

Use for automotive and aerospace. Plastic materials specification are **PA6, ABS, PE reinforced by glass fibers.**



### Fabric

High functional fabric. Based on Requirements

### Operation Chains

Has many colors and options.

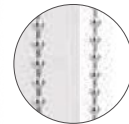

Metal

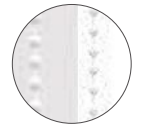

Plastic

### Bottom Bar

Sleek design with color options that are matched with fabric or room/interior design



**Chain Weight** also with option of simple design with color variations that match with fabric or interior.

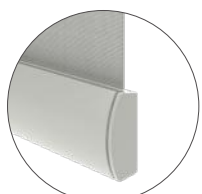

Small & Medium

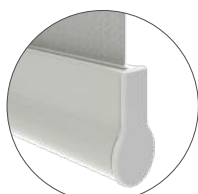

Large



Available child safety hook



- Designed & Crafted with materials and technology from **Germany**
- Can be applied to spaces with the height of **up to 6 meters**
- Best durability and strength like no other Roller Blinds
- Can be applied to all types, designs, and dimensions of space you desire
- Equipped with several choices of accessories to fulfill room's necessities
- Simple and modern look, match with any type of design

## Rolle components are produced in Germany



### Component Comparison

ROLLE

OTHERS

Side bracket

**High quality components**  
Use for automotive and aerospace plastic materials specification are **PA6, ABS, PE reinforced by glass fibers.**

Type Material :  
**PP**  
use for industry

Durability :  
**10.000 cycles**  
= 12 years

Durability :  
**2.000 cycles = 5 years**

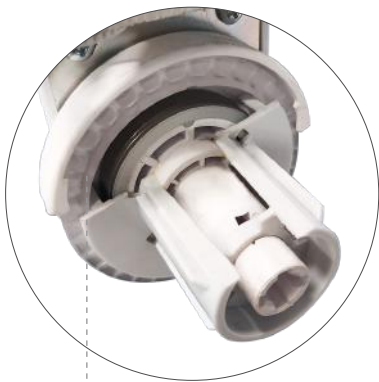

Spring Twist  
with high carbon steel

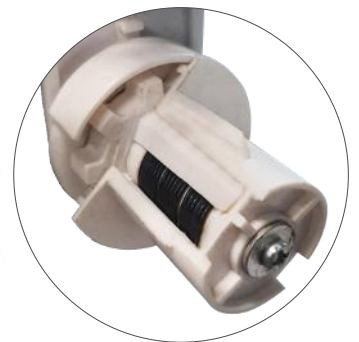

German Component

Taiwan Component

# Rolle®

Type (For All Space Requirement)



## Small

- The small Rolle® system is the solution for all roller blinds with a small opening area of up to 4 m<sup>2</sup>.
- Max Width : 1,6 m, Max Height : 4 m, øTube : 29 mm

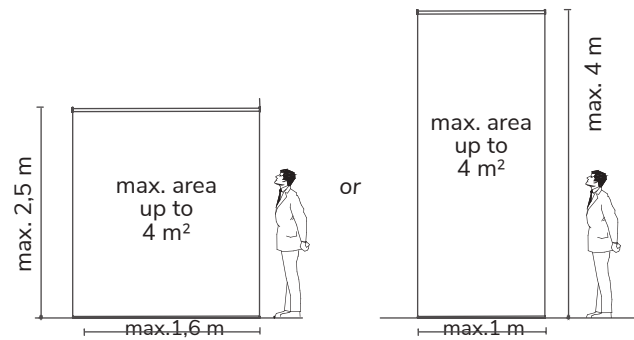

## Extra Features For Small & Medium

### 1. Head Rail

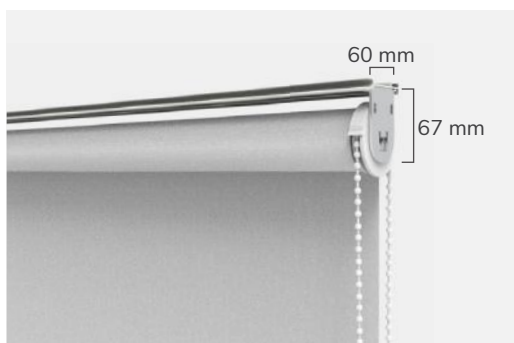

### 2. Cover Box

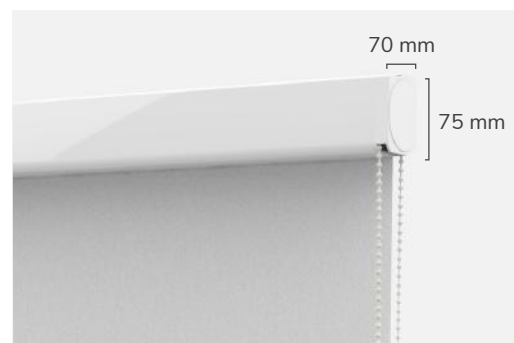

## Notes :

- Maximum height 3 m for Rolle with head rail and 2,5 m with coverbox features.



## Medium

- The medium rolle® system is the solution for all roller blinds with a medium opening area up to  $8 \text{ m}^2$ .
- Max Width : 2,2 m, Max Height : < 4 m,  $\varnothing$ Tube : 36 mm. This system is spring assisted.

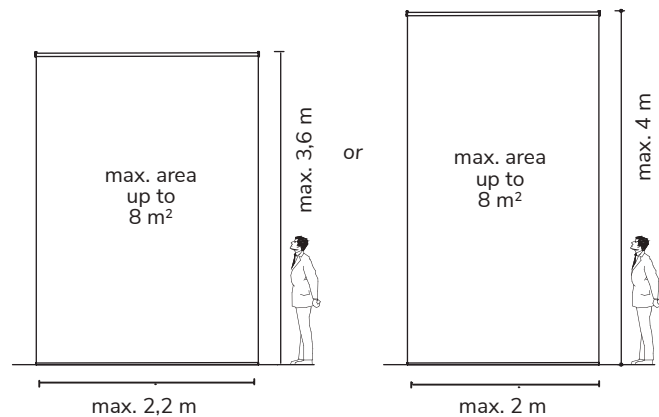

## Gaps

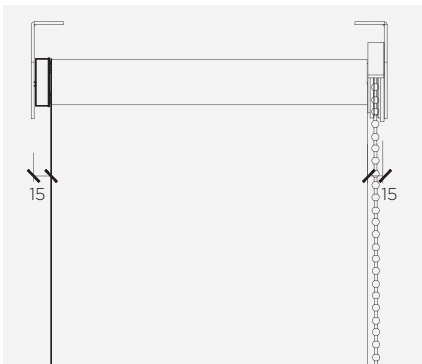

Small & Medium

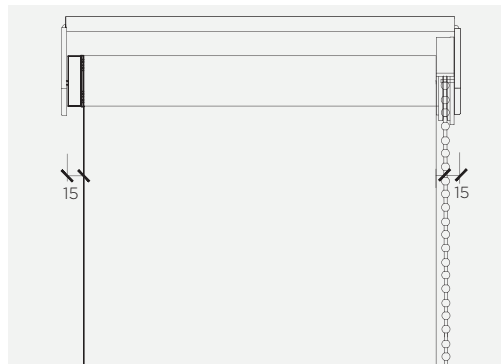

Small & Medium  
with Head Rail

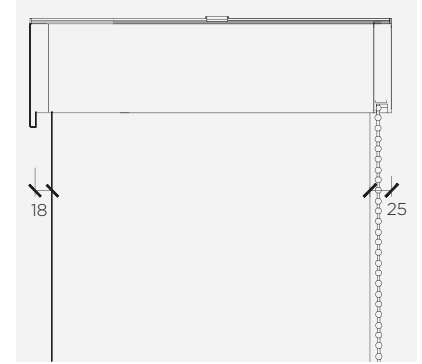

Small & Medium  
with Cover Box

## Notes :

- Maximum height 3 m for Rolle with head rail and 2,5 m with coverbox features.

## Large

- Your perfect solution for all roller blinds with a large.
- Opening area of **up to 12 m<sup>2</sup>**.
- Fitted with heavy and thick fabrics and offers ideal design options for modern architecture.
- Spring assisted system,  $\varnothing$ Tube < 2,2 m : 42 mm and 2,2 m to 2,8 m : 52 mm.

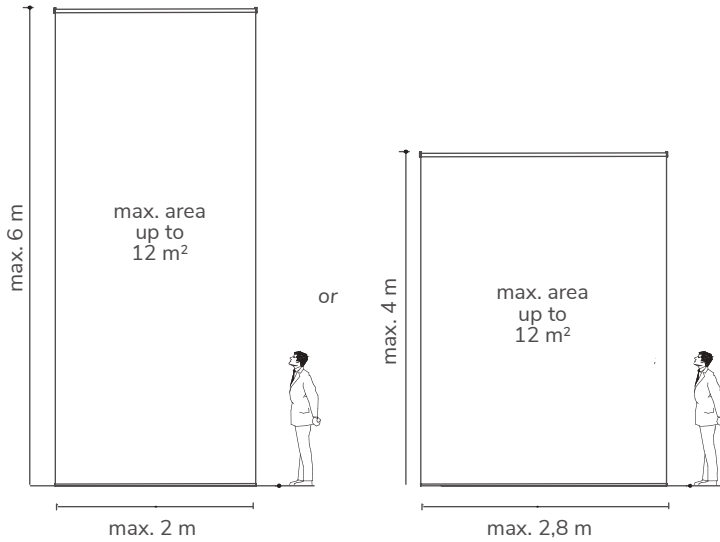

## Gaps

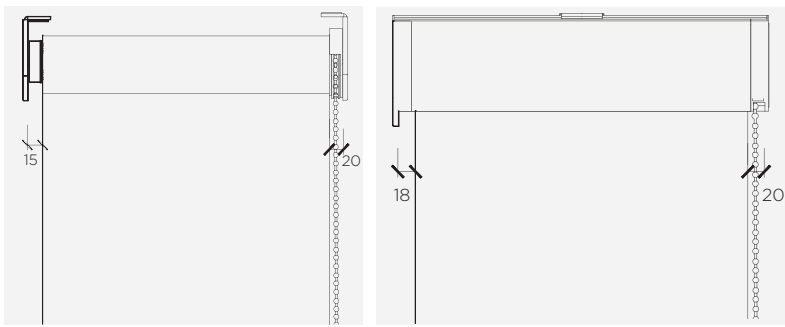

Large

Large with Cover Box

## Extra Features For Large

### 1. Cover Box

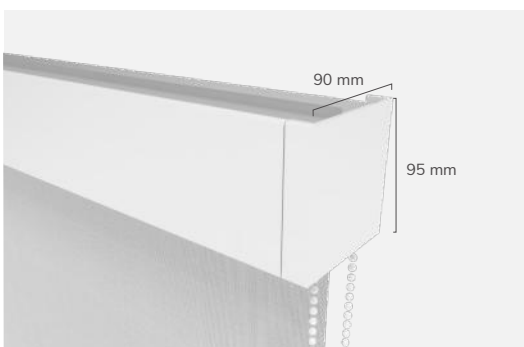

### 2. Cord Guiding for high blinds 1 width : 6 height

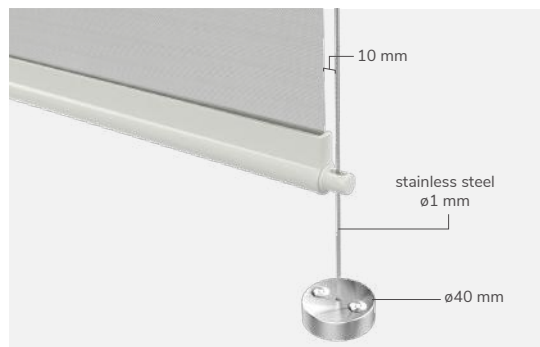

## Notes :

- Maximum height 4 m for Rolle with coverbox features.

### 3. Intermediate



- Intermediate system is a component to connect facilitate the operation of window blinds so could be operated at 2-3 with one system.
- For interior blinds with 2 intermediates **max 12 m<sup>2</sup>**.
- **Many factors will influence blinds with 2 intermediates. Therefore, if the result doesn't meet the standard, it will be recommended to use 1 intermediate only.**

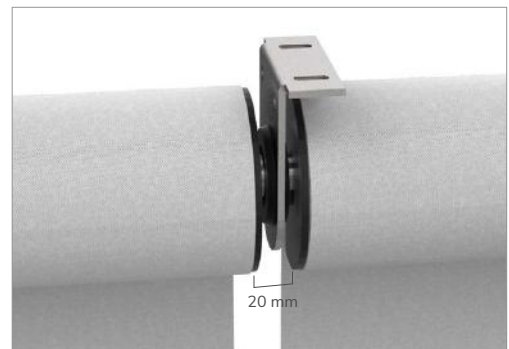

Intermediate System 180°

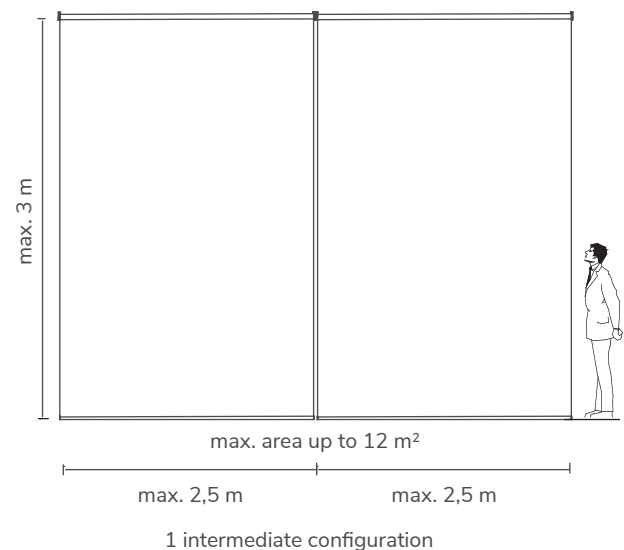
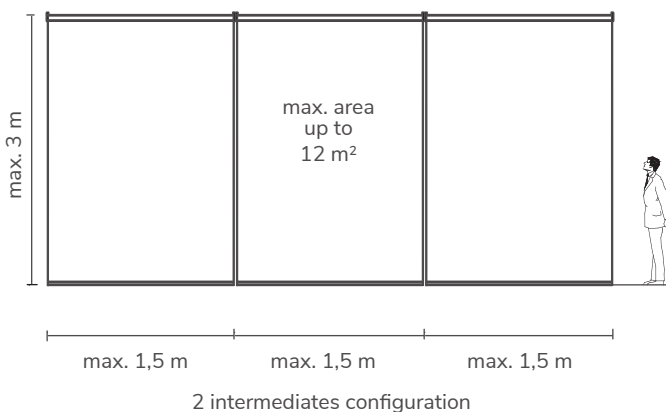

4. Guide Rail without Zipper  
for perfect Black Out

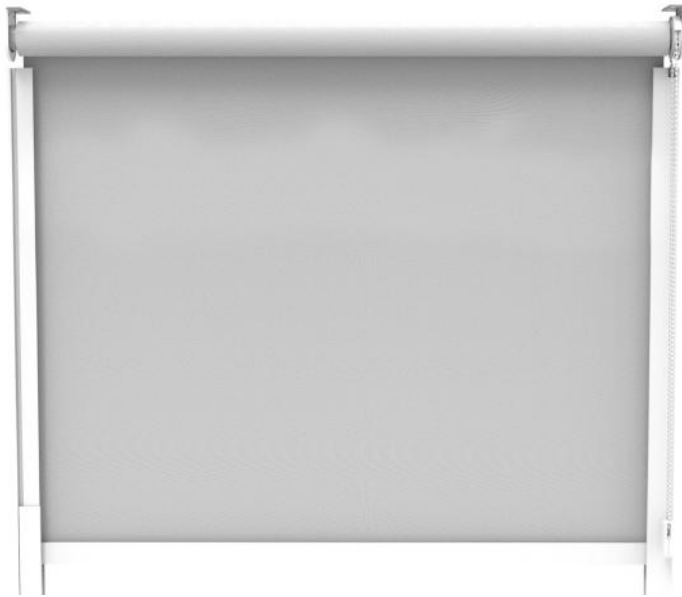

**Details**

Guide rail section

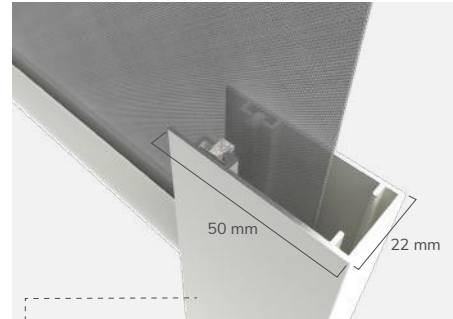

**Available Colors**



\*For other colors, pre-order 1 month and consultation with our product consultant is needed

Head Cover additional option for maximum blackout for Guide Rail system.

a. Cover Box

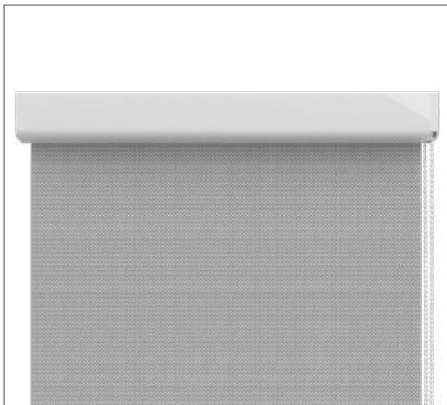

b. Cover L

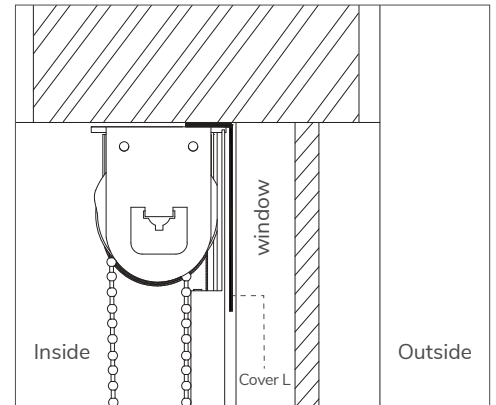
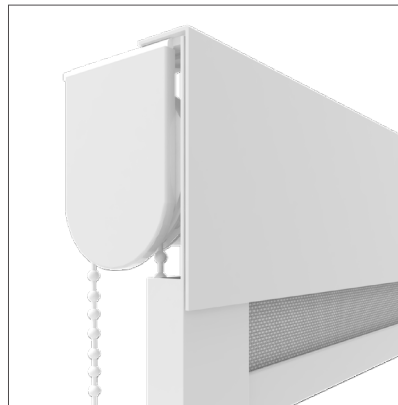

**Notes :**

- Maximum 3m depending on the thickness of the fabric
- Cover L covering the light window to reach perfect black out
- For cover L please kind contact us for consultation

**Child Safety Hook**

for all type Rolle®



## Installation

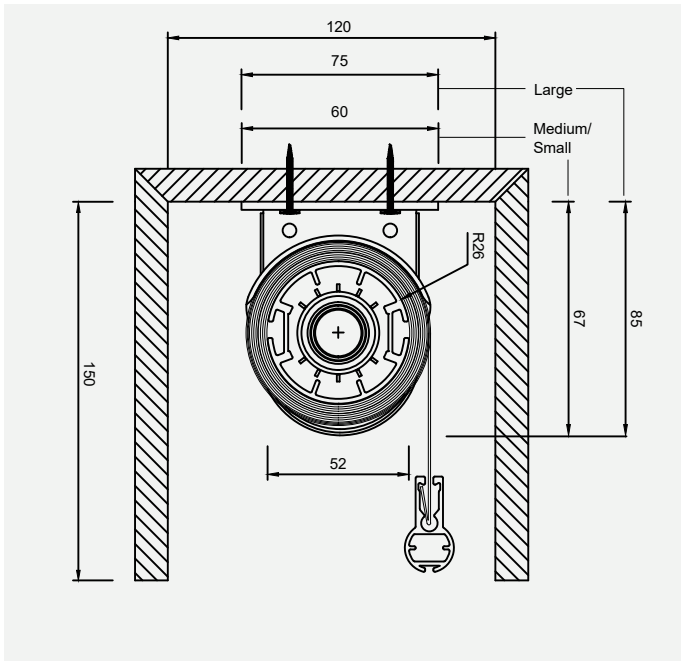

Ceiling

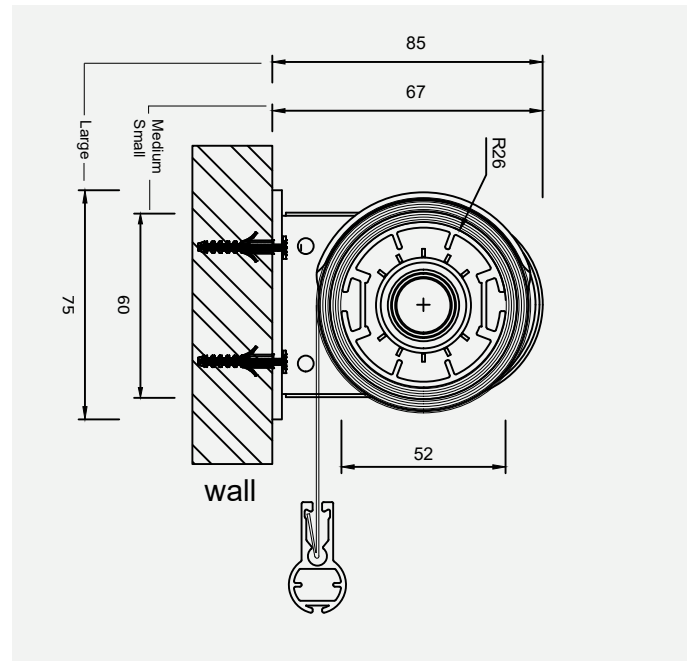

Wall

## Specifications

### Rolle® Small

Width	max. 1.60 m
Height	max. 4.00 m
Area	max. 4.00 m <sup>2</sup>
Brake Capacity	max. 2.5 kg
Tube Shaft	ø29 mm
Head Rail	50 x 10 mm
Bracket	65 x 50 mm
Cover Box	75 x 70 mm
Material Aluminium Tube	Aluminium extrusion with temper T6
Operational Unit	Plastic material are PA6, ABS
Chain	PVC / Stainless Steel
Spring	High carbon steel
Bottom Bar	11 x 23 mm Aluminium extrusion with temper T6

### Rolle® Medium

Width	max. 2.20 m
Height	max. 4.00 m
Area	max. 8.00 m <sup>2</sup>
Brake Capacity	max. 5 kg
Tube Shaft	ø36 mm
Head Rail	50x 10 mm
Bracket	65 x 50 mm
Cover Box	75 x 70 mm
Material Aluminium Tube	Aluminium extrusion with temper T6
Operational Unit	Plastic material are PA6, ABS
Chain	PVC / Stainless Steel
Spring	High carbon steel
Bottom Bar	11 x 23 mm Aluminium extrusion with temper T6

### Rolle® Large

Width	max. 2.80 m
Height	max. 6.00 m
Area	max. 12.00 m <sup>2</sup>
Brake Capacity	max. 7.5 kg
Tube Shaft	ø42 mm & ø52 mm
Bracket	85x60 mm
Cover Box	95 x 90 mm
Material Aluminium Tube	Aluminium extrusion with temper T6
Operational Unit	Plastic material are PA6, ABS
Chain	PVC / Stainless Steel
Spring	High carbon steel
Bottom Bar	18 x 36 mm Aluminium extrusion with temper T6



## Day & Night Blinds

- Designed for rooms that need double function blinds.
- The screen are lowered to filter light glare heat then when the rooms need to be blacked for privacy reason or from the light, Black-out blinds could be lowered.
- Day and night blinds could be installed **2x single blinds**, or **using double blinds brackets**.



12 years warranty for component

## Double Bracket

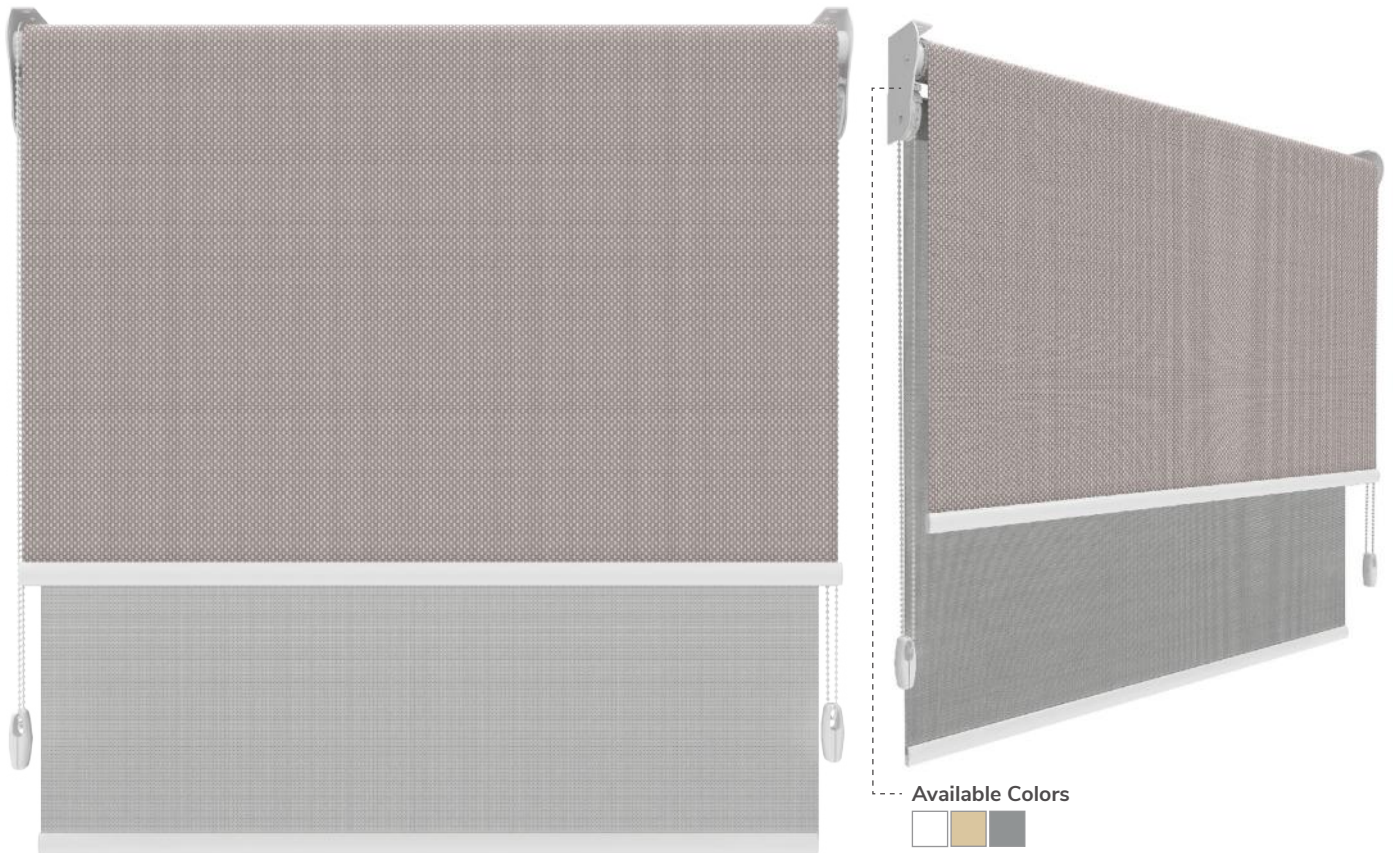

Inside

Available Colors



\*For other colors, pre-order 1 month and consultation with our product consultant is needed

### Details

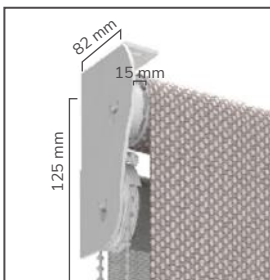

Bracket

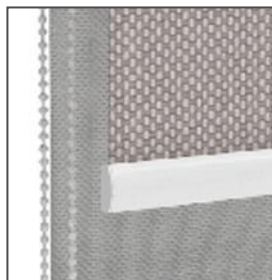

Fabric

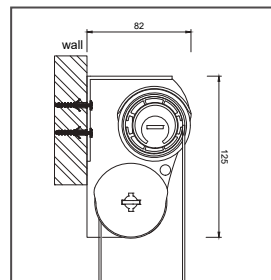

Wall

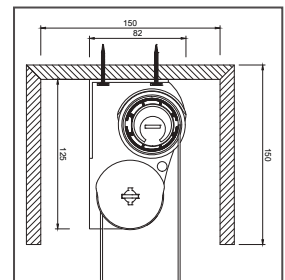

Ceiling

### Available Size Standard

Max. Width	1.6 m
Max. Height	3 m
Max. Area	3 m <sup>2</sup>

### Medium

Max. Width	2.2 m
Max. Height	3 m
Max. Area	6 m <sup>2</sup>

### Large

Max. Width	2.8 m
Max. Height	3 m
Max. Area	9 m <sup>2</sup>

### Notes :

- We recommend not using natural fabrics if the blinds are over 2 meters high
- Use the right and left chains to make them more neat and easy to operate

## Single-Single Brackets

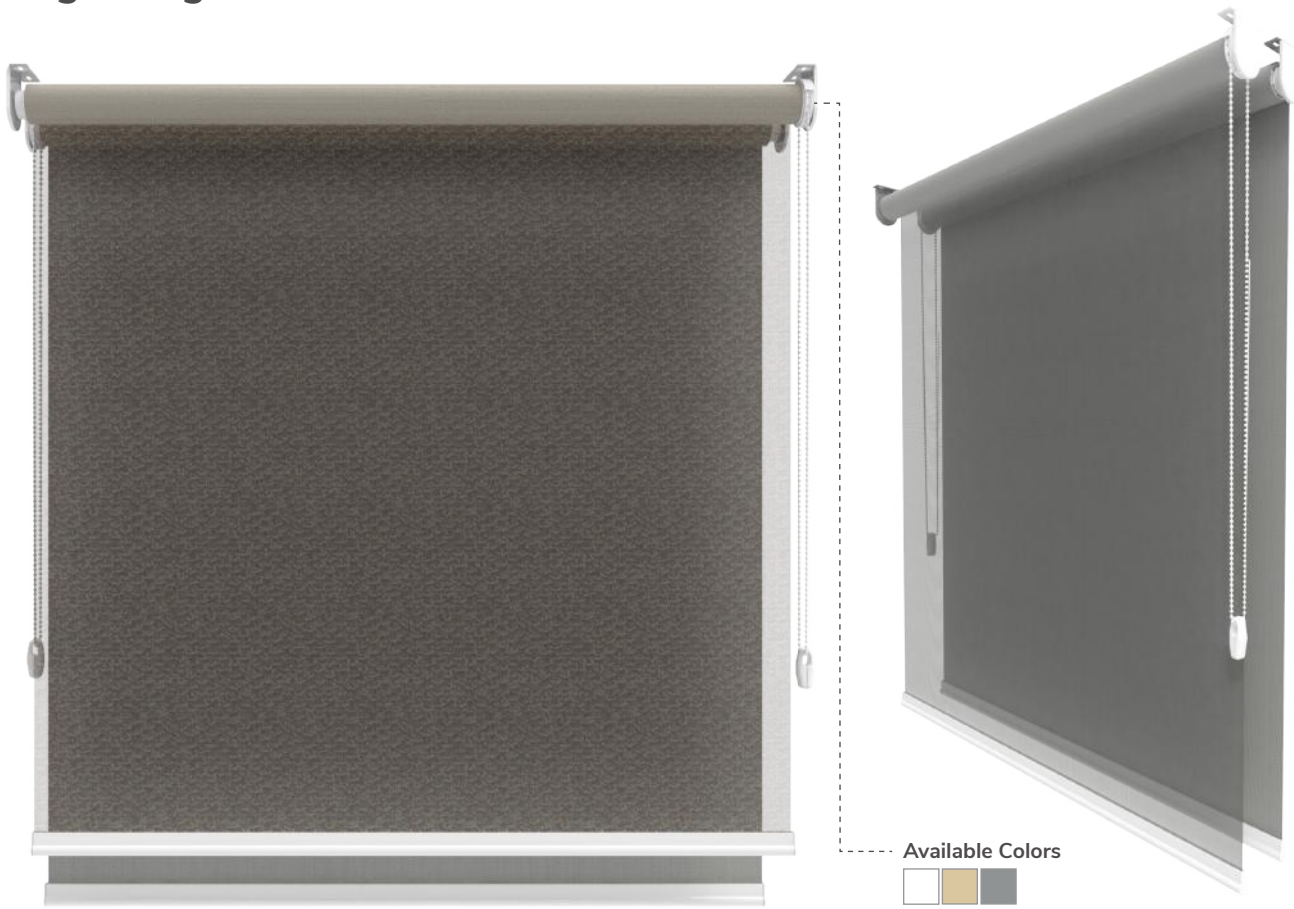

Inside

Available Colors



\*For other colors, pre-order 1 month and consultation with our product consultant is needed

### Details



Bracket



Fabric

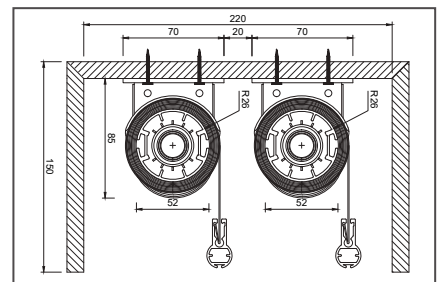

Ceiling

### Available Size Standard

Max. Width	1.6 m
Max. Height	4 m
Max. Area	4 m <sup>2</sup>

### Medium

Max. Width	2.2 m
Max. Height	4 m
Max. Area	8 m <sup>2</sup>

### Large

Max. Width	2.8 m
Max. Height	6 m
Max. Area	12 m <sup>2</sup>

#### Notes :

- We recommend not using natural fabrics if the blinds are over 2 meters high
- Use the right and left chains to make them more neat and easy to operate



## Sansheer Blinds

- Innovative design and functionality
- Unique three-dimensional structure
- An acoustic absorption effect is formed by the internal spacing
- Energy efficient and offers UV protection
- Superior functionality allows the angle of the vane to be adjusted to limit the amount of light transmitted.



5 years warranty for component

# Manual Sansheer Blinds

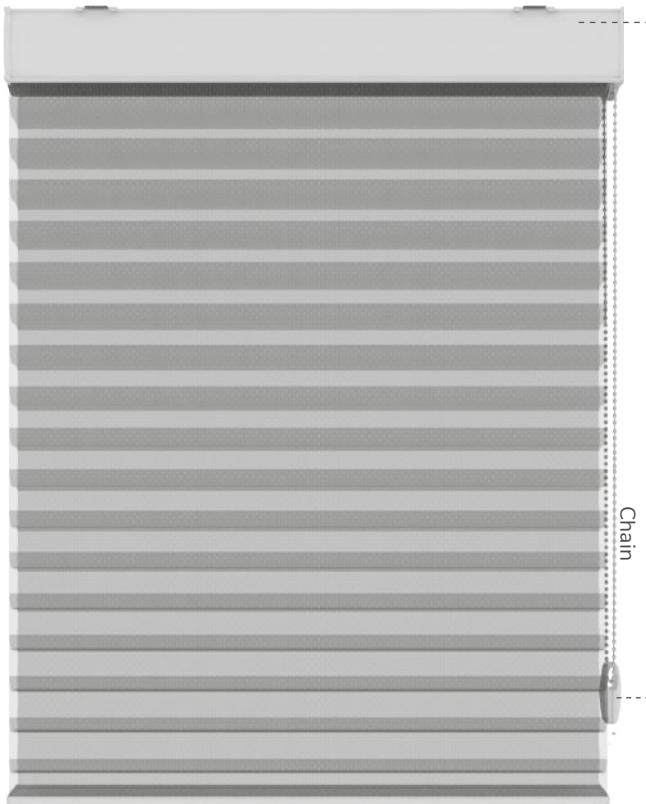

### Available Colors



\*For other colors, pre-order 1 month and consultation with our product consultant is needed

### Details

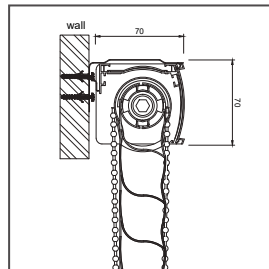

Wall

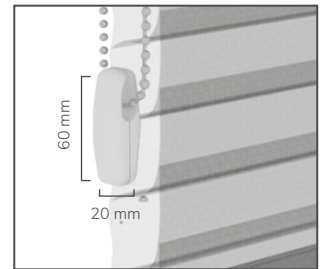

Chain

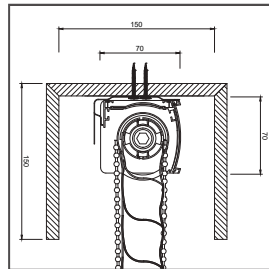

Ceiling

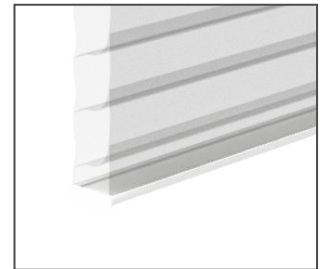

Bottom Bar

### Variant Fabric

Light Filtering & Semi-Black Out

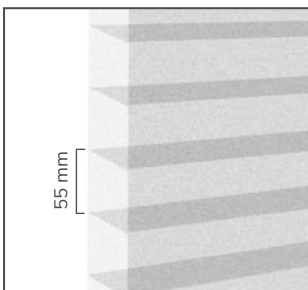

From USA

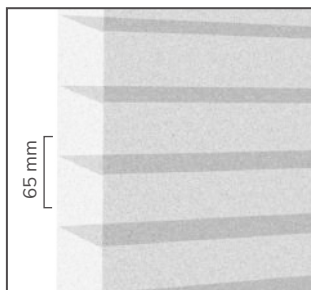

From Taiwan

### Cover Box

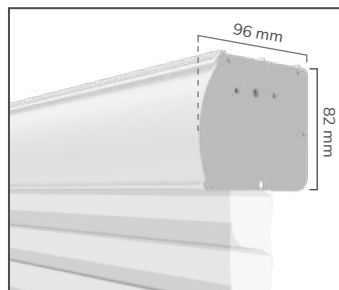

### Available Size

Max. Width	2,8 m
Max. Height	4 m
Max. Area	8 m <sup>2</sup>



## Roman Blinds

- More flowy creates softness feeling and breaks the rigidity
- Sandei Roman Blinds use shaper so the blind look tidy



5 years warranty for component

# Manual Roman Blinds

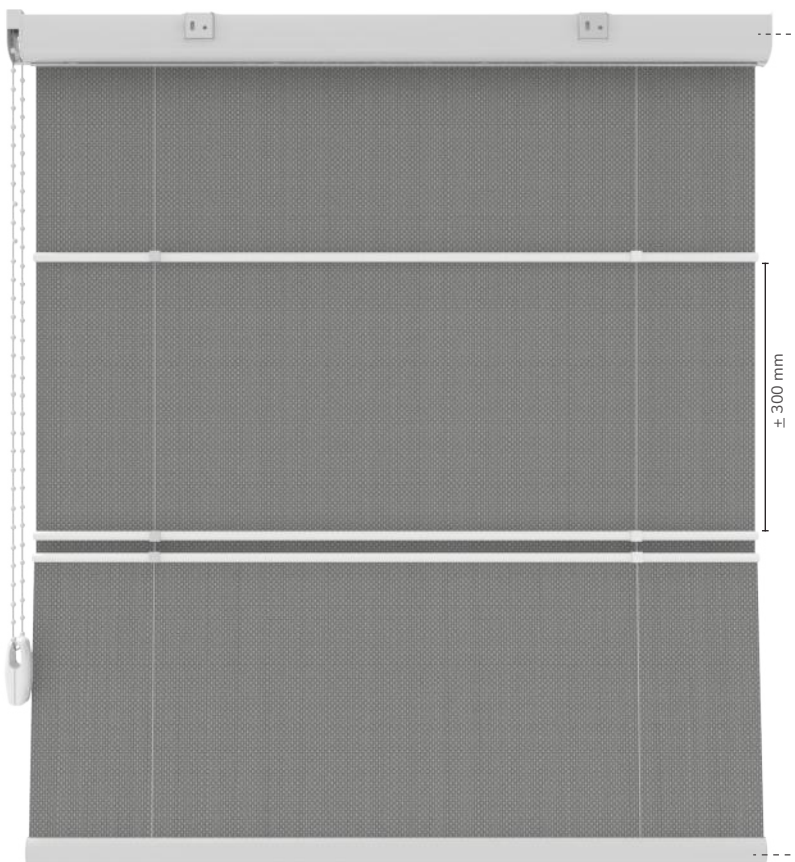

Inside

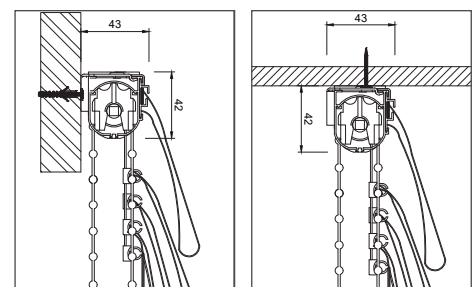
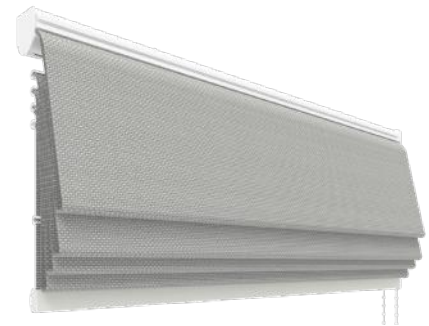

Wall

Ceiling

Available Colors



\*For other colors, pre-order 1 month and consultation with our product consultant is needed

Using gear Ratio 1 : 4  
Single pull take four rotations

Features :

- Strong
- Durable
- Lighter
- Aluminium Shaper
- Suitable for modern design fabrics

Available Size

Max. Width	3 m
Max. Height	3 m
Max. Area	9 m <sup>2</sup>

Details

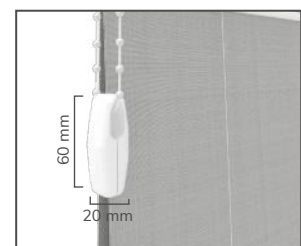
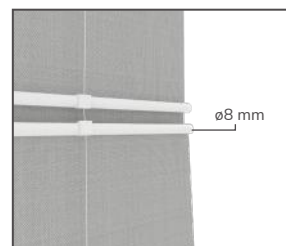
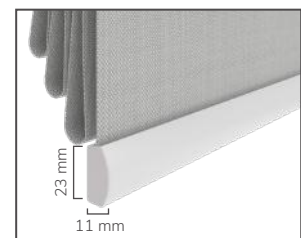
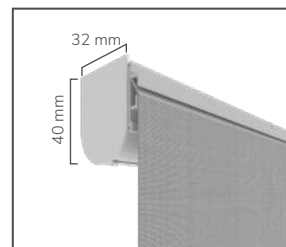

Notes :

- Available Track Only.
- Solar Screen, Black Out 947 & DA 943 is not recommended, it is recommended to use a fabric that is not stiff.
- The width of the blind is according to the width of the fabric.



# Venetian Blinds

- Create warm and natural ambience
- Strength and durability that you can rely on
- The availability wooden and polystyrene are suitable both residential and commercial applications
- Timeless and elegant



5 years warranty for component

# Manual Venetian Blinds

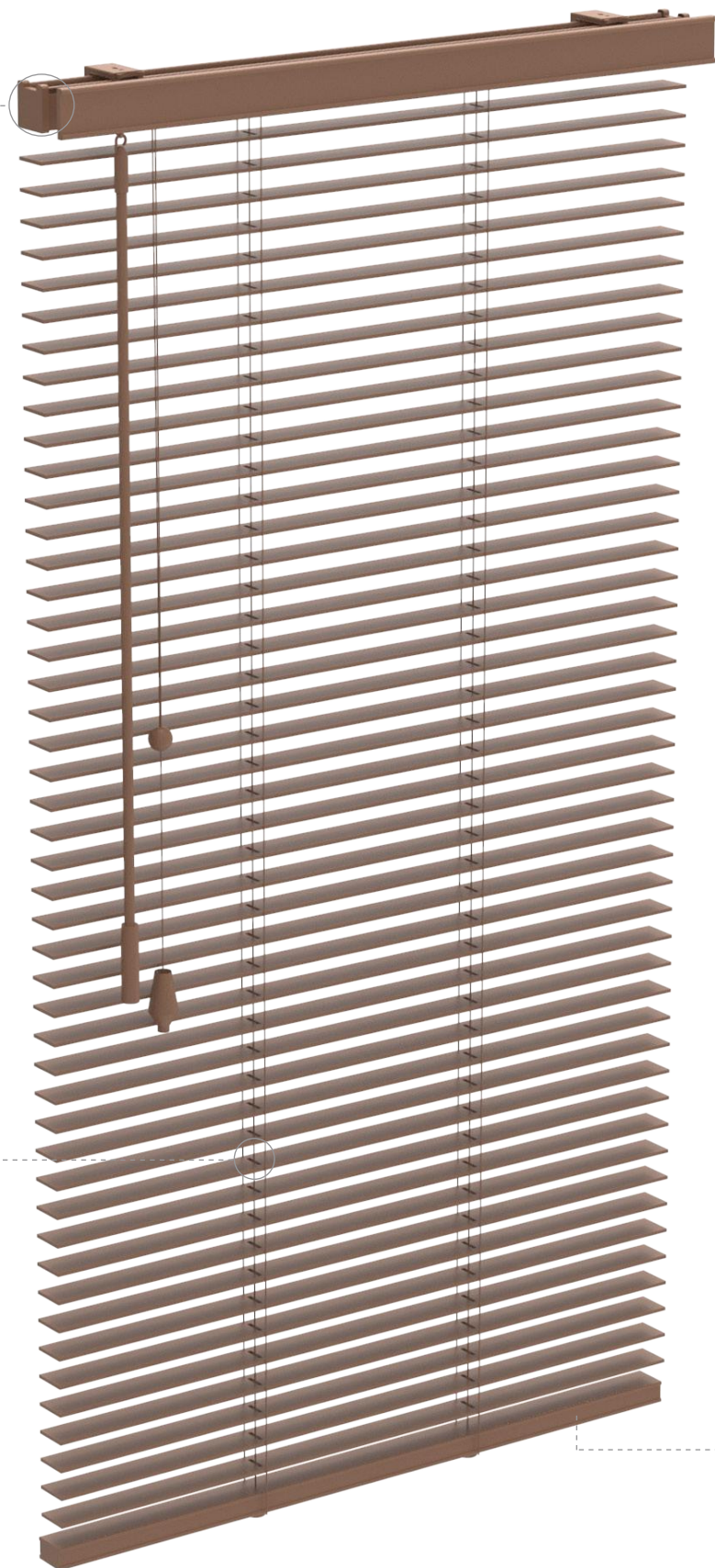

**Operation System**  
Has two options.



Cord Lock System

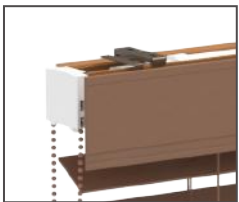

Monochain System

**Available Options**



Ladder Cord

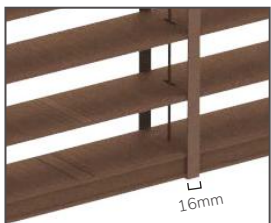

Ladder Tape

**Available Materials**

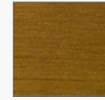

Wooden



Polystyrene  
(Recommended for wet area)

**Color Options**

**Wooden**



Pecan



Mom Groove



Sedona



Walnut



Mahogany



Dark Cedar



Egg Shell



Pure White



Black

**Import**



E08  
Walnut



E09  
Mahogany



E12  
Sun Kissed Oak



E18  
Warm Chestnut

**Polystyrene**



LB 901



LB 9DB



302



7007



7200A



9500



4003



4008



4010

**Bottom Bar**



## Venetian Cord Lock 25 mm

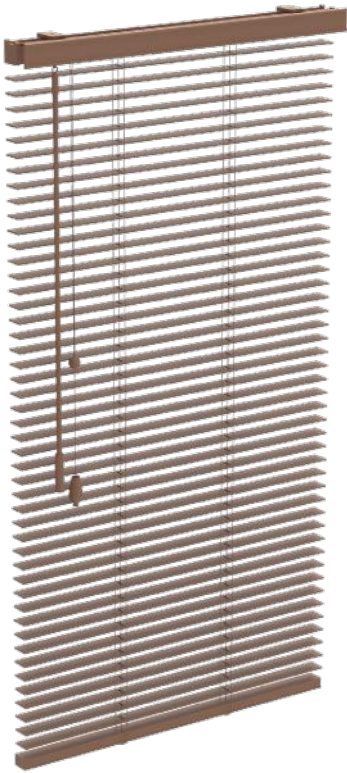

### Available Materials

Wooden

### Details

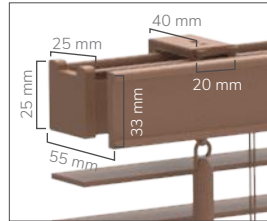

Head Rail

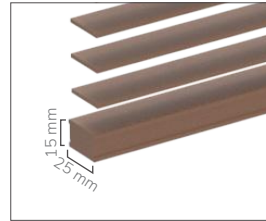

Bottom Bar

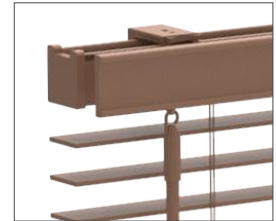

Cord lock System

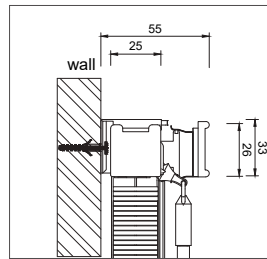

Wall

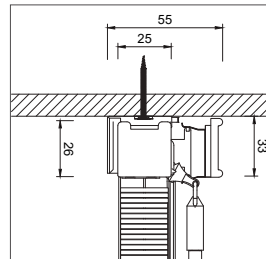

Ceiling

### Available Size

Max. Width	1,2 m
Max. Height	3 m
Max. Area	3 m <sup>2</sup>

## Venetian Monochain 25 mm



### Available Materials

Wooden

### Details

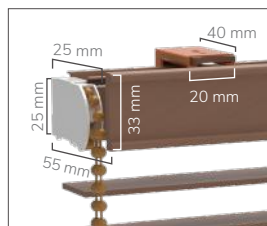

Head Rail

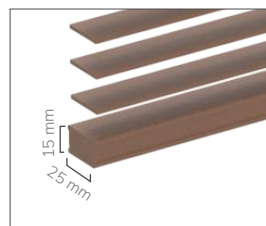

Bottom Bar

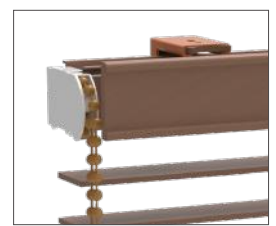

Monochain System

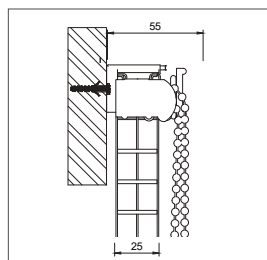

Wall

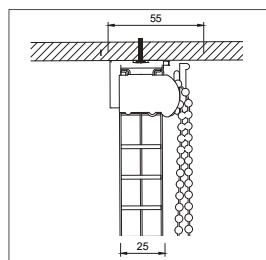

Ceiling

### Available Size

Max. Width	1,2 m
Max. Height	2 m
Max. Area	2 m <sup>2</sup>

## Venetian Cord Lock 50 mm

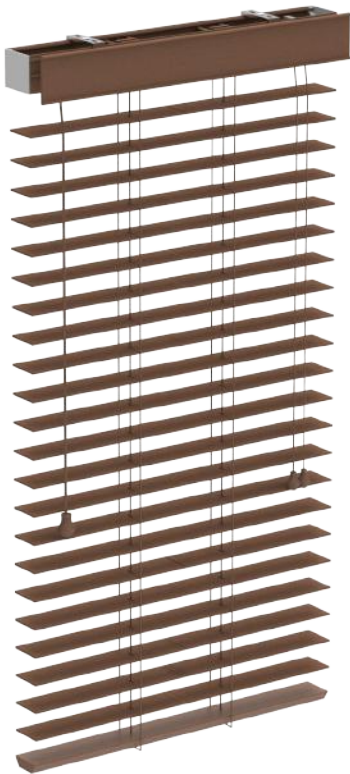

**Available Materials**  
Wooden | Polystyrene

### Details

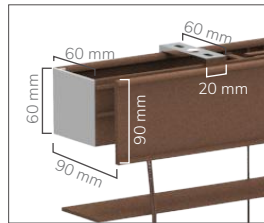

Head Rail

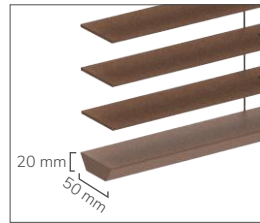

Bottom Bar

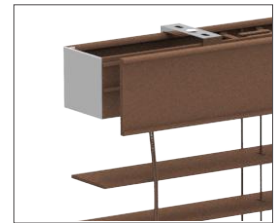

Cord lock System

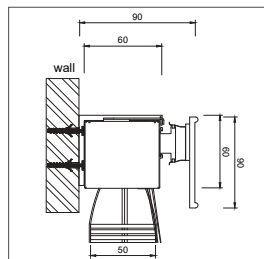

Wall

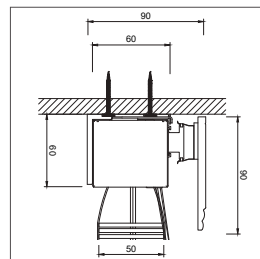

Ceiling

### Available Size

Max. Width	1,8 m
Max. Height	4 m
Max. Area	6 m <sup>2</sup>

## Venetian Monochain 50 mm

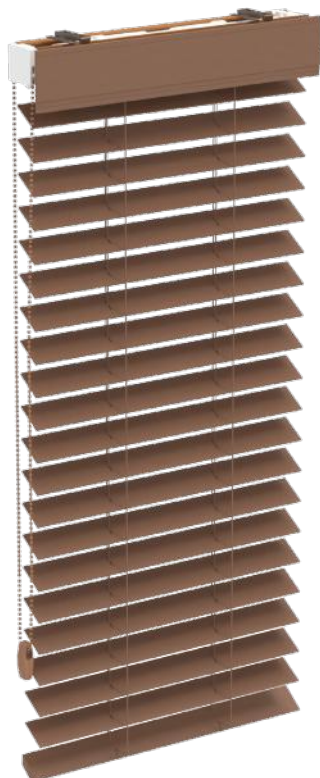

**Available Materials**  
Wooden | Polystyrene

### Details

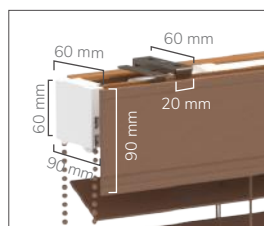

Head Rail

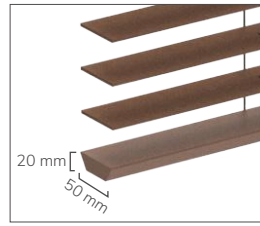

Bottom Bar



Monochain System

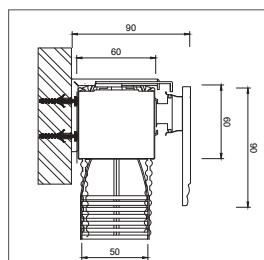

Wall

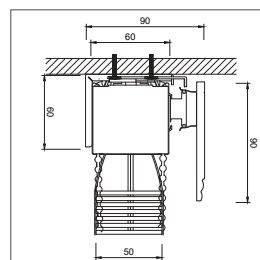

Ceiling

### Available Size

Max. Width	1,8 m
Max. Height	2,5 m
Max. Area	3,5 m <sup>2</sup>



# Vertical Blinds

- Vertical Blinds offers solution look a like curtain with modern look
- Widely used in office and residential spaces,
- Vertical Blinds is user friendly and efficient
- Privacy and light are easily controlled with chain to rotate vanes up to 180 degrees when closed
- Rapidly open to stack neatly allowing for maximum viewing capacity
- User friendly



5 years warranty for component

# Manual Vertical Blinds



## Details

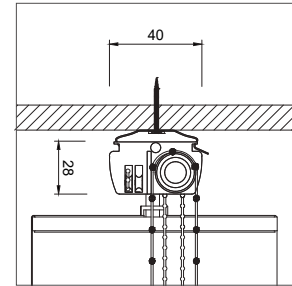

Ceiling

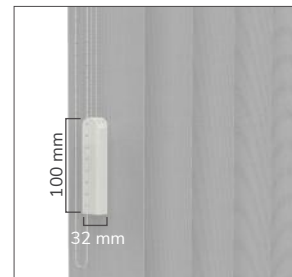

Chain

## Available Options

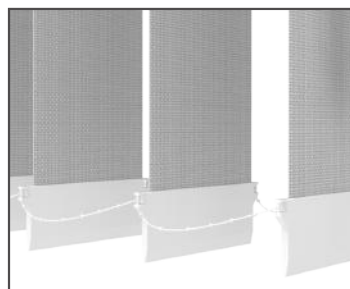

Vertical 127 mm

## Available Size

Vertical 127 mm	
Max. Width	4 m
Max. Height	4 m
Max. Area	16 m <sup>2</sup>

MOTORISED



# Motorised System

Our motorised blinds powered by :



Somfy - France



LSN by Somfy

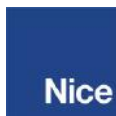

Nice - Italy



Mouve - China



2 years warranty for component



5 years warranty for motor

Somfy - France



- Worldwide brand motorised system spread across 57 countries
- One of the largest motorised system companies in the world
- Over 50 years experience in motorised systems, Somfy has guaranteed their quality, performance, and longevity.
- The latest generation of motors for rollers arrives on the market.
- Smart, quiet and eco-friendly. It has various types of motors for all needs, from affordable to a premium quality motor.



Type of motor	Torque /Speed (Nm)/(rpm)	Max. Weight (Kg)	RTS/ Wired	Watt	Capacity	Tube Size (diameter)	Application						Benefit
							Roller Blinds	Duo Blinds	Sansheer Blinds	Roman Blinds	Venetian Blinds	Day & Night Blinds	
Sonesse 40	6/20	18	RTS	120	230V - 50Hz	52 mm	●	●	●	●	●	<ul style="list-style-type: none"> <li>• Quiet operation</li> <li>• Slats tilting</li> <li>• Interior Use</li> </ul>	
Sonesse 50	10/28	25	RTS	180	230V - 50Hz	65 mm	●					<ul style="list-style-type: none"> <li>• Quiet operation</li> <li>• Interior Use</li> </ul>	
Sonesse Ultra 50	6/24	15	RTS	114	230V - 50Hz	65 mm	●					<ul style="list-style-type: none"> <li>• Silent operation</li> <li>• Interior Use</li> </ul>	
Maestria 50	15/17	25	RTS	140	230V - 50Hz	80 mm	●					<ul style="list-style-type: none"> <li>• Automatic self tensioning</li> <li>• Smart obstacle detection</li> <li>• Three setting modes</li> <li>• Exterior Use for large area</li> <li>• Suitable for zipper blinds</li> </ul>	
Altus 50	10/32	25	RTS	160	230V - 50Hz	65 mm	●					<ul style="list-style-type: none"> <li>• Remote limit setting</li> <li>• One click move</li> <li>• Interior &amp; Exterior Use</li> <li>• Available for large area</li> </ul>	
	15/17	25		140									
	30/17	50	240	80 mm	●								
	40/17	75									270		

LSN by Somfy 



- Motorised systems that have competitive prices.
- Controlled motor with Somfy remote technology makes LSN easy to integrate.
- Available for Interior roller blinds only.
- Mechanical and electrical functionality test and 10.000 cycles reliability made on each motor.



Type of motor	Torque /Speed (Nm) / (rpm)	Max. Weight (Kg)	RTS/ Wired	Watt	Capacity	Tube Size (diameter)	Application						Benefit	
							Roller Blinds	Duo Blinds	Sansheer Blinds	Roman Blinds	Venetian Blinds	Day & Night Blinds		
LSN 40 WT	6/28	20	Wired	150	230V - 50Hz	44 mm	●						●	<ul style="list-style-type: none"> <li>• Affordable</li> <li>• No need remote</li> <li>• Connect directly to system or home automation</li> </ul>
LSN 40	6/28	20	RTS	150	230V - 50Hz	44 mm	●						●	<ul style="list-style-type: none"> <li>• Affordable</li> <li>• Interior Use</li> </ul>



- Global leading manufacturer of smart home system and window & door automation
- Provide high-quality product in a long term stably
- Lean production system implemented
- Barcode tracking system for flow of materials and goods

Type of motor	Tube Size (diameter)	Torque/Speed (Nm)/(rpm)	RTS/Wired	Watt	Capacity	Application					Benefit
						Roller Blinds	Duo Blinds	Sansheer Blinds	Roman Blinds	Venetian Blinds	
DM35F	35 mm	6/28	RTS/Wired	121 W	230V - 50Hz	●	●	●	●	●	Low Noise Multiple Stop Postions Built-in Receiver
DM45EQ	45 mm	10/17	RTS/Wired	121 W	230V - 50Hz	●					Low Noise Electronic Limit
DM45F	45 mm	20/26	RTS/Wired	205 W	230V - 50Hz	●					Low Noise Multiple Stop Postions

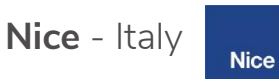

ERA INN - EDGE SV



ERA INN - EDGE MI



ERA MAT



- We use Nice for interior purposes only
- A brand that focused on refined design and advance technology
- Easy to use with many variant remote and simple to install, in both new construction and renovations.
- Bring simplify, safety and quiet motors.

Type of motor	Torque /Speed (Nm)/rpm	Max. Weight (Kg)	RTS/ Wired	Watt	Capacity	Tube Size (diameter)	Application						Benefit
							Roller Blinds	Duo Blinds	Sansheer Blinds	Roman Blinds	Venetian Blinds	Day & Night Blinds	
ERA INN - EDGE SV	6/20	18	RTS	50	230V - 50Hz	52 mm	●	●	●	●	●	●	<ul style="list-style-type: none"> <li>• Silent motor</li> <li>• Tilting operations</li> <li>• Adjustable speed</li> </ul>
ERA INN - EDGE MI	10/20	25	RTS	70	230V - 50Hz	65 mm	●						<ul style="list-style-type: none"> <li>• Silent motor</li> <li>• Adjustable speed</li> </ul>
ERA Mat MT	30/17	50	RTS	250	230V - 50Hz	80 mm	●						<ul style="list-style-type: none"> <li>• Available for large area</li> <li>• Has lock feature</li> </ul>
ERA Mat MVS	10/26	25	RTS	150	230V - 50Hz	65 mm	●						<ul style="list-style-type: none"> <li>• Standard motor</li> <li>• Available for large area</li> </ul>



## Motorised Roller Blinds

- Discover optimal comfort.
- Control the roller blinds the way you want with a remote, tablet, phone or home automation.
- Simple convenient and comfortable.
- Suitable for large opening.
- Perfect for any kind of design.



2 years warranty for component



5 years warranty for motor

# Motorised Roller Blinds

### MOTOR

Control the blinds with the attached remote control or use the Smart Life app, you can control each blind individually or group several blinds together

### Available Motors



Somfy - France



LSN by Somfy



Nice - Italy



Mouve - China

### Axle Motor

Precision engineered to run motor components smoothly.

### Crown and Wheel

Crown made of **Cosmoplene plastic** with High durability component, heat resistant plastic material.

### HEAD RAIL

The standard has many other options that could be chosen for the head such as extra head rail or cover box with various color options



### Side Bracket

With a thickness of 3mm and a powder coating finish, this side bracket designed for durability and rust-resistant yet more aesthetic

### Special Design Tube

Our standard tube Made of T6 aluminum which well built and anti-rust. Available in **ø45 mm - ø100 mm**



**Fabric**  
High functional fabric. Based on Requirements

### Bottom Bar

Sleek design wrapped by the fabrics with color options that are matched with room/interior design

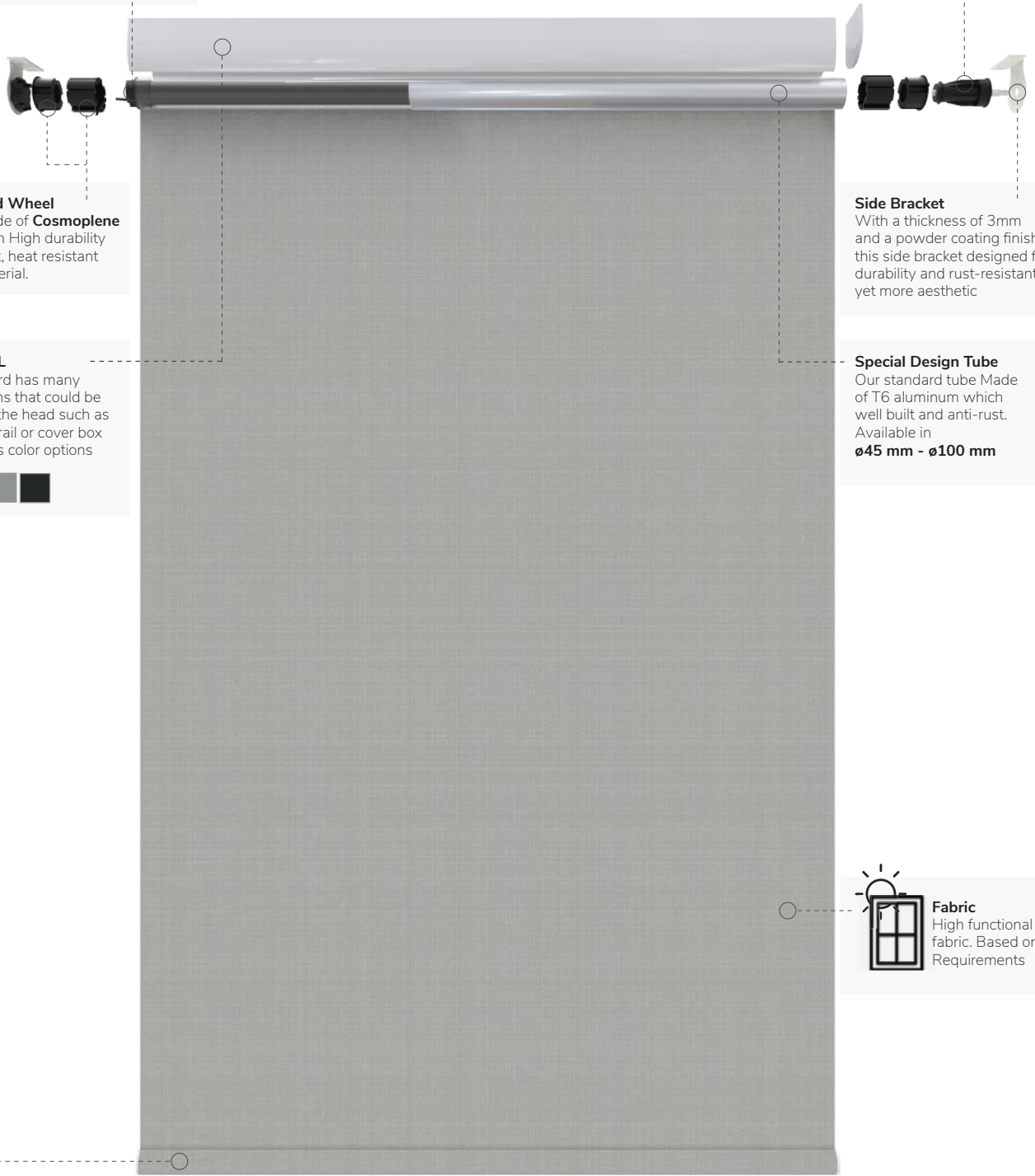

### Extra Features Roller Motorised

1. Intermediates System 180°

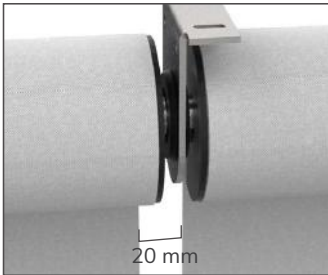

2. Cord Guiding for high blinds



3. Intermediates System 90°

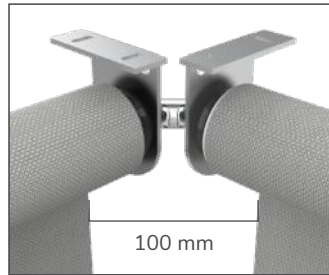

Standard Installation

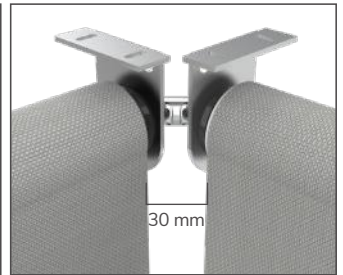

Reverse Fabric ( Order by request )

4. Guide Rail  
For black out

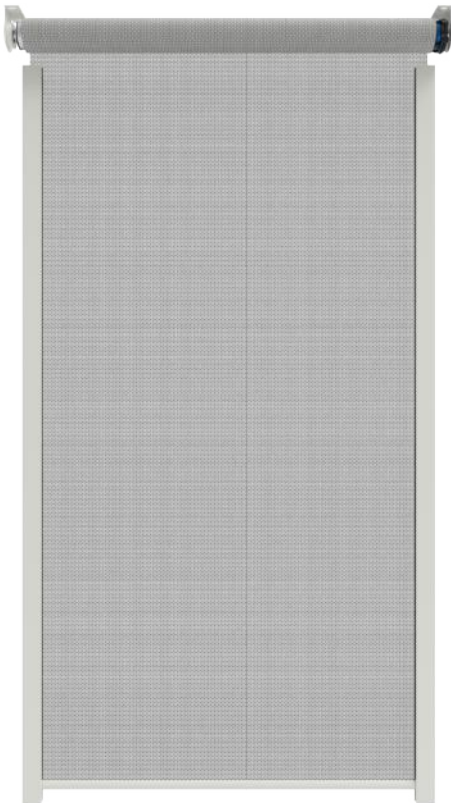

5. Guide Rail with Zipper  
Recommended for insect screen

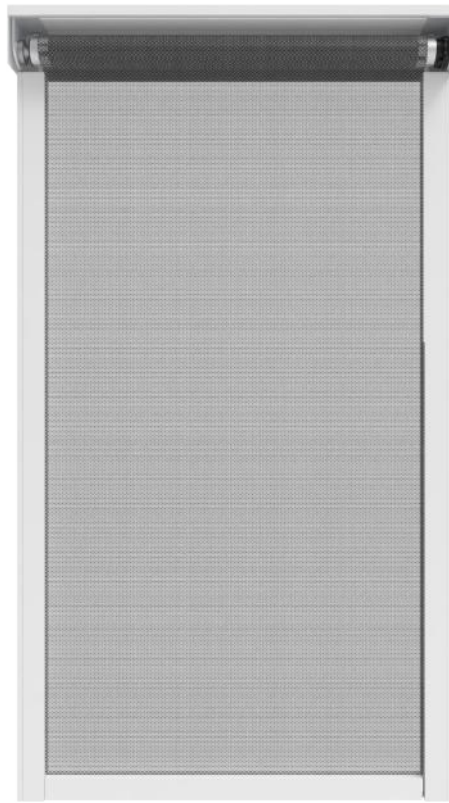

6. Cover Box

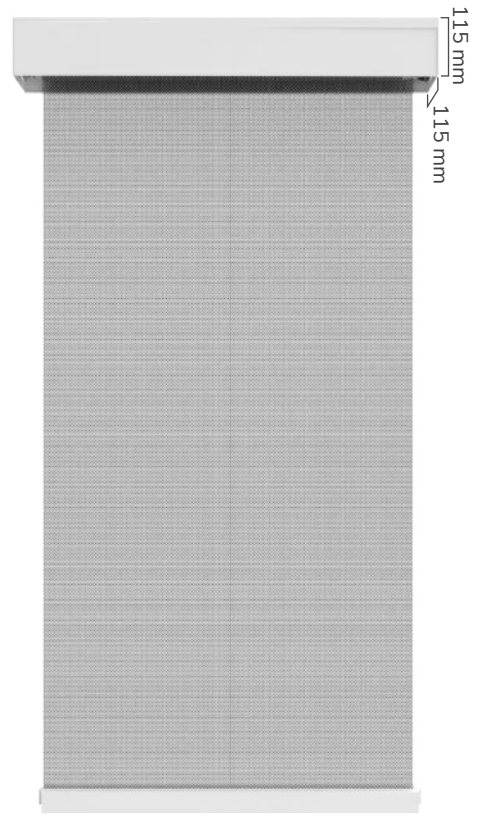

**Available Colors**

\*For other colors, pre-order 1 month and consultation with our product consultant is needed

**Available size**

Max. Width	3 m
Max. Height	4 m
Max. Area	12 m <sup>2</sup>

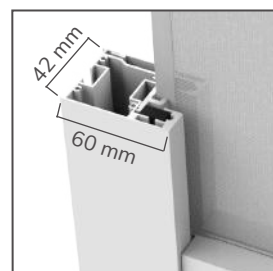

**Available size**

Max. Width	6 m
Max. Height	4 m
Max. Area	20 m <sup>2</sup>

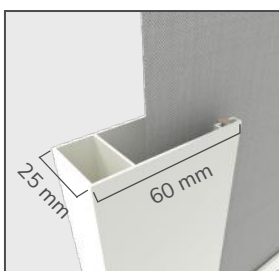

## Installation

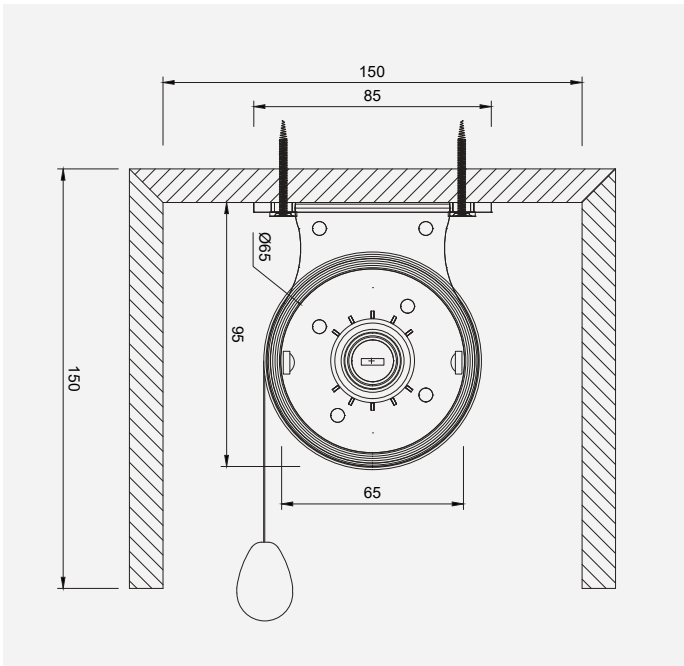

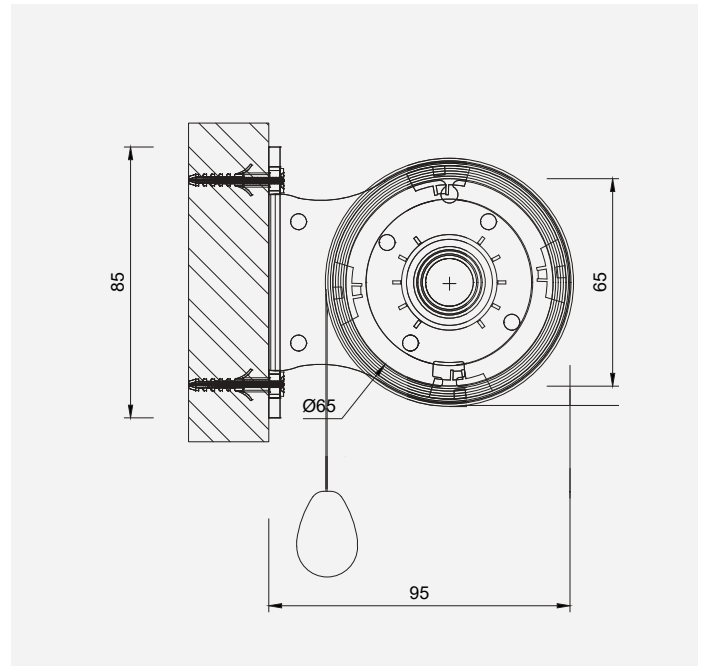

Ceiling



Wall

## Specifications

Type of motor		Torque (Nm)	Tube Size (diameter)	Fabric Module		Height	Area
				Single	Intermediate		
Mouve	DM 35F	6	35 mm	 2,25 m	 4,5 m	4 m	12 m <sup>2</sup>
Mouve	DM 45F	10	45 mm	2,25 m	4,5 m	4 m	12 m <sup>2</sup>
	DM 45EQ						
Somfy	LSN 40	10	45 mm	2,25 m	4,5 m	4 m	12 m <sup>2</sup>
	Sonessse 40						
Nice	ERA INN - EDGE SV	6	52 mm	2,5 m	4,5 m	4 m	12 m <sup>2</sup>
Somfy	Sonessse 50	10	65 mm	2,75 m	5 m	5 m	15 m <sup>2</sup>
	Altus 50						
Nice	ERA INN - EDGE MI	10	65 mm	2,75 m	5 m	5 m	15 m <sup>2</sup>
	ERA Mat MVS						
Somfy	Altus 50	15	80 mm	3 m	6 m	6 m	20 m <sup>2</sup>



## Day & Night Blinds

- With a motorized system, Day and Night blinds will be more practical and easier to operate.
- One easy mechanism you get all the privacy and light you require, all day long.

**2** 2 years warranty for component

**5** 5 years warranty for motor



Somfy - France

## Double Bracket

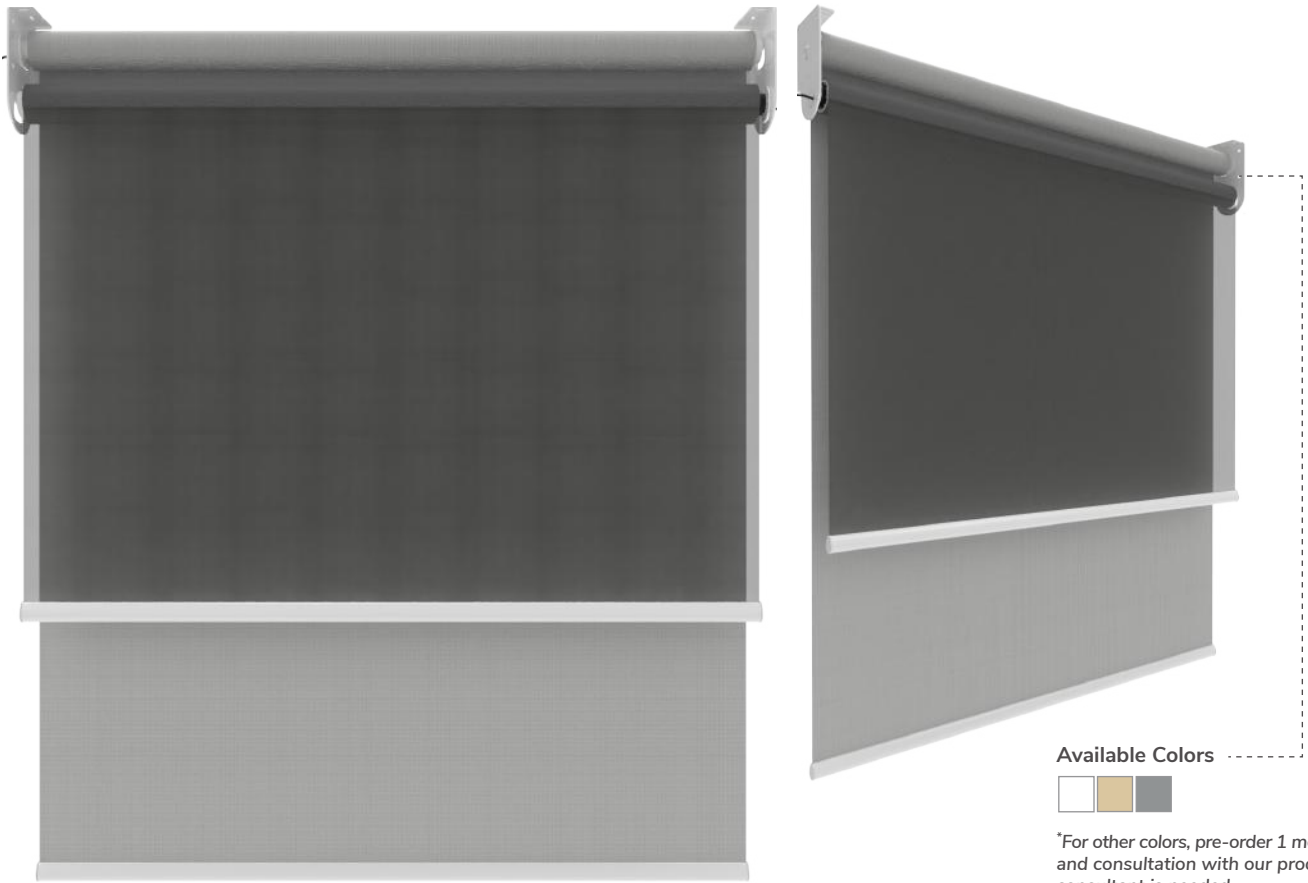

Available Colors



\*For other colors, pre-order 1 month and consultation with our product consultant is needed

Inside

### Details

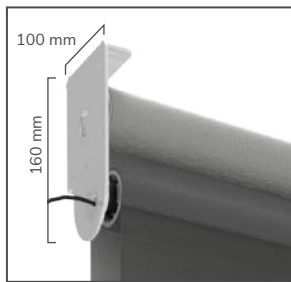

Bracket

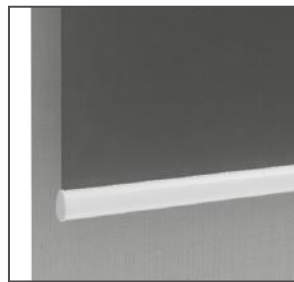

Fabric

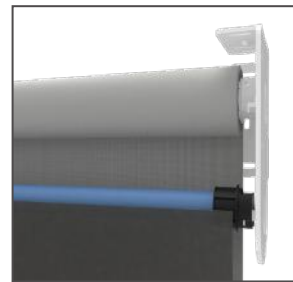

Motor Somfy  
\*Details on page 36

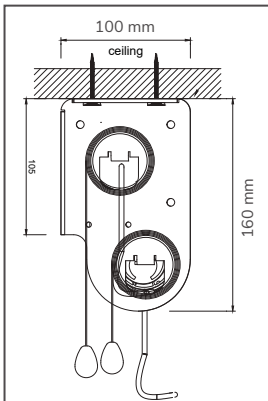

Wall

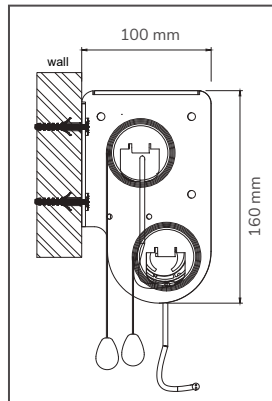

Ceiling

### Available Size

#### Standard

Max. Width	2,5 m
Max. Height	4 m
Max. Area	12 m <sup>2</sup>

#### Intermediate

Max. Width	4,5 m
Max. Height	4 m
Max. Area	12 m <sup>2</sup>

### Notes :

- We recommend not using natural fabrics if the blinds are over 2 meters high
- Use the right and left chains to make them more neat and easy to operate

## Single-Single Brackets

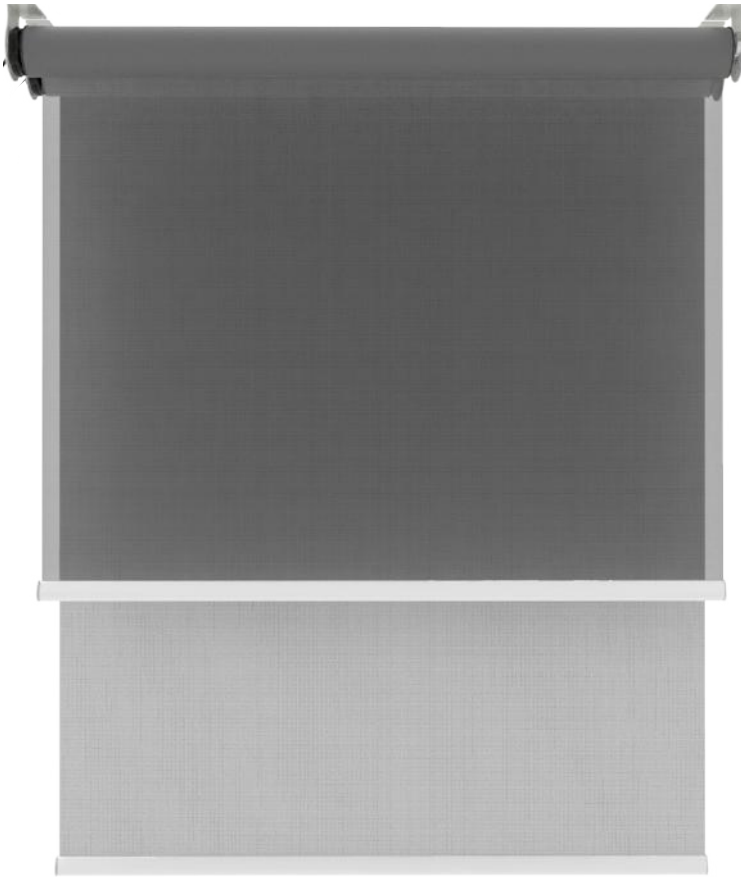

Inside

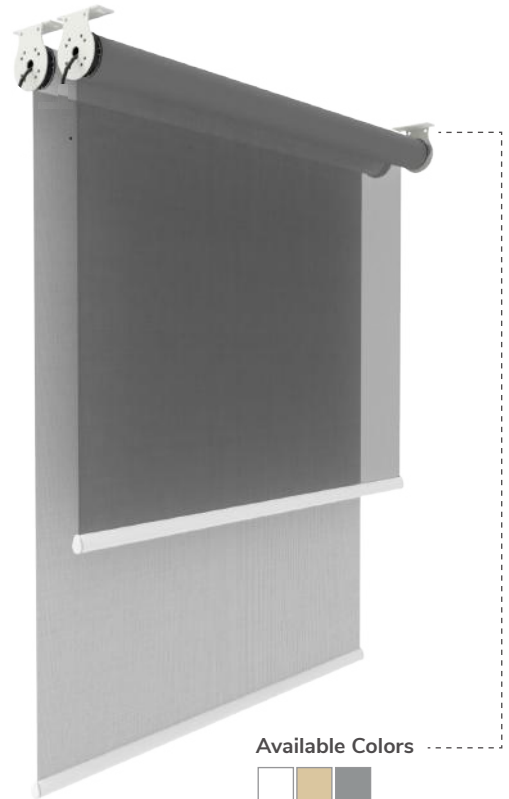

Available Colors



\*For other colors, pre-order 1 month and consultation with our product consultant is needed

### Details

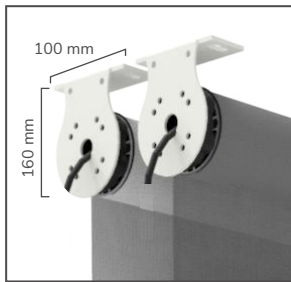

Bracket

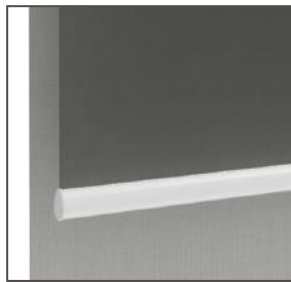

Fabric

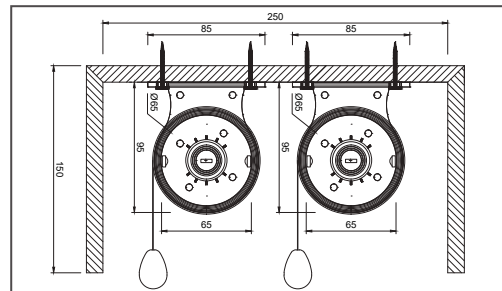

Ceiling

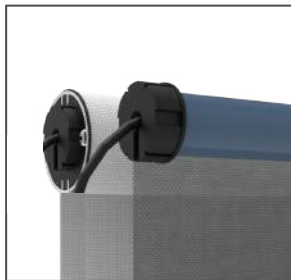

Motor Somfy  
\*Details on page 36

### Available Size

#### Standard

Max. Width	3 m
Max. Height	6 m
Max. Area	20 m <sup>2</sup>

\*Details on page 42

#### Intermediate

Max. Width	6 m
Max. Height	6 m
Max. Area	20 m <sup>2</sup>

### Notes :

- Available size depends on what type of motor do you use
- We recommend not using natural fabrics if the blinds are over 2 meters high
- Use the right and left chains to make them more neat and easy to operate



## Sansheer Blinds

- Composed of 2 pieces of fabric with motorised system, which can provide either a soft view to the outdoors or privacy with light control.
- Innovative design and easy to operate by remote.
- Light could be easily managed by tilting feature on the remote.



2 years warranty for component



5 years warranty for motor



Somfy - France

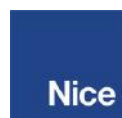

Nice - Italy

# Motorised Sansheer Blinds



Inside

## Details

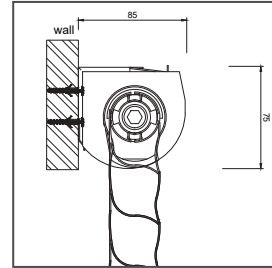

Wall

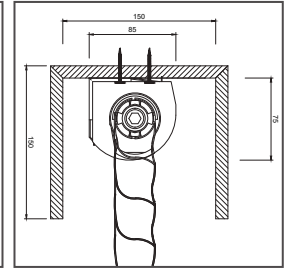

Ceiling

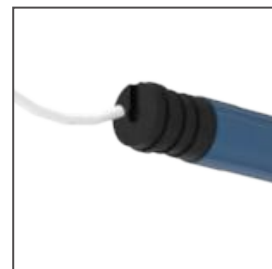

Motor Somfy & Nice  
\*Details on page 36-38

### Available Colors



\*For other colors, pre-order 1 month and consultation with our product consultant is needed

## Details Standard

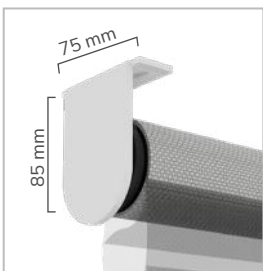

Standard

## Cover Box

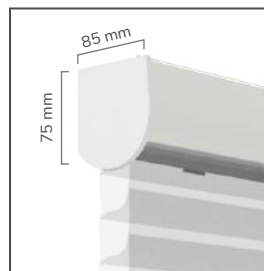

Large

## Cover Box Large

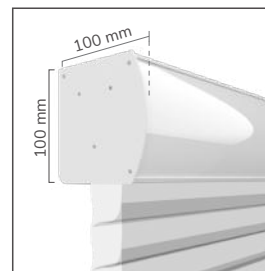

Bottom Bar

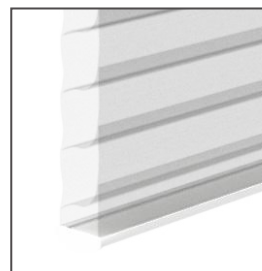

## Variant Fabrics

Light Filtering & Semi-Black Out

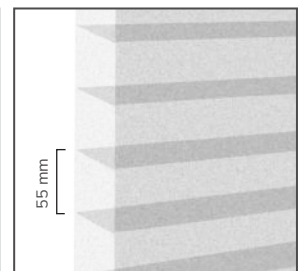

From USA

## Available Size

### Standard

Max. Width	3 m
Max. Height	3 m
Max. Area	9 m <sup>2</sup>

### Large

Max. Width	2,8 m
Max. Height	6 m
Max. Area	12 m <sup>2</sup>

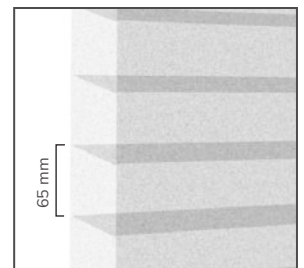

From Taiwan

\*For larger dimension please consultation with our product consultant



# Roman Blinds

- Perfect for creating a sophisticated space that feels cosy as well as stylish.
- With the support of a motorized system, raising and lowering blinds is so much easier



2 years warranty for component



5 years warranty for motor



Somfy - France

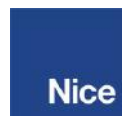

Nice - Italy

# Motorised Roman Blinds

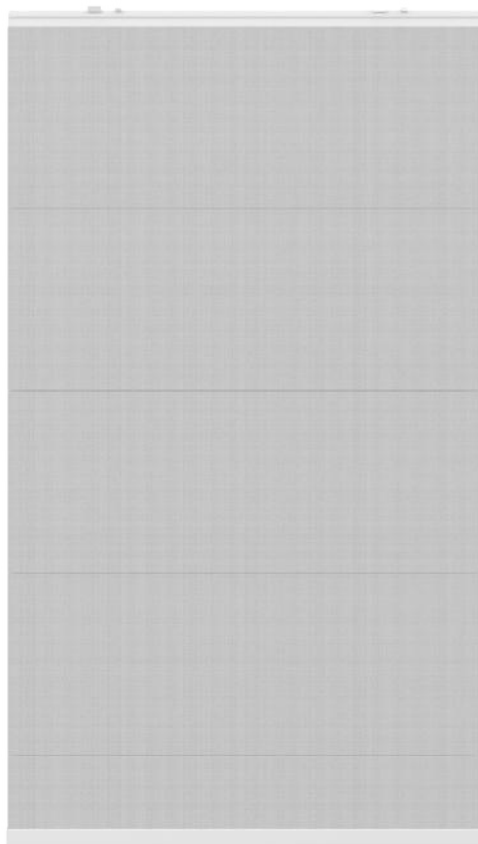

Outside

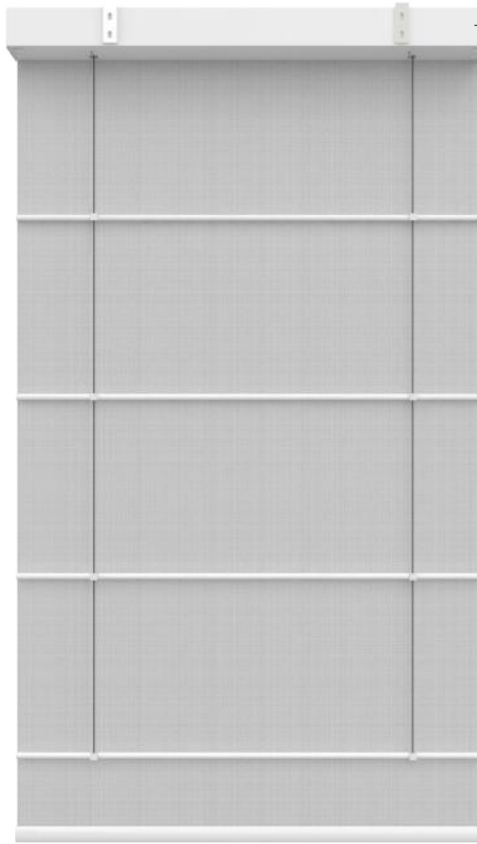

Inside



## Details

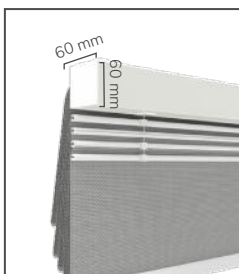

Head Rail

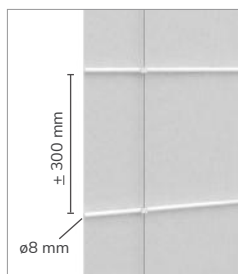

Shaper

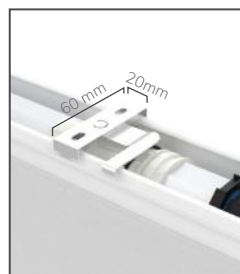

Bracket

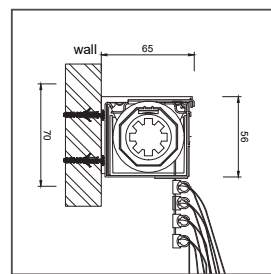

Wall

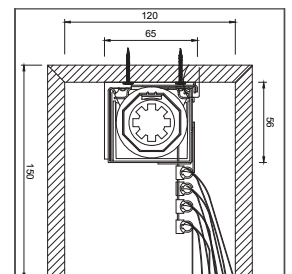

Ceiling

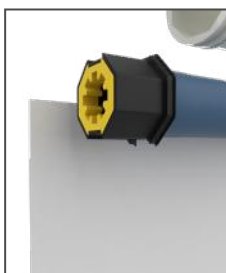

Motor Somfy  
\*Details on page 36

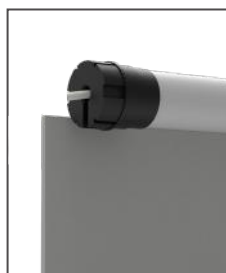

Motor Nice  
\*Details on page 38

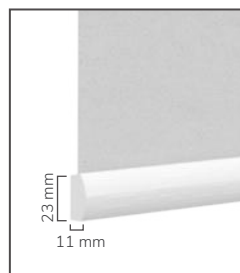

Bottom Bar

## Available Size

Max. Width	3 m
Max. Height	4 m
Max. Area	9 m <sup>2</sup>



## Venetian Blinds

- Effortless tilting and now even more effortless light control with motorised system.
- Looking for something natural but also incredibly contemporary then this Venetian blind needs to be your first port of call.



2 years warranty for component



5 years warranty for motor



Somfy - France

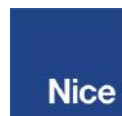

Nice - Italy

# Motorised Venetian Blinds

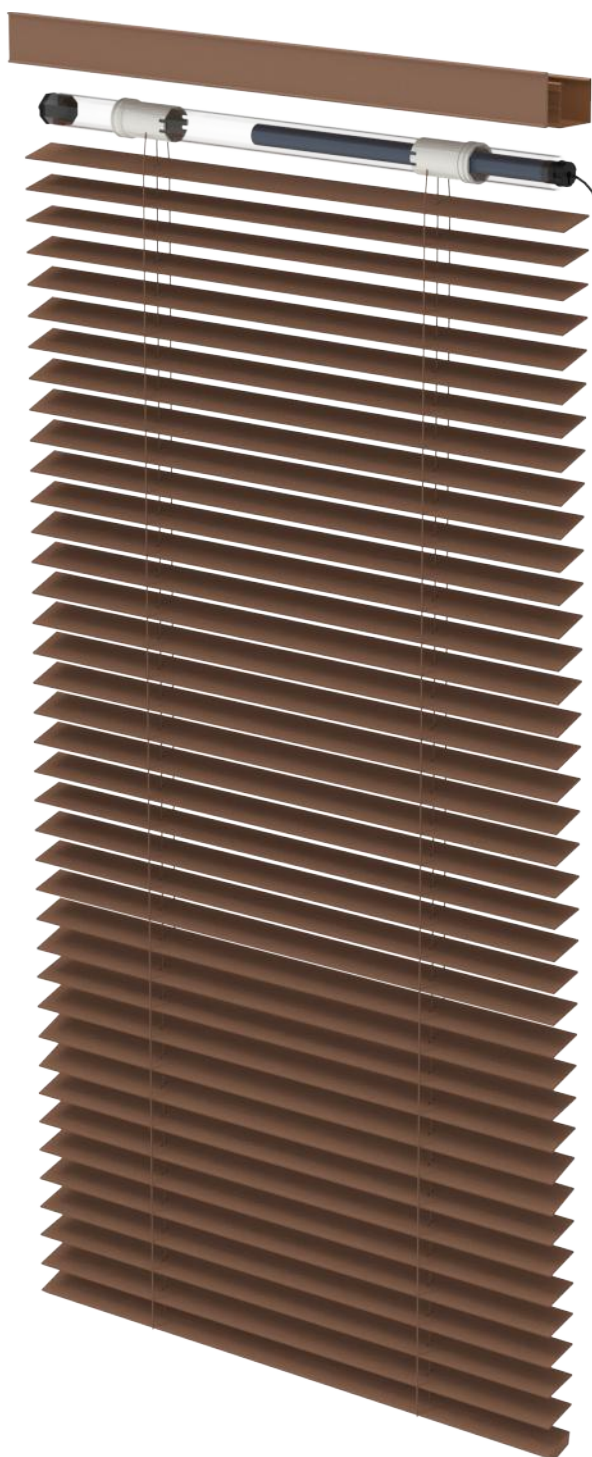

### Available Materials

Wooden | Polystyrene

### Details

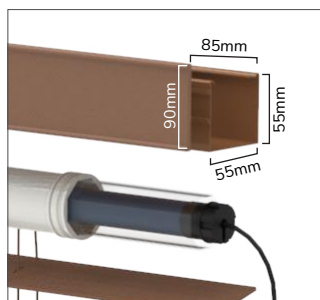

Motor Somfy & Nice  
\*Details on page 36-38

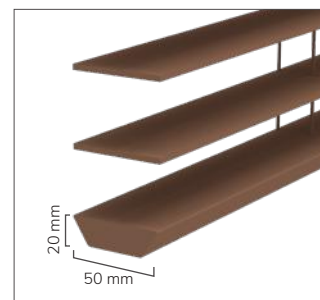

Bottom Bar

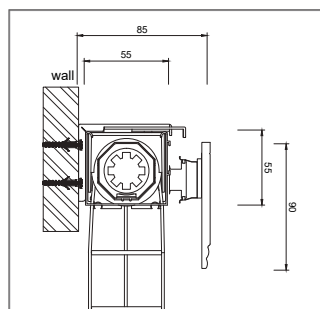

Wall

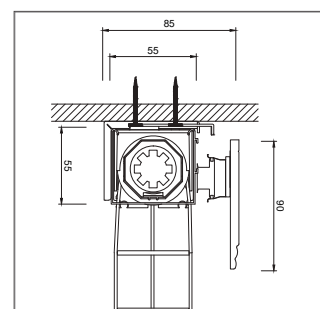

Ceiling

### Available Size

#### Local

Wooden 50mm	
Width	0,8 m - 1,8 m
Max. Height	3 m
Max. Area	4,5 m <sup>2</sup>

#### Import

Wooden 50mm	
Width	0,8 m - 1,8 m
Max. Height	3 m
Max. Area	4,5 m <sup>2</sup>

Polystyrene 50mm	
Width	0,8 m - 2,2 m
Max. Height	3 m
Max. Area	4,5 m <sup>2</sup>



# EXTERIOR BLINDS



- One stop technical solution for your outdoor or semi-outdoor space
- Rain breaking ability, wind endurance, and heavy duty components
- Maximizing the utility of your open space while maintaining modern living

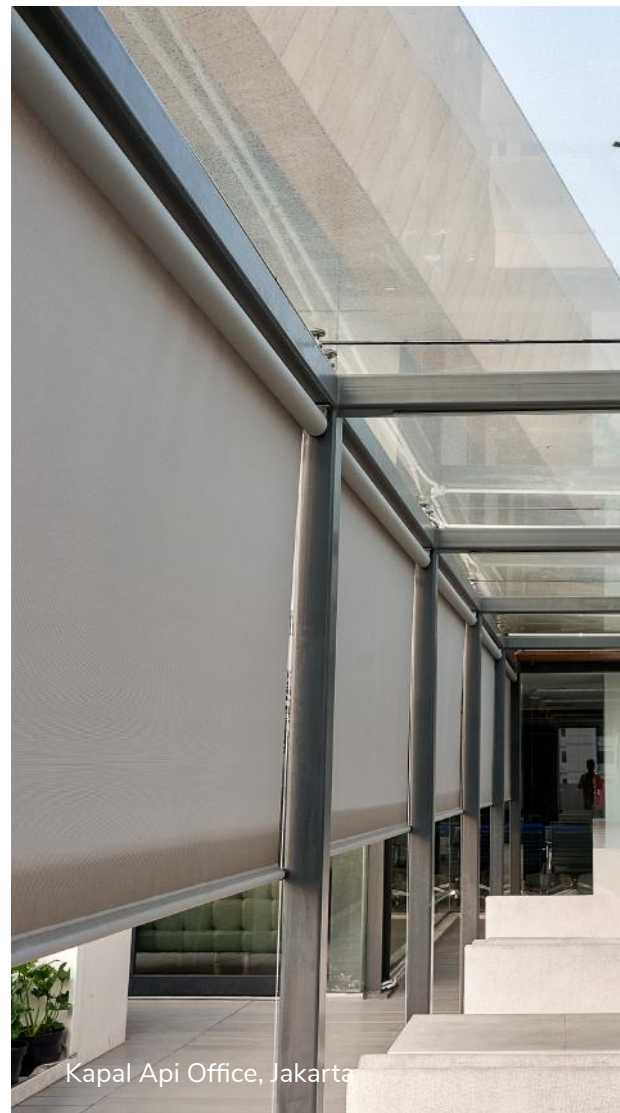
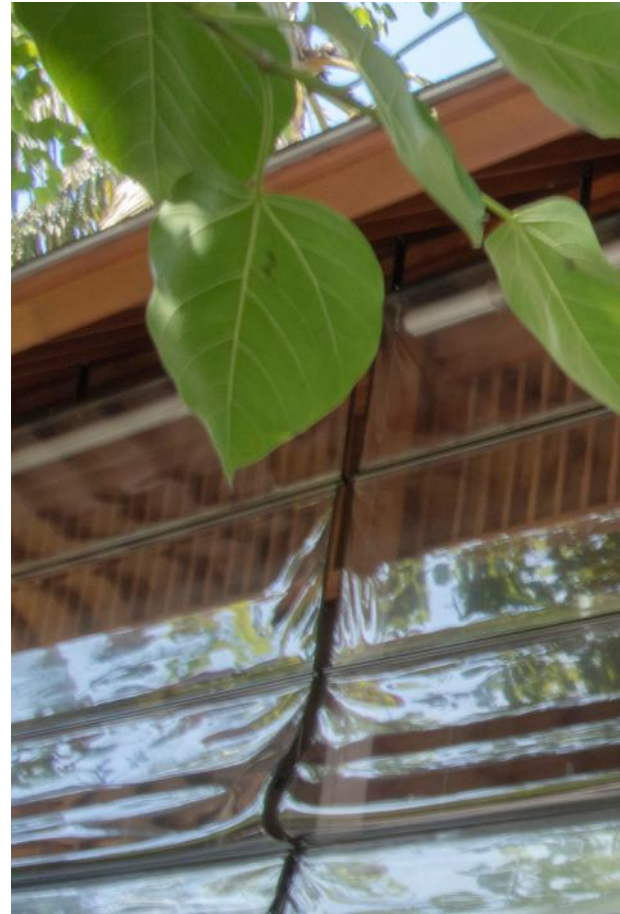



MANUAL



# Exterior Roller Blinds

- Created to accommodate mild to moderate wind, while maintaining clean and wider view
- Equipped with high quality wire slings at both sides to guide the blinds and hold against wind force

 2 years warranty for component

# Manual Exterior Roller Blinds

Lighty System (for mild wind)

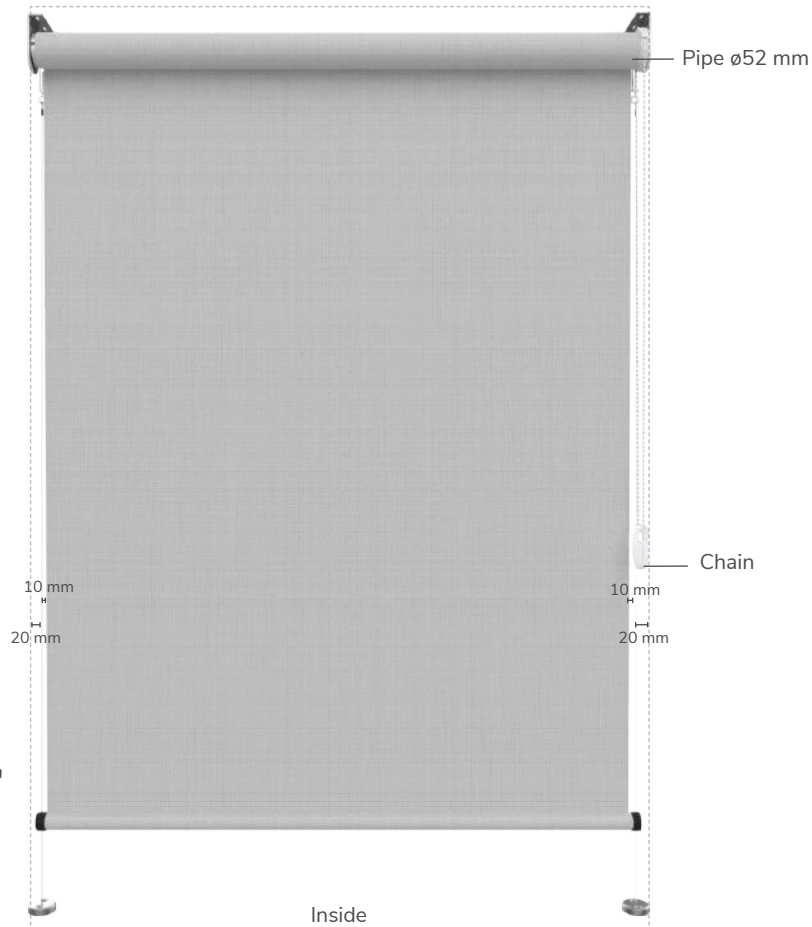

**Available Colors**



\*For other colors, pre-order 1 month and consultation with our product consultant is needed.

**Details**

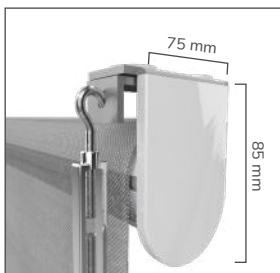

Head Rail

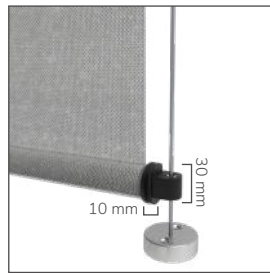

Bottom Bar

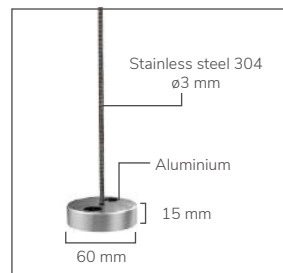

Cord Guiding

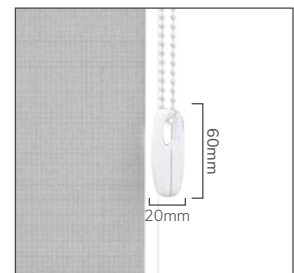

Chain Operated

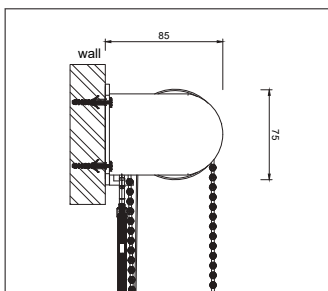

Wall

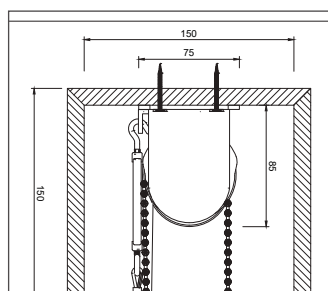

Ceiling

**Available Size**

Max. Width	2.8 m
Max. Height	3 m
Max. Area	8 m <sup>2</sup>

**Notes :**

- Recommended for fabric with openness factor (15%<)

# Manual Exterior Roller Blinds

## Heavy Duty System (for medium wind)

### Standard

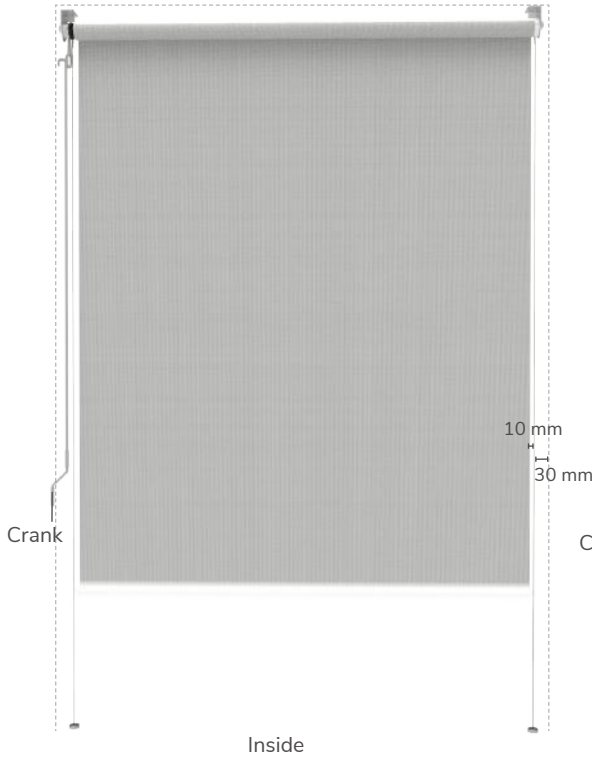

### Intermediate

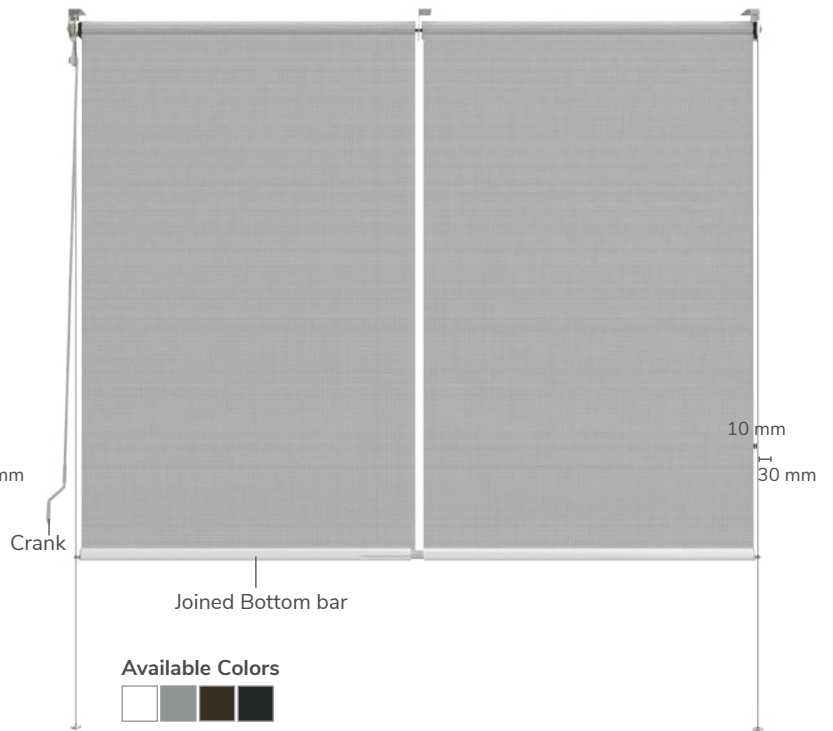

**Available Colors**



\*For other colors, pre-order 1 month and consultation with our product consultant is needed

### Details

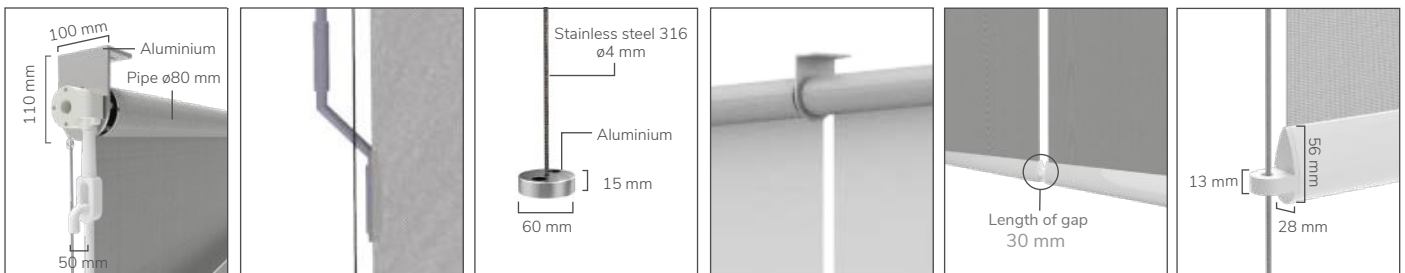

Head Rail

Crank

Cord Guiding

Intermediate Bracket

Joined Bottom Bar

Bottom Bar

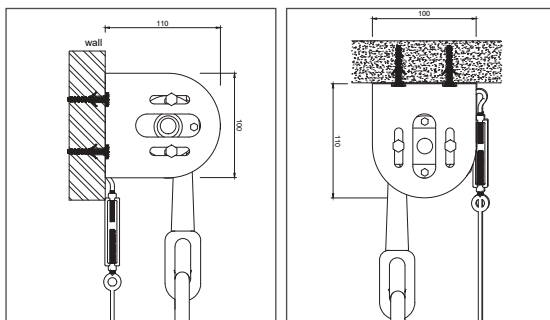

Wall

Ceiling

### Available Size

#### Standard

Max. Width	3 m
Max. Height	3 m
Max. Area	9 m <sup>2</sup>

#### Intermediate

Max. Width	6 m
Max. Height	3 m
Max. Area	15 m <sup>2</sup>

### Notes :

- Intermediate Bracket for width > 3 m
- Can be apply for one intermediate only

MOTORISED



# Exterior Roller Blinds

---

- Convenient and simple powered motor does all the heavily lifting for you, raising and lowering the blind.
- Total control with no more than the touch of a button on the sleek remote control.
- Equipped with high quality wire slings at both sides to guide the blinds and hold against wind force.

 2 years warranty for component

 5 years warranty for motor



Somfy - France

# Motorised Exterior Roller Blinds

(for medium wind)

## Standard

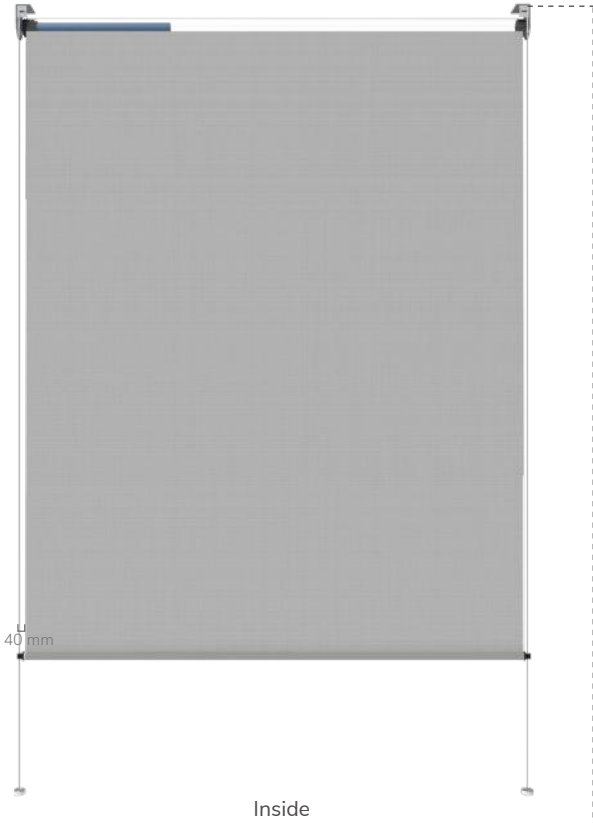

Inside

## Intermediate

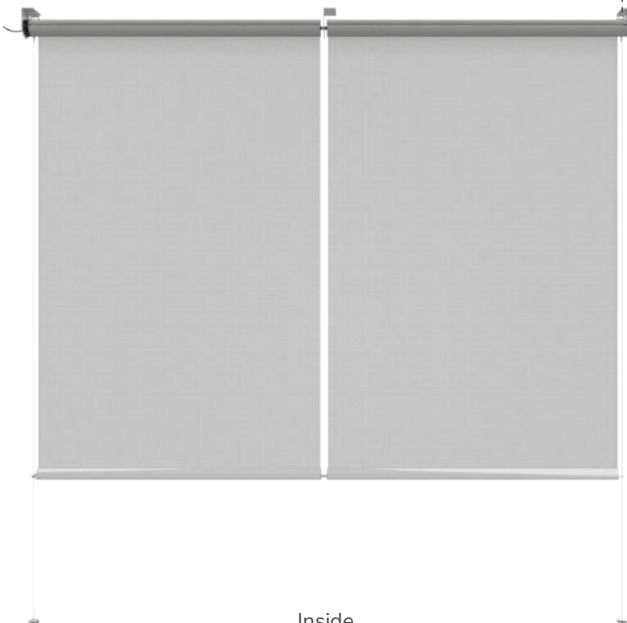

Inside

### Available Colors



\*For other colors, pre-order 1 month and consultation with our product consultant is needed

### Details

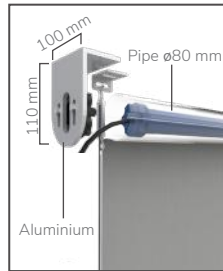

Motor Somfy  
\*Details on page 36

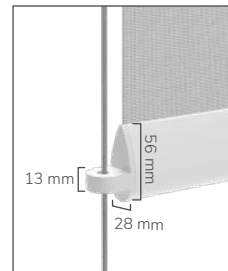

Bottom Bar

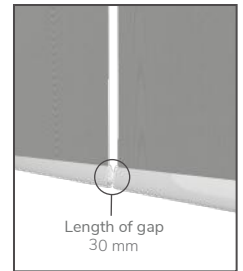

Joined Bottom Bar

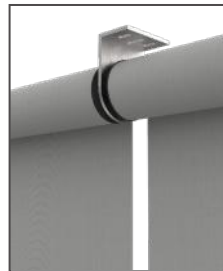

Intermediate Bracket



Cord Guiding

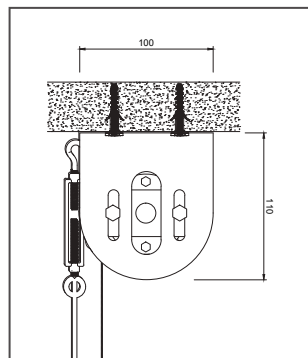

Ceiling

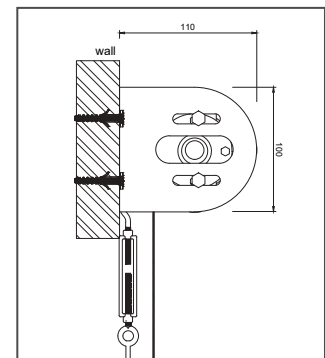

Wall

### Available Size

#### Standard

Max. Width	3 m
Max. Height	4 m
Max. Area	12 m <sup>2</sup>

#### Intermediate

Max. Width	6 m
Max. Height	4 m
Max. Area	24 m <sup>2</sup>

### Notes :

- Intermediate Bracket for width > 3 m
- For motorised exterior roller blinds, just could use 1 intermediate

## Extra Features Motorised

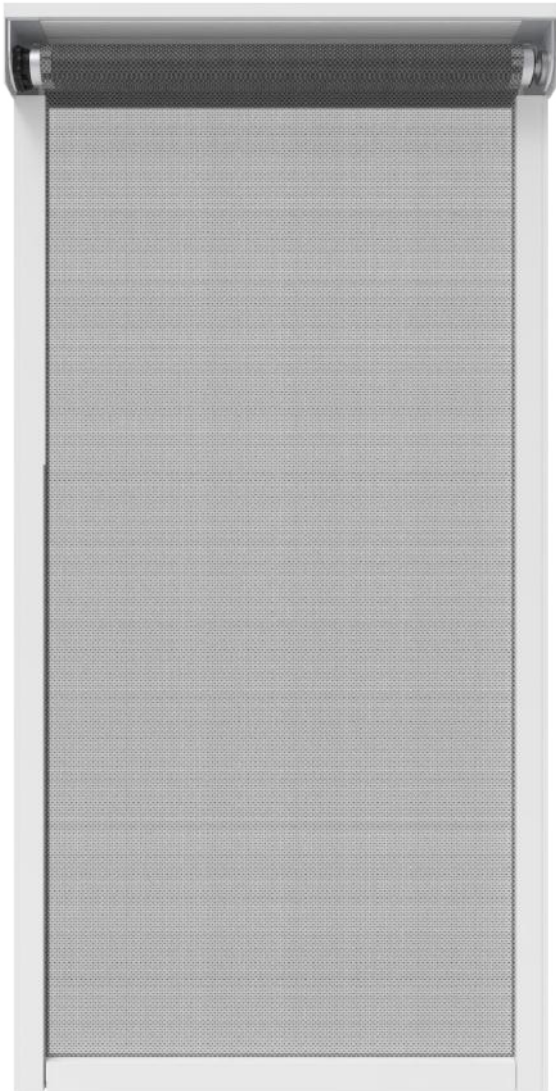

### Details

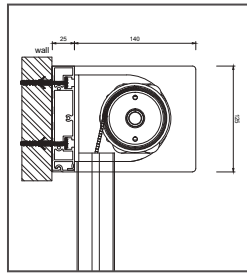

Wall

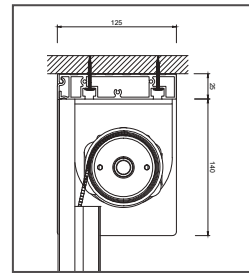

Ceiling

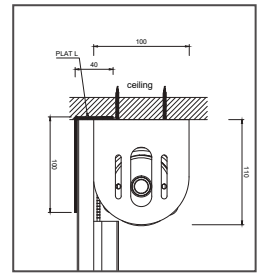

Cover L

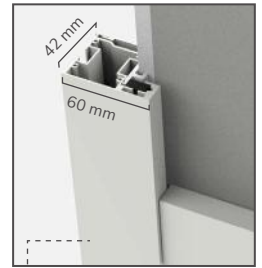
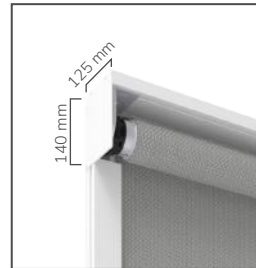

### Available Size (Solar Screen)

Max. Width	6 m
Max. Height	2,5 m
Max. Area	15 m <sup>2</sup>

### Available Colors



\*For other colors, pre-order 1 month and consultation with our product consultant is needed

### Claw for width < 4,5m

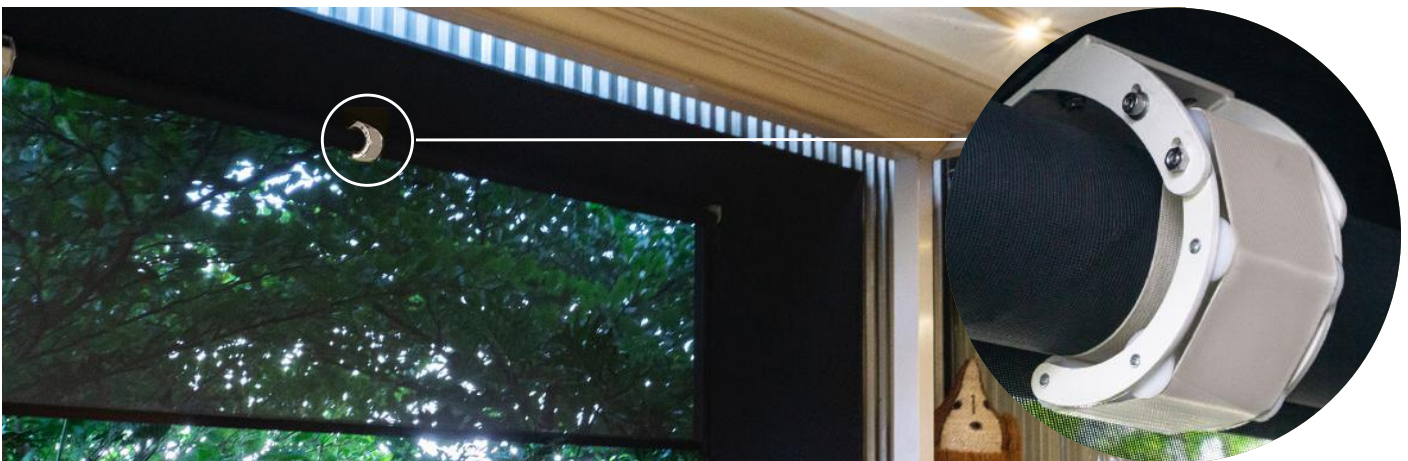

### Notes :

- Could be for insect screen
- Recommended for fabric screen exterior with openness factor (>10%)
- Recommended fabric : E860, S80, P400, AX15 fabric with larger openness factor (15% <)



# Exterior Roman Blinds

---

- A perfect choice for Luxurious yet contemporary look.
- With a multitude of power and control options including convenient and easy-to-install.
- Suitable for heavy wind and weather area.
- With high quality shappers the blinds could hold wind load steadily.



2 years warranty for component



5 years warranty for motor



Somfy - France

# Motorised Exterior Roman Blinds

(for stronger wind)

## Single

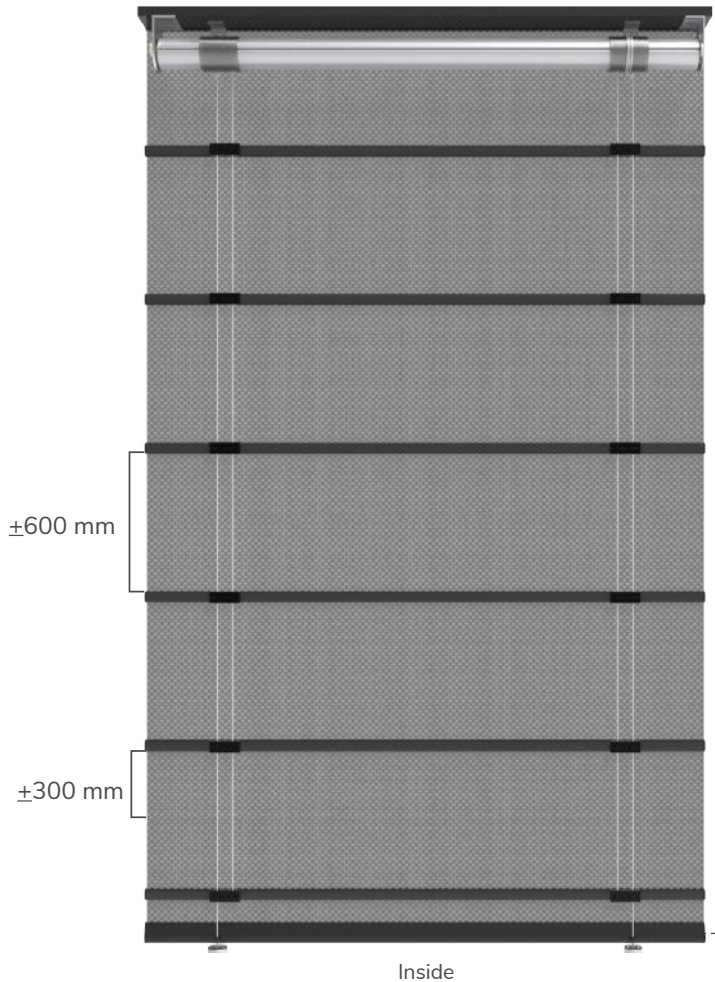

**Available Colors**



\*For other colors, pre-order 1 month and consultation with our product consultant is needed

### Details

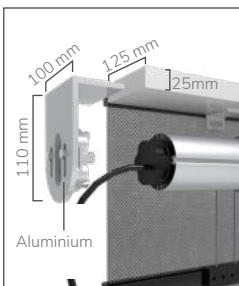

Motor Somfy  
\*Details on page 36

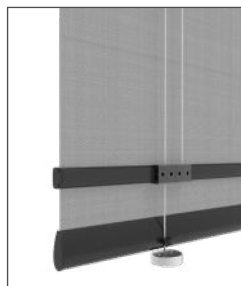

Bottom Bar

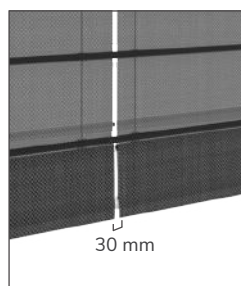

Gaps Between  
Single Roman

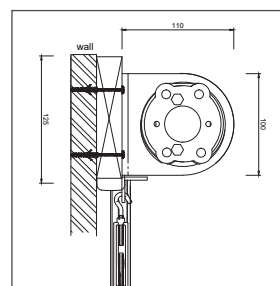

Wall

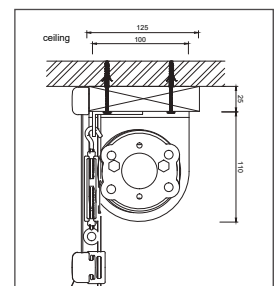

Ceiling

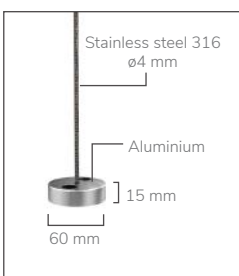

Cord Guiding

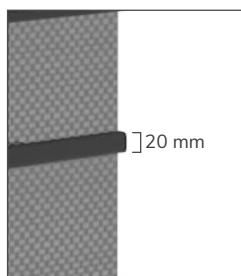

Shaper

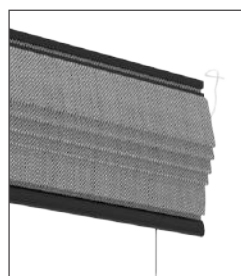

Closed Position

### Available Size

Max. Width	4,5 m
Max. Height	6 m
Max. Area	27 m <sup>2</sup>

### Two Type Fabrics Application

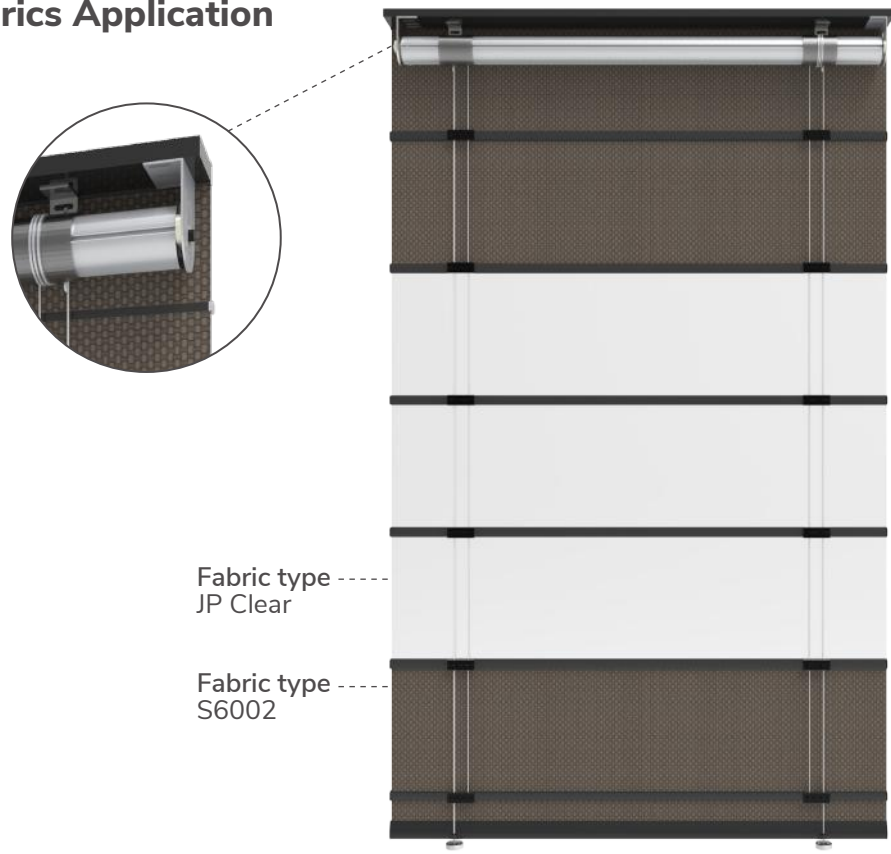

### Intermediate

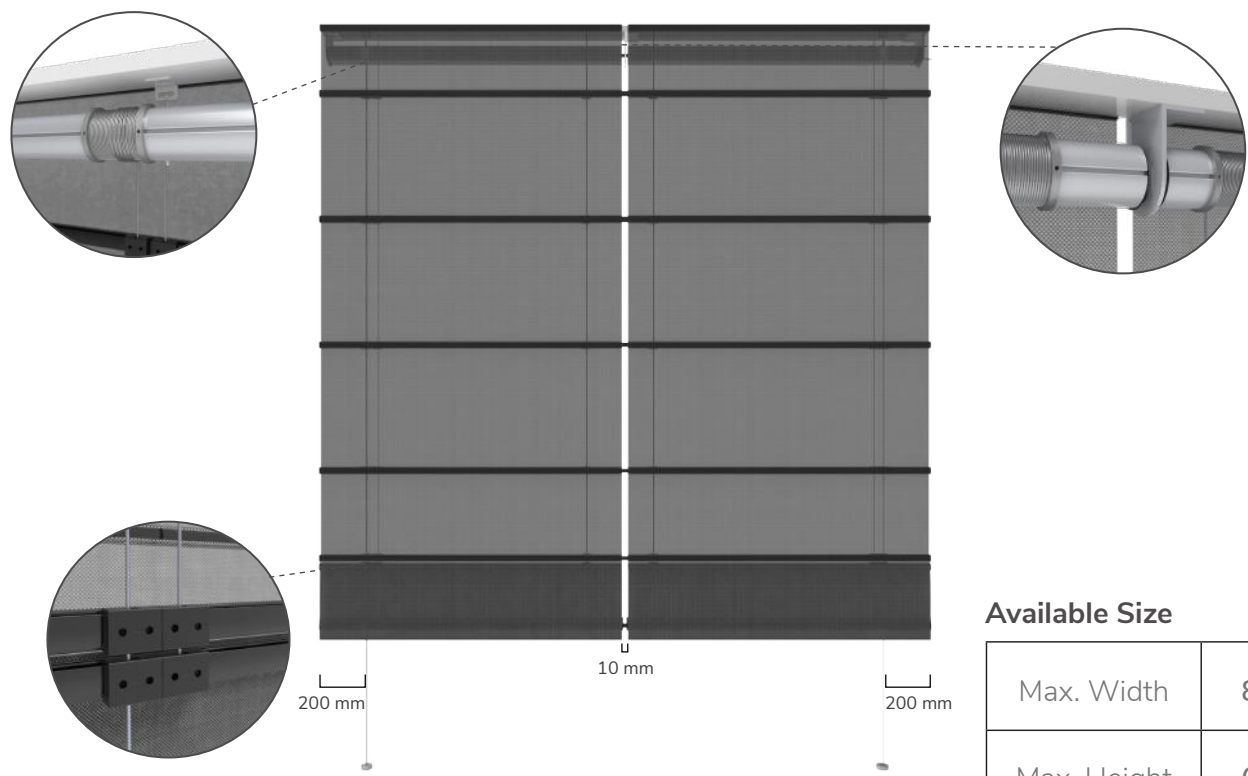

### Available Size

Max. Width	8 m
Max. Height	6 m
Max. Area	32m <sup>2</sup>

#### Notes :

- Intermediate Bracket for width > 4,5 m
- There are other types of fabric besides the example picture above
- The gap between cord guiding to the edge of fabric



## Skylight **Blinds**

- Controlled by motorised system only.
- Operated easily and assist you to manage natural light that coming through the skylight window or roof.

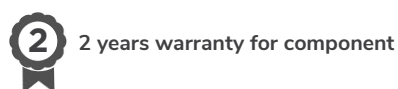

2 years warranty for component



5 years warranty for motor



Somfy - France



Nice - Italy

# Interior Skylight Flat

## Standard Motorised

Motor Altus 50 30/17 , 40/17  
Inside tubular tube  
\*Details on page 36

### Available Size

Width	1 m - 2 m
Length	1 m - 4 m
Max. Area	8 m <sup>2</sup>

#### Notes:

Recommended for lighter fabric

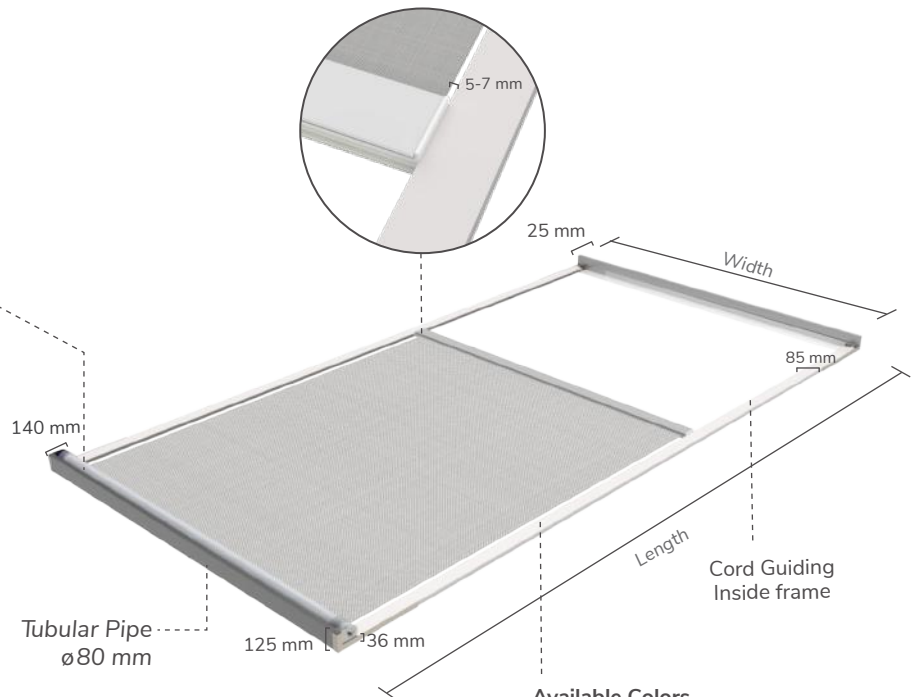

#### Available Colors



\*For other colors, pre-order 1 month and consultation with our product consultant is needed

## FTS Somfy (Fabric Tension System)

Automatic tension adjuster skylight flat with FTS, the motor will automatically pull fabric when it stops. Therefore, the fabric will look straight, not curving when it's closed.

Motor FTS 25/17  
Inside tubular tube

### Available Size

Width	1 m - 3 m
Length	1 m - 6 m
Max. Area	18 m <sup>2</sup>

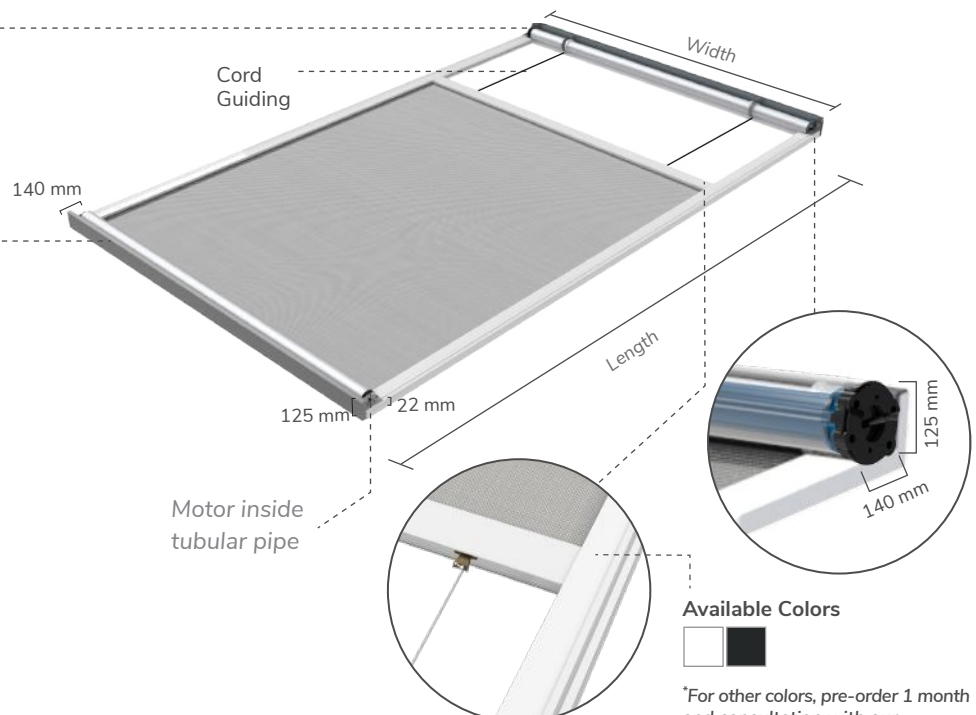

#### Available Colors



\*For other colors, pre-order 1 month and consultation with our product consultant is needed

# Interior L Shape Skylight

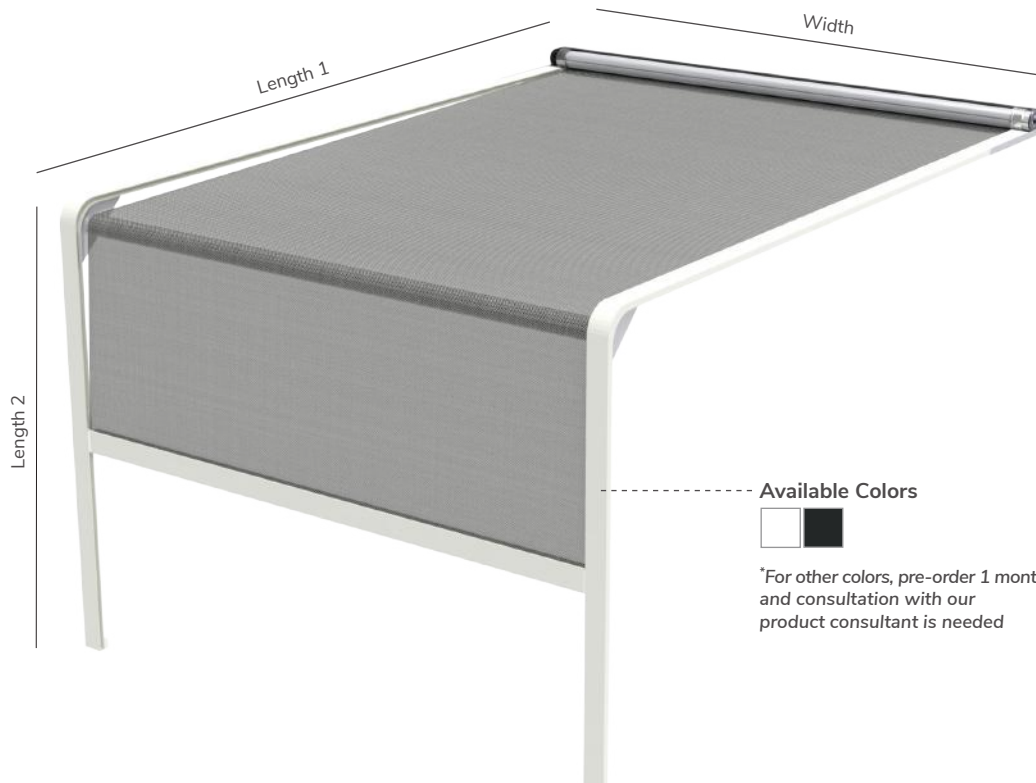

**Available Colors**



\*For other colors, pre-order 1 month and consultation with our product consultant is needed

## Details

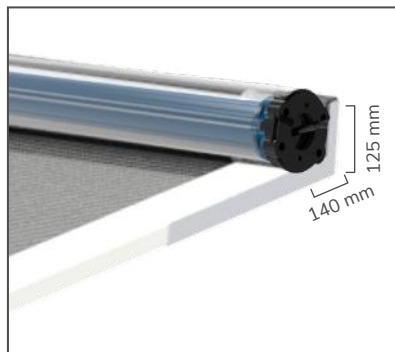

Motor Altus 50  
\*Details on page 36

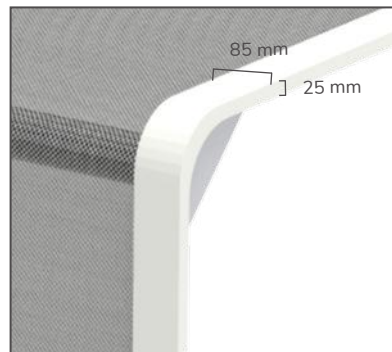

## Available Size

Max. Width	2 m
Max. Length 1	1,5 m
Max. Length 2	3 m
Max. Area	9 m <sup>2</sup>

# Interior Skylight Vellum

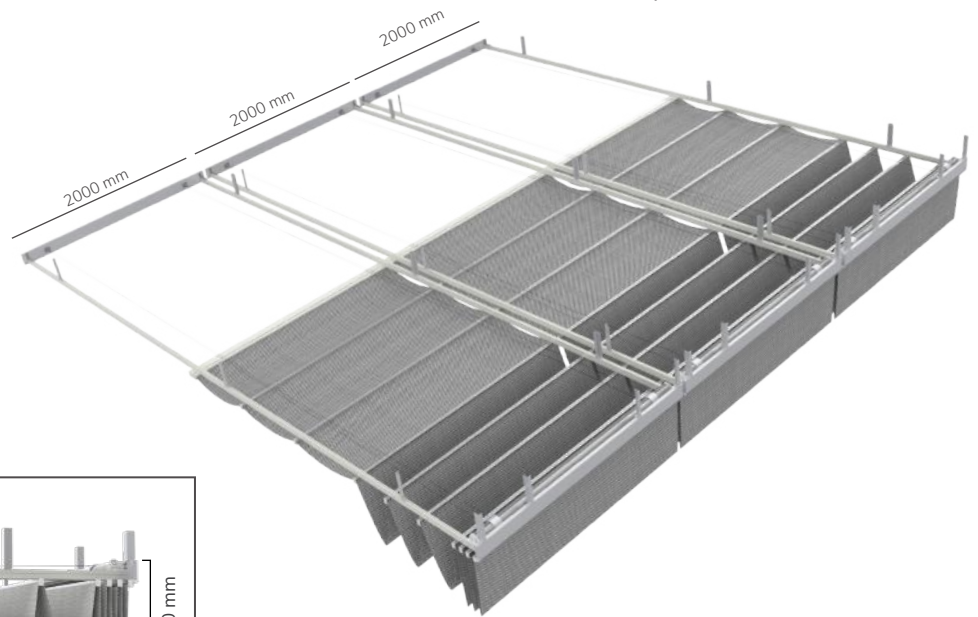
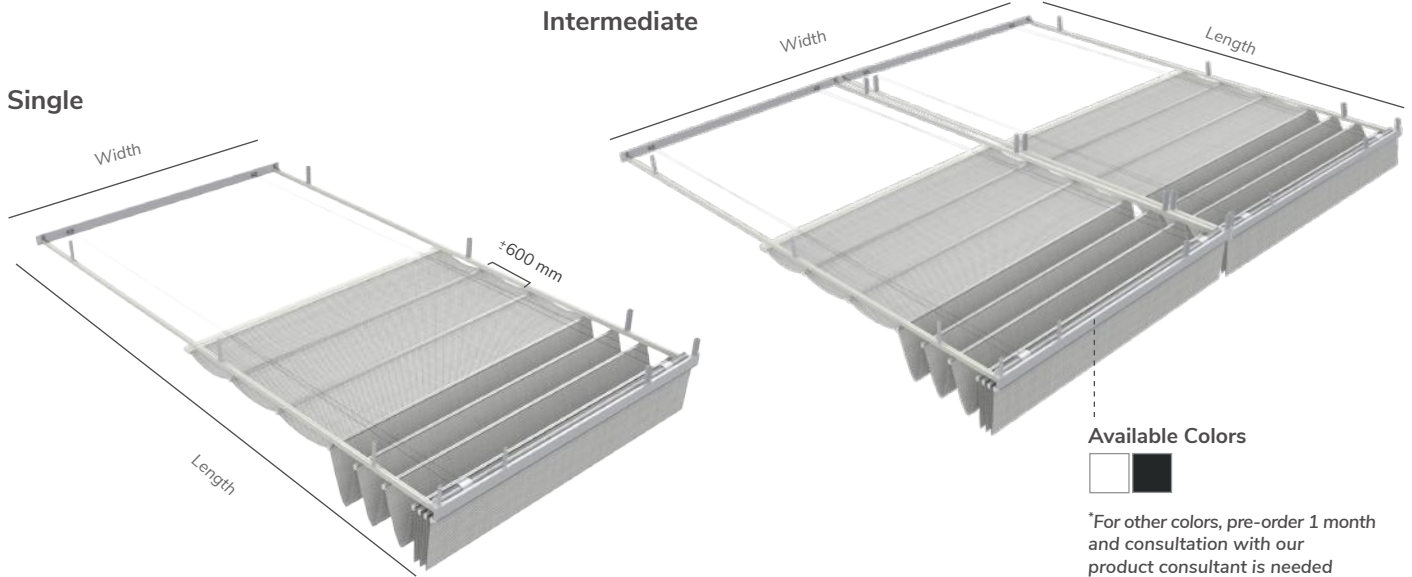

## Details

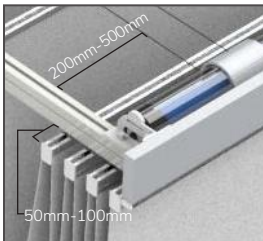

Motor Altus 50  
\*Details on page 36

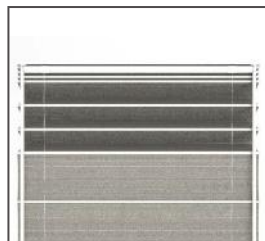
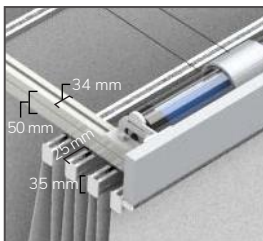
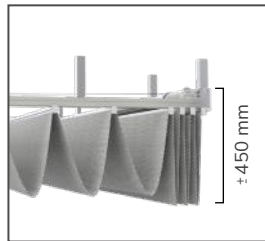

## Available Size

### Single

Max. Width	6 m
Max. Length	8 m
Max. Area	48 m <sup>2</sup>

### Intermediate

Max. Width	8 m
Max. Length	8 m
Max. Area	64 m <sup>2</sup>

## Notes :

- More than 2 m need extra support



## Retractable **Awning**

---

- Excellent protection against glaring heat
- Operated by manual or motorised system
- Your solution for relaxing outdoor experience
- Awning is not recommended for extreme weather

# Retractable Awning

## Manual

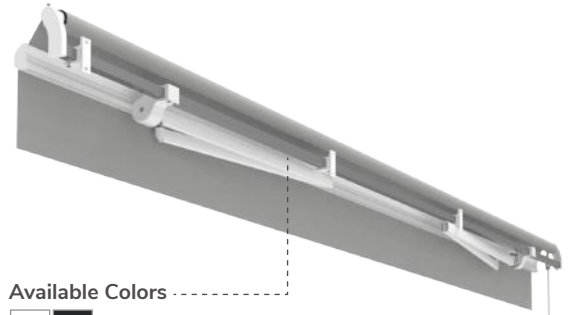
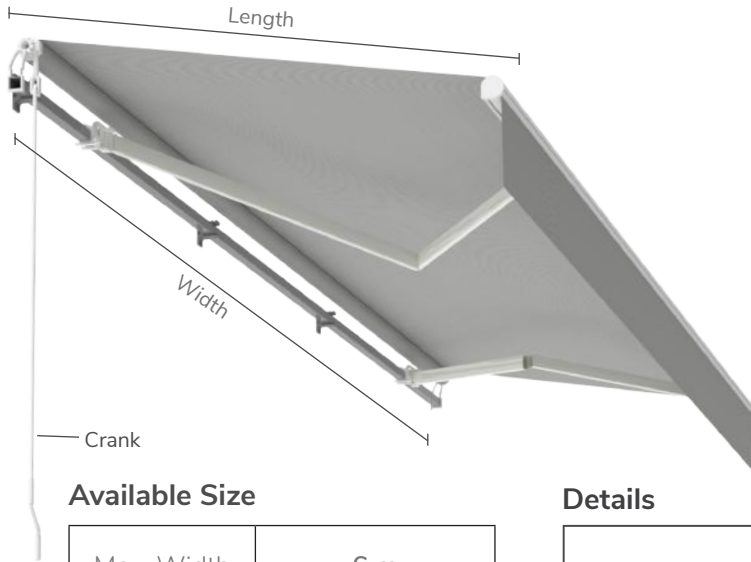

Available Colors



\*For other colors, pre-order 1 month and consultation with our product consultant is needed

### Available Size

Max. Width	6 m
Max. Length	2m   2,5m   3m
Max. Area	18 m <sup>2</sup>

Note : > 4,5m with Center Support

### Details



Manual System

### Extra Feature

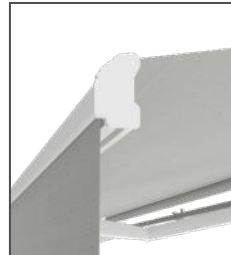

Rain Cover



Center Support

## Motorised

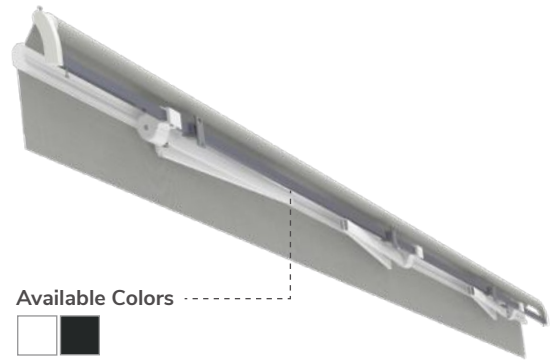
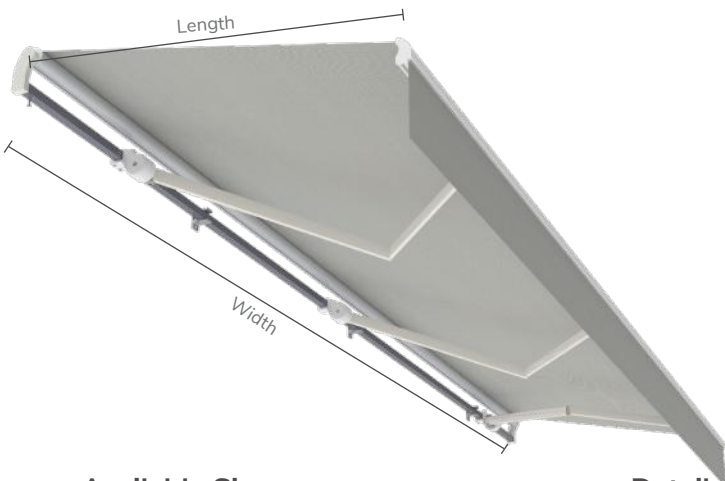

Available Colors



\*For other colors, pre-order 1 month and consultation with our product consultant is needed

### Available Size

Width	2,5 - 5,9 m	2 arm
Width	6 - 8,9 m	3 arm
Width	9 - 12 m	4 arm
Max. Length	2m   2,5m   3m	

Note : > 4,5m with Center Support

### Details



Motorised System

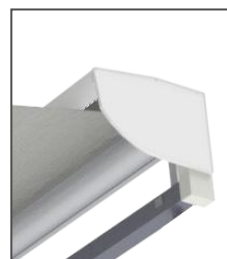

Rain Cover

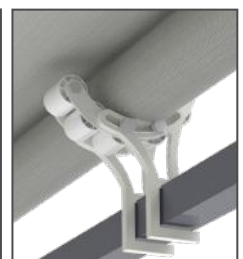

Center Support

FABRIC

## Interior Fabric

- Exquisite arrays of interior fabrics sourced from reputable, world-wide companies.
- Sandei Blinds provides various types of fabrics, ranging from decorative patterns to high specification fabrics, depending on the customer's necessities.



### Solar Screen

Solar screen is a highly technical fabric that is mainly designed to assist in glare and heat control to reach maximum room comfort, while maintaining a clear outdoor view. Sandei has an openness factor available : 1 %, 3 %, 5 %, 10 % Also available solar screen fabric with metalized backing.



### Light Filtering

Light filtering permits some light, but are not open weaves like sheer or screen, this the view is limited to shapes and shadows. Light filtering fabrics allow light to softly filter into the room, and are ideal for areas where soft illumination is preferred.



### Black Out

Blackout fabrics prevent all light from passing through the material. These fabrics are often combined with special side rail or zipper and other system components to ensure a complete light seal.

Please kindly contact our product consultant for our fabric catalogue

Our interior fabrics sourced from



Our interior fabrics certificated by



And other well-know world fabric companies.

## Exterior Fabric

- Maximize comfort at your outdoor space.
- Specially design to endure strong wind, heavy rain.
- The fabrics will break rain into spray.
- One stop solution to your exterior needs.
- Upvc (plastic) from japan is also available for exterior roman high durability and the plastic wouldn't easily turn yellow.



### Screen

High technical exterior screen with openness factor 1%, 15%, 25%.

### Préconstraint Polyester

A durable Polyester fabric with patented Serge Ferrari technology, highly dirt repellent, and UV resistant, ideal for textile architecture and installations. Supported by Préconstraint technology allows a material to have unique characteristics in durability, dimensions, lightweight, anti-deformation, and has a long service life.

### UPVC

UPVC is a robust material, mainly used in window construction due to its thermal efficiency and durability. The UPVC we use is made from Japan, with a transparent design made of sturdy plastic.

### Acrylic Fabric

Acrylic fabric for awnings are made of woven, breathable fabric that allows air to circulate. Acrylic fabric work well in windy environments and dry quickly. Moreover, they are durable in harsh elements.

Please kindly contact our product consultant for our fabric catalogue

Our exterior fabrics sourced from



**Serge Ferrari** **Achilles**

Our exterior fabrics certificated by



And other well-know world wide fabric companies.

# Accessories

Somfy, France



Transmitter 1 channel Pure (Situ)



Transmitter 2 channel Pure (Situ)



Transmitter 5 channel Pure (Situ)



Transmitter 1 channel Situ Variation RTS Pure



Transmitter 4 Channel Situ Variation RTS Pure

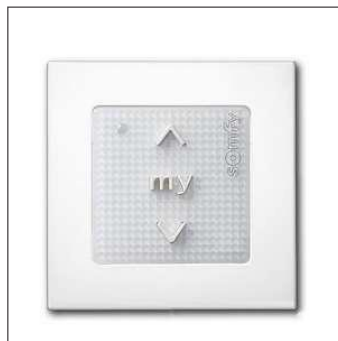

Wall transmitter 1 Channel Silver Shine

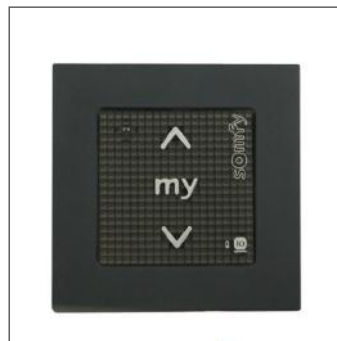

Wall transmitter 1 Channel Black



Wall transmitter 1 Channel Pure White



Dry Contact Transmitter



Inis Uno Switch



Inis Duo Switch



Telis 16 RTS Silver

# Accessories

Nice, Italy



Portable Transmitter  
1 channel (P.1)



Portable Transmitter  
6 channel (P.6)



P.1 V with Slider Dimmer  
- ERA IN EDGE 10/20



P.6 V with Slider Dimmer  
- ERA IN EDGE 10/20



Wall Transmitter  
1 channel



Wall Transmitter  
6 channel



ERA P.View



Air RW Touchless Radio Transmitter



AGIO AG 4 BWR 01  
Portable Transmitter White



AGIO AG 4 BWR 01  
Portable Transmitter Black

# Accessories



Mouve, Cina



Transmitter 1 Channel



Transmitter 15 Channel



Transmitter 5 Channel  
(with Timer)



Transmitter 1 Channel  
(with Tilting)







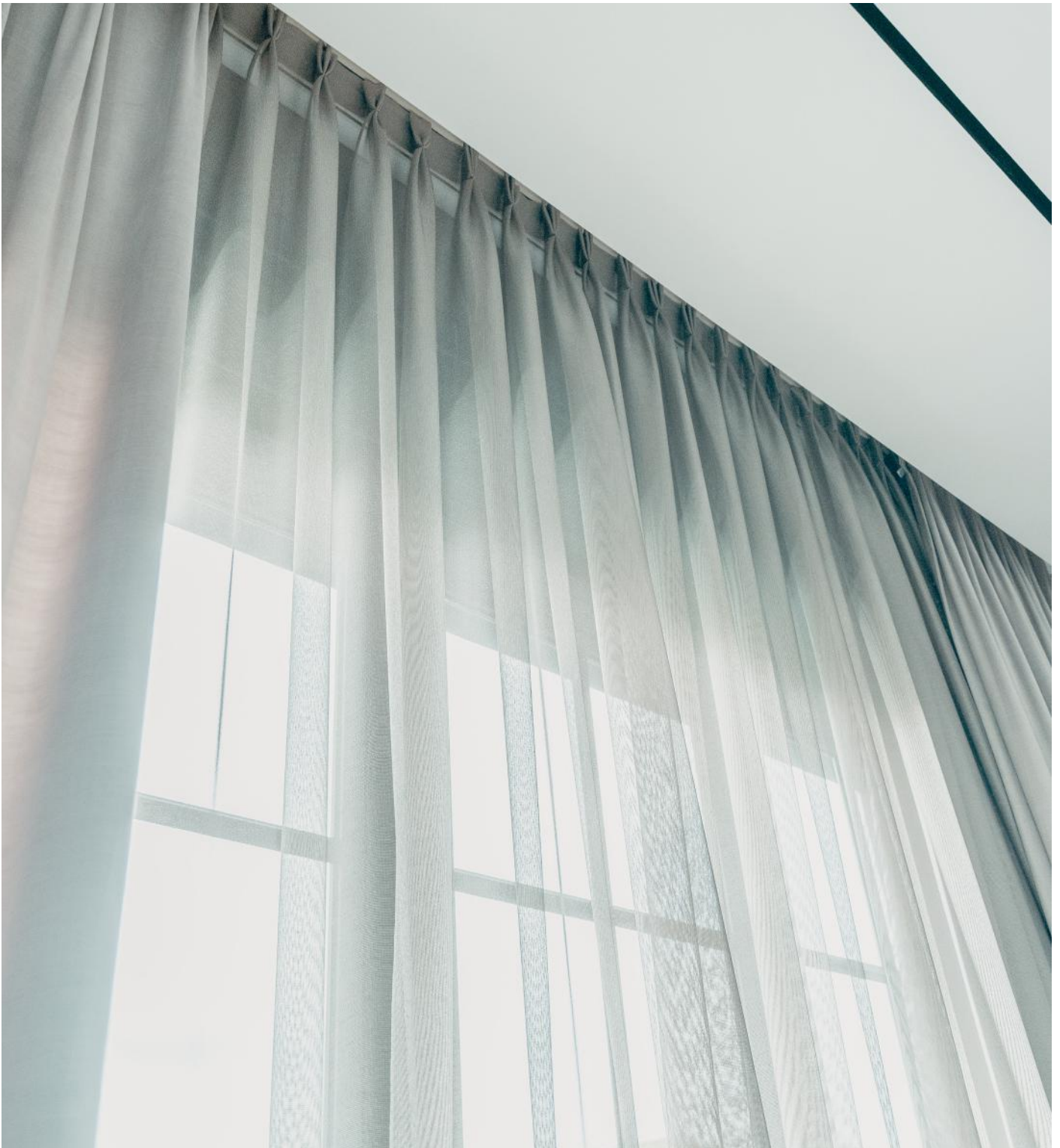

Transmitter 15 Channel  
(with Tilting)

# Curtain Track



- Sleek Design
- Easy Maintenance
- Accessibility/Ease of operation
- Convenience / Easy of operation
- Energy Efficiency



SOMFY CURTAIN TRACK MOTORS SELECTION CHART									
Track Type	Motor range 35			Motor range 60			Motor range 60° tandem		
	3m	6m	10m	6m	10m	12m	6m	10m	15m
	35	35	35	60	60	55	100	100	100
	35	35	35	60	60	55	100	100	100
	35	25	20	45	45	35	100	80	80
	35	25	20	45	45	35	100	80	80
	35	15	-	35	8m 25	-	70	8m 56	-
	30	10	-	30	8m 20	-	70	8m 56	-

## Specification Track

Single Track

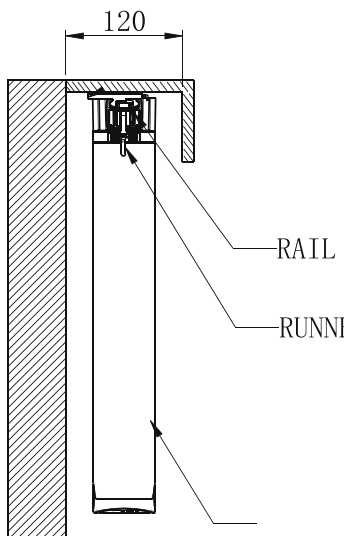

Double Track

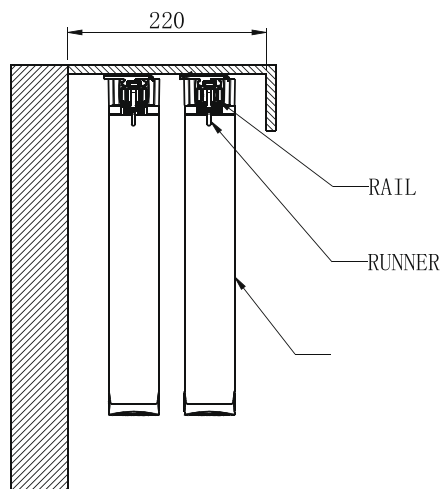

## Motor Features

### GLYDEA ULTRA

- Available in RTS, DCT, WT
- Available capacity for 35, 60 kg & 100 kg tandem
- Sound level: 30 dB (Silent Speed) & 44dB (Default Speed) using silent accessories
- Adjustable Speed & Mode Silent (20~7.5 cm/s)
- Able to operate when there is no electricity
- Soft start & Stop
- Motor position can be reversed
- 5 years warranty for Motor
- Touch Motion Feature for RTS & DCT



### ERA TRACK EDGE 158

- Available in RTS
- Available capacity for 50 kg
- Nominal Speed: 76 - 85 rpm
- Motor can be positioned on both side of the rail
- Able to operate when there is no electricity
- 5 years warranty for Motor
- Comfortable Hand Start Function
- Reliable and silent

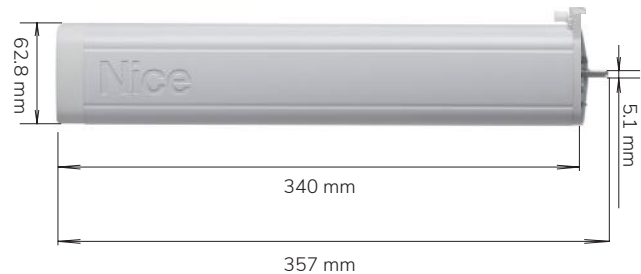

### CURTAIN MOTOR - DTV2EV

- Available in RTS
- Available capacity for 100 kg
- Running Speed: 20 cm/s – Ensures smooth and quiet operation
- Compatible remote or smart home system.
- The 75 W motor is energy-efficient
- Small and easy to hide in curtain tracks for a clean look

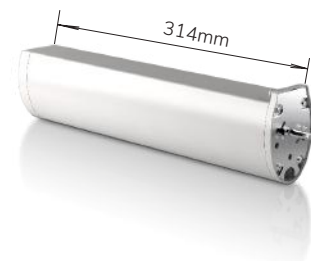

Somfy - France



Nice - Italy

MOUVE  
Mouve - China

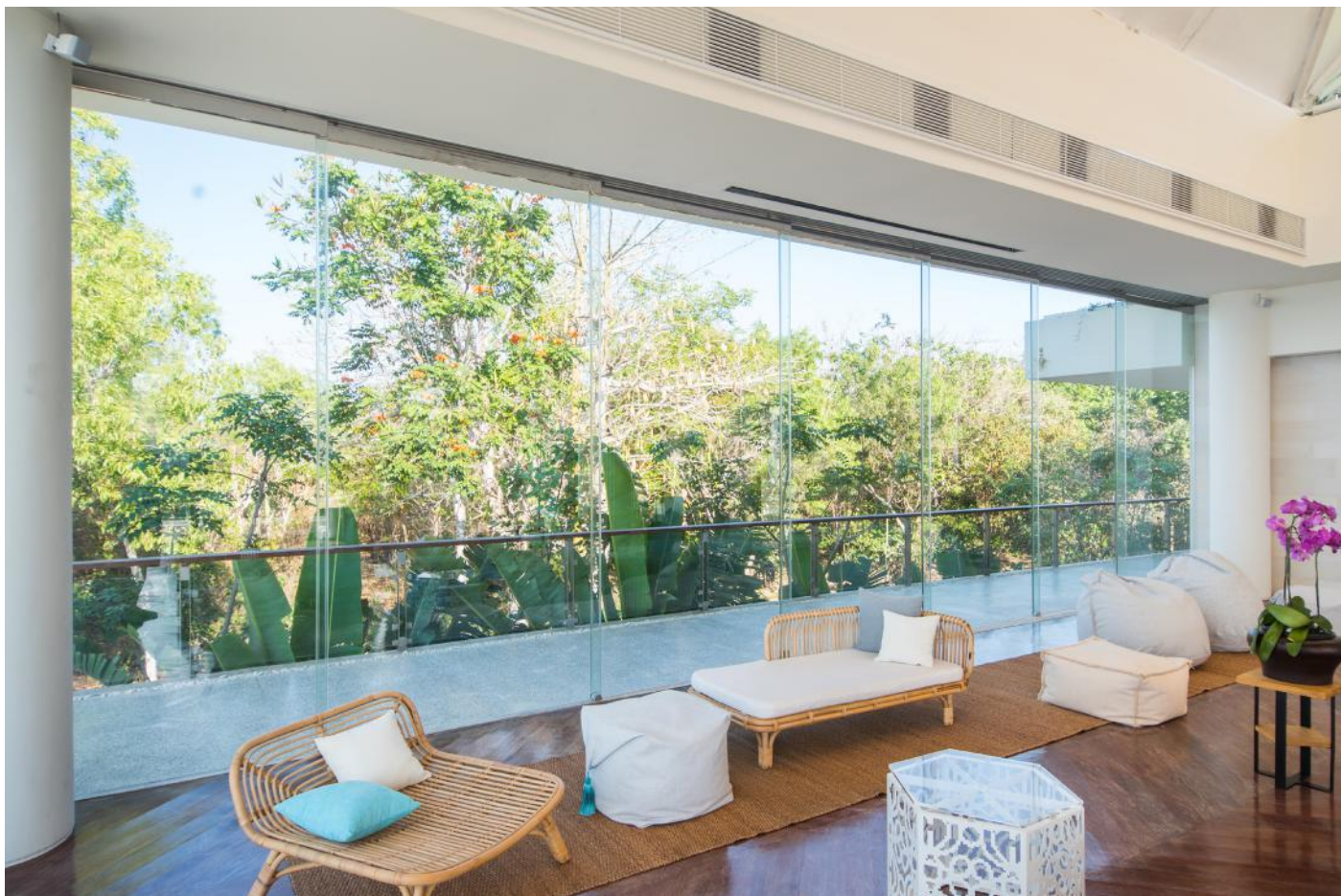

## OUR PRODUCT LINE

---

Sandei consists of two main products lines

Sandei believes that the ability to master the sensory qualities in spaces have a transformative power in enabling people to enrich their quality of life. It is an essential part of modern living. Through its range of **window blinds and operable partitions**, Sandei aims to curate a lineup of products that transcend mere functionality, intending to foster environments capable of evoking emotions, memories, and a deep connection by catering to the human senses.

Showroom and Main Factory  
Jl. Raya Narogong Km 15,  
Pangkalan VI Cikeutingudik No. 38  
Bantar Gebang - Bekasi

---

Information

📍 sandei\_official • info@sandei.co.id • www.sandei.co.id



The science of today is the  
technology of tomorrow



*Edward Teller*





Scan For Details

© AUG2024