

Amino acids have recently been of interest for their use in the booming healthcare supplements industry. Although there is a high demand for analysis, direct measurement by HPLC is not straightforward, this is because UV-visible detection is not selective nor sufficiently sensitive for amino acids in their native form. This application note describes a method of analysis using Post Column-OPA derivitization, which is highly sensitive, highly selective and quantitative for amino acids.

Features of the post-column-orthophthalaldehyde (OPA) method

The post-column derivatization method, in which the components are first separated by a column has the advantage that it does not change the derivatization efficiency due to the presence of contaminants. This results in it being possible to assay a wide range of samples with good quantitation and reproducibility.

The OPA method selectively derivatizes the amino group found on both amino acids and contaminants after separating them with the ion exchange column for fluorometric detection.

Because of its greater selectivity compared to other derivatization methods, the assay can be performed with simple pretreatment. Using fluorescence detection, the sensitivity is also superior.

Type of derivatization method

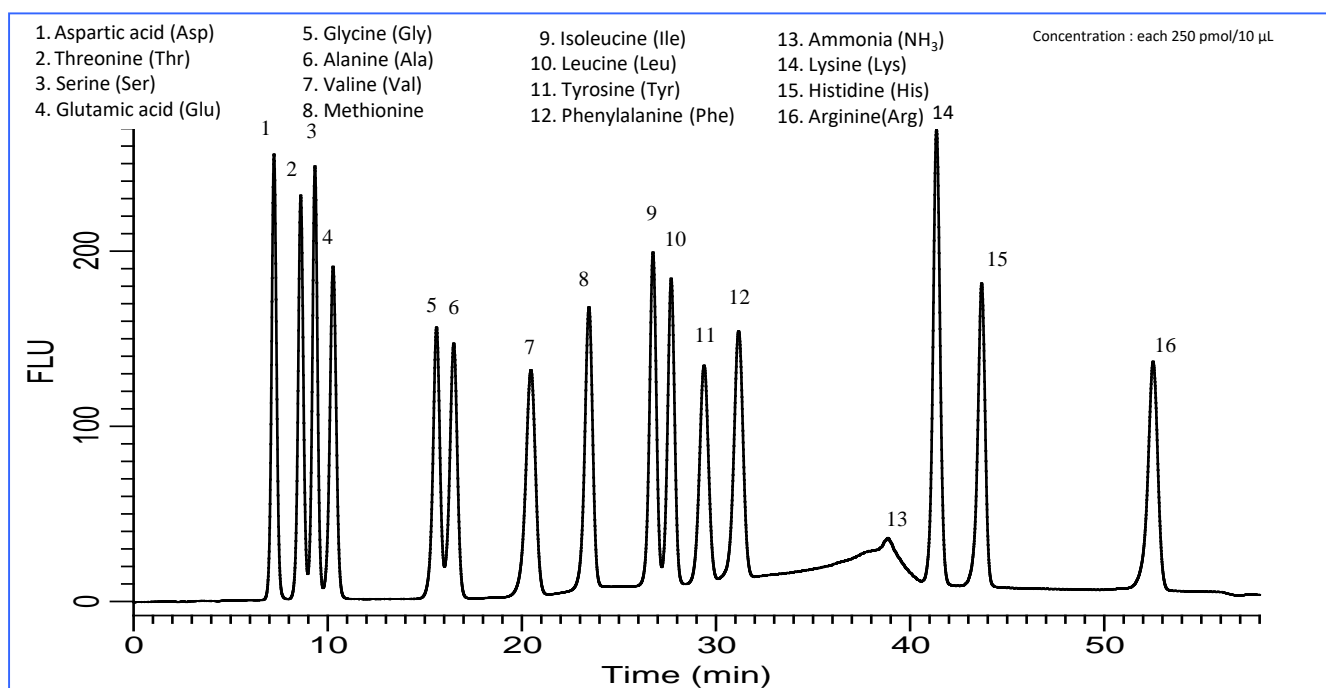
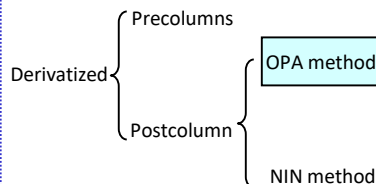

Analytical conditions and flow chart

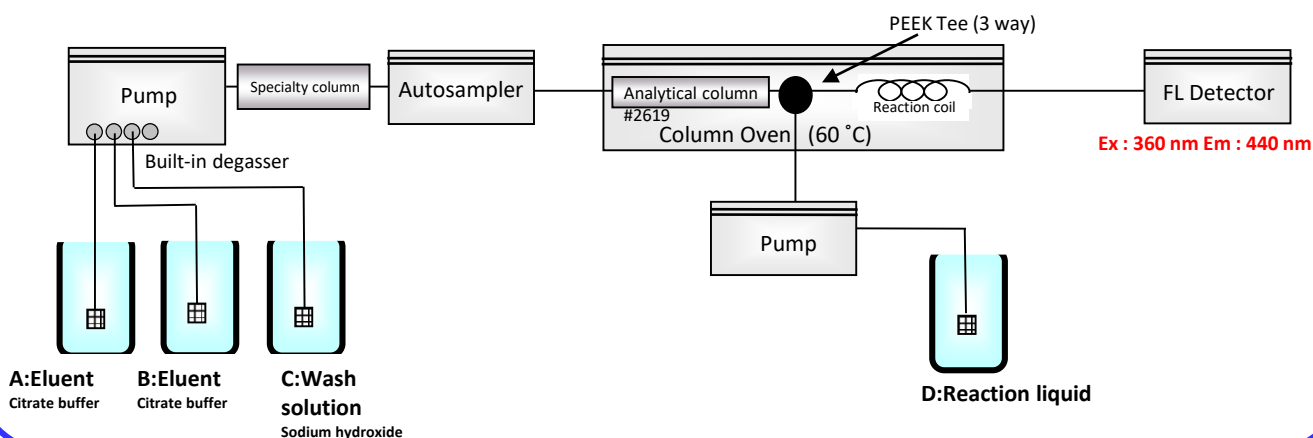

Amino acids in soy sauce

Pretreatment: Dilute soy sauce 200-fold with water and filtered

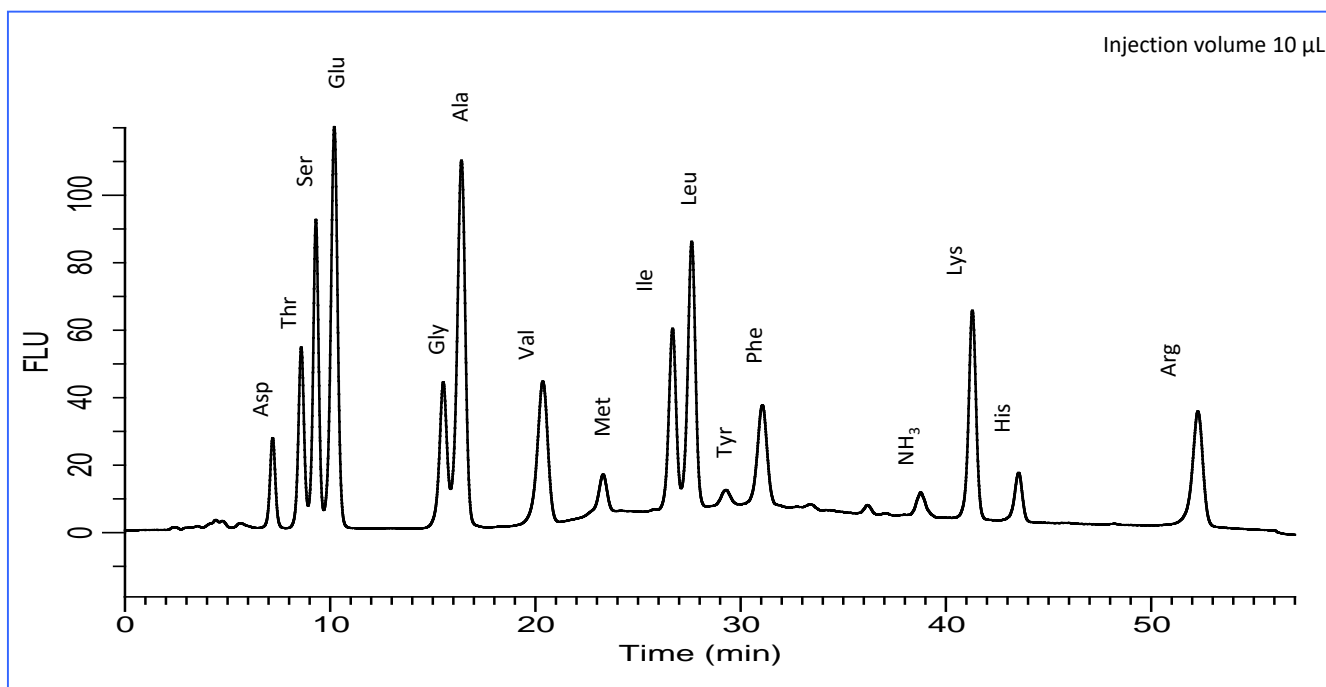

Amino acids in Mandarin oranges

Pretreatment: Dilute squeezed mandarin orange 50-fold with water and filtered

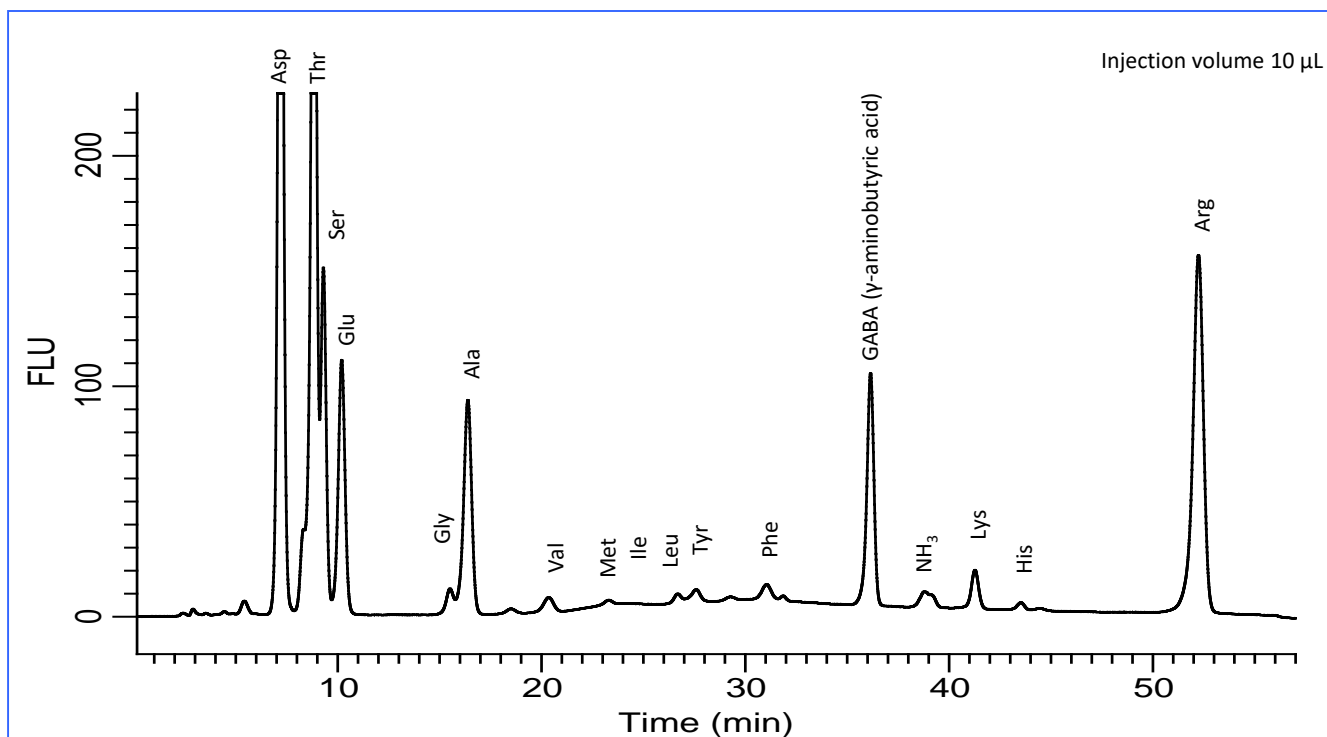

Amino acids in scallops

Pretreatment method: 15 mg of the adductor muscle of raw scallops was homogenized in 2 mL of water and filtered

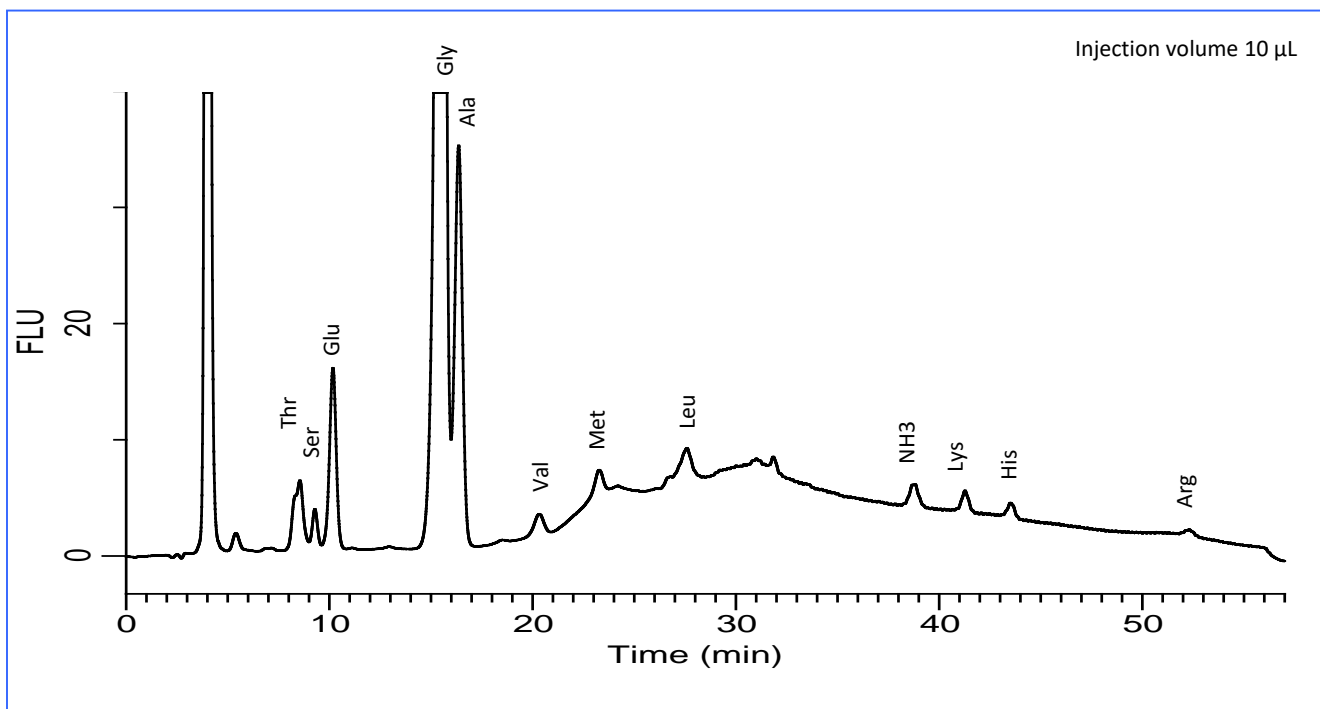

Amino acids in soft drinks containing amino acids

Pretreatment: 10-fold dilution of soft drink in water and filtered

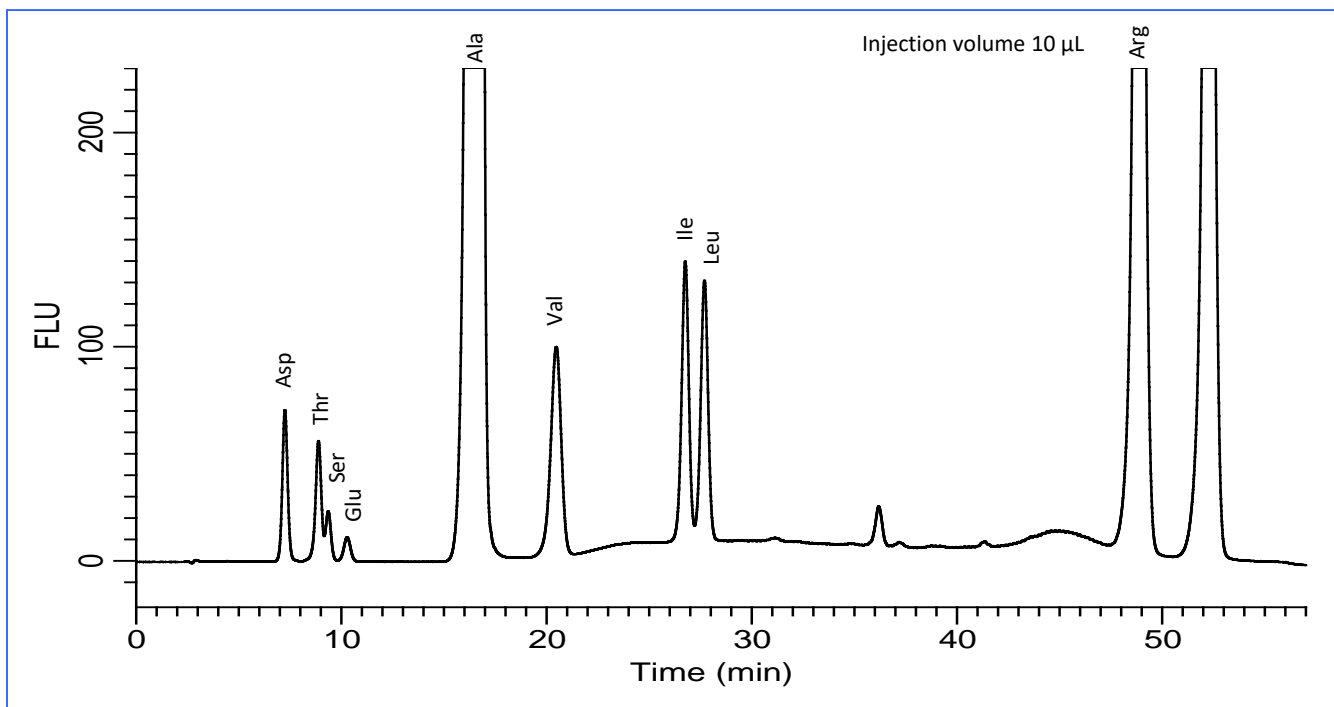

Example of application

The measurement of polyamines and guanidine compounds is also possible considering the eluent.

Polyamines

- Detection of allergic substances such as histamine
- Food freshness checks

Guanidine compounds

- Some compounds have been suggested to be associated with cancer

γ -Aminobutyric acid (GABA), which lowers blood pressure, can also be measured.

GL Sciences disclaims any and all responsibility for any injury or damage which may be caused by this data directly or indirectly. We reserve the right to amend this information or data at any time and without any prior announcement.

GL Sciences, Inc. Japan

22-1 Nishishinjuku 6-Chome
Shinjuku-ku, Tokyo,
163-1130, Japan
Phone: +81-3-5323-6620
Fax: +81-3-5323-6621
Email: world@glsc.co.jp
Web: www.glsciences.com

GL Sciences B.V.

De Sleutel 9
5652 AS Eindhoven
The Netherlands
Phone: +31 (0)40 254 95 31
Email: info@glsciences.eu
Web: www.glsciences.eu

GL Sciences (ShangHai) Ltd.

Tower B, Room 2003,
Far East International Plaza,
NO,317 Xianxia Road,
Changning District.
Shanghai, China P.C. 200032
Phone: +86 (0)21-6278-2272
Email: contact@glsciences.com.cn
Web: www.glsciences.com.cn

GL Sciences, Inc. USA

4733 Torrance Blvd. Suite 255
Torrance, CA 90503
Phone: 310-265-4424
Fax: 310-265-4425
Email: info@glsciencesinc.com
Web: www.glsciencesinc.com

International Distributors

Visit our Website at www.glsciences.com/distributors