



PRODUCT CATALOG 2025



Idea book for advertising display products like flags, pennants, banners, signs, and displays.

02



Featured Products

04



Flags

27



Banners

30



Display Products

40



Signs

46



Pennant Strings

57



Art Requirements



**FEATURED
PRODUCTS**

SILICONE EDGE GRAPHICS (SEG)

Silicone Edge Graphics (SEG) will bring new life to your interior displays with the highest quality resolution printed on cloth. Turn your walls into eye-catching art presentations with this simple, cost-effective display cloth solution.

- Fully customizable graphics that are easy to change out to update messaging
- Easy to install display (assembly tools included with frame purchase)
- Graphics are dye sublimated on a variety of materials including:
 - Display Cloth
 - Black Back Display Cloth with “black out” features to hide items behind the print
 - Backlit Cloth for use with Backlit Displays provide a glowing effect to your display

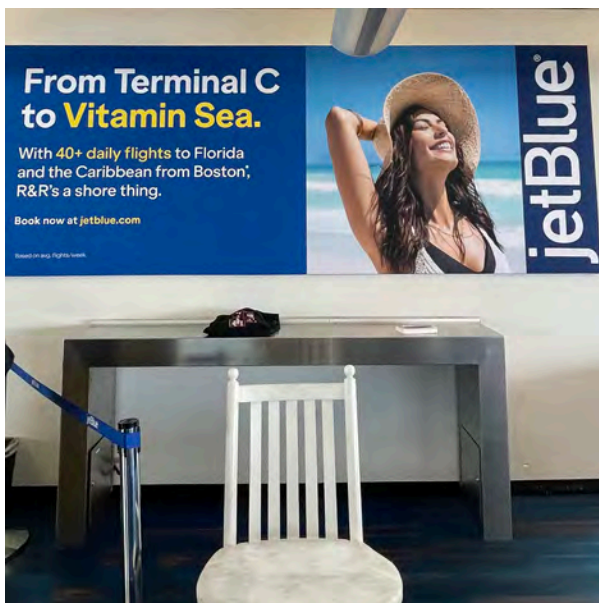

Custom print prices are based on customer provided artwork. Creative services available for an additional cost.

FLAGS

Horizontal.....	06
Vertical	06
State	07
Military.....	07
Size & Styles	08-09
Single vs. Double Sided	10
Base & Carry Options	10
Tail Feather	11
Feather Dancer	12
Kahuna	13
Windchaser.....	14
Hardware	15-16
Decorative Kahuna	17
Decorative Feather Dancer	18
Decorative Vertical	19
Decorative Horizontal.....	20
Nylon Color Chart	21
Custom Message Flags	22-23
Race Style	24
Patriotic.....	25

CUSTOM HORIZONTAL & VERTICAL FLAGS

Custom flags are perfect for displaying a logo at businesses, city halls, schools, and stadiums, or they can promote an upcoming event. Flags are digitally printed on polyester flag cloth using water-based heat-set dye sublimation inks.

Flags are single-sided (1S) or double-sided (2S) with a block out layer in-between.



6'x10'



5'x3'



8'x3'



5'x8'



4'x6'

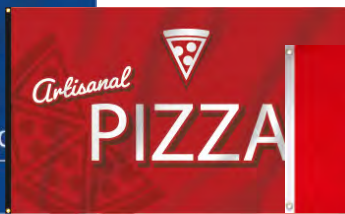

3'x5'



2'x3'

SKU	HORIZONTAL FLAG SIZE	QTY 1	2-10	11-25	26-100	101-249	250+
HF1-23	2'x3' Flag (1S)	\$66.15	\$48.30	\$37.80	\$33.60	\$29.40	Call
HF2-23	2'x3' Flag (2S)	\$100.80	\$79.80	\$70.35	\$57.75	\$48.30	Call
HF1-35	3'x5' Flag (1S)	\$131.25	\$88.20	\$67.20	\$59.85	\$50.40	Call
HF2-35	3'x5' Flag (2S)	\$226.80	\$166.95	\$115.50	\$108.15	\$95.55	Call
HF1-46	4'x6' Flag (1S)	\$140.70	\$107.10	\$86.10	\$79.80	\$70.35	Call
HF2-46	4'x6' Flag (2S)	\$238.35	\$197.40	\$170.10	\$156.45	\$138.60	Call
HF1-58	5'x8' Flag (1S)	\$176.40	\$153.30	\$130.20	\$124.95	\$116.55	Call
HF2-58	5'x8' Flag (2S)	\$327.60	\$282.45	\$259.35	\$249.90	\$228.90	Call
HF1-610	6'x10' Flag (1S)	\$227.85	\$194.25	\$176.40	\$169.05	\$155.40	Call
HF2-610	6'x10' Flag (2S)	\$421.05	\$387.45	\$352.80	\$337.05	\$309.75	Call

C

SKU	VERTICAL FLAG SIZE	QTY 1	2-10	11-25	26-100	101-249	250+
VF1-53	5'x3' Flag (1S)	\$133.35	\$90.30	\$68.25	\$60.90	\$50.40	Call
VF2-53	5'x3' Flag (2S)	\$227.85	\$168.00	\$115.50	\$109.20	\$96.60	Call
VF1-83	8'x3' Flag (1S)	\$143.85	\$109.20	\$88.20	\$81.90	\$72.45	Call
VF2-83	8'x3' Flag (2S)	\$240.45	\$199.50	\$172.20	\$159.60	\$139.65	Call

C

Custom print prices are based on customer provided artwork. Creative services available for an additional cost.

STATE FLAGS

Our state flags are manufactured with quality in mind. Each flag is crafted for proper display from any angle. Flags are digitally printed single-sided on polyester flag cloth using water-based heat-set dye sublimation inks, ensuring vibrant and lasting colors. Complete with a sturdy header and grommets, these state flags make a reliable and eye-catching addition to any display. Proudly made in the U.S.A.



SKU	STATE FLAG SIZE	QTY 1-10	11-25	26-100	101-249	250+
SF-35	3'x5' Flag	\$88.20	\$67.20	\$59.85	\$50.40	Call
SF-46	4'x6' Flag	\$107.10	\$86.10	\$79.80	\$70.35	Call
SF-58	5'x8' Flag	\$153.30	\$130.20	\$124.95	\$116.55	Call
SF-610	6'x10' Flag	\$194.25	\$176.40	\$169.05	\$155.40	Call

C



U.S. Marine Corps Flag



U.S. Army



U.S. Space Force



U.S. Air Force



U.S. Coast Guard

MILITARY FLAGS

Our military flags are manufactured with quality and precision in mind. Each flag is made for proper display from any angle, honoring the tradition and pride of our armed forces. Flags are digitally printed single-sided on polyester flag cloth using water-based heat-set dye sublimation inks, delivering vibrant and lasting colors. Complete with a sturdy header and grommets, these military flags are a reliable and distinguished addition to any display. Proudly made in the U.S.A.

SKU	MILITARY FLAG SIZE	QTY 1-10	11-25	26-100	101-249	250+
MF-35	3'x5' Flag	\$88.20	\$67.20	\$59.85	\$50.40	Call
MF-46	4'x6' Flag	\$107.10	\$86.10	\$79.80	\$70.35	Call
MF-58	5'x8' Flag	\$153.30	\$130.20	\$124.95	\$116.55	Call
MF-610	6'x10' Flag	\$194.25	\$176.40	\$169.05	\$155.40	Call

C

CUSTOM FLAG

SIZE & STYLE GUIDE

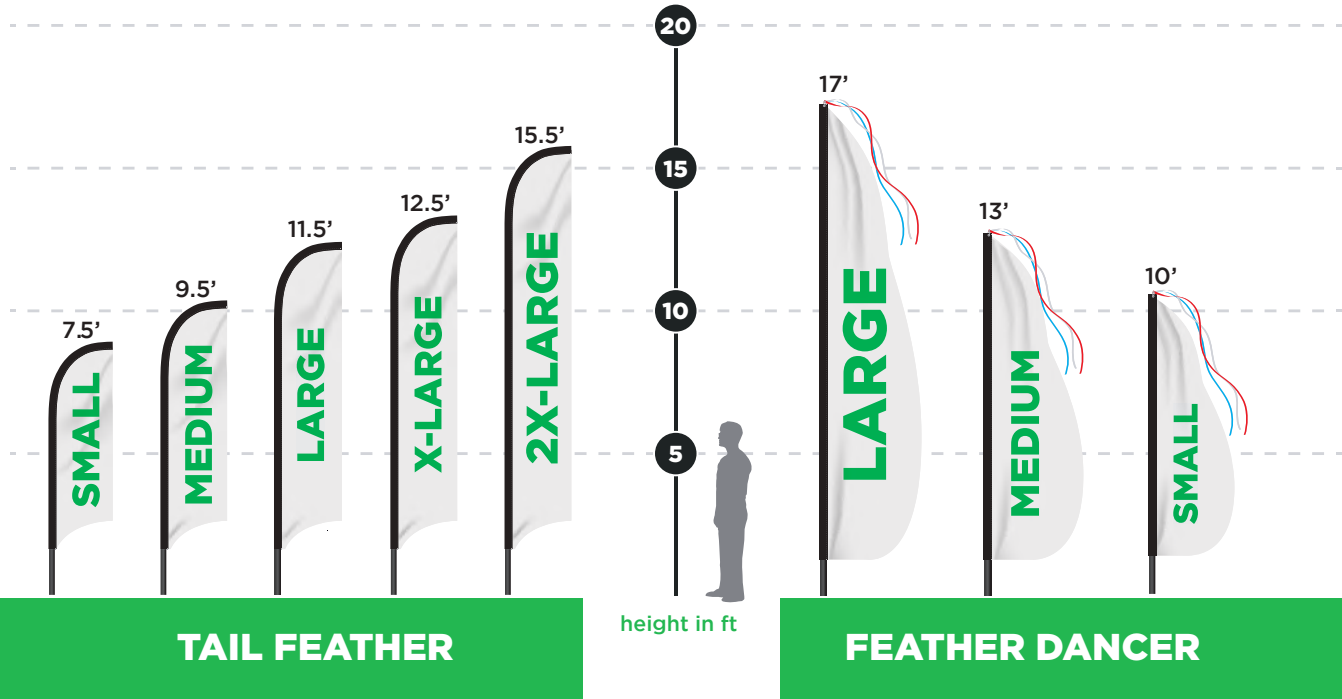

TAIL FEATHER

SIZE	POLE HEIGHT (FT)	FLAG DIMENSIONS	POLE SECTIONS	POLE MATERIAL
Small	7.5 ft	28" x 7'	1	1" Aluminum + Fiberglass Flex Tip
Medium	9.5 ft	28" x 8.5'	2	1" Aluminum + Fiberglass Flex Tip
Large	11.5 ft	28" x 10.5'	3	.885" dia. Fiberglass
X-Large	12.5 ft	28" x 11.5'	2	1" Aluminum + Fiberglass Flex Tip
2X-Large	15.5 ft	28" x 14'	4	Chrome Fiberglass

FEATHER DANCER

SIZE	POLE HEIGHT (FT)	FLAG DIMENSIONS	POLE SECTIONS	POLE MATERIAL
Small	10 ft	32" x 8'	3	1" dia. Fiberglass
Medium	13 ft	36" x 10'	3	1" dia. Fiberglass
Large	17 ft	36" x 14'	4	1" dia. Fiberglass

All flag kits come with a fiberglass stake mount and are designed for use with OEM hardware only.

CUSTOM FLAG

SIZE & STYLE GUIDE CONT.

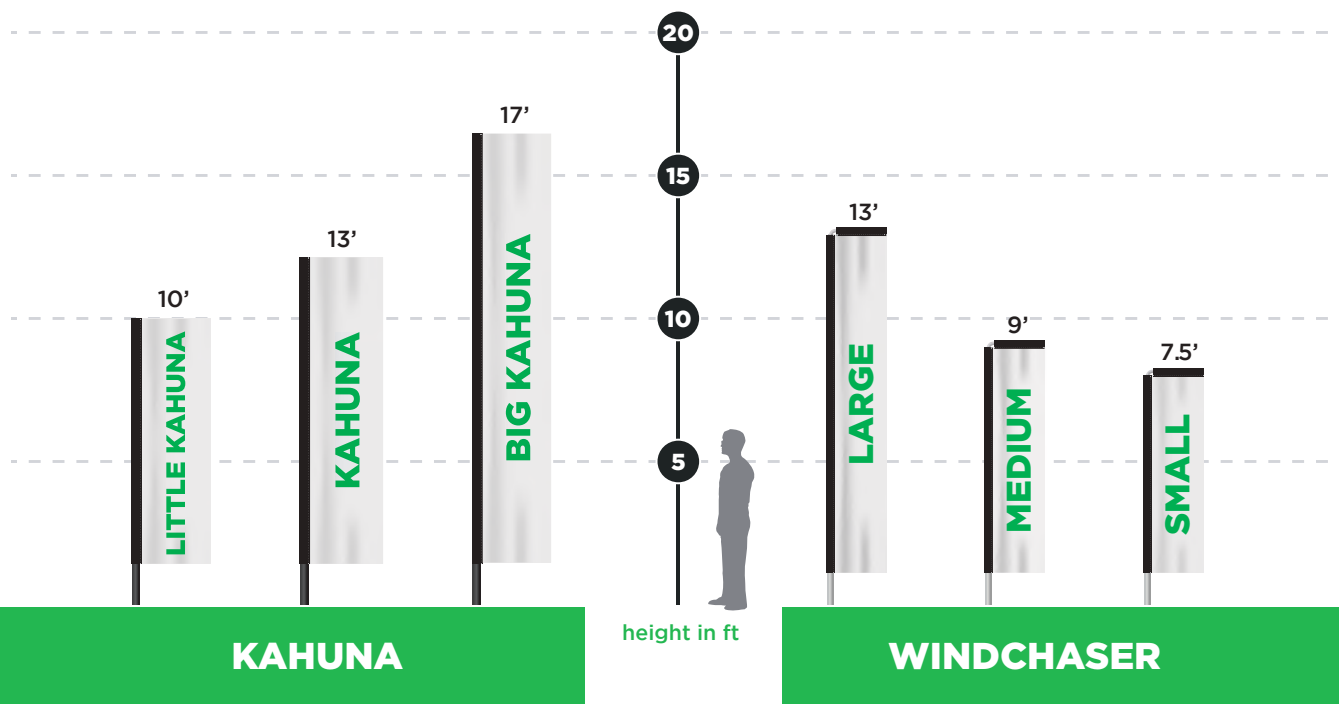

KAHUNA

SIZE	POLE HEIGHT (FT)	FLAG DIMENSIONS	POLE SECTIONS	POLE MATERIAL
Little Kahuna	10 ft	30" x 8'	3	1" dia. Fiberglass
Kahuna	13 ft	30" x 10'	3	1" dia. Fiberglass
Big Kahuna	17 ft	30" x 14'	4	1" dia. Fiberglass

WINDCHASER

SIZE	POLE HEIGHT (FT)	FLAG DIMENSIONS	POLE SECTIONS	POLE MATERIAL
Small	7.5 ft	24" x 7'	2	1" Aluminum
Medium	9 ft	24" x 8'	2	1" Aluminum
Large	13 ft	24" x 12'	4	1" Aluminum

All flag kits come with a fiberglass stake mount and are designed for use with OEM hardware only.

Prices are subject to change

SINGLE SIDED

Right-reading front reverse reading back



DOUBLE SIDED

Right-reading on both sides

FRONT | BACK



FRONT | BACK

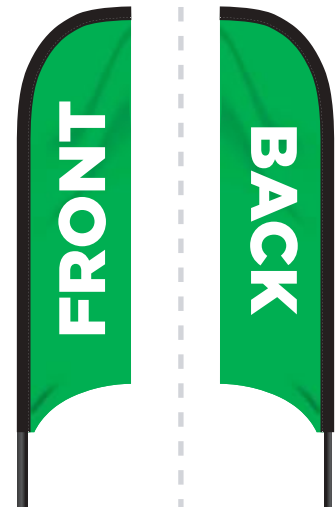

FLAG BASE OPTIONS

All flag kits include flag, flagpole hardware, and a fiberglass ground stake. Alternative base options to the ground stake are below.

SAND BASE

Unique portable plastic base will support flagpoles up to 10'. Just add sand to the base and it's ready to use.



SKU	1-10	11-20	21+
HW-SBASE	\$65.10	\$59.85	\$57.75

Approx. Shipping Weight:
Sand Base = 5 lbs ea.

C

X-STAND

Will support flagpoles up to 10' for indoor and temporary outdoor use. Use with the WATER BALLAST for additional stability.



x-stand

Water Ballast

SKU	1-10	11-20	21+
HW-XSTAND	\$71.40	\$65.10	\$61.95
HW-WBAG	\$22.05	\$19.95	\$15.75

Approx. Shipping Weight:
X-Stand = 4 lbs ea. Water Ballast = 1 lb ea.

C

FLAGPOLE CARRYING CASE

Optional carrying case available. One flagpole and a flag fit securely in a black nylon bag, ready for traveling.



SKU	PRODUCT	
HW-FPBAG	Flag Bag	\$29.40

C

CUSTOM TAIL FEATHER

Tail Feather Flags are wind directional & stay open for 24/7 readability, regardless of wind speed. Flags are digitally printed right-reading front, reverse-reading back (1S) and most sizes are available right-reading on both sides (2S).

Kit includes flag, flagpole hardware, and a fiberglass ground stake. Carrying case is available for \$20.00 ea (c).

Flags are designed for use with OEM hardware only.

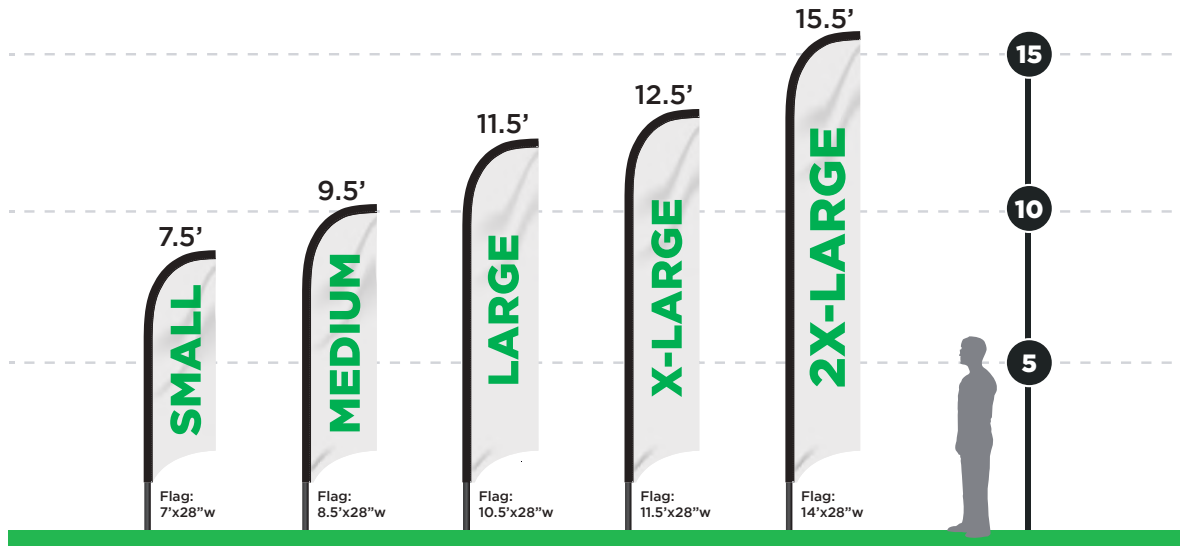

CUSTOM TAIL FEATHER KIT

SKU	KIT SIZE	QTY 1	2-10	11-25	26-100	101-249	250+
TFK1-S	Custom Small 7.5' (1S)	\$212.10	\$162.75	\$143.85	\$137.55	\$127.05	Call
TFK2-S	Custom Small 7.5' (2S)	\$330.75	\$282.45	\$245.70	\$236.25	\$214.20	Call
TFK1-M	Custom Medium 9.5' (1S)	\$219.45	\$191.10	\$156.45	\$149.10	\$136.50	Call
TFK2-M	Custom Medium 9.5' (2S)	\$388.50	\$330.75	\$288.75	\$277.20	\$250.95	Call
TFK1-L	Custom Large 11.5' (1S)	\$267.75	\$233.10	\$191.10	\$180.60	\$165.90	Call
TFK2-L	Custom Large 11.5' (2S)	\$450.45	\$379.05	\$327.60	\$309.75	\$278.25	Call
TFK1-XL	Custom X-Large 12.5' (1S)	\$291.90	\$254.10	\$207.90	\$198.45	\$180.60	Call
TFK2-XL	Custom X-Large 12.5' (2S)	\$470.40	\$392.70	\$346.50	\$337.05	\$302.40	Call
TFK1-2XL	Custom 2X-Large 15.5' (1S)	\$310.80	\$263.55	\$227.85	\$215.25	\$193.20	Call

C

CUSTOM TAIL FEATHER FLAG ONLY

SKU	FLAG SIZE	QTY 1	2-10	11-25	26-100	101-249	250+
TFF1-S	Custom Small 7' (1S)	\$176.40	\$128.10	\$112.35	\$108.15	\$99.75	Call
TFF2-S	Custom Small 7' (2S)	\$295.05	\$246.75	\$215.25	\$211.05	\$189.00	Call
TFF1-M	Custom Medium 8.5' (1S)	\$178.50	\$150.15	\$121.80	\$118.65	\$107.10	Call
TFF2-M	Custom Medium 8.5' (2S)	\$348.60	\$290.85	\$254.10	\$247.80	\$222.60	Call
TFF1-L	Custom Large 10.5' (1S)	\$223.65	\$187.95	\$151.20	\$149.10	\$132.30	Call
TFF2-L	Custom Large 10.5' (2S)	\$405.30	\$333.90	\$287.70	\$277.20	\$245.70	Call
TFF1-XL	Custom X-Large 11.5' (1S)	\$241.50	\$202.65	\$162.75	\$160.65	\$143.85	Call
TFF2-XL	Custom X-Large 11.5' (2S)	\$431.55	\$352.80	\$306.60	\$300.30	\$265.65	Call
TFF1-2XL	Custom 2X-Large 14' (1S)	\$257.25	\$210.00	\$179.55	\$175.35	\$154.35	Call

Approx. Shipping Weight for Kits: 7.5 ft = 4 lbs ea., 9.5 ft = 5 lbs ea., 11.5 ft = 5 lbs ea., 12.5 ft = 5 lbs ea., 15.5 ft = 5 lbs ea.

C

Custom print prices are based on customer provided artwork. Creative services available for an additional cost.

CUSTOM FEATHER DANCER

Popular Feather Dancer Flags are printed right-reading front, reverse reading back (1S). The metallic streamers provide additional movement in the wind to help attract attention.

Kit includes flag with metallic streamers, flagpole hardware, and a fiberglass ground stake.

Flags are designed for use with OEM hardware only.

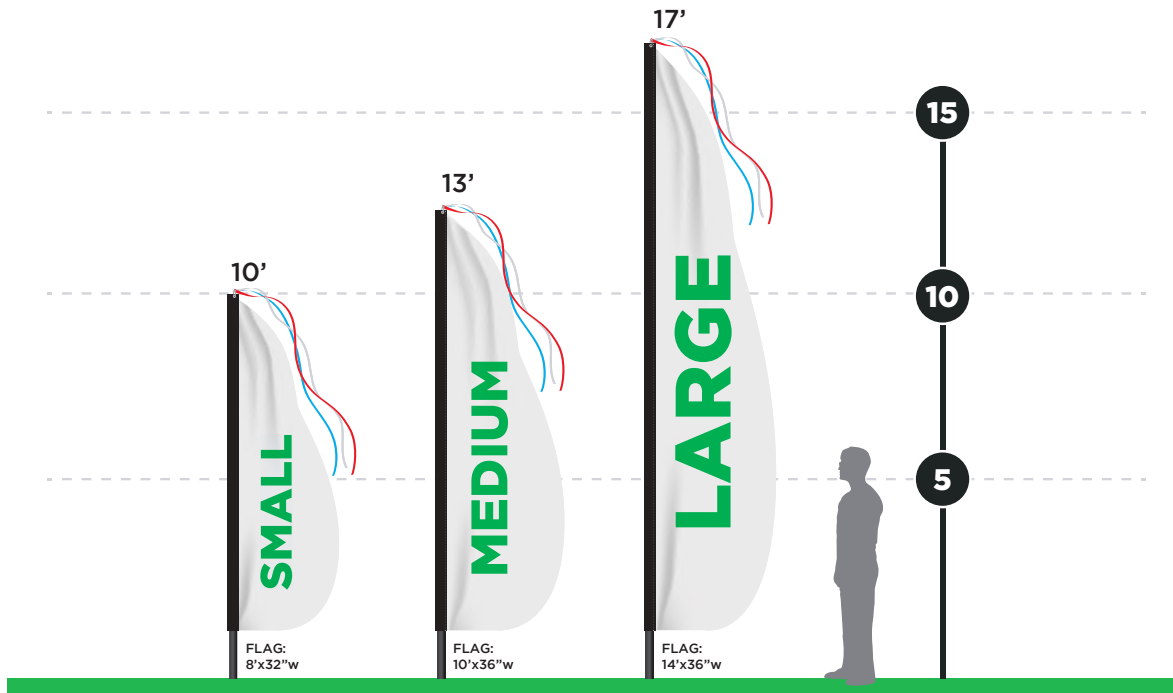

CUSTOM FEATHER DANCER KIT

SKU	KIT SIZE	QTY 1	2-10	11-25	26-100	101-249	250+
FDK-S	Custom Small 10'	\$266.70	\$192.15	\$154.35	\$138.60	\$117.60	Call
FDK-M	Custom Medium 13'	\$306.60	\$213.15	\$172.20	\$150.15	\$131.25	Call
FDK-L	Custom Large 17'	\$327.60	\$243.60	\$199.50	\$178.50	\$165.90	Call

C

CUSTOM FEATHER DANCER FLAG ONLY

SKU	FLAG ONLY	QTY 1	2-10	11-25	26-100	101-249	250+
FDF-S	Custom Small 8'	\$226.80	\$152.25	\$118.65	\$109.20	\$89.25	Call
FDF-M	Custom Medium 10'	\$265.65	\$172.20	\$136.50	\$119.70	\$101.85	Call
FDF-L	Custom Large 14'	\$276.15	\$192.15	\$154.35	\$140.70	\$128.10	Call

Approx. Shipping Weight for Kits: 10 ft = 4 lbs ea., 13 ft = 4 lbs ea., 17 ft = 5 lbs ea.

C

Custom print prices are based on customer provided artwork. Creative services available for an additional cost.

CUSTOM KAHUNA

Kahuna Flags combine the eye-catching movement of our Feather Dancer Flags with the large real estate and ease of layout found in a rectangular format. Great for retail businesses and property management promotions, Kahuna Flags are digitally printed with a right-reading front and reverse-reading back (1S).

Kit includes flag, flagpole hardware, and a fiberglass ground stake.

Flags are designed for use with OEM hardware only.

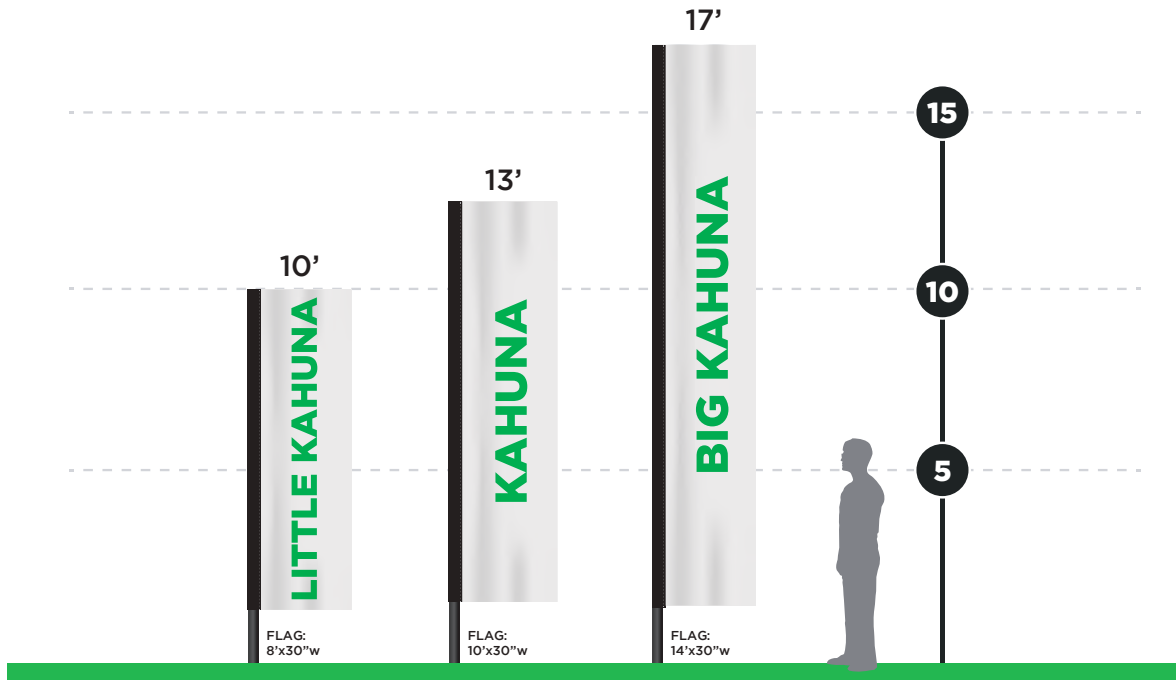

CUSTOM KAHUNA KIT

SKU	KIT SIZE	QTY 1	2-10	11-25	26-100	101-249	250+
LKFK	Custom Little Kahuna 10'	\$246.75	\$178.50	\$144.90	\$129.15	\$111.30	Call
KFK	Custom Kahuna 13'	\$271.95	\$192.15	\$156.45	\$135.45	\$119.70	Call
BKFK	Custom Big Kahuna 17'	\$283.50	\$213.15	\$176.40	\$156.45	\$145.95	Call

C

CUSTOM KAHUNA FLAG ONLY

SKU	FLAG ONLY	QTY 1	2-10	11-25	26-100	101-249	250+
LKFO	Custom Little Kahuna 8'	\$206.85	\$138.60	\$109.20	\$100.80	\$81.90	Call
KFO	Custom Kahuna 10'	\$222.60	\$149.10	\$118.65	\$105.00	\$88.20	Call
BKFO	Custom Big Kahuna 14'	\$232.05	\$161.70	\$130.20	\$118.65	\$108.15	Call

Approx. Shipping Weight for Kits: 10 ft = 4 lbs ea., 13 ft = 4 lbs ea., 17 ft = 5 lbs ea.

C

Custom print prices are based on customer provided artwork. Creative services available for an additional cost.

CUSTOM WINDCHASER

WindChaser Flags combine the eye-catching movement of a flag with the stay-open design of a banner. A swing arm allows the flag to swivel freely with the wind. Flags are available as right-reading front, reverse-reading back (1S), or right-reading both sides (2S).

Kit includes flag, flagpole hardware, and a fiberglass ground stake. Optional carrying case is available for \$20.00. See page 10

Flags are designed for use with OEM hardware only.

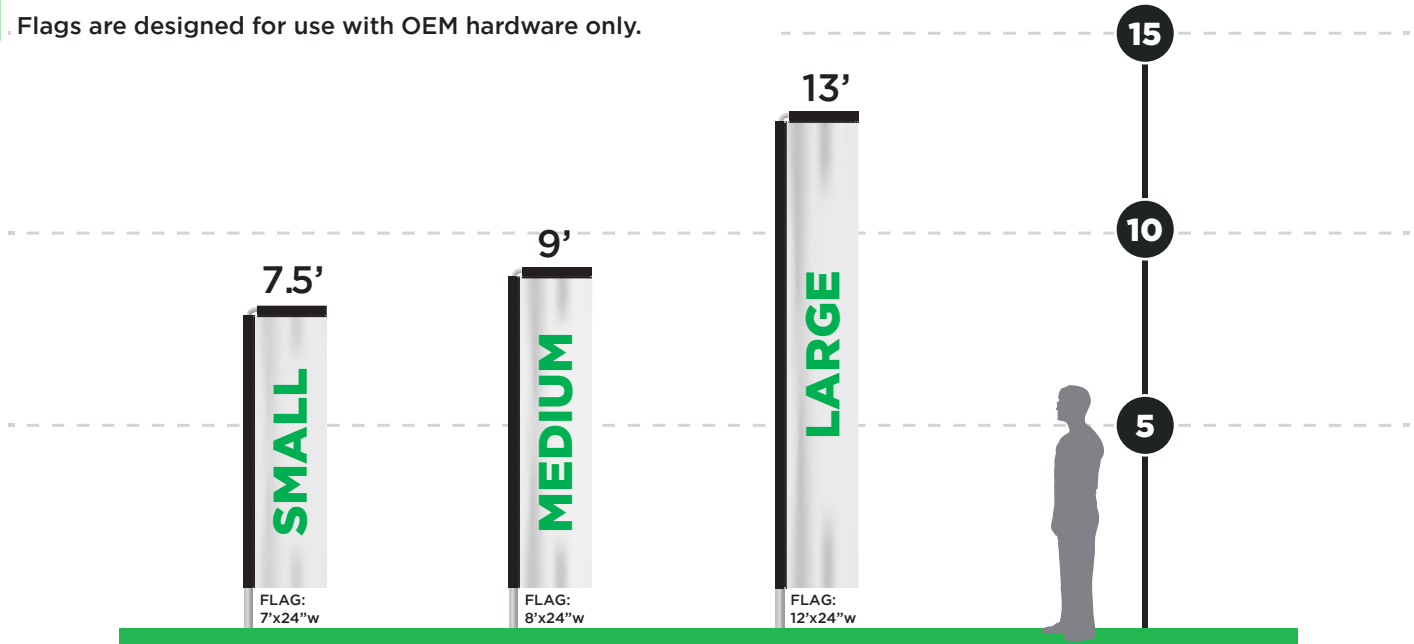

CUSTOM WINDCHASER KIT

SKU	KIT SIZE	QTY 1	2-10	11-25	26-100	101-249	250+
WCK1-S	Custom Small 7.5' (1S)	\$191.10	\$151.20	\$133.35	\$126.00	\$116.55	Call
WCK2-S	Custom Small 7.5' (2S)	\$288.75	\$248.85	\$218.40	\$205.80	\$190.05	Call
WCK1-M	Custom Medium 9' (1S)	\$196.35	\$173.25	\$143.85	\$133.35	\$124.95	Call
WCK2-M	Custom Medium 9' (2S)	\$330.75	\$285.60	\$248.85	\$237.30	\$216.30	Call
WCK1-L	Custom Large 13' (1S)	\$281.40	\$246.75	\$203.70	\$192.15	\$176.40	Call
WCK2-L	Custom Large 13' (2S)	\$434.70	\$366.45	\$324.45	\$313.95	\$284.55	Call

C

CUSTOM WINDCHASER FLAG ONLY

SKU	FLAG ONLY	QTY 1	2-10	11-25	26-100	101-249	250+
WCFO1-S	Custom Small 7' (1S)	\$148.05	\$108.15	\$94.50	\$91.35	\$85.05	Call
WCFO2-S	Custom Small 7' (2S)	\$245.70	\$205.80	\$179.55	\$175.35	\$157.50	Call
WCFO1-M	Custom Medium 8' (1S)	\$168.00	\$122.85	\$99.75	\$94.50	\$88.20	Call
WCFO2-M	Custom Medium 8' (2S)	\$281.40	\$235.20	\$204.75	\$199.50	\$179.55	Call
WCFO1-L	Custom Large 12' (1S)	\$217.35	\$182.70	\$148.05	\$141.75	\$130.20	Call
WCFO2-L	Custom Large 12' (2S)	\$384.30	\$316.05	\$274.05	\$268.80	\$238.35	Call

Approx. Shipping Weight for Kits: 7.5 ft = 4 lbs ea., 9 ft = 6 lbs ea., 13 ft = 7 lbs ea.

C

Custom print prices are based on customer provided artwork. Creative services available for an additional cost.

FEATHER DANCER FLAGPOLE

Interlocking fiberglass pole, metallic streamer assembly, and a ground stake with ground shield and washer. **All Pole Hardware Is Subject To Availability.**

13' FEATHER DANCER 3 SECTION POLE SHOWN



SKU	SIZE	QTY 1-10	11-20	21+
HW-FD-S	10ft	\$108.15	\$105.00	\$98.70
HW-FD-M	13ft	\$123.90	\$119.70	\$114.45
HW-FD-L	17ft	\$137.55	\$135.45	\$129.15

Approx. Shipping Weight: 10 ft = 3 lbs ea., 13 ft = 3 lbs ea., 17 ft = 4 lbs ea.

C

TAIL FEATHER FLAGPOLE

Wind directional hardware includes a flexible tip and a ground stake with ground shield and washer. **All Pole Hardware Is Subject To Availability.**

15.5' TAIL FEATHER POLE WITH FLEX TIP SHOWN



SKU	SIZE	QTY 1-10	11-20	21+
HW-TF-S	7.5ft	\$93.45	\$87.15	\$82.95
HW-TF-M	9.5ft	\$108.15	\$102.90	\$97.65
HW-TF-L	11.5ft	\$123.90	\$116.55	\$113.40
HW-TF-XL	12.5ft	\$137.55	\$133.35	\$128.10
HW-TF-2XL	15.5ft	\$154.35	\$147.00	\$142.80

Approx. Shipping Weight: 7.5 ft = 4 lbs ea., 9.5 ft = 5 lbs ea., 11.5 ft = 3 lbs ea., 12.5 ft = 5 lbs ea., 15.5 ft = 4 lbs ea

C

KAHUNA FLAGPOLE

Interlocking fiberglass pole and a ground stake with ground shield and washer.

All Pole Hardware Is Subject To Availability.

13' KAHUNA 3 SECTION POLE SHOWN



SKU	SIZE	QTY 1-10	11-20	21+
HW-K-10	10ft	\$108.15	\$105.00	\$98.70
HW-K-13	13ft	\$123.90	\$119.70	\$114.45
HW-K-17	17ft	\$137.55	\$135.45	\$129.15

Approx. Shipping Weight: 10 ft = 3 lbs ea., 13 ft = 3 lbs ea., 17 ft = 4 lbs ea.

C

visit **anchorage**
100 years of big wild life

WINDCHASER FLAGPOLE

Wind directional hardware with a swing arm and a ground stake with ground shield and washer. **All Pole Hardware Is Subject To Availability.**

3 SECTION ALUMINUM POLE WITH SWING ARM SHOWN



SKU	SIZE	QTY 1-10	11-20	21+
HW-WC-S	7.5ft	\$93.45	\$87.15	\$82.95
HW-WC-M	9ft	\$108.15	\$102.90	\$97.65
HW-WC-L	13ft	\$116.55	\$108.15	\$102.90

Approx. Shipping Weight: 7.5 ft = 5 lbs ea., 9 ft = 5 lbs ea., 13 ft = 6 lbs ea.

C

ALUMINUM FLAGPOLES

Poles are lightweight yet rugged and corrosion-resistant.

Style #FP195 2-PIECE

1" x 9' two-piece aluminum flagpole includes fiberglass ground stake and three nylon ties. Intended for use with our smaller decorative flags.

Style #FP140 3-PIECE

1" x 13' three-piece aluminum flagpole includes a fiberglass ground stake, five nylon ties, and is intended for use with 8' high x 3' wide flags.



SKU	ITEM	QTY 1	2-10
#FP195	2-Piece 9ft	\$52.50	\$45.15
#FP140	3-Piece 13ft	\$69.30	\$61.95

A

Approx. Shipping Weights:
FP195 = 4 lbs ea., FP140 = 5 lbs ea.

DECORATIVE KAHUNA

Attractive, decorative Kahuna flags are available in a solid color or in a ribbon or wave style. Flags are Dyed Nylon with a black canvas sleeve. Available in different heights.

Flag kits include: a flag, flagpole and fiberglass ground stake.



See page 13 for custom printed Kahuna Flags

CUSTOMIZE

SIZE - Choose between 3 flag kits and flag only sizes

STYLE - Choose from 3 styles below: Solid, Wave or Ribbon

COLOR - Select your nylon colors from the color chart on pg 21

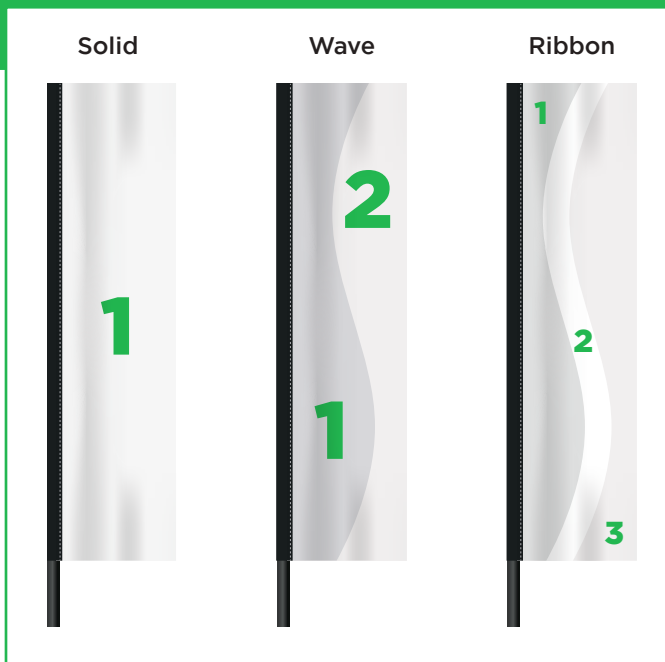

DECORATIVE KAHUNA FLAG KIT					
SKU	KIT SIZE	QTY 1-4	5-10	11+	
DKF-10	10ft	\$179.55	\$165.90	\$163.80	
DKF-13	13ft	\$196.35	\$175.35	\$171.15	
DKF-17	17ft	\$218.40	\$196.35	\$193.20	

C

DECORATIVE KAHUNA FLAG ONLY					
SKU	FLAG ONLY	QTY 1-4	5-10	11+	
DKF-10-FO	8ft	\$153.30	\$139.65	\$137.55	
DKF-13-FO	10ft	\$171.15	\$150.15	\$144.90	
DKF-17-FO	14ft	\$194.25	\$171.15	\$168.00	

C

DECORATIVE FEATHER DANCER

Feather Dancer flags with metallic streamers dance in the slightest breeze. They are available in a solid color, in a diagonal, or ribbon style. Flags are Dyed Nylon with a black canvas sleeve. Available in different heights.

Flag kits include: a flag, flagpole and fiberglass ground stake.



See page 12 for custom printed Feather Dancer Flags

CUSTOMIZE

SIZE - Choose between 3 flag kits and flag only sizes

STYLE - Choose from 3 styles below: Solid, Ribbon, or Diagonal

COLOR - Select your nylon colors from the color chart on pg 21

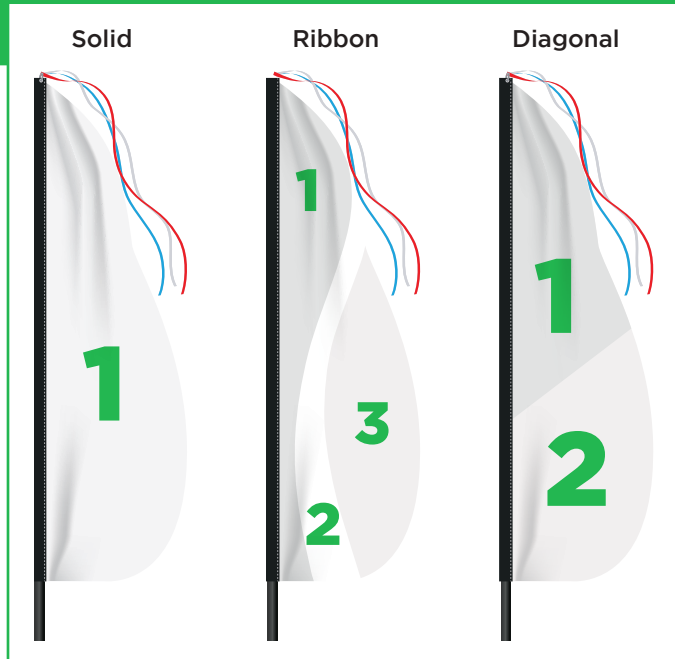

DECORATIVE FEATHER DANCER FLAG KIT

SKU	KIT SIZE	QTY 1-4	5-10	11+
DFD-10	10ft	\$196.35	\$175.35	\$171.15
DFD-13	13ft	\$218.40	\$196.35	\$193.20
DFD-17	17ft	\$239.40	\$218.40	\$216.30

C

DECORATIVE FEATHER DANCER FLAG ONLY

SKU	FLAG ONLY	QTY 1-4	5-10	11+
DFD-10-FO	8ft	\$171.15	\$150.15	\$144.90
DFD-13-FO	10ft	\$194.25	\$171.15	\$168.00
DFD-17-FO	14ft	\$216.30	\$194.25	\$192.15

C

VERTICAL DECORATIVE FLAGS

Vertical decorative flags in solid colors, stripe, wave, diagonal, or ribbon style are an eye-catching visual to attract customers. Flags are Dyed Nylon and finished with a sturdy white canvas header and brass grommets.

Choose your style and nylon color(s).

CUSTOMIZE

SIZE - Choose between 3 flag sizes

STYLE - Choose from 5 styles below:

Solid, Stripe, Wave, Diagonal or Ribbon

COLOR - Select your nylon colors from the color chart on pg 21

SOLID

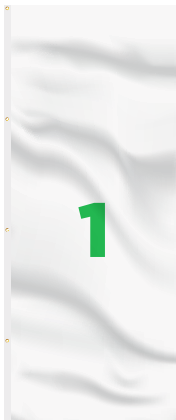

2-STRIPE



3-STRIPE



WAVE



DIAGONAL



RIBBON



SKU	SIZE (FT)	QTY 1-4	5-10	11-23	24+
VDF-53	5' X 3'	\$53.55	\$50.40	\$49.35	\$42.00
VDF-83	8' X 3'	\$79.80	\$75.60	\$73.50	\$64.05
VDF-103	10' X 3'	\$96.60	\$95.55	\$91.35	\$79.80

A

SKU	SIZE (FT)	QTY 1-4	5-10	11-23	24+
VDF-53	5' X 3'	\$55.65	\$54.60	\$53.55	\$53.55
VDF-83	8' X 3'	\$87.15	\$82.95	\$79.80	\$78.75
VDF-103	10' X 3'	\$107.10	\$103.95	\$98.70	\$97.65

A

SKU	SIZE (FT)	QTY 1-4	5-10	11-23	24+
VDF-53	5' X 3'	\$81.90	\$79.80	\$73.50	\$72.45
VDF-83	8' X 3'	\$128.10	\$123.90	\$117.60	\$115.50
VDF-103	10' X 3'	\$157.50	\$154.35	\$147.00	\$144.90

A

HORIZONTAL DECORATIVE FLAGS

Traditional flags fly high in solid colors, stripe, wave, diagonal, or ribbon styles. Flags are Dyed Nylon and finished with a sturdy white canvas header and brass grommets. Many color combinations are available.

CUSTOMIZE

SIZE - Choose your flag size(s)

STYLE - Choose from 5 styles below:
Solid, Stripes, Wave, Diagonal or Ribbon

COLOR - Select your nylon color(s) from the color chart on pg 21

SOLID



SKU	SIZE (FT)	QTY 1-4	5-10	11-23	24+
HDF-23	2' x 3'	\$32.55	\$31.50	\$30.45	\$27.30
HDF-35	3' x 5'	\$50.40	\$49.35	\$48.30	\$46.20
HDF-46	4' x 6'	\$82.95	\$81.90	\$80.85	\$78.75
HDF-58	5' x 8'	\$99.75	\$97.65	\$96.60	\$95.55

A

2-STRIPE

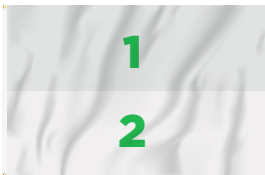

3-STRIPE



SKU	SIZE (FT)	QTY 1-4	5-10	11-23	24+
HDF-35	3' x 5'	\$57.75	\$55.65	\$54.60	\$50.40
HDF-46	4' x 6'	\$97.65	\$95.55	\$90.30	\$89.25
HDF-58	5' x 8'	\$114.45	\$113.40	\$109.20	\$107.10

A



DIAGONAL

WAVE



RIBBON



SKU	SIZE (FT)	QTY 1-4	5-10	11-23	24+
HDF-35	3' x 5'	\$70.35	\$67.20	\$66.15	\$63.00
HDF-46	4' x 6'	\$109.20	\$106.05	\$103.95	\$99.75
HDF-58	5' x 8'	\$182.70	\$175.35	\$171.15	\$163.80

A

NYLON COLOR CHART

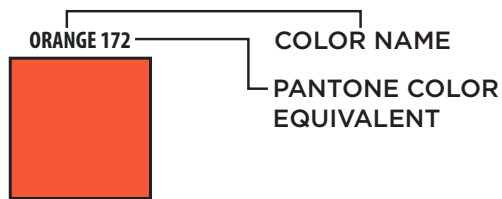

AQUA 338 	BLACK 	BRICK RED 188 	BRIGHT RED 032 	CANADA RED 485 	CHARCOAL 431
CROCUS 211 	DAHLIA 2415 	DARTM GREEN 350 	EMERALD 3425 	FLAME 180 	FLESH 4685
FM YELLOW 108 	FRENCH BLUE 285 	GOLD 146 	GOLD BROWN 470 	GOLDEN POPPY 151 	IRISH GREEN 349
LAVENDER 2587 	LIGHT TAN 728 	LILAC 2655 	MAGENTA 226 	MINT GREEN 347 	NICKEL 423
OG BLUE 2768 	OG RED 187 	ORANGE 172 	PANSY 2627 	PARROT BLUE 321 	PROCESS BLUE 2995
PURPLE 2695 	ROYAL BLUE 286 	RUBY 229 	SALMON 178 	SCARAB GREEN 369 	SILVER 427
SPANISH YELLOW 1235 	SPICE BROWN 1545 	TURQUOISE 3145 	WHITE 	WINEBERRY 222 	

MESSAGE FLAGS

Digitally printed on polyester flag cloth using water-based heat-set dye sublimation and finished with a canvas header and brass grommets. Message and color panels are fully customizable.

3' X 5' HORIZONTAL TRICOLOR

Reads correctly on one side and reverse on opposite side.

SKU	SIZE	QTY 1-10	11-25	26+
35PMF-H	3' x 5'	\$88.20	\$67.20	Call

C



5' X 2.5' VERTICAL TRICOLOR

Reads correctly on one side and reverse on opposite side.

SKU	SIZE	QTY 1-10	11-25	26+
35PMF	5' x 2.5'	\$88.20	\$67.20	Call

C



8' X 3' VERTICAL TRICOLOR

Single-sided reads correctly on one side and reverse on opposite side, double-sided right reading on both sides.

Available finishes include: Standard canvas header and brass grommets, pole banners style with optional top and bottom sleeve*.

SKU	SIZE	QTY 1-10	11-25	26+
38PMF	8' x 3'	\$103.95	\$84.00	Call
38PMF-DS	8' x 3'	\$199.50	\$172.20	Call

*See page 23 for price with top and bottom sleeves.

C

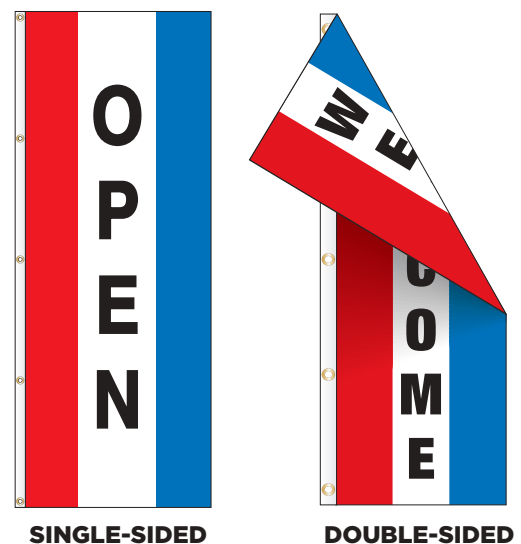

SINGLE-SIDED

DOUBLE-SIDED

10' TRICOLOR FEATHER DANCER KIT

A digitally printed flag finished in a popular shape that flutters with the slightest breeze. Metallic Red, Silver and Blue Streamers are included to provide additional movement in the wind.

Kit Includes: 8' flag, printed right-reading front, reverse-reading back (1S) with a white or black sleeve (please specify preference), streamers, and pole hardware.

Flags are designed for use with OEM hardware only.

SKU	SIZE	QTY 1-10	11-25	26-100	101+
TCMFDK	10ft	\$192.15	\$154.35	\$138.60	Call

Approx. Shipping Weight: 10 ft = 4 lbs ea.

C

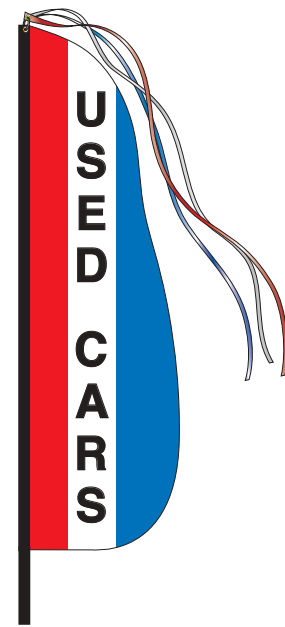

9' TRICOLOR WINDCHASER KIT

Kit Includes: 9' flag, pole hardware, reads correctly on one side and reverse on opposite, finished with canvas sleeves.

Flag Only: 9' flag finished with canvas sleeves.

Flags are designed for use with OEM hardware only.

SKU	SIZE	QTY 1-10	11-25	26+
28WCSET-K	Flag Kit	\$173.25	\$143.85	Call
28WCSET-FO	Flag Only	\$122.85	\$99.75	Call

Approx. Shipping Weight for Flag Kit: = 6 lbs ea.

C

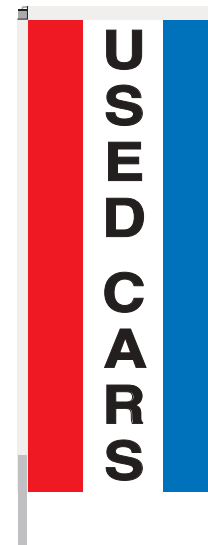

8' X 3' TRICOLOR & RACE STYLE SLEEVED MESSAGE FLAGS

Race Style flags are printed on ultra-rugged polyester fabric and the Tricolor flags are digital printed on flag cloth. Both styles are finished with a canvas header and brass grommets plus a top and bottom sleeve*. Available double-sided (2S).

SKU	SIZE	QTY 1-10	11-25	26+
38PMF-WS	8' x 3'	\$119.70	\$99.75	Call
38PMF-DS-WS	8' x 3'	\$211.05	\$182.70	Call
38R1HDV-WS	8' x 3'	\$79.38	\$78.12	Call
38R1HDV-DS-WS	8' x 3'	\$124.74	\$123.48	Call

*Prices include top and bottom sleeves for a 1" or 2" diameter pole. Please specify sleeve requirement upon order.

C

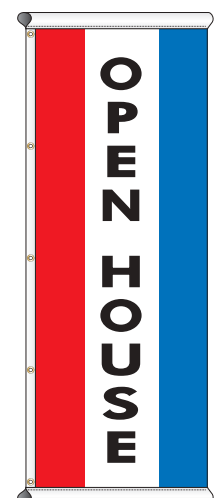
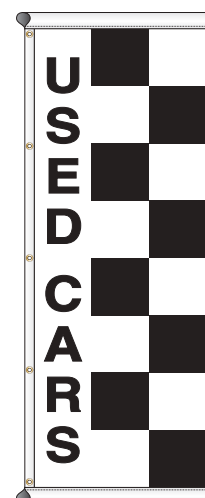
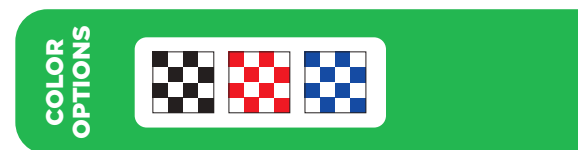

RACE STYLE FLAGS

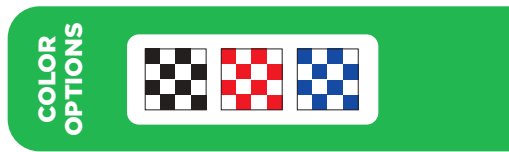

CHECKERED VERTICAL

Penetration printed for two sided display with fade resistant inks on ultra-rugged polyester fabric. Each flag is stitched with a durable canvas header and sturdy brass grommets. Three sizes available in three different colors.

Top and bottom sleeves can be added for an additional \$12.00 (A).

SKU	SIZE	QTY 1-10	11-15	16-24	25+
35R1HDV	5' x 3'	\$38.56	\$37.04	\$36.29	\$50.76
38R1HDV	8' x 3'	\$53.98	\$52.47	\$51.71	\$50.96
310R1HDV	10' x 3'	\$65.63	\$64.87	\$63.36	\$62.60

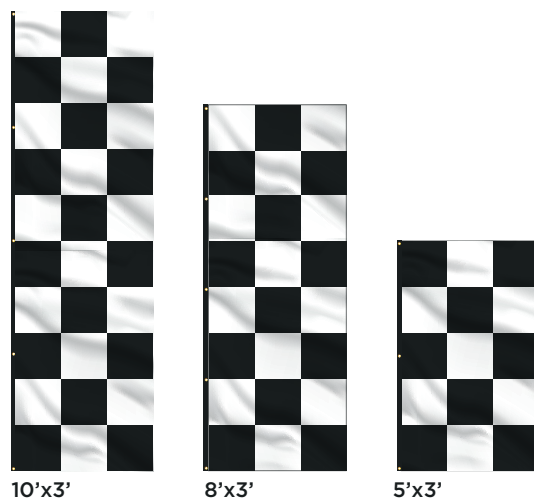

CHECKERED HORIZONTAL

Penetration printed for two sided display with fade-resistant inks on ultra-rugged style polyester fabric. Each flag is stitched with a durable canvas header and sturdy brass grommets. Two sizes available in three different colors

SKU	SIZE	QTY 1-10	11-15	16-24	25+
33RIHD	3' x 3'	\$29.34	\$28.58	\$27.83	\$27.07
35RIHD	3' x 5'	\$35.53	\$34.02	\$33.26	\$32.51

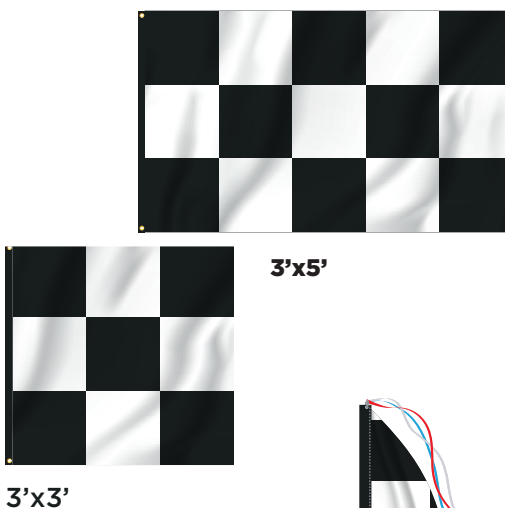

CHECKERED FEATHER DANCER

Penetration printed for double-sided display with fade-resistant inks on ultra-rugged polyester fabric.

Flags are finished with a white or black sleeve (please specify preference), metallic streamers, and pole hardware.

SKU	KIT SIZE	QTY 1-4	5-10	11+
CFD-10	10ft	\$127.16	\$117.74	\$113.02
CFD-13	13ft	\$139.71	\$124.02	\$117.74
CFD-17	17ft	\$155.41	\$139.71	\$133.43

Approx. Shipping Weight: 10 ft = 4 lbs ea., 13 ft = 4 lbs ea., 17 ft = 5 lbs ea.

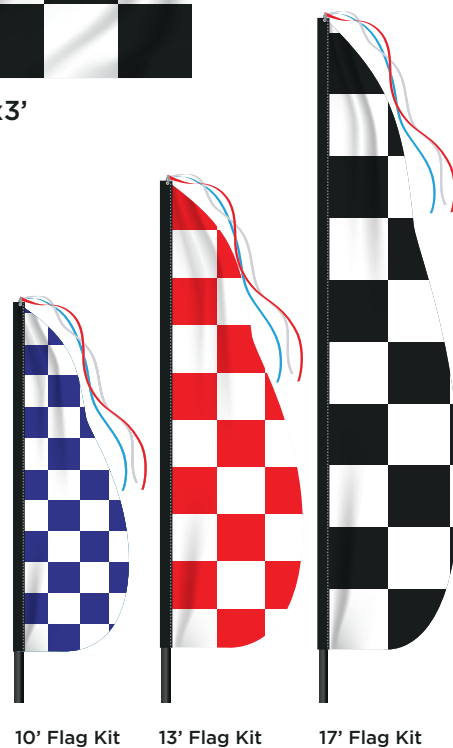

PATRIOTIC FLAGS

UNCLE SAM VERTICAL

All Uncle Sam-style flags are penetration printed for 2-sided display on ultra-rugged Dura-Knit style polyester fabric. Each flag is sewn and finished with a durable canvas header and sturdy brass grommets.

Optional top and bottom sleeves can be added for \$12.00 (A).

SKU	SIZE	QTY 1-10	11-15	16-24	25+
404US3605	5' x 3'	\$37.80	\$35.28	\$32.76	\$30.24
404US3608	8' x 3'	\$55.44	\$49.14	\$48.51	\$44.10
404US3610	10' x 3'	\$60.48	\$59.22	\$57.96	\$55.44
404US3612	12' x 3'	\$70.56	\$64.26	\$61.74	\$59.22

A

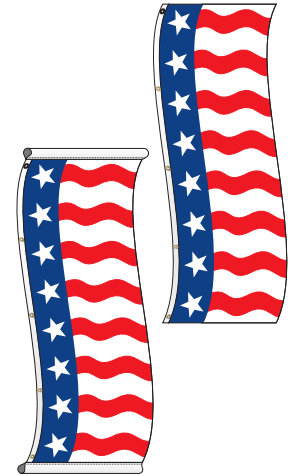

UNCLE SAM CUSTOM VERTICAL MESSAGE

All Uncle Sam style flags are printed right-reading front, reverse-reading back (1S) on Dura-Knit style polyester fabric. Each flag is sewn and finished with a durable canvas header and sturdy brass grommets.

SKU	SIZE	QTY 1-10	11-15	16-24	25+
404US608	8' x 3'	\$74.34	\$73.08	\$69.30	\$68.04
404US610	10' x 3'	\$89.46	\$88.20	\$86.94	\$83.16

A



MESSAGE AND STARS & STRIPES FLAG KITS

Bring high visibility and attention together with a pleasing patriotic design. The Stars & Stripes style is cost-effective and an attractive flag to get you noticed.

US6 Message Flag Kits include either a Kahuna flag or Feather Dancer flag, flagpole hardware, and a fiberglass ground stake.

KAHUNA/FEATHER DANCER STARS & STRIPES KIT

SKU	KIT SIZE	QTY 1-4	5-10	11+
FDKSS-10	10ft	\$147.11	\$139.85	\$136.21
FDKSS-13	13ft	\$161.64	\$154.37	\$143.48
FDKSS-17	17ft	\$179.80	\$172.54	\$161.64

C

KAHUNA/FEATHER DANCER US6 MESSAGE FLAG KIT

SKU	KIT SIZE	QTY 1-4	5-10	11+
FDKM-13	13ft	\$197.96	\$190.70	\$179.80
FDKM-17	17ft	\$216.12	\$208.86	\$197.96

Feather Dancer Kits also include metallic streamers.

C



KAHUNA STARS & STRIPES



FEATHER DANCER STARS & STRIPES



Kahuna US6 Welcome Message Flag Kit

Feather Dancer Stars & Stripes Flag Kit with Metallic Streamers



CUSTOM BANNERS

Vinyl.....	27
Mesh.....	27
Cloth.....	27
Banner Finishing Options	27
Pole Banners	28
Pole Banner Hardware	28

VINYL & MESH BANNERS

Our grand format printers offer seamless banners up to 16 feet using high quality, durable, and fade-resistant inks. Vinyl banners are affordable and versatile signage for property advertising and events. Mesh banners are perfect for very large or high wind applications. Custom banners are made to your size specifications with multiple finishing options available.

WARNING! This product can expose you to chemicals, including Methylpyrrolidone and Benzophenone which are known to the State of California to cause cancer or birth defects or other reproductive harm. For more information, go to www.p65Warnings.ca.gov



CLOTH BANNERS

Display cloth banners are a lightweight alternative to vinyl banners and are ideal for indoor applications. The printed surface cannot be scratched, and you can save on shipping costs due to the lighter weight. Wrinkles can be steamed away (do not iron or apply direct heat). Dry clean only.

SKU	MATERIAL	PRICED PER SQUARE FOOT				
		20-75	76-500	501-1,000	1,001-4,000	4,001+
VBAN	13oz Vinyl	\$4.87	\$3.25	\$2.60	\$1.95	Call
EMBAN	Event Mesh 60/40	\$5.04	\$3.52	\$2.81	\$2.11	Call
MBAN	Premium Mesh	\$5.13	\$4.05	\$3.24	\$2.70	Call
18VBAN	18oz Blockout Vinyl (priced per side)	\$6.77	\$4.52	\$4.07	\$3.61	Call
CBAN	Display Cloth	\$8.64	\$6.58	\$4.94	\$4.11	Call
FBAN	Flag Cloth	\$5.57	\$5.01	\$4.18	\$3.34	Call
PESMBAN	PES Mesh	\$8.93	\$5.95	\$4.47	\$3.57	Call

Vinyl and mesh hems may be stitched or heat seam welded. Please specify if you have a preference.

PROFESSIONAL FINISHING OPTIONS FOR VINYL & MESH BANNERS

CORNER O-RINGS - \$1.00 (c) each

VELCRO - \$1.52 (c) per linear foot

WELDED SEAM - \$1.00 (c) per LF (Required on sizes over 16ft)

WEBBING - \$1.10 (c) per LF (Recommended on large banners)



Custom print prices are based on customer provided artwork. Creative services available for an additional cost.

POLE BANNERS

Highlight your property name, amenities, or special events on light poles with double-sided pole banners. We offer time tested hardware that's available in several standard widths. Have existing hardware? We'll size your banners to fit!

WARNING! This product can expose you to chemicals, including Methylpyrrolidone and Benzophenone which are known to the State of California to cause cancer or birth defects or other reproductive harm. For more information, go to www.p65Warnings.ca.gov



POCKET SIZING

When specifying the required pocket size for pole banners, please base it off the size of the pole used for the crossbars. The size should be the outside diameter of the crossbar. Square crossbars will always require a larger sleeve than round crossbars. Please be sure to specify size and round or square crossbar.

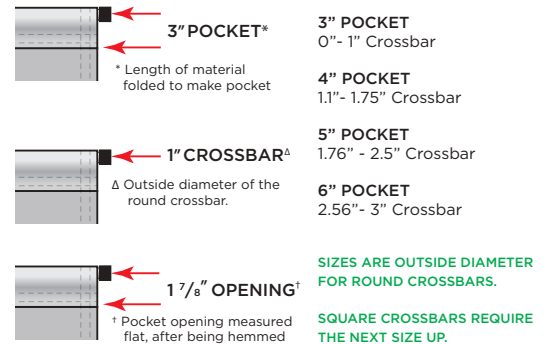

PRICED PER SQUARE FOOT

SKU	MATERIAL	20-75	76-500	501-1,000	1,001-4,000	4,001+
18VBAN	18oz Blockout Vinyl (per side)	\$6.77	\$4.52	\$4.07	\$3.61	Call

Prices are based on double-sided printing on standard widths of 18", 24", 30", and 36" with 3" pockets and trimmed side edges and customer provided art. In isolated instances, prices may be subject to yield. Creative services available for an additional cost.

POLE BANNER HARDWARE

One pole banner requires a single pole banner bracket kit which includes 2 horizontal poles (crossbars), 2 brackets, and 4 bands. A double pole banner (one on each side of a light pole) requires a double pole banner bracket kit which includes 4 horizontal poles (crossbars), 4 brackets, and 4 bands.

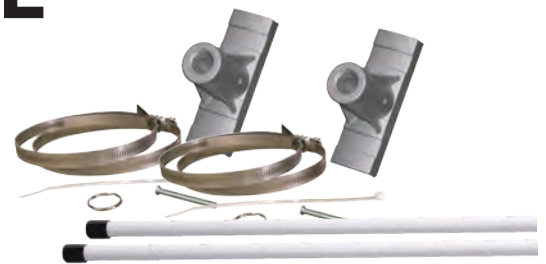

SKU	SIZE	1-11	12+
SPBK-18	18" Crossbar	\$92.40	\$90.30
SPBK-24	24" Crossbar	\$96.60	\$93.45
SPBK-30	30" Crossbar	\$101.85	\$99.75
SPBK-36	36" Crossbar	\$106.05	\$103.95

SKU	SIZE	1-11	12+
DPBK-18	18" Crossbar	\$181.65	\$168.00
DPBK-24	24" Crossbar	\$187.95	\$175.35
DPBK-30	30" Crossbar	\$196.35	\$181.65
DPBK-36	36" Crossbar	\$207.90	\$193.20

Custom print prices are based on customer provided artwork. Creative services available for an additional cost.

DISPLAY PRODUCTS

Softline A-Frame	30
Inteliframe	31
Adjustable Backdrop	32
Pop-Up Fabric Wall System	33
Retractable Displays	34
EZX Display Stand	34
Tablecloths	36
Fitted Table Covers	36
Table Runner	37
Table Throw	37
Smart Frame System	38

SOFTLINE PADDED A-FRAMES™

Softline A-Frames™, our signature padded a-frames, keep your athletes safe while showcasing your sponsors or team branding right next to the action. These padded a-frames are great for courtside or field side placement and are available in 3' x 4' or 3' x 8' size. They are easy to move and they fold up flat for easy storage.

Softline A-Frames™ feature vinyl banners with a quick-change Velcro® system which allows for easy and affordable season or game-to-game graphic changes. The ability to swap out graphics can be useful when sponsors change their artwork midseason or when hosting special events with unique sponsors.

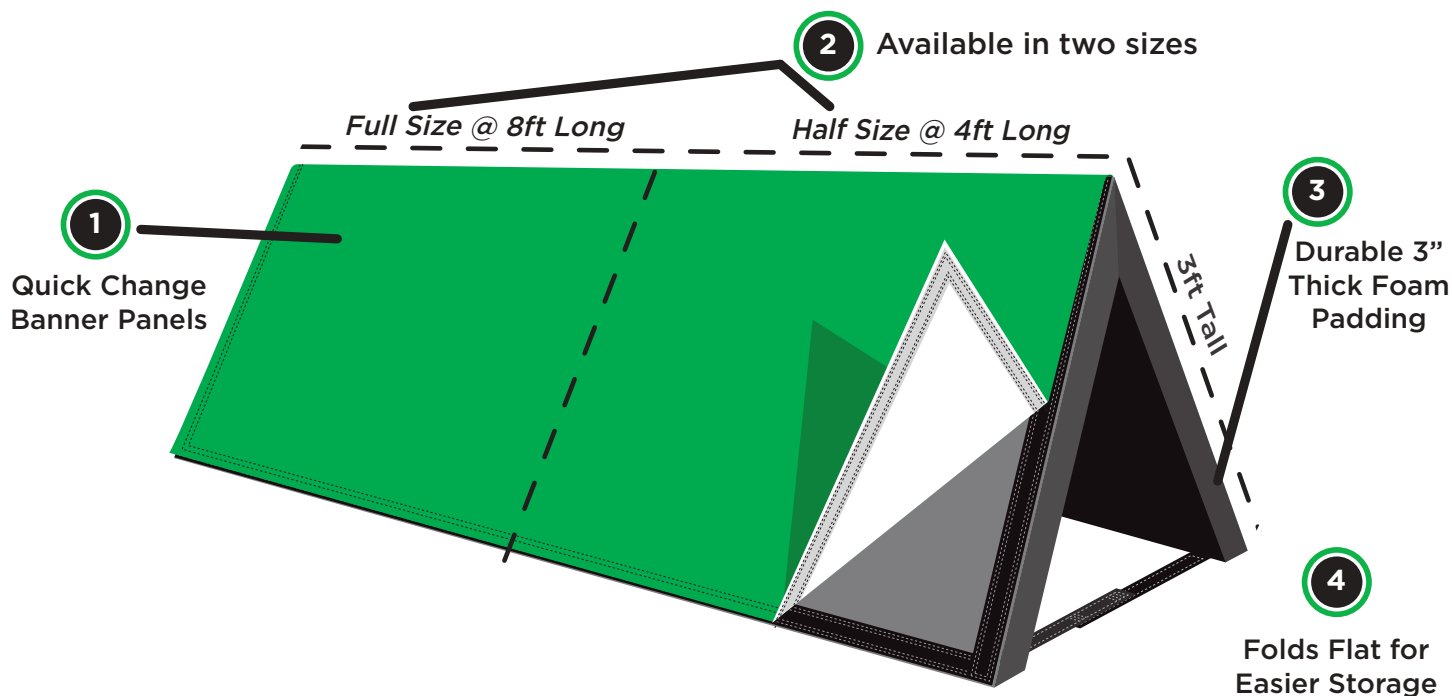

Custom print prices are based on customer provided artwork. Creative services available for an additional cost.

INTELIFRAME BACKDROP

A durable and portable solution that utilizes a display cloth slipcover for a self-standing, wrinkle free banner display. The Inteliframe kit includes a frame with powder-coated steel base, custom printed display cloth, and carry bag.

Available in three sizes below.

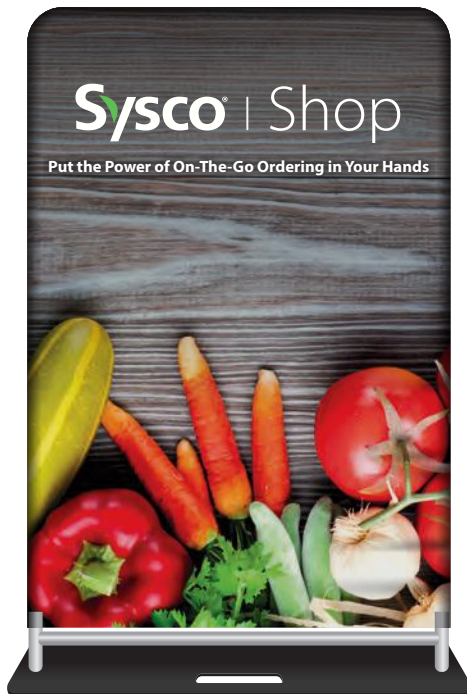

90" x 60" wide



90" x 48" wide



90" x 36" wide

WRINKLE FREE FABRIC

CARRYING CASE

The Inteliframe breaks down to fit into a convenient carry bag.



INTELIFRAME KIT

SKU	BACKDROP KIT SIZE	QTY 1-10	11-24	25+
INTEL-36-1S	90x36 1S	\$428	\$373	Call
INTEL-36-2S	90x36 2S	\$494	\$425	Call
INTEL-48-1S	90x48 1S	\$523	\$475	Call
INTEL-48-2S	90x48 2S	\$603	\$543	Call
INTEL-60-1S	90x60 1S	\$645	\$584	Call
INTEL-60-2S	90x60 2S	\$746	\$670	Call

C

INTELIFRAME FABRIC ONLY

SKU	BACKDROP FABRIC ONLY	QTY 1-10	11-24	25+
INTEL-36-1S-GO	90x36 1S	\$368	\$331	Call
INTEL-36-2S-GO	90x36 2S	\$462	\$383	Call
INTEL-48-1S-GO	90x48 1S	\$446	\$404	Call
INTEL-48-2S-GO	90x48 2S	\$509	\$457	Call
INTEL-60-1S-GO	90x60 1S	\$525	\$473	Call
INTEL-60-2S-GO	90x60 2S	\$630	\$567	Call

Approx. Shipping Weight: 90"x36" = 17 lbs ea., 90" x 48" = 22 lbs ea., 90" x 60" = 26 lbs ea.

C

Custom print prices are based on customer provided artwork. Creative services available for an additional cost.

ADJUSTABLE BACKDROP

A freestanding display cloth banner stand featuring telescoping metal poles that allow for the same frame to be used with backdrops of varying sizes. The poles adjust from 48" to 96" high and 48" to 96" wide. The pricing below includes custom printed display cloth banner, display stand, and carry case. Please contact us for a quote on other display cloth banner sizes.



DETAIL ZOOM

A close up view of how the fabric stays taugth on this frame. There are eight of these attachment points.



CARRYING CASE

Convenient case included with your purchase.

SKU	PRODUCT	QTY 1-10	11-24	25+
ADJBD-96	96" x 96" Adjustable Kit	\$642	\$567	Call
ADJBD-96-GO	Backdrop Fabric Only	\$473	\$416	Call

Approx. Shipping Weight: 13 lbs ea.

C

Custom print prices are based on customer provided artwork. Creative services available for an additional cost.

POP-UP FABRIC WALL SYSTEM

Custom printed display cloth on a sturdy, Pop-up Wall Frame with or without wrapped sides.

This display is easy to set up and offers a generous area to display your product or message. The cross-braced frame design employs interlocking tubing that maintains maximum tension on the graphic panel. Great for trade shows, in-store displays, and small stage backdrops. Entire display fits into a case which comes with your display.



POP-UP FABRIC WALL SYSTEM: FULL WRAP

SKU	PRODUCT	QTY 1-10	11-24	25+
POPUP-FW-90	90" x 90" Wide Kit	\$655	\$593	Call
POPUP-FW-118	90" x 118" Wide Kit	\$919	\$843	Call
POPUP-FW-90-GO	90" x 90" Wide Fabric Only	\$441	\$397	Call
POPUP-FW-118-GO	90" x 118" Wide Fabric Only	\$606	\$546	Call

Approx. Shipping Weight: 25lbs

C

POP-UP FABRIC WALL SYSTEM: NO-WRAP

SKU	PRODUCT	QTY 1-10	11-24	25+
POPUP-90	90" x 90" Wide Kit	\$574	\$526	Call
POPUP-118	90" x 118" Wide Kit	\$839	\$776	Call
POPUP-90-GO	90" x 90" Wide Fabric Only	\$386	\$347	Call
POPUP-118-GO	90" x 118" Wide Fabric Only	\$524	\$469	Call

Approx. Shipping Weight: 23lbs

C

Custom print prices are based on customer provided artwork. Creative services available for an additional cost.

RETRACTABLE DISPLAYS

Perfect for trade shows, point-of sale displays, presentations, theaters, museums, schools, and special events.

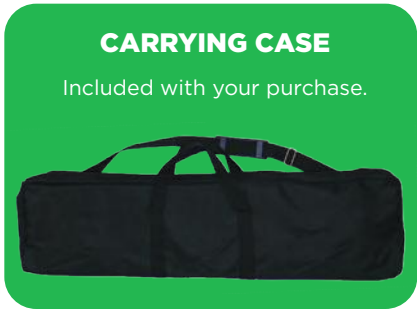
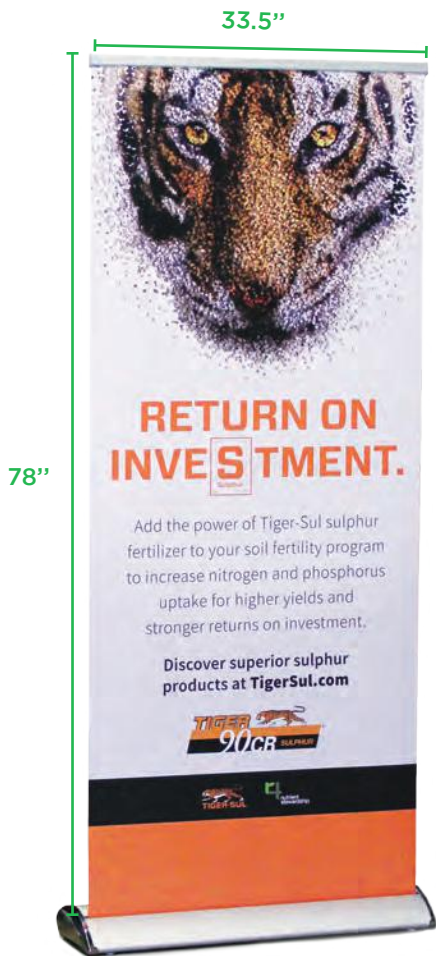

PREMIUM DISPLAY – Pictured above is the Premium retractable display with stylish design and proven reliability. Single-sided and specially designed for maximum convenience and ease of use.

ECONOMY DISPLAY – Pictured above is a good quality, easy to use retractable banner stand that is offered at an affordable price. Finished in anodized silver with heavy duty molded end plates and swivel out feet. Graphics printed on No Curl PET Display Face.

SKU	PRODUCT	QTY 1	2-10	11-25	26-100	101-249	250+
33578DISPLAYDLX	Premium Display	\$302	\$278	\$252	\$228	\$216	Call
33578DISPLAY	Economy Display	\$217	\$195	\$174	\$151	\$141	Call

Approx. Shipping Weight: Premium Display = 11 lbs ea.
Approx. Shipping Weight: Economy Display = 10 lbs ea.

C

Custom print prices are based on customer provided artwork. Creative services available for an additional cost.

EZX DISPLAY STAND

This is a portable featherweight stand that assembles easily. Variable adjustment allows you to use this display frame as small as 55" x 23" wide. The display face is printed on HD No Curl PET and it all comes with a convenient carrying case.



CARRYING CASE
 Convenient case included with your purchase.

EZX DISPLAY STAND WITH CUSTOM PRINTED 72"X32" HD NO CURL PANEL

SKU	PRODUCT	QTY 1	2-10	11-25	26-100	101-249	250+
EZX	EZX Display with Print	\$155	\$137	\$127	\$108	\$99	Call

Approx. Shipping Weight: 8 lbs ea.

C

Custom print prices are based on customer provided artwork. Creative services available for an additional cost.

Prices are subject to change

TABLECLOTHS

Custom Tablecloths are digitally dyed in full color on white display cloth. Tablecloths are available in standard 6' and 8' lengths. They are intended for use with standard 30" high trade show folding tables.

Steam away wrinkles & dry clean only.



PREMIUM



ECONOMY FRONT



ECONOMY BACK

SKU	PRODUCT	QTY 1	2-10	11-25	26-100	101-249	250+
TABL-P-72	Premium Tablecloth 6ft	\$324	\$292	\$227	\$194	\$163	Call
TABL-P-96	Premium Tablecloth 8ft	\$384	\$347	\$269	\$231	\$192	Call
TABL-ECO-72	Economy Tablecloth 6ft	\$224	\$201	\$156	\$134	\$112	Call
TABL-ECO-96	Economy Tablecloth 8ft	\$255	\$230	\$179	\$153	\$128	Call

Approx. Shipping Weight: 6' = 3 lbs ea., 8' = 4 lbs ea.

C

FITTED TABLE COVER

Available in standard 6' and 8' sizes, fitted table covers are designed to fit snugly around standard 30" high trade show folding tables.



SKU	PRODUCT	QTY 1	2-10	11-25	26-100	101-249	250+
TABL-F-72	6ft Tablecover	\$324	\$292	\$227	\$194	\$163	Call
TABL-F-96	8ft Tablecover	\$384	\$347	\$269	\$231	\$192	Call

Approx. Shipping Weight: 6' = 3 lbs ea., 8' = 4 lbs ea.

C

Custom print prices are based on customer provided artwork. Creative services available for an additional cost.

CUSTOM TABLE COVERS

Custom Table Throws and Table Runners are digitally printed in full color on white Deluxe Display Cloth. Table Throws are available in standard 6' and 8' table lengths. Table Runners are 30" wide and can be used with any length table. The Table Throw and the Table Runner are economical alternatives to our traditional Full Coverage Tablecloth and either one can be a great looking addition to a standard solid color trade show tablecloth. Steam away wrinkles.

Dry Clean Only.

TABLE RUNNER

Available sizes: 72" X 30"

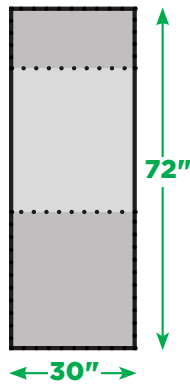
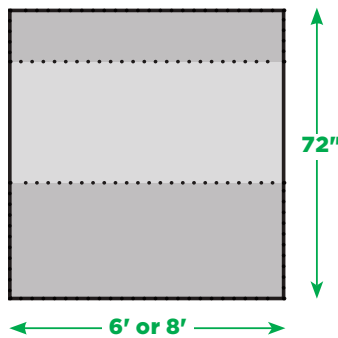

Table Runner Shown On A Black Tablecloth

TABLE THROW

Available sizes: 72" X 6' and 72" X 8'



SKU	PRODUCT	QTY 1	2-10	11-25	26-100	101-249	250+
TABL-RUN	Table Runner OS	\$123	\$92	\$75	\$62	\$56	Call
TABL-TH-72	6ft Table Throw	\$162	\$132	\$103	\$88	\$74	Call
TABL-TH-96	8ft Table Throw	\$214	\$175	\$137	\$118	\$98	Call

Approx. Shipping Weight: Table Runner = 2 lbs ea., 6' = 2 lbs ea., 8' = 3 lbs ea.

C

Custom print prices are based on customer provided artwork. Creative services available for an additional cost.

Prices are subject to change

SMART FRAME SYSTEM

Easy to assemble and made from corrosion-resistant aluminum tubing, this tensional system secures your banner and reduces wind load. Frame secures to the ground with fiberglass ground stakes. For viewing on two sides, install a 2-sided banner on the 6' frame or install two single-sided banners on the 10' or 14' frame.

WARNING! This product can expose you to chemicals, including Methylpyrrolidone and Benzophenone which are known to the State of California to cause cancer or birth defects or other reproductive harm. For more information, go to www.p65Warnings.ca.gov

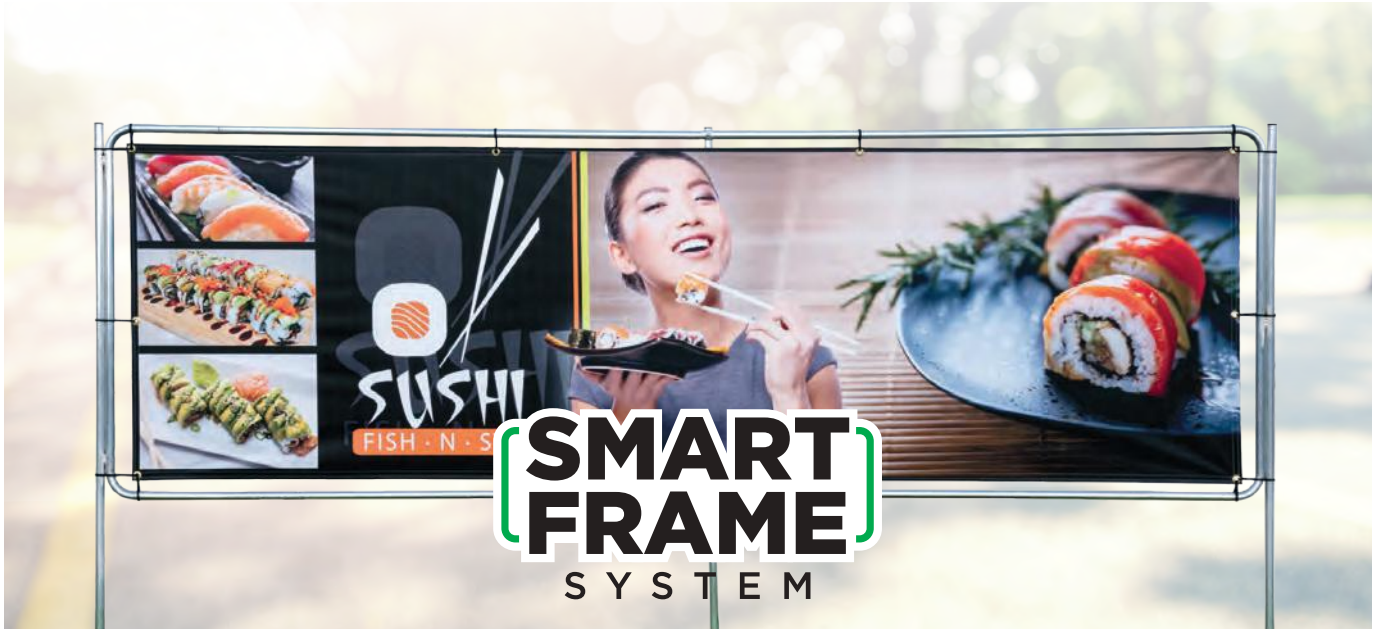

SIZE OPTIONS

3' X 14'



3' X 10'



3' X 6'



SKU	PRODUCT	QTY 1	2-10	11-25
SMTF-36	3' x 6' Smart Frame Only	\$181.65	\$175.35	\$166.95
SMTK1-36	3' x 6' with Banner (1S)	\$241.50	\$235.20	\$197.40
SMTK2-36	3' x 6' with Banner (2S)	\$402.15	\$355.95	\$275.10
SMTF-310	3' x 10' Smart Frame Only	\$250.95	\$245.70	\$232.05
SMTK1-310	3' x 10' with Banner (1S)	\$355.95	\$318.15	\$269.85
SMTF-314	3' x 14' Smart Frame Only	\$304.50	\$301.35	\$290.85
SMTK-314	3' x 14' with Banner (1S)	\$409.50	\$383.25	\$347.55

Approx. Shipping Weight for Smart Frame and one banner: 6 ft = 12 lbs ea., 10 ft = 17 lbs ea., 14 ft = 21 lbs ea.
Approx. Shipping Weight for Smart Frame Only: 6 ft = 11 lbs ea., 10 ft = 16 lbs ea., 14 ft = 19 lbs ea.

C

Custom print prices are based on customer provided artwork. Creative services available for an additional cost.



Little League

CUSTOM SIGNS

REGISTER ONLINE
APRIL 1-15

littleleagueocala.com

4mm Coroplast	40
10mm Coroplast	40
3mm Max Metal	41
.040 Styrene	41
Sidewalk A-Frame	42
Custom Vinyl Decals	42
Post Covers	43
Yard Signs	43
Auto Plate Inserts.....	44
Under Hood Signs.....	44

FULL COLOR PRINTS

Available in: 4' x 4' and 4' x 8' sheets. Single-Sided (1S) or Double-Sided (2S)

LAMINATE FINISHES

4' x 4' boards: Add \$13.25 (C) per printed side

4' x 8' boards: Add \$26.50 (C) per printed side

4MM COROPLAST

Lightweight and durable corrugated plastic signs are ideal for property management, political signs, event signage, and real estate signs.

4'X4' OF 4MM COROPLAST

SKU	QTY	SINGLE-SIDED	DOUBLE-SIDED
4MCORO44	1-10	\$127.05	\$177.45
4MCORO44	11-25	\$93.45	\$150.15
4MCORO44	26-49	\$82.95	\$139.65
4MCORO44	50+	\$78.75	\$134.40

C

4'X8' OF 4MM COROPLAST

SKU	QTY	SINGLE-SIDED	DOUBLE-SIDED
4MCORO48	1-10	\$177.45	\$280.35
4MCORO48	11-25	\$155.40	\$268.80
4MCORO48	26-49	\$143.85	\$260.40
4MCORO48	50+	\$136.50	\$256.20

C



SAMPLE OF 4MM COROPLAST THICKNESS

10MM COROPLAST

Lightweight and durable corrugated plastic signs are ideal for property management, political signs, event signage, and real estate signs.

4'X4' OF 10MM COROPLAST

SKU	QTY	SINGLE-SIDED	DOUBLE-SIDED
10MCORO44	1-10	\$147.00	\$199.50
10MCORO44	11-25	\$133.35	\$178.50
10MCORO44	26-49	\$119.70	\$173.25
10MCORO44	50+	\$116.55	\$169.05

C

4'X8' OF 10MM COROPLAST

SKU	QTY	SINGLE-SIDED	DOUBLE-SIDED
10MCORO48	1-10	\$240.45	\$332.85
10MCORO48	11-25	\$216.30	\$320.25
10MCORO48	26-49	\$207.90	\$307.65
10MCORO48	50+	\$199.50	\$301.35

C



SAMPLE OF 10MM COROPLAST THICKNESS

Custom print prices are based on customer provided artwork. Creative services available for an additional cost.

3MM MAX METAL PRINTS

Max metal is a solid PVC plastic core faced with thin white aluminum sheets on both sides and is suitable for long-term outdoor use.

4'X4' OF 3MM MAX METAL

SKU	QTY	SINGLE-SIDED	DOUBLE-SIDED
3MMAX44	1-10	\$287.70	\$340.20
3MMAX44	11-25	\$255.15	\$309.75
3MMAX44	26-49	\$242.55	\$304.50
3MMAX44	50+	\$239.40	\$296.10

c

4'X8' OF 3MM MAX METAL

SKU	QTY	SINGLE-SIDED	DOUBLE-SIDED
3MMAX48	1-10	\$452.55	\$570.15
3MMAX48	11-25	\$426.30	\$540.75
3MMAX48	26-49	\$414.75	\$531.30
3MMAX48	50+	\$409.50	\$526.05

c

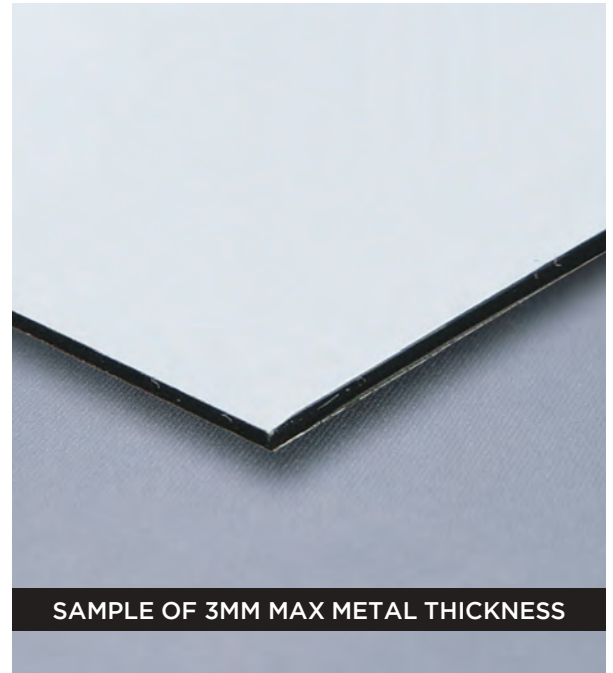

.040 STYRENE PRINTS

Styrene is a thin, high impact plastic material that is flexible but sturdy.

4'X4' OF .040 STYRENE

SKU	QTY	SINGLE-SIDED	DOUBLE-SIDED
STYRENE44	1-10	\$128.10	\$179.55
STYRENE44	11-25	\$94.50	\$152.25
STYRENE44	26-49	\$82.95	\$141.75
STYRENE44	50+	\$78.75	\$136.50

c

4'X8' OF .040 STYRENE

SKU	QTY	SINGLE-SIDED	DOUBLE-SIDED
STYRENE48	1-10	\$179.55	\$284.55
STYRENE48	11-25	\$156.45	\$271.95
STYRENE48	26-49	\$145.95	\$264.60
STYRENE48	50+	\$138.60	\$257.25

c

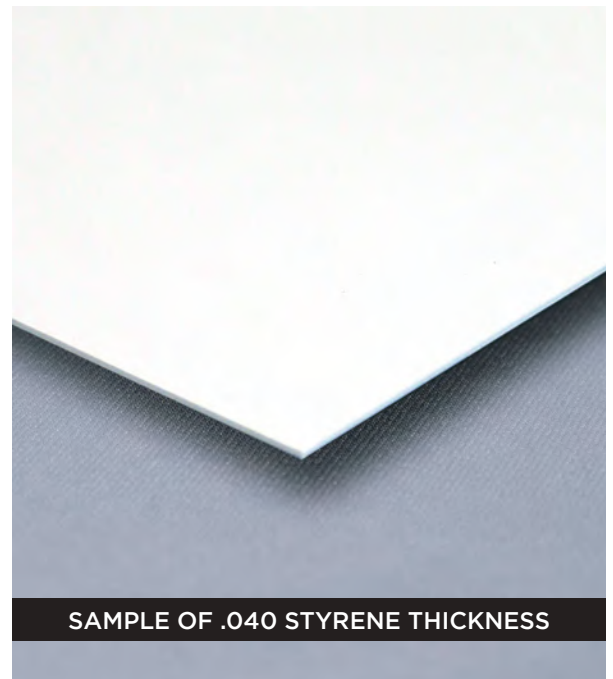

Custom print prices are based on customer provided artwork. Creative services available for an additional cost.

SIDEWALK A-FRAME

Heavy duty white sidewalk A-Frame comes with two custom printed 28" x 22" wide sign faces for bi-directional viewing. Metal crossbar prevents collapse. Folds flat for storage.

Kit pricing includes sign frame and a pair of 4mm coroplast inserts. You can have 2 different designs one per side or the same design for both sides.

SKU	PRODUCT	QTY 1-25	26+
AFRAME-K	A-Frame with Printed Insert	\$267.75	\$236.25
AFRAME-P	Printed Inserts (Set of 2)	\$66.15	\$53.55
AFRAME-H	Frame Only	\$201.60	\$182.70

Approx. Shipping Weight for a Custom Kit = 15 lbs ea.

C



EASY INSTALL

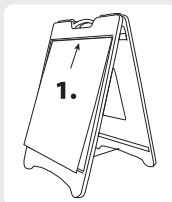

1. Insert the display face into the top slot.

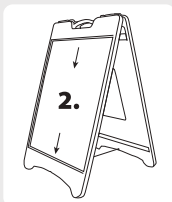

2. Seat the bottom of the display face into the lower slot..

CUSTOM DECALS

Elevate any room with our Custom Decals, brilliantly printed using cutting-edge printing technology with premium 3M material. Perfect for both professional settings and personal spaces, they add a touch of elegance and creativity wherever applied. With limitless possibilities in size, shape, and color, our Custom Decals adapt to your unique needs, whether for business branding or home decor, making every surface tell a story with flair.

Additional sizes, custom shapes, and applications for other uses are available. Contact for more details.

SKU	DECAL SIZE	QTY 1	2-10	11-25	26+
CD-1218	12" x 18"	\$23.63	\$23.10	\$22.31	Call
CD-1224	12" x 24"	\$31.50	\$30.98	\$29.93	Call
CD-1620	16" x 20"	\$34.91	\$33.86	\$32.81	Call
CD-1824	18" x 24"	\$47.25	\$46.20	\$44.63	Call
CD-2424	24" x 24"	\$63.00	\$61.69	\$59.59	Call

C



Custom print prices are based on customer provided artwork. Creative services available for an additional cost.

POST COVERS

Add extra opportunities for promotion and advertising in parking lots, storefronts, building reception areas and more with these custom parking post covers. Made of 4mm Coroplast material, these 46" x 12" sleeves have a rectangular design that slips easily over most standard poles and fixtures and attaches with double faced tape to keep it secure. Add your company logo or message to customize.

Lamination available at an extra cost.

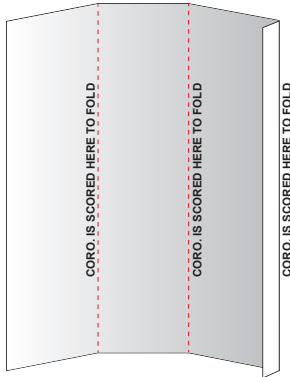
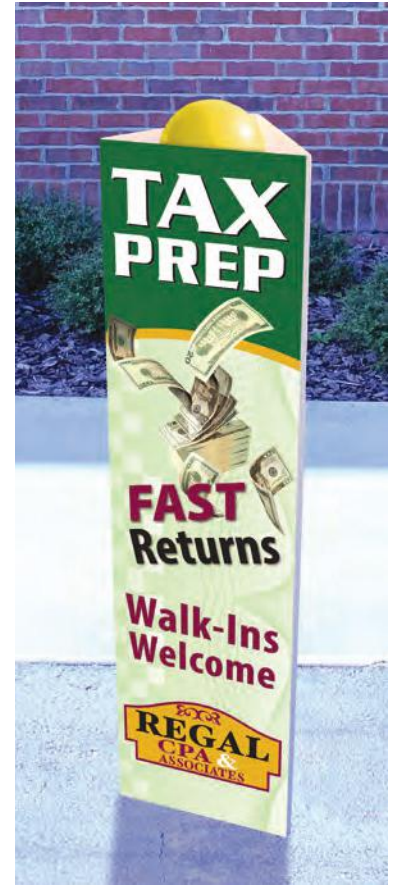

Illustration above shows the "inside" of the coroplast post cover.



SKU	PRODUCT	QTY 25-49	50-100	101-249	250+
POST	Post Cover (OS)	\$48.30	\$46.20	\$39.90	\$36.75

Approx. Shipping Weight: 1 lbs ea.

C

YARD SIGNS

Yard Signs are digitally printed right-reading on both sides. These signs on galvanized H-Stands make them highly visible for roadside advertising. Plus they are quick to put up and take down while remaining very economical

Galvanized H-Stands sold separately.

SKU	PRODUCT	QTY 10-20	21-75	76-150	151-499+	500+
YS-1S-1218	12" x 18" (1S)	\$10.26	\$6.67	\$6.42	\$5.13	\$4.26
YS-2S-1218	12" x 18" (2S)	\$12.80	\$9.31	\$6.98	\$5.81	\$5.23
YS-1S-1824	18" x 24" (1S)	\$18.66	\$12.13	\$11.66	\$9.33	\$7.74
YS-2S-1824	18" x 24" (2S)	\$23.25	\$16.91	\$12.68	\$10.57	\$9.51

Approx Shipping Weight for 10 Signs = 6 lbs ea

C

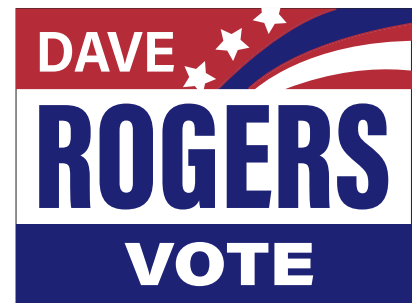

SINGLE-SIDED

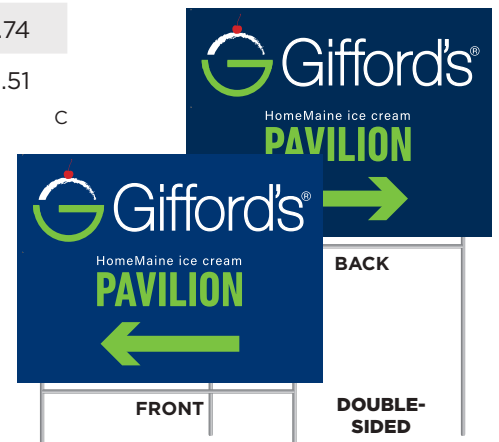

FRONT

BACK

DOUBLE-SIDED

GALVANIZED H-STANDS

SKU	PRODUCT	QTY 1-100	101-299	300+
BANHSTAKES	H-Stand	\$4.37	\$3.06	\$2.36

Approx. Shipping Weight for 10 Stands = 5 lbs

C

Custom print prices are based on customer provided artwork. Creative services available for an additional cost.

Prices are subject to change

AUTO PLATE INSERTS

Create a high octane promotion for events and activities pertaining to automobiles with these license plate inserts. Made of .20 or .040 styrene, these 6" x 11.9" accessories have four oval holes for easy mounting.

These plates are digitally printed for clarity and detail, then liquid laminated for durability and abrasion resistance.



SKU	MATERIAL THICKNESS	QTY 125	250	500	1000	1500	2500+
AUTOP020	.020 Styrene	\$2.80	\$2.40	\$1.73	\$1.46	\$1.33	\$1.26
AUTOP040	.040 Styrene	\$3.63	\$2.79	\$2.51	\$2.37	\$2.30	\$2.23

Approx. Shipping Weight: .020 and .040 = 0.1 lbs ea.

C

UNDER HOOD SIGNS

Transform a new or used car into an impactful promotional display with these under hood hanging signs and displays.

Made of 5mm Coroplast material, printed with a single sided design in UV and fade resistant inks, these signs fit beneath most styles of car hoods.

A great idea for a car lot, car wash or detailing, towing, repair and other auto-friendly events. Available in assorted colors and designs. Add your company logo or message to customize.

42" high x 30" wide.

SKU	PRODUCT	QTY 1	2-10	11-25
UHOOD	42" x 30" Print (1S)	\$63.00	\$56.70	\$39.90

Approx. Shipping Weight: 1 lbs ea.

C



Custom print prices are based on customer provided artwork. Creative services available for an additional cost.

PENNANTS, FLAG LINES, STREAMERS & BUNTING

Custom Pennant Strings.....	46
Economy Pennants.....	47
Deluxe Pennants.....	48
Metallic Pennant Strings	49
Metallic Fingers	50
Metallic Streamers	50
Mardi Gras	50
Race Style Strings	51-52
Patriotic Flag Lines & Strings	53
Patriotic Streamers & Poly Bunting	54
Fan Bunting	55

CUSTOM PENNANT STRINGS

Promote your product or organization around town with full color custom printed pennant strings that are affordable as well as festive. Printed on 8 mil opaque poly, pennants are double sided, and double sewn on a heavy-duty plastic covered header. Rectangular, triangular, and special shapes are available upon request.

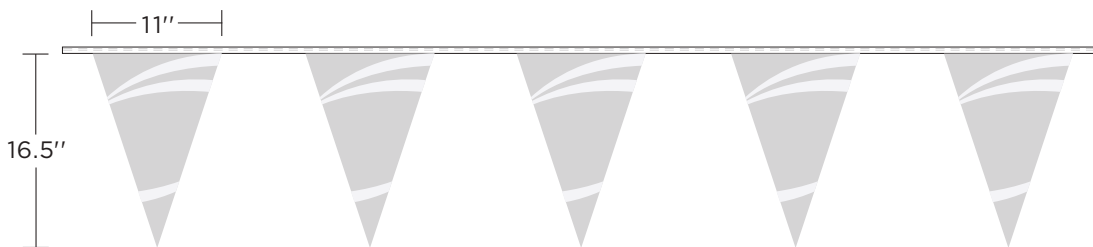

SKU	SIZE/QTY OF PENNANTS	QTY 5-9	10-24	25-40	41-62	63-99	100+
1611-CVPS-30	30ft (12 Pennants)	\$98.70	\$67.20	\$56.70	\$52.50	\$46.20	Call
1611-CVPS-60	60ft (24 Pennants)	\$107.10	\$105.00	\$100.80	\$94.50	\$79.80	Call

Approx. Shipping Weight: 1 lbs ea.

C

Custom print prices are based on customer provided artwork. Creative services available for an additional cost.

ECONOMY PENNANT STRINGS

12" x 9" 2.4 MIL SUPER-ECONOMY

Red, White and Blue or Multi-Color styles - 25 per case.

SKU	QTY	100FT (90' LIVE) - 60 PENNANTS
0912SE	Case (25)	\$276.15

Approx. Ship Weight: 60 ft = .65 lbs ea., 105 ft = 1.15 lbs ea., 120 ft = 1.3 lbs ea.

A



18" x 12" 4 MIL POLY

Red, White and Blue or Multi-Color styles - 25 per case.

SKU	QTY	105FT (95' LIVE) - 48 PENNANTS
1218S	Case (25)	\$408.45

Approx Ship Weight: 60 ft = .7 lbs ea., 105 ft = 1.25 lbs ea., 120 ft = 1.4 lbs ea.

A



ECONOMY 4 MIL POLY

Three different sizes available: 18"x12", 12"x9", 18"x6"

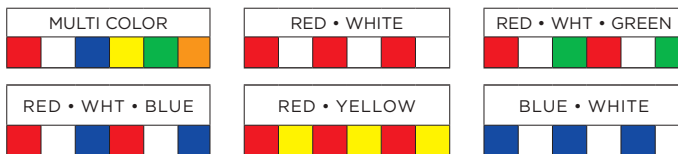

! NOTE: Other color combinations available upon request.



SKU	STRING LENGTH	QTY 5-20	21-50	51-100	101-249	250+
4-EPS30	30ft	\$9.20	\$8.88	\$7.91	\$7.59	Call
4-EPS60	60ft	\$16.62	\$14.85	\$13.88	\$13.40	Call
4-EPS105	105ft	\$25.82	\$22.27	\$19.05	\$18.40	Call
4-EPS120	120ft	\$29.54	\$27.60	\$24.53	\$24.05	Call

Approx. Shipping Weight: 60 ft = .7 lbs ea., 105 ft = 1.25 lbs ea., 120 ft = 1.4 lbs ea.

A

DELUXE 6 MIL PENNANT STRINGS

All weather resistant deluxe polyethylene pennants are double sewn on a plastic covered high strength, sag-resistant header. Many color combinations available.

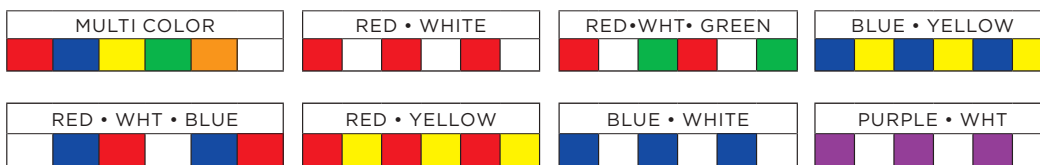

NOTE: Other color combinations available upon request. Solid purple is subject to a 10% surcharge for the 6mil deluxe pennants

SKU	STRING LENGTH	QTY 5-20	21-50	51-100	101-250	251+
6-DPS30	30ft	\$13.30	\$11.47	\$11.14	\$10.64	Call
6-DPS60	60ft	\$22.94	\$18.95	\$17.46	\$17.12	Call
6-DPS105	105ft	\$28.43	\$26.60	\$24.44	\$22.78	Call

Approx. Shipping Weight
 18 x 12: 60 ft = 1 lb ea., 105 ft = 1.9 lbs ea.;
 12 x 9: 60 ft = 1 lb ea., 105 ft = 1.9 lbs ea.;
 18 x 6: 60 ft = 60 ft = 1 lb ea., 105 ft = 1.9 lbs ea.

A

METALLIC PENNANT STRINGS

18" x 12" PENNANTS

V-shaped pennants are all weather resistant and double sewn on a plastic covered high strength, sag-resistant header.



SKU	LENGTH/QTY OF PENNANTS	QTY 5-20	21-50	51-100	101-250	251+
1218M-30	30ft (12 Pennants)	\$19.46	\$14.14	\$13.72	\$13.31	Call
1218M-60	60ft (24 Pennants)	\$21.96	\$20.46	\$19.63	\$19.13	Call
1218M-105	105ft (48 Pennants)	\$42.25	\$39.92	\$37.59	\$37.01	Call

Approx. Shipping Weight: 60 ft = 1 lb ea., 105 ft = 1 lb ea.

A

12" x 9" PENNANTS

V-shaped pennants are all weather resistant and double sewn on a plastic covered high strength, sag-resistant header.

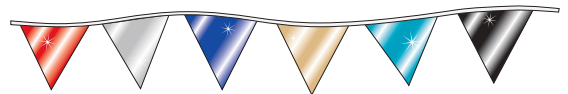

SKU	LENGTH/QTY OF PENNANTS	QTY 5-20	21-50	51-100	101-250	251+
0912M-30	30ft (18 Pennants)	\$15.64	\$14.14	\$12.89	\$12.48	Call
0912M-60	60ft (36 Pennants)	\$21.96	\$20.46	\$19.96	\$19.63	Call
0912M-105	105ft (72 Pennants)	\$41.75	\$35.76	\$34.93	\$34.52	Call

Approx. Shipping Weight: 60 ft = 1 lb ea., 105 ft = 1 lb ea.

A

18" X 6" PENNANTS

V-shaped pennants are all weather resistant and double sewn on a plastic covered high strength, sag-resistant header.

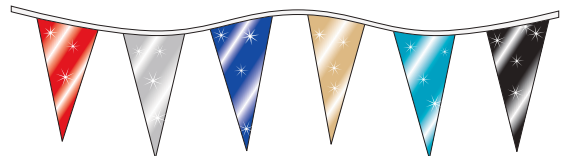

SKU	LENGTH/QTY OF PENNANTS	QTY 5-20	21-50	51-100	101-250	251+
0618M-30	30ft (20 Pennants)	\$15.64	\$14.14	\$12.89	\$12.48	Call
0618M-60	60ft (40 Pennants)	\$21.96	\$20.46	\$19.96	\$19.63	Call
0618M-105	105ft (80 Pennants)	\$41.75	\$35.76	\$34.93	\$34.52	Call

Approx. Shipping Weight: 60 ft = 1 lb ea., 105 ft = 1 lb ea.

A

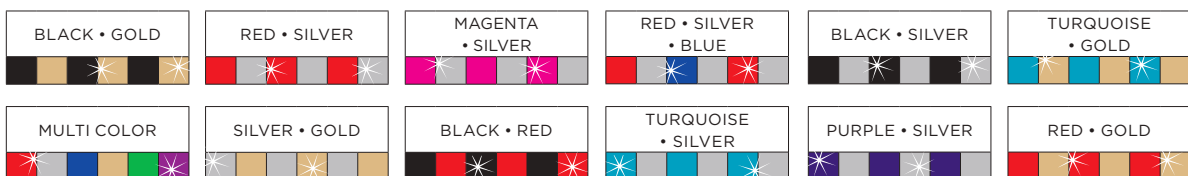

! NOTE: Other color combinations are available upon request for all sizes and thickness of pennants

METALLIC STREAMERS

METALLIC FINGERS

All weather resistant fingers are double sewn on a plastic covered high strength, sag-resistant header. Many color combinations available.

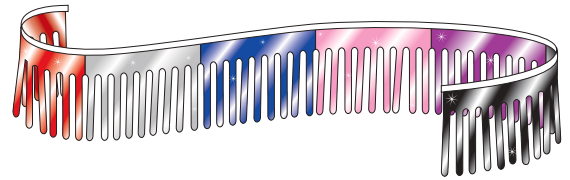

SKU	LENGTH/QTY OF PANELS	QTY 5-20	21-50	51-100	101-250	251+
1018DM-30	30ft (14 panels)	\$16.97	\$15.30	\$14.47	\$14.14	Call
1018DM-60	60ft (34 panels)	\$28.94	\$27.28	\$26.45	\$25.78	Call

Approx. Shipping Weight: 30 ft = .75 lbs ea., 60 ft = 1.5 lbs ea.

A

METALLIC STREAMERS

Dazzling metallic fringe panels sewn end-to-end are all weather resistant and are double sewn on a plastic covered high strength, sag-resistant header. Many color combinations available.

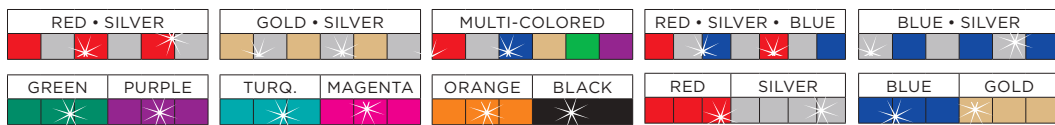
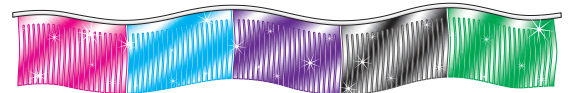

SKU	LENGTH/QTY OF PANELS	QTY 5-20	21-50	51-100	101-250	251+
1218MH-30	30ft (14 Panels)	\$24.79	\$21.46	\$21.13	\$20.46	Call
1218MH-60	60ft (34 Panels)	\$42.42	\$40.76	\$39.09	\$37.43	Call
1218MH-100	100ft (60 Panels)	\$74.69	\$69.70	\$67.87	\$66.21	Call

Approx. Shipping Weight: 30 ft = .75 lbs ea., 60 ft = 1.5 lbs ea.

A

MARDI-GRAS STREAMERS

All weather resistant streamers are double sewn on a plastic covered high strength, sag-resistant header. Many color combinations available. Wavy Cut is available upon request.

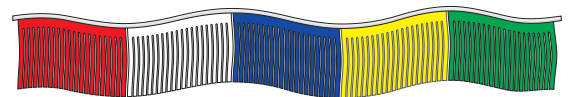

SKU	LENGTH/QTY OF PANELS	QTY 5-20	21-50	51-100	101-250	251+
1218SH-30	30ft (14 Panels)	\$19.06	\$17.12	\$16.77	\$16.24	Call
1218SH-60	60ft (34 Panels)	\$30.18	\$28.24	\$26.91	\$25.24	Call

Approx. Shipping Weight: 30 ft = .75 lbs ea., 60 ft = 1.5 lbs ea.

A

ECONOMY RACE STYLE STRINGS

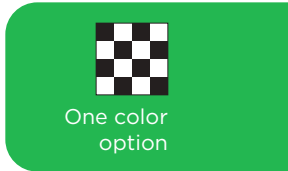

All economy checks are flexo-printed one side on clear 4 mil poly pennant film for double-sided visibility and double sewn on a plastic covered sag-resistant header.

18" X 12" FLAG LINE

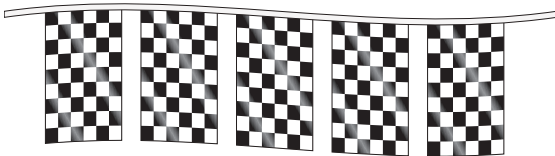

SKU	LENGTH/QTY OF FLAGS	QTY 5-20	21-50	51-100	101-250	251+
1218R1-30	30ft (12 Flags)	\$11.21	\$8.57	\$8.19	\$7.94	\$7.69
1218R1-60	60ft (24 Flags)	\$19.15	\$16.25	\$15.88	\$15.50	\$15.12
1218R1-105	105ft (48 Flags)	\$34.02	\$31.63	\$31.25	\$29.61	\$29.23

Approx. Ship. Wt.: 30 ft = .65 lbs ea., 60 ft = 1.25 lbs. ea., 105 ft = 2 lbs ea.

A

12" X 9" FLAG LINE

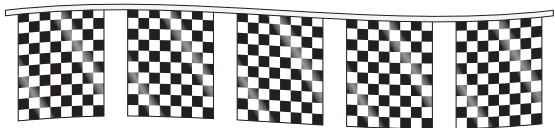

SKU	LENGTH/QTY OF FLAGS	QTY 5-20	21-50	51-100	101-250	251+
912R1-30	30ft (15 Flags)	\$8.95	\$7.43	\$6.93	\$6.43	\$5.80
912R1-60	60ft (30 Flags)	\$14.24	\$13.73	\$13.48	\$13.10	\$12.73
912R1-105	105ft (60 Flags)	\$22.55	\$21.55	\$21.04	\$20.66	\$20.41

Approx. Ship. Wt.: 30 ft = .65 lbs ea., 60 ft = 1.25 lbs. ea., 105 ft = 2 lbs ea.

A

18" X 12" PENNANT STRING

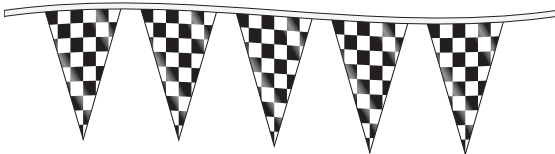

SKU	LENGTH/QTY OF PENNANTS	QTY 5-20	21-50	51-100	101-250	251+
1218R2-30	30ft (12 Pennants)	\$8.95	\$7.43	\$6.93	\$6.43	\$5.80
1218R2-60	60ft (24 Pennants)	\$14.24	\$12.35	\$12.10	\$11.59	\$10.96
1218R2-105	105ft (48 Pennants)	\$23.18	\$21.92	\$21.67	\$21.04	\$20.66

Approx. Ship. Wt.: 30 ft = .5 lbs ea., 60 ft = 1 lb ea., 105 ft = 1.4 lbs ea.

A

12" X 9" PENNANT STRING

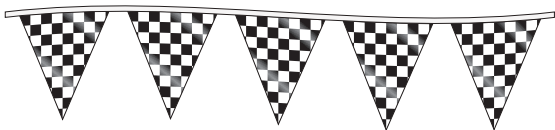

SKU	LENGTH/QTY OF PENNANTS	QTY 5-20	21-50	51-100	101-250	251+
912R2-30	30ft (15 Pennants)	\$7.31	\$5.54	\$5.29	\$5.04	\$4.91
912R2-60	60ft (30 Pennants)	\$12.73	\$10.96	\$10.46	\$10.21	\$9.95
912R2-105	105ft (60 Pennants)	\$21.55	\$18.65	\$18.02	\$17.39	\$16.76

Approx. Ship. Wt.: 30 ft = .5 lbs ea., 60 ft = 1 lb ea., 105 ft = 1.4 lbs ea.

A

DELUXE RACE STYLE STRINGS



All deluxe checks are flexo-printed one side on clear 6 mil super-duty poly pennant film for double-sided visibility and double sewn on a plastic covered high strength sag-resistant header.

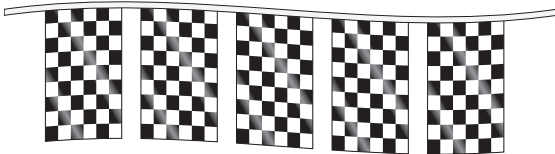

18" X 12" FLAG LINE

SKU	LENGTH/QTY OF FLAGS	QTY 5-20	21-50	51-100	101-250	251+
1218R1-30	30ft (12 Flags)	\$13.61	\$12.22	\$11.84	\$11.59	\$11.34
1218R1-60	60ft (24 Flags)	\$23.31	\$21.92	\$21.55	\$20.92	\$20.66
1218R1-105	105ft (48 Flags)	\$42.46	\$41.45	\$41.20	\$40.82	\$40.57

Approx. Ship. Wt.: 30 ft = .65 lbs ea., 60 ft = 1.25 lbs. ea., 105 ft = 2 lbs ea.

A

12" X 9" FLAG LINE

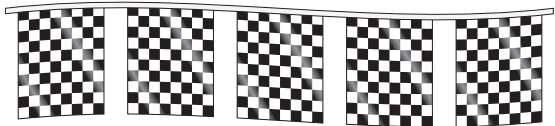

SKU	LENGTH/QTY OF FLAGS	QTY 5-20	21-50	51-100	101-250	251+
912R1-30	30ft (15 Flags)	\$10.71	\$8.95	\$8.57	\$8.19	\$7.81
912R1-60	60ft (30 Flags)	\$19.53	\$17.01	\$16.63	\$16.13	\$15.50
912R1-105	105ft (60 Flags)	\$31.50	\$28.98	\$28.35	\$27.72	\$27.09

Approx. Ship. Wt.: 30 ft = .65 lbs ea., 60 ft = 1.25 lbs. ea., 105 ft = 2 lbs ea.

A

18" X 12" PENNANT STRING

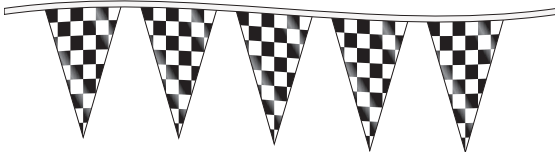

SKU	LENGTH/QTY OF PENNANTS	QTY 5-20	21-50	51-100	101-250	251+
1218R2-30	30ft (12 Pennants)	\$10.71	\$8.95	\$8.57	\$8.19	\$7.81
1218R2-60	60ft (24 Pennants)	\$19.15	\$17.01	\$16.51	\$16.00	\$15.50
1218R2-105	105ft (48 Pennants)	\$28.98	\$28.35	\$27.72	\$26.96	\$26.46

Approx. Ship. Wt.: 30 ft = .5 lbs ea., 60 ft = 1 lb ea., 105 ft = 1.4 lbs ea.

A

12" X 9" PENNANT STRING

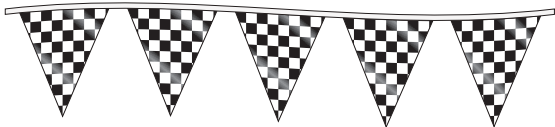

SKU	LENGTH/QTY OF PENNANTS	QTY 5-20	21-50	51-100	101-250	251+
912R2-30	30ft (15 Pennants)	\$9.20	\$7.43	\$6.93	\$6.43	\$6.17
912R2-60	60ft (30 Pennants)	\$13.86	\$12.73	\$12.60	\$12.22	\$11.59
912R2-105	105ft (60 Pennants)	\$24.07	\$23.81	\$21.92	\$21.55	\$21.29

Approx. Ship. Wt.: 30 ft = .5 lbs ea., 60 ft = 1 lb ea., 105 ft = 1.4 lbs ea.

A

PATRIOTIC FLAG LINES & STRINGS

17" x 11" AMERICAN FLAG LINE

LONG & SHORT
TERM OPTIONS

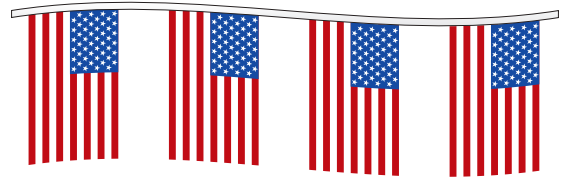

Long Term: Our highest quality flag line features a Dura-Knit style cloth flag with fused edge no-fray finish.

LONG TERM				
SKU	LENGTH/QTY OF FLAGS	QTY 1-20	21-40	41-99
1218US1HD-25	25ft (10 Flags)	\$32.82	\$29.35	\$27.61
1218US1HD-50	50ft (20 Flags)	\$57.65	\$54.18	\$50.53

Approx. Shipping Weight: 25 ft = .75 lbs ea., 50 ft = 1.25 lbs ea.lbs ea.

A

Short Term: 17"x 11" Printed three colors on clear 4 mil premium embossed poly film.

SHORT TERM				
SKU	LENGTH/QTY OF FLAGS	QTY 1-20	21-40	41-99
1218US1-30	30ft (12 Flags)	\$17.54	\$14.59	\$13.37
1218US1-60	60ft (24 Flags)	\$30.04	\$25.87	\$25.00
1218US1-105	105ft (48 Flags)	\$52.96	\$47.93	\$45.32

Approx. Shipping Weight: 30 ft = .75 lbs ea., 60 ft = 1.25 lbs ea., 105 ft = 2 lbs ea.

A

18" x 12" FLYING-V PENNANTS



All weather-resistant 4 mil polyethylene pennants printed three colors on clear poly film and double sewn on a plastic covered high strength, sag-resistant header.

SKU	LENGTH/QTY OF PENNANTS	QTY 1-20	21-40	41-99
1218US2-30	30ft (12 Pennants)	\$10.94	\$10.07	\$9.55
1218US2-60	60ft (24 Pennants)	\$21.71	\$18.23	\$17.02
1218US2-105	105ft (48 Pennants)	\$36.29	\$32.30	\$30.21

Approx. Shipping Weight: 25 ft = .75 lbs ea., 50 ft = 1.25 lbs ea., 105 ft = 2 lbs ea.

A

18" x 12" AMERICANA PENNANTS



SKU	LENGTH/QTY OF PENNANTS	QTY 1-20	21-40	41-99
1218AM2-30	30ft (12 Pennants)	\$9.88	\$9.12	\$8.66
1218AM2-60	60ft (24 Pennants)	\$19.45	\$16.41	\$15.19
1218AM2-105	105ft (48 Pennants)	\$31.76	\$28.26	\$26.44

Approx. Shipping Weight: 25 ft = .75 lbs ea., 50 ft = 1.25 lbs ea., 105 ft = 2 lbs ea.

A

PATRIOTIC STREAMERS & BUNTING

AMERICANA STREAMERS

All weather-resistant 4 mil poly are double sewn on a plastic-covered, high-strength, sag-resistant header.

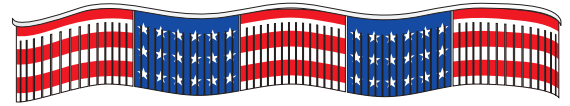

SKU	STRING SIZE/QTY OF PANELS	QTY 1-20	21-40	41-99
1218AMH-30	30ft (18 Panels)	\$18.23	\$16.50	\$15.45
1218AMH-60	60ft (36 Panels)	\$33.34	\$30.73	\$29.69

Approx. Shipping Weight: 30 ft = .75 lbs ea., 60 ft = 1.5 lbs ea.

A

STARS & STRIPES STREAMERS

All weather-resistant metallic are double sewn on a plastic-covered, high-strength, sag-resistant header.

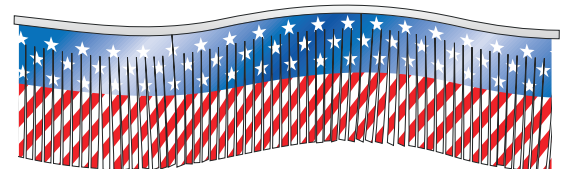

SKU	STRING SIZE/QTY OF PANELS	QTY 1-20	21-40	41-99
1218AMMH-30	30ft (18 Panels)	\$28.48	\$26.57	\$24.83
1218AMMH-60	60ft (36 Panels)	\$51.40	\$49.66	\$47.93

Approx. Shipping Weight: 30 ft = .75 lbs ea., 60 ft = 1.5 lbs ea.

A

PATRIOTIC POLY ROLL 36" X 300'

Printed 3 colors on clear 2 mil poly film for 2-sided display.

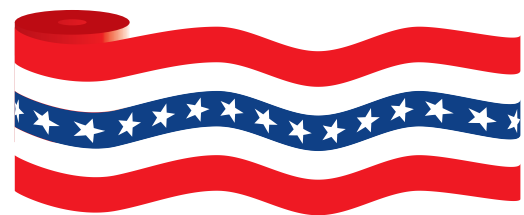

PATRIOTIC POLY ROLL 29" X 300'

Printed 2 colors on white 2 mil poly film for rich color and vibrant appearance.

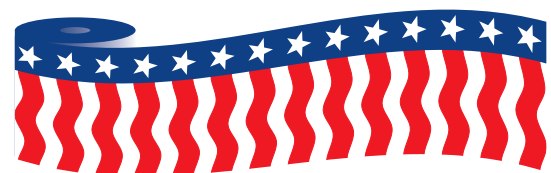

SKU	ROLL SIZE	QTY 1-4 ROLLS	5-10 ROLLS	11-24 ROLLS	25+ ROLLS
US5	29" x 300ft	\$138.77	\$131.75	\$129.99	\$126.48
US3	36" x 300ft	\$138.77	\$131.75	\$129.99	\$126.48

Approx. Shipping Weight: 1 roll US5 = 10 lbs, US3 = 12 lbs.

A

TRADITIONAL FAN BUNTING

TRADITIONAL PLEATED FAN BUNTING

3' x 6' Fully Pleated Poly Cotton Fan Bunting. Printed 2 colors on white. Includes flag style header with brass grommets.



SKU	SIZE	QTY 2-5	6-11	12-24	25+
36TPF	3' x 6'	\$43.20	\$41.57	\$38.30	\$35.05

Approx. Shipping Weight: 1 lbs ea.

A

PATRIOTIC MIRAGE FAN BUNTING

An economical alternative to traditional pleated fan bunting. This unique design projects a rich 3-D pleated appearance. The Mirage Fan Bunting is hemmed and includes a flag style header with grommets.



SKU	SIZE	QTY 1-11	12-24	25-72	73+
153MPF	1.5' x 3'	\$9.12	\$9.00	\$8.49	\$7.86
35MPF	3' x 5'	\$19.39	\$17.49	\$16.86	\$16.23

Approx. Shipping Weight: 1.5' x 3' = 0.5 lbs ea. and 3' x 5' = 1 lbs ea.

A

CUSTOM MIRAGE FAN BUNTING

Customize this unique 3-D pleated appearance design with your logo or slogan and color scheme. The Mirage Fan Bunting is printed on polyester flag cloth and finished with a hem and a flag style header with grommets.



SKU	SIZE	QTY 1-11	12-24	25-72	73+
MFB-35	3' x 5'	\$115.38	\$77.34	\$62.13	\$57.05
MFB-36	3' x 6'	\$125.52	\$87.48	\$69.73	\$65.93

Approx. Shipping Weight: 1 lbs ea.

C

Custom print prices are based on customer provided artwork. Creative services available for an additional cost.



ART REQUIREMENTS

Setting Up Your Document	57-59
File Formats	57
Templates	58
Image Resolution	58
Hem & Trim Allowances	59
Color Matching	59

SETTING UP YOUR DOCUMENT

Follow the guidelines in this section to get your files set up properly or you can contact us and our designers can get your files set up for an extra charge.

- 1 Please build one file per design. In the case of programs that support multiple pages only place one design per page.
- 2 All colors used in document must be specified as CMYK, not Spot colors. Files submitted in RGB will be converted to CMYK which may cause a color shift in the art.
- 3 Create your document to actual size, with the dimensions in inches, NOT feet. (For example, if your final product is 3' x 5', build it as 36" x 60".) For banners and flags, inset your text and important graphics 2.5" from the edge to prevent them from being sewn through in the finishing process.
- 4 Please remember to save a copy of your file with the type converted to outlines, paths or curves and send us this copy to prevent any font substitution problems.
- 5 Most programs allow the user to add an image to a file by linking or embedding. Embedded images are stored within the document itself, while linked files are not. Because of this, linked files can suddenly vanish when opened from a different computer. Embed all images to avoid losing them when files are submitted.

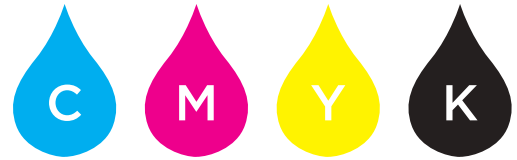

FILE FORMATS

We support two main types of file formats: Vector Art and Raster Art. If you're unsure of what type of art you have, check out the diagram below or see details to the right:

VECTOR

- Can be scaled to any size while maintaining quality
- Preferred unless printing photos

RASTER/BITMAP

- Made of pixels (tiny squares)
- When scaled larger, the image will look pixilated (fuzzy)

VECTOR ART

- Can be scaled to any size while maintaining quality
- Preferred unless printing photos

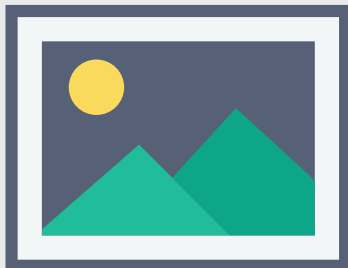

RASTER ART

- Also known as bitmap art
- Composed of pixels (tiny squares) grouped together to make an image
- When scaled larger, the image will look pixilated (jagged)



High resolution image
200 dpi

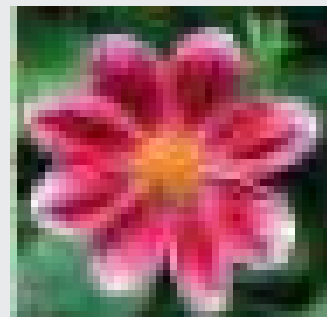

Low resolution image
25 dpi

SETTING UP YOUR DOCUMENT

While this applies mostly to vector documents, please follow the guidelines in this section to get your files set up properly or you can contact us and our designers can get your files set up for an extra charge.

BLEEDS

Consider the bleeds in a document the 'wobble room' to make sure you don't have any white showing once your graphic is trimmed out from its printed roll format. This also helps account for any minor shifting that may occur during the printing process.

TRIM SIZE

This is the finish size you'd like your graphic to be.

SAFE AREA

This area is where all important information, such as text and any logos, should stay so they don't get cut off if the material being printed on shifts slightly during the printing process or when the graphic is being trimmed.

Template Example:

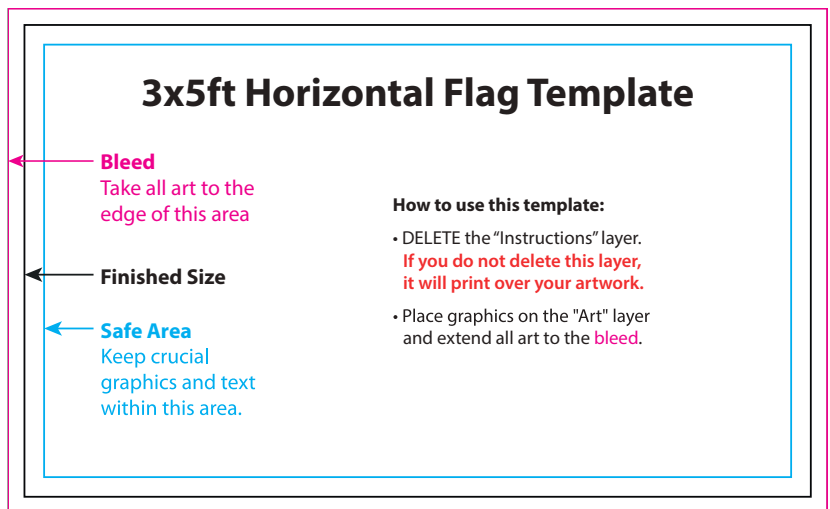

BEST QUALITY

NEEDS IMPROVEMENT



High resolution image: 200 dpi minimum

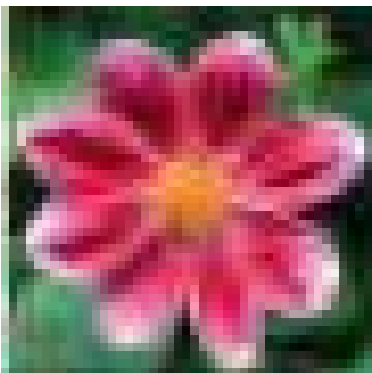

Low resolution image: 25 dpi

RESOLUTION FOR BITMAP & DIGITAL IMAGES

When including Photoshop (bitmap) images, you should scan or create your image at its final reproduction size at the following resolutions:

- 75-100 pixels per inch for vinyl banners
- 100-120 pixels per inch for textile printing
- 50-220 pixels per inch for rigid substrates

Rasterized type/images in Photoshop will lose its crisp look and appear 'out of focus' if the file resolution is too small. Save these files in the JPEG format with the quality or compression level set to **Highest Quality or Maximum Quality**. This setting ensures there is no distortion or loss of detail while providing the best compression of the file.

SETTING UP YOUR DOCUMENT

BANNERS

Our standard hem turns 1.125" of material (add 2.25" to your required finished size) and is double stitched with the stitching coming in 3/4" from the folded edge. A 2.5" margin from the (2.25" oversized) unfinished trim edge of the banner is required to prevent live content from being turned and sewn.

POLE POCKETS

Calculated based on the outside diameter of the pole. Up to 1" pole diameter would use a standard 3" pocket that has a 2.25" opening (measured flat). 1.25" - 1.875" Poles that use a 4" pocket would have a 3.25" opening (measured flat). Please request a template for banners that require pole pockets to help prevent your live content from being sewn through.

HORIZONTAL FLAGS

Standard hem for Horizontal Flags turns 0.75" of material and is Double Stitched along the top and bottom edges with the stitching coming in 3/8" from the folded edge. For 5' x 8' flags or larger, the Fly edge of the flag is Quad stitched and turns 2" of material with the stitching coming in 1.5" from the folded edge. All other flag sizes receive a standard hem fly end.

MARGINS

Double Stitched sides require a 1.5" margin from the unfinished trim edge to prevent live content from being turned and sewn. Quad Stitched sides require a margin of 2.5" - 3" from the unfinished trim edge. The canvas header covers 1.5" of the left hand side of the flag, so a margin of 2" from the header's unfinished trim edge is required.

COLOR MATCHING

If color is critical to your job, we can produce a small print sample of your file to inspect and/or supply a printed color chart so you can see how your Pantone spot colors will print.** Color corrections can then be made and another print sample made for final approval.

If you specify Pantone spot colors, our color management will attempt to get as close as possible.

** for additional cost

Due to the nature of digital imaging, exact Pantone spot color matches are not always possible.

Please note that metallic inks are not available for digital printing. Pantone's CMYK equivalent will be substituted for the metallic inks specified in your file. If you do not wish to have this substitution to occur, please select a nonmetallic color to simulate the effect you are trying to achieve.

NOTE: SETUP HELP

If you're setting up your own document, see the specific material guidelines below. If you need help, please give us a call and we can help or one of our designers can get your files set up for an extra charge.

NOTE: RIGID SIGNS

Please consult for rigid sign requests as these can have special requirements depending on project scope

