



RETRACTORS

Wundhaken
Separadores

Ecarteurs
Divaricatori



Beckman-Weitlaner Retractor
F8-510
16.5cm 6 1/2"
3 x 4 Sharp prongs



Beckman-Weitlaner Retractor
F8-511
16.5cm 6 1/2"
3 x 4 Blunt prongs

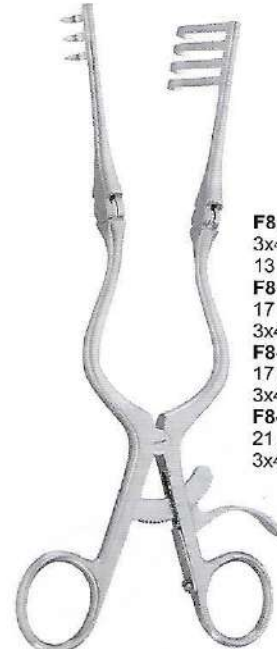

Cone Retractor

F8-512 31 cm, 12"
3x4 Blunt prongs,
13 mm x 14.5 mm
F8-513 16.5 cm, 6 1/2"
17 mm x 19 mm
3x4 Sharp prongs,
F8-514 16.5 cm, 6 1/2"
17 mm x 19 mm
3x4 Blunt prongs,
F8-515 20 cm, 8"
21 mm x 210 mm
3x4 Blunt prongs,



Beckman Retractor
F8-516 31.7cm 12 1/2"
Spread 3.5cm 5 3/8" 4 x 4
Sharp prongs, Arm length
8.5cm 3 3/8"



Beckman Retractor
F8-517 31.1cm 12 1/4"
4 x 4 Sharp prongs 27mm,
Side Blade 1.7cm 5/8" deep,



Beckman Retractor
F8-518 31.1cm 12 1/4"
4 x 4 Blunt prongs 27mm,
Side Blade 1.7cm 5/8" deep,

RETRACTORS



Wundhaken
Separadores

Ecarteurs
Divaricatori



Joll (Friedman)
F8-519 15.5 cm, 6 1/2"
Thyroid- and Vaginal Retractor

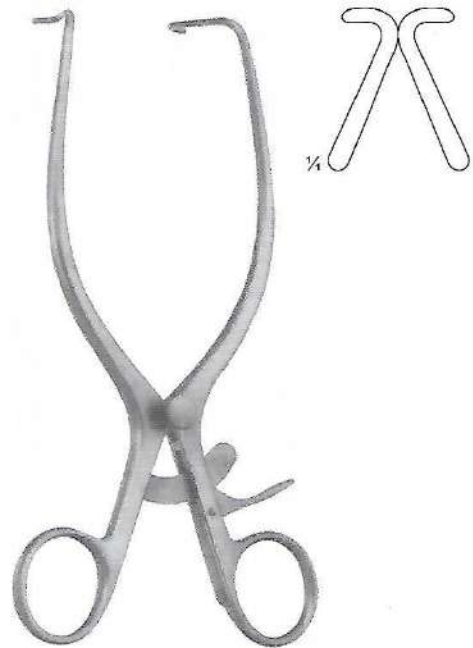

Jackson Burrows Retractor
F8-520 18.5 cm, 7"
Blunt



Gelpi Vaginal Retractor
F8-521 13.5 cm, 5"



Gelpi Skin & Vaginal Retractor
F8-522 17.5 cm, 7"



De Bakey Femur Retractor
F8-523 14.5 cm, 4 1/2"



RETRACTORS

Wundhaken
Separadores

Ecarteurs
Divaricatori

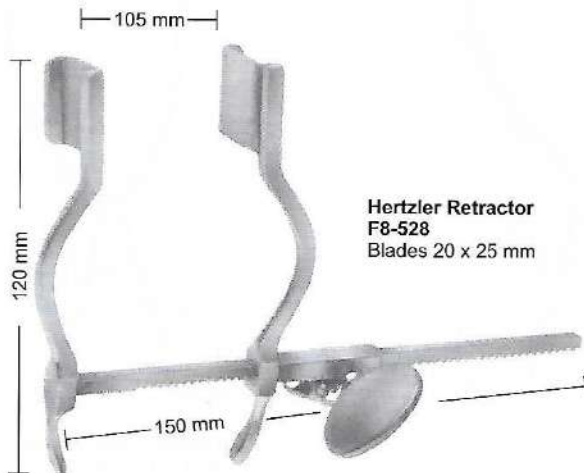
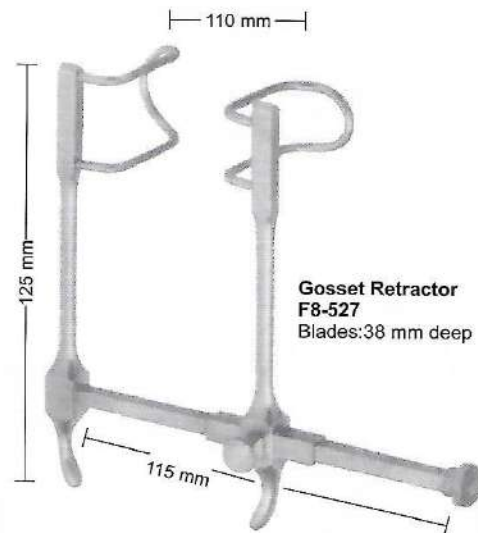
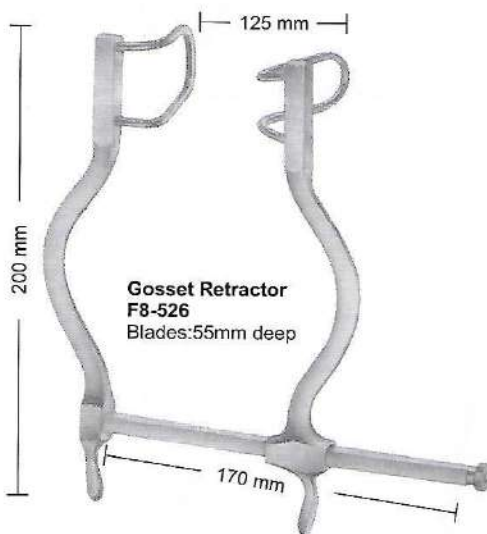
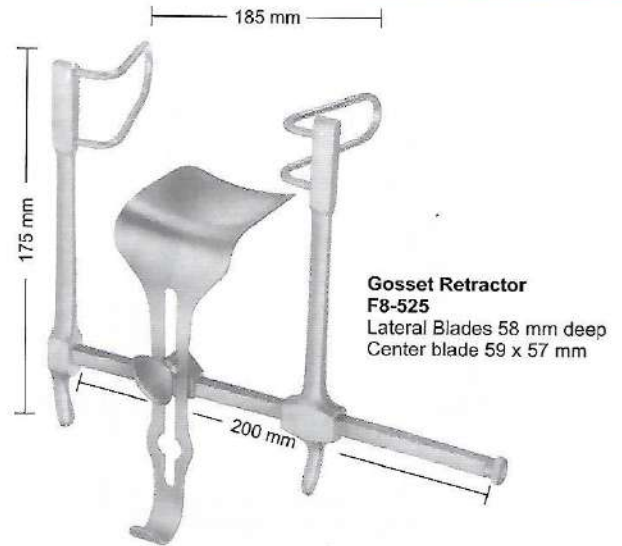

RETRACTORS



Wundhaken | Ecarteurs
 Separadores | Divaricatori

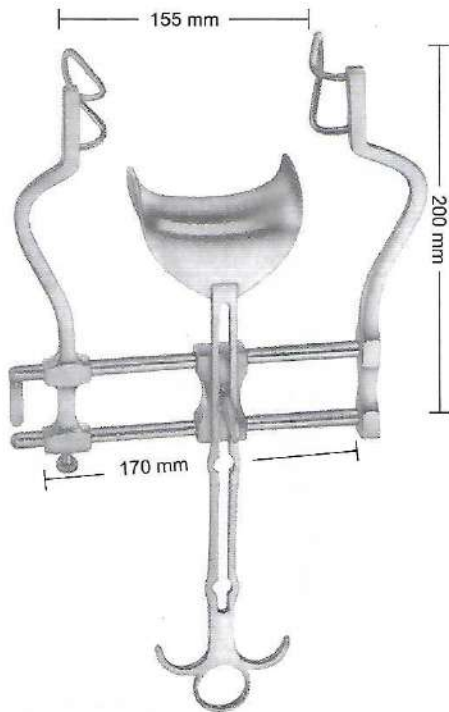

**Balfour Retractor
 F8-530**
 Lateral blades 60 mm deep
 Center blade 47 x 80 mm

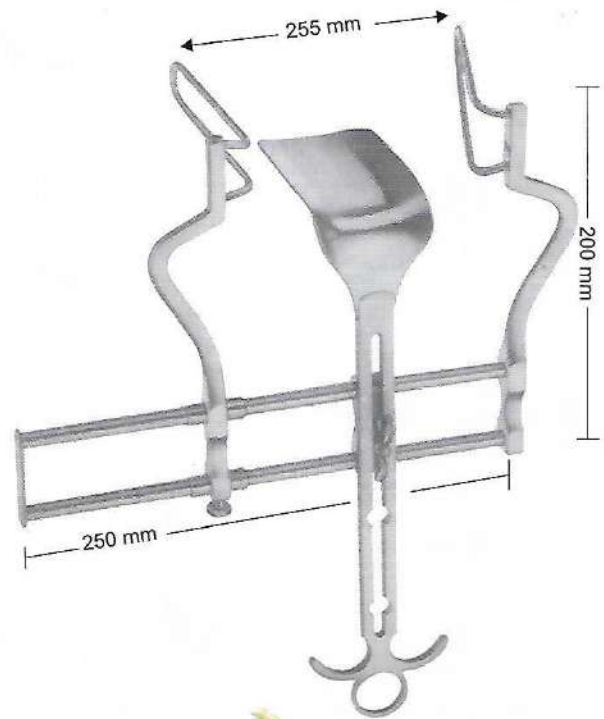

**Balfour Retractor
 F8-531**
 Lateral blades 105 mm deep
 Center blade 107 x 59 mm



F8-532
 Center blade only
 54 x 80 mm

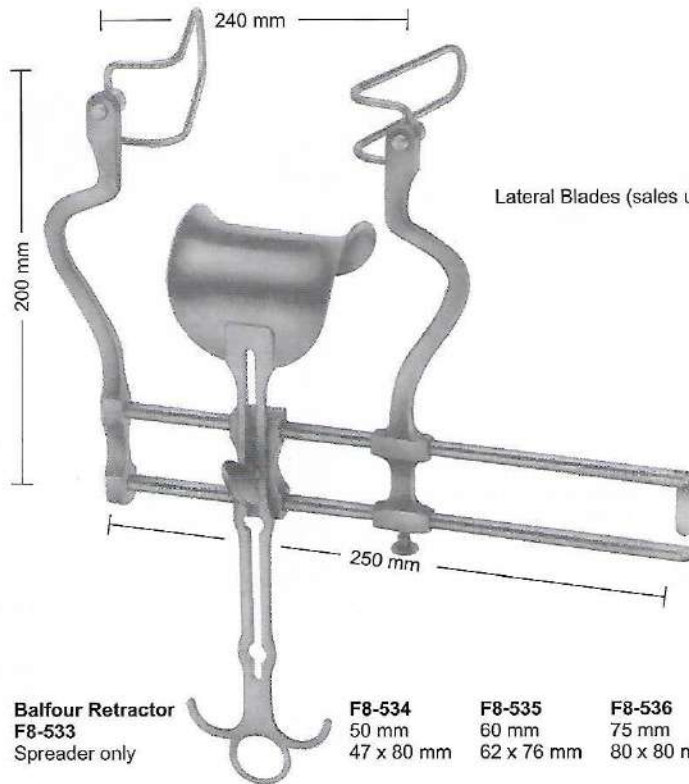

**Balfour Retractor
 F8-533**
 Spreader only

Lateral Blades (sales unit of blades in pairs)

- | | | | |
|--------------------------------------|--------------------------------------|--------------------------------------|--------------------------------------|
| F8-534
50 mm
47 x 80 mm | F8-535
60 mm
62 x 76 mm | F8-536
75 mm
80 x 80 mm | F8-537
90 mm
80 x 80 mm |
|--------------------------------------|--------------------------------------|--------------------------------------|--------------------------------------|



RETRACTORS

Wundhaken
Separadores

Ecarteurs
Divaricatori



O'Sullivan/O'Connor Retractor
F8-538 (Set includes frame & 3 blades)
F8-539 Frame Only (not pictured)



F8-540
Single Retractor Blade
110 x 70 mm



F8-541
Set of 2 Retractor Blade
80 x 45 mm



ABRE BOCA MC IVOR C/3 LAMINAS S/ SUCCAO
ABRE BOCA
F8-541A



F8-542
Center Blade
45 x 80 mm
70 x 85 mm



F8-543
Center Blade
100 x 60 mm

Sizes of These Blades to Same as about Blades.

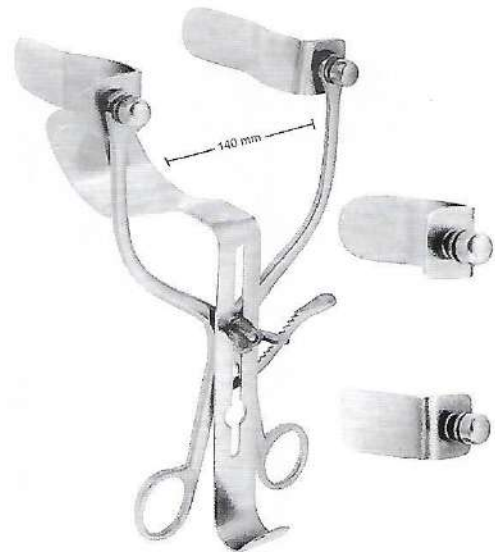

Collin Retractor
F8-544 Complete
F8-545 Spreader only
F8-546 Blades 55 x 25 mm
F8-547 Blades 80 x 25 mm
F8-548 Center Blade
115 x 45 mm

RETRACTORS

Wundhaken
Separadores

Ecarteurs
Divaricatori

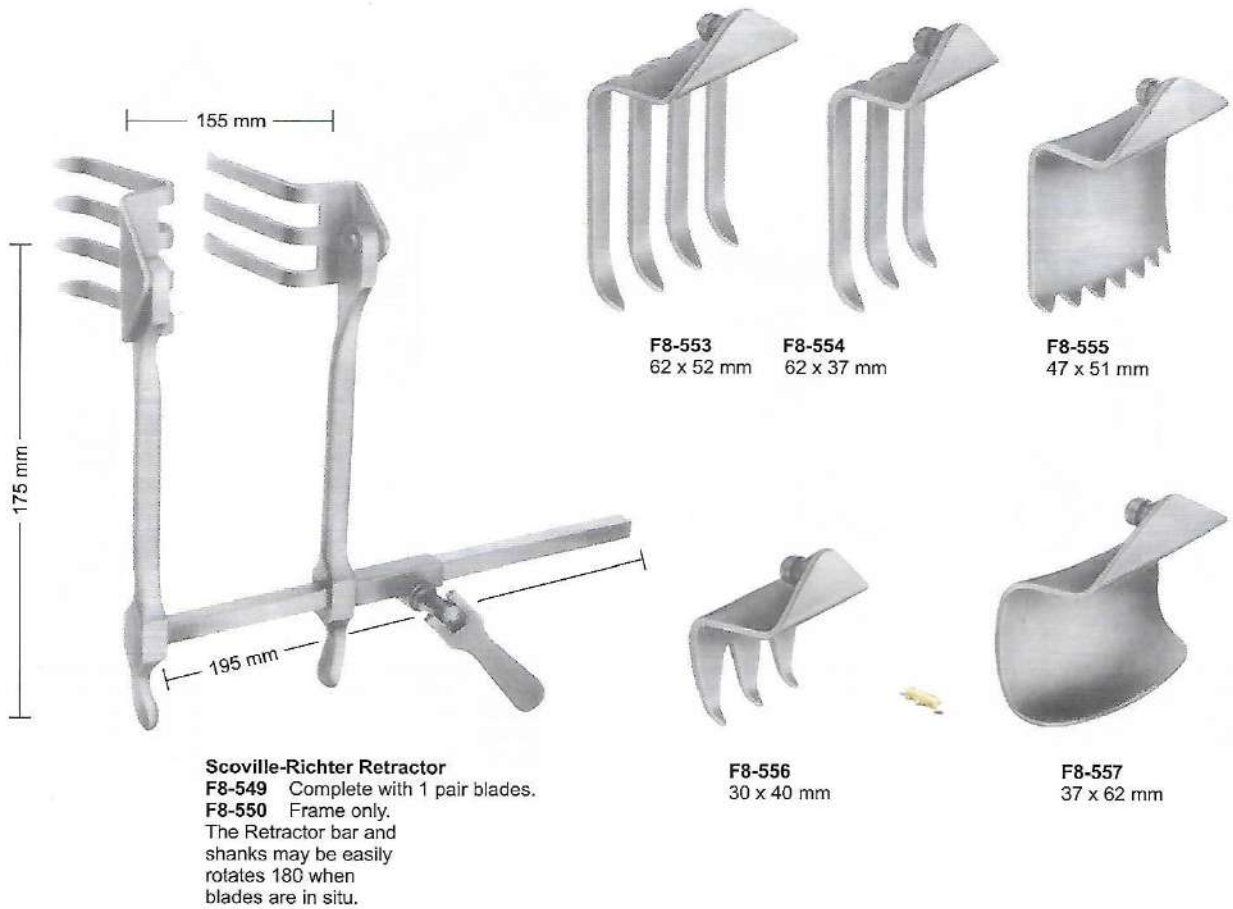

Scoville-Richter Retractor
F8-549 Complete with 1 pair blades.
F8-550 Frame only.
 The Retractor bar and shanks may be easily rotates 180 when blades are in situ.

F8-553
62 x 52 mm

F8-554
62 x 37 mm

F8-555
47 x 51 mm

F8-556
30 x 40 mm

F8-557
37 x 62 mm



Initial Incision Retractor
F8-558 30cm 11 3/4"
 Complete



RETRACTORS

Wundhaken | Ecarteurs
Separadores | Divaricatori



Collin Retractor
F8-559 20 cm, 8"
complete with 2 lateral
blades and central blade

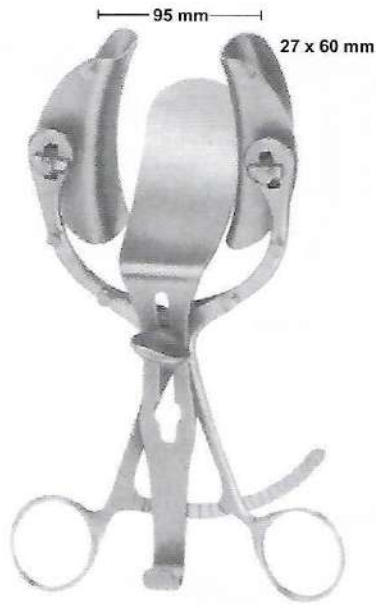

Legueu Retractor
F8-560
17 cm, 6 3/4"



Doyen Retractor
F8-561 48 mm x 90 mm
F8-562 48 mm x 105 mm
F8-563 48 mm x 120 mm
F8-564 48 mm x 135 mm
28 cm, 11"

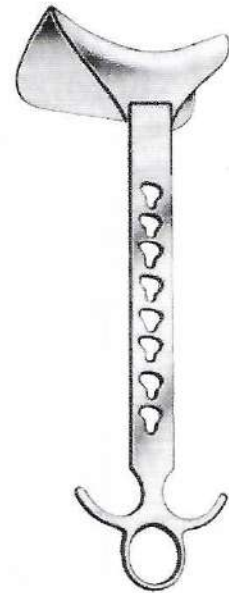

Rochard Retractor
F8-565 48 mm x 90 mm
F8-566 48 mm x 105 mm
F8-567 48 mm x 120 mm
F8-568 48 mm x 135 mm
F8-569 48 mm x 155 mm
31 cm, 12"

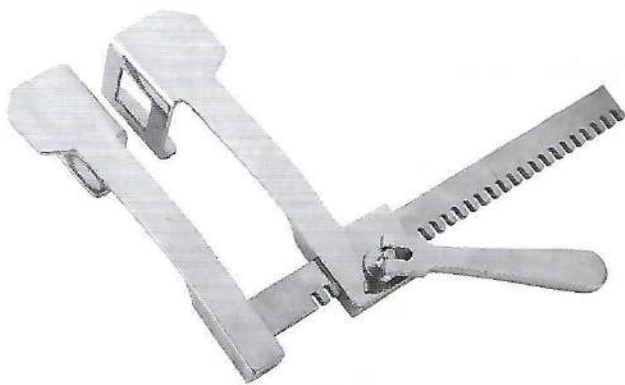

Finochietto Retractors
F8-569A 18x22 8cm
F8-569B 25x40 13cm
F8-569C 38x45 16cm
F8-569D 40x45 18cm

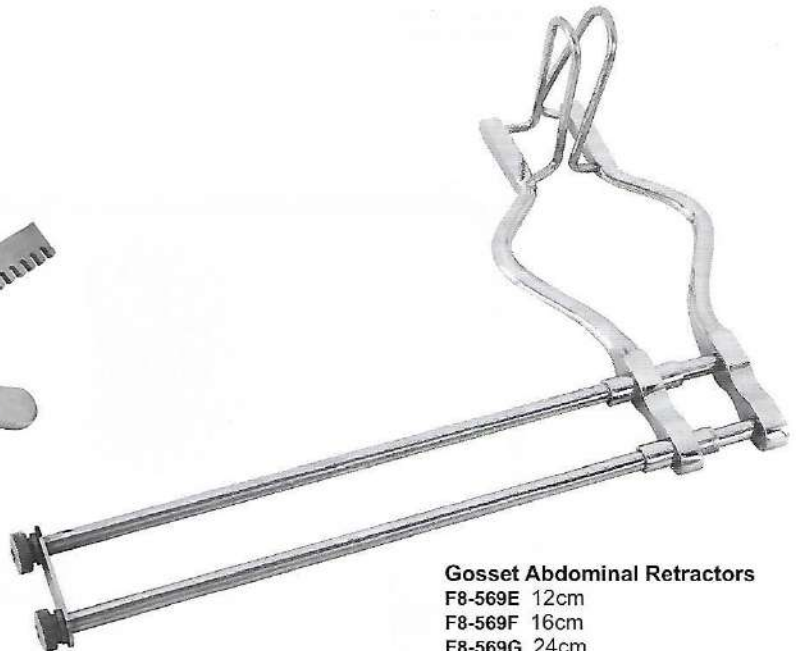

Gosset Abdominal Retractors
F8-569E 12cm
F8-569F 16cm
F8-569G 24cm
F8-569H 30cm

RETRACTORS



Wundhaken | Ecarteurs
 Separadores | Divaricatori

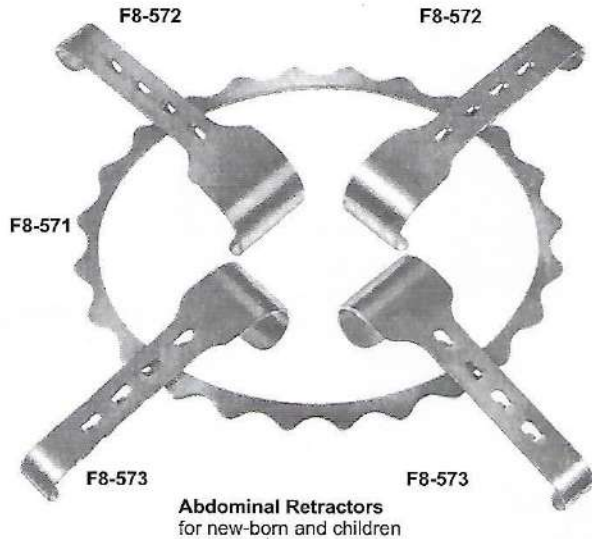

Denis-Browne Retractor

F8-570 Complete with 4 blades

F8-571 Frame 190 x 160 mm

F8-572 2 blades only 40 x 30 mm

F8-573 2 blades only 40 x 40 mm

F8-574
 Blades only 20 x 30 mm



F8-575
 Blades only 20 x 40 mm



Abdominal Retractors
 for new-born and children

Abdominal Retractors
 well suitable for gynaecologists

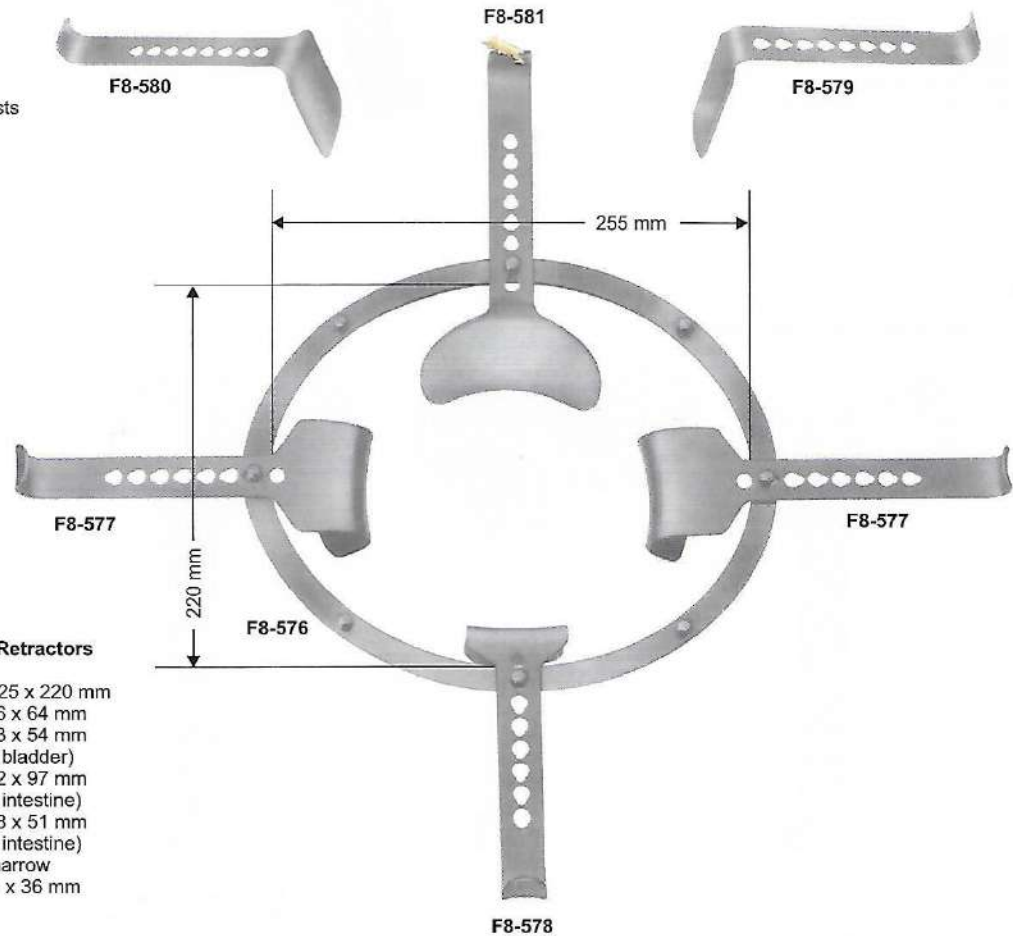

Semm Abdominal Retractors

consisting of:

- F8-576 1 frame 225 x 220 mm
- F8-577 2 blade 46 x 64 mm
- F8-578 1 blade 53 x 54 mm
(for bladder)
- F8-579 1 blade 82 x 97 mm
(for intestine)
- F8-580 1 blade 98 x 51 mm
(for intestine)
- F8-581 1 blade, narrow
107 x 36 mm



RETRACTORS

Wundhaken | Ecarteurs
Separadores | Divaricatori

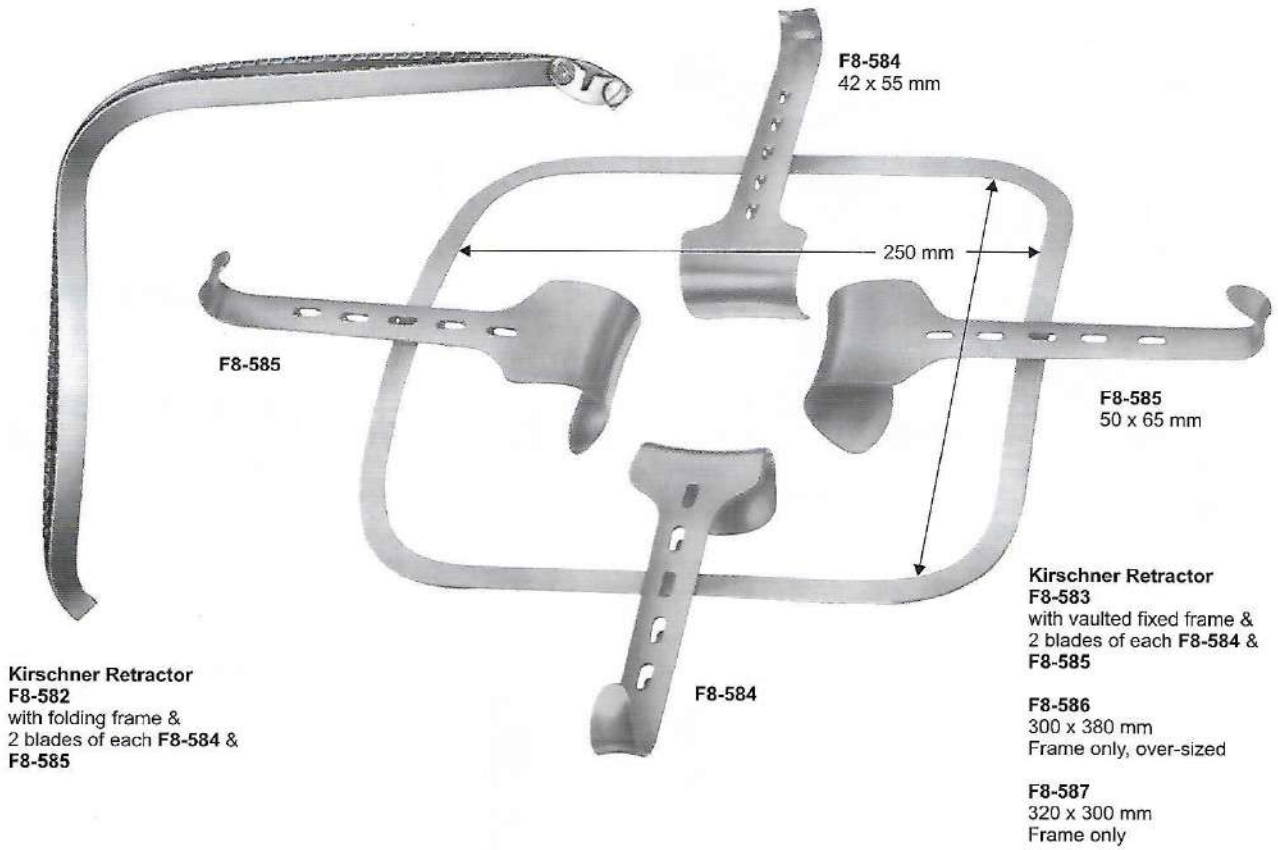

Additional valves for corpulent persons



Kirschner Retractor F8-588
64 x 80 mm

Kirschner-Balfour Retractor F8-589
80 x 82 mm

Kirschner Retractor F8-590 90 x 69 mm
F8-591 92 x 95 mm
F8-592 78 x 58 mm

Kirschner Retractor F8-593 108 x 42 mm
F8-594 91 x 55 mm
F8-595 121 x 55 mm

BONE SURGERY INSTRUMENTS

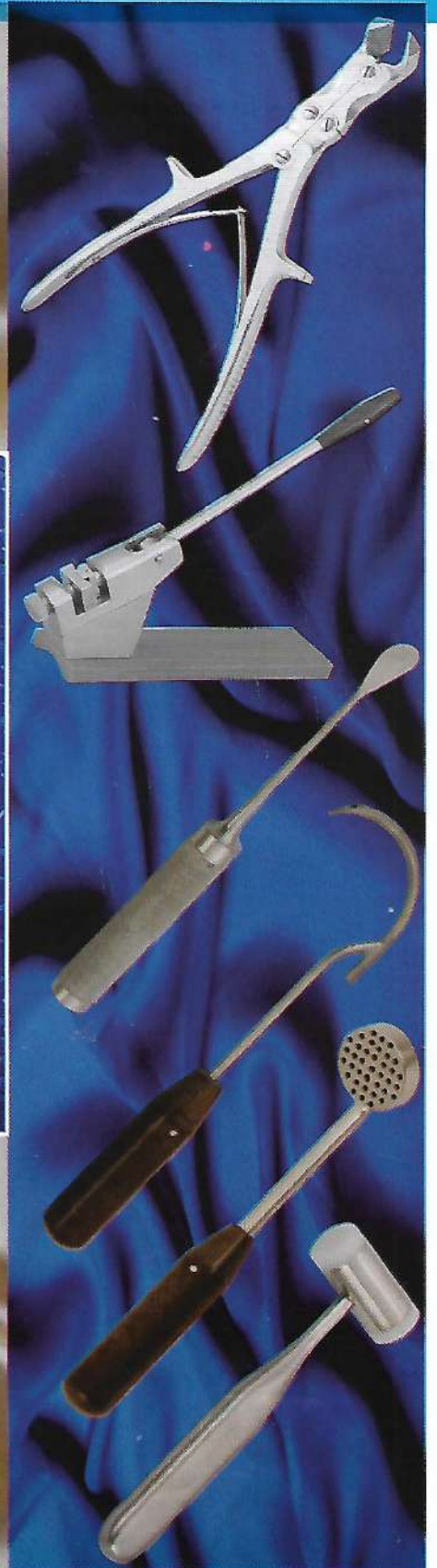



AMPUTATING & RESECTION SAWS

amputations-und resektiosagen
Scies a amputation et resection

sierra para amputacion y reseccion
seghe per amputazione

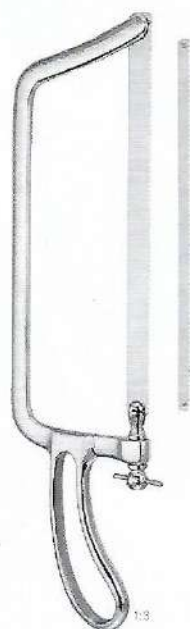

Charriere Saw
F9-001 35cm 13 3/4"
Spare saw blades
F9-002 12mm
F9-003 15mm



Charriere Bone Saw Complete
F9-004 35.5cm 14"
Straight tip, Straight shaft



Helferich-Bier Saw
F9-005 39cm 15 1/2"
Spare saw blades
F9-006 3mm
F9-007 5mm
F9-008 5mm



Engel Plaster Saw
F9-009 15.5 cm, 6"



Serra Gigli
F9-009A 30 cm
F9-009B 40 cm
F9-009C 50 cm



Percy Amputation Shield
F9-010
30.5cm 12"
Handles Detachable,
Simple Pattern

RASPS, FILES



Raspein, Feilen
Rapes, Limes

Escofinas, limas
Raspe, lime



**Putti Bone Rasp
F9-011**
27.0 cm 10 3/4"
Double ended, One end curved up
one end curved sideways

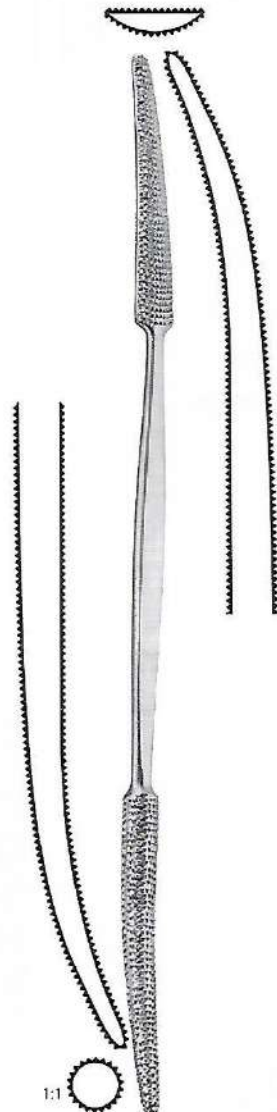

**Putti Rasp
F9-012**
30.0 cm 12"
Double Ended



**Putti Bone File
F9-013**
28.0 cm 11"
semicircular



**Putti Bone File
Bayonet Shape
F9-014**
24.5 cm 9 3/4"
X=13 mm
semicircular



**Putti Bone File
F9-015**
22.0 cm 8 3/4"
X=20 mm
flat



BONE FILES

Knochenfeilen
Limas para huesos

Limes à os
Lime per ossa



**Foman Rasp
F9-016** 21.5cm 8 1/2"
Double ended, Fine & coarse serrations
4-sided convex and flat blades



**Foman Rasp
F9-017**
21 cm, 8 1/2"



Miller-Colburn Bone File
18 cm, 7"

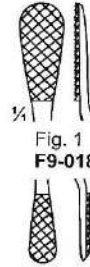

Fig. 1
F9-018

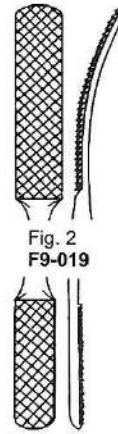

Fig. 2
F9-019

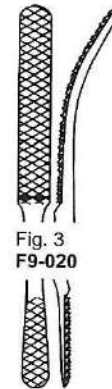

Fig. 3
F9-020



Fig. 4
F9-021

cross cut



**Kleinert-Kutz Bone Rasp
F9-022** 22.5cm 8 7/8"
Double ended,
Fine & coarse serrations



**Miller Alveotomy File
F9-023**
19 cm, 7 1/2"



**Miller Alveotomy File
F9-024**
19 cm, 7 1/2"

MALLETS



Hammer
Maillets

Martillos
Martelli



Doyen Mallets
25cm 7 3/4"
F9-025 25mmØ - 120g
F9-026 30mmØ - 180g
F9-027 35mmØ - 260g



Collin Mallets
F9-028 20cm 8"
30mmØ - 220g



Hajek Mallets
F9-029 21.5cm 8 1/2"
27mmØ - 140g

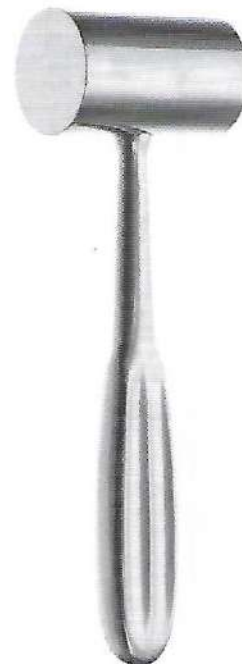

Kirk Mallets
F9-030 19cm 7 1/2"
38mmØ - 750g
F9-031 20.4cm 8"
Head diameter 38.0mm,
Weight: 1 lb. 4 oz.
570 grams



Partsch Mallets
F9-032 18cm 7"
22mmØ - 200g



Lucae Mallets
F9-033 19mmØ - 220g
F9-034 25mmØ - 260g
19cm 7 1/2"



Mallet Mallets
F9-035 19cm 7 1/2"
250mmØ - 205g
Solid steel, with
plastic faces



Cottle Mallets
F9-036 18.5cm 7 1/4"
30mmØ - 240g
1 side flat /
1 side convex



MALLETS

Hammer
Mailles

Martillos
Martelli



Solid Copper Head Mallet
F9-037 16.5cm 6 1/2"
Solid, Head diameter
20mm 3/4"



Nylon Head Mallet
F9-038 19.0cm 7 1/2"
Head diameter 25.4mm,
7.76 oz.
F9-039 19.5cm 7 5/8"
Head diameter 3cm 1 1/4"
Weight 11 oz.



**Extra 1 1/4" Nylon Face
FOR F9-039
F9-040 Head diameter
3cm 1 1/4"**

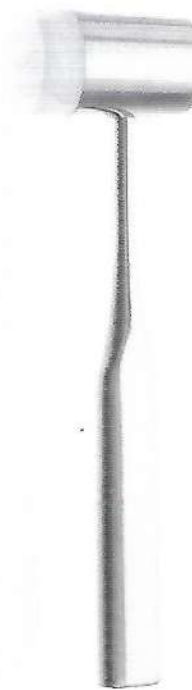

Combination Mallet
F9-041 19.5cm 7 5/8"
Solid, Head diameter 32.0mm,
Weight 12 oz 340 grams,
Head weight: 8 oz 227 grams



Bergmann Mallets
F9-042
24.5cm 9 3/4"
45mmØ - 300g



Ombredanne Mallets
F9-043
24cm 9 1/2"
40mmØ - 550g



Heath Mallets
F9-044 18cm 7"
40mmØ - 700g
F9-045 20cm 8"
45mmØ - 1000g



Williger Mallets
F9-046 28mmØ - 340g
F9-047 30mmØ - 400g
24cm 9 1/2"
Lead filled



Hajek Hammer
F9-047A 250gm
F9-047B 500gm



Universal Hammer
F9-047C 500gm
F9-047D 750gm

MALLETS



Hammer
Maillets

Martillos
Martelli



Mallet, Lightweight
F9-048 19.0cm 7 1/2"
Stainless Steel and Aluminum
Head diameter 25.0mm
Weight 7 oz 200 grams
Head Weight: 4 oz 113 grams

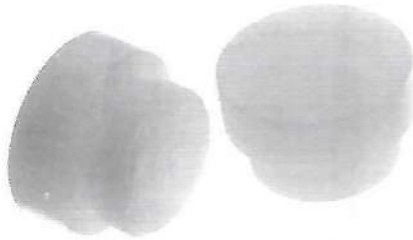

**Nylon Caps Left & Right
FOR F9-048 (PAIR)**
F9-049
1" (2.5cm)



Mallet #49
F9-050 19.5cm 7 3/4"
Head diameter 22.0mm
Weight 7 oz 200 grams
Head Weight: 5oz/150 grams



Mead Mallet
F9-051 19.0cm 7 1/2"
Head diameter 26.0mm
Weight 11 oz 315 grams
Head Weight: 6 oz 170 grams



Heath Mallet, Heavyweight
F9-052 19.0cm 7 1/2"
Head diameter 40.0mm
Weight 2 lbs. (907 grams)
Head Weight: 20 oz (567 grams)



Orthopedic Mallet
F9-053 27.5cm 10 3/4"
Lightweight
Solid, Head diameter 35.0mm
Weight 2 lbs. (907 grams)
Head Weight: 1 lb. (454 grams)



Orthopedic Mallet
F9-054 28.0cm 11"
Heavyweight
Solid, Head diameter 50.0mm
Head Weight: 2 lb. (900 grams)

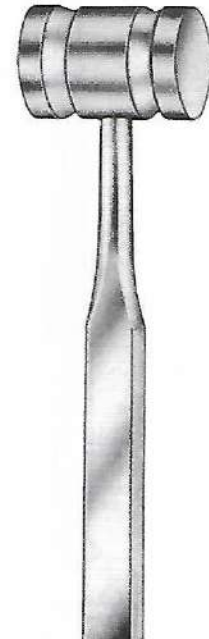

Ortho Mallets
F9-055 26.5 cm 10 1/2"
(450g)



BONE CHISELS & GOUGES

*Knochenmeißel
Ciseaux-burins, gouges*

*Cineles, gubias
Scalpelli, sgorbi*



Osteotome
13.5cm 5 1/4"
F9-056 8mm
F9-057 10mm
F9-058 12mm
F9-059 14mm
F9-060 16mm



Chisel
13.5cm 5 1/4"
F9-061 8mm
F9-062 10mm
F9-063 12mm
F9-064 14mm
F9-065 16mm



Gouge
13.5cm 5 1/4"
F9-066 8mm
F9-067 10mm
F9-068 12mm
F9-069 14mm
F9-070 16mm



Lucas Chisel
16cm 6 1/4"
F9-071 3mm
F9-072 4mm
F9-073 5mm
F9-074 6mm



Lucas Gouge
16cm 6 1/4"
F9-075 3mm
F9-076 4mm
F9-077 5mm
F9-078 6mm



U.S. Army Pattern Chisel
16.5 cm 6 1/2"
F9-079 6 mm wide
F9-080 12 mm wide
F9-081 18 mm wide



Alexander Chisel
18cm 7"
F9-082 4mm
F9-083 6mm
F9-084 8mm
F9-085 10mm
F9-086 12mm
F9-087 14mm



Alexander Gouge
18cm 7"
F9-088 4mm
F9-089 6mm
F9-090 8mm
F9-091 10mm
F9-092 12mm
F9-093 14mm



Partsch Chisel
11.5cm 4 1/2"
F9-094 2mm
F9-095 3mm
F9-096 4mm
F9-097 6mm
F9-098 7mm
F9-099 8mm

Partsch Chisel
13.5cm 5 1/4"
F9-100 2mm
F9-101 3mm
F9-102 4mm
F9-103 6mm
F9-104 7mm
F9-105 8mm

Partsch Chisel
17.5cm 6 3/4"
F9-106 2mm
F9-107 3mm
F9-108 4mm
F9-109 6mm
F9-110 7mm
F9-111 8mm

Partsch Gouge
11.5cm 4 1/2"
F9-112 2mm
F9-113 3mm
F9-114 4mm
F9-115 6mm
F9-116 7mm
F9-117 8mm

Partsch Gouge
13.5cm 5 1/4"
F9-118 2mm
F9-119 3mm
F9-120 4mm
F9-121 6mm
F9-122 7mm
F9-123 8mm

Partsch Gouge
17.5cm 6 3/4"
F9-124 2mm
F9-125 3mm
F9-126 4mm
F9-127 6mm
F9-128 7mm
F9-129 8mm

BONE CHISELS & GOUGES



Knochenmeißel
Ciseaux-burins, gouges

Cineles, gubias
ScalPELLI, sgorbi



Straight	
F9-130	09 mm
F9-131	14 mm
F9-132	19 mm
F9-133	25 mm
Curved	
F9-134	09 mm
F9-135	14 mm
F9-136	19 mm
F9-137	25 mm

Smith Peterson Gouge
20 cm, 8"



Straight	
F9-138	06 mm
F9-139	09 mm
F9-140	13 mm
F9-141	16 mm
F9-142	19 mm
F9-143	25 mm
F9-144	32 mm
Curved	
F9-145	06 mm
F9-146	09 mm
F9-147	13 mm
F9-148	16 mm
F9-149	19 mm
F9-150	25 mm
F9-151	32 mm

Smith Peterson Osteotome
20 cm, 8"



Straight	
F9-152	10 mm
F9-153	15 mm
F9-154	20 mm
F9-155	25 mm
Curved	
F9-156	10 mm
F9-157	15 mm
F9-158	20 mm
F9-159	25 mm

Stille Gouge
20 cm, 8"



Chisels	
F9-160	10 mm
F9-161	12 mm
F9-162	15 mm
F9-163	20 mm
F9-164	25 mm
Osteotome	
F9-165	10 mm
F9-166	12 mm
F9-167	15 mm
F9-168	20 mm
F9-169	25 mm

Stille
20 cm, 8"

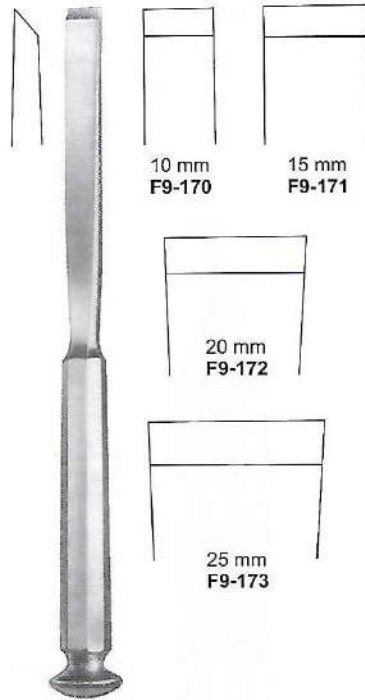

Stille Chisel
20 cm, 8"

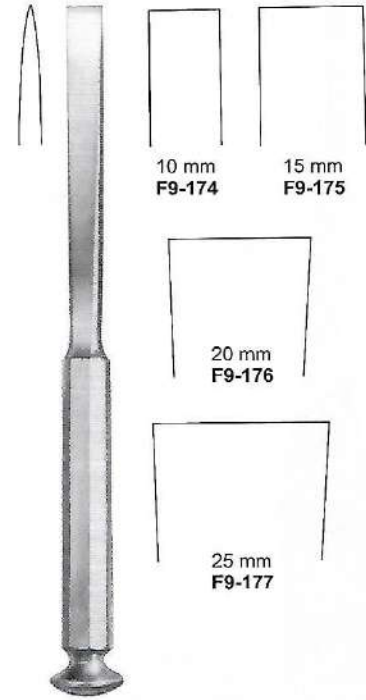

Stille Osteotome
20 cm, 8"



BONE CHISELS & GOUGES

Knochenmeißel
Ciseaux-burins, gouges

Cineles, gubias
Scalpelli, sgorbi



Lexer Osteotome

22 cm, 8 3/4"
F9-178 7 mm
F9-179 10 mm
F9-180 12 mm
F9-181 15 mm
F9-182 20 mm
F9-183 25 mm
F9-184 30 mm

Lexer Modif. Osteotome

29 cm, 11 1/2"
F9-185 7 mm
F9-186 10 mm
F9-187 12 mm
F9-188 15 mm
F9-189 20 mm
F9-190 25 mm
F9-191 30 mm



Lexer Modif. Chisel

29 cm, 11 1/2"
F9-192 7 mm
F9-193 10 mm
F9-194 12 mm
F9-195 15 mm
F9-196 20 mm
F9-197 25 mm
F9-198 30 mm

Lexer Chisel

22 cm, 8 3/4"
F9-199 7 mm
F9-200 10 mm
F9-201 12 mm
F9-202 15 mm
F9-203 20 mm
F9-204 25 mm
F9-205 30 mm



Lexer Gouge

25 mm, 10"
F9-206 7 mm
F9-207 10 mm
F9-208 15 mm
Straight



Lexer Gouge

25 mm, 10"
F9-209 7 mm
F9-210 10 mm
F9-211 15 mm
Curved



Lexer Osteotome Flat

22 cm, 8 3/4"
F9-212 10 mm
F9-213 15 mm
F9-214 20 mm
F9-215 25 mm



Lexer Gouge

Tuffnel Handle
22 cm, 8 3/4"
F9-216 10 mm
F9-217 15 mm
F9-218 20 mm
F9-219 25 mm

BONE CHISELS & GOUGES



Knochenmeißel
Ciseaux-burins, gouges

Cineles, gubias
ScalPELLi, sgorbi



Mini Lexer Osteotome
F9-220
18 cm, 7"



Mini Lexer Chisel
F9-221
18 cm, 7"
Hollow



Capener Osteotome
With Tuffnel Handle
25cm 10"
F9-222 10mm
F9-223 12mm
F9-224 15mm
F9-225 20mm
F9-226 25mm
F9-227 30mm
Straight



Capener Osteotome
With Tuffnel Handle
25cm 10"
F9-228 10mm
F9-229 12mm
F9-230 15mm
F9-231 20mm
F9-232 25mm
F9-233 30mm
Curved



Capener Chisels
With Tuffnel Handle
25cm 10"
F9-234 6mm
F9-235 8mm
F9-236 10mm
F9-237 12mm
F9-238 15mm
F9-239 20mm
F9-240 25mm
F9-241 30mm
Straight



Capener Osteotome
With Tuffnel Handle
25cm 10"
F9-242 6mm
F9-243 8mm
F9-244 10mm
F9-245 12mm
F9-246 15mm
F9-247 20mm
F9-248 25mm
F9-249 30mm
Curved



BONE CHISELS & GOUGES

Knochenmeißel

Ciseaux-burins, gouges

Cineles, gubias

Scalpelli, sgorbi



Lambotte Osteotome

25cm 9 3/4"

- F9-250 6mm
- F9-251 8mm
- F9-252 10mm
- F9-253 13mm
- F9-254 15mm
- F9-255 20mm
- F9-256 25mm
- F9-257 30mm
- F9-258 38mm
- F9-259 44mm
- F9-260 50mm
- Straight



Lambotte Osteotome

25cm 9 3/4"

- F9-261 6mm
- F9-262 8mm
- F9-263 10mm
- F9-264 13mm
- F9-265 15mm
- F9-266 20mm
- F9-267 25mm
- F9-268 30mm
- F9-269 38mm
- F9-270 44mm
- F9-271 50mm
- Curved



Mini-Lambotte Osteotome

12.5cm 5"

- F9-272 3mm
- F9-273 4mm
- F9-274 6mm
- F9-275 8mm
- F9-276 10mm
- F9-277 12mm
- F9-278 15mm
- Straight



Mini-Lambotte Osteotome

17cm 6 3/4"

- F9-279 3mm
- F9-280 4mm
- F9-281 6mm
- F9-282 8mm
- F9-283 10mm
- F9-284 12mm
- F9-285 15mm
- Straight



Lambotte Osteotome

12.5cm, 5" Straight

- F9-286 2mm tip width
- F9-287 4mm tip width
- F9-288 6mm tip width
- F9-289 8mm tip width
- F9-290 10mm tip width
- F9-291 12mm tip width
- F9-292 15mm tip width



Hex Handle Osteotome

15cm, 6" Straight

- F9-293 2mm tip width
- F9-294 3mm tip width
- F9-295 4mm tip width
- F9-296 5mm tip width
- F9-297 6mm tip width
- F9-298 7mm tip width
- F9-299 9mm tip width
- F9-300 10mm tip width



Cottle Osteotome

18.5cm, 7 1/4" Straight

- F9-301 4mm tip width
- F9-302 6mm tip width
- F9-303 9mm tip width
- F9-304 12mm tip width



Anderson-Nievert Osteotome

20.4cm 8"

- F9-305 Curved right
- F9-306 Curved left
- F9-307 Straight

BONE CHISELS & GOUGES



Knochenmeißel
Ciseaux-burins, gouges

Cineles, gubias
Scalpelli, sgorbi



Stille
20cm 8"



Stille Chisel
F9-308 10mm
F9-309 15mm
F9-310 20mm
F9-311 25mm
Straight



Stille Osteotome
F9-312 10mm
F9-313 15mm
F9-314 20mm
F9-315 25mm
Straight



Stille Osteotome
F9-316 10mm
F9-317 15mm
F9-318 20mm
F9-319 25mm
Curved



Stille Gouge
F9-320 10mm
F9-321 15mm
F9-322 20mm
F9-323 25mm
Straight



Stille Gouge
F9-324 10mm
F9-325 15mm
F9-326 20mm
F9-327 25mm
Curved



Smith-Petersen
20cm 8"

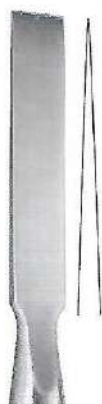

Smith-Petersen osteotome
F9-328 6mm
F9-329 9mm
F9-330 13mm
F9-331 16mm
F9-332 19mm
F9-333 25mm
F9-334 32mm
Straight

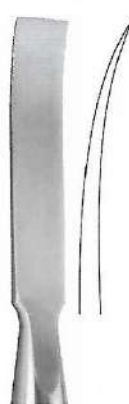

Smith-Petersen Osteotome
F9-335 6mm
F9-336 9mm
F9-337 13mm
F9-338 16mm
F9-339 19mm
F9-340 25mm
F9-341 32mm
Curved



Smith-Petersen Gouge
F9-342 9mm
F9-343 16mm
F9-344 19mm
F9-345 25mm
Straight



Smith-Petersen Gouge
F9-346 9mm
F9-347 16mm
F9-348 19mm
F9-349 25mm
Curved



BONE CHISELS & GOUGES

Knochenmeißel
Ciseaux-burins, gouges

Cineles, gubias
Scalpelli, sgorbi



Freer Gouge
F9-350 15cm 6"
06mm



Freer Chisel
F9-351 16cm 6 1/4"
04mm



**Shoulder Penetrating
Gouge**
F9-352
21.6cm 8 1/2"
Straight, 3mm distal tip



Ballenger Chisel
F9-353 04mm
F9-354 06mm
F9-355 08mm
16cm 6 1/4"



Mannerfelt Modif.

Osteotomes
F9-356 04mm
F9-357 06mm
F9-358 08mm
15.5cm 6"



Gouge
F9-359 03mm
15.5cm 6"



Kilian, Septum Gouge
F9-360 16cm 6 1/4"
05mm



**Kilian-Claus
Septum Gouge**
F9-361 16cm 6 1/4"
05mm



Cottle Osteotome
F9-362 07mm
F9-363 12mm
15cm 6"



Cottle Osteotome
F9-364 19cm 7 1/2"
04mm



**Cottle Osteotome
with depth markings**
F9-365 18cm 7"
06mm

BONE CHISELS & GOUGES



Knochenmeißel
Ciseaux-burins, gouges

Cineles, gubias
Scalpelli, sgorbi



F9-366
04mm



F9-367
05mm



F9-368
06mm



F9-369
07mm



F9-370
08mm

Fomon Chisel
17cm 6 3/4"

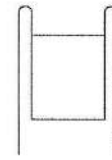

F9-371
10mm

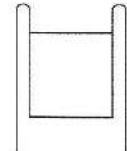

F9-372
12mm



F9-373
14mm

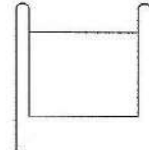

F9-374
16mm

Cinelli Chisel
18cm 7"



F9-375
04mm



F9-376
07mm



F9-377
09mm



F9-378
12mm



Cottle Osteotome
18cm 7"



F9-379
04mm



F9-380
07mm



F9-381
09mm



F9-382
12mm



Cottle Chisel
18cm 7"



CHISELS, OSTEOTOMES FOR RHINOPLASTIC

Meißel zur Nasenplastik

Osteotomes, ciseaux-burins pour rhinoplastique

Cinceles para rinoplastica

Scalpelli per plastica nasale



Sheehan osteotome
16cm 6 1/4"



F9-383
2mm



F9-384
4mm



F9-385
6mm



F9-386
8mm



F9-387
10mm



F9-388
12mm



F9-389
15mm



F9-390
18mm



Silver Rhinoplastic Chisel

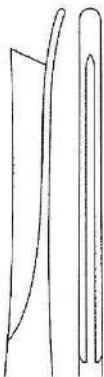

F9-391
18cm 7"
Straight

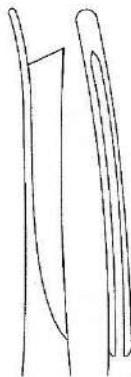

F9-392
18cm 7"
right

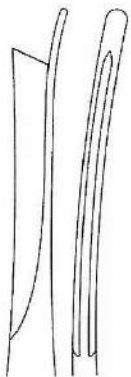

F9-393
18cm 7"
Left



Neivert-Anderson
osteotome

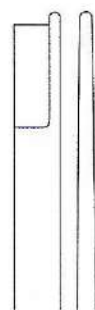

F9-394
20cm 8"
Straight

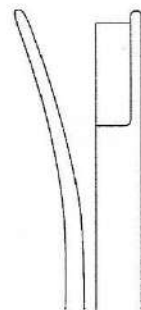

F9-395
20cm 8"
right

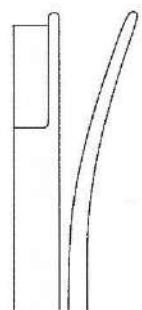

F9-396
20cm 8"
Left

TAMPERS



Stobel
Pilons

Punzones
Pestoni



Obwegeser Osteotome
F9-397 23.5cm 9 1/4"
11mm



Obwegeser Blade osteotome
F9-398 7mm
21.5cm 8 1/2"



Obwegeser Blade osteotome
F9-399 10mm
21.5cm 8 1/2"



Bone Tamper

- F9-400**
15.5cm 6"
Head diameter
2mm
- F9-401**
15.5cm 6"
Head diameter
3mm
- F9-402**
15.5cm 6"
Head diameter
4mm
- F9-403**
15.5cm 6"
Head diameter
5mm
- F9-404**
15.5cm 6"
Head diameter
6mm
- F9-405**
15.5cm 6"
Head diameter
8mm
- F9-406**
15.5cm 6"
Head diameter
10mm



F9-407
2.5mm x 2.5mm

F9-408
3.5mm x 3.5mm

Passow Bone Tamper
12cm 4 3/4"



F9-409
3mm

F9-410
5mm

F9-411
8mm

Caspar Bone Tamper
20cm 8"



F9-412
12mm

F9-413
14mm

F9-414
16mm

Caspar Bone Tamper
20cm 8"



Tip Size
2 mm
3 mm
4 mm
5 mm
6 mm
8 mm
10 mm

Bone Tamps
F9-415
15.4 cm, 6"



BONE CURETTES

Scharfe Löffel











Curettes tranchantes

cucharillas cortantes

Cucchiai taglianti









Volkman Bone Curette

-  **F9-416**
17 cm, 7"
0000
-  **F9-417**
17 cm, 7"
000
-  **F9-418**
17 cm, 7"
00
-  **F9-419**
17 cm, 7"
0
-  **F9-420**
17 cm, 7"
1
-  **F9-421**
17 cm, 7"
2
-  **F9-422**
17 cm, 7"
3
-  **F9-423**
17 cm, 7"
4
-  **F9-424**
17 cm, 7"
5
-  **F9-425**
17 cm, 7"
6











Schede Bone Curette
17 cm, 6 3/4"

-  **F9-426**
17 cm, 7"
000
-  **F9-427**
17 cm, 7"
00
-  **F9-428**
17 cm, 7"
0
-  **F9-429**
17 cm, 7"
1
-  **F9-430**
17 cm, 7"
2
-  **F9-431**
17 cm, 7"
3
-  **F9-432**
17 cm, 7"
4













Bruns Bone Curette

-  **F9-433**
17 cm, 7"
000
-  **F9-434**
17 cm, 7"
00
-  **F9-435**
17 cm, 7"
0
-  **F9-436**
17 cm, 7"
1
-  **F9-437**
17 cm, 7"
2
-  **F9-438**
17 cm, 7"
3
-  **F9-439**
17 cm, 7"
4
-  **F9-440**
17 cm, 7"
5
-  **F9-441**
17 cm, 7"
6



Spratt Bone Curette / Hollow Handle

-  **F9-442**
16.5 cm, 6 1/2"
00000
-  **F9-443**
16.5 cm, 6 1/2"
0000
-  **F9-444**
16.5 cm, 6 1/2"
000
-  **F9-445**
16.5 cm, 6 1/2"
00
-  **F9-446**
16.5 cm, 6 1/2"
0
-  **F9-447**
16.5 cm, 6 1/2"
1
-  **F9-448**
16.5 cm, 6 1/2"
2
-  **F9-449**
16.5 cm, 6 1/2"
3
-  **F9-450**
16.5 cm, 6 1/2"
4
-  **F9-451**
16.5 cm, 6 1/2"
5

BONE CURETTES



Scharfe Löffel
Curettes tranchantes

cucharillas cortantes
Cucchiai taglienti



**Schroeder
Bone Curette**
Sharp / rigid



F9-452
30.0 cm, 12"
1



F9-453
30.0 cm, 12"
2



F9-454
30.0 cm, 12"
3



F9-455
30.0 cm, 12"
4



F9-456
30.0 cm, 12"
5



F9-457
30.0 cm, 12"
6



**Simon
Bone Curette**
Sharp / rigid



F9-458
24.0 cm, 9 1/2"
0000



F9-459
24.0 cm, 9 1/2"
000



F9-460
24.0 cm, 9 1/2"
00



F9-461
24.0 cm, 9 1/2"
0



F9-462
25.0 cm, 9 3/4"
1



F9-463
25.0 cm, 9 3/4"
2



F9-464
25.0 cm, 9 3/4"
3



F9-465
25.0 cm, 9 3/4"
4



F9-466
25.0 cm, 9 3/4"
5

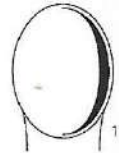

F9-467
25.0 cm, 9 3/4"
6



BONE CURETTES

Scharfe Löffel
Curettes tranchantes

cucharillas cortantes
Cucchiai taglienti

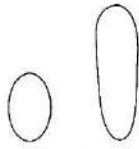

F9-468
13 cm, 5 1/4"

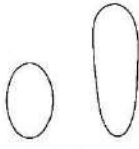

F9-469
14 cm, 5 1/4"

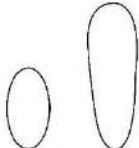

F9-470
17 cm, 6 3/4"

Volkman
Curette
Oval / Oval



F9-471
13 cm, 5 1/4"



F9-472
16 cm, 6 1/4"

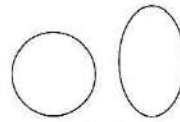

F9-473
20 cm, 8"

Volkman
Curette
Round / Oval



Curette
F9-474
21cm 8 1/4"
round / oval



- F9-475
00
- F9-476
0
- F9-477
0
- F9-478
1
- F9-479
1
- F9-480
2

Martini
Curette
13.5 cm, 5 1/4"



- F9-481
00
- F9-482
0
- F9-483
1

Martini
Curette
15.5 cm, 6"



- F9-484
00
- F9-485
0
- F9-486
0
- F9-487
1
- F9-488
1
- F9-489
2

Williger
Curette
13.5 cm, 5 1/4"



- F9-490
00
- F9-491
0
- F9-492
1

Williger
Curette
15.5 cm, 6"

BONE CURETTES



Scharfe Löffel
Curettes tranchantes

cucharillas cortantes
Cucchiai taglianti



Jansen Curette
F9-493
16 cm, 6 1/4"



Jansen Curette
F9-494
15 cm, 6"



Williger Curette
F9-495
13.25 cm, 5 1/2"
Double Ended
00/0



↑ ↓
F9-496
13 cm, 5"
Double Ended
6.2 mm & 6.7 mm

↑ ↓
F9-497
16 cm, 6 1/2"
Double Ended
7 mm & 9 mm

↑ ↓ 1/4
F9-498
20 cm, 8"
Double Ended
9.1 mm & 11.1 mm

Curette



Lucas Curette
double-ended
18 cm, 7"



Fig. 1 R/L
F9-499



Fig. 2 R/L
F9-500



Fig. 3 R/L
F9-501



Fig. 4 R/L
F9-502



PERIOSTEAL ELEVATORS

Raspatorien
Periostótomos

Rugines-raspatoires
Periostotomi

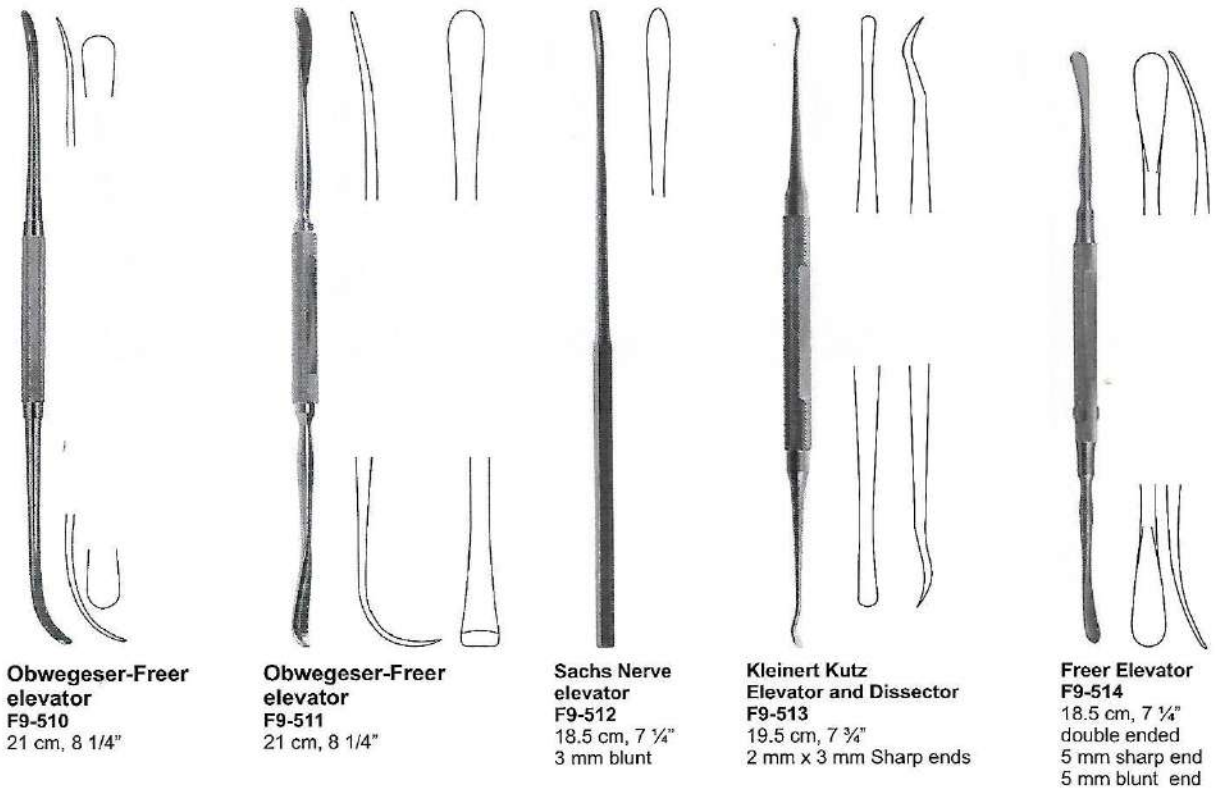
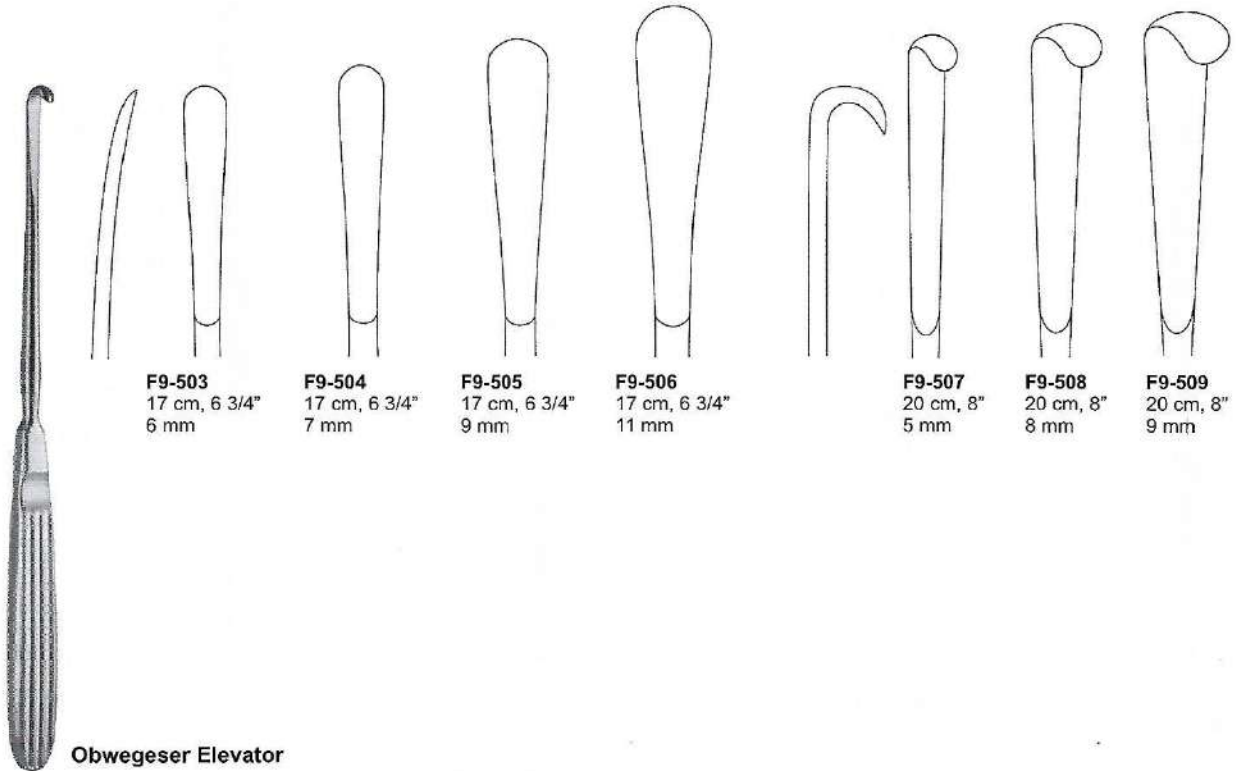

PERIOSTEAL ELEVATORS



Raspatorien
Periostótomos

Rugines-raspatoires
Periostotomi



**Obwegeser Needle
F9-515**
17.5 cm, 7"



**Obwegeser Needle
F9-516**
23 cm, 9"



**Obwegeser Needle
F9-517**
18 cm, 7"



**Obwegeser Needle
F9-518**
14 cm, 5 1/2"



F9-519
Right Crved
For Adults



F9-520
Right Crved
For Children

Doyen Rib Raspatory
17 cm, 7"

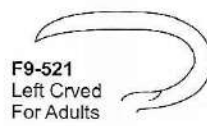

F9-521
Left Crved
For Adults



F9-522
Left Crved
For Children

Doyen Rib Raspatory
17 cm, 7"

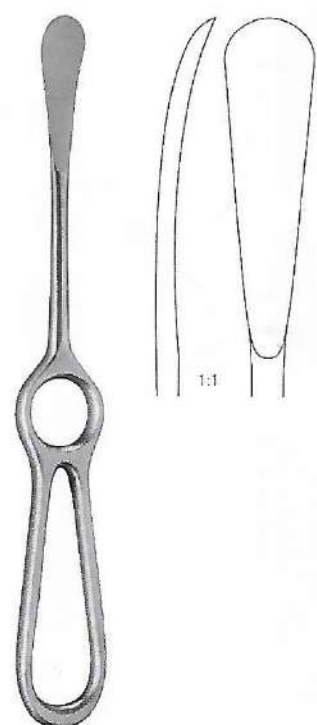

**Sedillot Elevator
F9-523** 18.5cm, 7 1/4"
F9-524 21.0cm, 8 1/4"



PERIOSTEAL ELEVATORS

Raspatorien
Periostótomos

Rugines-raspatoires
Periostotomi



Grego Periosteal Elevator
F9-525
15.5cm, 6"



Williger Elevator
F9-526 13cm, 5"
5mm



Williger Elevator
F9-527 4mm
F9-528 6mm
16cm, 6 1/4"



Williger Elevator
F9-529
16cm, 6 1/4"
5mm



Williger Elevator
F9-530
16cm, 6 1/4"
6.5mm



Farabeuf-Collin Elevator
F9-531
16cm, 6 1/4"
11mm
Straight



Farabeuf-Collin Elevator
F9-532
16cm, 6 1/4"
11mm
Curved

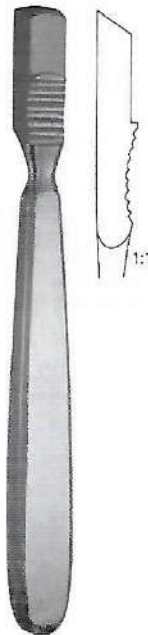

Farabeuf Elevator
F9-533
15cm, 6"
Straight

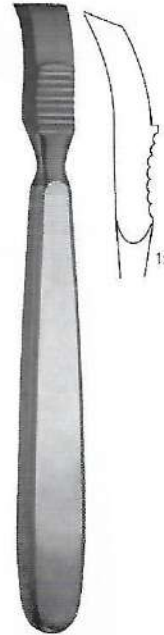

Farabeuf Elevator
F9-534
15cm, 6"
Curved



Lambotte Elevator
F9-535 5mm
F9-536 10mm
F9-537 15mm
F9-538 20mm
F9-539 25mm
21cm, 8 1/4" Straight

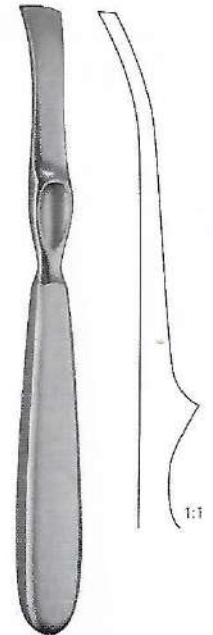

Lambotte Elevator
F9-540 5mm
F9-541 10mm
F9-542 15mm
F9-543 20mm
F9-544 25mm
21cm, 8 1/4" Curved

BONE LEVERS



Knochenhebel
Leviers a os

Elevadores para huesos
Elevatori per ossa



**Hohmann
Bone Elevator
F9-545 .43mm
24.5 cm, 9 1/2"**

**Hohmann
Bone Elevator
F9-546 22mm
26cm, 10 1/4"**

**Hohmann
Bone Elevator
F9-547 33mm
28cm, 11"**

**Hohmann
Bone Elevator
F9-548 24mm
26.5cm, 10 1/2"**

**Hohmann
Bone Elevator
F9-549 22mm
26cm, 10 1/4"**



BONE LEVERS

Knochenhebel
Leviers a os

Elevadores para huesos
Elevatori per ossa



Capsule Retractor
F9-550 25.5cm 10"
3 sharp-pronged,
22mm width blade



**Bristow-Bankart
Humeral Retractor**
F9-551 19.0cm 7 1/2"
Double-pronged,
25mm width x 102mm
depth blade



**Bristow-Bankart Soft
Tissue Retractor**
F9-552 20.0cm 7 7/8"
3-pronged
21mm width blade,



Humeral Head Retractor
F9-553 22.0cm 8 3/4"
18mm width blade



Hohmann Bone Elevator
F9-554 22cm, 8 3/4"
08mm width blade
F9-555 23.0cm 9"
10mm width blade



Hohmann Bone Elevator
F9-556 24cm, 9 1/2"
18mm



Hohmann Bone Elevator
F9-557 24cm, 9 1/2" 70mm
F9-558 28.5cm 11 1/4" 35mm width blade
F9-559 33.0cm 13" 40mm width blade



**Hohmann Long Shank
Retractor**
F9-560 23.0cm 9"
43mm width blade

BONE LEVERS



Knochenhebel
Levers a os

Elevadores para huesos
Elevatori per ossa



**Mini-Hohmann
Bone Elevator**



F9-561
16cm, 6 1/4"
6mm width blade

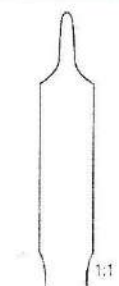

F9-562
16cm, 6 1/4"
8mm width blade



**Hohmann
Bone Lever
F9-563**
15 cm, 6"



**Hohmann
Bone Lever
F9-564**
15.4 cm, 6"
Short tip



**Hohmann Retractor
F9-565**
15.0cm 6"
15mm width blade



**Hayes Hand Retractor
F9-566** 16.0cm 6 1/4"
3mm width blade



**Hayes Hand Retractor
F9-567** 15.0cm 6"
6mm width blade



Bone Lever

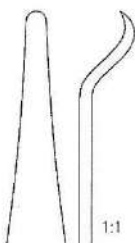

F9-568 14cm, 5 1/2"
2.8mm

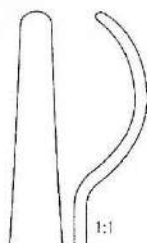

F9-569 14cm, 5 1/2"
4.5mm

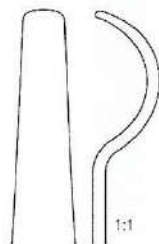

F9-570 14cm, 5 1/2"
6mm



**Bristow Bone Lever
F9-571** 23cm, 9"



**Lane Bone Lever
F9-572**
21cm, 8 1/4"



BONE LEVERS

Knochenhebel
Leviers a os

Elevadores para huesos
Elevatori per ossa

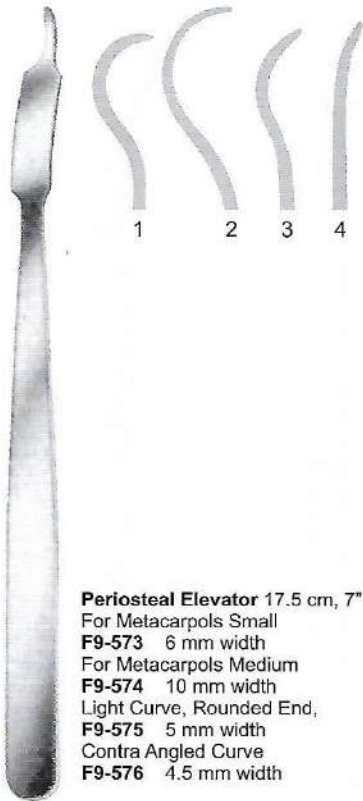

Periosteal Elevator 17.5 cm, 7"
For Metacarpals Small
F9-573 6 mm width
For Metacarpals Medium
F9-574 10 mm width
Light Curve, Rounded End,
F9-575 5 mm width
Contra Angled Curve
F9-576 4.5 mm width

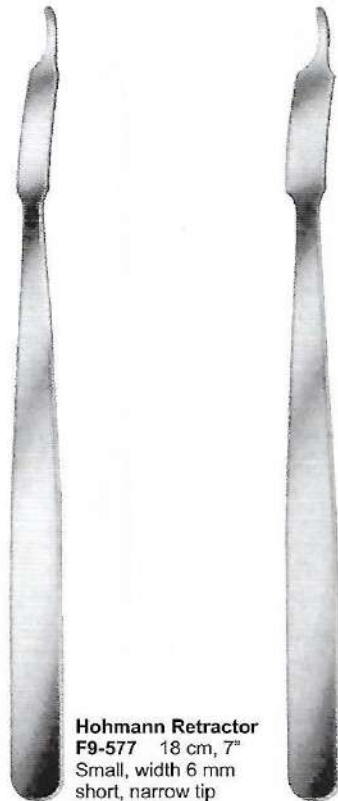

Hohmann Retractor
F9-577 18 cm, 7"
Small, width 6 mm
short, narrow tip

Hohmann Retractor
F9-578 18 cm, 7"
Small, width 8 mm
short, narrow tip



Hohmann Retractor
F9-579 12.5 cm, 5"
Finger Ring handle,
16mm width blade

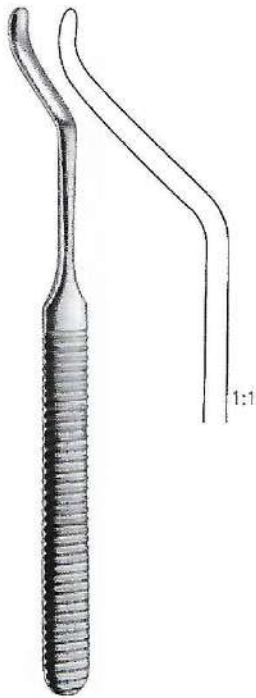

Hohmann-Williger
Retractor
F9-580 16 cm, 6 1/4"

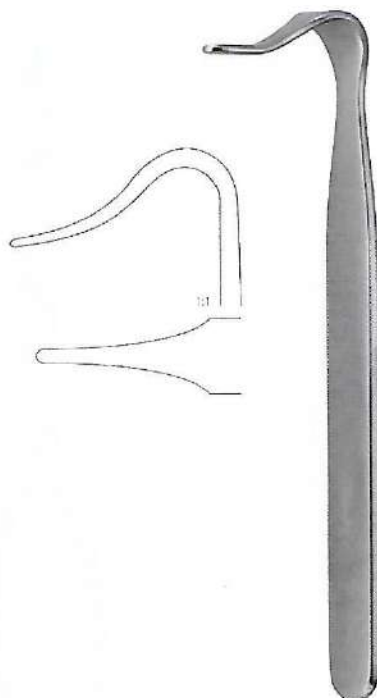

Blount Retractor
F9-581
17.5cm, 7"



Taylor Retractor.
16.5cm, 6 1/2"
F9-582 a=75mm - b=30mm
F9-583 a=100mm - b=30mm

BONE LEVERS



Knochenhebel
Leviers a os

Elevadores para huesos
Elevatori per ossa



Cushing Vein Retractor
F9-584 22.5 cm, 9"
with fenestrated handle
Blade 12 mm width x 10 mm



Cushing Decompression Retractor
F9-585 21.5 cm, 8 1/2"
with fenestrated blade and handle
Blade 13 mm width x 22 mm



Scoville Nerve Retractor
F9-586
24 cm, 9 1/2", 7 mm
straight



Scoville Nerve Retractor
F9-587
24 cm, 9 1/2", 7 mm
angled



Taylor Retractor
17 cm, 6 3/4"
F9-588 30 x 75 mm
F9-589 30 x 100 mm



Hibbs Retractor
F9-590 25 x 75 mm, 23 cm, 9"
F9-591 25 x 80 mm, 24 cm, 9 1/2"



Meyerdig Retractor
F9-592 16 X 50 mm, 20 cm, 8"
F9-593 25 X 75 mm, 23 cm, 9"
F9-594 50 X 90 mm, 24 cm, 9 1/2"



MENISCOTOMY KNIVES

Meniskotome

Bisturios para meniscos

Bistouries a menisques

Bisturi per menisco



Bircher Meniscotomy Knife
F9-595
19cm 7 1/2"



Matson Meniscotomy Knife
F9-596
22 cm, 9"



Downing Cartilage Knife
F9-597 25.5cm 10"
Curved tip, Straight shaft

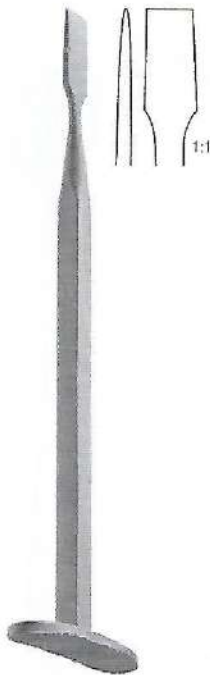

Smillie Meniscotomy Knife
F9-598
16cm 6 1/4" Straight shaft,
Blade tip width is 7.8mm
Straight tip

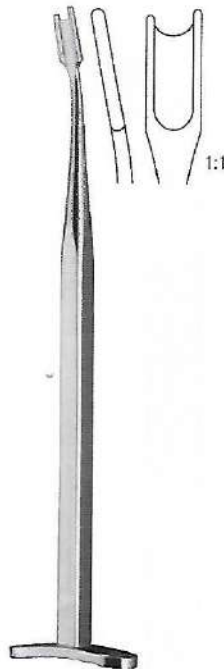

Smillie Meniscotomy Knife
F9-599
16cm 6 1/4" curved shaft,
Blade tip width is 7.8mm
Curved left tip



Smillie Meniscotomy Knife
F9-600
16cm 6 1/4" Curved shaft,
Blade tip width is 7.8mm
Curved left tip

ORTHOPAEDICS

Orthopädie
Ortopedia

Orthopédie
Ortopedia



**Nail Extracting Forceps
F9-601**
14 cm, 5 1/2"

**Nail Extracting Forceps
F9-602**
14.5 cm, 5 3/4"

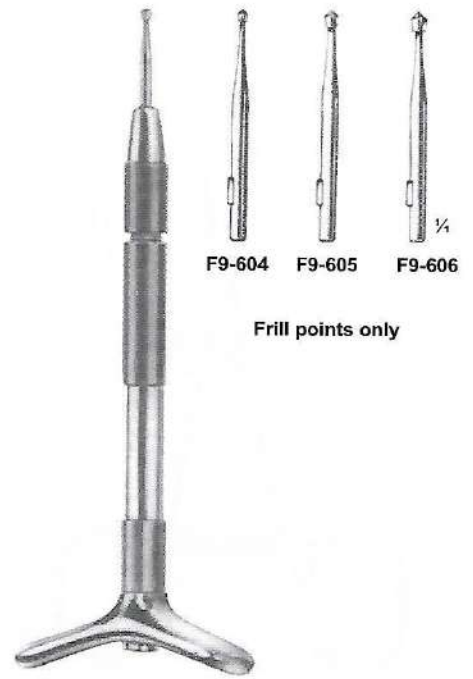

Frill points only

**Finger Nail Drill
with 3 drill points
F9-603**

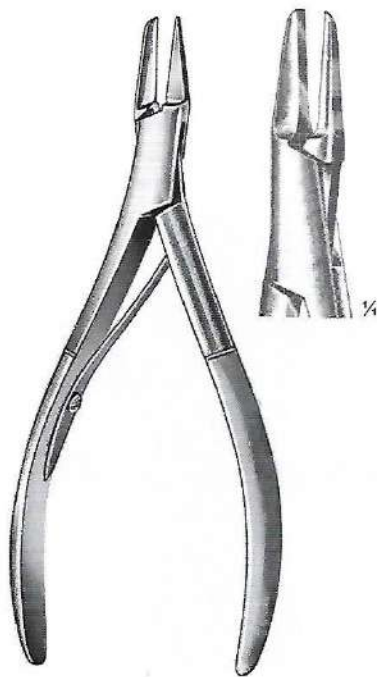

**Nail Splitting Forceps
F9-607**
13.5 cm, 5 1/4"



**F9-609
Saw Blade Only
for F9-608**

**Ring Cutter
F9-608**
17 cm, 6 3/4"



**F9-611
Saw Blade Only
for F9-610**

**Ring Cutter
F9-610**
17 cm, 6 3/4"



TENDON STRIPPERS

Sehnenstripper
Instruments a ecorcher les tendons

enucleadores de tendones
Scollatendini

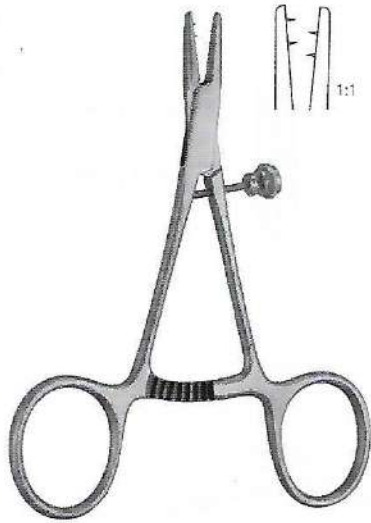

Tendon Tunelling Forceps
F9-612
13cm 5"



Tendon Tunelling Forceps

F9-613
15cm 6"

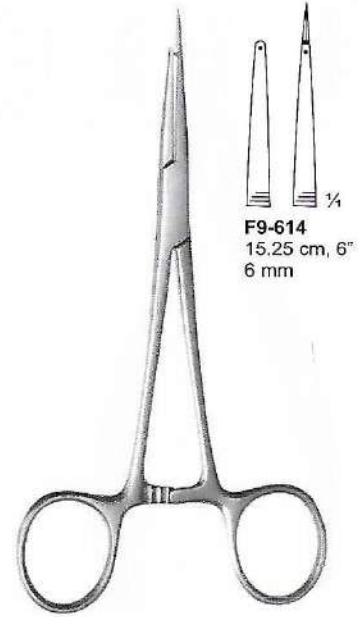

Tendon Tunelling Forceps

F9-614
15.25 cm, 6"
6 mm

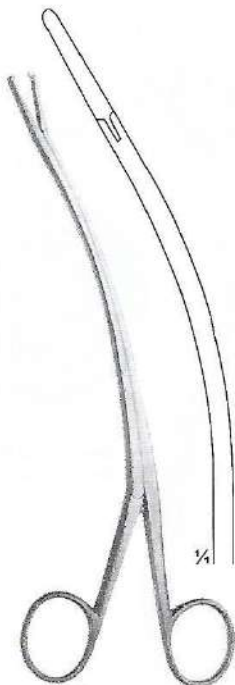

Brand Tendon Forceps
F9-615 15 cm, 6"
F9-616 19 cm, 7 1/2"
F9-617 24 cm, 9 1/2"

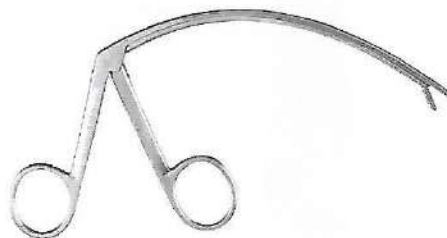

Carroll Tendon Forceps
F9-618 13 cm, 5"
Curved Shaft
2 mm x 6 mm



Lead Hand
F9-619
Adult Size

TENDON STRIPPERS



Sehnenstripper

Instruments a ecorcher les tendons

enucleadores de tendones

Scollatendini

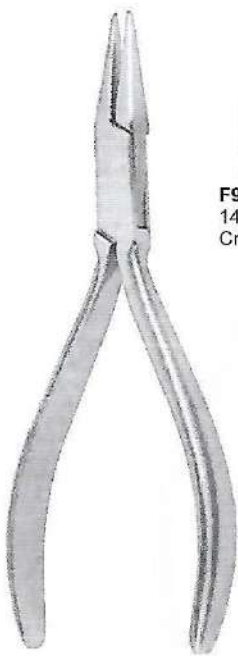

F9-620
14 cm, 5 1/2"
Cross serrated

Needle Nose Pliers

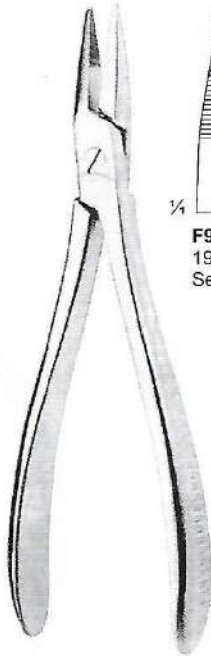

F9-621
19 cm, 7 1/2"
Serrated

Needle Nose Pliers

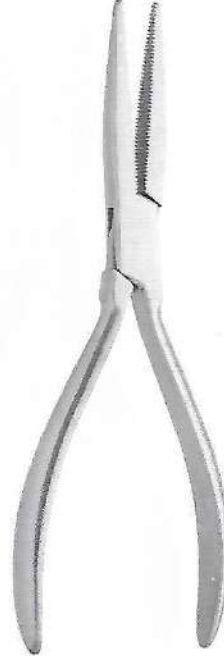

Flat Nose Plier
F9-622
18 cm, 7"



Flat Nose Pliers
F9-623
13.5cm 5 3/8"
Broad, 4mm tip,



Flat Nose Pliers
F9-624
16.5cm 6 1/2"
Combination plier and
cutter



Needle Nose Pliers
F9-625
13.5cm 5 3/8"



Flat Nose Pliers
F9-626
15cm 6" Delicate, 1.5mm tip



K-Wire Extraction Pliers
W/Screw Lock
F9-627
13cm 5" 3mm tip



TECHNICAL FORCEPS

Technische Zangen
Pinces techniques

Pinzas técnicas
Pinze tecniche



Flat Nose K-Wire Pliers
F9-628 14.0cm 5 1/2"
F9-629 17.0cm 6 3/4"

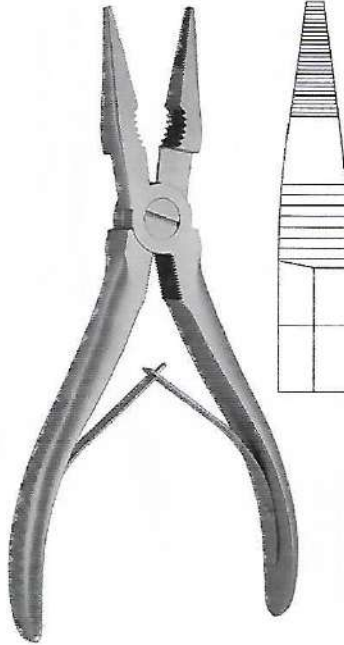

Nose Pliers
F9-630
17cm 6 3/4"



Pin Puller W/ Groove TC
F9-631
14.0cm 5 1/2"



Utility Technical Forceps Pliers
F9-632 19cm 7 1/2"
adjustable



Vital Heavy Duty Pliers TC
F9-633 22cm 8 3/4"
Grip Forceps, Combined
with cutter



Vital Wire Extraction Pliers T.C
F9-634 5mm
F9-635 7mm
18cm 7"

TECHNICAL FORCEPS



Technische Zangen
Pincas técnicas

Pinzas técnicas
Pinze tecniche

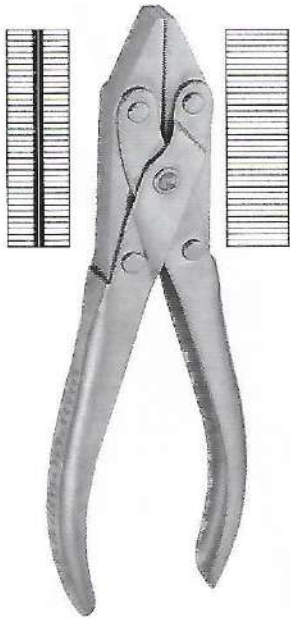

Wire Bending Forceps
F9-636 18.5.0cm 7 1/4"



Flat Nose Plier
F9-637 18.5.0cm 7 1/4"
parallel grip, incorporated
cutter, for hard wires up to
1.6mm



Locking Plier
F9-643 22cm 8 3/4"
F9-644 25cm 9 3/4"
F9-645 30cm 12"
Locking plier, only
F9-646 30cm 12"
with holding pins
F9-647 46cm 18"
with extraction device



Locking Plier
F9-638 18cm 7"
F9-639 20cm 8"
F9-640 24cm 9 1/2"



Plate Bending Plier
F9-641 20cm 8"
for plates up to 2.7mm
F9-642 24cm 9 1/2"
for plates up to 4mm



TECHNICAL FORCEPS

Technische Zangen
Pinces techniques

Pinzas tecnicas
Pinze tecniche



Needle-Nose Locking Pliers
F9-648



Needle-Nose Locking Pliers
F9-649



Needle-Nose Locking Pliers
F9-650



Flat Nosed Plier
F9-651 18 cm, 7"
parallell, with lateral
wire cutter



Cast Spreader
Model Usa
F9-652 23 cm, 9"
3 Prong



Nail Extractor
F9-653 16 cm, 6 1/2"
with Longitudinal Groove
(for Intramedullary Gliding Nails)

BONE RONGEURS



Hohlmeißelzangen
Pinzas gubias

Pinces-gouges
Pinze-sgorbie

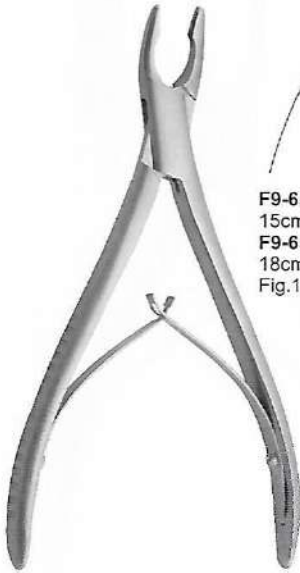

Luer Bone Rongeur
Single action
Curved, 8 x 12mm

F9-654
15cm 6"
F9-655
18cm 7 1/8"
Fig.1

F9-656
15cm 6"
F9-657
18cm 7 1/8"
Fig.2

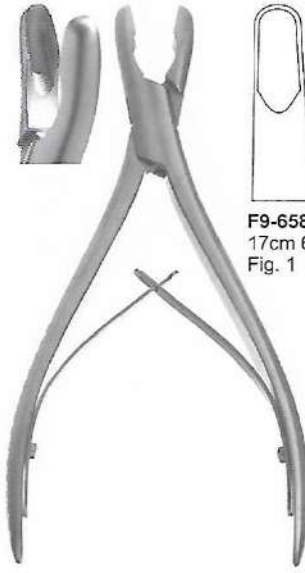

Luer Bone Rongeur
Single action,
Straight, 8 x 12mm

F9-658
17cm 6 3/4"
Fig. 1

F9-659
17cm 6 3/4"
Fig. 2



Friedmann Bone Rongeur
F9-660 14.5cm 5 3/4"
Single action, Curved,
4 x 11mm,



Blumenthal Bone Rongeur

F9-661
15.5cm 6"
Fig. 1

F9-662
15.5cm 6"
Fig. 2

F9-663
15.5cm 6"
Fig. 3

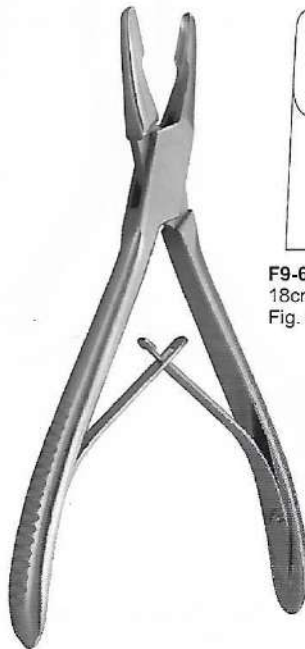

Jasen Bone Rongeur

F9-664
18cm 7"
Fig. 1

F9-665
18cm 7"
Fig. 2

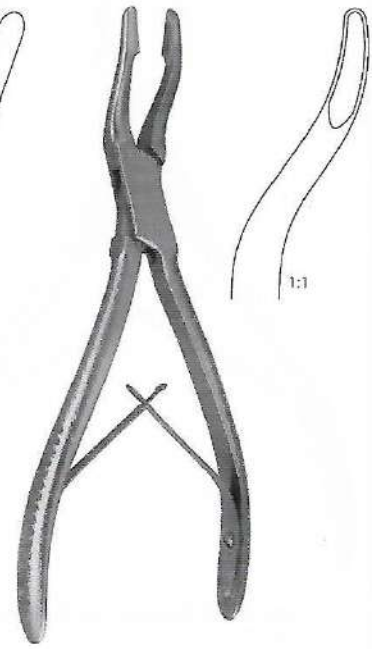

Jansen Bone Rongeur
F9-666 19cm 7 1/2"



BONE RONGEURS

Hohlmeißelzangen
Pinzas gubias

Pinces-gouges
Pinze-sgorbie



F9-667
17.5cm 7"
slightly curved

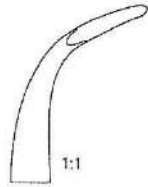

F9-668
17.5cm 7"
Strongly curved

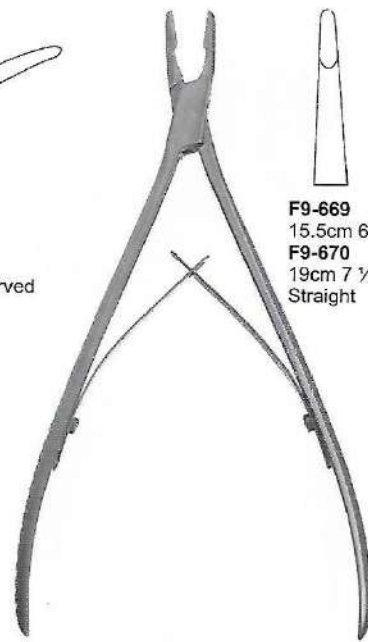

F9-669
15.5cm 6 1/8"
F9-670
19cm 7 1/2"
Straight



F9-671
15.5cm 6 1/8"
F9-672
19cm 7 1/2"
Curved

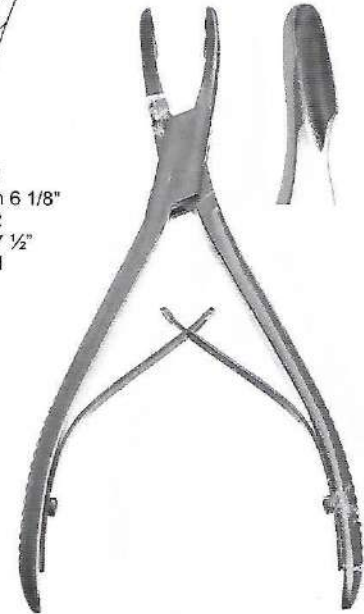

Rongeur #4
F9-673 14cm 5 1/2"
Rongeur #4A
F9-674 16.5cm 6 1/2"
Single action,
Curved, 4 x 9mm



Chichirelli (Blumenthal) Rongeur
F9-675
15cm 6"
Single action, Curved 45°,
4 x 13mm



Dean (Blumenthal) Rongeur
F9-676
15cm 6"
Single action,
Curved 90°, 4 x 11mm

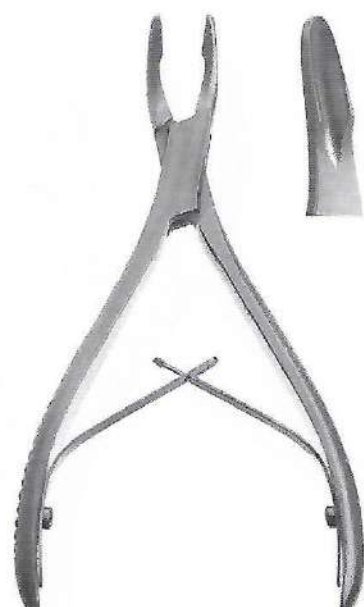

Dean Rongeur
F9-677 14.5cm 5 3/4"
Single action
Curved, 3mm



BONE RONGEURS



Hohlmeißelzangen
Pinzas gubias

Pinces-gouges
Pinze-sgorbie

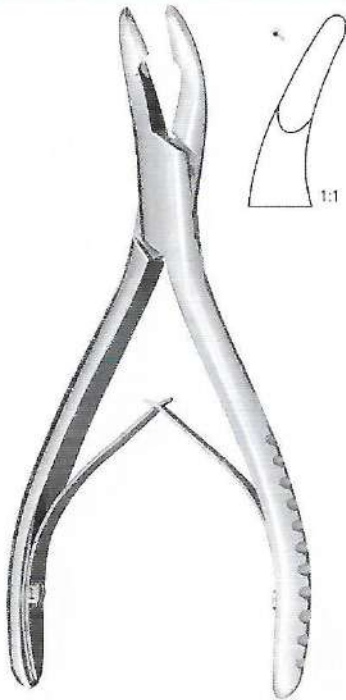

Hartmann Bone Rongeur
F9-678 18.5cm 7 1/4"
Single action
Curved, 4 x 14mm

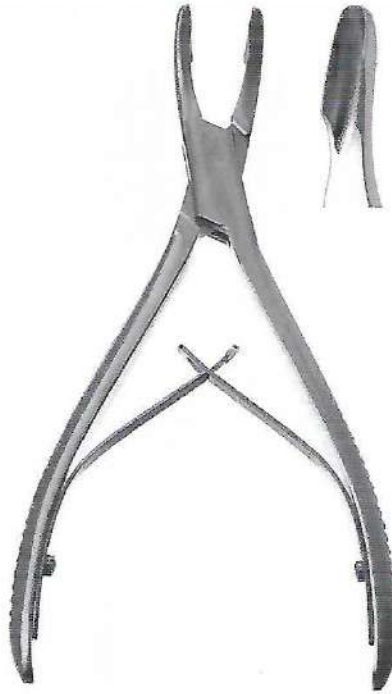

Mead Bone Rongeur
F9-679 16.5cm 6 1/2"
Single action,
Curved, 5 x 13mm



Cleveland Bone Rongeur
F9-680
14cm 5 1/2"



Cleveland Bone Rongeur
F9-681
17cm 6 3/4"

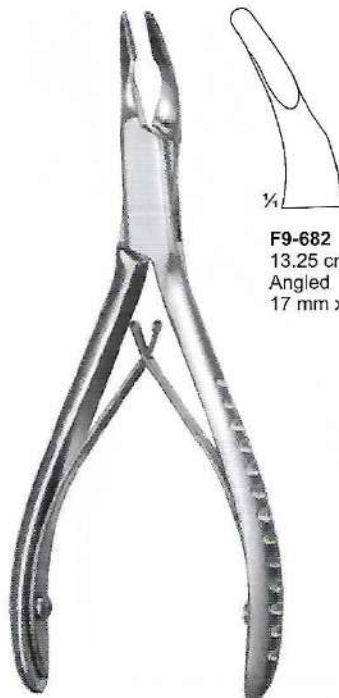

F9-682
13.25 cm, 5 1/2"
Angled
17 mm x 3.5 mm

Universal Bone Rongeur

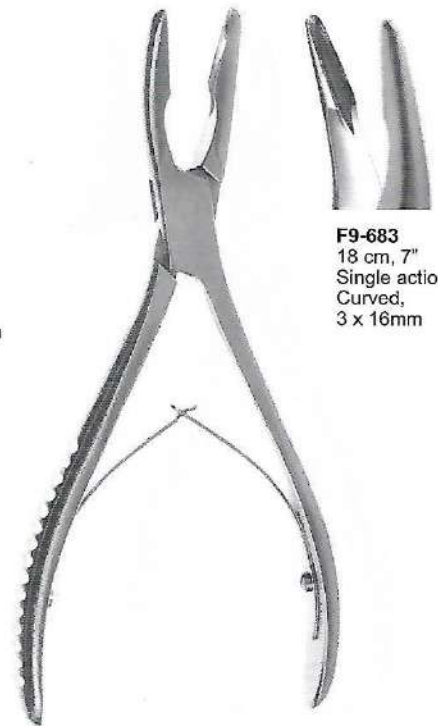

F9-683
18 cm, 7"
Single action
Curved,
3 x 16mm

Bane Bone Rongeur



BONE RONGEURS

Hohlmeißelzangen
Pinzas gubias

Pinces-gouges
Pinze-sgorbie

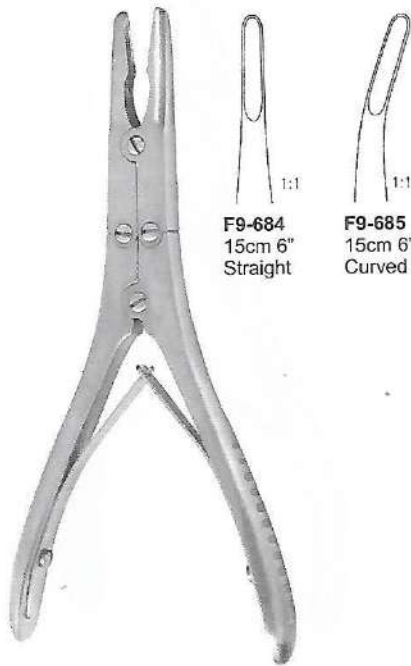

F9-684
15cm 6"
Straight

F9-685
15cm 6"
Curved

Bohler Bone Rongeur



Zaufal-Jansen Bone Rongeur
F9-686 18cm 7"
Double action
Curved, 5x15mm



Marquardt Bone Rongeur
F9-687
18cm 7"



Beyer Bone Rongeur
7" 18cm
F9-688 3 x 14mm
F9-689 4 x 15mm
Double action, Curved

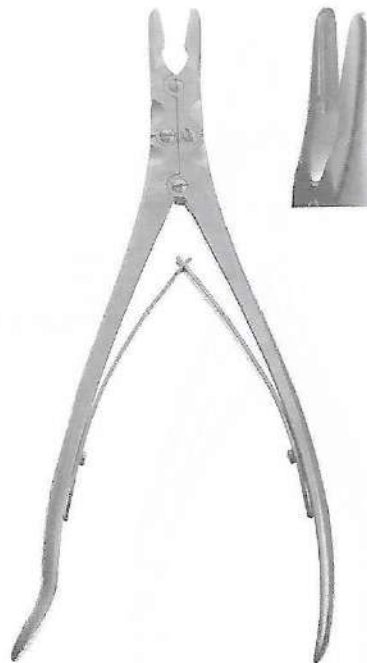

Smith-Peterson Laminectomy Rongeur
F9-690 24cm 9 1/2"
Double action,
Straight 3 x 16mm

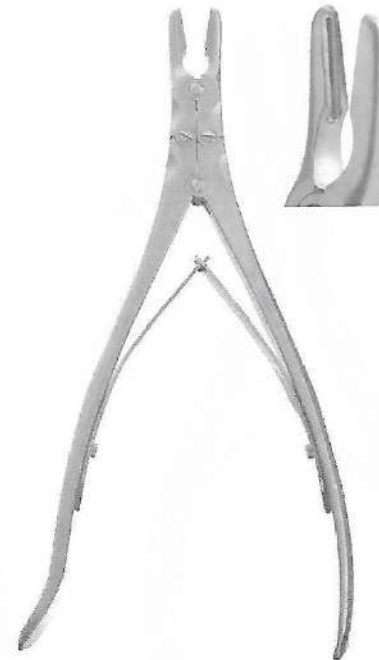

Smith-Peterson Laminectomy Rongeur
F9-691 24cm 9 1/2"
Double action
Curved 3 x 16mm

BONE RONGEURS



Hohlmeißelzangen
Pinzas gubias

Pinces-gouges
Pinze-sgorbie



Ruskin Rongeur
F9-692 18cm 7 1/8" 4 x 16mm
F9-693 18.5cm 7 1/4" 5 x 10mm
Double action, Curved on side



Ruskin Rongeur
F9-694 18.5cm 7 1/4"
Double action, 6 x 16mm,
Straight, Curved



Ruskin Rongeur
F9-695 15.5cm 6" Straight, 3.2mm
F9-696 15cm 6" Curved, 2 x 15mm
F9-697 15cm 6" Curved, 3 x 15mm
Double action,



Riskin Bone Rongeur



F9-698 15.5cm 6"
F9-699 18cm 7"
Double action
Straight, 2 x 14mm



F9-700 15.5cm 6"
F9-701 18cm 7"
Double action
Curved 2 x 14mm



Mayfield Bone Rongeur
F9-702 18cm 7"



Stille-Ruskin Bone Rongeur



F9-703
23cm 9"
Curved



F9-704
23cm 9"
Straight



BONE RONGEURS

Hohlmeißelzangen
Pinzas gubias

Pinces-gouges
Pinze-sgorbie

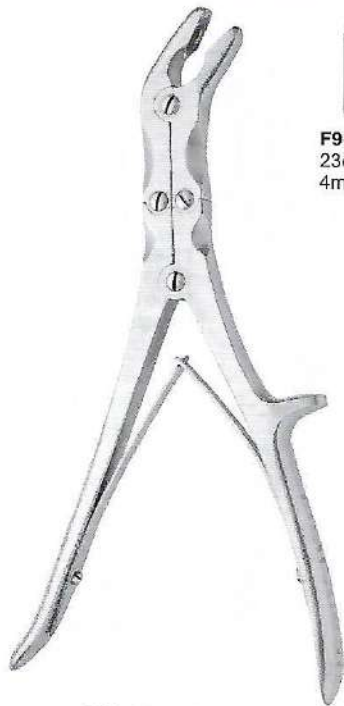

Stille Bone Rongeur

F9-705
23cm 9"
4mm

F9-706
23cm 9"
6mm

F9-707
23cm 9"
8mm



Leksell Bone Rongeur
F9-708 24.5cm 9 5/8" 5 x 13mm
F9-709 24cm 9 1/2" 8 x 14.5mm
Double action, Curved 50°

Leksell Rongeur
F9-710 24cm 9 1/2"
6 x 15mm
F9-711 24cm 9 1/2"
7 x 13mm
Double action, Curved

Leksell Rongeur
F9-712 24cm 9 1/2"
3 x 18mm
Double action, Curved

Leksell Rongeur
F9-713 23cm 9"
4 x 13mm
Double action
Fully curved

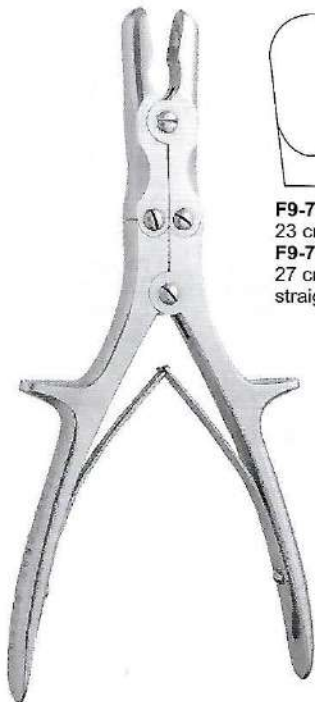

Stille-Luer Rongeur Forceps

F9-714
23 cm, 9"
F9-715
27 cm, 10 1/2"
straight

F9-716
23 cm, 9"
F9-717
27 cm, 10 1/2"
curved



Echlin Duckbill Bone Rongeur
23cm 9"

F9-718
2 x 12mm
Double action
Curved on side

F9-719
3 x 12mm
Double action
Curved on side

F9-720
4.5 x 11mm
Double action
Curved on side

BONE RONGEURS



Hohlmeißelzangen
Pinzas gubias

Pinces-gouges
Pinze-sgorbie



Stille-Leur Rongeur
F9-721 21.5cm 8 1/2"
Curved, Straight
Double action, 10 x 18mm



Stille-Leur Rongeur
F9-722 26.5cm 10 1/2"
Straight, Curved
Double action, 10 x 18mm

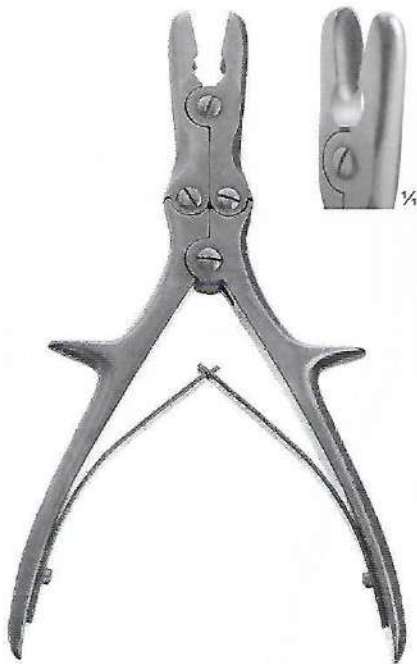

Stille-Luer Echlin Duckbill Rongeur
23cm 9"
F9-723 6 x 13mm
F9-724 6 x 15mm
Double action Curved on side



Stille-Leur Rongeur
F9-725 21.5cm 8 1/2"
Double action
Curved 10 x 16mm



BONE RONGEURS

Hohlmeißelzangen
Pinzas gubias

Pinces-gouges
Pinze-sgorbie



Rottgen-Ruskin Bone Rongeur
F9-726 23cm 9"

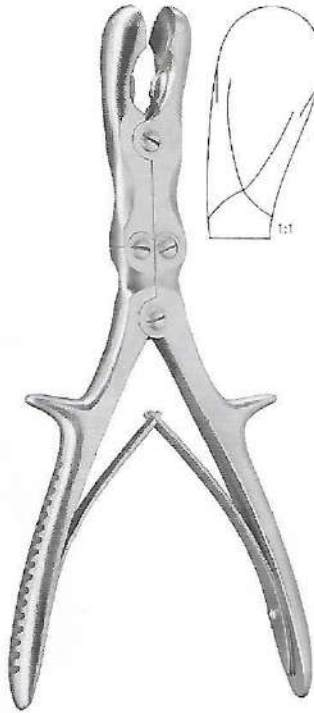

Semb Bone Rongeur
F9-727 24cm 9 1/2"



Frykholm Bone Rongeur
F9-728 24cm 9 1/2"

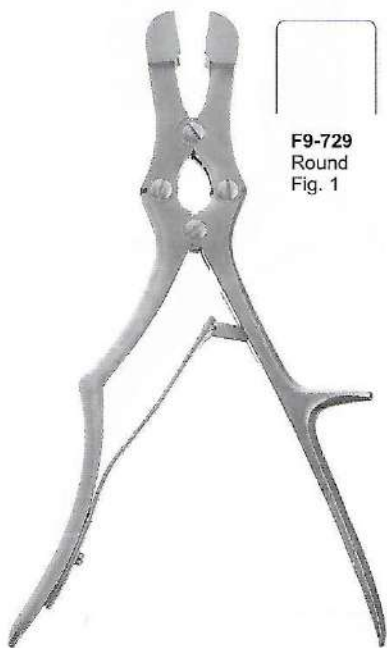

Sauerbruch Bone Rongeur
30 cm, 12"



F9-729
Round
Fig. 1



F9-730
Straight
Fig. 2



Luer-Stille Bone Rongeur
27 cm, 10 3/4"

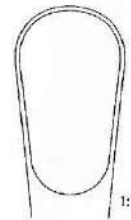

F9-731
Fig. 1

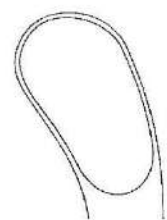

F9-732
Fig. 2

BONE RONGEURS

Hohlmeißelzangen
Pinzas gubias

Pinces-gouges
Pinze-sgorbie

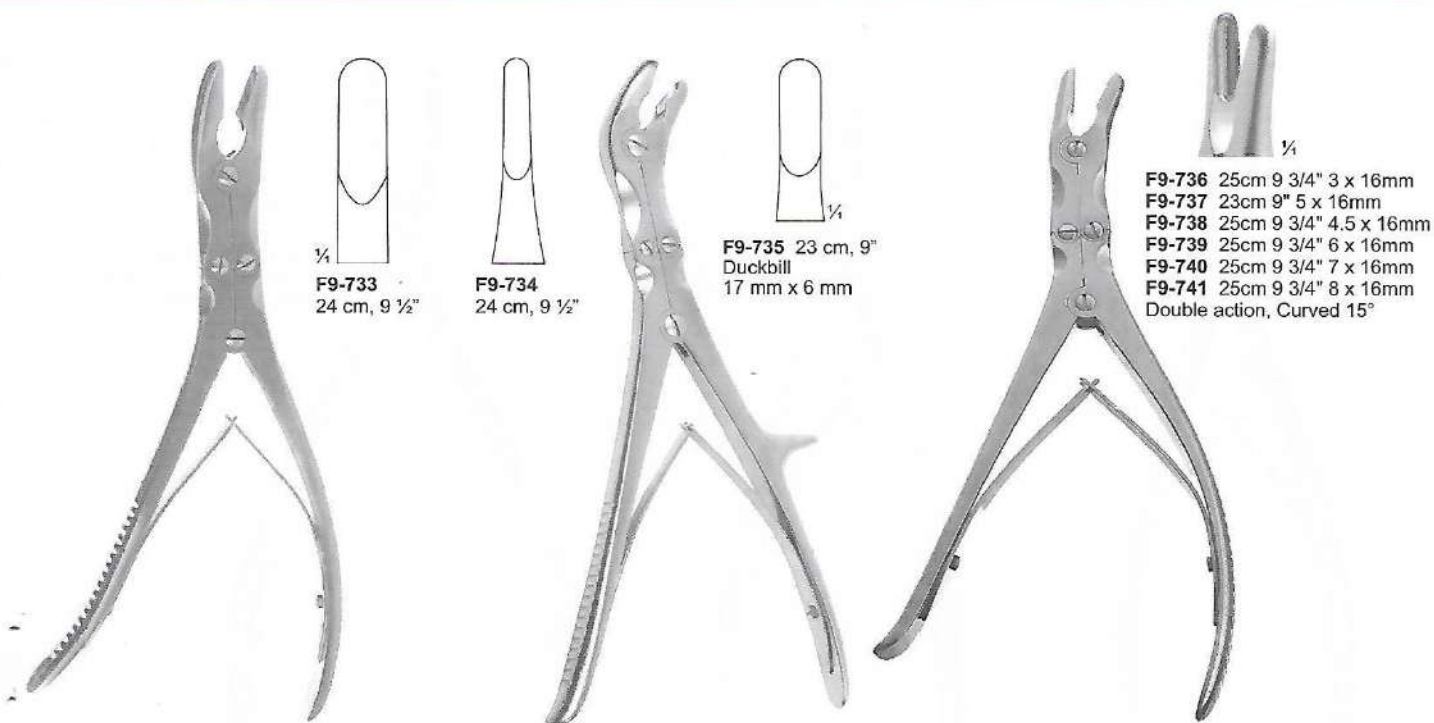

F9-733
24 cm, 9 1/2"

F9-734
24 cm, 9 1/2"

F9-735 23 cm, 9"
Duckbill
17 mm x 6 mm

- F9-736** 25cm 9 3/4" 3 x 16mm
- F9-737** 23cm 9" 5 x 16mm
- F9-738** 25cm 9 3/4" 4.5 x 16mm
- F9-739** 25cm 9 3/4" 6 x 16mm
- F9-740** 25cm 9 3/4" 7 x 16mm
- F9-741** 25cm 9 3/4" 8 x 16mm
- Double action, Curved 15°

Leksell-Stille Bone Rongeur

Stille Bone Rongeur

Leksell Bonerongeur

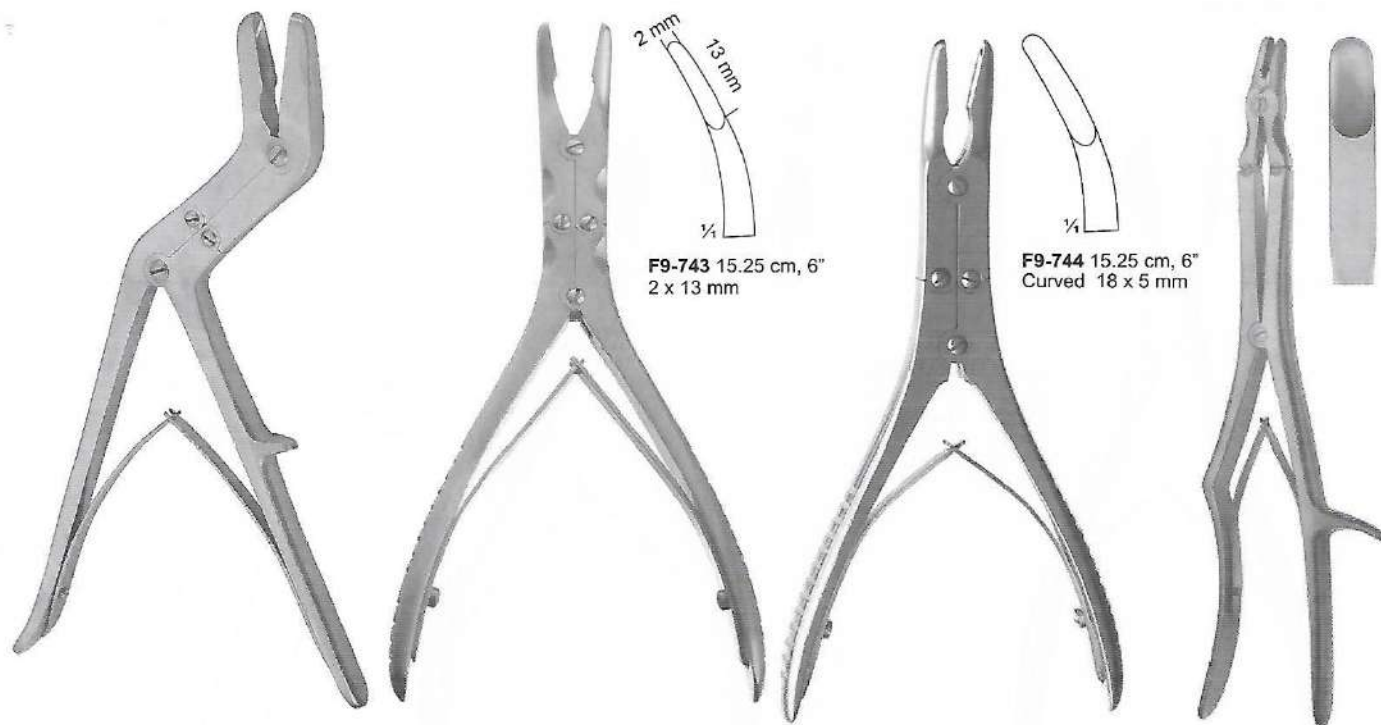

Hakansson Bone Rongeur
F9-742 20cm, 8"

Kleinert-Kutz Bone Rongeur

F9-743 15.25 cm, 6"
2 x 13 mm

F9-744 15.25 cm, 6"
Curved 18 x 5 mm

Ruskin-Mini Bone Rongeur

- Syvert Rongeur**
- F9-745** 35.5cm 14" 4 x 16mm
- F9-746** 35.5cm 14" 8 x 16mm
- F9-747** 35.5cm 14" 12 x 16mm
- F9-748** 37cm 14 1/2" 5 x 16mm
- Double action, Angled



BONE CUTTING FORCEPS

Knochensplitterzangen

Pinzas cortantes para huesos

Pinces coupantes a os

Cesioie per ossa



Cottle-Kazanjian Bone Cutting Rongeur Forceps
F9-749 19 cm, 7 1/2"

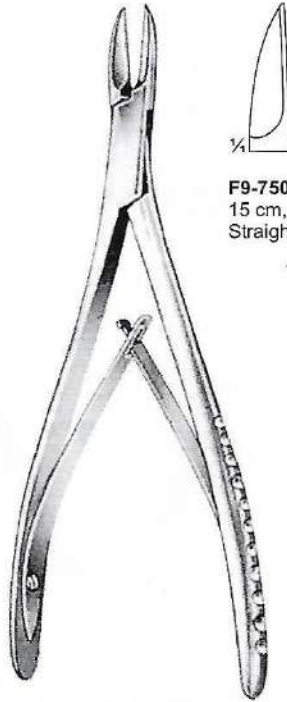

Littauer / Liston Bone Cutting Rongeur Forceps

F9-750
15 cm, 6"
Straight,

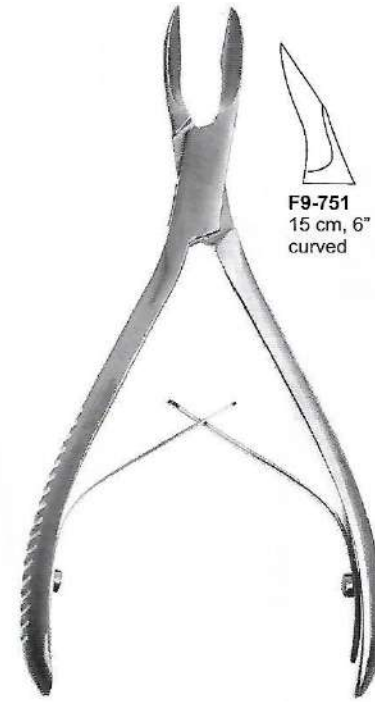

Cleveland Bone Cutting Rongeur Forceps

F9-751
15 cm, 6"
curved

F9-752
17 cm, 6 3/4"
curved

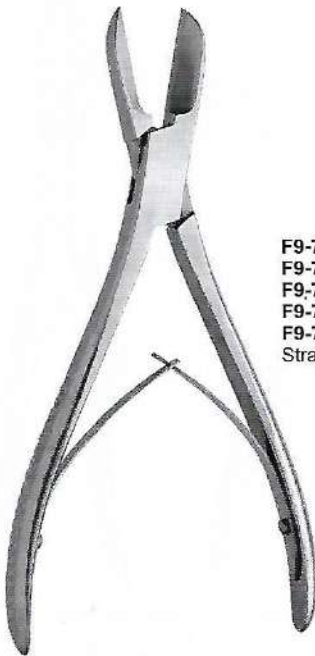

Liston Bone Cutting Rongeur Forceps

F9-753 14 cm, 5 1/2"
F9-754 17 cm, 6 3/4"
F9-755 19 cm, 7 1/2"
F9-756 20 cm 7 7/8"
F9-757 22 cm, 8 5/8"
Straight



Liston Bone Cutting Rongeur Forceps

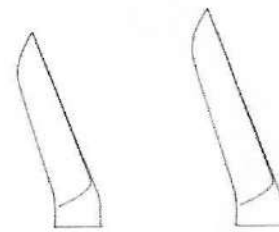

F9-758
14 cm, 5 1/2"
Angled

F9-759
17 cm, 6 3/4"
Angled

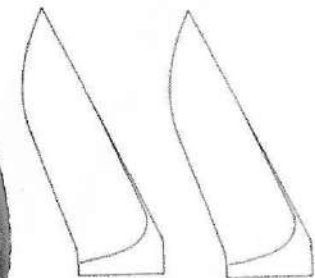

F9-760
19 cm, 7 1/2"
Angled

F9-761
22 cm, 8 3/4"
Angled

BONE CUTTING FORCEPS



Knochensplitterzangen
Pinces coupantes a os

Pinzas cortantes para huesos
Cesoie per ossa



Stille-Liston Bone Cutting Rongeur Forceps



F9-762
27 cm, 10 3/4"
Straight



F9-763
27 cm, 10 3/4"
Angled 45°

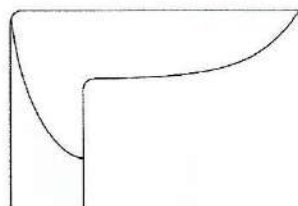

F9-764
27 cm, 10 3/4"
Angled 90°



Semb Bone Cutting Rongeur Forceps
F9-765 24 cm, 9 1/2"



Liston Key Horsley Bone Cutting Rongeur Forceps
F9-766 27 cm, 10 3/4"

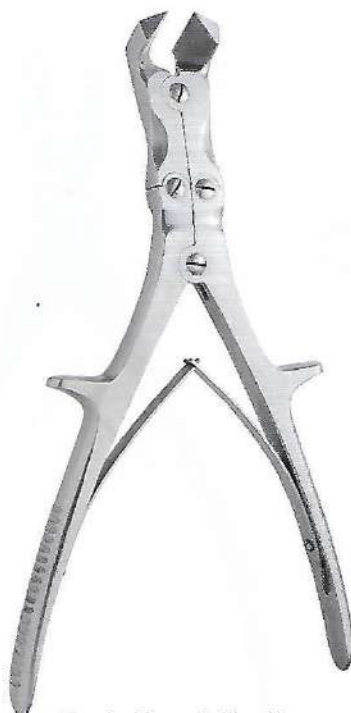

Horsley Bone Cutting Rongeur Forceps
F9-767 25 cm, 10"



Ruskin Bone Cutting Rongeur Forceps
F9-768 20 cm, 8"
Double-Action



BONE CUTTING FORCEPS

Knochensplitterzangen
Pinces coupantes a os

Pinzas cortantes para huesos
Cesoie per ossa

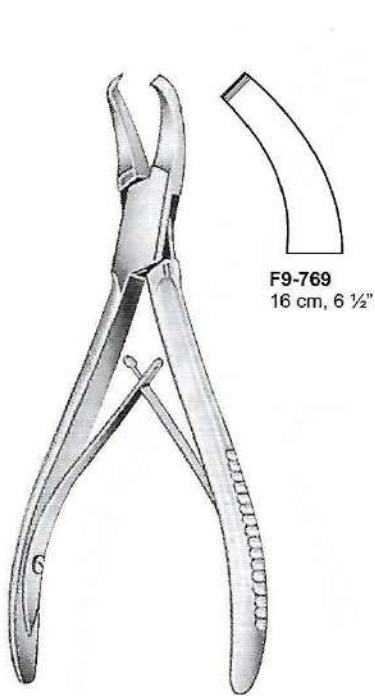

Cleveland-Gardner Bone Cutting Rongeur Forceps

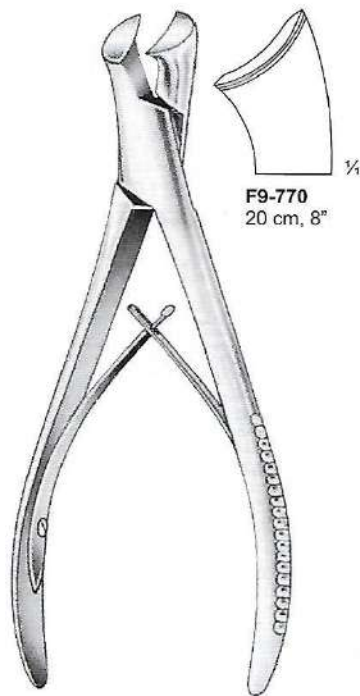

Markwalder Bone Cutting Rongeur Forceps

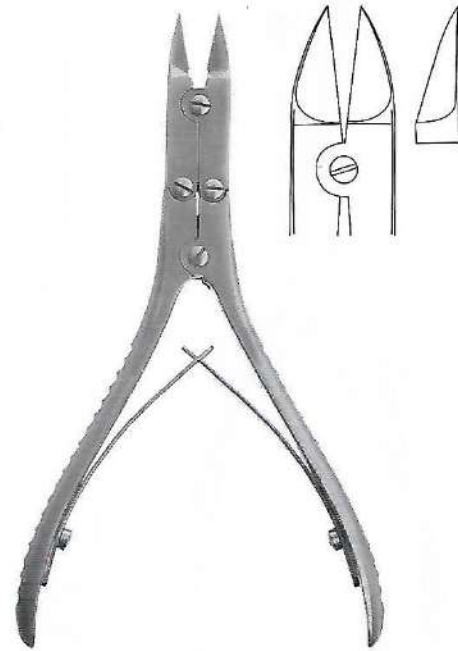

Bone Cutting Rongeur Forceps



Bohler Bone Cutting Rongeur Forceps

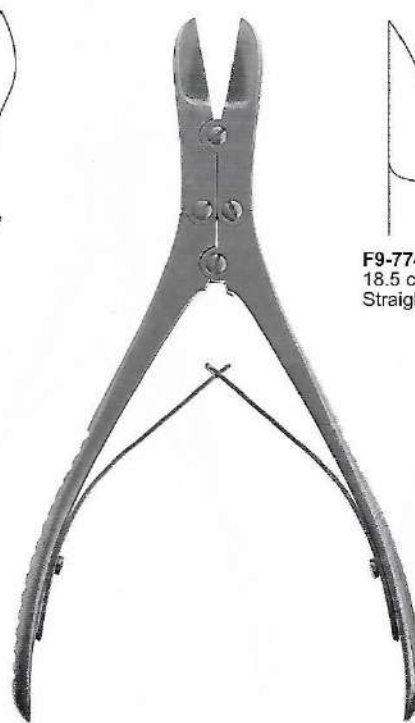
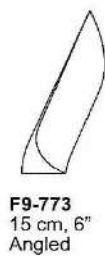

Ruskin-Liston Bone Cutting Rongeur Forceps

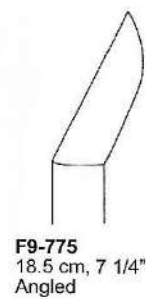
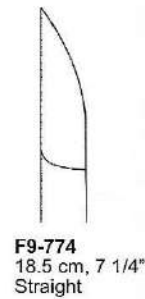

F9-775
18.5 cm, 7 1/4"
Angled

BONE CUTTING FORCEPS



Knochensplitterzangen
Pinces coupantes a os

Pinzas cortantes para huesos
Cesoie per ossa



Walton-Liston Bone Cutting Rongeur Forceps



F9-776
15 cm, 6"
Straight



F9-777
15 cm, 6"
Angled

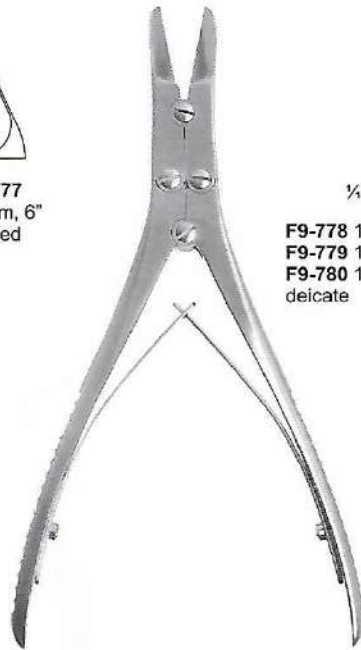

Ruskin-Liston Bone Cutting Rongeur Forceps



F9-778 19 cm, 7 1/2" Straight
F9-779 19 cm, 7 1/2" Curved
F9-780 19 cm, 7 1/2" Angled delicate

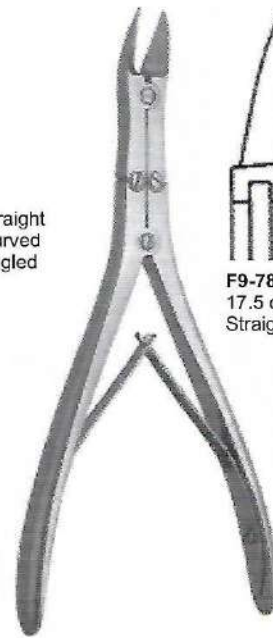

Mc Indoe Bone Cutting Rongeur Forceps



F9-781
17.5 cm, 7"
Straight

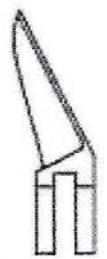

F9-782
17.5 cm, 7"
Curved



Mc Indoe Bone Cutting Forceps
F9-783 18 cm 7"
Angled, delicate,

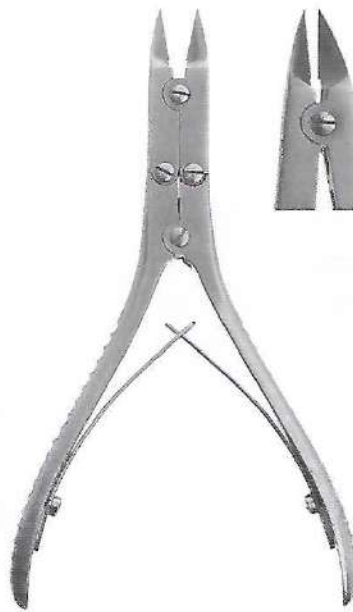

Kleinert-Kutz Bone Cutting Forceps
F9-784 15 cm 5 5/8"
Straight, delicate,

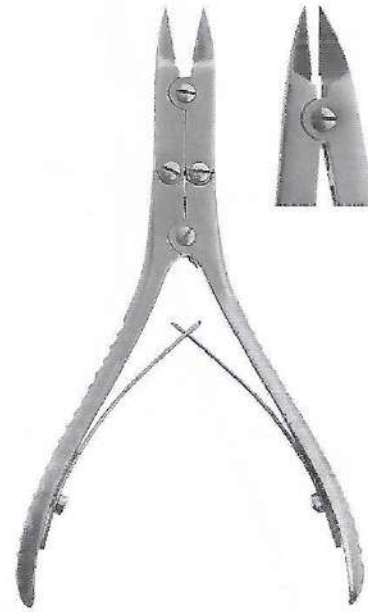

Kleinert-Kutz Synovectomy Rongeur
F9-785 15cm 6" 2 x 10mm
Double action,
Curved on side, delicate,





BONE CUTTING FORCEPS

Knochensplitterzangen
Pinces coupantes a os

Pinzas cortantes para huesos
Cesoie per ossa



F9-786
27 cm, 10 1/2"
Straight

Stille-Liston Bone Cutting Rongeur Forceps

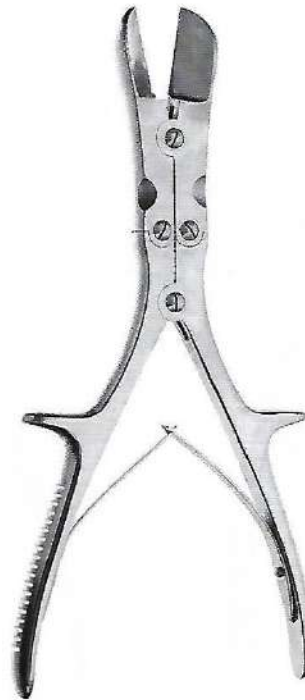

Stille-Horsley Bone Cutting Forceps
F9-787 24 cm 9 3/8"

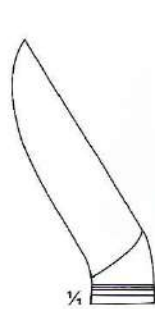

F9-788
23 cm, 9"
Angled

Liston Bone Cutting Rongeur Forceps



F9-789
27 cm, 10 1/2"
Angled

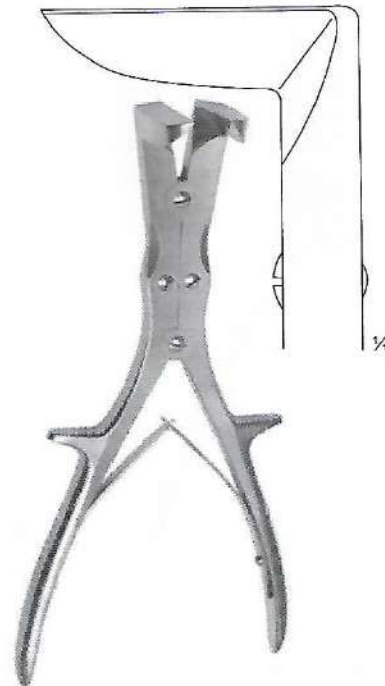

Liston-Stille Bone Cutting Rongeur Forceps
F9-790 26 cm, 10 1/4"

WIRE CUTTING INSTRUMENTS

Drahtschneidezangen
Pincès coupantes

Alicates para cortar alambre
Pinze taglia Filo

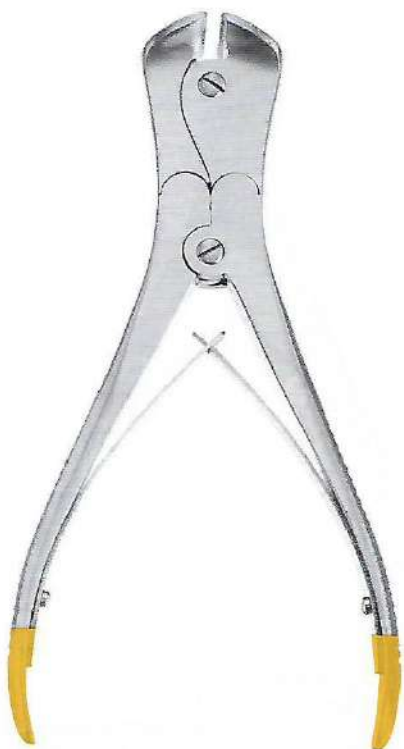

Vital Wire Cutter
F9-791 22cm 8 3/4"
for hard wires up to 2.2mm,
for soft wires up to 3mm



Vital Wire Cutter
F9-792 22cm 8 3/4"
for hard wires up to 2.2mm,
for soft wires up to 2.8mm



Vital Wire Cutter
F9-793 23cm 9"
for hard wires up to 2.2mm,
for soft wires up to 3mm



Vital Wire Cutter
F9-794 18cm 7"
for hard wires up to 1.5mm,
for soft wires up to 2mm



Vital Wire Cutter
F9-795 18cm 7"
for hard wires up to 1.7mm,
for soft wires up to 2mm



Vital Wire Cutter
F9-796 15cm 6"
for hard wires up to 1mm,
for soft wires up to 1.5mm



Vital Wire Cutter
F9-797 14.5cm 5 3/4"
for hard wires up to 1mm,
for soft wires up to 1mm



WIRE CUTTING INSTRUMENTS

Drahtschneidezangen
Pinces coupantes

Alicates para cortar alambre
Pinze taglia Filo

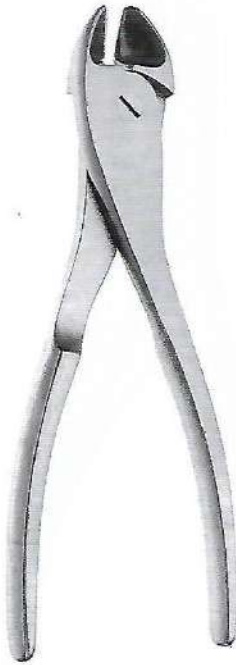

Side Cutter
F9-798 18.5cm 7 1/4"
Welded carbide jaws
max capacity. 1.6mm 062"



Delicate Wire Cutter
F9-799 12.5cm 4 7/8"
Side cutting w/ carbide inserts
max capacity. 0.7mm 028"



Front & Side Wire Cutter
F9-800 17cm 6 3/4"
Front and side cutting w/ carbide inserts,
double action. Max capacity. 1.6mm 062"



Double Action Wire Cutter
Angled, Side cutting w/ carbide inserts
F9-801 17cm 6 5/8"
max cap 1.6mm 062"
F9-802 21.5cm 8 1/2"
max cap. 2.4mm 3/32"



Flush Wire Cutter
F9-803 17cm 6 3/4"
Front and side cutting w/ carbide inserts,
double action. Max capacity. 1.5mm 059"



Wire Forceps
F9-804 17 cm 6 1/2"
Straight, serrated 5.4 mm tip

WIRE CUTTING INSTRUMENTS

Drahtschneidezangen
Pincers coupantes

Alicates para cortar alambre
Pinze taglia Filo



Stille Plaster Shear
F9-805
37cm 14 1/2" 9" to 15"



Schumacher Sternum Shears
F9-806 21cm 8 1/4"



**Kirschner Wires & Steinmann
Pins Cutter**
F9-807 57cm 22 1/2"
up to 6mm



Cannulated Wire / Pin Cutter
F9-808 19 cm 7 1/2"
Cuts wire upto 1.6 mm



Hard Wire Cutter Cuts
F9-809 26.0cm 10 1/4"
for hard wires up to 3mm



Side Pin Cutter
F9-810 57.5cm 22 5/8"
Side cutting w/ carbide inserts
max. cap: 5/32"



WIRE CUTTING INSTRUMENTS

Drahtschneidezangen
Pinces coupantes

Alicates para cortar alambre
Pinze taglia Filo



Pin Cutter Small
F9-811 26cm 10 1/4"
Max cap: 3.2mm



Pin Cutter Medium
F9-812 36.5cm 14 3/8"
Max cap: 4.7mm,



Large Pin Cutter
F9-813 57.5cm 22 5/8"
Large, Straight, Max.
capacity 6.3mm 1/4"

BONE HOLDING CLAMPS - BONE HOLDING FORCEPS



Knochenhalteklammern - Knochenhaltezangen | *Pinzas porta huesos - Pinzas para huesos*
Daviers a os - Daviers porte-os | *tenaglie per ossa*



Gerster-Lowmann Bone Clamp

F9-814 12.1cm, 4.75"
F9-815 14.5cm 5 5/8"
F9-816 18cm, 7", 28mm
F9-817 20cm, 8", 35mm
F9-818 22cm, 8 3/4", 40mm
 1x2 Jaws



Lowmann Bone Clamp

F9-818A 12cm
F9-818B 15cm
F9-818C 17cm
F9-818D 18.5cm
F9-818E 20cm



Lambert-Lowman Bone Clamp

F9-819 17.5 cm, 7"
F9-820 20.3 cm, 8"
 2x2 Jaws

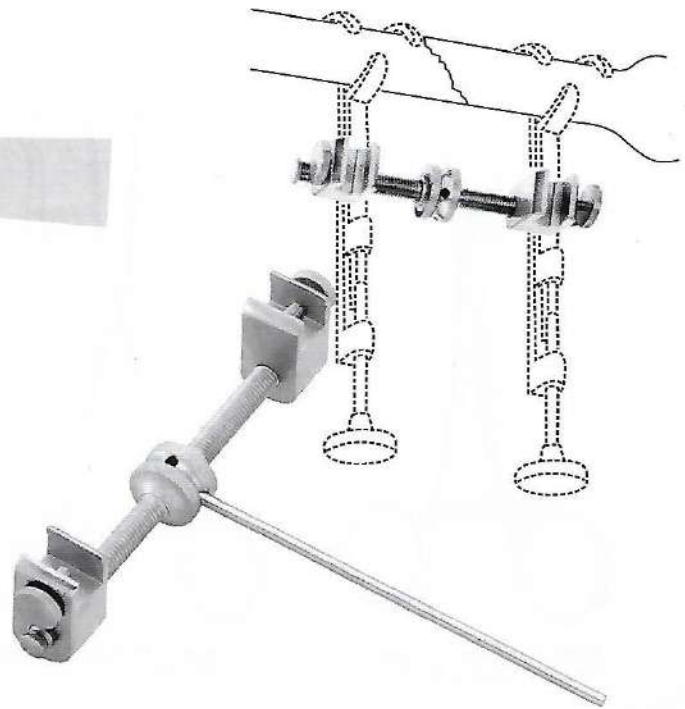

Gerster Bone Holding Clamp F9-821 15cm, 6"



Gerster Bone Holding Clamp F9-822



Gerster Bone Holding Clamp F9-823



Parham-Martin Bone Clamp F9-824
 21cm 8 1/4"
 Straight

Parham Martin Bands F9-825
 19.0cm 7 1/2"



BONE HOLDING FORCEPS - REPOSITION FORCEPS

Knochenhaleezangen - Repositionszangen
Daviers porte-so-pinces de reposition

Pinzas para huesos - pinzas para reposicion
Tenaglie per ossa - Pinze per riposizioni



Bone Reduction Forceps
F9-826 13.5cm, 5 1/4"

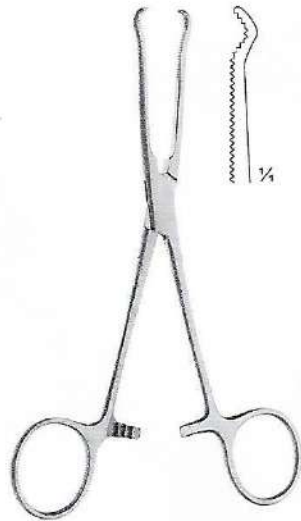

Locke Phalangeal Forceps
F9-827 14cm, 5 1/2"



Lewin Perforating Bone Holding Forceps
F9-828 17.5cm, 7" serrated



Stagbeetle Bone Reduction Forceps
F9-829
Pointed tips, 13 cm 4 7/8"



Bone Reduction Orthopedic Forceps

F9-830
13.5 cm, 5 1/2"
Angled Serrated



Shoulder Percussion Awl
Pointed, 21.6cm 8 1/2"
F9-831 Small
F9-832 Medium
F9-833 Large
F9-834 Pointed, 23.5cm 9 1/4"

BONE HOLDING FORCEPS



Knochenhaltezaugen
Daviers porte-so

Pinzas para huesos
Tenaglie per ossa



Meniscus Clamp
F9-835 13.5cm 5 3/8"
Serrated



Meniscus Clamp
F9-836 13.5cm 5 3/8"
Angled 20°, serrated



**Preston Logamentum
Flavum Forceps**
F9-837 19 cm 7-1/4"
Curved, 1 x 2 teeth

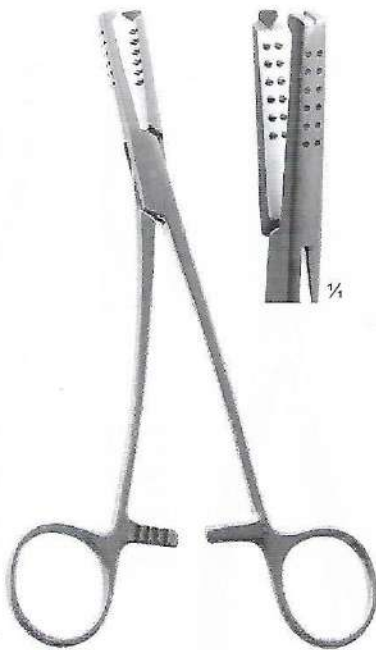

Meniscus Clamp
F9-838 18cm 7 1/8"
Straight, Curved shaft

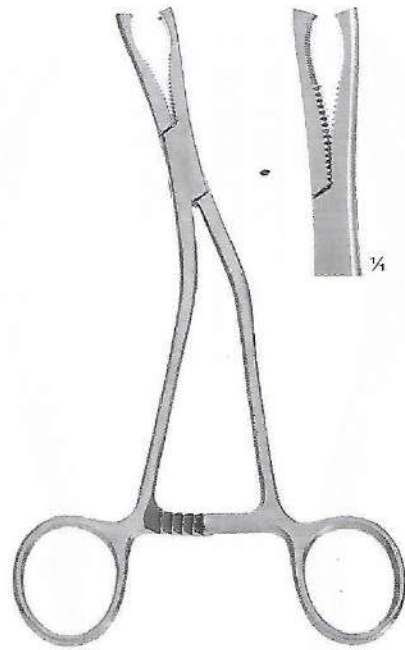

Dingman Bone Clamp
F9-839 19cm 7 1/2"
Straight, Serrated,
1 1/2" tip length,
Curved shaft



BONE HOLDING FORCEPS

Knochenhaltezaugen
Daviers porte-so

Pinzas para huesos
Tenaglie per ossa

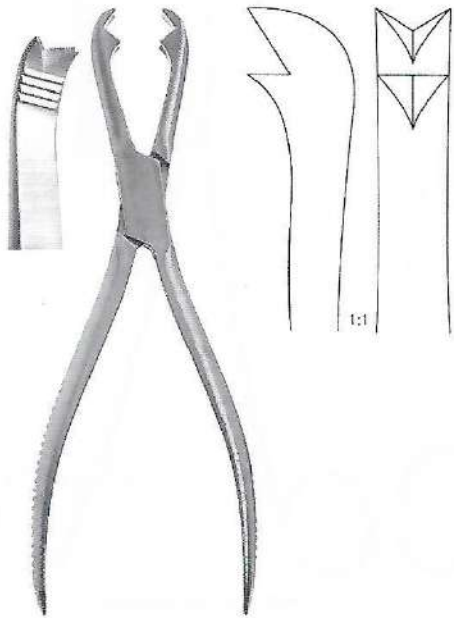

Fergusson Bone Holding Forceps
F9-840 21.0 cm, 8 1/4"
2 x 2 teeth



Van Buren Sequestrum Forceps
F9-841 23.0 cm, 9"
Curved on side, serrated



Langenbeck Bone Holding Forceps
F9-842 21 cm, 8 1/4"

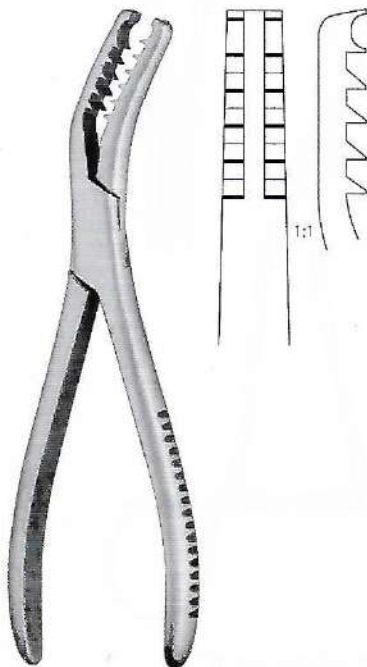

Semb Bone Holding Forceps
F9-843 19 cm, 7 1/2" without ratchet
curved sideways deep teeth

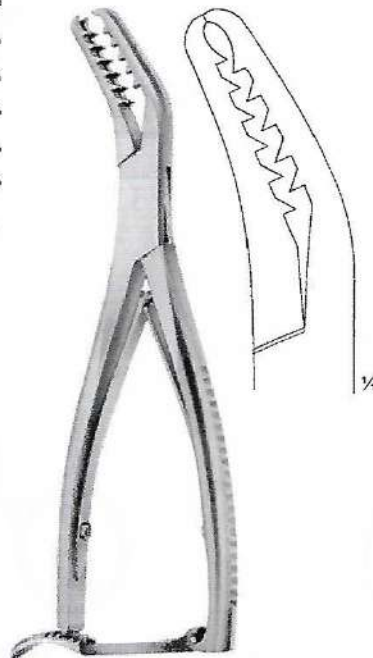

Semb Bone Holding Forceps
F9-844 20.3cm, 8", with ratchet
curved sideways deep teeth

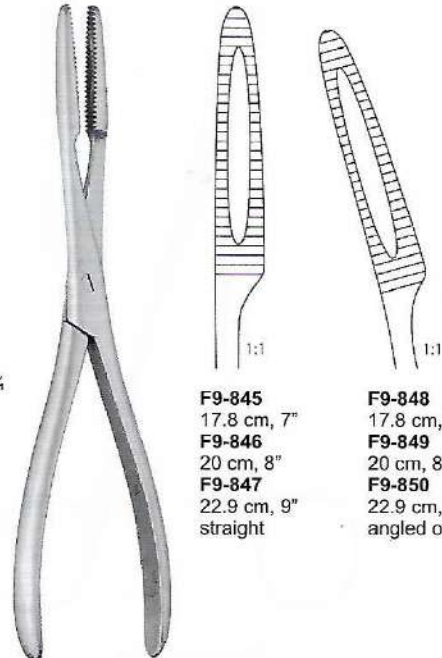

Sequestrum (Nircosis) Bone Holding Forceps

F9-845
17.8 cm, 7"
F9-846
20 cm, 8"
F9-847
22.9 cm, 9"
straight

F9-848
17.8 cm, 7"
F9-849
20 cm, 8"
F9-850
22.9 cm, 9"
angled on flat

BONE HOLDING FORCEPS



Knochenhaltezaugen
Daviers porte-so

Pinzas para huesos
Tenaglie per ossa

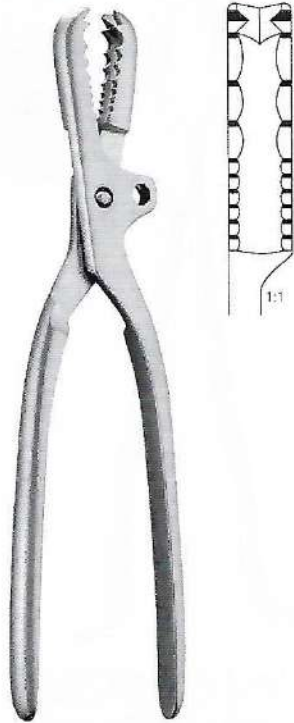

Farabeuf Bone Holding Forceps
F9-851 23 cm, 9"
F9-852 26 cm, 10 1/4"
with adjustable jaw

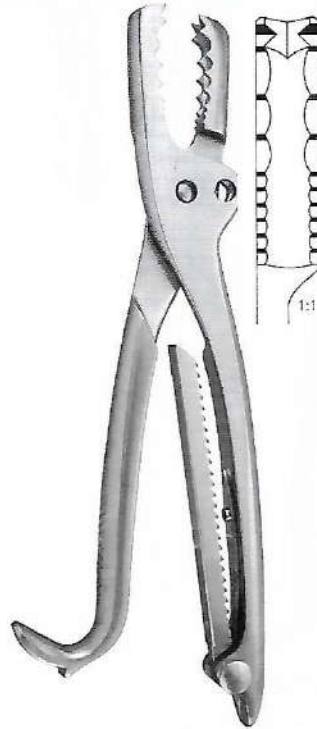

Farabeuf-Lambotte Bone Holding Forceps
F9-853 26 cm, 10 1/4"
with adjustable jaw

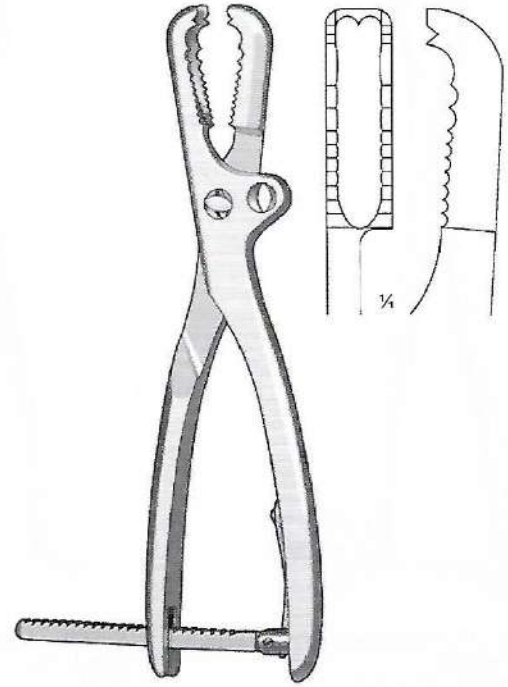

Farabeuf-Lambotte Bone Holding Forceps
F9-854 26 cm, 10 1/4"
with adjustable jaw



Bishop Bone Clamp
F9-855 22.5cm 8 7/8"
Straight



Kern Bone Holding Forceps
F9-856 17 cm, 6 3/4"
F9-857 24 cm, 9 1/2"
without ratchet



Kern Bone Holding Forceps
F9-858 17 cm, 6 3/4"
F9-859 24 cm, 9 1/2"
with ratchet



BONE HOLDING FORCEPS

Knochenhaltezaugen
Daviers porte-so

Pinzas para huesos
Tenaglie per ossa

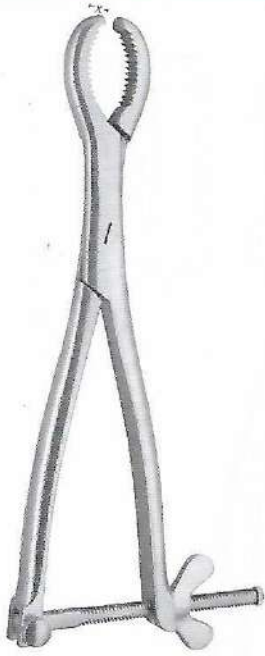

Hey Groves Bone Holding Forceps
F9-860 21 cm, 8 1/4"
F9-861 27 cm, 10 3/4"
F9-862 30. cm, 12"



Lane Bone Holding Forceps Light Model
F9-863 33 cm 13" 11 mm tip W/ Ratchet
F9-864 33 cm 13" 13 mm tip W/ Ratchet
F9-865 43 cm 17" 13.5 mm tip W/ Ratchet
F9-866 13 cm 13" 10 mm tip W/o Ratchet

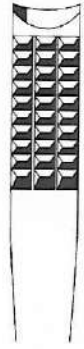

1/4



Lane Bone Holding Forceps
F9-867 33 cm 13" 13 mm tip
F9-868 43 cm 14" 12 mm tip without ratchet

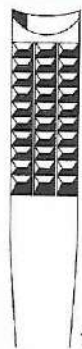

1:1



Ulrich Bone Holding Self Retaining Forceps

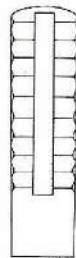

F9-869 18 cm, 7" mini
F9-870 22 cm, 8 1/2"
F9-871 26 cm, 10"
F9-872 28 cm, 11"
Straight with speed lock



Ulrich Bone Holding Forceps



F9-873 18 cm, 7"
F9-874 22 cm, 8 1/2"
F9-875 26 cm, 10"
F9-876 28 cm, 11"
Angular, with speed lock



Ulrich Bone Holding Forceps
F9-877 28 cm 11"
Angular With Speed Lock & swivel jaw

1/4

BONE HOLDING FORCEPS

Knochenhaltezaugen
Daviers porte-os

Pinzas para huesos
Tenaglie per ossa

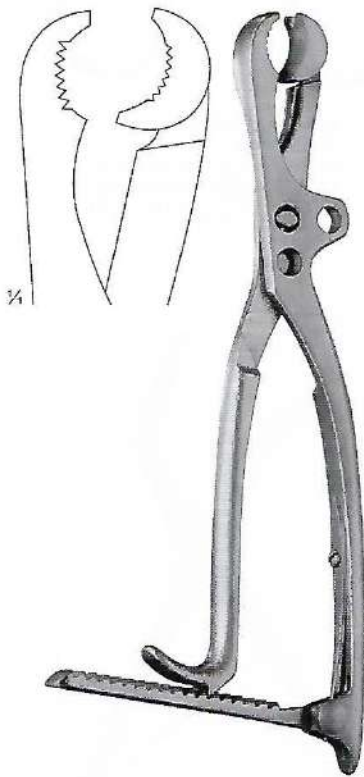

Lambotte Bone Holding Forceps
F9-878 22 cm, 8 3/4"
F9-879 27 cm, 10 3/4"
F9-880 30 cm, 12"
 One Jaw Mobile
 adjustable jaw

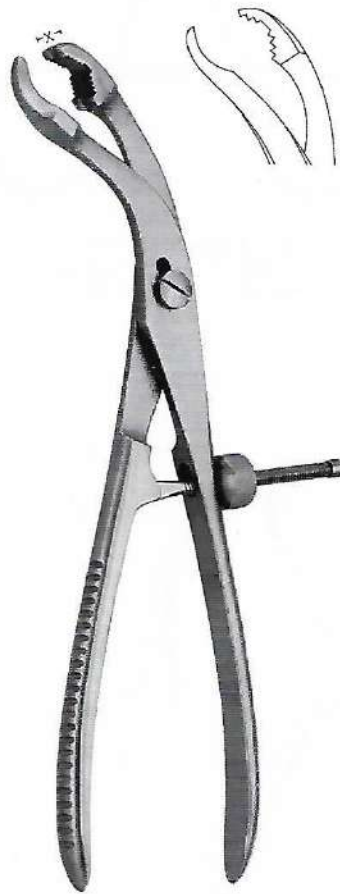

Lambotte Bone Holding Forceps
F9-881 15 cm, 6", 2.5mm
F9-882 19 cm, 7 1/2", 6.5mm
F9-883 24 cm, 9 1/2", 9.5mm
F9-884 26 cm, 10 1/4", 10mm
F9-885 28 cm, 11", 11
 Self-Centering, with speed lock

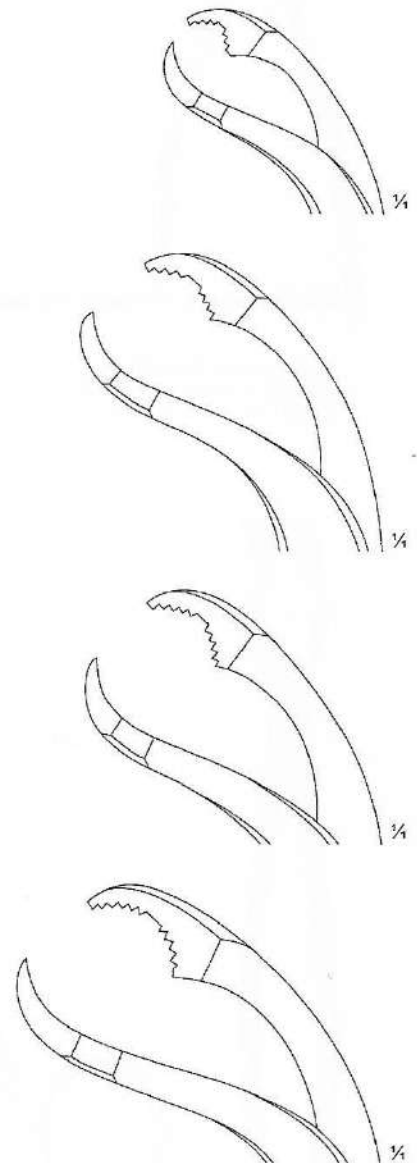



BONE HOLDING FORCEPS

Knochenhaltezaugen
Daviers porte-so

Pinzas para huesos
Tenaglie per ossa

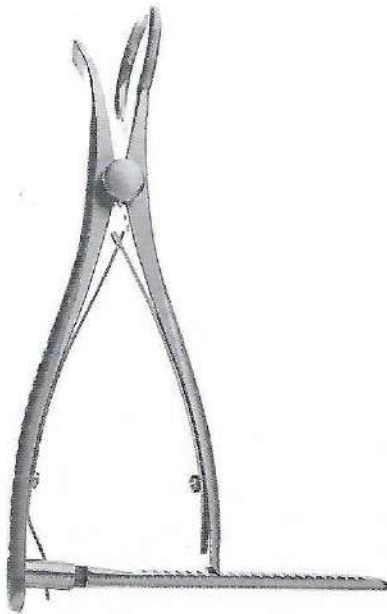

Subacromion Spreader
F9-886 26.75cm 10.5" Right
F9-887 26.75cm 10.5" Left

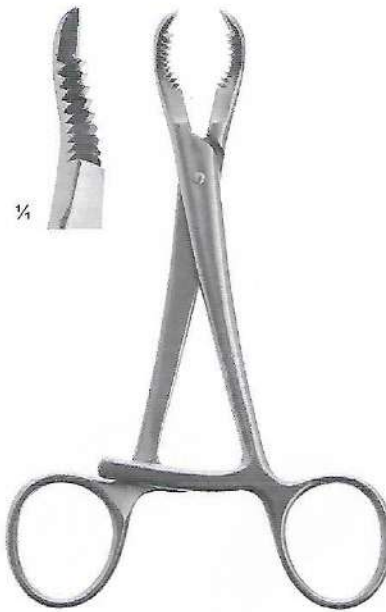

Bone Reduction Forceps
F9-888 14 cm 5 1/2" Curved
F9-889 15 cm 6" Serrated



Bone Reduction Forceps, Pointed Tips
F9-890 14 cm 5 1/2" Serrated
F9-891 14 cm 5 1/4" Curved
F9-892 17 cm 6 3/4" Curved



Lane Bone Holding Forceps
F9-893 31.5 cm
F9-894 39 cm



Bone Reduction Forceps
F9-895 14 cm 5 1/4"
Serrated with pointed tips



Semb Bone Holding Forceps
Curved on side
F9-896 19 cm 7 1/2" 4 x 5 teeth
F9-897 21 cm 8" 5 x 5 teeth

BONE HOLDING FORCEPS



Knochenhalte-zangen
Daviers porte-so

Pinzas para huesos
Tenaglie per ossa



**Martin Cartilage Bone Holding
Clamp Forceps**
F9-898 19 cm, 7 1/2" Str.

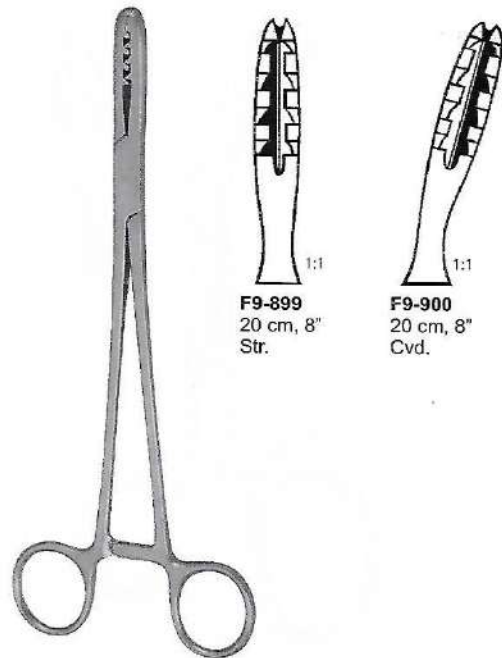

F9-899
20 cm, 8"
Str.

F9-900
20 cm, 8"
Cvd.

Bircher-Ganske
Bone Holding Forceps

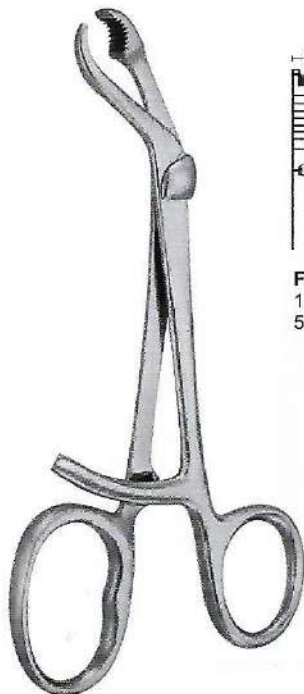

Verbrugge Bone Holding Forceps

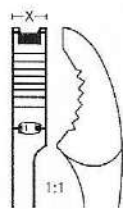

F9-901
17.5 cm, 7"
5.0mm

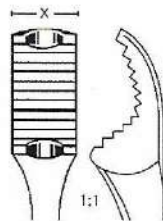

F9-902
25 cm, 10"
9.5mm

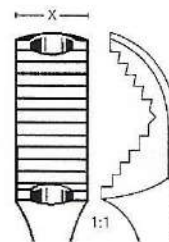

F9-903
26 cm, 10 1/4"
10.5mm

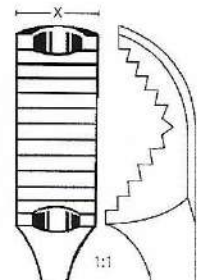

F9-904
27 cm, 10 3/4"
12.0mm



BONE HOLDING FORCEPS

Knochenhaltezaugen
Daviers porte-so

Pinzas para huesos
Tenaglie per ossa

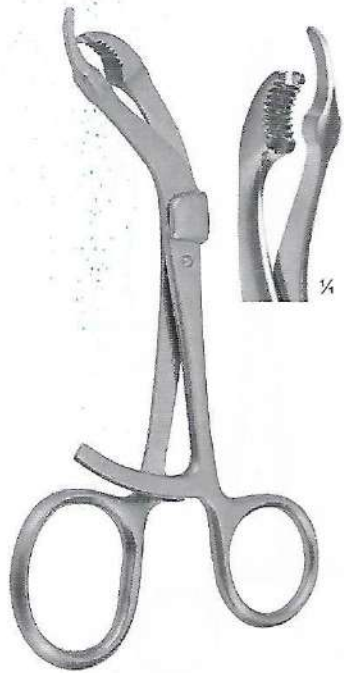

Verbrugge Bone Holding Forceps
F9-905 18 cm 7"
F9-906 26 cm 10"
F9-907 27 cm 10 1/2"
F9-908 28 cm 11"
W/ Long Ratchet



Verbrugge Self-Centering Bone Holding Forceps
F9-909 15 cm 5 3/4"
F9-910 19 cm 7 1/4"
F9-911 24 cm 9 1/4"
F9-912 26 cm 10"
F9-913 29 cm 11 1/4"
with long ratchet

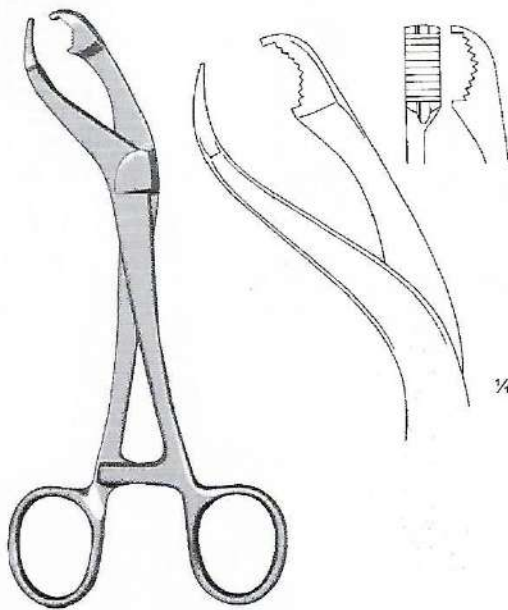

Verbrugge Bone Holding Forceps
F9-914 17.2cm, 6.75"
with short ratchet



Lane Bone Plate Holding Forceps
F9-915 22cm 8 3/4"

BONE HOLDING FORCEPS



Knochenhalte-
zangen
Daviers porte-so

Pinzas para huesos
Tenaglie per ossa

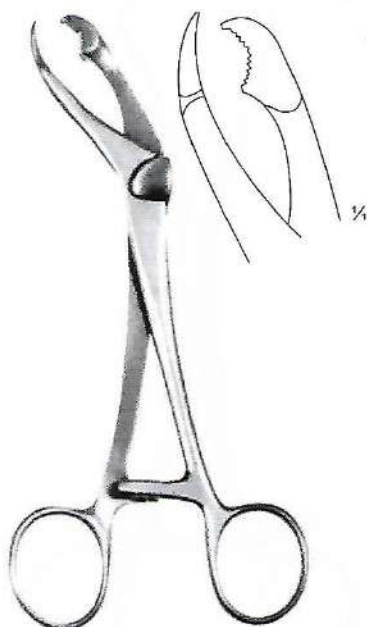

**Verbrugge Bone Holding
Forceps**
F9-916 18 cm, 7"



**Verbrugge Bone Holding
Forceps**
F9-917 18 cm, 7"



**Verbrugge Bone Holding
Forceps**
F9-918 25 cm, 10"
F9-919 26 cm, 10 1/4"
F9-920 27 cm, 10 1/2"

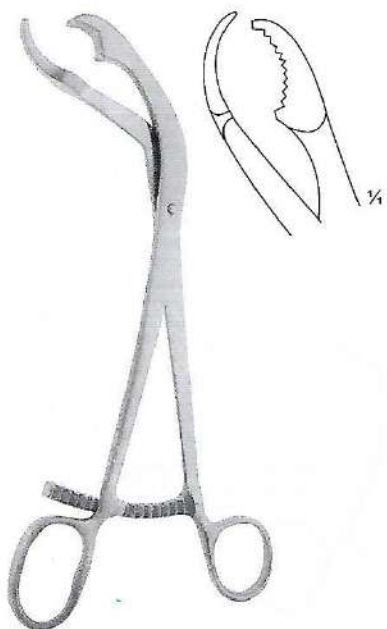

**Verbrugge Bone Holding
Forceps**
F9-921 25 cm, 10"
F9-922 26 cm, 10 1/4"
F9-923 27 cm, 10 1/2"



**Verbrugge Bone Holding
Forceps**
F9-924 18 cm, 7"

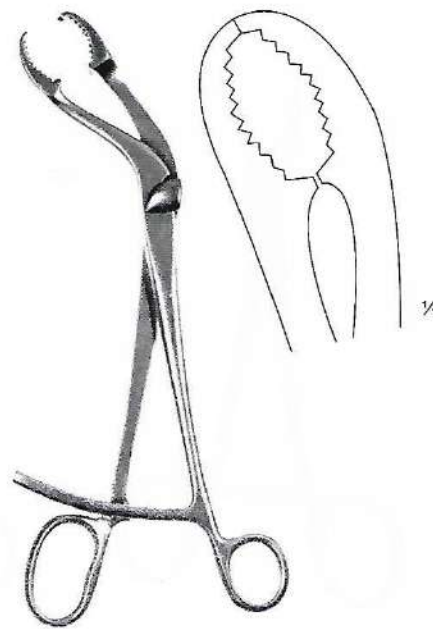

**Verbrugge Bone Holding
Forceps**
F9-925 25 cm, 10"
F9-926 26 cm, 10 1/4"
F9-927 27 cm, 10 1/2"



BONE HOLDING FORCEPS

Knochenhaltezaugen
Daviers porte-so

Pinzas para huesos
Tenaglie per ossa



Bone Reduction Forceps
F9-928 13.5 cm, 5 1/4"



Reill Bone Reduction Forceps
F9-929 17 cm 6 3/4"
Curved, pointed tips

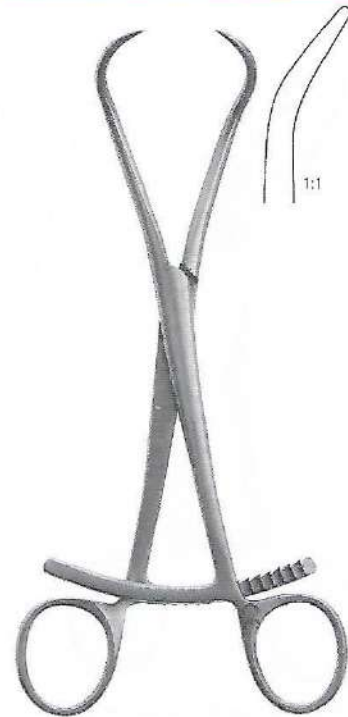

Bone Reduction Forceps
F9-930 20.4 cm, 8"
Pointed tips

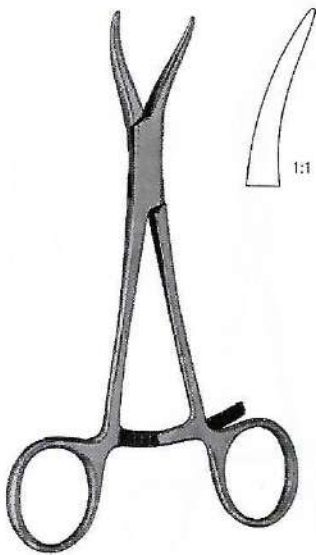

Bone Reduction Forceps
F9-931 13.5 cm, 5"
for maxillary reposition

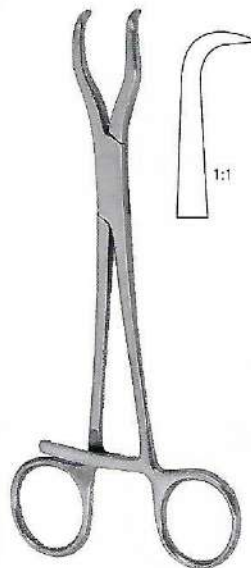

Haase
F9-932
16.5 cm, 6 1/2"
for mandibular
fractures

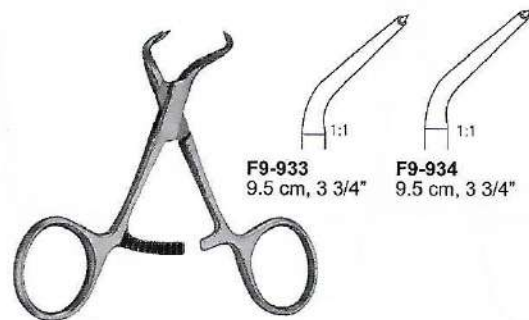

F9-933
9.5 cm, 3 3/4"

F9-934
9.5 cm, 3 3/4"

Bone Holding forceps

BONE HOLDING FORCEPS



Knochenhaltezaugen
Daviers porte-os

Pinzas para huesos
Tenaglie per ossa



Fibula Bone Holding Forceps
F9-935
22 cm 8 1/2"



Glenoid Perforating Forceps
F9-936 17 cm 6 1/2"
Lightly curved, pointed tips
Strongly curved, pointed tips



Reil Bone Holding Forceps
F9-937 17 cm, 7"



Bone Reduction Forceps
F9-938 20 cm, 8"
with Points



Malleolar Bone Holding Forceps
F9-939 21 cm 8 1/4"
Straight, 1 x 1 teeth



BONE HOLDING FORCEPS

Knochenhaltezaugen
Daviers porte-so

Pinzas para huesos
Tenaglie per ossa



Patella Malleolar Forceps
F9-940 21.0 cm, 8 1/4"

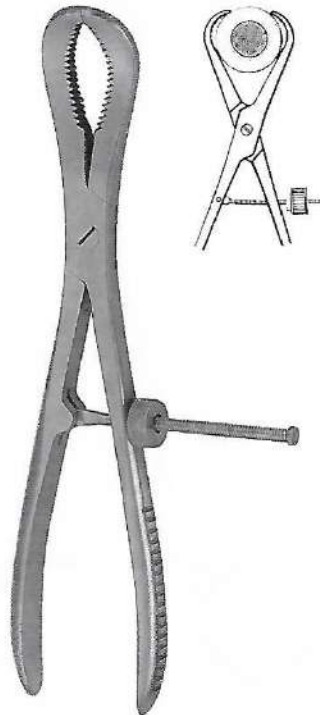

Reduction Forceps
F9-941 16 cm, 6 1/2"
F9-942 24 cm, 9 1/2"
with Thread Lock



Reposition Forceps
F9-943 23 cm, 9"

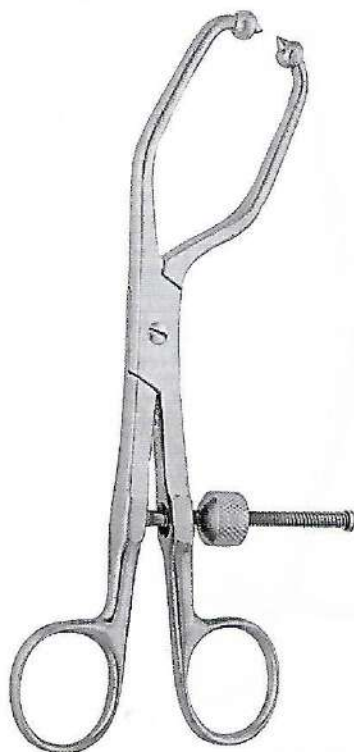

Pelvic Reposition Forceps
F9-944 19 cm, 7 1/2"

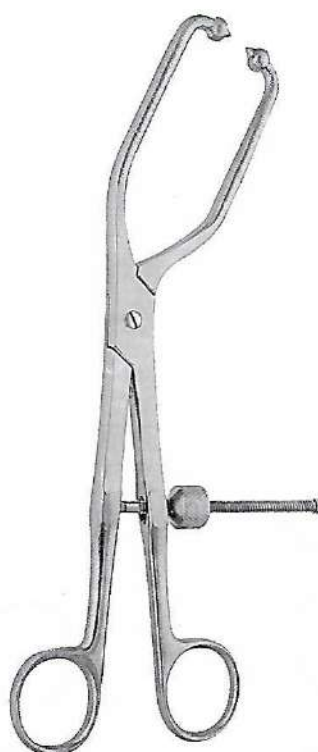

Pelvic Reposition Forceps
F9-945 23 cm, 9"



Pelvic Reposition Forceps
F9-946 25.0 cm, 10"

BONE HOLDING FORCEPS



Knochenhaltezaugen
Daviers porte-so

Pinzas para huesos
Tenaglie per ossa



Pelvic Reposition Forceps
F9-947 25 cm, 10"
3 Balls Spikes



Pelvic Reposition Forceps
F9-948 40 cm, 15 3/4"

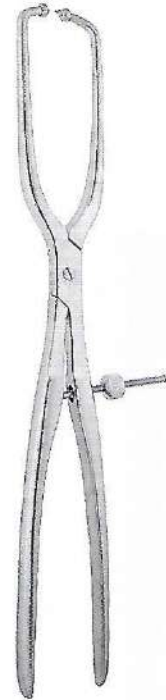

Pelvic Reposition Forceps
F9-949 40 cm, 15 3/4"



Pelvic Reduction Forceps Asymmetric
F9-950 25 cm, 10"
with 3 ball Spikes



Pelvic Reduction Forceps Asymmetric
F9-951 25 cm, 10"



Pelvic Reduction Forceps Asymmetric
F9-952 40 cm, 15 3/4"



HAND DRILLS

Handbohrapparate
Perforateurs a main

Perforadores de mano
Perforatori a mano



**Moore Drill And Bit Set Complete
F9-953**



**Stille Pattern Drill Set
F9-954**
Complete set of stainless
drill bits and burs



**Fig. 1
F9-955
2.5mm**



**Fig. 2
F9-956
3.0mm**



**Fig. 3
F9-957
3.5mm**



**Fig. 4
F9-958
4.0mm**



**Fig. 5
F9-959
5.0mm**



**Fig. 6
F9-960
8.0mm**



**Fig. 7
F9-961
12.0mm**



**Fig. 8
F9-962
16.0mm**



**Fig. 09
F9-963**



**Fig. 10
F9-964
1.0mm**



**Fig. 11
F9-965
1.5mm**



**Fig. 12
F9-966
2.0mm**

HAND DRILLS

Handbohrapparate
Perforateurs a main

Perforadores de mano
Perforatori a mano



F9-967
Hudson Brace 10 1/2" (26.7cm),
with standard thumb screw chuck

F9-968
Hudson Brace 11" (27.9cm),
with Improved Snap-Lock chuck

- C F9-969 Hudson Bur, 9mm Diameter
- D F9-970 Hudson Bur, 14mm Diameter
- E F9-971 Hudson Bur, 16mm Diameter
- F F9-972 Hudson Bur, 22mm Diameter
- G F9-973 Cushing Perforator, for Hudson Brace
- H F9-974 Hudson Cerabellar Extension, 4" for Hudson Brace
- I F9-975 McKenzie Perforator for Hudson Brace



HAND DRILLS

Handbohrapparate
Perforateurs a main

Perforadores de mano
Perforatori a mano



Jacobs
F9-976 28cm 11"
opening up to 6.35mm



Hand Drill
F9-977
opening up to 6.35mm



T-Handle
F9-978
AO Coupling



Jacob's Chuck
F9-979 T-Handle and key
F9-980 only
F9-981 Key

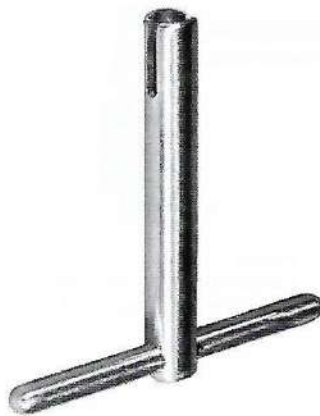

Key Handle
F9-982



T-Handle
F9-983
for AO Coupling

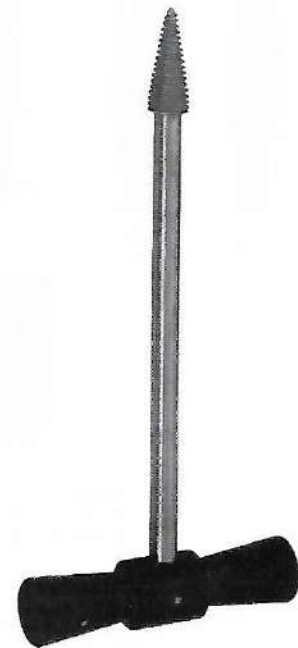

Memoral Head Extrator
F9-984

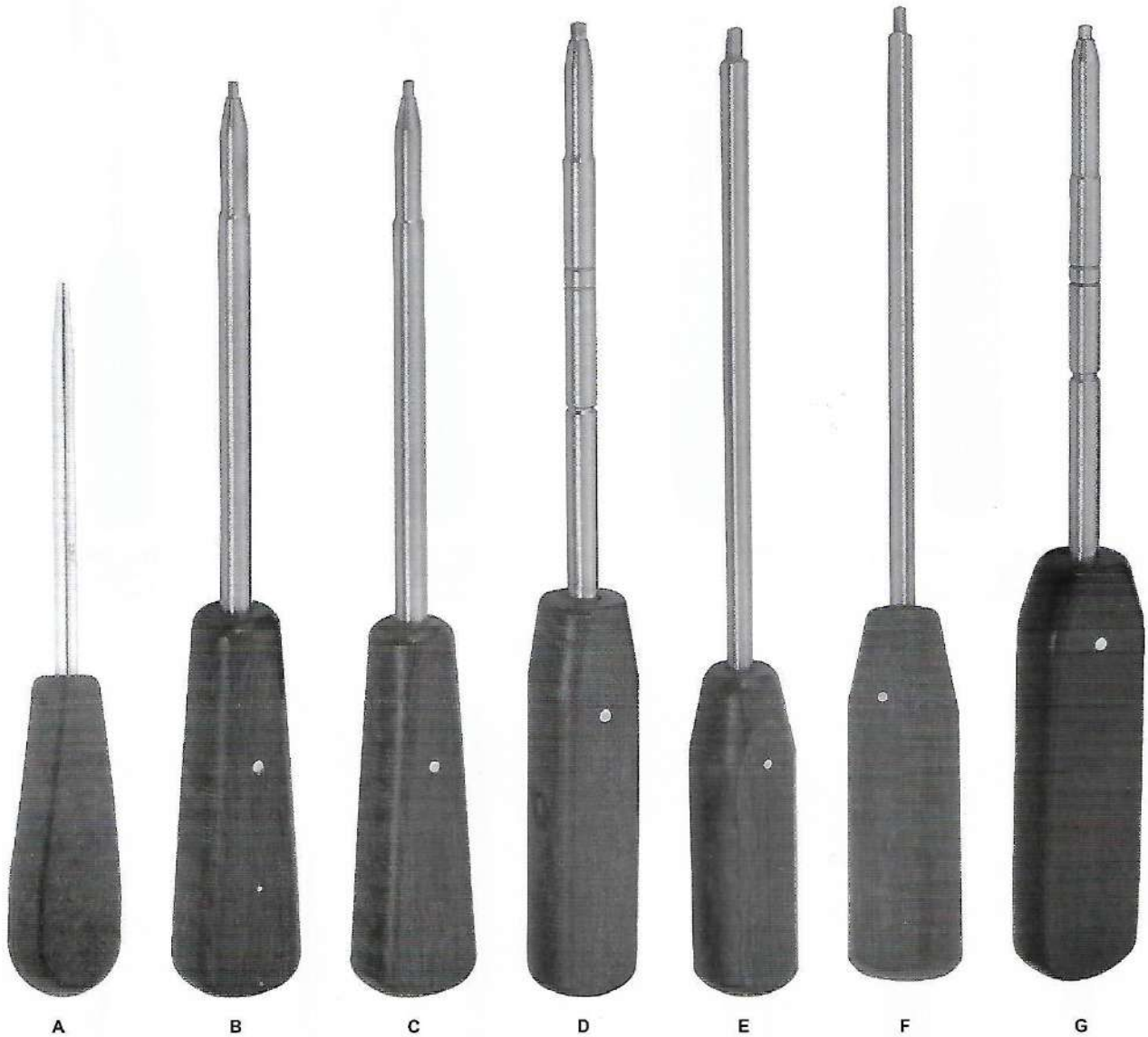

HEXAGONAL HEAD

	Size of screws	Head Size	Fiber-Handle	AO Coupling	Dental Coupling
A	1.5mm	1.5mm	F9-985	F9-988	F9-991
B	2.0mm				
C	2.7mm				
D	3.5mm	2.5mm	F9-986	F9-989	
E	4.0mm				
F	4.5mm	3.5mm	F9-987	F9-990	
G	6.5mm				



TWIST DRILLS - REAMERS - FORCEPS

Spiralbohrer - Pfrieme - zangen
Meches - Alenes - Daviers

Taladros espirales - Escariadores - Pinzas
Punte a spirale - Perforatori a mano - Tenaglie



Parallel Target Device
F9-992
for guide wires 2mm



Mortising Chisel
F9-993



Wire Guide
F9-994
45mm



Wire Guide
F9-995
70mm



Countersink
F9-996



Countersink
F9-997



Countersink
F9-998



Perthes
F9-999 18cm 7"
F9-1000 21cm 8 1/4"



F9-1001
14cm 5 1/2"

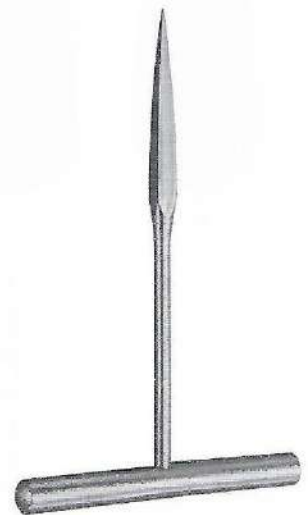

F9-1002
14cm 5 1/2"



Mini Drill Sleeve
F9-1003
 1.1 mm and 1.5 mm drill bits
F9-1004
 1.5 mm and 2.0 mm drill bits



Drill Guide
F9-1005
 drill sleeve for 2.0 mm
 drill bit



F9-1006 Tap Sleeve, 2.0 mm ϕ
F9-1007 Drill Sleeve, 2.7 mm ϕ
F9-1008 Tap Sleeve, 2.5 mm ϕ
F9-1009 Drill Sleeve, 3.5 mm ϕ



Neutral & Load Drill Guide
F9-1010 1.5 mm for 2.0 mm Screws
F9-1011 2.0 mm for 2.7 mm Screws
F9-1012 2.5 mm for 3.5 mm Screws
F9-1013 3.2 mm for 4.5 mm Screws

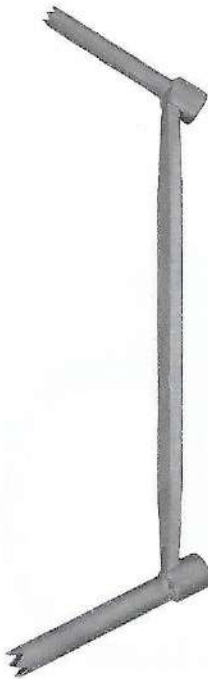

Tap Sleeve
F9-1014
 3.5 mm

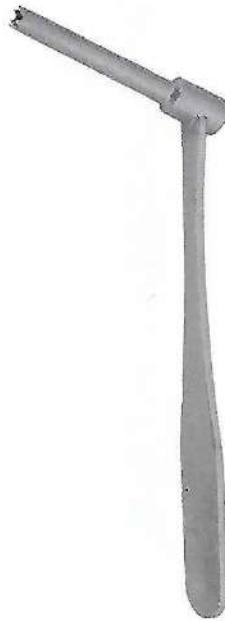

Tap Sleeve
F9-1015
 3.5 mm also for used
 as 3.2 mm drill Guide



Tap Sleeve
F9-1016
 4.5 mm



Drill Sleeve
F9-1017
 3.2 mm for Round
 Hole Plates



Insert Drill Sleeve
F9-1018 2.7 / 2.0 mm Drill Bit 2.0 mm
F9-1019 3.5 / 2.5 mm Drill Bit 2.5 mm
F9-1020 4.5 / 3.2 mm Drill Bit 3.2 mm



**Drill Small Pointed
 F9-1021**
 Drill Bit 3.5 mm



**Drill Pointed Guide
 F9-1022**
 6.5 mm



**Drill Pointed Guide
 F9-1023**
 6.5 mm



**Drill Guide
 F9-1024**
 4.5 mm Screws
 Drill Bit 4.5 mm &
 3.2 mm



**Drill Guide
 F9-1025**
 6.5 mm Screws
 Drill Bit 3.2 mm



**Drill Guide
 F9-1026**
 3.5 mm for neutral
 and compression Positioning
 Drill Bit 2.5 mm



**C - Clamp
 F9-1027**
 Drill Guide with thread
 for Drill Bit 4.5 mm

WIRE INSTRUMENTS



Draht-Instrumentarium
Instruments pour cerclage

Instrumental para cerclaje
Strumenti per filo di cerchiaggio



**Bending Device
F9-1028**
21.5cm 8 1/4"
to bend straight
and angled plates



**Rod Bender
F9-1029**
to bend straight
and angled



**Universal Rod Bender
F9-1030**
28.5cm 11 1/4"
to bend straight
and angled



**Rod Bender
F9-1031**
to bend straight
and angled



**Slotted Hammer
F9-1032 14mm**



WIRE INSTRUMENTS

Draht-Instrumentarium
Instruments pour cerclage

Instrumental para cerclaje
Strumenti per filo di cerchiaggio



Plate Bender
F9-1033



Plate Bender
F9-1034



Plate Bender
F9-1035



Plate Bender
F9-1036

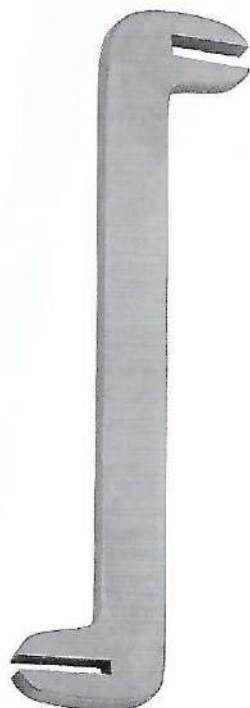

Plate Bender
F9-1037



Plate Bender
F9-1038



Plate Bender
F9-1039

EXTENSION BOWS

Extensionsbugel
Etriers pour extension

Estribos para extension
Archi per estensione



F9-1040 18cm, 7"
Wire strainer for
kirschner wires



Kirschner Extension Bows
F9-1041 x=95mm y=70mm
F9-1042 x=100mm y=100mm
F9-1043 x=120mm y=120mm
F9-1044 x=155mm y=155mm
F9-1045 x=200mm y=155mm
 with 3 traction hooks

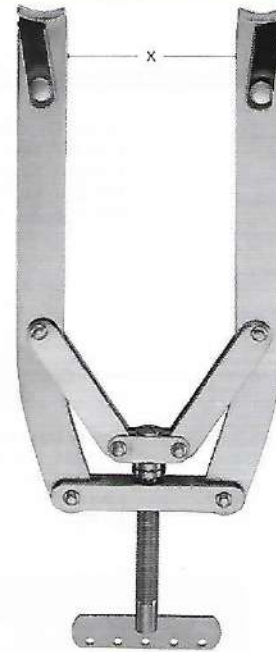

Kirschner Extension Bows
F9-1046 x=130mm
F9-1047 x=185mm
F9-1048 x=220mm
 with 3 traction hooks



Wrench
Kirschner
Extension Bows
F9-1049
 14mm/17mm



Kirschner Extension Bows
F9-1050 x=180mm y=100mm
F9-1051 x=270mm y=160mm
 with 3 traction hooks

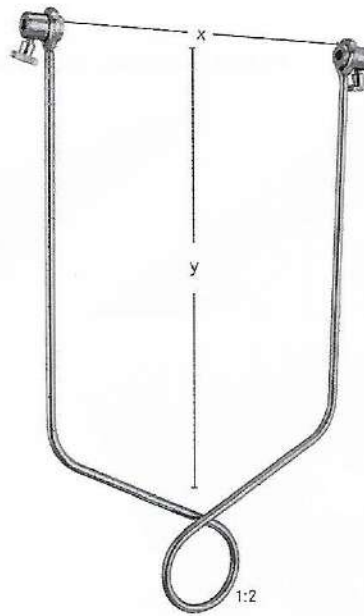

Bohler Kirschner Extension Bows
F9-1052 x=75mm y=90mm
F9-1053 x=90mm y=160mm
F9-1054 x=110mm y=210mm
F9-1055 x=150mm y=210mm
 with 3 traction hooks



Charnley-mueller
F9-1056
 Compression Clamp



ANGLED BLADE PLATE



Screw Depth Gauges

- F9-1057 Mini Gauge, 4 3/4" Longmeasures up to 30mm
- F9-1058 Small Gauge, 6 1/2" Longmeasures up to 50mm
- F9-1059 Large Gauge, 8 3/4" Longmeasures up to 100mm
- F9-1060 X-Large Gauge, 11" Longmeasures up to 120mm



Screw Depth Gauges

- F9-1061 Mini Gauge, 4 3/4" Longmeasures up to 30mm
- F9-1062 Small Gauge, 6 1/2" Longmeasures up to 50mm
- F9-1063 Large Gauge, 8 3/4" Longmeasures up to 100mm
- F9-1064 X-Large Gauge, 11" Longmeasures up to 120mm

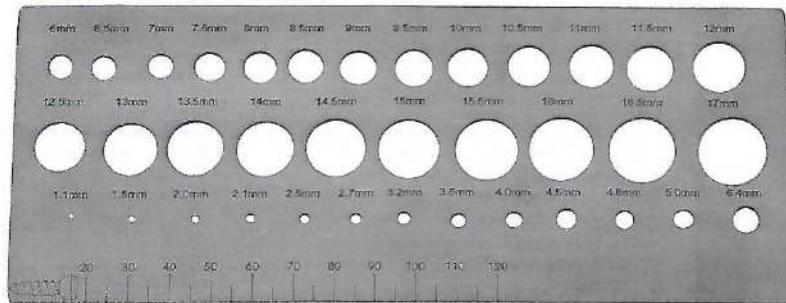

Measuring Gauge
F9-1065
for nail

F9-1066 Tri Angular Positioning Plate

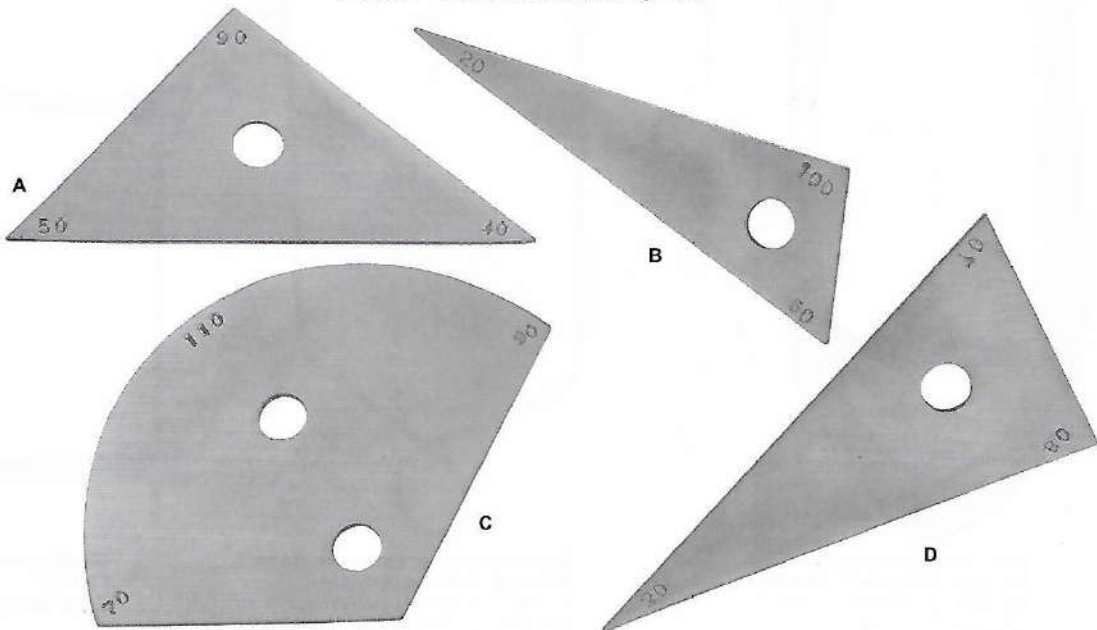



ENT Surgery

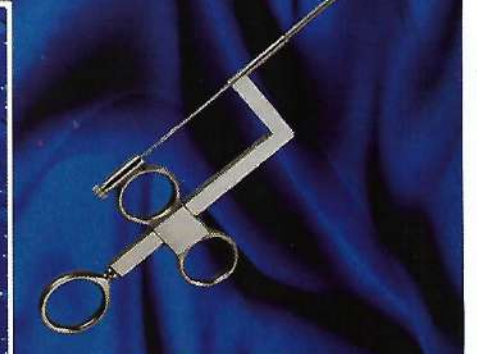
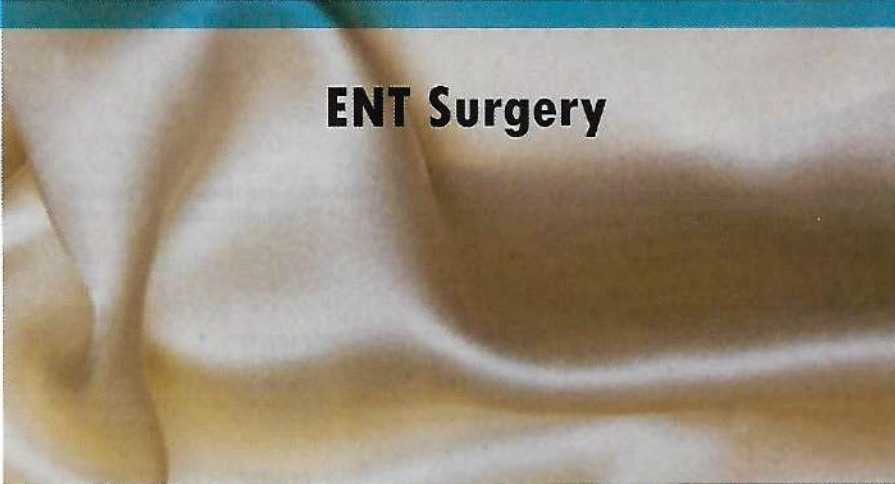



EAR SPECULUM

Ohrspekula

Espéculos auriculares

Speculums auriculares

Spécoli auricolari



F10-001
4.5 mm Ø



F10-002
5.5 mm Ø



F10-003
6.5 mm Ø



F10-004
7.5 mm Ø



F10-007
2 mm Ø



F10-008
3 mm Ø



F10-009
4 mm Ø



F10-010
5 mm Ø



Toynbee Ear Speculum
3.6 cm 1 1/2"
Set for adults

F10-005
Set of 3
5.5 mm
6.5 mm
7.5 mm

F10-006
Set of 4
4.5 mm
5.5 mm
6.5 mm
7.5 mm



Poltzer Ear Speculum
Set for adults

F10-011
Set of 3
2 mm
3 mm
4 mm

F10-012
Set of 4
2 mm
3 mm
4 mm
5 mm



Gruber Ear Speculum
Set for adults



F10-013
a - 4.5 mm Ø



F10-014
a - 5.5 mm Ø



F10-015
a - 6.5 mm Ø



F10-016
a - 7.5 mm Ø



Gruber Ear Speculum
Set for adults



F10-017
a - 4.5 mm Ø



F10-018
a - 5.5 mm Ø



F10-019
a - 6.5 mm Ø



F10-020
a - 7.5 mm Ø



F10-021
4.5 mm Ø



F10-022
5.5 mm Ø



F10-023
6.5 mm Ø



F10-024
7.5 mm Ø



Boucheron Ear Speculum
Set for adults



F10-025
3 mm Ø



F10-026
4.5 mm Ø



F10-027
5.5 mm Ø



Boucheron Ear Speculum
Set for children

TUNING FORKS



Stimmungsgabeln | Diapasones
Diapasons | Diapasoni



Hartmann
Tuning Fork
F10-028
C 64



Hartmann
Tuning Fork
F10-029
c 128



Hartmann
Tuning Fork
F10-030
c1 256

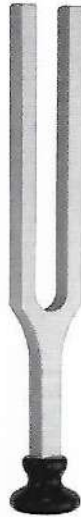

Hartmann tuning
fork with or without
plastic base a1 440
F10-031
a1 440



Tuning Forks neurol
with hammer
F10-032

NOISE DRUM

Lärmtrommel | Aparato
Assourdisseur | Assordatore



Barany Noise Drum
F10-033



Lucae
Tuning Fork
F10-034
c 128
Variable up to h (ehn, b)



Rydel-Seiffer
Tuning Fork
F10-035
C 64 / c 128
With clamps C 64,
Without clamps c 128



French
Tuning Fork
F10-036
C2 16



French
Tuning Fork
F10-037
C1 32



TUNING FORKS

Stimmgabeln | Diapasones
Diapasons | Diapasoni



F10-038
c 128



F10-039
c1 256



F10-040
c2 512



F10-041
c3 1024



F10-042
c4 2048



F10-043
c5 4096

Hartmann Tuning Fork



F10-044
Hartmann tuning Forks Set case/5



F10-045
c 128



F10-046
c1 256



F10-047
c2 512



F10-048
c3 1024



F10-049
c4 2048



F10-050
TUNING FORKS Set in case of 5

EAR CURETTES



Ohrküretten

Curetas auriculares

Curettes auriculaires

Curette auricolari

	F10-051 16.5 cm 6 1/2" Blunt	F10-052 16.5 cm 6 1/2" Blunt	F10-053 16.5 cm 6 1/2" Blunt	F10-054 16.5 cm 6 1/2" Blunt	F10-055 16.5 cm 6 1/2" Blunt	F10-056 16.5 cm 6 1/2" Blunt	F10-057 16.5 cm 6 1/2" Blunt	F10-058 16.5 cm 6 1/2" Blunt
	F10-059 16.5 cm 6 1/2" Sharp	F10-060 16.5 cm 6 1/2" Sharp	F10-061 16.5 cm 6 1/2" Sharp	F10-062 16.5 cm 6 1/2" Sharp	F10-063 16.5 cm 6 1/2" Sharp	F10-064 16.5 cm 6 1/2" Sharp	F10-065 16.5 cm 6 1/2" Sharp	F10-066 16.5 cm 6 1/2" Sharp
F10-067 16.5 cm 6 1/2" Curved, Blunt	F10-068 16.5 cm 6 1/2" Curved, Blunt	F10-069 16.5 cm 6 1/2" Curved, Blunt	F10-070 16.5 cm 6 1/2" Curved, Blunt	F10-071 16.5 cm 6 1/2" Curved, Blunt	F10-072 16.5 cm 6 1/2" Curved, Blunt	F10-073 16.5 cm 6 1/2" Curved, Blunt	F10-074 16.5 cm 6 1/2" Curved, Blunt	
F10-075 16.5 cm 6 1/2" Curved, Sharp	F10-076 16.5 cm 6 1/2" Curved, Sharp	F10-077 16.5 cm 6 1/2" Curved, Sharp	F10-078 16.5 cm 6 1/2" Curved, Sharp	F10-079 16.5 cm 6 1/2" Curved, Sharp	F10-080 16.5 cm 6 1/2" Curved, Sharp	F10-081 16.5 cm 6 1/2" Curved, Sharp	F10-082 16.5 cm 6 1/2" Curved, Sharp	

Buck, Ear
Curette



Pictures show the outer diameter



EAR LOOPS - HOOKS

Ohrschlingen - Häkchen

Asas - ganchos auriculares

Anses - crochets auriculaires

Anse - uncini auricolari



**Billeau
Ear Loop**



F10-083
16.5 cm 6 1/2"



F10-084
16.5 cm 6 1/2"



F10-085
16.5 cm 6 1/2"



**Lucae
Hooklet**



F10-086
14 cm 5 1/2"



F10-087
14 cm 5 1/2"



F10-088
14 cm 5 1/2"



**Wagner
Hooklet Buttoned**



F10-089
14 cm 5 1/2"



F10-090
14 cm 5 1/2"



F10-091
14 cm 5 1/2"



F10-092
14 cm 5 1/2"



F10-093
14 cm 5 1/2"



F10-094
14 cm 5 1/2"



F10-095
14 cm 5 1/2"



Farrell Applicator
F10-096
16.5 cm 6 1/2"
cross-serrated tip

EAR POLYPUS SNARES



Ohrpolypenschnürer

Serre noeuds auriculaires

Polipótomos auriculares

Serranodi auricolari



Nasal Polypus Snares
F10-097
0.3 mm Ø X 100 mm
In bundles of 12 pieces



Krause Nasal Polypous Snares
F10-098
25.4 cm 10"

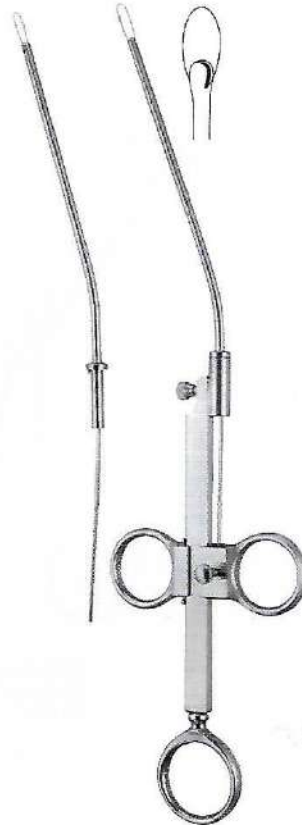

Kraus -Vosse Nasal Polypous Snares
F10-099
25.4 cm 10"
With 2 inserts

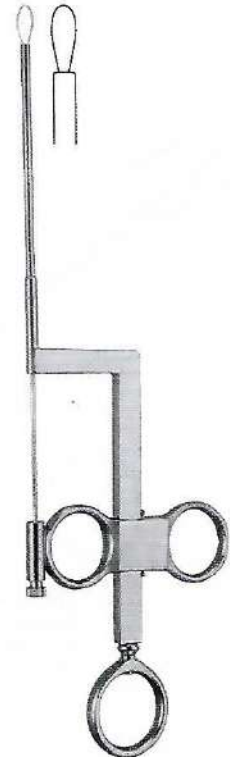

Kraus -Wilde Nasal Polypous Snares
F10-100
24 cm 9 1/2"



F10-101
50CC Complete
F10-102
75CC Complete



Reiner Ear Syringe Tip Only
F10-105
Tip Only



Reiner Ear Syringe Tip Only
F10-106
Tip Only



Reiner Ear Syringe Shield
F10-107

F10-103
100CC Complete
F10-104
150CC Complete
Reiner Ear syringe
With Tip & Shield



EAR POLYPUS FORCEPS

Ohrpolypenzangen

Pinzas para pólipos auriculares

Pinces pour polypes auriculaires

Pinze per polipi auricolari



**Littauer Ear
Polypus Forceps
F10-108**
12 cm 4 3/4"



**Hartmann Ear
Polypus Forceps
F10-109**
12 cm 4 3/4"
Delicate jaw



**Hartmann Ear
Polypus Forceps
F10-110**
14 cm 5 1/2"
Normal jaw



**Quire Ear
Polypus Forceps
F10-111**
10.5 cm 4 1/4"
Foreign body lever



**Buck Ear
Polypus Forceps
F10-112**
11.5 cm 4 1/2"
Foreign body forceps

EAR FORCEPS



Ohrzängchen | Pinzas auriculares
Pincès auriculaires | Pinze auricolari



**Hartman
Ear Forceps
F10-113**

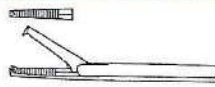

**Hartmann
Ear Forceps
F10-114**
X = 8.5 cm, 3 1/4"
F10-115
X = 14 cm, 5 1/2"

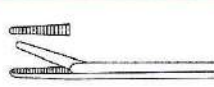

**Hartmann
Ear Forceps
F10-116**
X = 8.5 cm, 3 1/4"
F10-117
X = 14 cm, 5 1/2"
F10-118
X = 16 cm, 6 1/4"

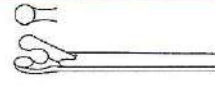

**Hartmann
Ear Forceps
F10-119** 2 mm Ø
X = 8.5 cm, 3 1/4"
F10-120 2.5 mm Ø
X = 8.5 cm, 3 1/4"
F10-121 3 mm Ø
X = 8.5 cm, 3 1/4"



**Hartmann
Ear Forceps
F10-122**

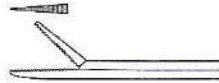

**Hartmann-Wullstein
Ear Forceps
F10-123**
X = 8.5 cm, 3 1/4"



**Hartmann-Wullstein
Ear Forceps
F10-124**
1 mm Ø
X = 8.5 cm, 3 1/4"



**Hartmann-Weingartner
Ear Forceps
F10-125**
X = 8.5 cm, 3 1/4"



**Duckbill
Ear Forceps
F10-126**



**Weingärtner
Ear Forceps
F10-127**

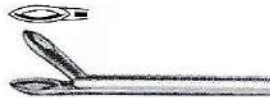

**Strümpel
Ear Forceps
F10-128**



**Hartmann-hoffmann
Ear Forceps
F10-129**

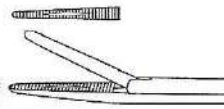

**Hartmann-Noyes
Ear Forceps
F10-130**
X = 9 cm, 3 1/2"



**Struempel
Ear Forceps
F10-131** 0°
X = 8.5 cm, 3 1/4"



**Struempel
Ear Forceps
F10-132** 45°
X = 8.5 cm, 3 1/4"

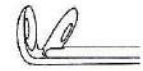

**Struempel
Ear Forceps
F10-133** 90°
X = 8.5 cm, 3 1/4"



**MICRO CUP FORCEPS
F10-134**
X = 75 mm 3"
a = 4.0 mm
b = 1.0 mm
c = 0.9 mm
Straight, Ovel

**MICRO CUP FORCEPS
F10-135**
X = 75 mm 3"
a = 4.0 mm
b = 1.0 mm
c = 0.9 mm
Curved upwards, Ovel

**MICRO CUP FORCEPS
F10-136**
X = 75 mm 3"
a = 4.0 mm
b = 1.0 mm
c = 0.9 mm
Curved to left, Ovel

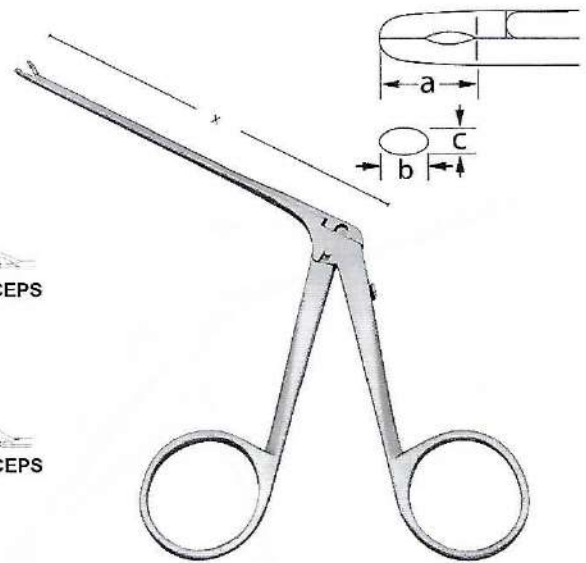

MICRO CUP FORCEPS

**MICRO CUP FORCEPS
F10-137**
X = 75 mm 3"
a = 4.0 mm
b = 1.0 mm
c = 0.9 mm
Curved to right, Ovel

**MICRO CUP FORCEPS
F10-138**
X = 75 mm 3"
a = 4.0 mm
b = 1.0 mm
c = 0.9 mm
Curved downwards, Ovel



BONE-RONGEURS

Ohr-Knochenstanzen
Rongeurs auriculaires

Pinzas osteótomos auriculares
Conchotomi auricolari

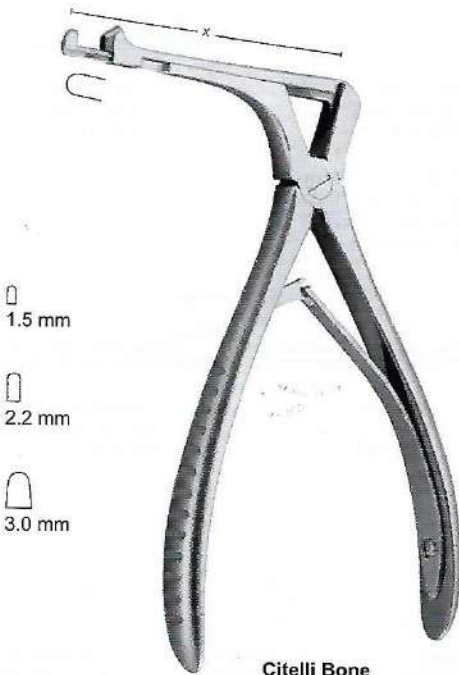

**Citelli Bone
Ear Rongeurs
F10-139**
17 cm 6 3/4"
X = 60 mm



**Kerrison Bone
Ear Rongeurs
F10-140**
20 cm 8"
X = 80 mm

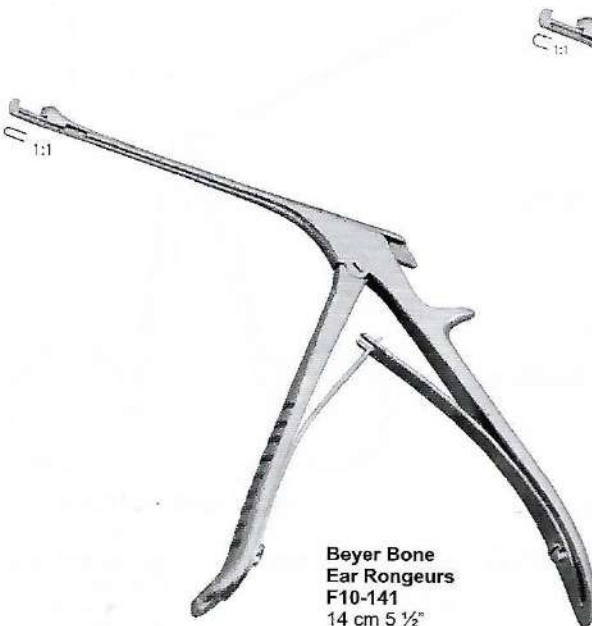

**Beyer Bone
Ear Rongeurs
F10-141**
14 cm 5 1/2"
1 mm



**Beyer Bone
Ear Rongeurs
F10-142**
19 cm 7 1/2"
2 mm

NASAL SPECULA



Nasenspekula
Spéculums nasaux

Especulos nasales
Specoli nasali



**Thudichum
(Goldsmith)
Nasal Speculum**



F10-143
6.5 cm 2 1/2"
21 mm X 9.5 mm



F10-144
6.5 cm 2 1/2"
21 mm X 10.5 mm

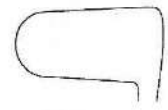

F10-145
6.5 cm 2 1/2"
21 mm X 11.5 mm



**Hartmann
Nasal Speculum**

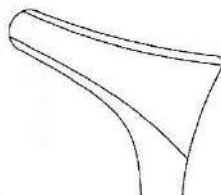

F10-146
16 cm 6 1/4"

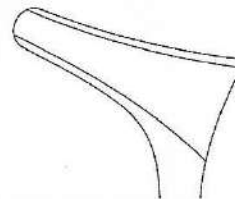

F10-147
16 cm 6 1/4"

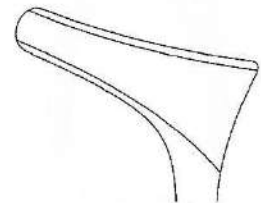

F10-148
16 cm 6 1/4"



**Hartmann-Halle
Nasal Speculum**

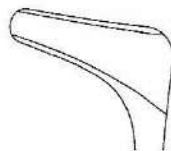

F10-149
15 cm 6"

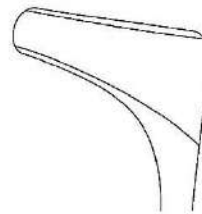

F10-150
15 cm 6"

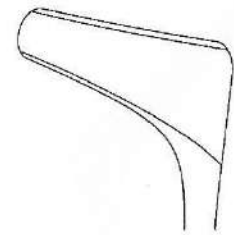

F10-151
15 cm 6"



NASAL SPECULA

Nasenspekula

Especulos nasales

Spéculums nasaux

Specoli nasali



F10-152
13.5 cm 5 1/4"
For babies

Tieck-Halle
Nasal Speculum

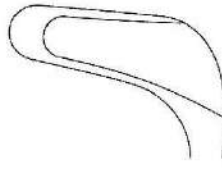

F10-153
14 cm 5 1/2"

Schwarz Nasal Speculum



Vienna Speculum
F10-154
14.6cm 5 3/4"
medium standard patter



Killian Nasal Speculum

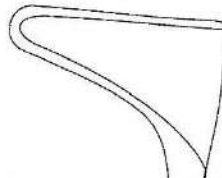

F10-155
13 cm 5"
X = 35 mm

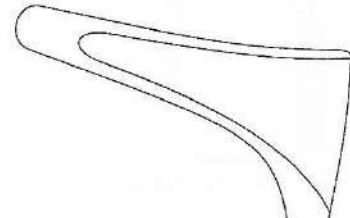

F10-156
13 cm 5"
X = 50 mm

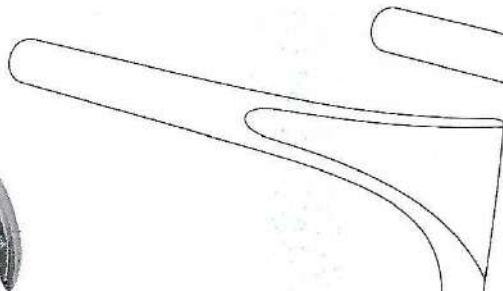

F10-157
13 cm 5"
X = 75 mm

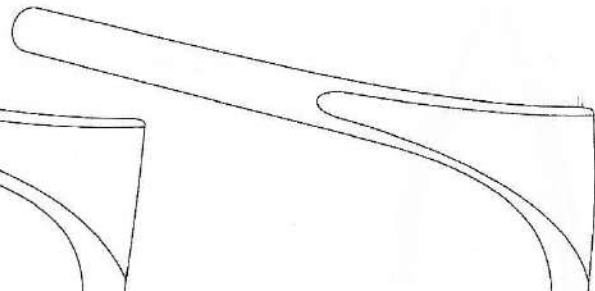

F10-158
13 cm 5"
X = 90 mm

NASAL SPECULA



Nasenspekula
Spéculums nasaux

Especulos nasales
Specoli nasali



**Killian Septum Speculum
F10-159**
15.2 cm 6"
2.51 cm blades
withset screw



**Killian Septum Speculum
F10-160**
15.2 cm 6"
8.9cm 3 1/2 blades
set screw



**Killian Septum Speculum
F10-161**
Fiber Optic 5 1/2" 14.0mm
length 2.51mm deep



**Beckmann
Nasal Speculum**

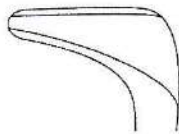

F10-162
15 cm 6"

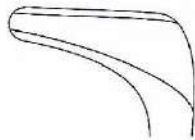

F10-163
15 cm 6"

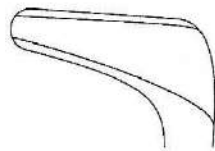

F10-164
15 cm 6"



**Mod. Wien
Nasal Speculum**

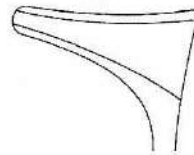

F10-165
14.5 cm 5 3/4"

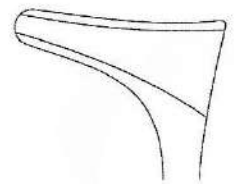

F10-166
14.5 cm 5 3/4"

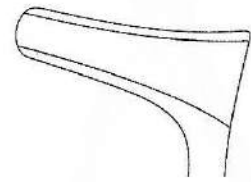

F10-167
14.5 cm 5 3/4"



NASAL SPECULA

Nasenspekula

Especulos nasales

Spéculums nasaux

Specoli nasali



Cottle Nasal Speculum

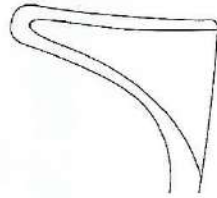

F10-168
15 cm 6"
X = 35 mm

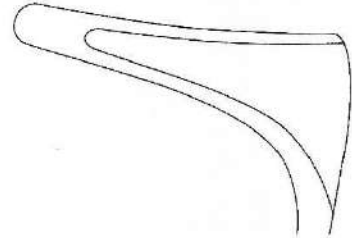

F10-169
15 cm 6"
X = 50 mm

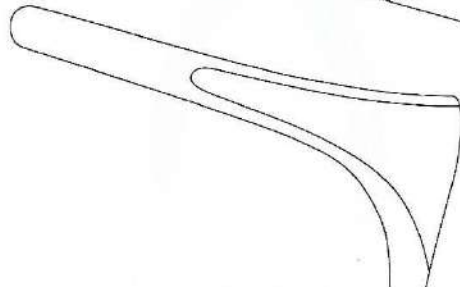

F10-170
15 cm 6"
X = 75 mm

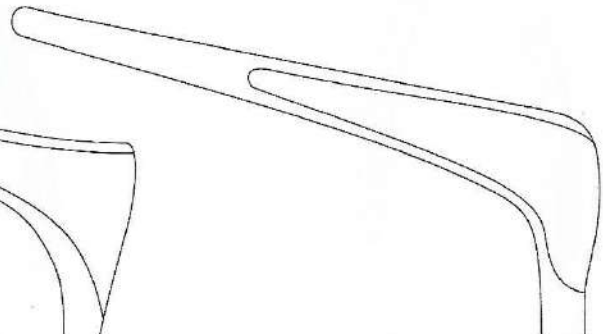

F10-171
15 cm 6"
X = 90 mm



Cottle Nasal Speculum

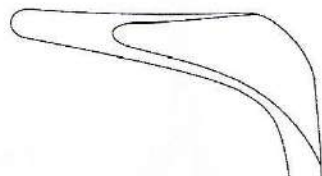

F10-172
14 cm 5 1/2"
X = 45 mm

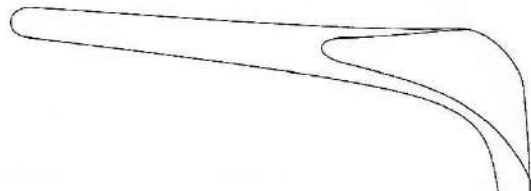

F10-173
14 cm 5 1/2"
X = 75 mm



NASAL SPECULA

Nasenspekula

Especulos nasales

Spéculums nasaux

Specoli nasali



Cottle Nasal Speculum

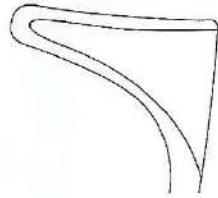

F10-168
15 cm 6"
X = 35 mm

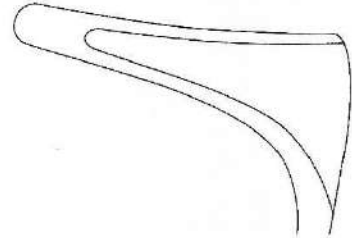

F10-169
15 cm 6"
X = 50 mm

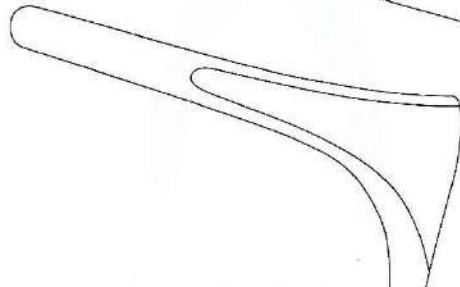

F10-170
15 cm 6"
X = 75 mm

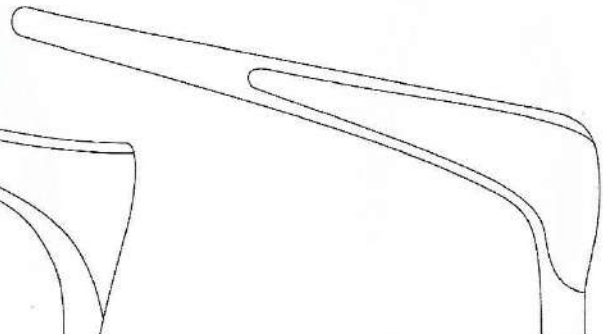

F10-171
15 cm 6"
X = 90 mm



Cottle Nasal Speculum

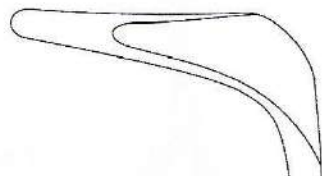

F10-172
14 cm 5 1/2"
X = 45 mm

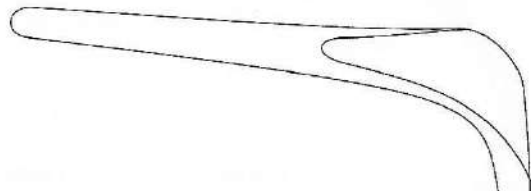

F10-173
14 cm 5 1/2"
X = 75 mm



NASAL POLYPUS & NASAL DRESSING FORCEPS

Nasenpolypenzangen, Nasentamponzange

Pinzas para pólipos nasales, Pinza nasale para tamponamiento

Pinces à polypes nasales, Pince à pansement pour le nez

Pinze per polipi nasali, Pinza per tamponamento nasale

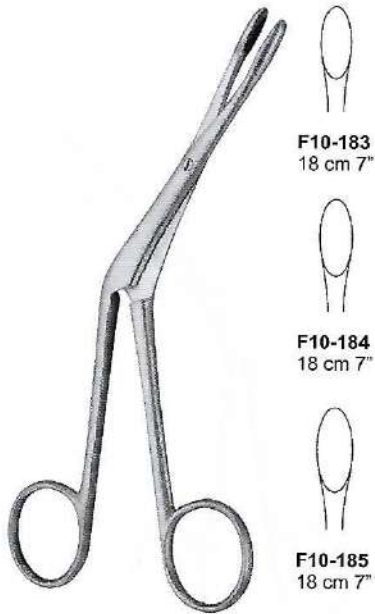

Heymann Nasal Dressing Forceps

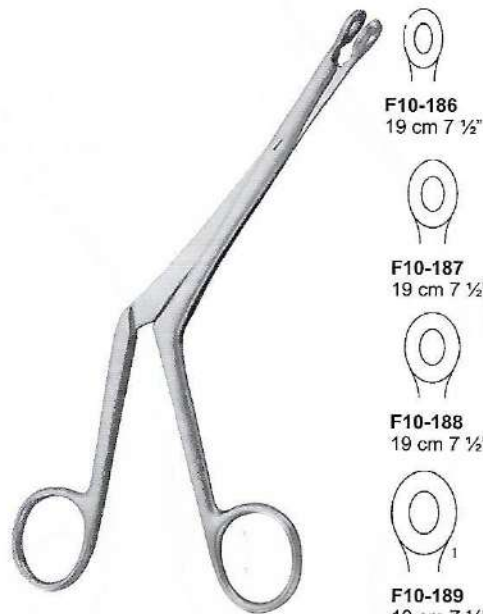

Bruenings Nasal Cutting Forceps



Takahashi Nasal Cutting Forceps

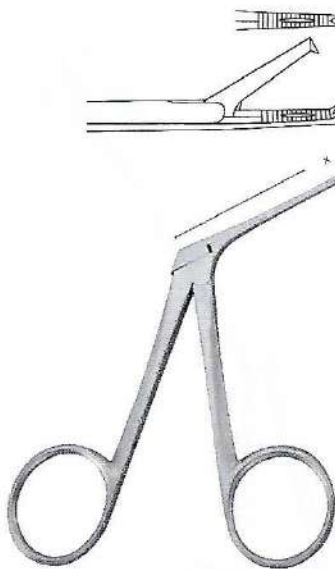

Noyes Nasal Dressing Forceps
F10-192
X = 11 cm 3 1/2"
1 X 2

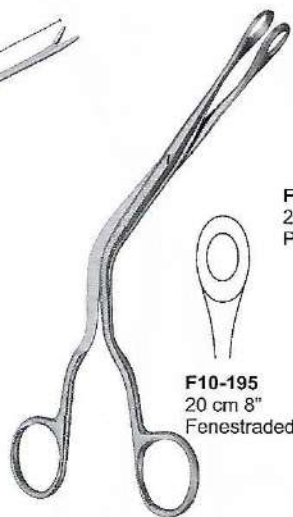

Luc Nasal Cutting Forceps



Weil Nasal Cutting Forceps
F10-197
X = 12 cm 4 3/4"

Watson-Williams Nasal Cutting Forceps
F10-198
X = 12 cm 4 3/4"

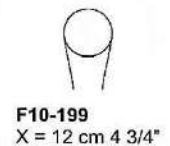

F10-199
X = 12 cm 4 3/4"

TONSIL KNIVES



Tonsillennmesser
Couteaux à tonsils

Bisturis para amigdales
Bisturi per tonsille



**Freer
Tonsil Knife
F10-200**
21 cm 8 1/4"



**Freer
Tonsil Knife
F10-201**
21 cm 8 1/4"



**Tonsil Knife
F10-202**
20 cm 8"
Sharp



**Tonsil Knife
F10-203**
20 cm 8"
Sickle knife



**Bruenings
Tonsil Knife
F10-204**
23 cm 9"



**Abraham
Tonsil Knife
F10-205**
22 cm 8 3/4"



**Fischer Tonsil
Knife and Dissector
F10-206**
21.6 cm 8 1/2"
semi-sharp tip, with teeth

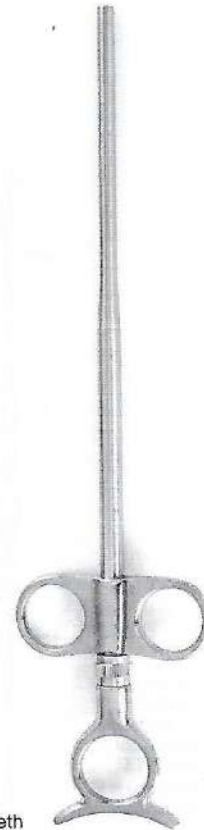

EVE Tonsil Snare
27.9 cm 11"
F10-207 without ratchet
F10-208 with ratchet



SEPTUM ELEVATORS - RASPATORIES

Septum elevatorien - Raspatorien

Elevadores - legras para el tabique nasal

Elevateurs - rugines pour la cloison nasale

Elevatori - periostotomi per setto



**Lempert
Septum
Elevators
Raspatory
F10-209**
20.5 cm 8"
X = 6 mm



**Lempert
Septum
Elevators
Raspatory
F10-210**
18 cm 7"
X = 6 mm



**Cottle
Septum
Elevators
Raspatory
F10-211**
19 cm 7 1/2"
X = 8 mm
Sharp



**Joseph
Septum
Elevators
Raspatory
F10-212**
16 cm 6 1/4"
X = 5 mm
Periosteal elevators



**Joseph-Masing
Septum Elevators
Raspatory
F10-213**
21.5 cm 8 1/2"
Sharp



**Pennington
Septum
Elevators
Raspatory
F10-214**
21.5 cm 8 1/2"
Blunt



**Freer
Septum
Elevators
Raspatory
F10-215**
19 cm 7 1/2"
Blunt



**Freer
Septum
Elevators
Raspatory
F10-216**
18 cm 7"
Sharp/Blunt



**Freer
Septum
Elevators
Raspatory
F10-217**
20.5 cm 8"
Sharp/Blunt



**Cottle
Septum
Elevators
Raspatory
F10-218**
23.5 cm 9 1/4"
X = 5 mm
Sharp

PERIOSTEAL ELEVATORS, SEPTUM ELEVATORS



Periostelevatorien, Septumelevatorien

Legras para periostio, Elevadores para el tabique nasal

Elevateurs pour la perioste, Elevateurs pour la cloison nasale

Elevatori per il periostio, Elevatori per setto



Masing Periosteal Septum Elevators
F10-219
20 cm 8"



Ballenger-Hajek Periosteal Septum Elevators
F10-220
19 cm 7 1/4"
F10-221
22 cm 8 3/4"



Cottle Periosteal Septum Elevators
F10-222
22 cm 8 3/4"



Cottle Periosteal Septum Elevators
F10-223
21 cm 8 1/4"

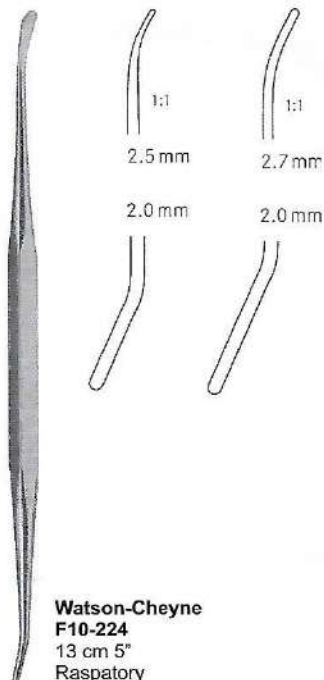

Watson-Cheyne
F10-224
13 cm 5"
Raspatory



Boies
F10-225
19 cm 7 1/2"
Nasal fracture elevator,
Blunt



Goldman
F10-226
17 cm 6 3/4"
Septum displacer



NASAL SAWS

Nasensägen
Scies nasales

Sirerras nasales
Seghe nasali



Joseph Nasal Saw
F10-227
19 cm 7 1/2"



Joseph Nasal Saw
F10-228
19 cm 7 1/2"



Joseph Nasal Saw
F10-229
19 cm 7 1/2"



Maltz Rasp
F10-230
21 cm 8-1/4"
improved double end
pattern, forward and
backward cutting



Joseph Rasp
F10-231
15.9 cm 6-1/4"
fine cross serrations



Joseph Nasal Saw
F10-232
17 cm 6 3/4"

Joseph Nasal Saw
F10-233
17 cm 6 3/4"

RASPS WITH TUNGSTEN CARBIDE



Raspeln mit Hartmetall

Rapes avec inserts de carbure de tungstene

limas con carburo de tungsteno

raspe con tungsteno

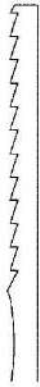

**Fomon
Rasp with
Tungsten
Carbide**

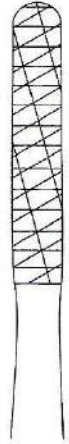

F10-234
20 cm 8"
Teeth 12



F10-235
20 cm 8"
Teeth 16



F10-236
20 cm 8"
Teeth 24



F10-237
20 cm 8"
Teeth 36



F10-238
20 cm 8"
Teeth 52



**Fomon Rasp
with Tungsten
Carbide TC**



F10-239
20 cm 8"
Teeth 14



F10-240
20 cm 8"
Teeth 20



F10-241
20 cm 8"
Teeth 30



F10-242
20 cm 8"
Teeth 44



F10-243
20 cm 8"
Teeth 62



NASAL SAWS

Nasensägen
Scies nasales

Sirerras nasales
Seghe nasali

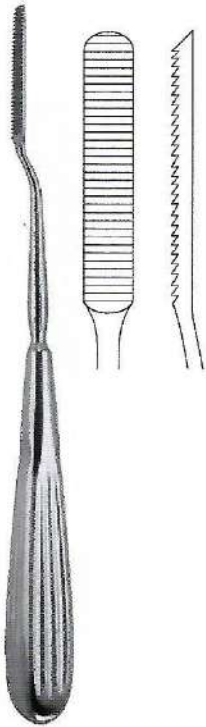

Cottle Nasal Saw
F10-244
21 cm 8 1/4"



Maltz Nasal Saw

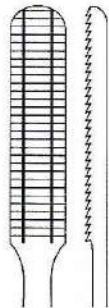

F10-245
17 cm 6 3/4"
34 mm x 7 mm
Pushing cut



F10-246
17 cm 6 3/4"
34 mm x 7 mm
Drawing cut



Aufrecht Nasal Saw
Glabella Rasp,
backward cutting



F10-247
21 cm 8 1/4"
Pushing cut



F10-248
21 cm 8 1/4"
Drawing cut



F10-249
17.5 cm 7"
40 mm X 9 mm



Wiener Nasal Saw



F10-250
18 cm 7"
3.5 mm Ø
Antrum rasps

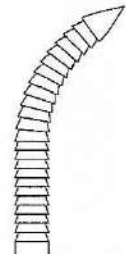

F10-251
18 cm 7"
3.5 mm Ø
Antrum rasps



Gallaher Nasal Saw



F10-252
16 cm 6 1/4"



F10-253
16 cm 6 1/4"



F10-254
16 cm 6 1/4"



Fomon Nasal Saw
F10-255
21 cm 8 1/4"



SEPTUM INSTRUMENTS



Septuminstrumente
instruments pour la cloison nasale

Instrumentos para el tabique nasal
Strumenti per il setto nasale



Bruenings-Brunk
F10-256
19 cm 7 1/2"
Antrum Retractor
Serrated



Ritter-Halle
F10-257 16 cm 6 1/4"
2.5 mm Ø
F10-258 16 cm 6 1/4"
3.0 mm Ø
F10-259 16 cm 6 1/4"
4.0 mm Ø
Forntal sinus bougies



Cottle
F10-260
1.2 cm 4 3/4"
Handle



Cottle
F10-261
7 mm
Guide support
for osteotomes



Cottle
F10-262
65 mm X 30 mm X 30 mm
Cartilage crusher



Cottle-Walsham
Septum Forceps



F10-263
23 cm 9"
Straight



F10-264
23 cm 9"
Left



F10-265
23 cm 9"
Right



Ash Septum
Forceps
F10-266
23 cm 9"

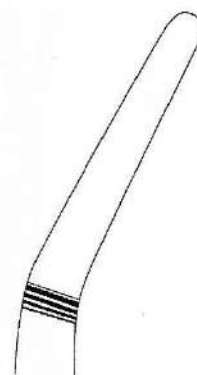



SEPTUM FORCEPS

Septumzangen

Pinces pour la cloison nasale

Pinzas para el tabique nasal

Pinze per il setto nasale



**Middleton-Jansen
Septum Forceps
F10-267**
19 cm 7 1/2"



**Middleton-Jansen
Septum Forceps
F10-268**
19 cm 7 1/2"

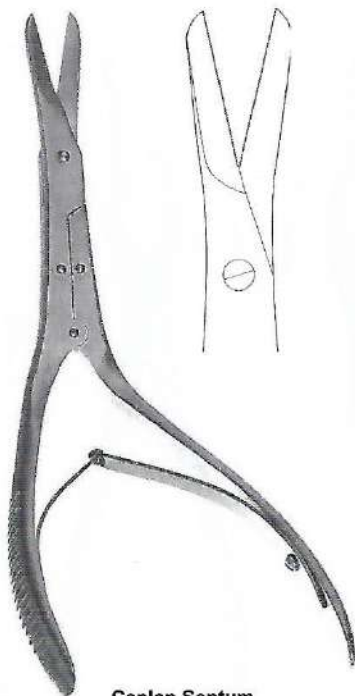

**Caplan Septum
Forceps
F10-269**
20 cm 8"
Toothed



**Rubin Septum
Forceps
F10-270**
21 cm 8 1/4"
Protection cap

RINGMESSER



adenoid currettes

Cuchillos para vegetaciones adenoides

Couteaux a vegetations adenoides

Adenotomi



F10-271
21 cm 8 1/4"

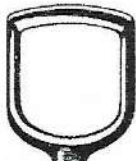

F10-272
21 cm 8 1/4"



F10-275
22 cm 8 3/4"

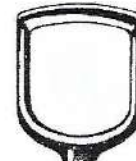

F10-276
22 cm 8 3/4"



F10-273
21 cm 8 1/4"

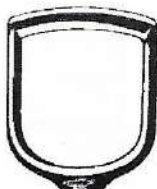

F10-274
21 cm 8 1/4"

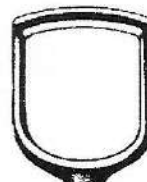

F10-277
22 cm 8 3/4"

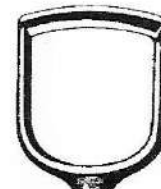

F10-278
22 cm 8 3/4"



Barnhill
Adenoid Curette



Beckmann
Adenoid Curette



F10-279
22 cm 8 3/4"
Straight



F10-280
22 cm 8 3/4"
Straight



F10-281
22 cm 8 3/4"
Straight



F10-282
22 cm 8 3/4"
Straight



F10-283
22 cm 8 3/4"
Straight



F10-284
22 cm 8 3/4"
Straight



Beckman
Adenoid Curette



F10-285
22 cm 8 3/4"
Curved

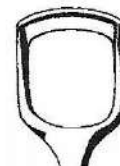

F10-286
22 cm 8 3/4"
Curved



F10-287
22 cm 8 3/4"
Curved

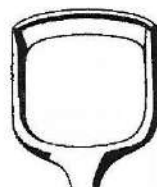

F10-288
22 cm 8 3/4"
Curved



F10-289
22 cm 8 3/4"
Curved

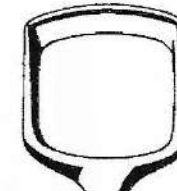

F10-290
22 cm 8 3/4"
Curved



RINGMESSER

adenoid currettes

Couteaux a vegetations adenoides

Cuchillos para vegetaciones adenoides

Adenotomi



La Force

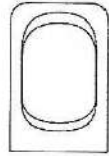

La Force adenotome unperforated Fig 1
F10-291
21.6 cm 8 1/2"
25 x 16.0mm
Infant

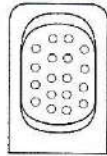

La Force adenotome perforated Fig 1
F10-292
21.6 cm 8 1/2"
25 x 16.0mm
Infant

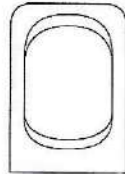

La Force adenotome unperforated Fig 2
F10-293
24.1 cm 9 1/2"
26 x 19.3mm
Medium

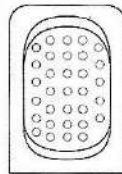

La Force adenotome perforated Fig 2
F10-294
24.1 cm 9 1/2"
26 x 19.3mm
Medium

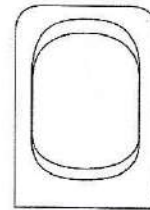

La Force adenotome unperforated Fig 3
F10-295
25 cm 10"
30 x 22.2mm
Large

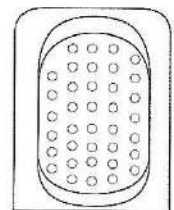

La Force adenotome perforated Fig 3
F10-296
25 cm 10"
30 x 22.2mm
Large



F10-297
20 cm 8"
X = 3 mm
Straight
F10-298
20 cm 8"
Straight
X = 4 mm
F10-299
20 cm 8"
Straight
X = 5 mm

Ballenger Knife



F10-300
20 cm 8"
X = 3 mm
Bayonet
F10-301
20 cm 8"
Bayonet
X = 4 mm
F10-302
20 cm 8"
Bayonet
X = 5 mm

Ballenger Knife



Wieder Tongue Depressor
F10-303 large blade 36mm
wide serrated

Wieder Tongue Depressor
F10-304 43.5mm width blade

MOUTH GAGS



Mundsperrer | Abrebocas
Ouvre-bouches | Apribocca

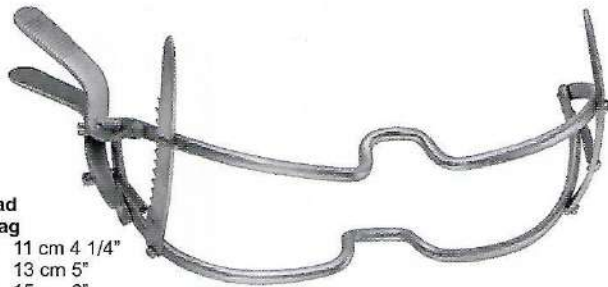

**Whitehead
Mouth Gag**
F10-305 11 cm 4 1/4"
F10-306 13 cm 5"
F10-307 15 cm 6"



**Jennings
Mouth Gag**
F10-308 9 cm 3 1/2"
F10-309 11 cm 4 1/4"
F10-310 13 cm 5"
F10-311 15 cm 6"



**Heister
Mouth Gag**
F10-312
13 cm 5"



**Maunder
Mouth Gag**
F10-313
10 cm 4"
4 mm Ø
Wood



Molt Mouth Gag
F10-314
11 cm 4 1/4"
For children



Molt Mouth Gag
F10-315
14 cm 5 1/2"
For adults

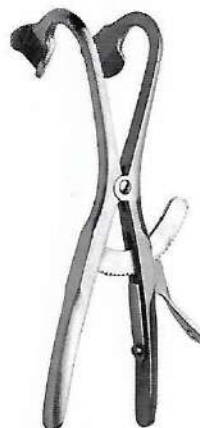

**Denhart
Mouth Gag**
F10-316
12 cm 4 3/4"



**Fergusson-Ackland
Mouth Gag**
F10-317
14.5 cm 5 3/4"



**Roser-Konig
Mouth Gag**
F10-318
16 cm 6 1/4"
F10-319
19 cm 7 1/2"



TONSIL INSTRUMENTS

Tonsillieninstrumente
Instruments pour amygdales

Instrumentos para amígdalas
Strumenti per tonsille



**Jackson
F10-320**
22 cm 8 3/4"
Laryngeal forceps



**Marschik
F10-321**
22 cm 8 3/4"
Tonsil seizing forceps



**Blohmke
Tonsil
Forceps
F10-322**
20 cm 8"



**Colver Tonsil
Forceps
F10-323**
19 cm 7 1/2"
Straight
F10-324
19 cm 7 1/2"
Curved



**White Tonsil
Seizing Forceps
F10-325**
19.1 cm 7 1/2"
F10-326
23 cm 9"

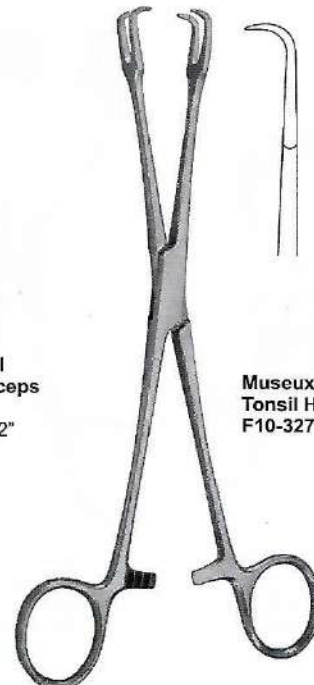

**Museux
Tonsil Holding Forceps
F10-327** 20 cm 8"

TONSIL INSTRUMENTS



Tonsilleninstrumente
Instruments pour amygdales

Instrumentos para amígdalas
Strumenti per tonsille



**Wilde Nasal
Dressing Forceps**
F10-328
16.5cm 6 1/2"
angular



**Troeltsch
Dressing Forceps**
F10-329
11cm, 4 1/2"



**Troeltsch
Dressing Forceps**
F10-330
13 cm, 5"



**Lucae Dressing
Forceps**
F10-331
14 cm, 5 1/2"



**Jansen Dressing
Forceps**
F10-332
16 cm, 6 1/4"



TONSIL INSTRUMENTS

Tonsilleninstrumente

Instruments pour amygdales

Instrumentos para amígdalas

Strumenti per tonsille

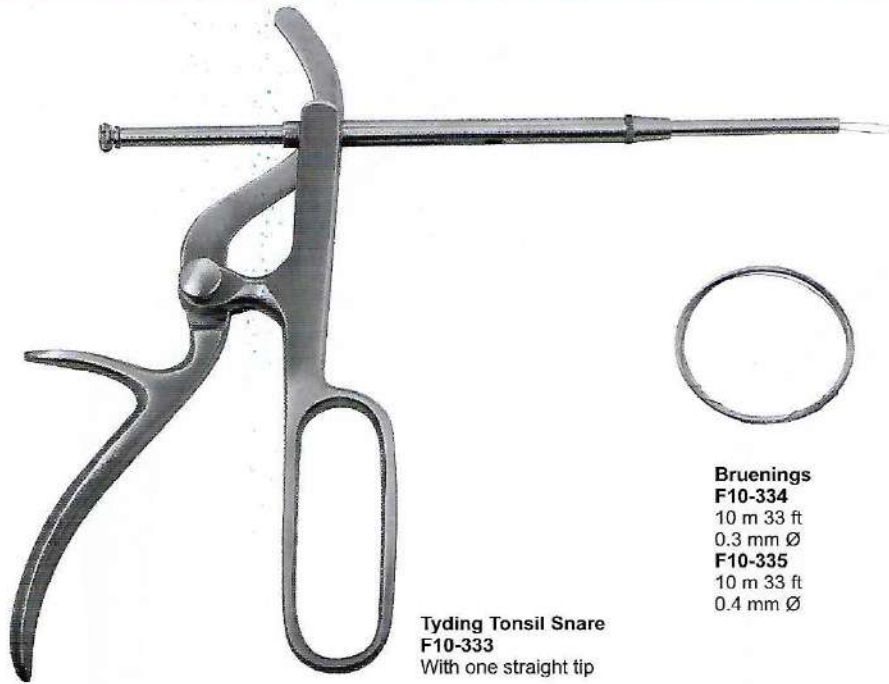

Tyding Tonsil Snare
F10-333
With one straight tip



Bruenings
F10-334
10 m 33 ft
0.3 mm Ø
F10-335
10 m 33 ft
0.4 mm Ø

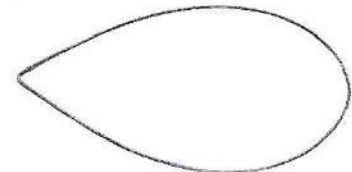

Bruenings
F10-336
40 mm
Package of 100 pieces
F10-337
50 mm
Package of 100 pieces

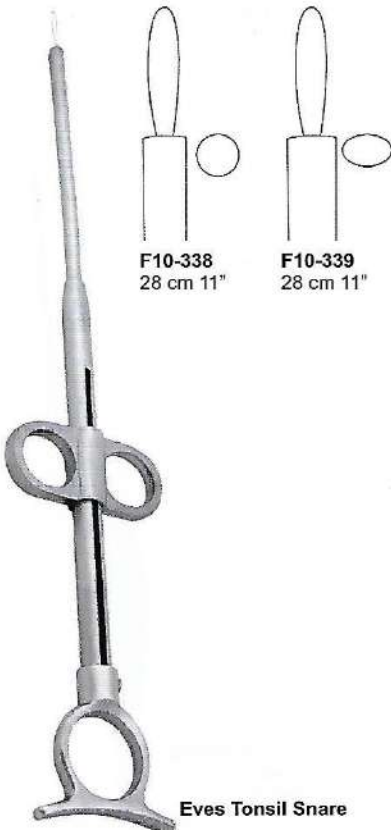

F10-338
28 cm 11"

F10-339
28 cm 11"

Eves Tonsil Snare



F10-340
28 cm 11"

Eves Tonsil Snare



F10-341
28 cm 11"

Bruenings Tonsil Snare

LARYNGEAL MIRRORS



Kehlkopfspiegel
Miroirs laryngiens

Especjos laringeos
Specchi laringei

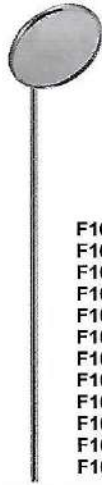

- F10-342 8 mm Ø
- F10-343 10 mm Ø
- F10-344 12 mm Ø
- F10-345 14 mm Ø
- F10-346 16 mm Ø
- F10-347 18 mm Ø
- F10-348 20 mm Ø
- F10-349 22 mm Ø
- F10-350 24 mm Ø
- F10-351 26 mm Ø
- F10-352 28 mm Ø
- F10-353 30 mm Ø

Laryngeal mirrors



Laryngeal Mirrors
Handle
F10-354
10 cm 4"



- F10-355 8 mm Ø
- F10-356 10 mm Ø
- F10-357 12 mm Ø
- F10-358 14 mm Ø
- F10-359 16 mm Ø
- F10-360 18 mm Ø
- F10-361 20 mm Ø
- F10-362 22 mm Ø
- F10-363 24 mm Ø
- F10-364 26 mm Ø
- F10-365 28 mm Ø
- F10-366 30 mm Ø

Laryngeal Mirrors
with Handle



- F10-367 10 mm Ø
- F10-368 12 mm Ø
- F10-369 14 mm Ø
- F10-370 16 mm Ø
- F10-371 18 mm Ø

Michel Moveable
Mirror



TRACHEA DILATORS, TRACHEA TUBES

Trachealdilatatore, Trachealkanulen

Dilatateurs pour la tracheotomie, Canules pour la tracheotomie

Dilatadores para la traqueotomía, Cabykas oara ka traqvea

Dilatatori tracheali, Cabyke tracheali



Laborde Trachea Dilator 3 Prong
F10-372
14 cm 5 1/2"



Trousseau Trachea Dilator 2 Prong
F10-373
14 cm 5 1/2"



Uckermann Trachea Tubes
F10-374
13 cm 5"
10 mm Ø



Luer-Standard Trachea Tubes
German silver

- F10-375 4 mm Ø
- F10-376 5 mm Ø
- F10-377 6 mm Ø
- F10-378 7 mm Ø
- F10-379 8 mm Ø
- F10-380 9 mm Ø
- F10-381 10 mm Ø
- F10-382 11 mm Ø
- F10-383 12 mm Ø
- F10-384 13 mm Ø



Chevalier-Jackson Trachea Tubes
German silver

- F10-385 4 mm Ø
- F10-386 5 mm Ø
- F10-387 6 mm Ø
- F10-388 7 mm Ø
- F10-389 8 mm Ø
- F10-390 9 mm Ø
- F10-391 10 mm Ø
- F10-392 11 mm Ø
- F10-393 12 mm Ø
- F10-394 13 mm Ø

LARYNGEAL POLYPUD FORCEPS



Kehlkopfpolypenzangen
Pincas a polypes laryngiens

Pinzas para polipos laringeos
Pinze per polipi laringei



**Jako-Cherry Micro
Laryngoscope
F10-395**
Type II, Newborn
Small, Overall length 114mm
min. I.D. 7.8mm



**Carlens Mediastinoscope, Short
F10-396**
Overall length 116mm, min. I.D. 10.8mm,
nominal proximal dims 16.0mm, max O.D. 18.4mm



**Carlens Mediastinoscope, Long
F10-397**
Overall length 162mm, min. I.D. 11.0mm,
nominal proximal dims 18.0mm, max O.D. 22.3mm



**Carlens Mediastinoscope,
Extra-long
F10-398**
Overall length 191mm, min. I.D. 11.9mm,
nominal proximal dims 19.0mm, max O.D. 22.3mm



**Tucker Mid-Lighted Side Slide
Laryngoscope
F10-399**
Overall length 91mm, min. I.D. 6.9mm

**Tucker Mid-Lighted Side Slide
Laryngoscope, Adolescent
F10-400**
Overall length 106mm, min. I.D. 9.0mm



**Tucker Mid-Lighted Side Slide
Laryngoscope
F10-401 Adult**
Overall length 121mm, min. I.D. 10.7mm

**Tucker Mid-Lighted Side Slide
Laryngoscope
F10-402 Adult Long**
Overall length 160mm, min. I.D. 11.8mm



LARYNGEAL POLYPUD FORCEPS

Kehlkopfpolypenzangen

Pinzas para polipos laringeos

Pinces a polypes laryngiens

Pinze per polipi laringei

(Note) Required size available on Demand

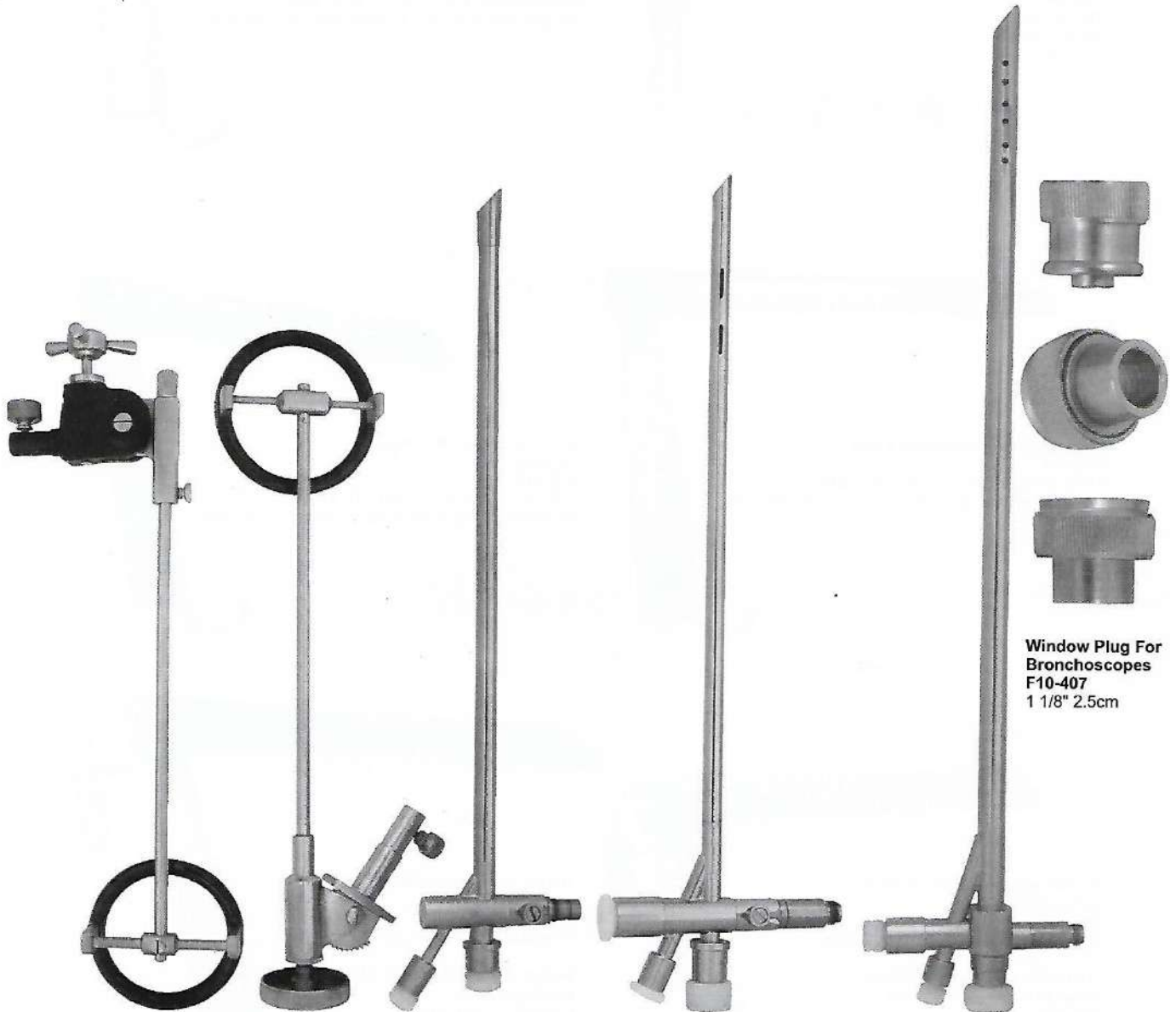

**Laryngoscope Holder
F10-403**
Chest Support
complete, for adults and children

**Holinger Bronchoscope
F10-404 3X20**
Infant, Scope size 3 x 20,
overall length 203mm,
min. I.D. 2.9mm

**Holinger Bronchoscope
F10-405 3.5X20**
Infant, Scope size 3.5 x 20,
overall length 203mm, min.
I.D. 3.5mm

**Holinger Bronchoscope
F10-406 9X40**
Scope size 9 x 40,
overall length 400mm,
min. I.D. 8.5mm

**Window Plug For
Bronchoscopes
F10-407**
1 1/8" 2.5cm

LARYNGEAL POLYPUD FORCEPS



Kehlkopfpolypenzangen
Pinças a polypes laryngiens

Pinzas para polipos laringeos
Pinze per polipi laringei

Jesburg Esophagoscope
F10-408 6 x 8 x 32, Overall
length 317mm,
min. I.D. 5.1mm

Jesburg Esophagoscope
F10-409 6.5 x 10 x 35, Overall
length 349mm,
min. I.D. 5.5mm

Jesburg Esophagoscope
F10-410 7 x 10 x 42, Overall
length 421mm,
min. I.D. 5.8mm

Suction Tube
F10-411
with fix head

Fenestrated Cupped
Grasping Forceps
F10-412

Frazier Suction Tube
F10-413
11 French tip, Working
length 19cm 7 1/2"



NEUROSURGERY

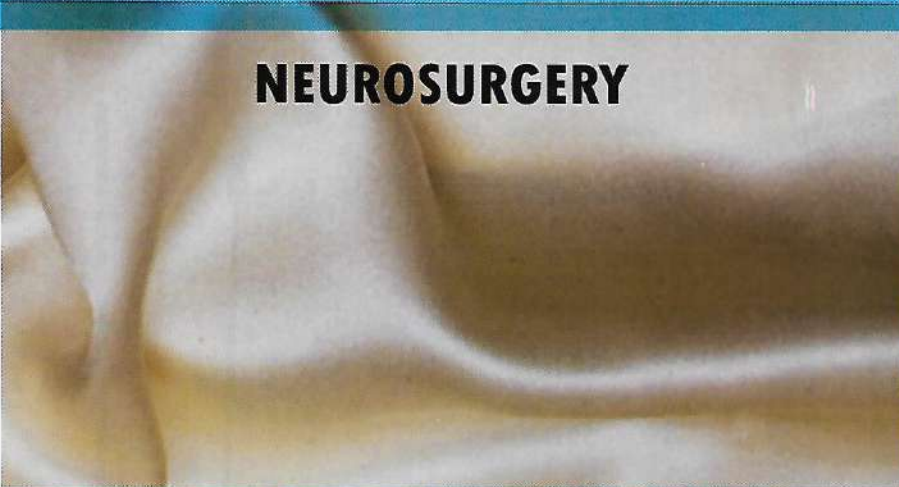

CERVICAL TRACTION TONGS



Schadelhalter
Pincas de traction Cranienne

Pinzas de traccion cranial
Pinze per trazione craniale



**Crutchfield
Traction Tongs
F11-001 13cm
small**



**Crutchfield drill bit
F11-002 3.5mm**



**Crutchfield drill bit
F11-003 5.0mm**

Set of 2 Pieces for
F11-001 and F11-004



**Crutchfield
Traction Tongs
F11-004 18.5cm**



**Crutchfield Skull
F11-005
large type, cervical traction
tongs-pins adjustable no drilling
to be done 11cm**



**F11-006
Wrench double
ended for F11-005**



**De Martel
Saw Conductor
F11-007
33cm 13"**



**Adson
Drill guide
F11-008
15cm 6"**



**De Vibiss
Skull Forceps
F11-009
20cm 8 1/4"**

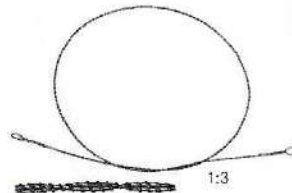

**Olivecrona
Wire Saw
F11-010 30cm 12"
F11-011 40cm 16"
F11-012 50cm 20"
F11-013 60cm 23 1/2"
F11-014 70cm 27 1/2"**

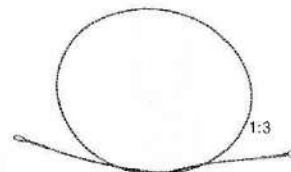

**Gigle, Wire Saw
F11-015 30cm 12"
F11-016 40cm 16"
F11-017 50cm 20"
6 wires twisted**



**Gigle-Strully
Handle for
wire saw
F11-018**



BRAIN SPATULAS

Hirnspatel

Espatules cerebrales

Spatules cerebrales

Spatole cerebrali



Supra Cut Distraction Screw

- F11-019 12mm Non Sterile
- F11-020 14mm Non Sterile
- F11-021 16mm Non Sterile
- F11-022 18mm Non Sterile
- F11-023 12mm Sterile
- F11-024 14mm Sterile
- F11-025 16mm Sterile
- F11-026 18mm Sterile



Supra Cut
Distraction
Screw Driver
F11-027



Cushing, brain spatula
F11-028 7mm x 9mm
F11-029 11mm x 13mm
F11-030 15mm x 18mm
F11-031 18mm x 22mm
18cm 7"



Olivecrona
F11-032
brain spatula
18cm 7"



Brain Spatula
F11-033 7mm x 9mm
F11-034 11mm x 13mm
F11-035 15mm x 18mm
F11-036 18mm x 22mm
18cm 7", Convex



Brain Spatula
F11-037 7mm x 9mm
F11-038 11mm x 13mm
F11-039 15mm x 18mm
F11-040 18mm x 22mm
18cm 7", Concave



Heifetz, brain spatula
F11-041 8mm
F11-042 11mm
F11-043 14mm
F11-044 17mm
F11-045 20mm
20cm 8", Malleable

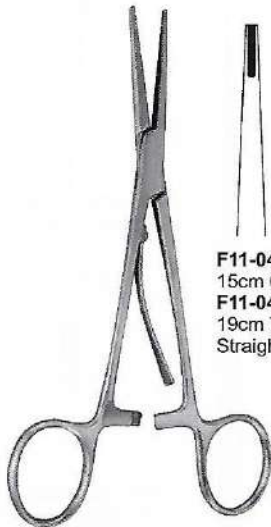

McKenzie Clip Applying Forceps

F11-046
15cm 6"
F11-047
19cm 7 1/2"
Straight

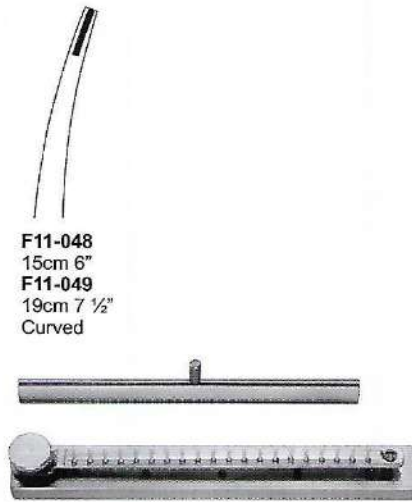

McKenzie F11-050 148mm x 40mm x 6mm
5 3/4" x 1 1/2" x 1/2", Brain clip rack for 20 clips

F11-048
15cm 6"
F11-049
19cm 7 1/2"
Curved

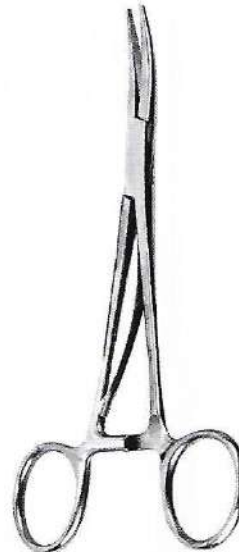

McKenzie Clip Applying Forceps F11-051
Straight Handle, Curved Jaws, 6"



McKenzie Clip Applying Forceps F11-052
Curved Handle, Curved Jaws, 6"

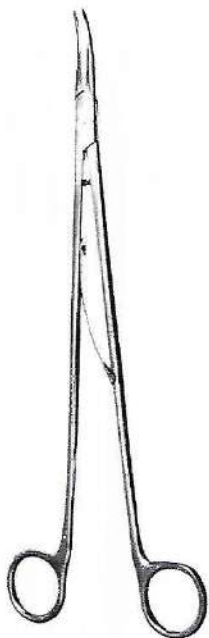

Smithwick Clip Applying Forceps F11-053
9", Curved Jaws
Straight Handle

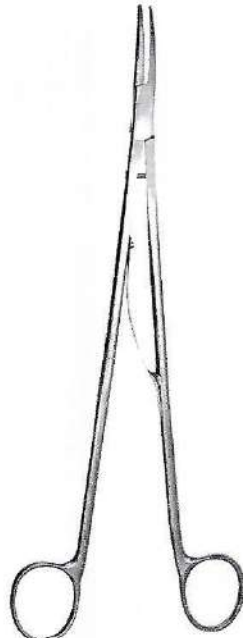

Smithwick Clip Applying Forceps F11-054
10 1/2", Curved Jaws
Straight Handle



Smithwick Clip Applying Forceps F11-055
10 1/2", Straight Jaws
Straight Handle



Schwartz Clip Applying Forceps

F11-056 20.3cm 8"
Schwartz Vessel Clip
F11-057 1" (2.5cm), Straight Jaws 1.7x 8mm
F11-058 1" (2.5cm), Slightly Angled Jaws 1.7x 8mm
F11-059 1" (2.5cm), Strong Angled Jaws 1.7x 8mm

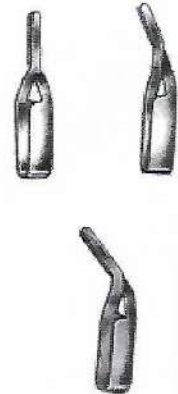



NERVE HOOKS - DURA HOOKS

Nervenhaken - Durahaken

Crochets a nerfs - Crochets pour duremers

Ganchos para nervios - Ganchos para duramadre

Uncini per nervi - Uncini per duramadre

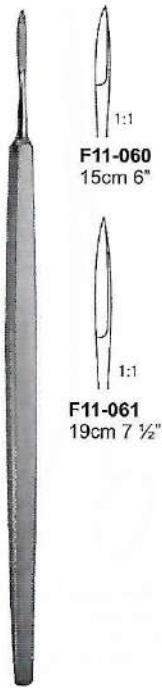

F11-060
15cm 6"

F11-061
19cm 7 1/2"

Toennis Nerve
Dura Hook



Halle Nerve
Dura Hook
F11-062
20cm 8"



Smithwick Nerve
Dura Hook
F11-063 17cm 6 3/4"
F11-064 21cm 8 1/4"



Hoen Nerve
Dura Hook
F11-065
22cm 8 3/4"

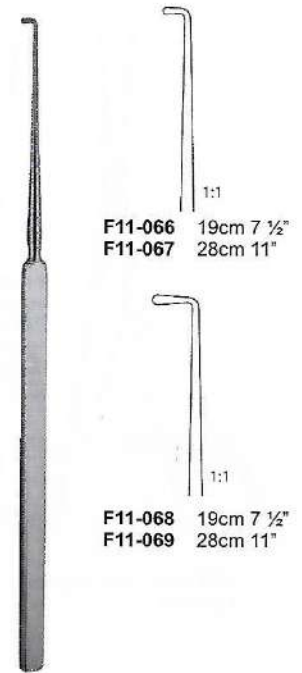

F11-066 19cm 7 1/2"
F11-067 28cm 11"

F11-068 19cm 7 1/2"
F11-069 28cm 11"

Cushing Nerve
Dura Hook

DURA DISSECTORS



Penfield Dura
Dissector
F11-070
17.5cm 7"



Penfield Dura
Dissector
F11-071
19.5cm 7 3/4"



Penfield Dura
Dissector
F11-072
19.5cm 7 3/4"



Penfield Dura
Dissector
F11-073
19.5cm 7 3/4"



Penfield Dura
Dissector
F11-074
19.5cm 7 3/4"

NERVE HOOKS - DURA HOOKS



Nervenhooken - Durahaken

Crochets a nerfs - Crochets pour duremers

Ganchos para nervios - Ganchos para duramadre

Uncini per nervi - Uncini per duramadre



**Love Nerve Dura
Hook Retractor
F11-075**
19cm 7 1/2"
Straight



**Love Nerve Dura
Hook Retractor
F11-076**
19cm 7 1/2"
45° Angled



**Love Nerve Dura
Hook Retractor
F11-077**
19cm 7 1/2"
90° Angled



**Cushing Nerve Dura
Hook Retractor
F11-078**
14cm 5 1/2"



F11-079
13cm 5"
F11-080
18cm 7"
Sharp



F11-081
13cm 5"
F11-082
18cm 7"
Blunt



**Lahey Nerve Dura
Hook Retractor
F11-083**
13cm 5"



**Yasargil Nerve Dura
Hook Retractor**
F11-084 21cm 12 1/4"
F11-085 41cm 16 1/4"
Galea retractor



DURA DISSECTORS

Dura-Dissektoren

Decolleurs duremere

Disectores de duramadre

Dissetori per duramadre



Toennis Dura Dissector
F11-086
25cm 9 3/4"



Davis Dura Dissector
F11-087
24.5cm 9 3/4"



Dura Dissector
F11-088
22cm 8 3/4"



Sachs Dura Dissector
F11-089
21cm 8 1/4"



Sachs Dura Dissector
F11-090
21cm 8 1/4"



Sachs Dura Dissector
F11-091
21cm 8 1/4"

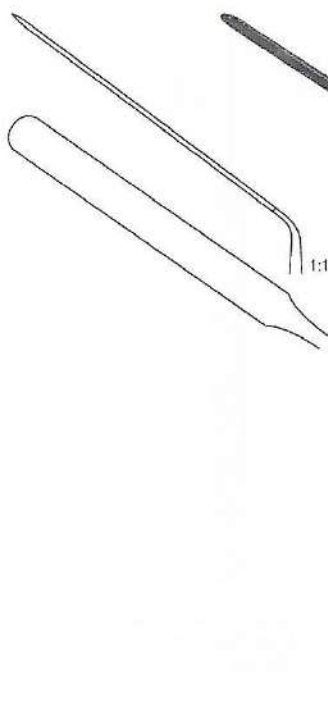

Horsley Dura Dissector
F11-092
20cm 8"

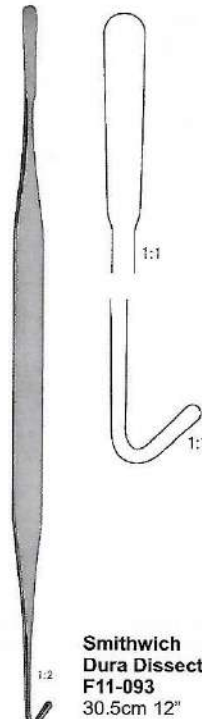

Smithwich Dura Dissector
F11-093
30.5cm 12"

LAMINECTOMY PUNCHES



Laminektomiestanzen

Pinces emporte-pieces a laminectomie

Pinzas cortantes para laminectomia

Pinze taglianti per laminectomia



Cushing Intervertebral Disc Rongeurs

2 X 10mm, 6"	2 X 10mm, 9"
F11-094 straight	F11-106 straight
F11-095 UP	F11-107 UP
F11-096 Down	F11-108 Down

1.5 X 10mm, 7"	2 X 10mm, 10"
F11-097 straight	F11-109 straight
F11-098 Up	F11-110 UP
F11-099 Down	F11-111 Down

2 X 10mm, 7"	2 X 10mm, 11"
F11-100 straight	F11-112 straight
F11-101 UP	F11-113 UP
F11-102 Down	F11-114 Down

1.5 X 10mm, 9"	2 X 10mm, 12"
F11-103 straight	F11-115 straight
F11-104 Up	F11-116 UP
F11-105 Down	F11-117 Down



Love-Gruenwald Intervertebral Disc Rongeurs

3 X 10mm, 6"	3 X 10mm, 10"
F11-118 straight	F11-127 straight
F11-119 Up	F11-128 Up
F11-120 Down	F11-129 Down

3 X 10mm, 7"	3 X 10mm, 11"
F11-121 straight	F11-130 straight
F11-122 Up	F11-131 Up
F11-123 Down	F11-132 Down

3 X 10mm, 9"	3 X 10mm, 12"
F11-124 straight	F11-133 straight
F11-125 Up	F11-134 Up
F11-126 Down	F11-135 Down

Spurling Intervertebral Disc Rongeurs

4 X 10mm, 6"	4 X 10mm, 10"
F11-136 straight	F11-145 straight
F11-137 Up	F11-146 Up
F11-138 Down	F11-147 Down

4 X 10mm, 7"	4 X 10mm, 11"
F11-139 straight	F11-148 straight
F11-140 Up	F11-149 Up
F11-141 Down	F11-150 Down

4 X 10mm, 9"	4 X 10mm, 12"
F11-142 straight	F11-151 straight
F11-143 Up	F11-152 Up
F11-144 Down	F11-153 Down

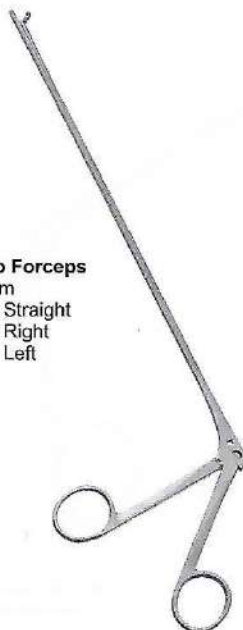

Micro Cup Forceps

5.5", 0.5mm
 F11-154 Straight
 F11-155 Right
 F11-156 Left



Micro Cup Forceps

5.5", 1mm
 F11-157 Straight
 F11-158 Right
 F11-159 Left

5.5", 2mm
 F11-160 Straight

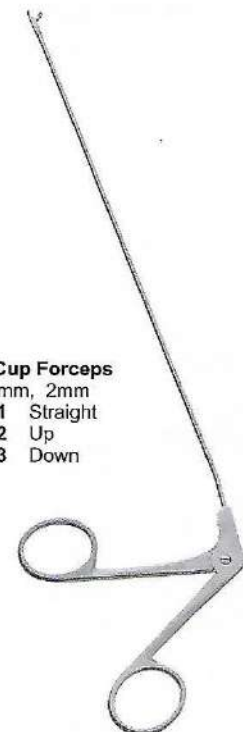

Micro Cup Forceps

8", 200mm, 2mm
 F11-161 Straight
 F11-162 Up
 F11-163 Down



LAMINECTOMY ROUGEURS

Laminektomieezangen

Pinces emporte pieces a laminectomie

Pinzas cortantes para laminectomia

Pinze taglianti per laminectomia



Wilde Intervertebral Disc Rongeurs

7" Straight

- F11-164 2.5mm
- F11-165 3mm
- F11-166 4mm
- F11-167 5mm

7" Angled up

- F11-168 2.5mm
- F11-169 3mm
- F11-170 4mm
- F11-171 5mm

9" Straight

- F11-172 3mm
- F11-173 4mm
- F11-174 5mm

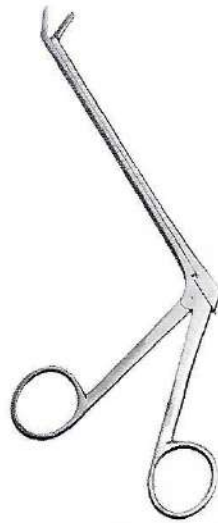

Caspar Type Intervertebral Disc Rongeurs

6.25" Straight

- F11-175 2 x 12mm
- F11-176 3 x 12mm
- F11-177 4 x 14mm
- F11-178 5 x 14mm
- F11-179 6 x 16mm

6.25" Up

- F11-180 3 x 12mm
- F11-181 4 x 14mm
- F11-182 5 x 14mm

6.25" Down

- F11-183 3 x 12mm
- F11-184 4 x 14mm



Caspar Type Intervertebral Disc Rongeurs

7.25" Straight

- F11-185 2 x 12mm
- F11-186 3 x 12mm
- F11-187 4 x 14mm
- F11-188 5 x 14mm
- F11-189 6 x 16mm

7.25" Up

- F11-190 2 x 12mm
- F11-191 3 x 12mm
- F11-192 4 x 14mm
- F11-193 5 x 14mm

7.25" Down

- F11-194 2 x 12mm
- F11-195 3 x 12mm
- F11-196 4 x 14mm



Cushing Intervertebral Disc Rongeurs

w/teeth 2 x 10mm, 7"

- F11-197 Straight
- F11-198 Up
- F11-199 Down

L-G Intervertebral Disc Rongeurs

w/teeth 3 x 10mm, 7"

- F11-200 Straight
- F11-201 Up
- F11-202 Down

3 x 10mm, 10"

- F11-203 Straight

Angle	Length	Fig. 1	Fig. 2	Fig. 2	Fig. 4	Fig. 5
0°	12cm 4 3/4" Straight	3.0mm F11-204	3.5mm F11-205	4.5mm F11-206	5.0mm F11-207	5.5mm F11-208
45°	12cm 4 3/4" 45° up	F11-209	F11-210	F11-211	F11-212	F11-213
90°	12cm 4 3/4" 90° up	F11-214	F11-215	F11-216		
45°	18cm 7" 45° up	Fig. 1 3.0mm F11-217	Fig. 2 3.5mm F11-218	Fig. 2 4.5mm F11-219	Fig. 4 5.0mm F11-220	Fig. 5 5.5mm F11-221
90°	18cm 7" 90° up	F11-222	F11-223	F11-224	F11-225	



Well Blakesley Laminectomy rongeurs

LAMINECTOMY PUNCHES



Laminectomiestanzen

Pinces emporte-pieces a laminectomie

Pinzas cortantes para laminectomia

Pinze taglianti per laminectomia

Spurling Intervertebral Disc Rongeurs

w/teeth 4 x 10mm, 7"

F11-226 Straight

F11-227 Up

F11-228 Down

4 x 10mm, 10"

F11-229 Straight

5 x 10mm, 10"

F11-230 Straight



Schlesinger Intervertebral Disc Rongeurs

F11-231 2 x 10mm, 5" Straight

F11-232 3 x 10mm, 5" Straight

F11-233 4 x 10mm, 5" Straight

F11-234 3 x 10mm, 5" Angled Up

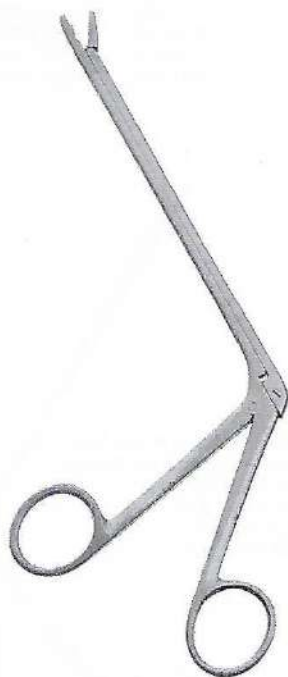

Cloward Intervertebral Disc Rongeurs

serrated 6 x 10mm, 5"

F11-235 Straight

F11-236 Up

F11-237 Down



Oldberg Intervertebral Disc Rongeurs

F11-238 6mm Diameter
7-1/8"

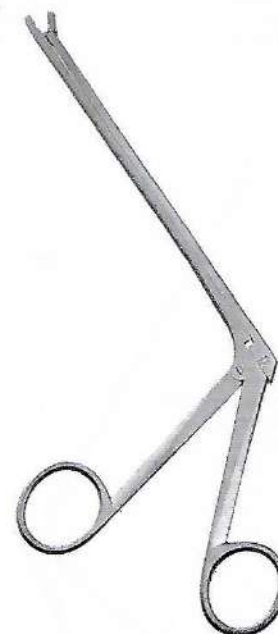

Selverstone Intervertebral Disc Rongeurs

F11-239 2 x 3mm, 6"

F11-240 2 x 5mm, 6"



LAMINECTOMY PUNCHES

Laminektomiestanzen

Pinces emporte-pieces a laminectomie

Pinzas cortantes para laminectomia

Pinze taglianti per laminectomia

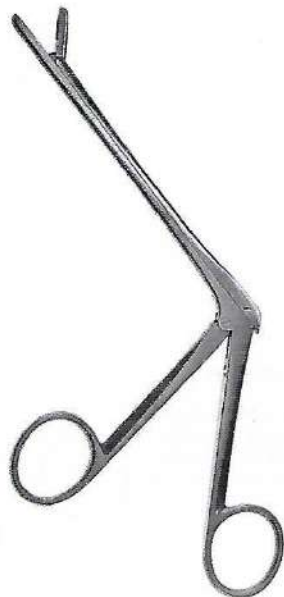

Cushing Intervertebral Disc Rongeurs

2 X 10mm, 5"

F11-241 Straight

F11-242 UP

F11-243 Down



Peapod Intervertebral Disc Rongeurs, 5-1/2"

F11-250 Angle up 1.5mm, x-small

F11-251 Angle up 2mm, small

F11-252 Angle up 2.5mm, medium

F11-253 Angle up 3mm, large



Peapod Intervertebral Disc Rongeurs,

F11-254 Angle up 2.5mm, 7"

F11-255 Angle up 3mm, 7"

F11-256 Angle up 4mm, 7"

F11-257 Straight 2mm, 5-1/2"

F11-258 Straight 2.5mm, 5-1/2"

F11-259 Straight 3mm, 5-1/2"

Love-Gruenwald Intervertebral Disc Rongeurs

3 X 10mm, 5"

F11-244 Straight

F11-245 Up

F11-246 Down

Spurling Intervertebral Disc Rongeurs

4 X 10mm, 5"

F11-247 Straight

F11-248 Up

F11-249 Down

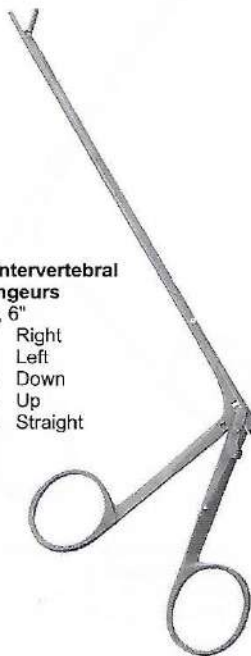

Decker Intervertebral Disc Rongeurs

2 x 5mm, 6"

F11-260 Right

F11-261 Left

F11-262 Down

F11-263 Up

F11-264 Straight



Jackson Intervertebral Disc Rongeurs

70° Up 7"

F11-265 2 x 8mm

F11-266 3 x 8mm

F11-267 4 x 8mm

Williams Style Micro Disc Intervertebral Disc Rongeurs

1 x 2 teeth, Straight

F11-268 5.5"

F11-269 7"

F11-270 10"



LAMINECTOMY PUNCHES



Laminectomiestanzen

Pinces emporte-pieces a laminectomie

Pinzas cortantes para laminectomia

Pinze taglianti per laminectomia

Ferris Smith Micro Kerrison Laminectomy Rongeurs

90° UP 9mm bite opening, 7"

- F11-271 1mm
- F11-272 2mm
- F11-273 3mm
- F11-274 4mm
- F11-275 5mm
- F11-276 6mm

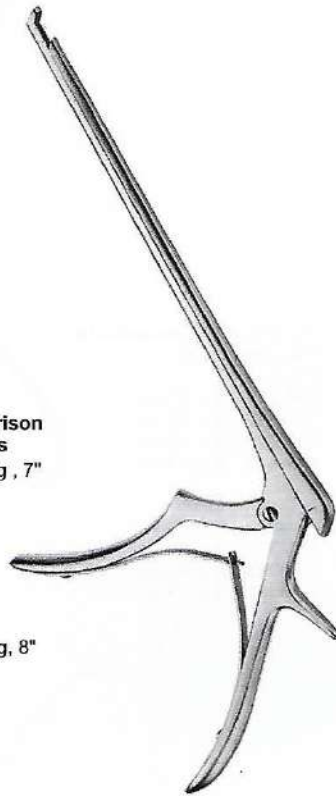

90° UP 9mm bite opening, 8"

- F11-277 1mm
- F11-278 2mm
- F11-279 3mm
- F11-280 4mm
- F11-281 5mm
- F11-282 6mm

Ferris Smith Micro Kerrison Laminectomy Rongeurs

90° Down 9mm bite opening, 7"

- F11-283 1mm
- F11-284 2mm
- F11-285 3mm
- F11-286 4mm
- F11-287 5mm
- F11-288 6mm



90° Down 9mm bite opening, 8"

- F11-289 1mm
- F11-290 2mm
- F11-291 3mm
- F11-292 4mm
- F11-293 5mm
- F11-294 6mm

Micro Ejector Kerrison Laminectomy Rongeurs

40° Up 8"

- F11-295 2mm
- F11-296 3mm
- F11-297 4mm
- F11-298 5mm
- F11-299 6mm



Wide Mouth Ejector Kerrison Laminectomy Rongeurs

40° Up 7"

- F11-300 2mm
- F11-301 3mm
- F11-302 4mm
- F11-303 5mm
- F11-304 6mm

40° Up 8"

- F11-305 2mm
- F11-306 3mm
- F11-307 4mm
- F11-308 5mm
- F11-309 6mm

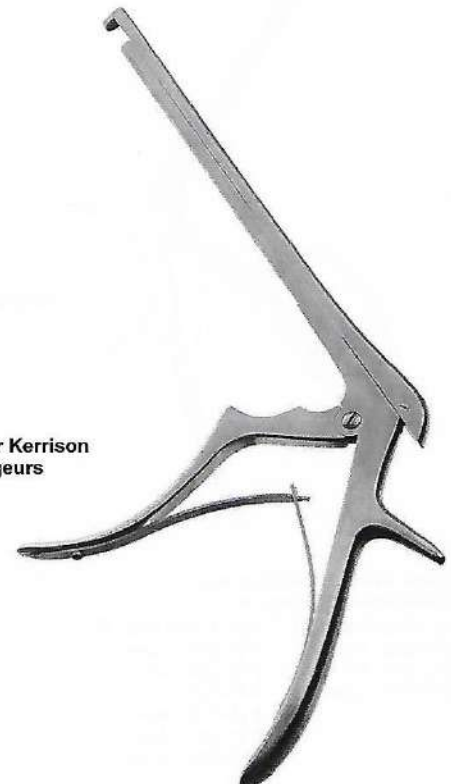



LAMINECTOMY PUNCHES

Laminektomiestanzen

Pinces emporte-pieces a laminectomie

Pinzas cortantes para laminectomia

Pinze taglianti per laminectomia

Ferris-Smith Intervertebral Disc Rongeurs

7" straight

F11-310	2 x 10mm
F11-311	3 x 10mm
F11-312	4 x 8mm
F11-313	4 x 10mm
F11-314	6 x 10mm
F11-315	6 x 12mm

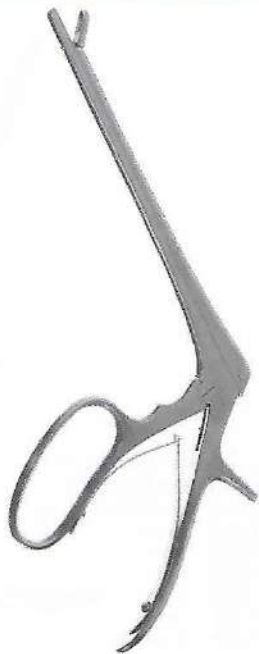

Ferris-Smith Intervertebral Disc Rongeurs

7" Up

F11-316	2 x 10mm
F11-317	3 x 10mm
F11-318	4 x 10mm
F11-319	6 x 10mm

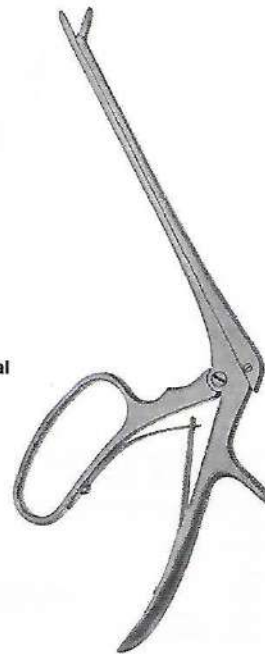

7" Down

F11-320	2 x 10mm
F11-321	3 x 10mm
F11-322	4 x 10mm
F11-323	6 x 10mm



Ferris Smith Micro Kerrison Laminectomy Rongeurs

130° Down Bite, 11" 130° Down Bite, 12"

F11-324	4mm	F11-327	1mm
F11-325	5mm	F11-328	2mm
F11-326	6mm	F11-329	3mm
		F11-330	4mm
		F11-331	5mm
		F11-332	6mm



Kerrison Cervical Rongeur F11-333

17.8 cm 7" shaft, 3 mm
40 degree forward angle



Schlesinger Cervical Rongeur F11-334

thin tips, 6" (15.2 cm) shaft,
up-bite, 3 mm

LAMINECTOMY PUNCHES



Laminektomiestanzen

Pinces emporte-pieces a laminectomia

Pinzas cortantes para laminectomia

Pinze taglianti per laminectomia



**Ferris Smith Micro Kerrison
Laminectomy Rongeurs
Upward**

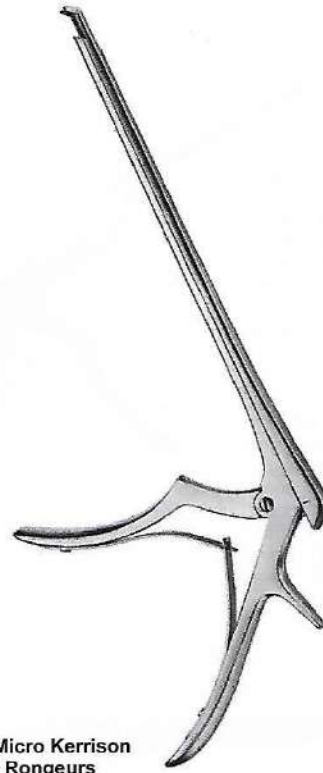

**Ferris Smith Micro Kerrison
Laminectomy Rongeurs
Downward**

40° UP
9mm bite opening, 7"
F11-335 1mm
F11-336 2mm
F11-337 3mm
F11-338 4mm
F11-339 5mm
F11-340 6mm

40° Down
9mm bite opening, 7"
F11-342 2mm
F11-343 3mm
F11-344 4mm
F11-345 5mm
F11-346 6mm

40° UP
9mm bite opening, 8"
F11-347 1mm
F11-349 2mm
F11-350 3mm
F11-351 4mm
F11-352 5mm
F11-353 6mm

40° Down
9mm bite opening, 8"
F11-354 1mm
F11-355 2mm
F11-356 3mm
F11-357 4mm
F11-358 5mm
F11-359 6mm

40° UP
9mm bite opening, 9"
F11-360 1mm
F11-361 2mm
F11-362 3mm
F11-363 4mm
F11-364 5mm
F11-365 6mm

40° UP
9mm bite opening, 10"
F11-366 2mm
F11-367 3mm
F11-368 4mm
F11-369 5mm
F11-370 6mm

40° UP
9mm bite opening,
F11-371 2mm
F11-372 3mm
F11-373 4mm
F11-374 5mm
F11-375 6mm

40° UP
9mm bite opening, 12"
F11-376 2mm
F11-377 3mm
F11-378 4mm
F11-379 5mm
F11-380 6mm

130° Down
9mm bite opening, 7"
F11-381 1mm
F11-382 2mm
F11-383 3mm
F11-384 4mm
F11-385 5mm
F11-386 6mm

130° Down
9mm bite opening, 8"
F11-387 1mm
F11-388 2mm
F11-389 3mm
F11-390 4mm
F11-391 5mm
F11-392 6mm

130° Down
9mm bite opening, 9"
F11-393 1mm
F11-394 2mm
F11-395 3mm
F11-396 4mm
F11-397 5mm
F11-398 6mm

130° Down
9mm bite opening, 10"
F11-399 1mm
F11-400 2mm
F11-401 3mm
F11-402 4mm
F11-403 5mm
F11-404 6mm

130° Down
9mm bite opening, 11"
F11-405 1mm
F11-406 2mm
F11-407 3mm
F11-408 4mm
F11-409 5mm
F11-410 6mm

130° Down
9mm bite opening, 12"
F11-411 1mm
F11-412 2mm
F11-413 3mm
F11-414 4mm
F11-415 5mm
F11-416 6mm



LAMINECTOMY PUNCHES

Laminektomiestanzen

Pinces emporte-pieces a laminectomie

Pinzas cortantes para laminectomia

Pinze taglianti per laminectomia

Bayonet Micro Kerrison Laminectomy Rongeurs

40° Up, 150 mm	90° Up, 150 mm
Working Length 8"	Working Length 8"
F11-417 1mm	F11-423 1mm
F11-418 2mm	F11-424 2mm
F11-419 3mm	F11-425 3mm
F11-420 4mm	F11-426 4mm
F11-421 5mm	F11-427 5mm
F11-422 6mm	F11-428 6mm

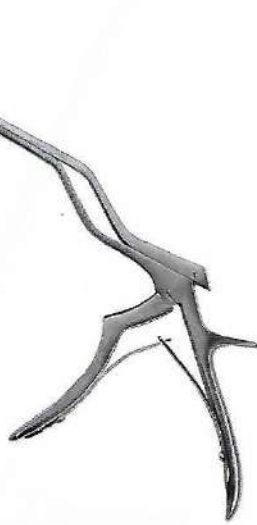

Foramenotomy Kerrison Laminectomy Rongeurs, Curved

F11-441	UP, 9mm Bite opening, 8" 2mm
F11-442	UP, 9mm Bite opening, 8" 3mm
F11-443	UP, 9mm Bite opening, 8" 4mm
F11-444	UP, 9mm Bite opening, 8" 5mm
F11-445	UP, 9mm Bite opening, 8" 6mm
F11-446	Left, 9mm Bite opening, 8" 6mm
F11-447	Right, 9mm Bite opening, 8" 6mm

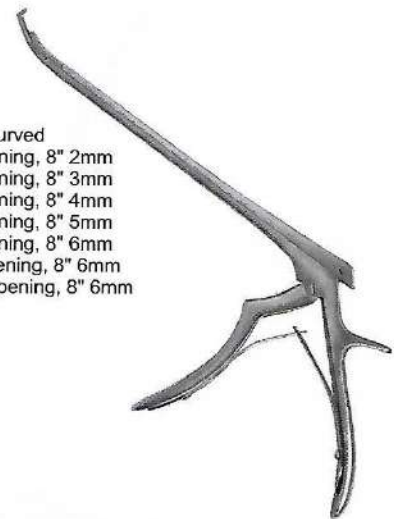

Bayonet Spurling Kerrison Laminectomy Rongeurs

40° Up, 150 mm	90° Up, 150 mm
Working Length 8"	Working Length 8"
F11-429 1mm	F11-435 1mm
F11-430 2mm	F11-436 2mm
F11-431 3mm	F11-437 3mm
F11-432 4mm	F11-438 4mm
F11-433 5mm	F11-439 5mm
F11-434 6mm	F11-440 6mm

40° UP,
15mm Bite Opening, 7"
F11-448 2mm
F11-449 3mm
F11-450 4mm
F11-451 5mm
F11-452 6mm

40° UP,
15mm Bite Opening, 8"
F11-453 2mm
F11-454 3mm
F11-455 4mm
F11-456 5mm
F11-457 6mm

40° UP,
15mm Bite Opening, 9"
F11-458 2mm
F11-459 3mm
F11-460 4mm
F11-461 5mm
F11-462 6mm

40° UP,
15mm Bite Opening, 10"
F11-463 2mm
F11-464 3mm
F11-465 4mm
F11-466 5mm
F11-467 6mm

40° UP,
15mm Bite Opening, 11"
F11-468 2mm
F11-469 3mm
F11-470 4mm
F11-471 5mm
F11-472 6mm

90° UP,
15mm Bite Opening, 7"
F11-473 2mm
F11-474 3mm
F11-475 4mm
F11-476 5mm
F11-477 6mm

90° UP,
15mm Bite Opening, 8"
F11-478 2mm
F11-479 3mm
F11-480 4mm
F11-481 5mm
F11-482 6mm

90° Down,
15mm Bite Opening, 7"
F11-483 2mm
F11-484 3mm
F11-485 4mm
F11-486 5mm
F11-487 6mm

90° Down,
15mm Bite Opening, 8"
F11-488 2mm
F11-489 3mm
F11-490 4mm
F11-491 5mm
F11-492 6mm

40° UP, 15mm
Bite Opening, 7"
F11-493 2mm
F11-494 3mm
F11-495 4mm
F11-496 5mm
F11-497 6mm

40° UP, 15mm
Bite Opening, 9"
F11-503 2mm
F11-504 3mm
F11-505 4mm
F11-506 5mm
F11-507 6mm

40° UP, 15mm
Bite Opening, 8"
F11-498 2mm
F11-499 3mm
F11-500 4mm
F11-501 5mm
F11-502 6mm

40° UP, 15mm
Bite Opening, 10"
F11-508 2mm
F11-509 3mm
F11-510 4mm
F11-511 5mm
F11-512 6mm

40° UP, 15mm
Bite Opening, 11"
F11-513 2mm
F11-514 3mm
F11-515 4mm
F11-516 5mm
F11-517 6mm

Spurling Kerrison
Laminectomy Rongeurs
Large Handle

Spurling Laminectomy
Rongeurs

LAMINECTOMY PUNCHES



Laminektomiestanzen

Pinzas cortantes para laminectomia

Pinces emporte-pieces a laminectomie

Pinze taglianti per laminectomia

Spurling Laminectomy Rongeurs

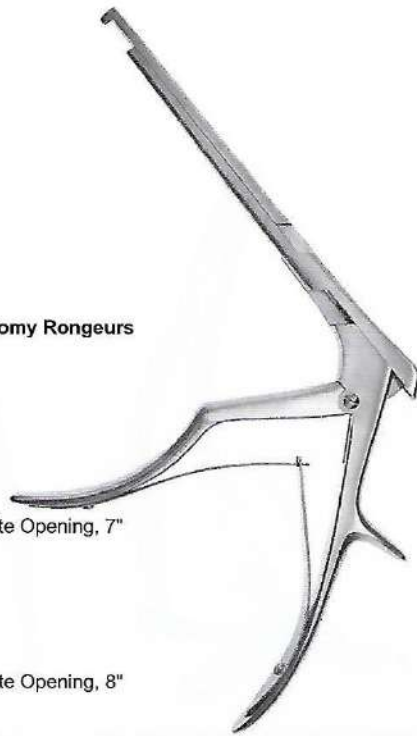

90° Down, 15mm Bite Opening, 7"
F11-518 2mm
F11-519 3mm
F11-520 4mm
F11-521 5mm
F11-522 6mm

90° Down, 15mm Bite Opening, 8"
F11-523 2mm
F11-524 3mm
F11-525 4mm
F11-526 5mm
F11-527 6mm

Spurling Laminectomy Rongeurs

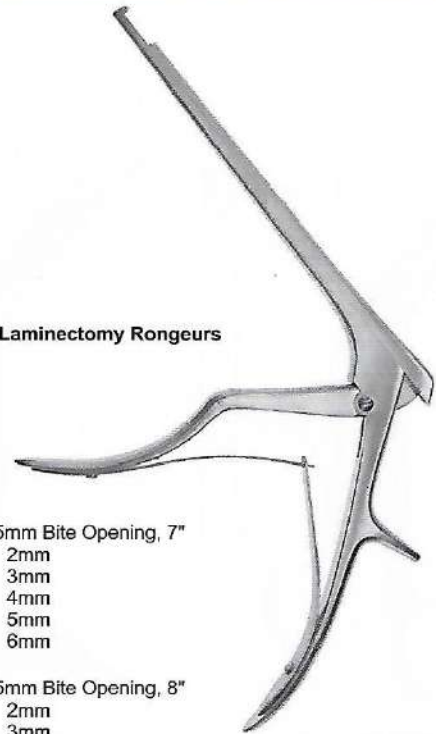

90° UP, 15mm Bite Opening, 7"
F11-528 2mm
F11-529 3mm
F11-530 4mm
F11-531 5mm
F11-532 6mm

90° UP, 15mm Bite Opening, 8"
F11-533 2mm
F11-534 3mm
F11-535 4mm
F11-536 5mm
F11-537 6mm

Micro Ejector Kerrison Laminectomy Rongeurs



40° Up 8"
F11-538 2mm
F11-539 3mm
F11-540 4mm
F11-541 5mm
F11-542 6mm

Wide Mouth Ejector Kerrison Laminectomy Rongeurs

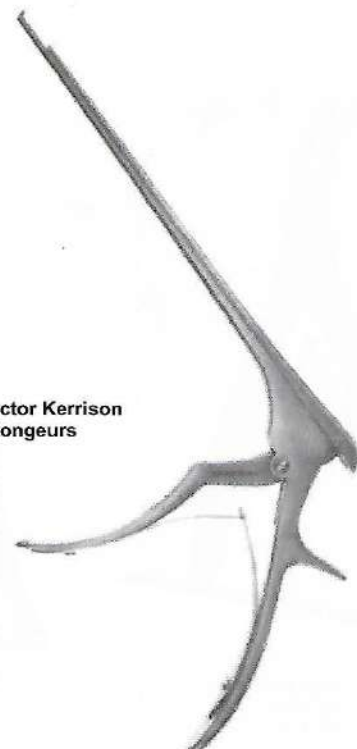

40° Up 7"
F11-543 2mm
F11-544 3mm
F11-545 4mm
F11-546 5mm
F11-547 6mm

40° Up 8"
F11-548 2mm
F11-549 3mm
F11-550 4mm
F11-551 5mm
F11-552 6mm



SPREADER

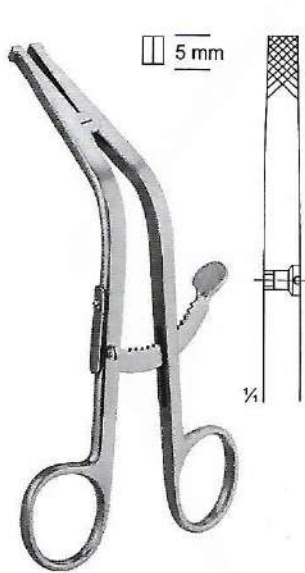

Cloward Retractor
F11-553
15.5 cm, 6"

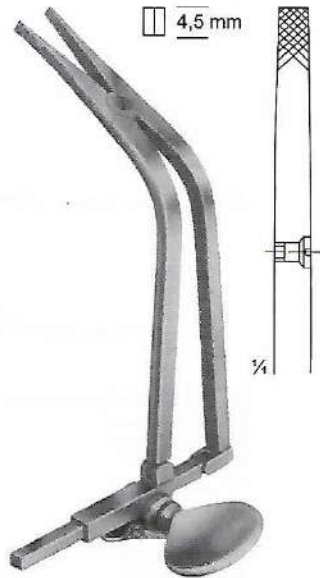

Cloward Retractor
F11-554
13.5 cm, 5 1/4"



Cloward Vertebral Cervical Spreader
F11-555



Spinal Distractor
F11-556 24cm 9 1/2"
45° angle / small style
1/4" rods

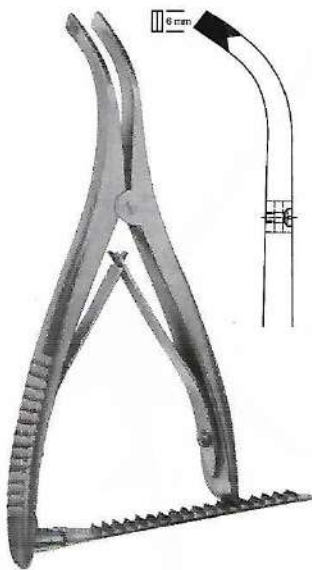

Inge Retractor
F11-557
17.0 cm, 6 3/4"

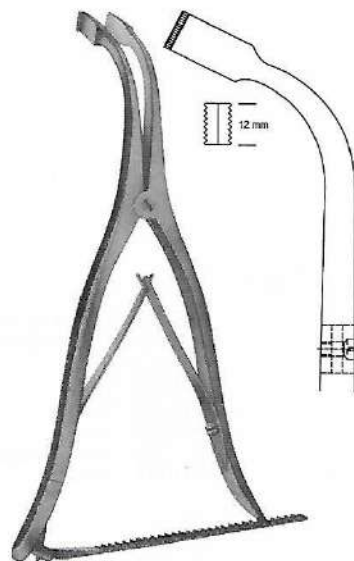

Inge Retractor
F11-558
27.5 cm, 10 3/4"

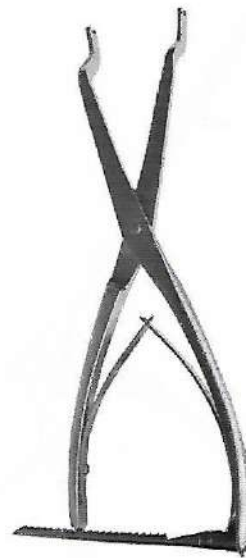

Spinal Distractor
F11-559 25.5cm 10"
small style



Inge Retractor
F11-560 20cm 8"
toothed w/spindle



INTESTINAL AND RECTAL INSTRUMENTS





INTESTINAL & TISSUE GRASPING FORCEPS

Darm- und Gewebefassungen
Pinzas Para Intestinos y Tejidos

Pinces Pour Saisir Intestins et Tissus
Pinze Per Afferrare Intestino e Tessuti

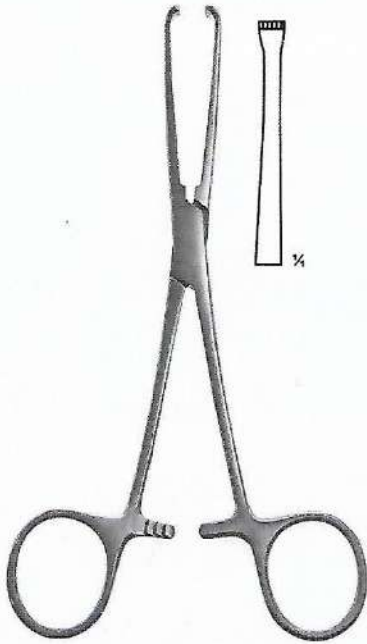

Allis Tissue Forceps
F12-001
3 x 4 teeth
15.5 cm, 6"

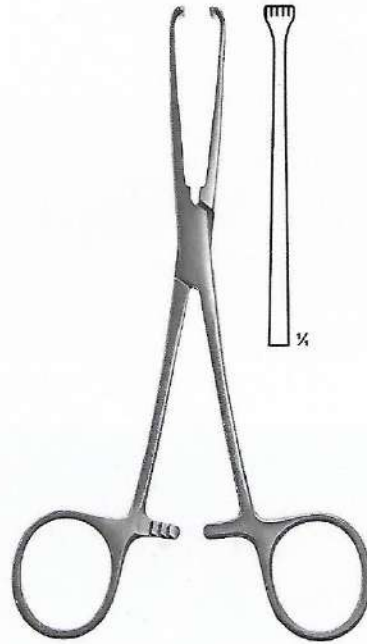

Allis Tissue Forceps
F12-002
4 x 5 teeth
15.5 cm, 6"

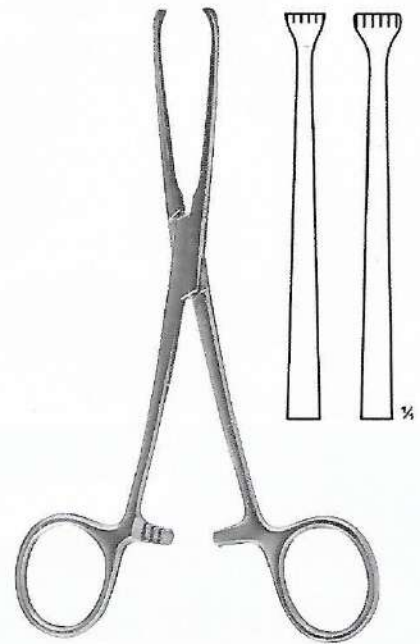

Allis Tissue Forceps
F12-003 19.0 cm, 7 1/2"
F12-004 25.5 cm, 10"
5 x 6 teeth



Baby Allis Tissue Forceps
F12-005
14 cm 5 1/2" 4 X 5 teeth
delicate jaws 4 mm wide

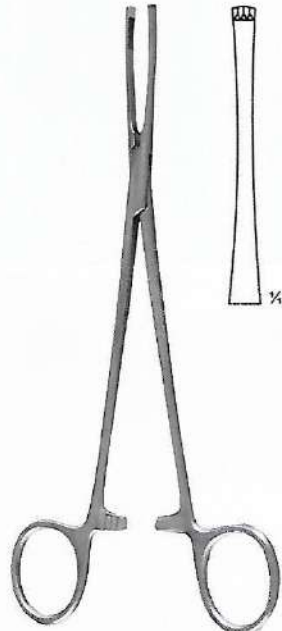

Judd-Allis Tissue Forceps
F12-006
3 x 4 teeth
19.5 cm, 7 3/4"

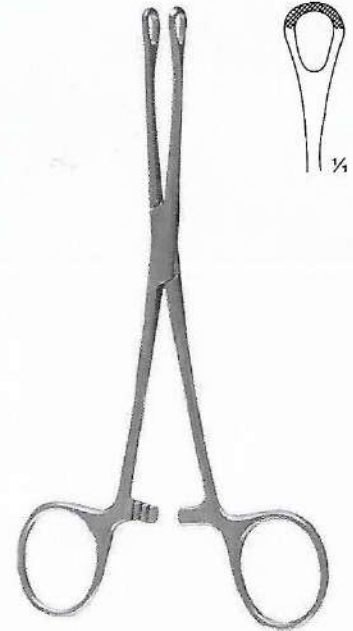

Williams Grasp Forceps
F12-007
16 cm, 6 1/4"

INTESTINAL & TISSUE GRASPING FORCEPS



Darm- und Gewebefasszangen
Pinzas Para Intestinos y Tejidos

Pinces Pour Saisir Intestins et Tissus
Pinze Per Afferrare Intestino e Tessuti

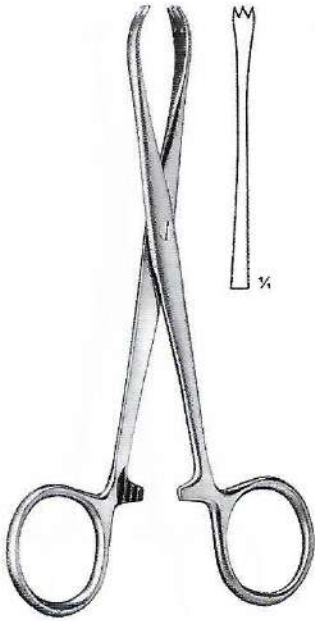

Chaput Tissue Forceps
F12-008
2 x 3 teeth, sharp
12.5 cm, 5"

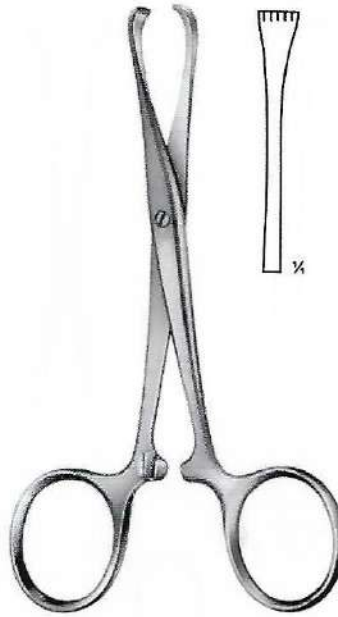

Tuffier Tissue Forceps
F12-009
5 x 6 teeth, sharp
12.5 cm, 5"

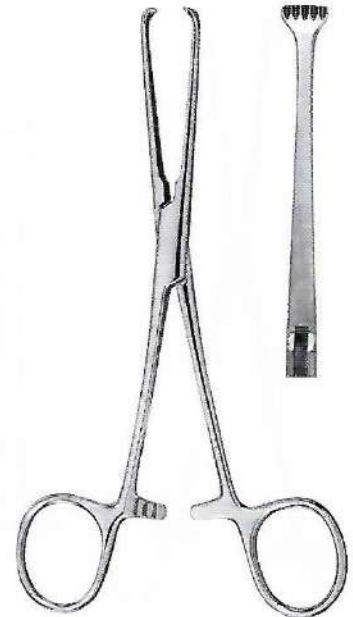

Boys-Allis Tissue Forceps
F12-010
5 x 6 teeth, sharp
15.5 cm, 6"

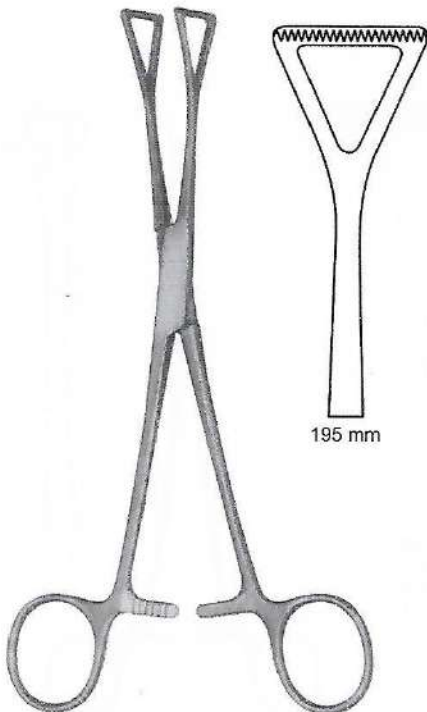

Duval-Collin Grasp Forceps
F12-011 19.5 cm, 7 3/4"
F12-012 20.0 cm, 8"

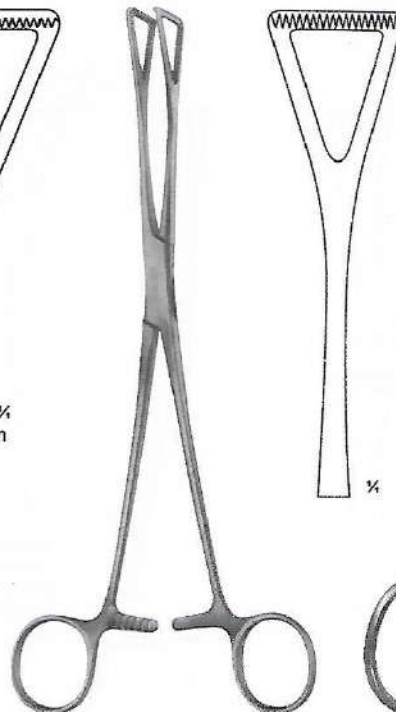

Duval Grasp Forceps
F12-013
23.0 cm, 9"

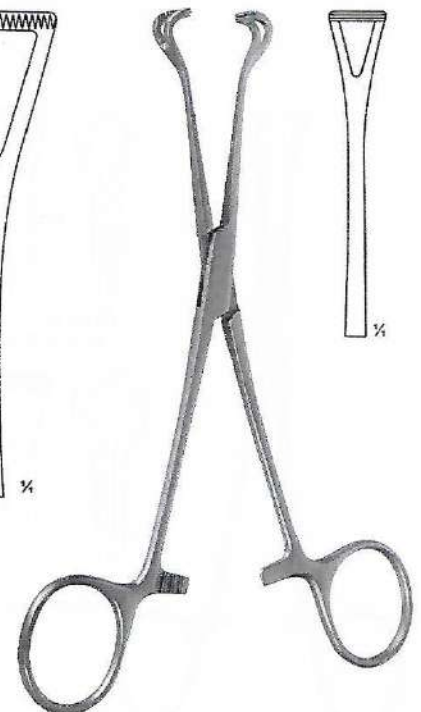

Babcock Seizing Forceps
F12-014
15.5 cm, 6"



INTESTINAL & TISSUE GRASPING FORCEPS

Darm- und Gewebefasszangen
Pinzas Para Intestinos y Tejidos

Pinces Pour Saisir Intestins et Tissus
Pinze Per Afferrare Intestino e Tessuti



Babcock Seizing Forceps

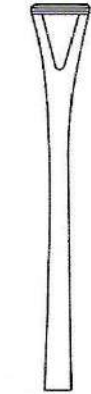

F12-015
17.0 cm, 6 3/4"



F12-016
21.5 cm, 8 1/2"

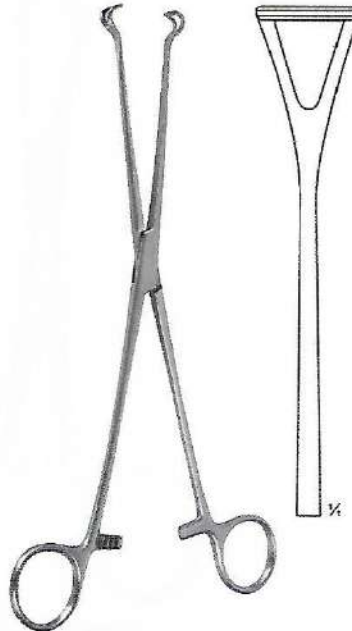

Babcock Seizing Forceps
F12-017
22.0 cm, 8 3/4"



Babcock Tissue Grasping
Forceps
F12-018 18 cm, 7"
F12-019 24 cm, 9 1/2"

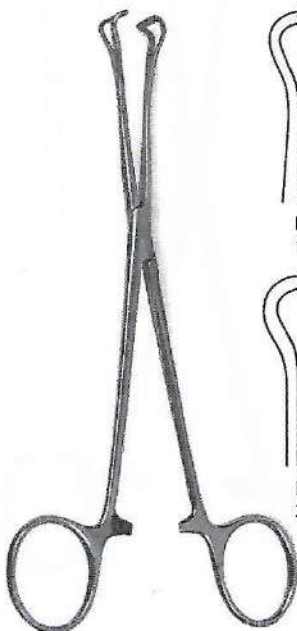

Babcock Tissue Grasping
Forceps

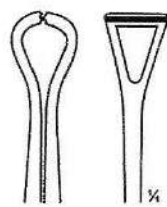

F12-020
16.0 cm, 6 1/4"

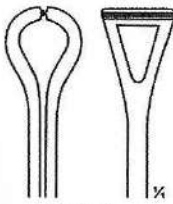

F12-021
21.5 cm, 8 1/2"

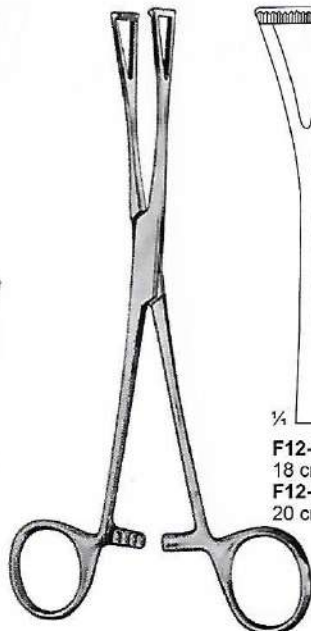

Duval Tissue Grasping Forceps



F12-022
18 cm, 7"
F12-023
20 cm, 8"

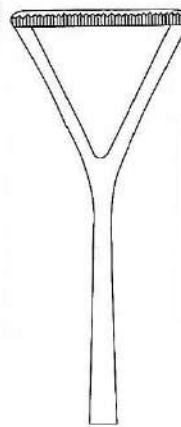

F12-024
20 cm, 8"
F12-025
23 cm, 9"

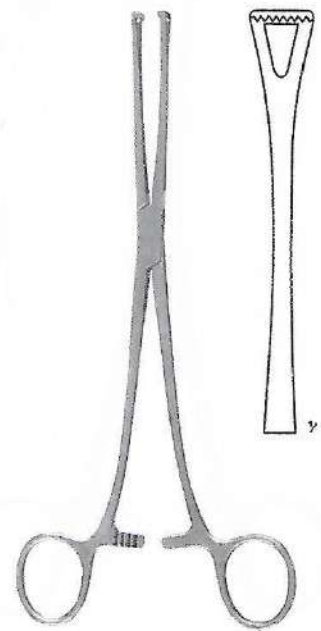

Lockwood Grasp Forceps
F12-026
20.0 cm, 8"

INTESTINAL & TISSUE GRASPING FORCEPS



Darm- und Gewebefasszangen | Pincés Pour Saisir Intestins et Tissus
 Pinzas Para Intestinos y Tejidos | Pinze Per Afferrare Intestino e Tessuti



Little Wood Tissue Grasping Forceps
 F12-027 19 cm, 7 1/2"
 Box Joint



Lane Tissue Grasping Forceps
 F12-028 12.7 cm, 5"
 F12-029 15 cm, 6"
 F12-030 19 cm, 7 1/2"

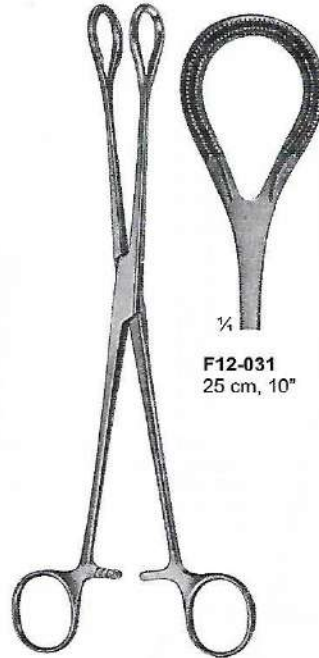

F12-031
 25 cm, 10"



F12-032
 27 cm, 10 3/4"



Babcock Intestinal & Tissue Grasping Clamp Forceps T.C

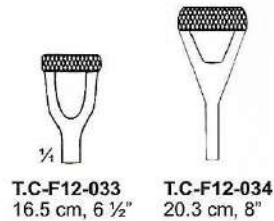

T.C-F12-033 16.5 cm, 6 1/2"
 T.C-F12-034 20.3 cm, 8"

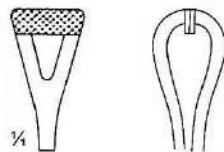

T.C-F12-035
 17.5 cm, 7"

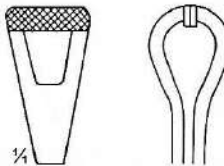

T.C-F12-036
 19.5 cm, 8"



Duval Intestinal & Tissue Grasping Clamp Forceps T.C

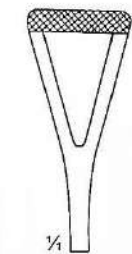

T.C-F12-037
 13 cm, 5 1/4"

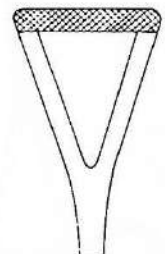

T.C-F12-038
 18 cm, 7"



INTESTINAL CLAMPS

Darmklemmen | Pincas Intestinales
 Pinzas Intestinales | Pinze Intestinali

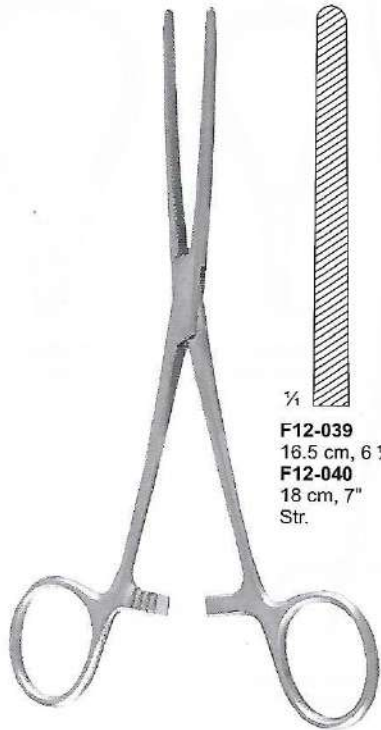

Baby-Doyen Intestinal Forceps Clamps

$\frac{1}{4}$
F12-039
 16.5 cm, 6 ½"
F12-040
 18 cm, 7"
 Str.

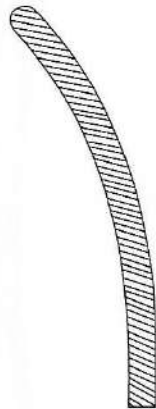

F12-041
 16.5 cm, 6 ½"
F12-042
 18 cm, 7"
 Cvd.

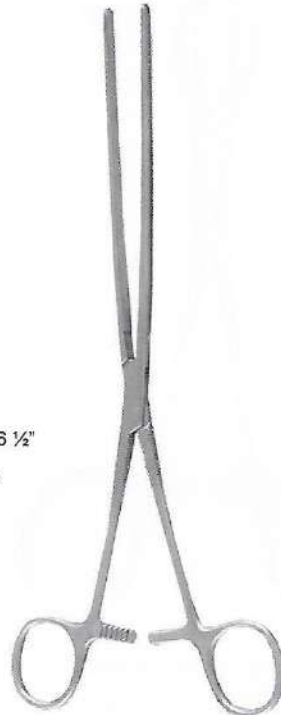

Mayo-Robson Intestinal Forceps Clamps



$\frac{1}{4}$
F12-043
 21 cm, 8 ¼"
F12-044
 23 cm, 9"
F12-045
 25 cm, 10"
 Str.



F12-046
 21 cm, 8 ¼"
F12-047
 23 cm, 9"
F12-048
 25 cm, 10"
 Cvd.

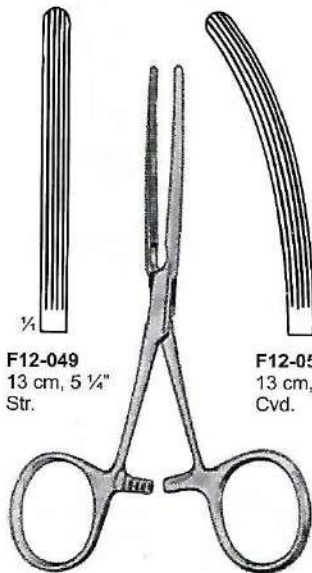

Baby-Kocher Intestinal Forceps Clamps

$\frac{1}{4}$
F12-049
 13 cm, 5 ¼"
 Str.



F12-050
 13 cm, 5 ¼"
 Cvd.

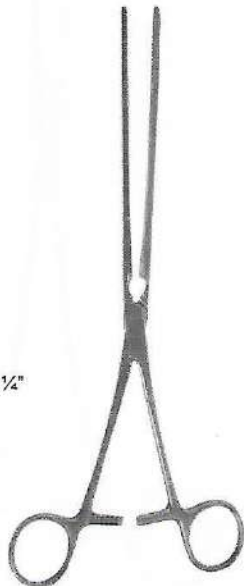

Kocher Intestinal Forceps Clamps



$\frac{1}{4}$
F12-051
 22 cm, 8 ¾"
 Straight

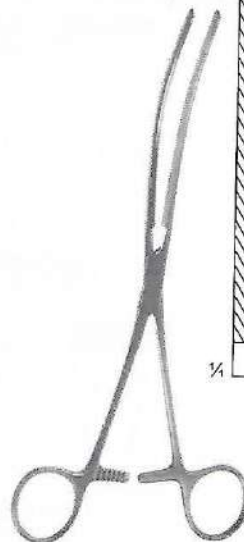

Doyen Intestinal Forceps Clamps



F12-052
 21 cm, 8 ¼"
F12-053
 23 cm, 9"
 straight,
 grooved

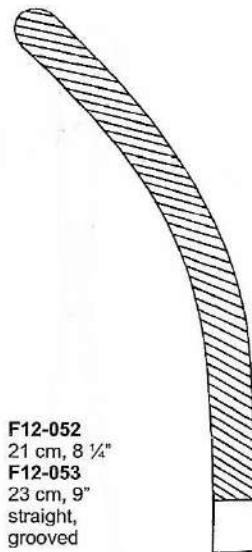

F12-054
 22 cm, 8 ¾"
 Curved,
 grooved

POLYOUS GRASPING FORCEPS, ANASTOMOSIS



Polypenfasszange, Darm-anastomosenklemmen

Pince Pour Saisir Polypes, Pincés-clamps Pour Anastomose Intestinale

Pinza Para Coger Pólipos, Clamps Para Anastomosis Intestinales

Pinze Per Afferrare Polipi, Pinze Per Anastomosi Intestinali

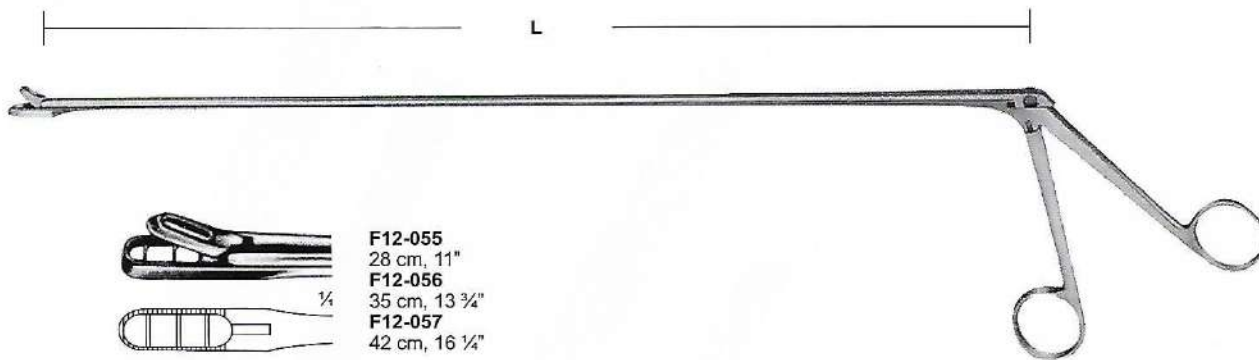

Yeomann Intestinal Polyous Grasping Forceps

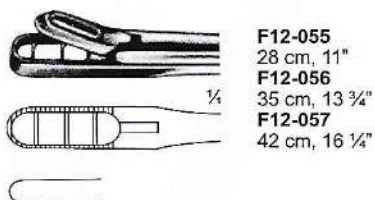

F12-055
28 cm, 11"
F12-056
35 cm, 13 3/4"
F12-057
42 cm, 16 1/4"

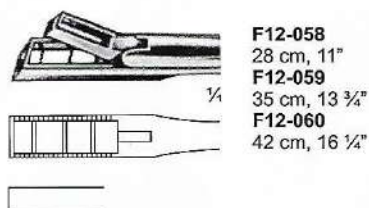

F12-058
28 cm, 11"
F12-059
35 cm, 13 3/4"
F12-060
42 cm, 16 1/4"

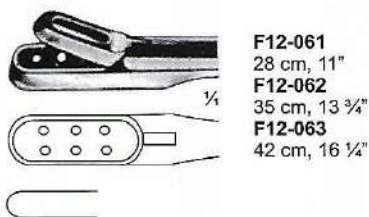

F12-061
28 cm, 11"
F12-062
35 cm, 13 3/4"
F12-063
42 cm, 16 1/4"

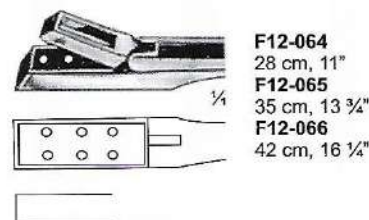

F12-064
28 cm, 11"
F12-065
35 cm, 13 3/4"
F12-066
42 cm, 16 1/4"



INTESTINAL CLAMPS

Darmklemmen | Pincas Intestinales
Pinzas Intestinales | Pinze Intestinali



Payr-Baby Crushing Intestinal Clamp
F12-067
15 cm, 6"
without pin
F12-068
15 cm, 6"
with pin

Payr Crushing Intestinal Clamp
F12-069
21 cm, 8 1/4"
without pin
F12-070
21 cm, 8 1/4"
with pin

Payr Crushing Intestinal Clamp
F12-071
29 cm, 11 1/2"
without pin
F12-072
29 cm, 11 1/2"
with pin

Payr Crushing Intestinal Clamp
F12-073
35 cm, 13 3/4"
without pin
F12-074
35 cm, 13 3/4"
with pin

INTESTINAL CLAMPS



Darmklemmen	Pinces Intestinales
Pinzas Intestinales	Pinze Intestinali



**Lane Stomach Intestinal
Clamp Forceps**
F12-075
30 cm, 12" Str.

**Lane Stomach Intestinal
Clamp Forceps**
F12-076
30 cm, 12" Cvd.



INTESTINAL RECTAL SPECULA

Mastdarmspekula
Especulos Rectales

Spéculums Rectaux
Specoli Rettali

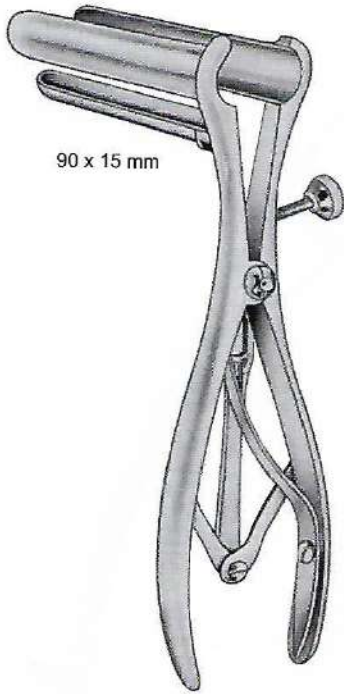

90 x 15 mm

Mathieu Rectal Speculum
F12-077 19.5 cm, 7 3/4"
90 x 15 mm



Sims Rectal Speculum
F12-078 15 cm, 6"

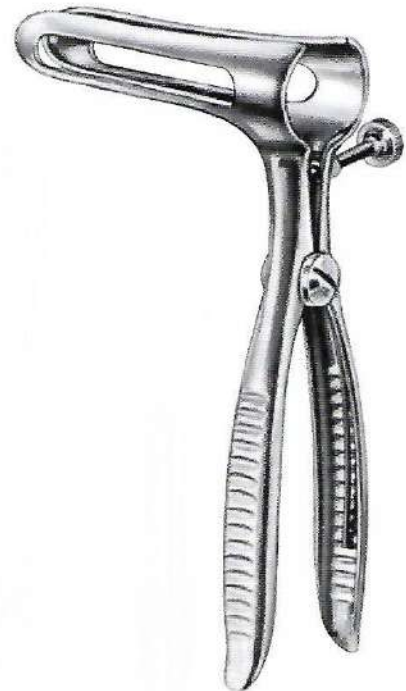

Sims Rectal Speculum
F12-079 15 cm, 6"

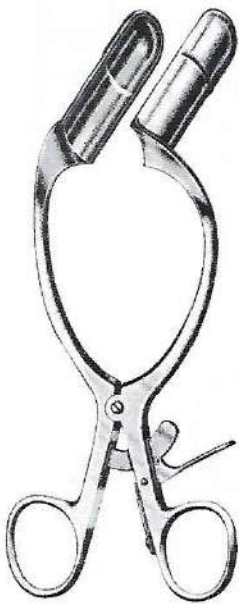

Barr Rectal Speculum
F12-080 80mm
Blade size

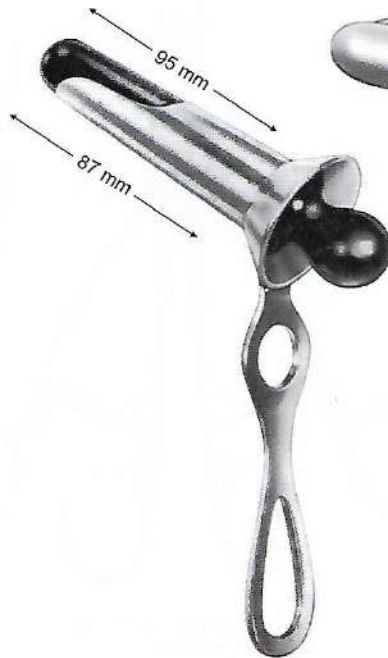

Ives-Fansler Rectal Speculum
F12-081 14.5 mm, 5 3/4"
22 mm Ø



Pratt Rectal Speculum
F12-082 21.5 cm, 8 1/2"
85 x 25 mm blade

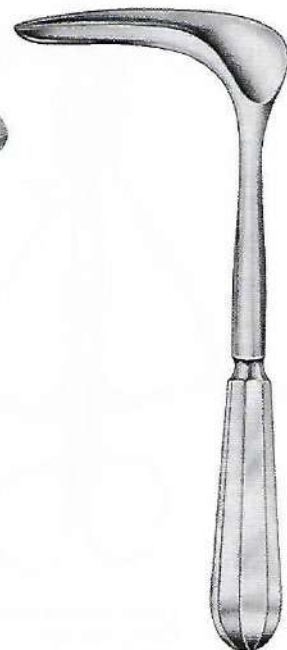

Czerny Rectal Speculum
F12-083
22 cm, 8 3/4"

INTESTINAL RECTAL SPECULA

Mastdarmspekula
Especulos Rectales

Spéculums Rectaux
Specoli Rettali



Hirschmann Intestinal Rectal Speculum
F12-084
23 mm Ø
proctoscope
working length: 145 mm



F12-085
22 Ø x 50 mm
F12-086
22 Ø x 100 mm
F12-087
22 Ø x 140 mm
F12-088
22 Ø x 200 mm

Kelly Intestinal Rectal Speculum



F12-089
19 Ø x 70 mm
F12-090
22 Ø x 70 mm

Bensaude Intestinal Rectal Speculum

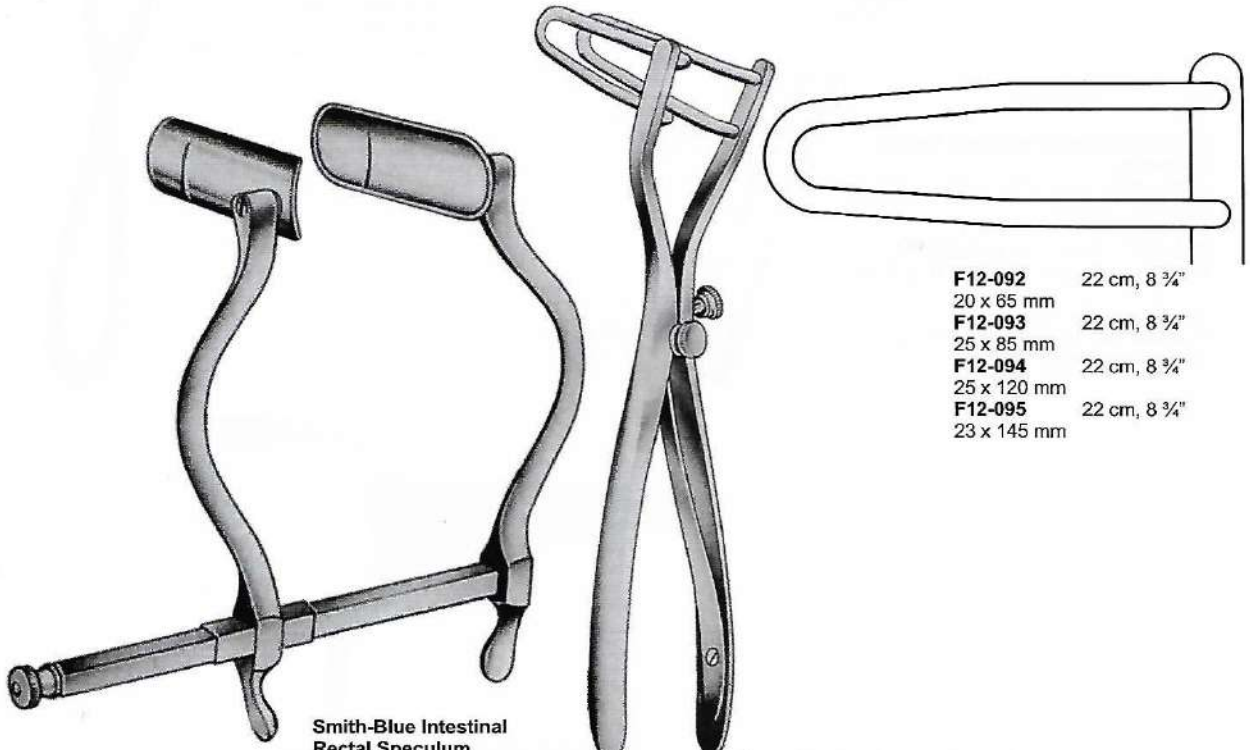

Smith-Blue Intestinal Rectal Speculum
F12-091 15 cm, 6"
75 x 23 mm

Schulze-Bergmann Intestinal Rectal Speculum

F12-092 22 cm, 8 3/4"
20 x 65 mm
F12-093 22 cm, 8 3/4"
25 x 85 mm
F12-094 22 cm, 8 3/4"
25 x 120 mm
F12-095 22 cm, 8 3/4"
23 x 145 mm



INTESTINAL RECTAL SPECULA

Mastdarmspekula
Especulos Rectales

Spéculums Rectaux
Specoli Rettali



Barr-Shilford Intestinal Rectal Speculum
F12-096



Vernon-David Intestinal Rectal Speculum
with thumb grip handle
F12-097 short handle
F12-098 long (standard) handle



Fansler Operating Intestinal Rectal Speculum
with slotted / extra long handle
F12-101 standard
F12-102 25 mm x 65 mm (1" x 2 1/2")
F12-103 29 mm x 65 mm (1 1/4" x 2 1/2")
F12-104 38 mm x 70 mm (1 1/2" x 2 3/4")

with slotted tube / short handle
F12-105 29 mm x 60 mm (1 1/4" x 2 1/4")
F12-106 operating speculum



Chelsea-Eaton Intestinal Rectal Speculum
solid handle
F12-099 small
F12-100 large
with light connection available



Brinkerhoff Intestinal Rectal Speculum
F12-107 smal 3 1/2" x 1" tapers to 1/2"
F12-108 medium 4" x 1" tapers to 5/8"
F12-109 large 4 3/4" x 1 1/4" tapers to 3/4"

INTESTINAL RECTAL SPECULA

Mastdarmspekula
Especulos Rectales

Spéculums Rectaux
Specoli Rettali



**Ives-fansler Anoscope
Intestinal Rectal Speculum**
with hard rubber obturator /
fenestrated handle
F12-110 22 mm x 85 mm



**Long Chrome Handle
Intestinal Rectal Speculum**
F12-111 3 1/4" x 1 1/8"

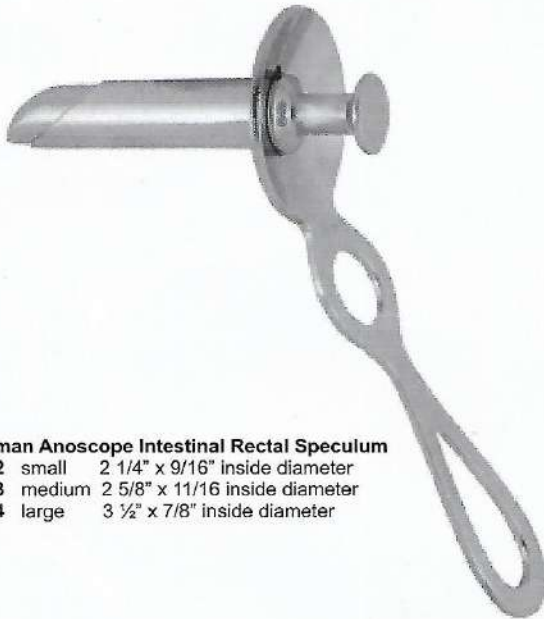

Hirschman Anoscope Intestinal Rectal Speculum
F12-112 small 2 1/4" x 9/16" inside diameter
F12-113 medium 2 5/8" x 11/16" inside diameter
F12-114 large 3 1/2" x 7/8" inside diameter



**Buie Hirschman Anoscope Intestinal
Rectal Speculum**
F12-115 small 2 1/4" x 9/16" inside diameter
F12-116 medium 3 3/4" x 3/4" inside diameter
F12-117 large 3 7/8" x 15/16" inside diameter

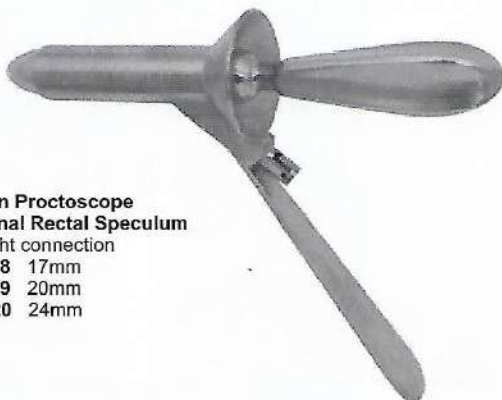

**Morgen Proctoscope
Intestinal Rectal Speculum**
with light connection
F12-118 17mm
F12-119 20mm
F12-120 24mm



**Kelly Proctoscope
Intestinal Rectal Speculum**
chrome plated
F12-121 22mm x 50 mm
F12-122 22mm x 100 mm
F12-123 22mm x 145 mm



GYNECOLOGY / OBSTETRICS

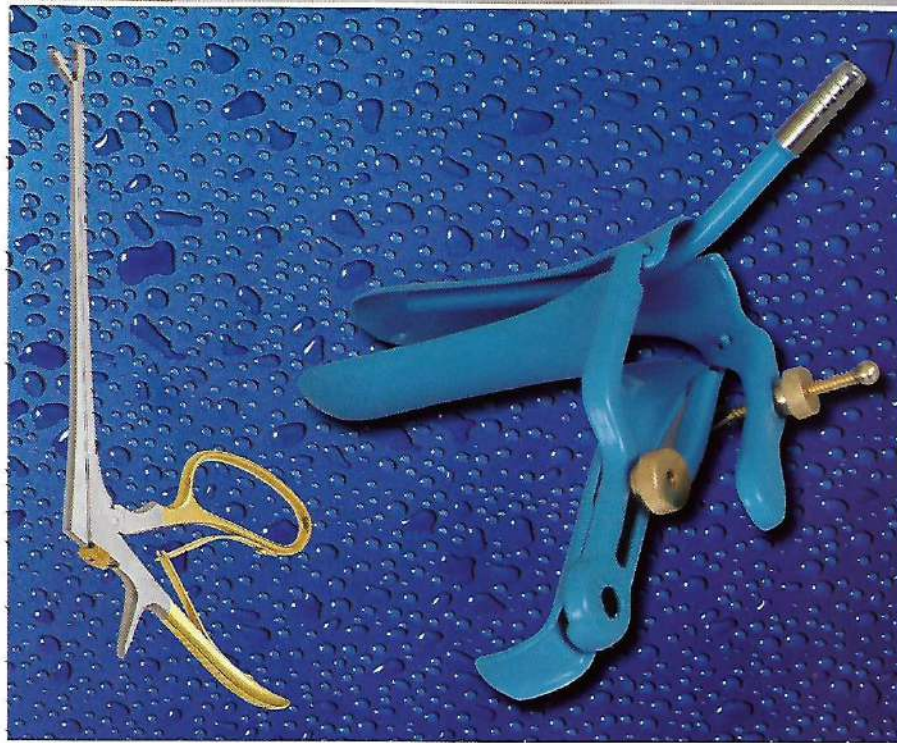

VAGINAL SPECULUM



Scheidenspekula
Spéculums vaginaux

Espéculos vaginales
Specoli vaginali



Cusco vaginal speculum
F13-001 75 mm x 32 mm
F13-002 85 mm x 35 mm
F13-003 100 mm x 35 mm
F13-004 75 mm x 17 mm
for virgines



Cusco vaginal speculum
F13-005 75 mm x 32 mm
F13-006 80 mm x 35 mm
F13-007 100 mm x 37 mm

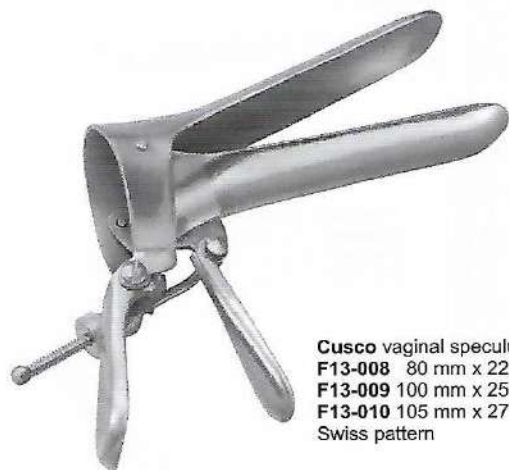

Cusco vaginal speculum
F13-008 80 mm x 22 mm
F13-009 100 mm x 25 mm
F13-010 105 mm x 27 mm
Swiss pattern



Grave vaginal speculum
F13-011 75 mm x 20 mm
F13-012 95 mm x 35 mm
F13-013 115 mm x 35 mm



Collin vaginal speculum
F13-014 85 mm x 30 mm
F13-015 100 mm x 35 mm
F13-016 110 mm x 40 mm



Semm vaginal speculum
F13-017 90 mm x 14 / 18 mm
F13-018 100 mm x 17 / 20 mm
F13-019 110 mm x 25 / 30 mm



VAGINAL SPECULUM

Scheidenspekula
Spéculums vaginaux

Espécúlos vaginales
Specoli vaginali



Graves Vaginal Speculum
F13-020 Small 2.2 cm 7/8" Blade
F13-021 Medium 3.5 cm 1 3/8" Blade
F13-022 Large 3.7 cm 1 1/2" Blade



Trelat vaginal speculum
F13-023 85 mm x 30 mm
F13-024 95 mm x 35 mm
F13-025 115 mm x 43 mm



Collin vaginal speculum
F13-025A Virgin
F13-025B Small
F13-025C Medium
F13-025D Large



Pederson vaginal speculum
F13-026 75 mm x 13 mm
F13-027 100 mm x 22 mm
F13-028 120 mm x 25 mm

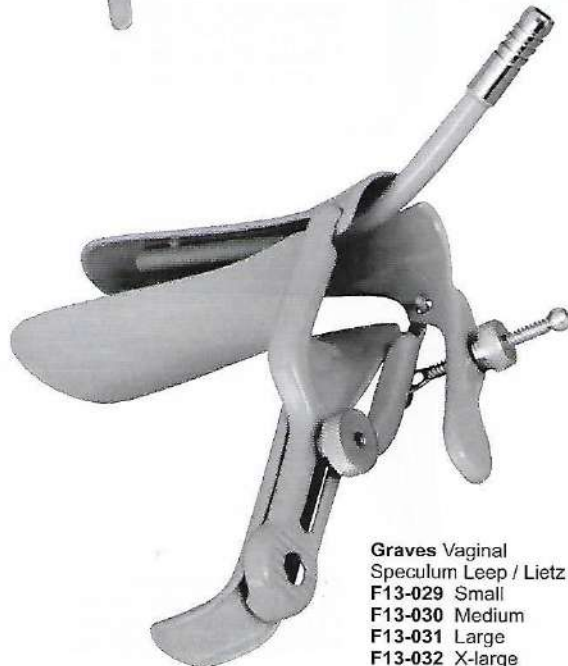

Graves Vaginal Speculum Leep / Lietz
F13-029 Small
F13-030 Medium
F13-031 Large
F13-032 X-large



Pederson Vaginal Speculum Leep / Lietz
F13-033 Small
F13-034 Medium
F13-035 Large
F13-036 X-Large

VAGINAL SPECULUM



Scheidenspekula
Spéculums vaginaux

Espéculos vaginales
Specoli vaginali



Kristeller Speculum & Retractor
F13-037 70 mm x 27 mm
F13-038 80 mm x 30 mm
F13-039 90 mm x 36 mm
F13-040 110 mm x 27 mm
F13-041 110 mm x 30 mm
F13-042 110 mm x 36 mm



**Kristeller Speculum
& Retractor**
F13-043 75 mm x 23 mm
F13-044 85 mm x 26 mm
F13-045 100 mm x 32 mm
F13-046 115 mm x 23 mm
F13-047 115 mm x 26 mm
F13-048 115 mm x 32 mm

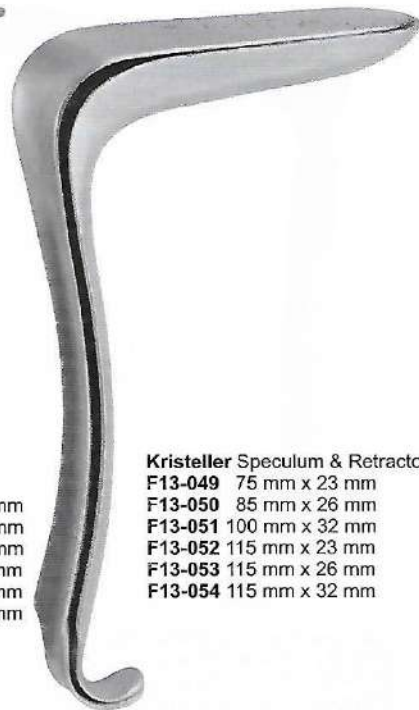

Kristeller Speculum & Retractor
F13-049 75 mm x 23 mm
F13-050 85 mm x 26 mm
F13-051 100 mm x 32 mm
F13-052 115 mm x 23 mm
F13-053 115 mm x 26 mm
F13-054 115 mm x 32 mm



Kristeller speculum & retractor
F13-055 105 mm x 18 mm
F13-056 105 mm x 21 mm
Speculum tapered, for virgins



Kristeller Speculum & Retractor
F13-057 110 mm x 14 mm
F13-058 115 mm x 17 mm



**Kristeller Speculum
& Retractor**
F13-059 110 mm x 14 mm
F13-060 115 mm x 17 mm



VAGINAL SPECULUM

Scheidenspekula | *Espéculos vaginales*
Spéculums vaginaux | *Specoli vaginali*



Jackson Speculum & Retractor
F13-061 75 mm x 35 mm
F13-062 75 mm x 40 mm
F13-063 90 mm x 35 mm
F13-064 90 mm x 40 mm
F13-065 100 mm x 35 mm
F13-066 100 mm x 40 mm



Sims Speculum & Retractor
F13-067 60 mm x 25 mm / 30 mm
F13-068 70 mm x 30 mm / 35 mm
F13-069 80 mm x 35 mm / 40 mm



Kallmorgen Speculum & Retractor
F13-070 70 mm x 40 mm
F13-071 90 mm x 40 mm



Kallmorgen Speculum & Retractor
F13-072 70 mm x 33 mm
F13-073 90 mm x 33 mm



Kallmorgen Speculum & Retractor
F13-074 70 mm x 33 mm
F13-075 90 mm x 33 mm

VAGINAL SPECULUM



Scheidenspekula
Spéculum vaginaux

Espéculos vaginales
Specoli vaginali



AUVARD,
speculum & retractor
F13-076
80 x 38 mm - 28 mm
1,530 kg
with fixed weight
23 cm, 9"

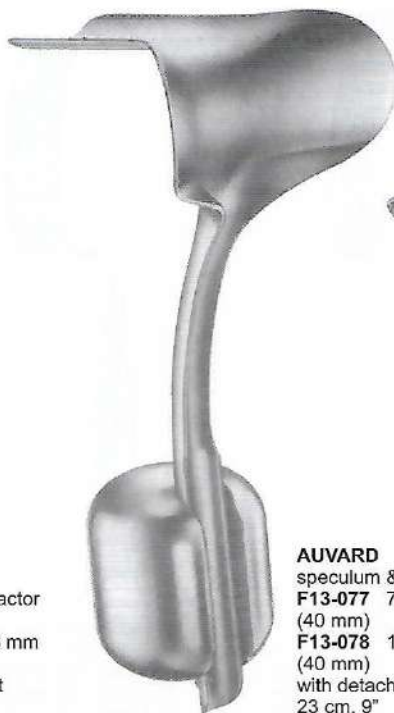

AUVARD
speculum & retractor
F13-077 75 x 42 mm
(40 mm)
F13-078 105 x 43 mm
(40 mm)
with detachable weight
23 cm, 9"



WEISSBARTH
speculum & retractor
F13-079 80 x 28 mm
F13-080 85 x 42 mm
21 cm, 8 1/4"



Garrigue Weighted Vaginal Speculum
F13-081 4.0 cm x 8.0 cm 1 5/8" x 3 1/8"
Weight 2 lbs



Henrotin Weighted Vaginal Speculum
F13-082 3.8 cm x 9.0 cm 1 1/2" x 3 1/2"
Weight 3 lbs.



VAGINAL SPECULUM

Scheidenspekula
Spéculum vaginaux

Espéculos vaginales
Specoli vaginali



Landau speculum
29.0 cm 11 1/2"
F13-083 100 mm x 28 mm
F13-084 100 mm x 38 mm



Breisky speculum
30.0 cm 12"
F13-085 130 mm x 20 mm
F13-086 130 mm x 25 mm
F13-087 130 mm x 30 mm
F13-088 130 mm x 35 mm
F13-089 130 mm x 40 mm
Vienna pattern



Breisky speculum
30.0 cm 12"
F13-090 100 mm x 20 mm
F13-091 100 mm x 25 mm
F13-092 100 mm x 30 mm
F13-093 100 mm x 35 mm
F13-094 100 mm x 40 mm



Breisky speculum
35.0 cm 13 3/4"
F13-095 160 mm x 40 mm
F13-096 180 mm x 40 mm

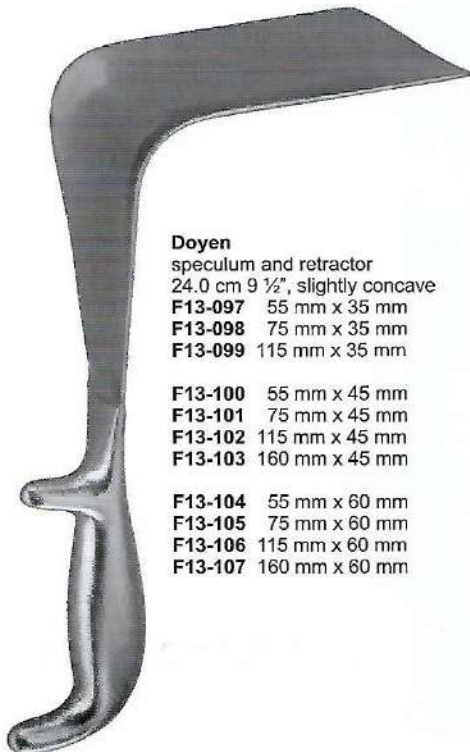

Doyen
speculum and retractor
24.0 cm 9 1/2", slightly concave
F13-097 55 mm x 35 mm
F13-098 75 mm x 35 mm
F13-099 115 mm x 35 mm

F13-100 55 mm x 45 mm
F13-101 75 mm x 45 mm
F13-102 115 mm x 45 mm
F13-103 160 mm x 45 mm

F13-104 55 mm x 60 mm
F13-105 75 mm x 60 mm
F13-106 115 mm x 60 mm
F13-107 160 mm x 60 mm



Doyen
speculum and retractor
24.0 cm 9 1/2", medium concave
F13-108 55 mm x 35 mm
F13-109 75 mm x 35 mm
F13-110 115 mm x 35 mm

F13-111 55 mm x 45 mm
F13-112 75 mm x 45 mm
F13-113 115 mm x 45 mm

F13-114 55 mm x 60 mm
F13-115 75 mm x 60 mm
F13-116 115 mm x 60 mm

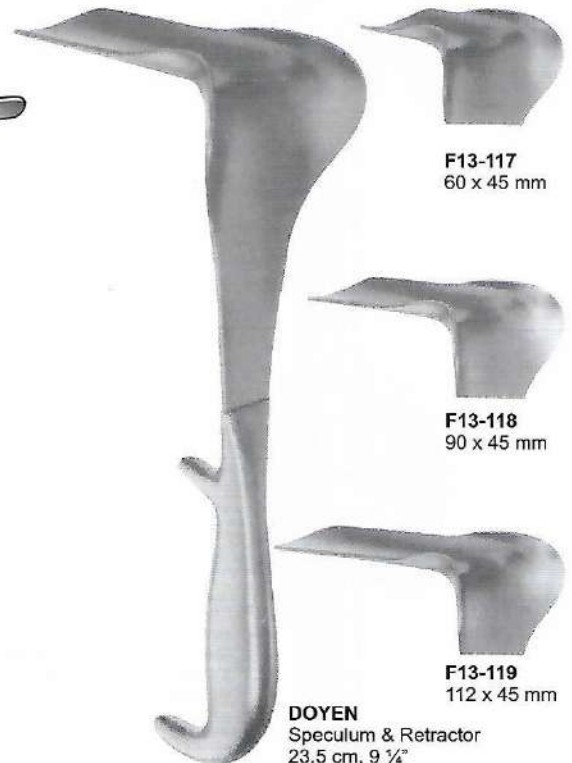

DOYEN
Speculum & Retractor
23.5 cm, 9 1/4"

F13-117
60 x 45 mm

F13-118
90 x 45 mm

F13-119
112 x 45 mm

VAGINAL SPECULUM



Scheidenspekula | Espéculos vaginales
Spéculums vaginaux | Specchi vaginali



**Scherback Speculum
F13-120**
Set consisting of:
handle weight 5 blades



F13-121
80 x 30 mm



F13-122
85 x 35 mm



F13-123
85 x 40 mm



F13-124
55 x 40 - 60 mm



F13-125
70 x 45 - 70 mm

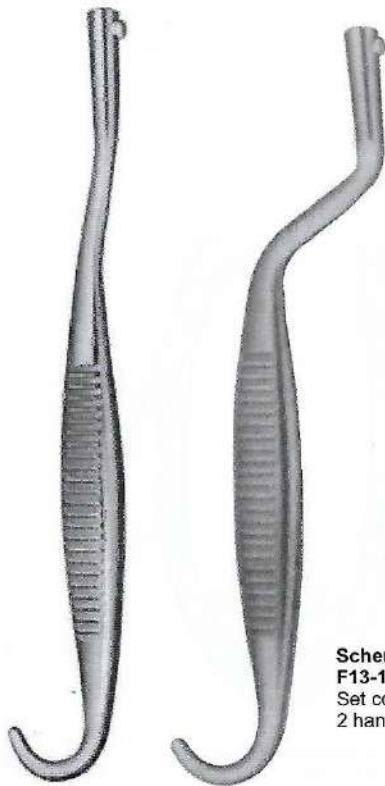

**Scherback Speculum
F13-126**
Set consisting of:
2 handle, 8 blades



F13-127
80 x 30 mm



F13-131
65 x 30 mm



F13-128
85 x 33 mm



F13-132
75 x 35 mm



F13-129
100 x 38 mm



F13-133
85 x 35 mm



F13-130
110 x 42 mm



F13-134
95 x 35 mm



VAGINAL SPECULUM

Scheidenspekula

Espéculos vaginales

Spéculum vaginaux

Specoli vaginali



O'Sullivan - O'Connor
Vaginal Retractor
F13-135 Set of 3 Complete



F13-136
45 x 17 mm



F13-137
90 x 37 mm



F13-138
90 x 45 mm



Abdominal Retractor
F13-139 9 cm, 3 1/2" wide
F13-140 10 cm, 4" wide
F13-141 11.5 cm, 4 1/2" wide

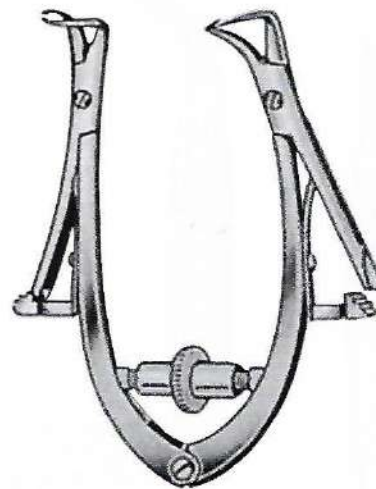

Friedmann Retractor
F13-142
10 cm, 4"

VAGINAL SPECULUM



Scheidenspekula
Spéculum vaginaux

Espéculos vaginales
Specoli vaginali



**Kogan speculum
F13-143**
24 cm, 9 1/2"
with scale-ratchet
and fixation screw



**Kogan speculum
F13-144**
24 cm, 9 1/2"



**Kogan - Modif.
speculum
F13-145**
28 cm, 11"
x=4 mm y=8mm
F13-146
x=2 mm y=4mm



**Lateral Nonconductive
Vaginal Retractor
F13-147** 6.3 cm wide

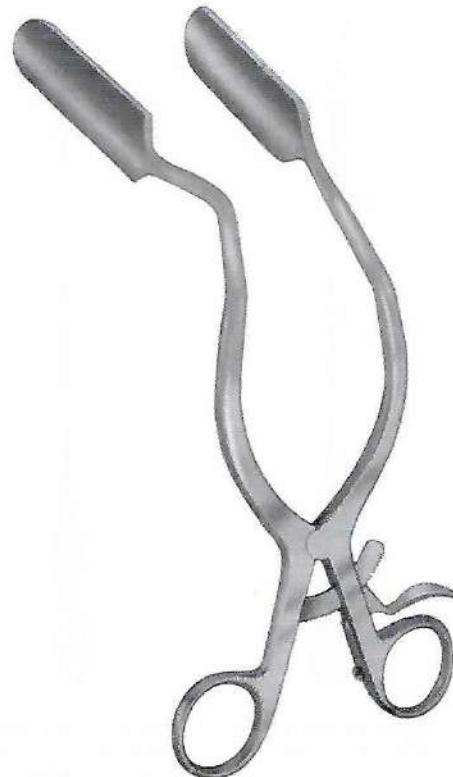

**McGee Lateral
Vaginal Retractor
With Ratchet Handle
F13-148** 20cm, 8"



UTERINE SOUNDS

Uterus-Sonden

Hystéromètres du col de l'utérus

Histerómetros uterinos

Isterometri uterini



**Sims Uterine Sound
F13-149**
33 cm, 13"
right, malleable



**Sims Uterine Sound
F13-150**
32.5cm 12 3/4"
Non-graduated



**Sims Uterine Sound
F13-151**
32.5cm 12 3/4"
Graduated in cm



**Sims-Special Uterine
Sound
F13-152** 33 cm, 13"



**Sims Uterine Sound
schwed. Modell
F13-153**
26 cm, 10 1/4"



**Martin Uterine Sound
F13-154** 30 cm, 12"
malleable



**Valleix Uterine Sound
F13-155** 25 cm, 10"



**Mayo Uterine Sound
F13-156** 33 cm 13"
biegam malleable



**Simpson Uterine Sound
F13-157** 29 cm 11 1/2"
malleable silver-plated



**Simpson Uterine Sound
F13-158** 32.5cm 12 3/4"
Graduated in inches

UTERINE SOUNDS



Uterus-Sonden

Histerómetros uterinos

Hystéromètres du col de l'utérus

Isterometri uterini



Hegar Uterine Dilator single ended

F13-159	1.0mm Ø	F13-179	11.5mm Ø	F13-199	23.0mm Ø
F13-160	1.5mm Ø	F13-180	12.0mm Ø	F13-200	24.0mm Ø
F13-161	2.0mm Ø	F13-181	12.5mm Ø	F13-201	25.0mm Ø
F13-162	2.5mm Ø	F13-182	13.0mm Ø	F13-202	26.0mm Ø
F13-163	3.0mm Ø	F13-183	13.5mm Ø	F13-203	27.0mm Ø
F13-164	3.5mm Ø	F13-184	14.0mm Ø	F13-204	28.0mm Ø
F13-165	4.0mm Ø	F13-185	14.5mm Ø	F13-205	29.0mm Ø
F13-166	4.5mm Ø	F13-186	15.0mm Ø	F13-206	30.0mm Ø
F13-167	5.0mm Ø	F13-187	15.5mm Ø		
F13-168	6.0mm Ø	F13-188	16.0mm Ø		
F13-169	6.5mm Ø	F13-189	16.5mm Ø		
F13-170	7.0mm Ø	F13-190	17.0mm Ø		
F13-171	7.5mm Ø	F13-191	17.5mm Ø		
F13-172	8.0mm Ø	F13-192	18.0mm Ø		
F13-173	8.5mm Ø	F13-193	18.5mm Ø		
F13-174	9.0mm Ø	F13-194	19.0mm Ø		
F13-175	9.5mm Ø	F13-195	19.5mm Ø		
F13-176	10.0mm Ø	F13-196	20.0mm Ø		
F13-177	10.5mm Ø	F13-197	21.0mm Ø		
F13-178	11.0mm Ø	F13-198	22.0mm Ø		



Hegar Uterine Dilator single ended

F13-207 4 mm - 17 mm Ø
8 Pieces per set
F13-208 1 mm - 26 mm Ø
24 Pieces per set

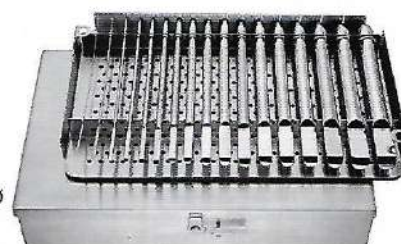

Hegar Uterine Dilator

single ended
F13-209 4 mm - 17 mm Ø
24 pieces per set



Hegar uterine dilator

F13-210	1 / 2 mm Ø
F13-211	3 / 4 mm Ø
F13-212	5 / 6 mm Ø
F13-213	7 / 8 mm Ø
F13-214	9 / 10 mm Ø
F13-215	11 / 12 mm Ø
F13-216	13 / 14 mm Ø
F13-217	15 / 16 mm Ø
F13-218	17 / 18 mm Ø
F13-219	19 / 20 mm Ø
F13-220	21 / 22 mm Ø
F13-221	23 / 24 mm Ø
F13-222	25 / 26 mm Ø

double ended



Hegar uterine dilator

F13-223 3 / 4 mm - 17 / 18 mm Ø
8 Pieces per set
F13-224 1 / 2 mm - 25 / 26 mm Ø
14 Pieces per set





UTERINE SOUNDS

Uterus-Sonden

Hystéromètres du col de l'utérus

Histerómetros uterinos

Isterometri uterini



Hegar Uterine Dilator, Double-ended

- F13-225 3mm & 4mm, 7 7/8" (20cm)
- F13-226 5mm & 6mm, 7 7/8" (20cm)
- F13-227 7mm & 8mm, 7 7/8" (20cm)
- F13-228 9mm & 10mm, 7 7/8" (20cm)
- F13-229 11mm & 12mm, 7 7/8" (20cm)
- F13-230 13mm & 14mm, 7 7/8" (20cm)
- F13-231 15mm & 16mm, 7 7/8" (20cm)
- F13-232 17mm & 18mm, 7 7/8" (20cm)



Hegar Uterine Dilators 8 Set W/Roll

- F13-233 Complete Set
- Curved, Delicate, 3mm to 18mm, Curved



Hank Dilator

- F13-234 Fig. 19 / 10 4.5 / 5.0 mm Ø
- F13-235 Fig. 11 / 12 5.5 / 6.0 mm Ø
- F13-236 Fig. 13 / 14 6.5 / 7.0 mm Ø
- F13-237 Fig. 15 / 16 7.5 / 8.0 mm Ø
- F13-238 Fig. 17 / 18 8.5 / 9.0 mm Ø
- F13-239 Fig. 19 / 20 9.5 / 10.0 mm Ø

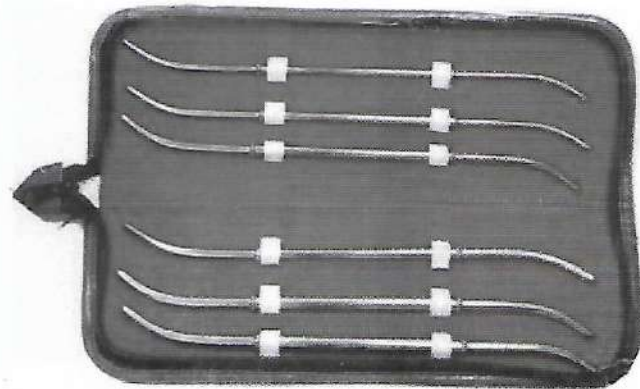

Hank Dilator set

- F13-240 Fig. 4.5 / 5 mm - 9.5 / 10.0 mm Ø
- 6 Pieces per set

PARAMETRIUM FORCEPS, HYSTERECTOMY FORCEPS



Parametriumklemmen, Hysterektomieklemmen
Pinces parametrium, Pinces à hystérectomie

Pinzas parametrium, Pinzas-clamps para histerectomia
Pinze parametrium, Pinze per isterectomia

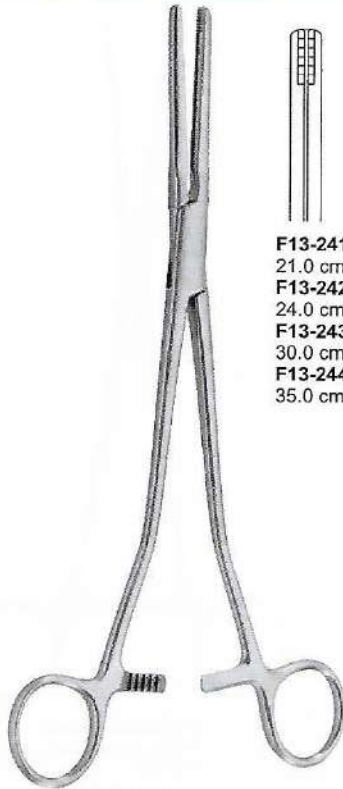

**Parametrium
Hysterectomy
Forceps**

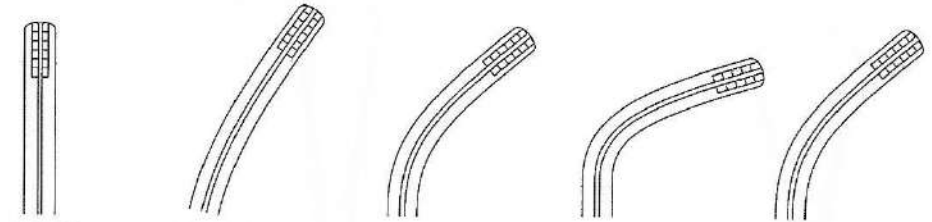

- | | | | | |
|-----------------------------------|-----------------------------------|-----------------------------------|-----------------------------------|---|
| F13-241
21.0 cm 8 1/4" | F13-245
21.0 cm 8 1/4" | F13-249
21.0 cm 8 1/4" | F13-253
21.0 cm 8 1/4" | F13-257
21.0 cm 8 1/4" |
| F13-242
24.0 cm 9 1/2" | F13-246
24.0 cm 9 1/2" | F13-250
24.0 cm 9 1/2" | F13-254
24.0 cm 9 1/2" | F13-258
24.0 cm 9 1/2" |
| F13-243
30.0 cm 12" | F13-247
30.0 cm 12" | F13-251
30.0 cm 12" | F13-255
30.0 cm 12" | F13-259
30.0 cm 12" |
| F13-244
35.0 cm 13 3/4" | F13-248
35.0 cm 13 3/4" | F13-252
35.0 cm 13 3/4" | F13-256
35.0 cm 13 3/4" | F13-260
35.0 cm 13 3/4"
S-curved |

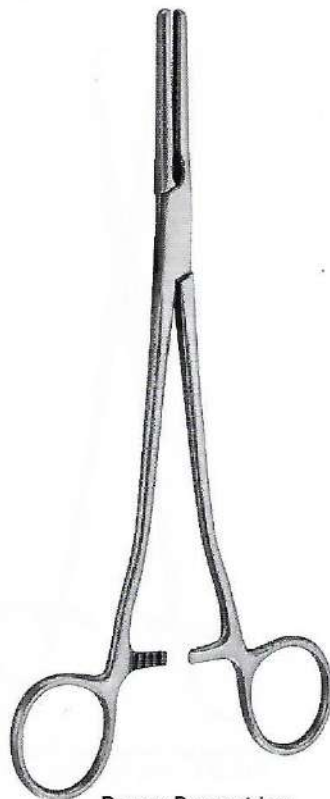

**Rogers Parametrium
Hysterectomy Forceps**

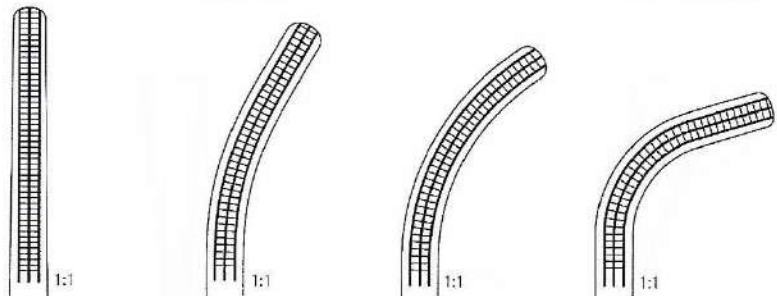

- | | | | |
|--|--|--|--|
| F13-261
Fig. 1
22.0 cm 8 3/4" | F13-262
Fig. 2
21.5 cm 8 1/2" | F13-263
Fig. 3
21.0 cm 8 1/4" | F13-264
Fig. 4
20.5 cm 8" |
|--|--|--|--|

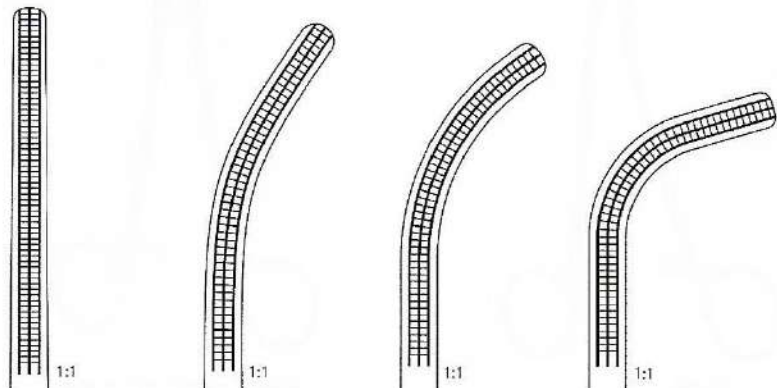

- | | | | |
|--|--|--|--|
| F13-265
Fig. 1
25.0 cm 9 3/4" | F13-266
Fig. 2
25.0 cm 9 3/4" | F13-267
Fig. 3
24.5 cm 9 1/2" | F13-268
Fig. 4
23.0 cm 9" |
|--|--|--|--|



TENACULUM FORCEPS

Hakenzangen

Pinces pour l'abaissement du col de l'utérus

Pinzas para coger el cuello del útero

Pinze per abbassare il collo dell'utero

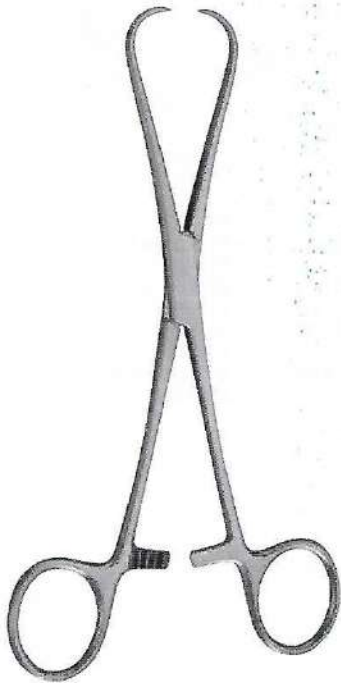

Staude - Moore
Tenaculum Forceps
F13-269
17.0 cm 6 3/4"



Barrett
Tenaculum Forceps
F13-270
18.0 cm 7"

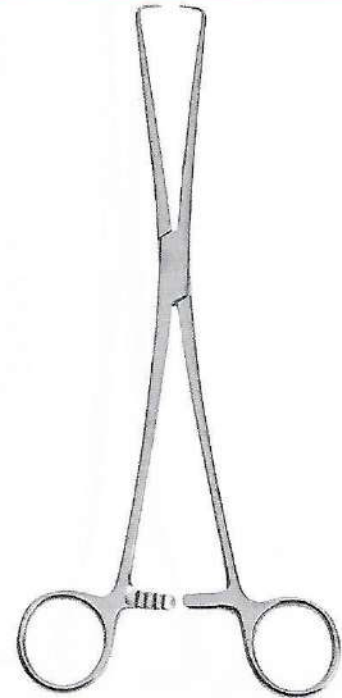

Schroeder-Braun
Tenaculum Forceps
F13-271
25.0 cm 9 3/4"



Skene
Tenaculum Forceps
F13-272
24.0 cm 9 1/2"



Pozzi Tenaculum Forceps
F13-273 25.5 cm 10"



Schroeder Tenaculum Forceps
F13-274 25.0 cm 9 3/4"

TENACULUM FORCEPS



Hakenzangen

Pinces pour l'abaissement du col de l'utérus

Pinzas para coger el cuello del útero

Pinze per abbassare il collo dell'utero

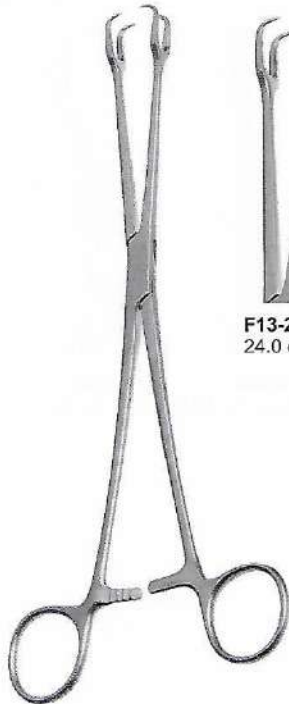

**Schroeder Vulsellum
Tenaculum Forceps**



F13-275
24.0 cm 9 1/2"



F13-276
24.0 cm 9 1/2"



**Duplay Tenaculum
Forceps**
F13-277 28.0 cm 11"

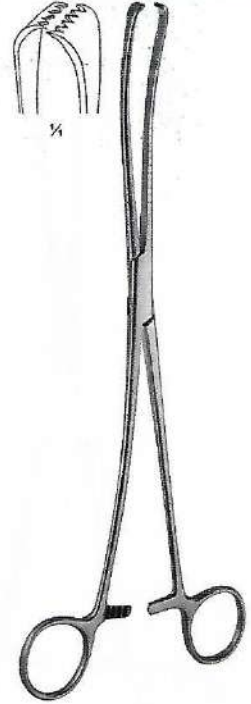

Iowa Tenaculum Forceps
F13-278 26.0 cm 10 1/4"



Beacham Amniotome
F13-279 26.0 cm 10 1/4"



Pratt Tenaculum Forceps
F13-280
26.0 cm 10 1/4"

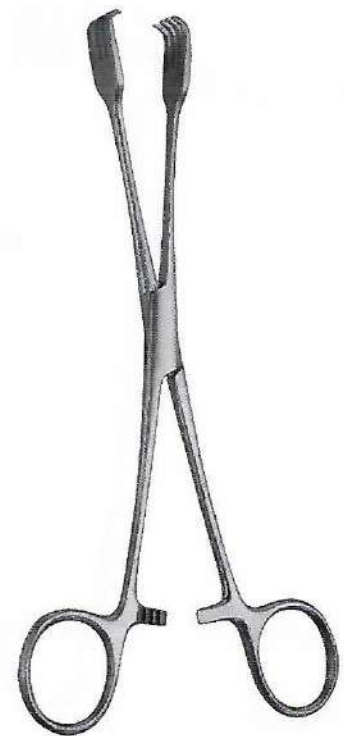

Czerny Tenaculum Forceps
F13-281
20.5 cm 8"



TENACULUM FORCEPS

Hakenzangen

Pinces pour l'abaissement du col de l'utérus

Pinzas para coger el cuello del útero

Pinze per abbassare il collo dell'utero

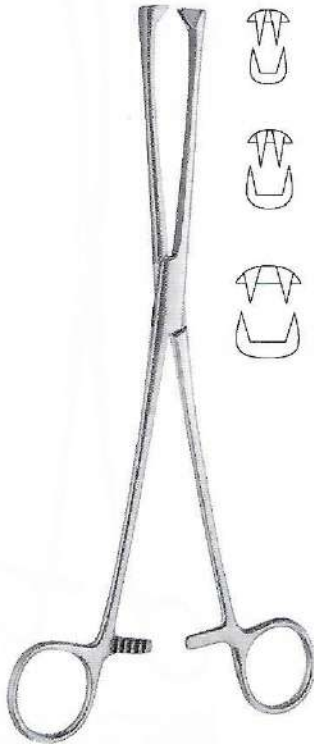

Museux Tenaculum Forceps

F13-282 8 mm
F13-283 6 mm
F13-284 10 mm
24.0 cm 9 1/2"



F13-285 8 mm
F13-286 6 mm
F13-287 10 mm
24.0 cm 9 1/2"



Jacobs Uterine Vulsellum Forceps

F13-288
21.0 cm 8 1/4"



F13-289
21.0 cm 8 1/4"



Teale Tenaculum Forceps
F13-290
23.0 cm 9"



Gellhorn Biopsy Forceps
F13-291
23.0 cm 9"



Thoms-Gaylor Biopsy Forceps
F13-292 22.0 cm 8 3/4"
F13-293 24.0 cm 9 1/2"

CERVICAL BIOPSY AND SPECIMEN FORCEPS



Probeexzisionszangen

Pinzas saca-bocados para biopsia

Pinces emporte-pièces à biopsie

Pinze taglianti per biopsia



Schubert Biopsy Forceps
F13-294 21.0 cm 8 1/2"
F13-295 28.0 cm 11"

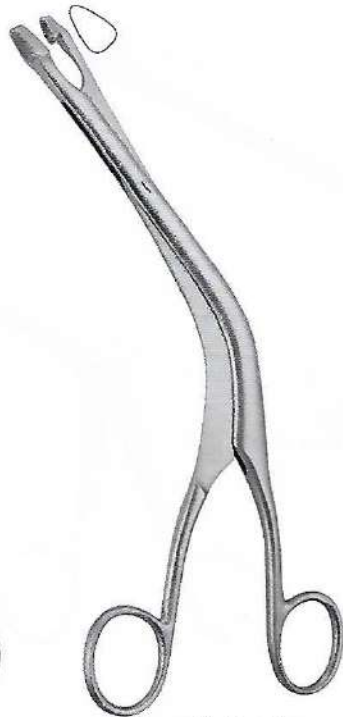

Faure Uterine Biopsy Forceps
F13-296 21.0 cm 8 1/2"



Schubert Biopsy Forceps
F13-297
 26.0 cm 10 1/4"



Van Doren Biopsy Forceps
F13-298
 24.0 cm 9 1/2"



Schumacher Biopsy Forceps

1:1
Fig. 1
F13-299
 24.0 cm 9 1/2"

1:1
Fig. 2
F13-300
 24.0 cm 9 1/2"



CERVICAL BIOPSY AND SPECIMEN FORCEPS

Probeexzisionszangen

Pinzas saca-bocados para biopsia

Pinces emporte-pièces à biopsie

Pinze taglianti per biopsia

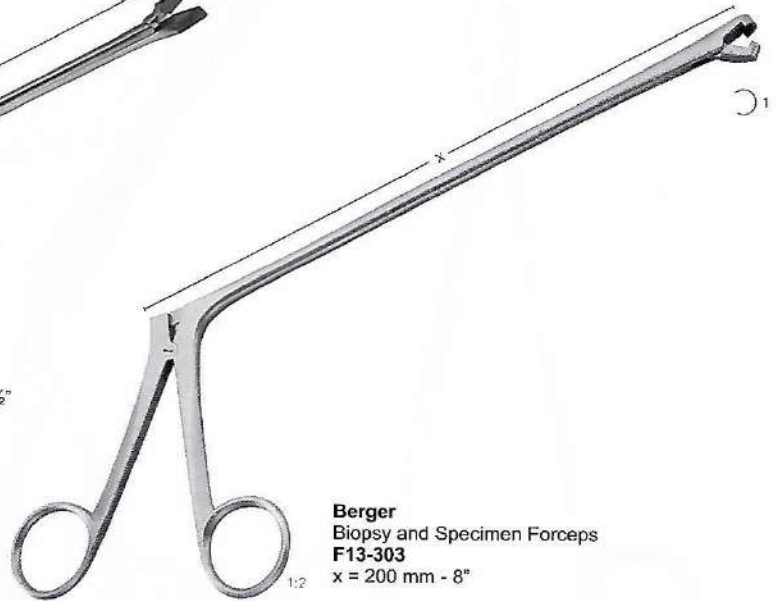
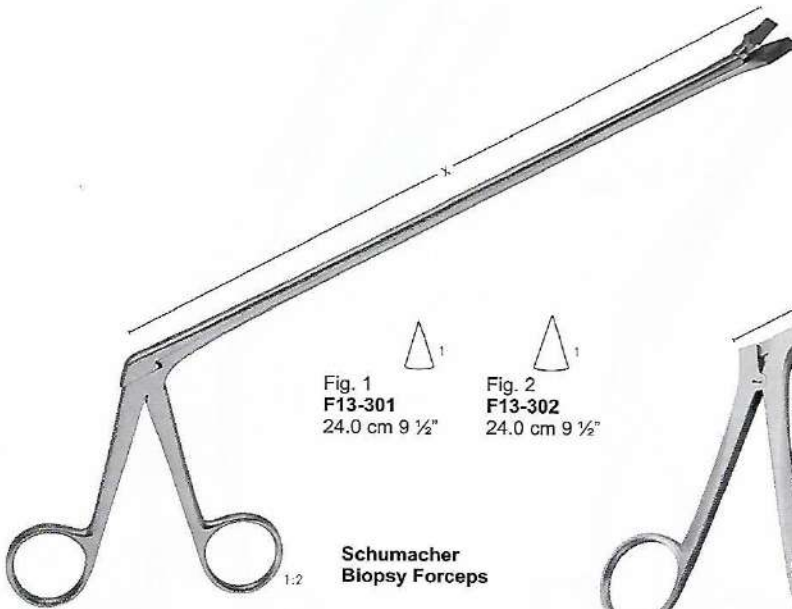

CERVICAL BIOPSY AND SPECIMEN FORCEPS



Probeexzisionszangen

Pinzas saca-bocados para biopsia

Pinces emporte-pièces à biopsie

Pinze taglianti per biopsia

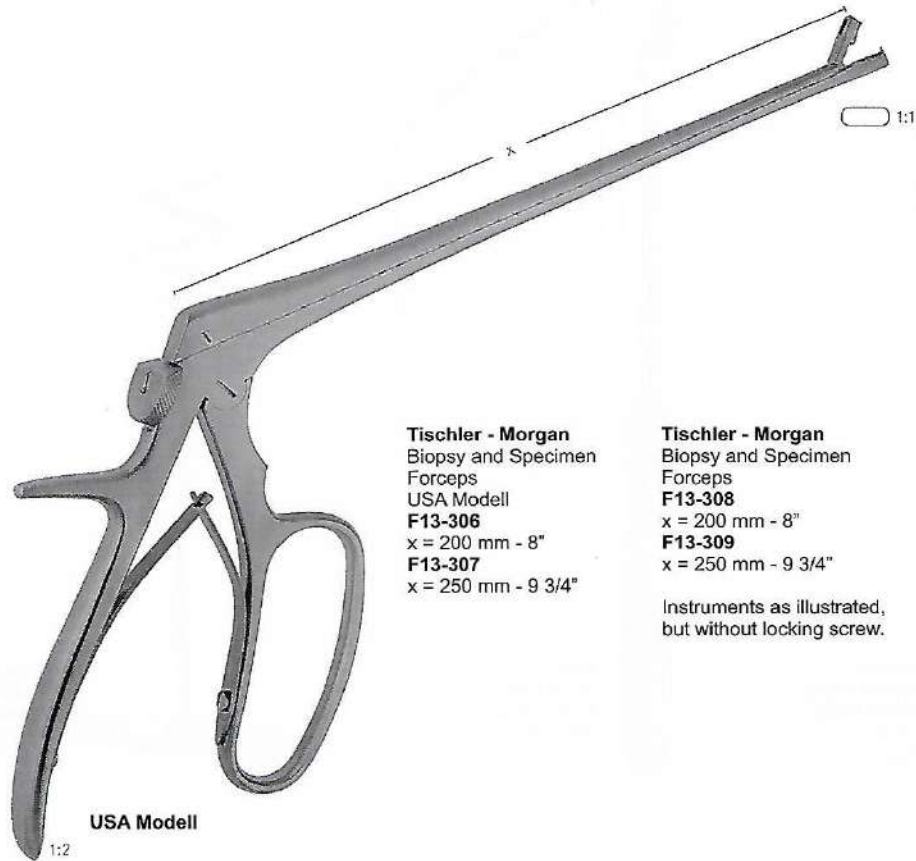

Tischler - Morgan
Biopsy and Specimen
Forceps
USA Modell
F13-306
x = 200 mm - 8"
F13-307
x = 250 mm - 9 3/4"

Tischler - Morgan
Biopsy and Specimen
Forceps
F13-308
x = 200 mm - 8"
F13-309
x = 250 mm - 9 3/4"

Instruments as illustrated,
but without locking screw.

USA Modell

1:2

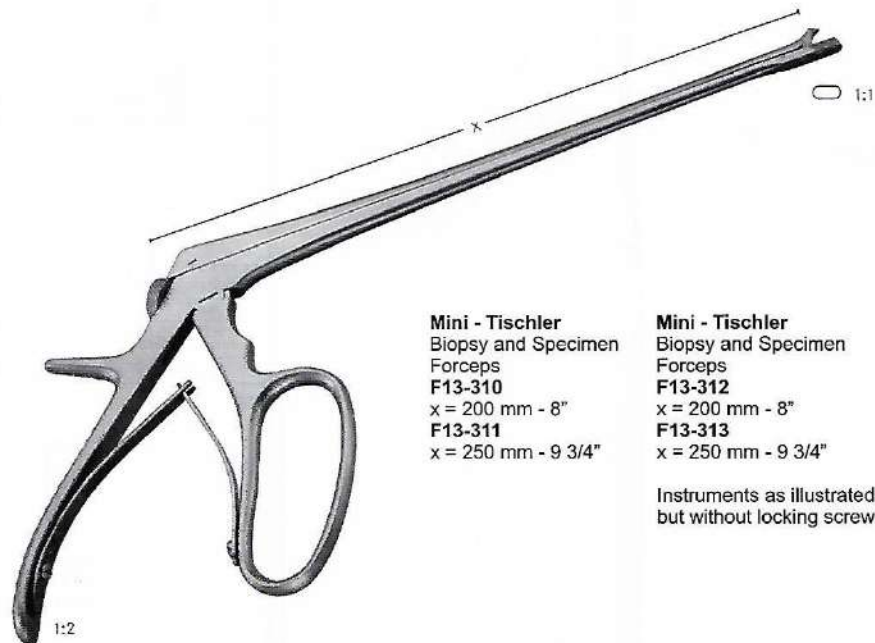

Mini - Tischler
Biopsy and Specimen
Forceps
F13-310
x = 200 mm - 8"
F13-311
x = 250 mm - 9 3/4"

Mini - Tischler
Biopsy and Specimen
Forceps
F13-312
x = 200 mm - 8"
F13-313
x = 250 mm - 9 3/4"

Instruments as illustrated,
but without locking screw.

1:2



MYOMA INSTRUMENTS, FISTULA HOOKS

Myom-Instrumente, Fistelhaken

Instrumentos para fibroma, Ganchos para fistulas

Instruments pour myomes, Crochets pour fistules

Strumenti per miomi, Uncini per fistole

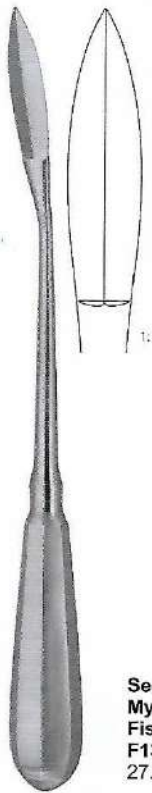

**Segond
Myoma Knife
Fistula Hook
F13-314
27.0 cm 10 3/4"**

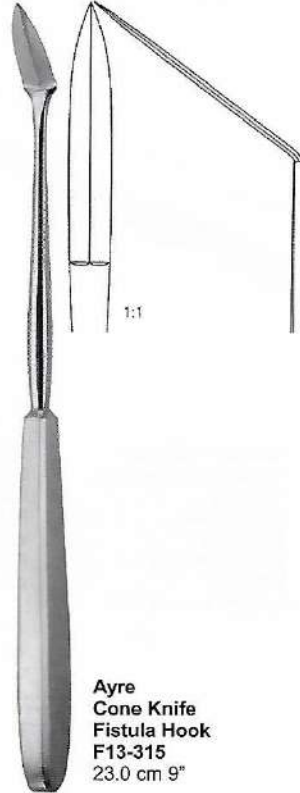

**Ayre
Cone Knife
Fistula Hook
F13-315
23.0 cm 9"**



**Doyen
Myoma Screw
And Fistula Hook
F13-316
17.0 cm 6 3/4"**



**Fig. 1
F13-317
22.0 cm 8 3/4"**

**Simon
Fistula Hook,
One Prong**



**Fig. 2
F13-318
22.0 cm 8 3/4"**

**Simon
Fistula Hook,
Two Prong**

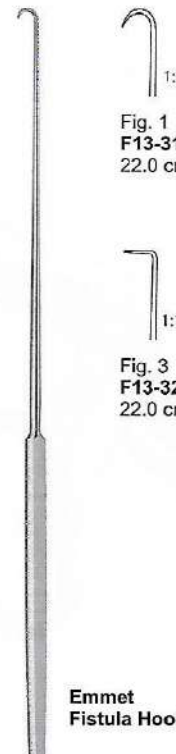

**Emmet
Fistula Hook**



**Fig. 1
F13-319
22.0 cm 8 3/4"**



**Fig. 2
F13-320
22.0 cm 8 3/4"**



**Fig. 3
F13-321
22.0 cm 8 3/4"**



**Fig. 4
F13-322
22.0 cm 8 3/4"**



**Fig. 5
F13-323
22.0 cm 8 3/4"**

BIOPSY CURETTES, ASPIRATING CURETTES



Biopsieküretten, Absaugküretten

Curetas de aspiración

Curettes pour biopsie, Curettes d'aspiration

Curette per aspirazione



Uni - Randall
aspirating curette
F13-324 4 mm Ø
24.0 cm 9 1/2"



Novak
aspirating curette
F13-325 4 mm Ø
23.0 cm 9"

Mini - Novak
aspirating curette
23.5 cm 9 1/4"
F13-326 1 mm Ø
F13-327 2 mm Ø
F13-328 3 mm Ø



Uni - Randall
aspirating curette
F13-329
30.0 cm 12"
rigid, without basket

Uni - Randall
aspirating curette
F13-330
30.0 cm 12"
malleable,
without basket



Uni - Randall
aspirating curette
F13-331
30.0 cm 12"
rigid, with basket

Uni - Randall
aspirating curette
F13-332
30.0 cm 12"
malleable,
with basket

- Specimen And Aspirating Curette**
20.0 cm 11 1/2"
- F13-333 3 mm Ø
 - F13-334 4 mm Ø
 - F13-335 6 mm Ø
 - F13-336 8 mm Ø
 - F13-337 10 mm Ø
 - F13-338 12 mm Ø
 - F13-339 14 mm Ø

Coupling Piece
aspirating curette
12.0 cm 4 3/4"
F13-340



Braun Uterine Depressor
F13-341 28.0 cm 11"



Blake Double Ended
F13-342 245mm (9.3/4")
Sharp / Blunt



Zweifel Double Ended
F13-343 245mm (9.3/4")
Sharp / Sharp



UTERINE CURETTES

Uterusküretten | Curettes uterinas
Curettes utérines | Curette uterine

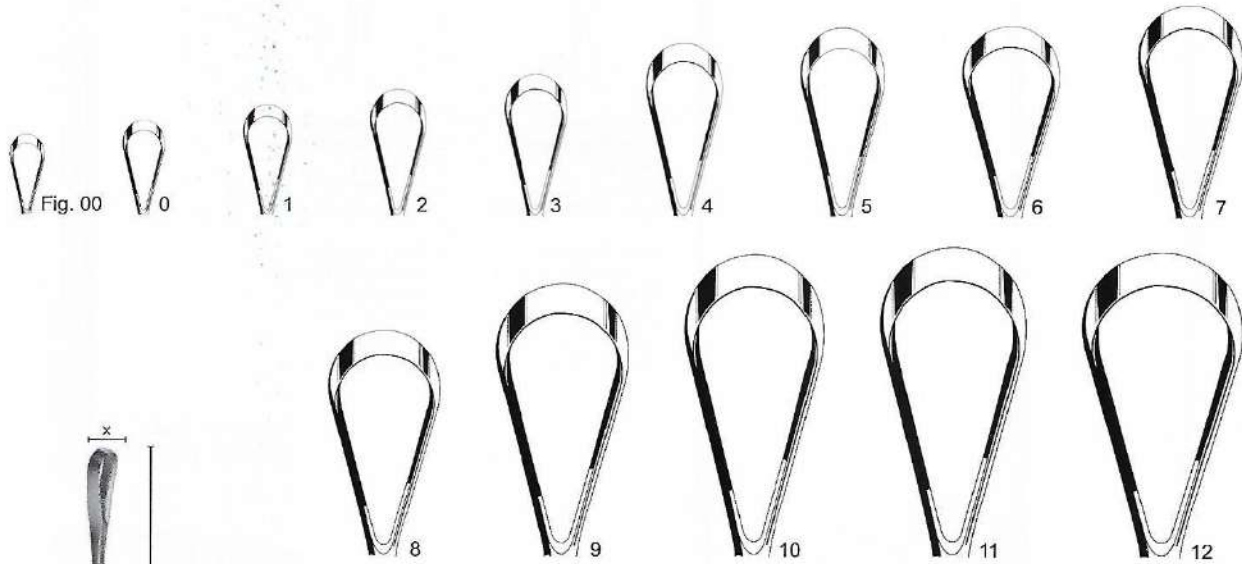

Recamier
uterine curette
y=26.0 cm 10 1/4"

Fig.	x=mm	Sharp, malleable	Blunt, malleable	Sharp, rigid	Blunt, rigid
00	5	F13-344	F13-358	F13-372	F13-386
0	6	F13-345	F13-359	F13-373	F13-387
1	7	F13-346	F13-360	F13-374	F13-388
2	8	F13-347	F13-361	F13-375	F13-389
3	9	F13-348	F13-362	F13-376	F13-390
4	11	F13-349	F13-363	F13-377	F13-391
5	12	F13-350	F13-364	F13-378	F13-392
6	14	F13-351	F13-365	F13-379	F13-393
7	15	F13-352	F13-366	F13-380	F13-394
8	16	F13-353	F13-367	F13-381	F13-395
9	19	F13-354	F13-368	F13-382	F13-396
10	20	F13-355	F13-369	F13-383	F13-397
11	21	F13-356	F13-370	F13-384	F13-398
12	23	F13-357	F13-371	F13-385	F13-399

Recamier
uterine curette
y=31.0 cm 12 1/4"

Fig.	x=mm	Sharp, malleable	Blunt, malleable	Sharp, rigid	Blunt, rigid
00	5	F13-400	F13-414	F13-428	F13-442
0	6	F13-401	F13-415	F13-429	F13-443
1	7	F13-402	F13-416	F13-430	F13-444
2	8	F13-403	F13-417	F13-431	F13-445
3	9	F13-404	F13-418	F13-432	F13-446
4	11	F13-405	F13-419	F13-433	F13-447
5	12	F13-406	F13-420	F13-434	F13-448
6	14	F13-407	F13-421	F13-435	F13-449
7	15	F13-408	F13-422	F13-436	F13-450
8	16	F13-409	F13-423	F13-437	F13-451
9	19	F13-410	F13-424	F13-438	F13-452
10	20	F13-411	F13-425	F13-439	F13-453
11	21	F13-412	F13-426	F13-440	F13-454
12	23	F13-413	F13-427	F13-441	F13-455

UTERINE CURETTES



Uterusküretten
Curettes utérines

Curettes uterinas
Curette uterine

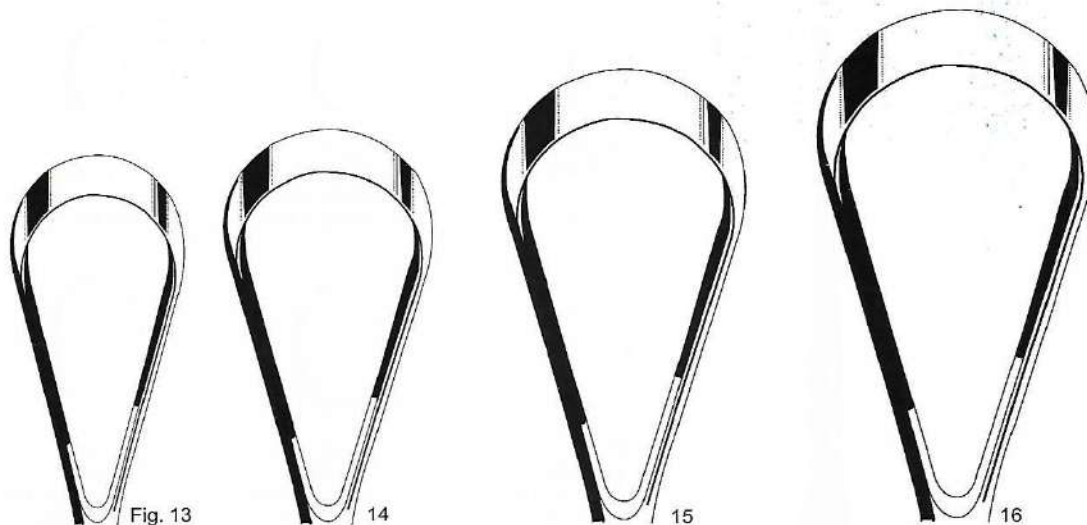

Fig.	x=mm	Sharp, malleable	Blunt, malleable	Sharp, rigid	Blunt, rigid
13	25	F13-456	F13-460	F13-464	F13-468
14	30	F13-457	F13-461	F13-465	F13-469
15	35	F13-458	F13-462	F13-466	F13-470
16	40	F13-459	F13-463	F13-467	F13-471

Recamier
uterine curette
y=34.0 cm 13 1/2"

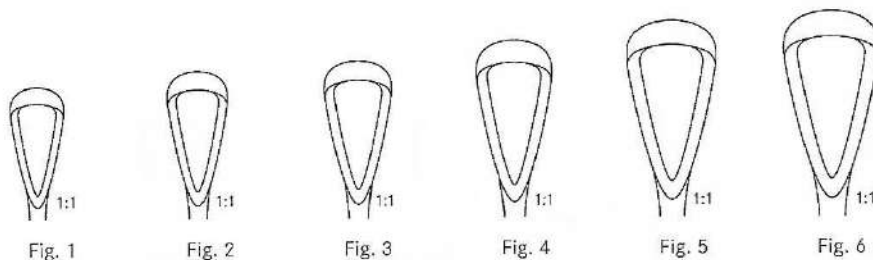

Fig.	x=mm	Sharp, malleable	Blunt, malleable	Sharp, rigid	Blunt, rigid
1	7	F13-472	F13-478	F13-484	F13-490
2	8	F13-473	F13-479	F13-485	F13-491
3	9	F13-474	F13-480	F13-486	F13-492
4	11	F13-475	F13-481	F13-487	F13-493
5	12	F13-476	F13-482	F13-488	F13-494
6	14	F13-477	F13-483	F13-489	F13-495

Sims
uterine curette
27.9 cm 11"



UTERINE SPOONS

Scharfe Löffel

Cucharillas cortantes

Curettes tranchantes

Cucchiai taglienti



Fig. 1
F13-496
25.0 cm 9 3/4"
Sharp, rigid



Fig. 2
F13-497
25.0 cm 9 3/4"
Sharp, rigid



Fig. 3
F13-498
25.0 cm 9 3/4"
Sharp, rigid



Fig. 4
F13-499
25.0 cm 9 3/4"
Sharp, rigid

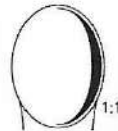

Fig. 5
F13-500
25.0 cm 9 3/4"
Sharp, rigid

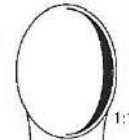

Fig. 6
F13-501
25.0 cm 9 3/4"
Sharp, rigid

Schröder
Uterine Spoon



Fig. 1
F13-502
30.0 cm 12"



Fig. 2
F13-503
30.0 cm 12"



Fig. 3
F13-504
30.0 cm 12"



Fig. 4
F13-505
30.0 cm 12"

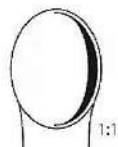

Fig. 5
F13-506
30.0 cm 12"

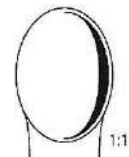

Fig. 6
F13-507
30.0 cm 12"

Schröder
Uterine Spoon

PELVIMETER, OBSTETRICAL FORCEPS



Beckenzirkel, Geburtszangen
Pelvimètre, Forceps obstétriques

Pelvimetro, Forceps obstétricos
Pelvimetri, Forcipi obstetrici

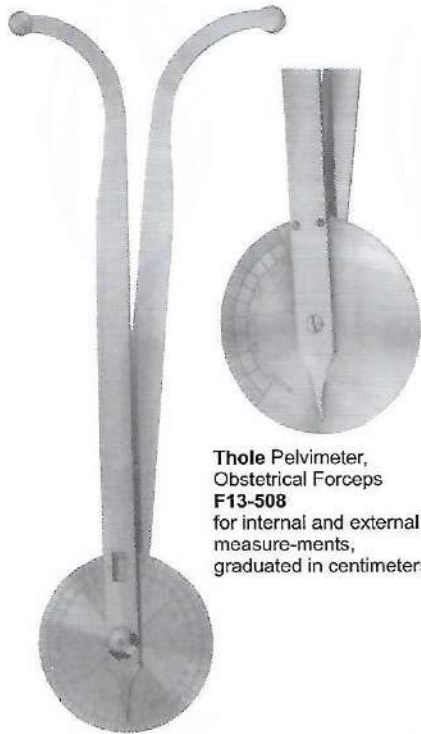

Thole Pelvimeter, Obstetrical Forceps F13-508
for internal and external measurements, graduated in centimeters



De Lee Pelvimeter, Obstetrical Forceps F13-509
graduated in centimeters and inches



Collin Pelvimeter, Obstetrical Forceps F13-510
Graduated in Centimeters



Martin Pelvimeter, Obstetrical Forceps F13-511
graduated in centimeters

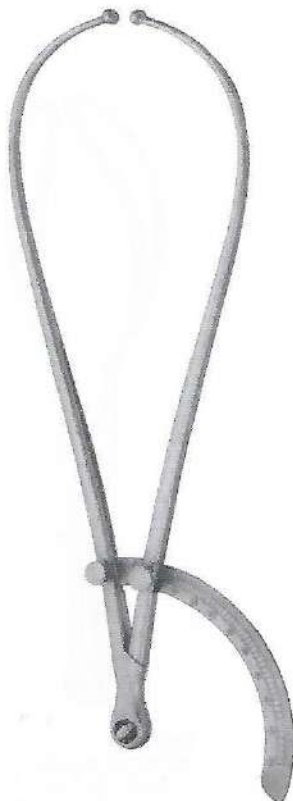

for internal measurements between symphysis and promontory

Collin Pelvimeter, Obstetrical Forceps F13-512
graduated in centimeters



The additional straight arm can be replaced. The pelvimeter with straight arm is used for localisation of the portio vaginalis uteri and of vaginal metastasis.



Breisky Pelvimeter, Obstetrical Forceps F13-513
graduated in centimeters



OBSTETRICAL FORCEPS

Geburtszangen
Forceps obstétriques

Forceps obstétricos
Forcipi



Simpson
obstetrical forceps
F13-514
30.0 cm 12"



Simpson - Braun
obstetrical forceps
F13-515 33.0 cm 13"
F13-516 36.0 cm 14 1/4"

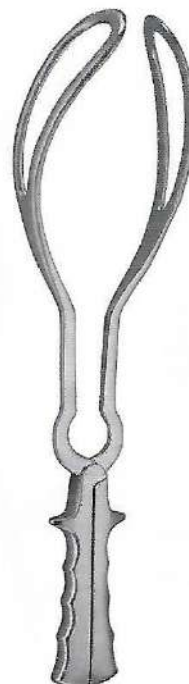

Naegele
obstetrical forceps
F13-517 36.0 cm 14 1/4"
F13-518 40.0 cm 16"



Piper
obstetrical forceps
F13-519
44.0 cm 17 1/4"



Simpson - Luikart
obstetrical forceps
F13-520
36.0 cm 14 1/4"



Wrigley
obstetrical forceps
F13-521 25.0 cm 9 3/4"
for caesarian section



De Lee
obstetrical forceps
F13-522
30.0 cm 12"



De Lee
obstetrical forceps
F13-523 36.0 cm 14 1/4"
F13-524 15.0 cm 15 1/2"

OBSTETRICAL FORCEPS

Geburtszangen
Forceps obstétricus

Forceps obstétricos
Forcipi



Elliot
obstetrical forceps
F13-525 32.0 cm 12 1/2"
F13-526 38.0 cm 15"



McLean
obstetrical forceps
F13-527 36.0 cm 14 1/4"

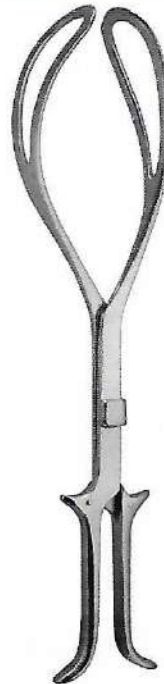

Kielland
obstetrical forceps
F13-528 41.0 cm 16 1/4"



Kielland-Luikart
obstetrical forceps
F13-529 40.0 cm 16"



Braun
obstetrical forceps
F13-530
42.0 cm 16 1/2"
Cranioclast, one
jaw fenestrated



Tarnier
obstetrical forceps
F13-531
46.0 cm 17 1/4"
Basiotribe



Sellheim
Obstetrical Lever
F13-532
28.0 cm 11"



OBSTETRICS

Geburtshilfe | obstetrica
obstétrique | Ostetricia

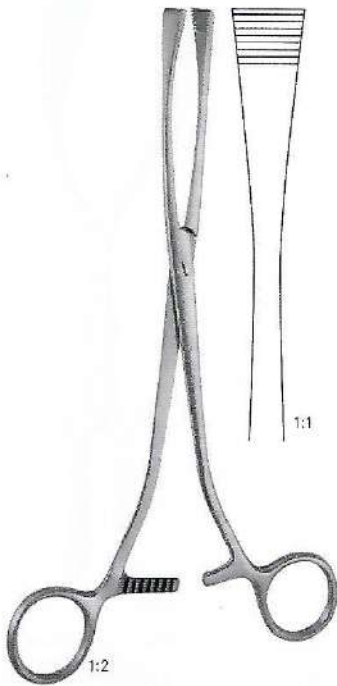

Green-Armytage
Uterine Elevating Forceps
F13-533 21.0 cm 8 1/4"



Smellie
Obstetrical Forceps
F13-534 25.0 cm 10"
Perforator

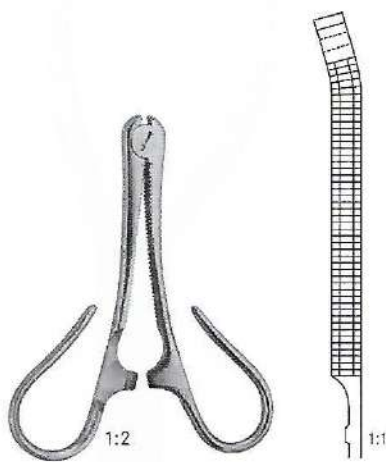

Kane
obstetrical forceps
F13-535
85.0 cm 3 1/4"



Collin
obstetrical forceps
F13-536
90.0 cm 3 1/2"



Braun, Midwifery
Decapitating hook
F13-537
32.5 cm 12 3/4"

ABORTION FORCEPS - OVUM CURETTES



Abortuszangen - Abortusküretten

Pinzas para abort - Curetas para aborto

Pinces à faux germes - Curette d'avortement

Pinze per placenta ed aborto - Curette per placenta ed aborto

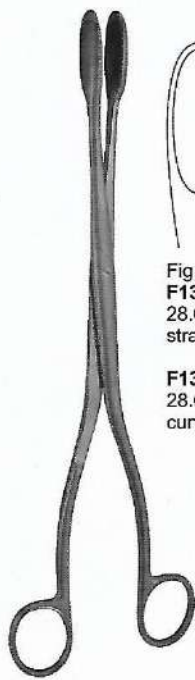

Winter
abortion forceps



Fig. 1
F13-538
28.0 cm 11"
straight

F13-539
28.0 cm 11"
curved

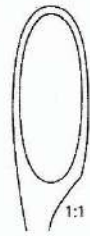

Fig. 2
F13-540
28.0 cm 11"
straight

F13-541
28.0 cm 11"
curved

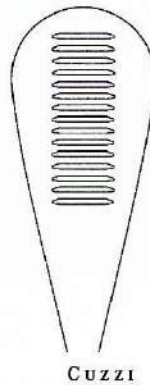

Fig. 3
F13-542
28.0 cm 11"
straight

F13-543
28.0 cm 11"
curved



Cuzzi
ovum curette
blunt, back serrated



C U Z Z I



14.5 mm
F13-544
30.0 cm 12"



18.0 mm
F13-545
30.0 cm 12"



21.0 mm
F13-546
30.0 cm 12"

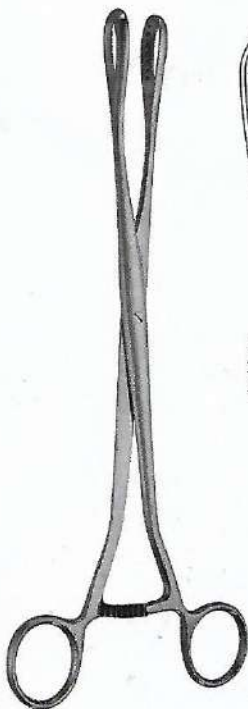

Saenger
abortion forceps

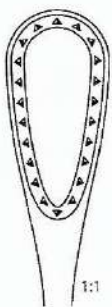

F13-547
27.0 cm 10 3/4"
Straight

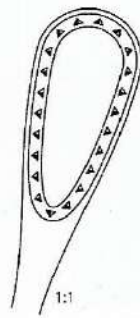

F13-548
27.0 cm 10 3/4"
Curved

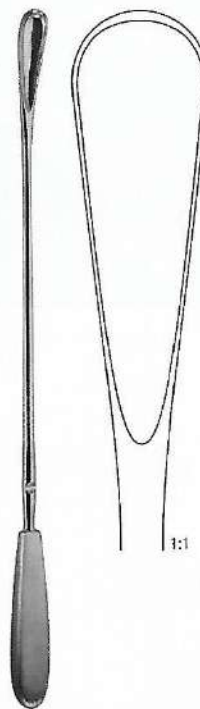

Wallich
ovum curette
F13-549 42.0 cm 16 1/2"



1:1

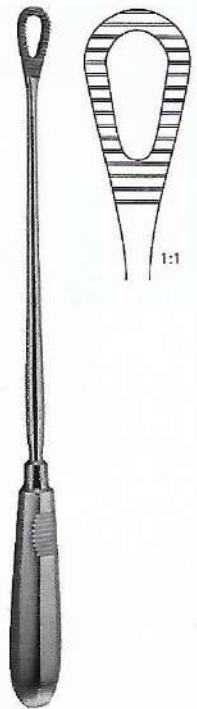

Pestalozza
ovum curette
F13-550 30.0 cm 12"

1:1



UROLOGY INSTRUMENTS



KIDNEY STONE FORCEPS



Nierensteinzangen

Pinces pour les calculs du bassin

Pinzas para cálculos renales

Pinze per calcoli renali



Randall Kidney Stone Clamps Forceps

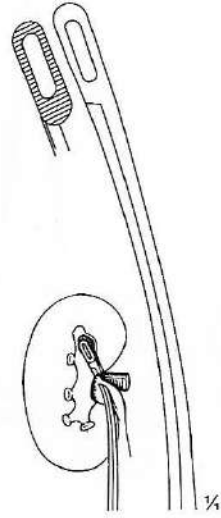

F14-001
23 cm, 9"
quarter curved

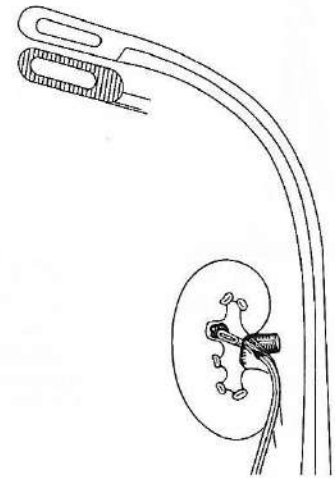

F14-002
23 cm, 9"
half curved

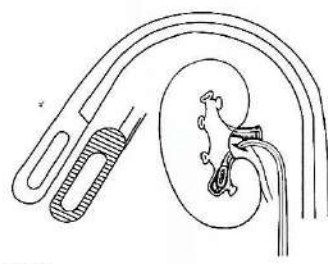

F14-003
23 cm, 9"
full curved

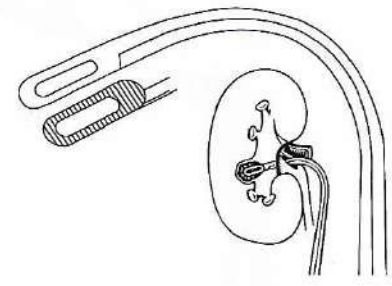

F14-004
23 cm, 9"
three quarter curved



KIDNEY STONE FORCEPS

Nierensteinzangen

Pinces pour les calculs du bassin

Pinzas para cálculos renales

Pinze per calcoli renali

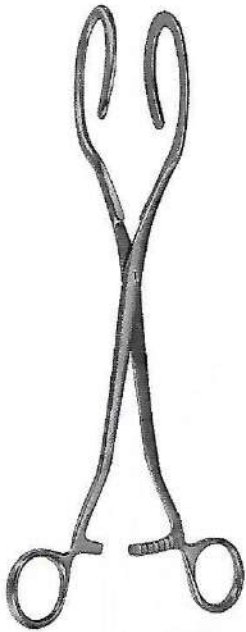

Dartigues Uterine Elevating Forceps
F14-005
27 cm, 10 3/4"



Collin Kidney Elevating Stone Clamps Forceps
F14-006
28.5 cm, 11 1/4"



Hulka-Kenwick Uterine Elevating & Manipulating Forceps
F14-007
27.3 cm, 11"



Sommer Kidney Elevating Stone Clamps Forceps
F14-008
23.5 cm, 9"



Strassmann Kidney Elevating Stone Clamps Forceps
F14-009
26 cm, 10 1/4"



Collin Kidney Elevating Stone Clamps Forceps
F14-010
26.5 cm, 10 1/2"

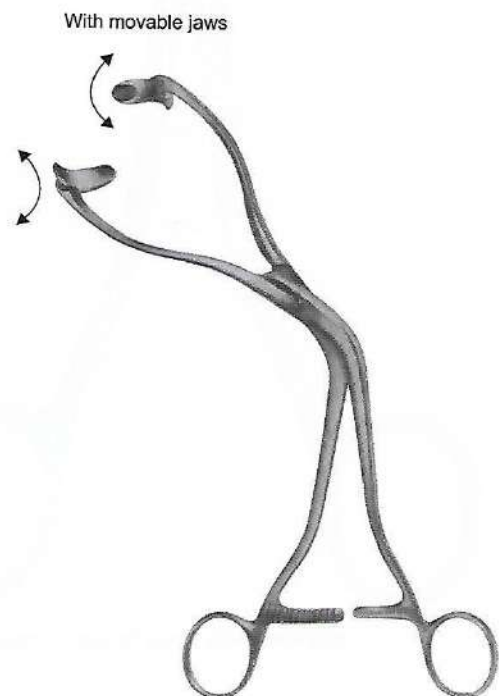

Collin Kidney Elevating Stone Clamps Forceps
F14-011
26 cm, 10 1/4"

PROSTATIC RETRACTOR



Prostatahaken

Separadores para próstata

Ecarteurs prostatiques

Divaricatori prostatici

11 x 50 mm

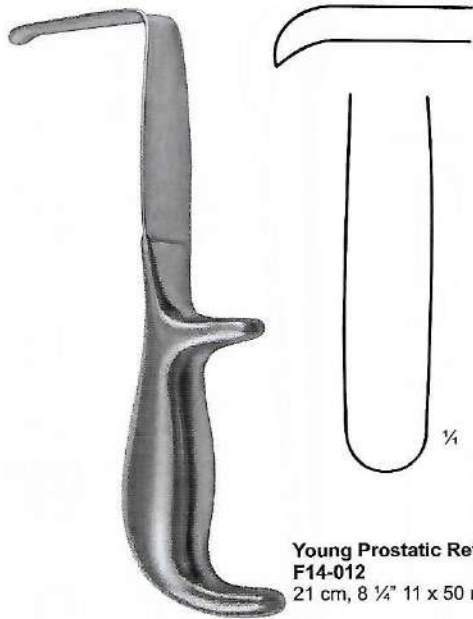

**Young Prostatic Retractor
F14-012**
21 cm, 8 1/4" 11 x 50 mm

38 x 64 mm

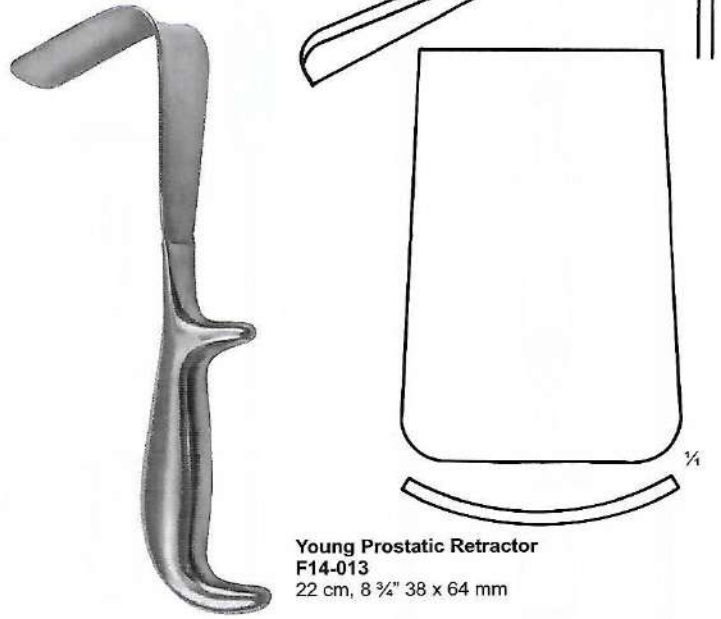

**Young Prostatic Retractor
F14-013**
22 cm, 8 3/4" 38 x 64 mm

25 x 25 mm

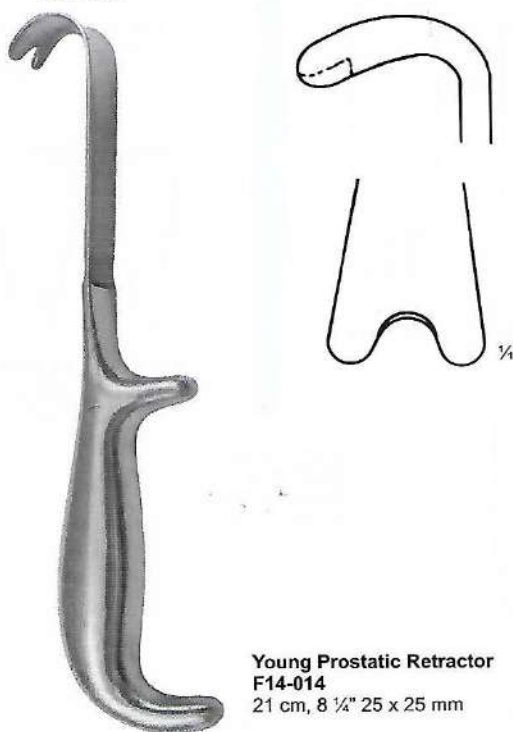

**Young Prostatic Retractor
F14-014**
21 cm, 8 1/4" 25 x 25 mm

39 x 35 mm

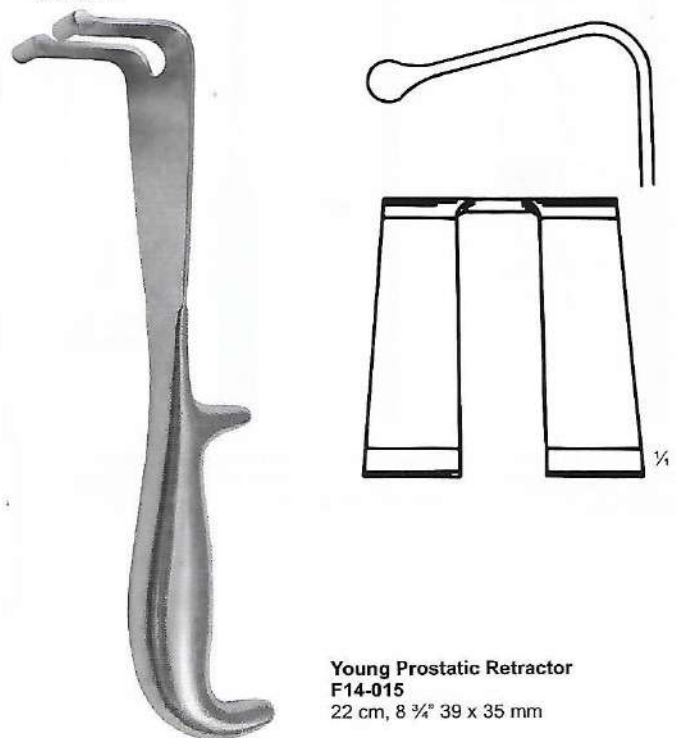

**Young Prostatic Retractor
F14-015**
22 cm, 8 3/4" 39 x 35 mm



GALL DUCT DILATOR

Gallenkanaldilatatoren
Gallensteinzangen

Dilatateurs pour les voies biliaires
Pinces pour calculs biliaires



F14-016
17 F.G.



F14-017
21 F.G.



F14-018
24 F.G.



F14-019
27 F.G.

**Desjardins Probe
& Catch with flexible
shaft 28 cm, 11"**



**Moynihan
F14-020
34.0 cm, 13 1/2"**



**Bakes Common Bile
Duct Dilators, Malleable
Set of 13, 32 cm, 13"**



Fig. 1
F14-021



Fig. 2
F14-022



Fig. 3
F14-023



Fig. 4
F14-024



Fig. 5
F14-025

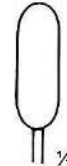

Fig. 6
F14-026



Fig. 7
F14-027



Fig. 8
F14-028



Fig. 9
F14-029



Fig. 10
F14-030



Fig. 11
F14-031



Fig. 12
F14-032



Fig. 13
F14-033



F14-034
2.8mm
Fig. 000



F14-035
3.4mm
Fig. 00



F14-036
4.3mm
Fig. 0



F14-037
5.5mm
Fig. 1



F14-038
6.7mm
Fig. 0



F14-039
8.0mm
Fig. 3



F14-040
11mm
Fig. 4



F14-041
15mm
Fig. 5

**Luer-Koerte
Modif With
Malleable Shaft
31 cm, 12.20"**

URETHRAL CATHETERS

Urethalkatheter | Cateteri Uretrali
Sondes Urétrales | Catéteres Uretrales



Catheter
F14-042
15 cm, 6"
No. 6-16

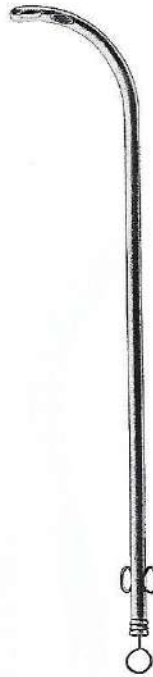

Catheters
F14-043 29 cm, 11 1/2"
Male Catheters charr., Metal

French
F14-044 8
F14-045 10
F14-046 12
F14-047 14
F14-048 16
F14-049 18
F14-050 20

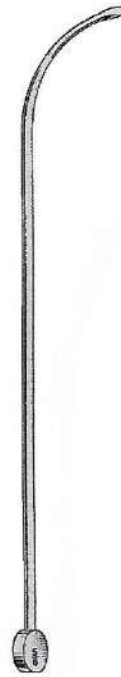

Lister Bougies
F14-051
27 cm, 10 3/4"
00 / 1 to 15 / 18
set of 17



Clutton Bougies
F14-052 27 cm, 10 3/4"
06 / 10 FG to 28 / 32
set of 12



Van Buren
Urethral Sound
A TO O
Set of 15

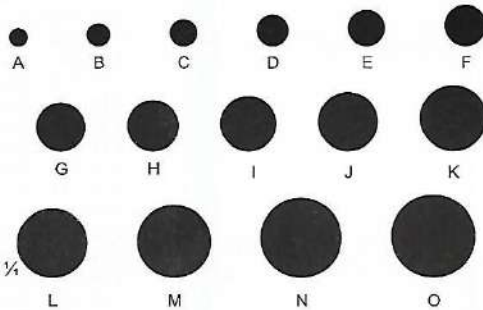
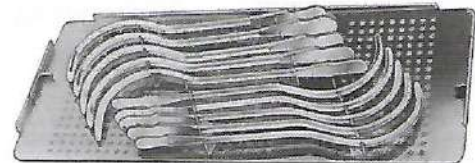
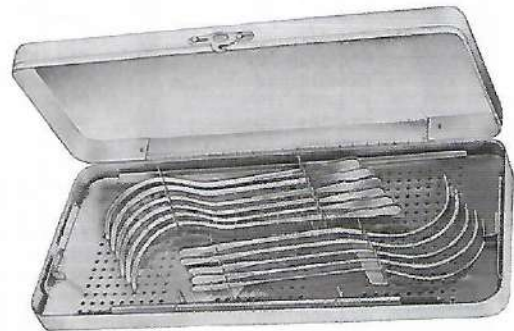

Fig.	Item	Description	Inches	Dia. Charr
A	F14-053	28 cm	11"	8 French
B	F14-054	28 cm	11"	10 French
C	F14-055	28 cm	11"	12 French
D	F14-056	28 cm	11"	14 French
E	F14-057	28 cm	11"	16 French
F	F14-058	28 cm	11"	18 French
G	F14-059	28 cm	11"	20 French
H	F14-060	28 cm	11"	22 French
I	F14-061	28 cm	11"	24 French
J	F14-062	28 cm	11"	26 French
K	F14-063	28 cm	11"	28 French
L	F14-064	28 cm	11"	30 French
M	F14-065	28 cm	11"	32 French
N	F14-066	28 cm	11"	34 French
O	F14-067	28 cm	11"	36 French



Guyon
F14-068
420 x 175 x 40 mm
Set in metal case containing:
— 21 Bougies Guyon
— 6 filiform Bougies



URETHRAL CATHETERS

Urethalkatheter
Sondes Urétrales

Cateteri Uretrali
Catéteres Uretrales



Dittel
F14-069
22.5 cm, 8 3/4"
urethral bougies and
dilating sounds

	Charr. (French)
F14-070	8
F14-071	9
F14-072	10
F14-073	11
F14-074	12
F14-075	13
F14-076	14
F14-077	15
F14-078	16
F14-079	17
F14-080	18
F14-081	19
F14-082	20
F14-083	21
F14-084	22
F14-085	23
F14-086	24
F14-087	25
F14-088	26
F14-089	27
F14-090	28
F14-091	29
F14-092	30

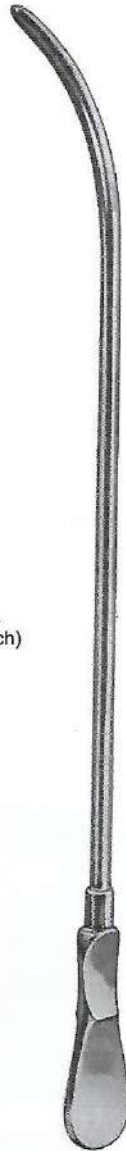

Dittel
14-093
35 cm, 14"
urethral bougies and
dilating sounds

	Charr. (French)
F14-094	8
F14-095	9
F14-096	10
F14-097	11
F14-098	12
F14-099	13
F14-100	14
F14-101	15
F14-102	16
F14-103	17
F14-104	18
F14-105	19
F14-106	20
F14-107	21
F14-108	22
F14-109	23
F14-110	24
F14-111	25
F14-112	26
F14-113	27
F14-114	28
F14-115	29
F14-116	30



14-217
33 cm, 13"
filiform guides,
olive tip

	Charr. (French)
F14-118	3
F14-119	4
F14-120	5
F14-121	6

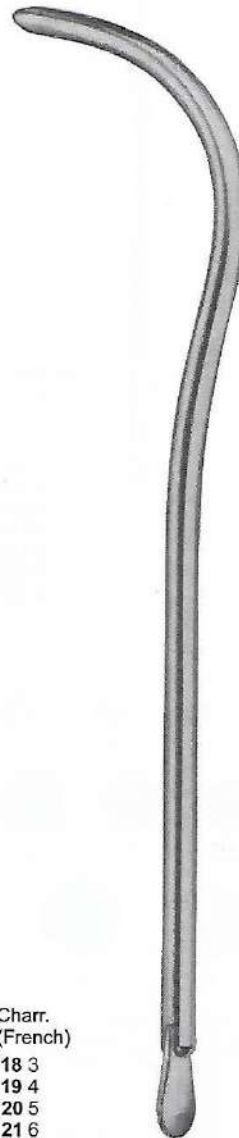

Guyon
F14-122
25 cm, 10"
urethral bougies and
dilating sounds
without filiform guides,
with thread in tip

	Charr. (French)
F14-123	Ben. 24 / Charr. 12
F14-124	Ben. 25
F14-125	Ben. 26 / Charr. 13
F14-126	Ben. 27
F14-127	Ben. 28 / Charr. 14
F14-128	Ben. 29
F14-129	Ben. 30 / Charr. 15
F14-130	Ben. 31
F14-131	Ben. 32 / Charr. 16
F14-132	Ben. 33
F14-133	Ben. 34 / Charr. 17
F14-134	Ben. 35
F14-135	Ben. 36 / Charr. 18
F14-136	Ben. 37
F14-137	Ben. 38 / Charr. 19
F14-138	Ben. 39
F14-139	Ben. 40 / Charr. 20
F14-140	Ben. 41
F14-141	Ben. 42 / Charr. 21
F14-142	Ben. 43
F14-143	Ben. 44 / Charr. 22
F14-144	Ben. 45
F14-145	Ben. 46 / Charr. 23
F14-146	Ben. 47
F14-147	Ben. 48 / Charr. 24
F14-148	Ben. 49
F14-149	Ben. 50 / Charr. 25
F14-150	Ben. 51
F14-151	Ben. 52 / Charr. 26
F14-152	Ben. 53
F14-153	Ben. 54 / Charr. 27
F14-154	Ben. 55
F14-155	Ben. 56 / Charr. 28
F14-156	Ben. 57
F14-157	Ben. 58 / Charr. 29
F14-158	Ben. 59
F14-159	Ben. 60 / Charr. 30

GALL STONE FORCEPS



Gallensteinzangen
Gallensteinlöffel

Pinces pour calculs biliaires
Curettes pour calculs biliaires

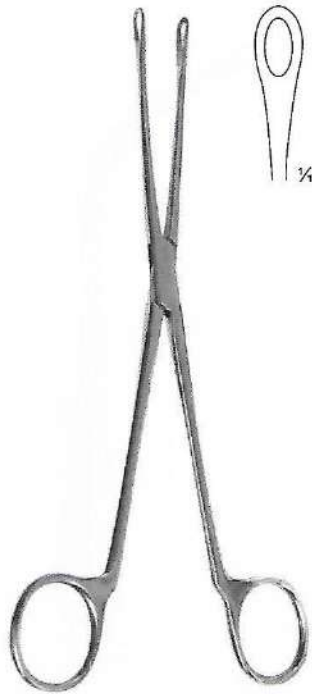

Blake Gall Stone Forceps
F14-160 20 cm, 8"
Straight

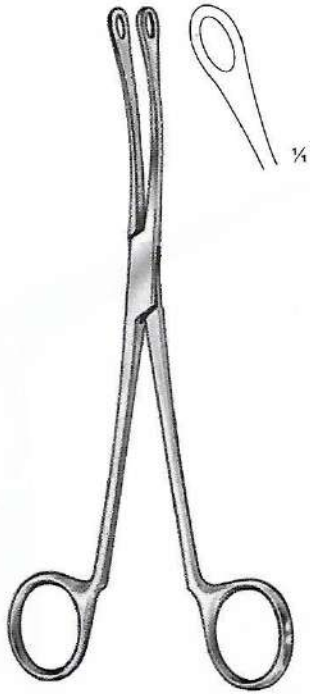

Blake Gall Stone Forceps
F14-161 20 cm, 8"
Curved

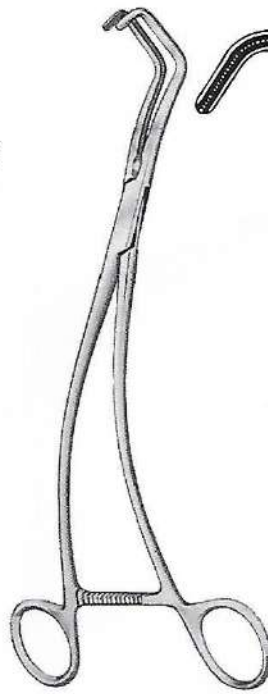

Uro-Tangential Gall Stone Forceps



F14-162
26 cm, 10 1/4"



F14-163
26 cm, 10 1/4"



Mayo-Blake Gall Stone Forceps
F14-164 20 cm, 8"
Straight

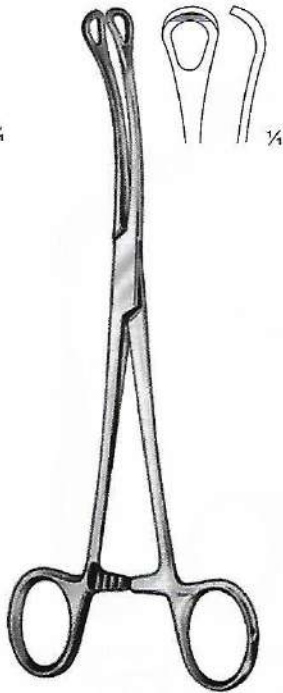

Mayo-Blake Gall Stone Forceps
F14-165 20 cm, 8"
Curved

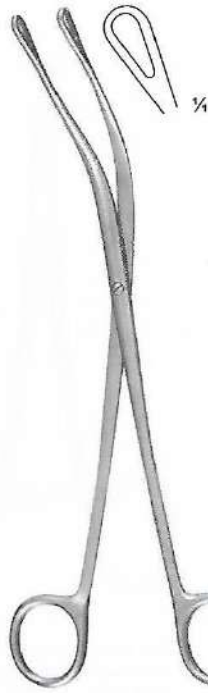

Mixer Gall Stone Forceps
F14-166 22 cm, 8 3/4"



Desjardins Gall Stone Forceps
F14-167 23 cm, 9"

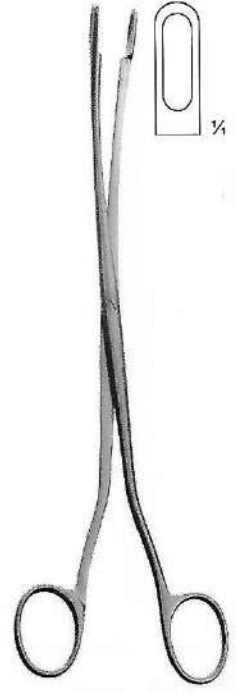

Desjardins Gall Stone Forceps
F14-168 23 cm, 9"



HERNIA DIRECTOR, VASECTOMY FORCEPS, CLAMP & BLADDER RETRACTOR

Leistenbruch Director, Vasektomie Zange, Schraubstock & Blase Retractor
Directora Hernia, Pinzas vasetomia, abrazadera y la vejiga retractor

Directeur de hernie, Pinces de vasetomie, Clamp et la vessie enrrouleur
Direttore Ernia, Pinze vasetomia, Clamp & vescica Divarcatore



Child Hernia Director
F14-169



Key Hernia Director
F14-170



Teale Hernia Director
F14-171

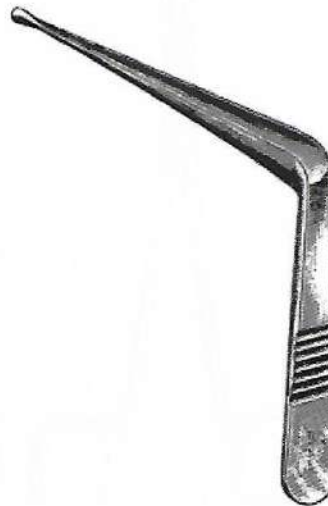

Millin Suction Tube
F14-172

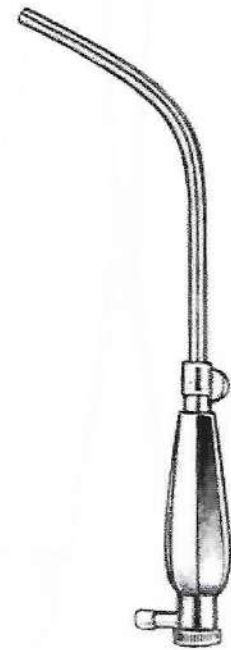

Cord Hook
F14-173
blunt 16cm



Gutmann Secretions Scoop
F14-174 26cm

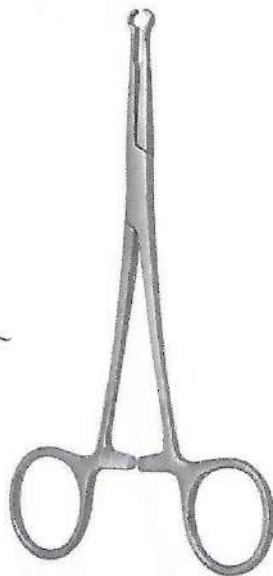

No Scalpel Vasectomy Ringed Forceps Clamps
F14-175 14cm, 5.5"



No Scalpel Vasectomy Hemostat Forceps
F14-176 14cm, 5.5"
smooth sharp point curved

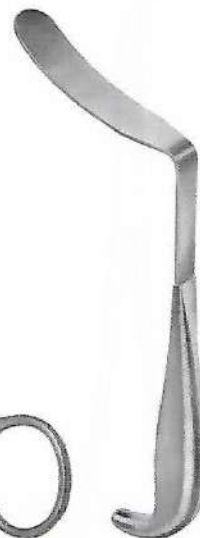

Legueu Bladder Retractor
F14-177



Kocher's Bladder retractor
F14-178 23.5 cm, 9.25"

BLADDER NECK SPREADER, BLADDER RETRACTORS



Blasenhalsperrer, Blasenwundsperrer

Dilatador para el cuello vesical, Separadores vesicales

Ecarteur pour le col de la vessie, Ecarteurs vésicaux

Divaricatore del collo vescicale, Divaricatore vescicale

**Knutson
F14-179
18 cm, 7"
Urethrographie-Instruments**



F14-180
Spare



Winkelmann Circumcision Clamps
F14-181 12 mm Ø
F14-182 16 mm Ø
F14-183 20 mm Ø

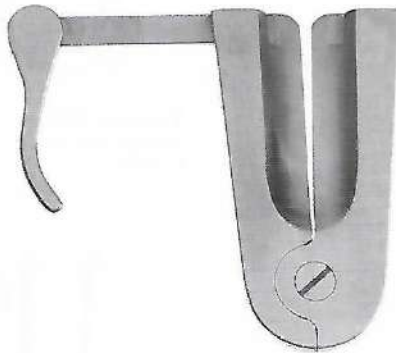

**Mogen Circumcision Clamp
F14-184**

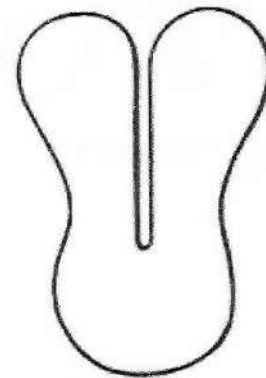

**Circumcision Shield
F14-185
10cm**

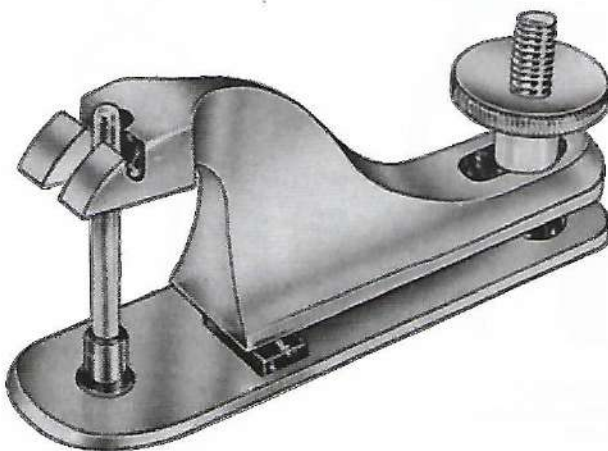

**Gumco Circumcision
Clamp**

	mm Ø
F14-186	8
F14-187	11
F14-188	13
F14-189	16
F14-190	21
F14-191	26
F14-192	32

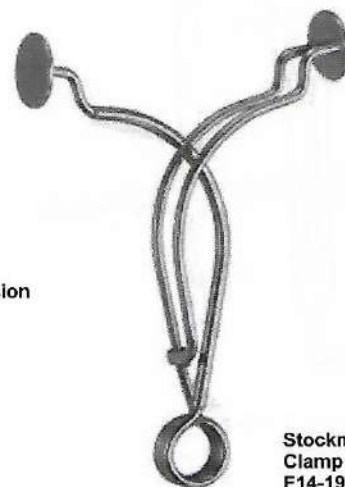

**Stockmann Penile
Clamp
F14-193 8cm**



BLADDER NECK SPREADER, BLADDER RETRACTORS

Blasenhalsperrerr, Blasenwundsperrerr

Dilatador para el cuello vesical, Separadores vesicales

Ecarteur pour le col de la vessie, Ecarteurs vésicaux

Divaricatore del collo vescicale, Divaricatore vescicale



**Legueu Bladder Spatula
F14-194**

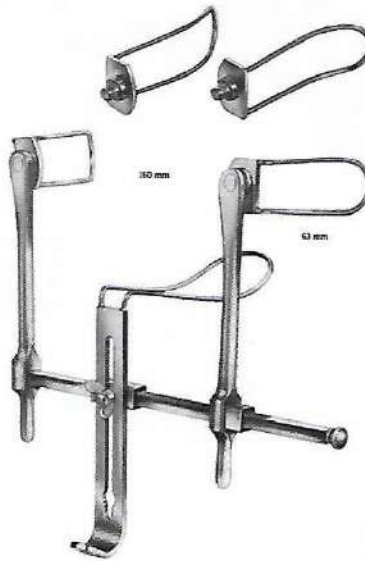

**Gosset Bladder Retractor
F14-195 160mm**



**Thomson Walker Bladder Retractor
F14-196**

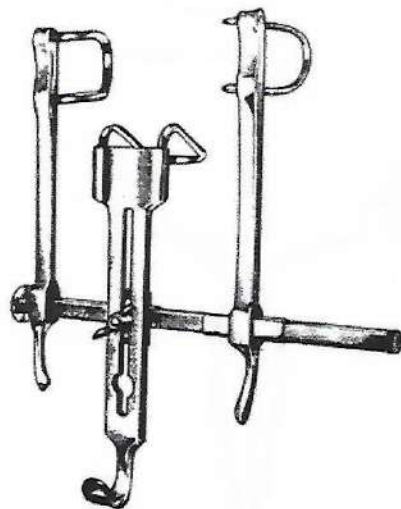

**Pantings Bladder Retractor
F14-197**



**Judd Masson Bladder Retractor
F14-198
w/center blade**



**Millin Bladder Neck Spreader
F14-199
28 cm, 11"**



HOLLOW WARES

MESH BASKETS

JARS

KIDNEY TRAYS

INSTRUMENTS BOXES

STERILIZING DRUMS





STERILIZING DRUMS

Sterilisieren Schlagzeug

Tambours de stérilisation

Tambores de esterilización

Tamburi di sterilizzazione



STERILIZING DRUMS

	Ø	h
	mm	mm
F15-001	80 x 80	mm
F15-002	120 x 120	mm
F15-003	160 x 120	mm
F15-004	190 x 140	mm
F15-005	190 x 200	mm
F15-006	240 x 120	mm
F15-007	240 x 160	mm
F15-008	240 x 240	mm
F15-009	290 x 120	mm
F15-010	290 x 160	mm
F15-011	290 x 240	mm
F15-012	340 x 160	mm
F15-013	340 x 240	mm
F15-014	390 x 145	mm
F15-015	390 x 200	mm
F15-016	390 x 290	mm



STERILIZING DRUM

	Ø	h
	mm	Size mm
F15-017	150 x 150	mm
F15-018	175 x 175	mm
F15-019	190 x 190	mm
F15-020	200 x 140	mm
F15-021	200 x 200	mm
F15-022	240 x 120	mm
F15-023	225 x 225	mm
F15-024	240 x 240	mm
F15-025	290 x 160	mm
F15-026	280 x 240	mm
F15-027	230 x 150	mm
F15-028	300 x 250	mm
F15-029	340 x 250	mm
F15-030	350 x 250	mm
F15-031	390 x 200	mm

STERILIZING DRUM

	Ø	h
	mm	Size mm
F15-032	150 x 150	mm
F15-033	175 x 175	mm
F15-034	190 x 190	mm
F15-035	200 x 140	mm
F15-036	200 x 200	mm
F15-037	240 x 120	mm
F15-038	225 x 225	mm
F15-039	240 x 240	mm
F15-040	290 x 160	mm
F15-041	280 x 240	mm
F15-042	230 x 150	mm
F15-043	300 x 250	mm
F15-044	340 x 250	mm
F15-045	350 x 250	mm
F15-046	390 x 200	mm

STERILIZING DRUM

	Ø	h
	mm	Size mm
F15-047	150 x 150	mm
F15-048	175 x 175	mm
F15-049	190 x 190	mm
F15-050	200 x 140	mm
F15-051	200 x 200	mm
F15-052	240 x 120	mm
F15-053	225 x 225	mm
F15-054	240 x 240	mm
F15-055	290 x 160	mm
F15-056	280 x 240	mm
F15-057	230 x 150	mm
F15-058	300 x 250	mm
F15-059	340 x 250	mm
F15-060	350 x 250	mm
F15-061	390 x 200	mm

STERILIZING DRUM

	Ø	h
	mm	Size mm
F15-062	150 x 150	mm
F15-063	175 x 175	mm
F15-064	190 x 190	mm
F15-065	200 x 140	mm
F15-066	200 x 200	mm
F15-067	240 x 120	mm
F15-068	225 x 225	mm
F15-069	240 x 240	mm
F15-070	290 x 160	mm
F15-071	280 x 240	mm
F15-072	230 x 150	mm
F15-073	300 x 250	mm
F15-074	340 x 250	mm
F15-075	350 x 250	mm
F15-076	390 x 200	mm

HOLLOWARE INSTRUMENTS

Hohlware Instrumenten
Orfebreria Instrumentos

orfèvrerie de Instruments de
Holloware Gli strumenti



G LOVES BOX
F15-077
300 x 150 mm



INSTRUMENT TRAY WITH COVER
F15-078



INSTRUMENT TRAY
F15-079



CATHER TRAY

	Size
F15-080	230 x 75 mm
F15-081	350 x 90 mm
F15-082	430 x 100 mm
F15-083	200 x 100 mm
F15-084	300 x 100 mm
F15-085	350 x 100 mm



PERFORATED BOX

	Size
F15-086	100 x 50 mm
F15-087	165 x 65 mm
F15-088	250 x 100 mm
F15-089	250 x 150 mm
F15-090	250 x 200 mm
F15-091	150 x 65 mm
F15-092	170 x 70 mm
F15-093	200 x 100 mm
F15-094	250 x 125 mm
F15-095	300 x 150 mm
F15-096	300 x 200 mm
F15-097	300 x 130 mm
F15-098	320 x 150 mm
F15-099	420 x 180 mm
F15-100	460 x 125 mm
F15-101	355 x 180 mm
F15-102	300 x 180 mm
F15-103	400 x 200 mm
F15-104	510 x 200 mm

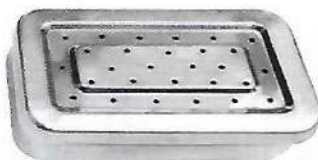

BOX WITH FILTER

	Size
F15-105	100 x 50 mm
F15-106	165 x 65 mm
F15-107	250 x 100 mm
F15-108	250 x 150 mm
F15-109	250 x 200 mm
F15-110	150 x 65 mm
F15-111	170 x 70 mm
F15-112	200 x 100 mm
F15-113	250 x 125 mm
F15-114	300 x 150 mm
F15-115	300 x 200 mm
F15-116	300 x 130 mm
F15-117	320 x 150 mm
F15-118	420 x 180 mm
F15-119	460 x 125 mm
F15-120	355 x 180 mm
F15-121	300 x 180 mm
F15-122	400 x 200 mm
F15-123	510 x 200 mm

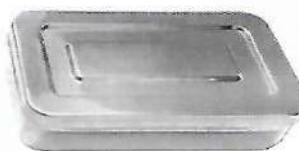

INSTRUMENTS BOX

Without Clip	Size
F15-124	100 x 50 mm
F15-125	165 x 65 mm
F15-126	250 x 100 mm
F15-127	250 x 150 mm
F15-128	250 x 200 mm
F15-129	150 x 65 mm
F15-130	170 x 70 mm
F15-131	200 x 100 mm
F15-132	250 x 125 mm
F15-133	300 x 150 mm
F15-134	300 x 200 mm
F15-135	300 x 130 mm
F15-136	320 x 150 mm
F15-137	420 x 180 mm
F15-138	460 x 125 mm
F15-139	355 x 180 mm
F15-140	300 x 180 mm
F15-141	400 x 200 mm
F15-142	510 x 200 mm



INSTRUMENT BOX

With Clip	Size
F15-143	100 x 50 mm
F15-144	165 x 65 mm
F15-145	250 x 100 mm
F15-146	250 x 150 mm
F15-147	250 x 200 mm
F15-148	150 x 65 mm
F15-149	170 x 70 mm
F15-150	200 x 100 mm
F15-151	250 x 125 mm
F15-152	300 x 150 mm
F15-153	300 x 200 mm
F15-154	300 x 130 mm
F15-155	320 x 150 mm
F15-156	420 x 180 mm
F15-157	460 x 125 mm
F15-158	355 x 180 mm
F15-159	300 x 180 mm
F15-160	400 x 200 mm
F15-161	510 x 200 mm



HOLLOWARE INSTRUMENTS

Hohlware Instrumenten
Orfebreria Instrumentos

orfèverie de Instruments de
Holloware Gli strumenti

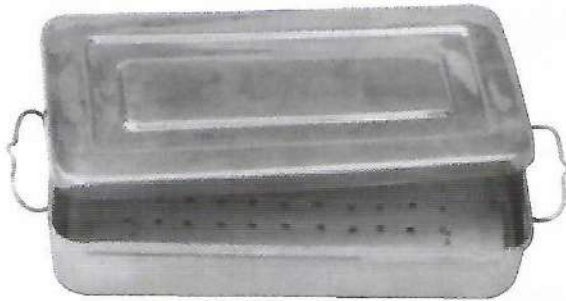

INSTRUMENT BOILER

	Size
F15-162	180 x 80 x 40 mm
F15-163	200 x 100 x 50 mm
F15-164	250 x 125 x 40 mm
F15-165	300 x 150 x 60 mm
F15-166	350 x 175 x 75 mm
F15-167	400 x 200 x 100 mm



PERFORATED TRAY

	Size
F15-168	180 x 80 x 40 mm
F15-169	200 x 100 x 50 mm
F15-170	250 x 125 x 40 mm
F15-171	300 x 150 x 60 mm
F15-172	350 x 175 x 75 mm
F15-173	400 x 200 x 100 mm



INSTRUMENT BOILER WITH STAND

	Size
F15-174	180 x 80 x 40 mm
F15-175	200 x 100 x 50 mm
F15-176	250 x 125 x 40 mm
F15-177	300 x 150 x 60 mm
F15-178	350 x 175 x 75 mm
F15-179	400 x 200 x 100 mm



INSTRUMENT BOILER ELECTRIC

	Size
F15-180	180 x 80 x 40 mm
F15-181	200 x 100 x 50 mm
F15-182	250 x 125 x 40 mm
F15-183	300 x 150 x 60 mm
F15-184	350 x 175 x 75 mm
F15-185	400 x 200 x 100 mm

HOLLOWARE INSTRUMENTS



Hohlware Instrumenten
Orfebreria Instrumentos

orfèbrerie de Instruments de
Holloware Gli strumenti



NEEDLE CASE
F15-186
230 x 125 mm

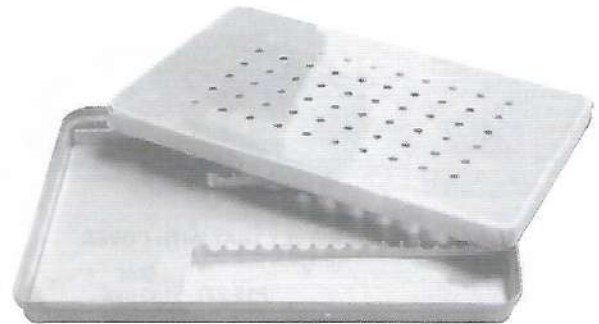

SCALER BOX
F15-187
300 x 180 mm

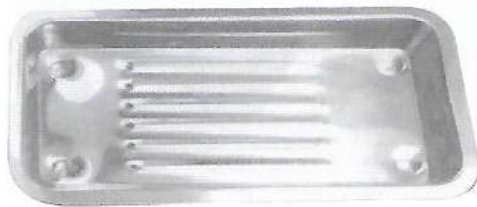

SCALER TRAY
F15-188
100 x 200 mm



INDO BOX WITH SILVER FRAME
F15-189



Autoclaveable
F15-190

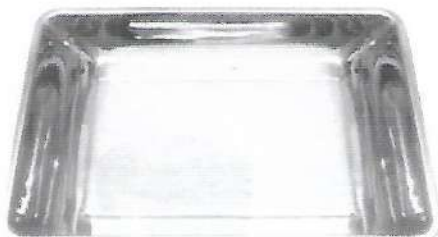

INSTRUMENT TRAY WITHOUT COVER

	Size		Size
F15-191	240 x 240 mm	F15-202	230 x 125 mm
F15-192	355 x 400 mm	F15-203	200 x 150 mm
F15-193	300 x 150 mm	F15-204	250 x 200 mm
F15-194	300 x 180 mm	F15-205	300 x 250 mm
F15-195	300 x 240 mm	F15-206	350 x 300 mm
F15-196	340 x 320 mm	F15-207	400 x 350 mm
F15-197	230 x 180 mm	F15-208	450 x 300 mm
F15-198	250 x 130 mm	F15-209	300 x 200 mm
F15-199	200 x 130 mm	F15-210	350 x 250 mm
F15-200	180 x 130 mm	F15-211	250 x 125 mm
F15-201	150 x 100 mm	F15-212	200 x 100 mm
		F15-213	400 x 200 mm



INSTRUMENT TRAY WITHOUT COVER

	Size		Size
F15-214	240 x 240 mm	F15-225	230 x 125 mm
F15-215	355 x 400 mm	F15-226	200 x 150 mm
F15-216	300 x 150 mm	F15-227	250 x 200 mm
F15-217	300 x 180 mm	F15-228	300 x 250 mm
F15-218	300 x 240 mm	F15-229	350 x 300 mm
F15-219	340 x 320 mm	F15-230	400 x 350 mm
F15-220	230 x 180 mm	F15-231	450 x 300 mm
F15-221	250 x 130 mm	F15-232	300 x 200 mm
F15-222	200 x 130 mm	F15-233	350 x 250 mm
F15-223	180 x 130 mm	F15-234	250 x 125 mm
F15-224	150 x 100 mm	F15-235	200 x 100 mm
		F15-236	400 x 200 mm



HOLLOWARE INSTRUMENTS

Hohlware Instrumenten
Orfebreria Instrumentos

orfèverie de Instruments de
Holloware Gli strumenti



KIDNEY TRAY WITH COVER
(English Pattern)

	Size
F15-237	150 mm
F15-238	200 mm
F15-239	240 mm
F15-240	300 mm



KIDNEY TRAY (German Pattern)
(without cover)

	Size
F15-241	150 mm
F15-242	200 mm
F15-243	240 mm
F15-236	300 mm



SPLIT LAMP
F15-245
100 ml.



BOWL

	Size
F15-246	80 mm
F15-247	100 mm
F15-248	125 mm
F15-249	150 mm
F15-250	200 mm
F15-251	250 mm
F15-252	300 mm
F15-253	350 mm
F15-254	400 mm



WASH BASIN

	Size
F15-255	80 mm
F15-256	100 mm
F15-257	125 mm
F15-258	150 mm
F15-259	200 mm
F15-260	250 mm
F15-261	300 mm
F15-262	350 mm
F15-263	400 mm



BOWL

	Size
F15-264	80 mm
F15-265	100 mm
F15-266	125 mm
F15-267	150 mm
F15-268	200 mm
F15-269	250 mm
F15-270	300 mm
F15-271	350 mm
F15-272	400 mm



DRESSING JAR WITH KNOB

	Size
F15-273	80 x 80 mm
F15-274	100 x 100 mm
F15-275	125 x 125 mm
F15-276	150 x 150 mm
F15-277	200 x 200 mm



DRESSING JAR

	Size
F15-278	80 x 80 mm
F15-279	100 x 100 mm
F15-280	125 x 125 mm
F15-281	150 x 150 mm
F15-282	200 x 200 mm



DRESSING JAR

	Size
F15-283	80 x 80 mm
F15-284	100 x 100 mm
F15-285	125 x 125 mm
F15-286	150 x 150 mm
F15-287	200 x 200 mm



DRESSING JAR

	Size
F15-288	80 x 80 mm
F15-289	100 x 100 mm
F15-290	125 x 125 mm
F15-291	150 x 150 mm
F15-292	200 x 200 mm

HOLLOWARE INSTRUMENTS



Hohlware Instrumenten
Orfebreria Instrumentos

orfèvrerie de Instruments de
Holloware Gli strumenti



**FORCEPS
JAR**

	Size
F15-293	55 x 100 mm
F15-294	55 x 140 mm
F15-295	55 x 170 mm
F15-296	55 x 180 mm
F15-297	80 x 100 mm



**FORCEPS
JAR**

	Size
F15-298	55 x 100 mm
F15-299	55 x 140 mm
F15-300	55 x 170 mm
F15-301	55 x 180 mm
F15-302	80 x 100 mm



**FORCEPS
JAR**

	Size
F15-303	55 x 100 mm
F15-304	55 x 140 mm
F15-305	55 x 170 mm
F15-306	55 x 180 mm
F15-307	80 x 100 mm



**FORCEPS
JAR**

	Size
F15-308	55 x 100 mm
F15-309	55 x 140 mm
F15-310	55 x 170 mm
F15-311	55 x 180 mm
F15-312	80 x 100 mm



**FORCEPS
JAR**

	Size
F15-313	55 x 100 mm
F15-314	55 x 140 mm
F15-315	55 x 170 mm
F15-316	55 x 180 mm
F15-317	80 x 100 mm



**COTTON HOLDER
F15-318**



GALIPOTS

	Capacity
F15-319	2 Ounces
F15-320	3 Ounces
F15-321	4 Ounces
F15-322	5 Ounces
F15-323	6 Ounces
F15-324	7 Ounces
F15-325	8 Ounces



GALIPOTS

	Capacity
F15-326	2 Ounces
F15-327	3 Ounces
F15-328	4 Ounces
F15-329	5 Ounces
F15-330	6 Ounces
F15-331	7 Ounces
F15-332	8 Ounces



**SPRIT LAMP
F15-333
100 ml.**



**INDO BOX ROUND
F15-334**

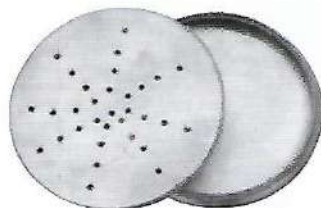

**NEEDLE CASE
F15-335**



MEASURING JUG

	Capacity
F15-336	1.00 Ltr
F15-337	1.50 Ltr
F15-338	2.00 Ltr



MEDICINE CUP GRADUATED

	Capacity
F15-339	50 ml
F15-340	60 ml
F15-341	100 ml



BUCKET WITH LID

	Capacity
F15-342	10 Ltr
F15-343	12 Ltr
F15-344	15 Ltr



HOLLOWARE INSTRUMENTS

Hohlware Instrumenten
Orfebreria Instrumentos

orfèverie de Instruments de
Holloware Gli strumenti



SPUTUM MUG
F15-345
100 x 50 mm



ENEMA CANE
Capacity
F15-346 0.5 Ltr
F15-347 1.5 Ltr
F15-348 2.0 Ltr



DUST BIN
F15-349
20 Lit



ROUND BEDPAN
F15-350
300 x 85 mm



BEDPAN
F15-351
Size: Adult, Child



BEDPAN
F15-352
Size: Adult, Child



FUNNAL
F15-353
100 mm



URINAL - FEMALE
F15-354



URINAL - MALE
F15-355



SHAVING MUG
F15-356
100 mm

PERFORATED BASKETS

perforiert Körbe
Cestas perforadas

paniers perforés
ceste forate

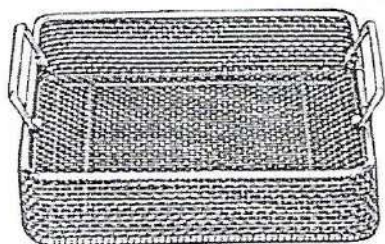

MESH BASKET

F15-357 240 x 258 x 50 mm
F15-358 250 x 240 x 100 mm
F15-359 240 x 250 x 60mm

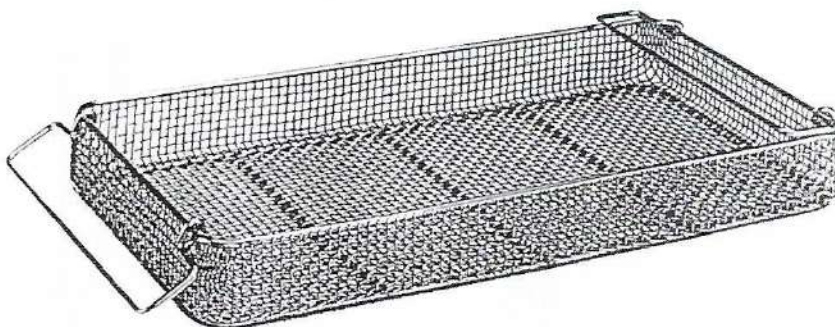

MESH BASKET

F15-360 480 x 258 x 50 mm
F15-361 480 x 258 x 100 mm
F15-362 520 x 258 x 60mm
F15-363 520 x 258 x 70mm
F15-364 450 x 340 x 70mm
F15-365 320 x 230 x 70mm



MESH BASKET

With Perforated Sheet Side

F15-366 230 x 130 x 50 mm
F15-367 230 x 130 x 60 mm
F15-368 240 x 130 x 50 mm
F15-369 240 x 130 x 60 mm
F15-370 240 x 250 x 50 mm
F15-371 240 x 250 x 60 mm
F15-372 480 x 250 x 50 mm
F15-373 480 x 250 x 60 mm
F15-374 480 x 250 x 70 mm
F15-375 300 x 300 x 50 mm
F15-376 350 x 350 x 60 mm
F15-377 470 x 400 x 60 mm
F15-378 480 x 480 x 50 mm
F15-379 480 x 480 x 60 mm
F15-380 500 x 300 x 50 mm
F15-381 520 x 300 x 50 mm
F15-382 520 x 300 x 60 mm
F15-383 550 x 430 x 50 mm
F15-384 600 x 300 x 60 mm



ARTHROSCOPE BASKET

F15-385 290 x 80 x 52 mm

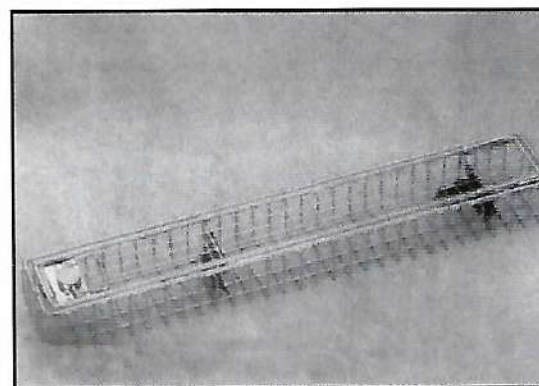

ENDOSCOPE BASKET

F15-386 460 x 80 x 52 mm
F15-387 660 x 80 x 52 mm
F15-388 670 x 80 x 52 mm



STERILIZING FORCEPS

Sterilisieren Zange

Pinces stérilisation

Pinzas de esterilización

Pinze di sterilizzazione



DAVIS
F15-389 16 cm, 6 1/4"
F15-390 20 cm, 8"
F15-391 24 cm, 9 1/2"

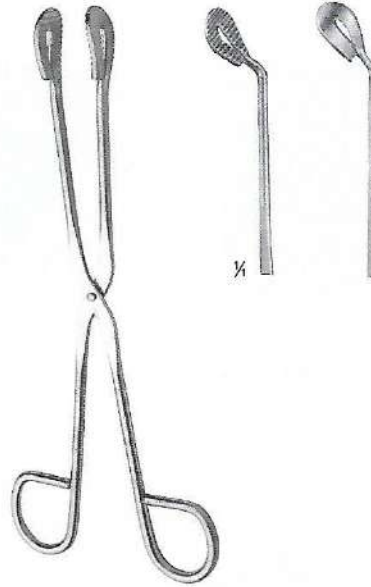

UTILITY
F15-392 20 cm, 8"
F15-393 28 cm, 11"



F15-394 20 cm, 8"
F15-395 25 cm, 10"
F15-396 30 cm, 11 1/4"



ROGGE
F15-397
 27 cm, 11"



CHEATEL
 Box Joint
F15-398
 27 cm, 11"



CHEATEL
 Screw Joint
F15-399
 27 cm, 11"



INDEX



INDEX

Index
indice

Index
indice

DESCRIPTION PAGE

A

ABDOMINAL RETRACTOR209, 359

ABRAHAM TONSIL KNIFE305

ABRE BOCA MC IVOR C/3 LAMINAS S/ SUCCAO206

ADLERKREUTZ TISSUE FORCEPS70

ADSON DRESSING FORCEPS TC84

ADSON TISSUE FORCEPS TC84

ADSON BROWN TISSUE FORCEPS76

ADSON DRILL GUIDE324

ADSON HAEMOSTATIC FINE POINT FORCEPS94

ADSON HAEMOSTATIC TISSUE FORCEPS94

ADSON NEEDLE HOLDERS128

ADSON RETRACTOR201

ADSON SUCTION TUBES17

ADSON TISSUE FORCEPS76, 85

ADSON-BROWN TISSUE FORCEPS85

AESCULAP SPONGE & DRESSING FORCEPS120

ALEXANDER CHISEL217

ALEXANDER GOUGE217

ALLIS TISSUE FORCEPS340

ALM RETRACTOR196

AMPUTATION KNIFE28

ANAESTHON STETHOSCOPE01

ANDERSON-ADSON RETRACTOR201

ANDERSON-NIEVERT OSTEOTOME221

ARRUGANEEDE HOLDERS133-134

ARRUGANEEDE HOLDERS TC146

ARTERY SCISSORS47

ARTHROSCOPE BASKET398

ASH SEPTUM FORCEPS311

AUFRICT NASAL SAW310

AUVAUD SPECULUM & RETRACTOR356

AYRE CONE KNIFE FISTULA HOOK371

B

BABCOCK INTESTINAL & TISSUE GRASPING CLAMP FORCEPS T.C343

BABCOCK SEIZING FORCEPS341-342

BABCOCK TISSUE GRASPING FORCEPS342

BABINSKY HAMMER03

BABY ALLIS TISSUE FORCEPS340

BABY CRILE-WOOD NEEDLE HOLDER126

BABY CRILE-WOOD NEEDLE HOLDERS T.C140

BABY METZENBAUM SUPER CUT SCISSORS61

BABY-DOYEN INTESTINAL FORCEPS CLAMPS344

BABY-KOCHER INTESTINAL FORCEPS CLAMPS344

BABY-MIKULICZ HAEMOSTATIC TISSUE FORCEPS107

BABY-ROUX RETRACTOR178

BACKHAUS CLIP TOWEL FORCEPS113

BACKHAUS TOWEL FORCEPS113

BAKES COMMON BILE384

BALFOUR RETRACTOR205

BALFOUR-BABY RETRACTOR204

BALL & SOCKET TOWEL FORCEPS113

BALLENGER KNIFE314

BALLENGER-HAJEK PERIOSTEAL SEPTUM ELEVATORS307

BANDAGE SCISSORS56

BANE BONE RONGEUR248

BARANY NOISE DRUM291

BARNHILLADENOID CURETTE313

BARR CRYPT HOOK21

BARR FISTULA PROBE21

BARR RECTAL SPECULUM348

BARRAQUER CILIA FORCEPS80

BARRAQUER NEEDLE HOLDERS132-133

BARRAQUER SCISSORS49

BARRAQUER-TROUTMAN NEEDLE HOLDERS134

BARRETT TENACULUM FORCEPS365

BARR-SHILFORD INTESTINAL RECTAL SPECULUM350

BAUMGARTNER NEEDLE HOLDER125

BAUMGARTNER NEEDLE HOLDERS T.C136

BAUMGARTNER NEEDLE HOLDERS T.C141

BAYONET MICRO KERRISON LAMINECTOMY RONGEURS337

BAYONET SPURLING KERRISON LAMINECTOMY RONGEURS337

BEACHAMAMNIOTOME366

BECKMAN ADENOID CURETTE313

BECKMAN RETRACTOR202

BECKMANN ADENOID CURETTE313

BECKMANN NASAL SPECULUM301

BECKMAN-WEITLANER RETRACTOR202

BEDPAN397

BEER CILIA FORCEPS80

BEEBEE WIRE CUTTING SCISSORS45

BENDING DEVICE ANGLED PLATES286

BENNET RETRACTOR187

BENGOLEA HAEMOSTATIC FORCEPS100

BENGOLEA HAEMOSTATIC TISSUE FORCEPS100

BENSAUDE INTESTINAL RECTAL SPECULUM349

BERGER BIOPSY FORCEPS369

DESCRIPTION PAGE

BERGMANN MALLETS215

BERGMANN SCISSORS55

BERLINER HAMMER03

BERNHARD TOWEL FORCEPS114

BERTILLON MEASURING DEVICE13

BEYER BONE EAR RONGEURS298

BEYER BONE RONGEUR249

BILLEAU EAR LOOP294

BIOLVAR21

BIRCHER MENISCOTOMY KNIFE239

BIRCHER-GANSKE BONE HOLDING FORCEPS272

BISHOP BONE CLAMP268

BISHOP FORCEPS70

BLAKE DOUBLE ENDED372

BLAKE GALL STONE FORCEPS387

BLOHMKE TONSIL FORCEPS316

BLOOD SCOOP195

BLOUNT KNEE RETRACTOR177

BLOUNT RETRACTOR237

BLUMENTHAL BONE RONGEUR246

BOHLER BONE CUTTING RONGEUR FORCEPS257

BOHLER BONE RONGEUR249

BOHLER KIRSCHNER EXTENSION BOWS288

BOIES NASAL FRACTURE ELEVATOR307

BONE CURETTE227

BONE CUTTING RONGEUR FORCEPS257

BONE HOLDING FORCEPS275

BONE LEVER236

BONE REDUCTION FORCEPS265, 271, 275-276

BONE REDUCTION ORTHOPEDIC FORCEPS265

BONE TAMPS226

BONNEY DISSECTING & TISSUE FORCEPS T.C87

BONNEY TISSUE FORCEPS73

BOUCHERON EAR SPECULUM290

BOWL395

BOWMAN LACRIMAL PROBES155

BOYNTON NEEDLE HOLDERS133

BOYS-ALLIS TISSUE FORCEPS341

BOZEMANN HAEMOSTATIC FORCEPS106

BOZEMANN NEEDLE HOLDERS127

BOZEMANN NEEDLE HOLDERS T.C137

BRAIN SPATULA325

BRAND TENDON FORCEPS241

BRAUN OBSTETRICAL FORCEPS378

BRAUN UTERINE DEPRESSOR372

BRAUN, MIDWIFERY DECAPITATING HOOK379

BRAUN-STADLER PLASTER SCISSORS56

BREISKY PELVIMETER, OBSTETRICAL FORCEPS376

BREISKY SPECULUM357

BRINKERHOFF INTESTINAL RECTAL SPECULUM350

BRISTOW BONE LEVER236

BRISTOW-BANKART HUMERAL RETRACTOR235

BRISTOW-BANKART SOFT TISSUE RETRACTOR235

BRODIE PROBE156

BROM HOOKLET RETRACTORS162

BROPHY DRESSING FORCEPS69

BROWN NEEDLE HOLDER126, 128

BRUENINGS NASAL CUTTING FORCEPS304

BRUENINGS TONSIL KNIFE305

BRUENINGS TONSIL SNARE318

BRUENINGS-BRUNK ANTRUM RETRACTOR311

BRUNER RETRACTOR182-183

BRUNS BONE CURETTE227

BRUENING SPATULA195

BUCK EAR POLYPUS FORCEPS286

BUCK HAMMER02

BUCK STITCH SCISSORS42

BUCK EAR CURETTE293

BUCKET WITH LID396

BUCKLEY RETRACTOR196

BUIE HIRSCHMAN ANOSCOPE INTESTINAL RECTAL SPECULUM351

BUIE SUCTION TUBE21

BULLDOG CURVED70

BULLDOG STRAIGHT70

BURNHAM BANDAGE PLASTER SCISSORS55

BUSCH PLASTER SCISSORS56

BUTTERFLY GROOVED DIRECTOR WITH TONGUE TIE PLAIN END20

C

CAIRNS HAEMOSTATIC FORCEPS94

CANNULATED WIRE / PIN CUTTER262

CAPENER CHISELS220

CAPENER OSTEOTOME220

CAPLAN SEPTUM FORCEPS312

CAPSULE RETRACTOR235

CARLENS MEDIASTINOSCOPE, EXTRA-LONG321

CARLENS MEDIASTINOSCOPE, LONG321

CARLENS MEDIASTINOSCOPE, SHORT321

CARMALT FORCEPS81

INDEX



Index | Index
indice | indice

DESCRIPTION	PAGE #	DESCRIPTION	PAGE #
CAROLL POCKET GONIOMETER	13	COTTLE SCISSORS	43
CARROLL NEEDLE HOLDERS T.C.	135	COTTLE SEPTUM ELEVATORS RASPARTORY	306
CARROLL TENDON FORCEPS	241	COTTLE-KAZANJIAN BONE CUTTING RONGEUR FORCEPS	255
CASPAR BONE TAMPERS	226	COTTLE-WALSHAM SEPTUM FORCEPS	311
CASPAR RETRACTOR	176	COTTON HOLDER	396
CASPAR TYPE INTERVERTEBRAL DISC RONGEURS	331	COUNTERSINK REAMERS	283
CAST SPREADER MODEL USA	245	CRAFOORD HAEMOSTATIC FORCEPS	101
CASTROVIEJO BONE CALIPER	14	CRAFOORD-SELLORS HAEMOSTATIC FORCEPS	102
CASTROVIEJO CORNEAL MICRO SCISSORS	49	CRAIG NASAL POLYPUS AND SEPTUM FORCEPS	303
CASTROVIEJO EYE SPECULUM	196	CREGO PERIOSTEAL ELEVATOR	233
CASTROVIEJO EYE VIEW CALIPER	14	CRILE HAEMOSTATIC FINE POINT TISSUE FORCEPS	91
CASTROVIEJO NEEDLE HOLDERS	132-134	CRILE HAEMOSTATIC FINE POINT FORCEPS	91
CASTROVIEJO NEEDLE HOLDERS T.C.	141, 146-147	CRILE HAEMOSTATIC FORCEPS	91
CASTROVIEJO OLSEN HEAGER/NEEDLE HOLDERS/SCISSORS	133	CRILE HAEMOSTATIC TISSUE FORCEPS	91
CASTROVIEJO SCISSORS	48	CRILE HOOKLET & SKIN HOOKS	160
CASTROVIEJO SCISSORS T/C INSERT	66	CRILE RETRACTOR	177
CASTROVIEJO-EPKER CALIPER	14	CRILE-MURRAY NEEDLE HOLDERS	130
CATHER TRAY	392	CRILE-WOOD NEEDLE HOLDER	126
CATHETERS	365	CRILE-WOOD NEEDLE HOLDER T.C.	143-135, 145
CATLIN AMPUTATION	28	CRUTCHFIELD DRILL BIT	324
CATLIN DISSECTING KNIVES	27	CRUTCHFIELD SKULL LARGE TYPE, CERVICAL TRACTION	324
CHAPUT HAEMOSTATIC FORCEPS	116	CRUTCHFIELD TRACTION TONGS	324
CHAPUT TISSUE FORCEPS	341	CURETTE	229
CHARNLEY TISSUE FORCEPS	72	CUSCO VAGINAL SPECULUM	352
CHARNLEY-MUELLER COMPRESSION CLAMP	288	CUSHING DECOMPRESSION RETRACTOR	238
CHARRIERE AMPUTATION & RESECTION	28	CUSHING HOOKLET RETRACTORS	168
CHARRIERE BONE SAW COMPLETE	211	CUSHING HOOKLET RETRACTORS	168
CHARRIERE PLASTER SAW	59	CUSHING INTERVERTEBRAL DISC RONGEURS	330-331, 333
CHARRIERE SAW	211	CUSHING NERVE DURA HOOK	327
CHEATEL STERILIZING FORCEPS	399	CUSHING NERVE DURA HOOK RETRACTOR	328
CHEEK-AND LIP RETRACTOR	187	CUSHING TISSUE FORCEPS T.C.	86
CHELSEA-EATON INTESTINAL RECTAL SPECULUM	350	CUSHING VEIN RETRACTOR	238
CHERON FORCEPS	121	CUSHING, BRAIN SPATULA	325
CHEVALIER-JACKSON TRACHEA TUBES	320	CUSHING-KOCHER HOOKLET RETRACTORS	168
CHICHIRELLI (BLUMENTHAL) RONGEUR	247	CUZZI OVUM CURETTE	380
CHILD HERNIA DIRECTOR	388	CZERNY RECTAL SPECULUM	348
CHILDE TISSUE FORCEPS	83	CZERNY TENACULUM FORCEPS	366
CHRISTOPHE HAEMOSTATIC FORCEPS	93		
CINELLI CHISEL	224	D	
CIRCUMCISION SHIELD	389	DANDY HAEMOSTATIC FORCEPS	90
CITELLI BONE EAR RONGEURS	298	DANDY HAEMOSTATIC TISSUE FORCEPS	90
CLEVELAND BONE CUTTING RONGEUR FORCEPS	255	DARLING RETRACTOR	197
CLEVELAND BONE RONGEUR	248	DARTIGUES UTERINE ELEVATING FORCEPS	382
CLEVELAND-GARDNER BONE CUTTING RONGEUR FORCEPS	257	DAVIDSON RETRACTOR	181
CLIPS MAYO	157	DAVIS DURA DISSECTOR	329
CLOWARD INTERVERTEBRAL DISC RONGEURS	332	DAVIS STERILIZING FORCEPS	399
CLOWARD RETRACTOR	339	DAY HOOKLET & SKIN HOOKS	160
CLOWARD VERT BRAL CERVICAL SPREADER	339	DE BAKEY DRESSING FORCEPS T.C.	88
CLUTTON BOUGIES	385	DE BAKEY FEMUR RETRACTOR	203
COAKLEY, TROCAR	16	DE BAKEY NEEDLE HOLDERS T.C.	145
COHEN NIPPERS	46	DE BAKEY VASCULAR SCISSORS	39-40
COLLER HAEMOSTATIC FORCEPS	93	DE LEE OBSTETRICAL FORCEPS	377
COLLIER NEEDLE HOLDERS	130	DE LEE PELVIMETER, OBSTETRICAL FORCEPS	376
COLLIN DISSECTING KNIVES	27	DE MARTEL SAW CONDUCTOR	324
COLLIN FORCEPS	83	DE VILBISS SKULL FORCEPS	324
COLLIN KIDNEY ELEVATING STONE CLAMPS FORCEPS	382	DEAN (BLUMENTHAL) RONGEUR	247
COLLIN MALLET	214	DEAN RONGEUR	247
COLLIN OBSTETRICAL FORCEPS	379	DEAN-DELICATE DISSECTING SCISSORS	40
COLLIN PELVIMETER, OBSTETRICAL FORCEPS	376	DEAVER OPERATING, DISSECTING SCISSORS	31
COLLIN RETRACTOR	179, 206, 208	DEAVER RETRACTOR	184-185
COLLIN SPONGE & DRESSING FORCEPS	119, 123	DEBAKEY GELPI RETRACTOR	198
COLLIN VAGINAL SPECULUM	352	DEBAKEY MICRO NEEDLE TISSUE FORCEPS T.C.	87
COLLIN-DUVAL FORCEPS	74	DEBAKEY NEEDLE HOLDERS	151
COLLING DRESSING HAEMOSTATIC FORCEPS	117	DEBAKEY-COOLEY RETRACTOR	189
COLLIN-HARTMANN RETRACTOR	166	DECKER INTERVERTEBRAL DISC RONGEURS	333
COLLIN VAGINAL SPECULUM	353	DEJERINE HAMMER	02
COLVER TONSIL FORCEPS	316	DELICATE WIRE CUTTER	281
COMBINATION MALLET	215	DENHART MOUTH GAG	315
CONE RETRACTOR BECKMAN RETRACTOR	202	DERF NEEDLE HOLDER	130, 150
CONVERSE HOOK	160	DERF NEEDLE HOLDERS T.C.	141
COOLEY INTRACARDIAC NEEDLE HOLDERS T.C.	140	D'ERRICO-ADSON RETRACTOR	201
COOLEY MICROVASCULAR NEEDLE HOLDER T.C.	144	DESCHAMPS NEEDLE	153-154
COOLEY REVERSE CUT SCISSORS	38	DESJARDINS GALL STONE FORCEPS	387
COOLEY VASCULAR SCISSORS	39	DESJARDINS HAEMOSTATIC FORCEPS	104
COOLEY-BAUMGARTEN WIRE TWISTER NEEDLE HOLDERS T.C.	142	DESJARDINS PROBE	384
CORD HOOK	388	DESJARDIM	21
CORWIN NEEDLE HOLDERS T.C.	148	DESMARRES LID RETRACTORS	168
CORWIN ROUND SCALPEL HANDLE	24	DIAGNOSTIC PENTOSCOPE SET	09
CORWIN ROUND SCALPEL HANDLE, #4R	24	DICK HAEMOSTATIC FORCEPS	111
CORYLLOS RETRACTOR	181	DIEFFENBACH DISSECTING KNIVES	27
COTTLE CARTILAGE CRUSHER	311	DIEFFENBACH SCALPEL HANDLES	26
COTTLE CHISEL	224	DINGMAN BONE CLAMP	266
COTTLE GUIDE SUPPORT FOR OSTEOTOMES	311	DIRECTOR PROBE END	156
COTTLE HANDLE	311	DIRECTORS LARRY PROBE	156
COTTLE MALLET	214	DISSECTING DRESSING FORCEPS	72
COTTLE NASAL SAW	310	DISSECTING KITS	11-12
COTTLE NASAL SPECULUM	302	DISSECTING SETS	10
COTTLE OSTEOTOME	221, 223-224	DISSECTING TISSUE FORCEPS T.C.	86
COTTLE PERIOSTEAL SEPTUM ELEVATORS	307	DITTEL URETHRAL BOUGIES AND DILATING SOUNDS	386
COTTLE RETRACTOR	167		



INDEX

Index | Index
indice | indice

DESCRIPTION	PAGE #
DIXON-LOVELACE HAEMOSTATIC TISSUE FORCEPS	103
DOUBLE ACTION WIRE CUTTER	261
DOUBLE PRONG MICRO HOOK & SKIN HOOK	159
DOUGLAS CILIA FORCEPS	80
DOWNING CARTILAGE KNIFE	239
DOYEN INTESTINAL FORCEPS CLAMPS	344
DOYEN MALLETS	214
DOYEN MYOMA SCREW AND FISTULA HOOK	371
DOYEN NEEDLE HOLDERS	130
DOYEN OPERATING, DISSECTING SCISSORS	36
DOYEN PROBE	156
DOYEN PROBES & DIRECTORS	20
DOYEN RETRACTOR	187, 208
DOYEN RIB RASPATORY	232
DOYEN SPECULUM AND RETRACTOR	357
DOYEN TOWEL FORCEPS	112
DOYEN VAGINAL RETRACTORS	191
DRESSING FORCEPS, TISSUE FORCEPS	67
DRESSING JAR	395
DRESSING JAR WITH KNOB	395
DRILL GUIDE	284-285
DRILL POINTED GUIDE	285
DRILL SLEEVE	284
DRILL SMALL POINTED	285
DUCKBILL EAR FORCEPS	297
DUCT DILATORS	384
DUEHRSSEN DRESSING FORCEPS	74
DUMONT FORCEPS	78-79
DUPLOY SPONGE & DRESSING FORCEPS	119
DUPLOY SPONGE FORCEPS	121
DUPLOY TENACULUM FORCEPS	366
DUPLEX, STETHOSCOPE	.01
DUPLEX-BABY STETHOSCOPE	.01
DURADISSECTOR	329
DURANTE TISSUE GRASPING FORCEPS	73
DUST BIN	397
DUVAL GRASP FORCEPS	341
DUVAL INTESTINAL & TISSUE GRASPING CLAMP FORCEPS T.C	343
DUVAL TISSUE GRASPING FORCEPS	342
DUVAL-COLLIN GRASP FORCEPS	341

E

EISELSBERG-MATHEIU NEEDLE HOLDERS T.C	149
ELLIOT OBSTETRICAL FORCEPS	378
EMMET FISTULA HOOK	371
EMMET SPONGE & DRESSING FORCEPS	121
ENDOSCOPE BASKET	398
ENEMA CANE	397
ENGEL PLASTER SAW	59
ENGL. MODELL TOWEL FORCEPS	112
ENT-DEAN SCISSORS	40
ENT-DEAN SCISSORS T/C INSERT	65
EPPENDORFER BIOPSY AND SPECIMEN FORCEPS	369
ESMARCH KNIFE BRUNS SCISSORS	55
ESMARCH SCISSORS	55
EUFRATE PASQUE T.C NEEDLE HOLDERS	140
EVANS PELVIC NEEDLE DRESSING FORCEPS T.C	87
EVE TONSIL SNARE	305, 318
EXTRA 1 1/4" NYLON FACE	215

F

FANSLER OPERATING INTESTINAL RECTAL SPECULUM	350
FARABEUF BONE HOLDING FORCEPS	268
FARABEUF ELEVATOR	233
FARABEUF RETRACTOR	179
FARABEUF-COLLIN ELEVATOR	233
FARABEUF-LAMBOTTE BONE HOLDING FORCEPS	268
FARR WIRE REFRACTOR	196
FARRELL PROBE	158
FARRELL APPLICATOR	294
FAURE HAEMOSTATIC TISSUE FORCEPS	108
FAURE UTERINE BIOPSY FORCEPS	368
FAVALORO CORONARY	40
FEILCHENFELD FORCEPS	81
FEIN COTTON APPLICATOR	21
FENESTRATED CUPPED GRASPING FORCEPS	323
FERGUSON-MOON RECTAL RETRACTORS	192
FERGUSON BONE HOLDING FORCEPS 267	
FERGUSON SUCTION TUBES	17
FERGUSON TUBING CLAMP	115
FERGUSON-ACKLAND MOUTH GAG	315
FERRIS SMITH MICRO KERRISON LAMINECTOMY RONGEURS	334-335
FERRIS SMITH MICRO KERRISON LAMINECTOMY RONGEURS DOWNWARD	336
FERRIS SMITH MICRO KERRISON LAMINECTOMY RONGEURS UPWARD	336
FERRIS-SMITH INTERVERTEBRAL DISC RONGEURS	335
FERRIS-SMITH TISSUE FORCEPS	73
FIBULA BONE HOLDING FORCEPS	276
FINGER NAIL DRILL	240

DESCRIPTION	PAGE #
FINGER RAKE, RETRACTOR	163
FINOCCHIETTO NEEDLE HOLDERS	127
FINOCCHIETTO NEEDLE HOLDERS T.C	138-139
FINOCCHIETTO RETRACTOR	208
FINSEN RETRACTOR	196
FISCH HOOKLET & SKIN HOOK	159
FISCHER TONSIL KNIFE AND DISSECTOR	305
FLAT NOSE K-WIRE PLIERS	243
FLAT NOSE PLIER	242, 244, 245
FLETCHER SPONGE FORCEPS	120
FLEXIVAL ABDOMINAL SPATULA	195
FLUSH WIRE CUTTER	261
FOERSTER-BALLENGER SPONGE FORCEPS	123
FOMAN OPERATING SCISSORS T/C INSERT	66
FOMAN RASP	213
FOMON CHISEL	224
FOMON NASAL SAW	310
FOMON RASP WITH TUNGSTEN CARBIDE T.C	309
FOMON SCISSORS	43
FORAMENOTOMY KERRISON LAMINECTOMY RONGEURS	337
FORCEPS JAR	396
FRAZIER HOOKLET & SKIN HOOK	159
FRAZIER NERVE DURA HOOK RETRACTOR	328
FRAZIER SUCTION TUBE	17, 323
FREER CHISEL	223
FREER ELEVATOR	231
FREER GOUGE	223
FREER SEPTUM ELEVATORS RASPATORY	306
FREER TONSIL KNIFE	305
FRENCH TUNING FORK	291
FRENCH-EYE NEEDLE HOLDERS T.C	137
FRICKE ARTERY FORCEPS	115
FRIEDMANN BONE RONGEUR	246
FRIEDMANN RETRACTOR	359
FRITCH RETRACTOR	187
FRONT & SIDE WIRE CUTTER	261
FRYKHOLM BONE RONGEUR	253
FUNNAL	397

G

GALI	396
GALLAHER NASAL SAW	310
GARRIGUE WEIGHTED VAGINAL SPECULUM	356
GELL HORN BIOPSY FORCEPS	367
GELPI SKIN & VEGINAL RETRACTOR	203
GELPI-LOKITER RETRACTOR	198, 203
GEMINI MIXTER HAEMOSTATIC FORCEPS	110
GERSTER BONE HOLDING CLAMP	264
GERSTER-LOWMANN BONE CLAMP	264
GIGLE WIRE SAW	324
GIGLE-STRULLY HANDLE FOR WIRE SAW	324
GILLIES NEEDLE HOLDERS	129
GILLIES NEEDLE HOLDERS T.C	139
GILLIES SKIN HOOK	159
GILLIES TISSUE FORCEPS	70
GILLIES TISSUE FORCEPS T.C	88
GLENOID PERFORATING FORCEPS	276
GOELET RETRACTOR	190
GOLDMAN SRPTUM DISPLACER	307
GOLDMAN-FOX SUPER CUT SCISSORS	61
GOLDMANN-FOX OPERATING SCISSORS T/C INSERT	65
GOOD SCISSORS	44
GOSSET BLADDER RETRACTOR	390
GOSSET RETRACTOR	204
GOUGE	217, 223
GRADLE CILIA FORCEPS	80
GRADUATED METAL RULER JAMESON CALIPER	13
GRAEFE DRESSING FORCEPS	77
GRAEFE FIXATION FORCEPS	77
GRAEFE FORCEPS	77
GRAEFE TISSUE FORCEPS	77
GRAVE VAGINAL SPECULUM	352
GRAVES VAGINAL SPECULUM	353
GRAVES VAGINAL SPECULUM LEEP/LIETZ	353
GREEN-ARMYTAG UTERINE ELEVATING FORCEPS	379
GROSS MAIER DRESSING FORCEPS	117-119
GROSS MAIER DRESSING SPONGE & DRESSING FORCEPS	118
GOSSET ABDOMINAL RETRACTORS	208
GRUBER EAR SPECULUM	290
GUMCO CIRCUMCISION CLAMP	389
GUTHRIE HOOKLET	159
GUTMANN SECRETIONS SCOOP	388
GUYON SOUND SET IN METAL CASE	385
GUYON URETHRAL BOUGIES AND DILATING SOUNDS	386

H

HAEMOSTATIC FORCEPS	104
HAEK MALLETS	214

INDEX



Index Index
indice indice

DESCRIPTION	PAGE #	DESCRIPTION	PAGE #
HAKANSSON BONE RONGEUR	254	I	
HALLE NERVE DURAHOOK	327	INCISION OPERATING SCISSORS	31
HALLE SCISSORS	44	INDO BOX ROUND	396
HALSEY NEEDLE HOLDERS	129, 150	INDO BOX WITH SILVER FRAME	394
HALSEY NEEDLE HOLDERS T.C	139, 141	INGE RETRACTOR	339
HALSTED HAEMOSTATIC FINE POINT FORCEPS	92	INITIAL INCISION RETRACTOR	207
HALSTED HAEMOSTATIC FINE POINT TISSUE FORCEPS	92	INSERT DRILL SLEEVE	285
HALSTED HAEMOSTATIC FORCEPS	92, 100	INSTRUMENT BOILER	393
HALSTED HAEMOSTATIC TISSUE FORCEPS	92	INSTRUMENT BOILER ELECTRIC	393
HALSTED-MOSQUITO HAEMOSTATIC FORCEPS	89	INSTRUMENT BOILER WITH STAND	393
HAJEK HAMMER	215	INSTRUMENT TRAY WITH COVER	392
HAND DRILL	281	INSTRUMENT TRAY WITHOUT COVER	394
HANK DILATOR	363	INTRACARDIAC NEEDLE HOLDER	151
HANK DILATOR SET	363	INTRACARDIAC NEEDLE HOLDERS T.C	136
HARD WIRE CUTTER CUTS	262	IOWA TENACULUM FORCEPS	366
HARRINGTON EXTRADEEP RETRACTOR	189	IOWA SUCTION TUBE	19
HARRINGTON RETRACTOR	188	IRIS SCISSORS	37
HARRINGTON SPLANCHNIC RETRACTOR	189	IRIS SUPER CUT SCISSORS	61
HARTMAN EAR FORCEPS	297	IRIS TISSUE FORCEPS	71
HARTMANN BONE RONGEUR	248	IVES-FANSLER ANOSCOPE INTESTINAL RECTAL SPECULUM	351
HARTMANN EAR FORCEPS	297	IVES-FANSLER RECTAL SPECULUM	348
HARTMANN EAR POLYPUS FORCEPS	296		
HARTMANN EUSTACHIAN CATHETERS	18	J	
HARTMANN NASAL POLYPUS AND SEPTUM FORCEPS	303	JACKSON BURROWS RETRACTOR	203
HARTMANN NASAL SPECULUM	299	JACKSON INTERVERTEBRAL DISC RONGEURS	333
HARTMANN TUNING FORK	291-292	JACKSON LARYNGEAL FORCEPS	316
HARTMANN-HALLE NASAL SPECULUM	299	JACKSON SPECULUM & RETRACTOR	355
HARTMANN-HOFFMANN EAR FORCEPS	297	JACOB'S CHUCK HAND DRILLS	281
HARTMANN-NOYES EAR FORCEPS	297	JACOBS HAND DRILL	281
HARTMANN-WEINGARTNER EAR FORCEPS	297	JACOBS UTERINE VULSELLUM FORCEPS	367
HARTMANN-WULLSTEIN EAR FORCEPS	297	JACOBSON HEAVY NEEDLE HOLDERS	151
HAYES HAND RETRACTOR	236	JACOBSON HEAVY STYLE NEEDLE HOLDERS T.C	147
HEANEY/BALLANTINE HAEMOSTATIC FORCEPS	103	JACOBSON NEEDLE HOLDERS T.C	136, 146
HEANEY ATRAUMATA HYSTERECTOMY FORCEPS	109	JAKO-CHERRY MICRO LARYNGOSCOPE	321
HEANEY HAEMOSTATIC FORCEPS	105	JAMESON NEEDLE HOLDERS	127
HEANEY MODIF. HAEMOSTATIC FORCEPS	105	JANSEN BONE RONGEUR	245
HEANEY NEEDLE HOLDERS	128	JANSEN CURETTE	230
HEANEY NEEDLE HOLDERS T.C	143	JANSEN DRESSING FORCEPS	317
HEANEY-GYNE NEEDLE HOLDERS T.C	143	JANSEN RETRACTOR	197
HEANEY-KANTER HAEMOSTATIC FORCEPS	105	JASEN BONE RONGEUR	248
HEATH MALLET, HEAVYWEIGHT	216	JENNINGS MOUTH GAG	315
HEATH MALLETS	215	JESBURG ESOPHAGOSCOPE	323
HEATH VASCULAR SCISSORS	39	JOHNSON NEEDLE HOLDERS	131
HEGAR UTERINE DILATOR	362	JOLL (FRIEDMAN) THYROID- AND VEGINAL RETRACTOR	203
HEGAR UTERINE DILATOR	363	JONES /PERFORATING TOWEL FORCEPS	112
HEGAR UTERINE DILATORS 8 SET W/ROLL	363	JOPSON-HORNE COTTON APPLICATOR	21
HEGEMANN-DIETRICH VASCULAR SCISSORS	38	JOSEPH NASAL SAW	308
HEGENBARTH TISSUE FORCEPS	83	JOSEPH OPERATING SCISSORS T/C INSERT	66
HEIFETZ, BRAIN SPATULA	325	JOSEPH OPERATING, DISSECTING SCISSORS	36
HEISS RETRACTOR	196	JOSEPH RASP	308
HEISTER MOUTH GAG	315	JOSEPH SEPTUM ELEVATORS RASPATORY	306
HELFERICH-BIER SAW	211	JOSEPH-MASING SEPTUM ELEVATORS RASPATORY	306
HENNING PLASTER CAST SPREADER	59	JUDD MASSON BLADDER RETRACTOR	390
HENROTIN WEIGHTED VAGINAL SPECULUM	356	JUDD-ALLIS TISSUE FORCEPS	340
HERRICK HAEMOSTATIC FORCEPS	102	JULIAN NEEDLE HOLDERS T.C	144
HERTZLER RETRACTOR	204		
HERZ TENDON SEIZING FORCEPS	122	K	
HERZFELD RETRACTOR	167	KALLMORGEN SPECULUM & RETRACTOR	355
HEX HANDLE OSTEOTOME	221	KALT NEEDLE HOLDERS	134
HEXAGONAL HEAD	282	KALT NEEDLE HOLDERS T.C	147
HEY GROVES BONE HOLDING FORCEPS	269	KANE OBSTETRICAL FORCEPS	379
HEYMANN NASAL DRESSING FORCEPS	304	KAYE ROUND SCALPEL HANDLE	24
HEYMANN SCISSORS	43	KAYE-MILLARD RETRACTOR	190
HEYMANN-KNIGHT NASAL POLYPUS AND SEPTUM FORCEPS	303	KELLY HAEMOSTATIC FORCEPS	90
HEYWOOD SMITH SPONGE FORCEPS	121	KELLY INTESTINAL RECTAL SPECULUM	349
HEYWOOD-SMITH SPONGE & DRESSING FORCEPS	123	KELLY OPERATING, DISSECTING SCISSORS	36
HIBBS RETRACTOR	238	KELLY OPERATING, DISSECTING SCISSORS T/C INSERT	65
HILL FERGUSON RECTAL RETRACTORS	192	KELLY PROCTOSCOPE INTESTINAL RECTAL SPECULUM	351
HIRSCHMAN ANOSCOPE INTESTINAL RECTAL SPECULUM	351	KELLY RETRACTOR	186, 192, 194
HIRSCHMANN INTESTINAL RECTAL SPECULUM	349	KELLY RETRACTORS RICHARDSON RETRACTORS	192
HOEN NERVE DURAHOOK	327	KELLY SPONGE & DRESSING FORCEPS	122
HOHMANN BONE ELEVATOR	234-235	KERN BONE HOLDING FORCEPS	268
HOHMANN BONE LEVER	236	KERRISON BONE EAR RONGEURS	298
HOHMANN LONG SHANK RETRACTOR	235	KERRISON CERVICAL RONGEUR	335
HOHMANN RETRACTOR	236-237	KEVORKIAN BIOPSY AND SPECIMEN FORCEPS	369
HOHMANN-WILLIGER RETRACTOR	237	KEY HERNIA DIRECTOR	388
HOLINGER BRONCHOSCOPE	322	KIDNEY TRAY (GERMAN PATTERN)	395
HOOKLET RETRACTORS	162, 164	KIDNEY TRAY WITH COVER	395
HOOKLETS, RETRACTORS	163	KIELLAND OBSTETRICAL FORCEPS	378
HORSLEY BONE CUTTING RONGEUR FORCEPS	256	KIELLAND-LUIKART OBSTETRICAL FORCEPS	378
HORSLEY DURADISSECTOR	329	KILIAN, SEPTUM GOUGE	223
HOUZEL RETRACTOR	197	KILIAN-CLAUS SEPTUM GOUGE	223
HUDSON BRACE	280	KILLIAN NASAL SPECULUM	300
HULKA-KENWICK UTERINE ELEVATING & MANIPULATING FORCEPS	382	KILLIAN SEPTUM SPECULUM	301
HUMBY DERMATOMES	29	KILLIAN SPATULA	158
HUMERAL HEAD RETRACTOR	235	KILLIAN, EUSTACHIAN CATHETERS	18
HUNT TUMOR-AND VESSEL FORCEPS	75	KILNER HOOK	159
HUNTER FORCEPS	81		



INDEX

Index | Index
indice | indice

DESCRIPTION PAGE

KILNER NEEDLE HOLDERS	130
KILNER NEEDLE HOLDERS T.C	136
KIRK MALLETS	214
KIRSCHNER EXTENSION BOWS	288
KIRSCHNER RETRACTOR	210
KIRSCHNER WIRES & STEINMANN PINS CUTTER	262
KIRSCHNER-BALFOUR RETRACTOR	210
KLAPP RETRACTOR	176
KLEINERT KUTZ ELEVATOR AND DISSECTOR	231
KLEINERT-KUTZ BONE CUTTING FORCEPS	258
KLEINERT-KUTZ BONE RASP	213
KLEINERT-KUTZ BONE RONGEUR	254
KLEINERT-KUTZ SYNOVECTOMY RONGEUR	258
KLINIKUM BERLIN TUBING CLAMP	115
KNIFE HANDLE	23
KNIGHT NASAL POLYPUS AND SEPTUM FORCEPS	303
KNOWLES PLASTER SCISSORS	56
KNUTSON URETHROGRAPHIE-INSTRUMENTS	389
KOCHER HAEMOSTATIC FORCEPS	95
KOCHER HAEMOSTATIC FORCEPS STRONG PATTERN	95
KOCHER HOOKLET, RETRACTORS	164
KOCHER INTESTINAL FORCEPS CLAMPS	344
KOCHER RETRACTOR	169-172
KOCHER-LANGENBECK RETRACTOR	171
KOCHER-OCHSNER HAEMOSTATIC FORCEPS	98
KOCHER'S BLADDER RETRACTOR	388
KOCHER-WAGNER RETRACTOR	172
KOERTE RETRACTOR	180
KOGAN - MODIF. SPECULUM	360
KOGAN SPECULUM	360
KOLBEL SOFT TISSUE RETRACTOR	201
KONIG RETRACTOR	167
KORTE-WAGNER RETRACTOR	180
KRAUS-WILDE NASAL POLYPOUS SNARES	295
KRAUSE NASAL POLYPOUS SNARES	295
KRAUSE, TROCER	16
KRISTELLER SPECULUM & RETRACTOR	354
KUEHNE CILIA FORCEPS	80
K-WIRE EXTRACTION PLIERS	242

L

LA FORCE ADENOTOME UNPERFORATED	314
LABORDE TRACHEA DILATOR 3 PRONG	320
LAHEY GOITER RETRACTOR	175
LAHEY NERVE DURAHOOK RETRACTOR	328
LAHEY RETRACTOR	175
LAMBERT-LOWMAN BONE CLAMP	264
LAMBOTTE BONE HOLDING FORCEPS	270
LAMBOTTE ELEVATOR	233
LAMBOTTE OSTEOTOME	221
LAMBOTTE RETRACTORS	165
LANCASTER EYE SPECULUM	196
LANDAU SPECULUM	357
LANDAU, TROCER	16
LANDOLT OPERATING SCISSORS	31
LANE BONE HOLDING FORCEPS	269, 271
LANE BONE LEVER	236
LANE BONE PLATE HOLDING FORCEPS	273
LANE STOMACH INTESTINAL CLAMP FORCEPS	347
LANE TISSUE FORCEPS	73
LANE TISSUE GRASPING FORCEPS	343
LANGE BANDAGE SCISSORS	56
LANGE TISSUE FORCEPS	83
LANGENBECK AMPUTATION	28
LANGENBECK BONE HOLDING FORCEPS	267
LANGENBECK DISSECTING KNIVES BLADE	27
LANGENBECK RETRACTOR	173-174
LANGENBECK-RYDER NEEDLE HOLDERS T.C	149
LARGE PIN CUTTER	263
LARYNGEAL MIRRORS	319
LARYNGEAL MIRRORS HANDLE	319
LARYNGEAL MIRRORS WITH HANDLE	319
LARYNGOSCOPE HOLDER	322
LARYNGOSCOPE MILLER SET	07
LARYNGOSCOPE, ADOLESCEN	T321
LATERAL NONCONDUCTIVE VAGINAL RETRACTOR	360
LATHBURY-FARREL PROBE	158
LAXER OPERATING SUPER CUT SCISSORS	50
LEAD HAND	241
LEEDHAM TISSUE FORCEPS	72
LEGUEU BLADDER RETRACTOR	388
LEGUEU BLADDER SPATULA	390
LEGUEU RETRACTOR	208
LEKSELL BONE RONGEUR	251
LEKSELL BONE RONGEUR	254
LEKSELL-STILLE BONE RONGEUR	254
LEMPERT BONE RONGEUR	247
LEMPERT SEPTUM ELEVATORS RASPARTORY	306
LERCHE TISSUE FORCEPS	70

DESCRIPTION PAGE

LEWIN PERFORMING BONE HOLDING FORCEPS	265
LEXER GOUGE	219
LEXER CHISEL	219
LEXER GOUGE TUFFNEL HANDLE	219
LEXER MODIF. CHISEL	219
LEXER MODIF. OSTEOTOME	219
LEXER OSTEOTOME	219
LEXER OSTEOTOME FLAT	219
LEYLA SELF-RETAINING BRAIN RETRACTOR	325
L-G INTERVERTEBRAL DISC RONGEURS	331
LICHTENBERG NEEDLE HOLDERS T.C	148
LICHTWITZ ANTRUM TROCER	16
LISTER BANDAGE PLASTER SCISSORS	55
LISTER BANDAGE PLASTER SCISSORS T/C INSERT	65
LISTER BOUGIES	385
LISTER SINUS FORCEPS COLLIN DRESSING HAEMOSTATIC FORCEPS	117
LISTER-EXCENTRIC PLASTER SCISSORS	55
LISTON BONE CUTTING RONGEUR FORCEPS	255, 259
LISTON DISSECTING KNIVES	27
LISTON KEY HORSLEY BONE CUTTING RONGEUR FORCEPS	256
LISTON-STILLE BONE CUTTING RONGEUR FORCEPS	259
LITTAUER / LISTON BONE CUTTING RONGEUR FORCEPS	265
LITTAUER CILIA FORCEPS	80
LITTAUER EAR POLYPUS FORCEPS	296
LITTAUER NASAL POLYPUS AND SEPTUM FORCEPS	303
LITTAUER STITCH SCISSORS	42
LITTLE RETRACTOR	176
LITTLE WOOD TISSUE GRASPING FORCEPS	343
LOCKE PHALANGEAL FORCEPS	265
LOCKHART-MUMMERY PROBE	156
LOCKING PLIER	244
LOCKLIN DISSECTING SCISSORS	40
LOCKWOOD GRASP FORCEPS	342
LONG CHROME HANDLE INTESTINAL RECTAL SPECULUM	351
LONG HAEMOSTATIC TISSUE FORCEPS	107
LONGE OPERATING, DISSECTING SCISSORS	31
LORENZ PLASTER SCISSORS	56
LORNA TOWEL FORCEPS	113
LOVE NERVE DURAHOOK RETRACTOR	328
LOVE-GRUENWALD INTERVERTEBRAL DISC RONGEURS	330, 333
LOVES BOX	392
LOWER HAEMOSTATIC FORCEPS	104
LOWMANN BONE CLAMP	264
LUBET-BARBON NASAL POLYPUS AND SEPTUM FORCEPS	303
LUC NASAL CUTTING FORCEPS	304
LUCAE / ENT DRESSING FORCEPS	75
LUCAE DRESSING FORCEPS	317
LUCAE HOOKLET & SKIN HOOKS	160
LUCAE HOOKLET	294
LUCAE MALLETS	214
LUCAE TUNING FORK	291
LUCAS CHISEL	217
LUCAS CURETTE	230
LUCAS GOUGE	217
LUER BONE RONGEUR	246
LUER RETRACTOR	177
LUER, TROCER LUER LOCK ADAPTER	15
LUER-KOERTE PROBE	384
LUER-STANDARD TRACHEATUBES	320
LUER-STILLE BONE RONGEUR	253
LUETHY-BECK NEEDLE HOLDERS T.C	149

M

MACPHAIL NEEDLE HOLDERS	132
MAGILL CATHETER INTUBATING FORCEPS	04
MAGILL, SUCTION TUBE	19
MALLEABLE RETRACTOR	195
MALLEOLLAR BONE HOLDING FORCEPS	276
MALLET #49	216
MALLET MALLETS	214
MALLET, LIGHTWEIGHT	216
MALTZ NASAL SAW	310
MALTZ RASP	308
MANNERFELT HOOK	160
MANNERFELT HOOKLET RETRACTORS	168
MANNERFELT MODIF. BALLENGER CHISEL	223
MANNERFELT-LANGENBECK HOOK	160
MARBACH PLASTER SCISSORS	57
MARKHAM/MEYERDING RETRACTOR	197
MARKWALDER BONE CUTTING RONGEUR FORCEPS	257
MARQUARDT BONE RONGEUR	249
MARSCHIK TONSIL SEIZING FORCEPS	316
MARTEL HAEMOSTATIC FORCEPS	118
MARTIN CARTILAGE BONE HOLDING CLAMP FORCEPS	272
MARTIN PELVIMETER, OBSTETRICAL FORCEPS	376
MARTIN UTERINE SOUND	361
MARTINI CURETTE	229
MASING PERIOSTEAL SEPTUM ELEVATORS	307
MASS. GENERAL HOSPITAL NEEDLE HOLDERS	127

INDEX



Index Index
indice indice

DESCRIPTION	PAGE #	DESCRIPTION	PAGE #
MASSON NEEDLE HOLDERS T.C	145	MOD. BONN SCISSORS	44
MASSON-LUETHY NEEDLE HOLDERS	129	MOD. MARTIN DRESSING FORCEPS	68
MATHIEU NEEDLE HOLDERS	131	MOD. MICHEL FORCEPS	83
MATHIEU RECTAL SPECULUM	348	MOD. USA. DRESSING FORCEPS	68
MATHIEU RETRACTOR	177	MOD. USA. TISSUE FORCEPS	68
MATHIEU-RYDER NEEDLE HOLDERS T.C	148	MOD. WIEN NASAL SPECULUM	301
MATHIEU-RYDER VASCULAR NEEDLE HOLDERS T.C	148	MODEL USA CAST SPREADER PLASTER	59
MATHIEU-STILLE NEEDLE HOLDERS T.C	147	MODELL PICCOLO PROBE	158
MATSON MENISCOTOMY KNIFE	239	MODIFIED-USA PLASTER SCISSORS	57
MAUNDER MOUTH GAG	315	MOELTGEN CALIPER	13
MAYFIELD BONE RONGEUR	250	MOGEN CIRCUMCISION CLAMP	389
MAYO DISSECTING & GYNECOLOGICAL SCISSORS	32	MOLLISON RETRACTOR	197
MAYO DISSECTING & GYNECOLOGICAL SCISSORS T/C INSERT	64	MOLT MOUTH GAG	315
MAYO ROCHESTER NEEDLE HOLDERS	132	MOORE DRILL AND BIT SET COMPLETE	279
MAYO UTERINE SOUND	361	MORGEN PROCTOSCOPE INTESTINAL RECTAL SPECULUM	351
MAYO-BLAKE GALL STONE FORCEPS	387	MORRIS RETRACTOR	194
MAYO-COLLIN RETRACTOR	179	MORTISING CHISEL	283
MAYO-HARRINGTON DISSECTING & GYNECOLOGICAL SCISSORS	32	MOSQUITO HAEMOSTATIC FORCEPS	89, 99
MAYO-HEGAR NEEDLE HOLDERS	124, 151	MOYNIHAN PROBE	384
MAYO-HEGAR NEEDLE HOLDERS T.C	138, 145	MURPHY RETRACTORS	165
MAYO-NOBLE DISSECTING & GYNECOLOGICAL SCISSORS	32	MUSEUX TENACULUM FORCEPS	367
MAYO-ROBSON INTESTINAL FORCEPS CLAMPS	344	MUSEUX TONSIL HOLDING FORCEPS	316
MAYO-STILLE DISSECTING & GYNECOLOGICAL SCISSORS	32	MYRTLE LEAF PROBE	157
MAYO-STILLE DISSECTING & GYNECOLOGICAL SCISSORS T/C INSERT	64		
MC INDOE BONE CUTTING FORCEPS	258		
MC INDOE BONE CUTTING RONGEUR FORCEPS	258		
MC INDOE DRESSING FORCEPS T.C	88		
MC GEE LATERAL VAGINAL RETRACTOR	380		
MC-INTOSH LARYNGOSCOPE FIBER OPTIC SET	05		
MC-INTOSH LARYNGOSCOPE SET	06		
MCKENZIE CLIP APPLYING FORCEPS	326		
MCLEAN OBSTETRICAL FORCEPS	378		
MEAD BONE RONGEUR	248		
MEAD MALLET	216		
MEASURING GAUGE	289		
MEASURING JUG	396		
MEDICINE CUP GRADUATED	396		
MEMORAL HEAD EXTRACTOR HAND DRILLS	281		
MENISCUS CLAMP	266		
MESH BASKET	398		
MESH BASKET WITH PERFORATED	398		
METZENBAUM NEEDLE HOLDERS	131		
METZENBAUM NEEDLE HOLDERS T.C	147		
METZENBAUM OPERATING SCISSORS T/C INSERT	63		
METZENBAUM OPERATING, DISSECTING SCISSORS	33		
METZENBAUM-FINO OPERATING SCISSORS T/C INSERT	64		
METZENBAUM-FINO SCISSORS	35		
METZENBAUM-NELSON OPERATING SCISSORS T/C INSERT	63		
METZENBAUM-NELSON SCISSORS	34		
MEYERDING FINGER RETRACTOR	176		
MEYERDING RETRACTOR	190, 201, 238		
MICHEL FORCEPS	83		
MICHEL MOVEABLE MIRROR	319		
MICHEL TISSUE FORCEPS	83		
MICRO ADSON TISSUE FORCEPS	85		
MICRO ADSON TISSUE FORCEPS TC	84		
MICRO ADSON DRESSING FORCEPS TC	84		
MICRO CUP FORCEPS	297, 330		
MICRO DERF NEEDLE HOLDERS T.C	142		
MICRO EJECTOR KERRISON LAMINECTOMY RONGEURS	334, 338		
MICRO NEEDLE HOLDERS	134, 151		
MICRO RYDER NEEDLE HOLDERS T.C	135		
MICRO SCISSORS	50		
MICRO SURGICAL NEEDLE HOLDERS T.C	144		
MICROVASCULAR NEEDLE HOLDERS	151		
MICROVASCULAR NEEDLE HOLDERS T.C	135		
MIDDELDORPF RETRACTOR	175		
MIDDLETON-JANSEN SEPTUM FORCEPS	312		
MIKULICZ HAEMOSTATIC TISSUE FORCEPS	100		
MIKULICZ HAEMOSTATIC TISSUE FORCEPS	107-108		
MIKULICZ RETRACTOR	186, 188		
MILLER ALVEOTOMY FILE	213		
MILLER RETRACTOR	162		
MILLER-COLBURN BONE FILE	213		
MILLIGAN RETRACTOR	197		
MILLIN BLADDER NECK SPREADER	390		
MILLIN SUCTION TUBE	388		
MINI - NOVAK ASPIRATING CURETTE	372		
MINI - TISCHLER BIOPSY AND SPECIMEN FORCEPS	370		
MINI DRILL SLEEVE	284		
MINI LEXER CHISEL	220		
MINI LEXER OSTEOTOME	220		
MINI-HOHMANN BONE ELEVATOR	236		
MINI-LAMBOTTE OSTEOTOME	221		
MINI-ROUX RETRACTOR	178		
MIXTER FORCEPS	104		
MIXTER FORCEPS, LEE MODIF	104		
MIXTER GALL STONE FORCEPS	387		
MIXTER HAEMOSTATIC GALL DUCT FORCEPS	104		
MIXTER-O'SHAUGNESSY HAEMOSTATIC FORCEPS	101		
		NAEGELE OBSTETRICAL FORCEPS	377
		NAIL EXTRACTING FORCEPS	240
		NAIL EXTRACTOR	245
		NAIL NIPPERS	46
		NAIL SCISSORS	41
		NAIL SPLITTING FORCEPS	240
		NASAL POLYPUS SNARES	295
		NEEDLE CASE	394, 396
		NEEDLE NOSE PLIERS	242
		NEEDLE-NOSE LOCKING PLIERS	245
		NEGUS HAEMOSTATIC FORCEPS	99
		NEIVERT NEEDLE HOLDERS	130
		NEIVERT NEEDLE HOLDERS T.C	143
		NEIVERT-ANDERSON OSTEOTOME	225
		NELATON PROBE	156
		NELATON PROBES & DIRECTORS	20
		NELSON TISSUE FORCEPS	73
		NELSON TROCER THORAX	16
		NEURO-DUOFLEX HAMMER	02
		NEUTRAL & LOAD DRILL GUIDE	284
		NEUFIELD HAMMER	214
		NEW ORLEANS NEEDLE HOLDERS	128
		NEW ORLEANS NEEDLE HOLDERS T.C	135
		NO SCALPEL VASECTOMY HEMOSTAT FORCEPS	388
		NO SCALPEL VASECTOMY RINGED FORCEPS CLAMPS	388
		NON-PERFORATING TOWEL FORCEPS	114
		NORFOLK & NORWICH RETRACTOR	201
		NORTHBENT STITCHES SCISSORS	42
		NOSE PLIERS	243
		NOTO SPONGE & DRESSING FORCEPS	122
		NOVAK ASPIRATING CURETTE	372
		NOYES MICRO SCISSORS	50
		NOYES NASAL DRESSING FORCEPS	304
		NOYES SCISSORS	49
		NYLON CAPS LEFT & RIGHT	216
		NYLON HEAD MALLET	215
		O	
		O'BRIEN VASCULAR SCISSORS	39
		O'SHAUGNESSY HAEMOSTATIC FORCEPS	94
		O'SULLIVAN-O'CONNOR VAGINAL RETRACTOR	359
		O'SULLIVAN/O'CONNOR RETRACTOR	205
		OBWEGESER BLADE OSTEOTOME	226
		OBWEGESER ELEVATOR	231
		OBWEGESER NEEDLE	232
		OBWEGESER OSTEOTOME	226
		OBWEGESER-FREER ELEVATOR	231
		OCHSNER FORCEPS	83
		OCHSNER TROCER THORAX	16
		OEHLER TISSUE FORCEPS T.C	88
		OLDBERG INTERVERTEBRAL DISC RONGEURS	332
		OLIVECRONA BRAIN SPATULA	325
		OLIVECRONA VASCULAR SCISSORS	43
		OLIVECRONA WIRE SAW	324
		OLLIER RETRACTOR	175
		OLSEN-HEGAR NEEDLE HOLDERS	129, 137, 145
		OMBREDANNE MALLETS	215
		OPERATING SCISSORS, S/S STR. T/C INSERT	62
		ORTHOPEDIC MALLET	216
		OSTEOTOME	217, 223
		P	
		PACKER MOSQUITO FORCEPS	93



INDEX

Index | Index
indice | indice

DESCRIPTION	PAGE #
PANTINGS BLADDER RETRACTOR	390
PAPER DRESSING FORCEPS	75
PARALLEL TARGET DEVICE	283
PARAMETRIUM HAEMOSTATIC FORCEPS	106
PARAMETRIUM HYSTERECTOMY FORCEPS	364
PARHAM MARTIN BANDS	264
PARHAM-MARTIN BONE CLAMP	264
PARKER RETRACTOR	179
PARKER-LANGENBECK RETRACTOR	179
PARKER-MOTT RETRACTOR	179
PARTSCH CHISEL	217
PARTSCH GOUGE	217
PARTSCH MALLET	214
PASSOW BONE TAMPER	226
PATELLA MALLEOLAR FORCEPS	277
PAYR CRUSHING INTESTINAL CLAMP	346
PEAN HAEMOSTATIC FORCEPS SLENDER TYPE	95
PEAPOD INTERVERTEBRAL DISC RONGEURS	333
PECK RAKE RETRACTOR	163
PEDERSON VAGINAL SPECULUM	353
PEDERSON VAGINAL SPECULUM LOOP/LIETZ	353
PEERS-BERTMAN TOWEL FORCEPS	114
PEET SPLINTER FORCEPS	82
PELKMANN SPONGE FORCEPS	121
PELTESON COTTON APPLICATOR	21
PELVIC REDUCTION FORCEPS ASYMMETRIC	278
PELVIC REPOSITION FORCEPS	277-278
PENFIELD DURA DISSECTOR	327
PENNINGTON / SIEZING HAEMOSTATIC FORCEPS	116
PENNINGTON SEPTUM ELEVATORS RASPATORY	306
PERCY AMPUTATION SHIELD	211
PERFORATED BOX	392
PERFORATED TRAY	393
PERIOSTEAL ELEVATOR	237
PERKINS RETRACTOR	199
PERTHES REAMERS	283
PESTALOZZA OVUM CURETTE	380
PHANEUF HAEMOSTATIC TISSUE FORCEPS	107
PIERCE ANTRUM TROCAR	16
PIN CUTTER MEDIUM	263
PIN CUTTER SMALL	263
PIN PULLER W/ GROOVE	243
PINARD ALUMINIUM STETHOSCOPE	01
PINARD WOODEN STETHOSCOPE	01
PIPER OBSTETRICAL FORCEPS	377
PLASTER SCISSORS	55
PLASTER SHEARS	58
PLATE BENDER	287
PLATE BENDING PLIER	244
PLESTER RETRACTOR	199
PLESTER SUCTION TUBES	17
POLITZER EAR SPECULUM	290
POTTS-SMITH DRESSING FORCEPS	69
POTTS-SMITH DRESSING FORCEPS T.C.	67
POTTS-SMITH TISSUE FORCEPS	69
POTTS-SMITH VASCULAR SCISSORS	38
POZZI TENACULUM FORCEPS	365
PRATT HAEMOSTATIC FORCEPS	116
PRATT RECTAL SPECULUM	348
PRATT TENACULUM FORCEPS	366
PRESBYTERIAN TUBING CLAMP	114
PRESTON LOGAMENTUM FLAVUM FORCEPS	266
PRINCE SCISSORS	44
PROBE MYRTLE-SHAPED	20
PROBE WITH EYE	20
PROBE DOUBLE ENDED	20
PROBES WITH EYE	157
PROFESSIONAL OTOSCOPE & OPHTHALMOLOGY SET	08
PUTTI BONE FILE	212
PUTTI BONE RASP	212
PUTTI RASP	212

Q

QUIRE EAR POLYPUS FORCEPS	296
---------------------------	-----

R

RABINER HAMMER	03
RAGNELL-DAVIS RETRACTOR	167
RALK SPLINTER FORCEPS	
RAMSAY DISSECTING FORCEPS	72
RANDALL KIDNEY STONE CLAMPS FORCEPS	381
RAZOR HOLLOW BLADES	28
RECAMIER UTERINE CURETTE	373-374
REDUCTION FORCEPS	277
REILL BONE HOLDING FORCEPS	276
REILL BONE REDUCTION FORCEPS	275
REINER EAR SYRINGE	295
REINER EAR SYRINGE SHIELD	295

DESCRIPTION	PAGE #
RESANO DRESSING FORCEPS T.C.	86
RESECTION KNIFE	28
REVERDIN NEEDLE	152
REVERDIN RETRACTOR	195
REYNOLDS OPERATING SCISSORS T/C INSERT	66
RIBBON RETRACTOR	195
RICHARDS MICRO NEEDLE HOLDERS	150
RICHARDSON EASTMAN RETRACTOR	177
RICHARDSON RETRACTOR	193
RICHARDSON/KELLY RETRACTOR	190
RICHARDSON-EASTMAN RETRACTOR	193
RICHTER OPERATING, DISSECTING SCISSORS	36
RICHTER-HEATH FORCEPS	83
RIECHERT FIXATION BASE	325
RIGHBY RETRACTOR	199
RING CUTTER	240
RISKIN BONE RONGEUR	250
RITTER-HALLE FORNITAL SINUS BOUGIES	311
ROBERTS HAEMOSTATIC FORCEPS	102
ROCHARD RETRACTOR	208
ROCHESTER NEEDLE HOLDERS T.C.	139
ROCHESTER-CARMALT HAEMOSTATIC FORCEPS	99
ROCHESTER-OCHSNER HAEMOSTATIC FORCEPS	99
ROCHESTER-PEAN HAEMOSTATIC FORCEPS	96-97
ROD BENDER	286
ROEDER TOWEL FORCEPS	113
ROGERS PARAMETRIUM HYSTERECTOMY FORCEPS	364
ROGGE STERILIZING FORCEPS	399
ROLLET (BLAIR) HOOKLET RETRACTORS	162
ROLLET HOOK FREER SKIN HOOK	159
ROLLET HOOKLET RETRACTORS	162
RONGEUR #4	247
RONGEUR #4A	247
ROSE RETRACTOR	177
ROSEN SUCTION TUBE	19
ROSER-KONIG MOUTH GAG	315
ROSS RETRACTOR	191
ROTTGEN-RUSKIN BONE RONGEUR	253
ROUND BEDPAN	397
ROUND KNURLED SCALPEL HANDLE	23-24
ROUX RETRACTOR	178
ROUX-MAGNUS RETRACTOR	178
RUBIN SEPTUM FORCEPS	312
RUBIO WIRE TWISTER NEEDLE HOLDERS T.C.	142
RUSKIN BONE CUTTING RONGEUR FORCEPS	256
RUSKIN RONGEUR	250
RUSKIN-LISTON BONE CUTTING RONGEUR FORCEPS	257-258
RUSKIN-MINI BONE RONGEUR	254
RUSSIAN-MODELL TISSUE FORCEPS	74
RYDEL-SEIFFER TUNING FORK	291
RYDER NEEDLE HOLDERS	150
RYDER NEEDLE HOLDERS T.C.	140

S

SACHS DURA DISSECTOR	329
SACHS NERVE ELEVATOR	231
SAENGER ABORTION FORCEPS	380
SAFETY SUPER CUT SCISSORS	61
SAILER SCISSORS	43
SAMII FORCEPS	75
SAROOT HAEMOSTATIC FORCEPS	93
SAROT NEEDLE HOLDERS	127
SAROT NEEDLE HOLDERS T.C.	137
SAUERBRUCH BONE RONGEUR	253
SAUERBRUCH RETRACTOR	181
SAW BLADE ONLY	240
SAWYER RETRACTORS	192
SCALER BOX	394
SCALER TRAY	394
SCALPEL BLADES	25
SCALPEL HANDLE	24
SCALPEL HANDLE #3	22
SCALPEL HANDLE #3, #4	23
SCALPEL HANDLE #3P	24
SCALPEL HANDLE #4	22
SCALPEL HANDLE #4 GRADUATED	22
SCALPEL HANDLE #7	23
SCALPEL HANDLE / LONG ANGLED #3LA	23
SCALPEL HANDLE 3L LONG	23
SCALPEL HANDLE 4L LONG	23
SCALPEL HANDLE 4LA	22
SCALPEL HANDLE / GRADUATED #3	22
SCHAEDEL TOWEL FORCEPS	112
SCHERBACK SPECULUM	358
SCHINDLER HAEMOSTATIC TISSUE FORCEPS	105
SCHLESINGER CERVICAL RONGEUR	335
SCHLESINGER INTERVERTEBRAL DISC RONGEURS	332
SCHOENBORN RETRACTOR	167
SCHROEDER UTERINE SPOON	375

INDEX



Index Index
indice indice

DESCRIPTION	PAGE #	DESCRIPTION	PAGE #
SCHROEDER BONE CURETTE	228	SPREADER PLASTER	59
SCHROEDER TENACULUM FORCEPS	365	SPRIT LAMP	396
SCHROEDER VULSELLUM TENACULUM FORCEPS	366	SPURLING KERRISON LAMINECTOMY RONGEURS	337
SCHROEDER-BRAUN TENACULUM FORCEPS	65	SPURLING INTERVERTEBRAL DISC RONGEURS	330, 332, 333
SCHUBERT BIOPSY FORCEPS	368	SPURLING LAMINECTOMY RONGEURS	337-338
SCHUHKNECHT RETRACTOR	198	SPUTUM MUG	397
SCHULZE-BERGMANN INTESTINAL RECTAL SPECULUM	349	S-SHAPED RETRACTOR	185
SCHUMACHER BIOPSY FORCEPS	368-369	ST. CLAIR-THOMSON ADENOID CURETTE	313
SCHUMACHER PLASTER SCISSORS	57	STACKE SPATULA	158
SCHUMACHER STERNUM SHEARS	262	STAGBEETLE BONE REDUCTION FORCEPS	265
SCHWARTZ VESSEL CLIP	326	STANDARD DRESSING FORCEPS	67-68
SCHWARZ NASAL SPECULUM	300	STANDARD DRESSING FORCEPS T.C	86
SCOVILLE NERVE RETRACTOR	238	STANDARD OPERATING SCISSORS	30
SCOVILLE-RICHTER RETRACTOR	207	STANDARD OPERATING SUPER CUT SCISSORS	60
SCREW DEPTH GAUGES	289	STANDARD TISSUE FORCEPS	67
SCREW DRIVERS	282	STAUDE - MOORE TENACULUM FORCEPS	365
SEDLLOT ELEVATOR	232	STELLBRINK BONE RONGEUR	247
SEKOND MYOMAKNIFE FISTULA HOOK	371	STERILIZING DRUMS	391
SEKOND-LANDAU HAEMOSTATIC FORCEPS	105	STERNBERG RETRACTOR	166
SEIFFERT PROBE	158	STERNUM NEEDLE HOLDERS T.C	142
SELETZ-GELPI RETRACTOR	198	STEVENS OPERATING SCISSORS T/C INSERT	66
SELLHEIM OBSTETRICAL LEVER	378	STEVENS SCISSORS	41
SELVERSTONE INTERVERTEBRAL DISC RONGEURS	332	STEVENS TENOTOMY SUPER CUT SCISSORS	61
SEMB BONE CUTTING RONGEUR FORCEPS	256	STEVENS TISSUE FORCEPS	77
SEMB BONE HOLDING FORCEPS	267, 271	STIEGLITZ FORCEPS WITH MEGNIFYING MIRRORS	82
SEMB BONE RONGEUR	253	STIEGLITZ SPLINTER FORCEPS	82
SEMKEN DRESSING FORCEPS	68	STILLE BONE RONGEUR	251, 254
SEMKEN TISSUE FORCEPS T.C	86	STILLE CHISEL	218, 222
SEMM ABDOMINAL RETRACTORS	209	STILLE GOUGE	218, 222
SEMM VAGINAL SPECULUM	352	STILLE HAEMOSTATIC FORCEPS	103
SENN RETRACTOR	166	STILLE OSTEOTOME	218, 222
SENN-GREEN RETRACTOR	167	STILLE PATTERN DRILL SET	278
SENNING NEEDLE HOLDERS	128	STILLE PLASTER SHEAR	58, 262
SENNING NEEDLE HOLDERS T.C	136	STILLE-BARRAYA TISSUE FORCEPS	74
SENN-MUELLER RETRACTOR	166	STILLE-HORSLEY BONE CUTTING FORCEPS	259
SERRAGIGLI	211	STILLE-LEUR RONGEUR	252
SEQUESTRUM (NIRCOSIS) BONE HOLDING FORCEPS	267	STILLE-LISTON BONE CUTTING RONGEUR FORCEPS	258, 259
SEUTIN PLASTER SCISSORS	57	STILLE-LUER ECHLIN DUCKBILL RONGEUR	252
SHAVING MUG	397	STILLE-LUER RONGEUR FORCEPS	251
SHEEHAN OSTEOTOME	225	STILLE-RUSKIN BONE RONGEUR	250
SHORTBENT STITCH SCISSORS	42	STITCHES SCISSORS	42
SHOULDER PENETRATING GOUGE	223	STOCKMANN PENILE CLAMP	389
SHOULDER PERCUSSION AWL	265	STONE TISSUE FORCEPS	70
SIDE CUTTER	261	STRANDELL-STILLE RETRACTOR	167
SIDE PIN CUTTER	262	STRASSMANN KIDNEY ELEVATING STONE CLAMPS FORCEPS	382
SIEGEL ROUND SCALPEL HANDLE #3	22	STRATTE NEEDLE HOLDERS T.C	139
SILVER DERMATOMES	29	STRUMPEL EAR FORCEPS	287
SILVER RHINOPLASTIC CHISEL	225	SUBACROMION SPREADER	271
SIMON BONE CURETTE	226	SUCTION TUBE	323
SIMON DISSECTING KNIVES	27	SUCTION TUBE, GUIDE NEEDLE	19
SIMON FISTULA HOOK	371	SUCTION TUBE, GUIDE NEEDLE LANCET TIP	19
SIMON FISTULA HOOK, TWO PRONG	371	SULLIVAN SCISSORS	44
SIMPSON - BRAUN OBSTETRICAL FORCEPS	377	SUPRA CUT DISTRACTION SCREW	325
SIMPSON - LUIKART OBSTETRICAL FORCEPS	377	SUPRA CUT DISTRACTION SCREW DRIVER	325
SIMPSON OBSTETRICAL FORCEPS	377	SYSTRUNK SCISSORS	45
SIMPSON UTERINE SOUND	361	SYPERT RONGEUR	254
SIMS DISSECTING & GYNECOLOGICAL SCISSORS	37		
SIMS RECTAL SPECULUM	348		
SIMS SPECULUM & RETRACTOR	355		
SIMS UTERINE CURETTE	374		
SIMS UTERINE SOUND	361		
SIMS-MAIER SPONGE & DRESSING FORCEPS	119		
SINGLEY-TUTTLE FORCEPS	74		
SINUSCOPY, TROCAR	15		
SKENE TENACULUM FORCEPS	365		
SLOTTED HAMMER	286		
SMELLIE OBSTETRICAL FORCEPS	379		
SMILLIE MENISCOTOMY KNIFE	239		
SMITH (MOD. USA) PLASTER SCISSORS	56		
SMITH PETERSON GOUGE	218		
SMITH PETERSON OSTEOTOME	218		
SMITH-BLUE INTESTINAL RECTAL SPECULUM	349		
SMITH-PETERSEN CHISEL	222		
SMITH-PETERSEN GOUGE	222		
SMITH-PETERSEN OSTEOTOME	222		
SMITH-PETERSON LAMINECTOMY RONGEUR	249		
SMITHWICH DURADISSECTOR	329		
SMITHWICH CLIP APPLYING FORCEPS	326		
SMITHWICH NERVE DURA HOOK	327		
SOFIELD RETRACTOR	177		
SOLID COPPER HEAD MALLET	215		
SOMER KIDNEY ELEVATING STONE CLAMPS FORCEPS	382		
SPATULA	158		
SPECIMEN AND ASPIRATING CURETTE	372		
SPENCER STITCH SCISSORS	42		
SPENCER-WELLS HAEMOSTATIC FORCEPS SLENDER TYPE	95		
SPINAL DISTRACTOR	339		
SPLINTER FORCEPS	81-82		
SPLIT LAMP	395		
SPRATT BONE CURETTE/HOLLOW HANDLE	227		
		T	
		TAKAHASHI NASAL CUTTING FORCEPS	304
		TAP SLEEVE	284
		TARNIER OBSTETRICAL FORCEPS	378
		TAYLOR HAMMER	02
		TAYLOR RETRACTOR	237-238
		TAYLOR SPINAL RETRACTORS	177
		TEALE HERNIA DIRECTOR	388
		TEALE TENACULUM FORCEPS	367
		TENDON HOOKS RETRACTOR	176
		TENDON SEIZING FORCEPS	121
		TENDON TUNELLING FORCEPS	241
		T-HANDLE HAND DRILLS	281
		THOLE PELVIMETER, OBSTETRICAL FORCEPS	376
		THOMS-GAYLOR BIOPSY FORCEPS	367
		THOMSON WALKER BLADDER RETRACTOR	390
		THOMSON-WALKER'S PENILE CLAMPS	112
		THUDICHUM (GOLDSMITH) NASAL SPECULUM	299
		TIECK-HALLE NASAL SPECULUM	300
		TILLEY NASAL POLYPUS AND SEPTUM FORCEPS	303
		TISCHLER - MORGAN BIOPSY AND SPECIMEN FORCEPS USA MODEL	370
		TISSUE & DRESSING FORCEPS	69
		TISSUE FORCEPS	71
		TOENNIS DURA DISSECTOR	329
		TOENNIS HOOK & SKIN HOOK	159
		TOENNIS NEEDLE HOLDERS	132
		TOENNIS NERVE DURA HOOK	327
		TOHOKU TOWEL FORCEPS	113
		TONSIL KNIFE	305
		TOWNLEY CALIPER	13
		TOYNBEE EAR SPECULUM	290
		TRACHEAL RETRACTOR	161



INDEX

Index
indice

Index
indice

DESCRIPTION	PAGE #
TRAUBE HAMMER	03
TRAVERS RETRACTOR	199
TRELAT VAGINAL SPECULUM	353
TREVES TISSUE FORCEPS	72
TRIANGULAR POSITIONING PLATE	289
TROELTSCH DRESSING FORCEPS	317
TROEMNER HAMMER	02
TROEMNER-SIMPLEX HAMMER	02
TROELTSCH EUSTACHIAN CATHETERS	18
TROUSSEAU TRACHEA DILATOR 2 PRONG	320
TROUTMAN MICRO SCISSORS	49
TUBING CLAMP	114
TUBING CLAMP WITH PROTECTOR	115
TUCKER MID-LIGHTED SIDE SLIDE	321
TUCKER MID-LIGHTED SIDE SLIDE LARYNGOSCOPE	321
TUFFIER/HABERER RETRACTOR	195
TUFFIER HAEMOSTATIC FORCEPS	116
TUFFIER RETRACTOR	187
TUFFIER RETRACTOR	188
TUFFIER TISSUE FORCEPS	341
TUNING FORKS NEUROL WITH HAMMER	291
TURNBULL NIPPERS	46
TURNER-DOYEN RETRACTORS	191
TWIST DRILLS - REAMERS - FORCEPS	283
TYDING TONSIL SNARE	318
U	
U.S. ARMY PATTERN CHISEL	217
UCKERMANN TRACHEA TUBES	320
UCKERMANN, TROCAR	15
ULRICH BONE HOLDING FORCEPS	269
ULRICH BONE HOLDING SELF RETAINING FORCEPS	269
ULRICH SPONGE FORCEPS	120
ULTRA-MICRO NEEDLE HOLDERS	150
UNI-RANDALL ASPIRATING CURETTE	372
UNIVERSAL ABDOMINAL TROCER SET	15
UNIVERSAL BONE RONGEUR	248
UNIVERSAL PARAMEDIC SHEAR	51-52, 54
UNIVERSAL PARAMEDIC SHEAR PROB END	53
UNIVERSAL ROD BENDER	286
UNIVERSAL HAMMER	215
UNIVERSAL SCISSORS	51-54
UNIVERSAL WIRE CUTTING SCISSORS	45
URINAL - FEMALE	397
URINAL - MALE	397
URO-TANGENTIAL GALLSTONE FORCEPS	387
US-ARMY RETRACTOR	177
UTILITY STERILIZING FORCEPS	399
UTILITY TECHNICAL FORCEPS PLIERS	243
V	
VALLEIX UTERINE SOUND	361
VAN BUREN SEQUESTERUM FORCEPS	267
VAN BUREN URETHRAL SOUND	385
VAN DOREN BIOPSY FORCEPS	368
VASCULAR SCISSORS	38
VEBRUGGE SELF-CENTERING BONE HOLDING FORCEPS	273
VEBRUGGE BONE HOLDING FORCEPS	272-274
VERNIER CALIPER	13
VERNON-DAVID INTESTINAL RECTAL SPECULUM	350
VIENNA SPECULUM	300
VITAL HEAVY DUTY PLIERS T.C	243
VITAL WIRE CUTTER	260
VITAL WIRE EXTRACTION PLIERS T.C	243
VOLKMAN RETRACTOR	166
VOLKMAN BONE CURETTE	227
VOLKMAN CURETTE	229
VOLKMAN RETRACTORS	165
VOLKMAN RETRACTORS	180
VON GRAEFE STRABISMUS & SKIN HOOKS	160
W	
WACHENFELDT TISSUE FORCEPS	83
WAGENER HOOKLET & SKIN HOOKS	160
WAGENER HOOKLET BUTTONED	294
WALDMANN PLASTER SCISSORS	56
WALDMANN SCISSORS	57
WALLICH OVUM CURETTE	380
WALTON-LISTON BONE CUTTING RONGEUR FORCEPS	258
WANGENSTEEN DRESSING FORCEPS	70
WANGENSTEEN DRESSING FORCEPS T.C.	67
WANGENSTEEN NEEDLE HOLDERS	131
WANGENSTEEN NEEDLE HOLDERS T.C	138
WARTENBERG PINWHEEL	03
WASH BASIN	395
WASSMUND RETRACTOR	176
WATSON DERMATOMES	29
WATSON-CHEYNE RASPARTORY	307

DESCRIPTION	PAGE #
WATSON-WILLIAMS NASAL CUTTING FORCEPS	304
WAUGH DRESSING FORCEPS	72
WEBER AESTHESIOMETER	01
WEBSTER NEEDLE HOLDER	125, 150
WEBSTER NEEDLE HOLDERS T.C	144, 145
WECKER SCISSORS	49
WEIL NASAL CUTTING FORCEPS	304
WEINBERG VAGOTOMY RETRACTOR (JOE'S HOE)	191
WEINGARTNER EAR FORCEPS	297
WEISSBARTH SPECULUM & RETRACTOR	356
WEITLANER RETRACTOR	199-200
WELL BLAKESLEY LAMINECTOMY RONGEURS	331
WERTHEIM HAEMOSTATIC FORCEPS	111
WERTHEIM HAEMOSTATIC TISSUE FORCEPS	109
WERTHEIM HYSTERECTOMY FORCEPS	110
WERTHEIM NEEDLE HOLDERS	128
WERTHEIM NEEDLE HOLDERS T.C	136
WERTHEIM PARAMETRIUM CLAMP	110
WERTHEIM-CULLEN HAEMOSTATIC FORCEPS	111
WESTCOTT MICRO SCISSORS	49
WESTERMARK HAEMOSTATIC FORCEPS	106
WESTMACOTT NASAL POLYPUS AND SEPTUM FORCEPS	303
WHITE TONSIL SEIZING FORCEPS	316
WHITEHEAD MOUTH GAG	315
WIDE MOUTH EJECTOR KERRISON LAMINECTOMY RONGEURS	334, 338
WIEDER TONGUE DEPRESSOR	314
WIENER HOOK & SKIN HOOK	159
WIENER NASAL SAW	310
WILDE INTERVERTEBRAL DISC RONGEURS	331
WILDE NASAL DRESSING FORCEPS	317
WILDER LACRIMAL DILATOR	157
WILLET-MARTEL HAEMOSTATIC FORCEPS	116
WILLIAM LACRIMAL PROBES	155
WILLIAMS GRASP FORCEPS	340
WILLIAMS STYLE MICRO DISC INTERVERTEBRAL DISC RONGEURS	333
WILLIGER CURETTE	229-230
WILLIGER ELEVATOR	233
WILLIGER MALLETS	215
WILLIGER HAMMER	214
WINDOW PLUG FOR BRONCHOSCOPES	322
WINKELMANN CIRCUMCISION CLAMPS	389
WINTER ABORTION FORCEPS	380
WIRE BENDING FORCEPS	244
WIRE CUTTING SCISSORS T/C INSERT	65
WIRE FORCEPS	261
WIRE GUIDE	283
WIRE RETAINING RETRACTOR	196
WIRE TIGHTENING NEEDLE HOLDERS T.C	142
WIRE TWISTERS NEEDLE HOLDERS T.C	142
WOLFF SPREADER PLASTER	59
WRENCH DOUBLE ENDED	324
WRENCH KIRSCHNER EXTENSION BOWS	288
WRIGLEY OBSTETRICAL FORCEPS	377
WULLSTEIN RETRACTOR	199

Y	
YANKAUER SUCTION TUBE	17
YASARGIL NERVE DURA HOOK RETRACTOR	326
YASARGILL SCISSORS	50
YEOMANN INTESTINAL POLYOUS GRASPING FORCEPS	345
YOUNG PROSTATIC RETRACTOR	383

Z	
ZAUFAJ-JANSEN BONE RONGEUR	249
ZIEGLER CILIA FORCEPS	80
ZOLLNER SUCTION TUBE	19
ZWEIFEL DOUBLE ENDED	372
ZWEIFEL NEEDLE HOLDERS T.C	149